

HO148M NEUTRON ACER TENDL-2019 LIBRARY; T=293.16K
Principal cross sections

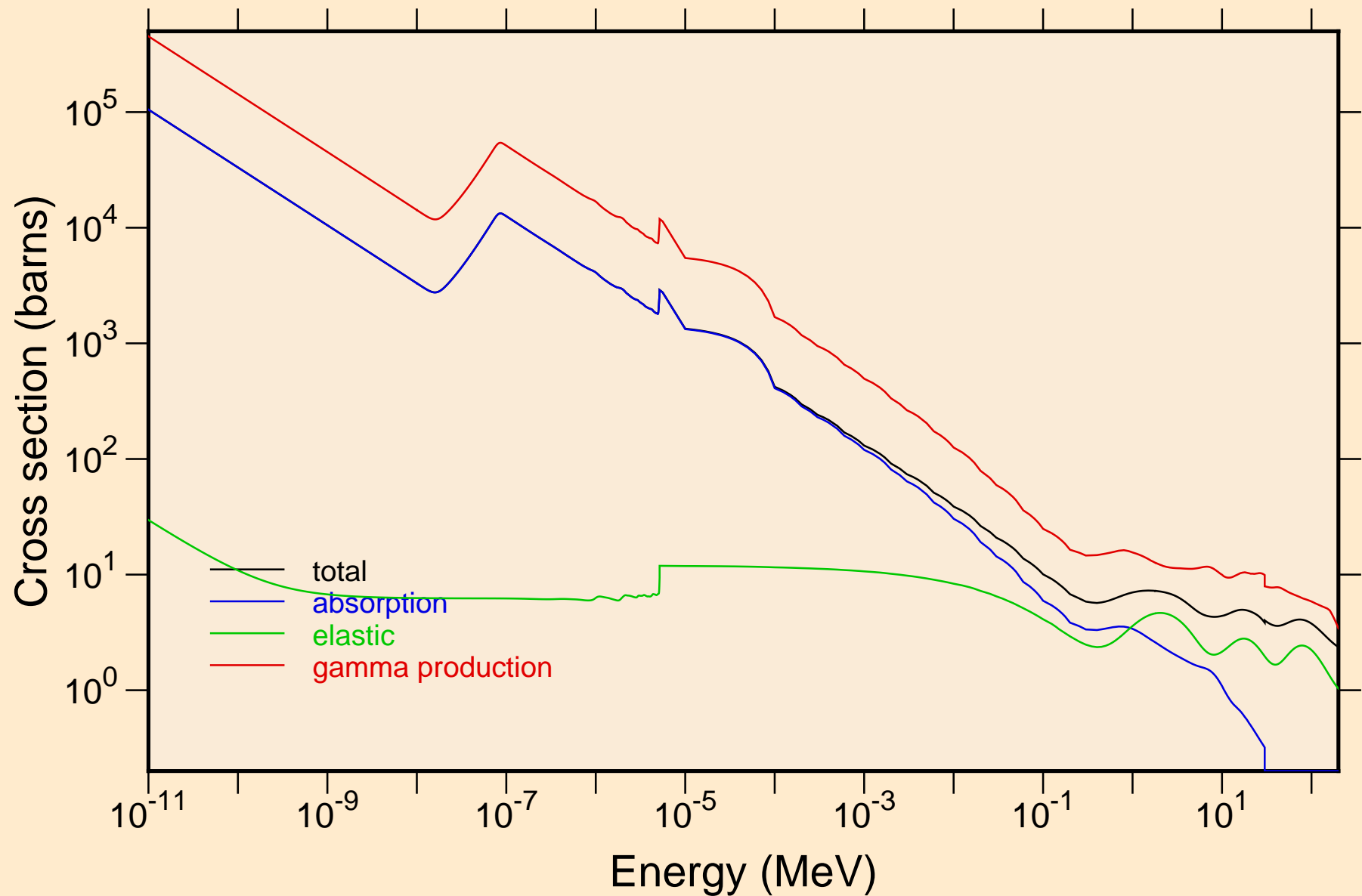

HO148M NEUTRON ACER TENDL-2019 LIBRARY; T=293.16K
Heating

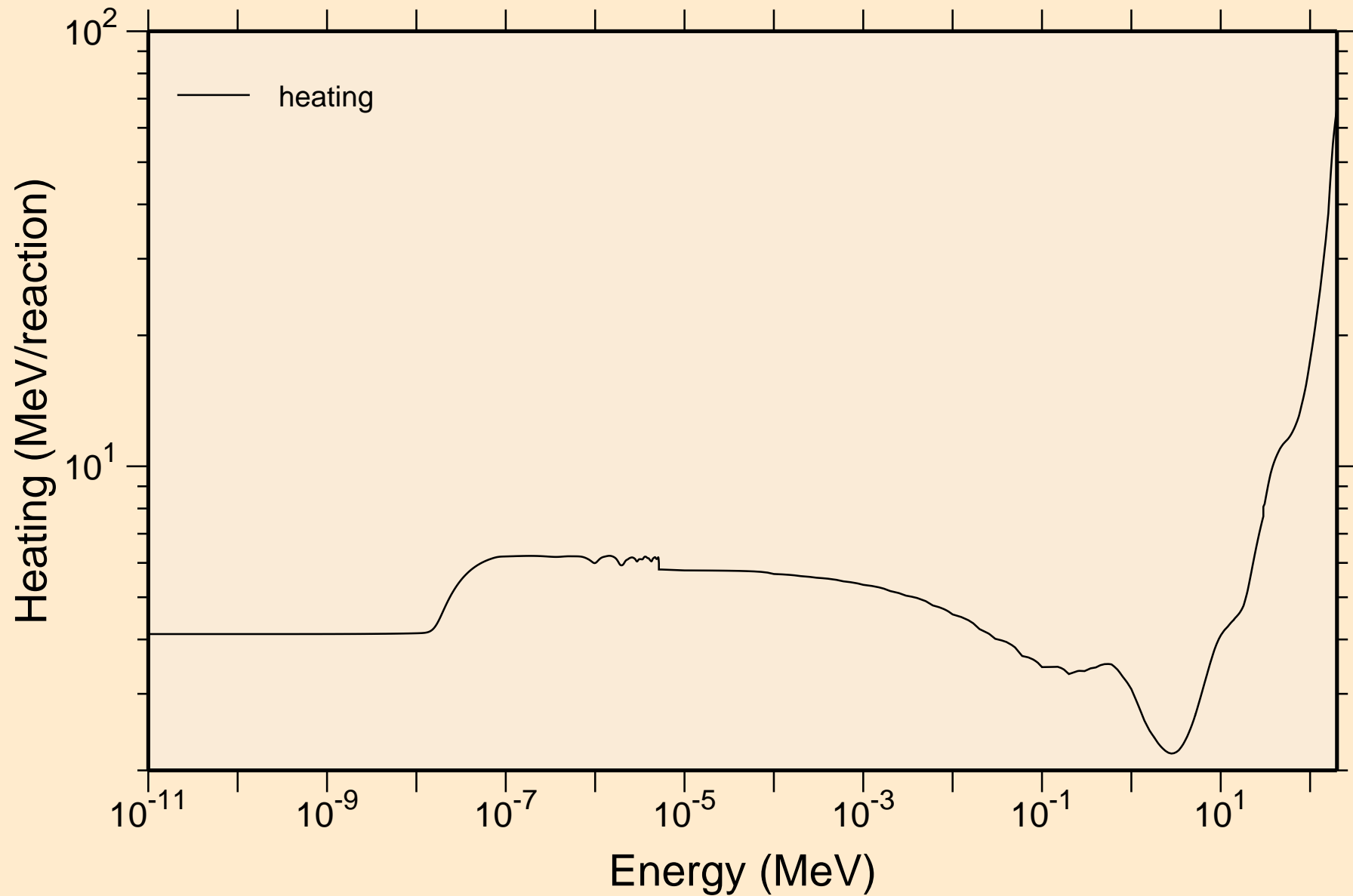

HO148M NEUTRON ACER TENDL-2019 LIBRARY; T=293.16K
Damage

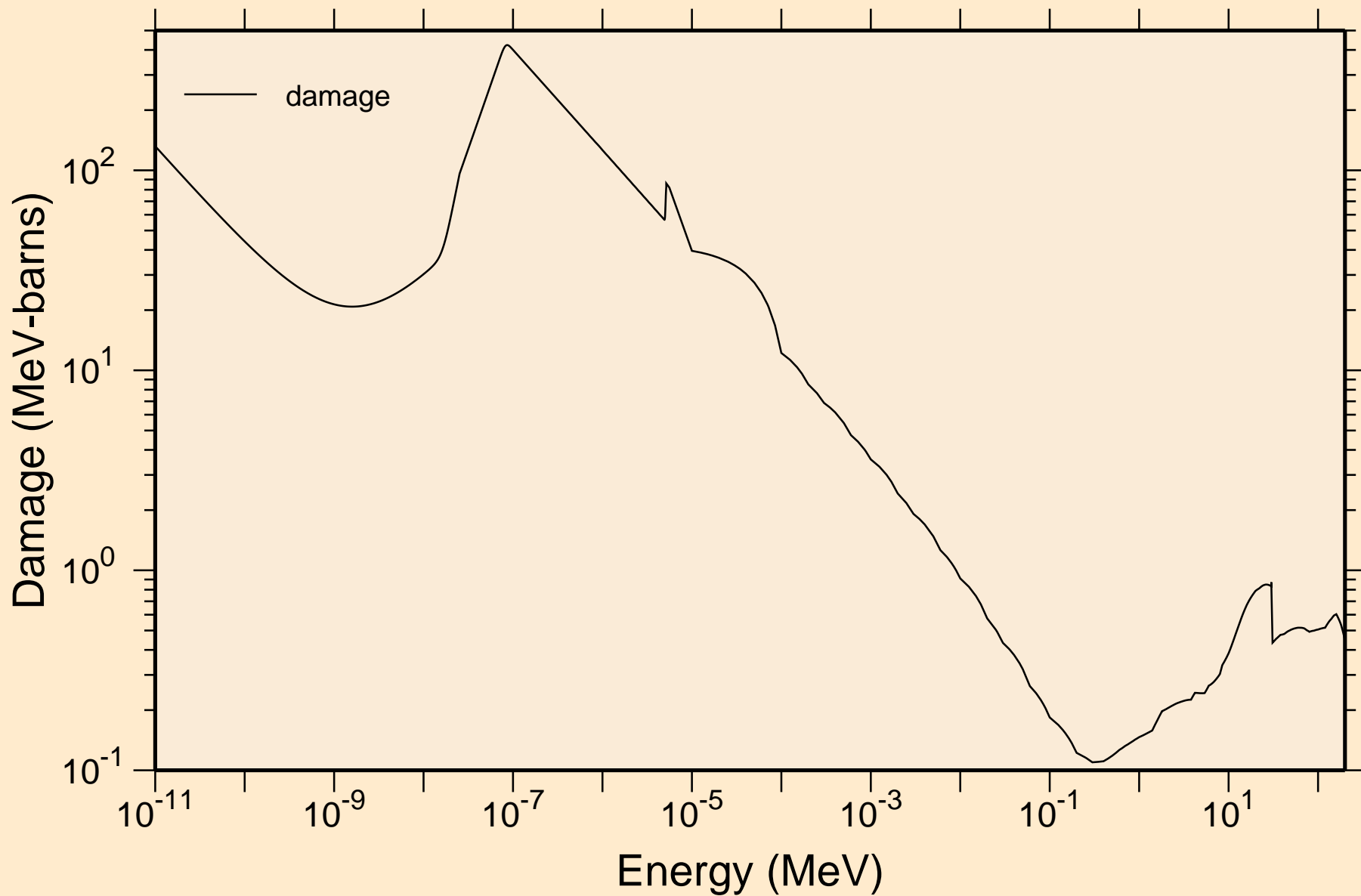

HO148M NEUTRON ACER TENDL-2019 LIBRARY; T=293.16K
Non-threshold reactions

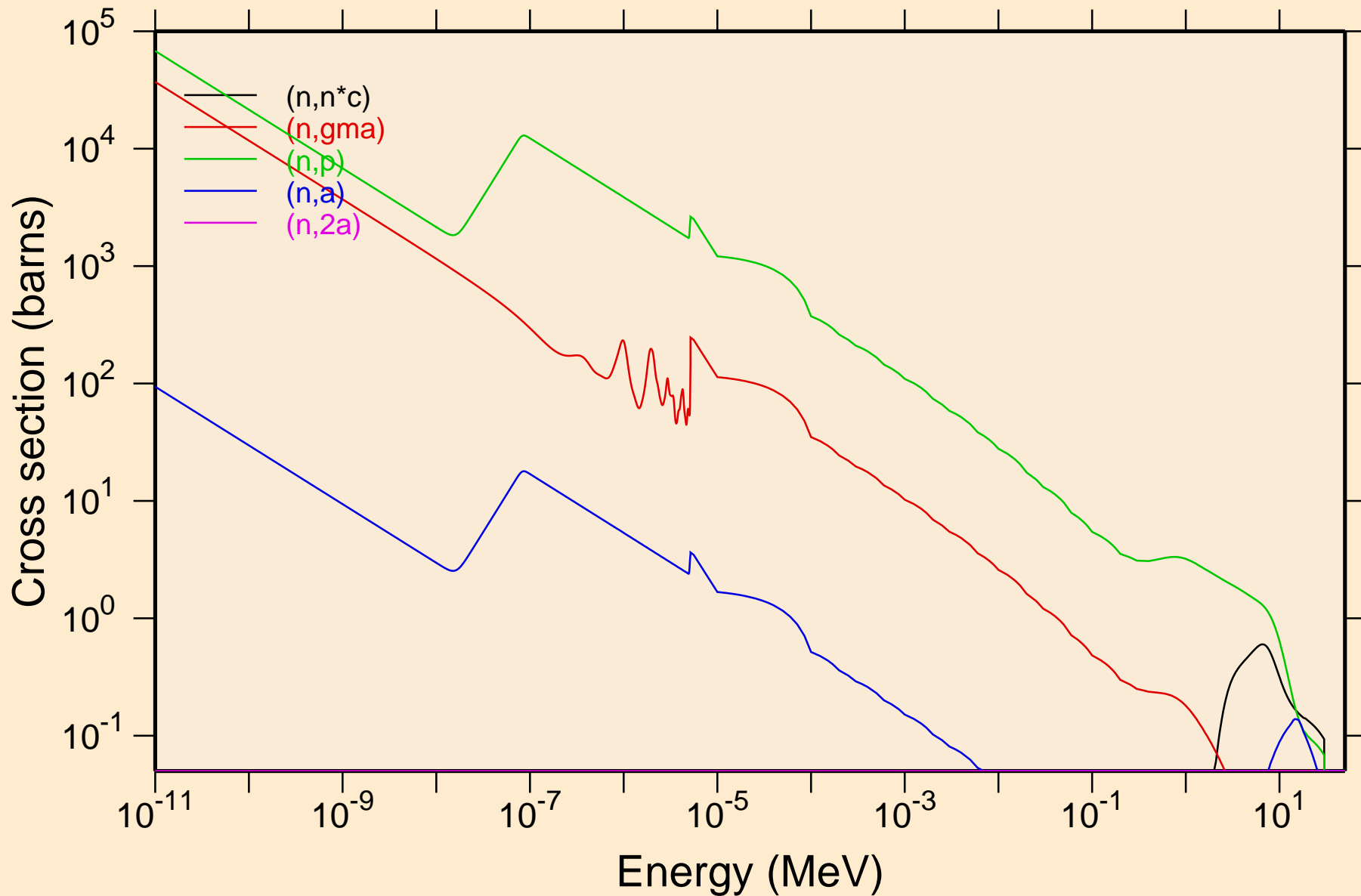

HO148M NEUTRON ACER TENDL-2019 LIBRARY; T=293.16K
Non-threshold reactions

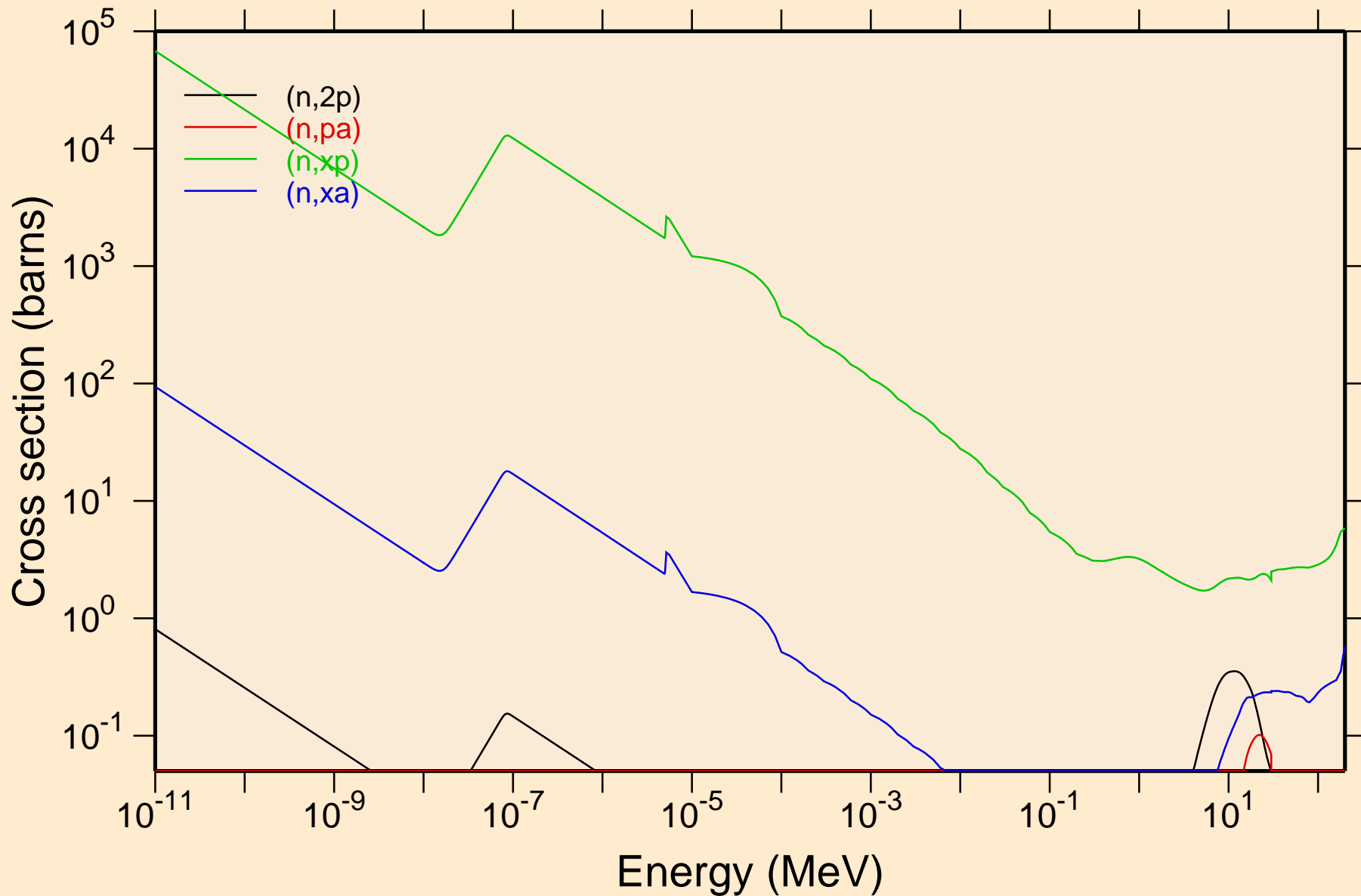

HO148M NEUTRON ACER TENDL-2019 LIBRARY; T=293.16K
Principal cross sections

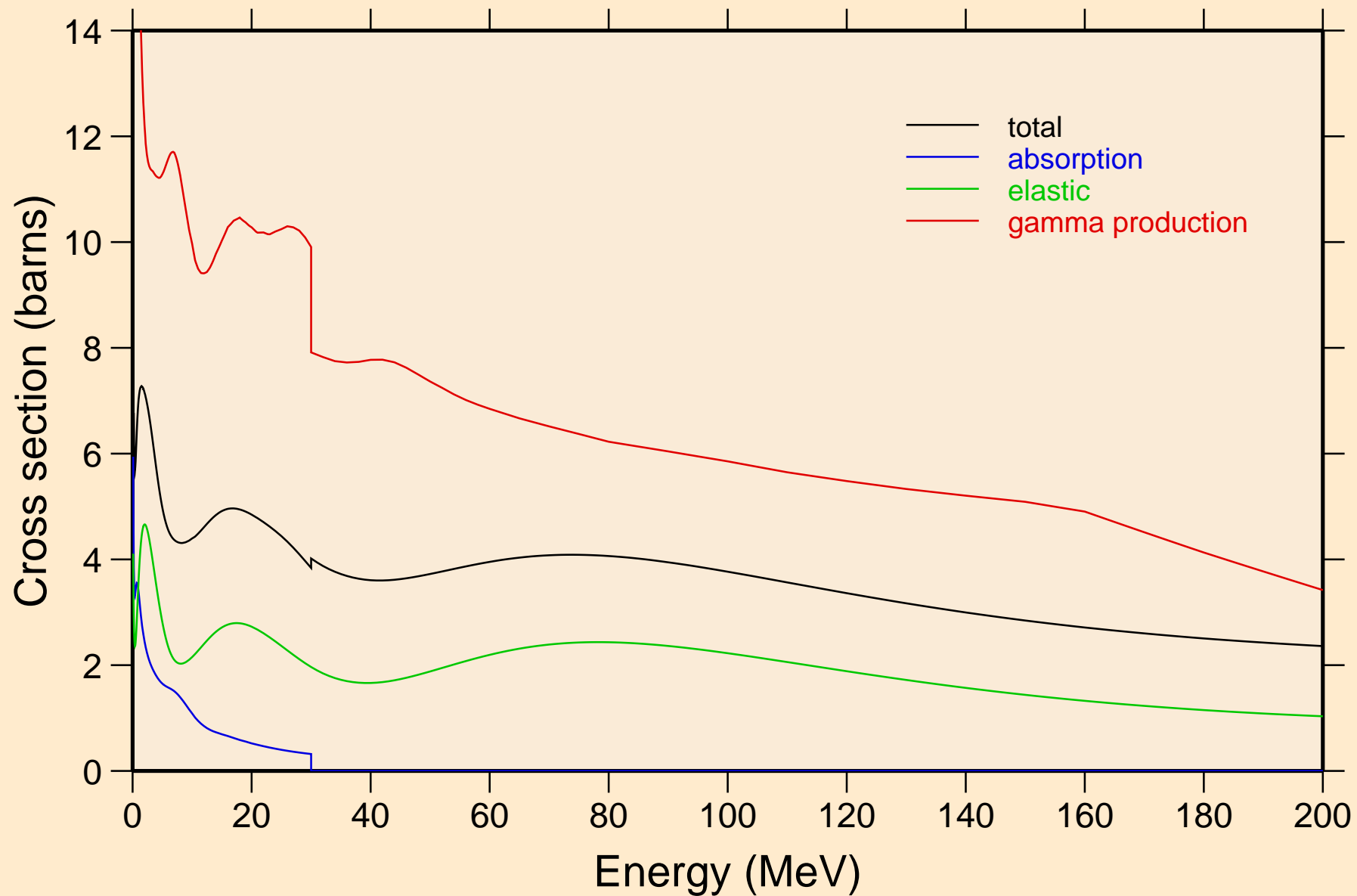

HO148M NEUTRON ACER TENDL-2019 LIBRARY; T=293.16K
Heating

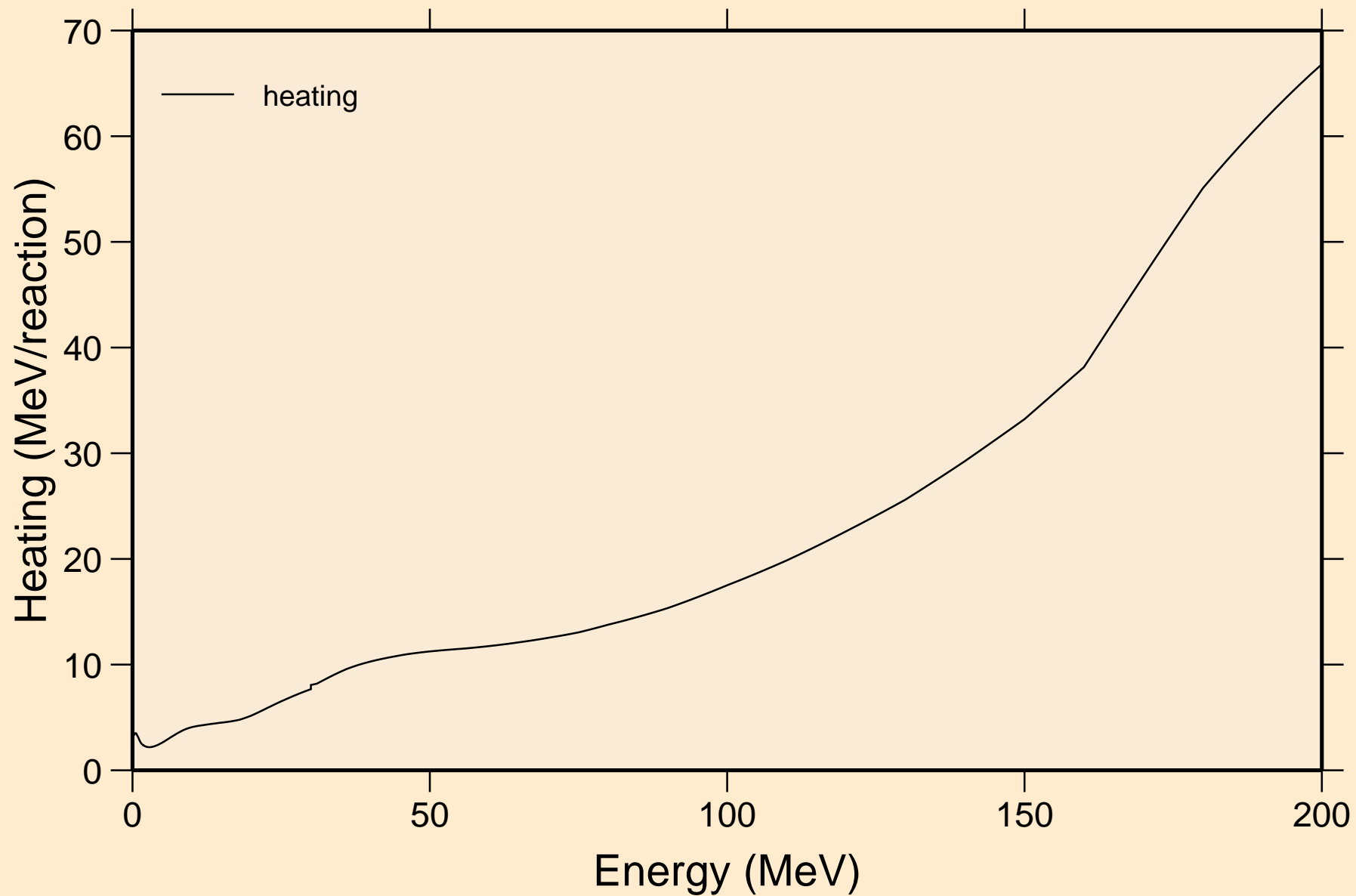

HO148M NEUTRON ACER TENDL-2019 LIBRARY; T=293.16K
Damage

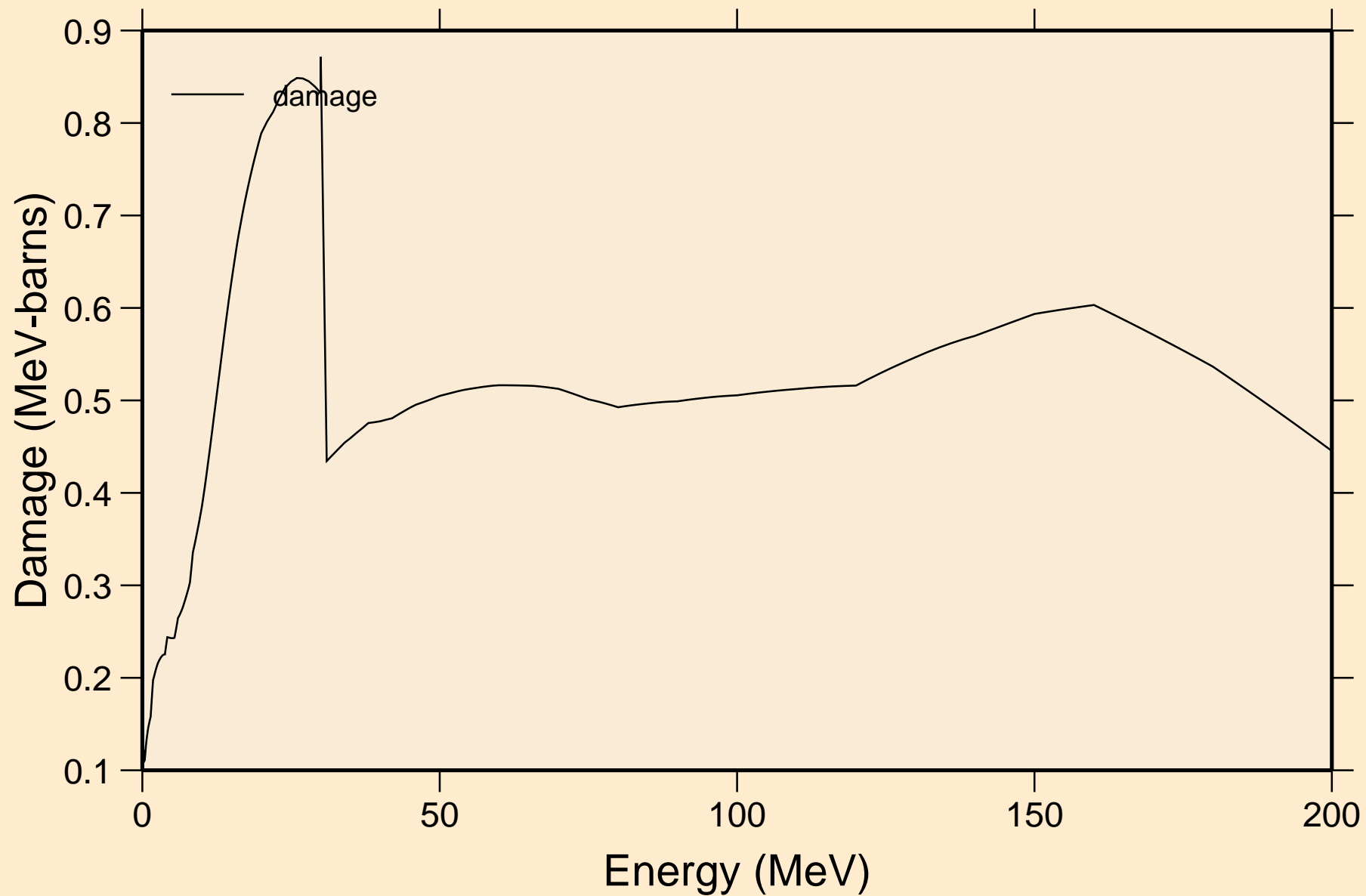

HO148M NEUTRON ACER TENDL-2019 LIBRARY; T=293.16K
Non-threshold reactions

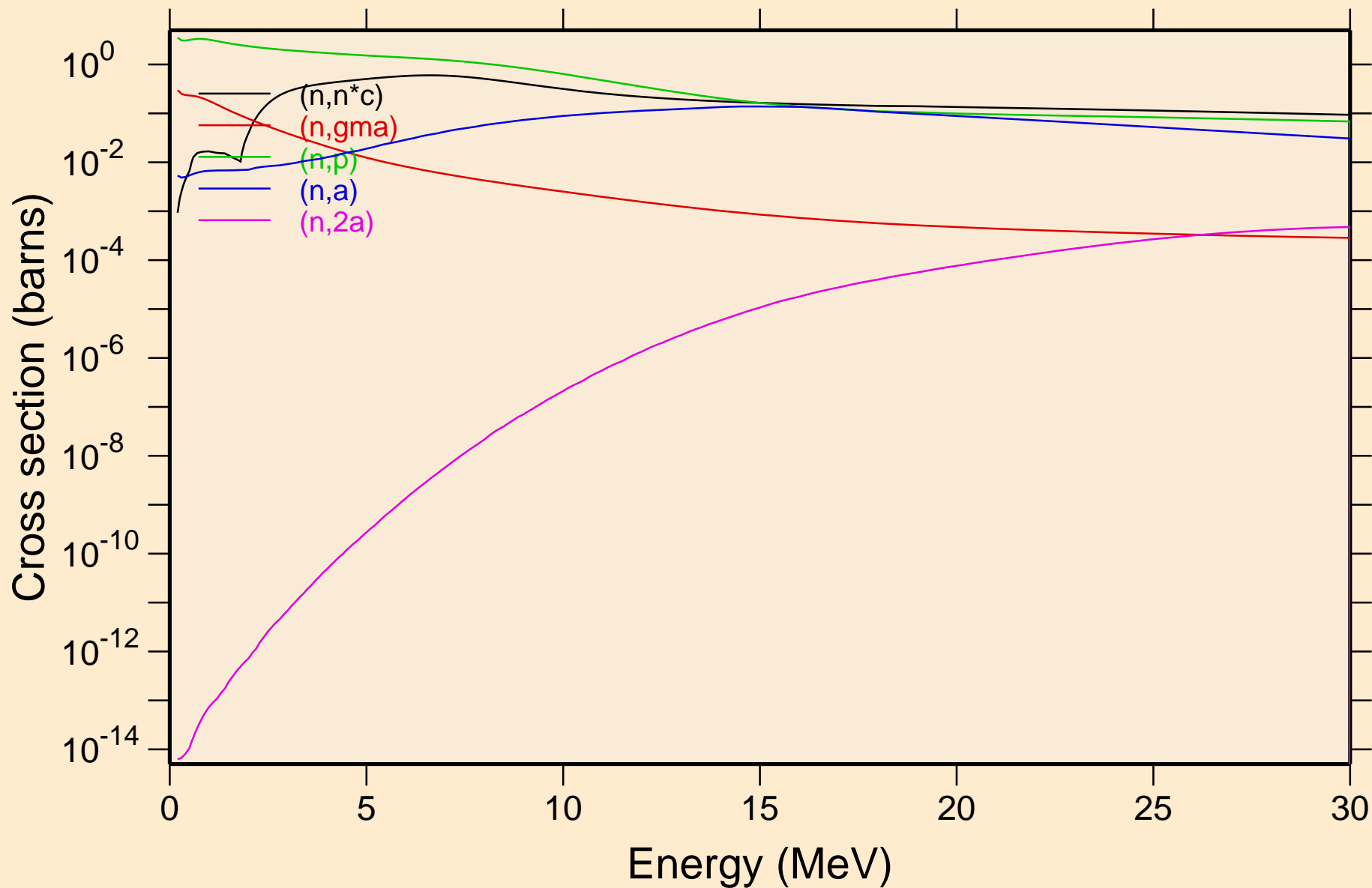

HO148M NEUTRON ACER TENDL-2019 LIBRARY; T=293.16K
Non-threshold reactions

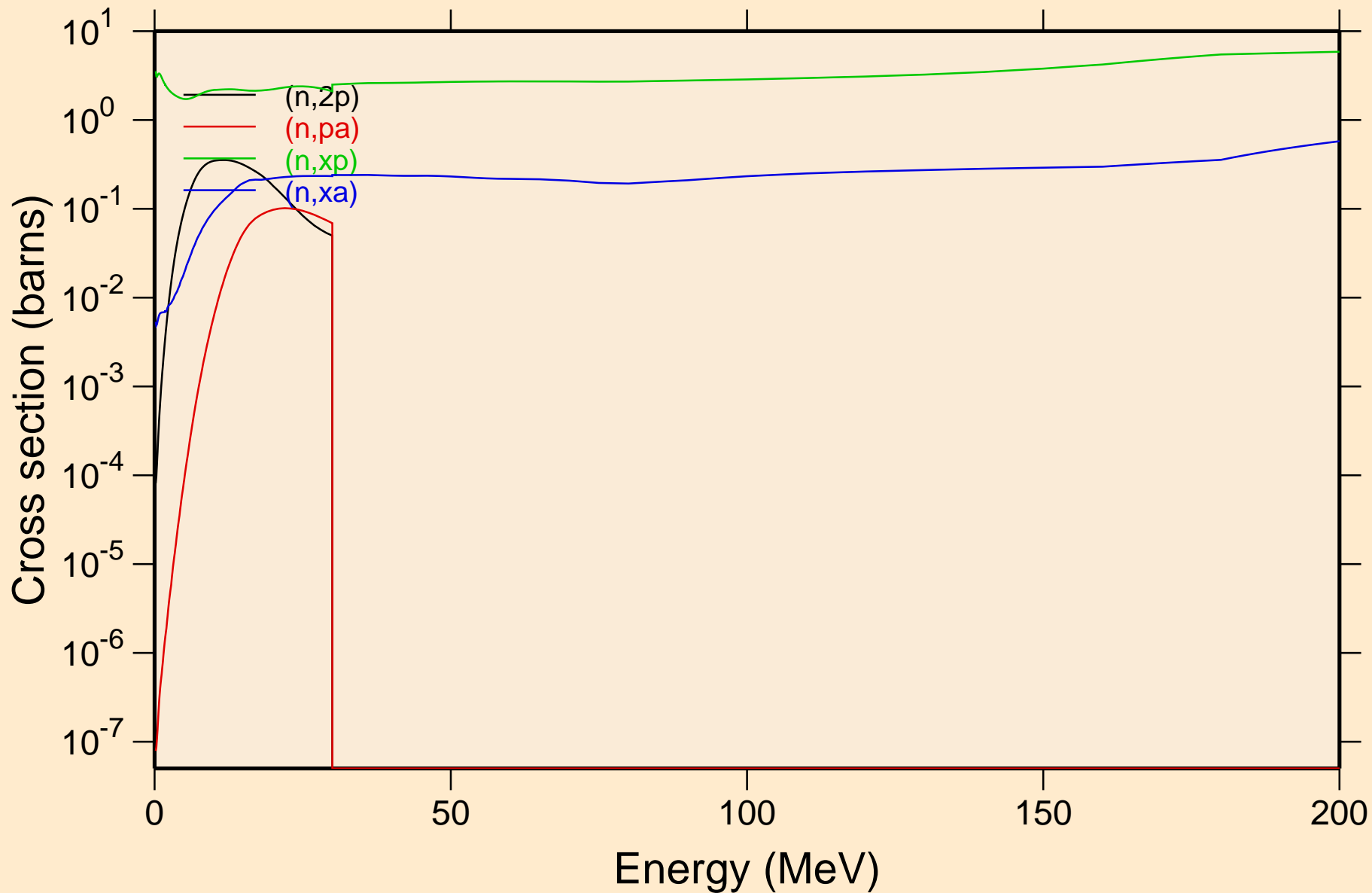

HO148M NEUTRON ACER TENDL-2019 LIBRARY; T=293.16K
Inelastic levels

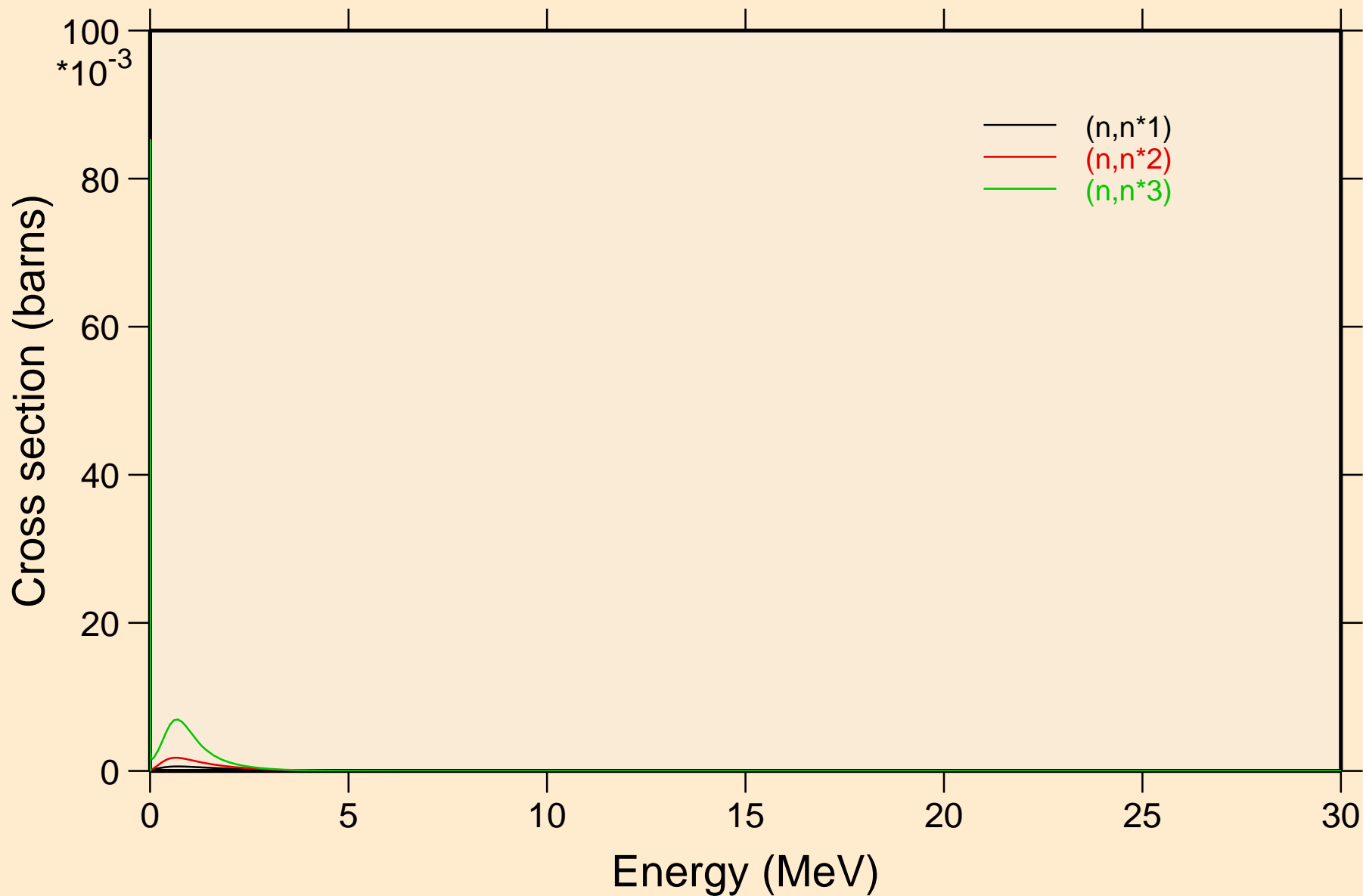

HO148M NEUTRON ACER TENDL-2019 LIBRARY; T=293.16K
Threshold reactions

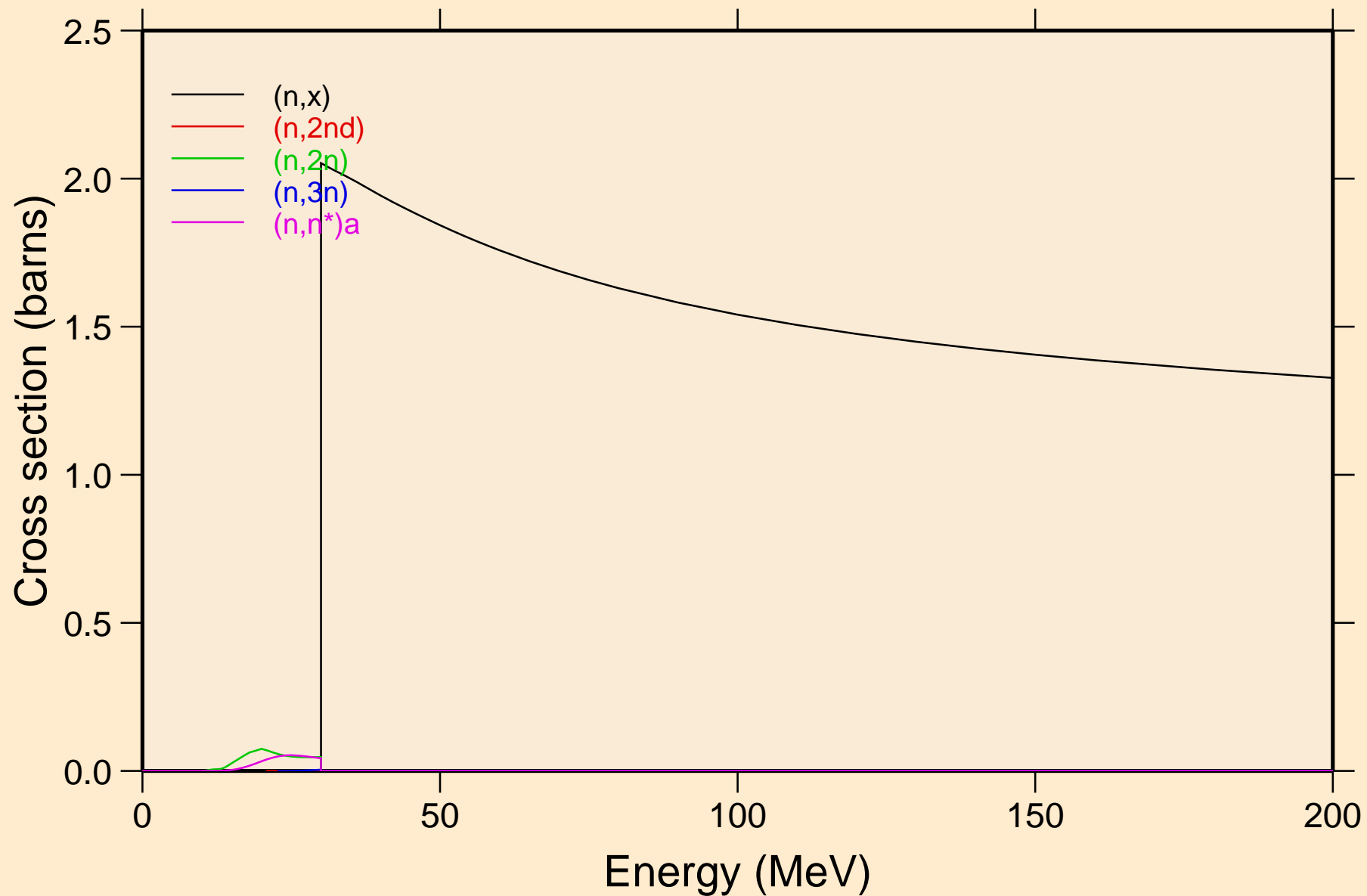

HO148M NEUTRON ACER TENDL-2019 LIBRARY; T=293.16K
Threshold reactions

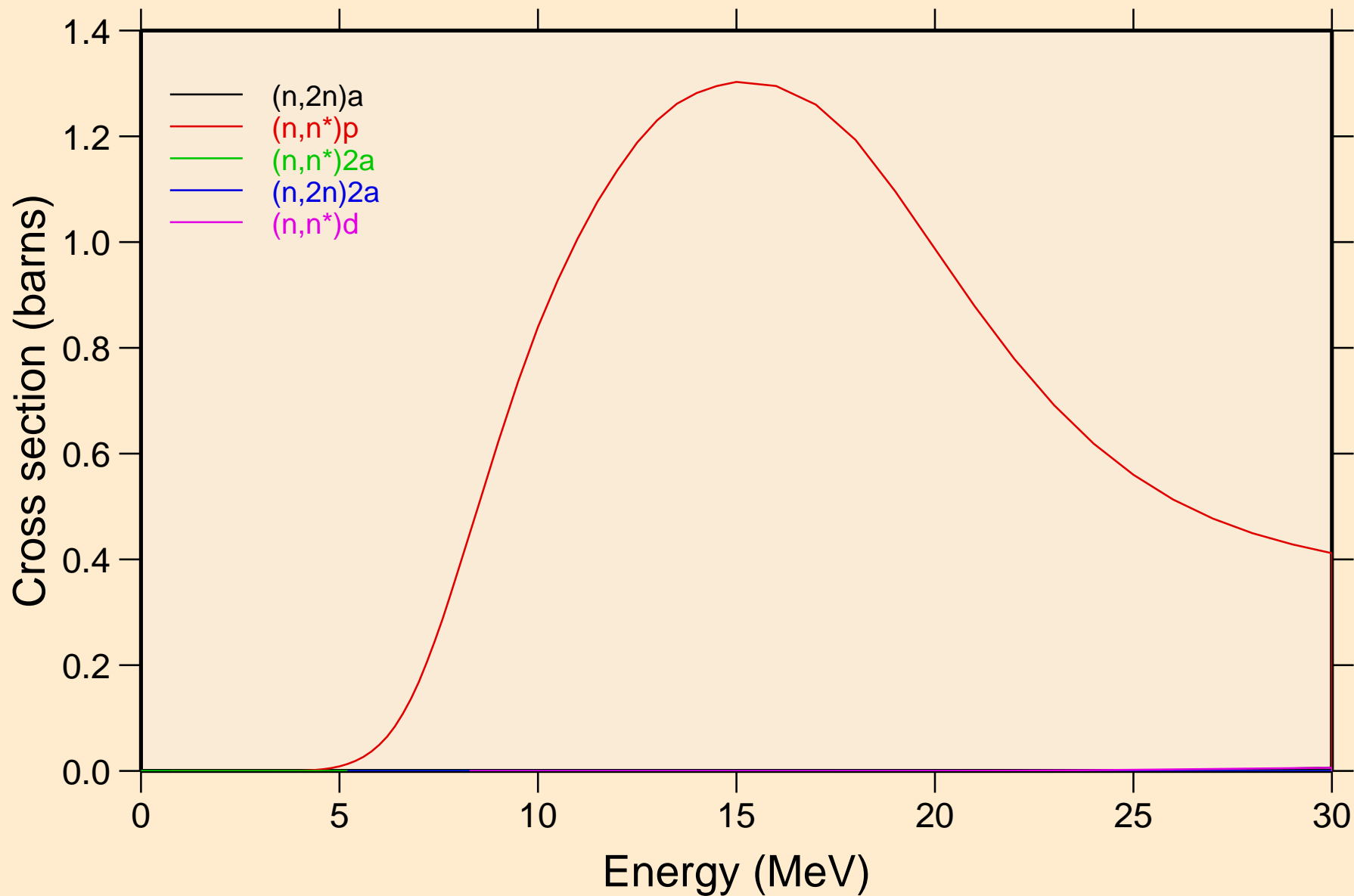

HO148M NEUTRON ACER TENDL-2019 LIBRARY; T=293.16K
Threshold reactions

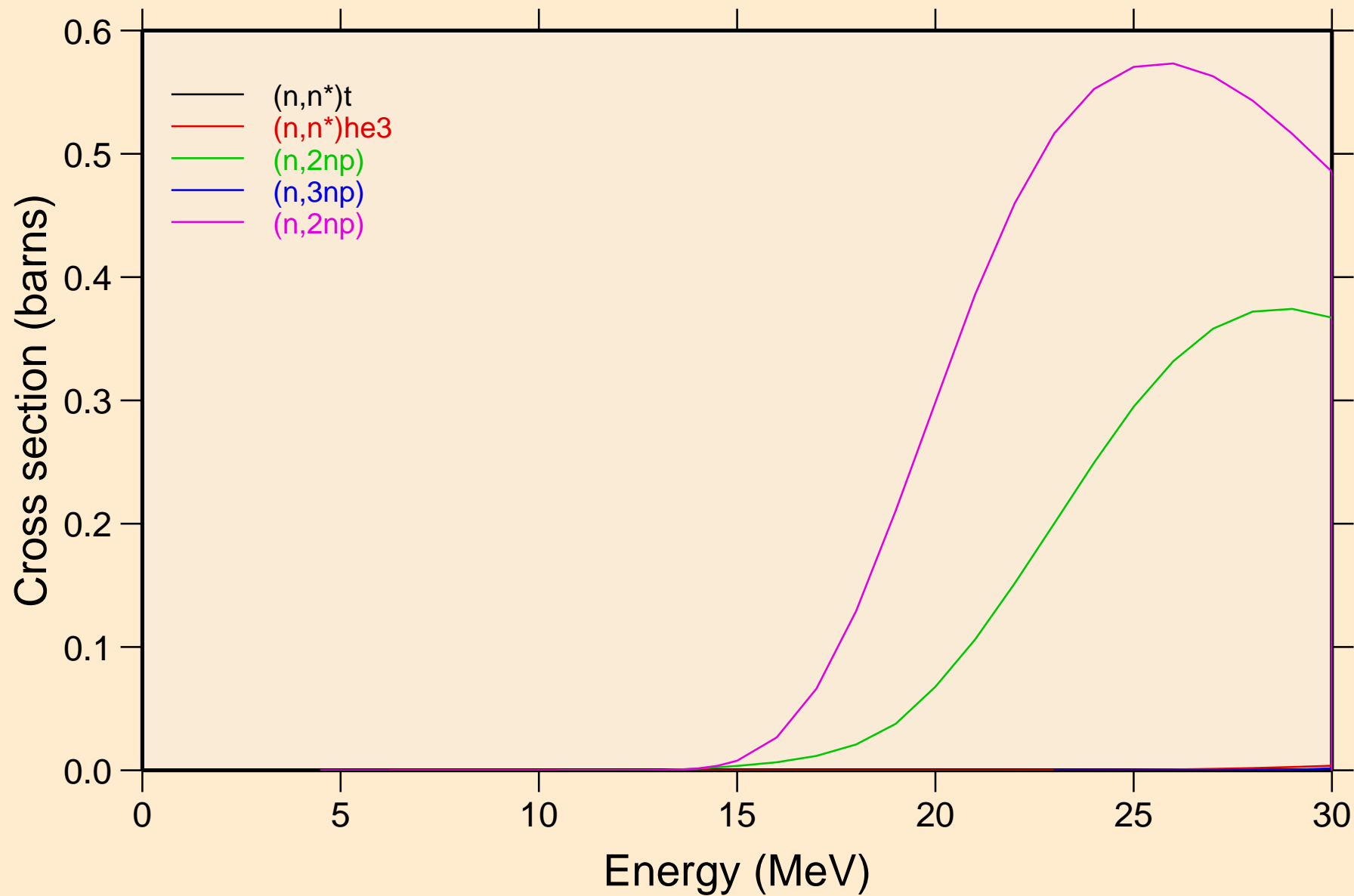

HO148M NEUTRON ACER TENDL-2019 LIBRARY; T=293.16K
Threshold reactions

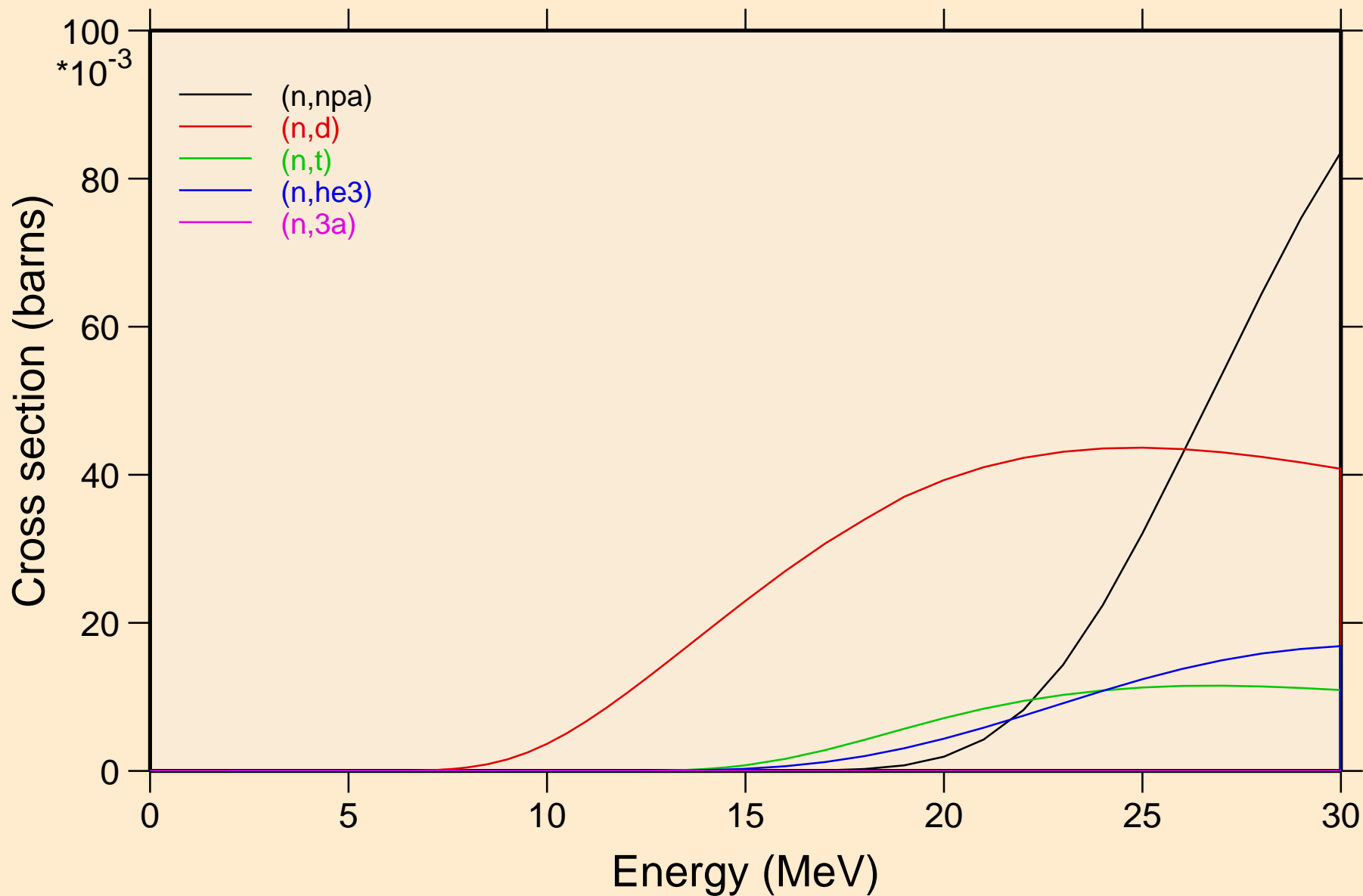

HO148M NEUTRON ACER TENDL-2019 LIBRARY; T=293.16K
Threshold reactions

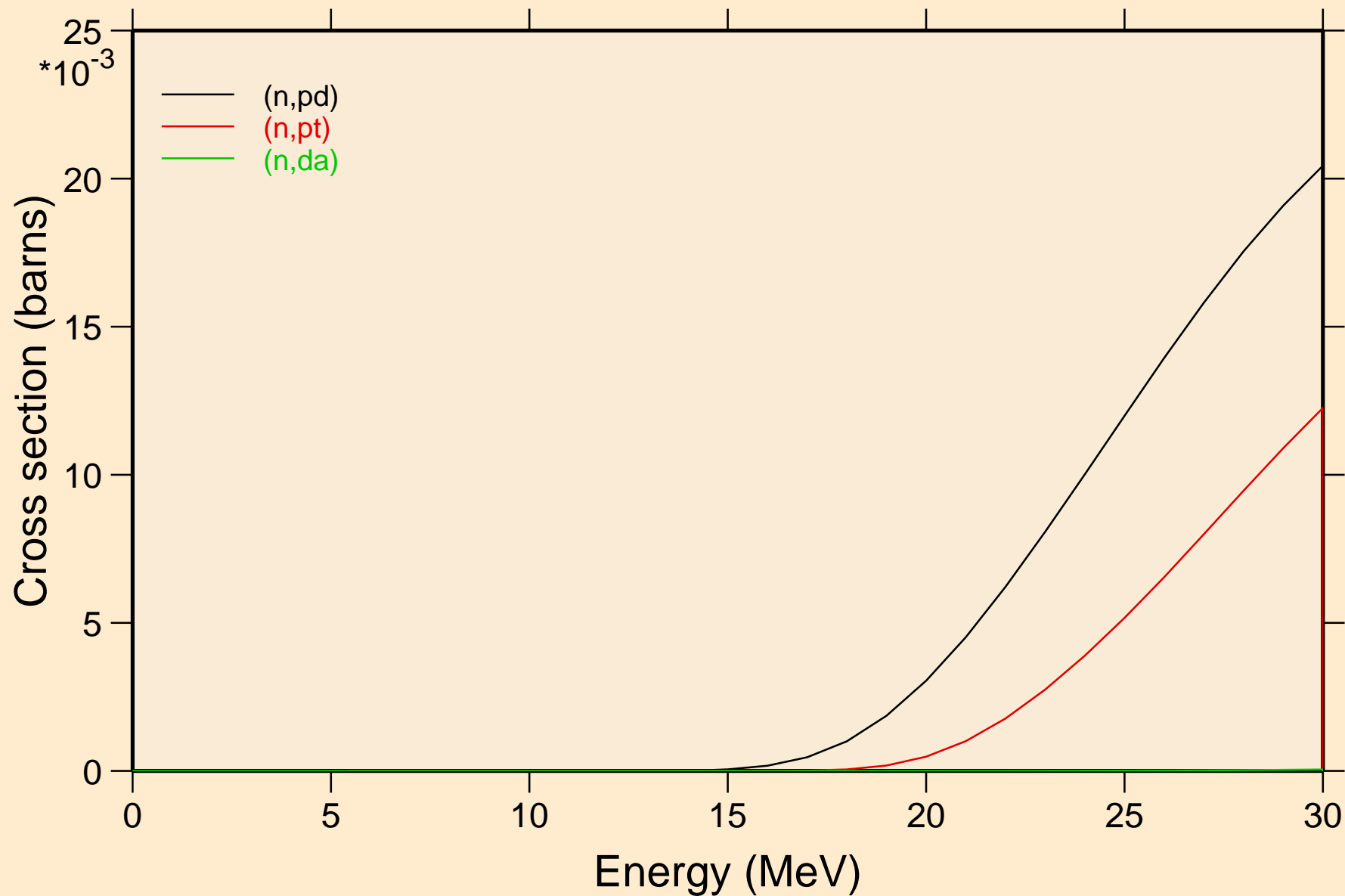

HO148M NEUTRON ACER TENDL-2019 LIBRARY; T=293.16K

Threshold reactions

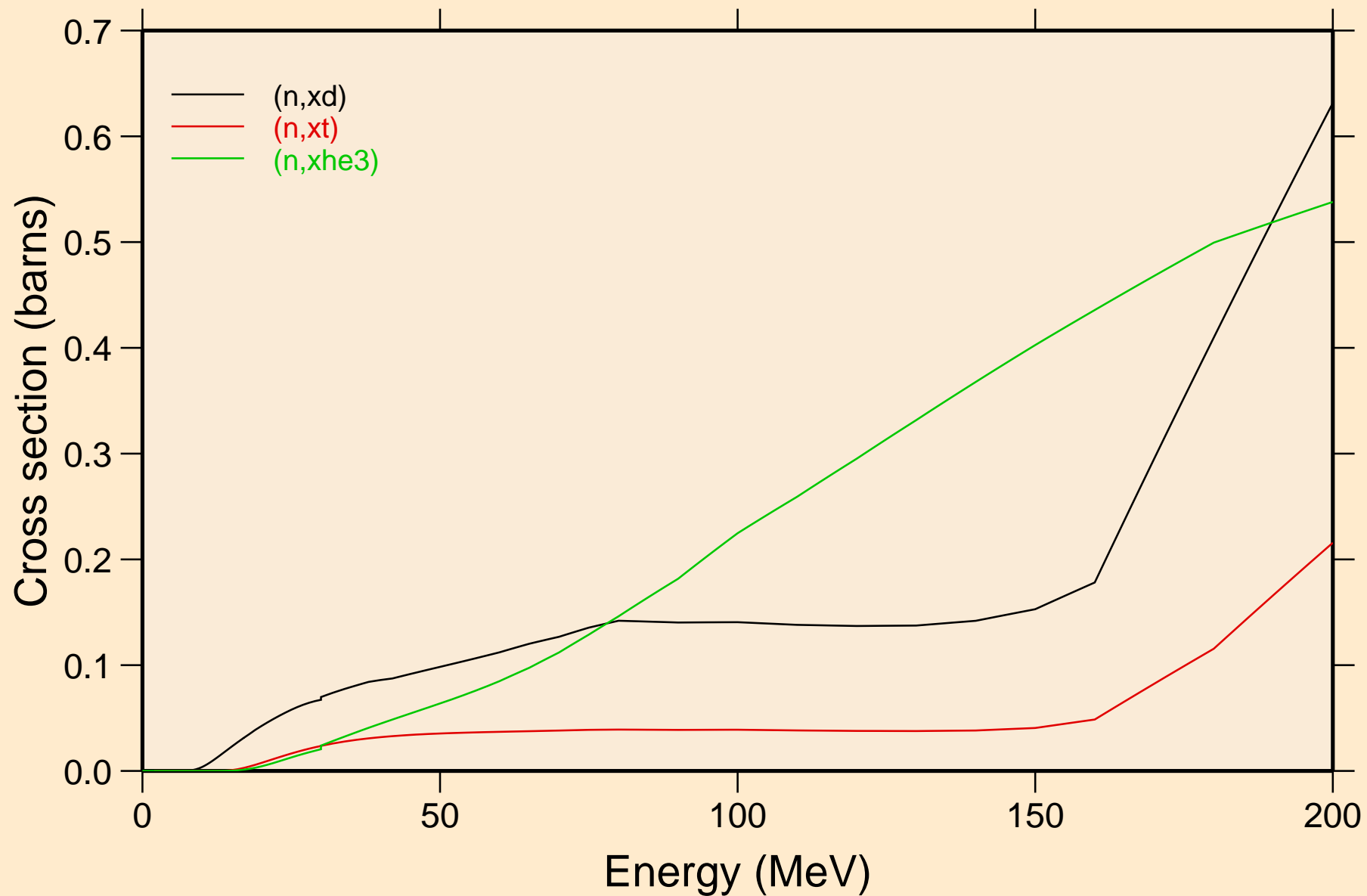

HO148M NEUTRON ACER TENDL-2019 LIBRARY; T=293.16K
angular distribution for elastic

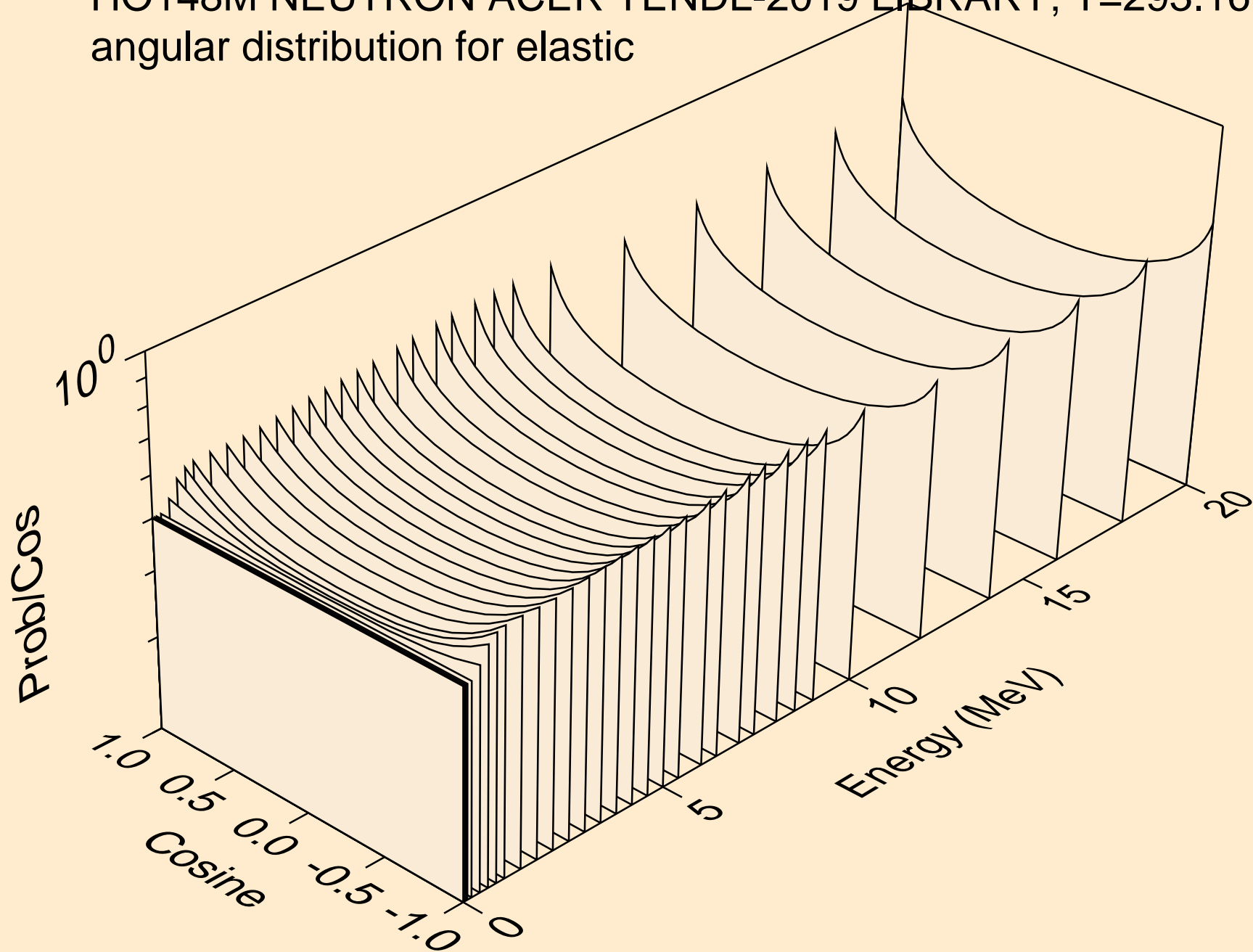

HO148M NEUTRON ACER TENDL-2019 LIBRARY; T=293.16K
angular distribution for elastic

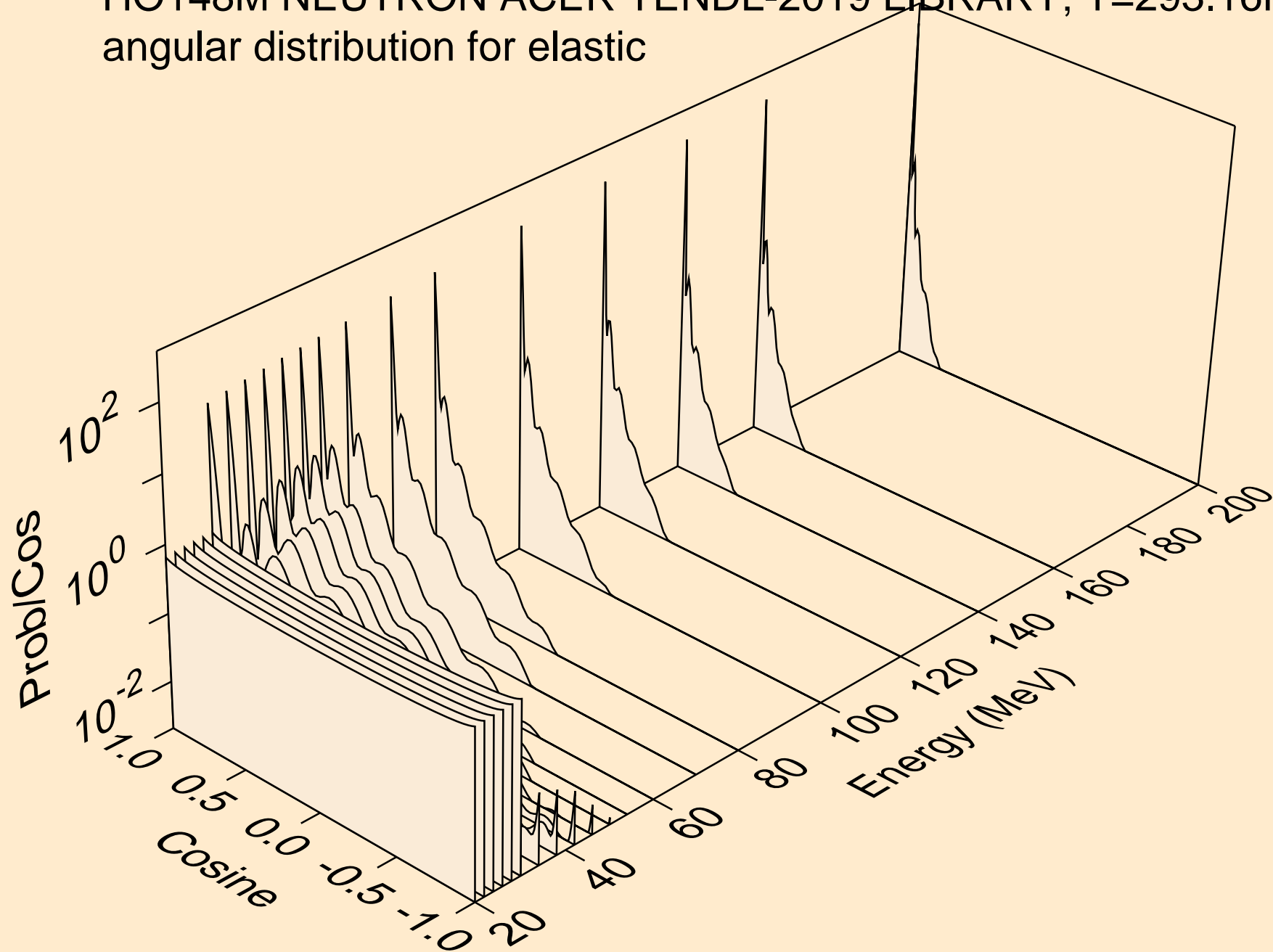

HO148M NEUTRON ACER TENDL-2019 LIBRARY; T=293.16K
angular distribution for (n,n*1)

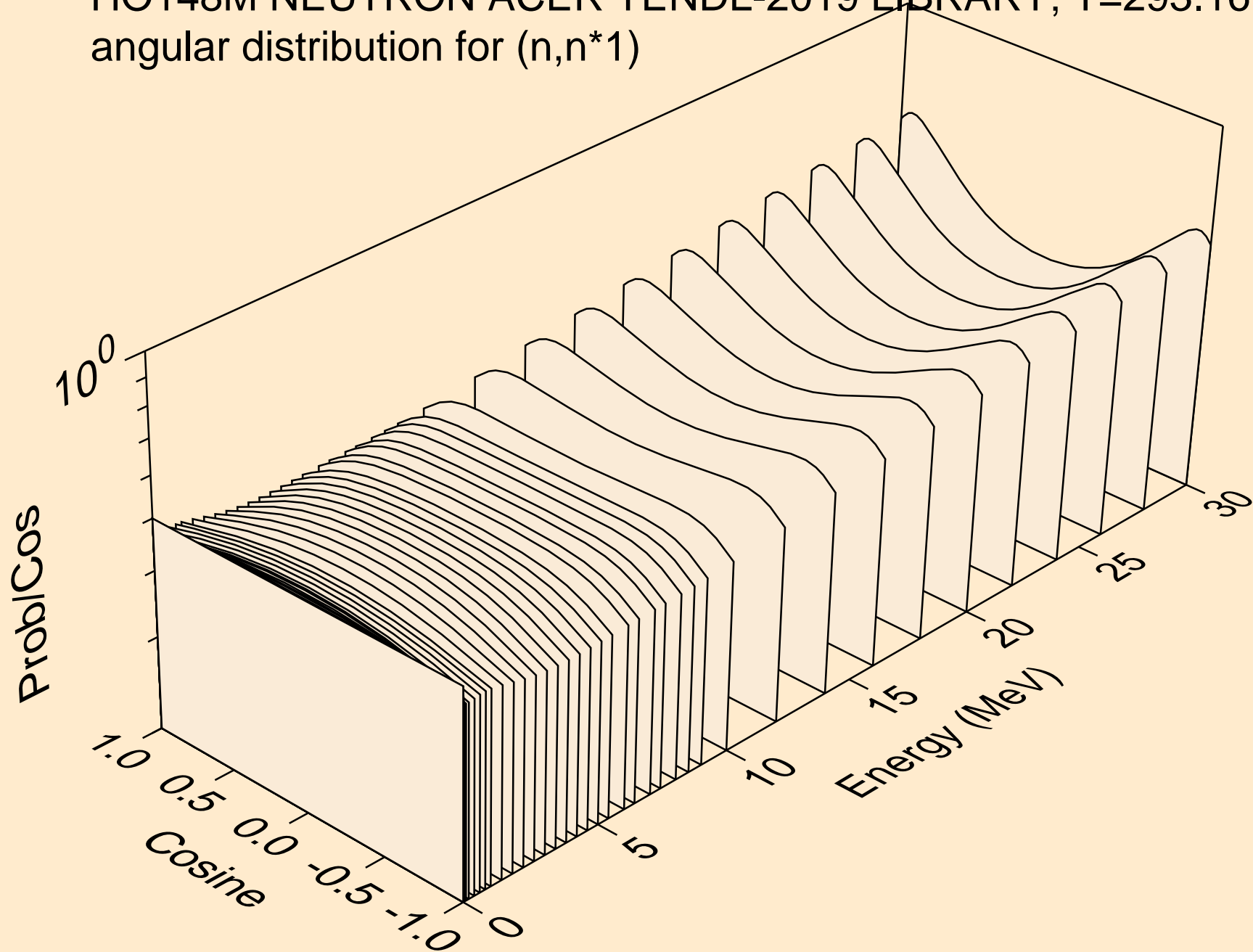

HO148M NEUTRON ACER TENDL-2019 LIBRARY; T=293.16K
angular distribution for (n,n*2)

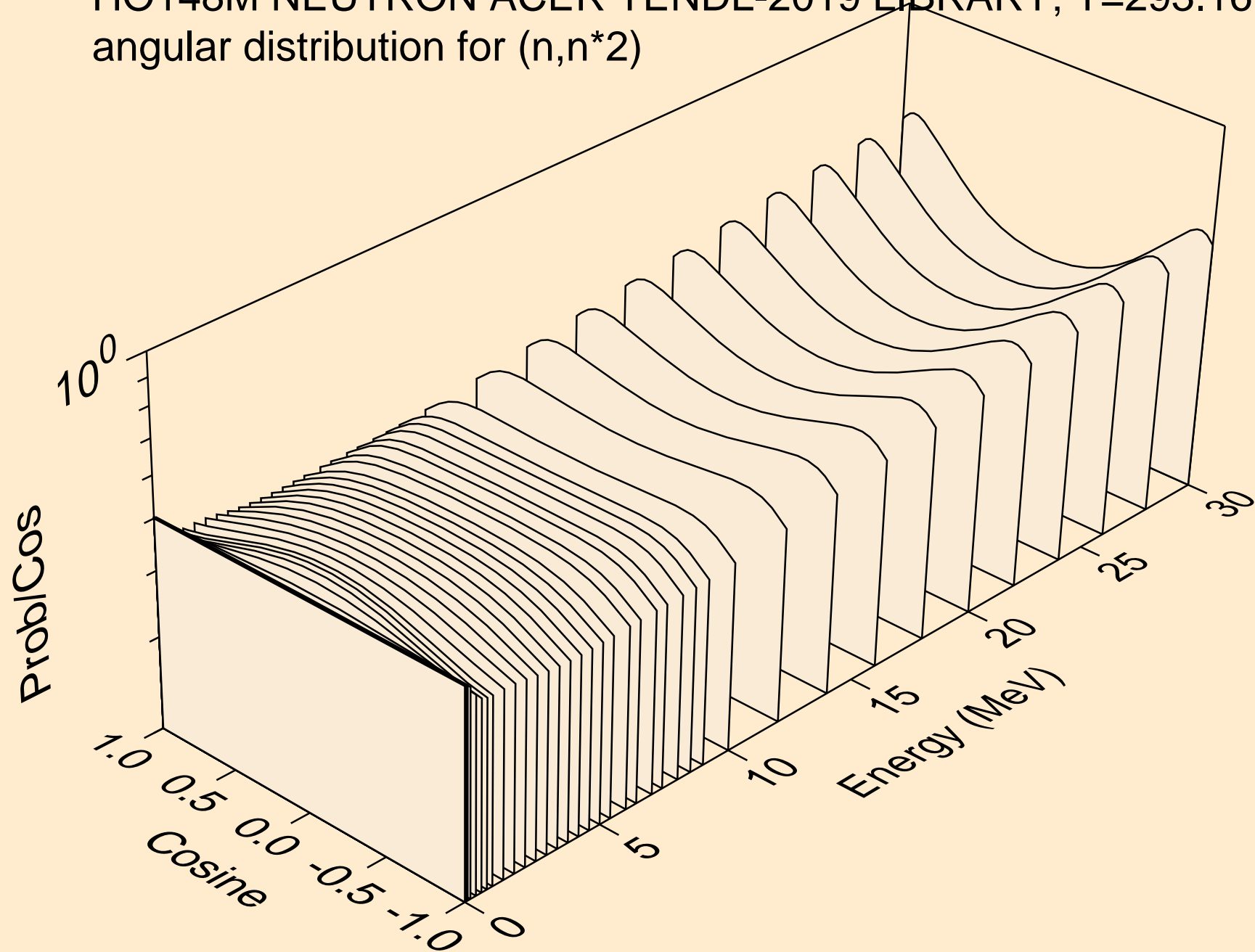

HO148M NEUTRON ACER TENDL-2019 LIBRARY; T=293.16K
angular distribution for (n,n*3)

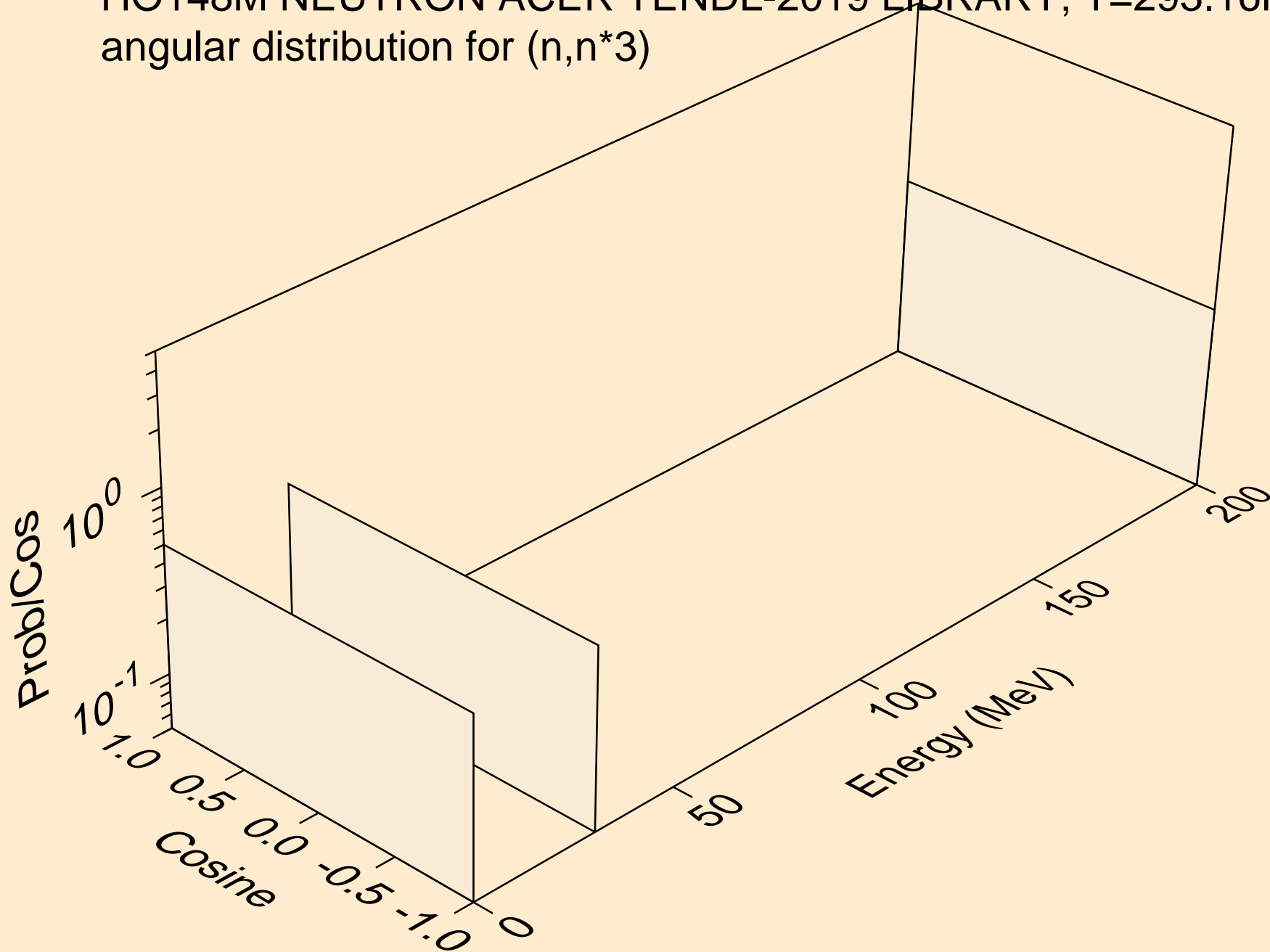

HO148M NEUTRON ACER TENDL-2019 LIBRARY; T=293.16K
Neutron emission for (n,x)

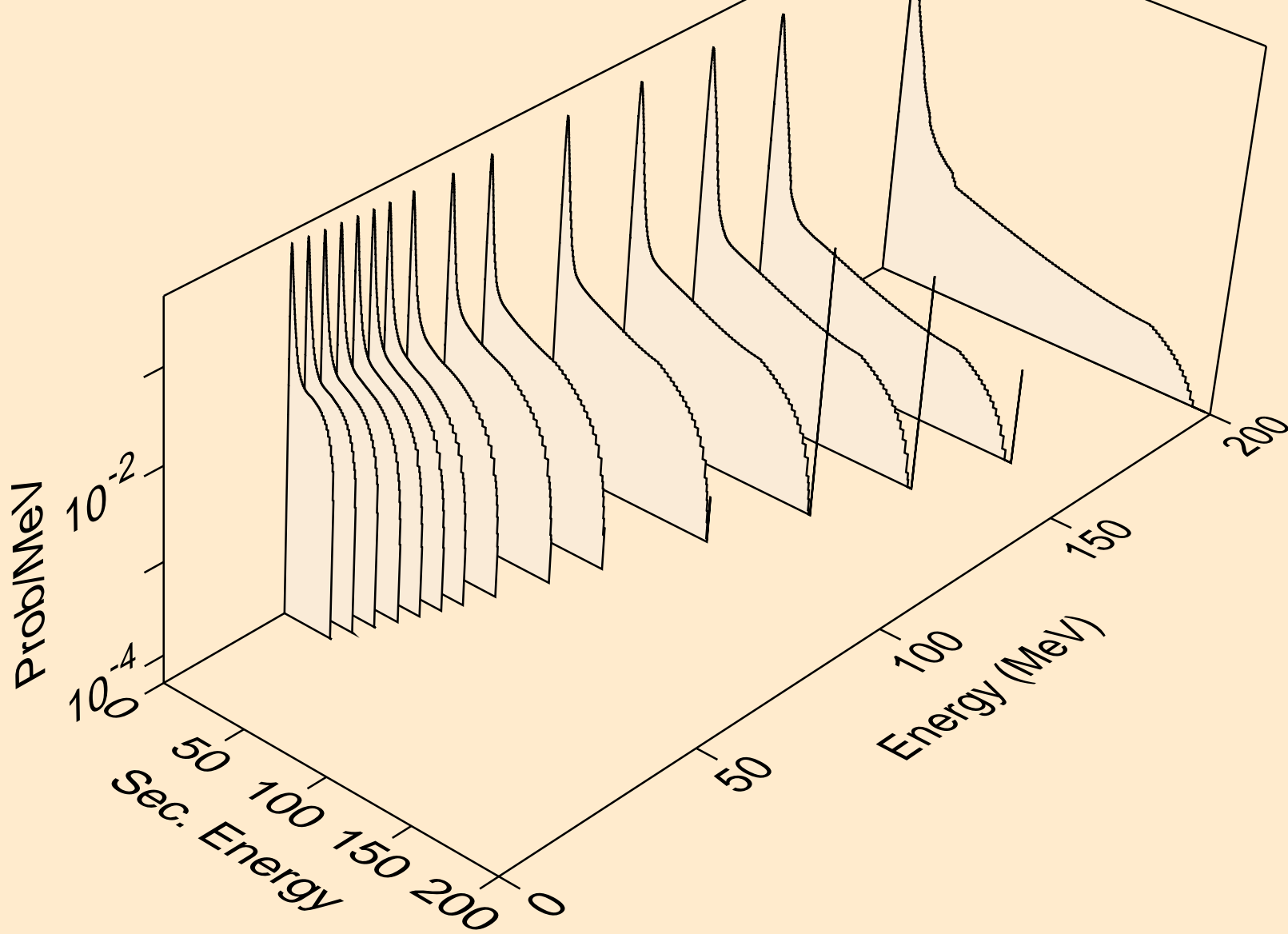

HO148M NEUTRON ACER TENDL-2019 LIBRARY; T=293.16K
Neutron emission for (n,2nd)

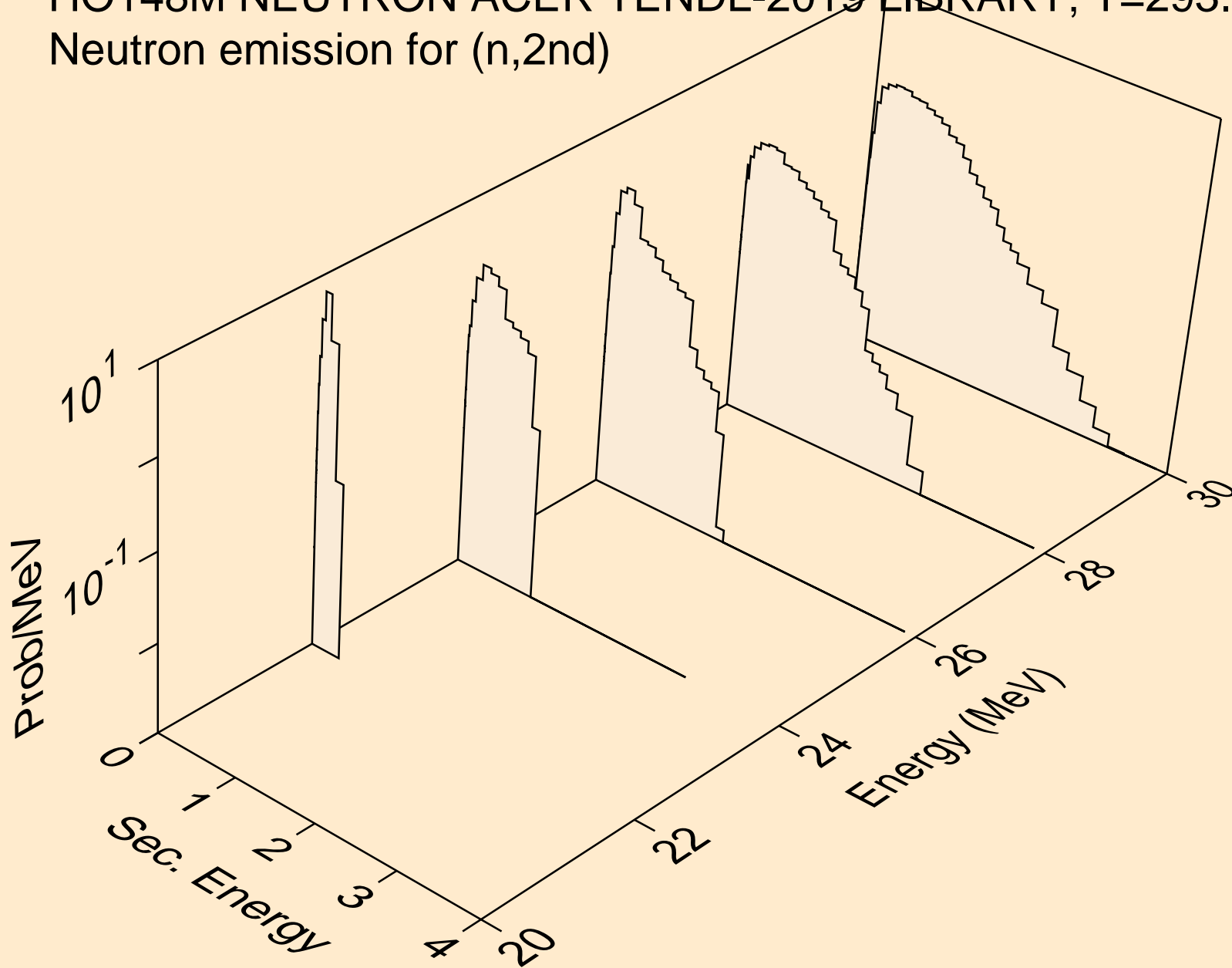

HO148M NEUTRON ACER TENDL-2019 LIBRARY; T=293.16K
Neutron emission for (n,2n)

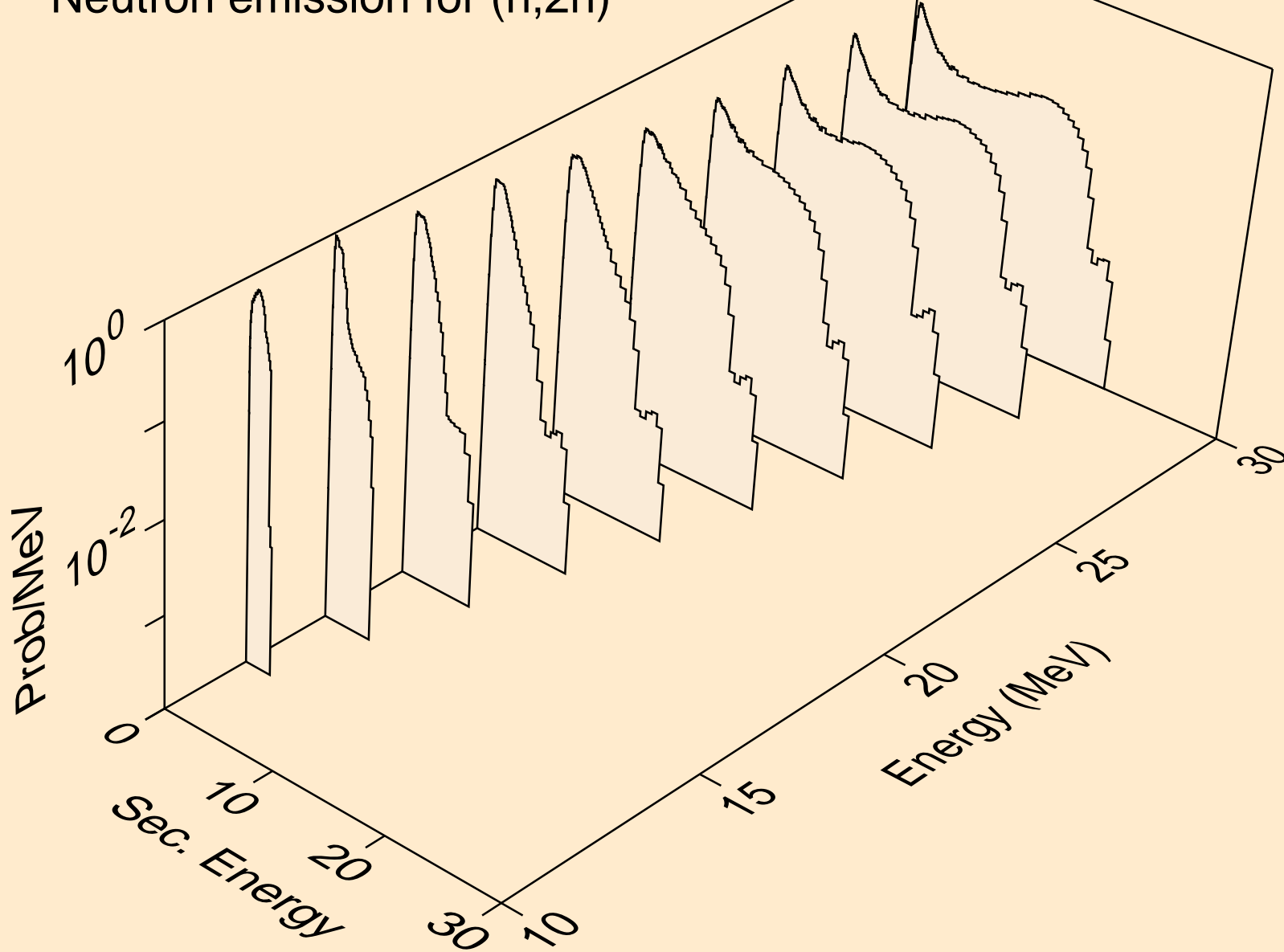

HO148M NEUTRON ACER TENDL-2019 LIBRARY; T=293.16K
Neutron emission for (n,3n)

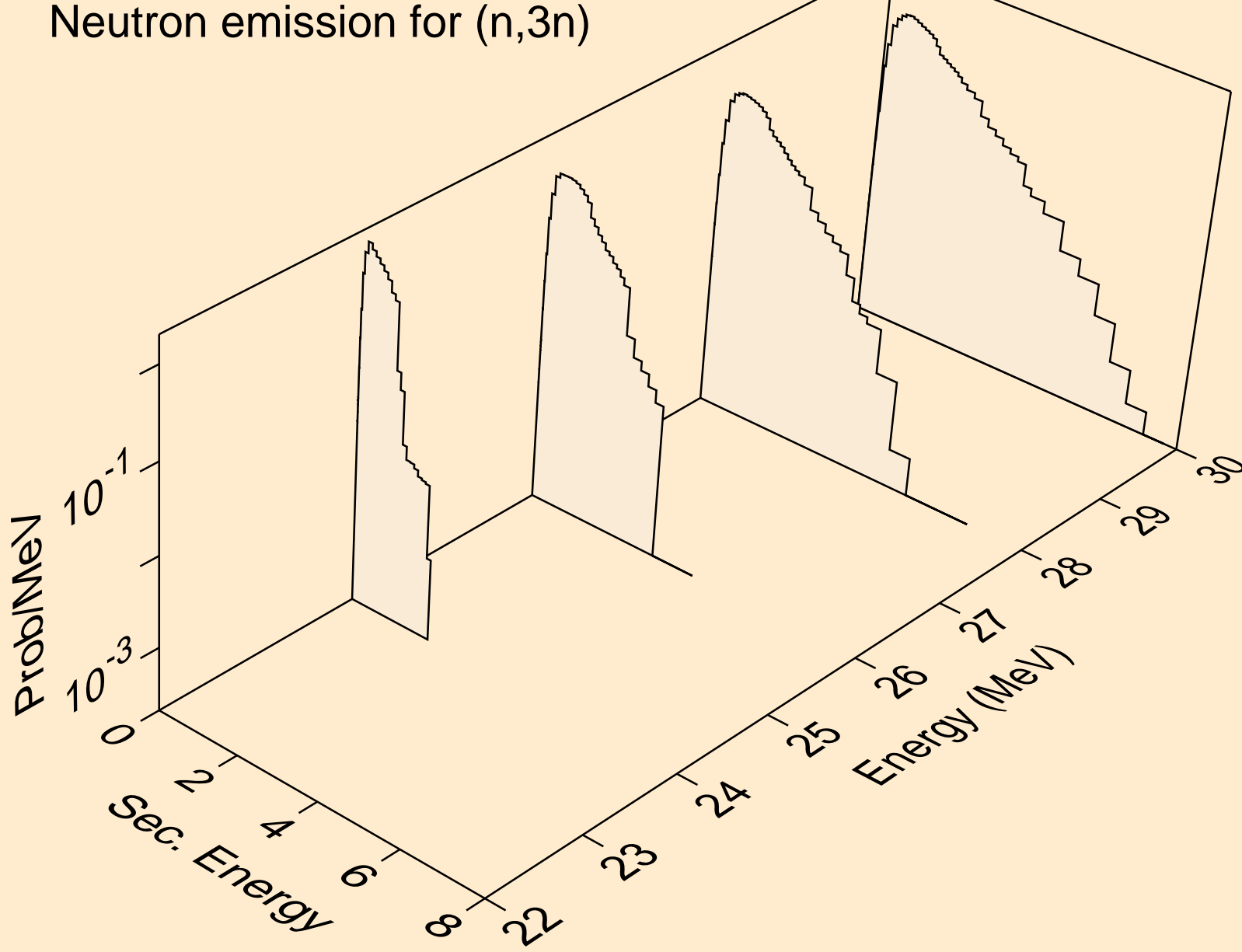

HO148M NEUTRON ACER TENDL-2019 LIBRARY; T=293.16K
Neutron emission for (n,n*)a

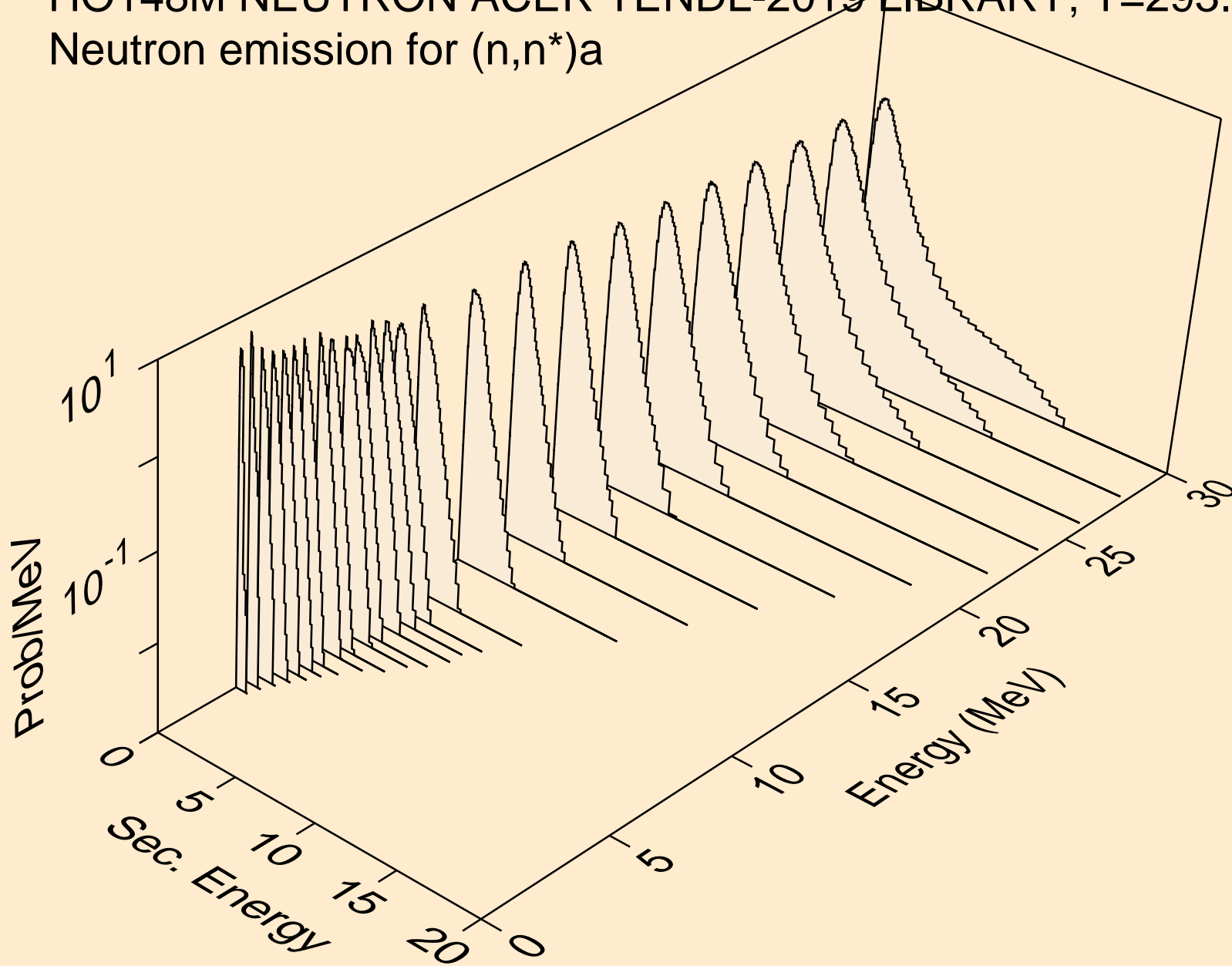

HO148M NEUTRON ACER TENDL-2019 LIBRARY; T=293.16K
Neutron emission for (n,2n)a

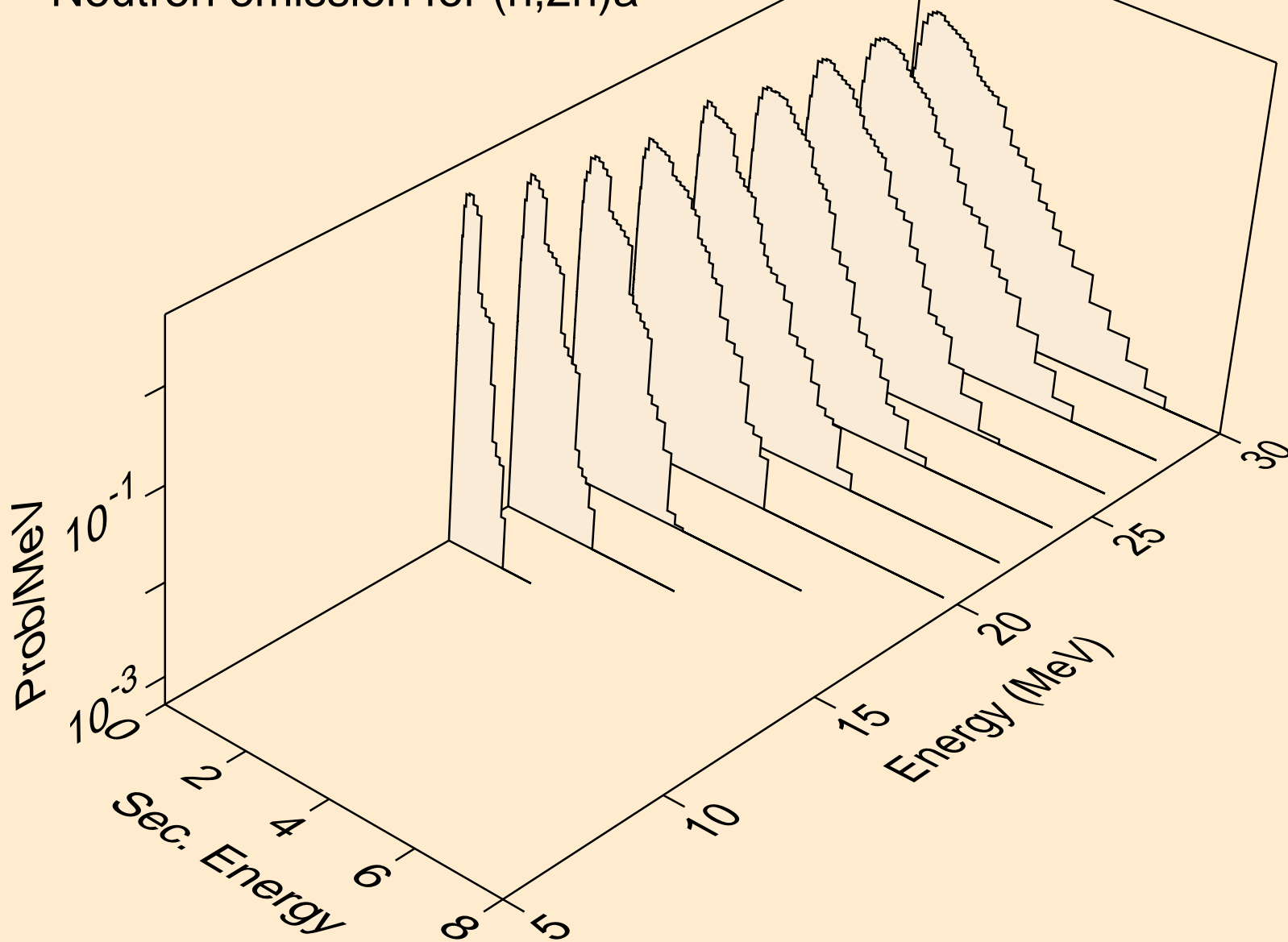

HO148M NEUTRON ACER TENDL-2019 LIBRARY; T=293.16K
Neutron emission for (n,n*)p

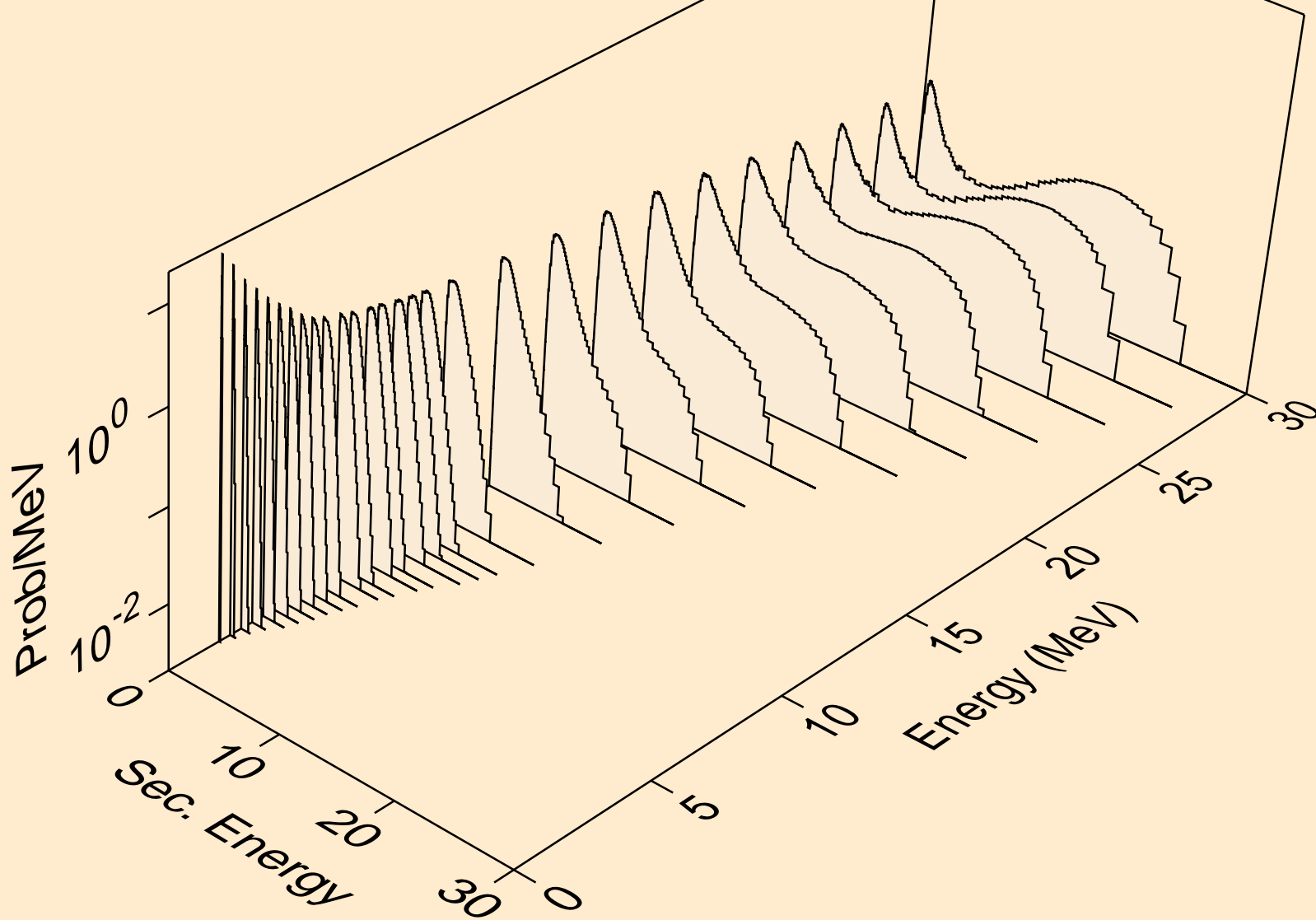

HO148M NEUTRON ACER TENDL-2019 LIBRARY; T=293.16K
Neutron emission for (n,n*)2a

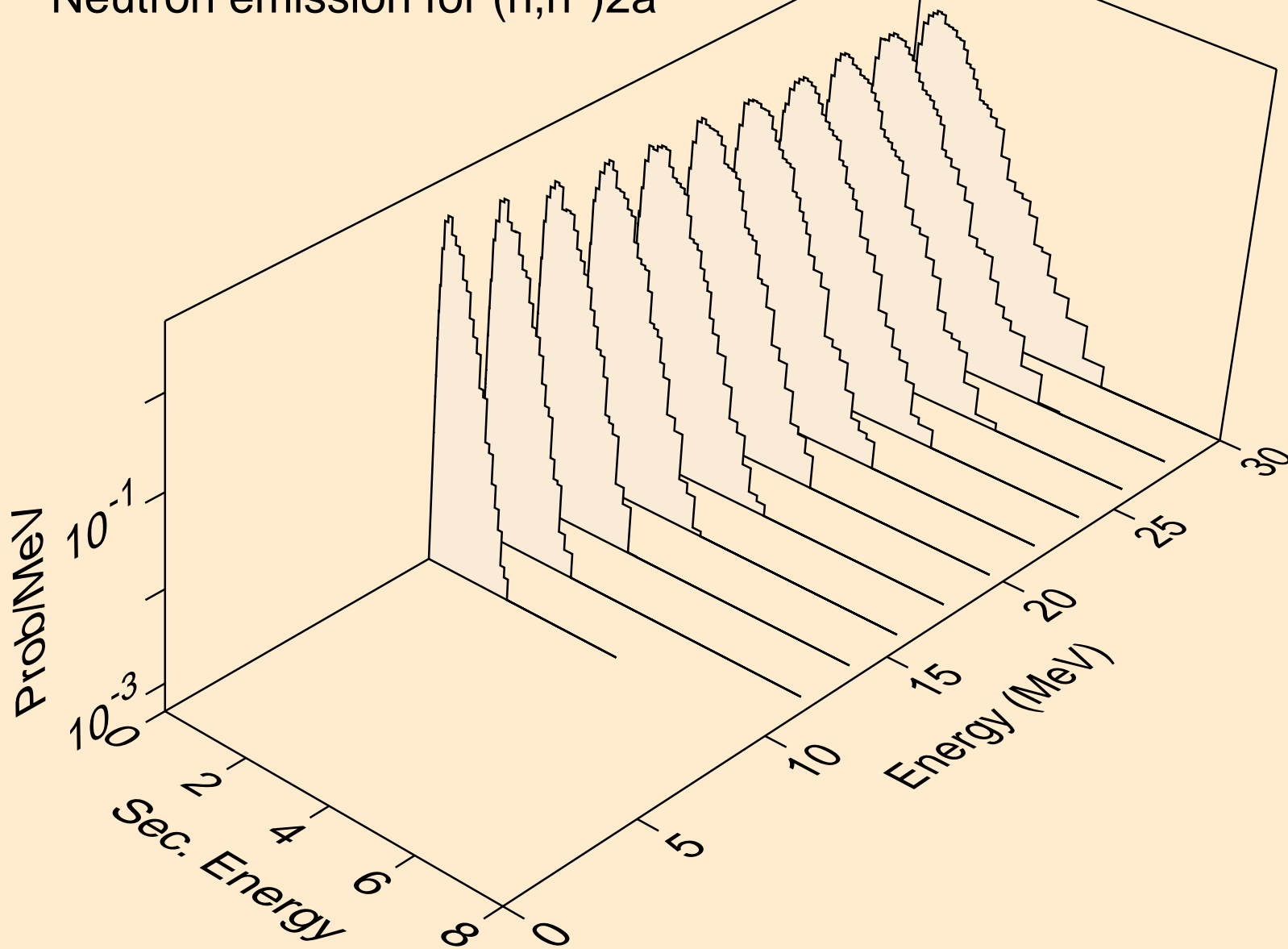

HO148M NEUTRON ACER TENDL-2019 LIBRARY; T=293.16K
Neutron emission for (n,2n)2a

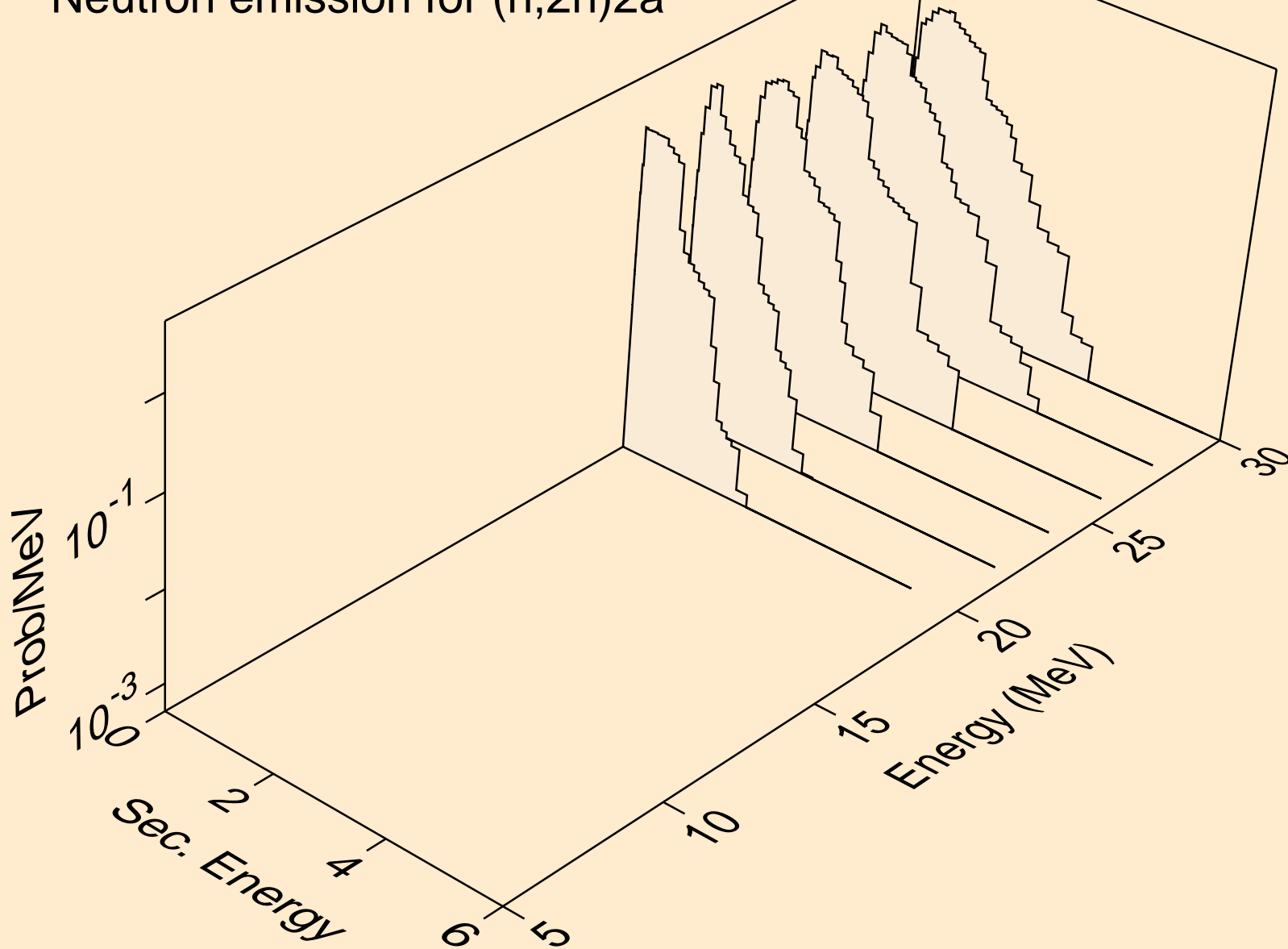

HO148M NEUTRON ACER TENDL-2019 LIBRARY; T=293.16K
Neutron emission for (n,n*)d

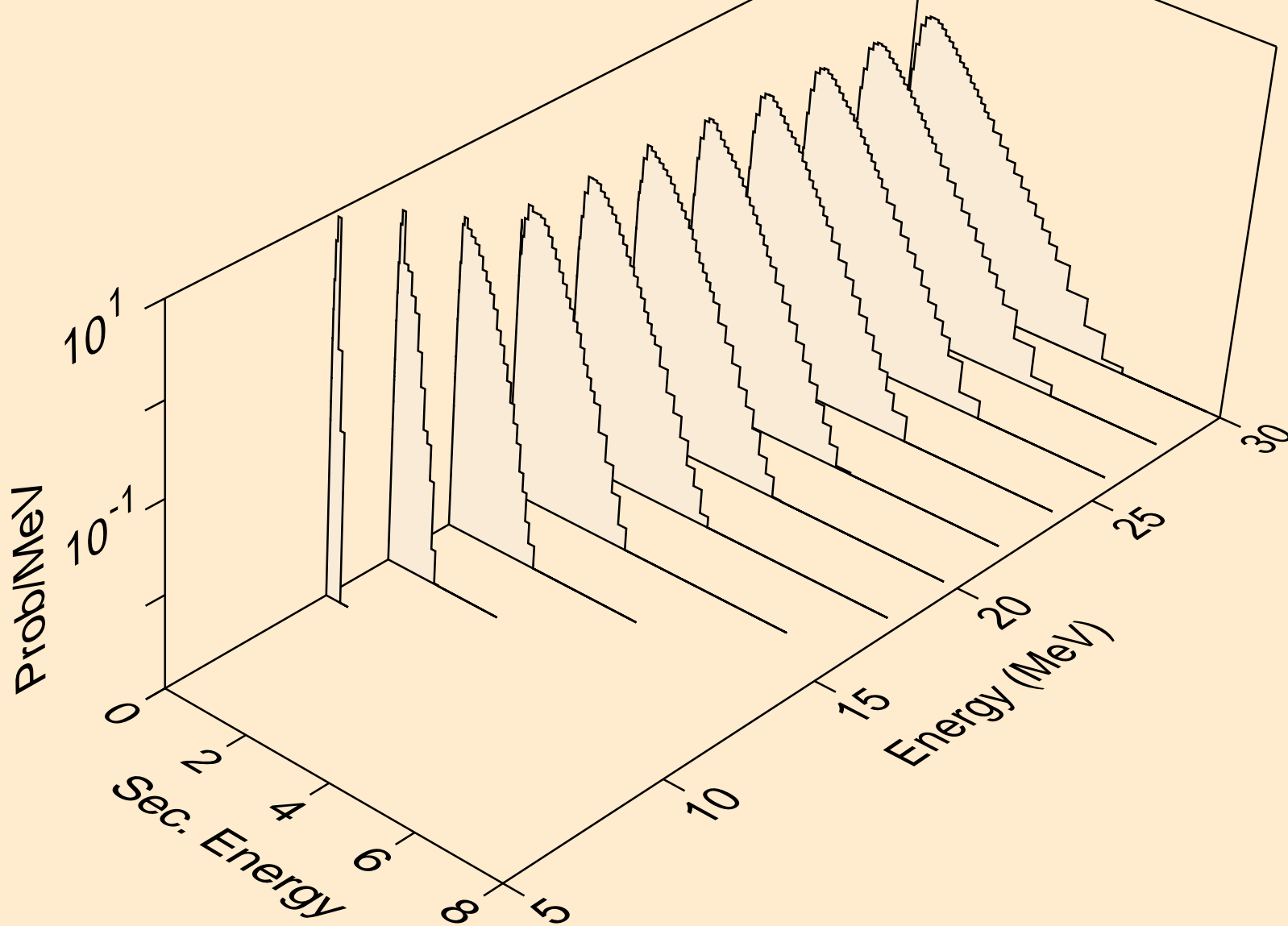

HO148M NEUTRON ACER TENDL-2019 LIBRARY; T=293.16K
Neutron emission for (n,n*)t

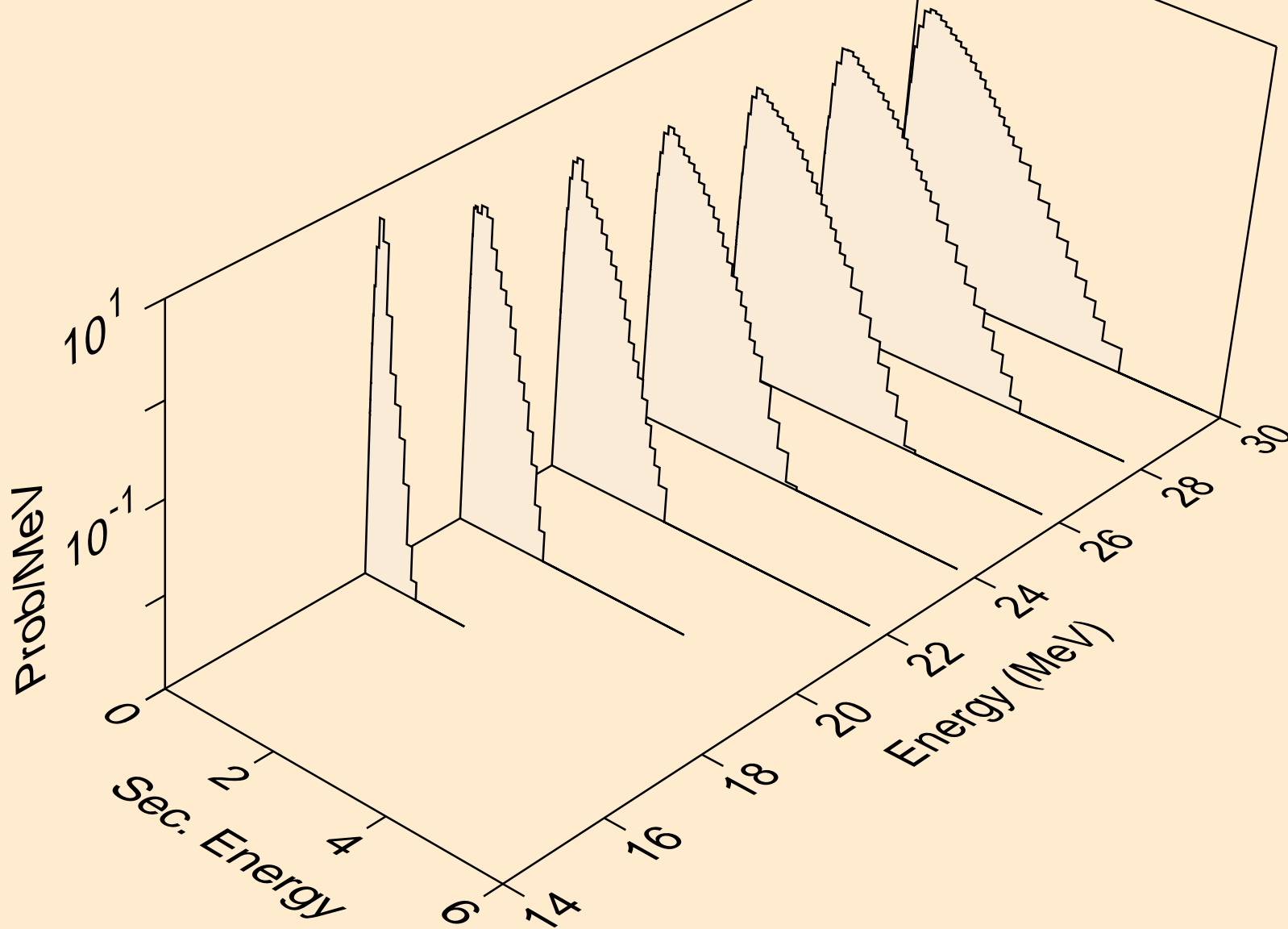

HO148M NEUTRON ACER TENDL-2019 LIBRARY; T=293.16K
Neutron emission for (n,n*)he3

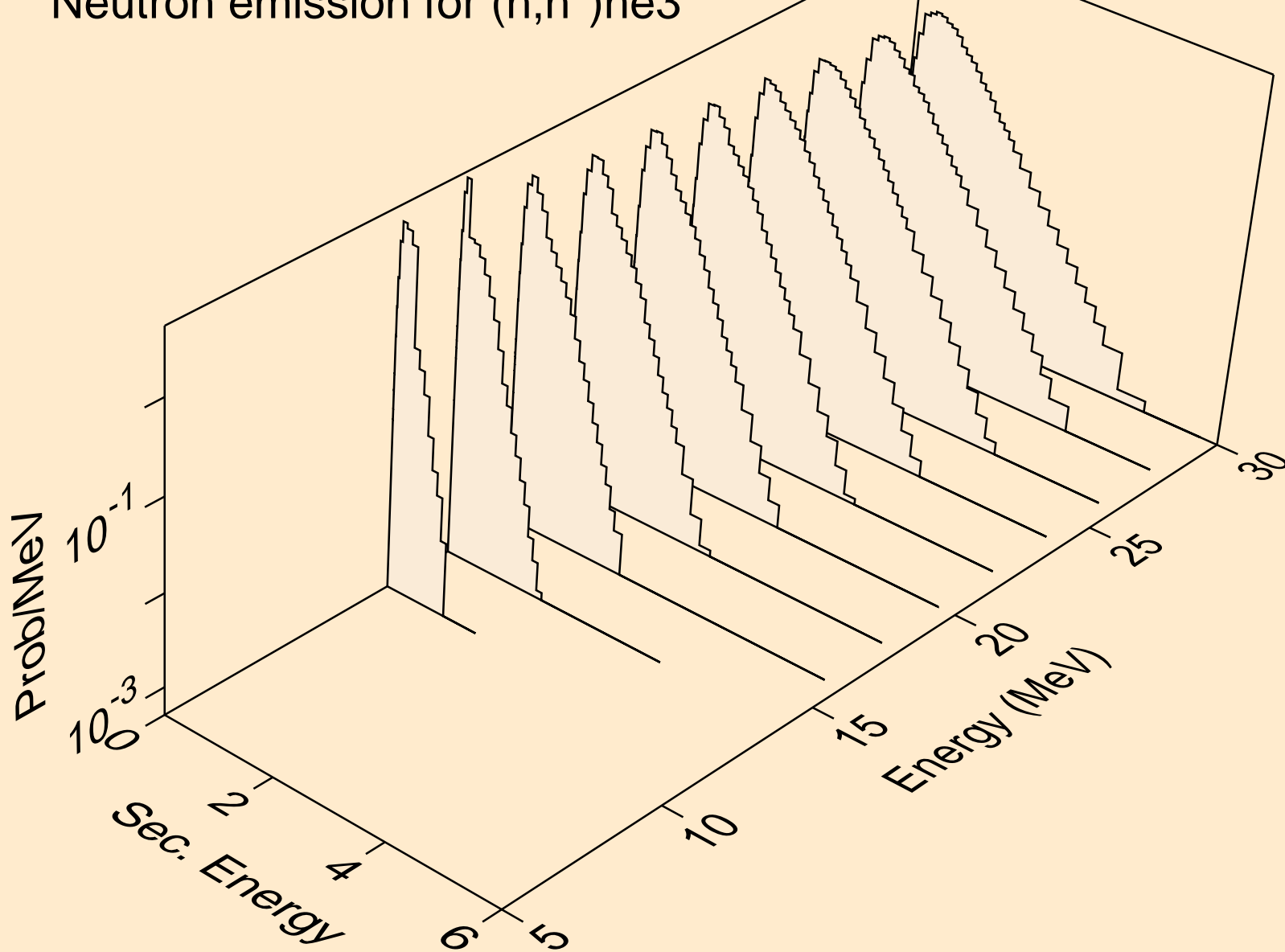

HO148M NEUTRON ACER TENDL-2019 LIBRARY; T=293.16K
Neutron emission for (n,2np)

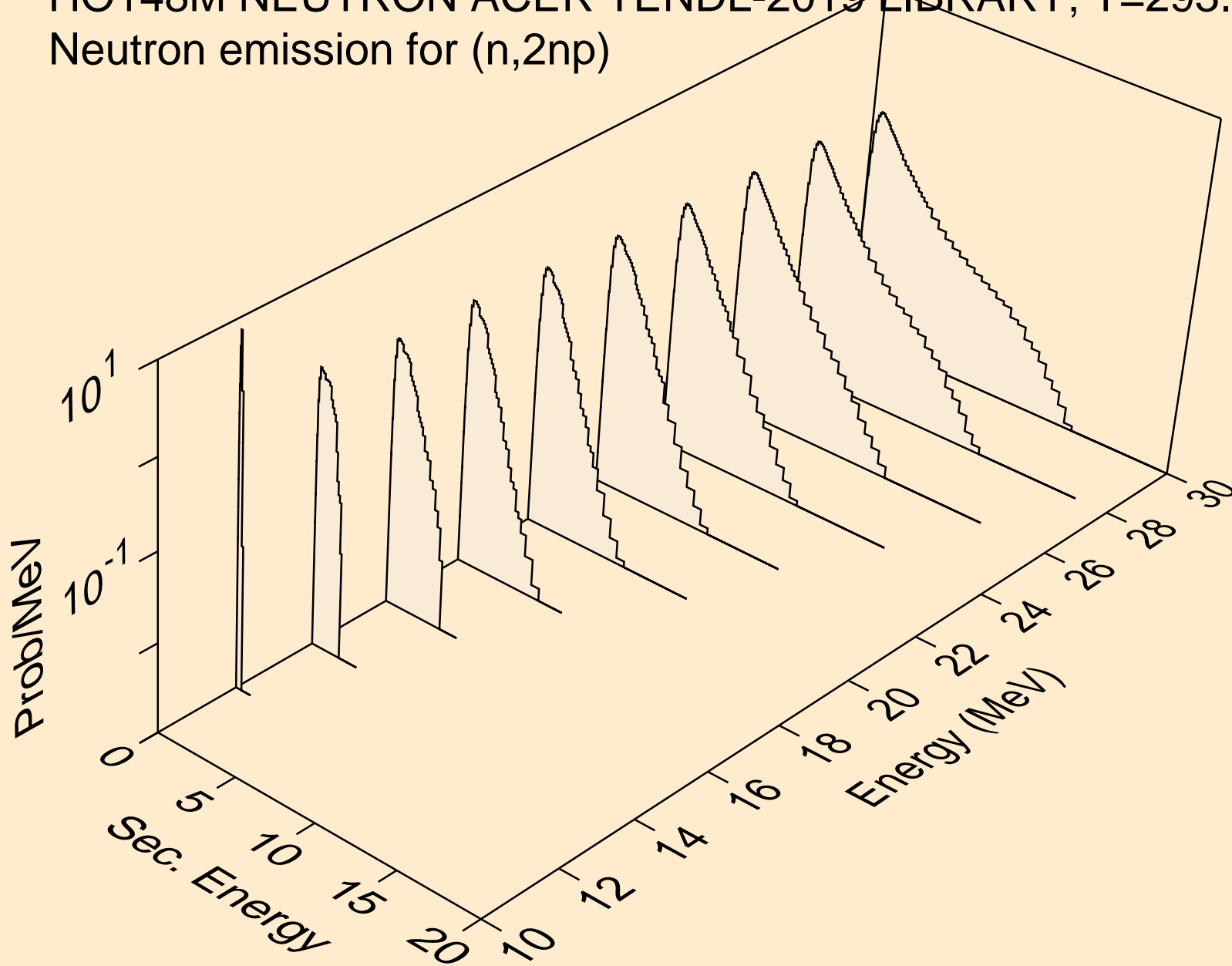

HO148M NEUTRON ACER TENDL-2019 LIBRARY; T=293.16K
Neutron emission for (n,3np)

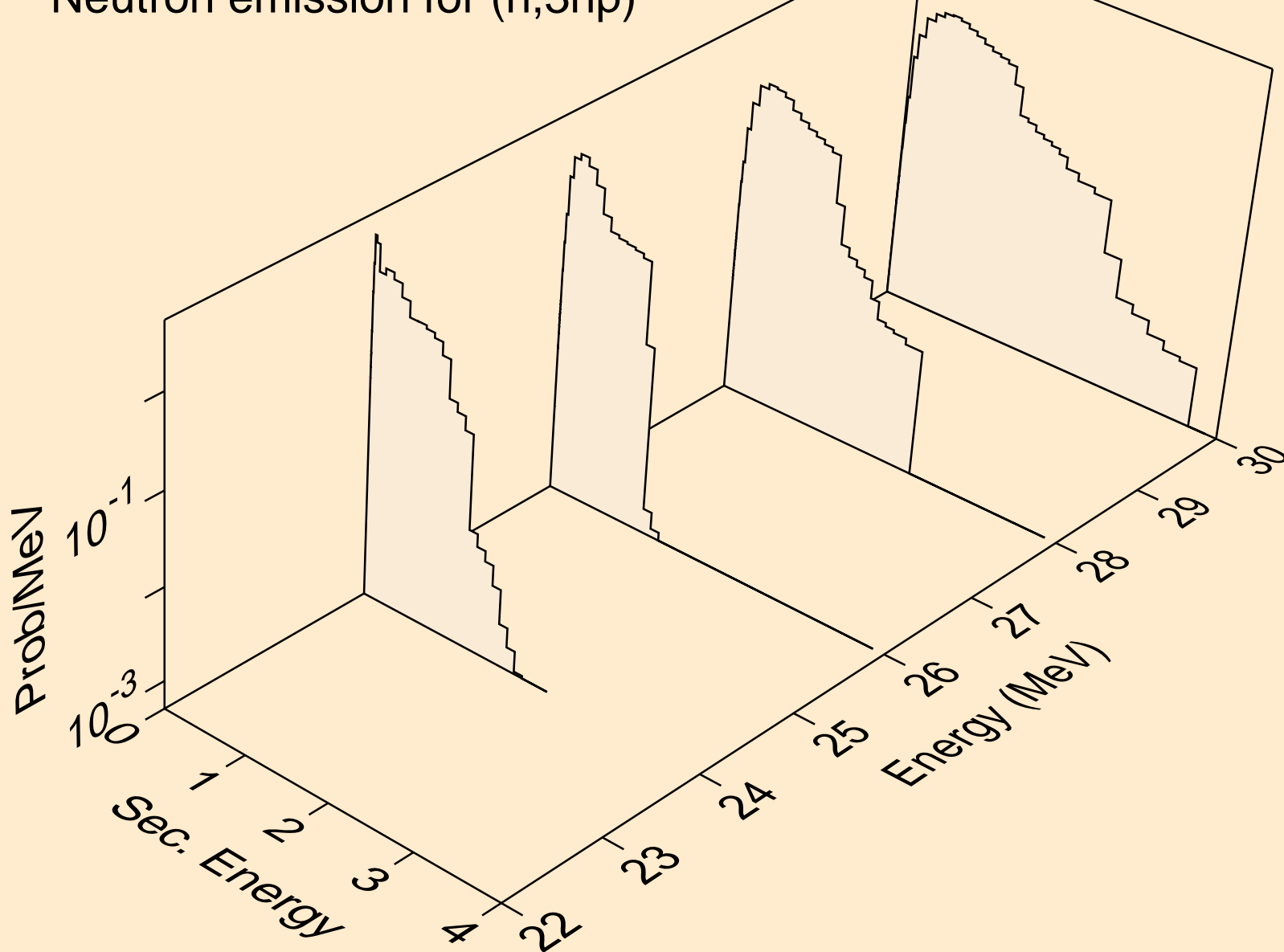

HO148M NEUTRON ACER TENDL-2019 LIBRARY; T=293.16K
Neutron emission for (n,2np)

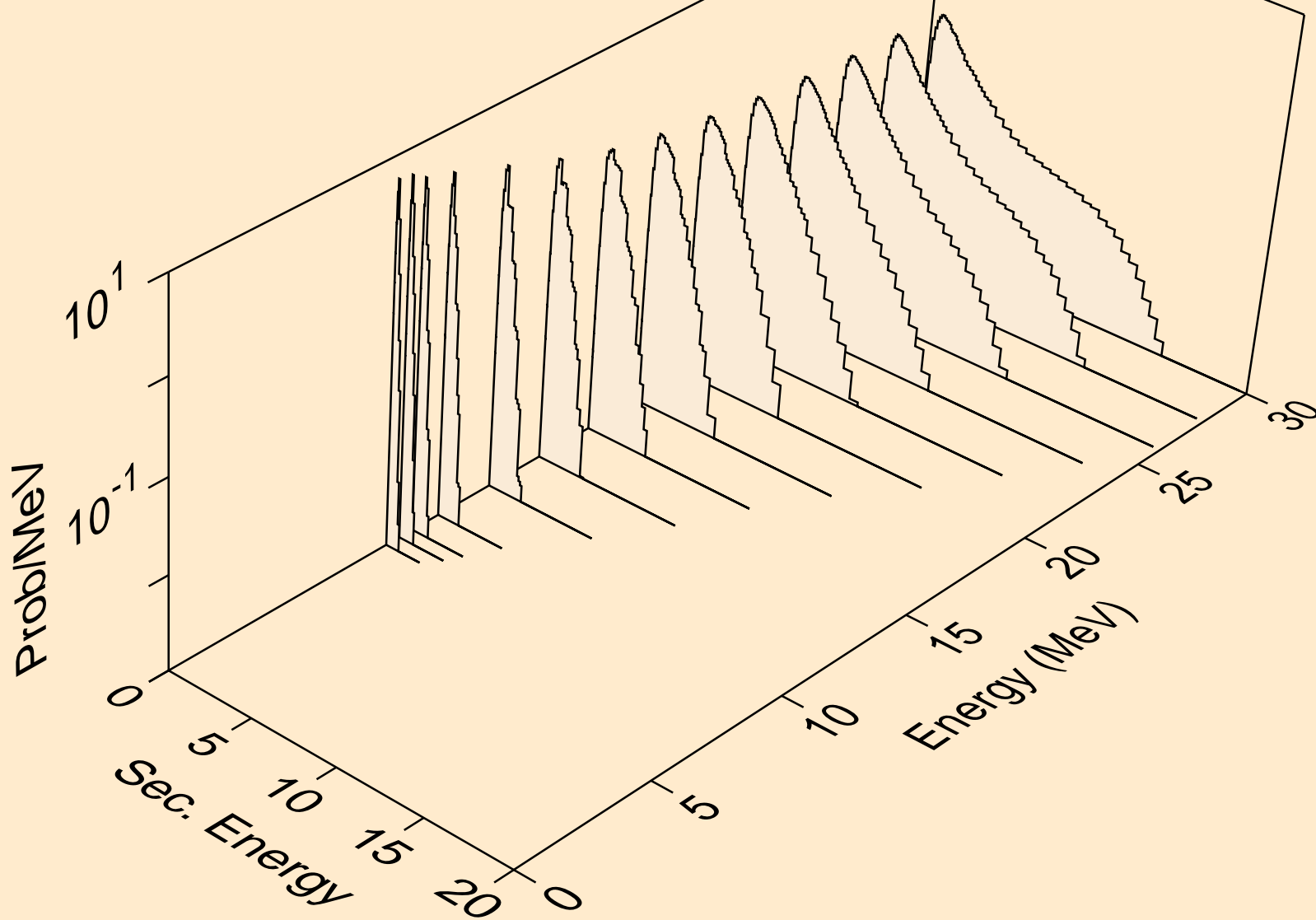

HO148M NEUTRON ACER TENDL-2019 LIBRARY; T=293.16K
Neutron emission for (n,npa)

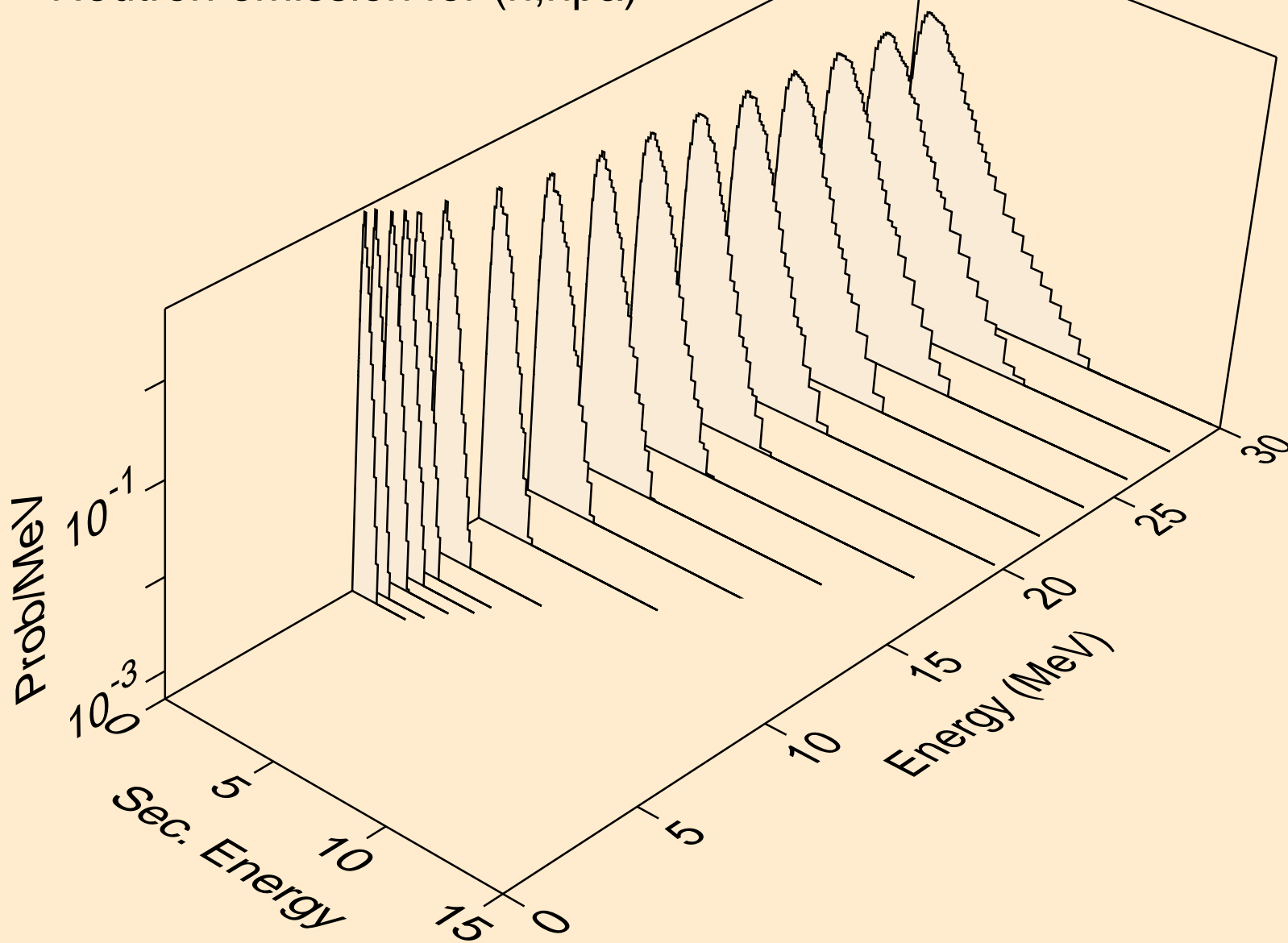

HO148M NEUTRON ACER TENDL-2019 LIBRARY; T=293.16K
Neutron emission for (n,n*c)

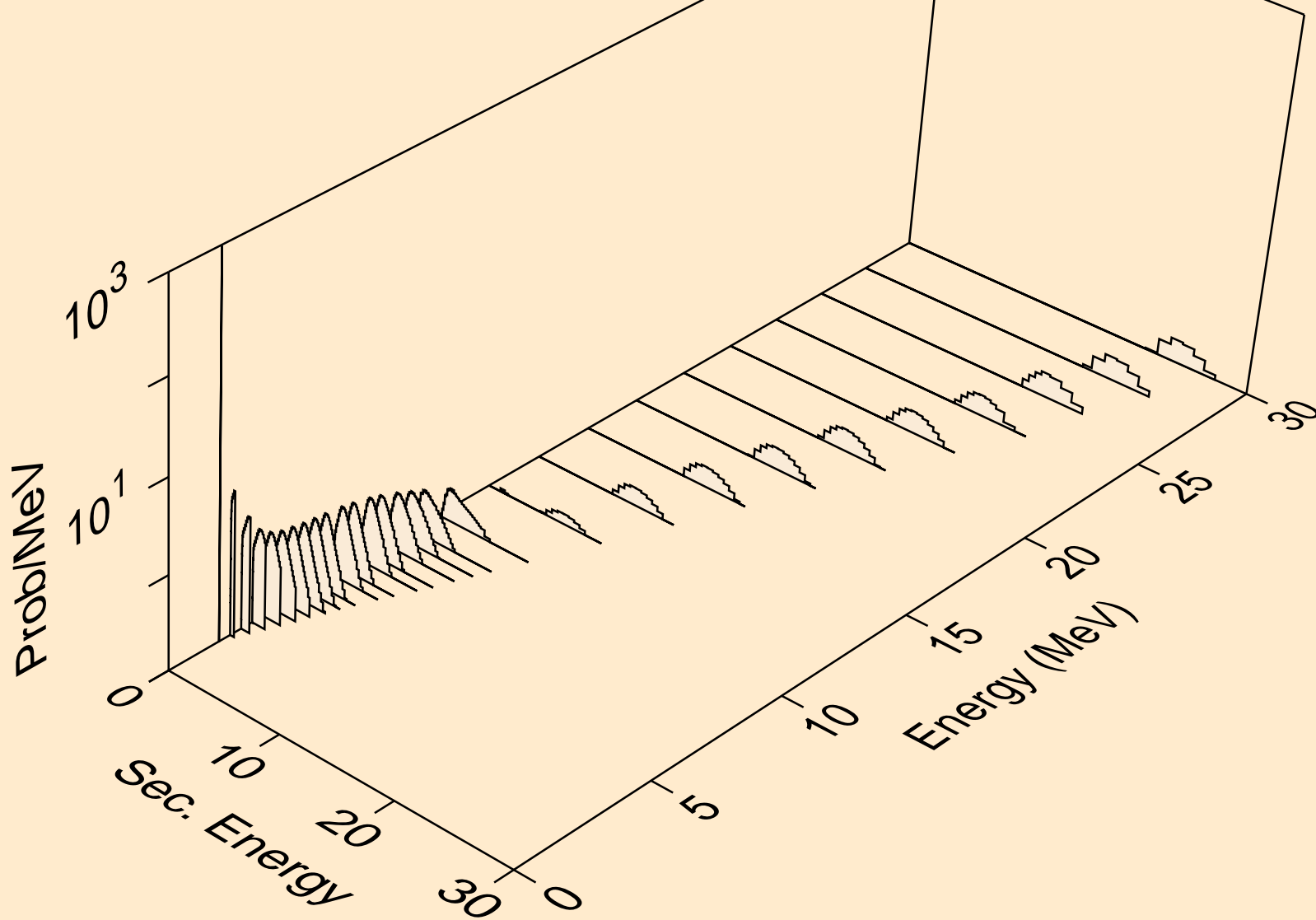

HO148M NEUTRON ACER TENDL-2019 LIBRARY; T=293.16K
Photon emission for (n,x)

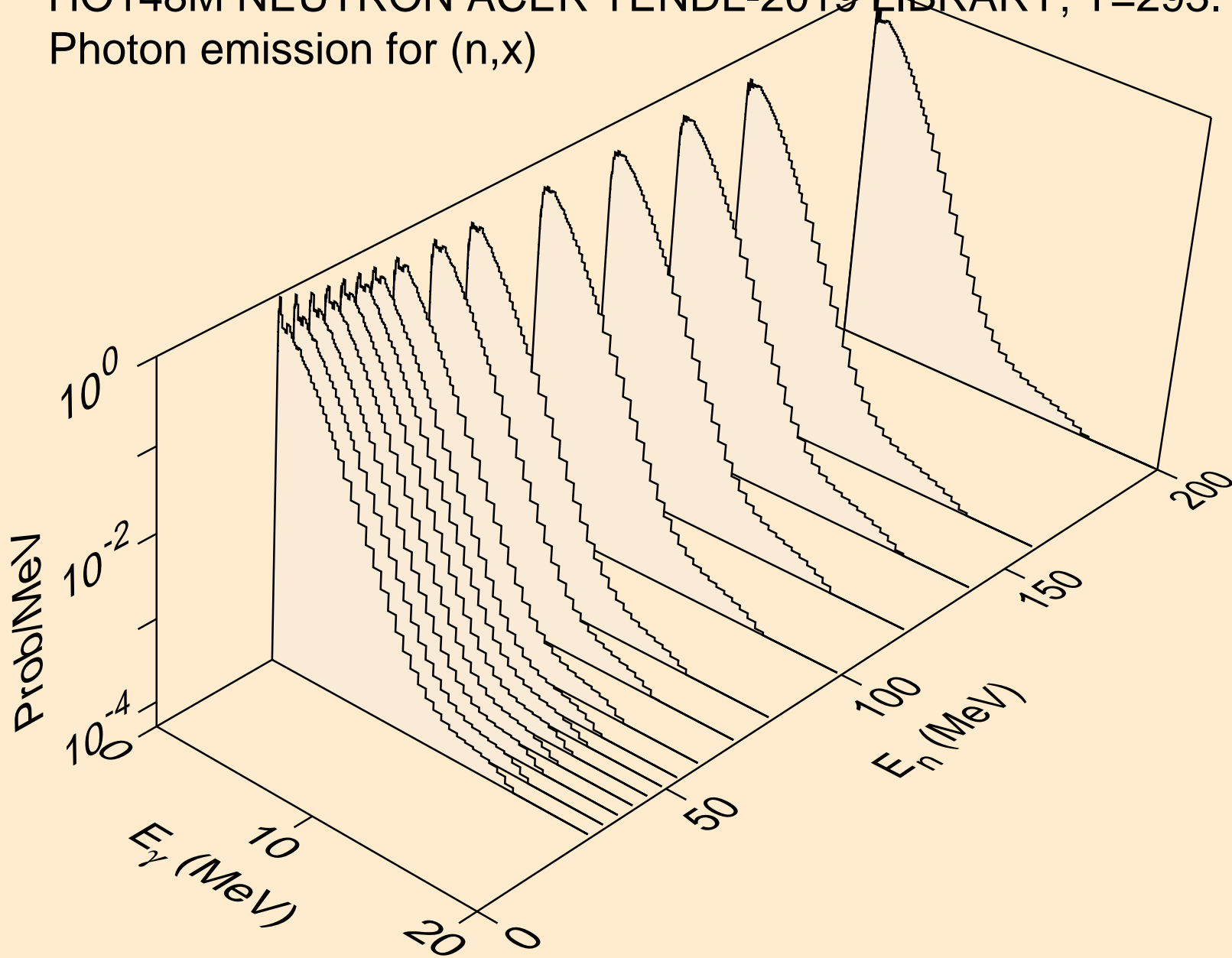

HO148M NEUTRON ACER TENDL-2019 LIBRARY; T=293.16K
Photon emission for (n,2nd)

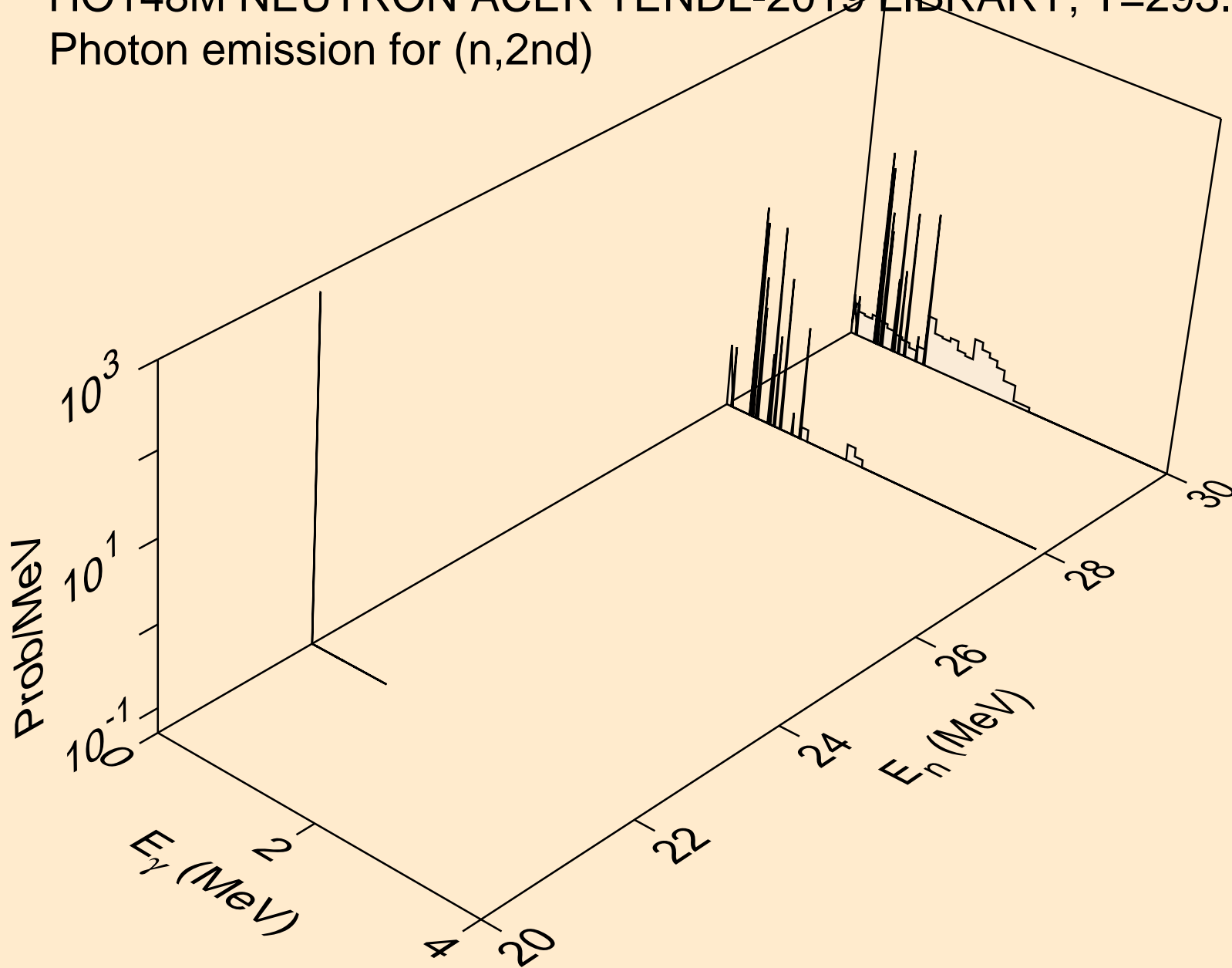

HO148M NEUTRON ACER TENDL-2019 LIBRARY; T=293.16K
Photon emission for (n,2n)

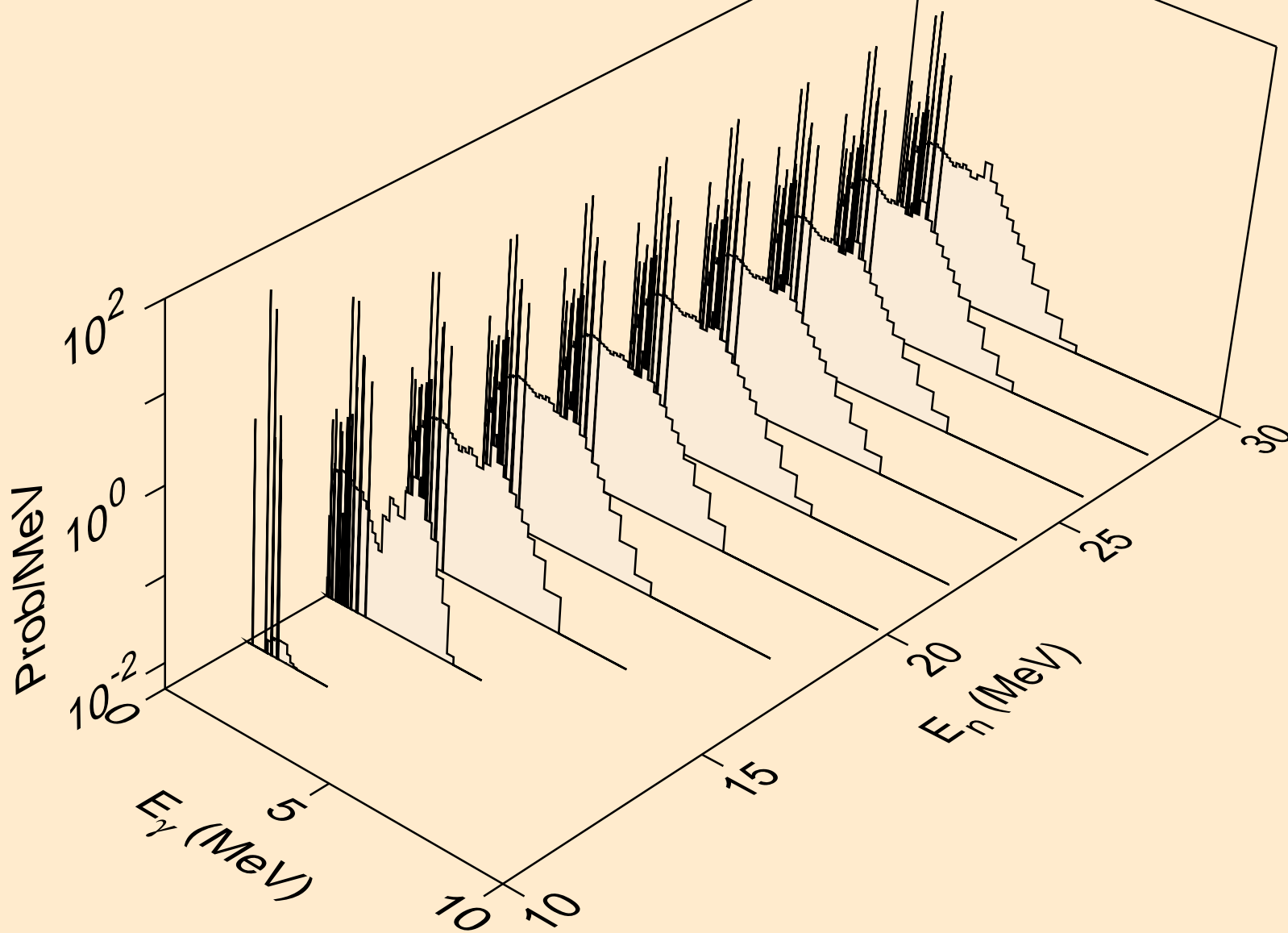

HO148M NEUTRON ACER TENDL-2019 LIBRARY; T=293.16K
Photon emission for (n,3n)

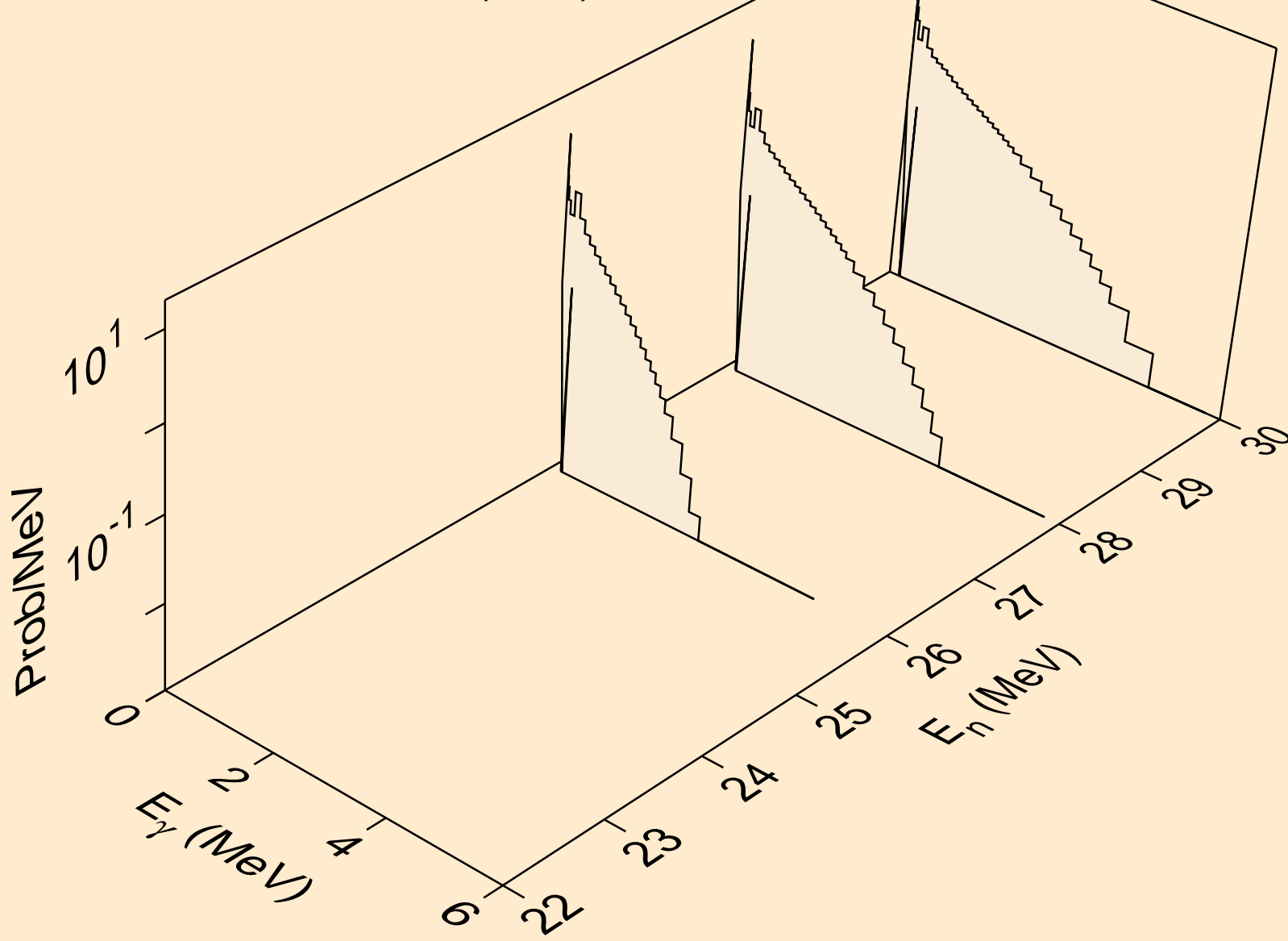

HO148M NEUTRON ACER TENDL-2019 LIBRARY; T=293.16K
Photon emission for (n,n*)a

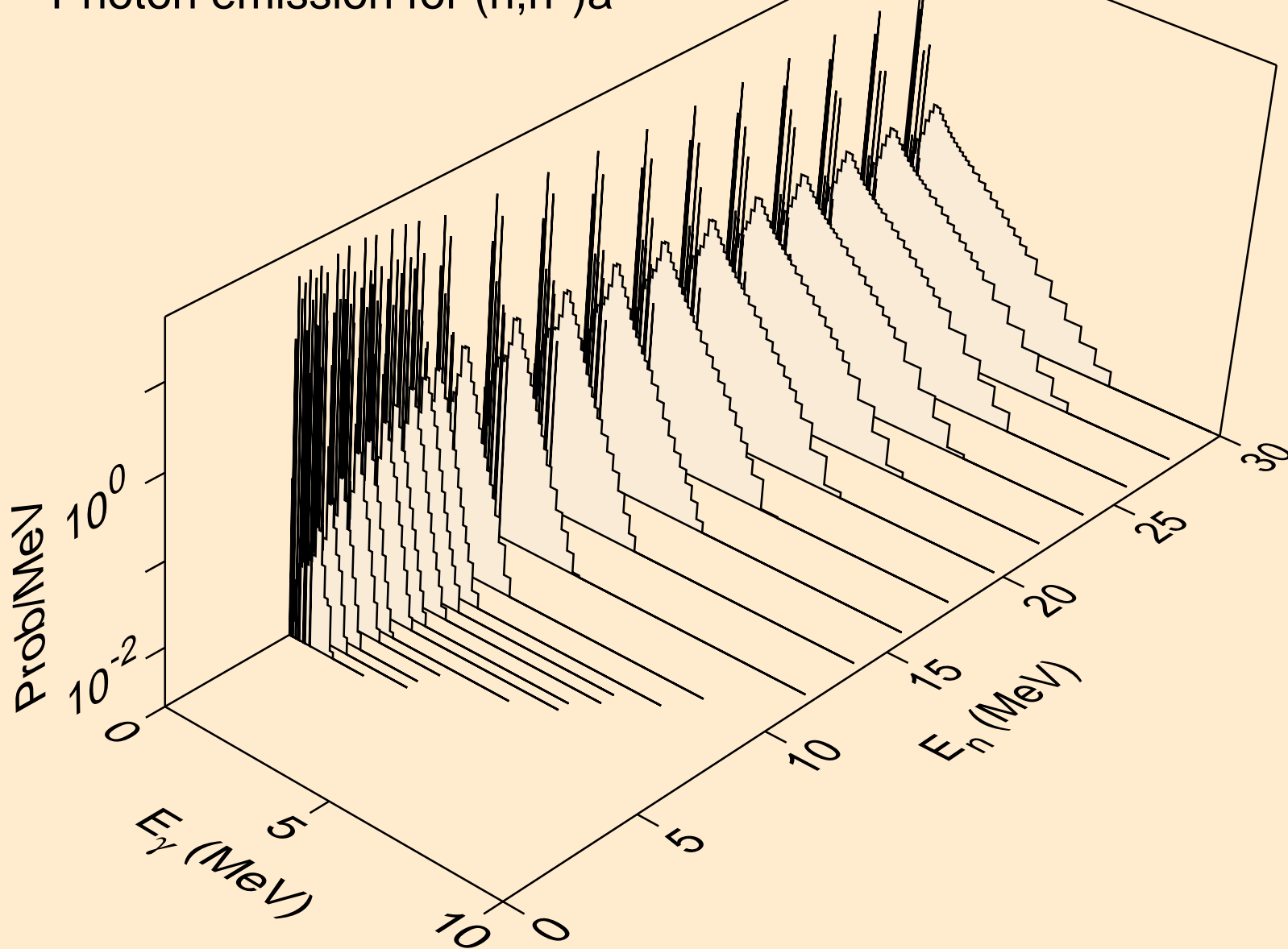

HO148M NEUTRON ACER TENDL-2019 LIBRARY; T=293.16K
Photon emission for (n,2n)a

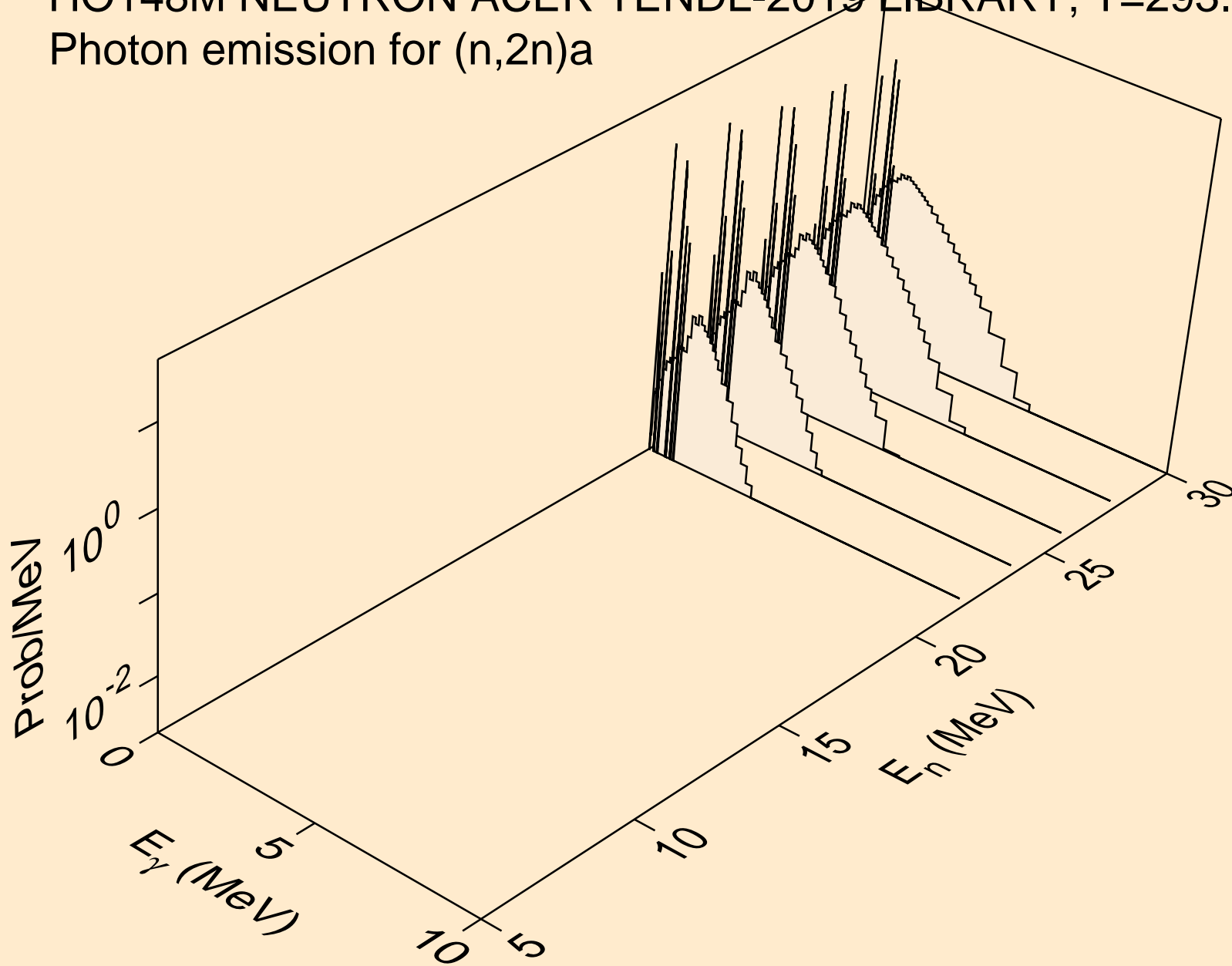

HO148M NEUTRON ACER TENDL-2019 LIBRARY; T=293.16K
Photon emission for (n,n*)p

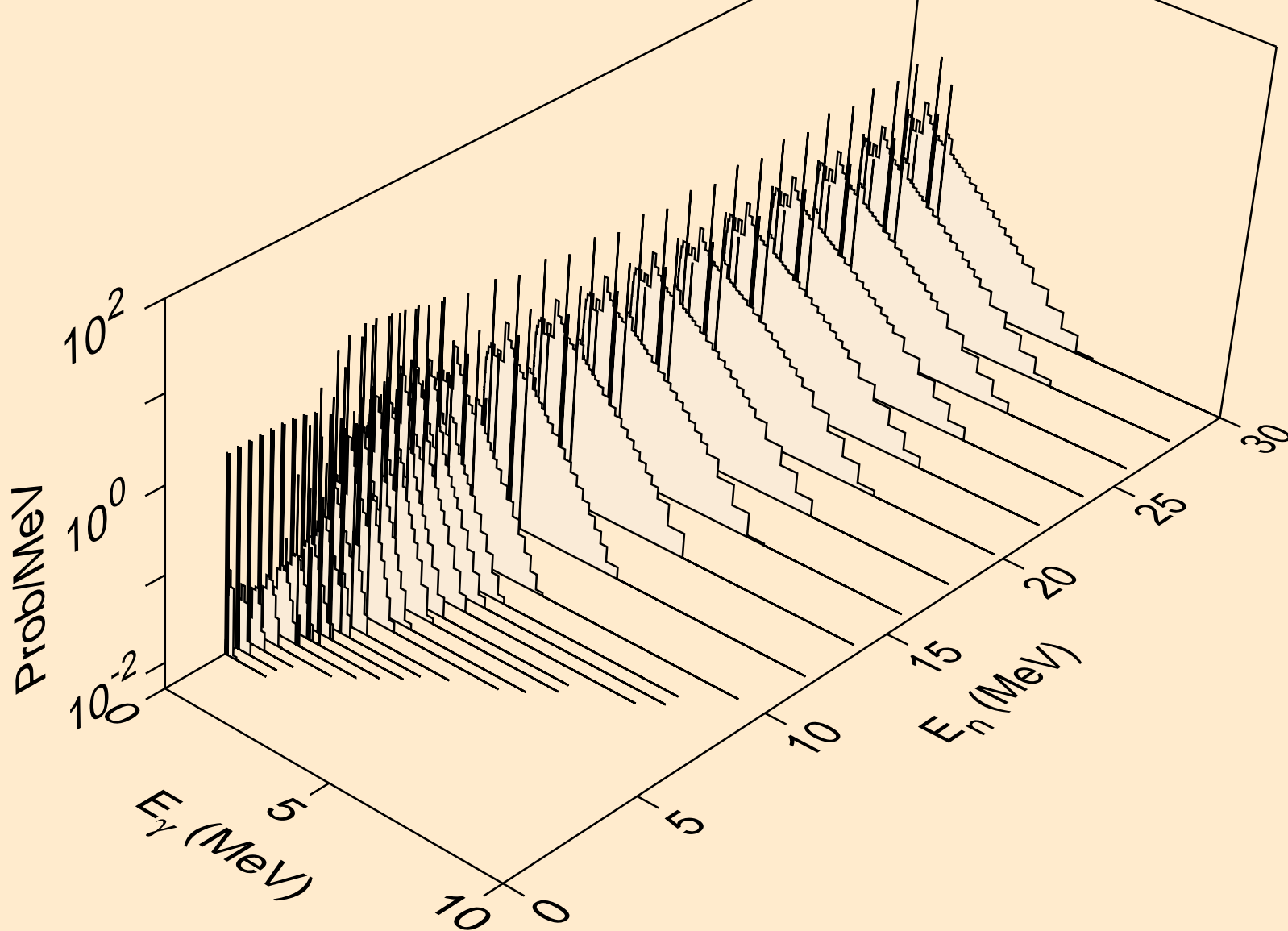

HO148M NEUTRON ACER TENDL-2019 LIBRARY; T=293.16K
Photon emission for (n,n*)2a

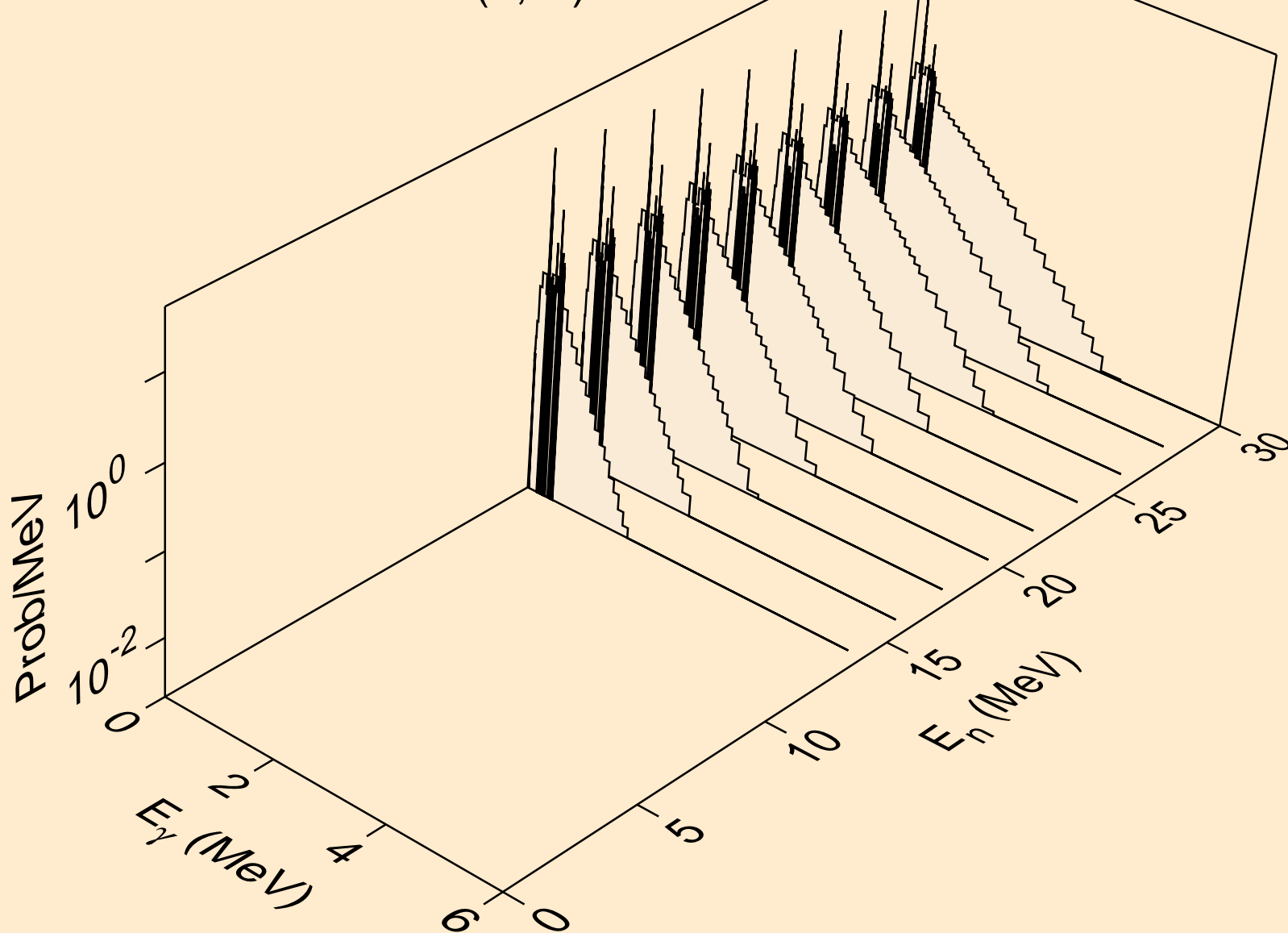

HO148M NEUTRON ACER TENDL-2019 LIBRARY; T=293.16K
Photon emission for (n,2n)2a

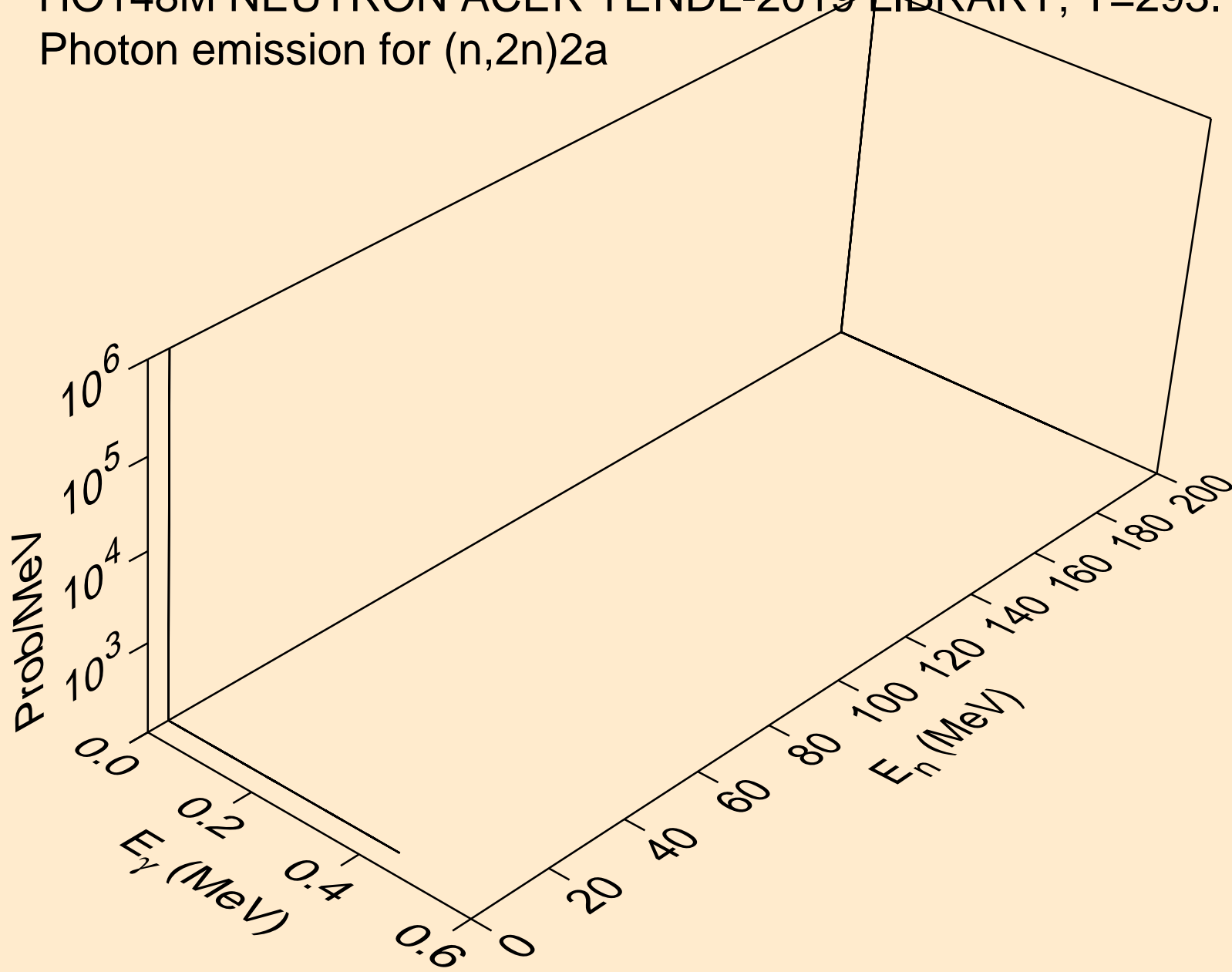

HO148M NEUTRON ACER TENDL-2019 LIBRARY; T=293.16K
Photon emission for (n,n*)d

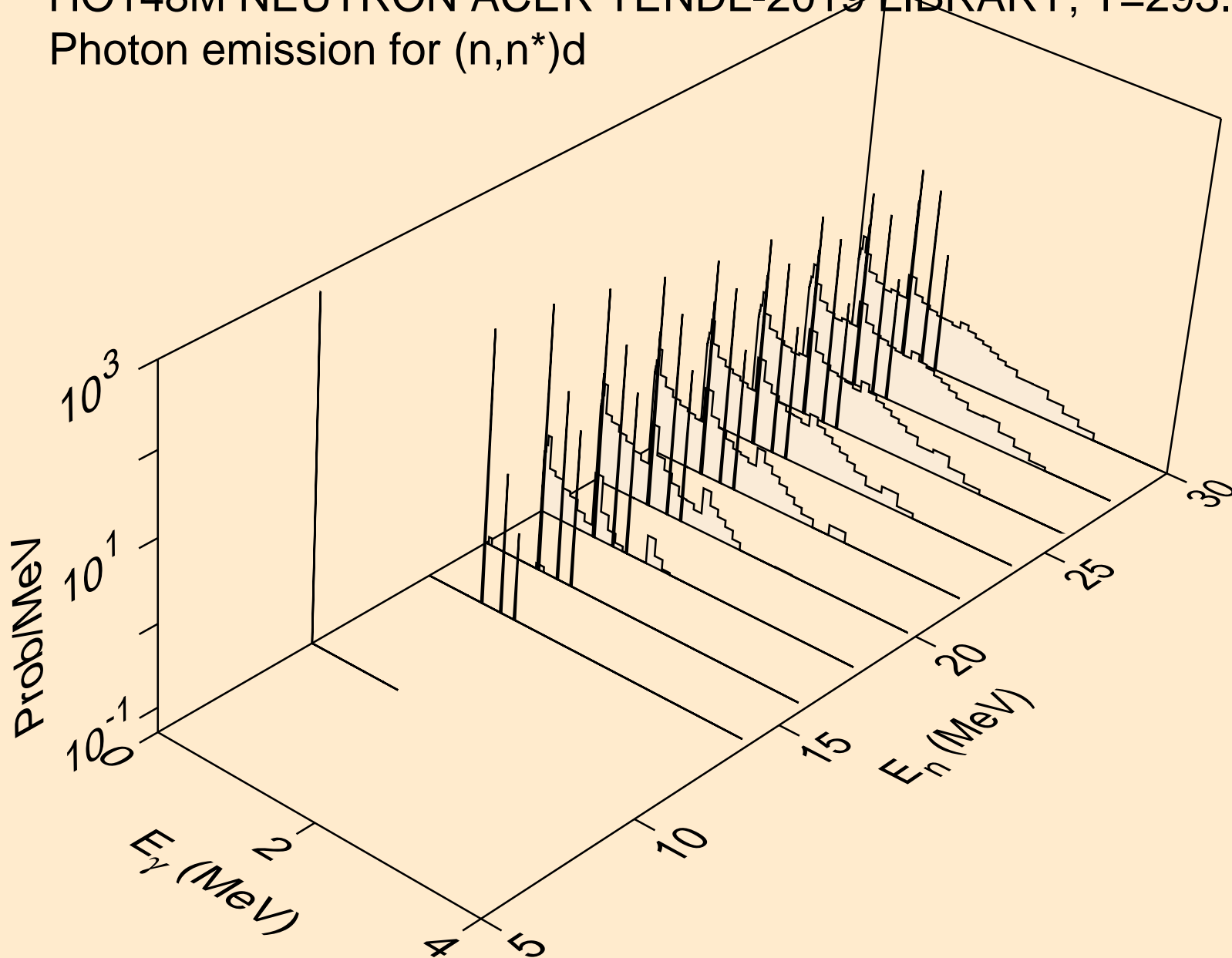

HO148M NEUTRON ACER TENDL-2019 LIBRARY; T=293.16K
Photon emission for (n,n*)t

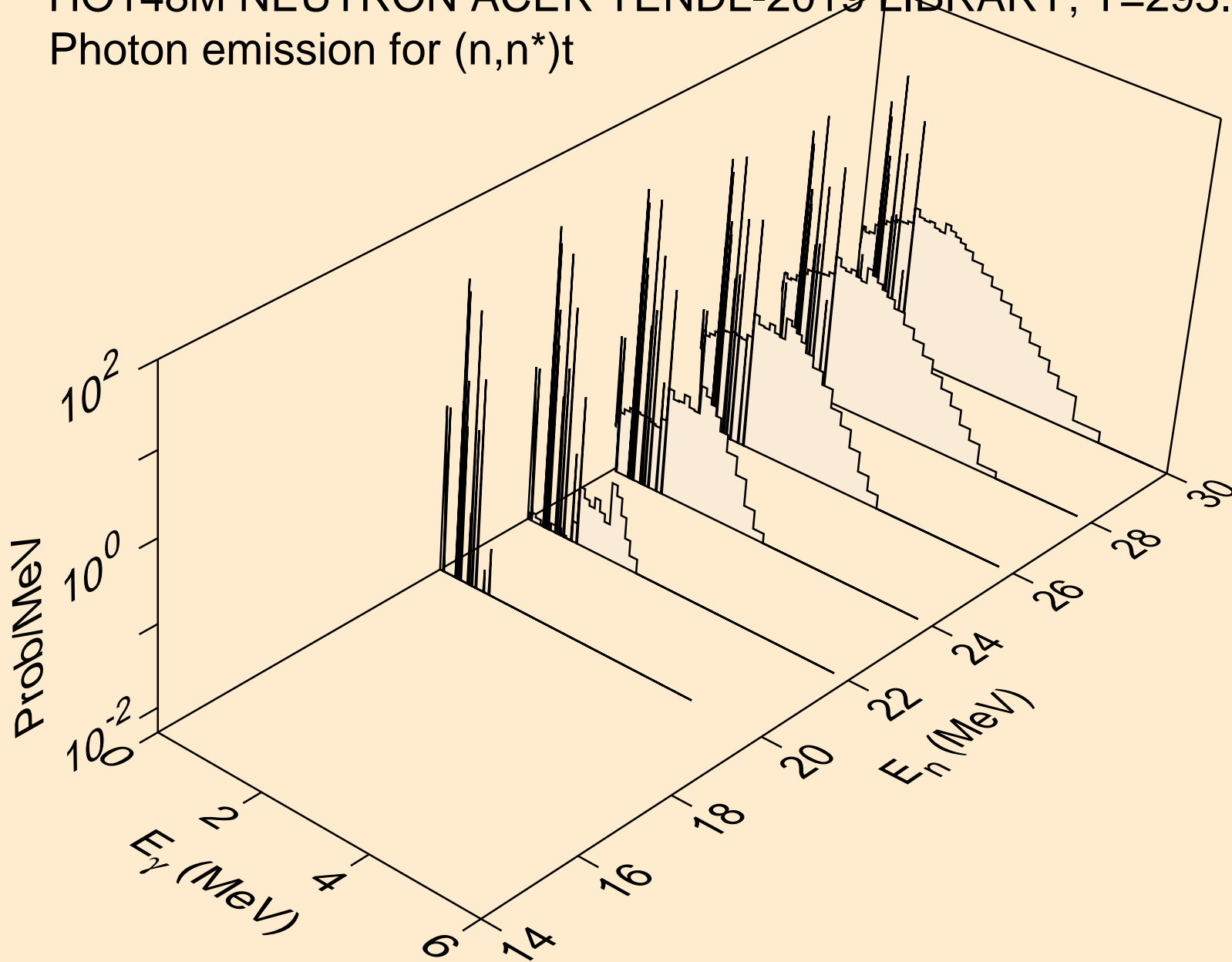

HO148M NEUTRON ACER TENDL-2019 LIBRARY; T=293.16K
Photon emission for (n,n*)he3

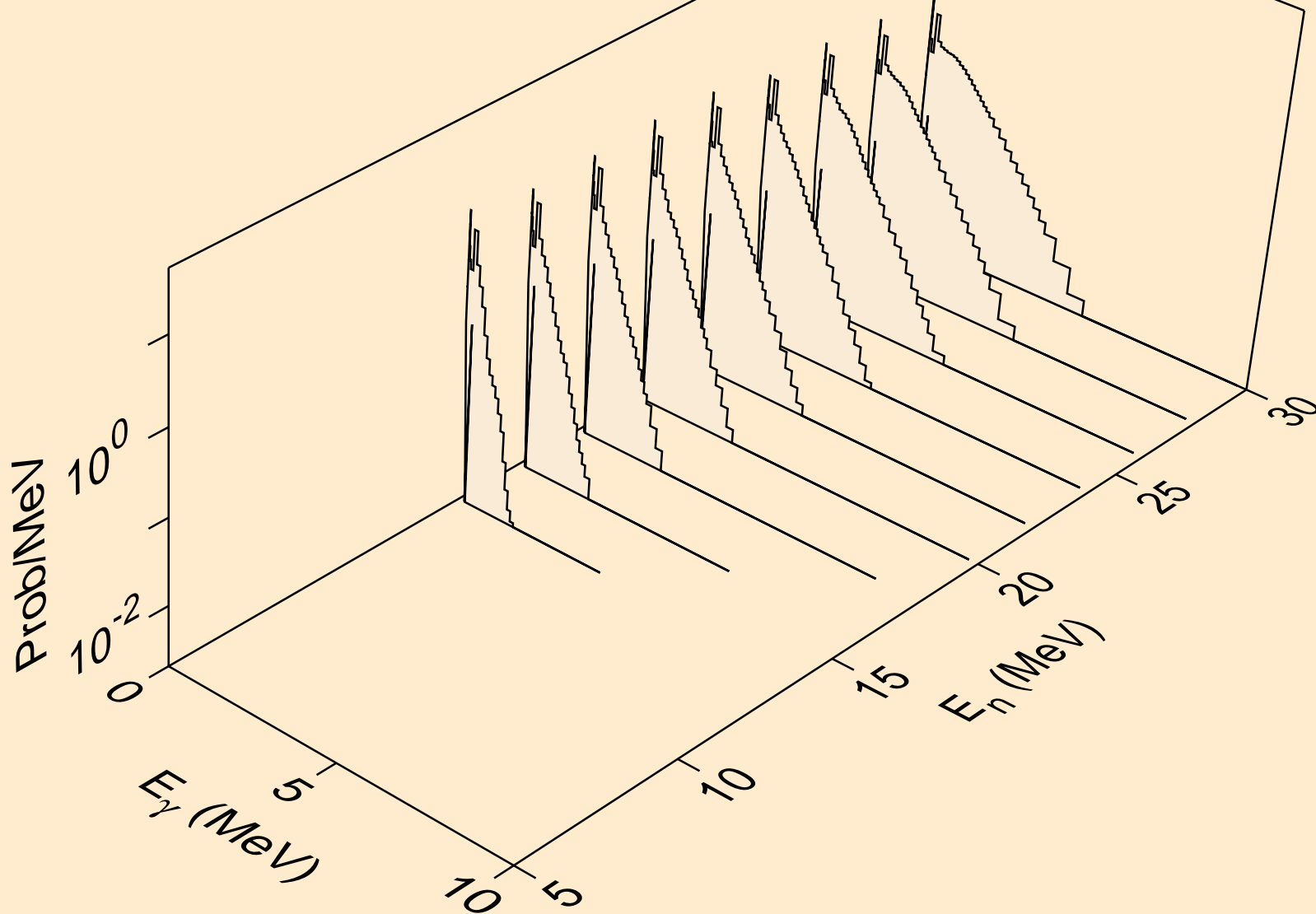

HO148M NEUTRON ACER TENDL-2019 LIBRARY; T=293.16K
Photon emission for (n,2np)

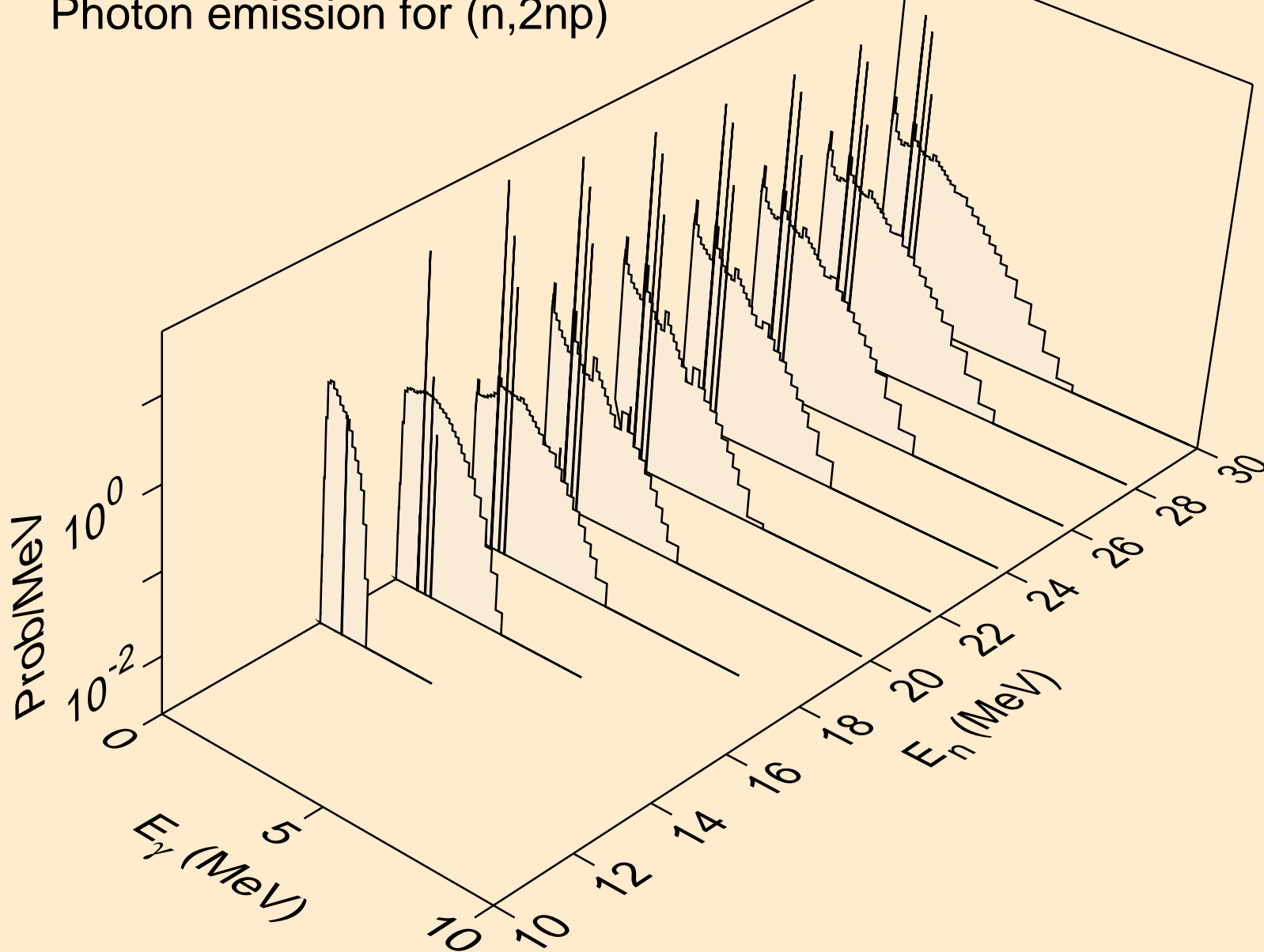

HO148M NEUTRON ACER TENDL-2019 LIBRARY; T=293.16K
Photon emission for (n,3np)

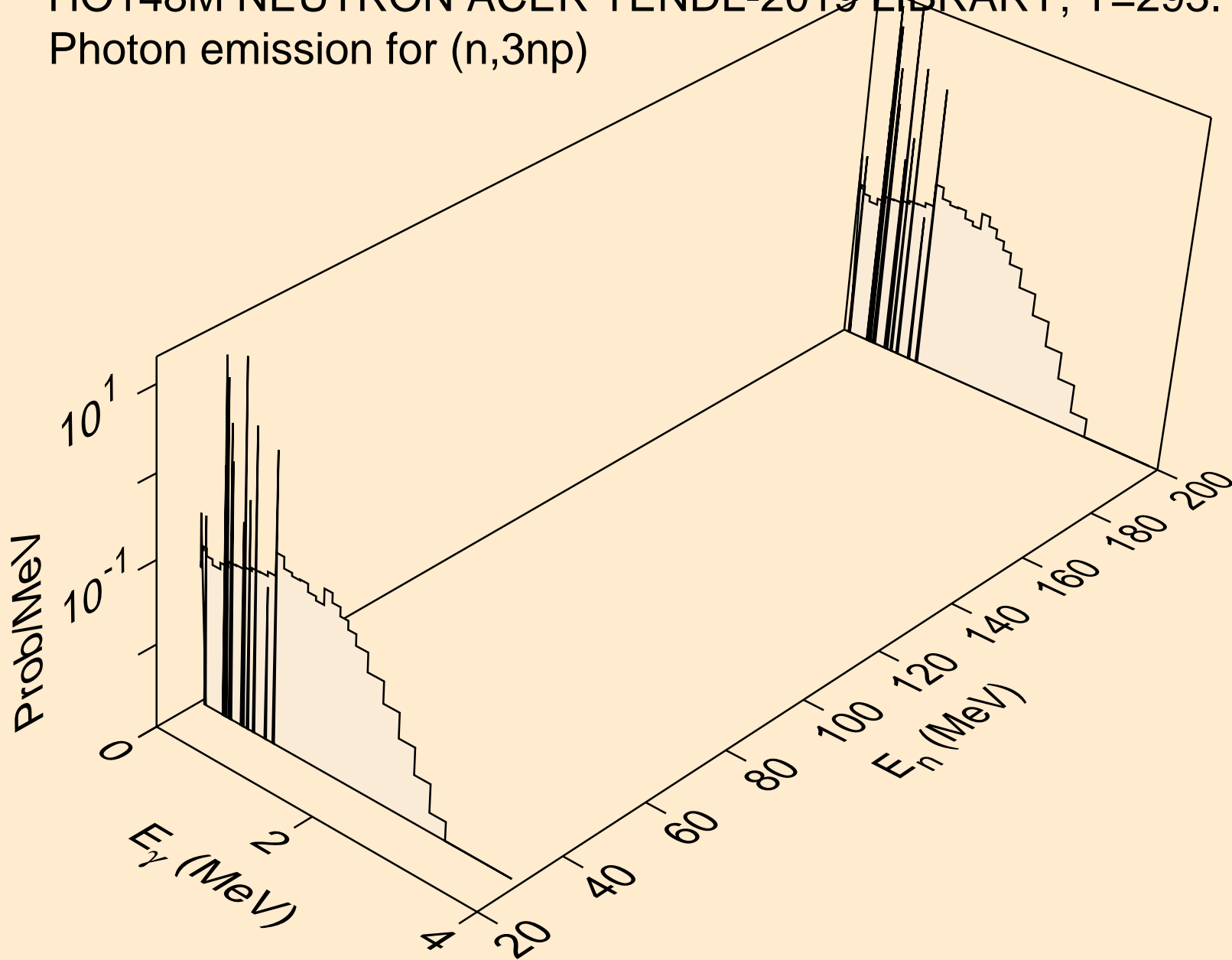

HO148M NEUTRON ACER TENDL-2019 LIBRARY; T=293.16K
Photon emission for (n,2np)

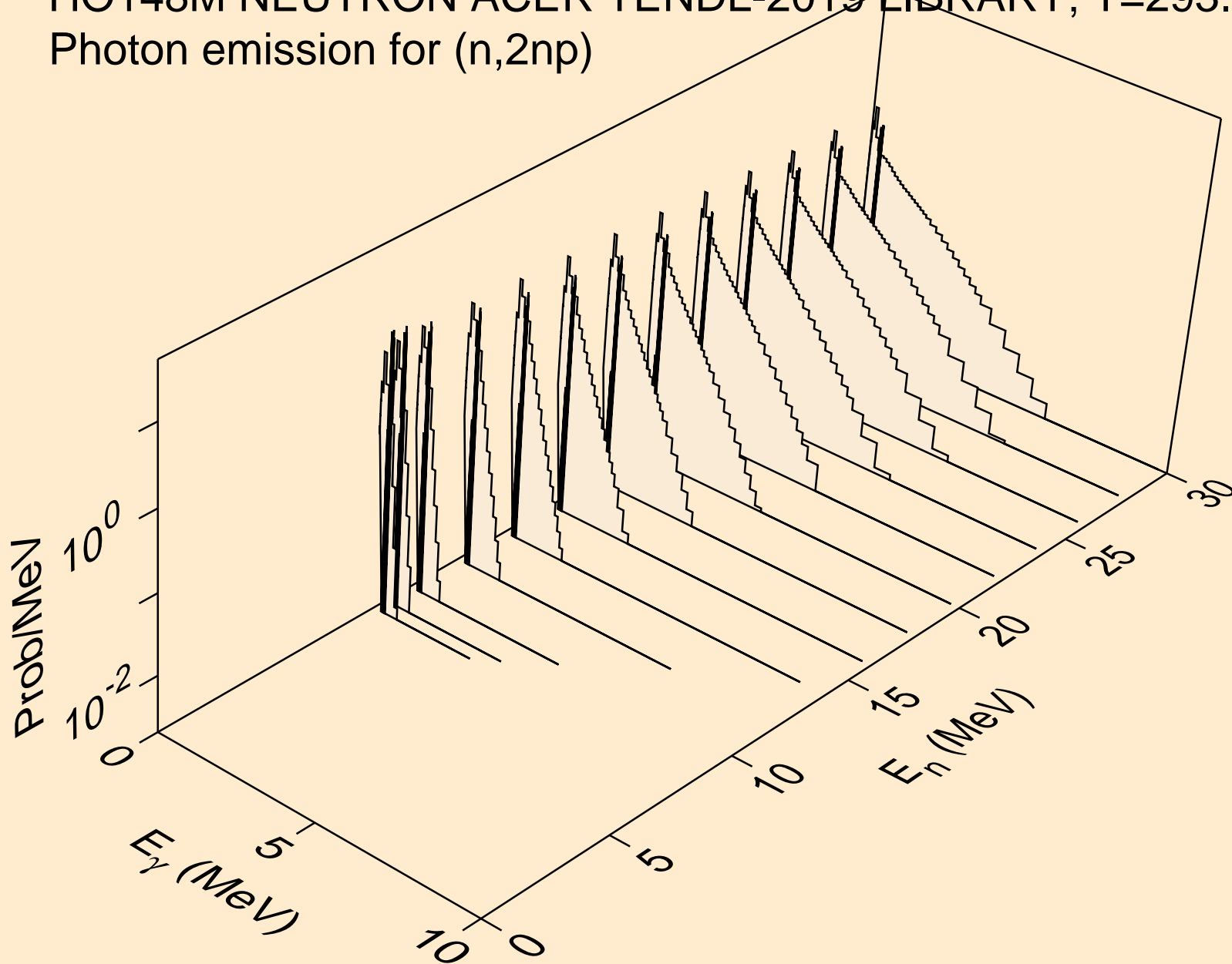

HO148M NEUTRON ACER TENDL-2019 LIBRARY; T=293.16K
Photon emission for (n,npa)

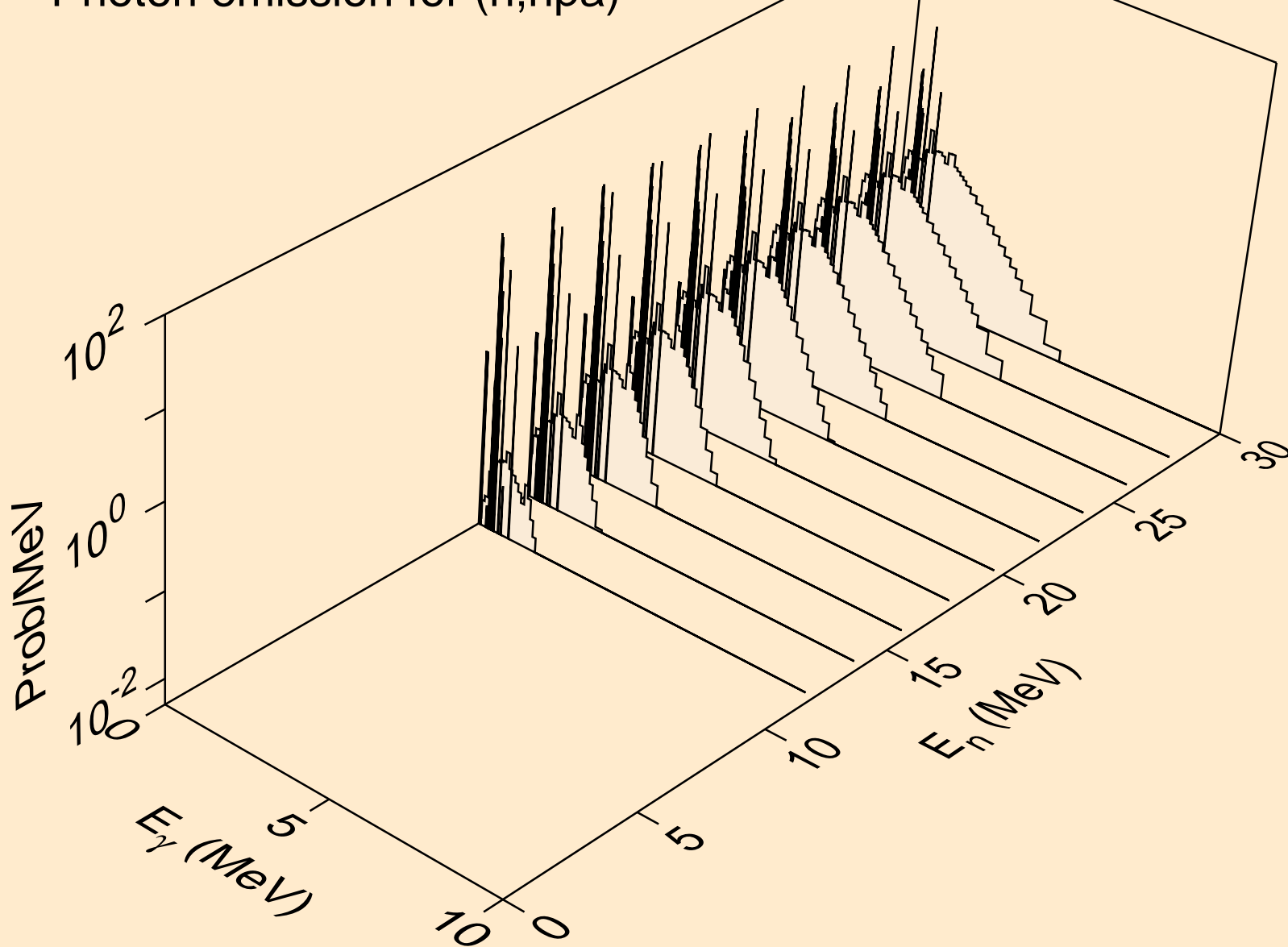

HO148M NEUTRON ACER TENDL-2019 LIBRARY; T=293.16K
Photon emission for (n,n*1)

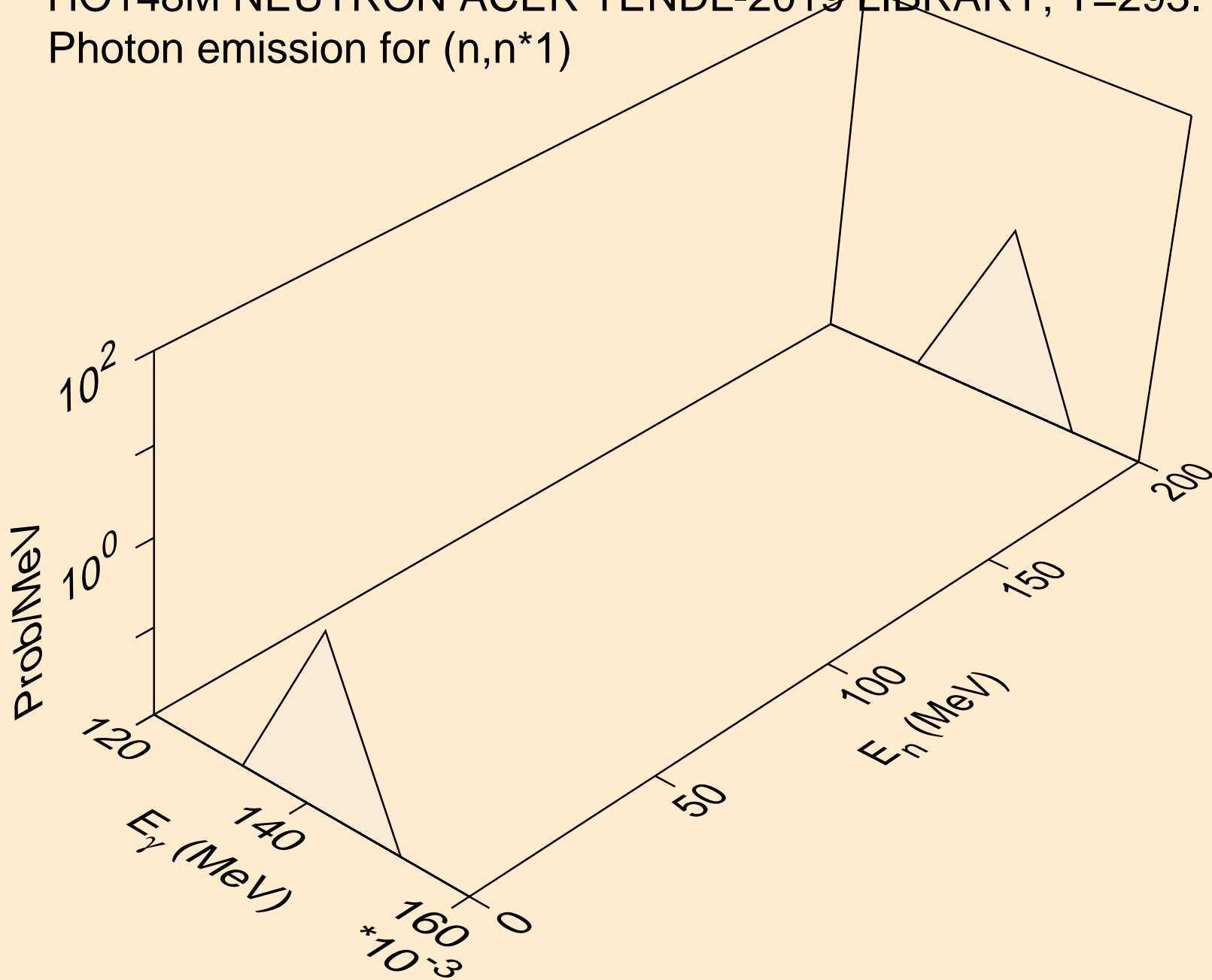

HO148M NEUTRON ACER TENDL-2019 LIBRARY; T=293.16K
Photon emission for (n,n*2)

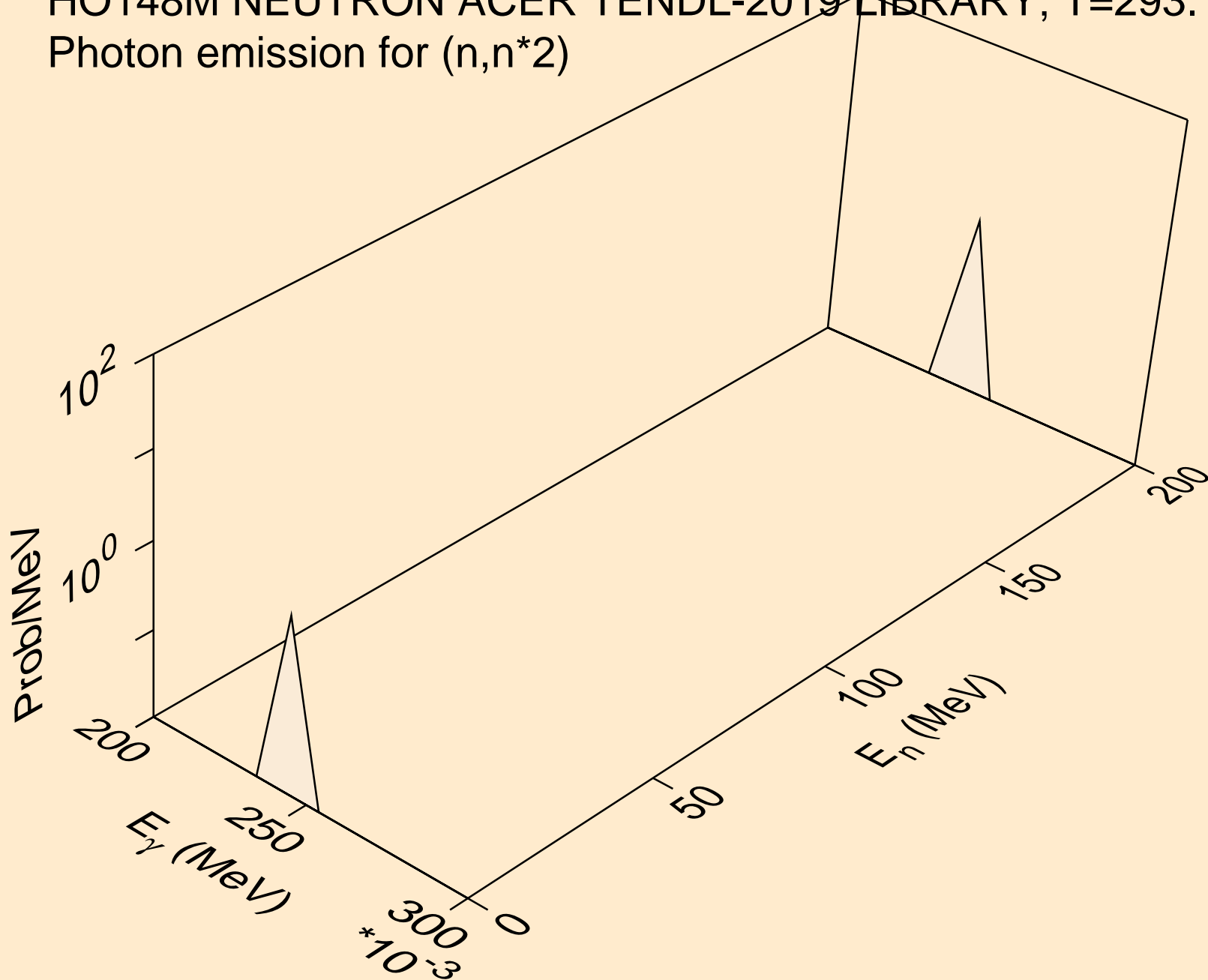

HO148M NEUTRON ACER TENDL-2019 LIBRARY; T=293.16K
Photon emission for (n,n*3)

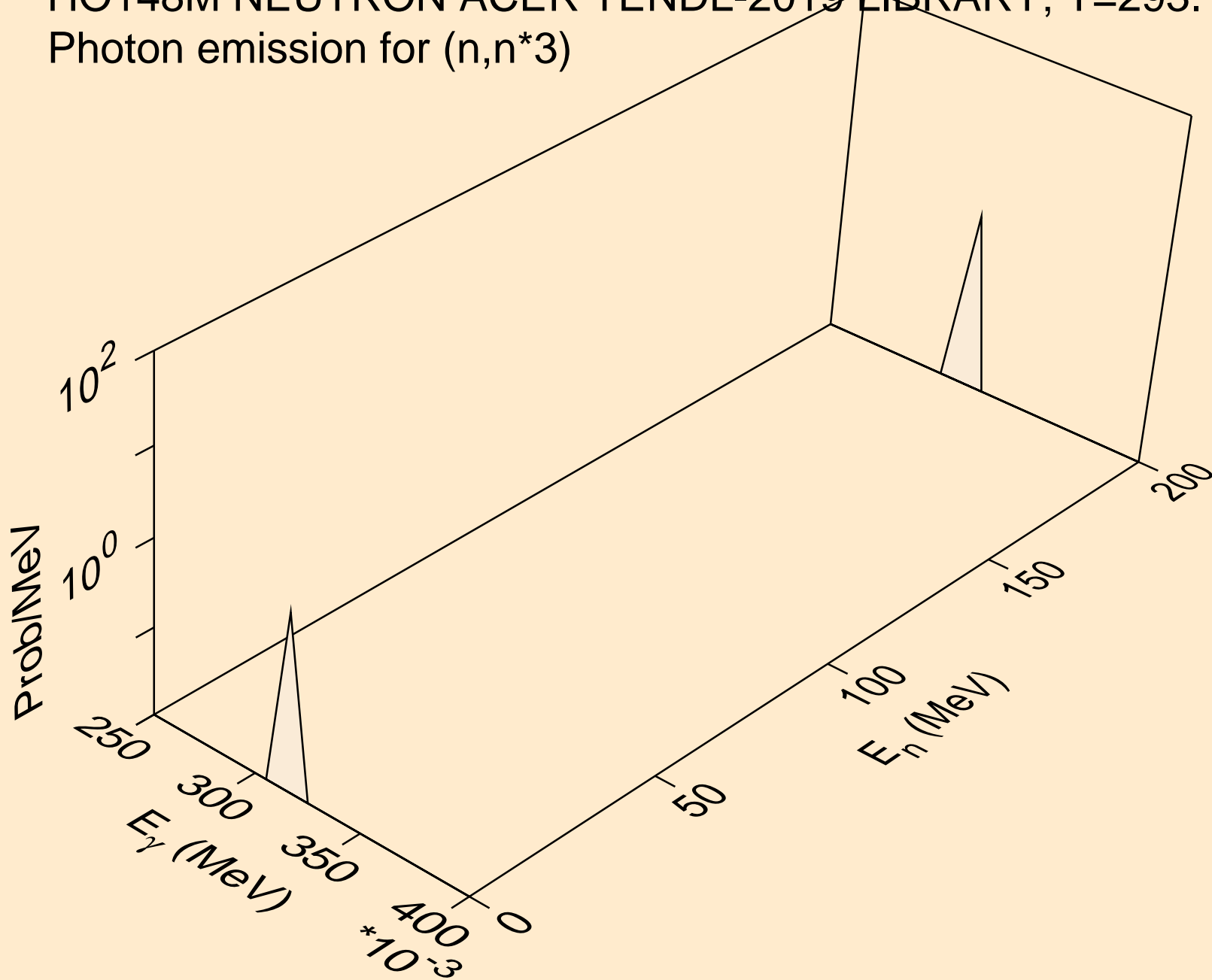

HO148M NEUTRON ACER TENDL-2019 LIBRARY; T=293.16K
Photon emission for (n,n*c)

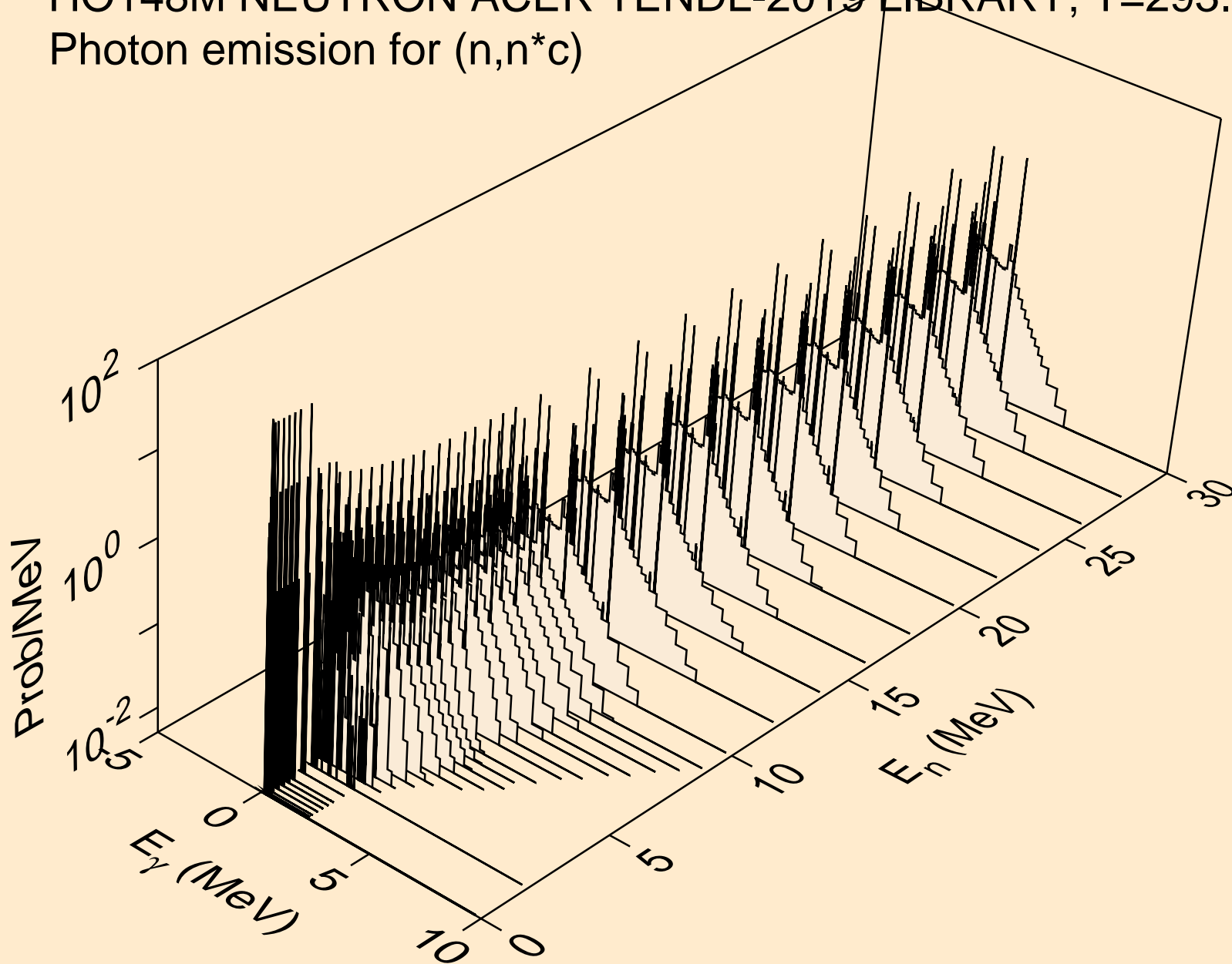

HO148M NEUTRON ACER TENDL-2019 LIBRARY; T=293.16K
Photon emission for (n,gma)

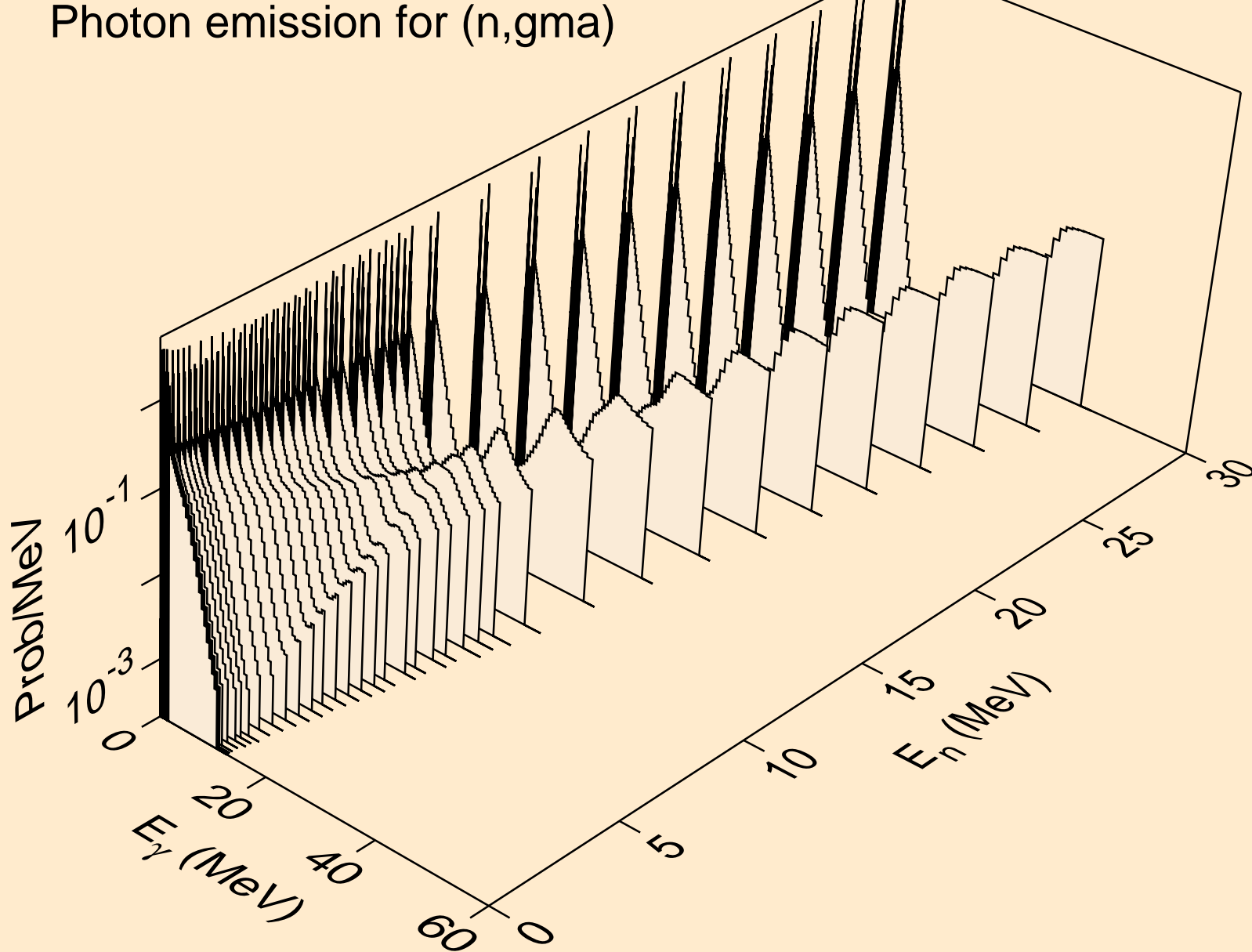

HO148M NEUTRON ACER TENDL-2019 LIBRARY; T=293.16K
Photon emission for (n,p)

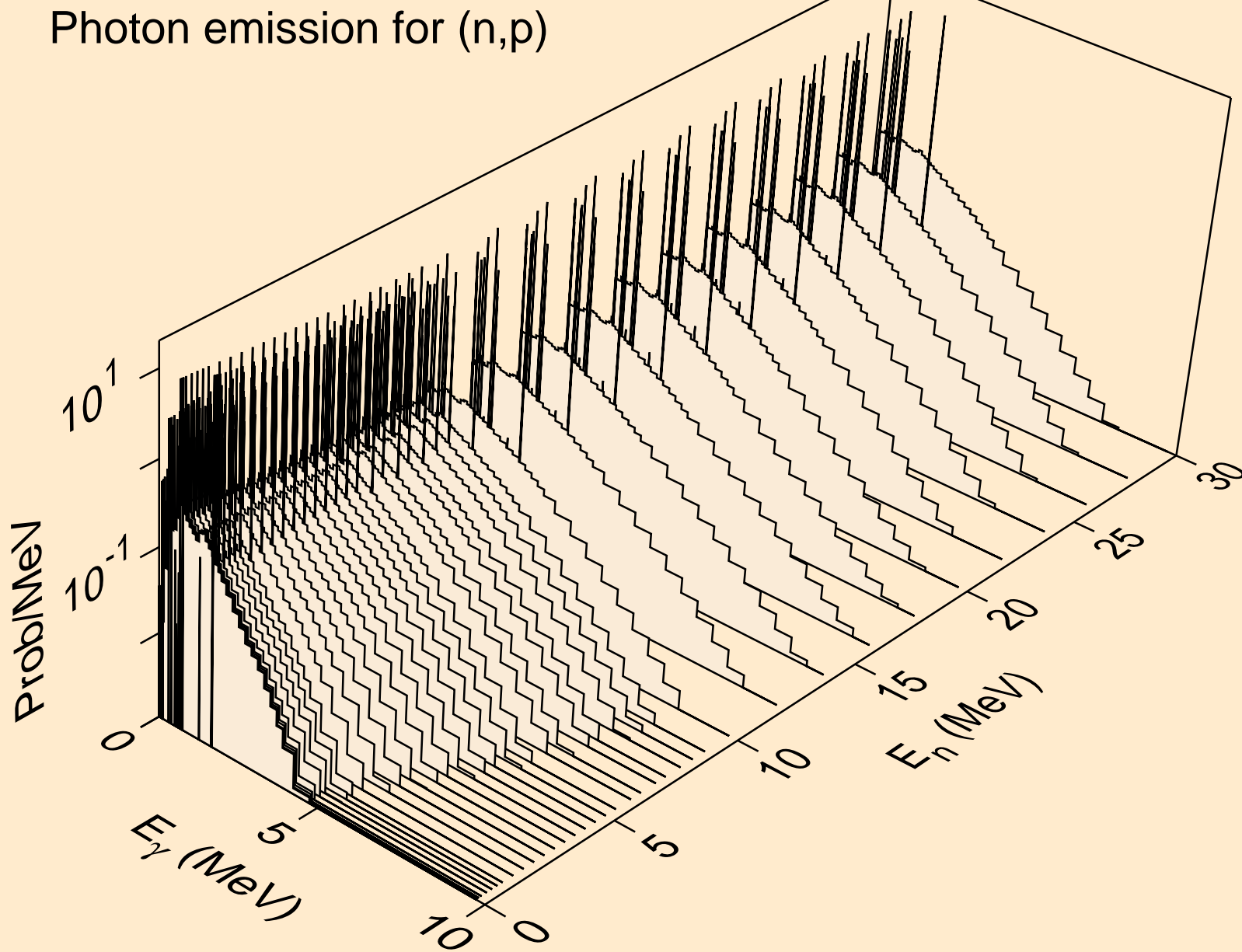

HO148M NEUTRON ACER TENDL-2019 LIBRARY; T=293.16K
Photon emission for (n,d)

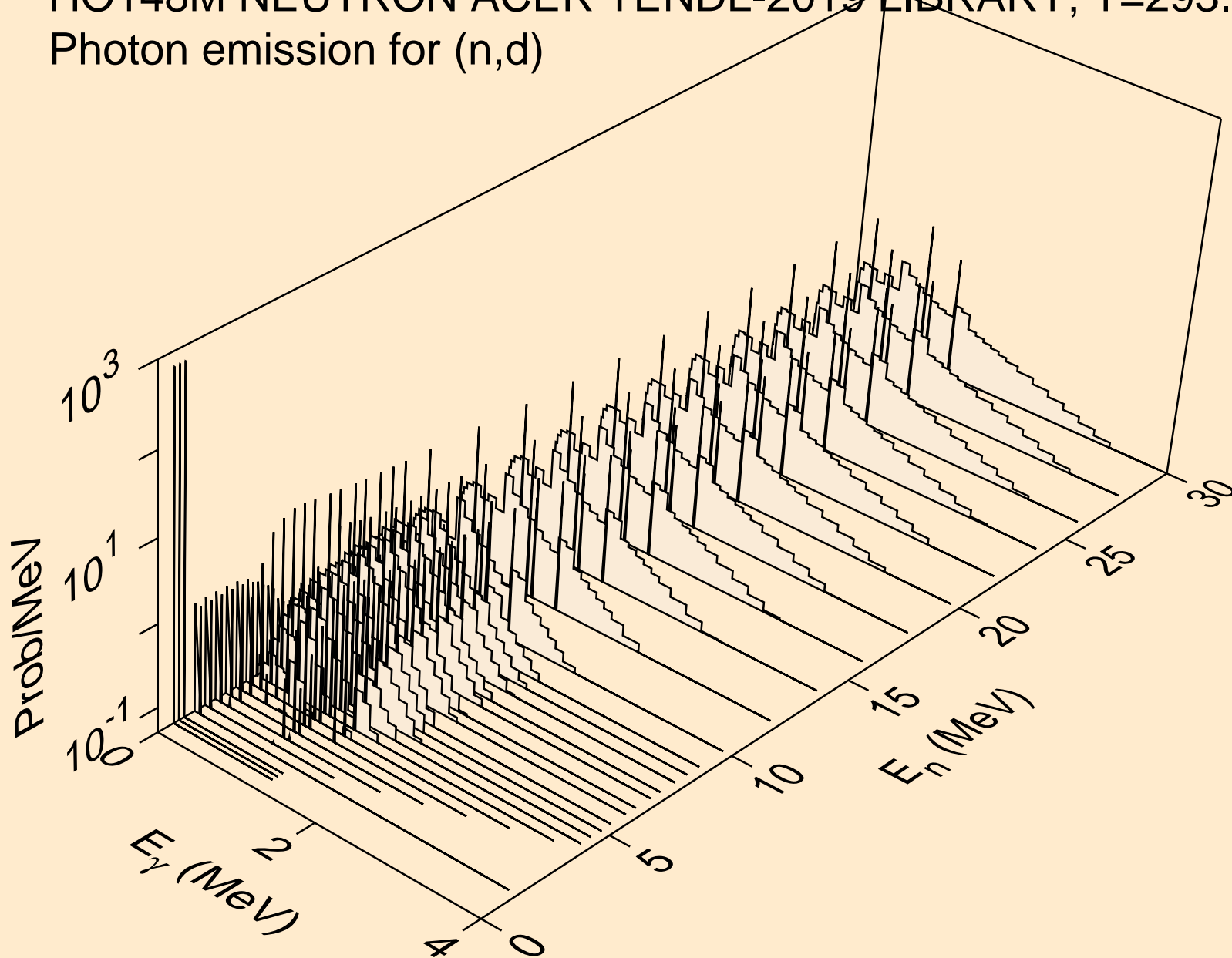

HO148M NEUTRON ACER TENDL-2019 LIBRARY; T=293.16K
Photon emission for (n,t)

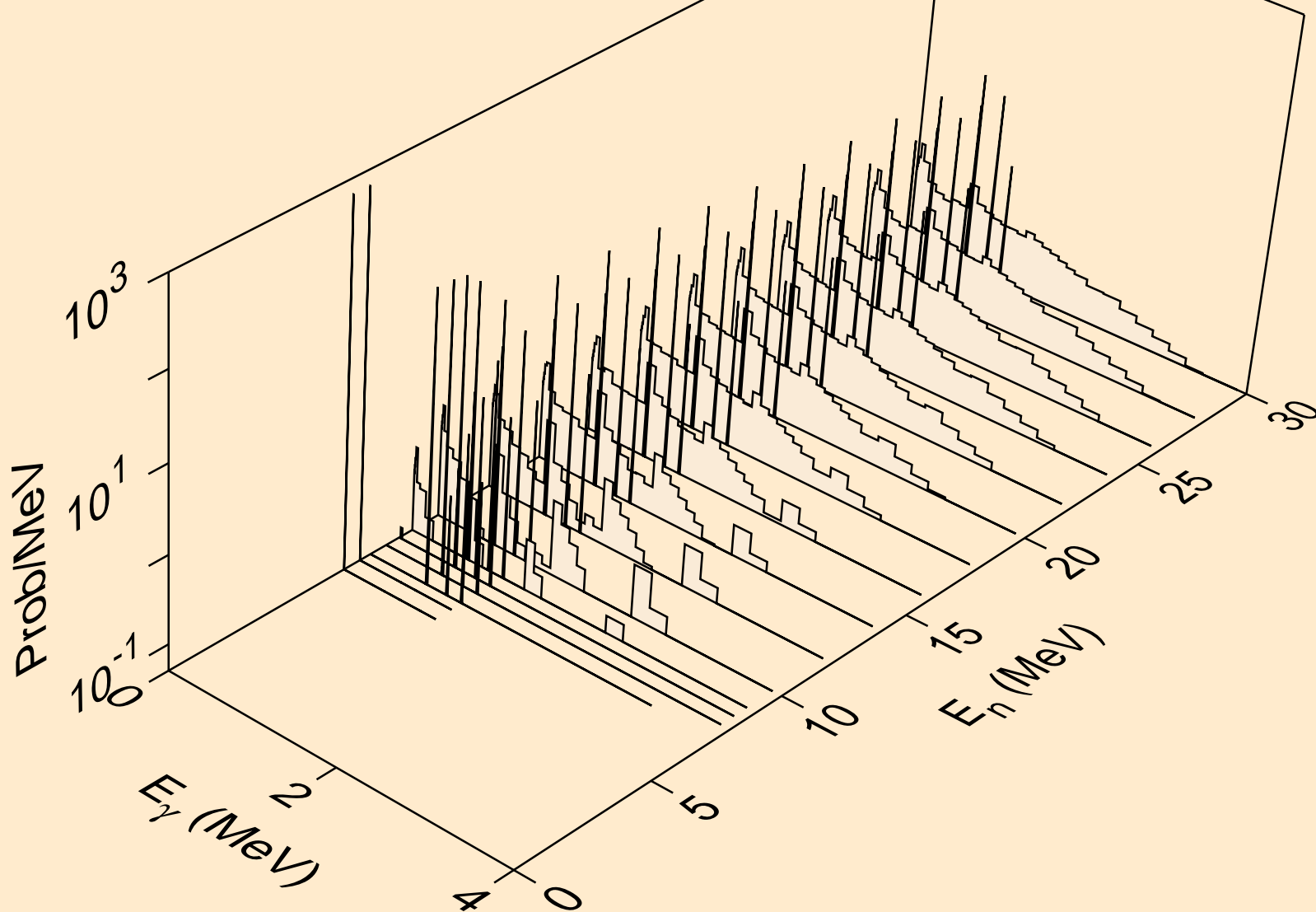

HO148M NEUTRON ACER TENDL-2019 LIBRARY; T=293.16K
Photon emission for (n,he3)

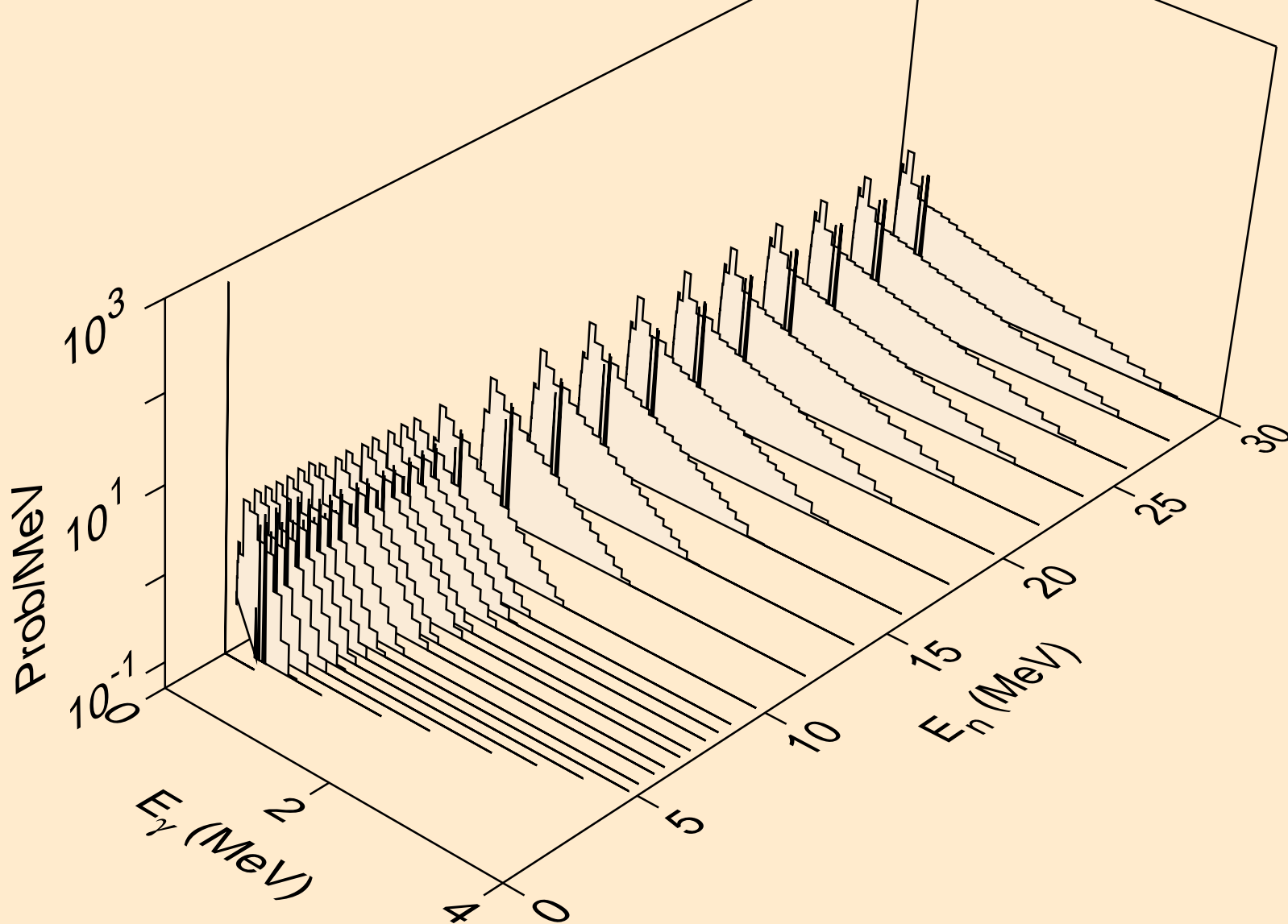

HO148M NEUTRON ACER TENDL-2019 LIBRARY; T=293.16K
Photon emission for (n,a)

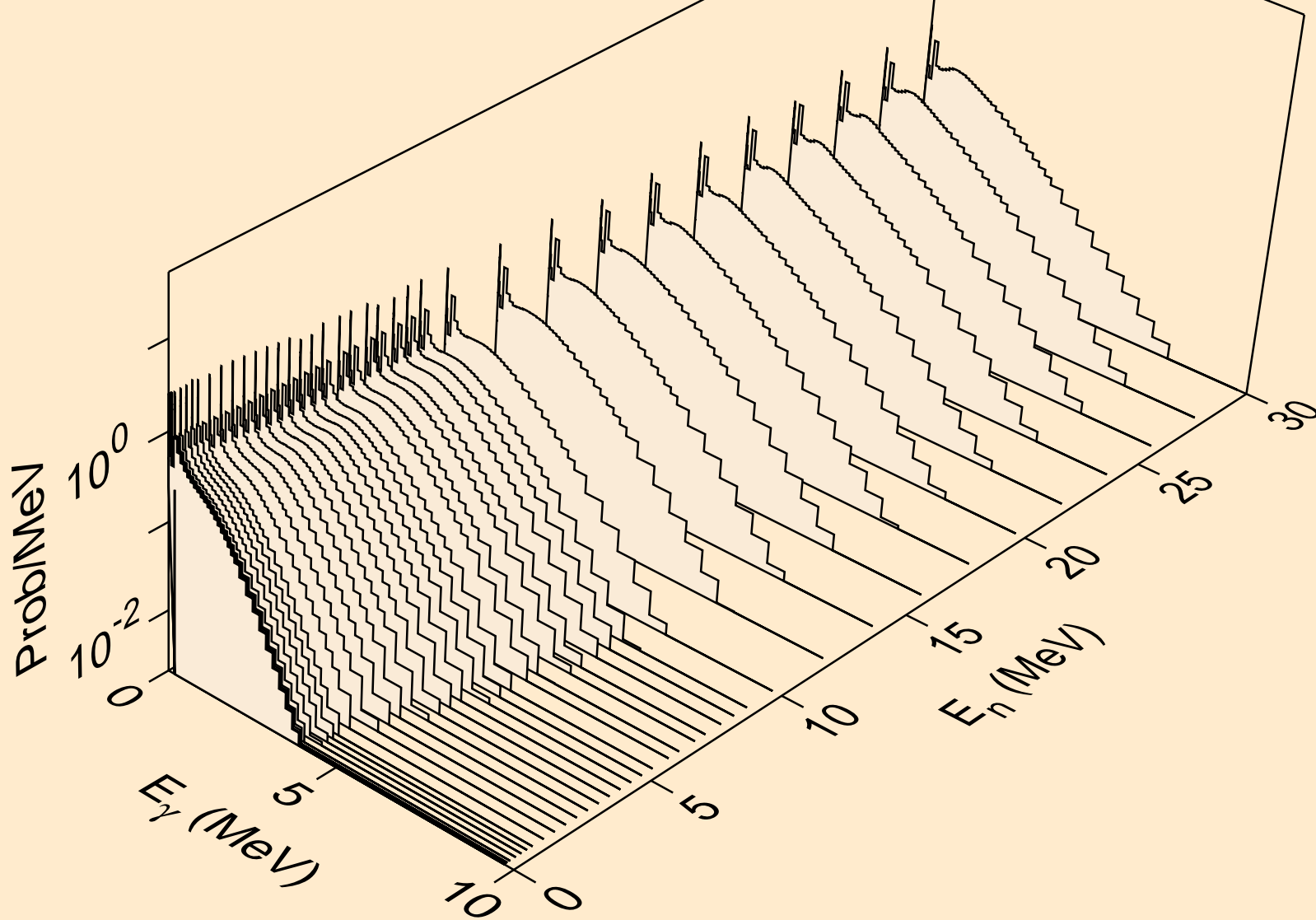

HO148M NEUTRON ACER TENDL-2019 LIBRARY; T=293.16K
Photon emission for (n,2a)

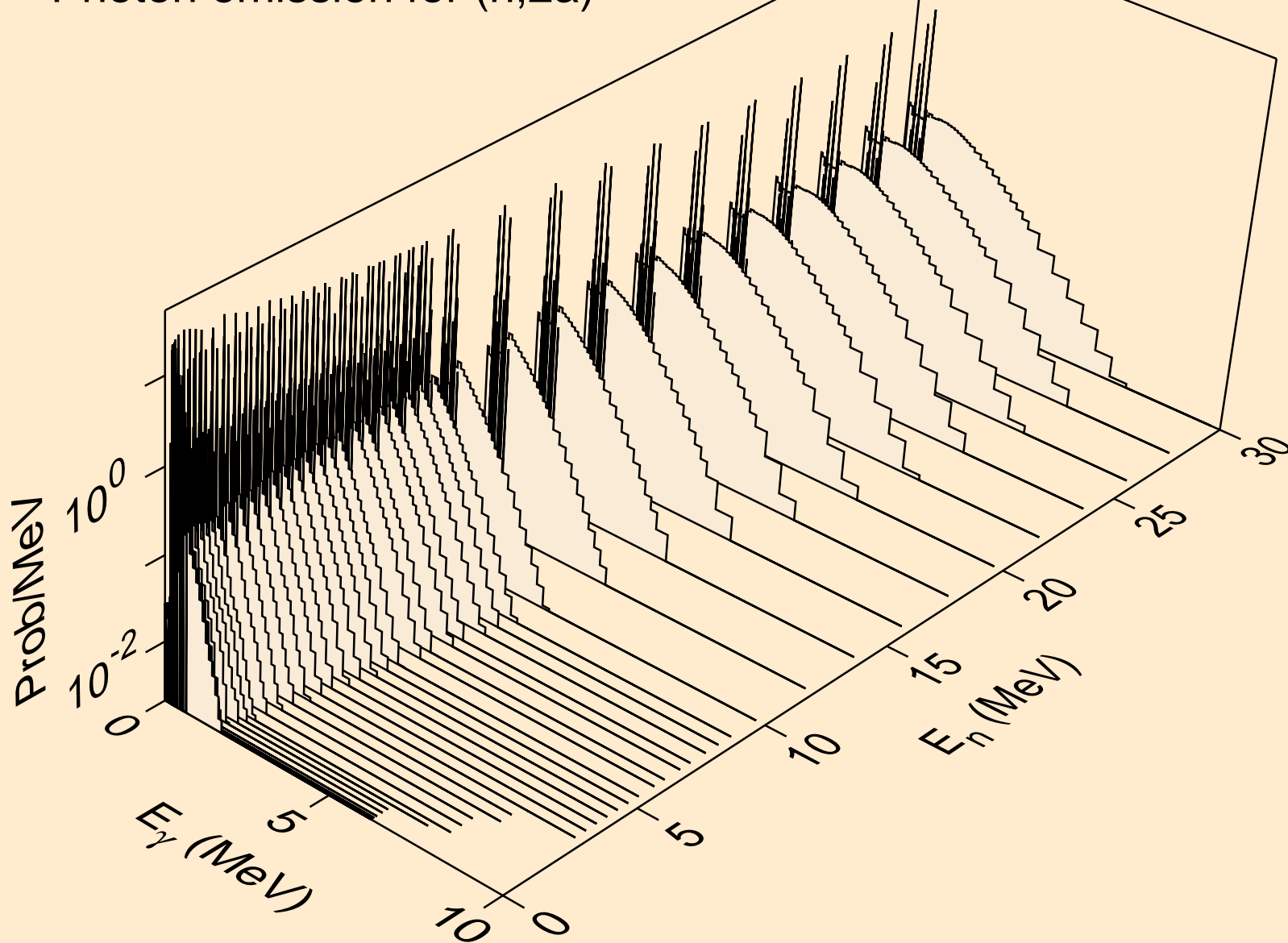

HO148M NEUTRON ACER TENDL-2019 LIBRARY; T=293.16K
Photon emission for (n,3a)

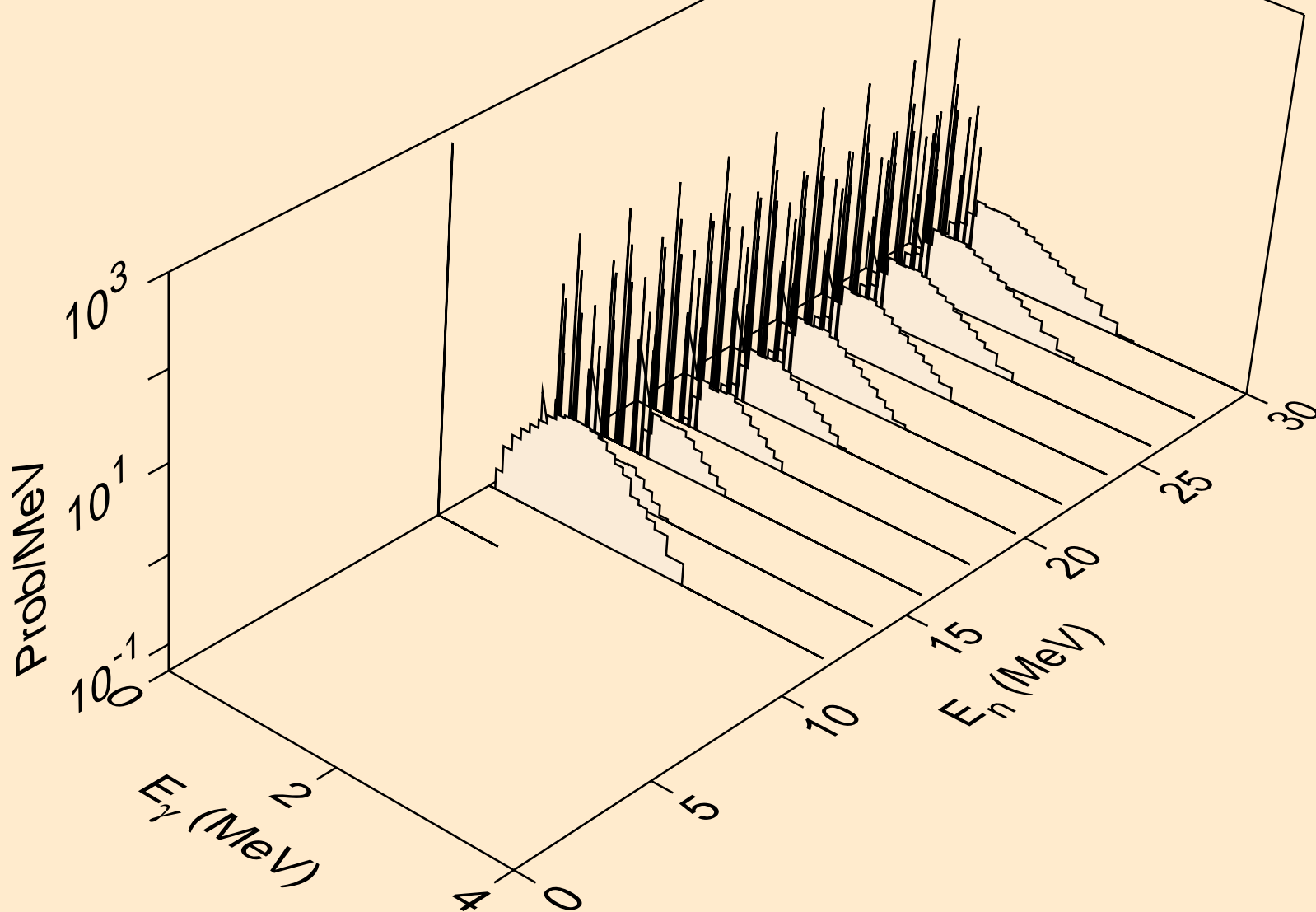

HO148M NEUTRON ACER TENDL-2019 LIBRARY; T=293.16K
Photon emission for (n,2p)

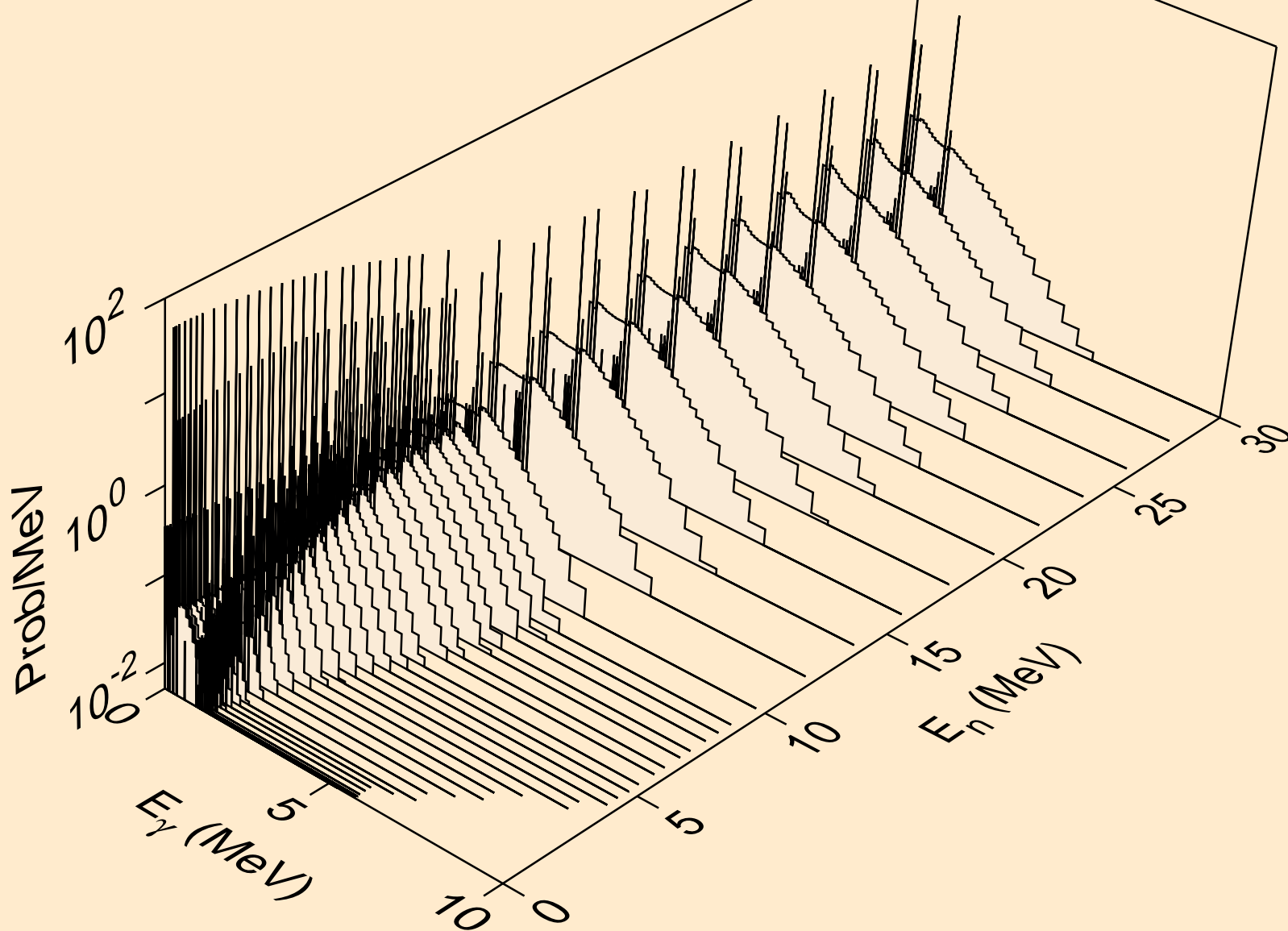

HO148M NEUTRON ACER TENDL-2019 LIBRARY; T=293.16K
Photon emission for (n,p α)

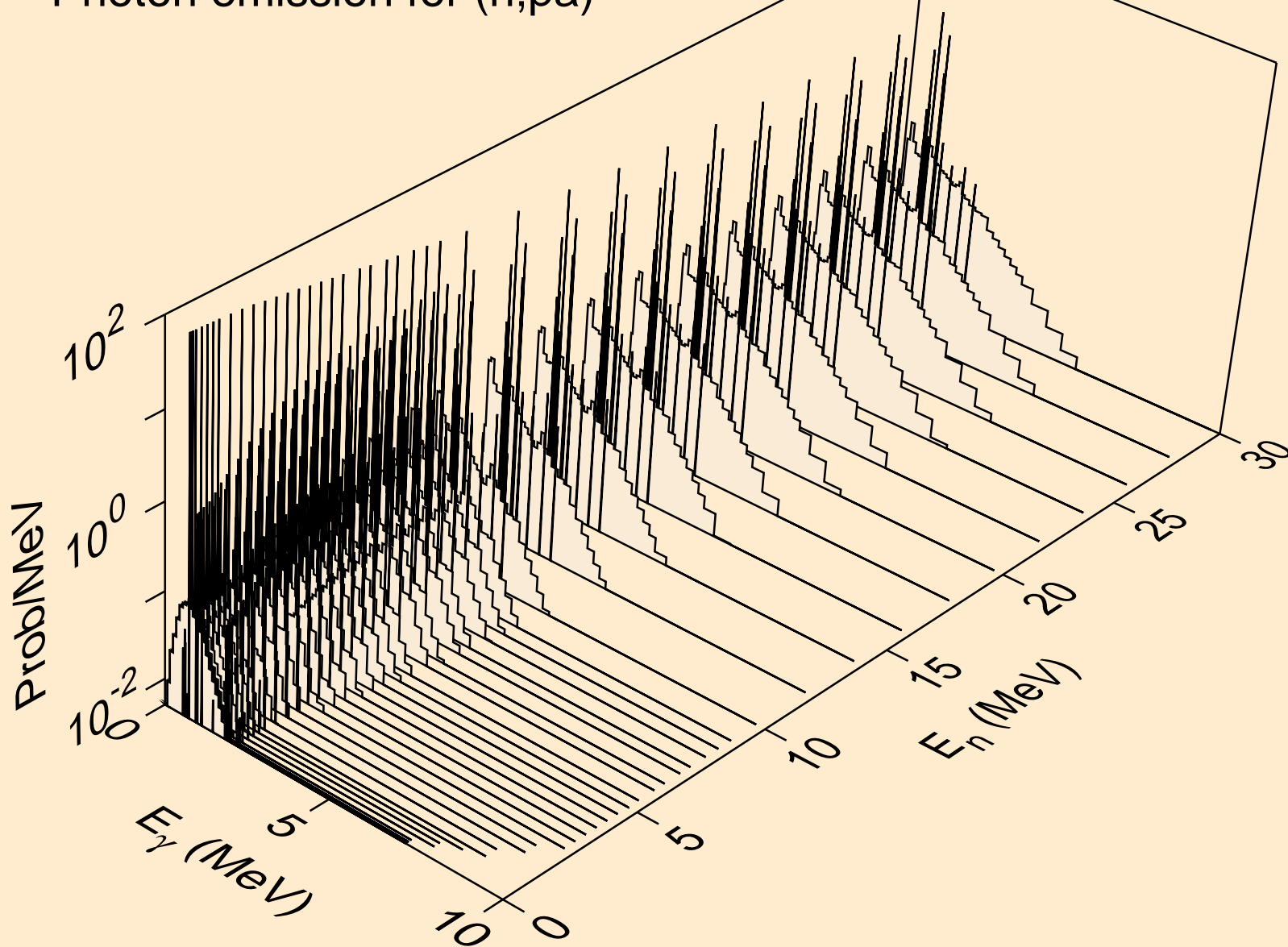

HO148M NEUTRON ACER TENDL-2019 LIBRARY; T=293.16K
Photon emission for (n,pd)

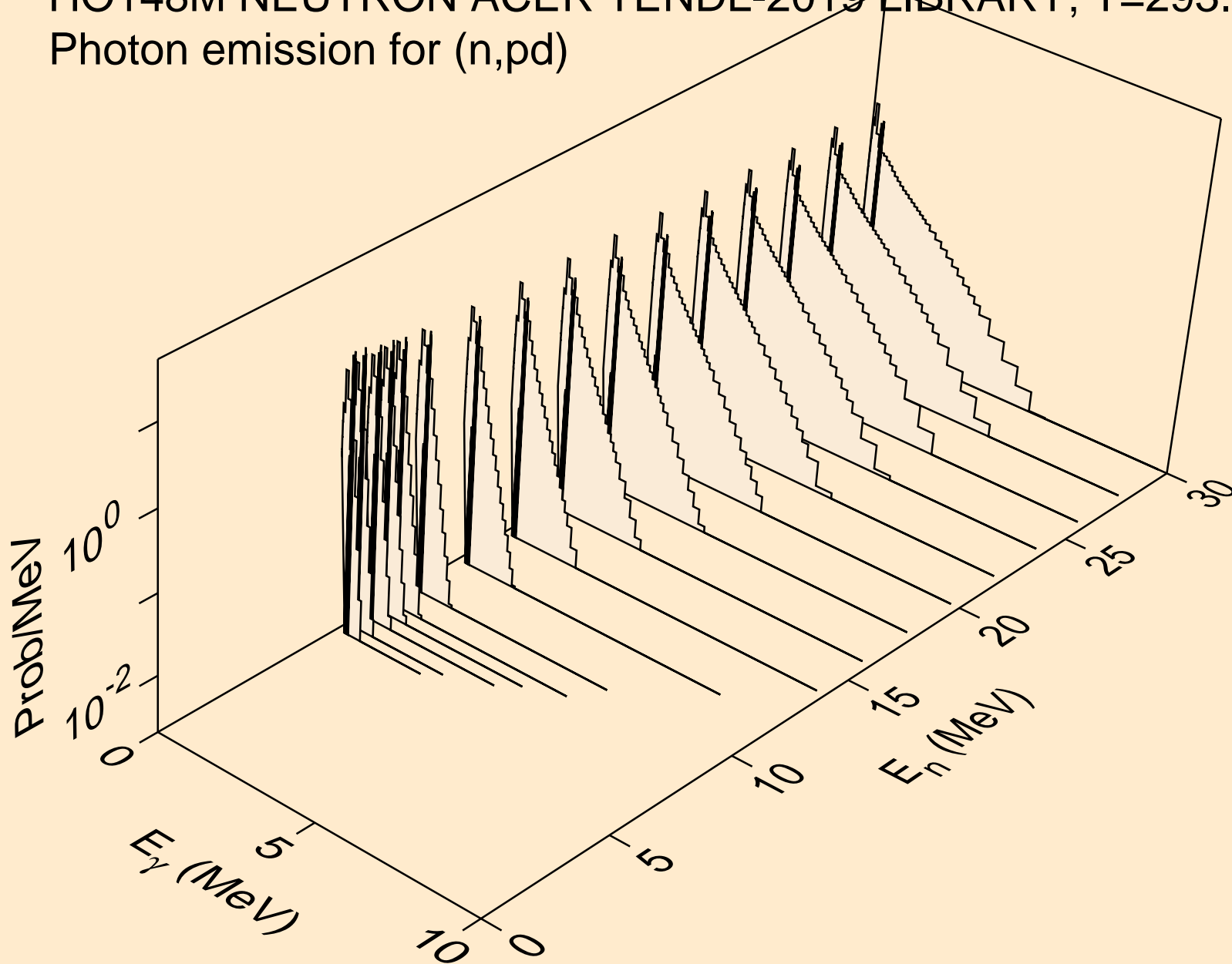

HO148M NEUTRON ACER TENDL-2019 LIBRARY; T=293.16K
Photon emission for (n,pt)

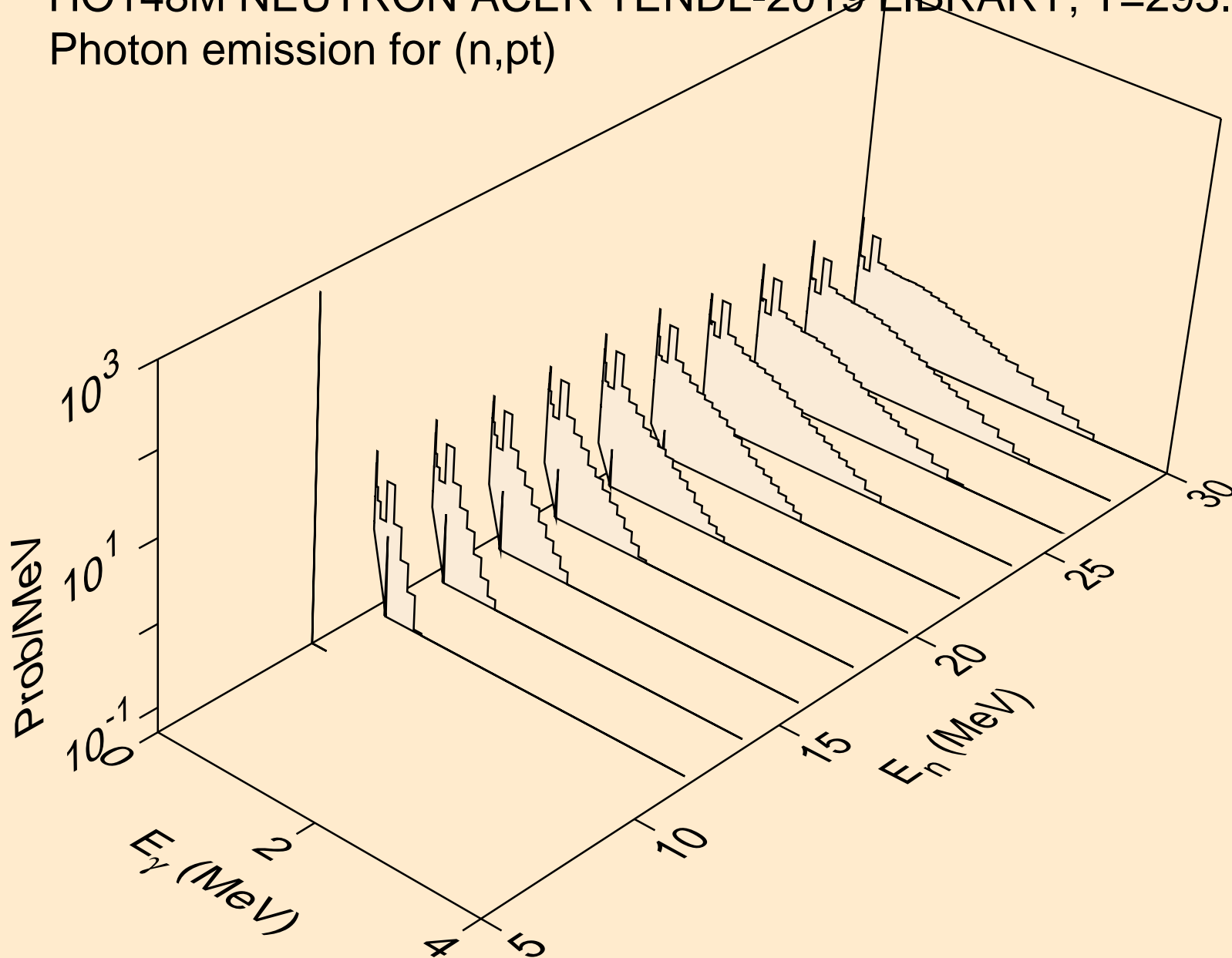

HO148M NEUTRON ACER TENDL-2019 LIBRARY; T=293.16K
Photon emission for (n,da)

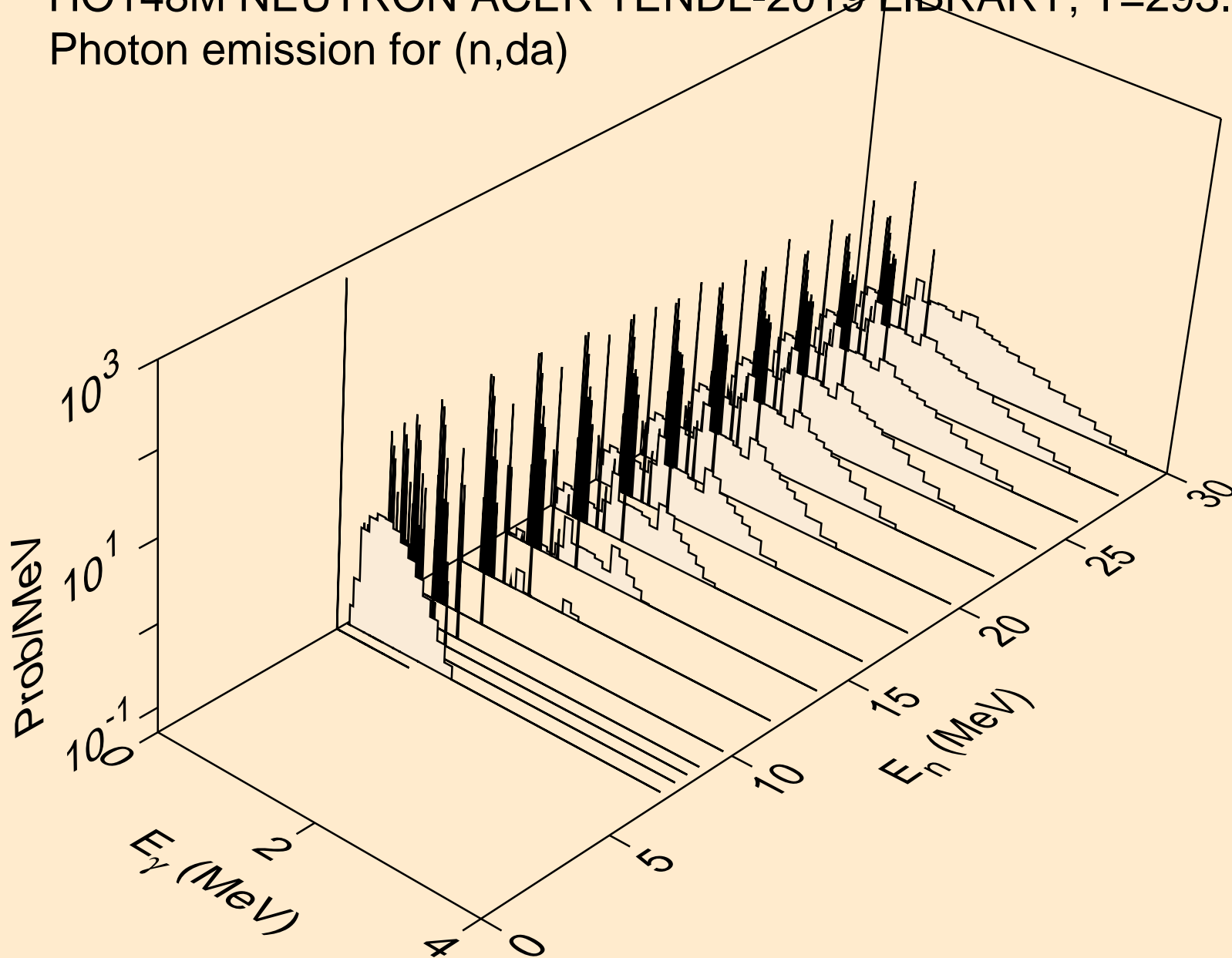

HO148M NEUTRON ACER TENDL-2019 LIBRARY; T=293.16K
thermal capture photon spectrum

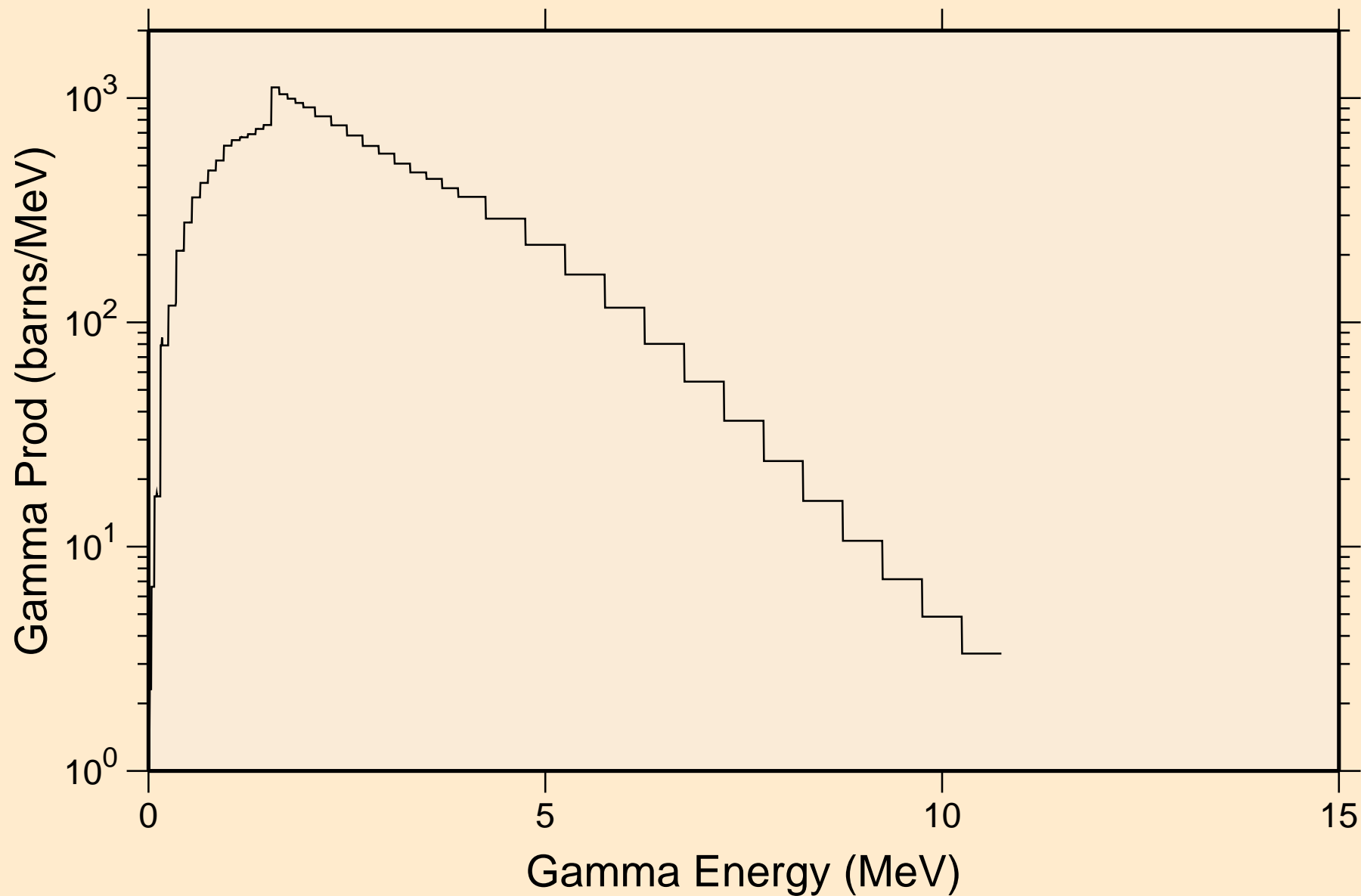

HO148M NEUTRON ACER TENDL-2019 LIBRARY; T=293.16K
14 MeV photon spectrum

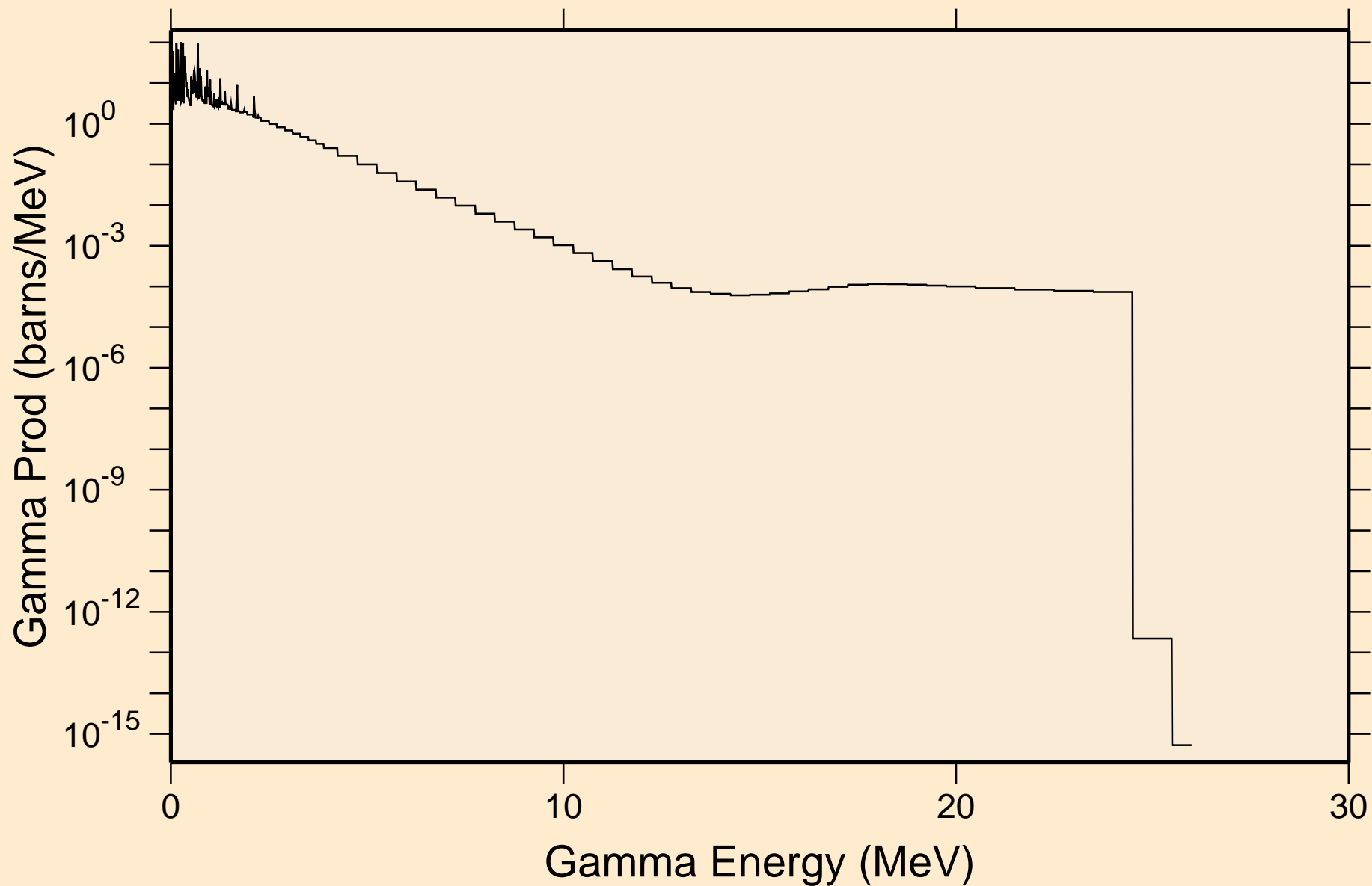

HO148M NEUTRON ACER TENDL-2019 LIBRARY; T=293.16K

Particle heating contributions

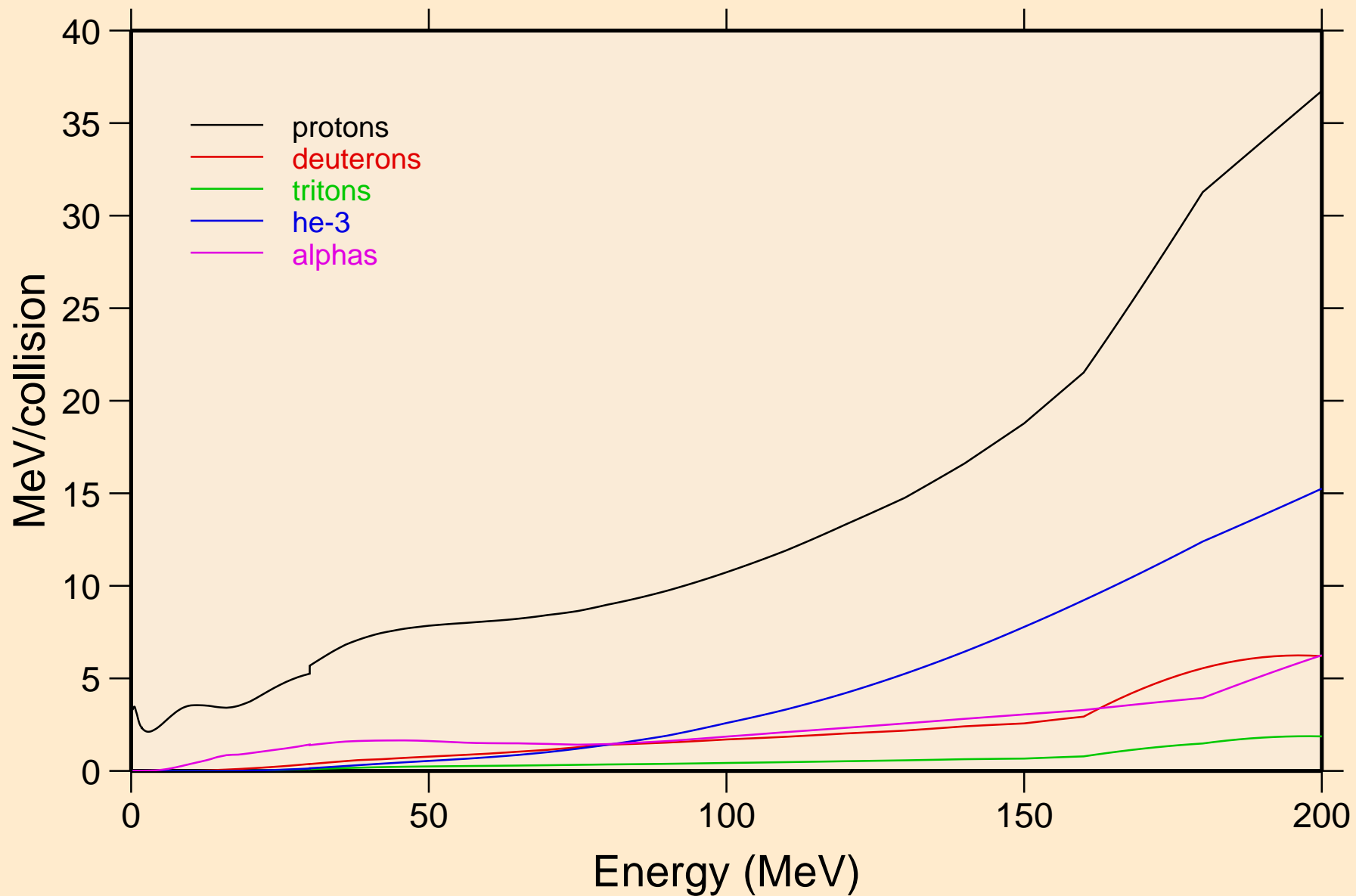

HO148M NEUTRON ACER TENDL-2019 LIBRARY; T=293.16K
Recoil Heating

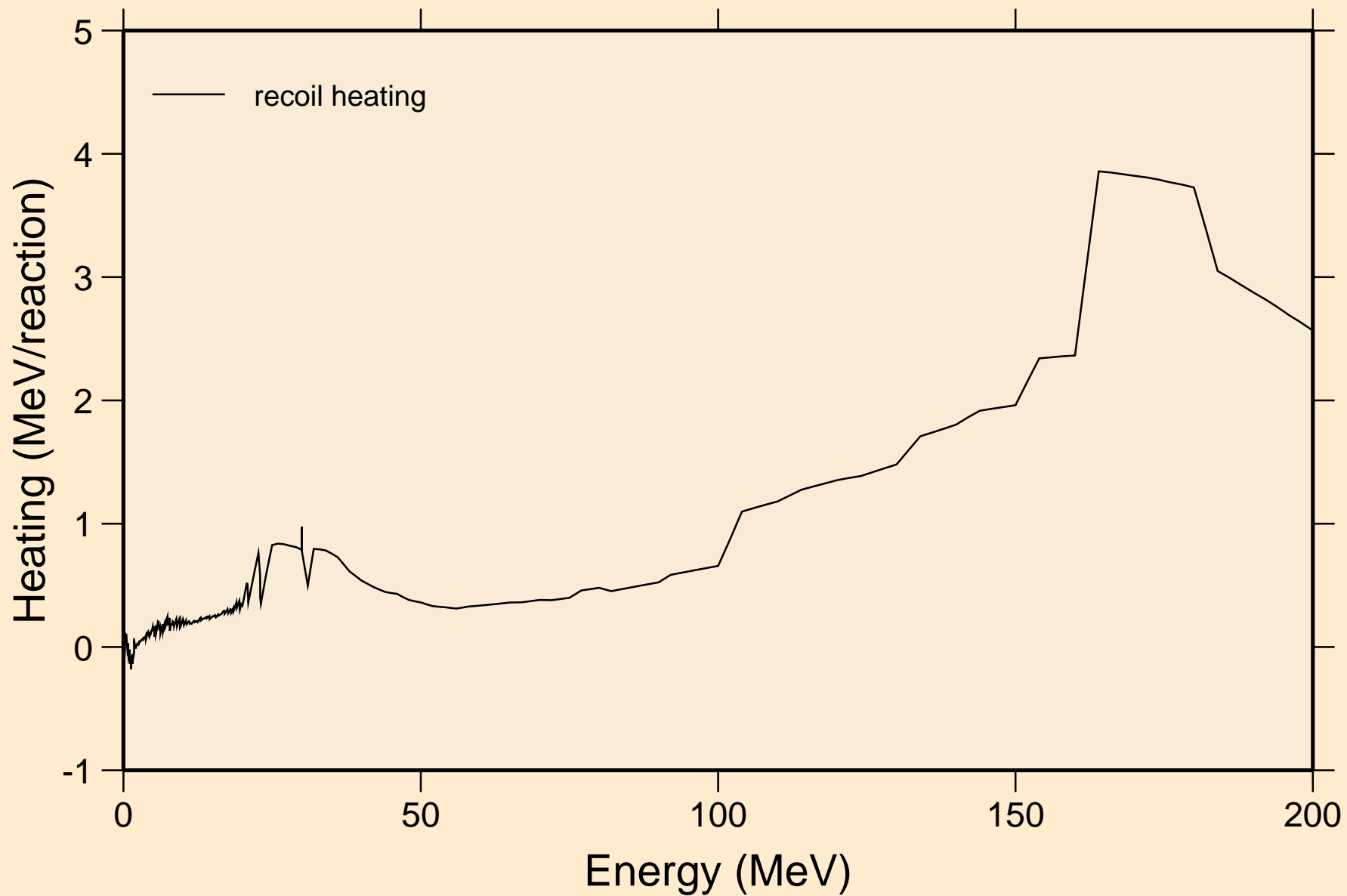

HO148M NEUTRON ACER TENDL-2019 LIBRARY; T=293.16K
Particle production cross sections

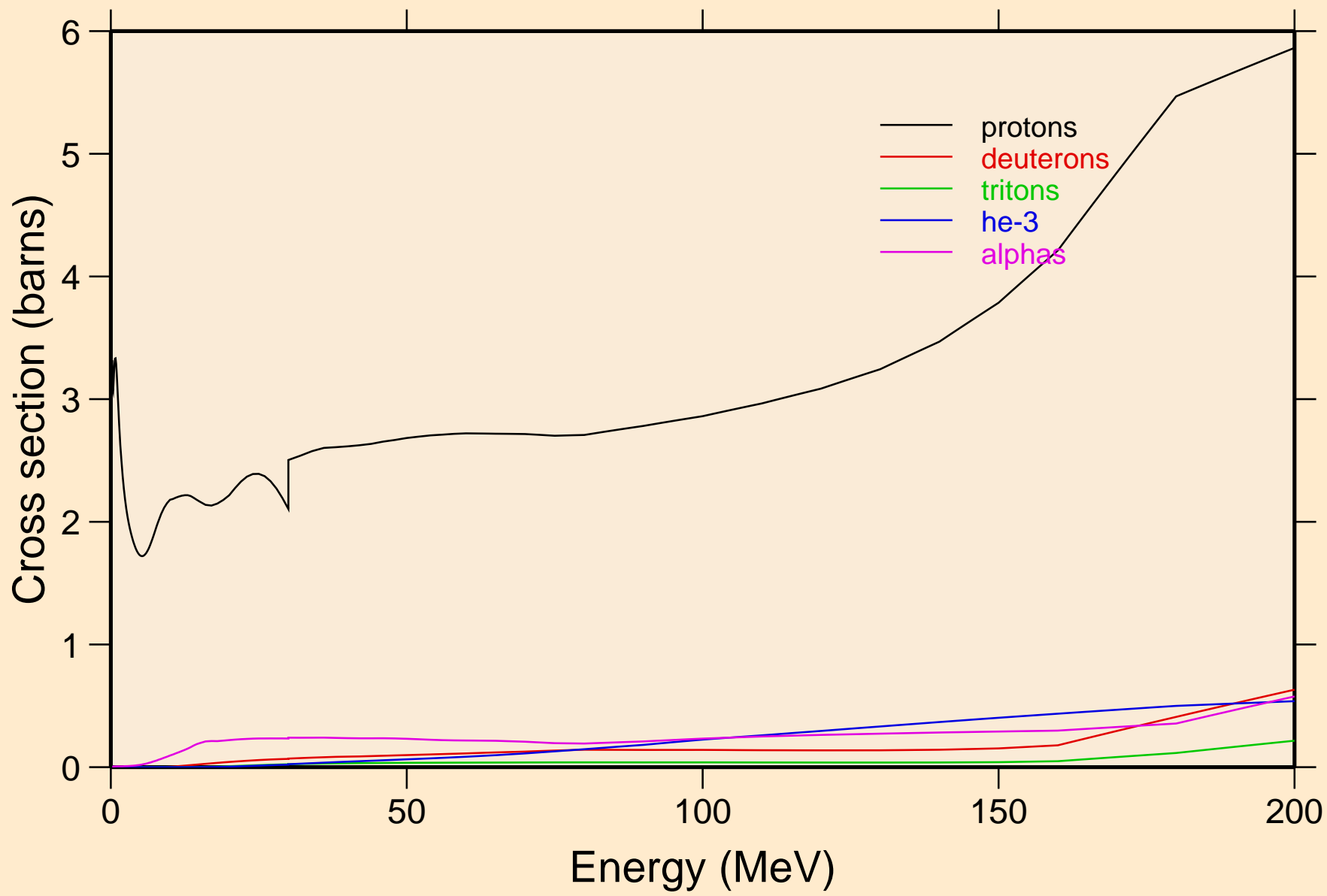

HO148M NEUTRON ACER TENDL-2019 LIBRARY; T=293.16K
protons from (n,x)

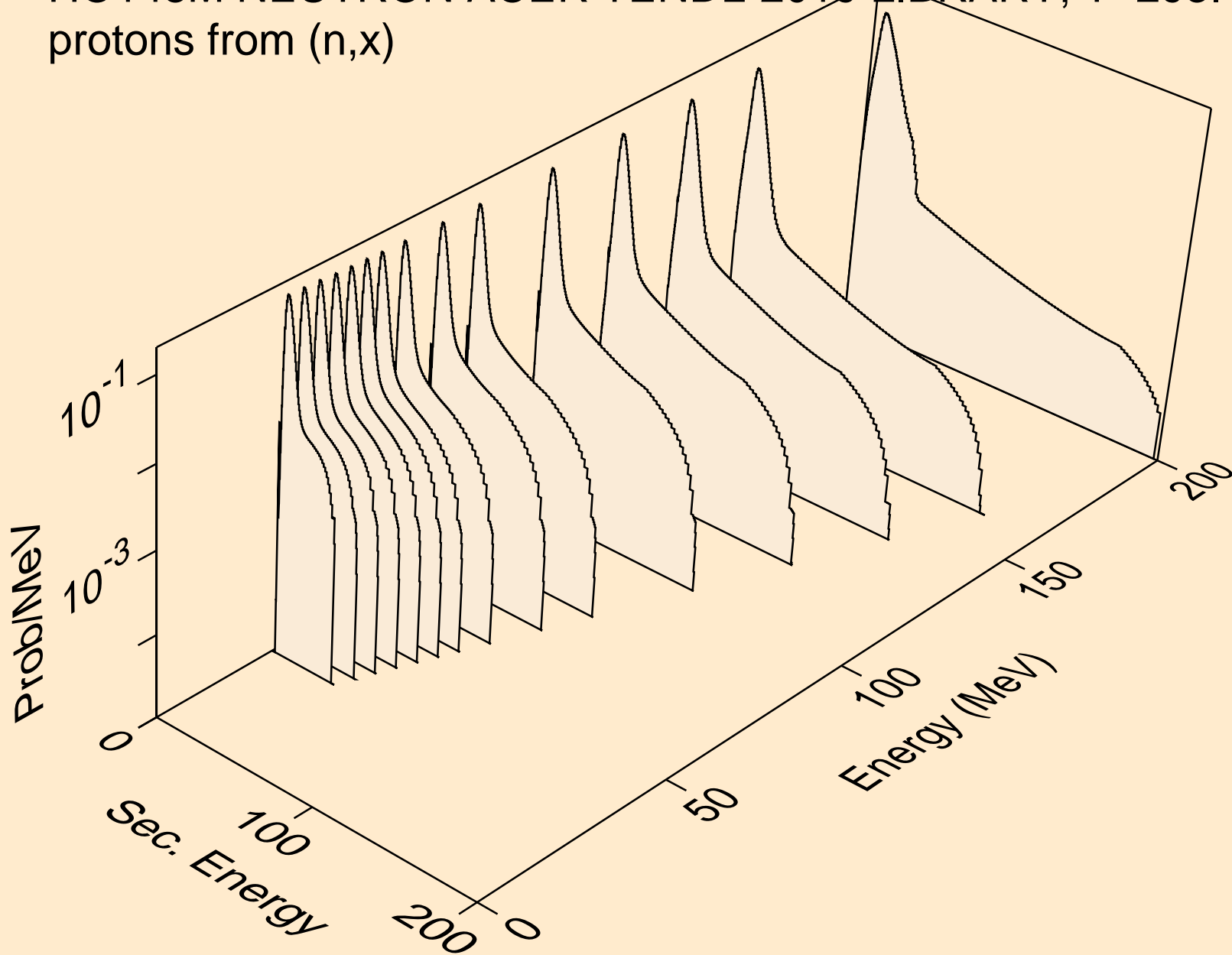

HO148M NEUTRON ACER TENDL-2019 LIBRARY; T=293.16K
protons from (n,n*)p

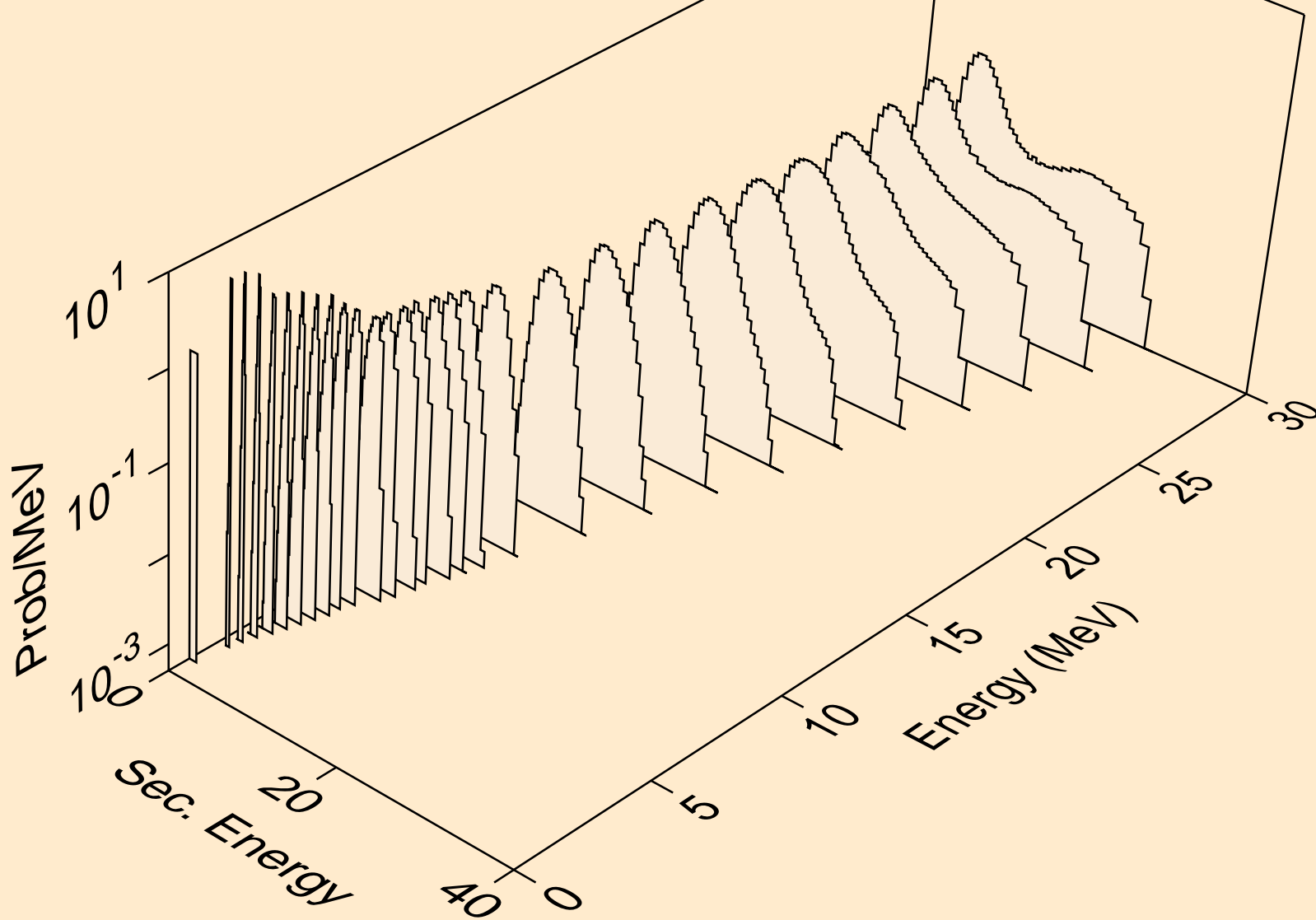

HO148M NEUTRON ACER TENDL-2019 LIBRARY; T=293.16K
protons from (n,2np)

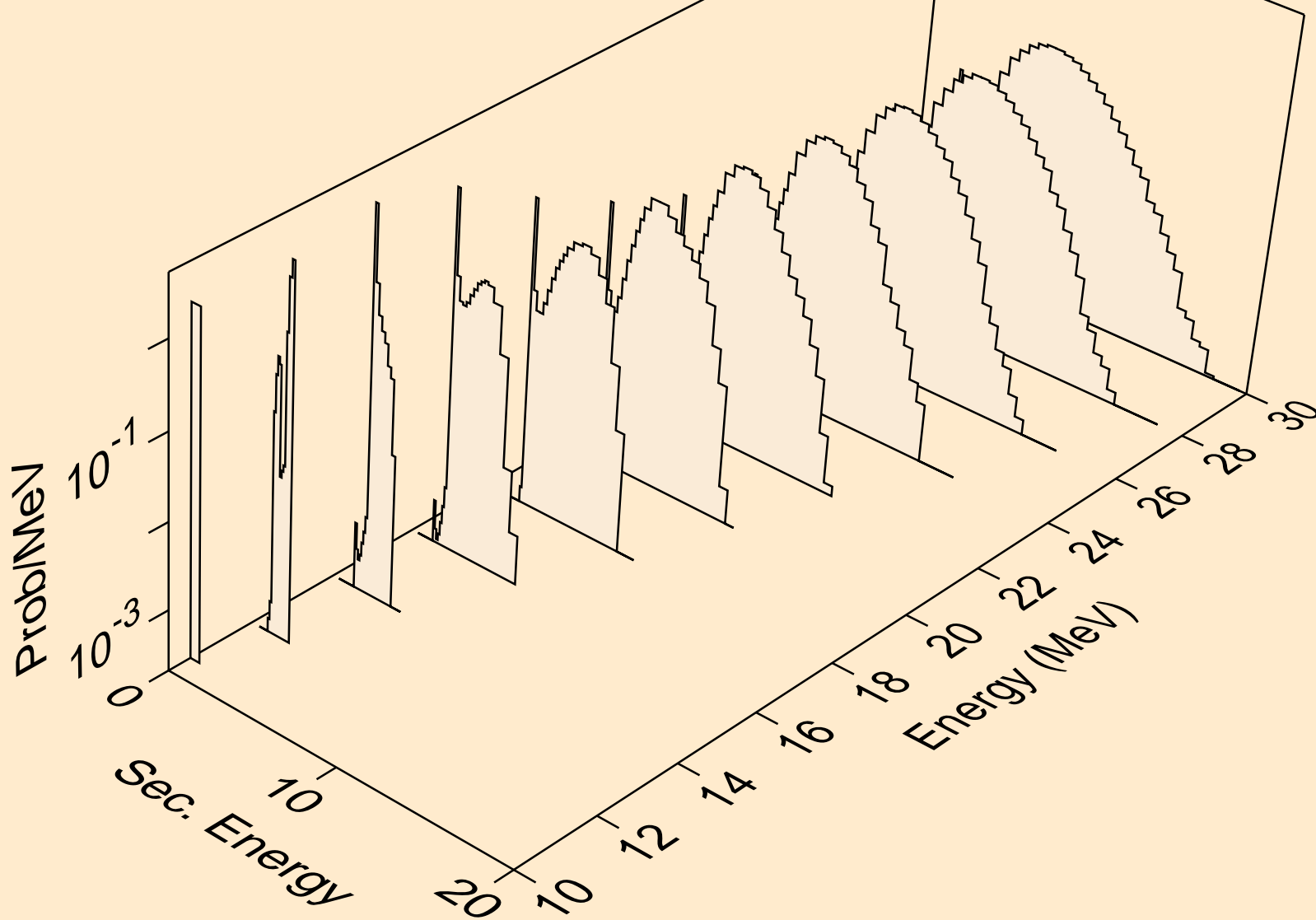

HO148M NEUTRON ACER TENDL-2019 LIBRARY; T=293.16K
protons from (n,3np)

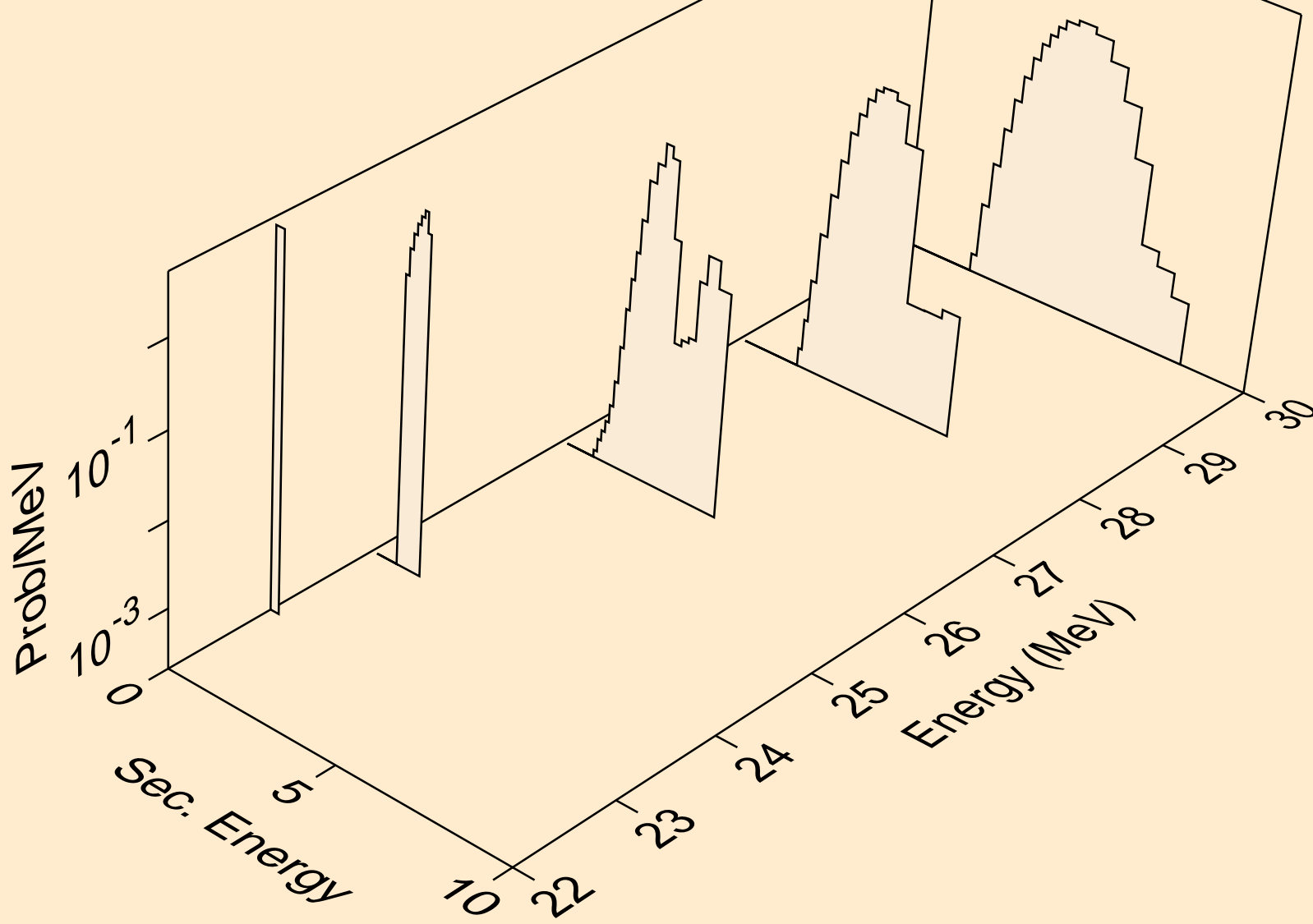

HO148M NEUTRON ACER TENDL-2019 LIBRARY; T=293.16K
protons from (n,2np)

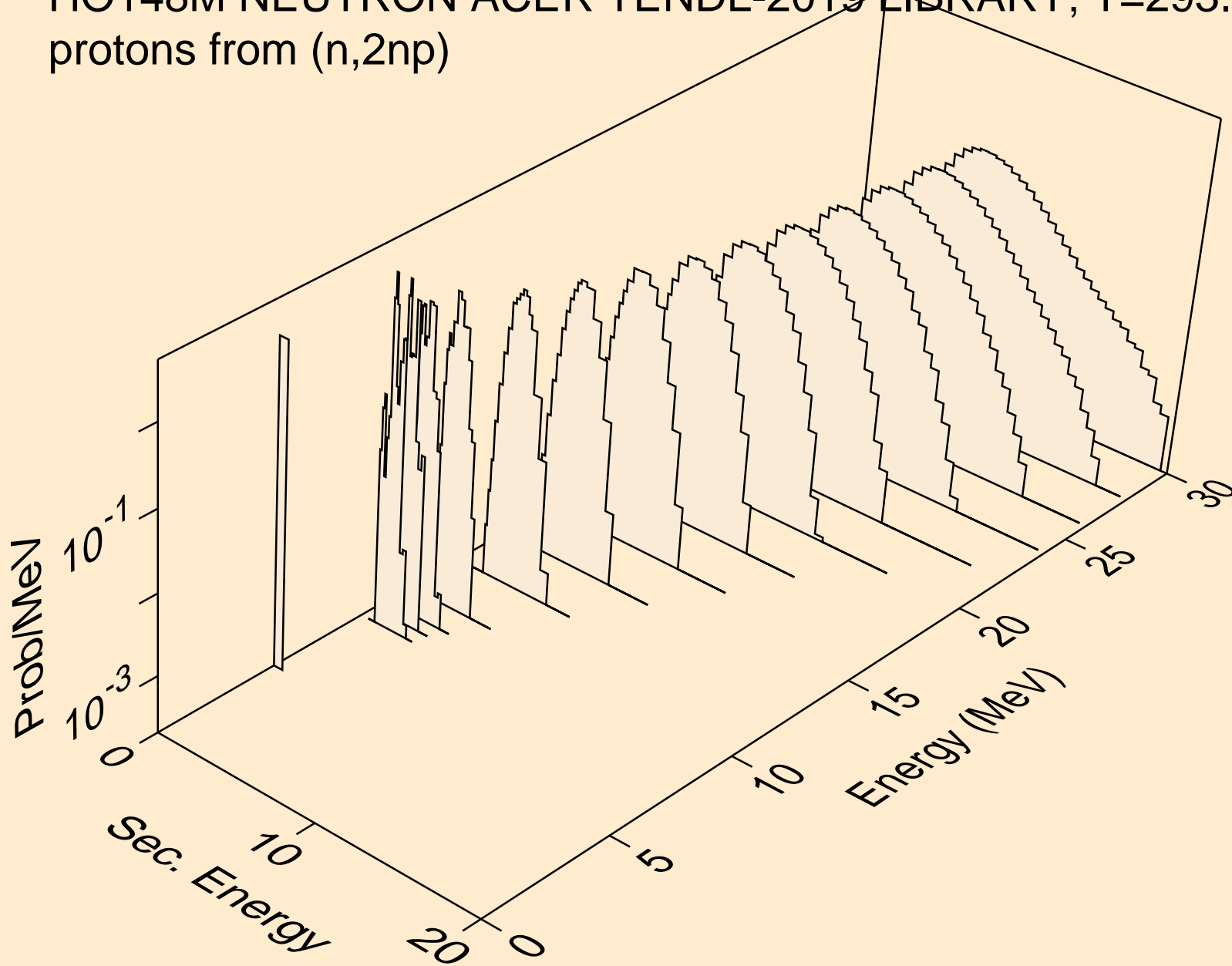

HO148M NEUTRON ACER TENDL-2019 LIBRARY; T=293.16K
protons from (n,npa)

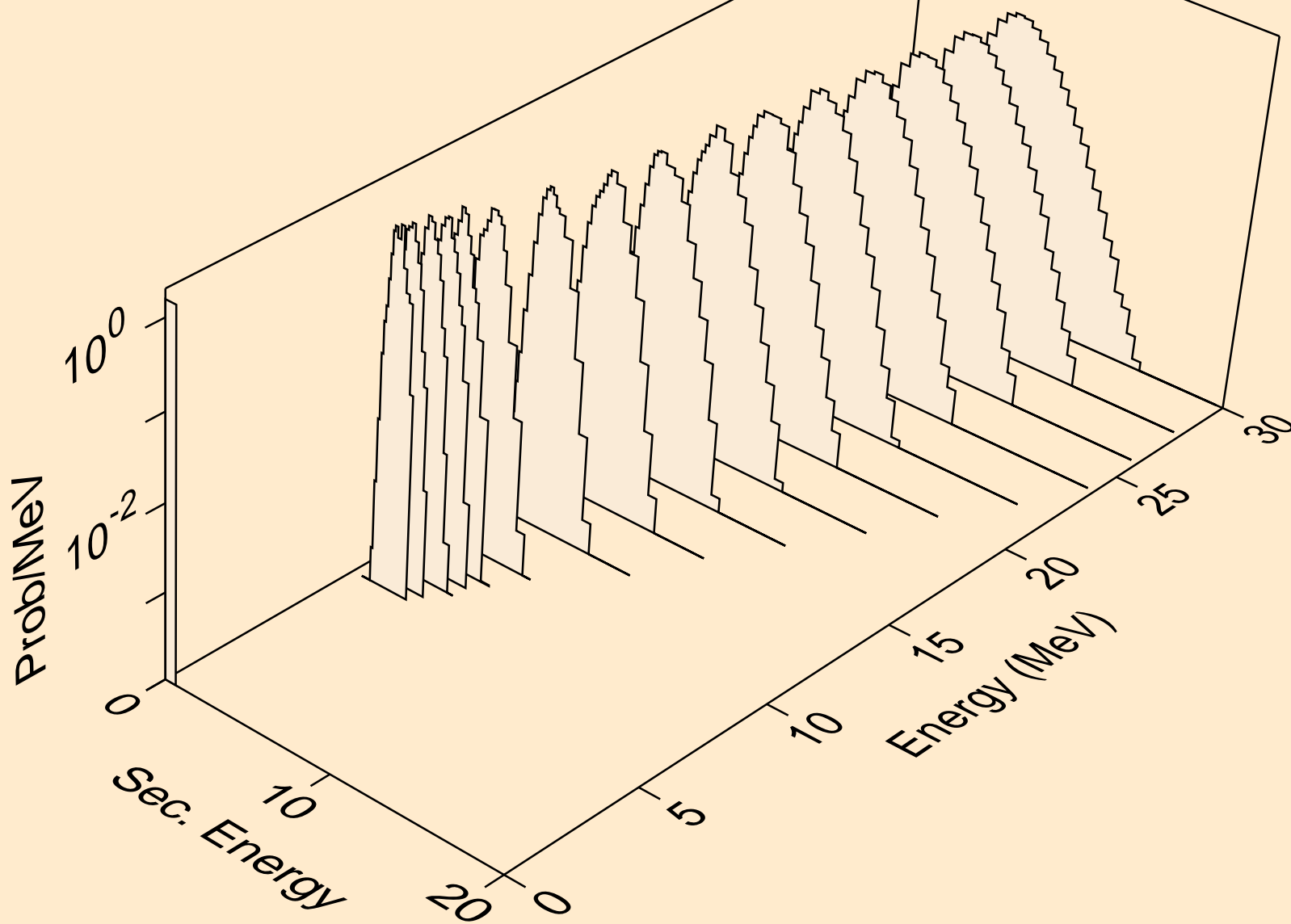

HO148M NEUTRON ACER TENDL-2019 LIBRARY; T=293.16K
protons from (n,p)

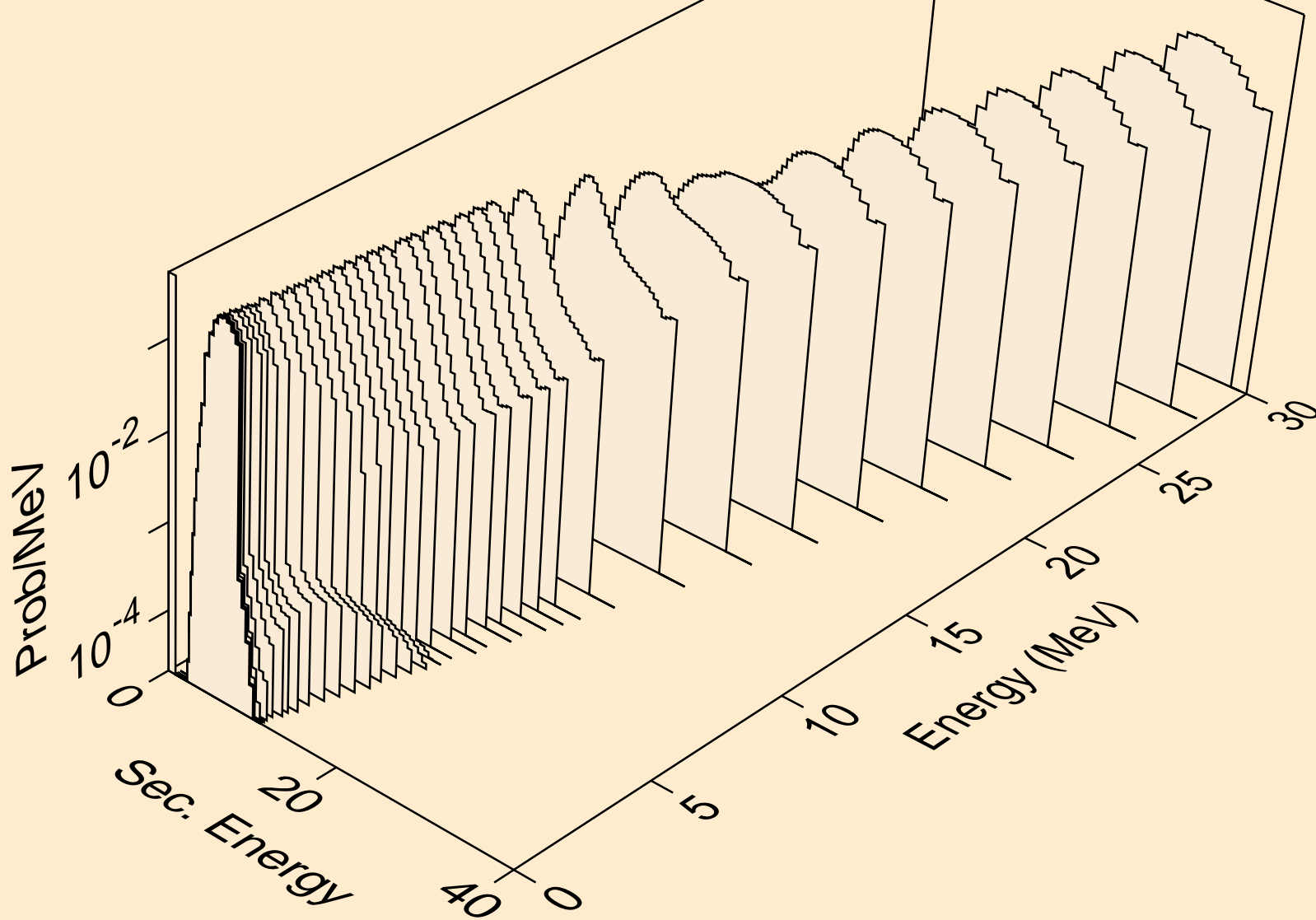

HO148M NEUTRON ACER TENDL-2019 LIBRARY; T=293.16K
protons from (n,2p)

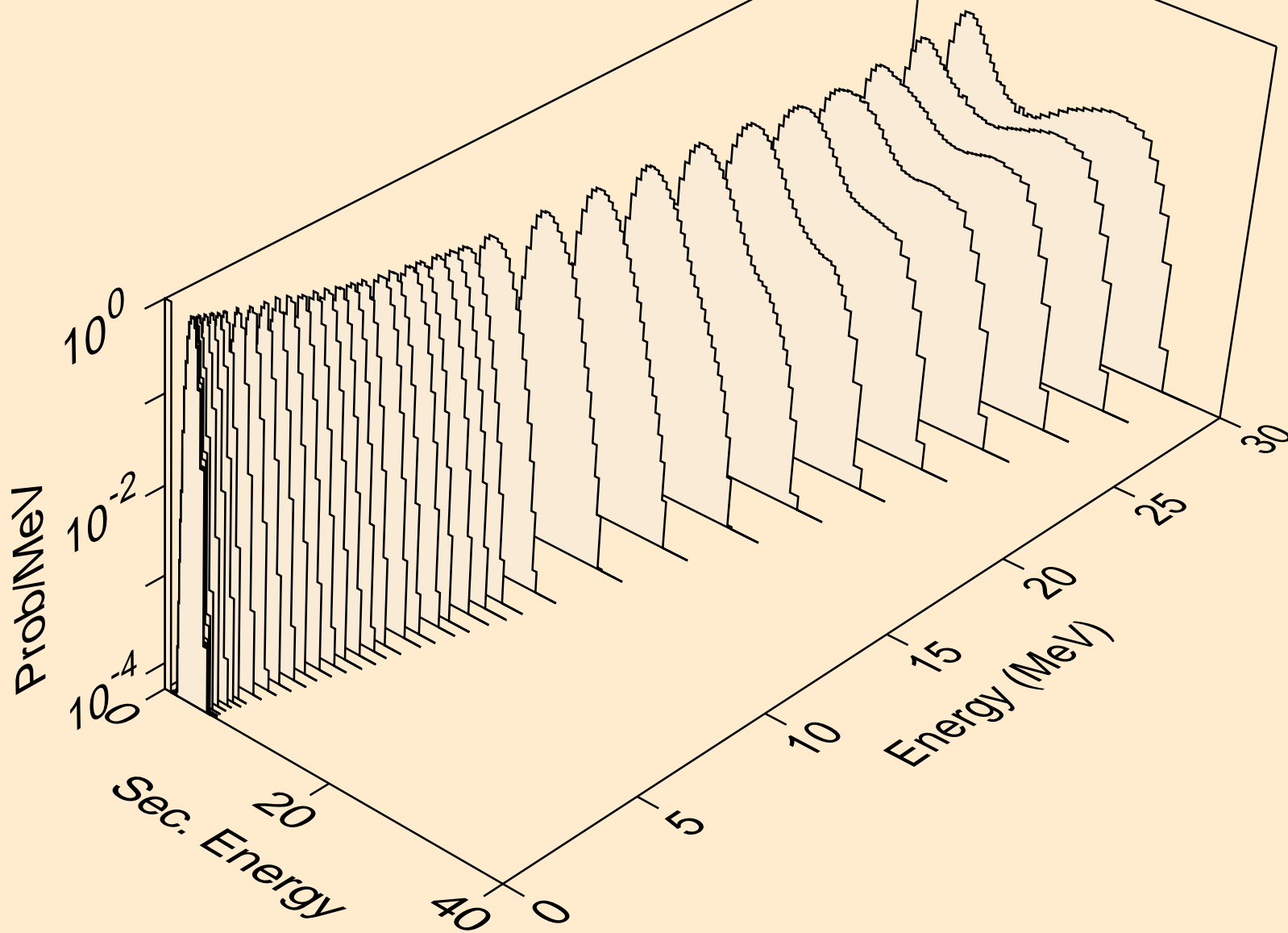

HO148M NEUTRON ACER TENDL-2019 LIBRARY; T=293.16K
protons from (n,p)

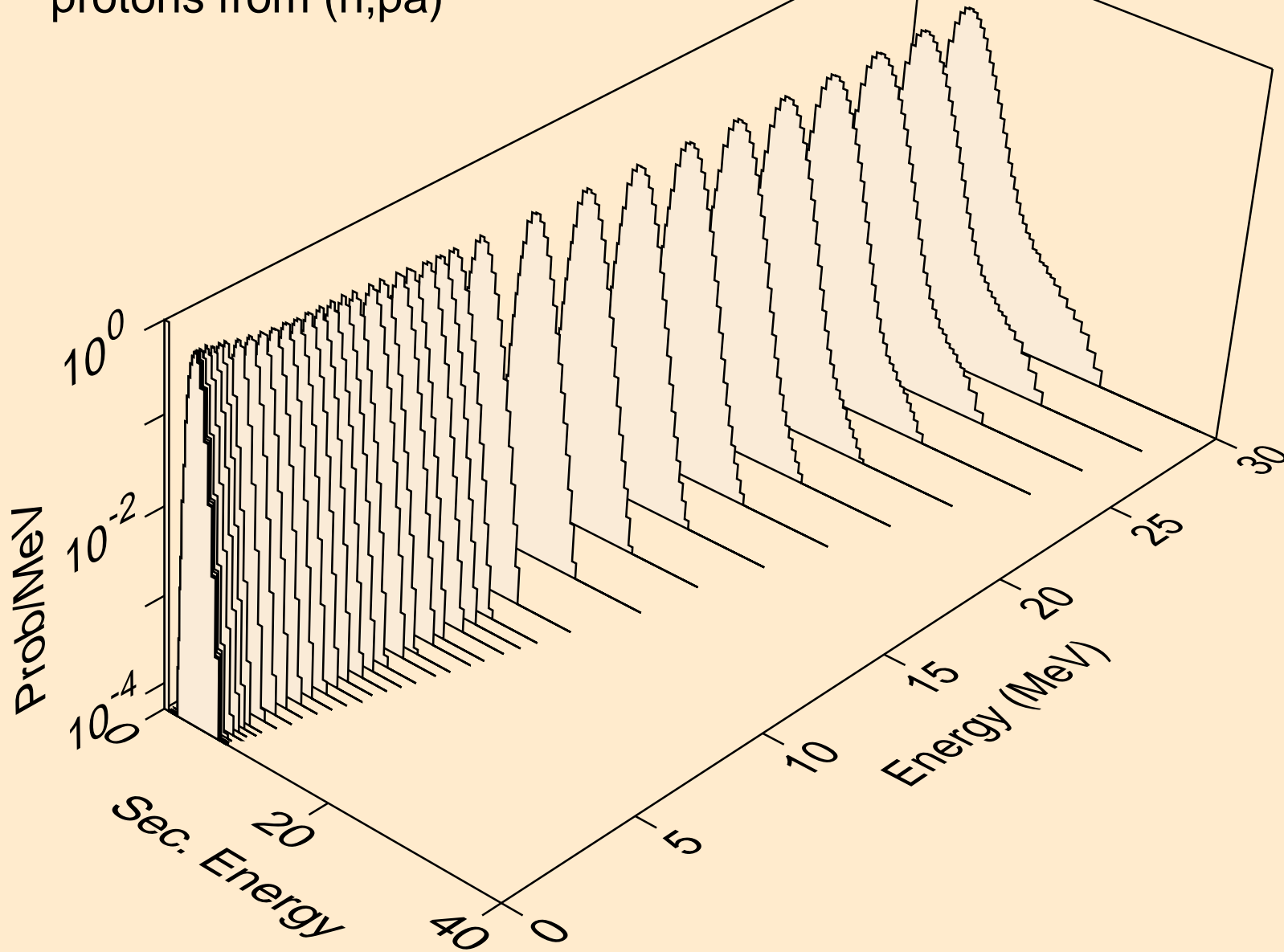

HO148M NEUTRON ACER TENDL-2019 LIBRARY; T=293.16K
protons from (n,pd)

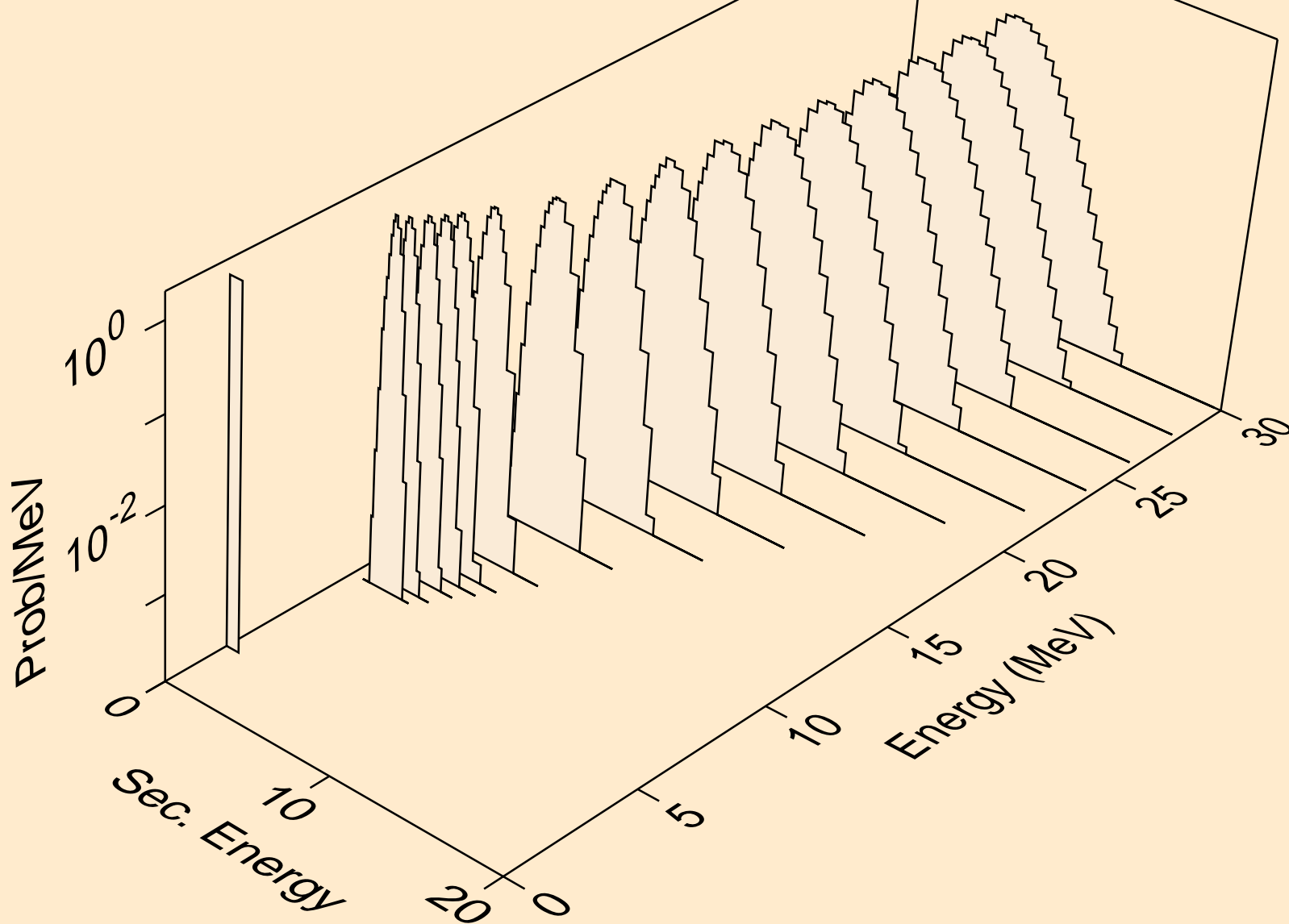

HO148M NEUTRON ACER TENDL-2019 LIBRARY; T=293.16K
protons from (n,pt)

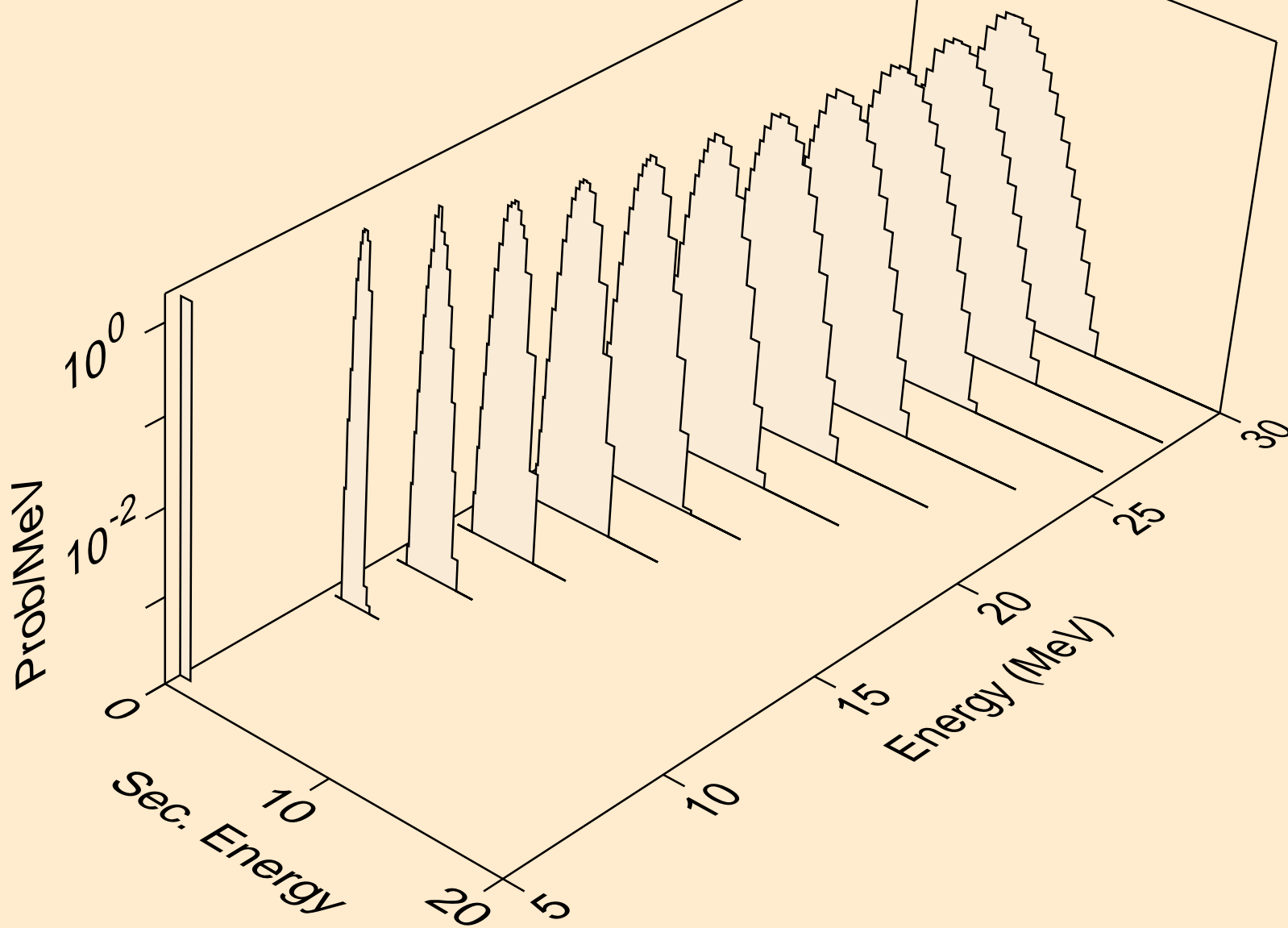

HO148M NEUTRON ACER TENDL-2019 LIBRARY; T=293.16K
deuterons from (n,x)

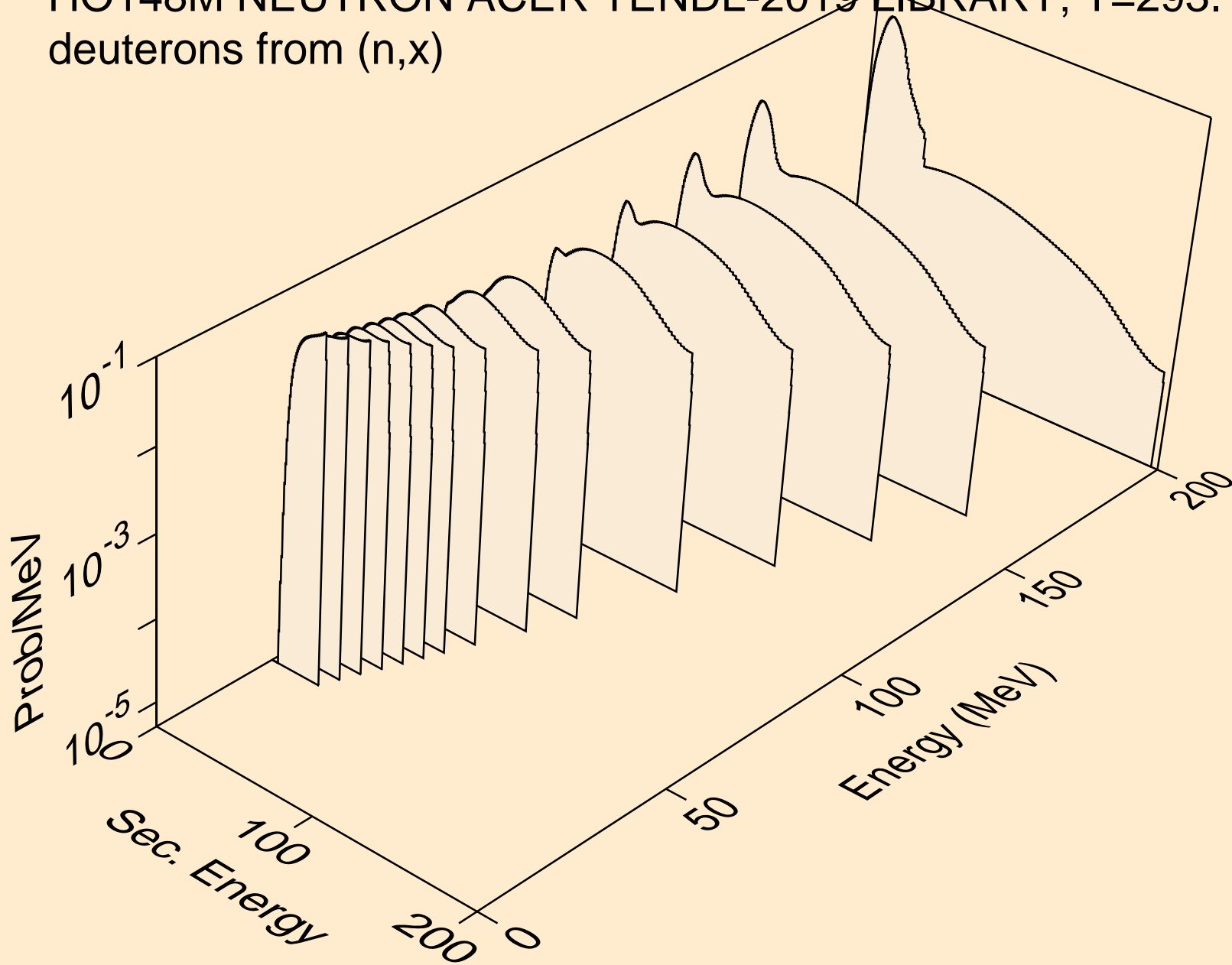

HO148M NEUTRON ACER TENDL-2019 LIBRARY; T=293.16K
deuterons from (n,2nd)

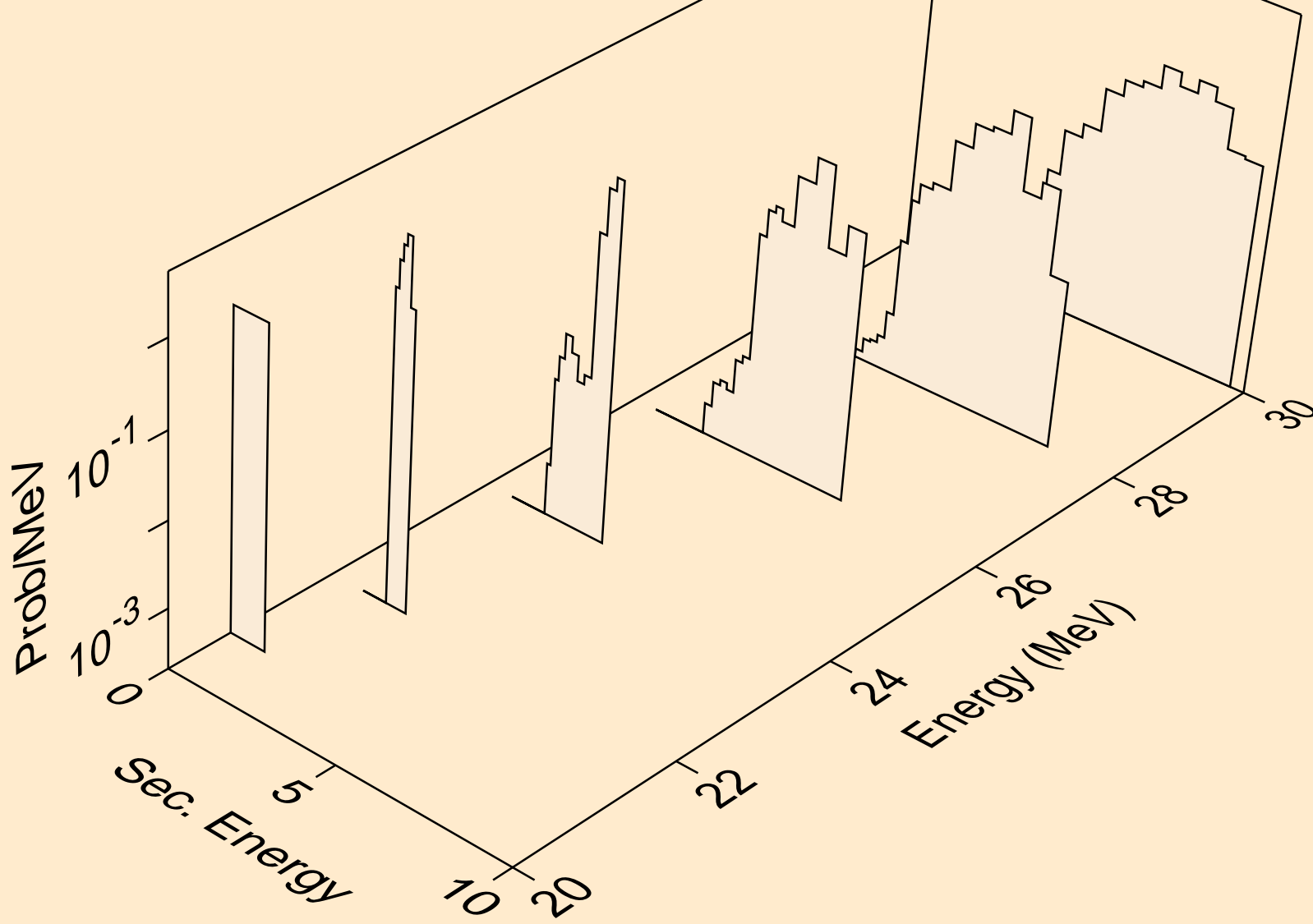

HO148M NEUTRON ACER TENDL-2019 LIBRARY; T=293.16K
deuterons from (n,n*)d

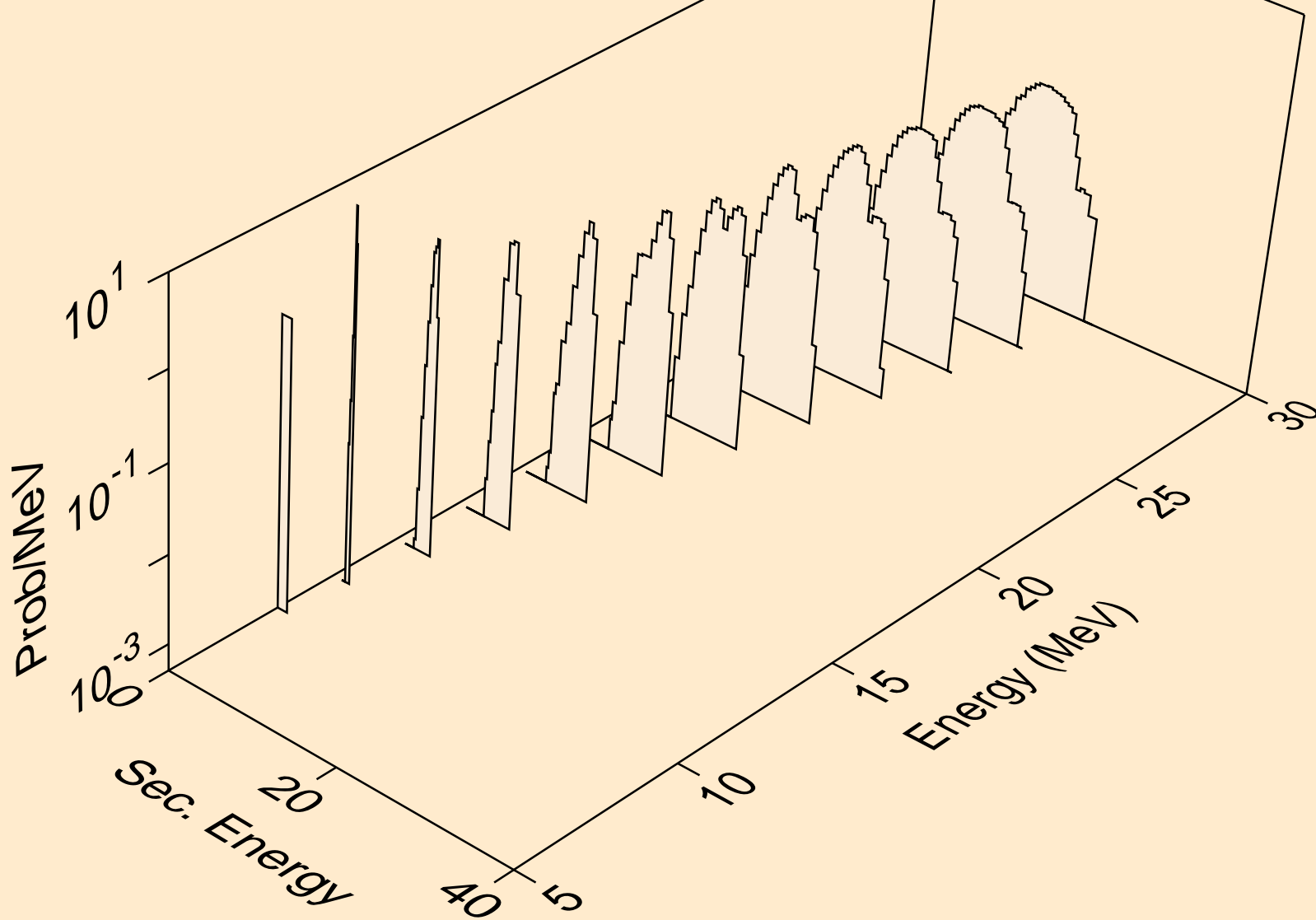

HO148M NEUTRON ACER TENDL-2019 LIBRARY; T=293.16K
deuterons from (n,d)

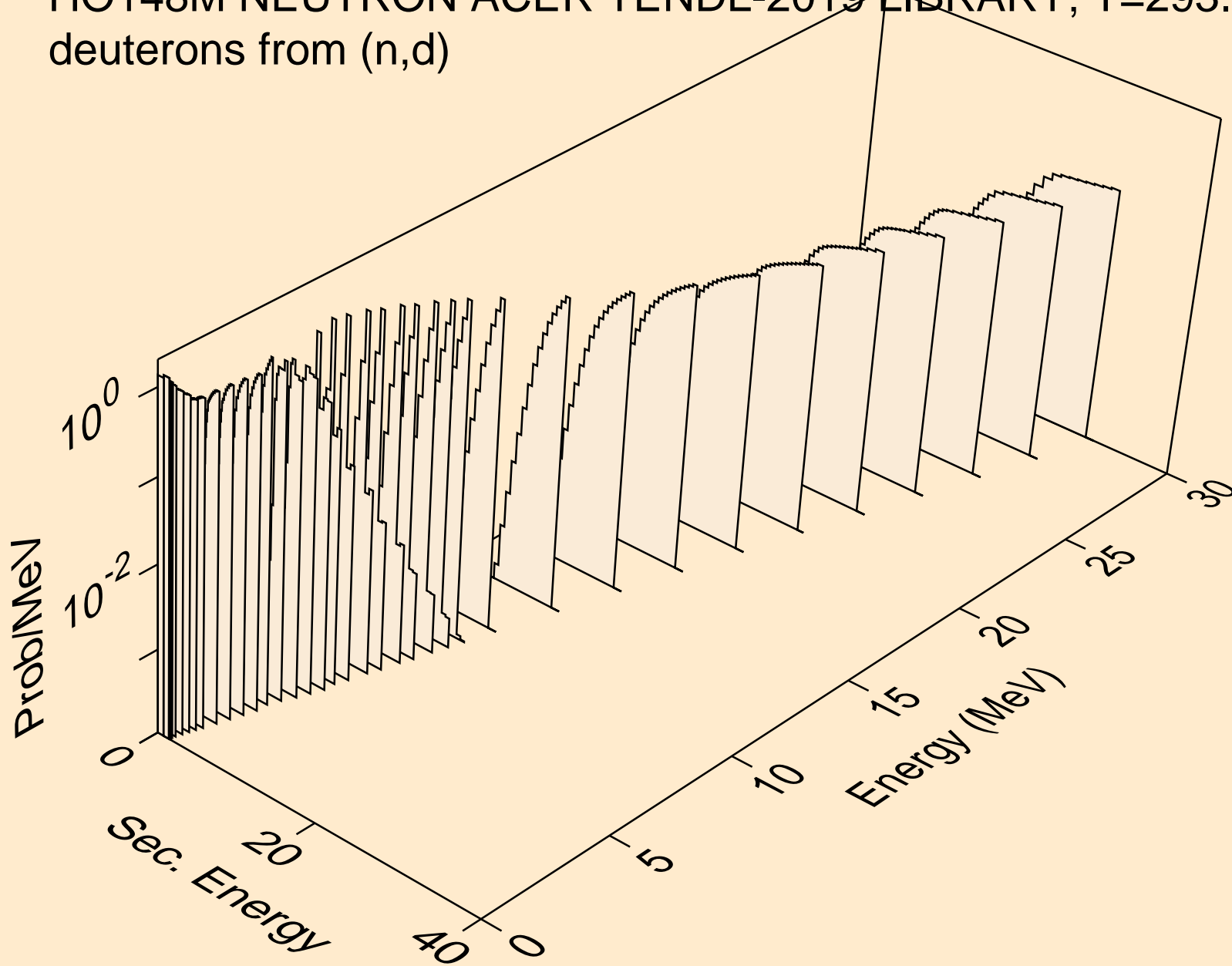

HO148M NEUTRON ACER TENDL-2019 LIBRARY; T=293.16K
deuterons from (n,pd)

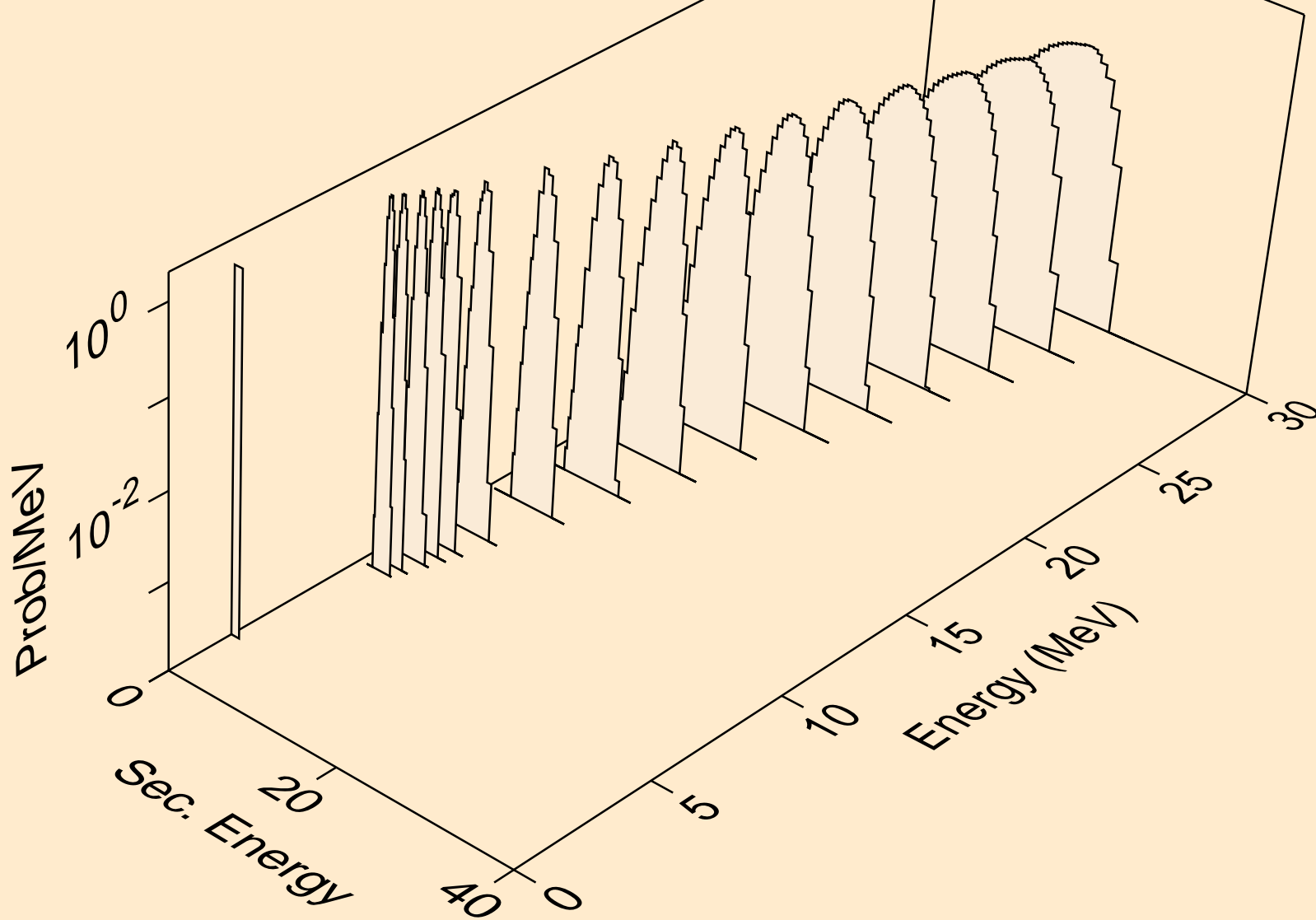

HO148M NEUTRON ACER TENDL-2019 LIBRARY; T=293.16K
deuterons from (n,da)

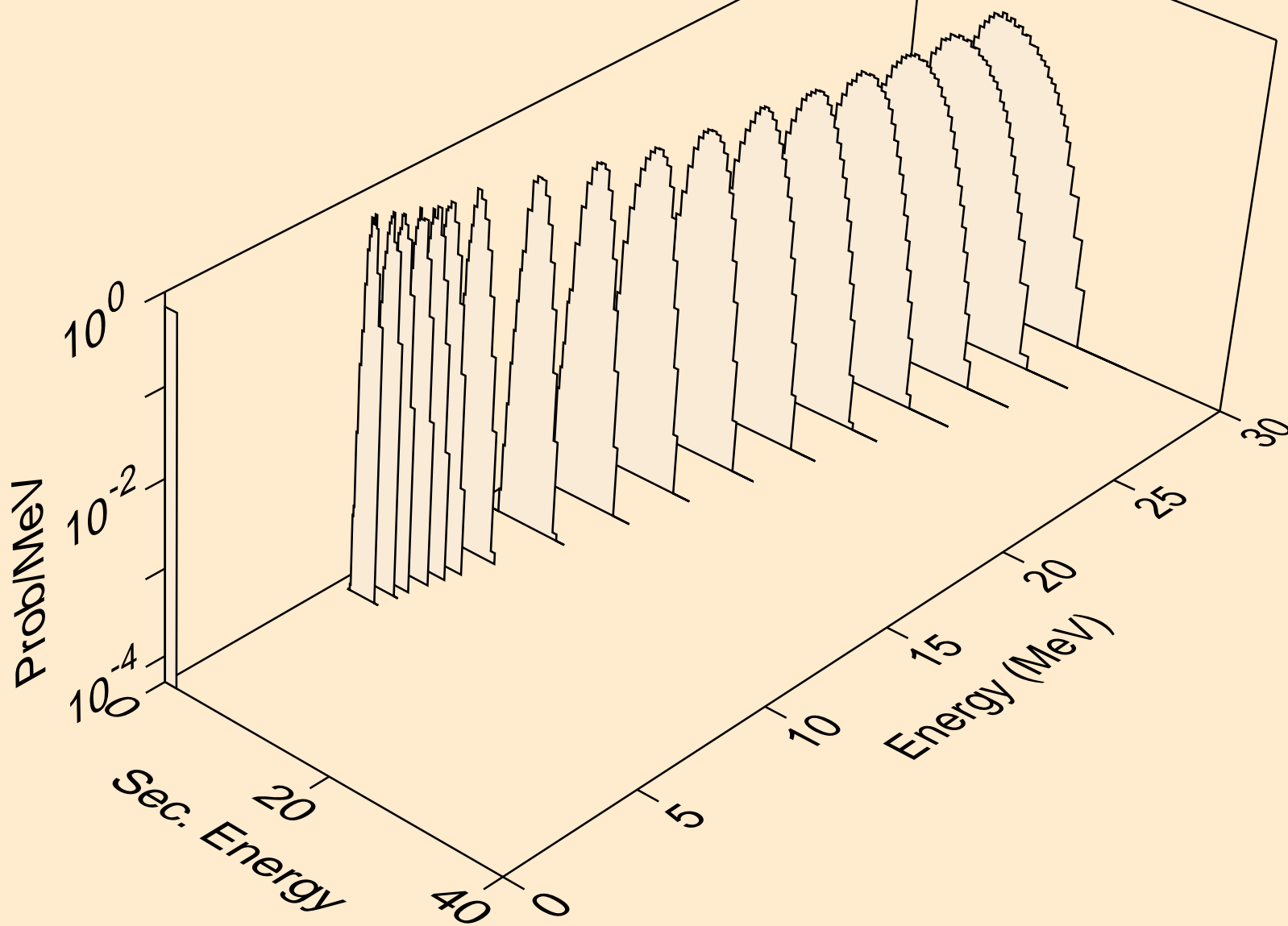

HO148M NEUTRON ACER TENDL-2019 LIBRARY; T=293.16K
tritons from (n,x)

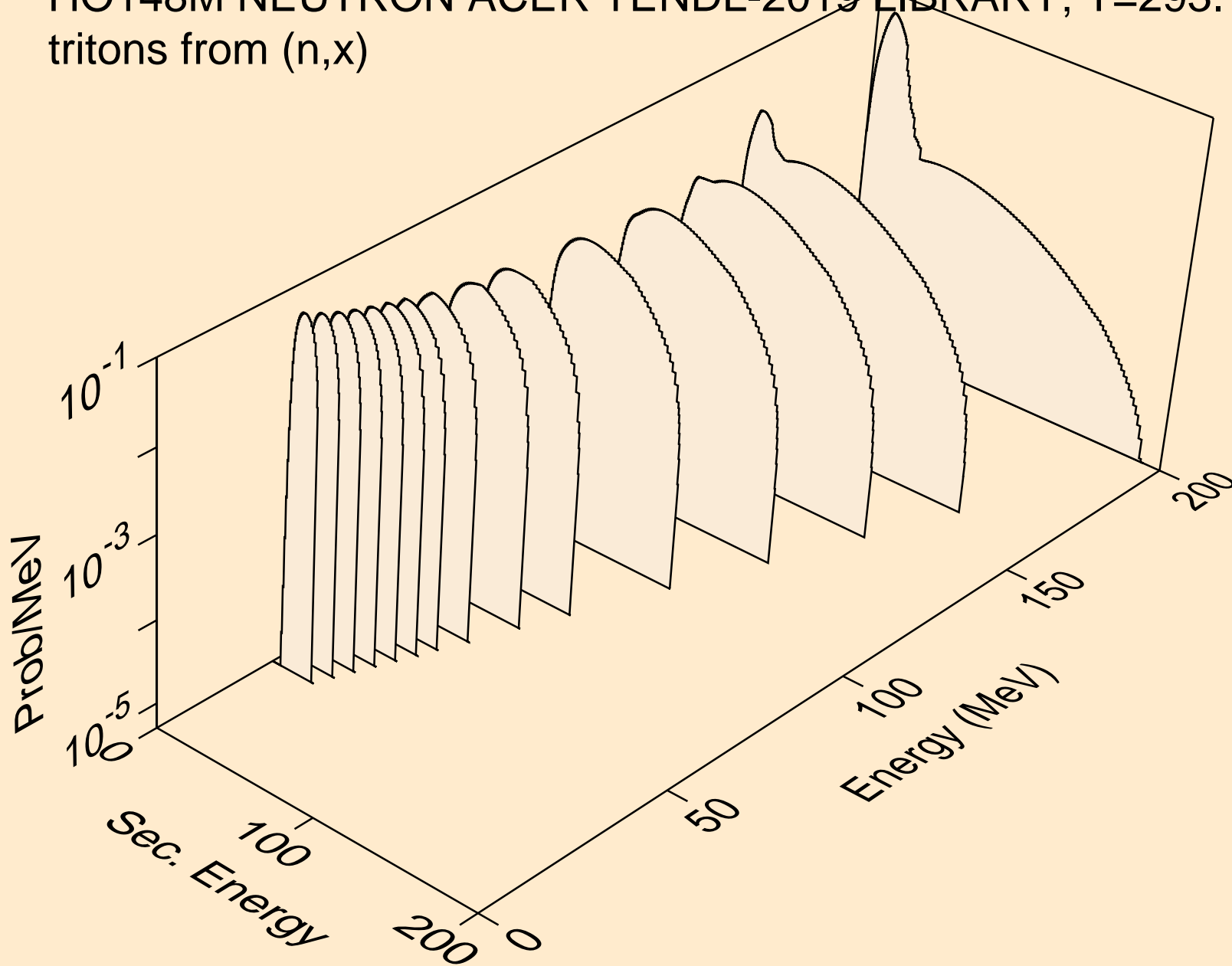

HO148M NEUTRON ACER TENDL-2019 LIBRARY; T=293.16K
tritons from (n,n*)t

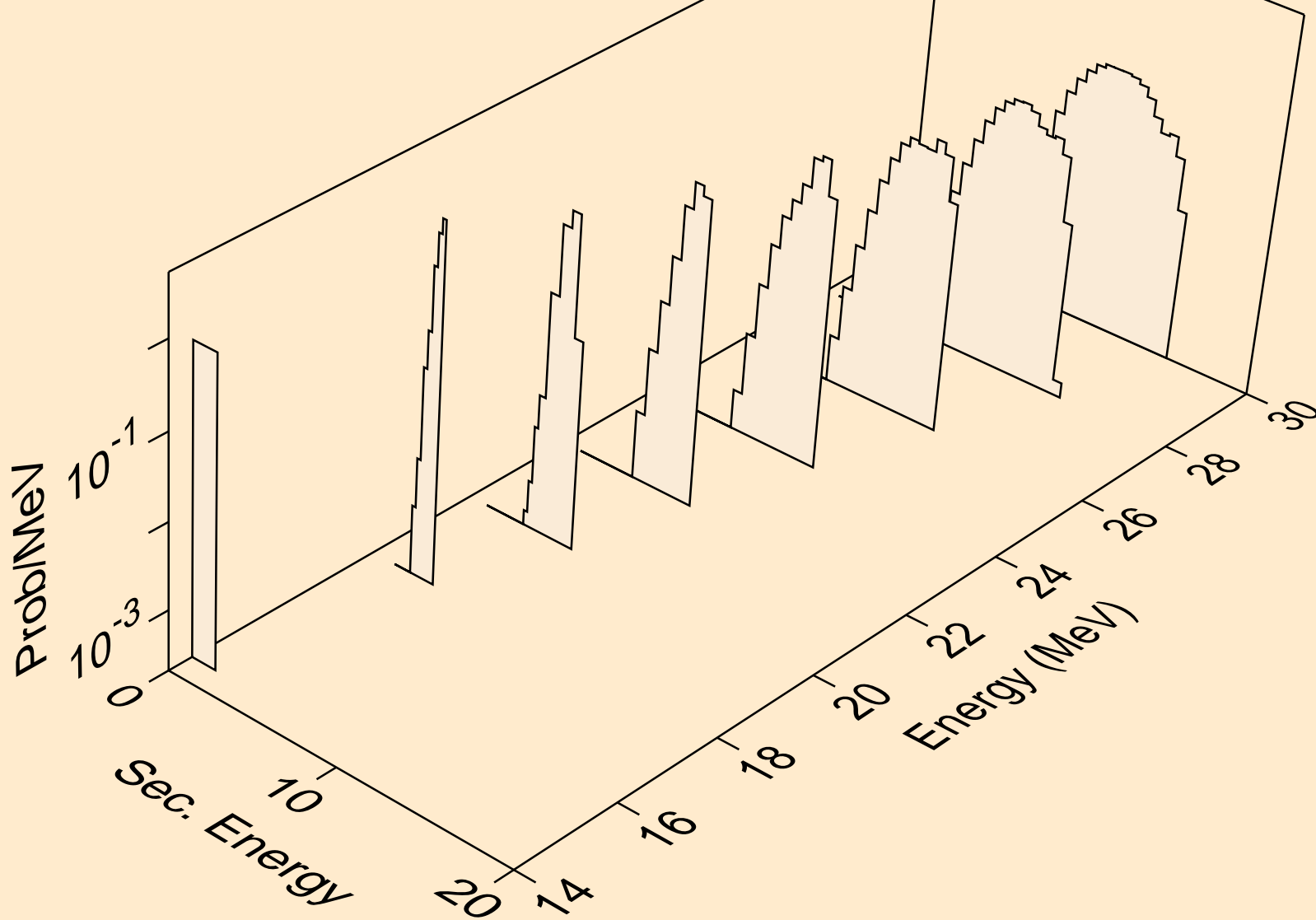

HO148M NEUTRON ACER TENDL-2019 LIBRARY; T=293.16K
tritons from (n,t)

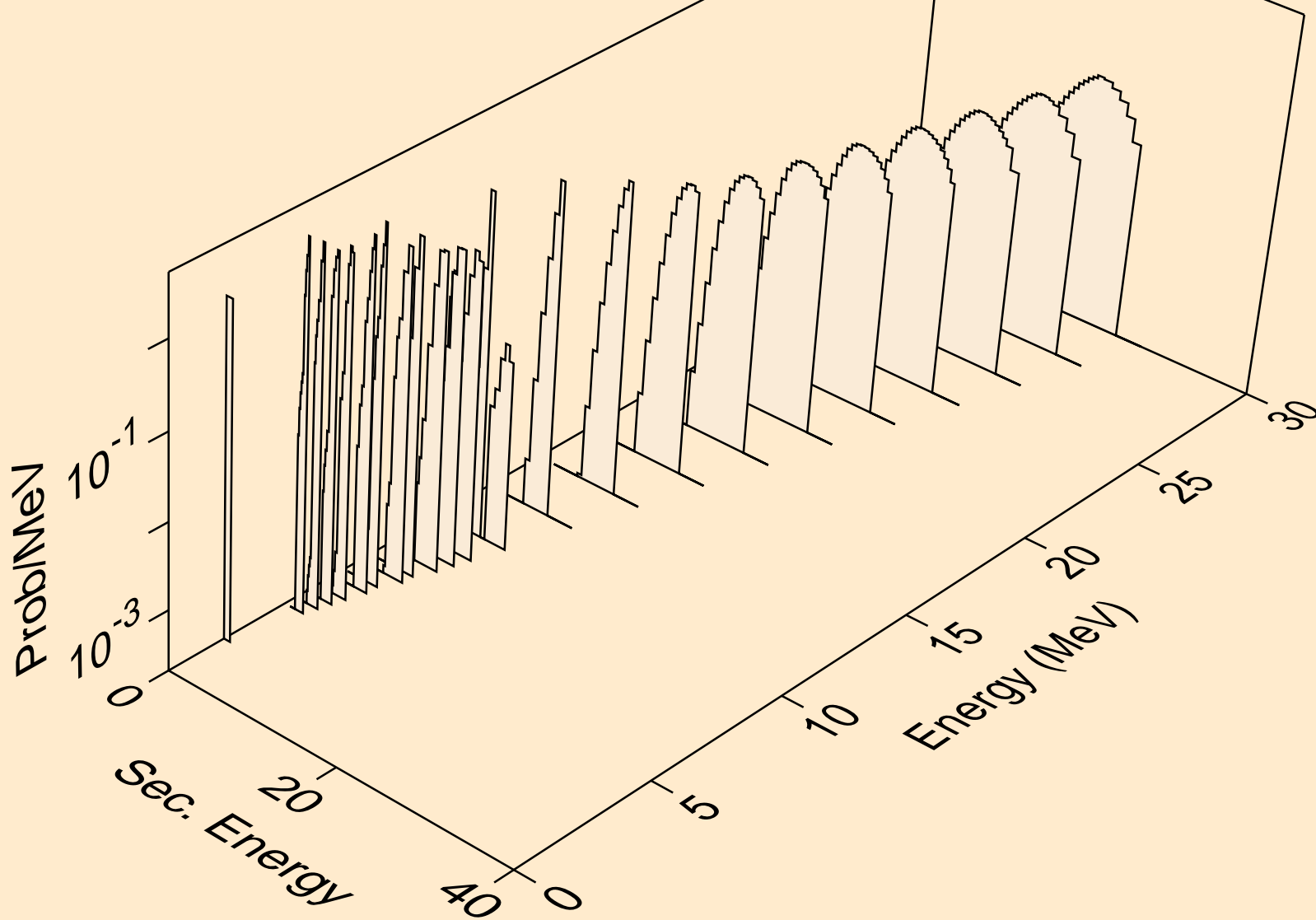

HO148M NEUTRON ACER TENDL-2019 LIBRARY; T=293.16K
tritons from (n,pt)

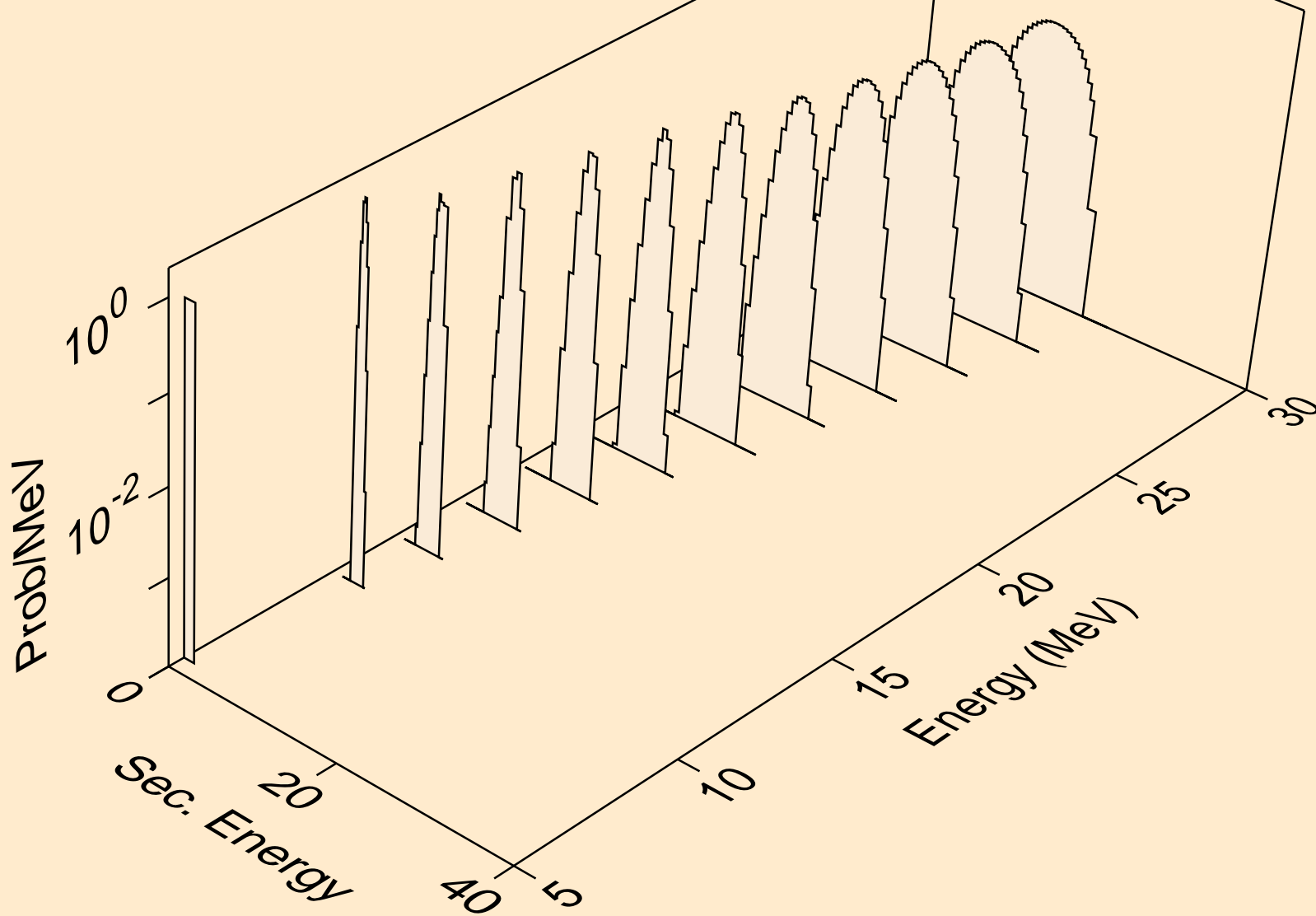

HO148M NEUTRON ACER TENDL-2019 LIBRARY; T=293.16K
he3s from (n,x)

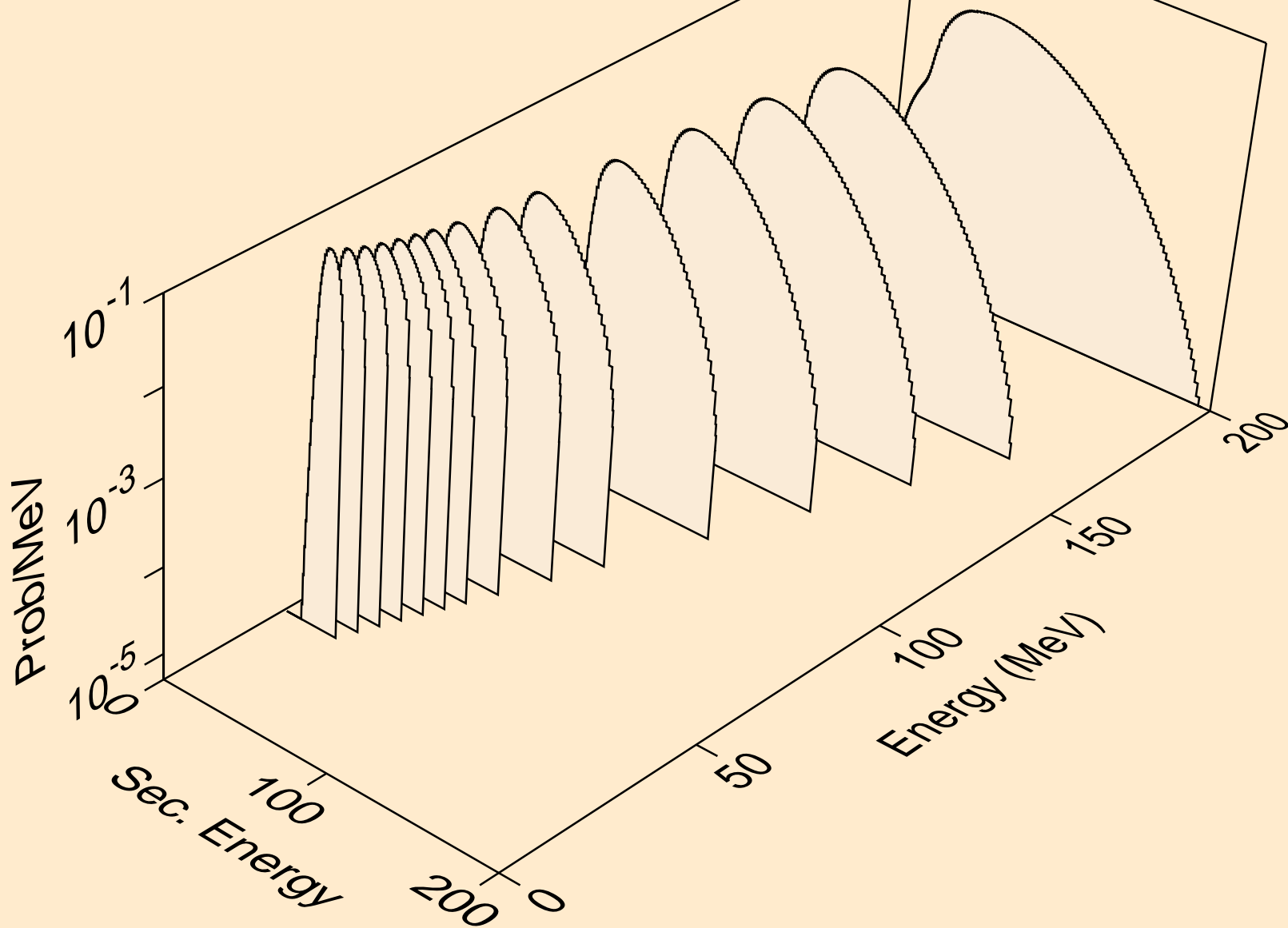

HO148M NEUTRON ACER TENDL-2019 LIBRARY; T=293.16K
he3s from (n,n*)he3

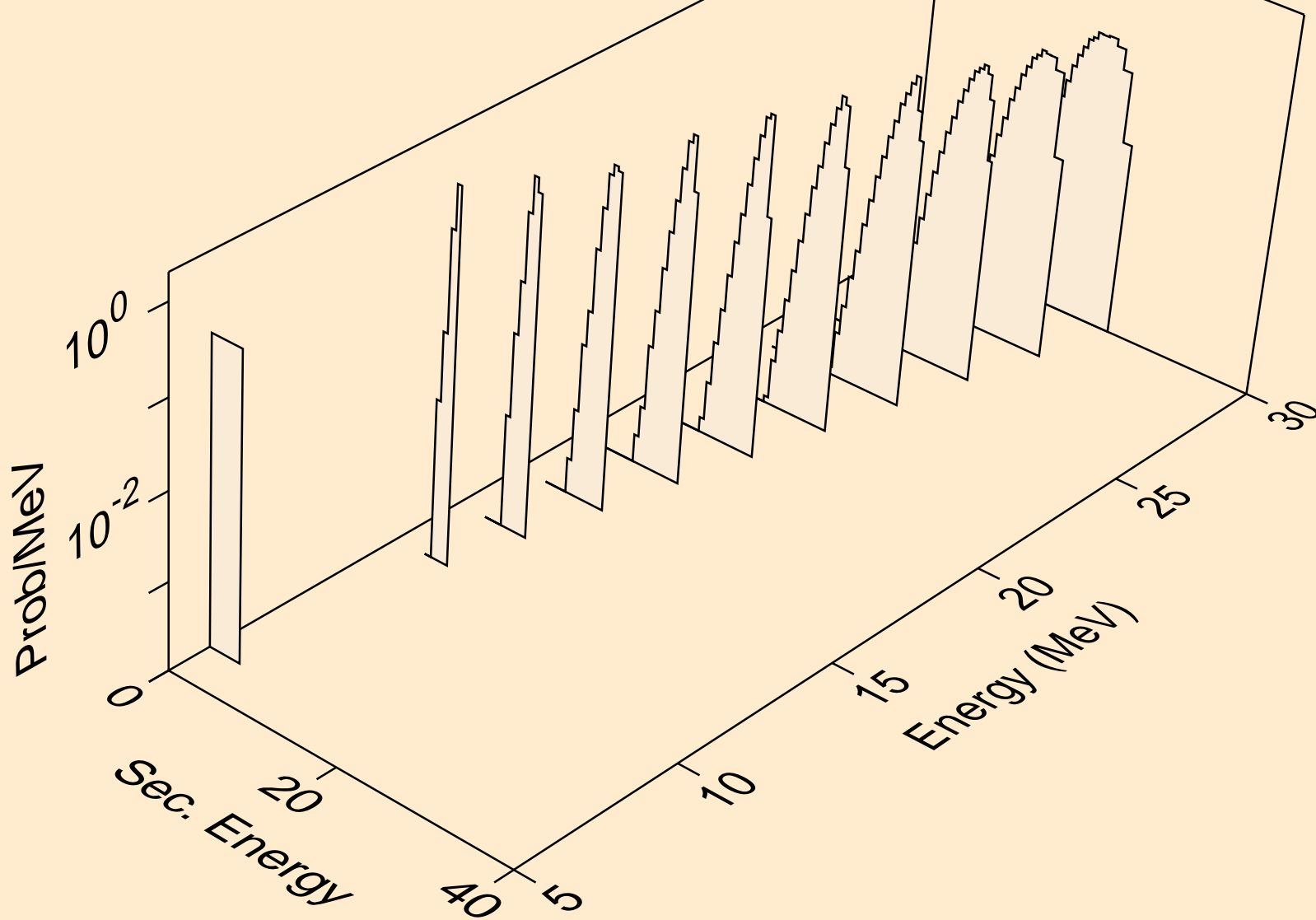

HO148M NEUTRON ACER TENDL-2019 LIBRARY; T=293.16K
he3s from (n,he3)

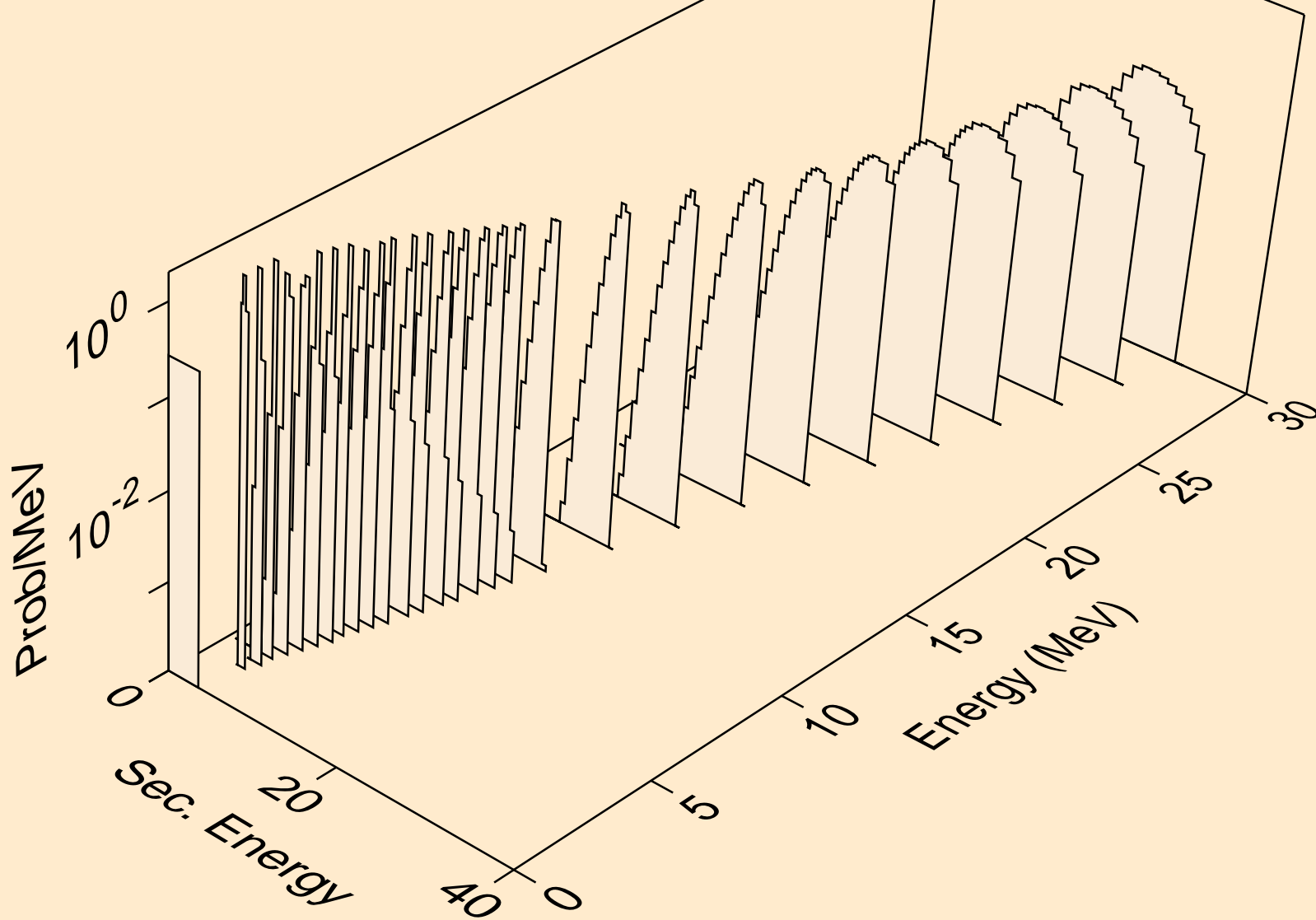

HO148M NEUTRON ACER TENDL-2019 LIBRARY; T=293.16K
alphas from (n,x)

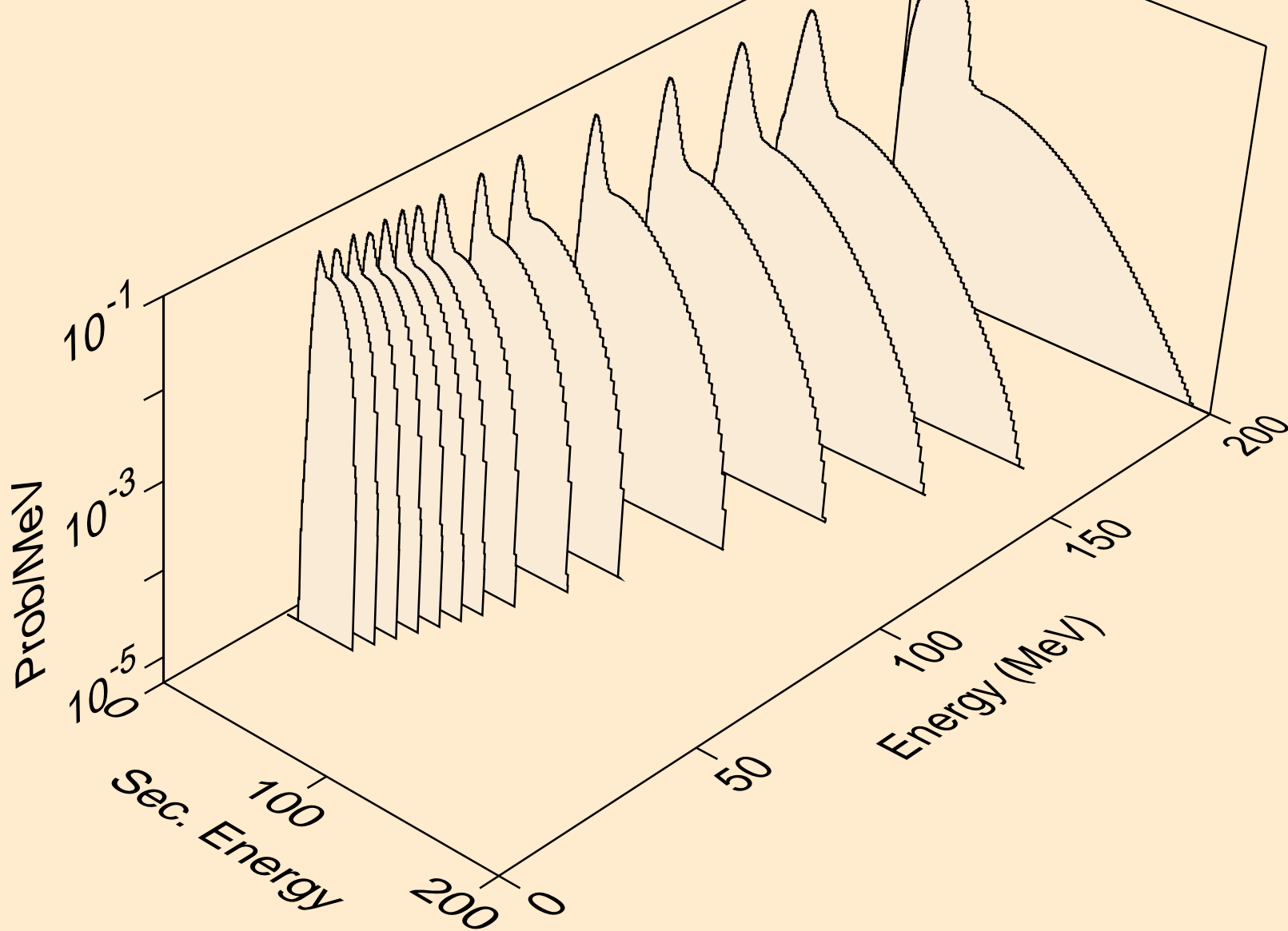

HO148M NEUTRON ACER TENDL-2019 LIBRARY; T=293.16K
alphas from (n,n*)a

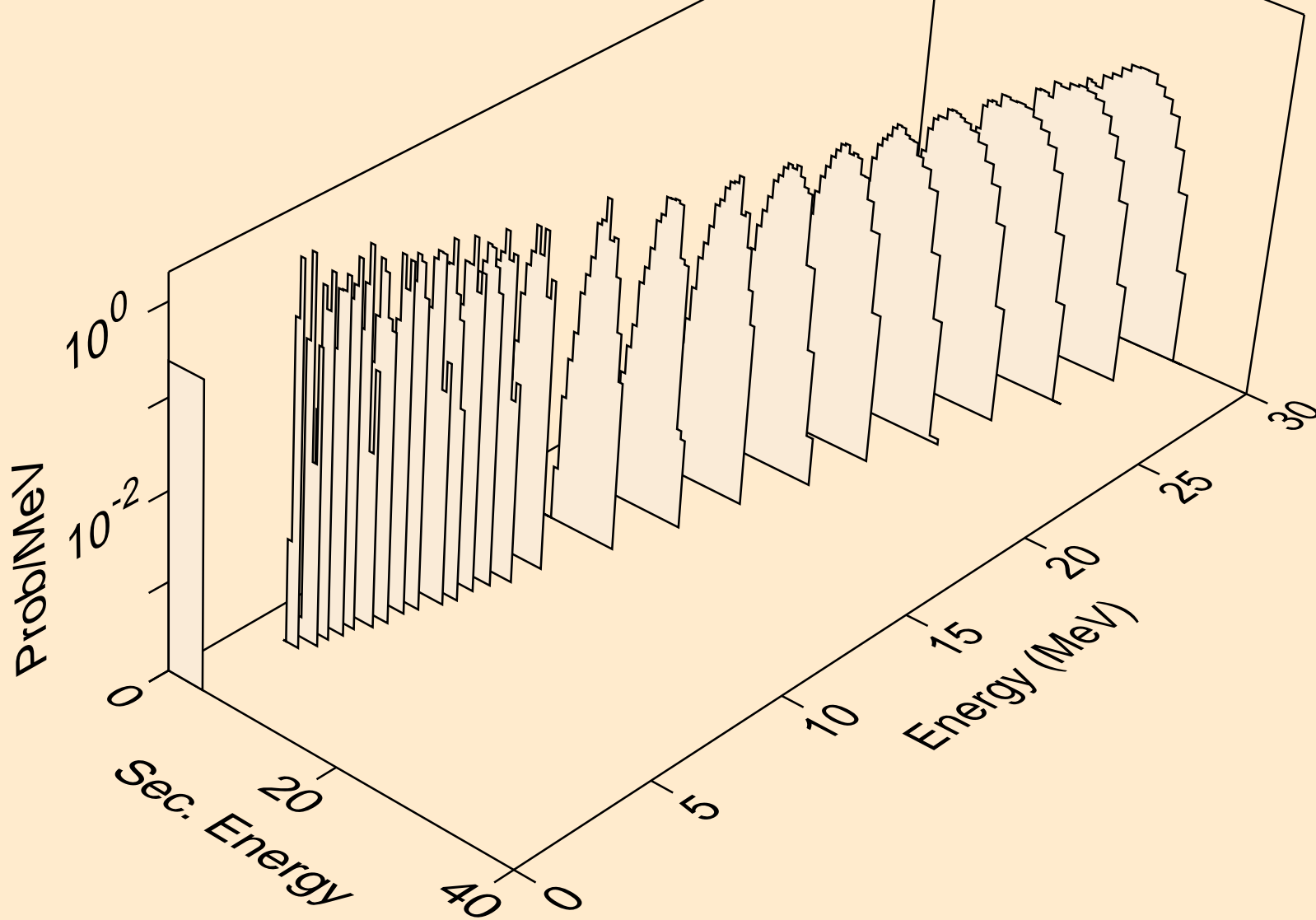

HO148M NEUTRON ACER TENDL-2019 LIBRARY; T=293.16K
alphas from (n,2n)a

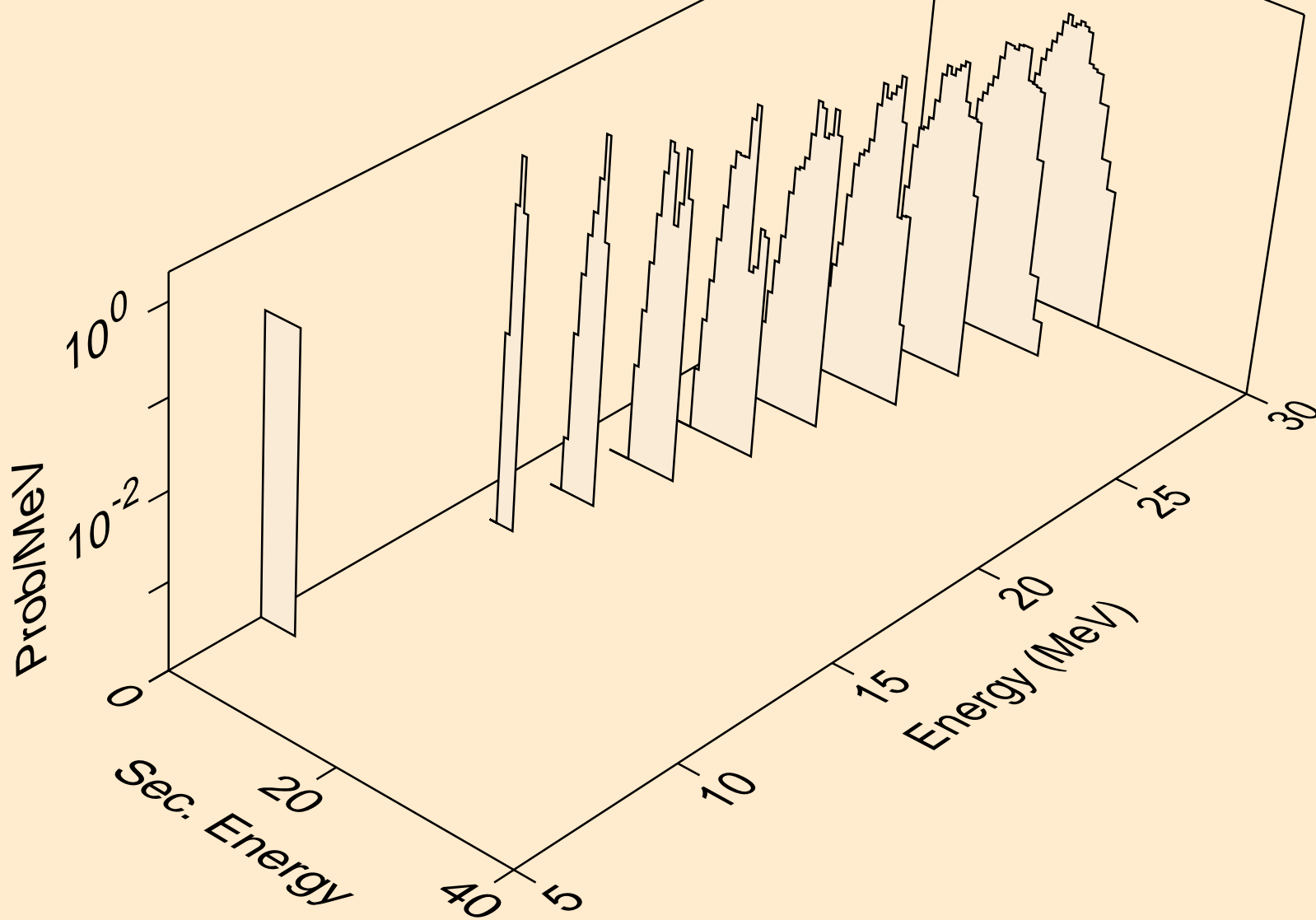

HO148M NEUTRON ACER TENDL-2019 LIBRARY; T=293.16K
alphas from (n,n*)2a

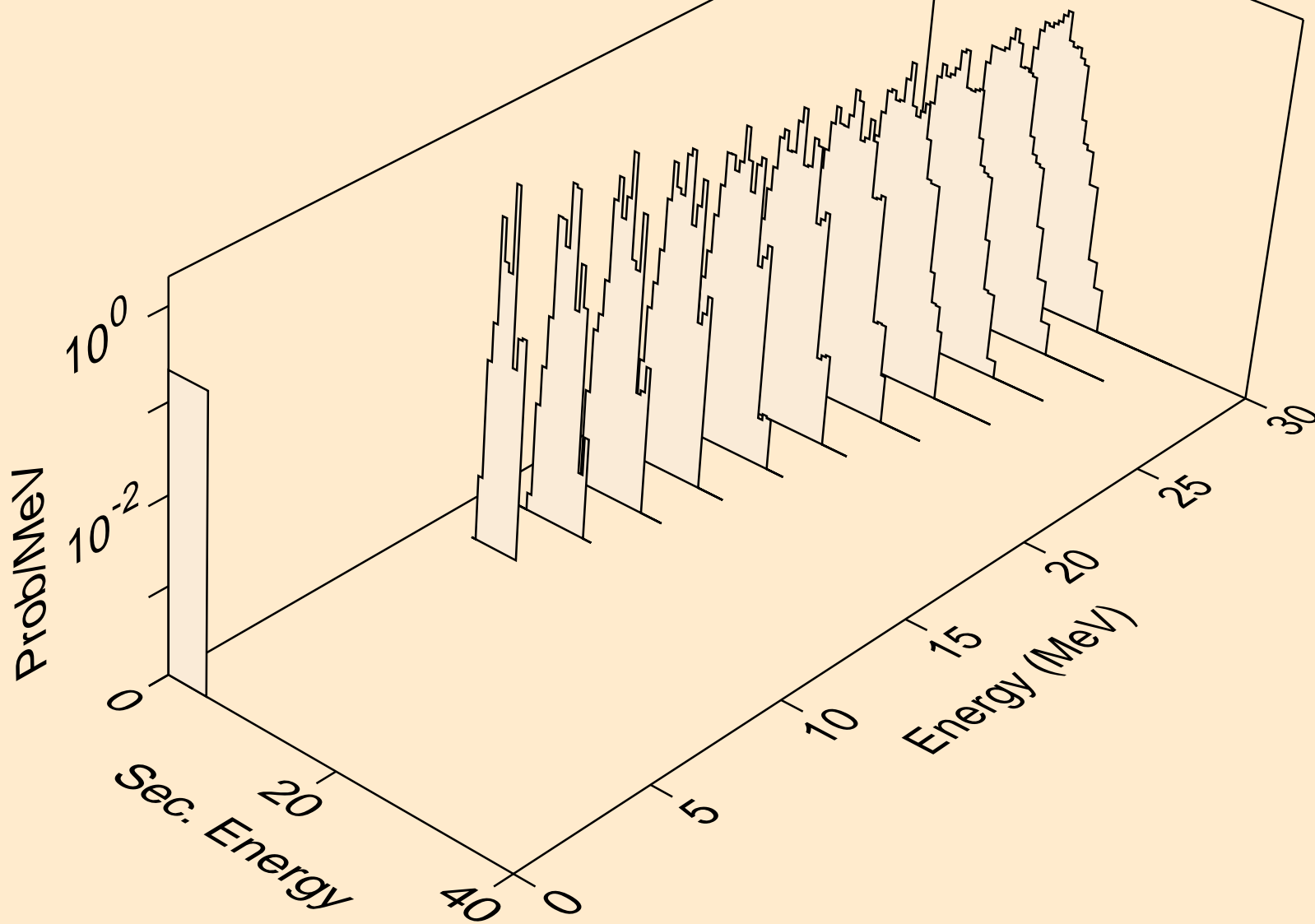

HO148M NEUTRON ACER TENDL-2019 LIBRARY; T=293.16K
alphas from (n,2n)2a

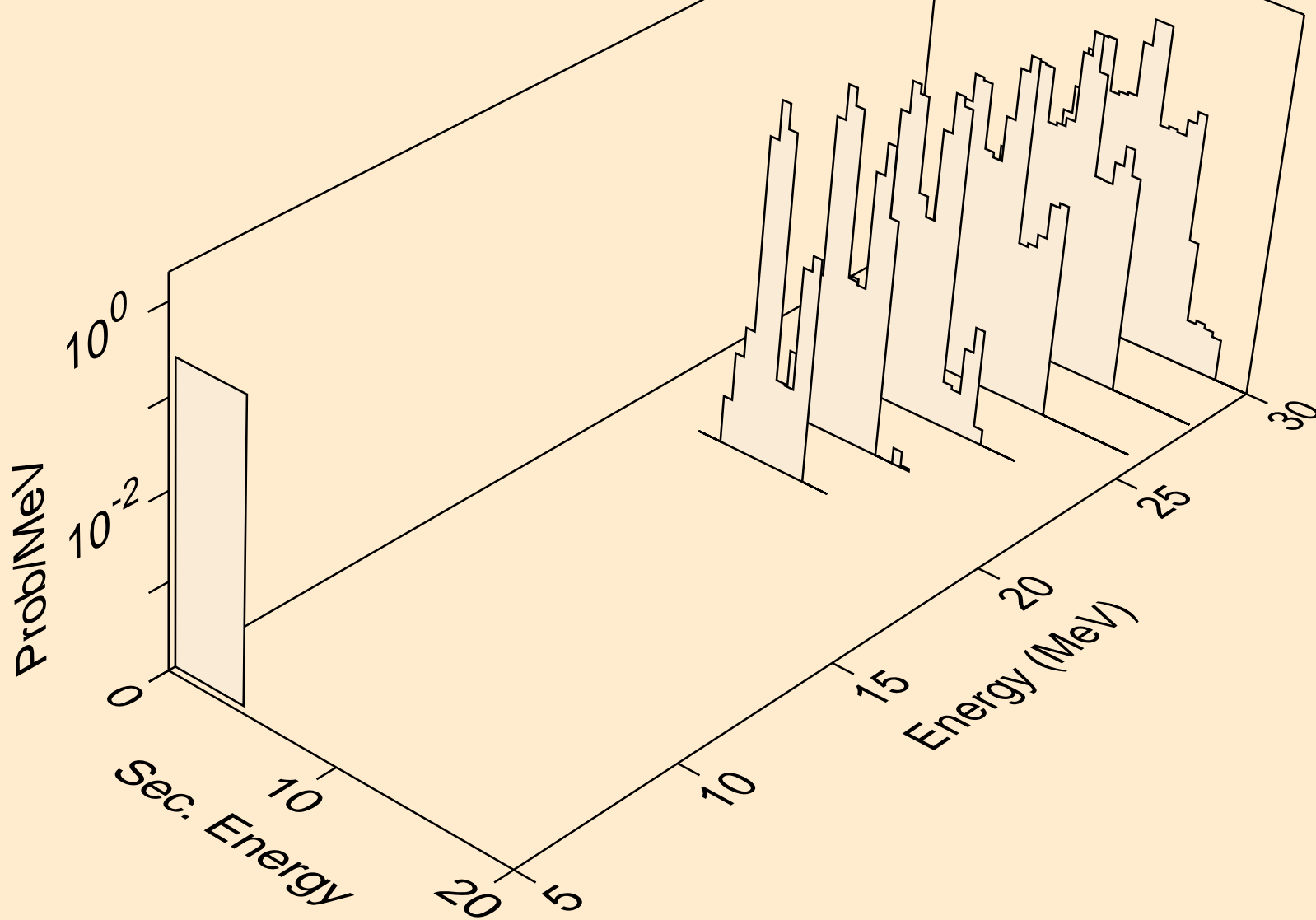

HO148M NEUTRON ACER TENDL-2019 LIBRARY; T=293.16K
alphas from (n,npa)

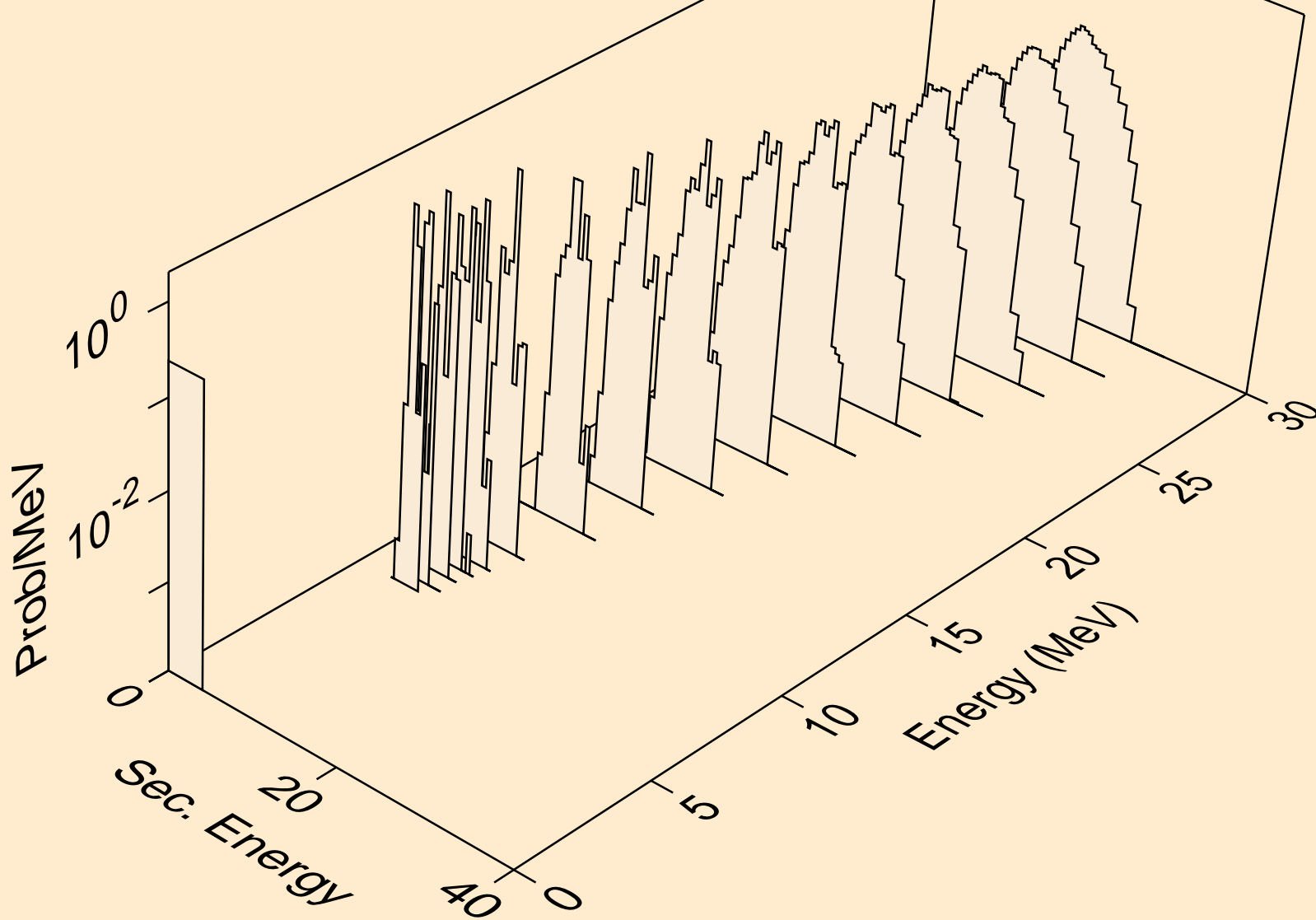

HO148M NEUTRON ACER TENDL-2019 LIBRARY; T=293.16K
alphas from (n,a)

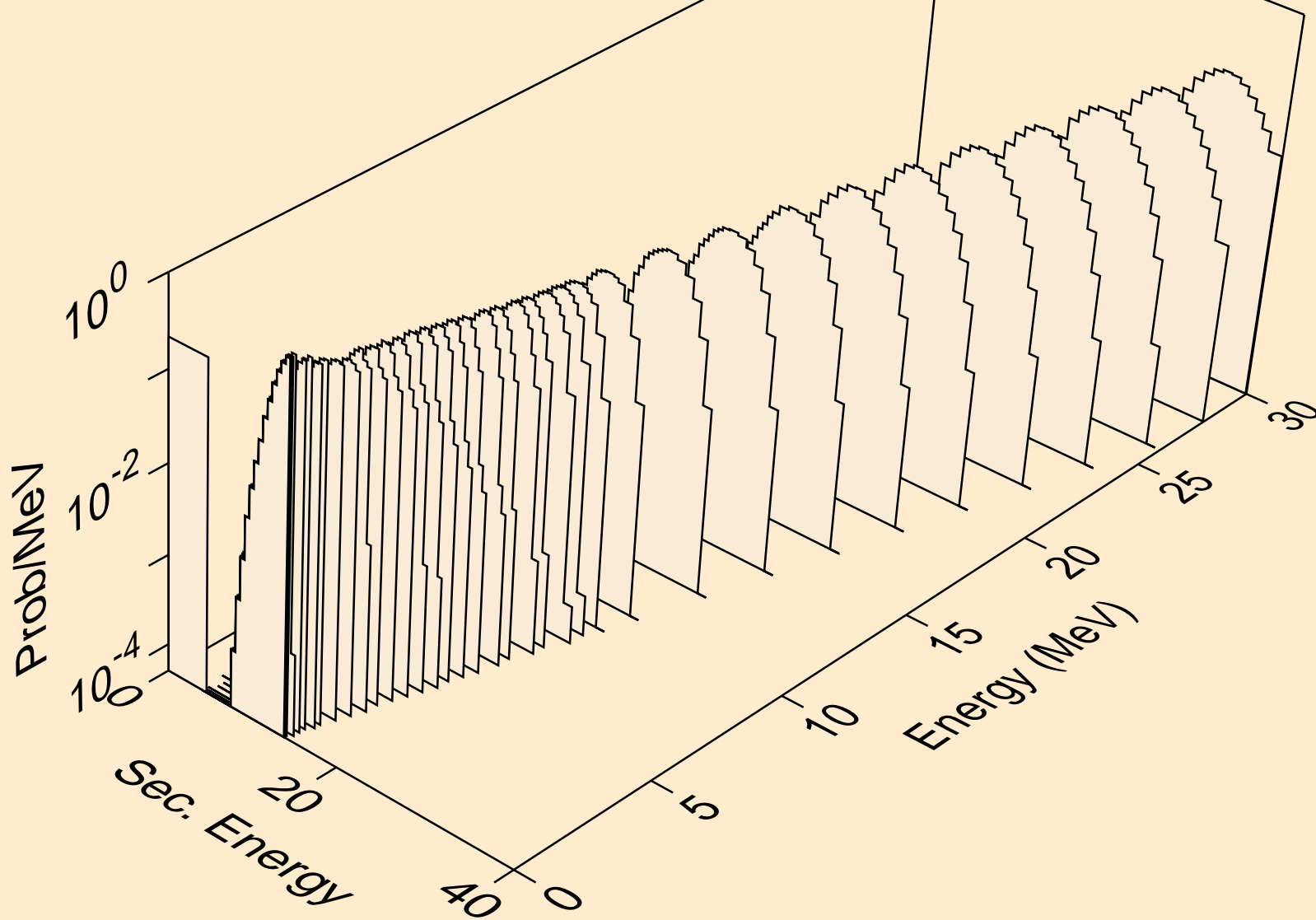

HO148M NEUTRON ACER TENDL-2019 LIBRARY; T=293.16K
alphas from (n,2a)

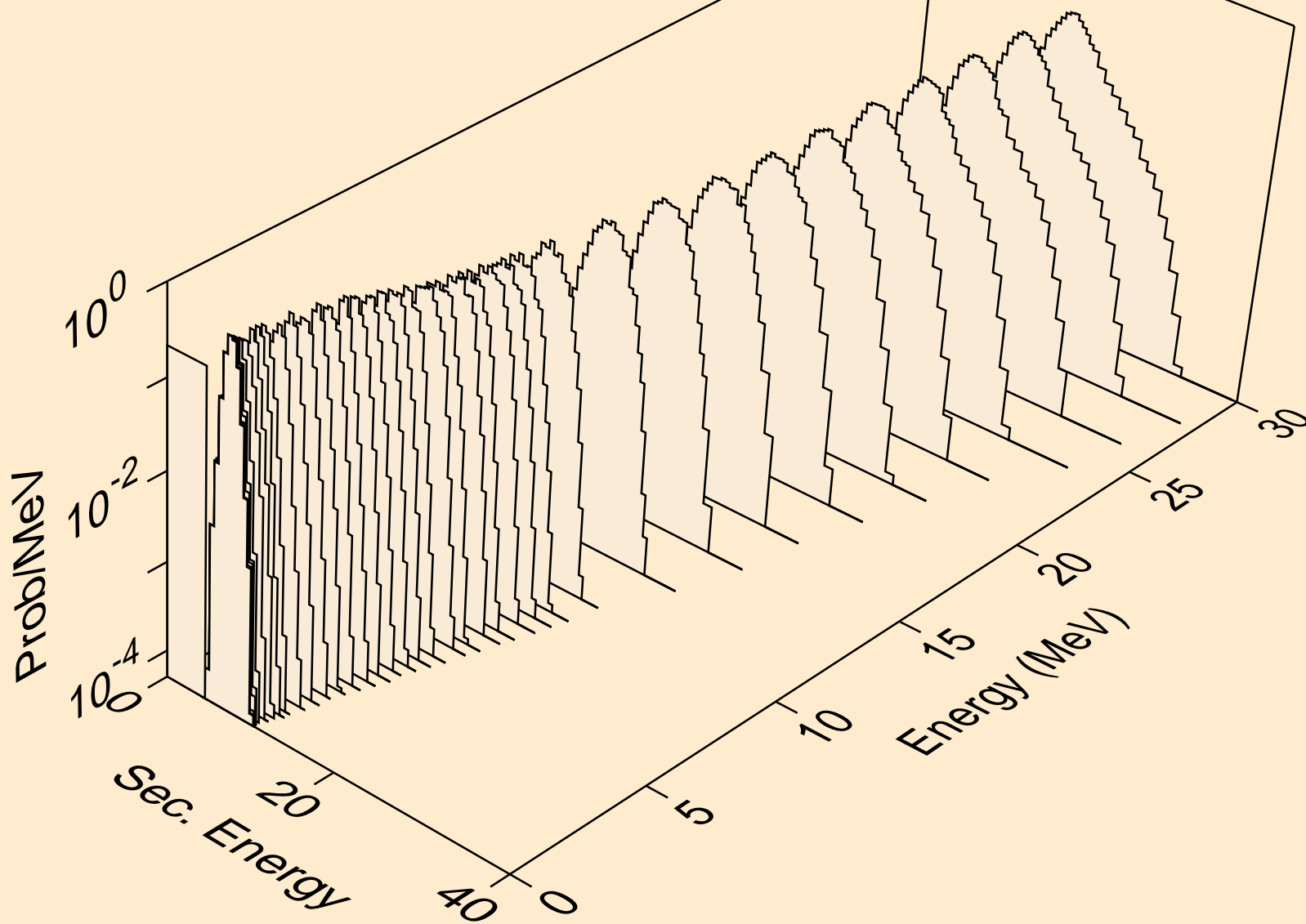

HO148M NEUTRON ACER TENDL-2019 LIBRARY; T=293.16K
alphas from (n,3a)

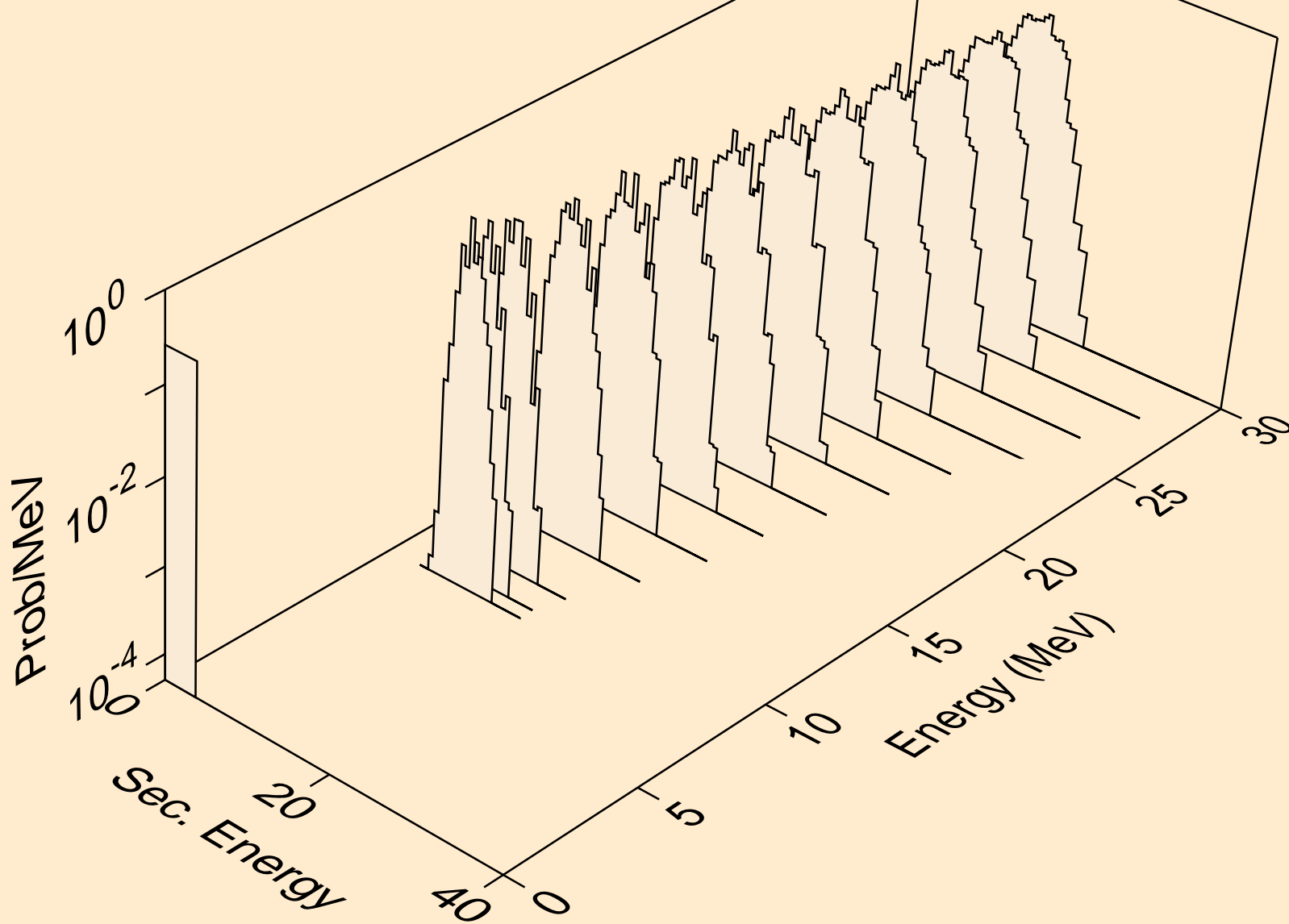

HO148M NEUTRON ACER TENDL-2019 LIBRARY; T=293.16K
alphas from (n,pa)

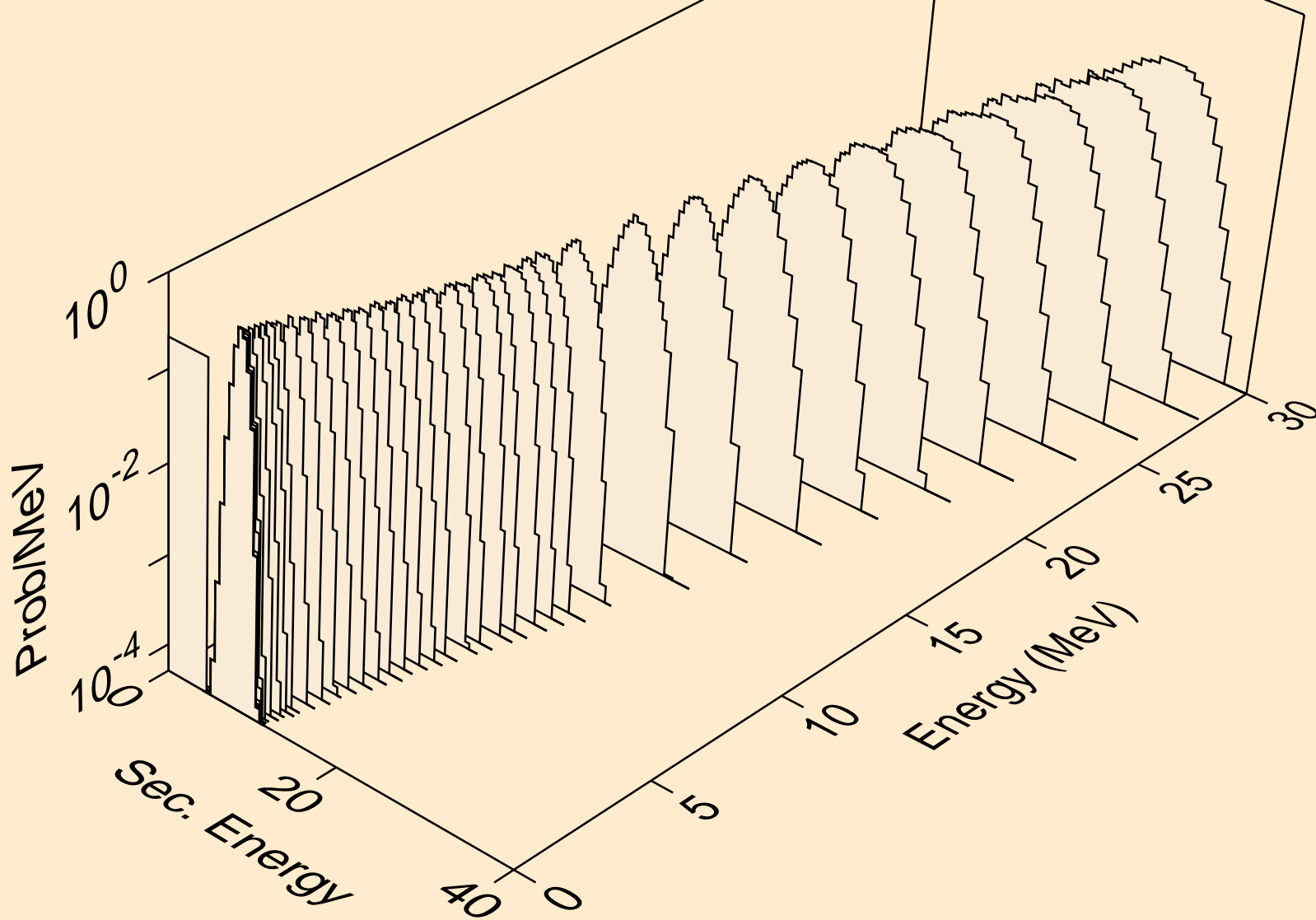

HO148M NEUTRON ACER TENDL-2019 LIBRARY; T=293.16K
alphas from (n,da)

