

HO162 NEUTRON ACER TENDL-2019 LIBRARY; T=293.16K

Principal cross sections

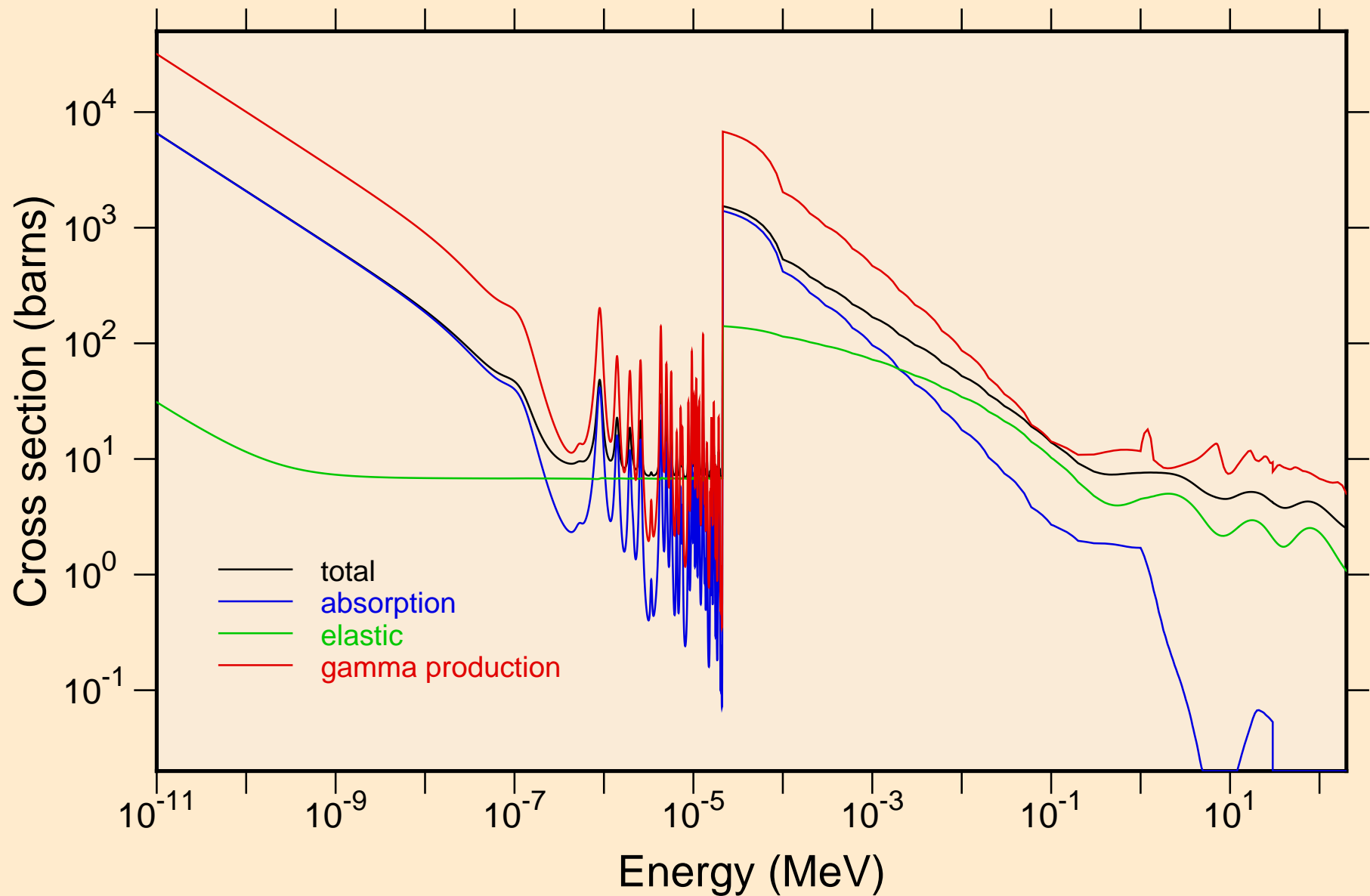

HO162 NEUTRON ACER TENDL-2019 LIBRARY; T=293.16K
resonance total cross section

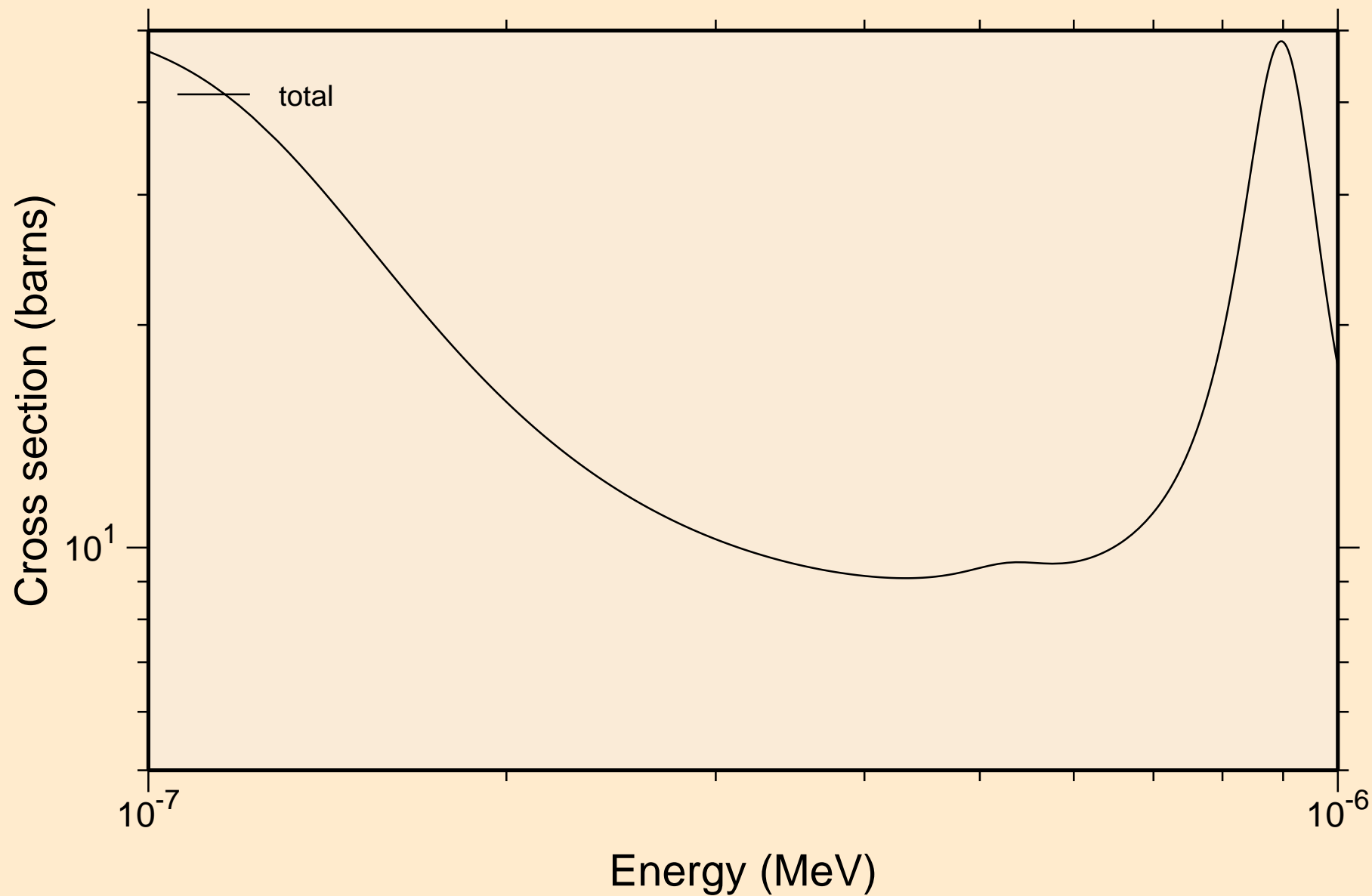

HO162 NEUTRON ACER TENDL-2019 LIBRARY; T=293.16K
resonance total cross section

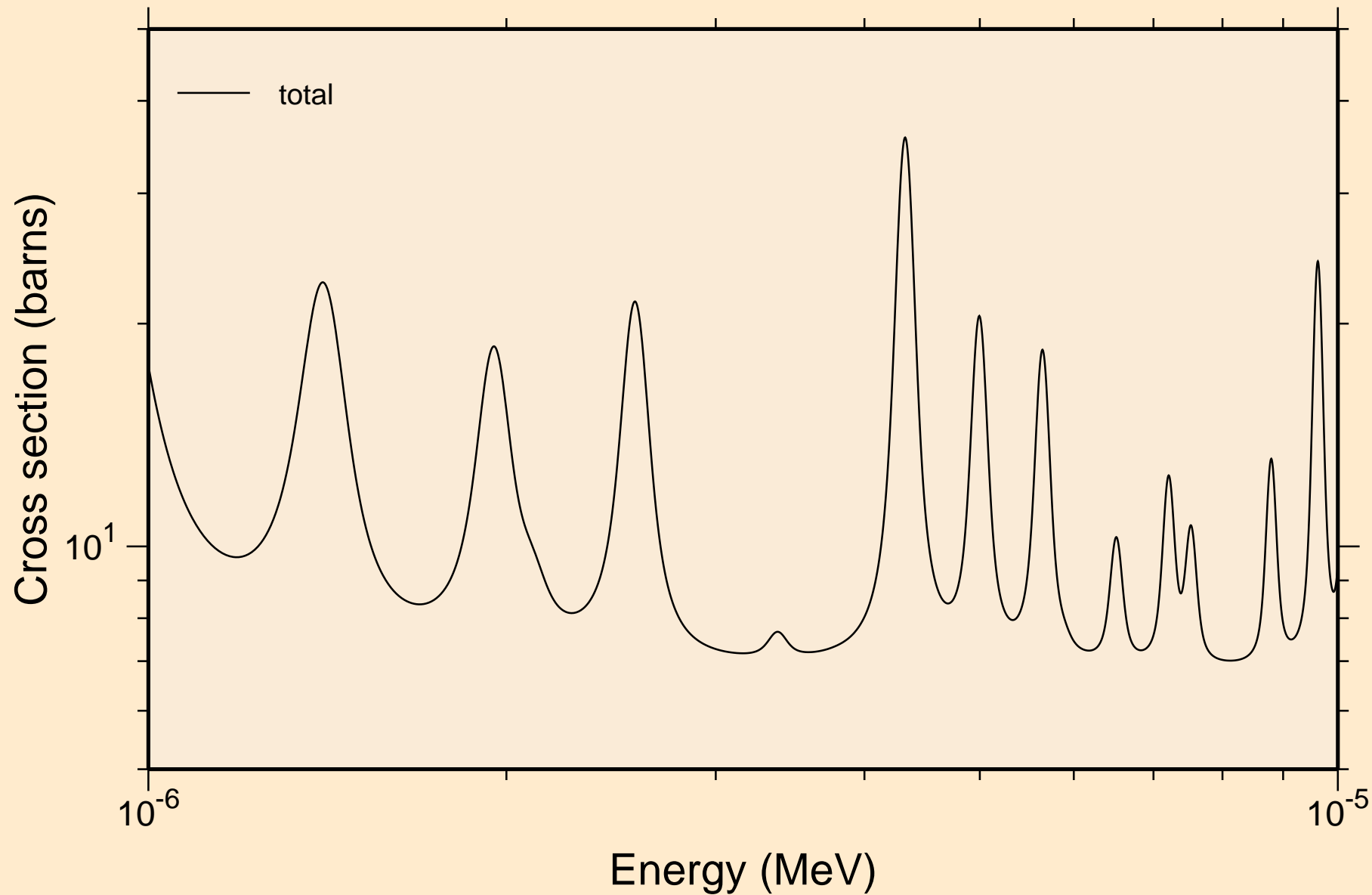

HO162 NEUTRON ACER TENDL-2019 LIBRARY; T=293.16K
resonance total cross section

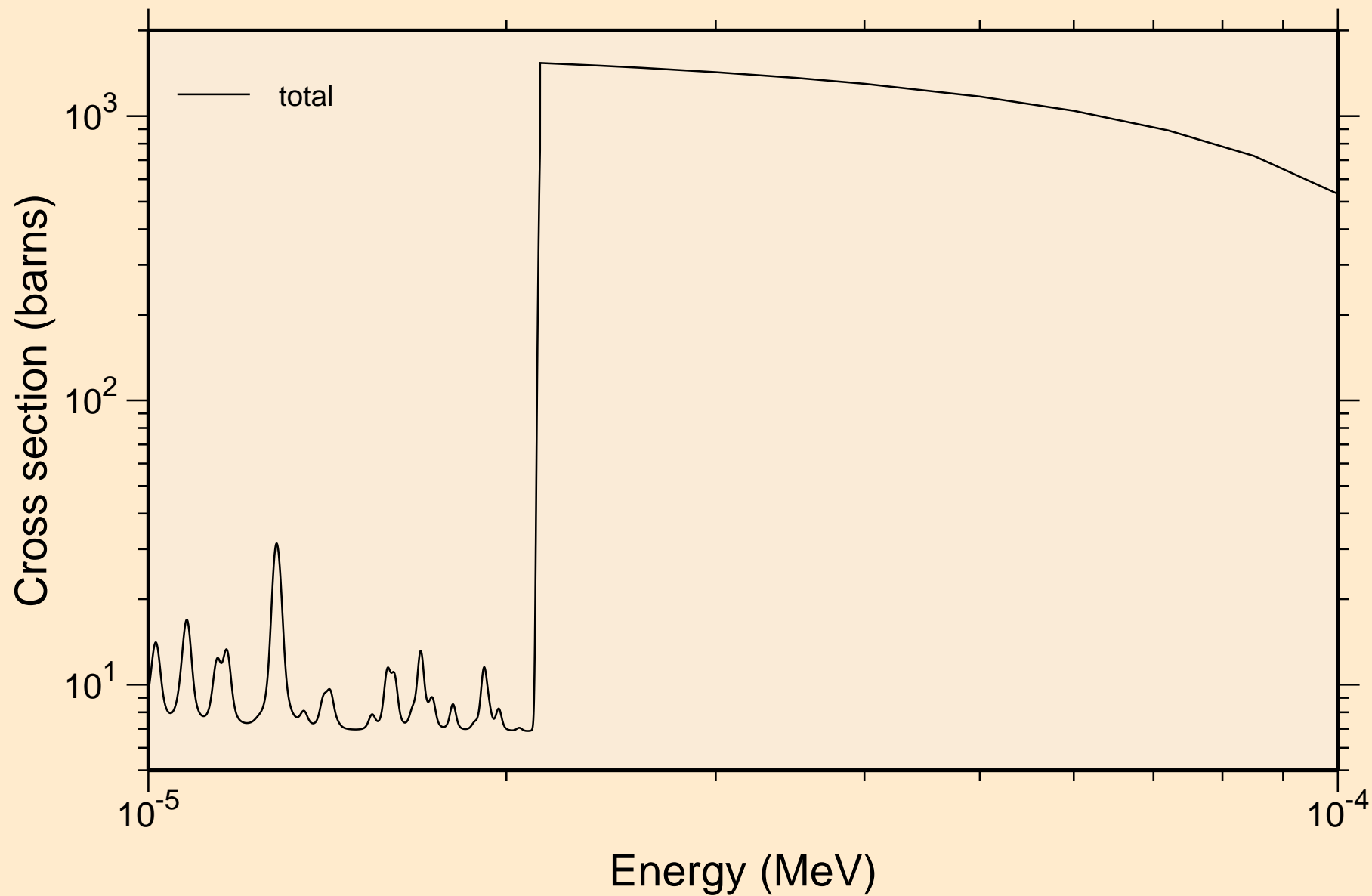

HO162 NEUTRON ACER TENDL-2019 LIBRARY; T=293.16K
resonance total cross section

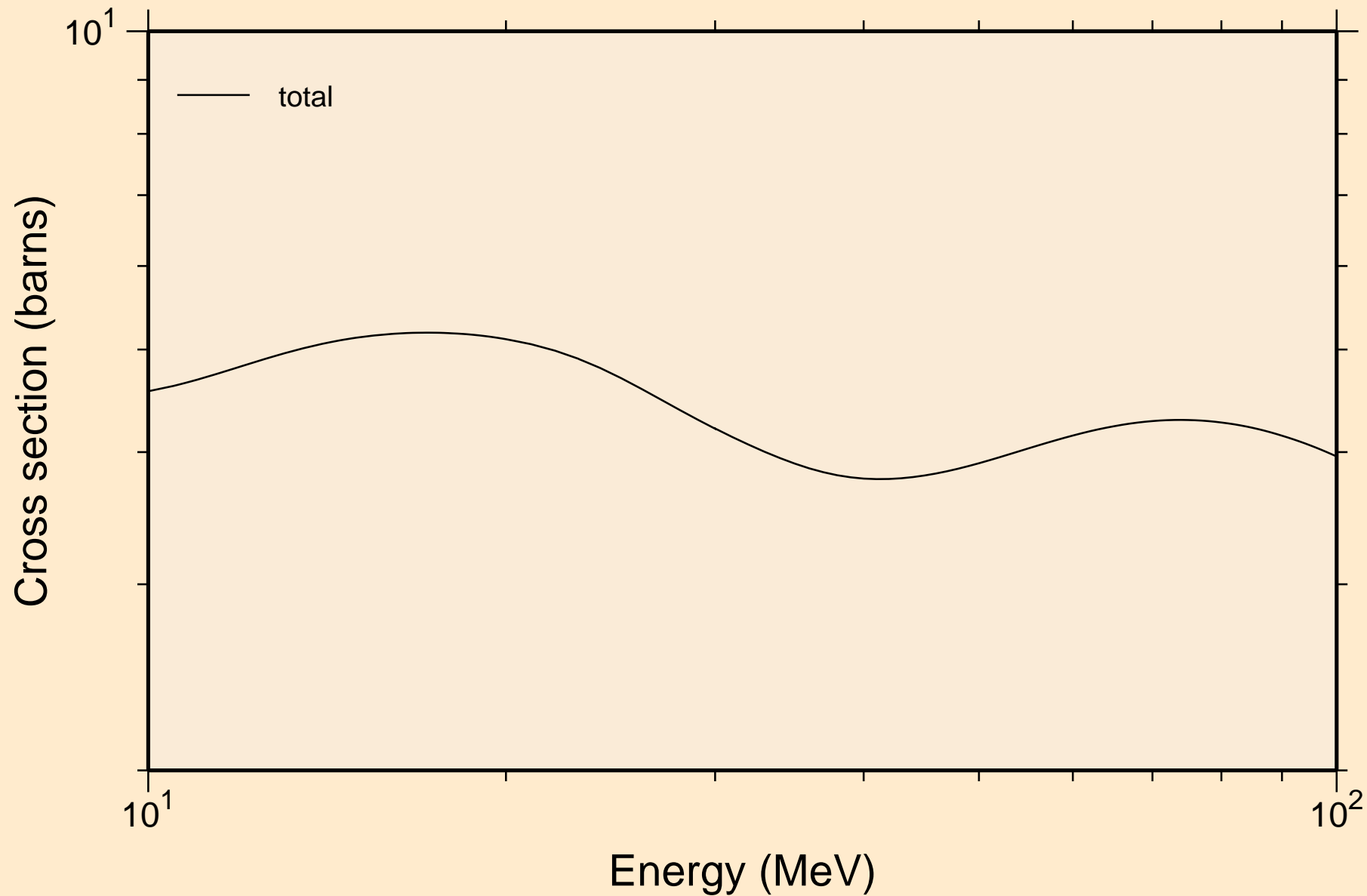

HO162 NEUTRON ACER TENDL-2019 LIBRARY; T=293.16K
resonance absorption cross sections

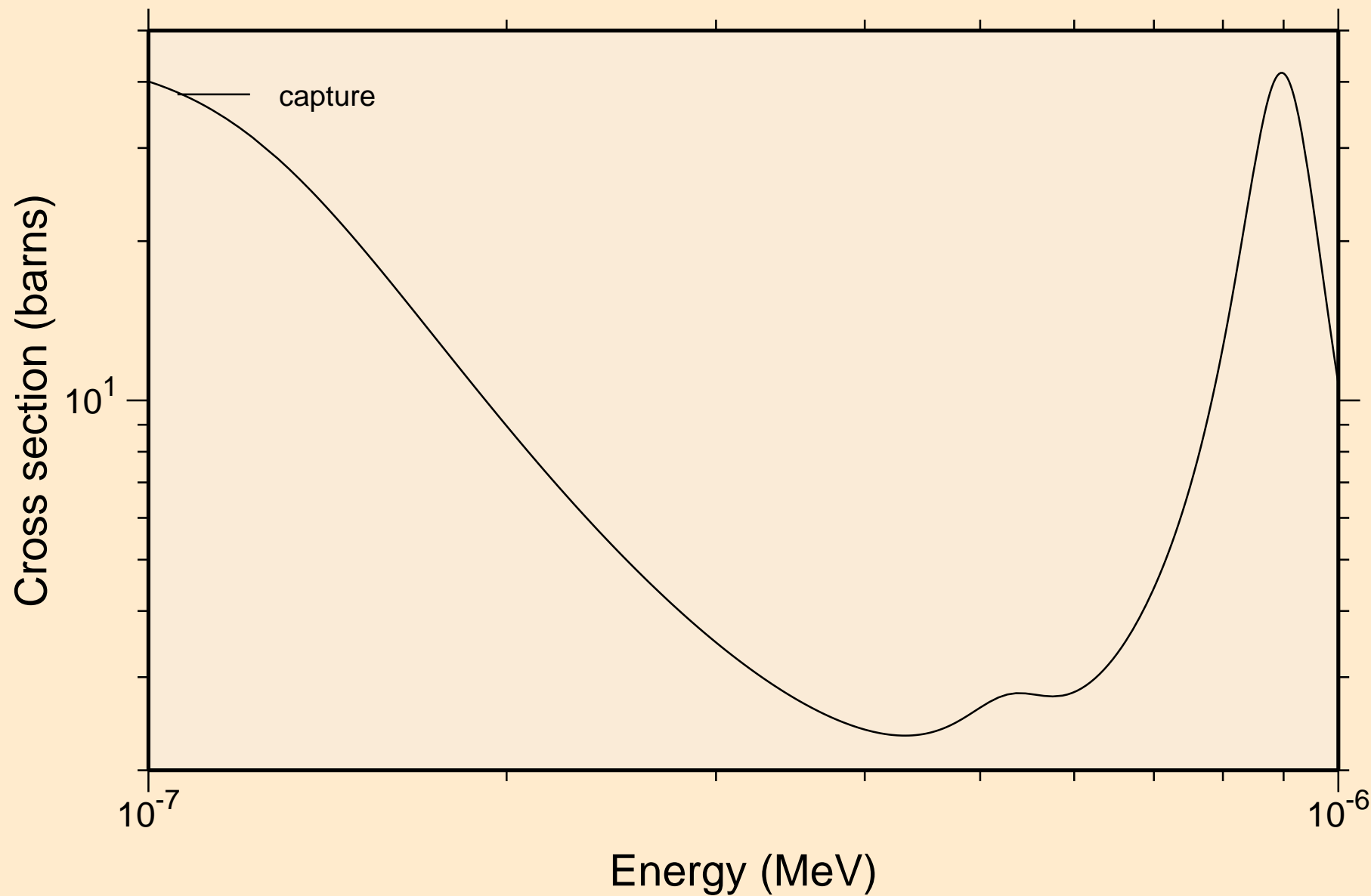

HO162 NEUTRON ACER TENDL-2019 LIBRARY; T=293.16K
resonance absorption cross sections

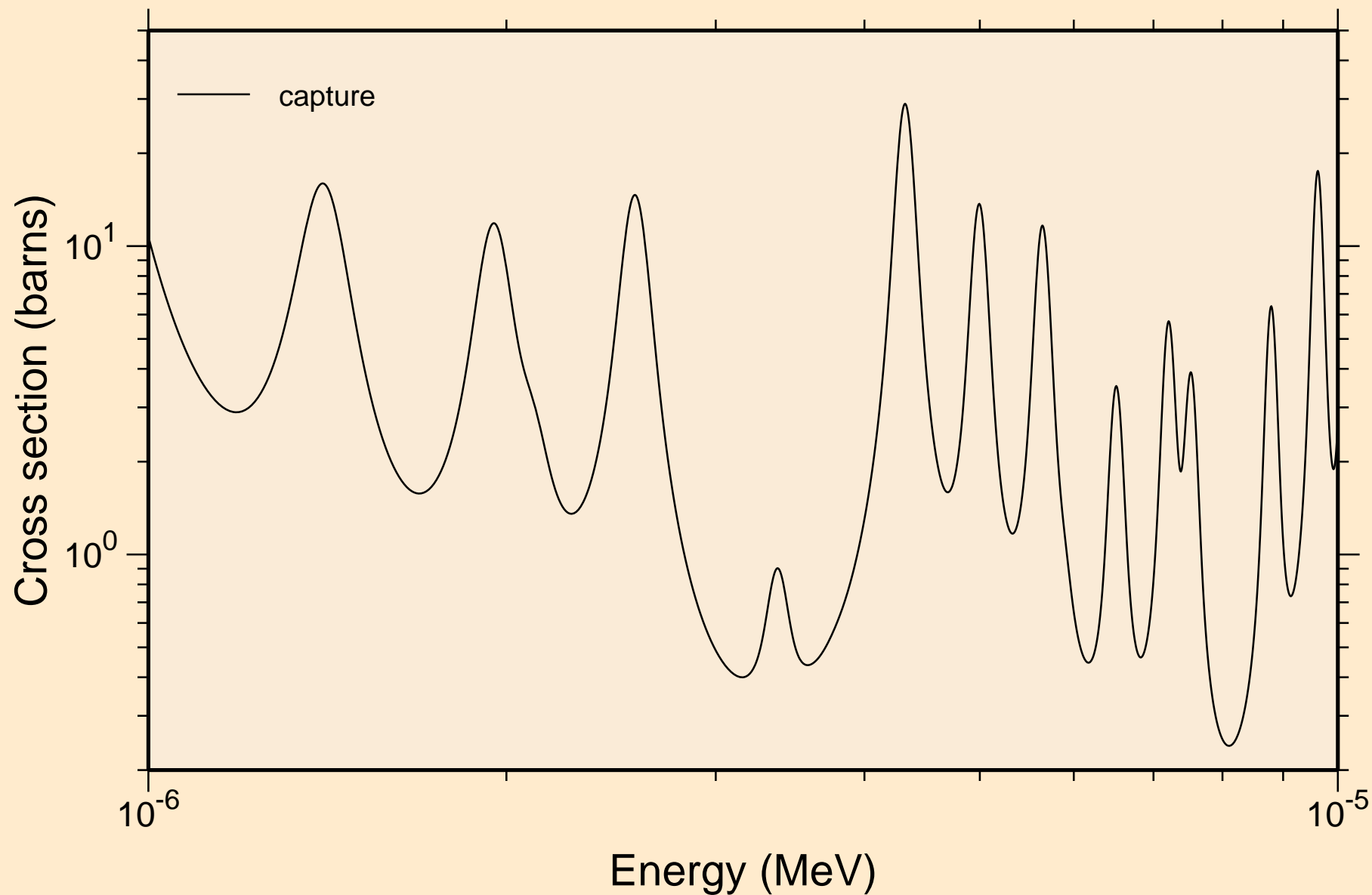

HO162 NEUTRON ACER TENDL-2019 LIBRARY; T=293.16K
resonance absorption cross sections

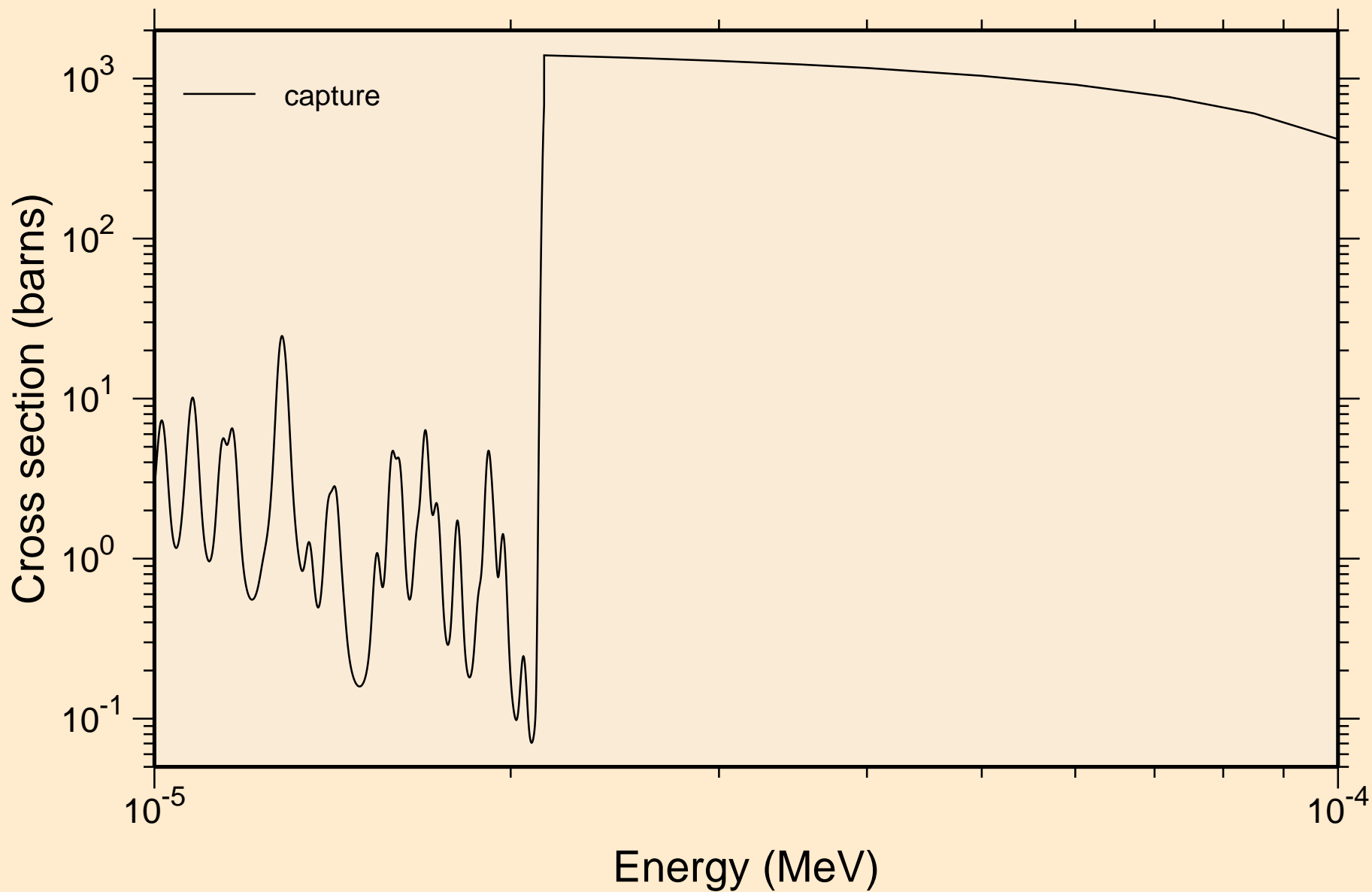

HO162 NEUTRON ACER TENDL-2019 LIBRARY; T=293.16K
resonance absorption cross sections

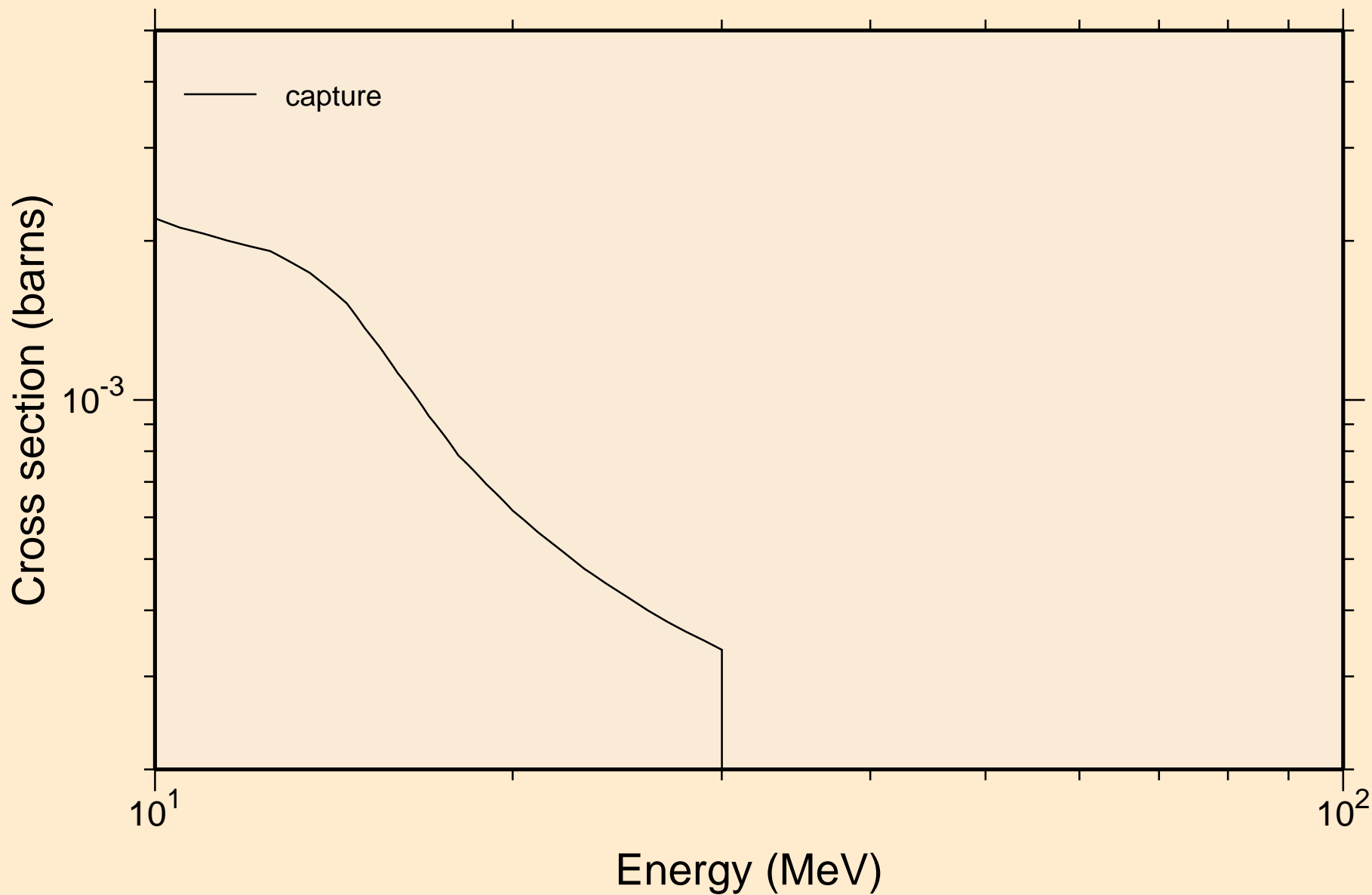

HO162 NEUTRON ACER TENDL-2019 LIBRARY; T=293.16K
Heating

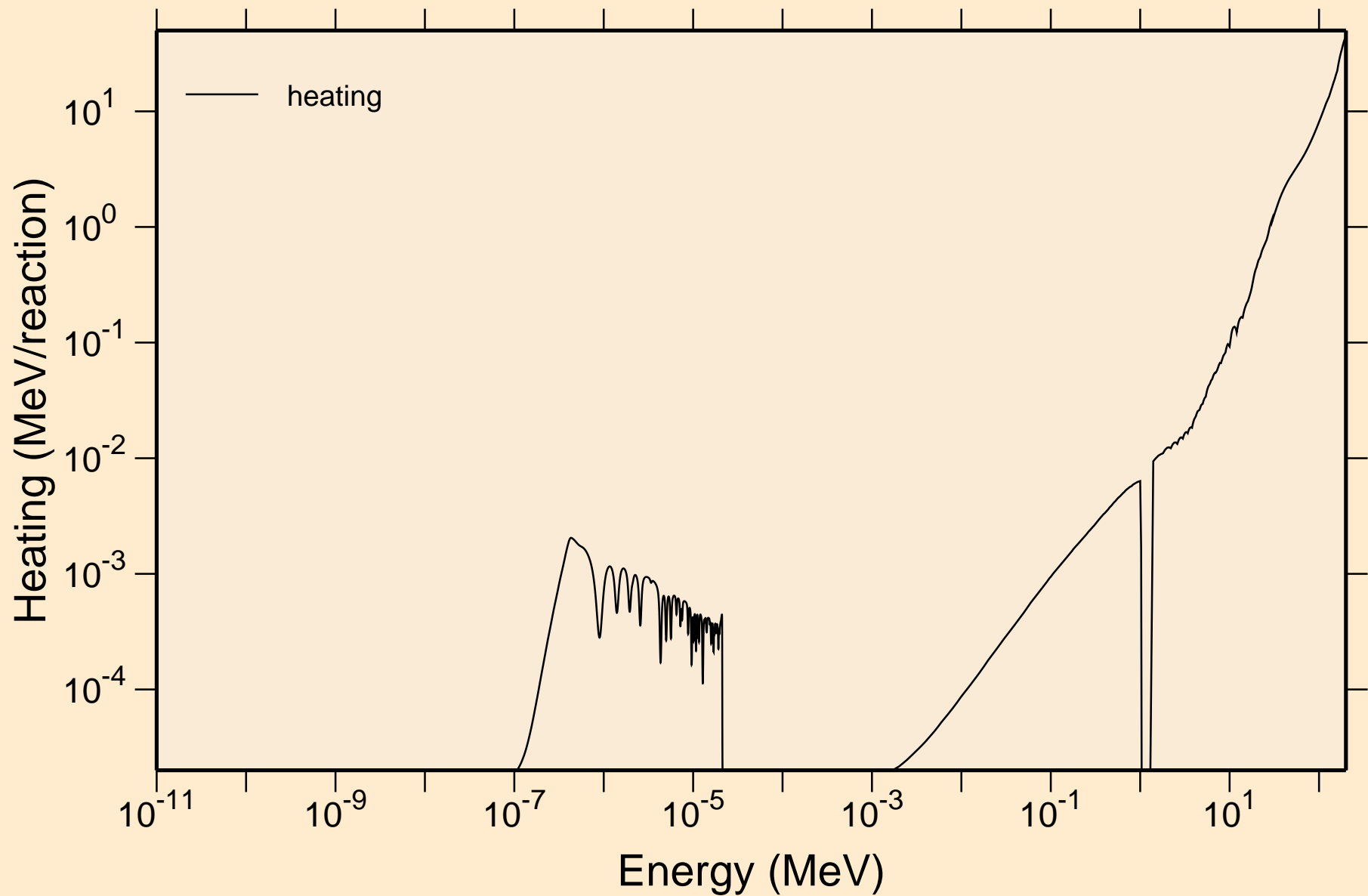

HO162 NEUTRON ACER TENDL-2019 LIBRARY; T=293.16K Damage

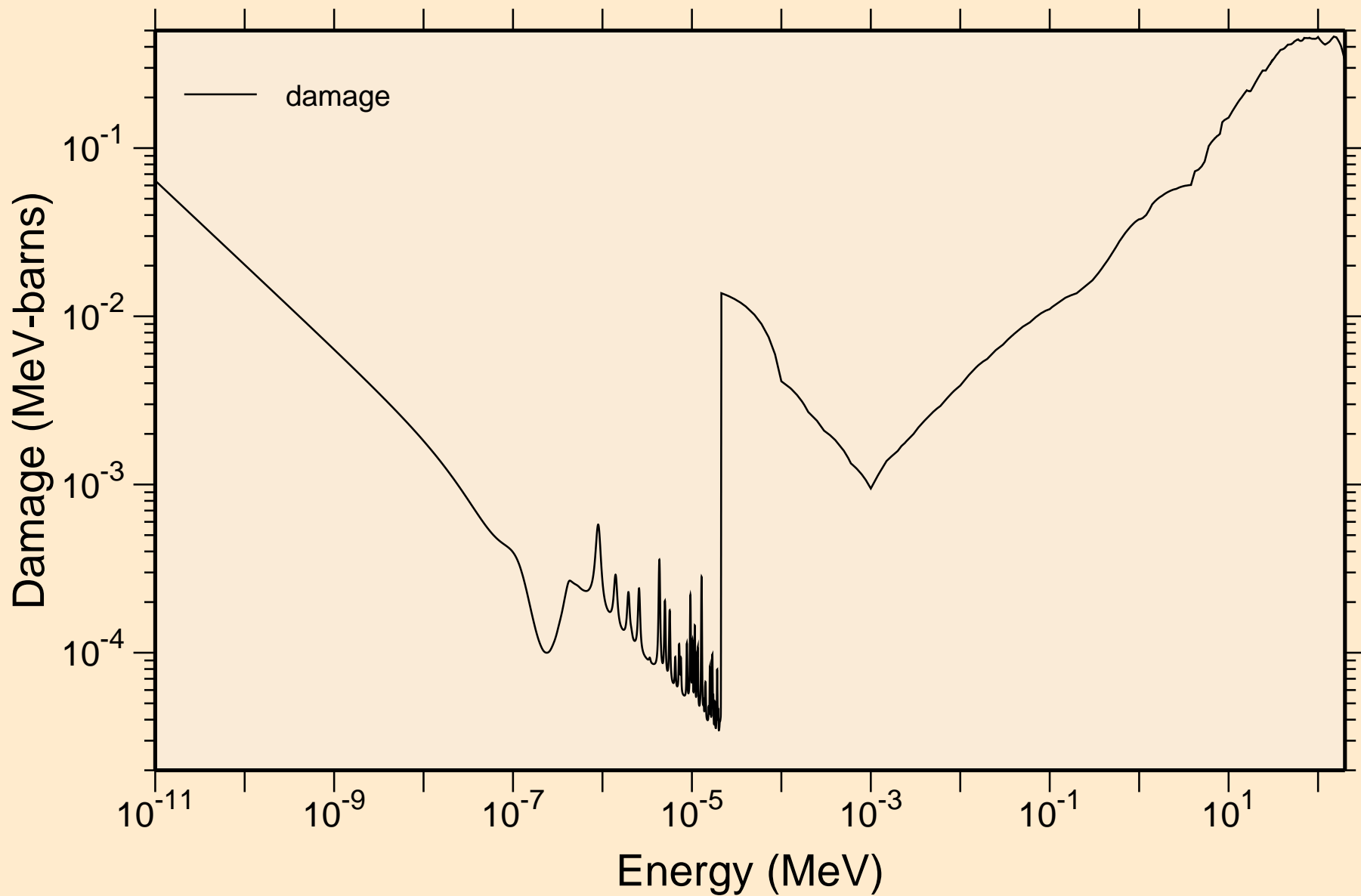

HO162 NEUTRON ACER TENDL-2019 LIBRARY; T=293.16K
Non-threshold reactions

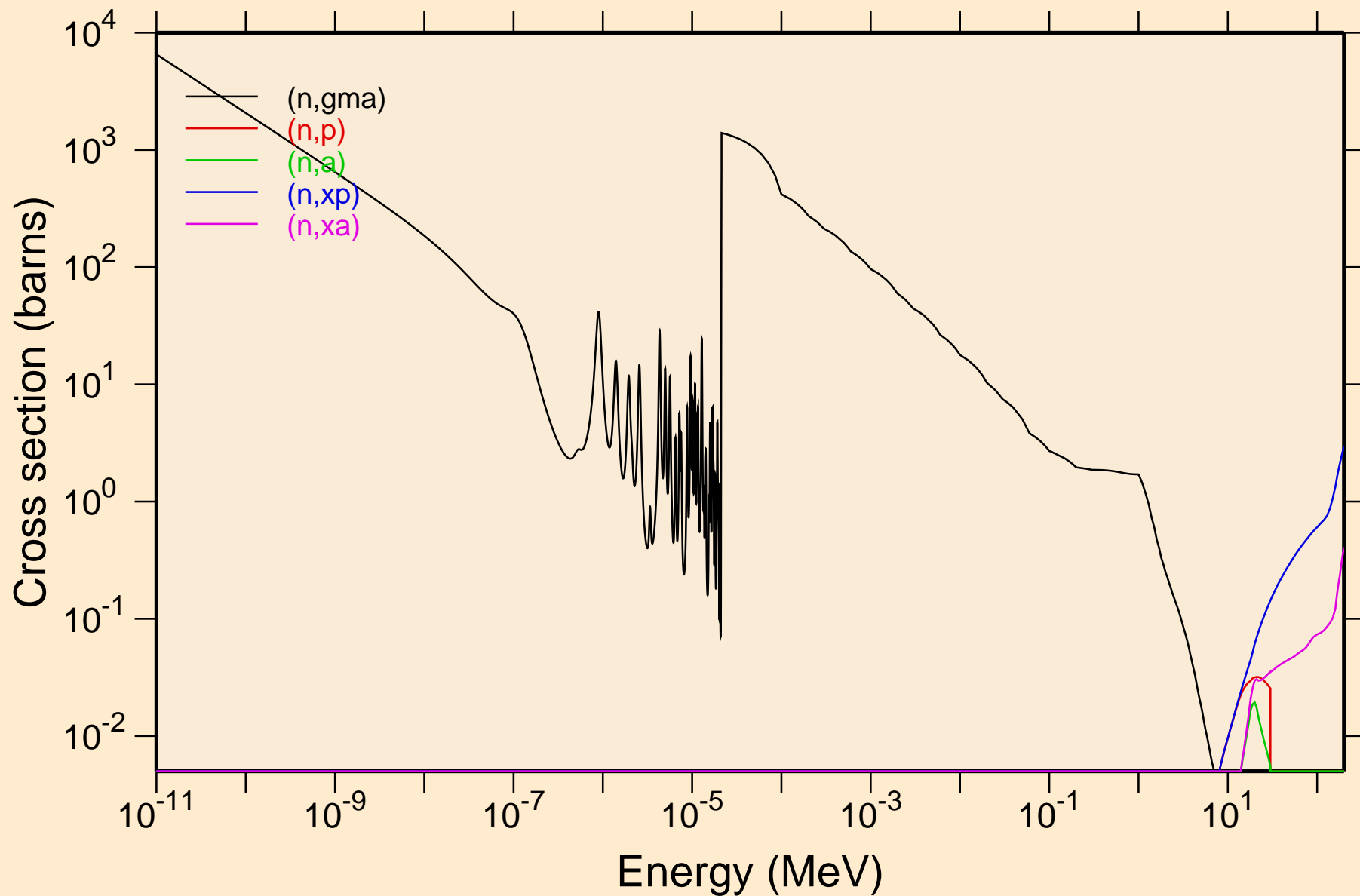

HO162 NEUTRON ACER TENDL-2019 LIBRARY; T=293.16K

Principal cross sections

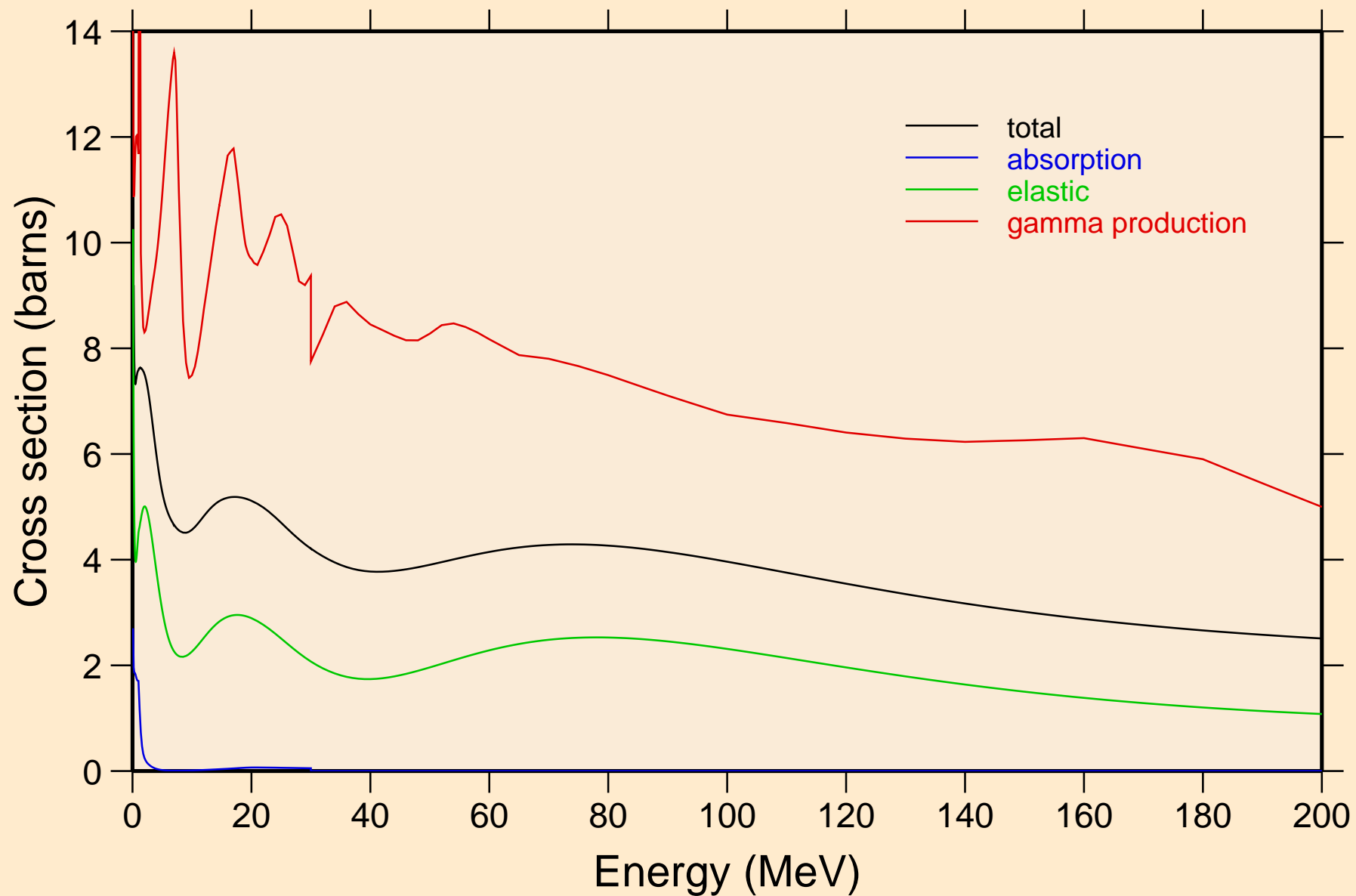

HO162 NEUTRON ACER TENDL-2019 LIBRARY; T=293.16K
Heating

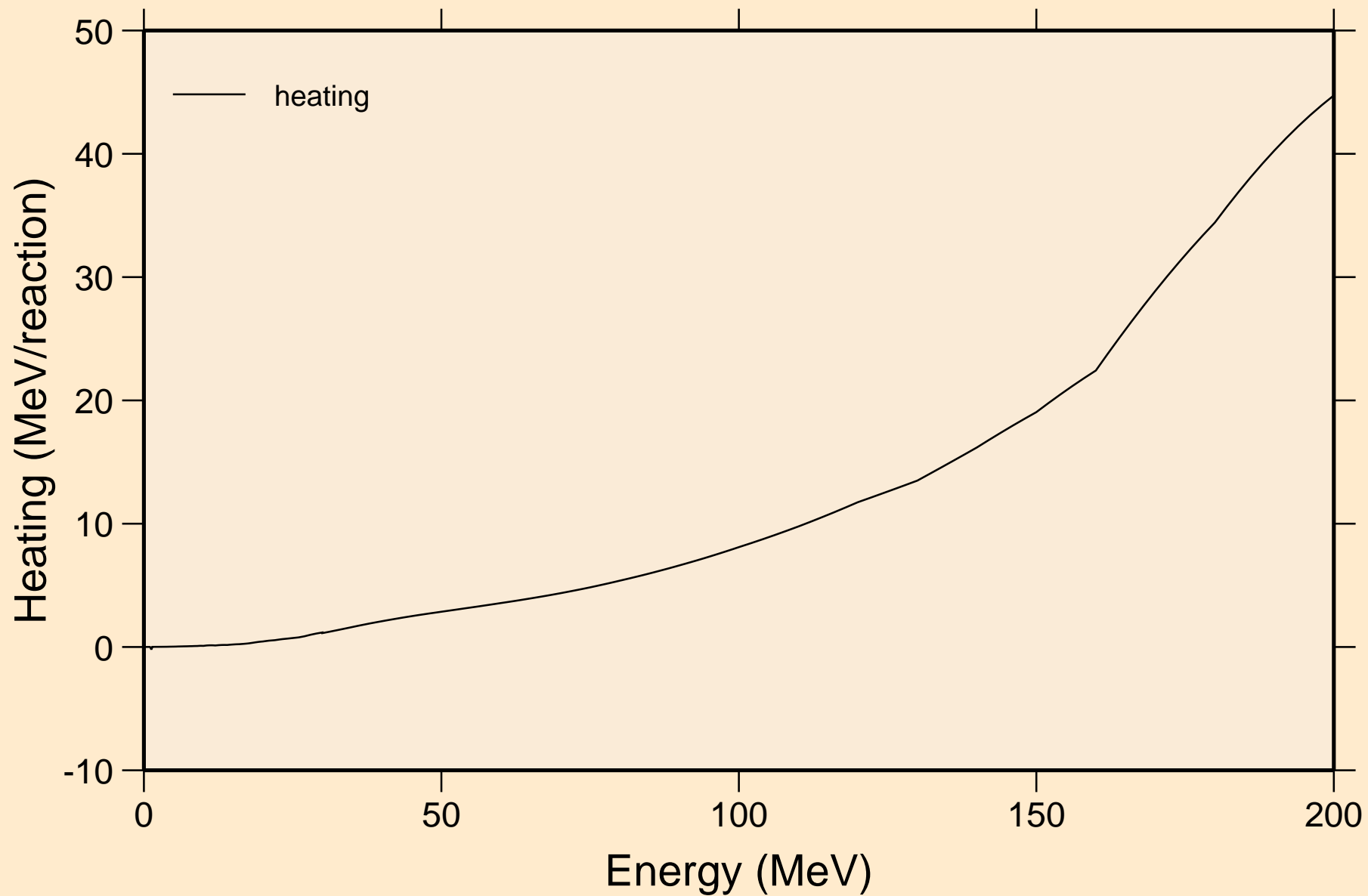

HO162 NEUTRON ACER TENDL-2019 LIBRARY; T=293.16K Damage

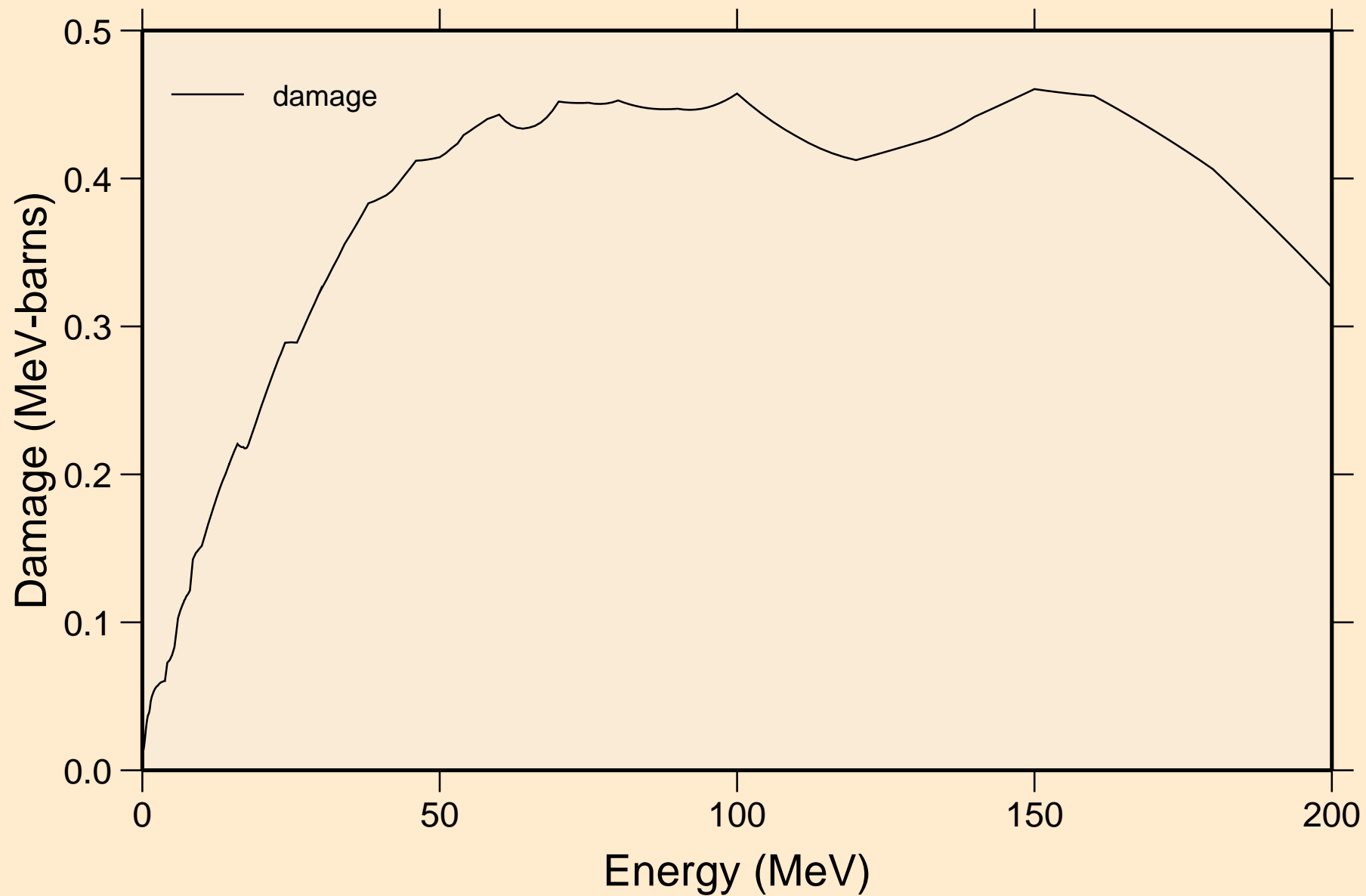

HO162 NEUTRON ACER TENDL-2019 LIBRARY; T=293.16K
Non-threshold reactions

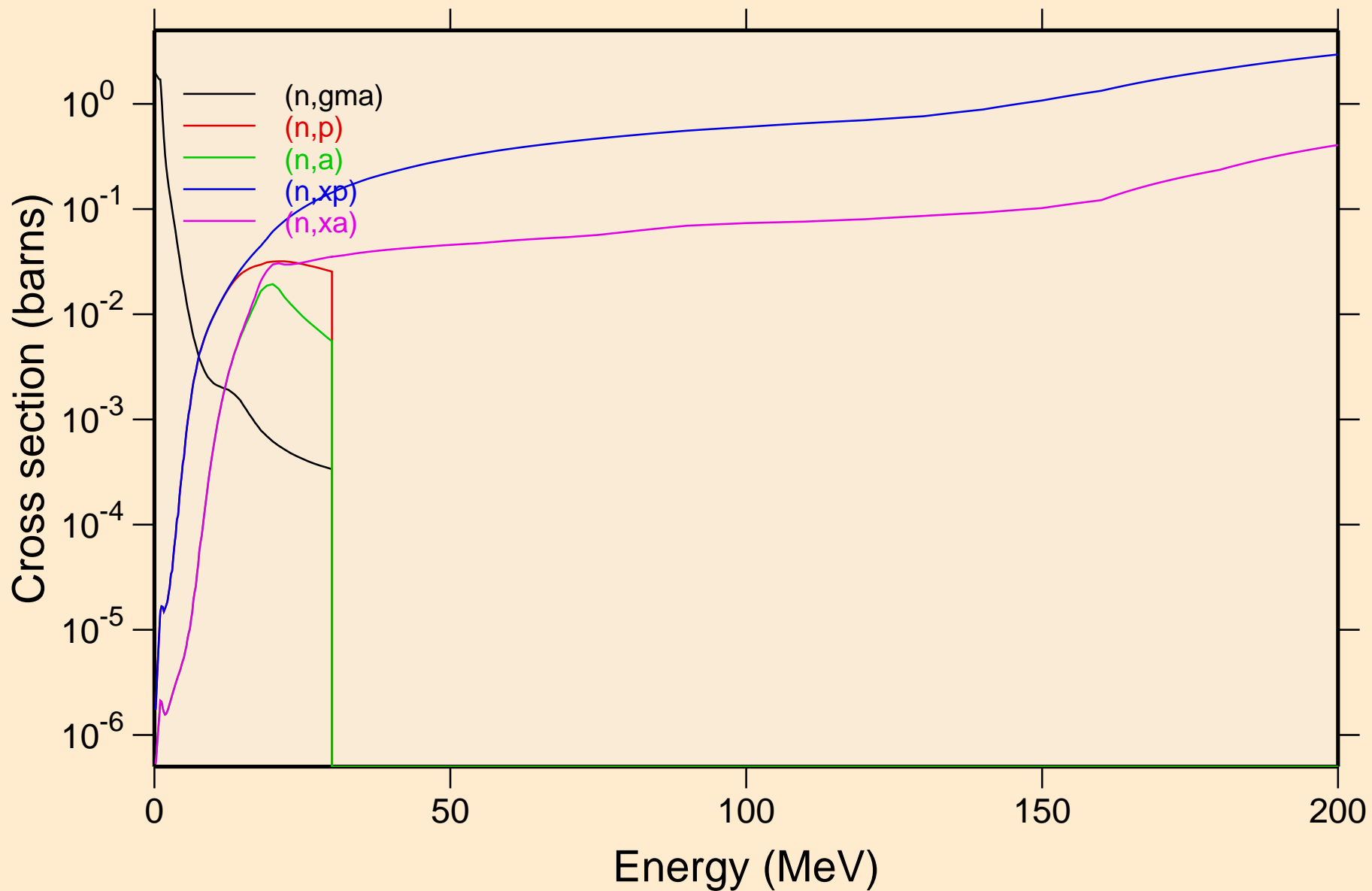

HO162 NEUTRON ACER TENDL-2019 LIBRARY; T=293.16K
Inelastic levels

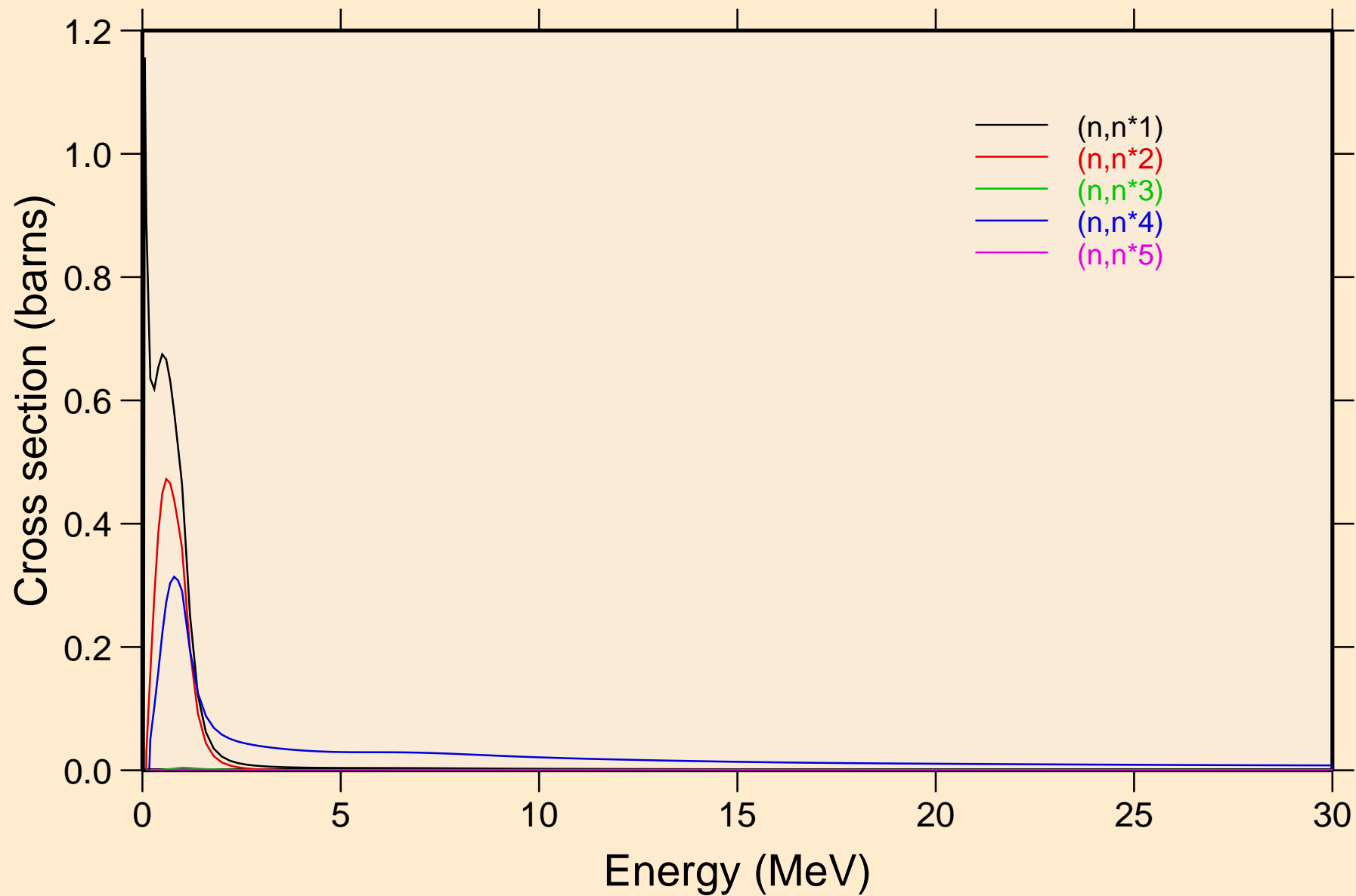

HO162 NEUTRON ACER TENDL-2019 LIBRARY; T=293.16K
Inelastic levels

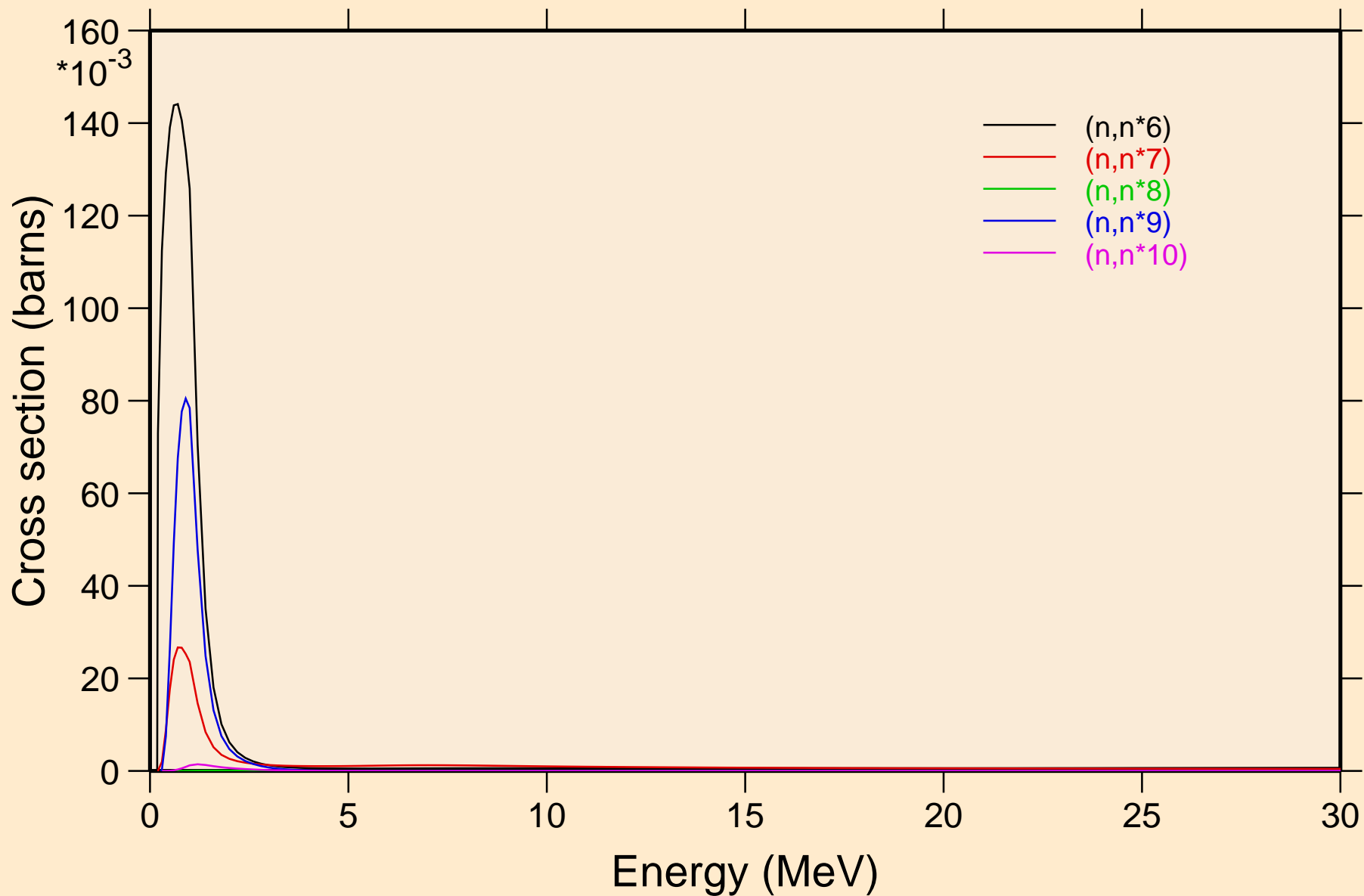

HO162 NEUTRON ACER TENDL-2019 LIBRARY; T=293.16K
Inelastic levels

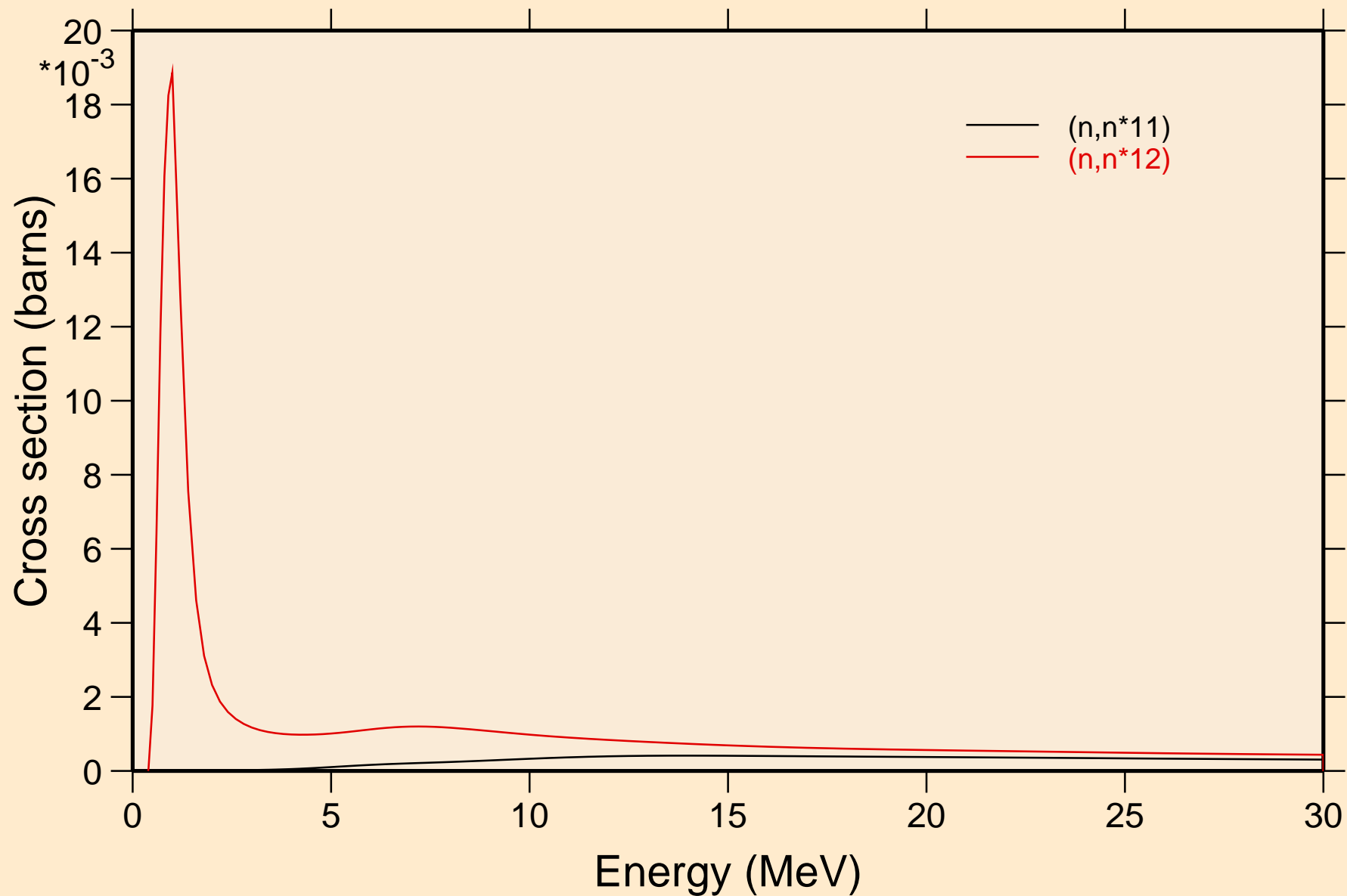

HO162 NEUTRON ACER TENDL-2019 LIBRARY; T=293.16K

Threshold reactions

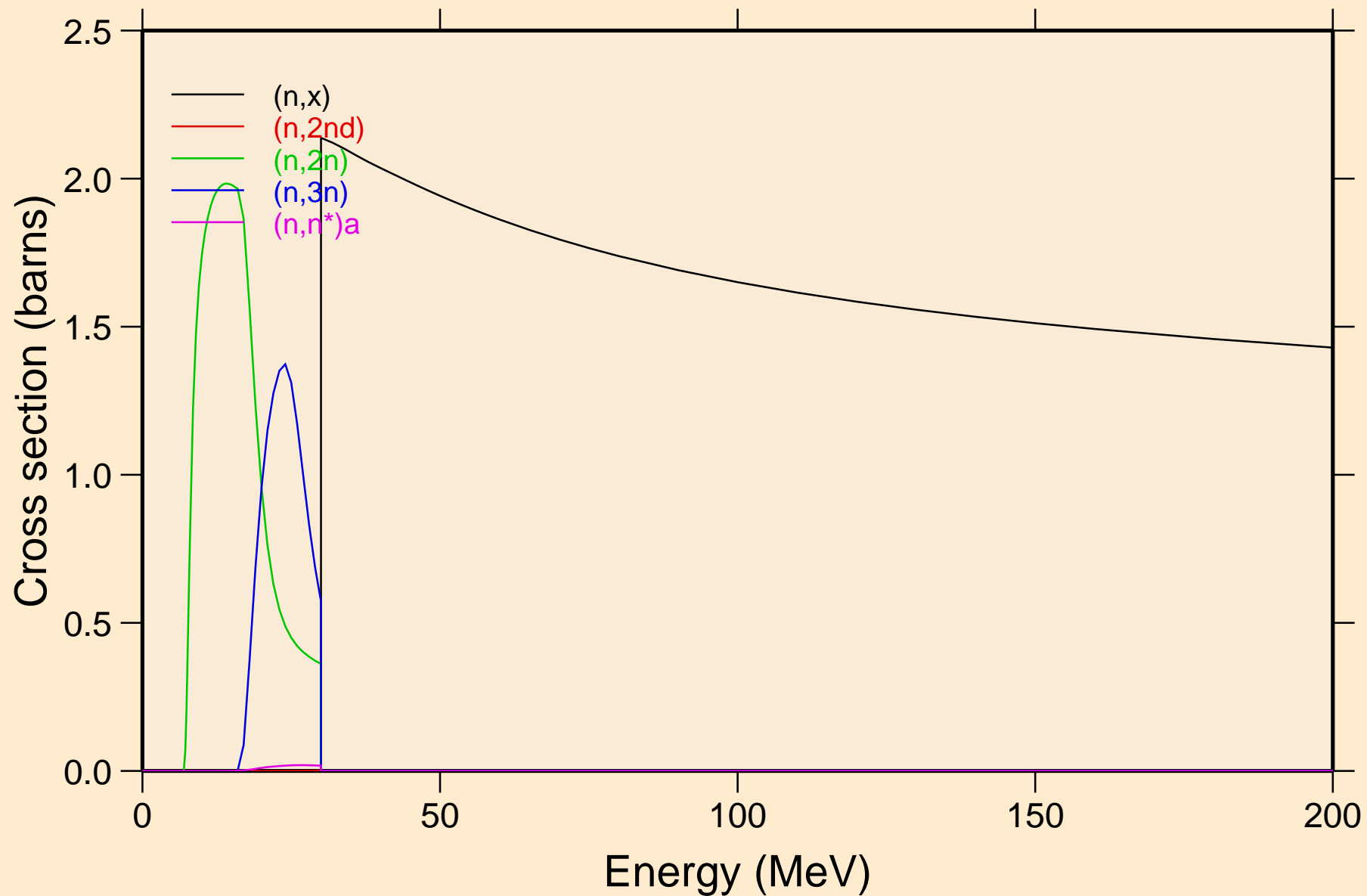

HO162 NEUTRON ACER TENDL-2019 LIBRARY; T=293.16K

Threshold reactions

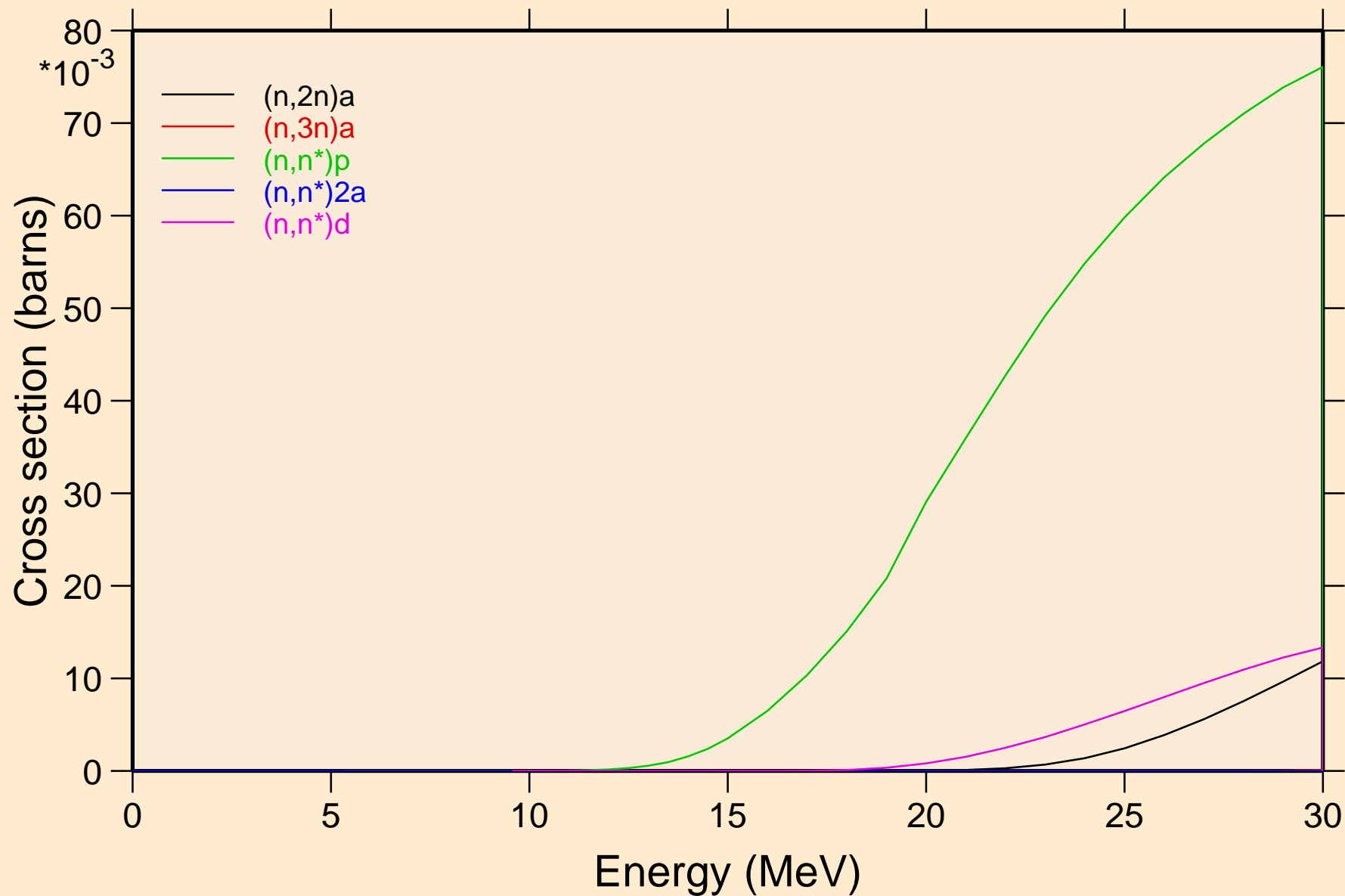

HO162 NEUTRON ACER TENDL-2019 LIBRARY; T=293.16K

Threshold reactions

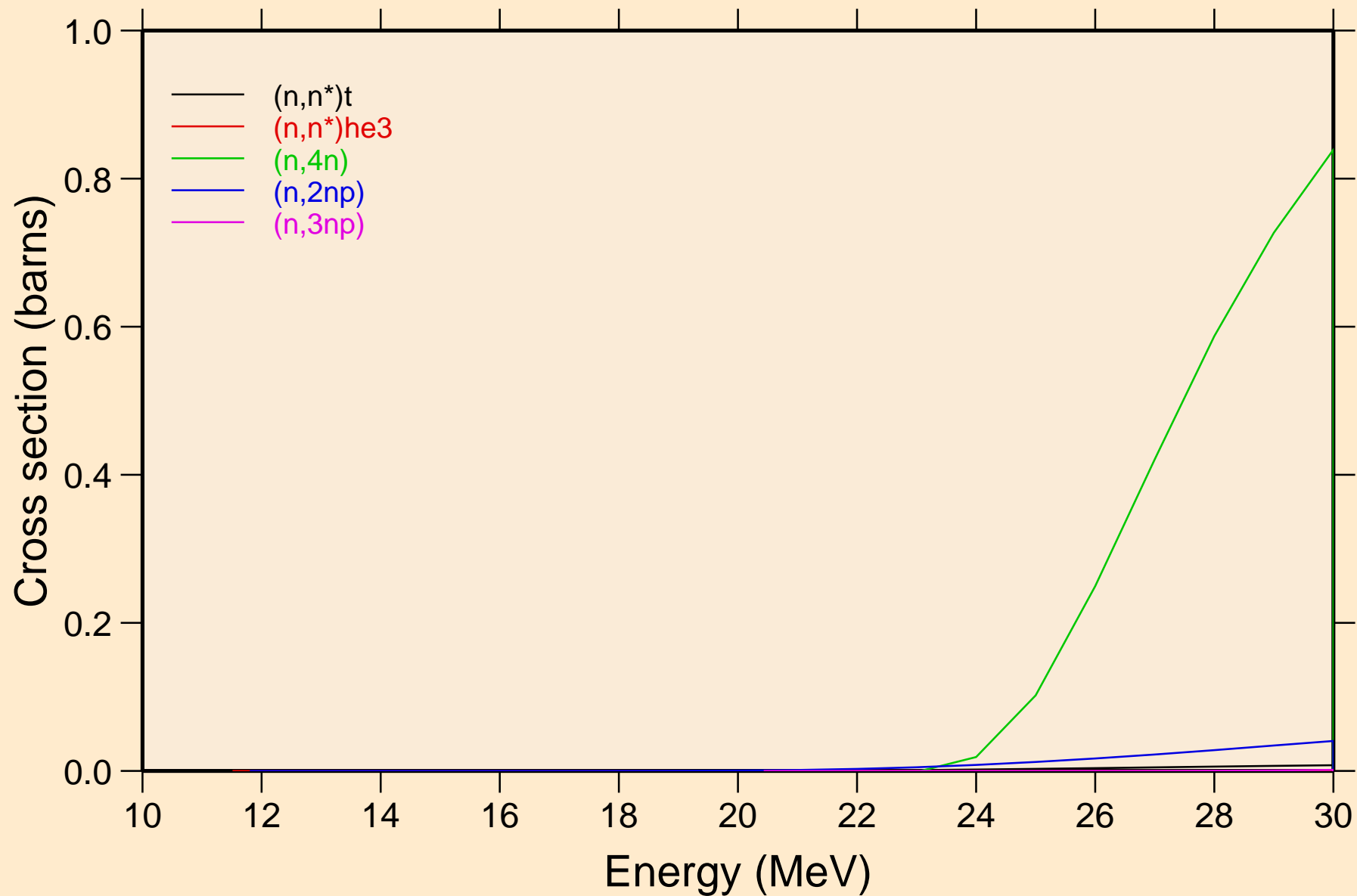

HO162 NEUTRON ACER TENDL-2019 LIBRARY; T=293.16K
Threshold reactions

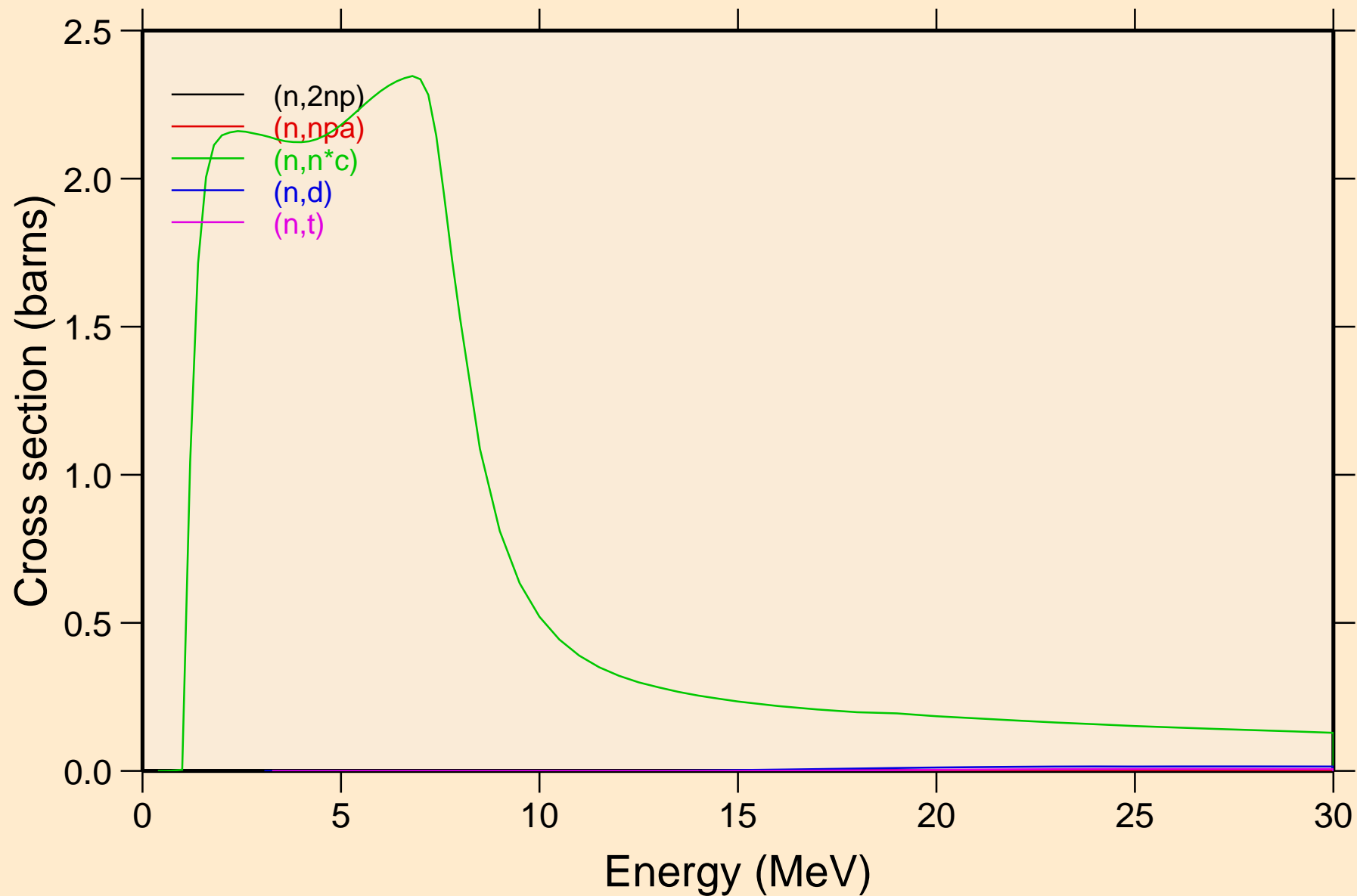

HO162 NEUTRON ACER TENDL-2019 LIBRARY; T=293.16K
Threshold reactions

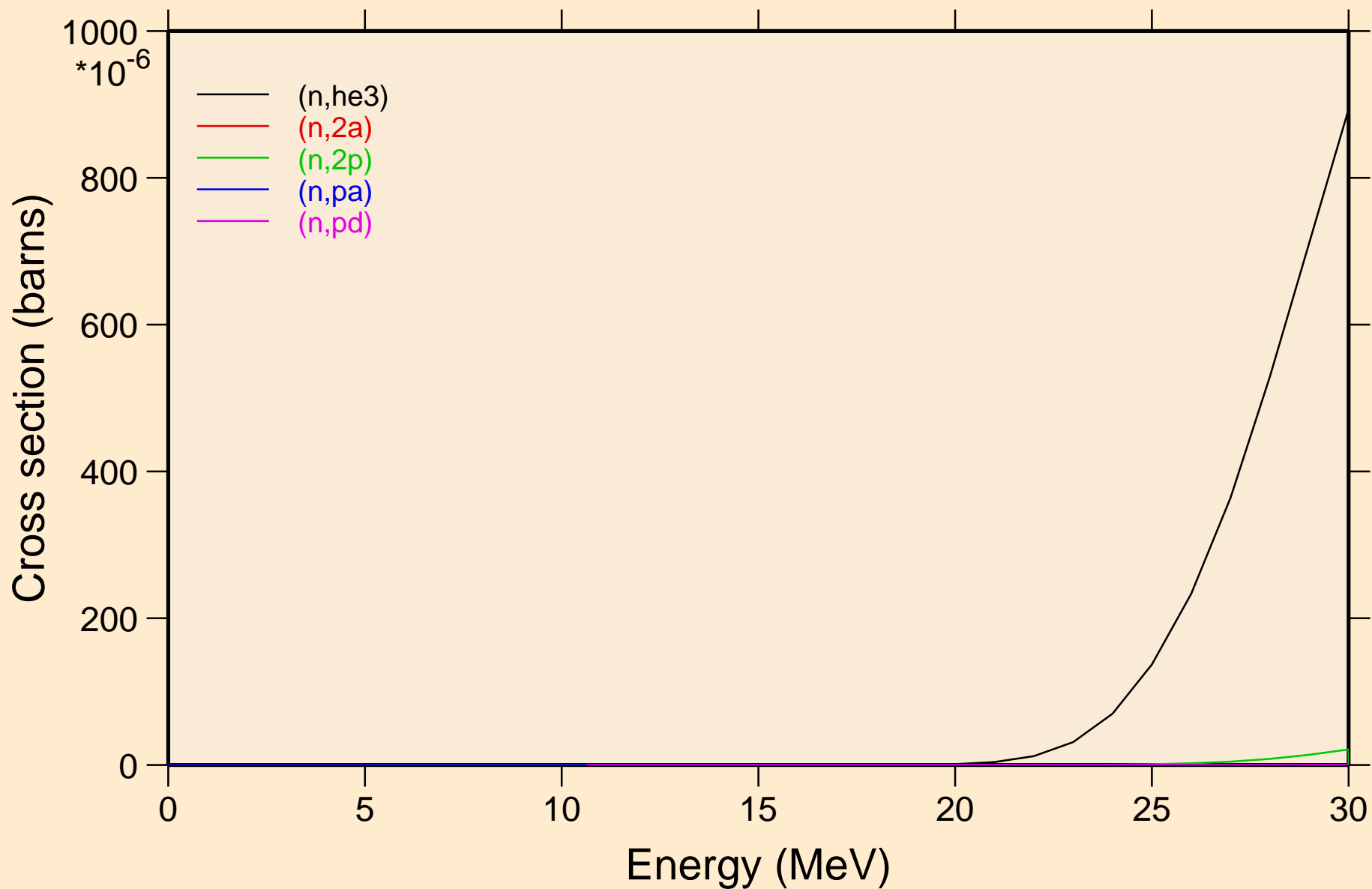

HO162 NEUTRON ACER TENDL-2019 LIBRARY; T=293.16K
Threshold reactions

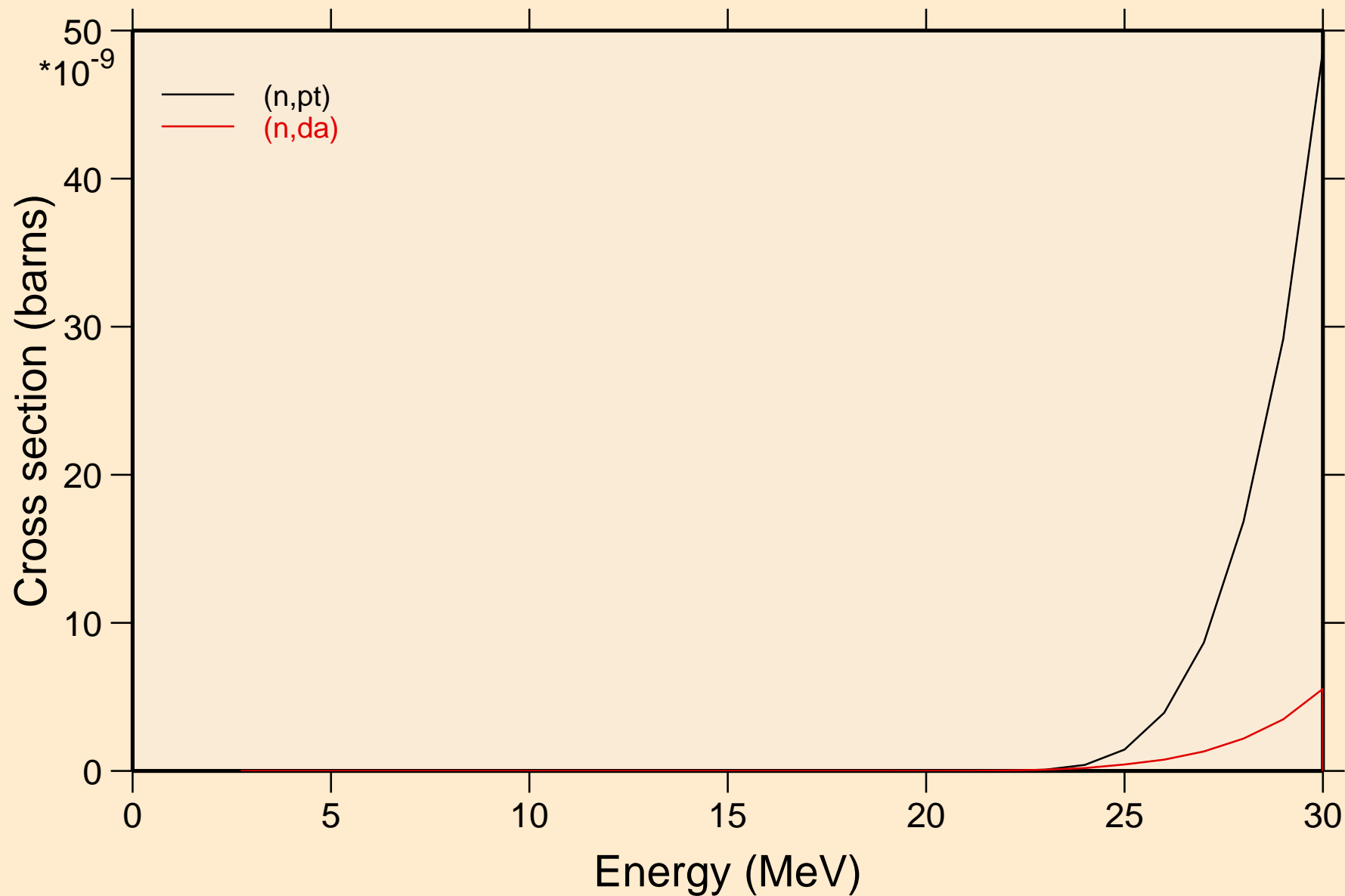

HO162 NEUTRON ACER TENDL-2019 LIBRARY; T=293.16K

Threshold reactions

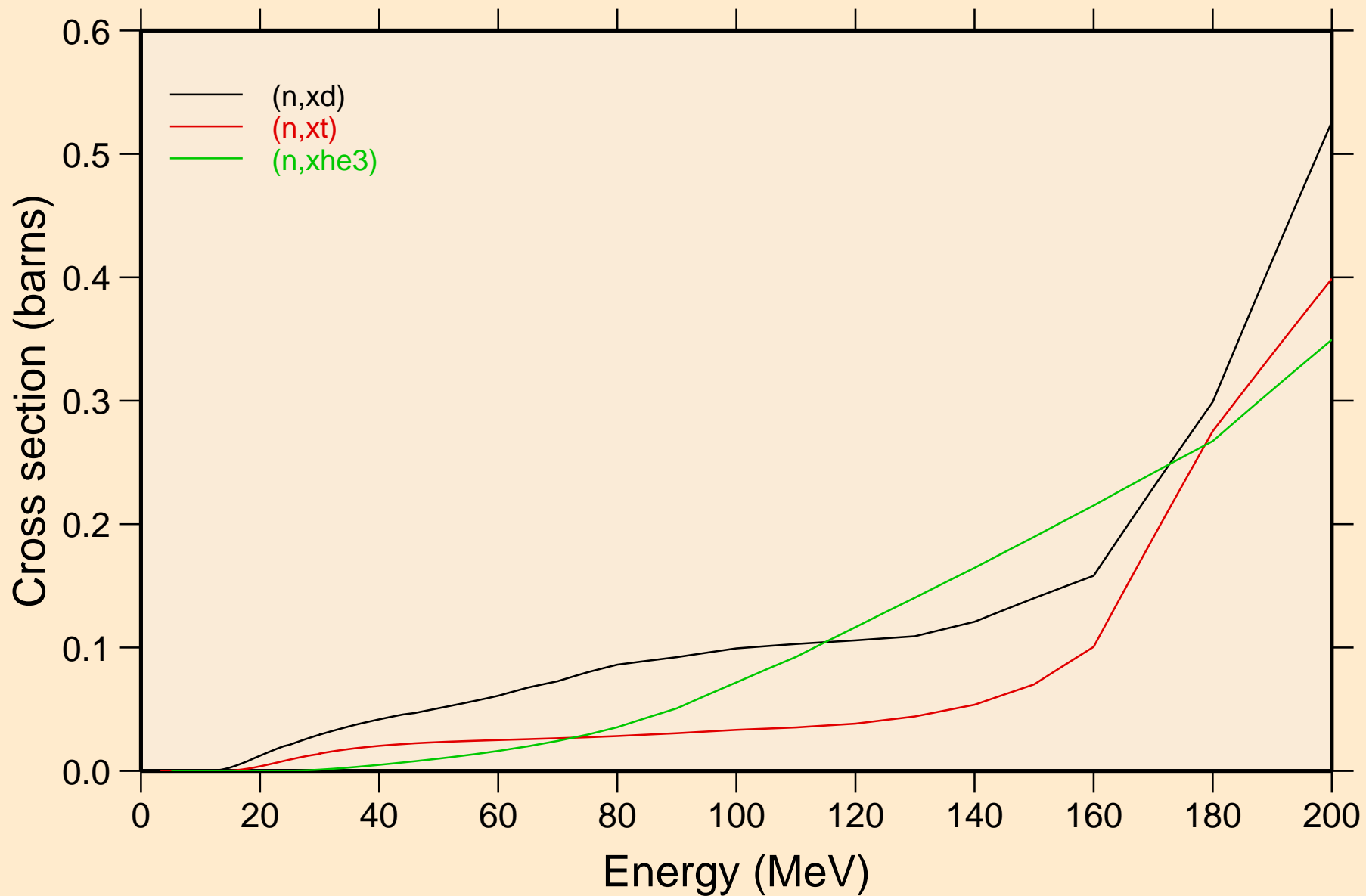

HO162 NEUTRON ACER TENDL-2019 LIBRARY; T=293.16K
angular distribution for elastic

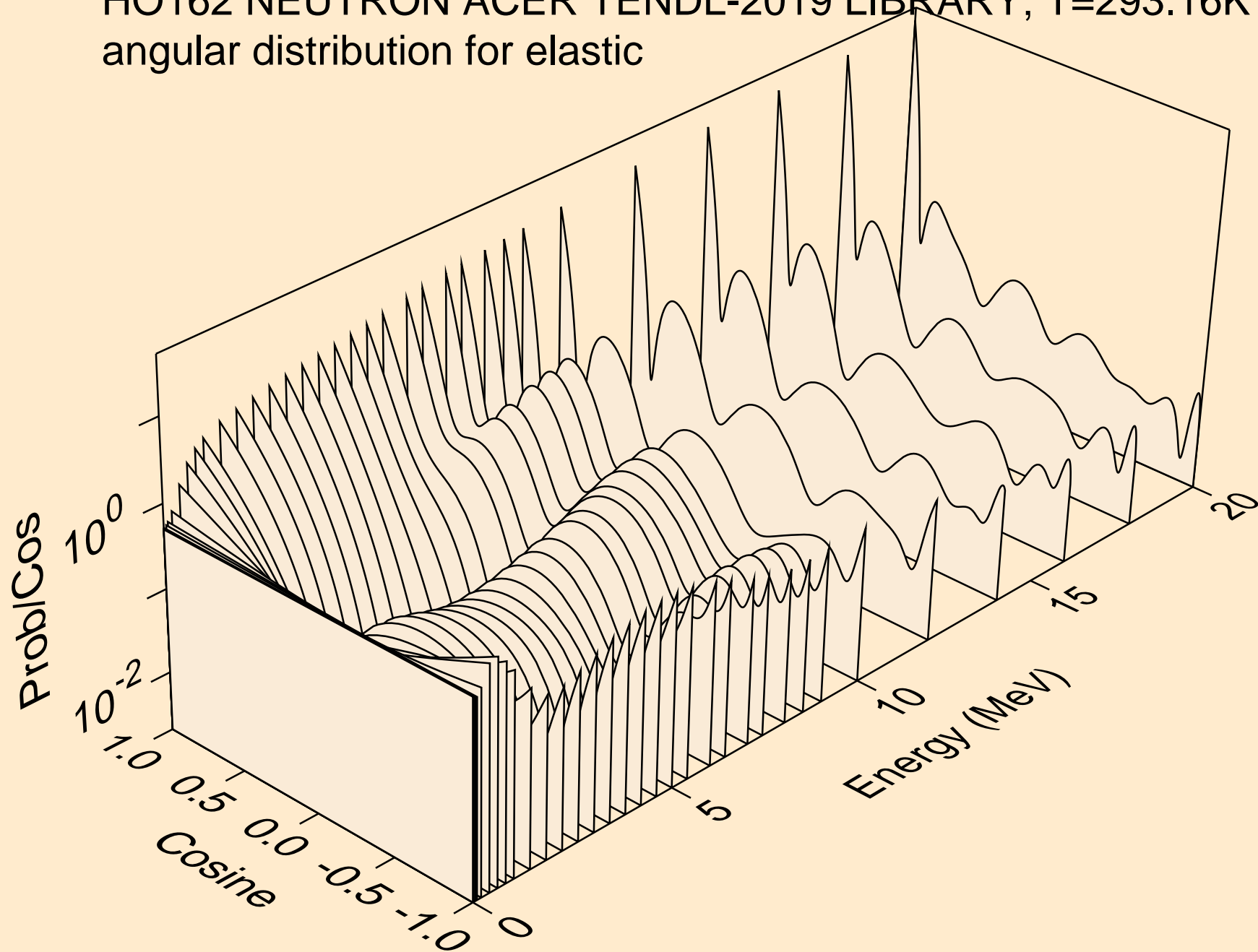

HO162 NEUTRON ACER TENDL-2019 LIBRARY; T=293.16K
angular distribution for elastic

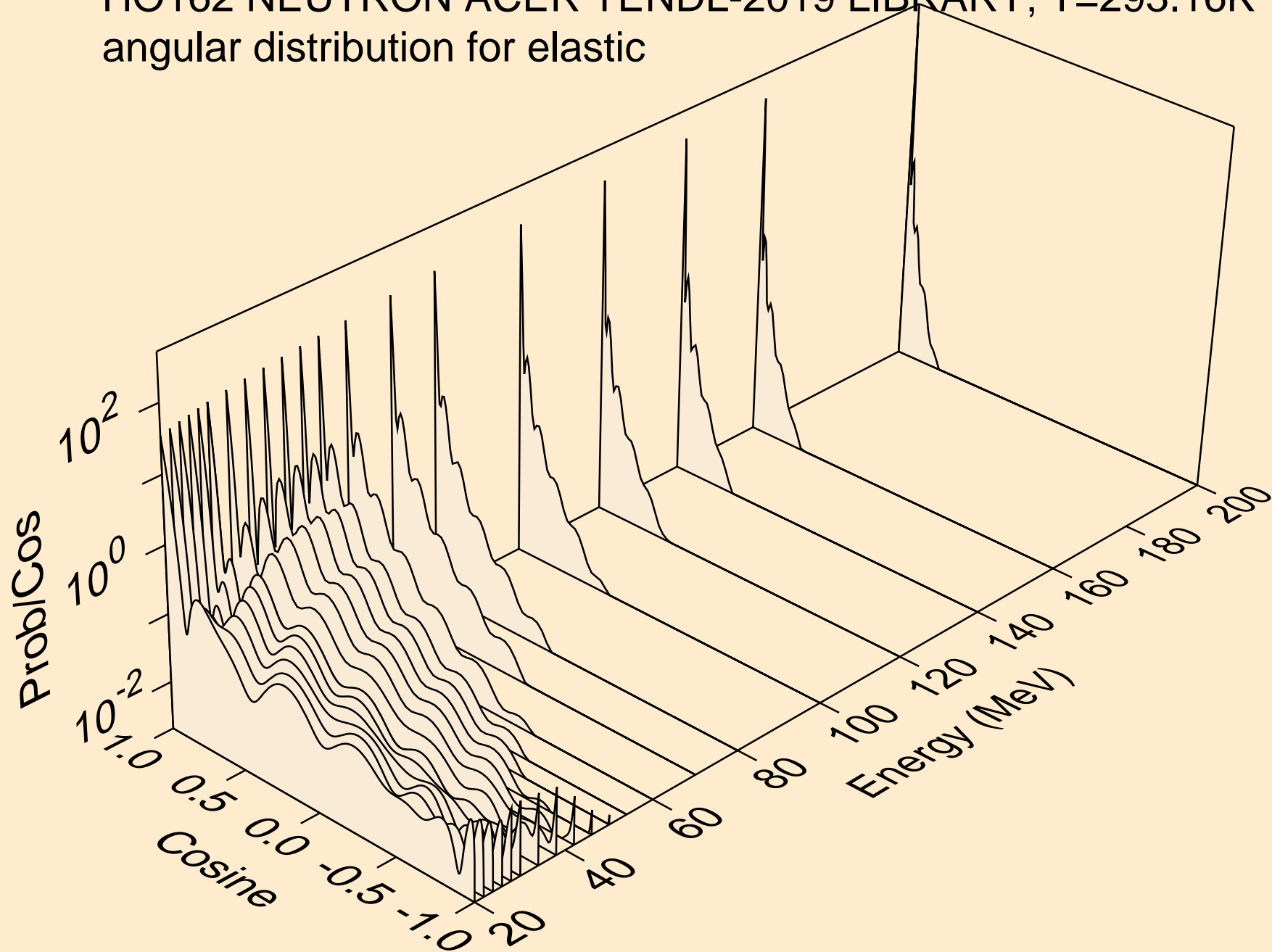

HO162 NEUTRON ACER TENDL-2019 LIBRARY; T=293.16K
angular distribution for (n,n*1)

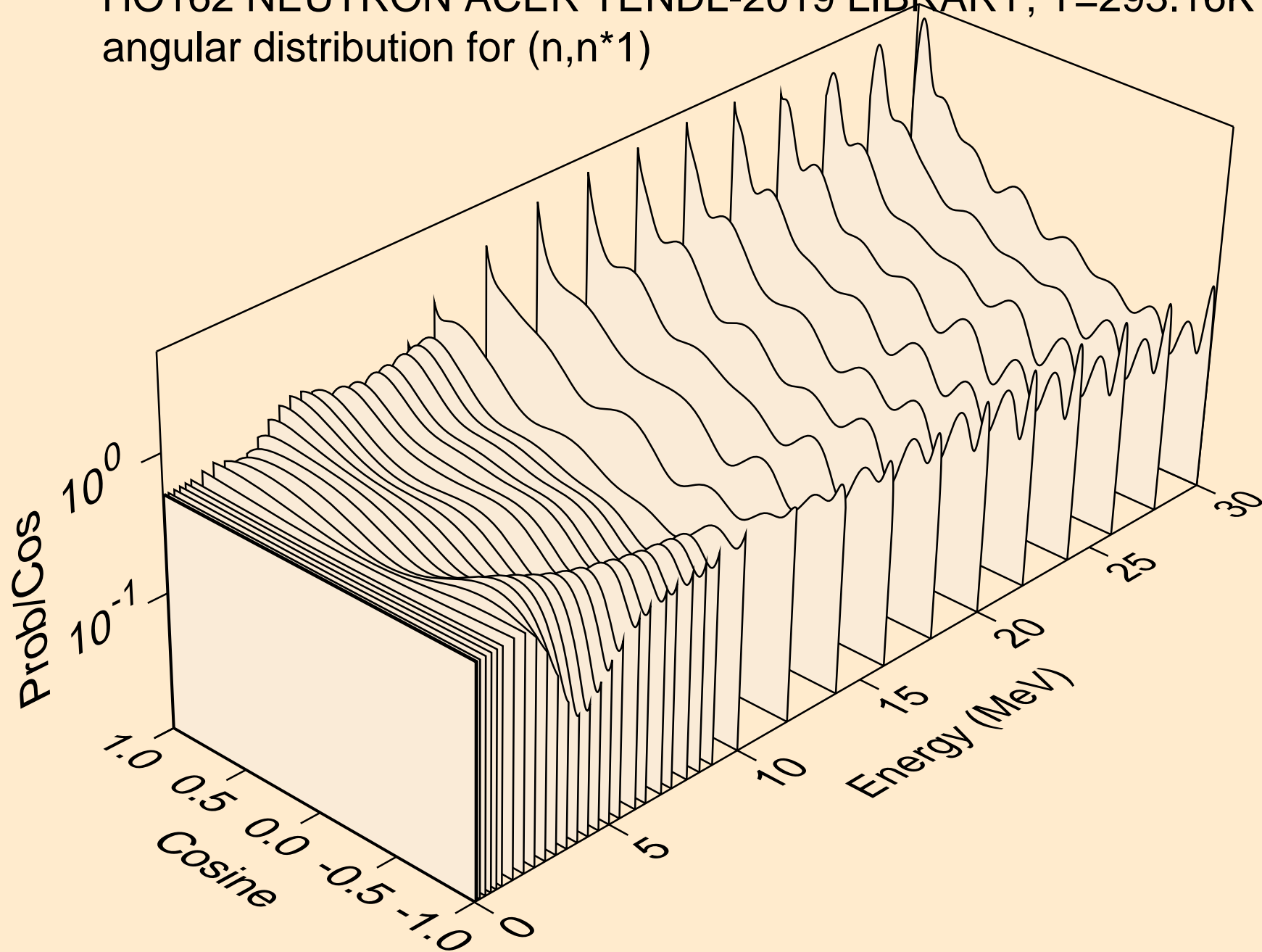

HO162 NEUTRON ACER TENDL-2019 LIBRARY; T=293.16K
angular distribution for (n,n*2)

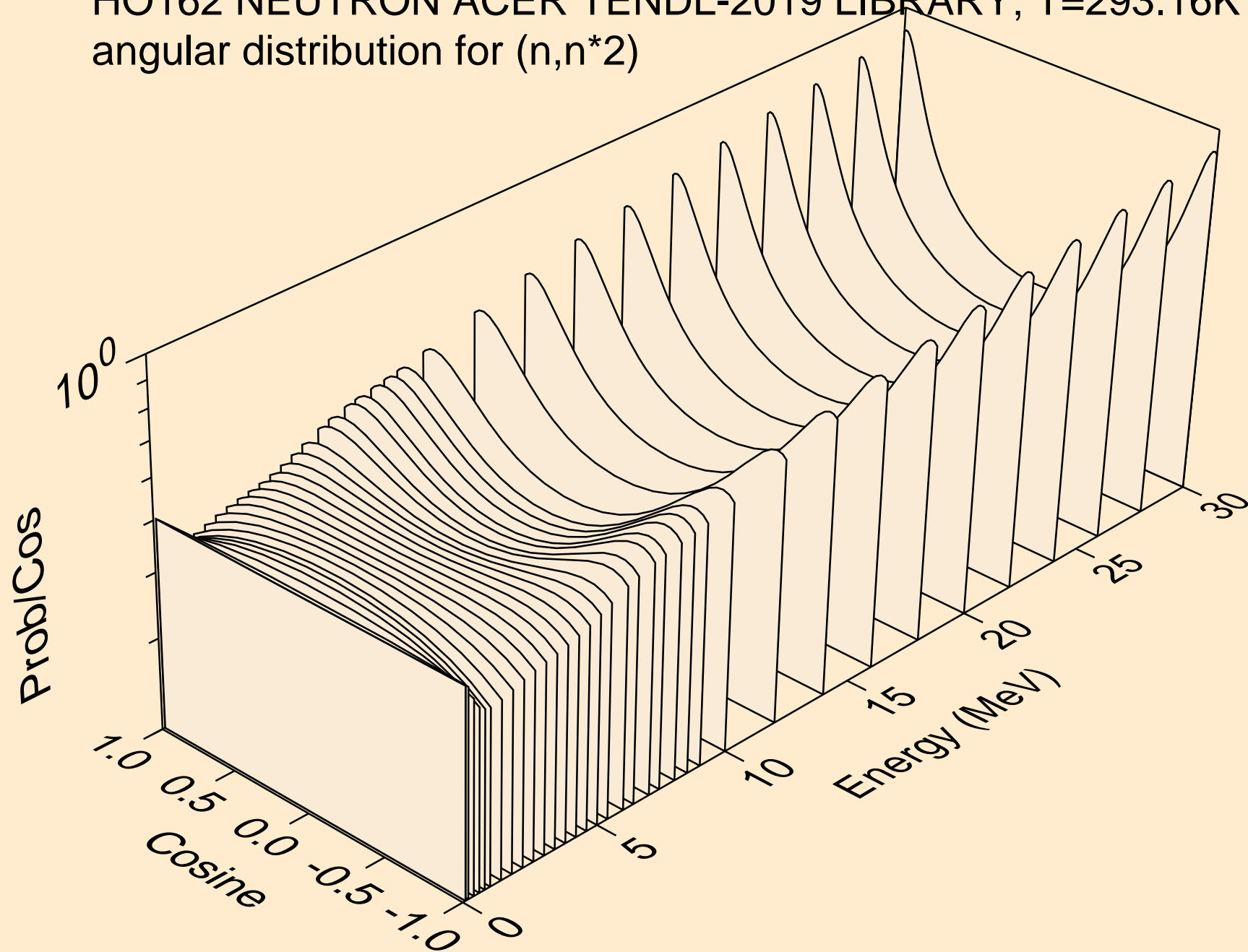

HO162 NEUTRON ACER TENDL-2019 LIBRARY; T=293.16K
angular distribution for (n,n*3)

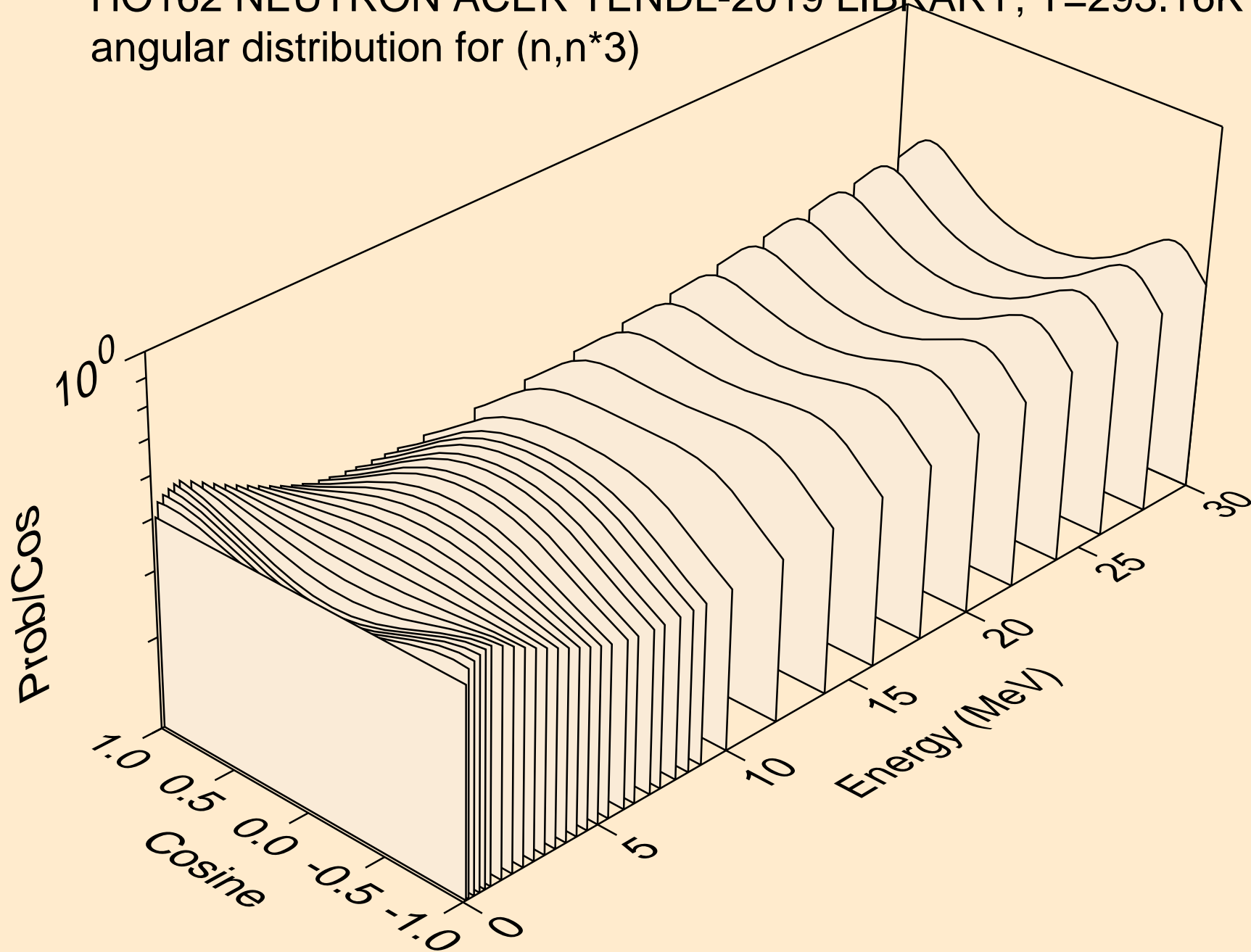

HO162 NEUTRON ACER TENDL-2019 LIBRARY; T=293.16K
angular distribution for (n,n*4)

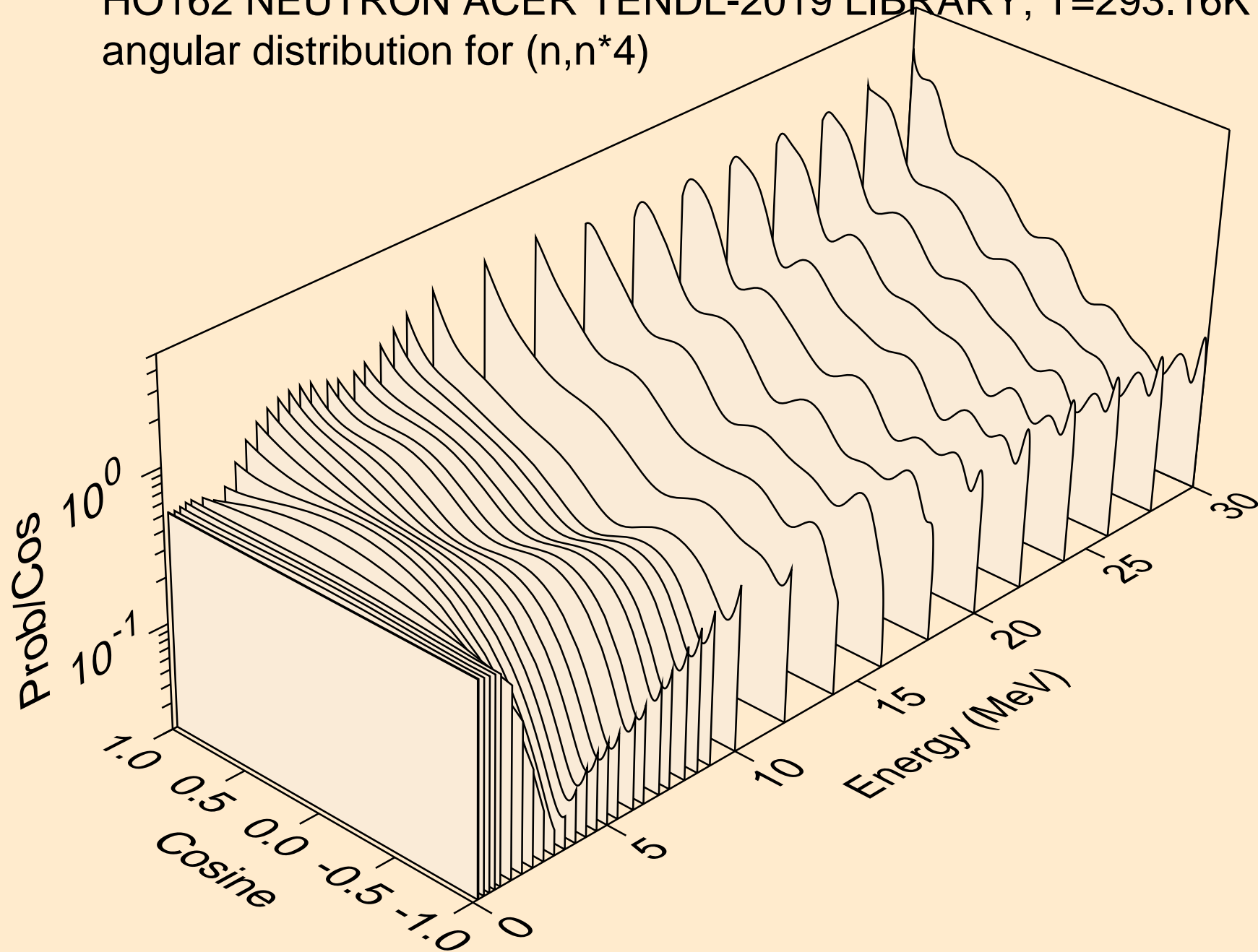

HO162 NEUTRON ACER TENDL-2019 LIBRARY; T=293.16K
angular distribution for (n,n*5)

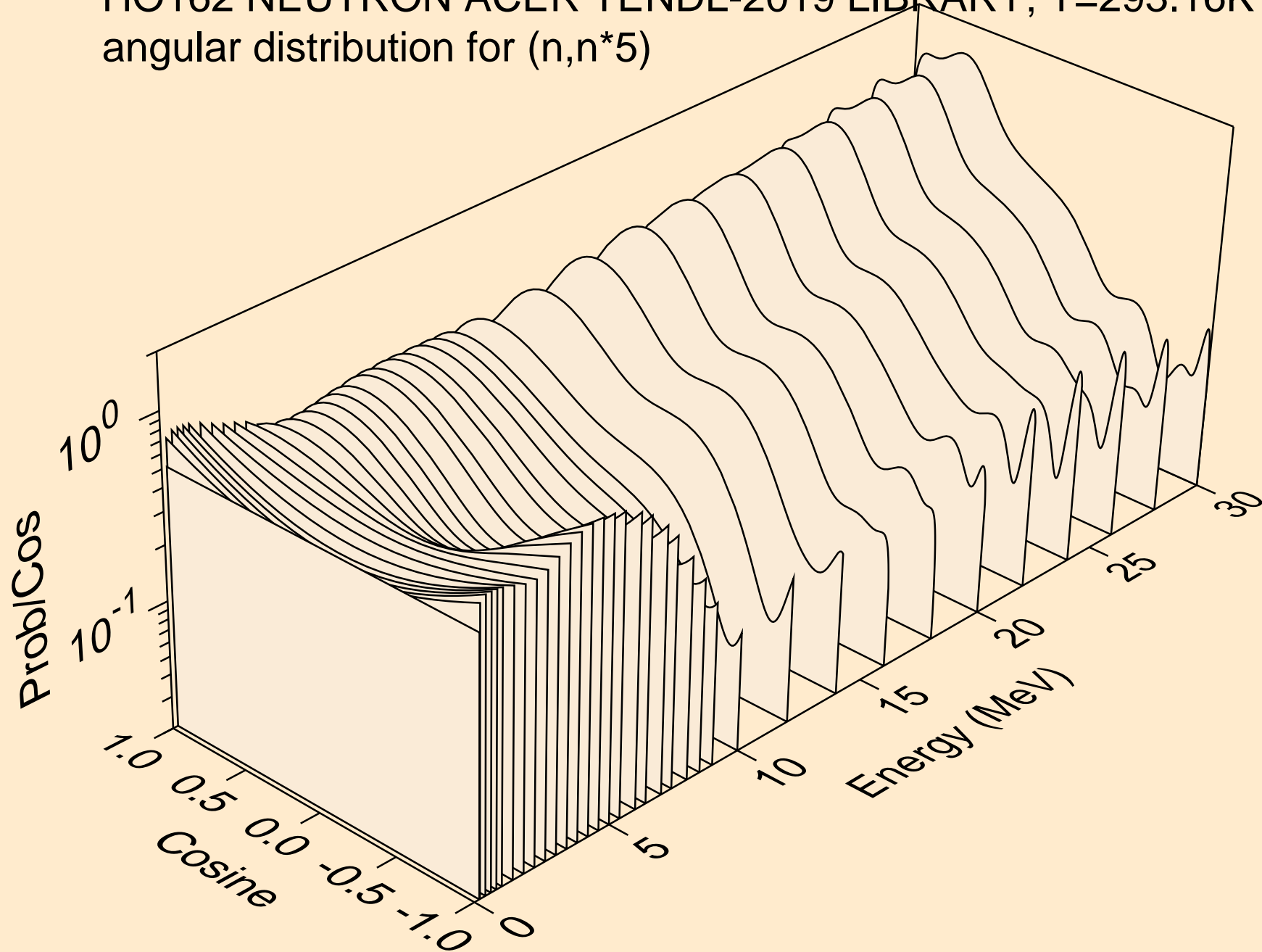

HO162 NEUTRON ACER TENDL-2019 LIBRARY; T=293.16K
angular distribution for (n,n*6)

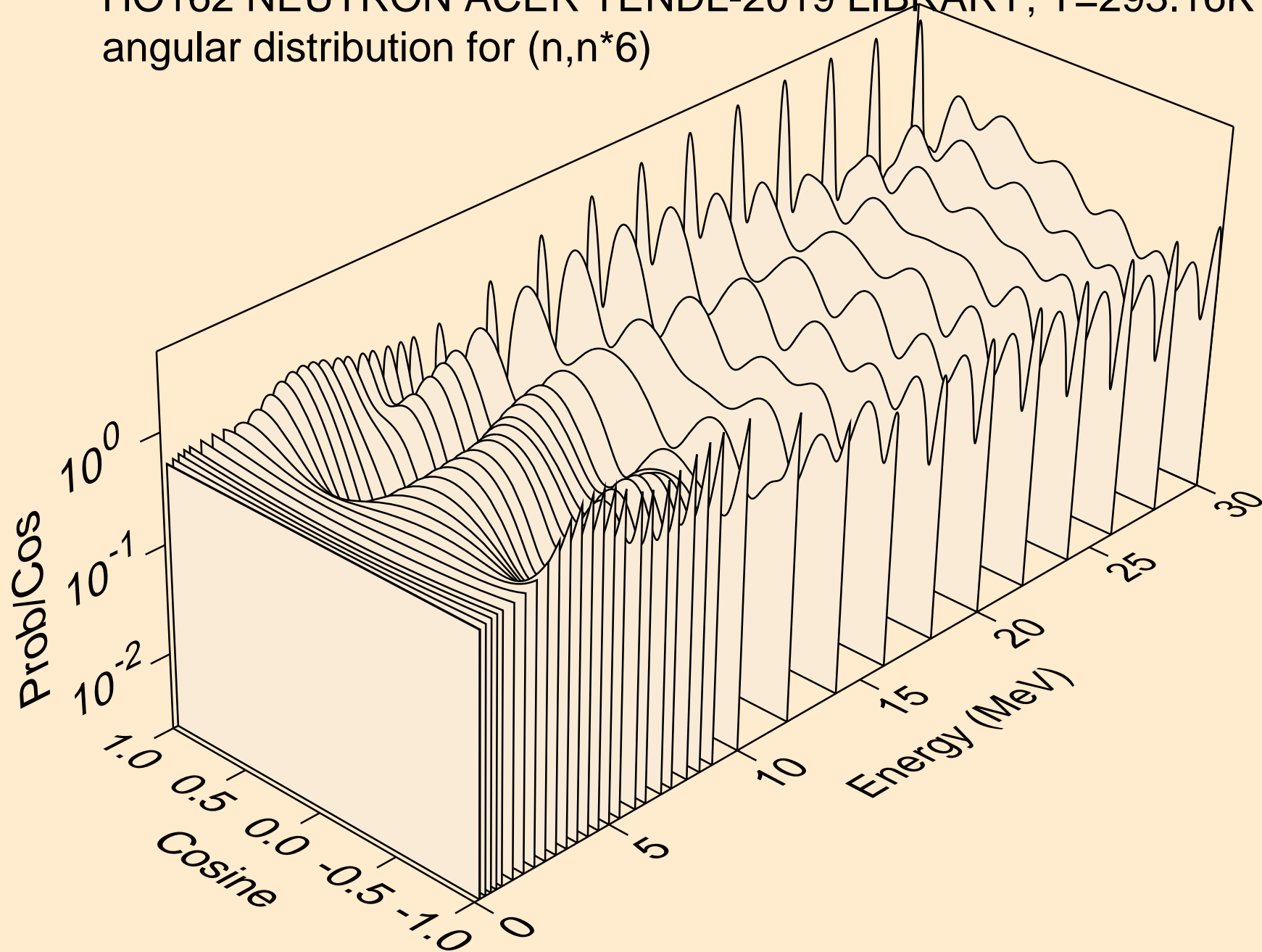

HO162 NEUTRON ACER TENDL-2019 LIBRARY; T=293.16K
angular distribution for (n,n*7)

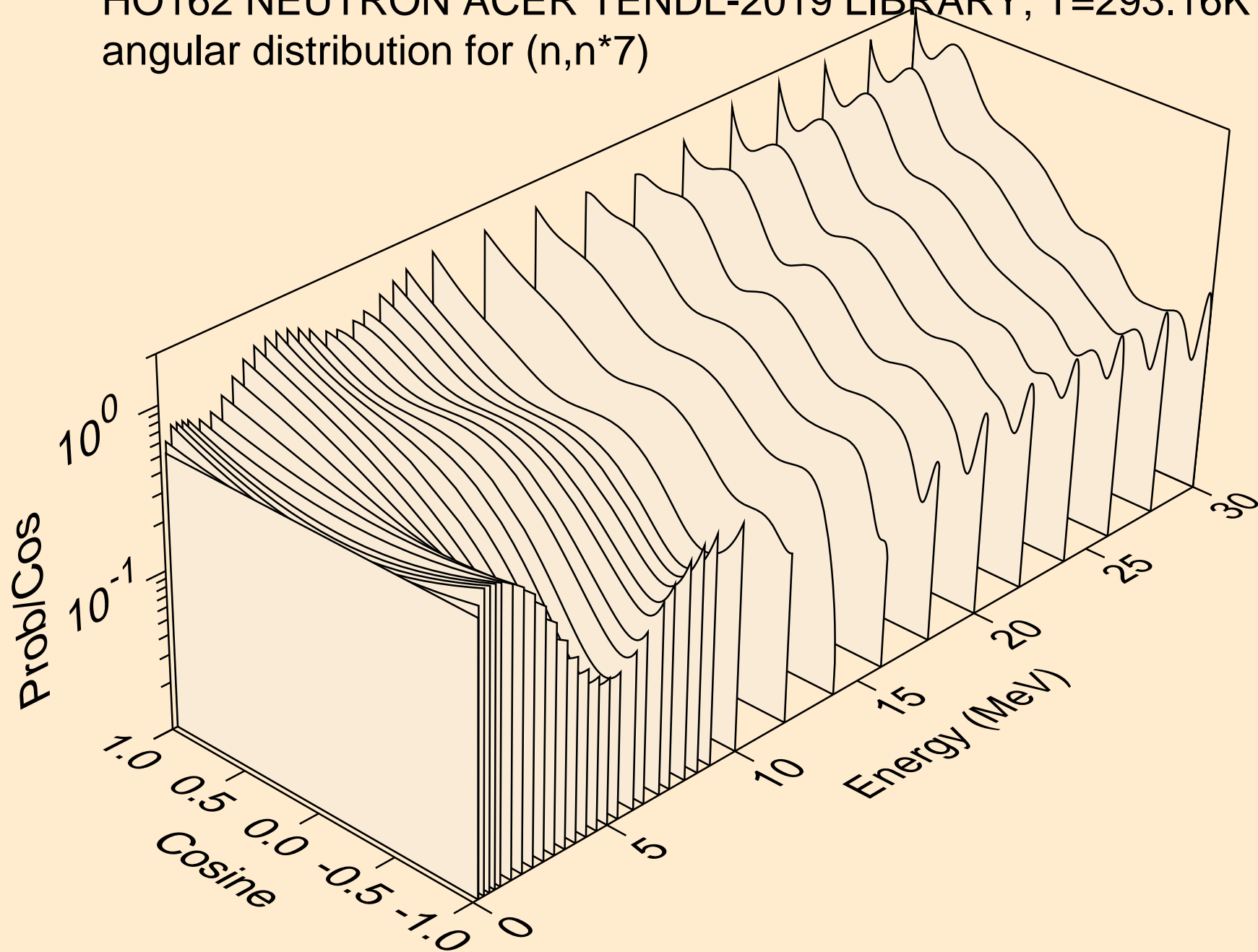

HO162 NEUTRON ACER TENDL-2019 LIBRARY; T=293.16K
angular distribution for (n,n*8)

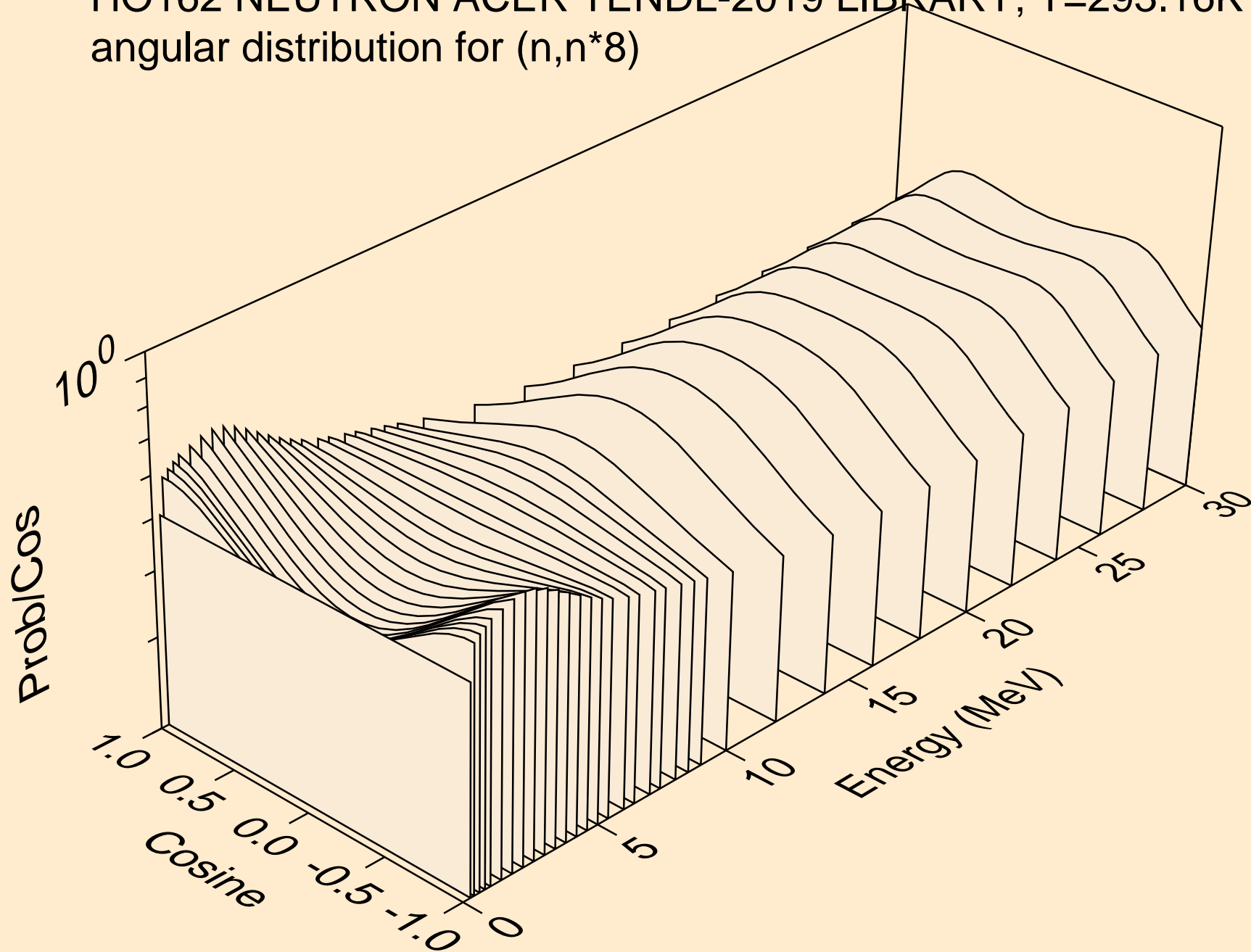

HO162 NEUTRON ACER TENDL-2019 LIBRARY; T=293.16K
angular distribution for (n,n*9)

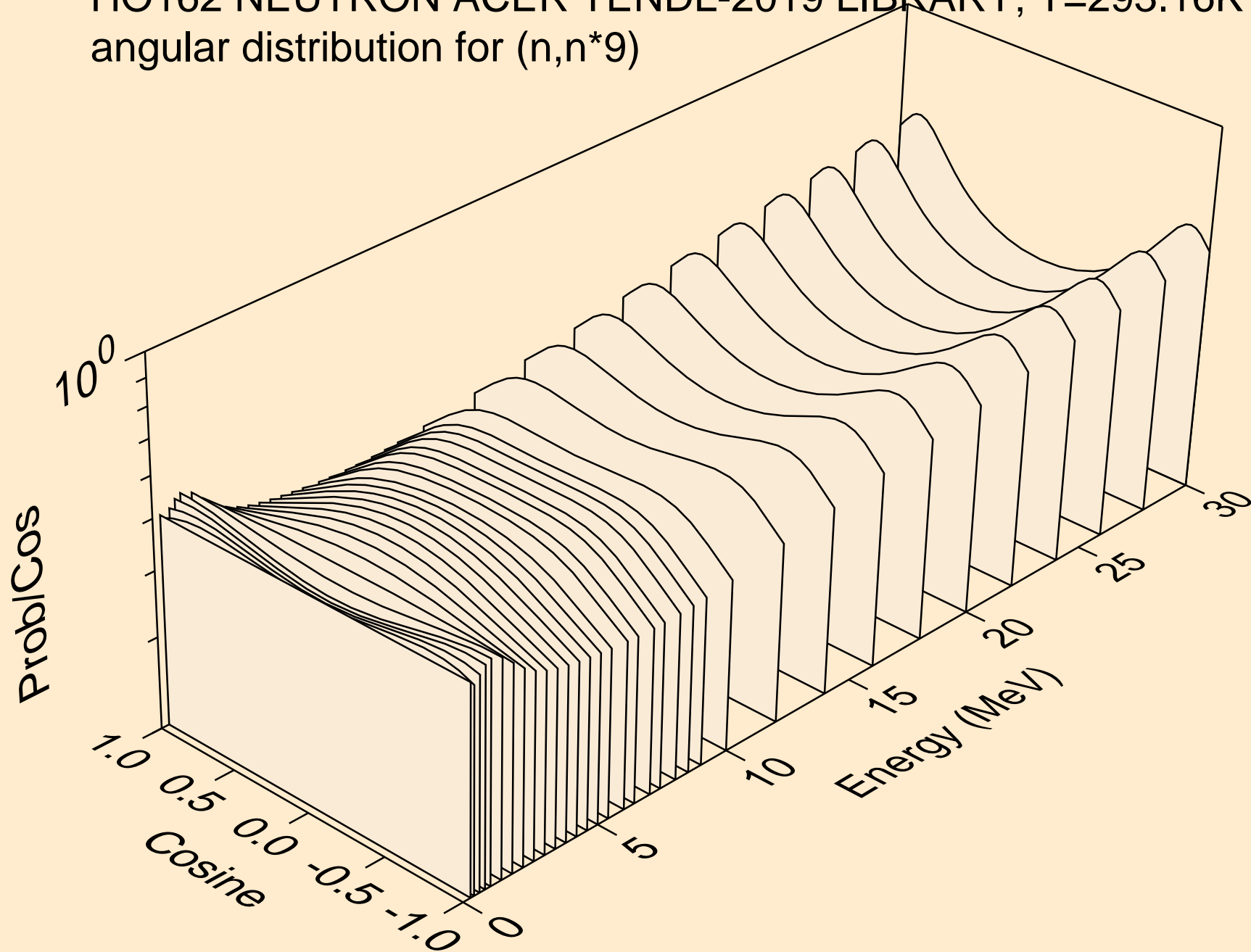

HO162 NEUTRON ACER TENDL-2019 LIBRARY; T=293.16K
angular distribution for (n,n*10)

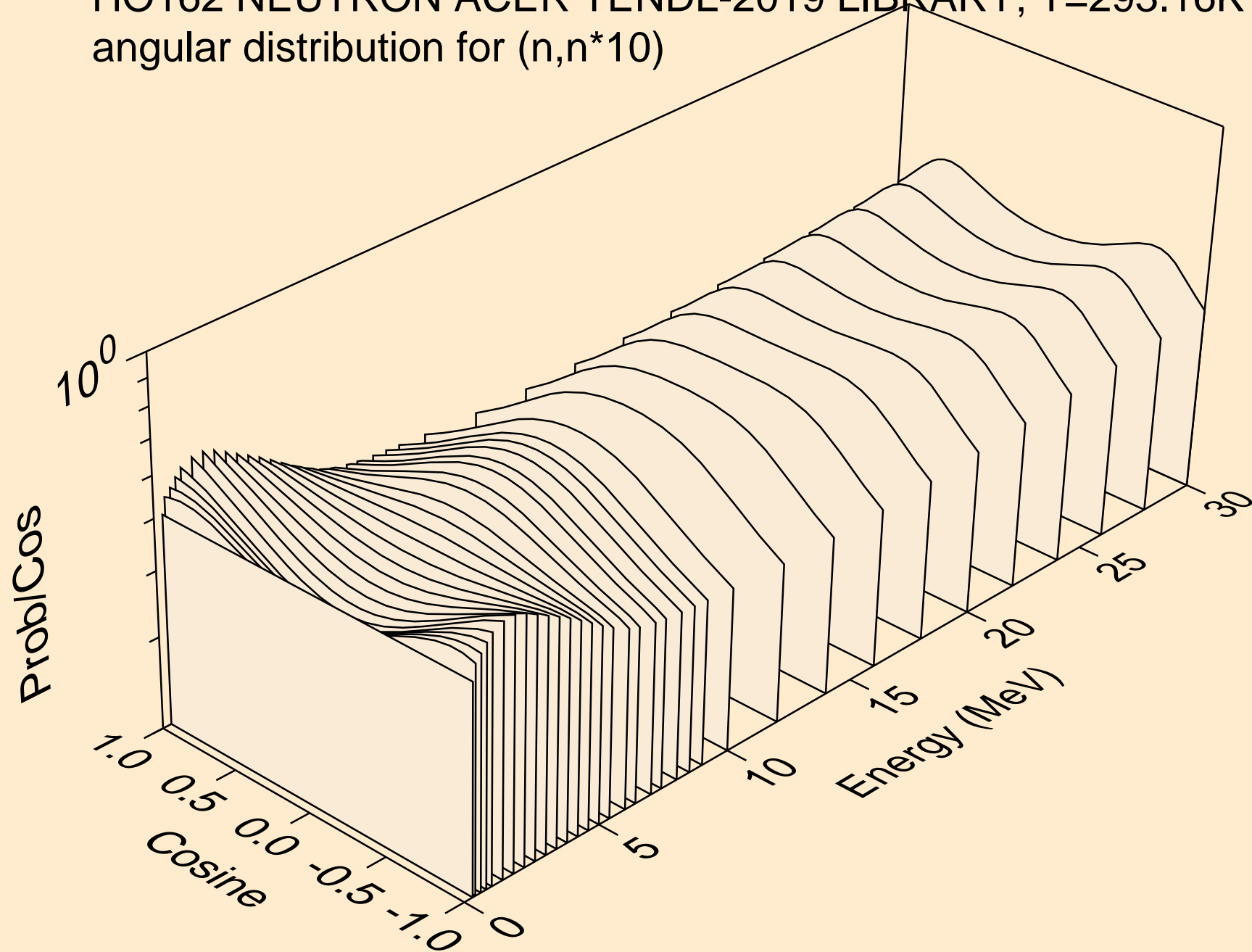

HO162 NEUTRON ACER TENDL-2019 LIBRARY; T=293.16K
angular distribution for (n,n*11)

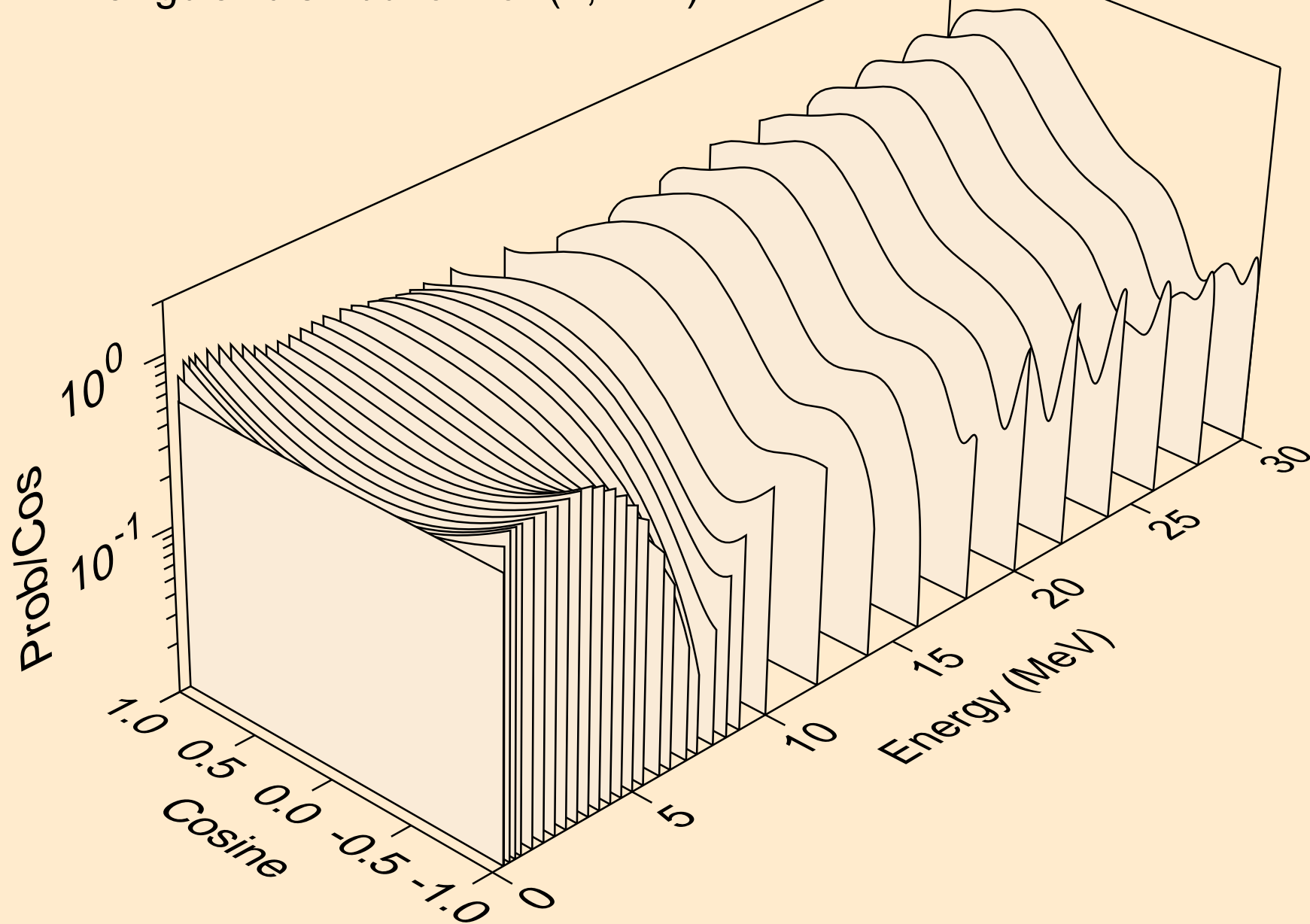

HO162 NEUTRON ACER TENDL-2019 LIBRARY; T=293.16K
angular distribution for (n,n*12)

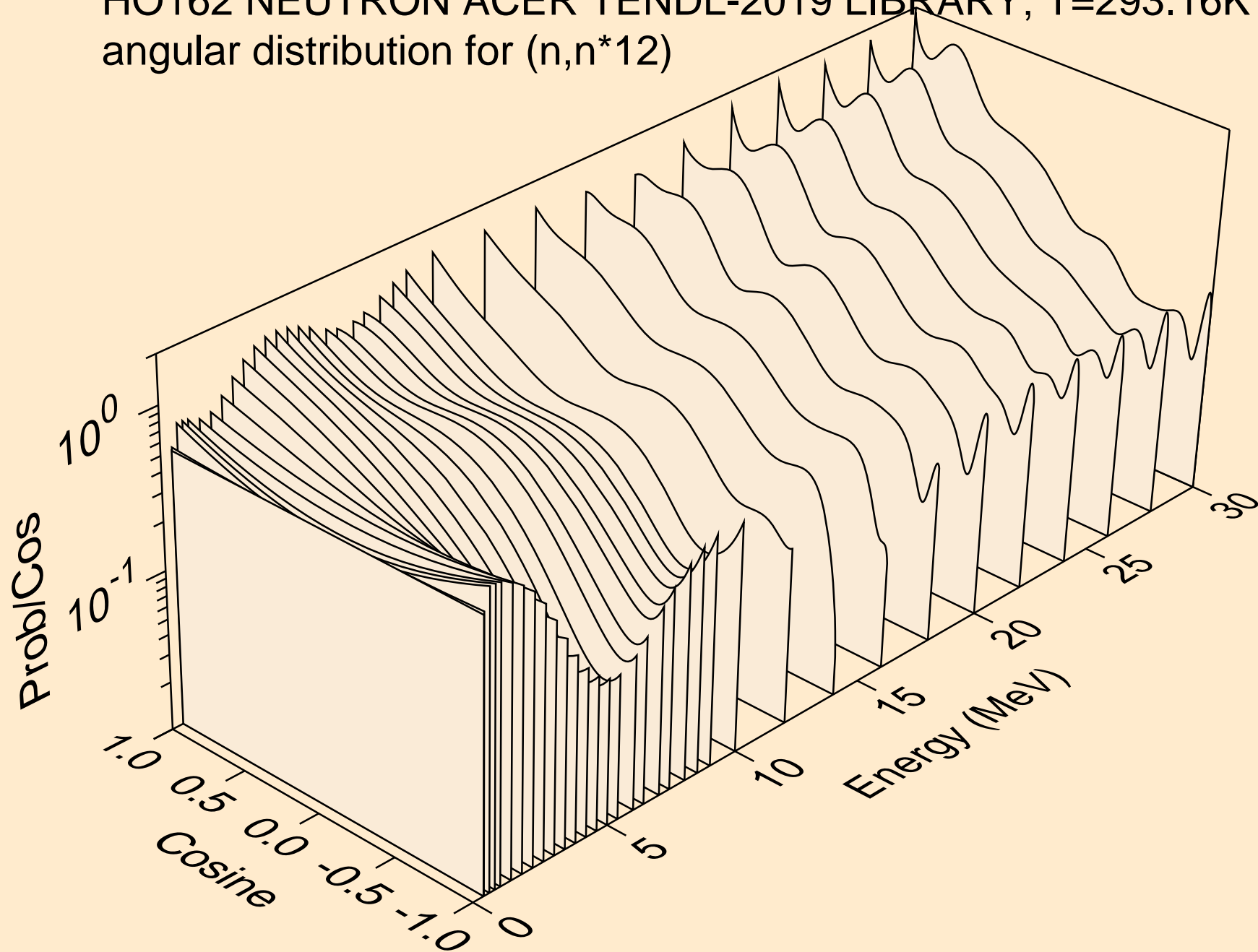

HO162 NEUTRON ACER TENDL-2019 LIBRARY; T=293.16K
Neutron emission for (n,x)

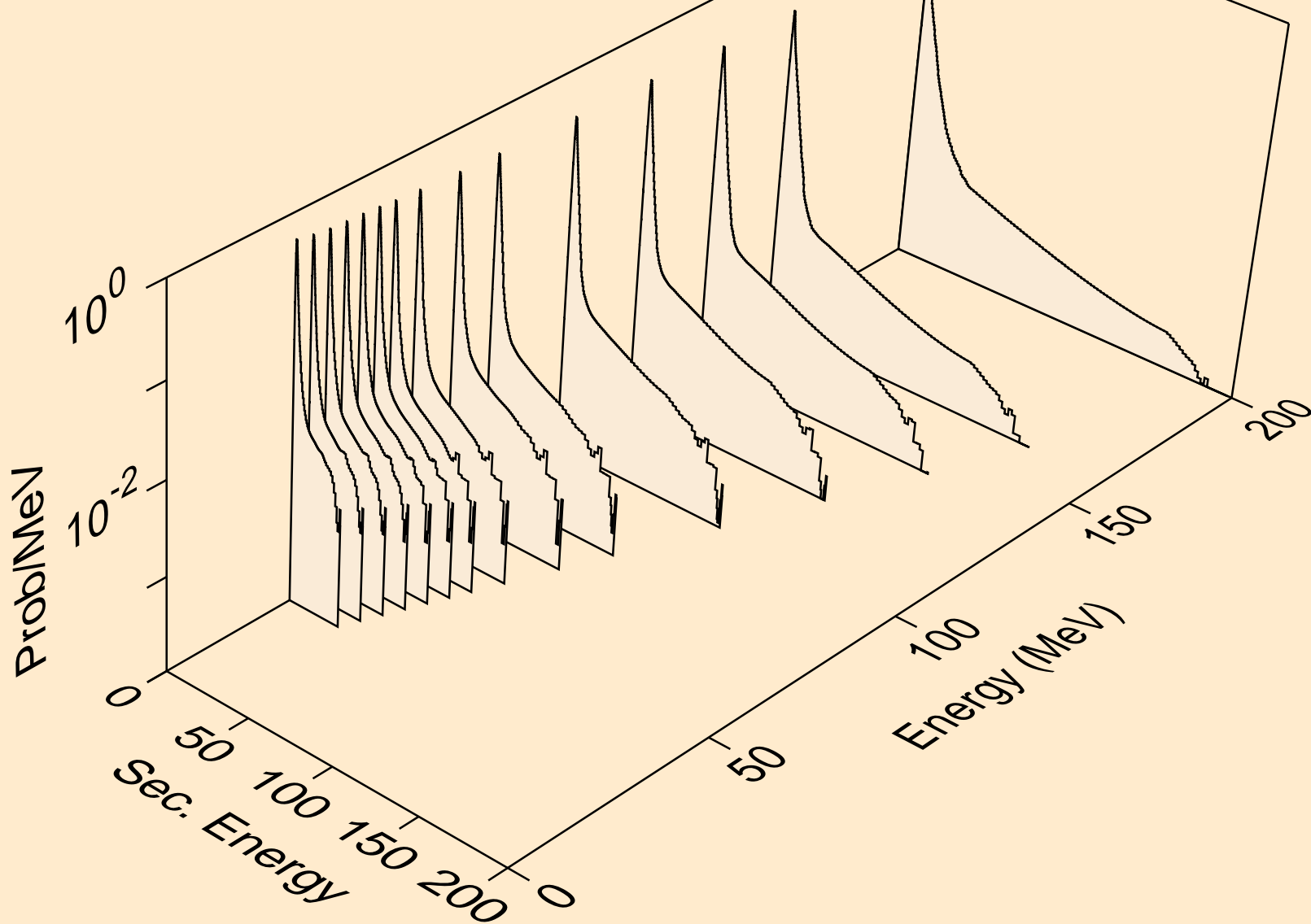

HO162 NEUTRON ACER TENDL-2019 LIBRARY; T=293.16K
Neutron emission for (n,2nd)

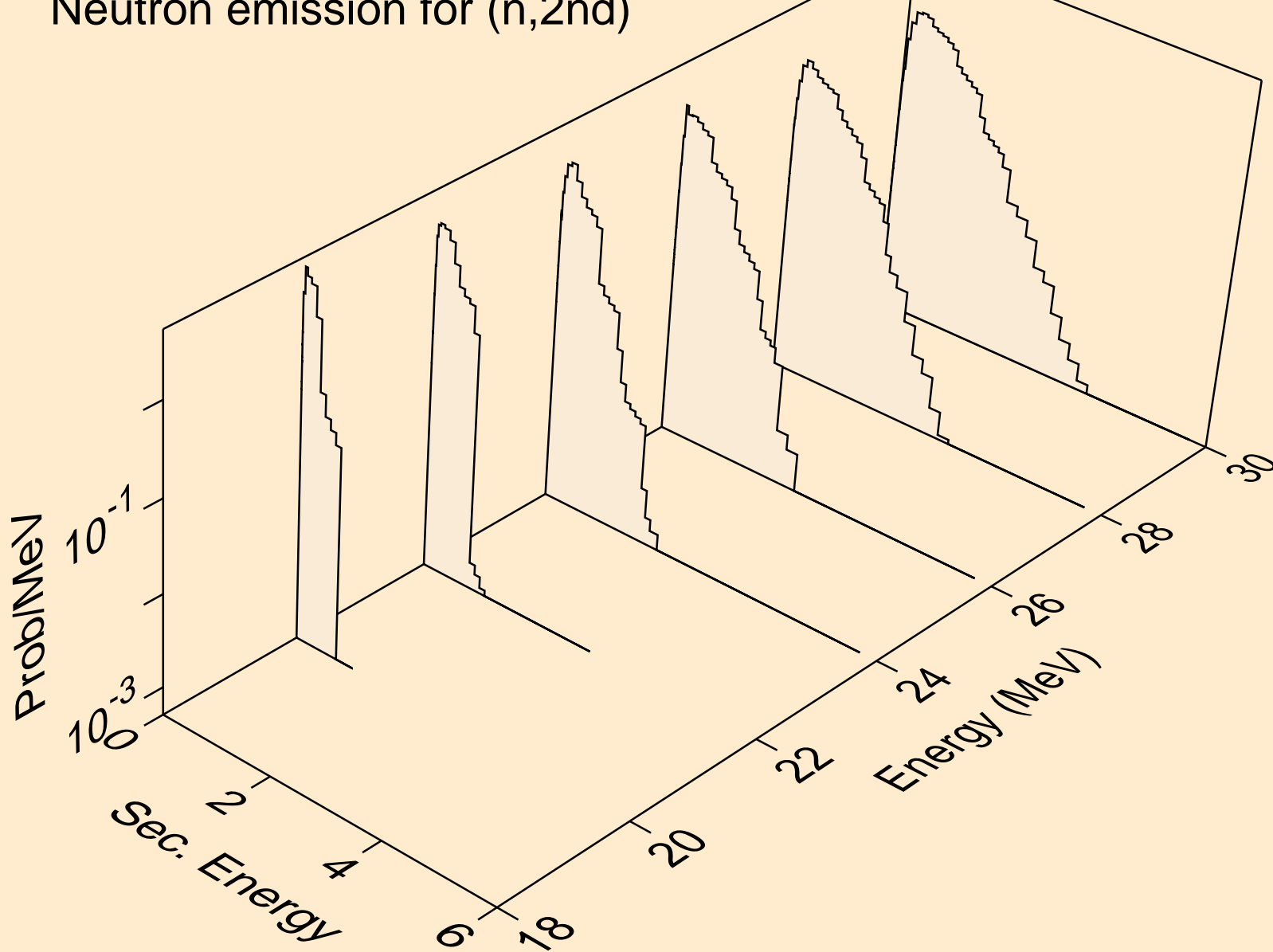

HO162 NEUTRON ACER TENDL-2019 LIBRARY; T=293.16K
Neutron emission for (n,2n)

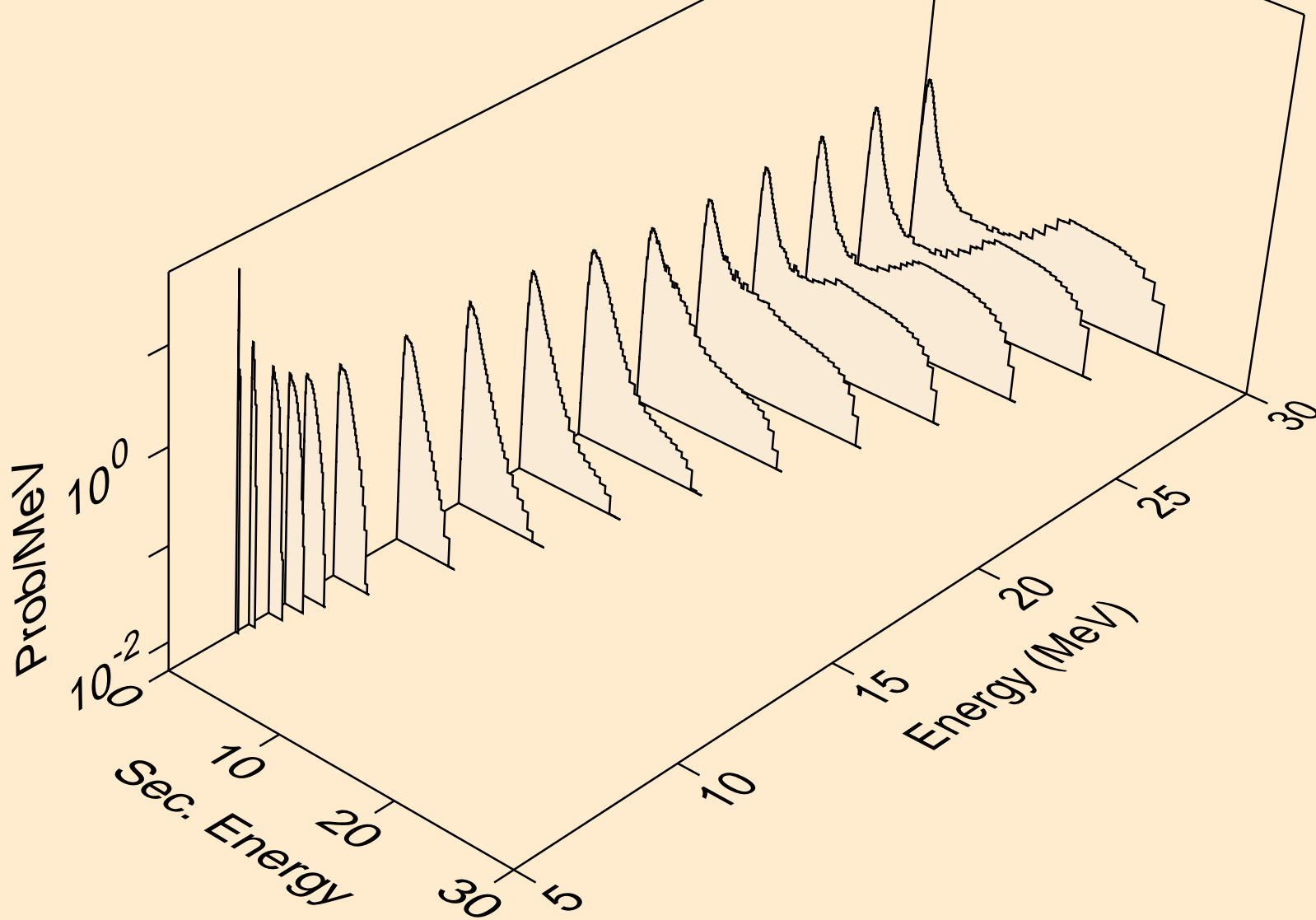

HO162 NEUTRON ACER TENDL-2019 LIBRARY; T=293.16K
Neutron emission for (n,3n)

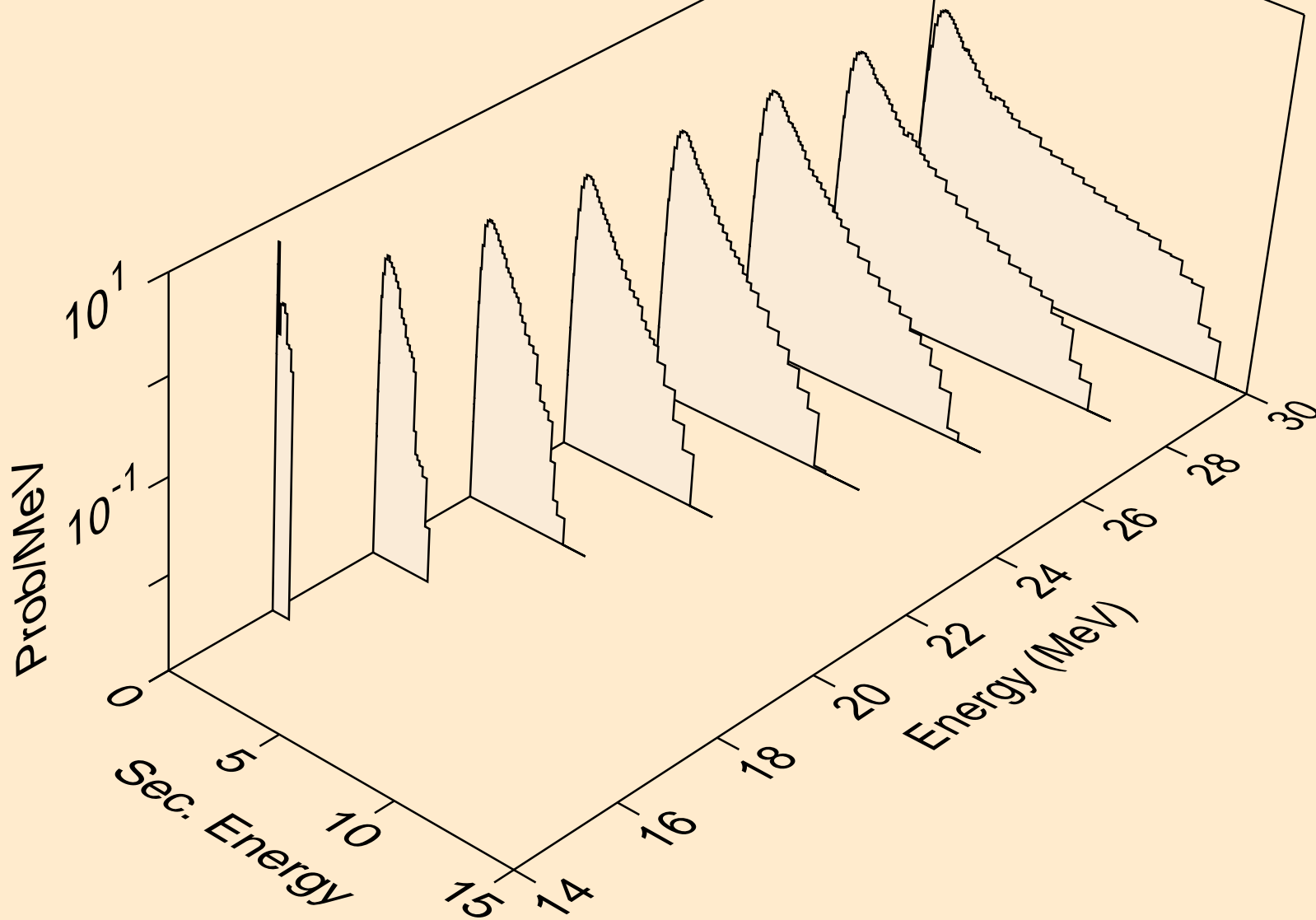

HO162 NEUTRON ACER TENDL-2019 LIBRARY; T=293.16K
Neutron emission for (n,n*)a

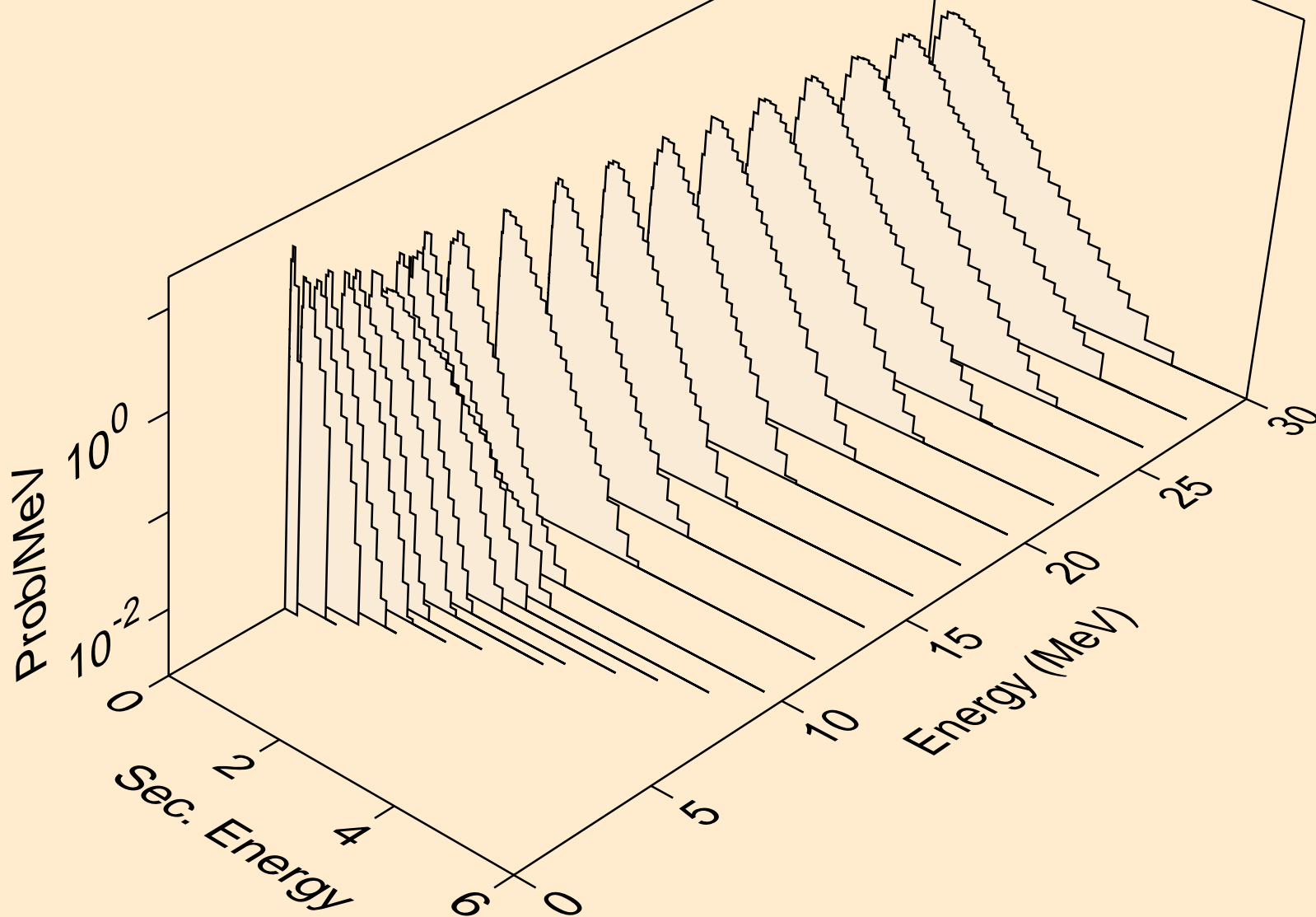

HO162 NEUTRON ACER TENDL-2019 LIBRARY; T=293.16K
Neutron emission for (n,2n)a

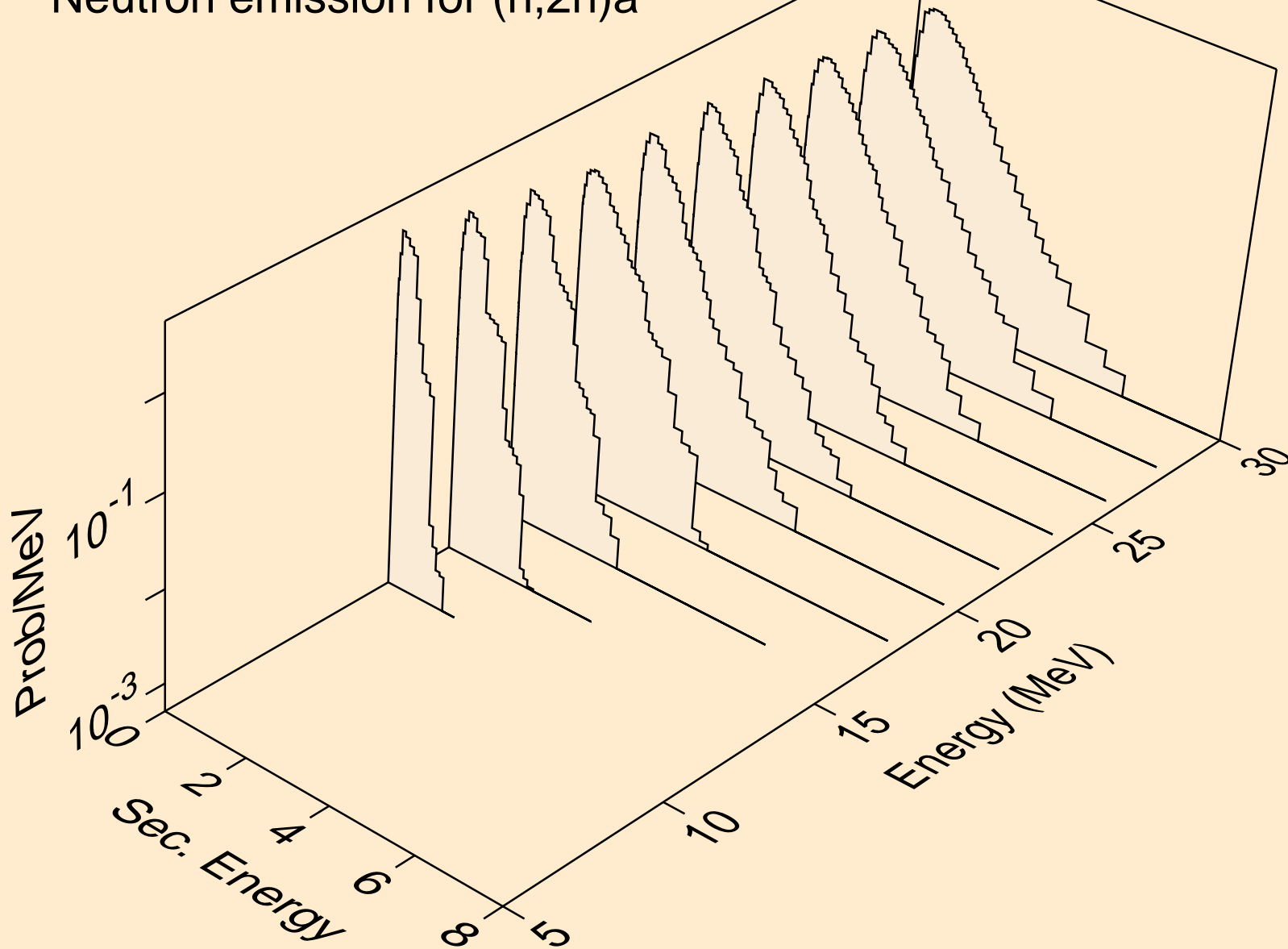

HO162 NEUTRON ACER TENDL-2019 LIBRARY; T=293.16K
Neutron emission for (n,3n)a

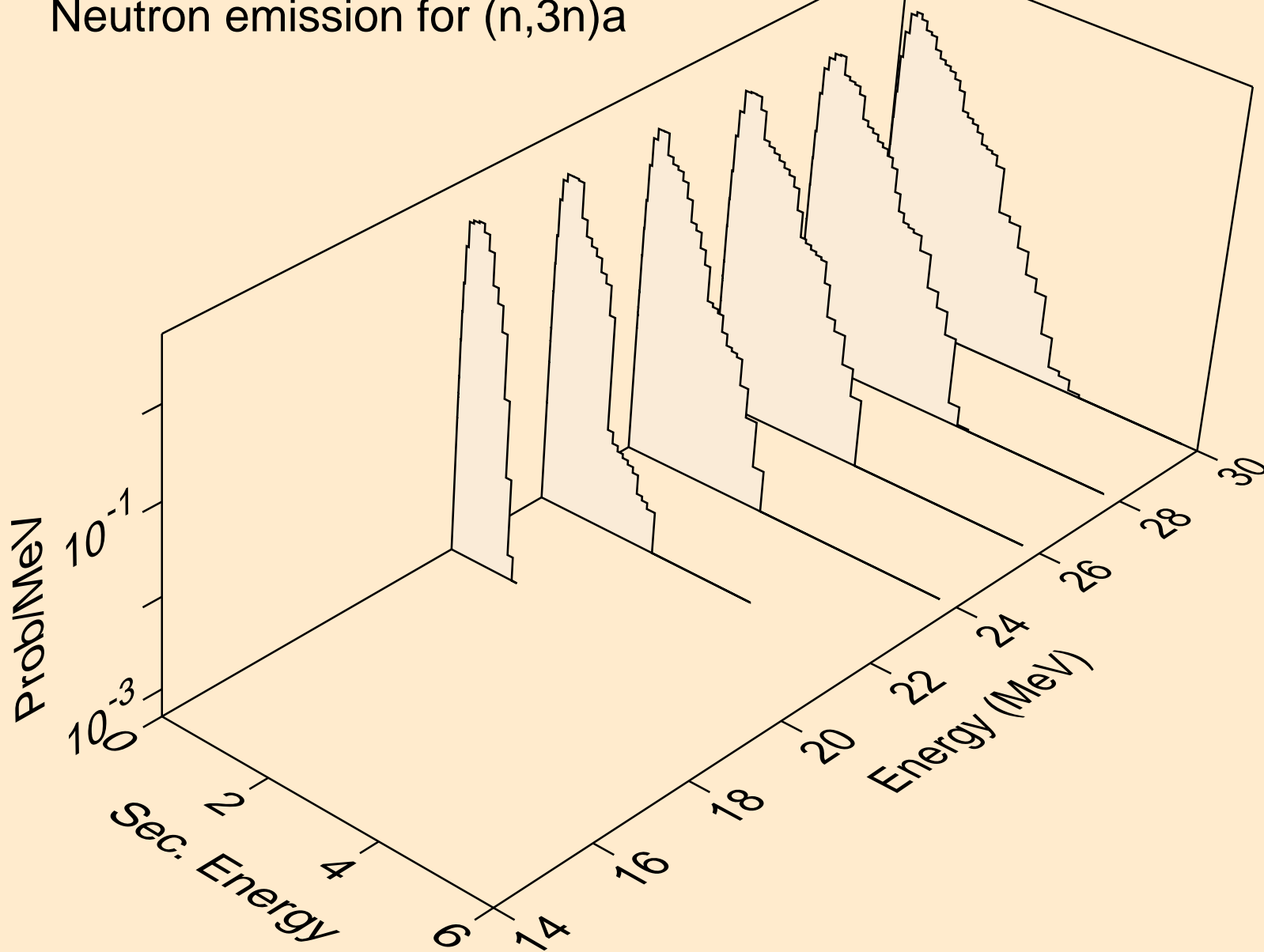

HO162 NEUTRON ACER TENDL-2019 LIBRARY; T=293.16K
Neutron emission for (n,n*)p

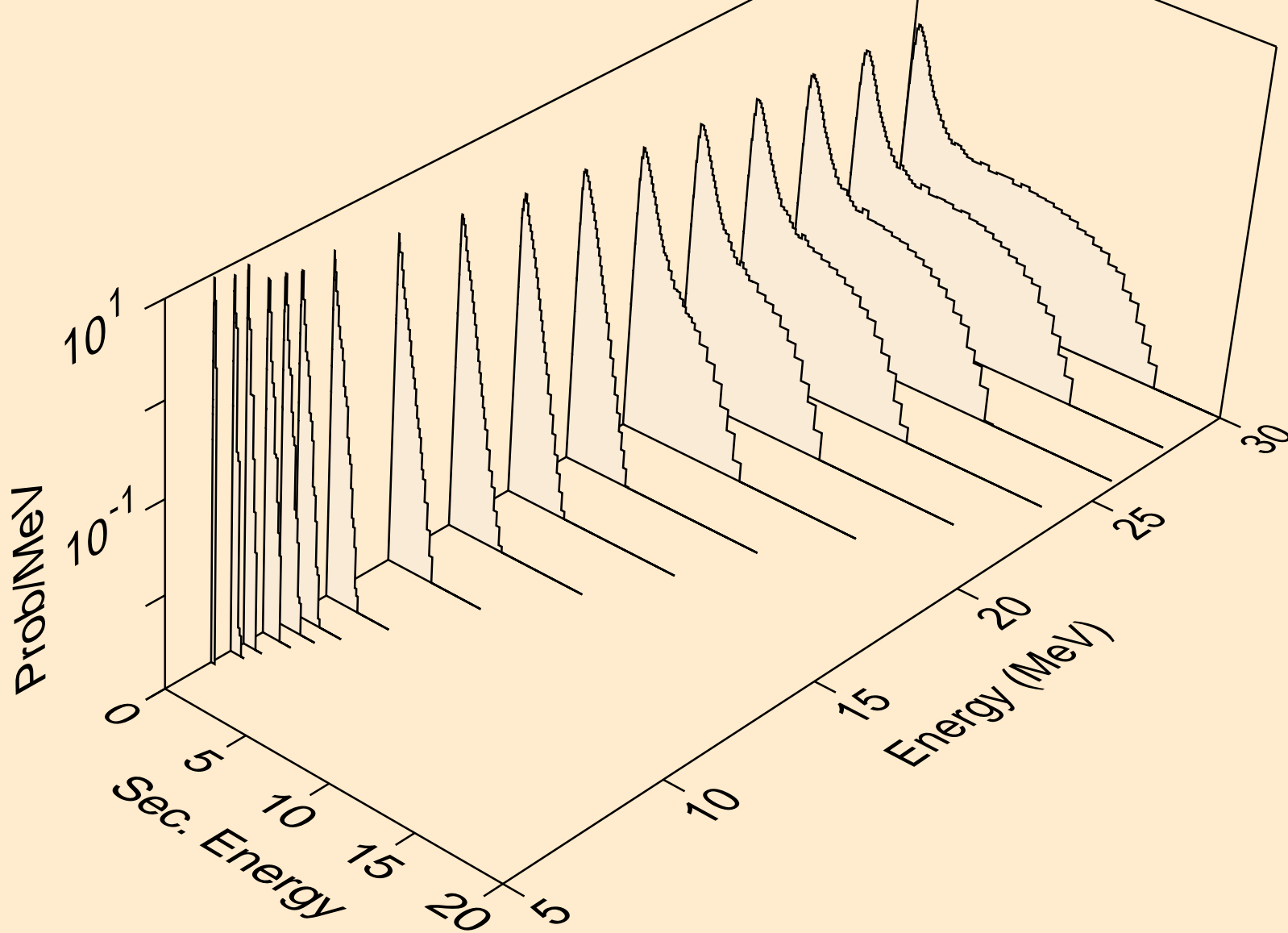

HO162 NEUTRON ACER TENDL-2019 LIBRARY; T=293.16K
Neutron emission for (n,n*)2a

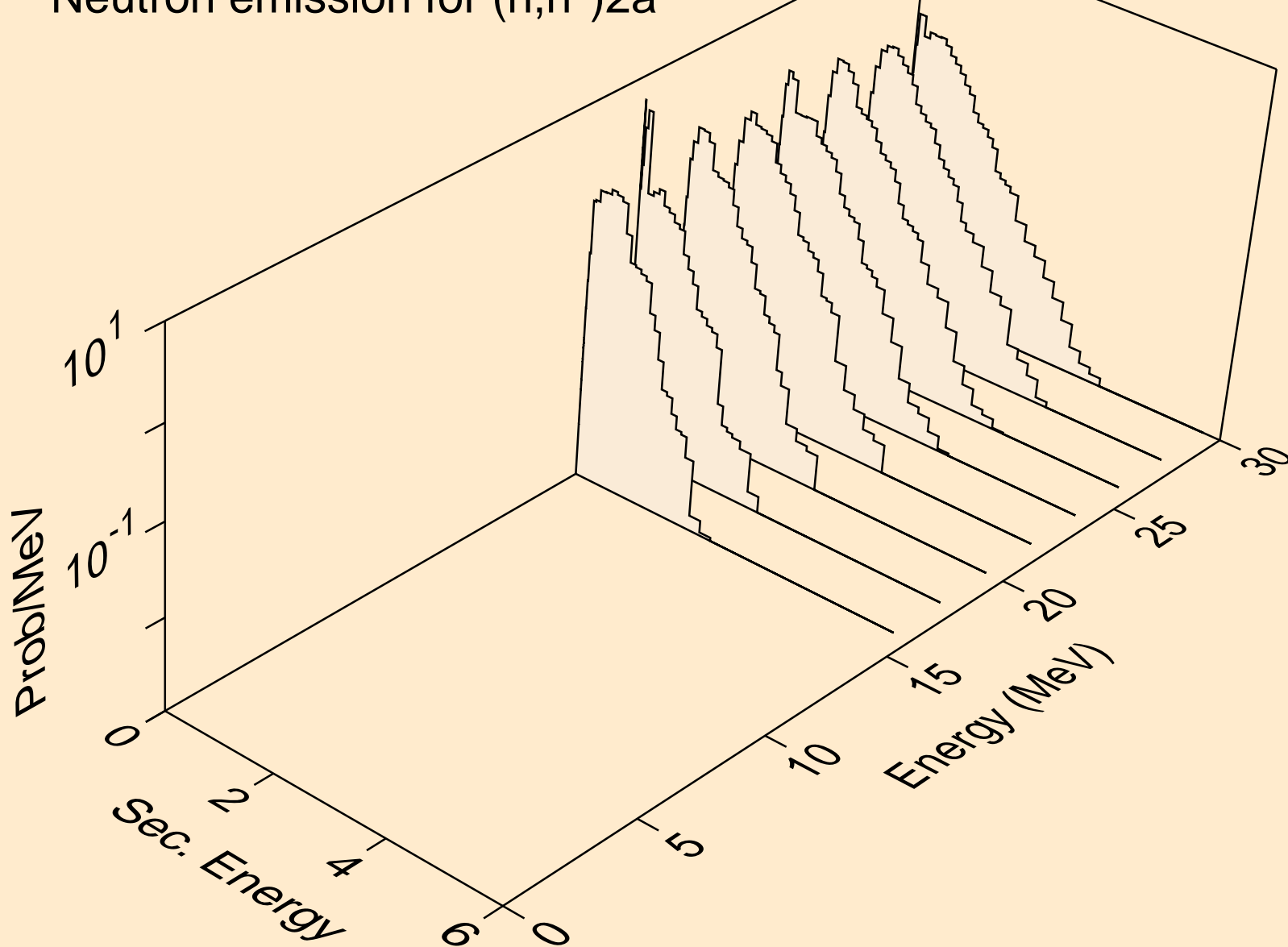

HO162 NEUTRON ACER TENDL-2019 LIBRARY; T=293.16K
Neutron emission for (n,n*)d

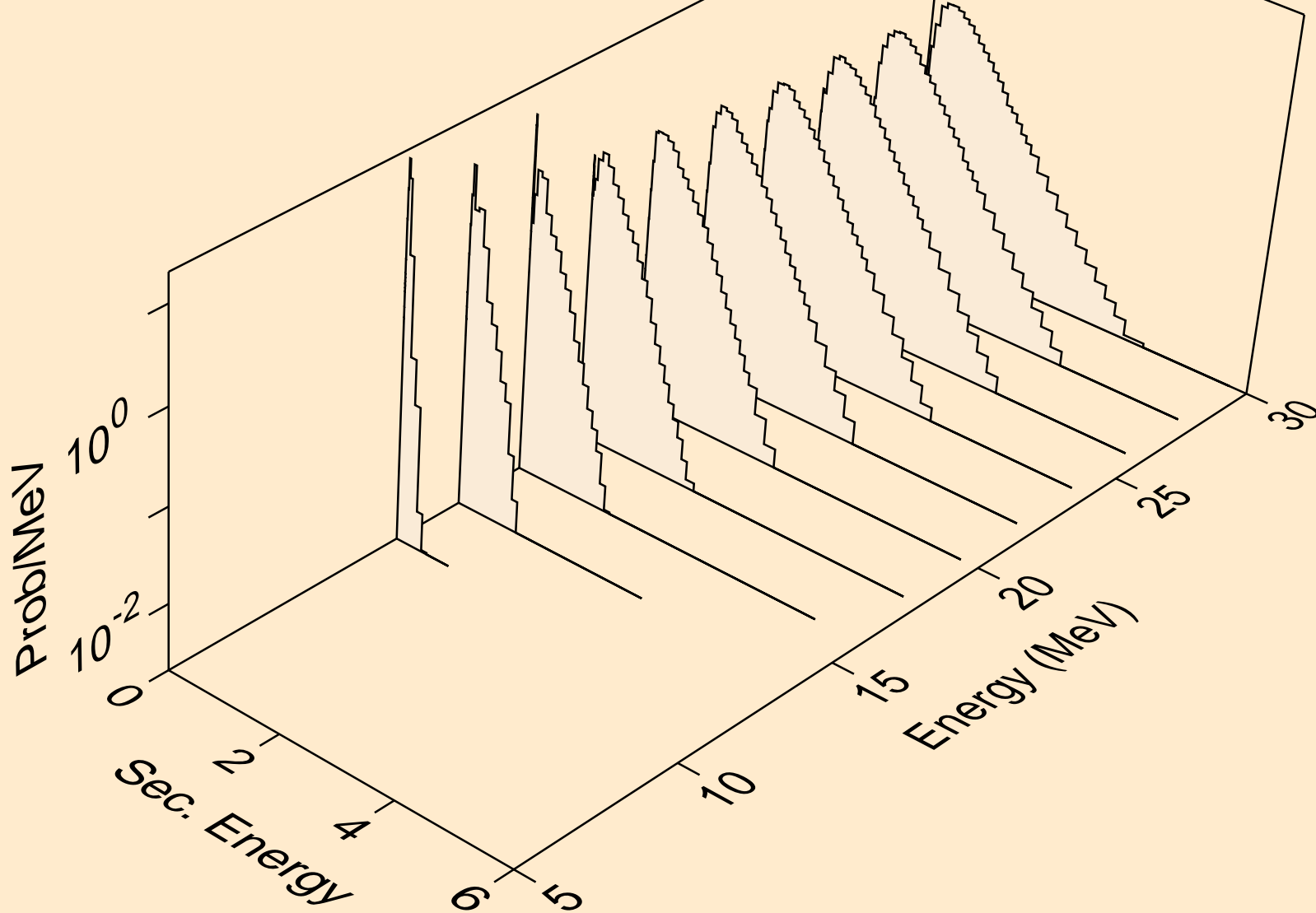

HO162 NEUTRON ACER TENDL-2019 LIBRARY; T=293.16K
Neutron emission for (n,n*)t

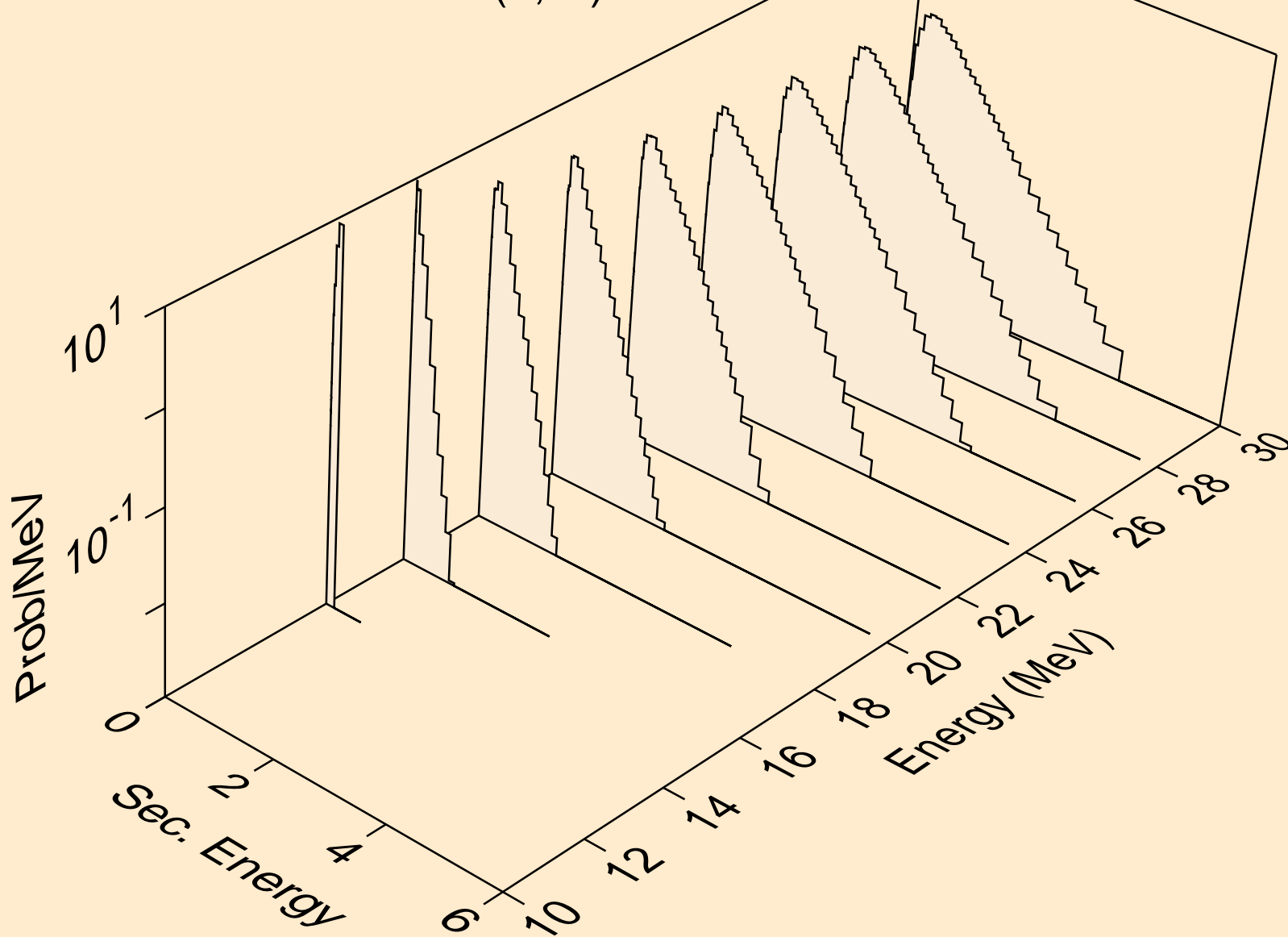

HO162 NEUTRON ACER TENDL-2019 LIBRARY; T=293.16K
Neutron emission for (n,n*)he3

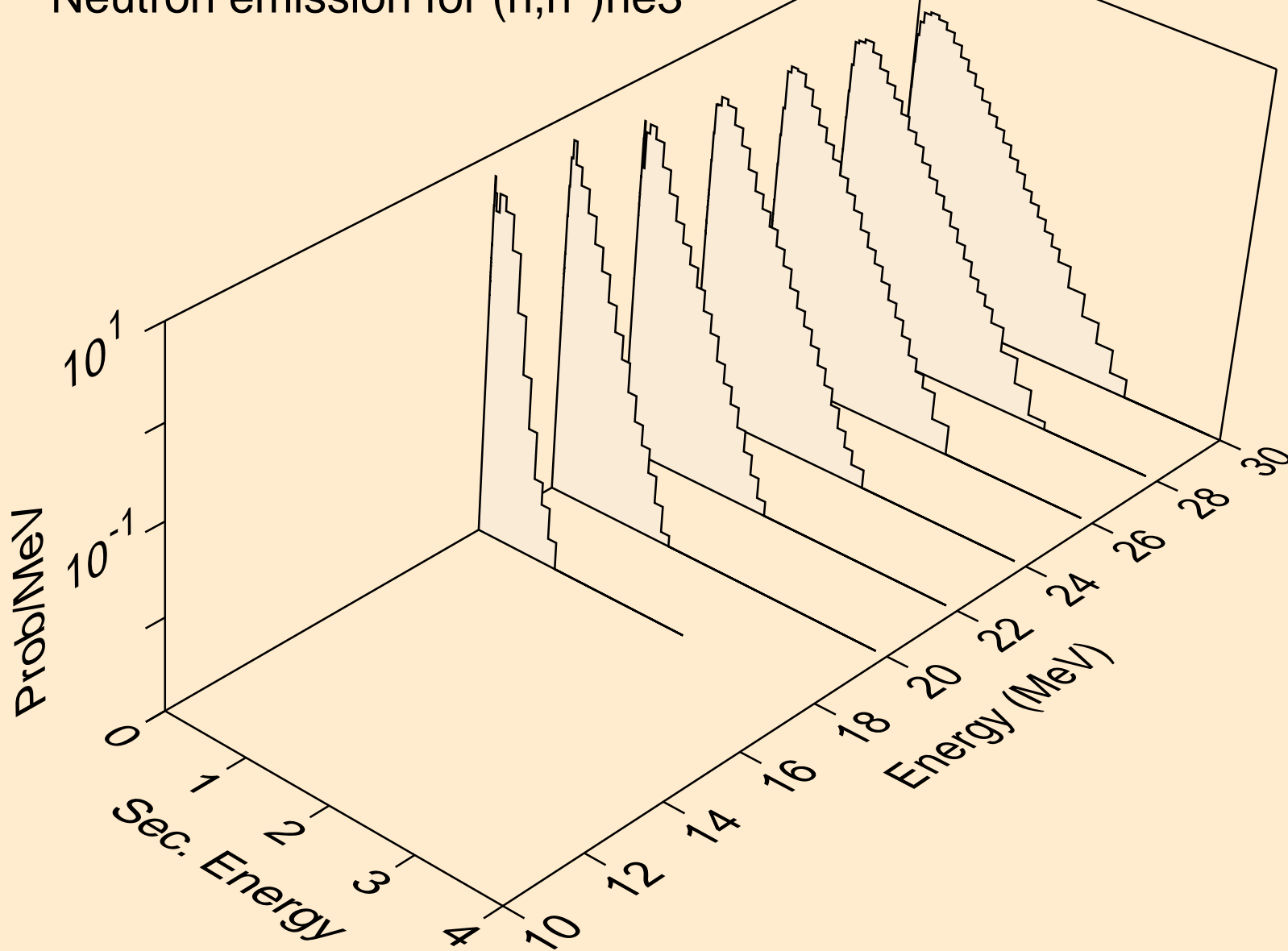

HO162 NEUTRON ACER TENDL-2019 LIBRARY; T=293.16K
Neutron emission for (n,4n)

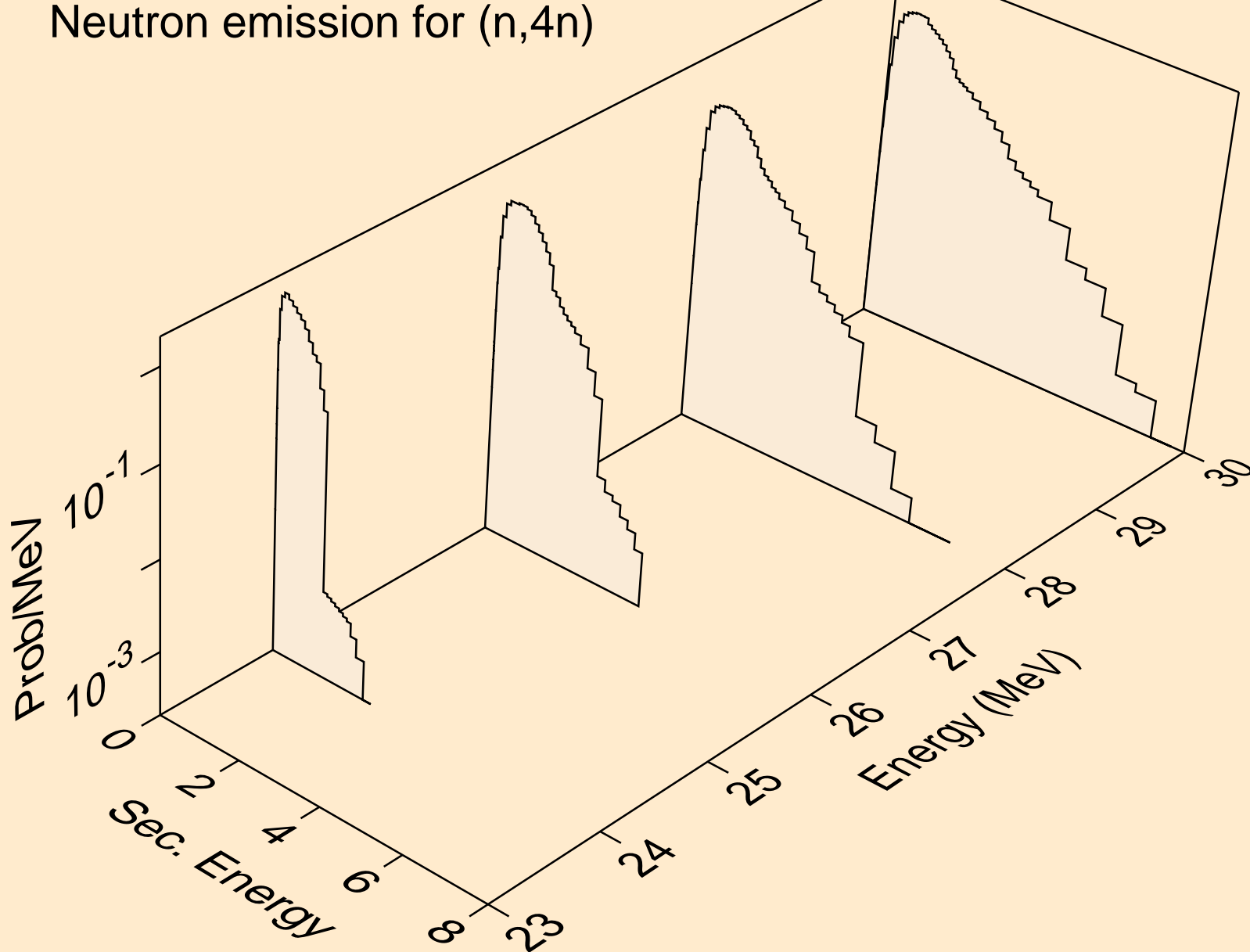

HO162 NEUTRON ACER TENDL-2019 LIBRARY; T=293.16K
Neutron emission for (n,2np)

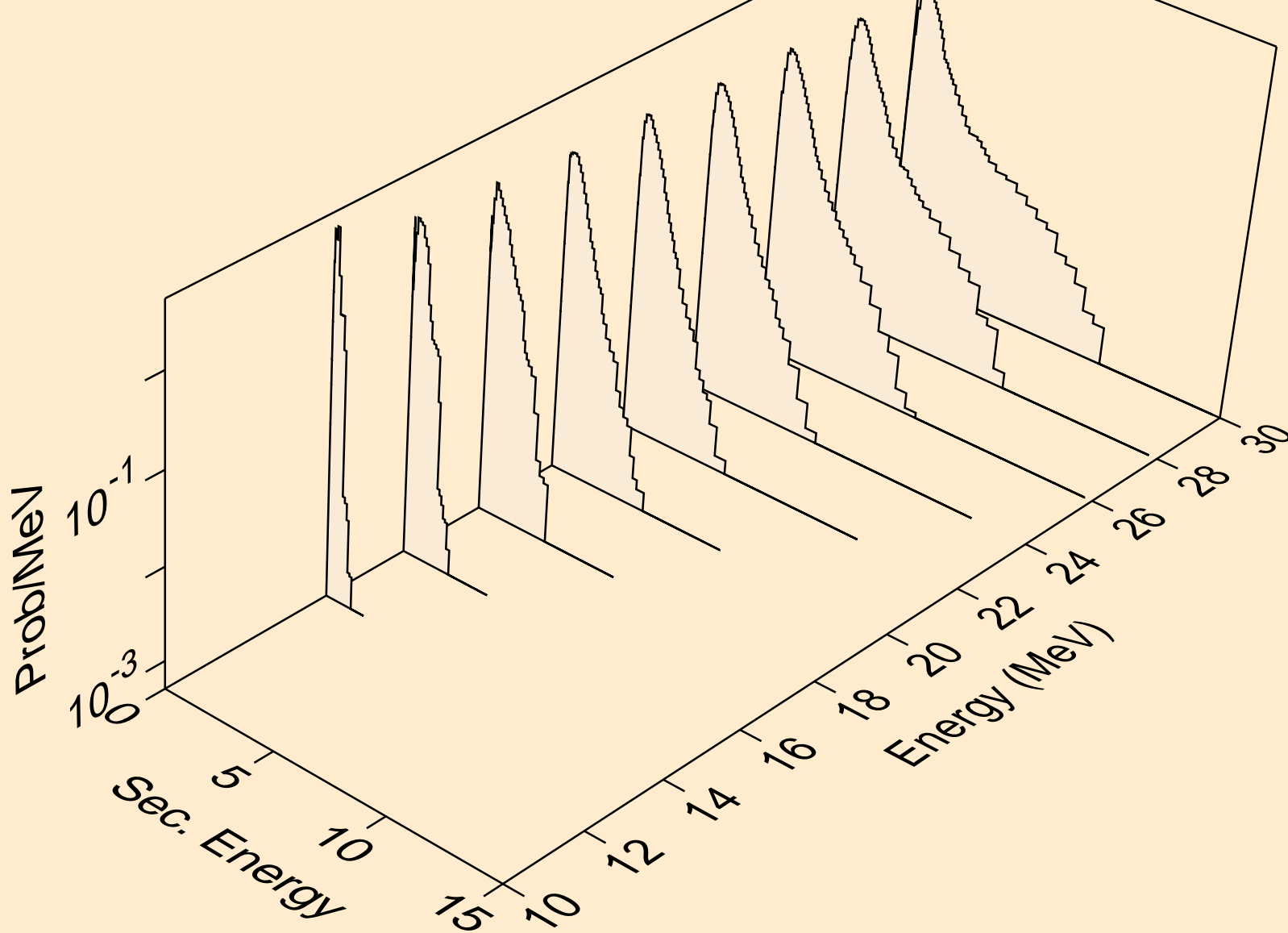

HO162 NEUTRON ACER TENDL-2019 LIBRARY; T=293.16K
Neutron emission for (n,3np)

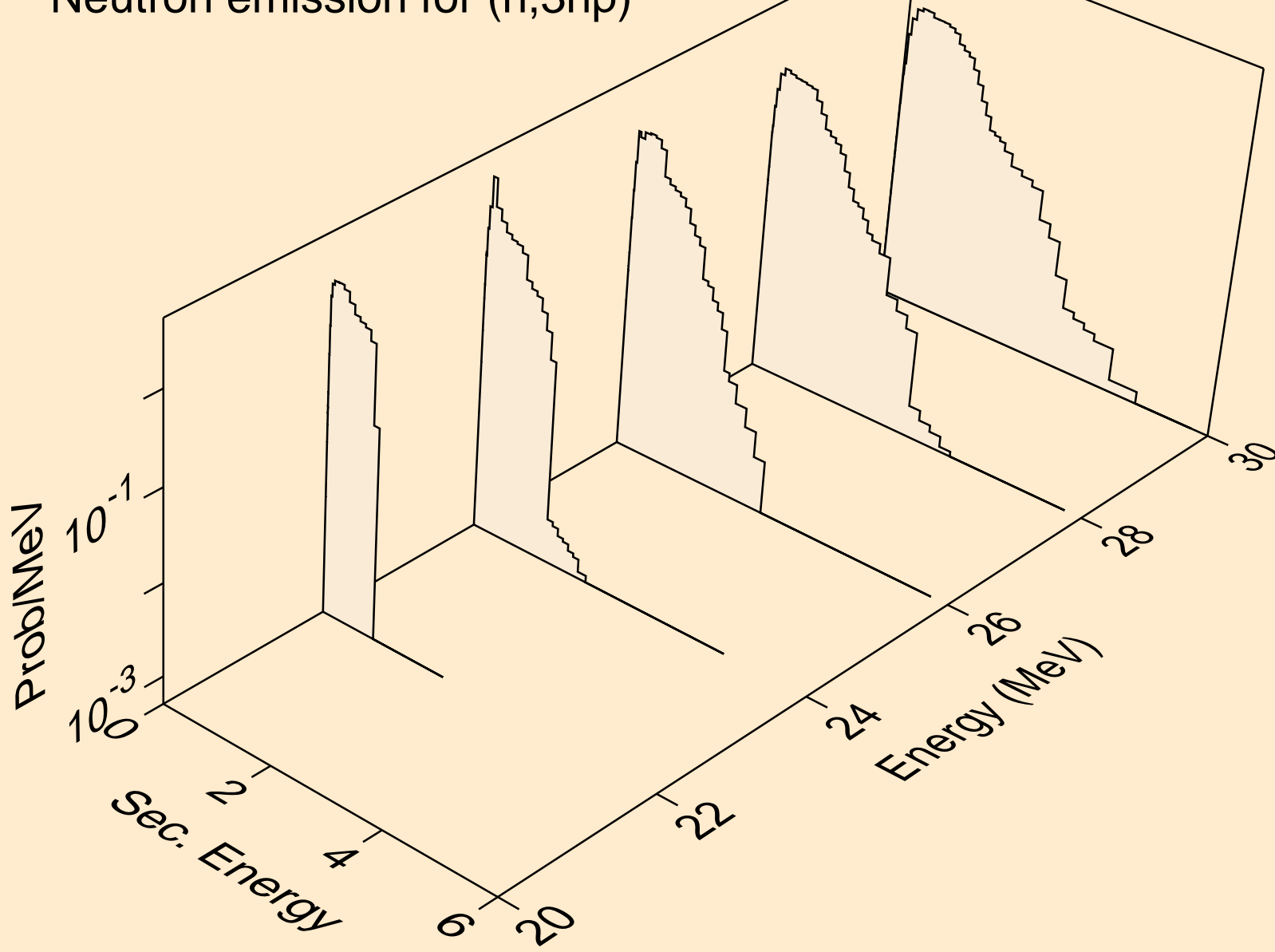

HO162 NEUTRON ACER TENDL-2019 LIBRARY; T=293.16K
Neutron emission for (n,2np)

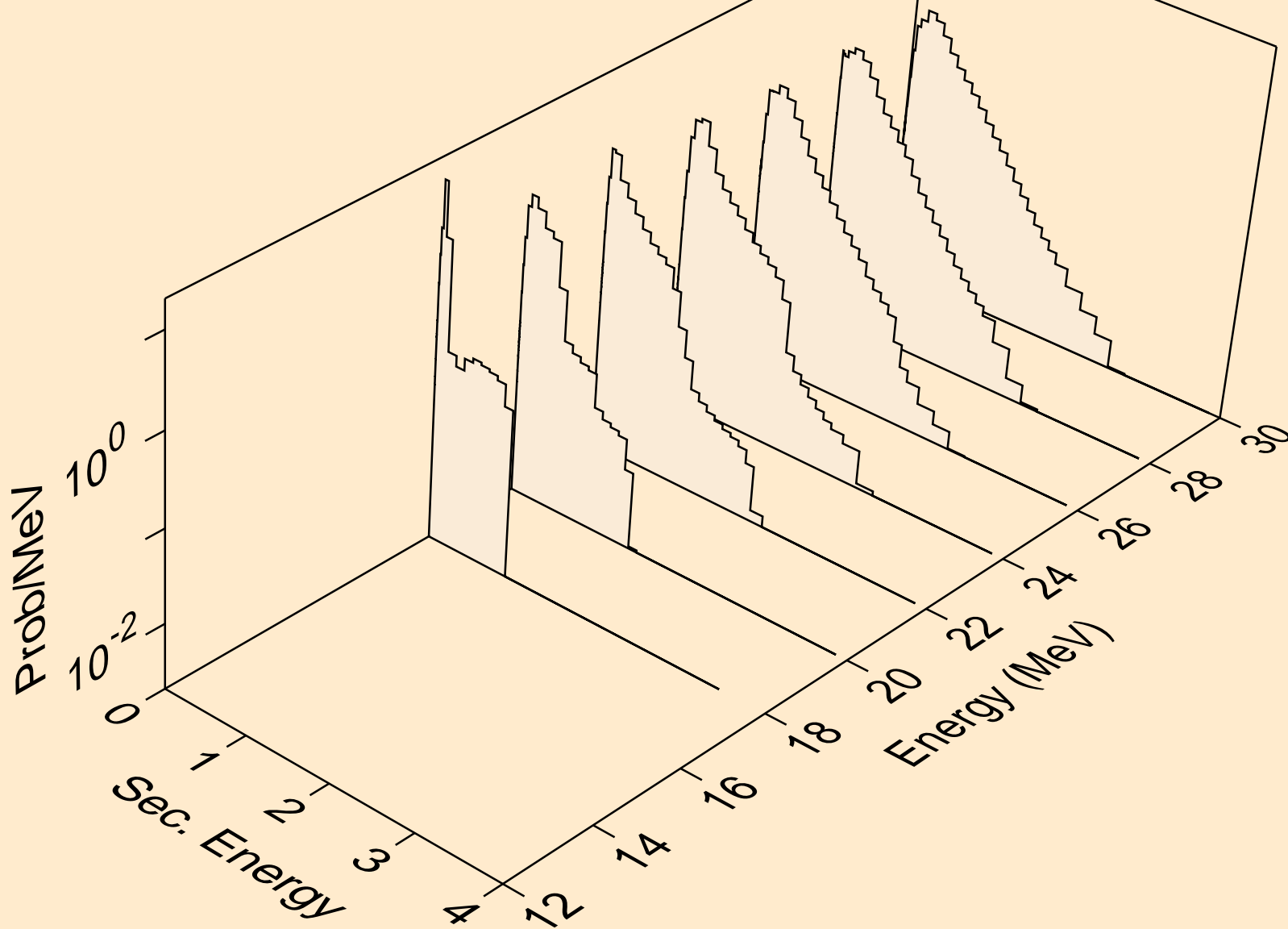

HO162 NEUTRON ACER TENDL-2019 LIBRARY; T=293.16K
Neutron emission for (n,npa)

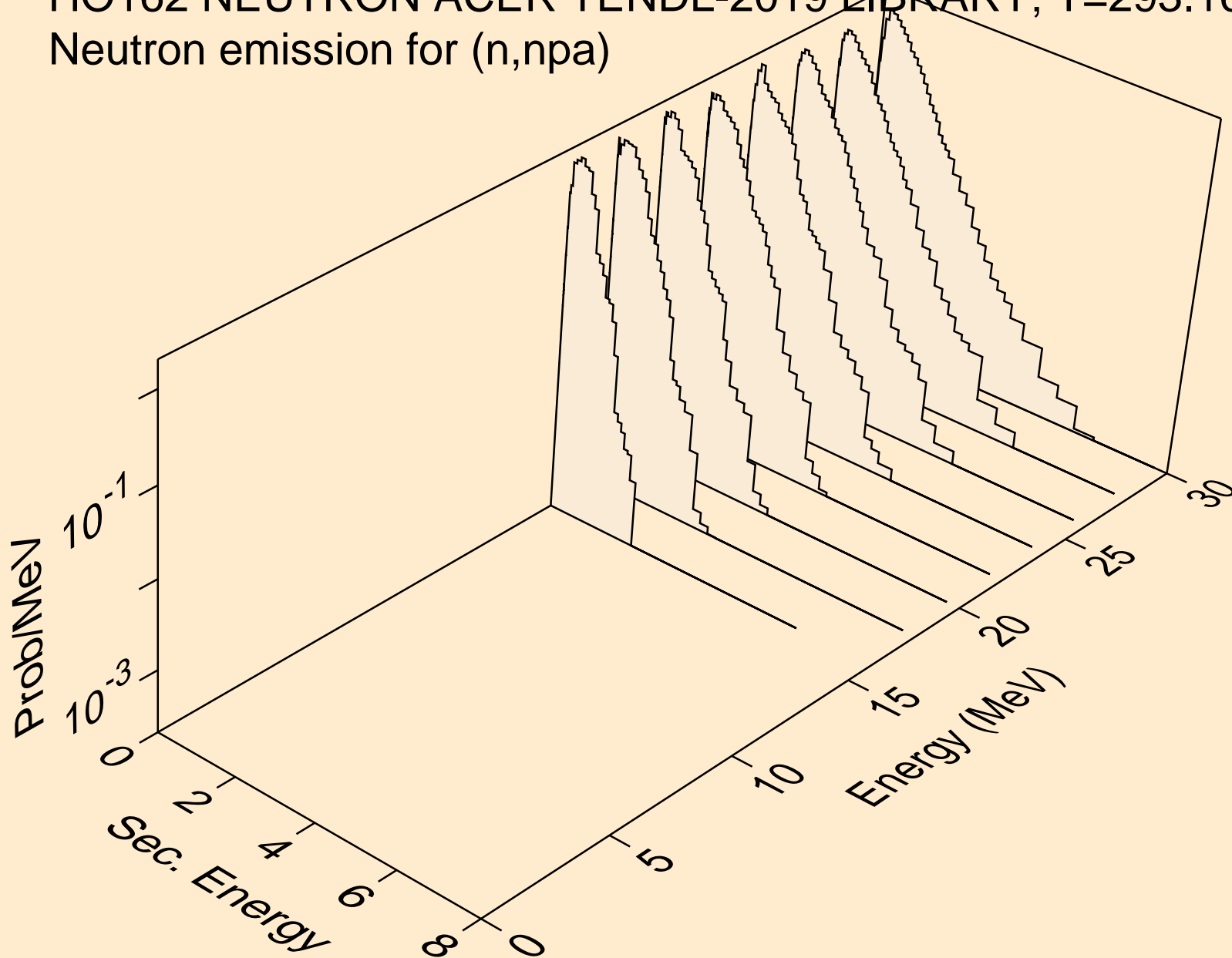

HO162 NEUTRON ACER TENDL-2019 LIBRARY; T=293.16K
Neutron emission for (n,n*c)

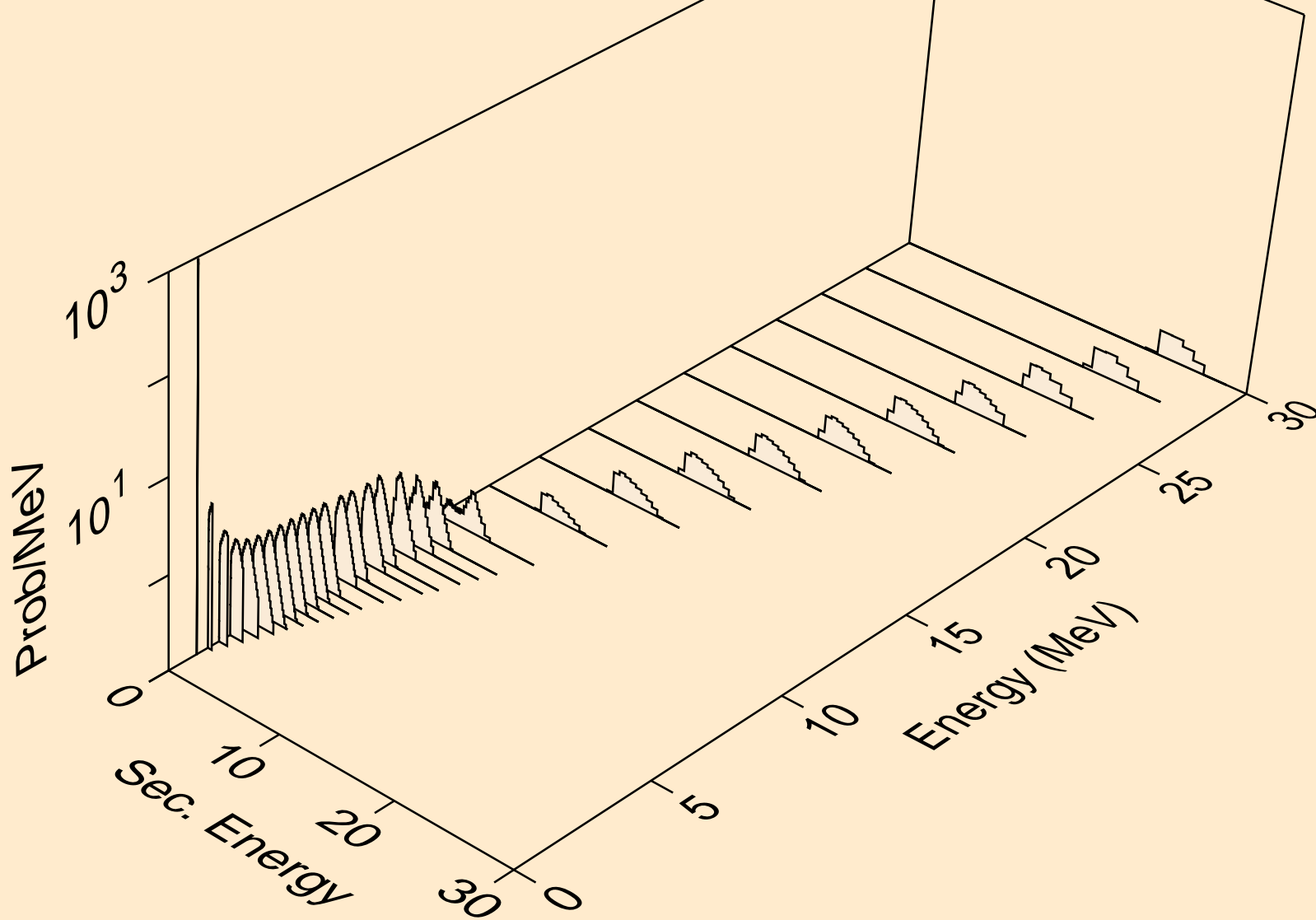

HO162 NEUTRON ACER TENDL-2019 LIBRARY; T=293.16K
Photon emission for (n,x)

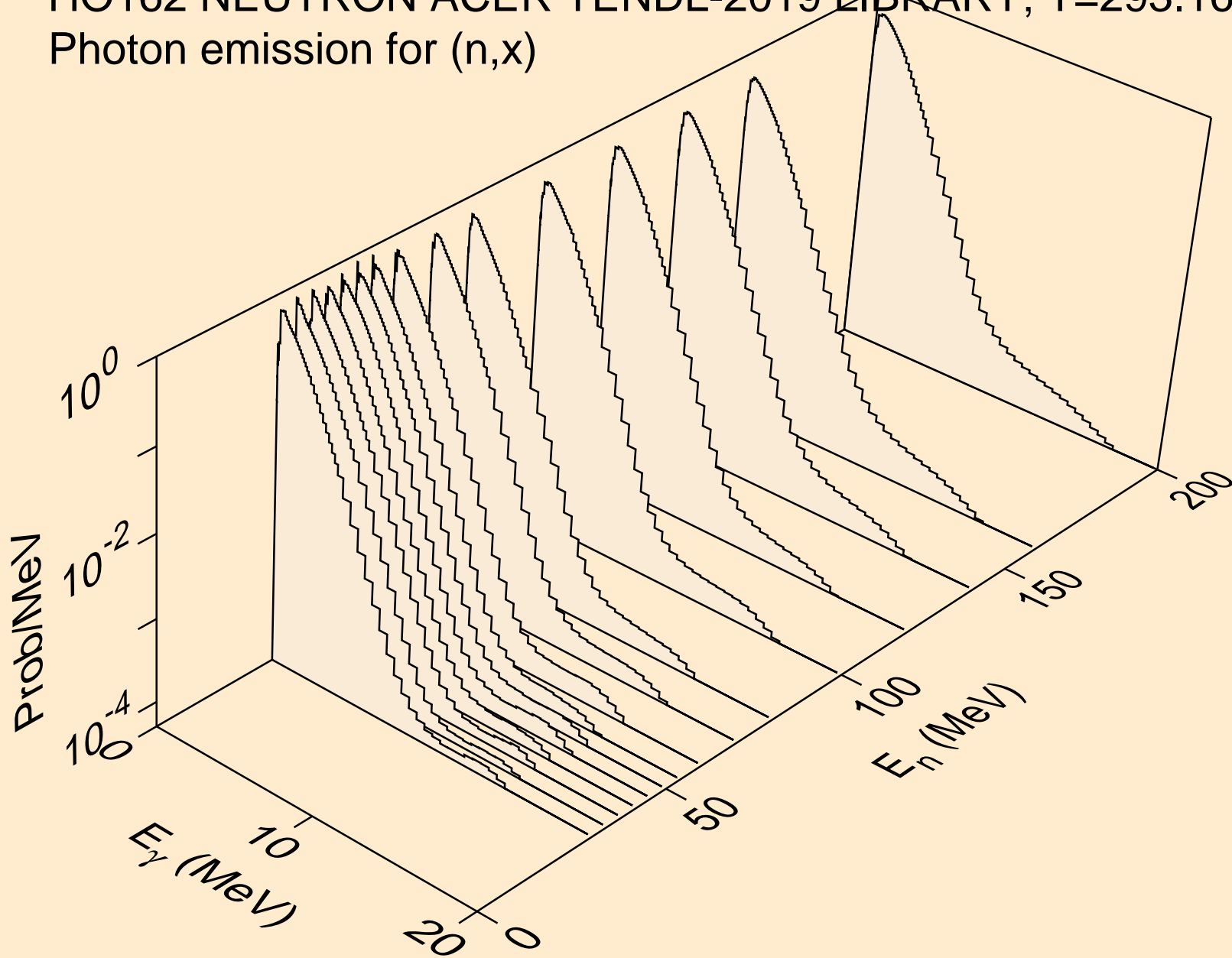

HO162 NEUTRON ACER TENDL-2019 LIBRARY; T=293.16K
Photon emission for (n,2nd)

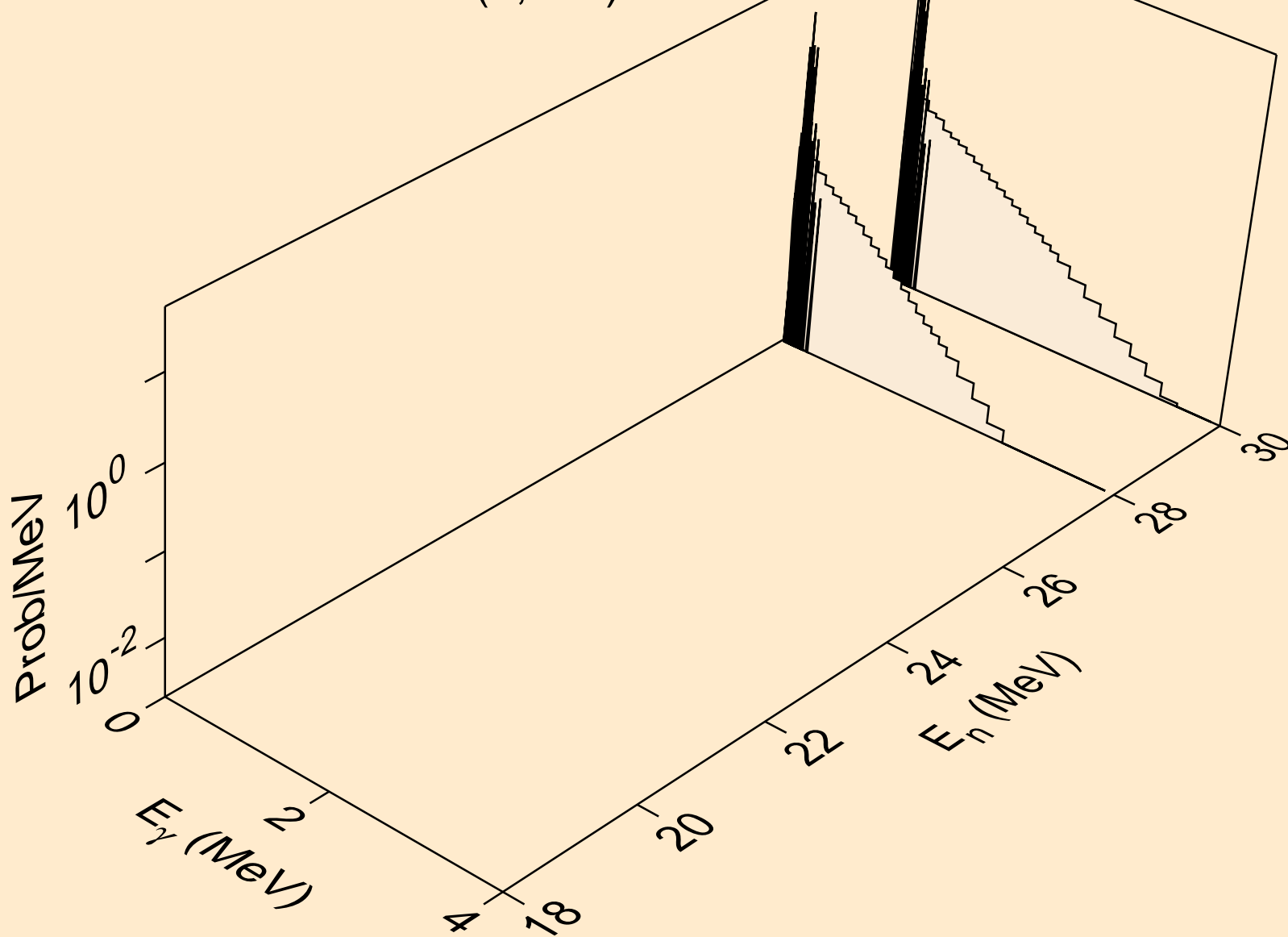

HO162 NEUTRON ACER TENDL-2019 LIBRARY; T=293.16K
Photon emission for (n,2n)

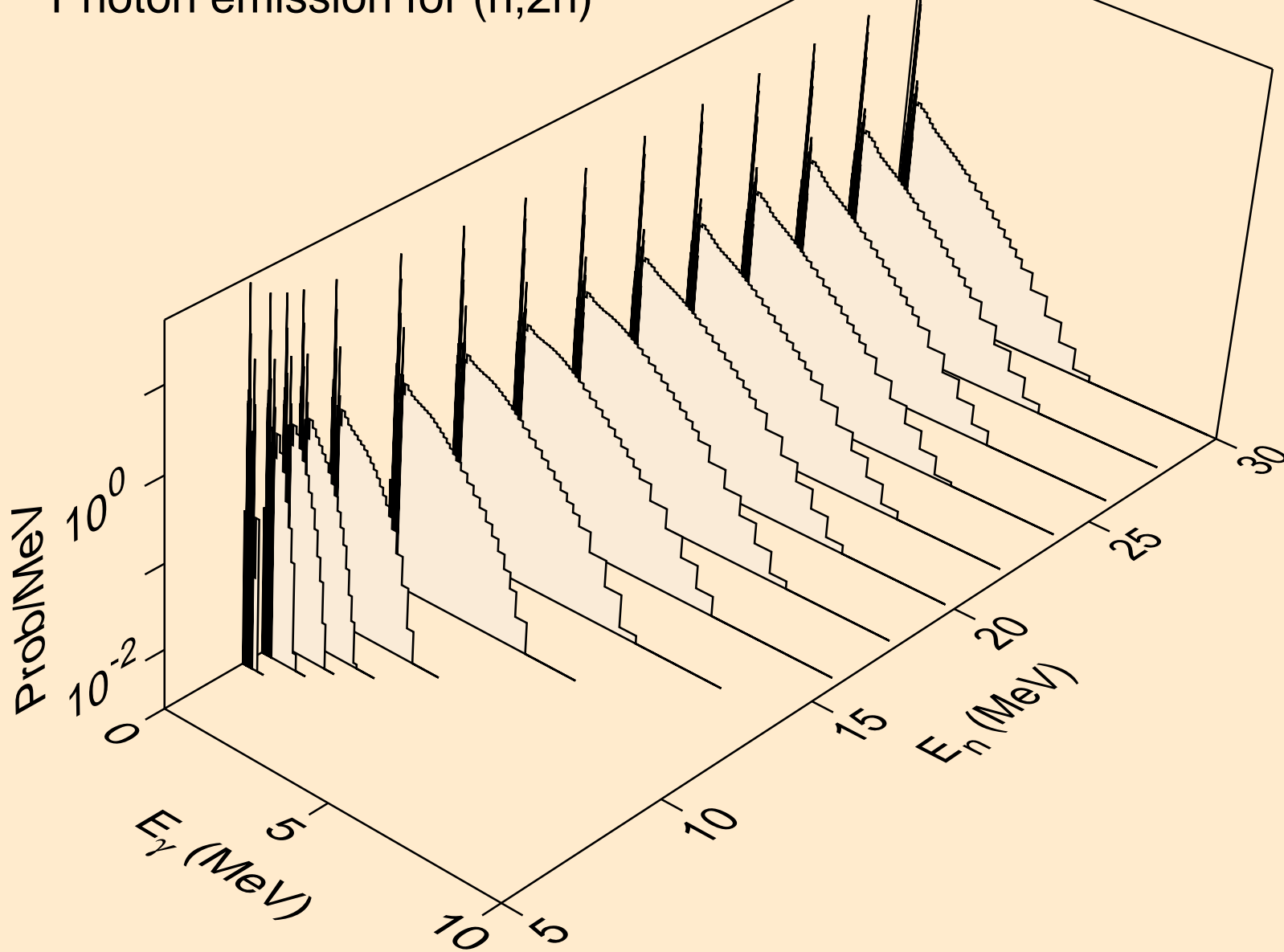

HO162 NEUTRON ACER TENDL-2019 LIBRARY; T=293.16K
Photon emission for (n,3n)

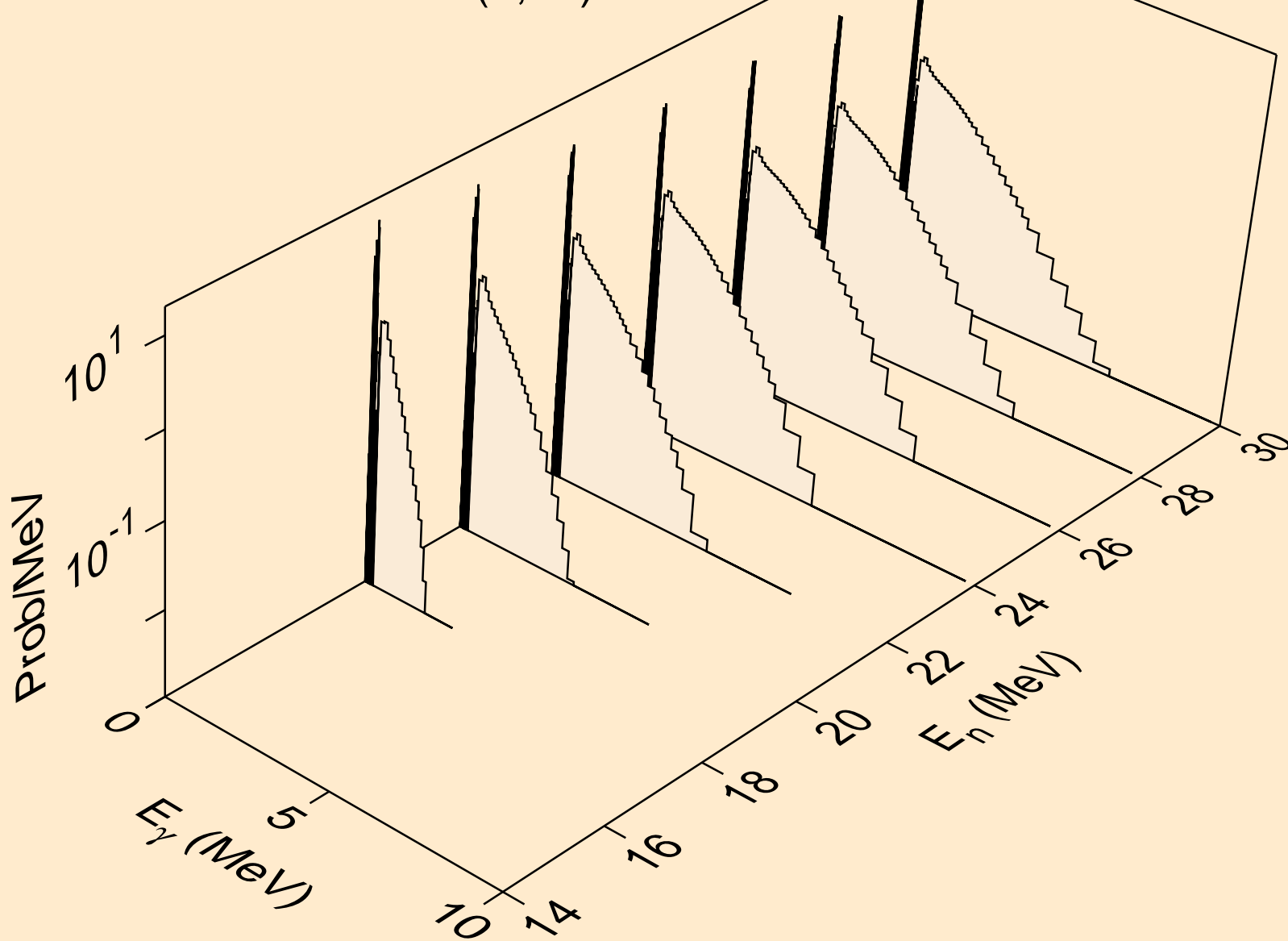

HO162 NEUTRON ACER TENDL-2019 LIBRARY; T=293.16K
Photon emission for (n,n*)a

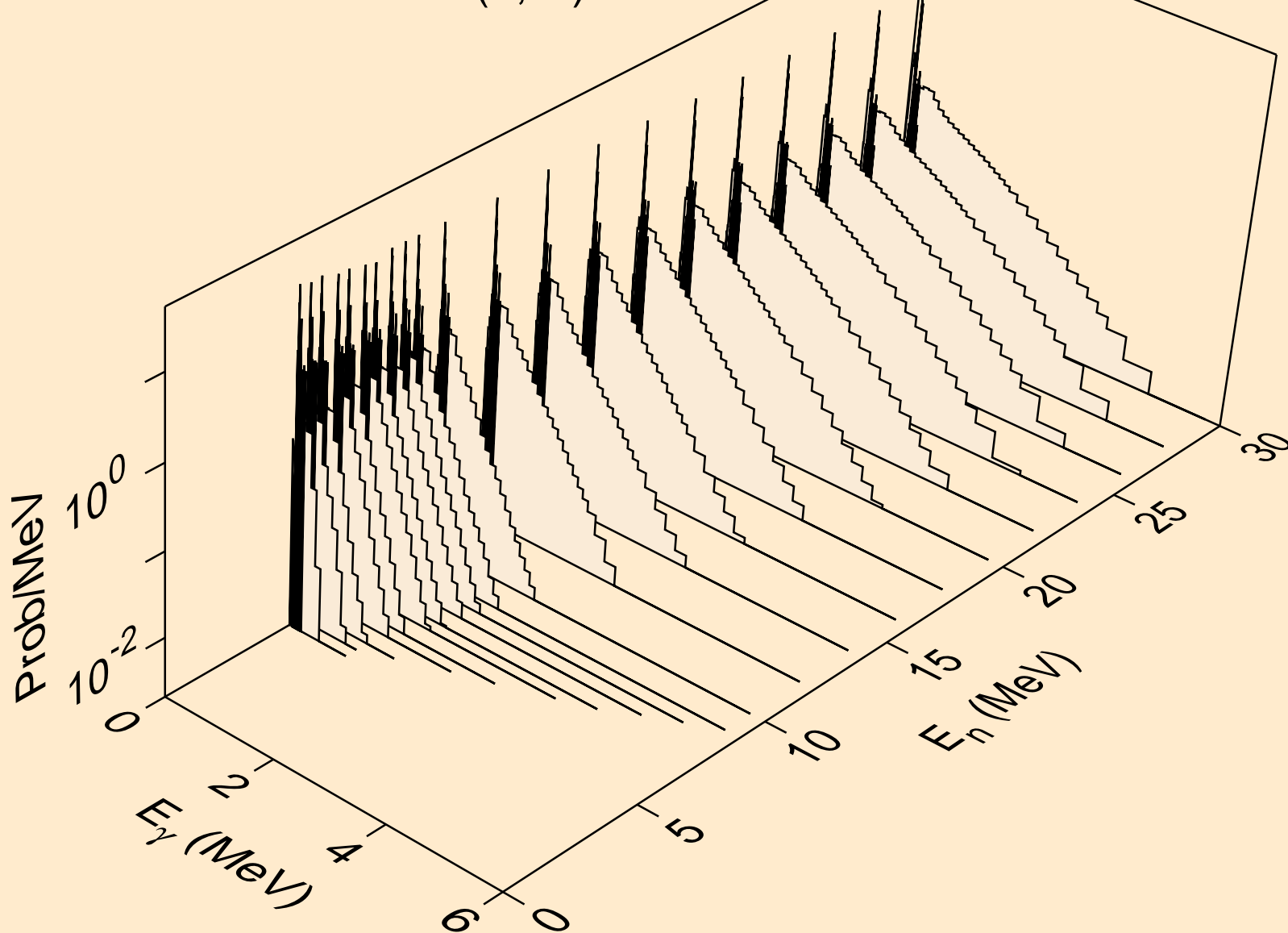

HO162 NEUTRON ACER TENDL-2019 LIBRARY; T=293.16K
Photon emission for (n,2n)a

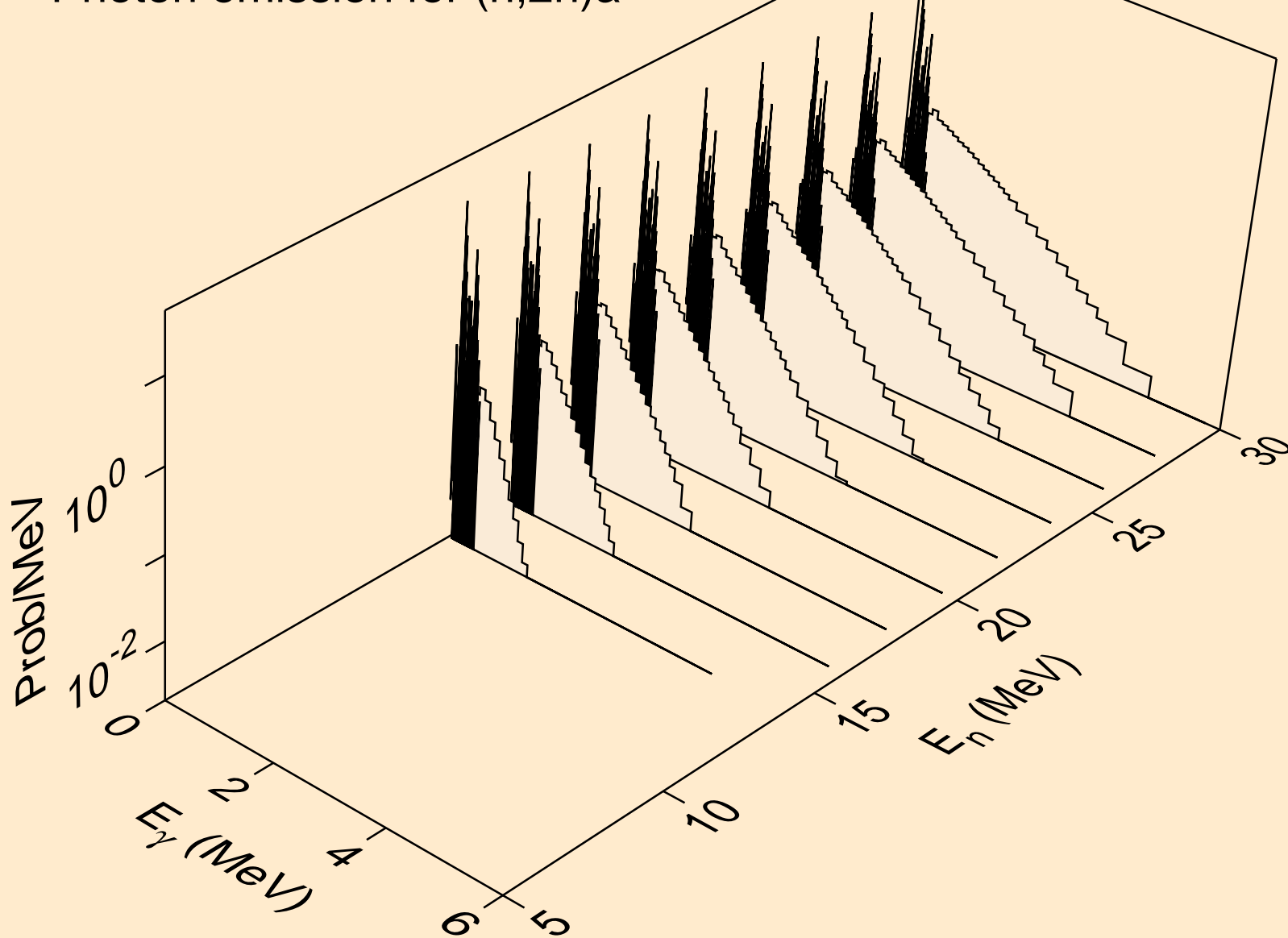

HO162 NEUTRON ACER TENDL-2019 LIBRARY; T=293.16K
Photon emission for (n,3n)a

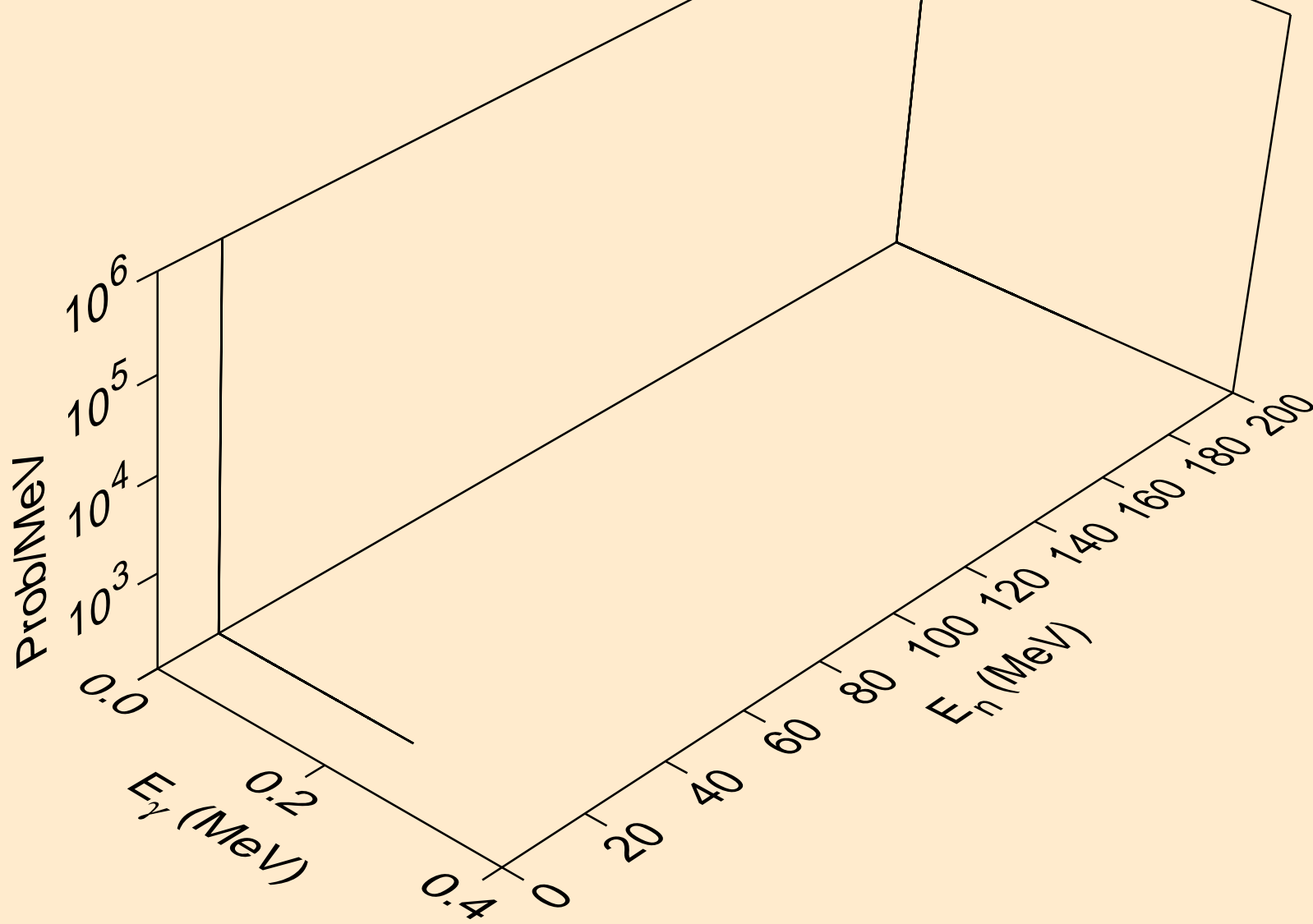

HO162 NEUTRON ACER TENDL-2019 LIBRARY; T=293.16K
Photon emission for (n,n*)p

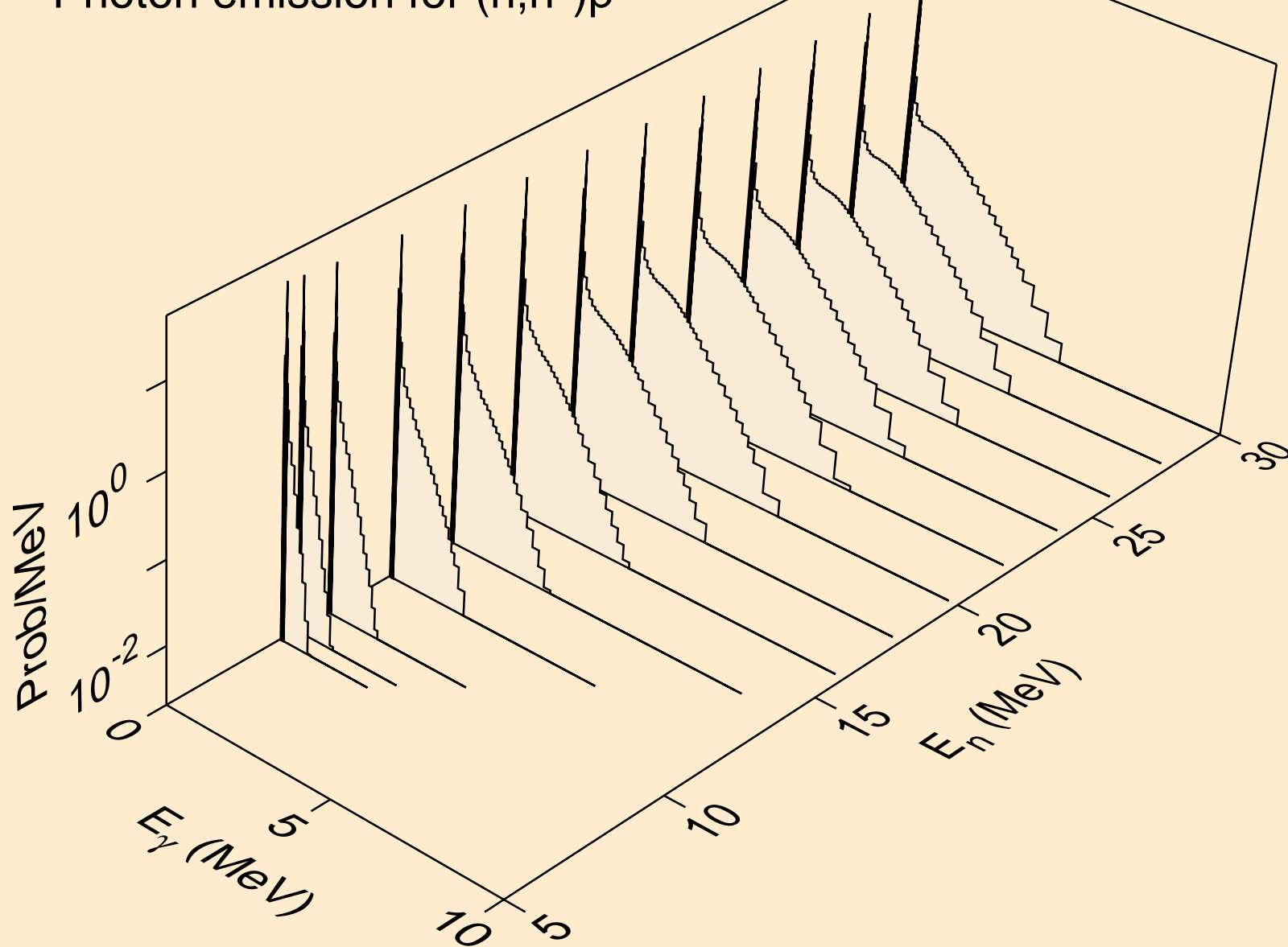

HO162 NEUTRON ACER TENDL-2019 LIBRARY; T=293.16K
Photon emission for (n,n*)2a

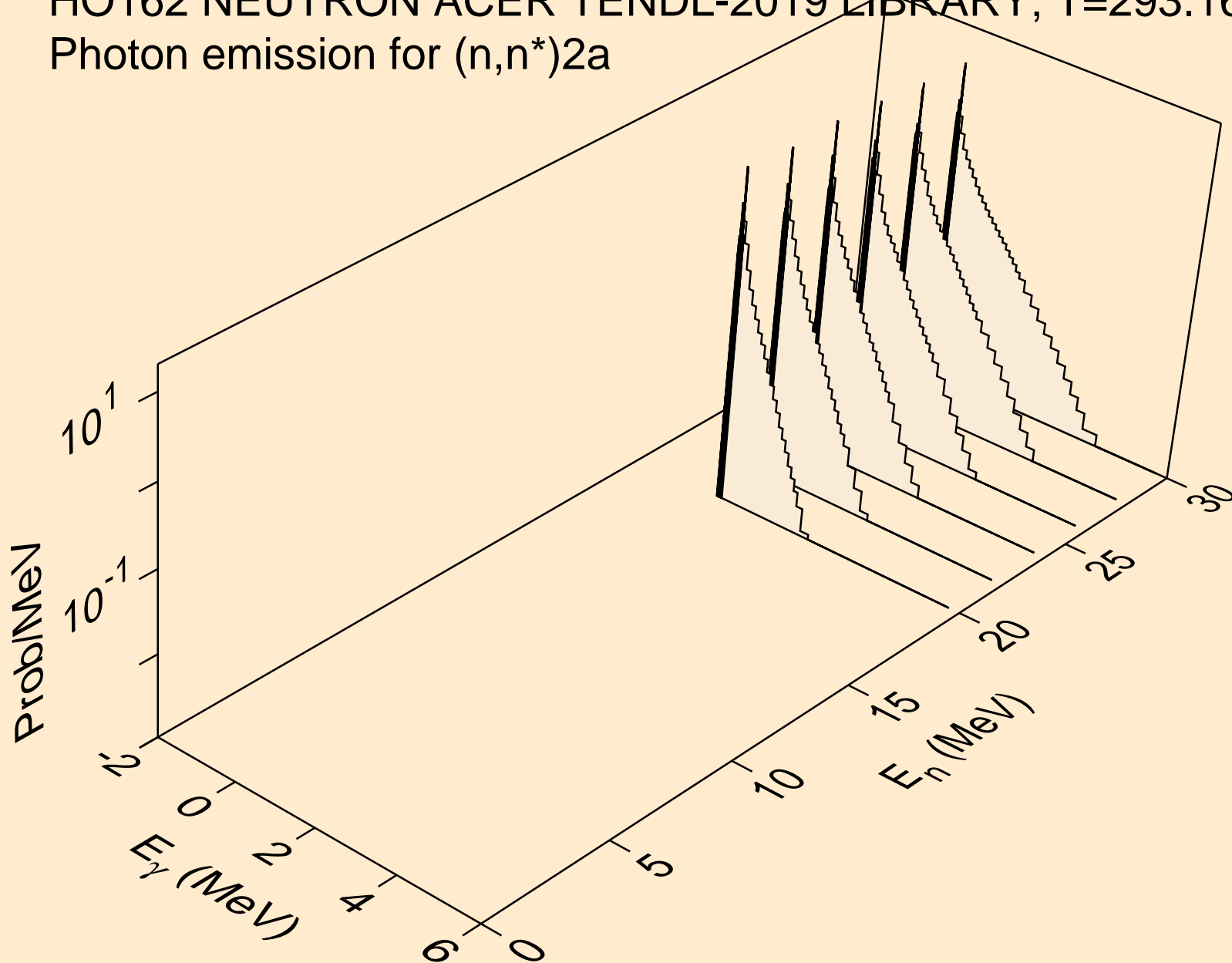

HO162 NEUTRON ACER TENDL-2019 LIBRARY; T=293.16K
Photon emission for (n,n*)d

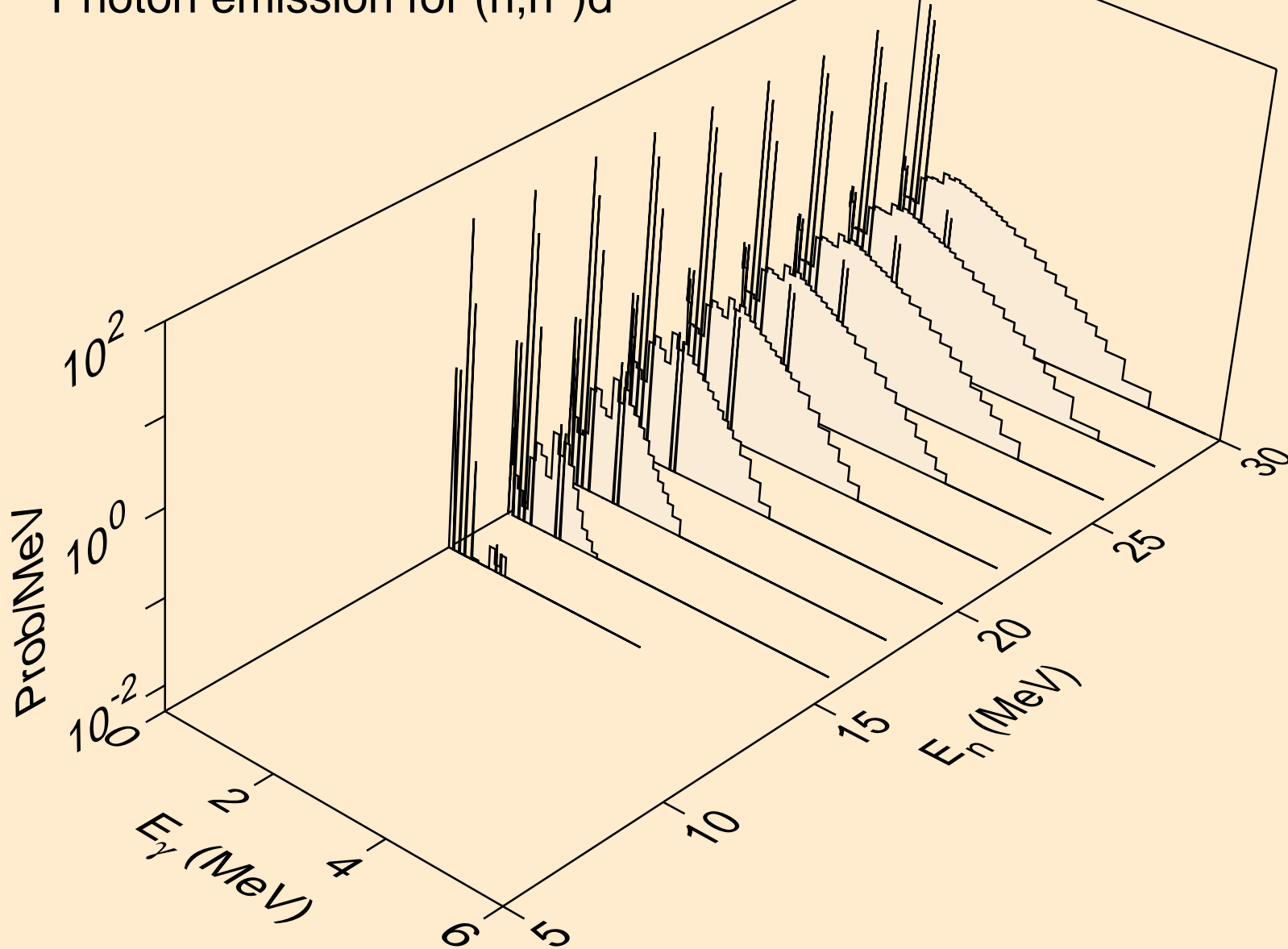

HO162 NEUTRON ACER TENDL-2019 LIBRARY; T=293.16K
Photon emission for (n,n*)t

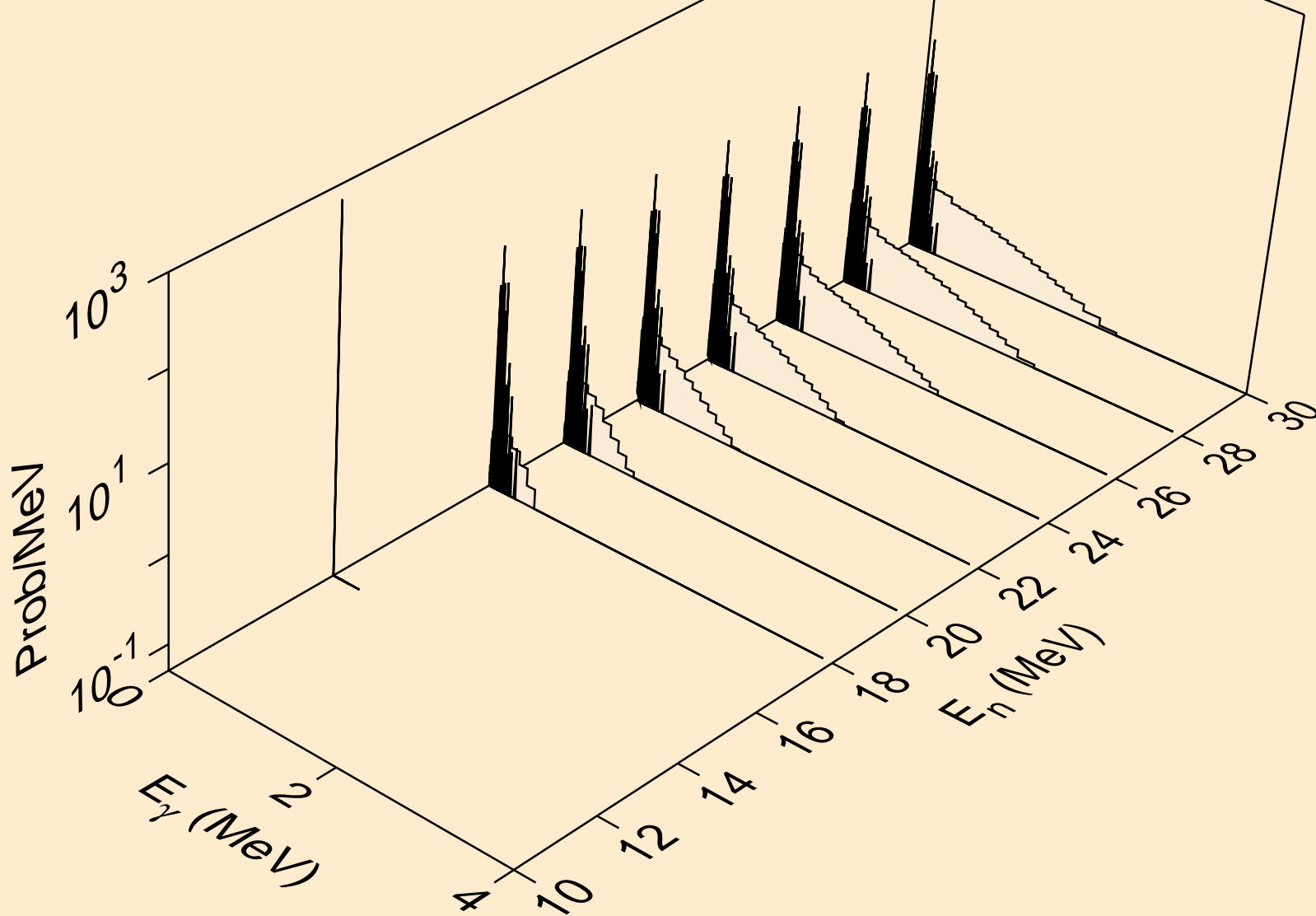

HO162 NEUTRON ACER TENDL-2019 LIBRARY; T=293.16K
Photon emission for (n,n*)he3

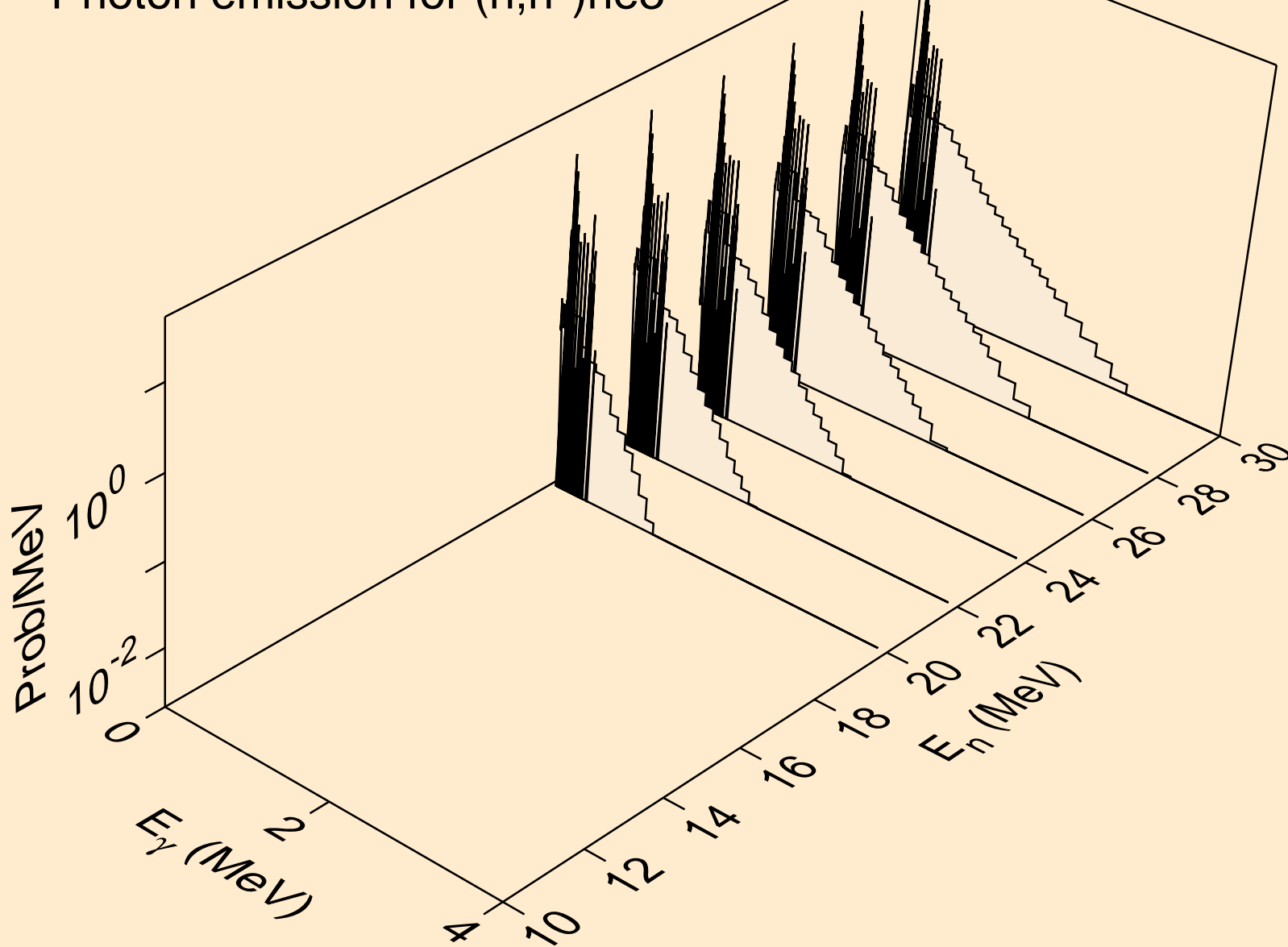

HO162 NEUTRON ACER TENDL-2019 LIBRARY; T=293.16K
Photon emission for (n,4n)

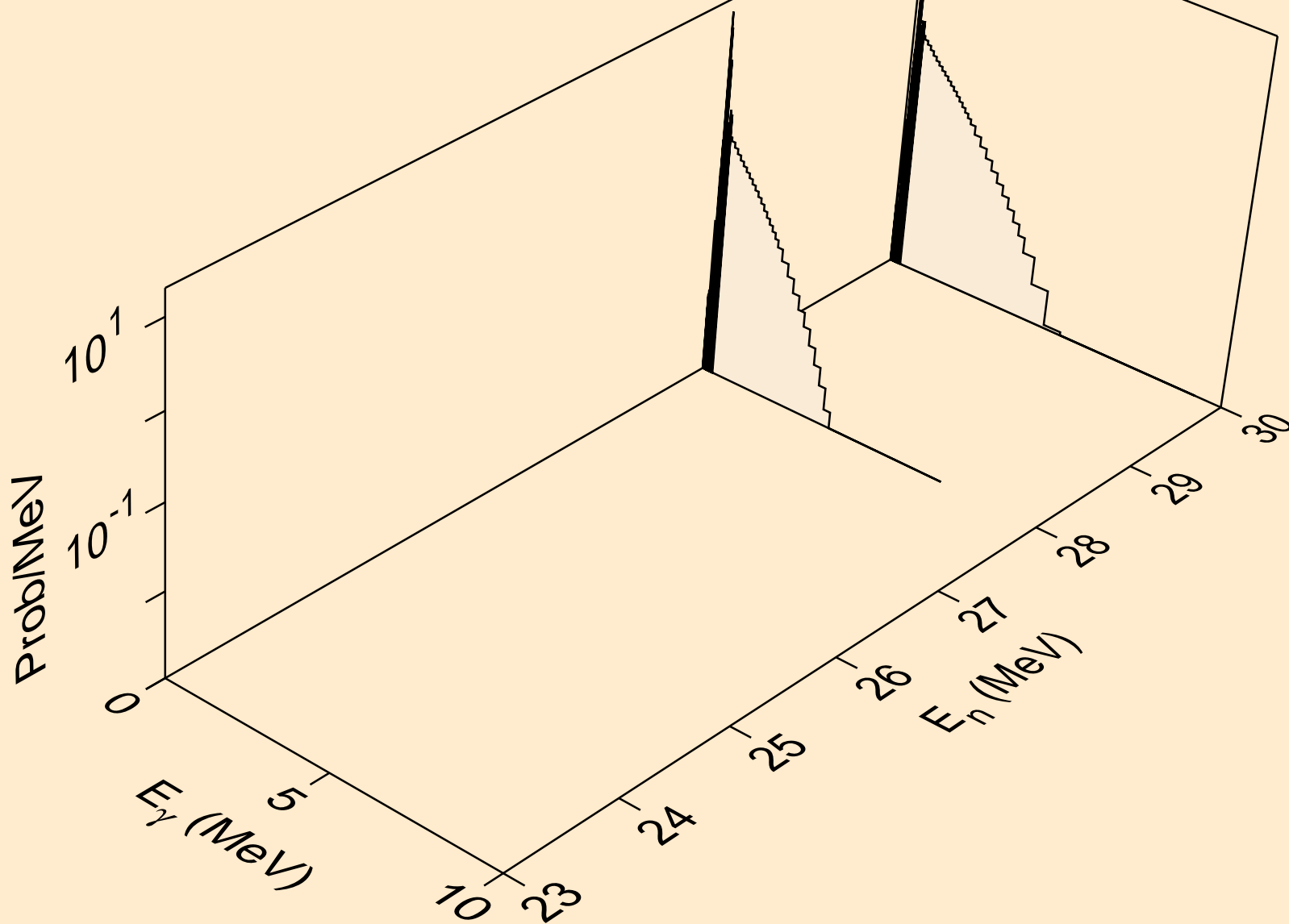

HO162 NEUTRON ACER TENDL-2019 LIBRARY; T=293.16K
Photon emission for (n,2np)

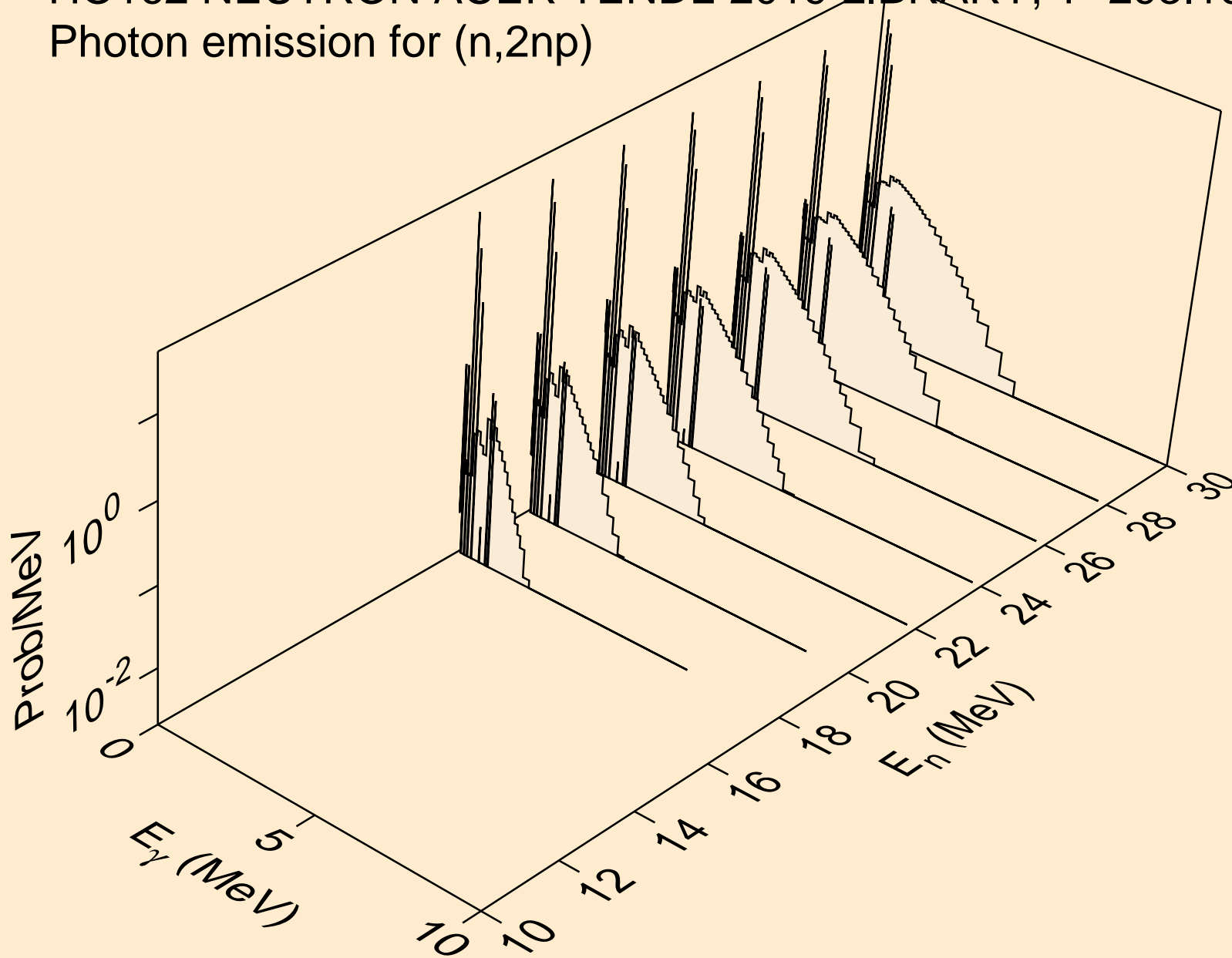

HO162 NEUTRON ACER TENDL-2019 LIBRARY; T=293.16K
Photon emission for (n,3np)

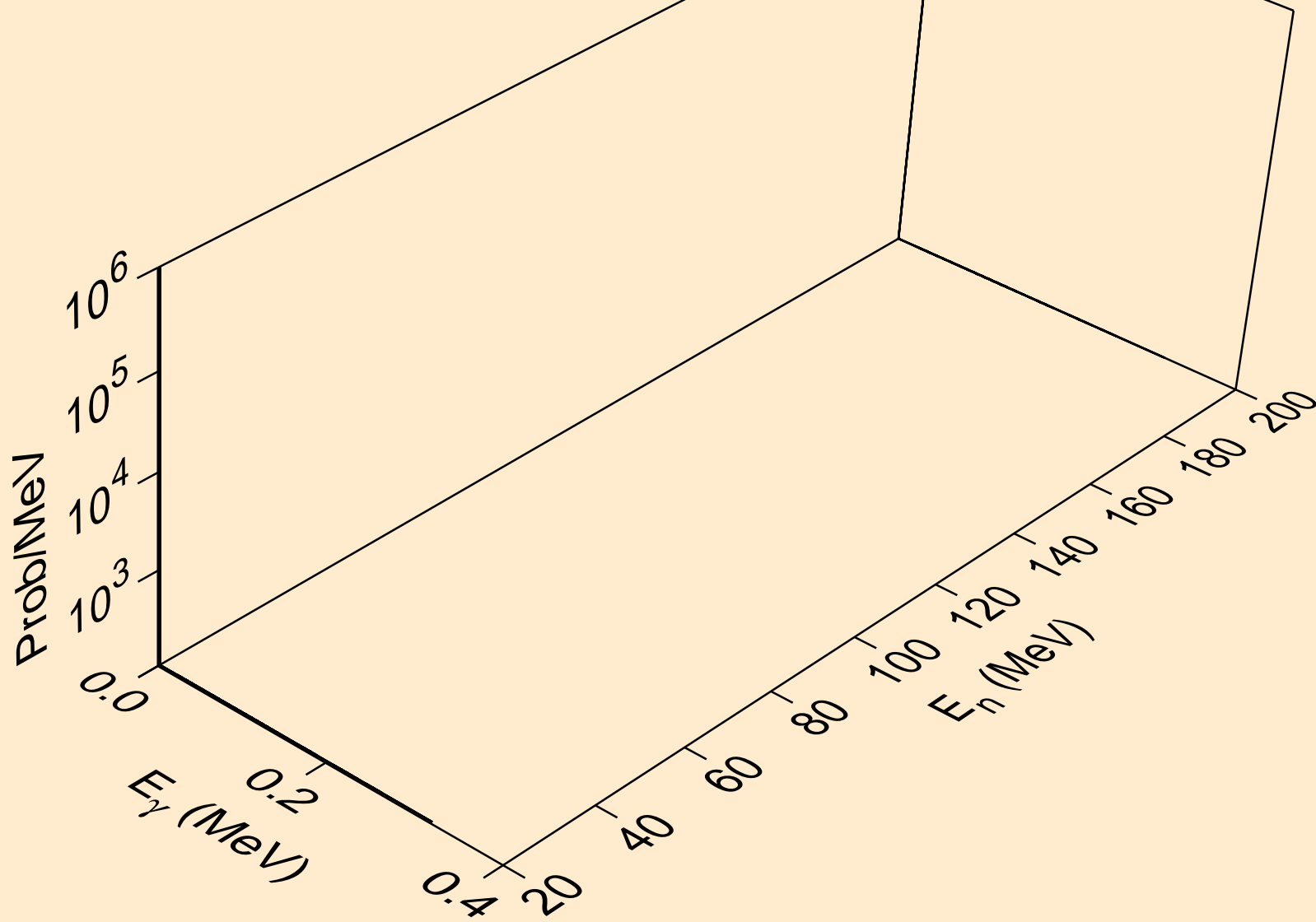

HO162 NEUTRON ACER TENDL-2019 LIBRARY; T=293.16K
Photon emission for (n,2np)

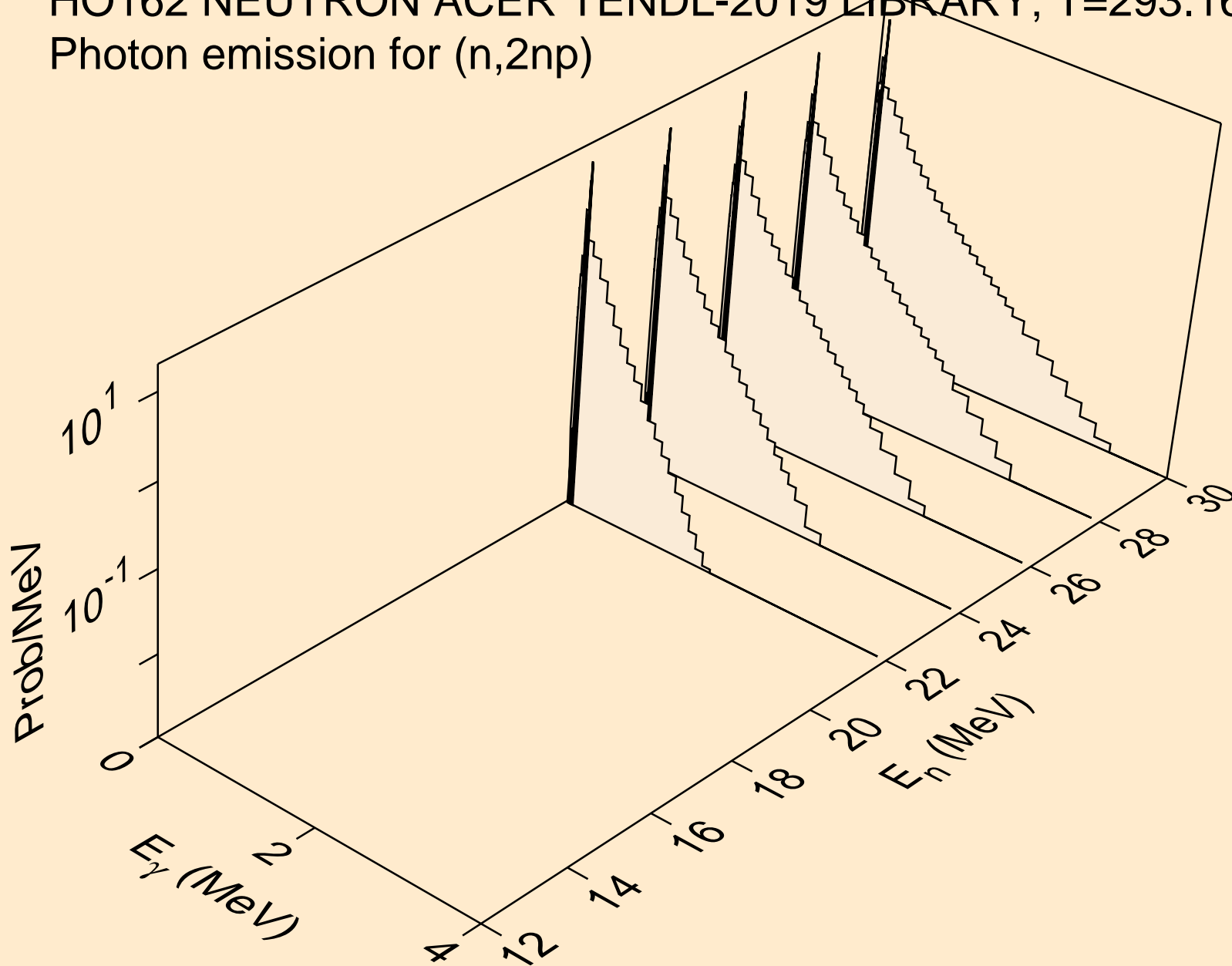

HO162 NEUTRON ACER TENDL-2019 LIBRARY; T=293.16K
Photon emission for (n,npa)

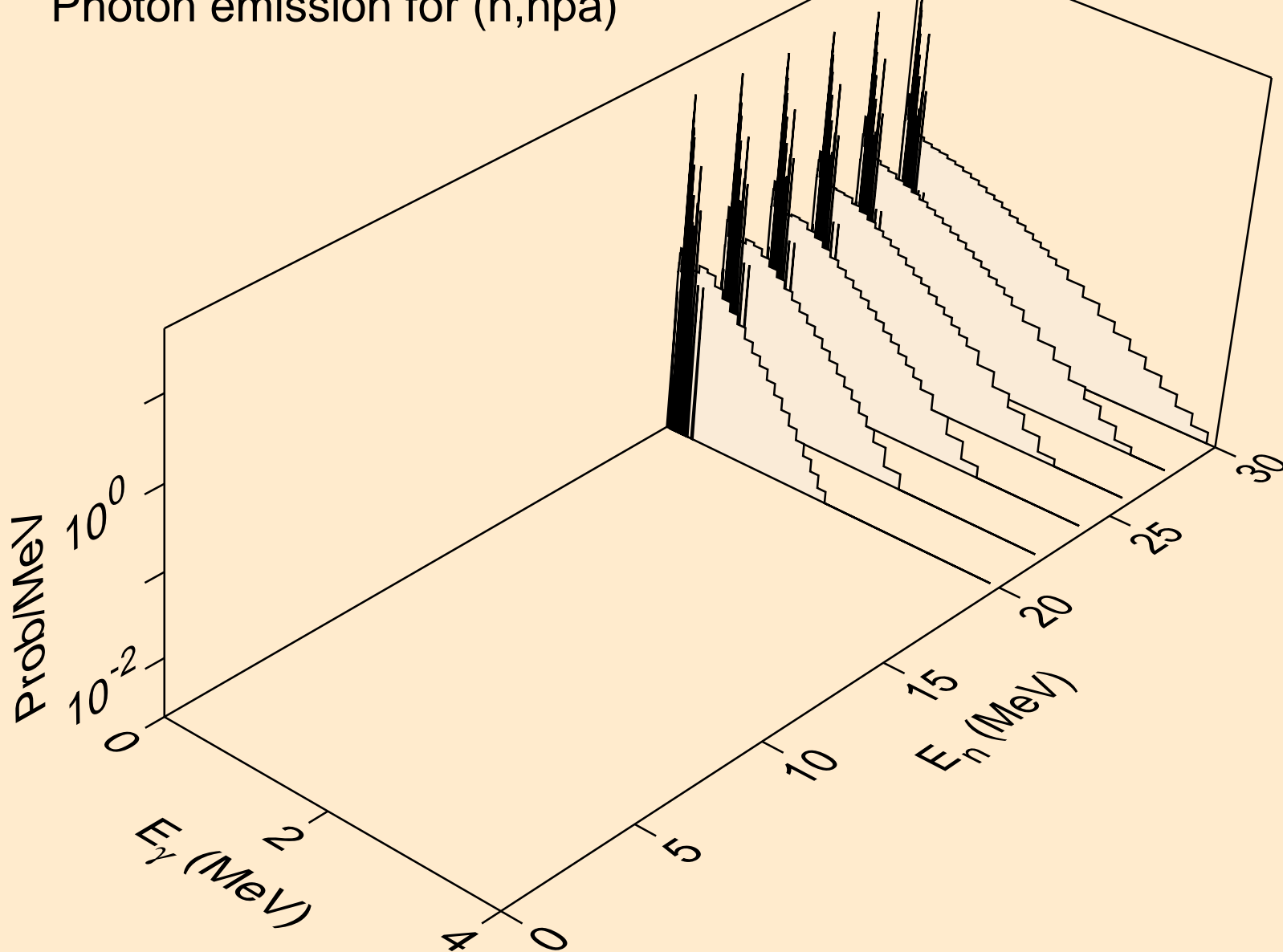

HO162 NEUTRON ACER TENDL-2019 LIBRARY; T=293.16K
Photon emission for (n,n*c)

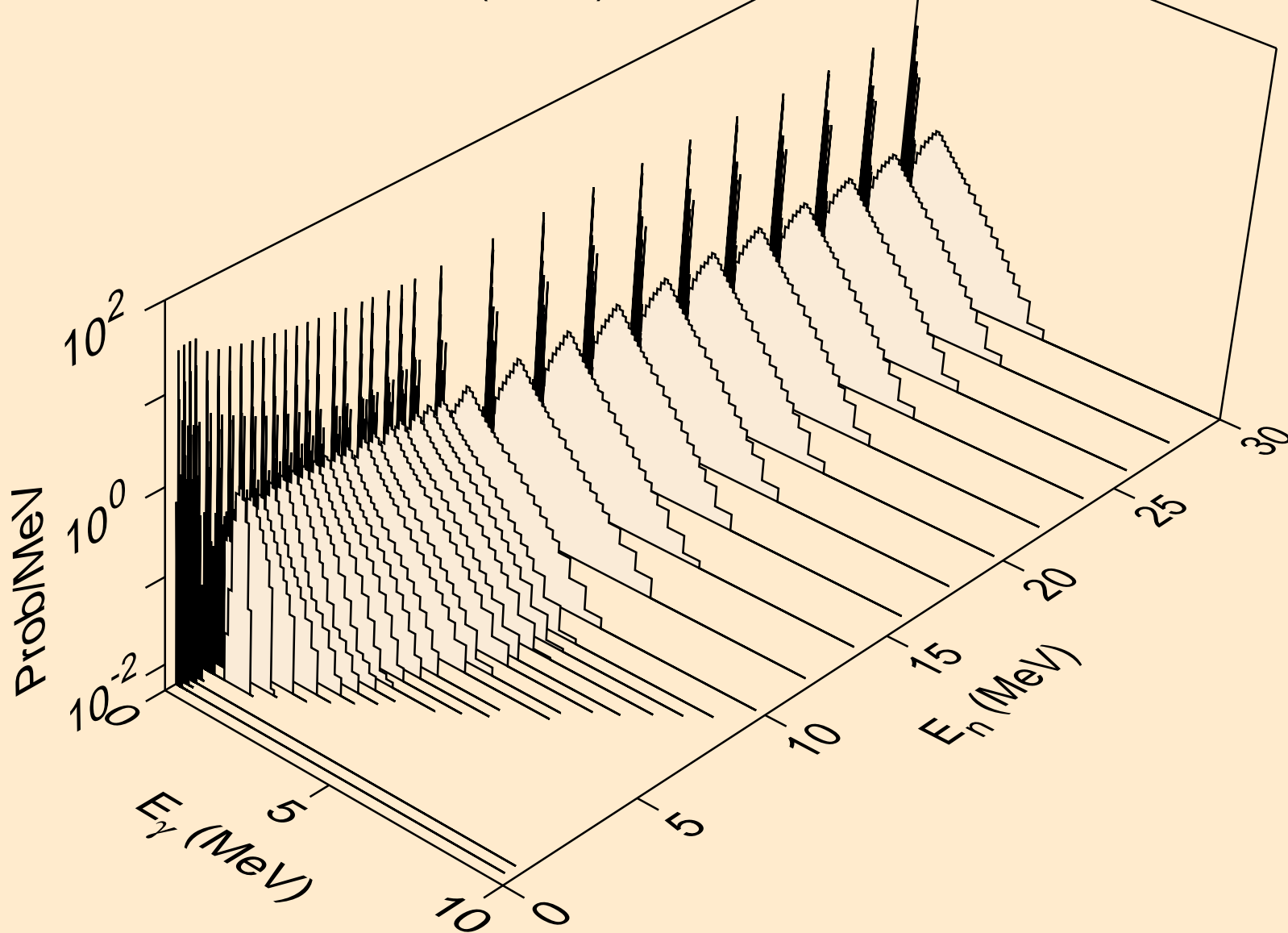

HO162 NEUTRON ACER TENDL-2019 LIBRARY; T=293.16K
Photon emission for (n,gma)

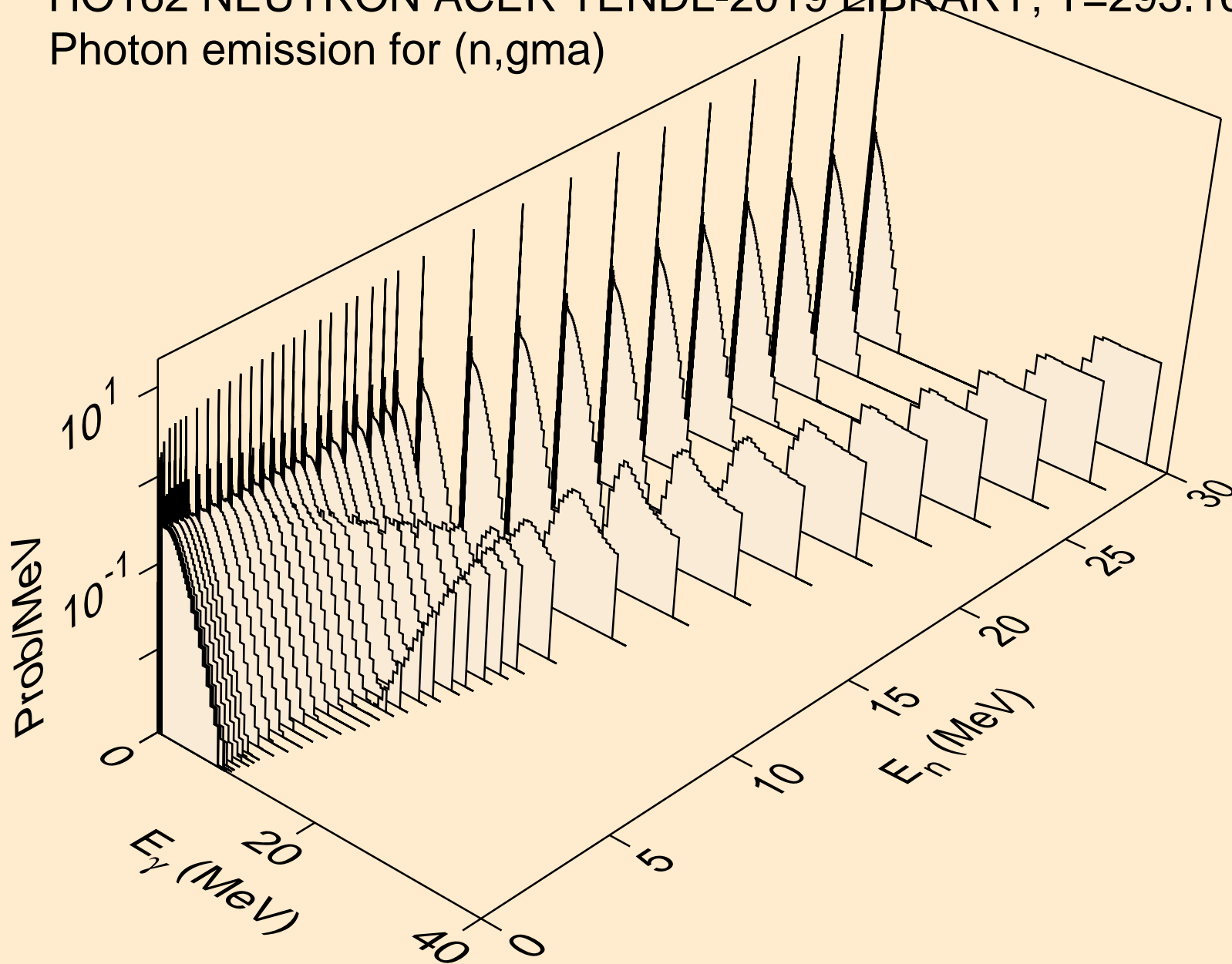

HO162 NEUTRON ACER TENDL-2019 LIBRARY; T=293.16K
Photon emission for (n,p)

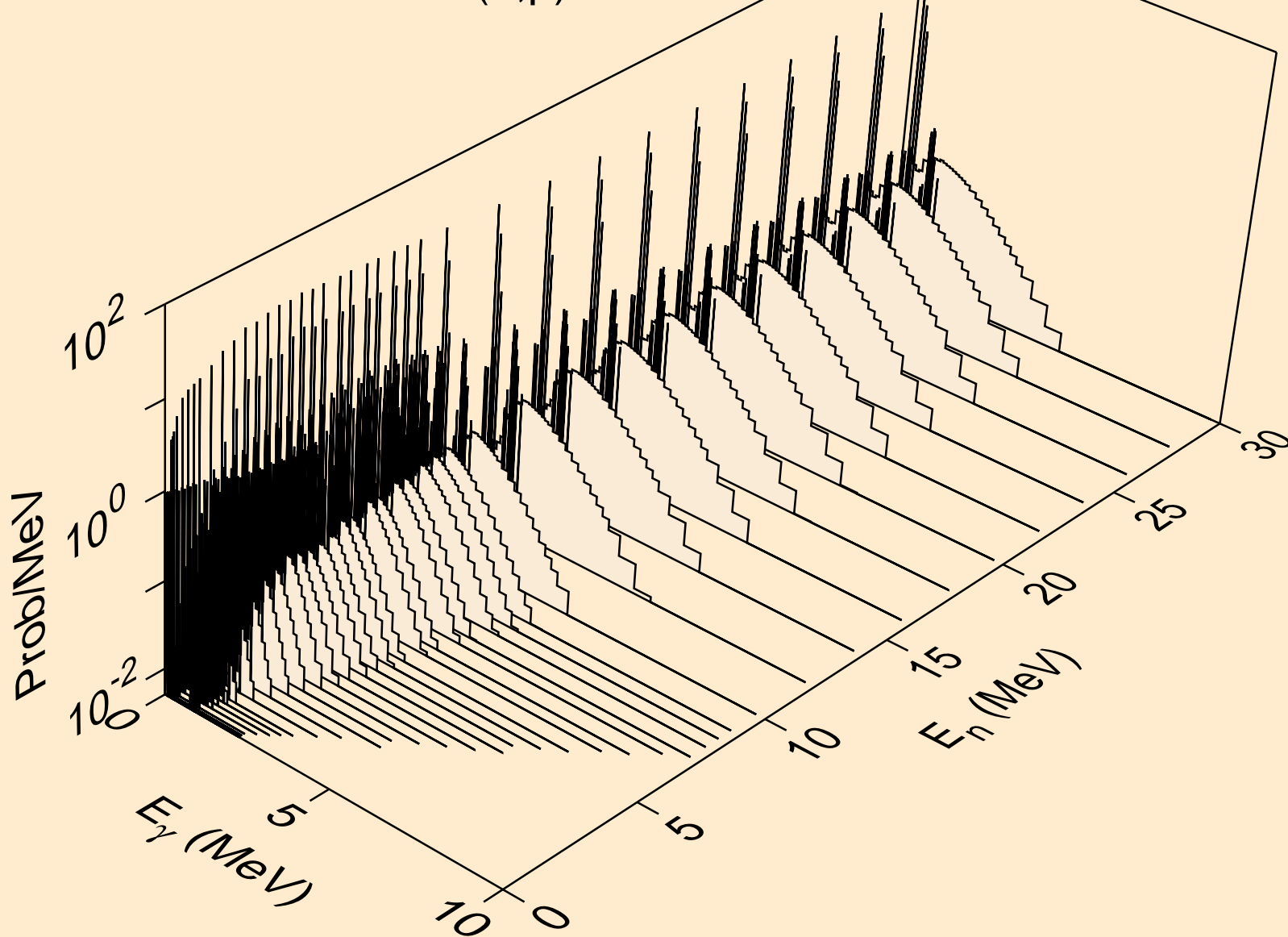

HO162 NEUTRON ACER TENDL-2019 LIBRARY; T=293.16K
Photon emission for (n,d)

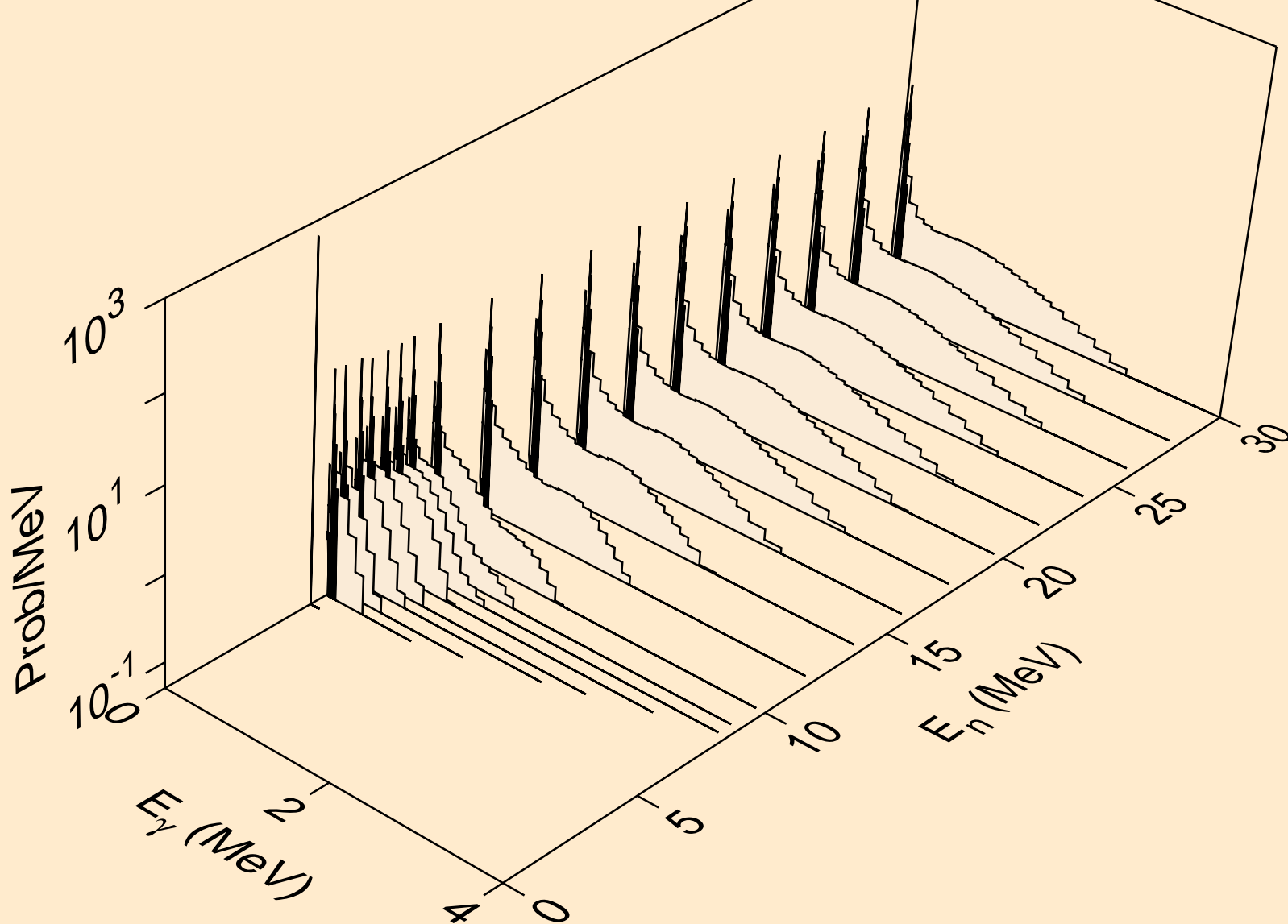

HO162 NEUTRON ACER TENDL-2019 LIBRARY; T=293.16K
Photon emission for (n,t)

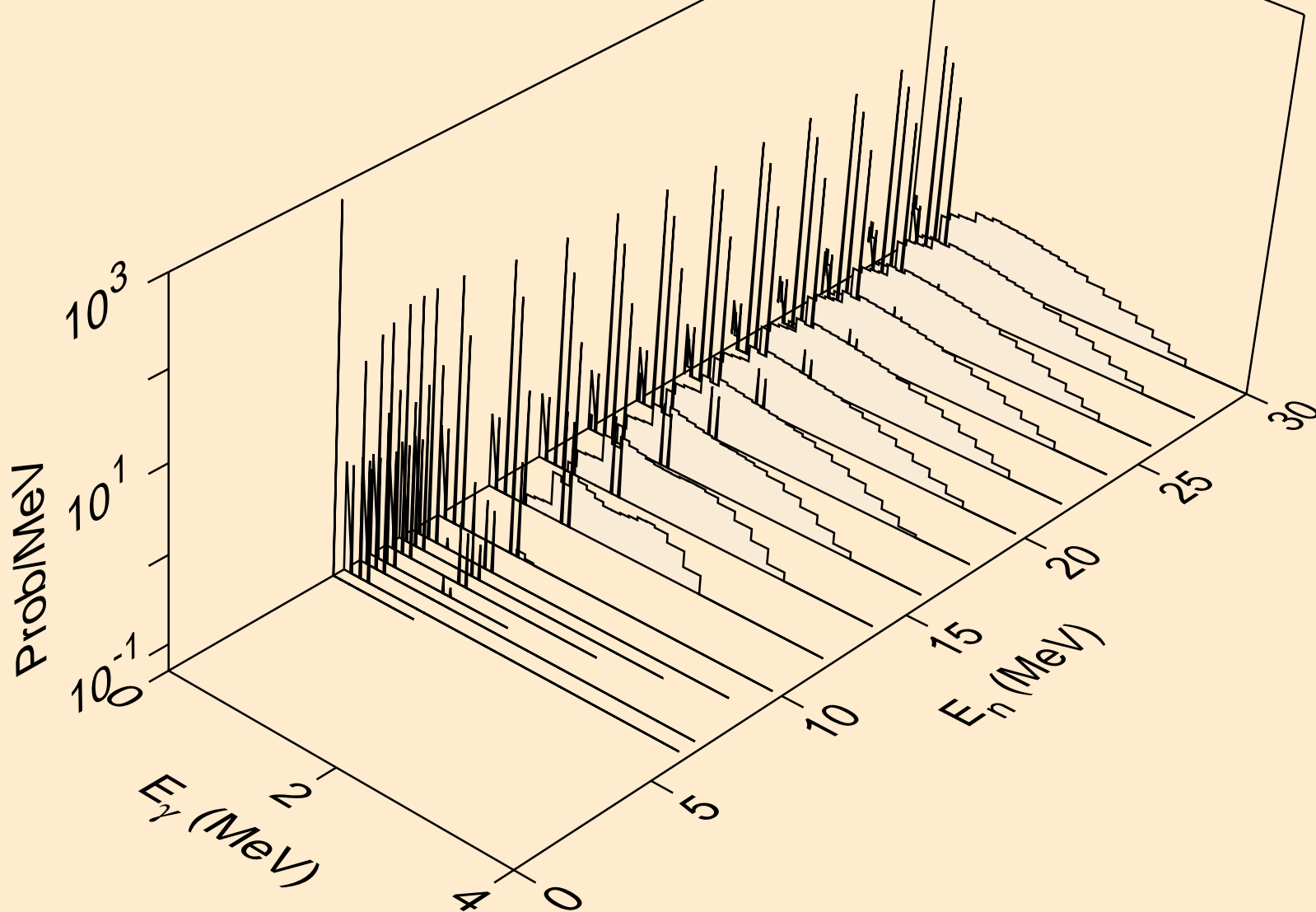

HO162 NEUTRON ACER TENDL-2019 LIBRARY; T=293.16K
Photon emission for (n,he3)

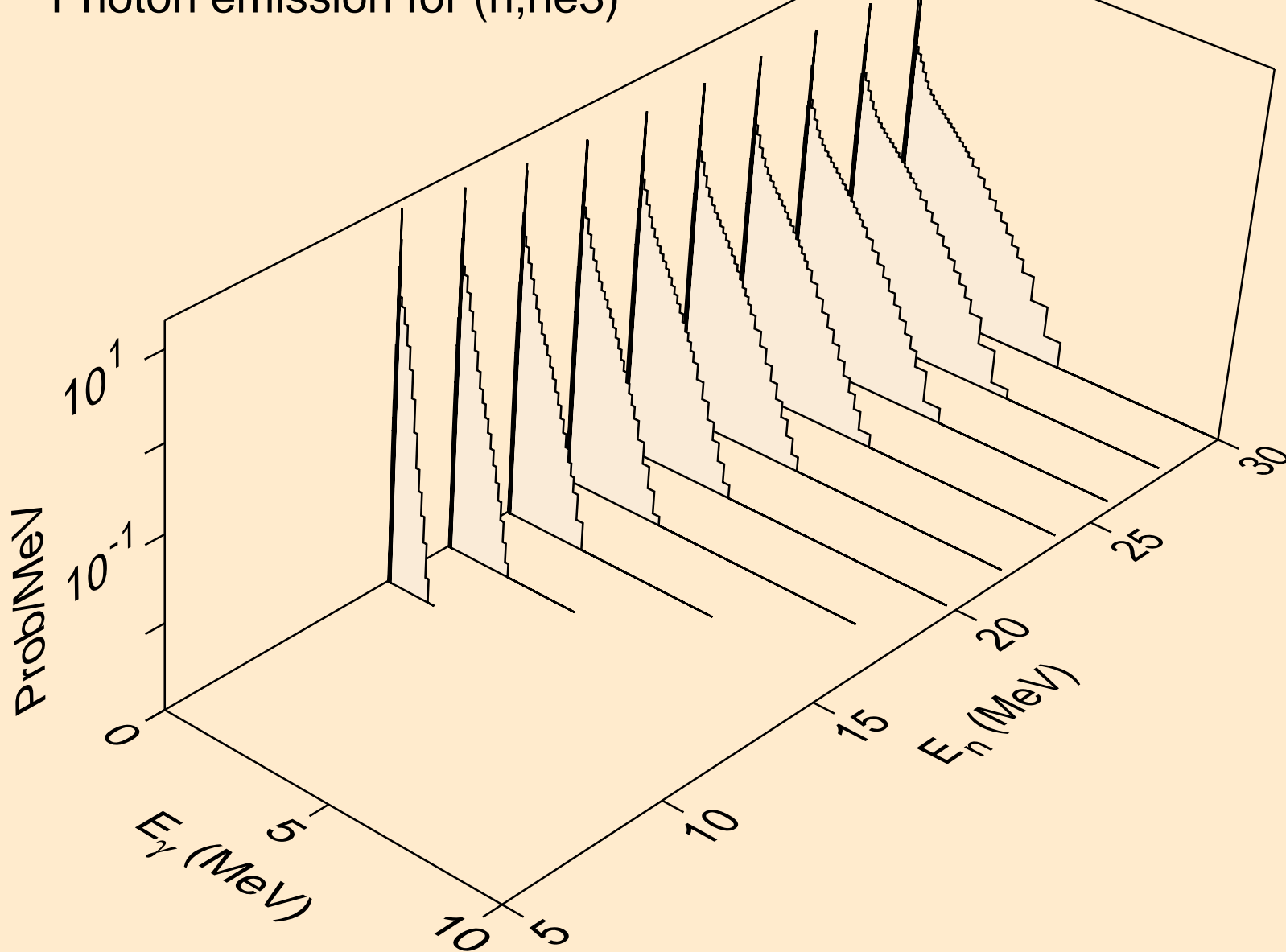

HO162 NEUTRON ACER TENDL-2019 LIBRARY; T=293.16K
Photon emission for (n,a)

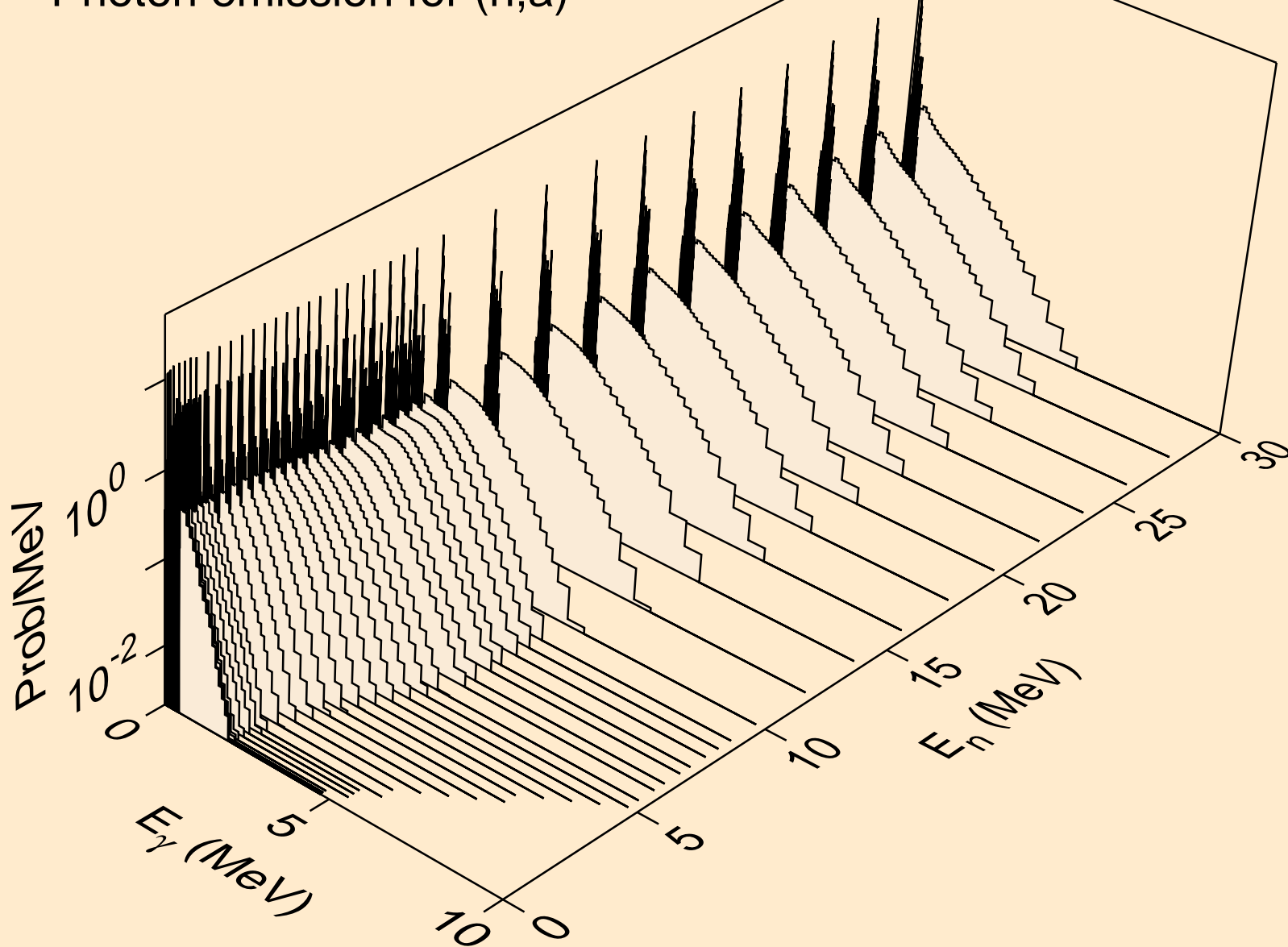

HO162 NEUTRON ACER TENDL-2019 LIBRARY; T=293.16K
Photon emission for (n,2a)

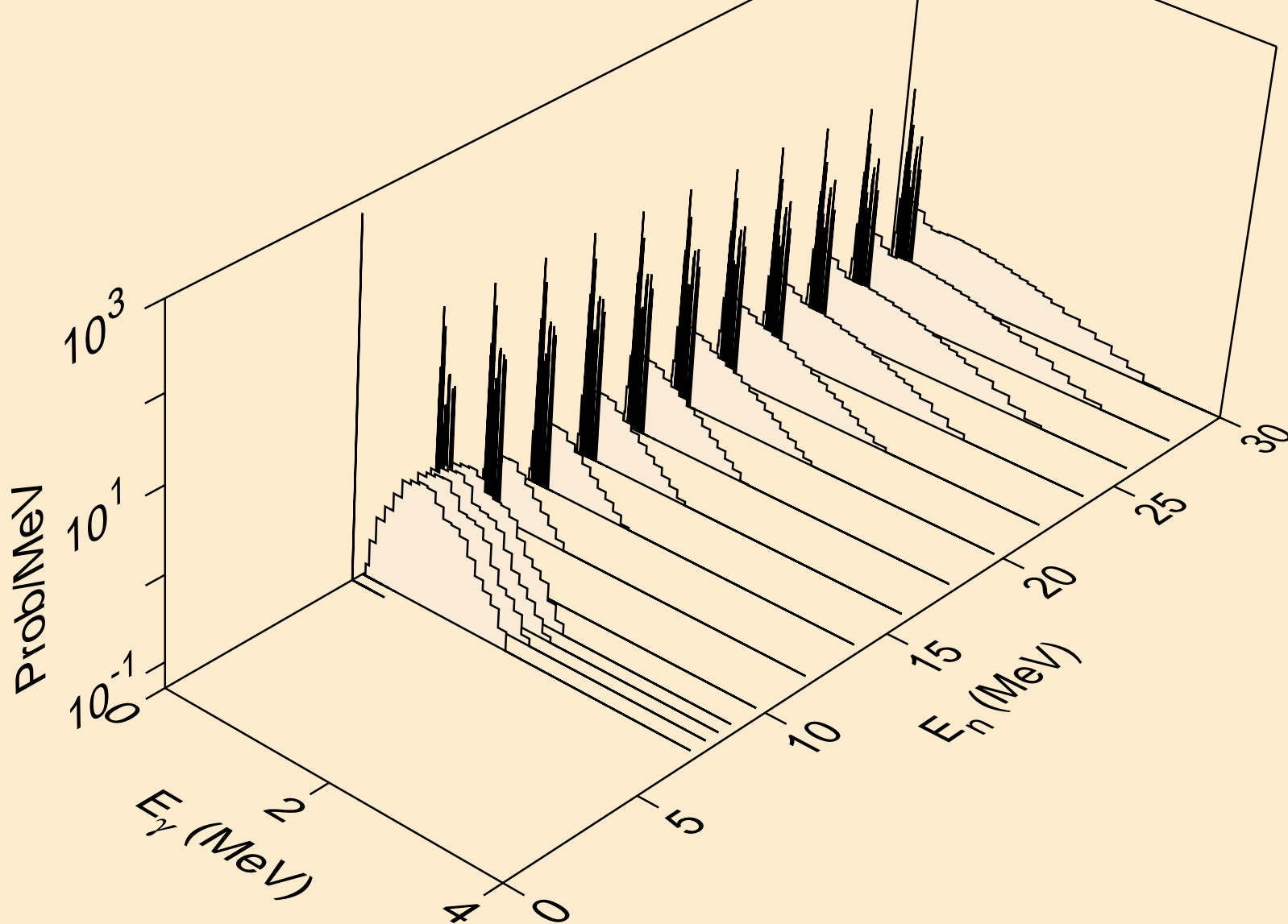

HO162 NEUTRON ACER TENDL-2019 LIBRARY; T=293.16K
Photon emission for (n,2p)

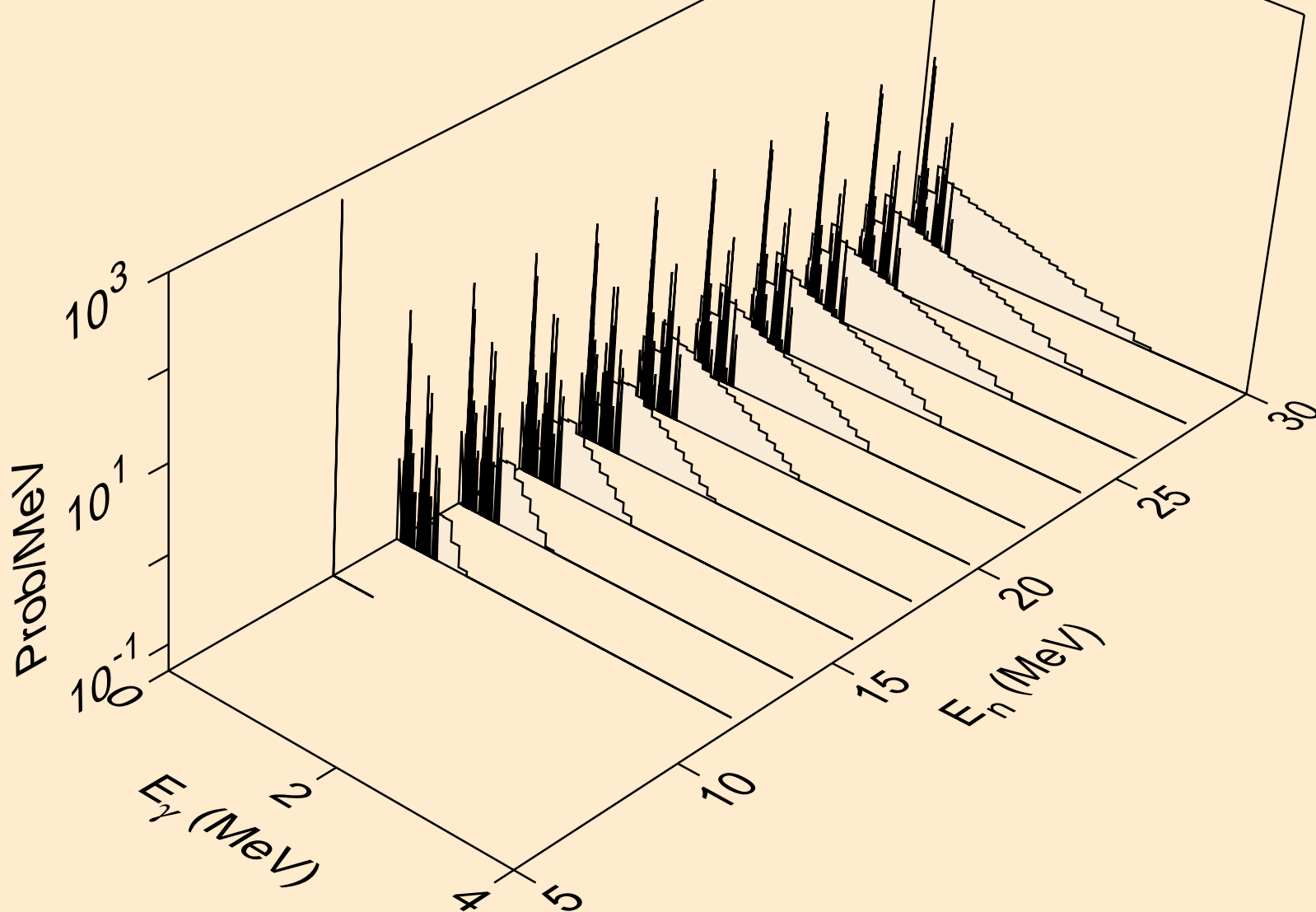

HO162 NEUTRON ACER TENDL-2019 LIBRARY; T=293.16K
Photon emission for (n,p)

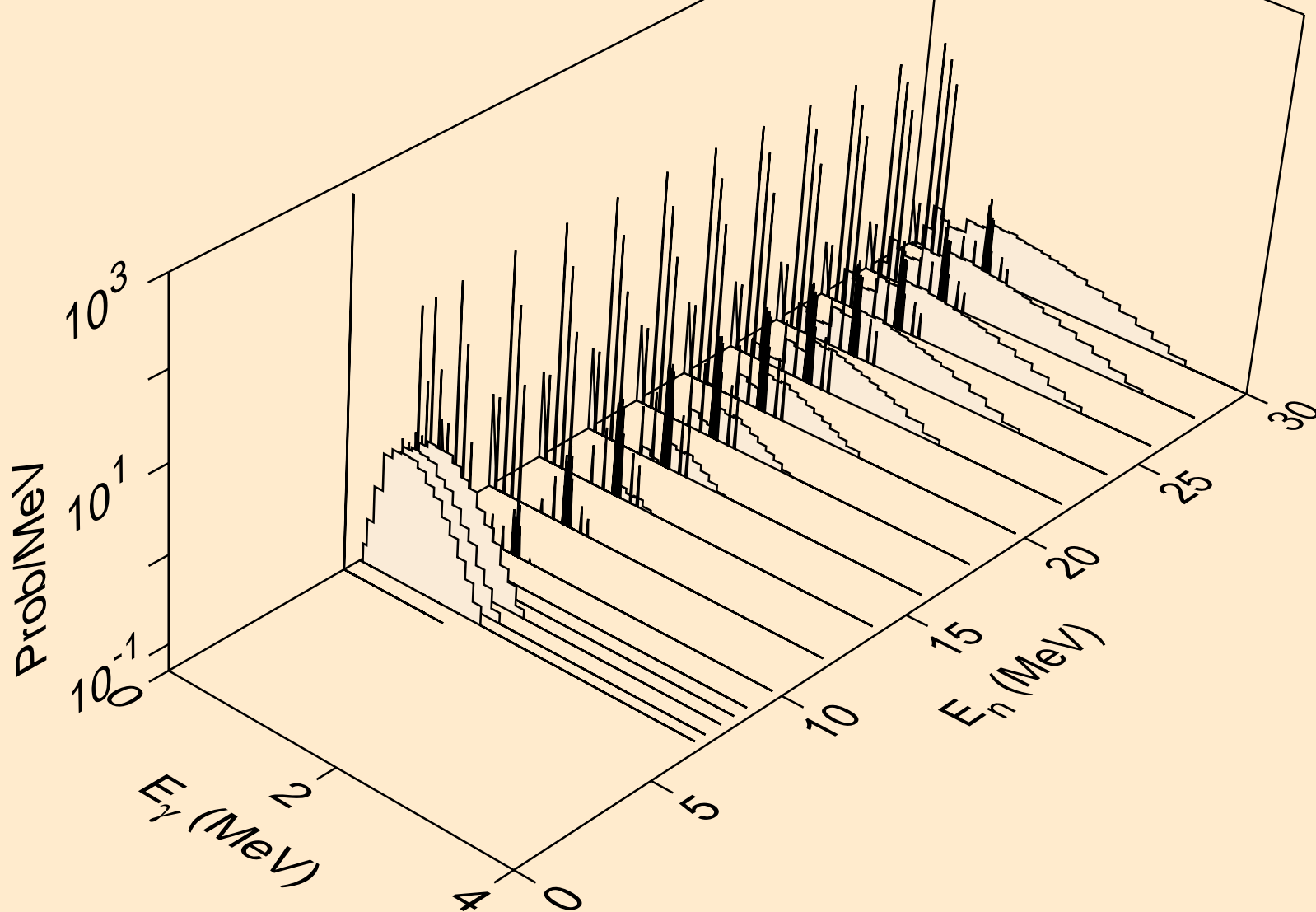

HO162 NEUTRON ACER TENDL-2019 LIBRARY; T=293.16K
Photon emission for (n,pd)

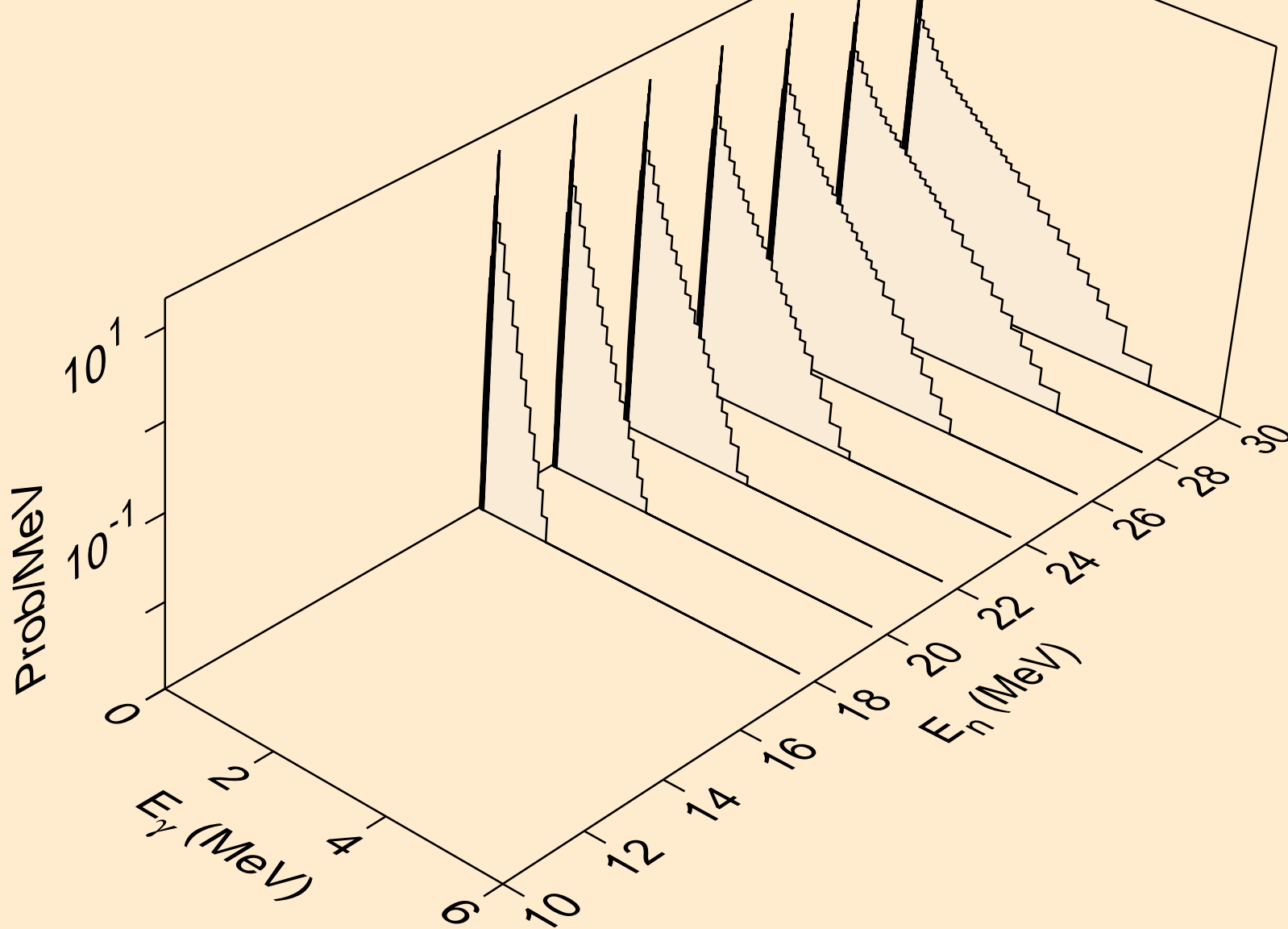

HO162 NEUTRON ACER TENDL-2019 LIBRARY; T=293.16K
Photon emission for (n,pt)

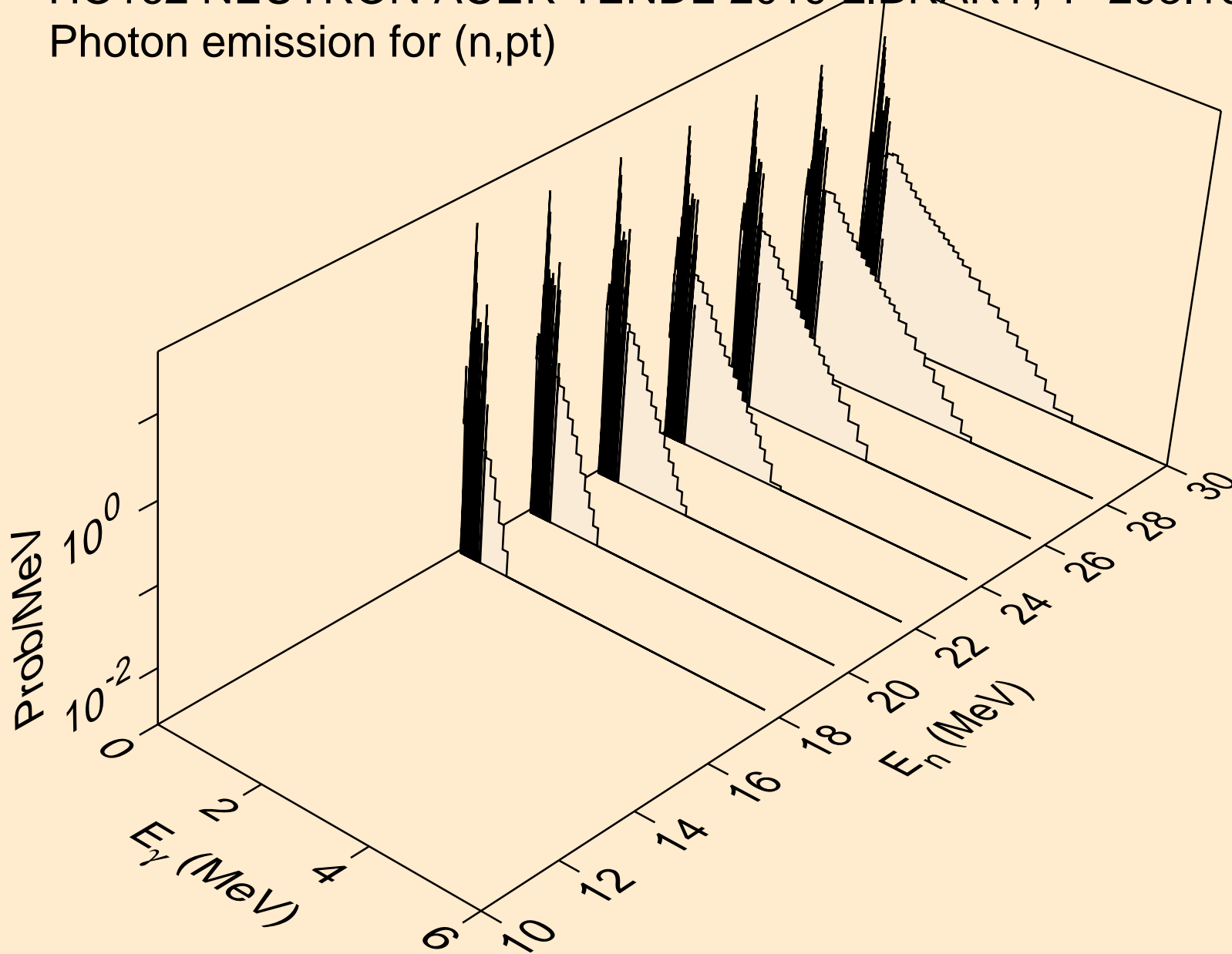

HO162 NEUTRON ACER TENDL-2019 LIBRARY; T=293.16K
Photon emission for (n,da)

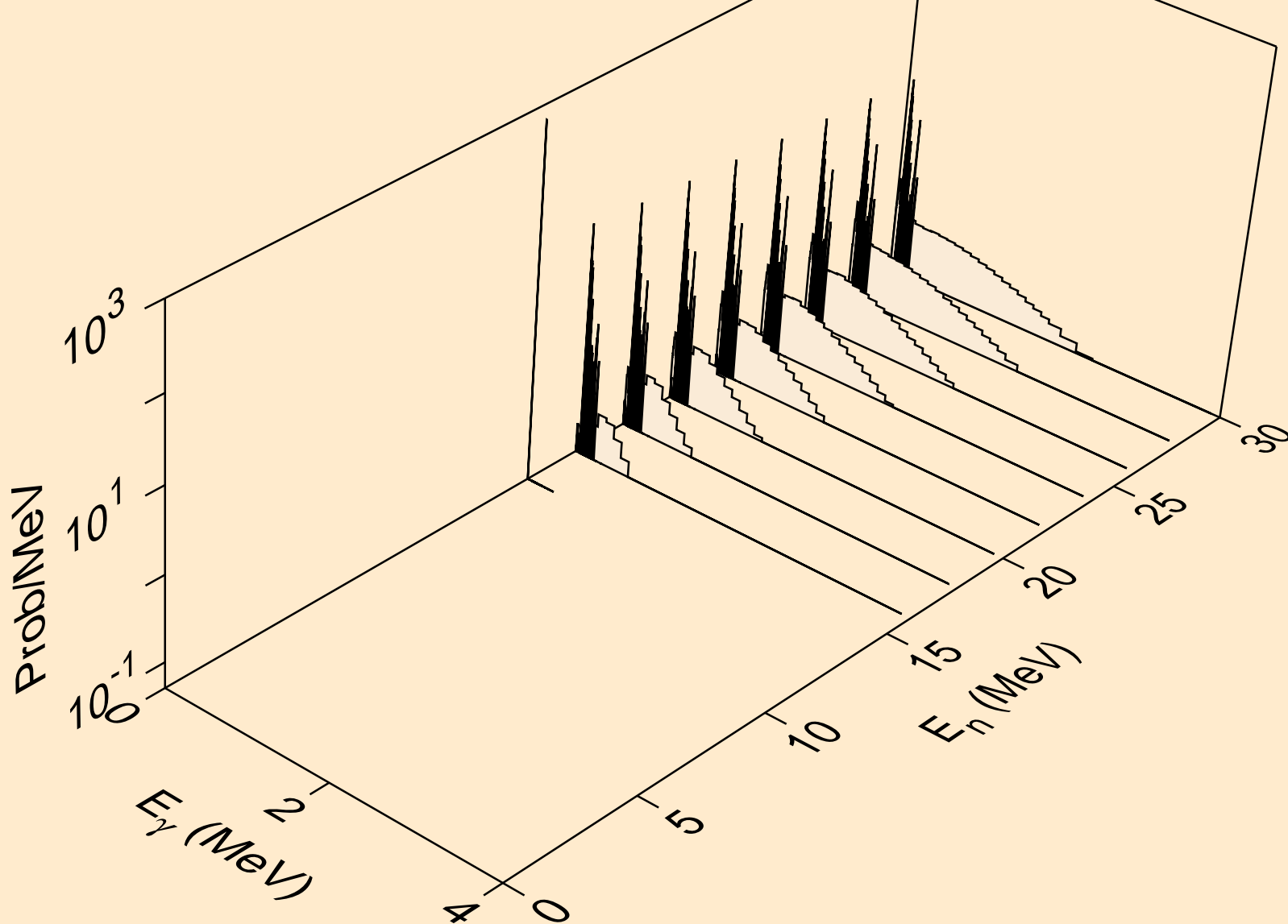

HO162 NEUTRON ACER TENDL-2019 LIBRARY; T=293.16K
thermal capture photon spectrum

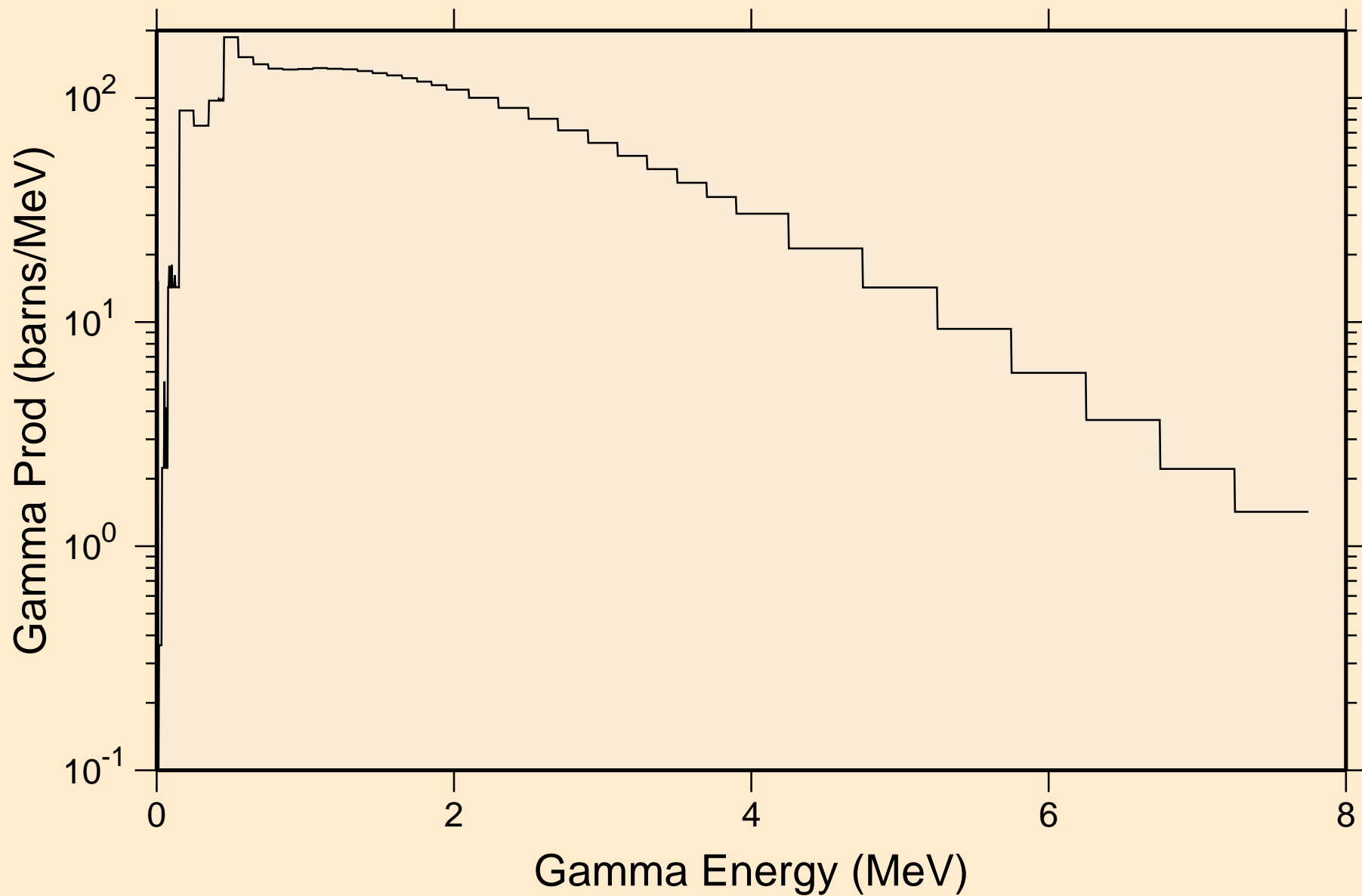

HO162 NEUTRON ACER TENDL-2019 LIBRARY; T=293.16K
14 MeV photon spectrum

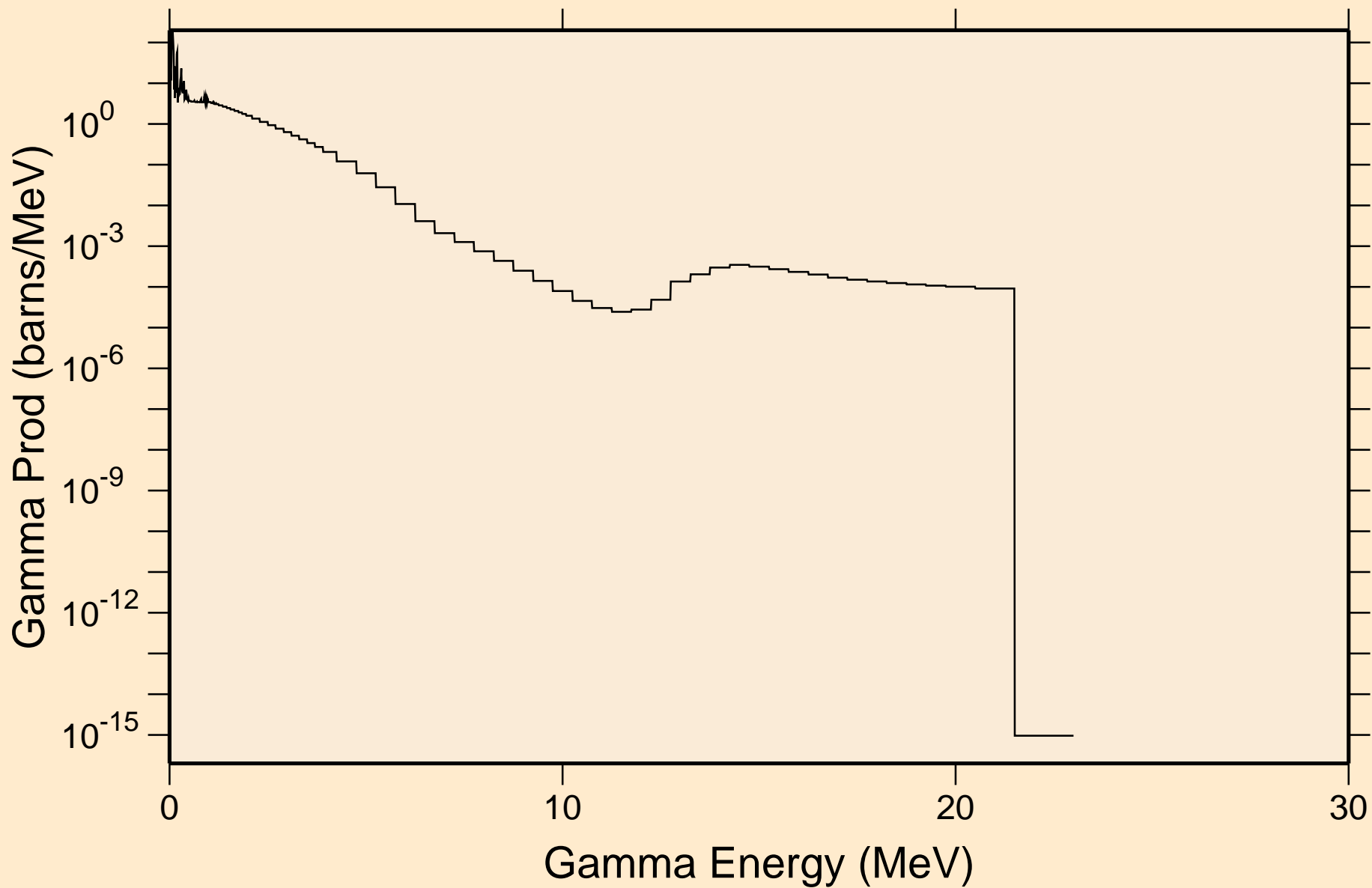

HO162 NEUTRON ACER TENDL-2019 LIBRARY; T=293.16K

Particle heating contributions

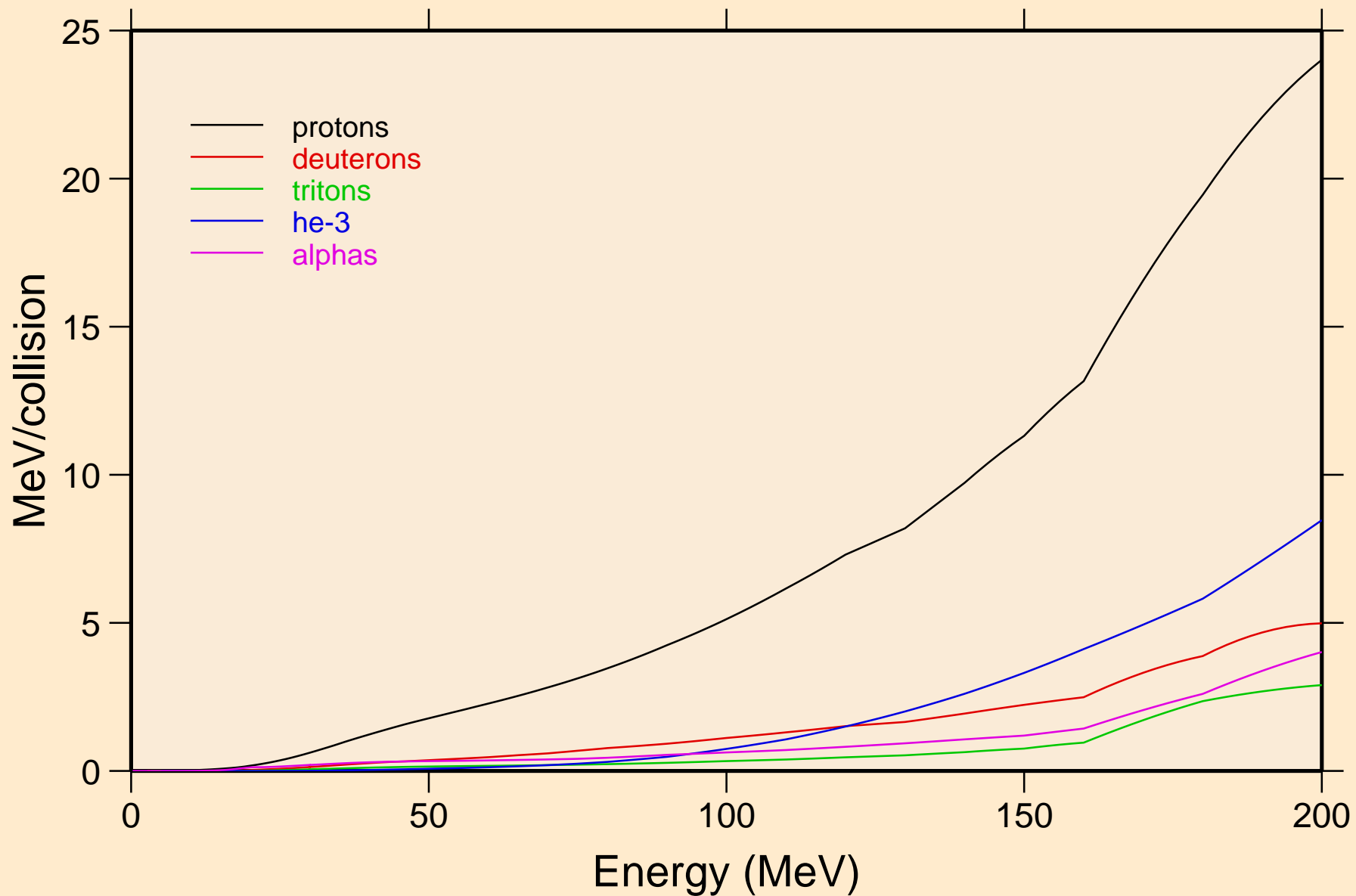

HO162 NEUTRON ACER TENDL-2019 LIBRARY; T=293.16K
Recoil Heating

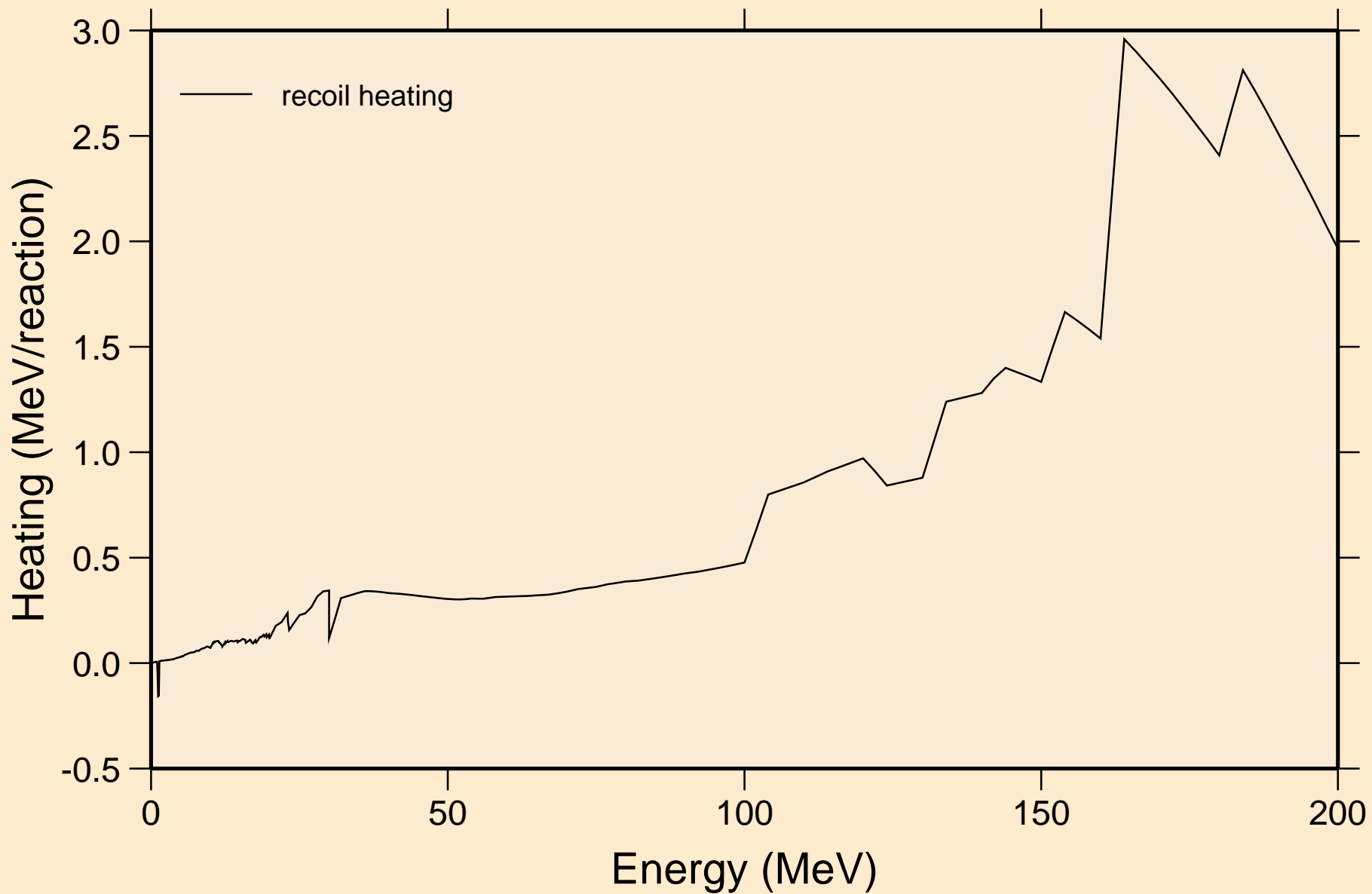

HO162 NEUTRON ACER TENDL-2019 LIBRARY; T=293.16K
Particle production cross sections

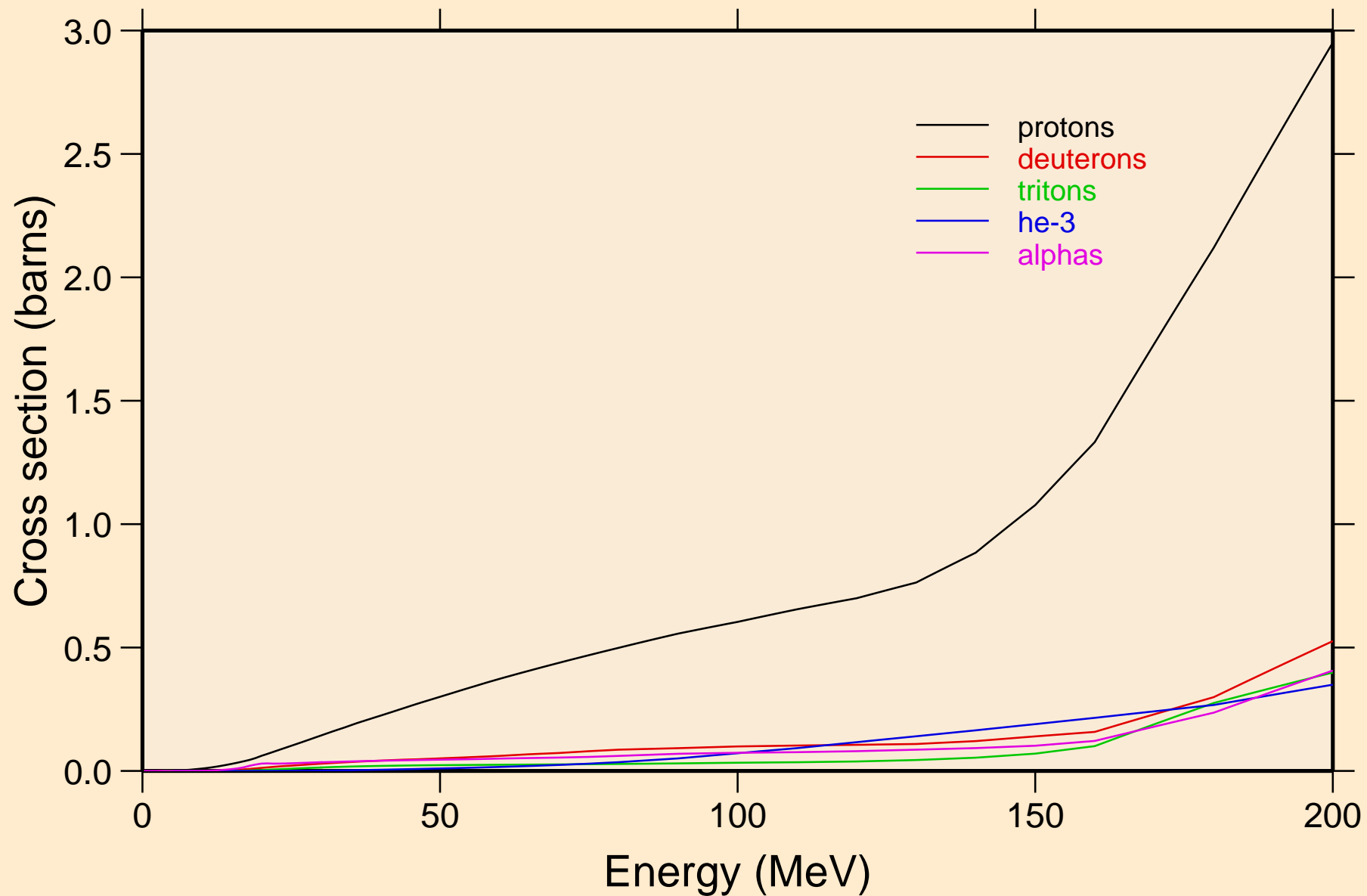

HO162 NEUTRON ACER TENDL-2019 LIBRARY; T=293.16K
protons from (n,x)

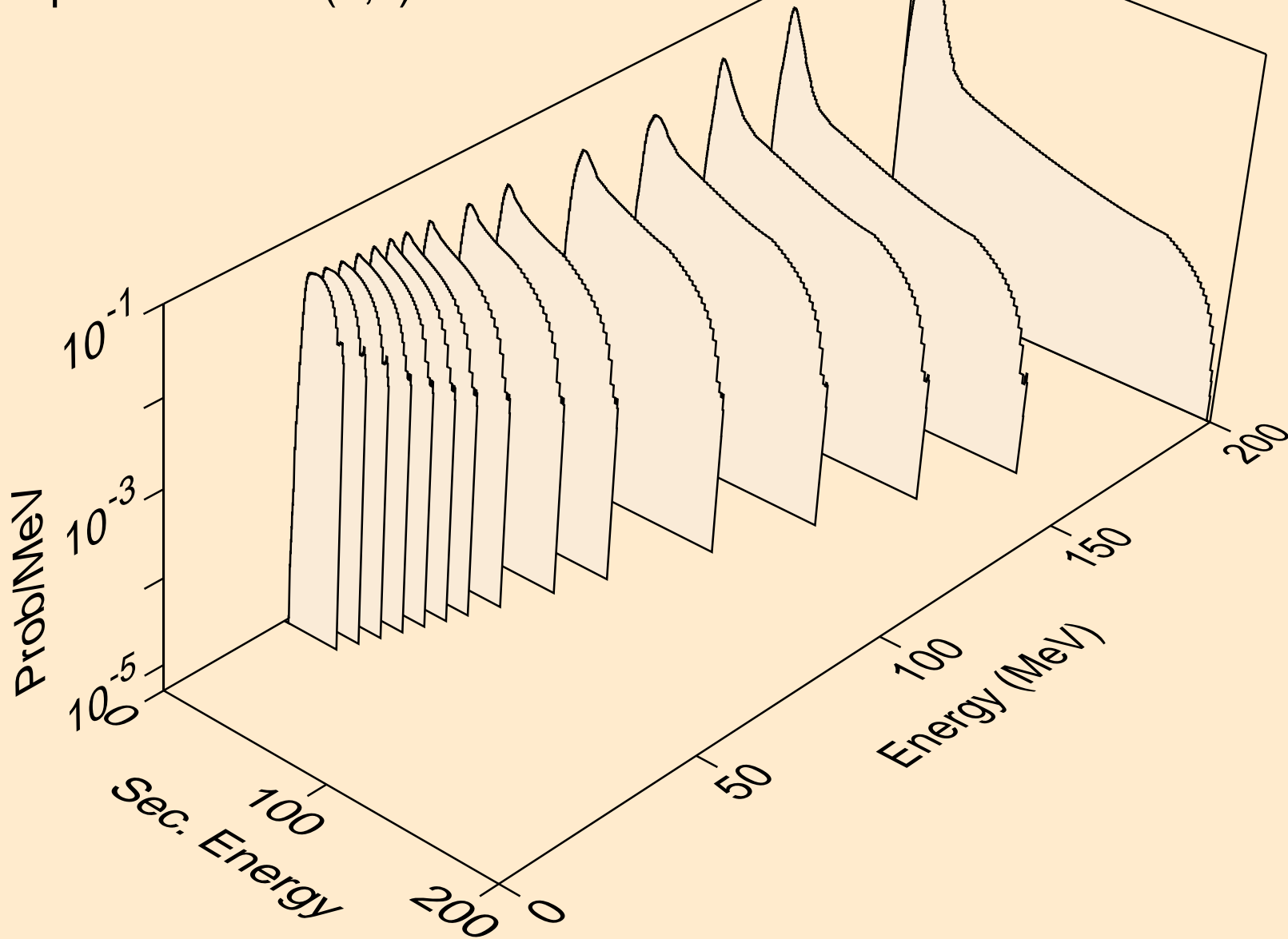

HO162 NEUTRON ACER TENDL-2019 LIBRARY; T=293.16K
protons from (n,n*)p

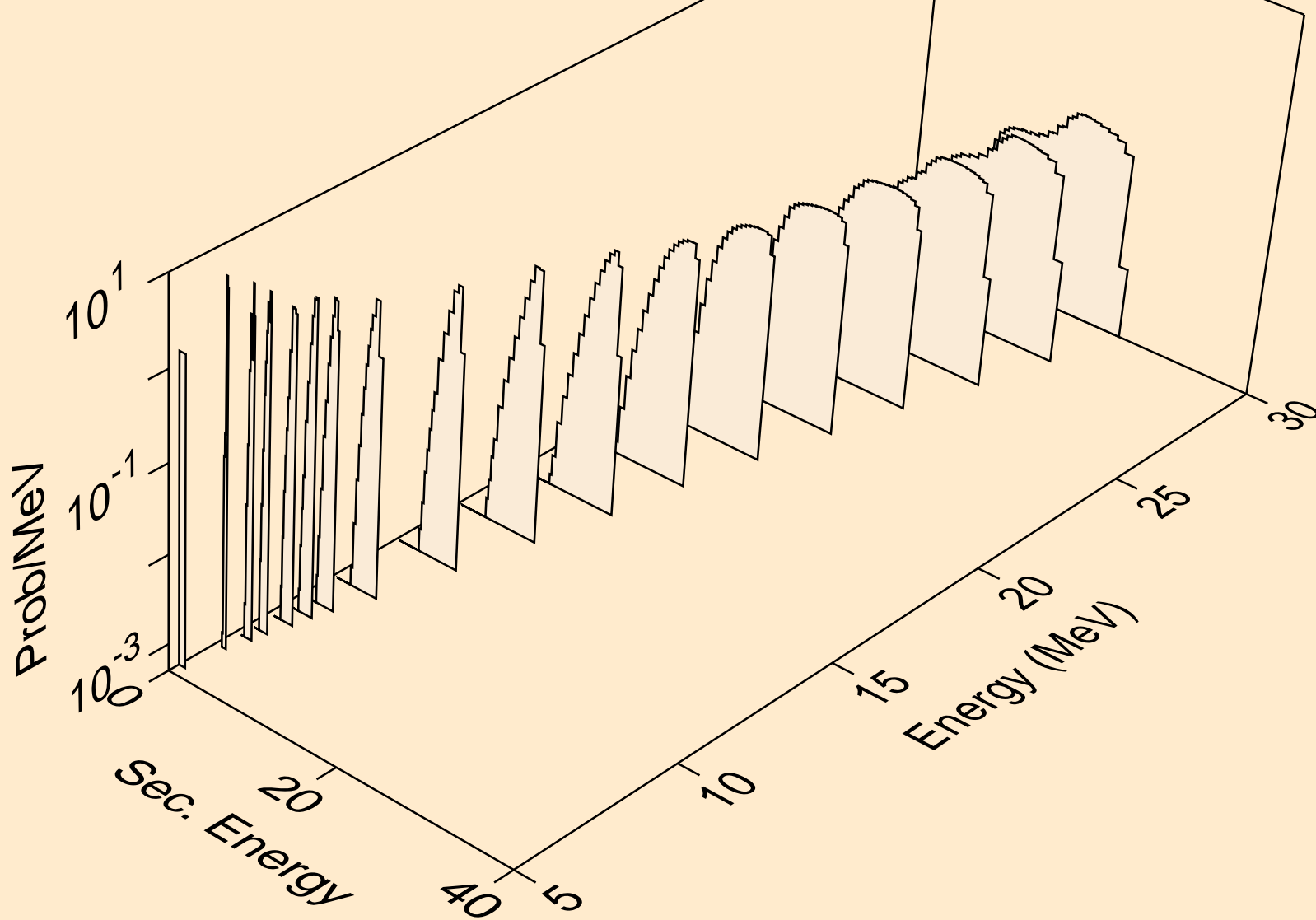

HO162 NEUTRON ACER TENDL-2019 LIBRARY; T=293.16K
protons from (n,2np)

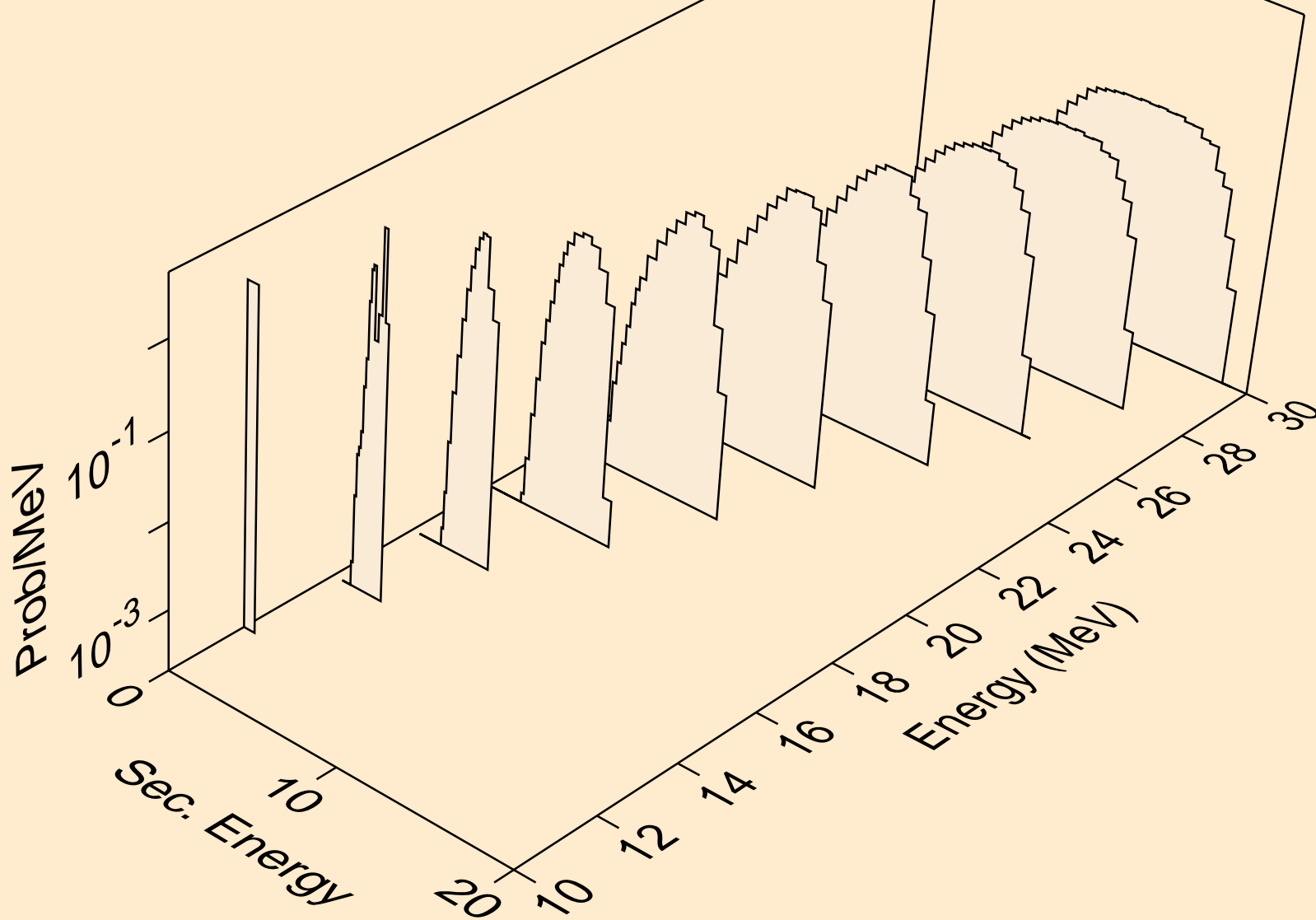

HO162 NEUTRON ACER TENDL-2019 LIBRARY; T=293.16K
protons from (n,3np)

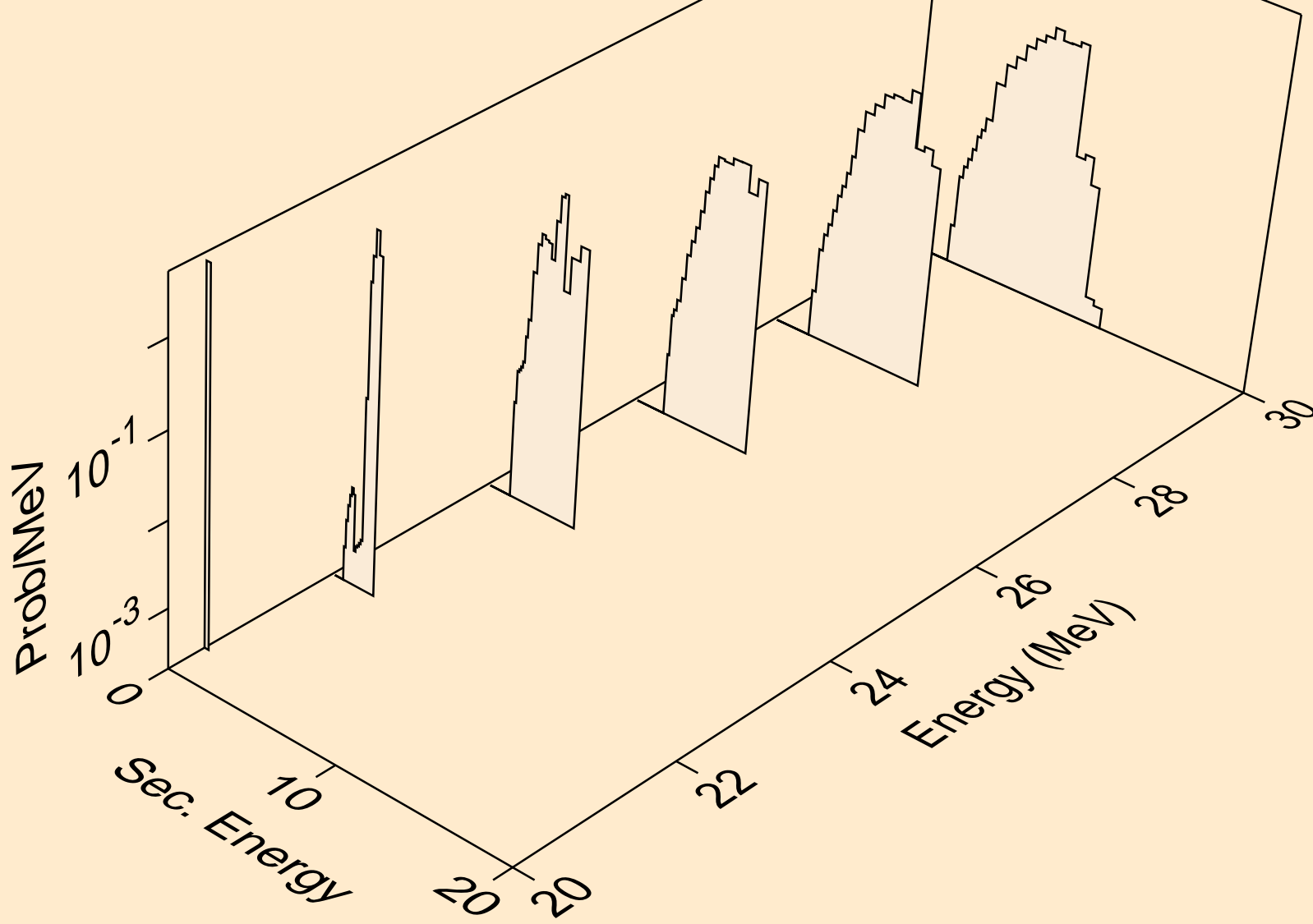

HO162 NEUTRON ACER TENDL-2019 LIBRARY; T=293.16K
protons from (n,2np)

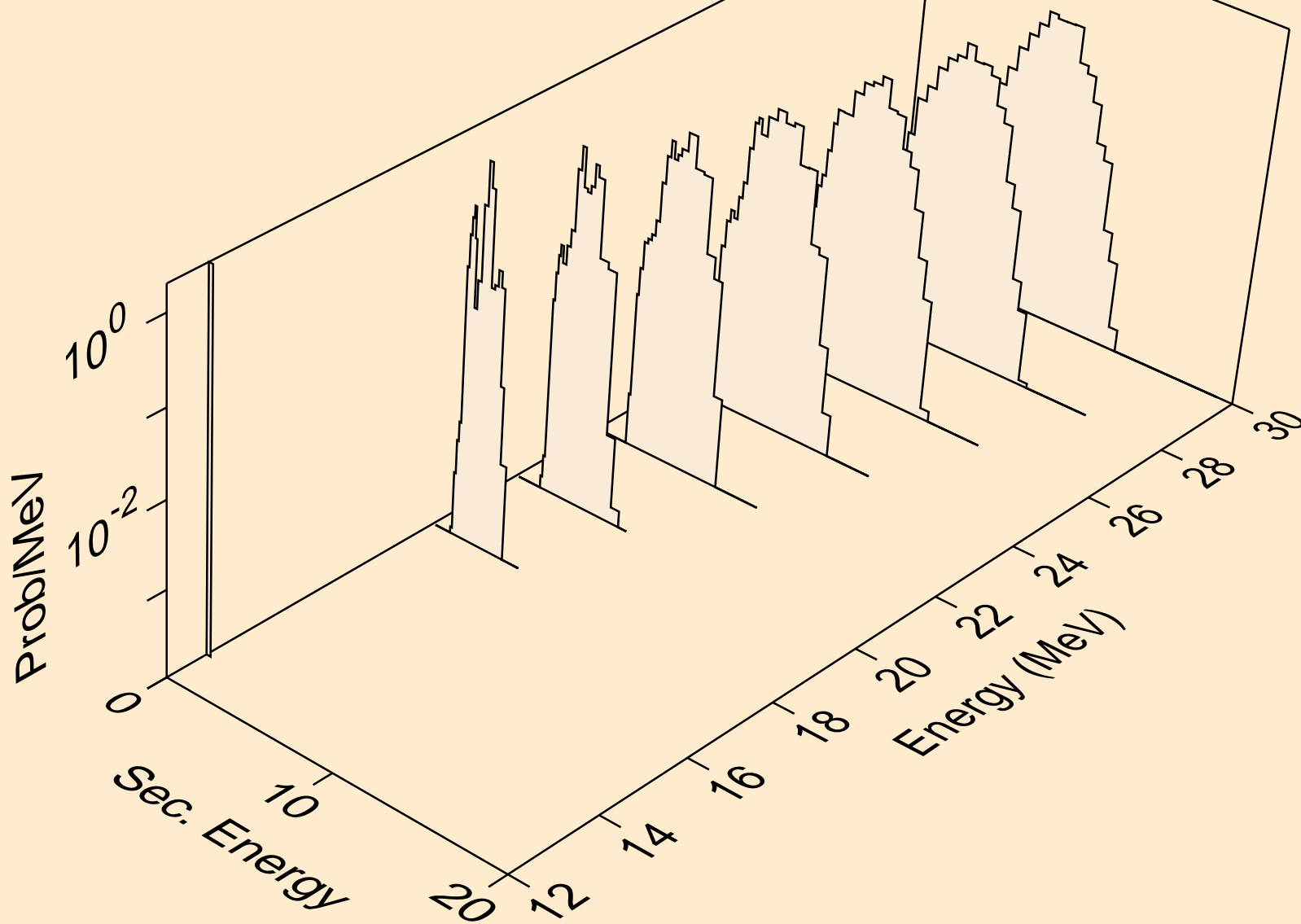

HO162 NEUTRON ACER TENDL-2019 LIBRARY; T=293.16K
protons from (n,npa)

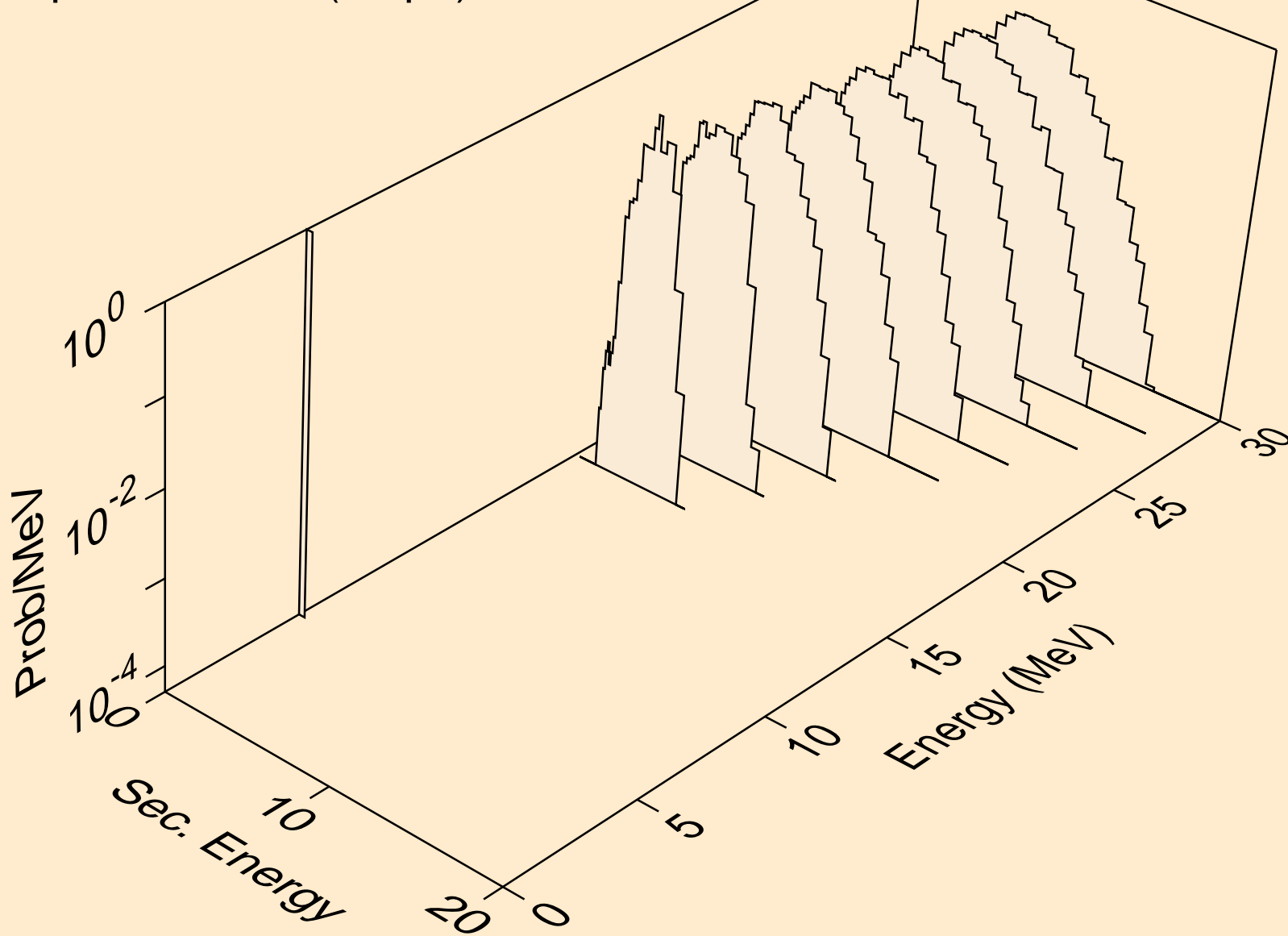

HO162 NEUTRON ACER TENDL-2019 LIBRARY; T=293.16K
protons from (n,p)

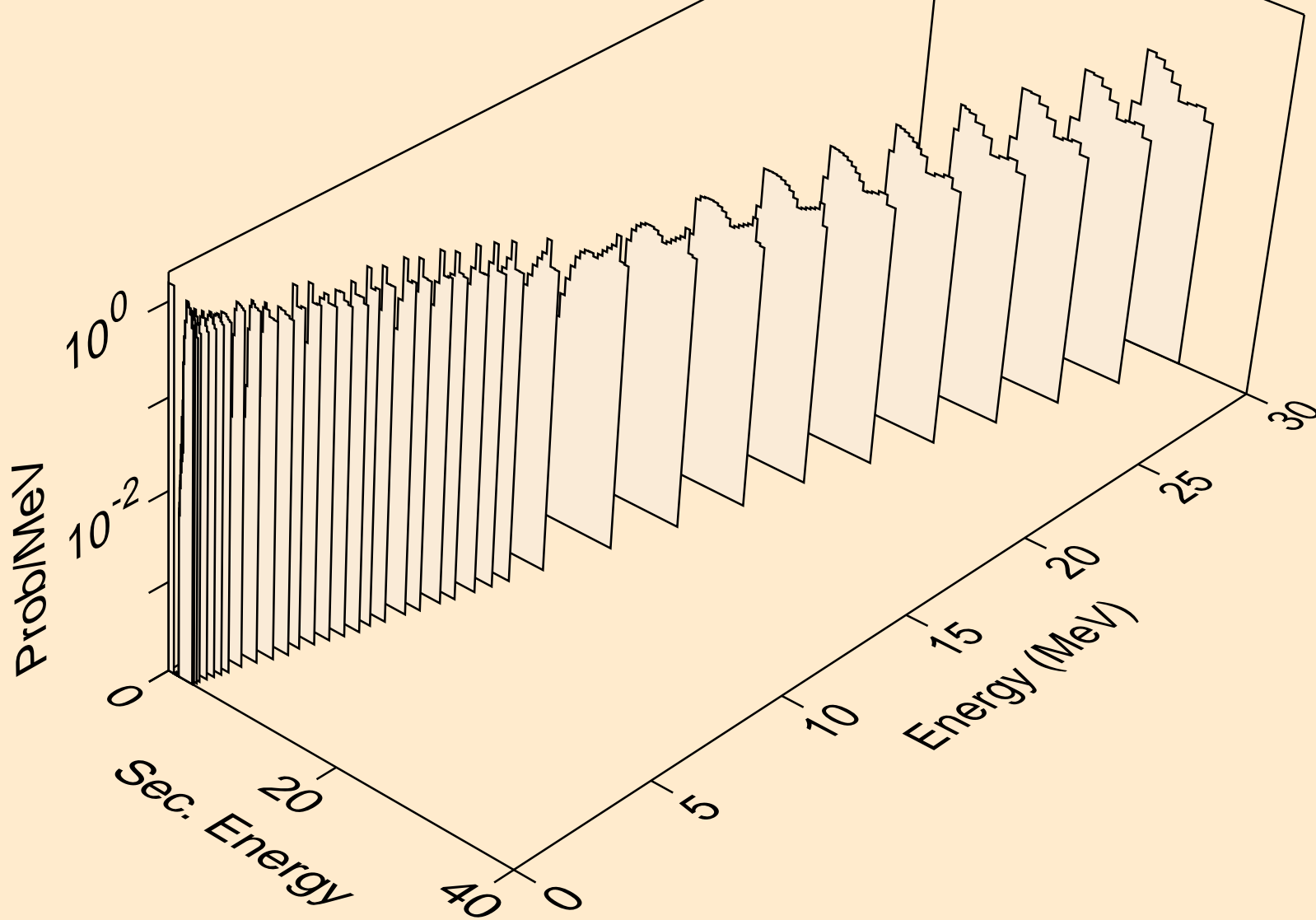

HO162 NEUTRON ACER TENDL-2019 LIBRARY; T=293.16K
protons from (n,2p)

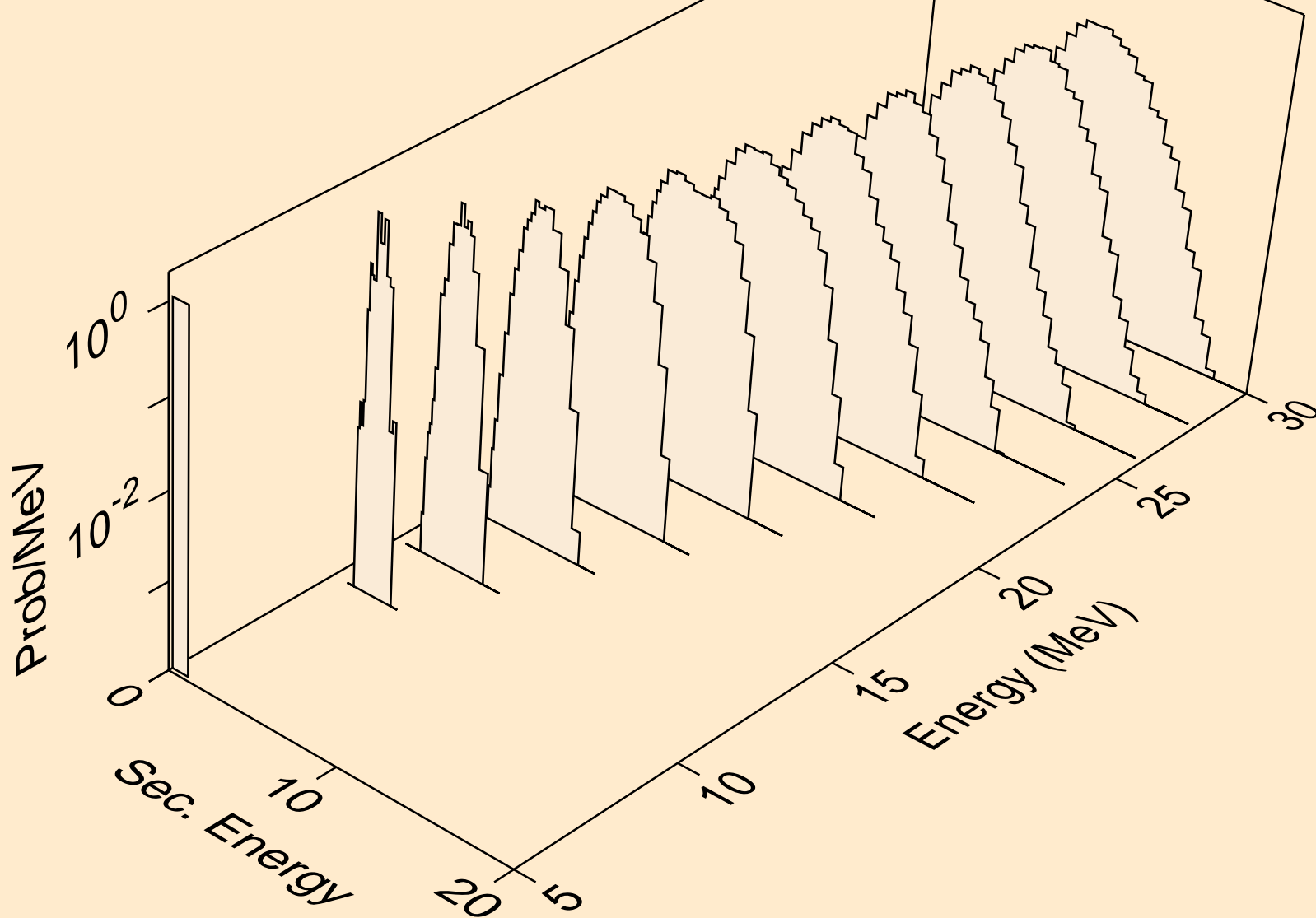

HO162 NEUTRON ACER TENDL-2019 LIBRARY; T=293.16K
protons from (n,p)

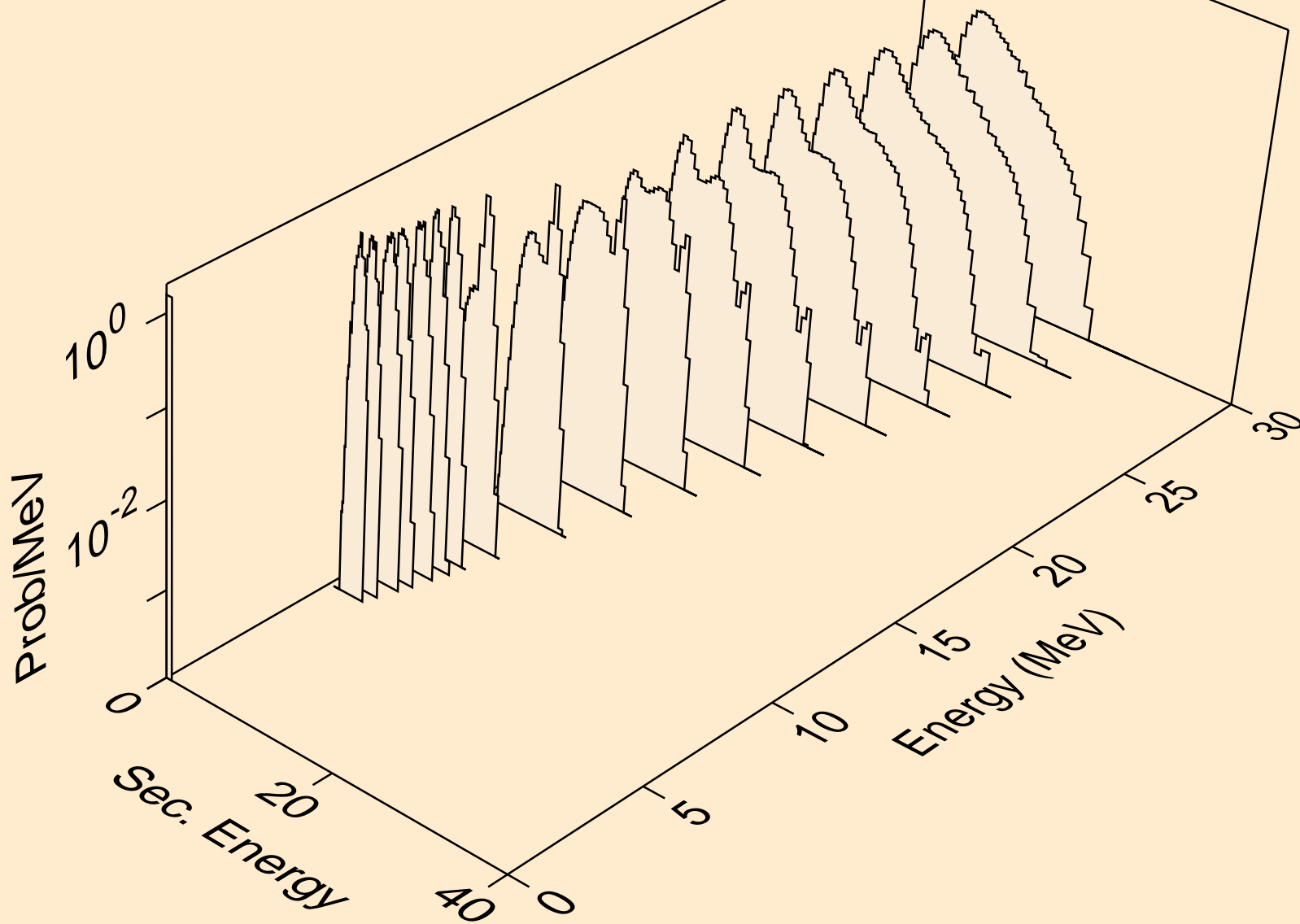

HO162 NEUTRON ACER TENDL-2019 LIBRARY; T=293.16K
protons from (n,pd)

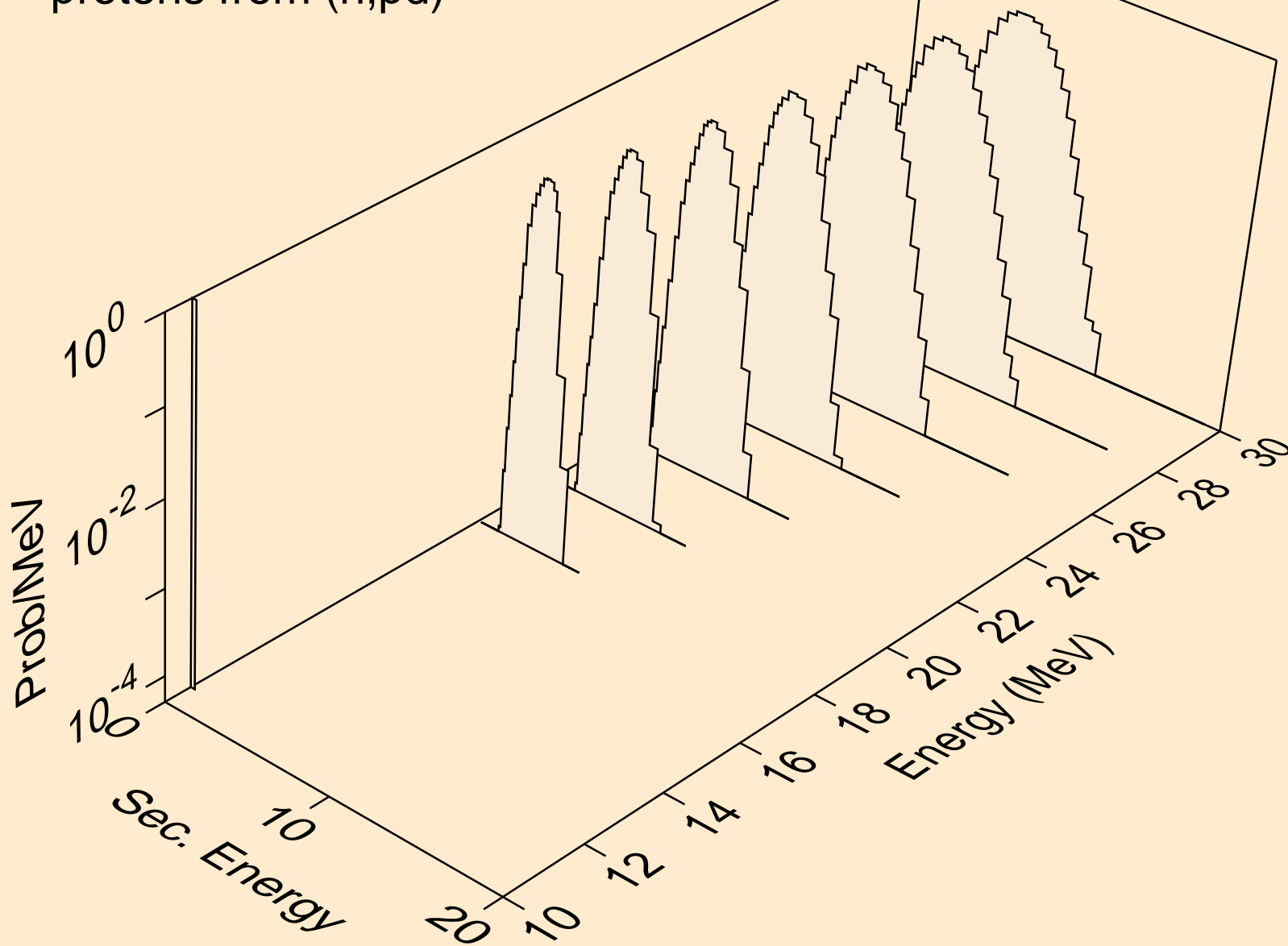

HO162 NEUTRON ACER TENDL-2019 LIBRARY; T=293.16K
protons from (n,pt)

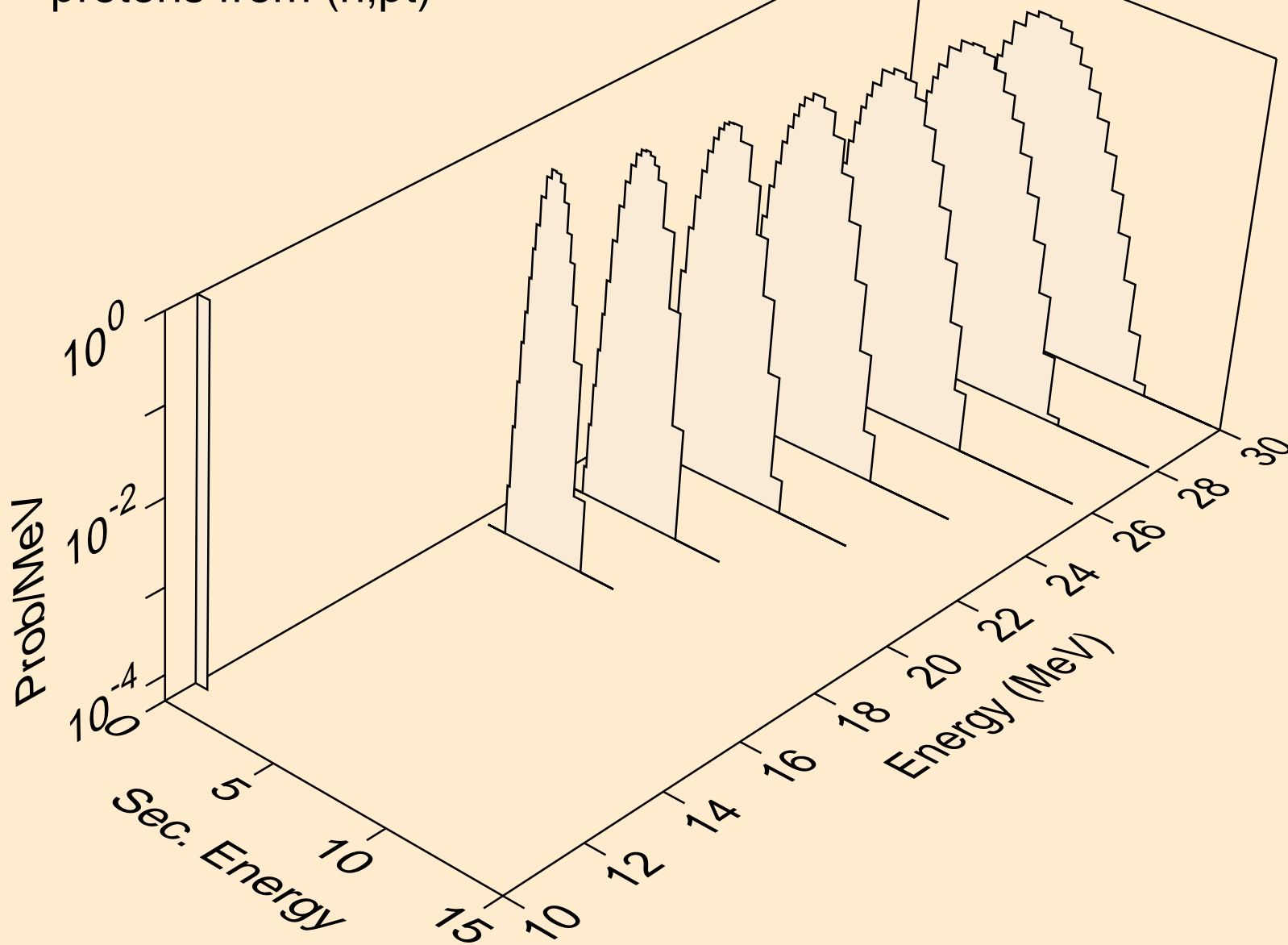

HO162 NEUTRON ACER TENDL-2019 LIBRARY; T=293.16K
deuterons from (n,x)

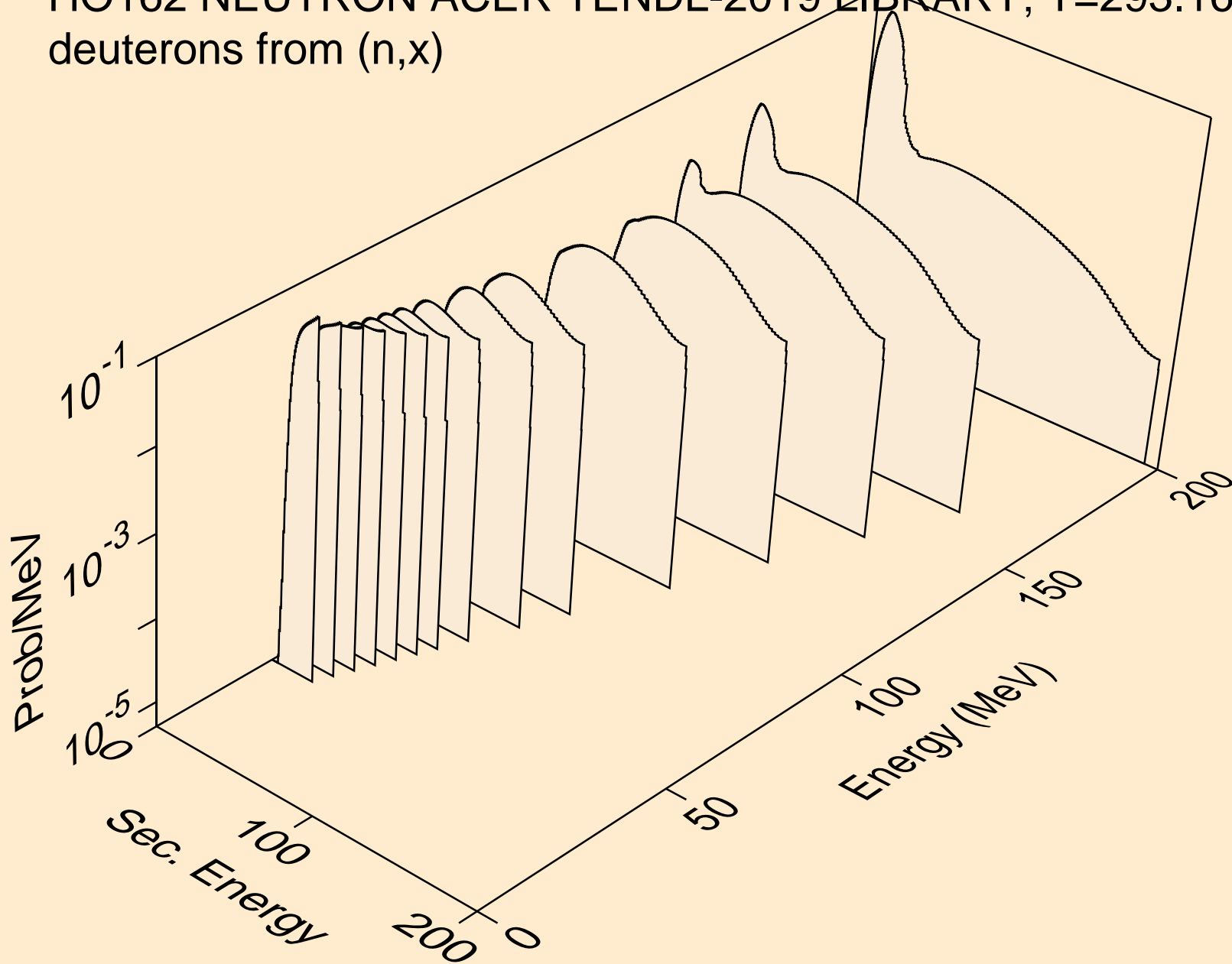

HO162 NEUTRON ACER TENDL-2019 LIBRARY; T=293.16K
deuterons from (n,2nd)

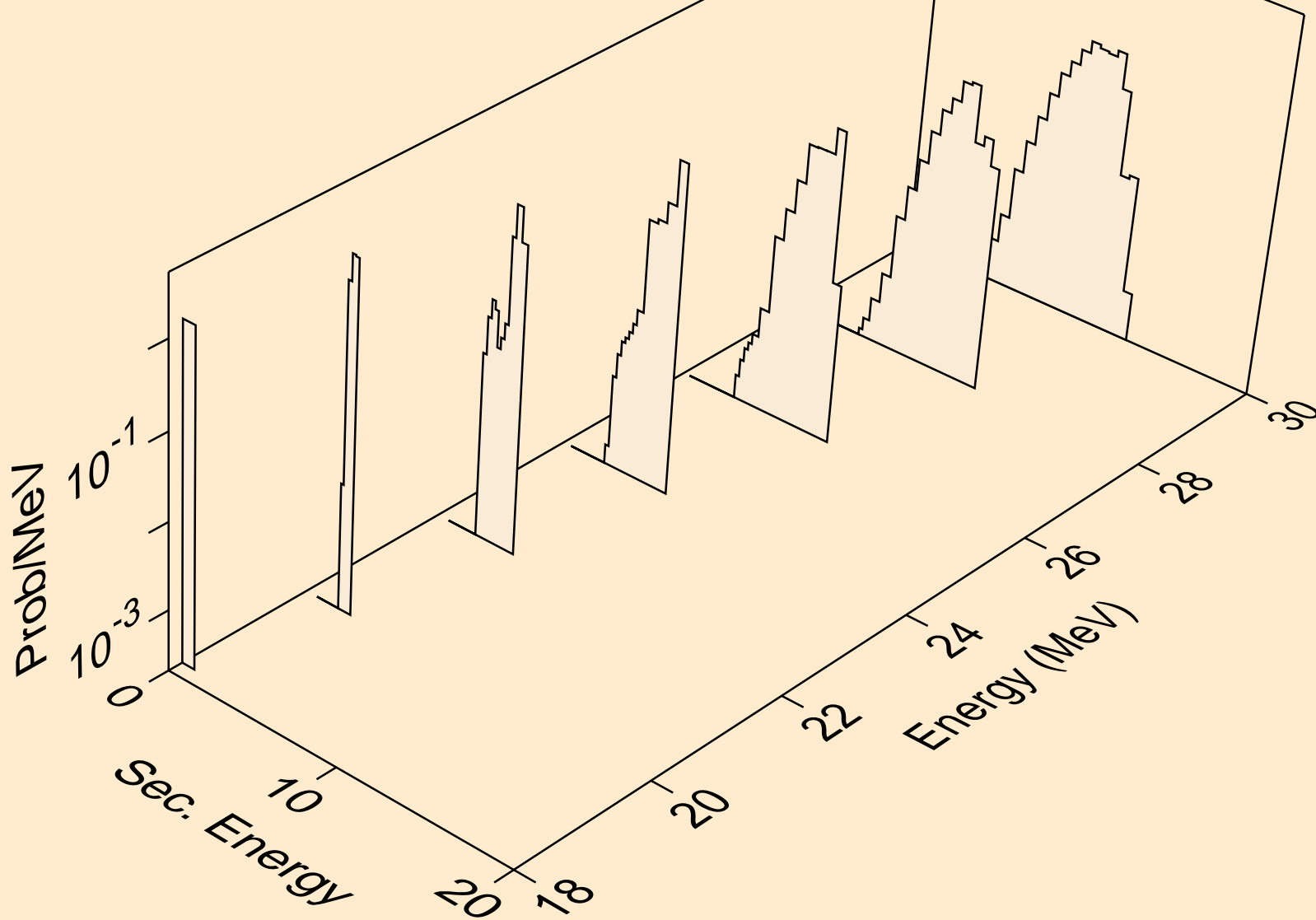

HO162 NEUTRON ACER TENDL-2019 LIBRARY; T=293.16K
deuterons from (n,n*)d

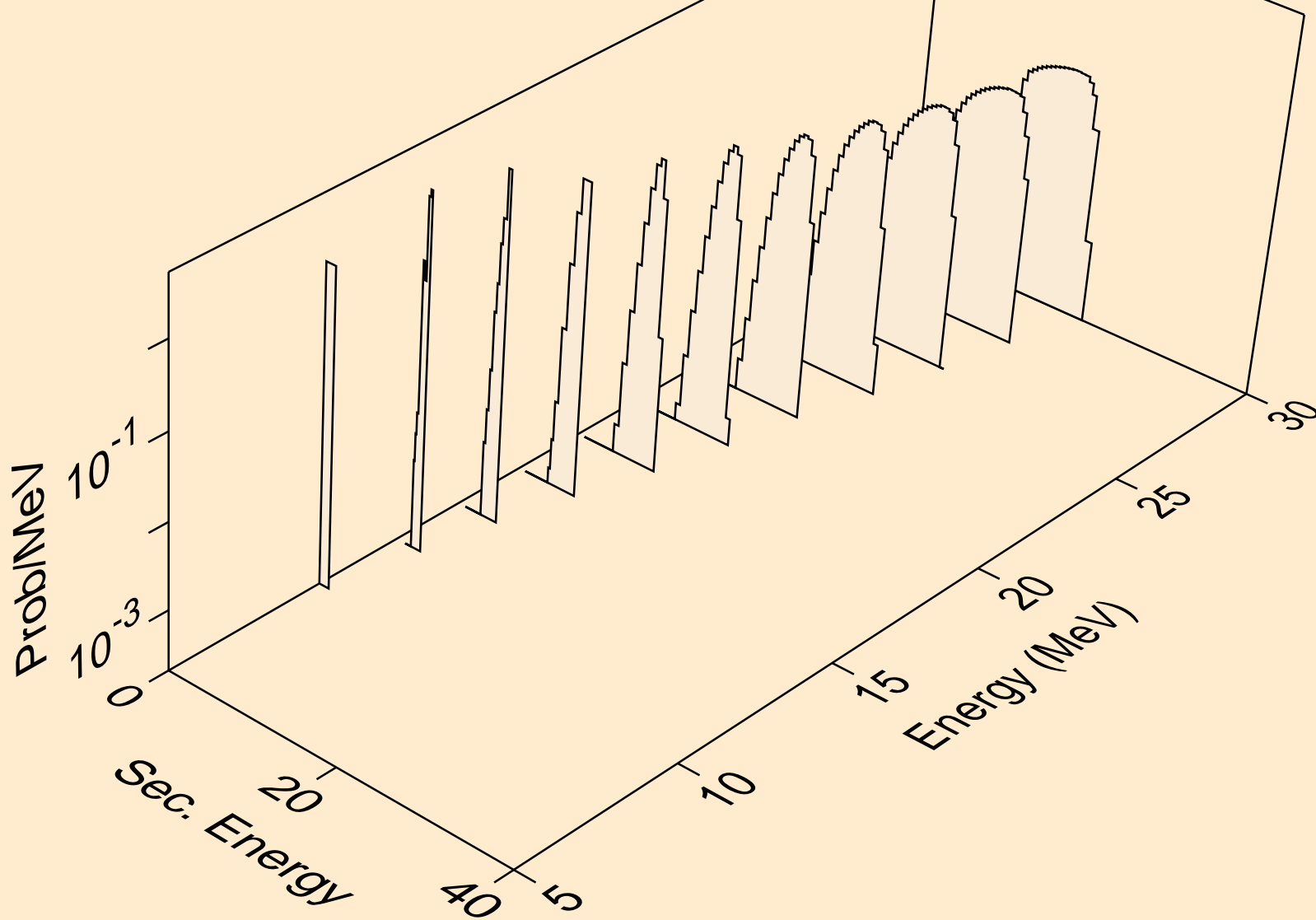

HO162 NEUTRON ACER TENDL-2019 LIBRARY; T=293.16K
deuterons from (n,d)

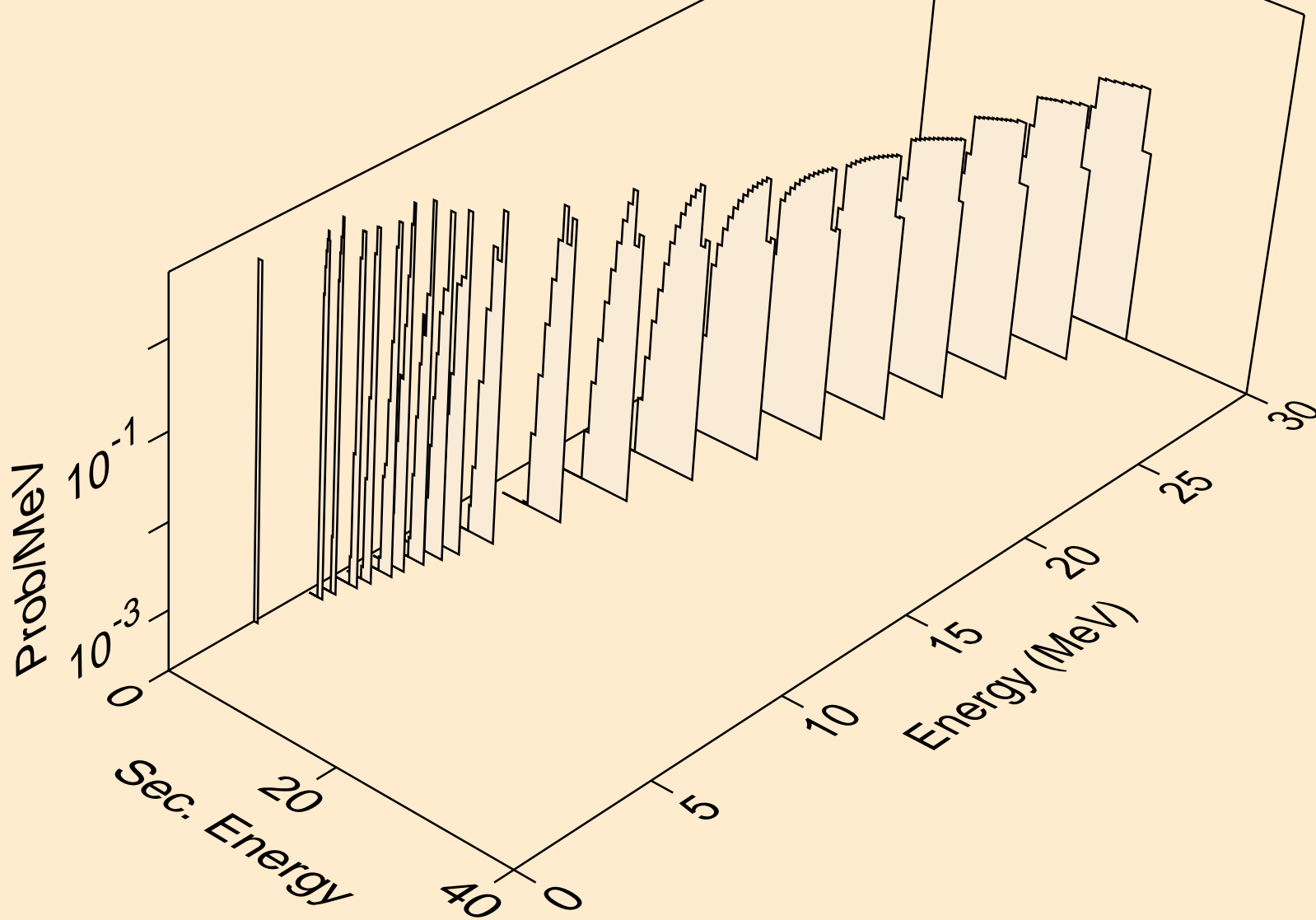

HO162 NEUTRON ACER TENDL-2019 LIBRARY; T=293.16K
deuterons from (n,pd)

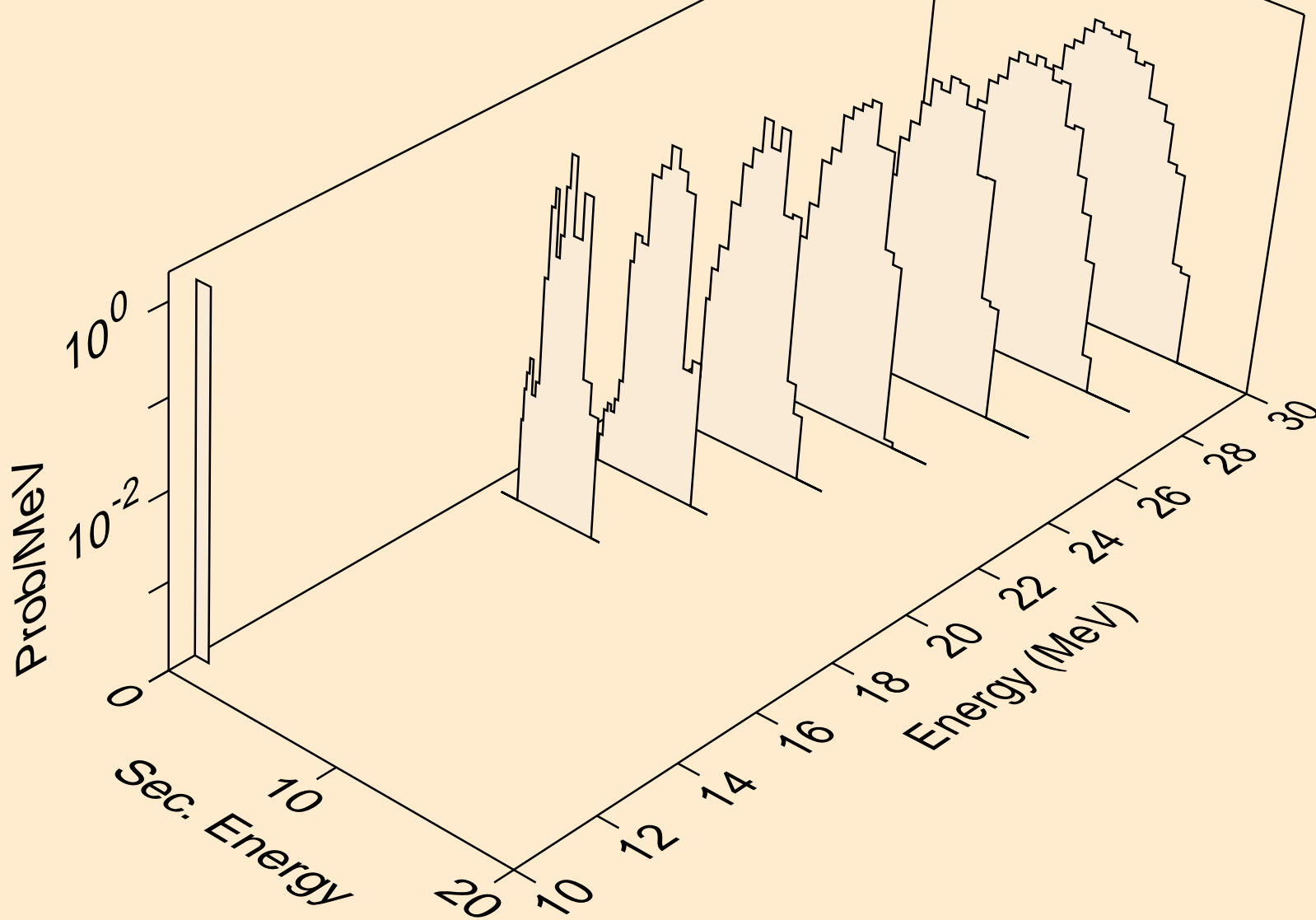

HO162 NEUTRON ACER TENDL-2019 LIBRARY; T=293.16K
deuterons from (n,da)

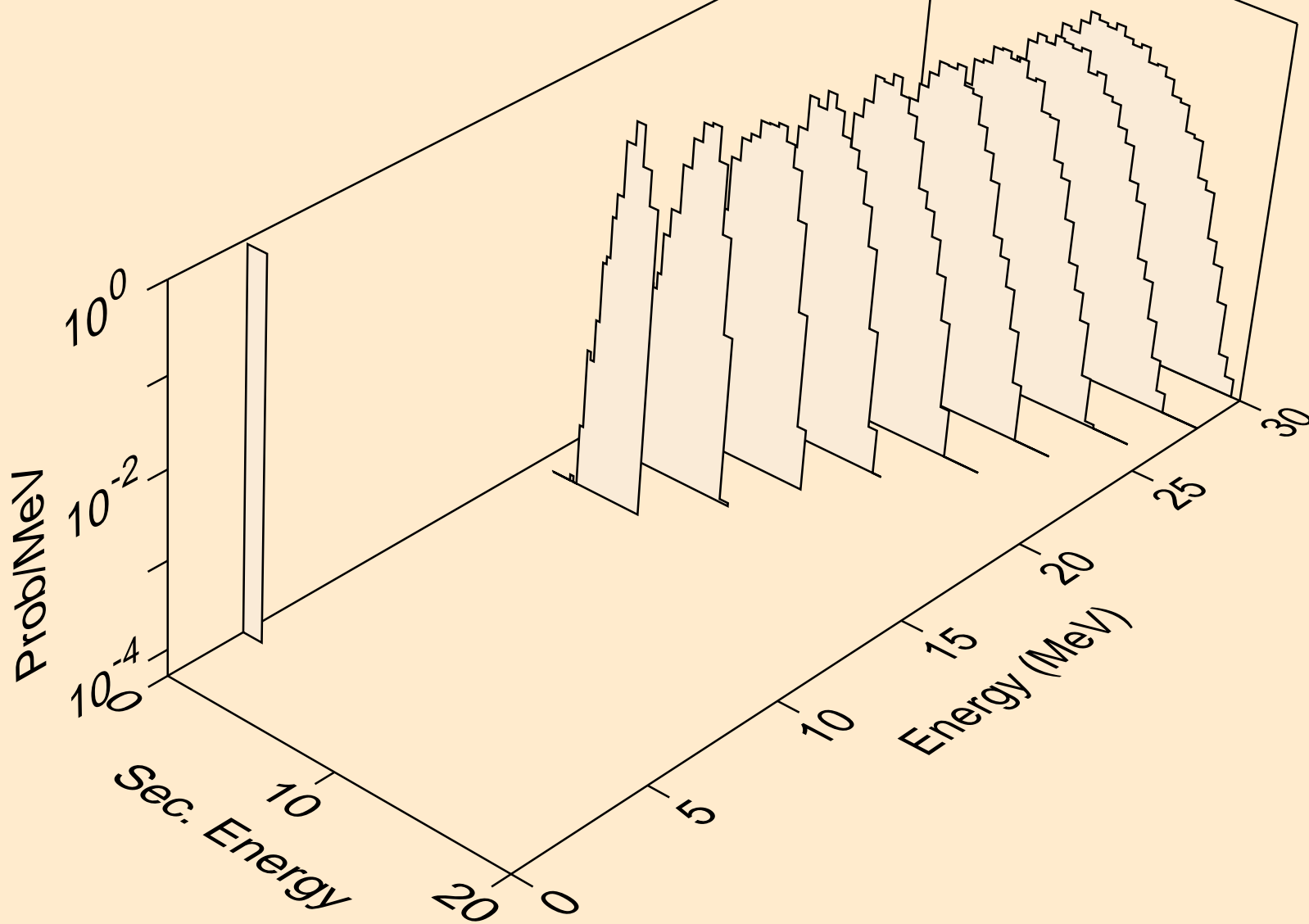

HO162 NEUTRON ACER TENDL-2019 LIBRARY; T=293.16K
tritons from (n,x)

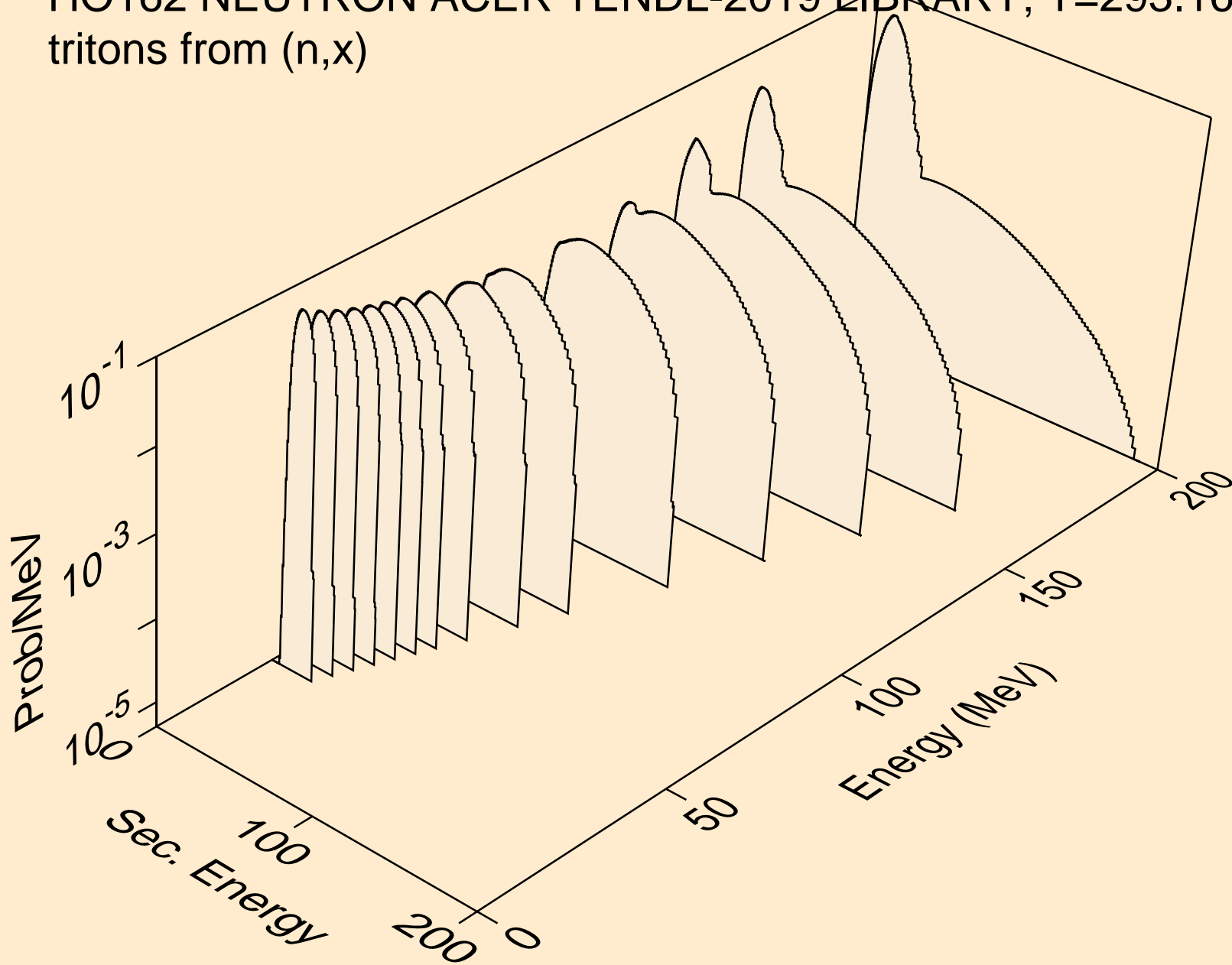

HO162 NEUTRON ACER TENDL-2019 LIBRARY; T=293.16K
tritons from (n,n*)t

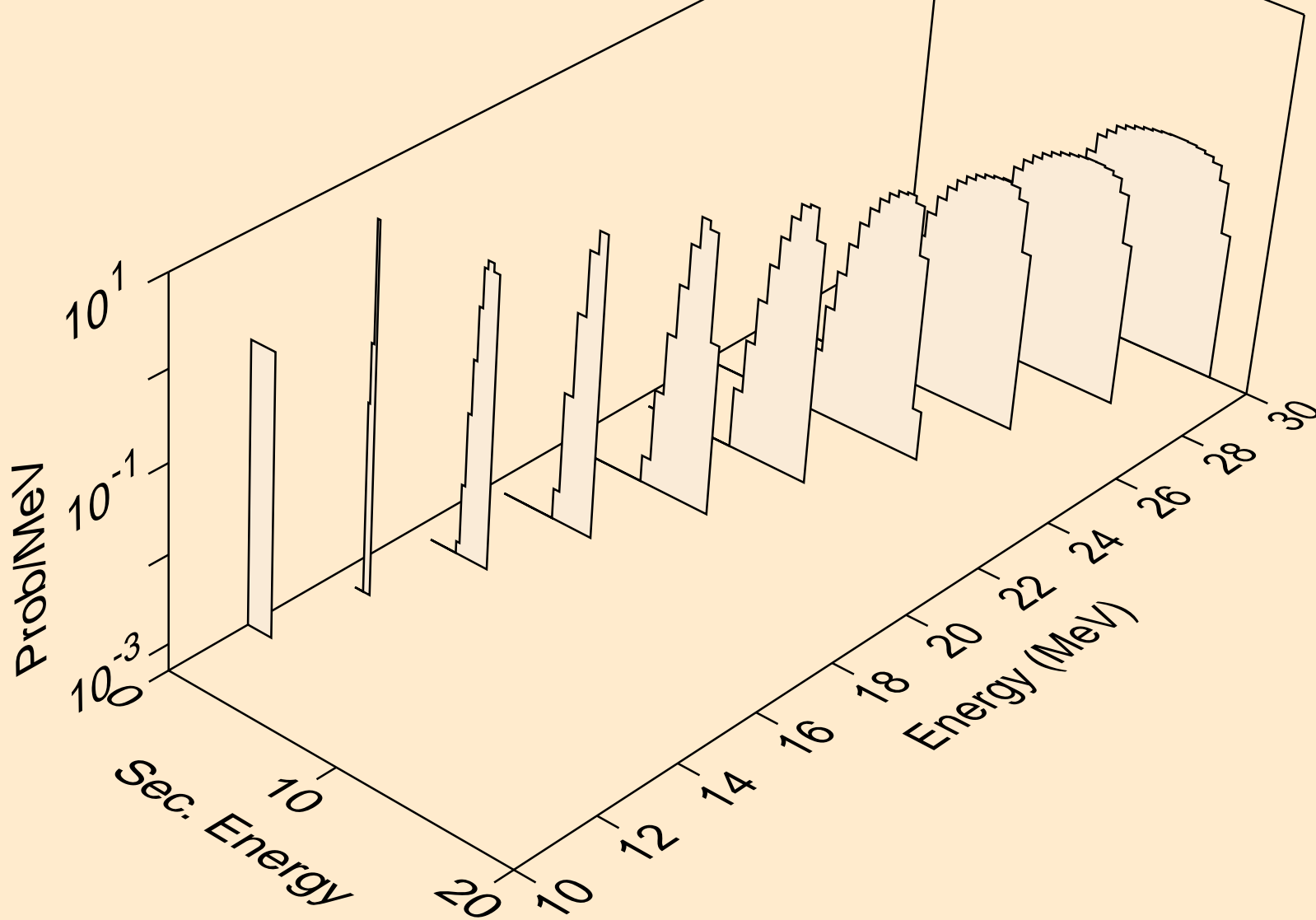

HO162 NEUTRON ACER TENDL-2019 LIBRARY; T=293.16K
tritons from (n,t)

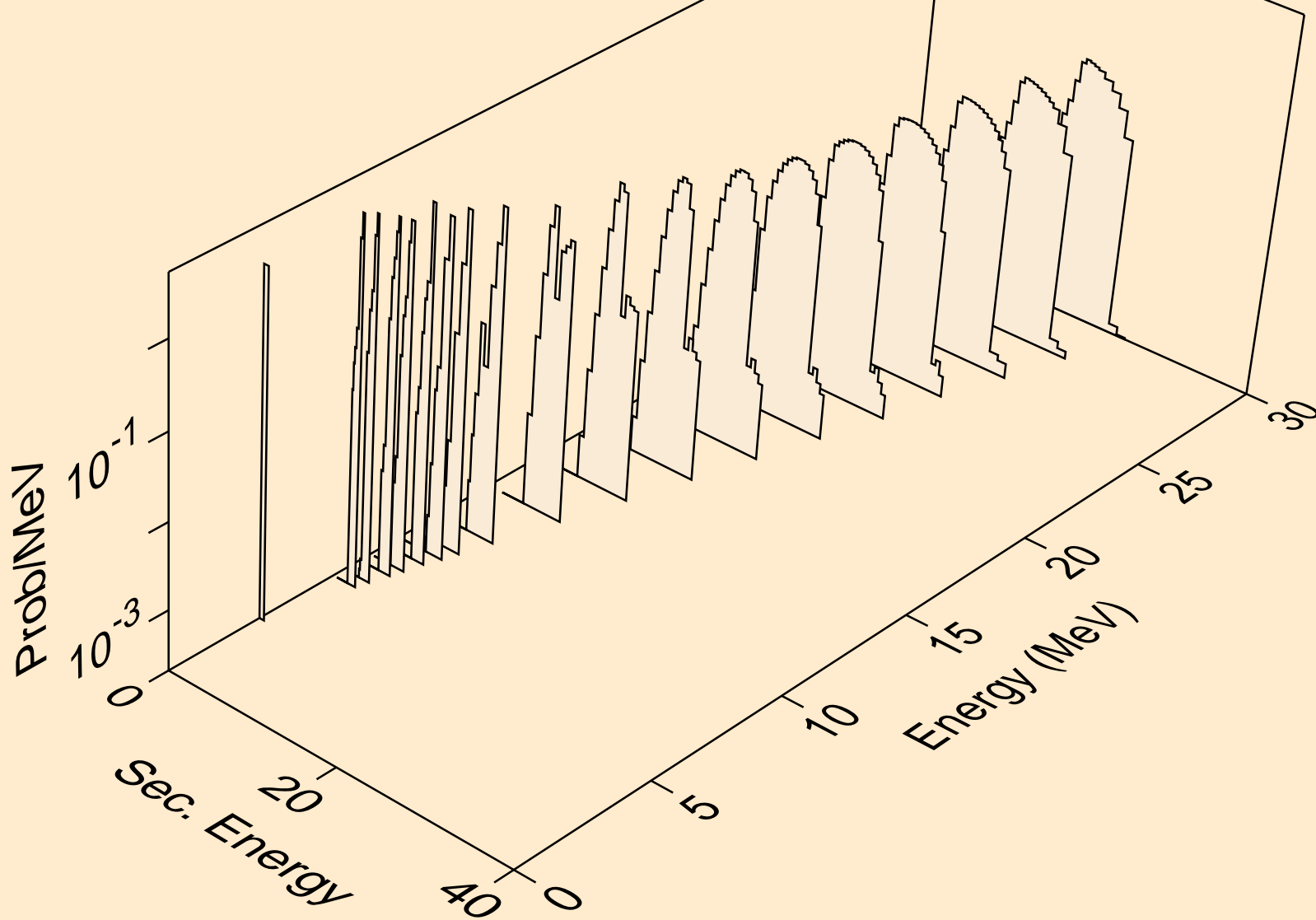

HO162 NEUTRON ACER TENDL-2019 LIBRARY; T=293.16K
tritons from (n,pt)

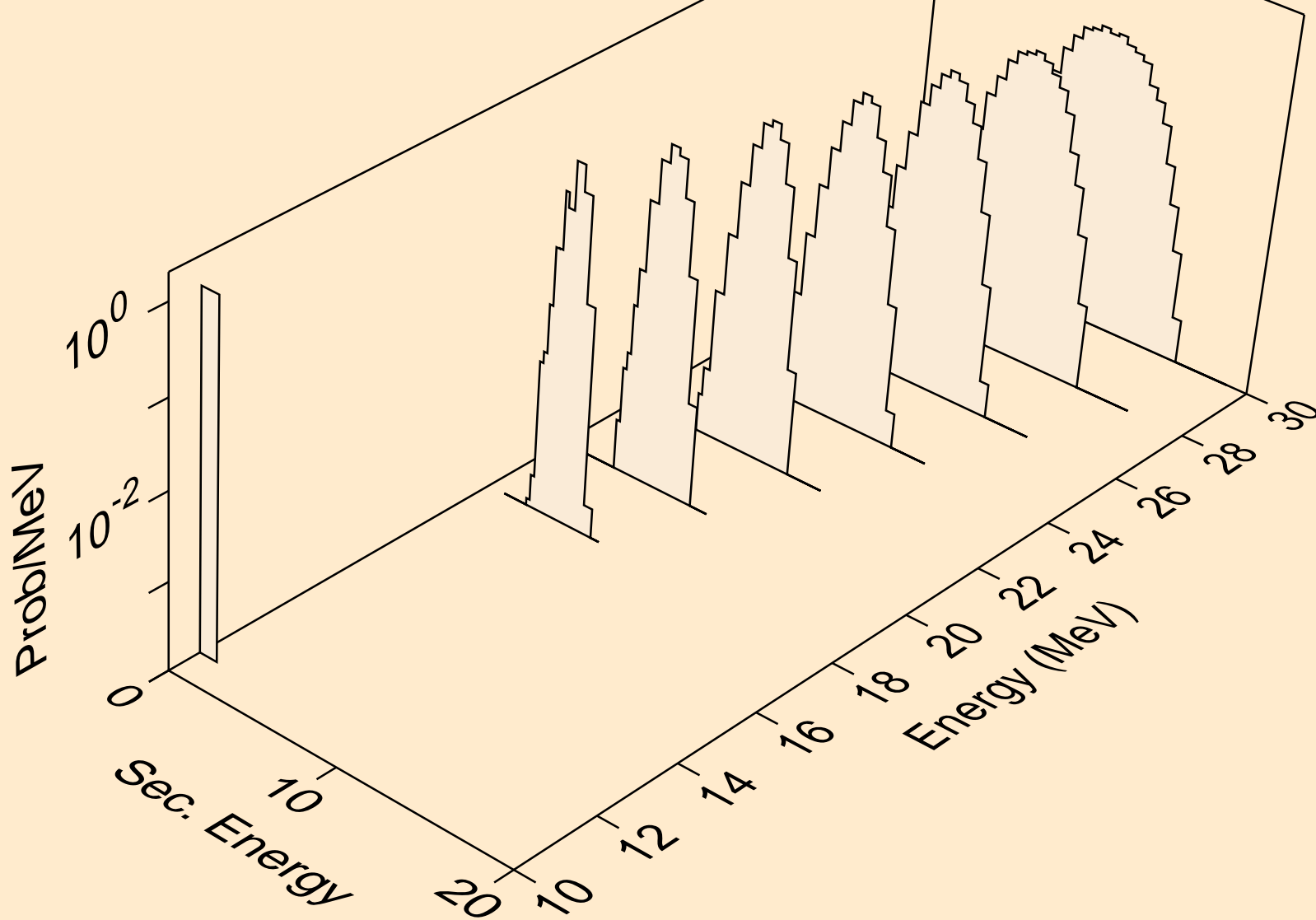

HO162 NEUTRON ACER TENDL-2019 LIBRARY; T=293.16K
he3s from (n,x)

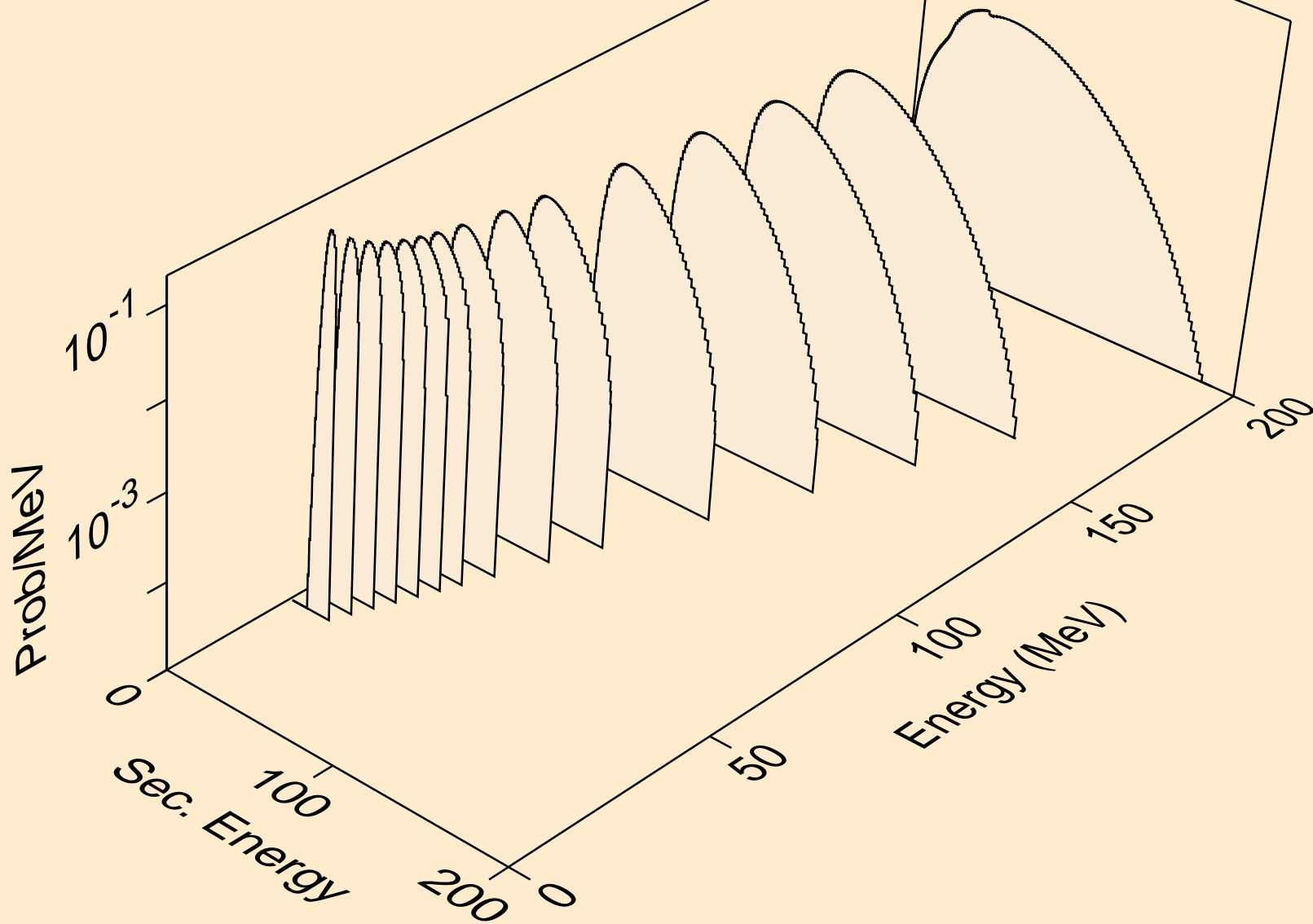

HO162 NEUTRON ACER TENDL-2019 LIBRARY; T=293.16K
he3s from (n,n*)he3

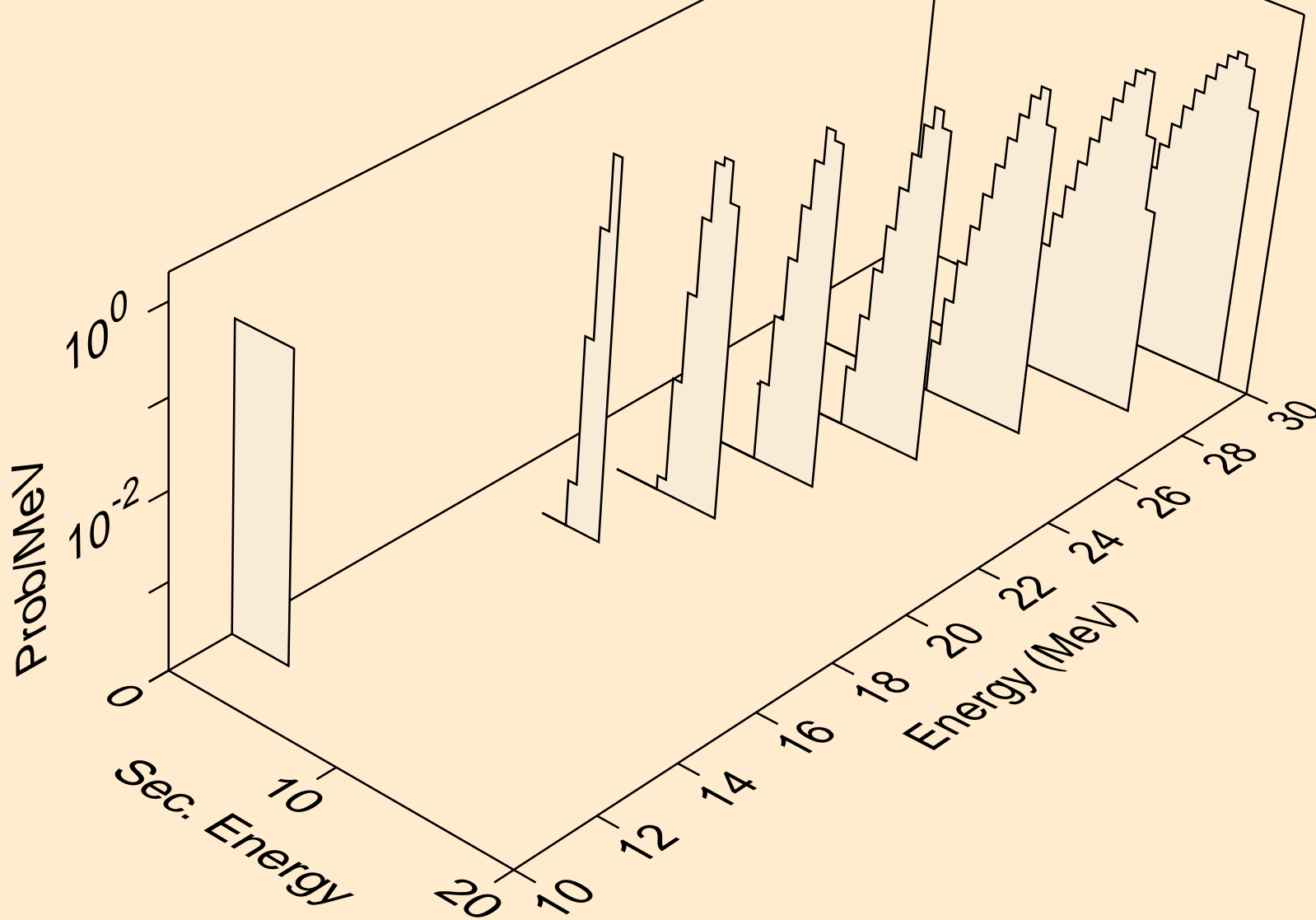

HO162 NEUTRON ACER TENDL-2019 LIBRARY; T=293.16K
he3s from (n,he3)

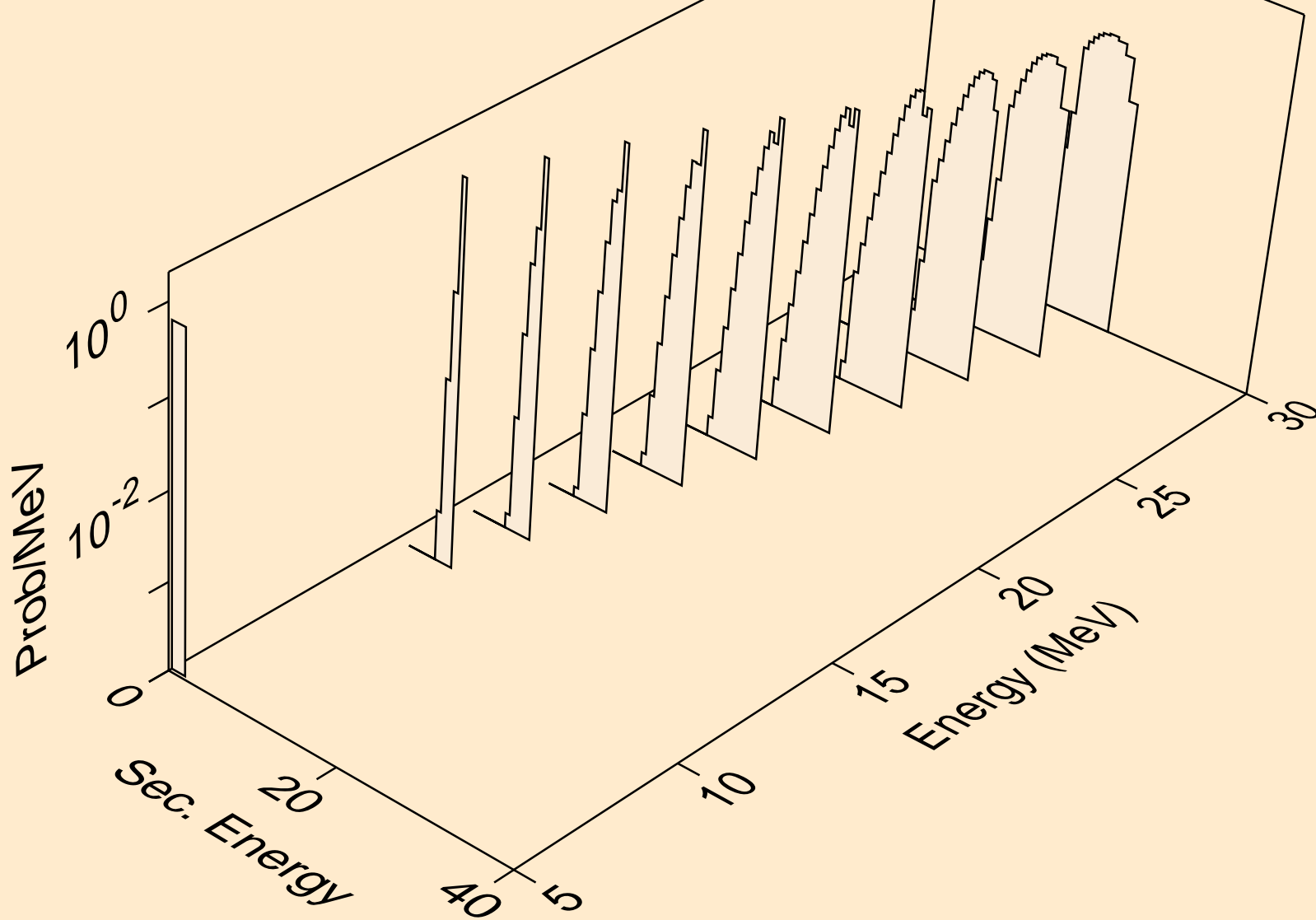

HO162 NEUTRON ACER TENDL-2019 LIBRARY; T=293.16K
alphas from (n,x)

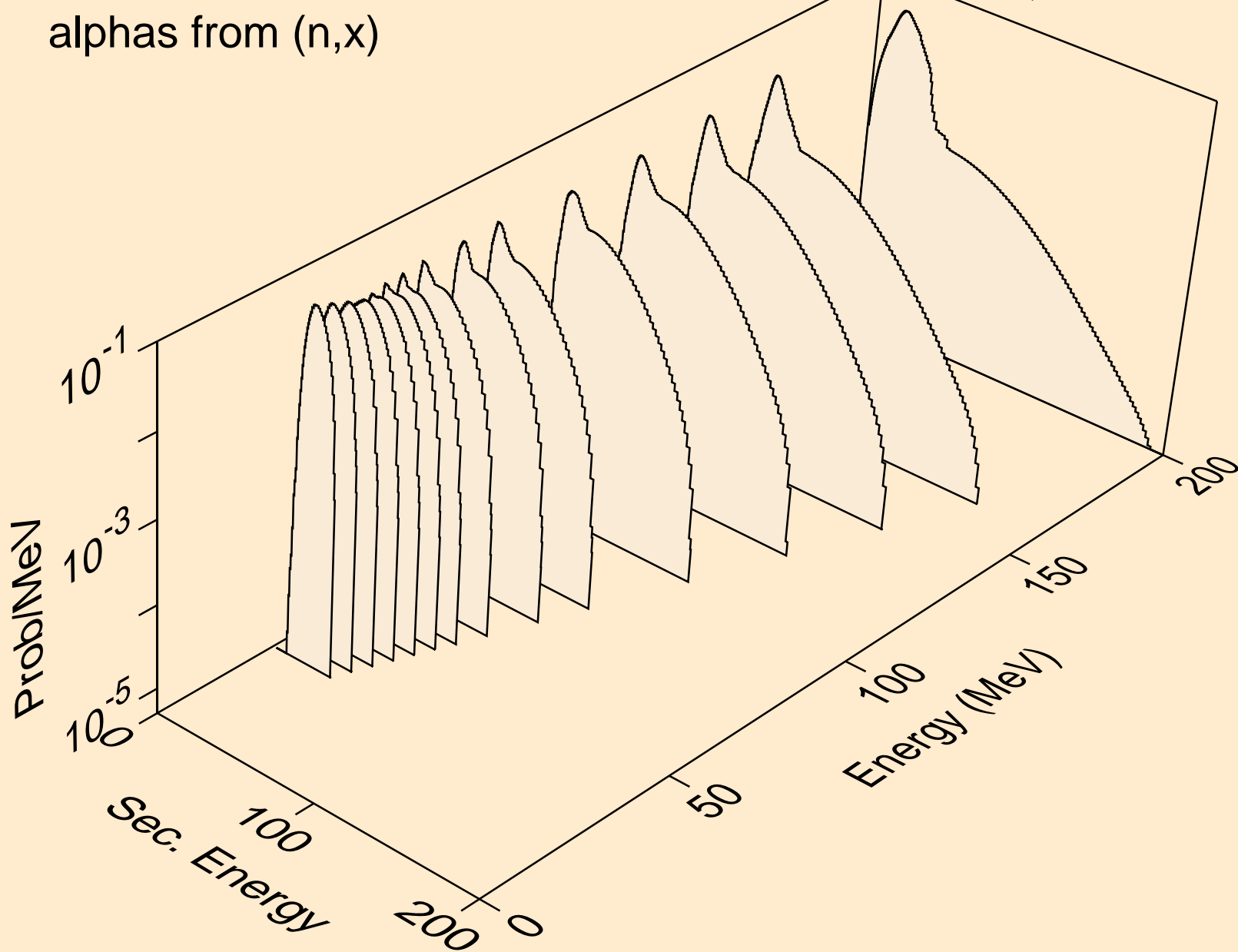

HO162 NEUTRON ACER TENDL-2019 LIBRARY; T=293.16K
alphas from (n,n*)a

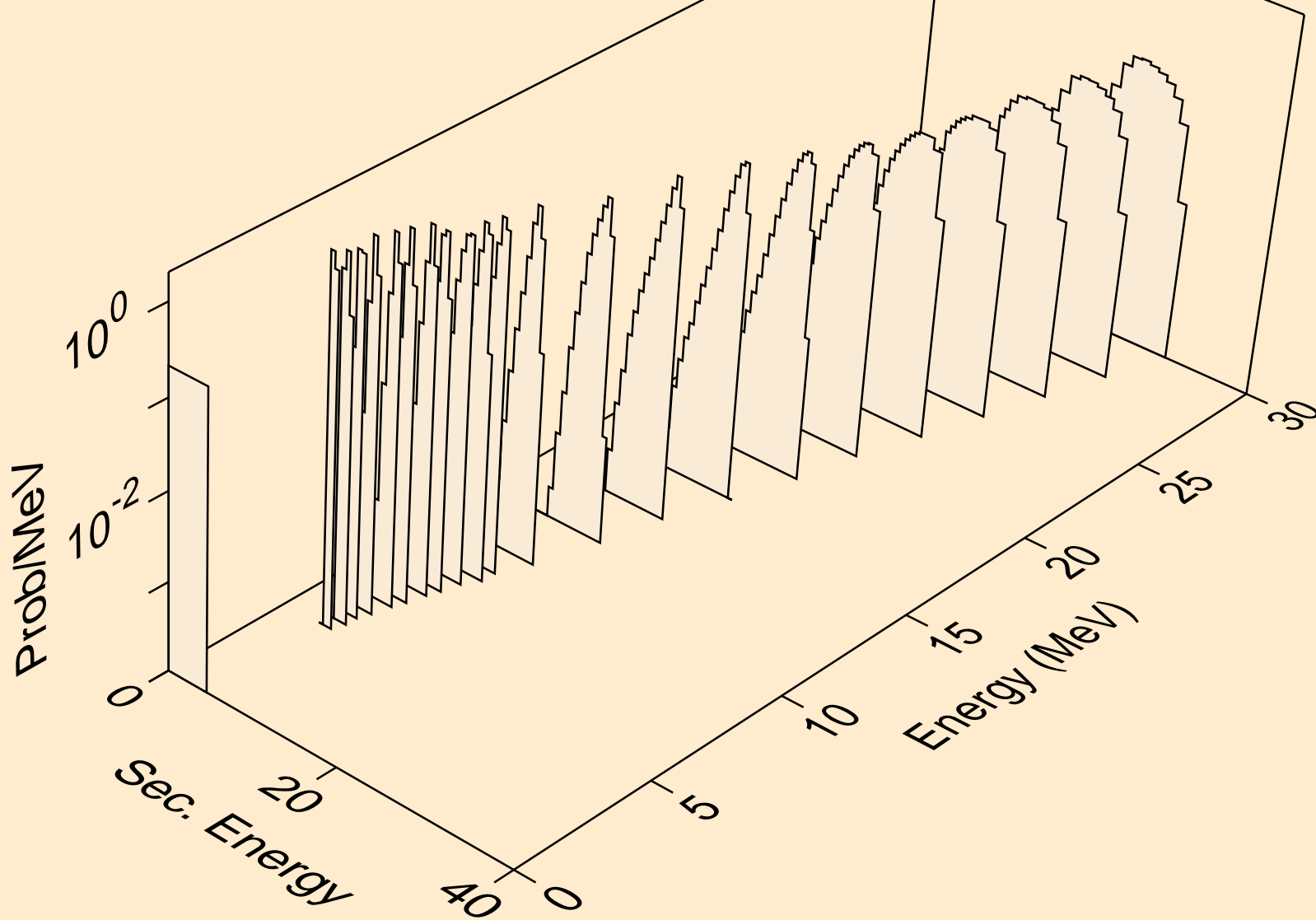

HO162 NEUTRON ACER TENDL-2019 LIBRARY; T=293.16K
alphas from (n,2n)a

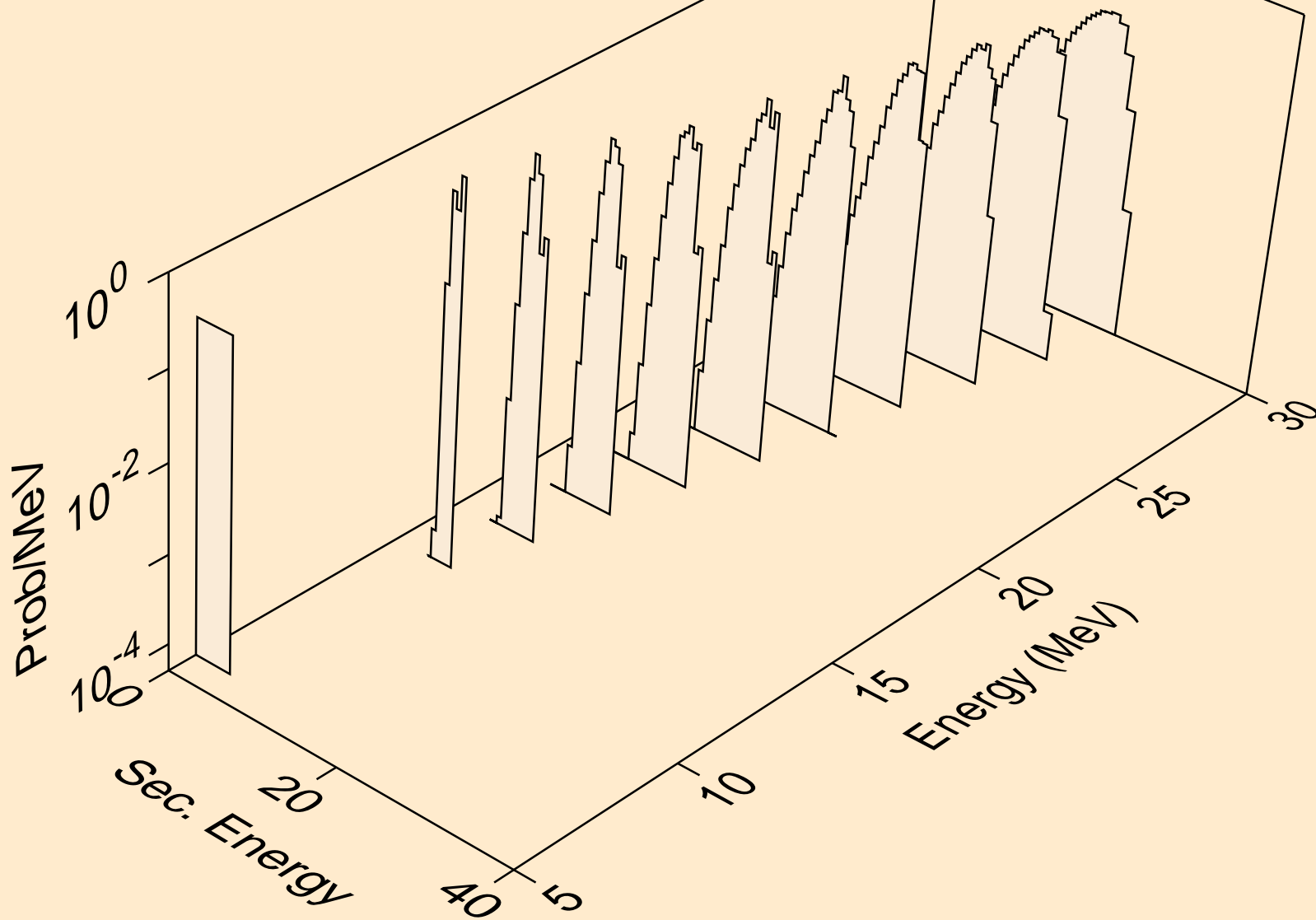

HO162 NEUTRON ACER TENDL-2019 LIBRARY; T=293.16K
alphas from (n,3n)a

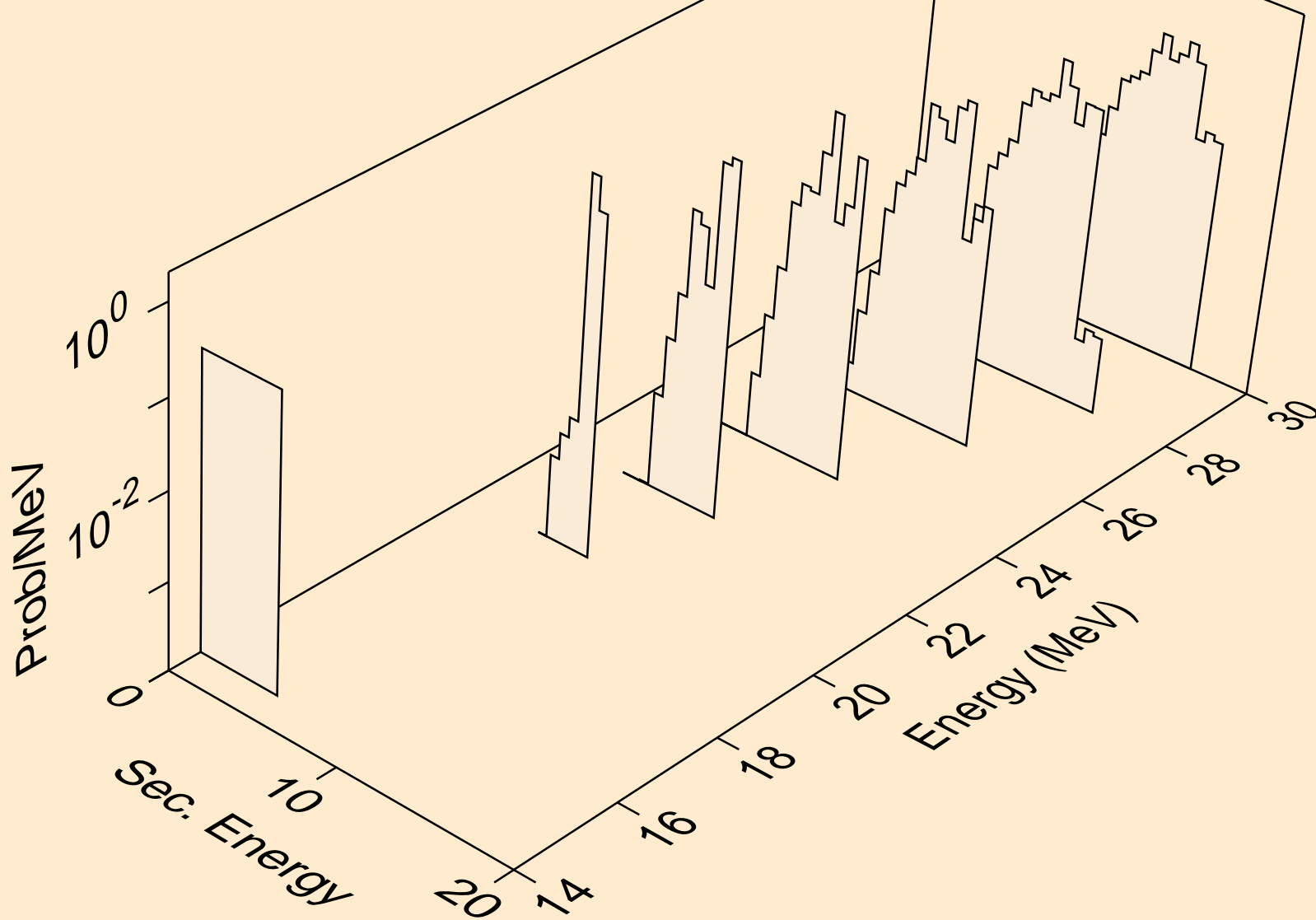

HO162 NEUTRON ACER TENDL-2019 LIBRARY; T=293.16K
alphas from (n,n*)2a

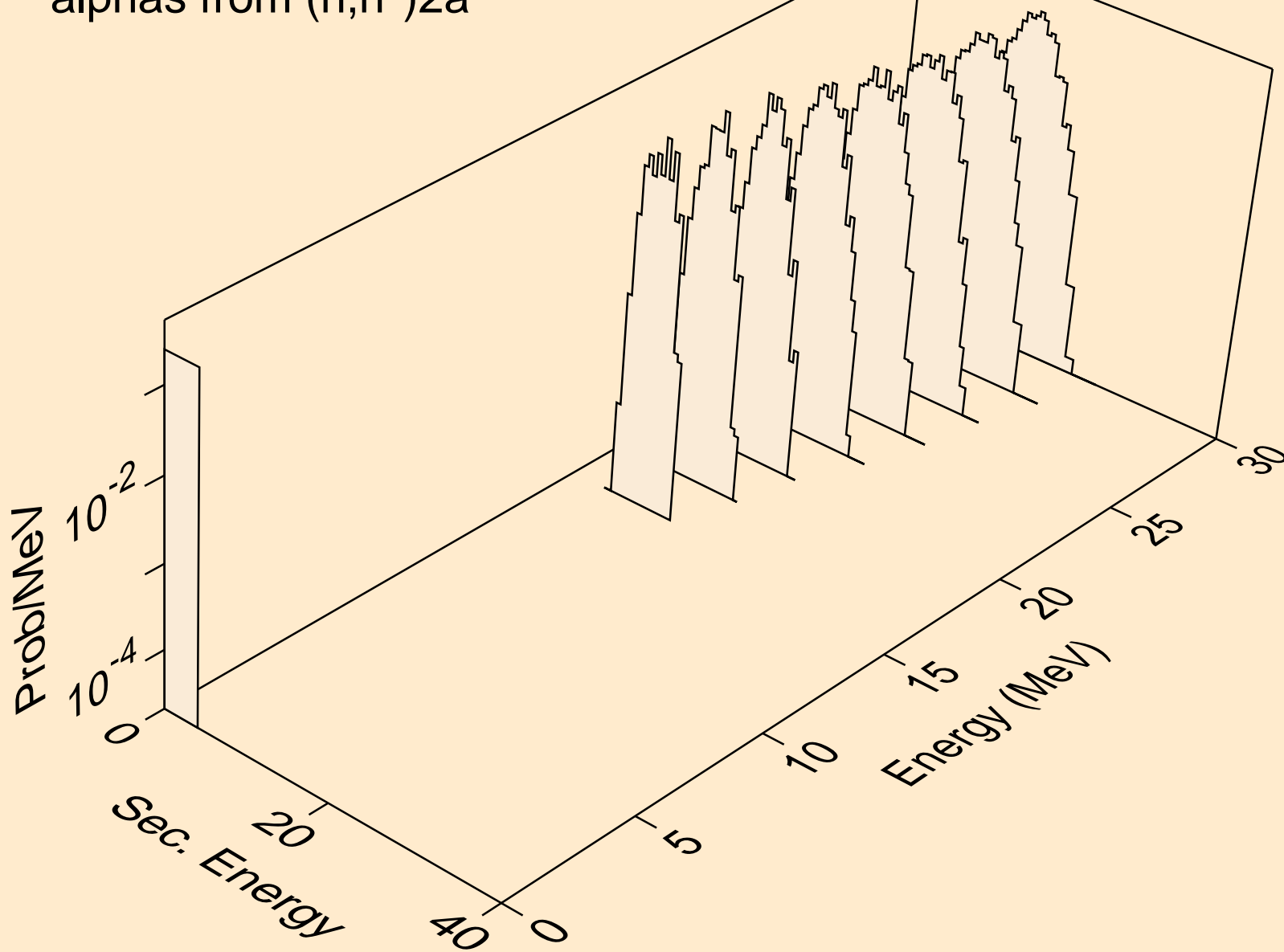

HO162 NEUTRON ACER TENDL-2019 LIBRARY; T=293.16K
alphas from (n,npa)

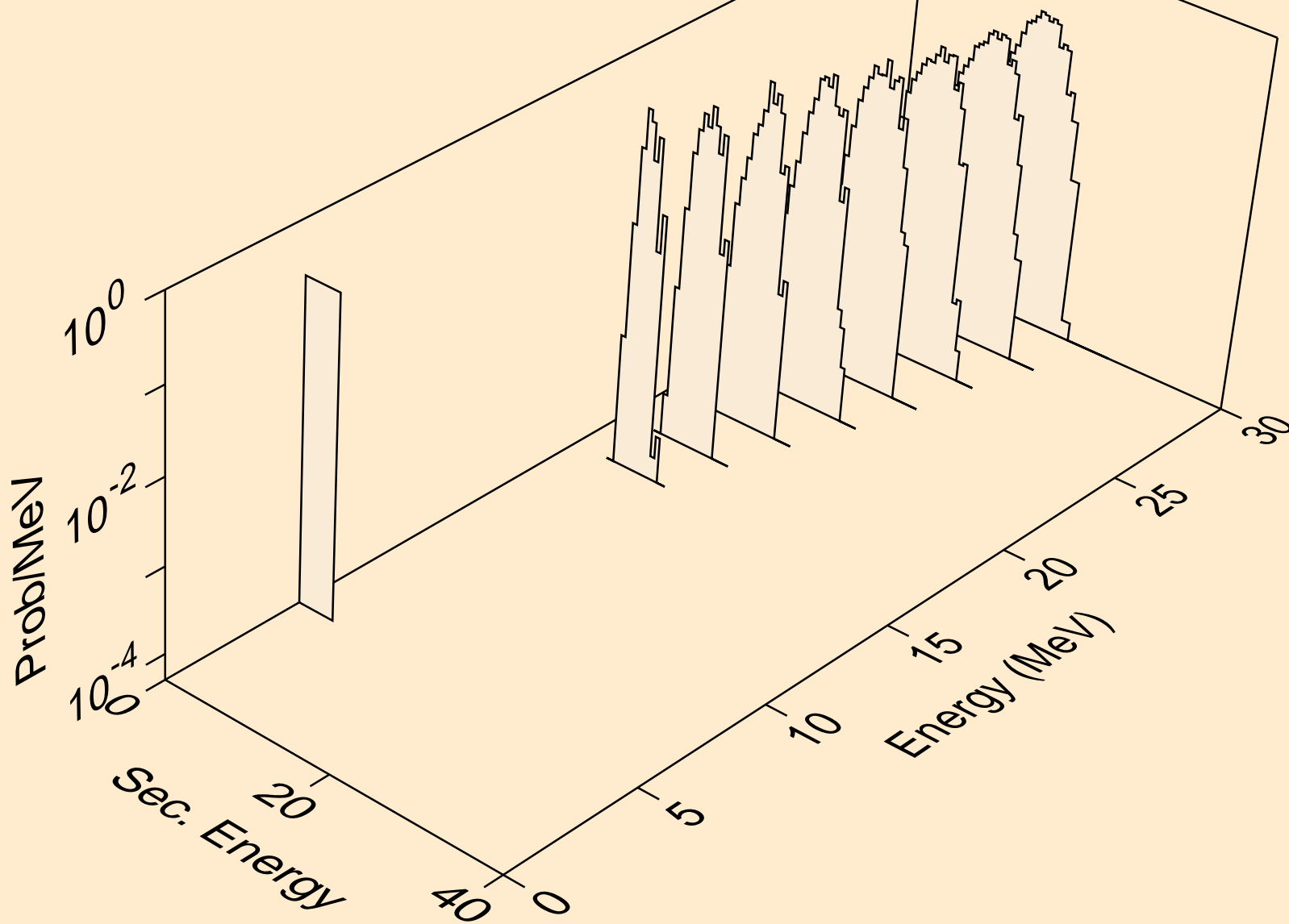

HO162 NEUTRON ACER TENDL-2019 LIBRARY; T=293.16K
alphas from (n,a)

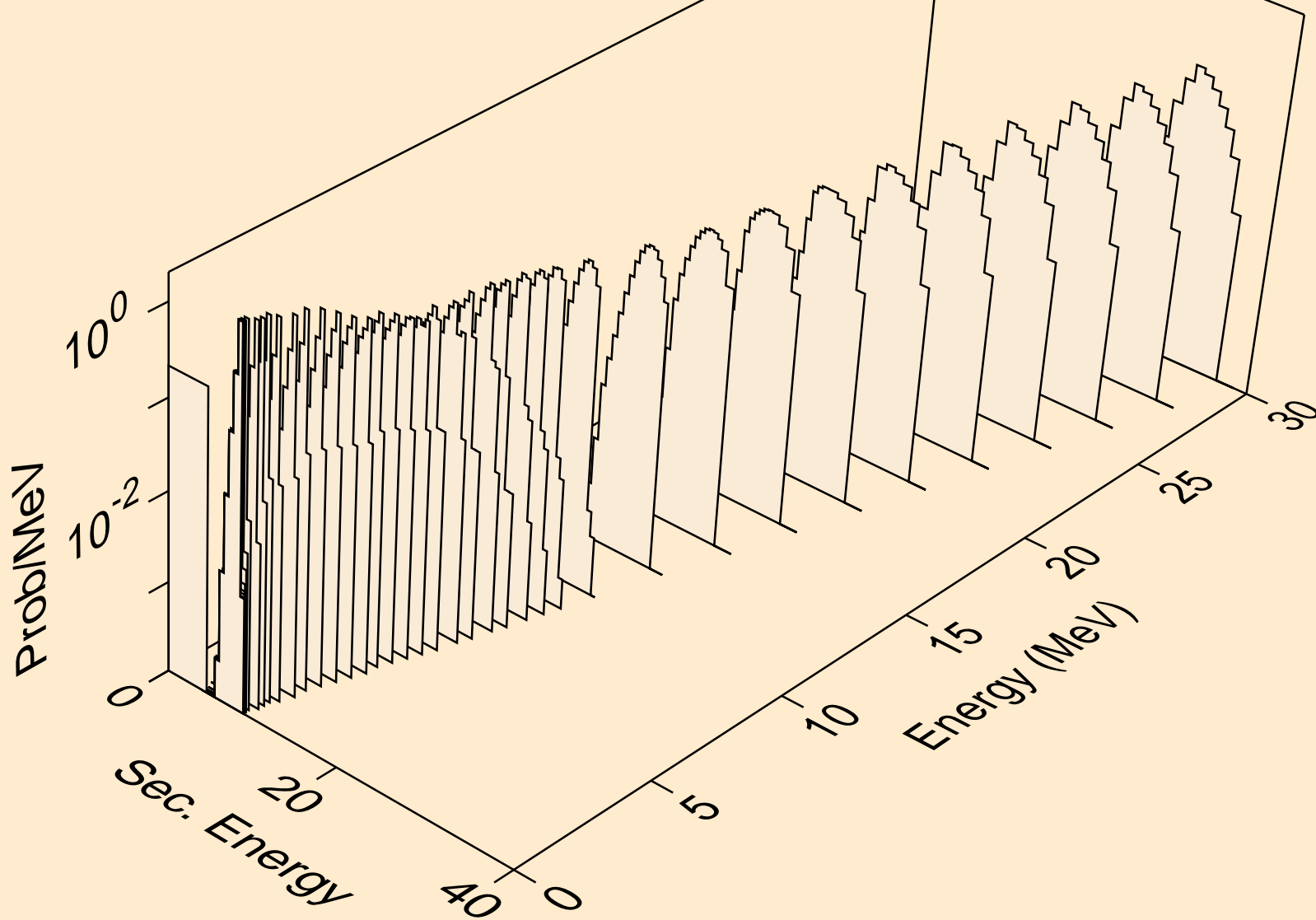

HO162 NEUTRON ACER TENDL-2019 LIBRARY; T=293.16K
alphas from (n,2a)

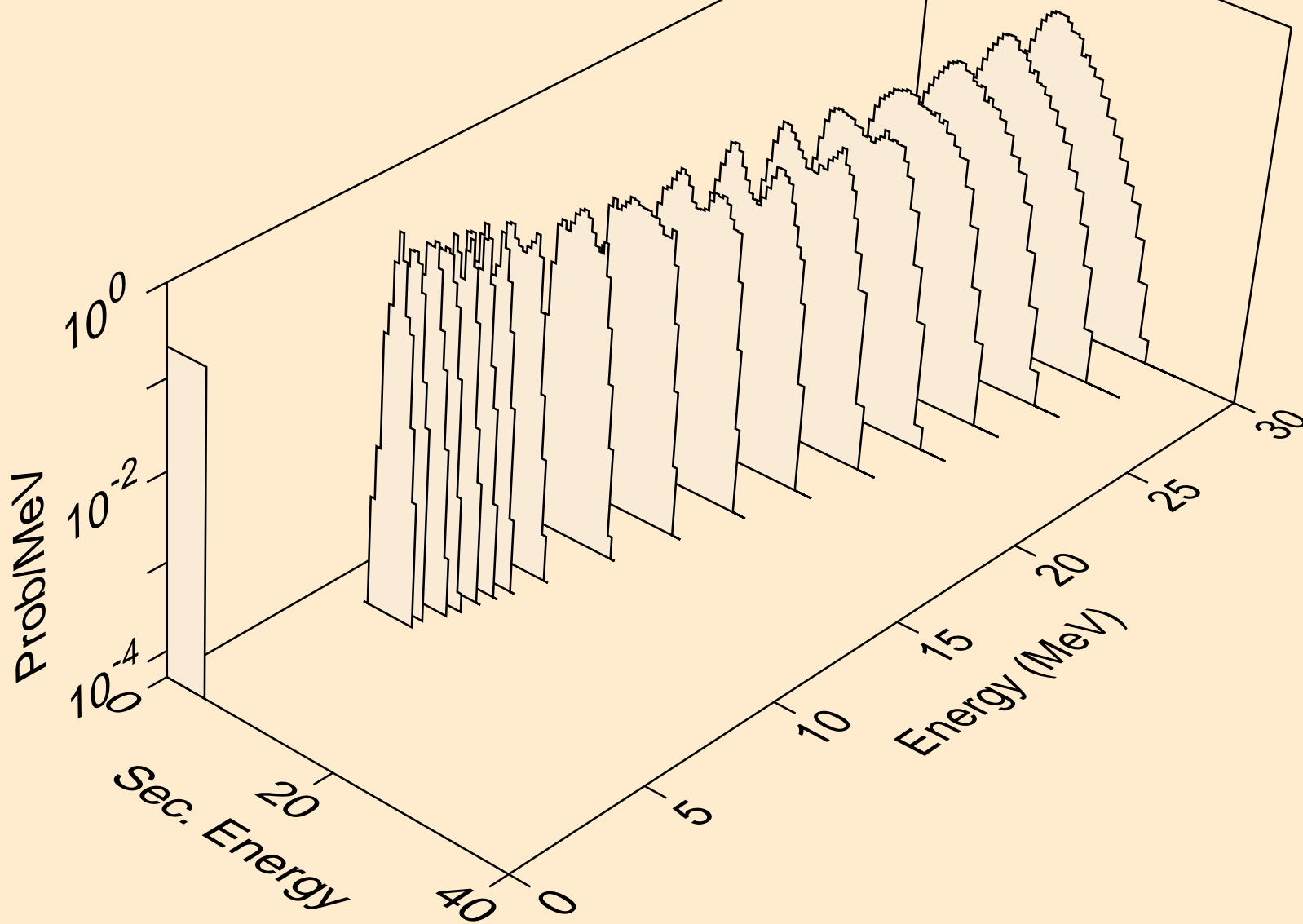

HO162 NEUTRON ACER TENDL-2019 LIBRARY; T=293.16K
alphas from (n,pa)

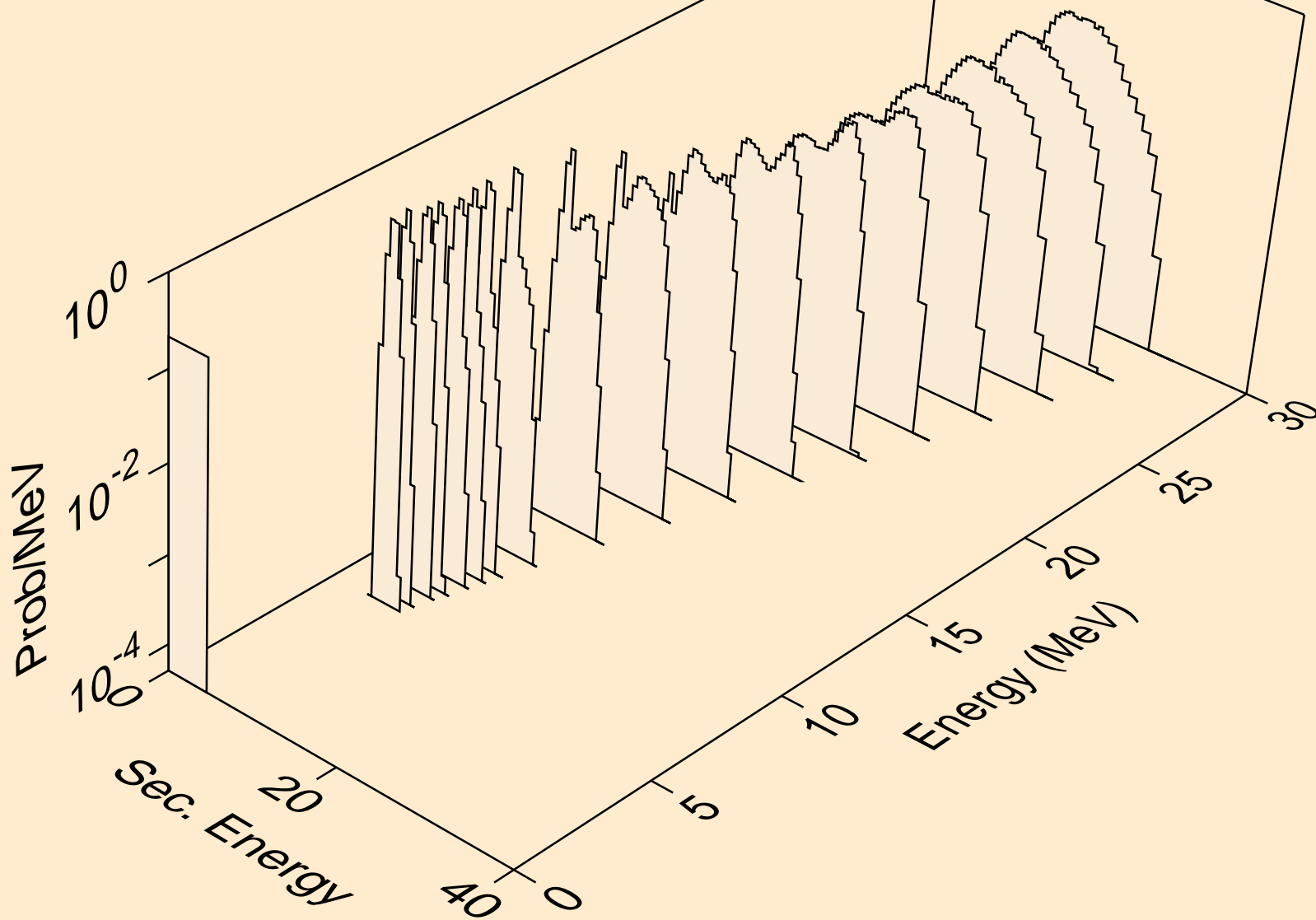

HO162 NEUTRON ACER TENDL-2019 LIBRARY; T=293.16K
alphas from (n,da)

