

HO165 NEUTRON ACER TENDL-2019 LIBRARY; T=293.16K
Principal cross sections

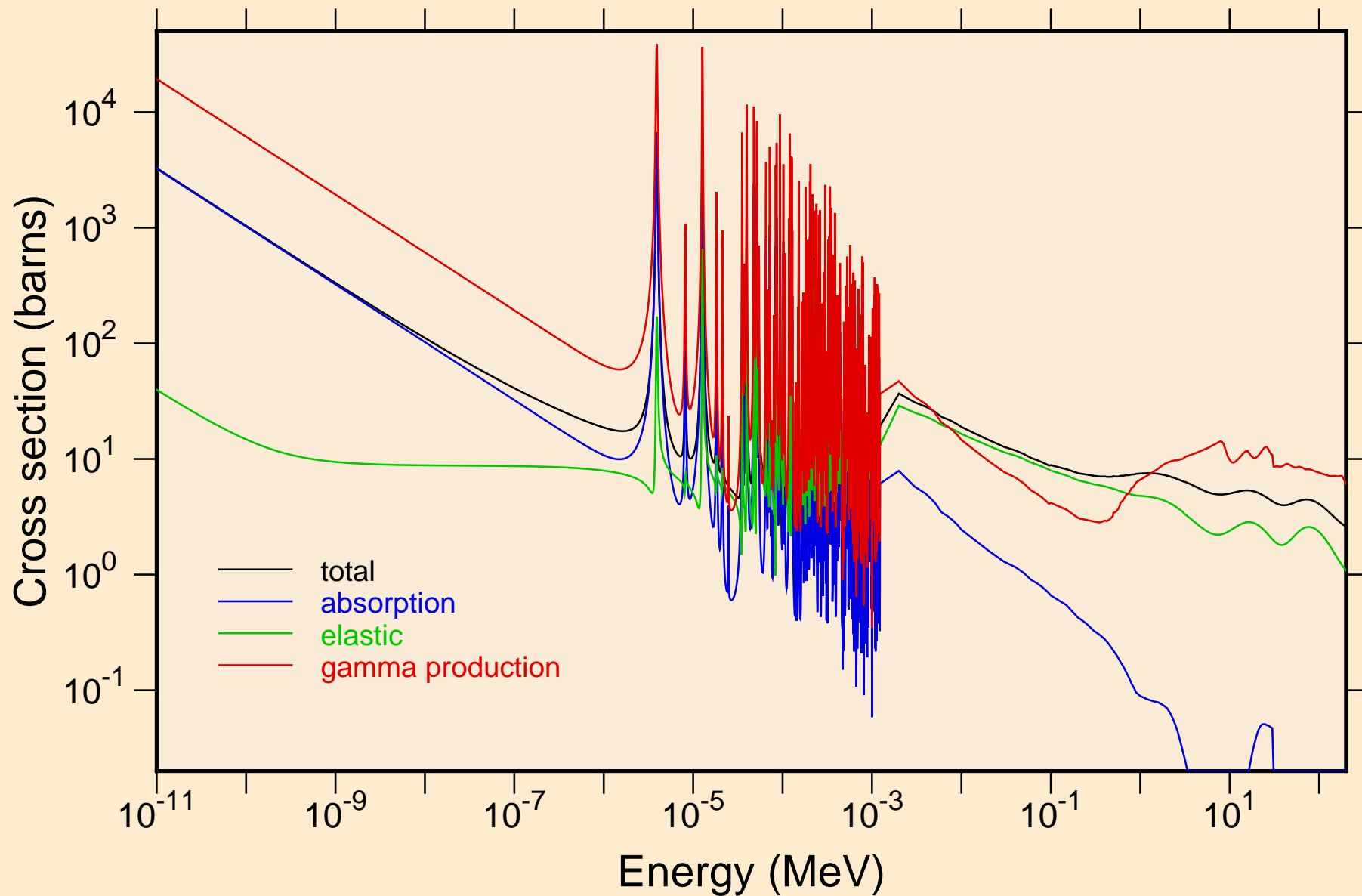

HO165 NEUTRON ACER TENDL-2019 LIBRARY; T=293.16K
resonance total cross section

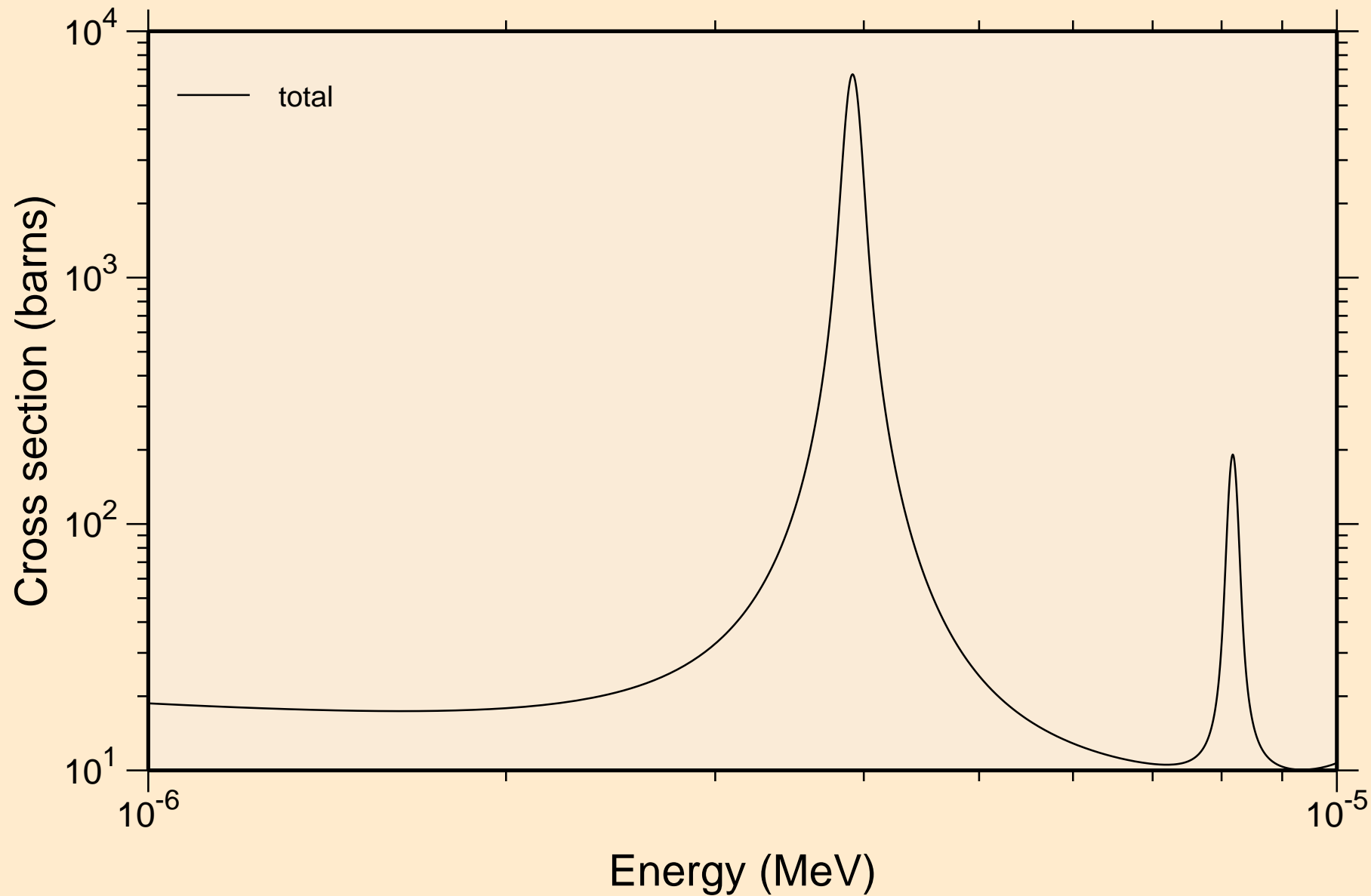

HO165 NEUTRON ACER TENDL-2019 LIBRARY; T=293.16K
resonance total cross section

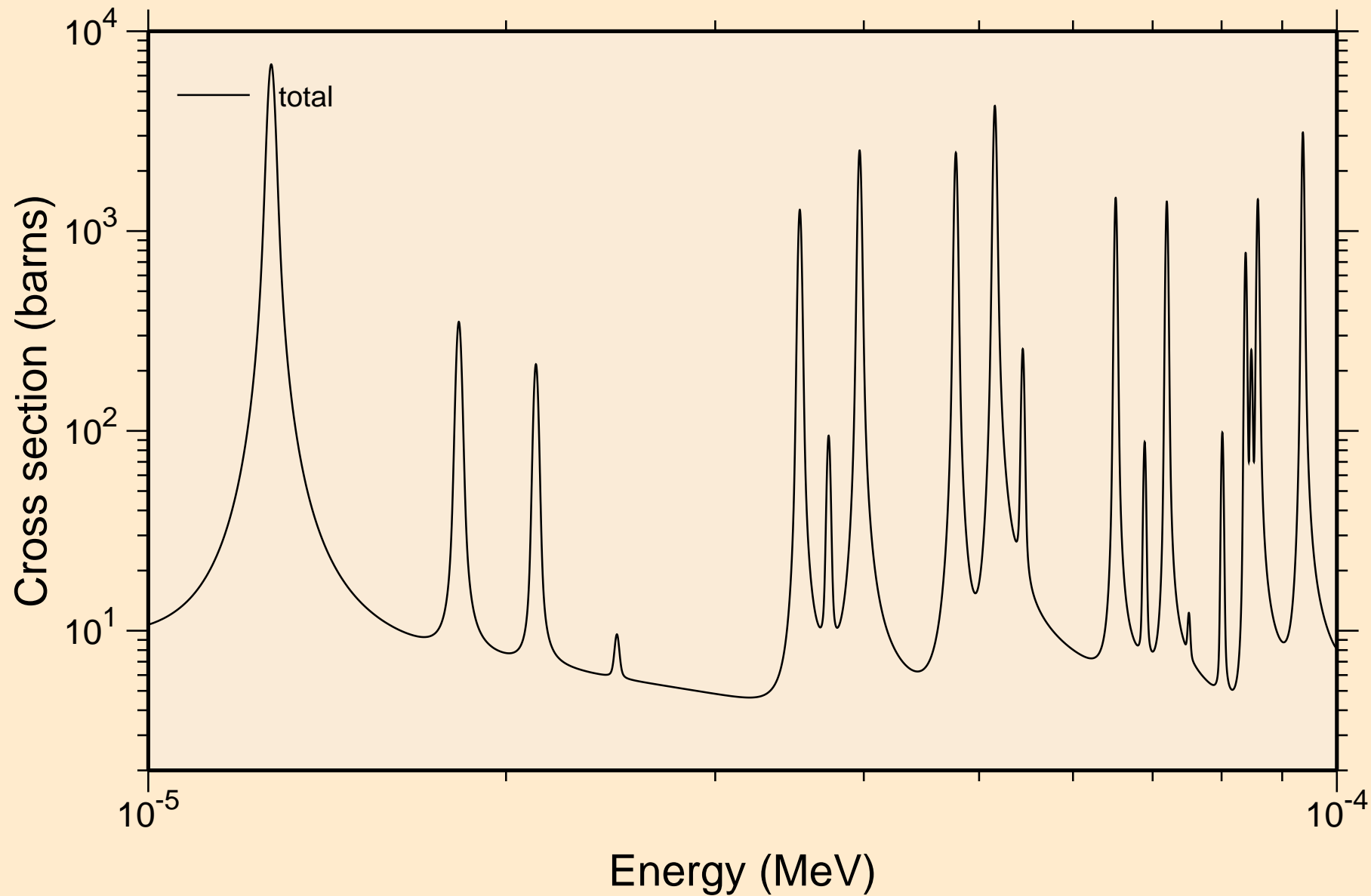

HO165 NEUTRON ACER TENDL-2019 LIBRARY; T=293.16K
resonance total cross section

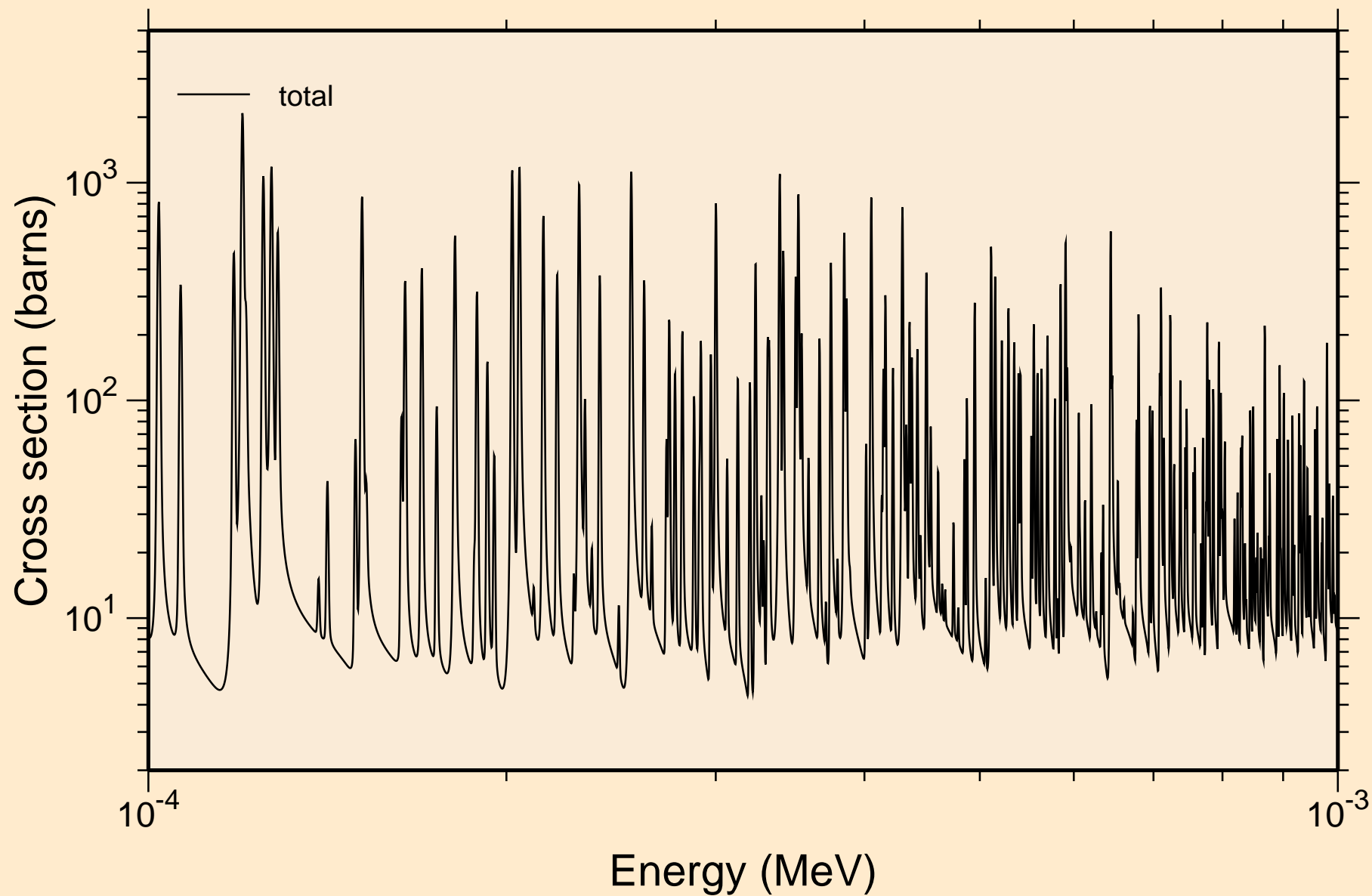

HO165 NEUTRON ACER TENDL-2019 LIBRARY; T=293.16K
resonance total cross section

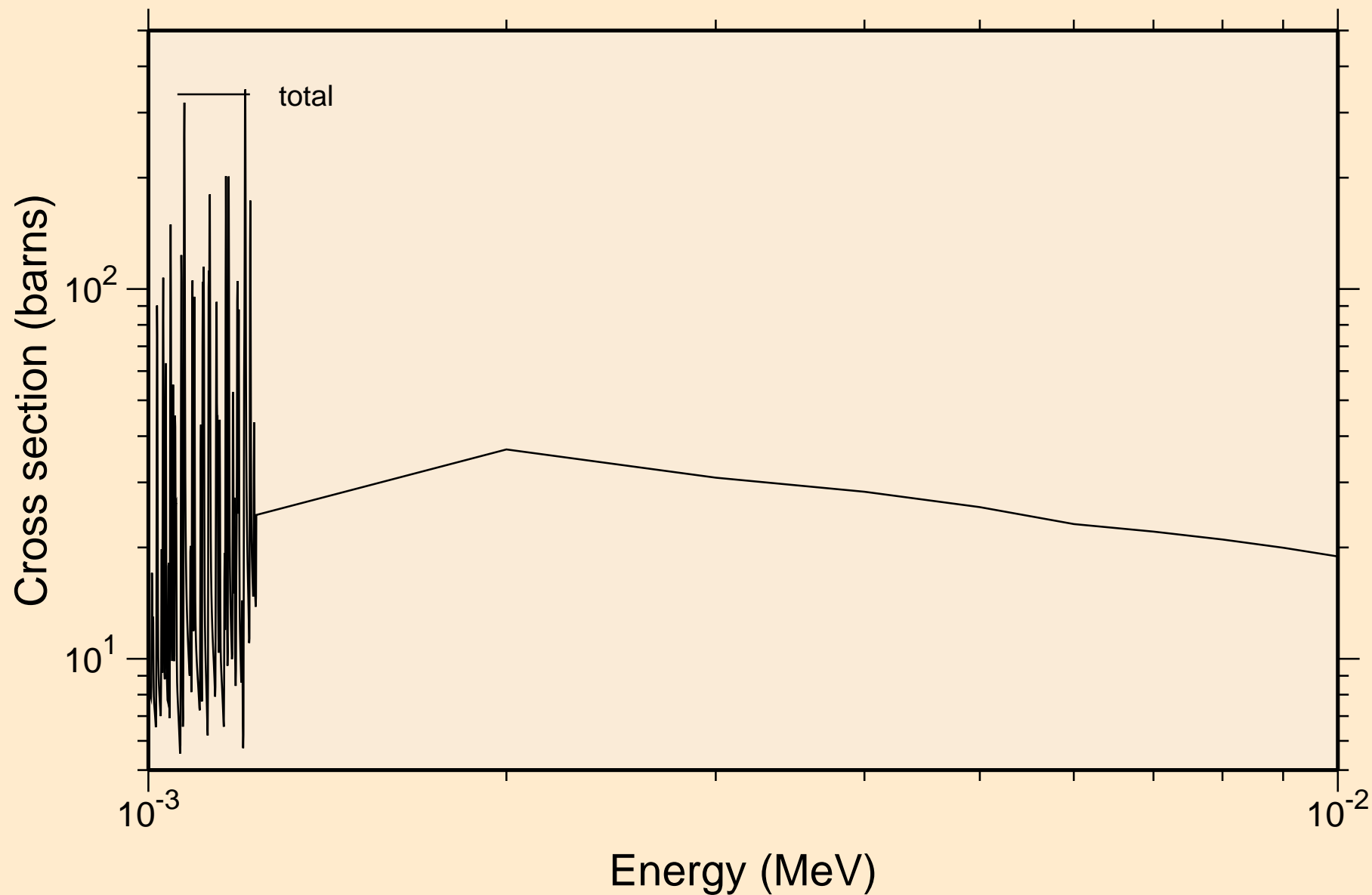

HO165 NEUTRON ACER TENDL-2019 LIBRARY; T=293.16K
resonance total cross section

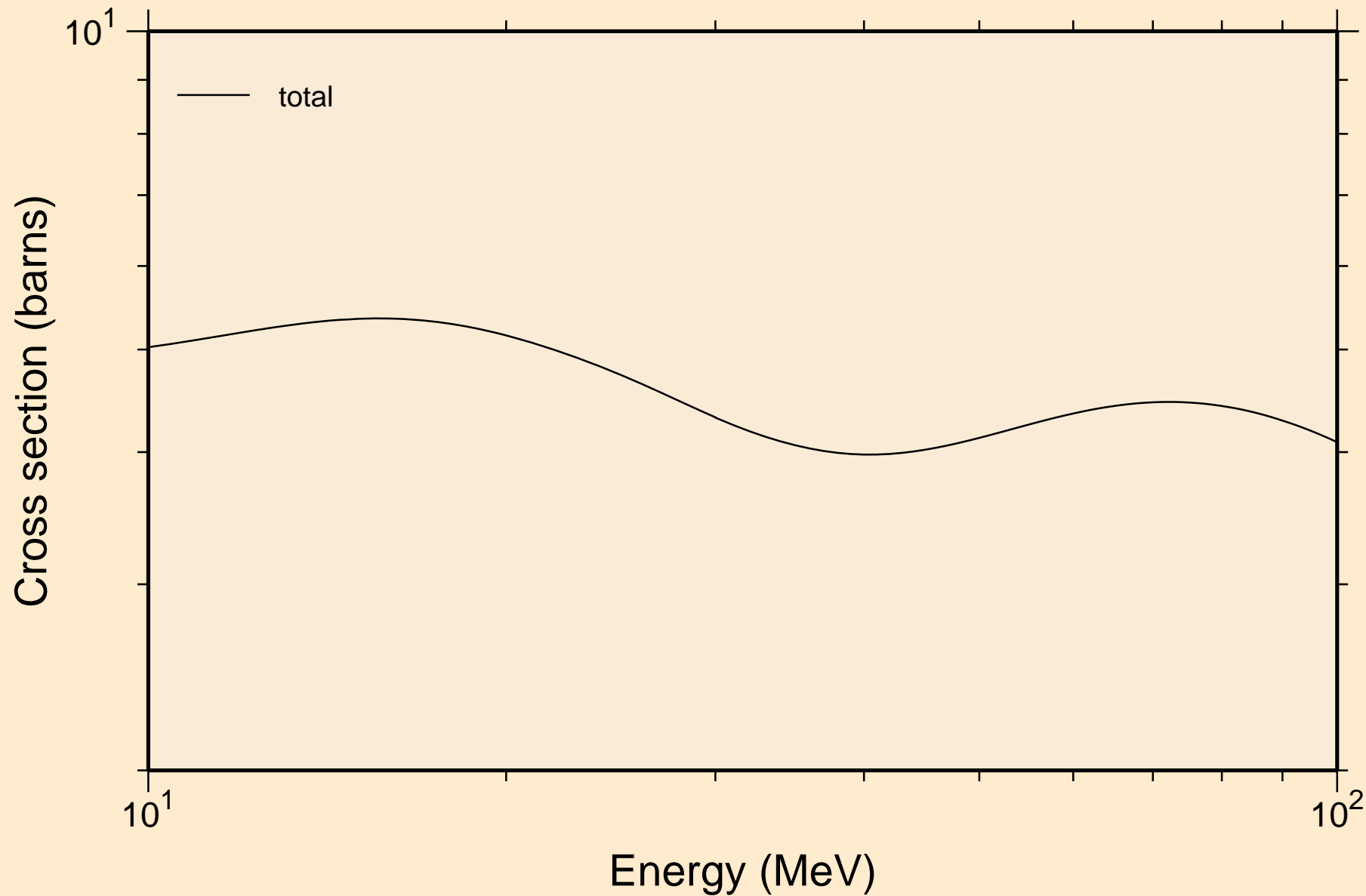

HO165 NEUTRON ACER TENDL-2019 LIBRARY; T=293.16K
resonance absorption cross sections

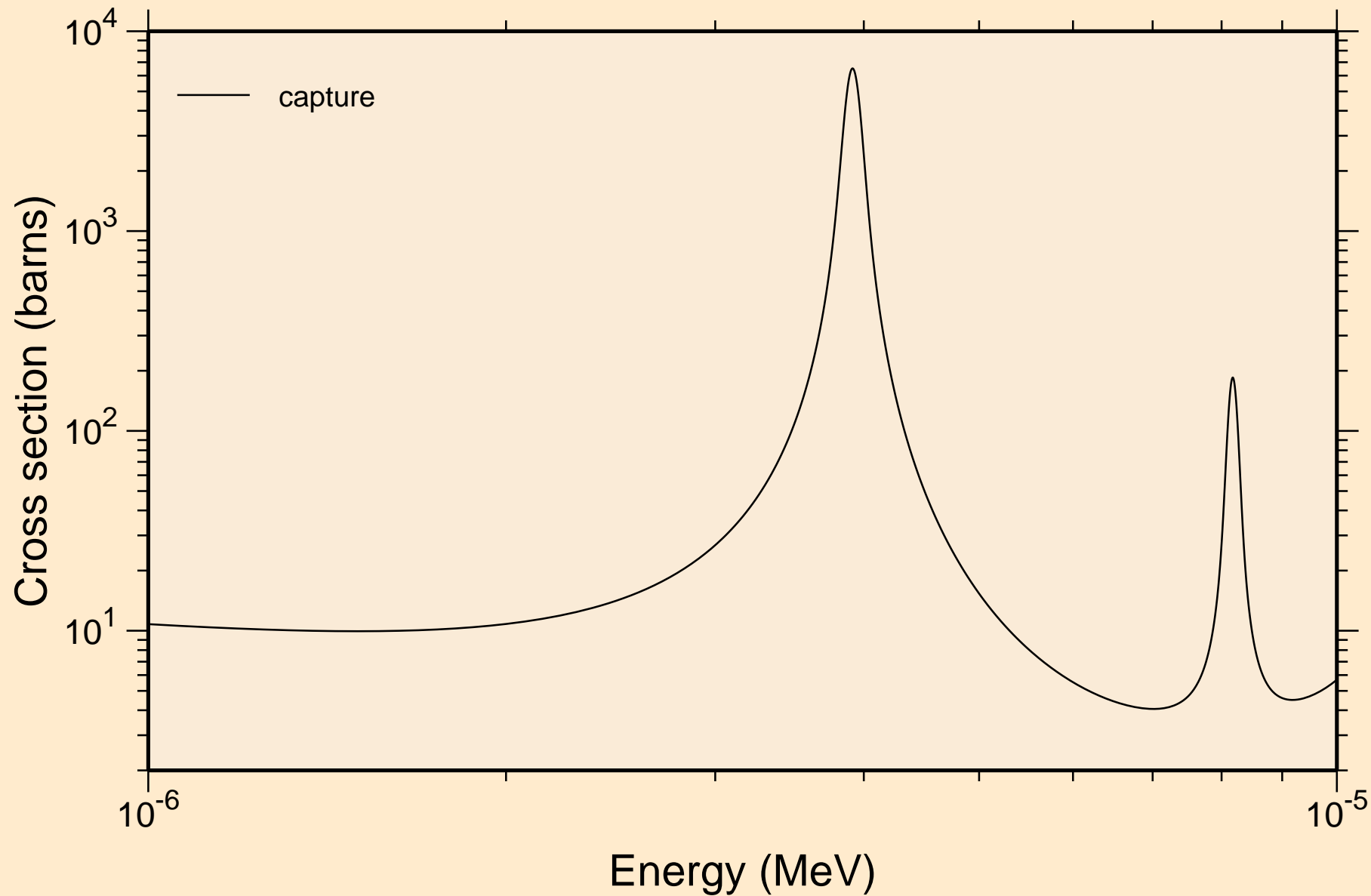

HO165 NEUTRON ACER TENDL-2019 LIBRARY; T=293.16K
resonance absorption cross sections

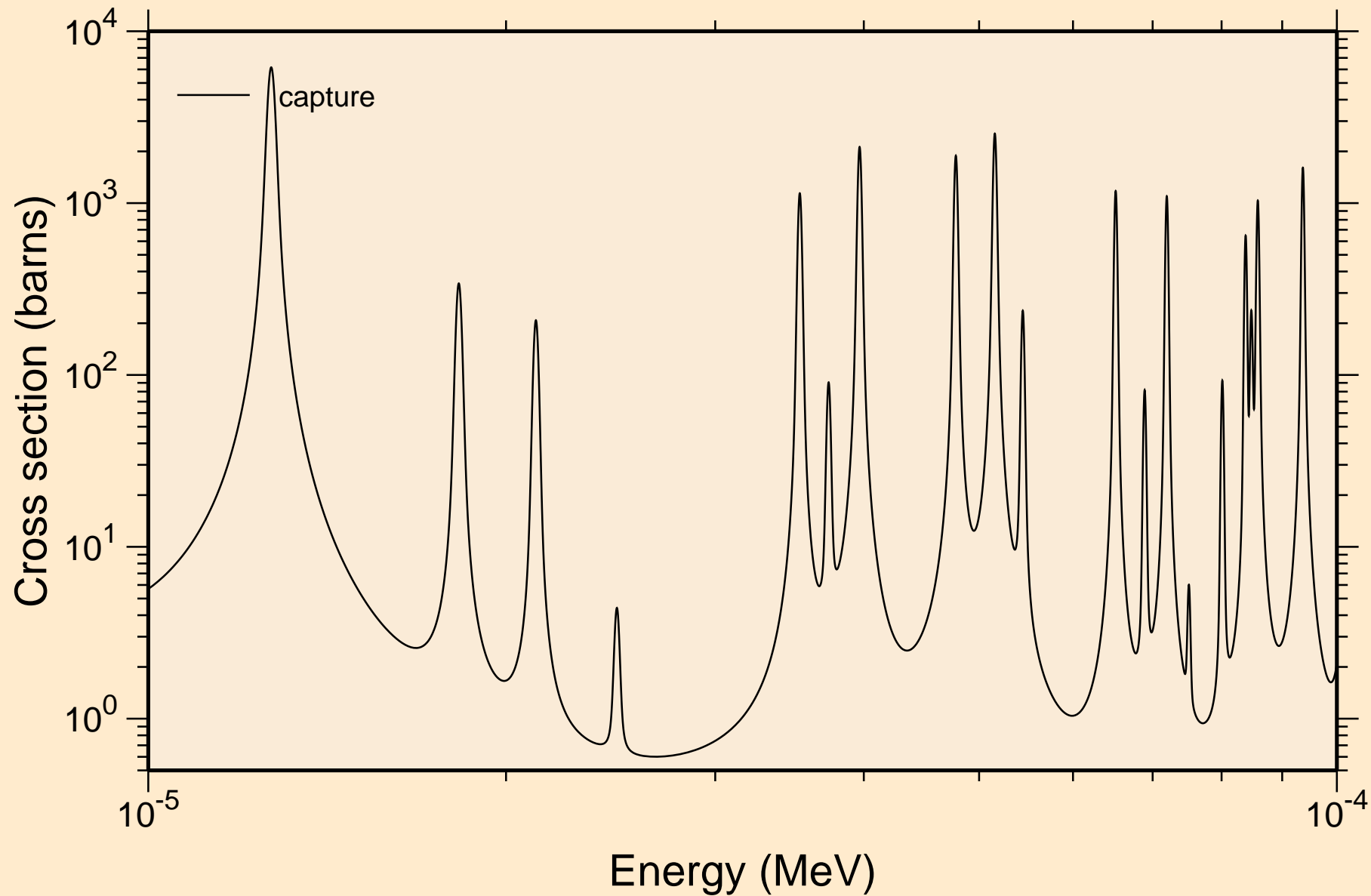

HO165 NEUTRON ACER TENDL-2019 LIBRARY; T=293.16K
resonance absorption cross sections

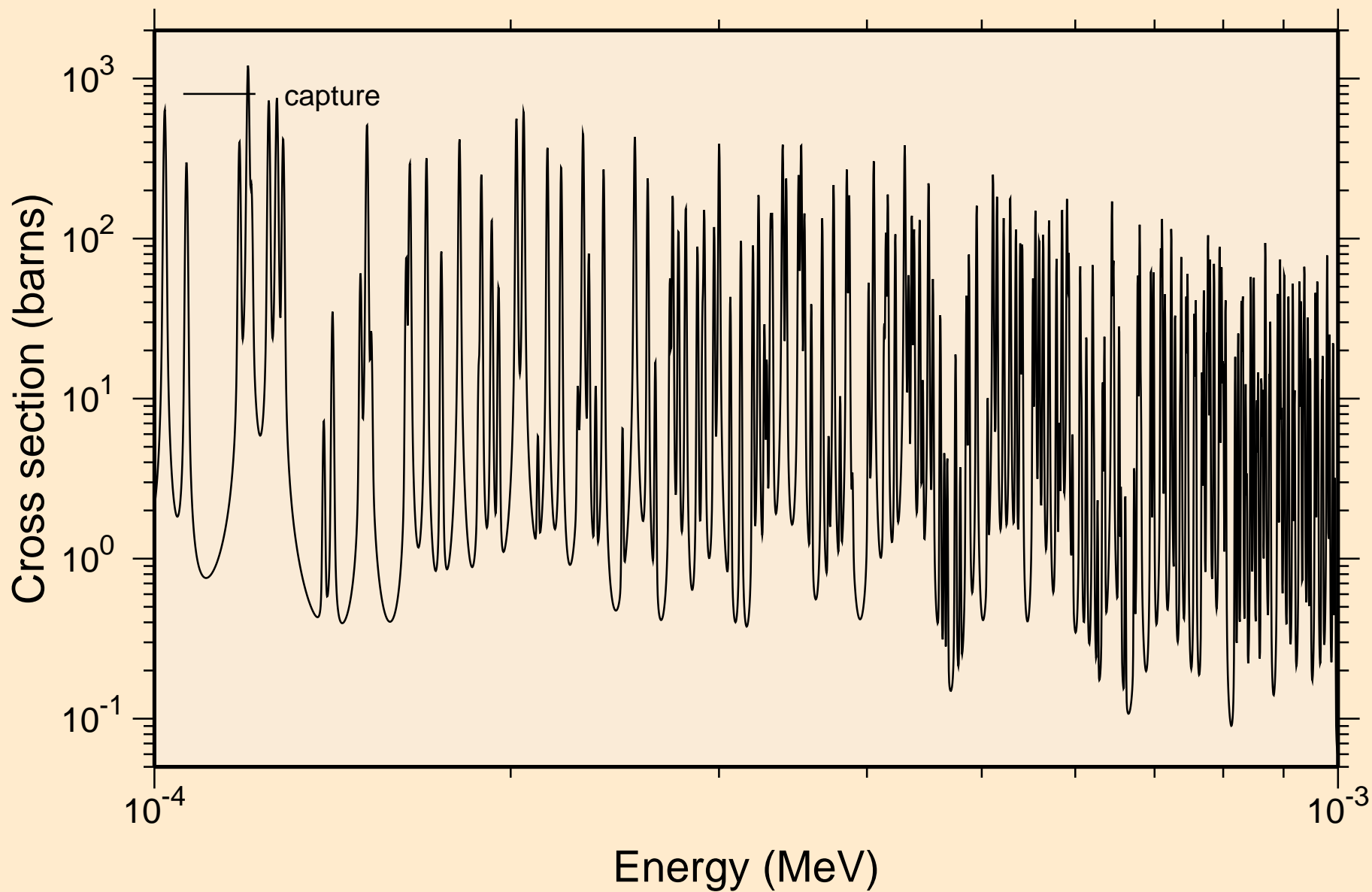

HO165 NEUTRON ACER TENDL-2019 LIBRARY; T=293.16K
resonance absorption cross sections

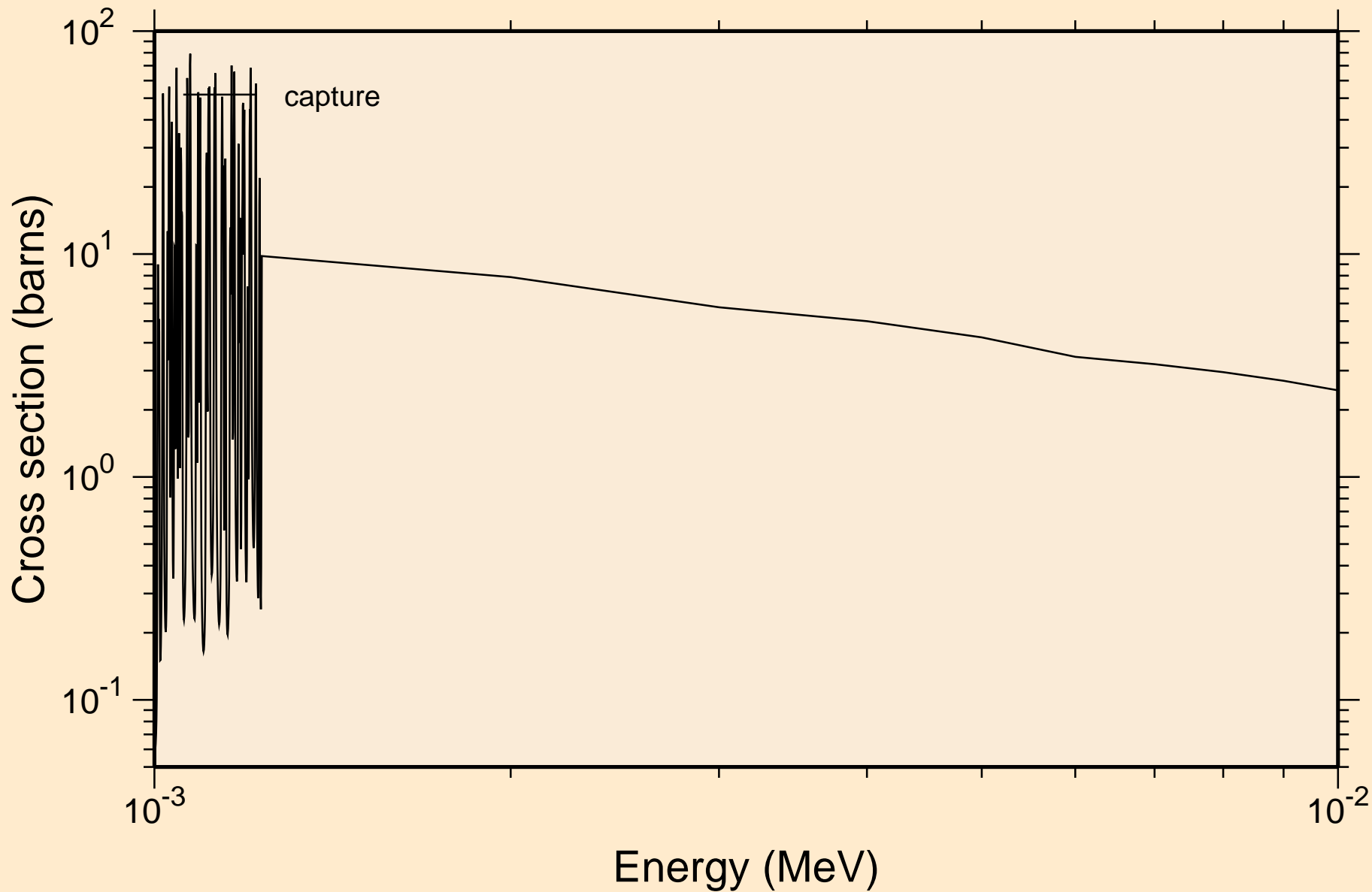

HO165 NEUTRON ACER TENDL-2019 LIBRARY; T=293.16K
resonance absorption cross sections

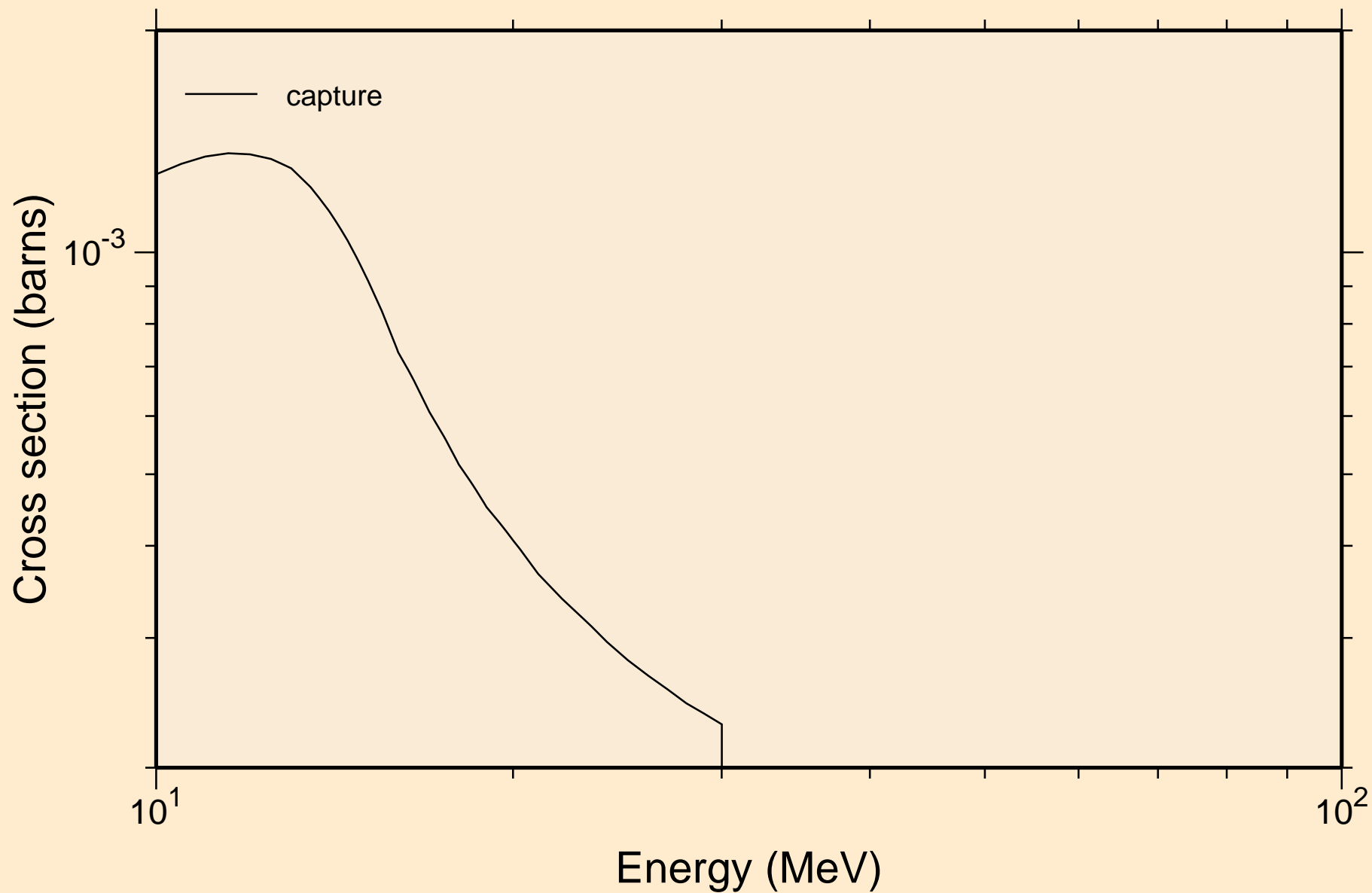

HO165 NEUTRON ACER TENDL-2019 LIBRARY; T=293.16K
Heating

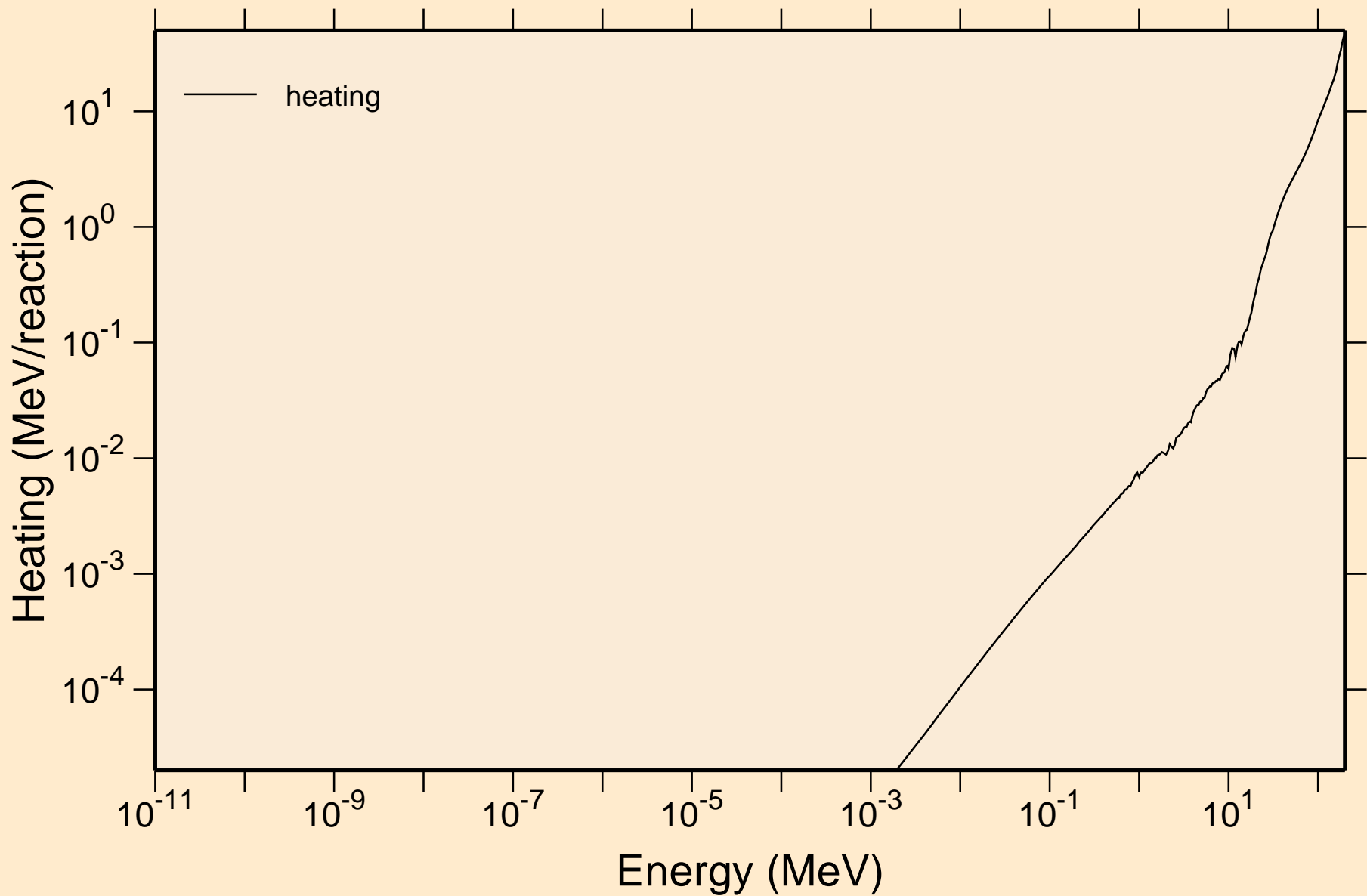

HO165 NEUTRON ACER TENDL-2019 LIBRARY; T=293.16K
Damage

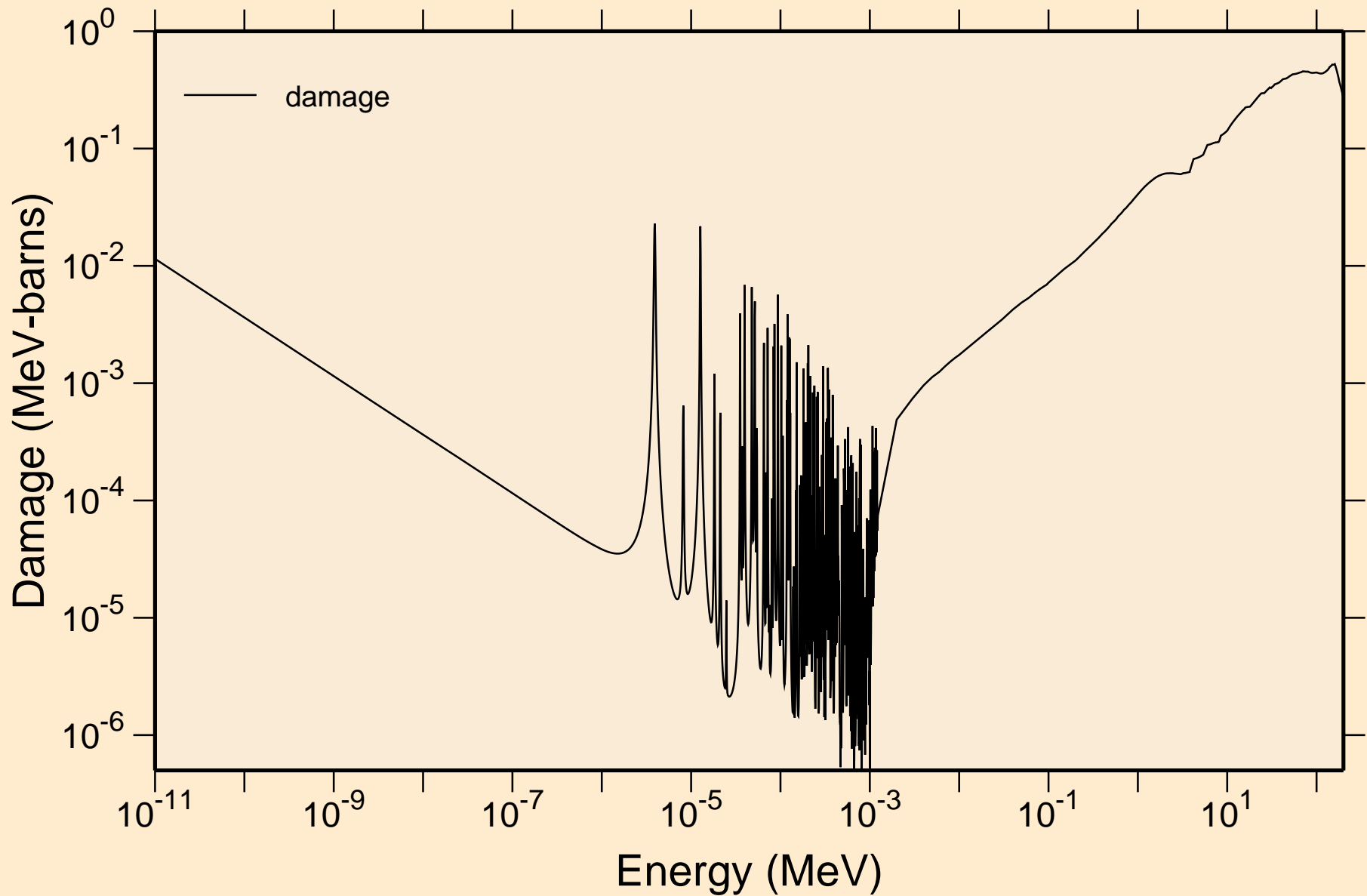

HO165 NEUTRON ACER TENDL-2019 LIBRARY; T=293.16K
Non-threshold reactions

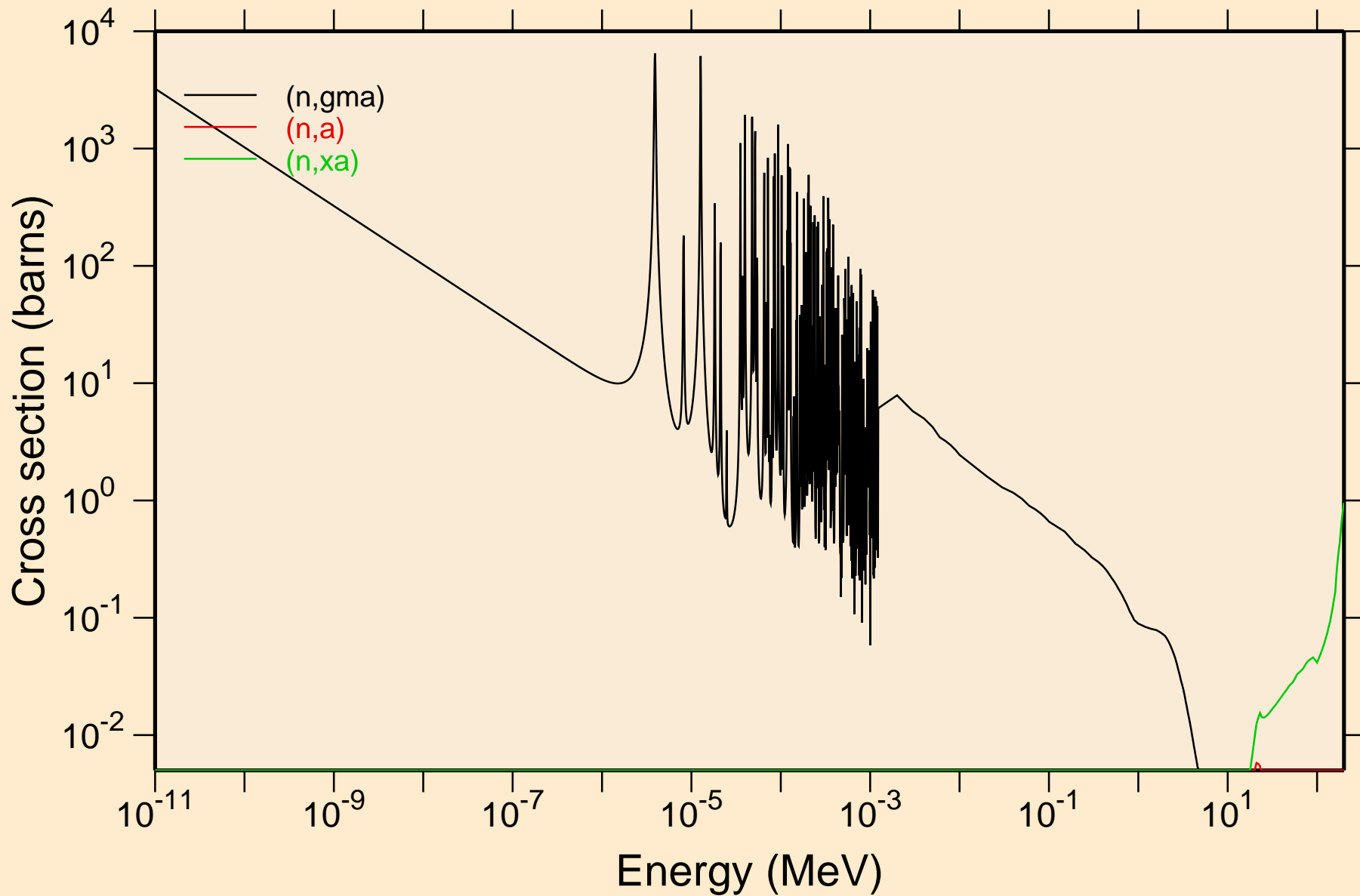

HO165 NEUTRON ACER TENDL-2019 LIBRARY; T=293.16K

Principal cross sections

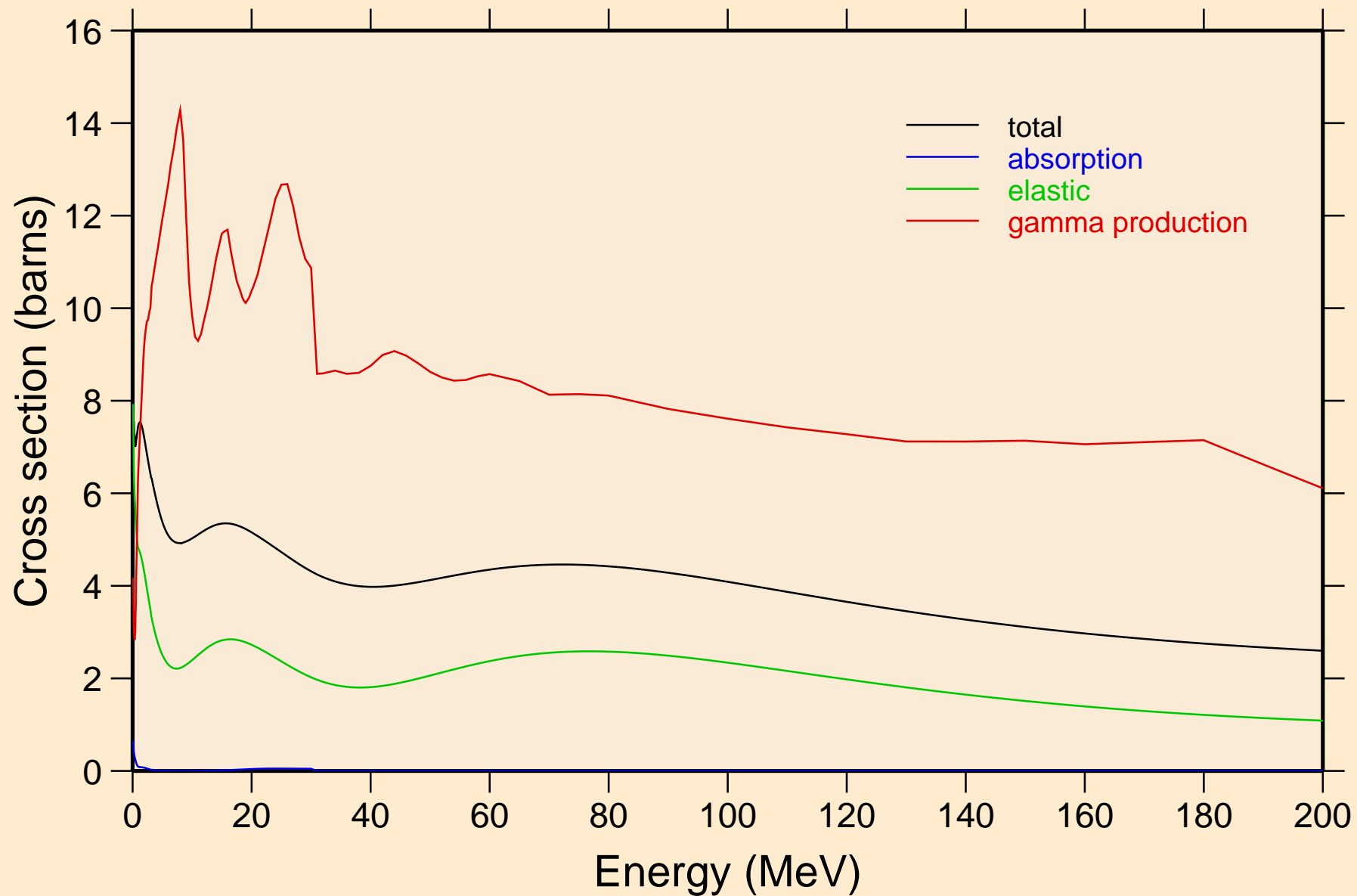

HO165 NEUTRON ACER TENDL-2019 LIBRARY; T=293.16K
Heating

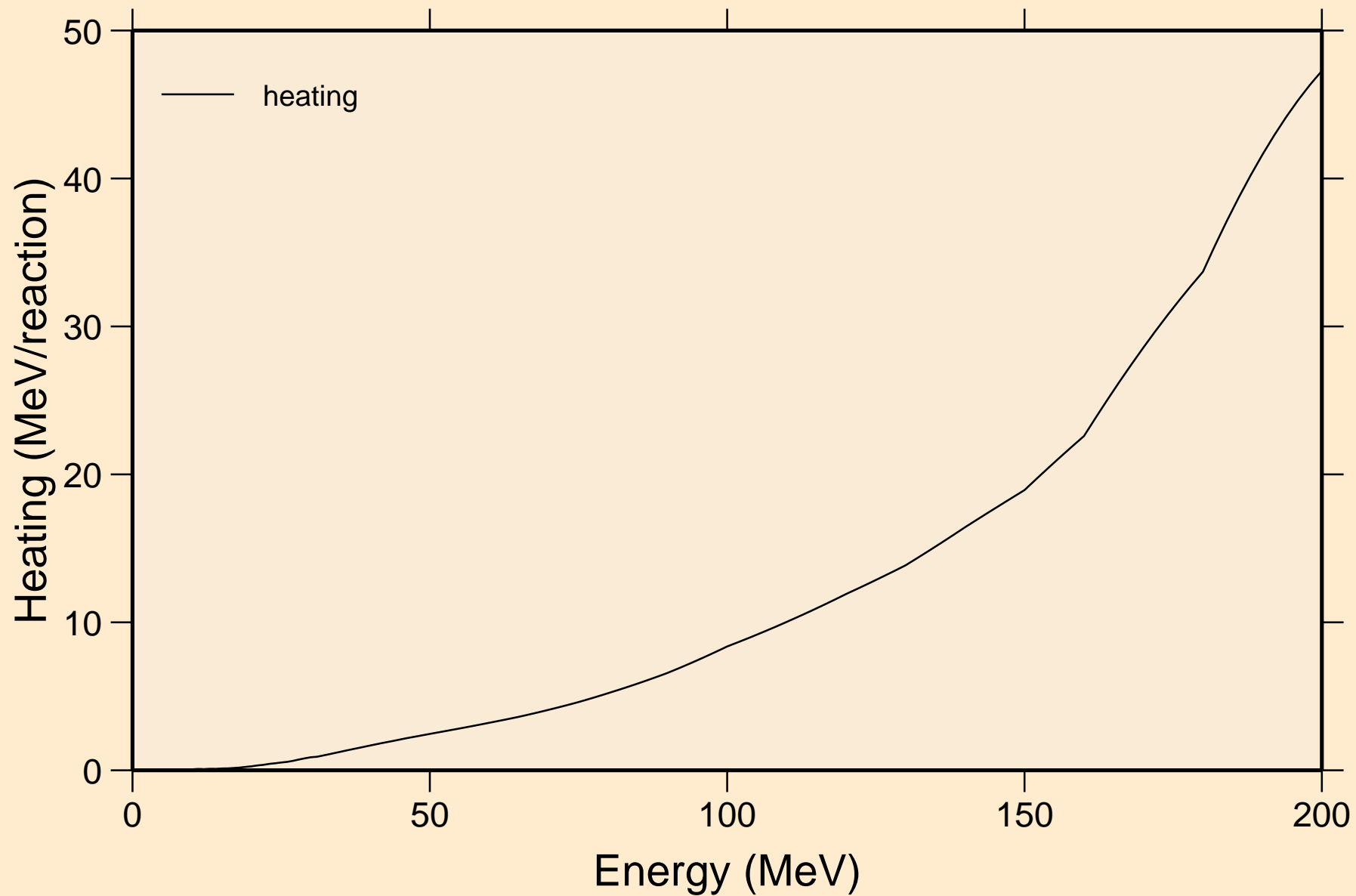

HO165 NEUTRON ACER TENDL-2019 LIBRARY; T=293.16K Damage

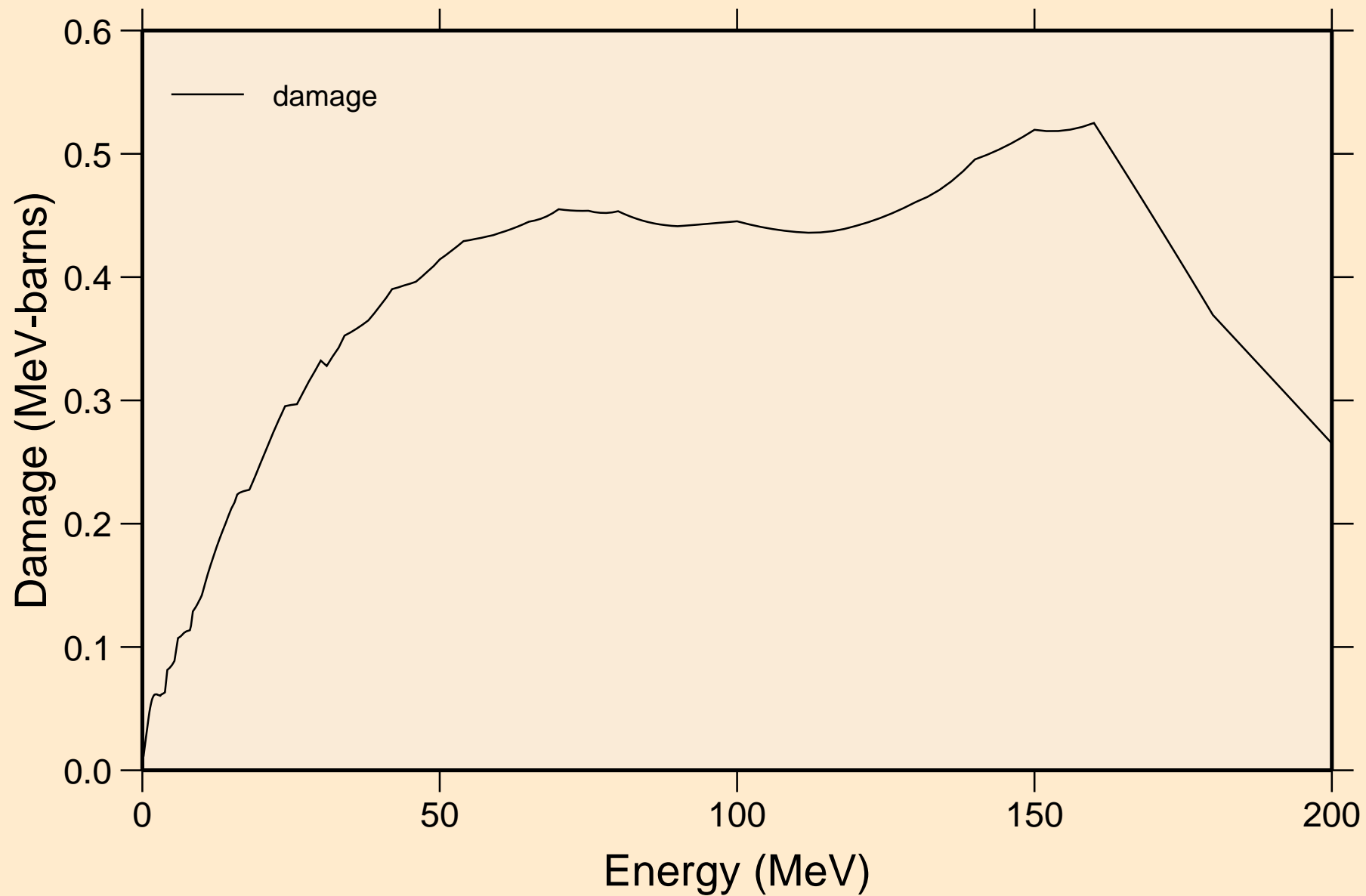

HO165 NEUTRON ACER TENDL-2019 LIBRARY; T=293.16K
Non-threshold reactions

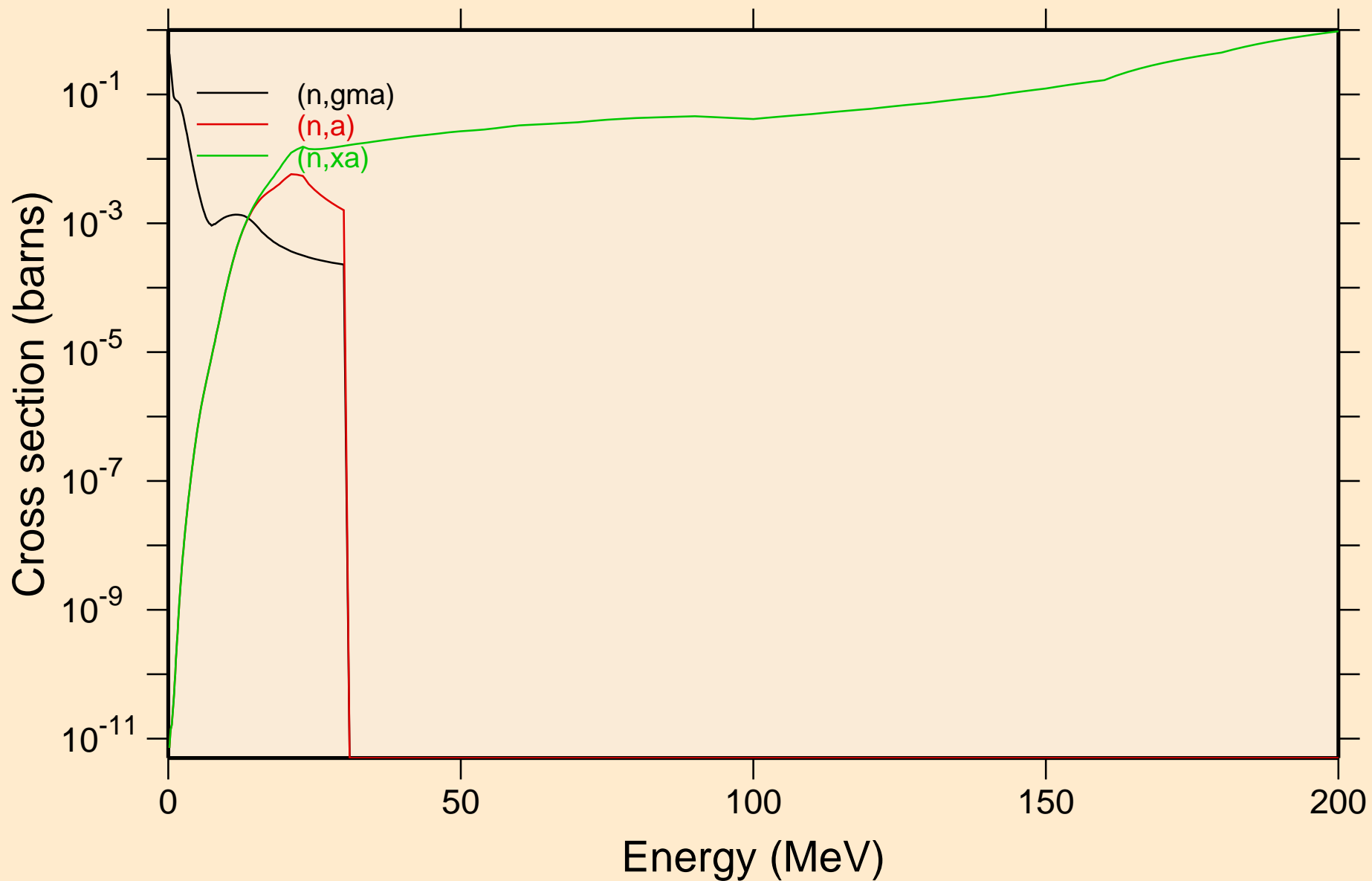

HO165 NEUTRON ACER TENDL-2019 LIBRARY; T=293.16K
Inelastic levels

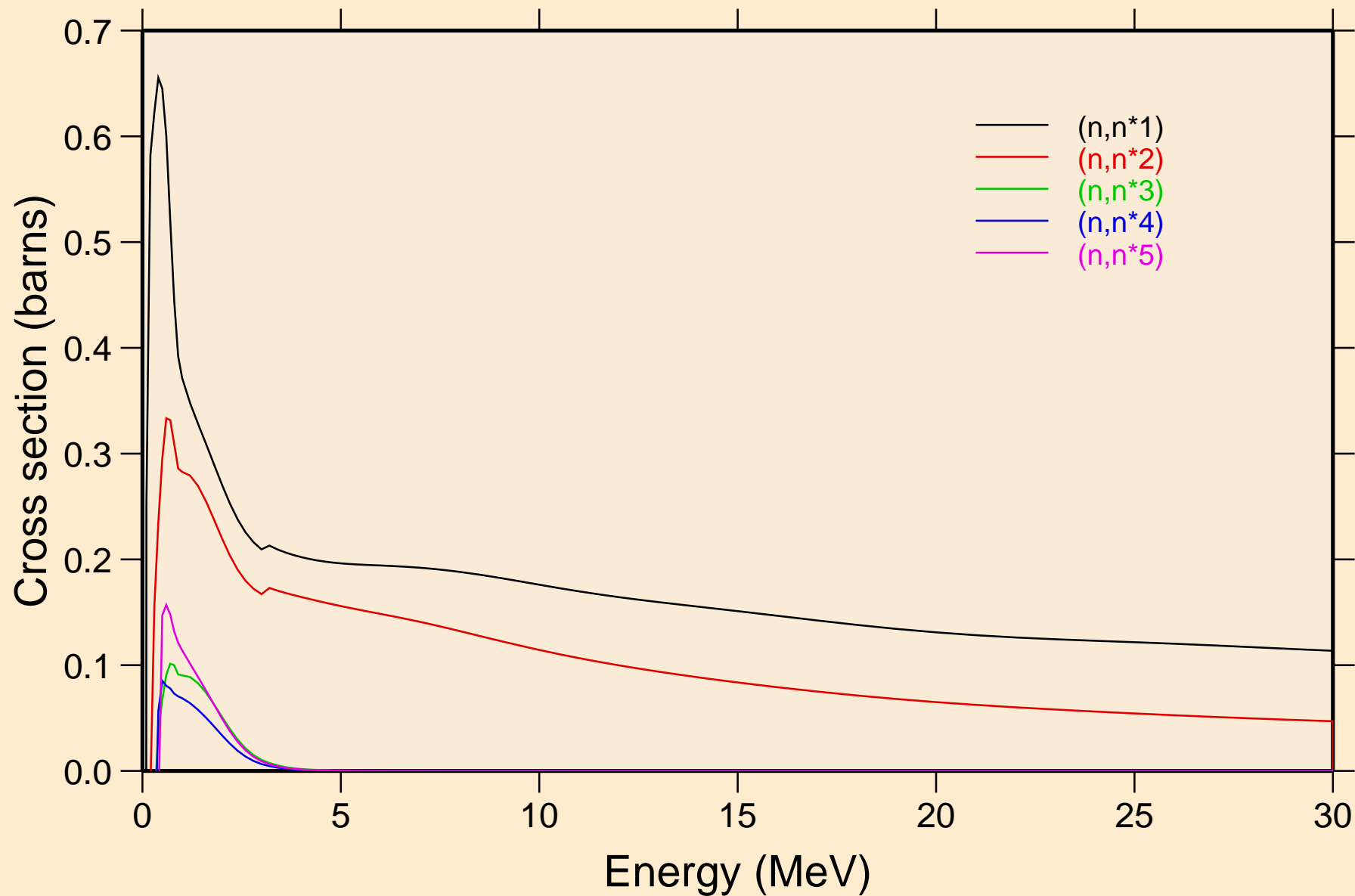

HO165 NEUTRON ACER TENDL-2019 LIBRARY; T=293.16K
Inelastic levels

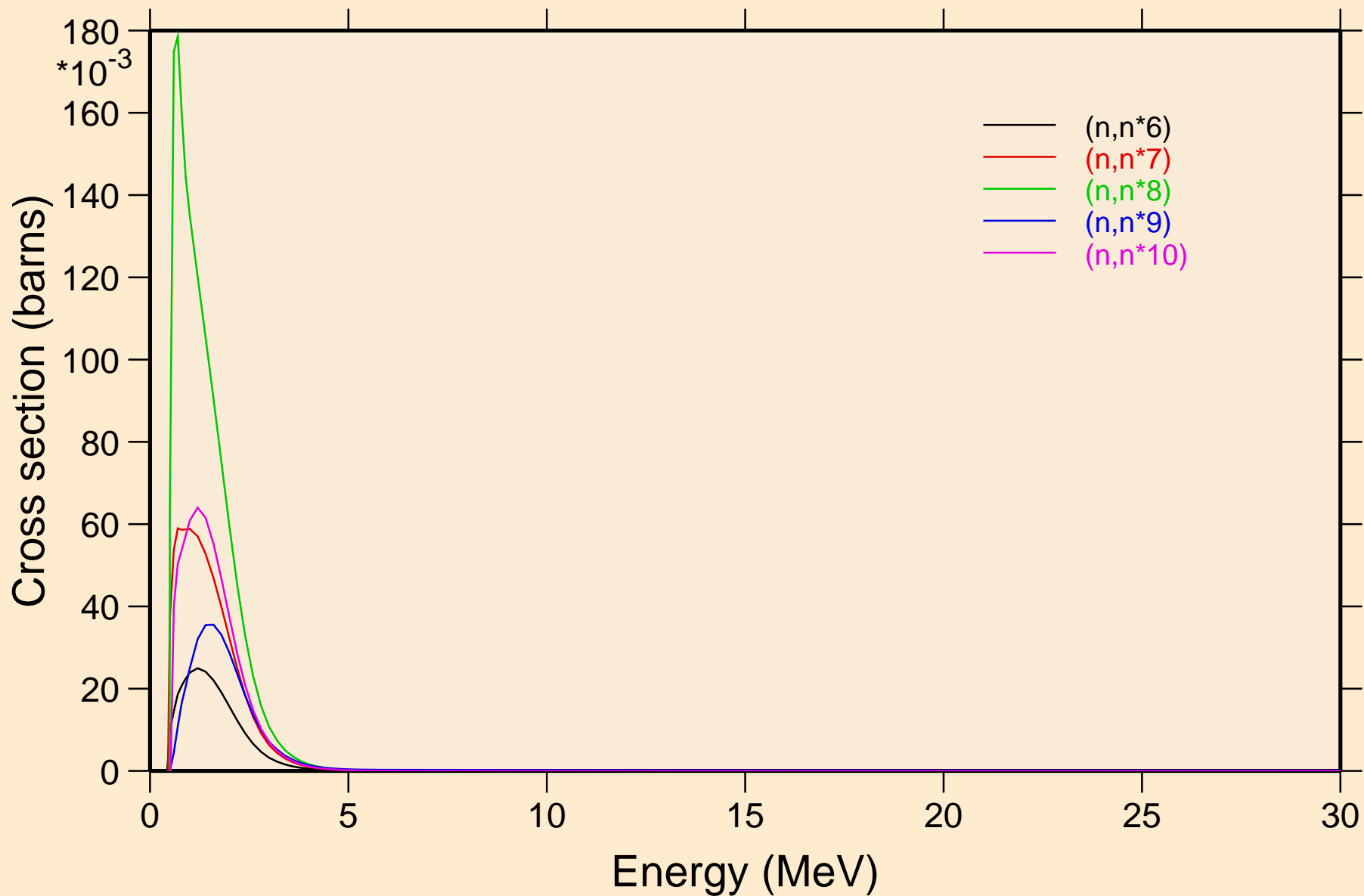

HO165 NEUTRON ACER TENDL-2019 LIBRARY; T=293.16K
Inelastic levels

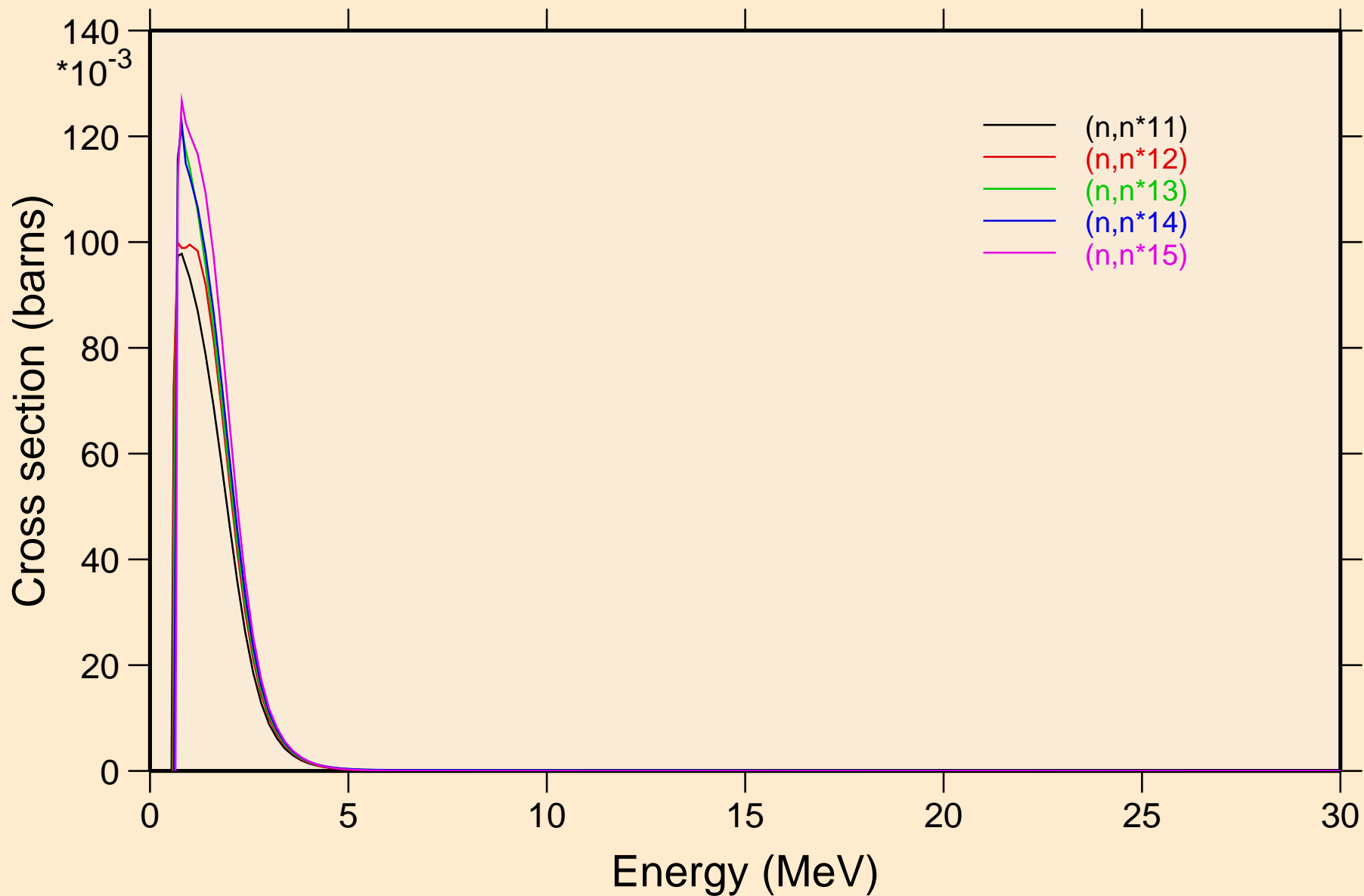

HO165 NEUTRON ACER TENDL-2019 LIBRARY; T=293.16K
Inelastic levels

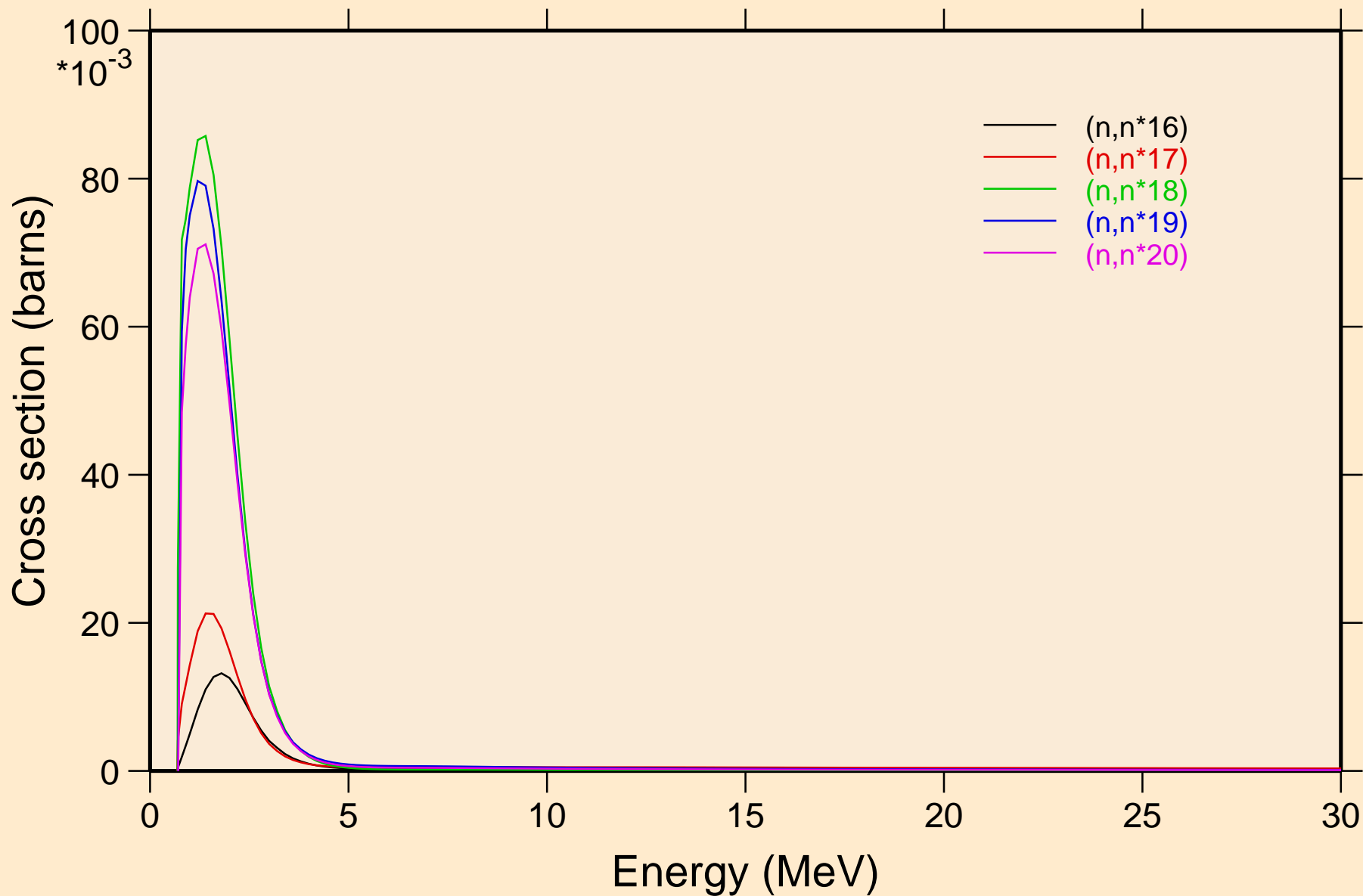

HO165 NEUTRON ACER TENDL-2019 LIBRARY; T=293.16K
Inelastic levels

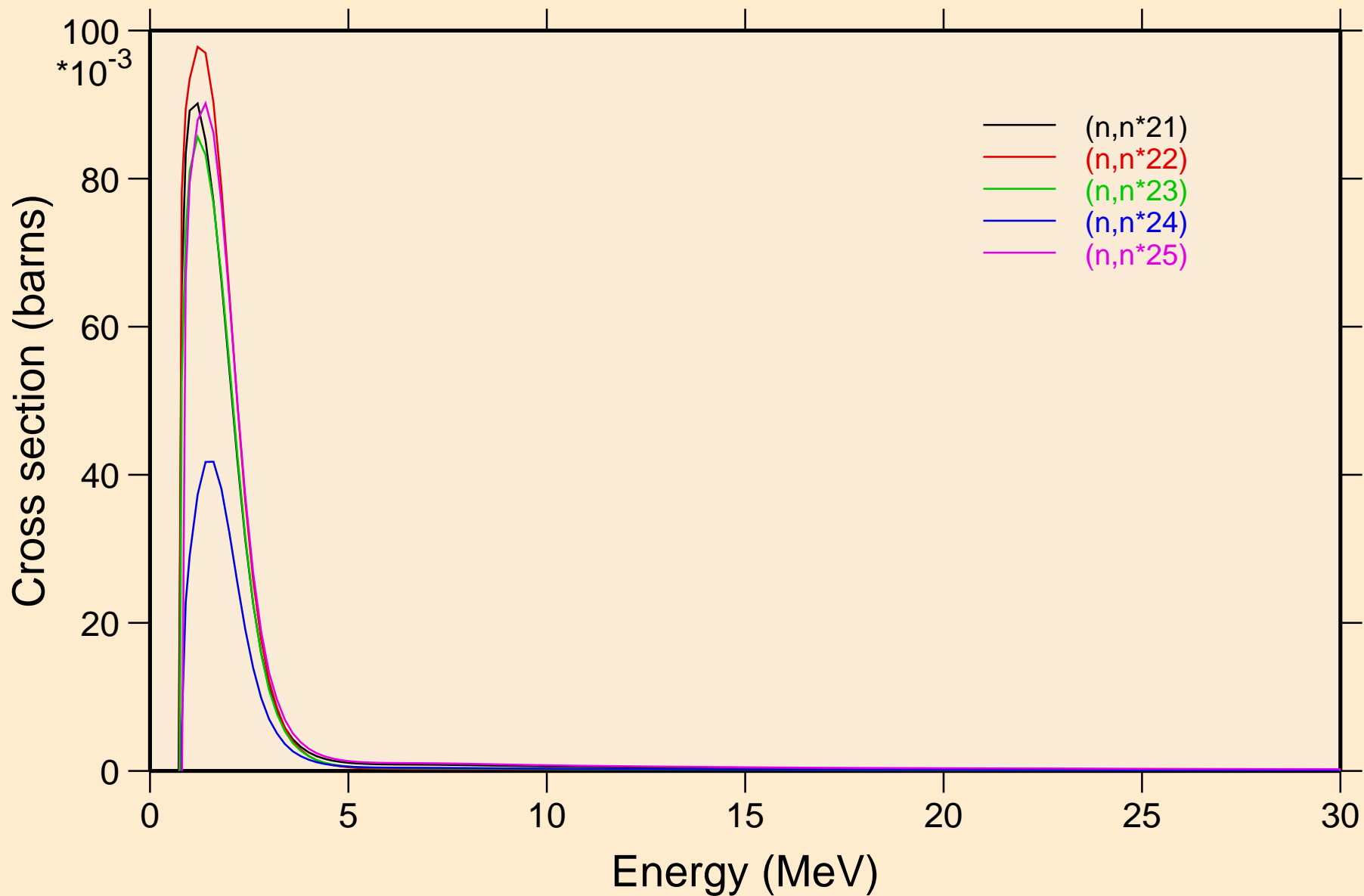

HO165 NEUTRON ACER TENDL-2019 LIBRARY; T=293.16K
Inelastic levels

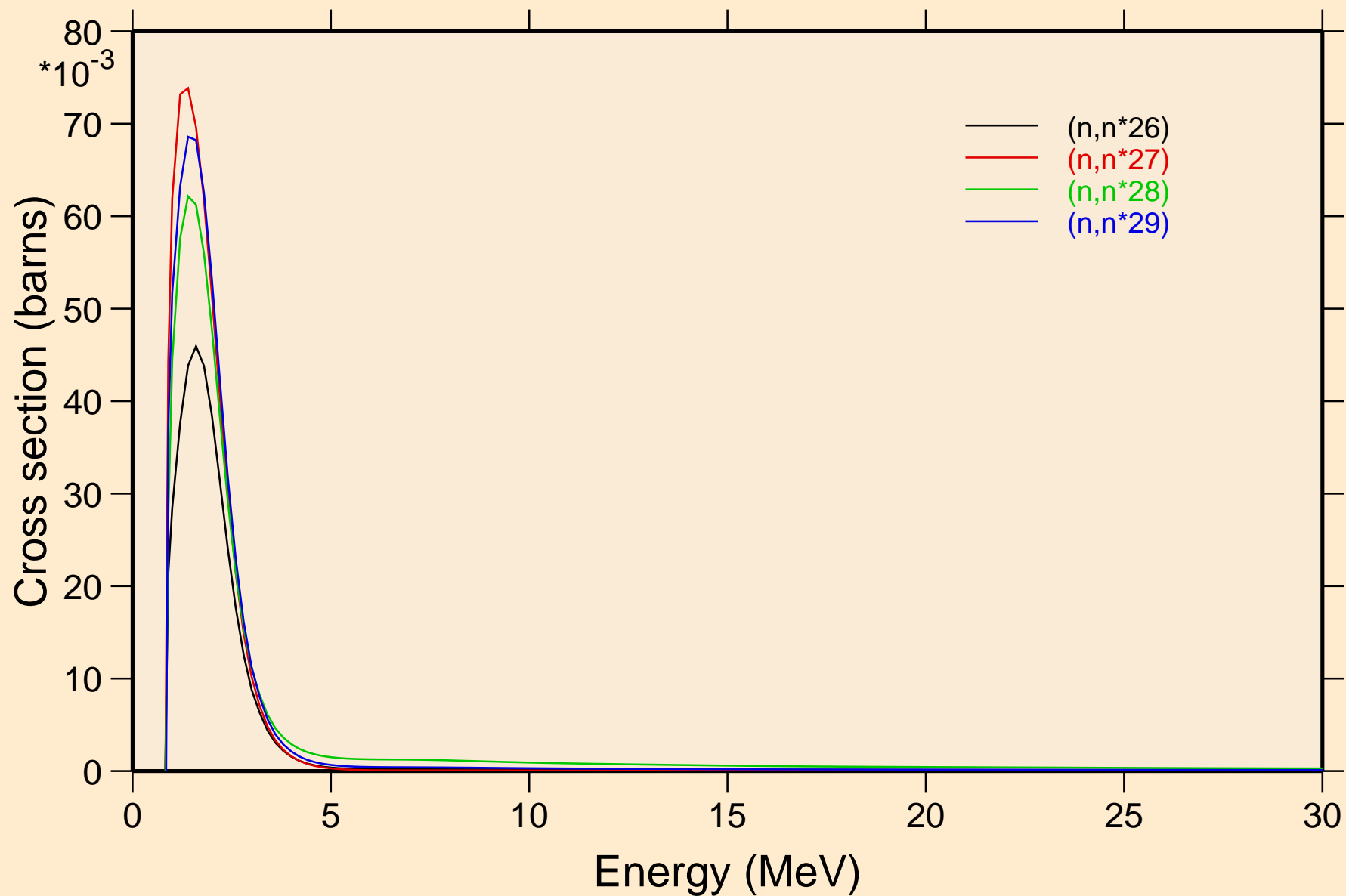

HO165 NEUTRON ACER TENDL-2019 LIBRARY; T=293.16K
Threshold reactions

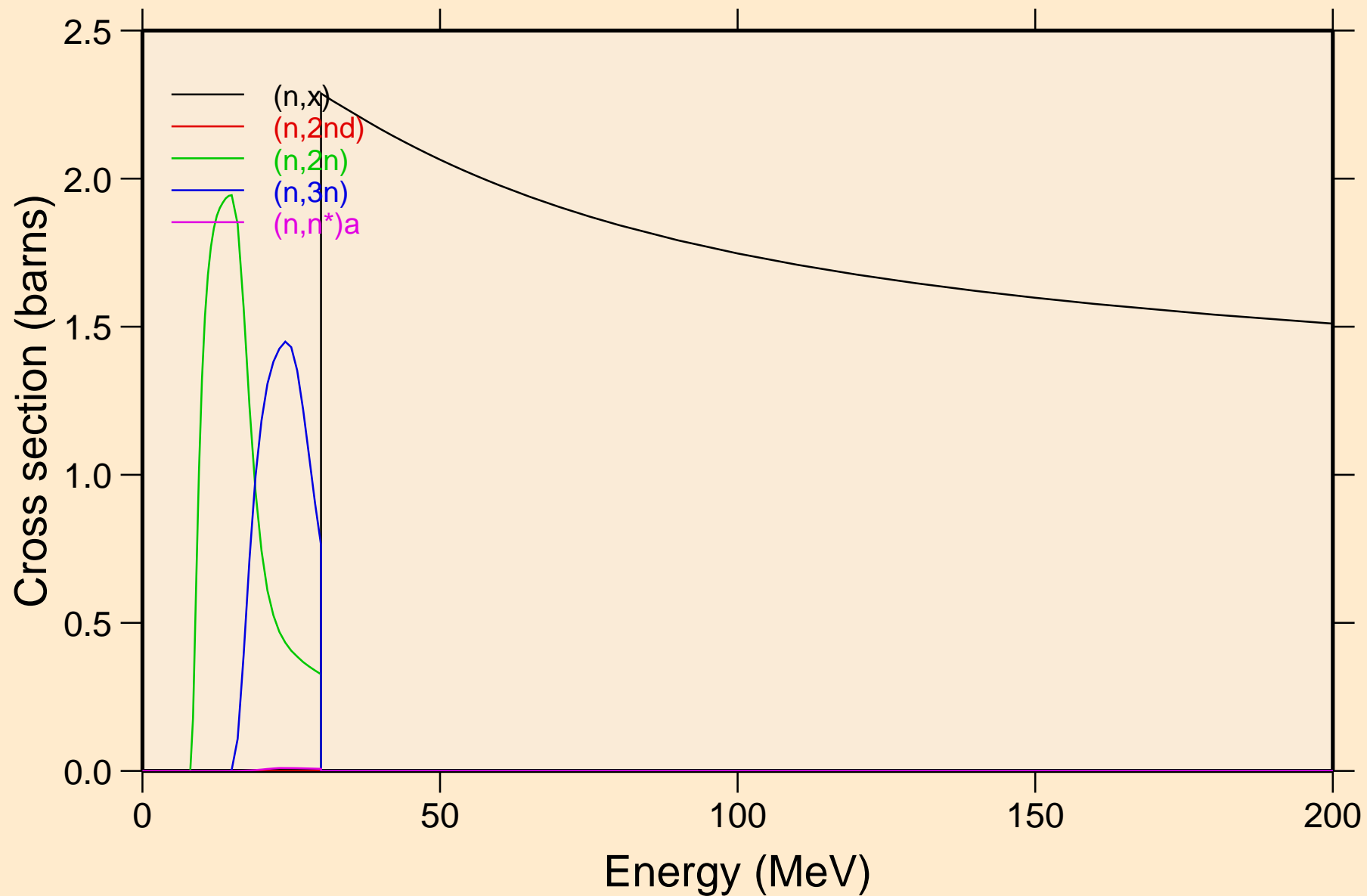

HO165 NEUTRON ACER TENDL-2019 LIBRARY; T=293.16K

Threshold reactions

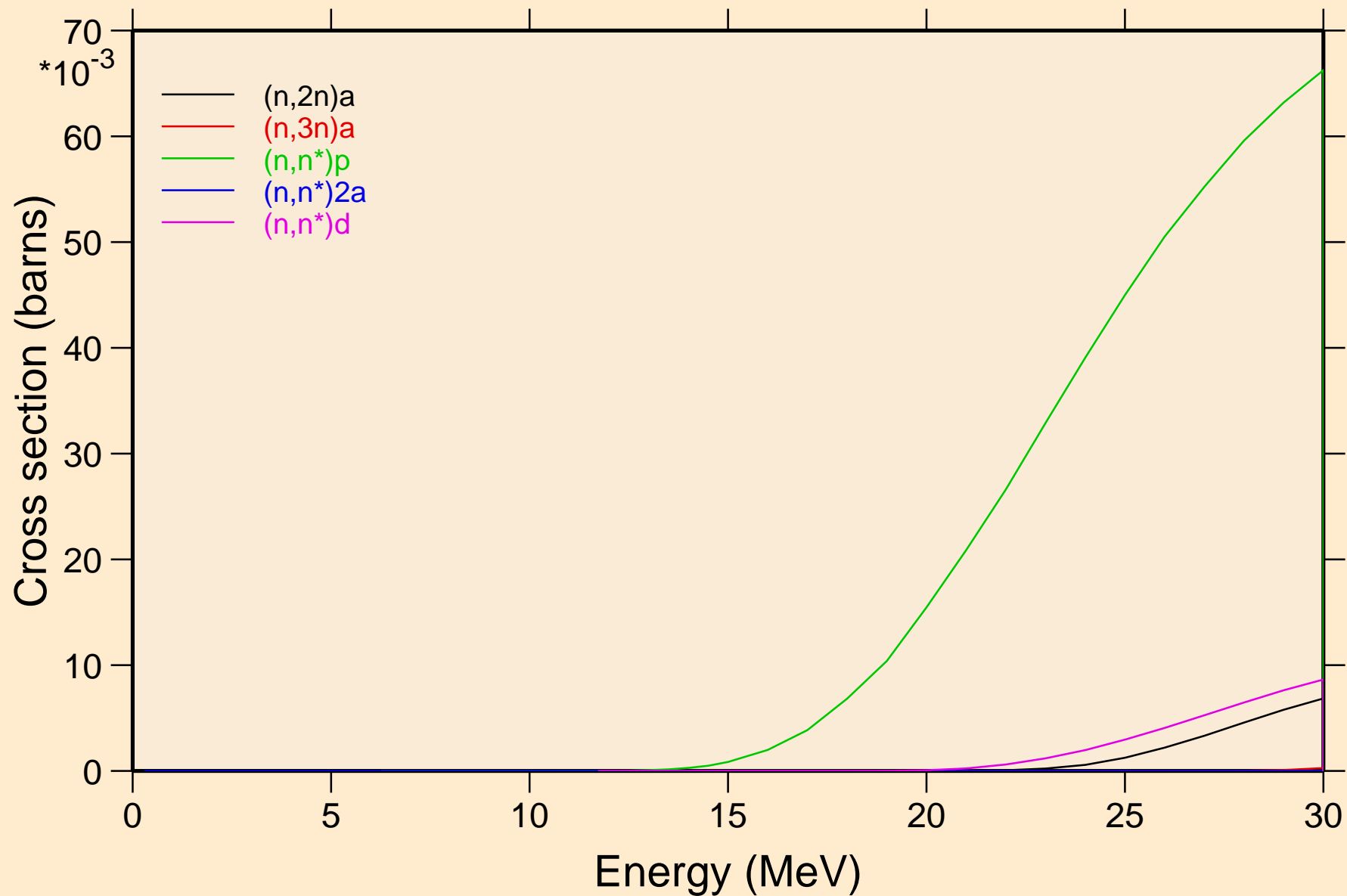

HO165 NEUTRON ACER TENDL-2019 LIBRARY; T=293.16K
Threshold reactions

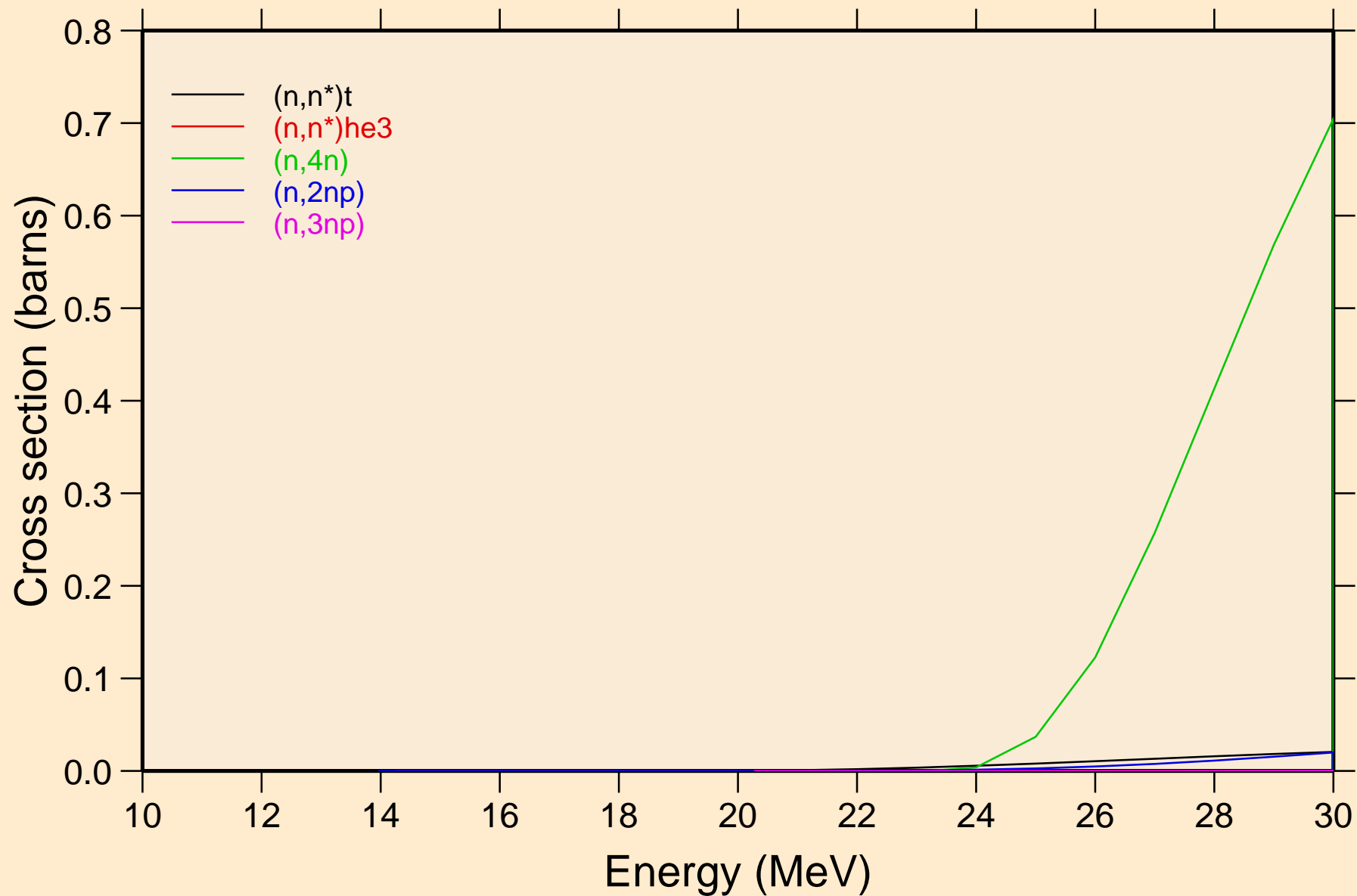

HO165 NEUTRON ACER TENDL-2019 LIBRARY; T=293.16K
Threshold reactions

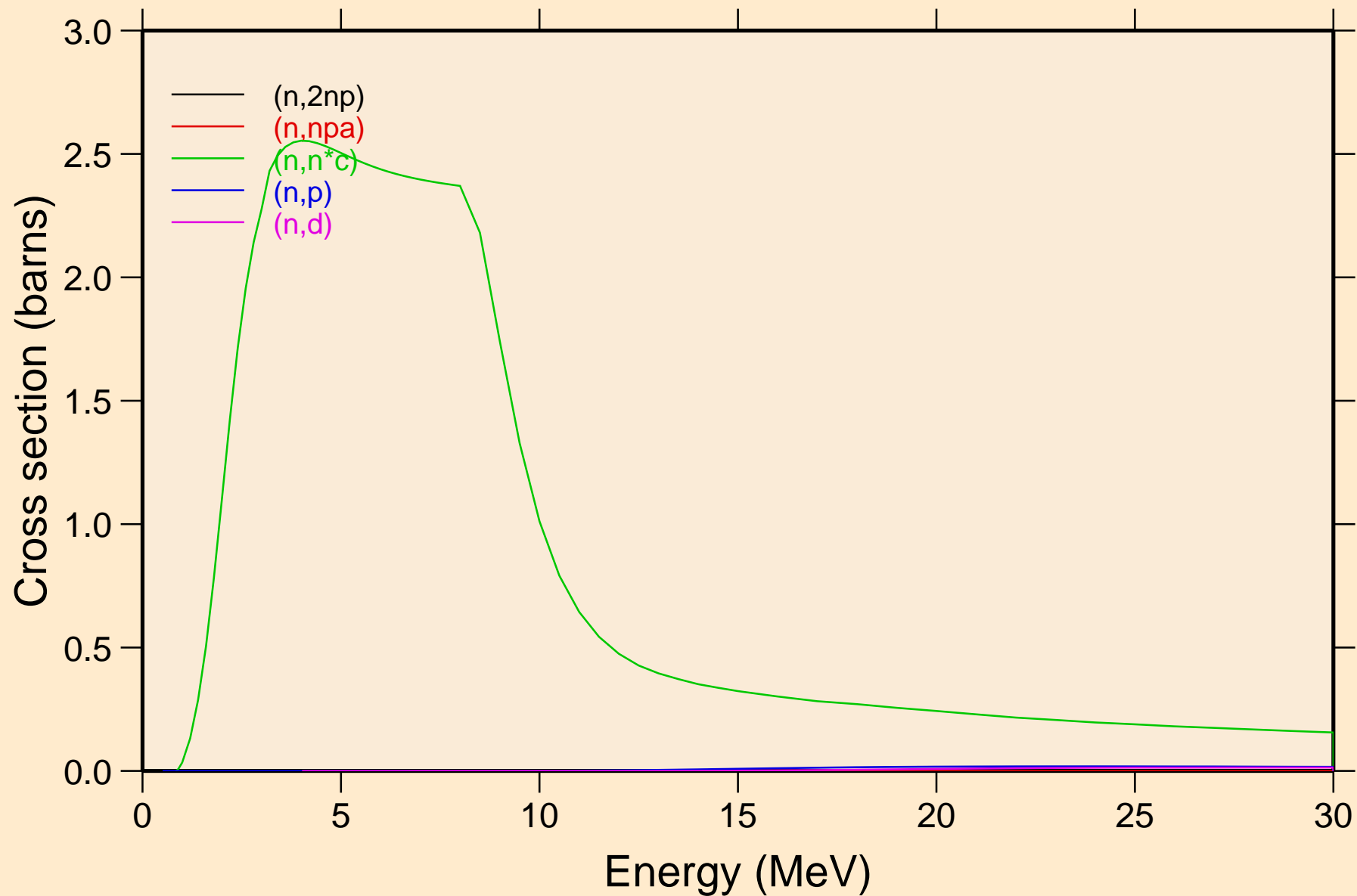

HO165 NEUTRON ACER TENDL-2019 LIBRARY; T=293.16K
Threshold reactions

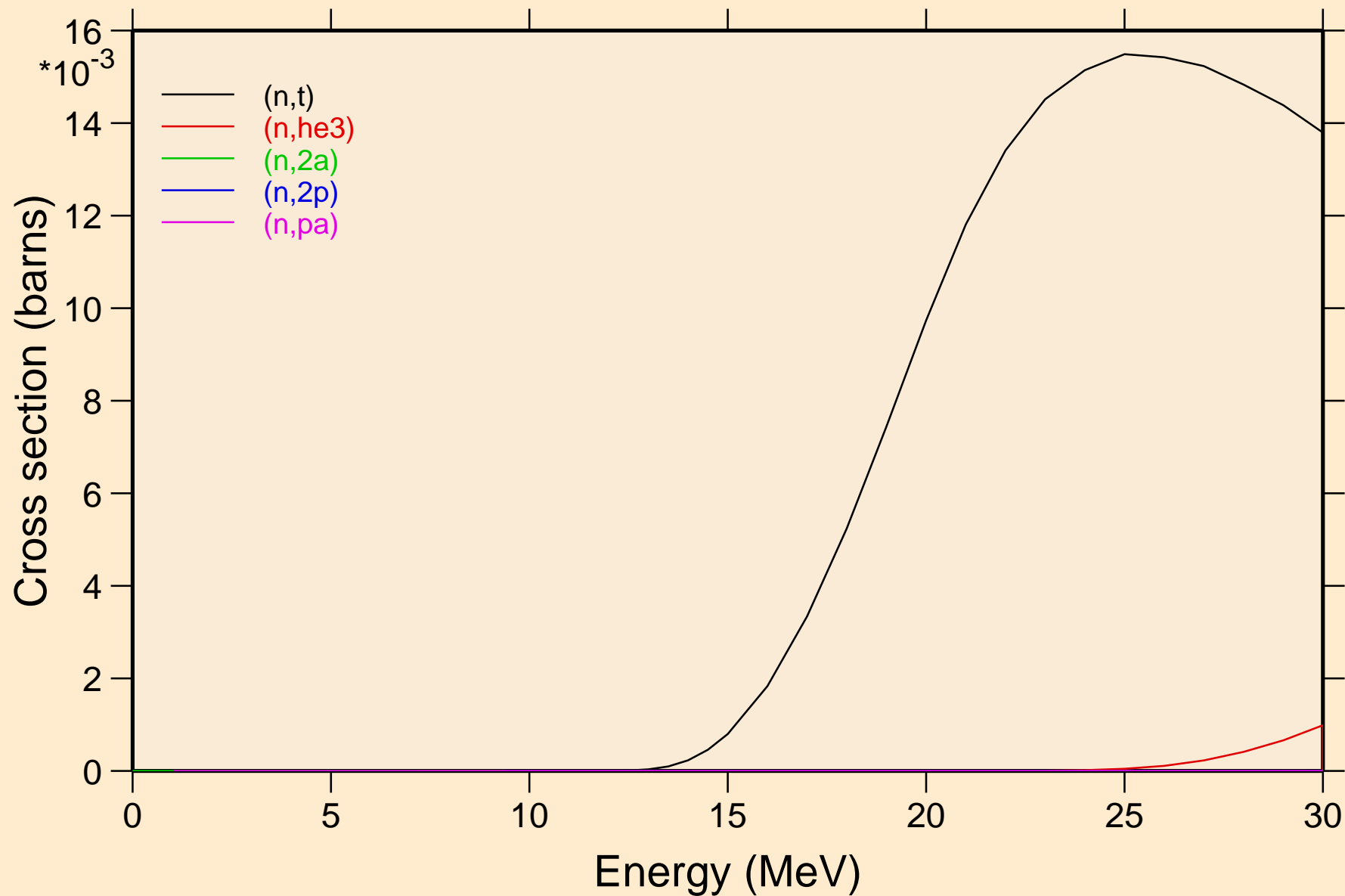

HO165 NEUTRON ACER TENDL-2019 LIBRARY; T=293.16K
Threshold reactions

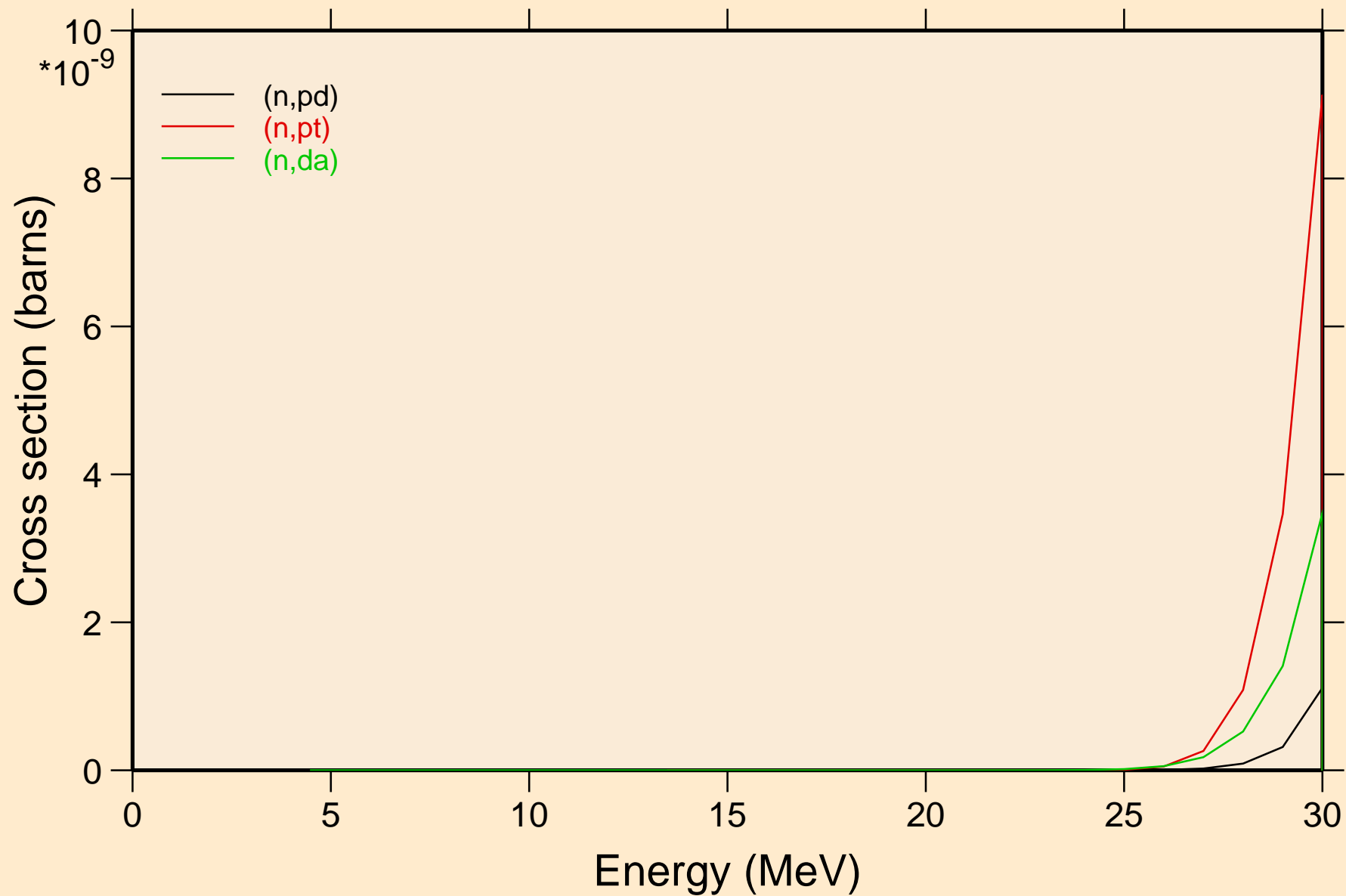

HO165 NEUTRON ACER TENDL-2019 LIBRARY; T=293.16K

Threshold reactions

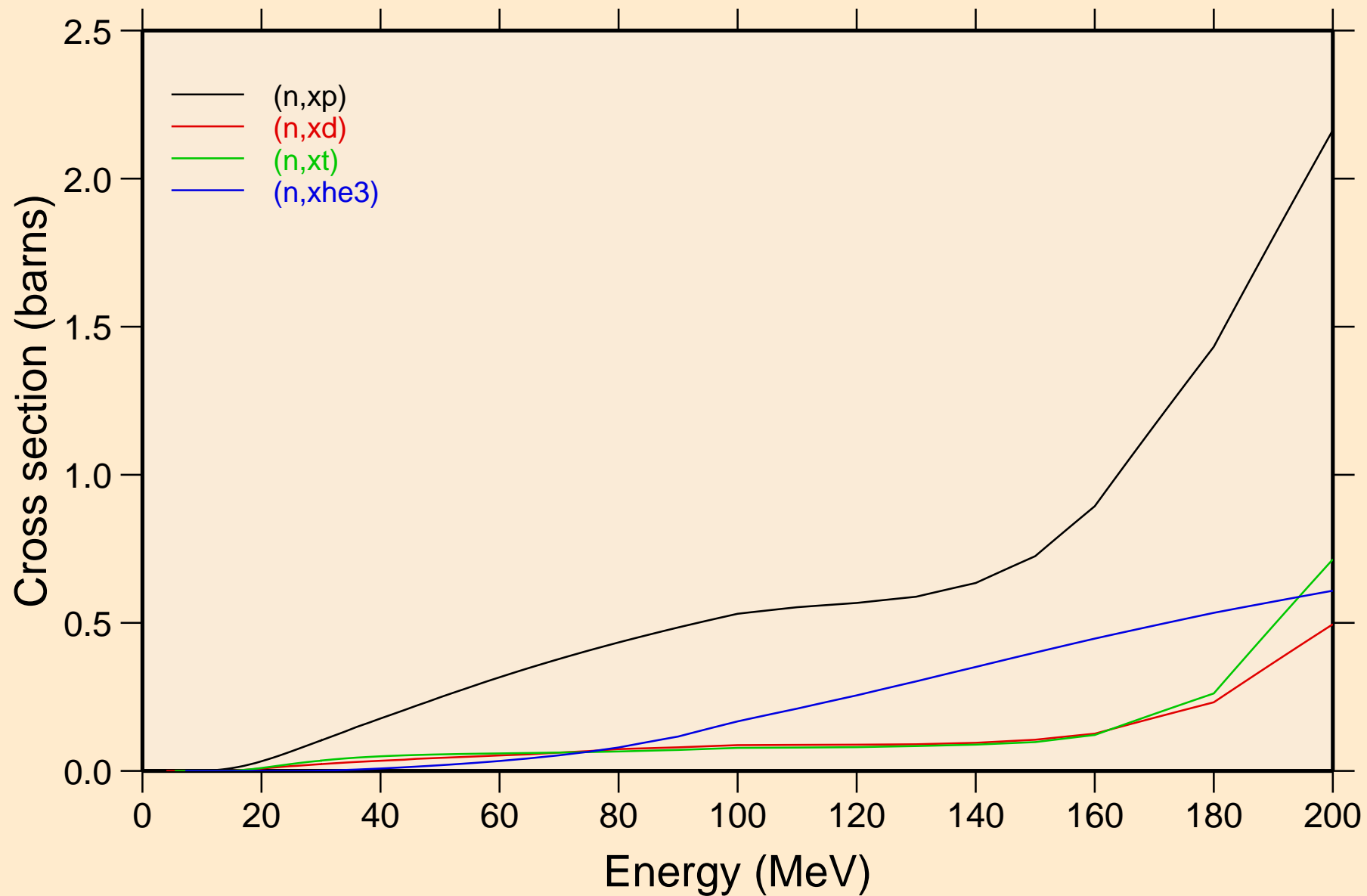

HO165 NEUTRON ACER TENDL-2019 LIBRARY; T=293.16K
angular distribution for elastic

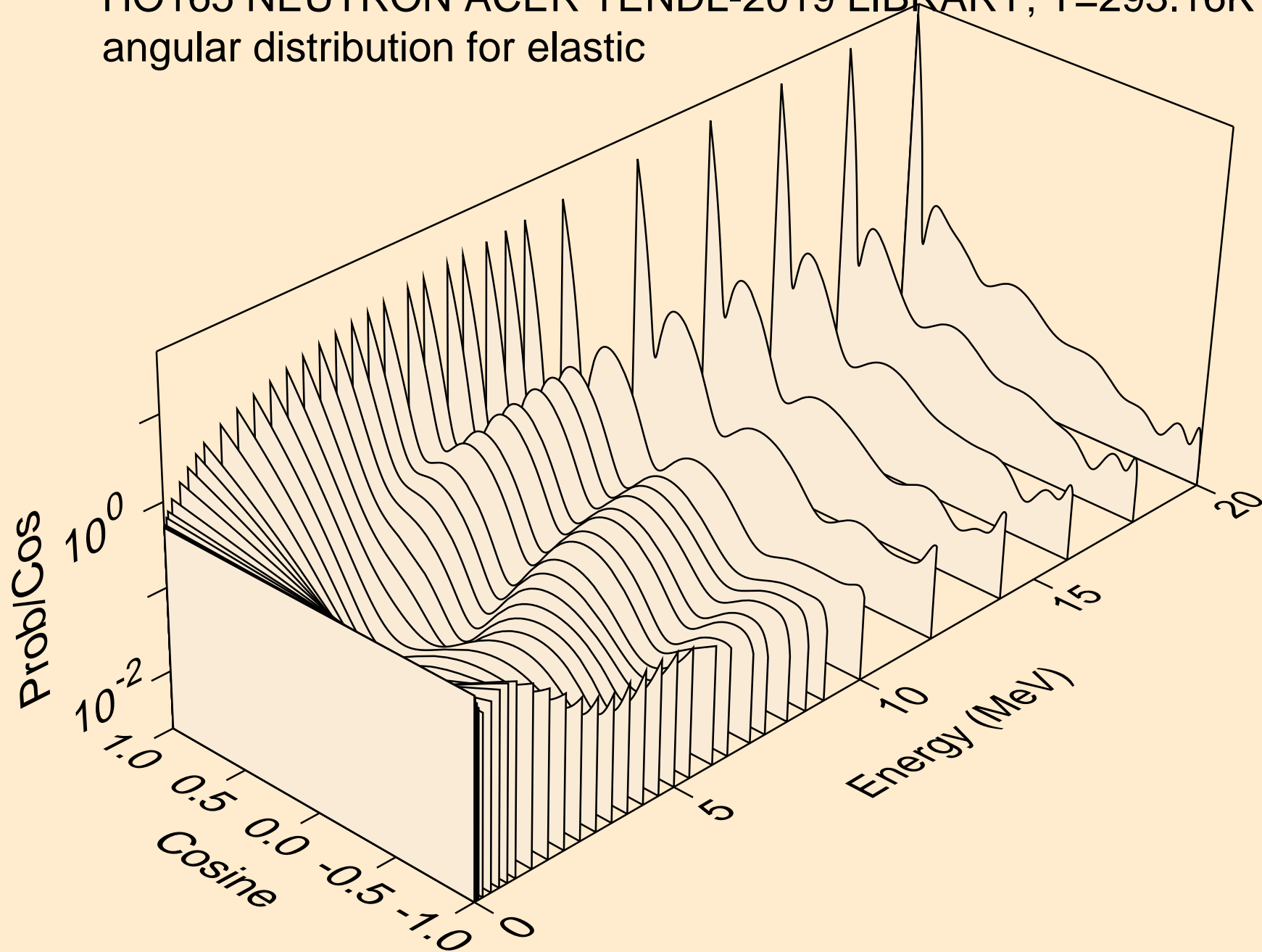

HO165 NEUTRON ACER TENDL-2019 LIBRARY; T=293.16K
angular distribution for elastic

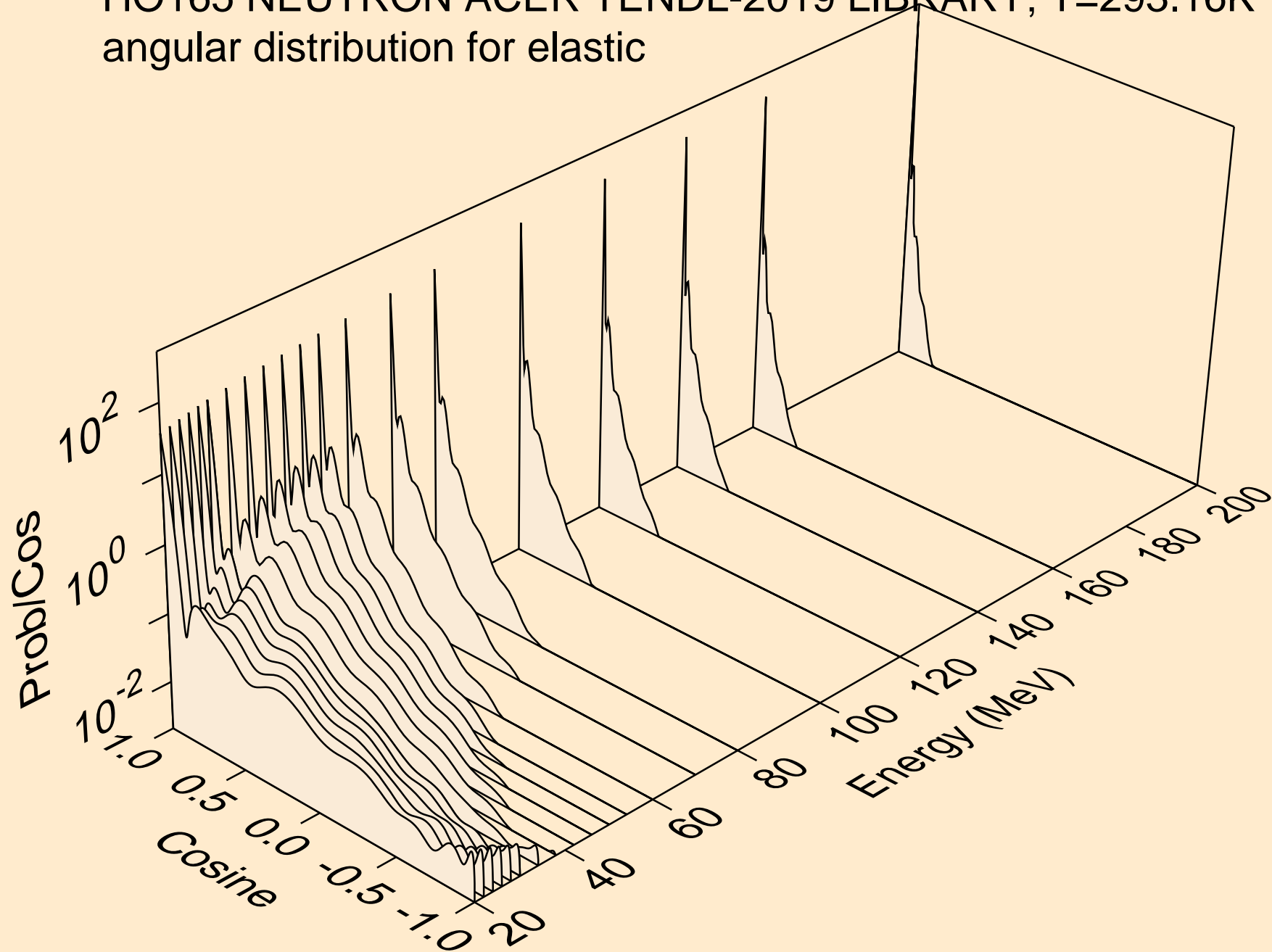

HO165 NEUTRON ACER TENDL-2019 LIBRARY; T=293.16K
angular distribution for (n,n*1)

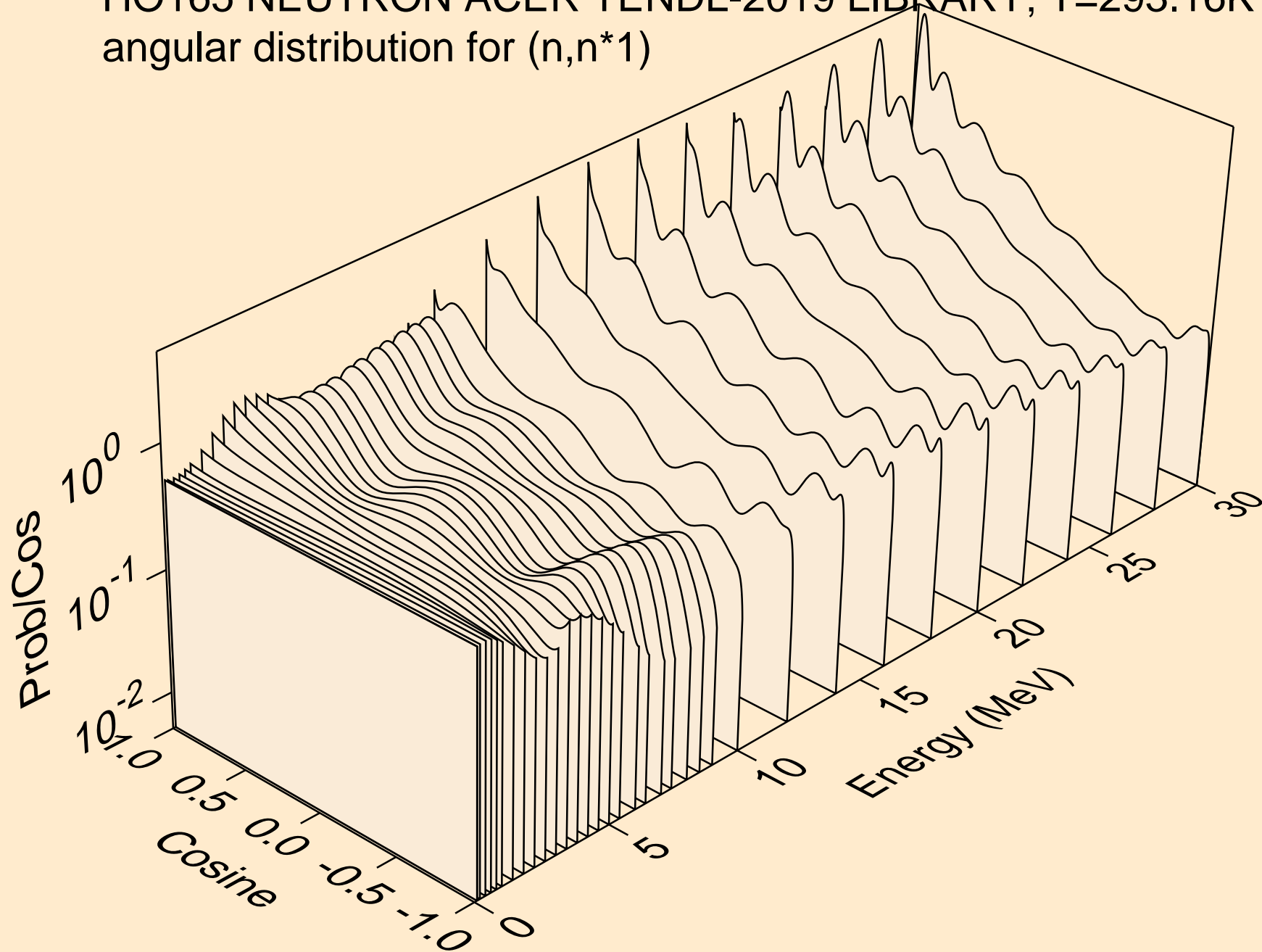

HO165 NEUTRON ACER TENDL-2019 LIBRARY; T=293.16K
angular distribution for (n,n*2)

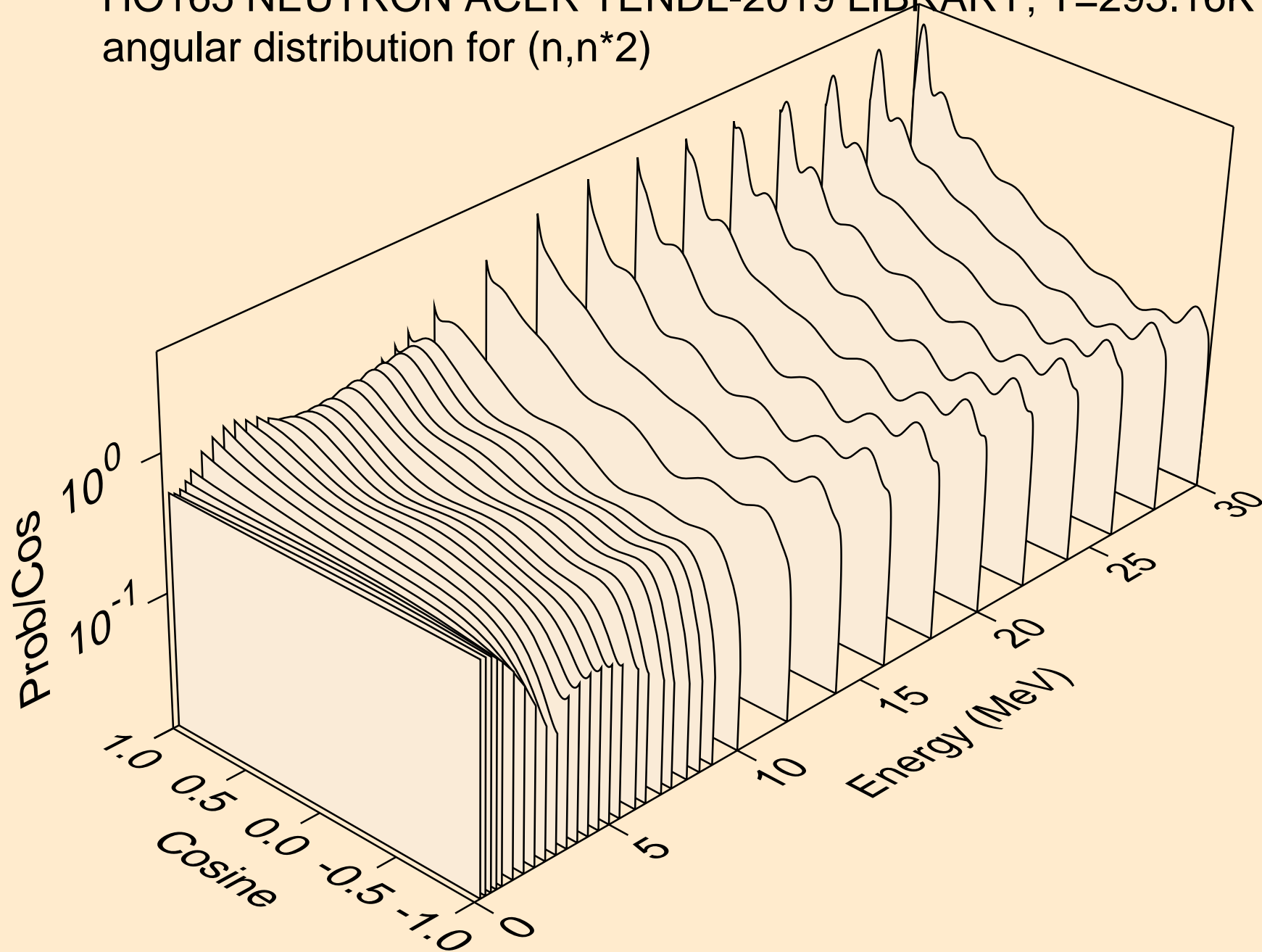

HO165 NEUTRON ACER TENDL-2019 LIBRARY; T=293.16K
angular distribution for (n,n*3)

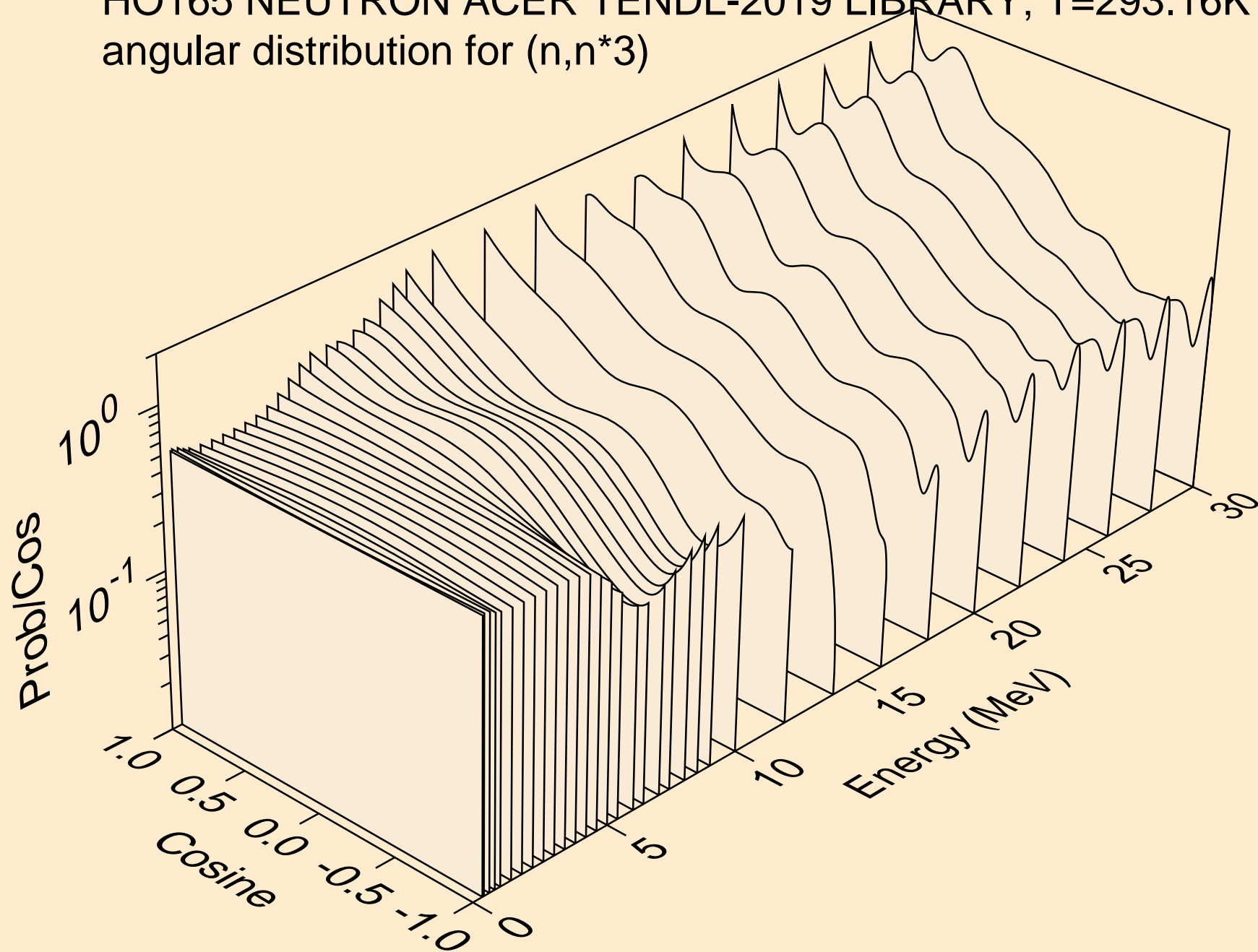

HO165 NEUTRON ACER TENDL-2019 LIBRARY; T=293.16K
angular distribution for (n,n*4)

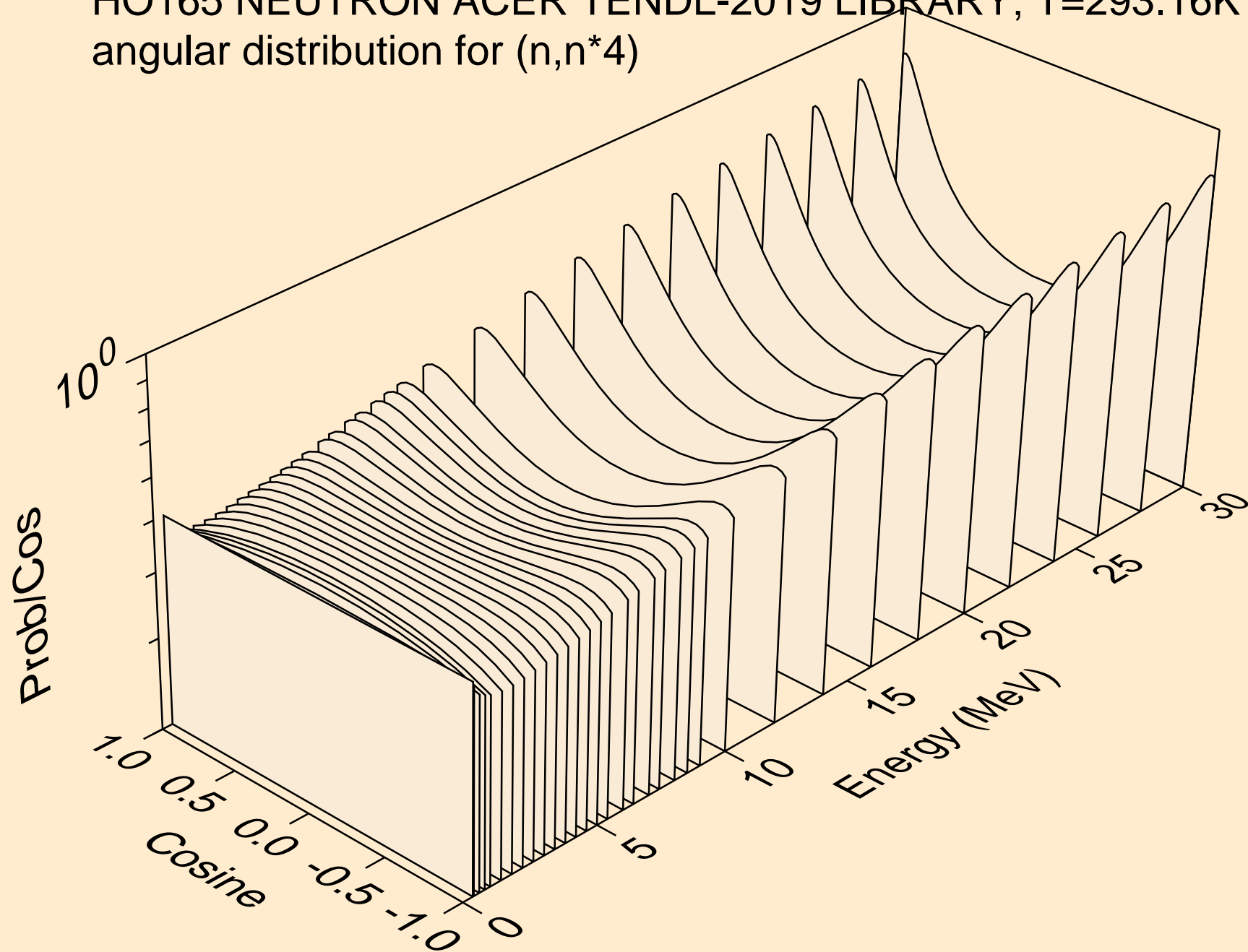

HO165 NEUTRON ACER TENDL-2019 LIBRARY; T=293.16K
angular distribution for (n,n*5)

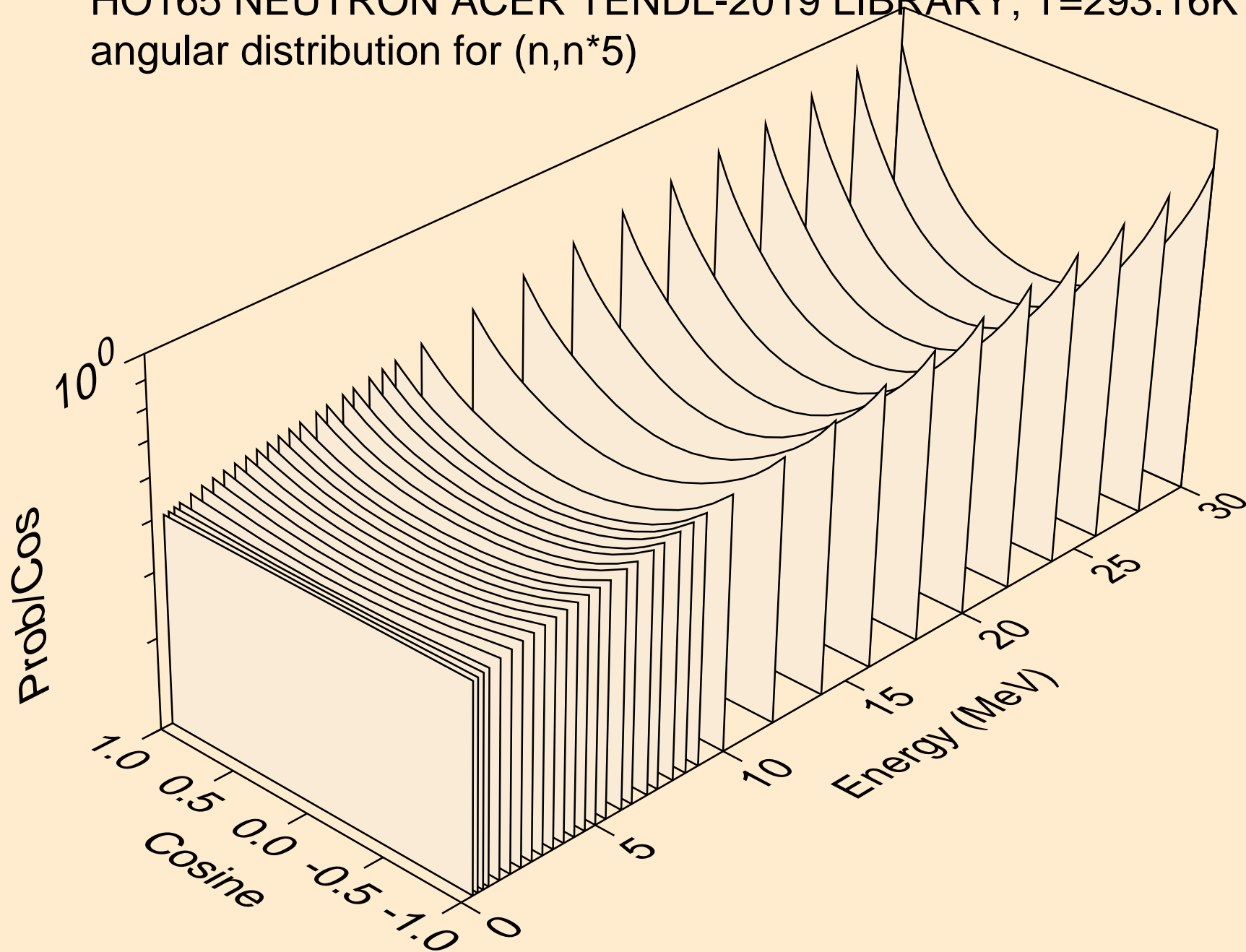

HO165 NEUTRON ACER TENDL-2019 LIBRARY; T=293.16K
angular distribution for (n,n*6)

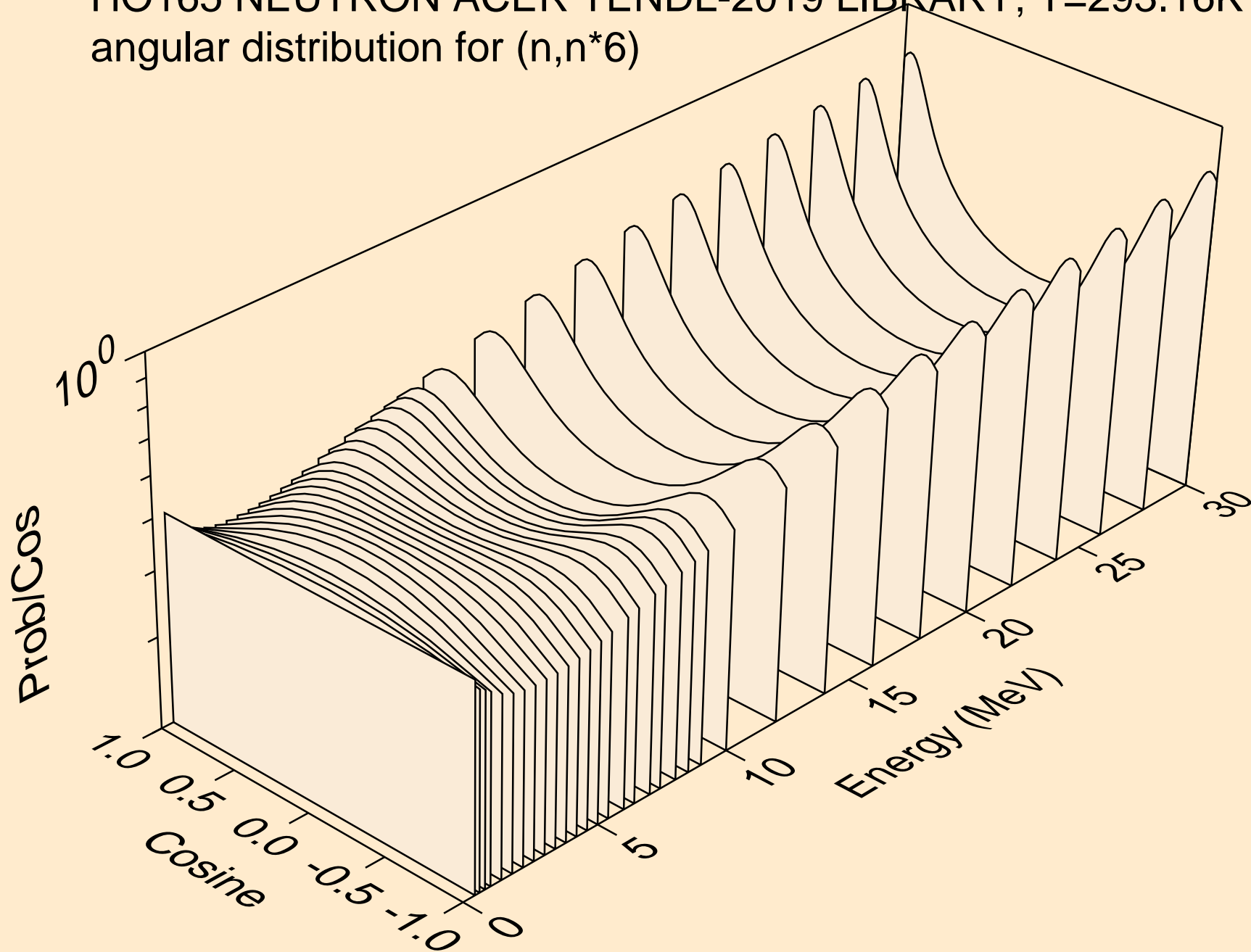

HO165 NEUTRON ACER TENDL-2019 LIBRARY; T=293.16K
angular distribution for (n,n*7)

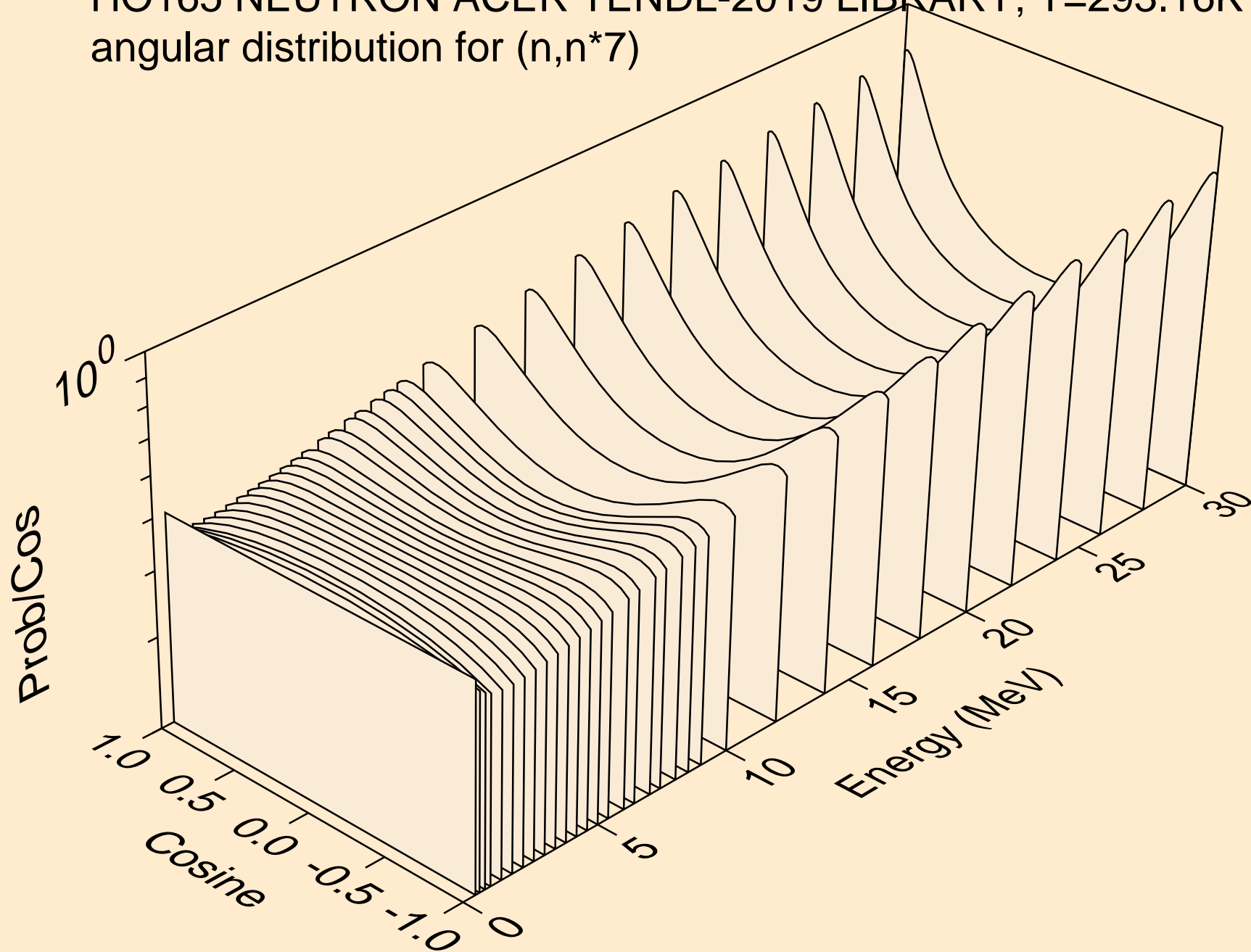

HO165 NEUTRON ACER TENDL-2019 LIBRARY; T=293.16K
angular distribution for (n,n*8)

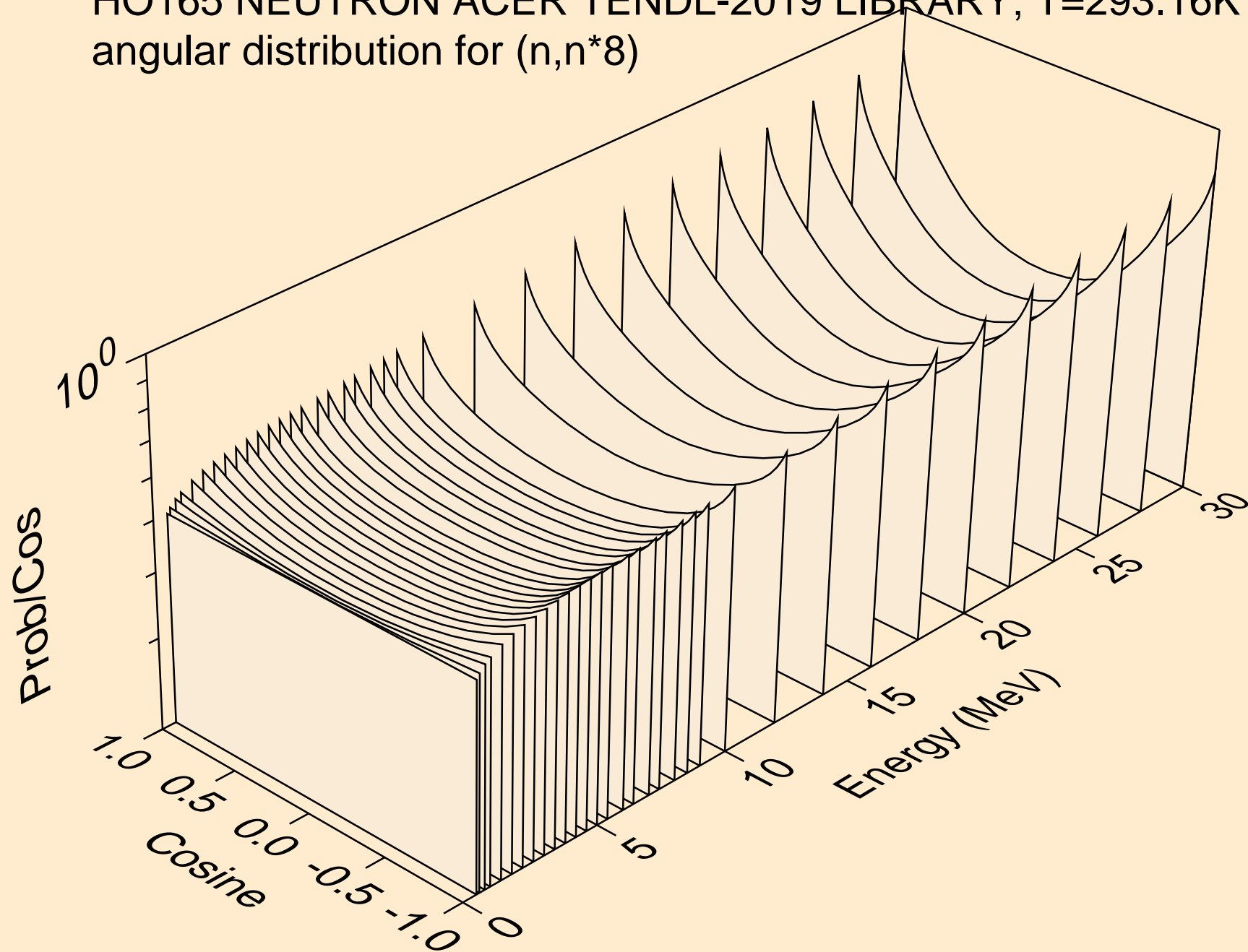

HO165 NEUTRON ACER TENDL-2019 LIBRARY; T=293.16K
angular distribution for (n,n*9)

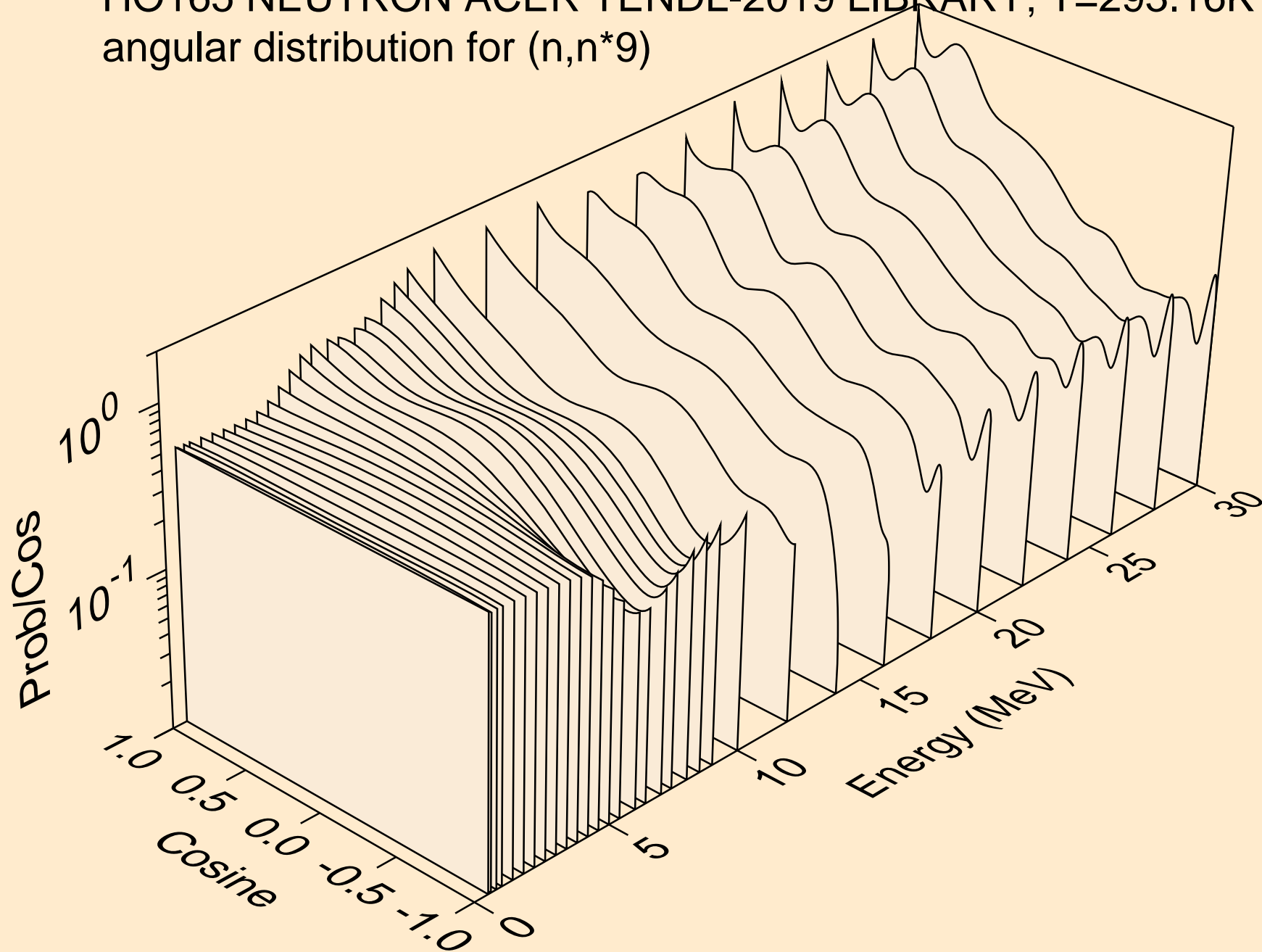

HO165 NEUTRON ACER TENDL-2019 LIBRARY; T=293.16K
angular distribution for (n,n*10)

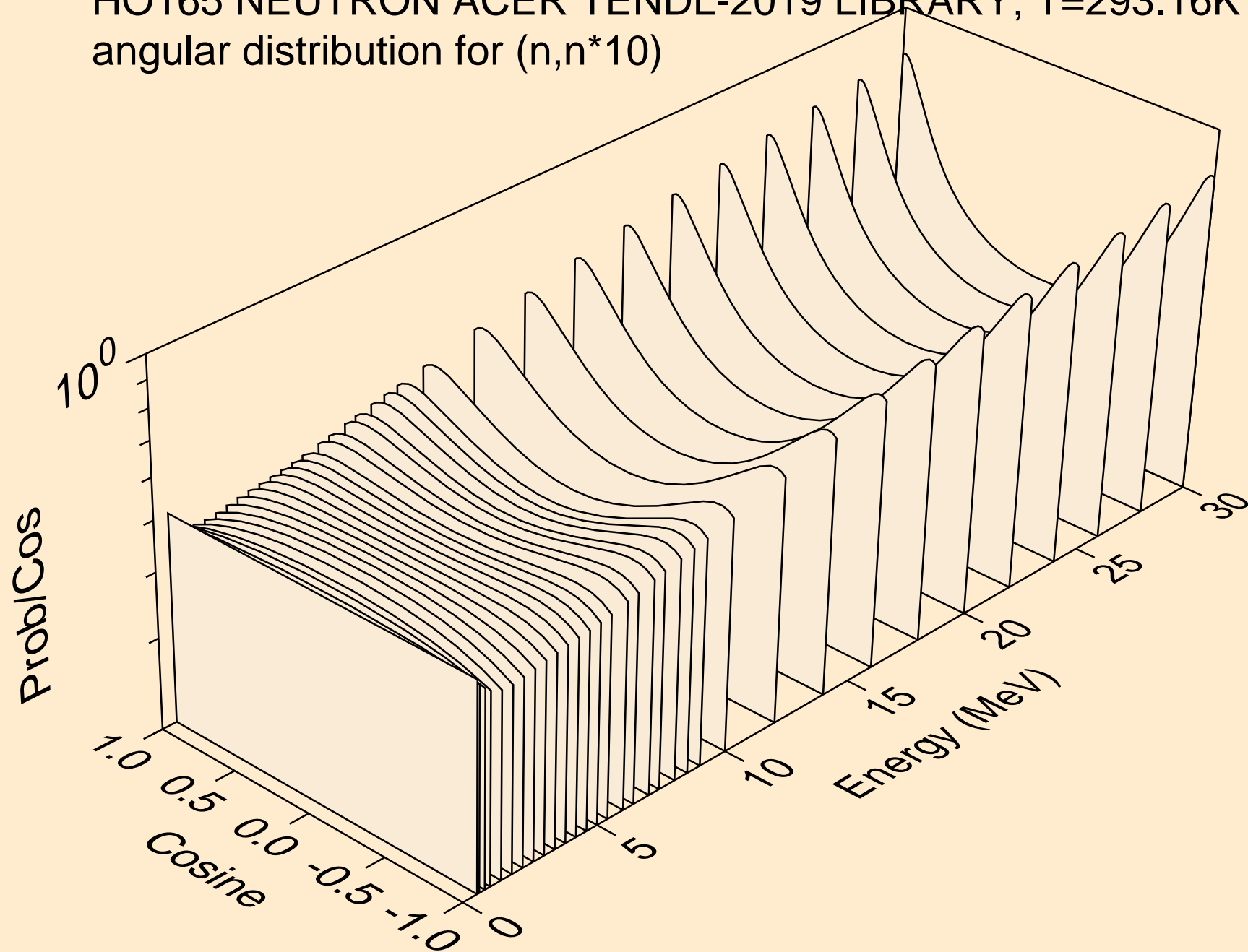

HO165 NEUTRON ACER TENDL-2019 LIBRARY; T=293.16K
angular distribution for (n,n*11)

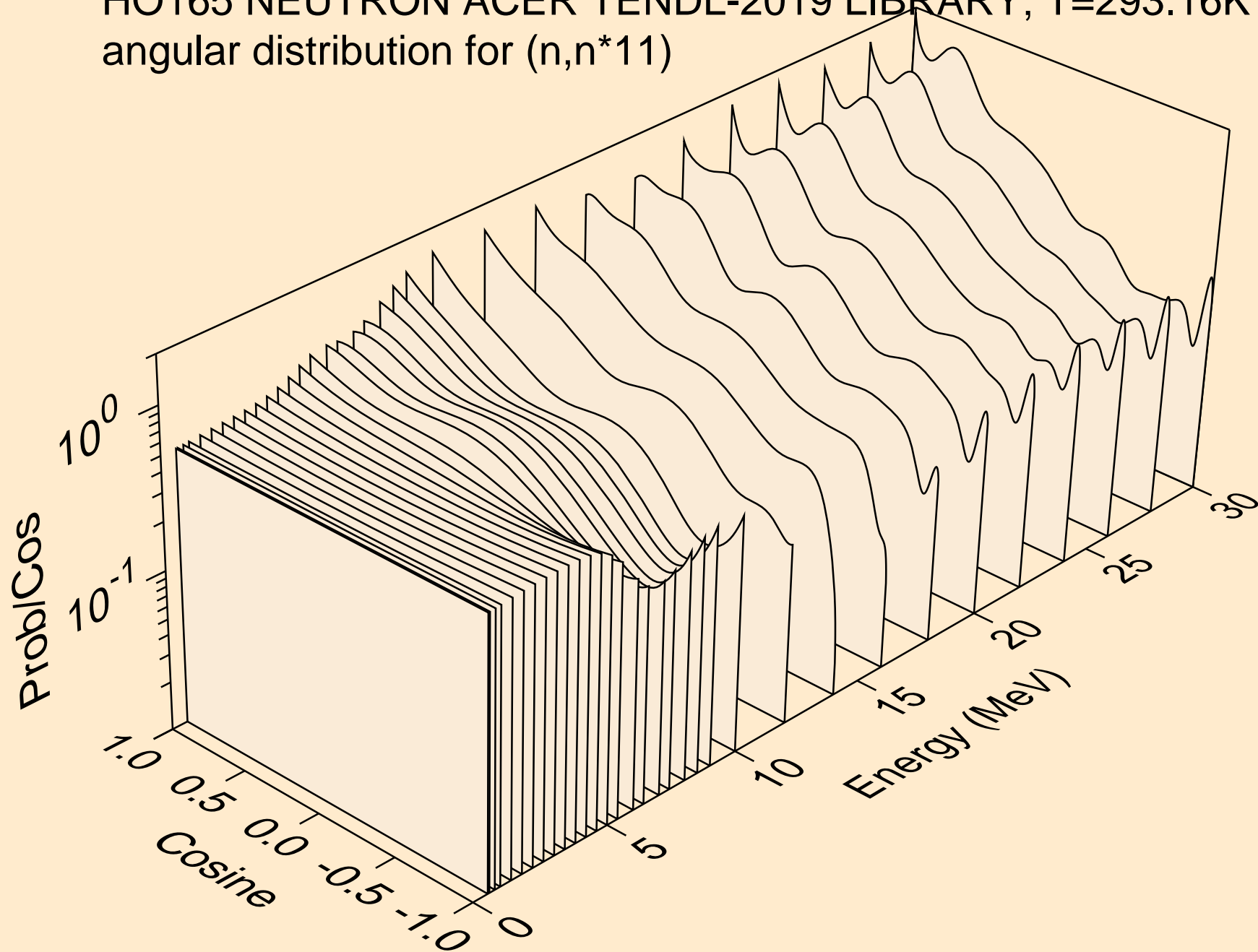

HO165 NEUTRON ACER TENDL-2019 LIBRARY; T=293.16K
angular distribution for (n,n*12)

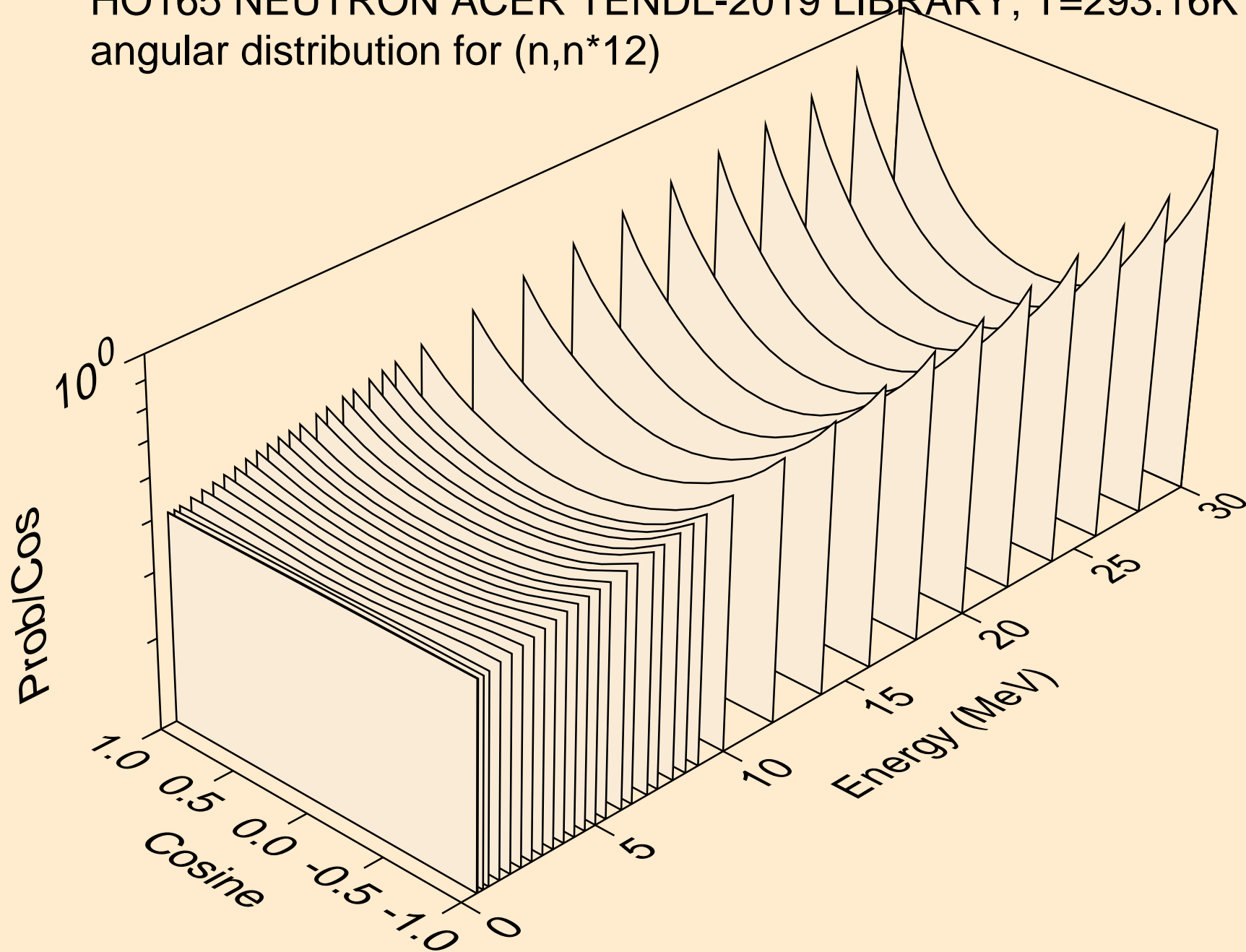

HO165 NEUTRON ACER TENDL-2019 LIBRARY; T=293.16K
angular distribution for (n,n*13)

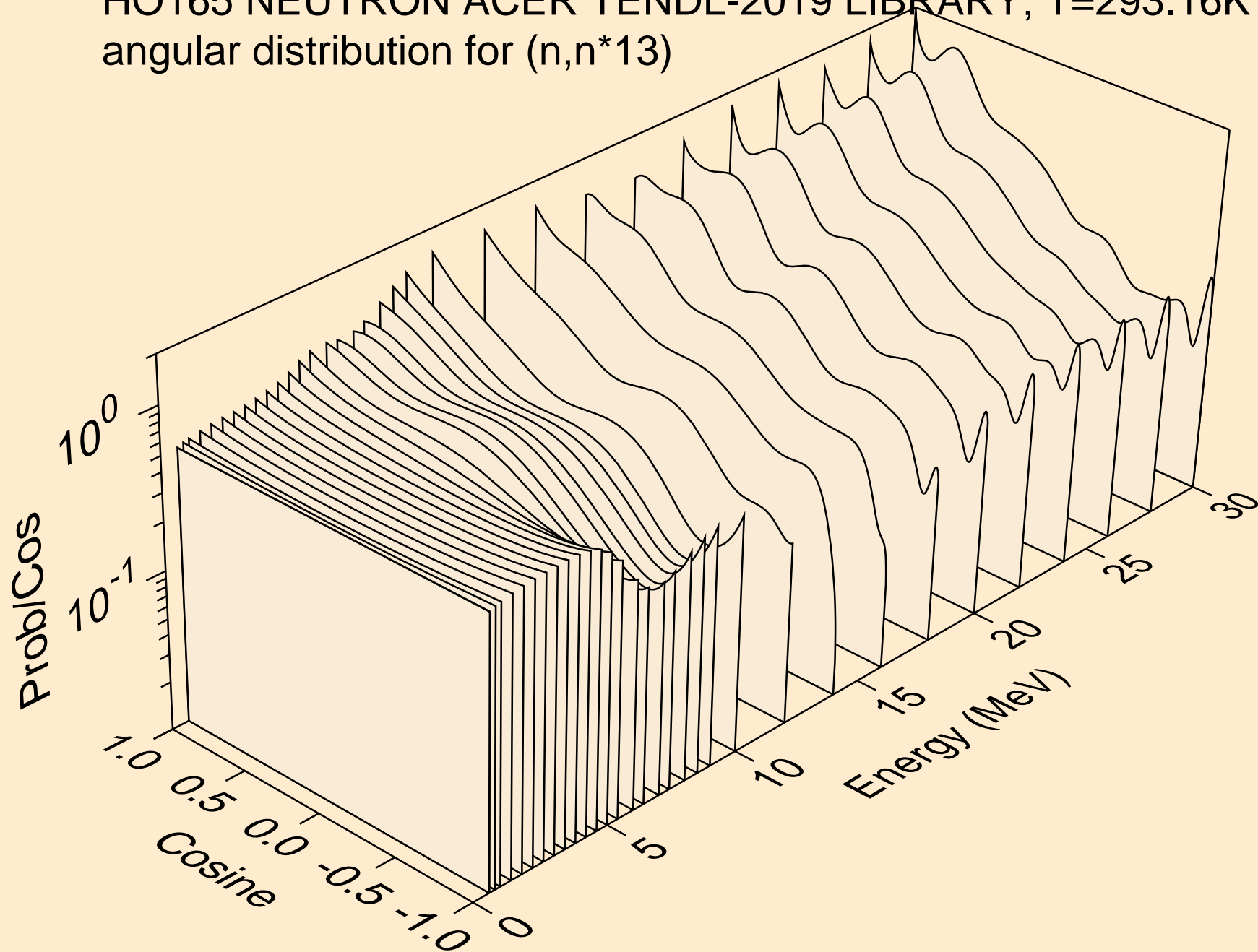

HO165 NEUTRON ACER TENDL-2019 LIBRARY; T=293.16K
angular distribution for (n,n*14)

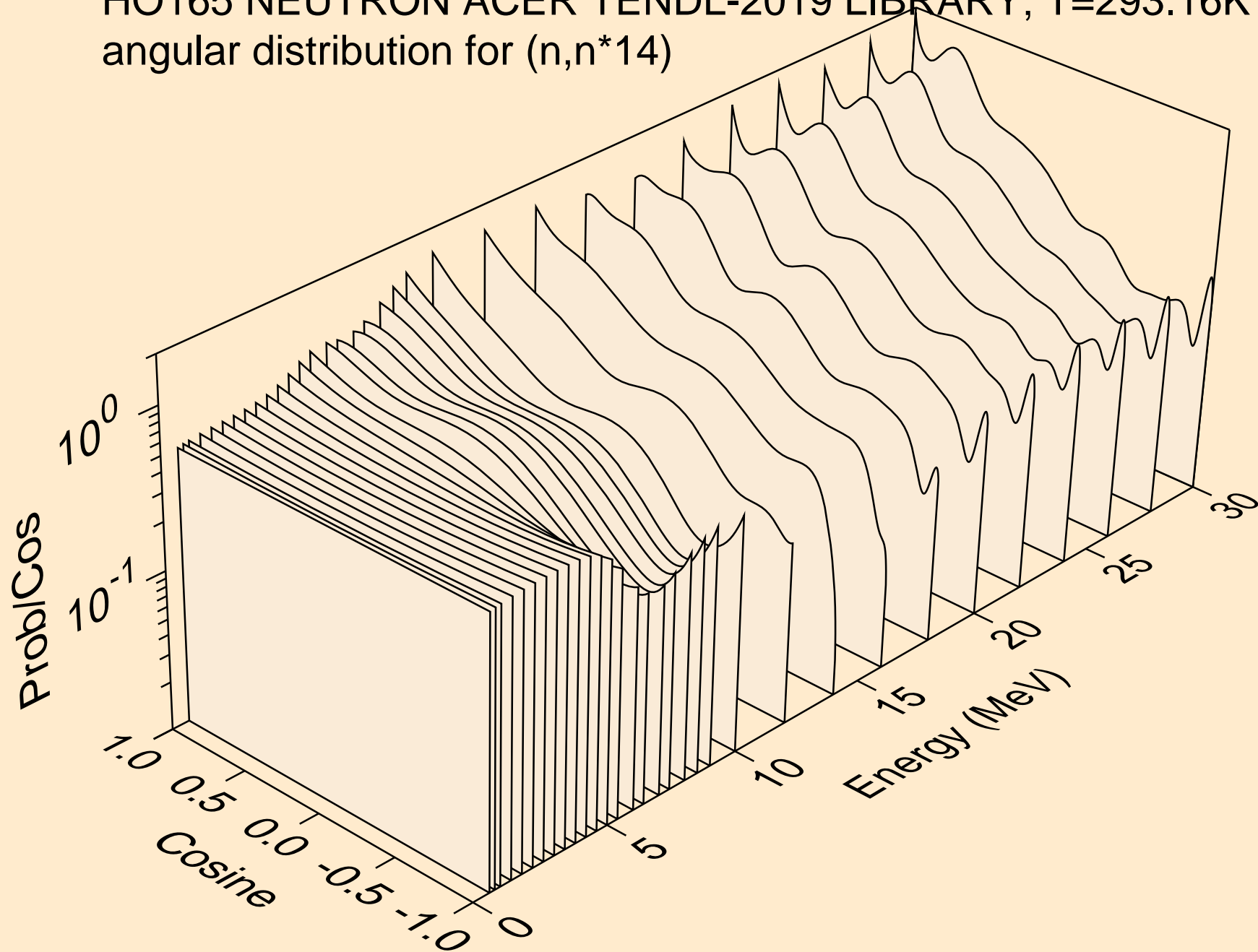

HO165 NEUTRON ACER TENDL-2019 LIBRARY; T=293.16K
angular distribution for (n,n*15)

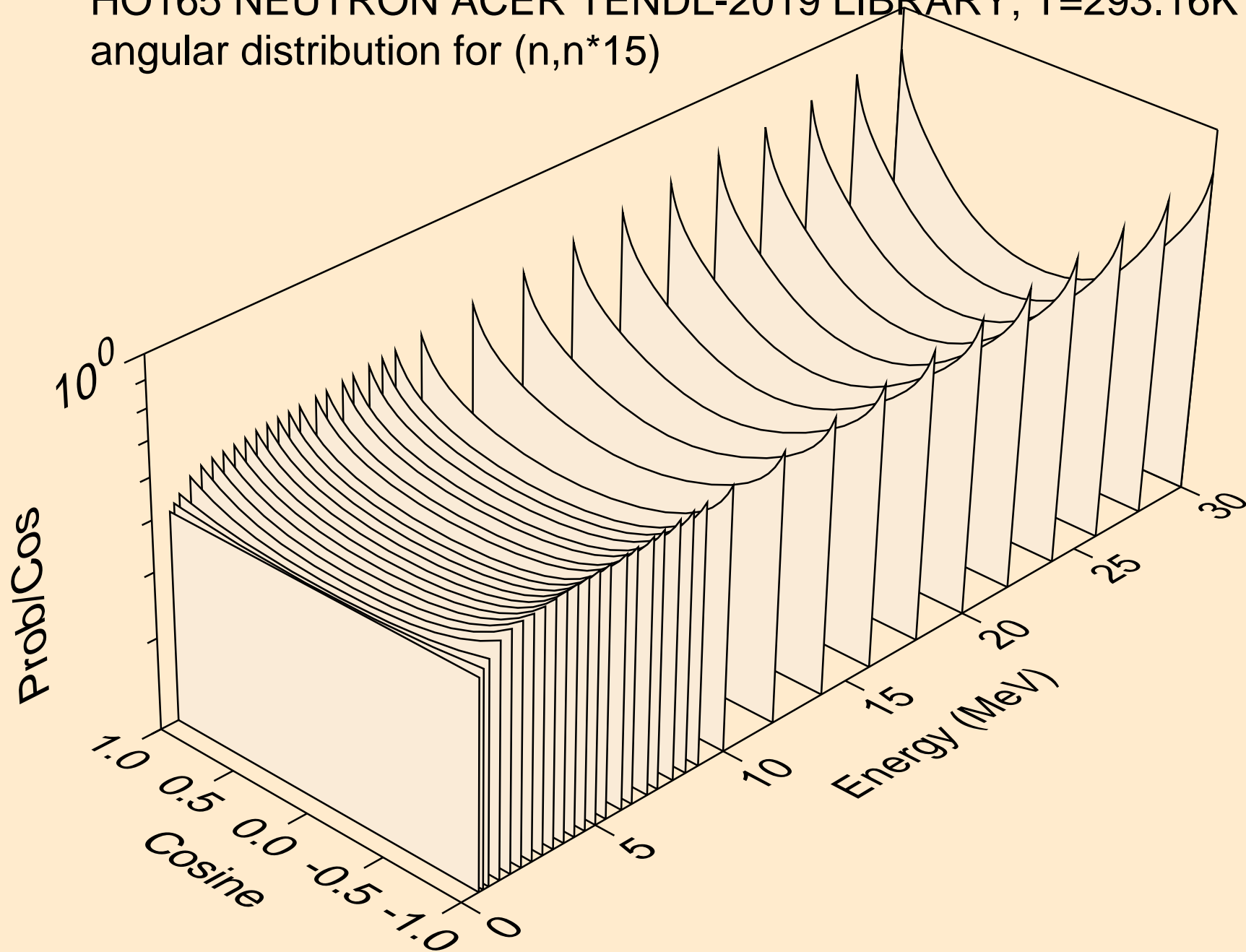

HO165 NEUTRON ACER TENDL-2019 LIBRARY; T=293.16K
angular distribution for (n,n*16)

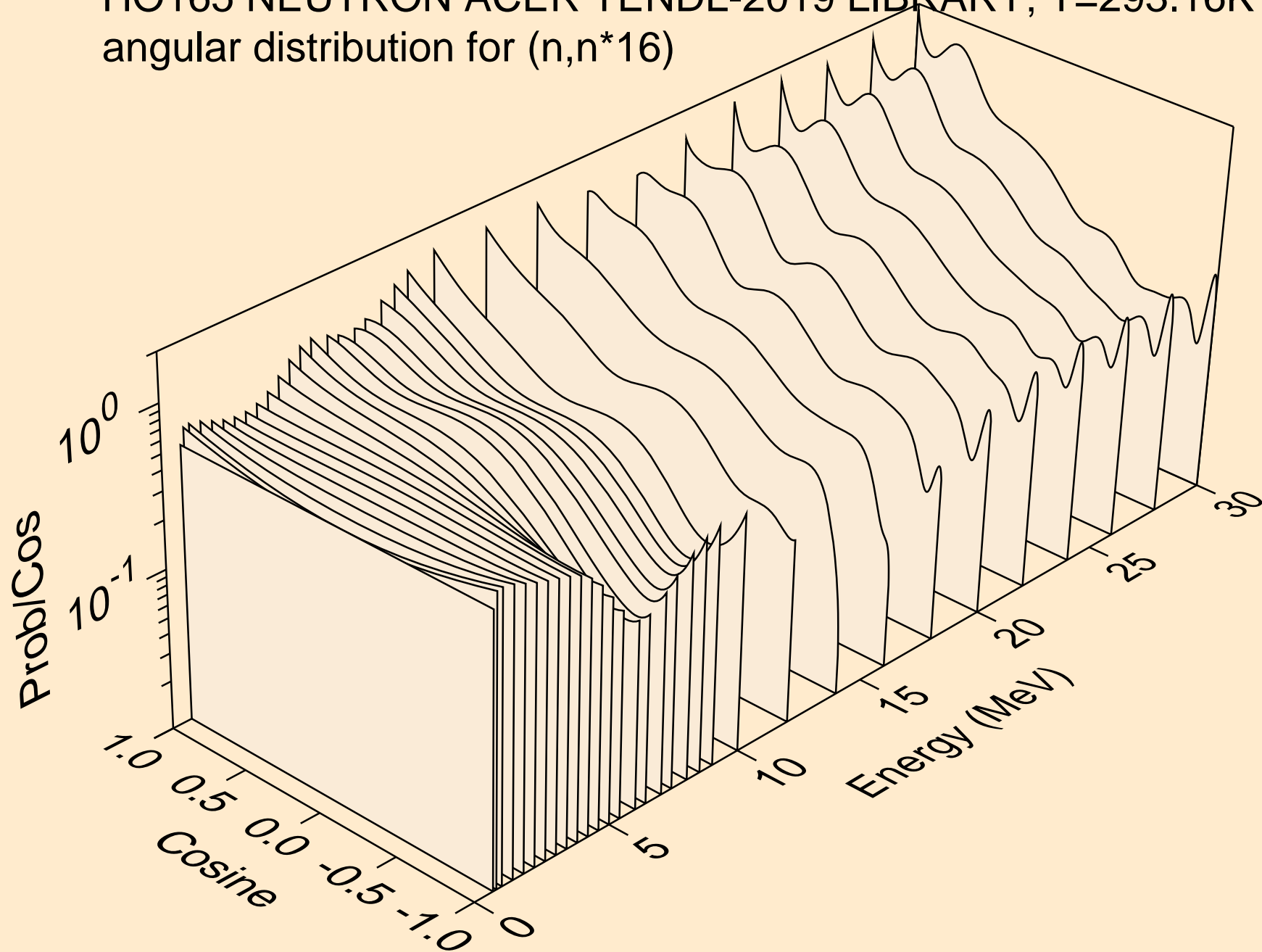

HO165 NEUTRON ACER TENDL-2019 LIBRARY; T=293.16K
angular distribution for (n,n*17)

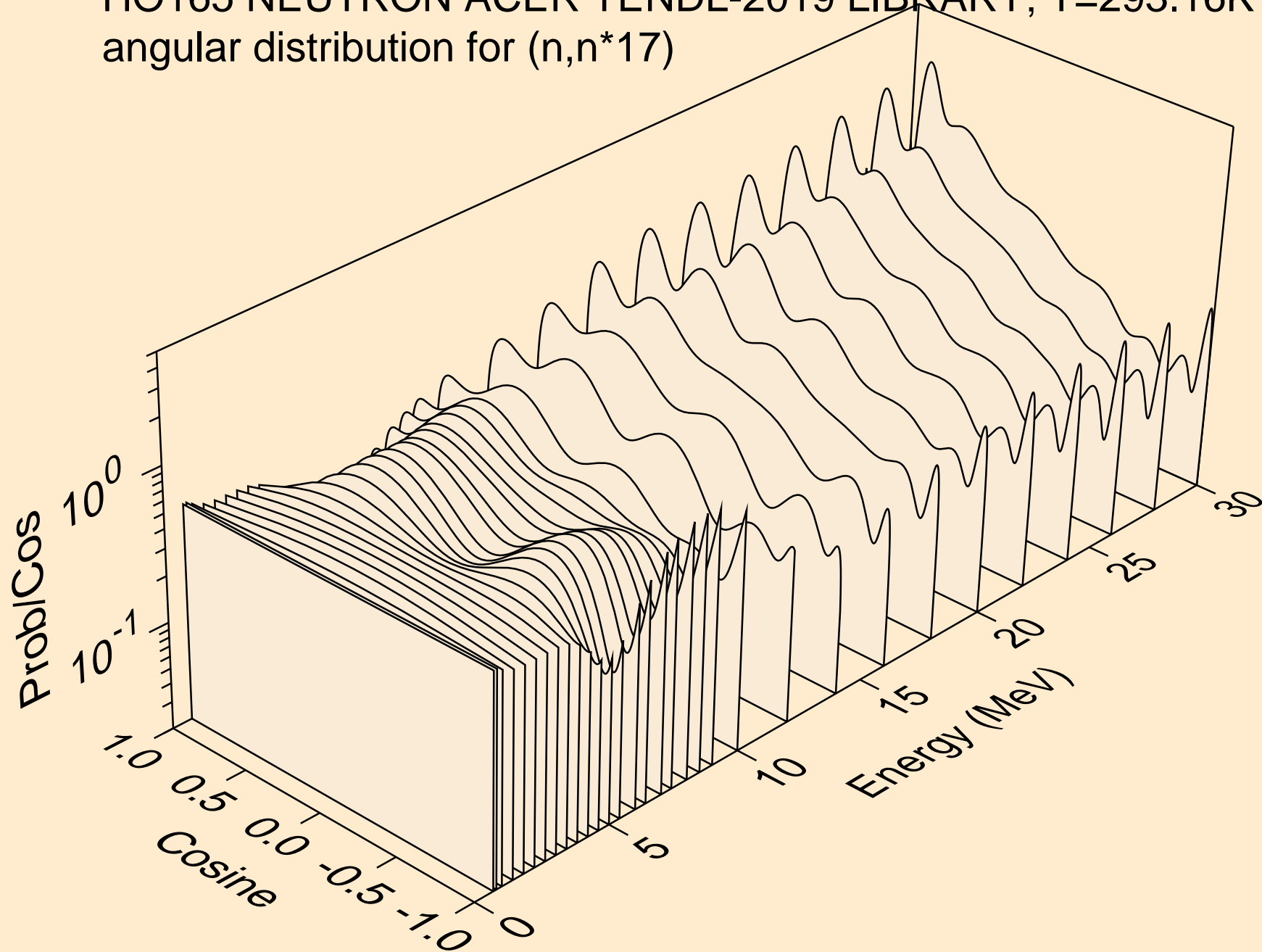

HO165 NEUTRON ACER TENDL-2019 LIBRARY; T=293.16K
angular distribution for (n,n*18)

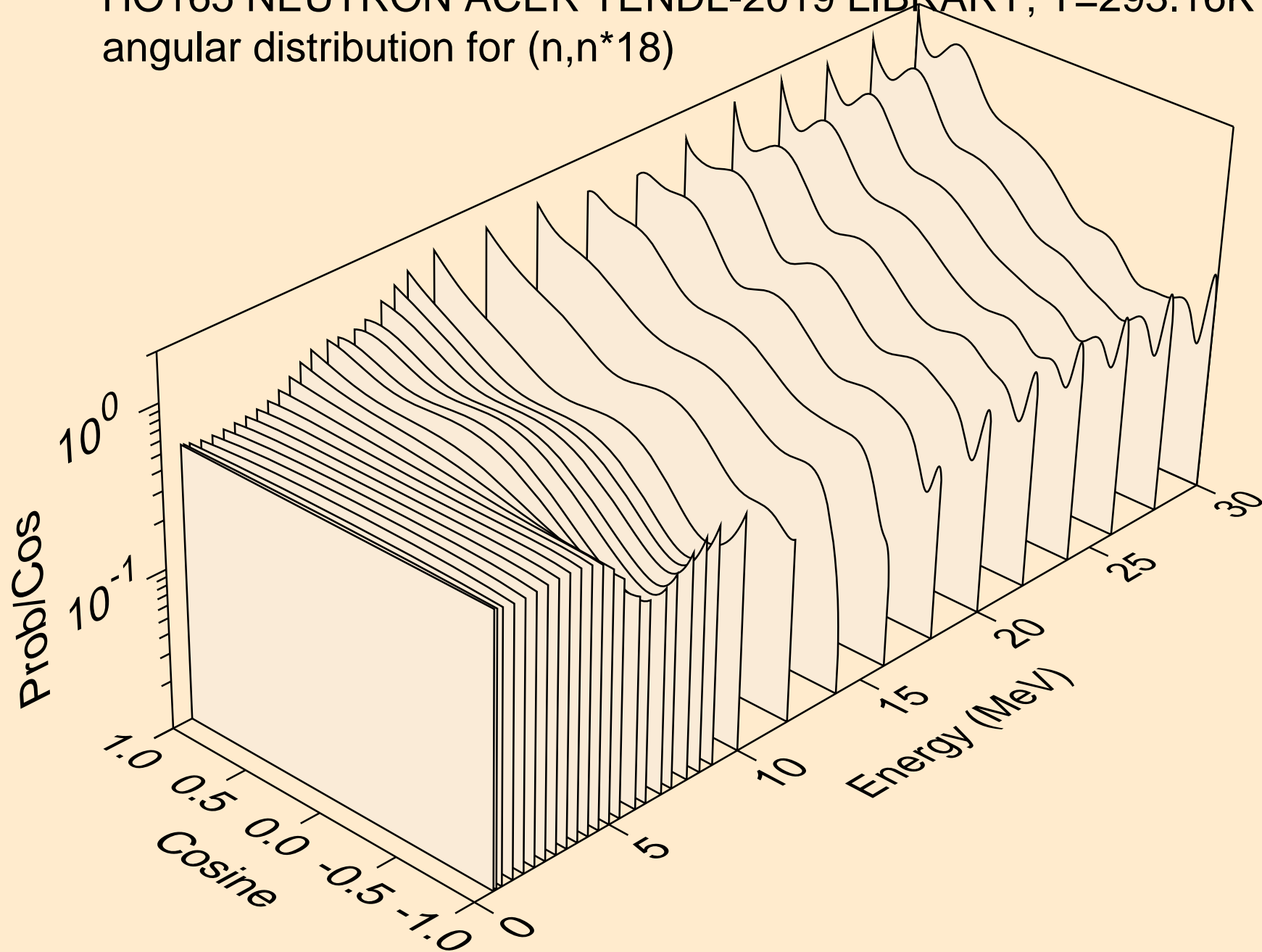

HO165 NEUTRON ACER TENDL-2019 LIBRARY; T=293.16K
angular distribution for (n,n*19)

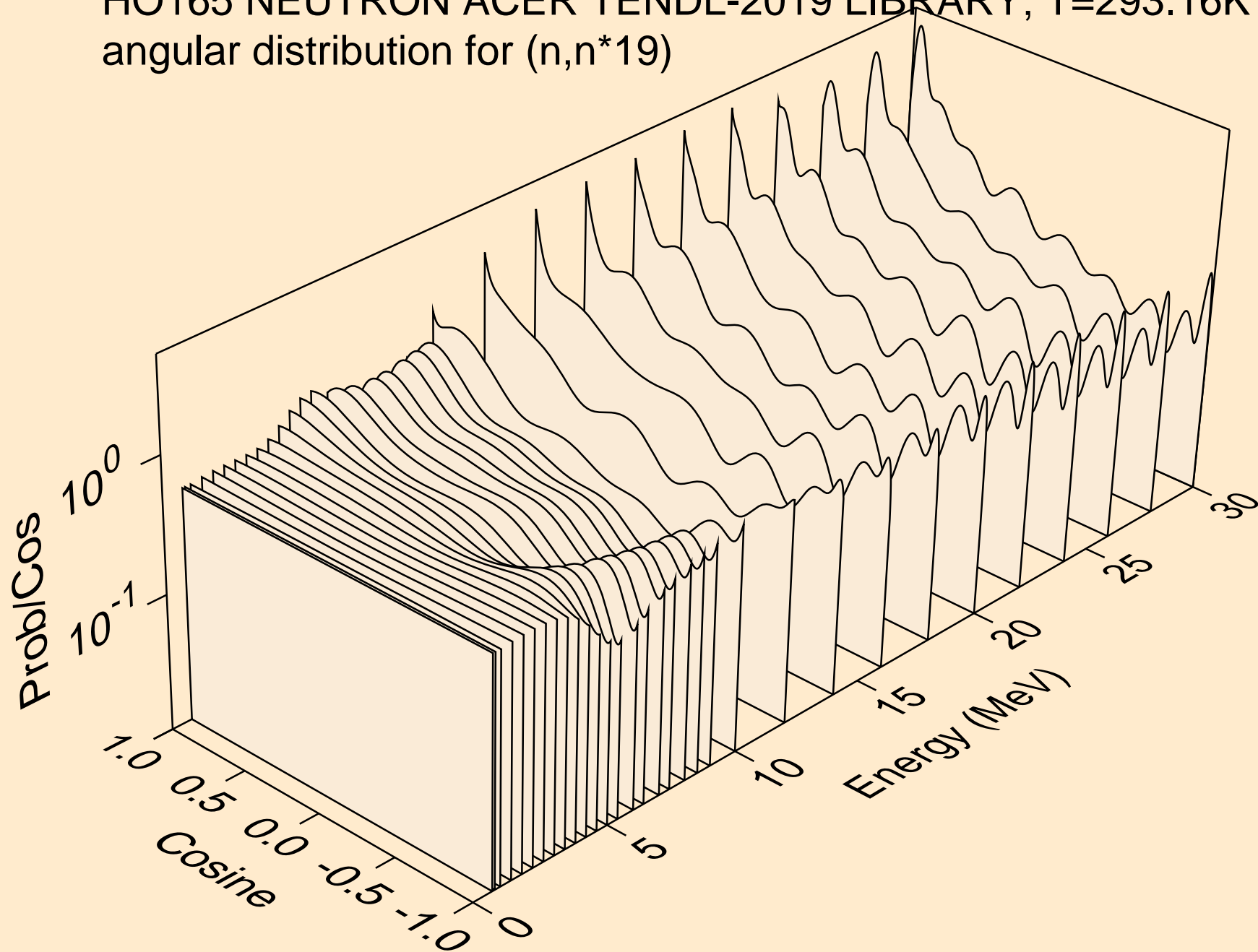

HO165 NEUTRON ACER TENDL-2019 LIBRARY; T=293.16K
angular distribution for (n,n*20)

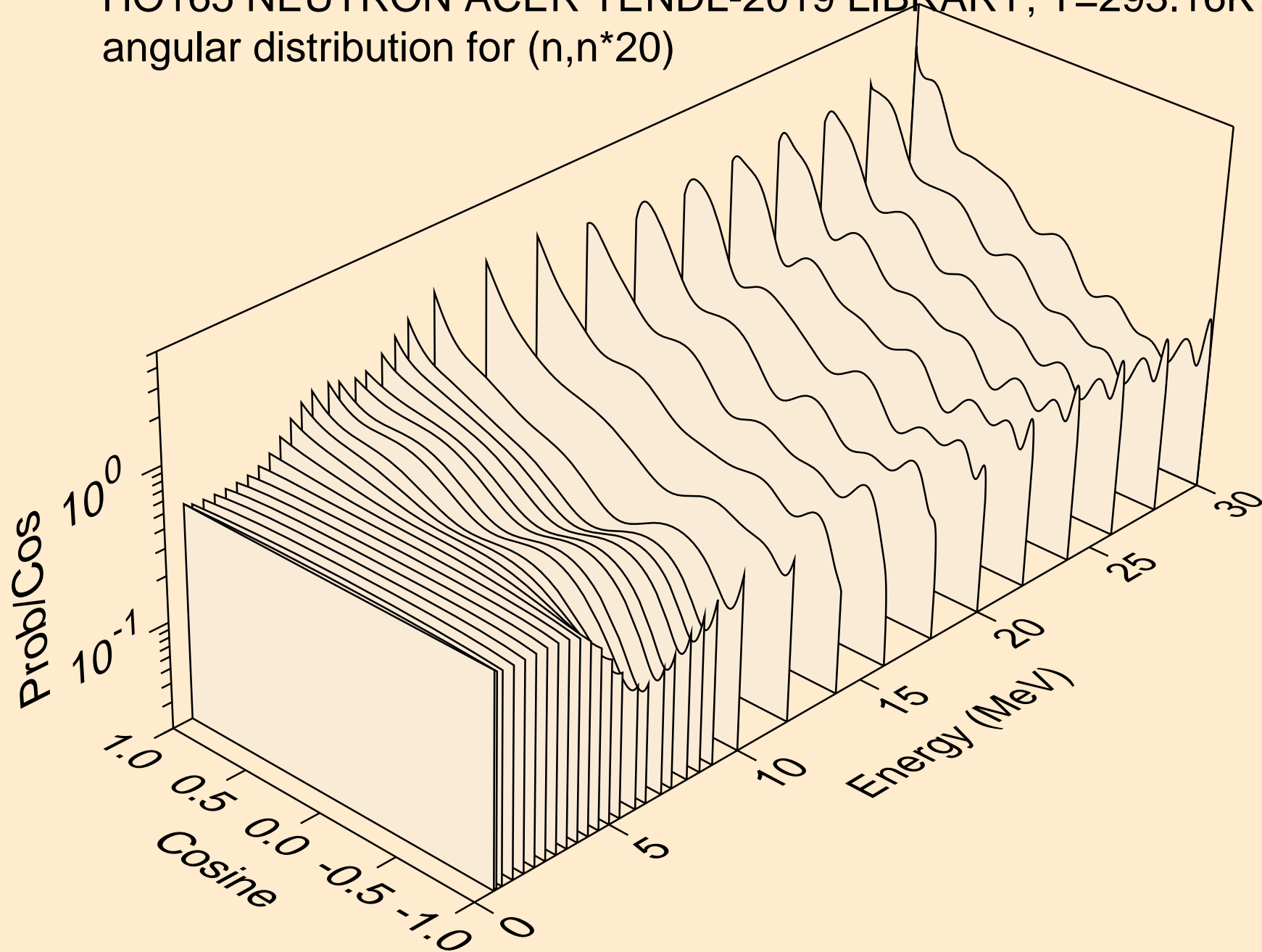

HO165 NEUTRON ACER TENDL-2019 LIBRARY; T=293.16K
angular distribution for (n,n*21)

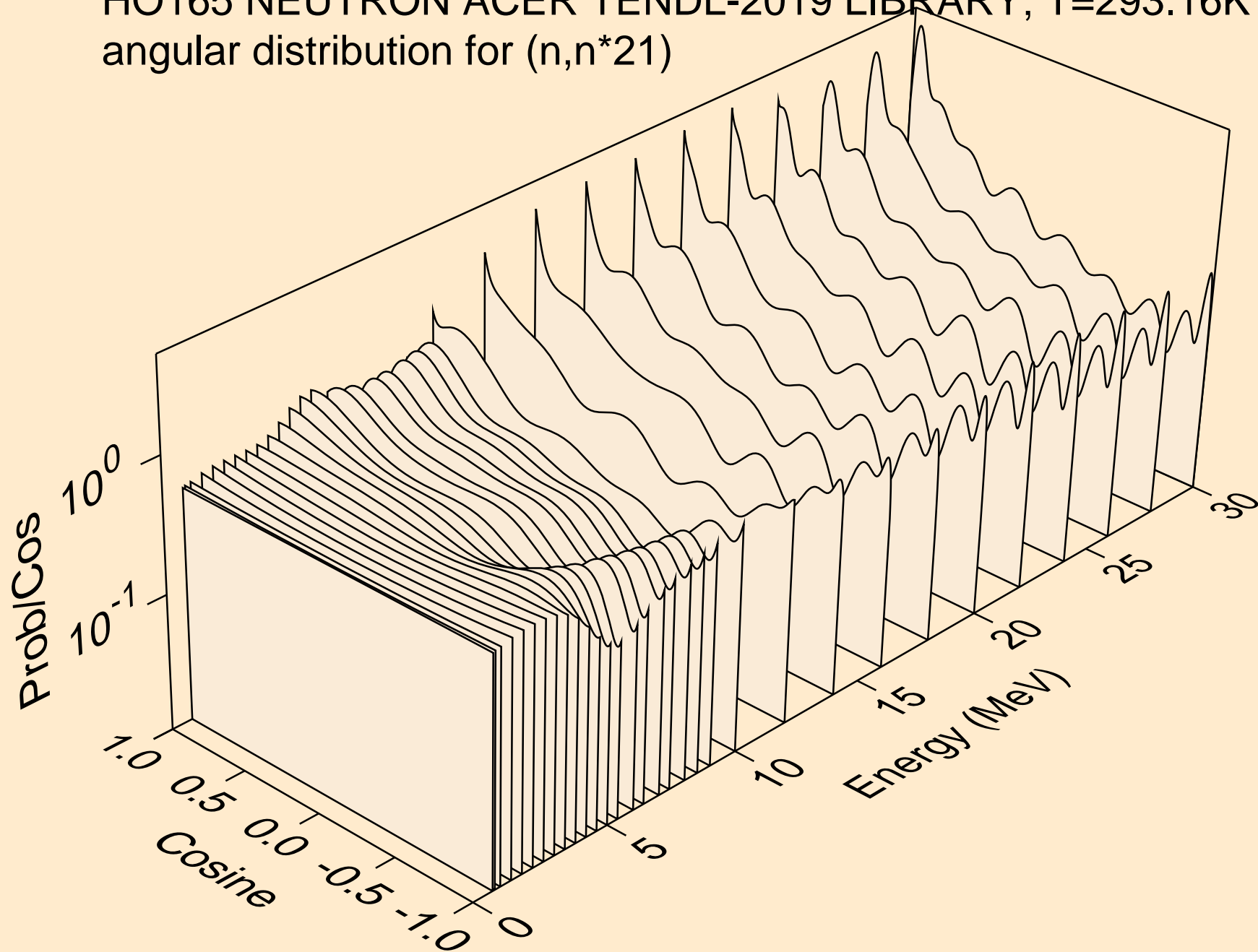

HO165 NEUTRON ACER TENDL-2019 LIBRARY; T=293.16K
angular distribution for (n,n*22)

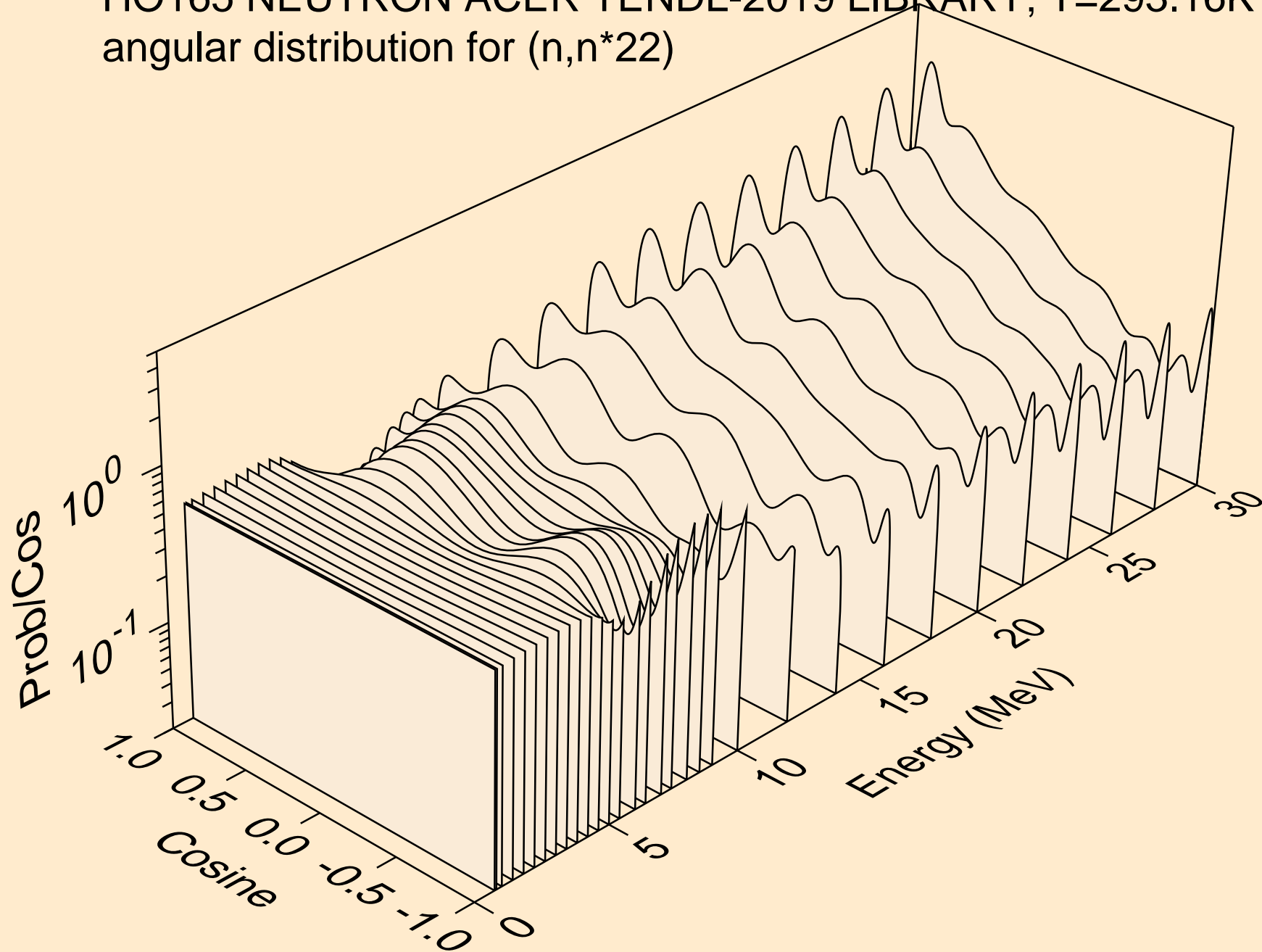

HO165 NEUTRON ACER TENDL-2019 LIBRARY; T=293.16K
angular distribution for (n,n*23)

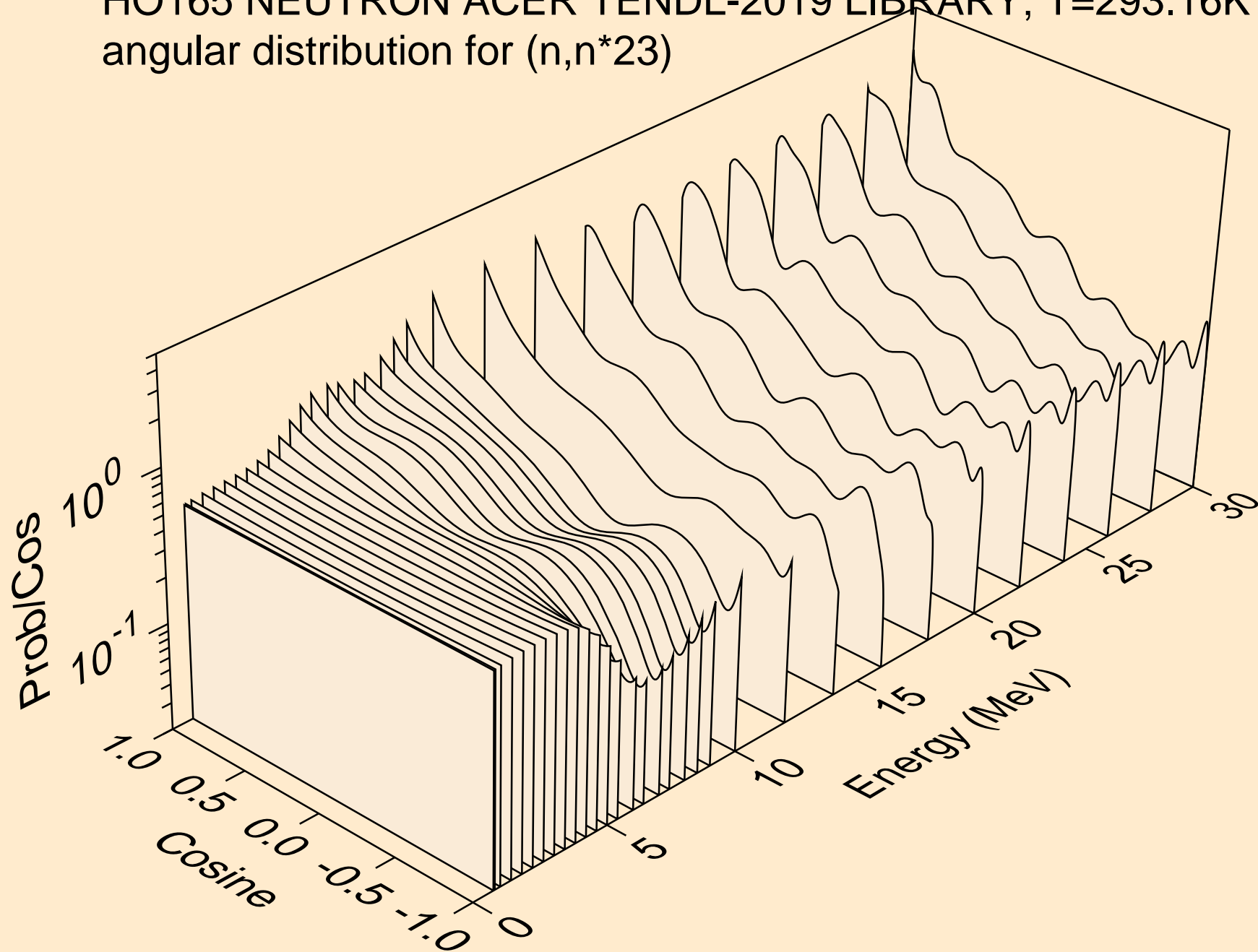

HO165 NEUTRON ACER TENDL-2019 LIBRARY; T=293.16K
angular distribution for (n,n*24)

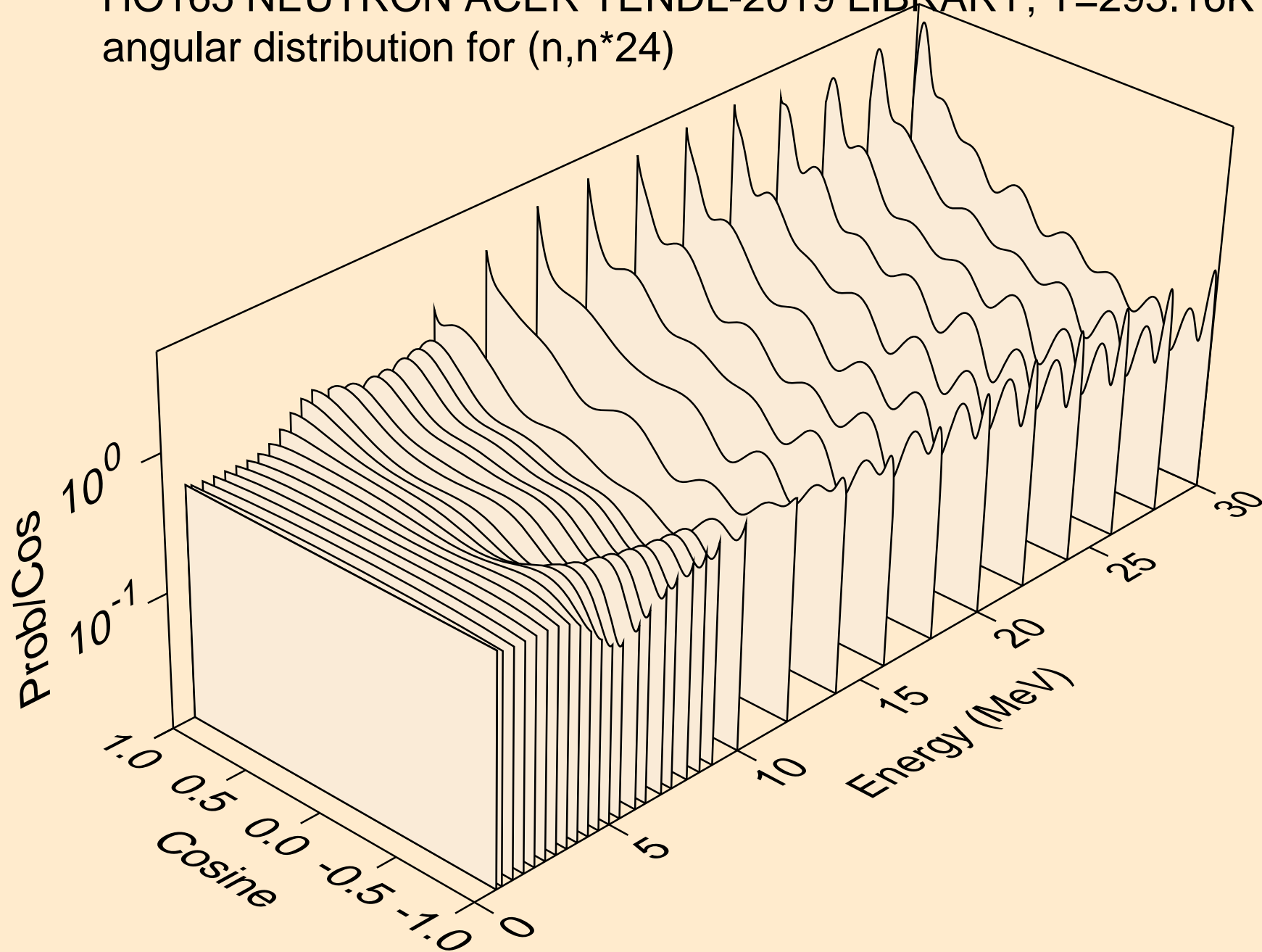

HO165 NEUTRON ACER TENDL-2019 LIBRARY; T=293.16K
angular distribution for (n,n*25)

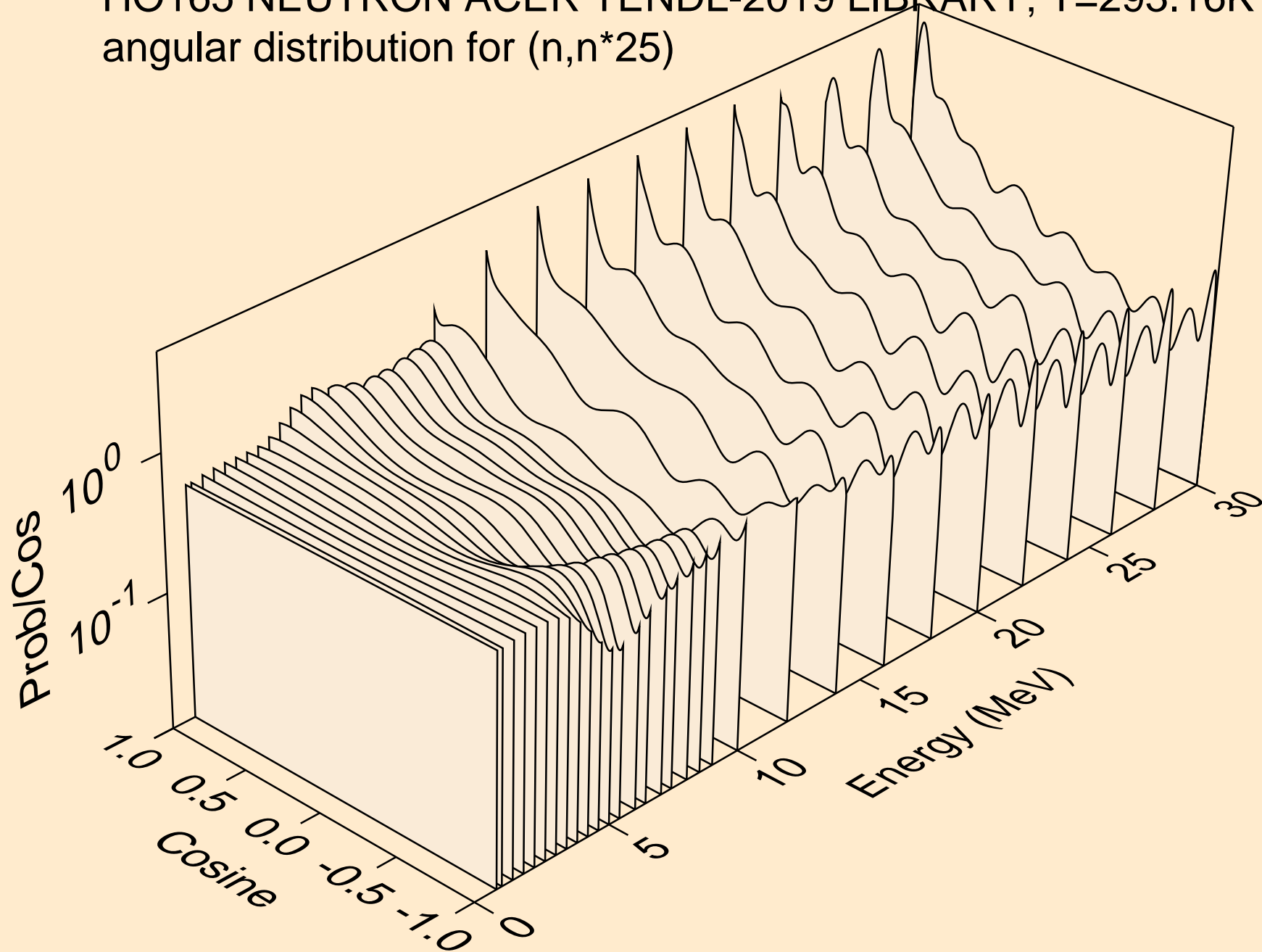

HO165 NEUTRON ACER TENDL-2019 LIBRARY; T=293.16K
angular distribution for (n,n*26)

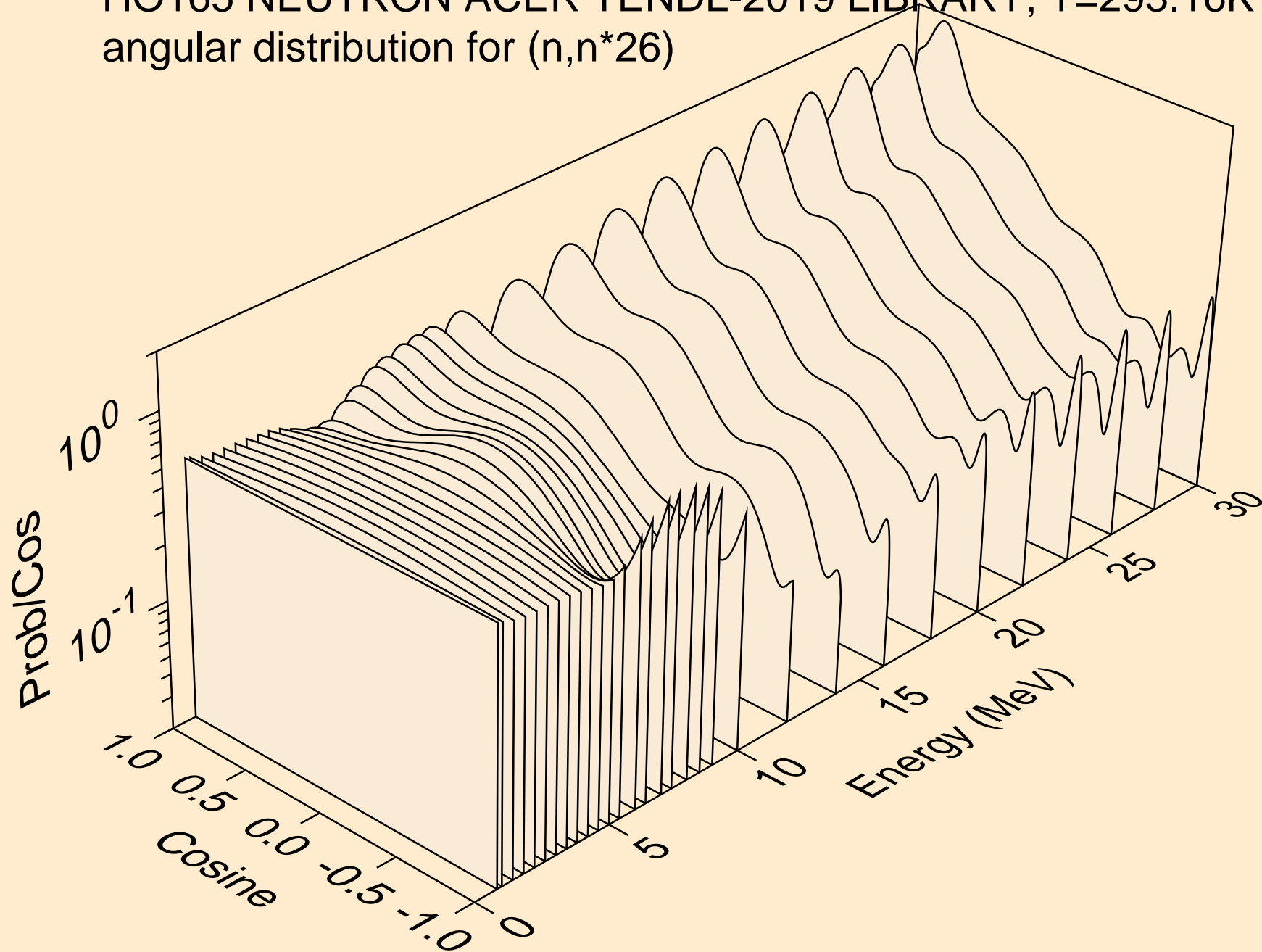

HO165 NEUTRON ACER TENDL-2019 LIBRARY; T=293.16K
angular distribution for (n,n*27)

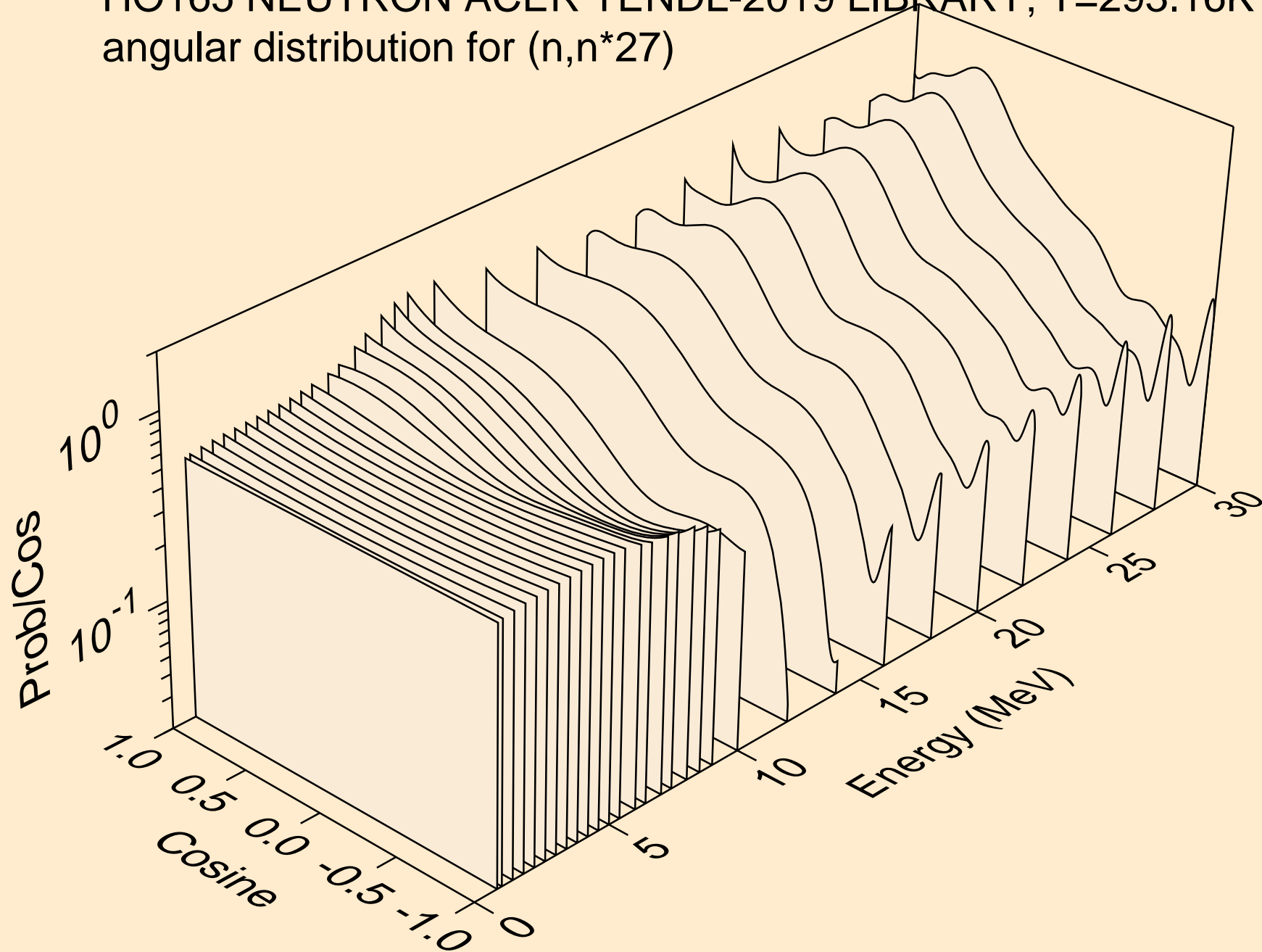

HO165 NEUTRON ACER TENDL-2019 LIBRARY; T=293.16K
angular distribution for (n,n*28)

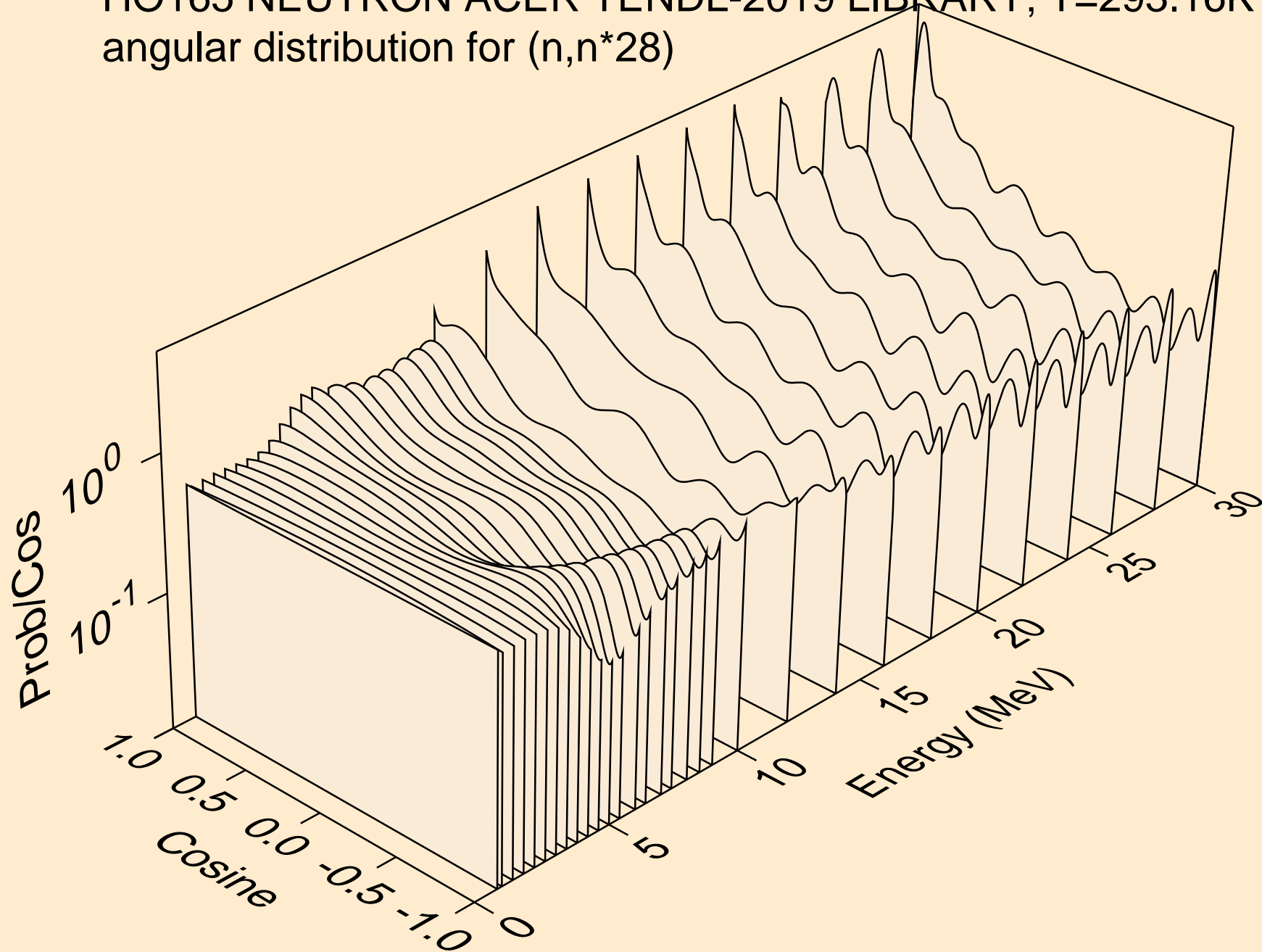

HO165 NEUTRON ACER TENDL-2019 LIBRARY; T=293.16K
angular distribution for (n,n*29)

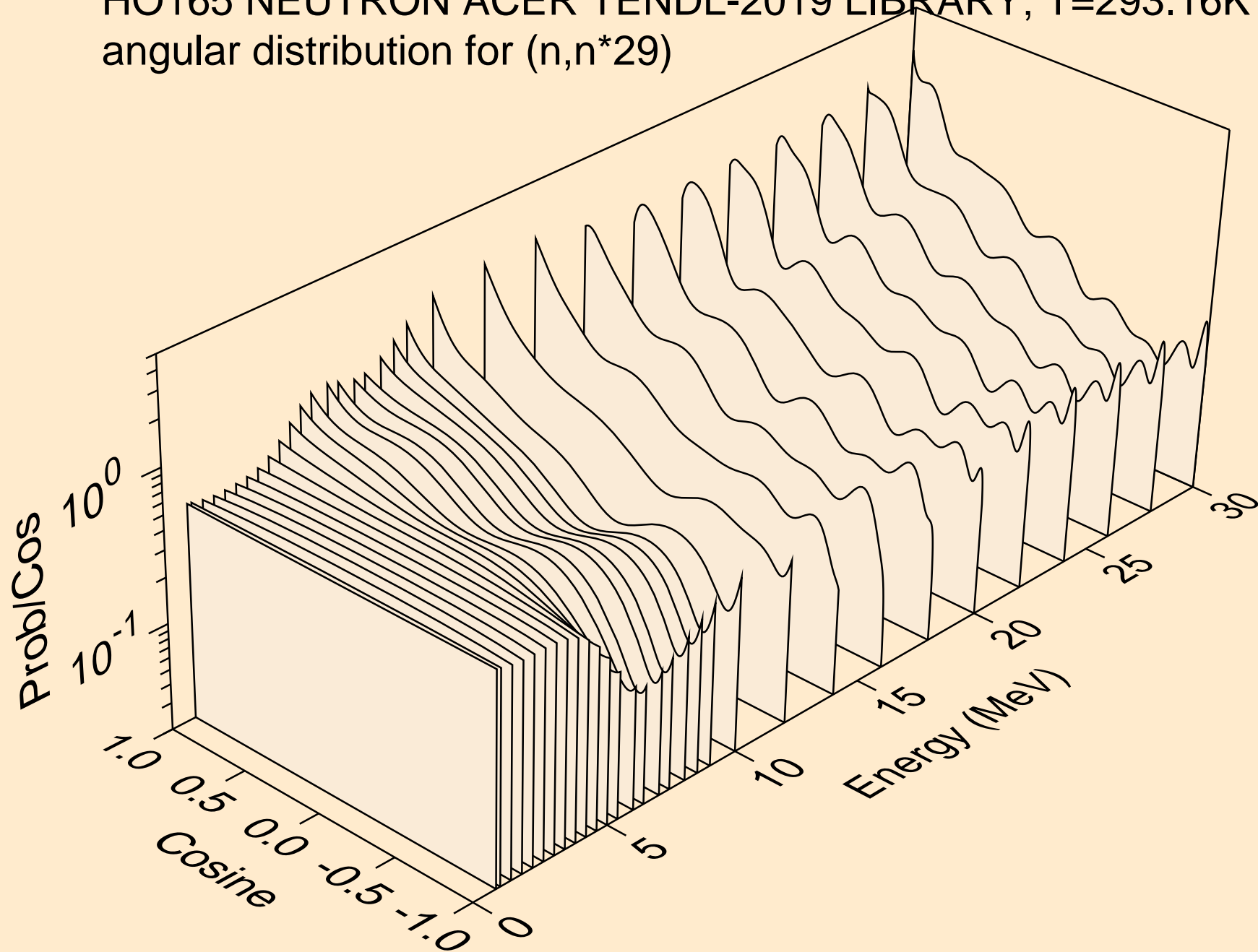

HO165 NEUTRON ACER TENDL-2019 LIBRARY; T=293.16K
Neutron emission for (n,x)

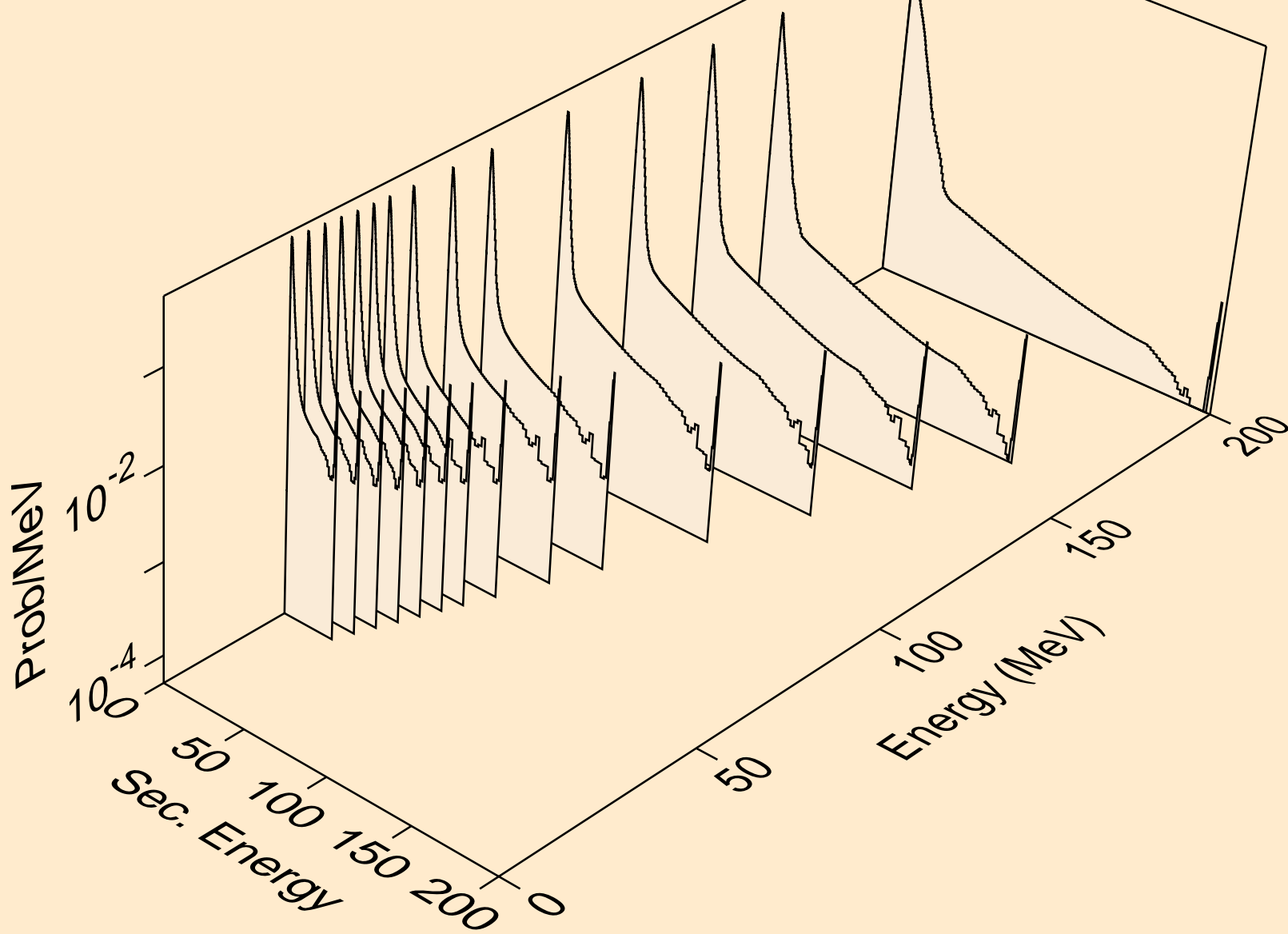

HO165 NEUTRON ACER TENDL-2019 LIBRARY; T=293.16K
Neutron emission for (n,2nd)

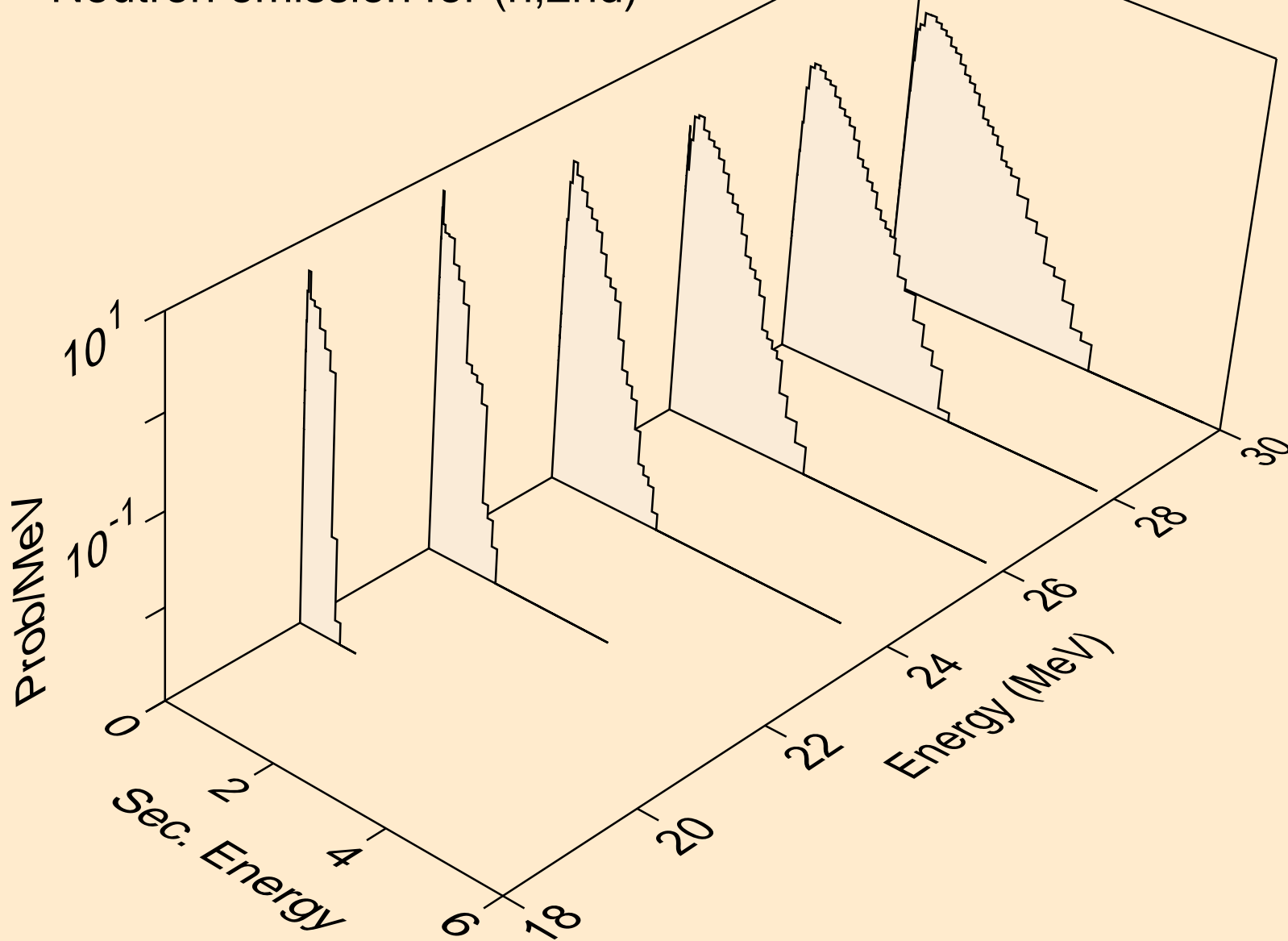

HO165 NEUTRON ACER TENDL-2019 LIBRARY; T=293.16K
Neutron emission for (n,2n)

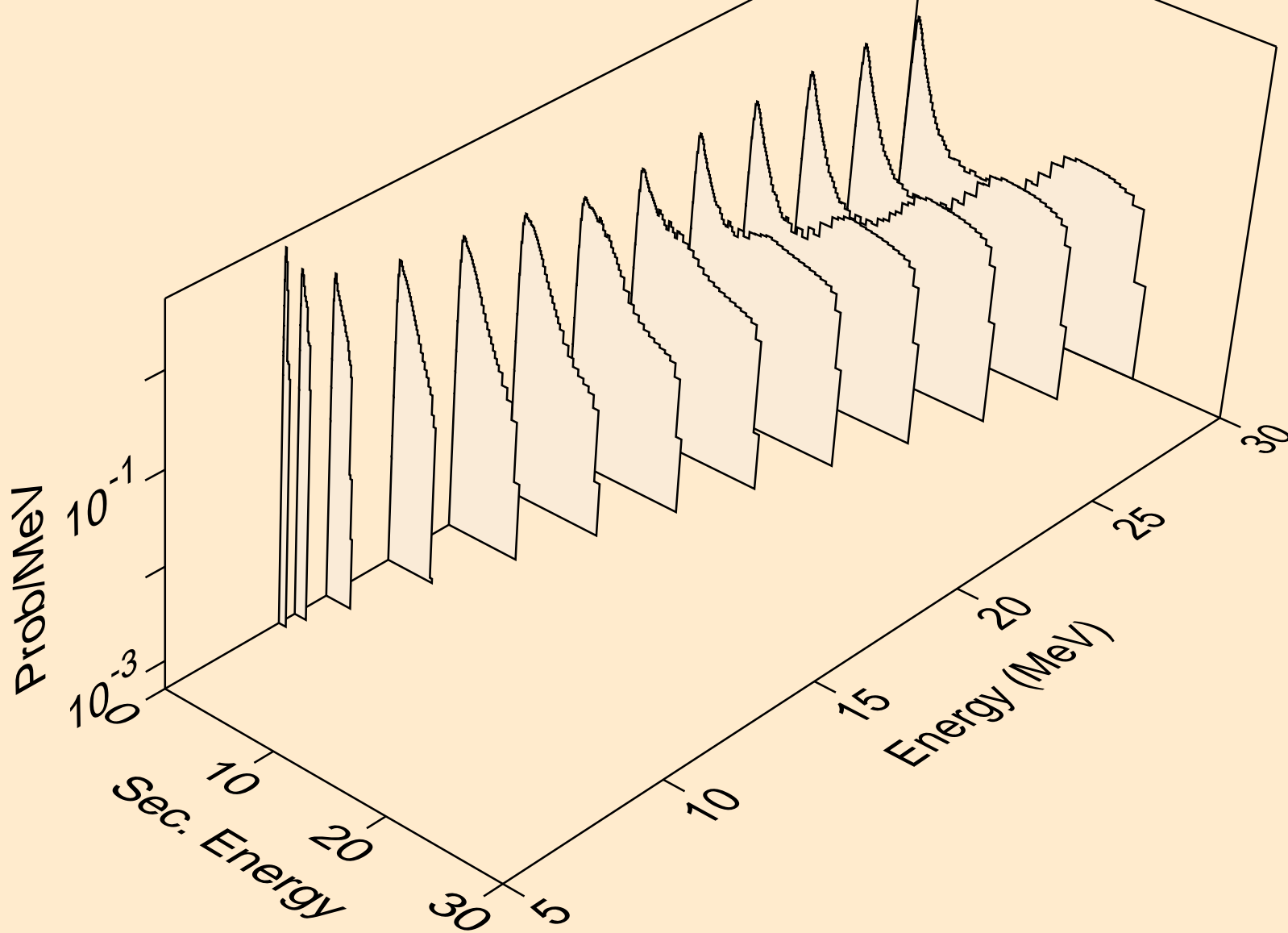

HO165 NEUTRON ACER TENDL-2019 LIBRARY; T=293.16K
Neutron emission for (n,3n)

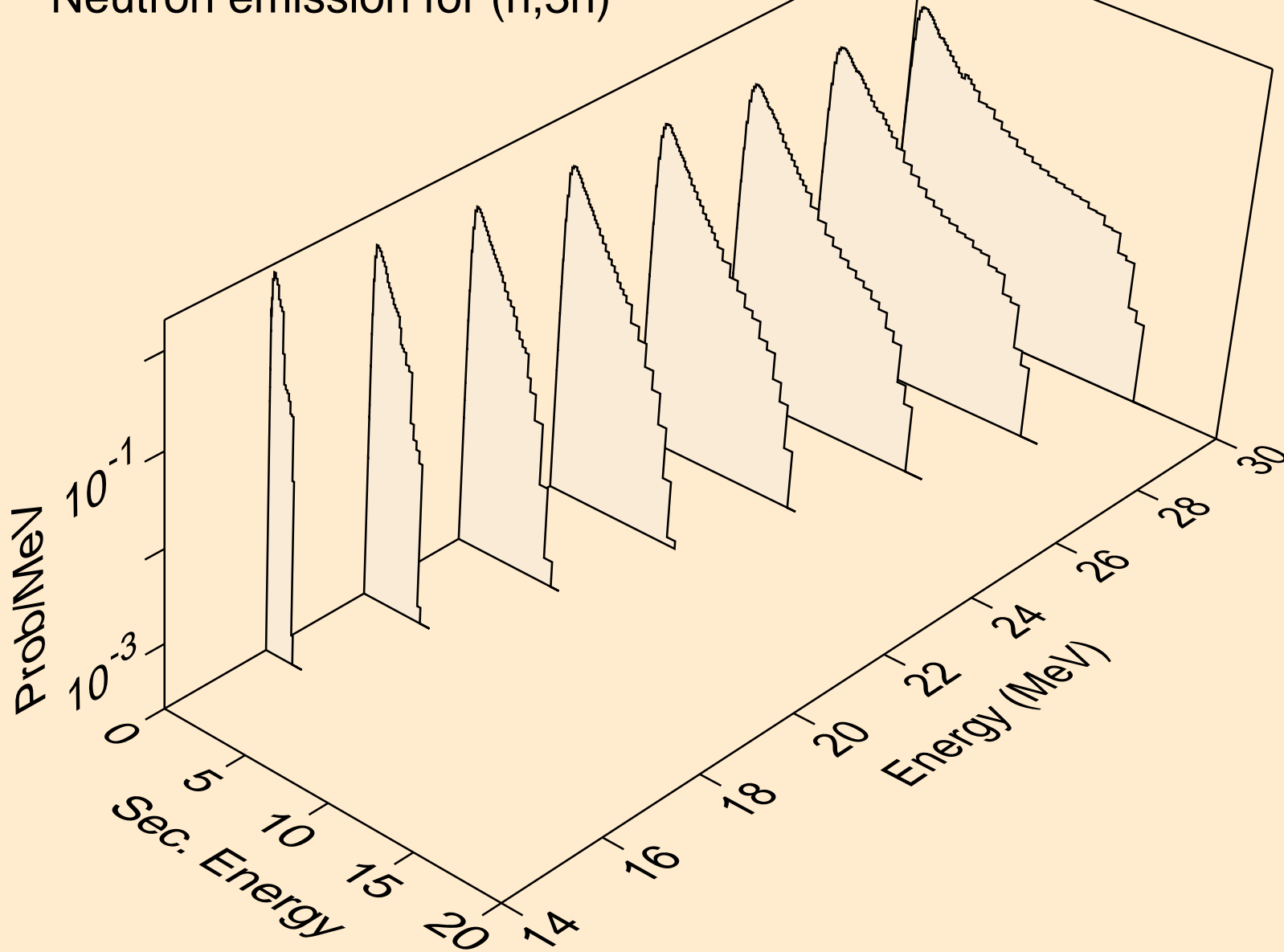

HO165 NEUTRON ACER TENDL-2019 LIBRARY; T=293.16K
Neutron emission for (n,n*)a

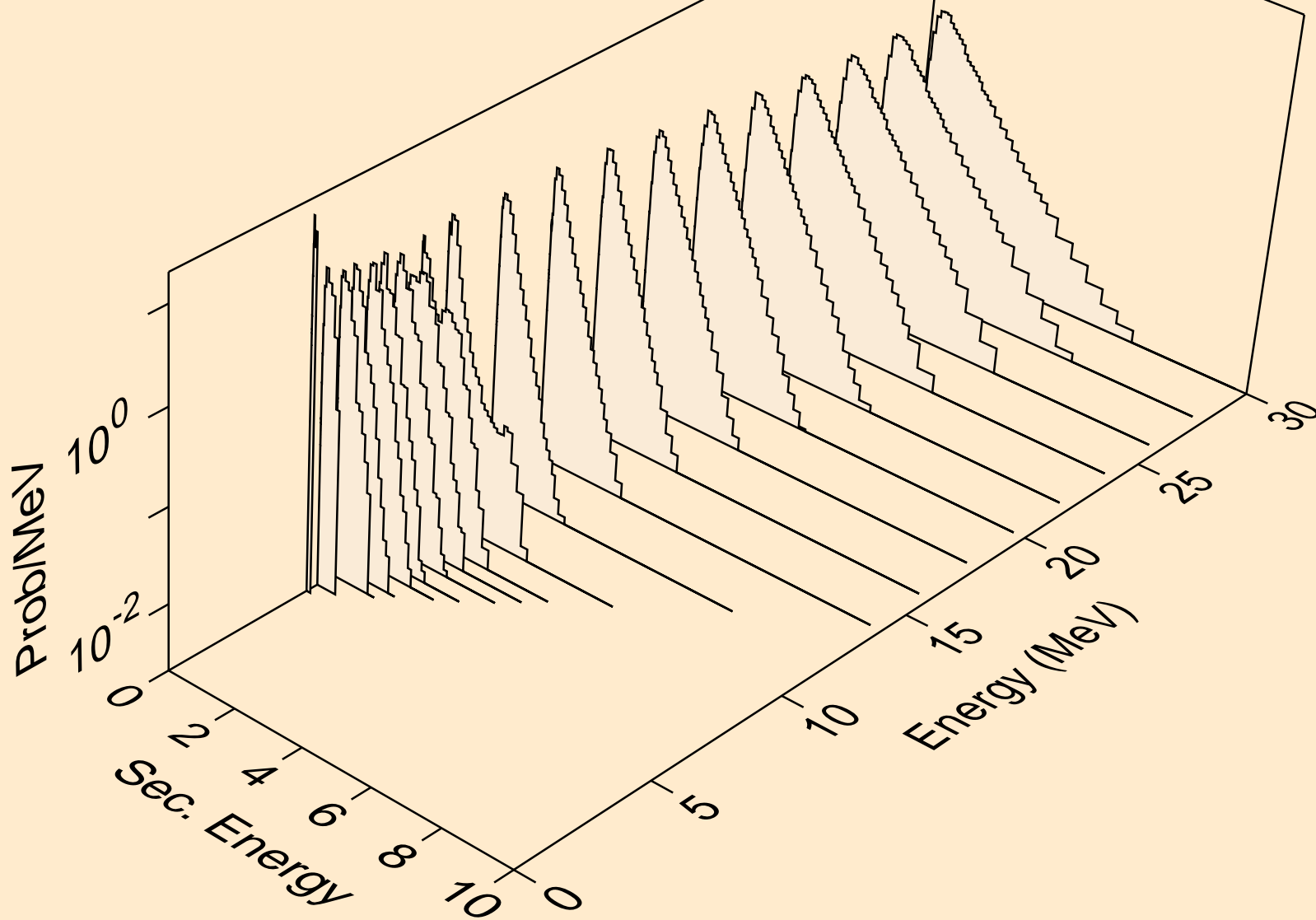

HO165 NEUTRON ACER TENDL-2019 LIBRARY; T=293.16K
Neutron emission for (n,2n)a

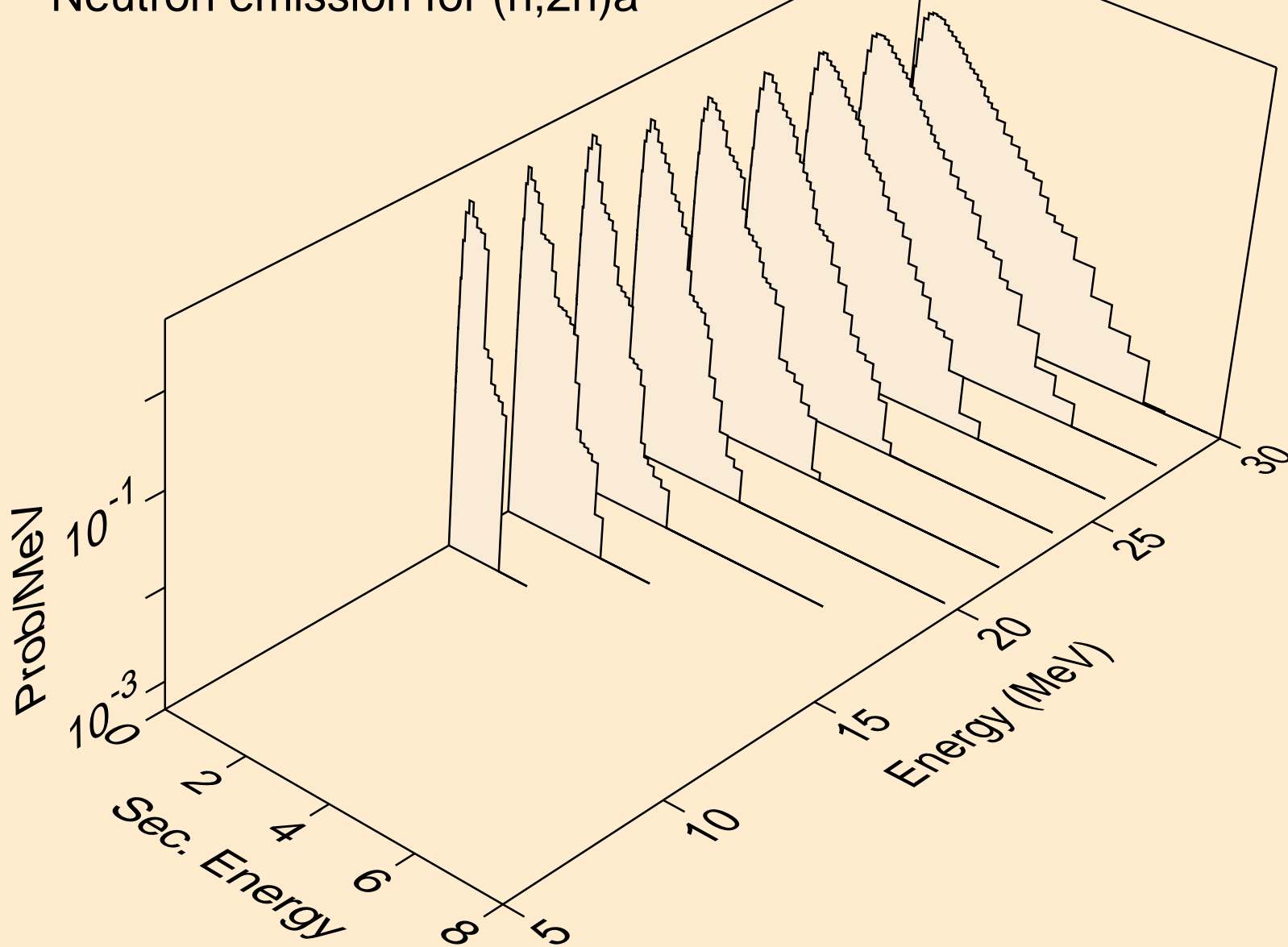

HO165 NEUTRON ACER TENDL-2019 LIBRARY; T=293.16K
Neutron emission for (n,3n)a

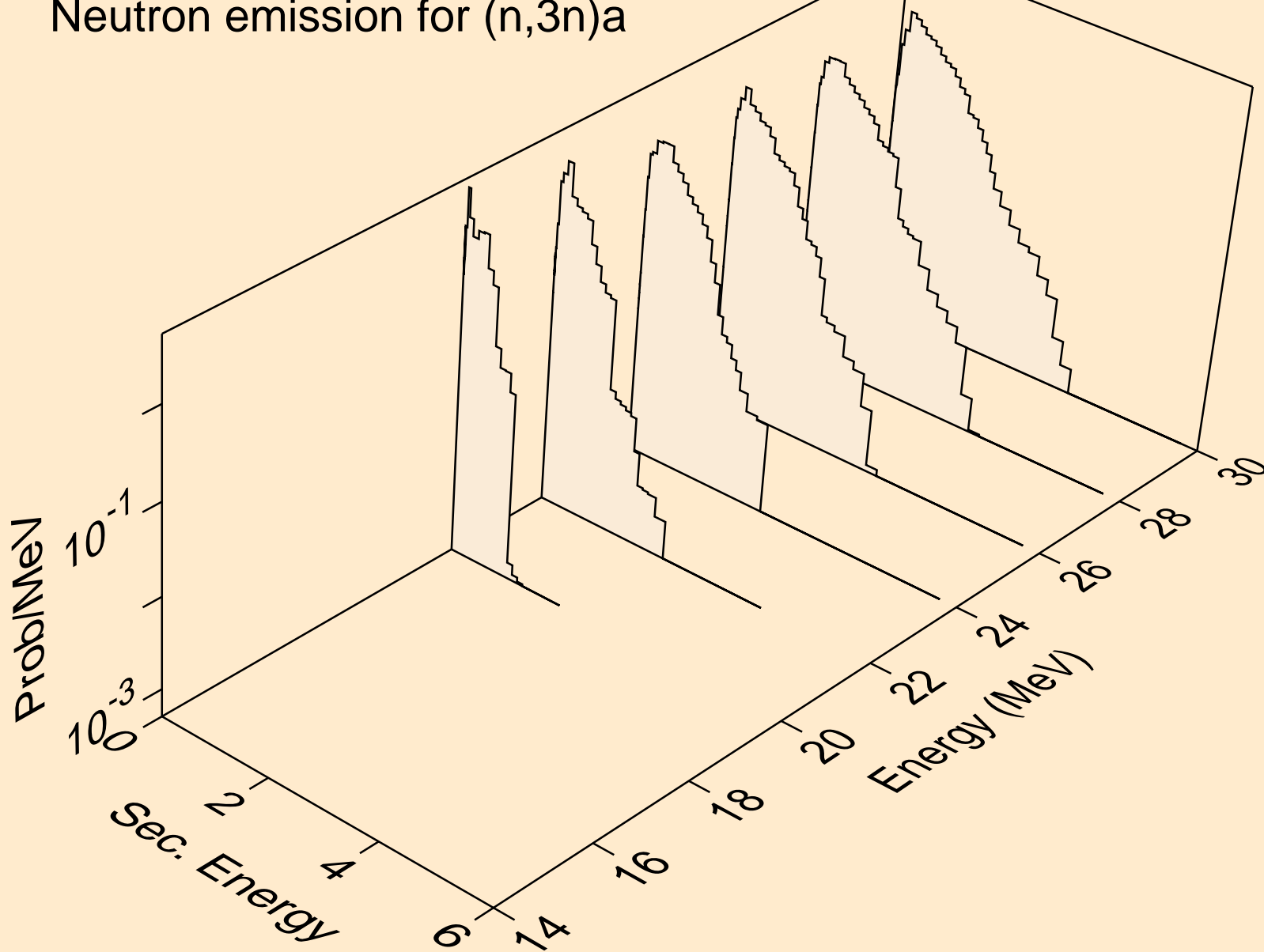

HO165 NEUTRON ACER TENDL-2019 LIBRARY; T=293.16K
Neutron emission for (n,n*)p

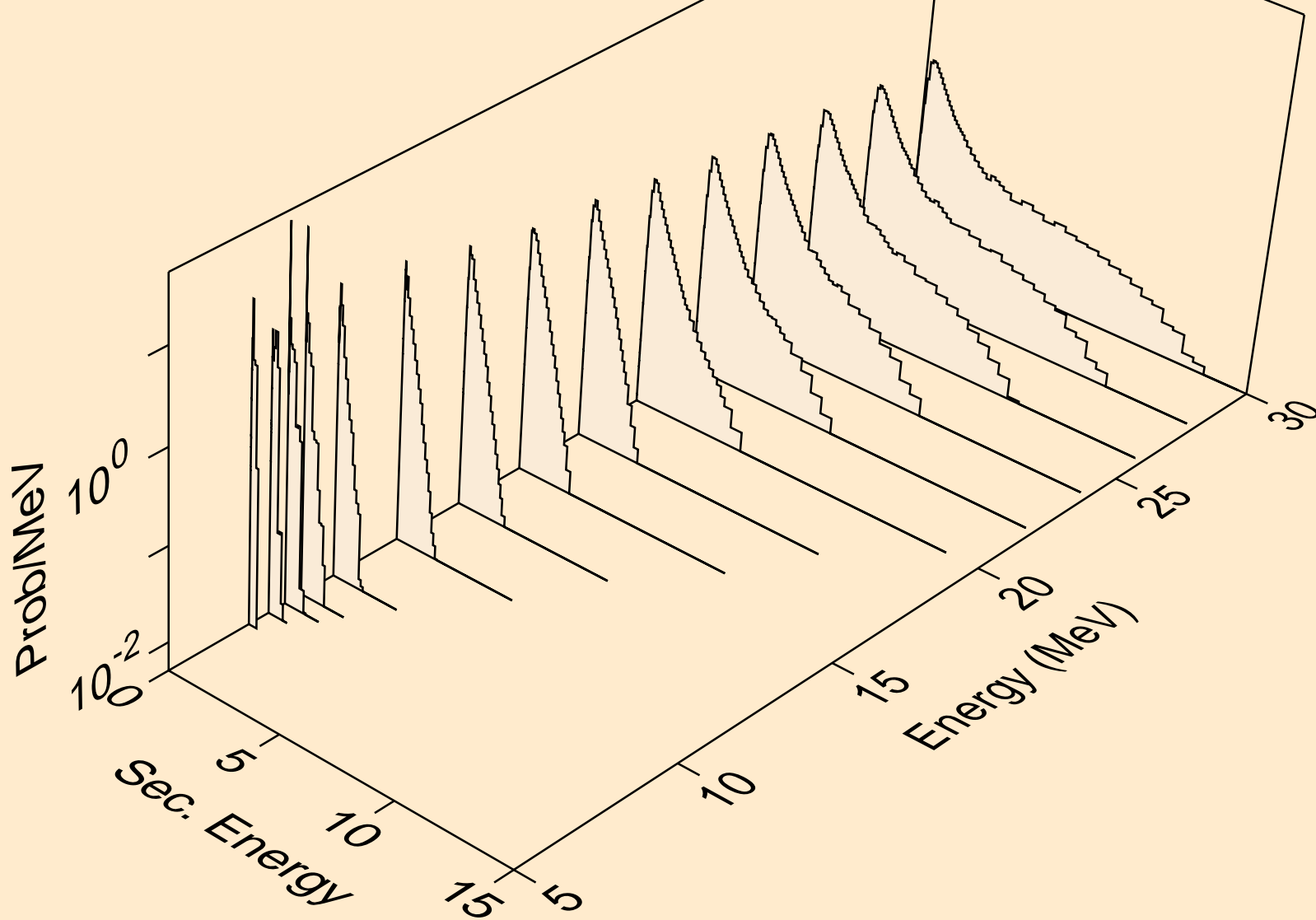

HO165 NEUTRON ACER TENDL-2019 LIBRARY; T=293.16K
Neutron emission for (n,n*)2a

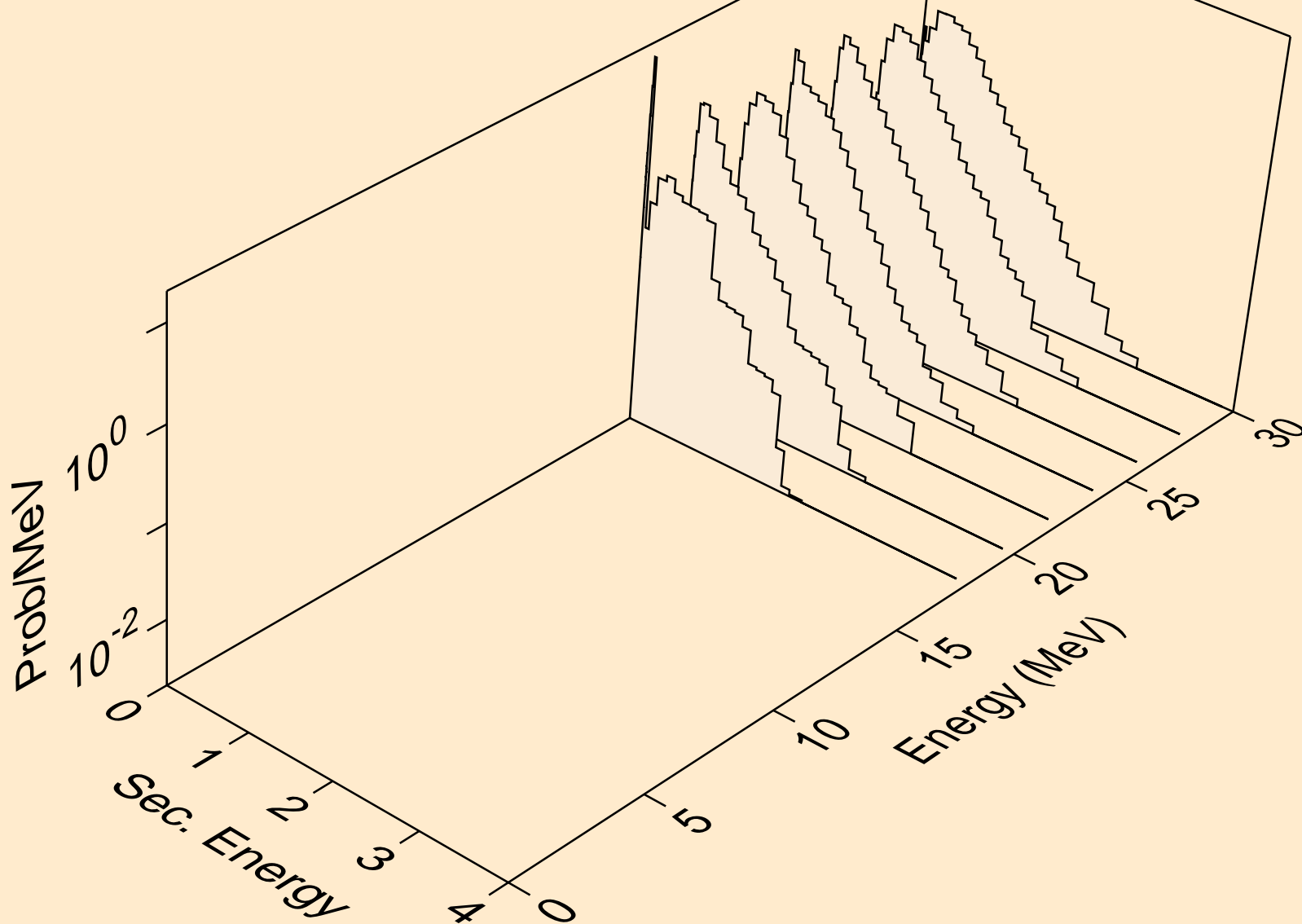

HO165 NEUTRON ACER TENDL-2019 LIBRARY; T=293.16K
Neutron emission for (n,n*)d

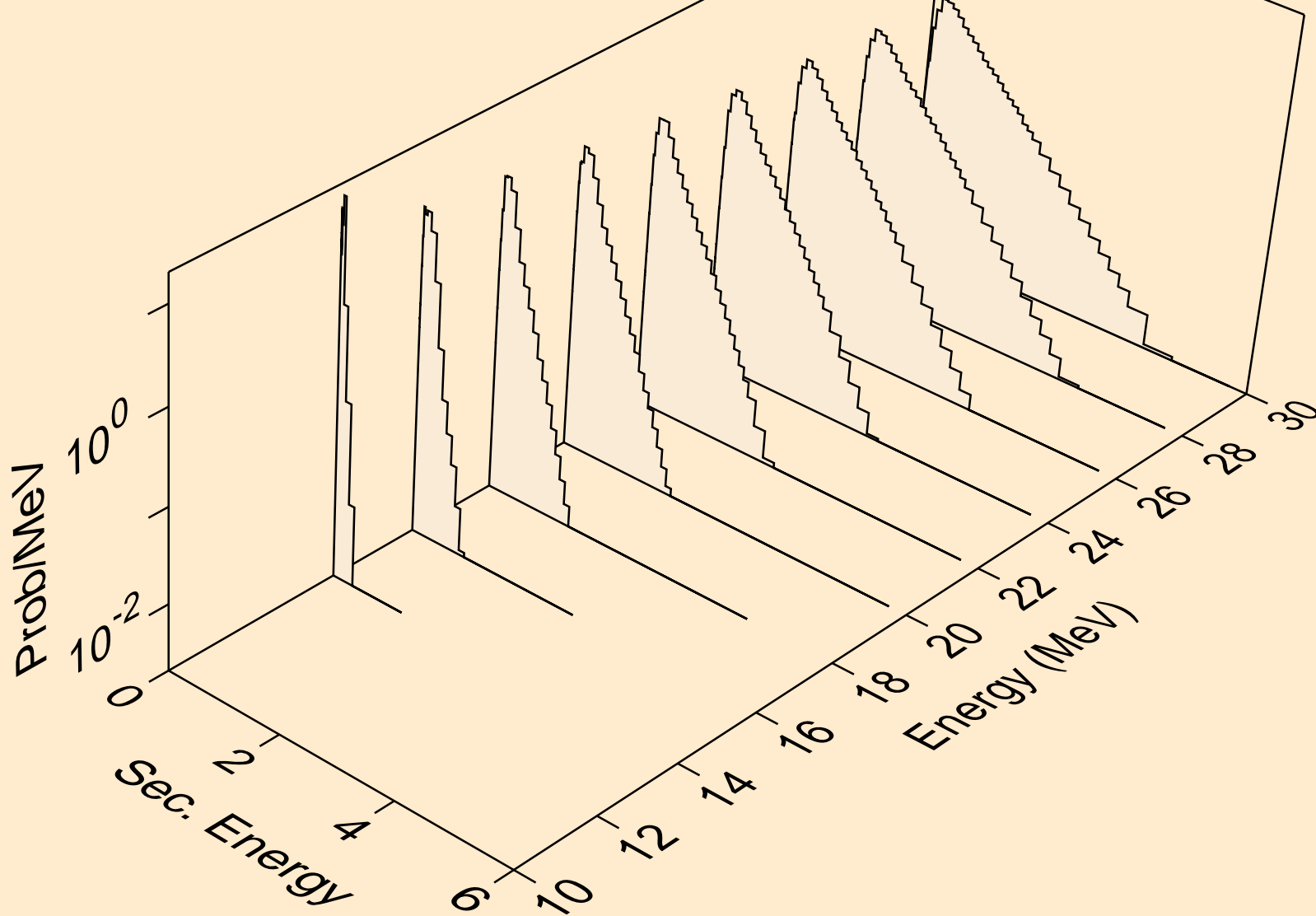

HO165 NEUTRON ACER TENDL-2019 LIBRARY; T=293.16K
Neutron emission for (n,n*)t

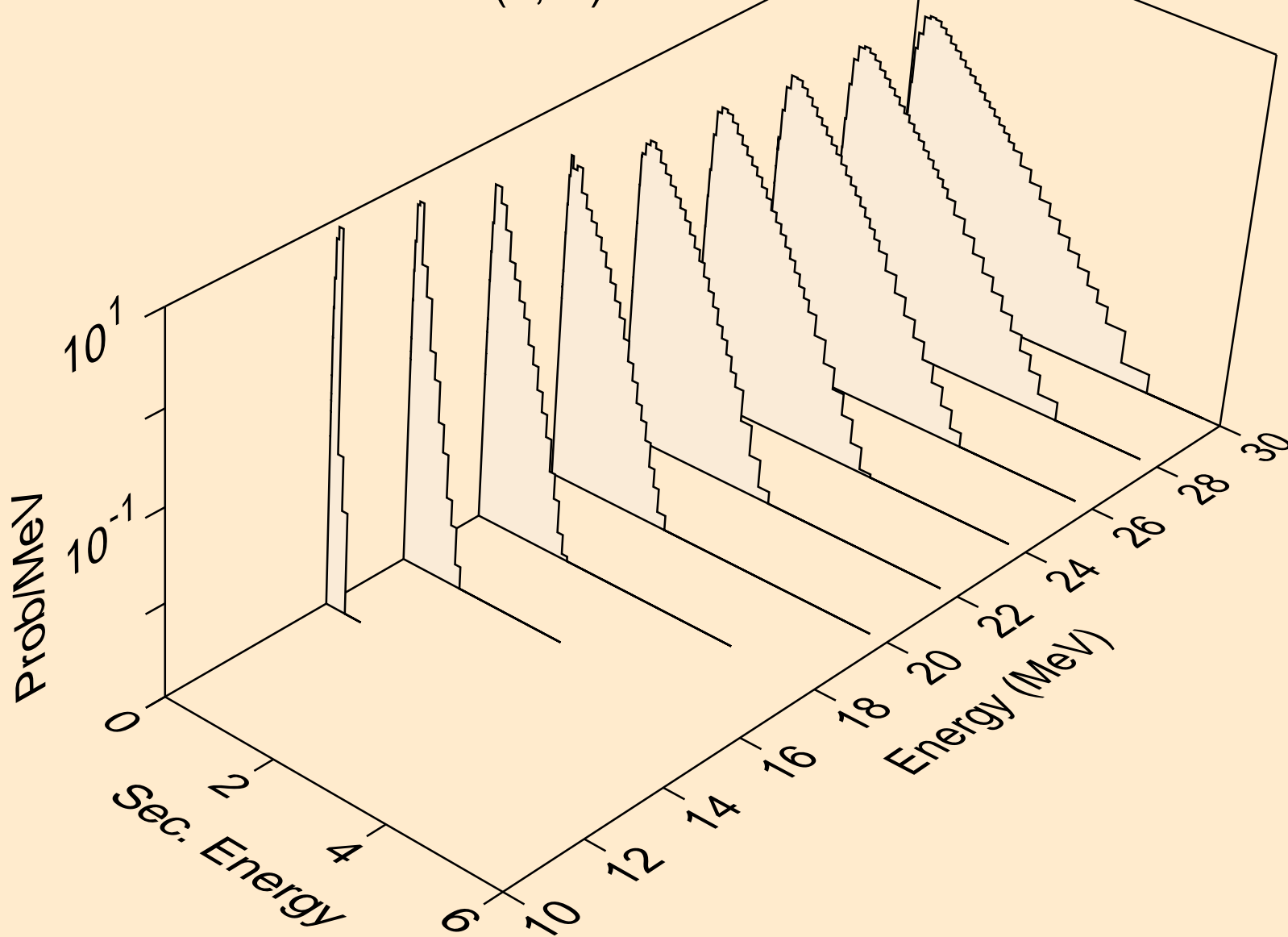

HO165 NEUTRON ACER TENDL-2019 LIBRARY; T=293.16K
Neutron emission for (n,n*)he3

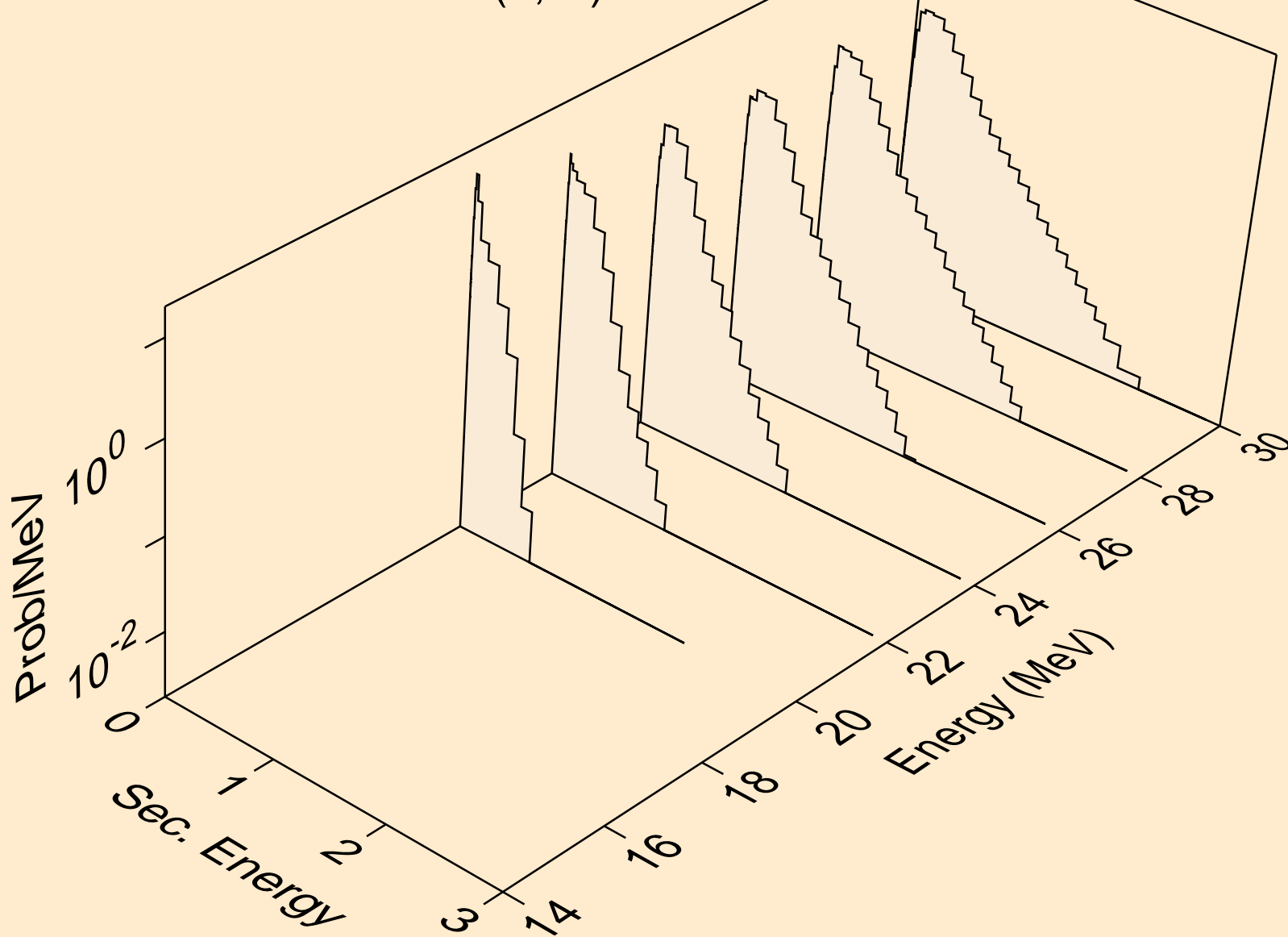

HO165 NEUTRON ACER TENDL-2019 LIBRARY; T=293.16K
Neutron emission for (n,4n)

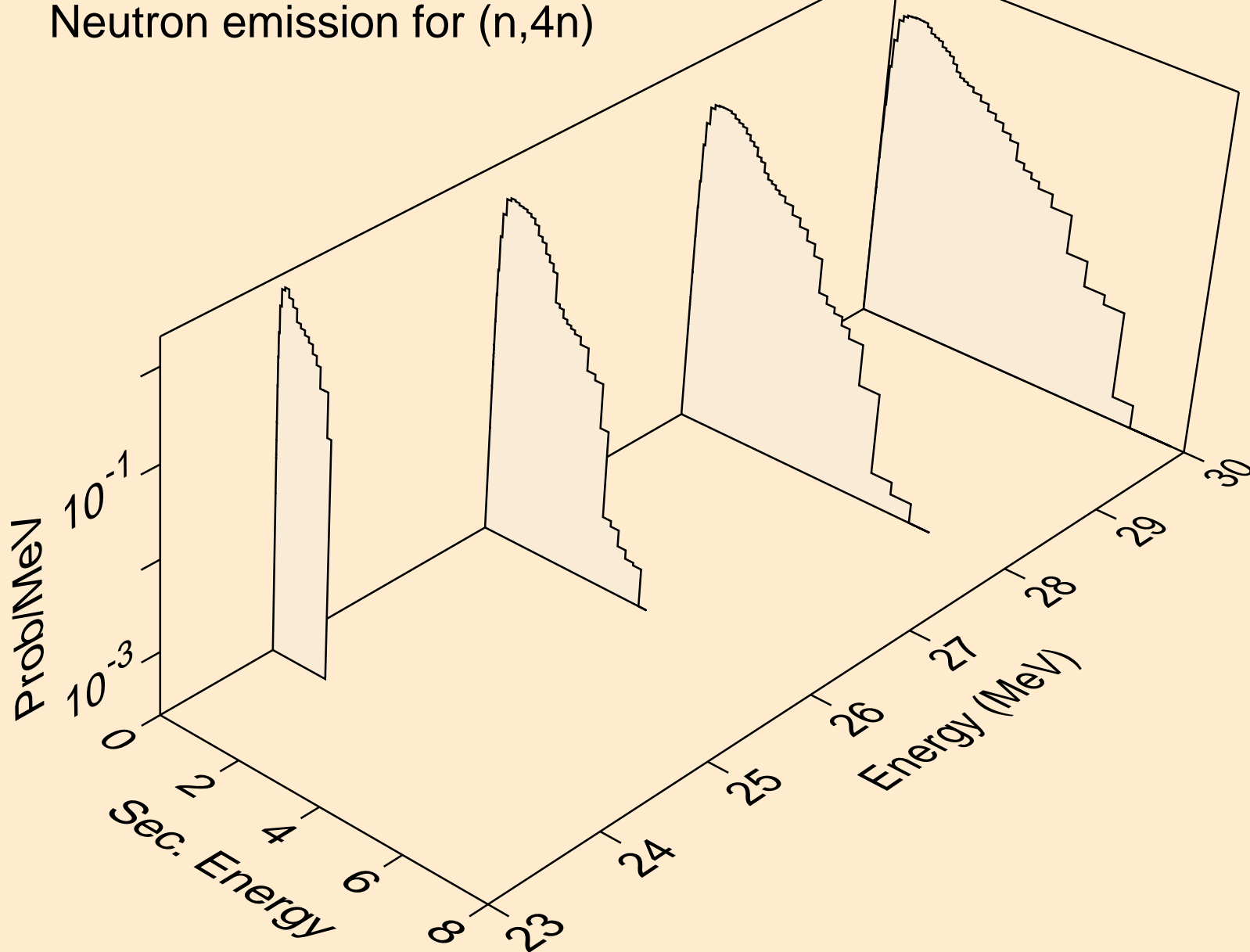

HO165 NEUTRON ACER TENDL-2019 LIBRARY; T=293.16K
Neutron emission for (n,2np)

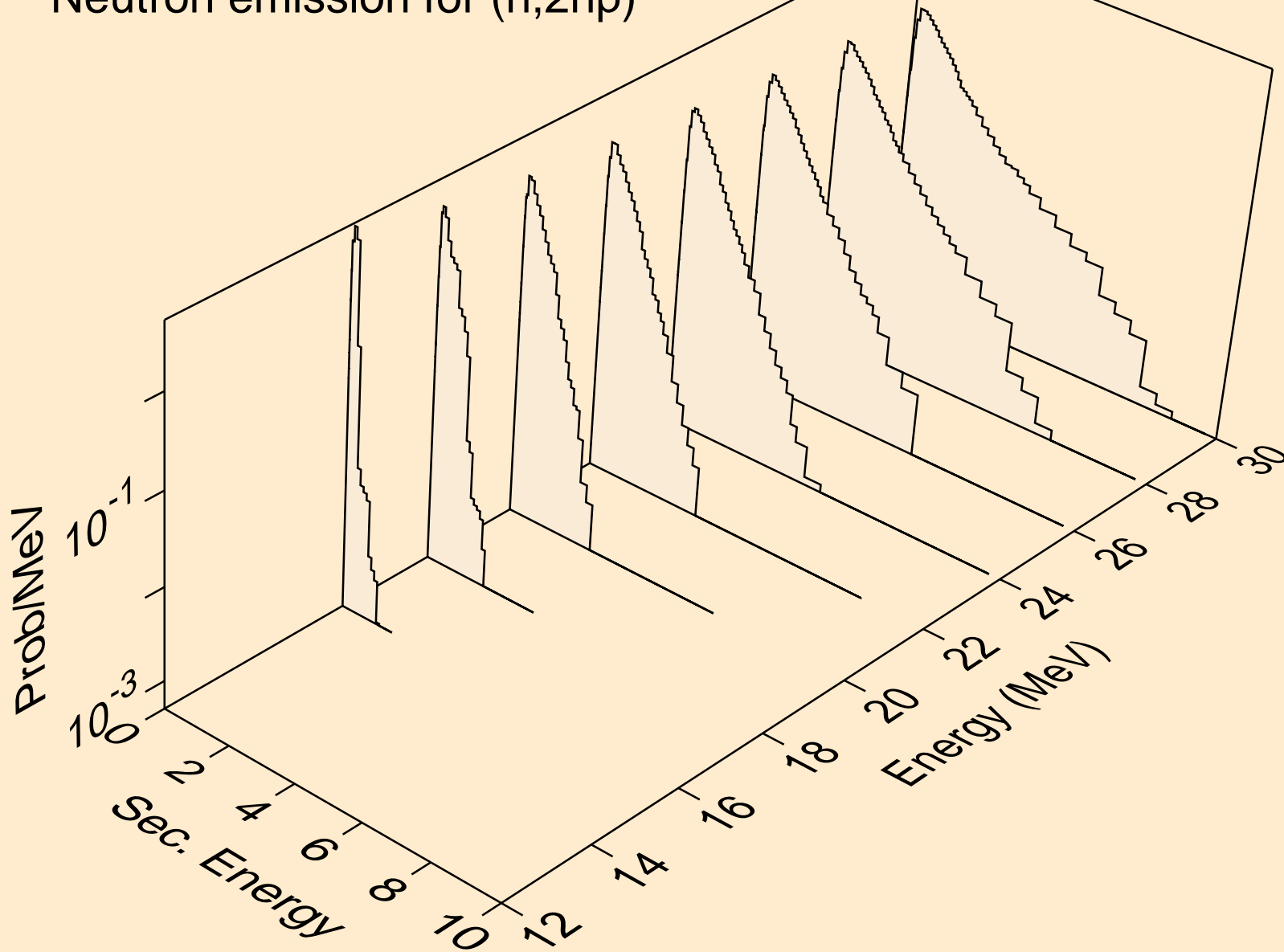

HO165 NEUTRON ACER TENDL-2019 LIBRARY; T=293.16K
Neutron emission for (n,3np)

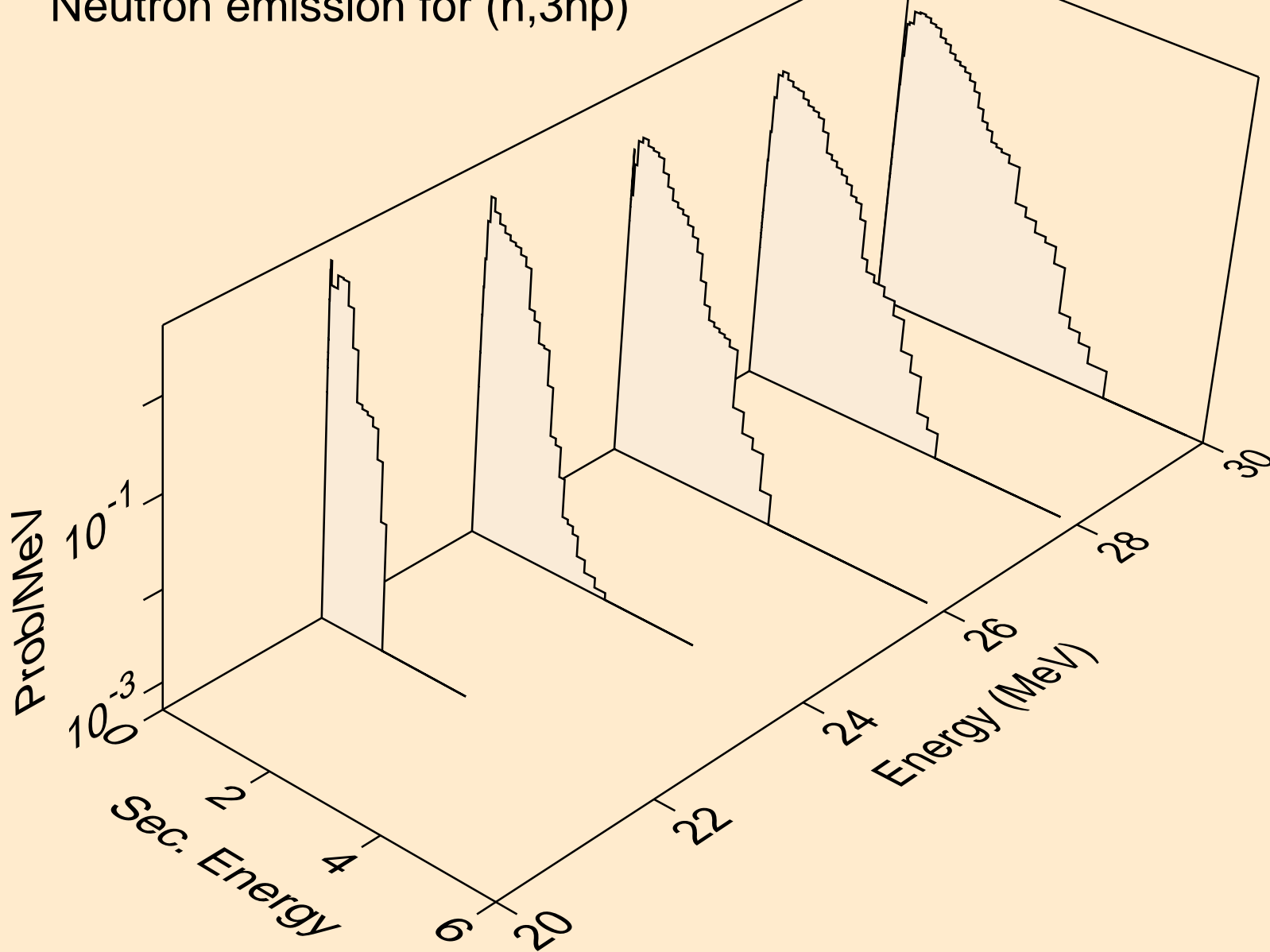

HO165 NEUTRON ACER TENDL-2019 LIBRARY; T=293.16K
Neutron emission for (n,2np)

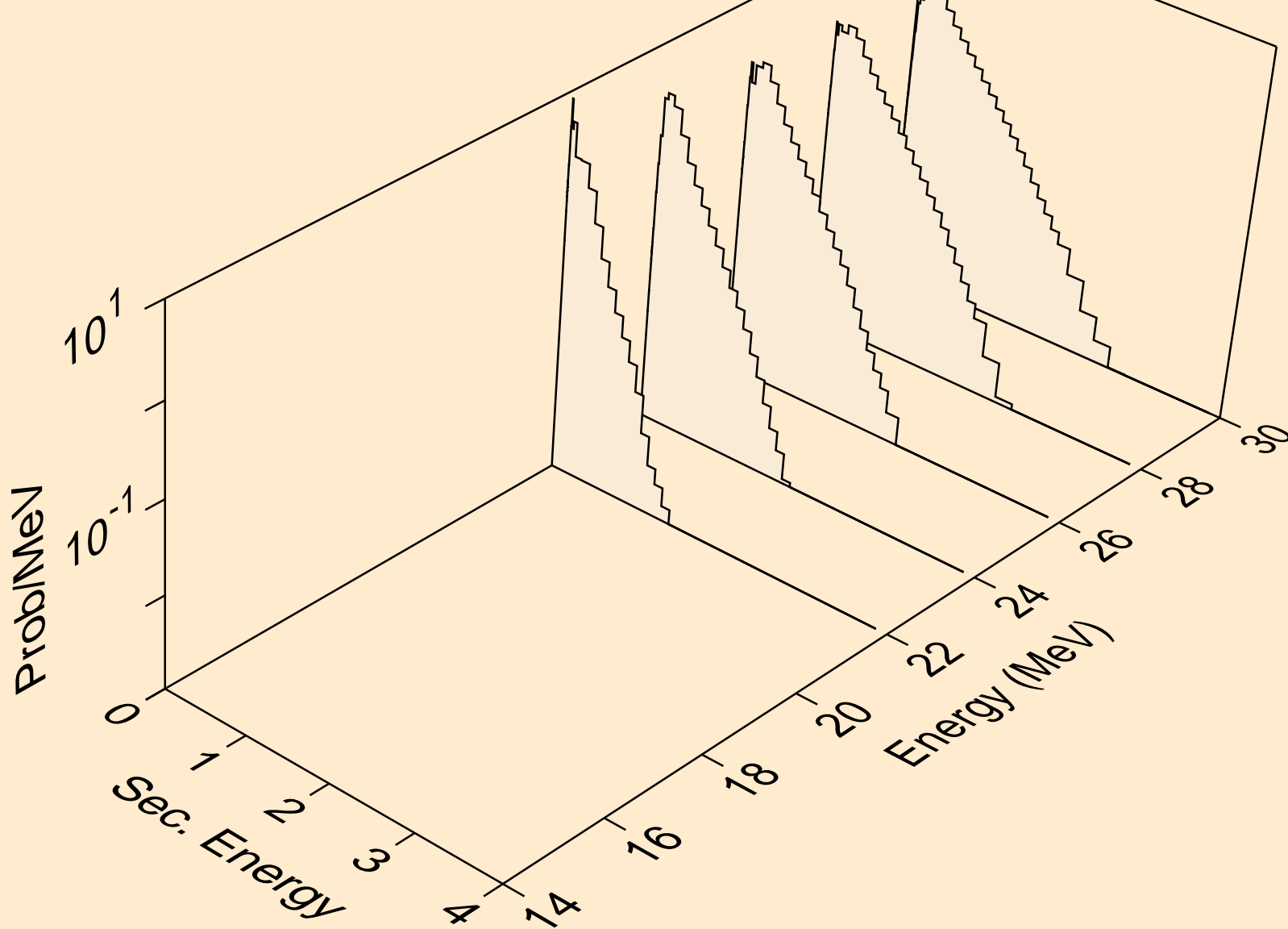

HO165 NEUTRON ACER TENDL-2019 LIBRARY; T=293.16K
Neutron emission for (n,npa)

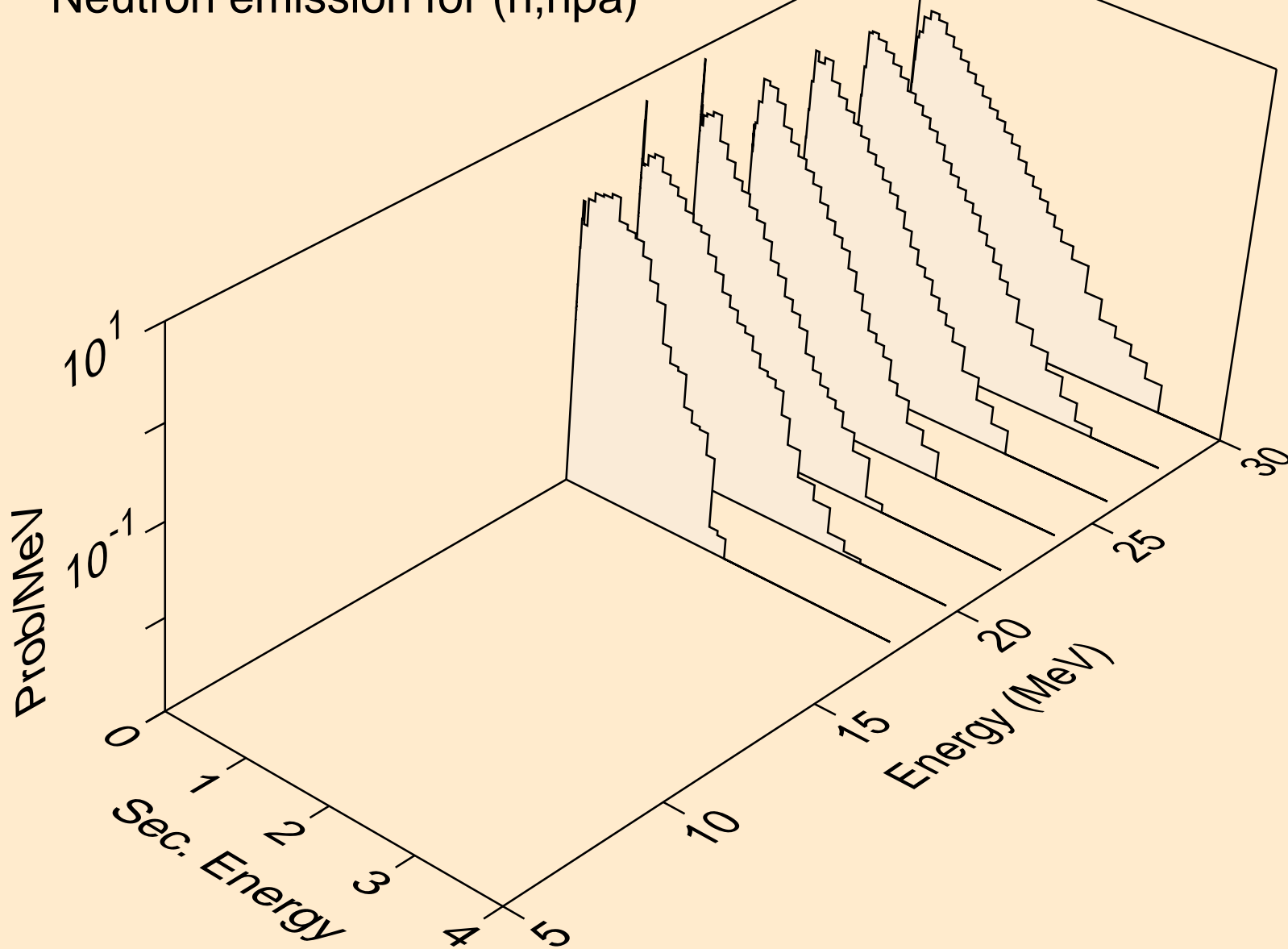

HO165 NEUTRON ACER TENDL-2019 LIBRARY; T=293.16K
Neutron emission for (n,n*c)

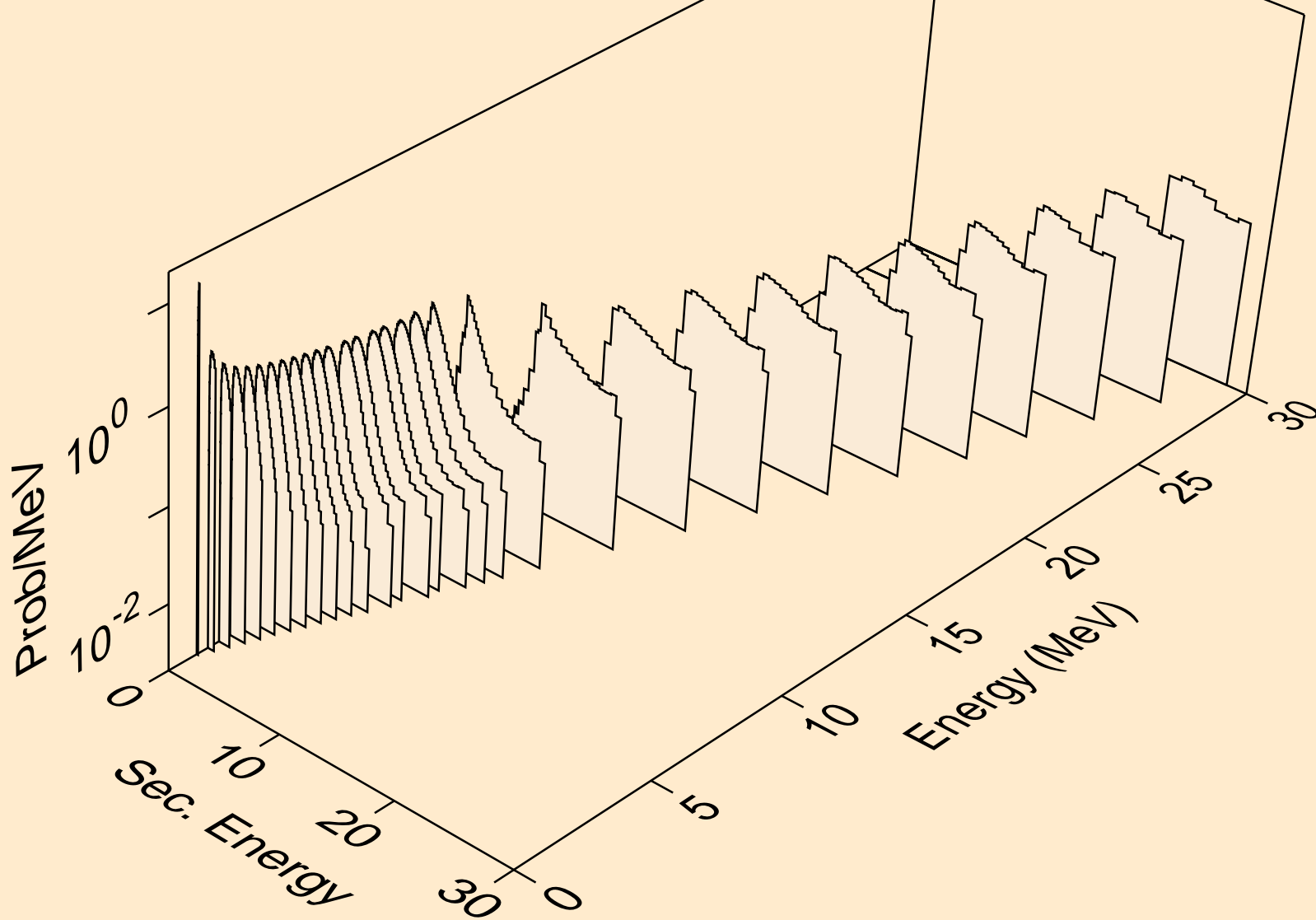

HO165 NEUTRON ACER TENDL-2019 LIBRARY; T=293.16K
Photon emission for (n,x)

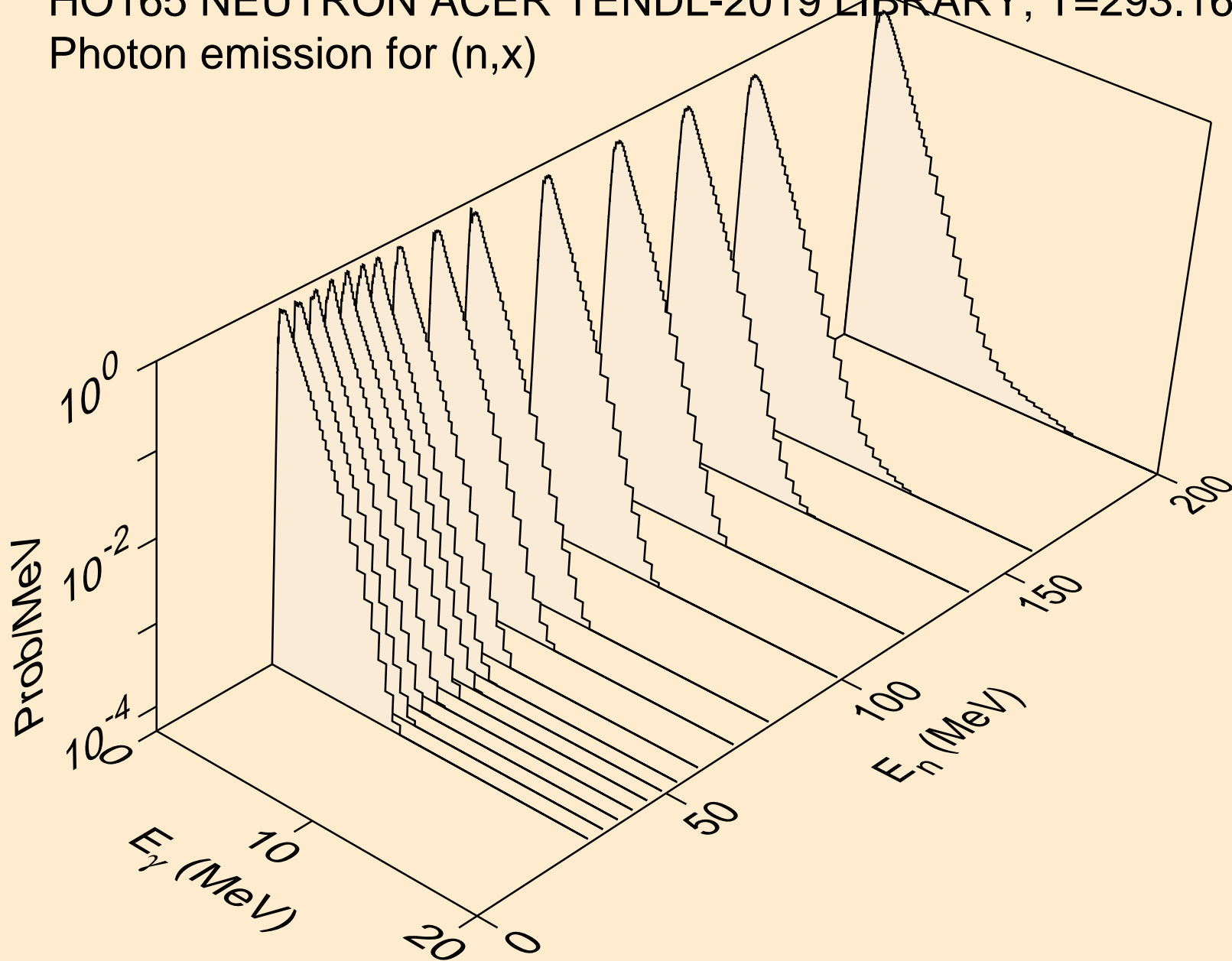

HO165 NEUTRON ACER TENDL-2019 LIBRARY; T=293.16K
Photon emission for (n,2nd)

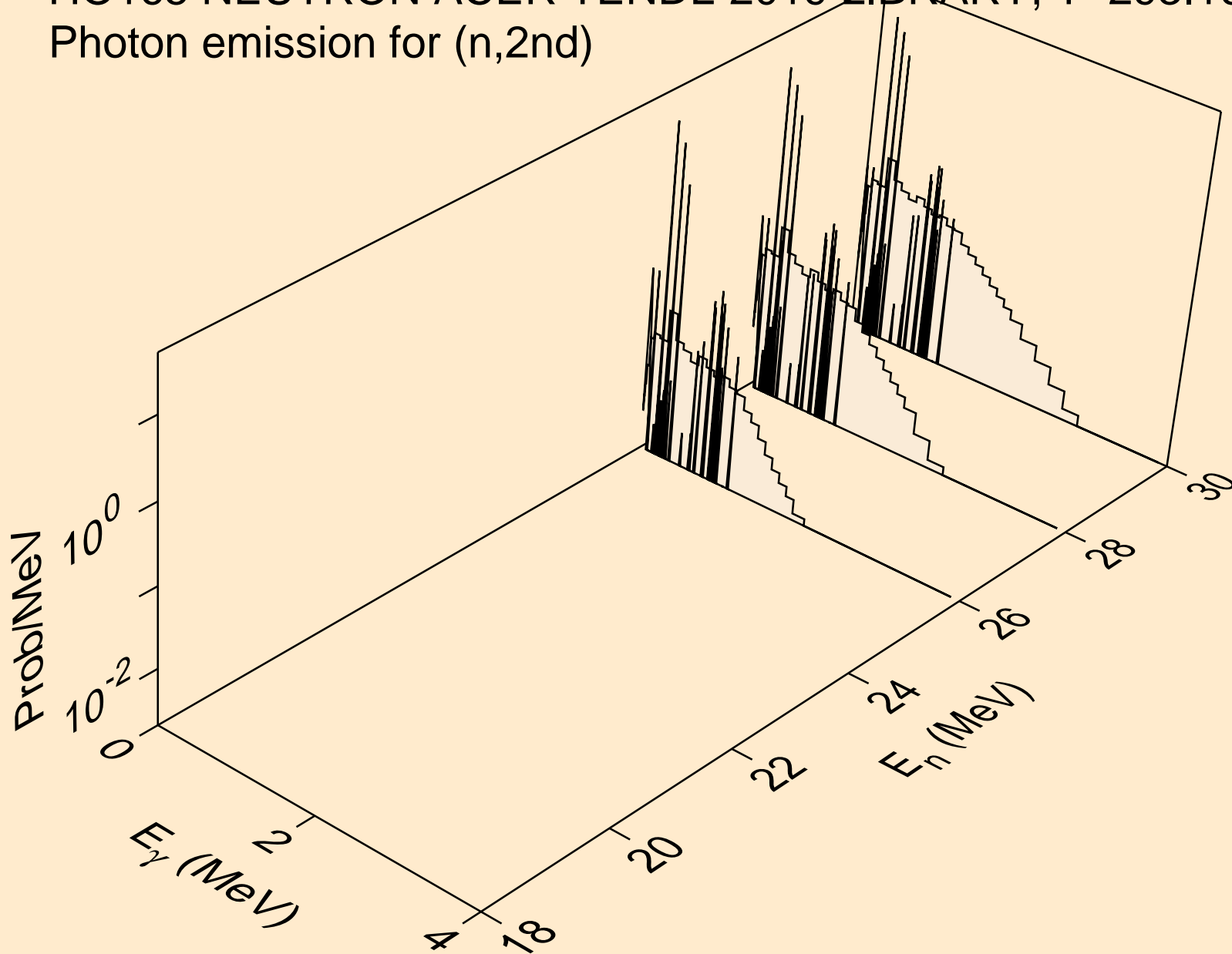

HO165 NEUTRON ACER TENDL-2019 LIBRARY; T=293.16K
Photon emission for (n,2n)

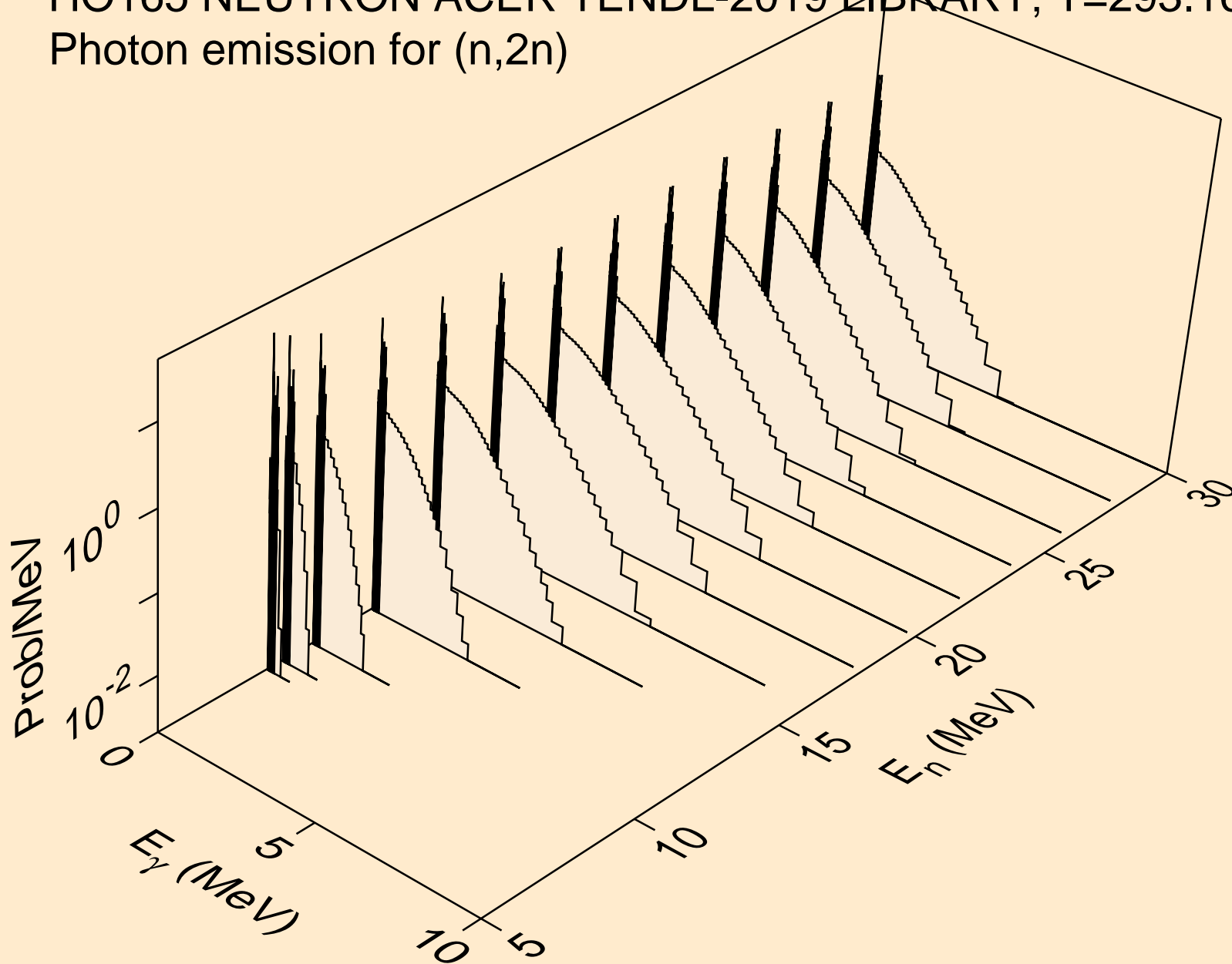

HO165 NEUTRON ACER TENDL-2019 LIBRARY; T=293.16K
Photon emission for (n,3n)

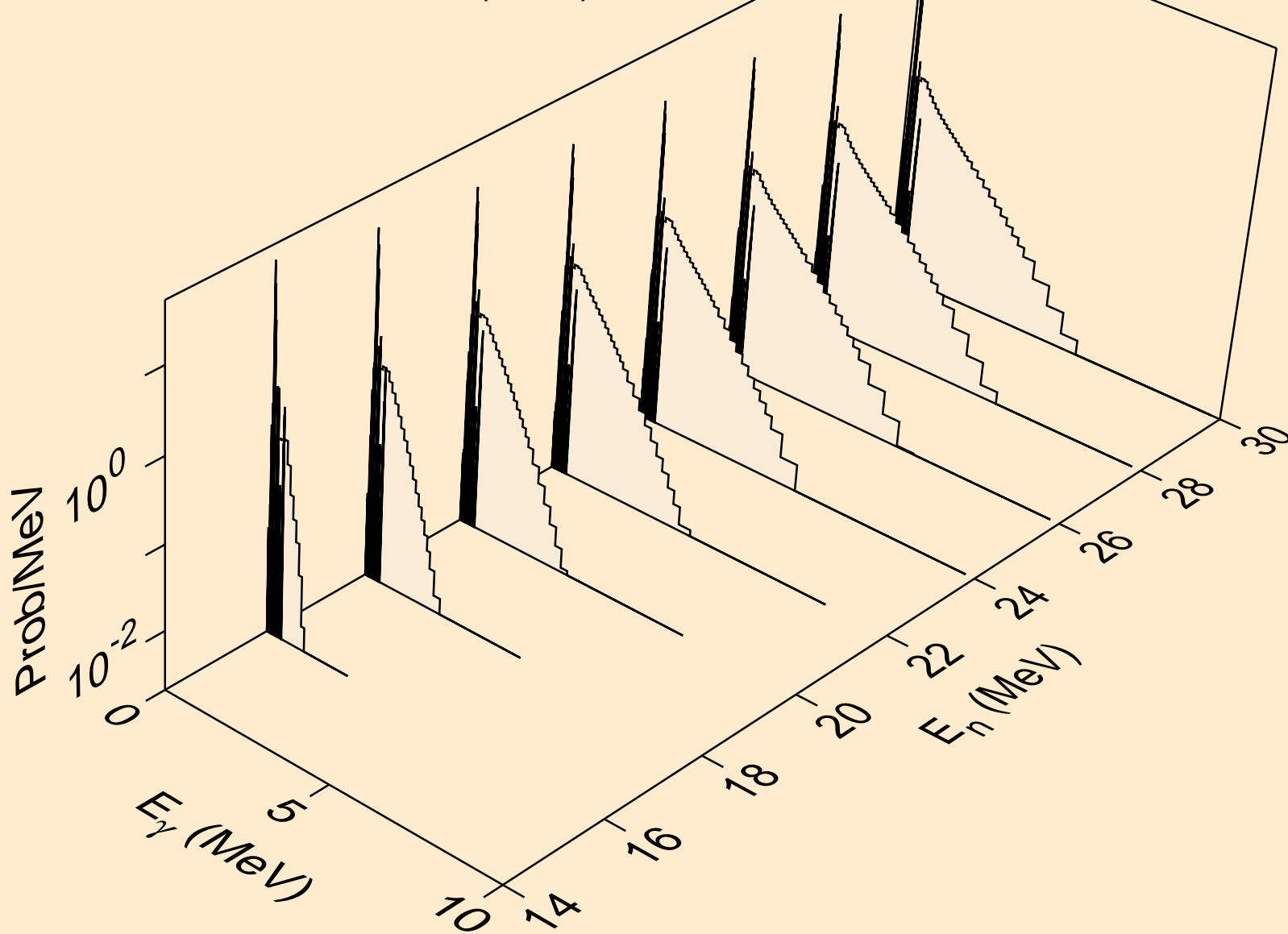

HO165 NEUTRON ACER TENDL-2019 LIBRARY; T=293.16K
Photon emission for (n,n*)a

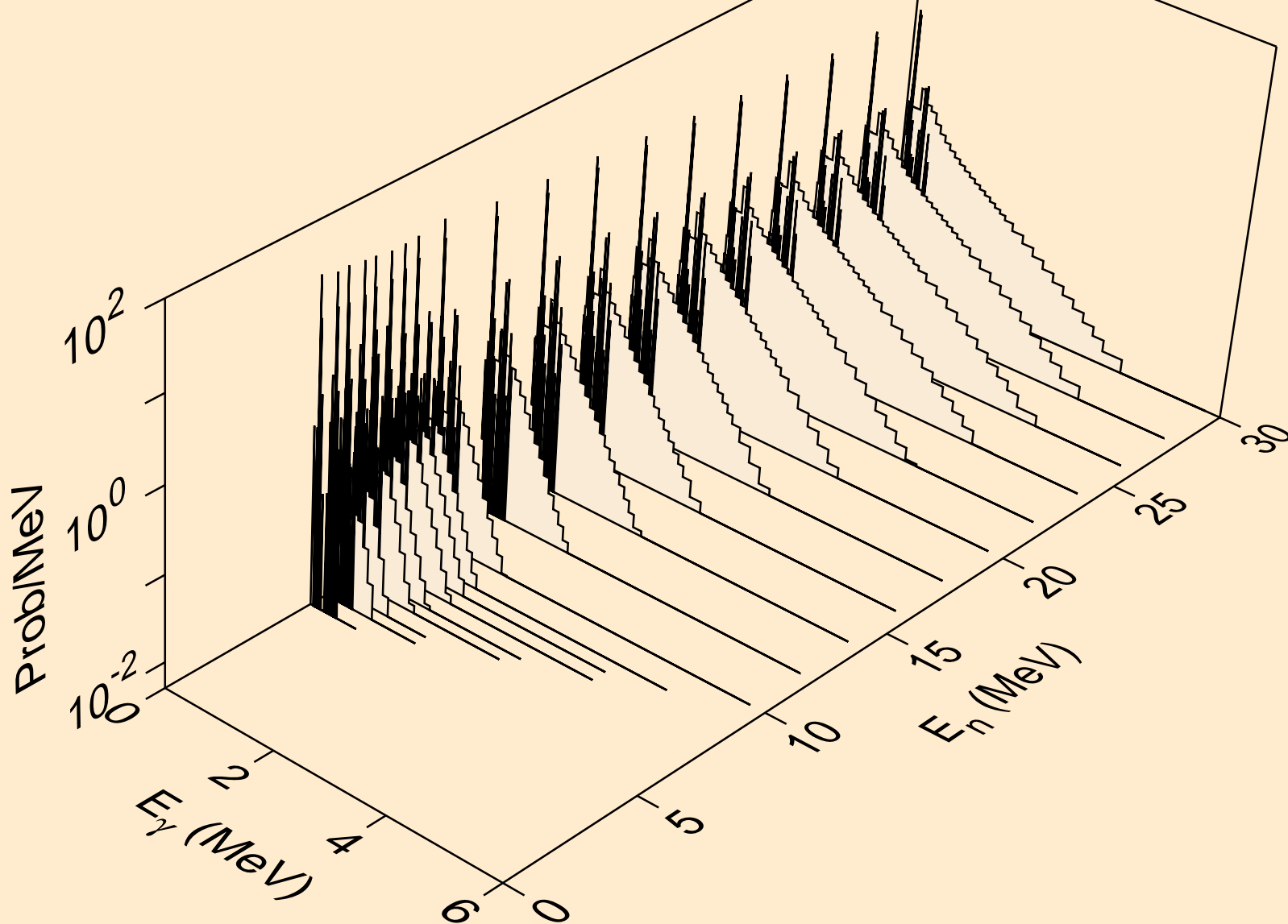

HO165 NEUTRON ACER TENDL-2019 LIBRARY; T=293.16K
Photon emission for (n,2n)a

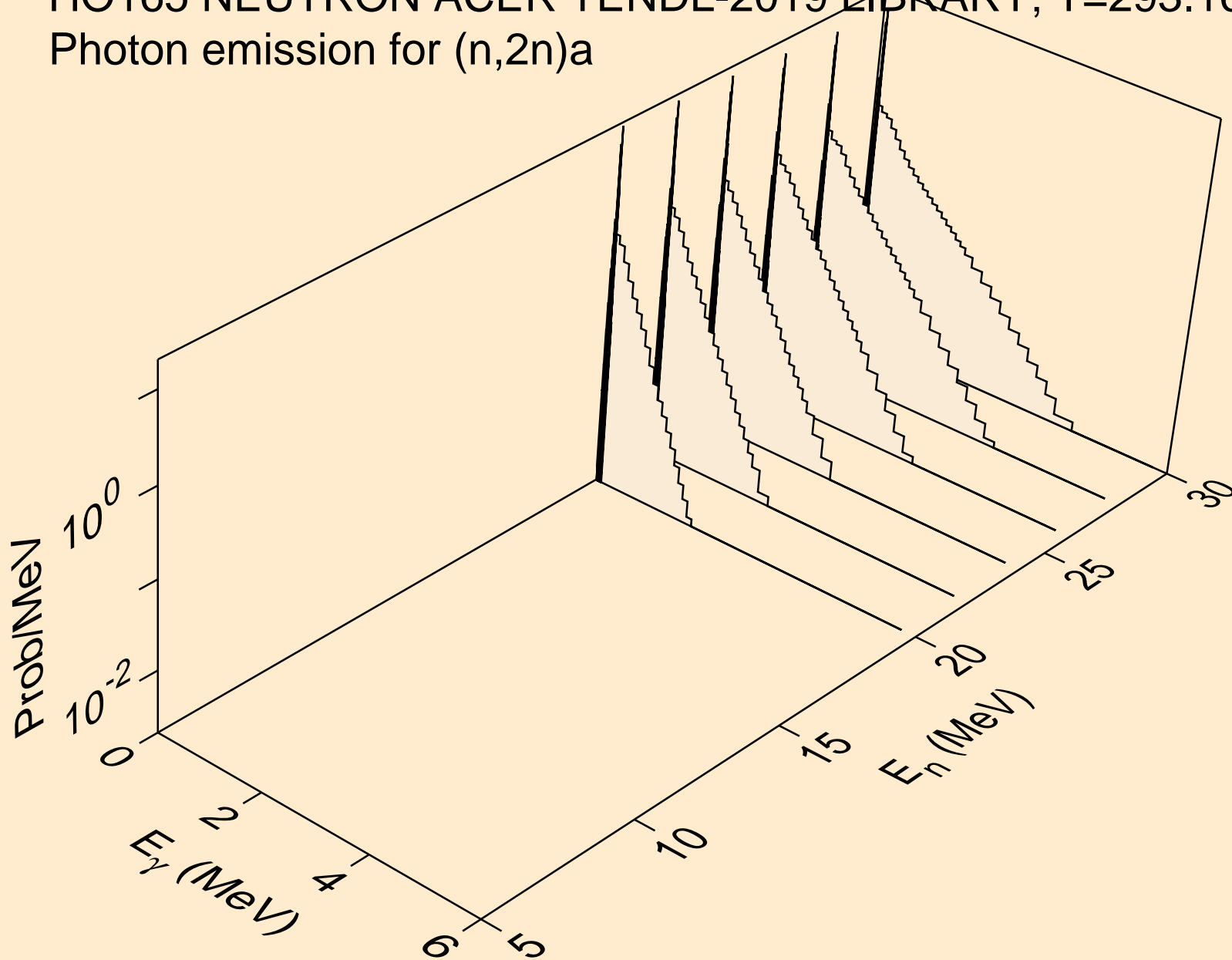

HO165 NEUTRON ACER TENDL-2019 LIBRARY; T=293.16K
Photon emission for (n,3n)a

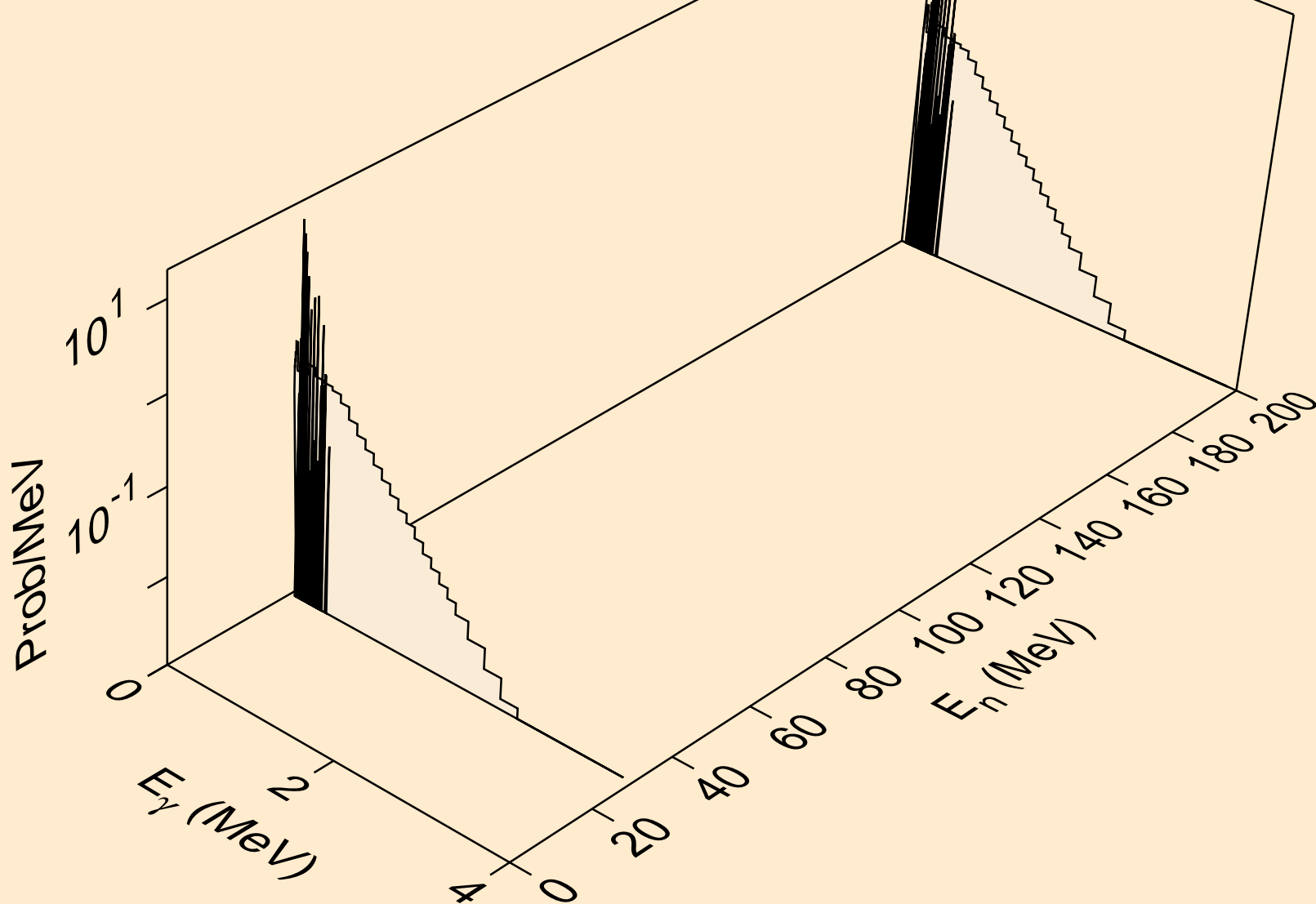

HO165 NEUTRON ACER TENDL-2019 LIBRARY; T=293.16K
Photon emission for (n,n*)p

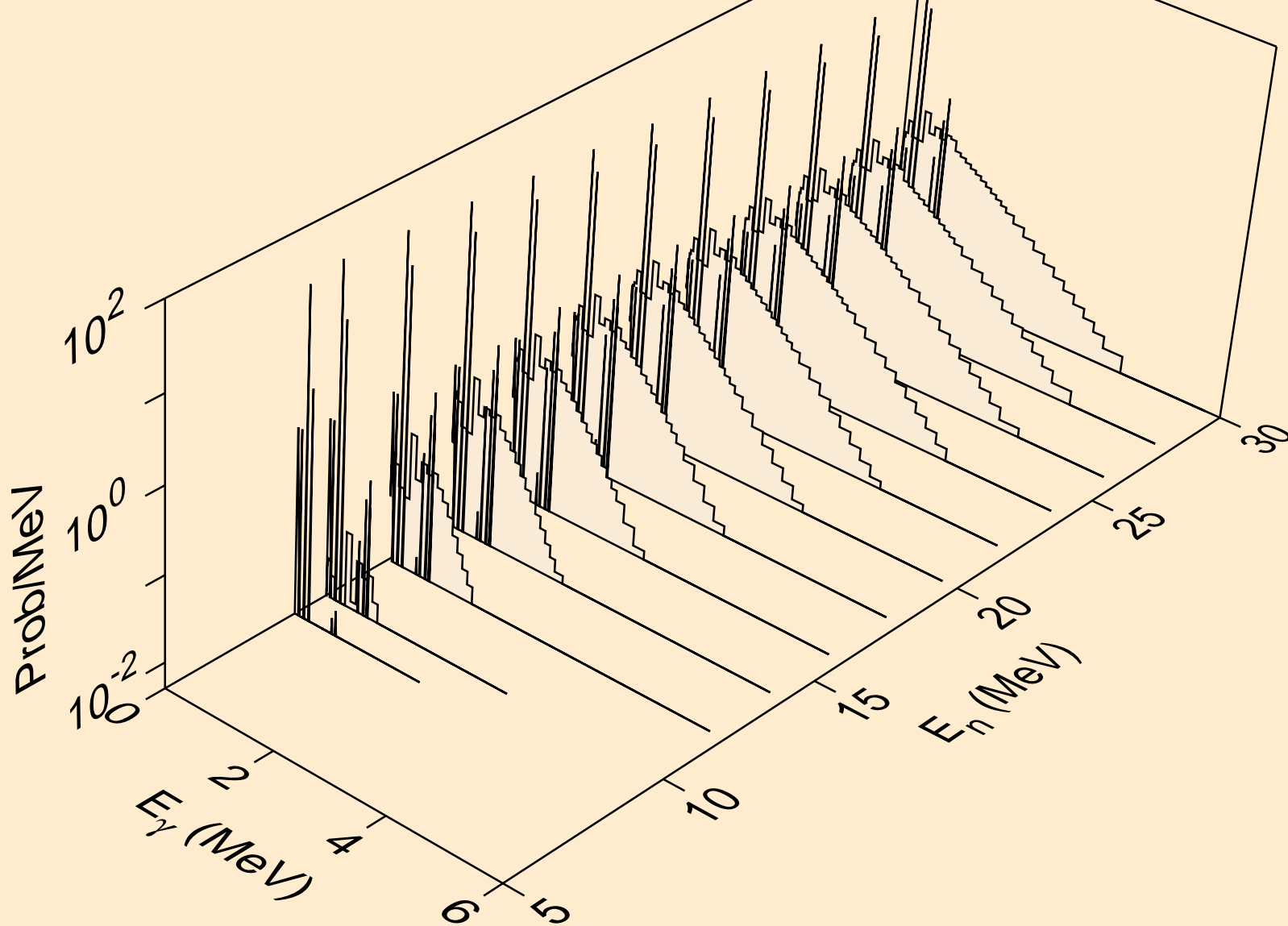

HO165 NEUTRON ACER TENDL-2019 LIBRARY; T=293.16K
Photon emission for (n,n*)2a

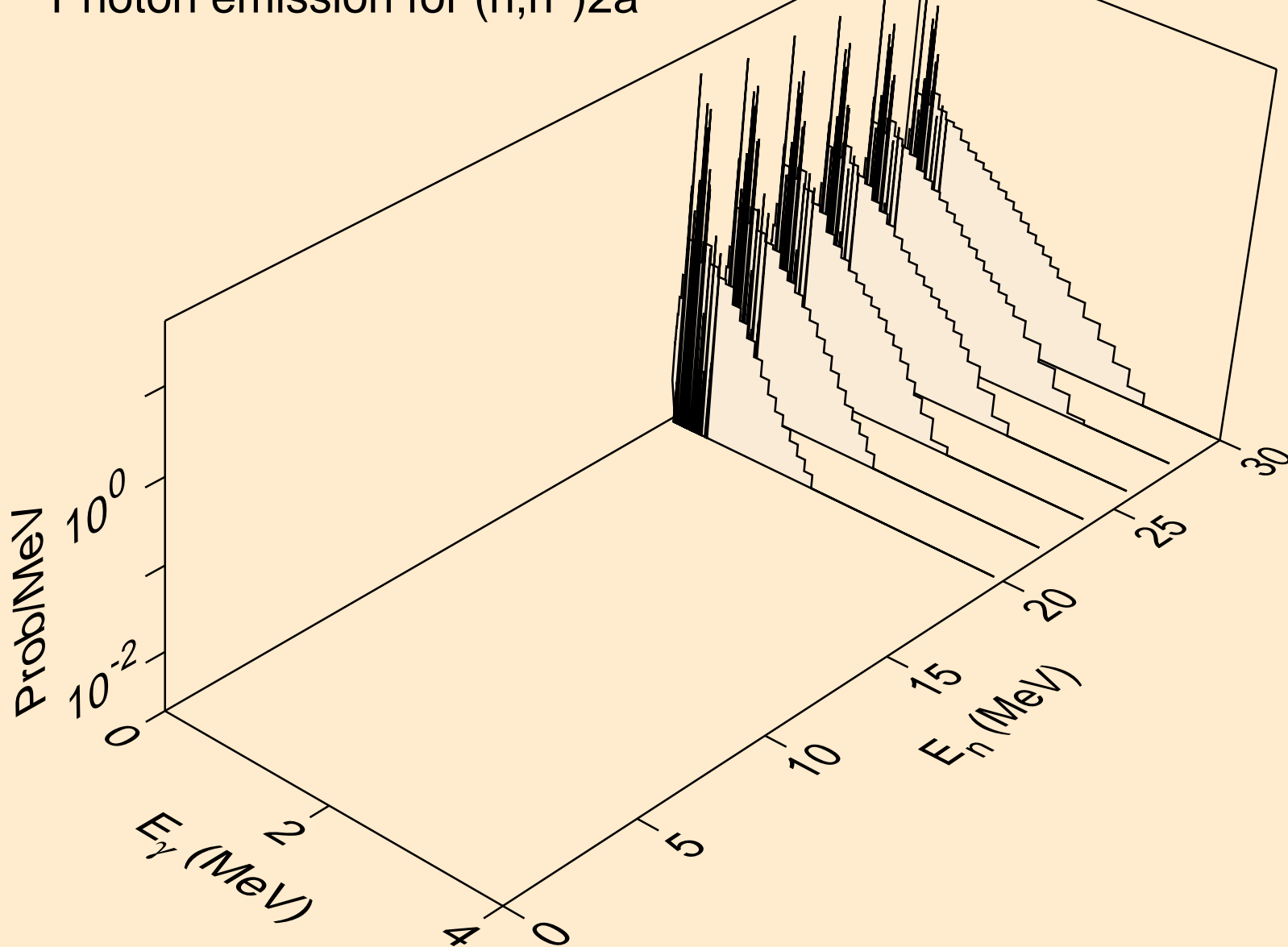

HO165 NEUTRON ACER TENDL-2019 LIBRARY; T=293.16K
Photon emission for (n,n*)d

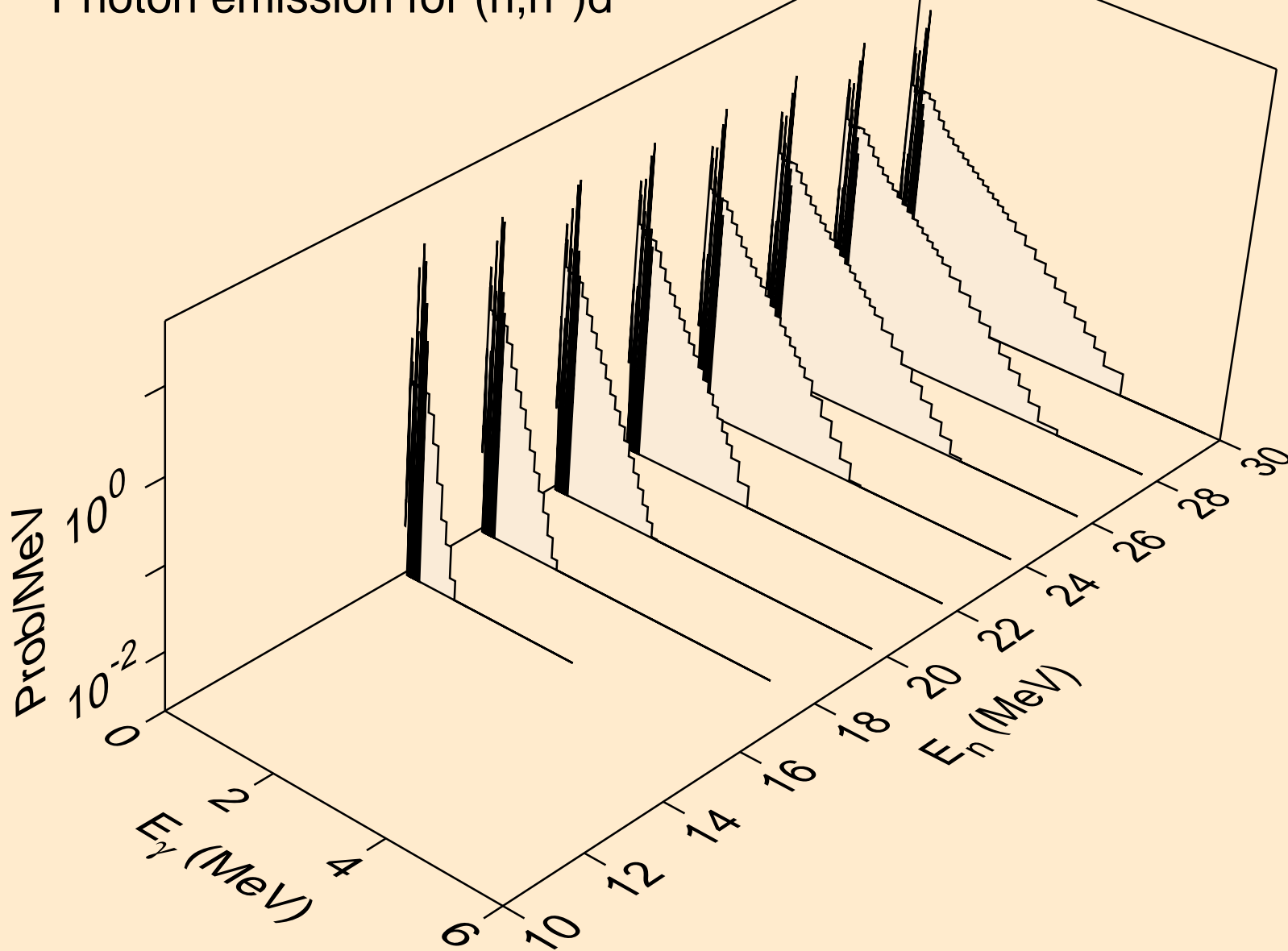

HO165 NEUTRON ACER TENDL-2019 LIBRARY; T=293.16K
Photon emission for (n,n*)t

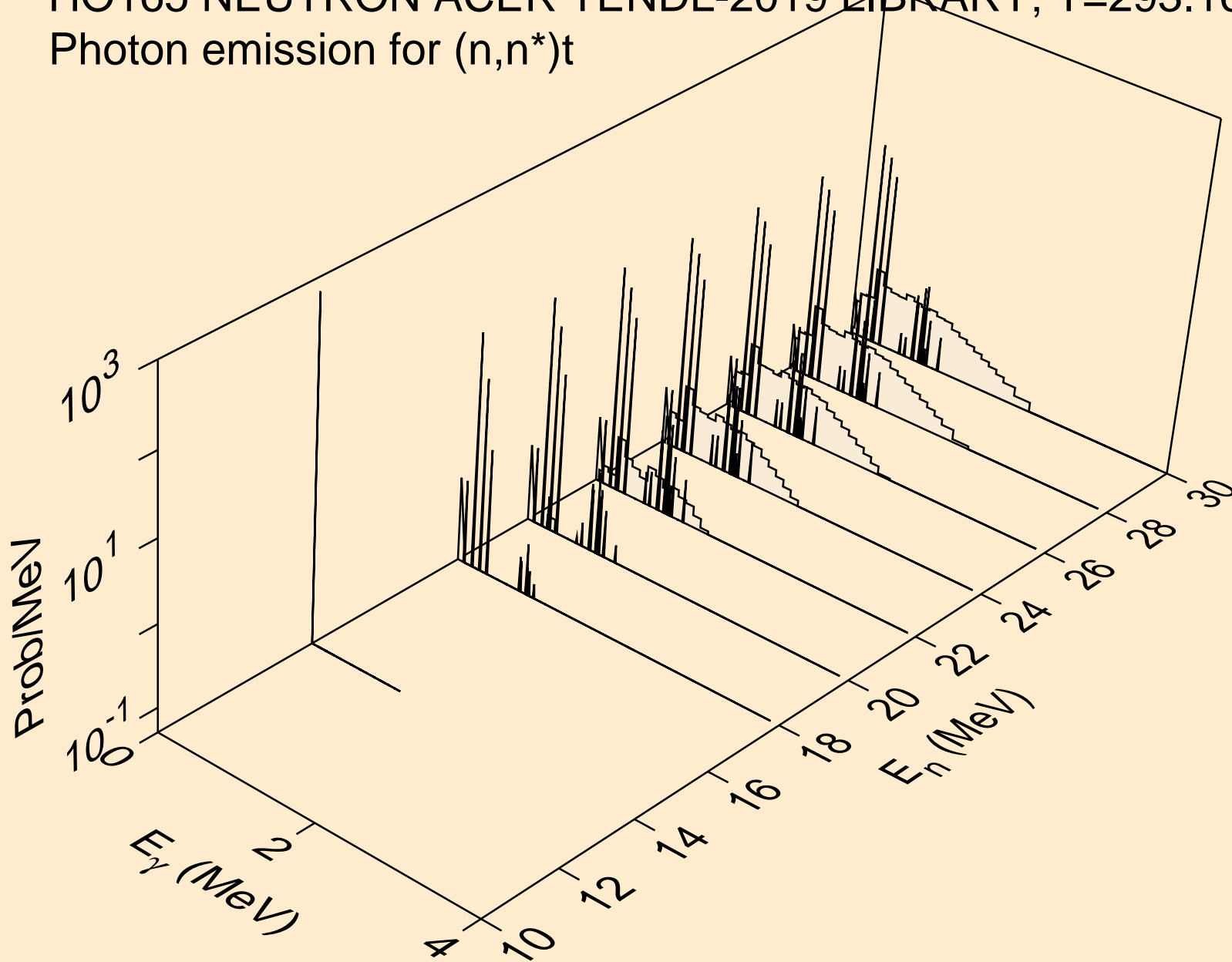

HO165 NEUTRON ACER TENDL-2019 LIBRARY; T=293.16K
Photon emission for (n,n*)he3

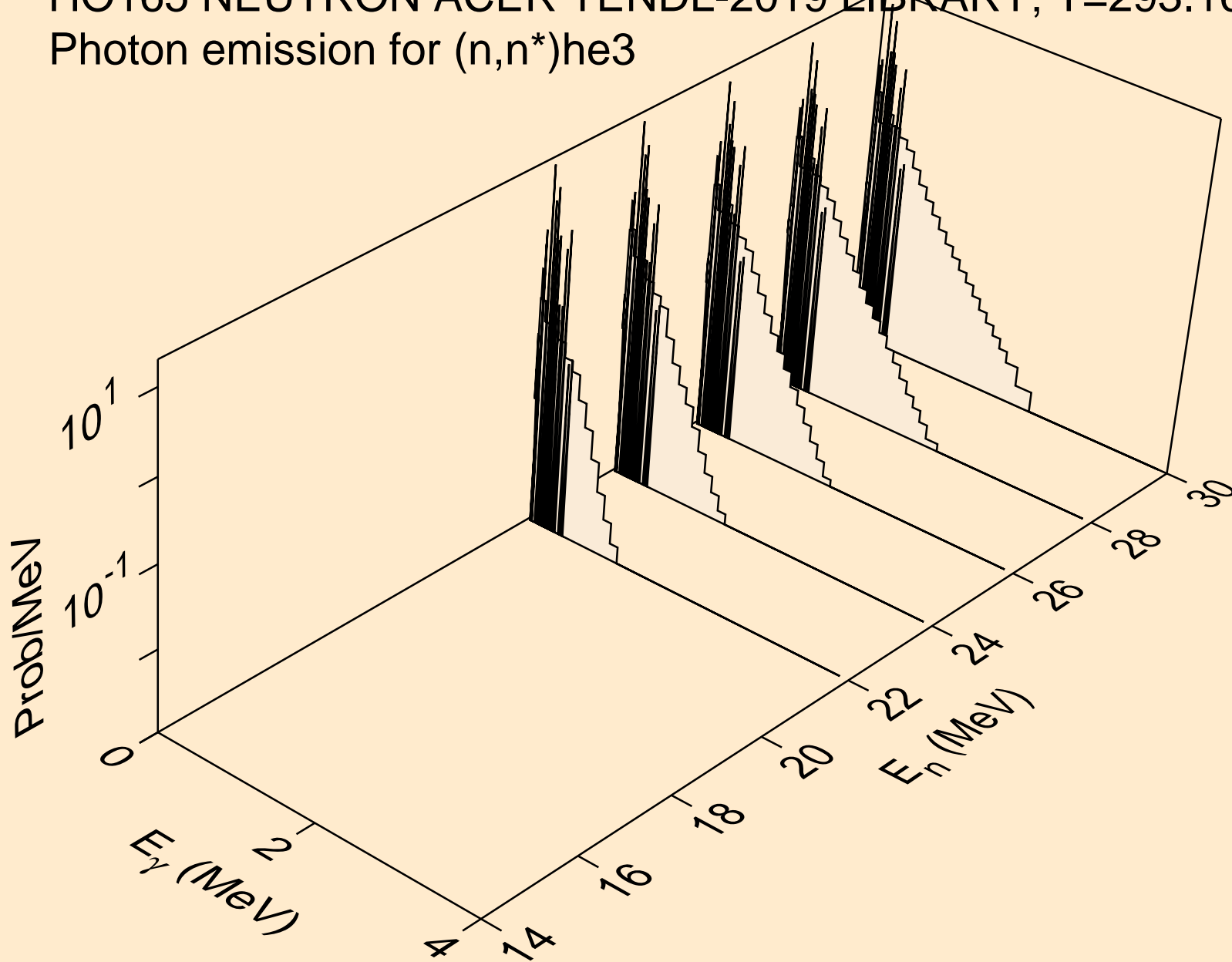

HO165 NEUTRON ACER TENDL-2019 LIBRARY; T=293.16K
Photon emission for (n,4n)

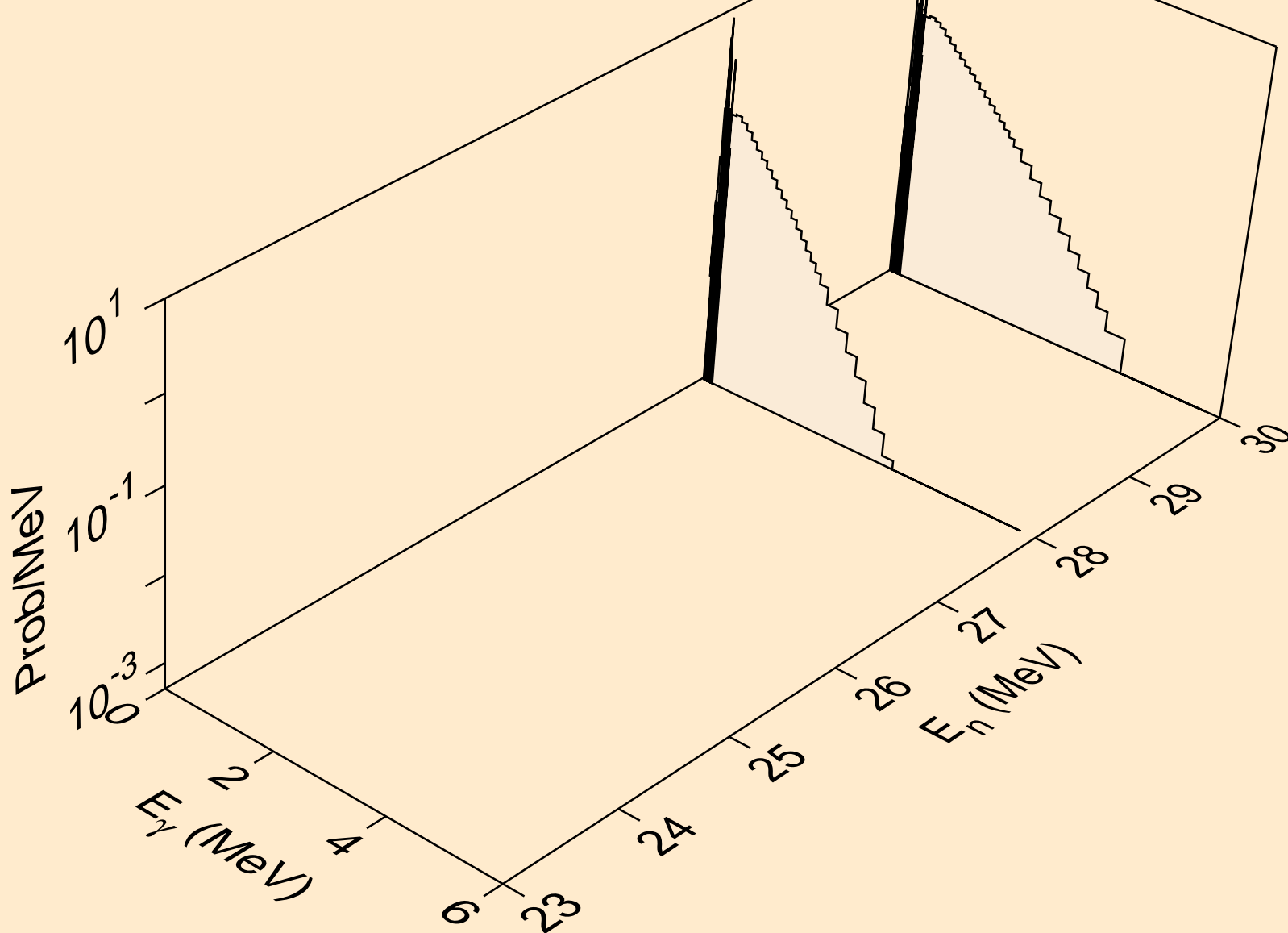

HO165 NEUTRON ACER TENDL-2019 LIBRARY; T=293.16K
Photon emission for (n,2np)

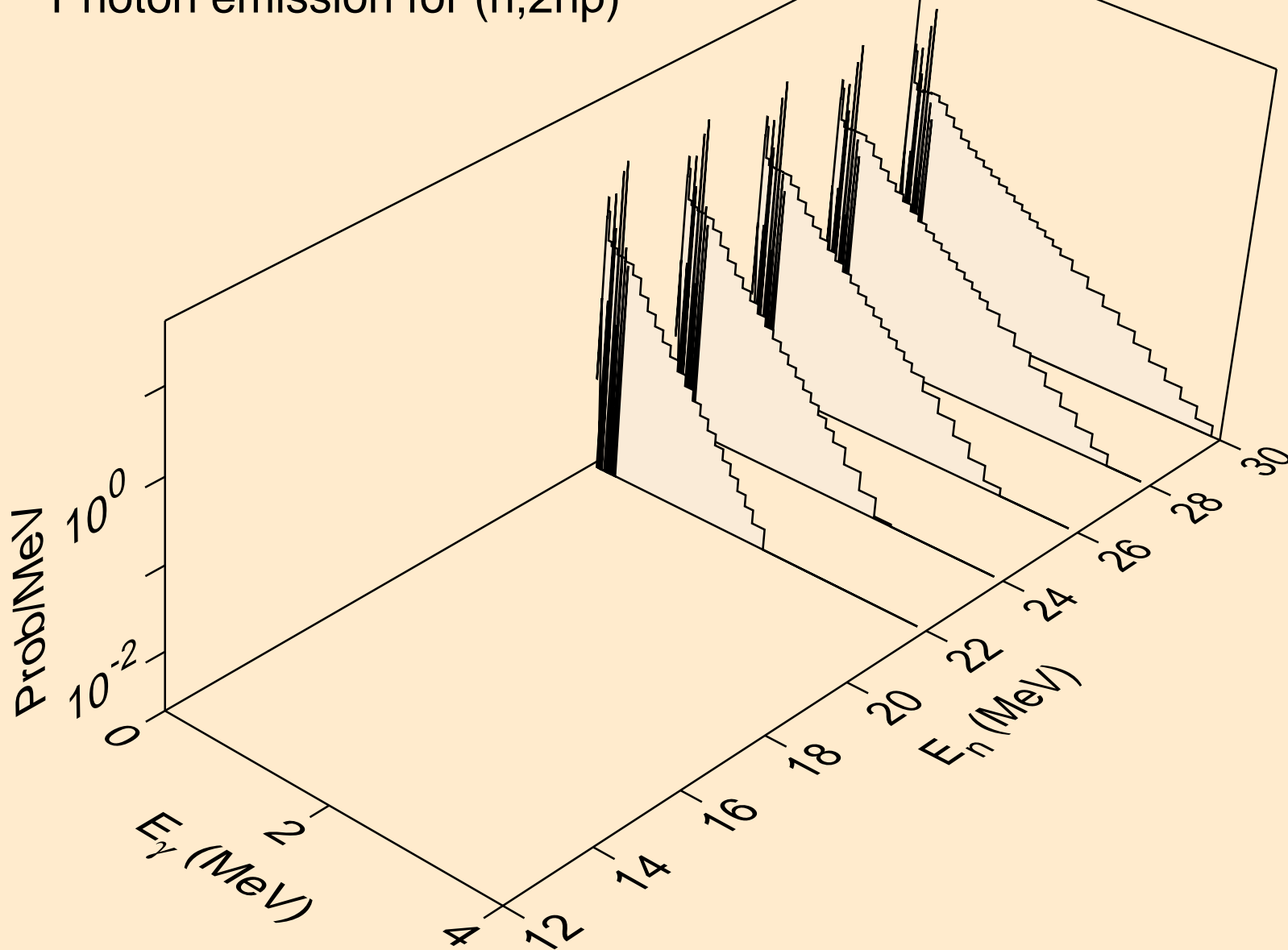

HO165 NEUTRON ACER TENDL-2019 LIBRARY; T=293.16K
Photon emission for (n,3np)

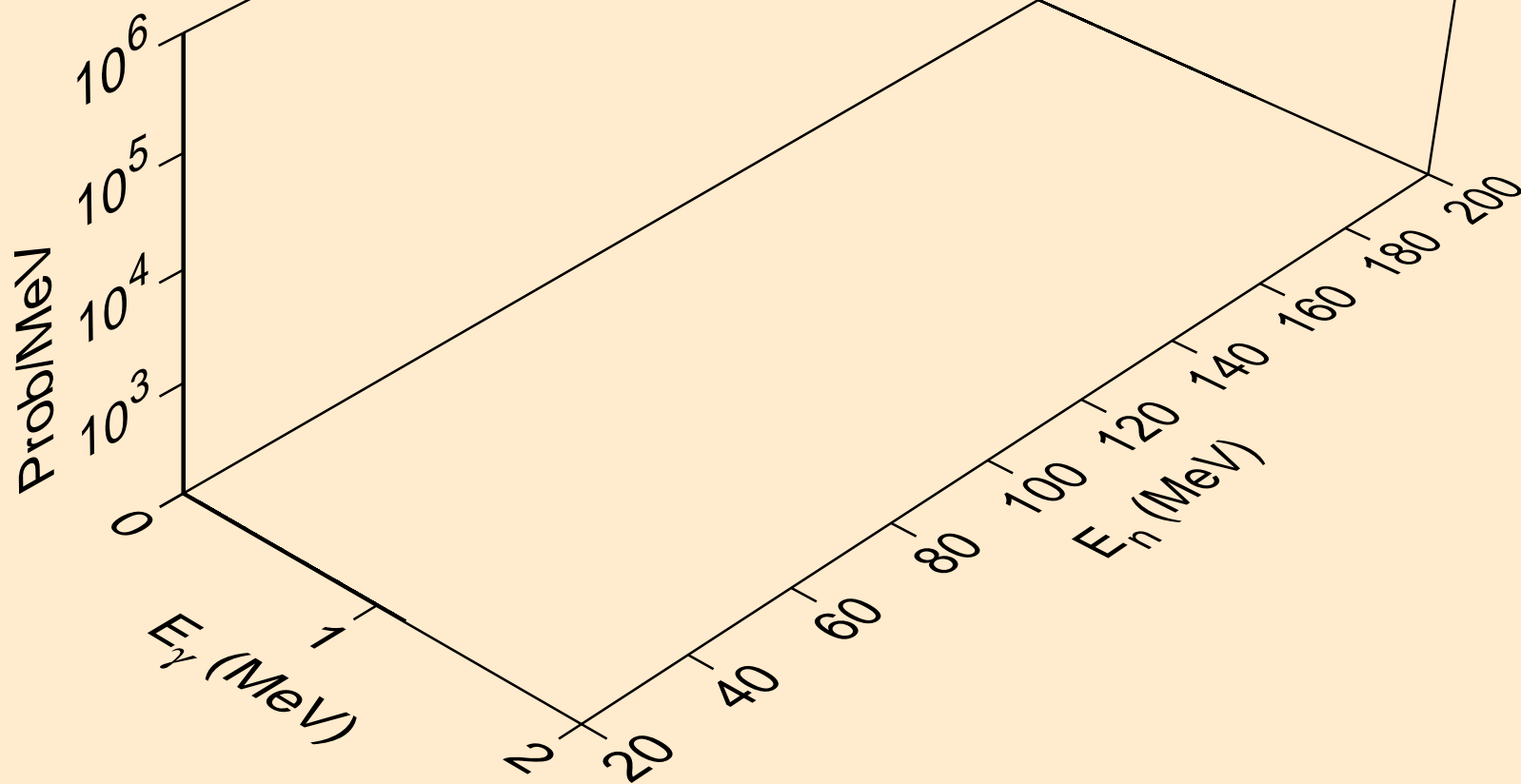

HO165 NEUTRON ACER TENDL-2019 LIBRARY; T=293.16K
Photon emission for (n,2np)

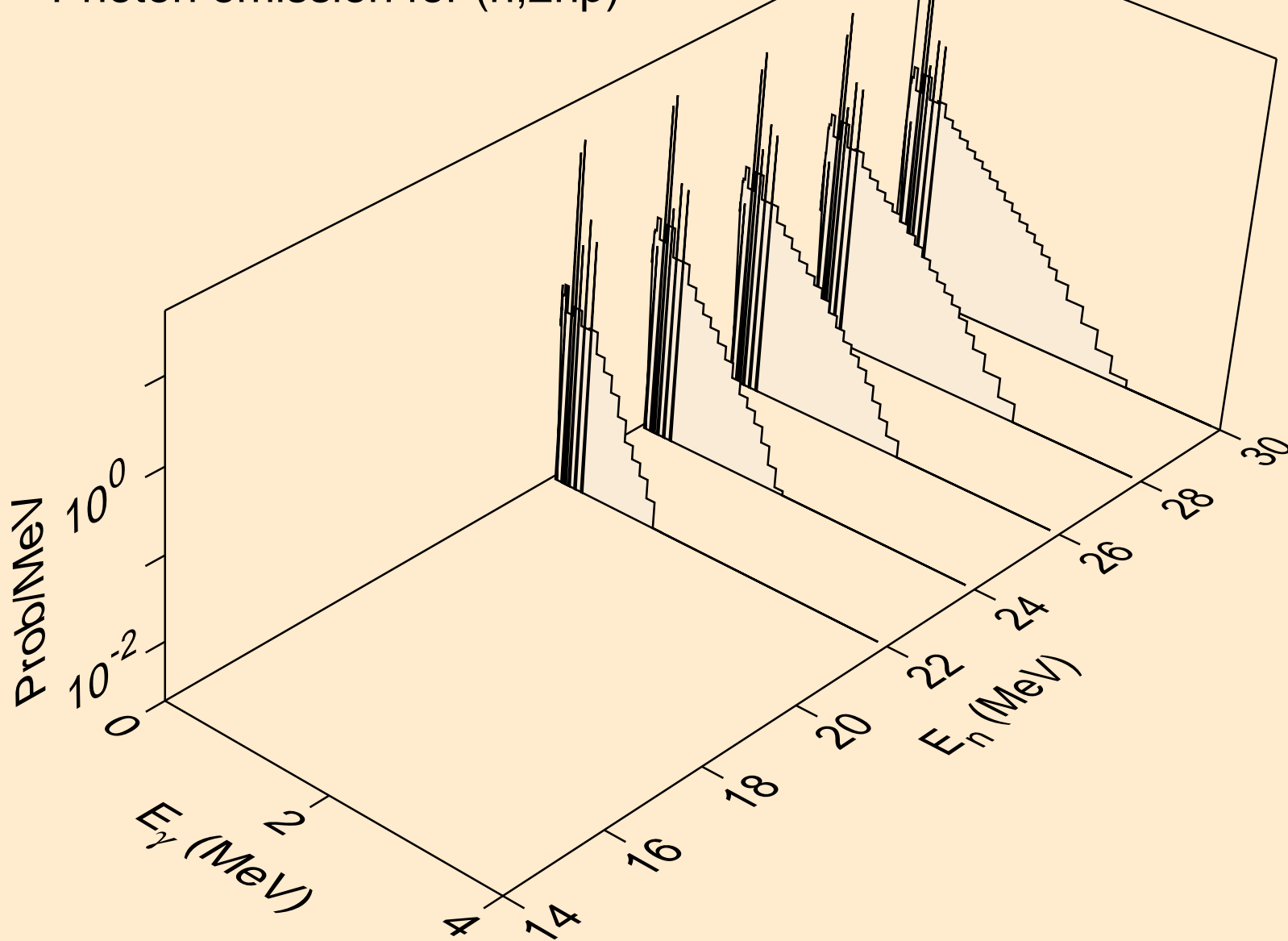

HO165 NEUTRON ACER TENDL-2019 LIBRARY; T=293.16K
Photon emission for (n,npa)

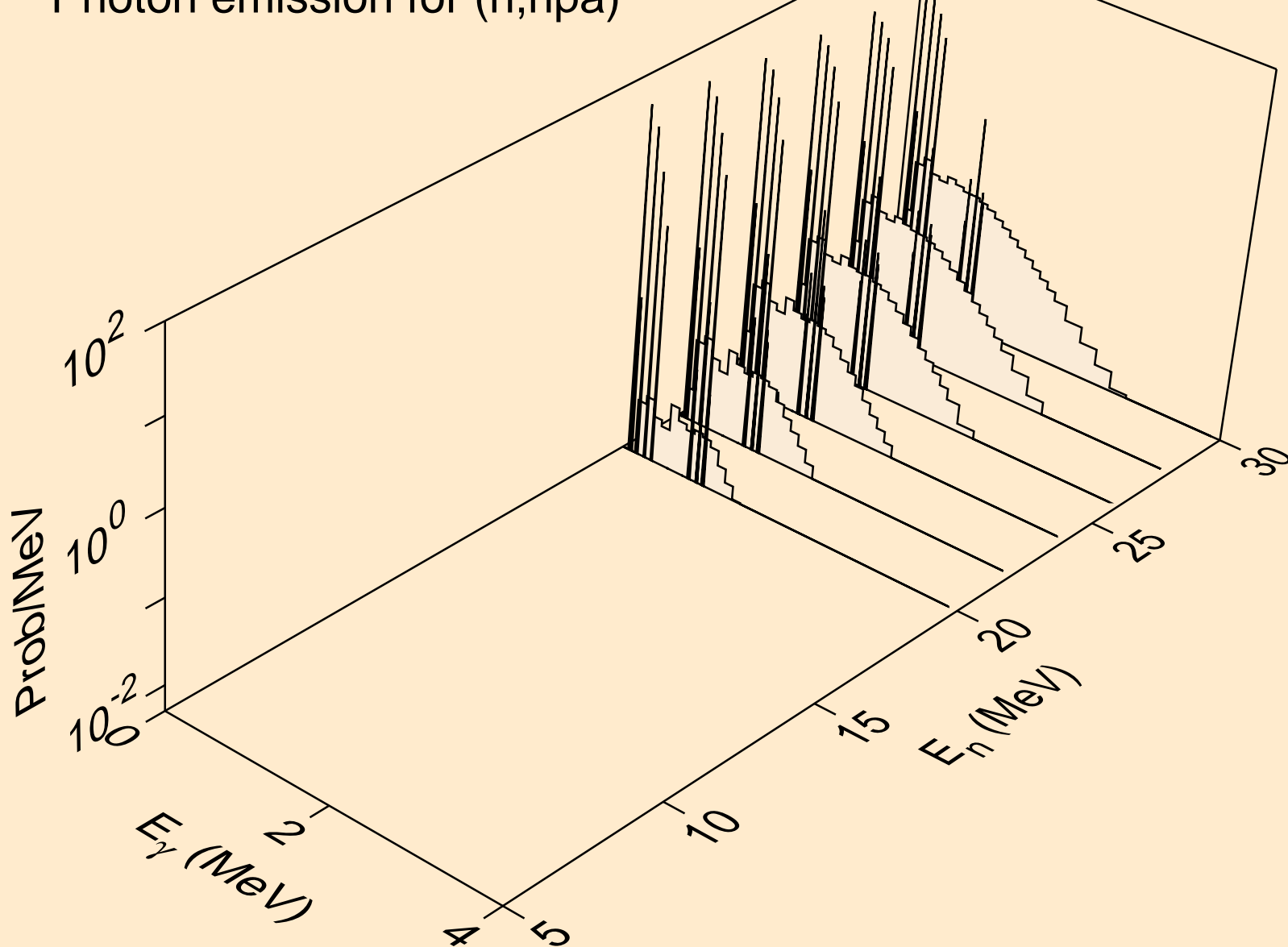

HO165 NEUTRON ACER TENDL-2019 LIBRARY; T=293.16K
Photon emission for (n,n*c)

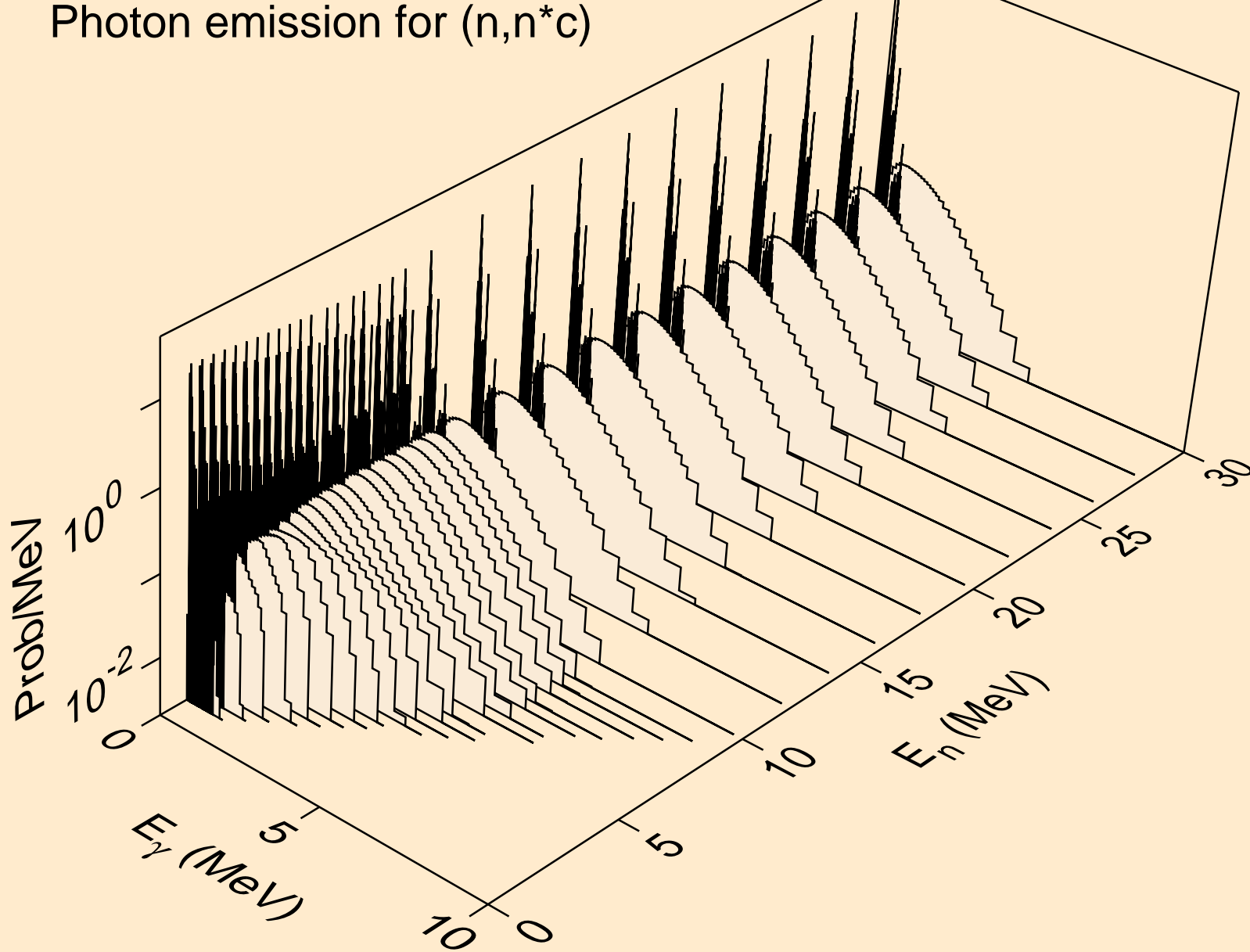

HO165 NEUTRON ACER TENDL-2019 LIBRARY; T=293.16K
Photon emission for (n,gma)

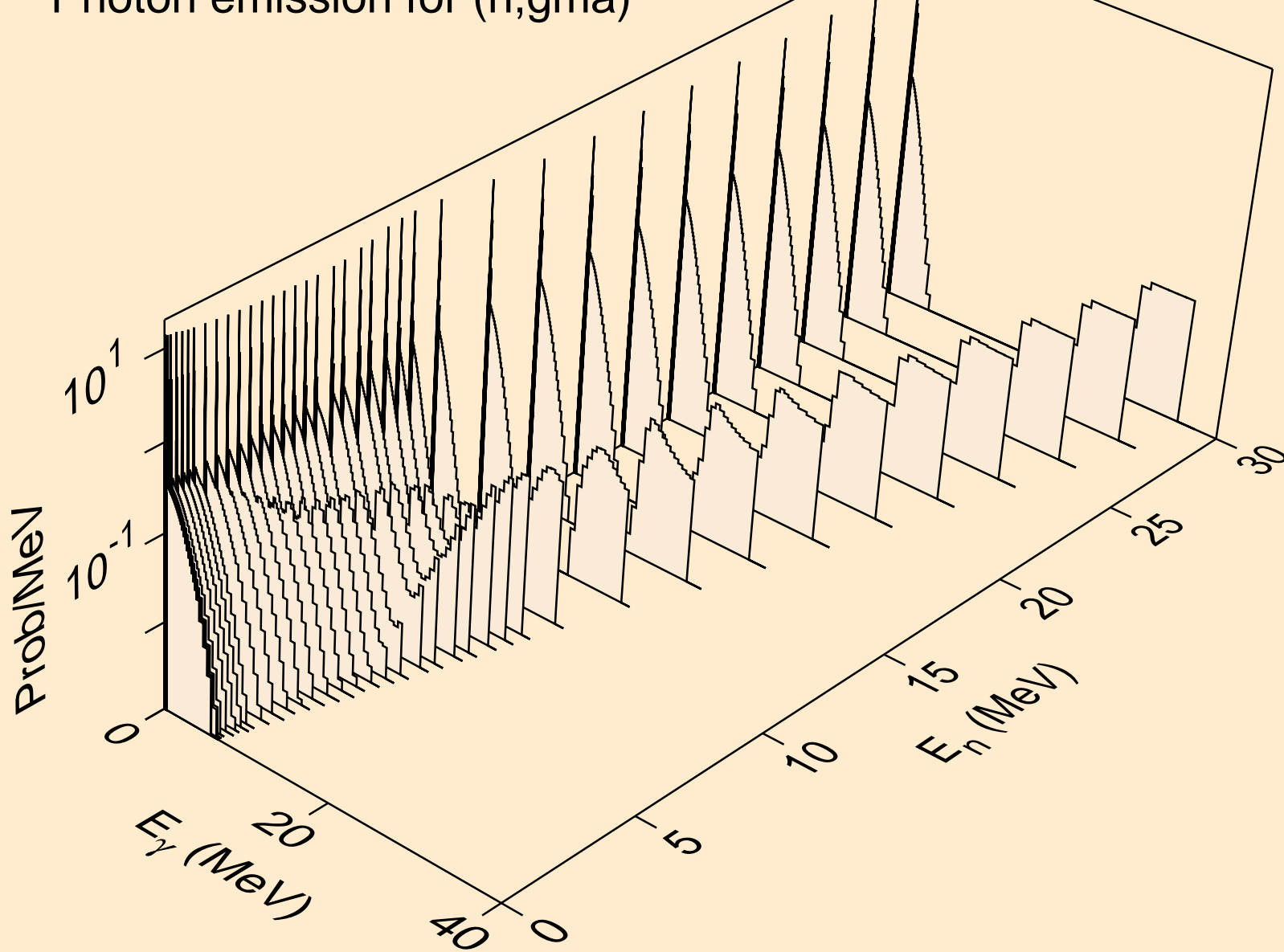

HO165 NEUTRON ACER TENDL-2019 LIBRARY; T=293.16K
Photon emission for (n,p)

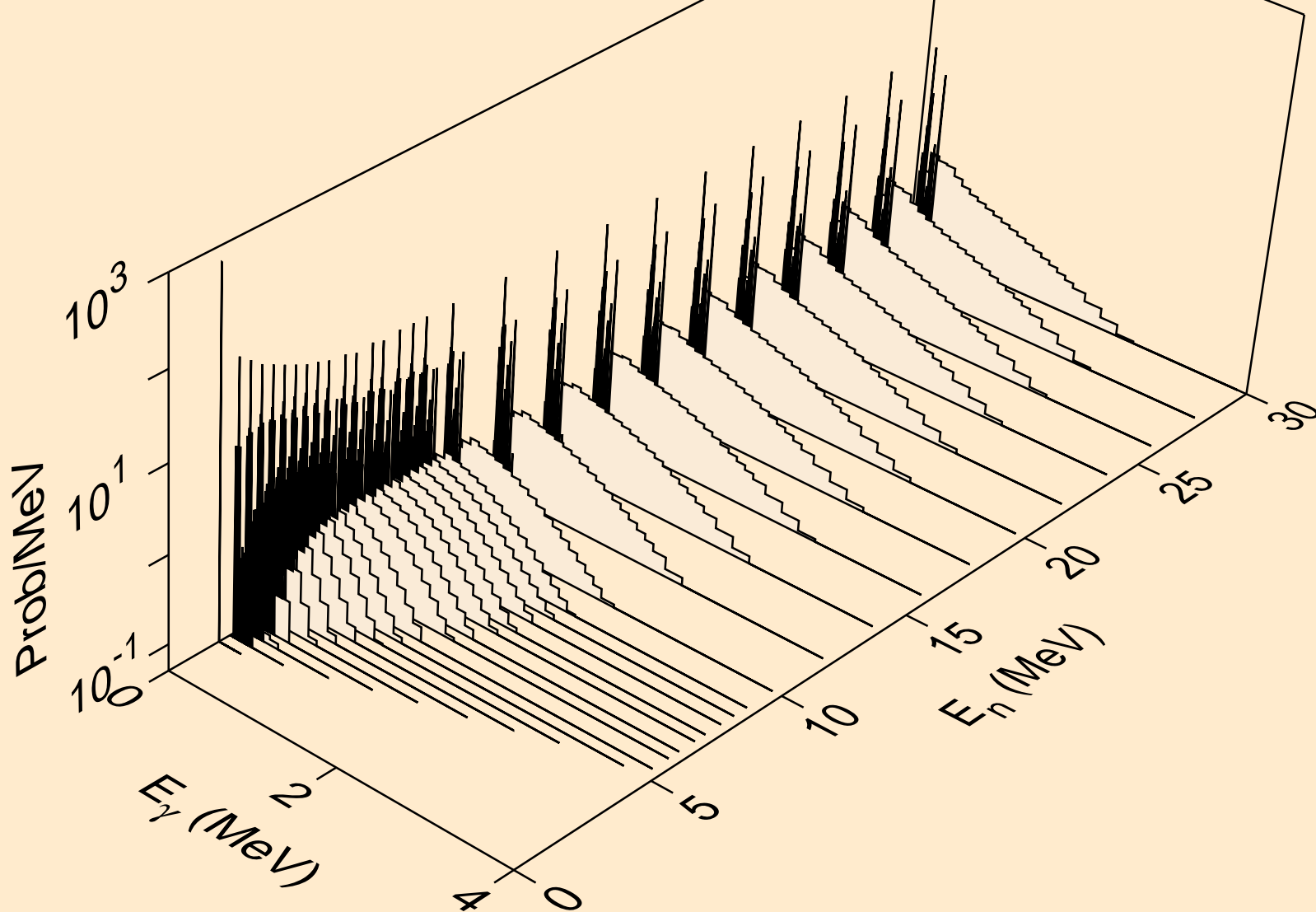

HO165 NEUTRON ACER TENDL-2019 LIBRARY; T=293.16K
Photon emission for (n,d)

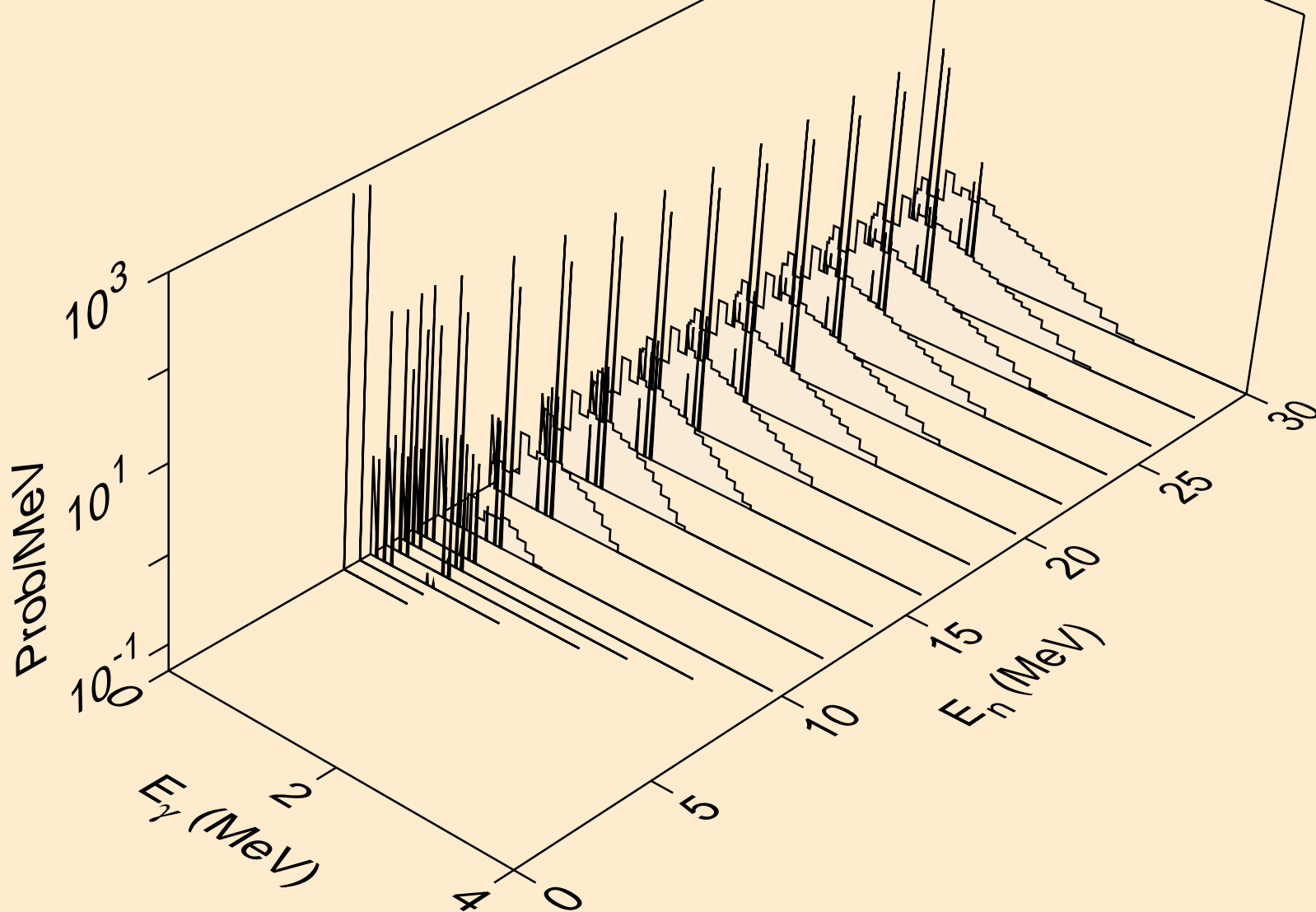

HO165 NEUTRON ACER TENDL-2019 LIBRARY; T=293.16K
Photon emission for (n,t)

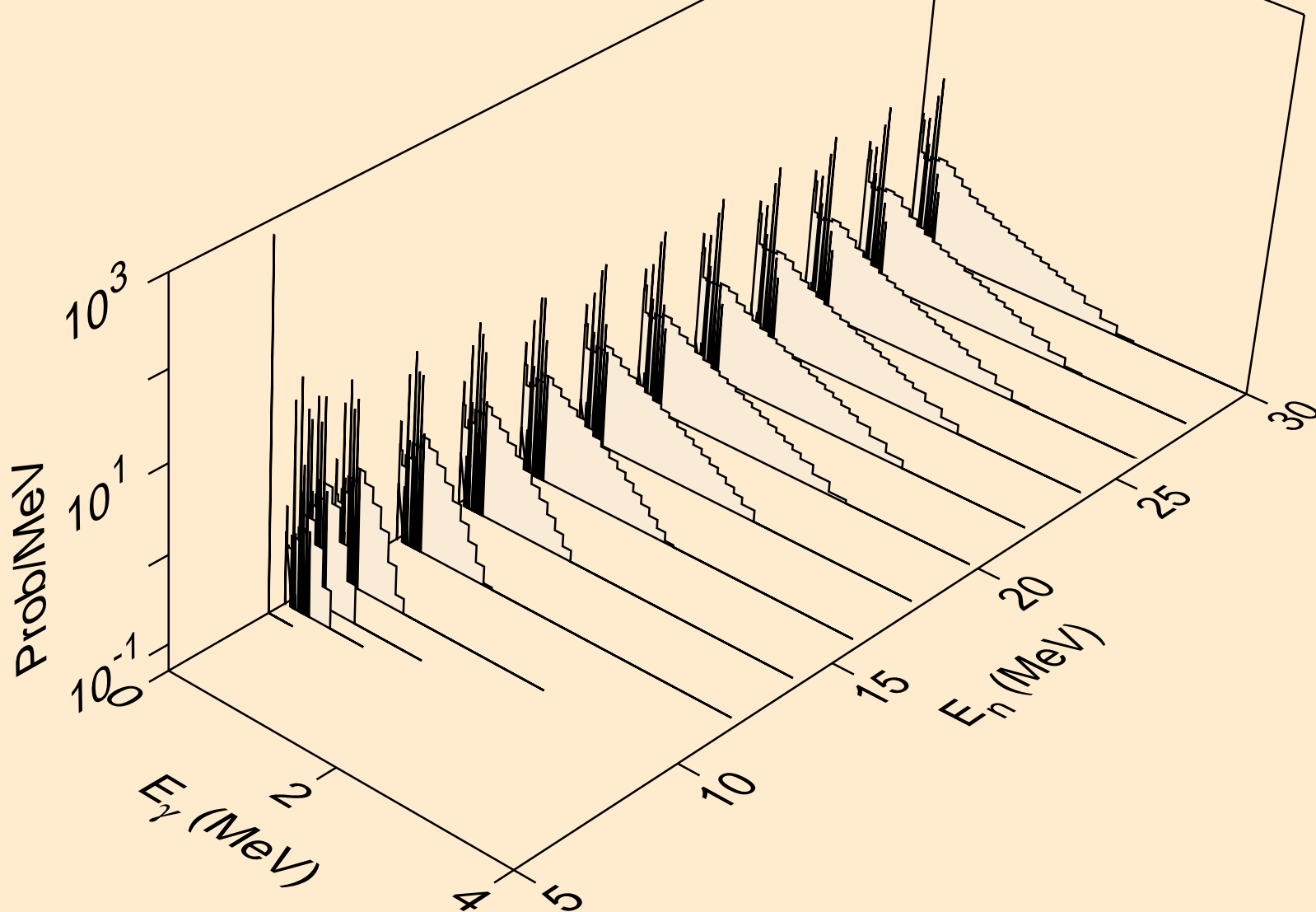

HO165 NEUTRON ACER TENDL-2019 LIBRARY; T=293.16K
Photon emission for (n,he3)

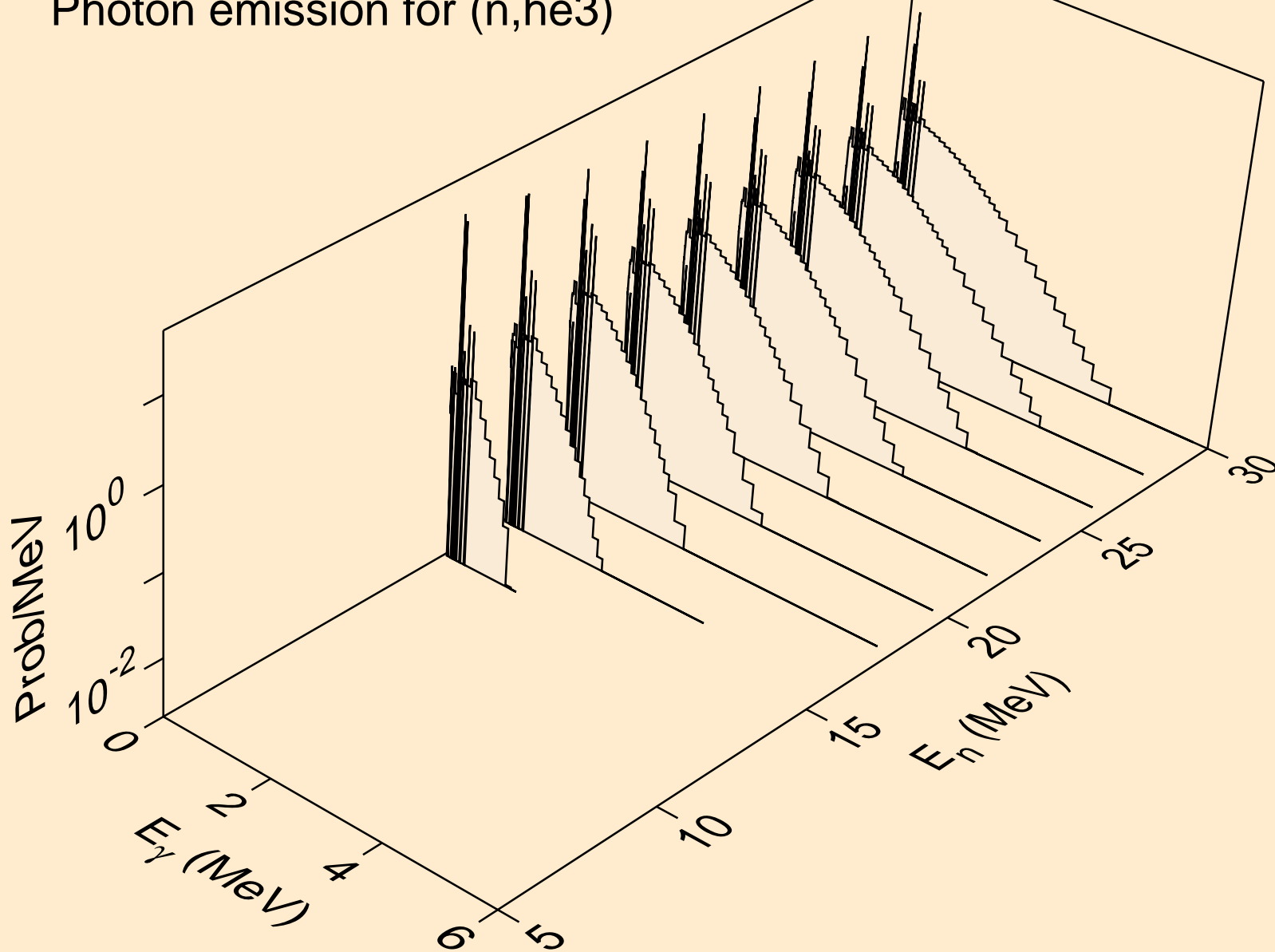

HO165 NEUTRON ACER TENDL-2019 LIBRARY; T=293.16K
Photon emission for (n,a)

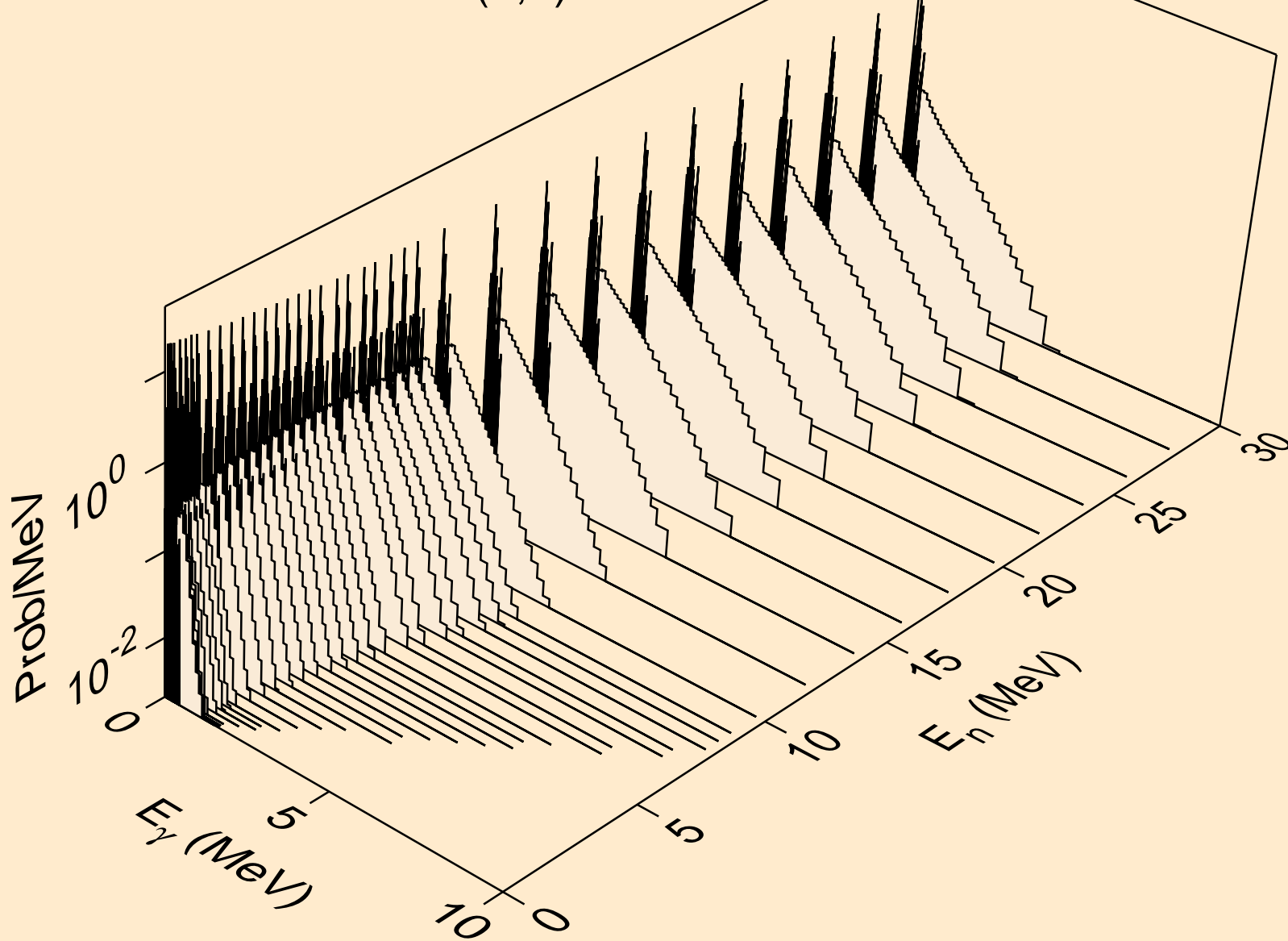

HO165 NEUTRON ACER TENDL-2019 LIBRARY; T=293.16K
Photon emission for (n,2a)

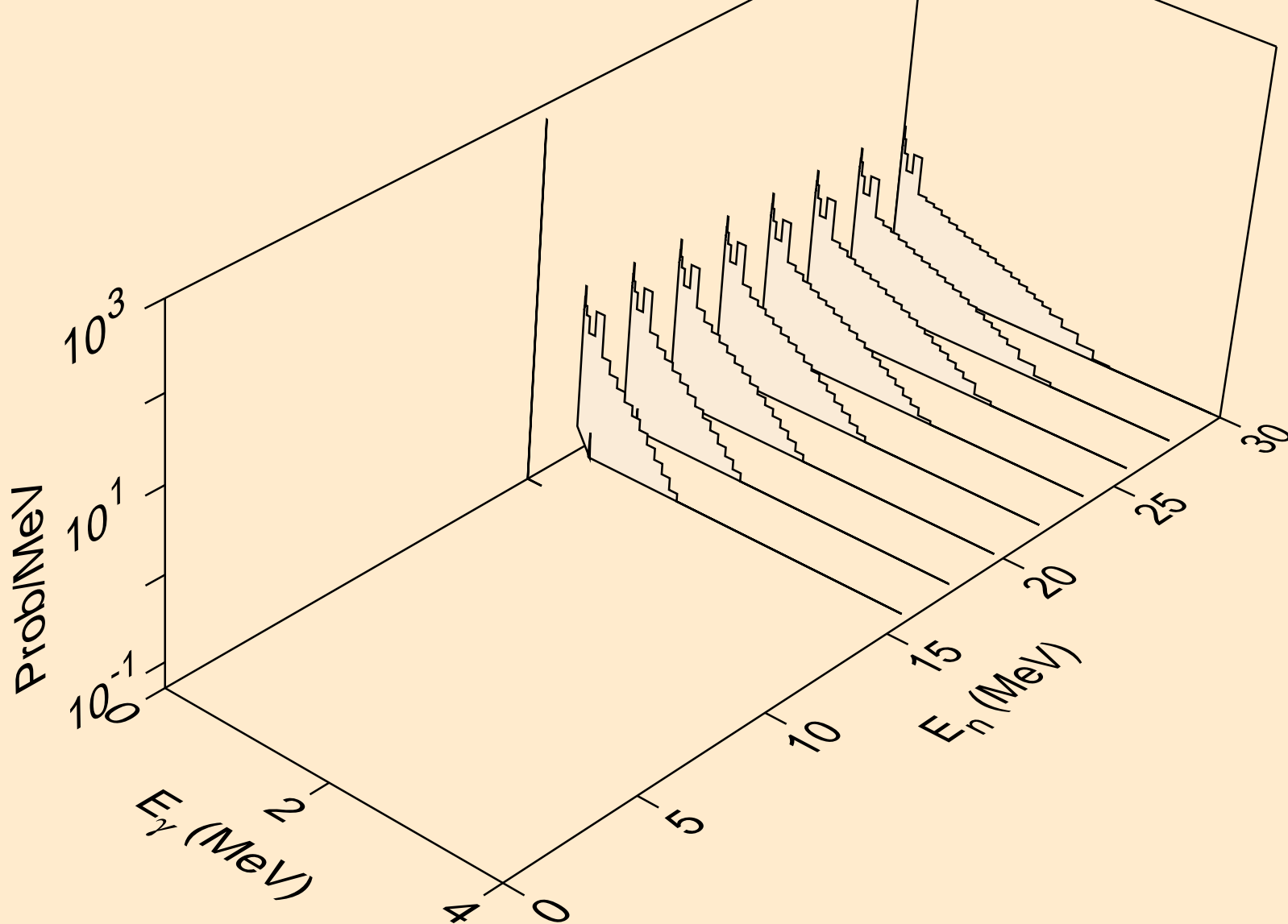

HO165 NEUTRON ACER TENDL-2019 LIBRARY; T=293.16K
Photon emission for (n,2p)

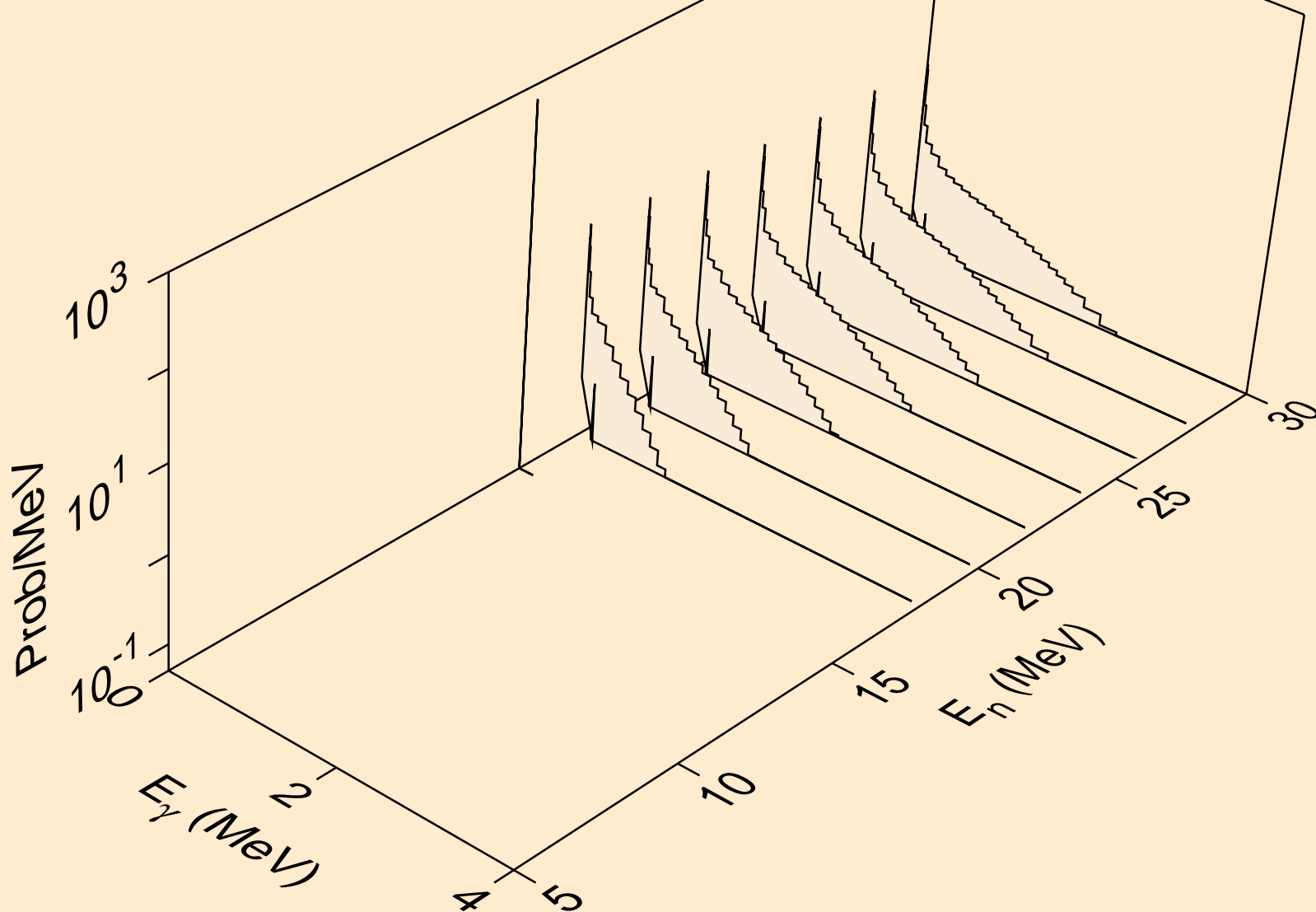

HO165 NEUTRON ACER TENDL-2019 LIBRARY; T=293.16K
Photon emission for (n,p α)

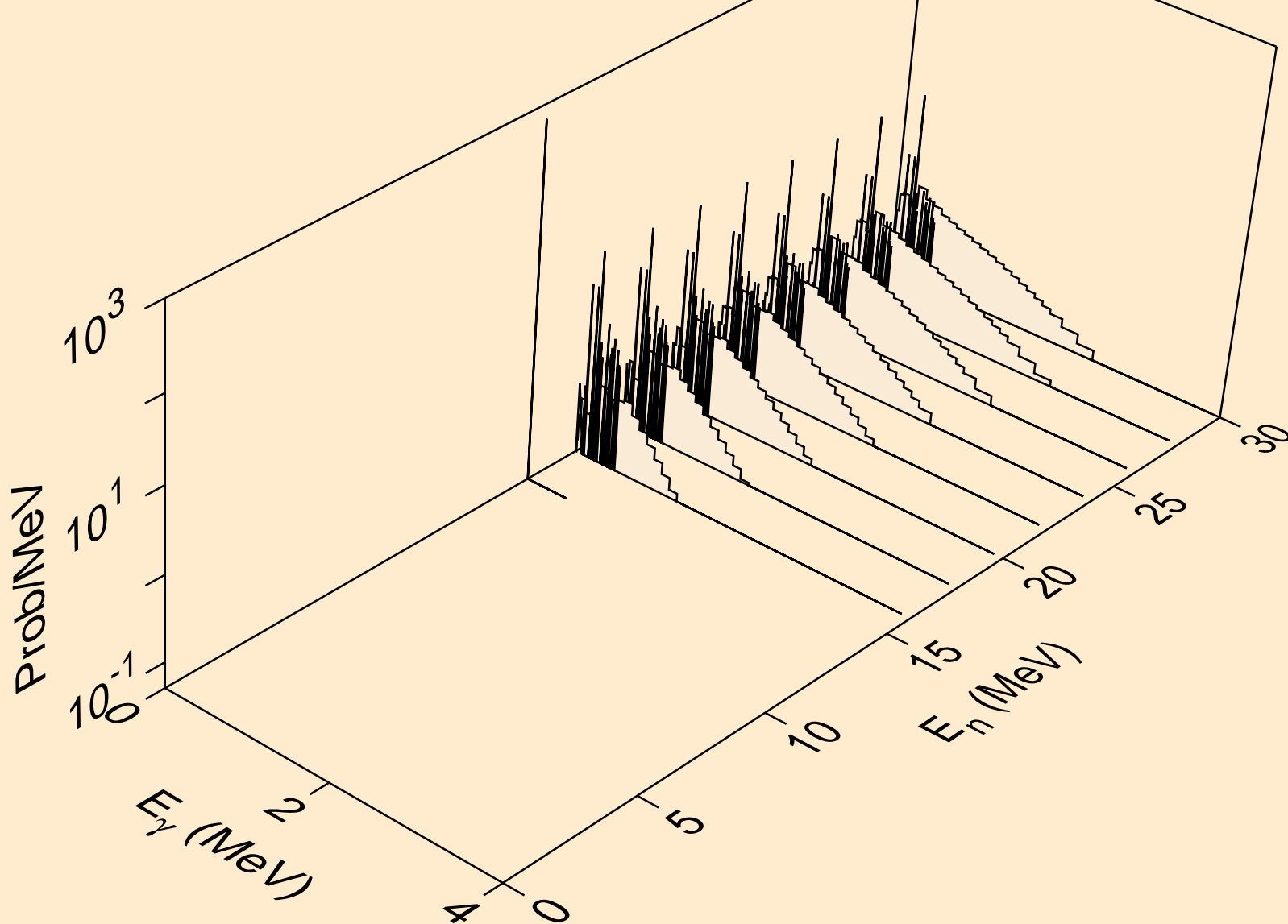

HO165 NEUTRON ACER TENDL-2019 LIBRARY; T=293.16K
Photon emission for (n,pd)

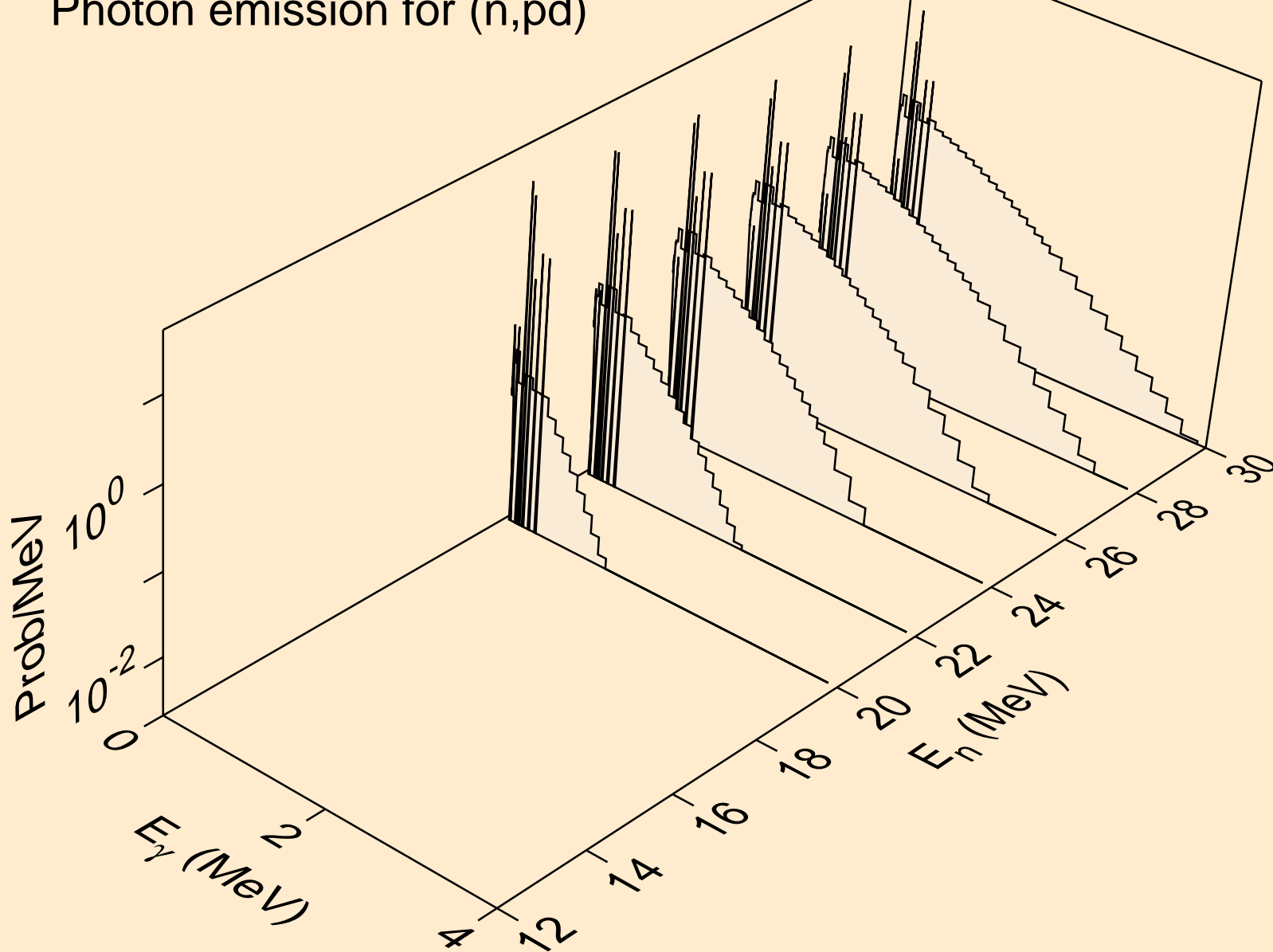

HO165 NEUTRON ACER TENDL-2019 LIBRARY; T=293.16K
Photon emission for (n,pt)

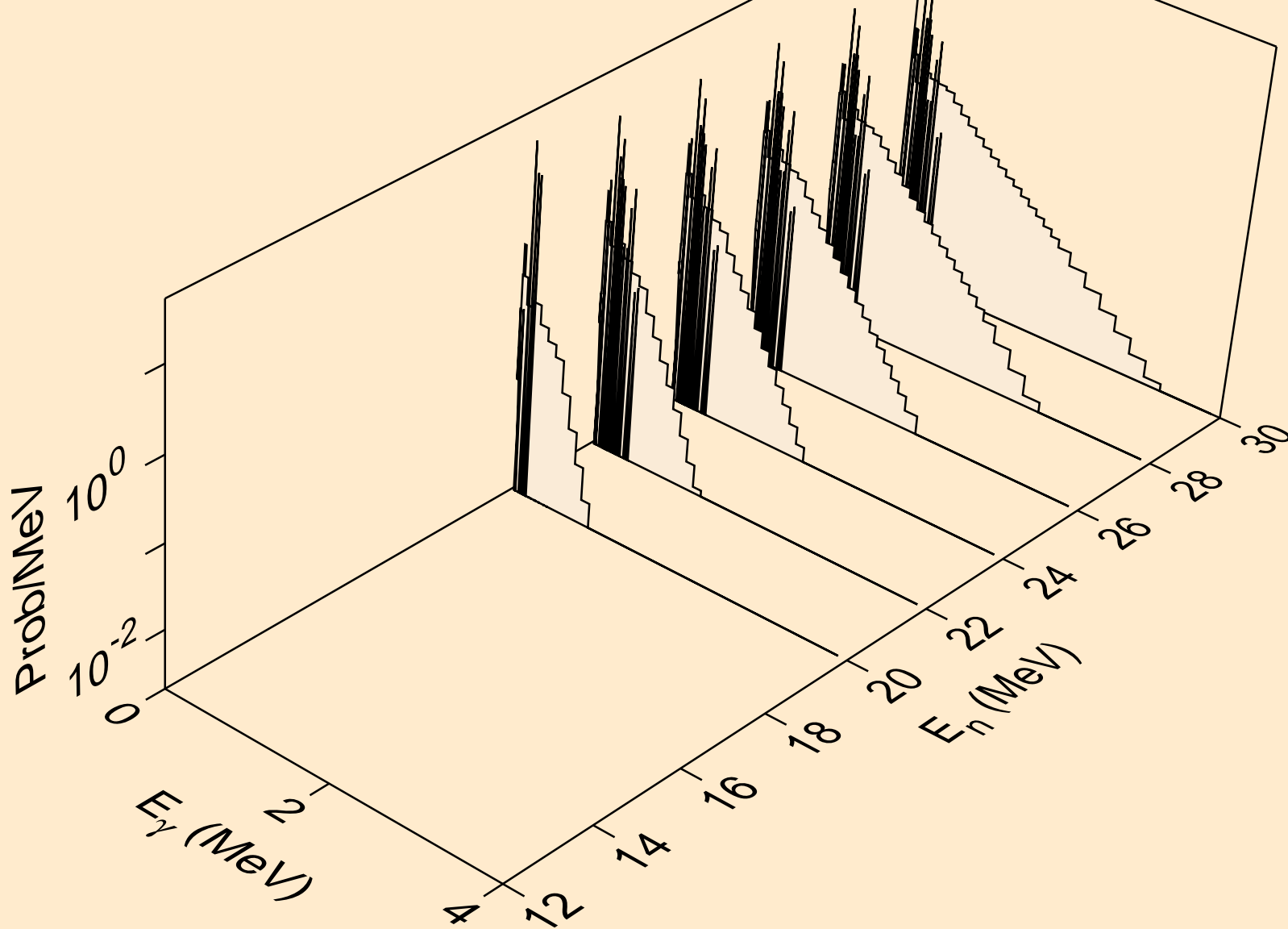

HO165 NEUTRON ACER TENDL-2019 LIBRARY; T=293.16K
Photon emission for (n,da)

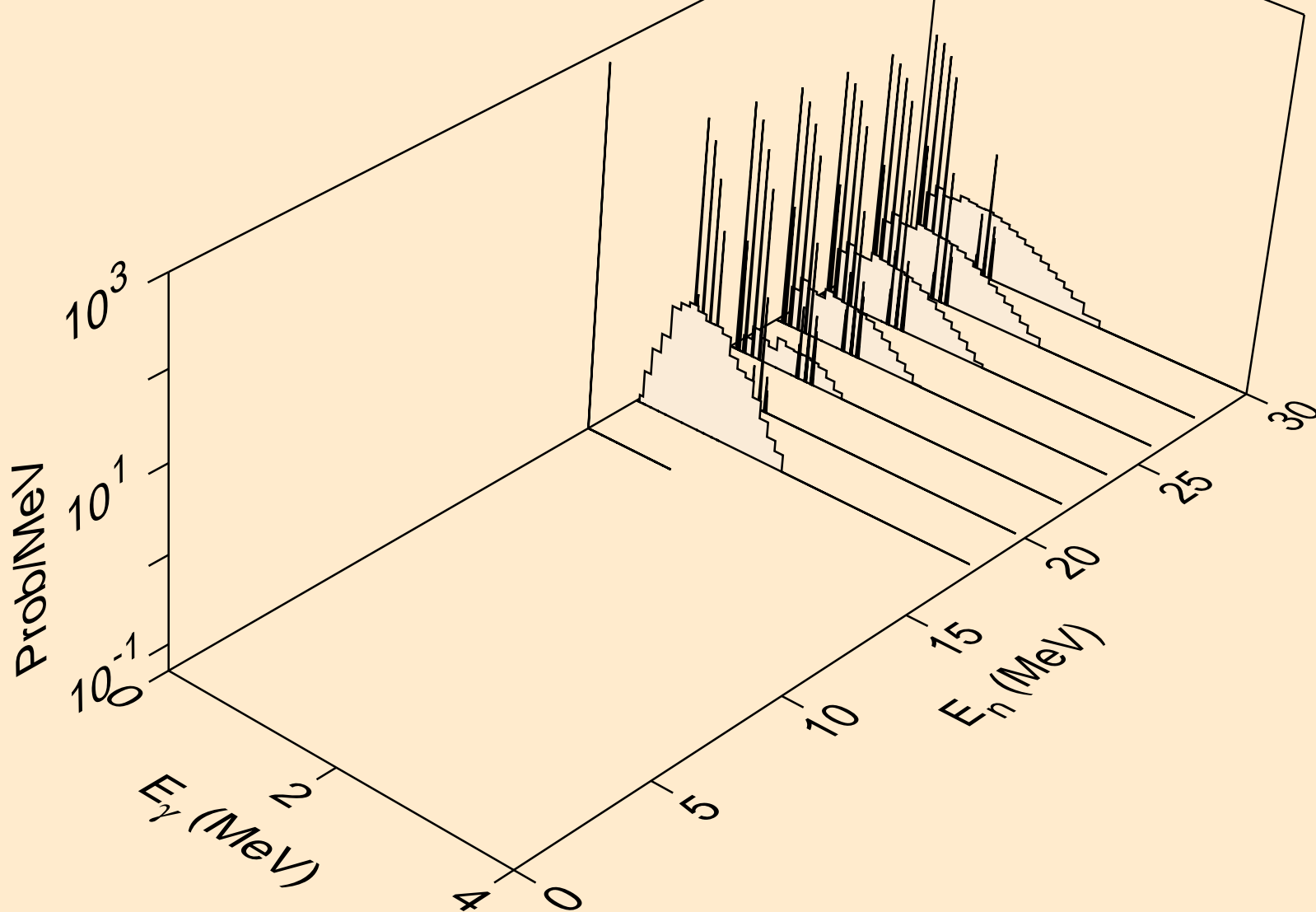

HO165 NEUTRON ACER TENDL-2019 LIBRARY; T=293.16K
thermal capture photon spectrum

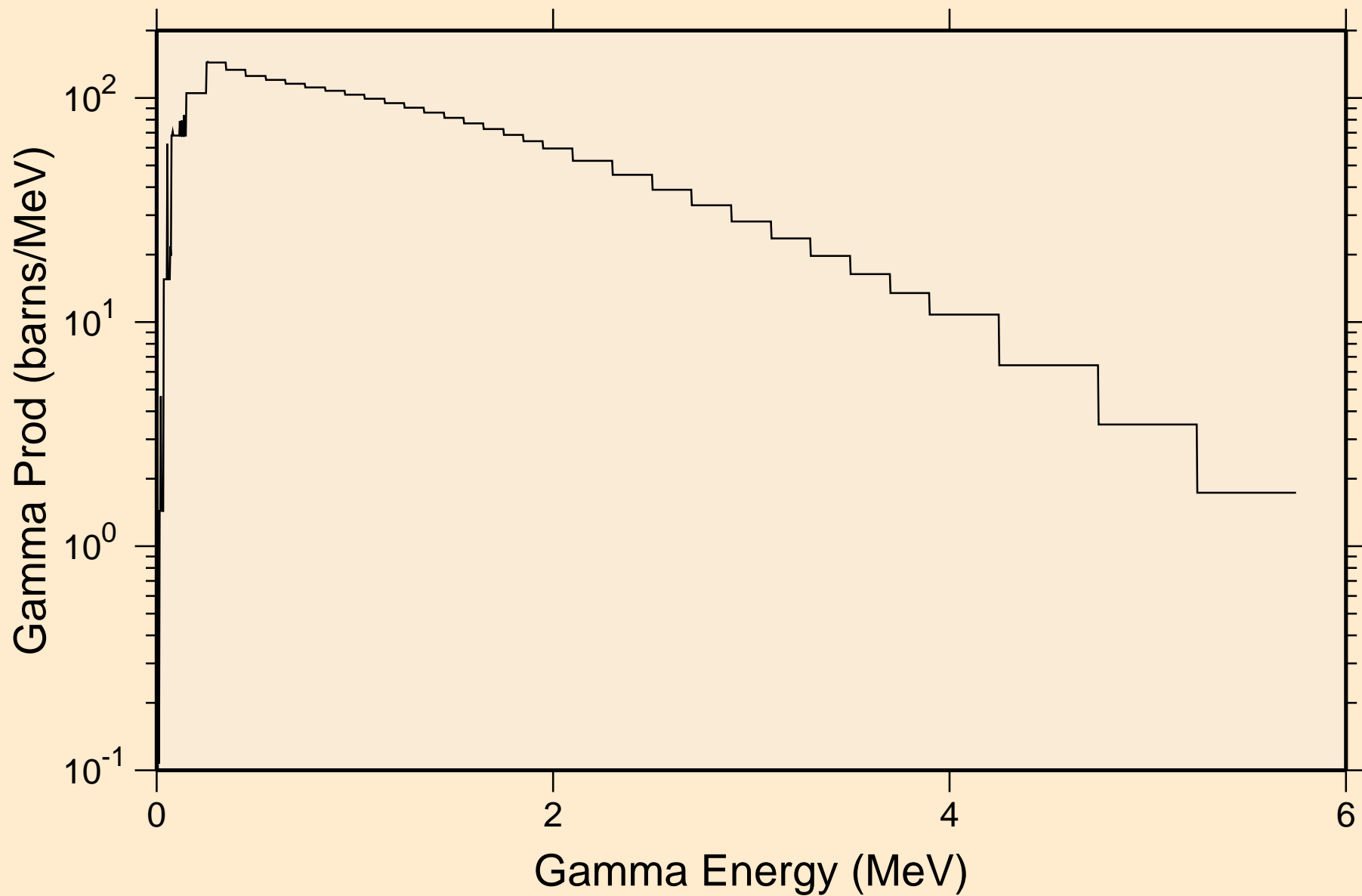

HO165 NEUTRON ACER TENDL-2019 LIBRARY; T=293.16K
14 MeV photon spectrum

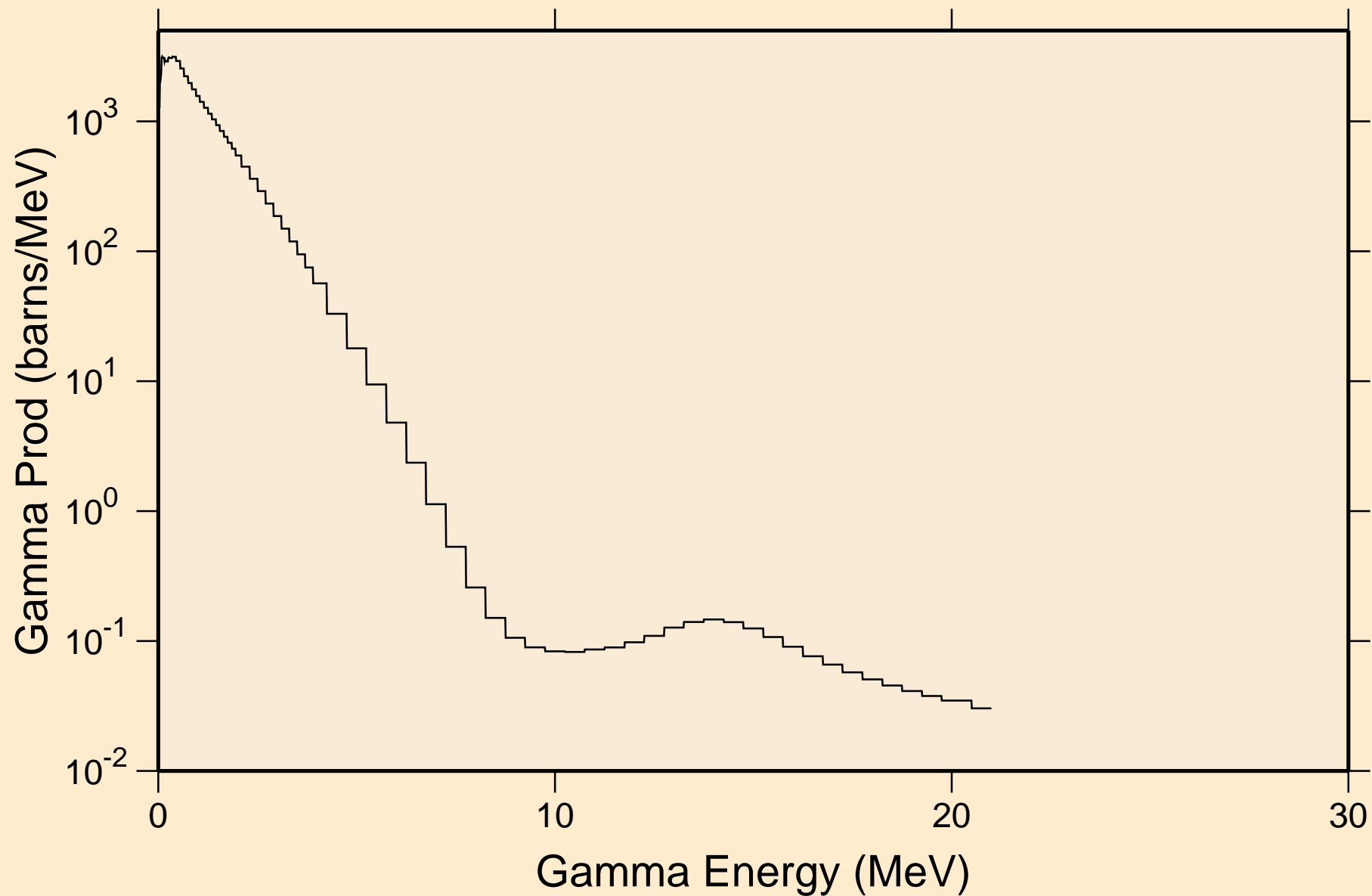

HO165 NEUTRON ACER TENDL-2019 LIBRARY; T=293.16K

Particle heating contributions

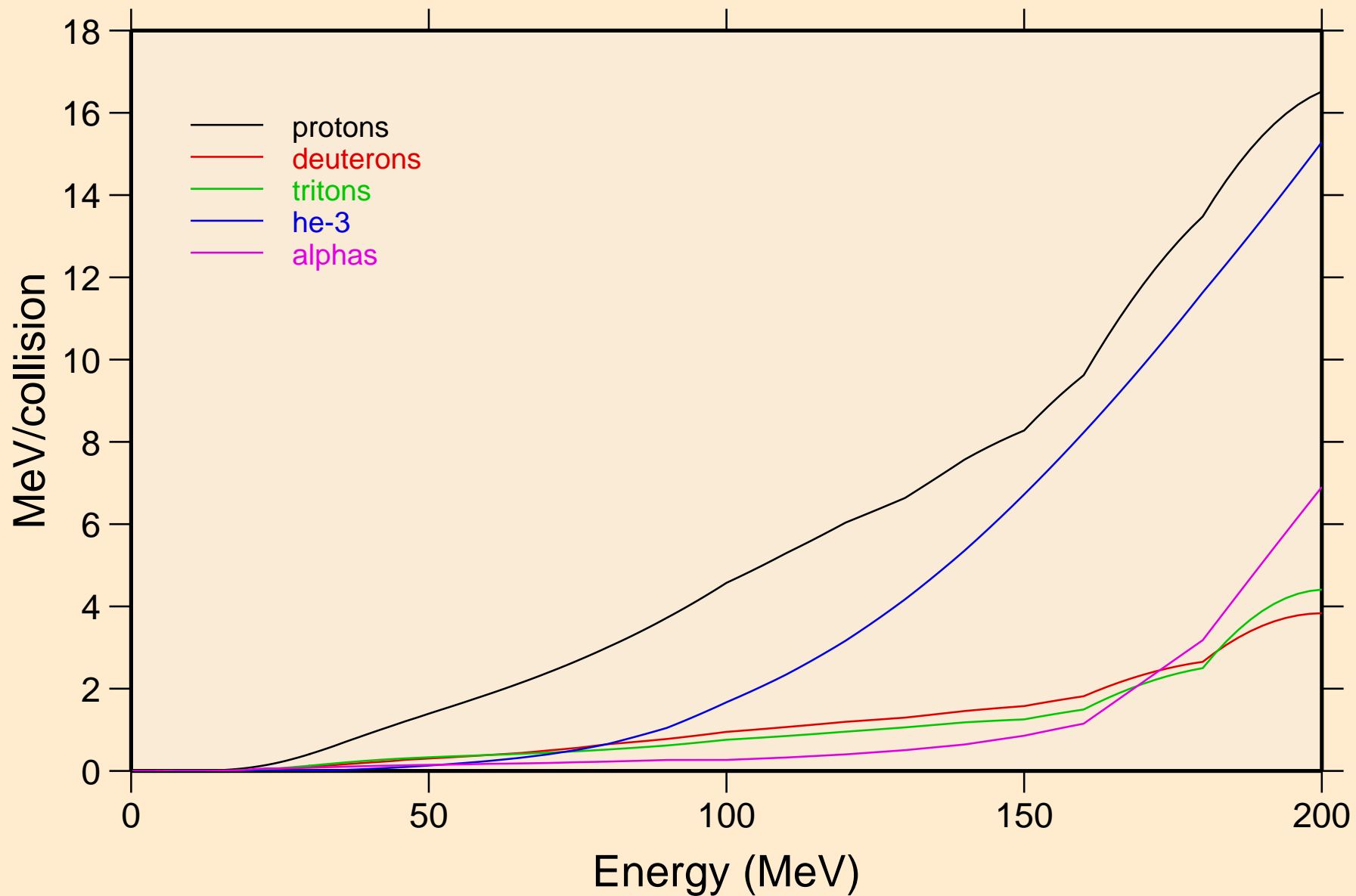

HO165 NEUTRON ACER TENDL-2019 LIBRARY; T=293.16K
Recoil Heating

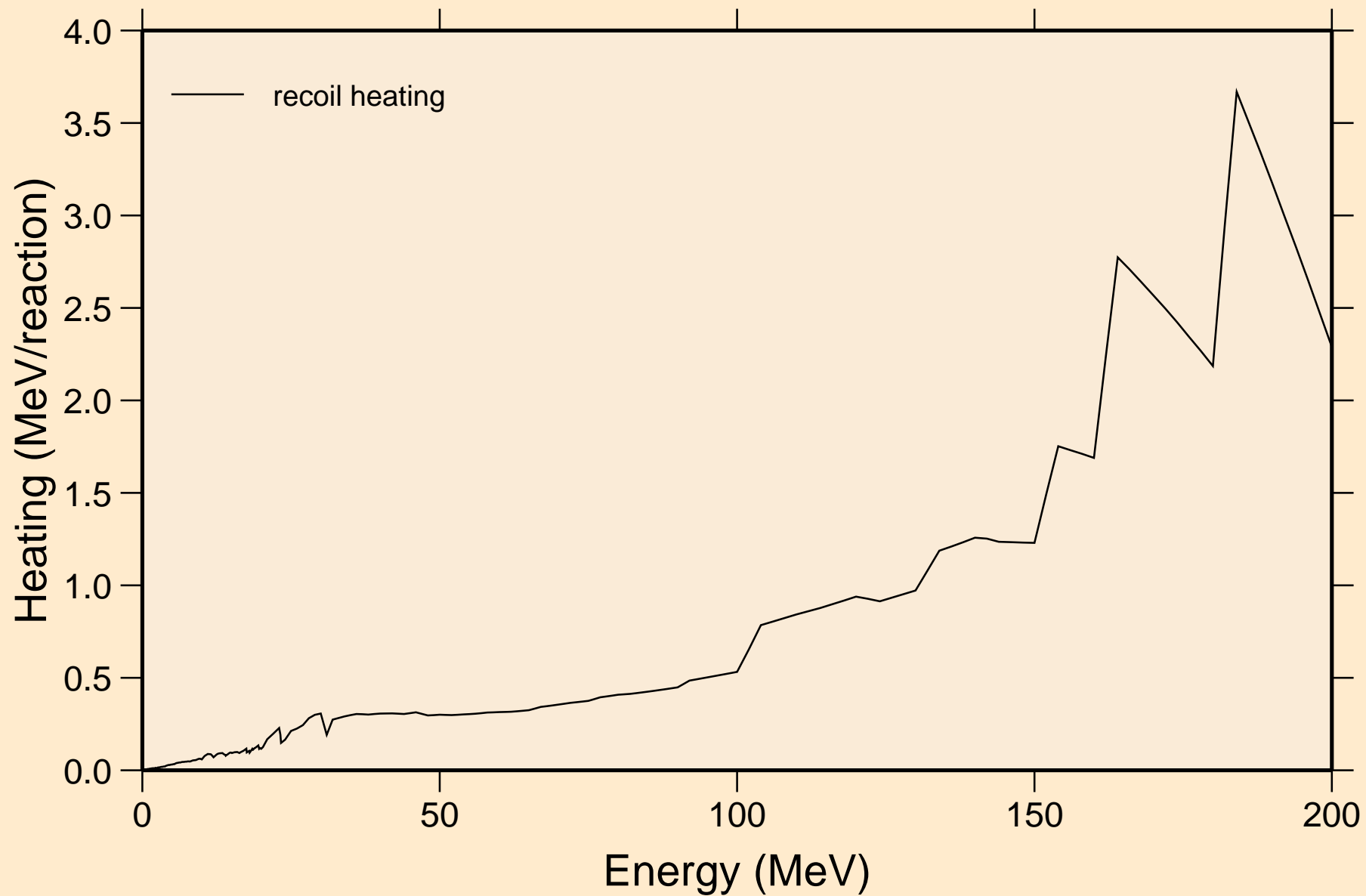

HO165 NEUTRON ACER TENDL-2019 LIBRARY; T=293.16K

Particle production cross sections

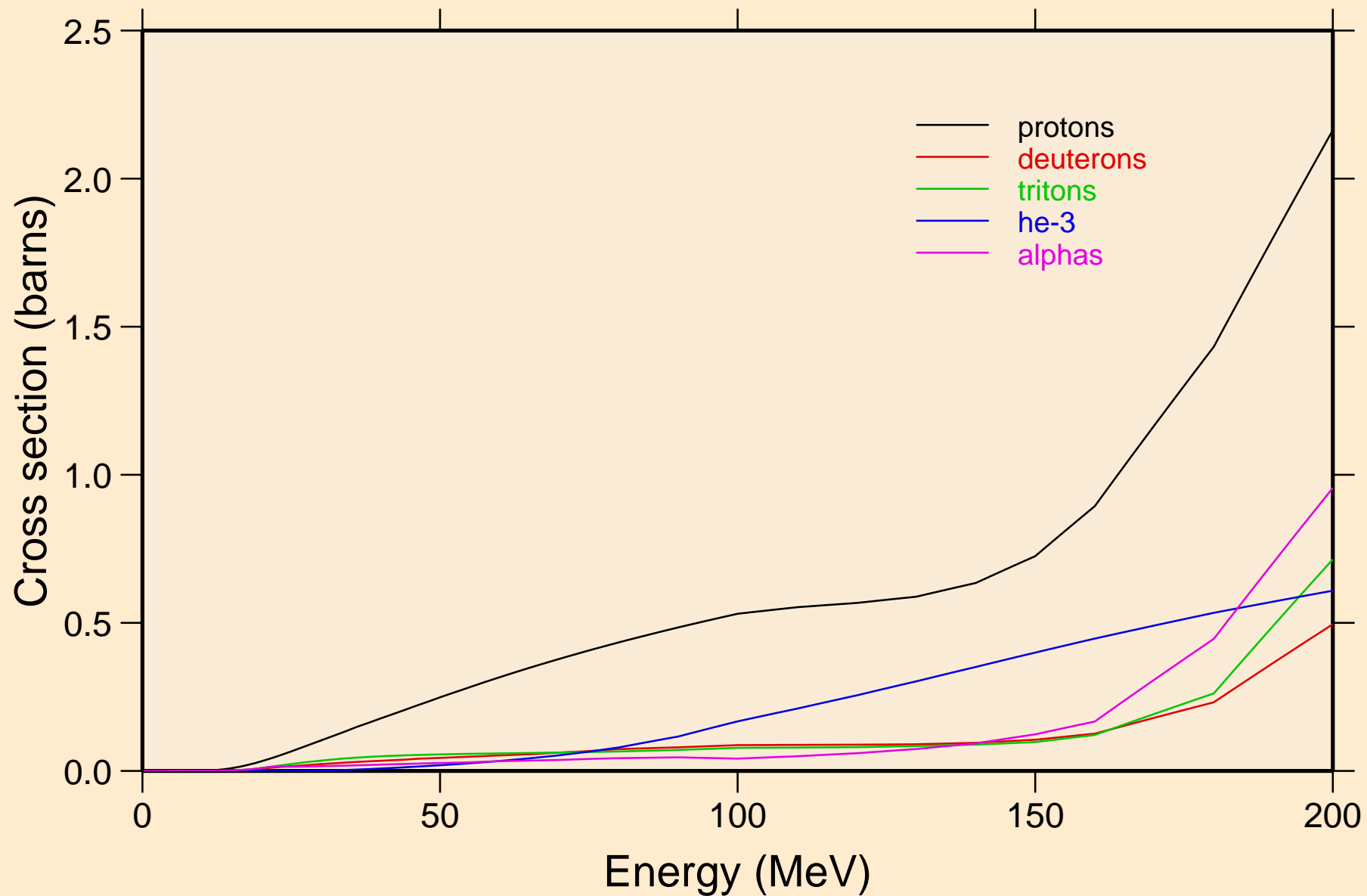

HO165 NEUTRON ACER TENDL-2019 LIBRARY; T=293.16K
protons from (n,x)

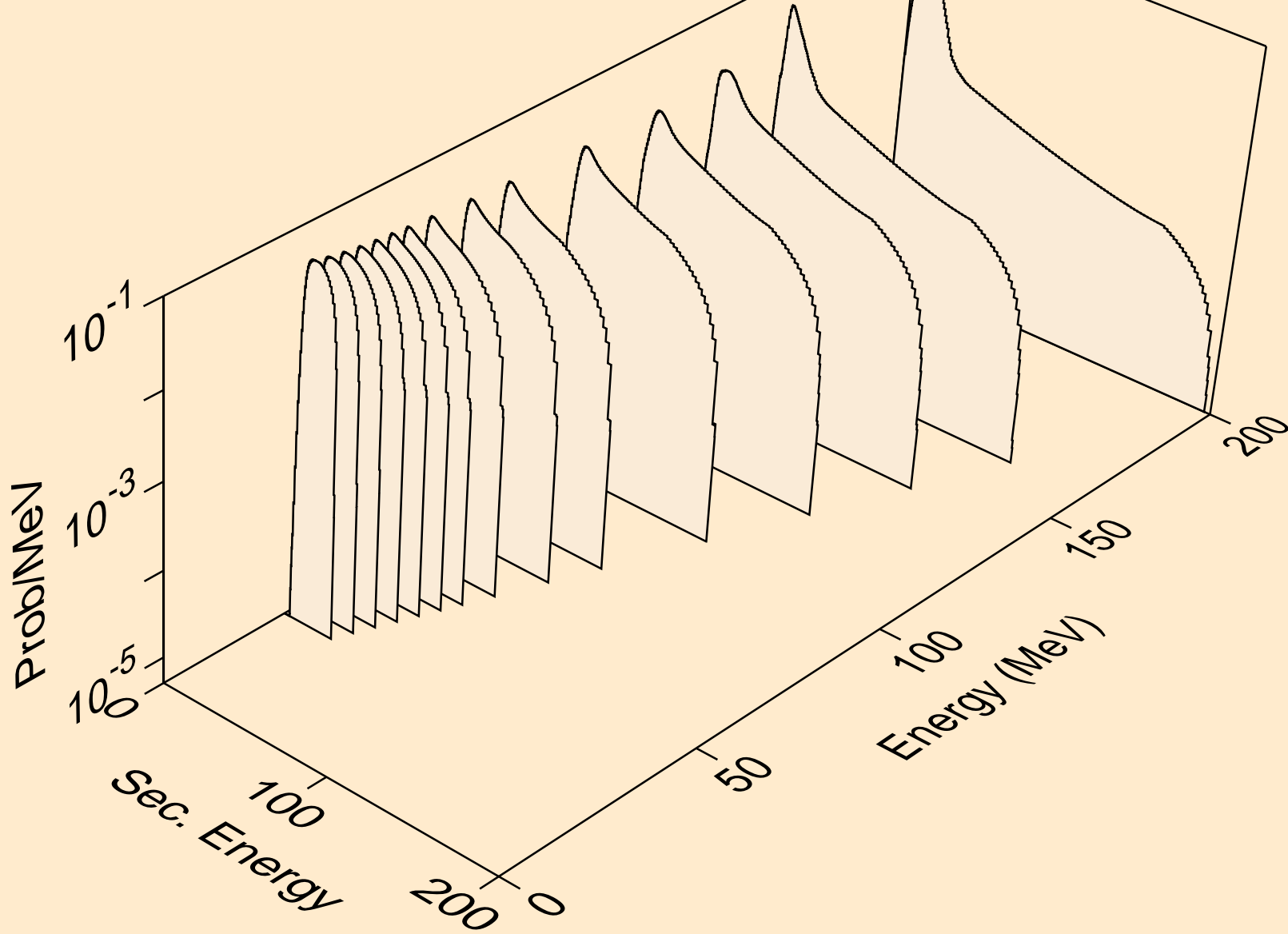

HO165 NEUTRON ACER TENDL-2019 LIBRARY; T=293.16K
protons from (n,n*)p

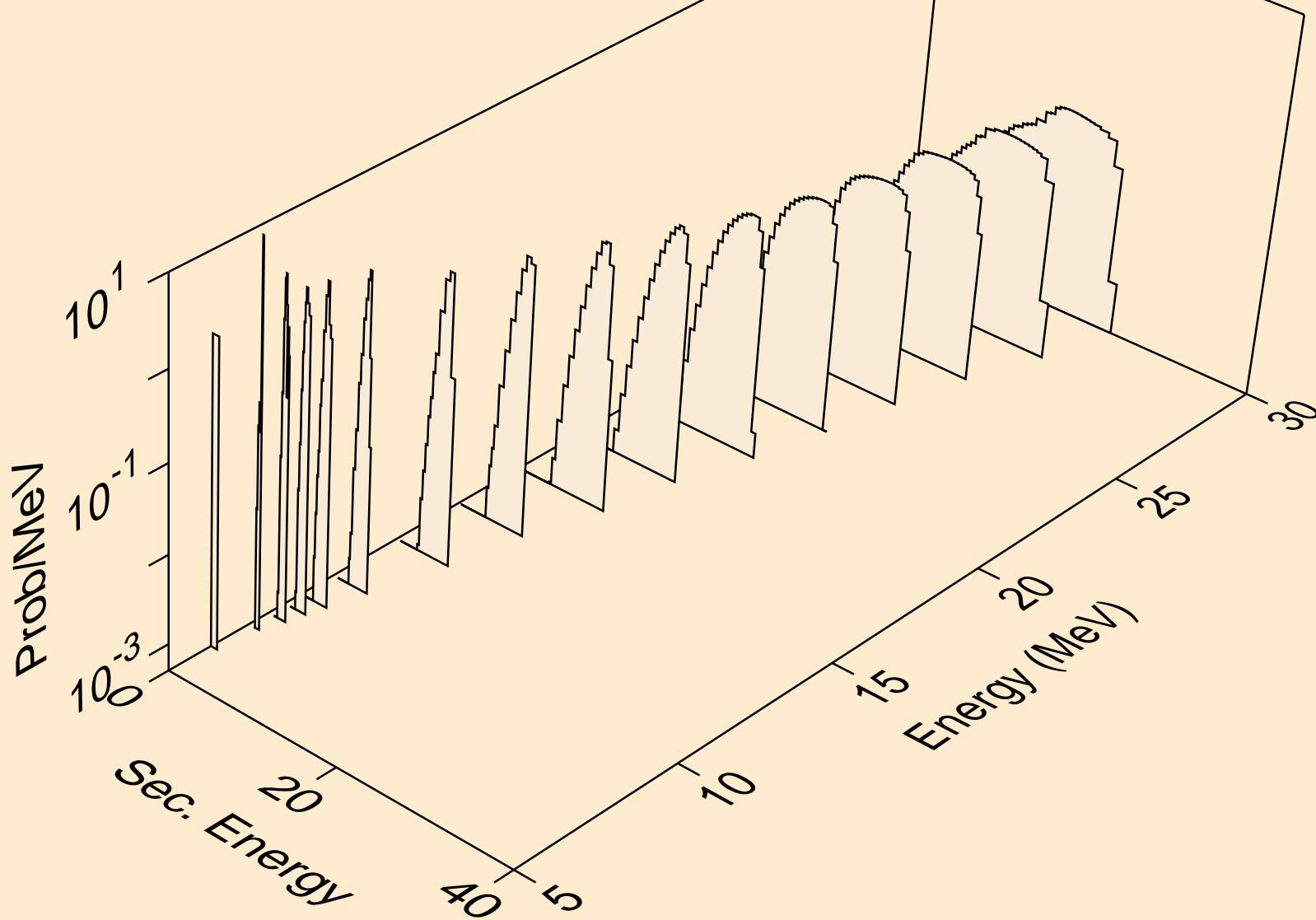

HO165 NEUTRON ACER TENDL-2019 LIBRARY; T=293.16K
protons from (n,2np)

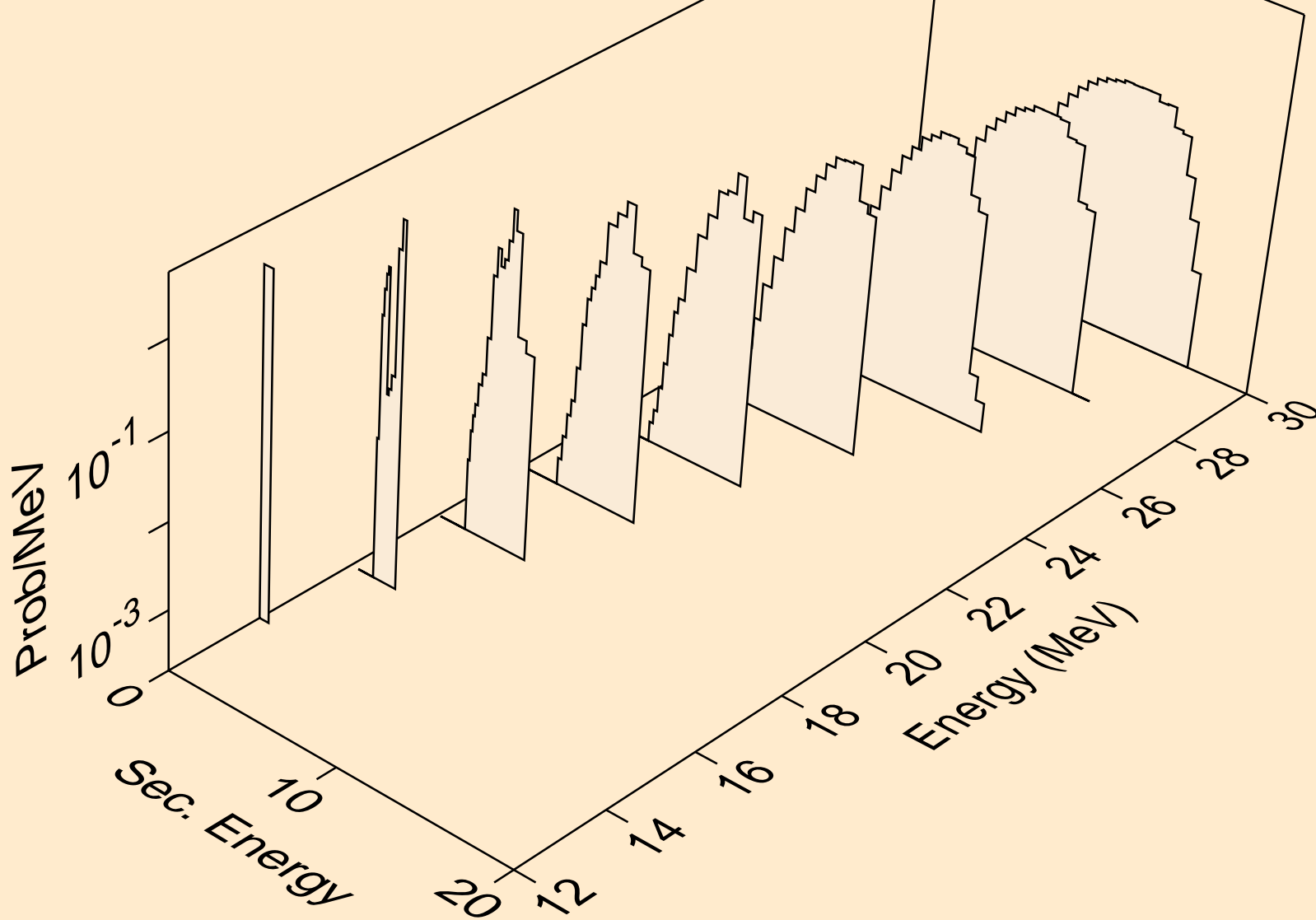

HO165 NEUTRON ACER TENDL-2019 LIBRARY; T=293.16K
protons from (n,3np)

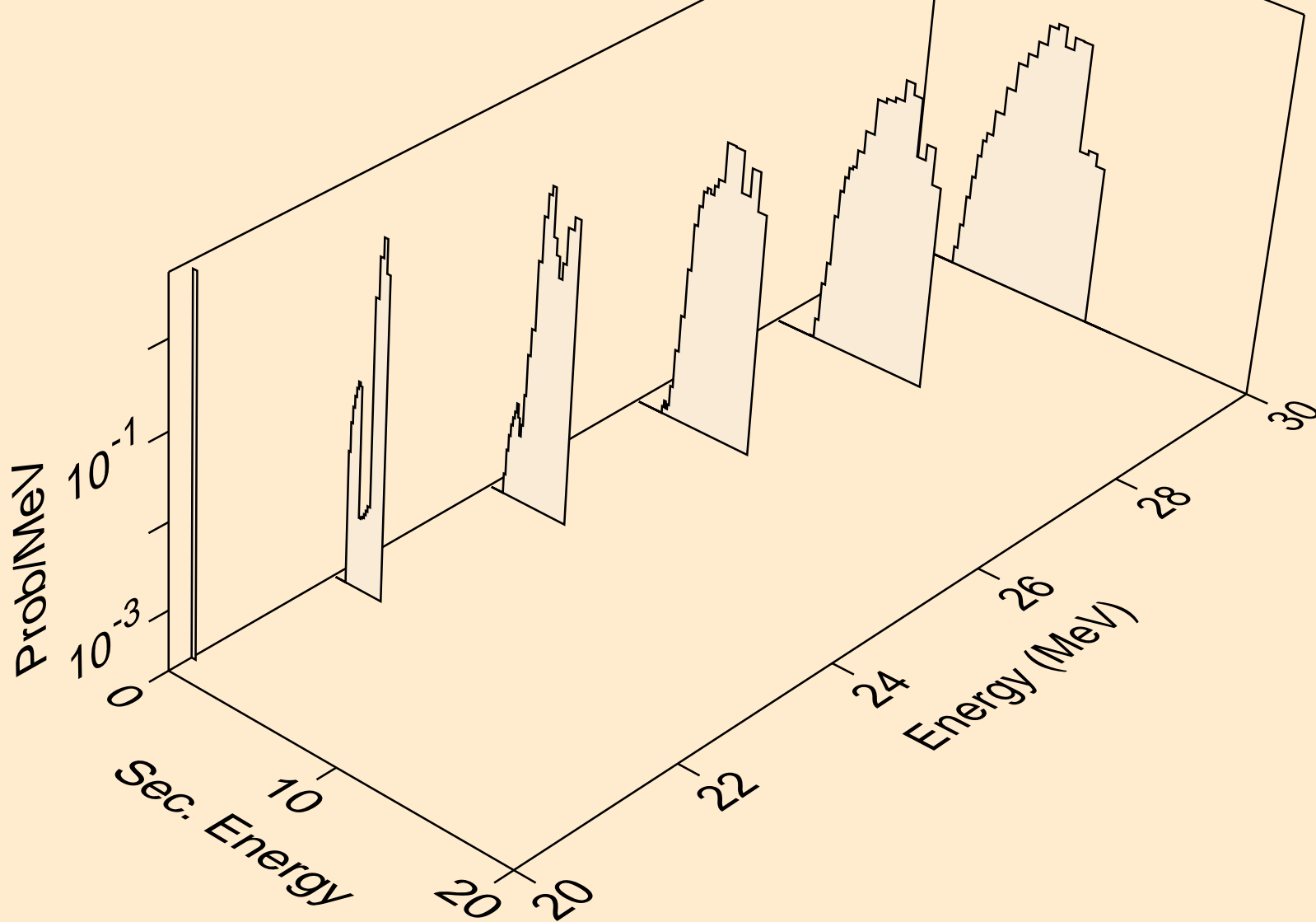

HO165 NEUTRON ACER TENDL-2019 LIBRARY; T=293.16K
protons from (n,2np)

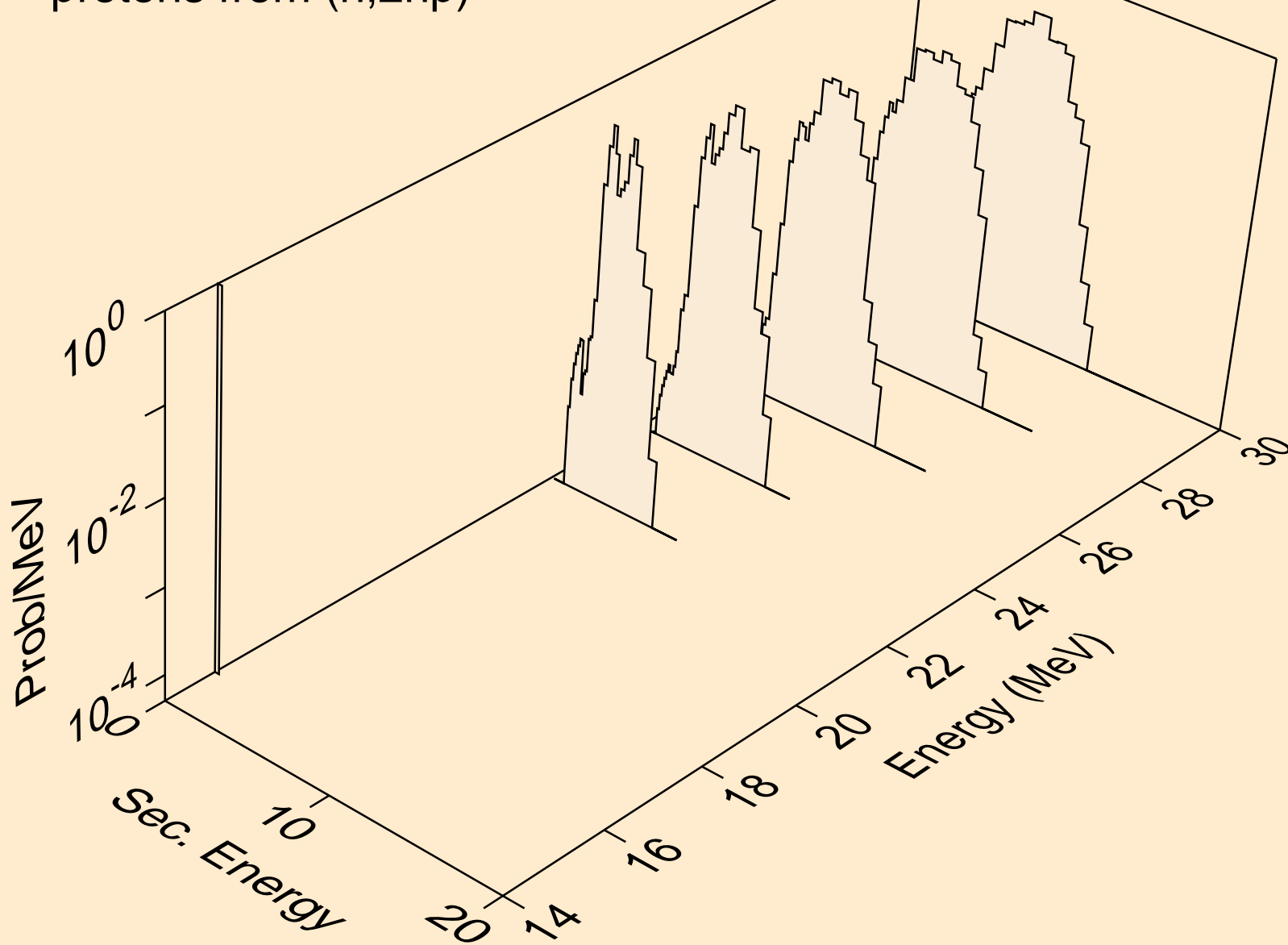

HO165 NEUTRON ACER TENDL-2019 LIBRARY; T=293.16K
protons from (n,npa)

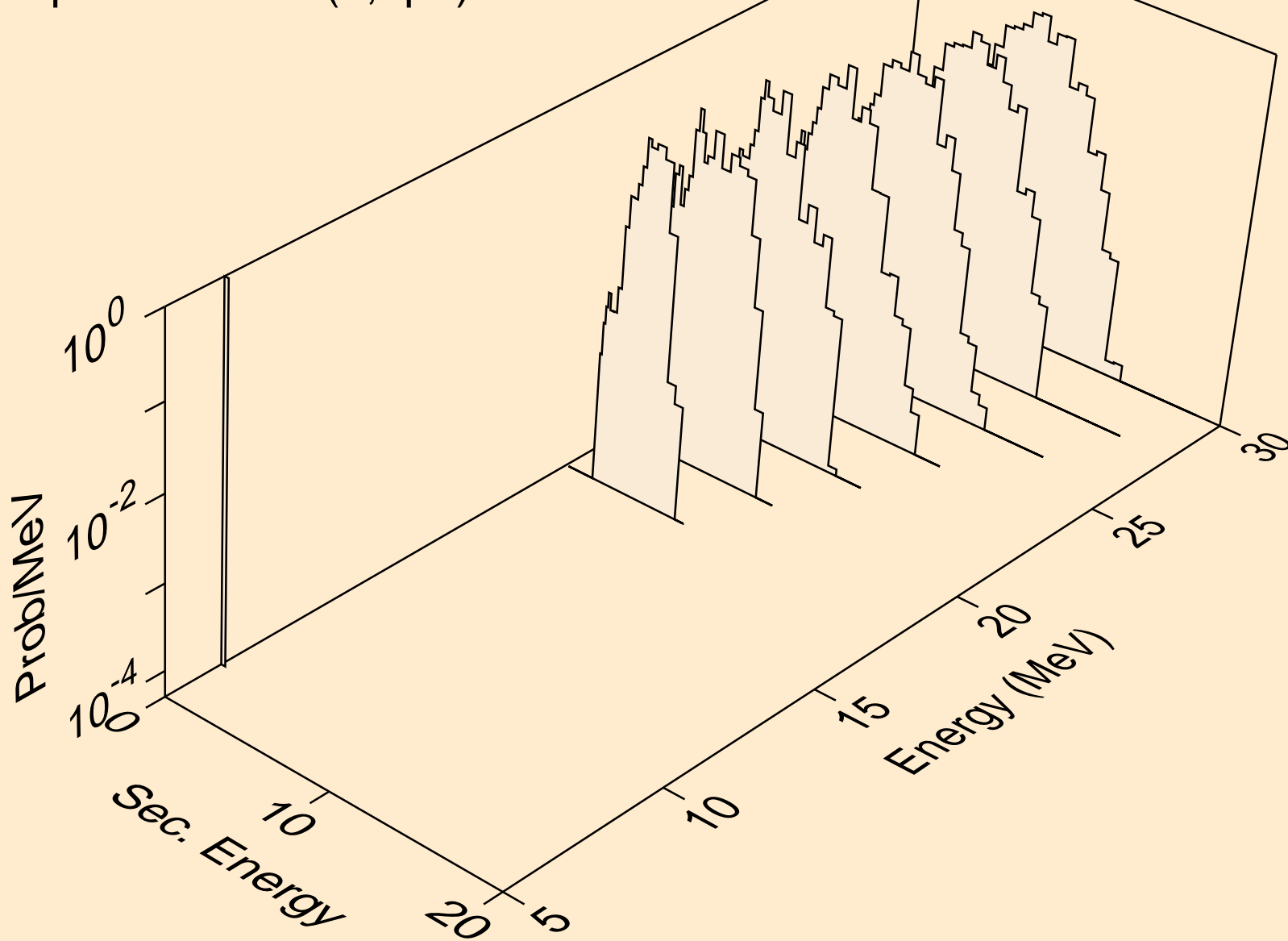

HO165 NEUTRON ACER TENDL-2019 LIBRARY; T=293.16K
protons from (n,p)

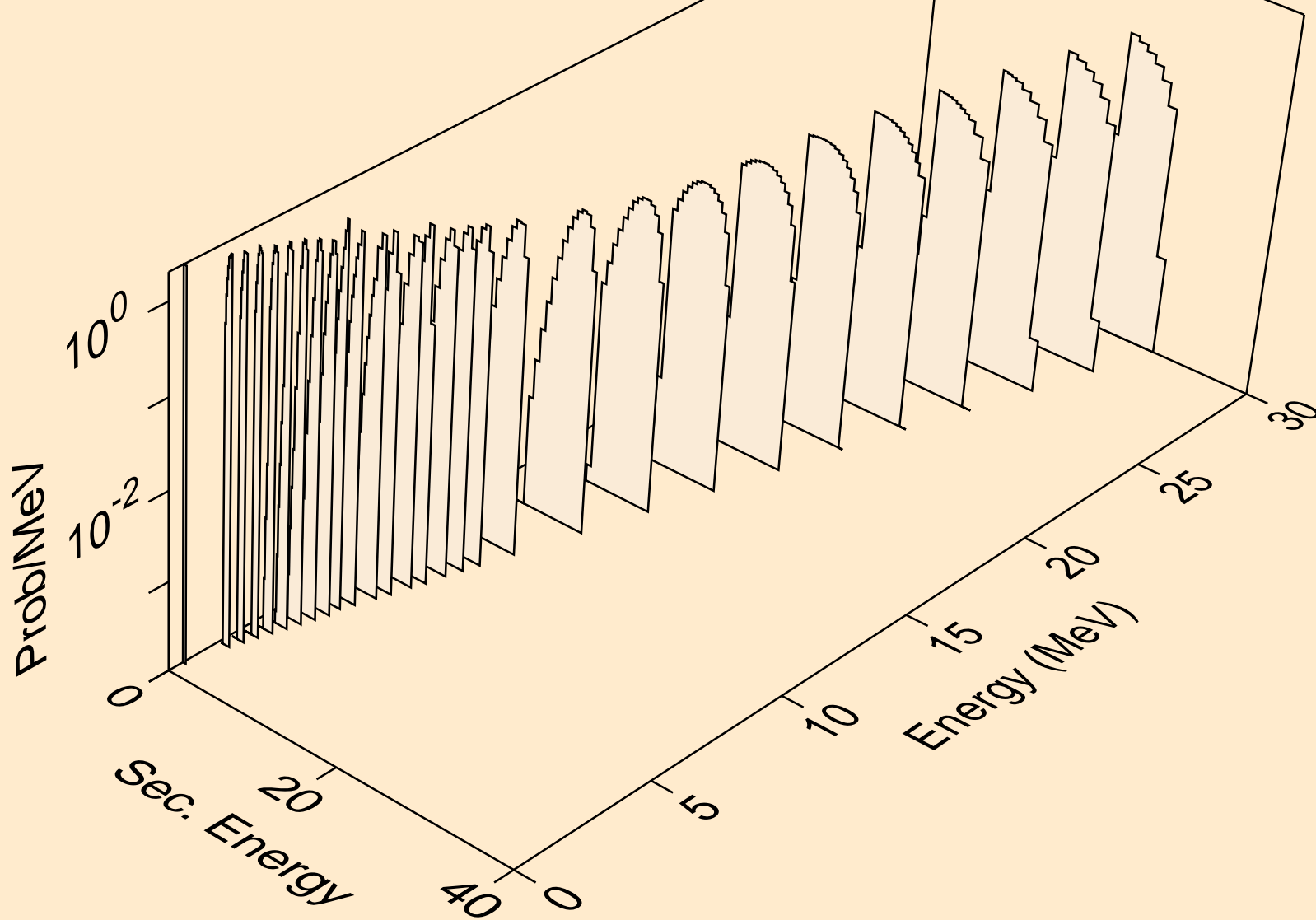

HO165 NEUTRON ACER TENDL-2019 LIBRARY; T=293.16K
protons from (n,2p)

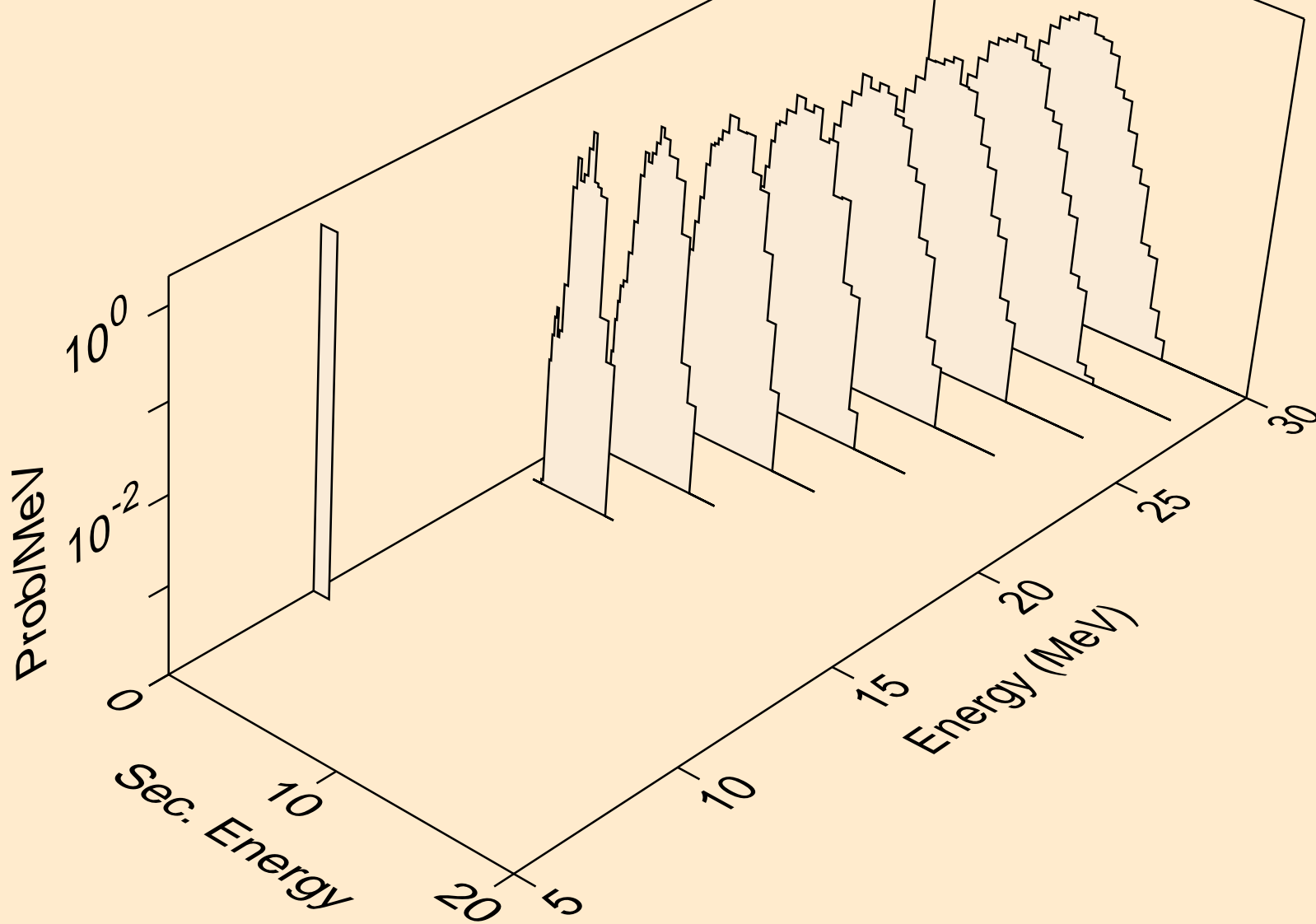

HO165 NEUTRON ACER TENDL-2019 LIBRARY; T=293.16K
protons from (n,p)

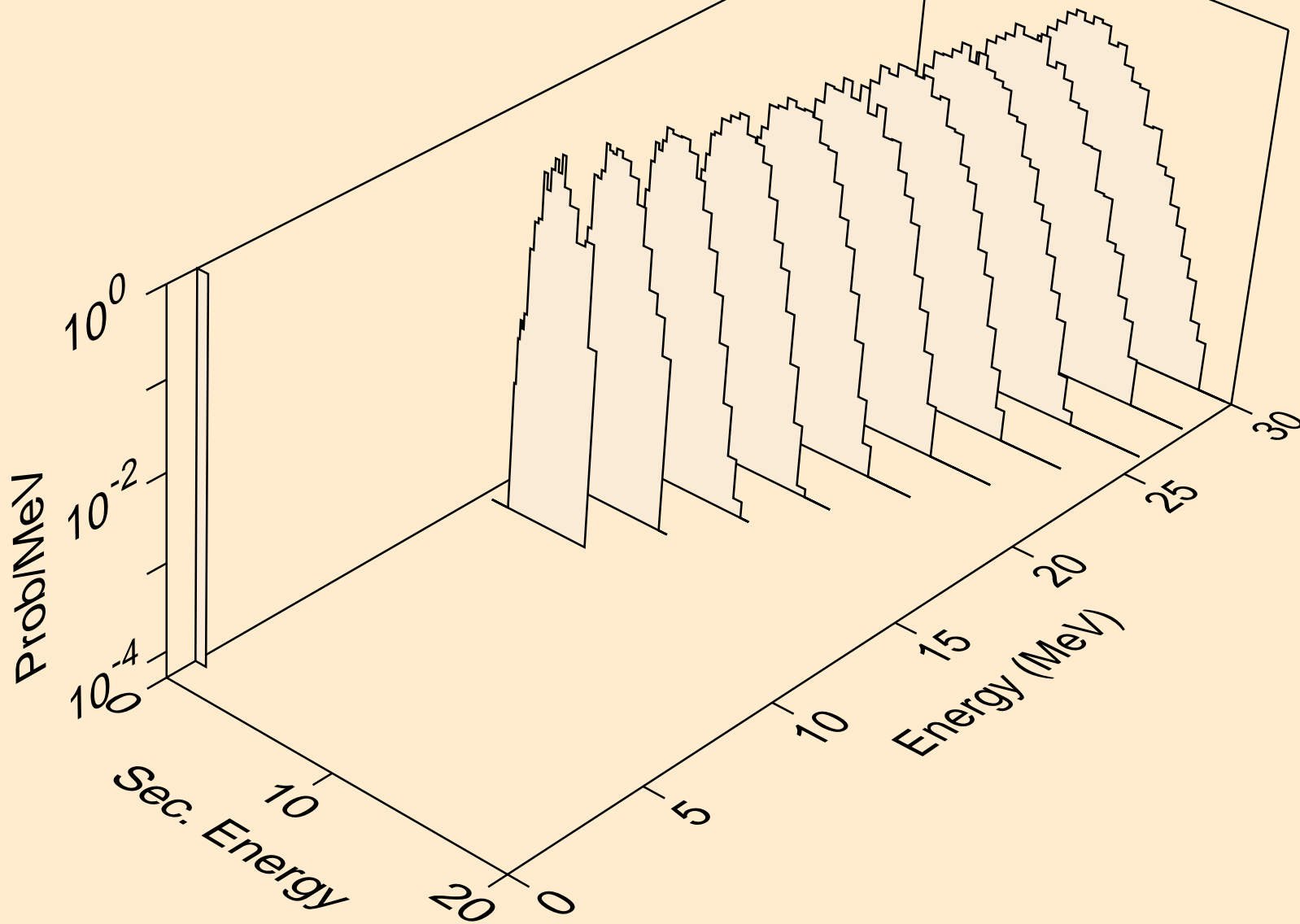

HO165 NEUTRON ACER TENDL-2019 LIBRARY; T=293.16K
protons from (n,pd)

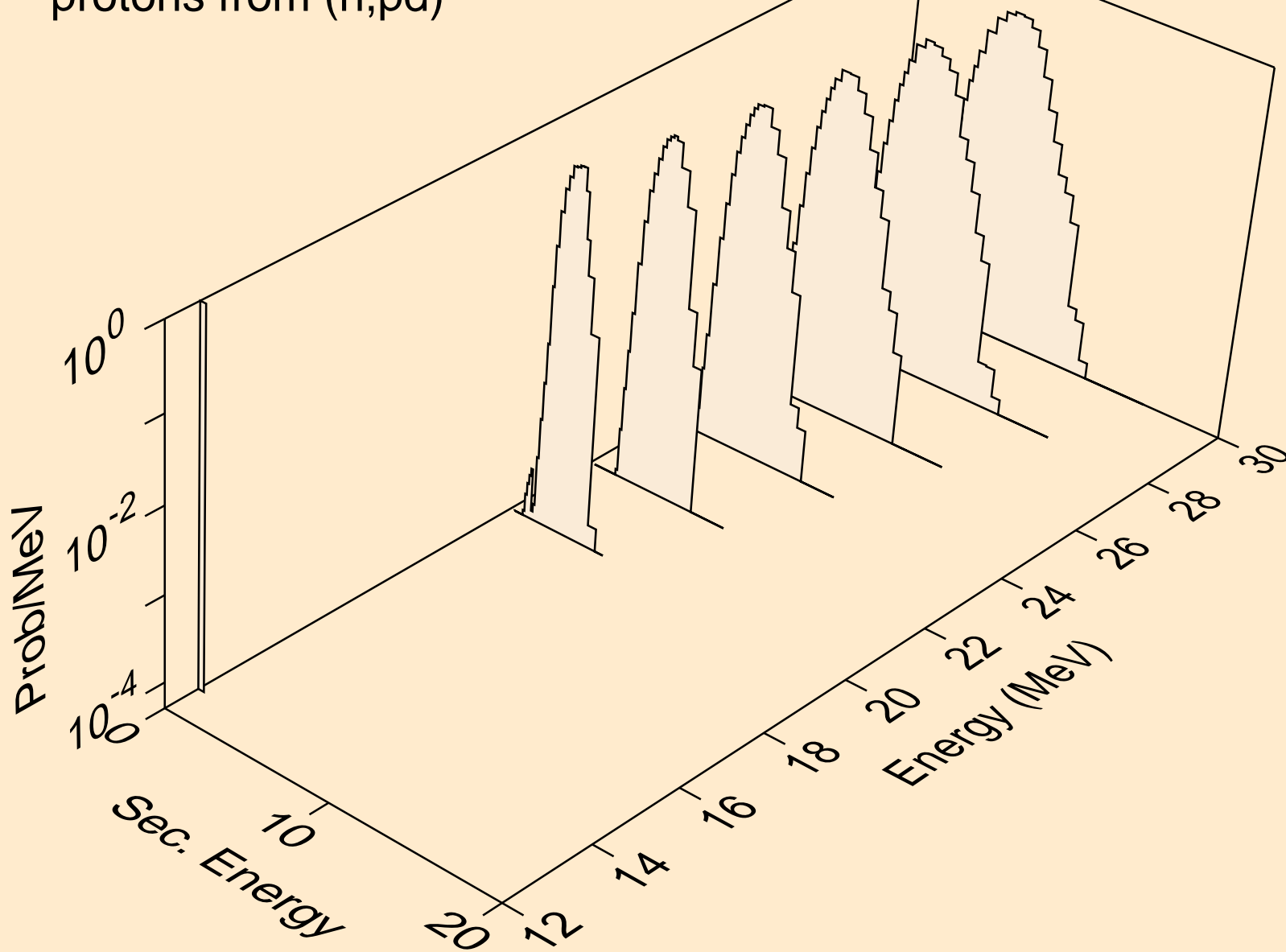

HO165 NEUTRON ACER TENDL-2019 LIBRARY; T=293.16K
protons from (n,pt)

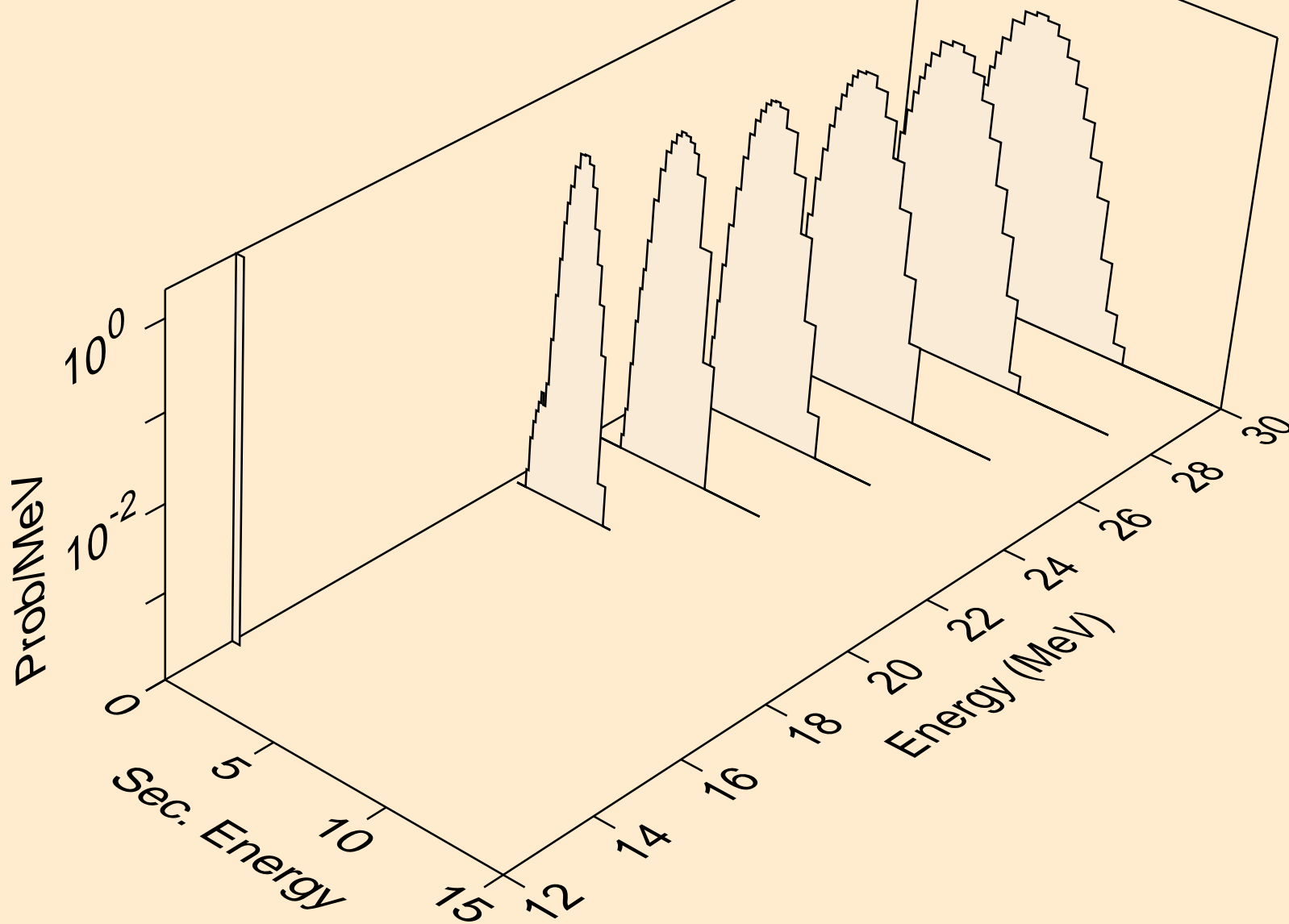

HO165 NEUTRON ACER TENDL-2019 LIBRARY; T=293.16K
deuterons from (n,x)

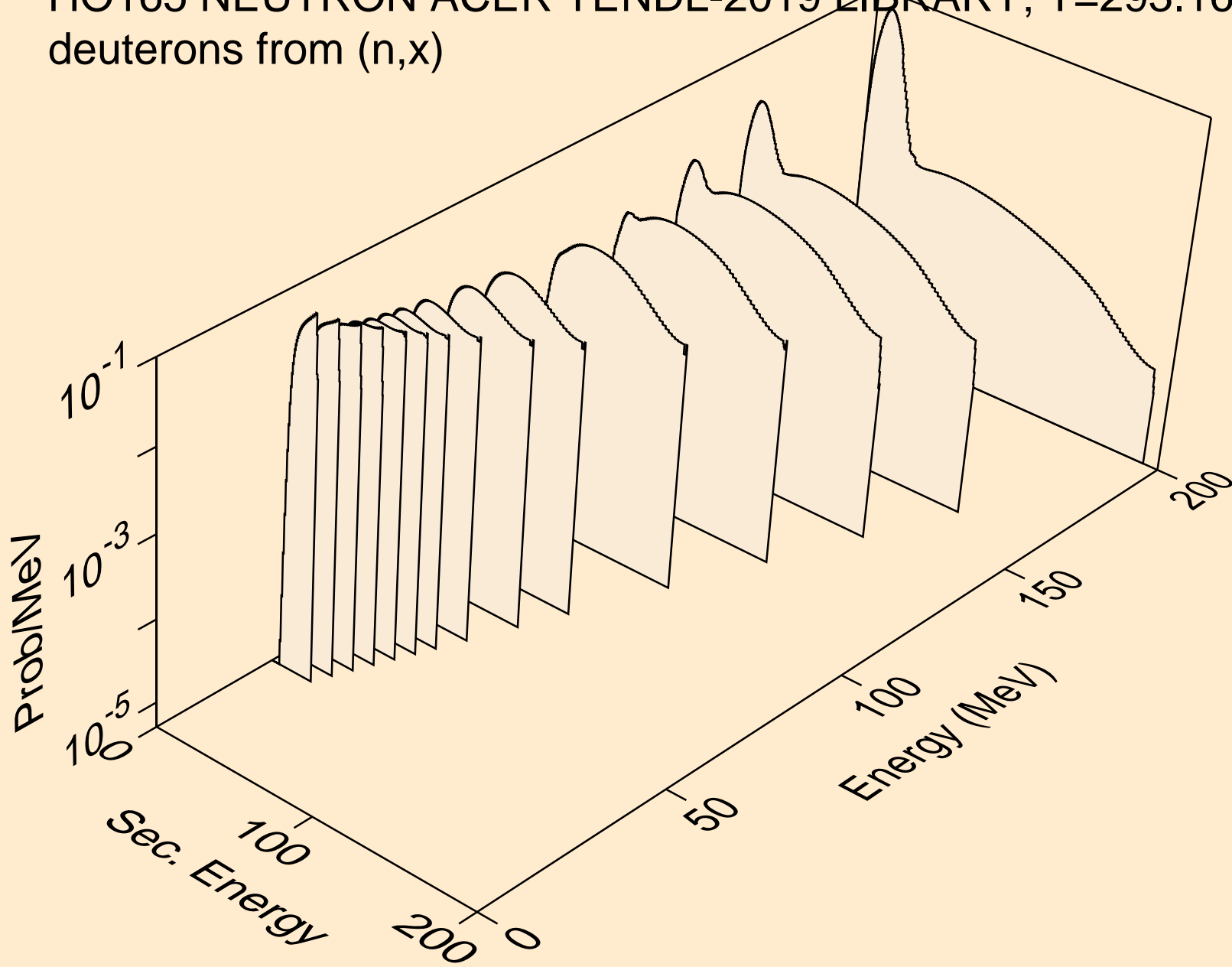

HO165 NEUTRON ACER TENDL-2019 LIBRARY; T=293.16K
deuterons from (n,2nd)

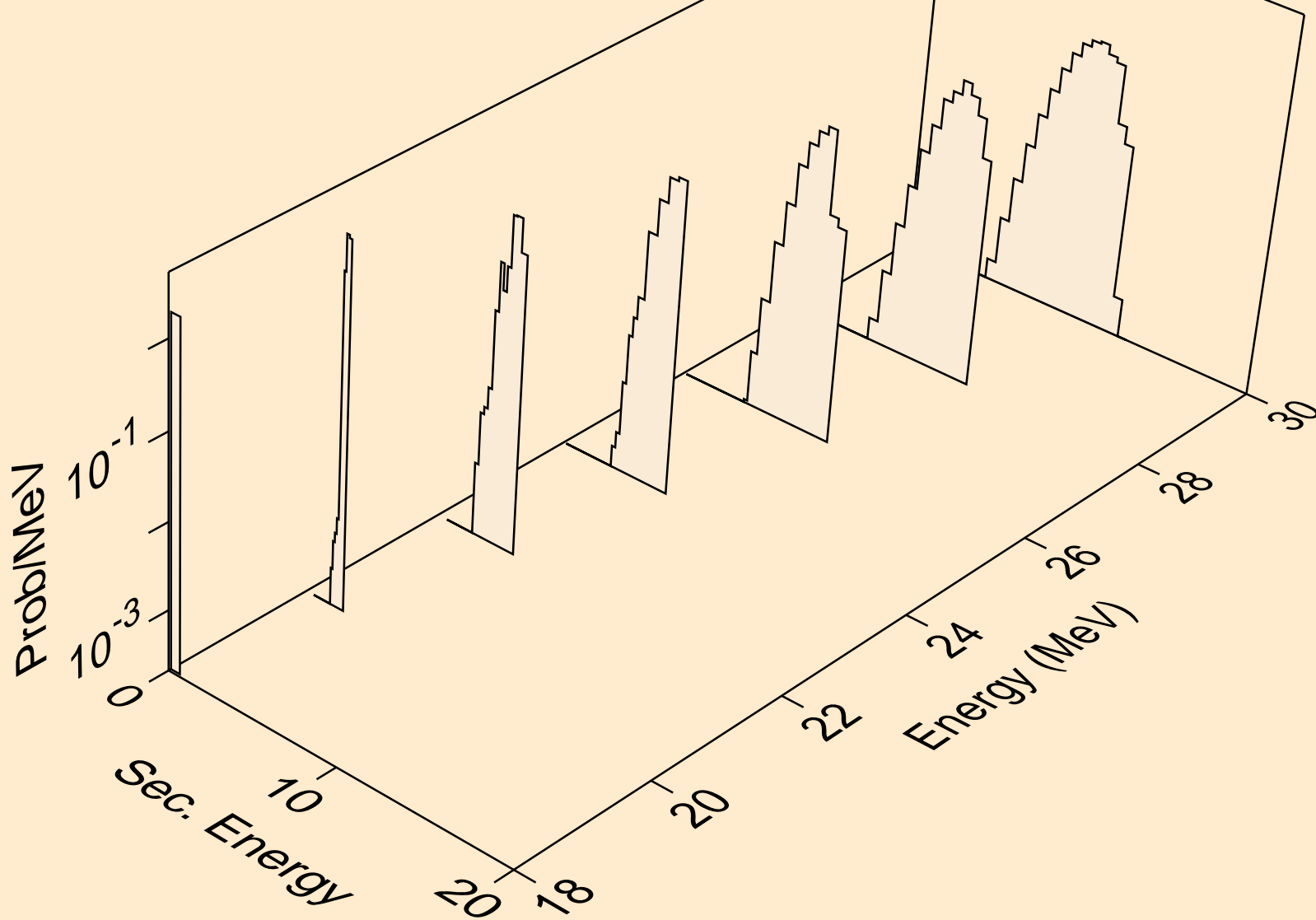

HO165 NEUTRON ACER TENDL-2019 LIBRARY; T=293.16K
deuterons from (n,n*)d

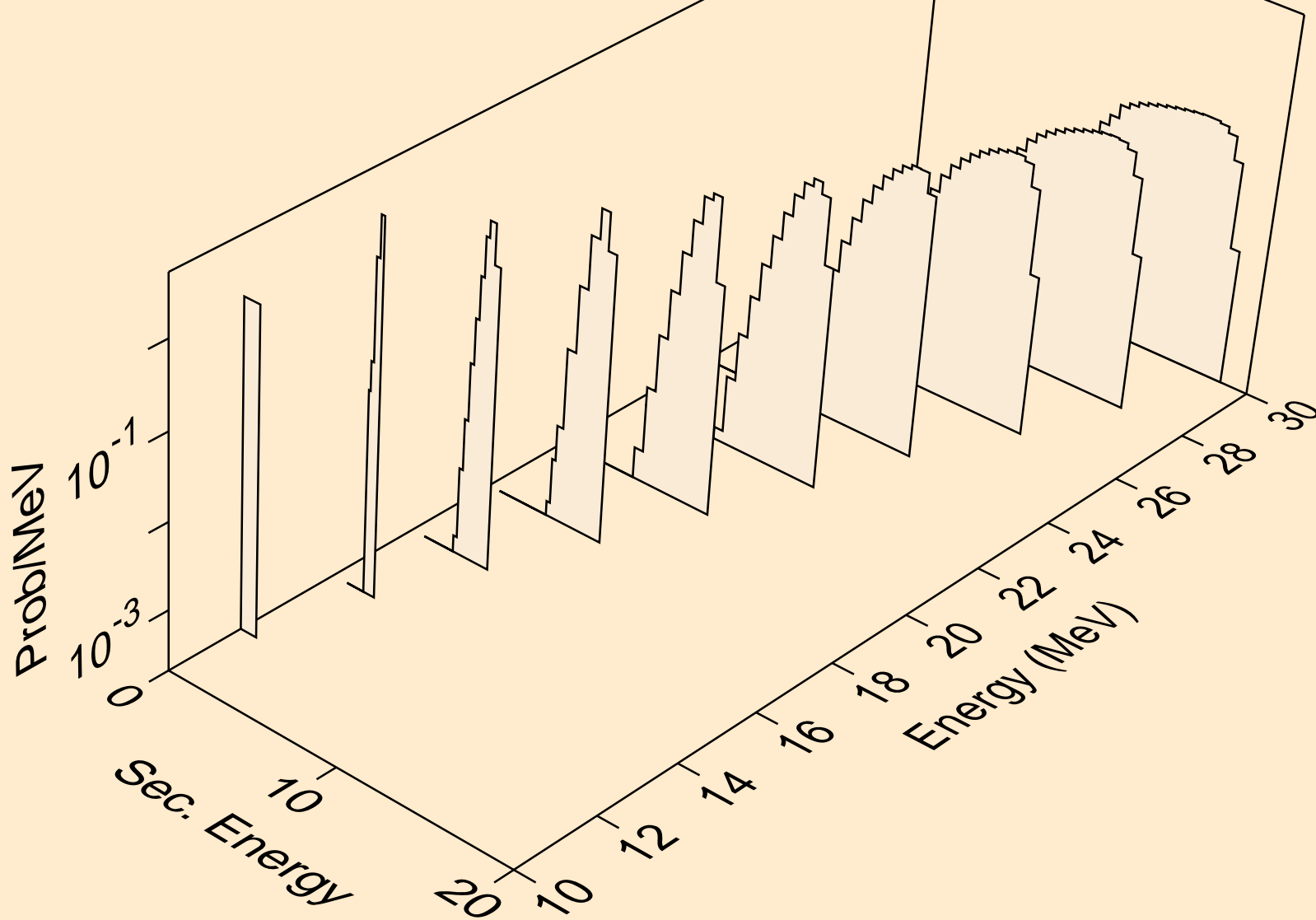

HO165 NEUTRON ACER TENDL-2019 LIBRARY; T=293.16K
deuterons from (n,d)

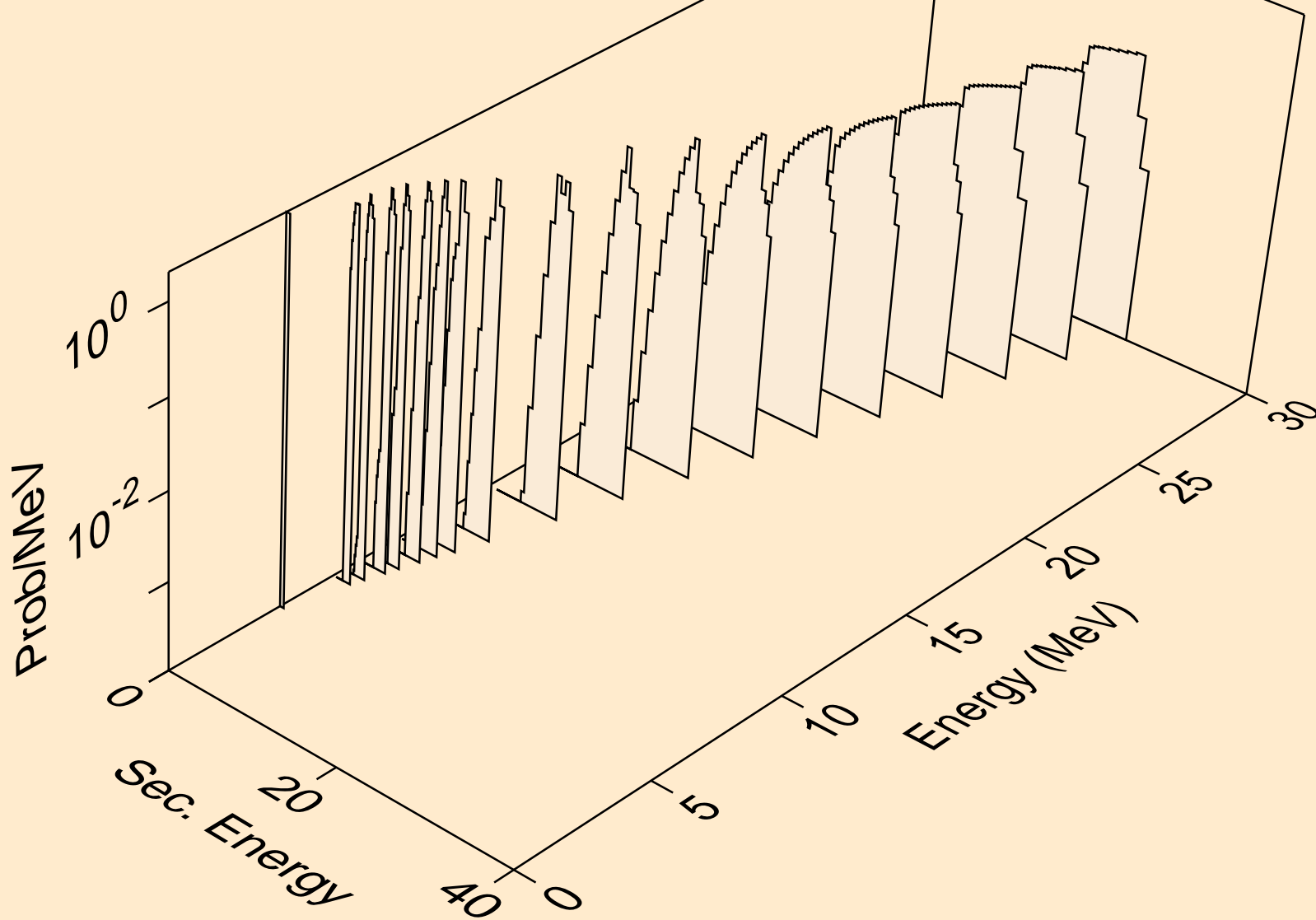

HO165 NEUTRON ACER TENDL-2019 LIBRARY; T=293.16K
deuterons from (n,pd)

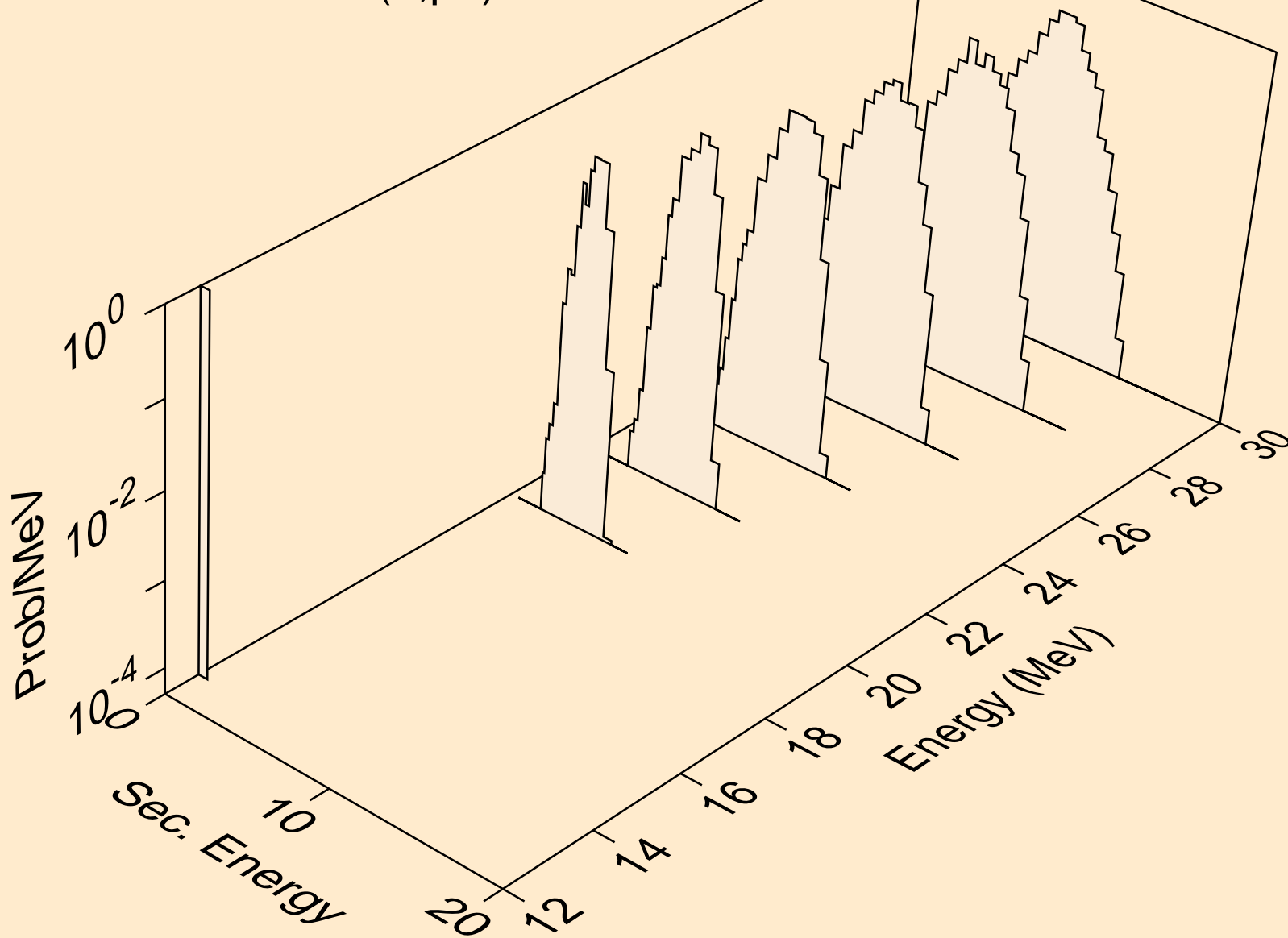

HO165 NEUTRON ACER TENDL-2019 LIBRARY; T=293.16K
deuterons from (n,da)

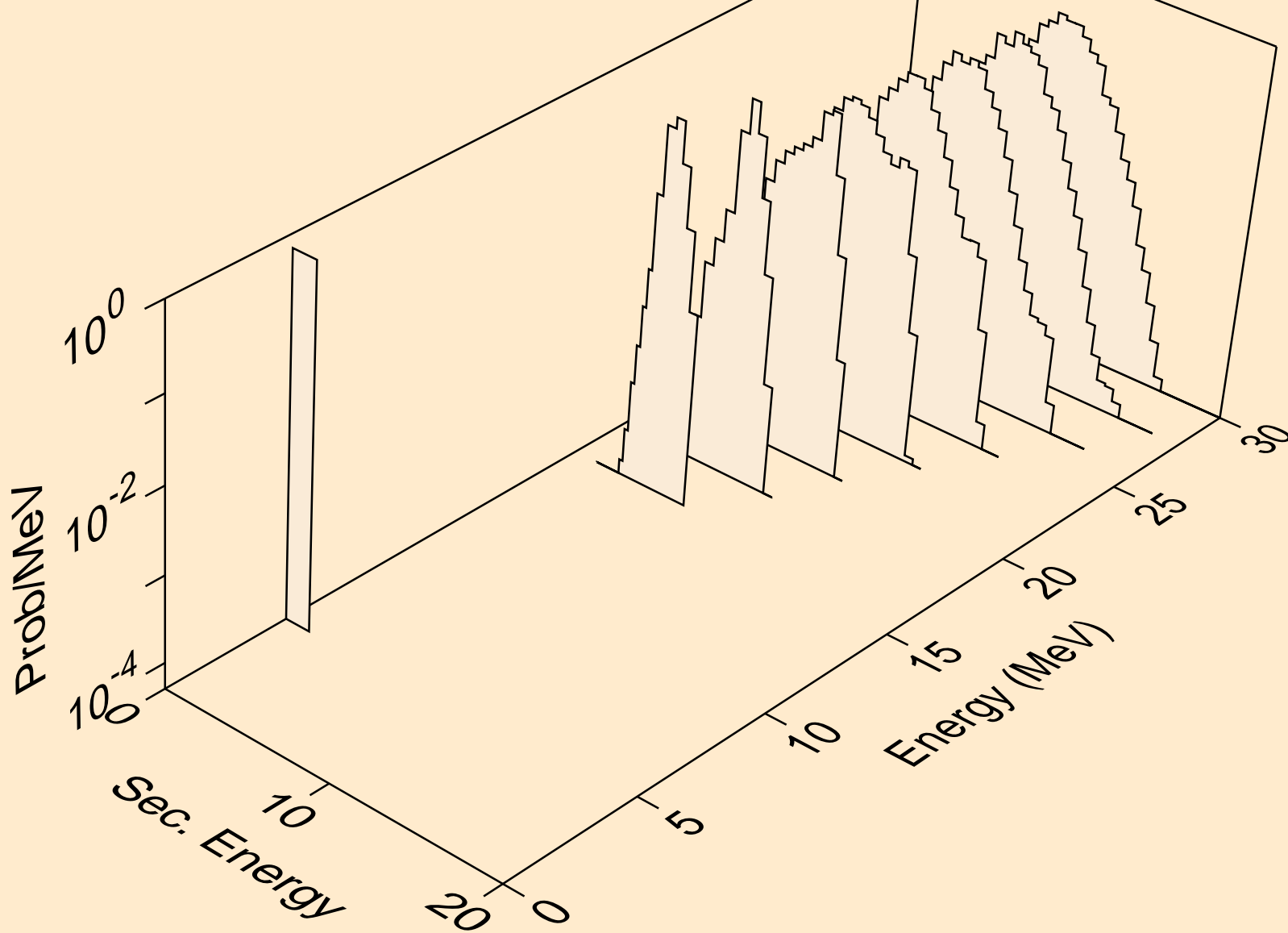

HO165 NEUTRON ACER TENDL-2019 LIBRARY; T=293.16K
tritons from (n,x)

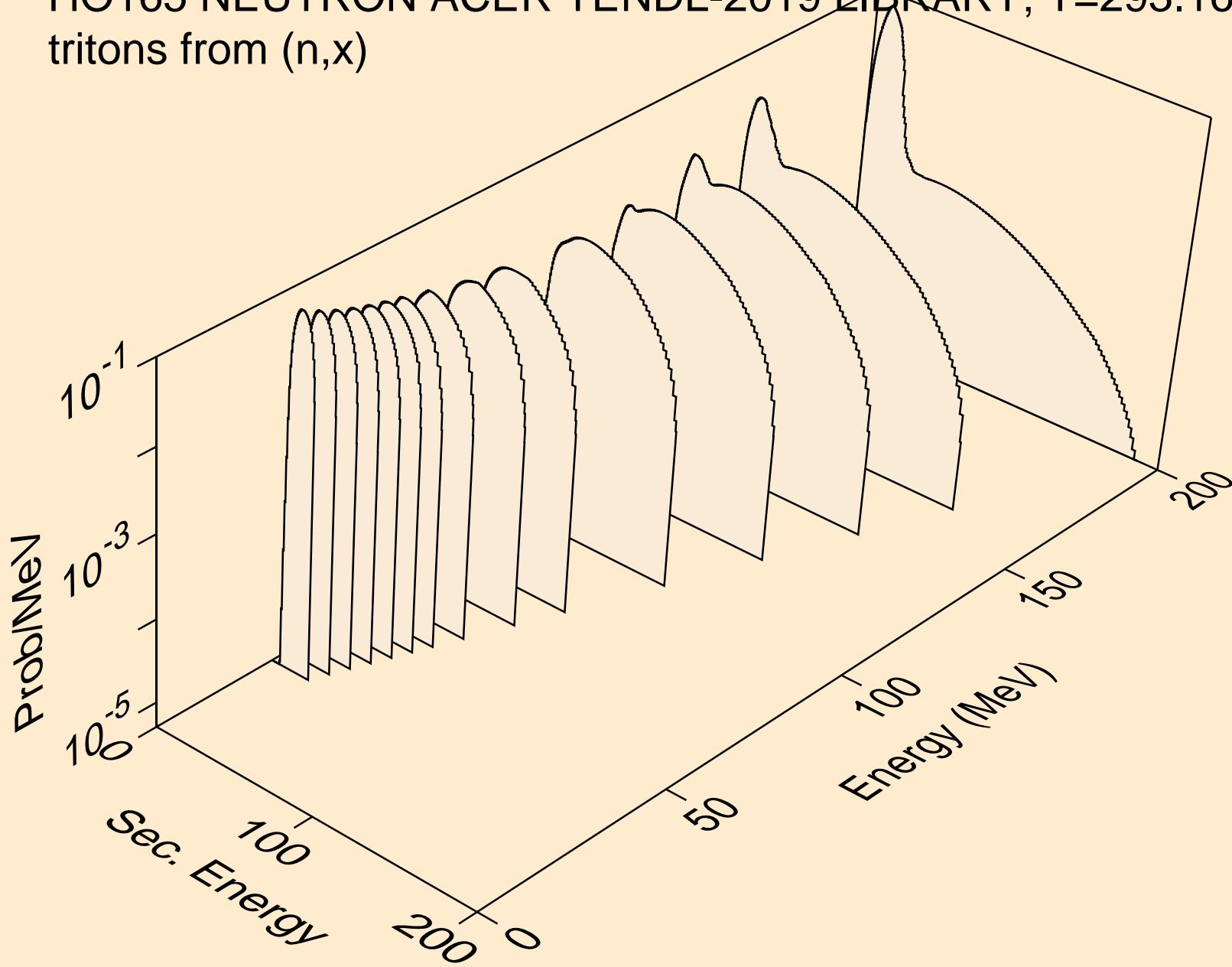

HO165 NEUTRON ACER TENDL-2019 LIBRARY; T=293.16K
tritons from (n,n*)t

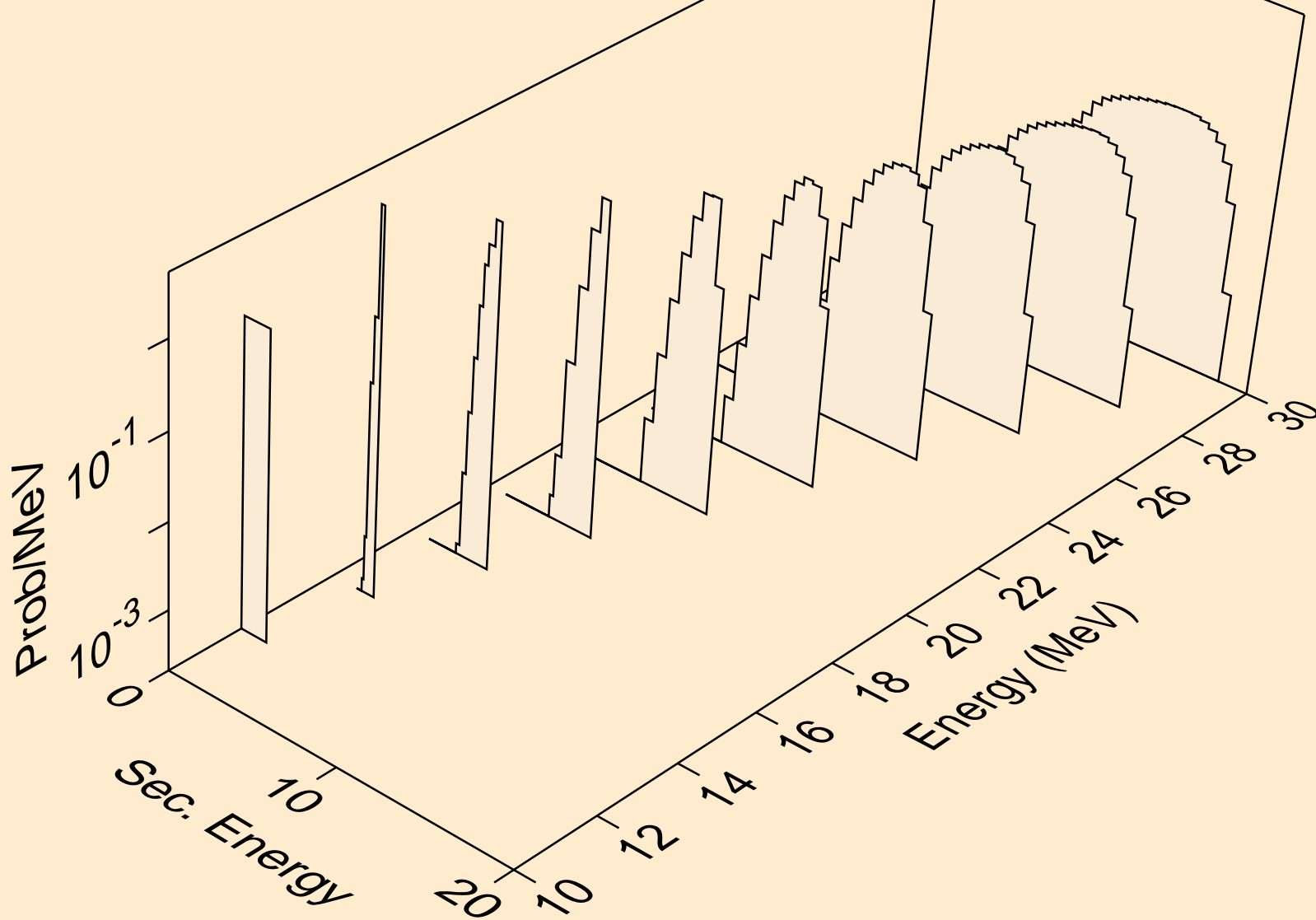

HO165 NEUTRON ACER TENDL-2019 LIBRARY; T=293.16K
tritons from (n,t)

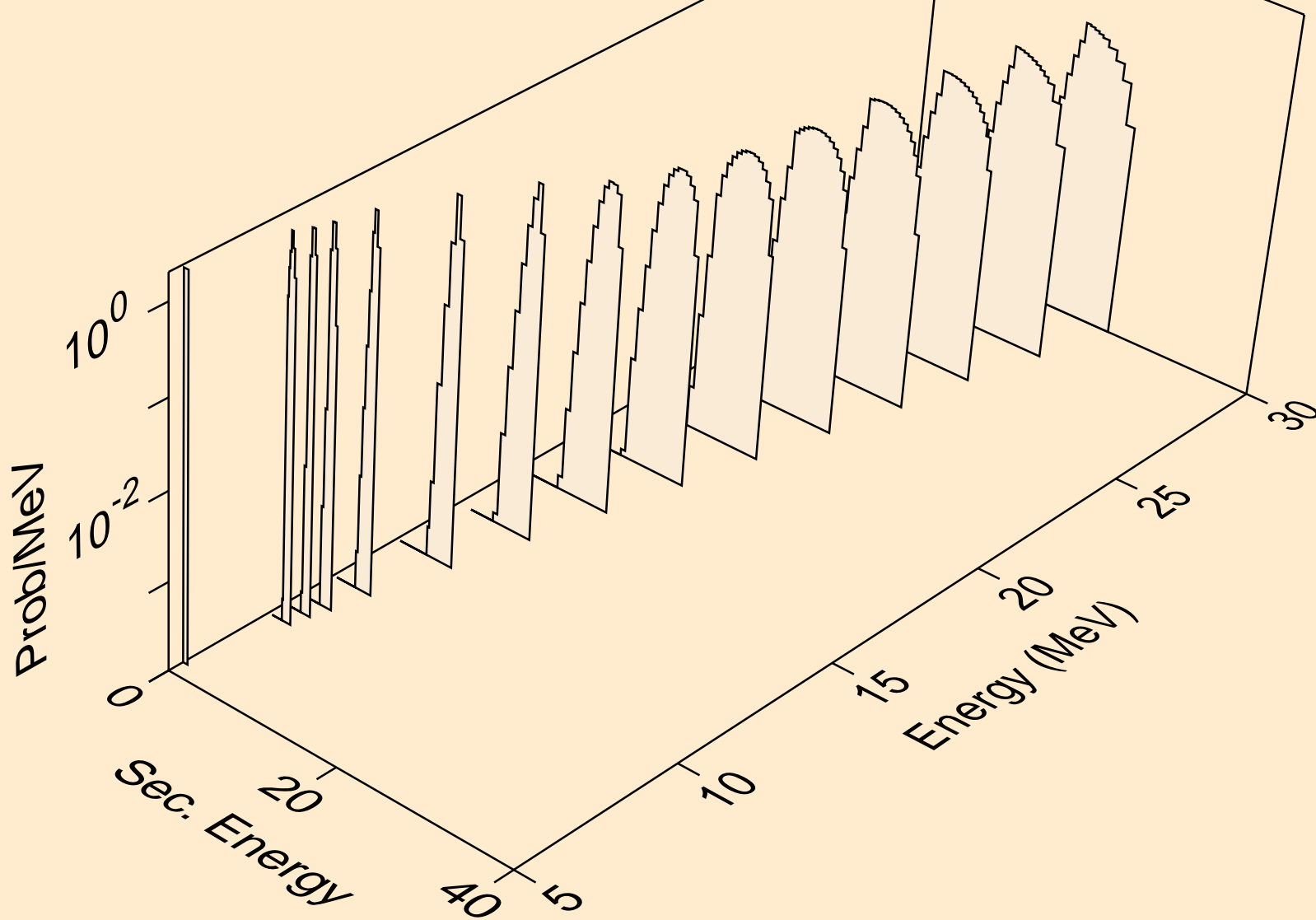

HO165 NEUTRON ACER TENDL-2019 LIBRARY; T=293.16K
tritons from (n,pt)

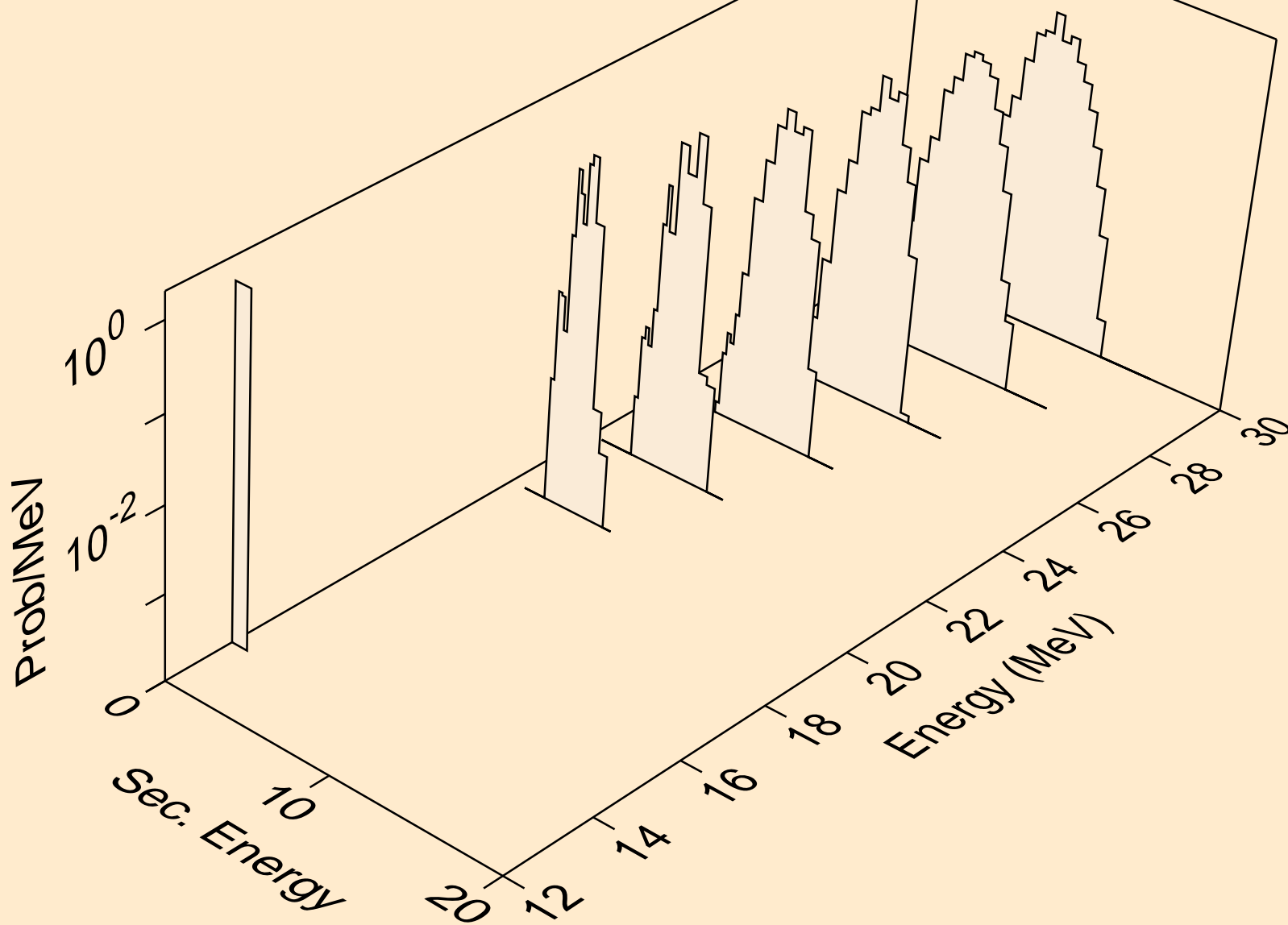

HO165 NEUTRON ACER TENDL-2019 LIBRARY; T=293.16K
he3s from (n,x)

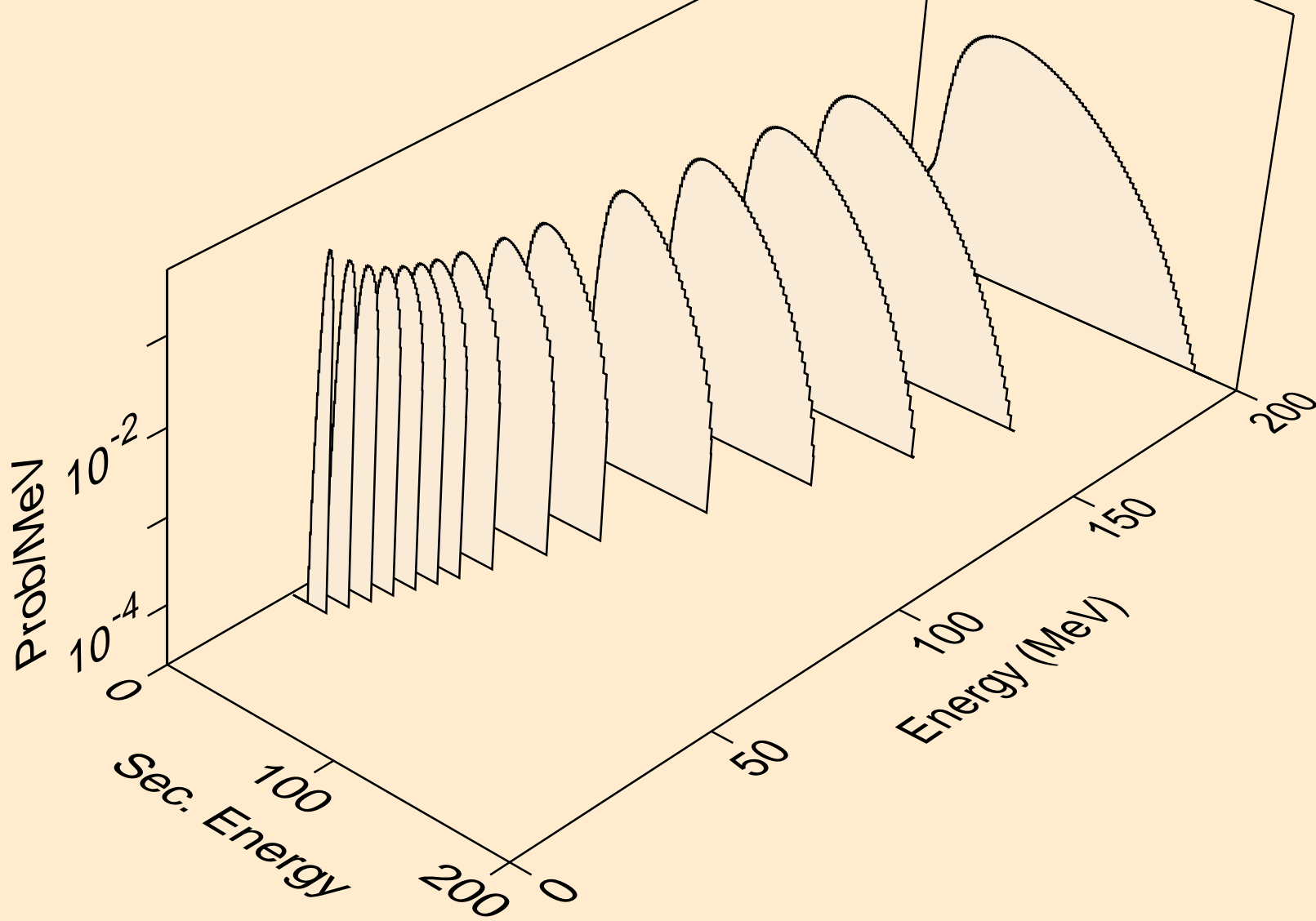

HO165 NEUTRON ACER TENDL-2019 LIBRARY; T=293.16K
he3s from (n,n*)he3

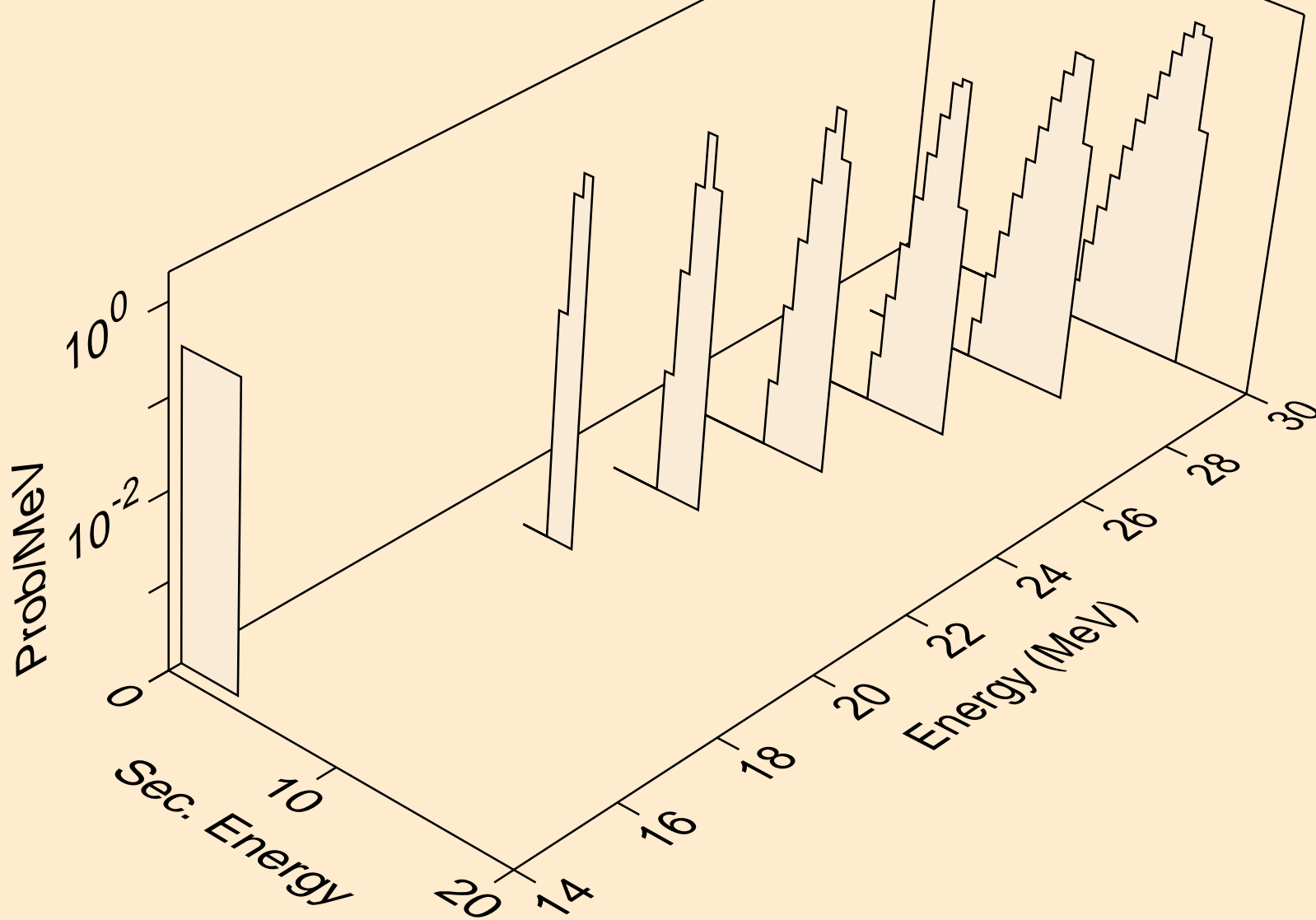

HO165 NEUTRON ACER TENDL-2019 LIBRARY; T=293.16K
he3s from (n,he3)

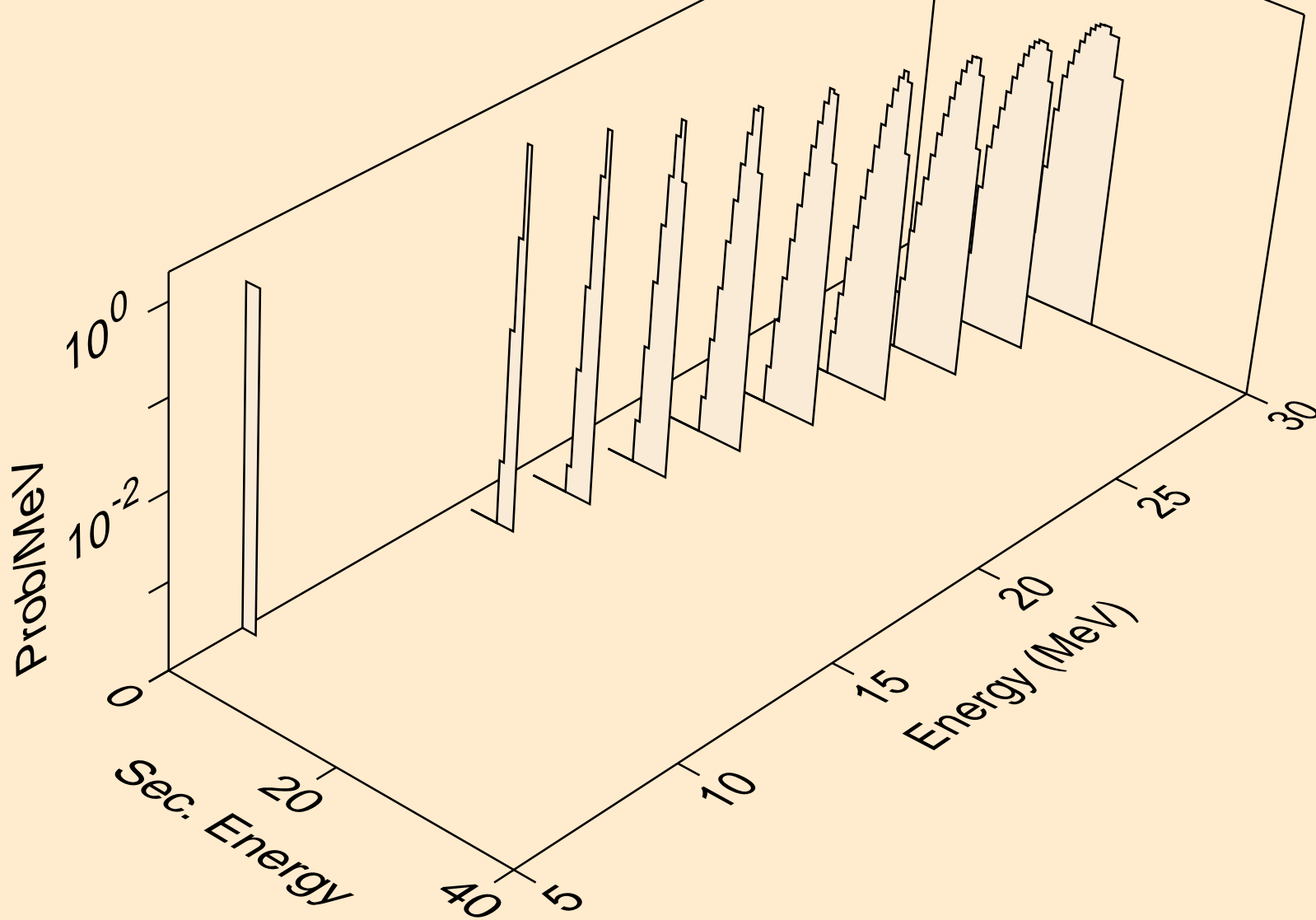

HO165 NEUTRON ACER TENDL-2019 LIBRARY; T=293.16K
alphas from (n,x)

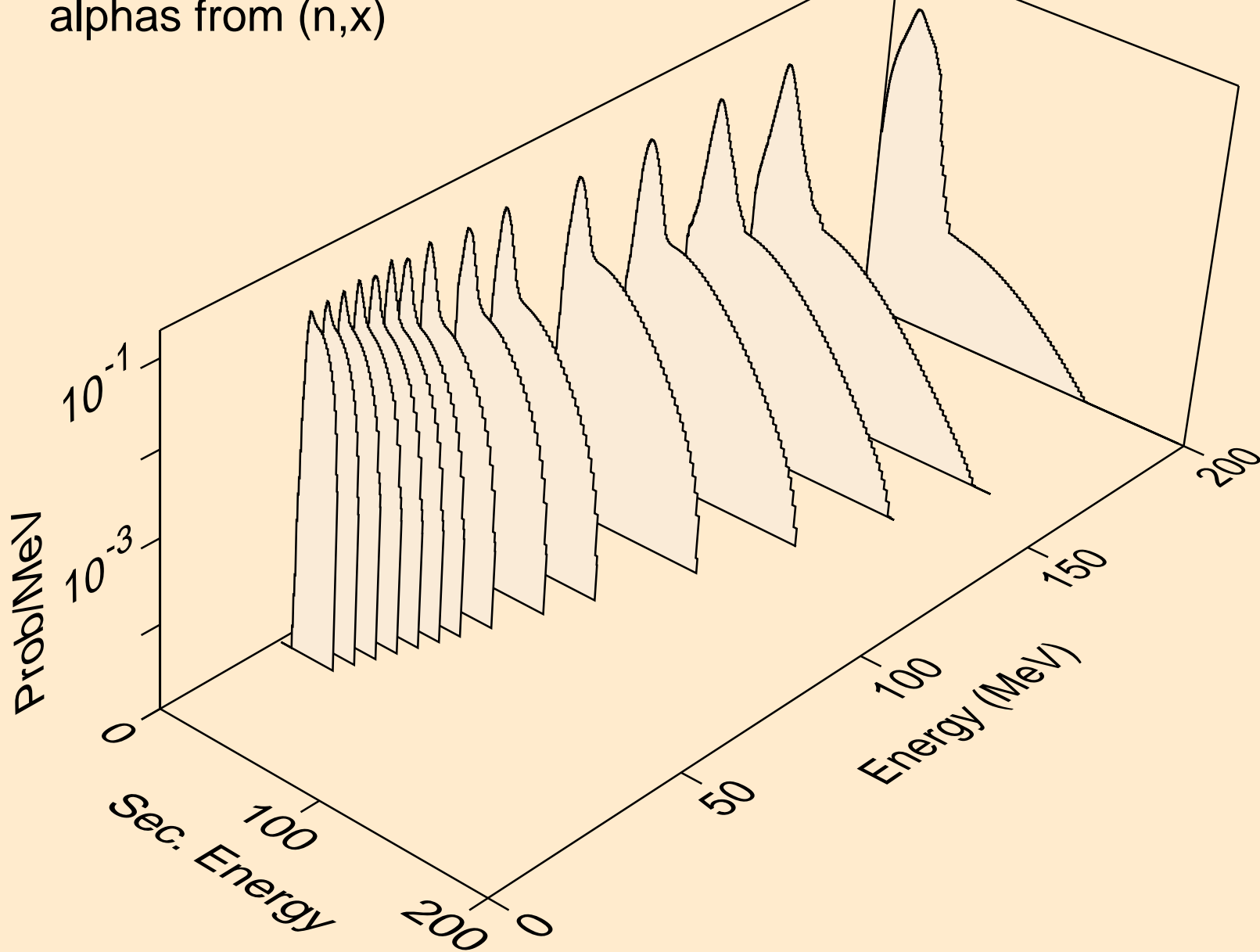

HO165 NEUTRON ACER TENDL-2019 LIBRARY; T=293.16K
alphas from (n,n*)a

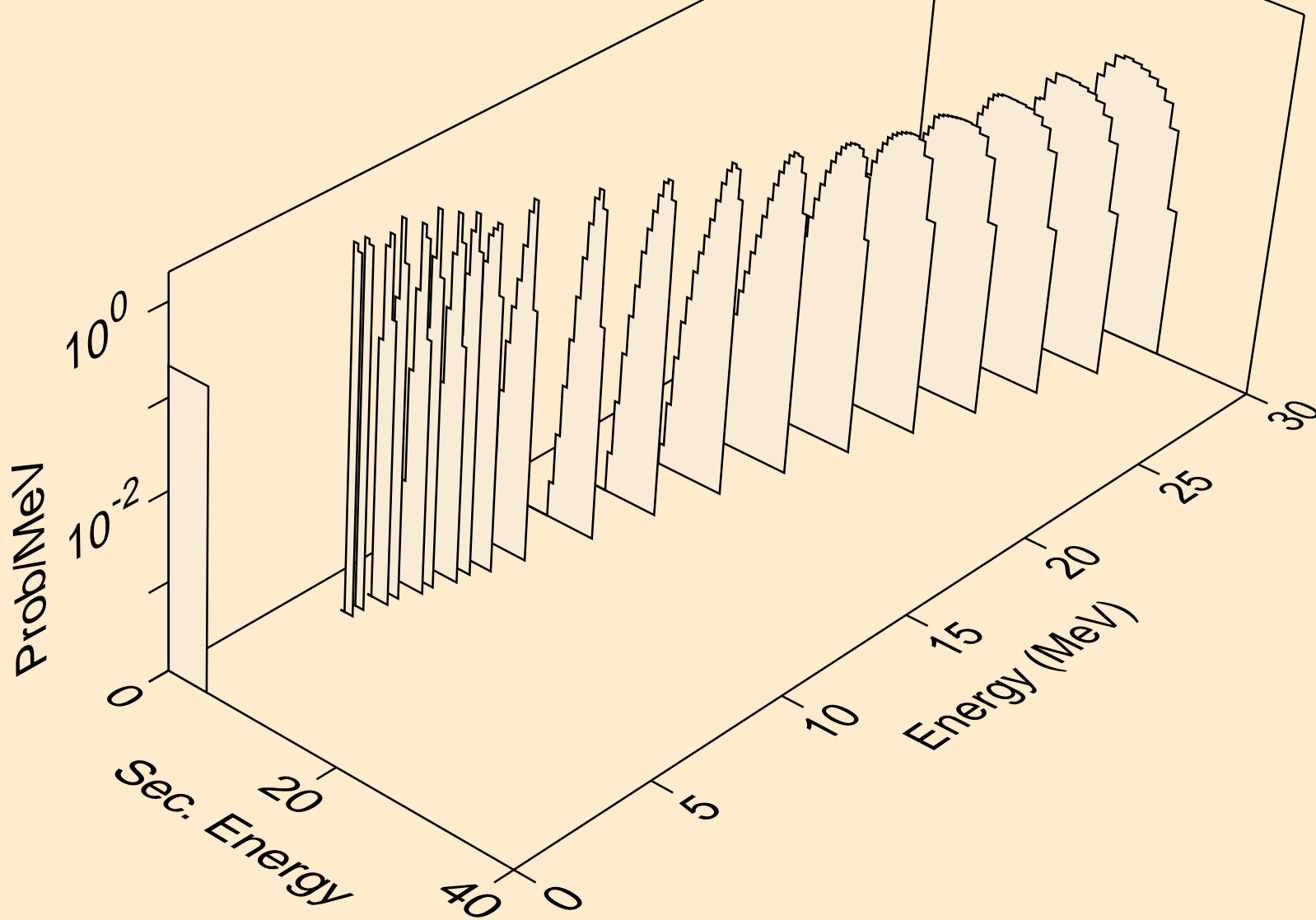

HO165 NEUTRON ACER TENDL-2019 LIBRARY; T=293.16K
alphas from (n,2n)a

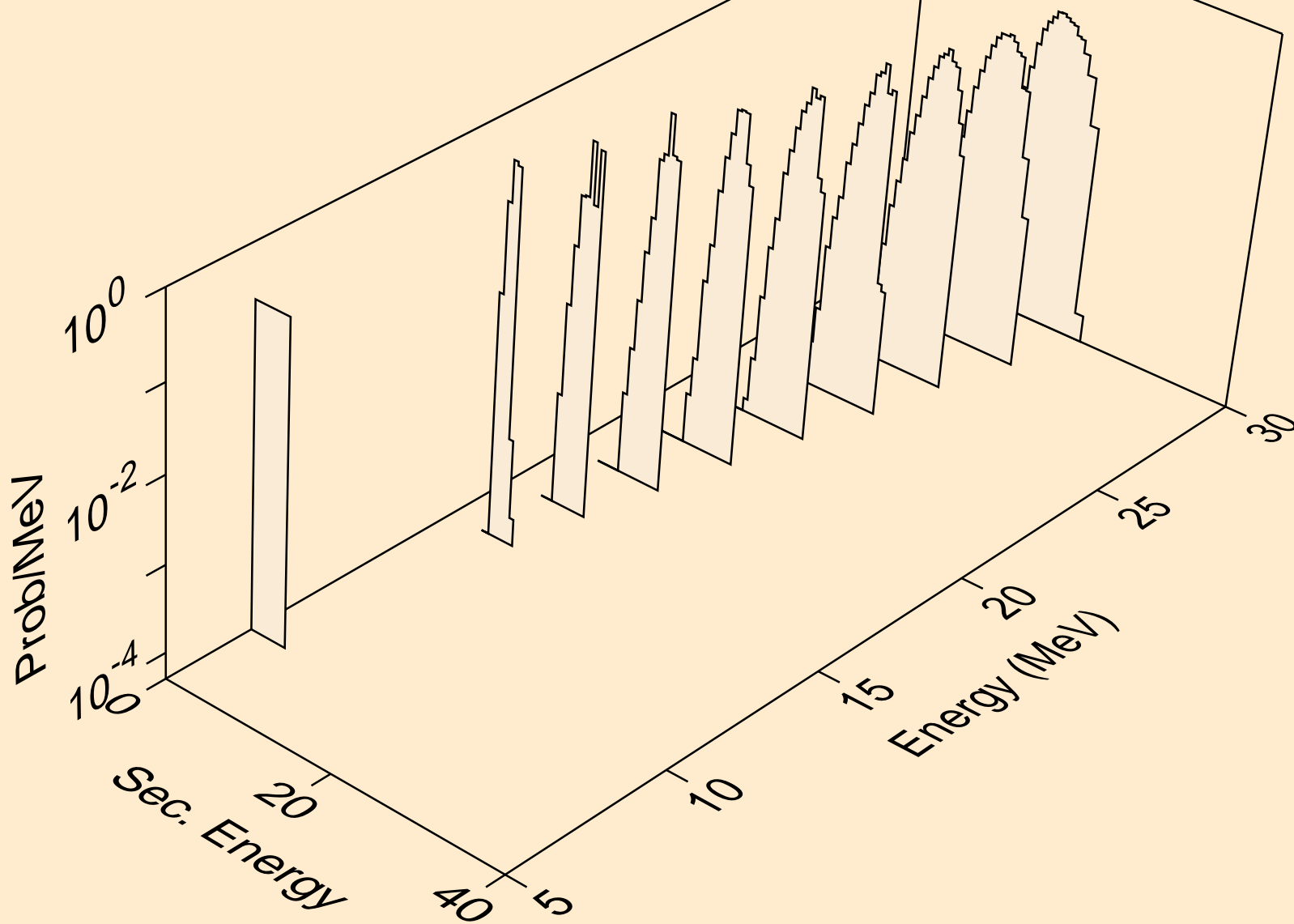

HO165 NEUTRON ACER TENDL-2019 LIBRARY; T=293.16K
alphas from (n,3n)a

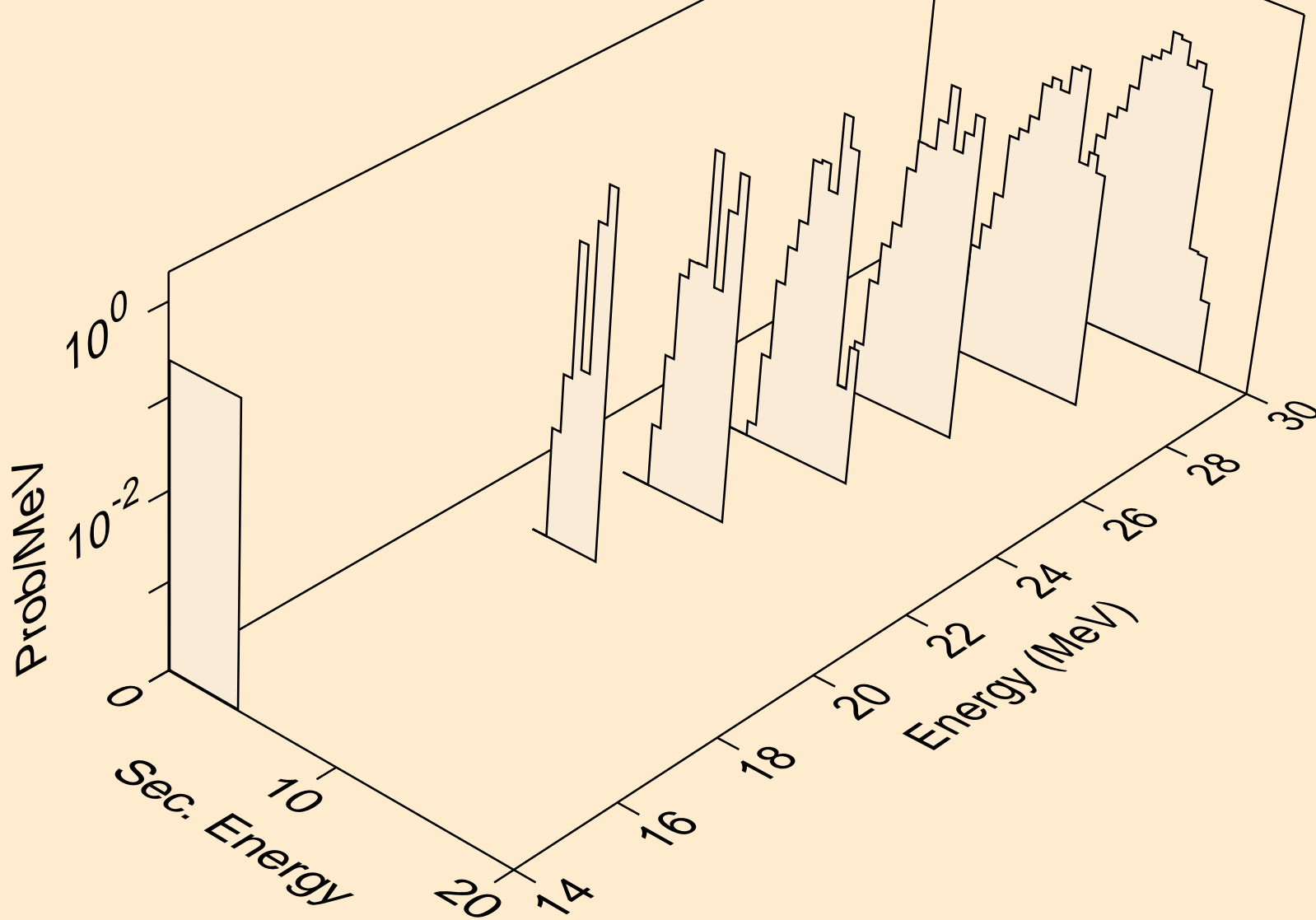

HO165 NEUTRON ACER TENDL-2019 LIBRARY; T=293.16K
alphas from (n,n*)2a

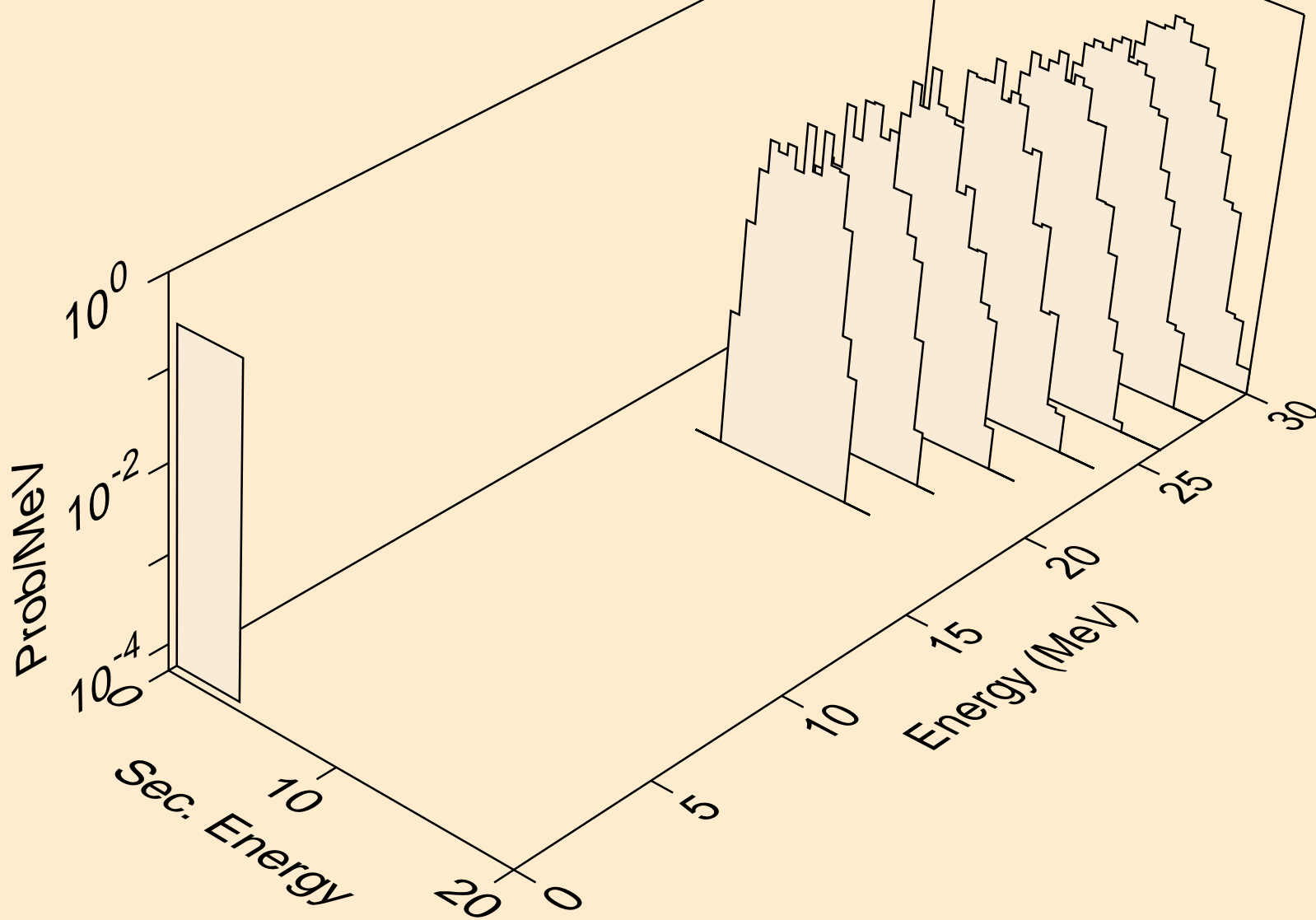

HO165 NEUTRON ACER TENDL-2019 LIBRARY; T=293.16K
alphas from (n,npa)

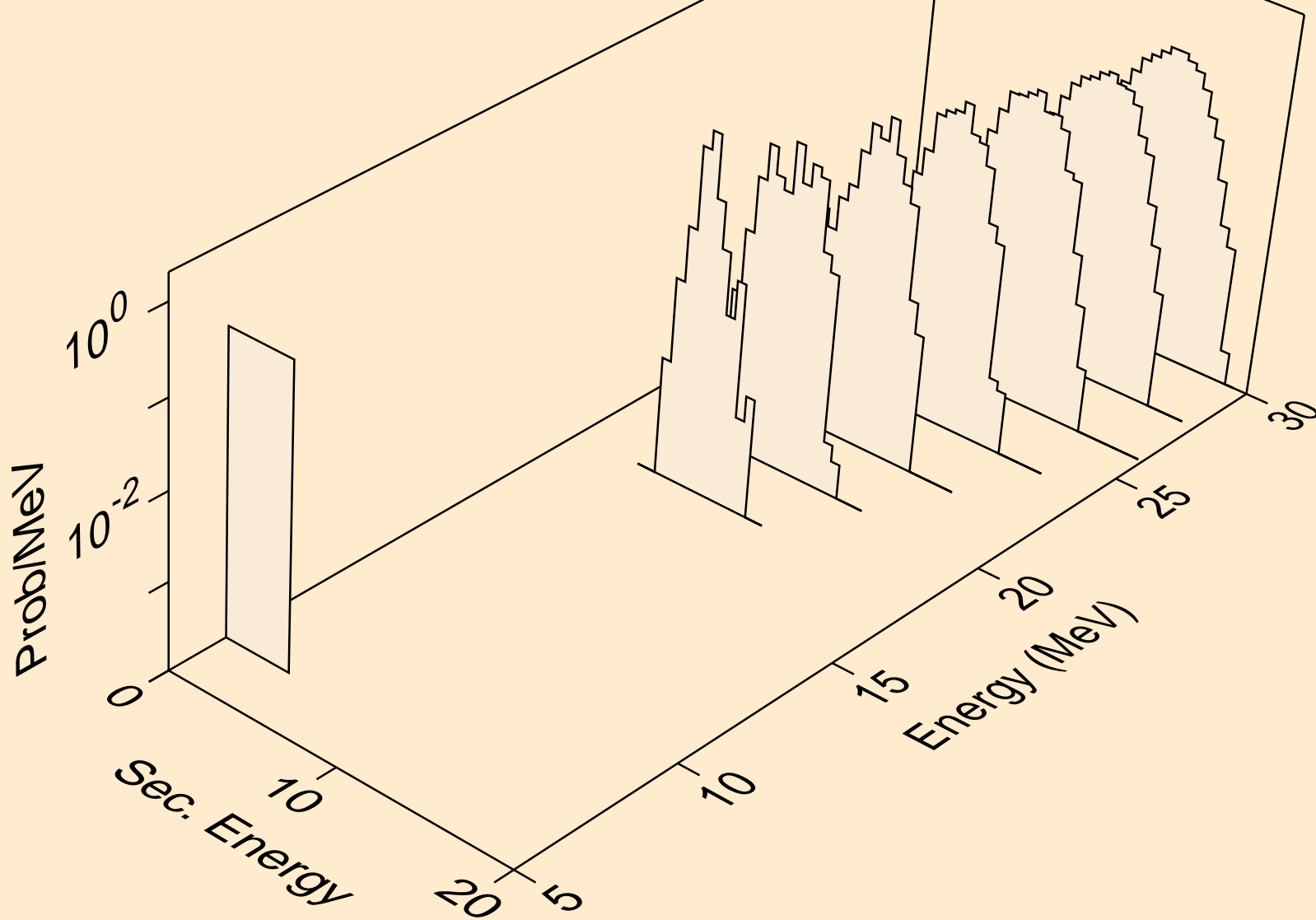

HO165 NEUTRON ACER TENDL-2019 LIBRARY; T=293.16K
alphas from (n,a)

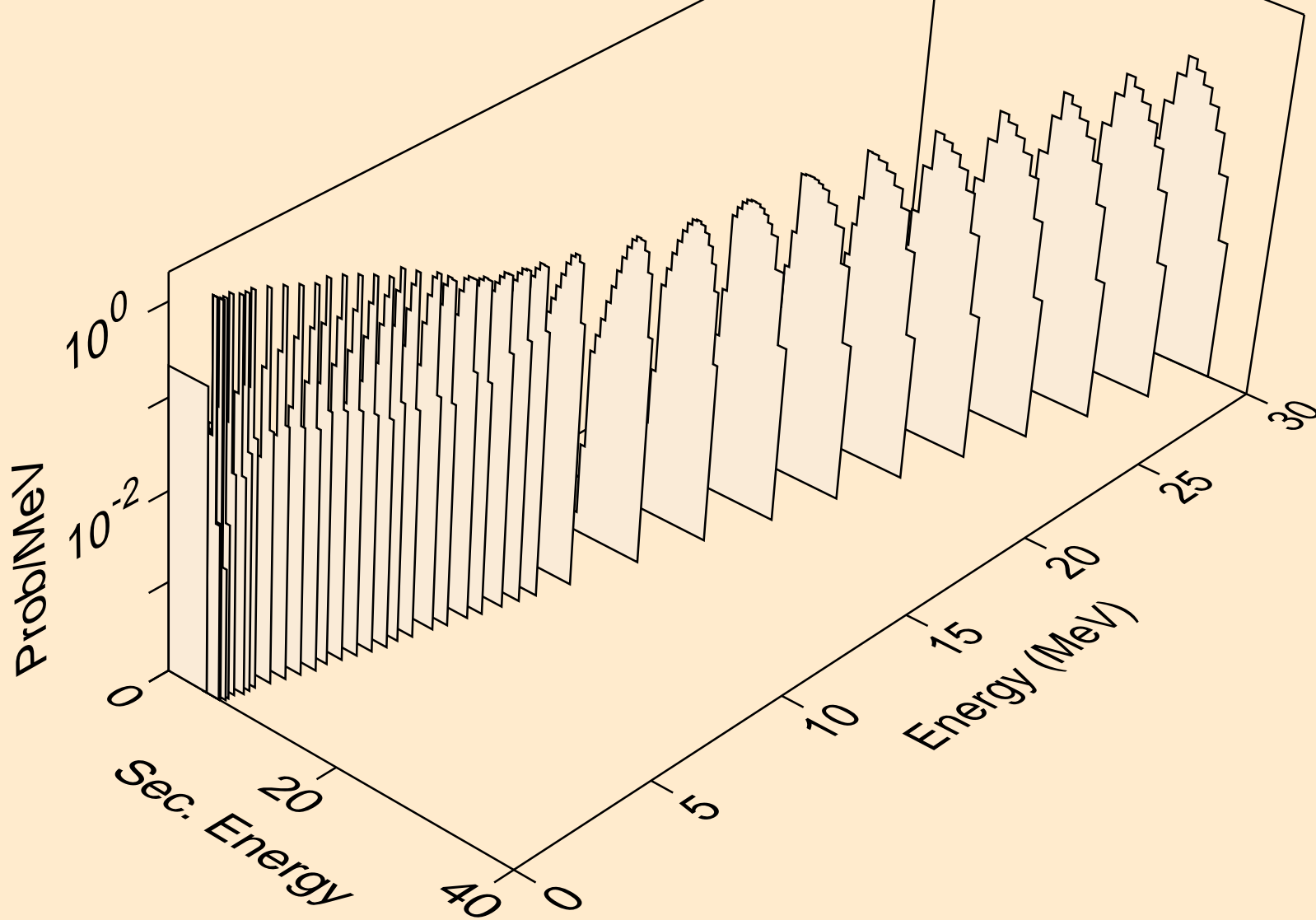

HO165 NEUTRON ACER TENDL-2019 LIBRARY; T=293.16K
alphas from (n,2a)

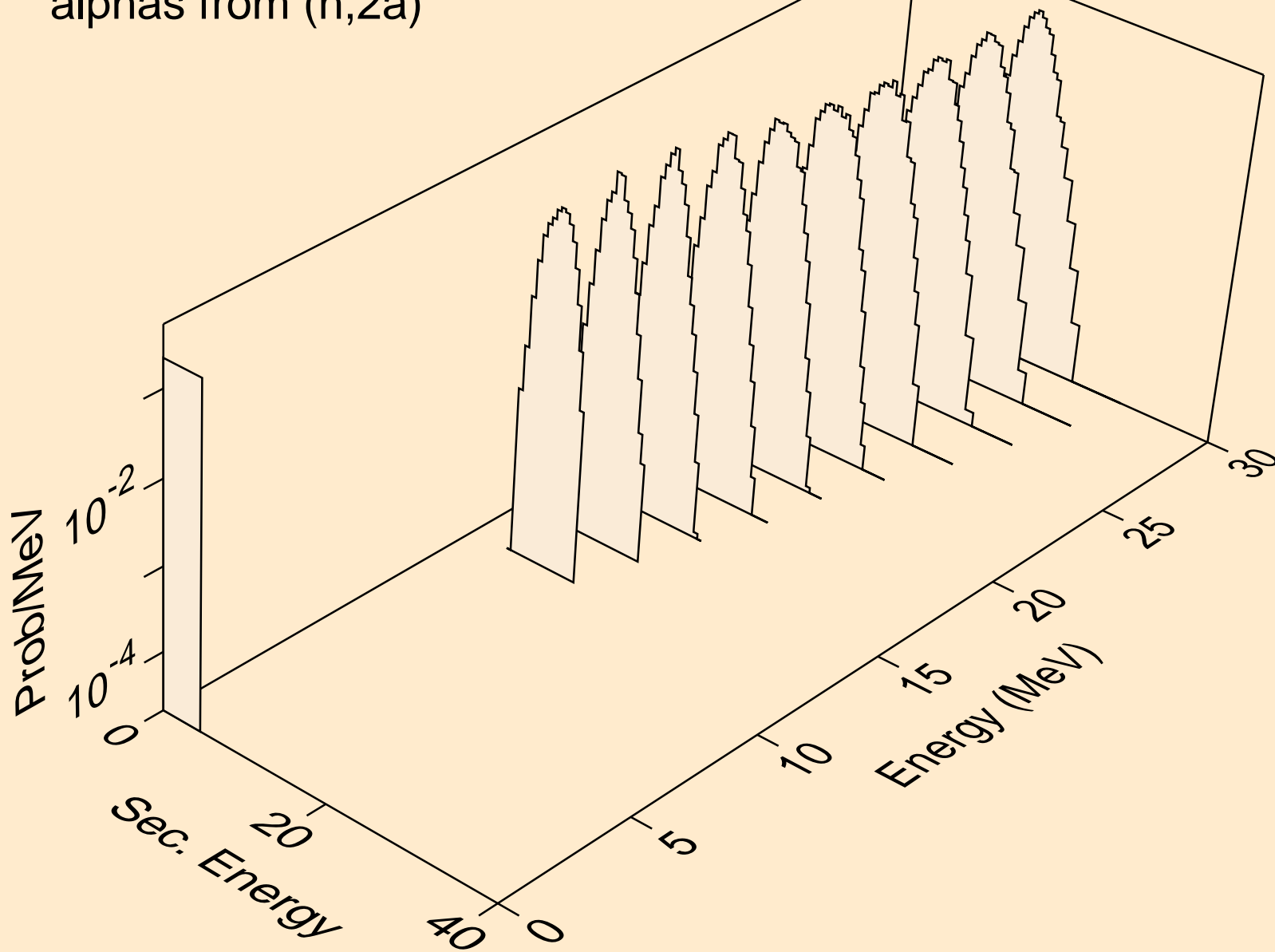

HO165 NEUTRON ACER TENDL-2019 LIBRARY; T=293.16K
alphas from (n,pa)

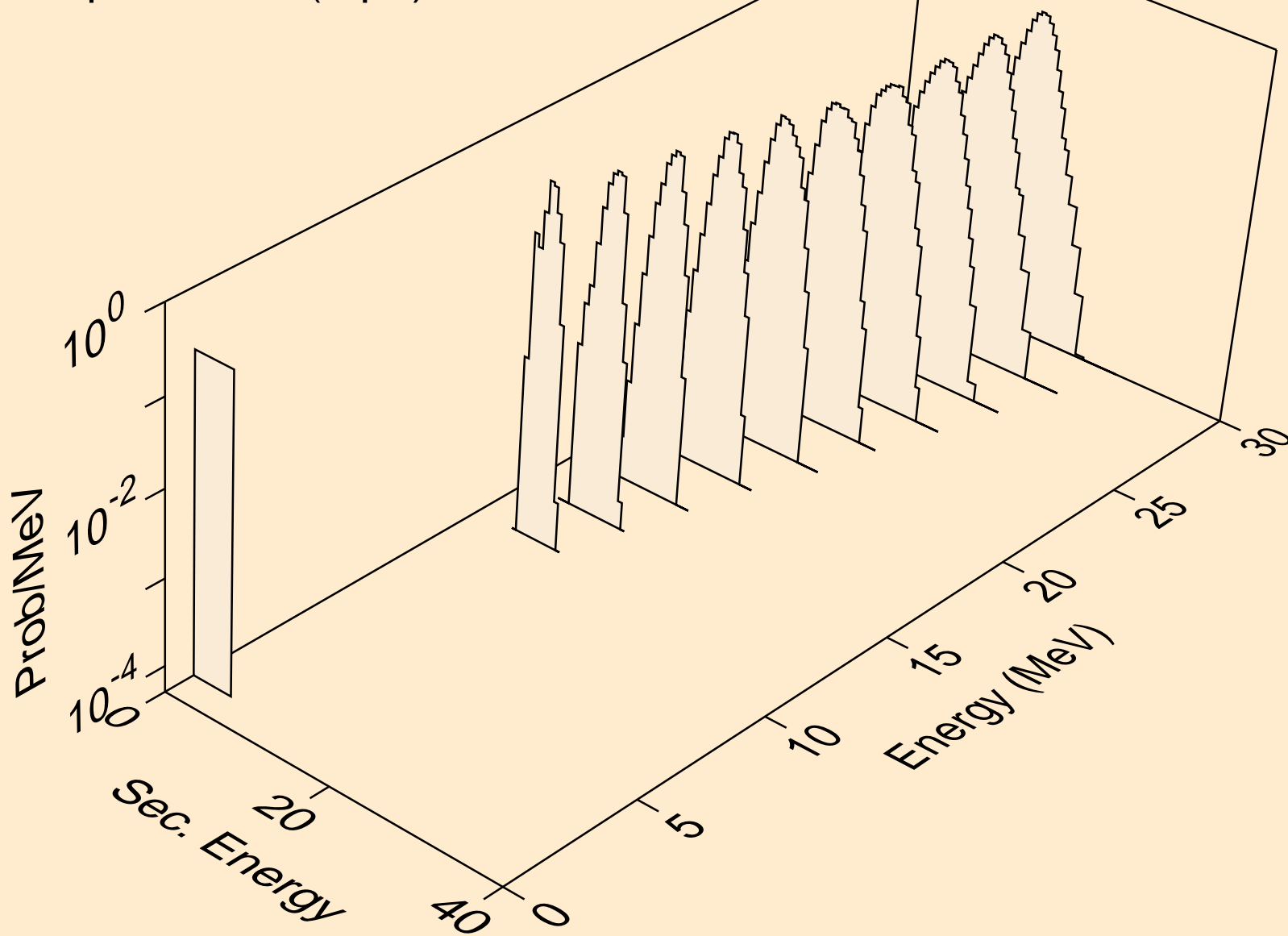

HO165 NEUTRON ACER TENDL-2019 LIBRARY; T=293.16K
alphas from (n,da)

