

LA120 NEUTRON ACER TENDL-2019 LIBRARY; T=293.16K
Principal cross sections

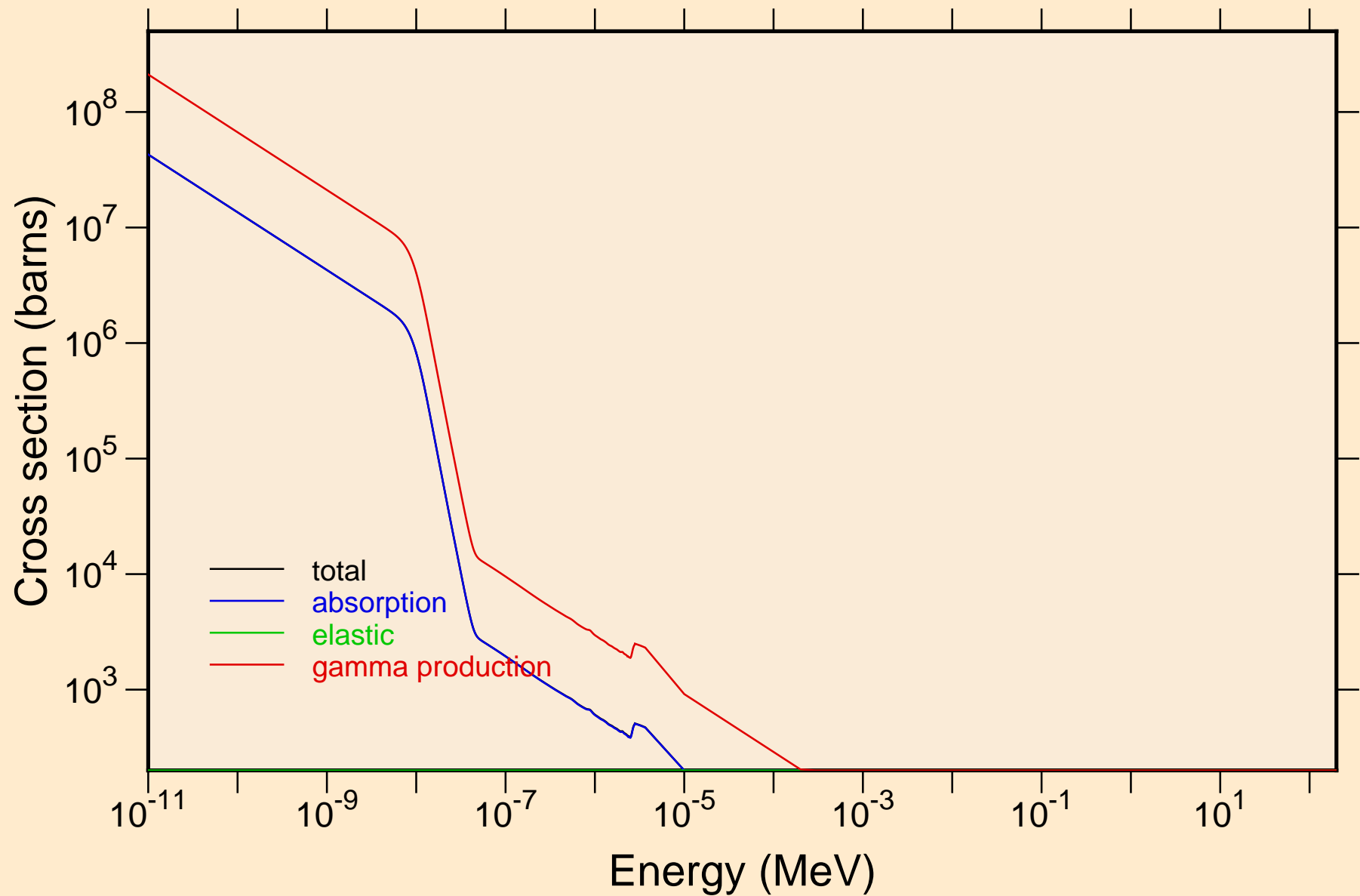

LA120 NEUTRON ACER TENDL-2019 LIBRARY; T=293.16K
Heating

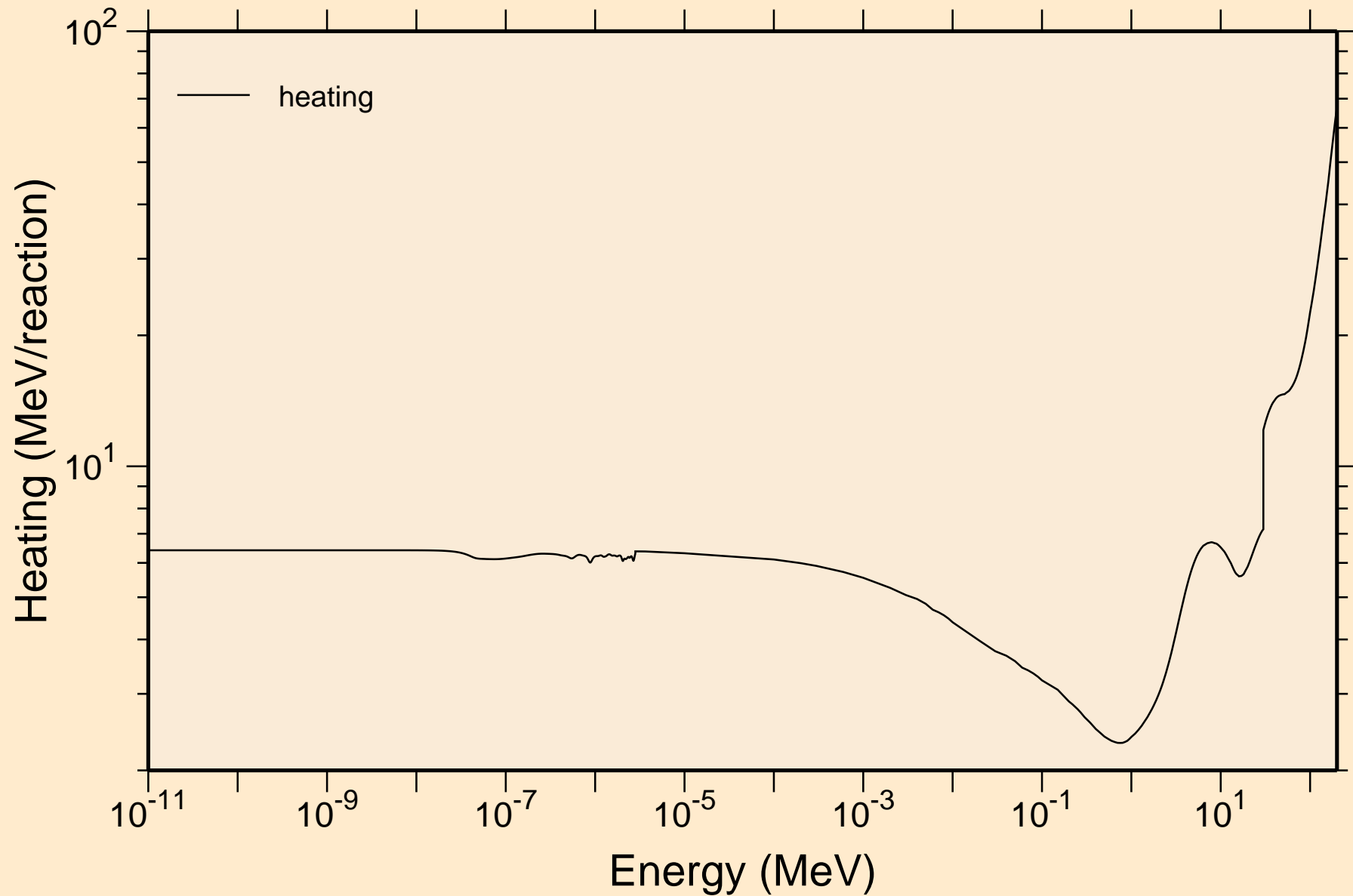

LA120 NEUTRON ACER TENDL-2019 LIBRARY; T=293.16K
Damage

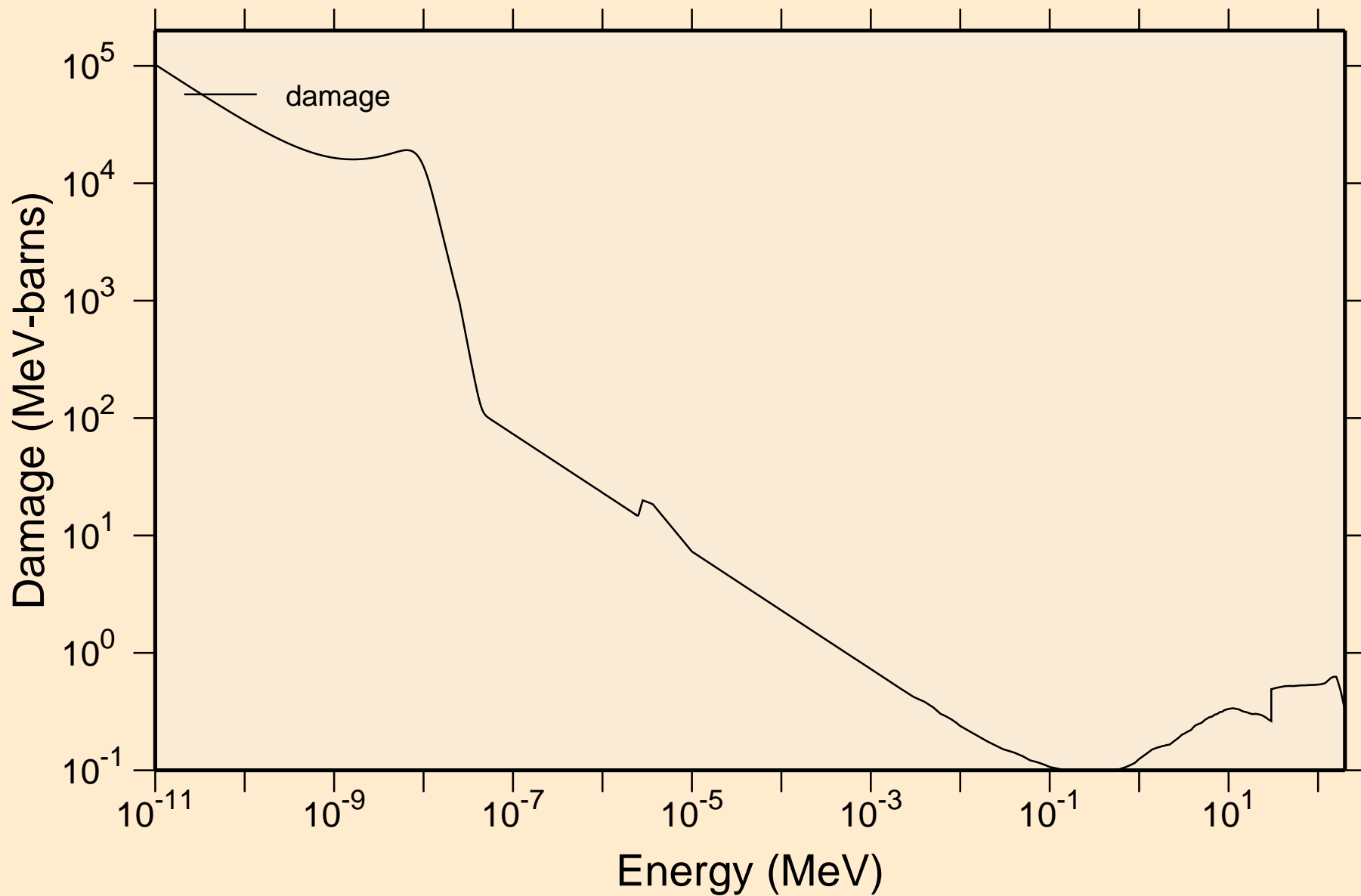

LA120 NEUTRON ACER TENDL-2019 LIBRARY; T=293.16K
Non-threshold reactions

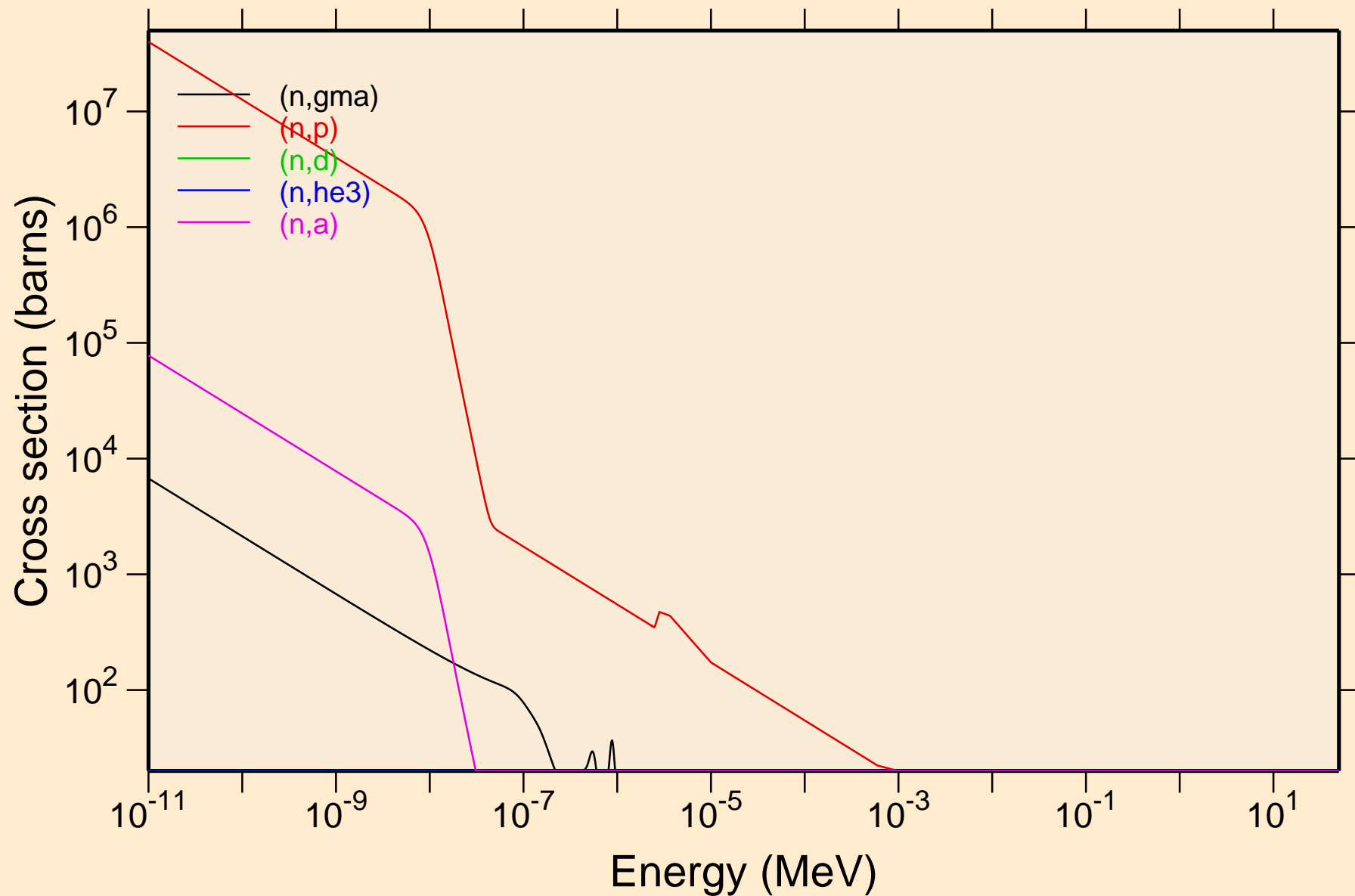

LA120 NEUTRON ACER TENDL-2019 LIBRARY; T=293.16K
Non-threshold reactions

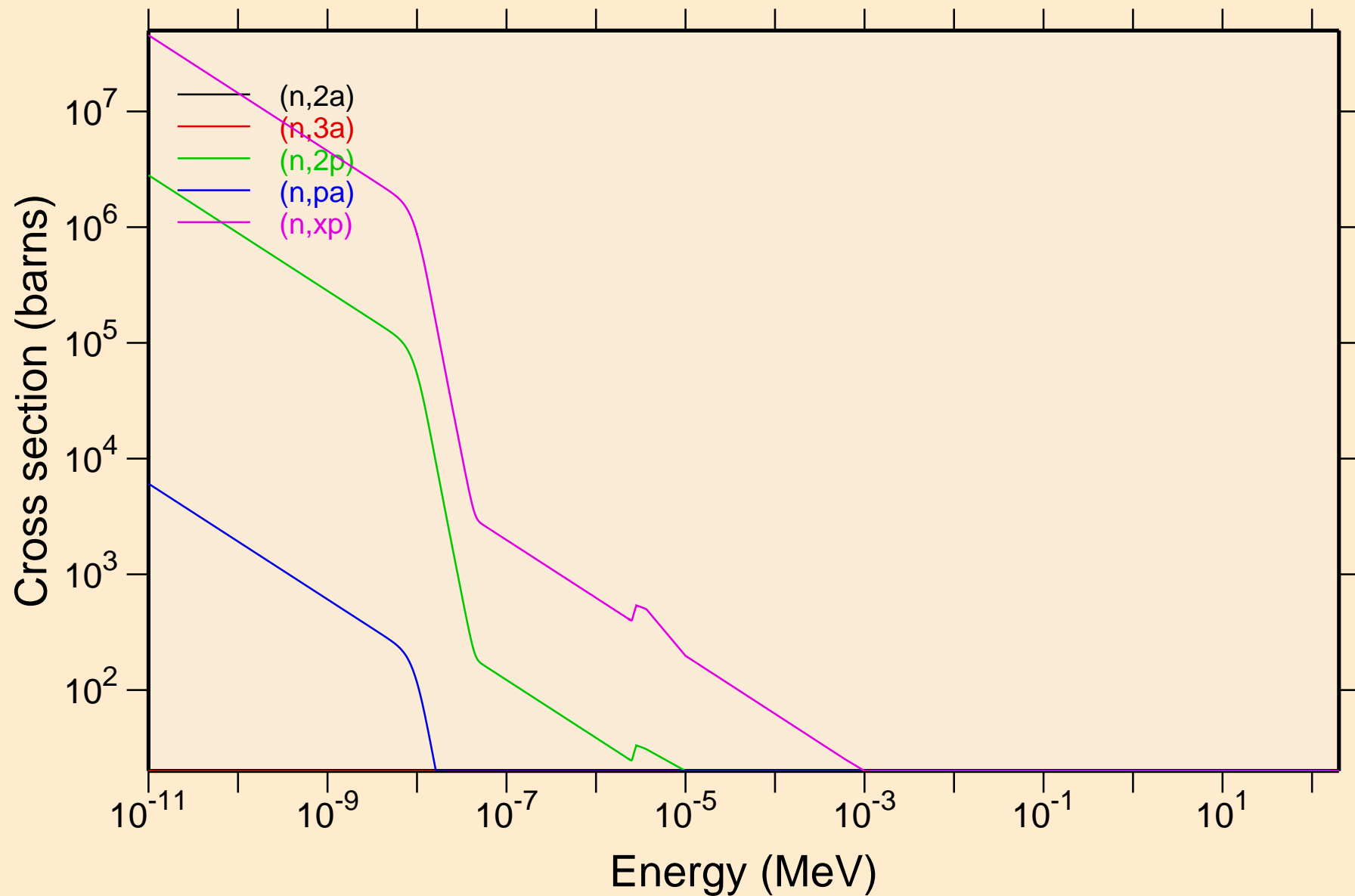

LA120 NEUTRON ACER TENDL-2019 LIBRARY; T=293.16K
Non-threshold reactions

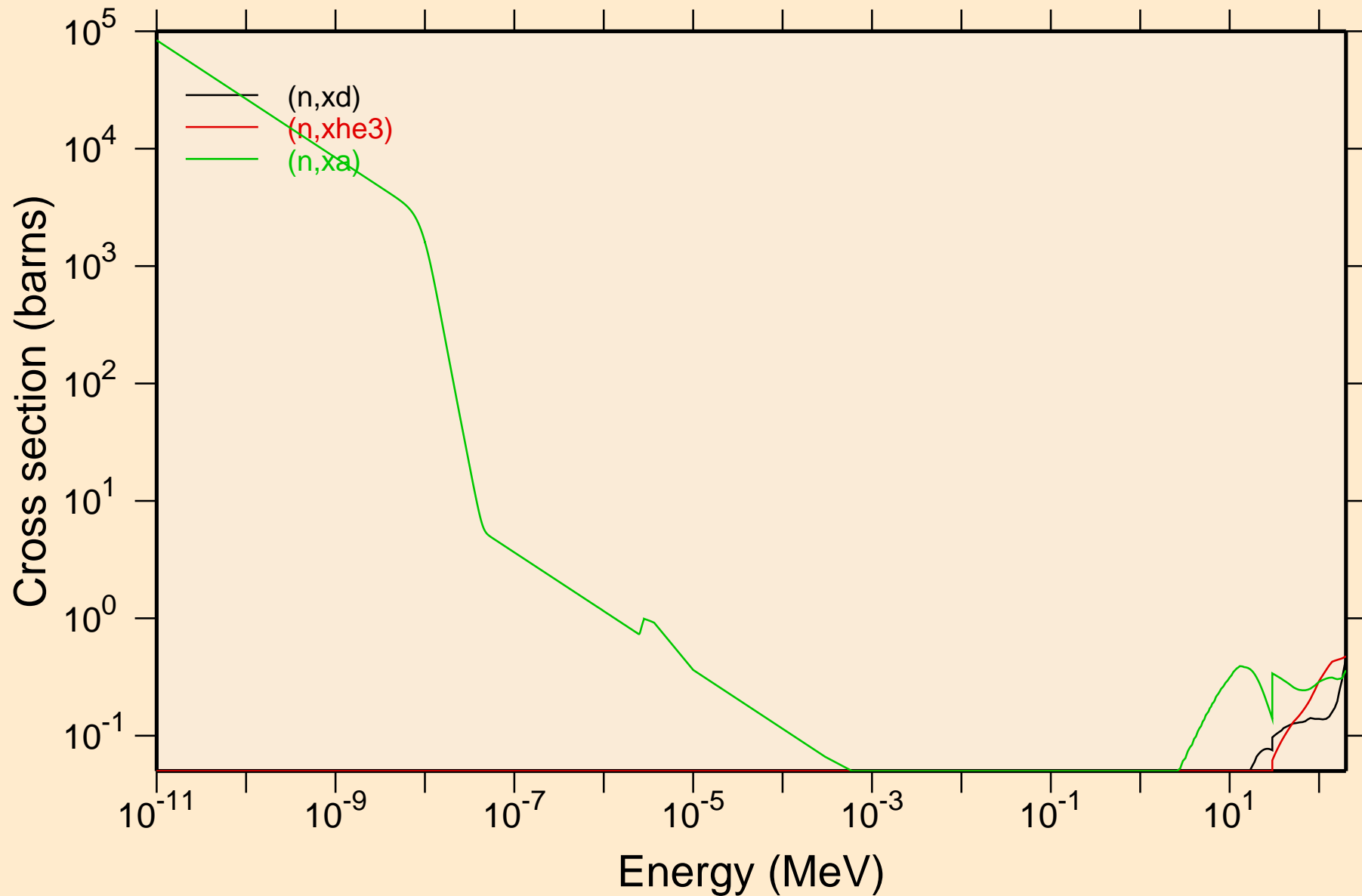

LA120 NEUTRON ACER TENDL-2019 LIBRARY; T=293.16K

Principal cross sections

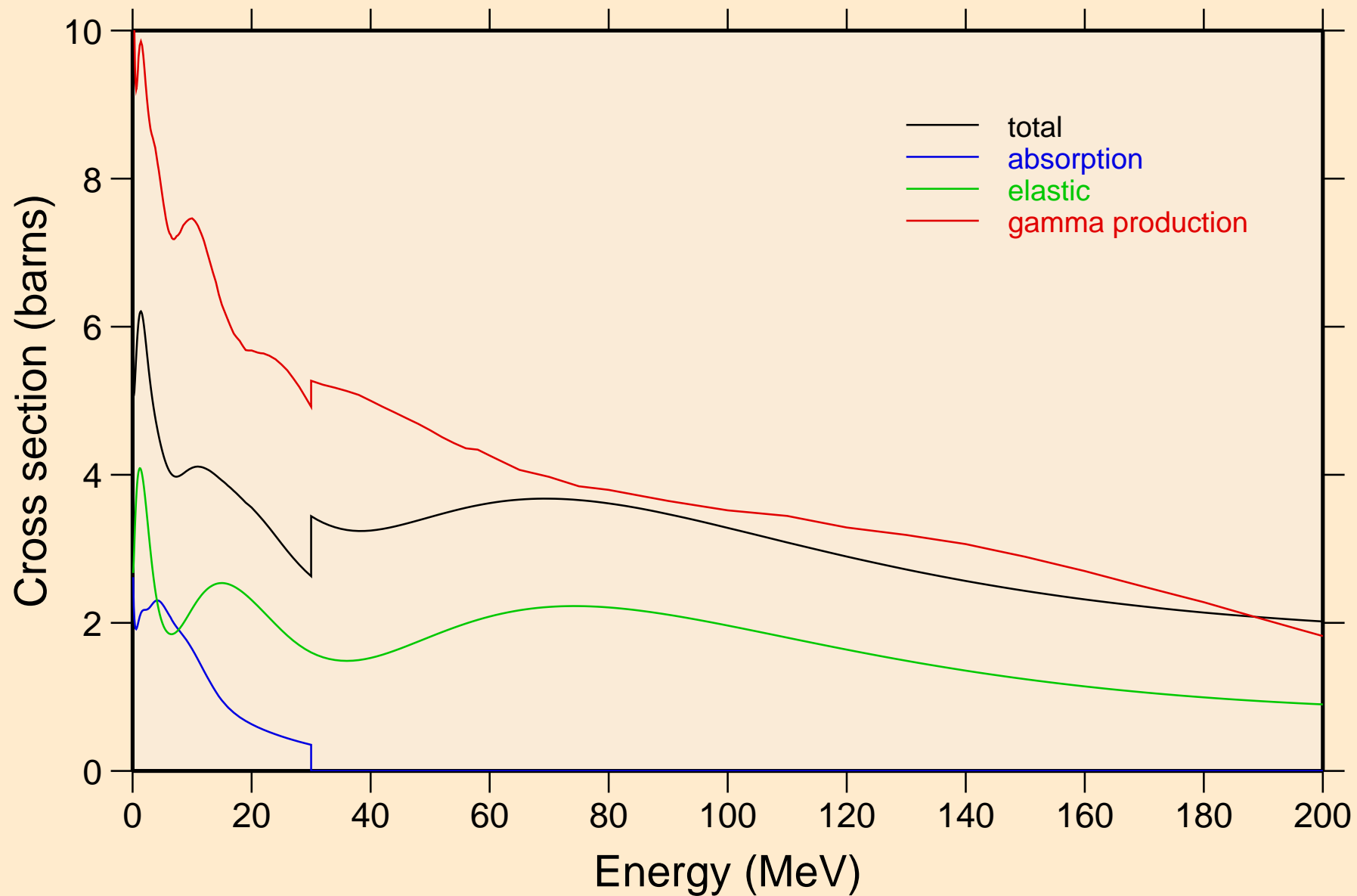

LA120 NEUTRON ACER TENDL-2019 LIBRARY; T=293.16K
Heating

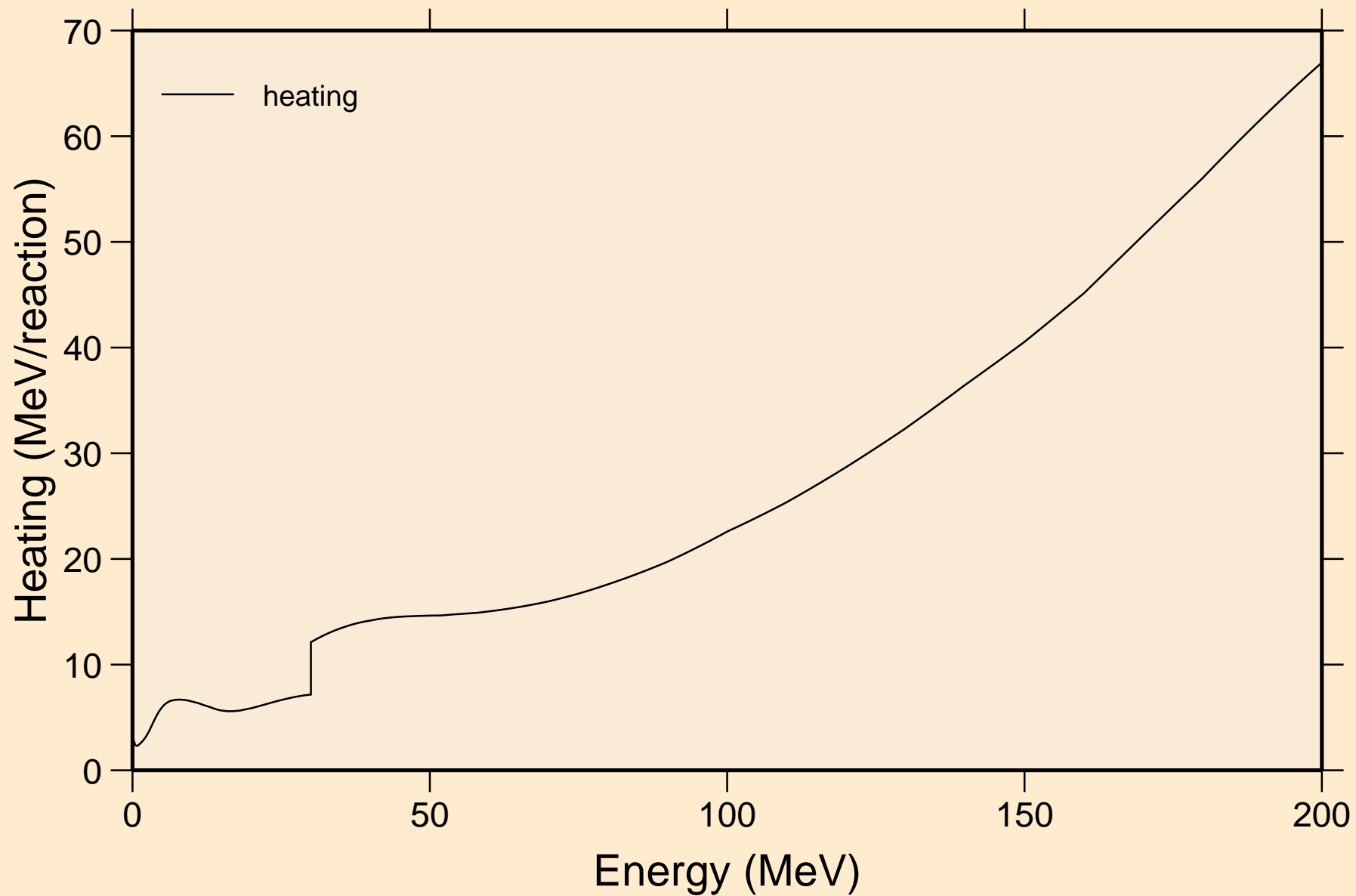

LA120 NEUTRON ACER TENDL-2019 LIBRARY; T=293.16K
Damage

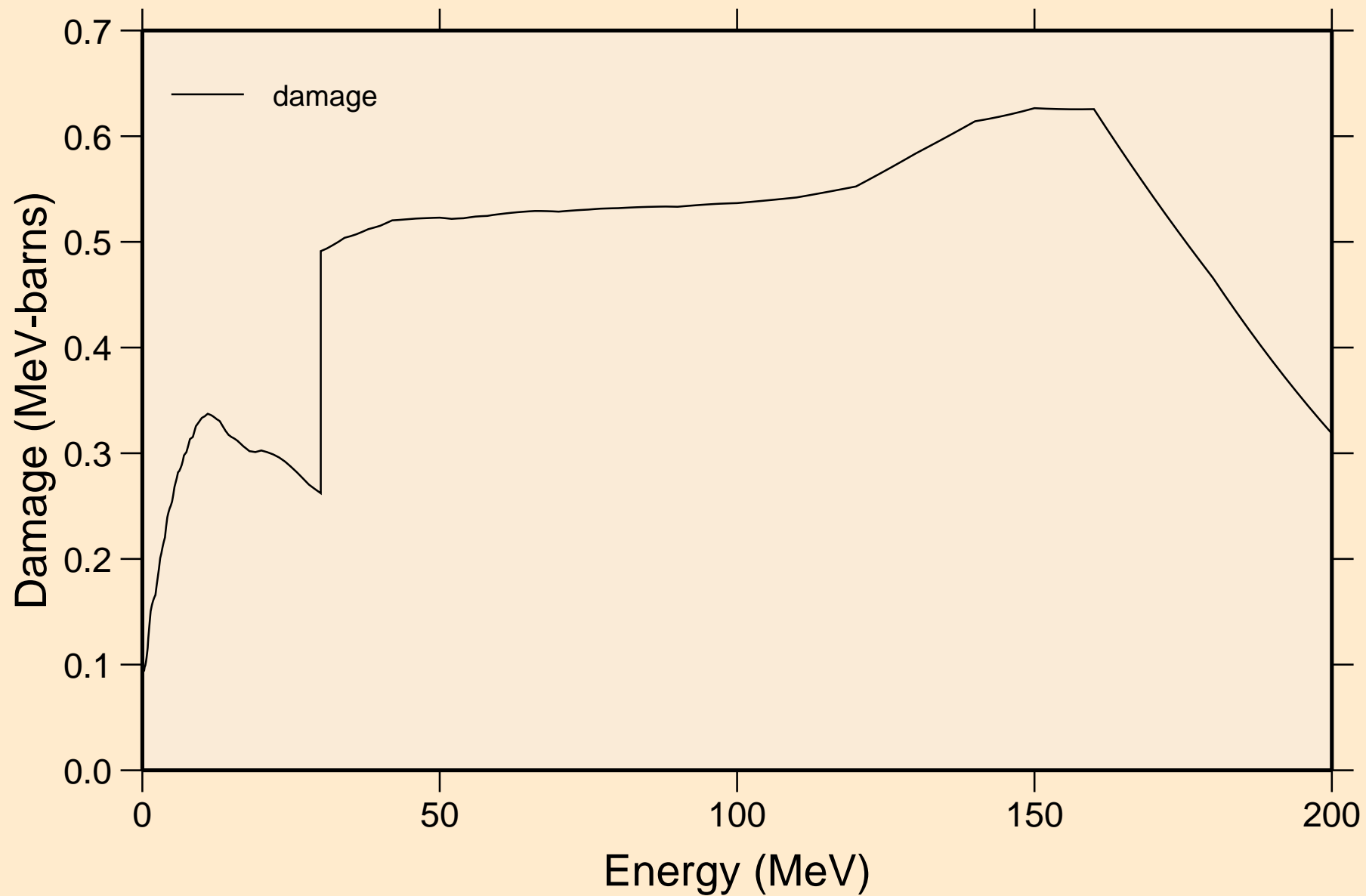

LA120 NEUTRON ACER TENDL-2019 LIBRARY; T=293.16K
Non-threshold reactions

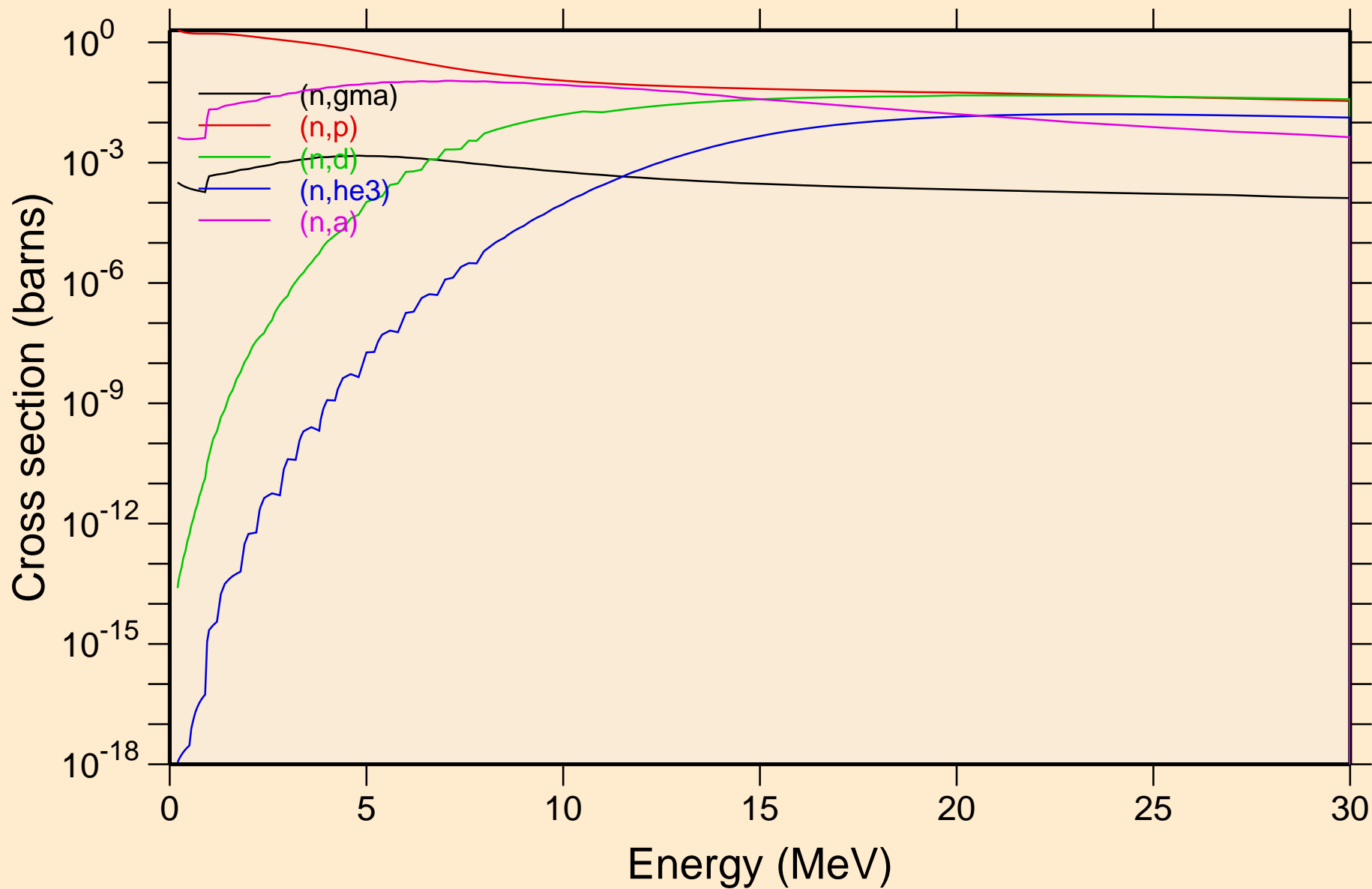

LA120 NEUTRON ACER TENDL-2019 LIBRARY; T=293.16K
Non-threshold reactions

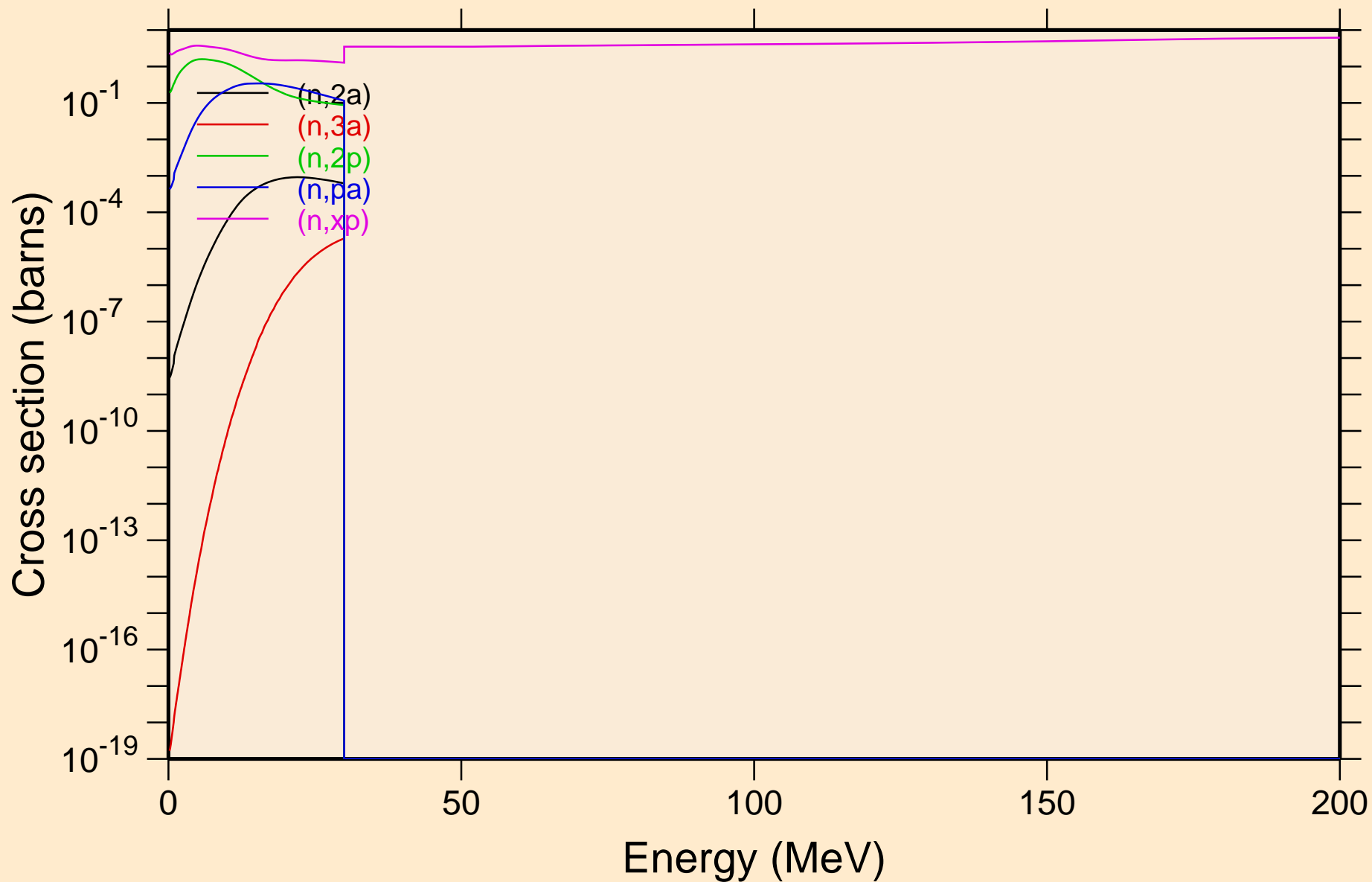

LA120 NEUTRON ACER TENDL-2019 LIBRARY; T=293.16K
Non-threshold reactions

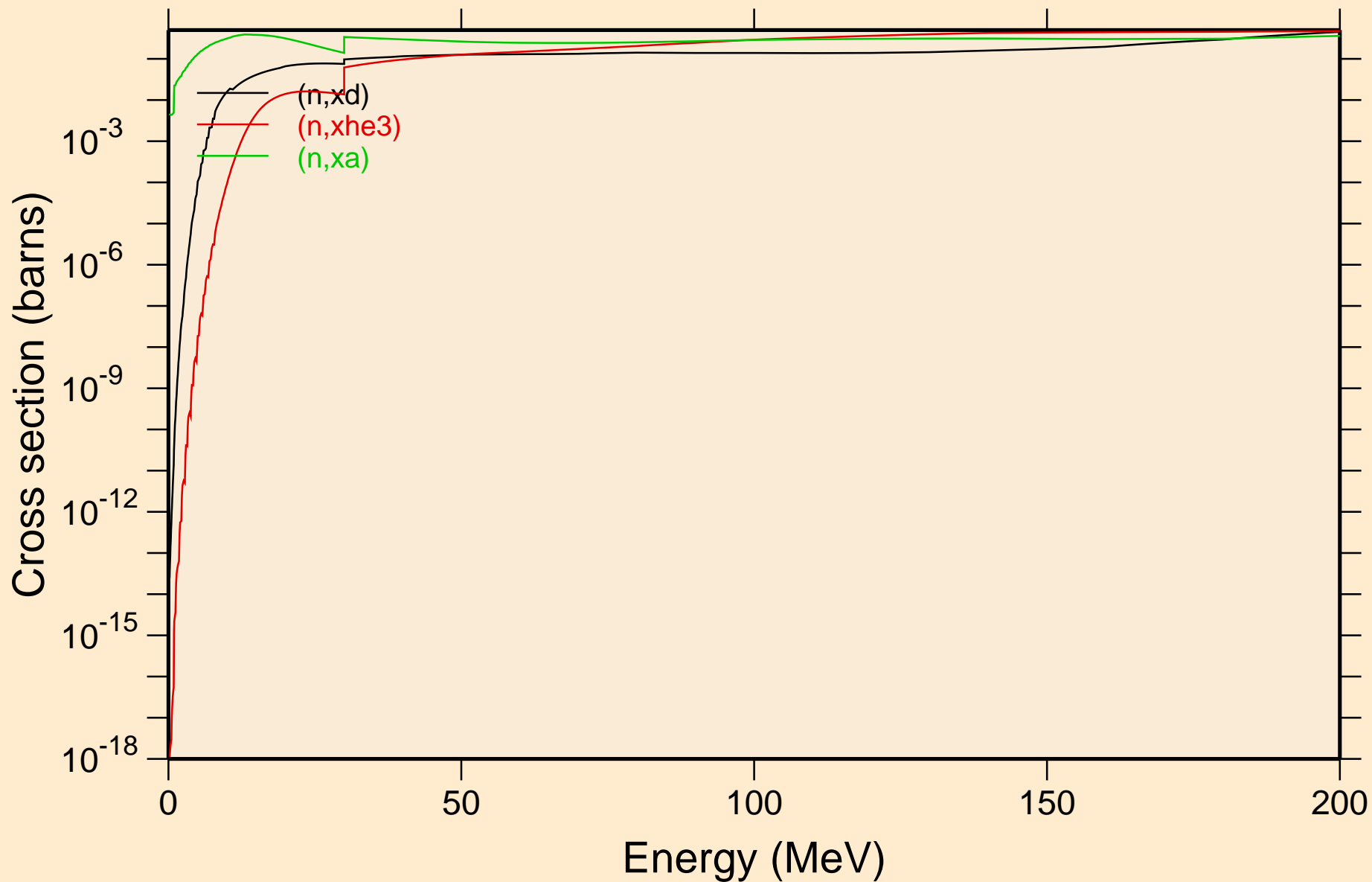

LA120 NEUTRON ACER TENDL-2019 LIBRARY; T=293.16K
Inelastic levels

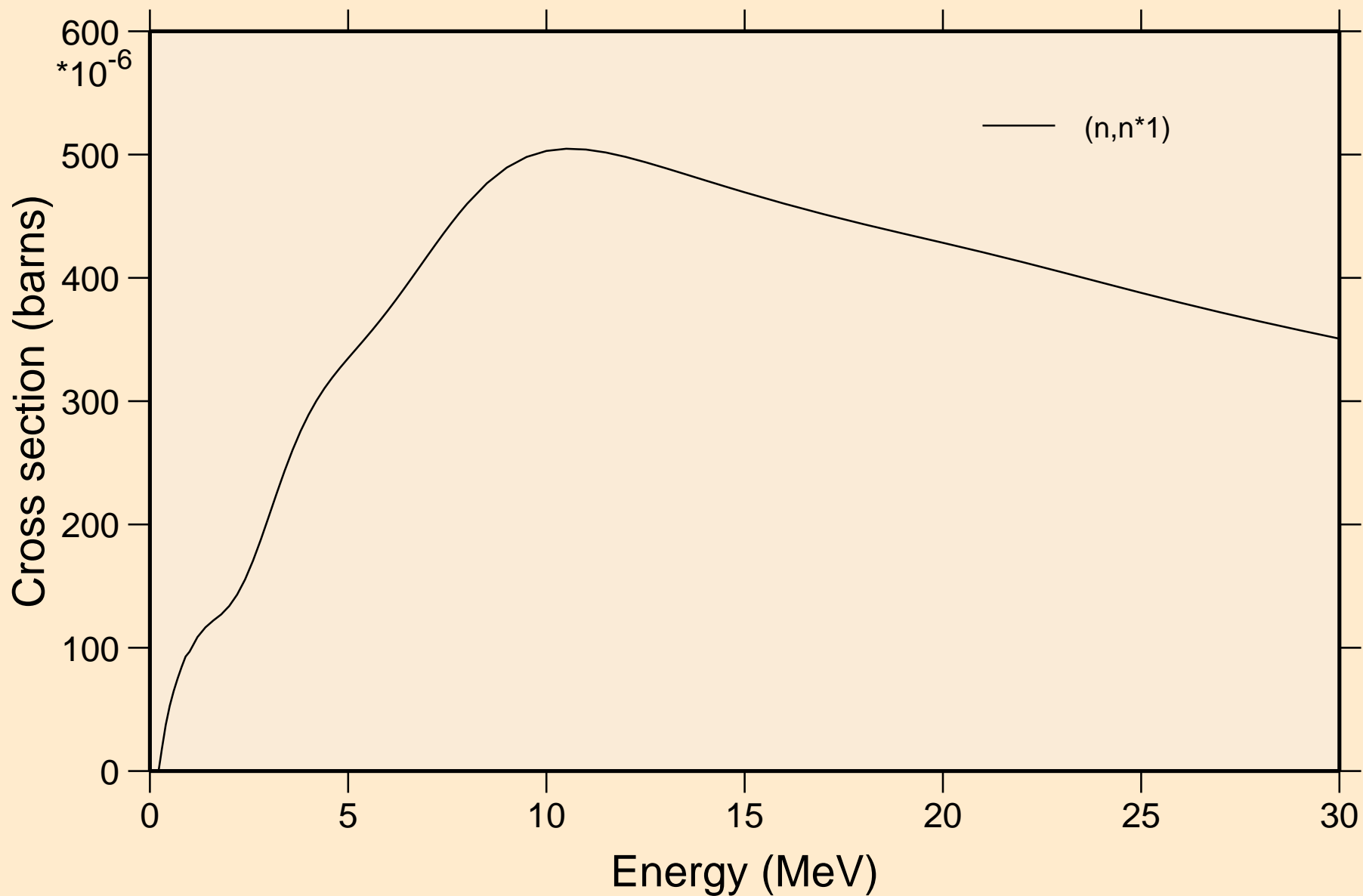

LA120 NEUTRON ACER TENDL-2019 LIBRARY; T=293.16K
Threshold reactions

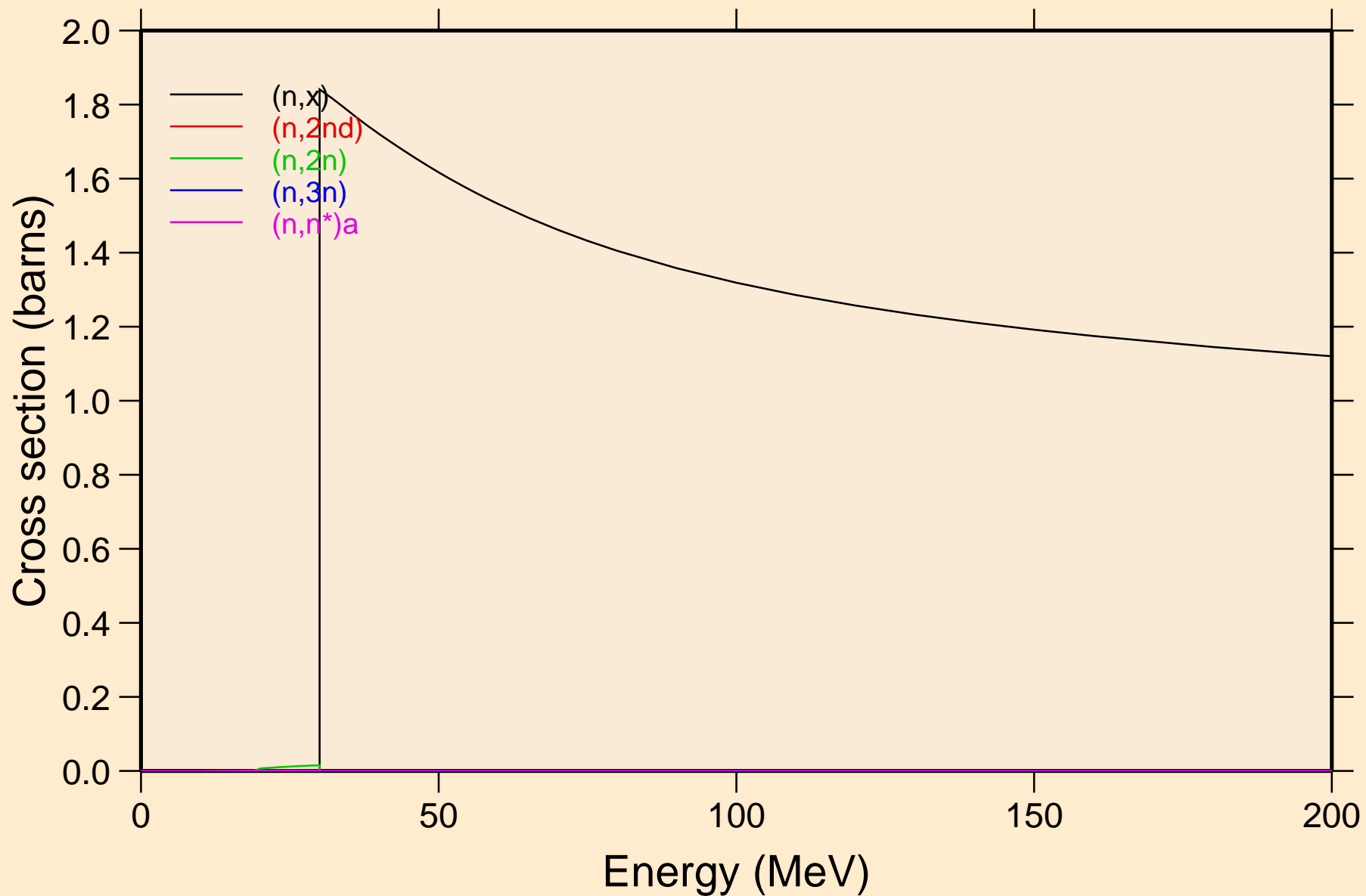

LA120 NEUTRON ACER TENDL-2019 LIBRARY; T=293.16K
Threshold reactions

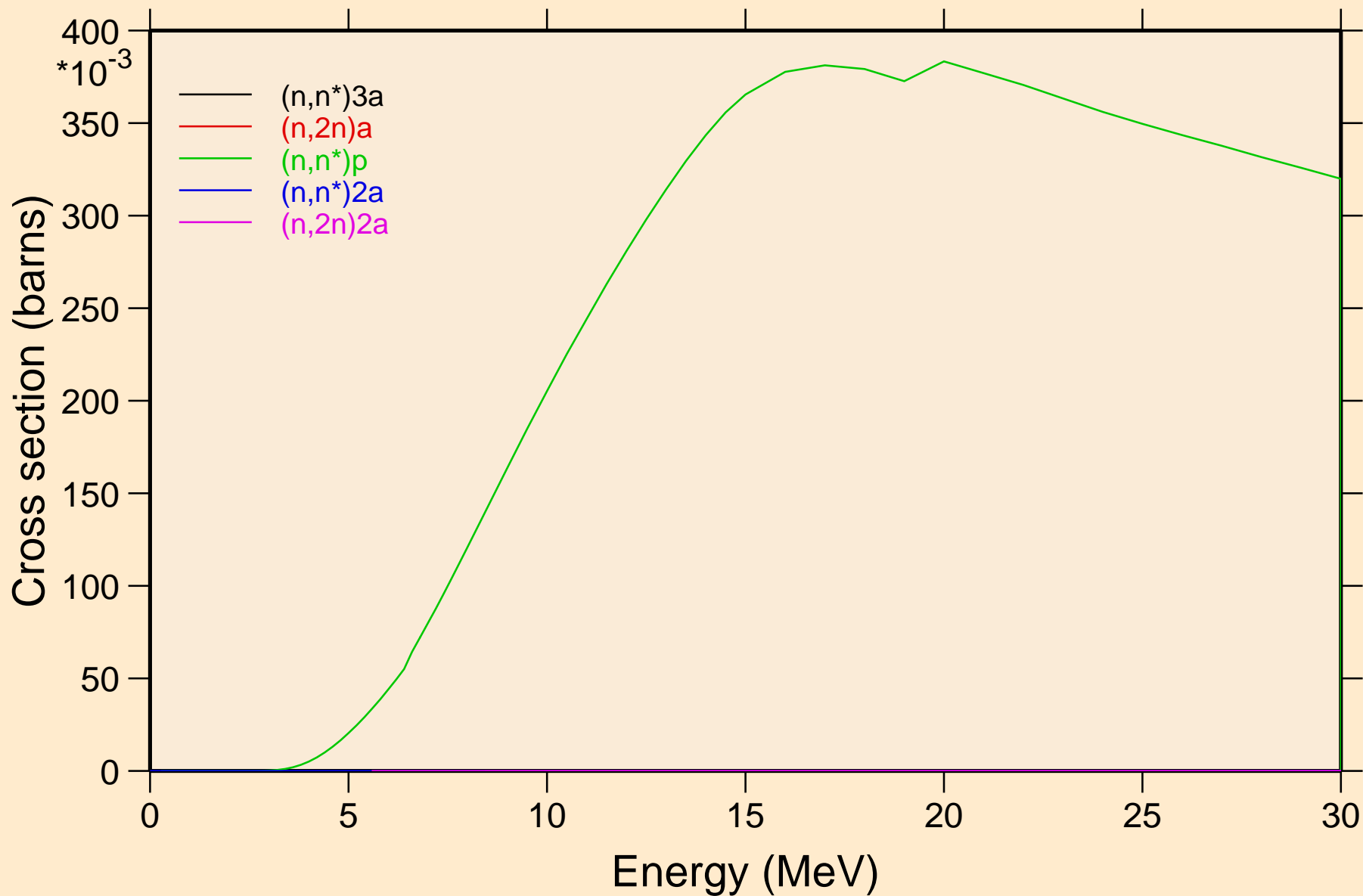

LA120 NEUTRON ACER TENDL-2019 LIBRARY; T=293.16K
Threshold reactions

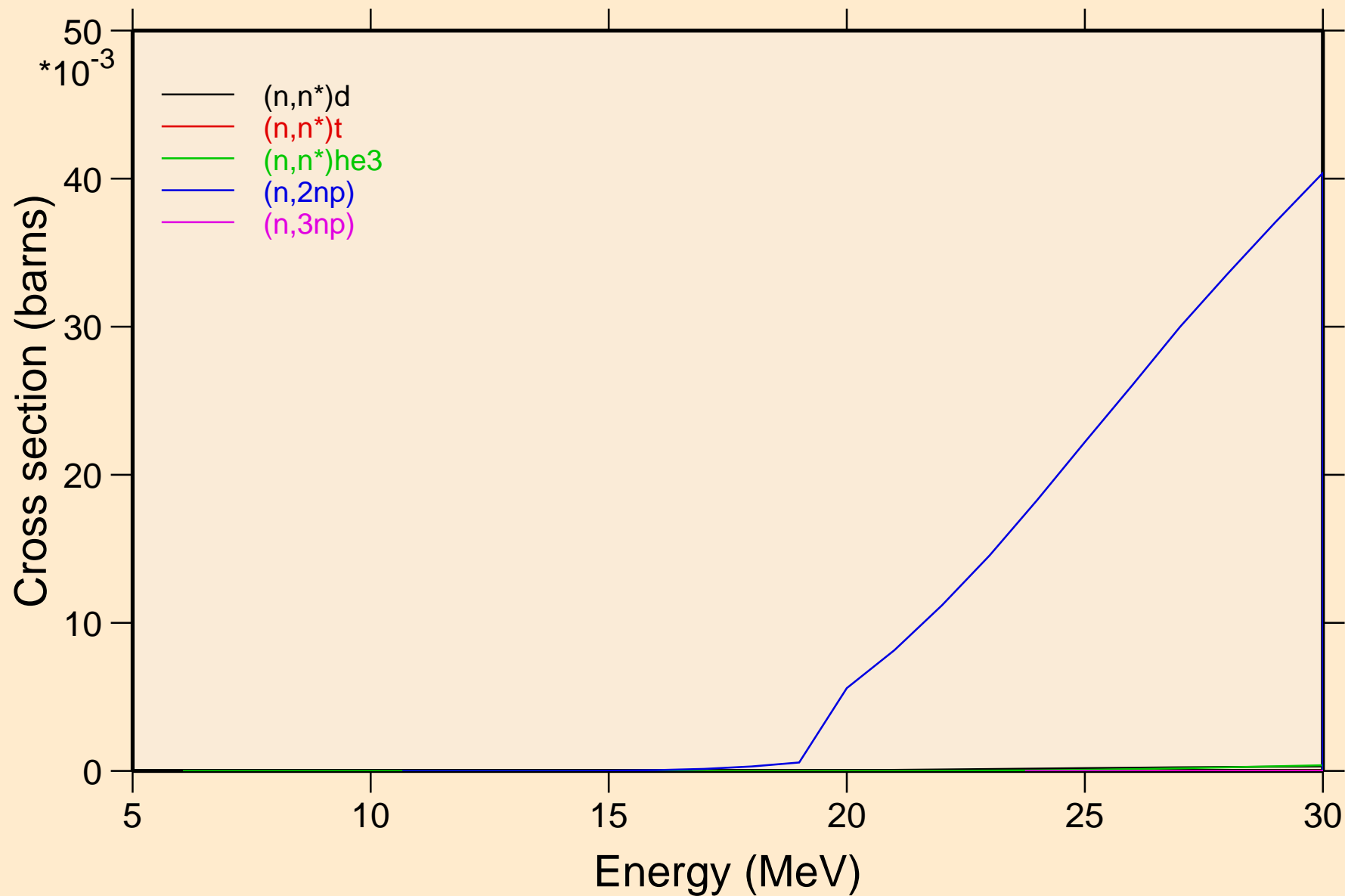

LA120 NEUTRON ACER TENDL-2019 LIBRARY; T=293.16K
Threshold reactions

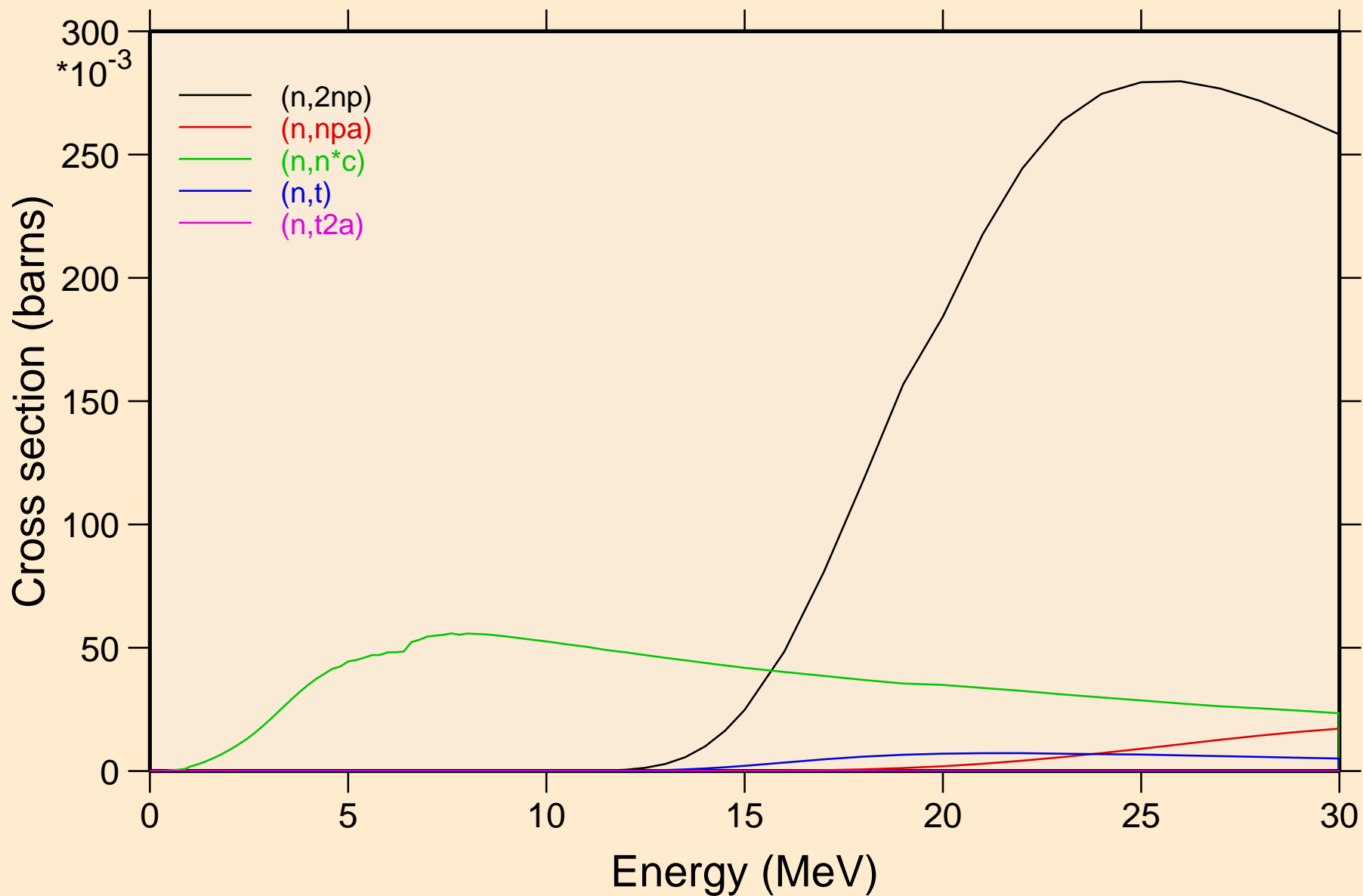

LA120 NEUTRON ACER TENDL-2019 LIBRARY; T=293.16K
Threshold reactions

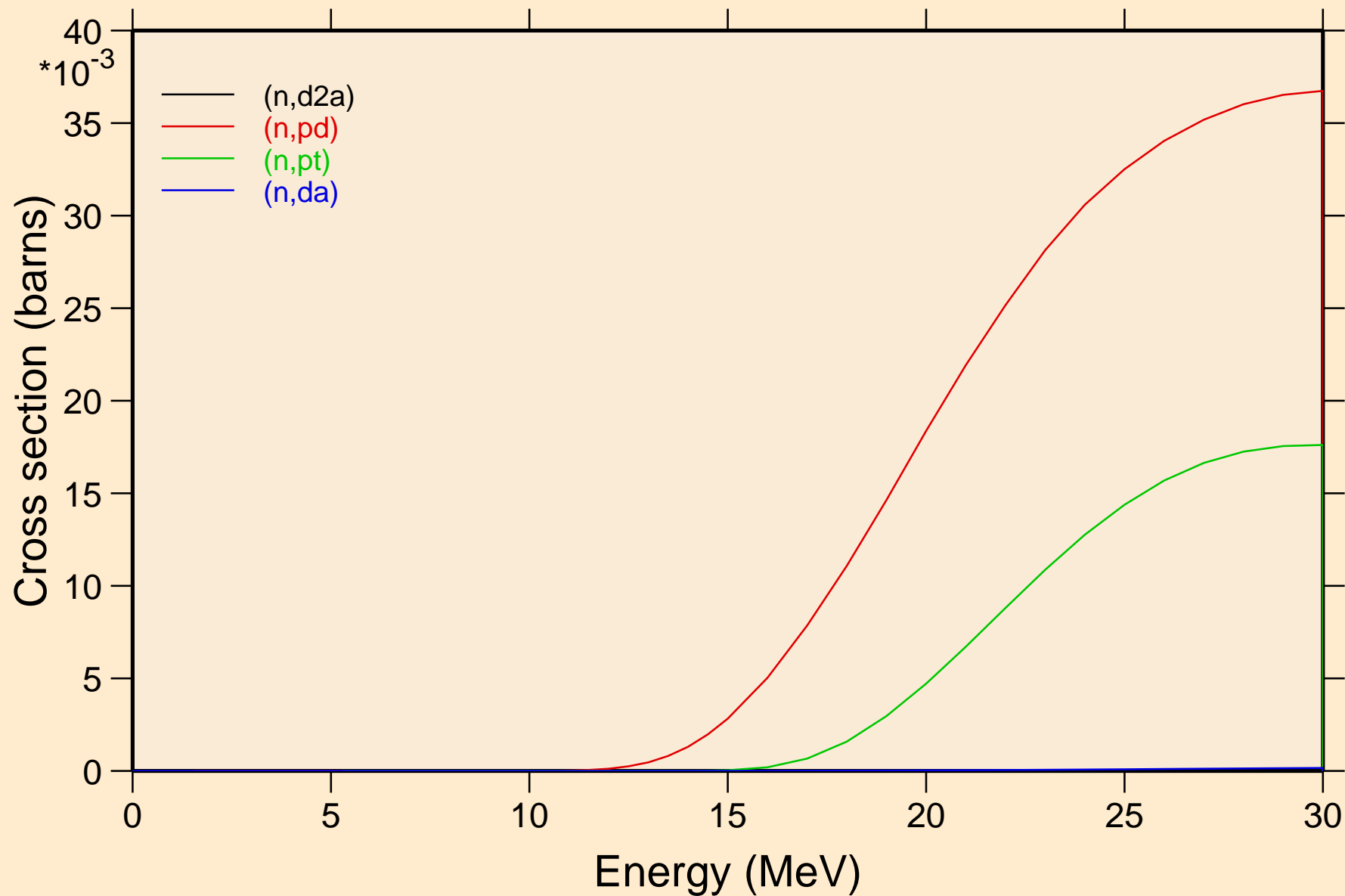

LA120 NEUTRON ACER TENDL-2019 LIBRARY; T=293.16K
Threshold reactions

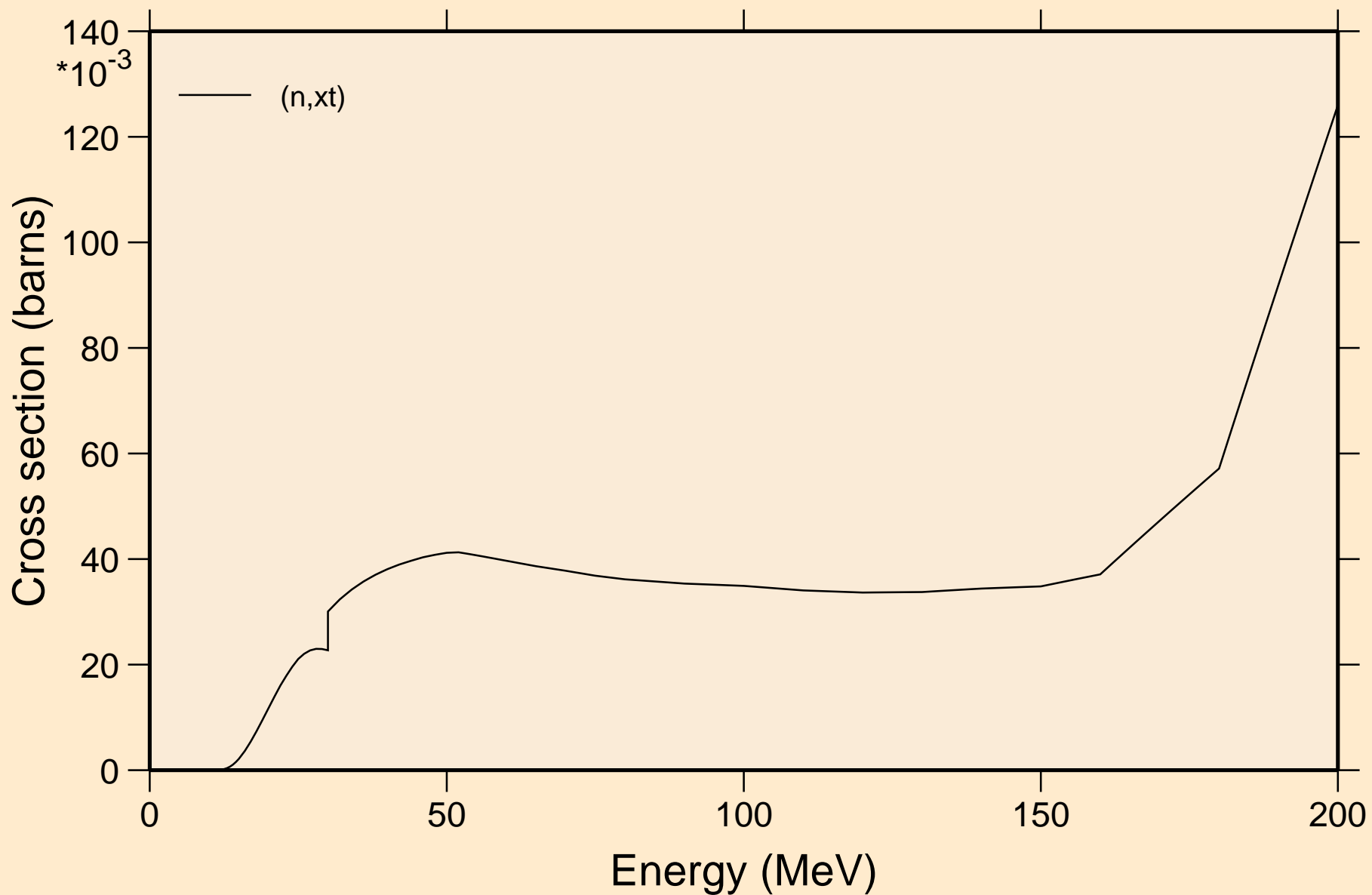

LA120 NEUTRON ACER TENDL-2019 LIBRARY; T=293.16K
angular distribution for elastic

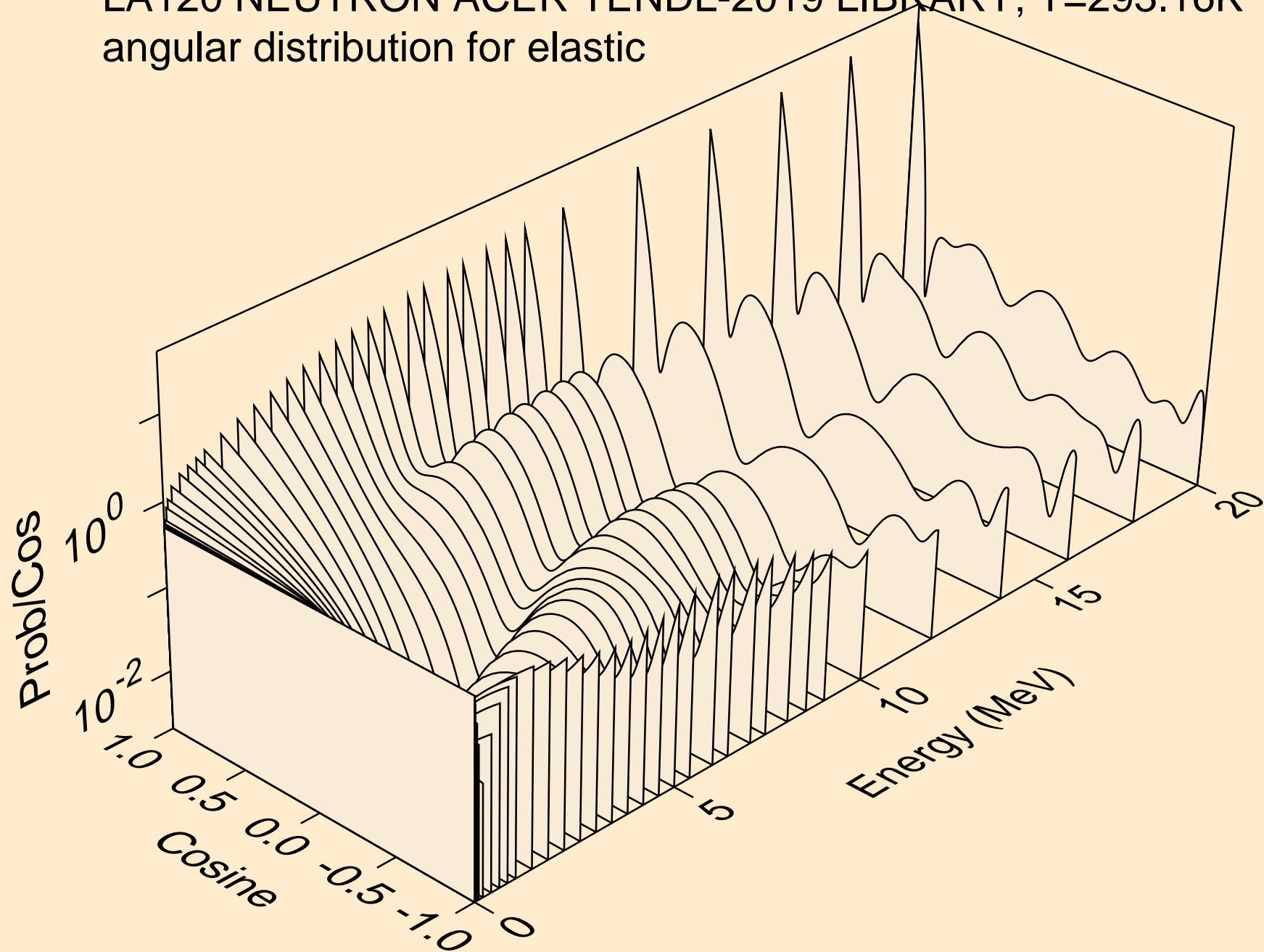

LA120 NEUTRON ACER TENDL-2019 LIBRARY; T=293.16K
angular distribution for elastic

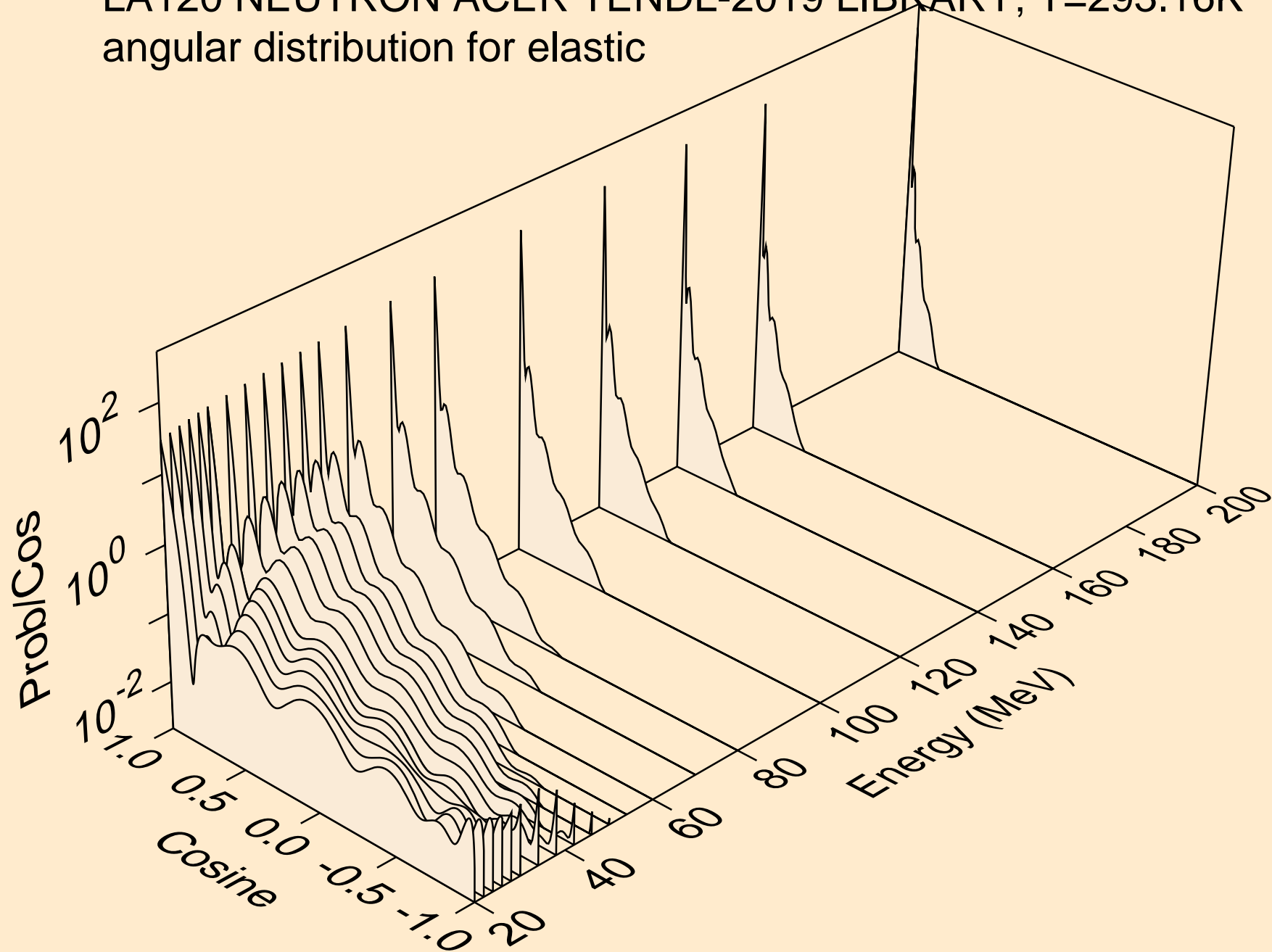

LA120 NEUTRON ACER TENDL-2019 LIBRARY; T=293.16K
angular distribution for (n,n*1)

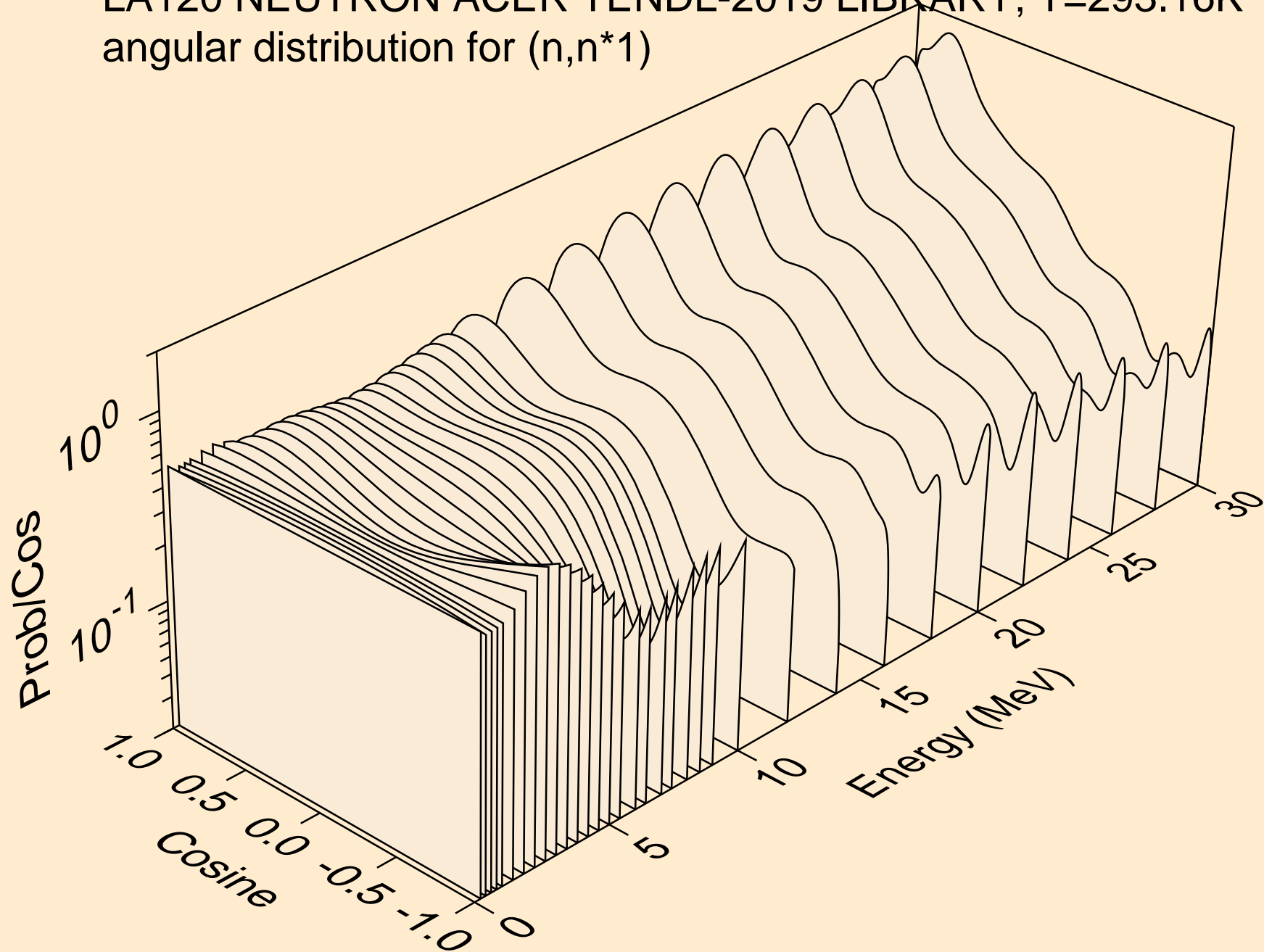

LA120 NEUTRON ACER TENDL-2019 LIBRARY; T=293.16K
Neutron emission for (n,x)

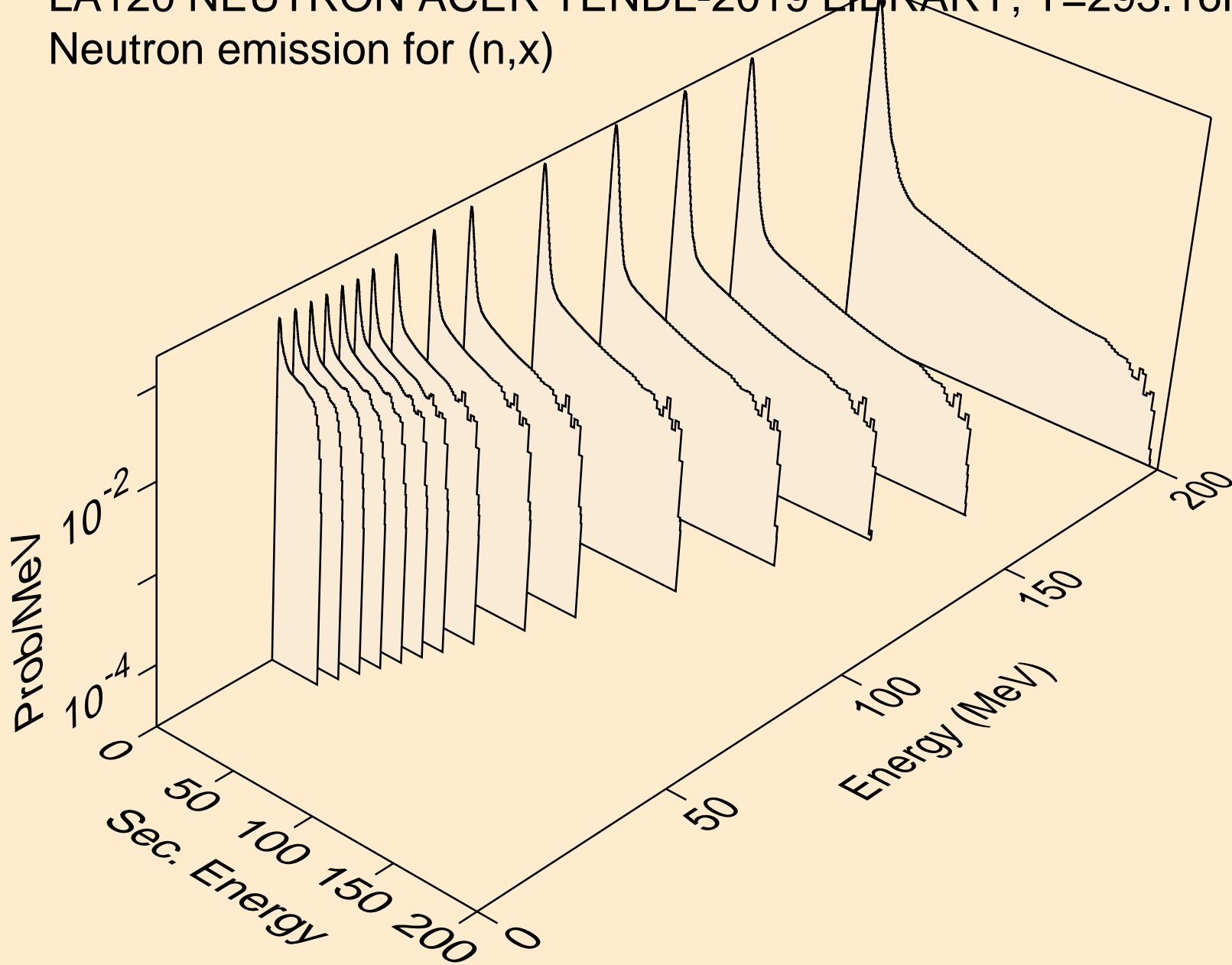

LA120 NEUTRON ACER TENDL-2019 LIBRARY; T=293.16K
Neutron emission for (n,2nd)

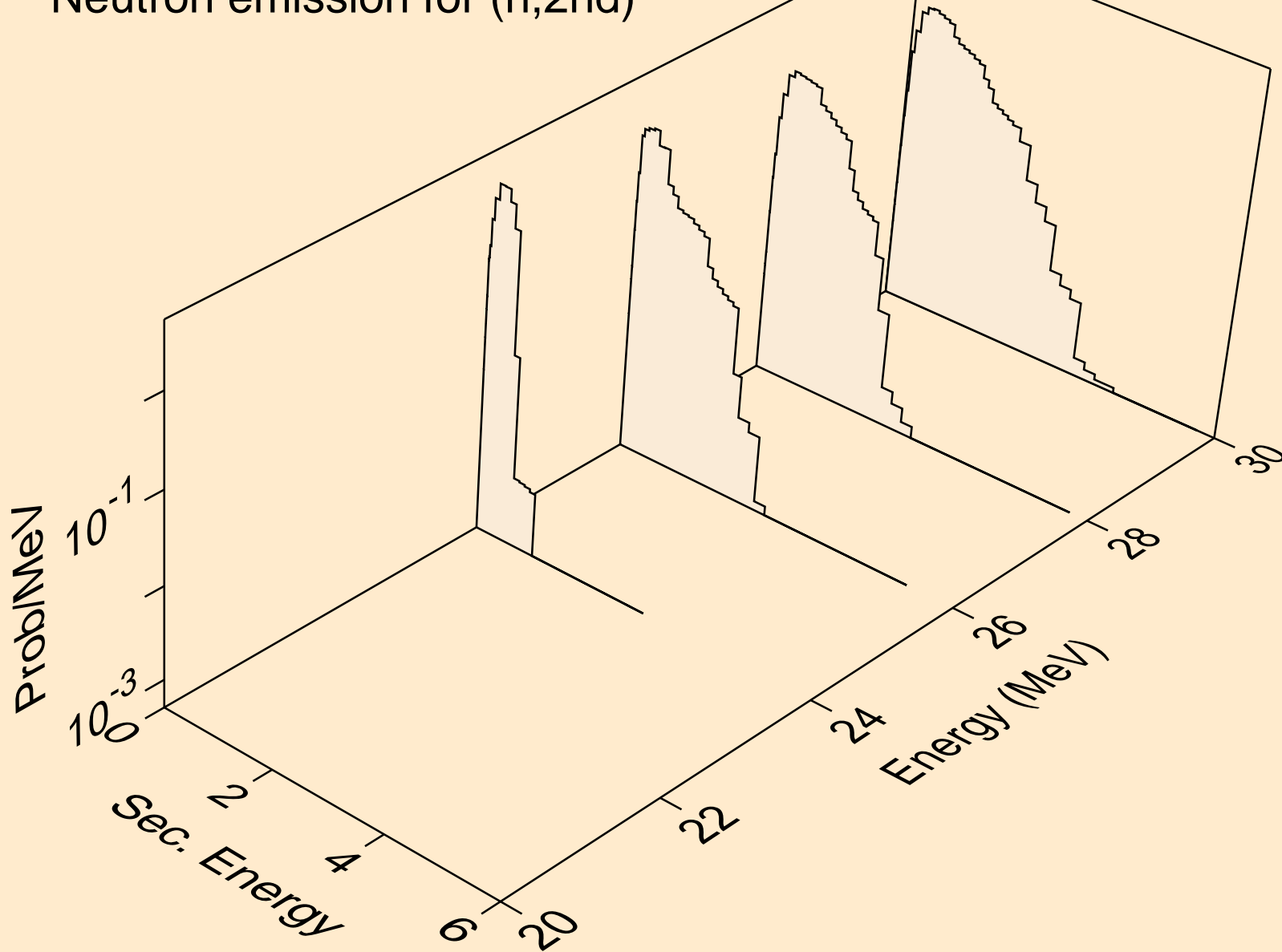

LA120 NEUTRON ACER TENDL-2019 LIBRARY; T=293.16K
Neutron emission for (n,2n)

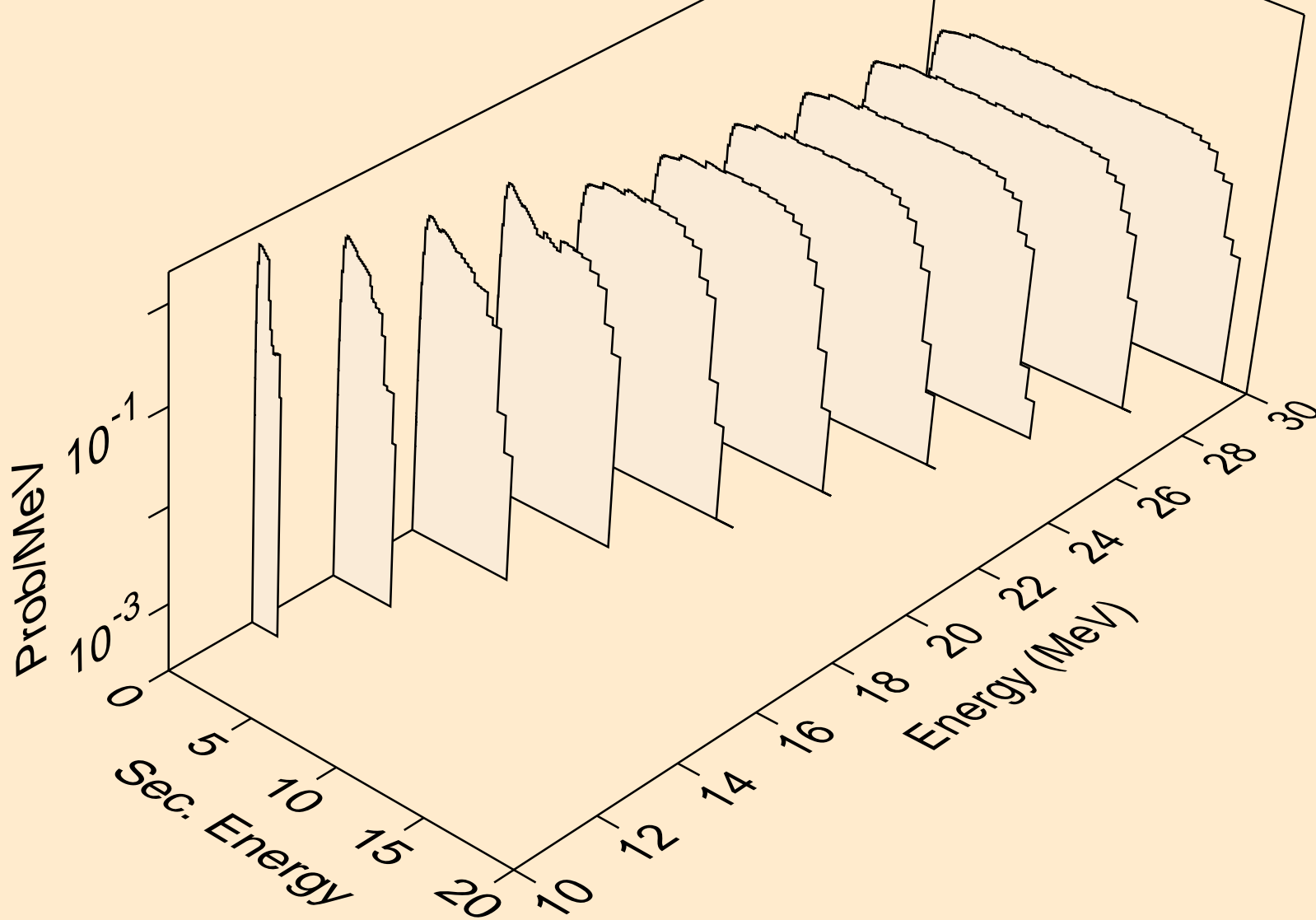

LA120 NEUTRON ACER TENDL-2019 LIBRARY; T=293.16K
Neutron emission for (n,3n)

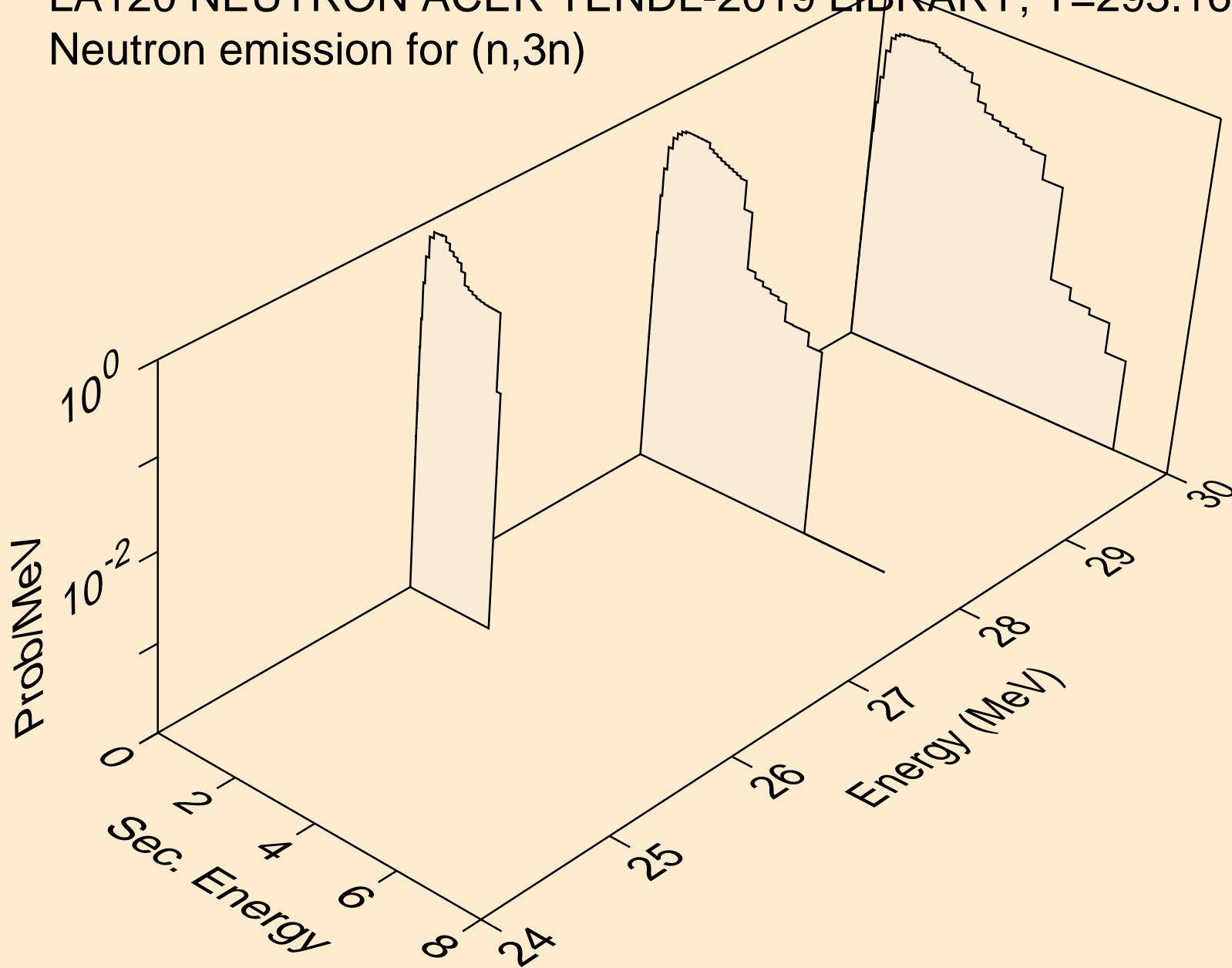

LA120 NEUTRON ACER TENDL-2019 LIBRARY; T=293.16K
Neutron emission for (n,n*)a

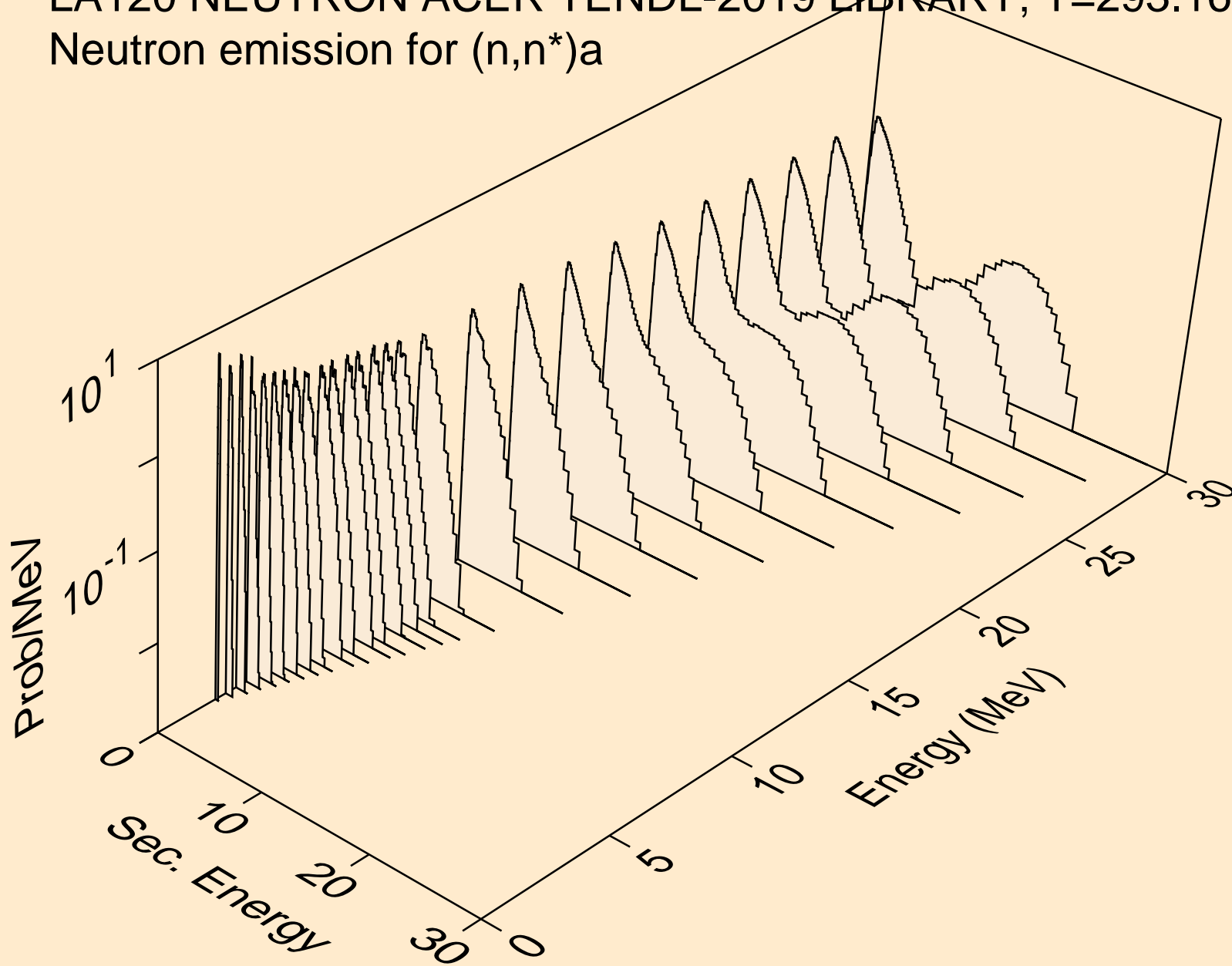

LA120 NEUTRON ACER TENDL-2019 LIBRARY; T=293.16K
Neutron emission for (n,n*)3a

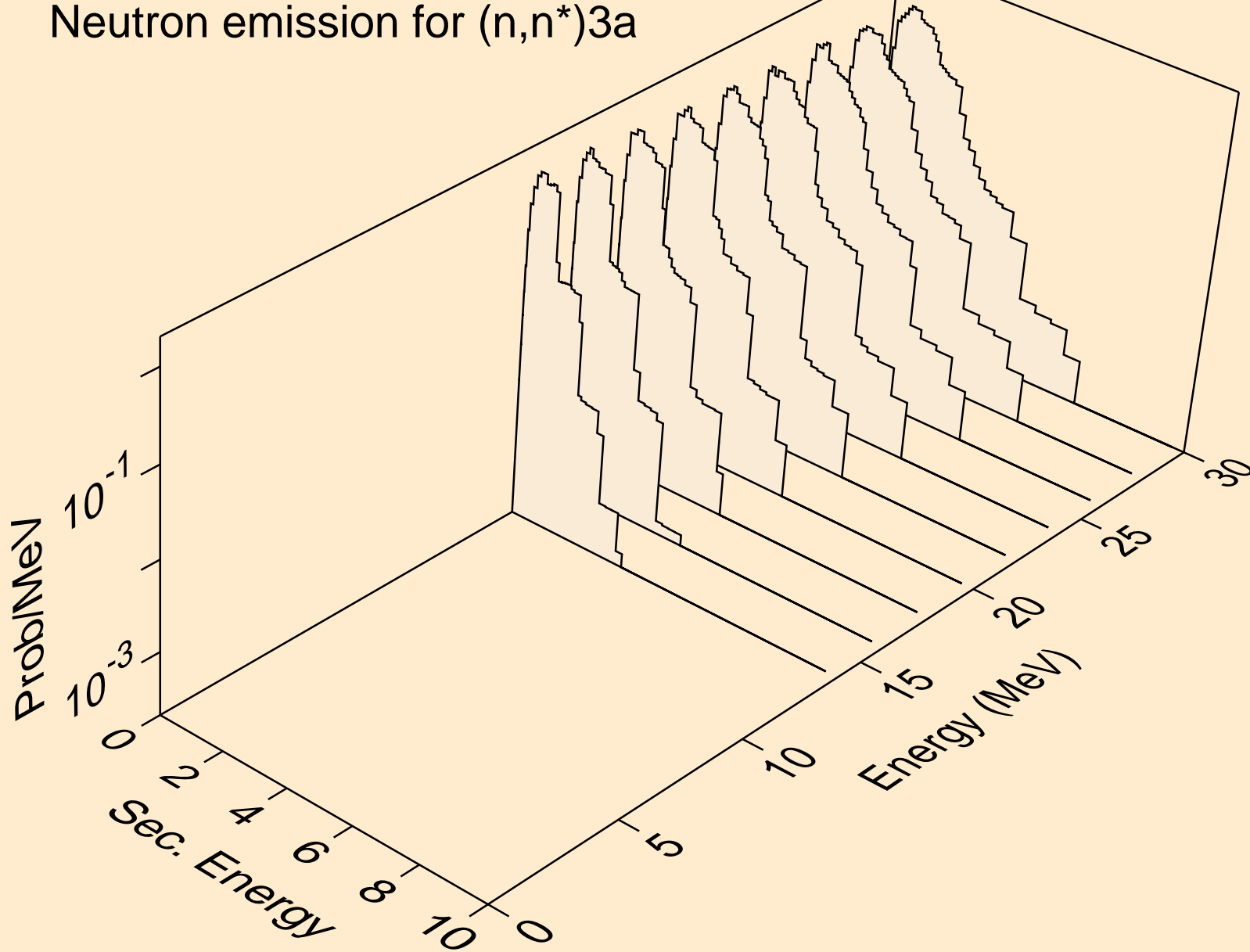

LA120 NEUTRON ACER TENDL-2019 LIBRARY; T=293.16K
Neutron emission for (n,2n)a

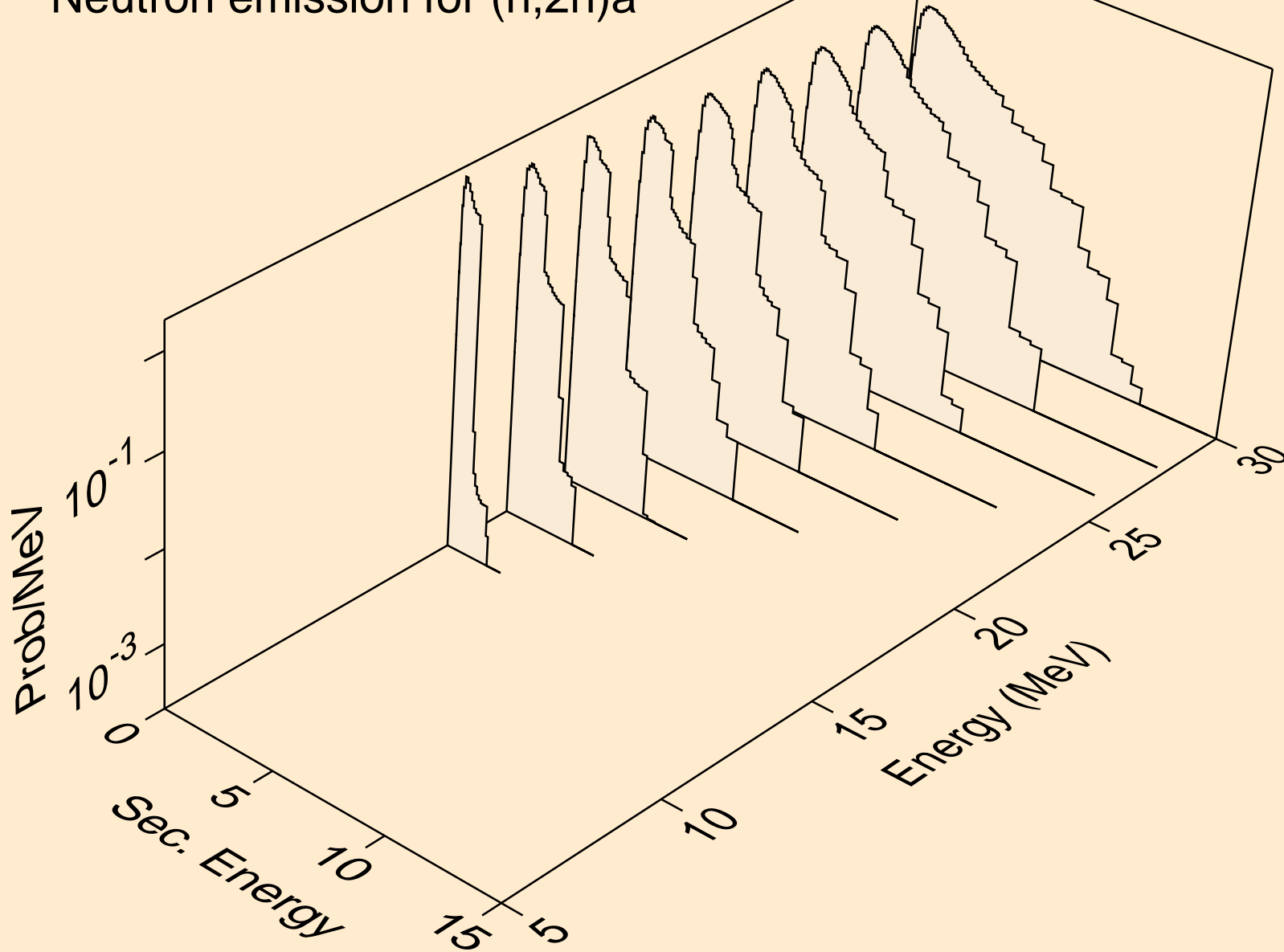

LA120 NEUTRON ACER TENDL-2019 LIBRARY; T=293.16K
Neutron emission for (n,n*)p

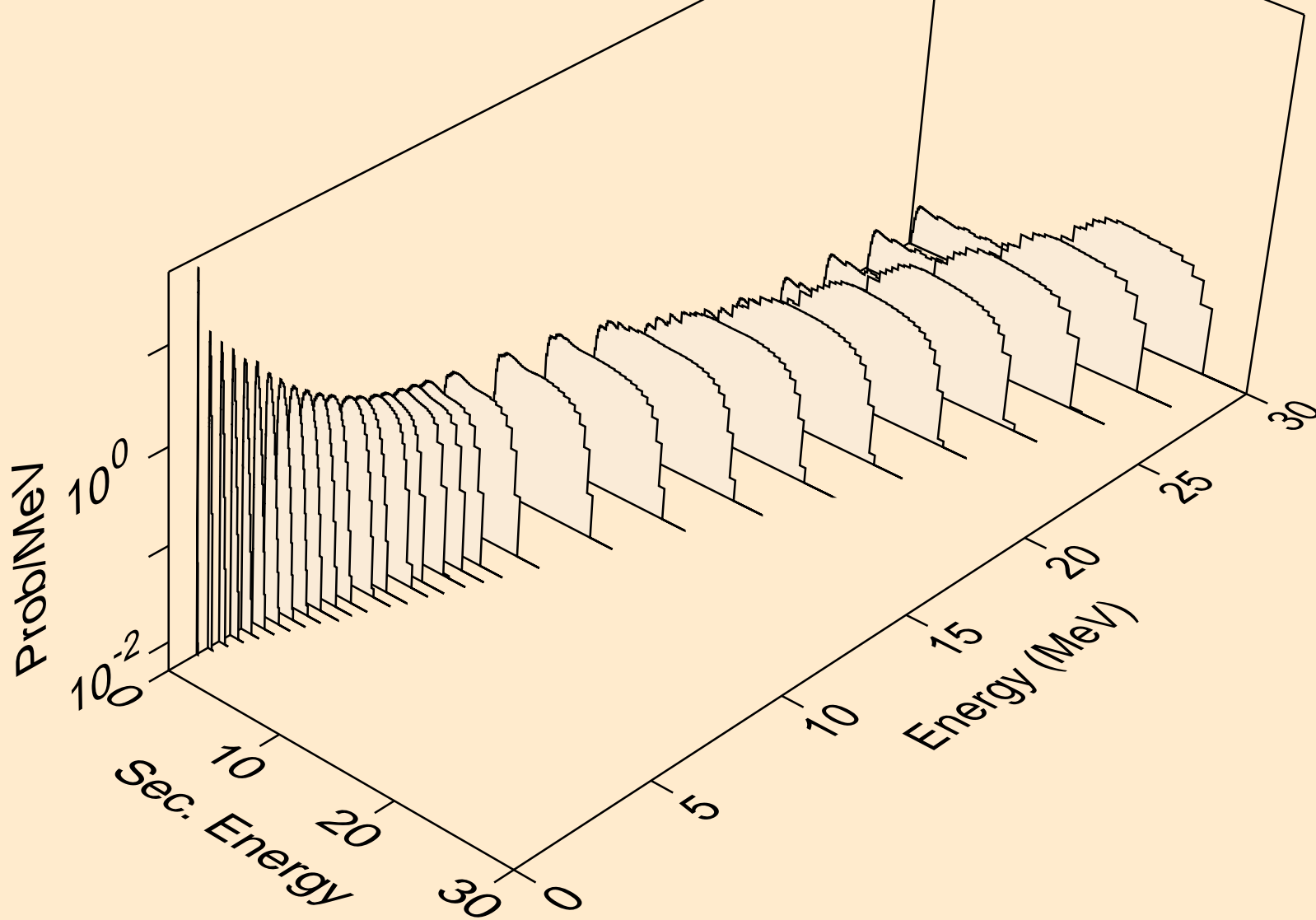

LA120 NEUTRON ACER TENDL-2019 LIBRARY; T=293.16K
Neutron emission for (n,n*)2a

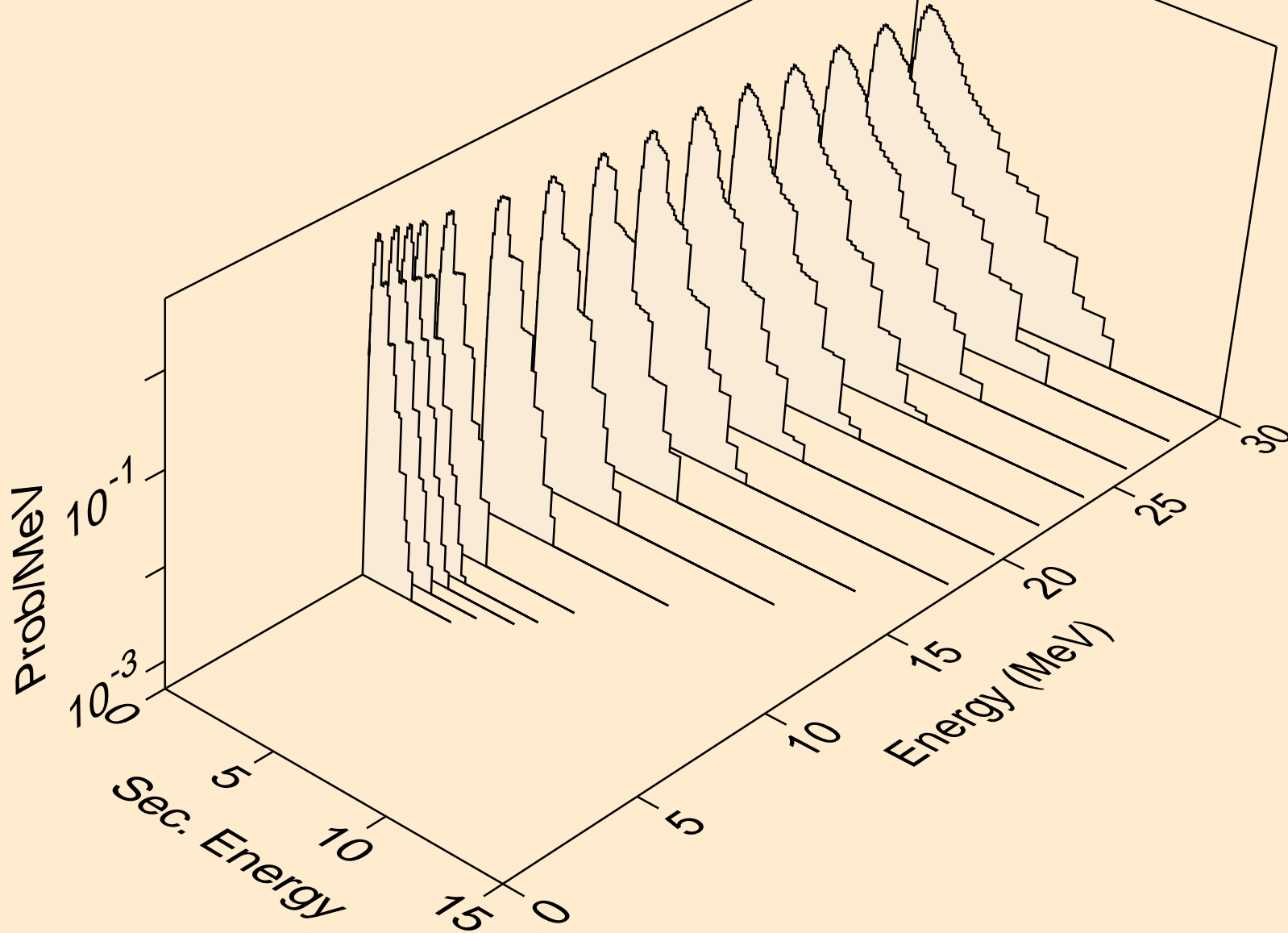

LA120 NEUTRON ACER TENDL-2019 LIBRARY; T=293.16K
Neutron emission for (n,2n)2a

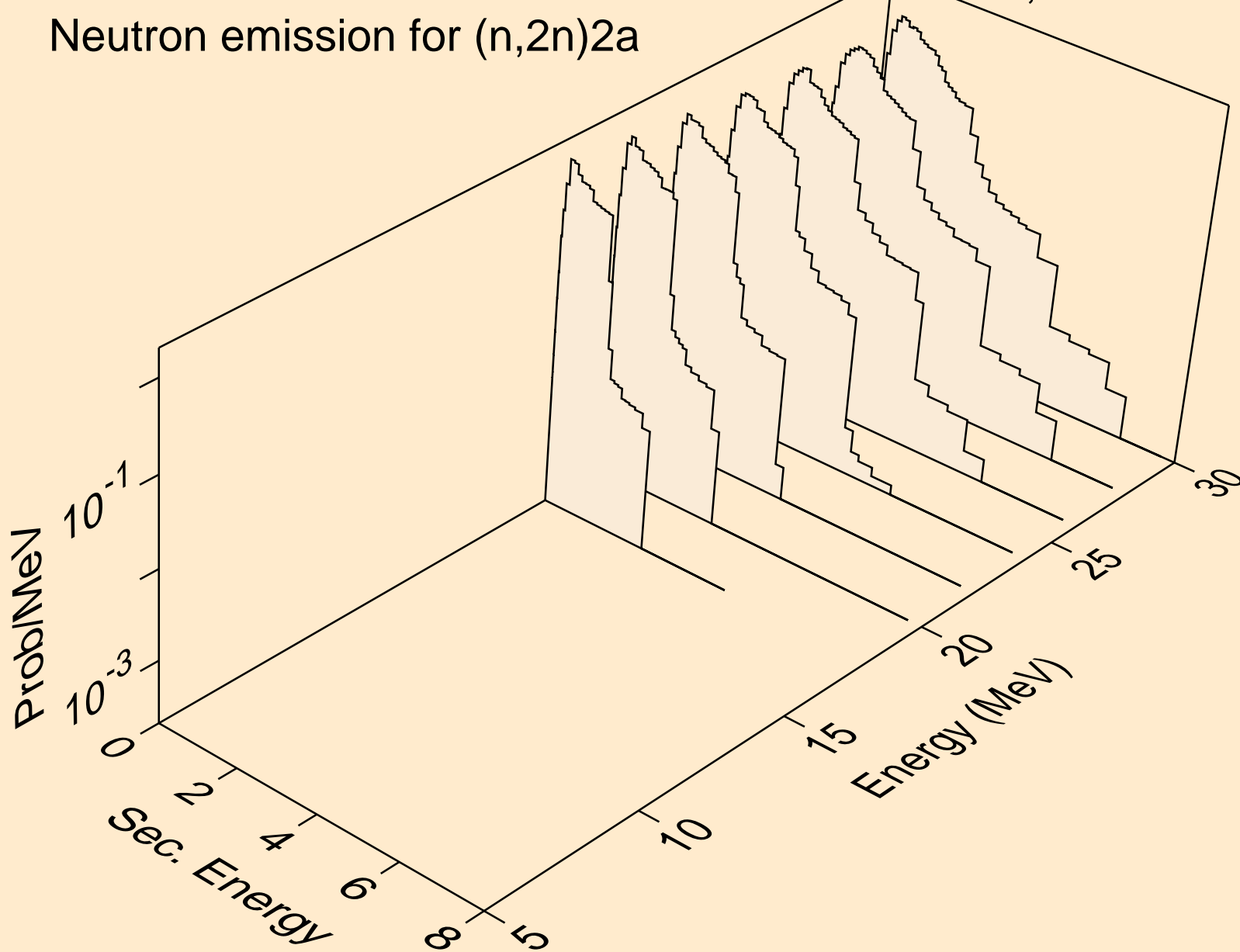

LA120 NEUTRON ACER TENDL-2019 LIBRARY; T=293.16K
Neutron emission for (n,n*)d

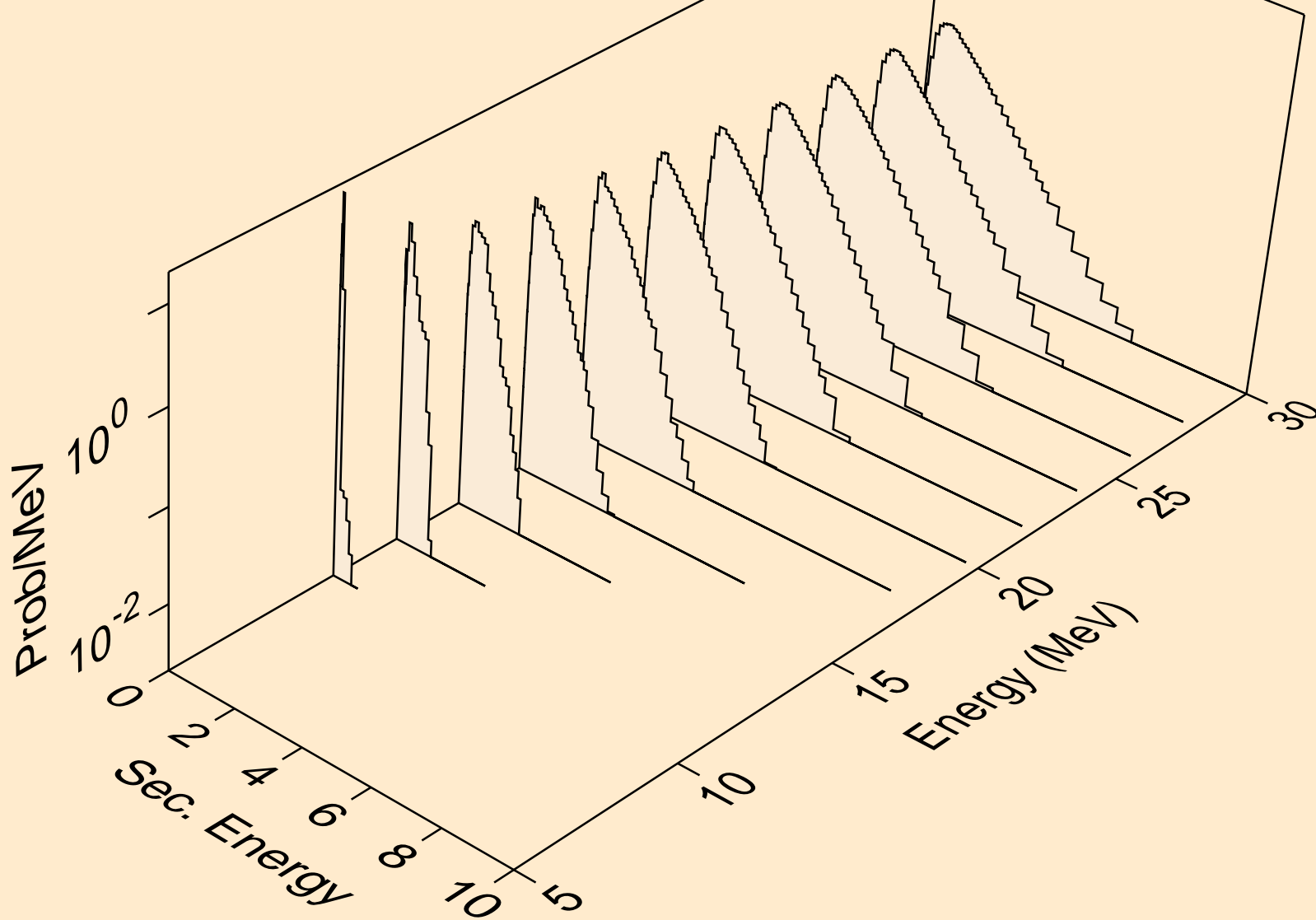

LA120 NEUTRON ACER TENDL-2019 LIBRARY; T=293.16K
Neutron emission for (n,n*)t

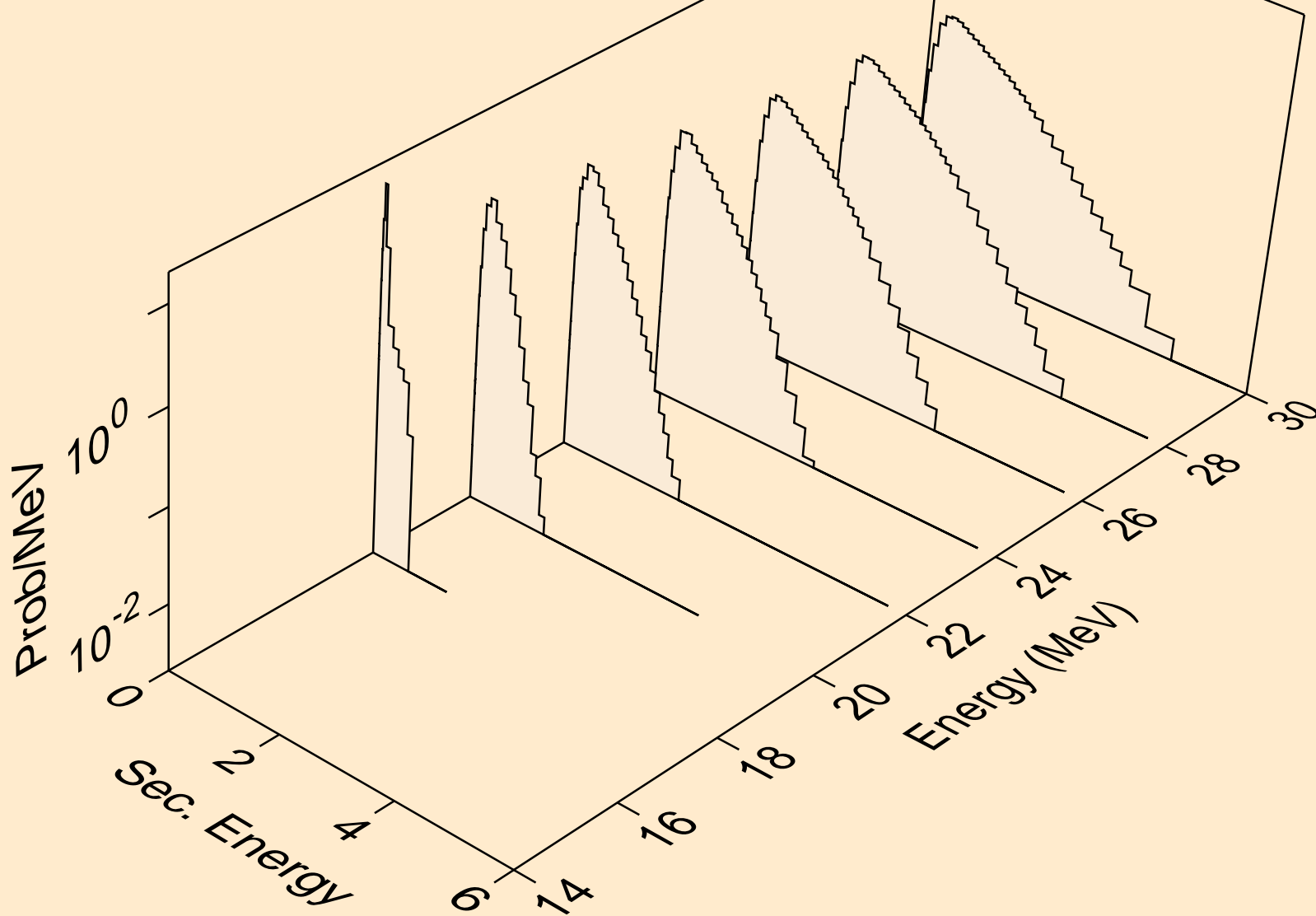

LA120 NEUTRON ACER TENDL-2019 LIBRARY; T=293.16K
Neutron emission for (n,n*)he3

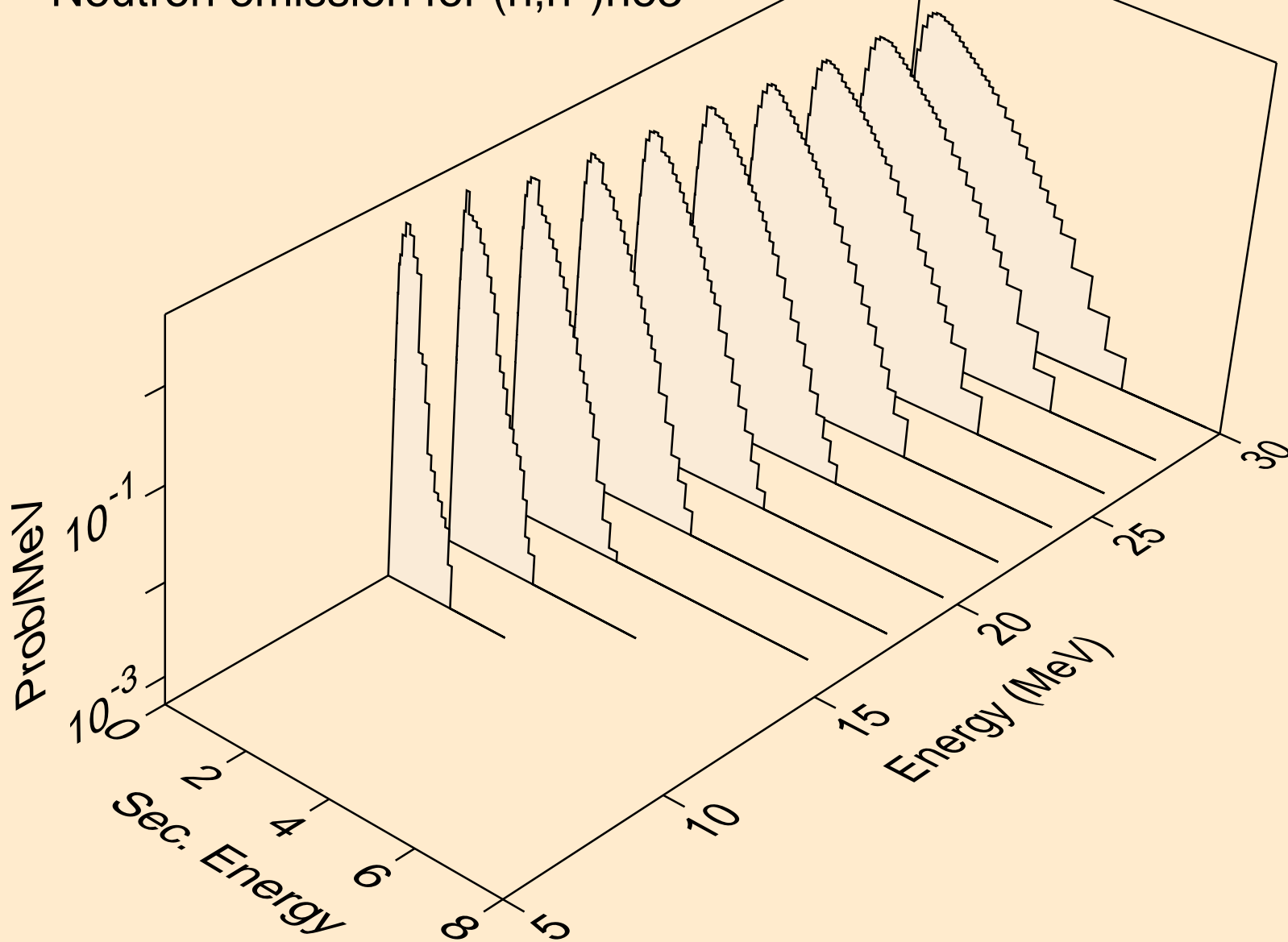

LA120 NEUTRON ACER TENDL-2019 LIBRARY; T=293.16K
Neutron emission for (n,2np)

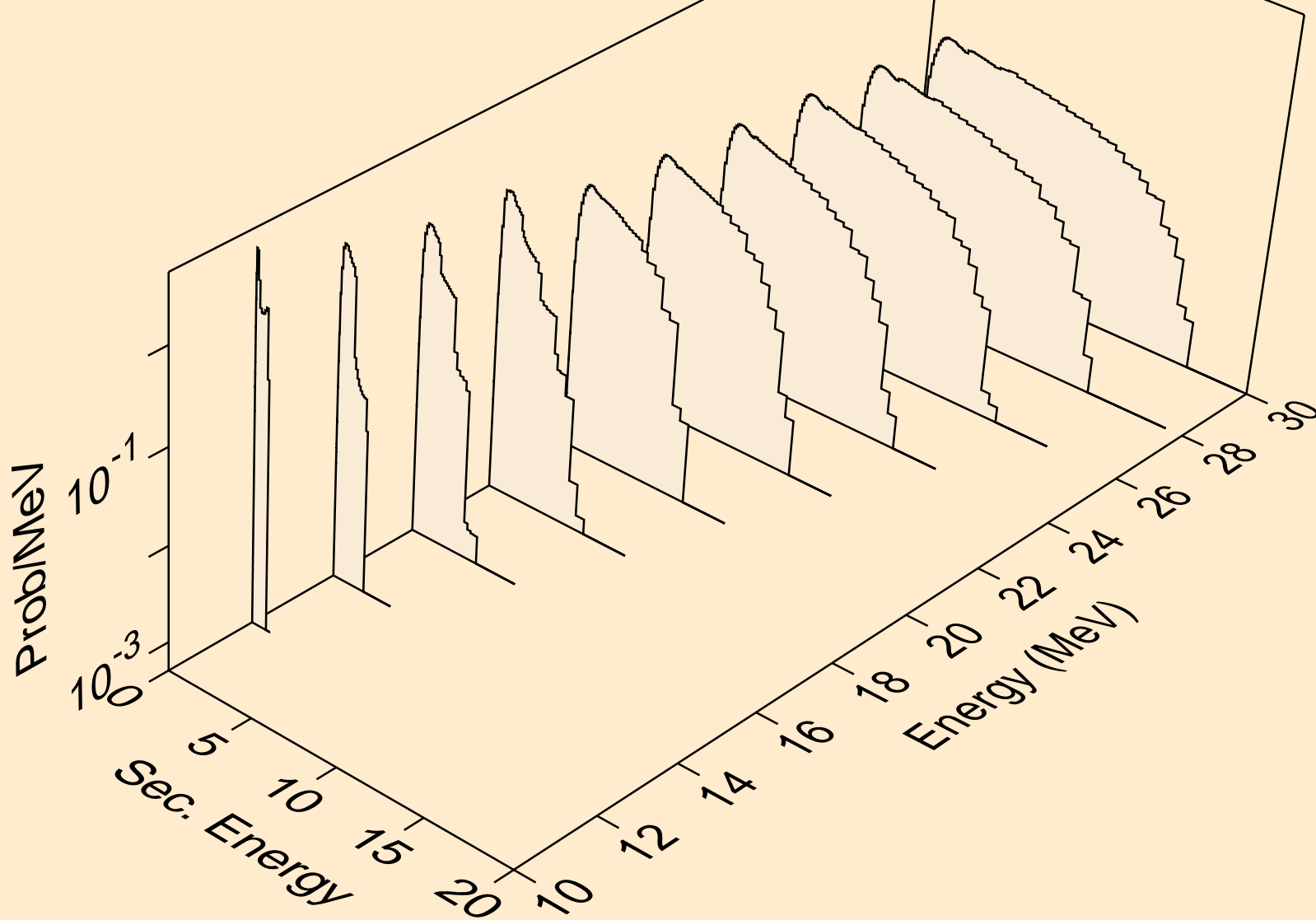

LA120 NEUTRON ACER TENDL-2019 LIBRARY; T=293.16K
Neutron emission for (n,3np)

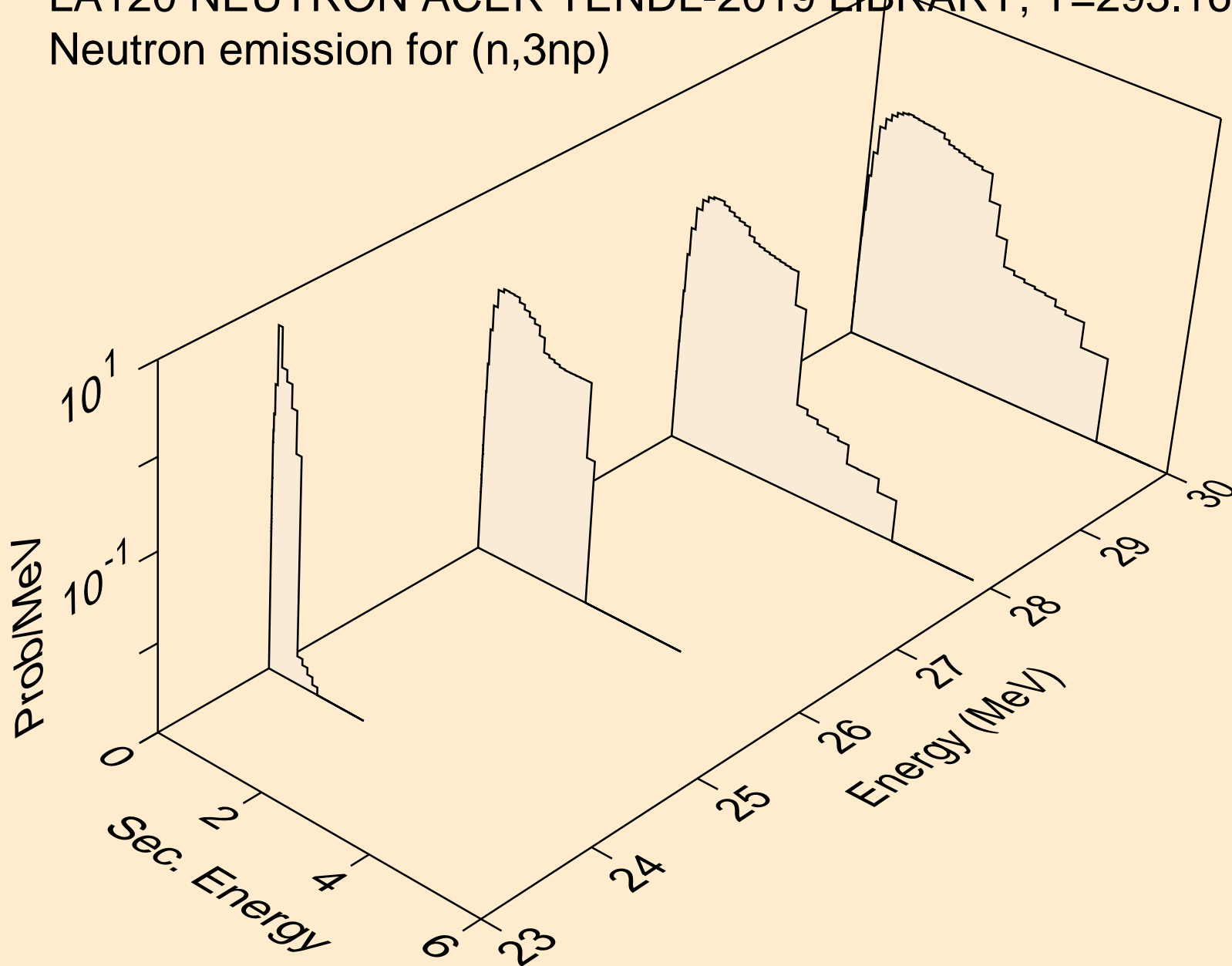

LA120 NEUTRON ACER TENDL-2019 LIBRARY; T=293.16K
Neutron emission for (n,2np)

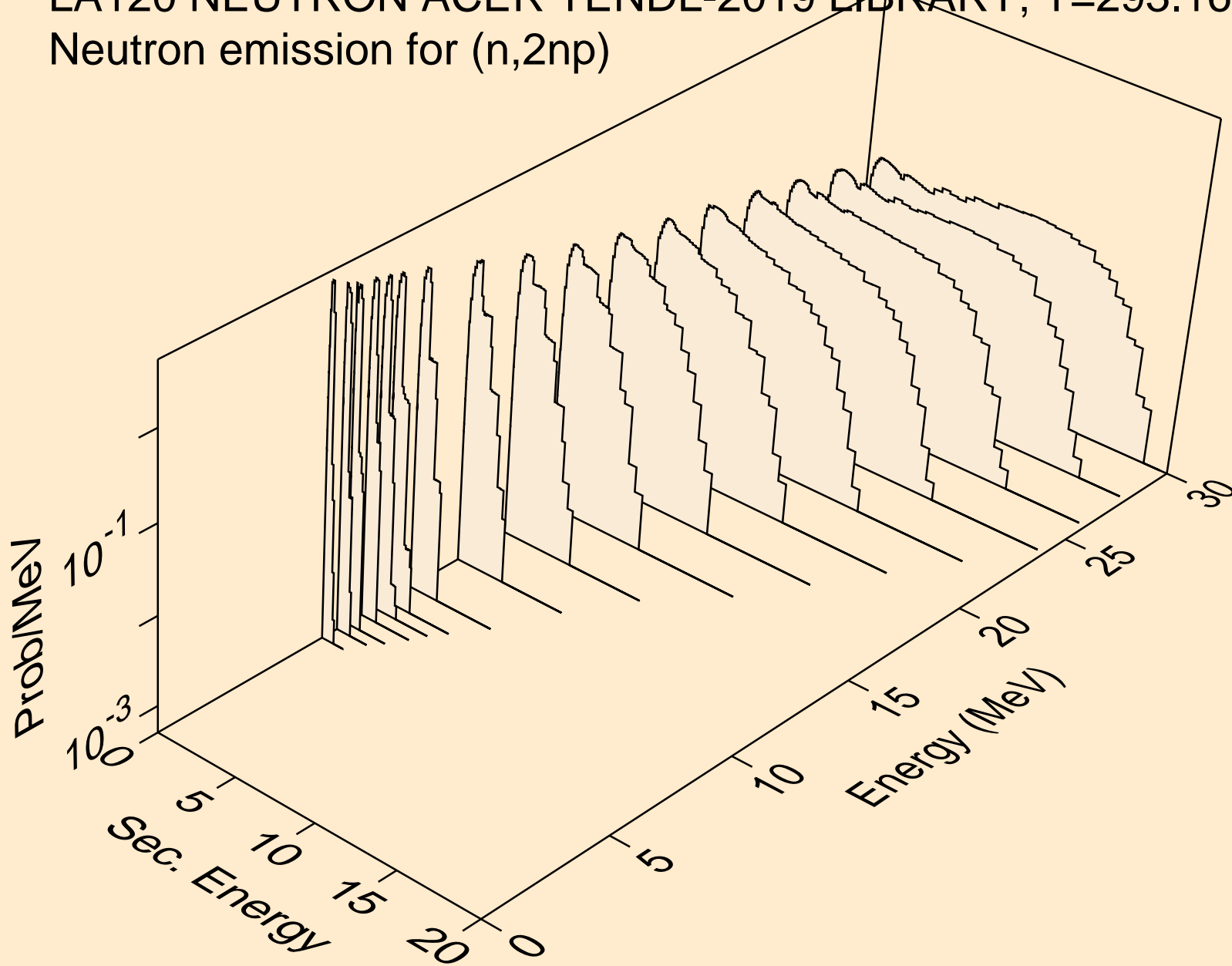

LA120 NEUTRON ACER TENDL-2019 LIBRARY; T=293.16K
Neutron emission for (n,npa)

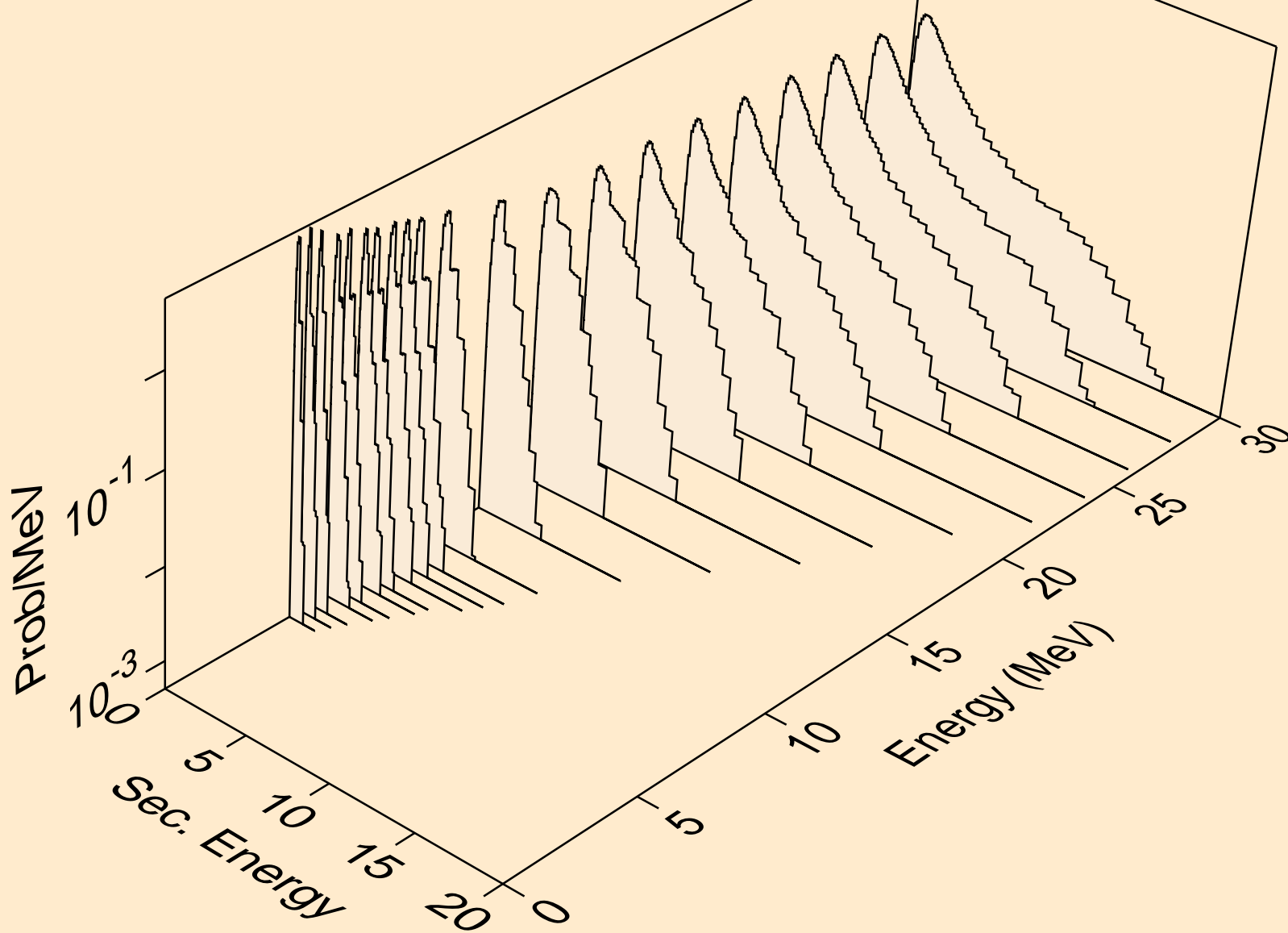

LA120 NEUTRON ACER TENDL-2019 LIBRARY; T=293.16K
Neutron emission for (n,n*c)

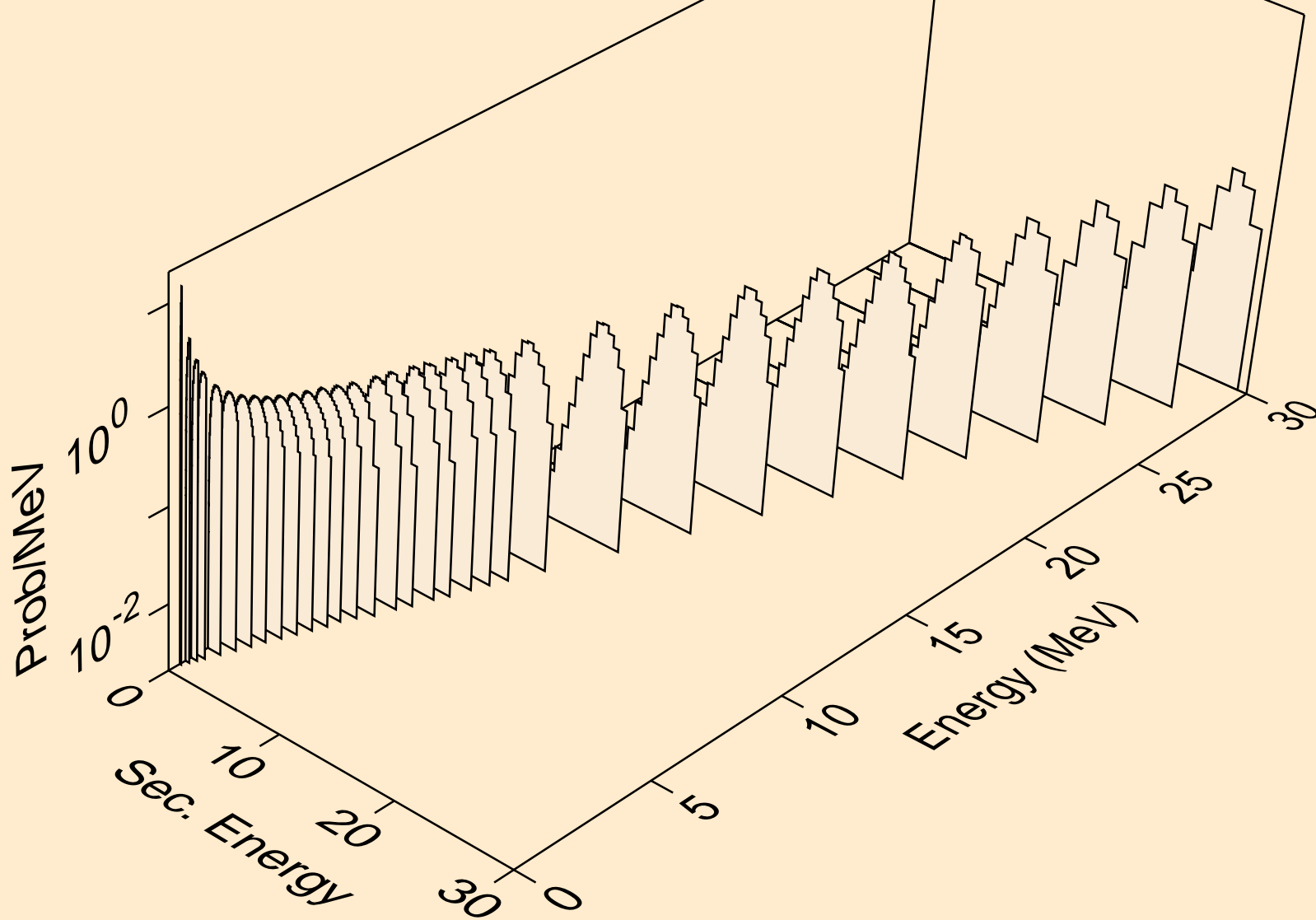

LA120 NEUTRON ACER TENDL-2019 LIBRARY; T=293.16K
Photon emission for (n,x)

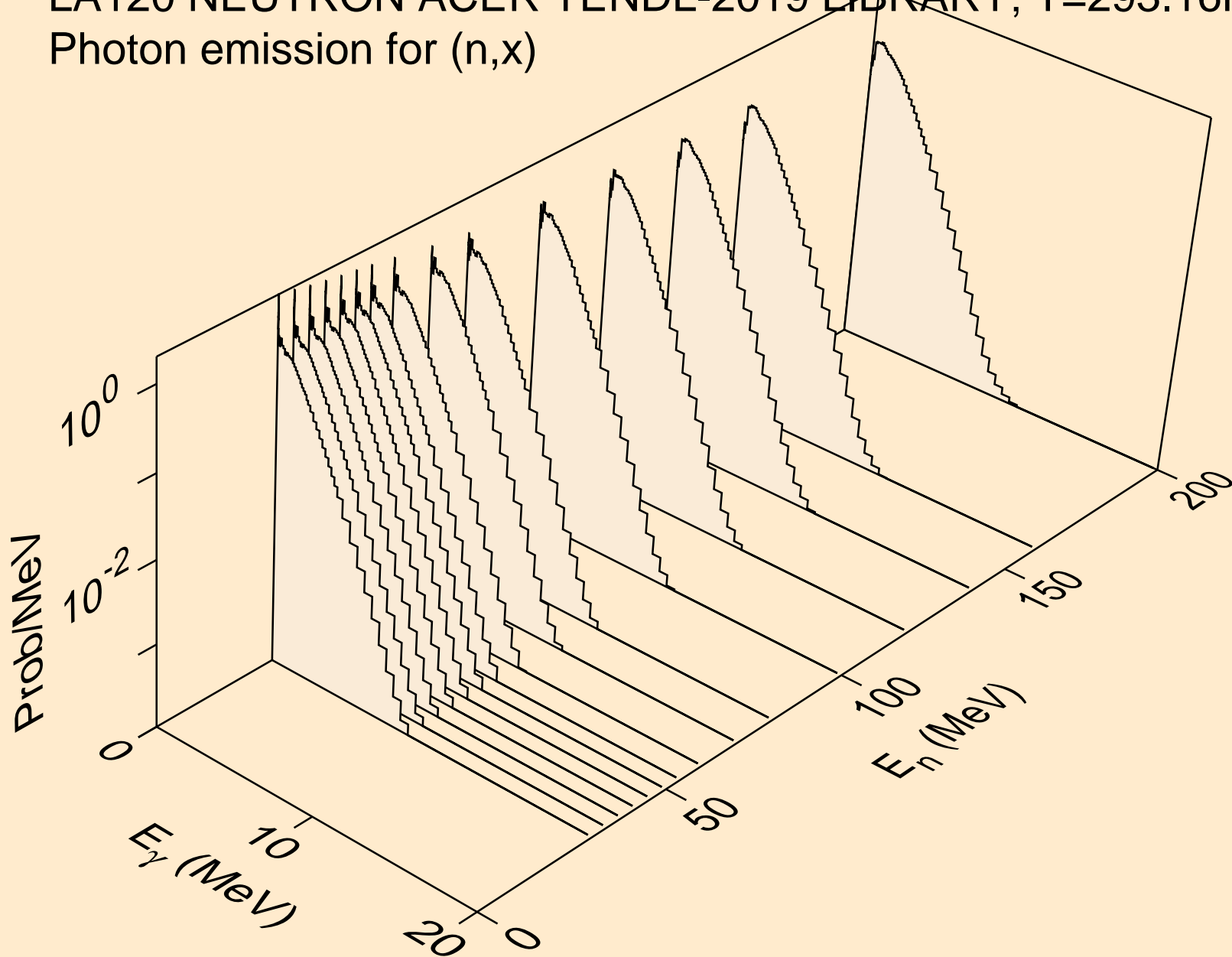

LA120 NEUTRON ACER TENDL-2019 LIBRARY; T=293.16K
Photon emission for (n,2nd)

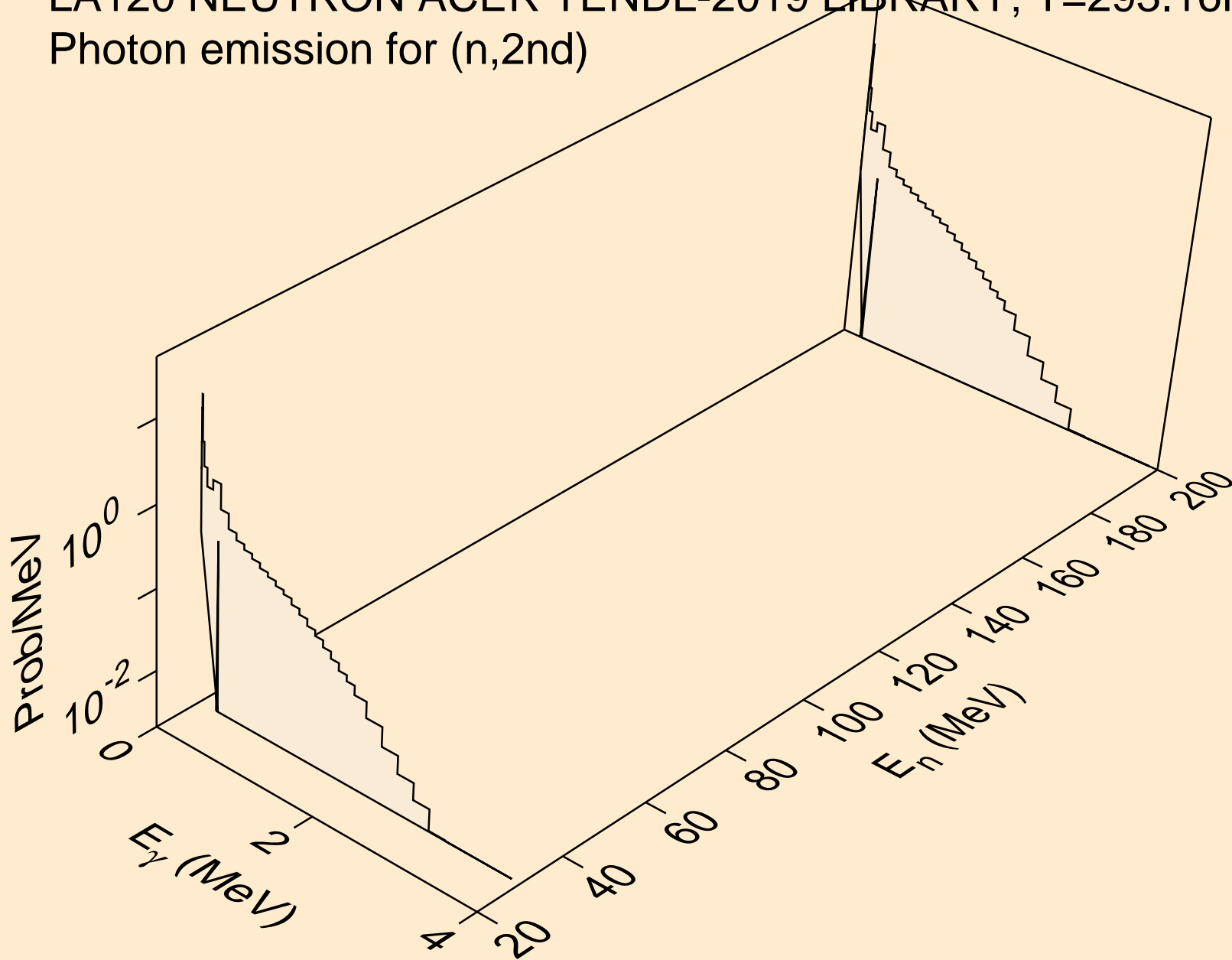

LA120 NEUTRON ACER TENDL-2019 LIBRARY; T=293.16K
Photon emission for (n,2n)

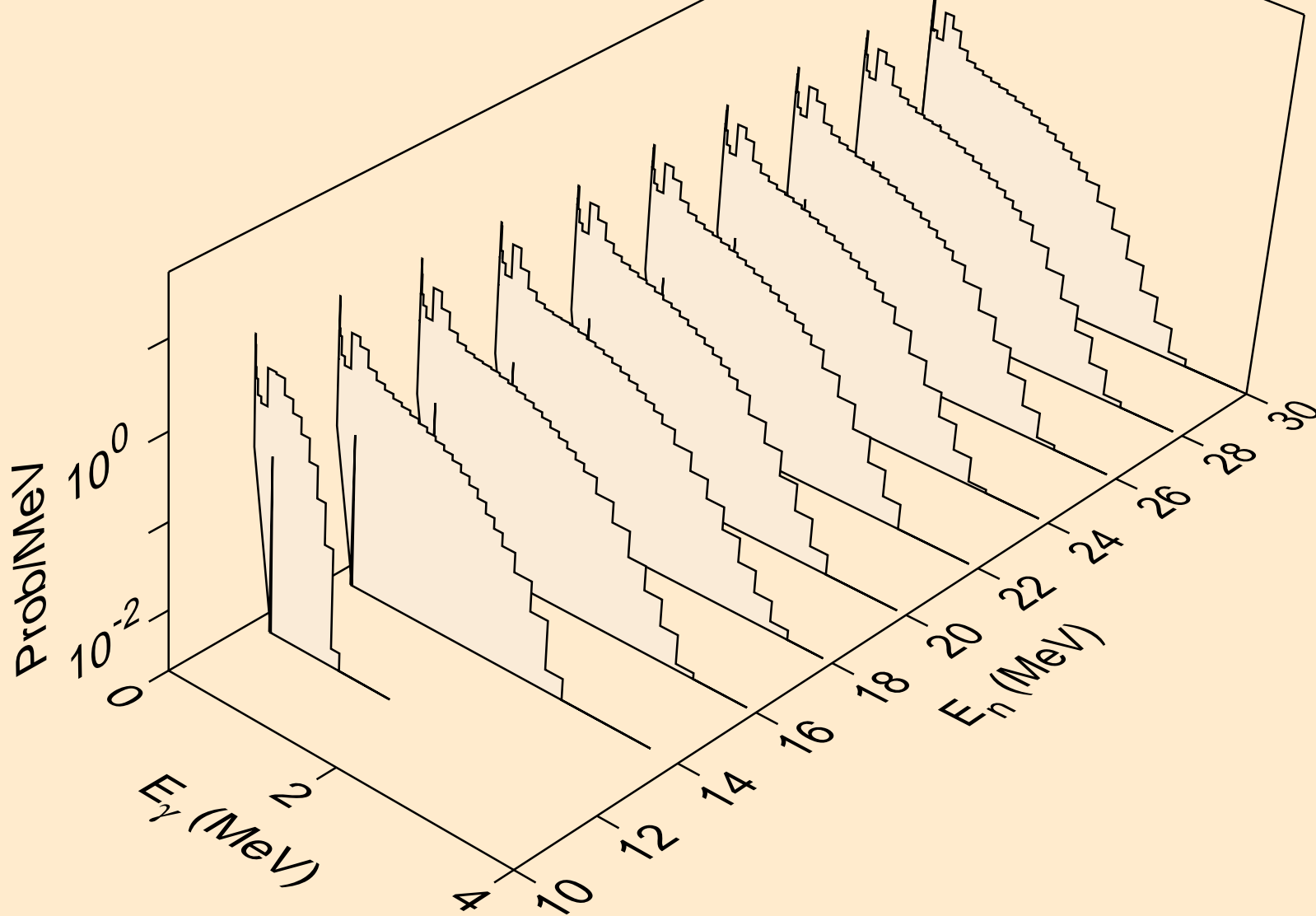

LA120 NEUTRON ACER TENDL-2019 LIBRARY; T=293.16K
Photon emission for (n,3n)

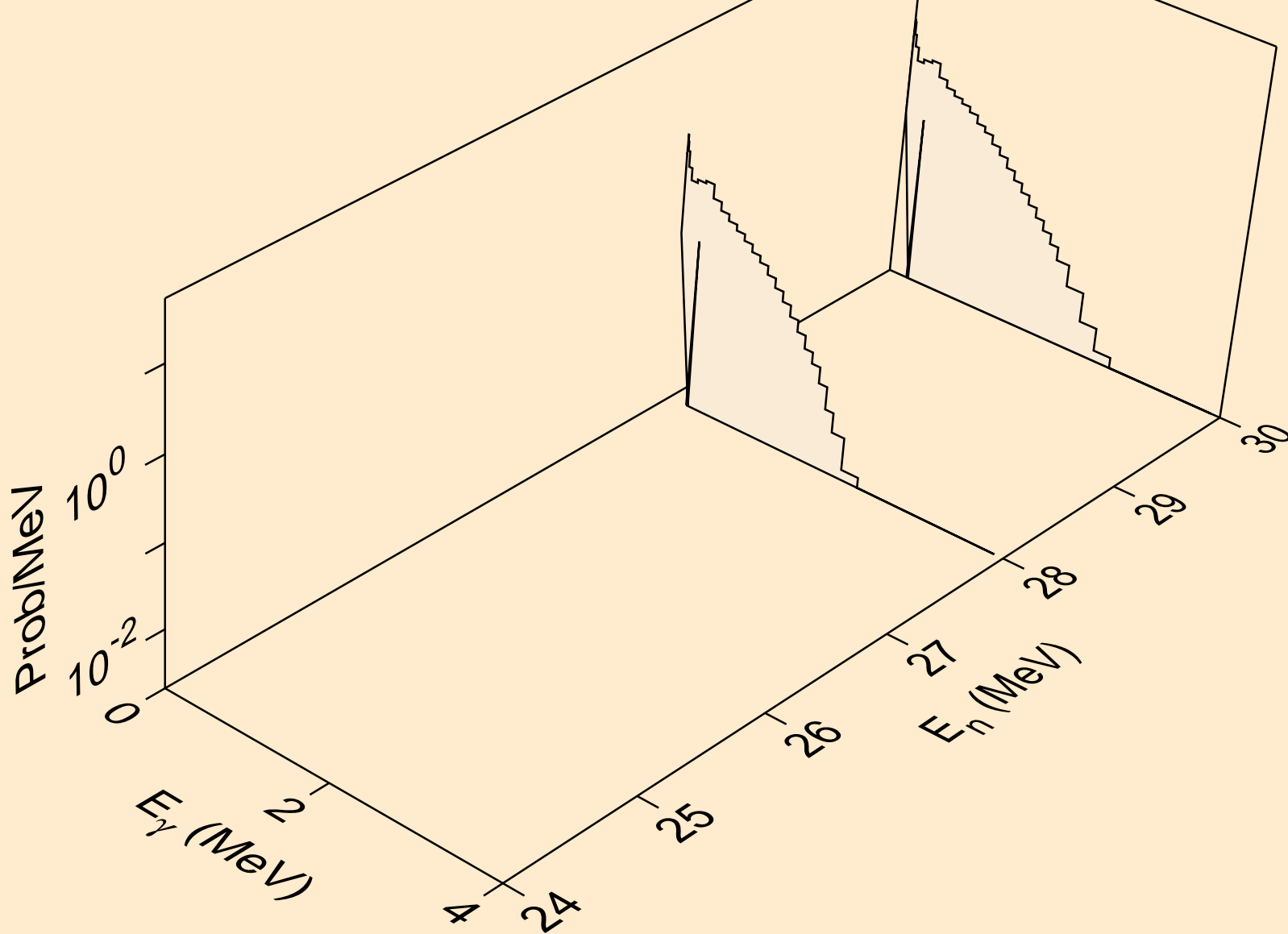

LA120 NEUTRON ACER TENDL-2019 LIBRARY; T=293.16K
Photon emission for (n,n*)a

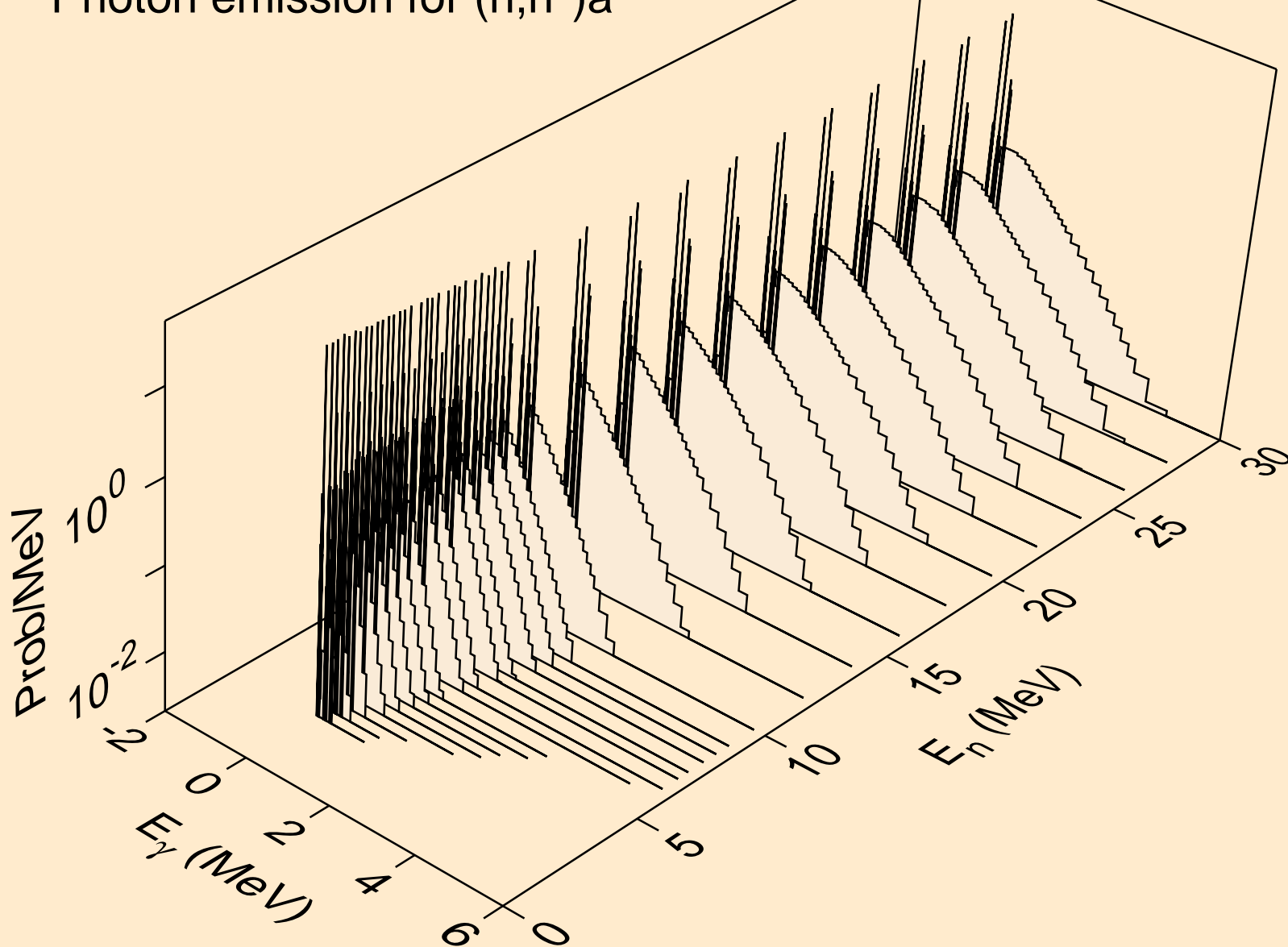

LA120 NEUTRON ACER TENDL-2019 LIBRARY; T=293.16K
Photon emission for (n,n*)3a

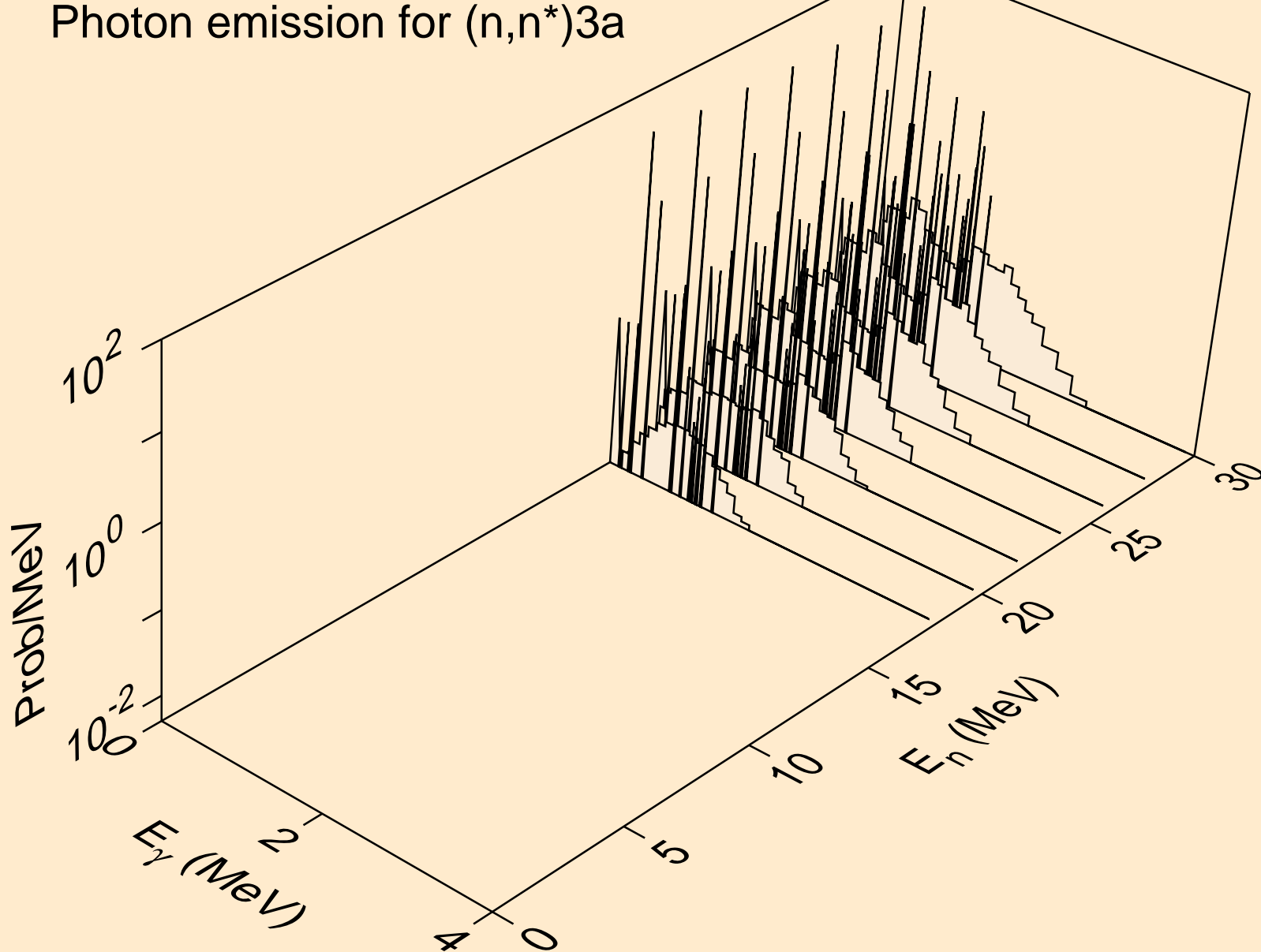

LA120 NEUTRON ACER TENDL-2019 LIBRARY; T=293.16K
Photon emission for (n,2n)a

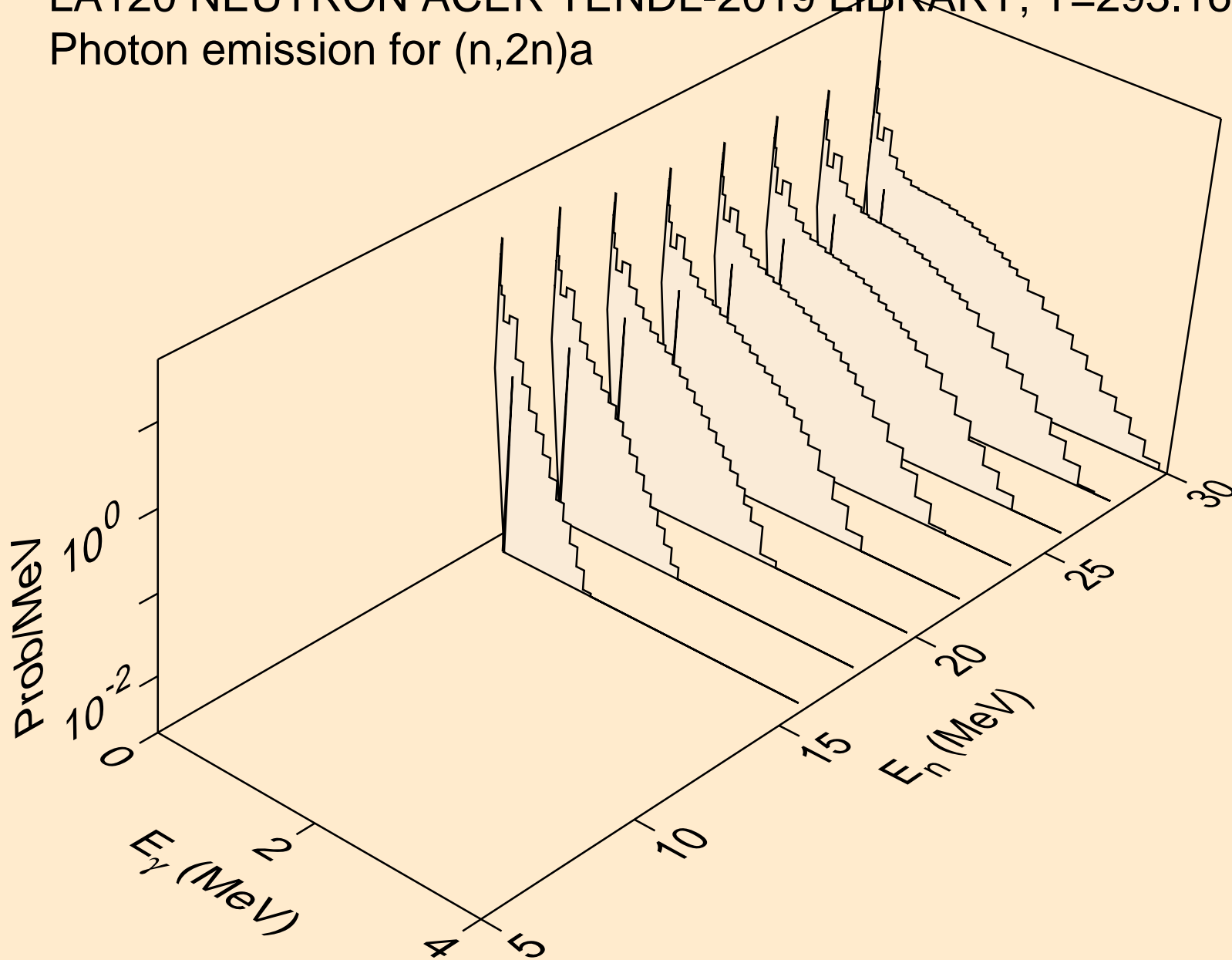

LA120 NEUTRON ACER TENDL-2019 LIBRARY; T=293.16K
Photon emission for (n,n*)p

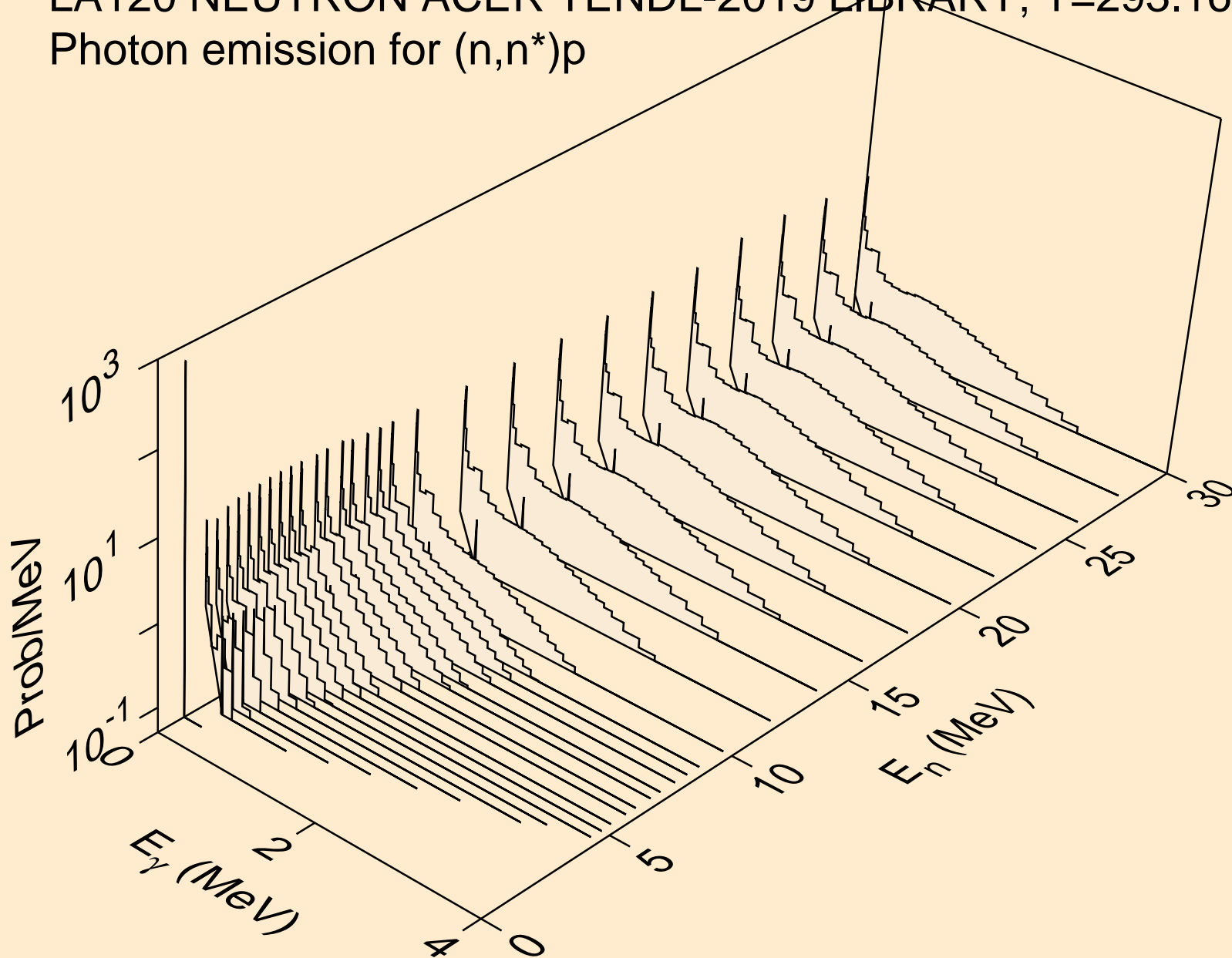

LA120 NEUTRON ACER TENDL-2019 LIBRARY; T=293.16K
Photon emission for (n,n*)2a

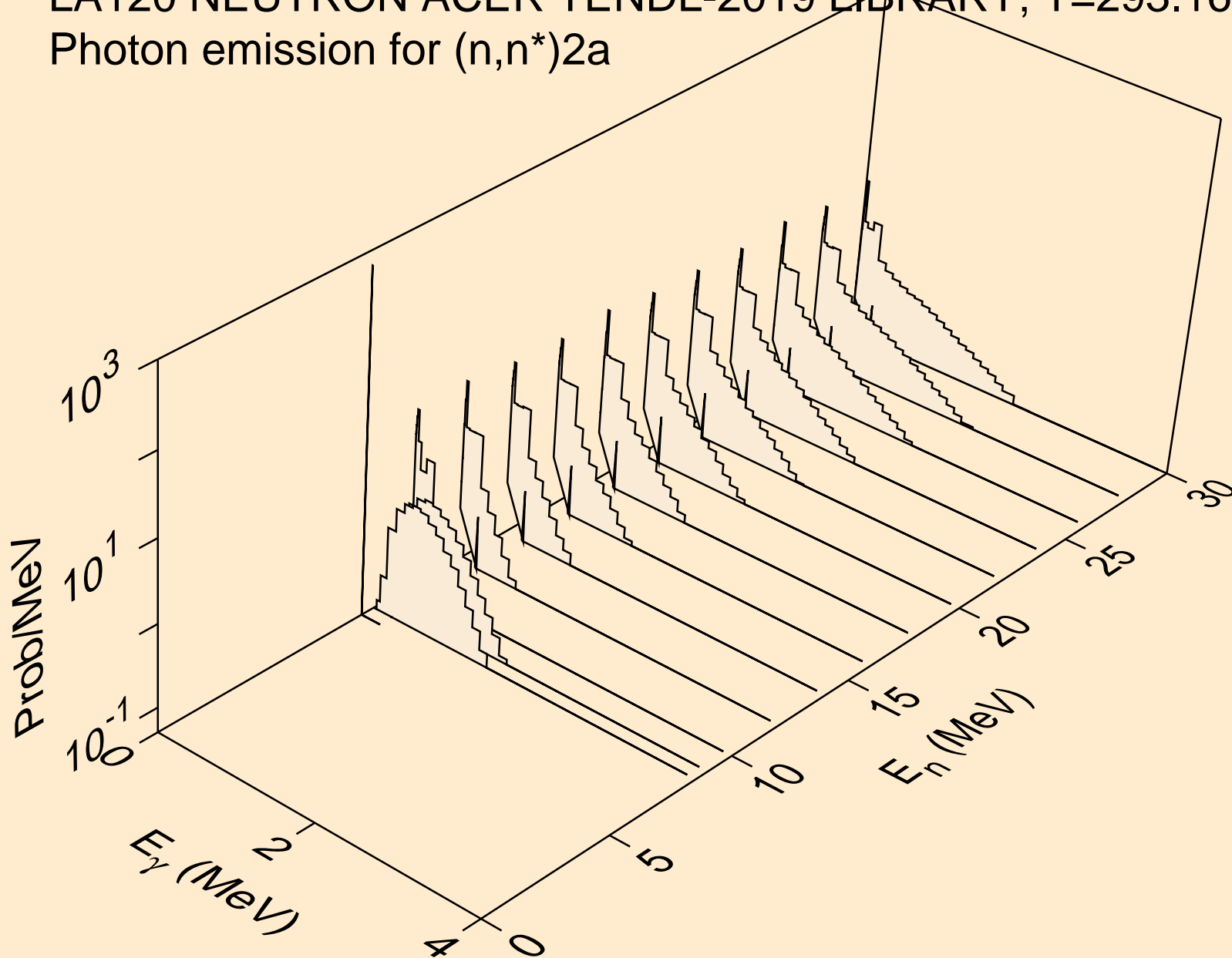

LA120 NEUTRON ACER TENDL-2019 LIBRARY; T=293.16K
Photon emission for (n,2n)2a

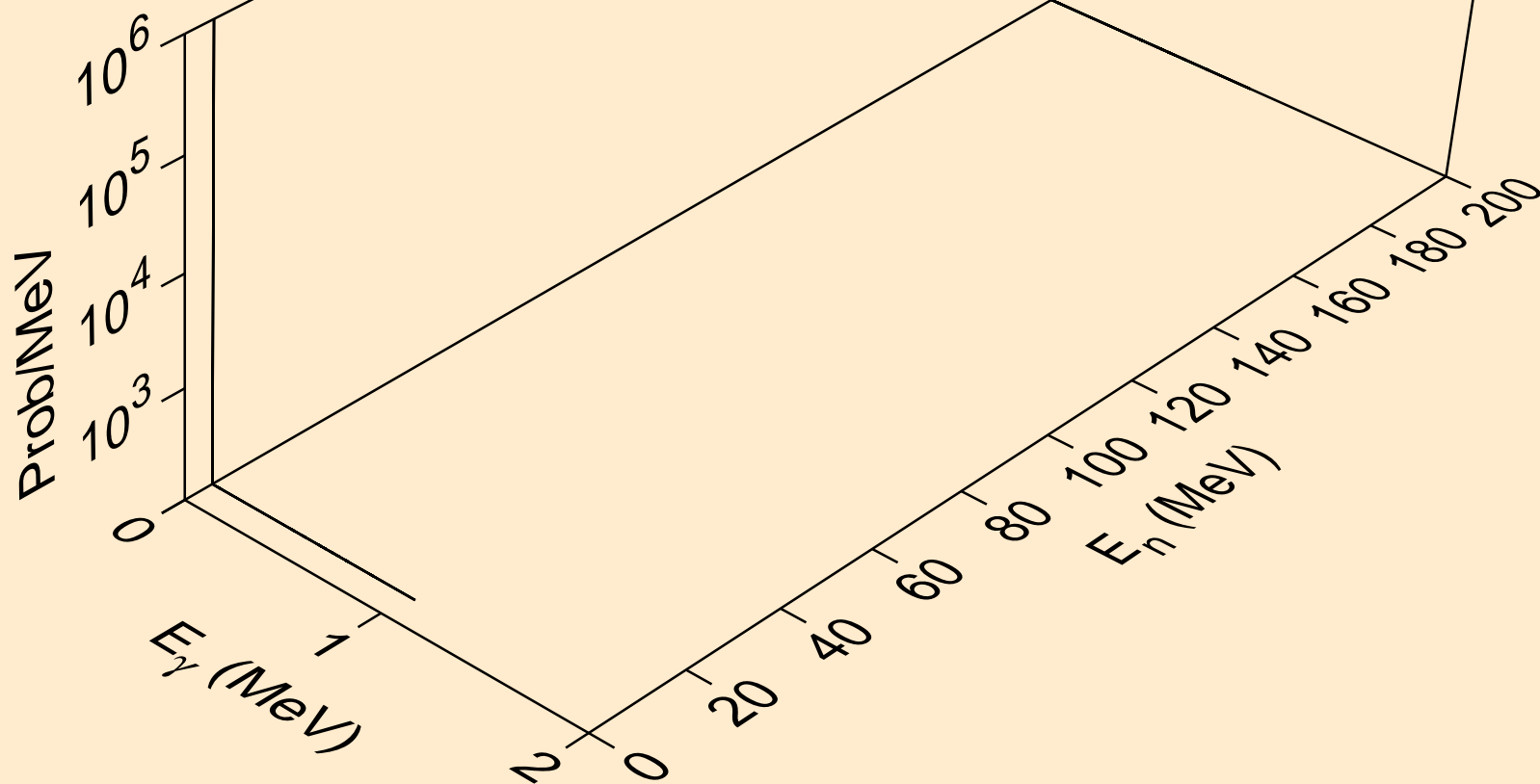

LA120 NEUTRON ACER TENDL-2019 LIBRARY; T=293.16K
Photon emission for (n,n*)d

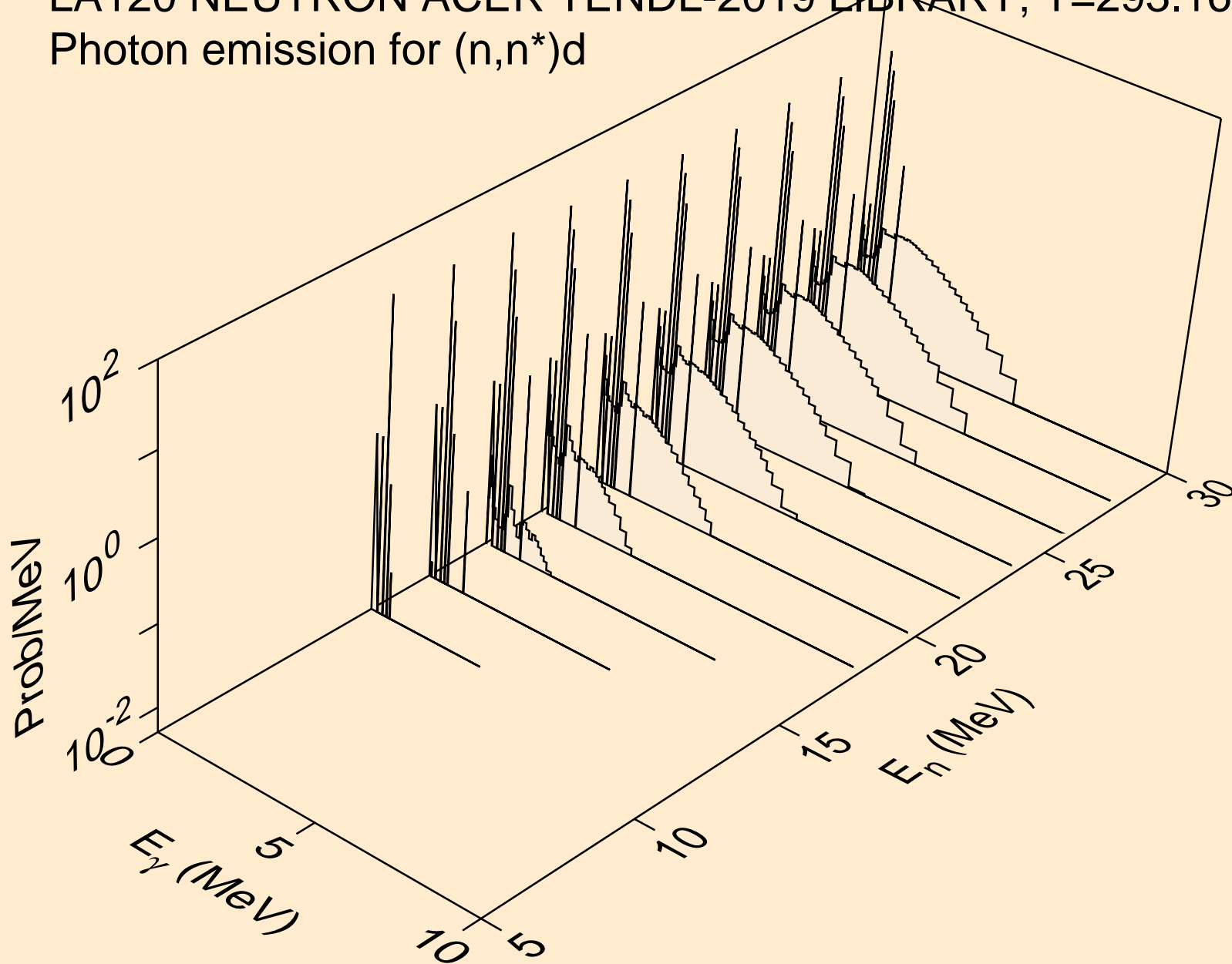

LA120 NEUTRON ACER TENDL-2019 LIBRARY; T=293.16K
Photon emission for (n,n*)t

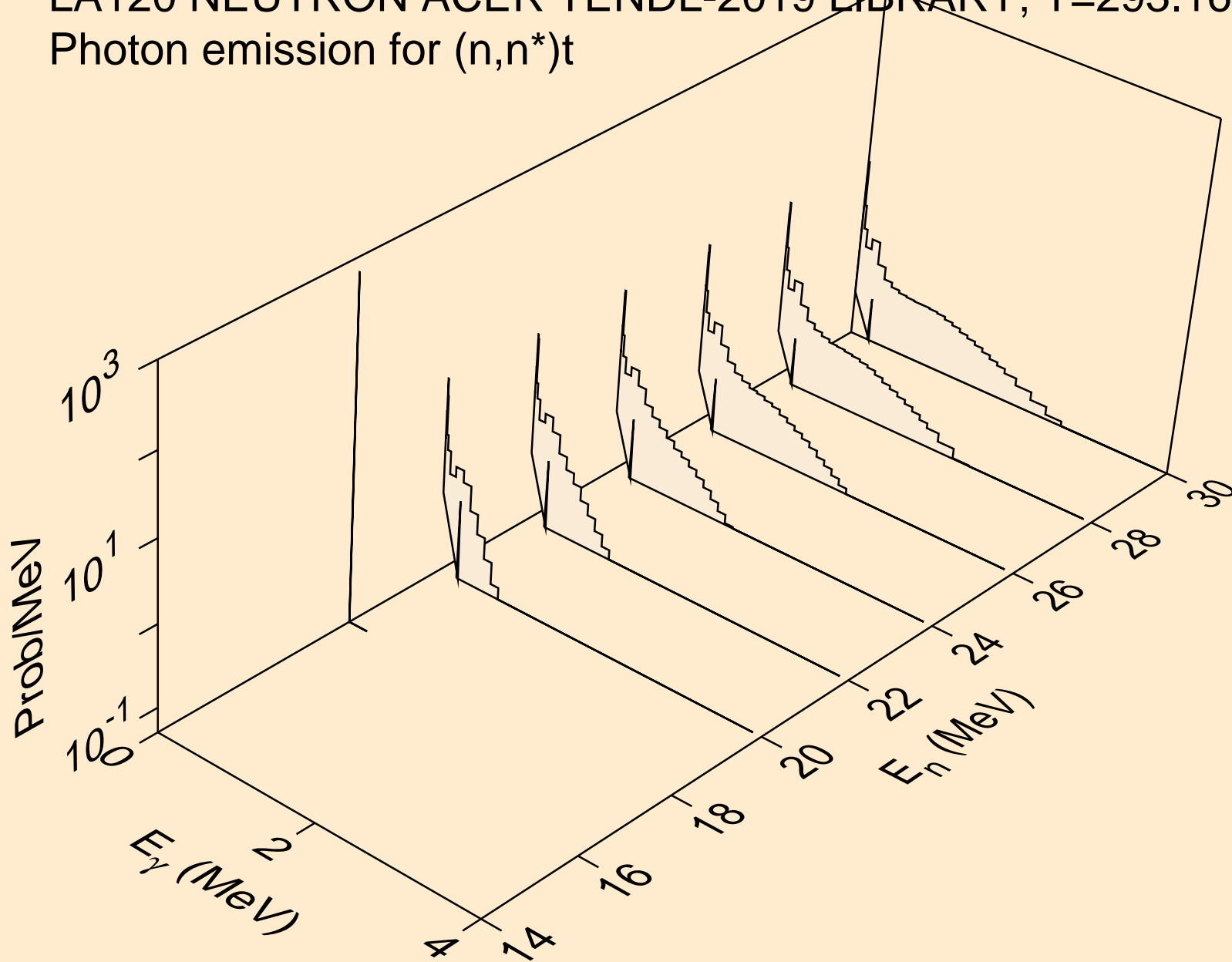

LA120 NEUTRON ACER TENDL-2019 LIBRARY; T=293.16K
Photon emission for (n,n*)he3

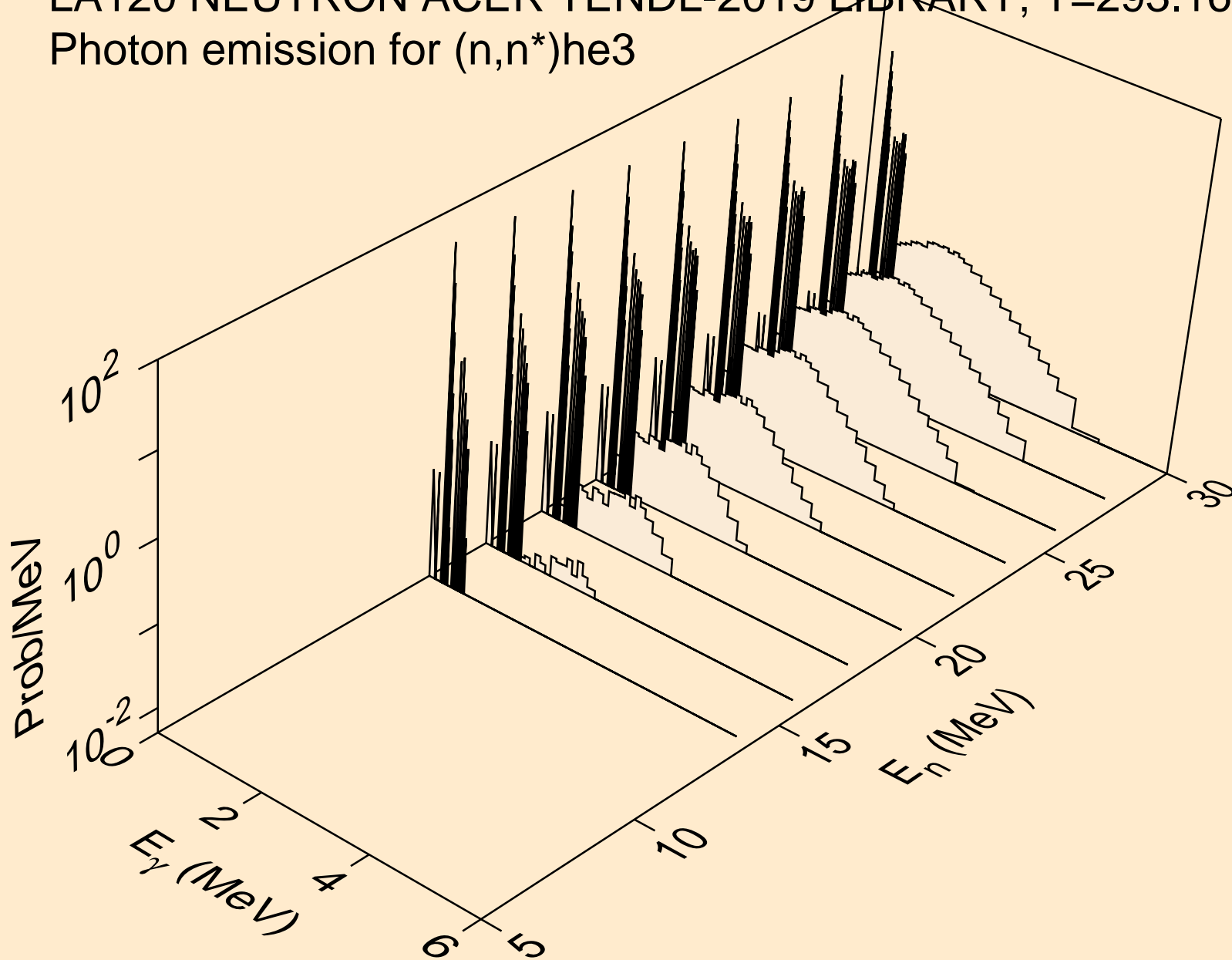

LA120 NEUTRON ACER TENDL-2019 LIBRARY; T=293.16K
Photon emission for (n,2np)

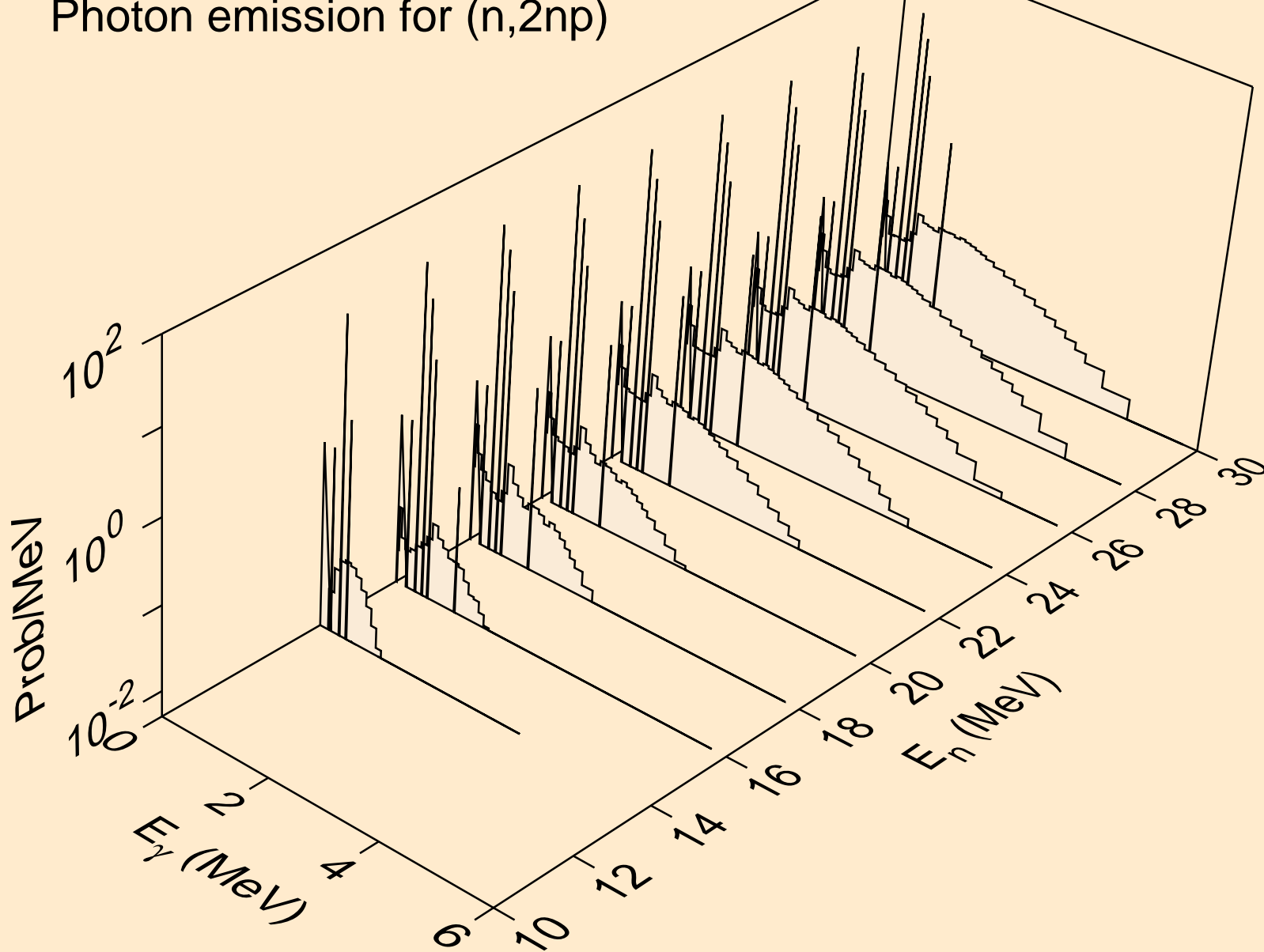

LA120 NEUTRON ACER TENDL-2019 LIBRARY; T=293.16K
Photon emission for (n,3np)

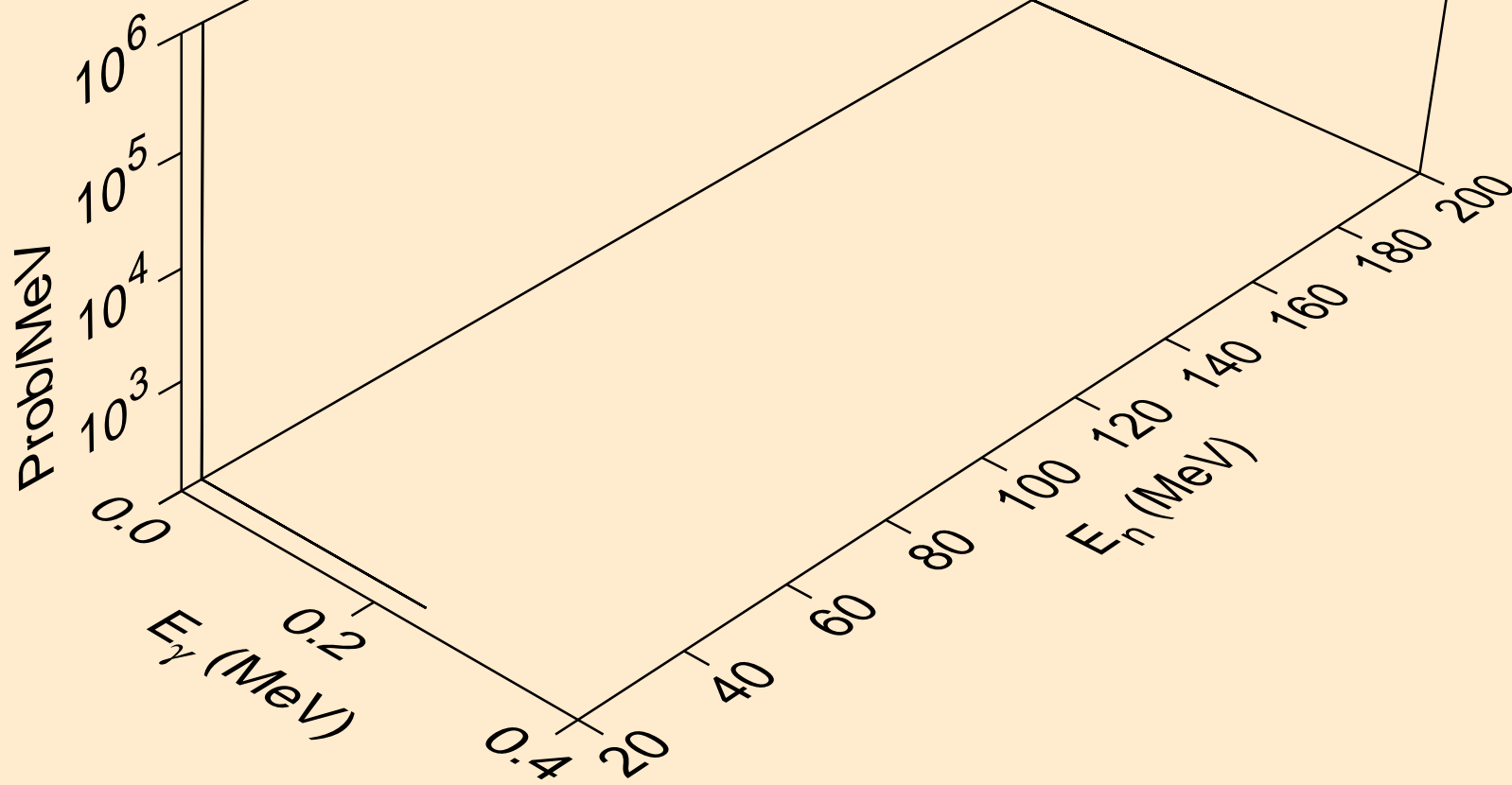

LA120 NEUTRON ACER TENDL-2019 LIBRARY; T=293.16K
Photon emission for (n,2np)

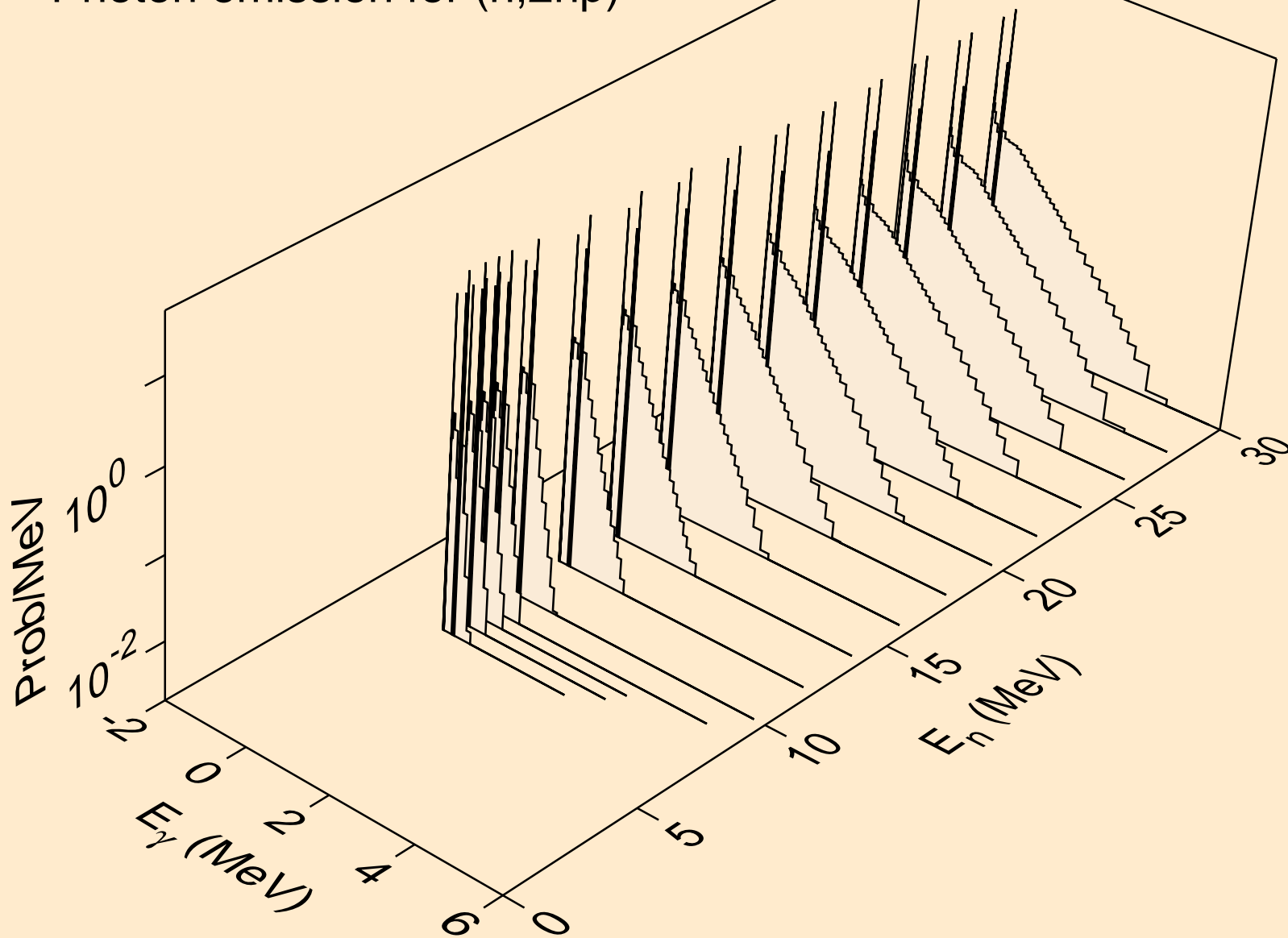

LA120 NEUTRON ACER TENDL-2019 LIBRARY; T=293.16K
Photon emission for (n,npa)

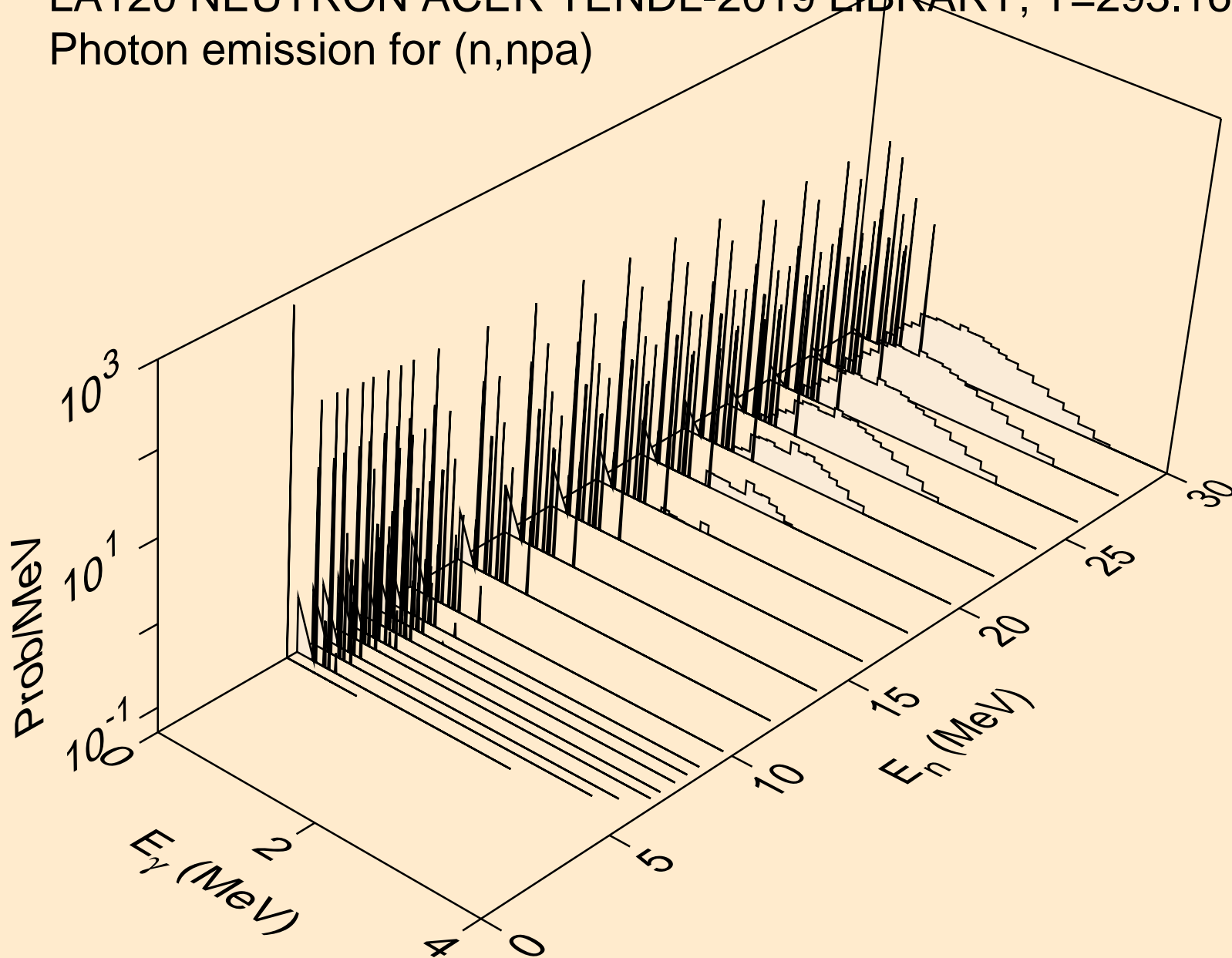

LA120 NEUTRON ACER TENDL-2019 LIBRARY; T=293.16K
Photon emission for (n,n*c)

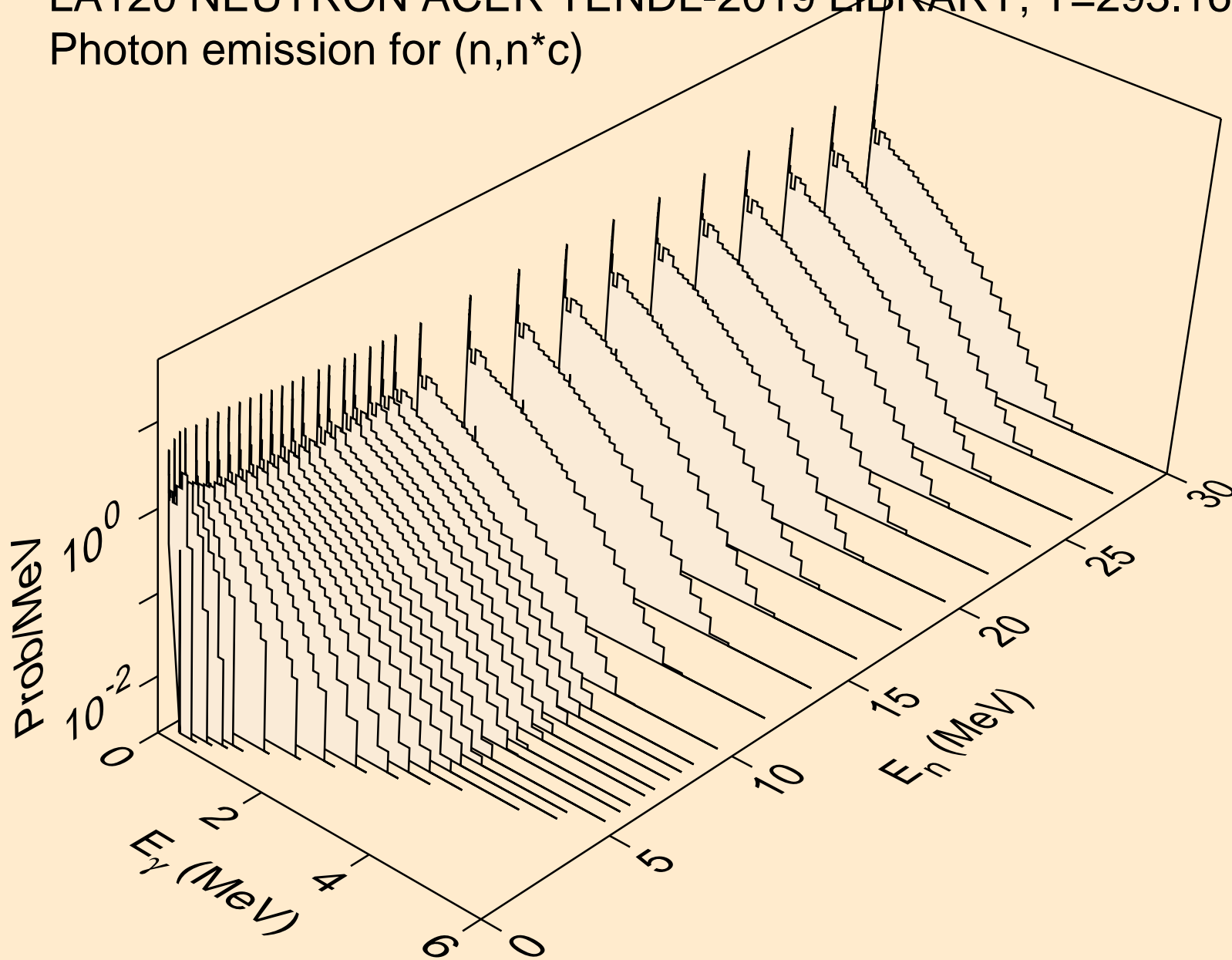

LA120 NEUTRON ACER TENDL-2019 LIBRARY; T=293.16K
Photon emission for (n,gma)

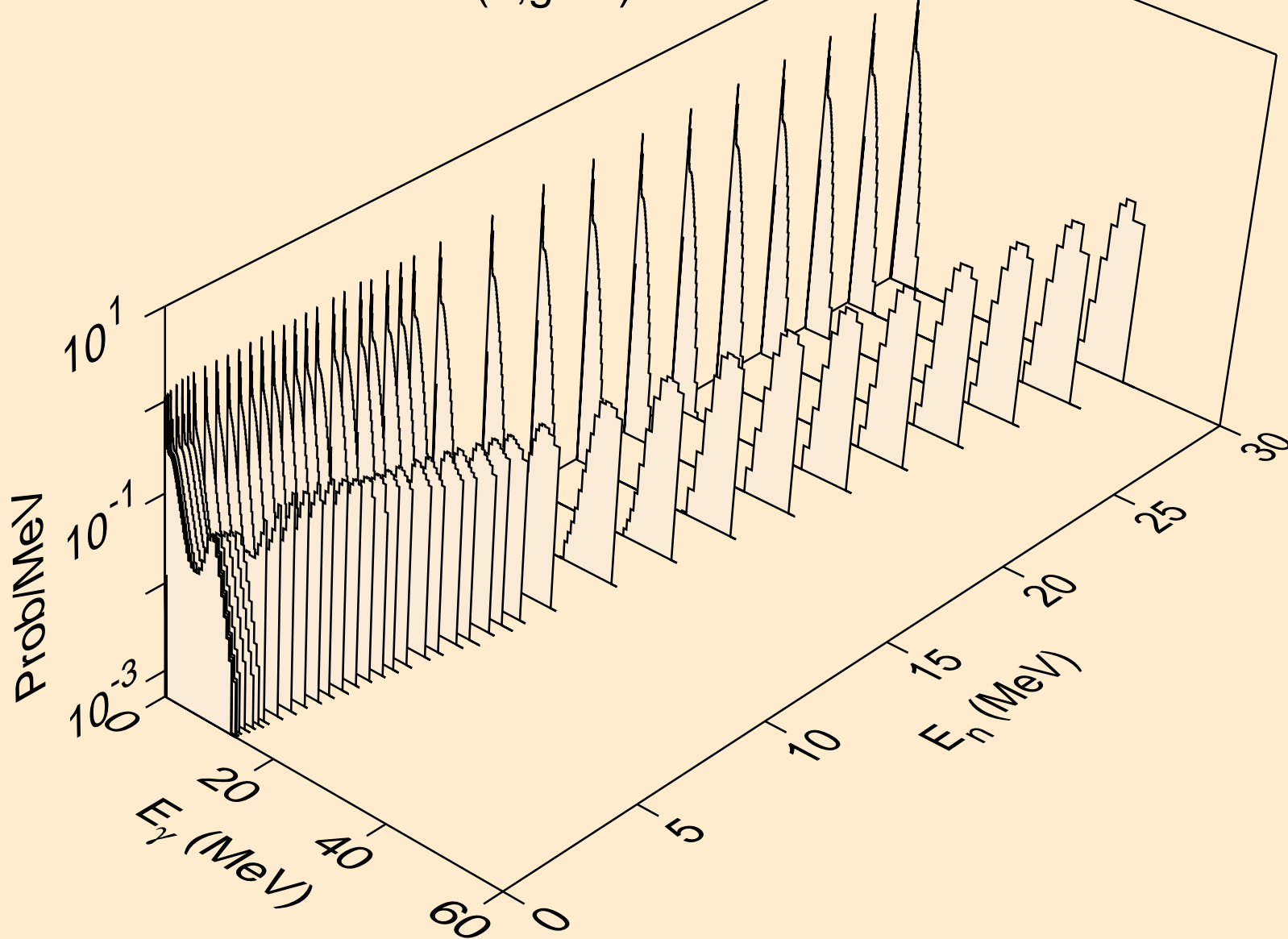

LA120 NEUTRON ACER TENDL-2019 LIBRARY; T=293.16K
Photon emission for (n,p)

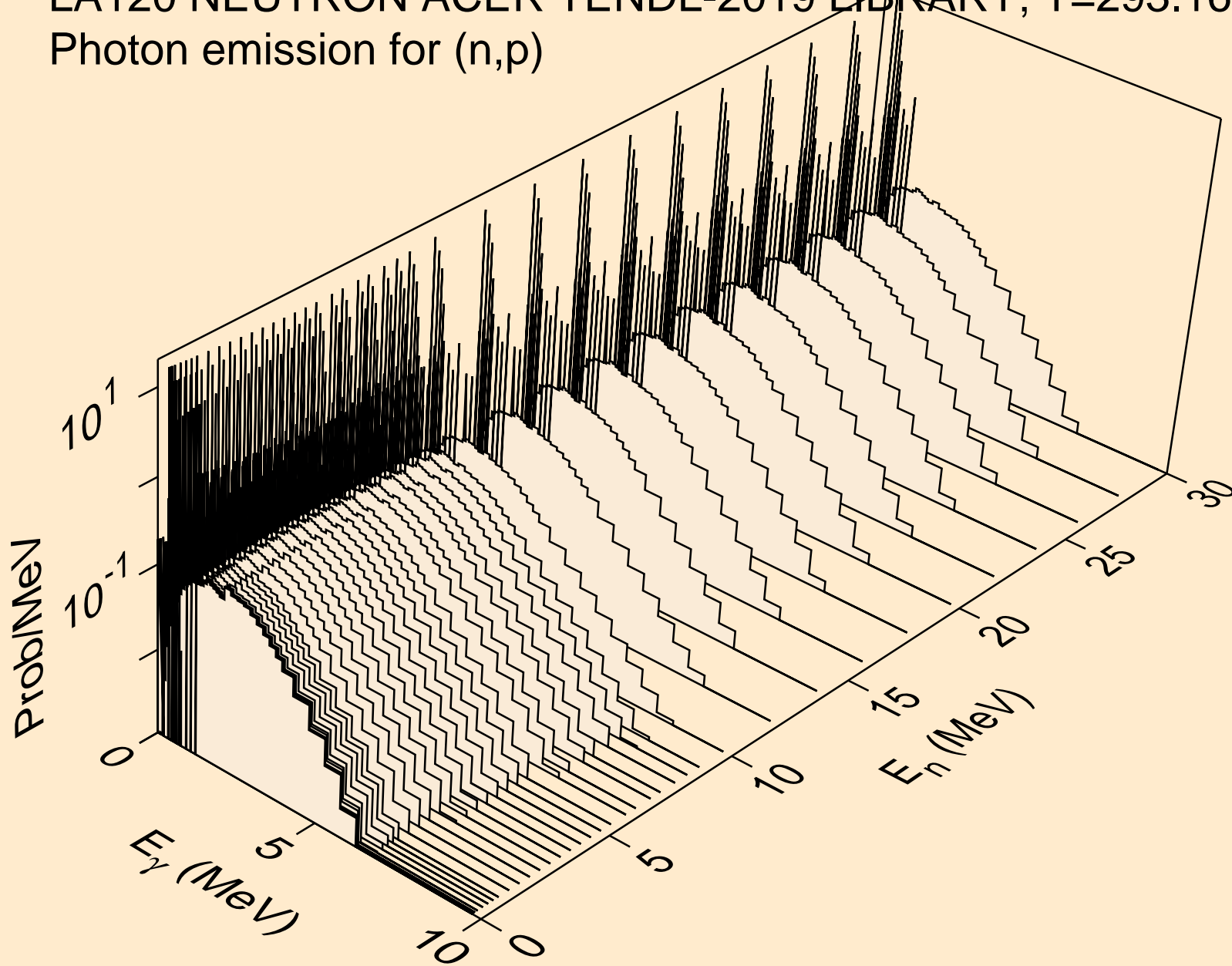

LA120 NEUTRON ACER TENDL-2019 LIBRARY; T=293.16K
Photon emission for (n,d)

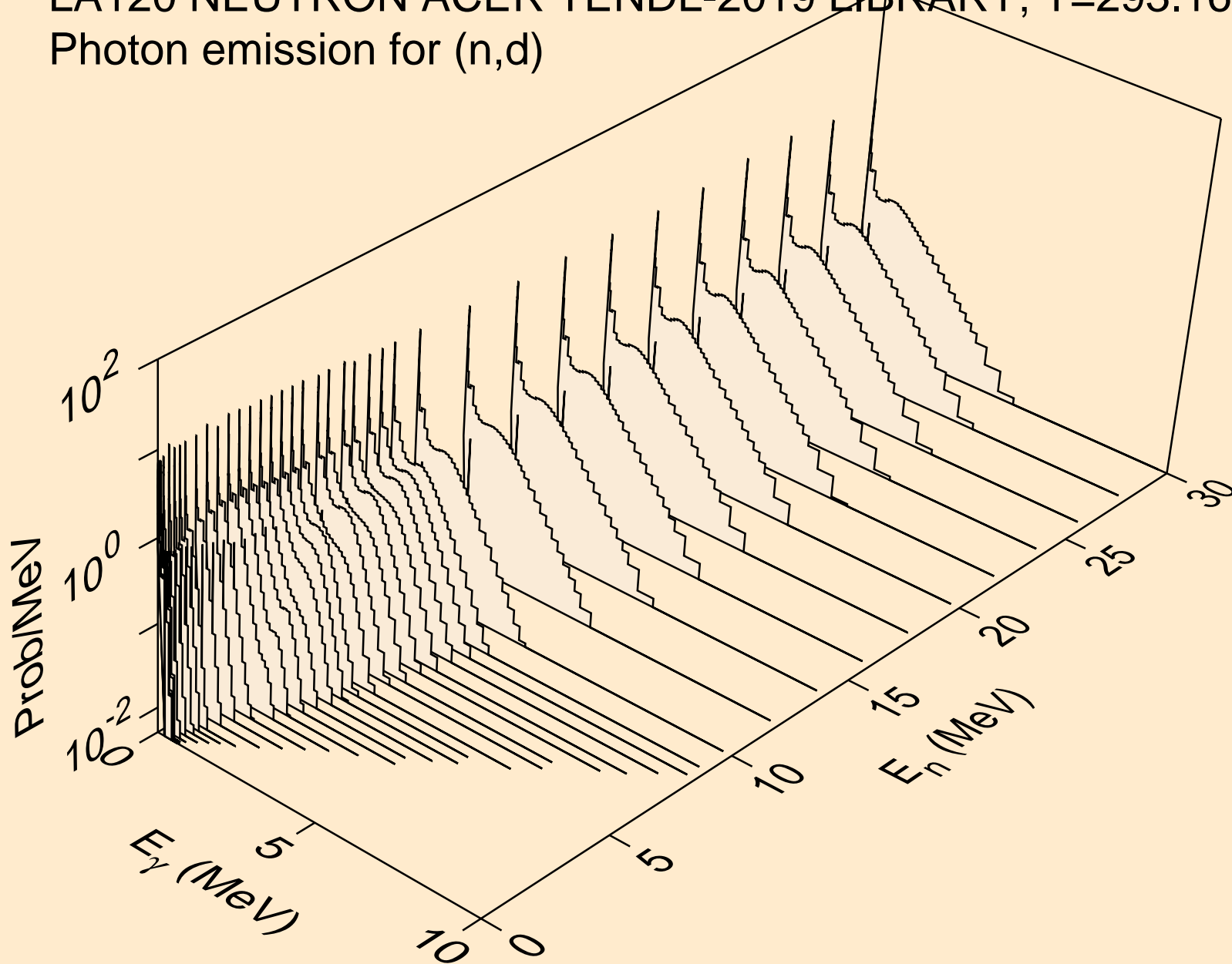

LA120 NEUTRON ACER TENDL-2019 LIBRARY; T=293.16K
Photon emission for (n,t)

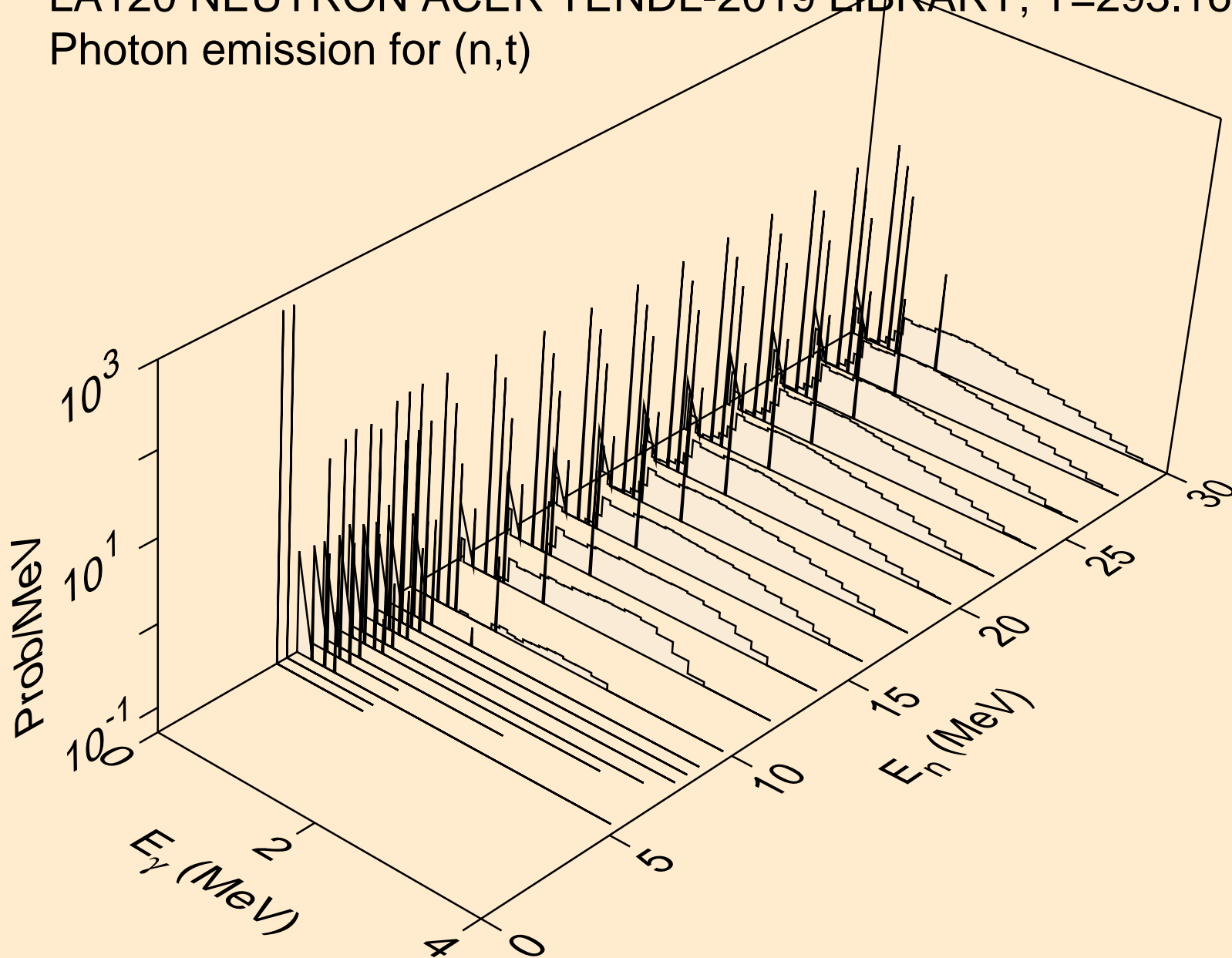

LA120 NEUTRON ACER TENDL-2019 LIBRARY; T=293.16K
Photon emission for (n,he3)

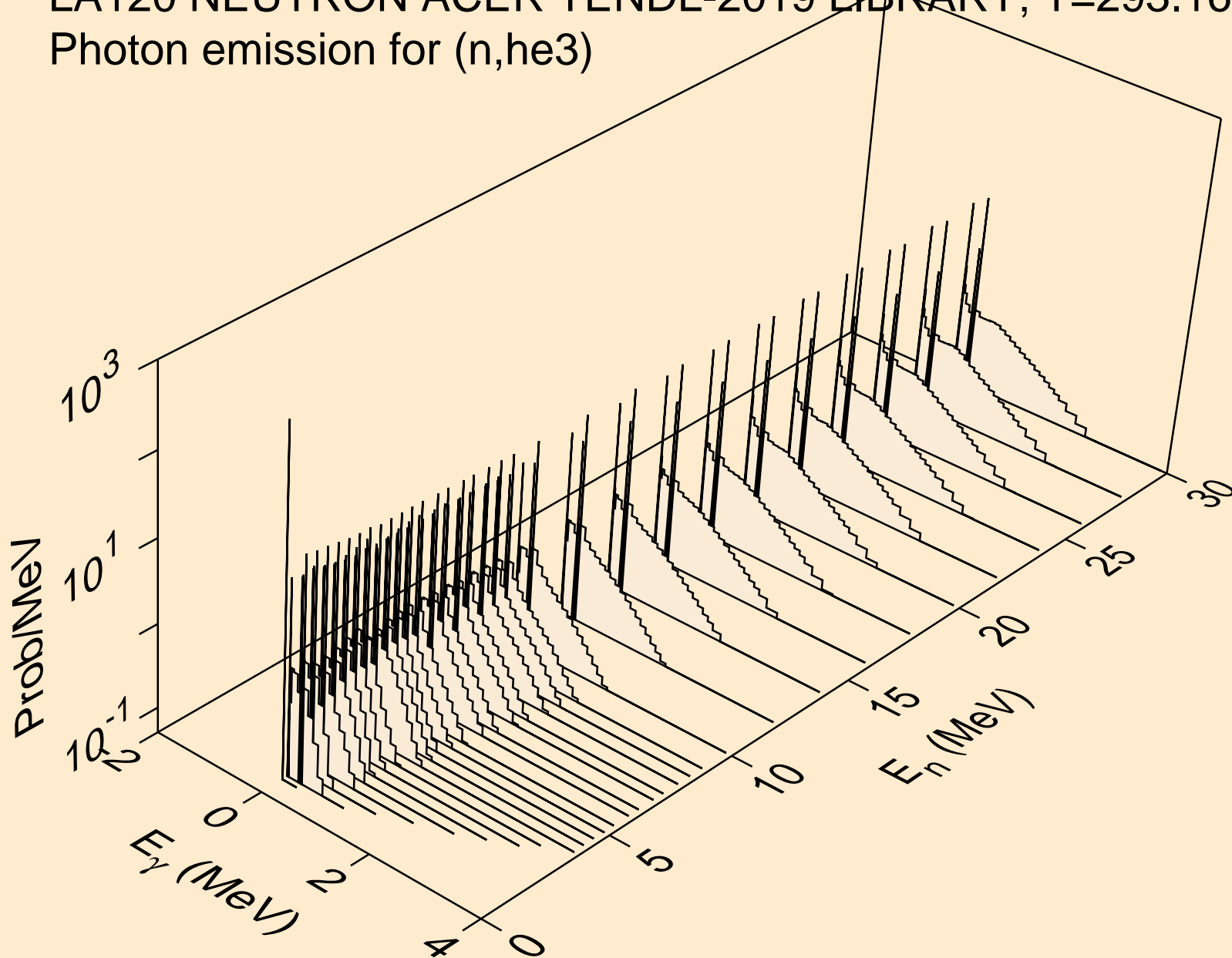

LA120 NEUTRON ACER TENDL-2019 LIBRARY; T=293.16K
Photon emission for (n,a)

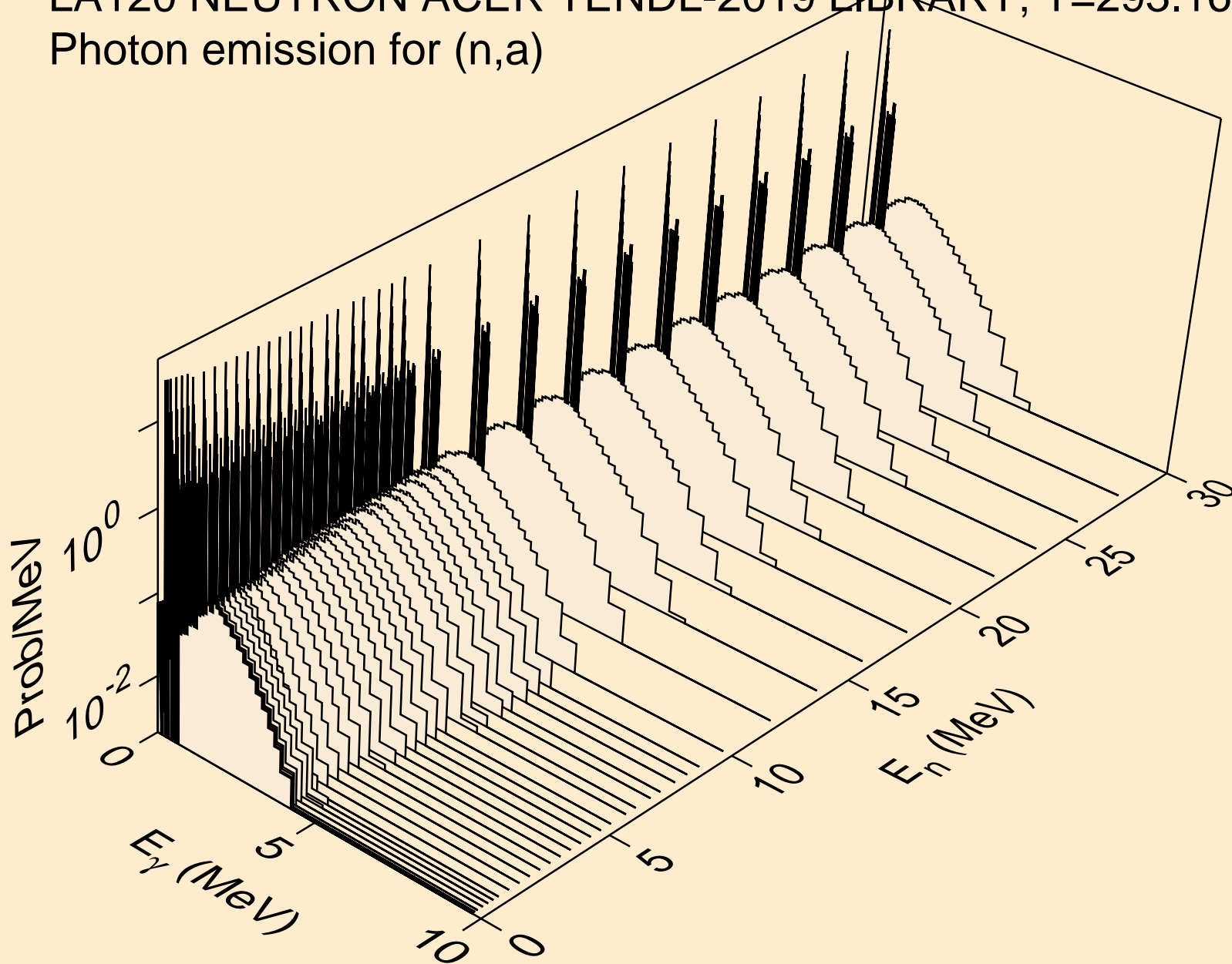

LA120 NEUTRON ACER TENDL-2019 LIBRARY; T=293.16K
Photon emission for (n,2a)

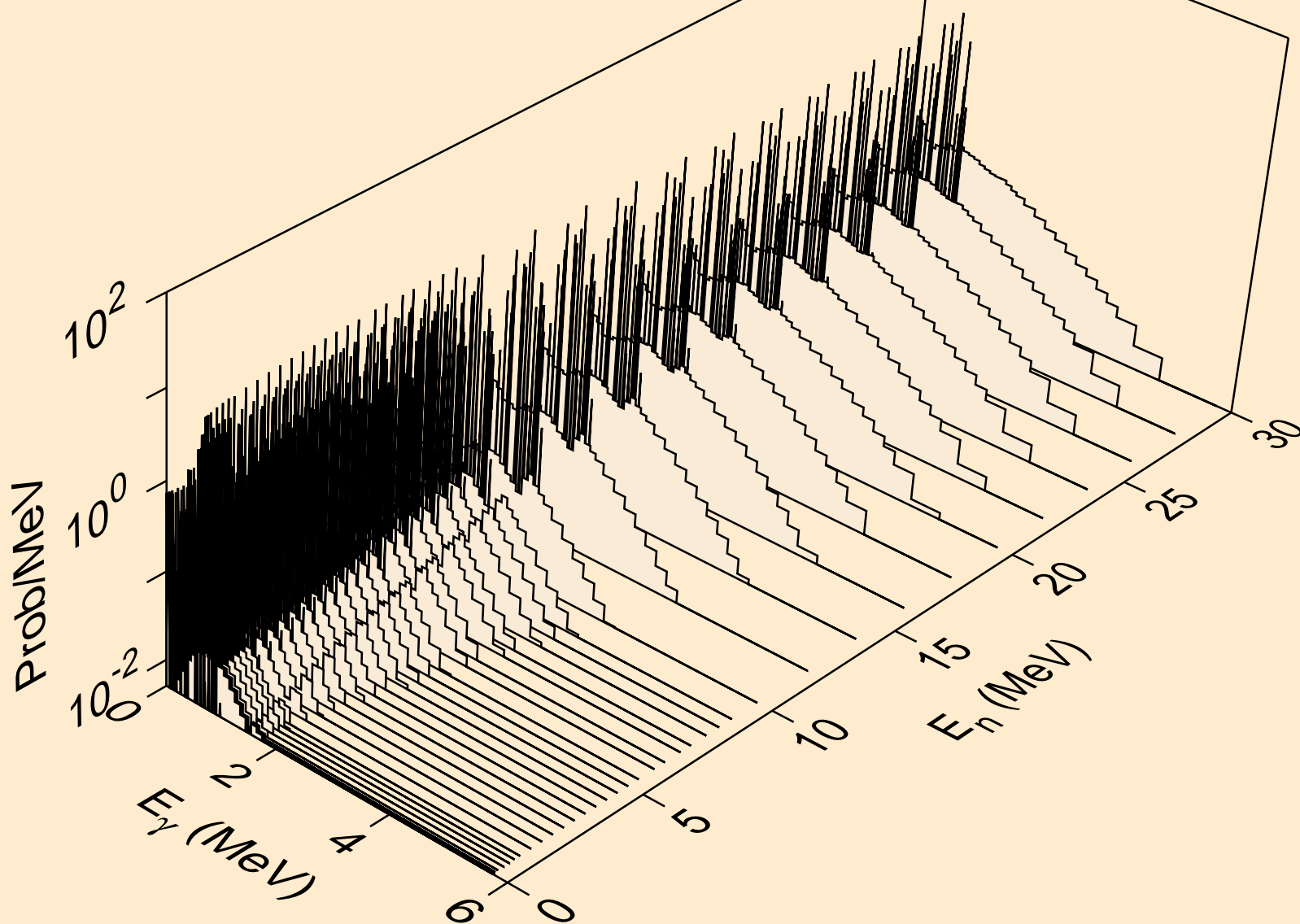

LA120 NEUTRON ACER TENDL-2019 LIBRARY; T=293.16K
Photon emission for (n,3a)

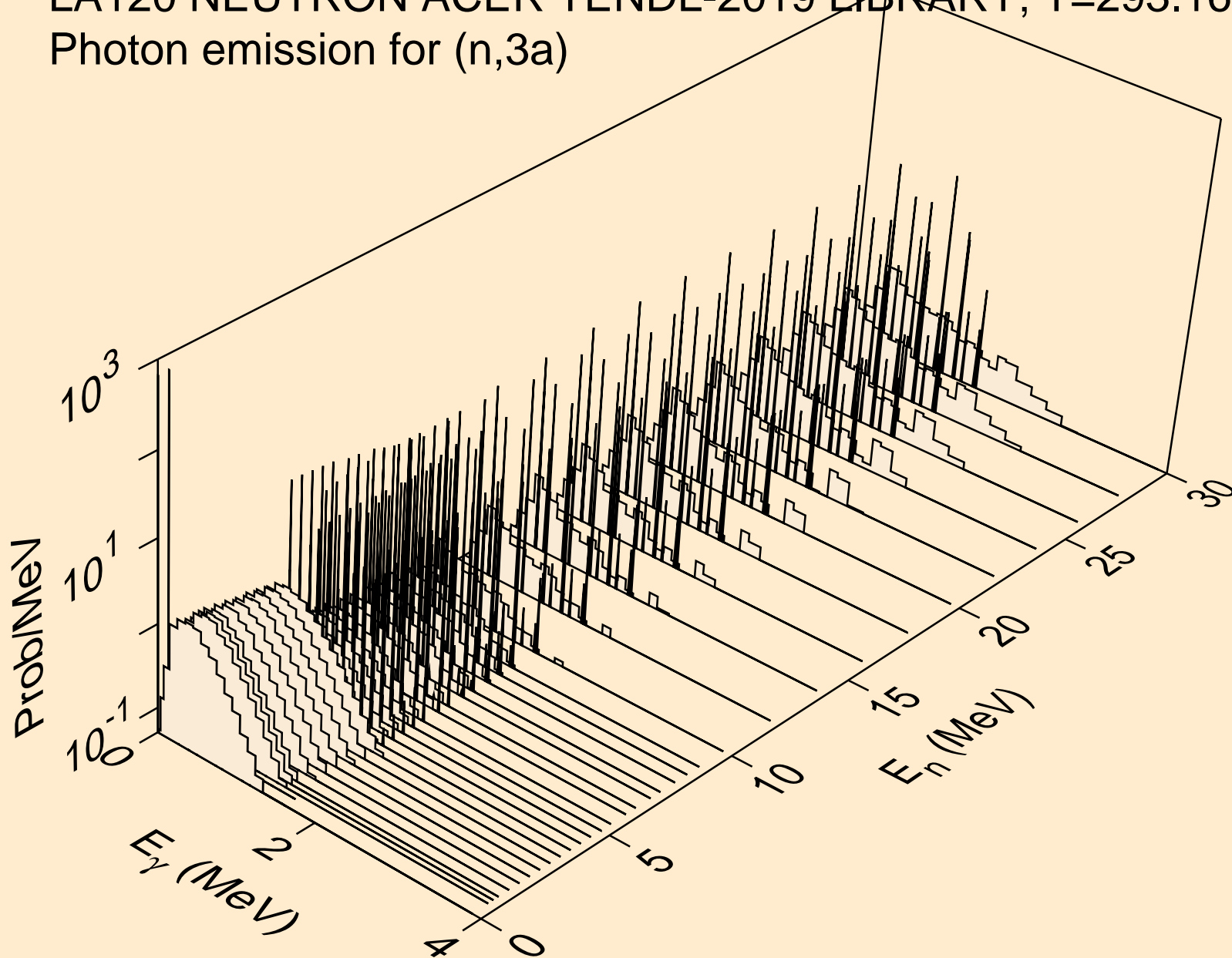

LA120 NEUTRON ACER TENDL-2019 LIBRARY; T=293.16K
Photon emission for (n,2p)

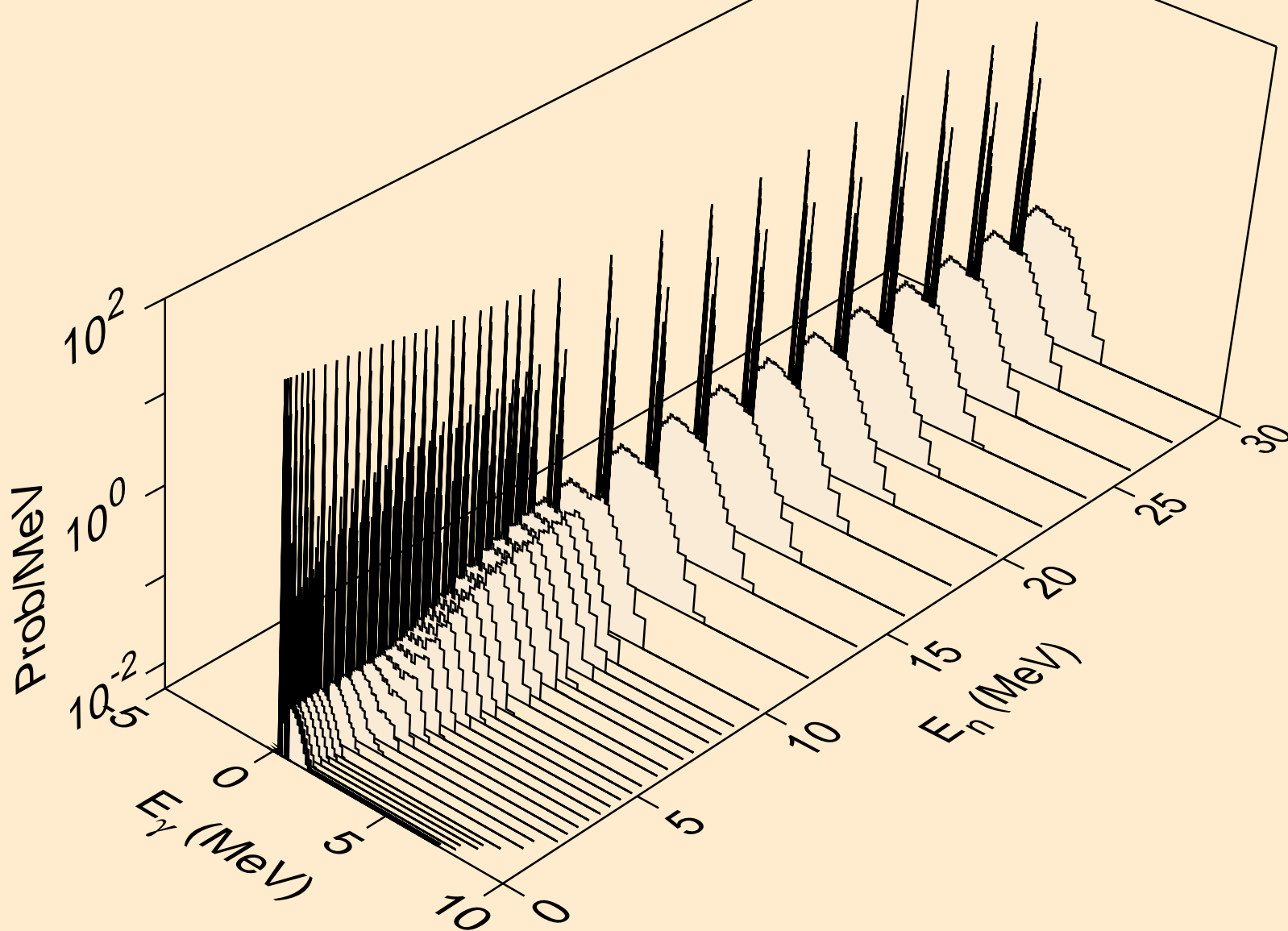

LA120 NEUTRON ACER TENDL-2019 LIBRARY; T=293.16K
Photon emission for (n,p α)

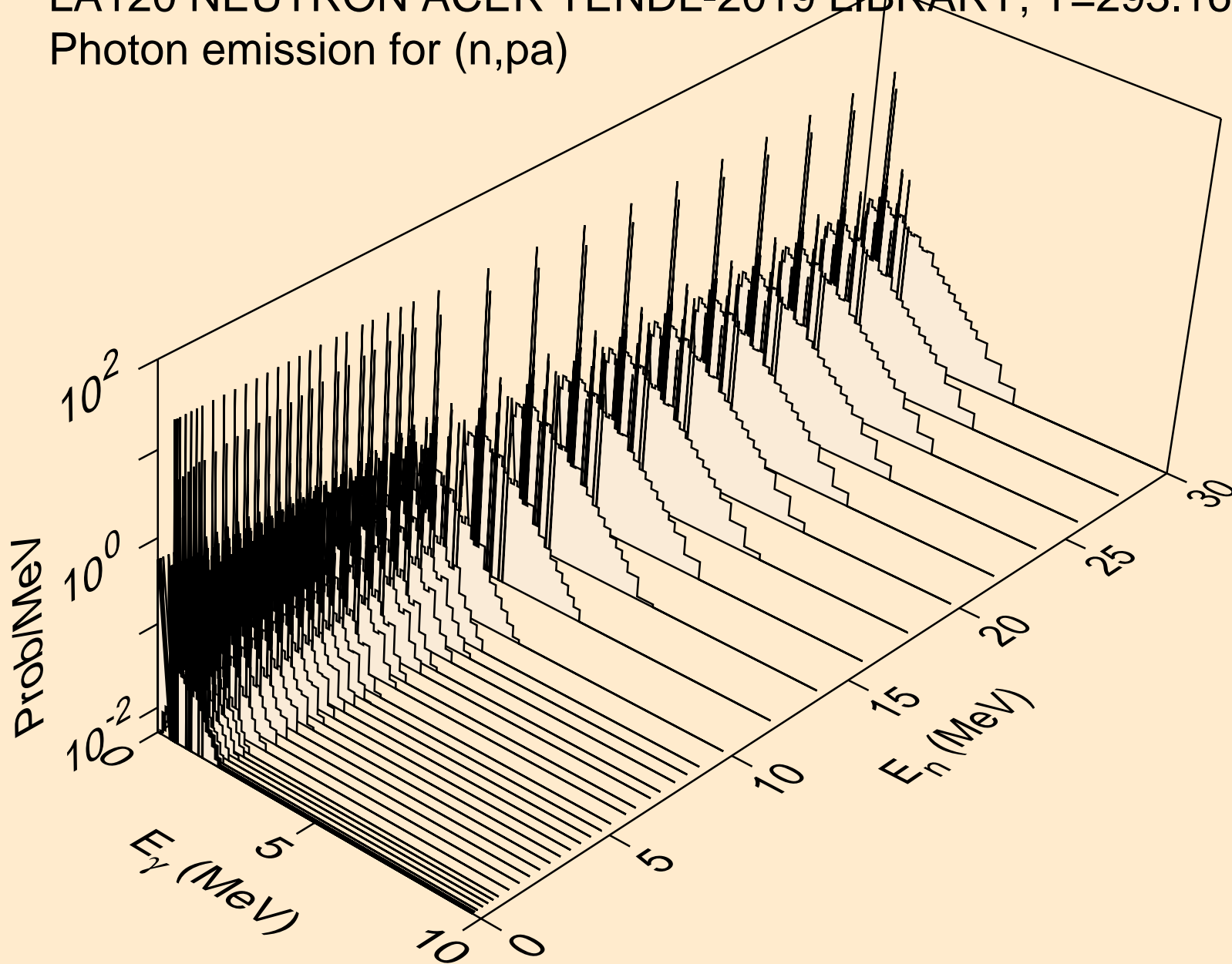

LA120 NEUTRON ACER TENDL-2019 LIBRARY; T=293.16K
Photon emission for (n,t2a)

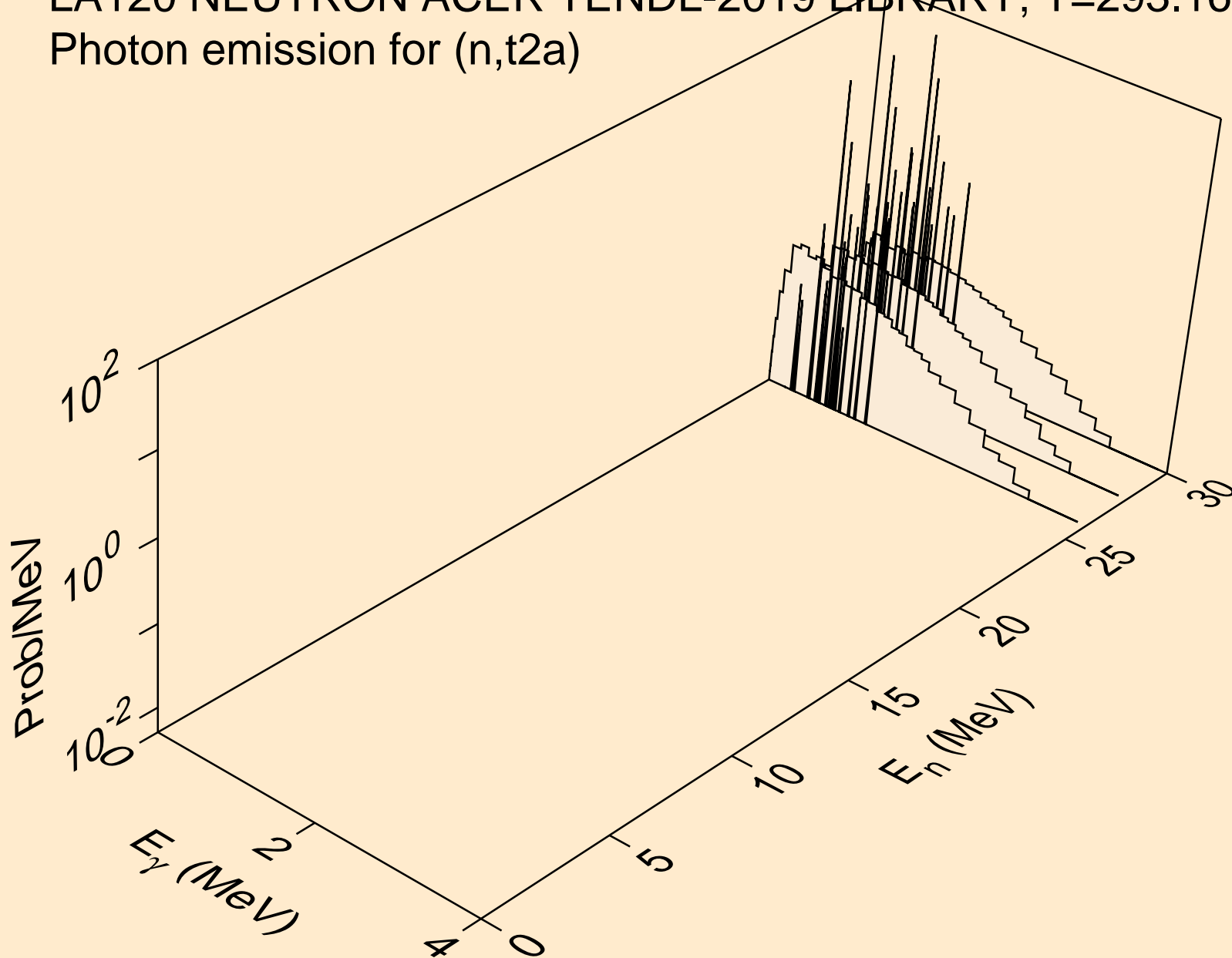

LA120 NEUTRON ACER TENDL-2019 LIBRARY; T=293.16K
Photon emission for (n,d2a)

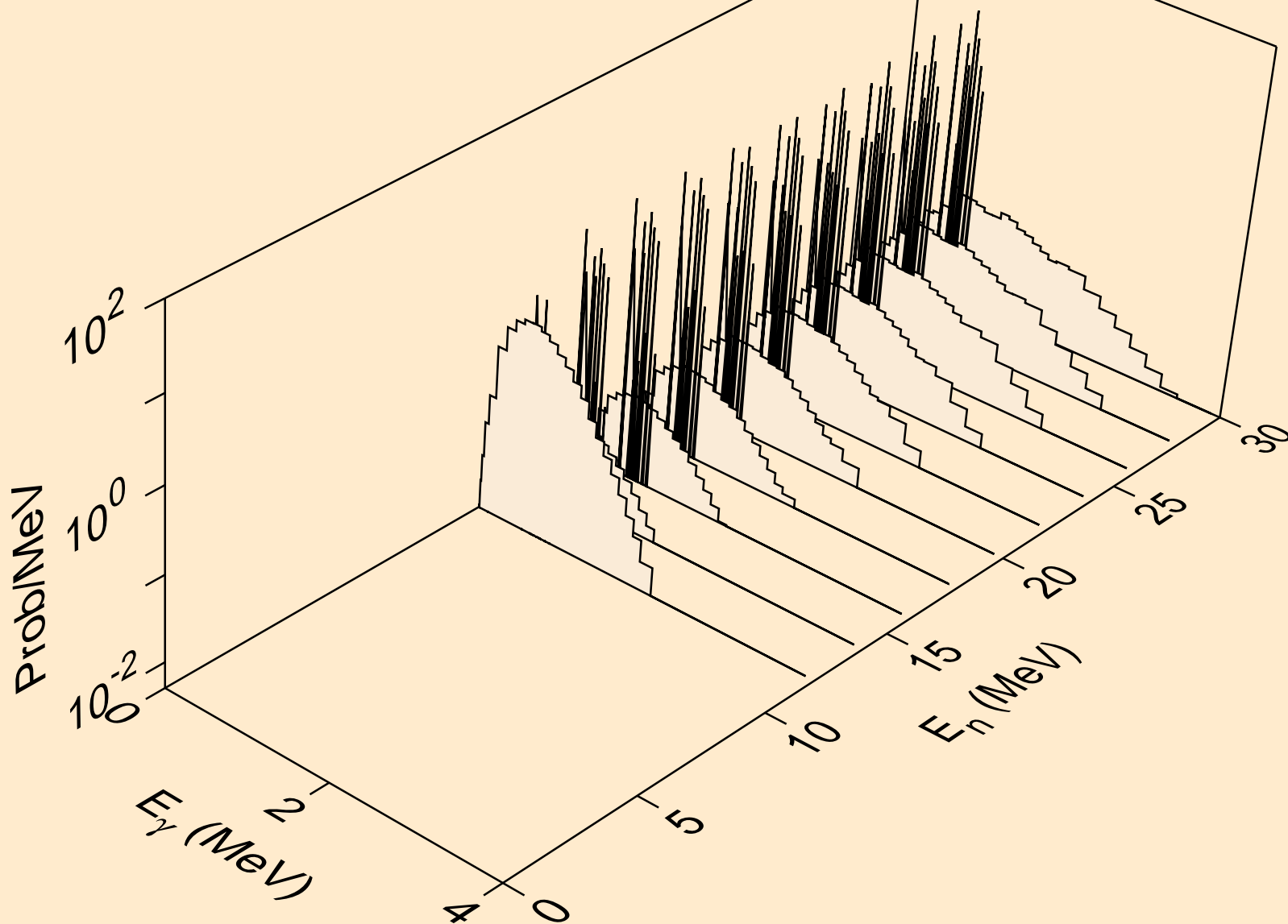

LA120 NEUTRON ACER TENDL-2019 LIBRARY; T=293.16K
Photon emission for (n,pd)

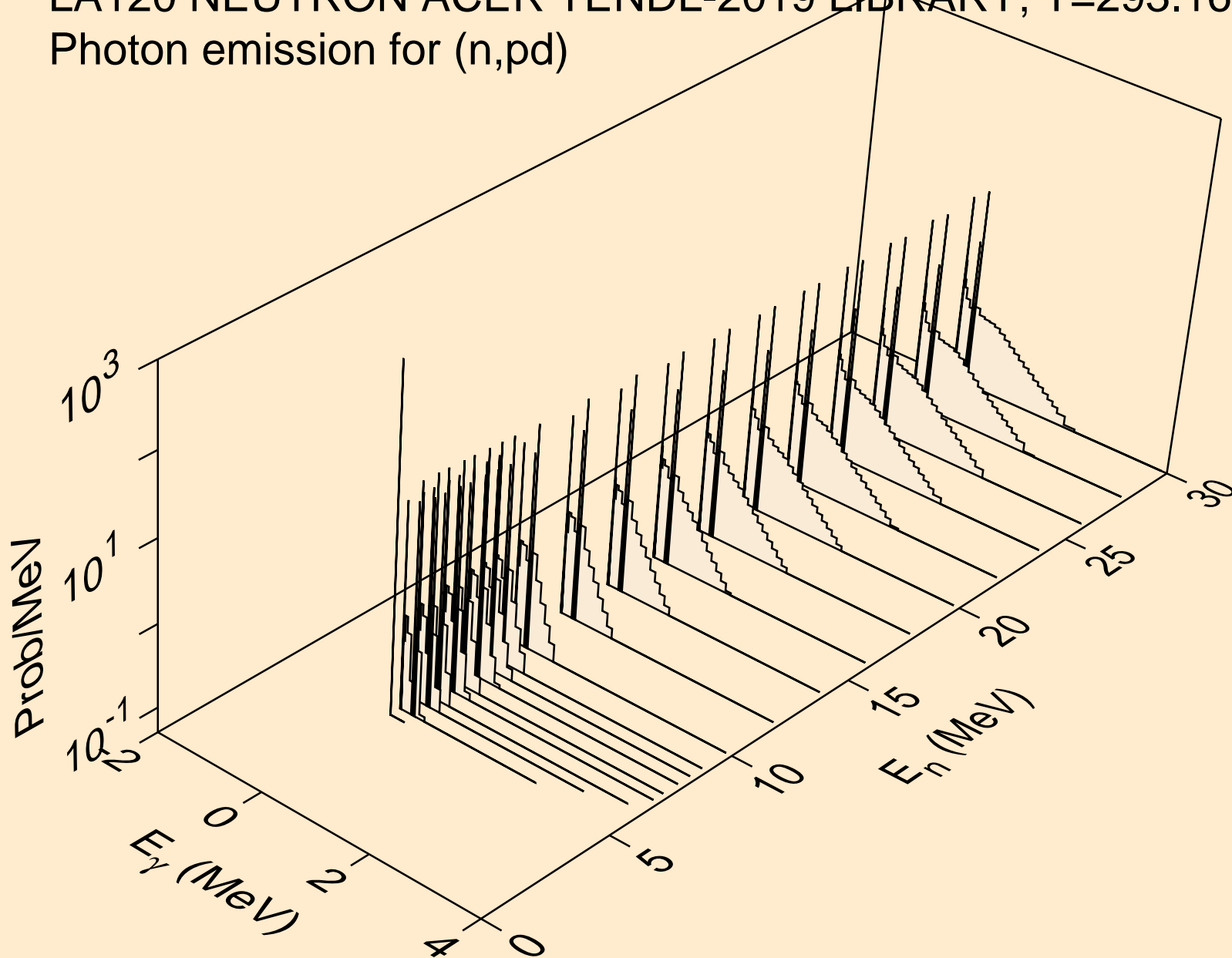

LA120 NEUTRON ACER TENDL-2019 LIBRARY; T=293.16K
Photon emission for (n,pt)

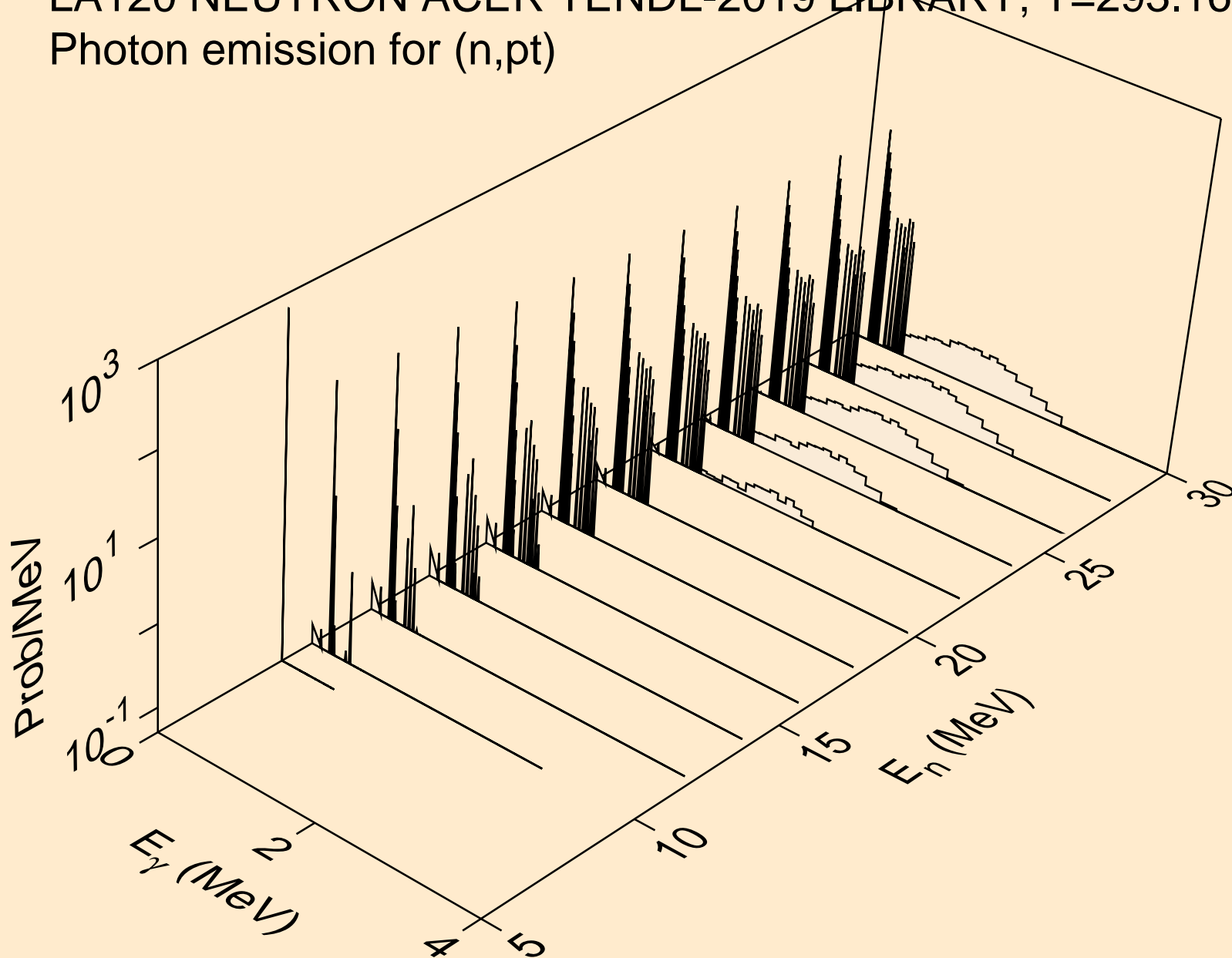

LA120 NEUTRON ACER TENDL-2019 LIBRARY; T=293.16K
Photon emission for (n,da)

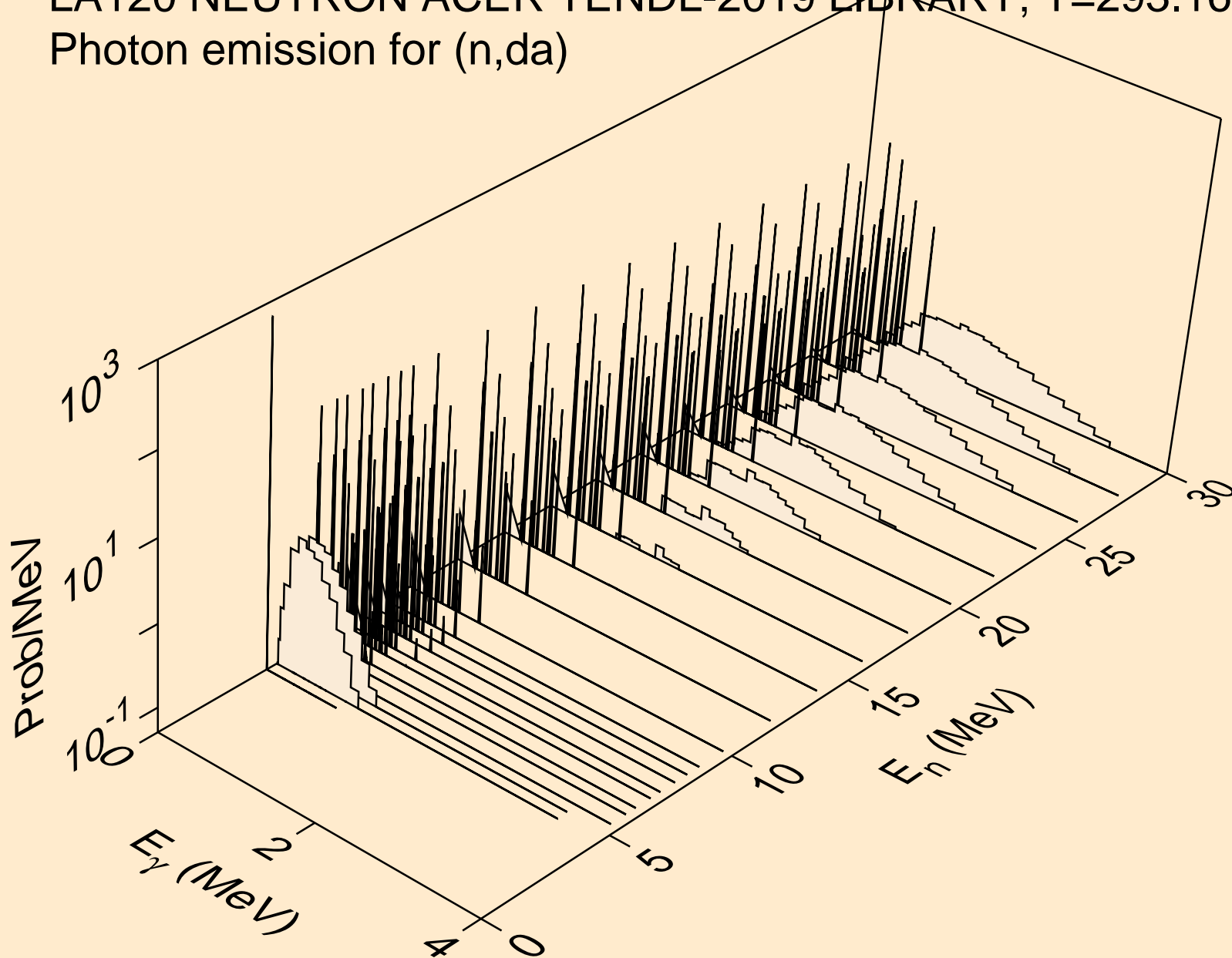

LA120 NEUTRON ACER TENDL-2019 LIBRARY; T=293.16K
thermal capture photon spectrum

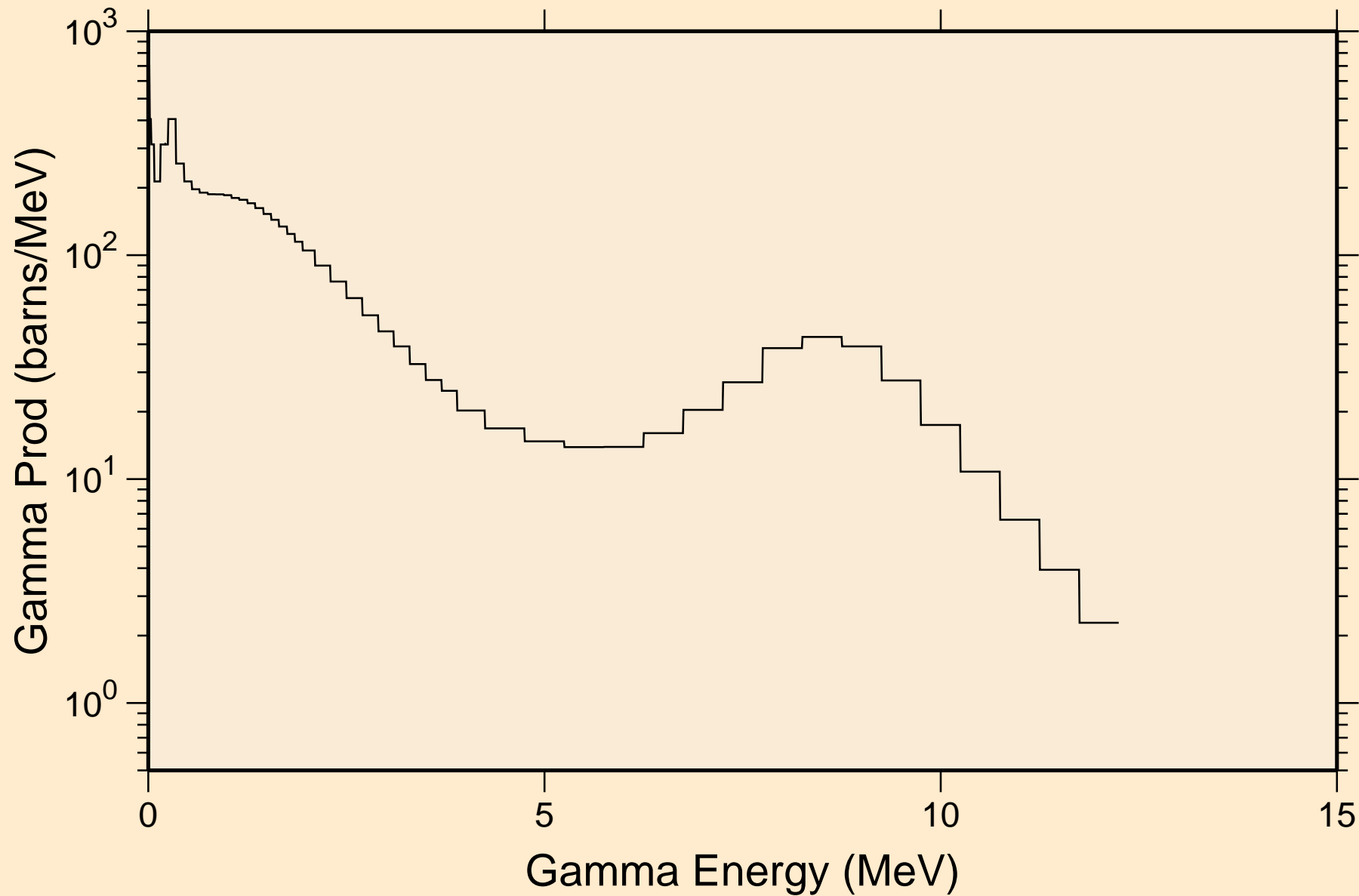

LA120 NEUTRON ACER TENDL-2019 LIBRARY; T=293.16K
14 MeV photon spectrum

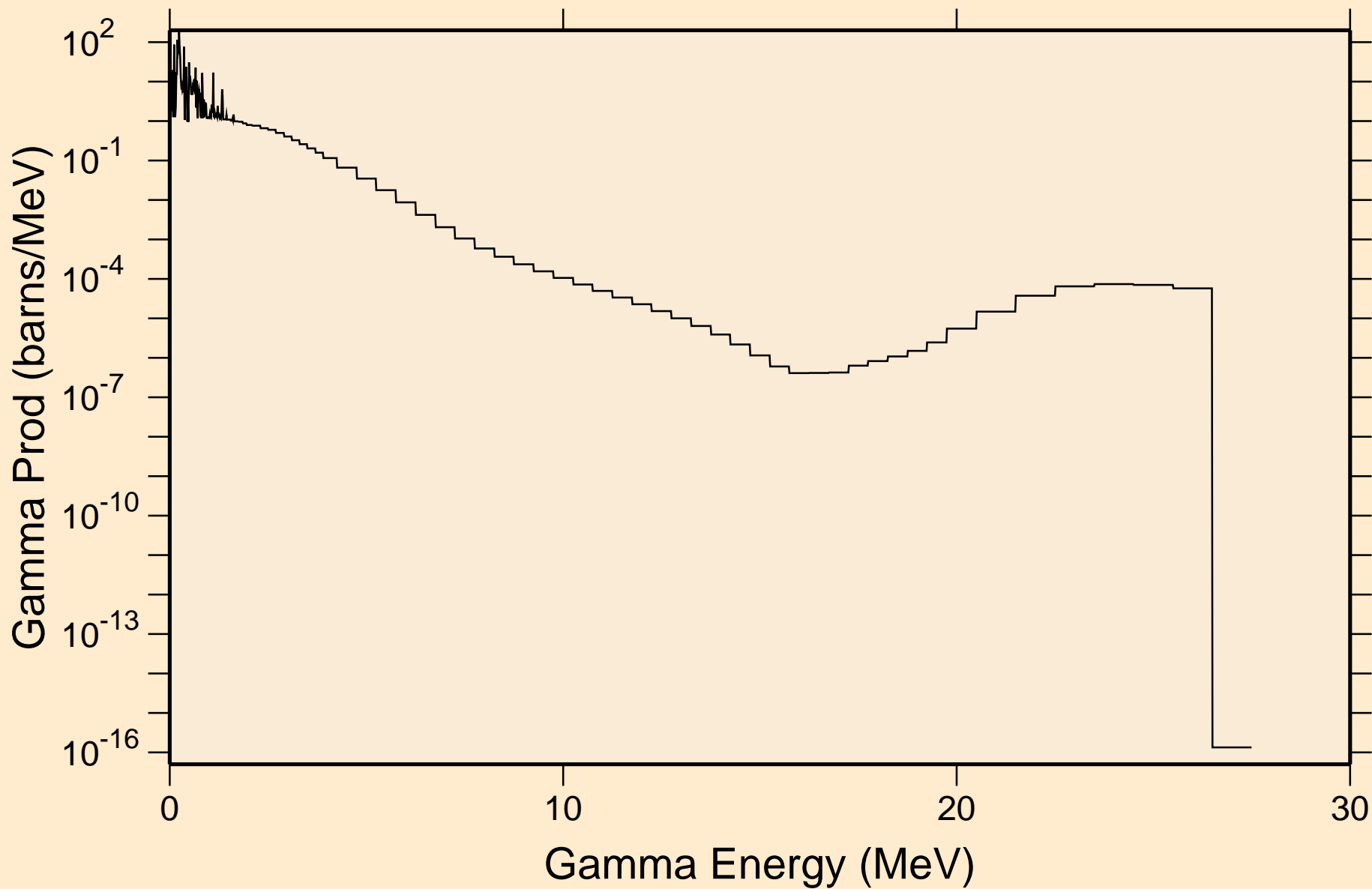

LA120 NEUTRON ACER TENDL-2019 LIBRARY; T=293.16K
Particle heating contributions

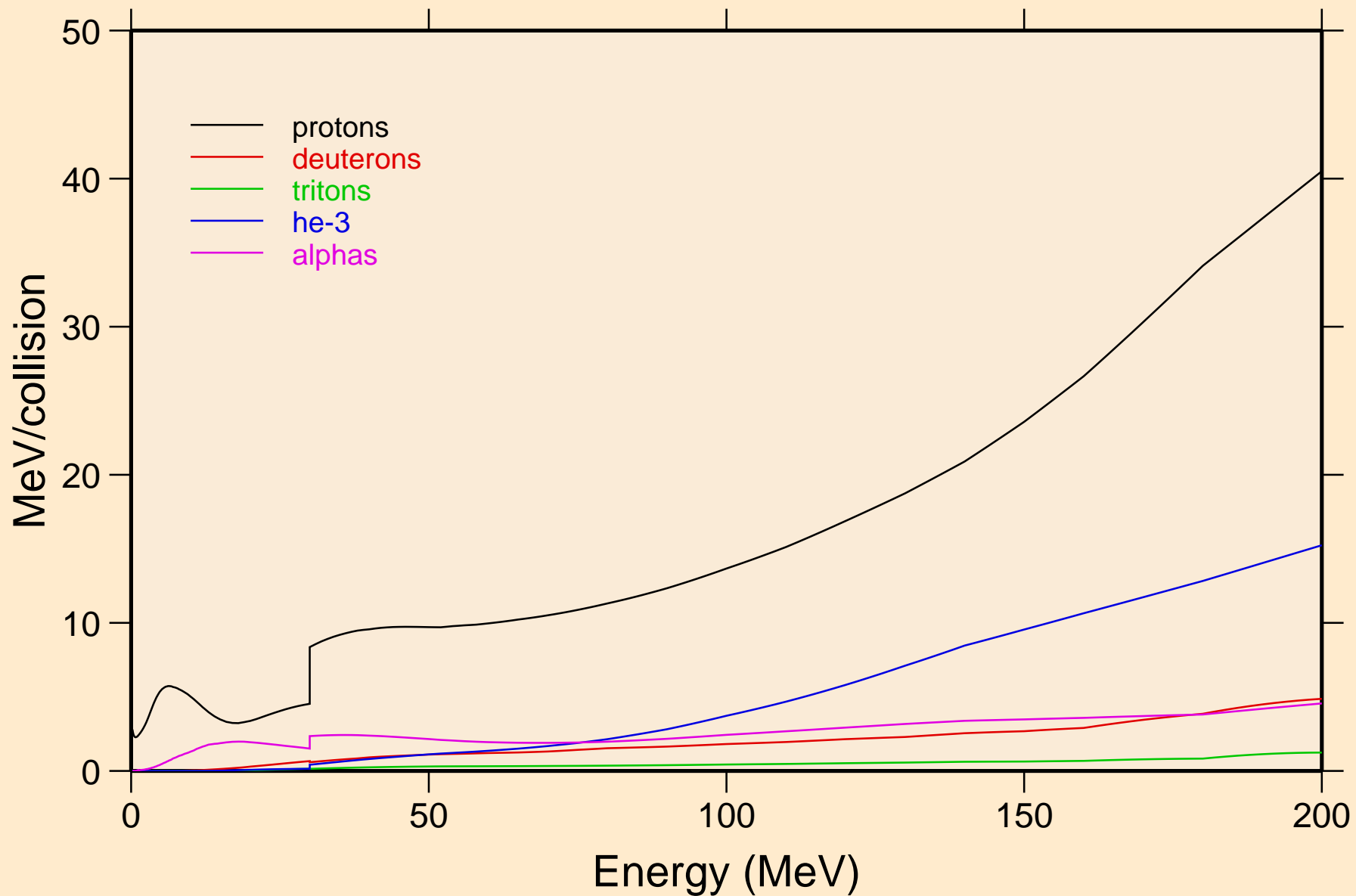

LA120 NEUTRON ACER TENDL-2019 LIBRARY; T=293.16K
Recoil Heating

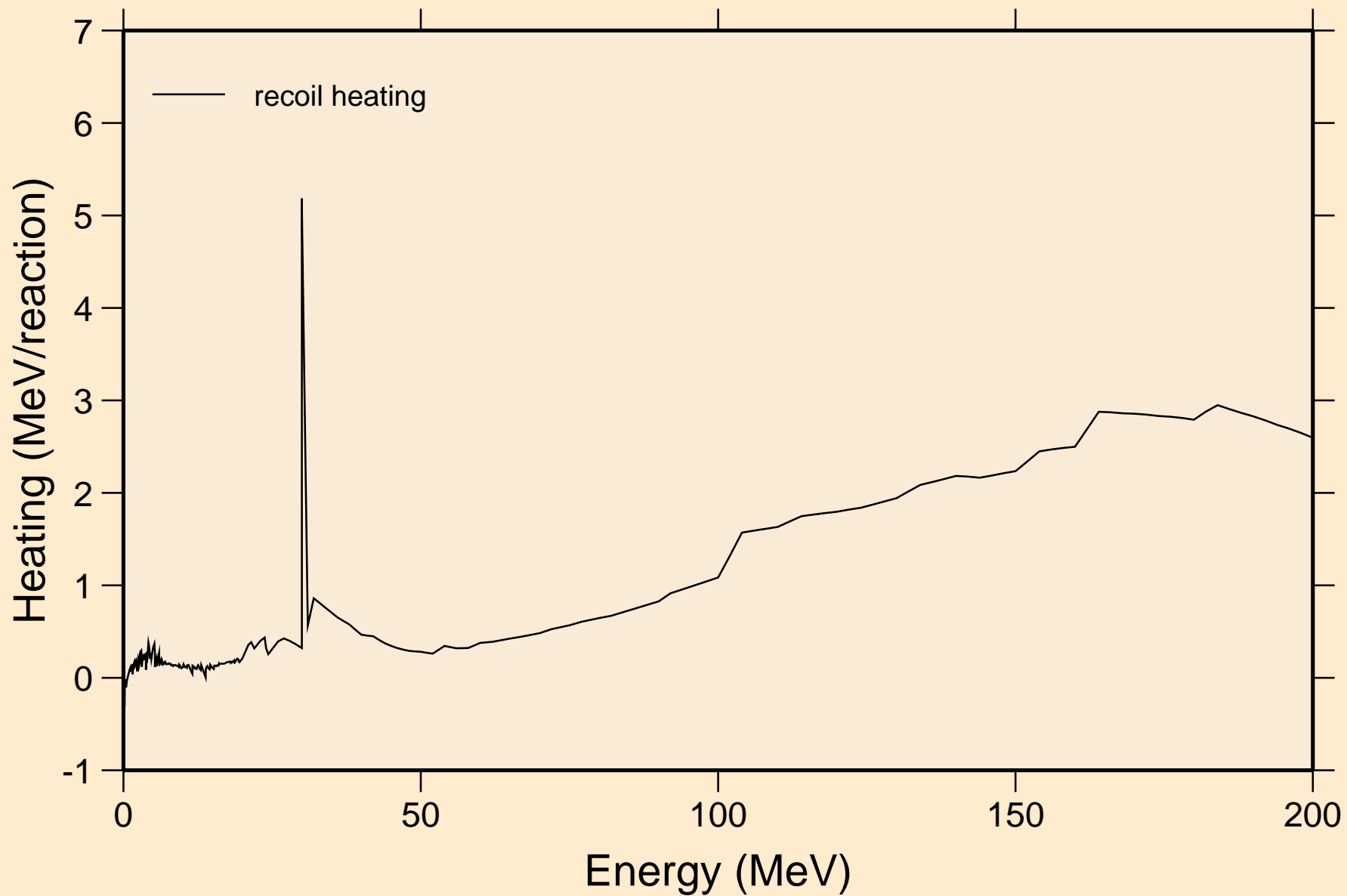

LA120 NEUTRON ACER TENDL-2019 LIBRARY; T=293.16K
Particle production cross sections

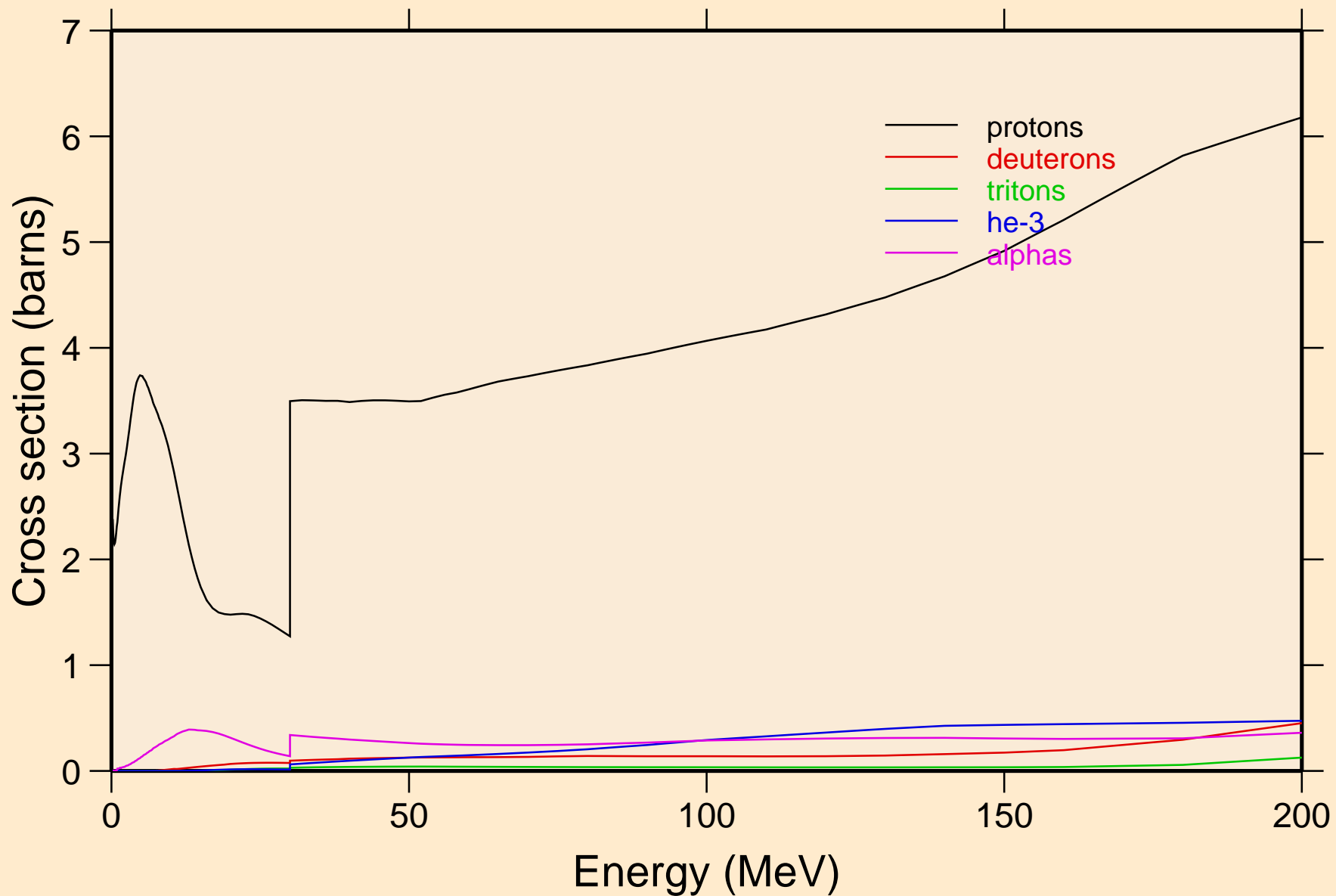

LA120 NEUTRON ACER TENDL-2019 LIBRARY; T=293.16K
protons from (n,x)

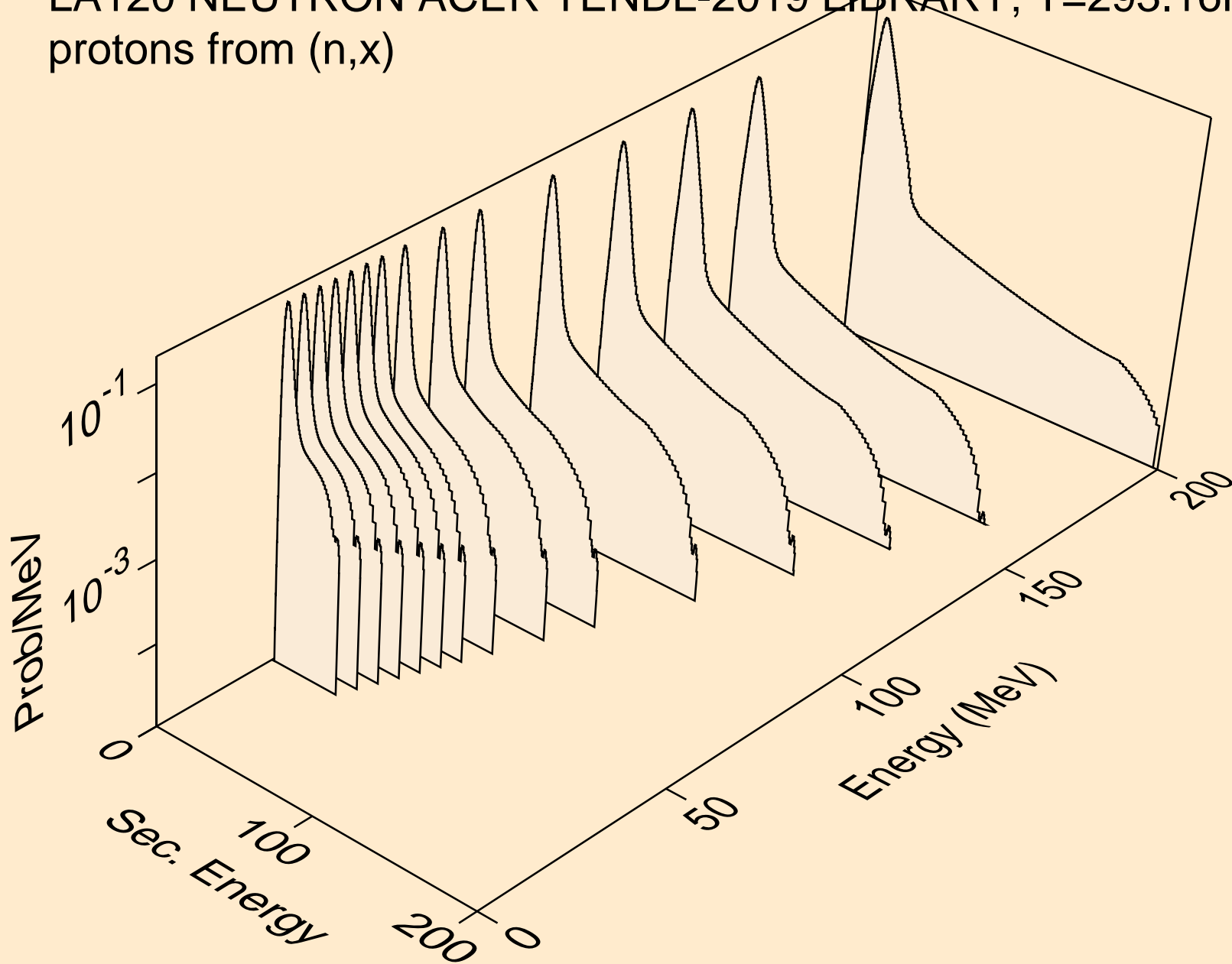

LA120 NEUTRON ACER TENDL-2019 LIBRARY; T=293.16K
protons from (n,n*)p

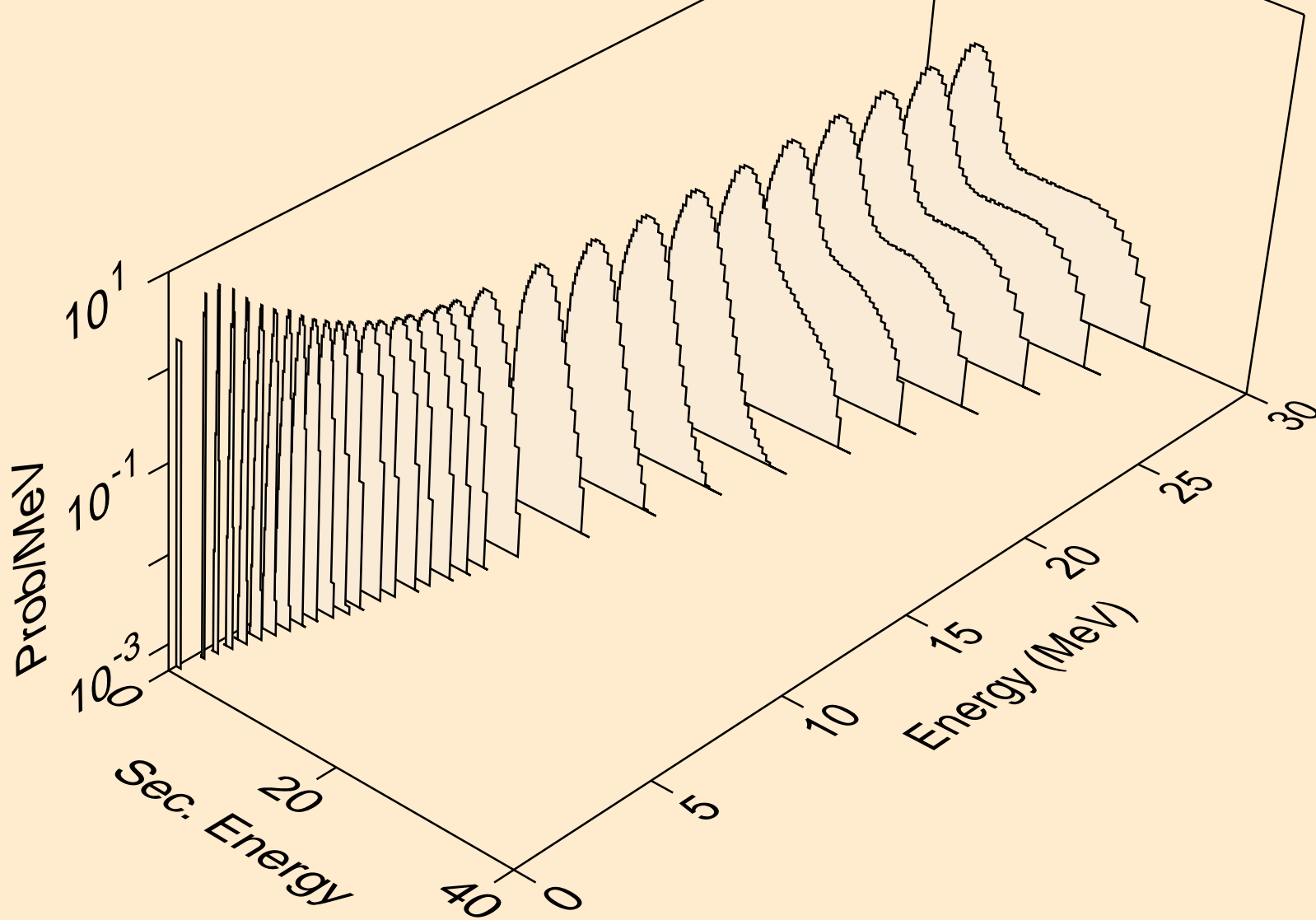

LA120 NEUTRON ACER TENDL-2019 LIBRARY; T=293.16K
protons from (n,2np)

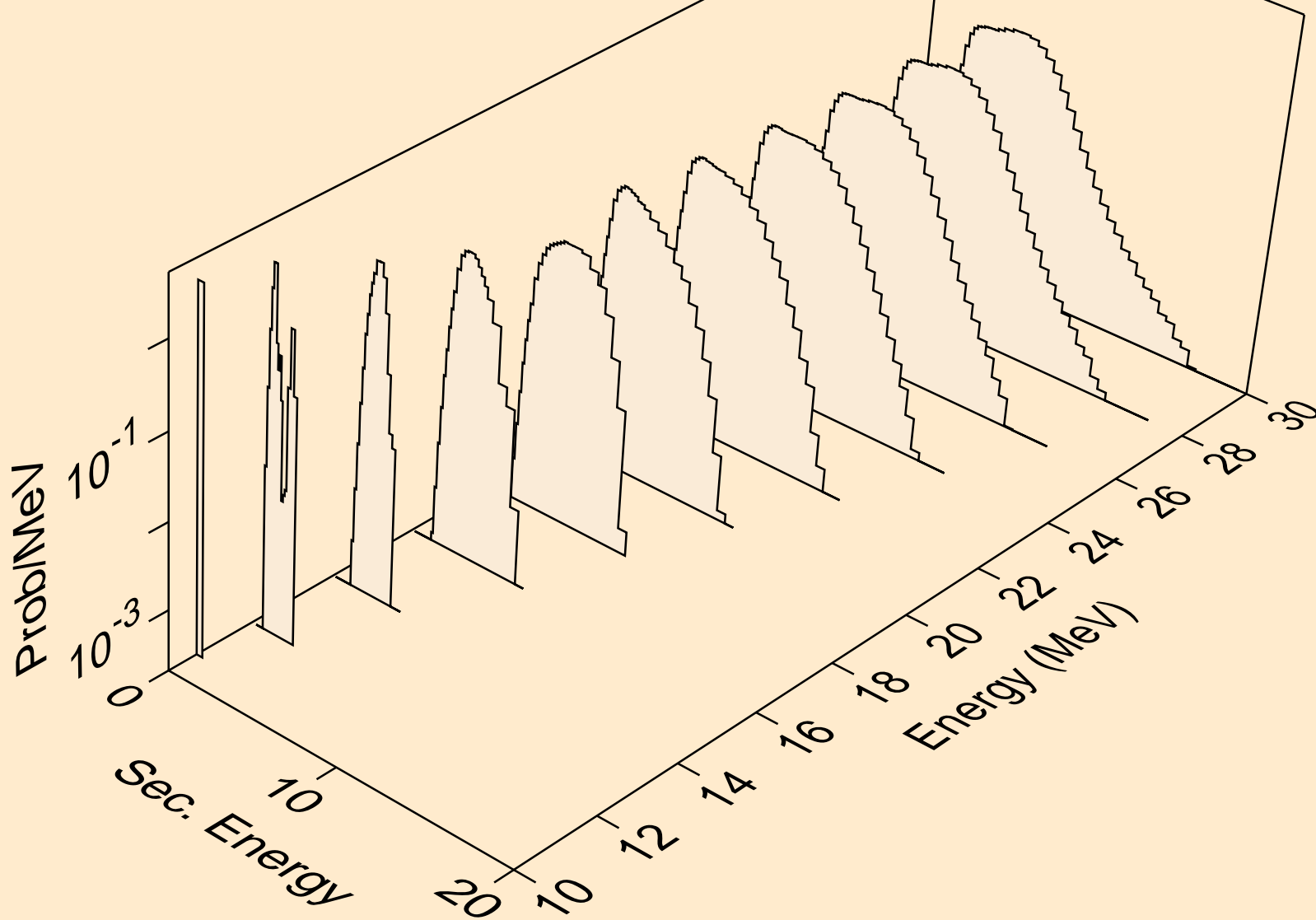

LA120 NEUTRON ACER TENDL-2019 LIBRARY; T=293.16K
protons from (n,3np)

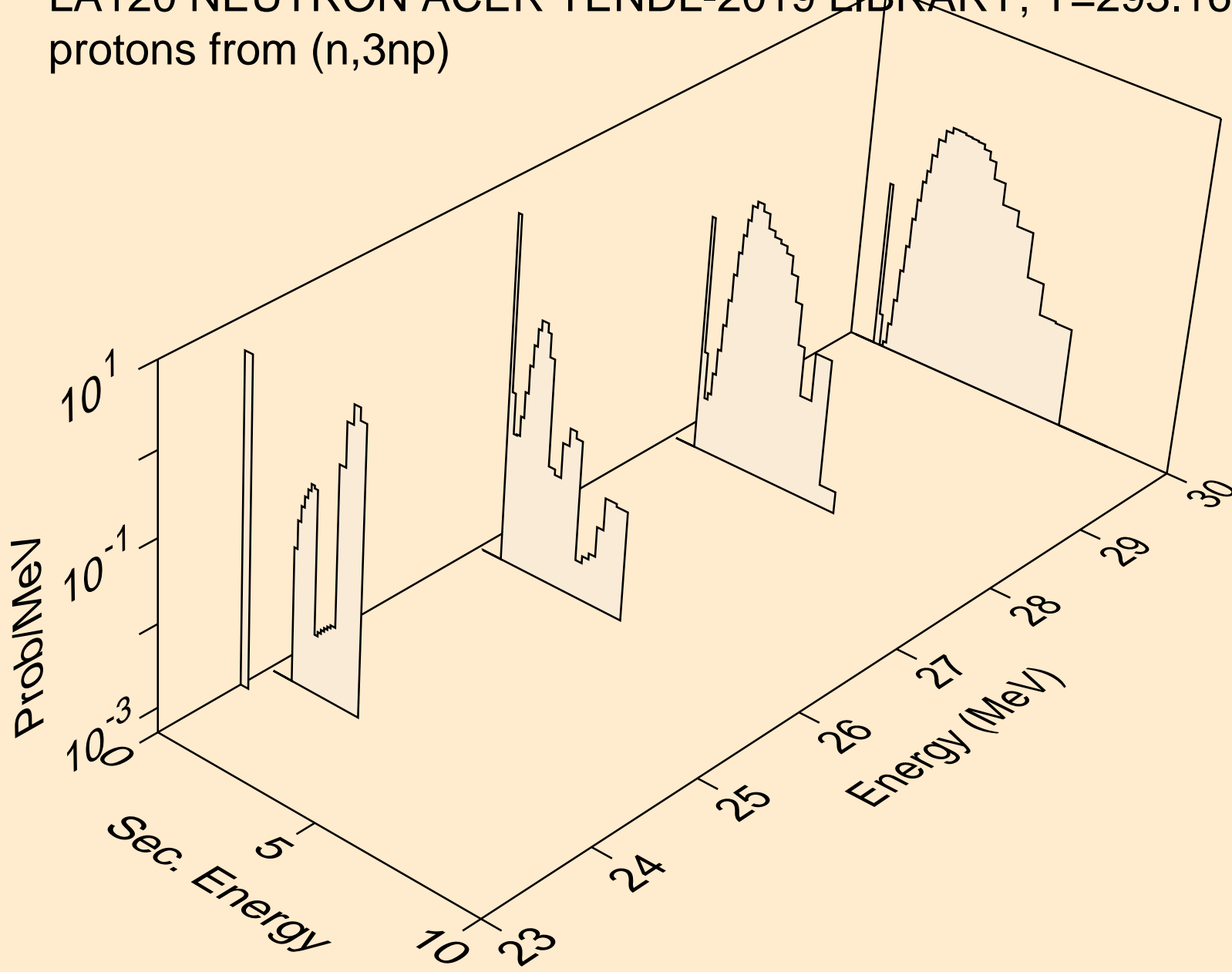

LA120 NEUTRON ACER TENDL-2019 LIBRARY; T=293.16K
protons from (n,2np)

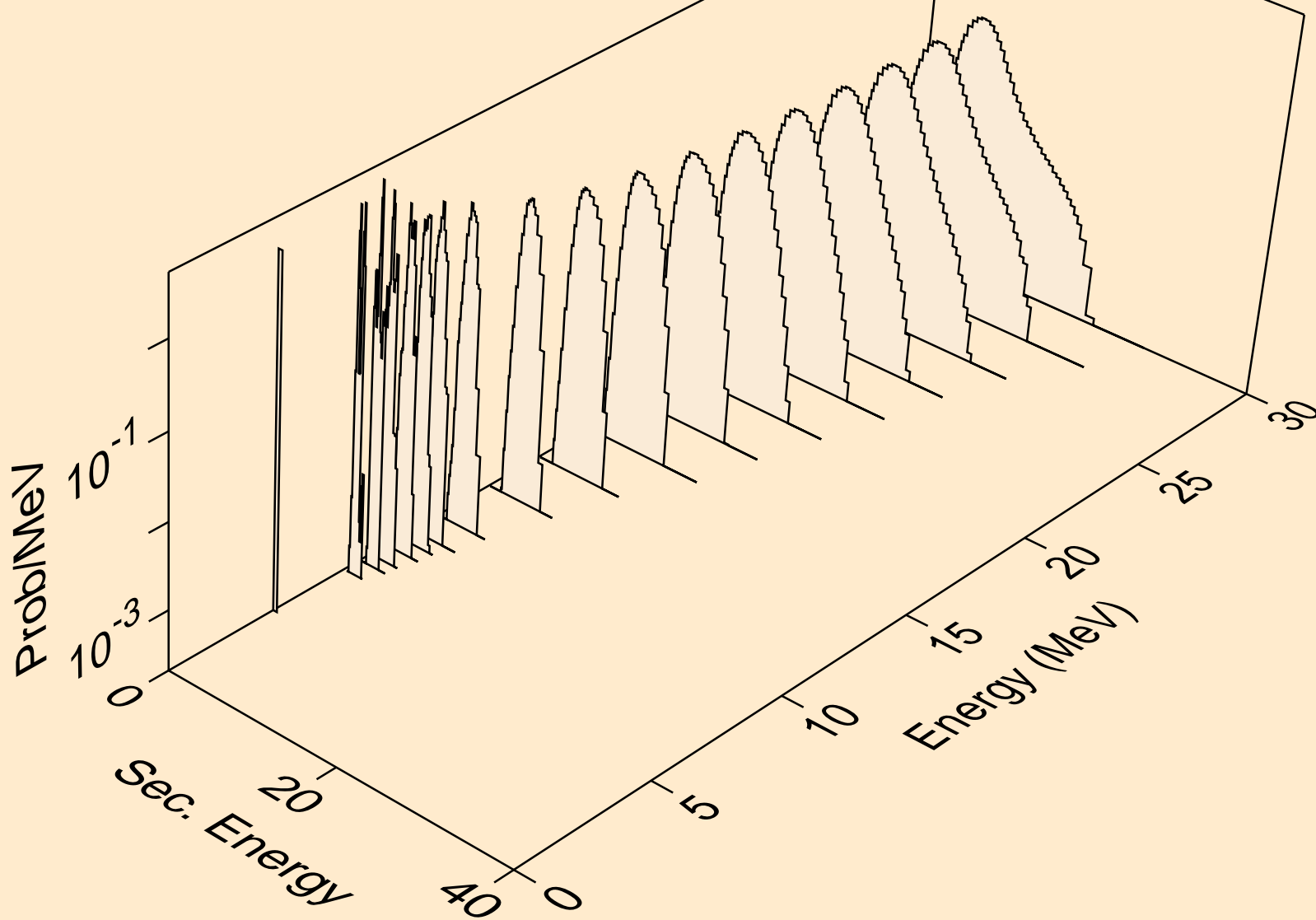

LA120 NEUTRON ACER TENDL-2019 LIBRARY; T=293.16K
protons from (n,npa)

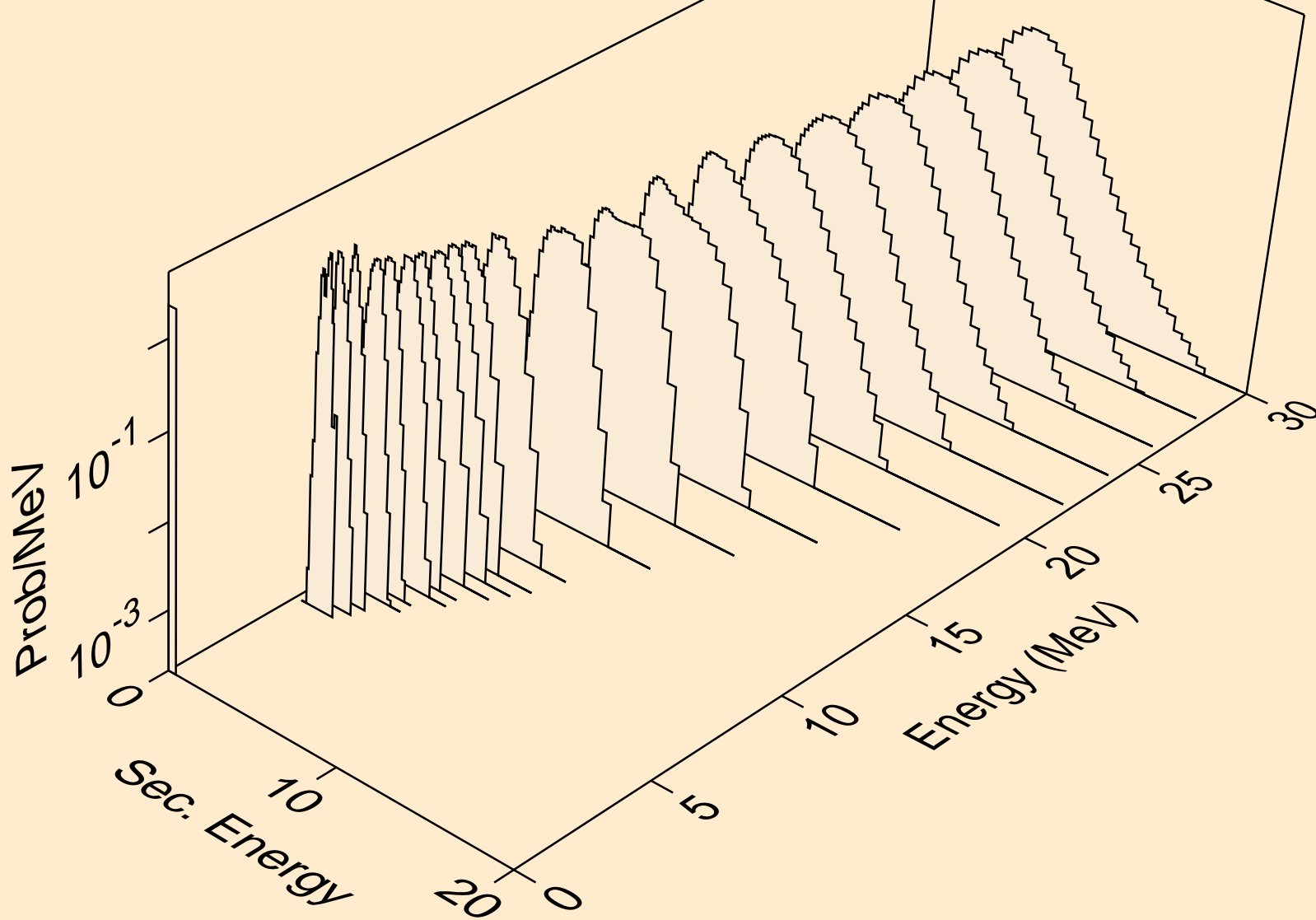

LA120 NEUTRON ACER TENDL-2019 LIBRARY; T=293.16K
protons from (n,p)

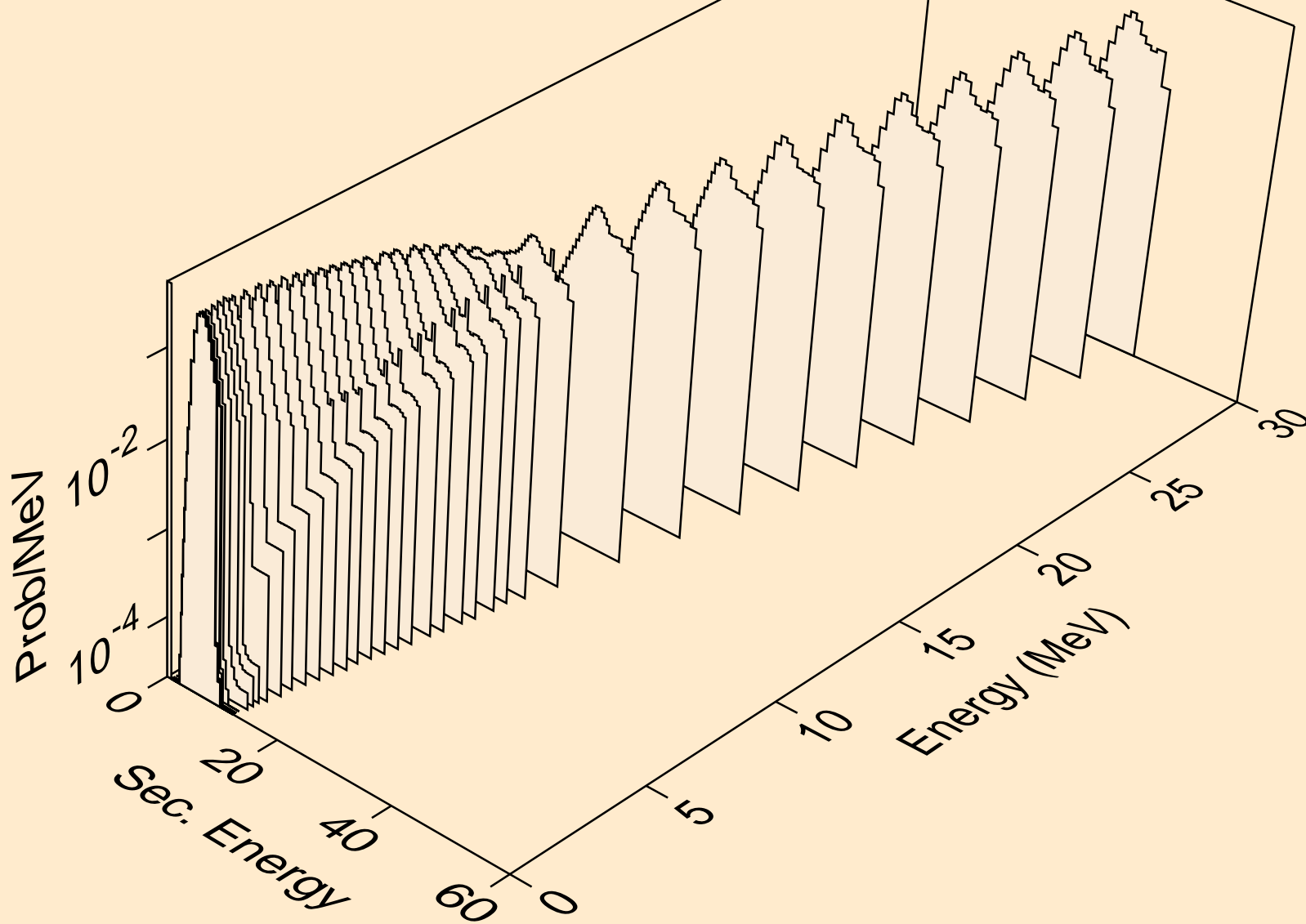

LA120 NEUTRON ACER TENDL-2019 LIBRARY; T=293.16K
protons from (n,2p)

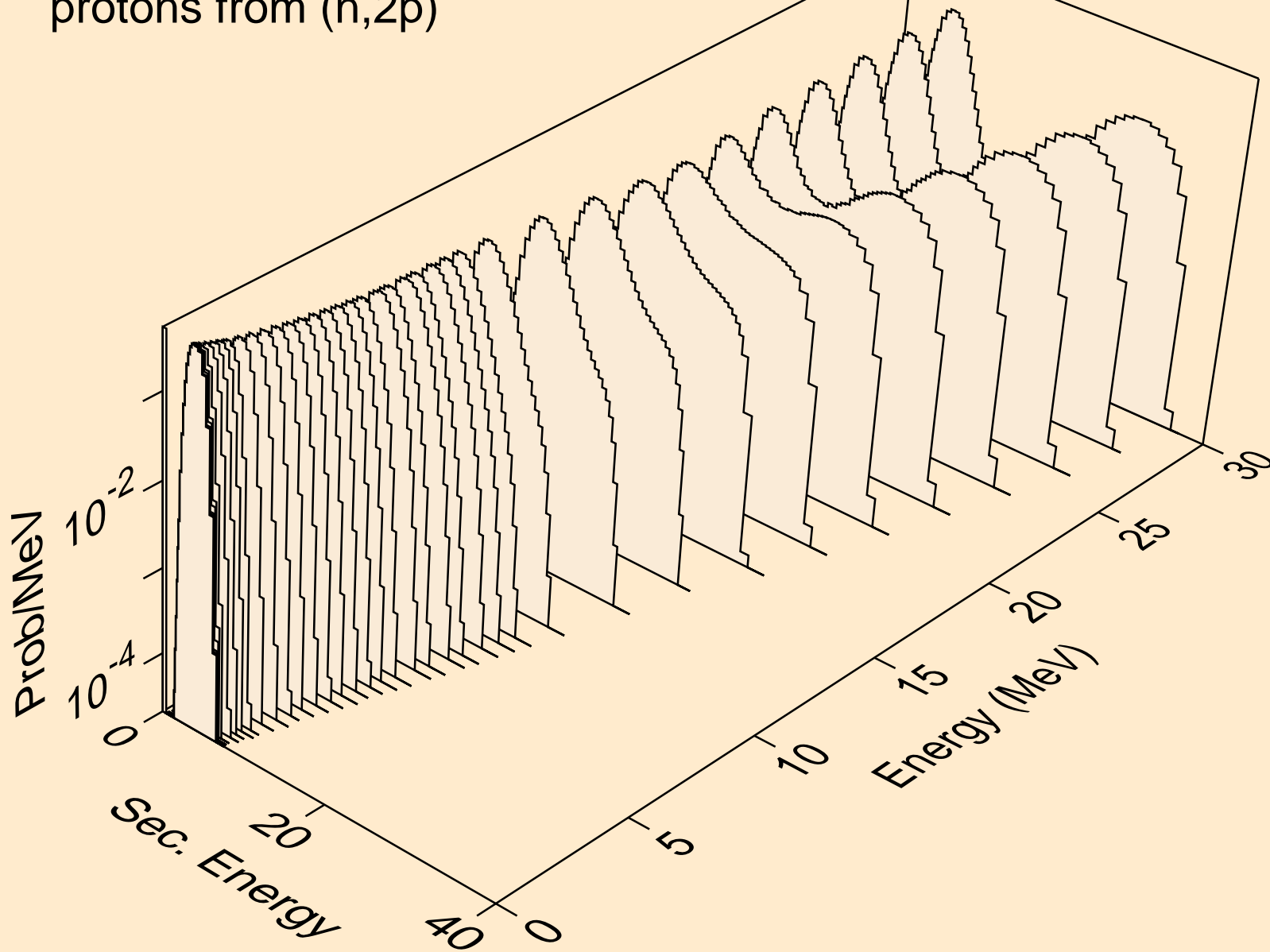

LA120 NEUTRON ACER TENDL-2019 LIBRARY; T=293.16K
protons from (n,p)

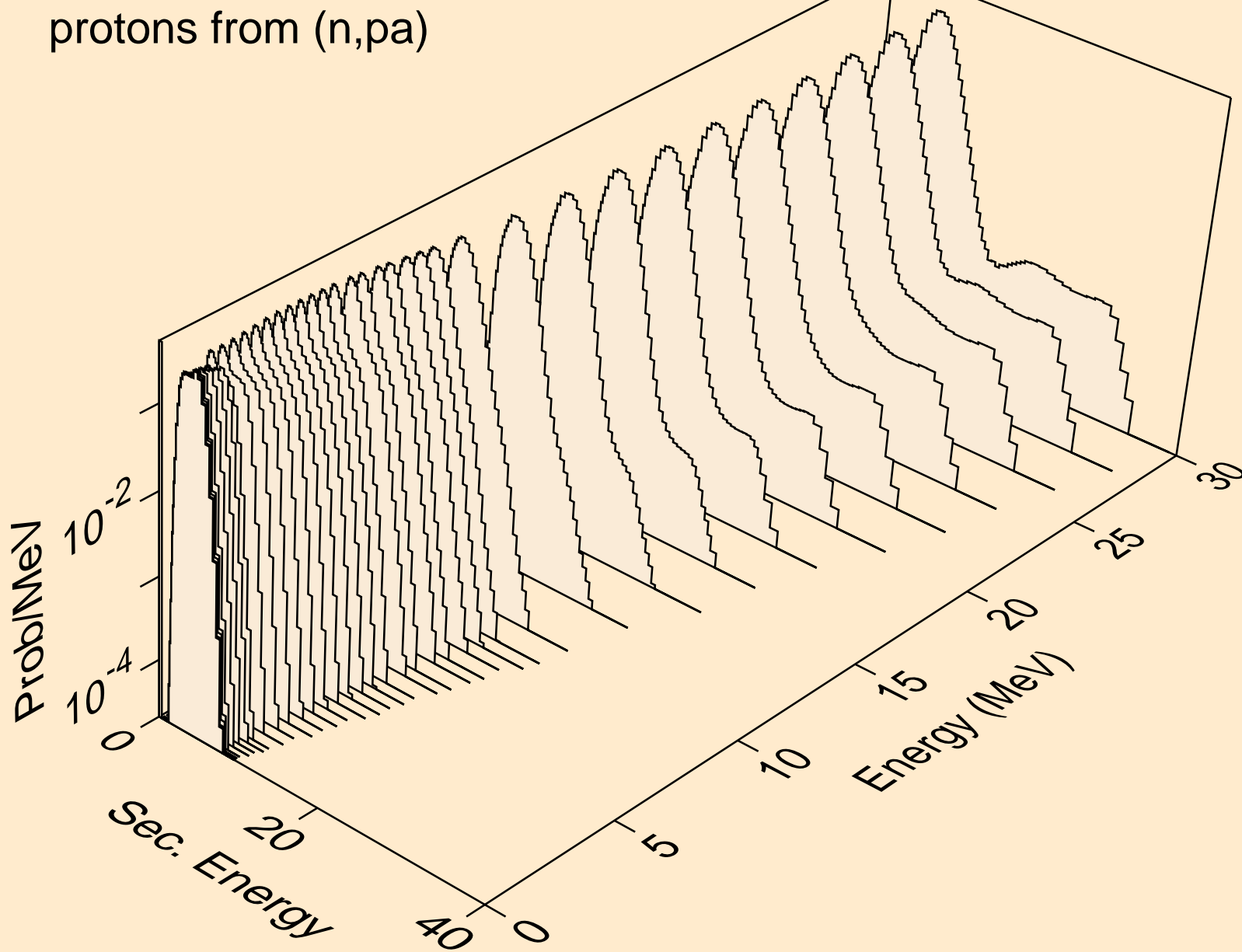

LA120 NEUTRON ACER TENDL-2019 LIBRARY; T=293.16K
protons from (n,pd)

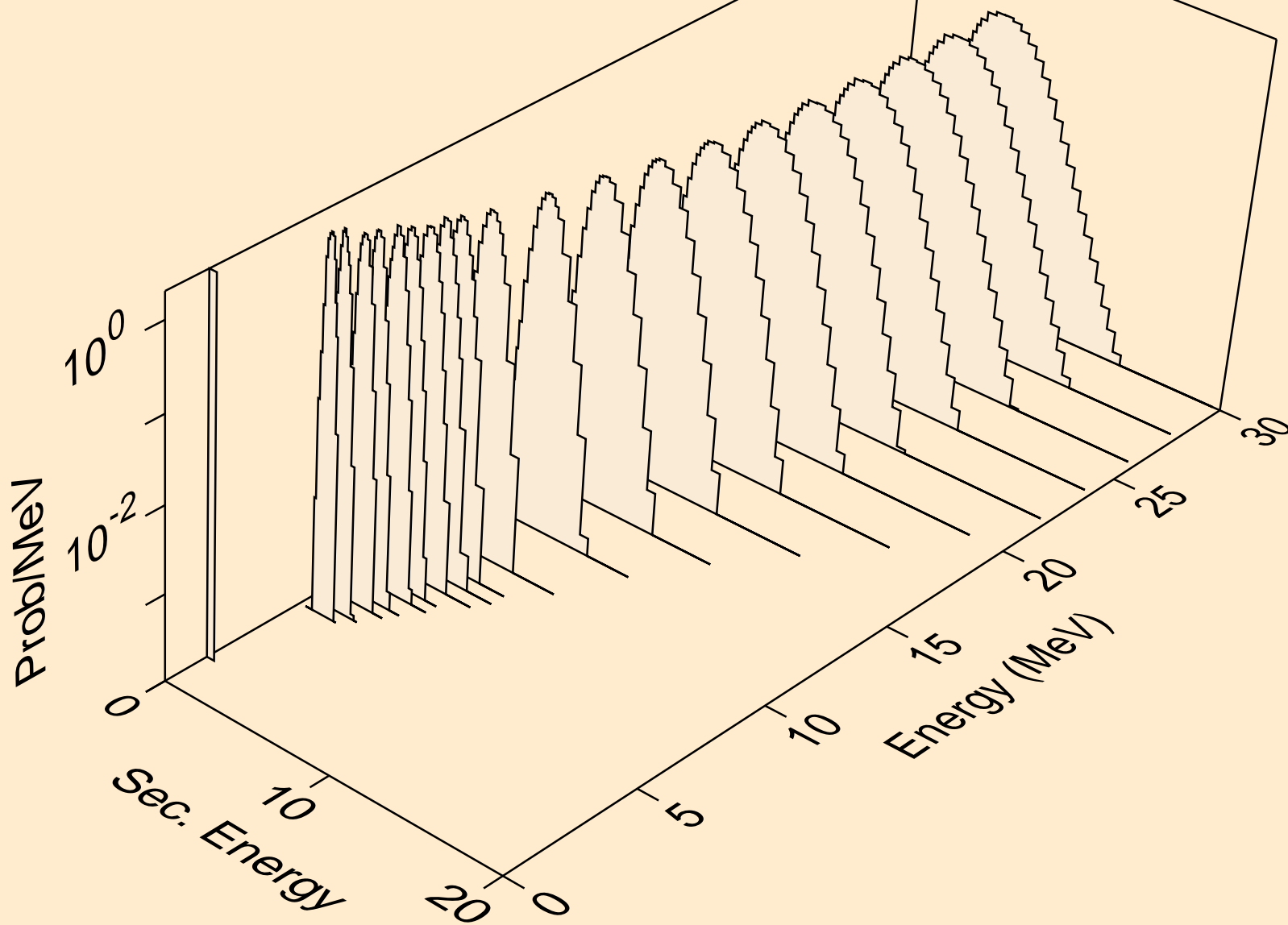

LA120 NEUTRON ACER TENDL-2019 LIBRARY; T=293.16K
protons from (n,pt)

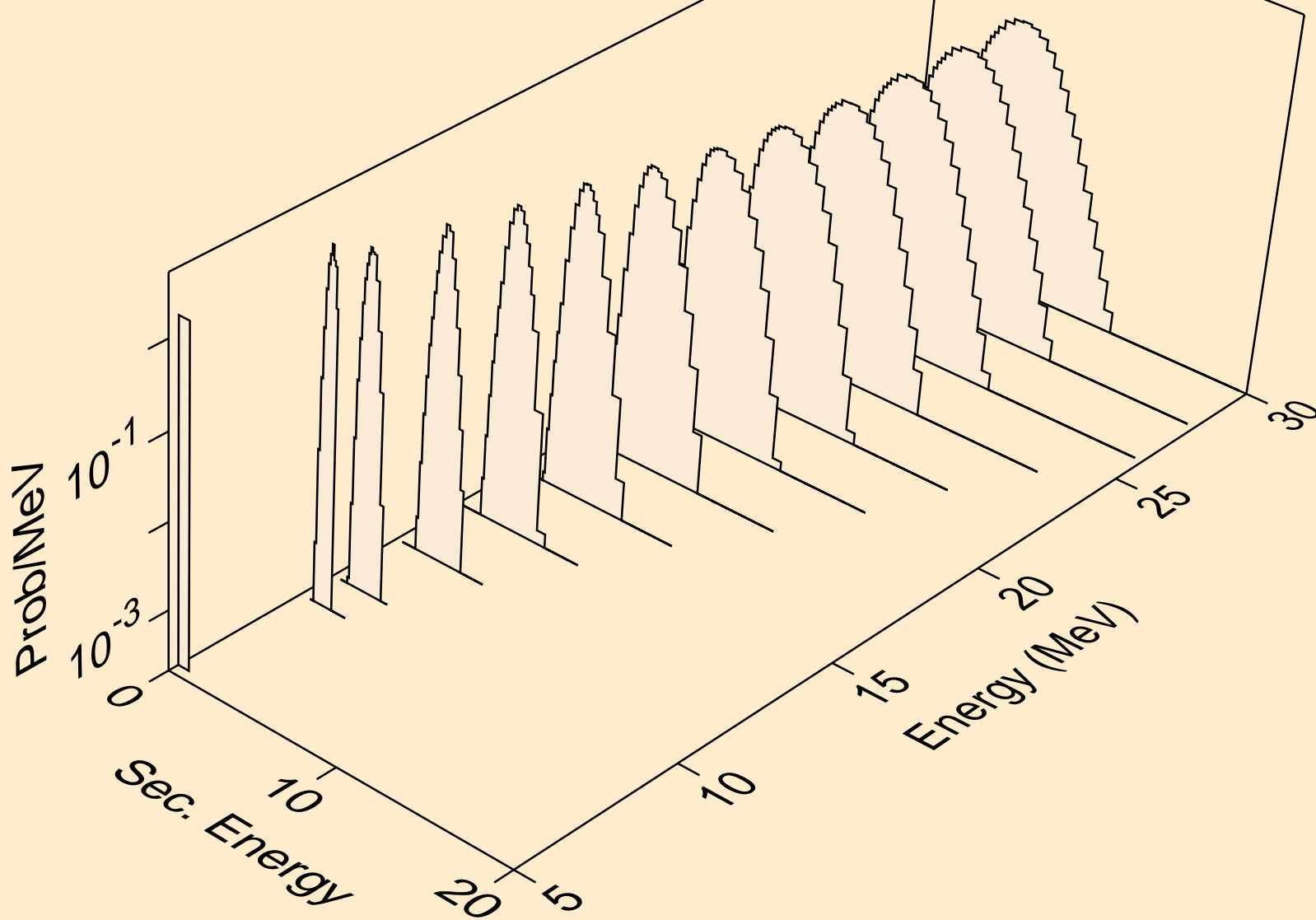

LA120 NEUTRON ACER TENDL-2019 LIBRARY; T=293.16K
deuterons from (n,x)

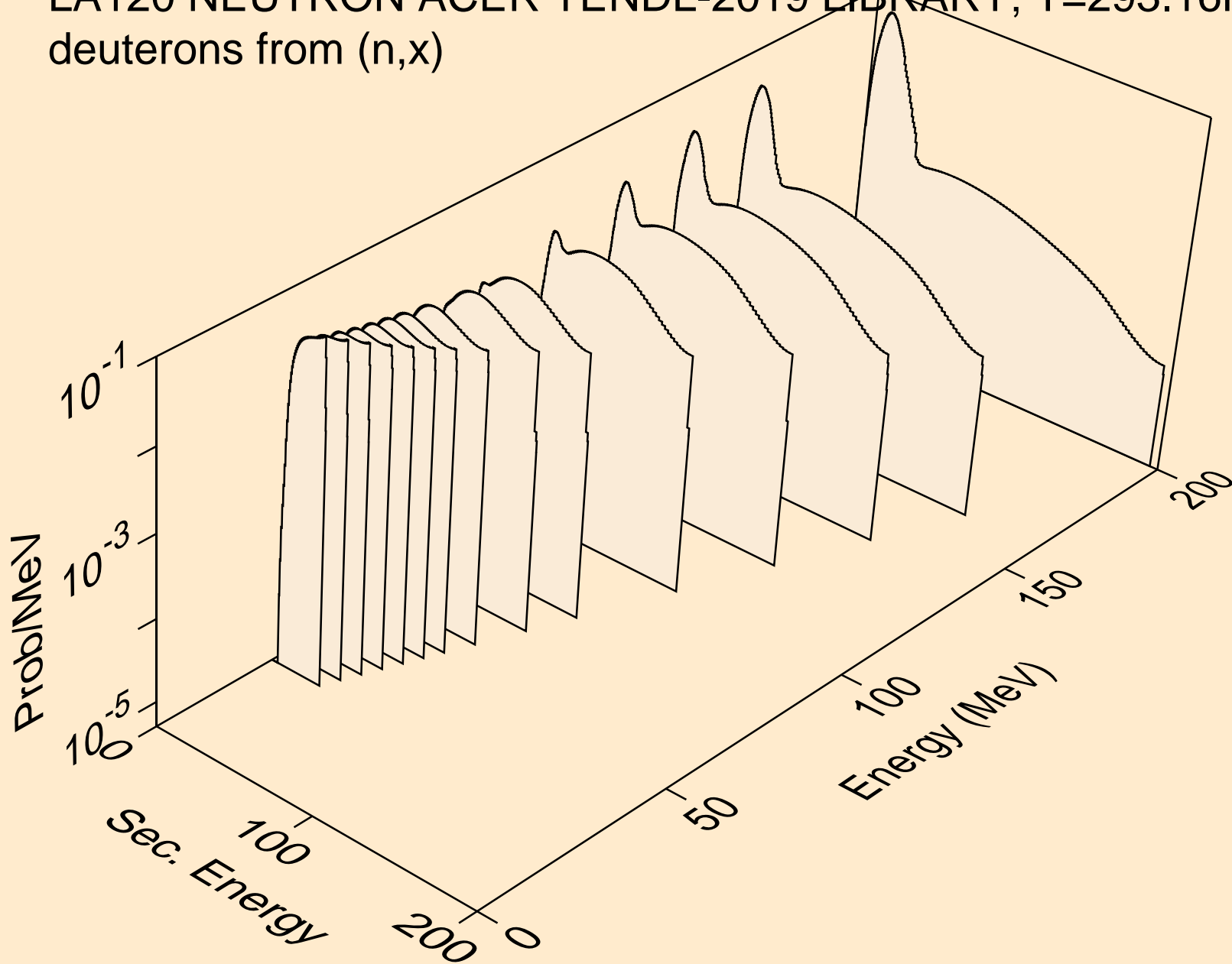

LA120 NEUTRON ACER TENDL-2019 LIBRARY; T=293.16K
deuterons from (n,2nd)

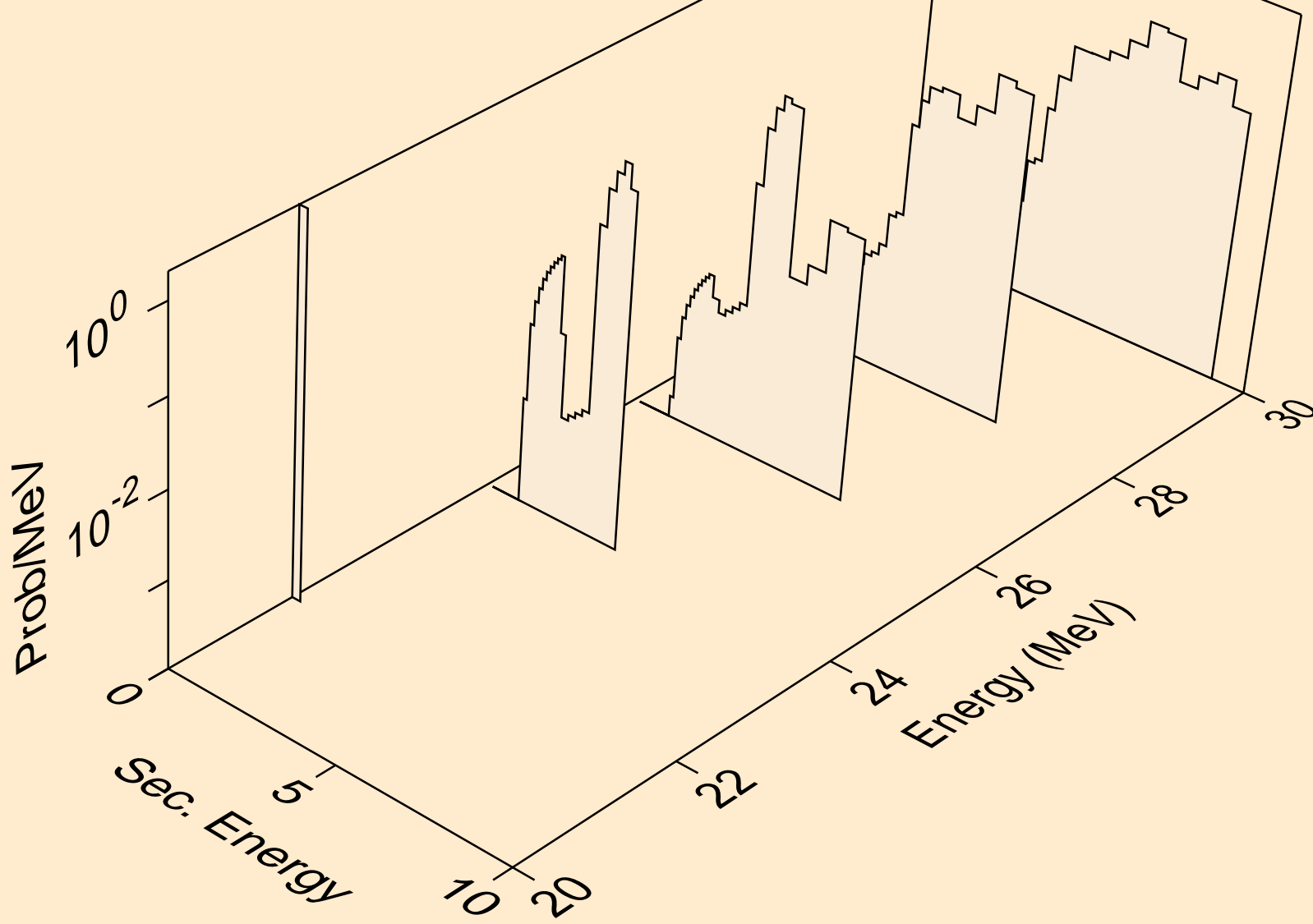

LA120 NEUTRON ACER TENDL-2019 LIBRARY; T=293.16K
deuterons from (n,n*)d

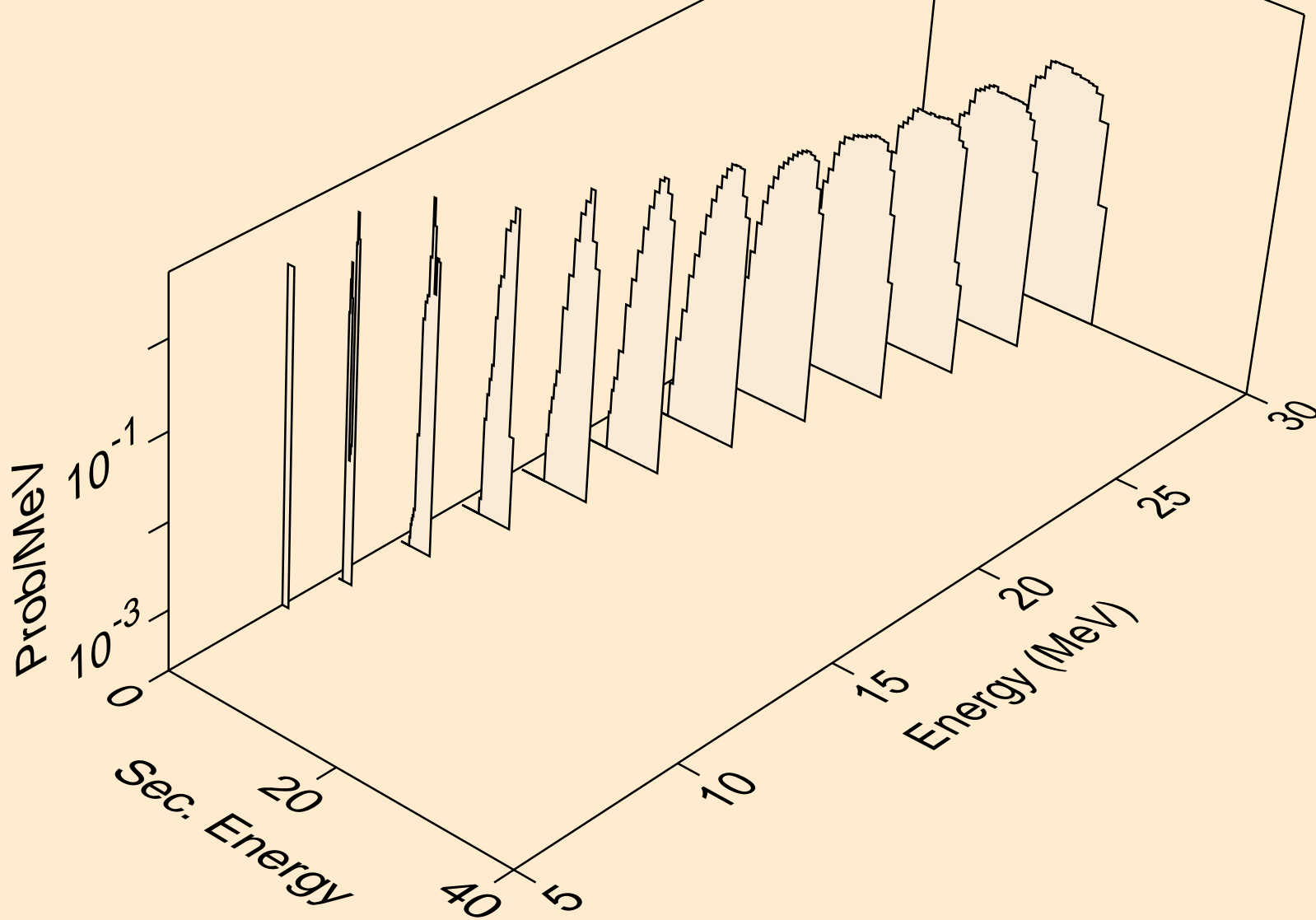

LA120 NEUTRON ACER TENDL-2019 LIBRARY; T=293.16K
deuterons from (n,d)

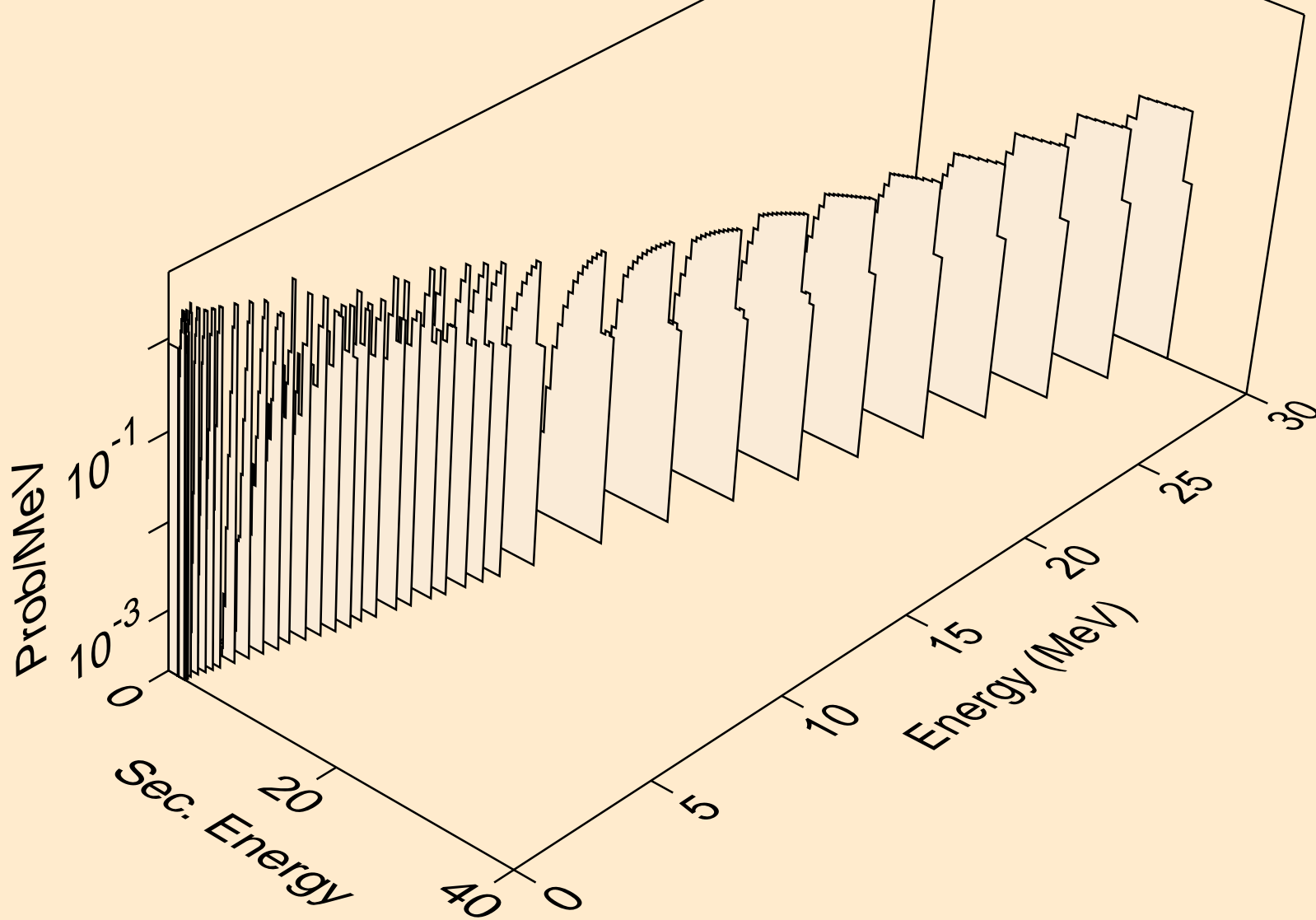

LA120 NEUTRON ACER TENDL-2019 LIBRARY; T=293.16K
deuterons from (n,d2a)

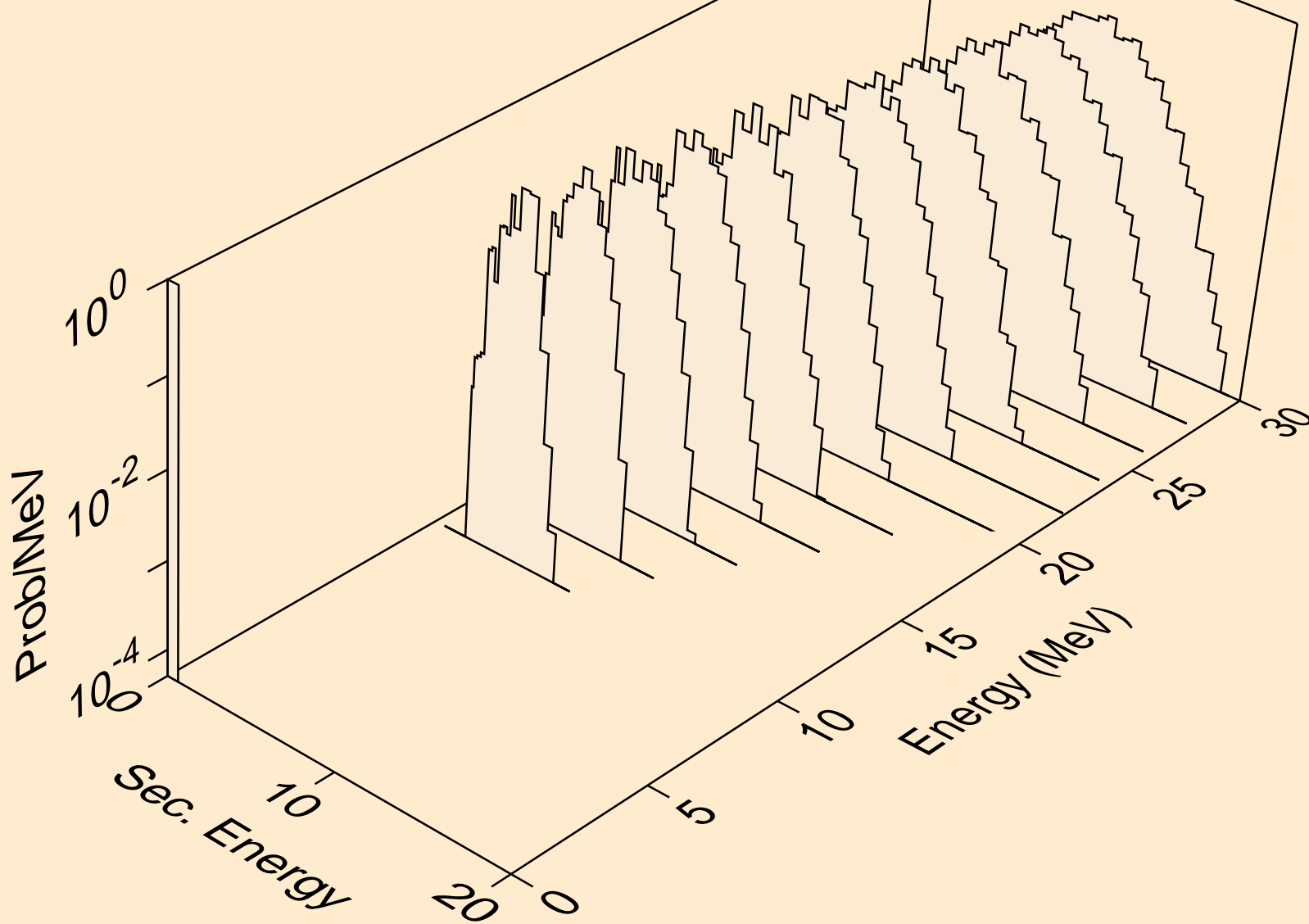

LA120 NEUTRON ACER TENDL-2019 LIBRARY; T=293.16K
deuterons from (n,pd)

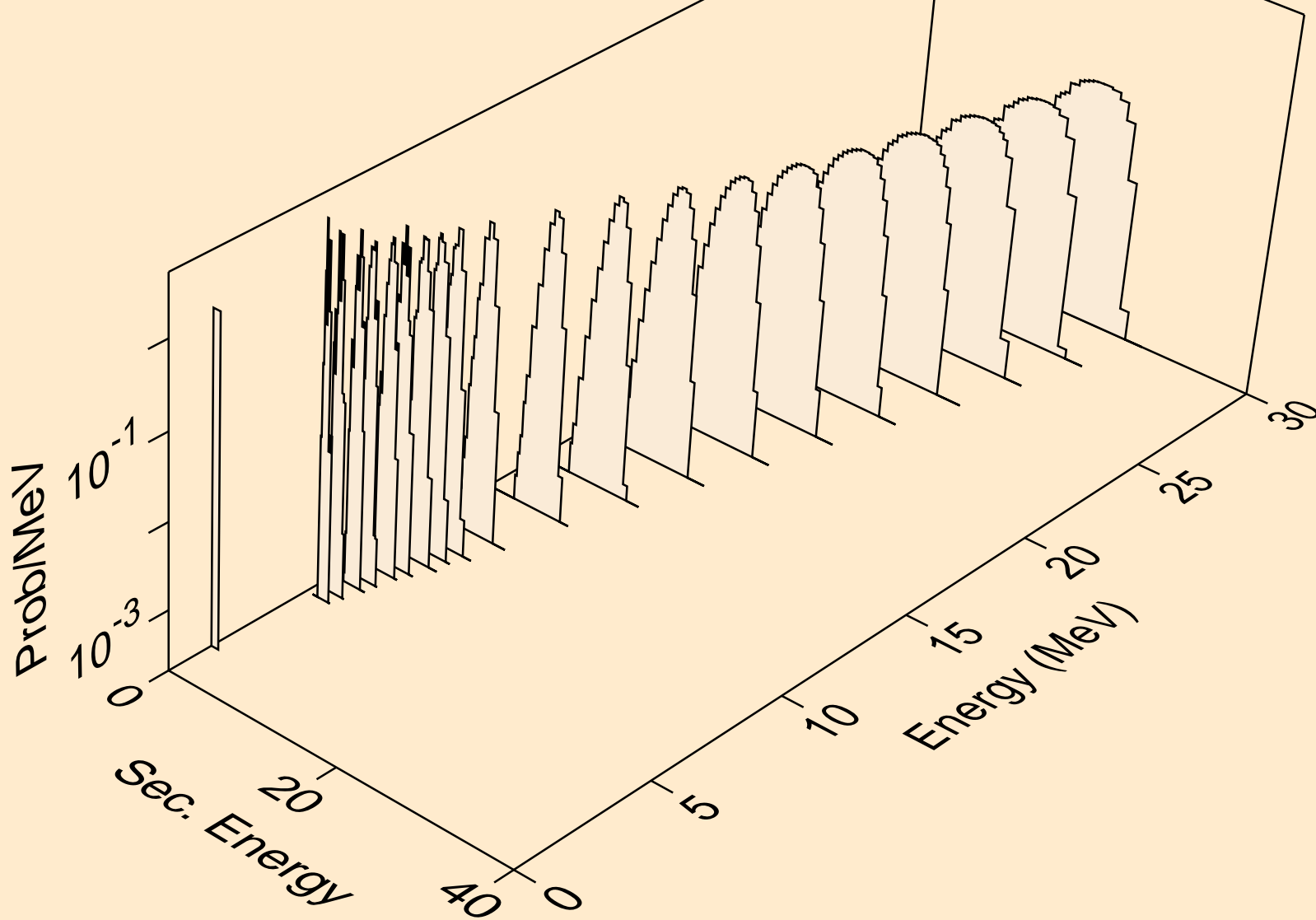

LA120 NEUTRON ACER TENDL-2019 LIBRARY; T=293.16K
deuterons from (n,da)

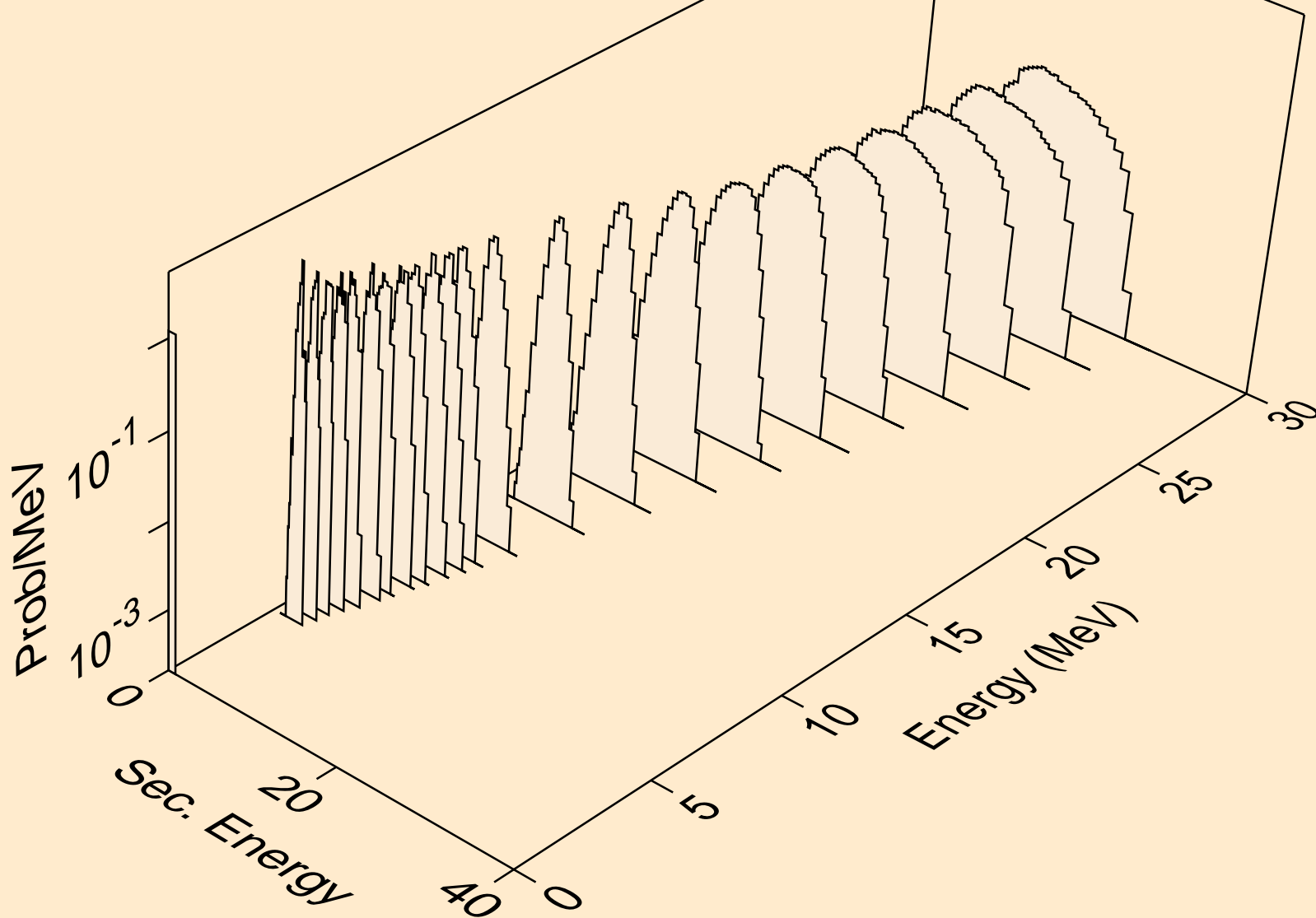

LA120 NEUTRON ACER TENDL-2019 LIBRARY; T=293.16K
tritons from (n,x)

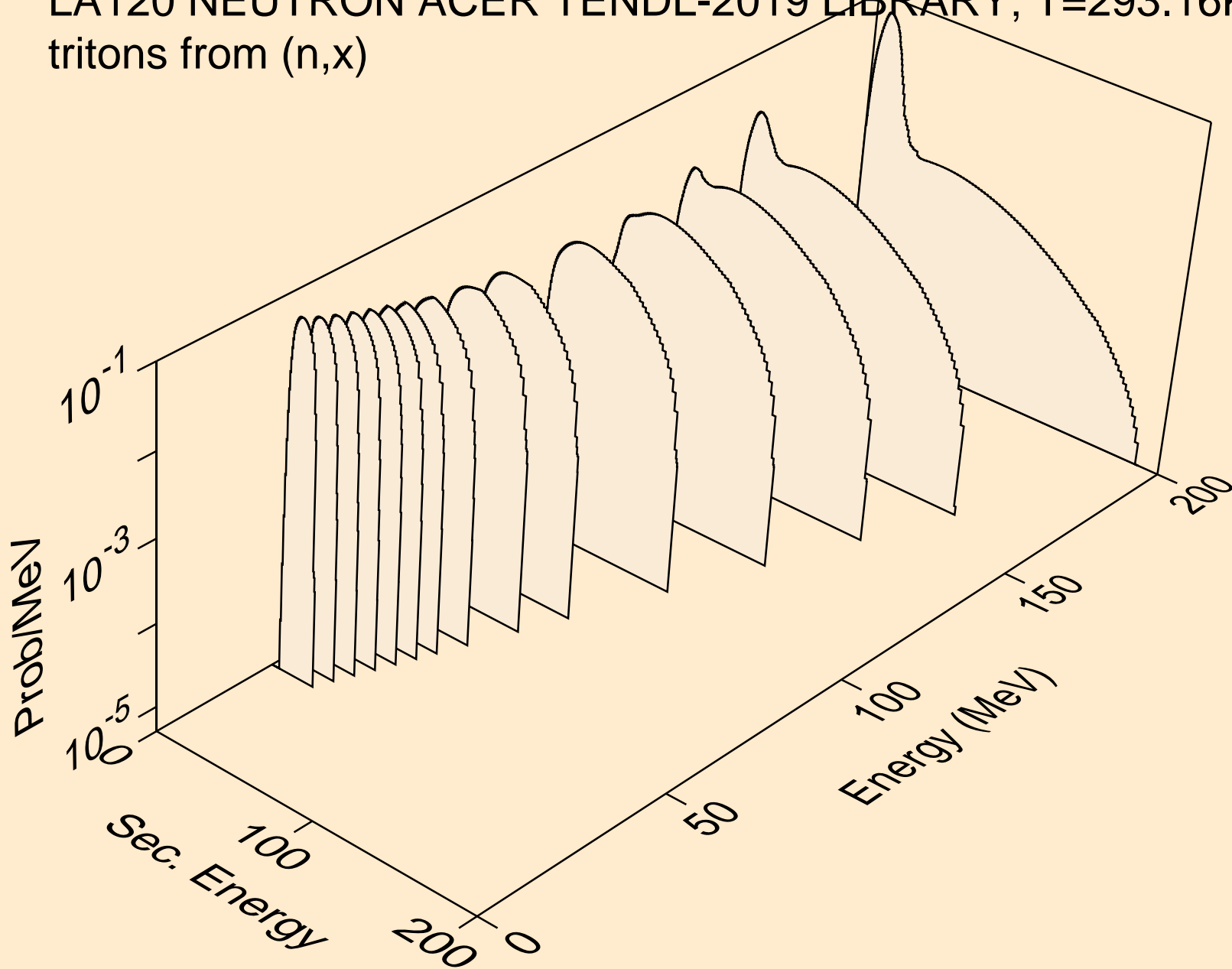

LA120 NEUTRON ACER TENDL-2019 LIBRARY; T=293.16K
tritons from (n,n*)t

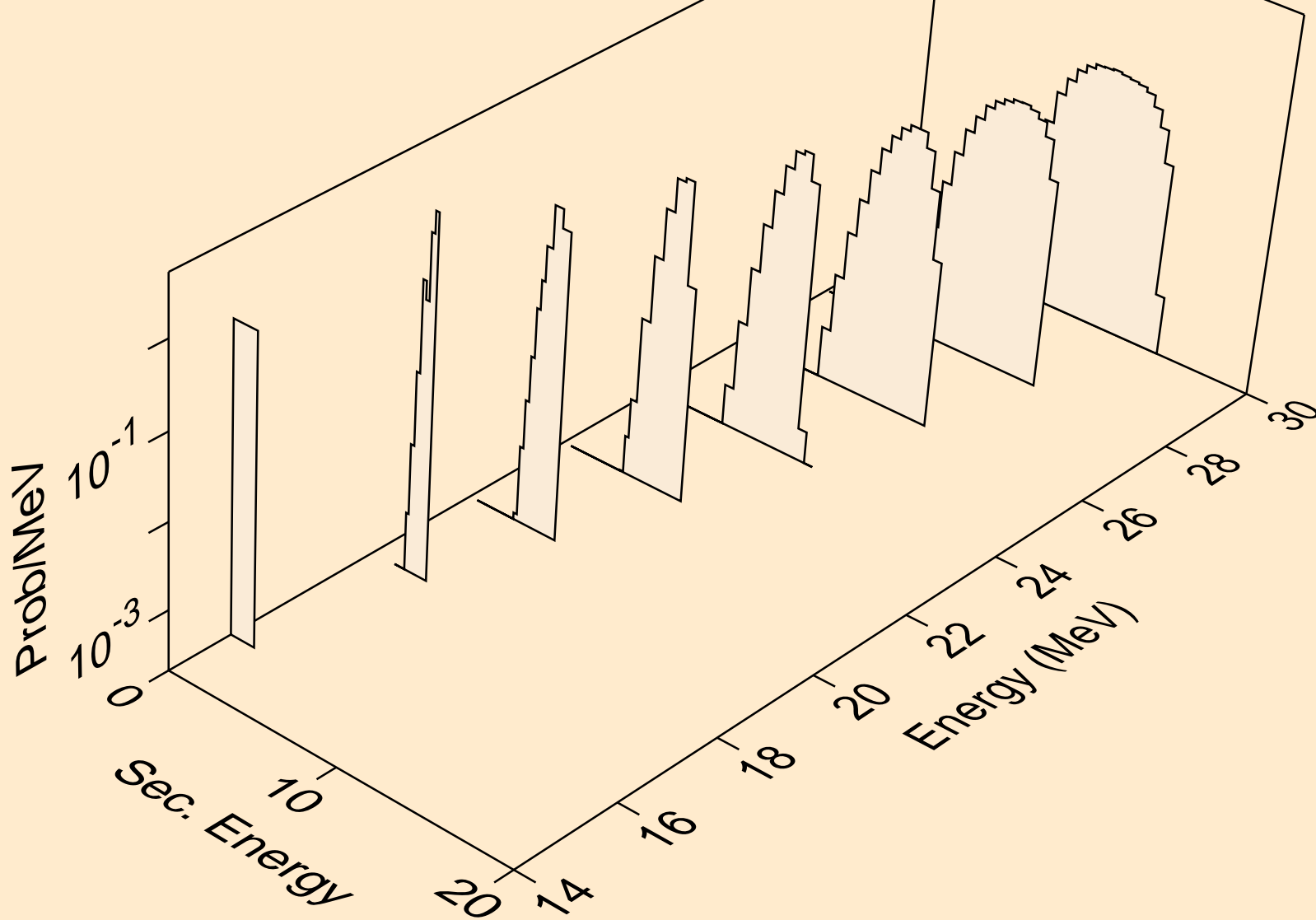

LA120 NEUTRON ACER TENDL-2019 LIBRARY; T=293.16K
tritons from (n,t)

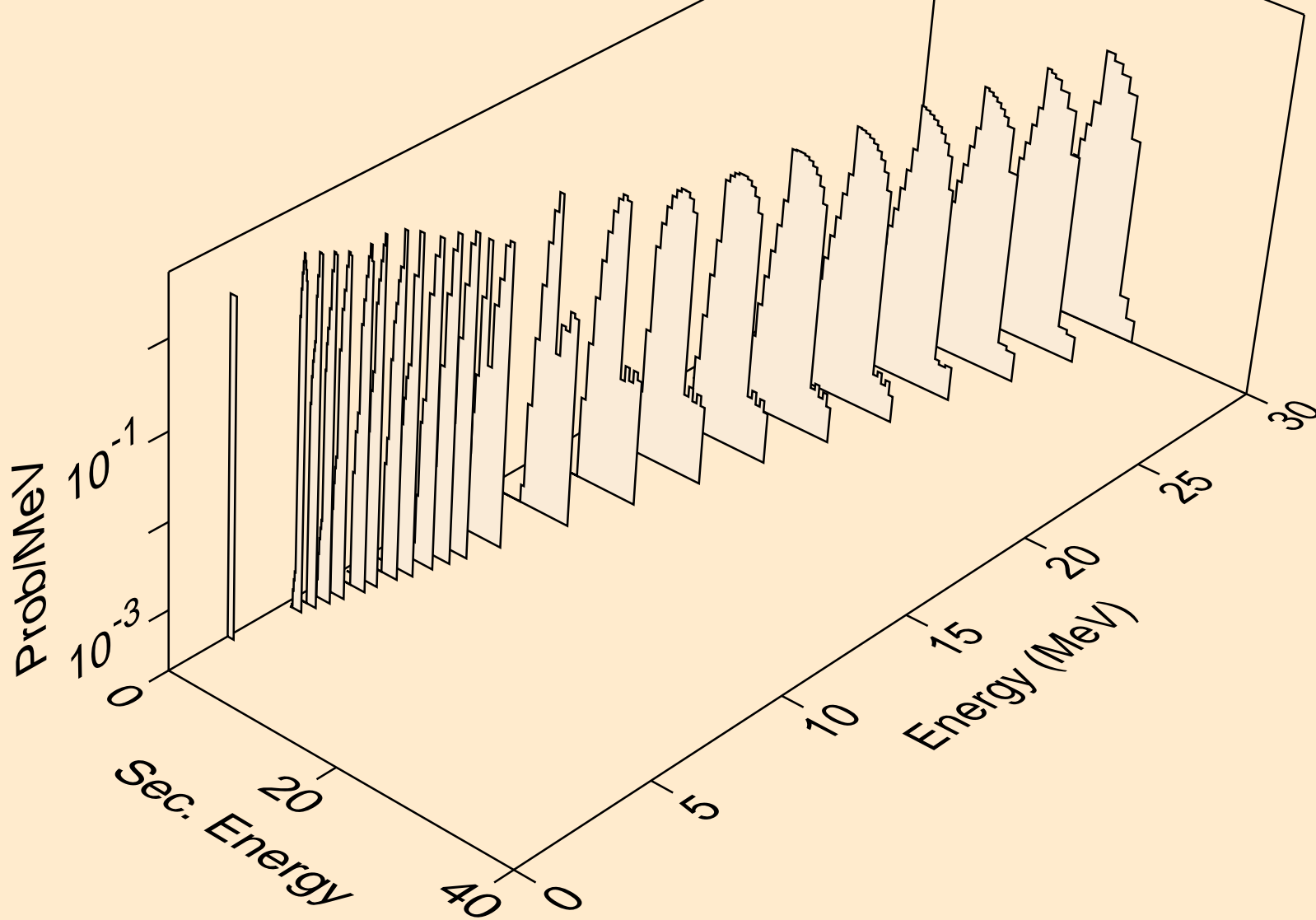

LA120 NEUTRON ACER TENDL-2019 LIBRARY; T=293.16K
tritons from (n,t2a)

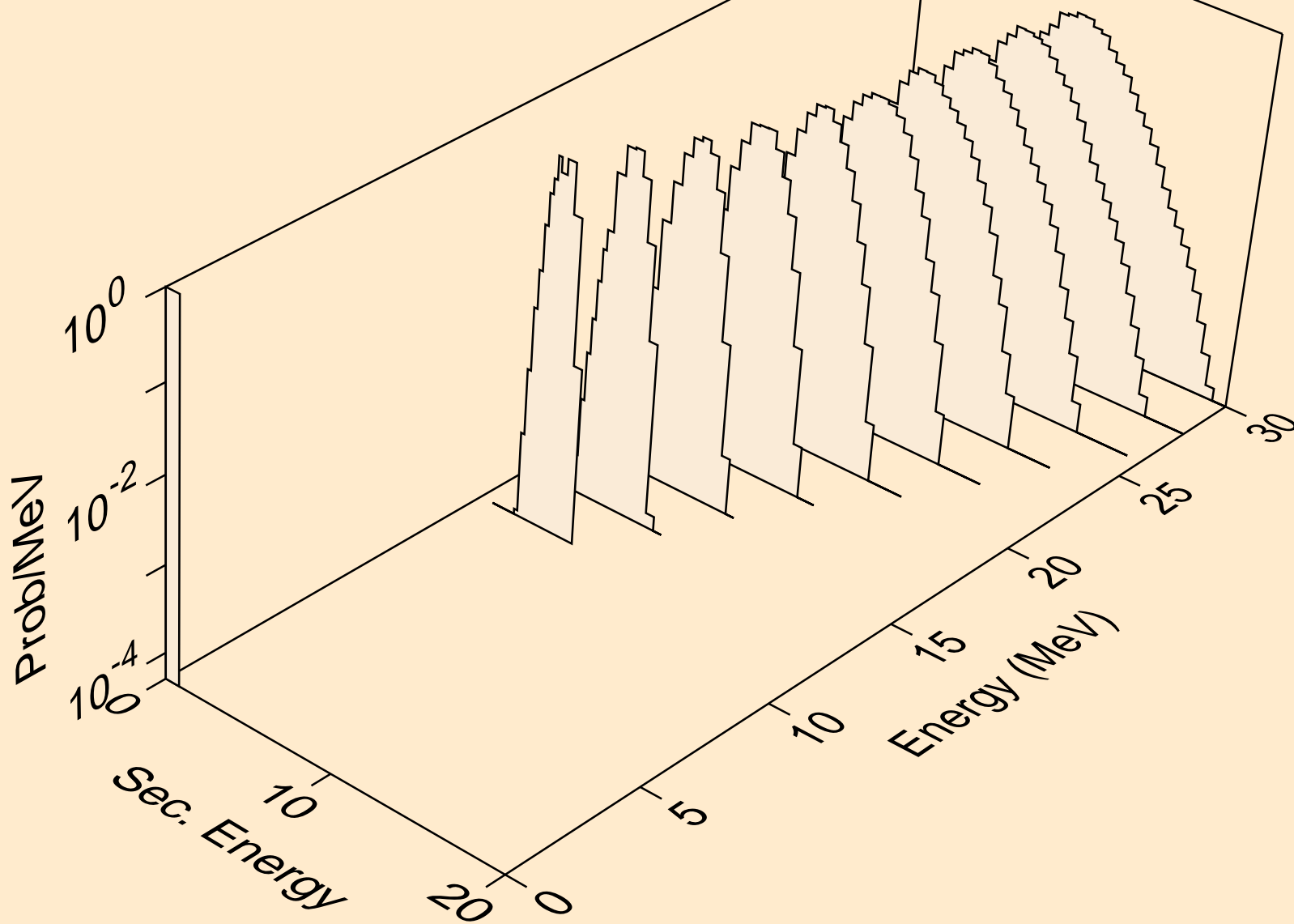

LA120 NEUTRON ACER TENDL-2019 LIBRARY; T=293.16K
tritons from (n,pt)

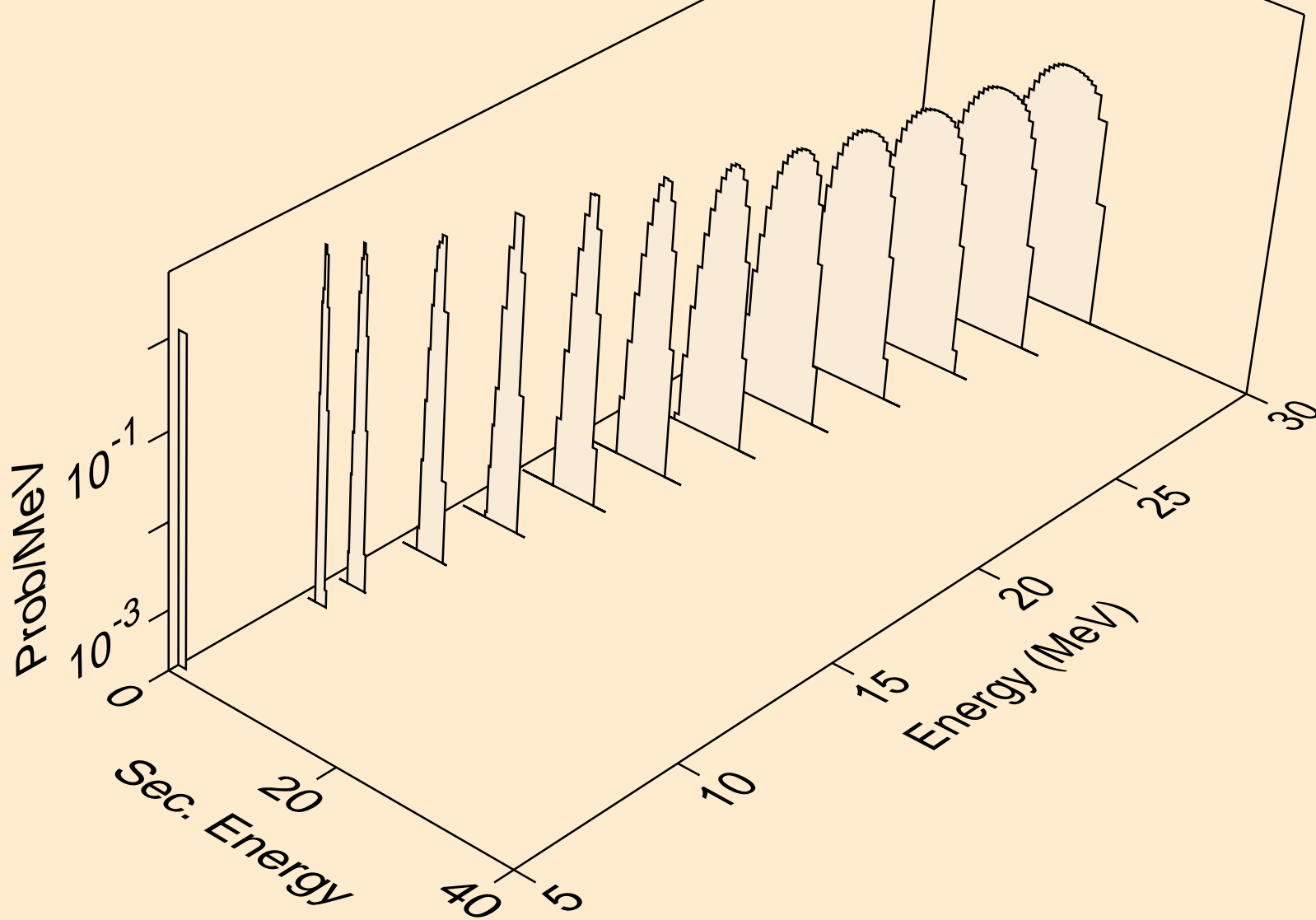

LA120 NEUTRON ACER TENDL-2019 LIBRARY; T=293.16K
he3s from (n,x)

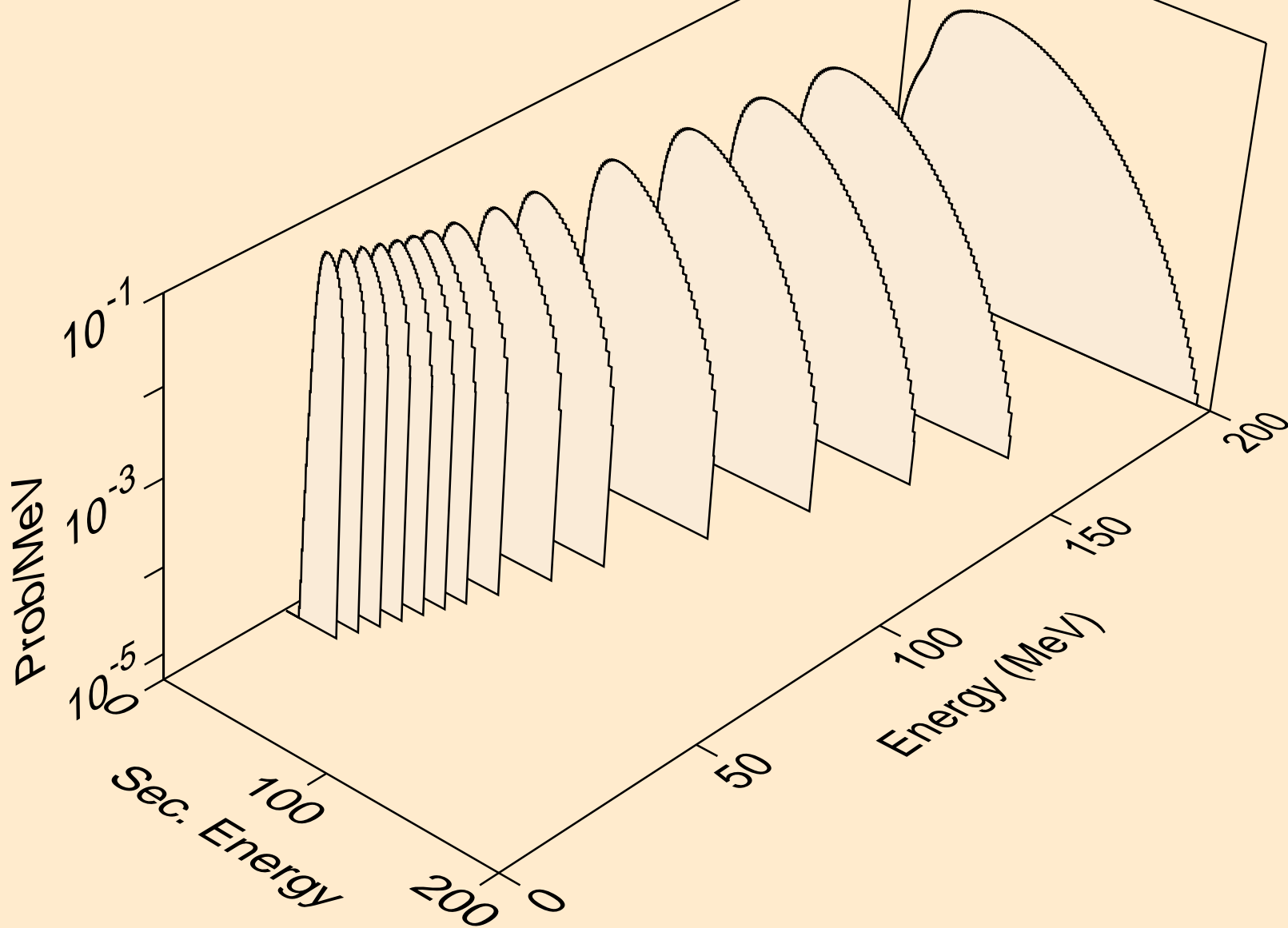

LA120 NEUTRON ACER TENDL-2019 LIBRARY; T=293.16K
he3s from (n,n*)he3

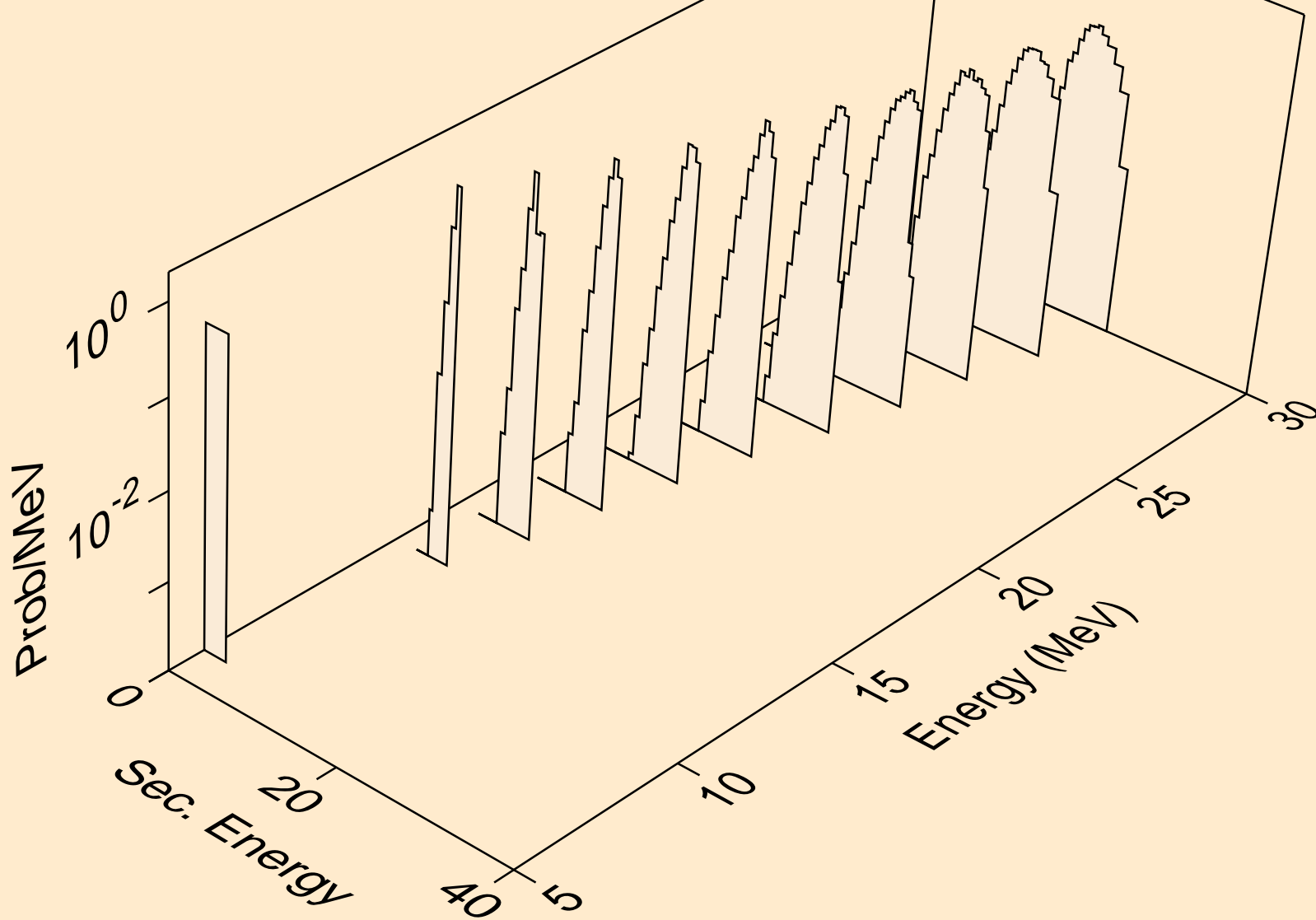

LA120 NEUTRON ACER TENDL-2019 LIBRARY; T=293.16K
he3s from (n,he3)

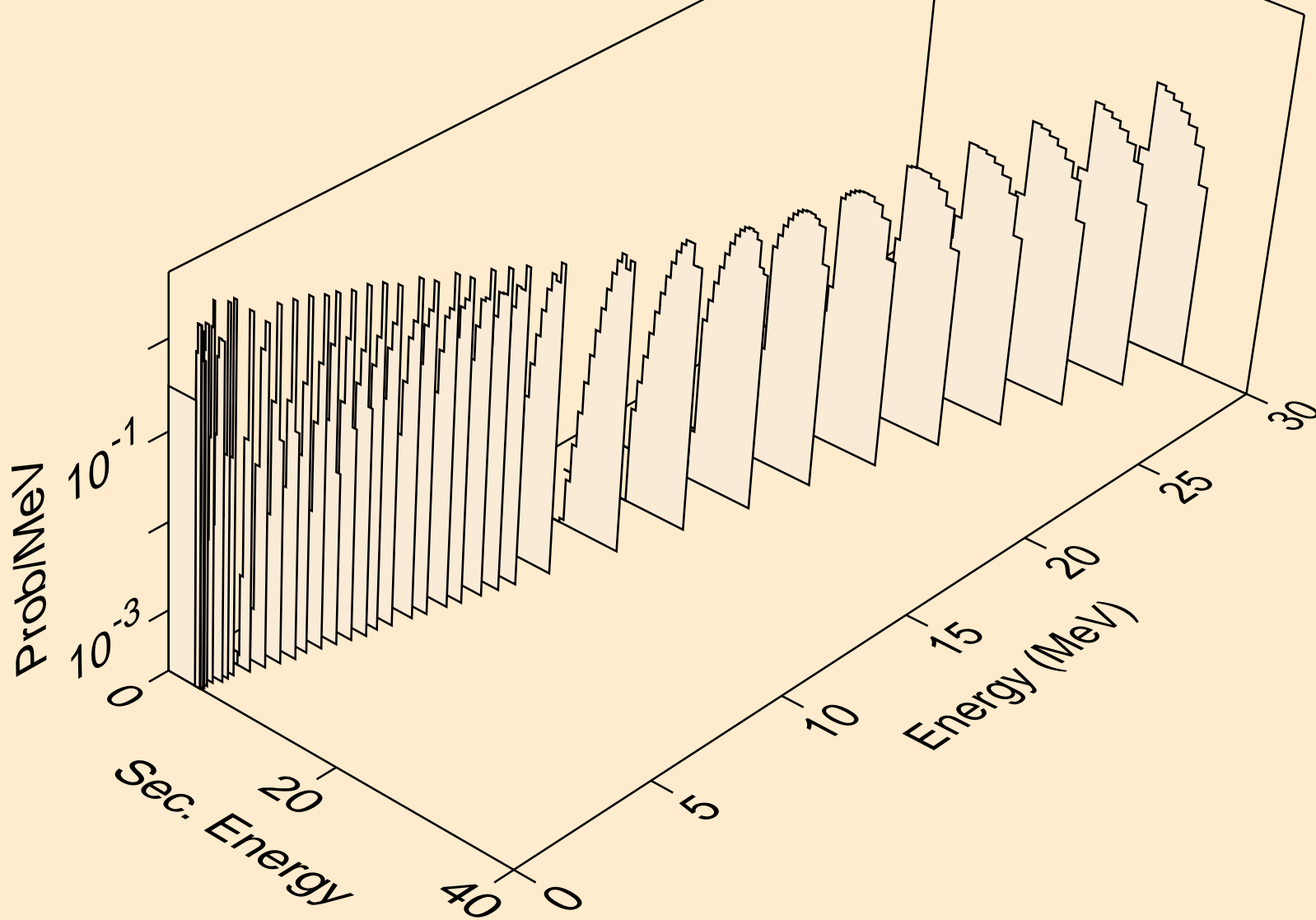

LA120 NEUTRON ACER TENDL-2019 LIBRARY; T=293.16K
alphas from (n,x)

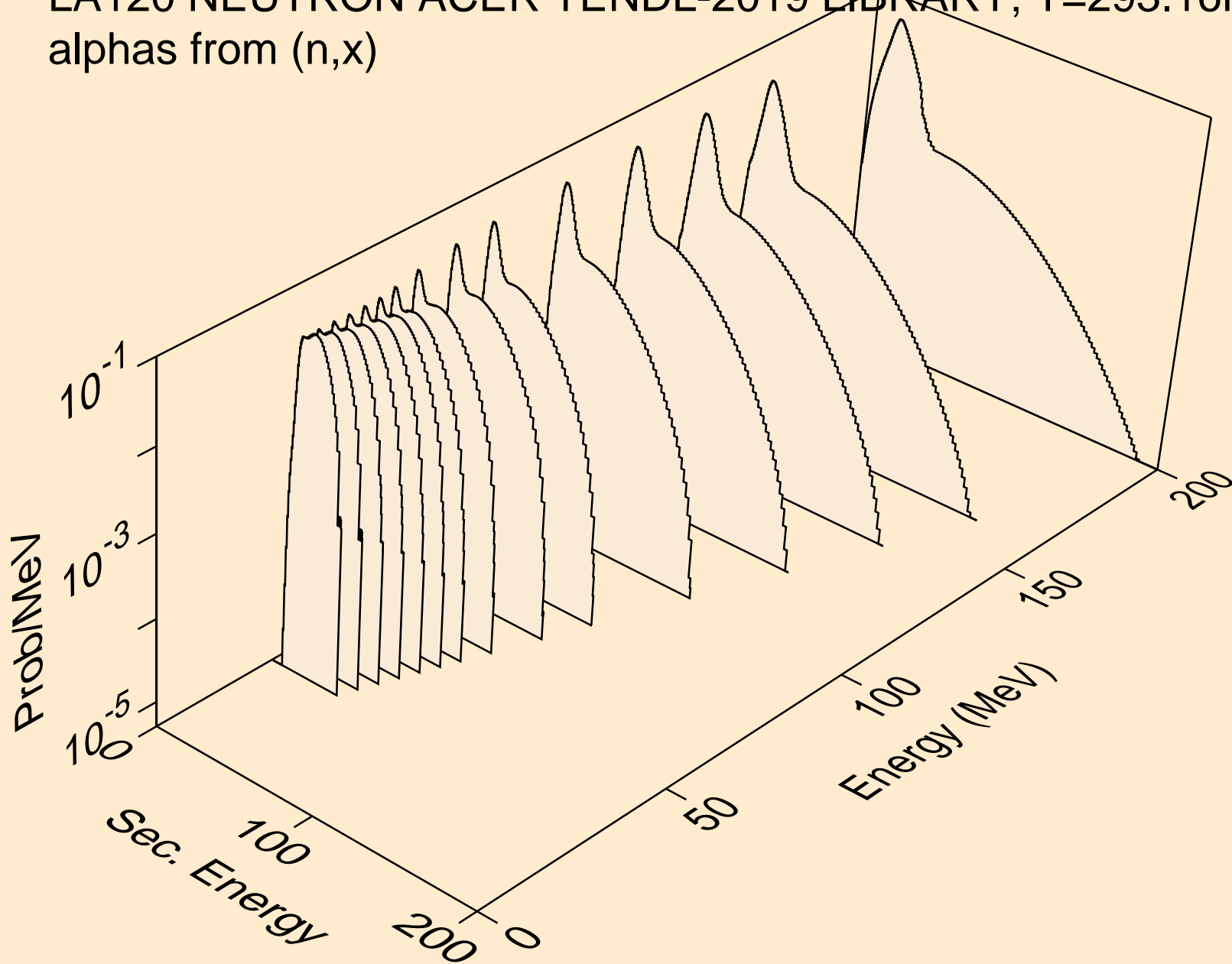

LA120 NEUTRON ACER TENDL-2019 LIBRARY; T=293.16K
alphas from (n,n*)a

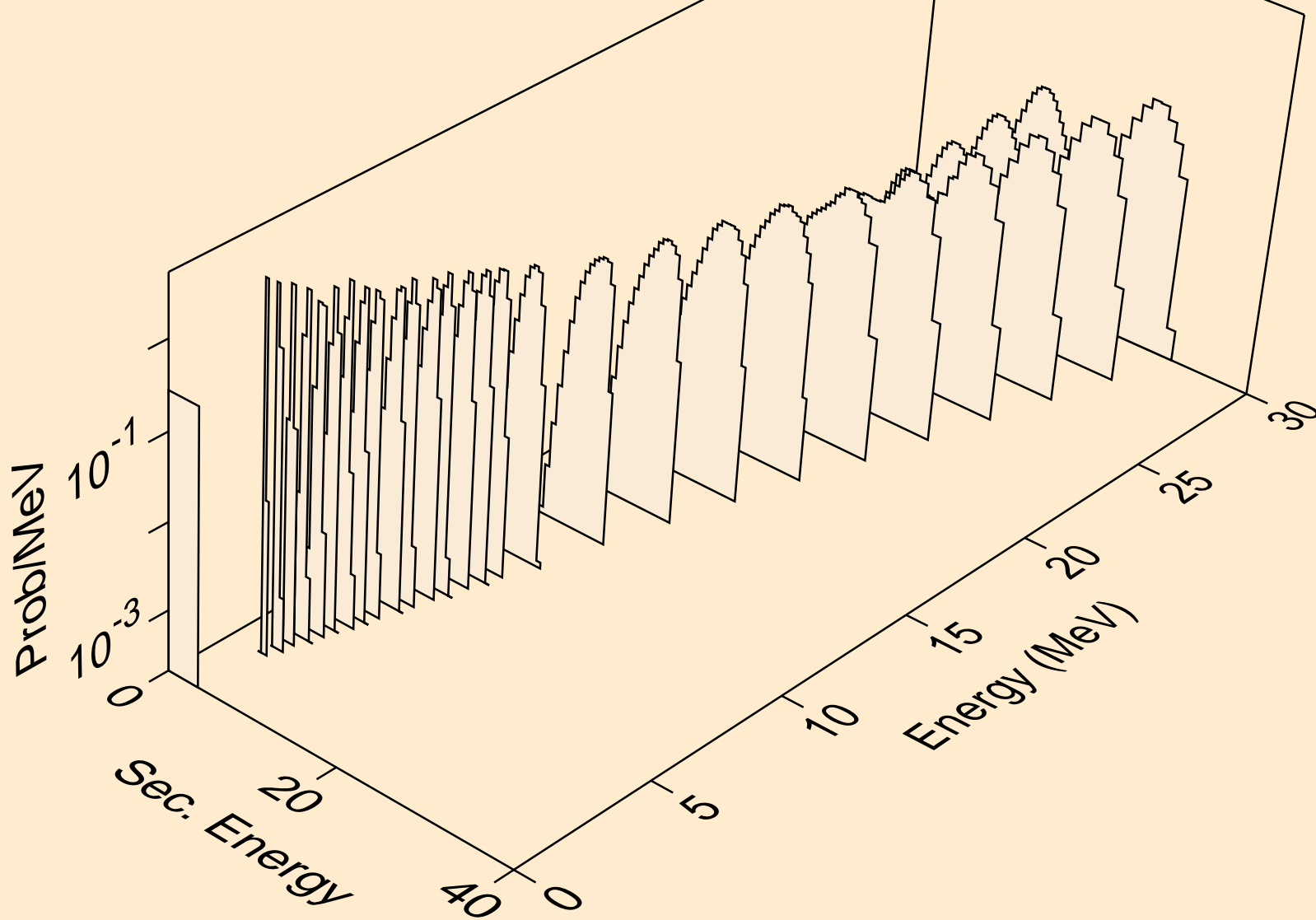

LA120 NEUTRON ACER TENDL-2019 LIBRARY; T=293.16K
alphas from (n,n*)3a

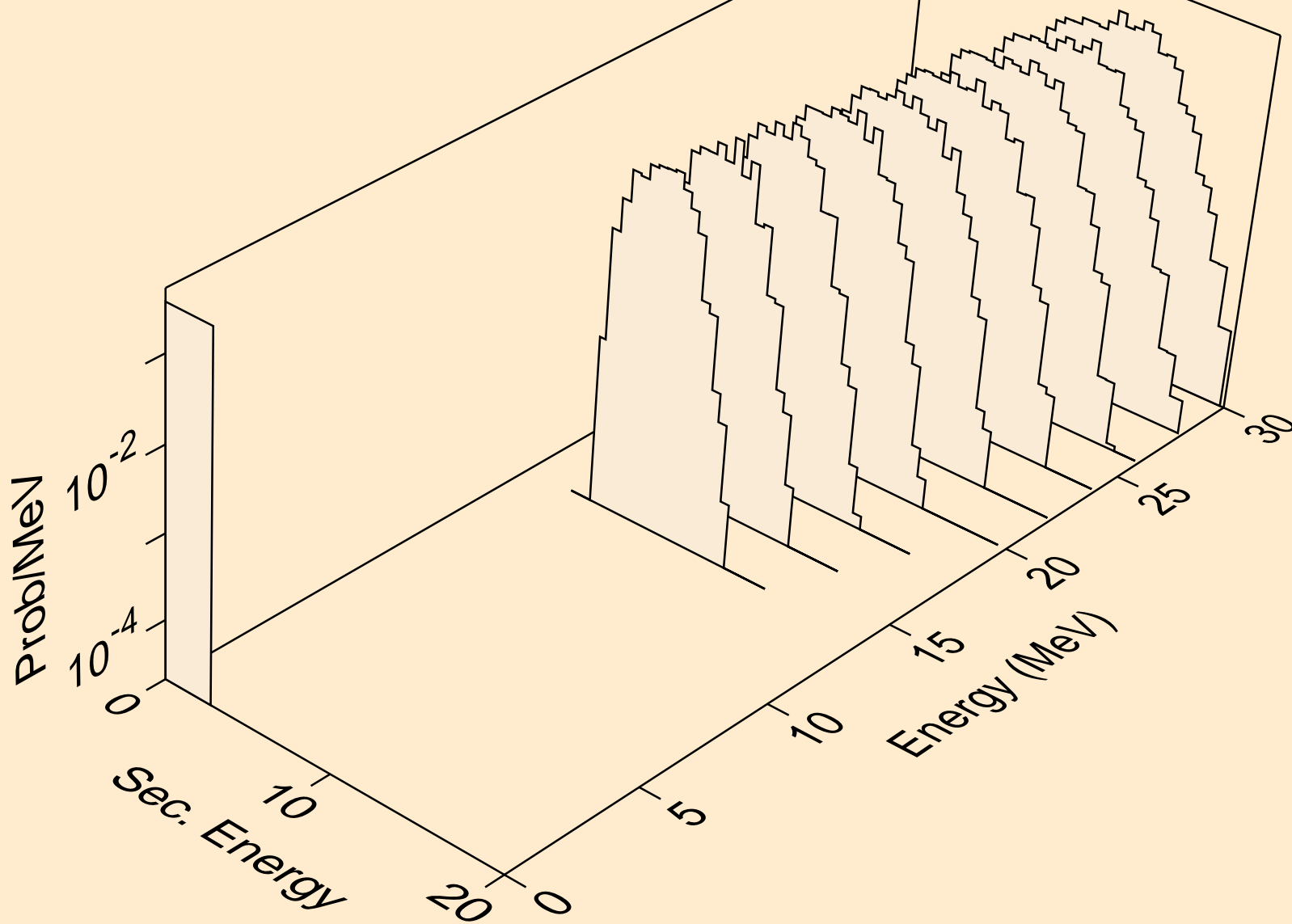

LA120 NEUTRON ACER TENDL-2019 LIBRARY; T=293.16K
alphas from (n,2n)a

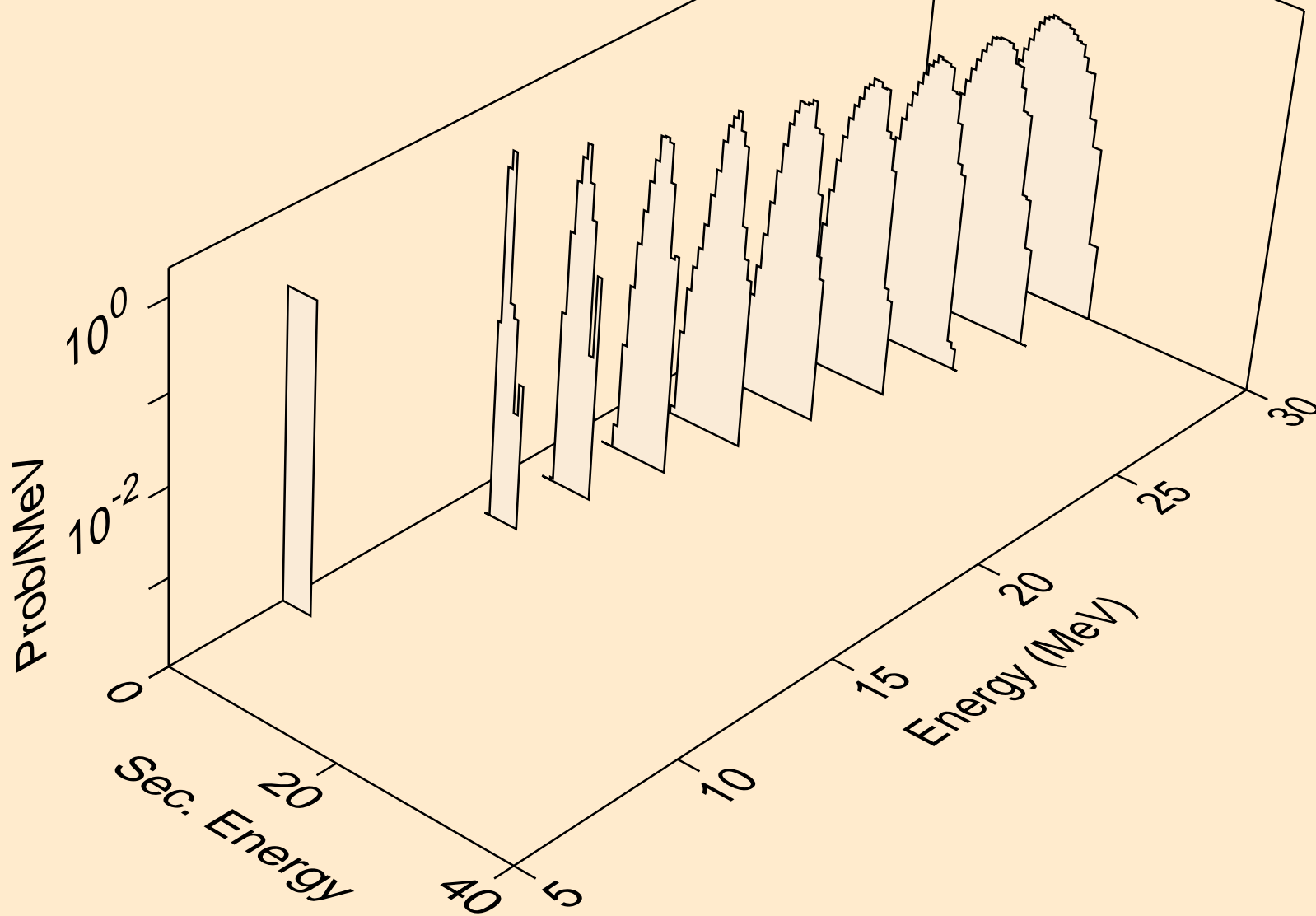

LA120 NEUTRON ACER TENDL-2019 LIBRARY; T=293.16K
alphas from (n,n*)2a

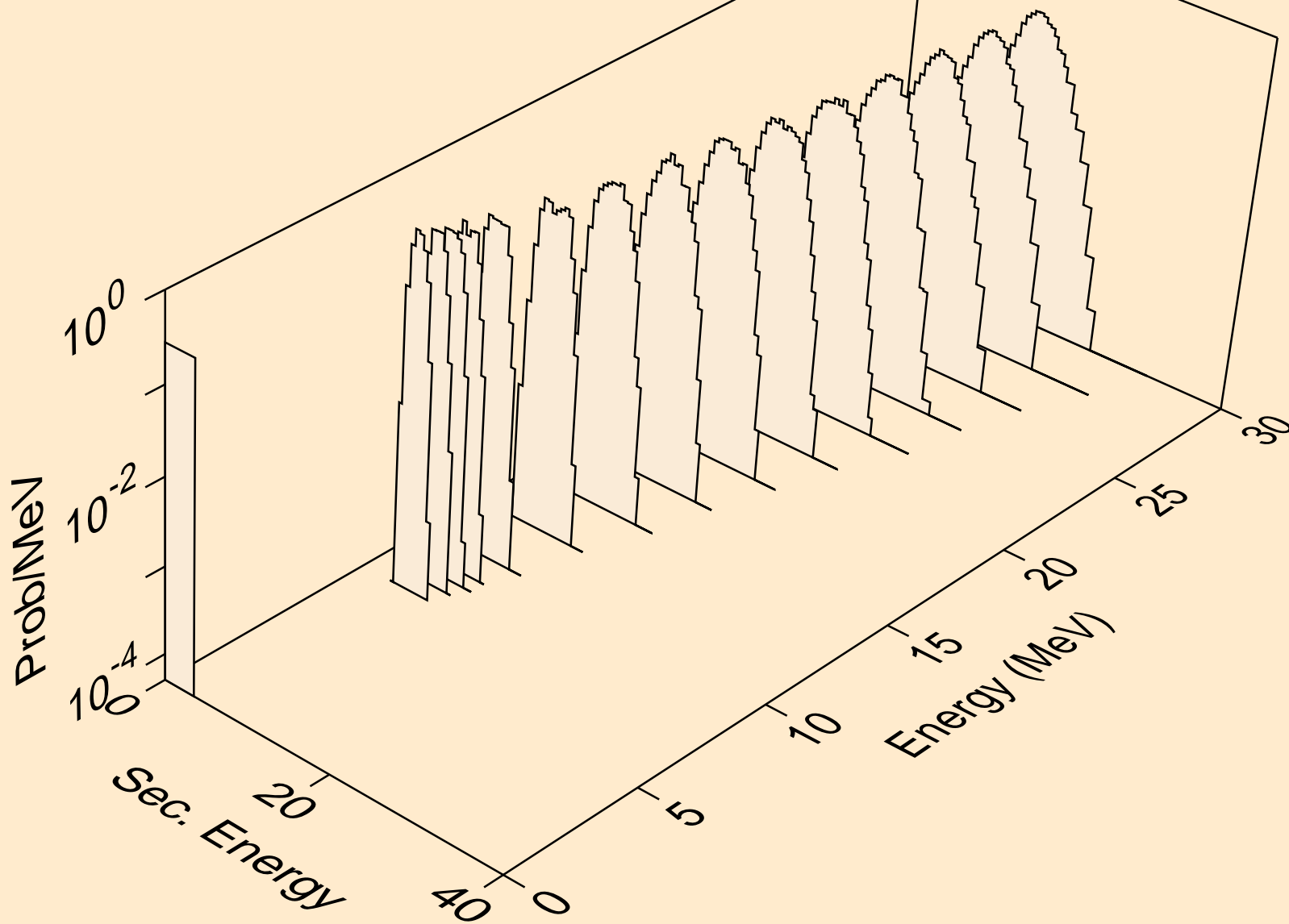

LA120 NEUTRON ACER TENDL-2019 LIBRARY; T=293.16K
alphas from (n,2n)2a

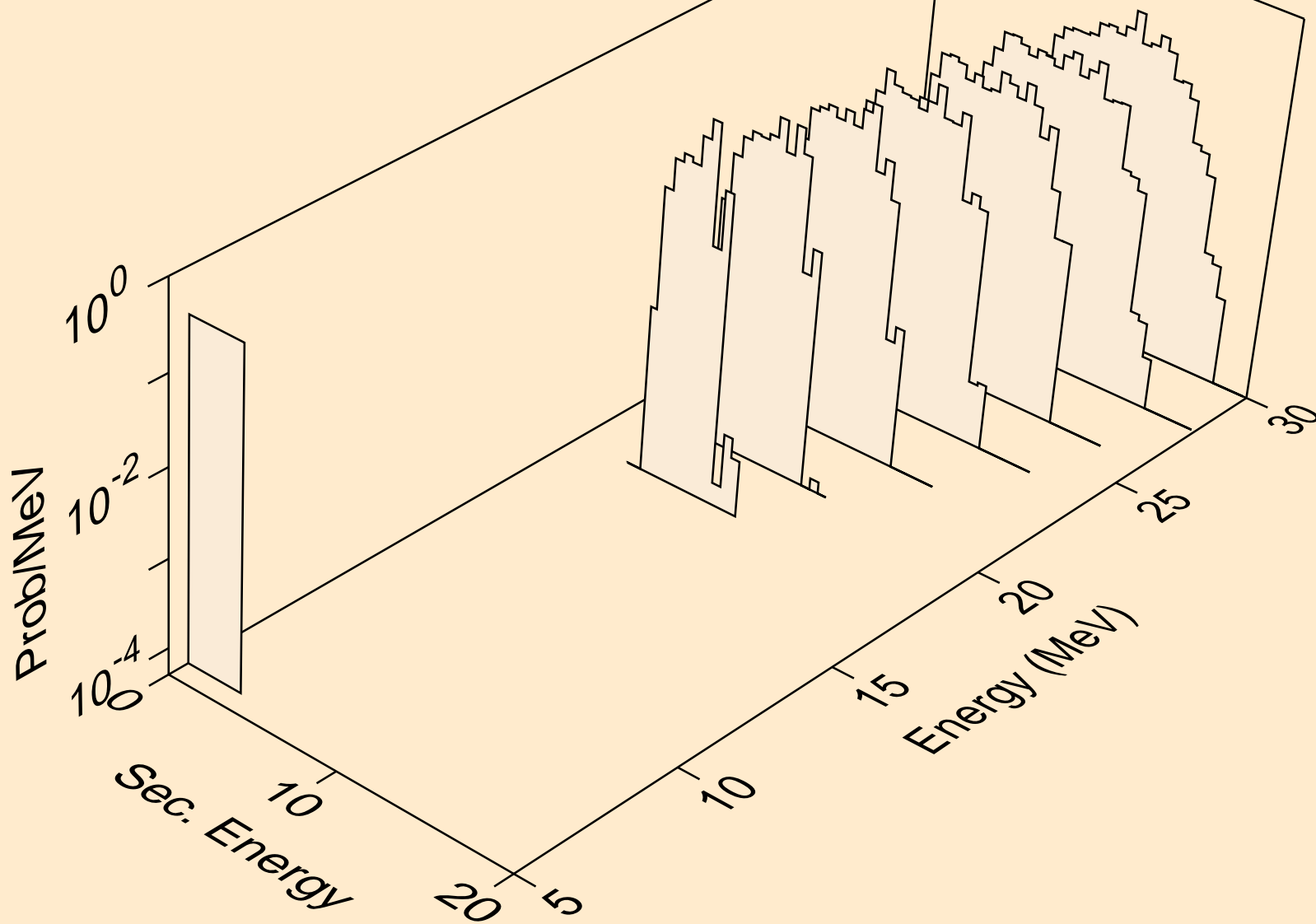

LA120 NEUTRON ACER TENDL-2019 LIBRARY; T=293.16K
alphas from (n,npa)

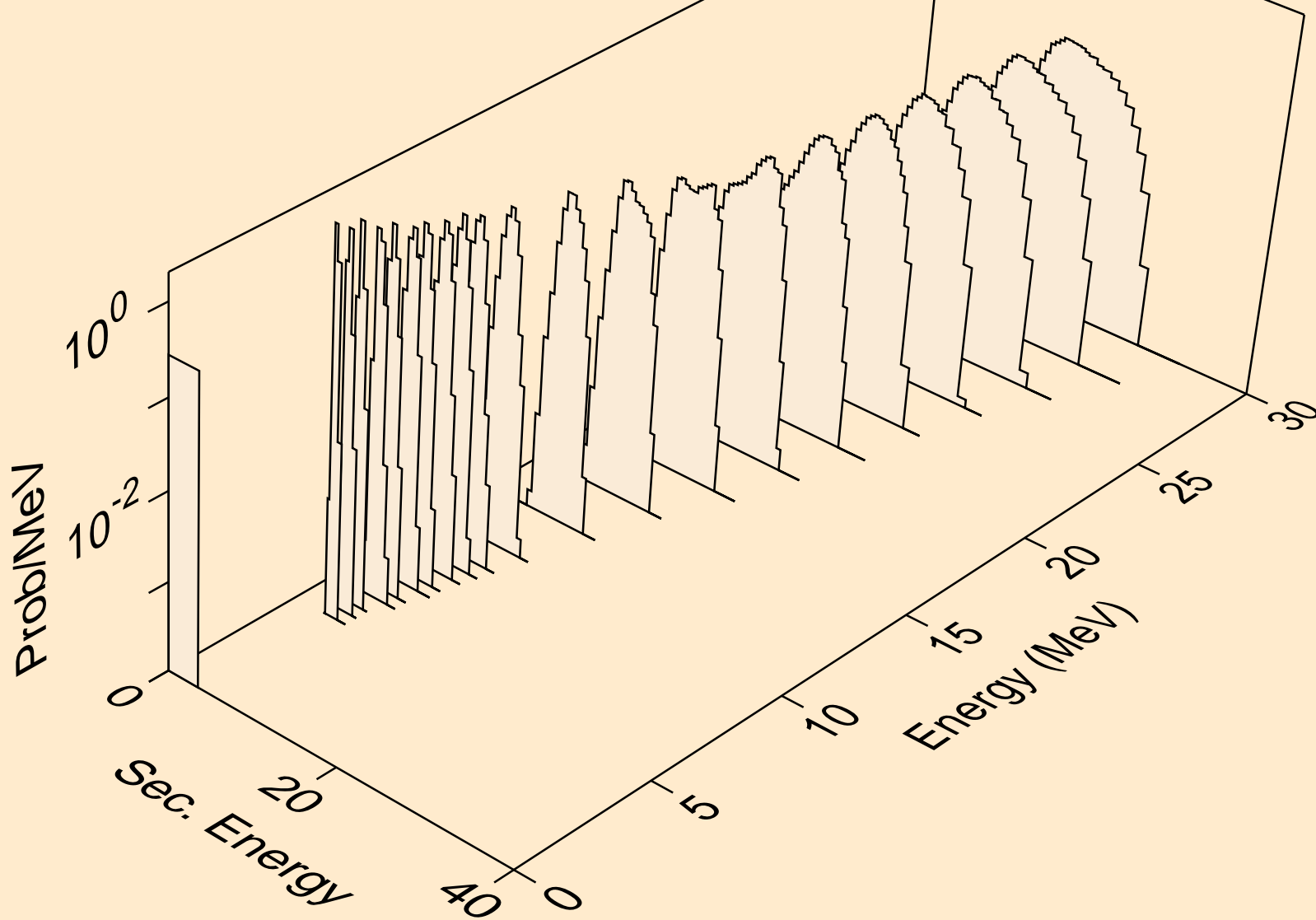

LA120 NEUTRON ACER TENDL-2019 LIBRARY; T=293.16K
alphas from (n,a)

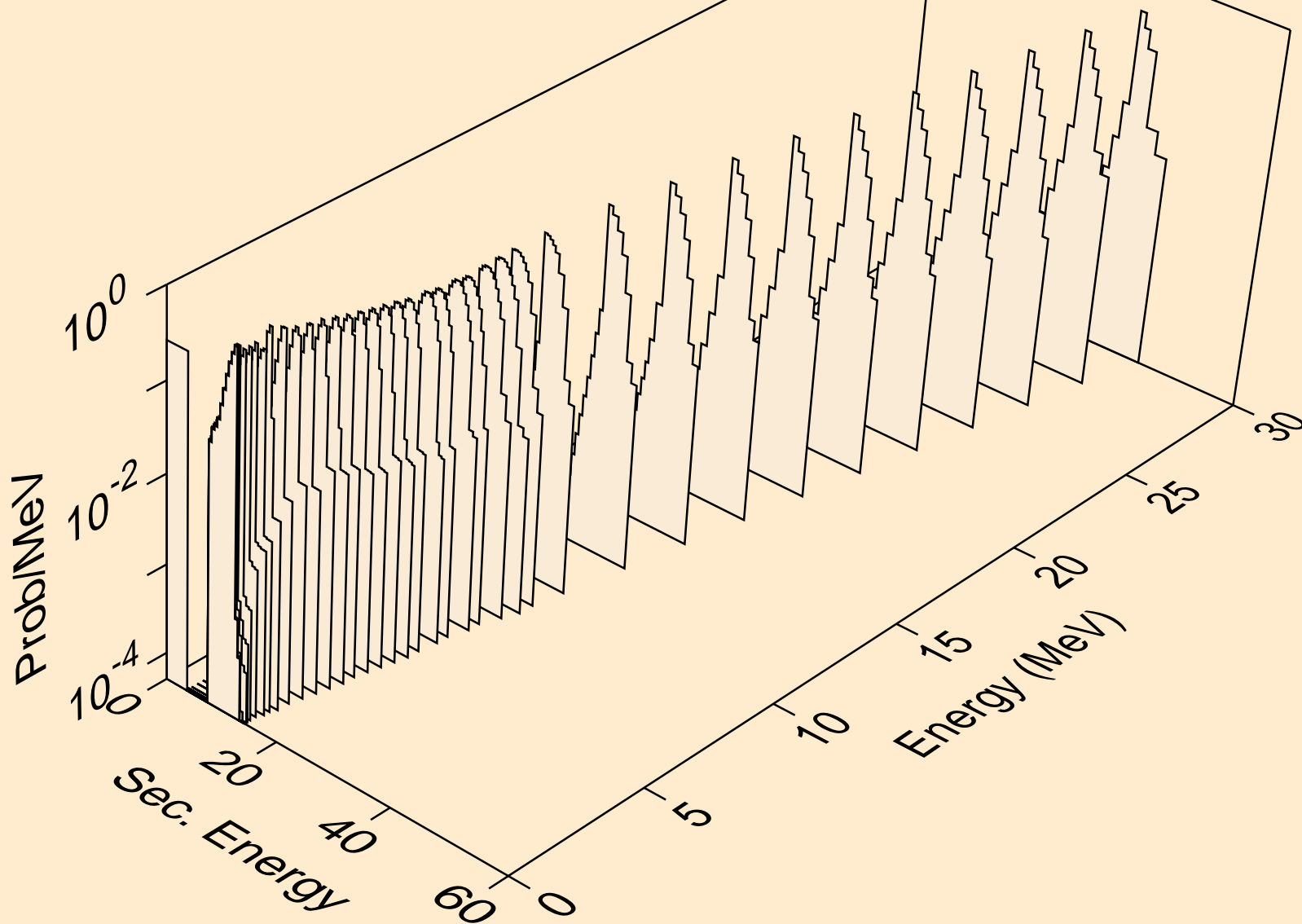

LA120 NEUTRON ACER TENDL-2019 LIBRARY; T=293.16K
alphas from (n,2a)

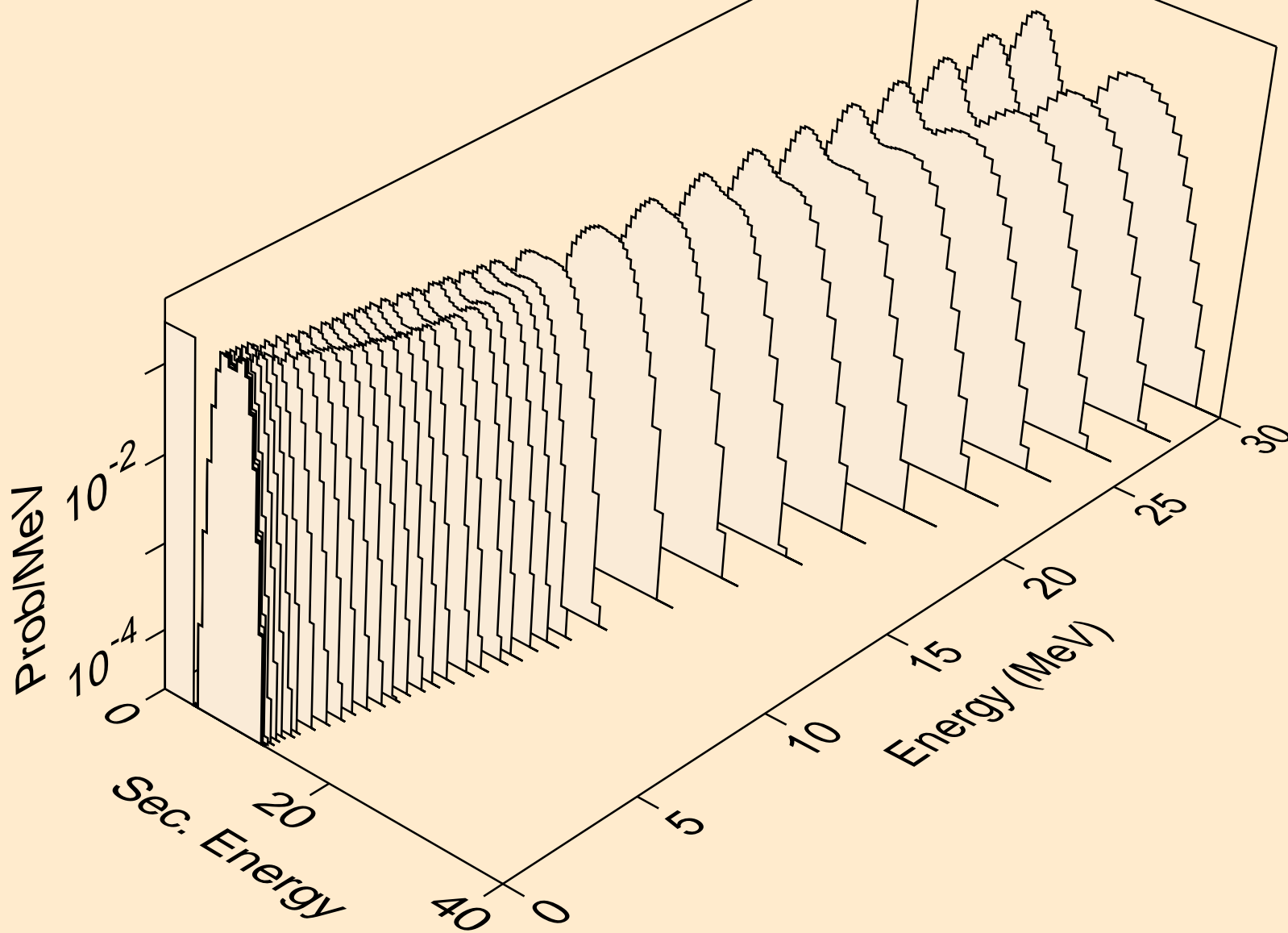

LA120 NEUTRON ACER TENDL-2019 LIBRARY; T=293.16K
alphas from (n,3a)

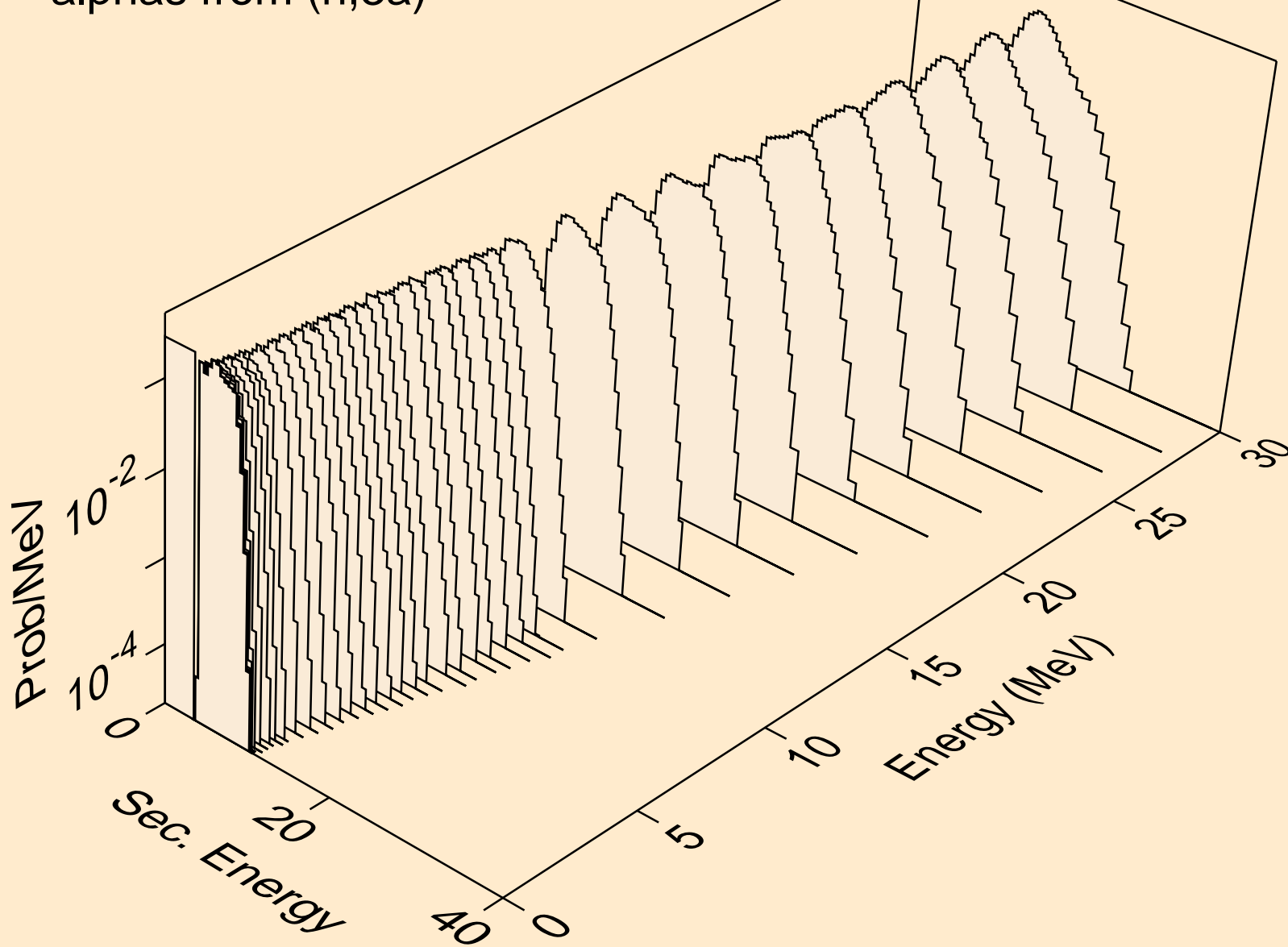

LA120 NEUTRON ACER TENDL-2019 LIBRARY; T=293.16K
alphas from (n,pa)

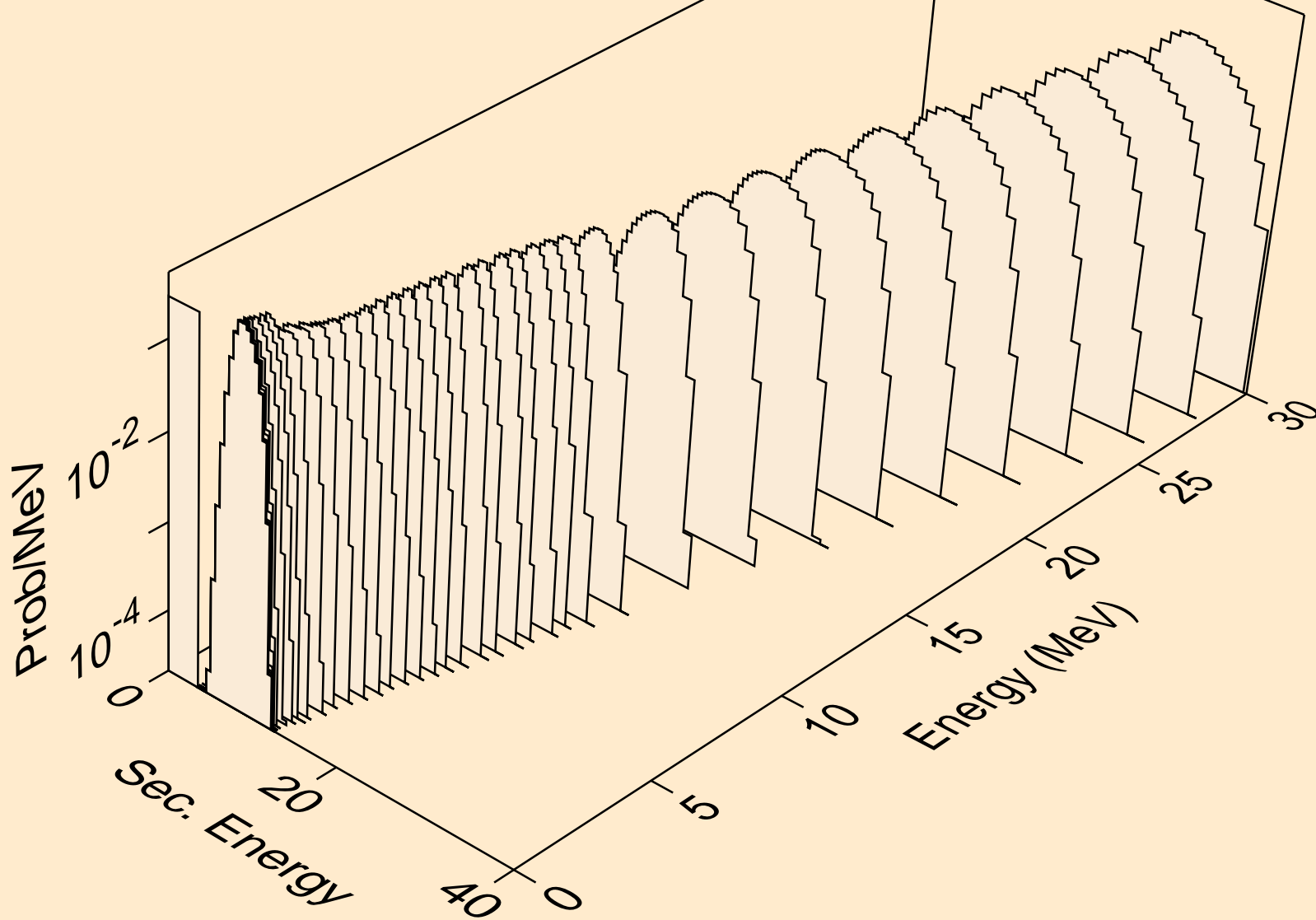

LA120 NEUTRON ACER TENDL-2019 LIBRARY; T=293.16K
alphas from (n,t2a)

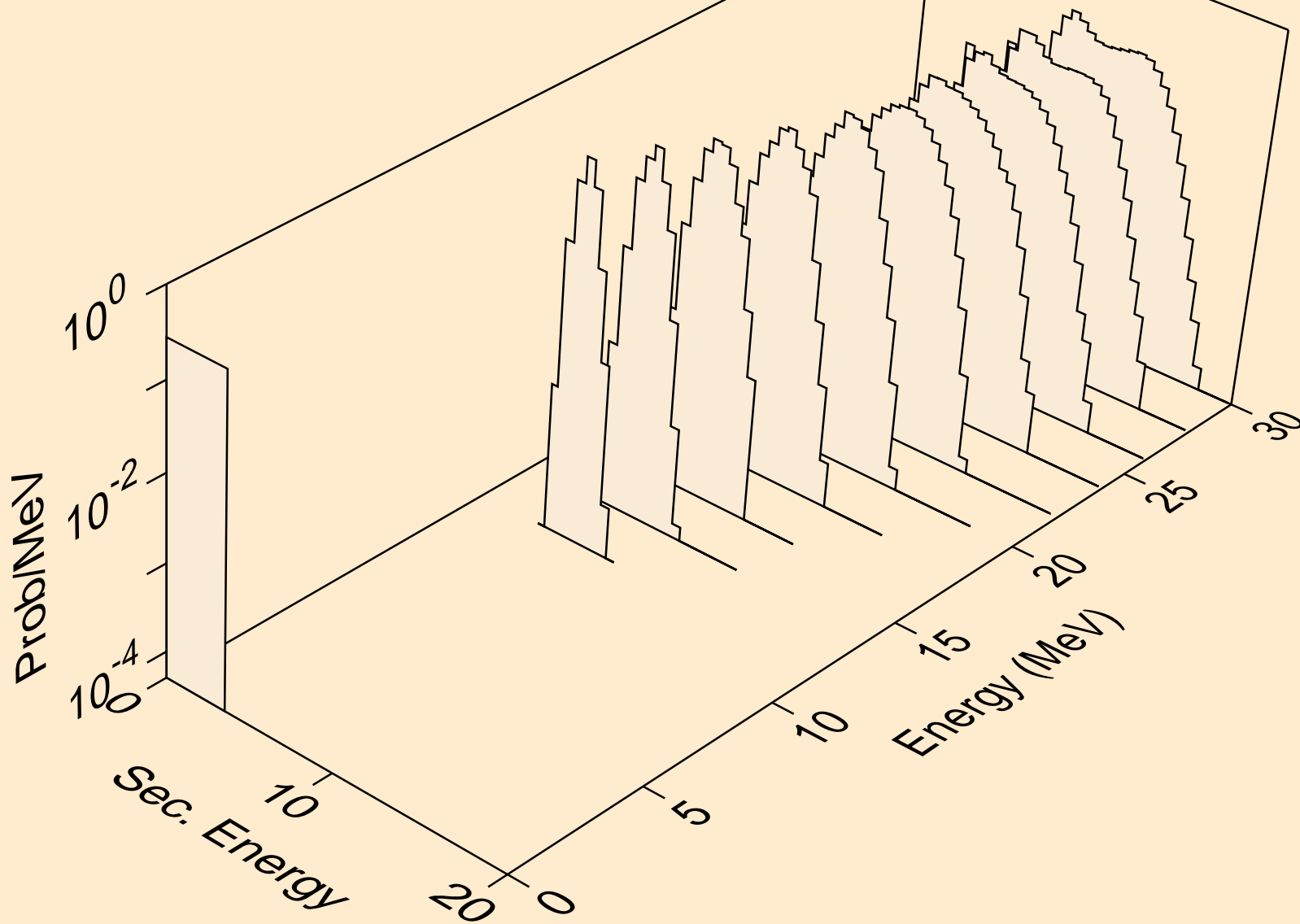

LA120 NEUTRON ACER TENDL-2019 LIBRARY; T=293.16K
alphas from (n,d2a)

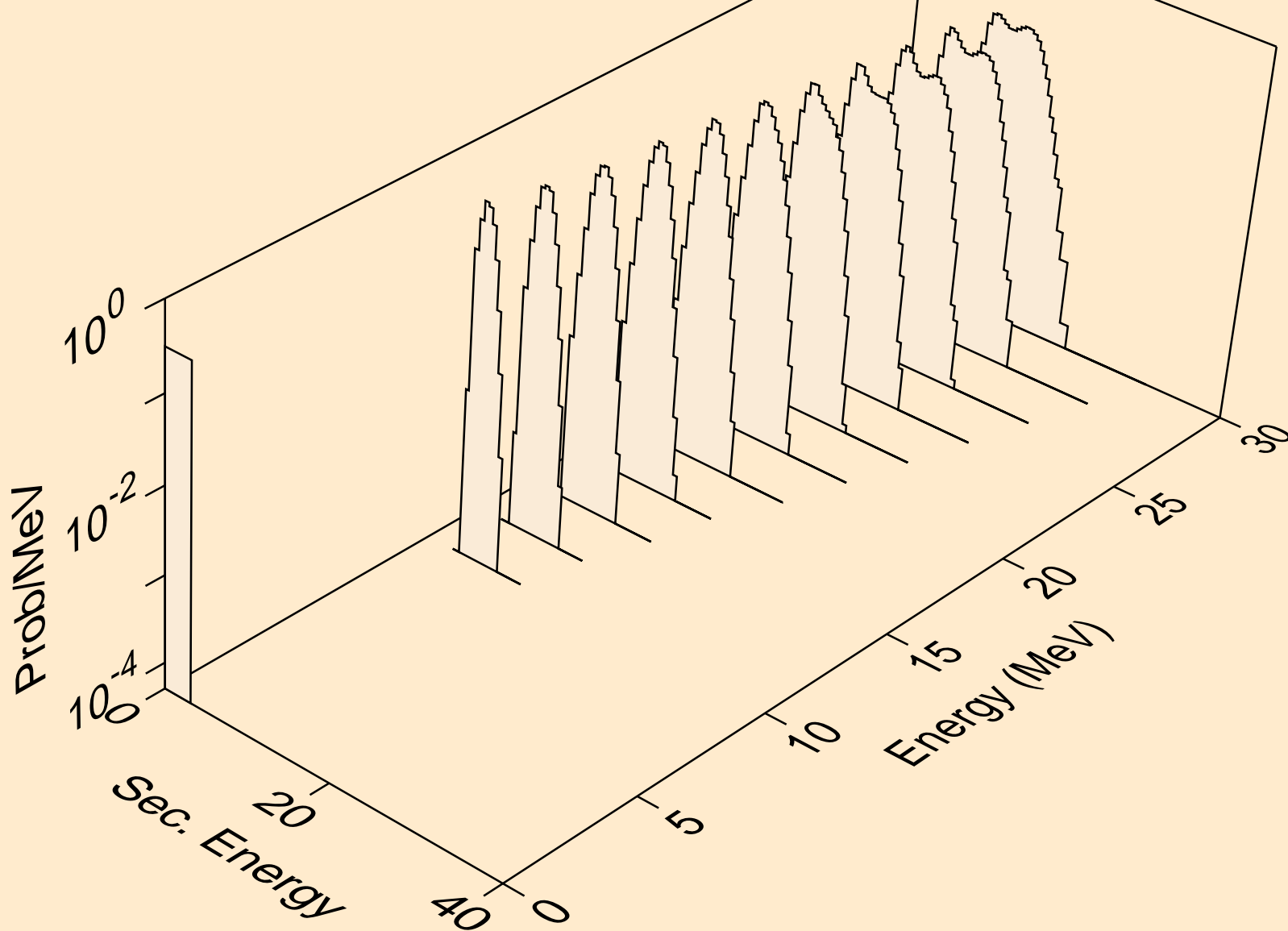

LA120 NEUTRON ACER TENDL-2019 LIBRARY; T=293.16K
alphas from (n,da)

