

LA132 NEUTRON ACER TENDL-2019 LIBRARY; T=293.16K  
Principal cross sections

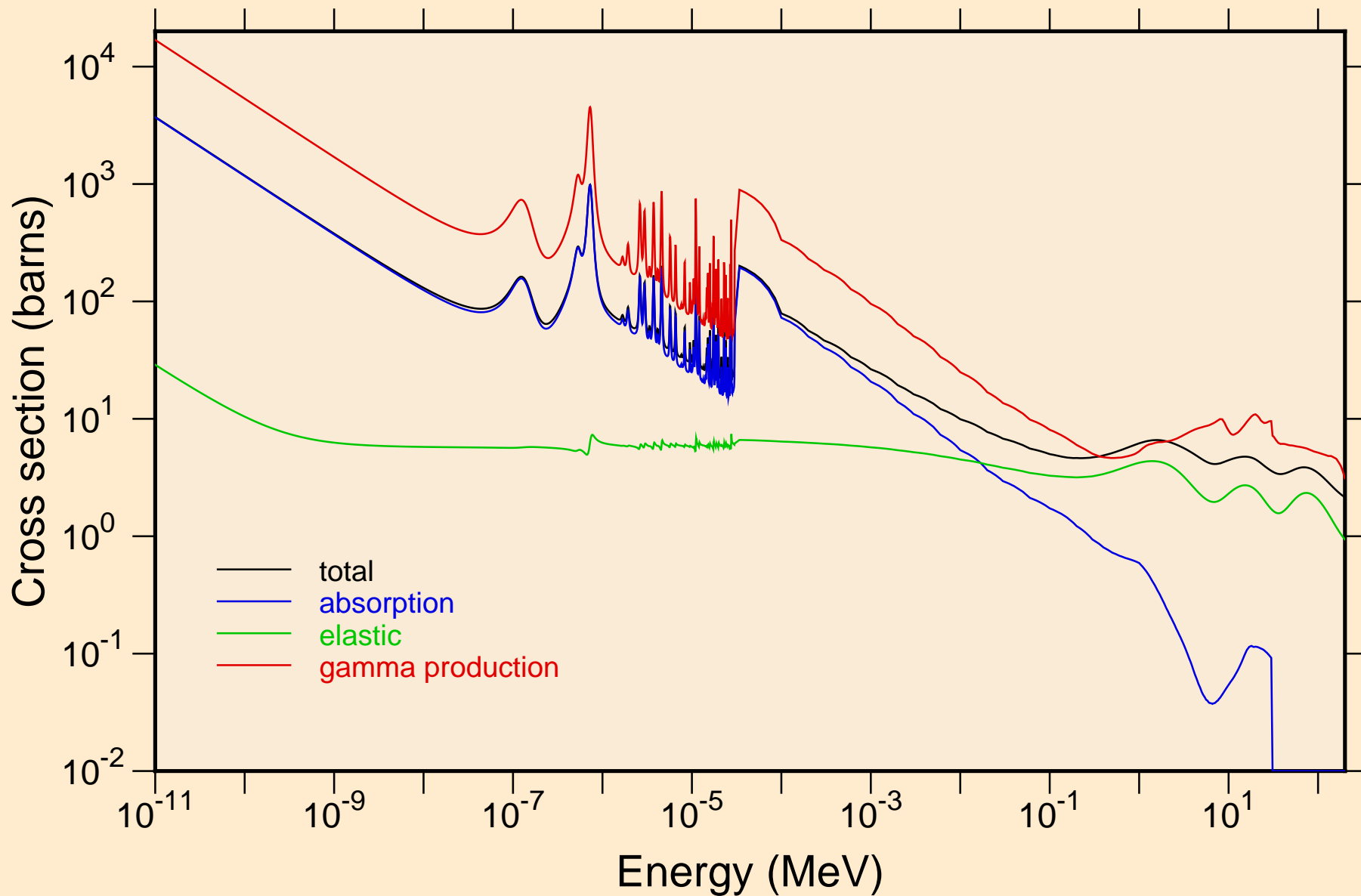

LA132 NEUTRON ACER TENDL-2019 LIBRARY; T=293.16K  
resonance total cross section

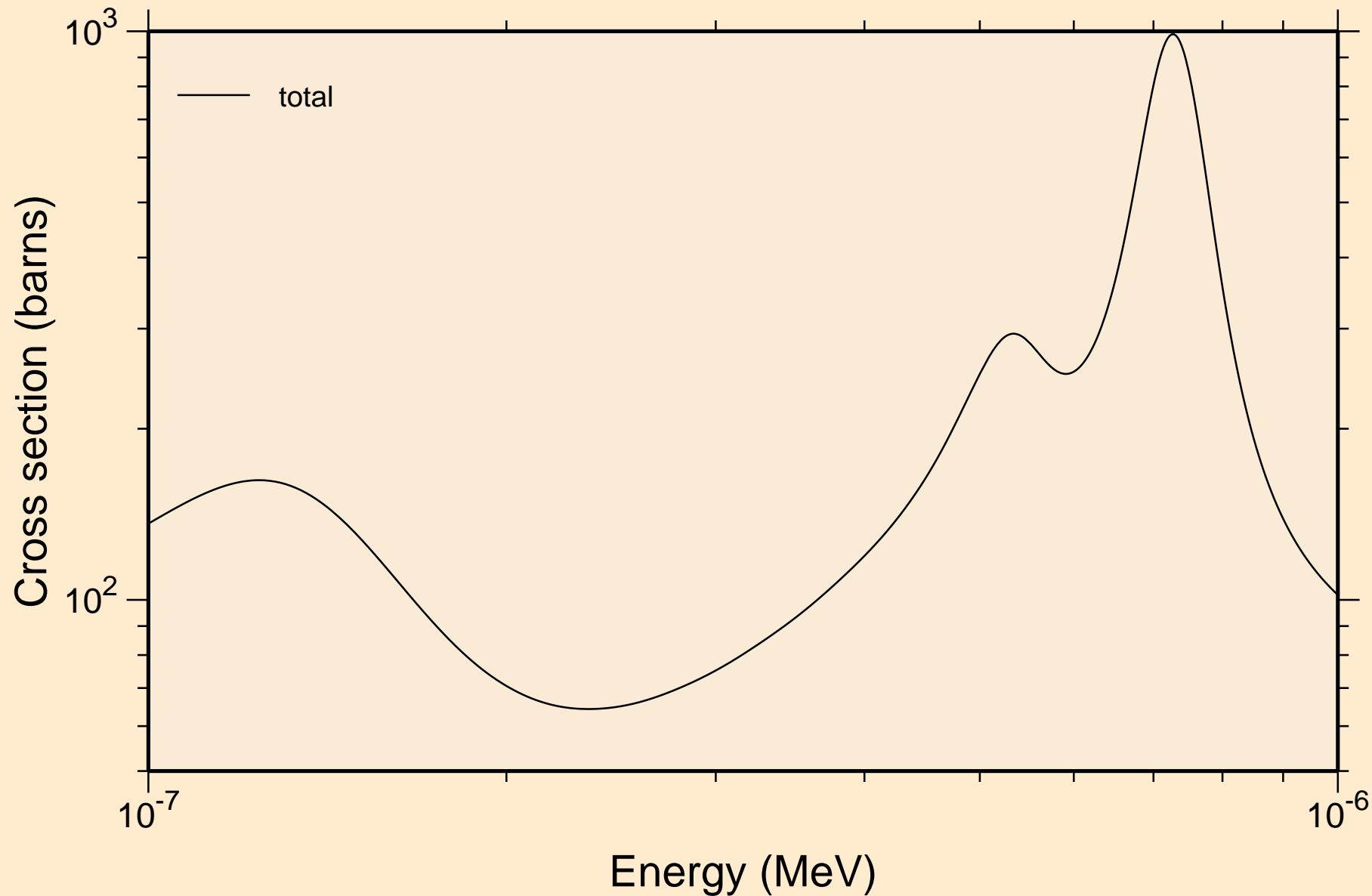

LA132 NEUTRON ACER TENDL-2019 LIBRARY; T=293.16K  
resonance total cross section

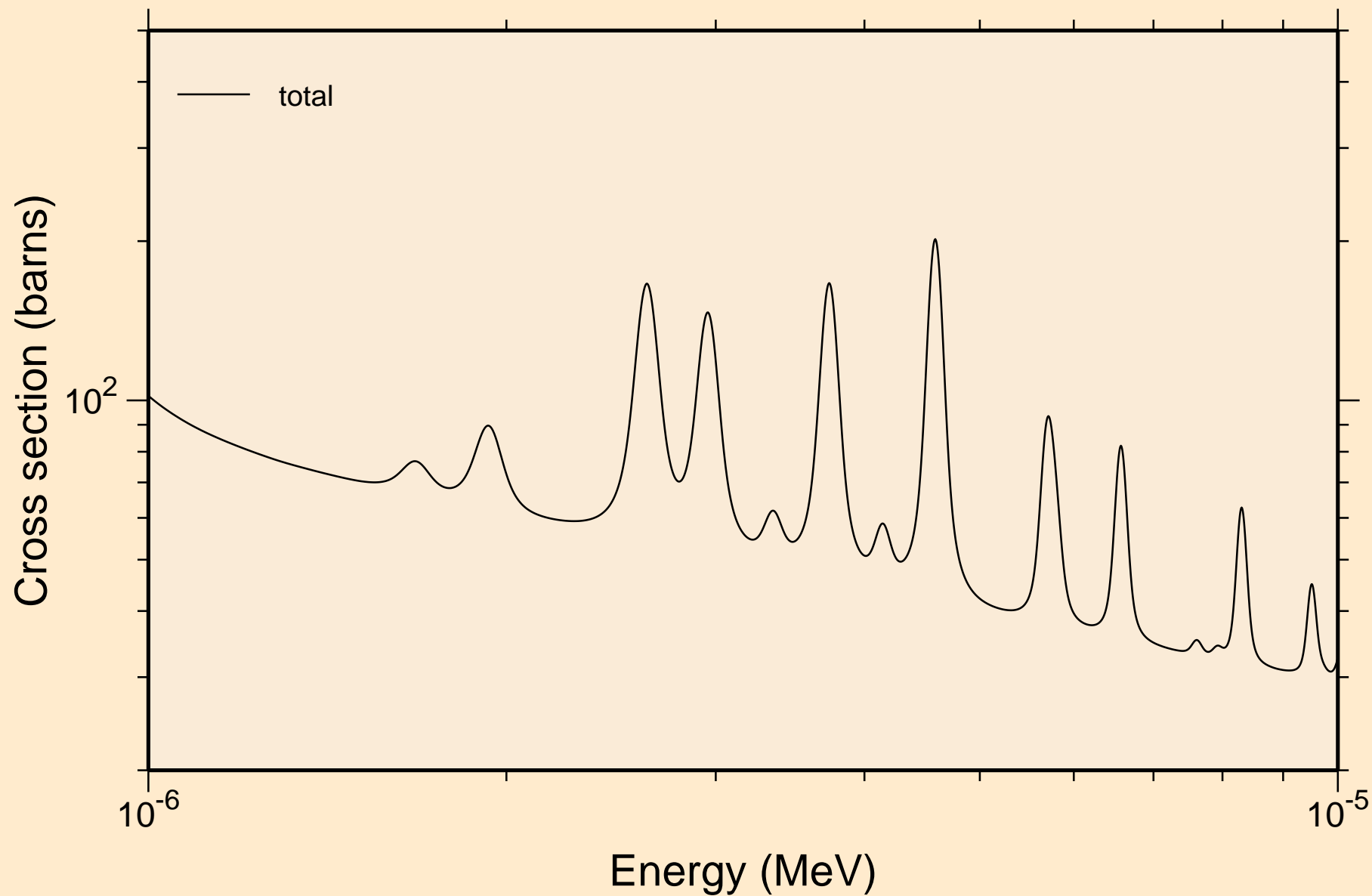

LA132 NEUTRON ACER TENDL-2019 LIBRARY; T=293.16K  
resonance total cross section

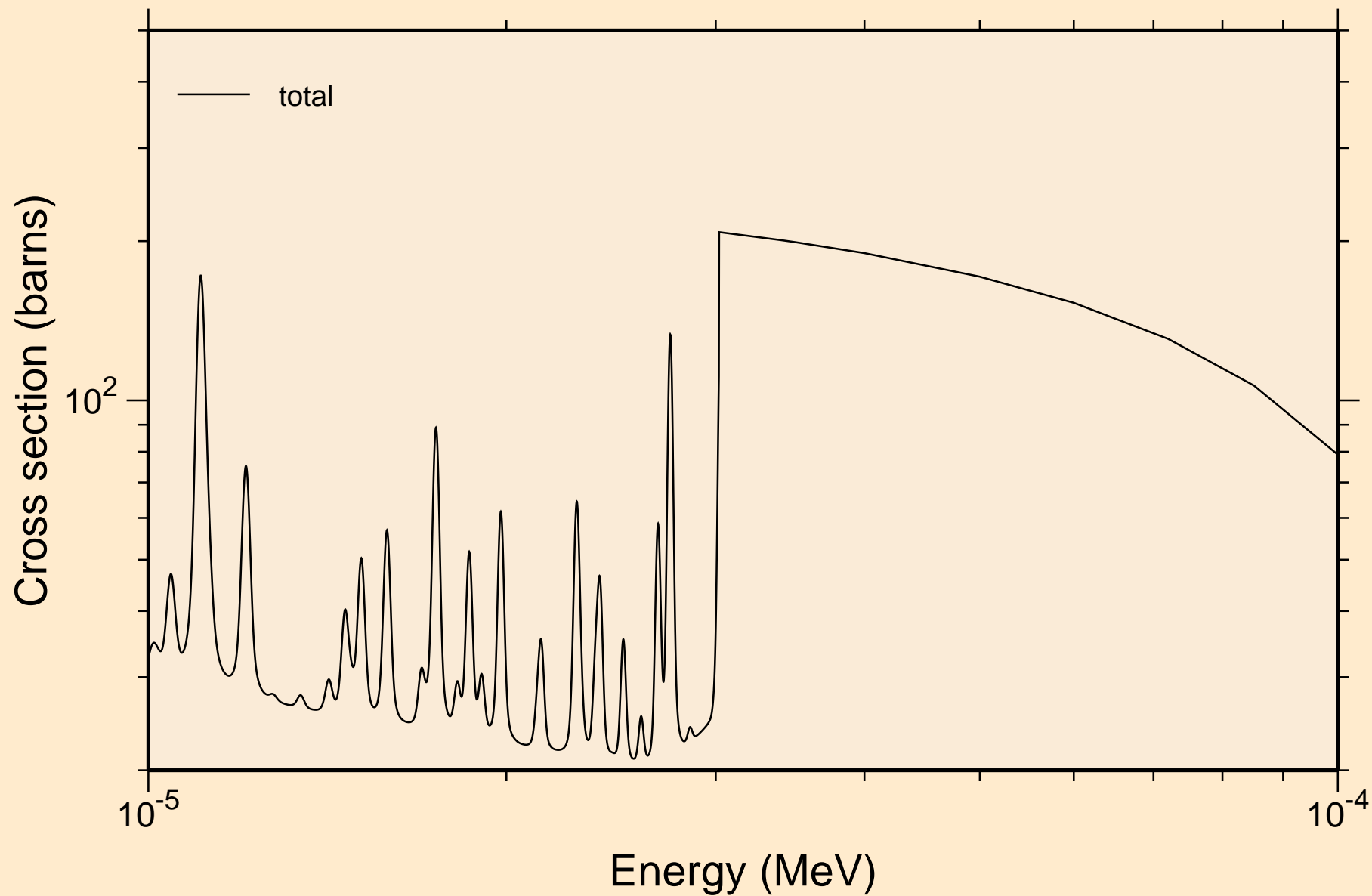

L̄A132 NEUTRON ACER TENDL-2019 LIBRARY; T=293.16K  
resonance total cross section

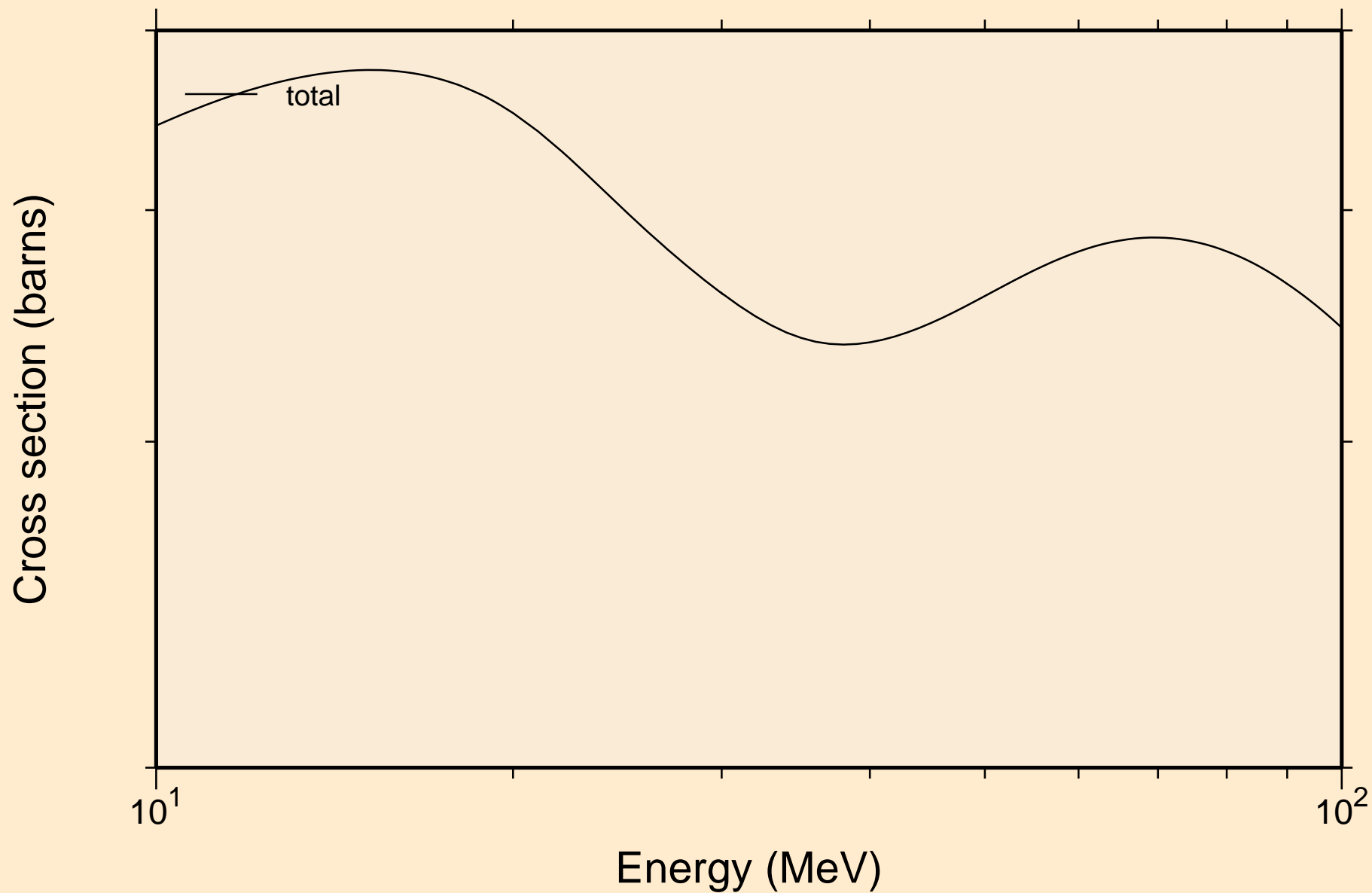

LA132 NEUTRON ACER TENDL-2019 LIBRARY; T=293.16K  
resonance absorption cross sections

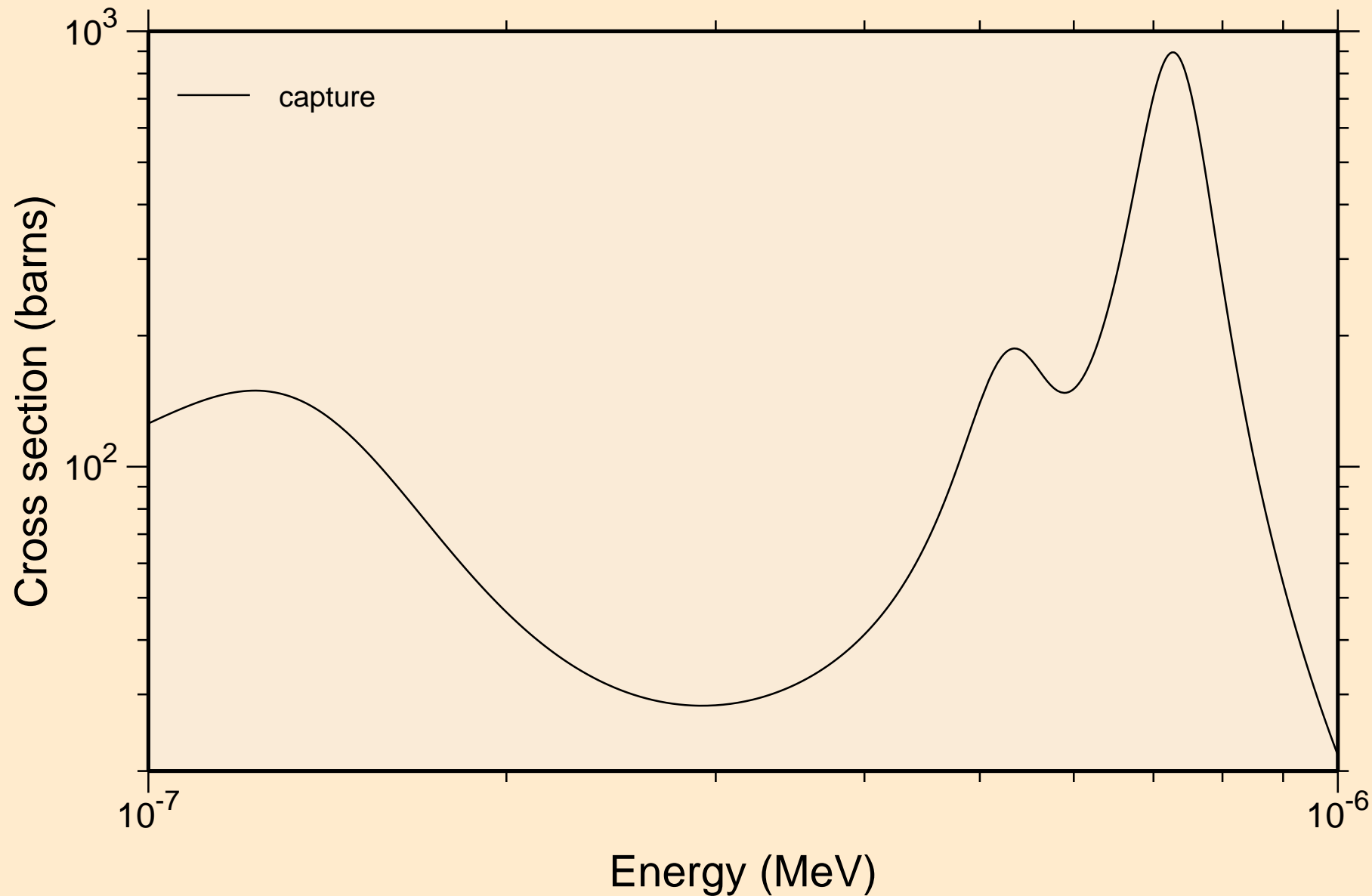

LA132 NEUTRON ACER TENDL-2019 LIBRARY; T=293.16K  
resonance absorption cross sections

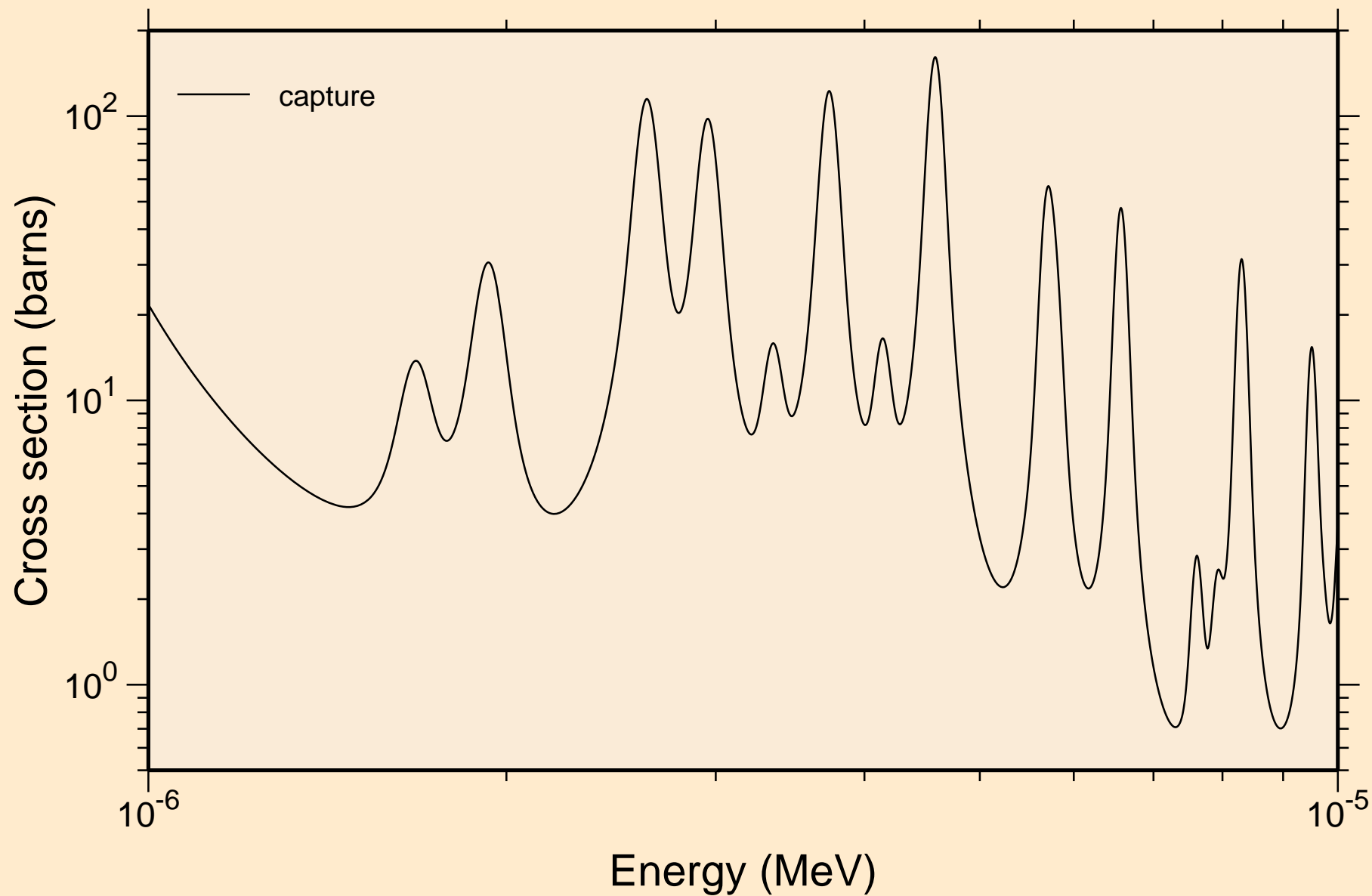

LA132 NEUTRON ACER TENDL-2019 LIBRARY; T=293.16K  
resonance absorption cross sections

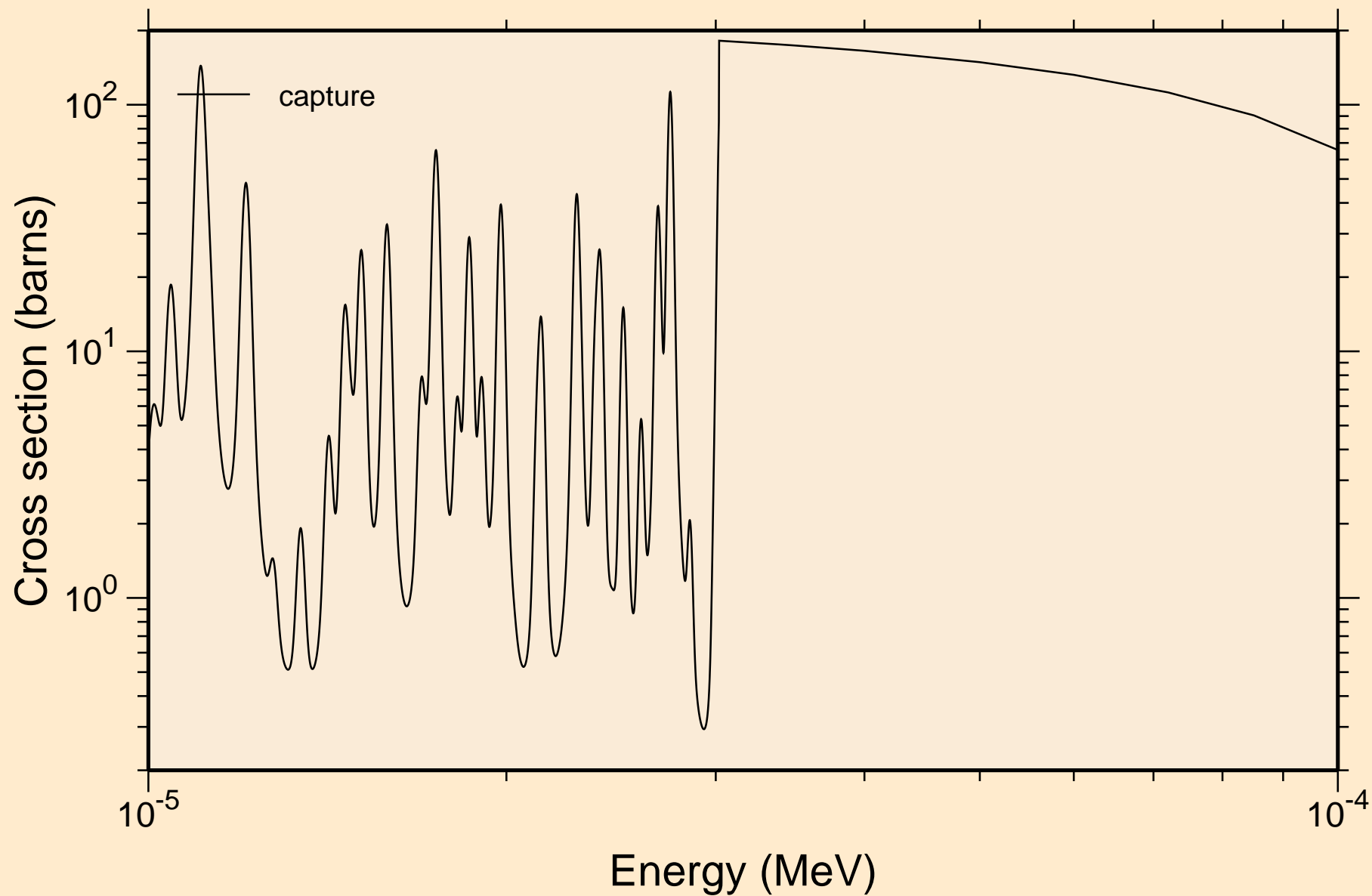



LA132 NEUTRON ACER TENDL-2019 LIBRARY; T=293.16K  
resonance absorption cross sections

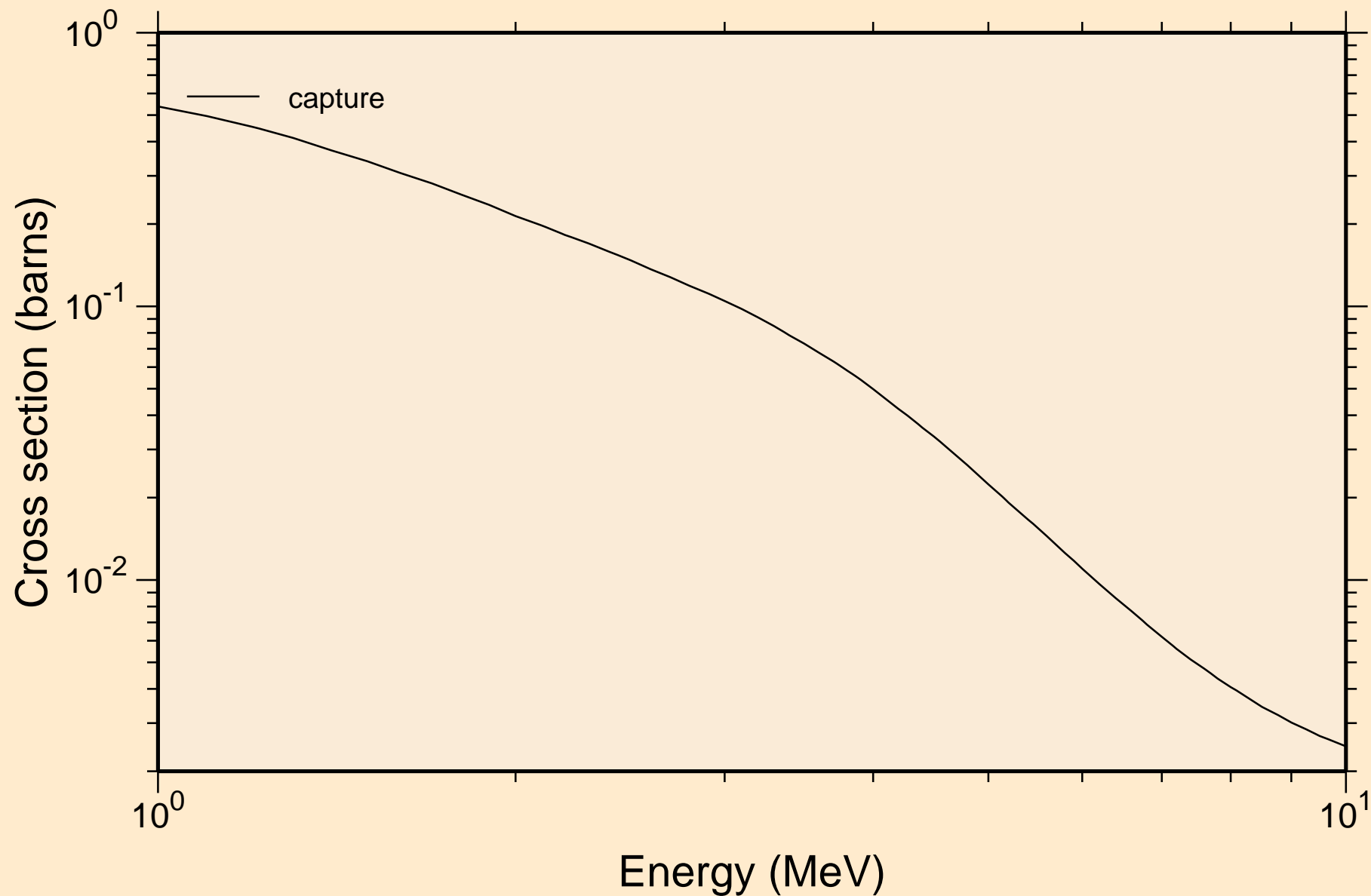

LA132 NEUTRON ACER TENDL-2019 LIBRARY; T=293.16K  
Heating

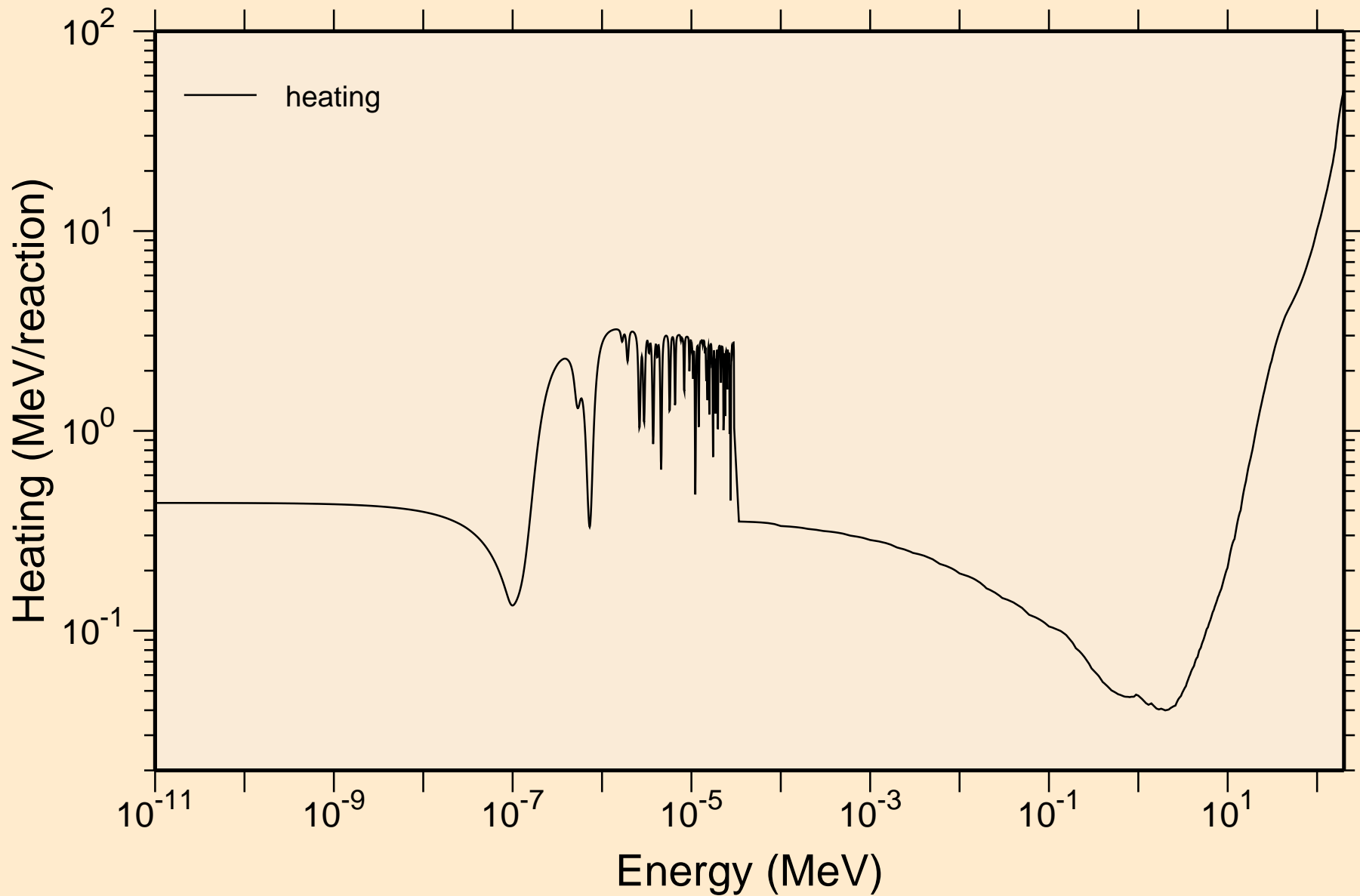

LA132 NEUTRON ACER TENDL-2019 LIBRARY; T=293.16K  
Damage

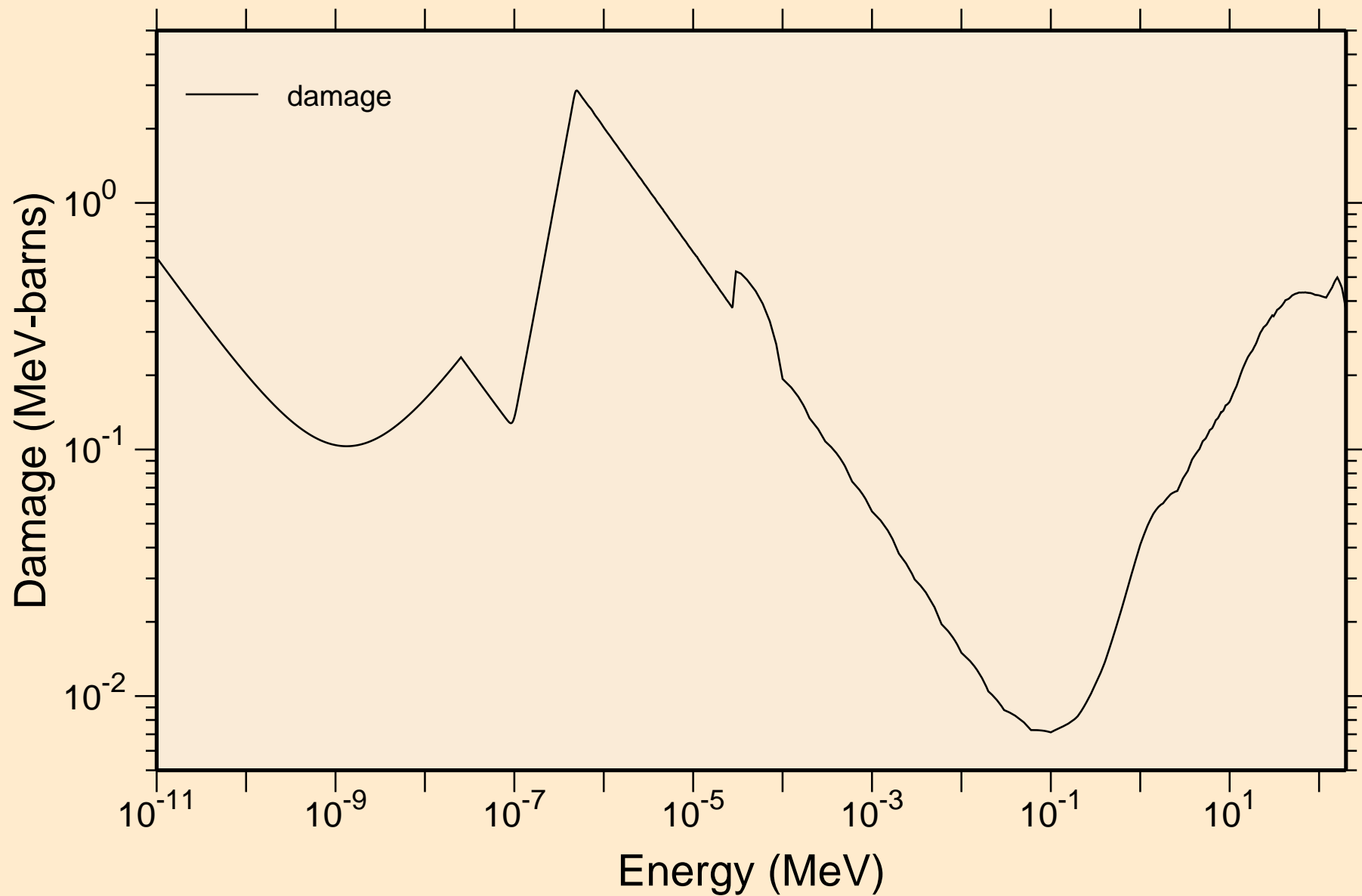

LA132 NEUTRON ACER TENDL-2019 LIBRARY; T=293.16K  
Non-threshold reactions

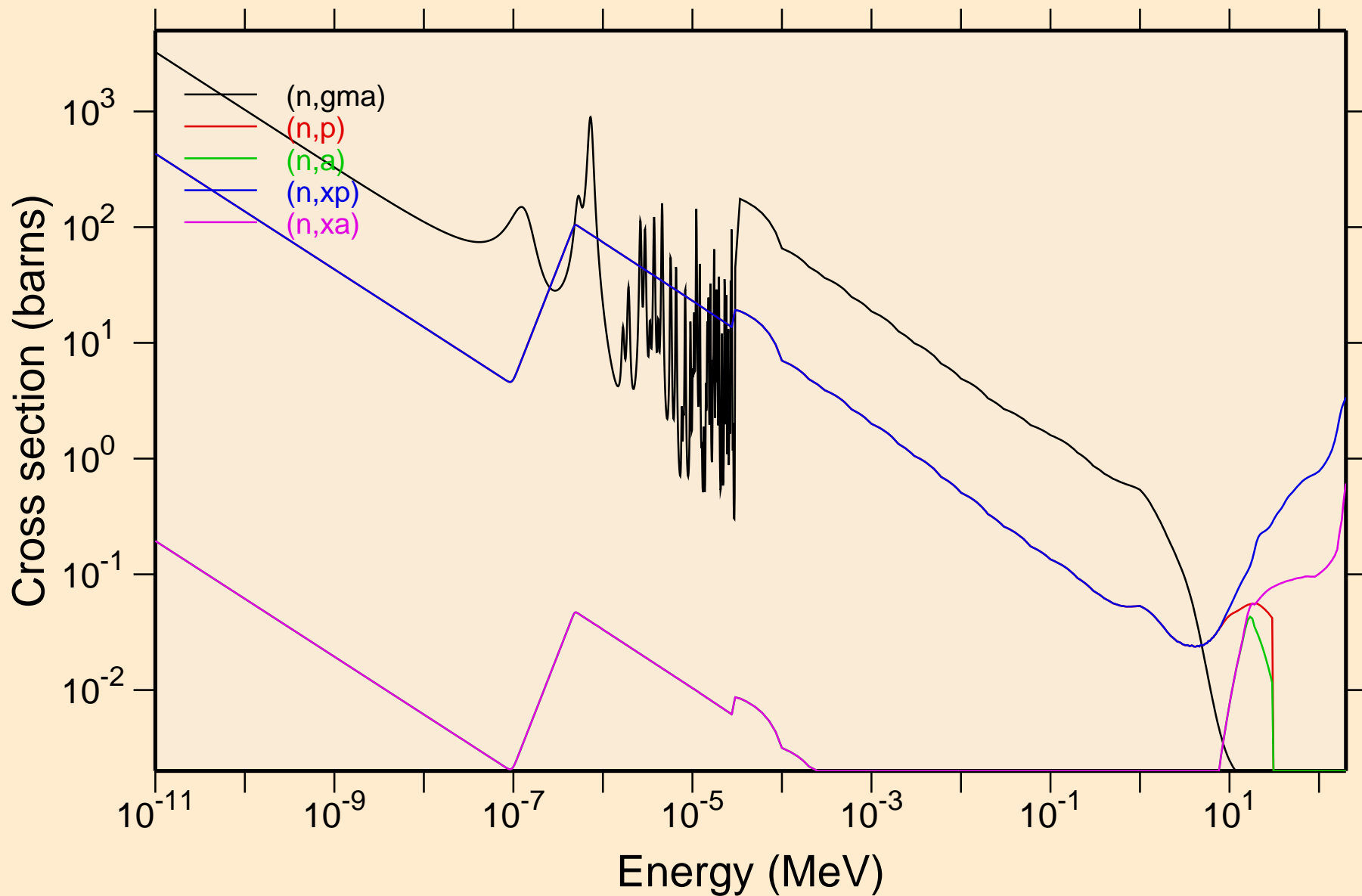

# LA132 NEUTRON ACER TENDL-2019 LIBRARY; T=293.16K

## Principal cross sections

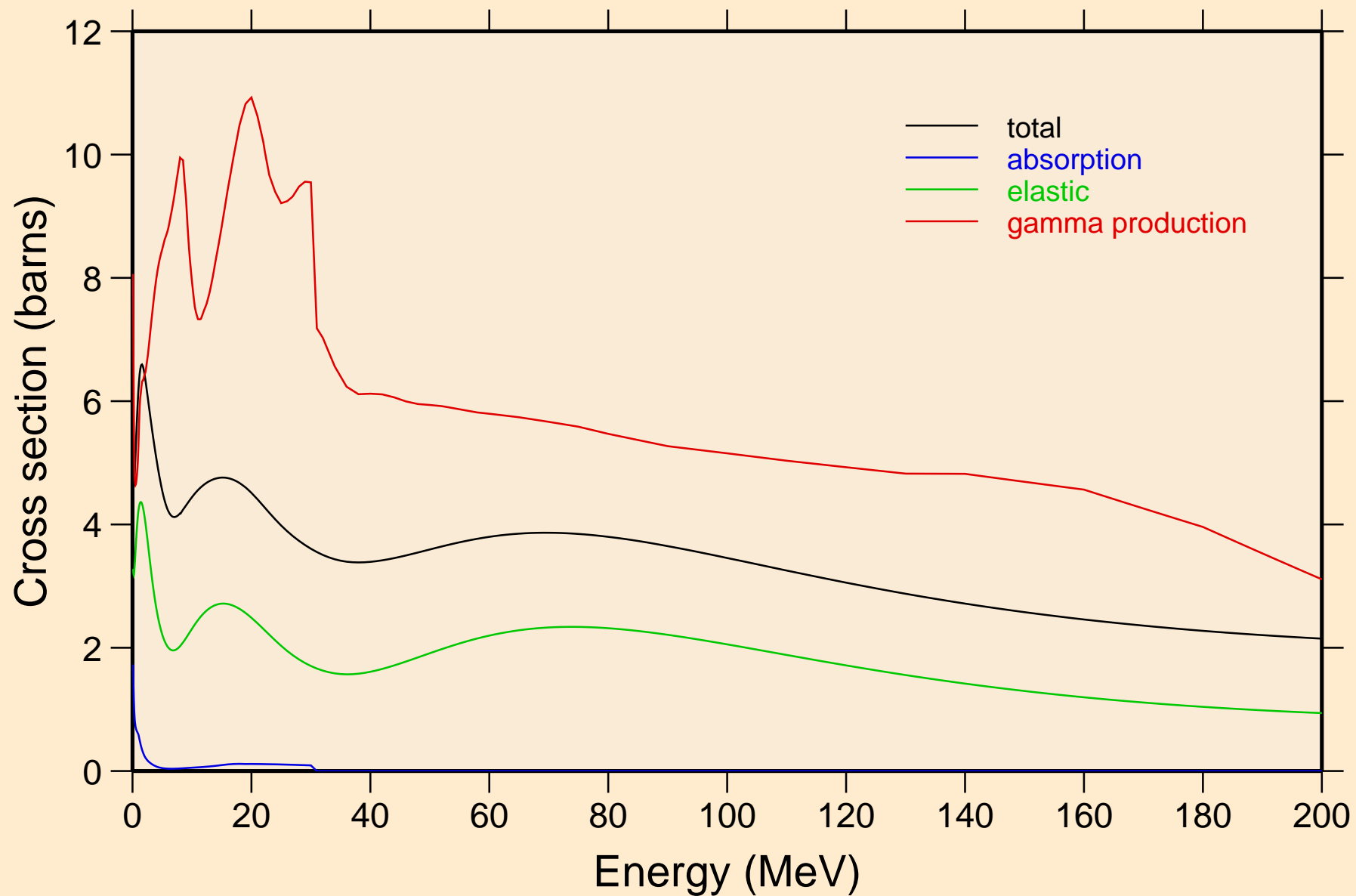

LA132 NEUTRON ACER TENDL-2019 LIBRARY; T=293.16K  
Heating

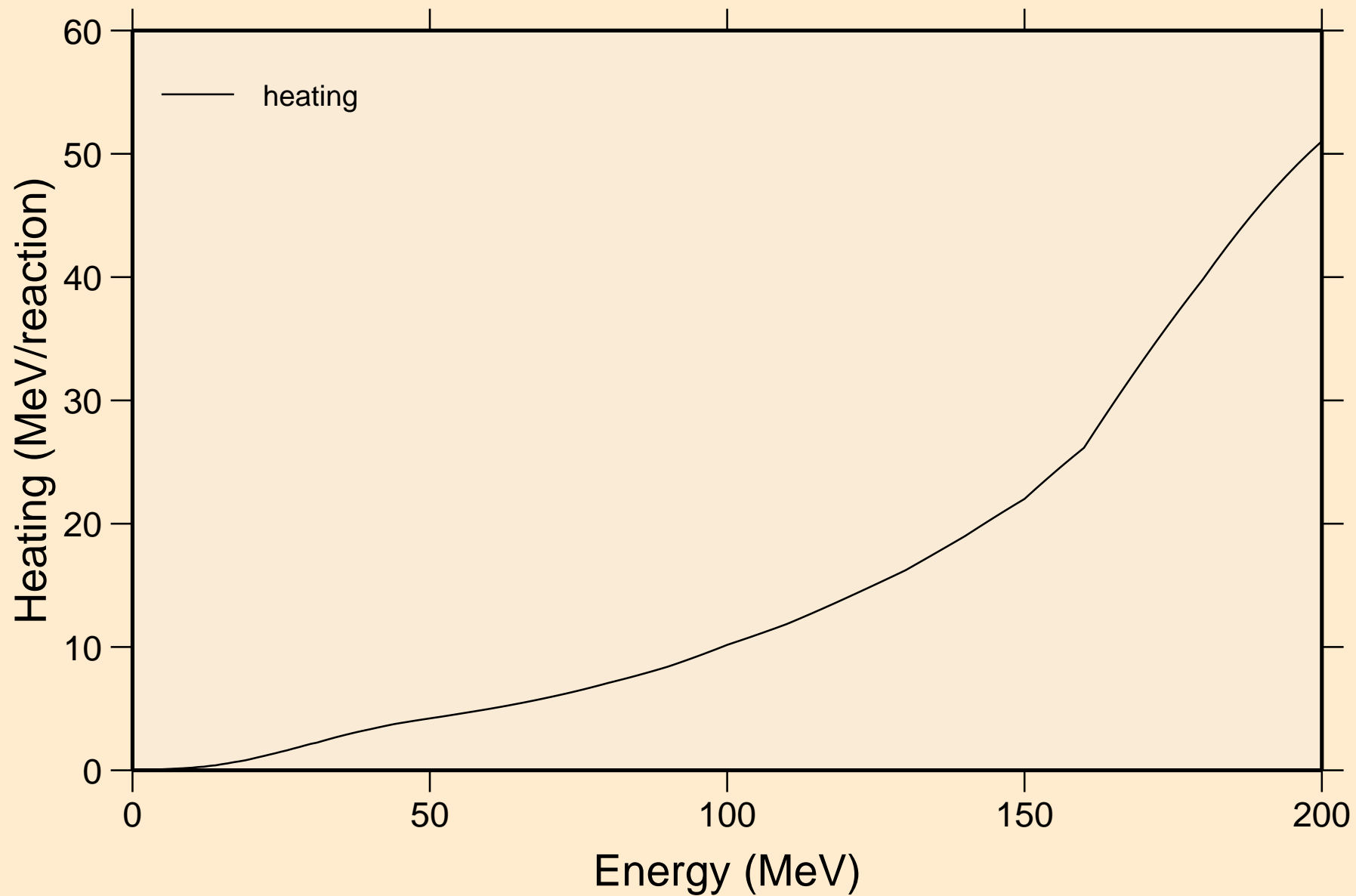

LA132 NEUTRON ACER TENDL-2019 LIBRARY; T=293.16K  
Damage

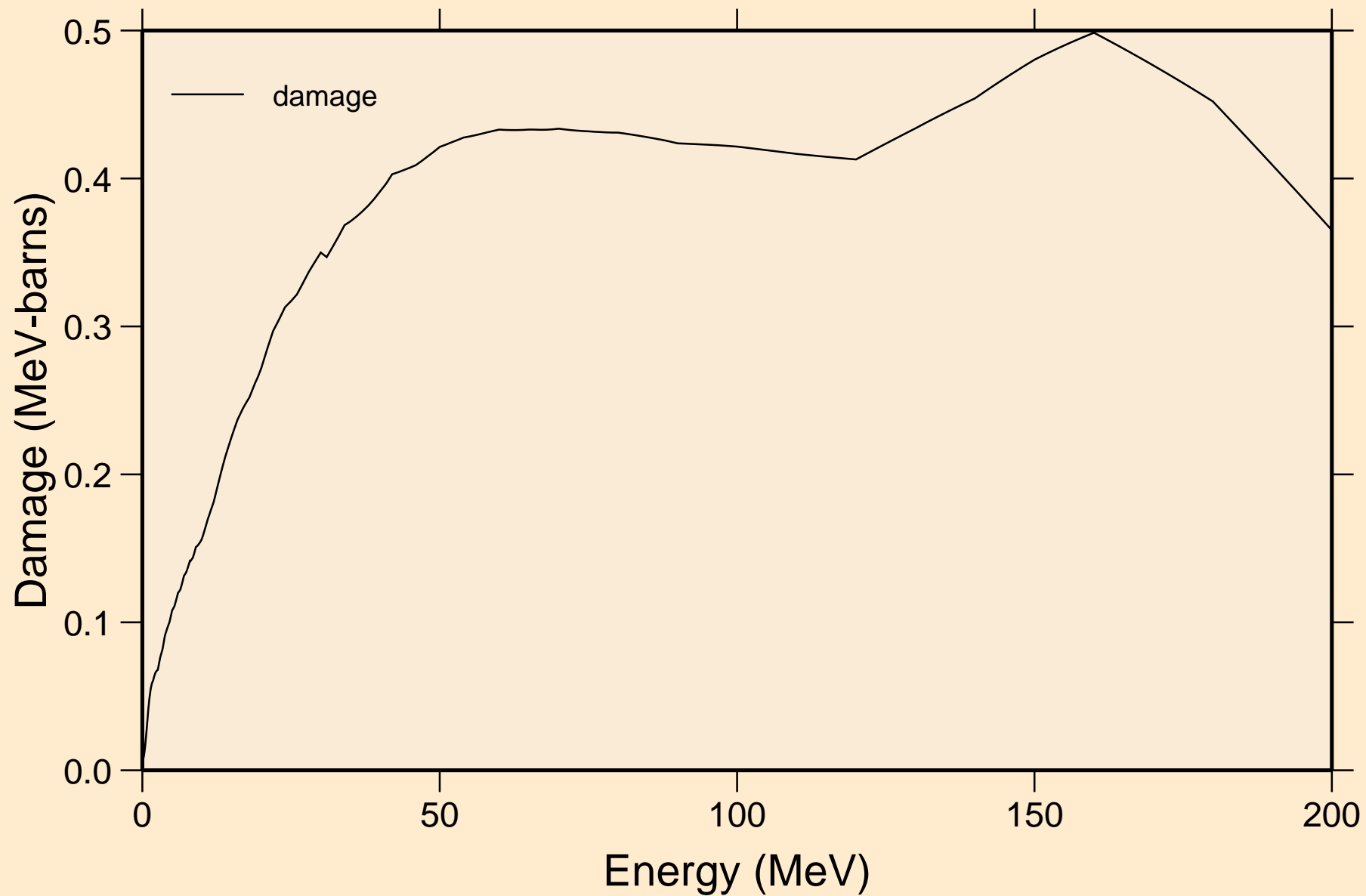

LA132 NEUTRON ACER TENDL-2019 LIBRARY; T=293.16K  
Non-threshold reactions

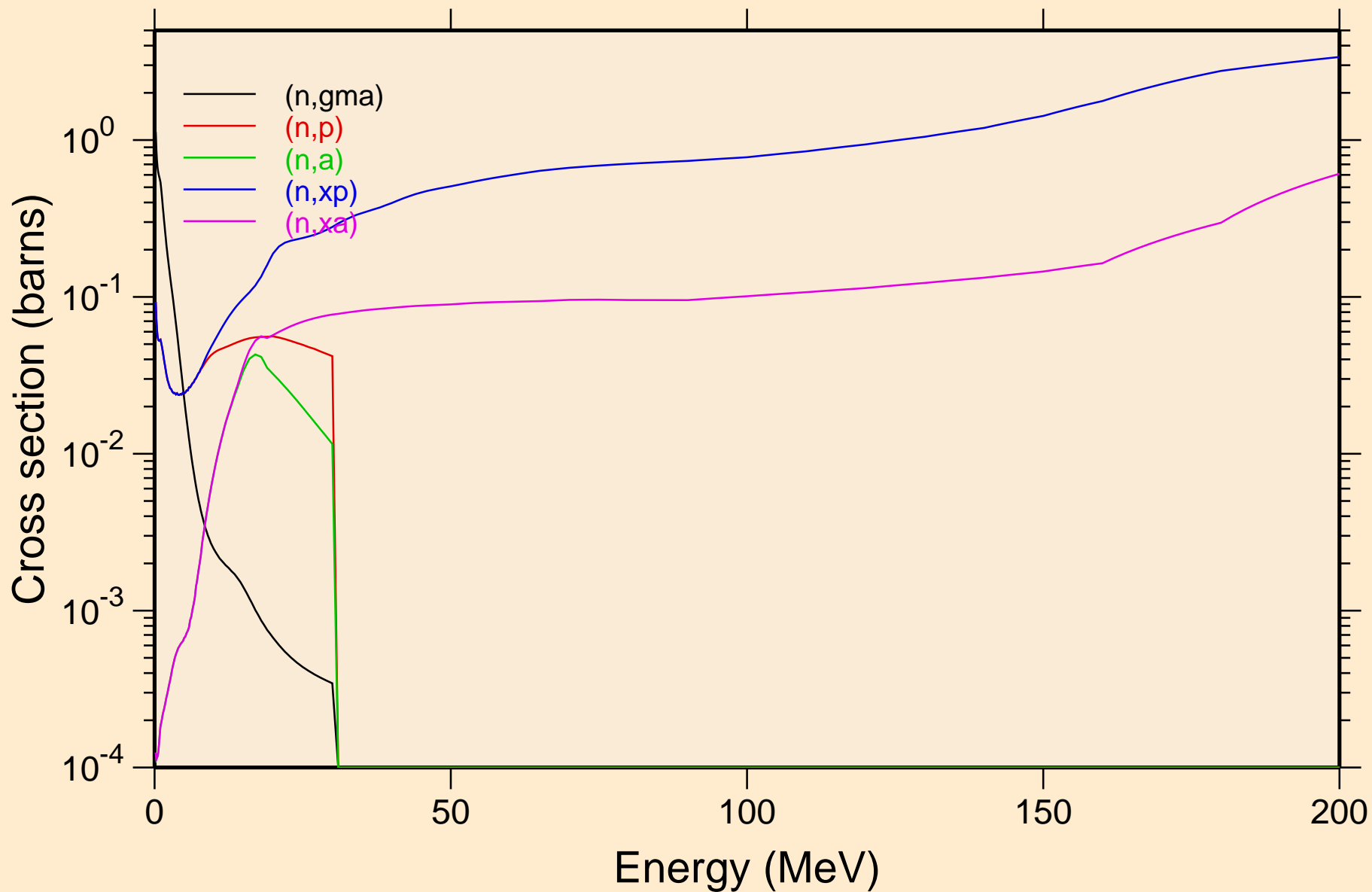



LA132 NEUTRON ACER TENDL-2019 LIBRARY; T=293.16K  
Inelastic levels

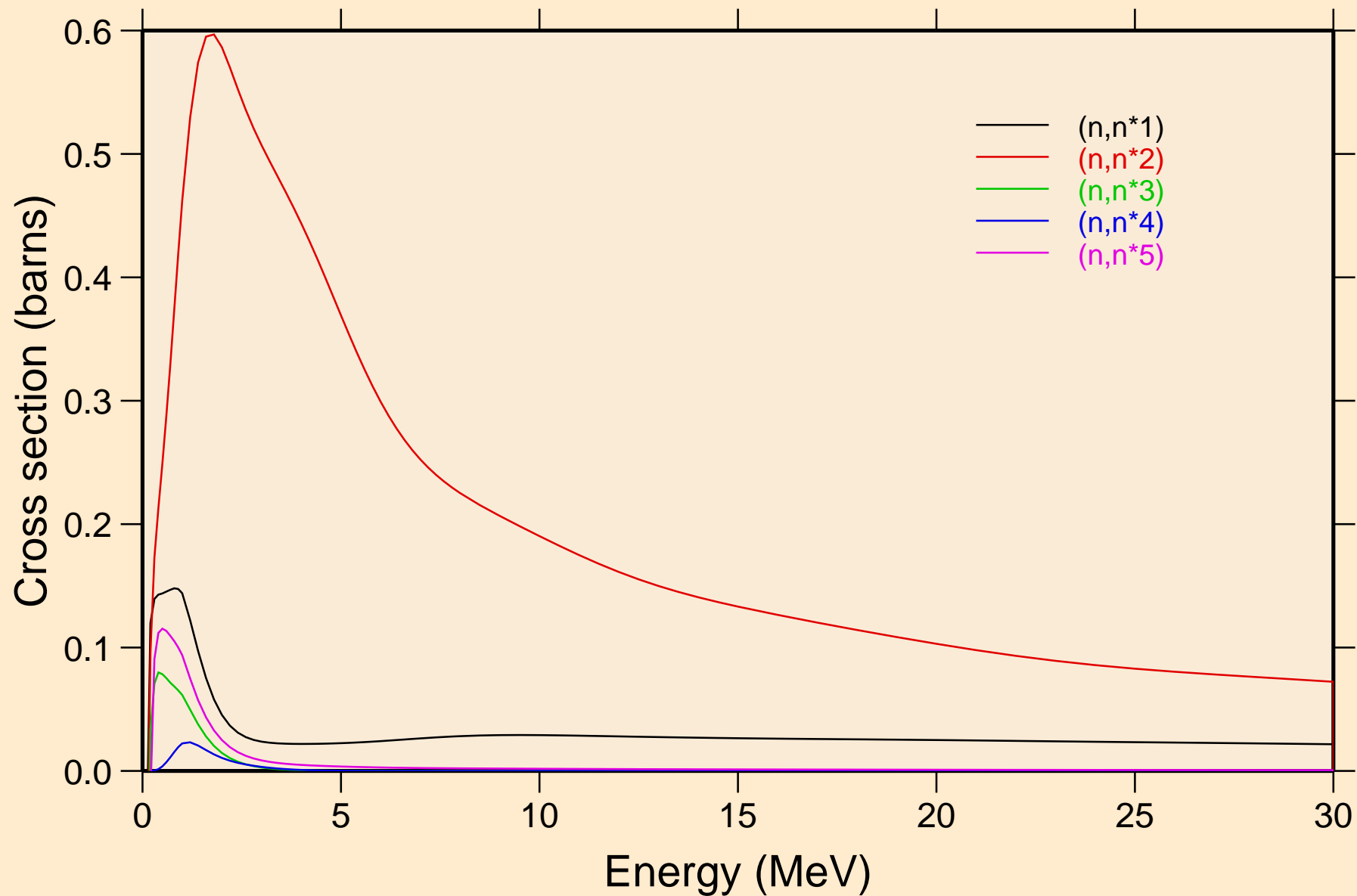

LA132 NEUTRON ACER TENDL-2019 LIBRARY; T=293.16K  
Inelastic levels

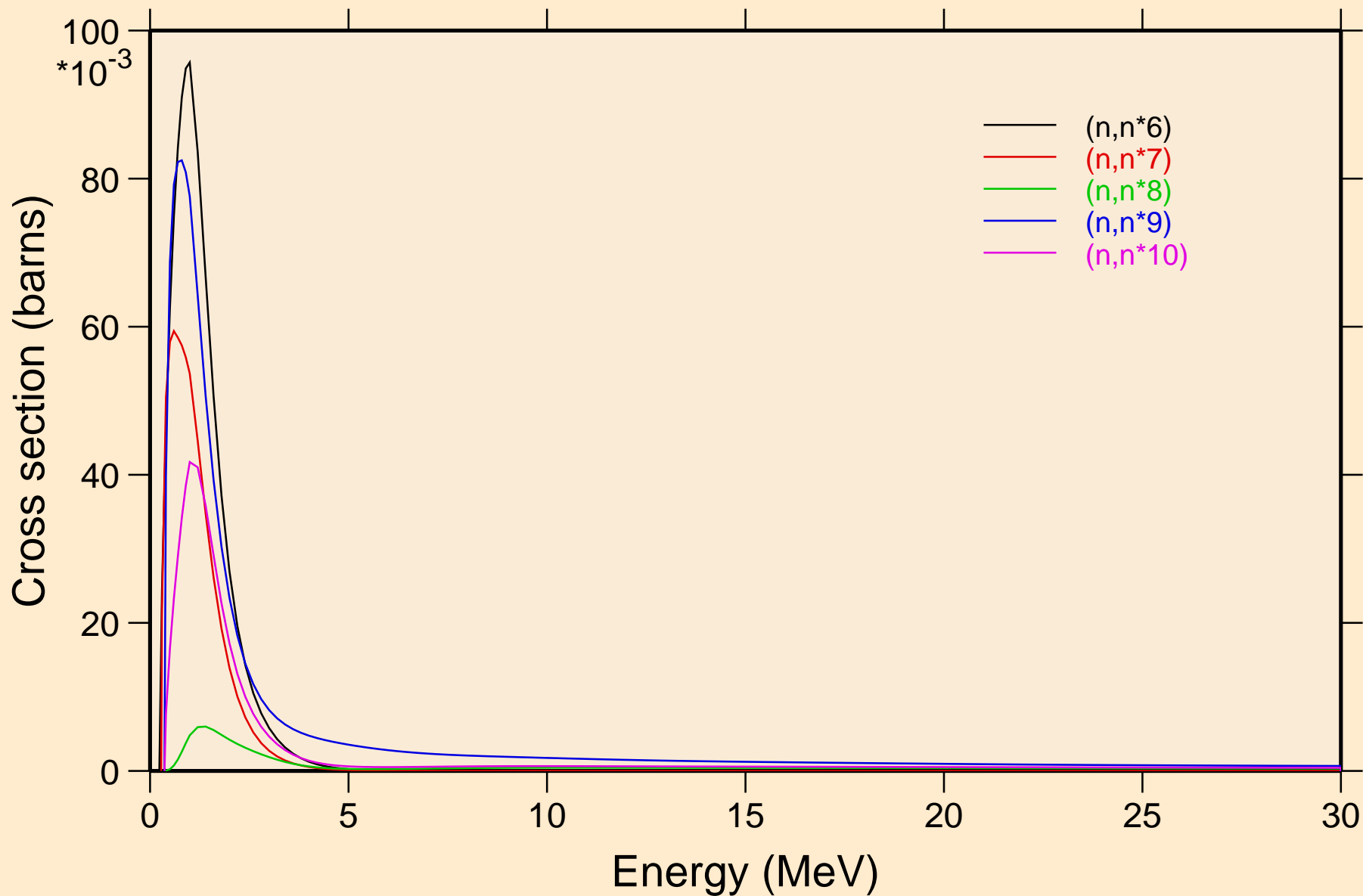

LA132 NEUTRON ACER TENDL-2019 LIBRARY; T=293.16K  
Inelastic levels

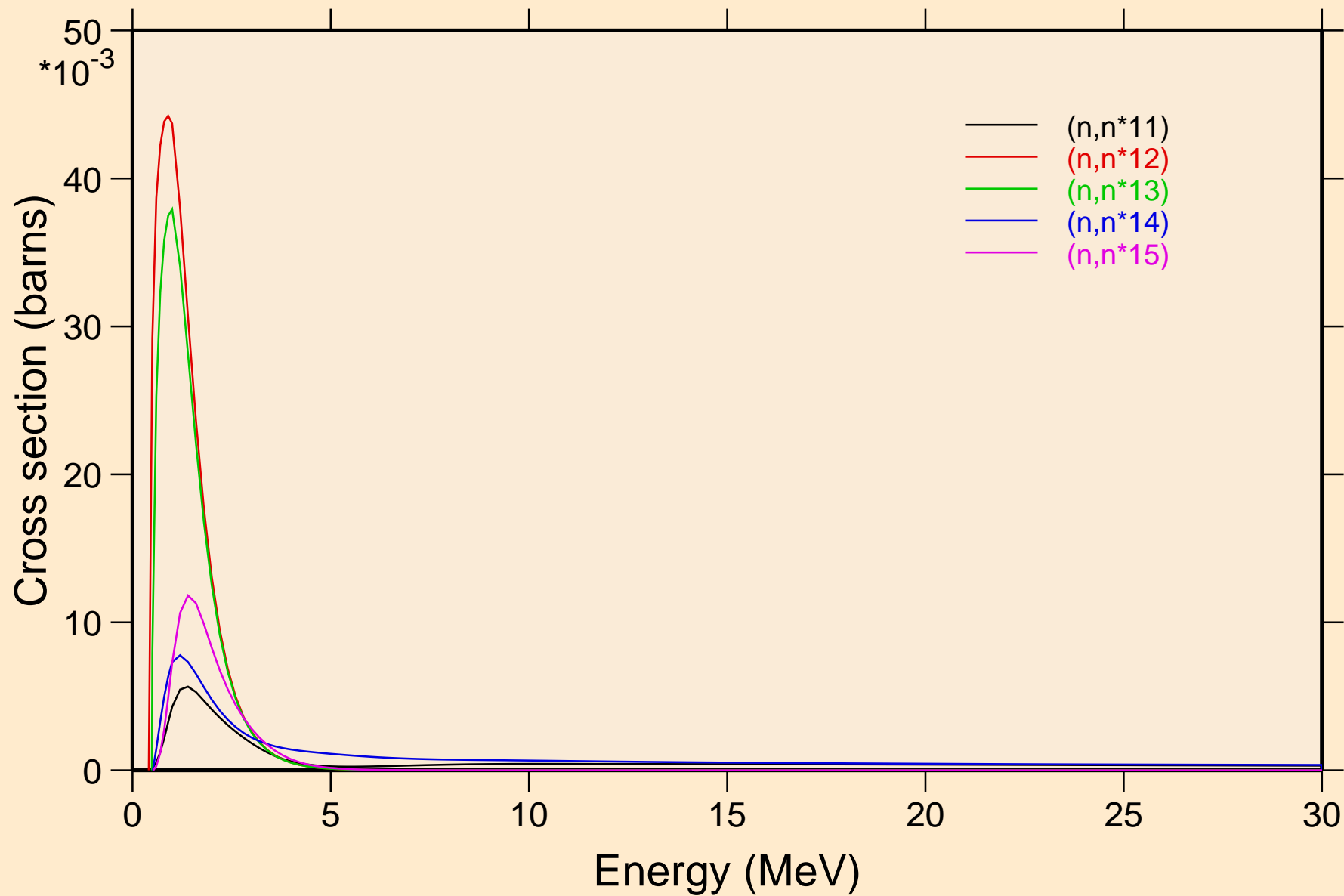

LA132 NEUTRON ACER TENDL-2019 LIBRARY; T=293.16K  
Inelastic levels

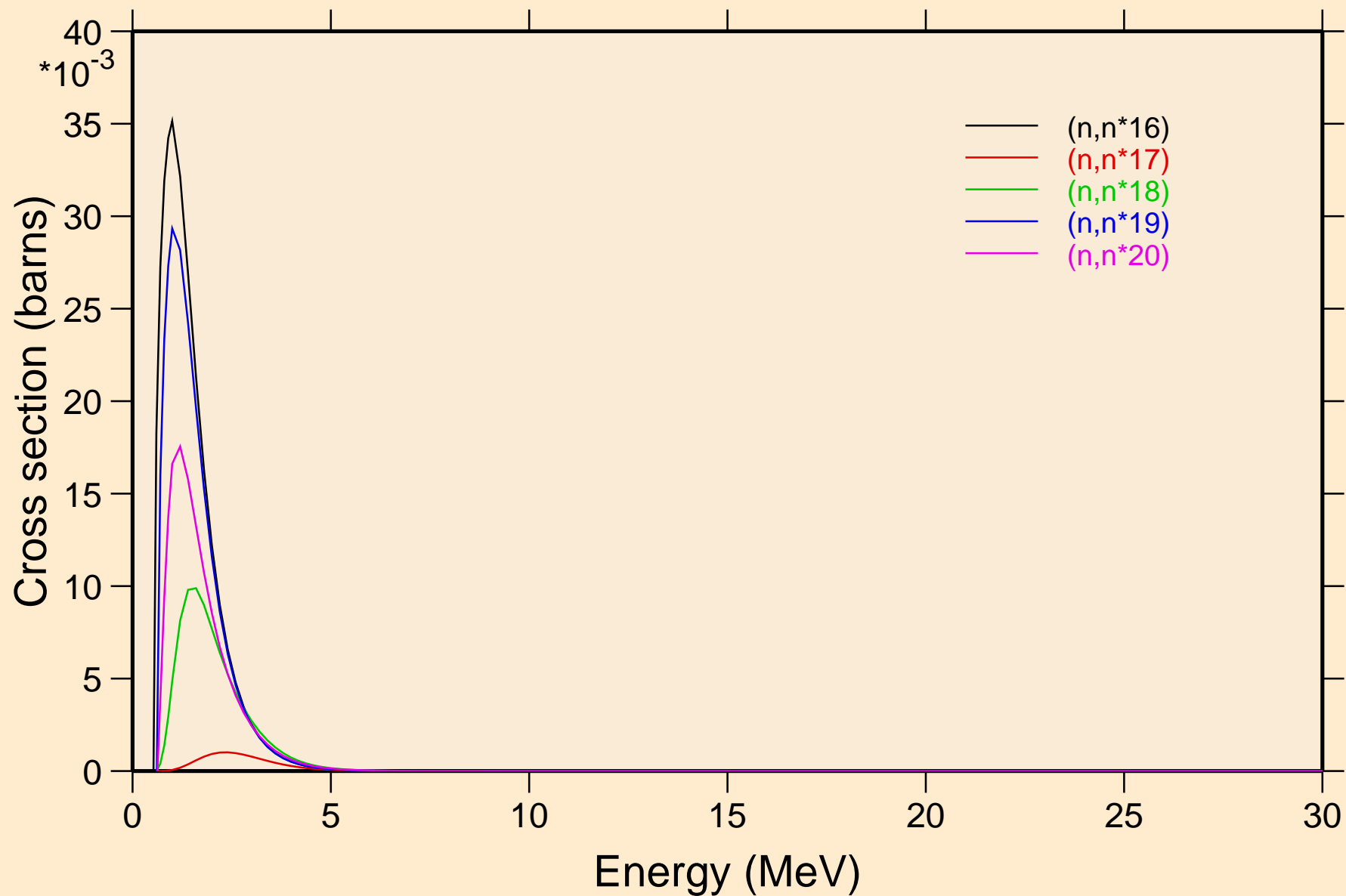

LA132 NEUTRON ACER TENDL-2019 LIBRARY; T=293.16K  
Inelastic levels

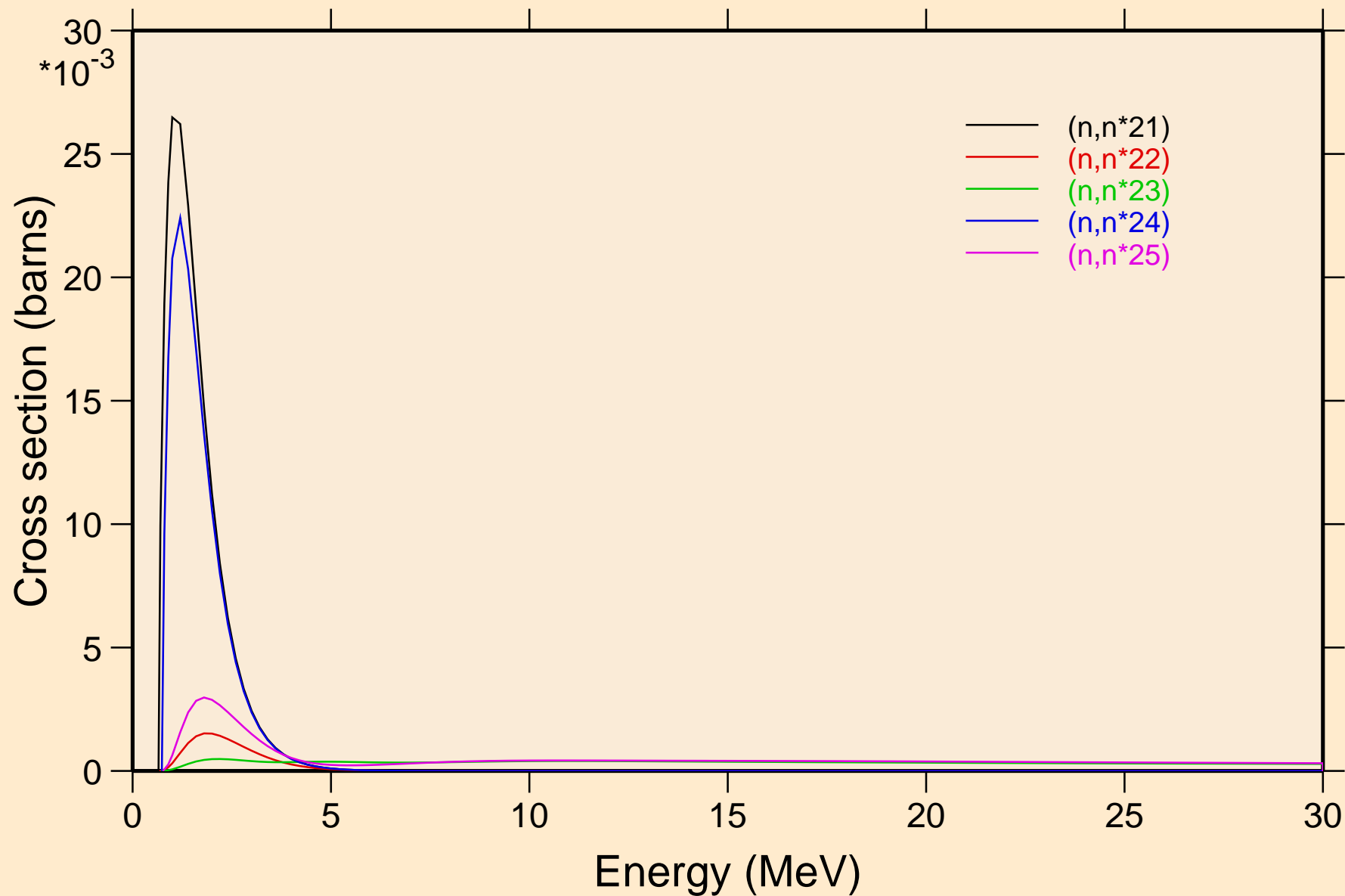

LA132 NEUTRON ACER TENDL-2019 LIBRARY; T=293.16K  
Inelastic levels

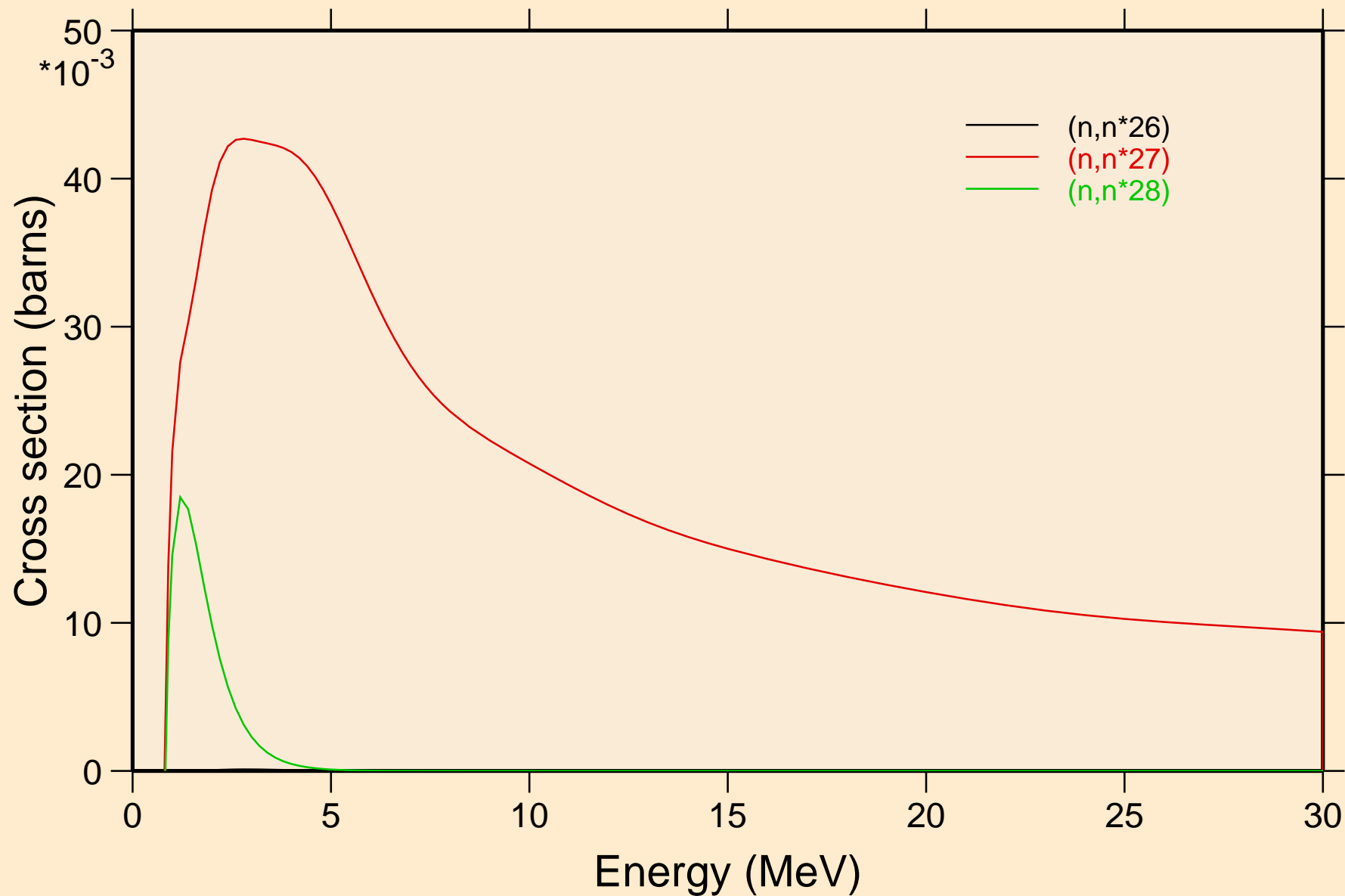

LA132 NEUTRON ACER TENDL-2019 LIBRARY; T=293.16K  
Threshold reactions

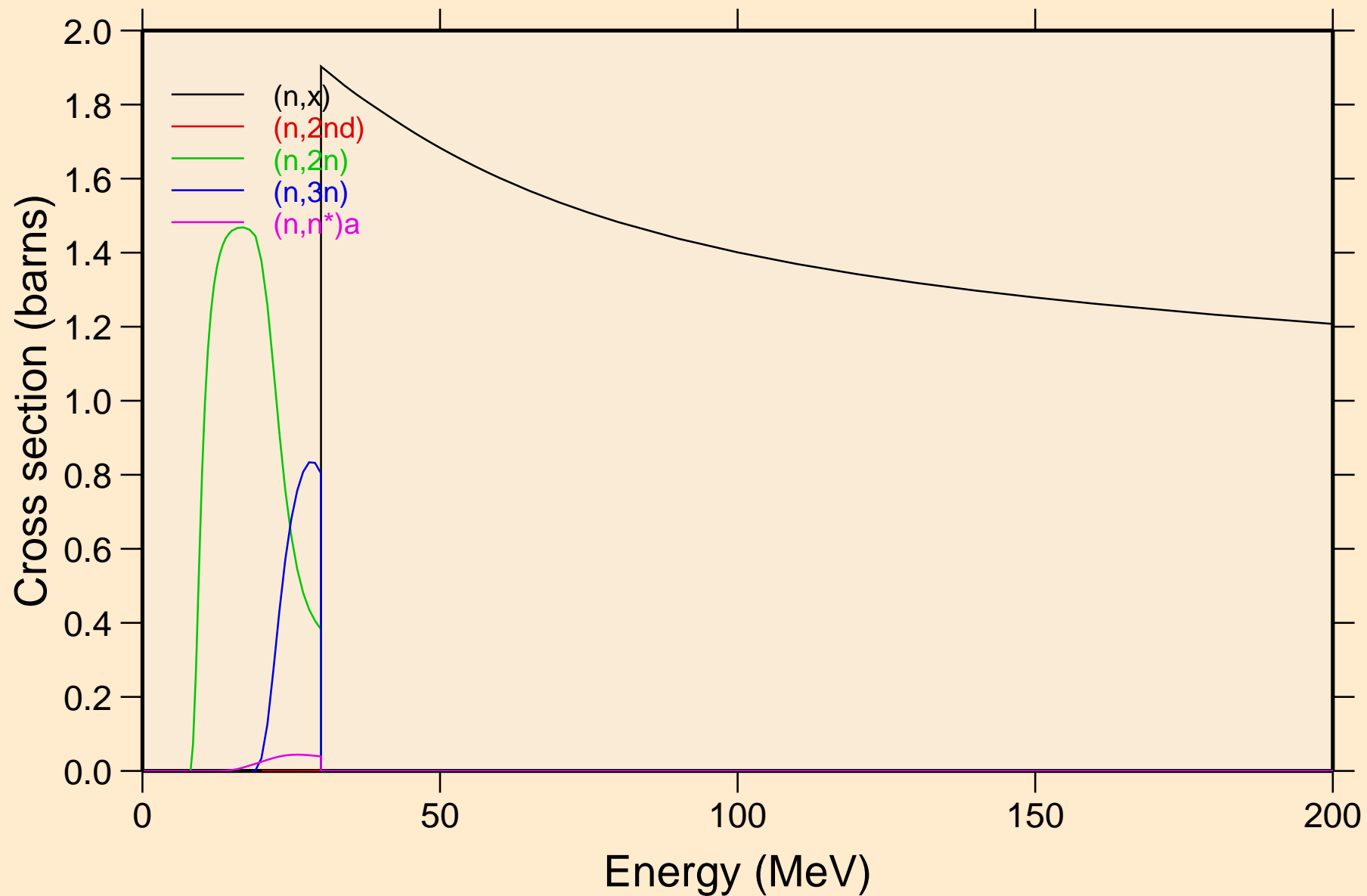

LA132 NEUTRON ACER TENDL-2019 LIBRARY; T=293.16K  
Threshold reactions

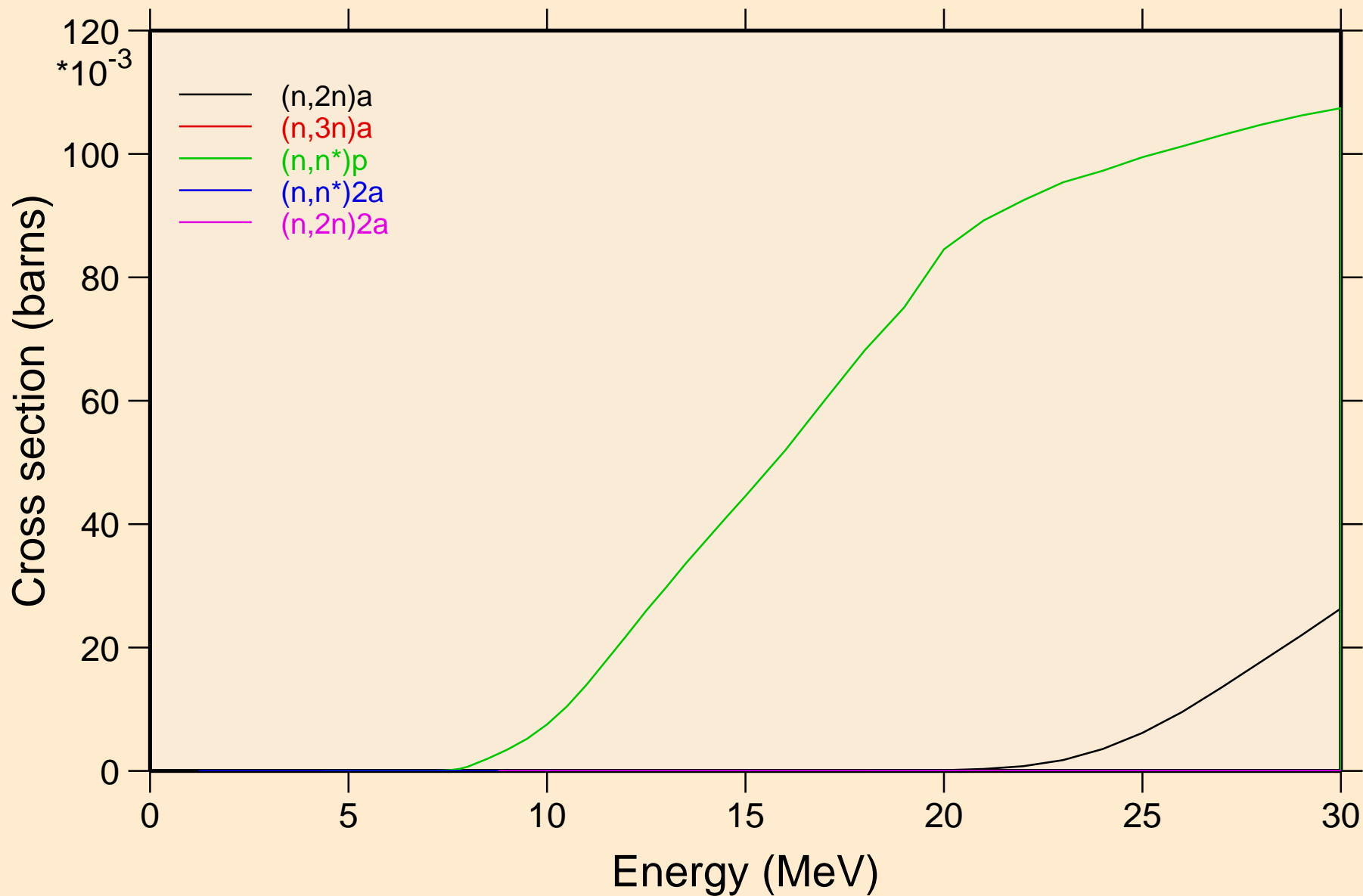



LA132 NEUTRON ACER TENDL-2019 LIBRARY; T=293.16K  
Threshold reactions

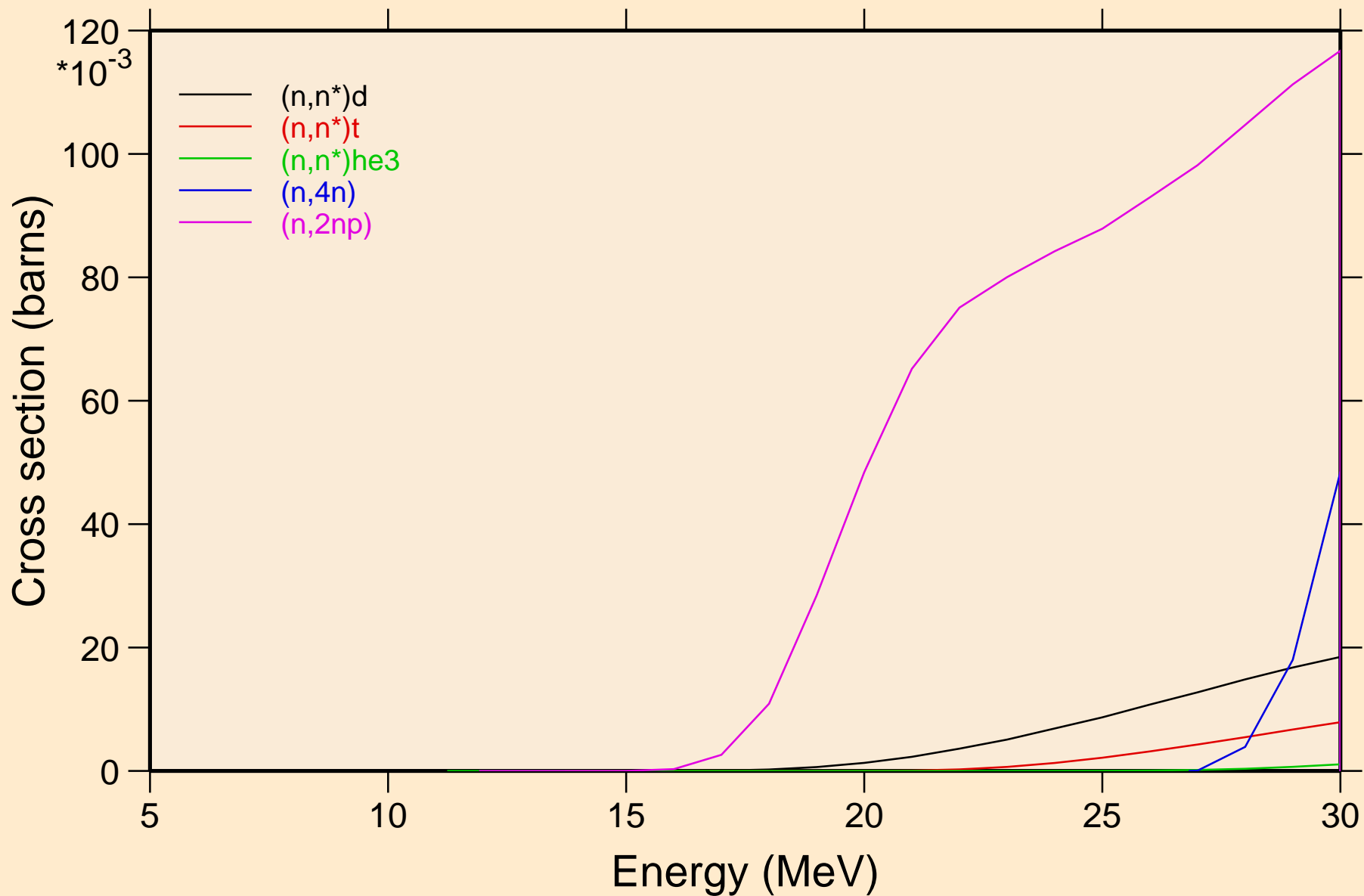

LA132 NEUTRON ACER TENDL-2019 LIBRARY; T=293.16K  
Threshold reactions

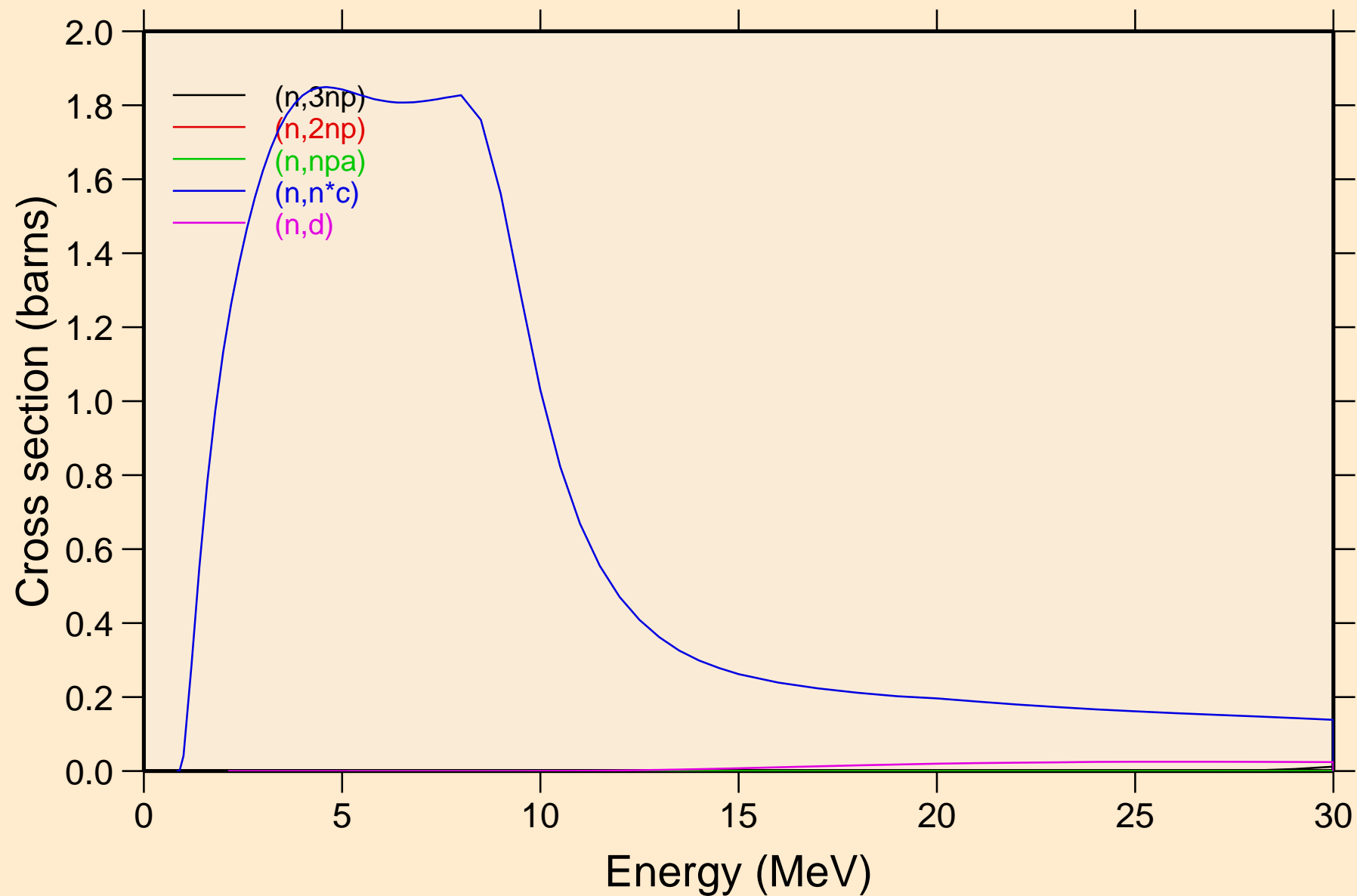

LA132 NEUTRON ACER TENDL-2019 LIBRARY; T=293.16K  
Threshold reactions

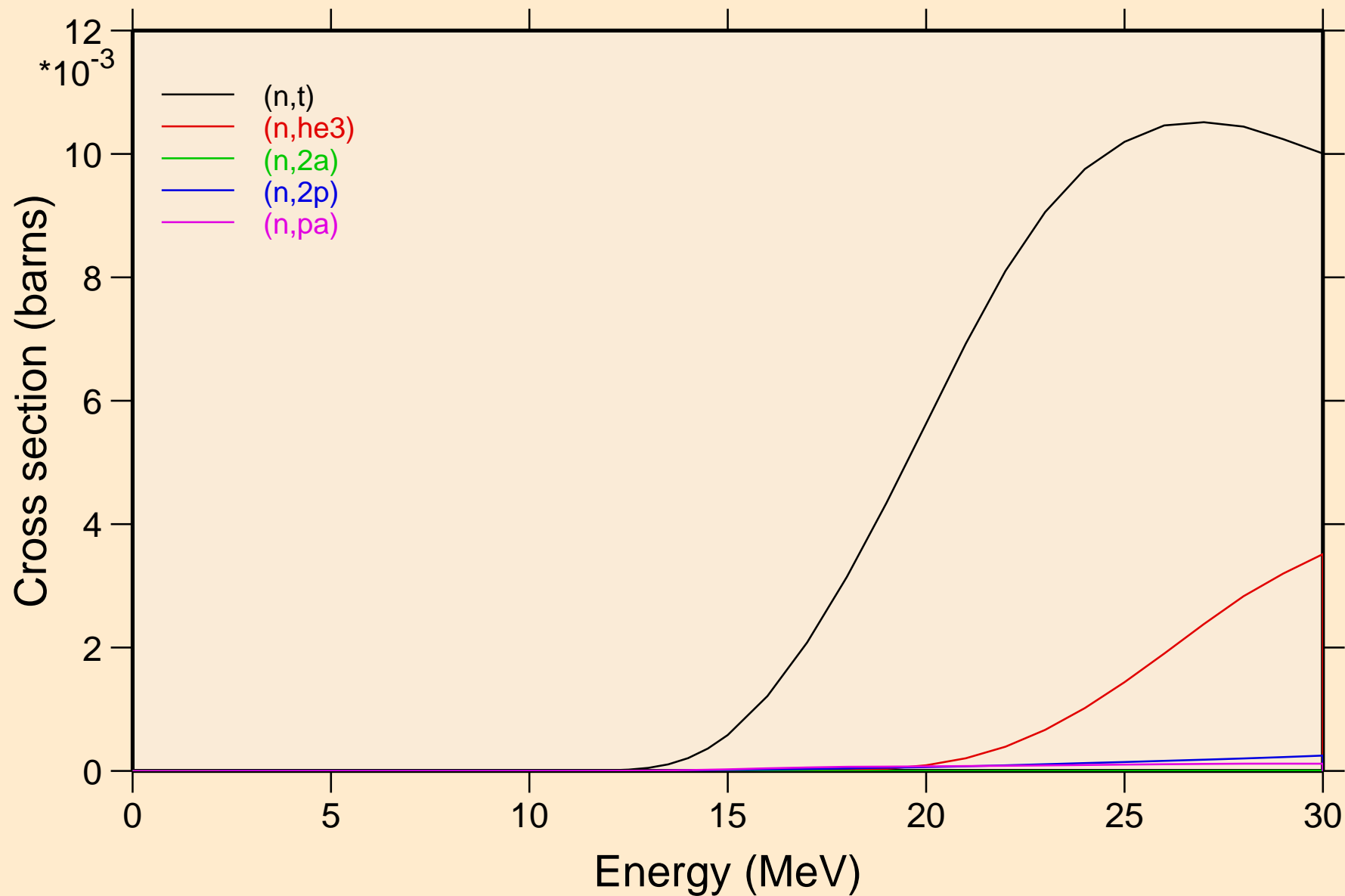

LA132 NEUTRON ACER TENDL-2019 LIBRARY; T=293.16K  
Threshold reactions

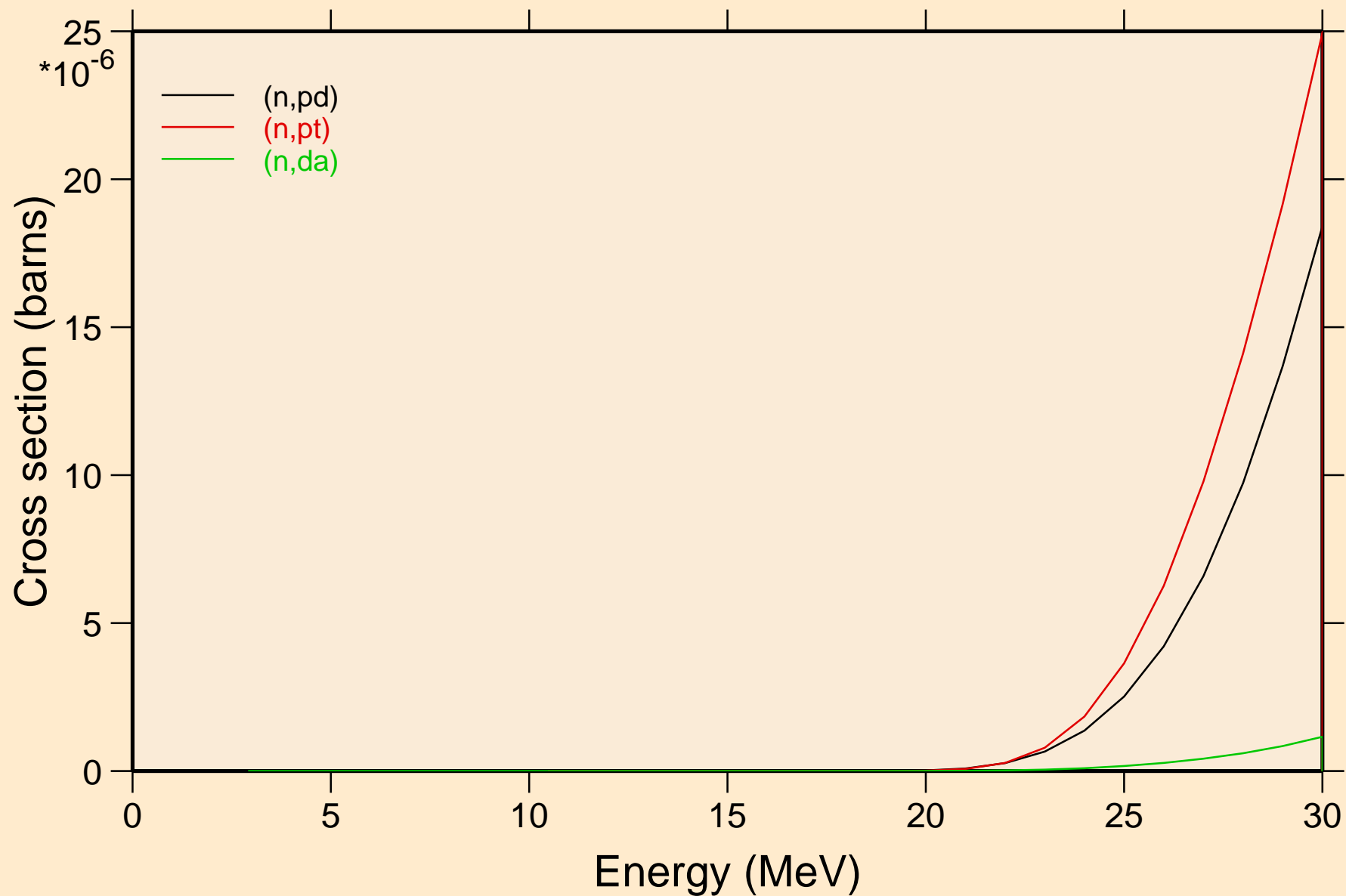

LA132 NEUTRON ACER TENDL-2019 LIBRARY; T=293.16K  
Threshold reactions

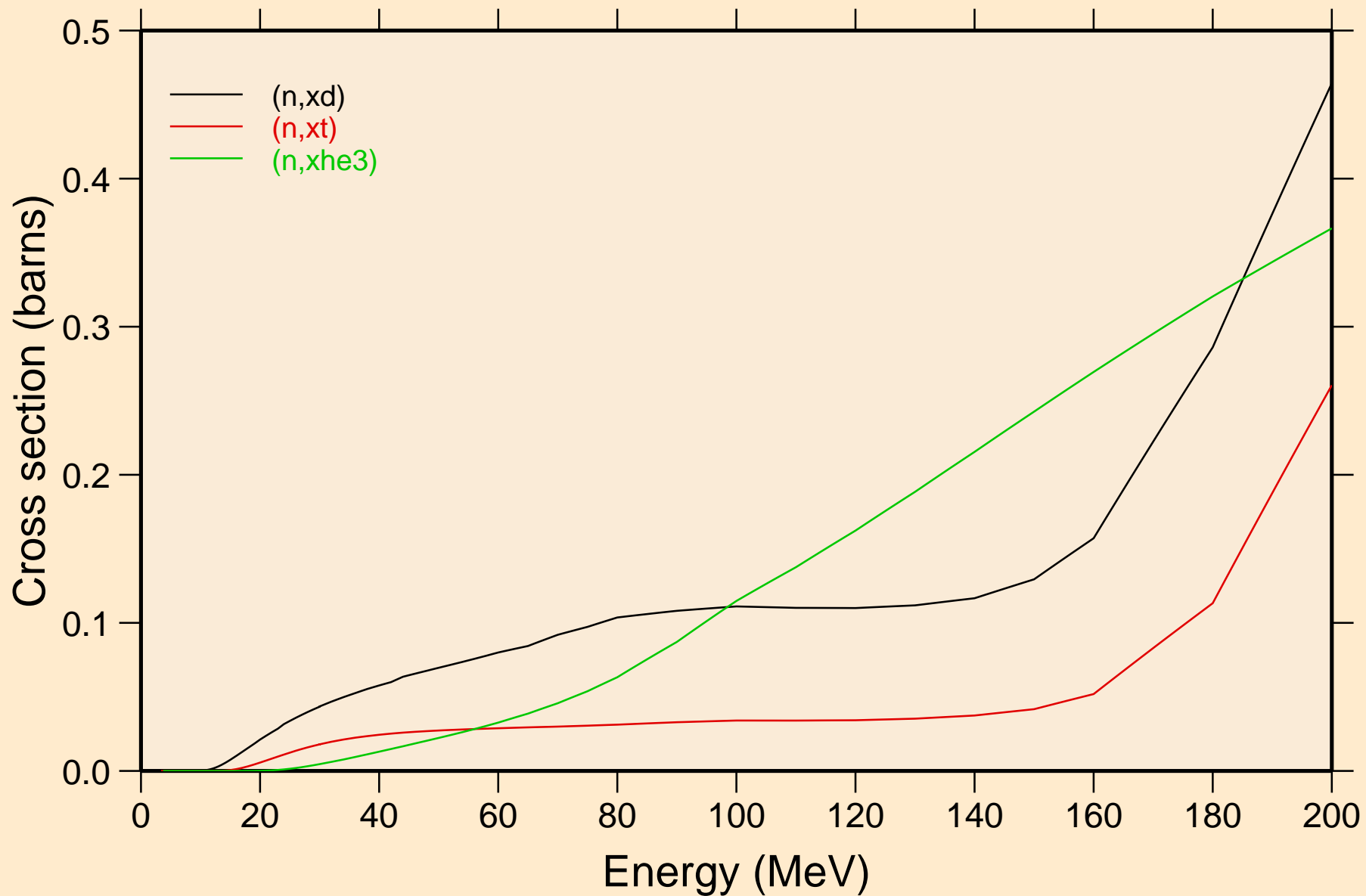

LA132 NEUTRON ACER TENDL-2019 LIBRARY; T=293.16K  
angular distribution for elastic

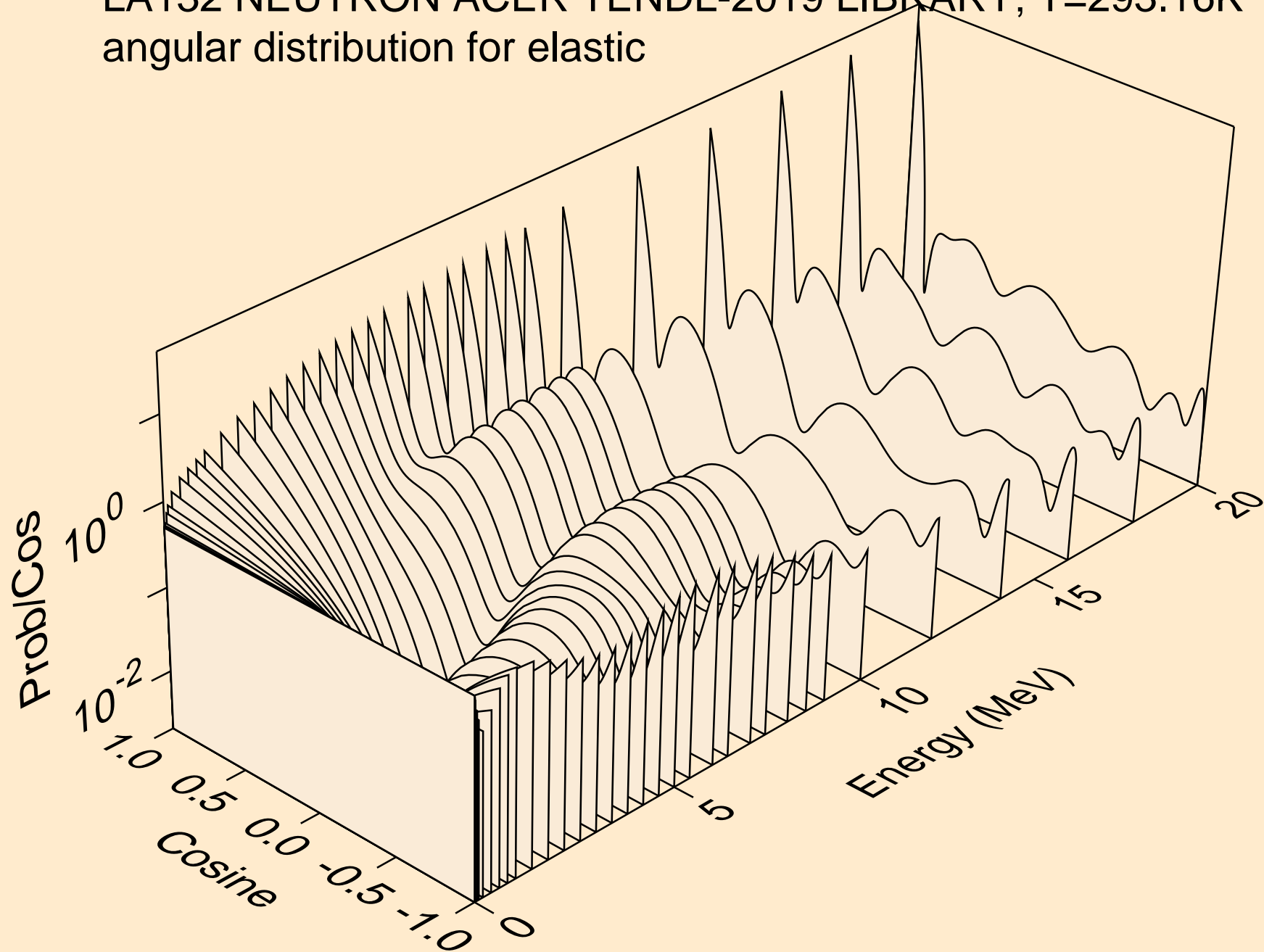

LA132 NEUTRON ACER TENDL-2019 LIBRARY; T=293.16K  
angular distribution for elastic

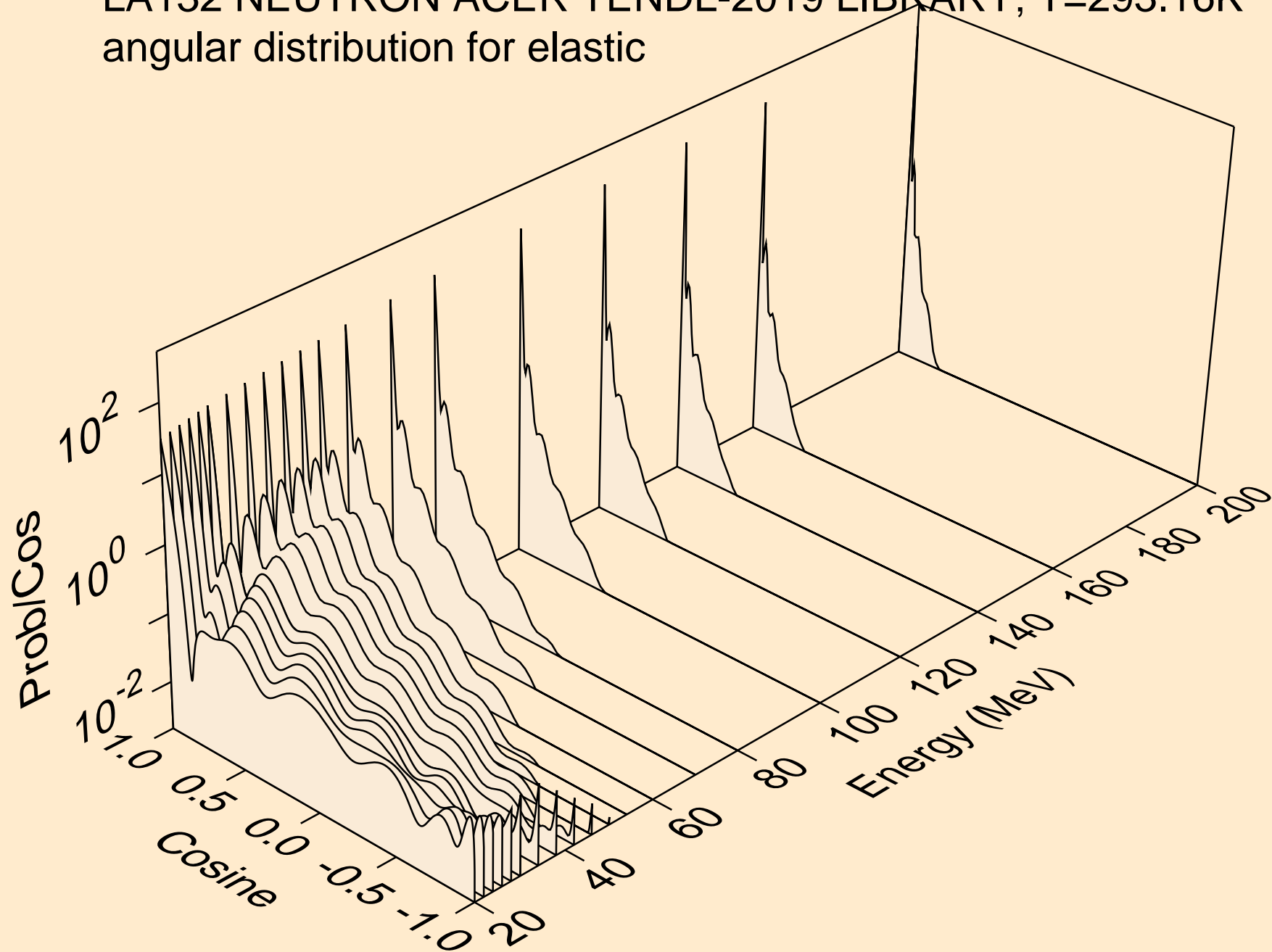

LA132 NEUTRON ACER TENDL-2019 LIBRARY; T=293.16K  
angular distribution for (n,n\*1)

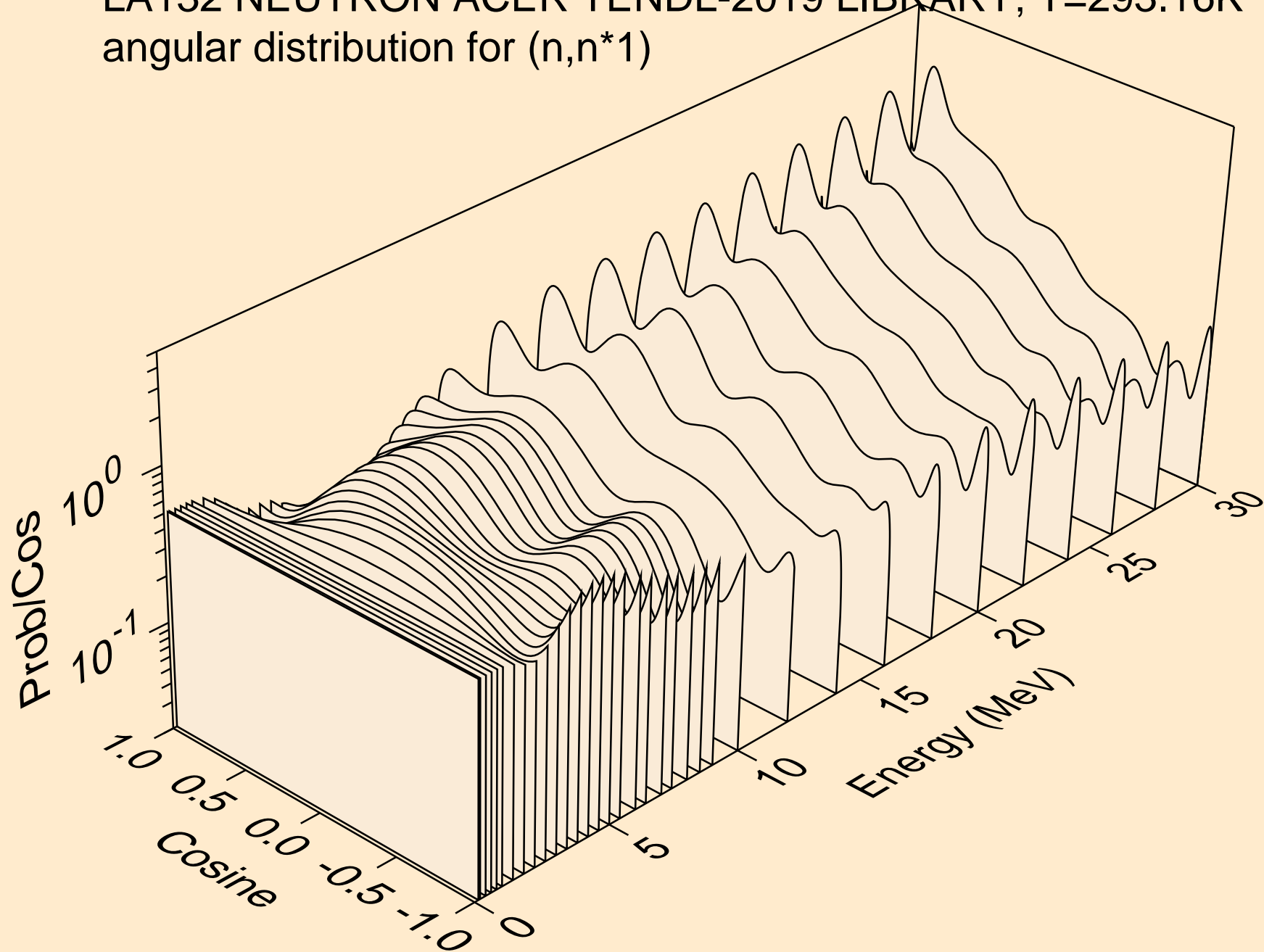



LA132 NEUTRON ACER TENDL-2019 LIBRARY; T=293.16K  
angular distribution for (n,n\*2)

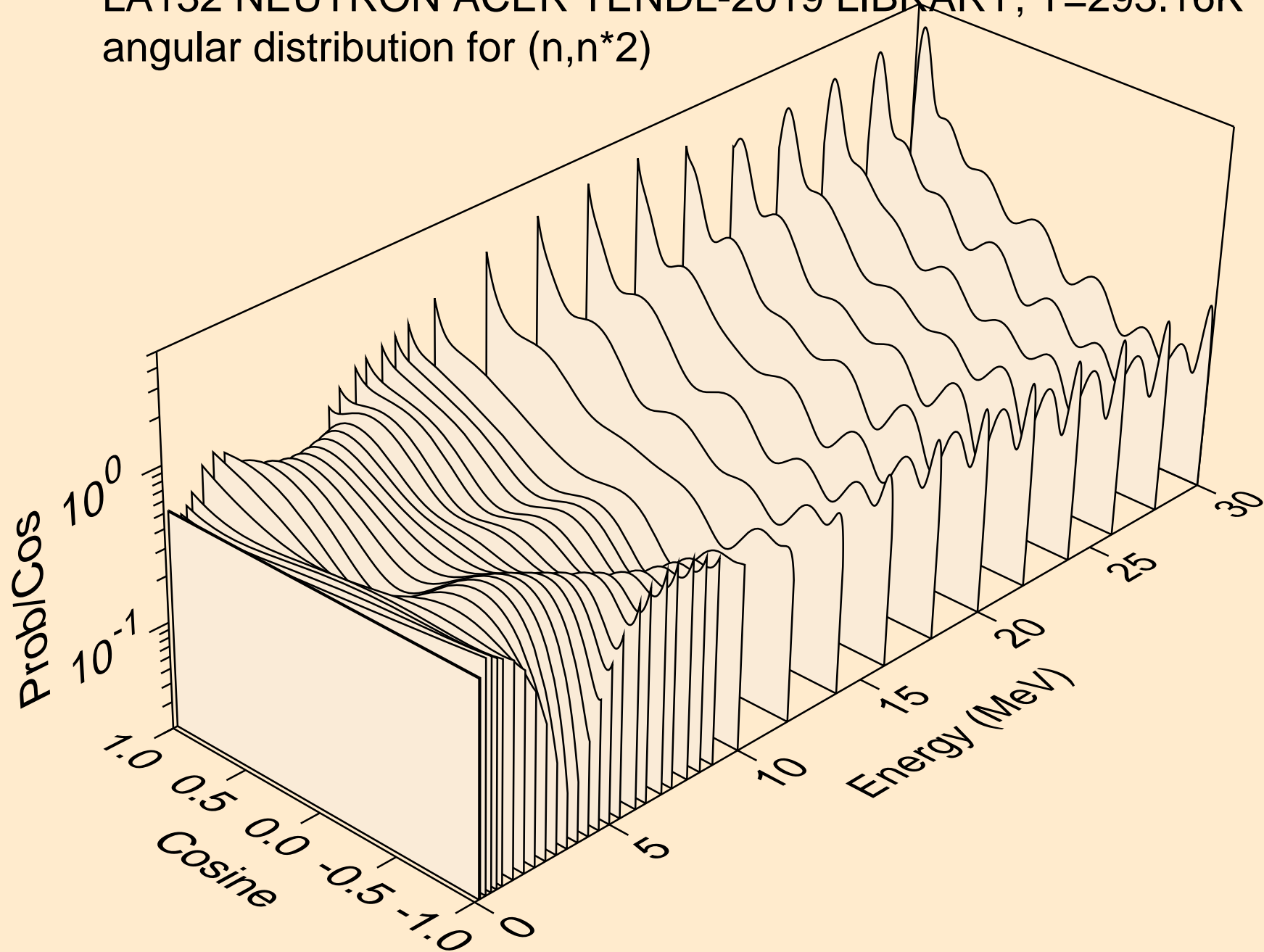

LA132 NEUTRON ACER TENDL-2019 LIBRARY; T=293.16K  
angular distribution for (n,n\*3)

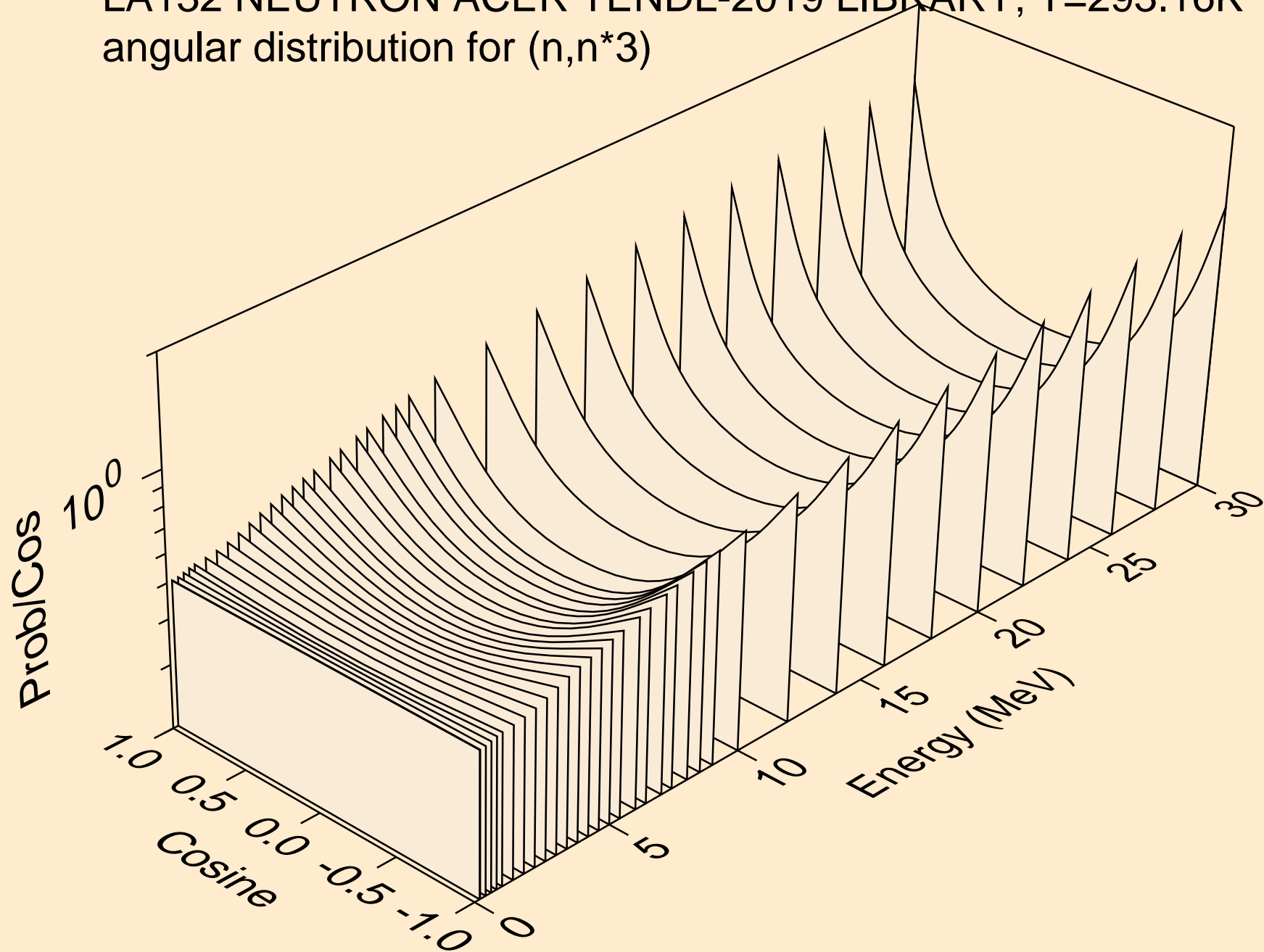

LA132 NEUTRON ACER TENDL-2019 LIBRARY; T=293.16K  
angular distribution for (n,n\*4)

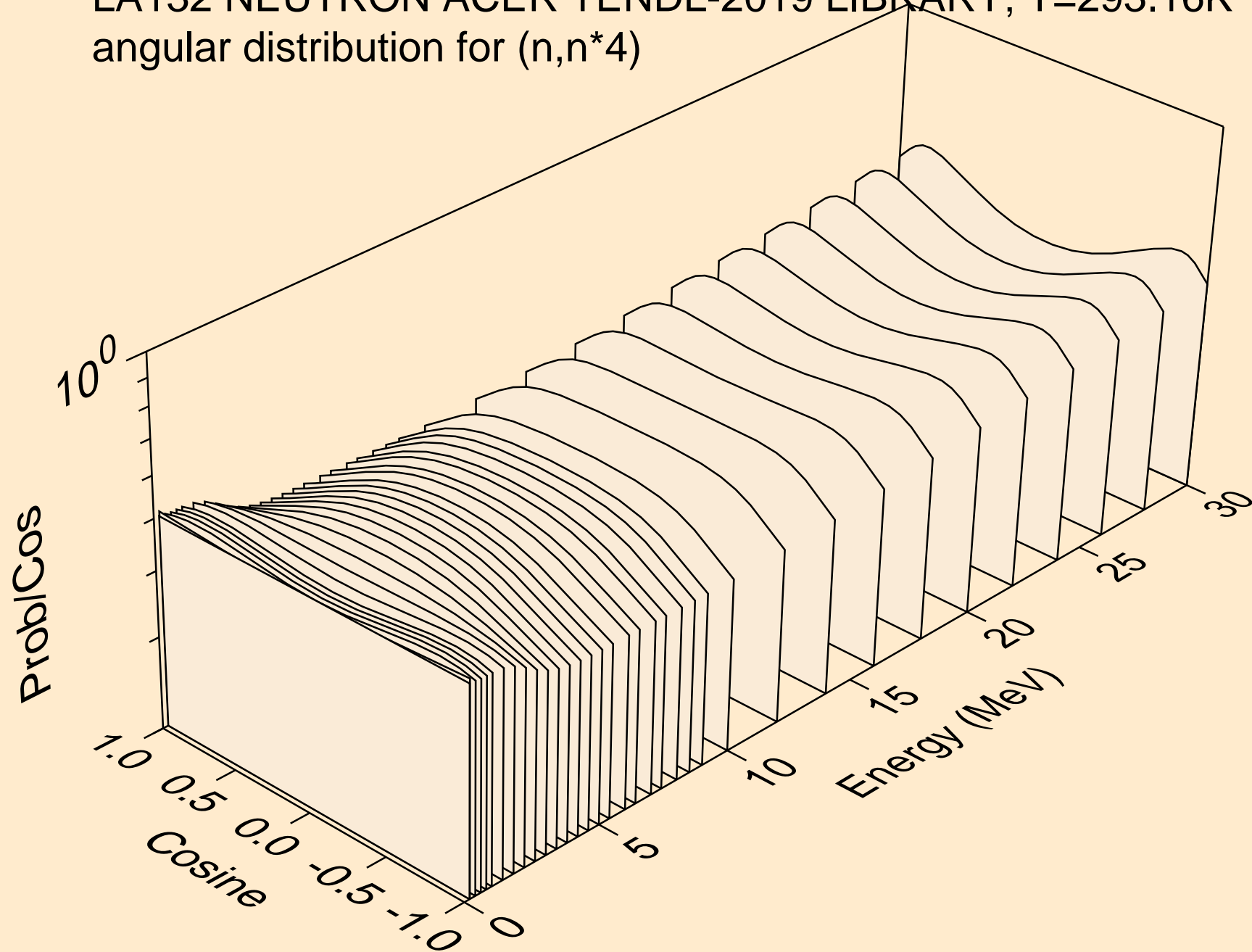

LA132 NEUTRON ACER TENDL-2019 LIBRARY; T=293.16K  
angular distribution for (n,n\*5)

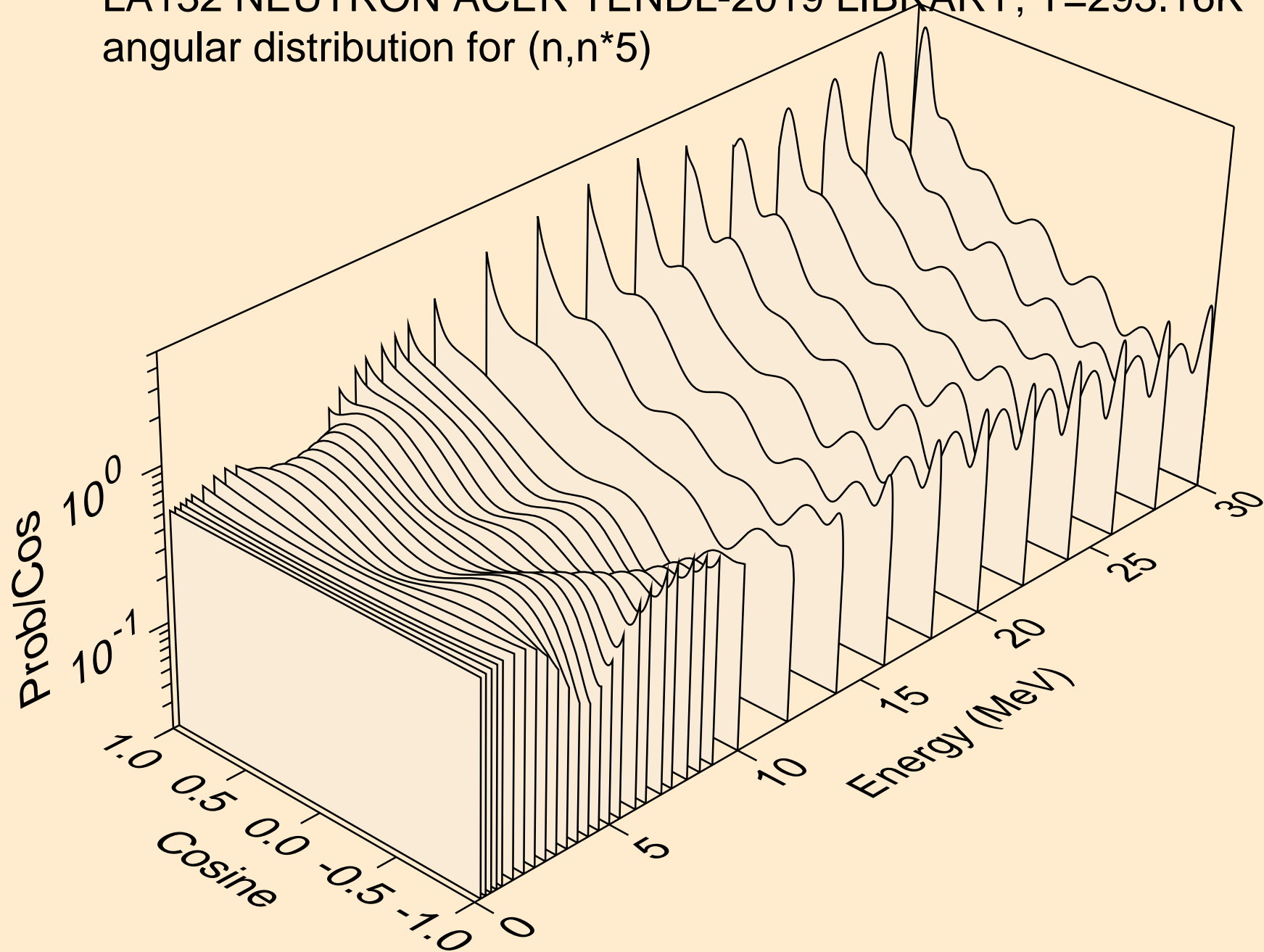

LA132 NEUTRON ACER TENDL-2019 LIBRARY; T=293.16K  
angular distribution for (n,n\*6)

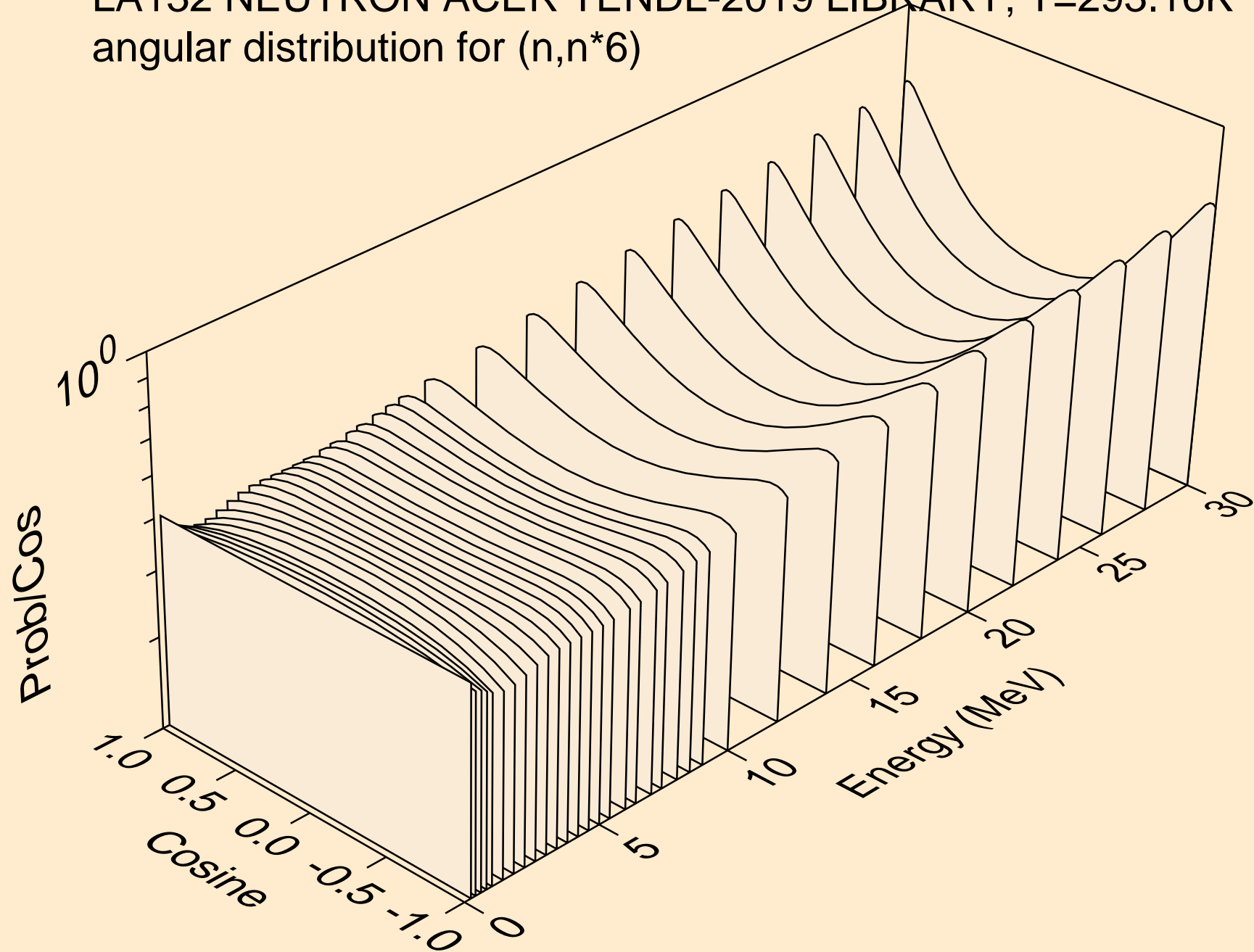

LA132 NEUTRON ACER TENDL-2019 LIBRARY; T=293.16K  
angular distribution for (n,n\*7)

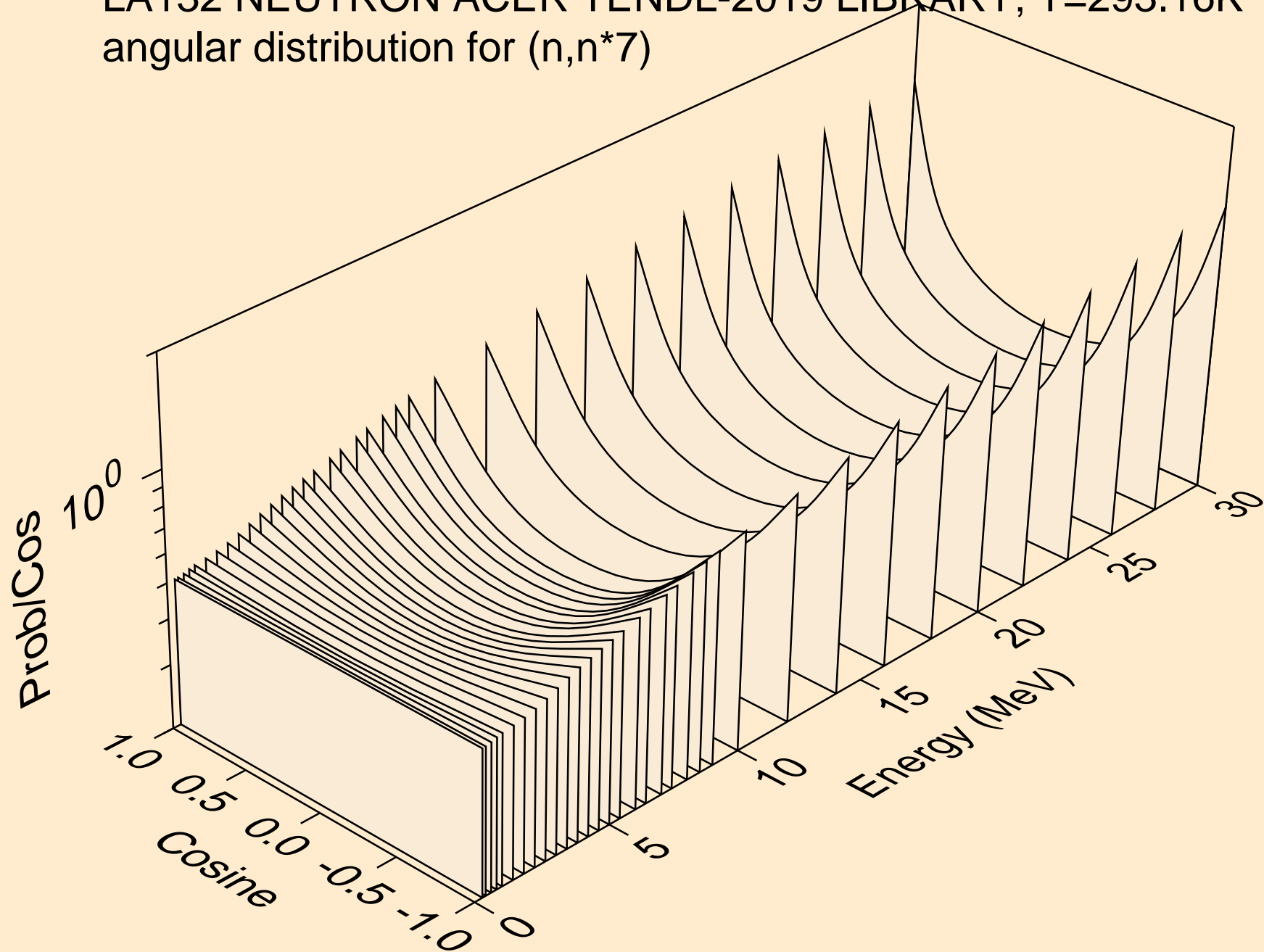

LA132 NEUTRON ACER TENDL-2019 LIBRARY; T=293.16K  
angular distribution for (n,n\*8)

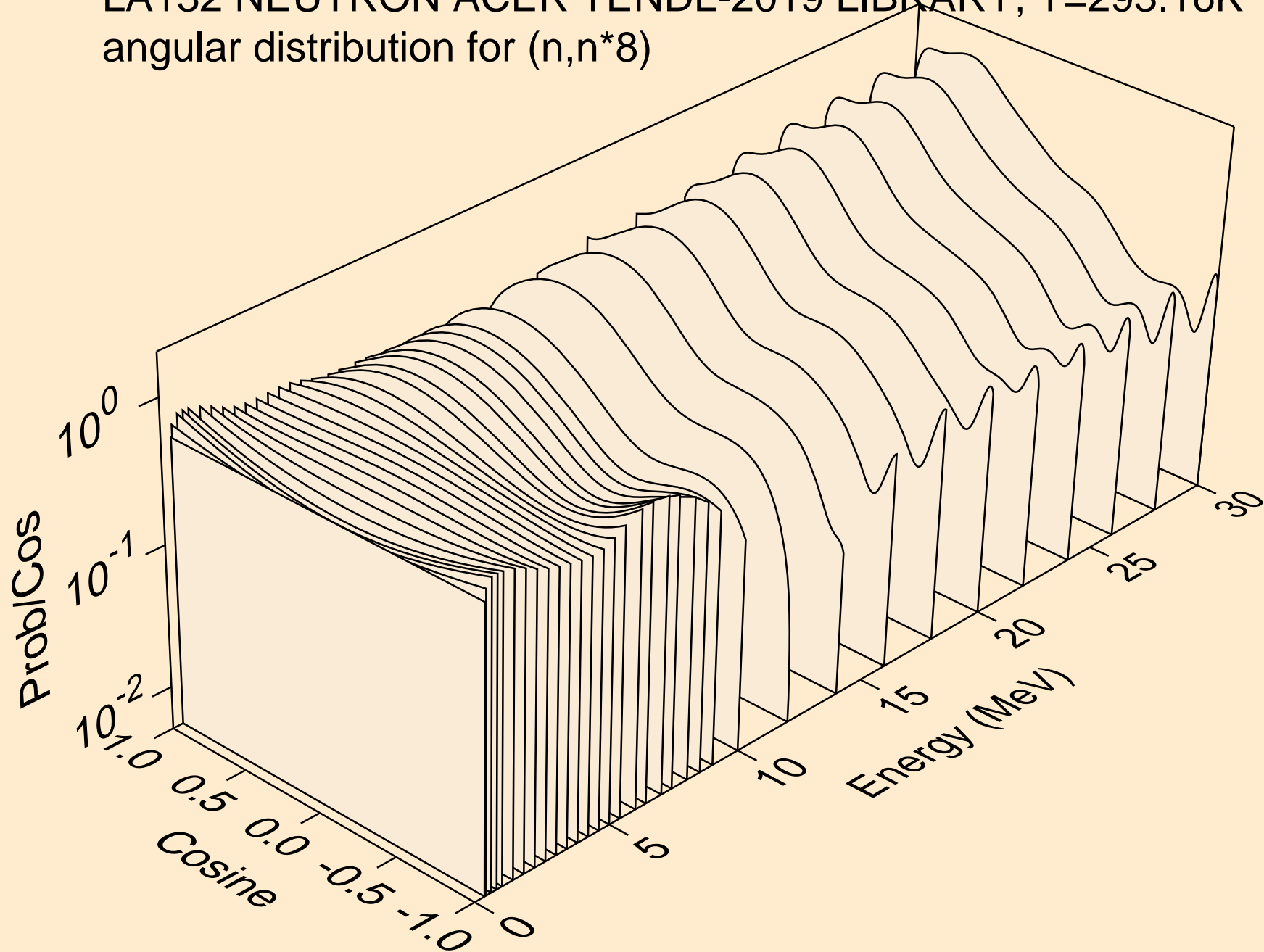

LA132 NEUTRON ACER TENDL-2019 LIBRARY; T=293.16K  
angular distribution for (n,n\*9)

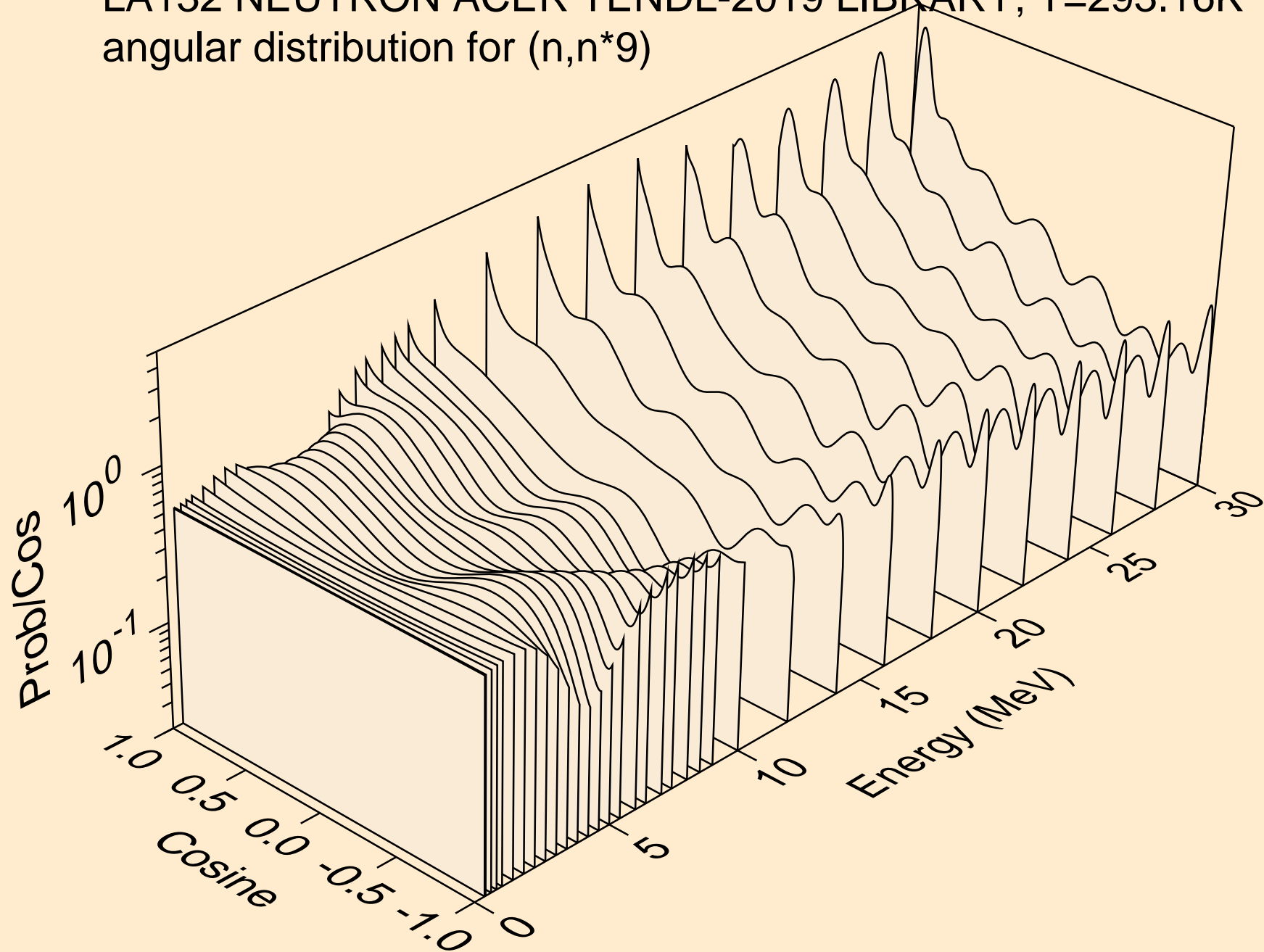



LA132 NEUTRON ACER TENDL-2019 LIBRARY; T=293.16K  
angular distribution for (n,n\*10)

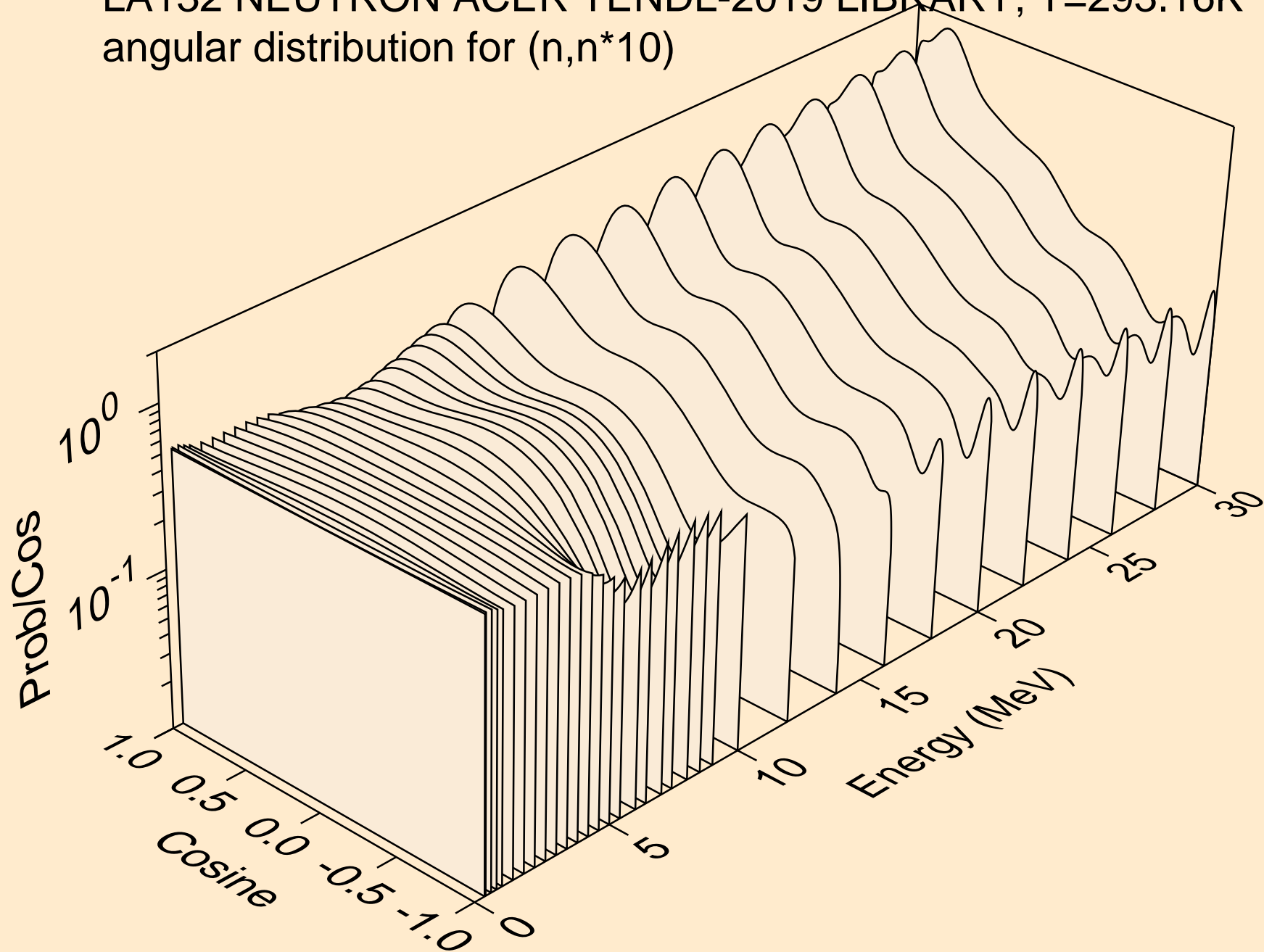

LA132 NEUTRON ACER TENDL-2019 LIBRARY; T=293.16K  
angular distribution for (n,n\*11)

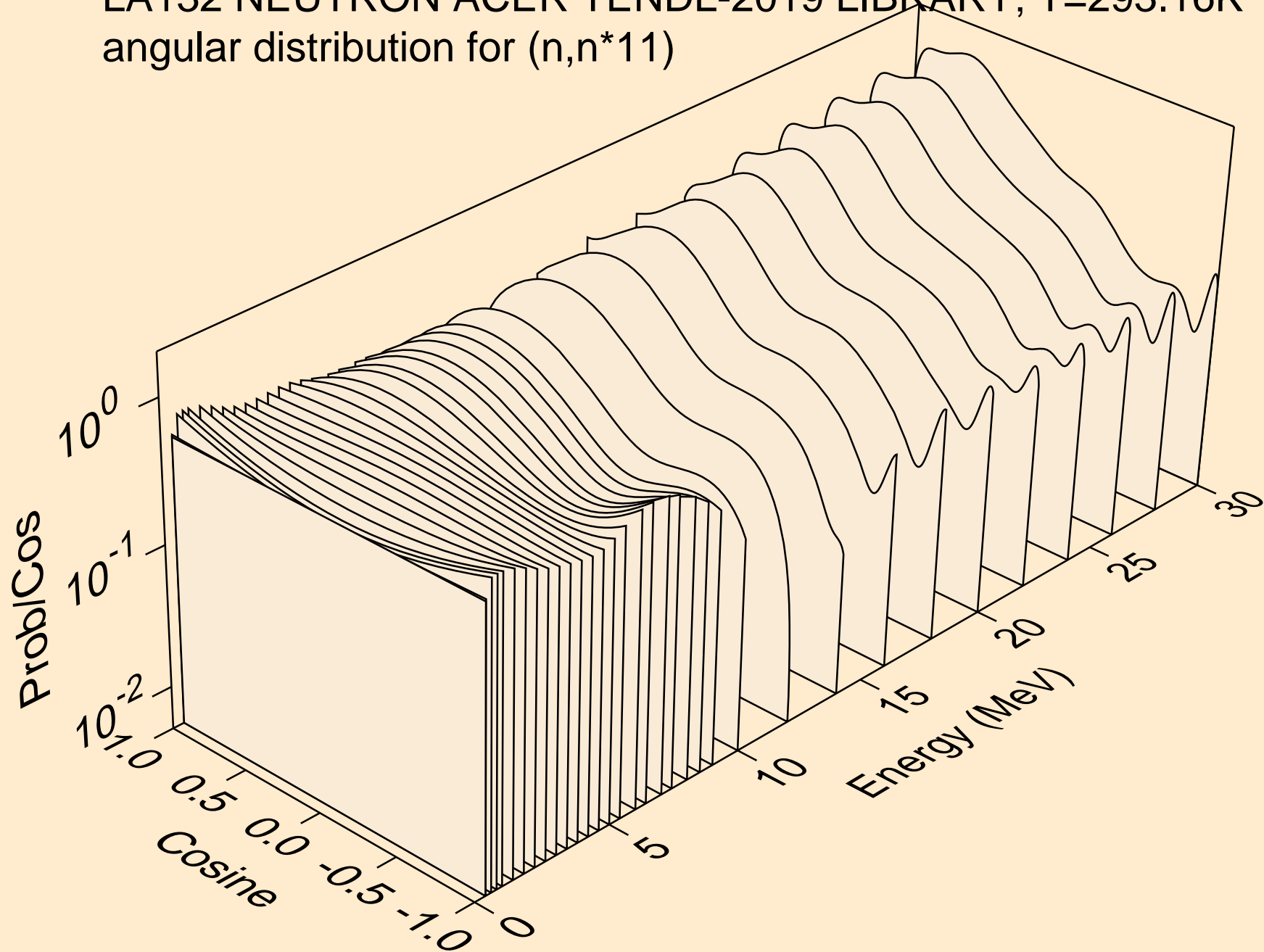

LA132 NEUTRON ACER TENDL-2019 LIBRARY; T=293.16K  
angular distribution for (n,n\*12)

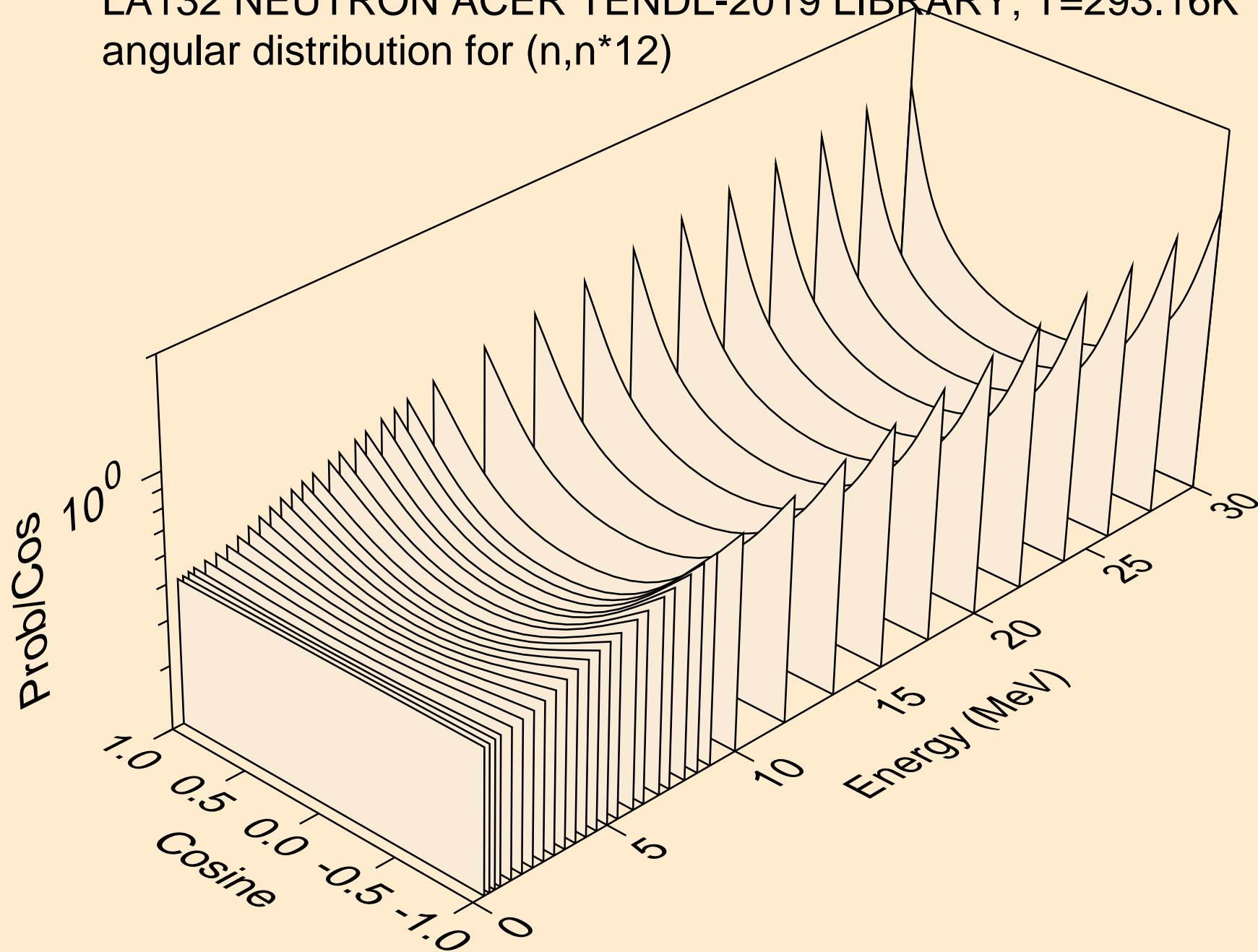

LA132 NEUTRON ACER TENDL-2019 LIBRARY; T=293.16K  
angular distribution for (n,n\*13)

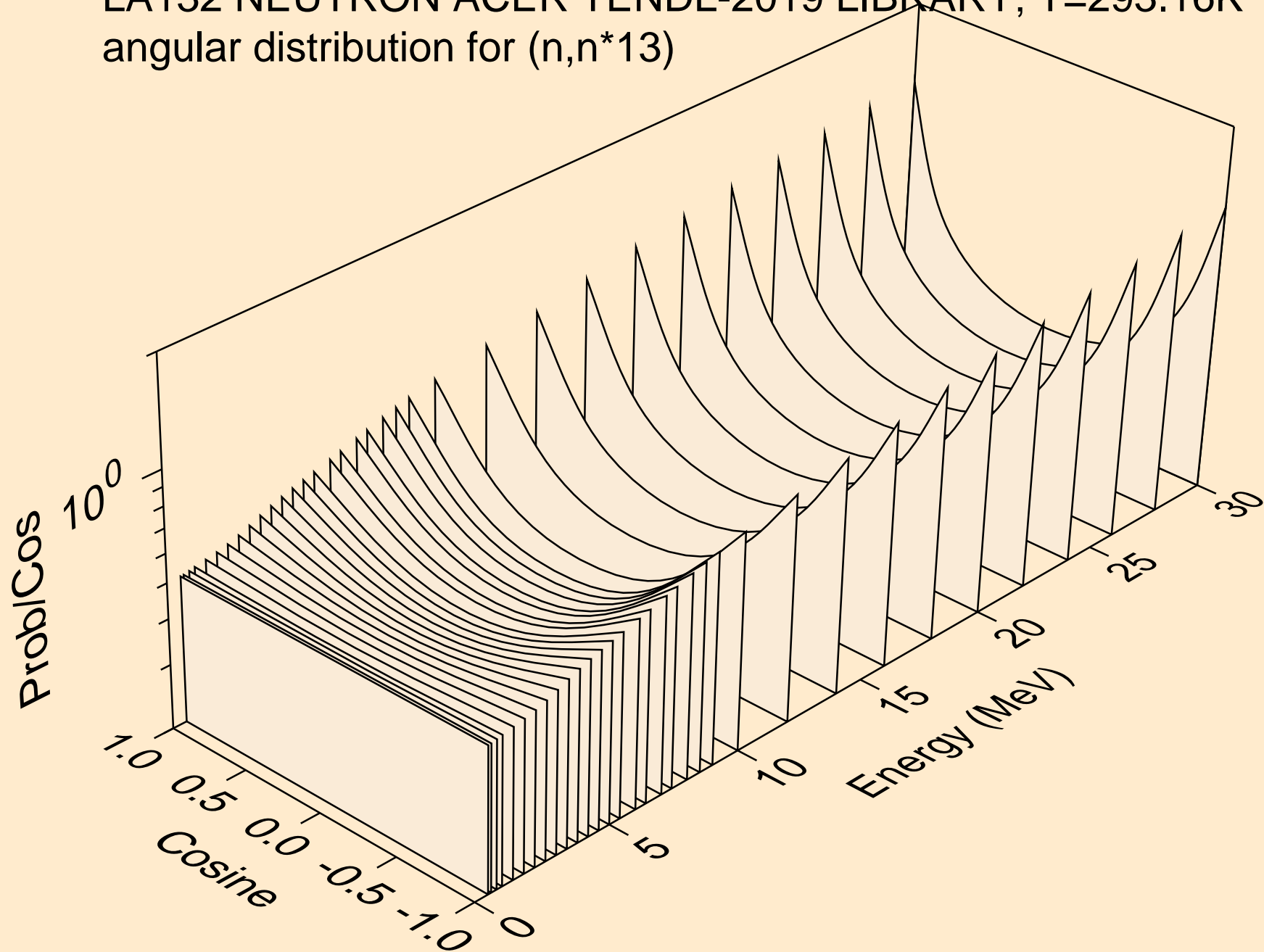

LA132 NEUTRON ACER TENDL-2019 LIBRARY; T=293.16K  
angular distribution for (n,n\*14)

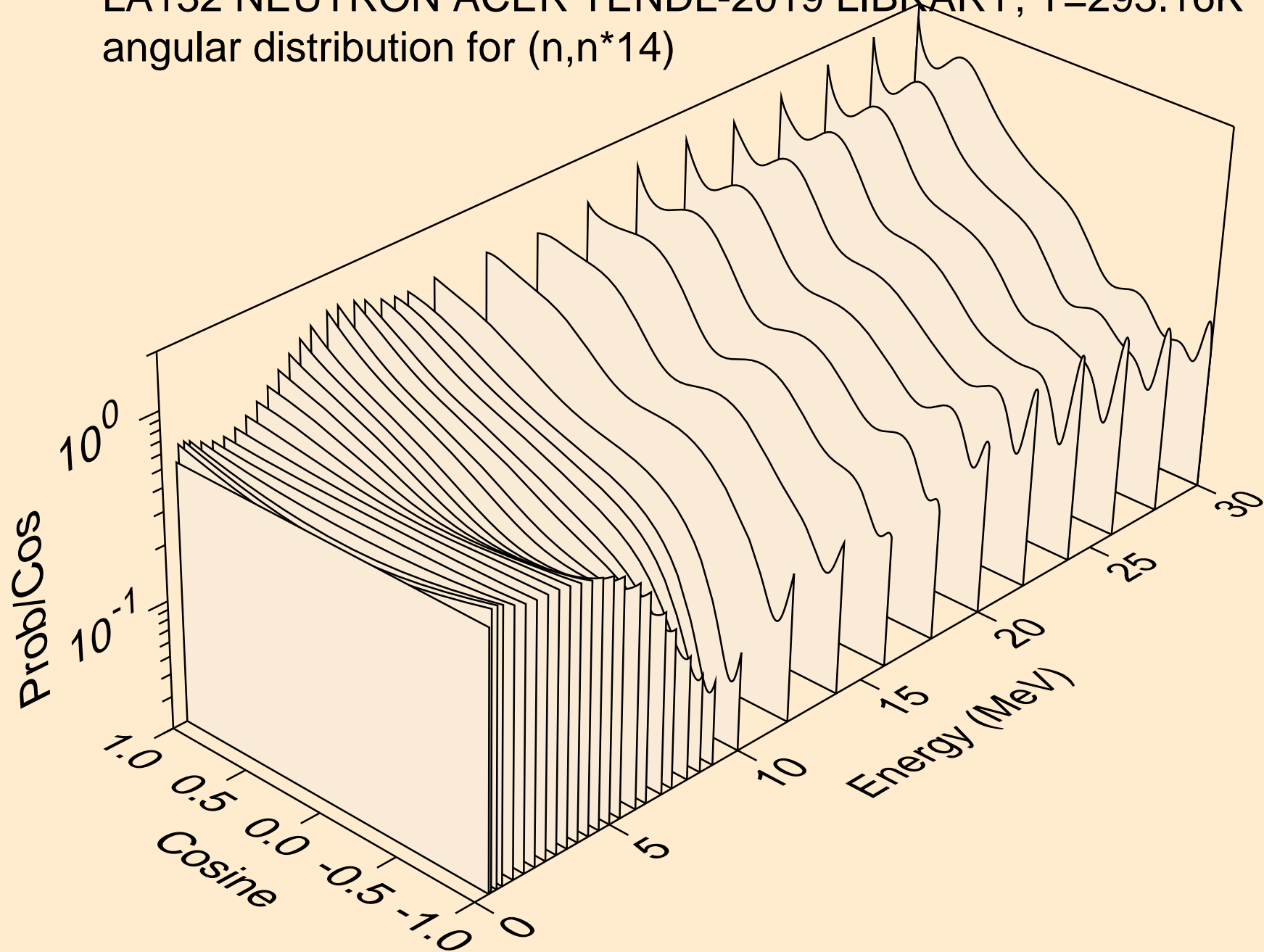

LA132 NEUTRON ACER TENDL-2019 LIBRARY; T=293.16K  
angular distribution for (n,n\*15)

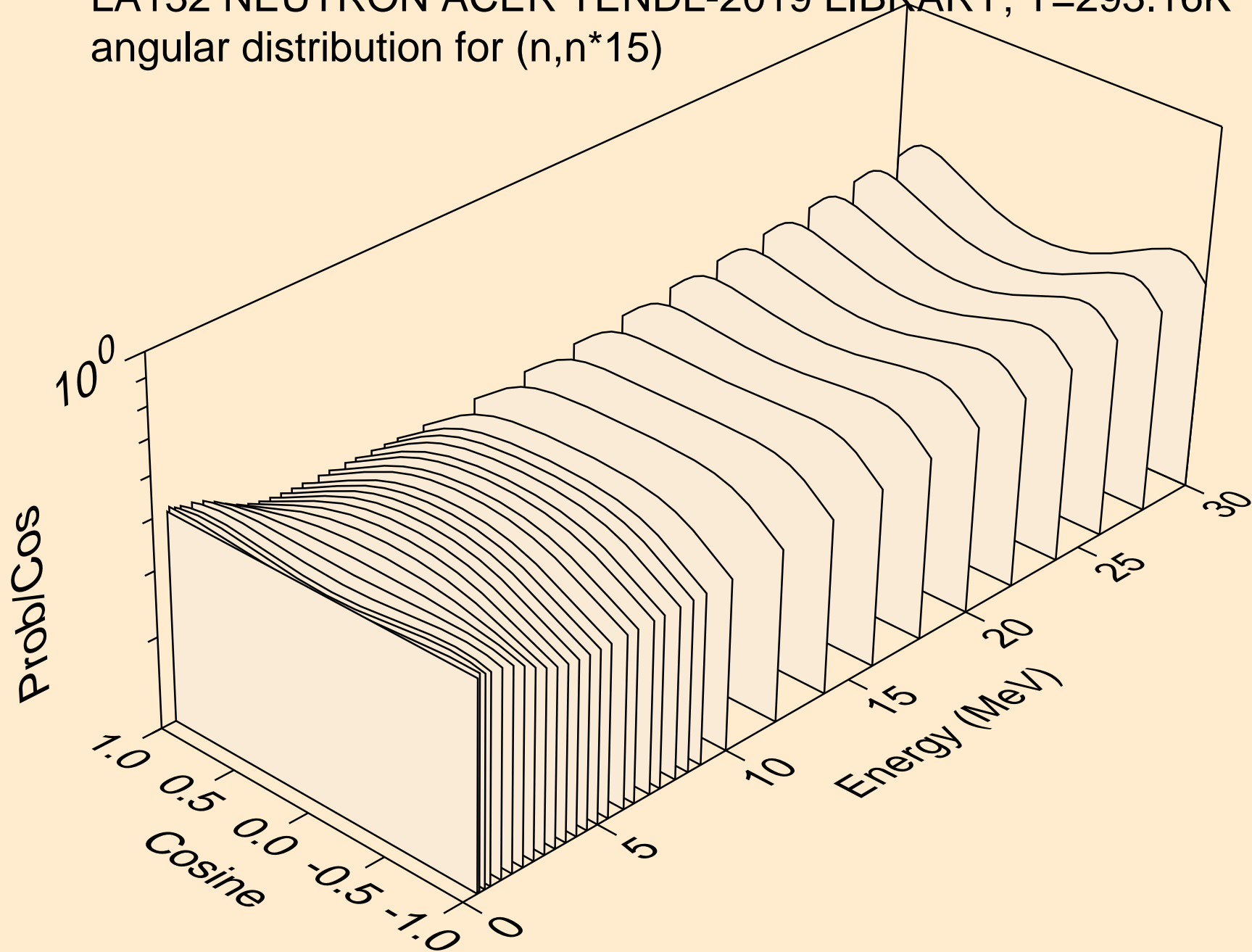

LA132 NEUTRON ACER TENDL-2019 LIBRARY; T=293.16K  
angular distribution for (n,n\*16)

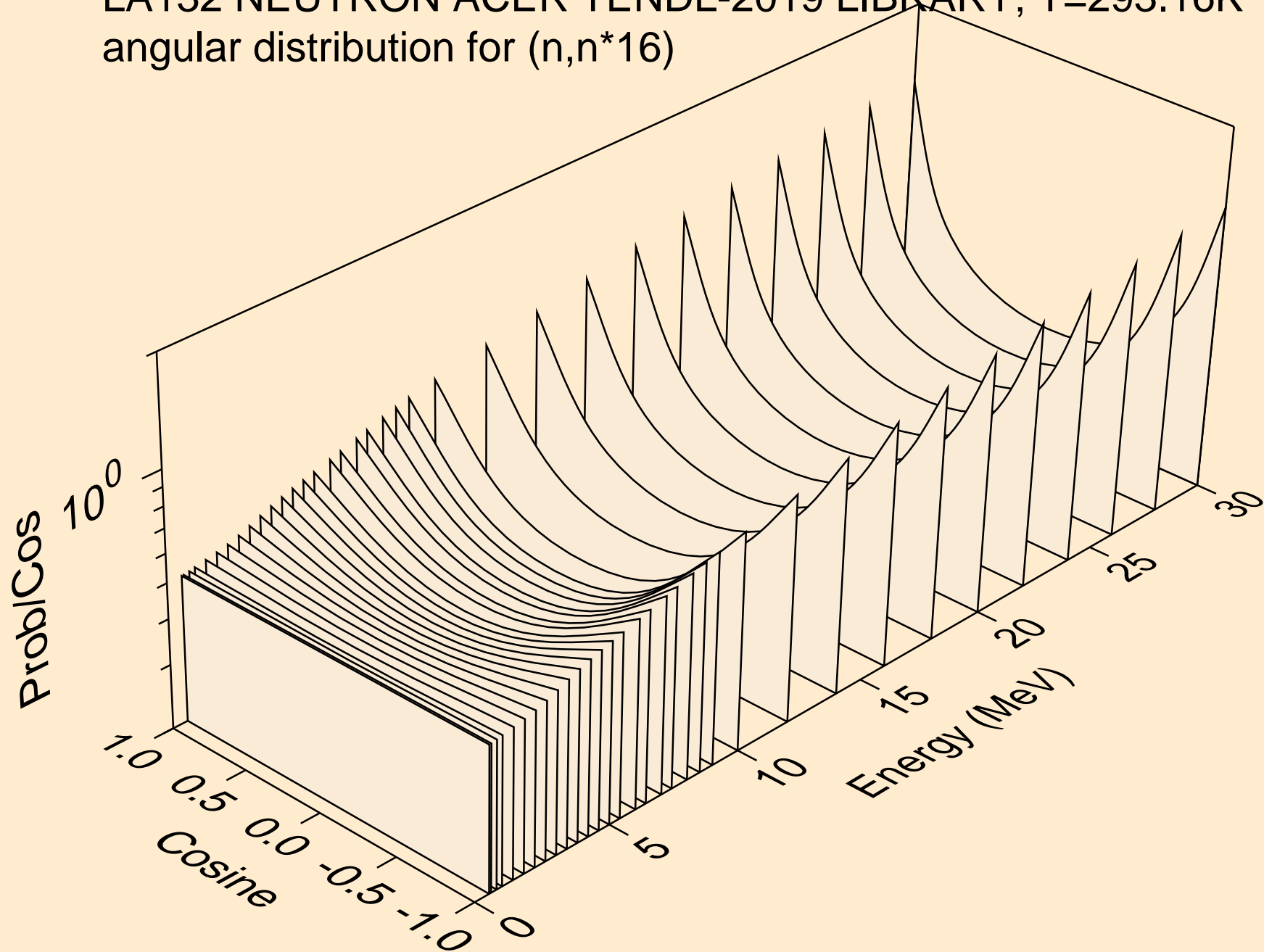

LA132 NEUTRON ACER TENDL-2019 LIBRARY; T=293.16K  
angular distribution for (n,n\*17)

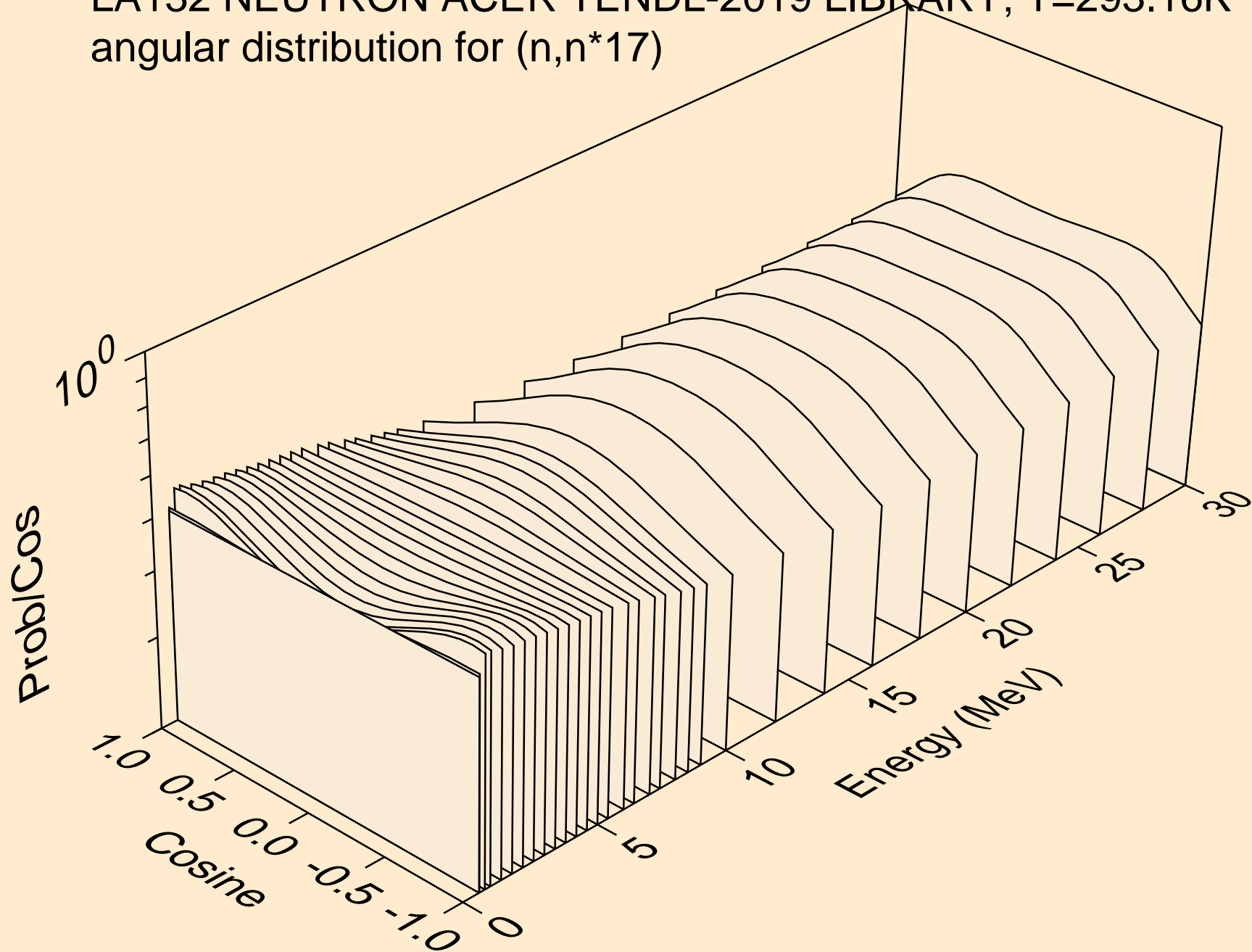



LA132 NEUTRON ACER TENDL-2019 LIBRARY; T=293.16K  
angular distribution for (n,n\*18)

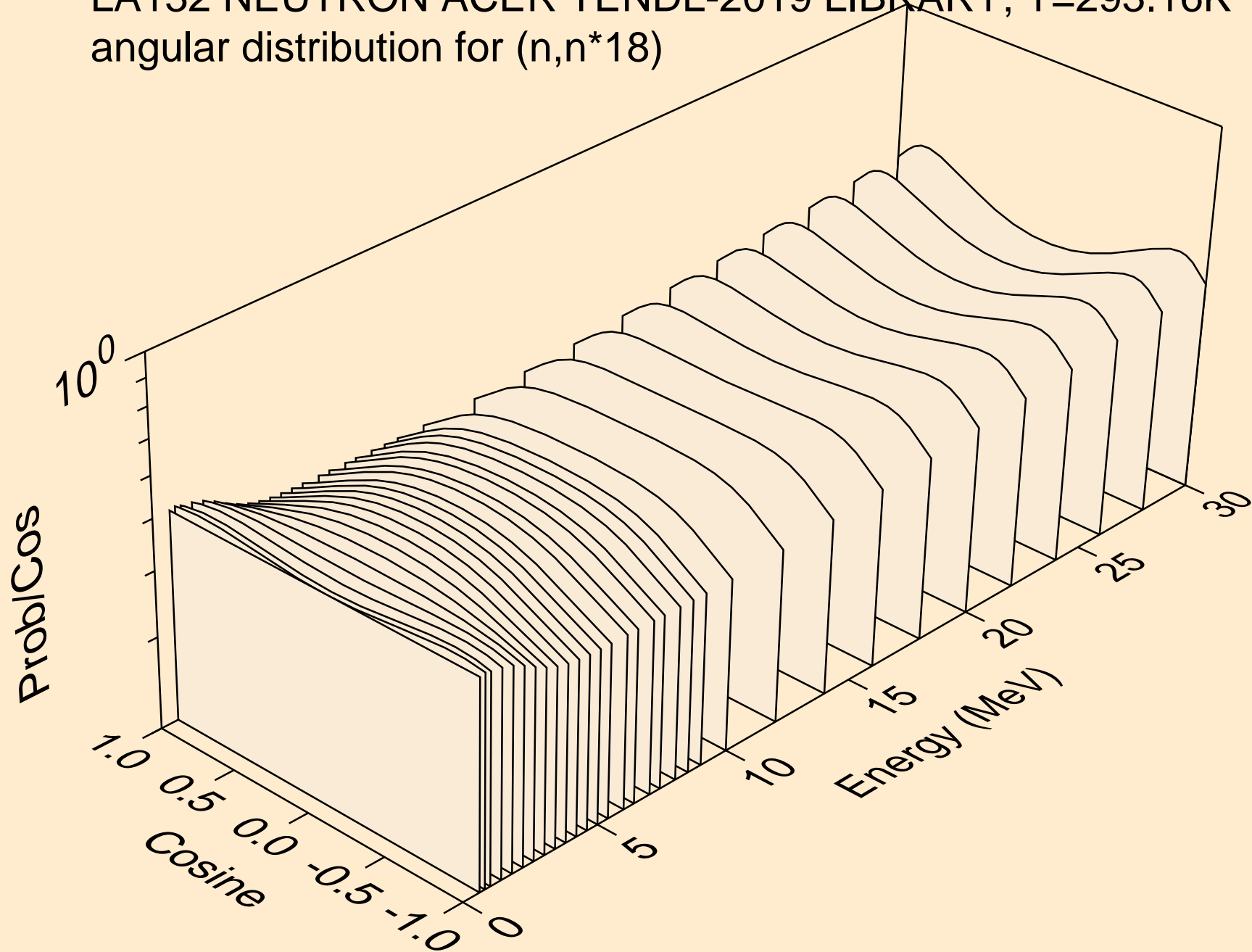

LA132 NEUTRON ACER TENDL-2019 LIBRARY; T=293.16K  
angular distribution for (n,n\*19)

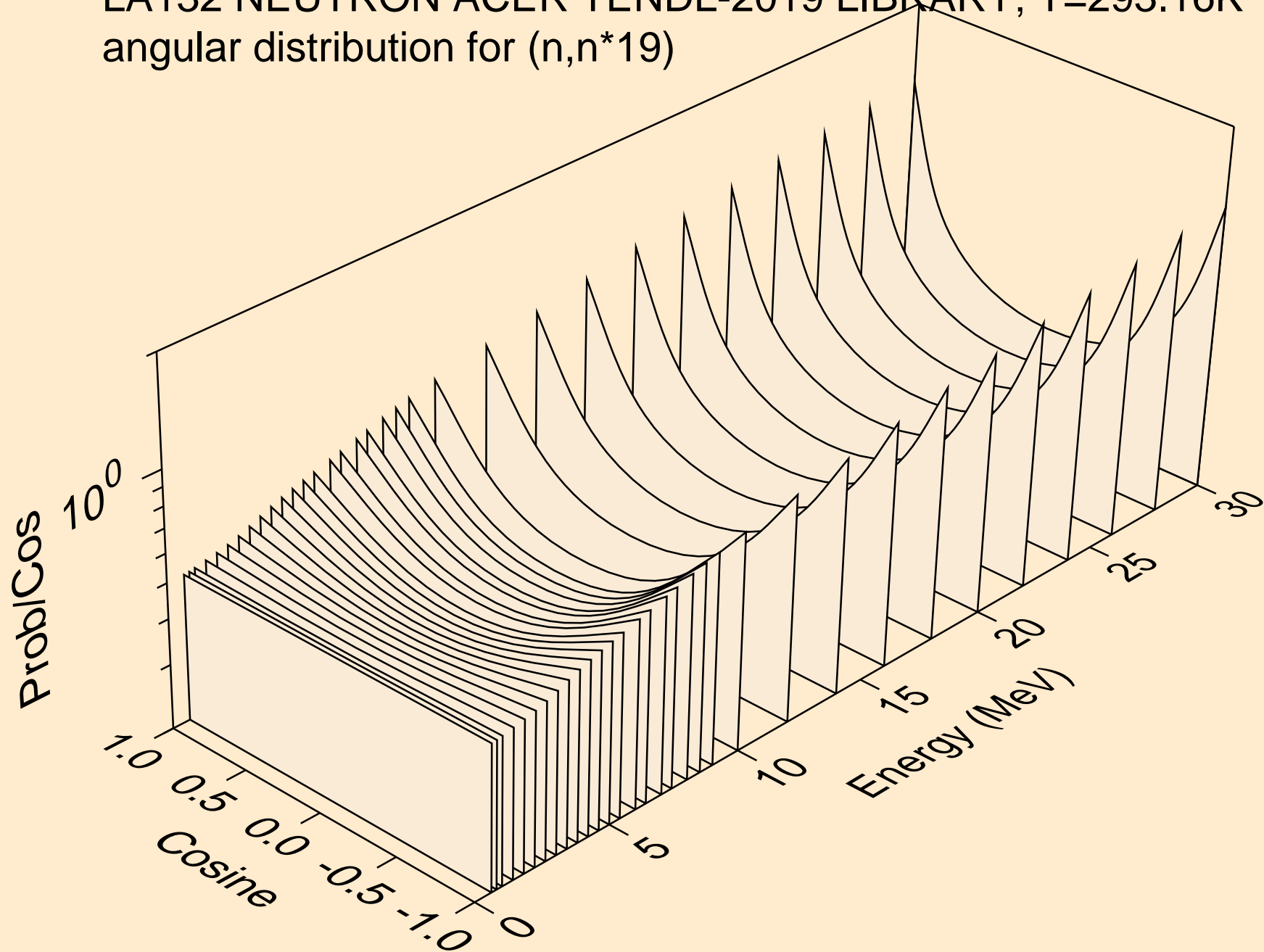

LA132 NEUTRON ACER TENDL-2019 LIBRARY; T=293.16K  
angular distribution for (n,n\*20)

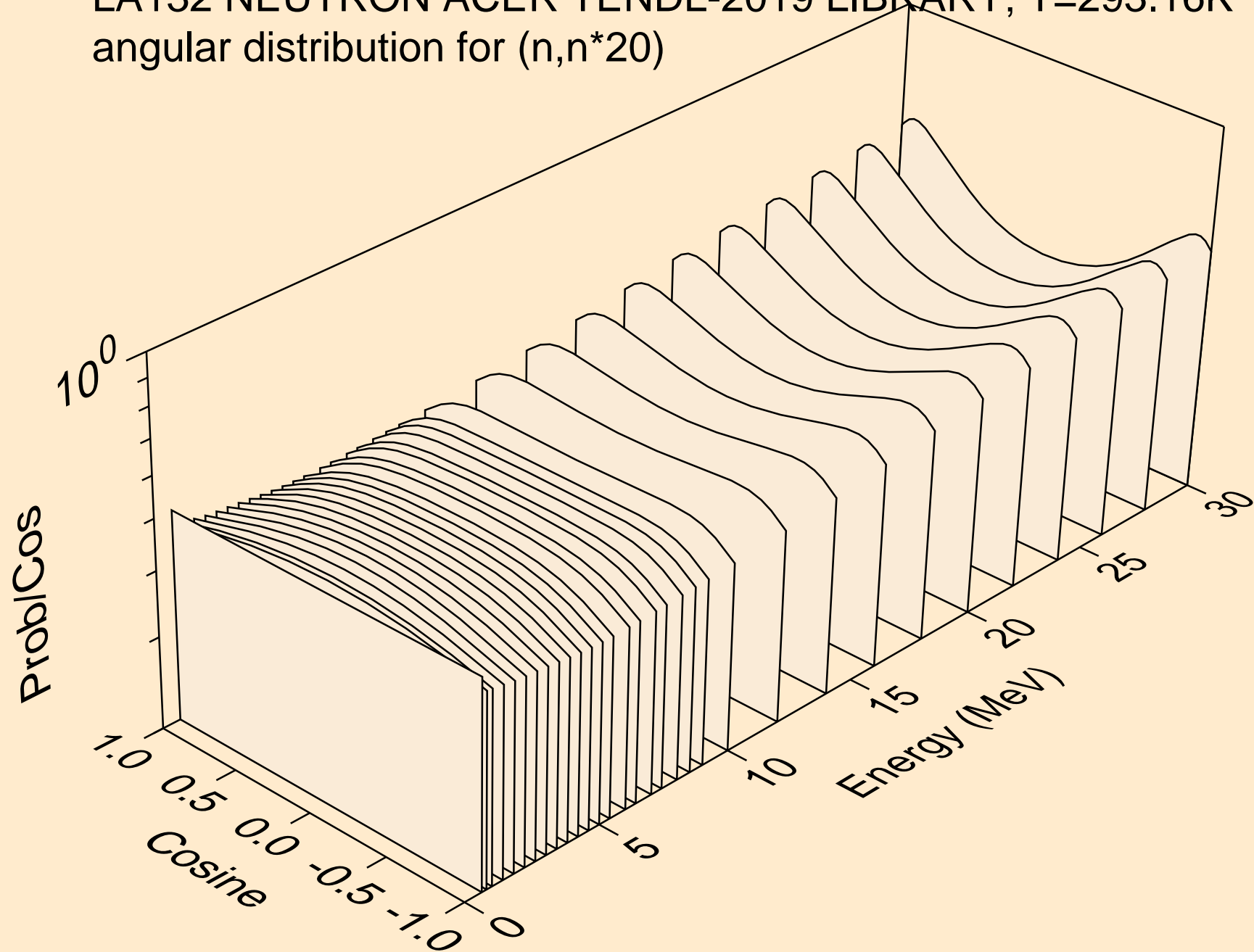

LA132 NEUTRON ACER TENDL-2019 LIBRARY; T=293.16K  
angular distribution for (n,n\*21)

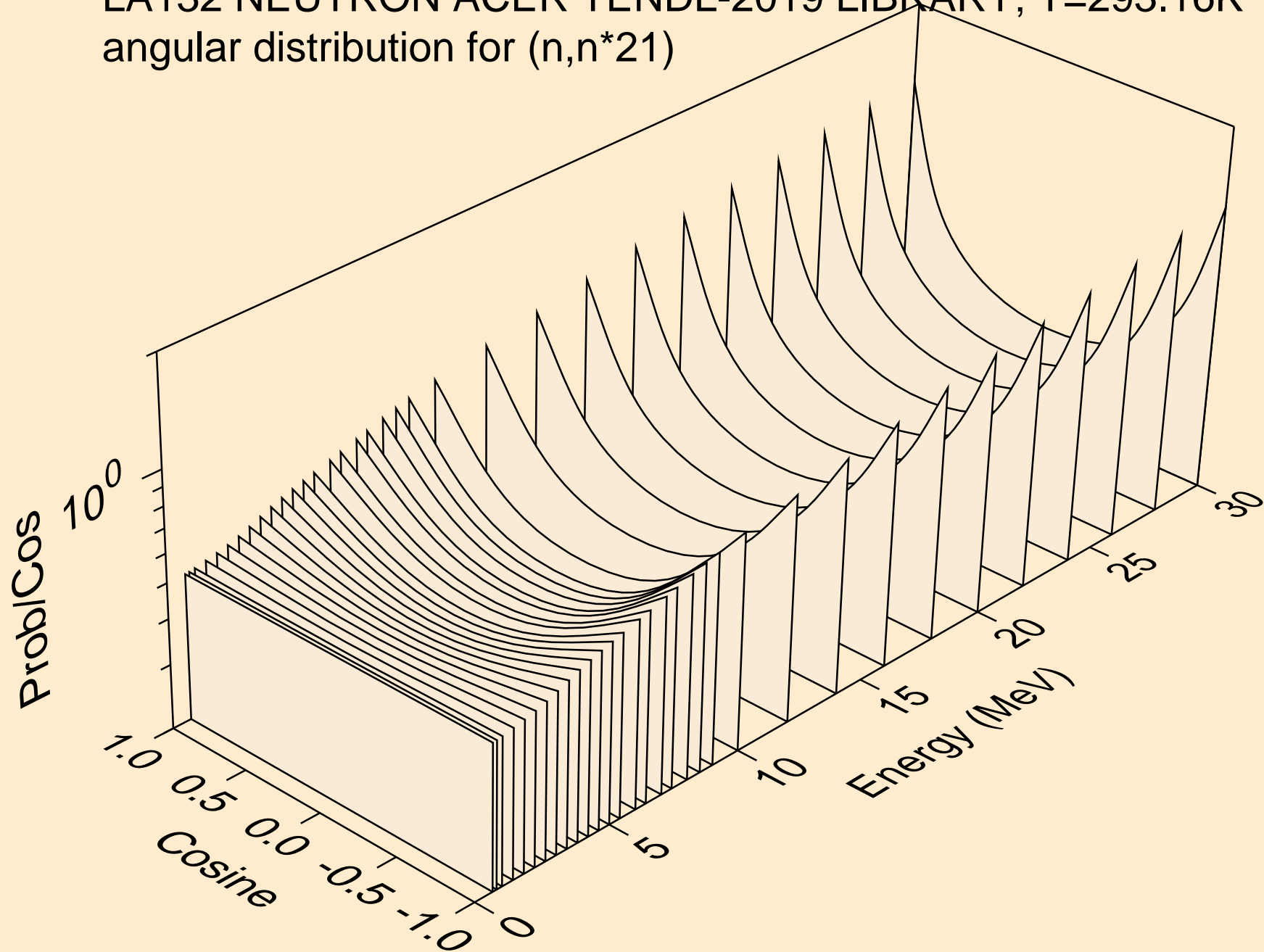

LA132 NEUTRON ACER TENDL-2019 LIBRARY; T=293.16K  
angular distribution for (n,n\*22)

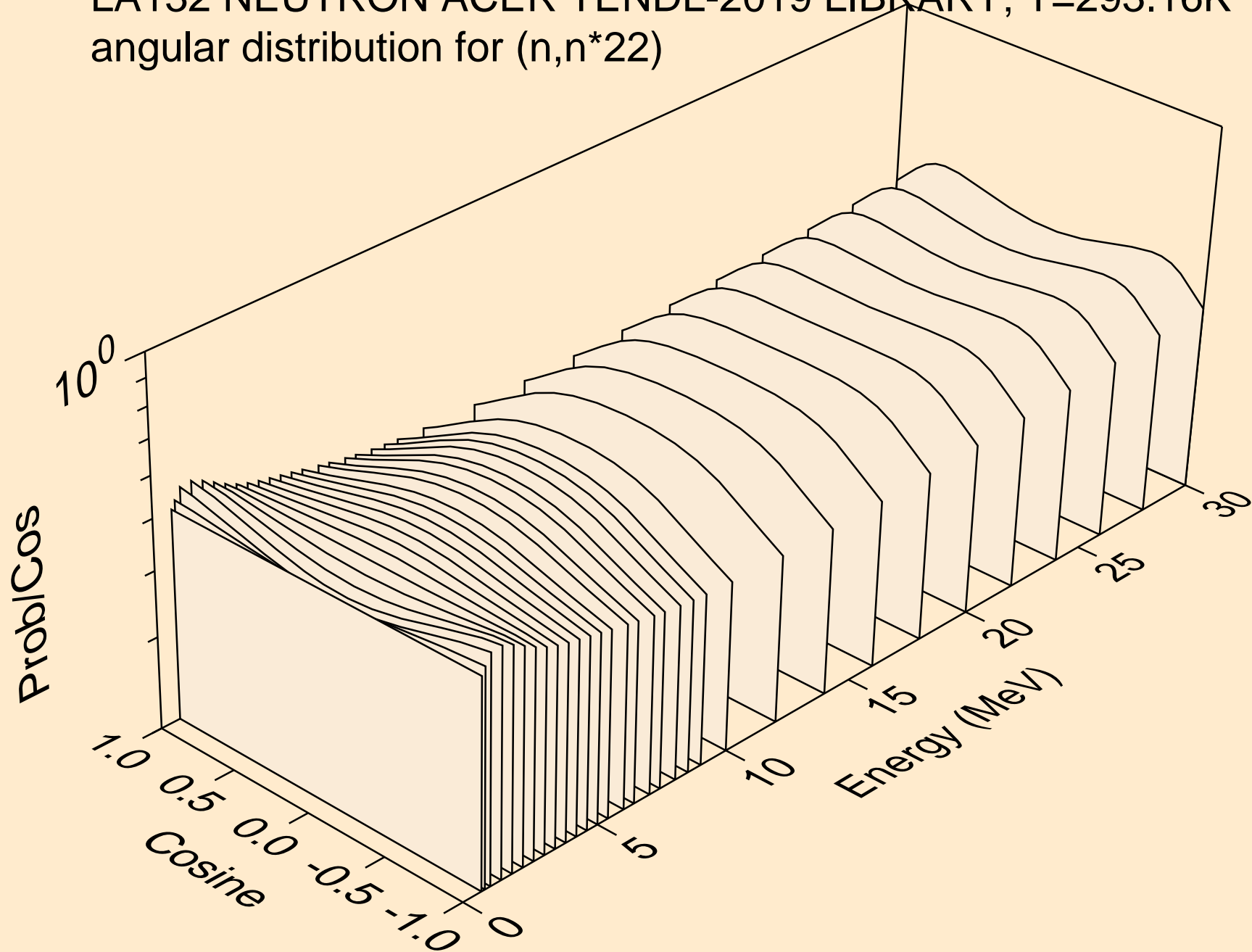

LA132 NEUTRON ACER TENDL-2019 LIBRARY; T=293.16K  
angular distribution for (n,n\*23)

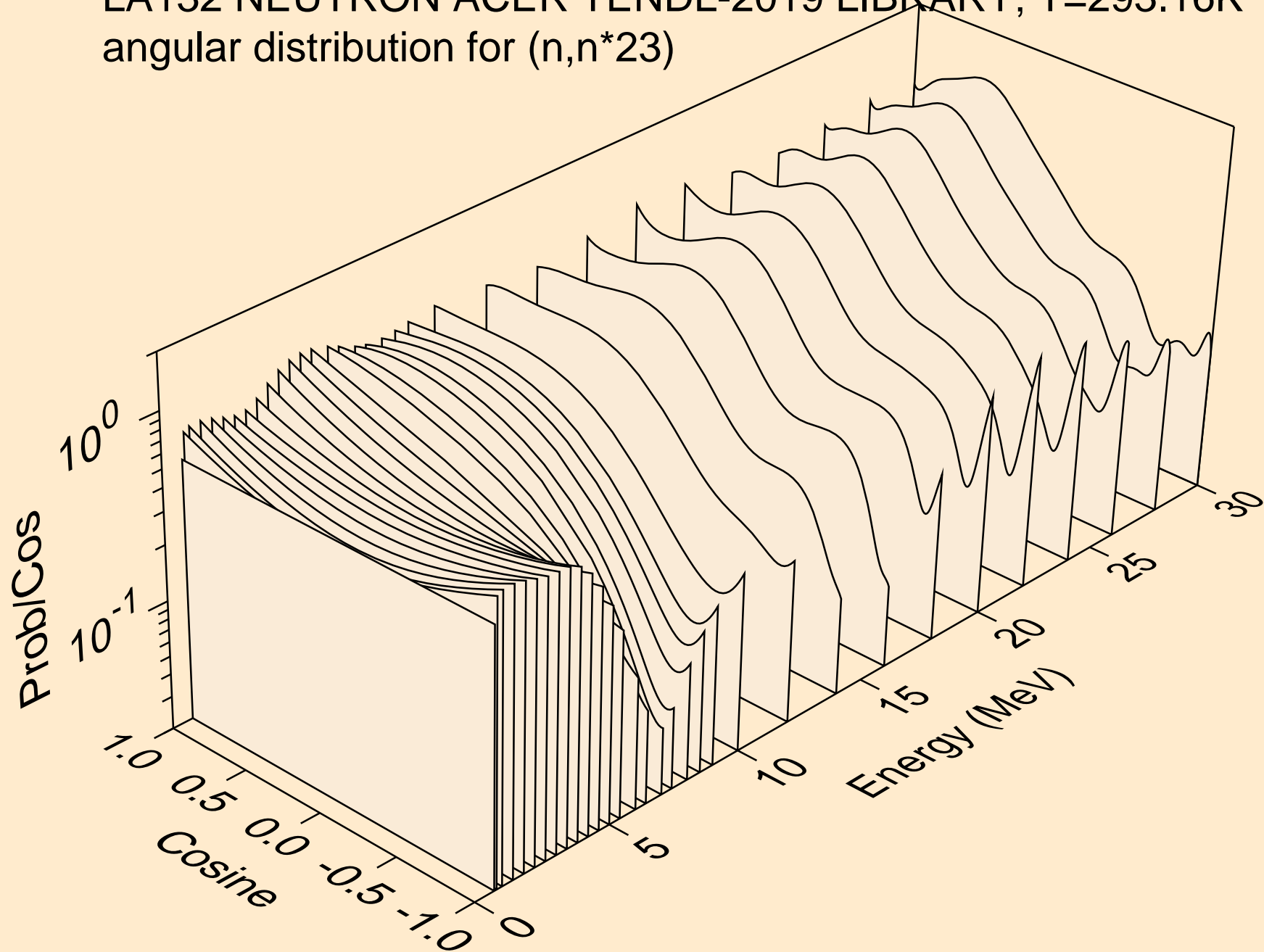

LA132 NEUTRON ACER TENDL-2019 LIBRARY; T=293.16K  
angular distribution for (n,n\*24)

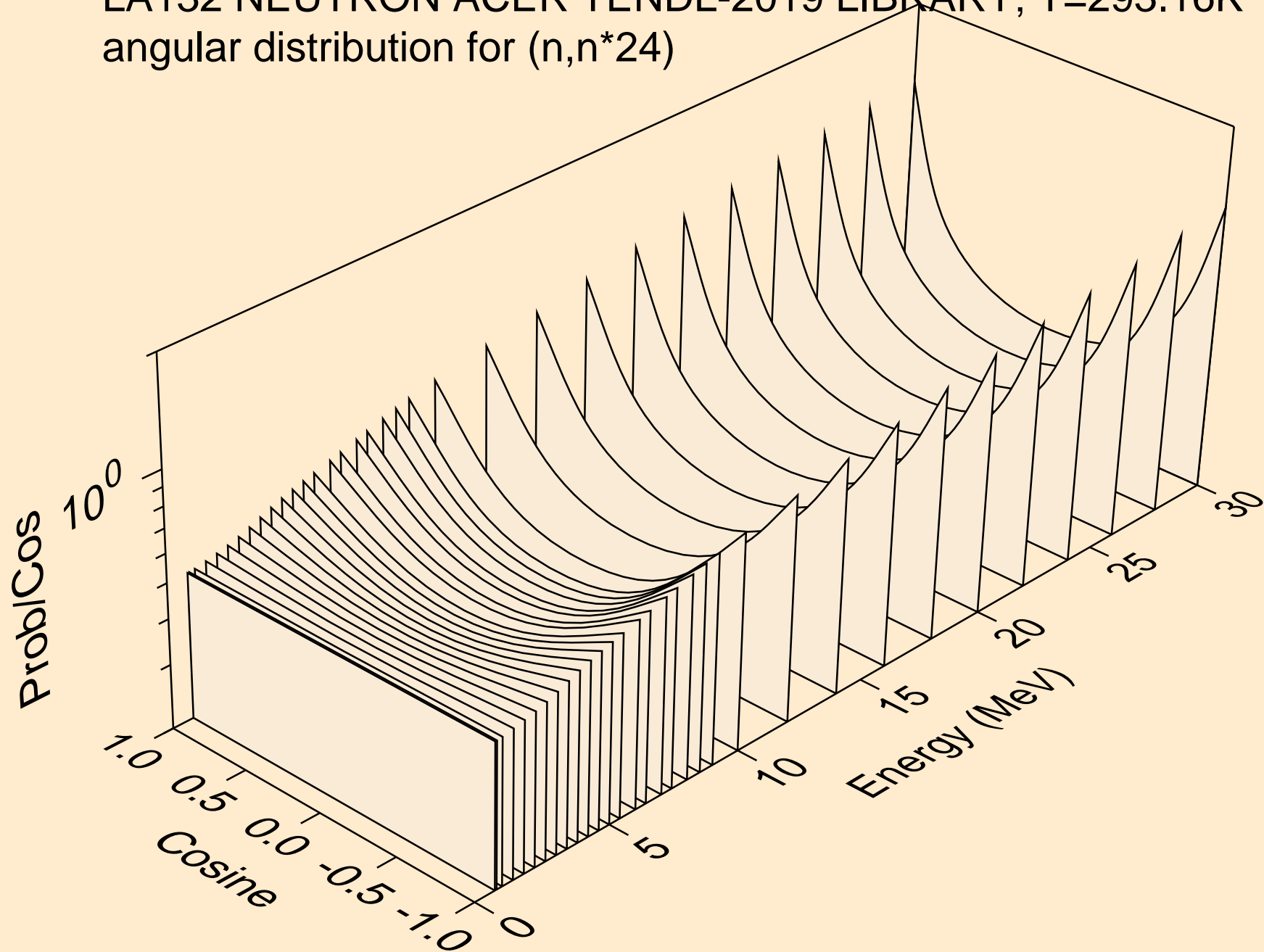

LA132 NEUTRON ACER TENDL-2019 LIBRARY; T=293.16K  
angular distribution for (n,n\*25)

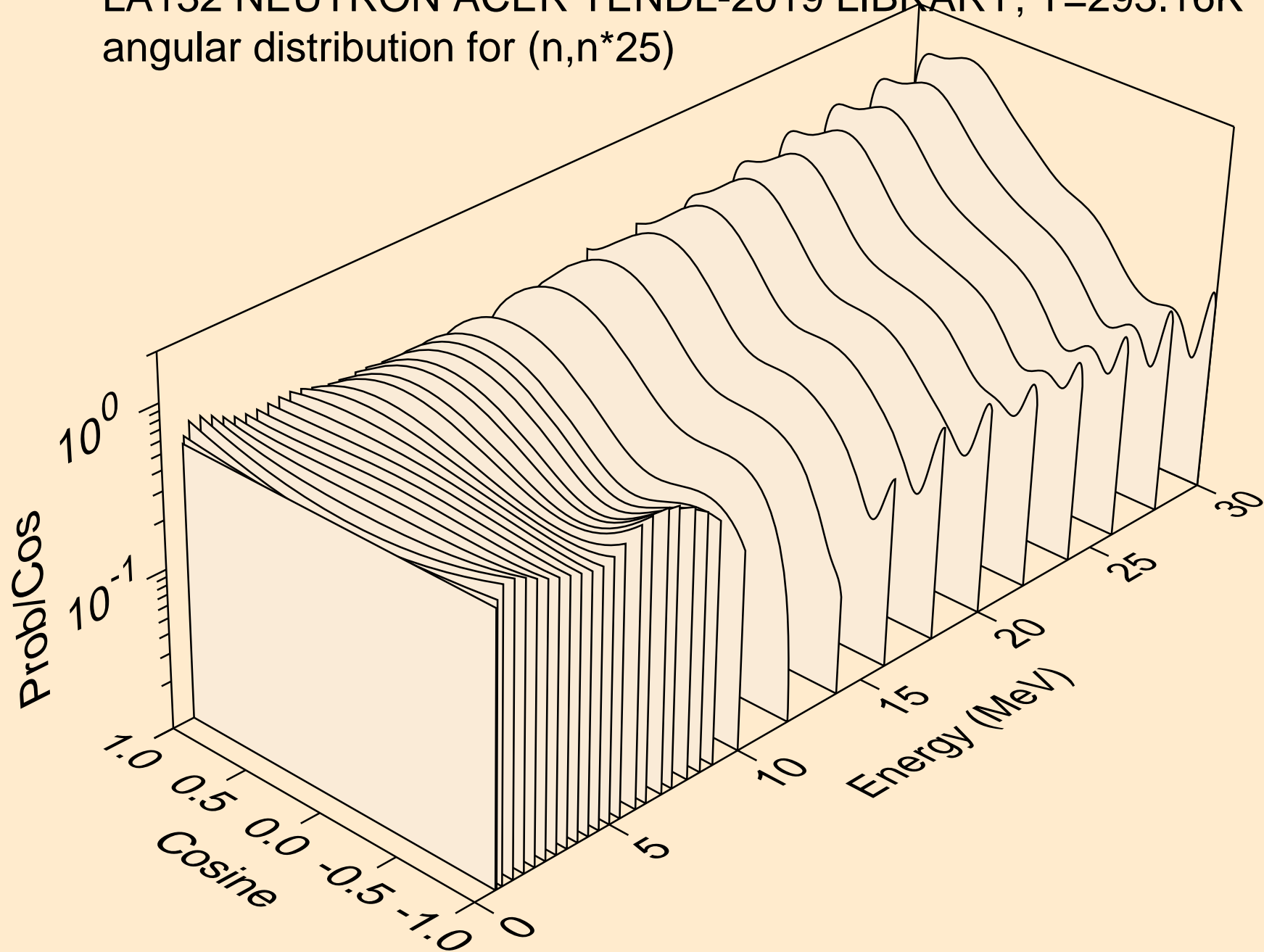



LA132 NEUTRON ACER TENDL-2019 LIBRARY; T=293.16K  
angular distribution for (n,n\*26)

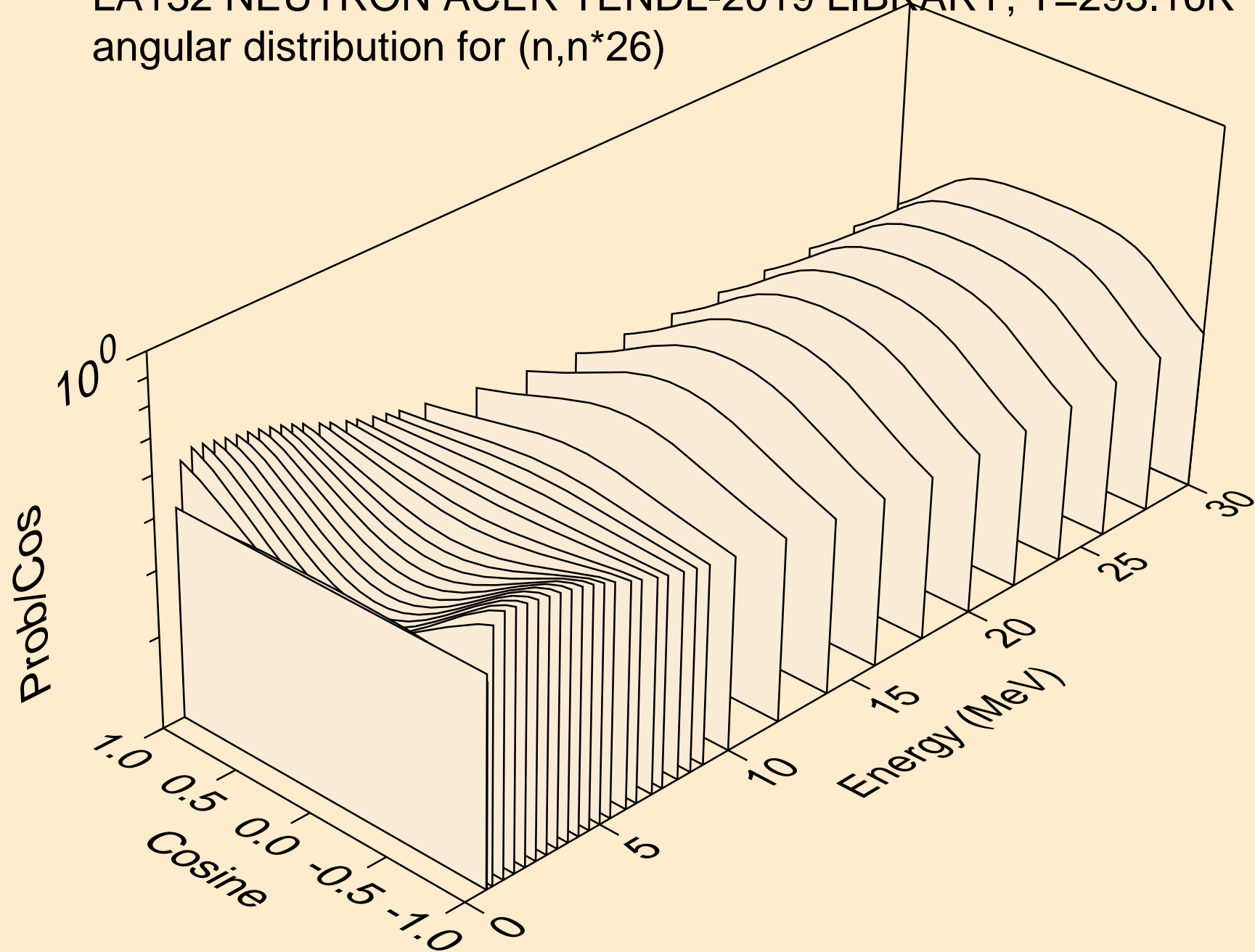

LA132 NEUTRON ACER TENDL-2019 LIBRARY; T=293.16K  
angular distribution for (n,n\*27)

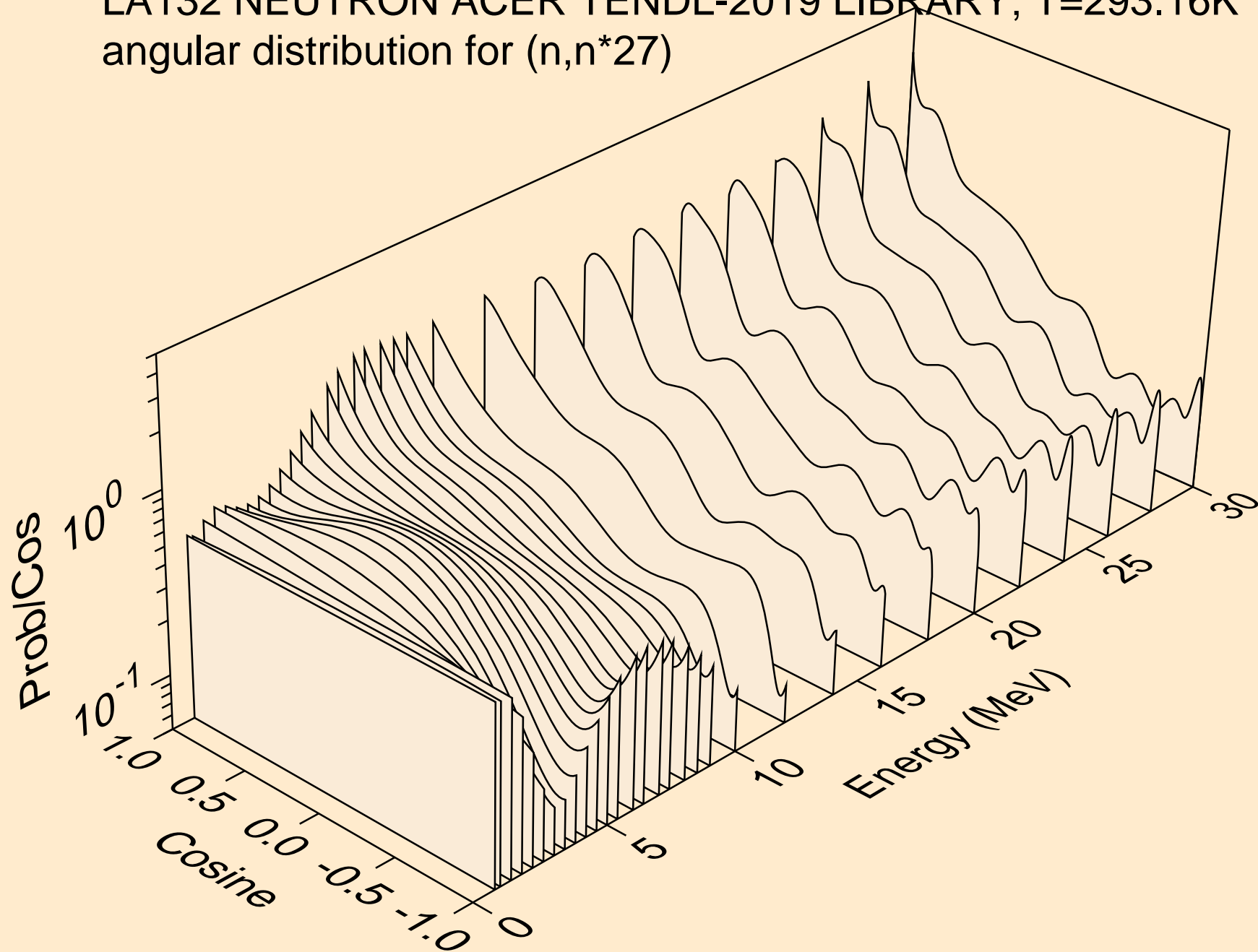

LA132 NEUTRON ACER TENDL-2019 LIBRARY; T=293.16K  
angular distribution for (n,n\*28)

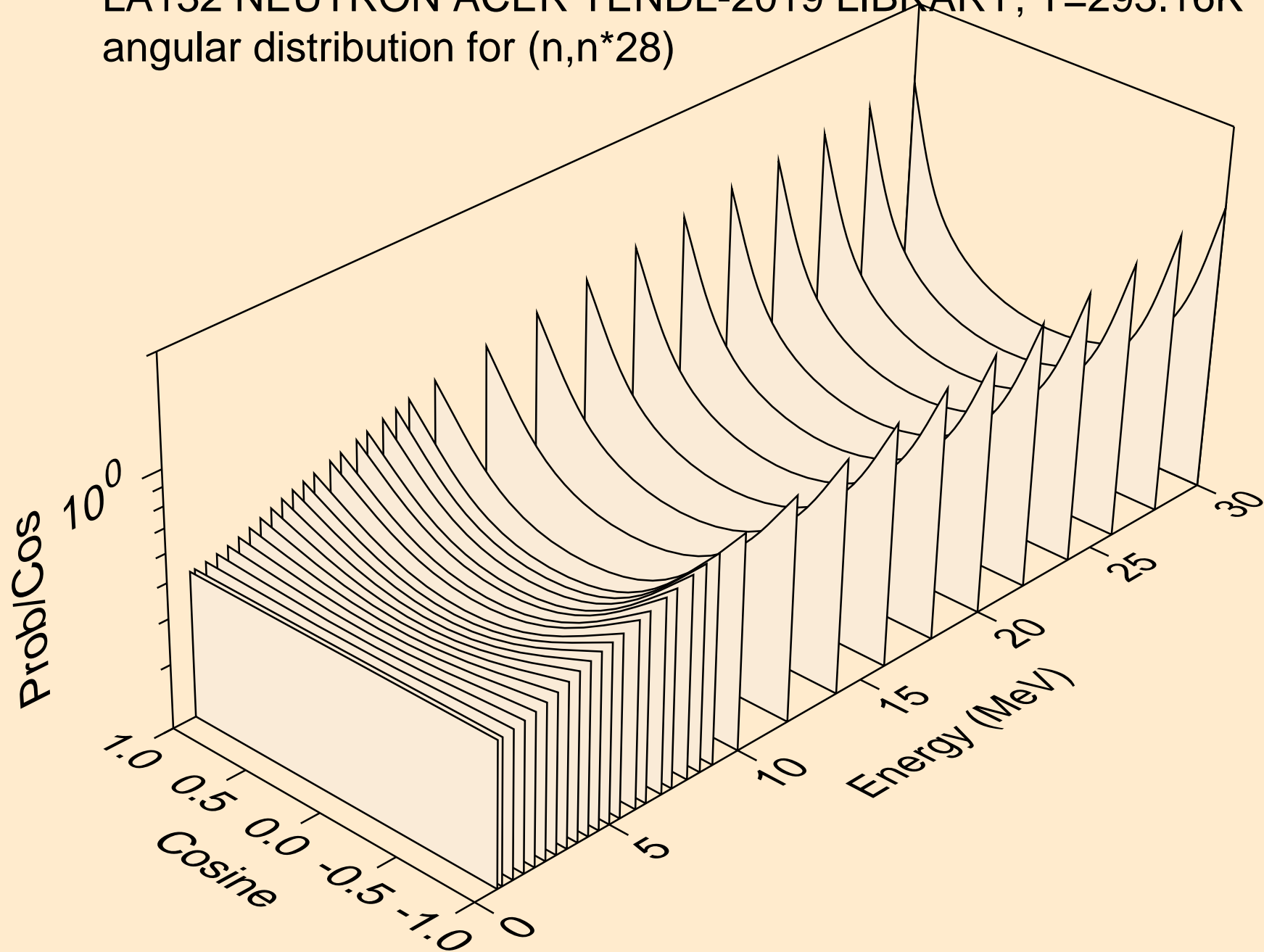

LA132 NEUTRON ACER TENDL-2019 LIBRARY; T=293.16K  
Neutron emission for (n,x)

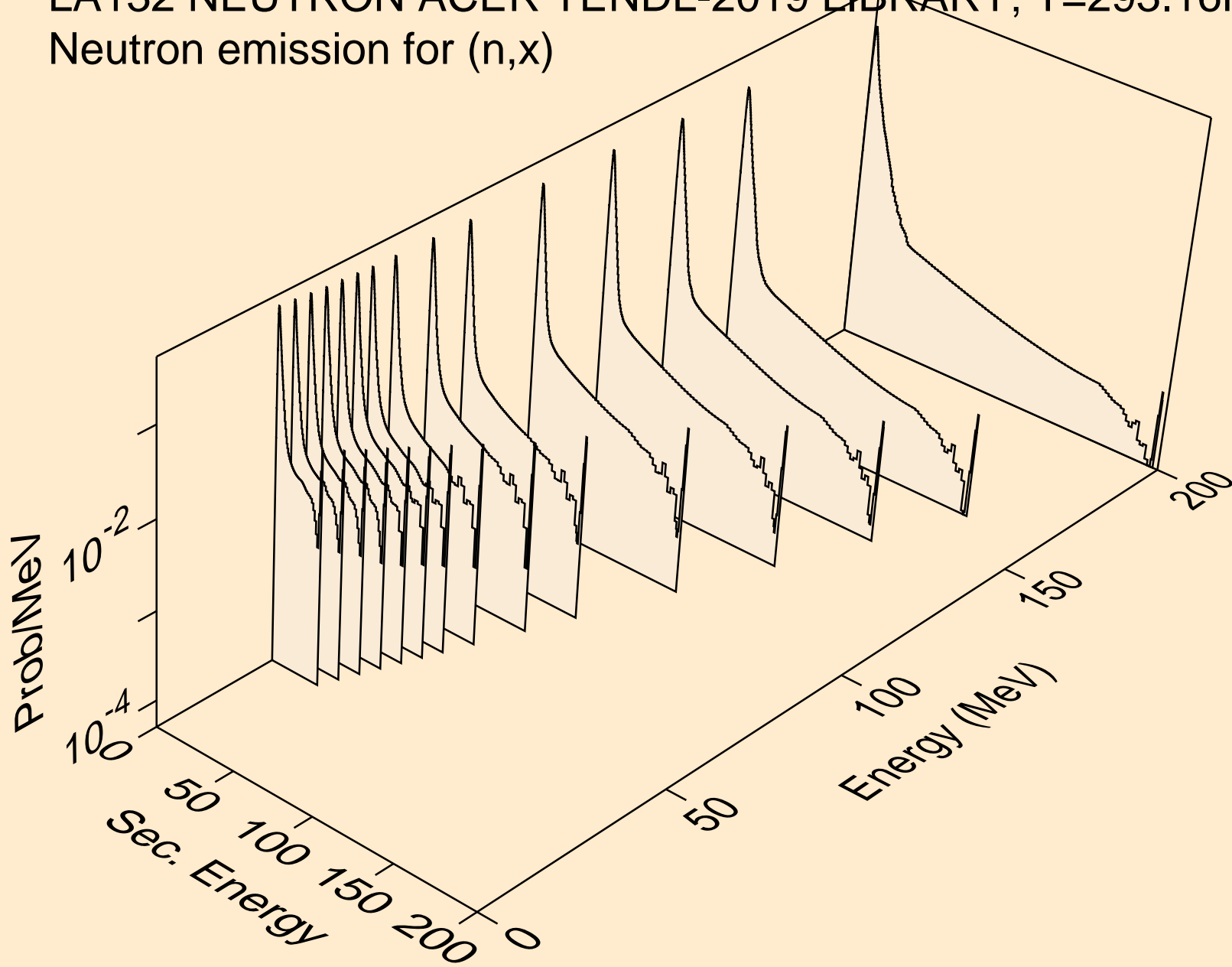

LA132 NEUTRON ACER TENDL-2019 LIBRARY; T=293.16K  
Neutron emission for (n,2nd)

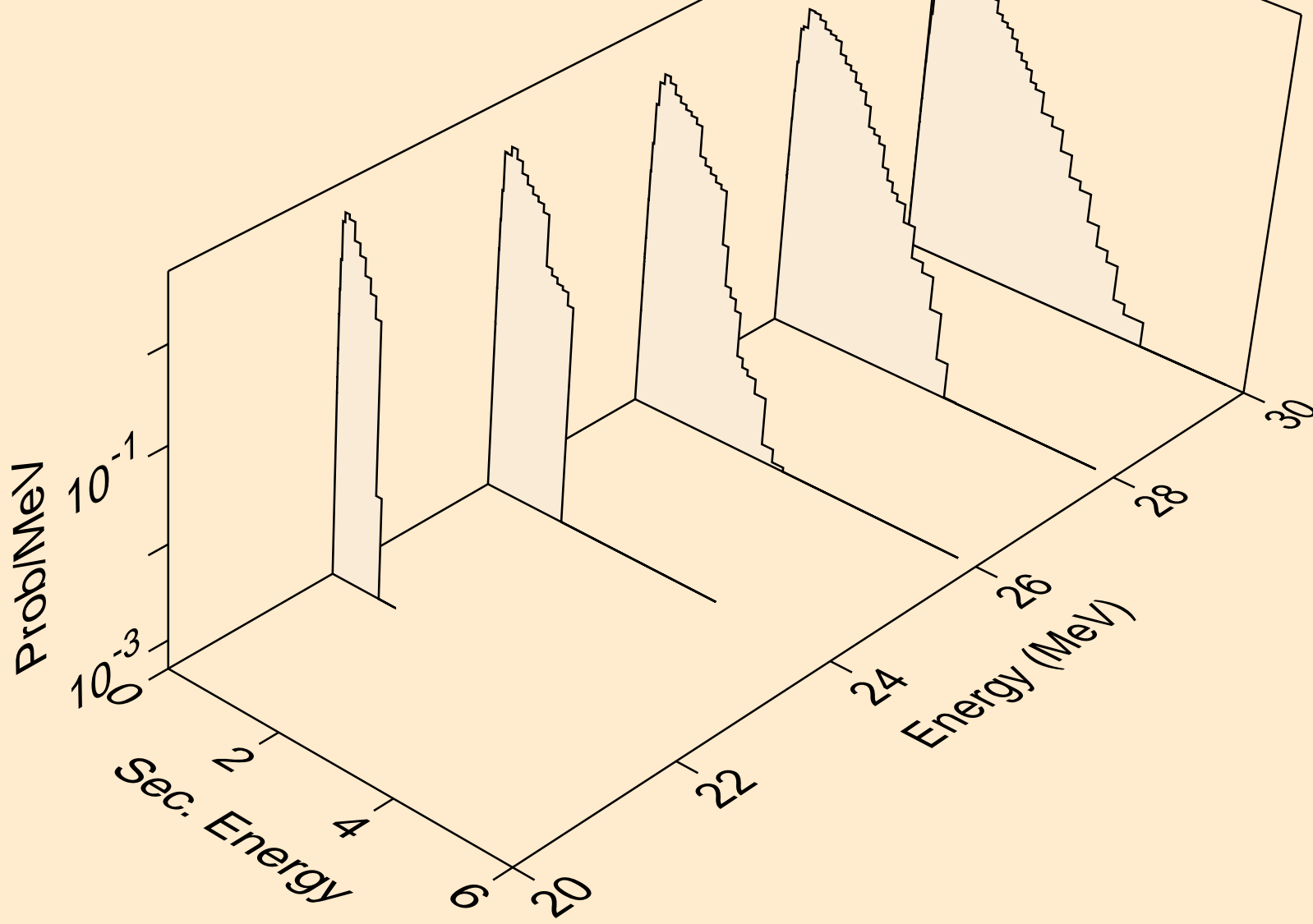

LA132 NEUTRON ACER TENDL-2019 LIBRARY; T=293.16K  
Neutron emission for (n,2n)

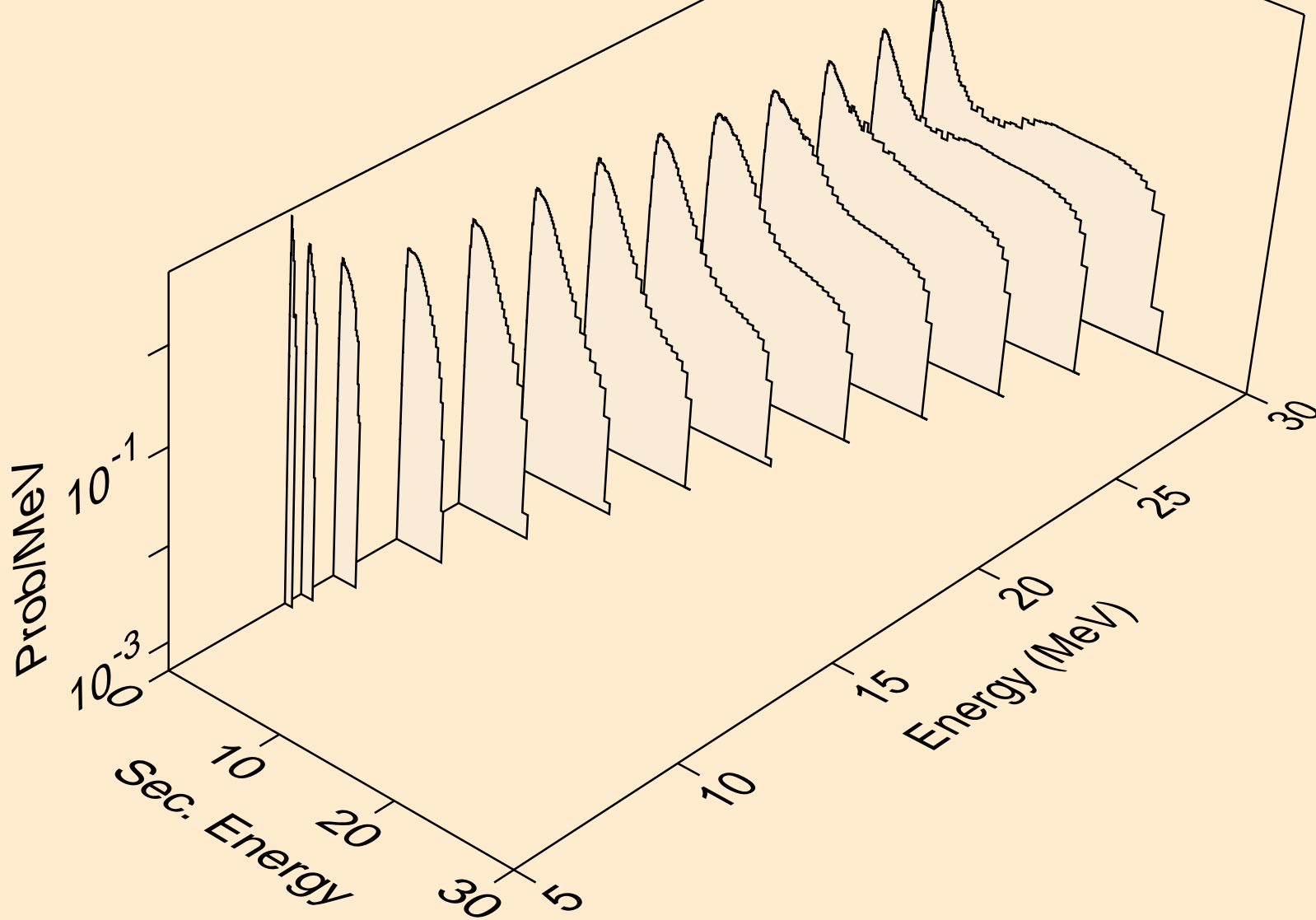

LA132 NEUTRON ACER TENDL-2019 LIBRARY; T=293.16K  
Neutron emission for (n,3n)

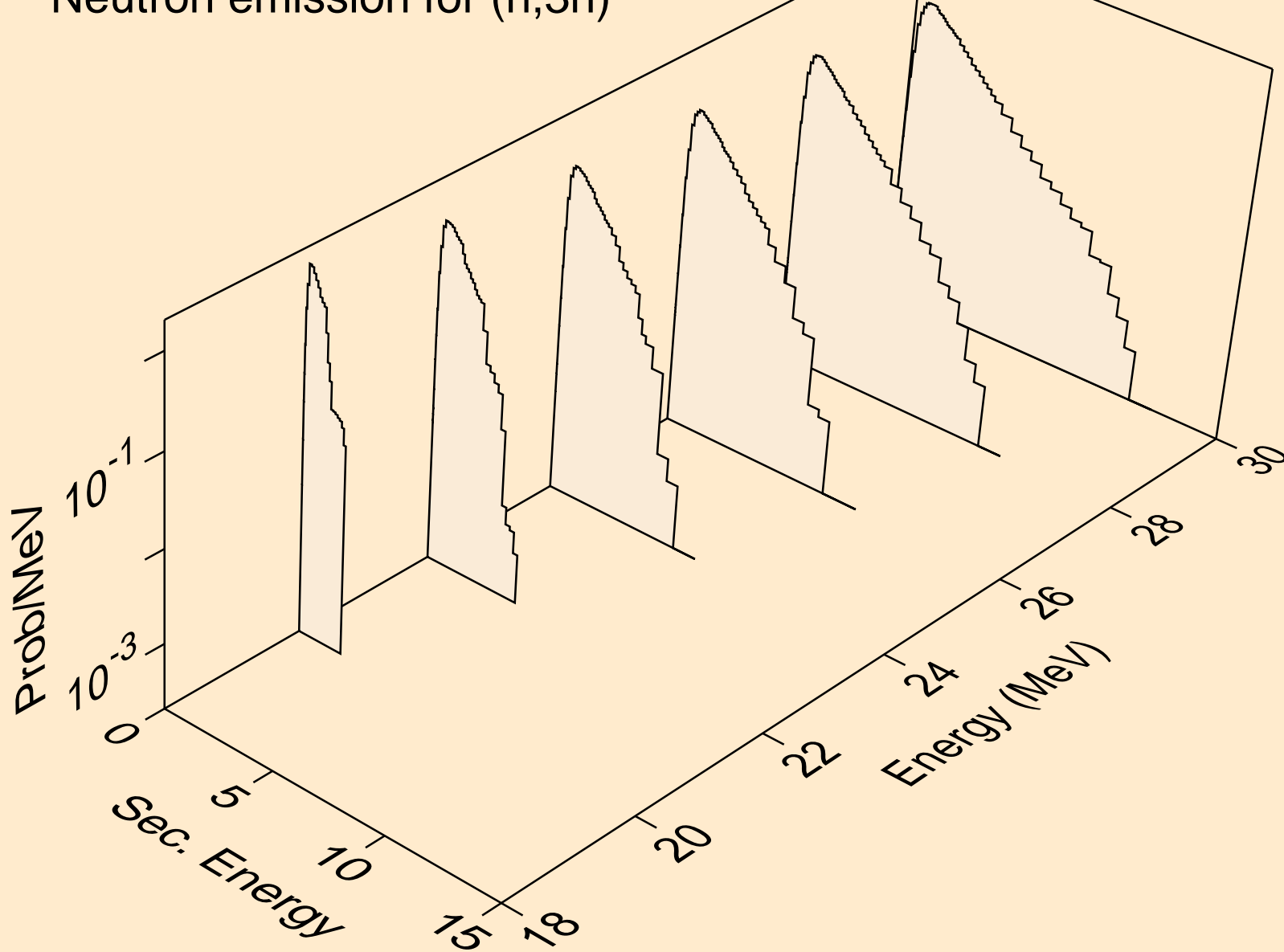

LA132 NEUTRON ACER TENDL-2019 LIBRARY; T=293.16K  
Neutron emission for (n,n\*)a

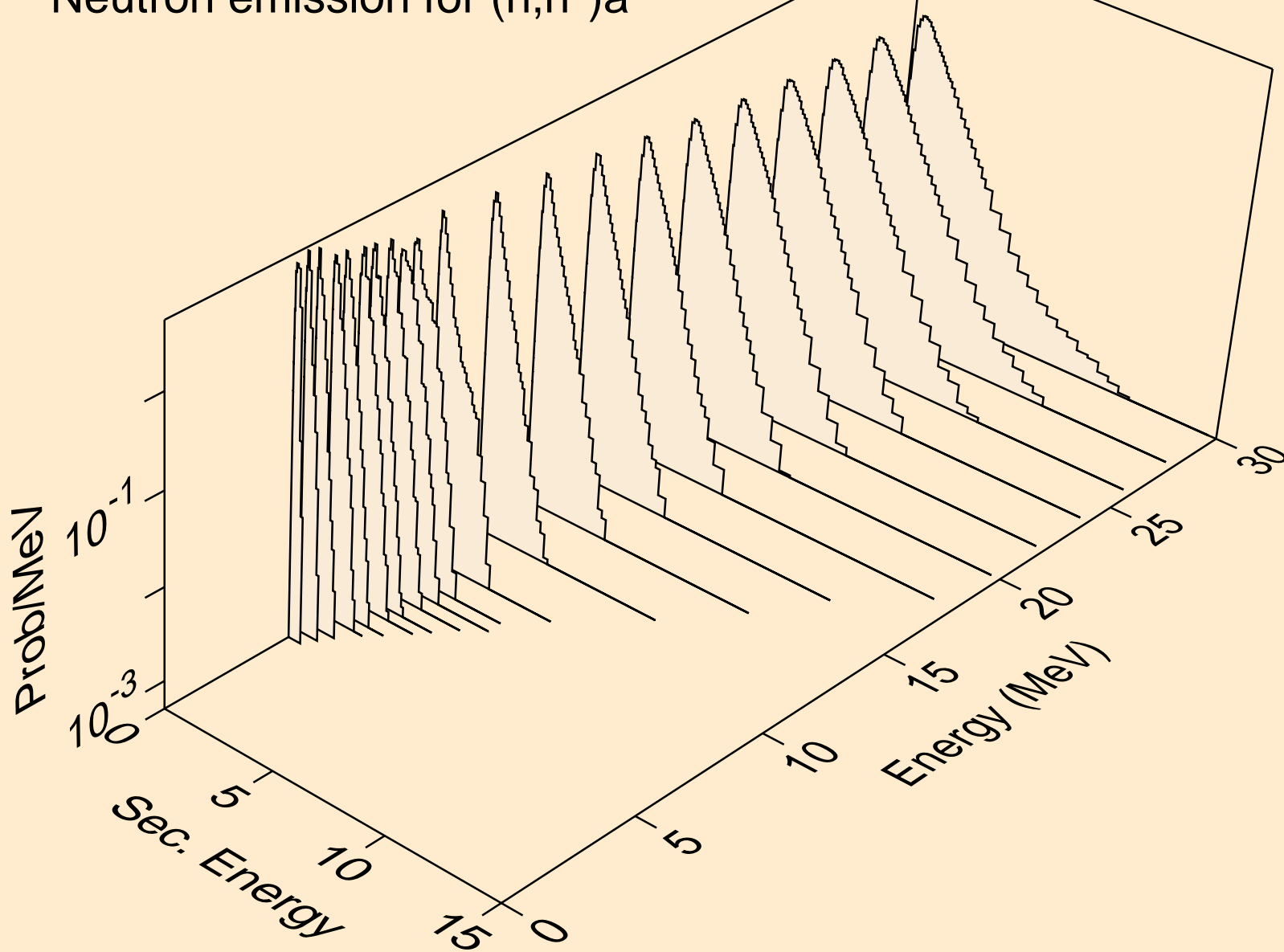



LA132 NEUTRON ACER TENDL-2019 LIBRARY; T=293.16K  
Neutron emission for (n,2n)a

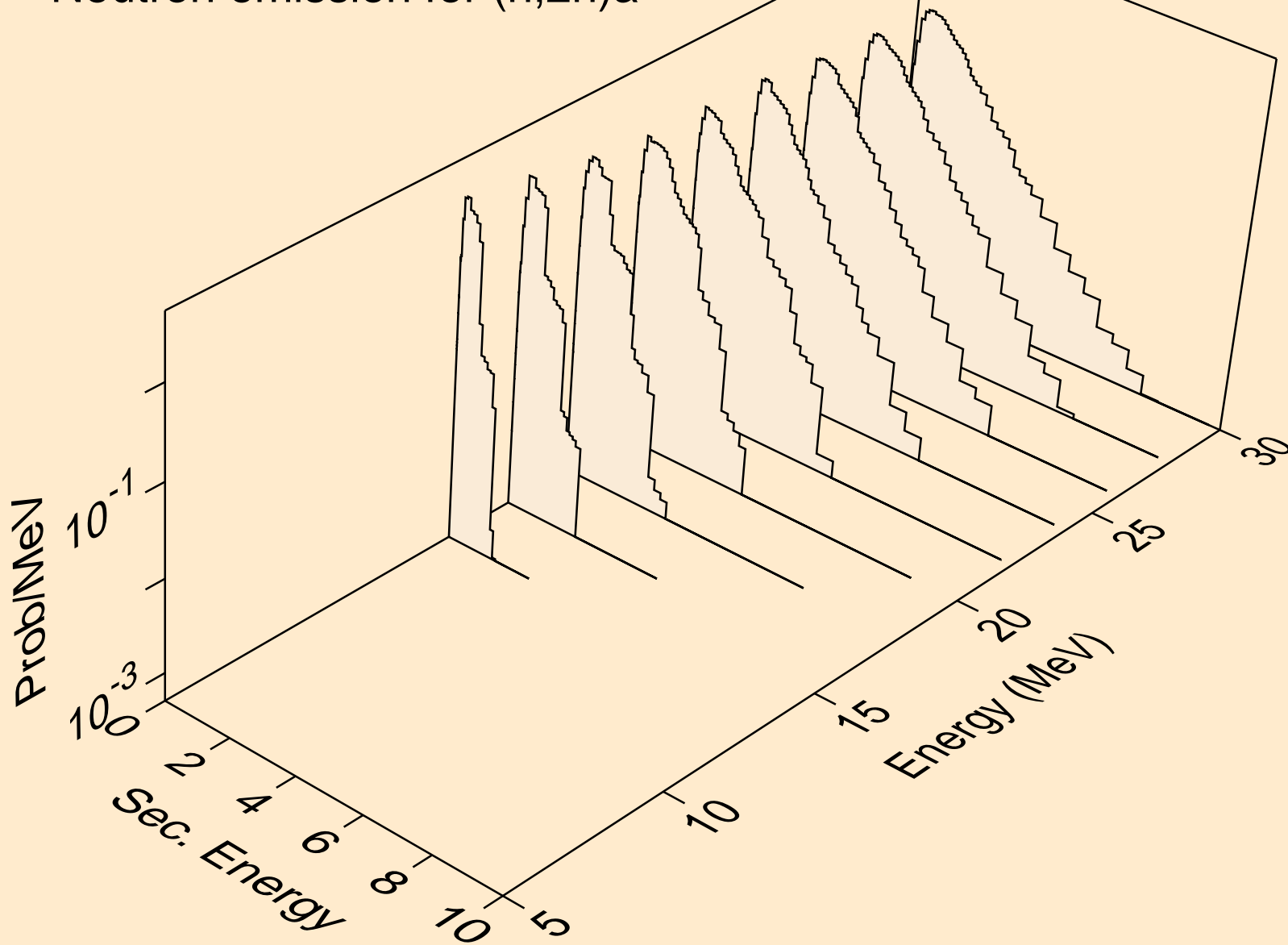

LA132 NEUTRON ACER TENDL-2019 LIBRARY; T=293.16K  
Neutron emission for (n,3n)a

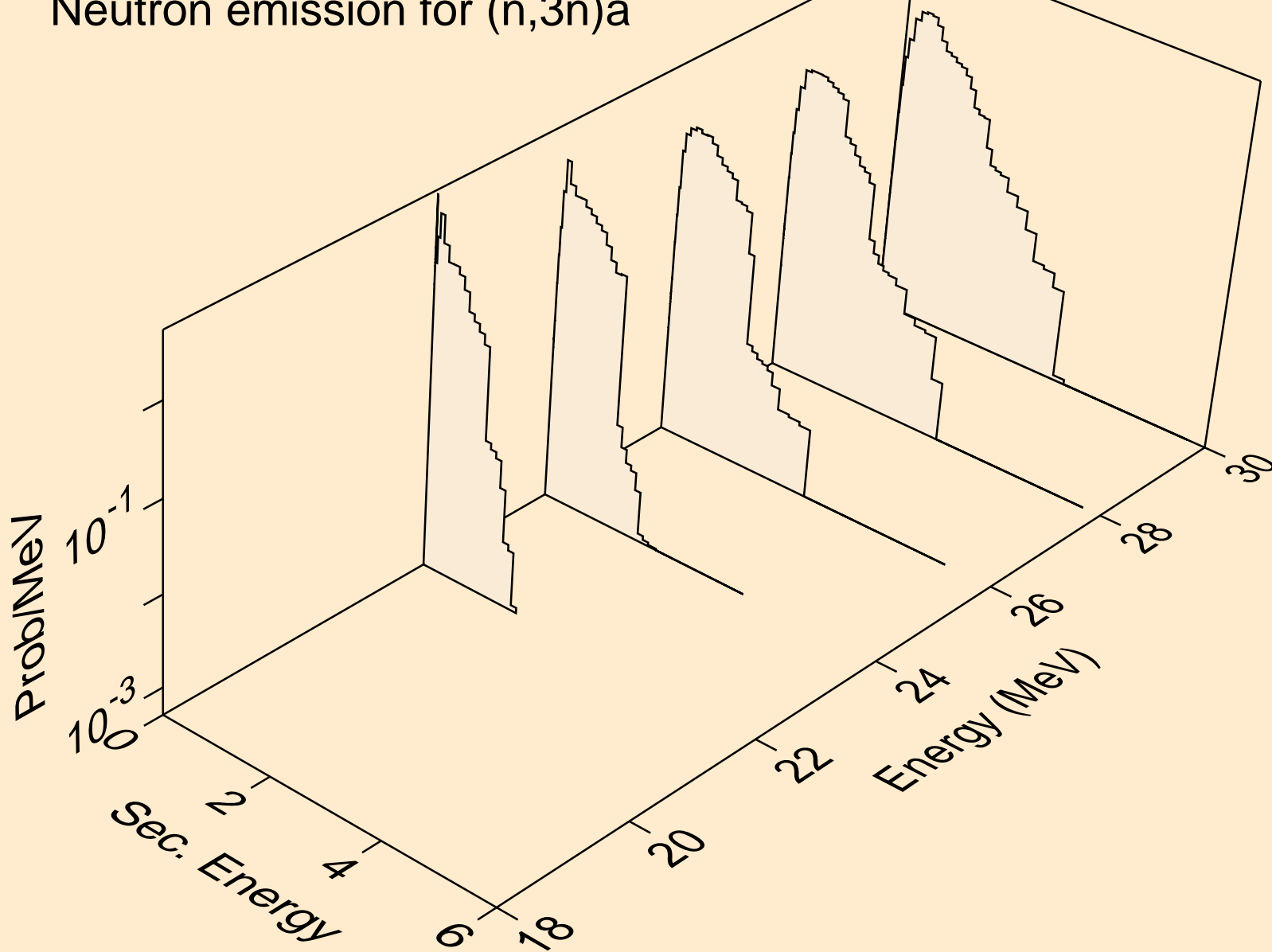

LA132 NEUTRON ACER TENDL-2019 LIBRARY; T=293.16K  
Neutron emission for (n,n\*)p

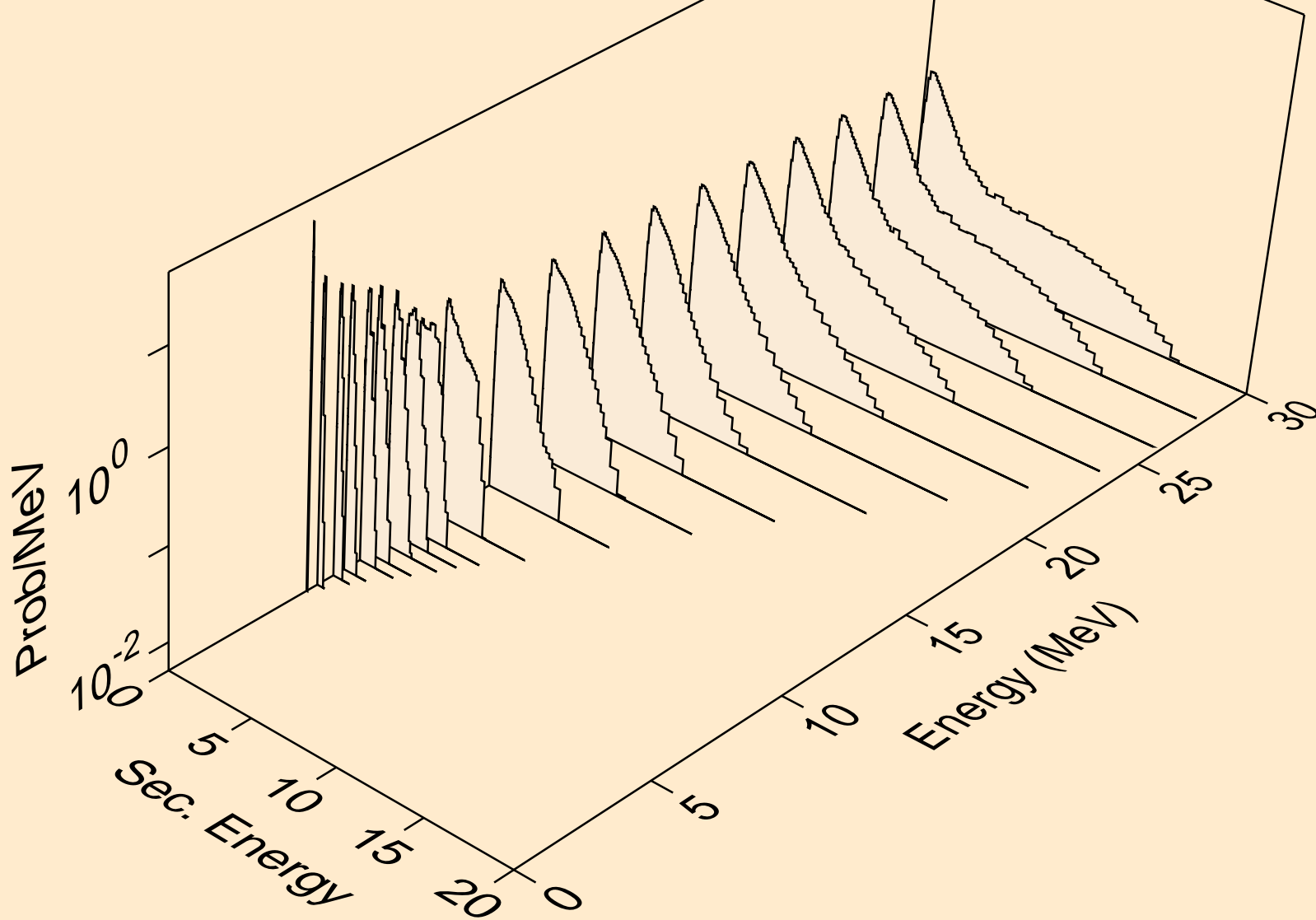

LA132 NEUTRON ACER TENDL-2019 LIBRARY; T=293.16K  
Neutron emission for (n,n\*)2a

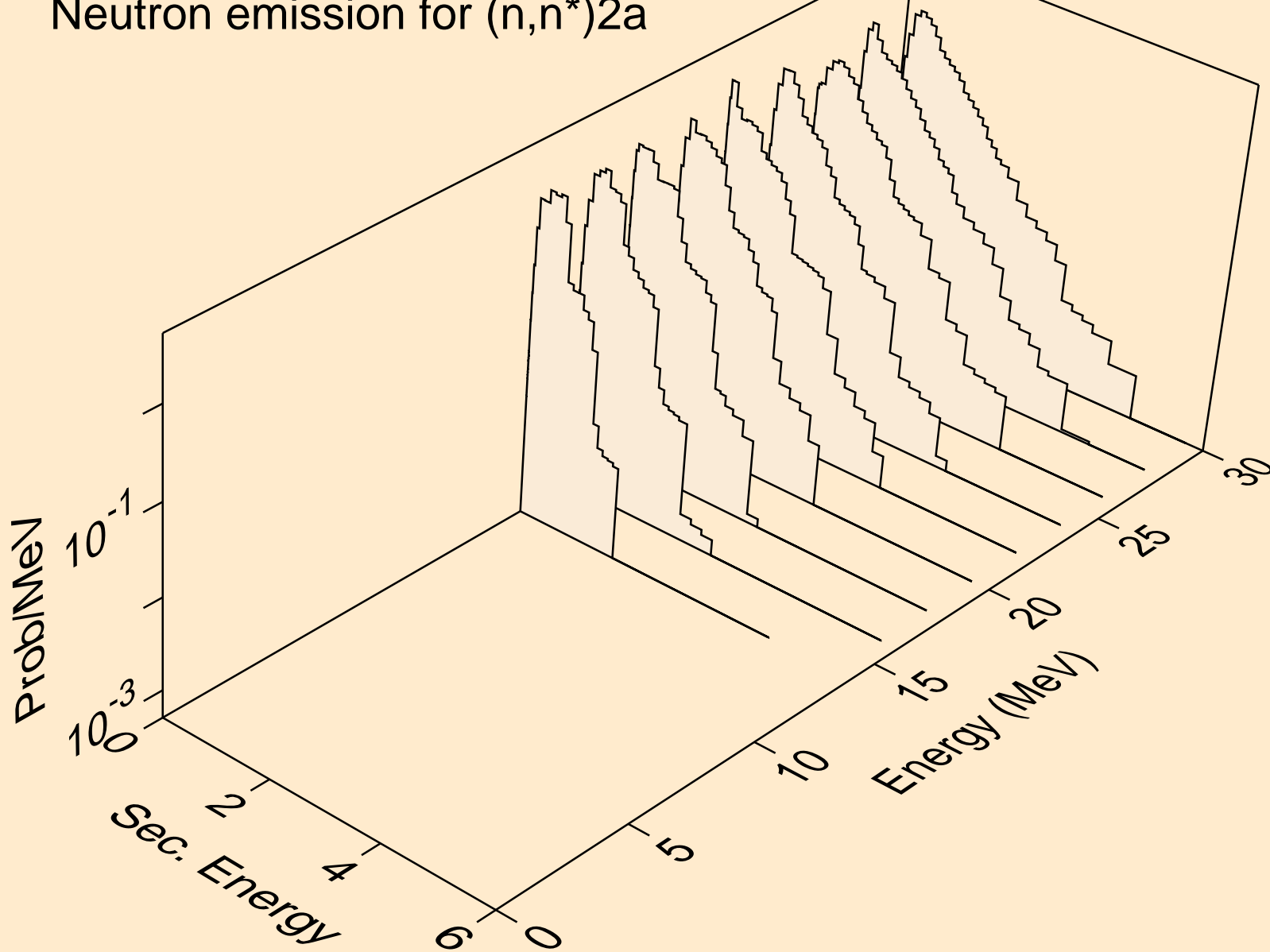

LA132 NEUTRON ACER TENDL-2019 LIBRARY; T=293.16K  
Neutron emission for (n,2n)2a

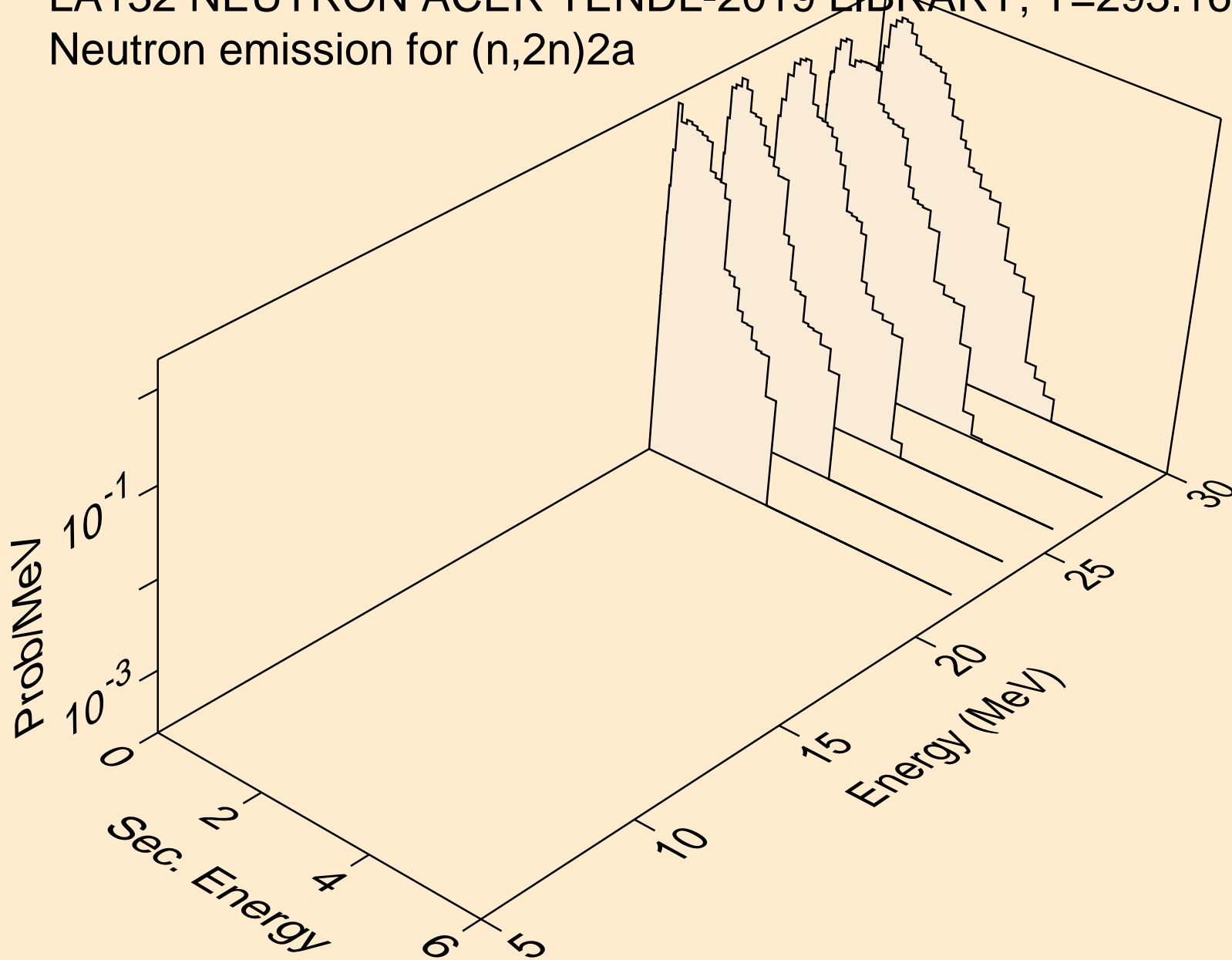

LA132 NEUTRON ACER TENDL-2019 LIBRARY; T=293.16K  
Neutron emission for (n,n\*)d

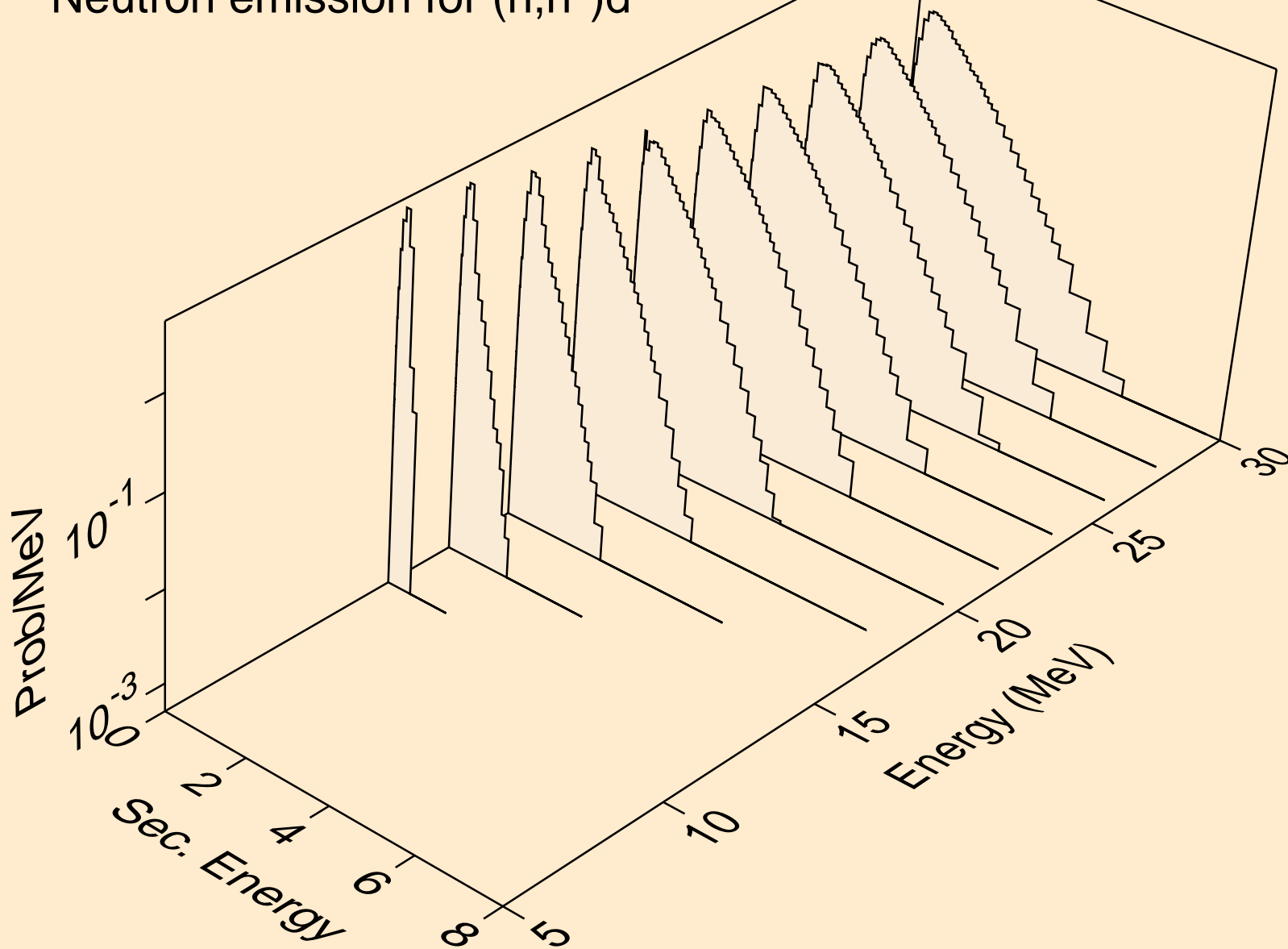

LA132 NEUTRON ACER TENDL-2019 LIBRARY; T=293.16K  
Neutron emission for (n,n\*)t

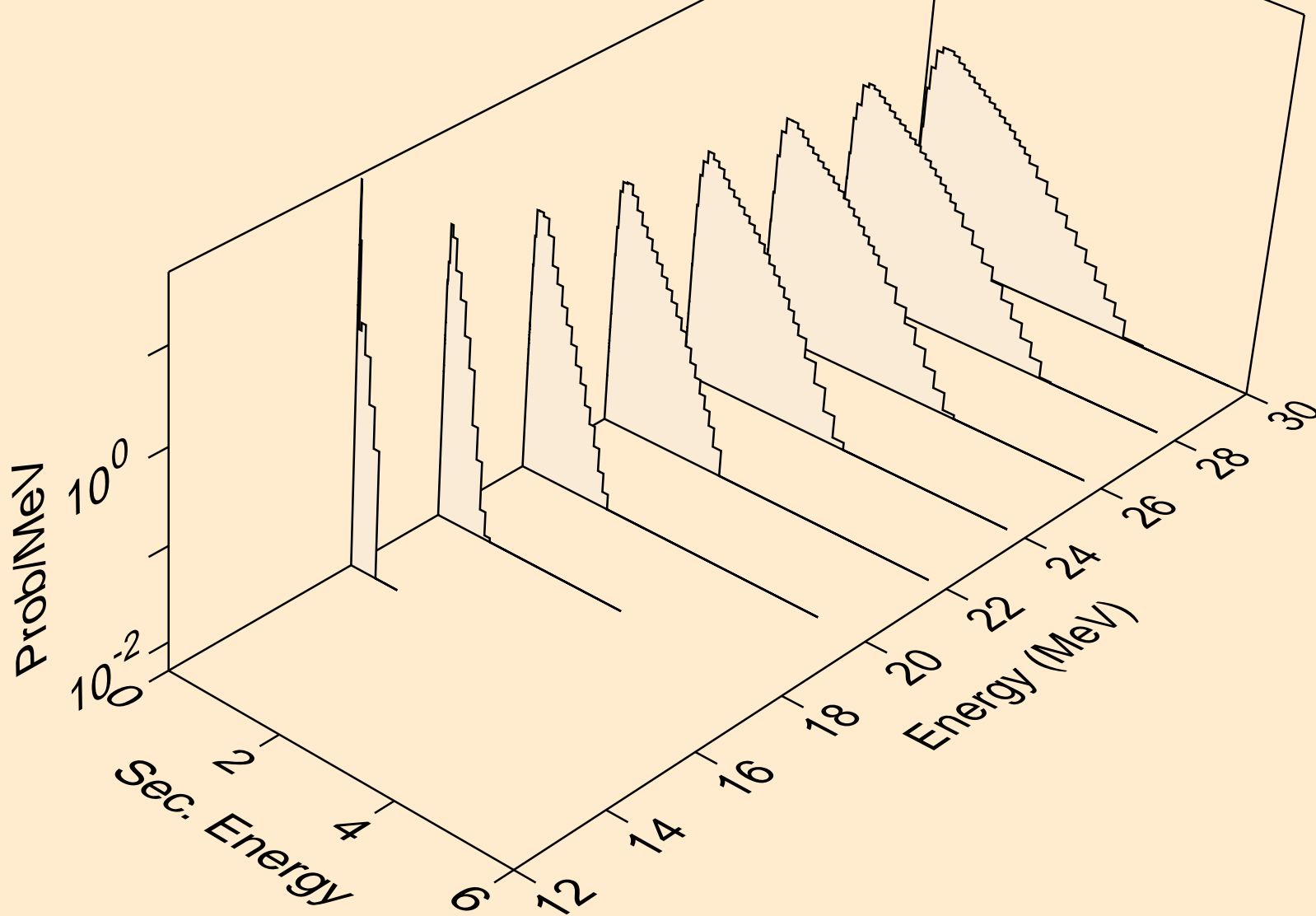

LA132 NEUTRON ACER TENDL-2019 LIBRARY; T=293.16K  
Neutron emission for (n,n\*)he3

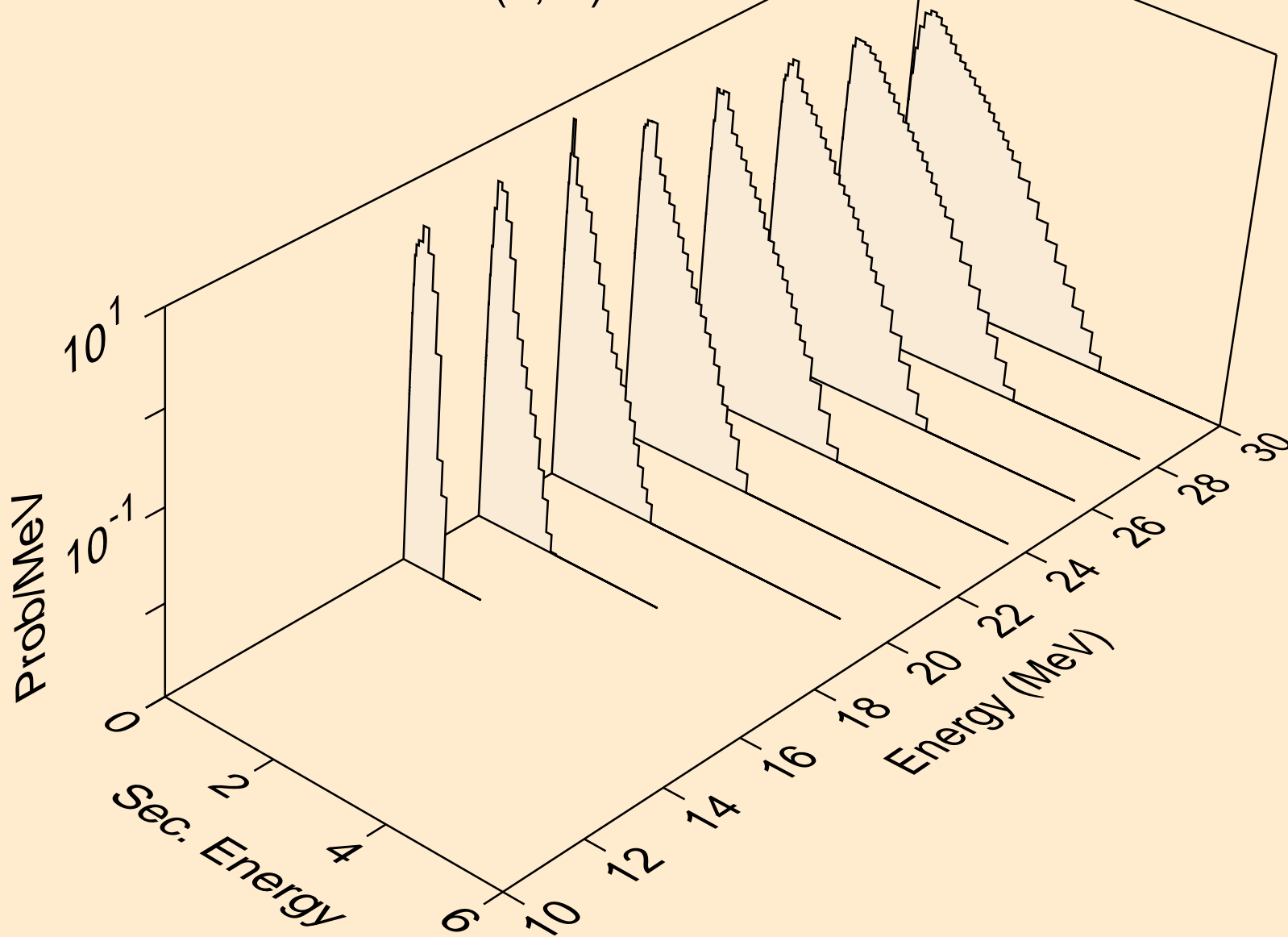



LA132 NEUTRON ACER TENDL-2019 LIBRARY; T=293.16K  
Neutron emission for (n,4n)

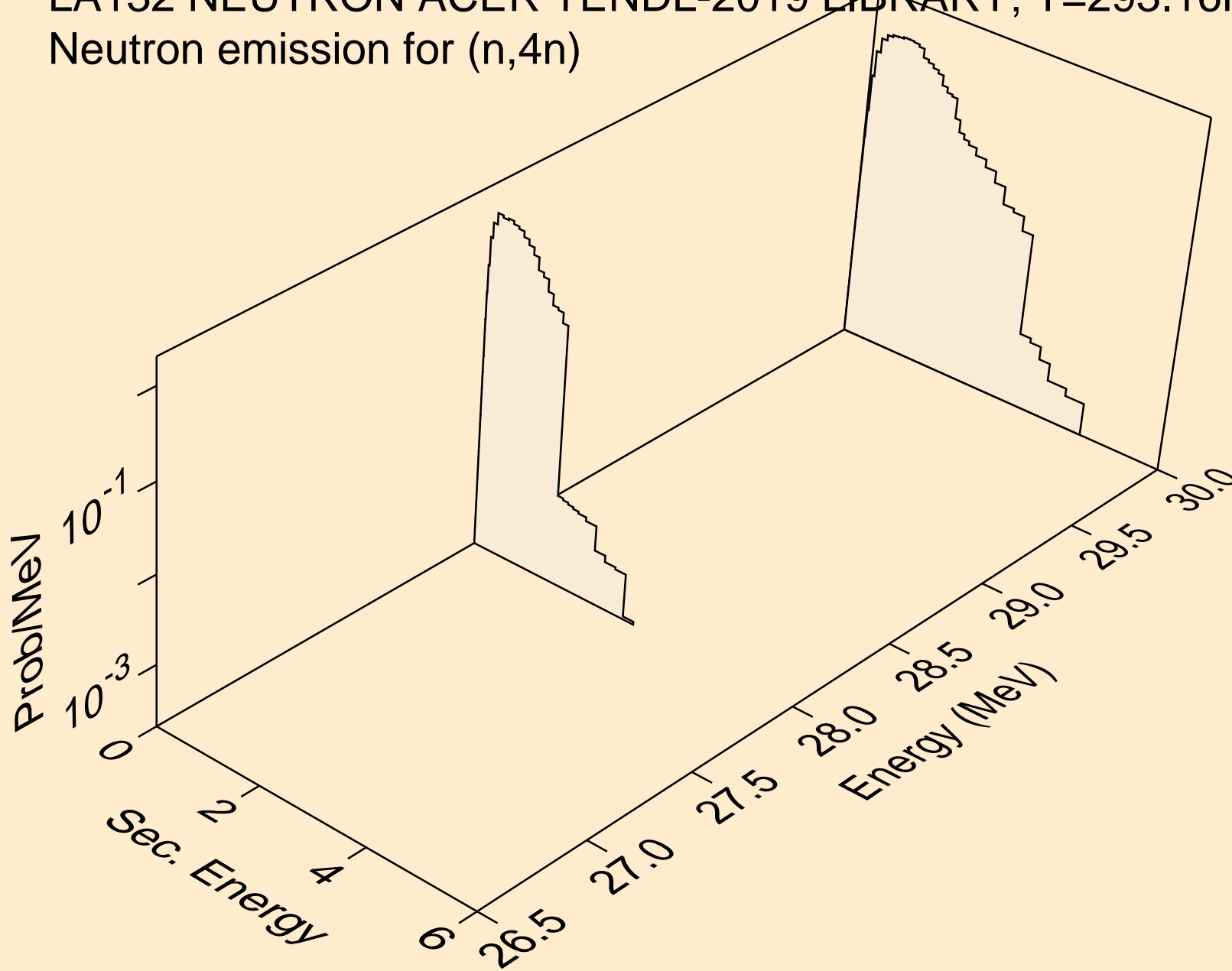

LA132 NEUTRON ACER TENDL-2019 LIBRARY; T=293.16K  
Neutron emission for (n,2np)

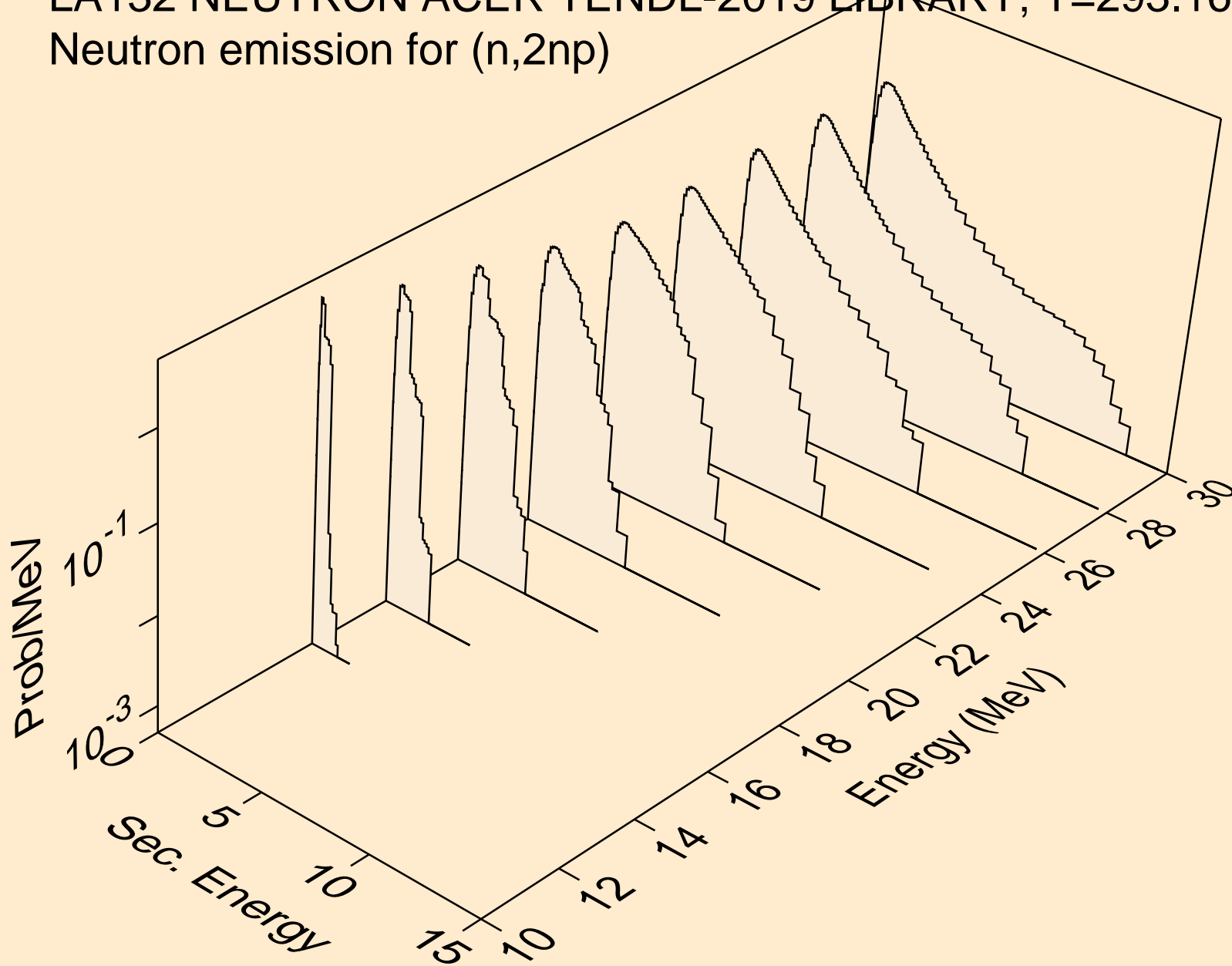

LA132 NEUTRON ACER TENDL-2019 LIBRARY; T=293.16K  
Neutron emission for (n,3np)

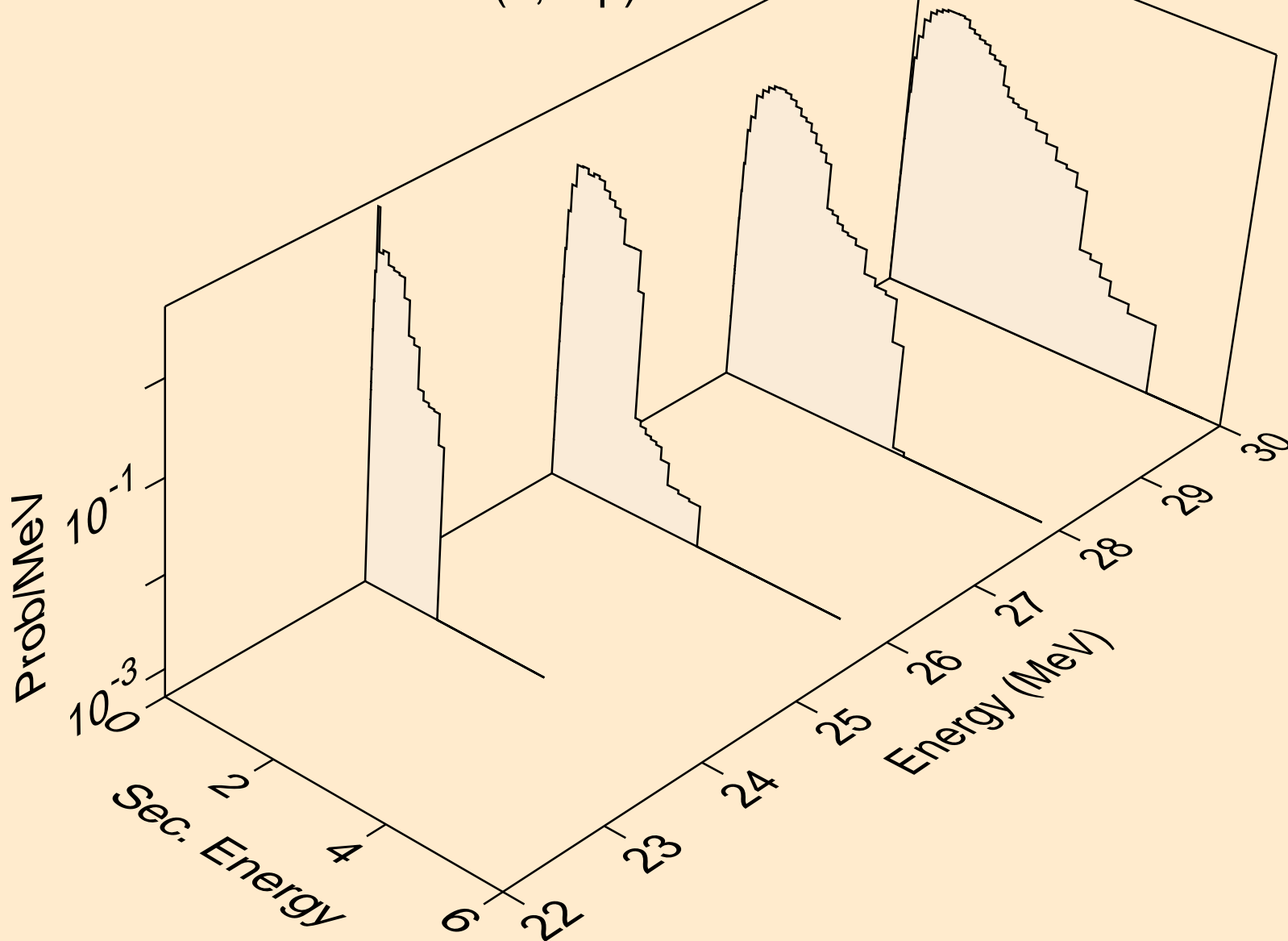

LA132 NEUTRON ACER TENDL-2019 LIBRARY; T=293.16K  
Neutron emission for (n,2np)

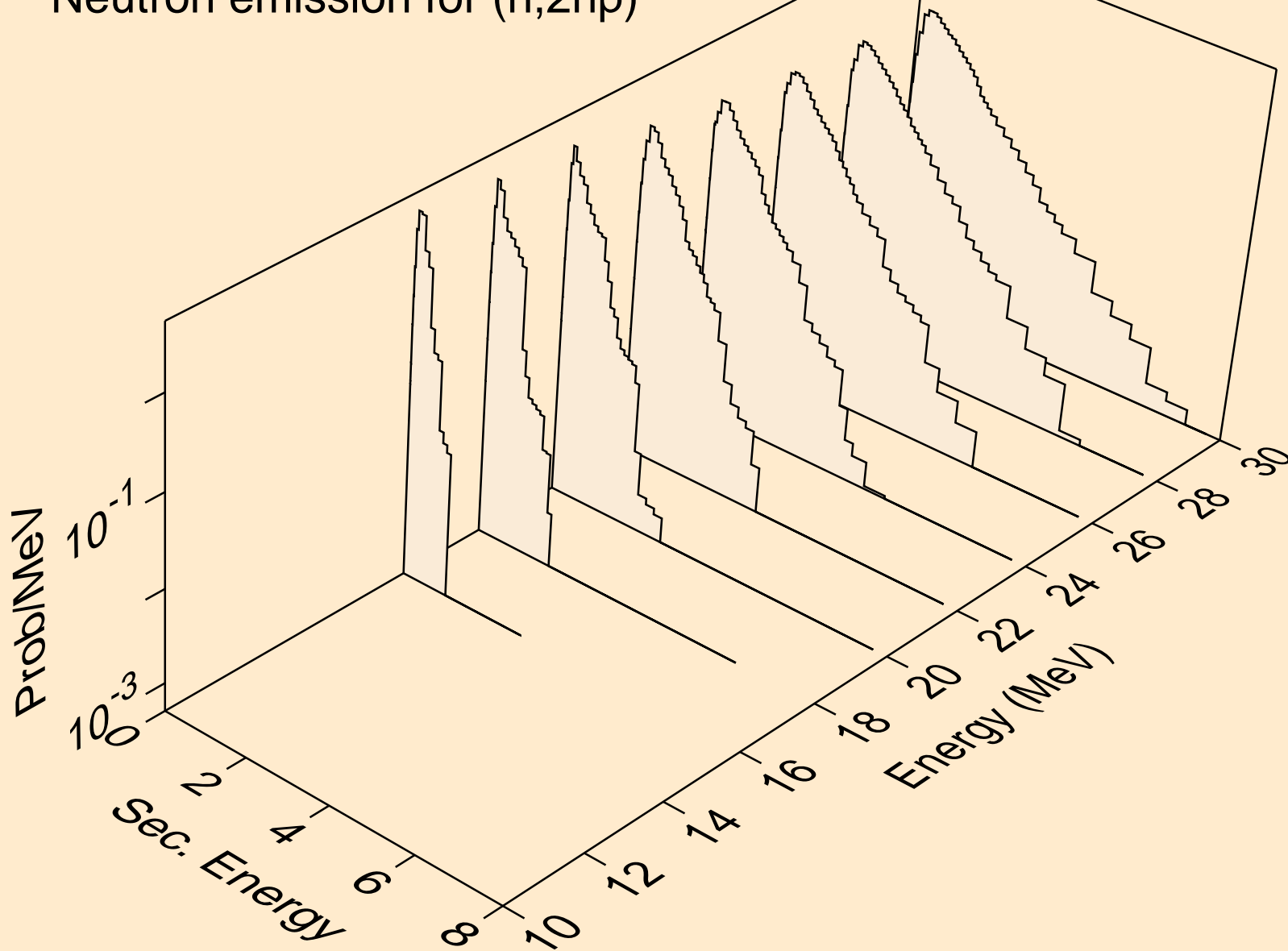

LA132 NEUTRON ACER TENDL-2019 LIBRARY; T=293.16K  
Neutron emission for (n,npa)

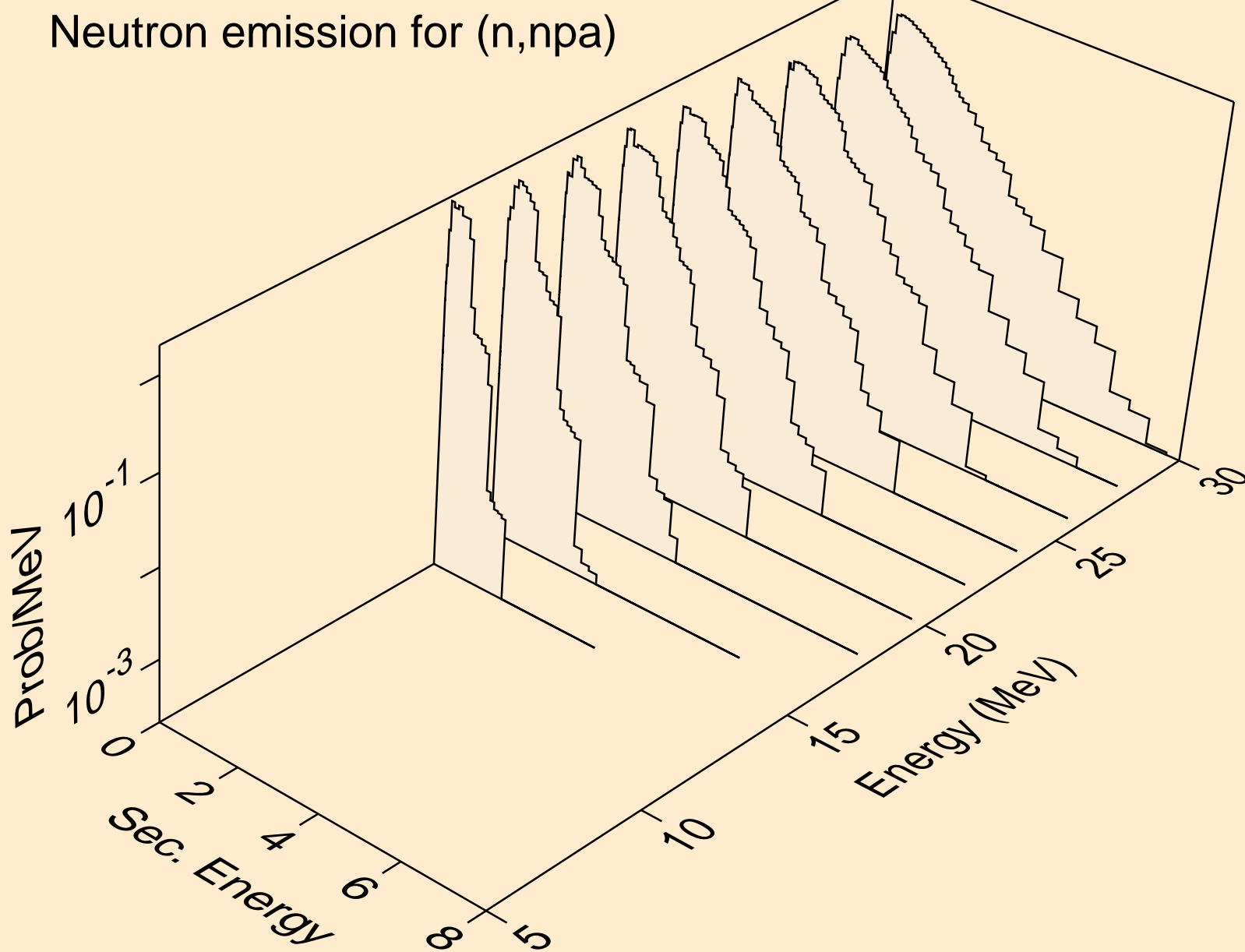

LA132 NEUTRON ACER TENDL-2019 LIBRARY; T=293.16K  
Neutron emission for (n,n\*c)

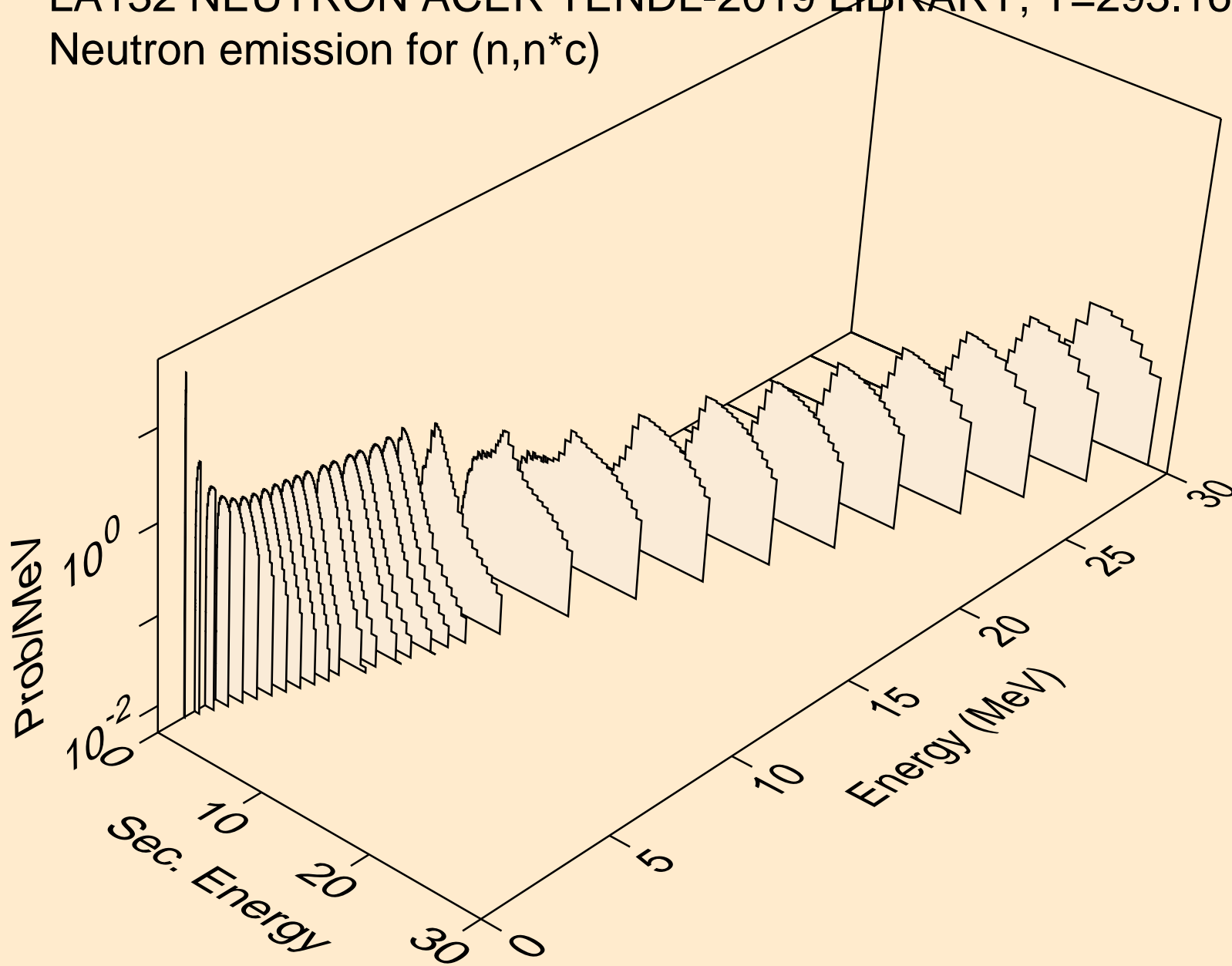

LA132 NEUTRON ACER TENDL-2019 LIBRARY; T=293.16K  
Photon emission for (n,x)

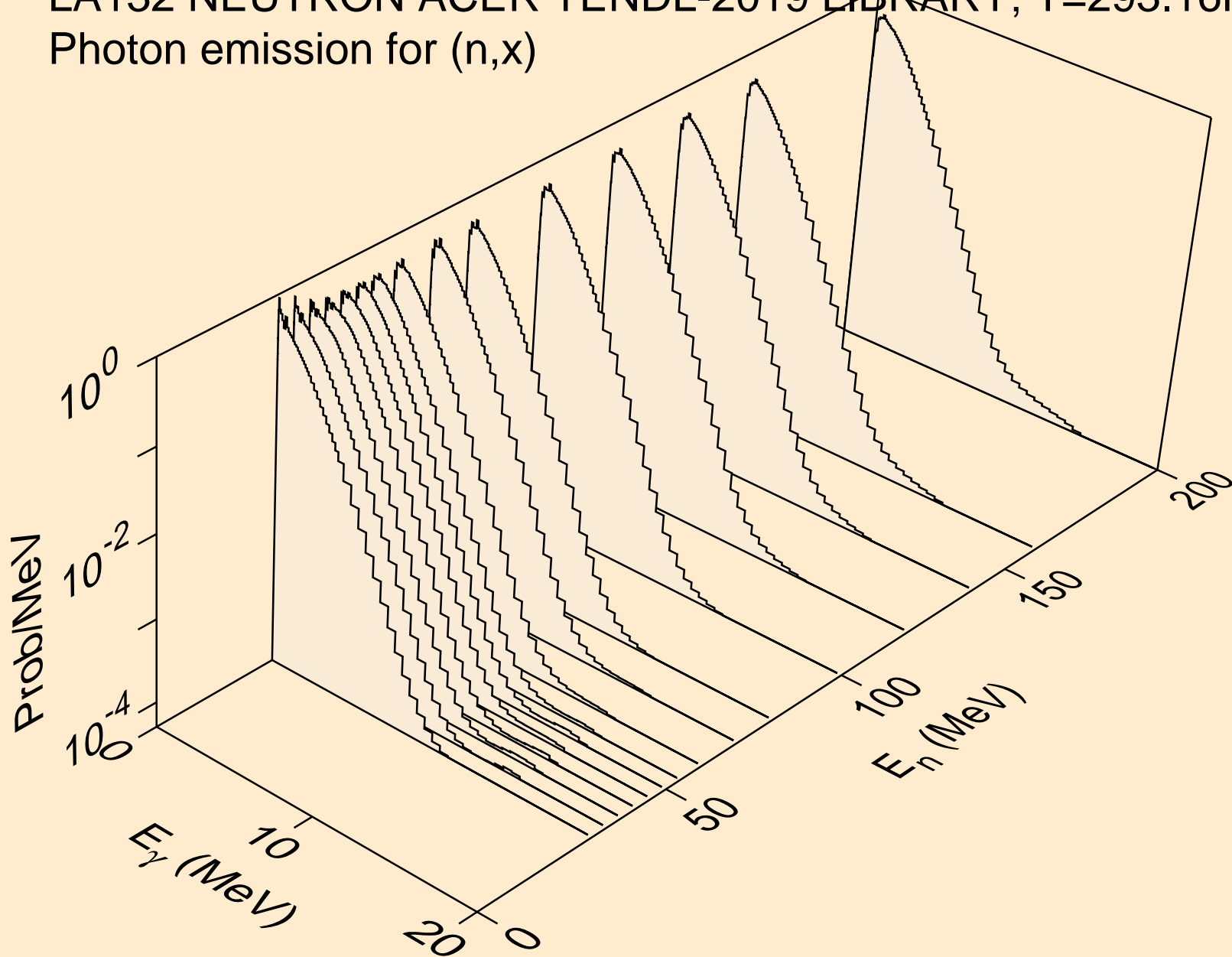

LA132 NEUTRON ACER TENDL-2019 LIBRARY; T=293.16K  
Photon emission for (n,2nd)

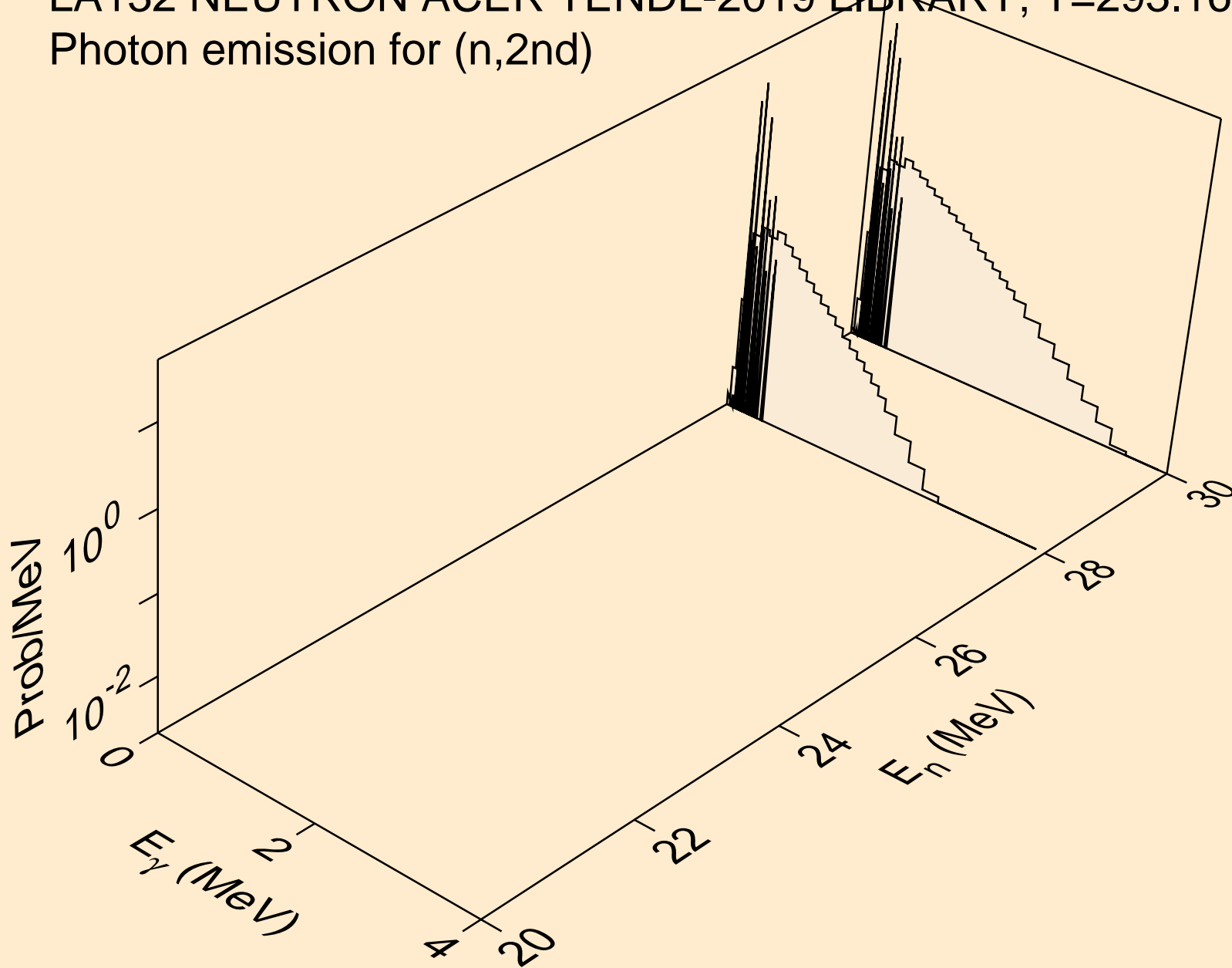



LA132 NEUTRON ACER TENDL-2019 LIBRARY; T=293.16K  
Photon emission for (n,2n)

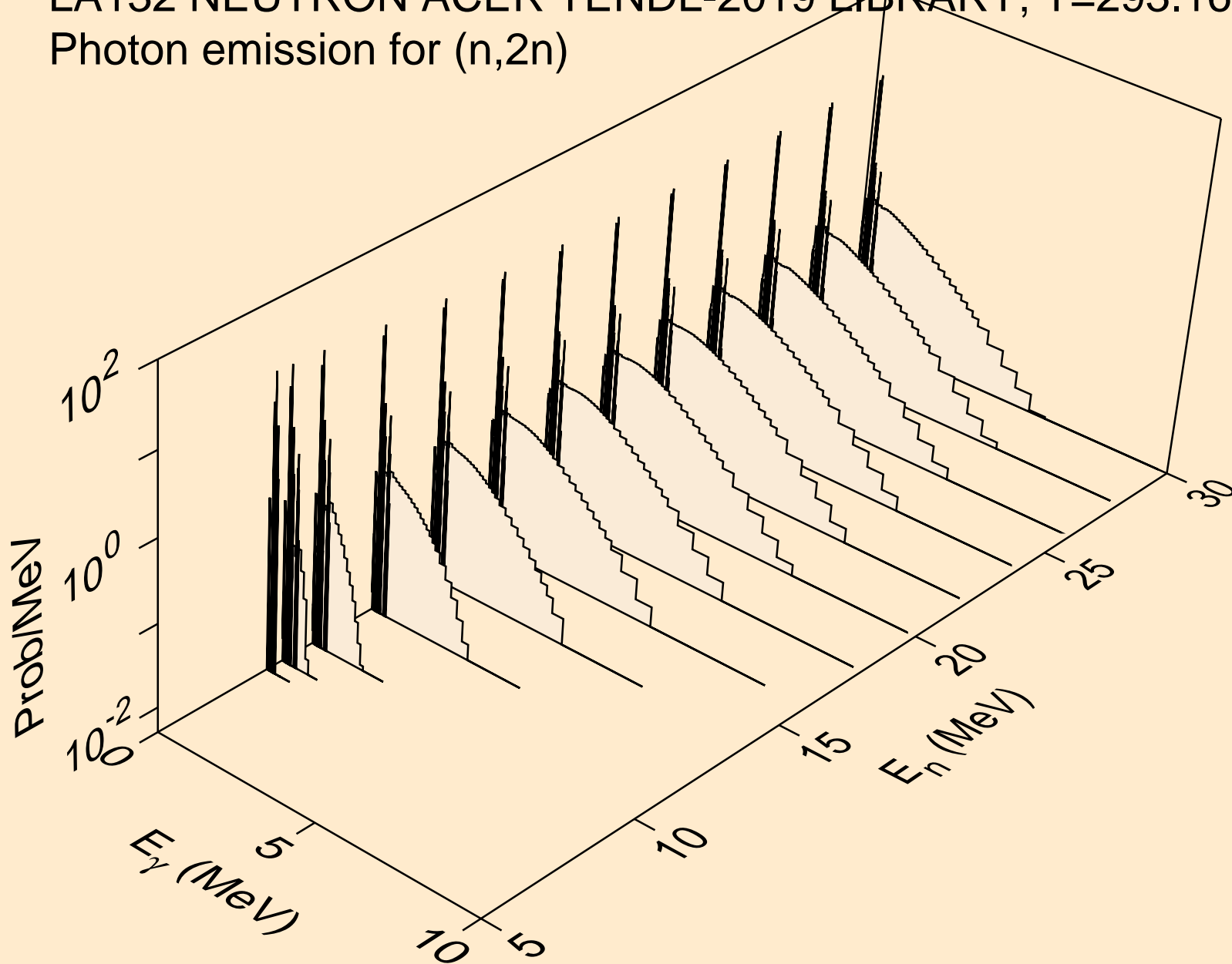

LA132 NEUTRON ACER TENDL-2019 LIBRARY; T=293.16K  
Photon emission for (n,3n)

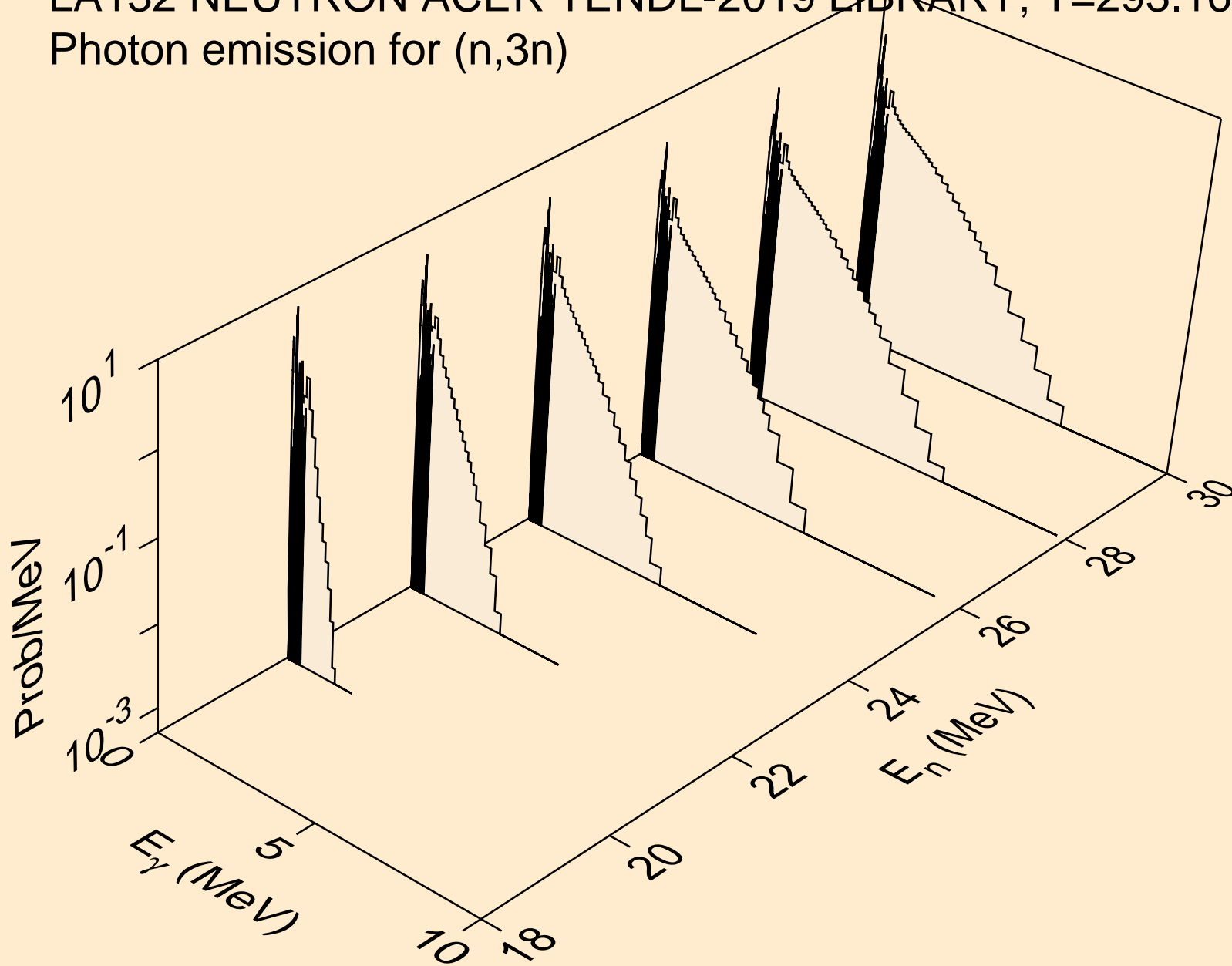

LA132 NEUTRON ACER TENDL-2019 LIBRARY; T=293.16K  
Photon emission for (n,n\*)a

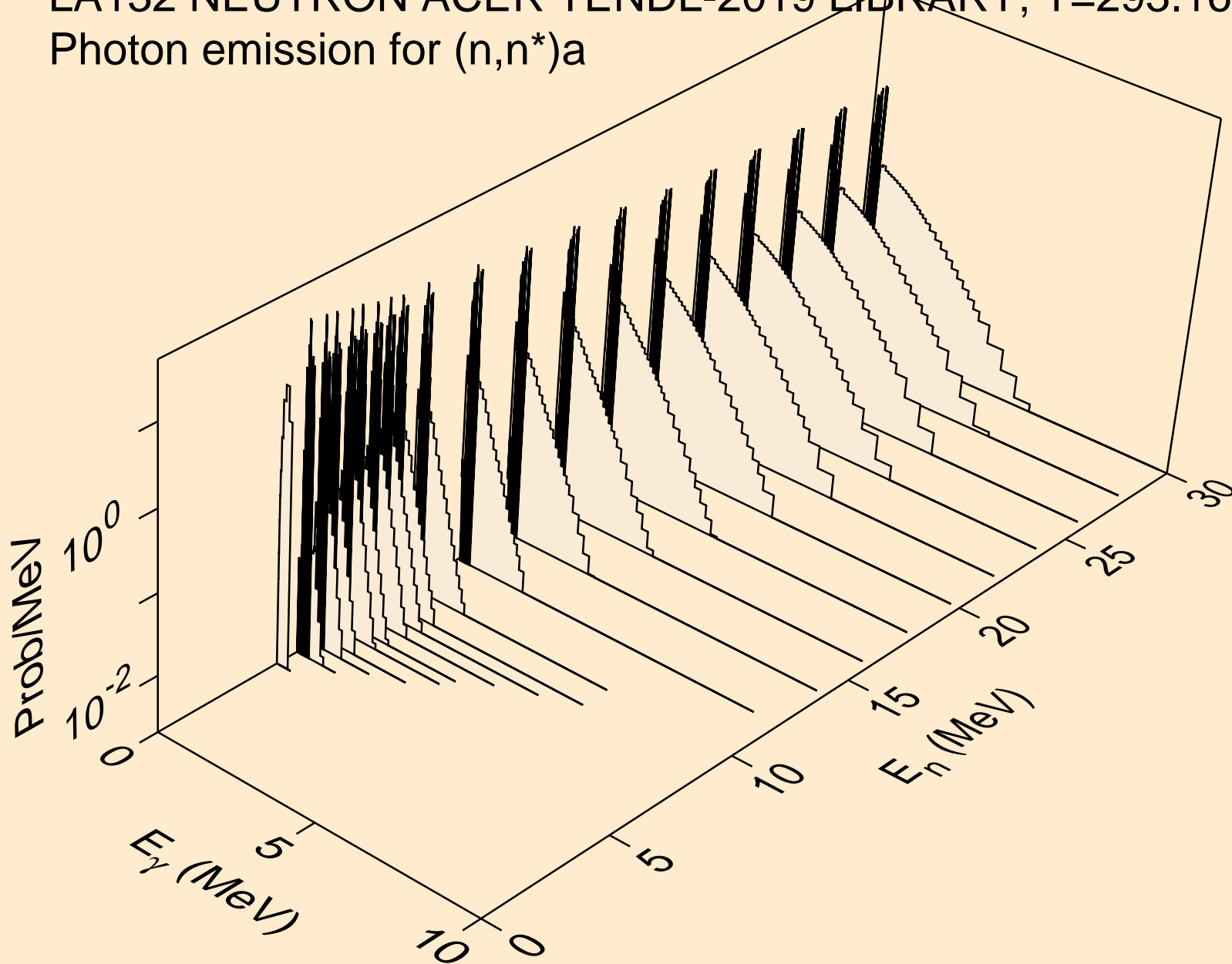

LA132 NEUTRON ACER TENDL-2019 LIBRARY; T=293.16K  
Photon emission for (n,2n)a

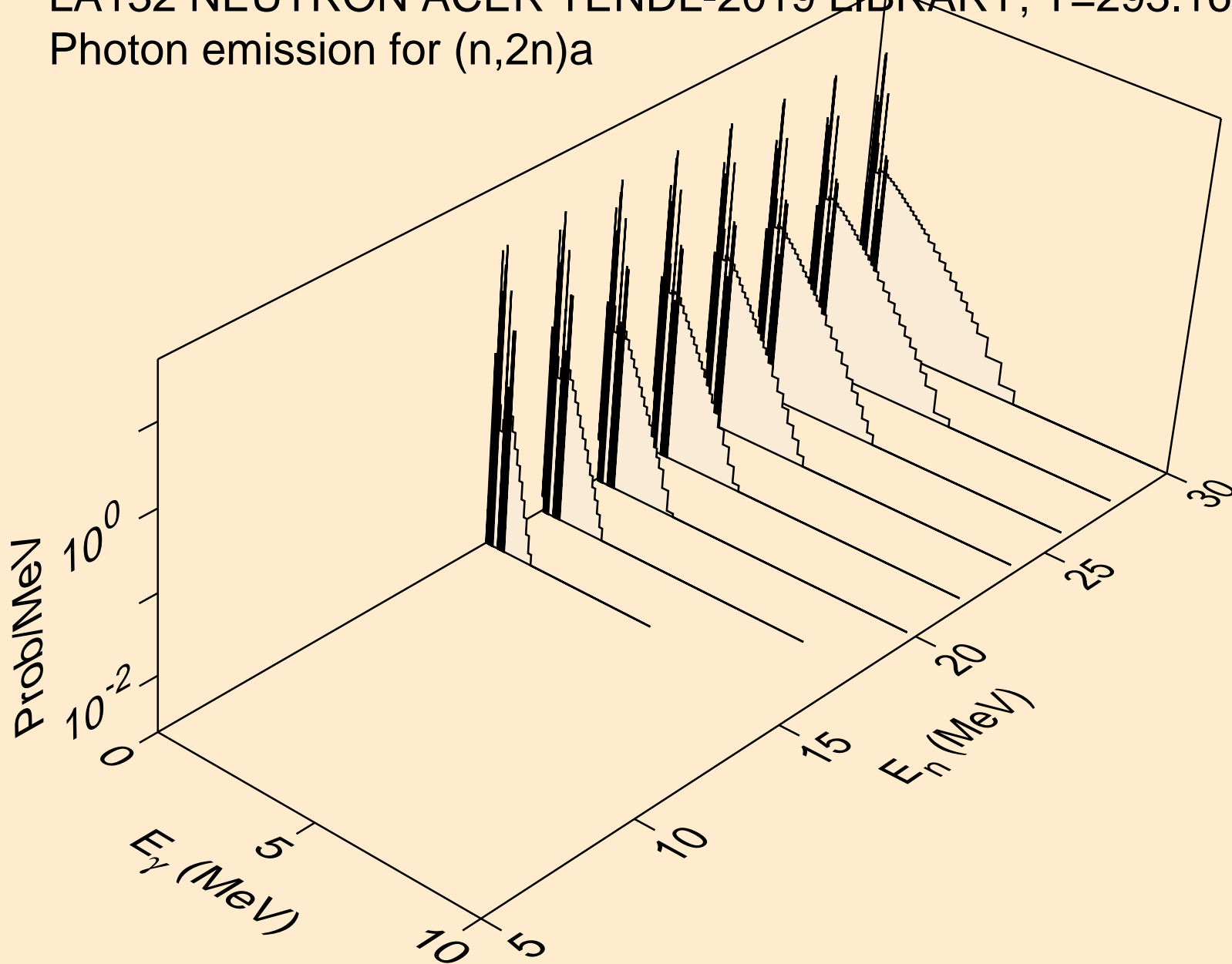

LA132 NEUTRON ACER TENDL-2019 LIBRARY; T=293.16K  
Photon emission for (n,3n)a

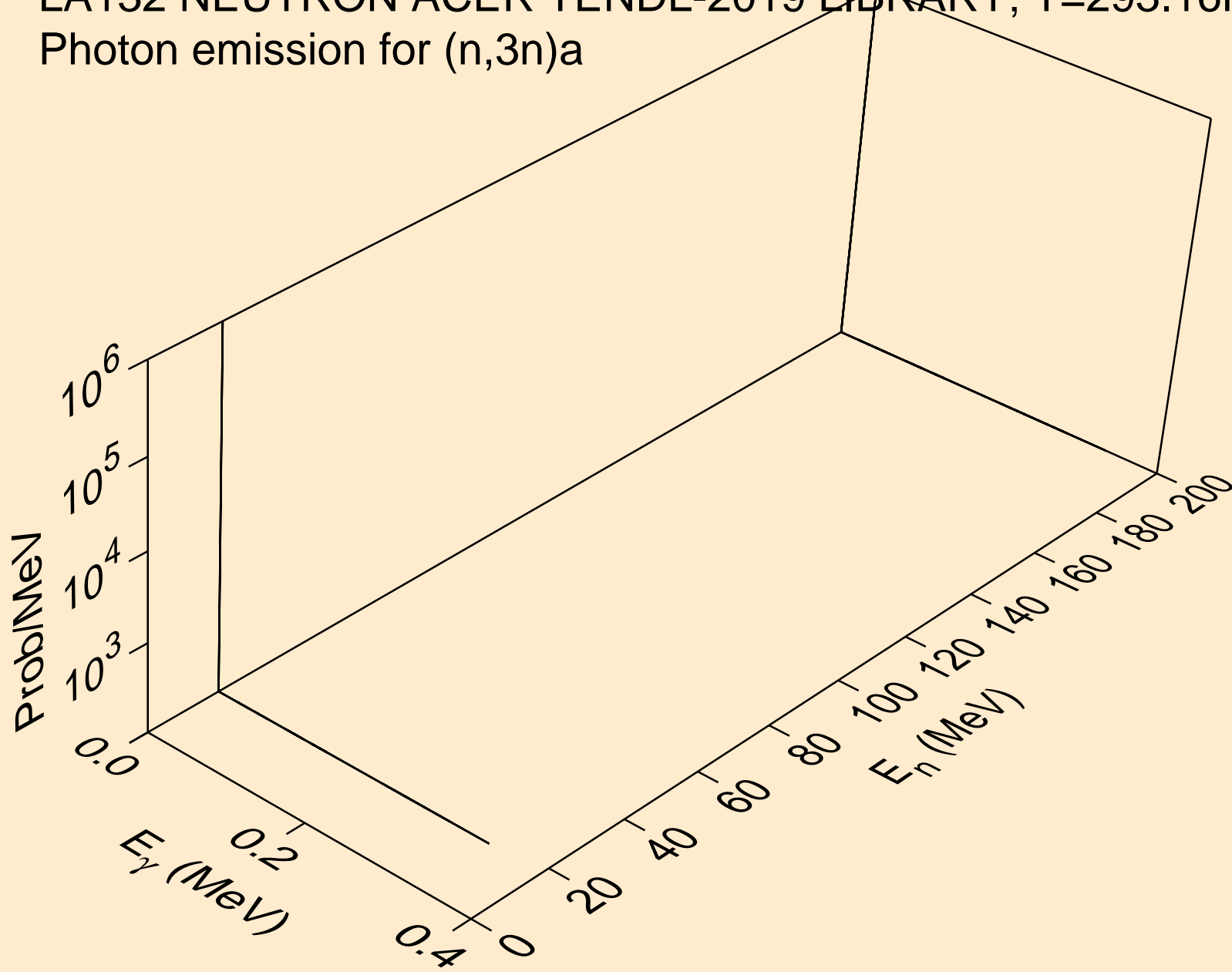

LA132 NEUTRON ACER TENDL-2019 LIBRARY; T=293.16K  
Photon emission for (n,n\*)p

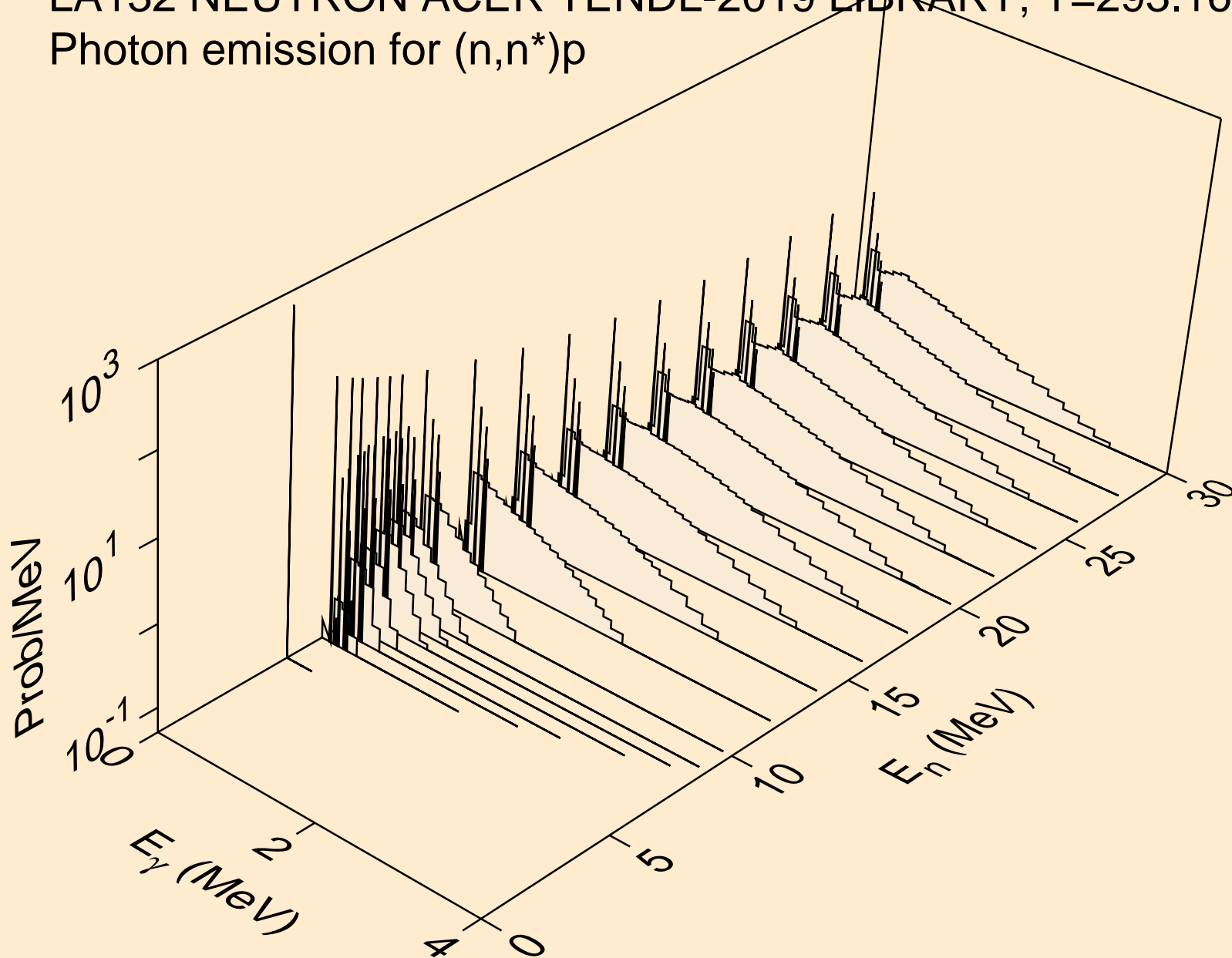

LA132 NEUTRON ACER TENDL-2019 LIBRARY; T=293.16K  
Photon emission for (n,n\*)2a

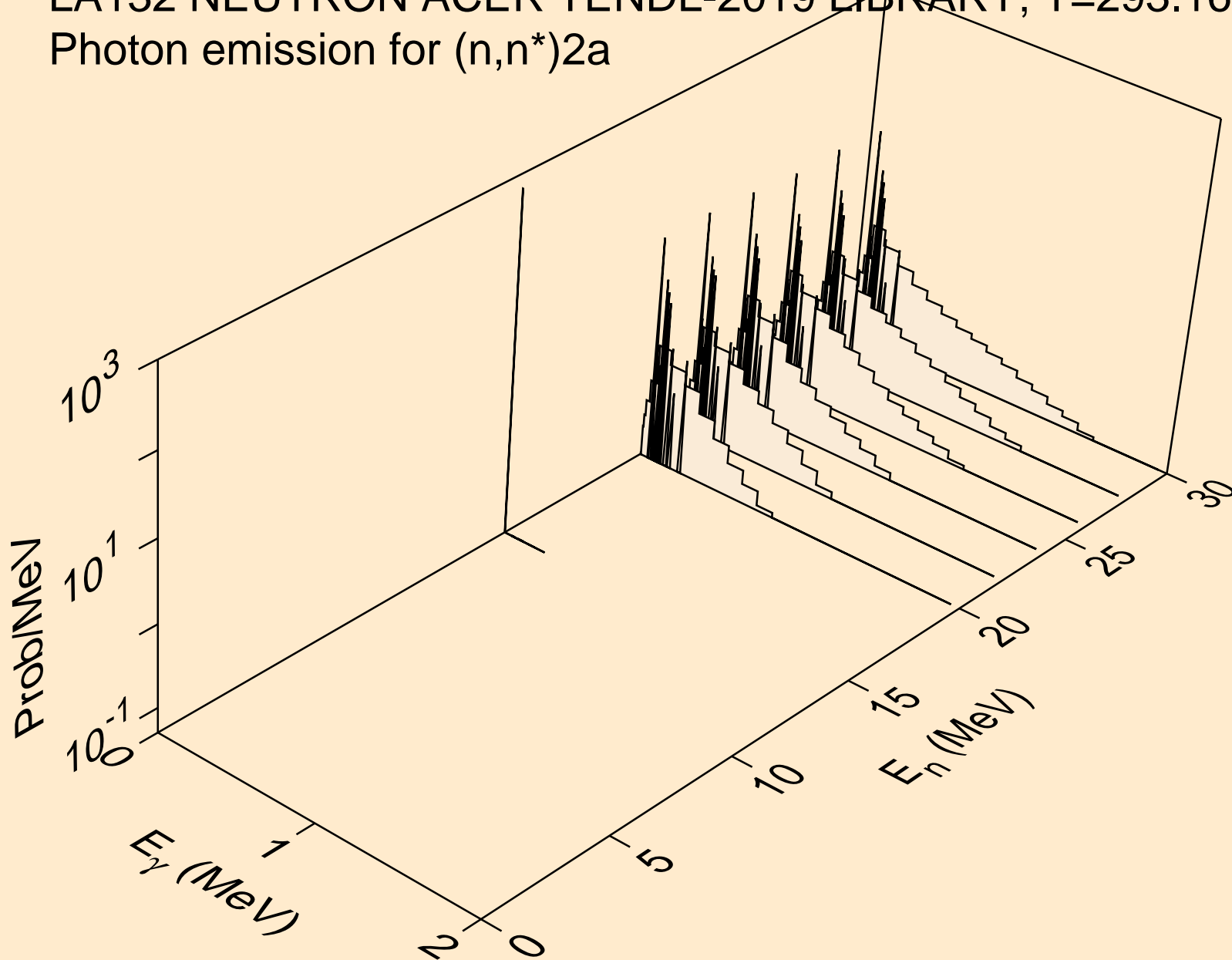

LA132 NEUTRON ACER TENDL-2019 LIBRARY; T=293.16K  
Photon emission for (n,2n)2a

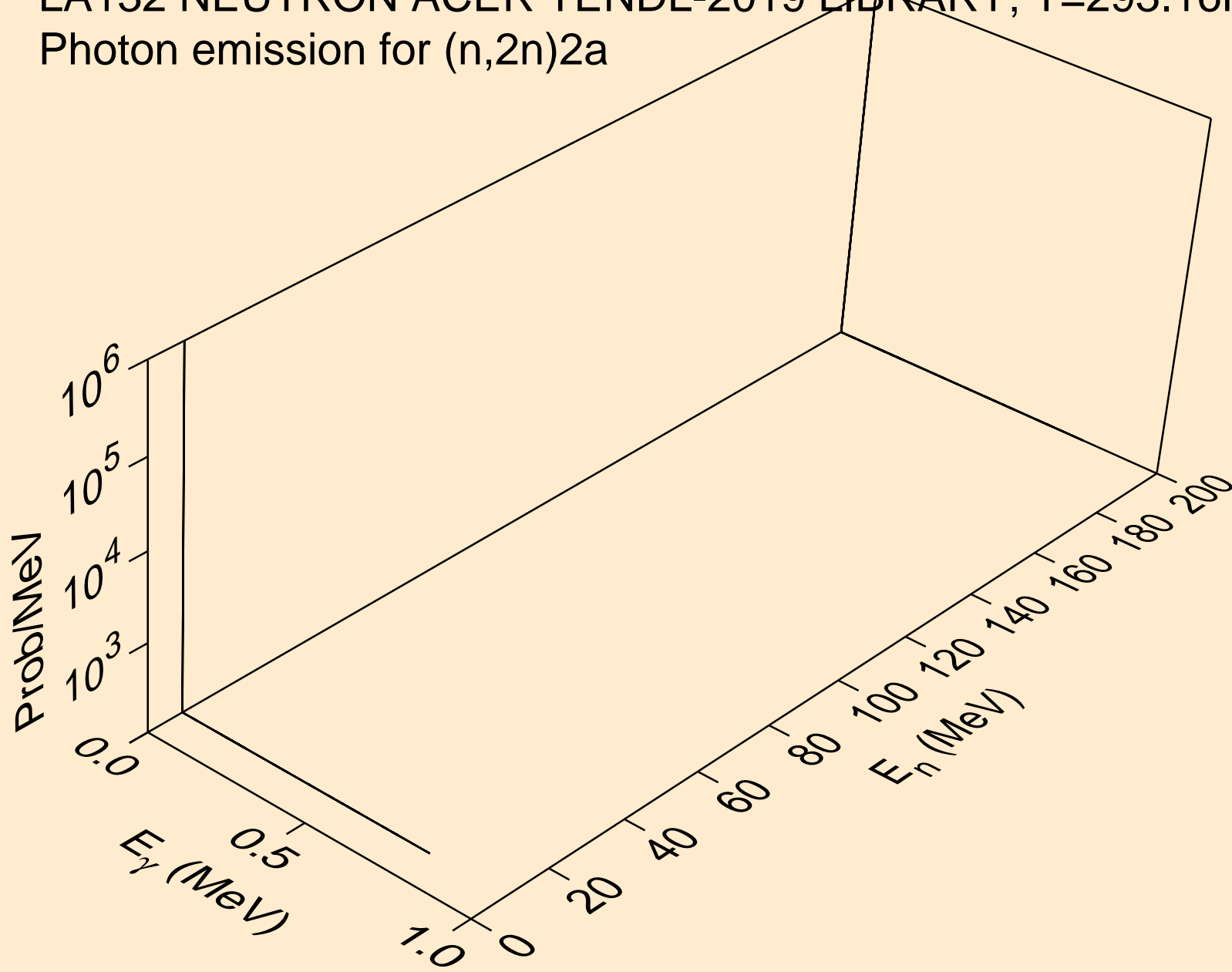



LA132 NEUTRON ACER TENDL-2019 LIBRARY; T=293.16K  
Photon emission for (n,n\*)d

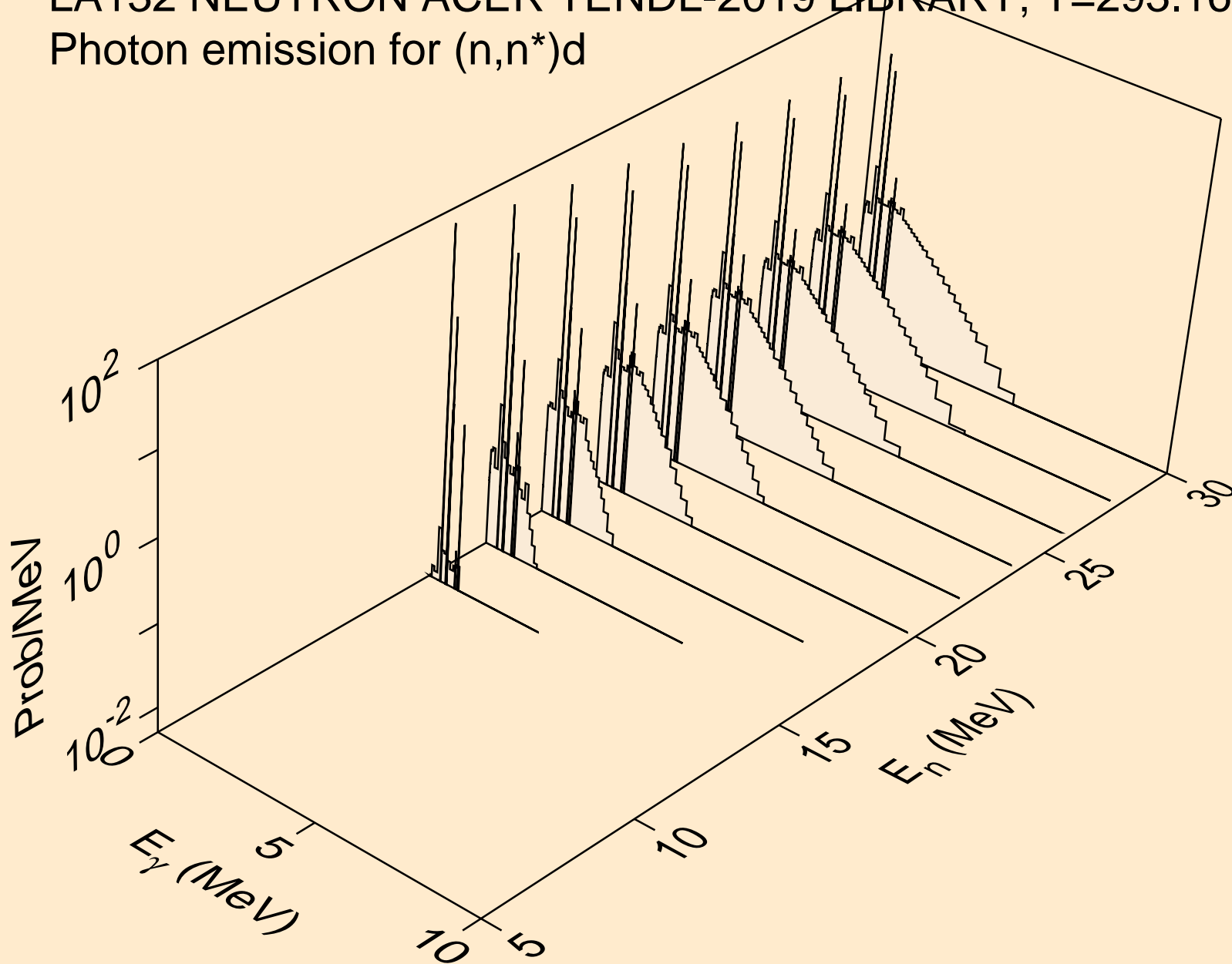

LA132 NEUTRON ACER TENDL-2019 LIBRARY; T=293.16K  
Photon emission for (n,n\*)t

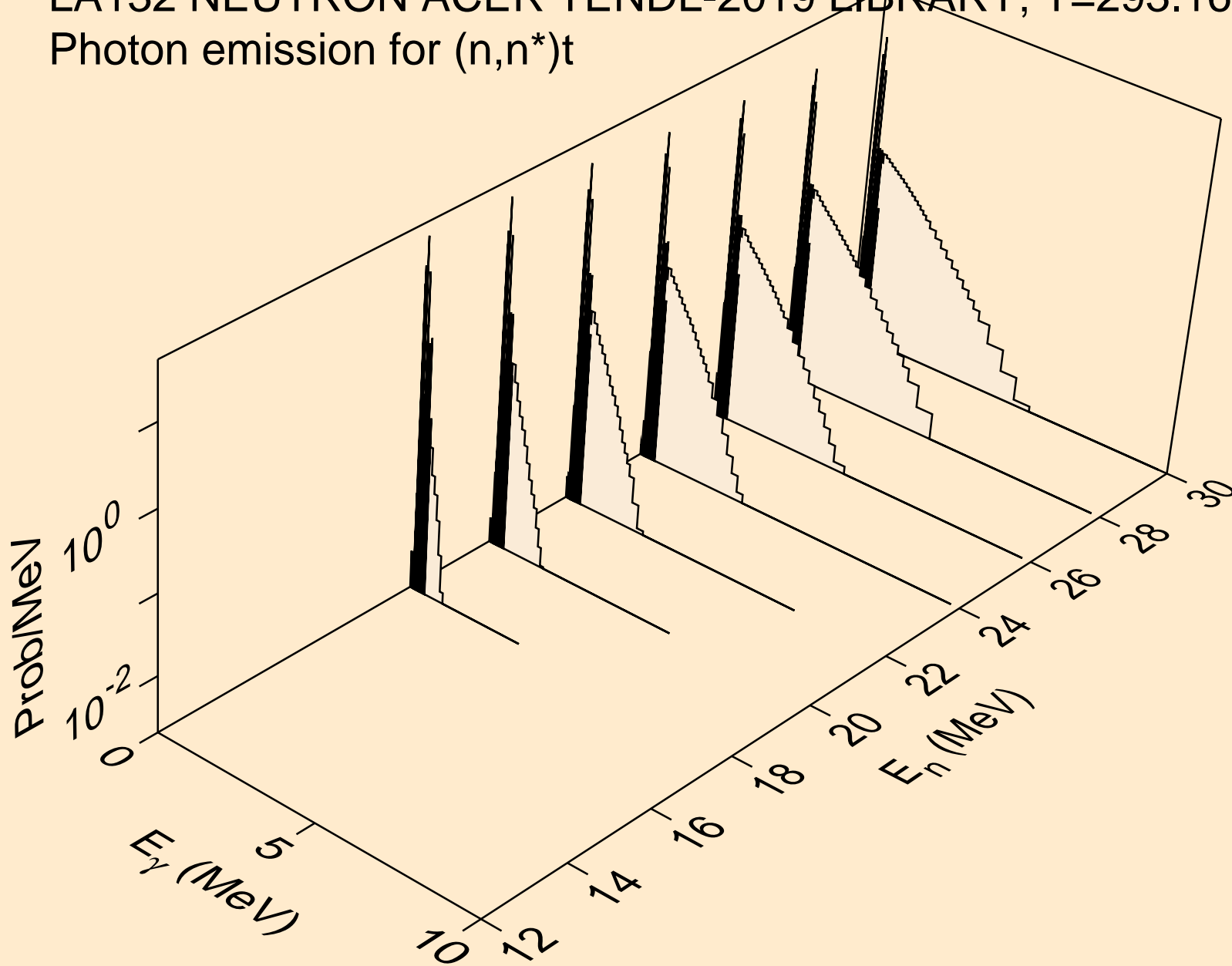

LA132 NEUTRON ACER TENDL-2019 LIBRARY; T=293.16K  
Photon emission for (n,n\*)he3

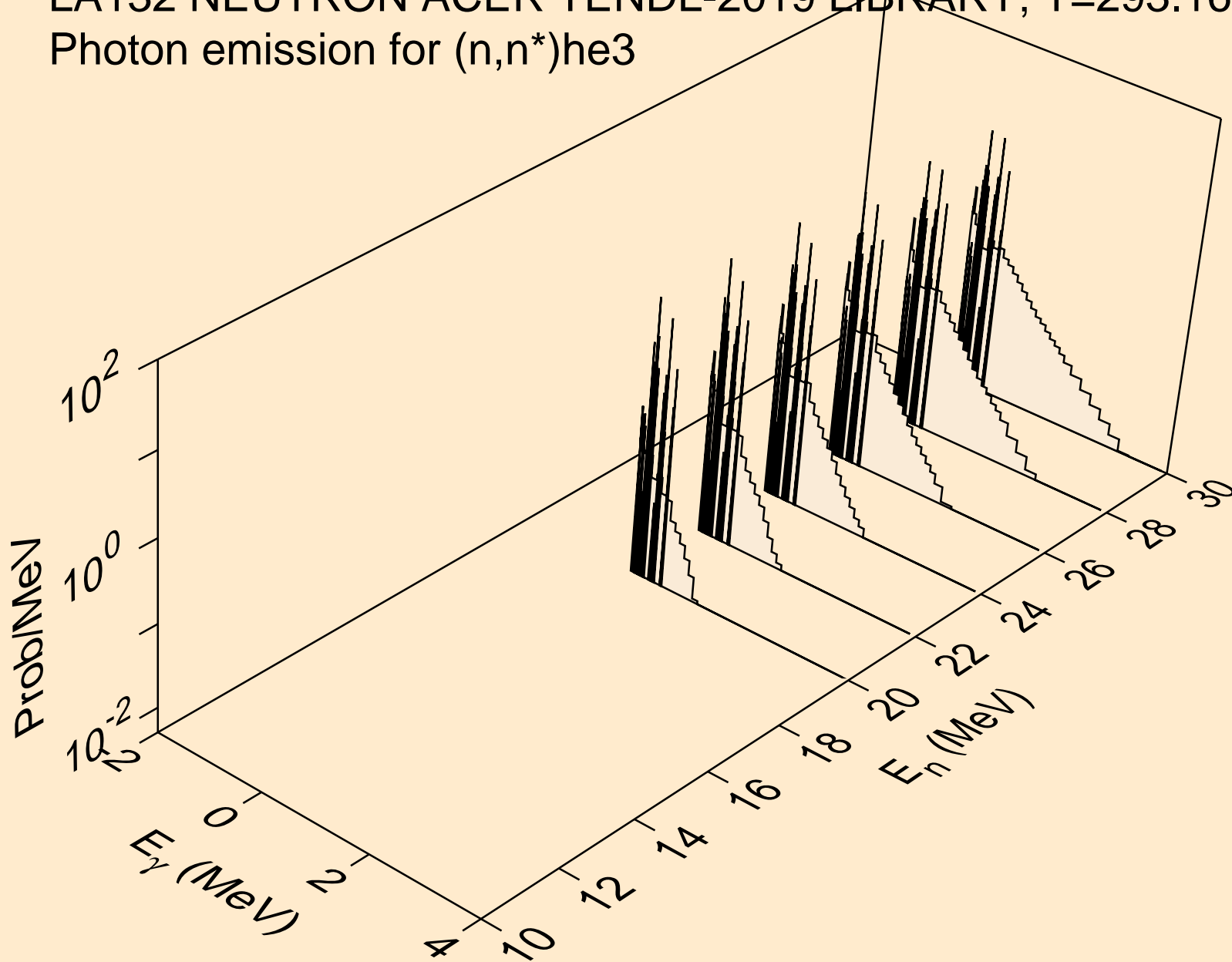

LA132 NEUTRON ACER TENDL-2019 LIBRARY; T=293.16K  
Photon emission for (n,4n)

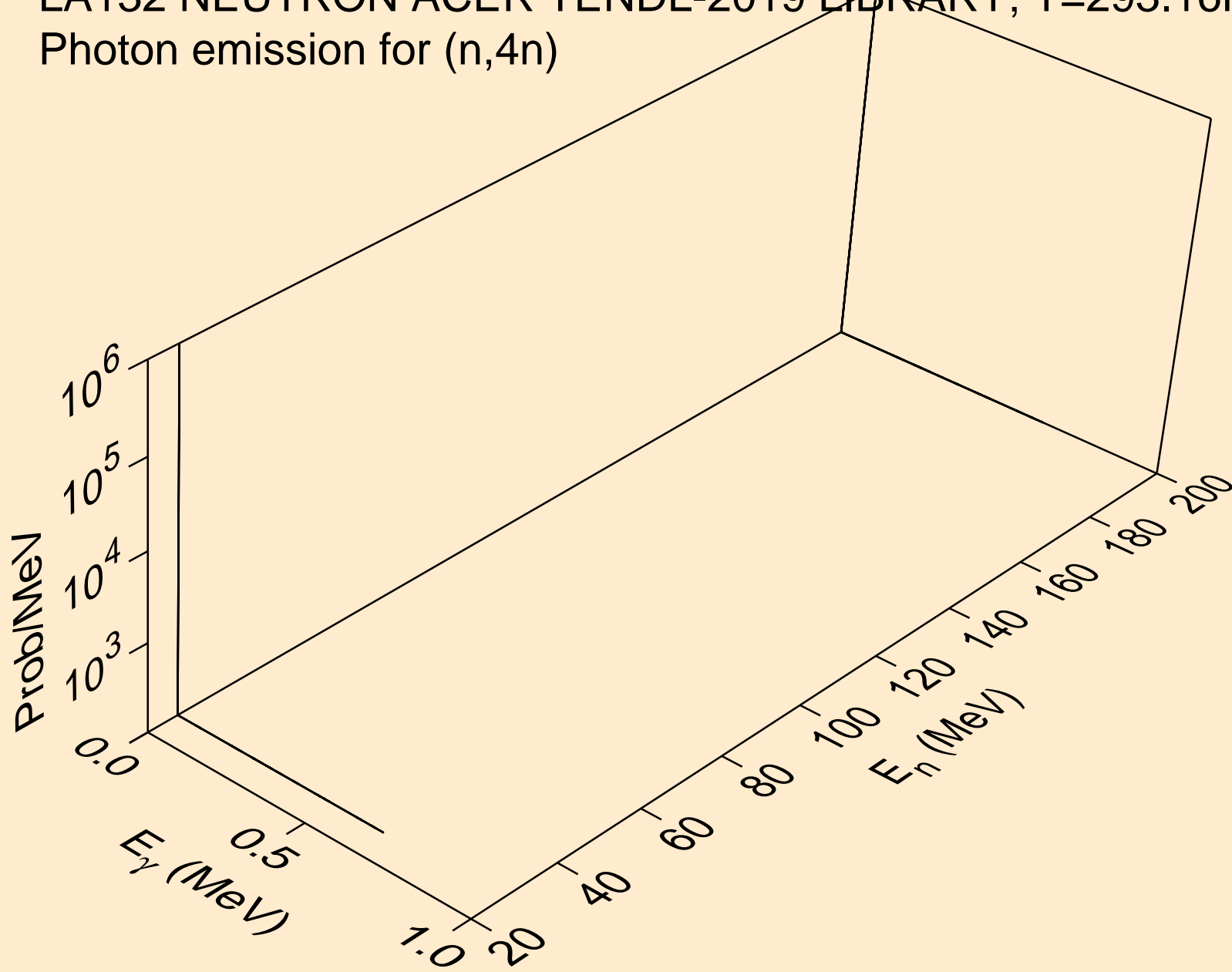

LA132 NEUTRON ACER TENDL-2019 LIBRARY; T=293.16K  
Photon emission for (n,2np)

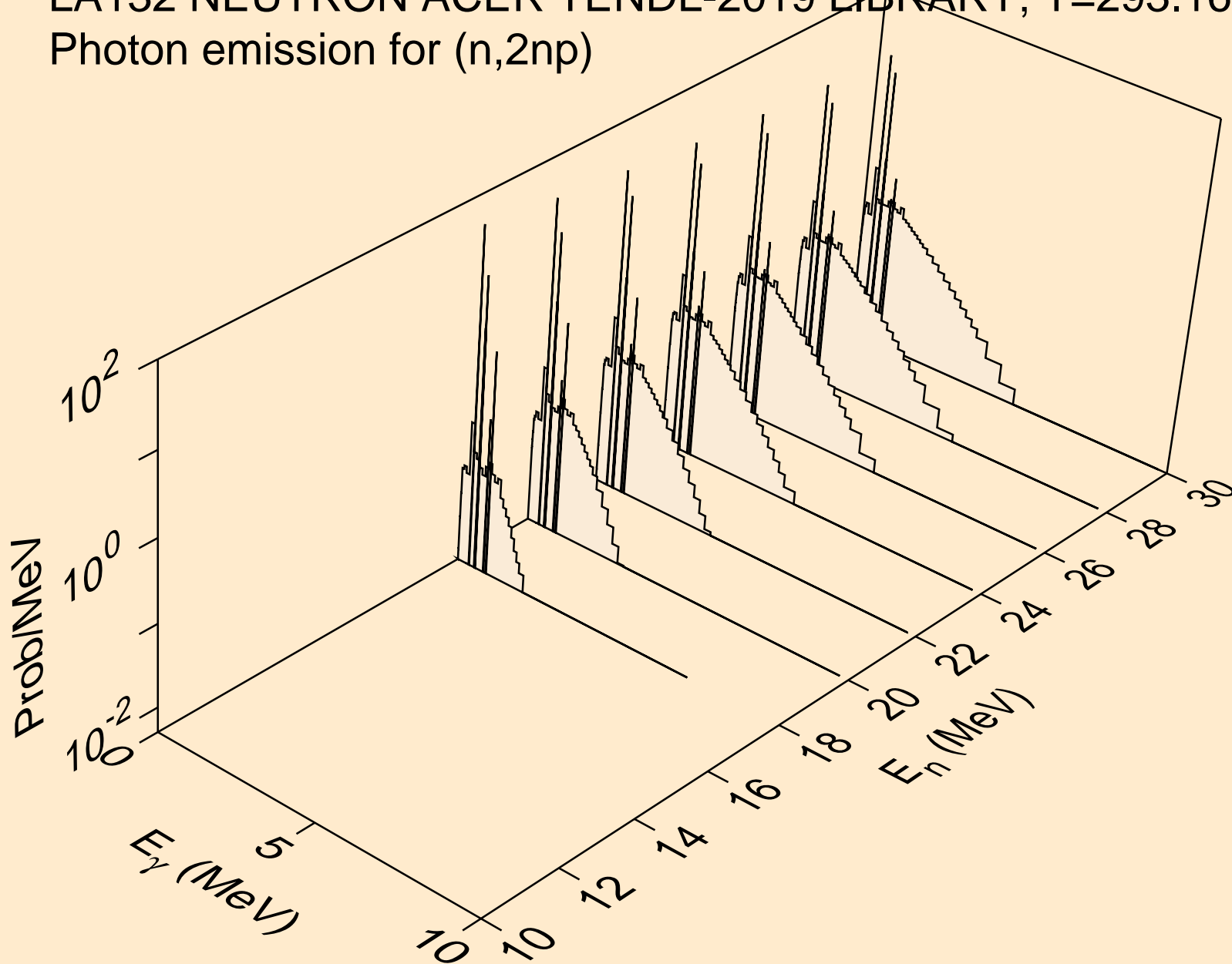

LA132 NEUTRON ACER TENDL-2019 LIBRARY; T=293.16K  
Photon emission for (n,3np)

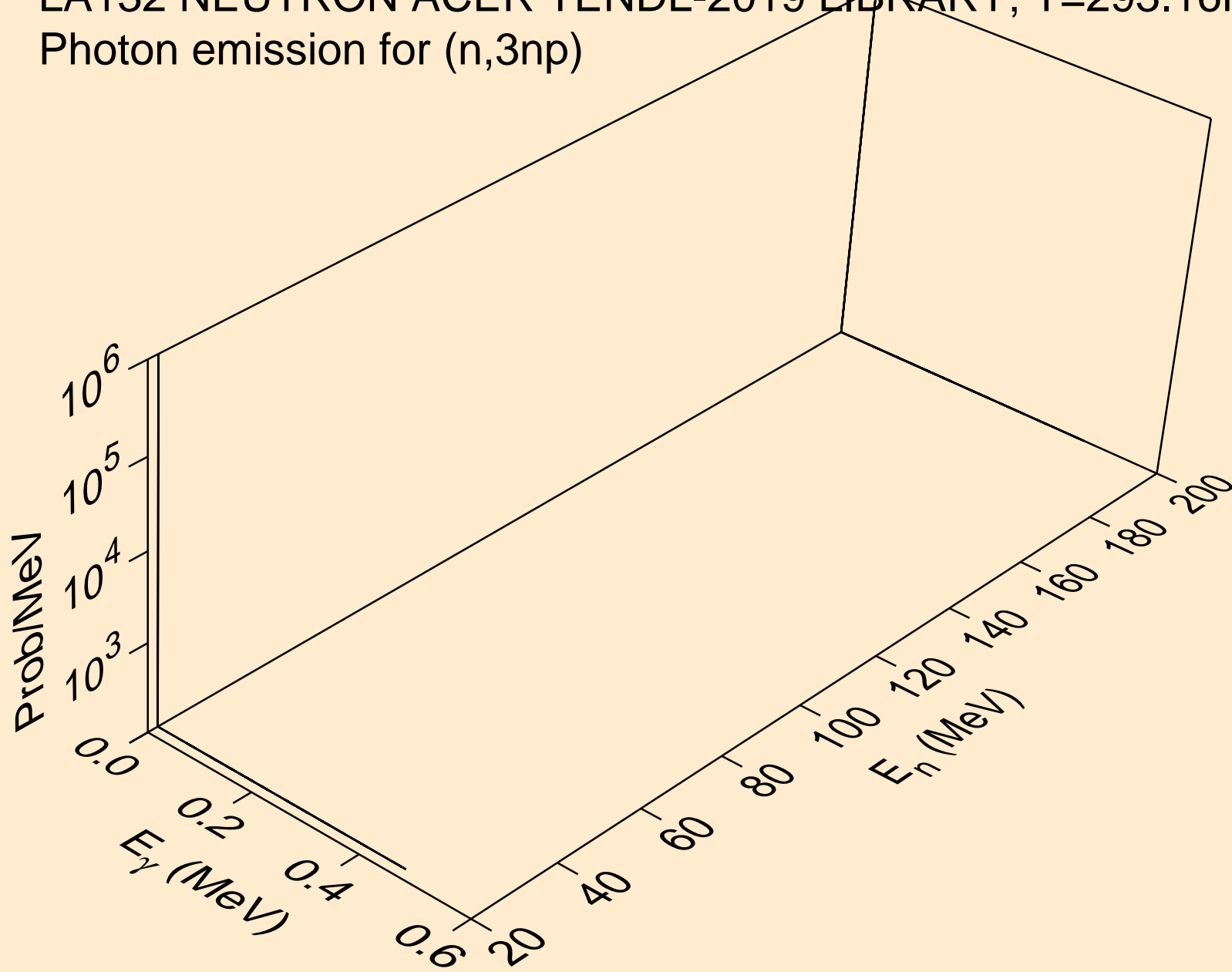

LA132 NEUTRON ACER TENDL-2019 LIBRARY; T=293.16K  
Photon emission for (n,2np)

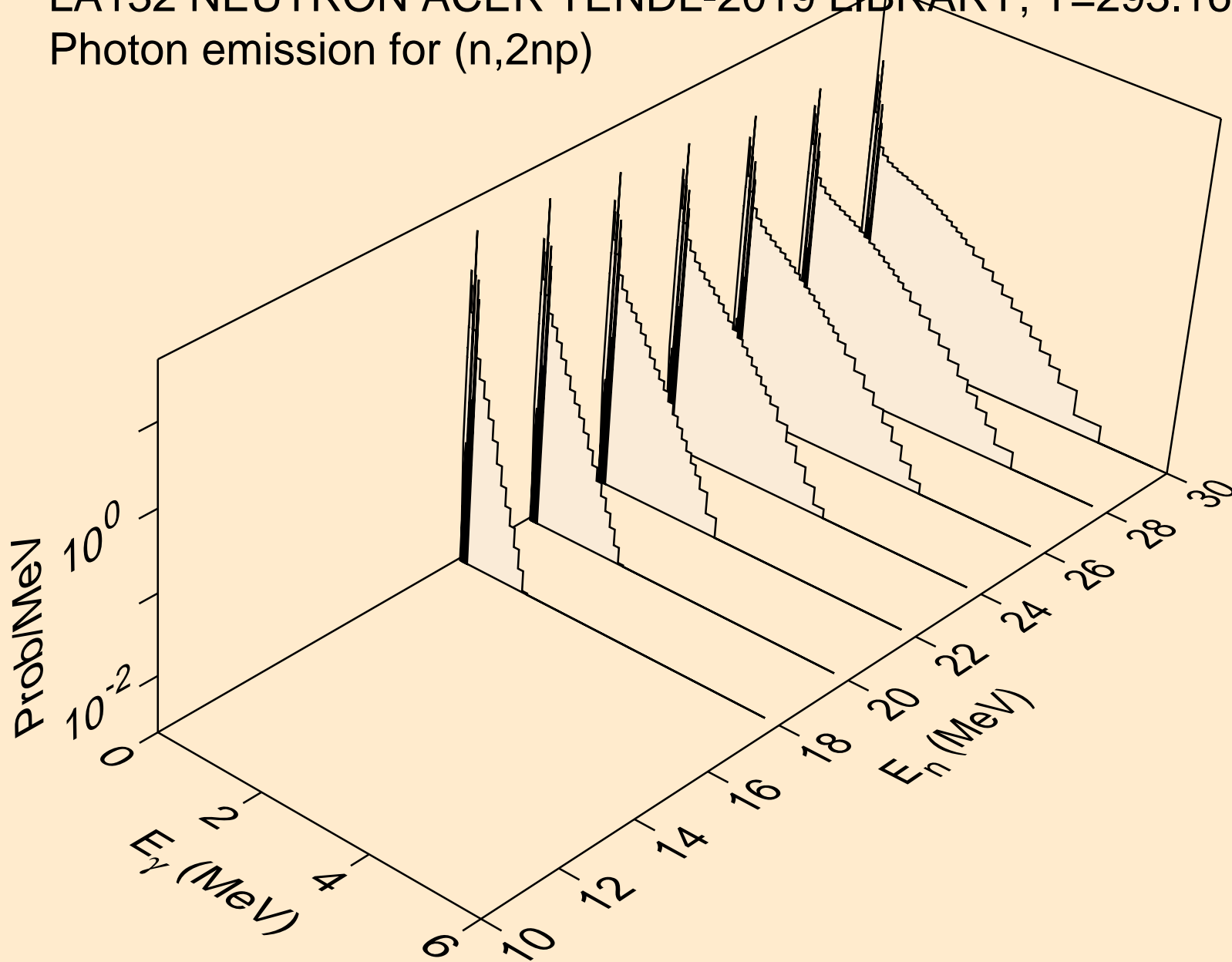

LA132 NEUTRON ACER TENDL-2019 LIBRARY; T=293.16K  
Photon emission for (n,npa)

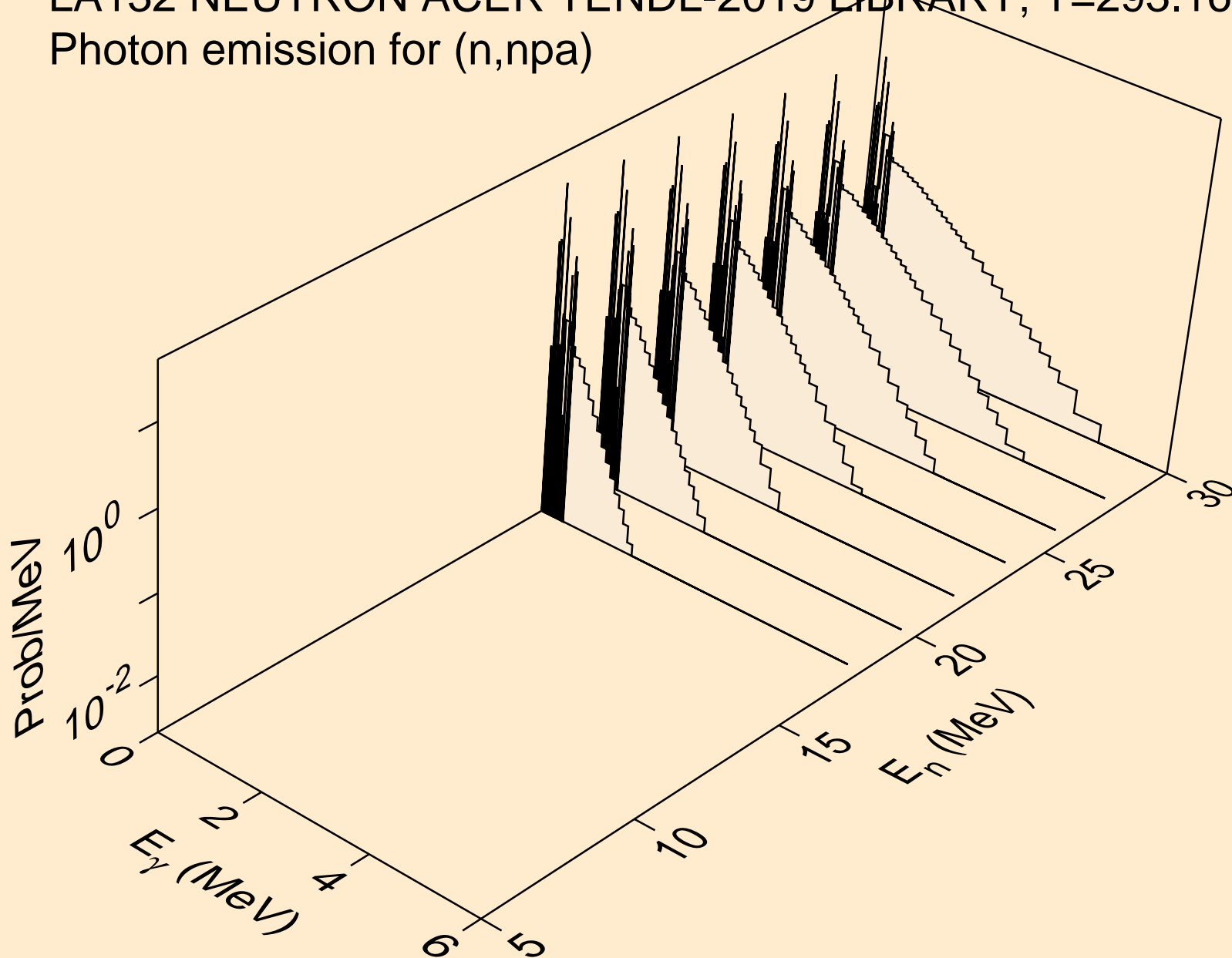



LA132 NEUTRON ACER TENDL-2019 LIBRARY; T=293.16K  
Photon emission for (n,n\*c)

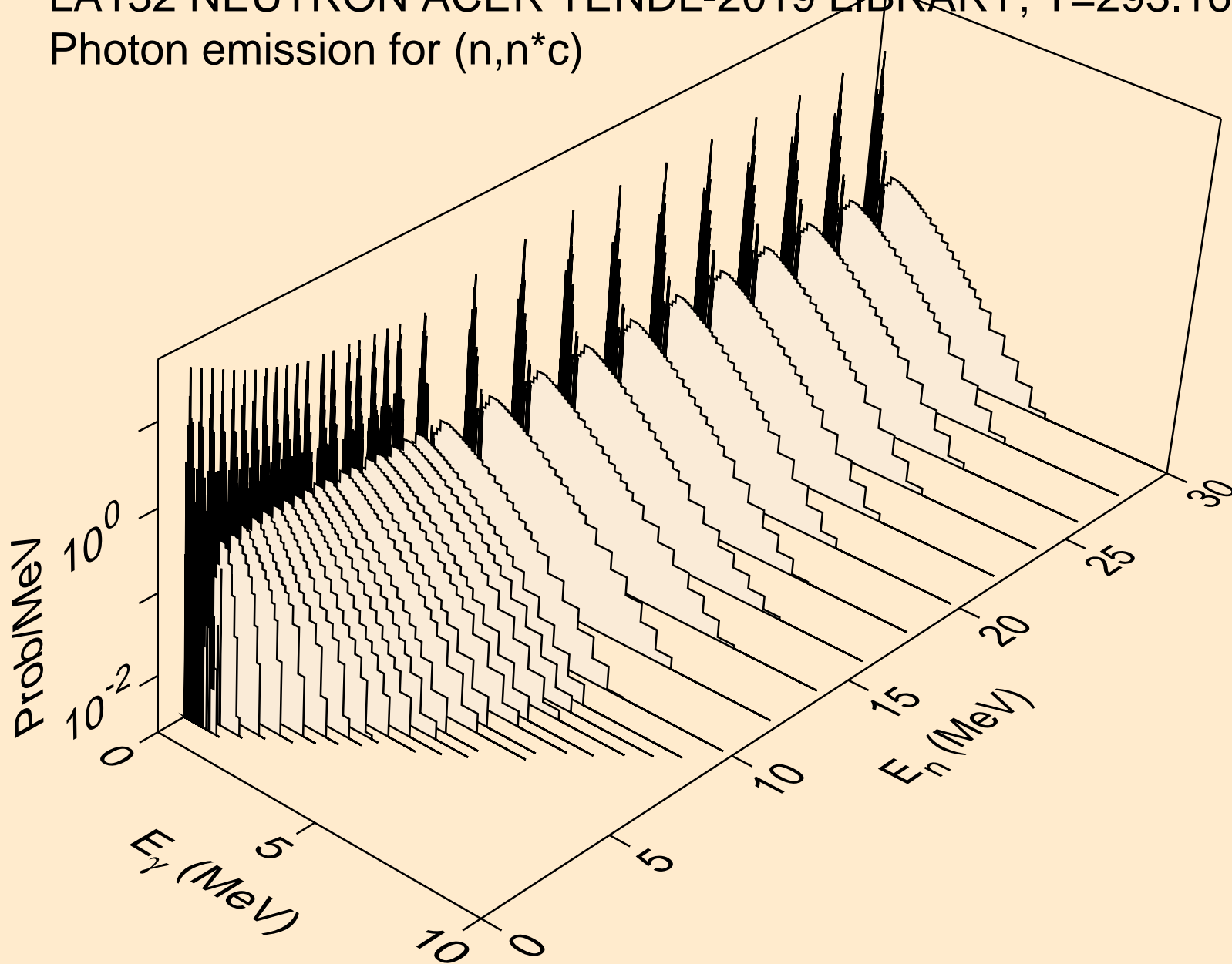

LA132 NEUTRON ACER TENDL-2019 LIBRARY; T=293.16K  
Photon emission for (n,gma)

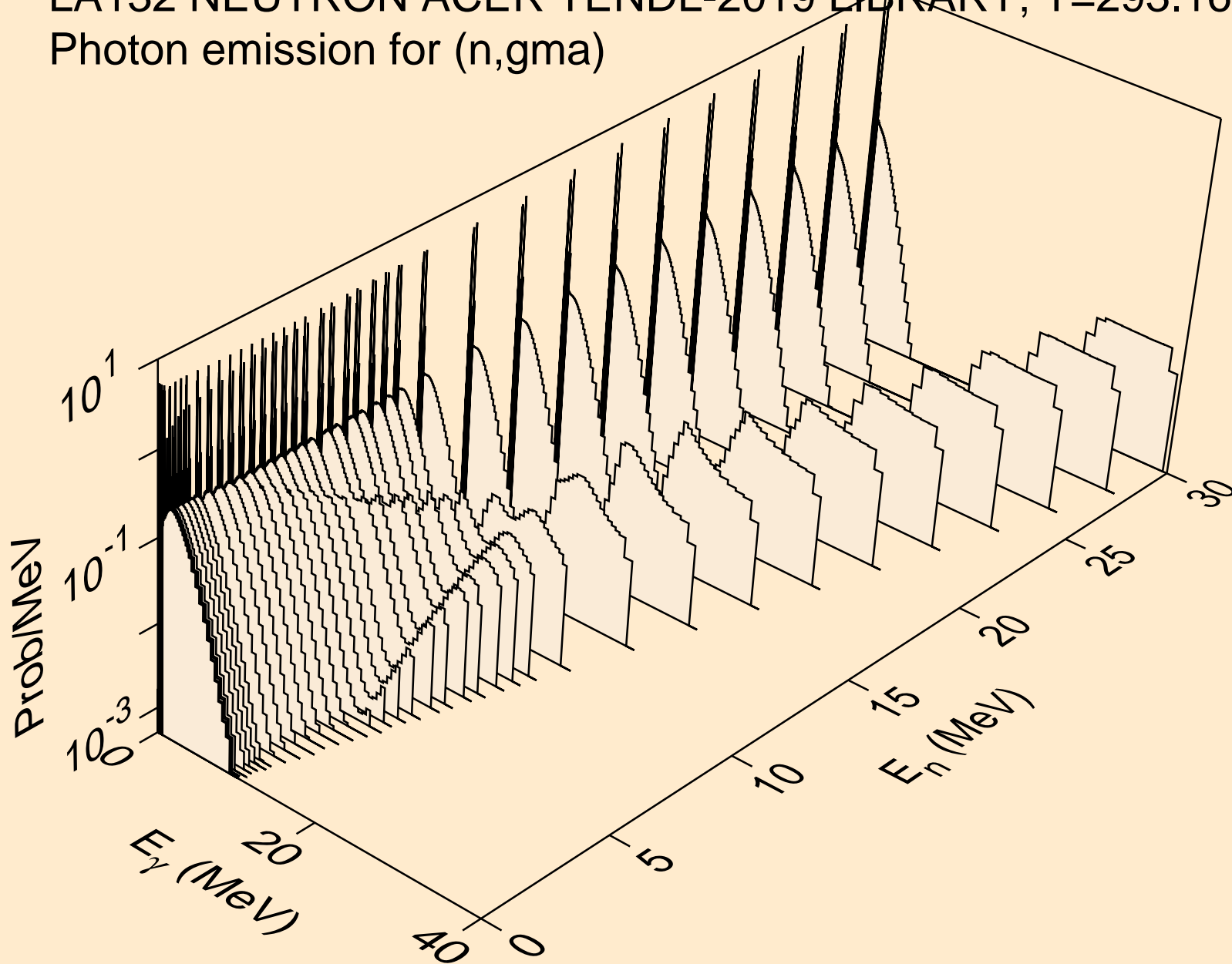

LA132 NEUTRON ACER TENDL-2019 LIBRARY; T=293.16K  
Photon emission for (n,p)

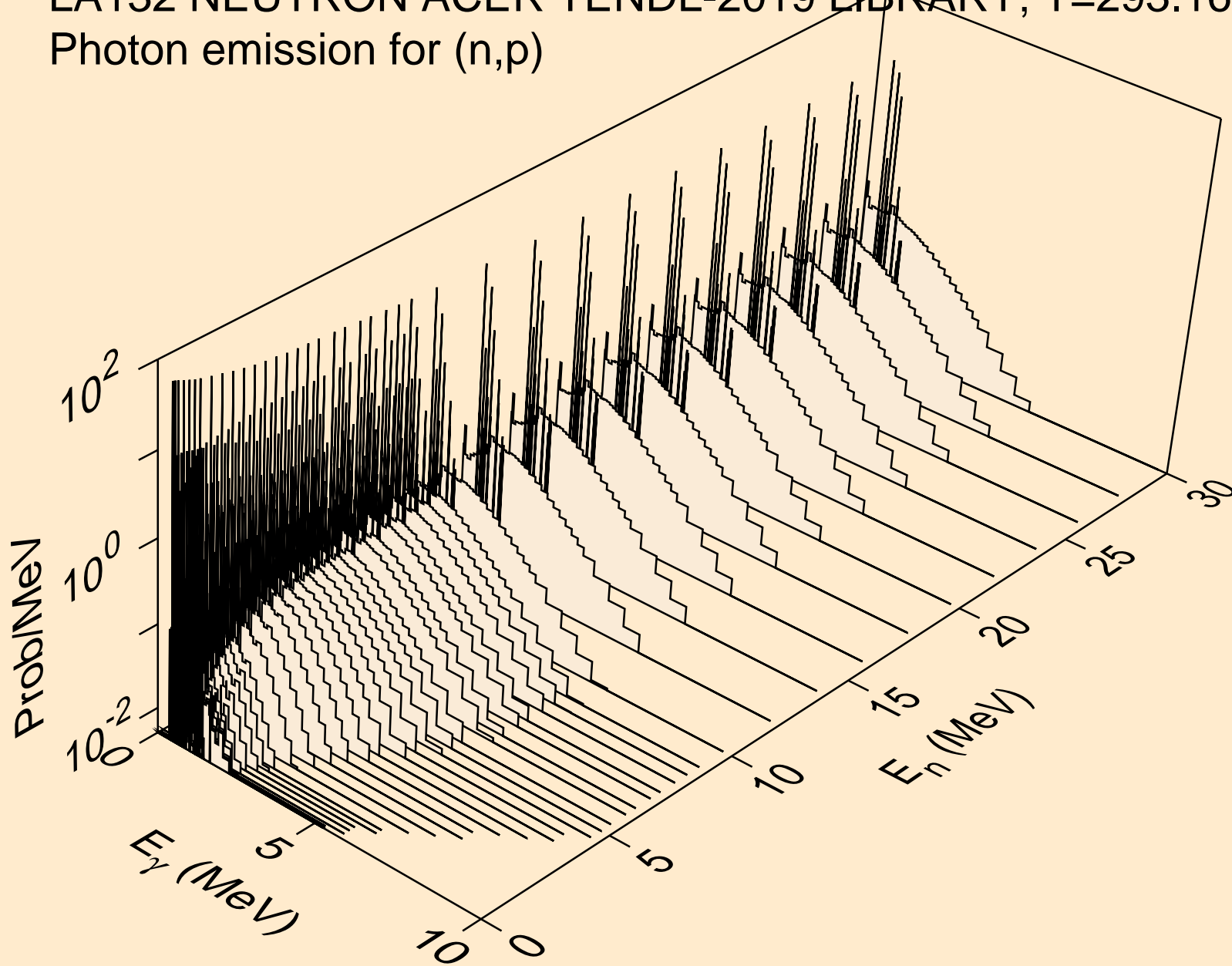

LA132 NEUTRON ACER TENDL-2019 LIBRARY; T=293.16K  
Photon emission for (n,d)

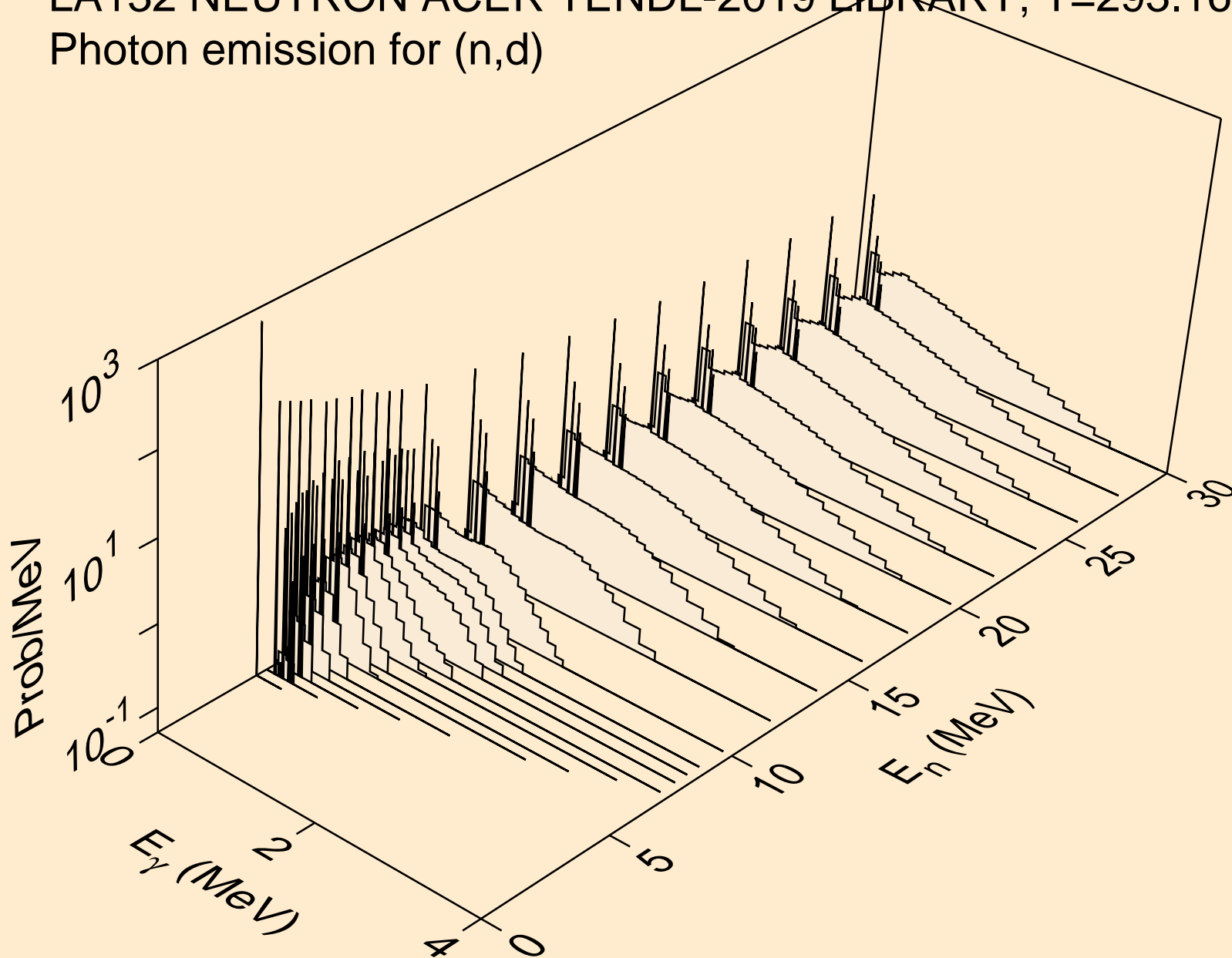

LA132 NEUTRON ACER TENDL-2019 LIBRARY; T=293.16K  
Photon emission for (n,t)

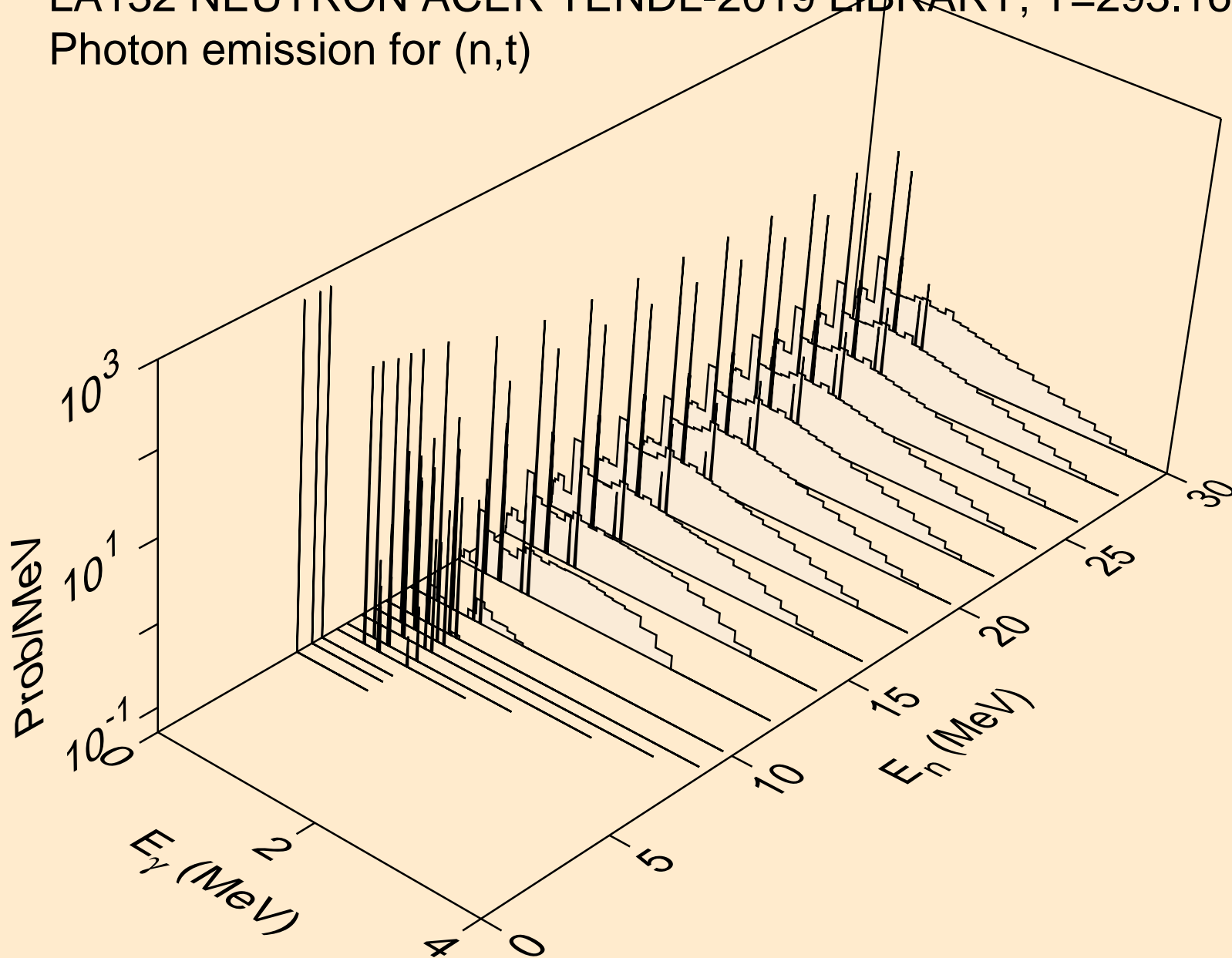

LA132 NEUTRON ACER TENDL-2019 LIBRARY; T=293.16K  
Photon emission for (n,he3)

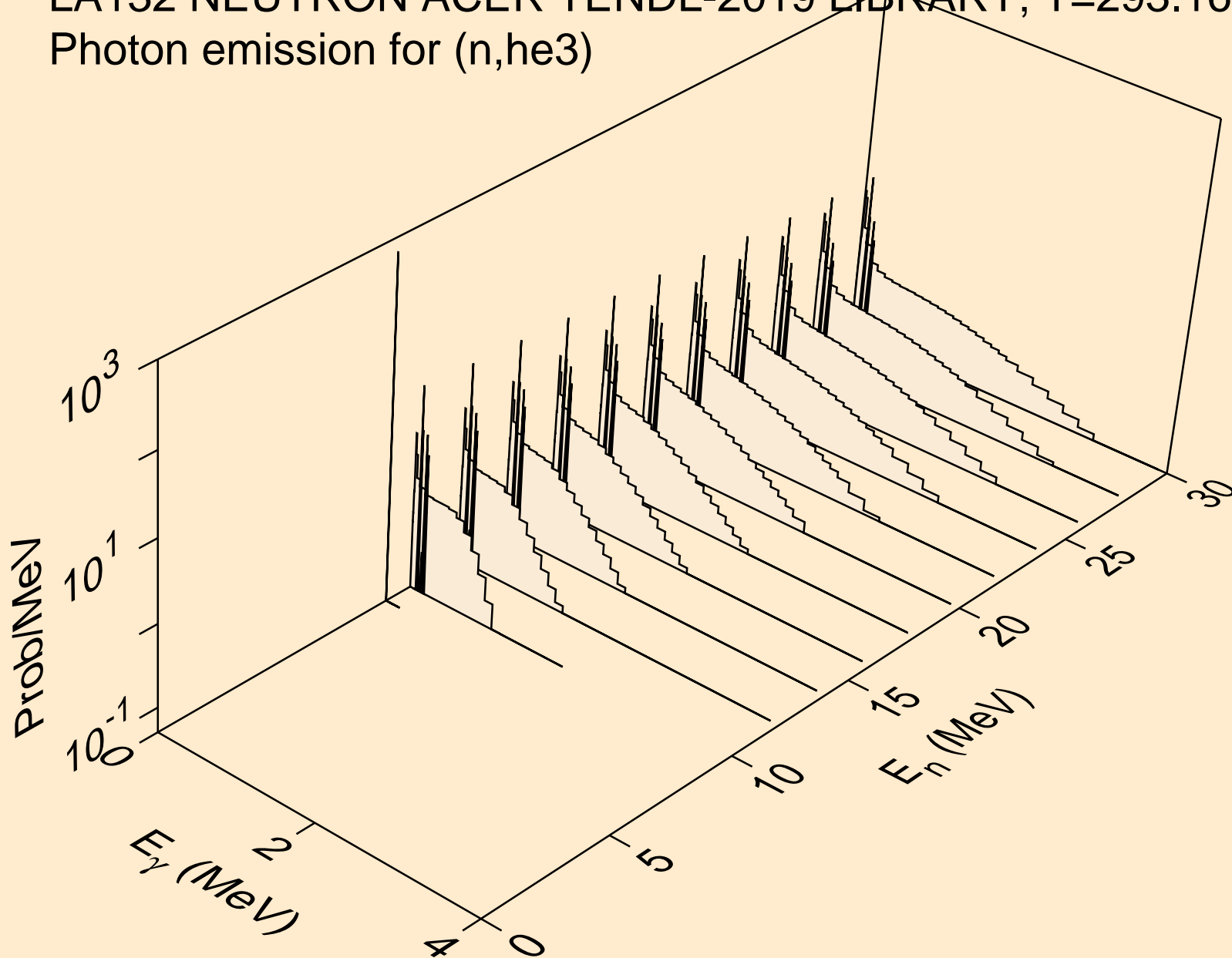

LA132 NEUTRON ACER TENDL-2019 LIBRARY; T=293.16K  
Photon emission for (n,a)

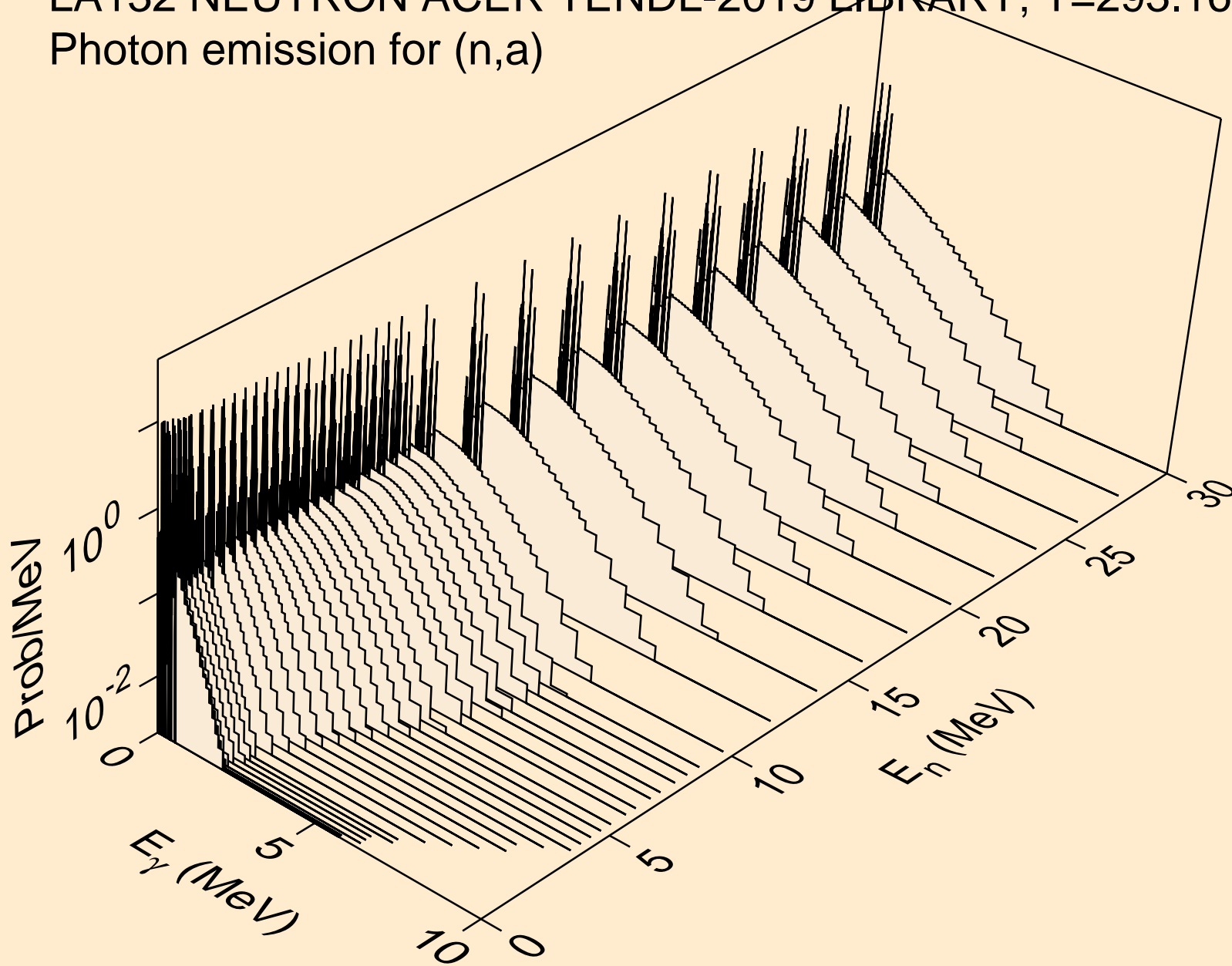

LA132 NEUTRON ACER TENDL-2019 LIBRARY; T=293.16K  
Photon emission for (n,2a)

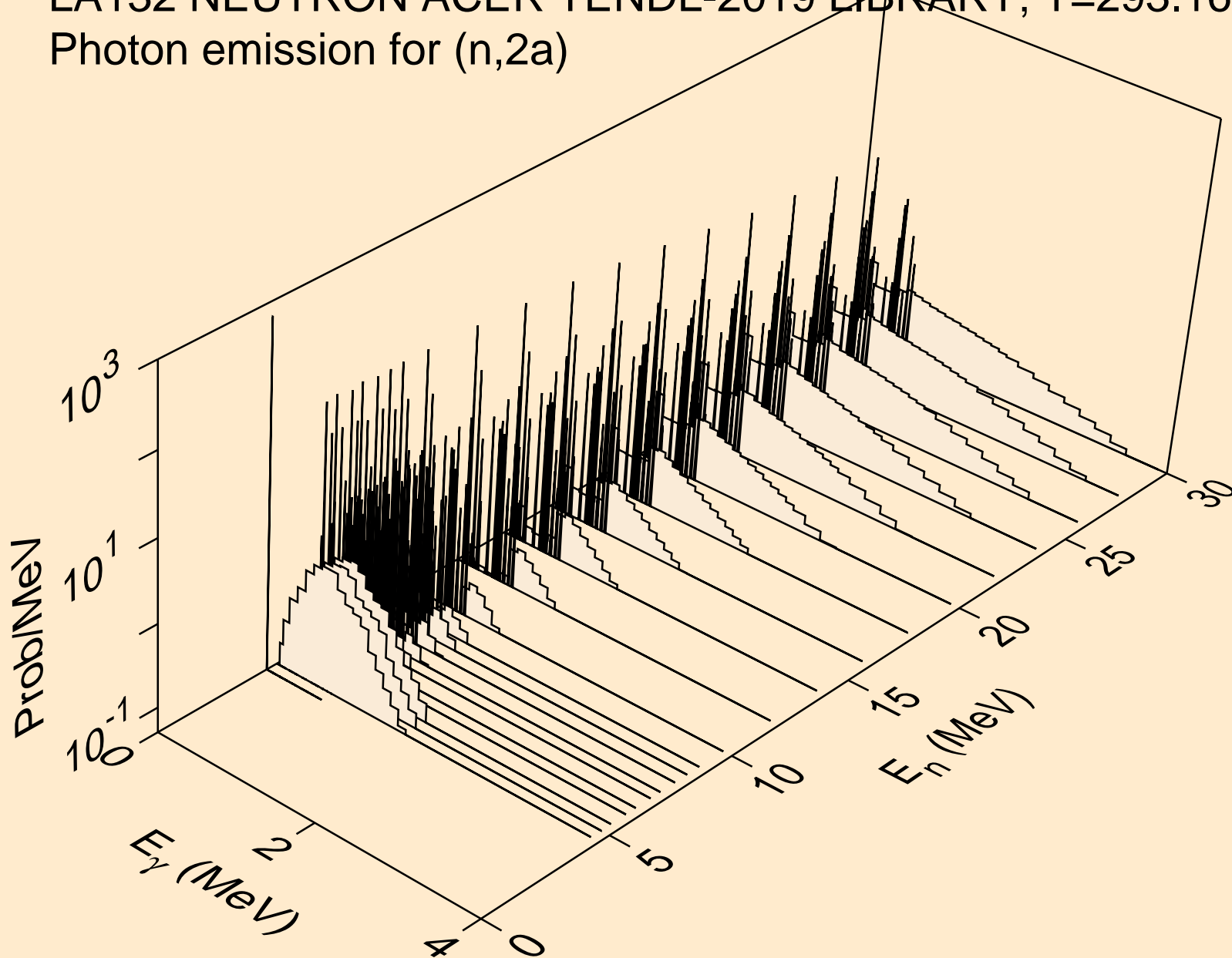



LA132 NEUTRON ACER TENDL-2019 LIBRARY; T=293.16K  
Photon emission for (n,2p)

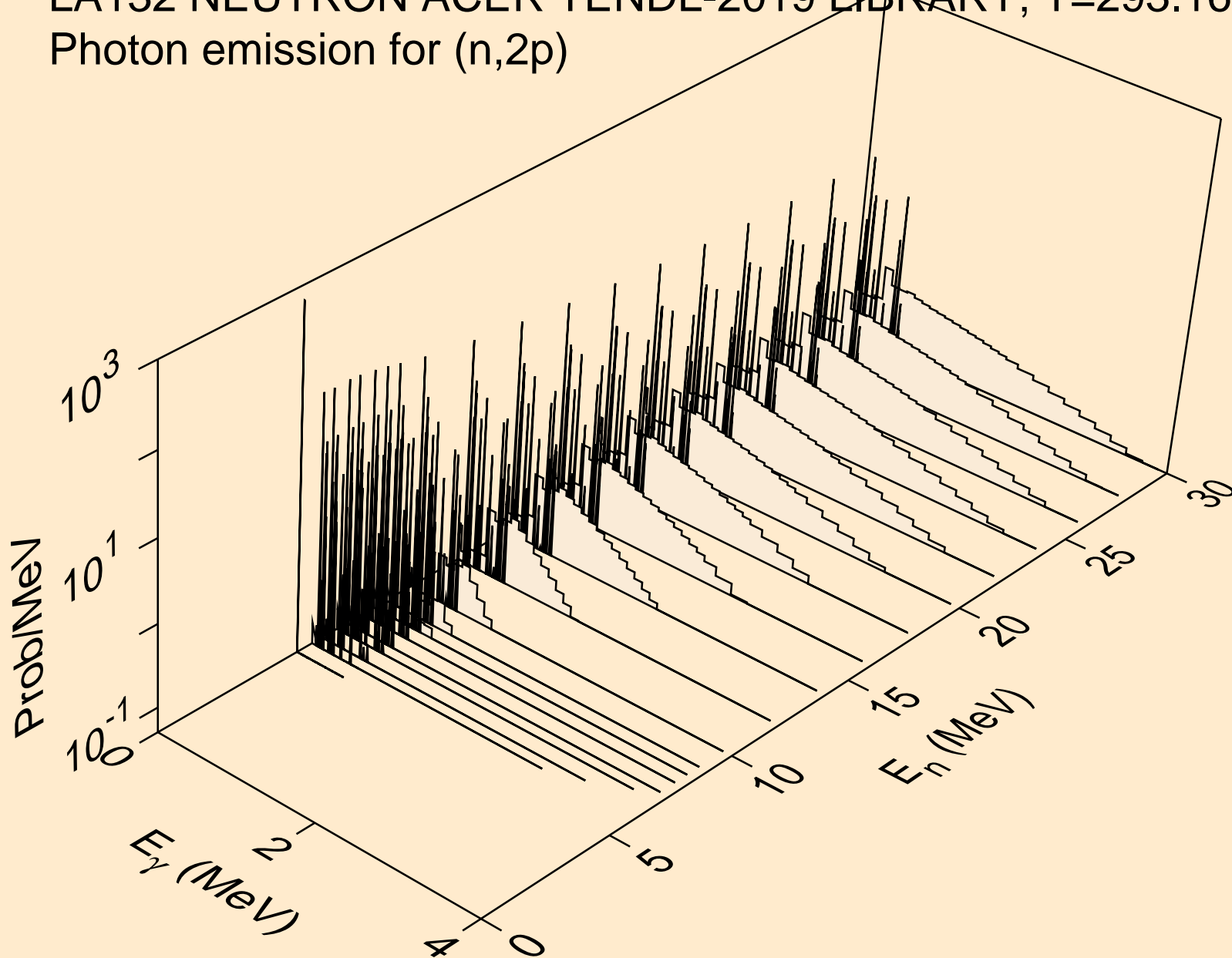

LA132 NEUTRON ACER TENDL-2019 LIBRARY; T=293.16K  
Photon emission for (n,p $\alpha$ )

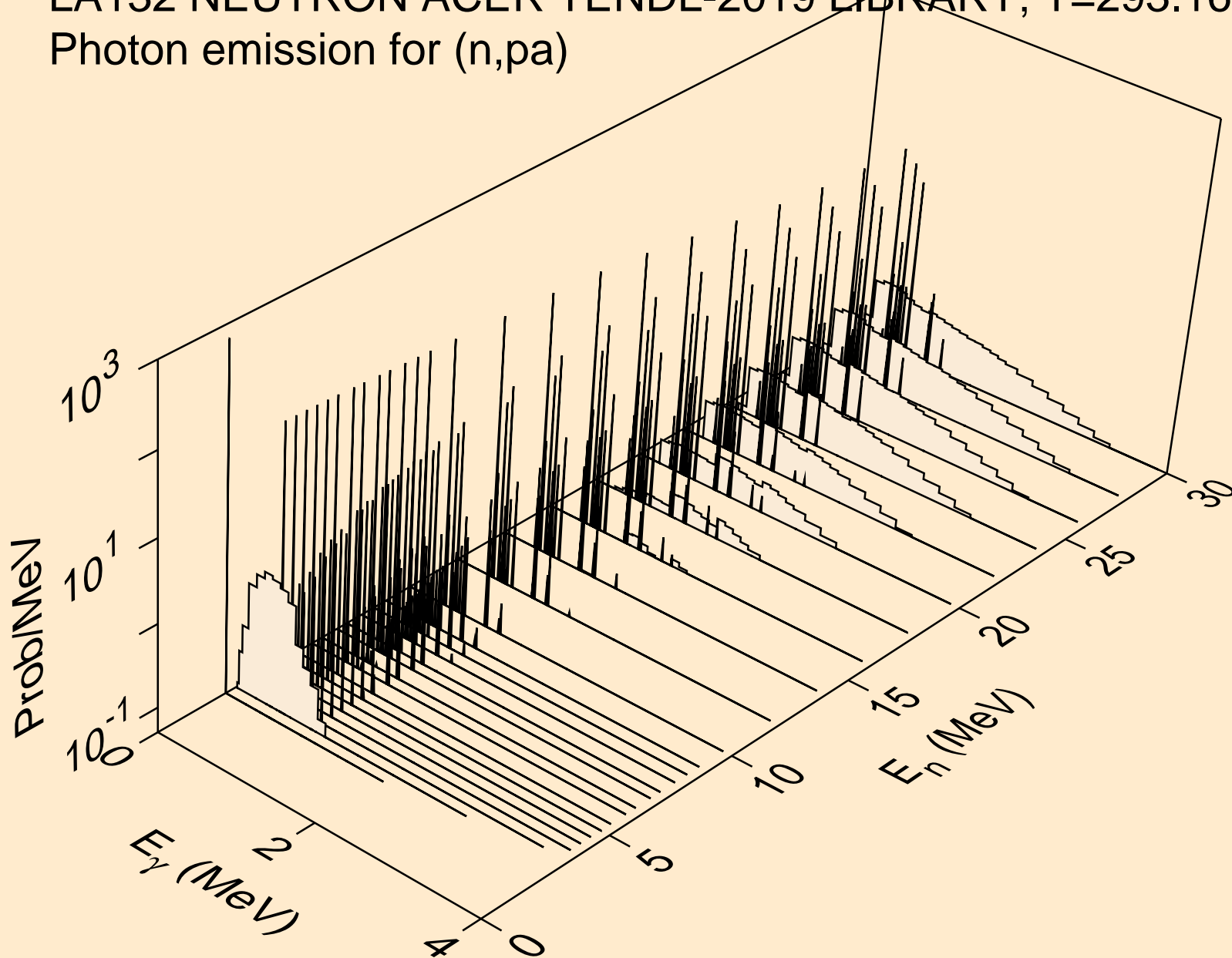

LA132 NEUTRON ACER TENDL-2019 LIBRARY; T=293.16K  
Photon emission for (n,pd)

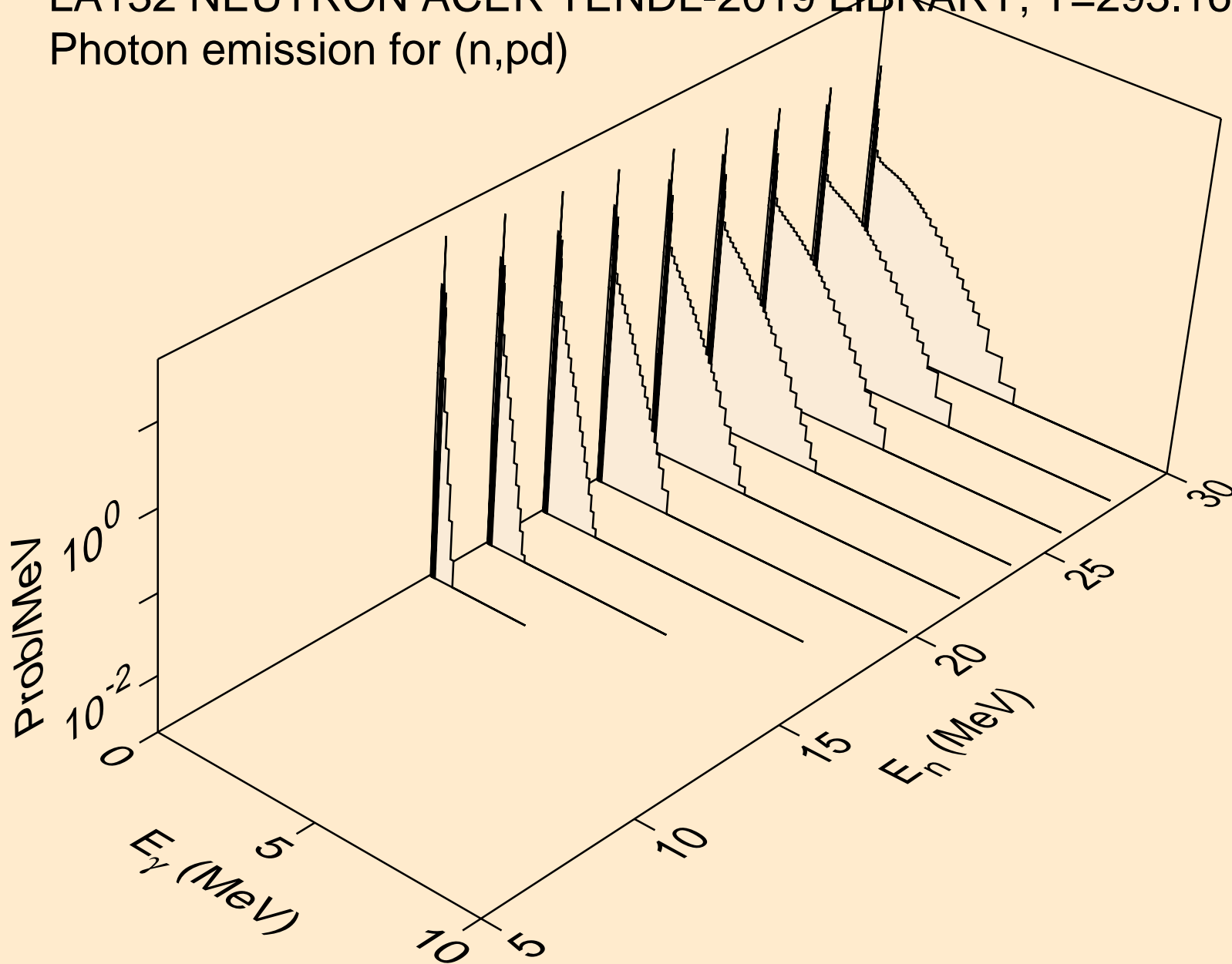

LA132 NEUTRON ACER TENDL-2019 LIBRARY; T=293.16K  
Photon emission for (n,pt)

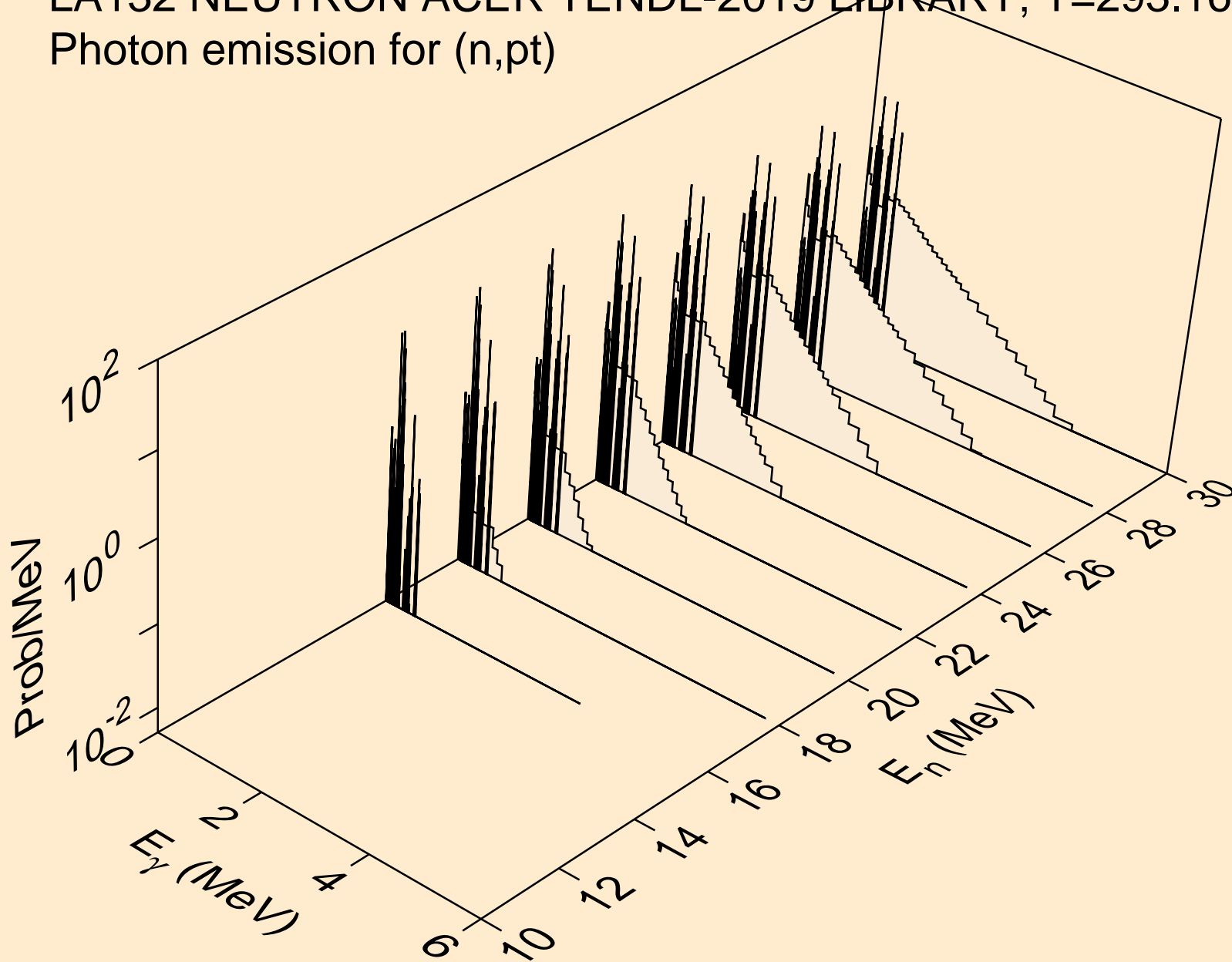

LA132 NEUTRON ACER TENDL-2019 LIBRARY; T=293.16K  
Photon emission for (n,da)

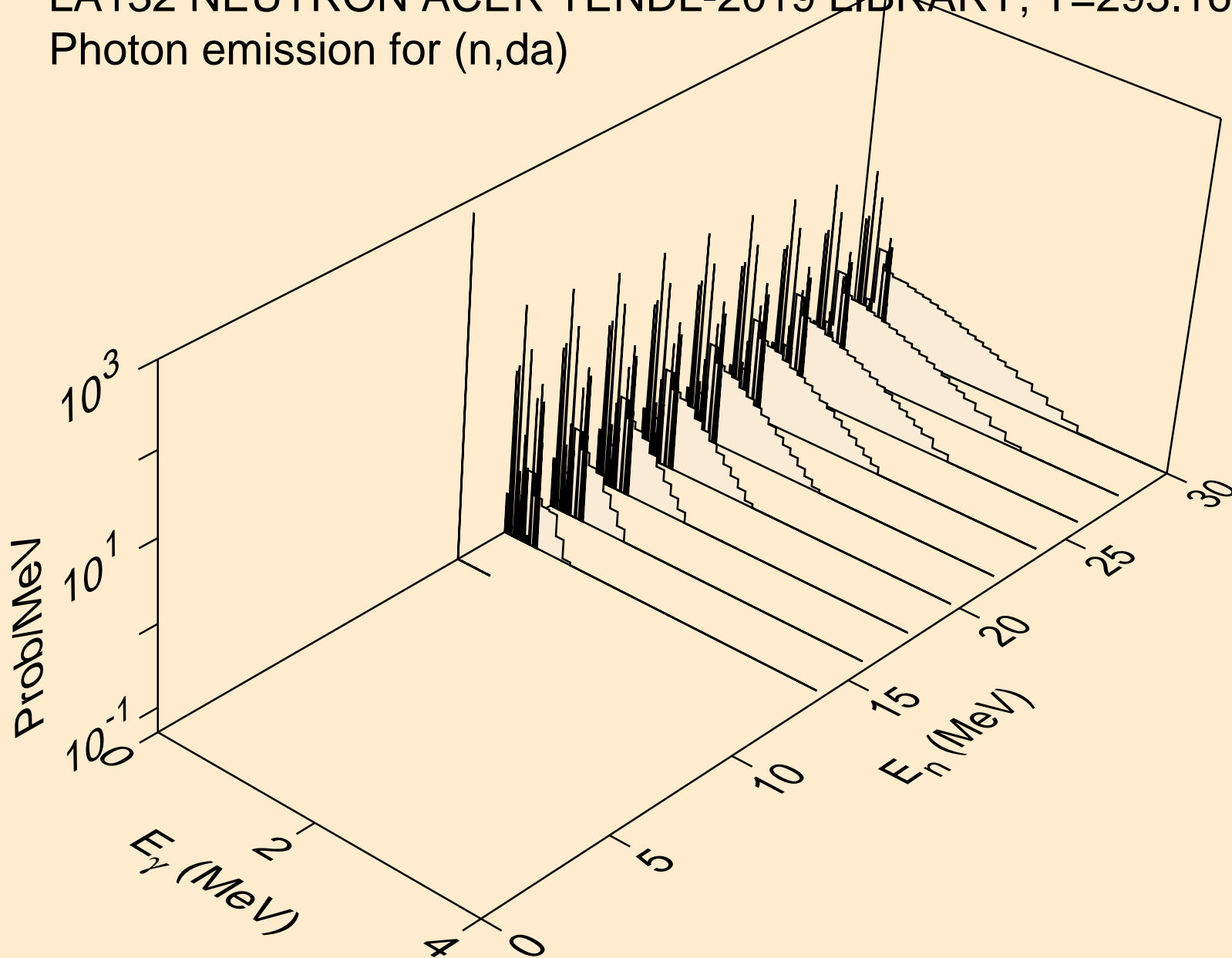

LA132 NEUTRON ACER TENDL-2019 LIBRARY; T=293.16K  
thermal capture photon spectrum

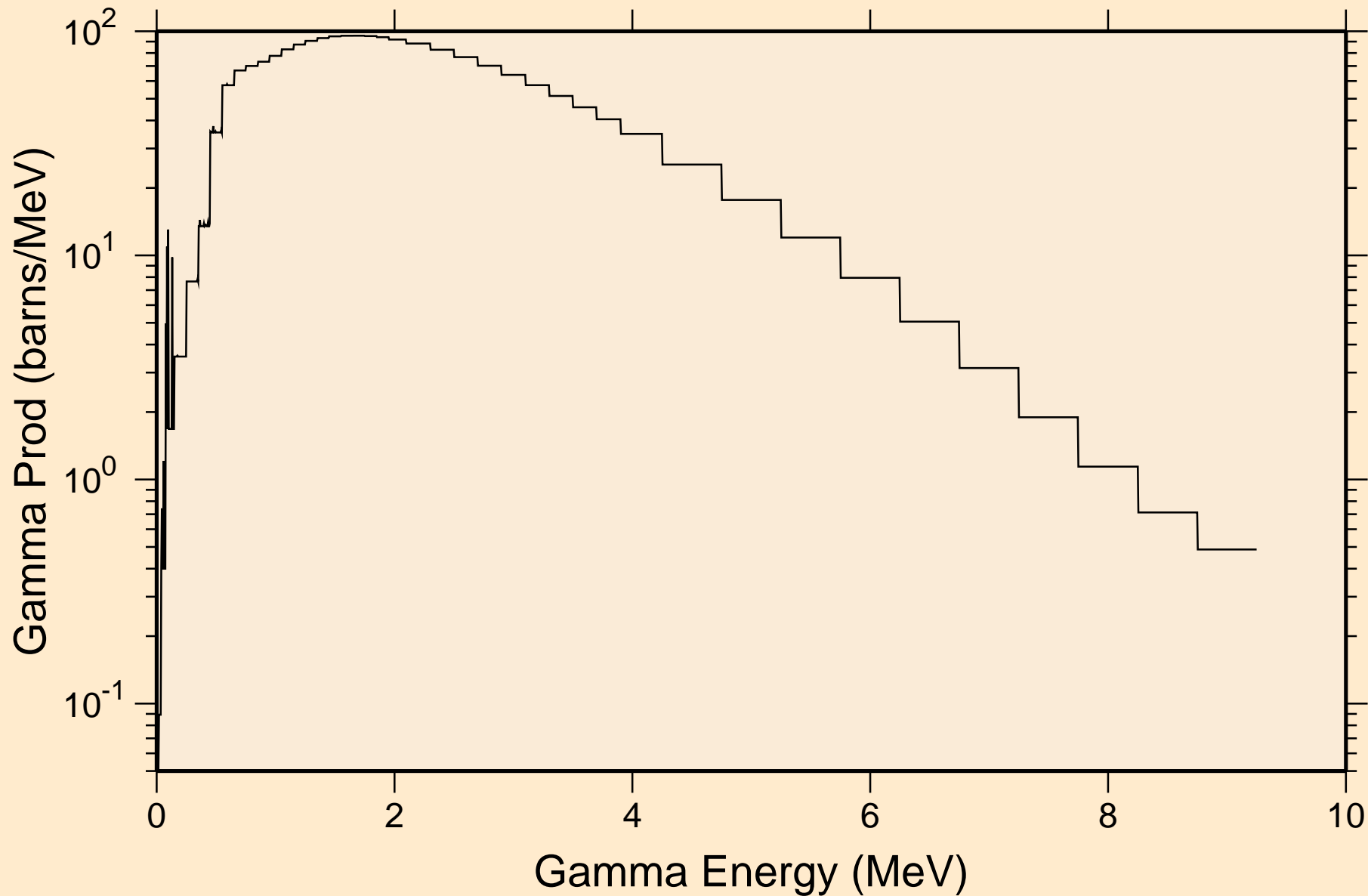

LA132 NEUTRON ACER TENDL-2019 LIBRARY; T=293.16K  
14 MeV photon spectrum

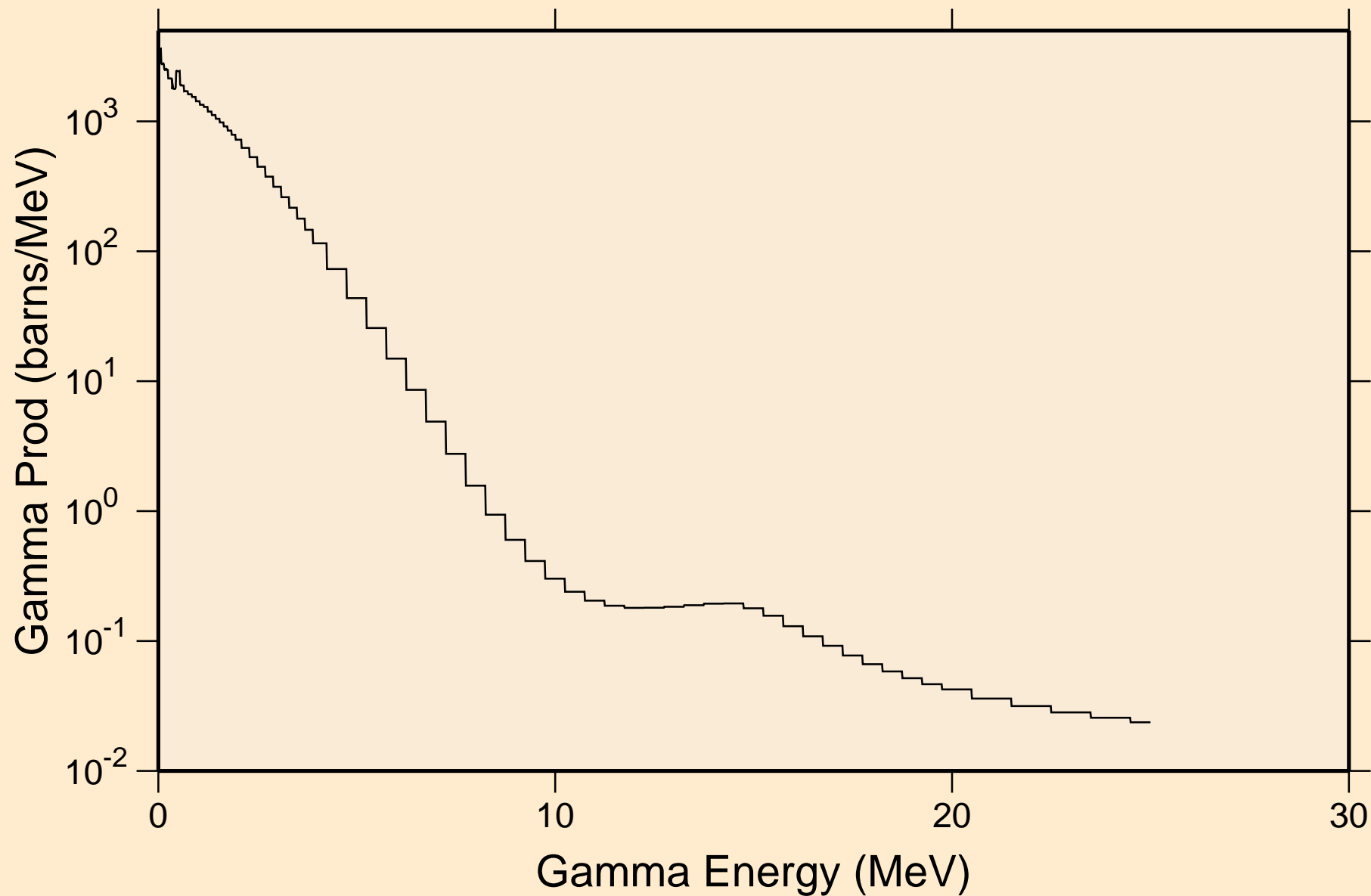

LA132 NEUTRON ACER TENDL-2019 LIBRARY; T=293.16K  
Particle heating contributions

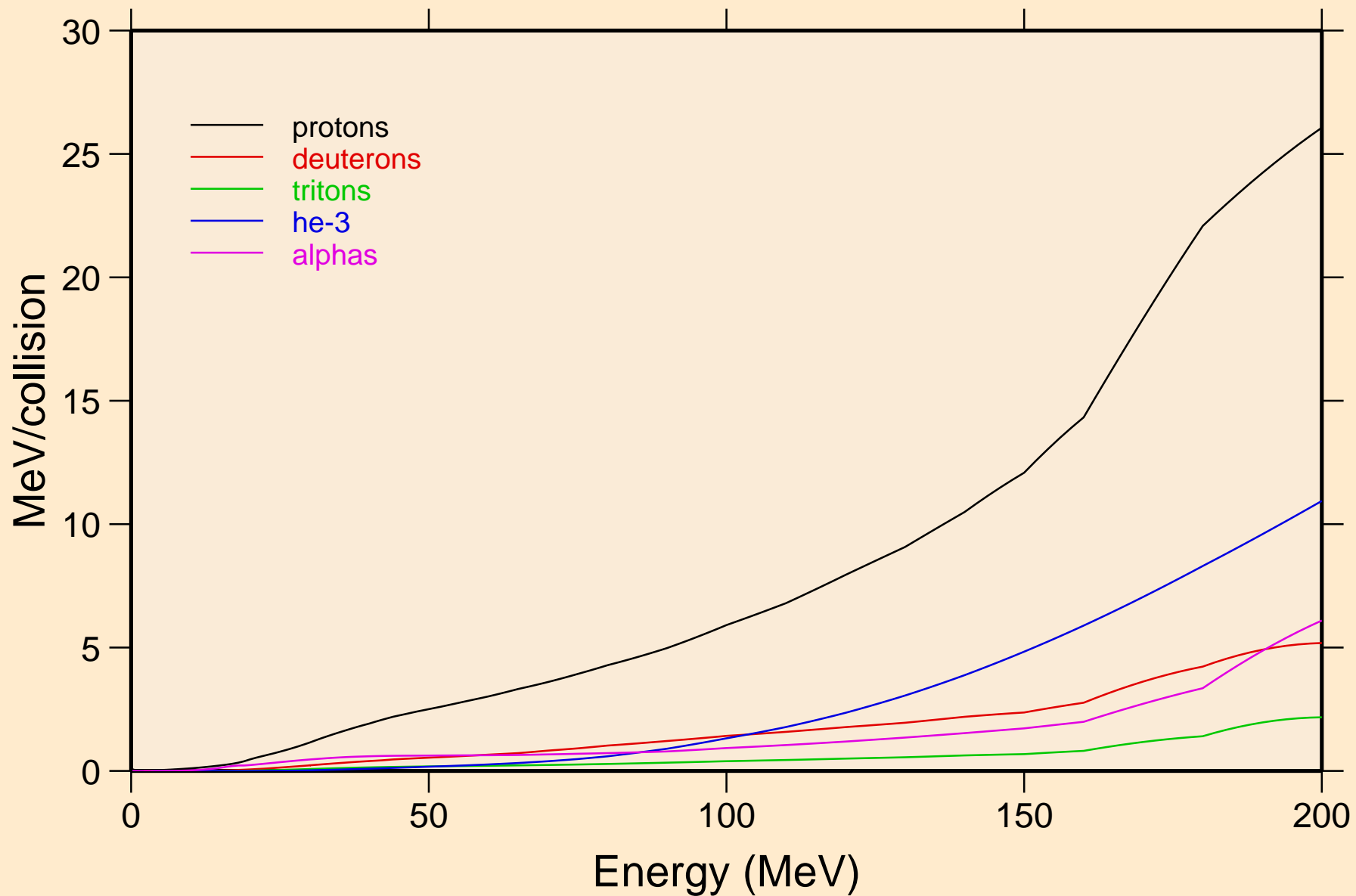



LA132 NEUTRON ACER TENDL-2019 LIBRARY; T=293.16K  
Recoil Heating

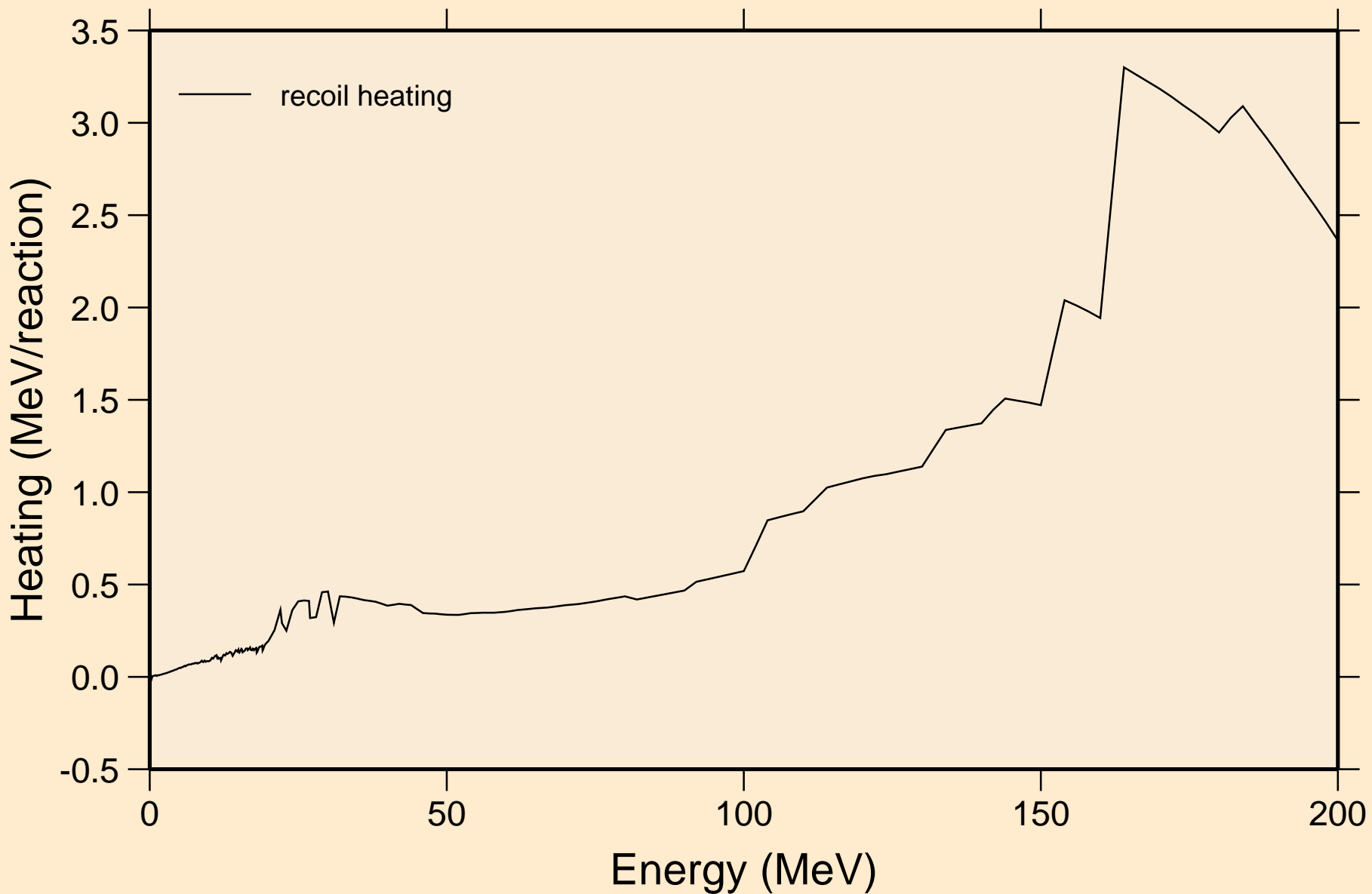

LA132 NEUTRON ACER TENDL-2019 LIBRARY; T=293.16K  
Particle production cross sections

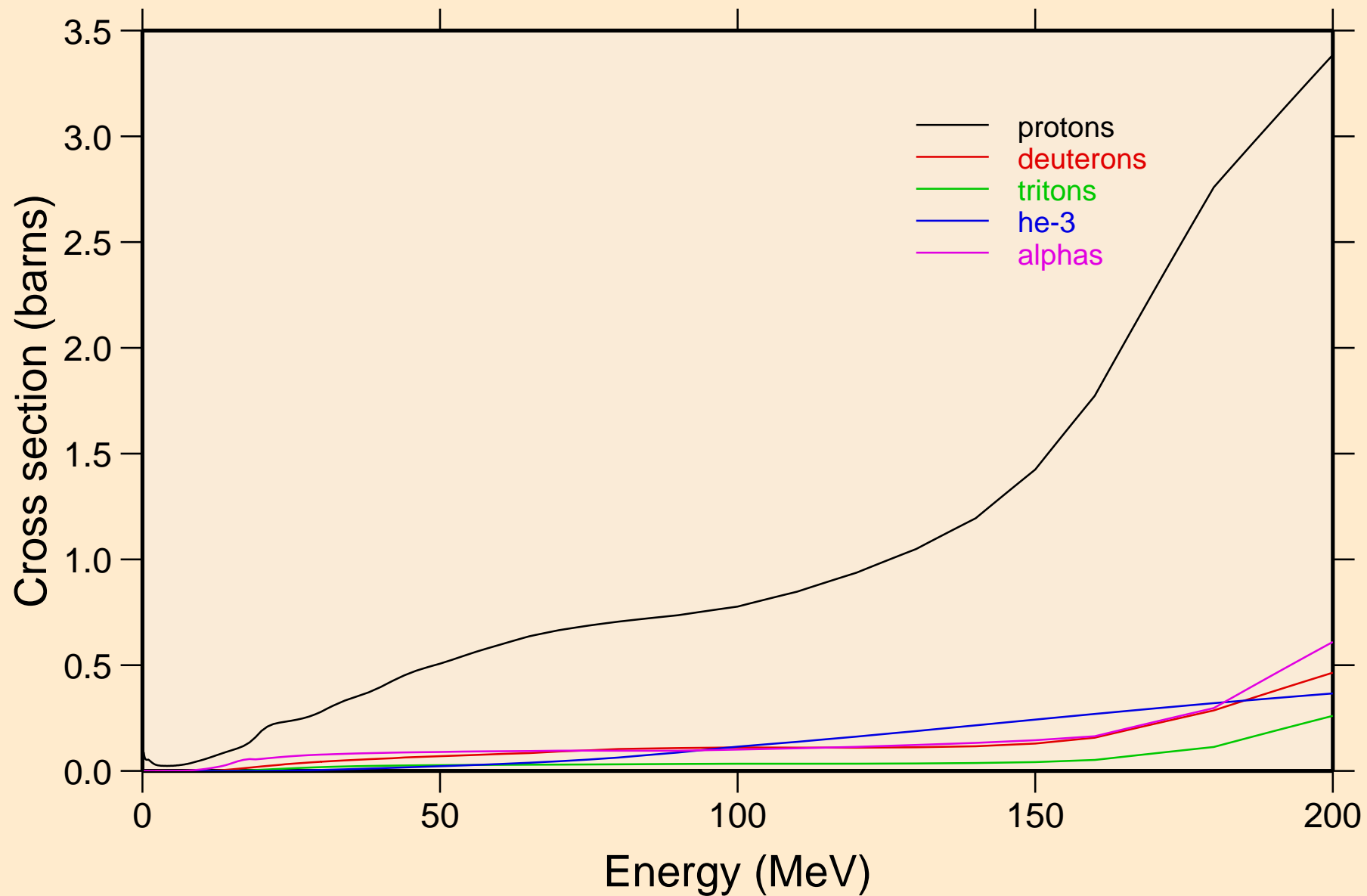

LA132 NEUTRON ACER TENDL-2019 LIBRARY; T=293.16K  
protons from (n,x)

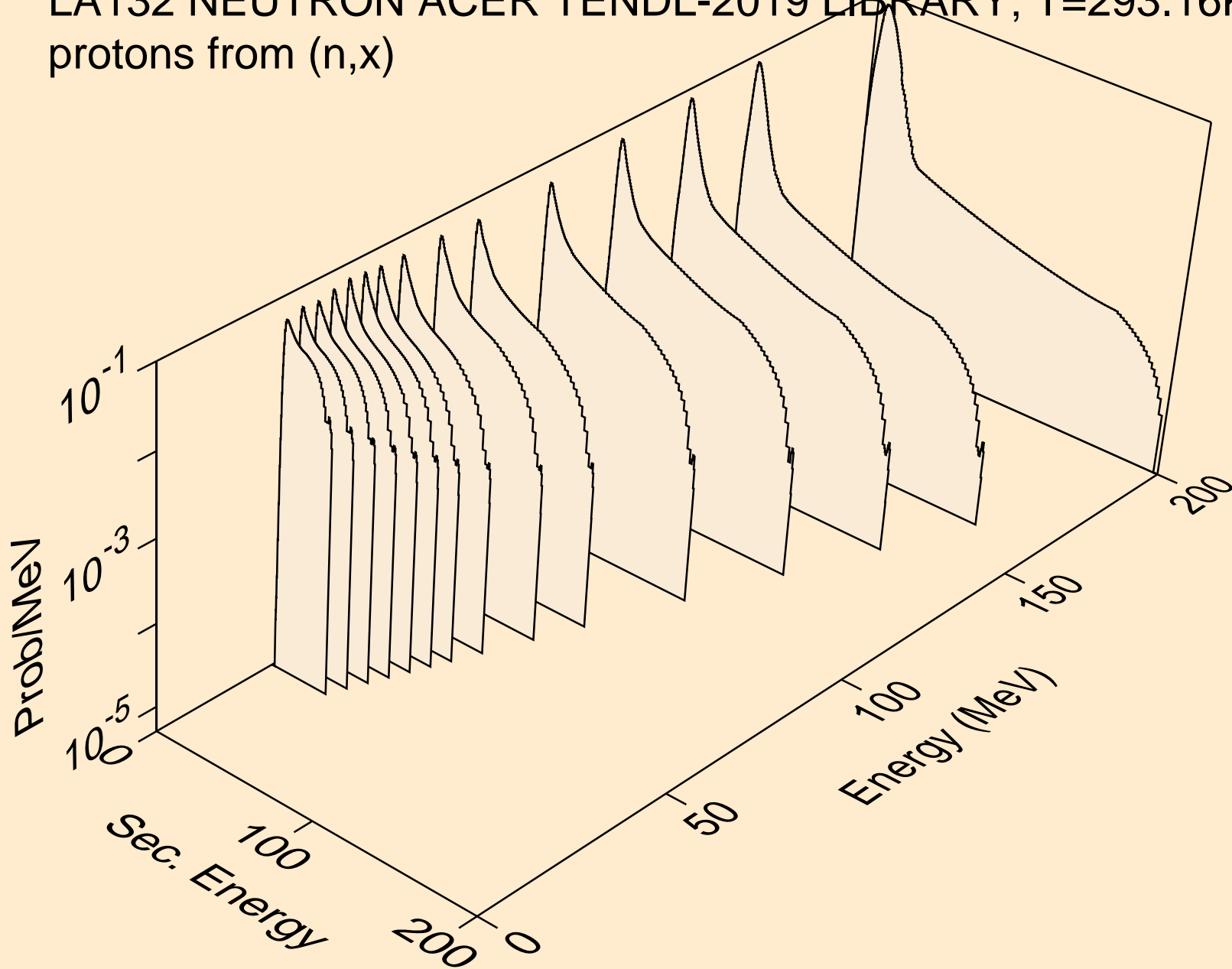

LA132 NEUTRON ACER TENDL-2019 LIBRARY; T=293.16K  
protons from (n,n\*)p

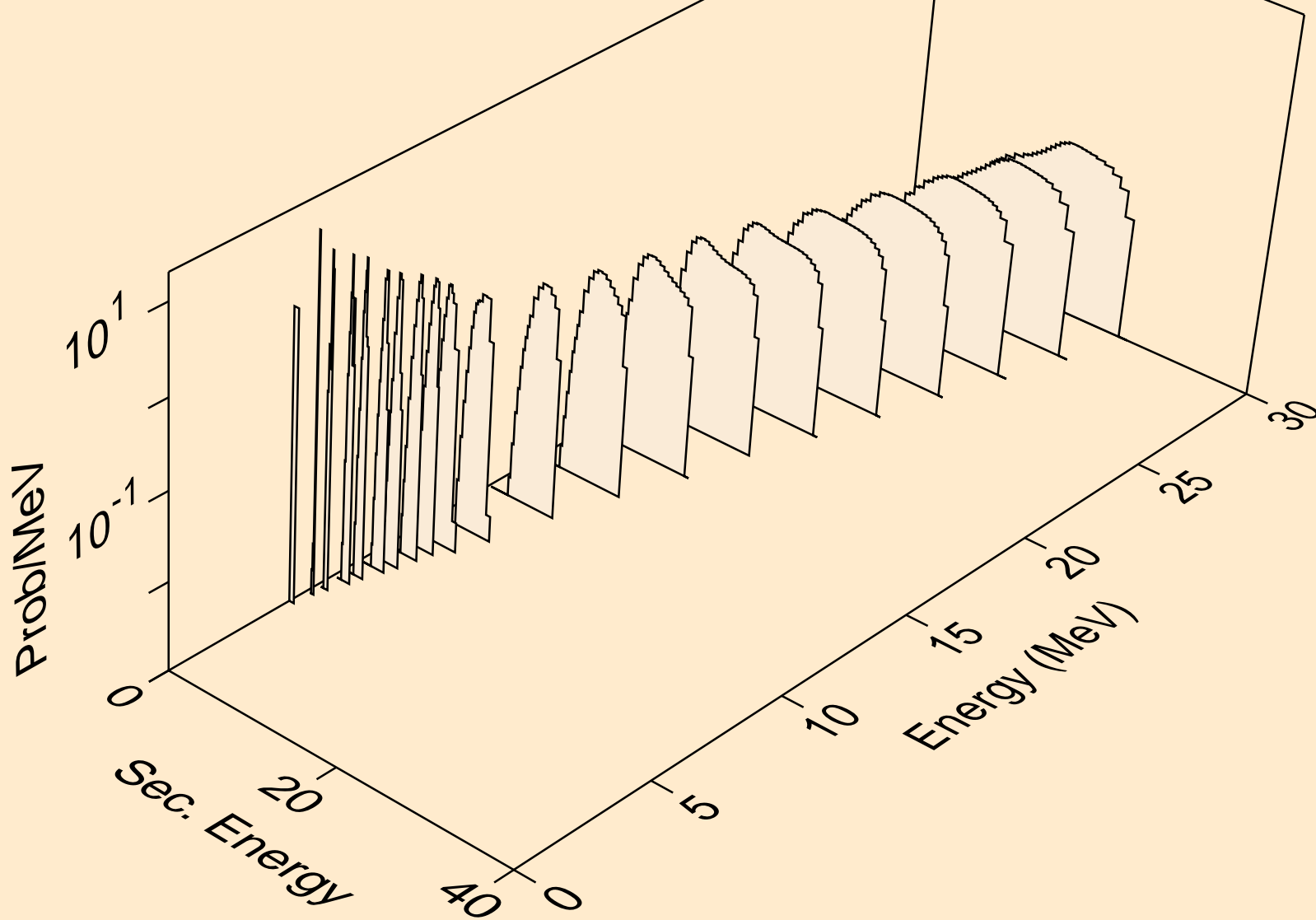

LA132 NEUTRON ACER TENDL-2019 LIBRARY; T=293.16K  
protons from (n,2np)

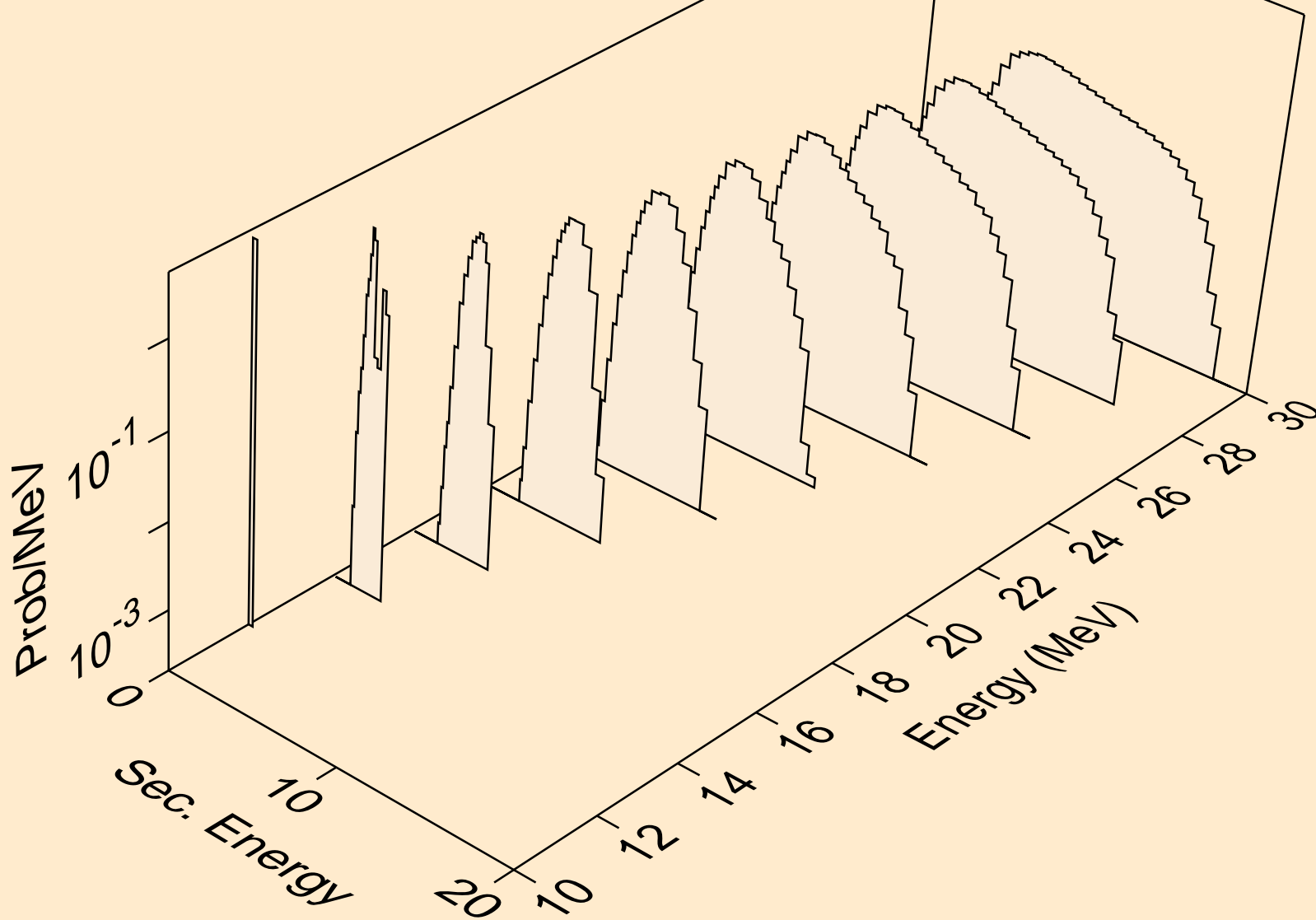

LA132 NEUTRON ACER TENDL-2019 LIBRARY; T=293.16K  
protons from (n,3np)

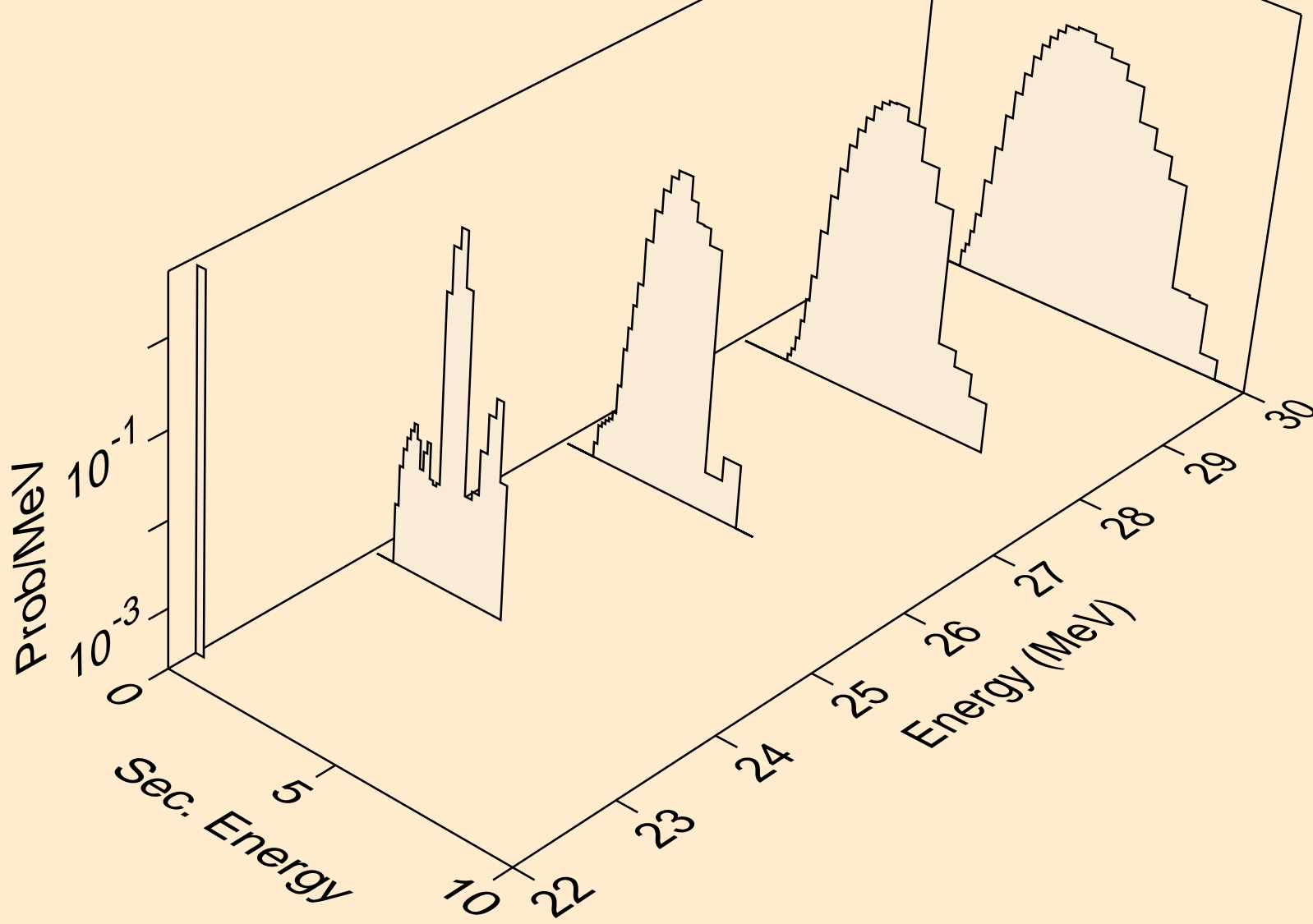

LA132 NEUTRON ACER TENDL-2019 LIBRARY; T=293.16K  
protons from (n,2np)

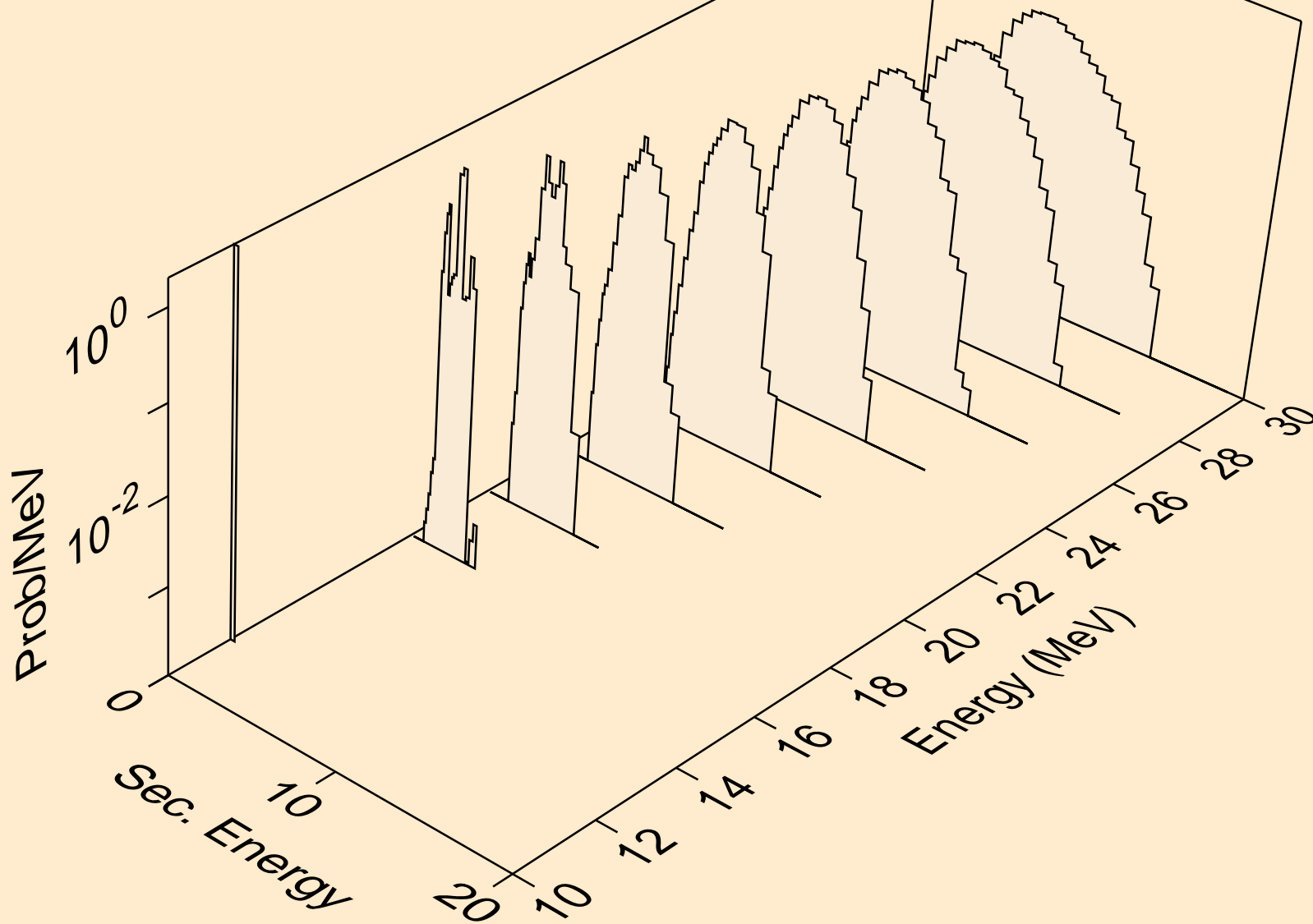

LA132 NEUTRON ACER TENDL-2019 LIBRARY; T=293.16K  
protons from (n,npa)

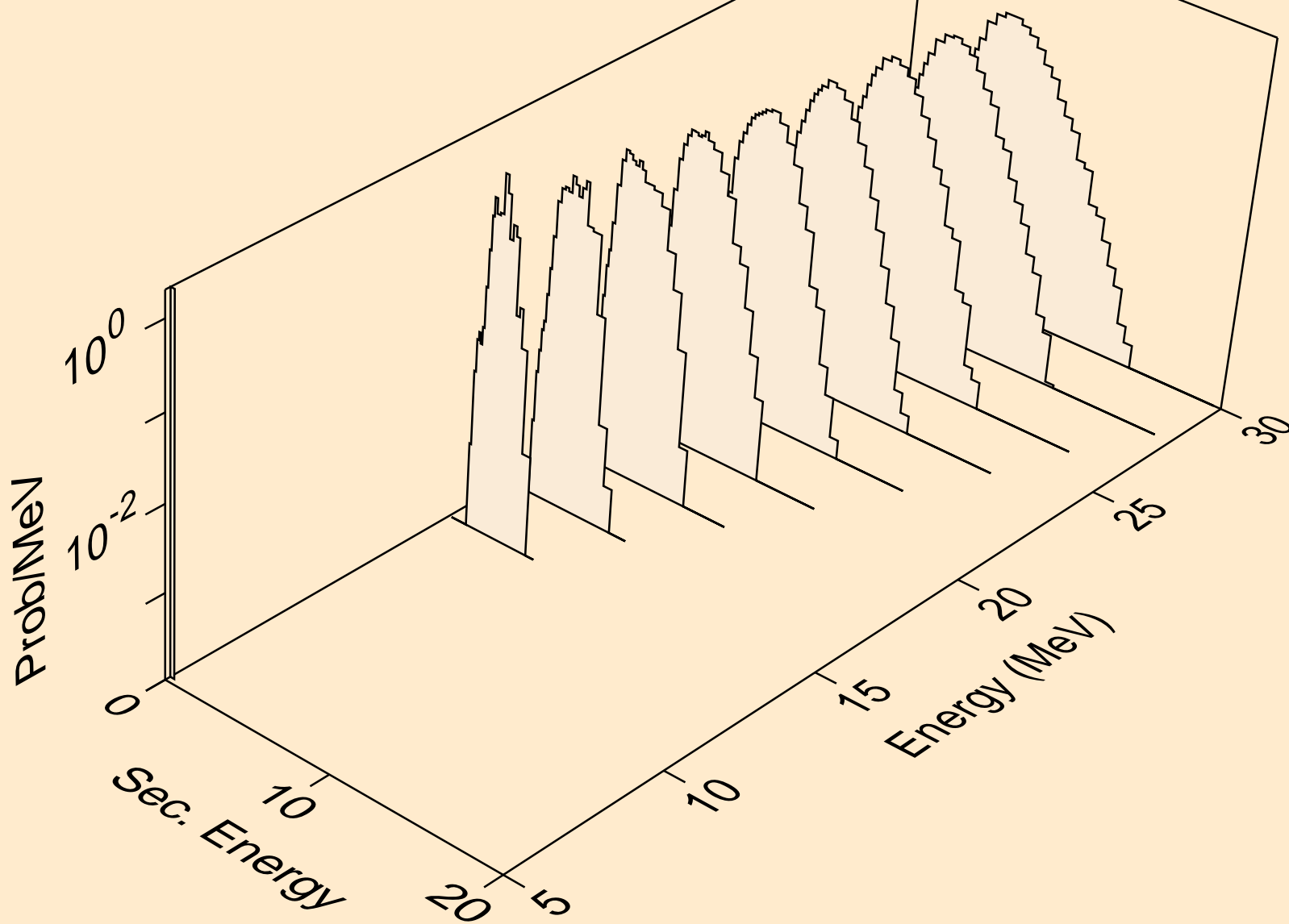



LA132 NEUTRON ACER TENDL-2019 LIBRARY; T=293.16K  
protons from (n,p)

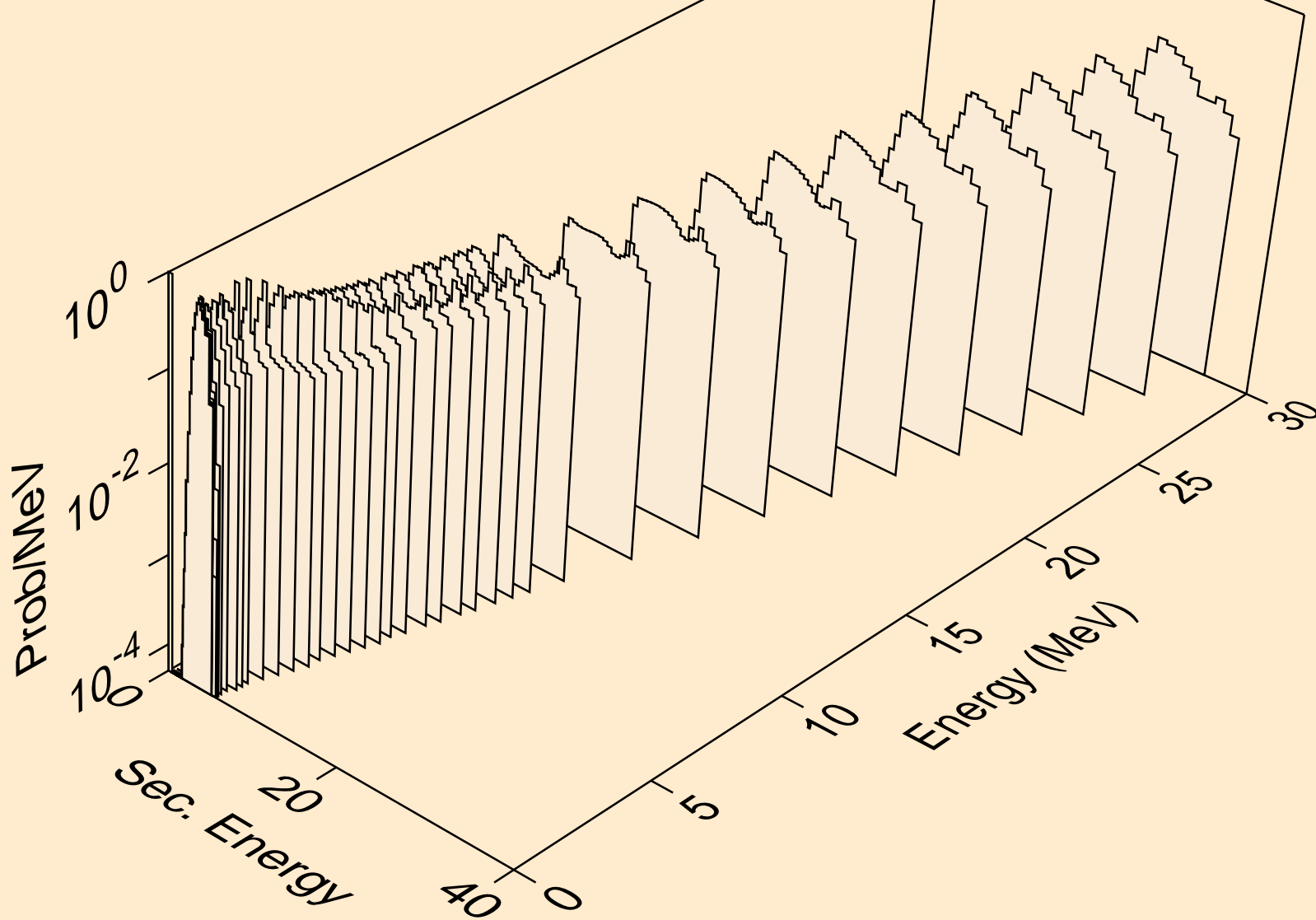

LA132 NEUTRON ACER TENDL-2019 LIBRARY; T=293.16K  
protons from (n,2p)

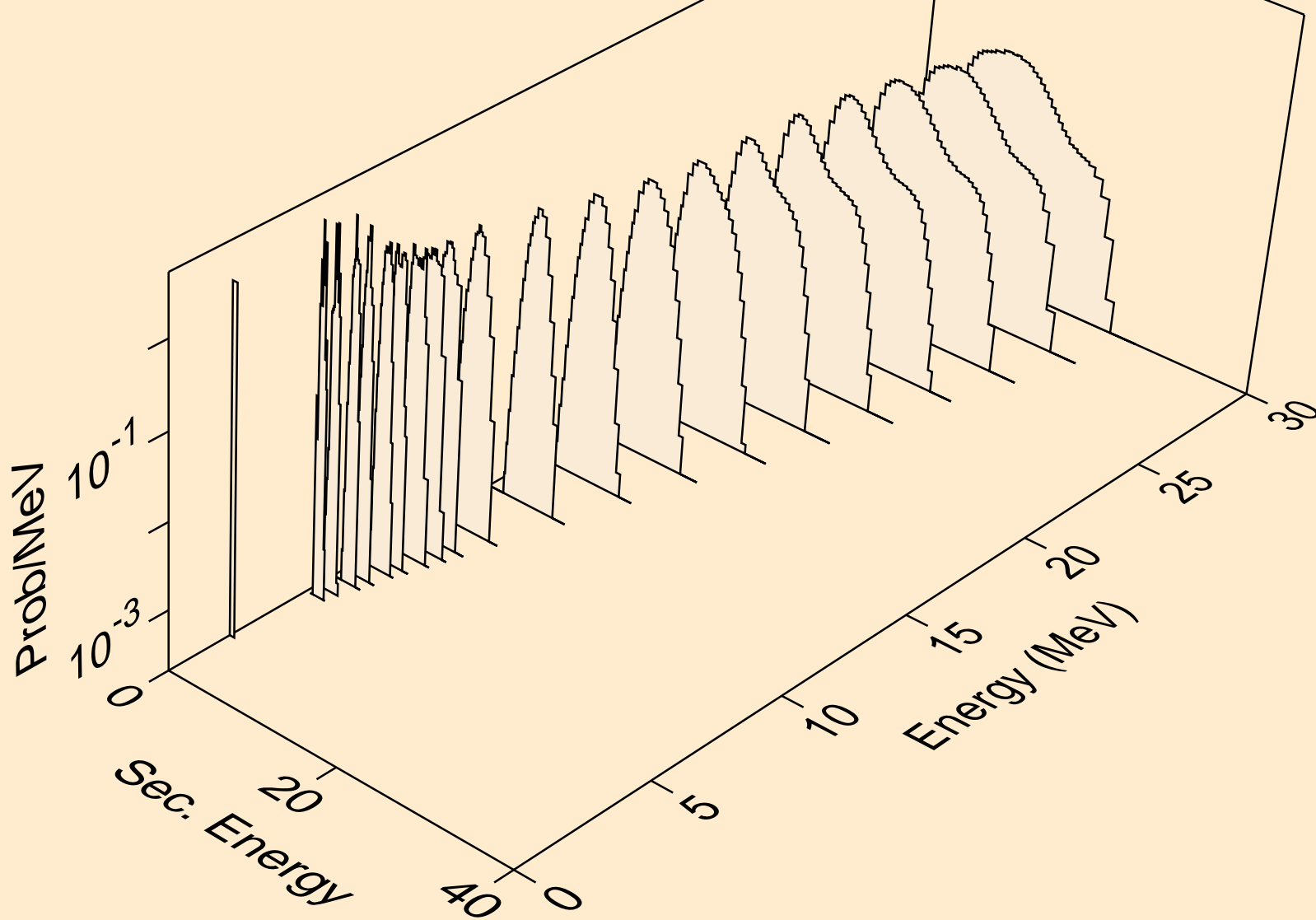

LA132 NEUTRON ACER TENDL-2019 LIBRARY; T=293.16K  
protons from (n,p)

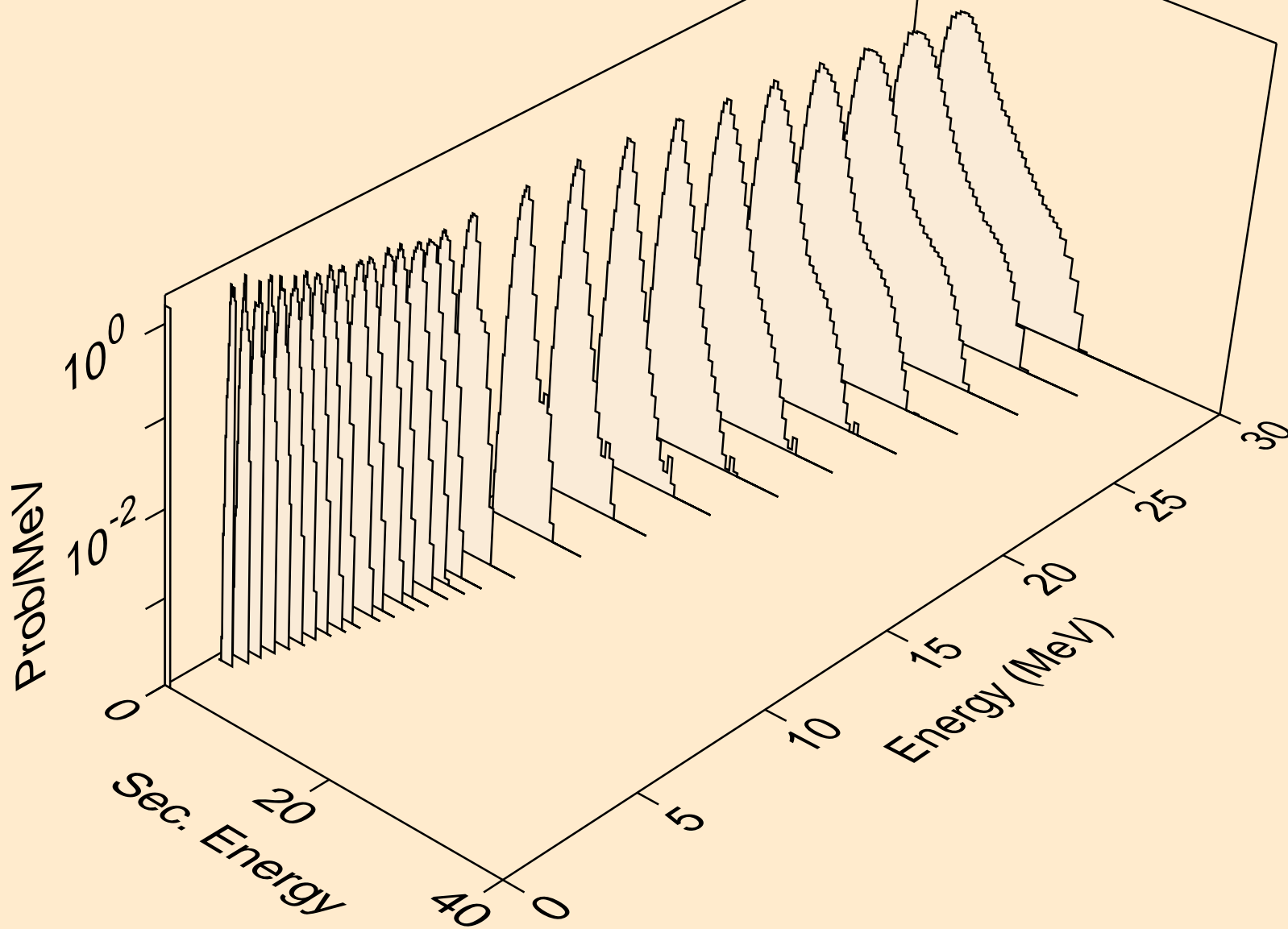

LA132 NEUTRON ACER TENDL-2019 LIBRARY; T=293.16K  
protons from (n,pd)

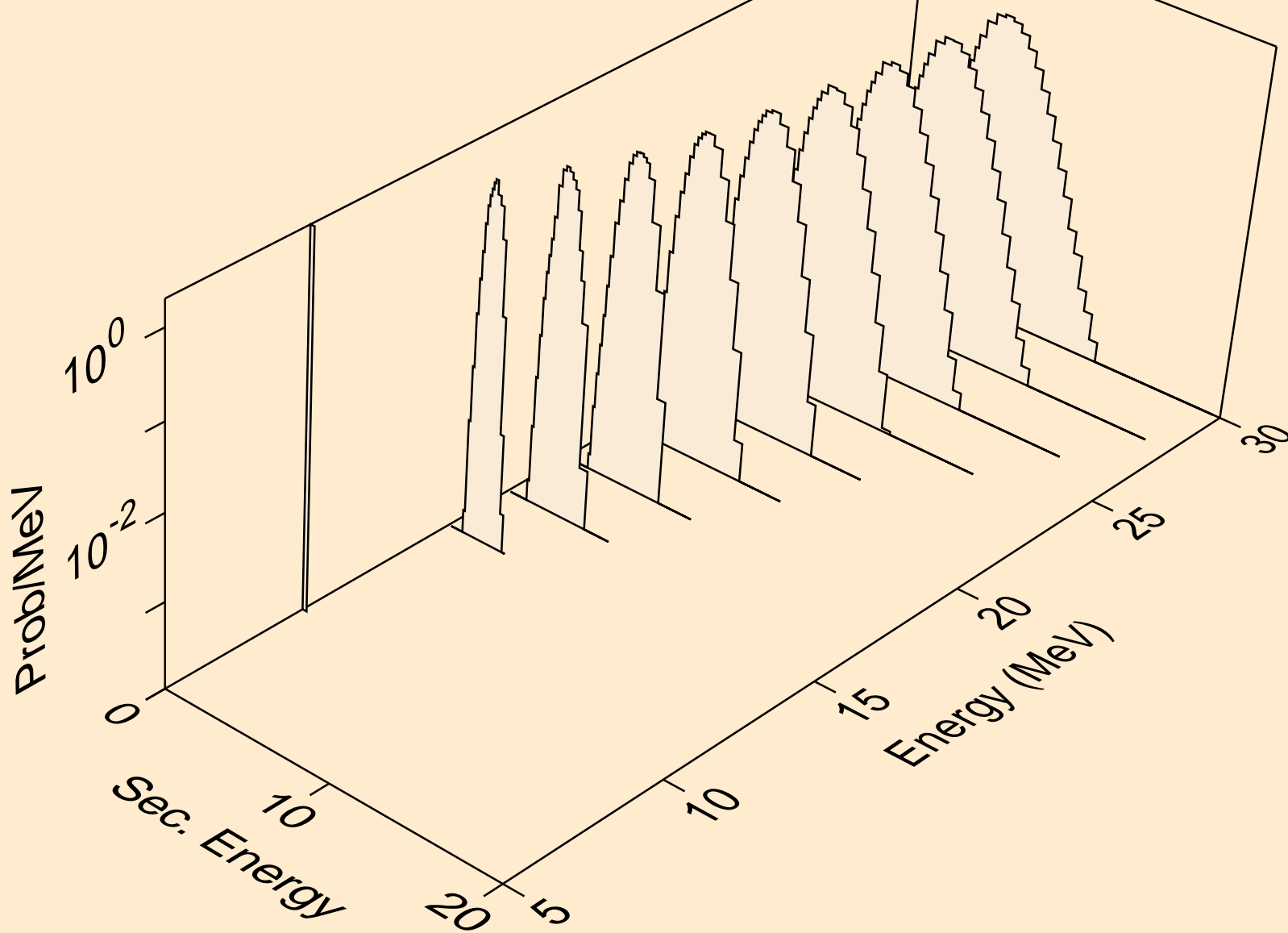

LA132 NEUTRON ACER TENDL-2019 LIBRARY; T=293.16K  
protons from (n,pt)

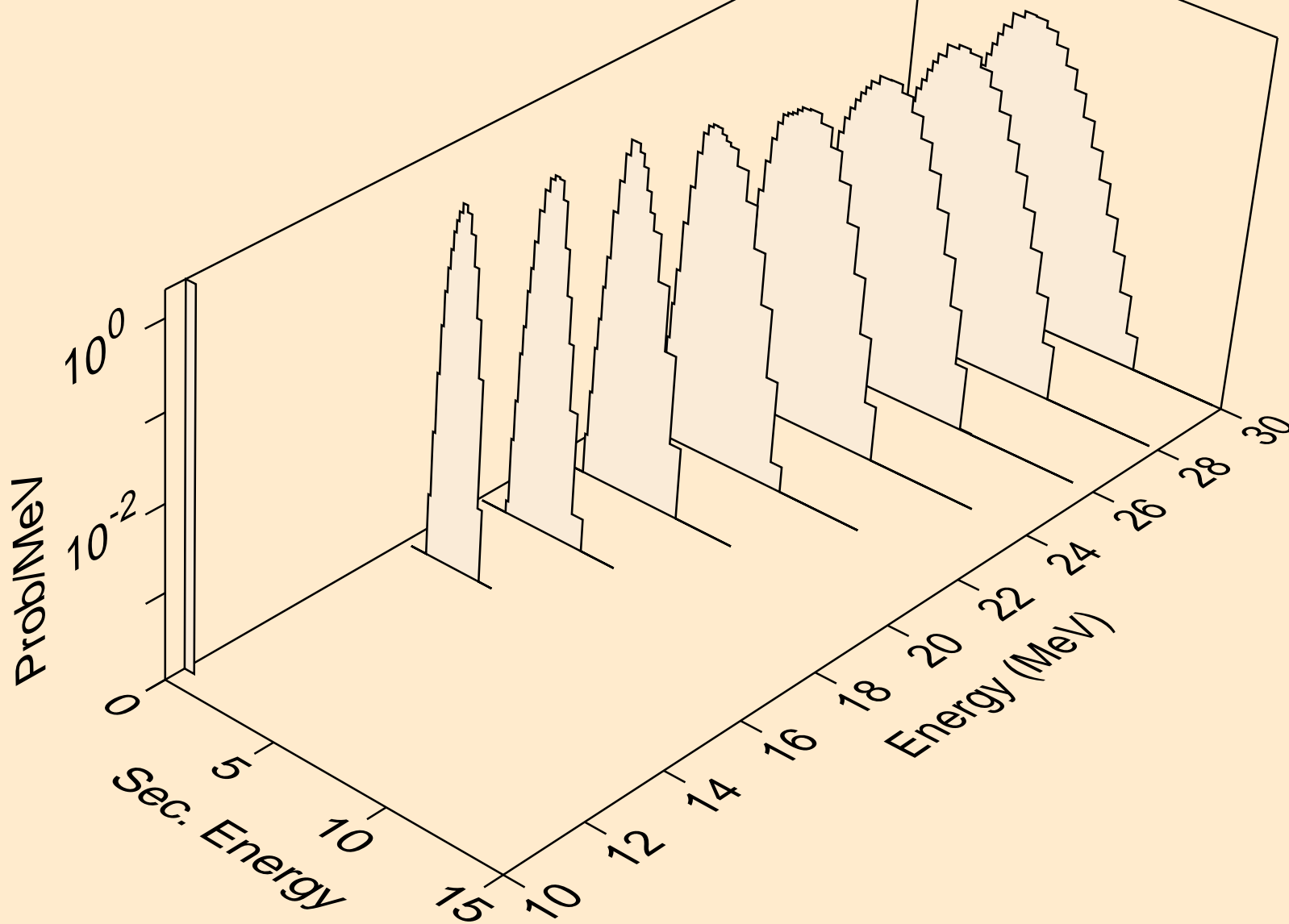

LA132 NEUTRON ACER TENDL-2019 LIBRARY; T=293.16K  
deuterons from (n,x)

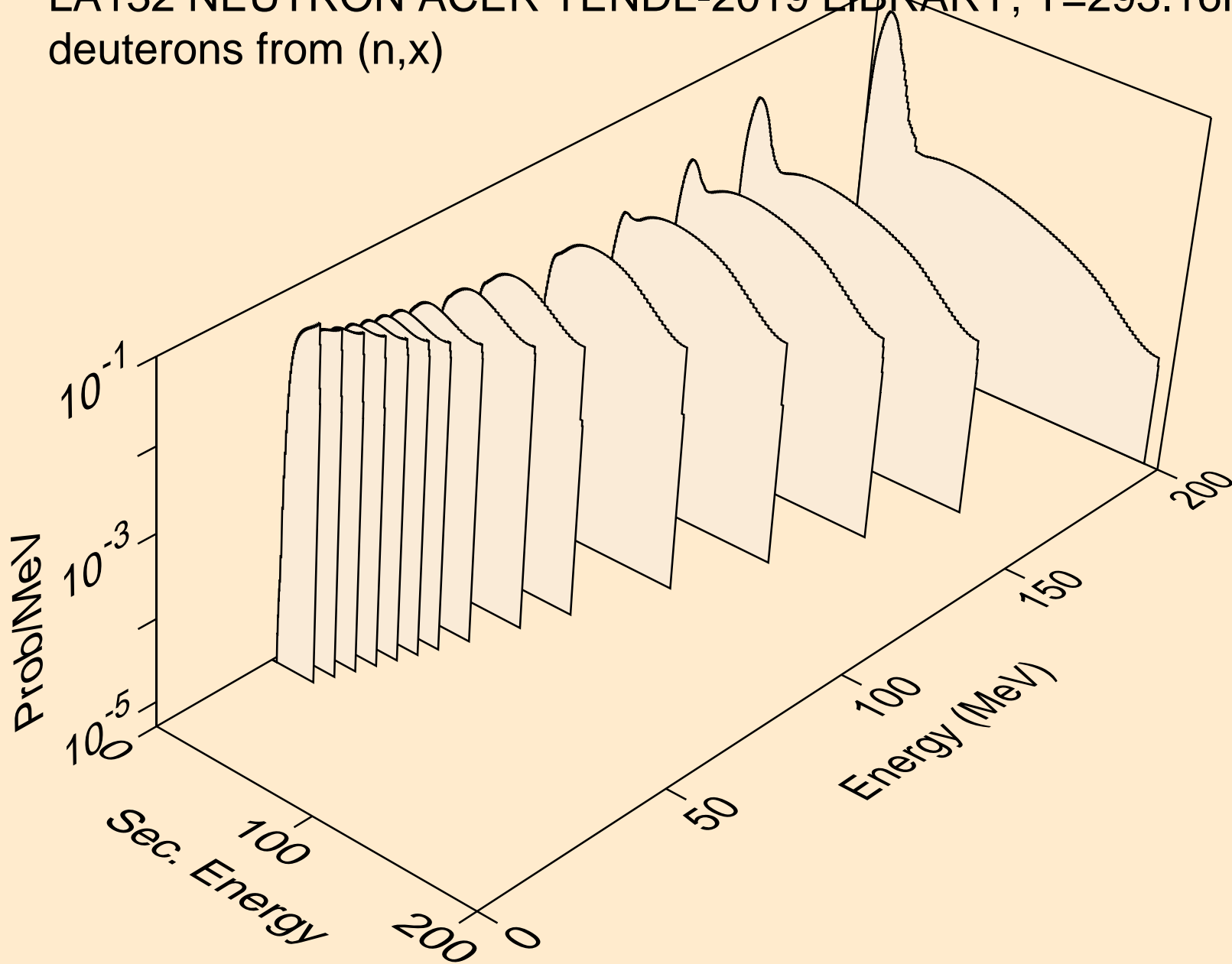

LA132 NEUTRON ACER TENDL-2019 LIBRARY; T=293.16K  
deuterons from (n,2nd)

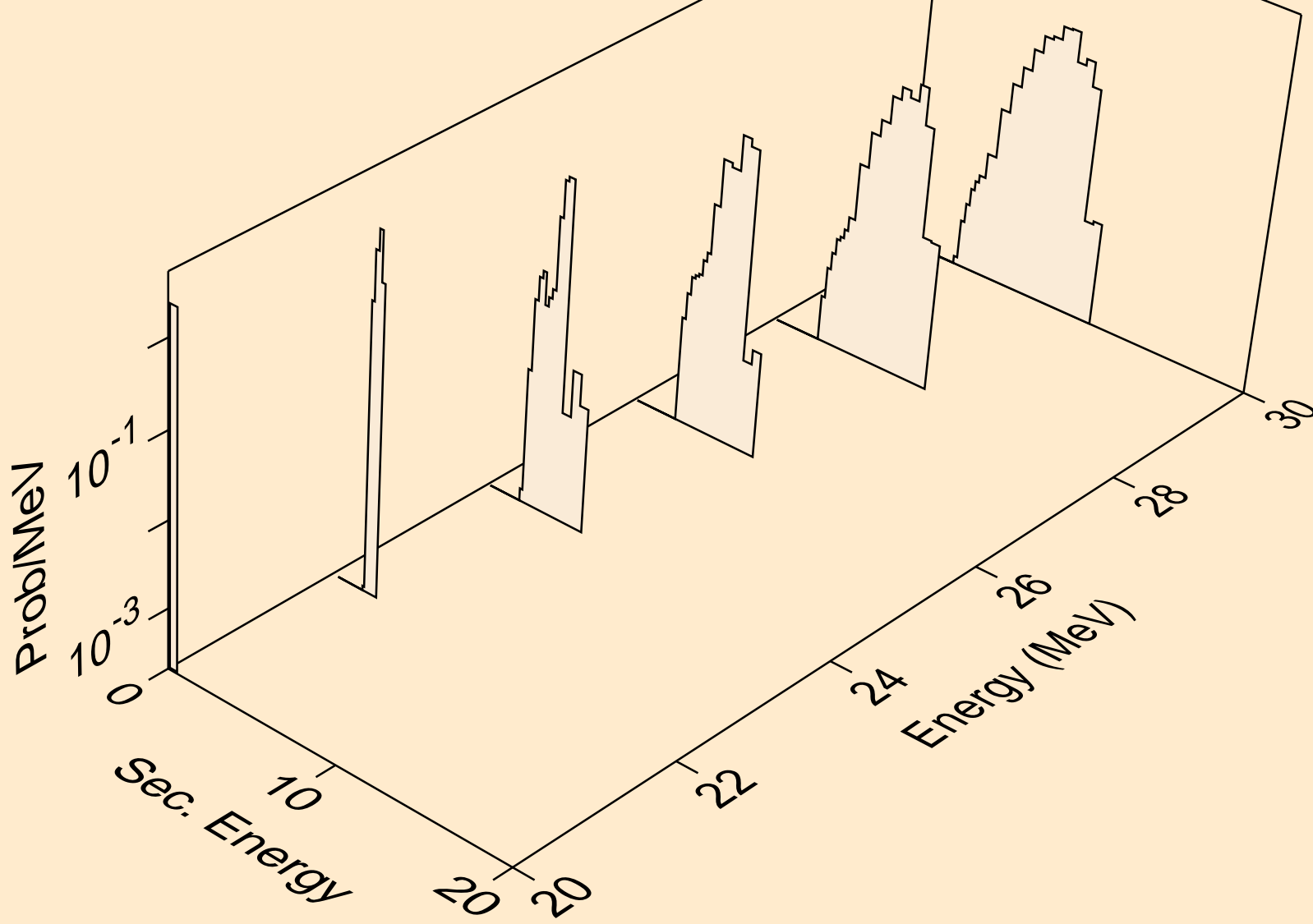

LA132 NEUTRON ACER TENDL-2019 LIBRARY; T=293.16K  
deuterons from (n,n\*)d

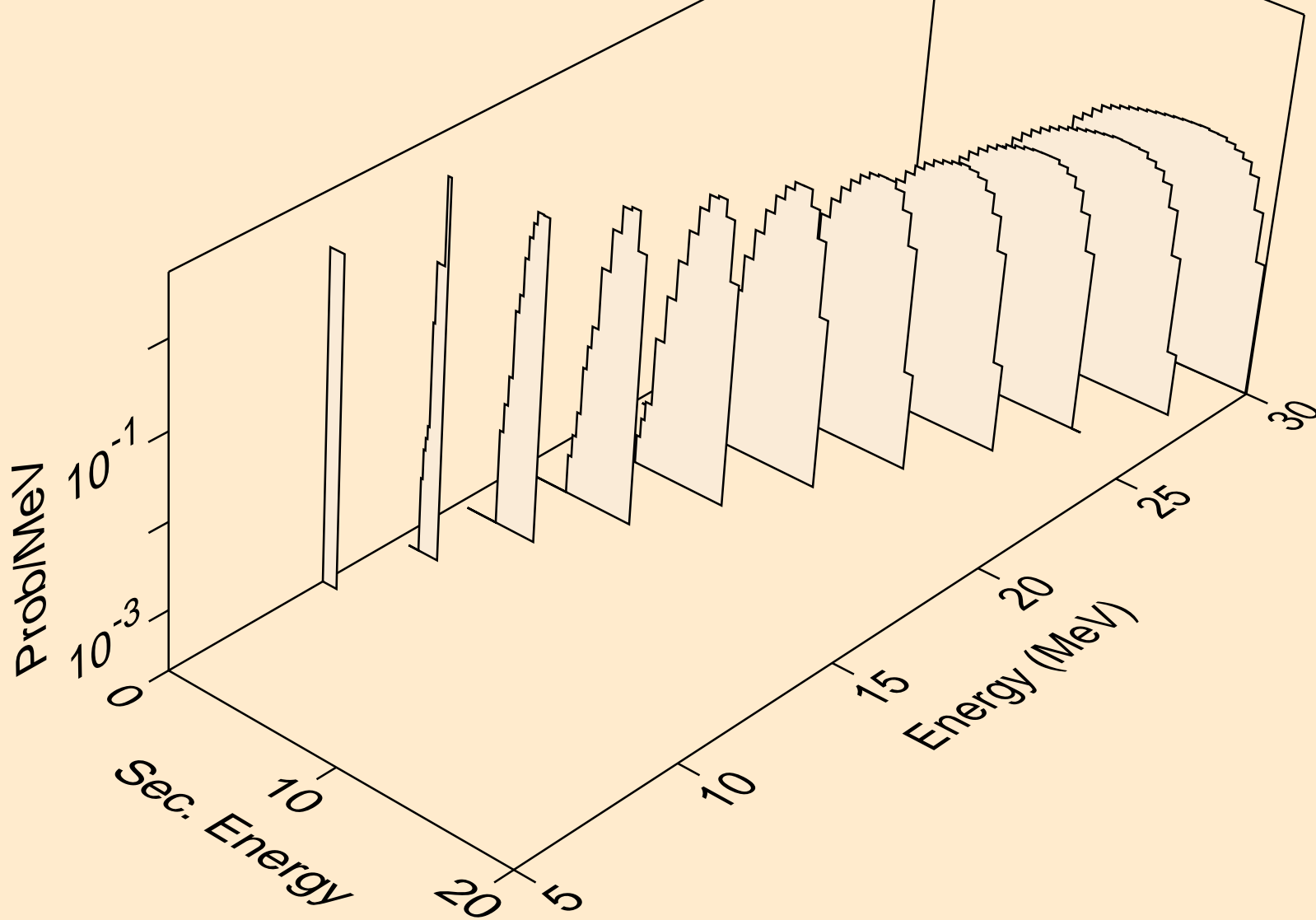



LA132 NEUTRON ACER TENDL-2019 LIBRARY; T=293.16K  
deuterons from (n,d)

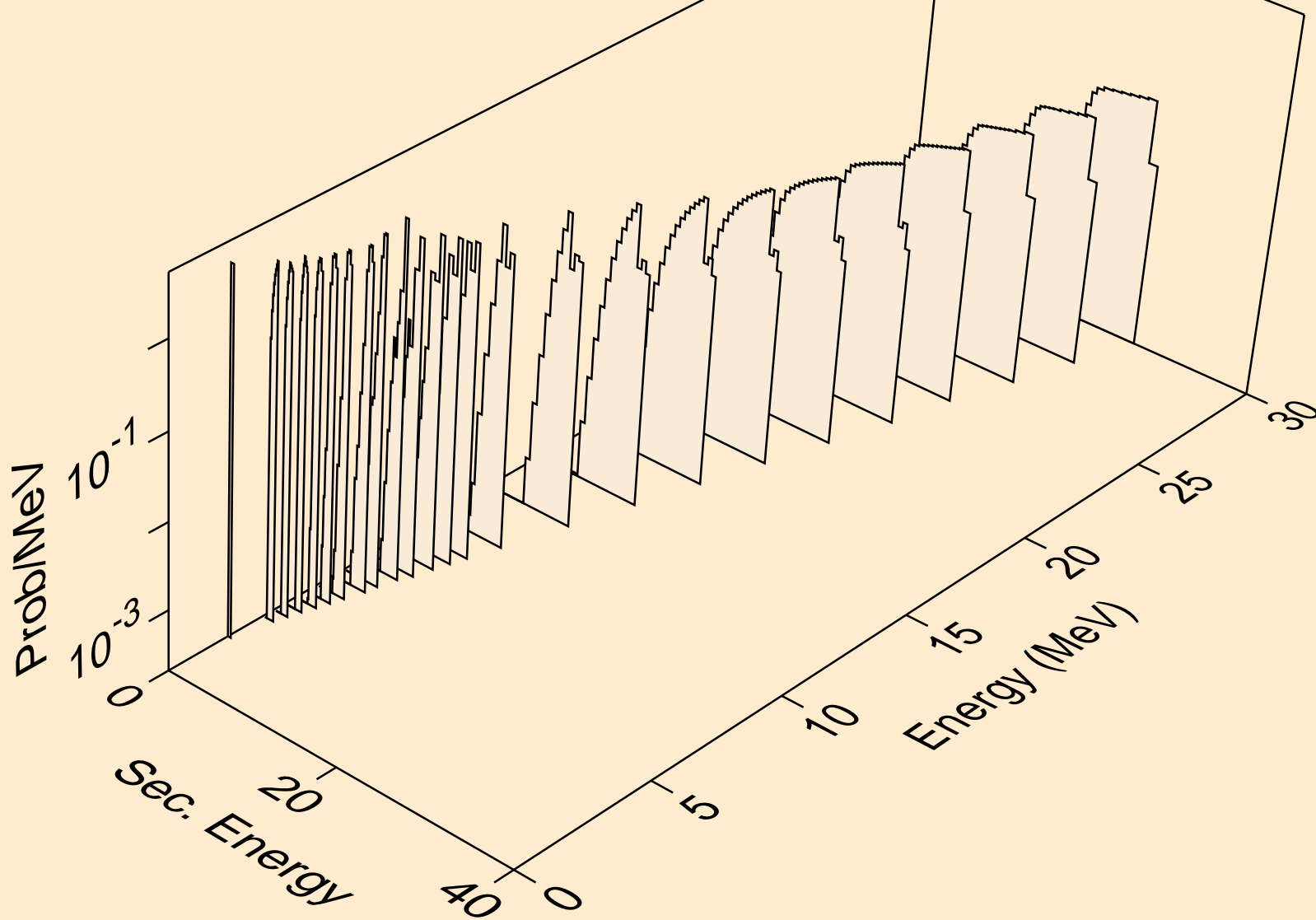

LA132 NEUTRON ACER TENDL-2019 LIBRARY; T=293.16K  
deuterons from (n,pd)

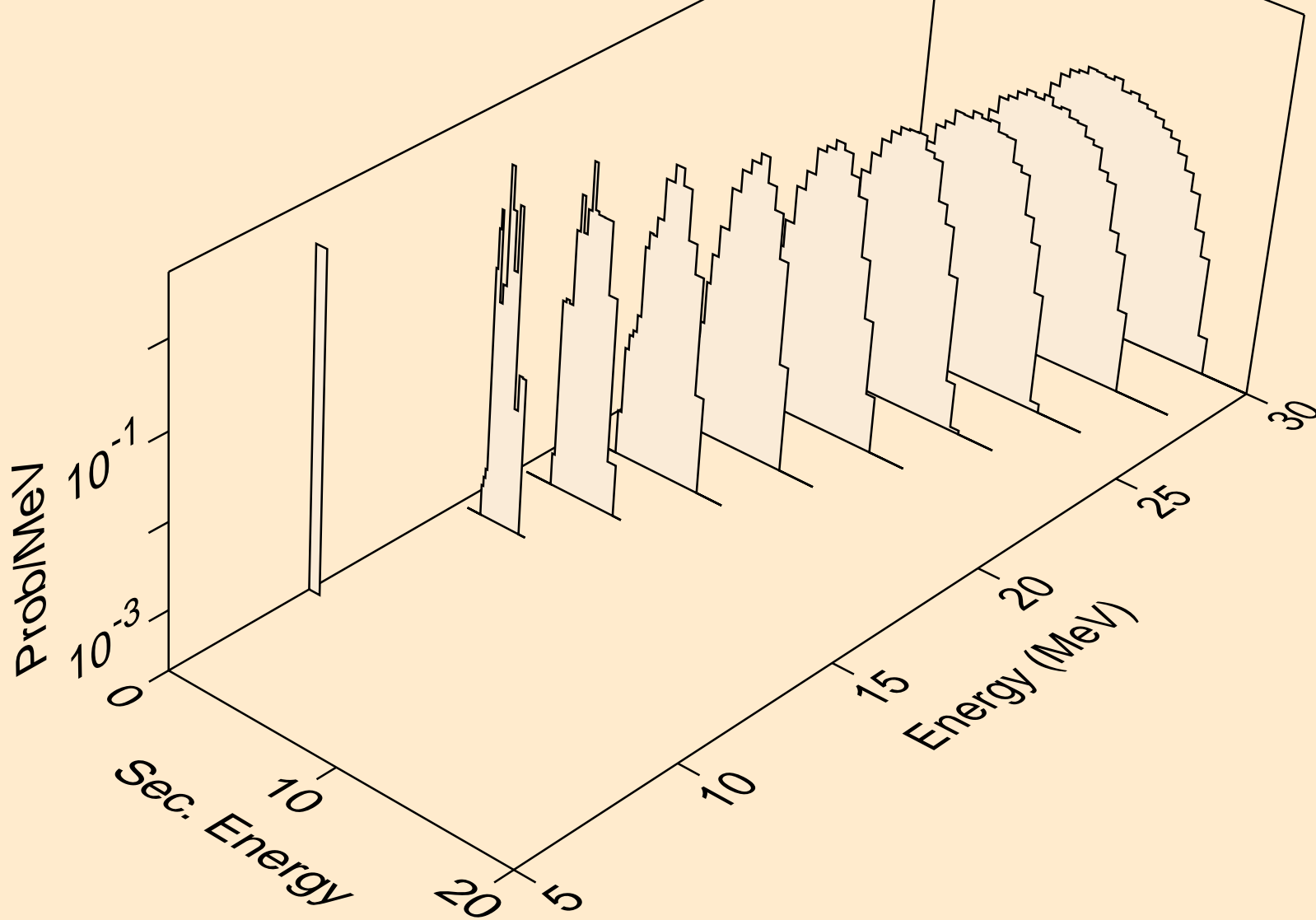

LA132 NEUTRON ACER TENDL-2019 LIBRARY; T=293.16K  
deuterons from (n,da)

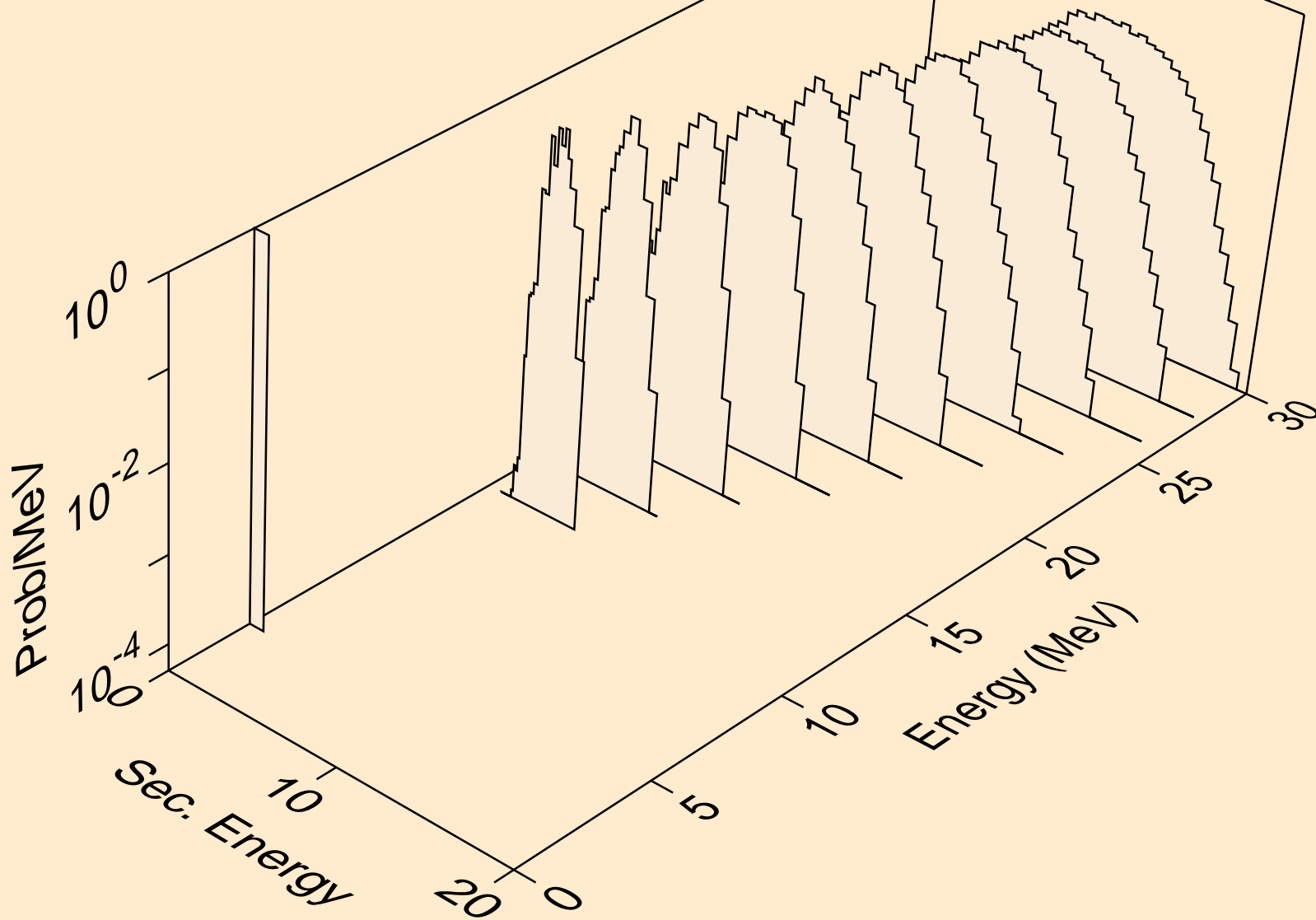

LA132 NEUTRON ACER TENDL-2019 LIBRARY; T=293.16K  
tritons from (n,x)

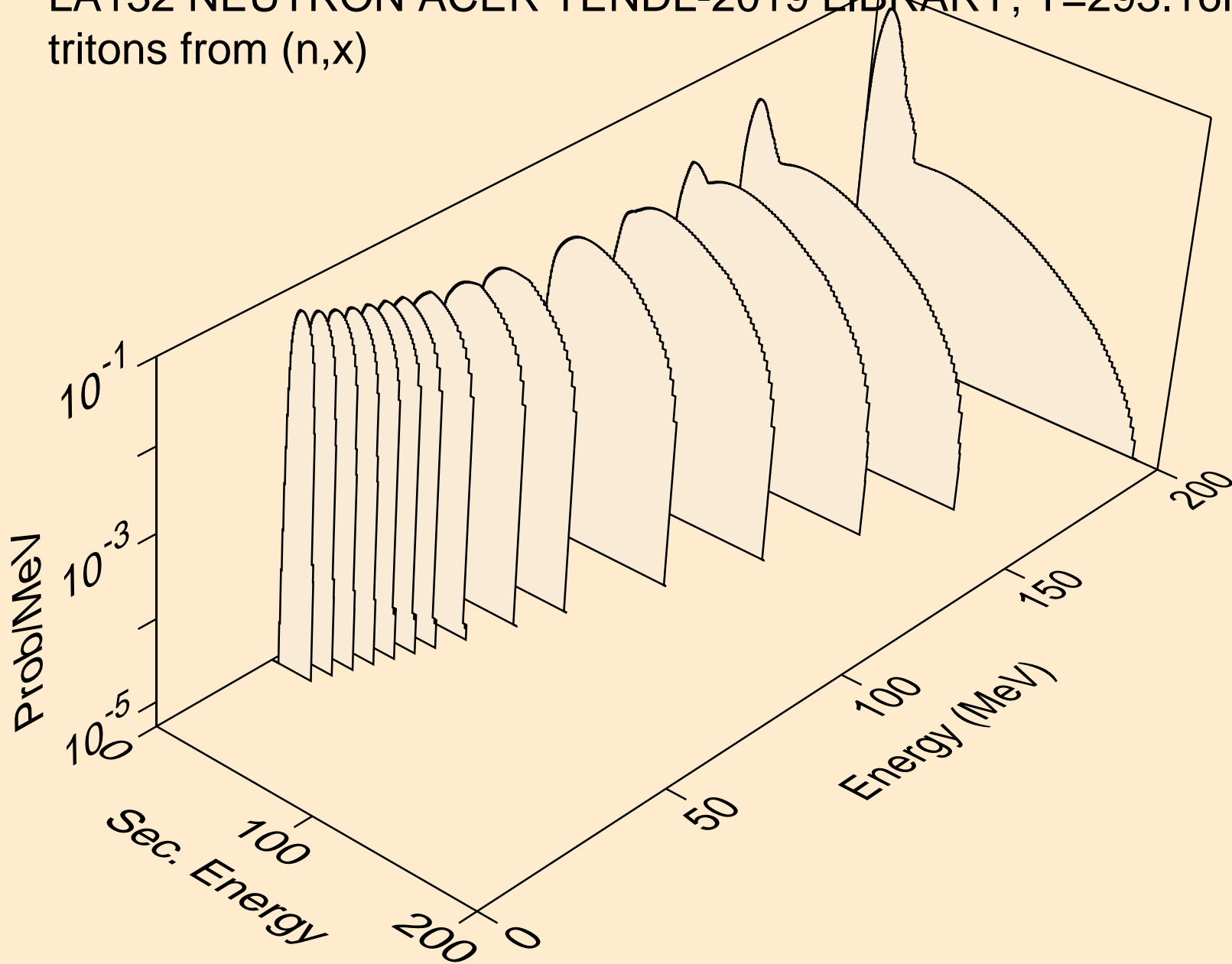

LA132 NEUTRON ACER TENDL-2019 LIBRARY; T=293.16K  
tritons from (n,n\*)t

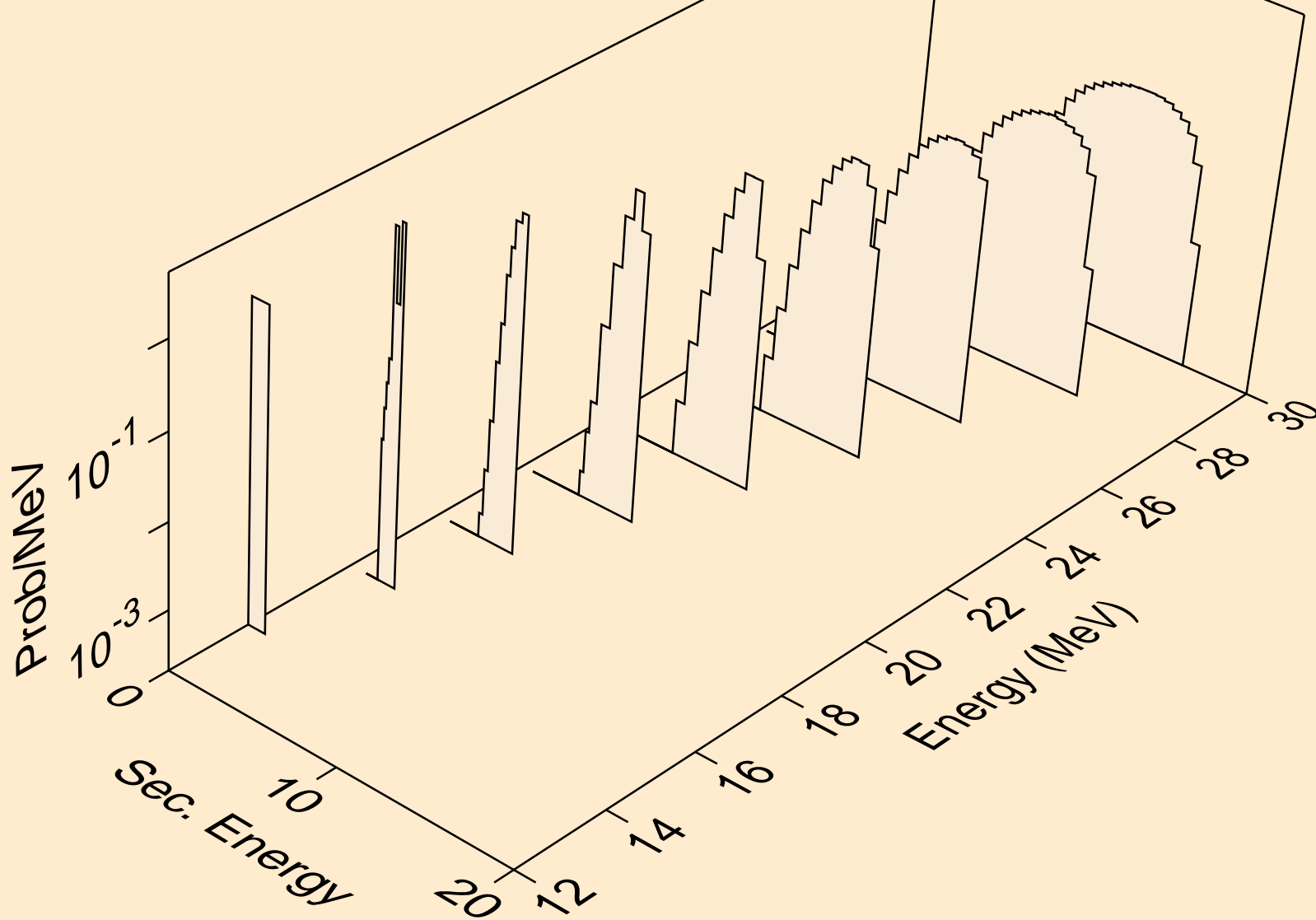

LA132 NEUTRON ACER TENDL-2019 LIBRARY; T=293.16K  
tritons from (n,t)

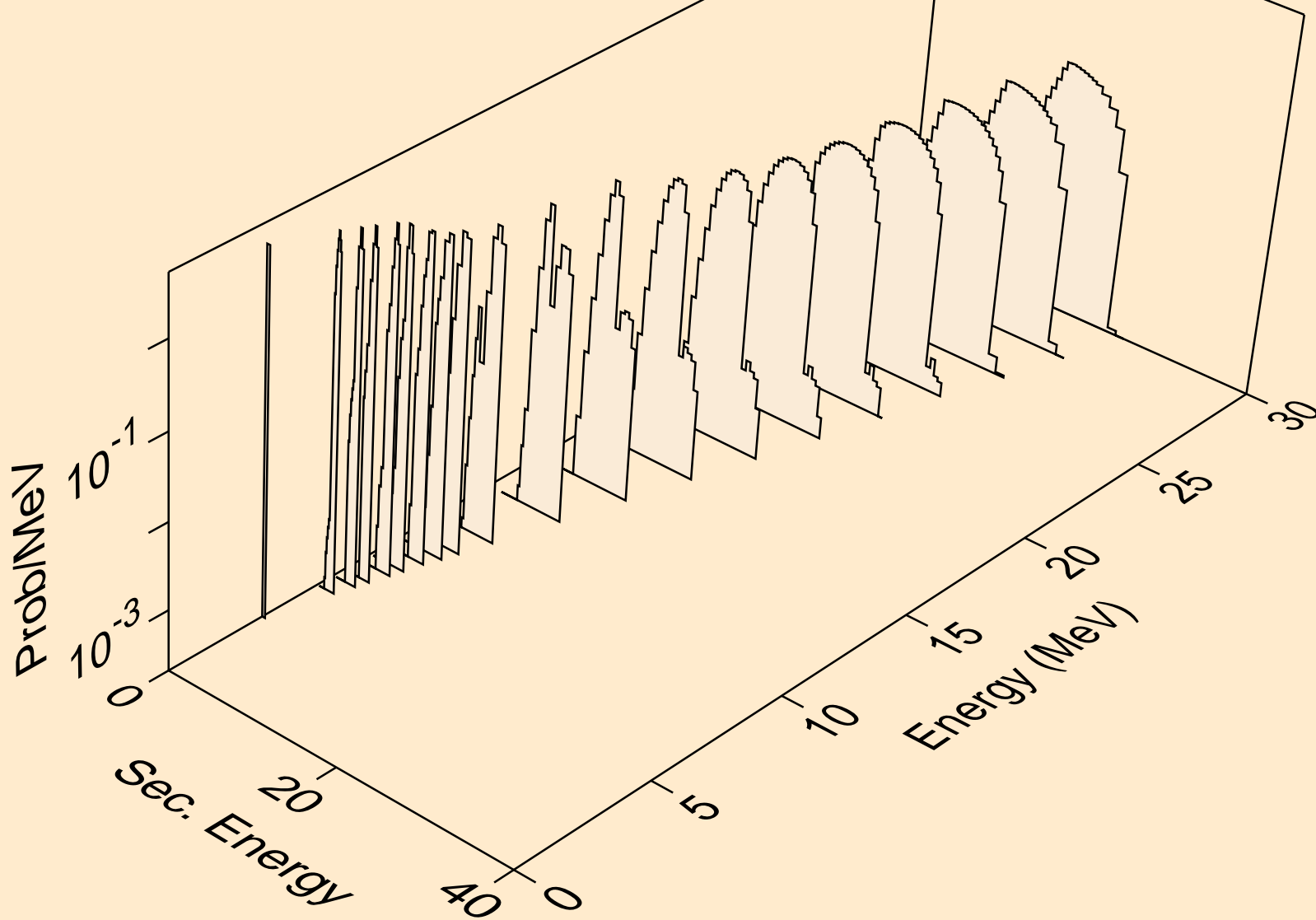

LA132 NEUTRON ACER TENDL-2019 LIBRARY; T=293.16K  
tritons from (n,pt)

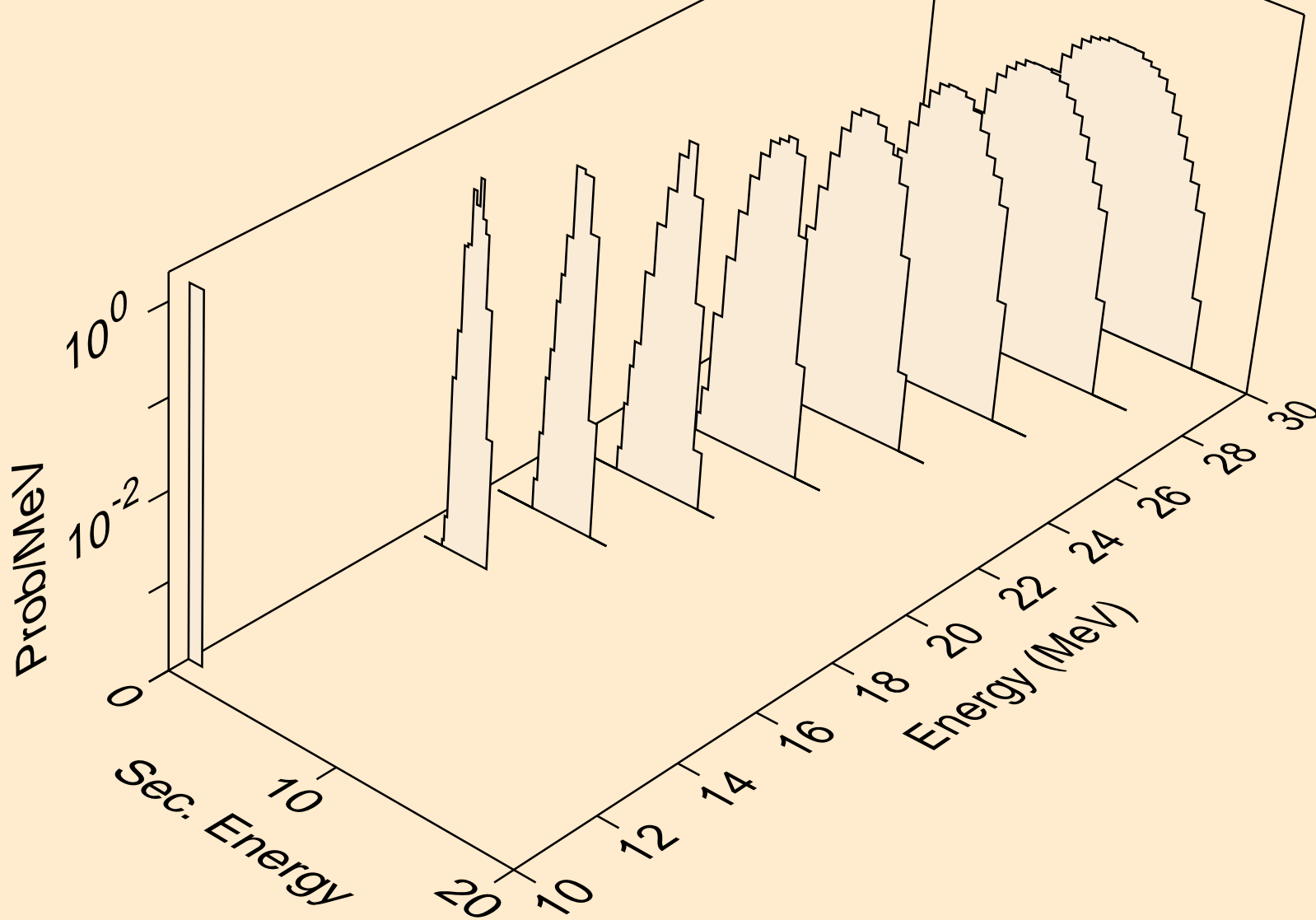

LA132 NEUTRON ACER TENDL-2019 LIBRARY; T=293.16K  
he3s from (n,x)

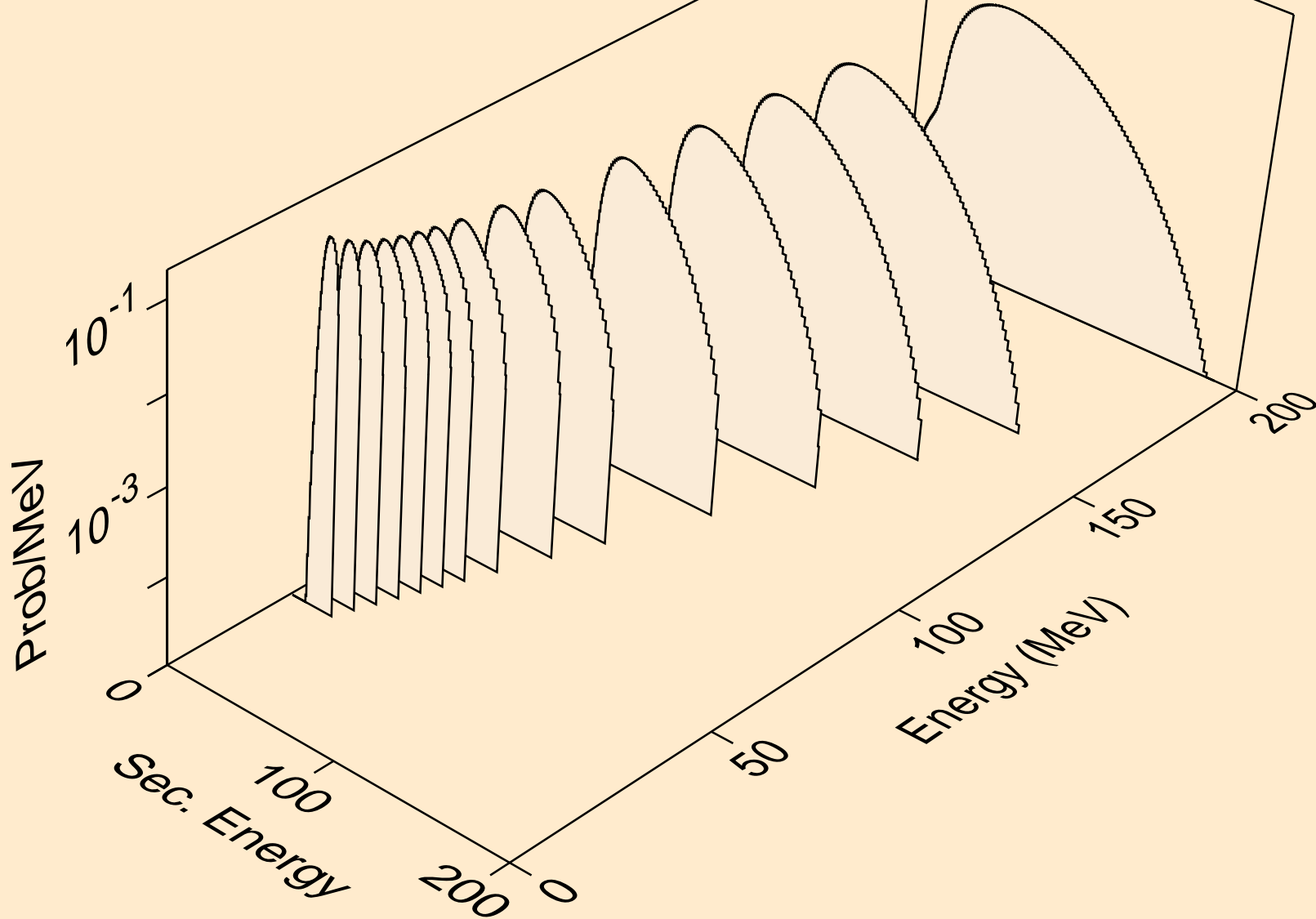



LA132 NEUTRON ACER TENDL-2019 LIBRARY; T=293.16K  
he3s from (n,n\*)he3

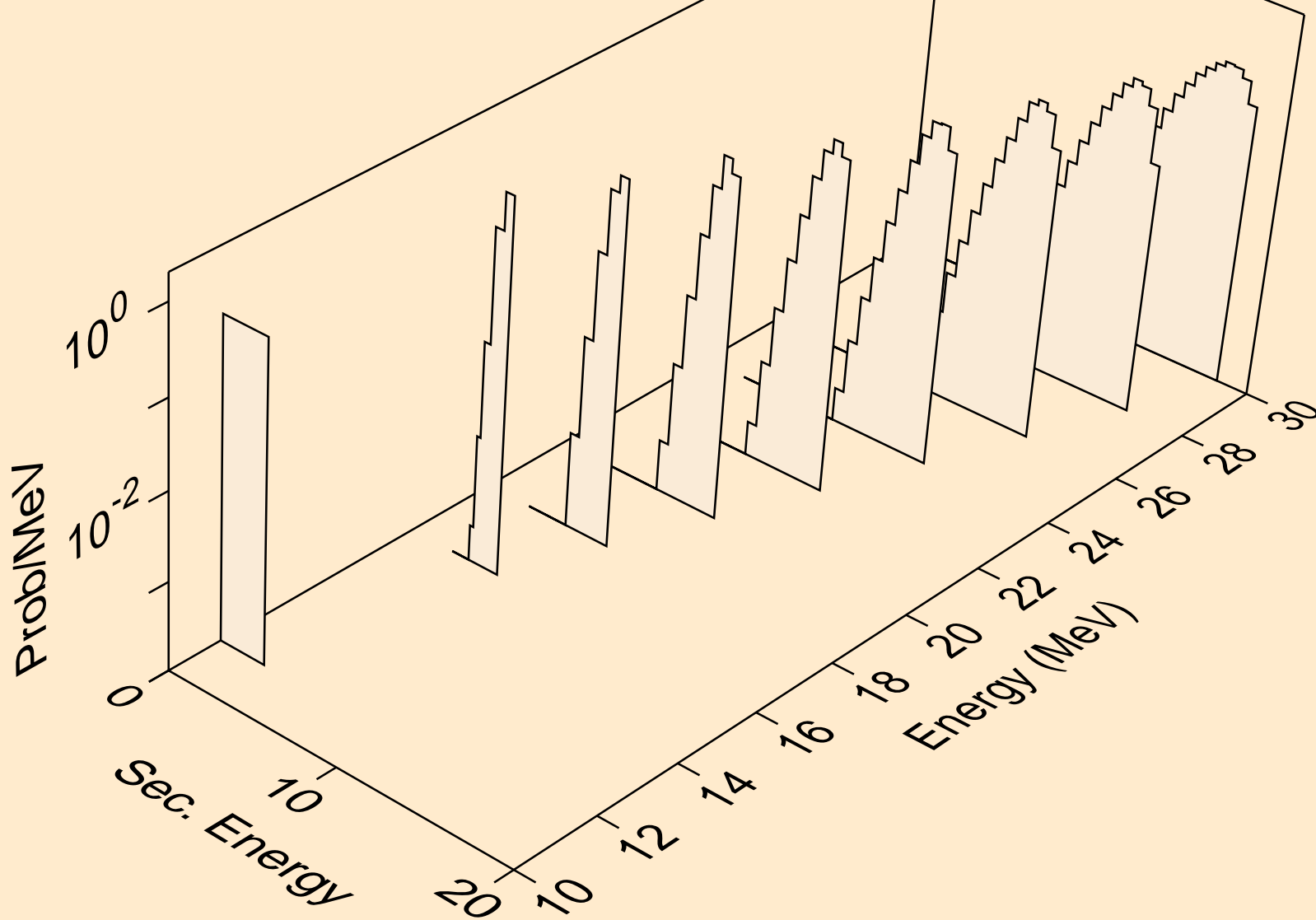

LA132 NEUTRON ACER TENDL-2019 LIBRARY; T=293.16K  
he3s from (n,he3)

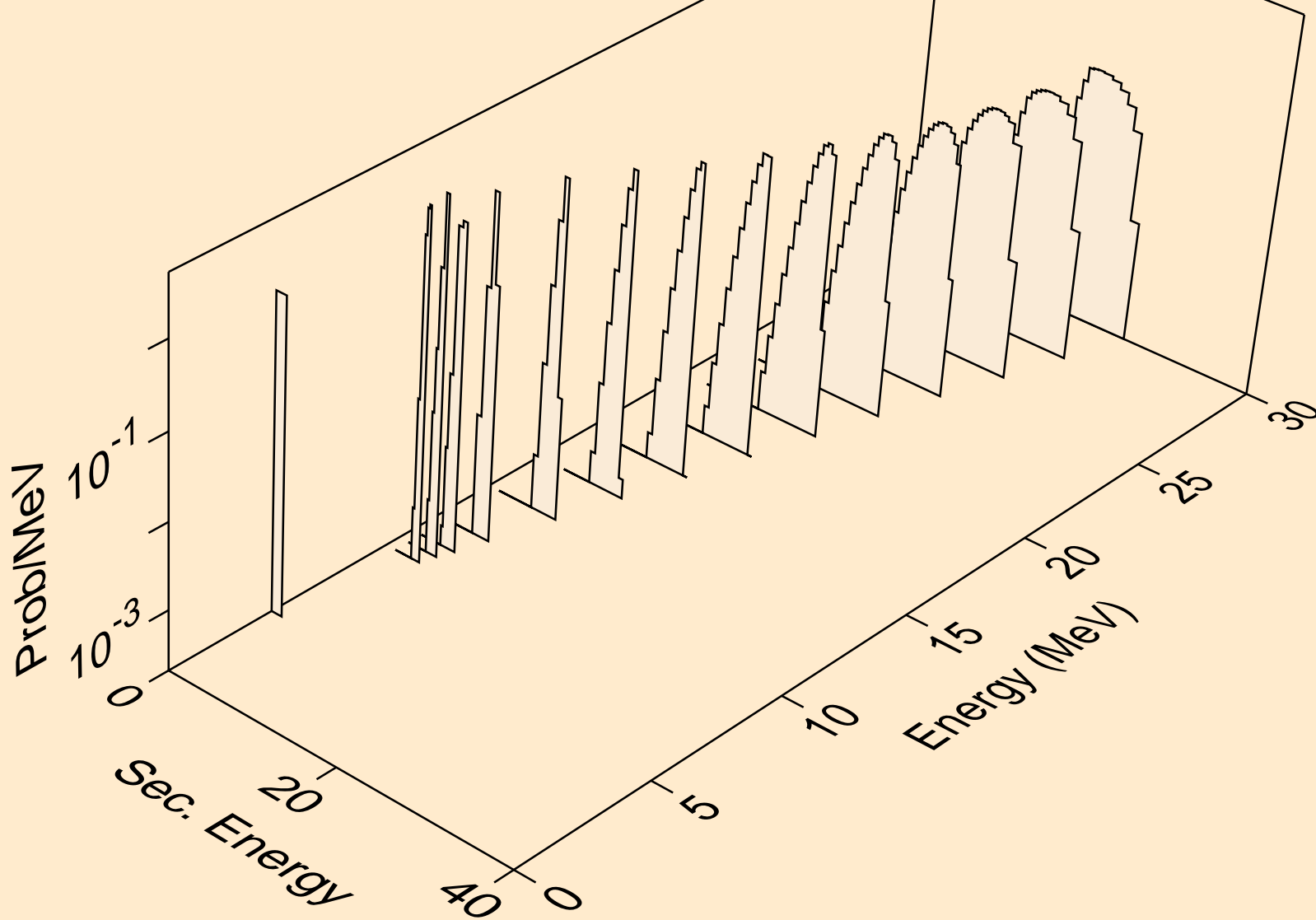

LA132 NEUTRON ACER TENDL-2019 LIBRARY; T=293.16K  
alphas from (n,x)

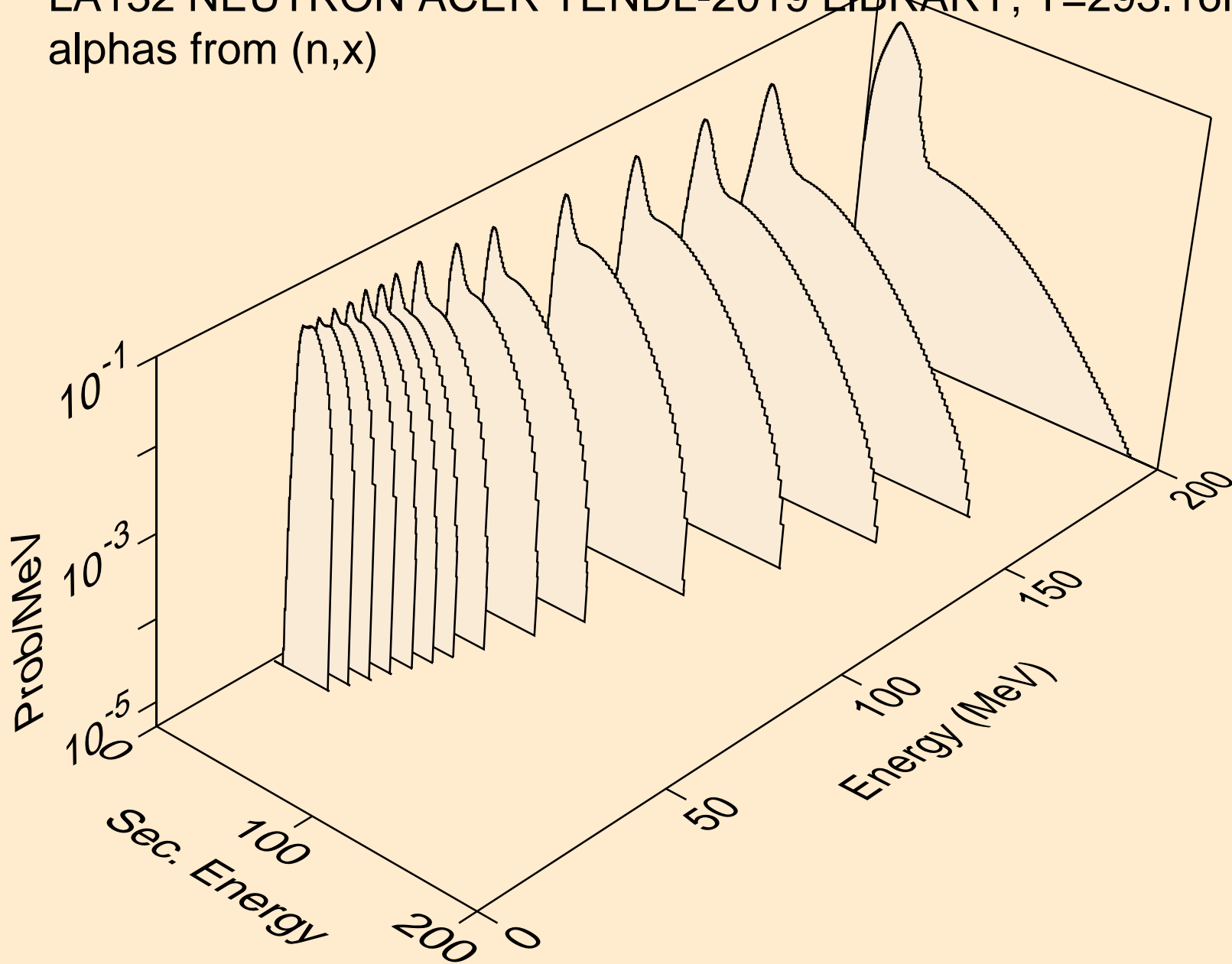

LA132 NEUTRON ACER TENDL-2019 LIBRARY; T=293.16K  
alphas from (n,n\*)a

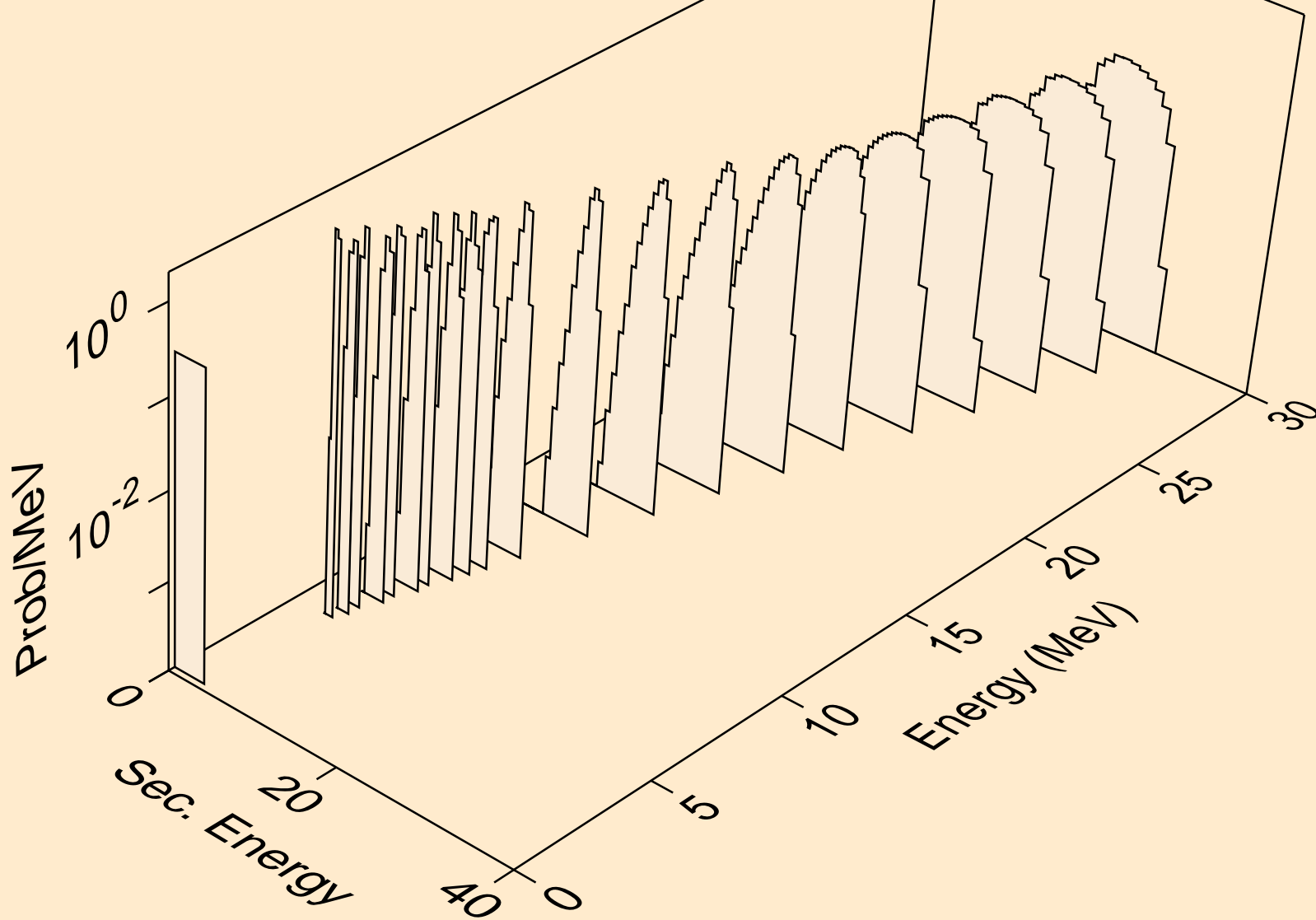

LA132 NEUTRON ACER TENDL-2019 LIBRARY; T=293.16K  
alphas from (n,2n)a

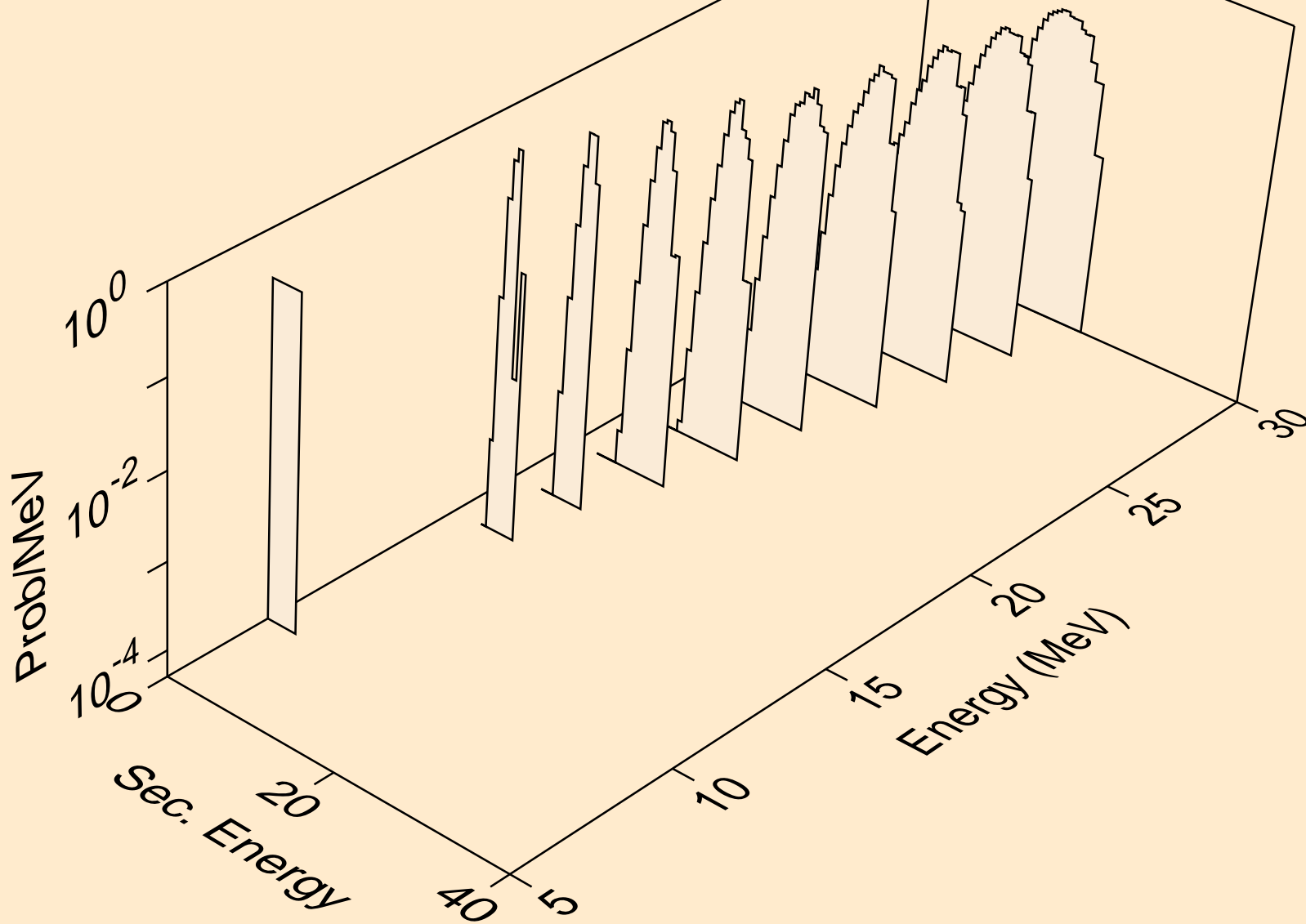

LA132 NEUTRON ACER TENDL-2019 LIBRARY; T=293.16K  
alphas from (n,3n)a

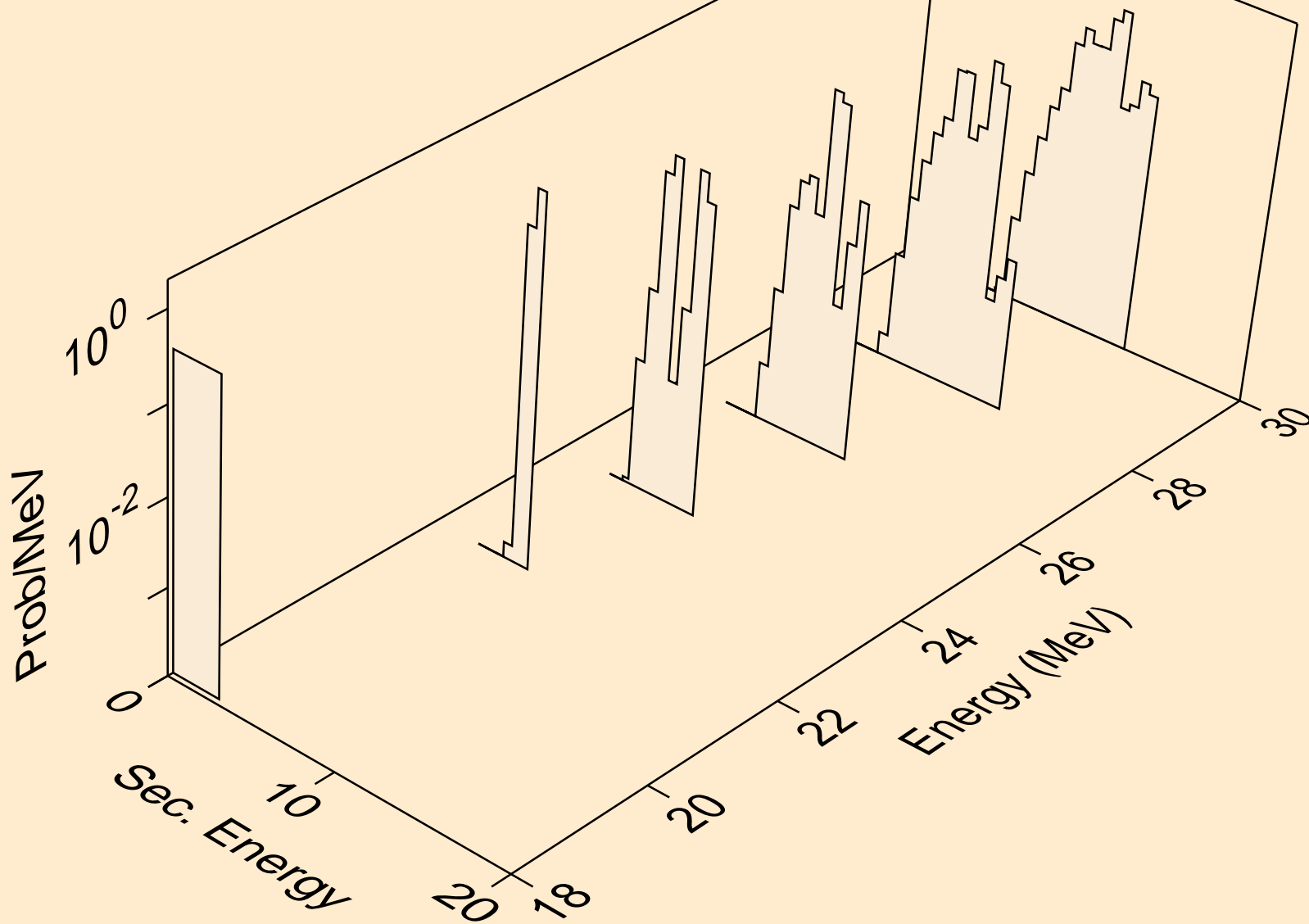

LA132 NEUTRON ACER TENDL-2019 LIBRARY; T=293.16K  
alphas from (n,n\*)2a

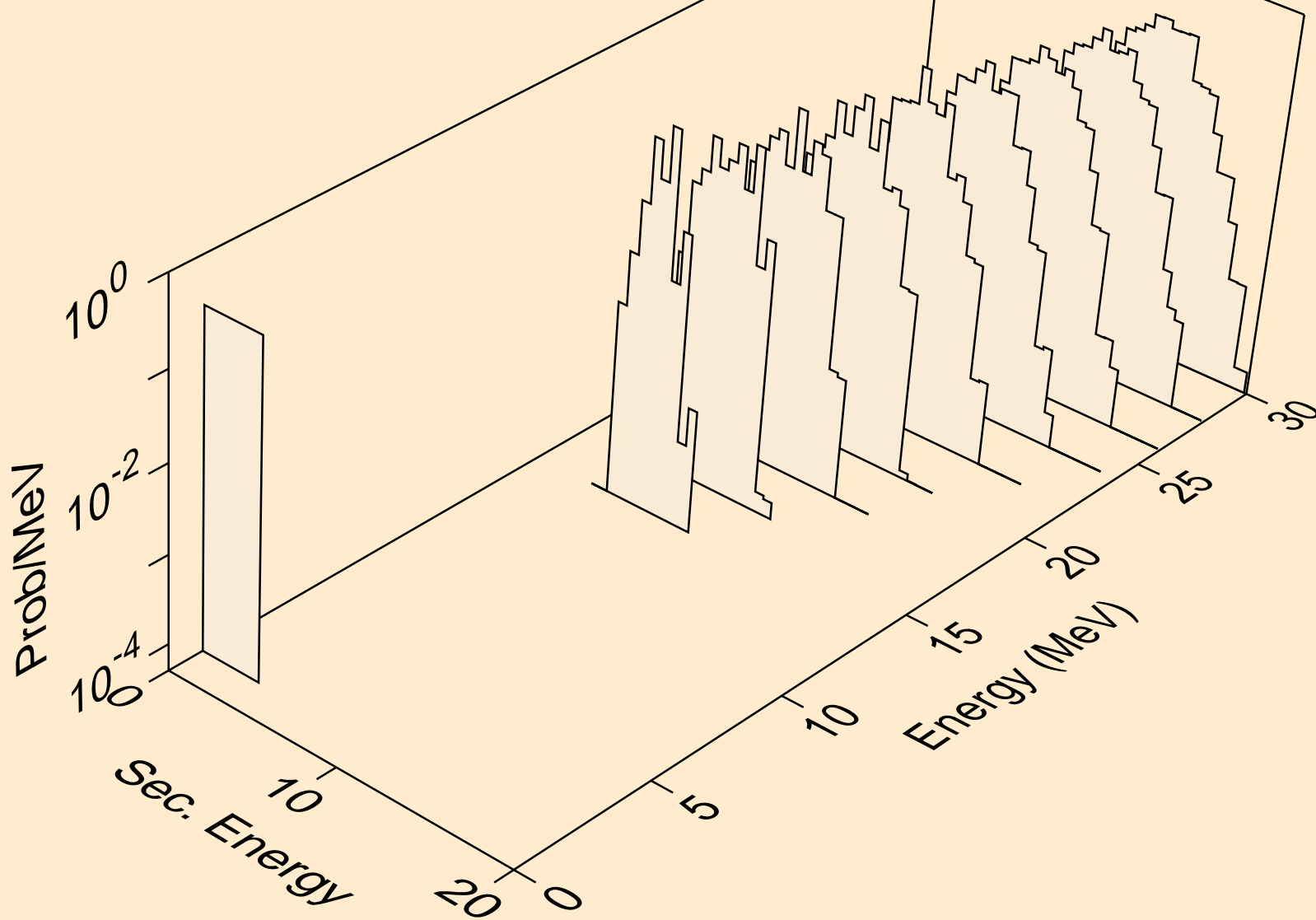

LA132 NEUTRON ACER TENDL-2019 LIBRARY; T=293.16K  
alphas from (n,2n)2a

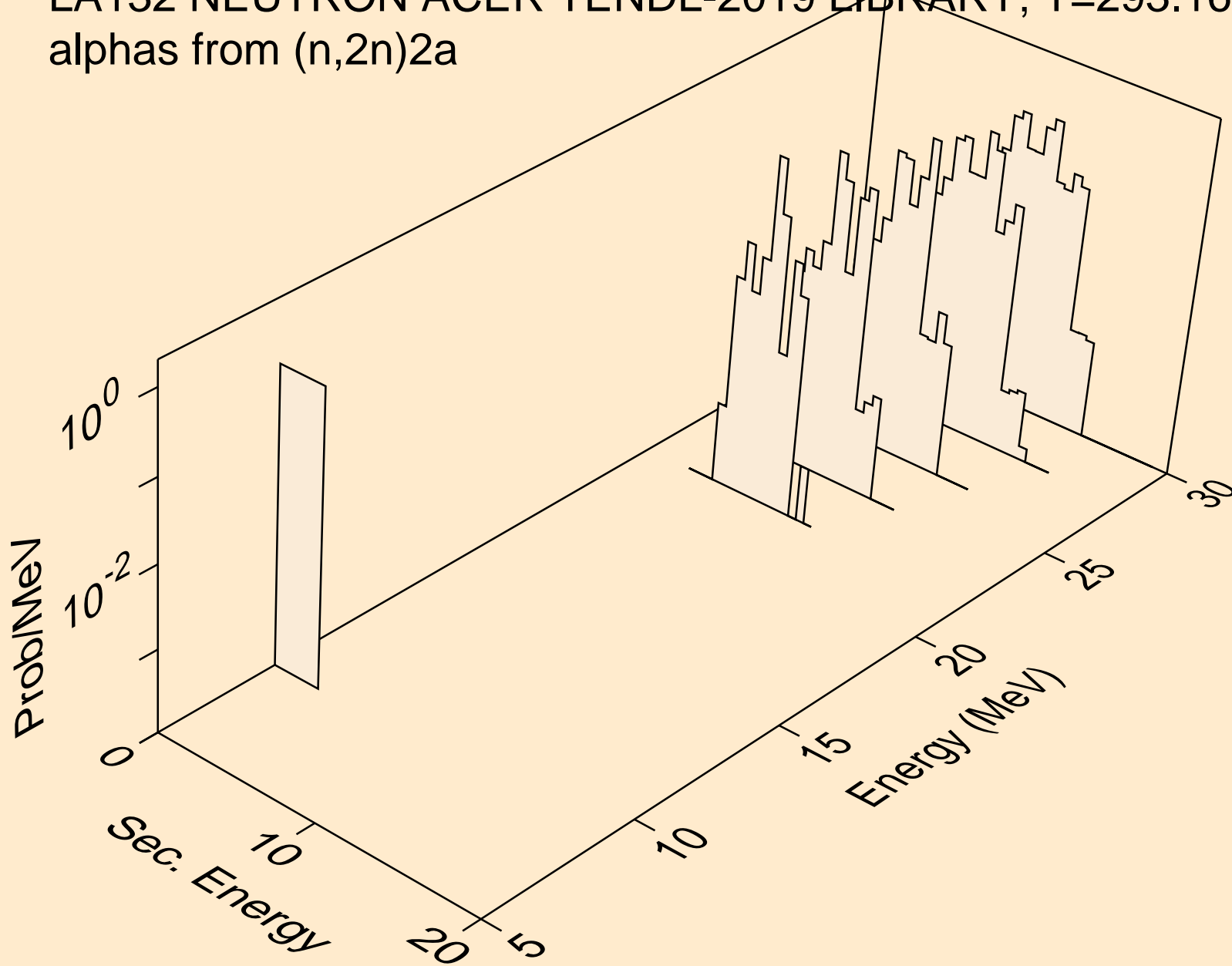



LA132 NEUTRON ACER TENDL-2019 LIBRARY; T=293.16K  
alphas from (n,npa)

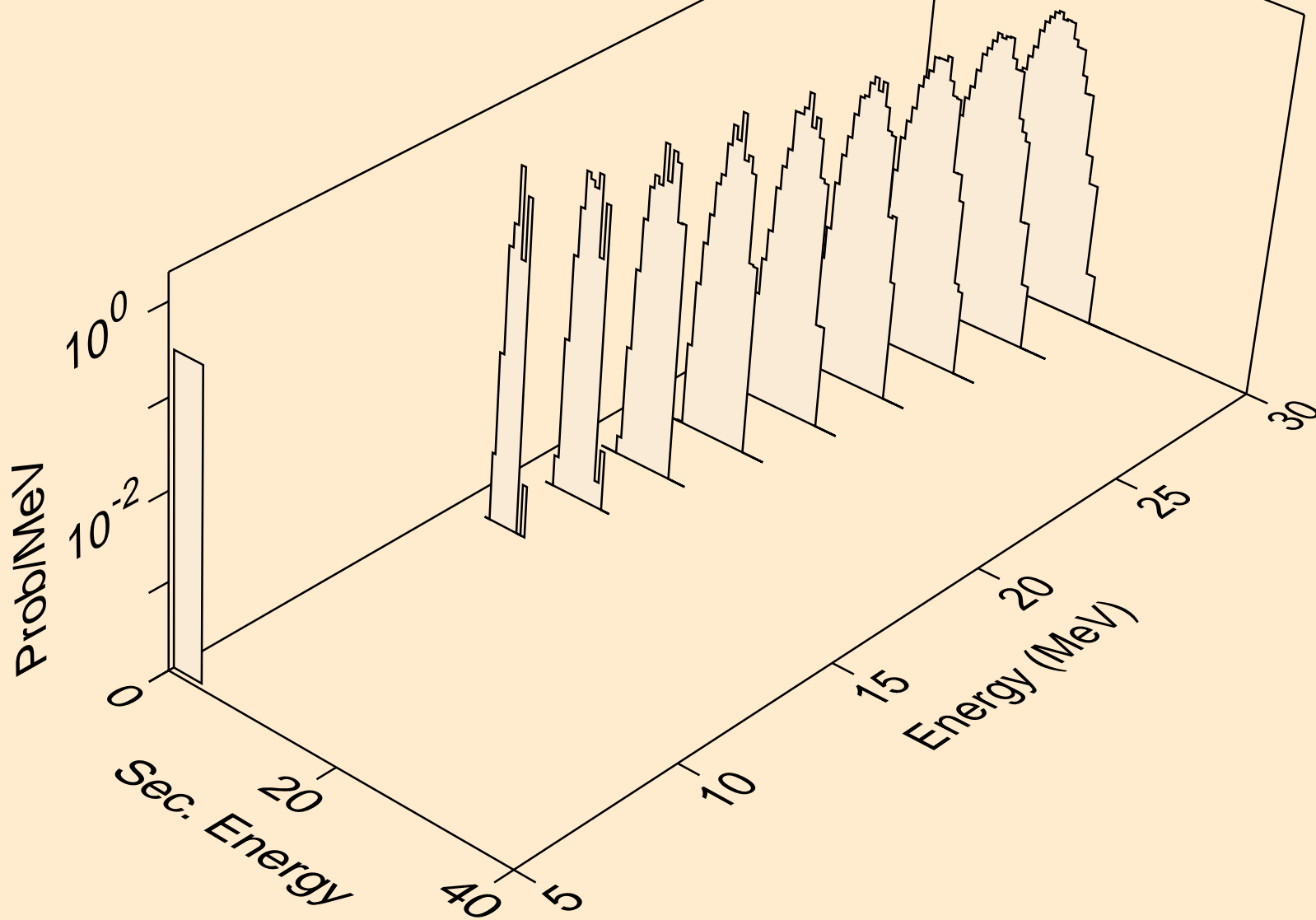

LA132 NEUTRON ACER TENDL-2019 LIBRARY; T=293.16K  
alphas from (n,a)

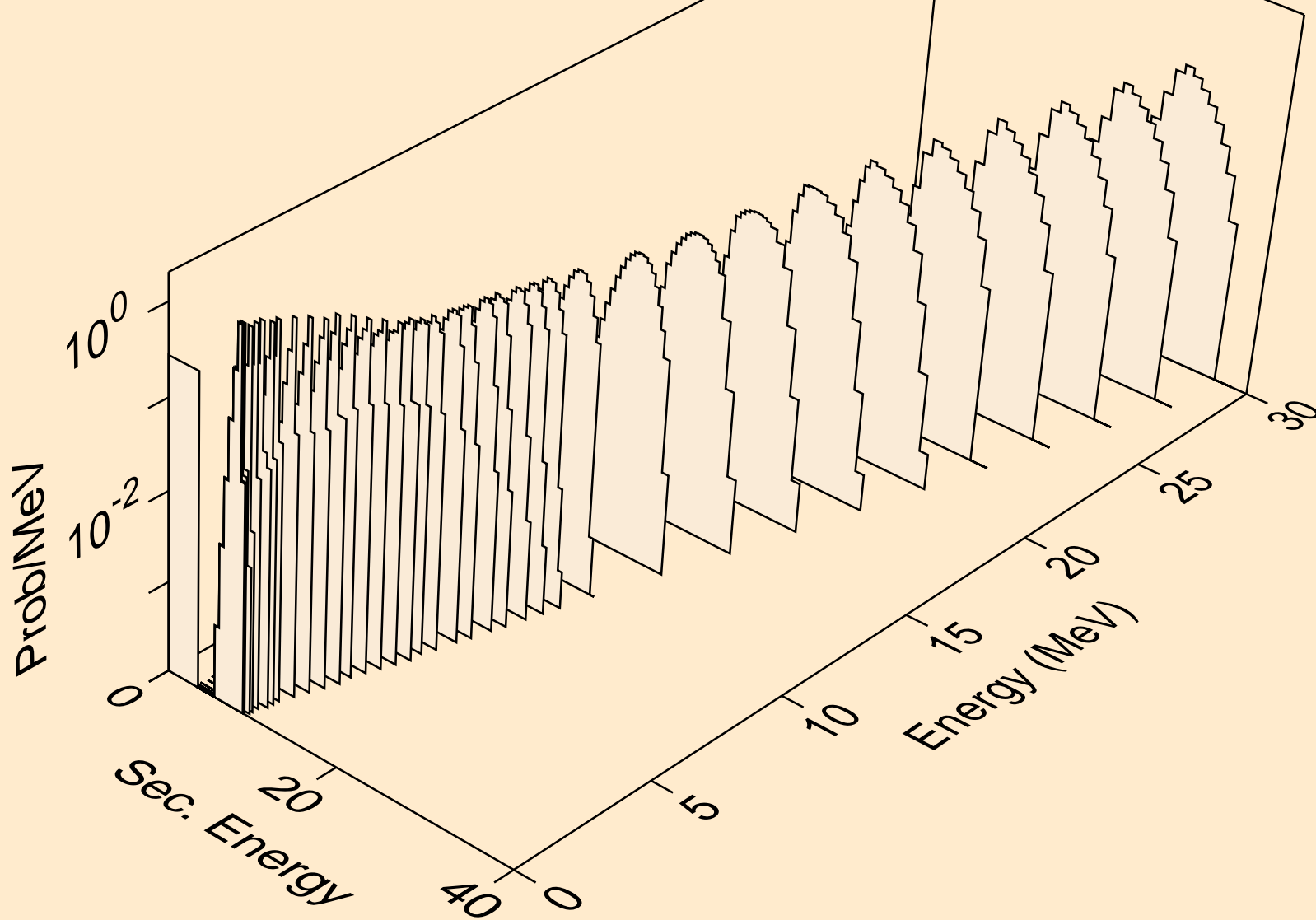

LA132 NEUTRON ACER TENDL-2019 LIBRARY; T=293.16K  
alphas from (n,2a)

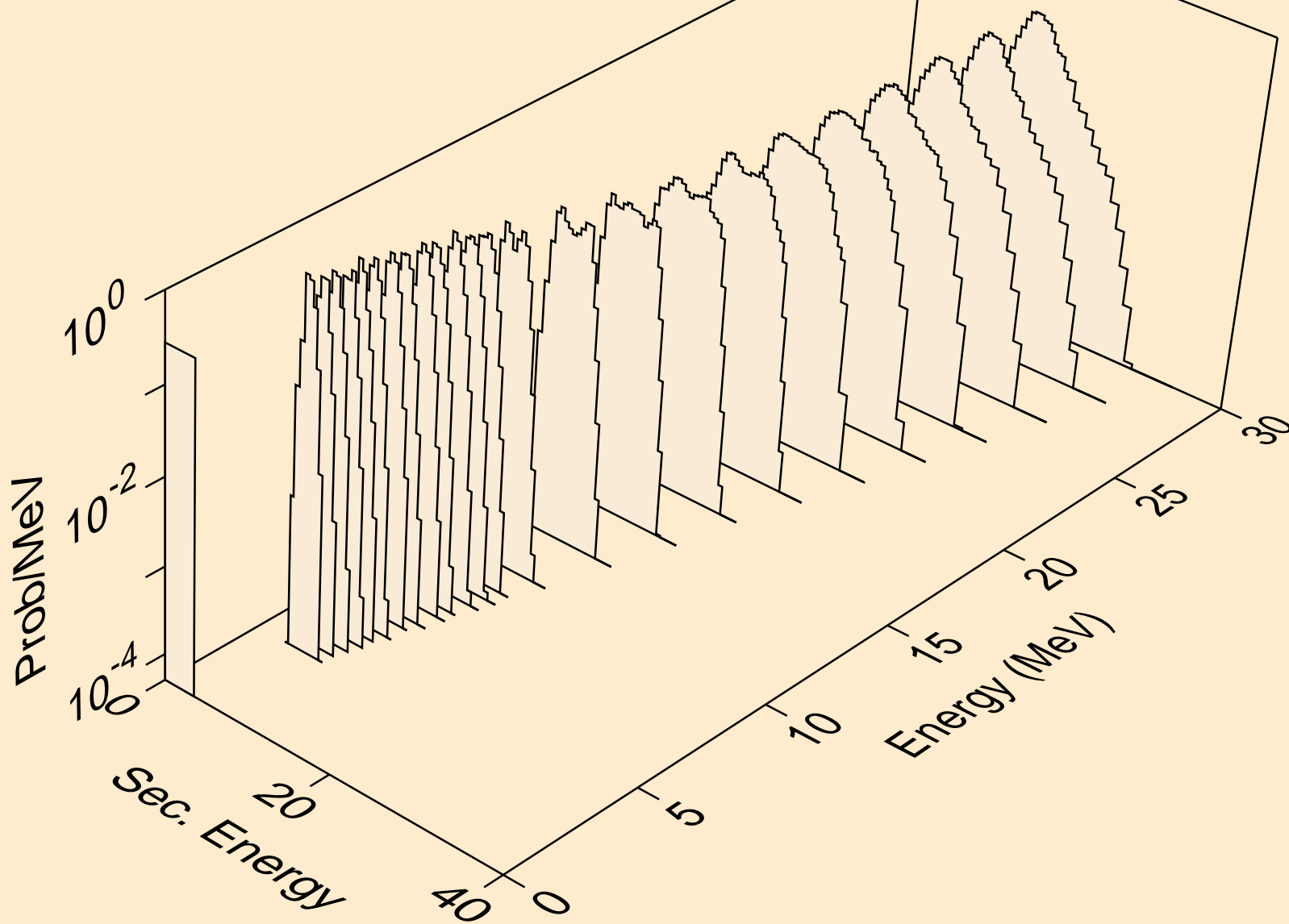

LA132 NEUTRON ACER TENDL-2019 LIBRARY; T=293.16K  
alphas from (n,pa)

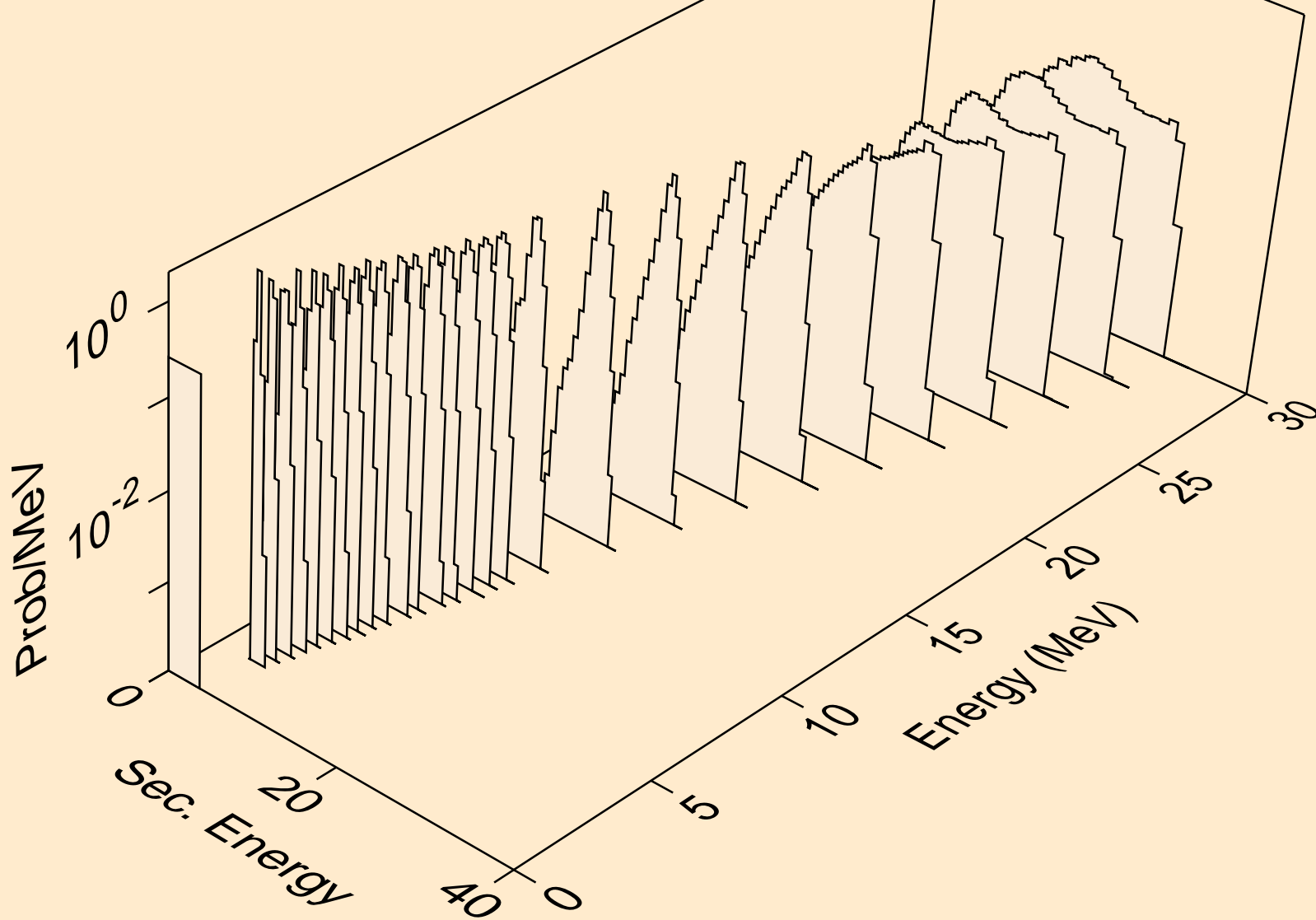

LA132 NEUTRON ACER TENDL-2019 LIBRARY; T=293.16K  
alphas from (n,da)

