

LA138 NEUTRON ACER TENDL-2019 LIBRARY; T=293.16K
Principal cross sections

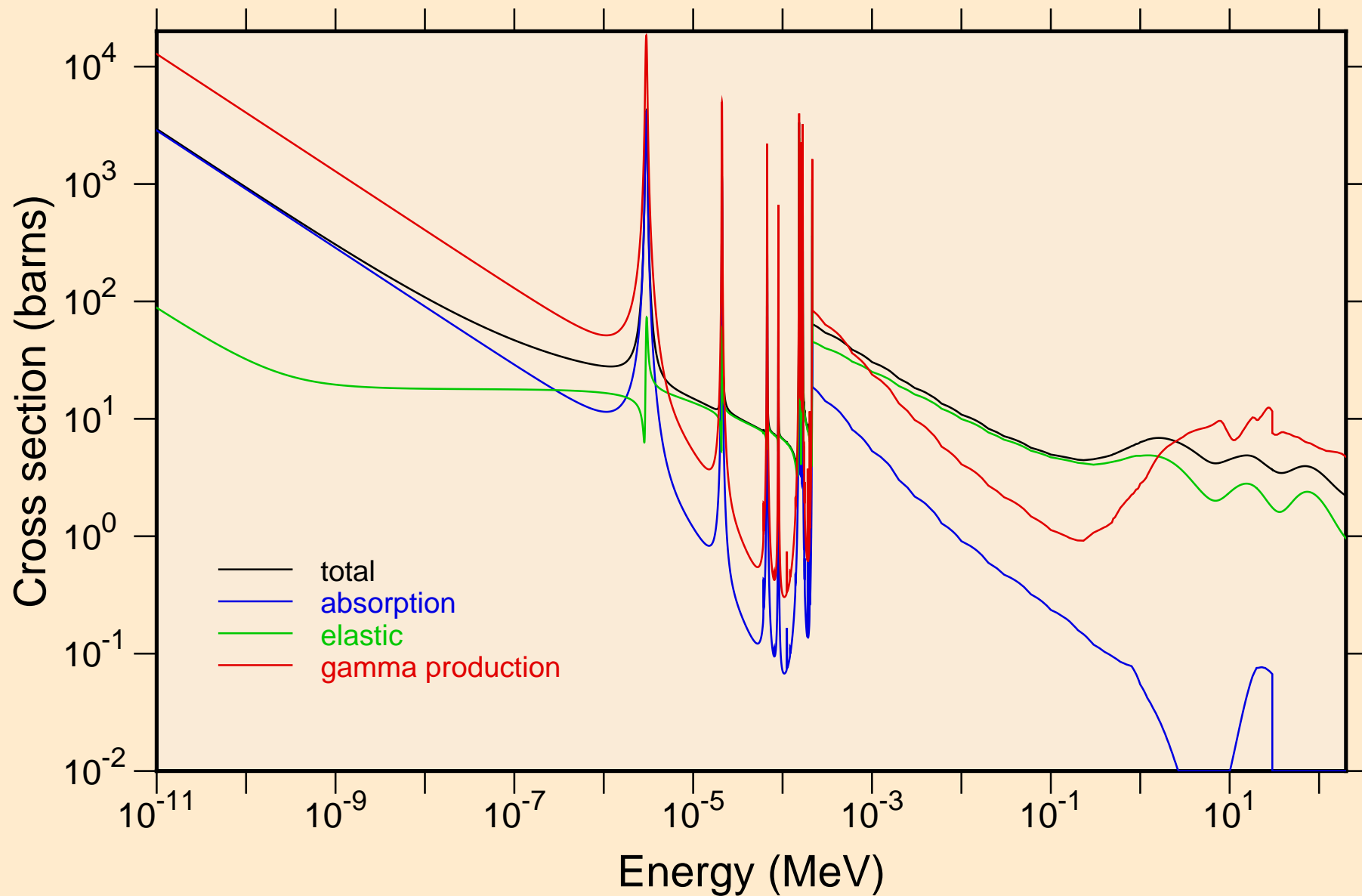

LA138 NEUTRON ACER TENDL-2019 LIBRARY; T=293.16K
resonance total cross section

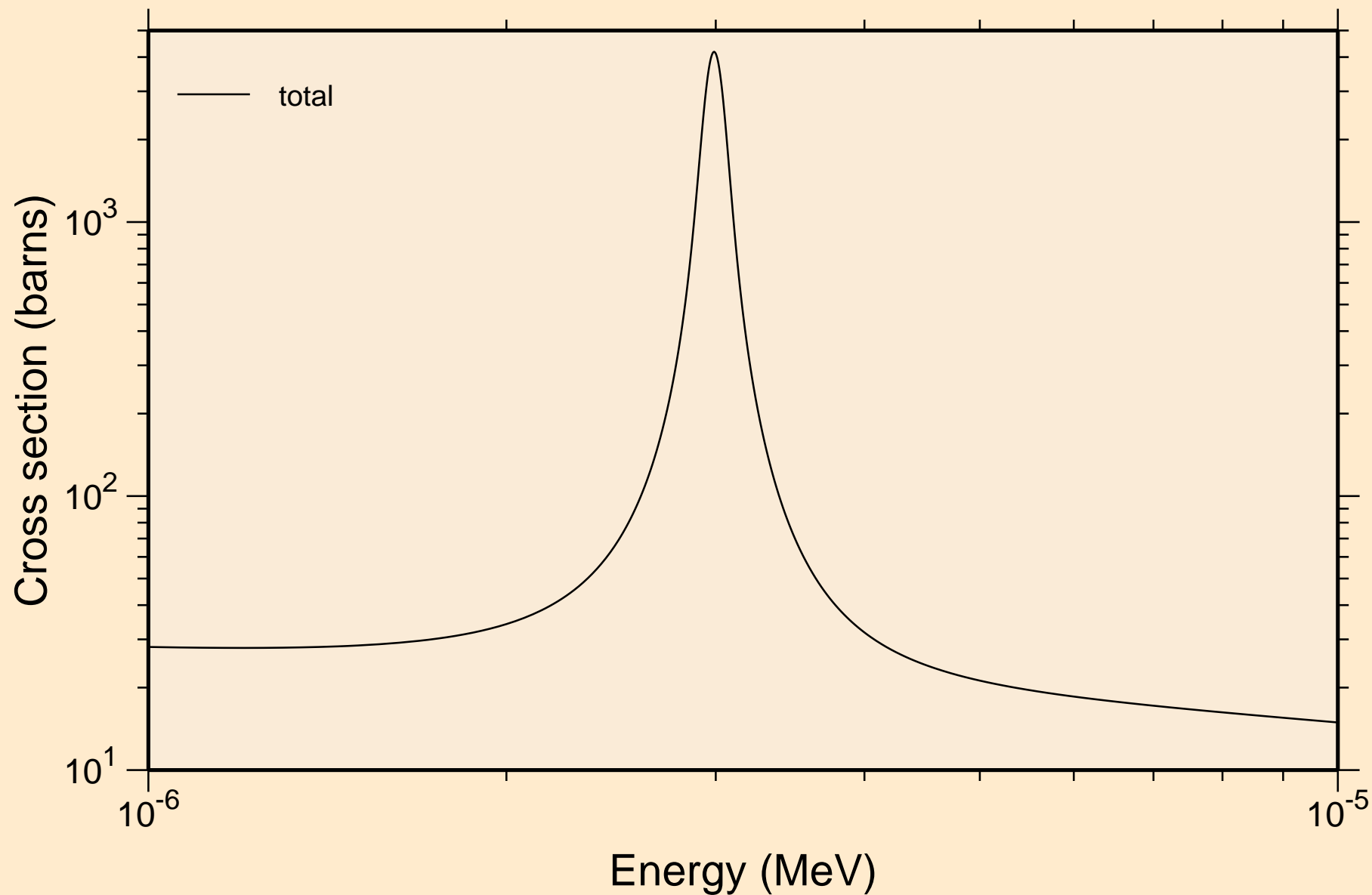

LA138 NEUTRON ACER TENDL-2019 LIBRARY; T=293.16K
resonance total cross section

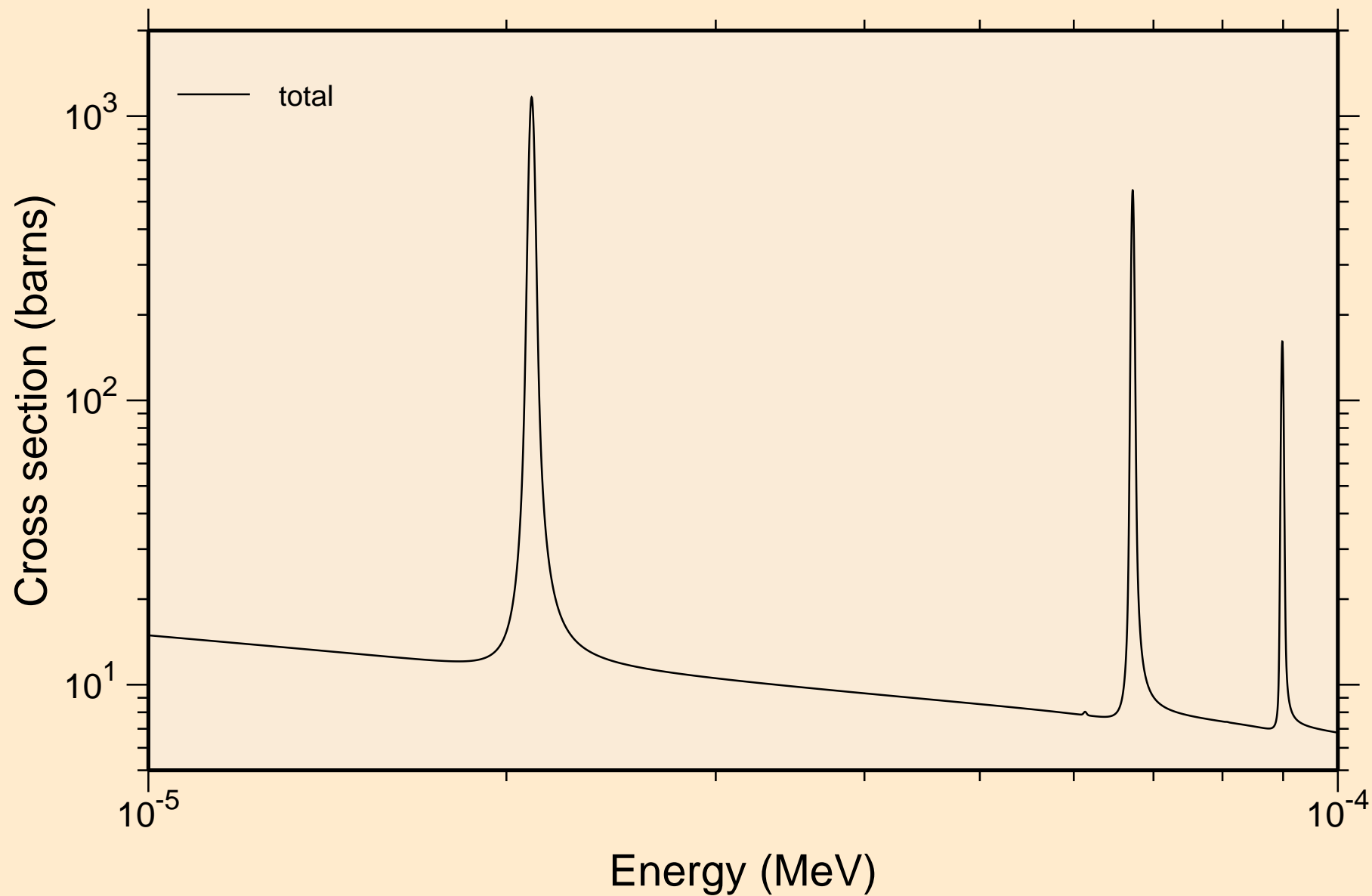

LA138 NEUTRON ACER TENDL-2019 LIBRARY; T=293.16K
resonance total cross section

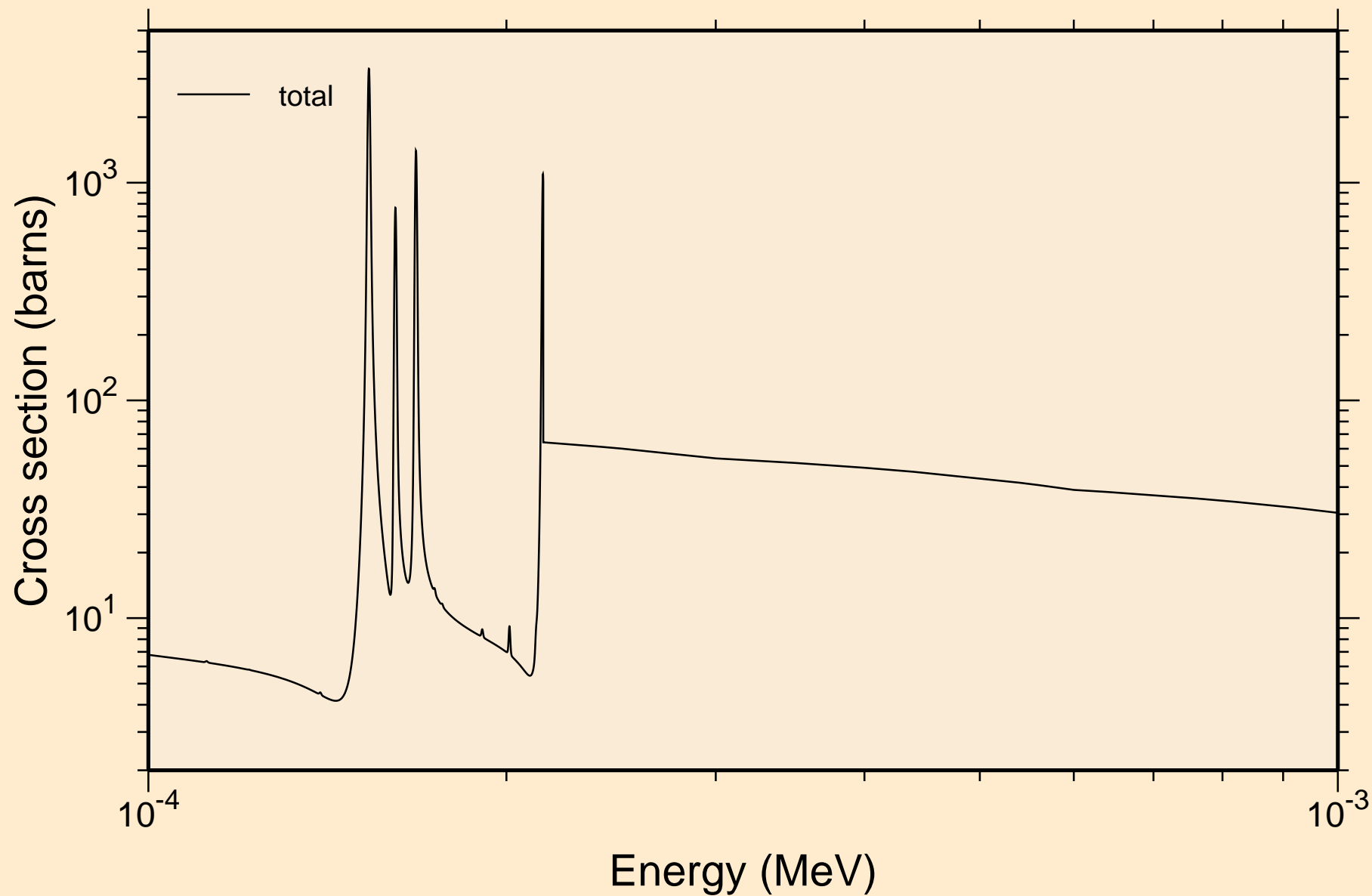

L¹³⁸ NEUTRON ACER TENDL-2019 LIBRARY; T=293.16K
resonance total cross section

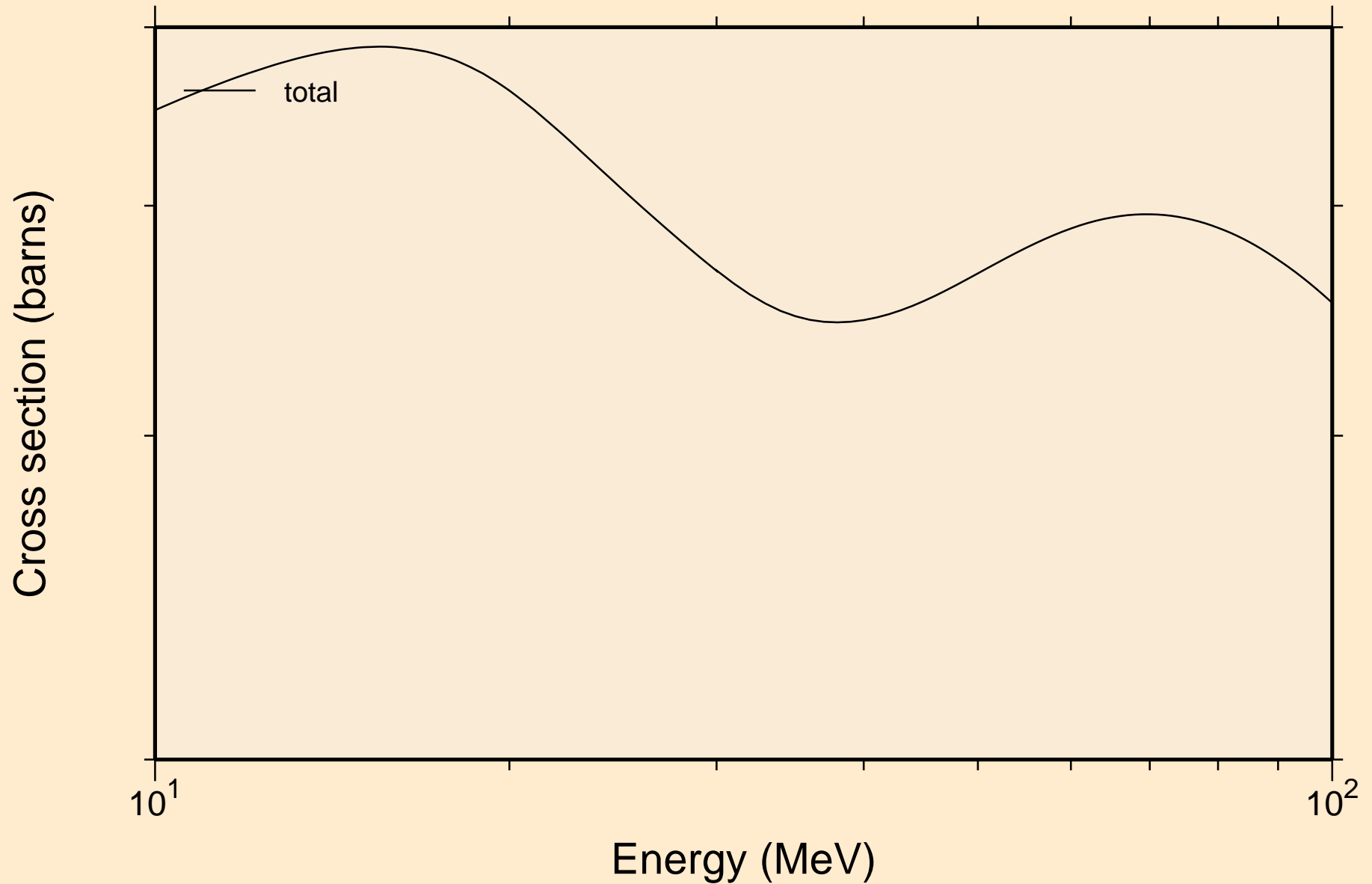

LA138 NEUTRON ACER TENDL-2019 LIBRARY; T=293.16K
resonance absorption cross sections

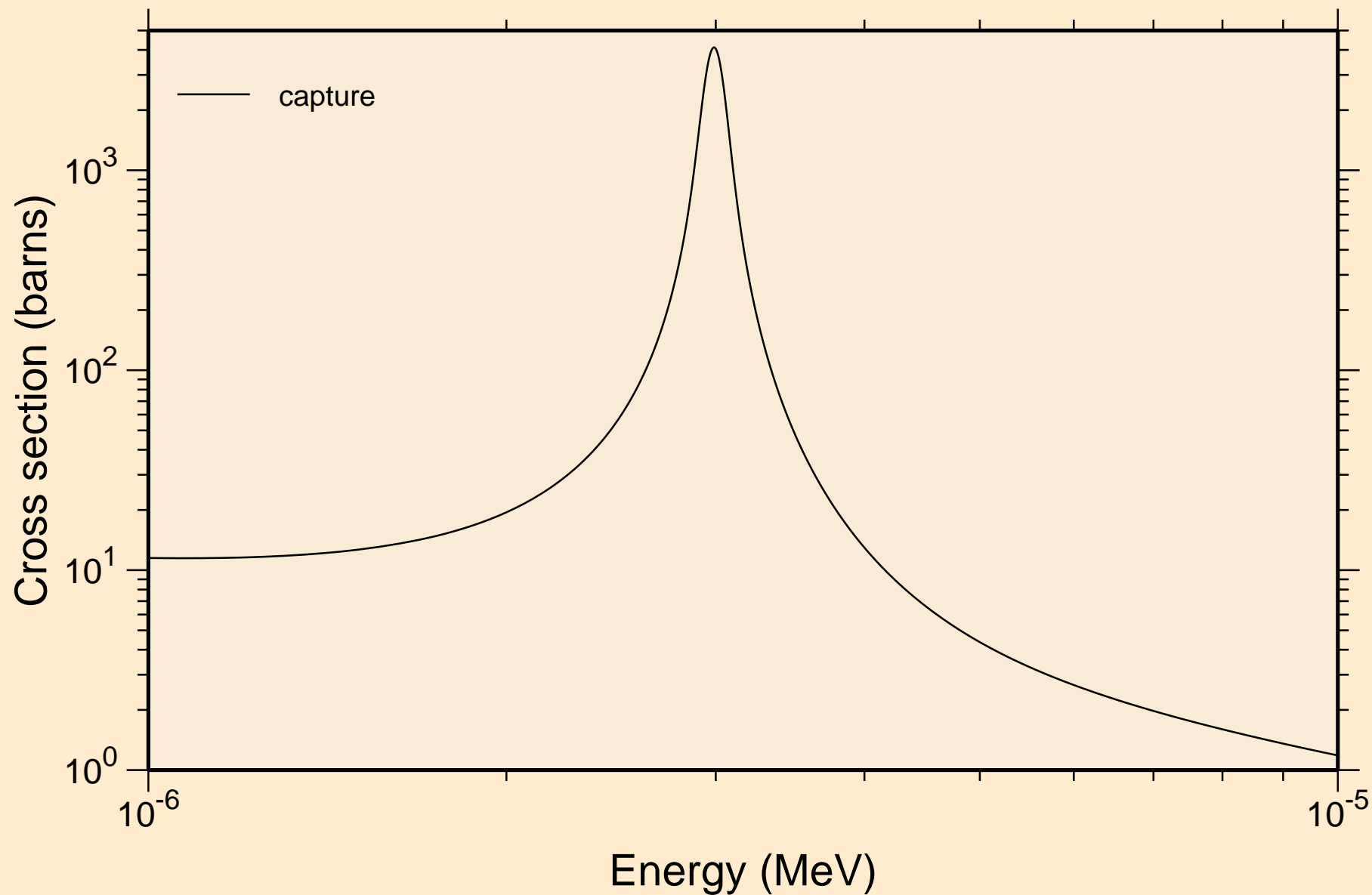

LA138 NEUTRON ACER TENDL-2019 LIBRARY; T=293.16K
resonance absorption cross sections

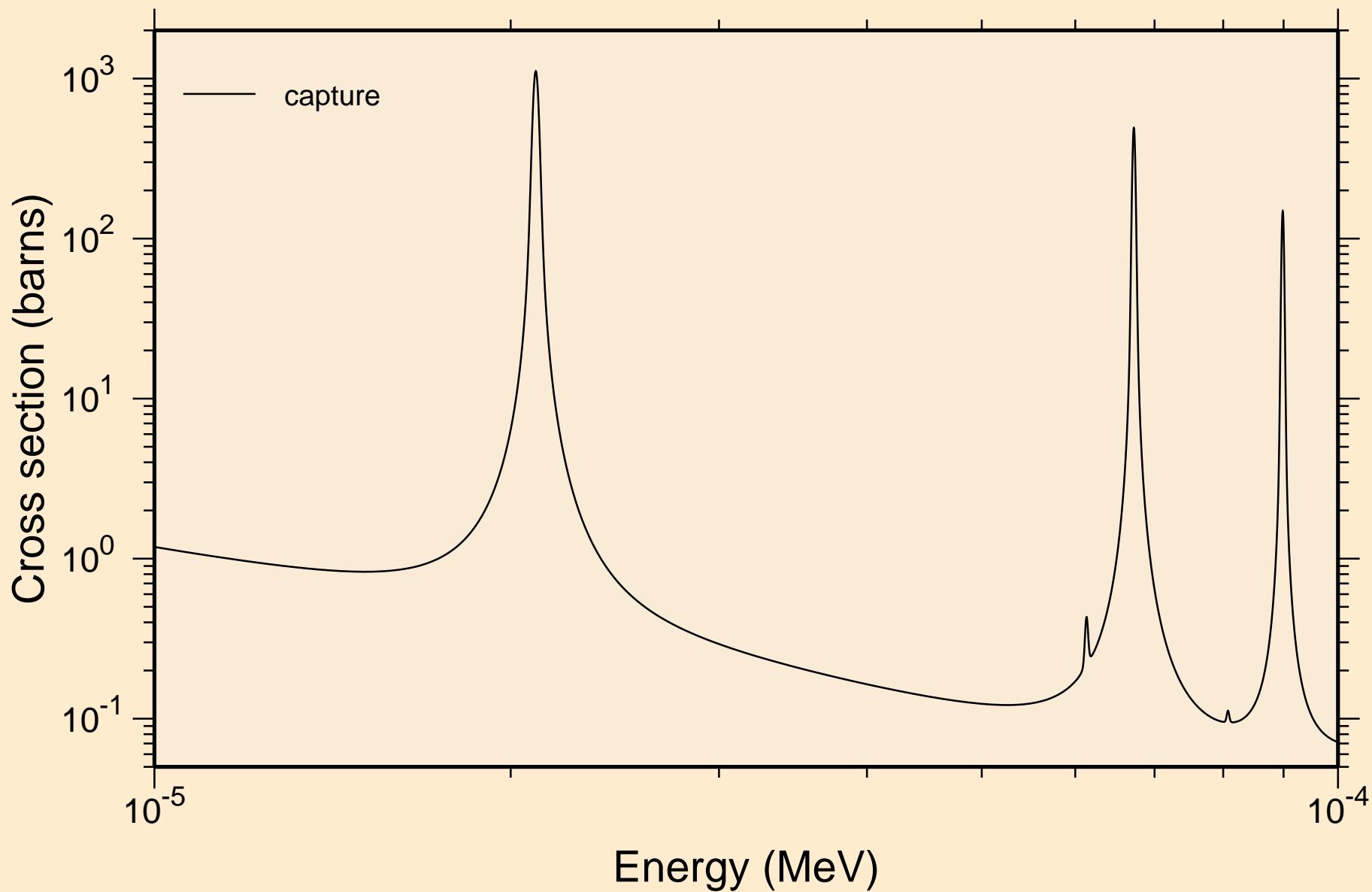

LA138 NEUTRON ACER TENDL-2019 LIBRARY; T=293.16K
resonance absorption cross sections

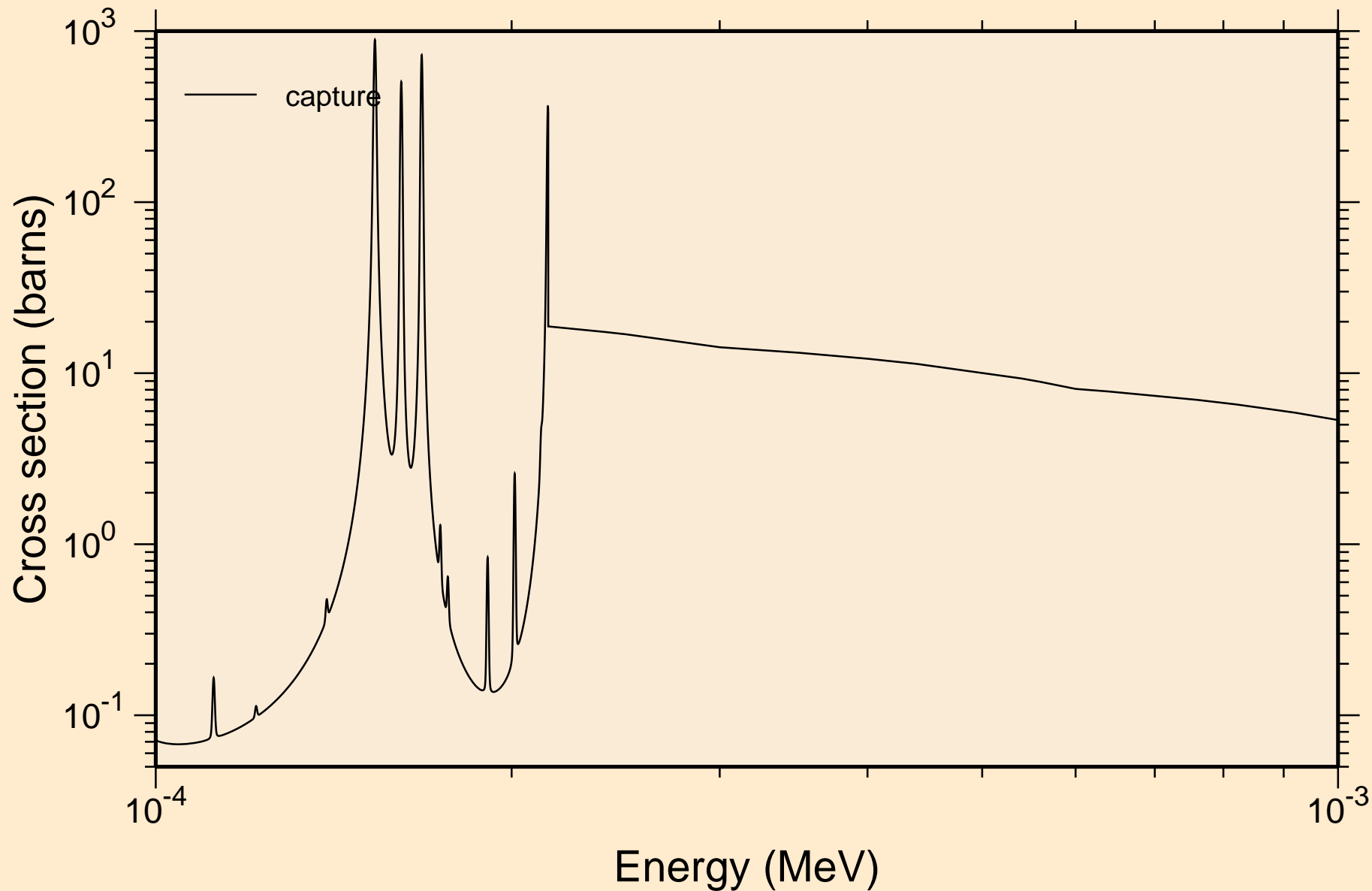

LA138 NEUTRON ACER TENDL-2019 LIBRARY; T=293.16K
resonance absorption cross sections

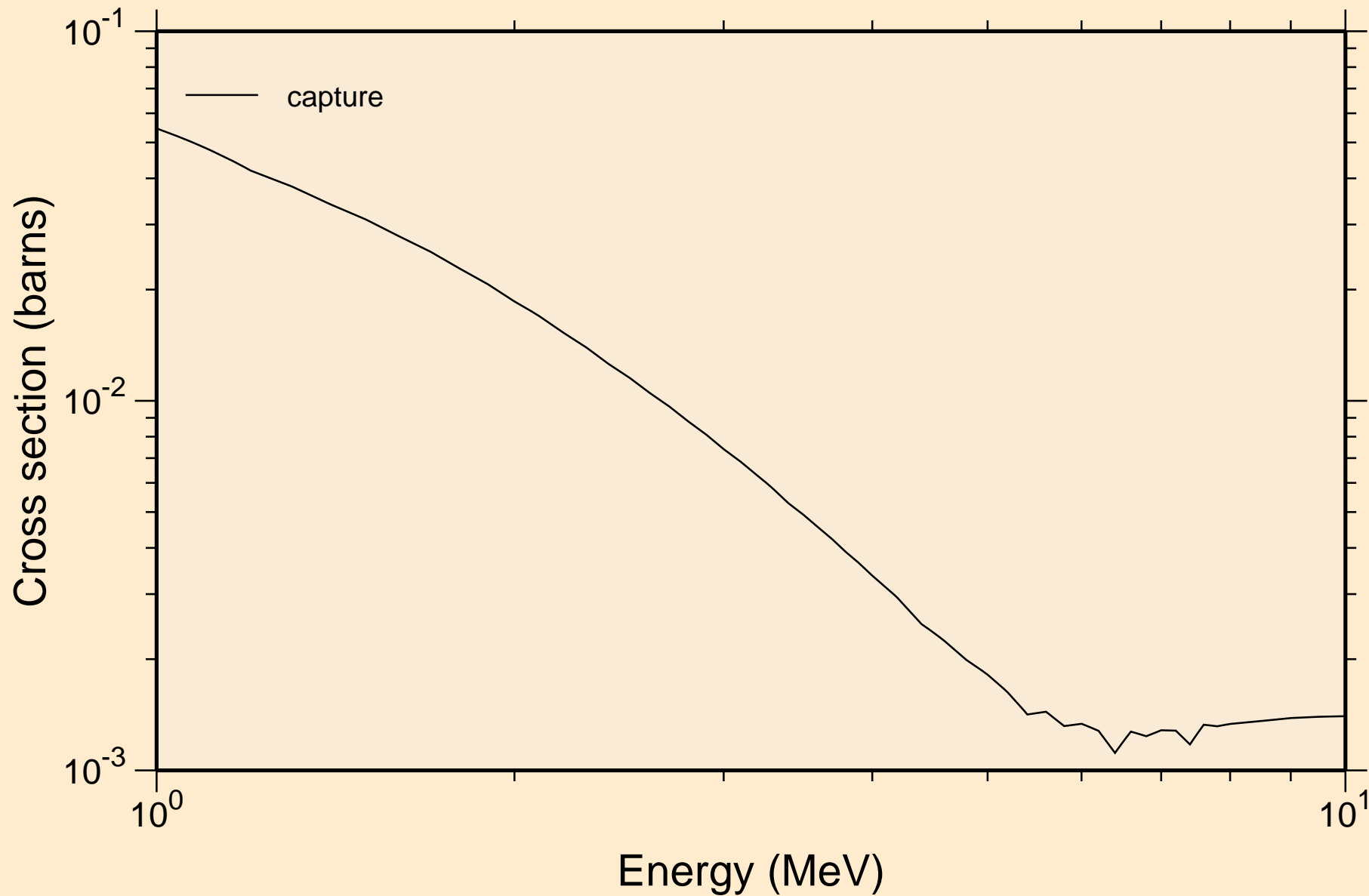

LA138 NEUTRON ACER TENDL-2019 LIBRARY; T=293.16K
Heating

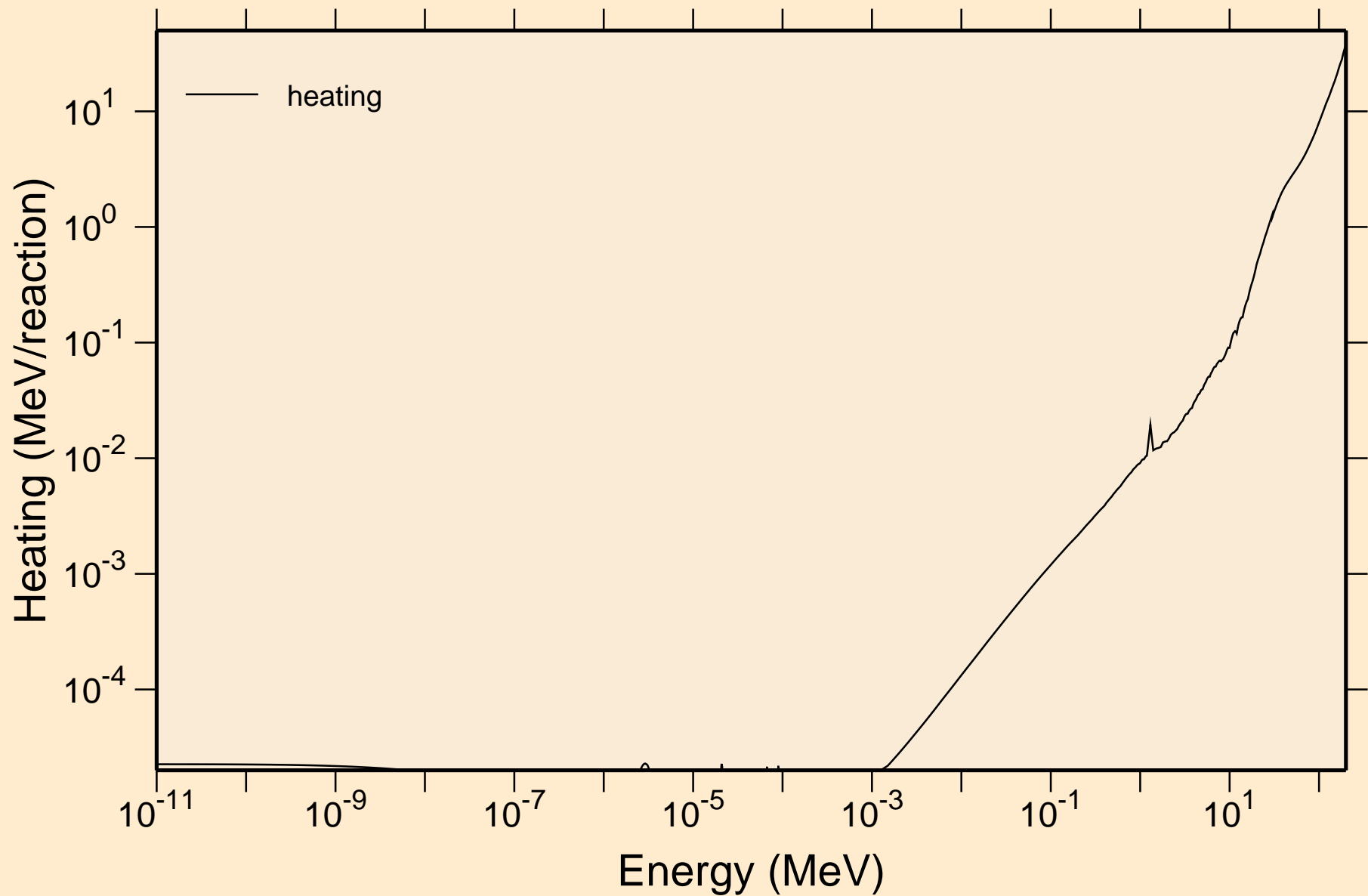

LA138 NEUTRON ACER TENDL-2019 LIBRARY; T=293.16K
Damage

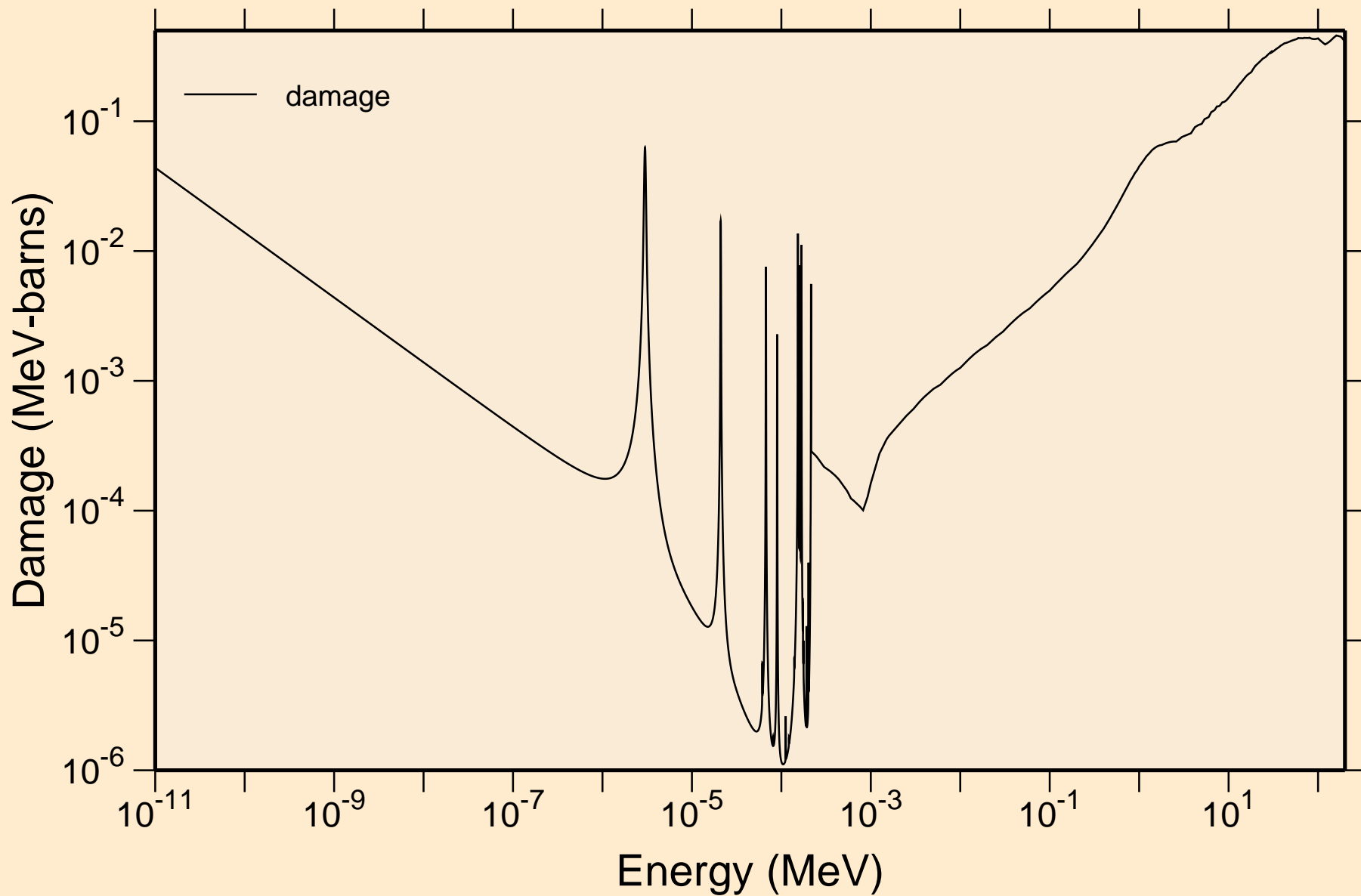

LA138 NEUTRON ACER TENDL-2019 LIBRARY; T=293.16K
Non-threshold reactions

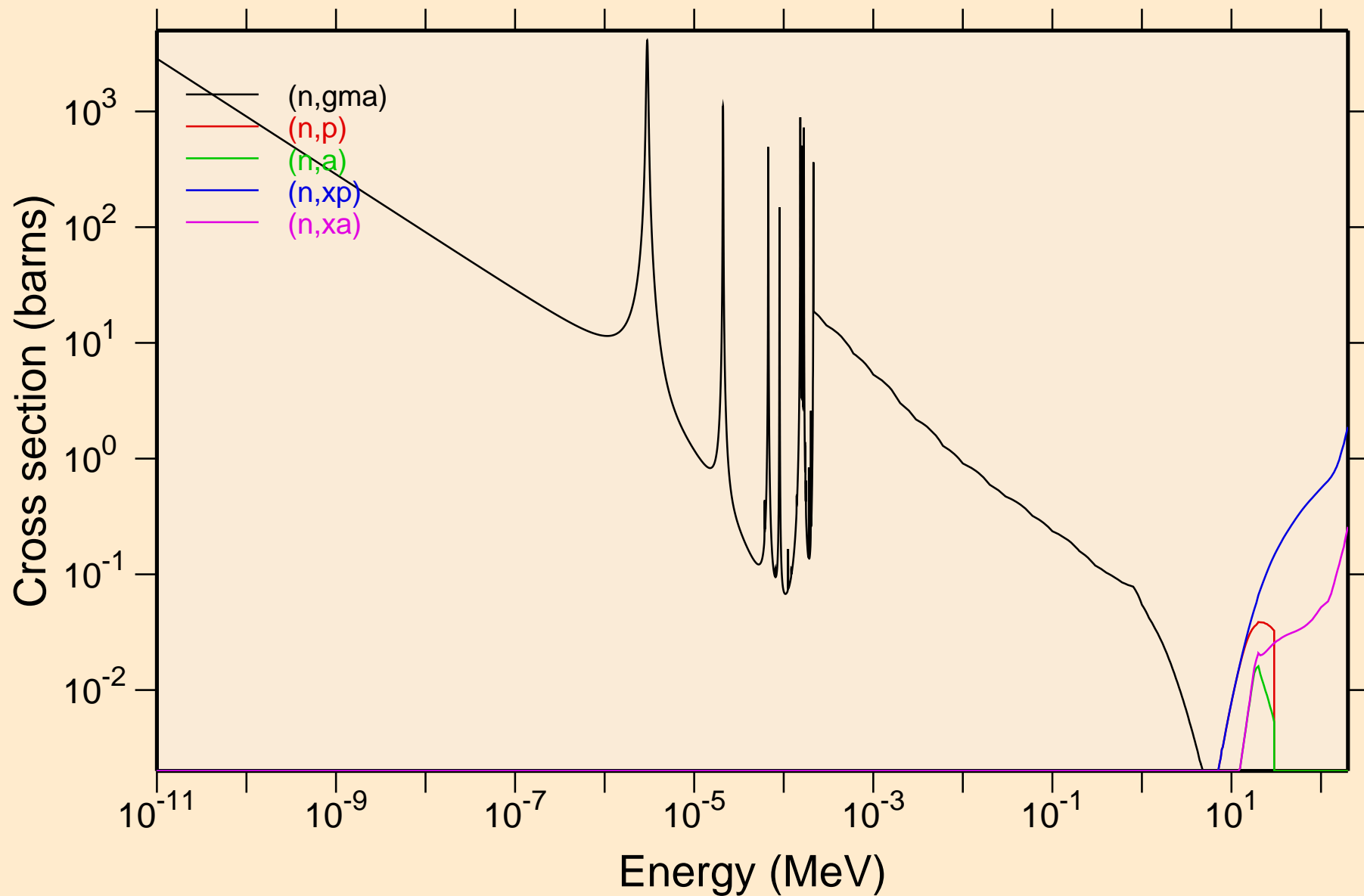

LA138 NEUTRON ACER TENDL-2019 LIBRARY; T=293.16K
Principal cross sections

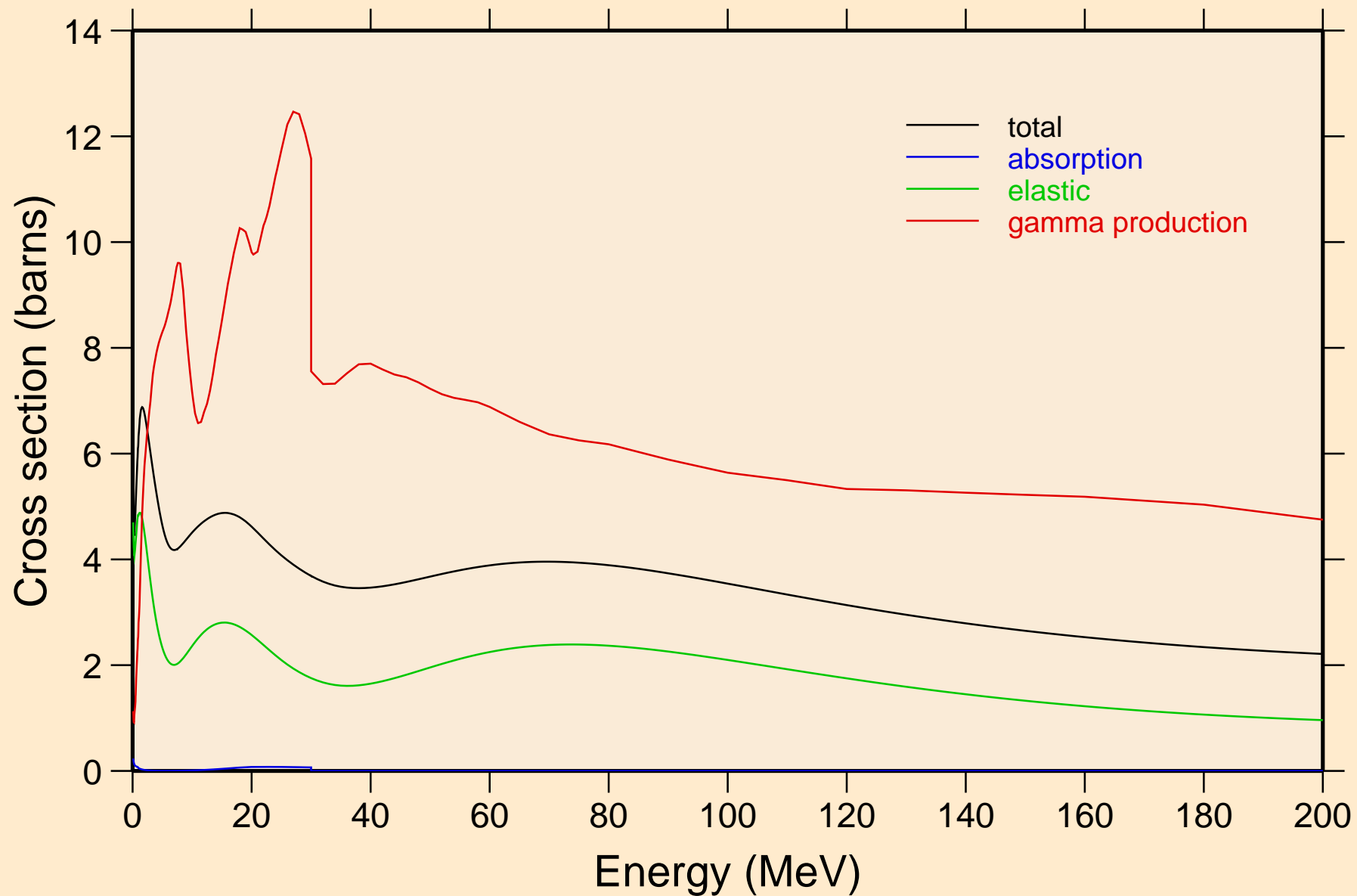

LA138 NEUTRON ACER TENDL-2019 LIBRARY; T=293.16K
Heating

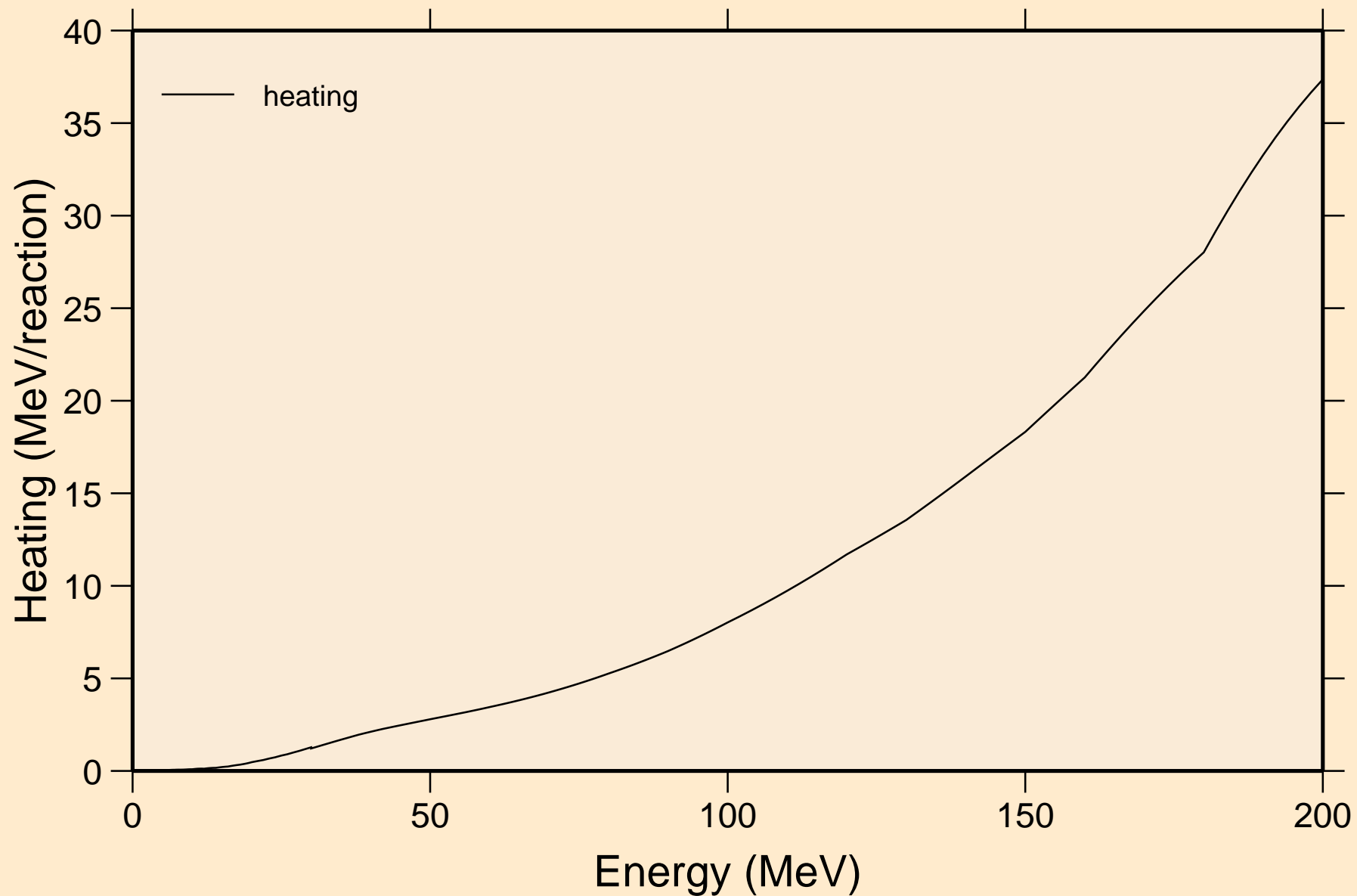

LA138 NEUTRON ACER TENDL-2019 LIBRARY; T=293.16K
Damage

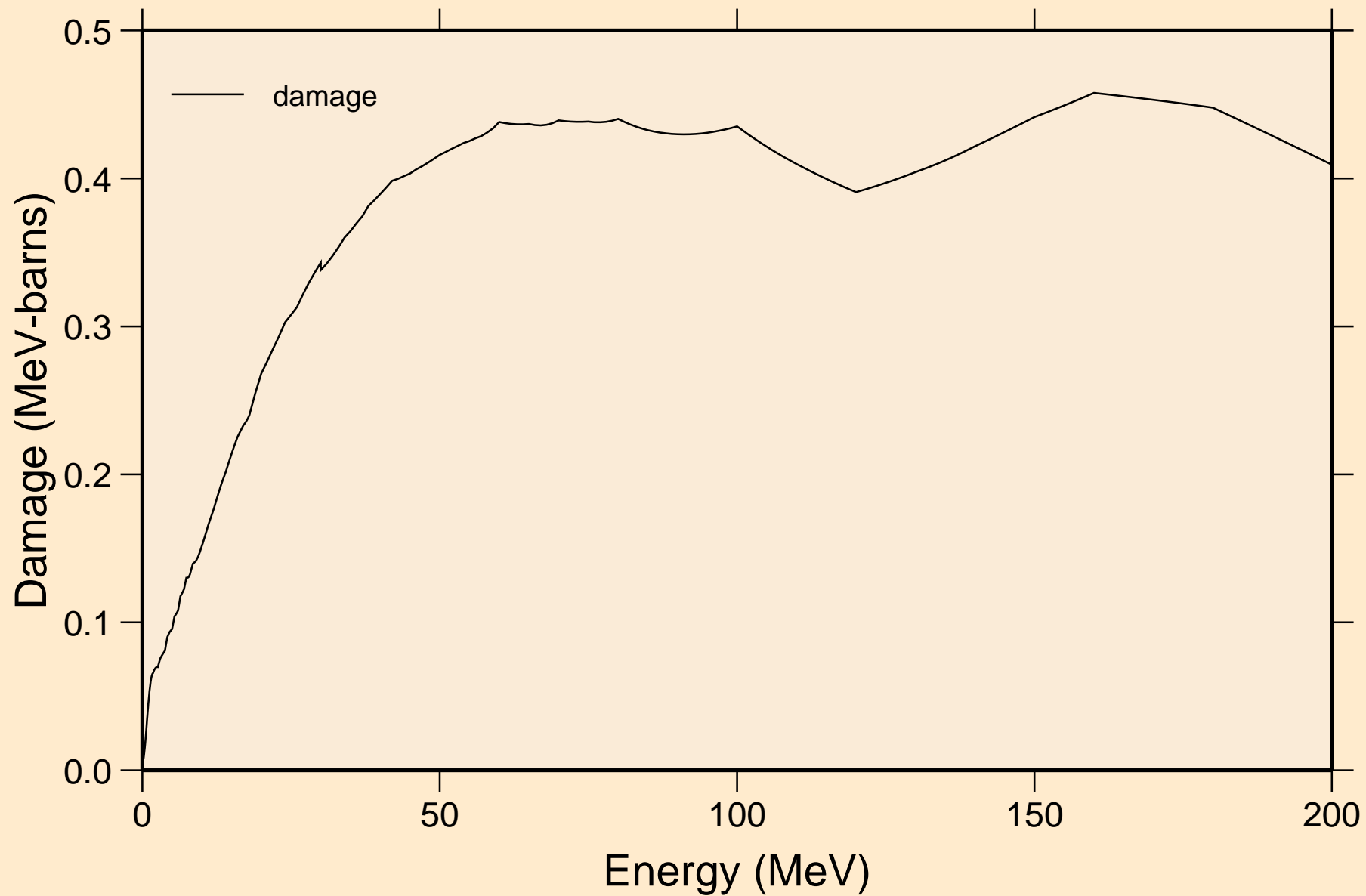

LA138 NEUTRON ACER TENDL-2019 LIBRARY; T=293.16K
Non-threshold reactions

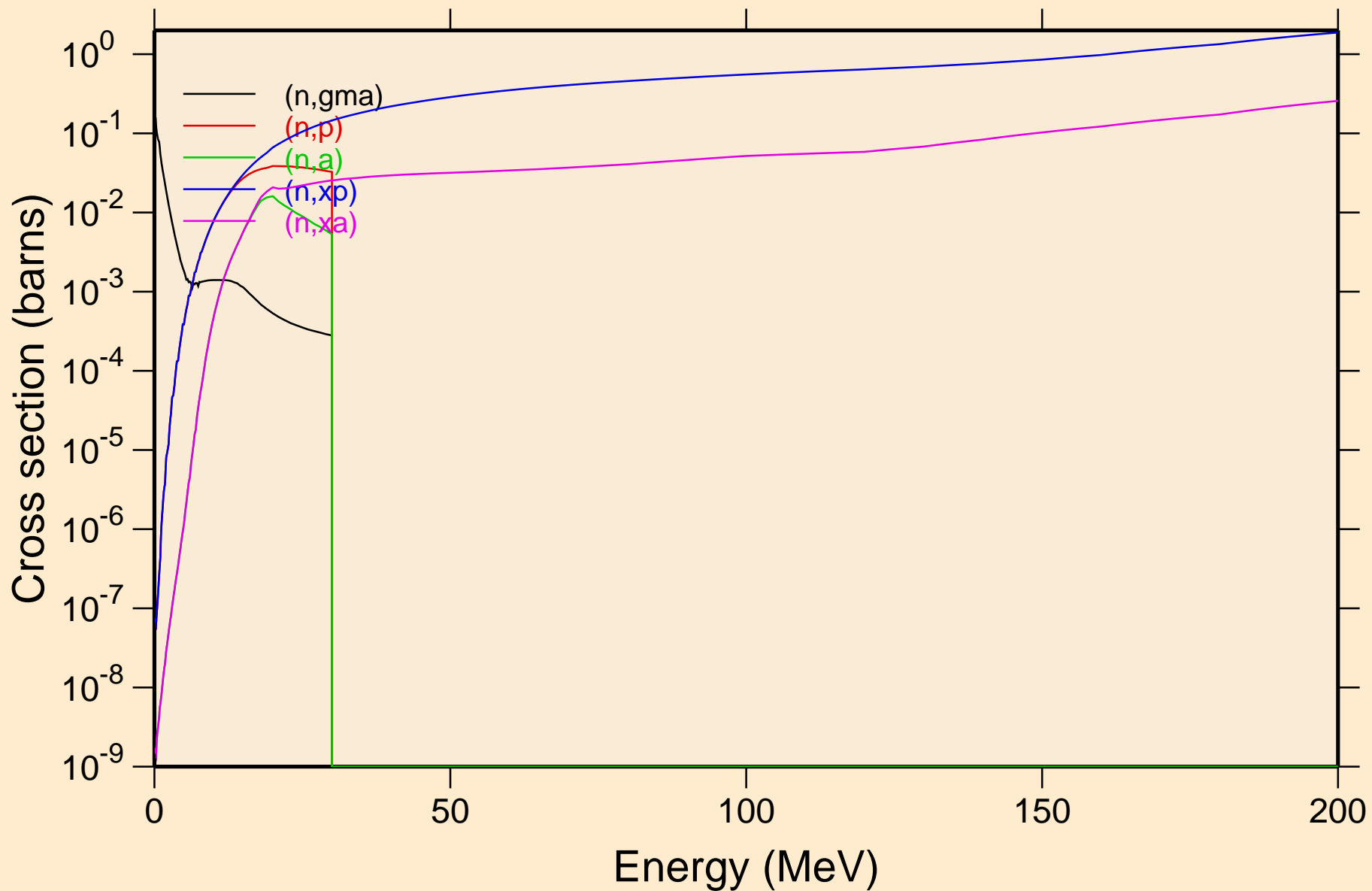

LA138 NEUTRON ACER TENDL-2019 LIBRARY; T=293.16K
Inelastic levels

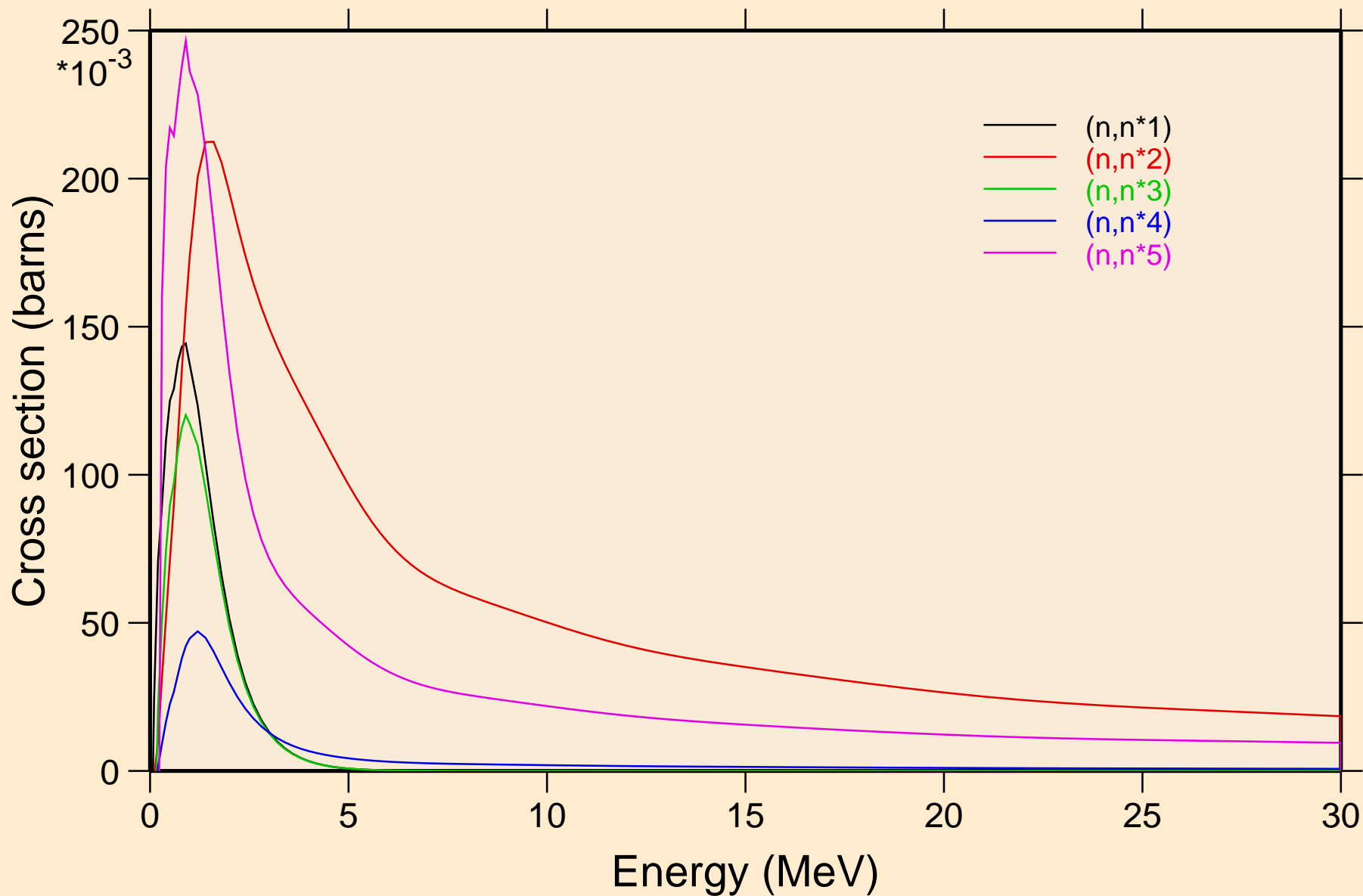

LA138 NEUTRON ACER TENDL-2019 LIBRARY; T=293.16K
Inelastic levels

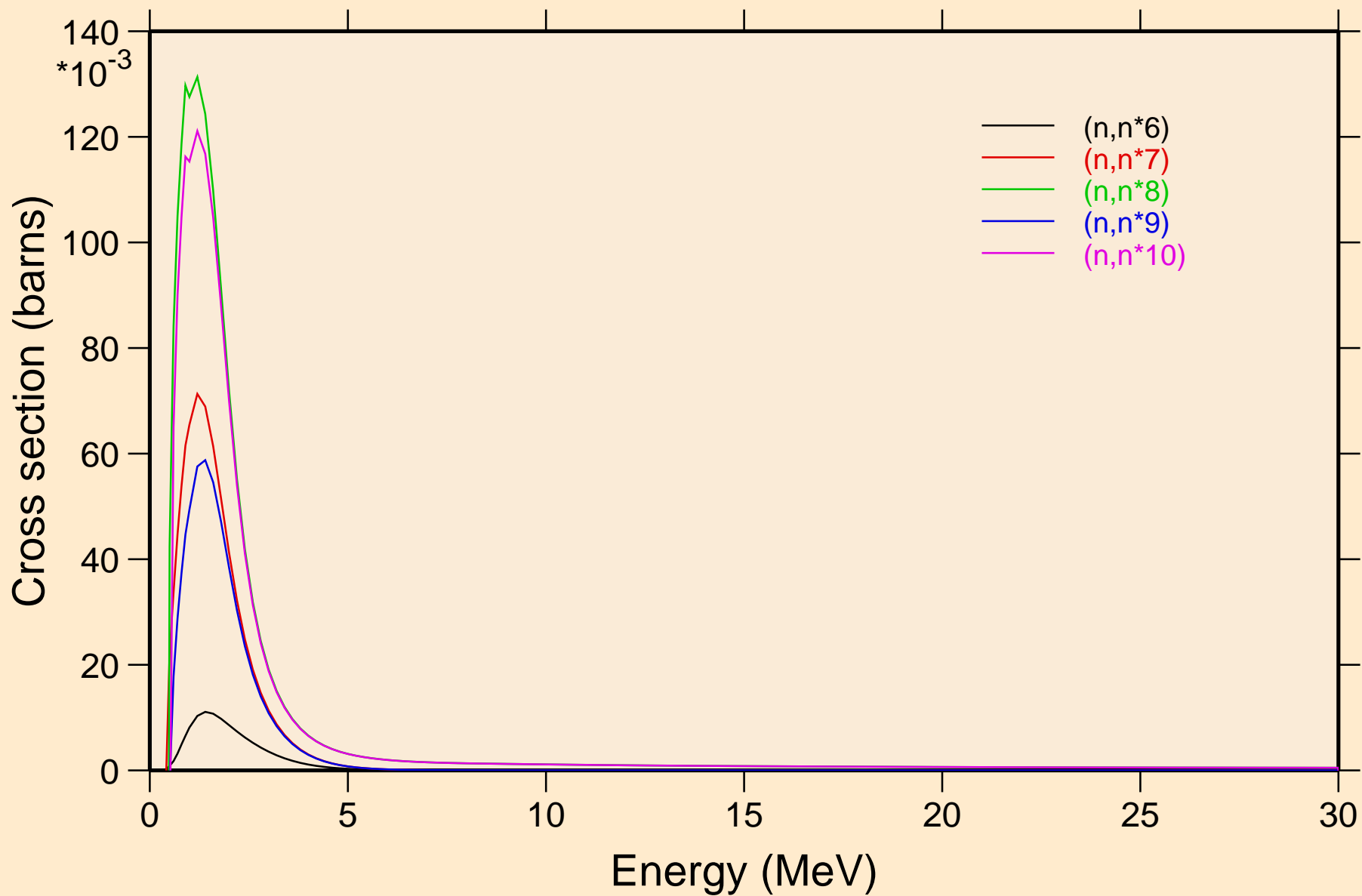

LA138 NEUTRON ACER TENDL-2019 LIBRARY; T=293.16K
Inelastic levels

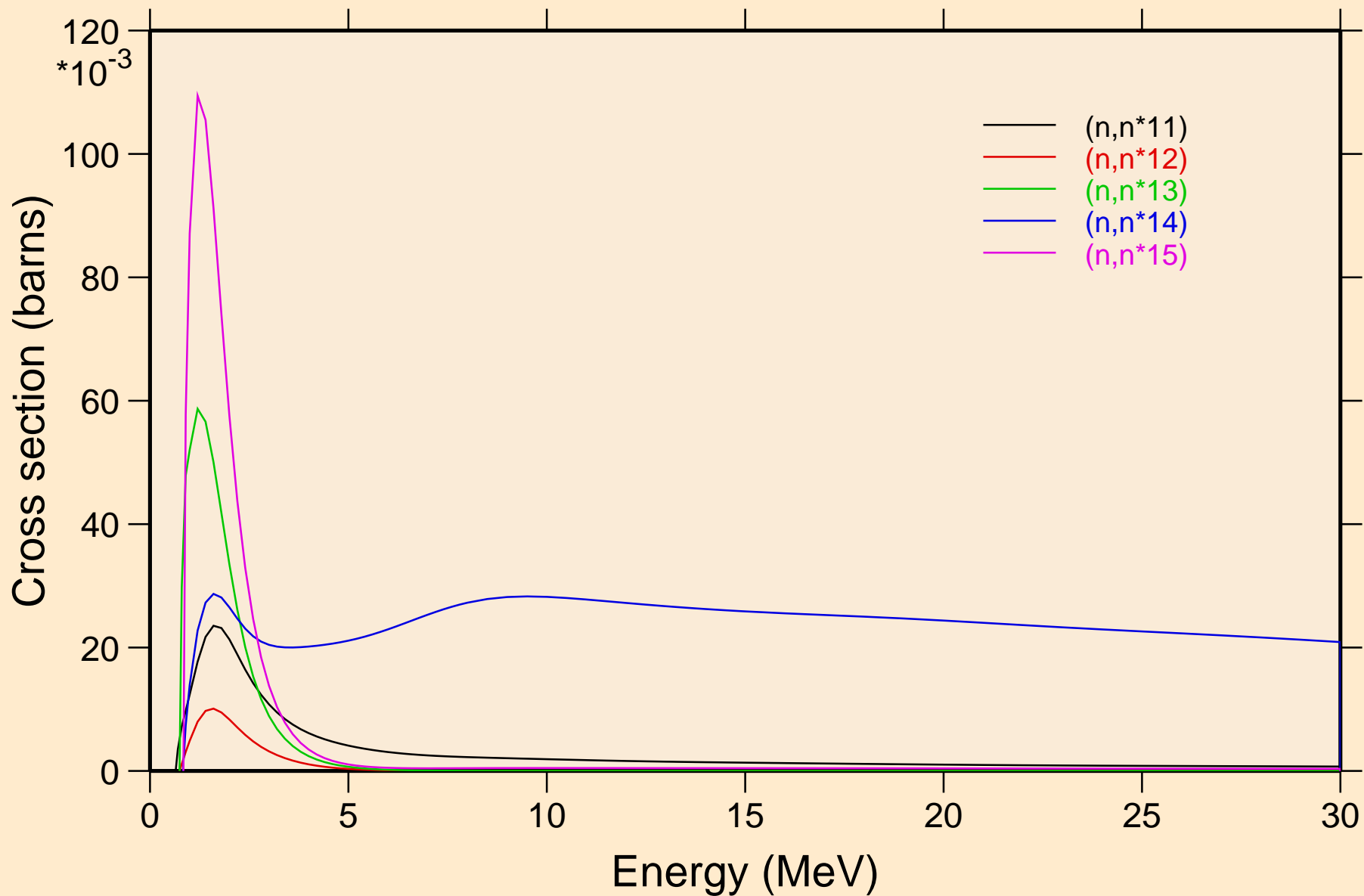

LA138 NEUTRON ACER TENDL-2019 LIBRARY; T=293.16K
Inelastic levels

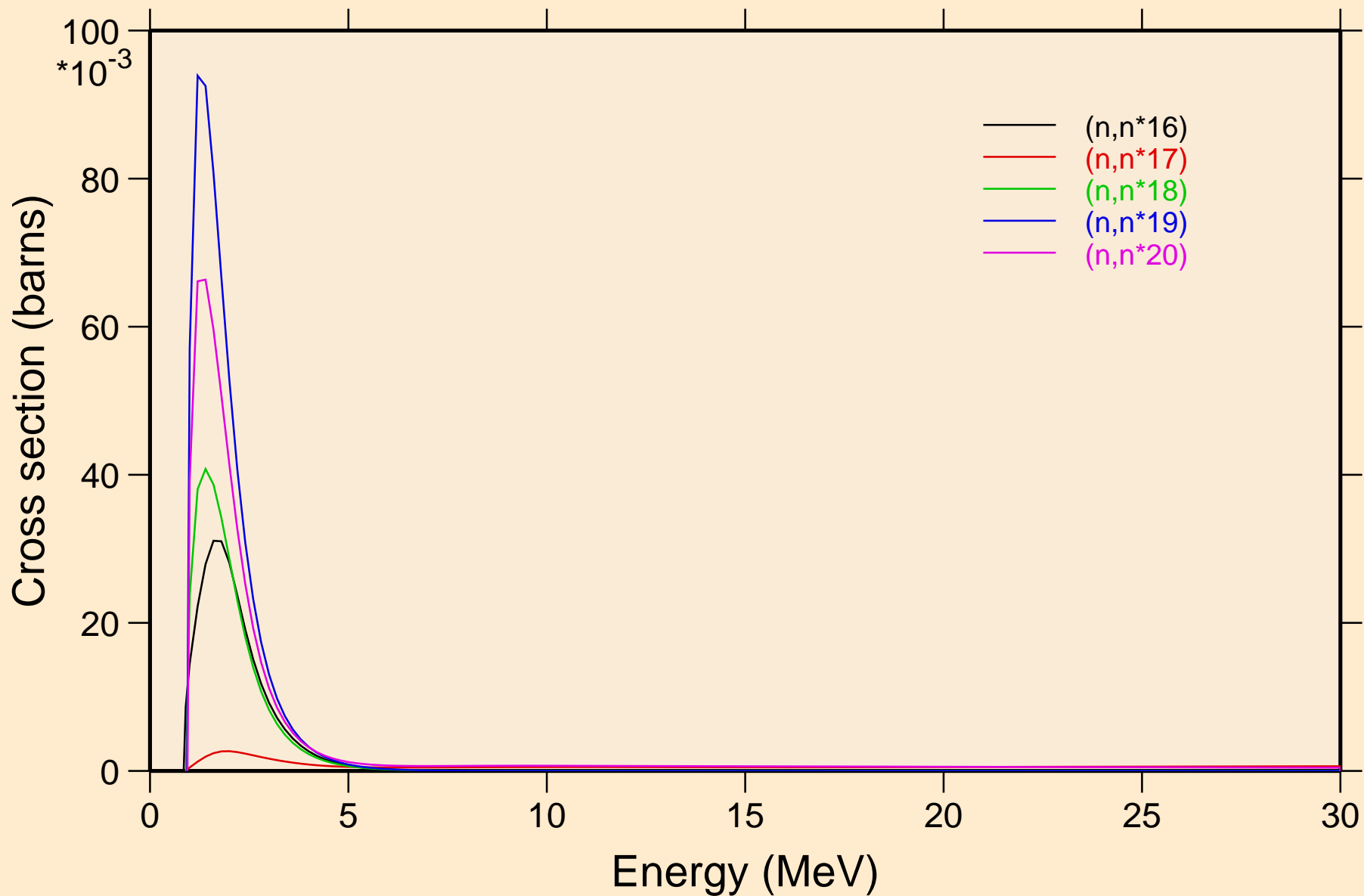

LA138 NEUTRON ACER TENDL-2019 LIBRARY; T=293.16K
Inelastic levels

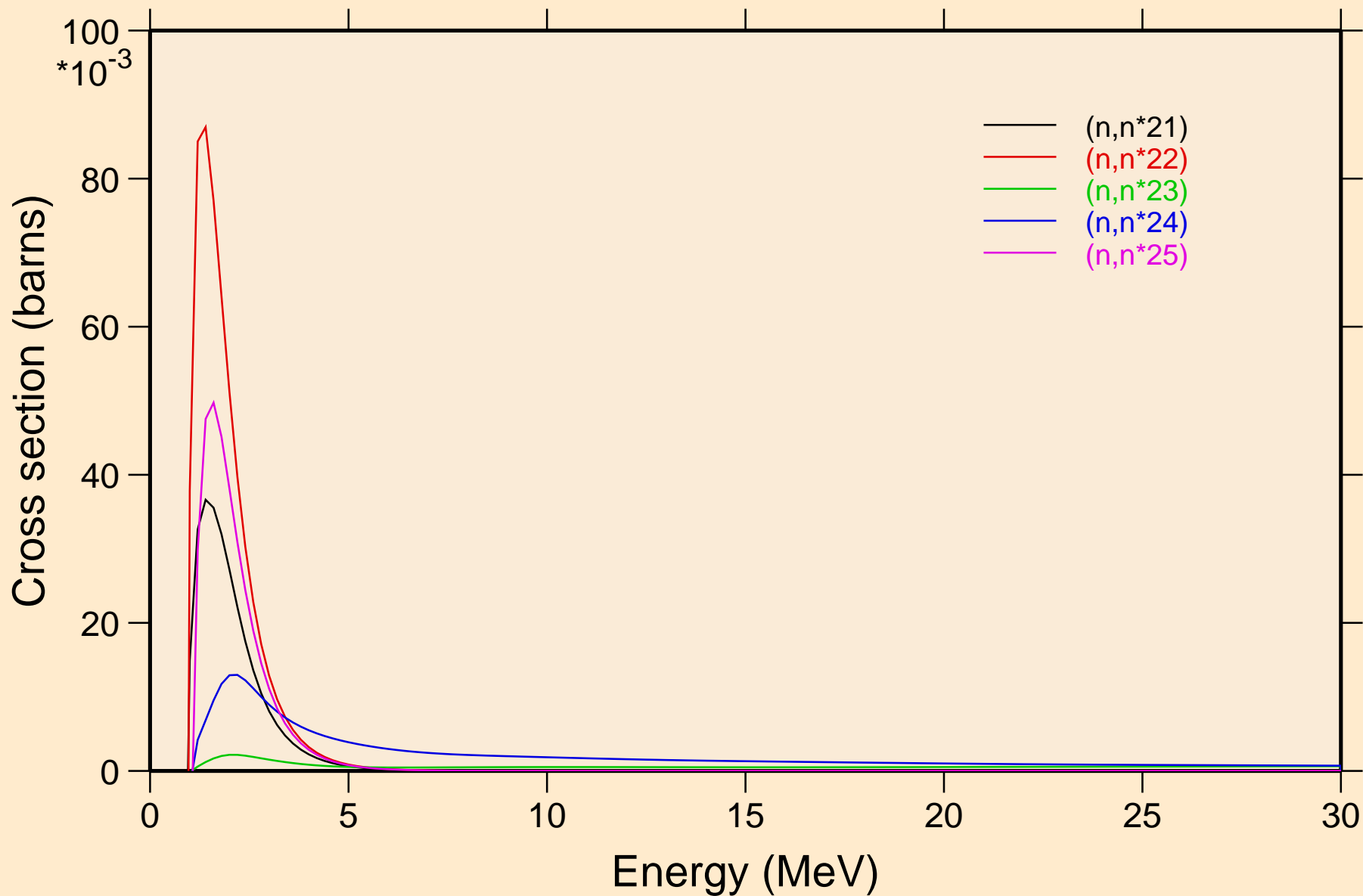

LA138 NEUTRON ACER TENDL-2019 LIBRARY; T=293.16K
Inelastic levels

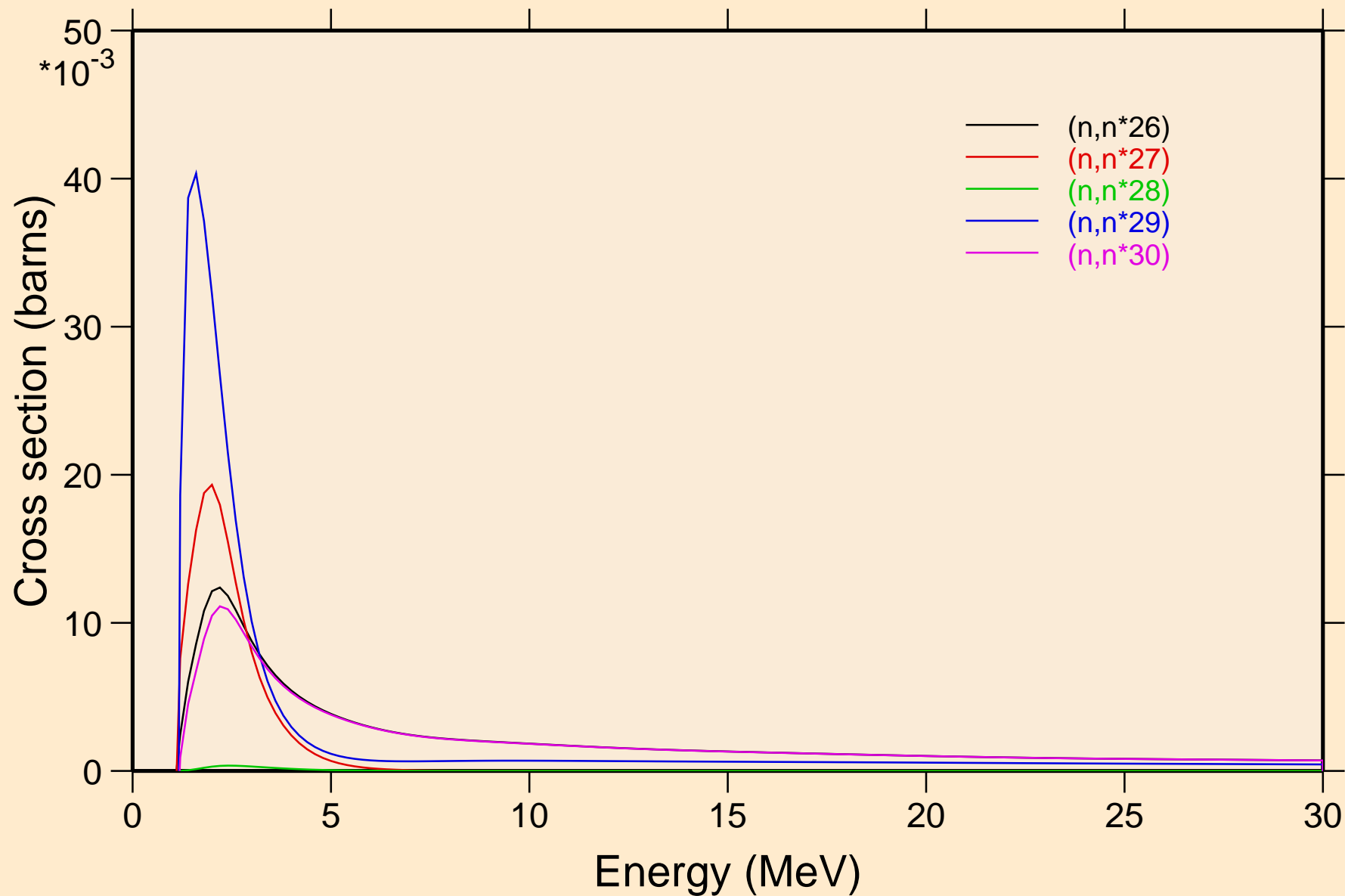

LA138 NEUTRON ACER TENDL-2019 LIBRARY; T=293.16K
Threshold reactions

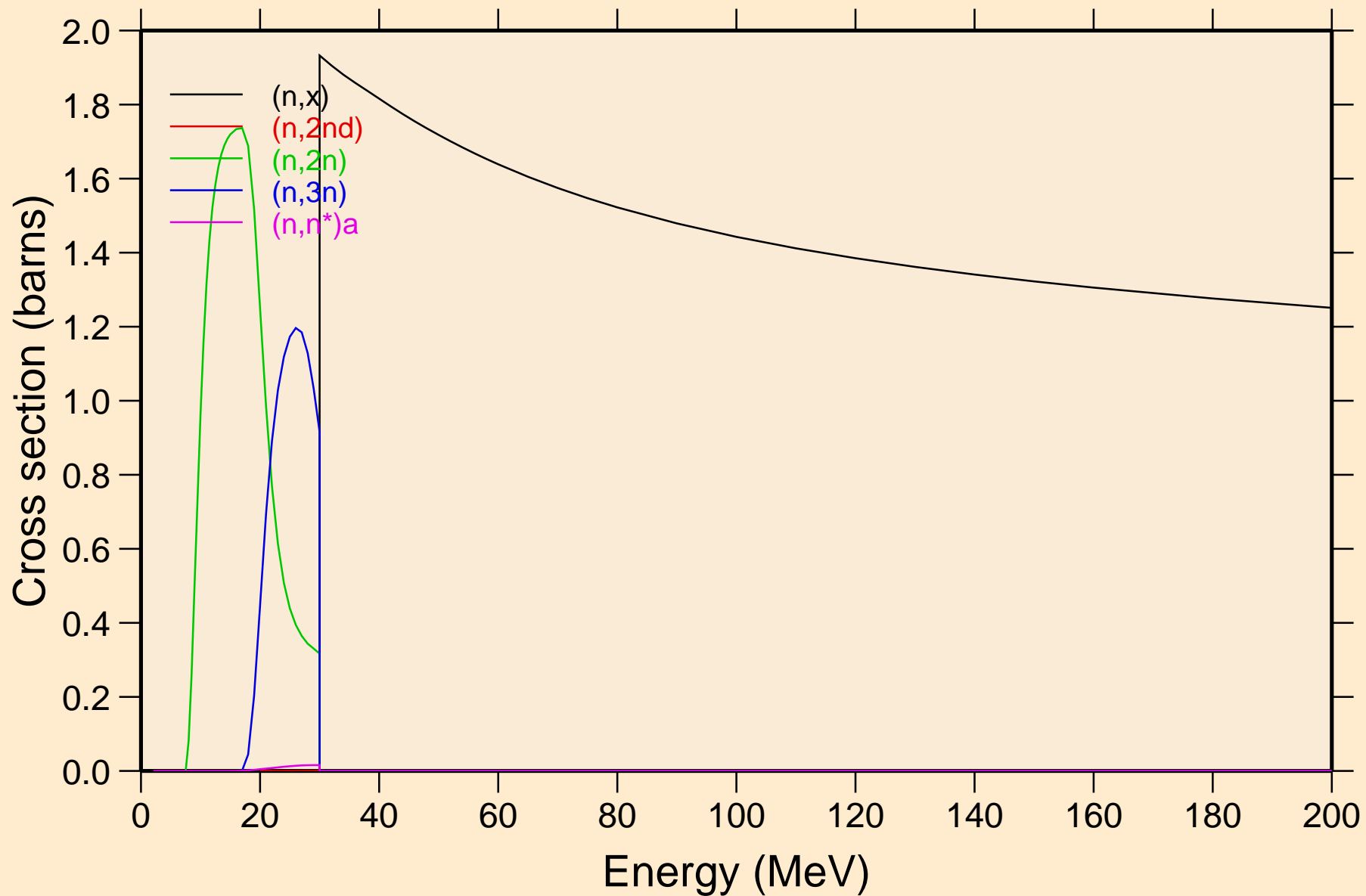

LA138 NEUTRON ACER TENDL-2019 LIBRARY; T=293.16K
Threshold reactions

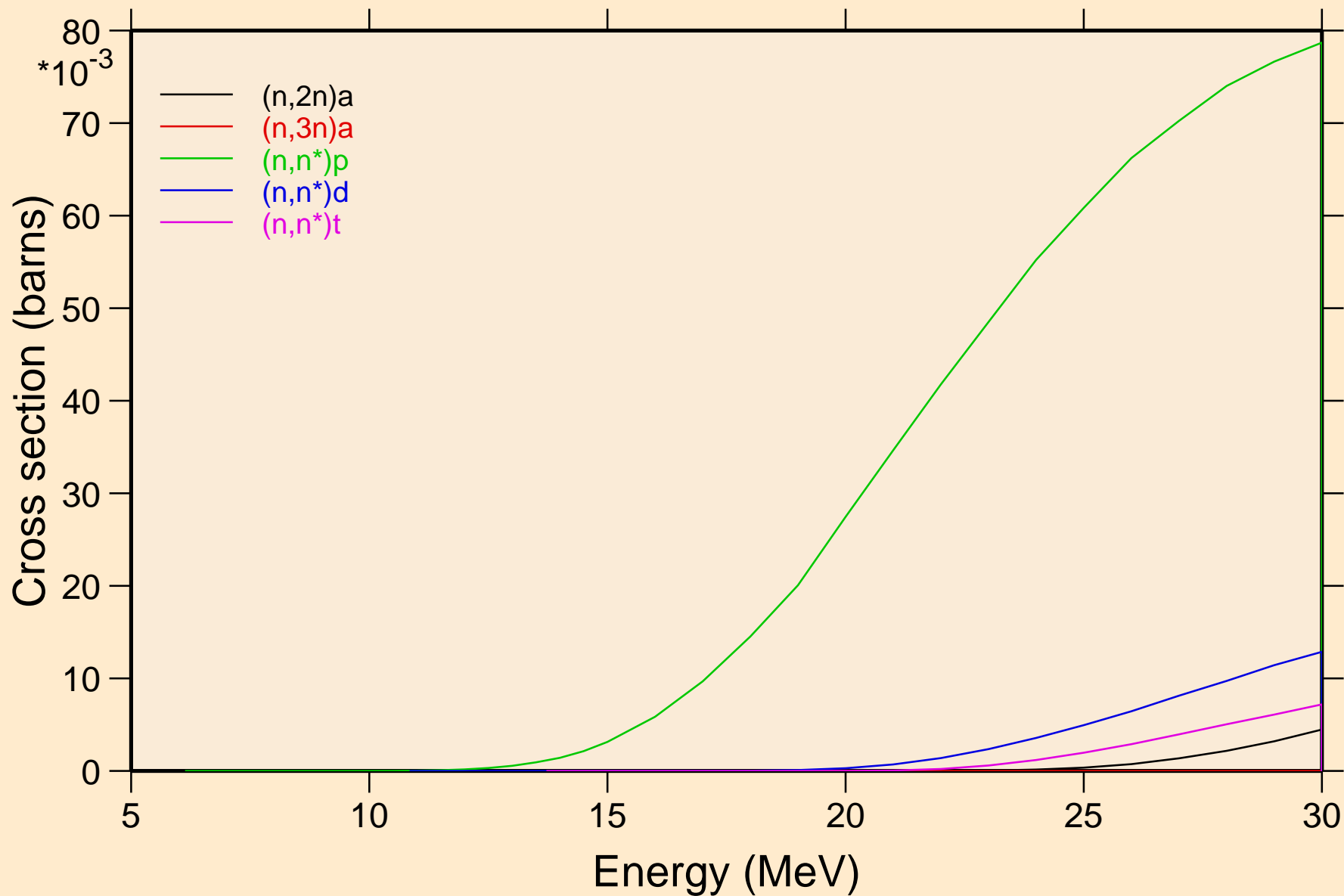

LA138 NEUTRON ACER TENDL-2019 LIBRARY; T=293.16K
Threshold reactions

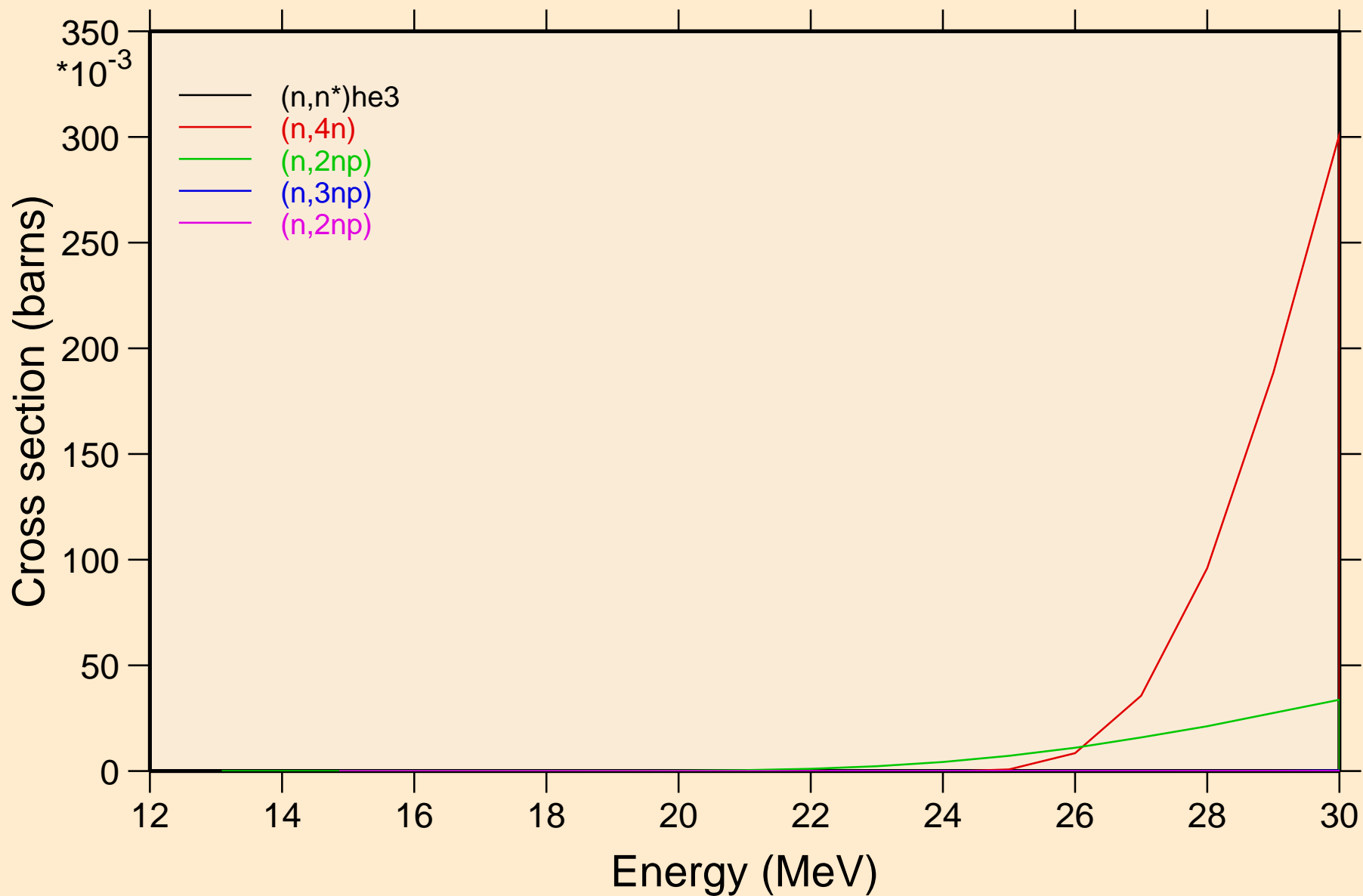

LA138 NEUTRON ACER TENDL-2019 LIBRARY; T=293.16K
Threshold reactions

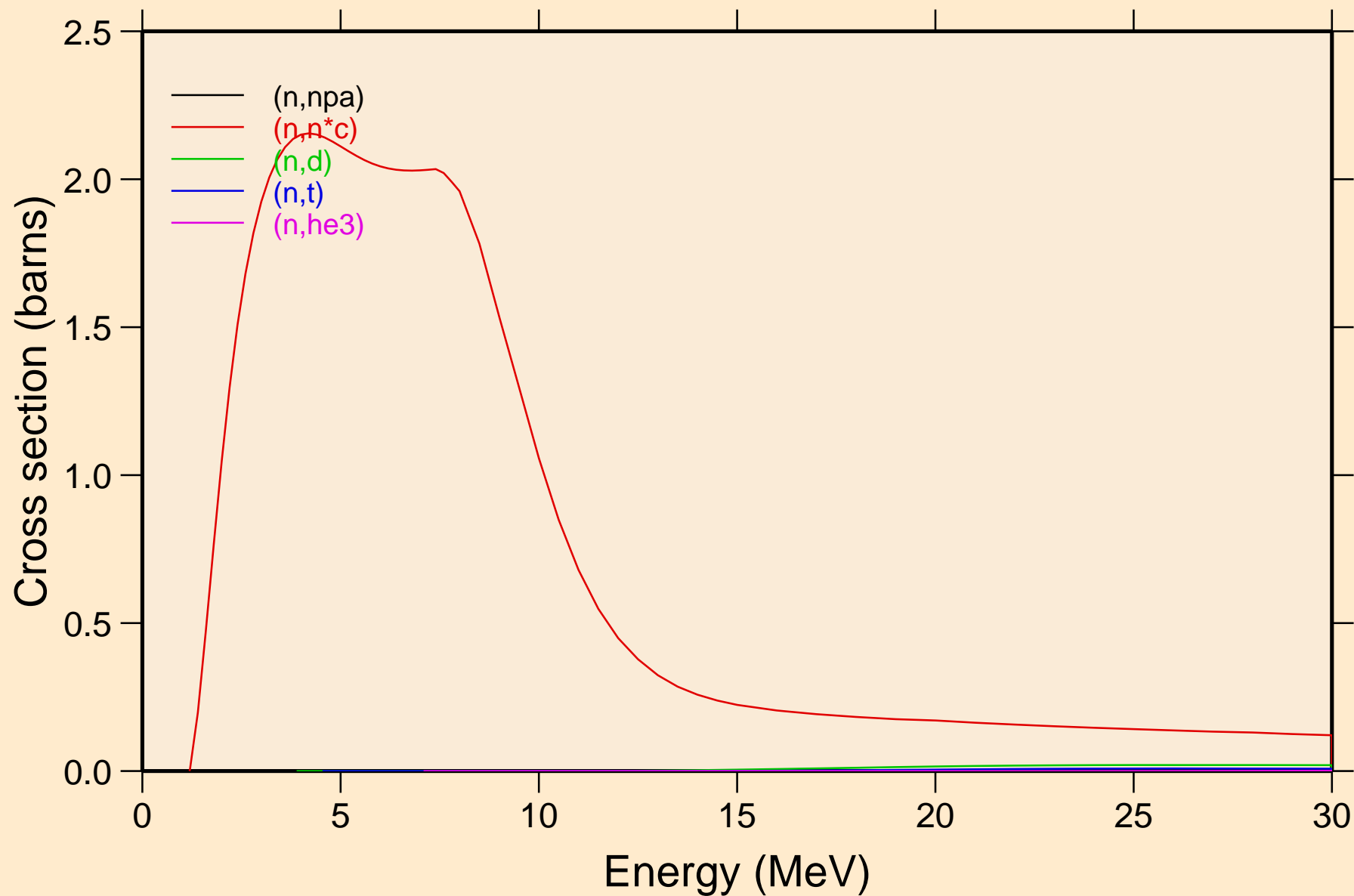

LA138 NEUTRON ACER TENDL-2019 LIBRARY; T=293.16K
Threshold reactions

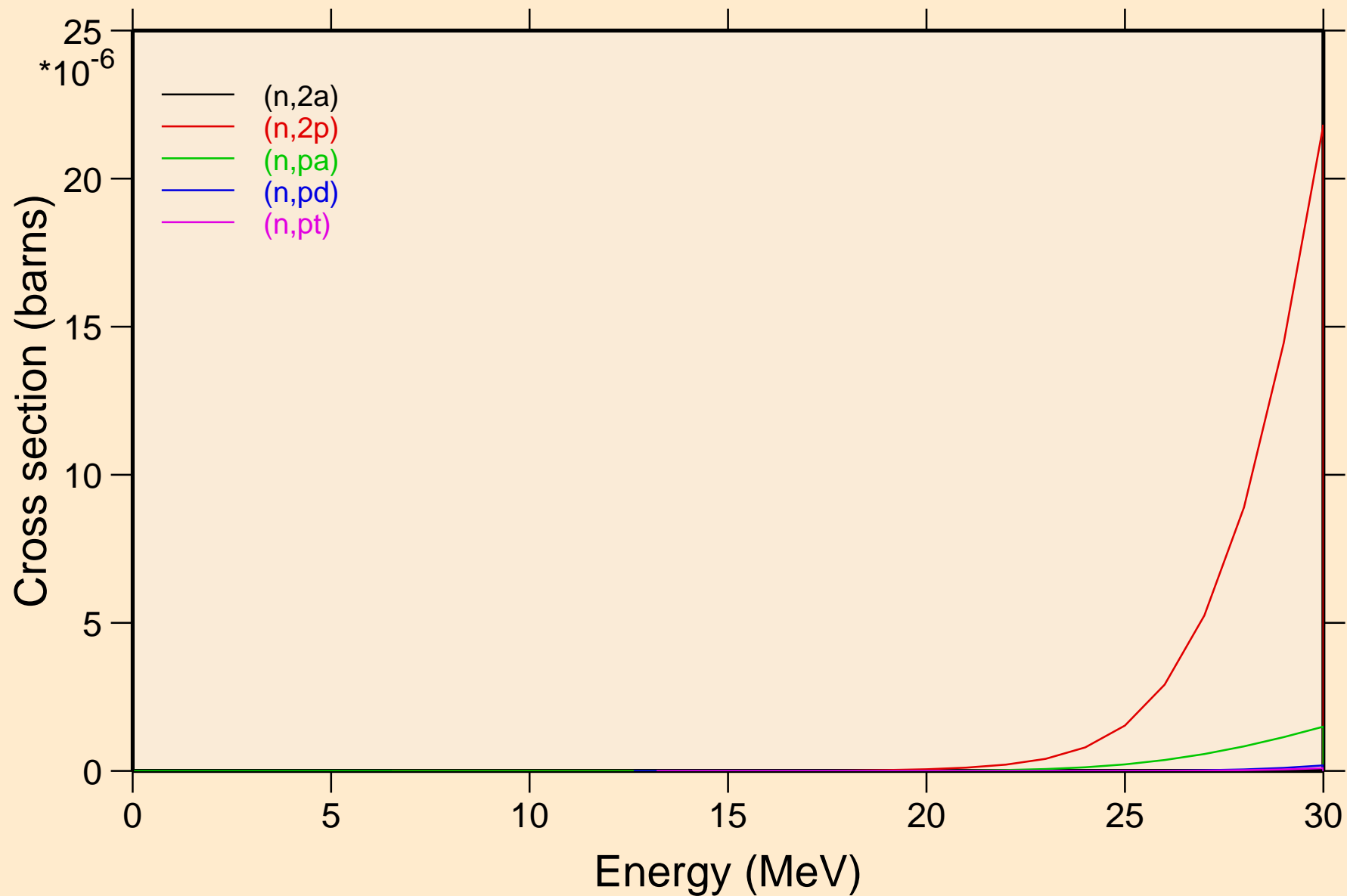

LA138 NEUTRON ACER TENDL-2019 LIBRARY; T=293.16K
Threshold reactions

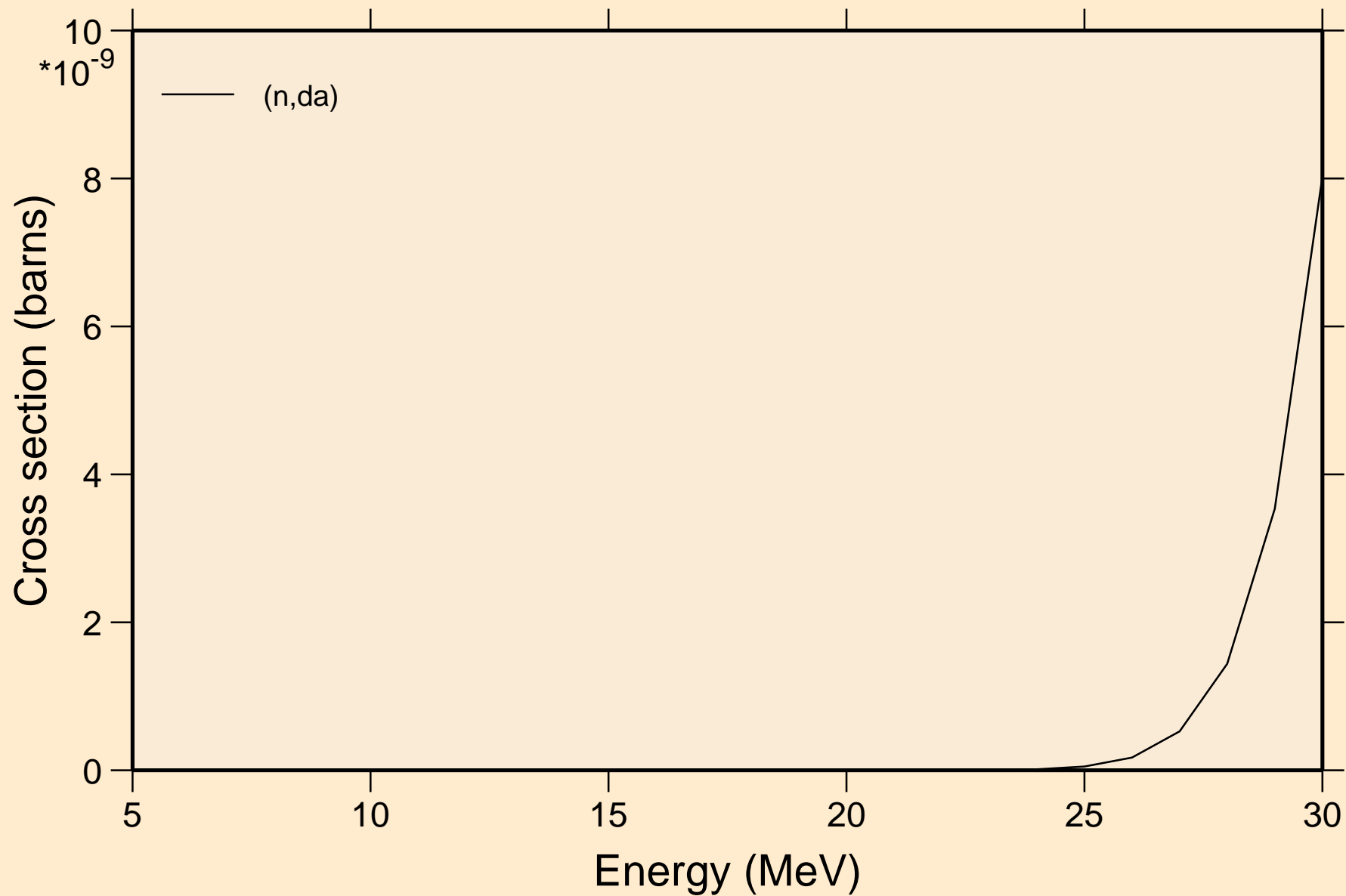

LA138 NEUTRON ACER TENDL-2019 LIBRARY; T=293.16K
Threshold reactions

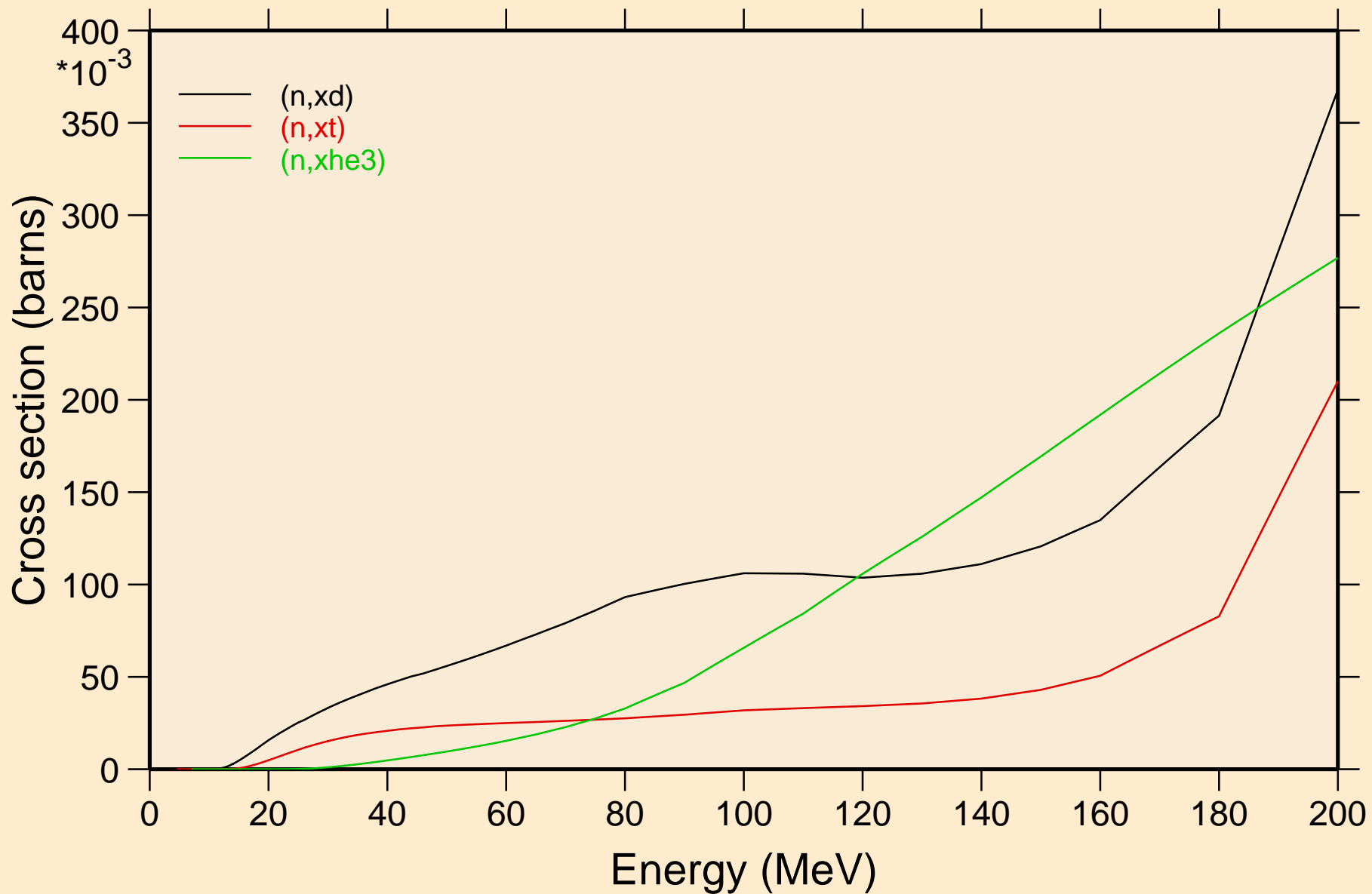

LA138 NEUTRON ACER TENDL-2019 LIBRARY; T=293.16K
angular distribution for elastic

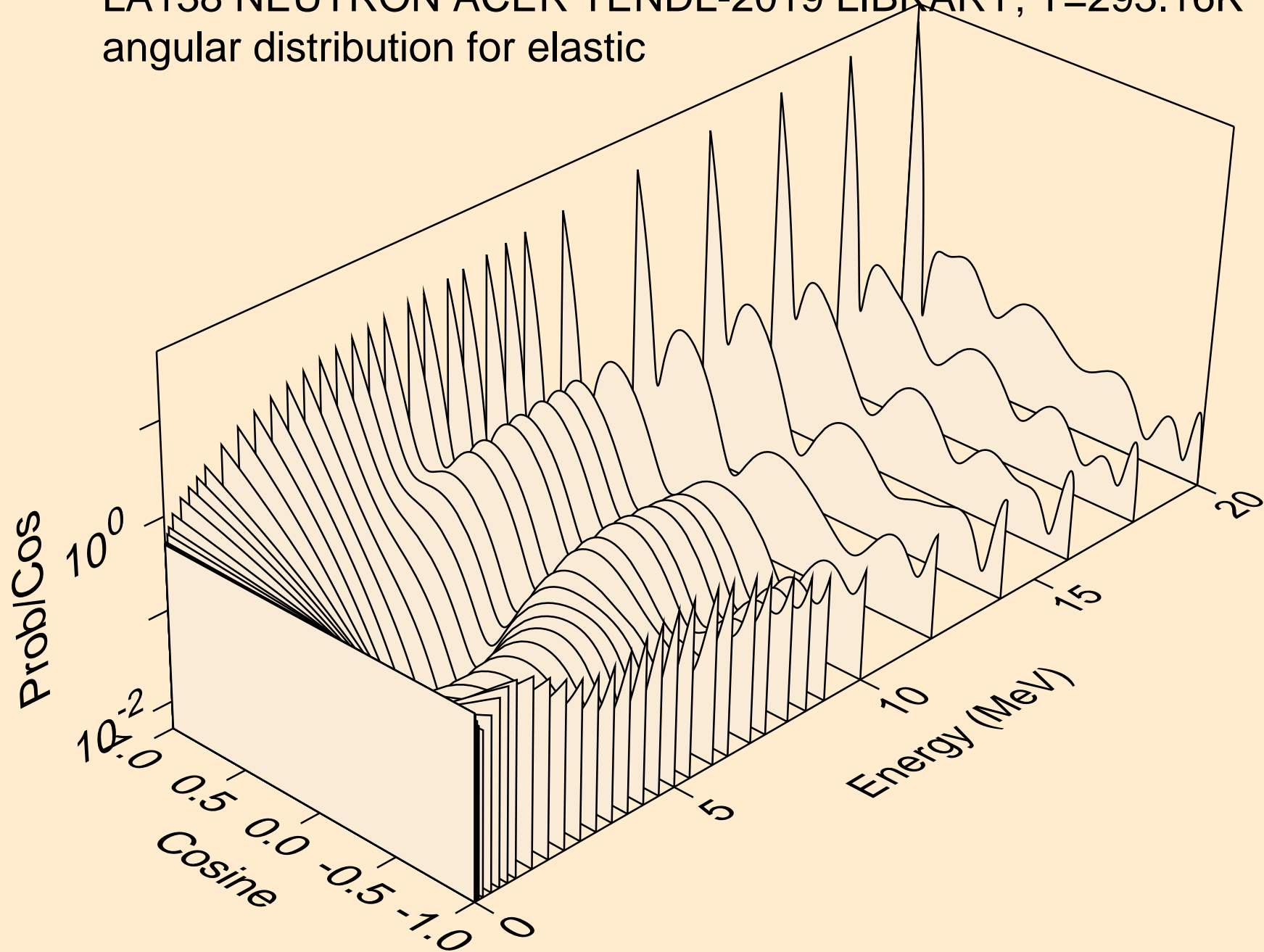

LA138 NEUTRON ACER TENDL-2019 LIBRARY; T=293.16K
angular distribution for elastic

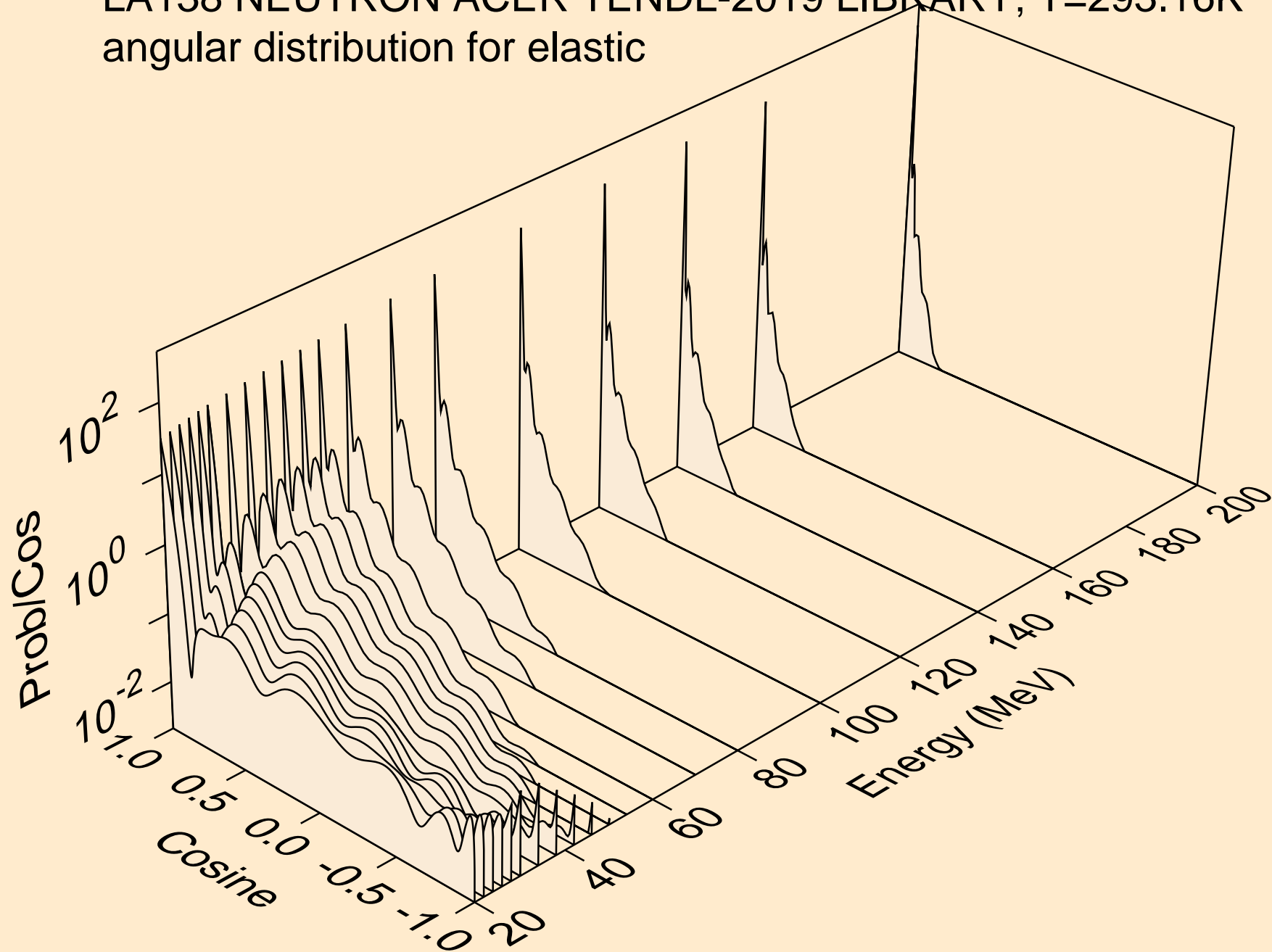

LA138 NEUTRON ACER TENDL-2019 LIBRARY; T=293.16K
angular distribution for (n,n*1)

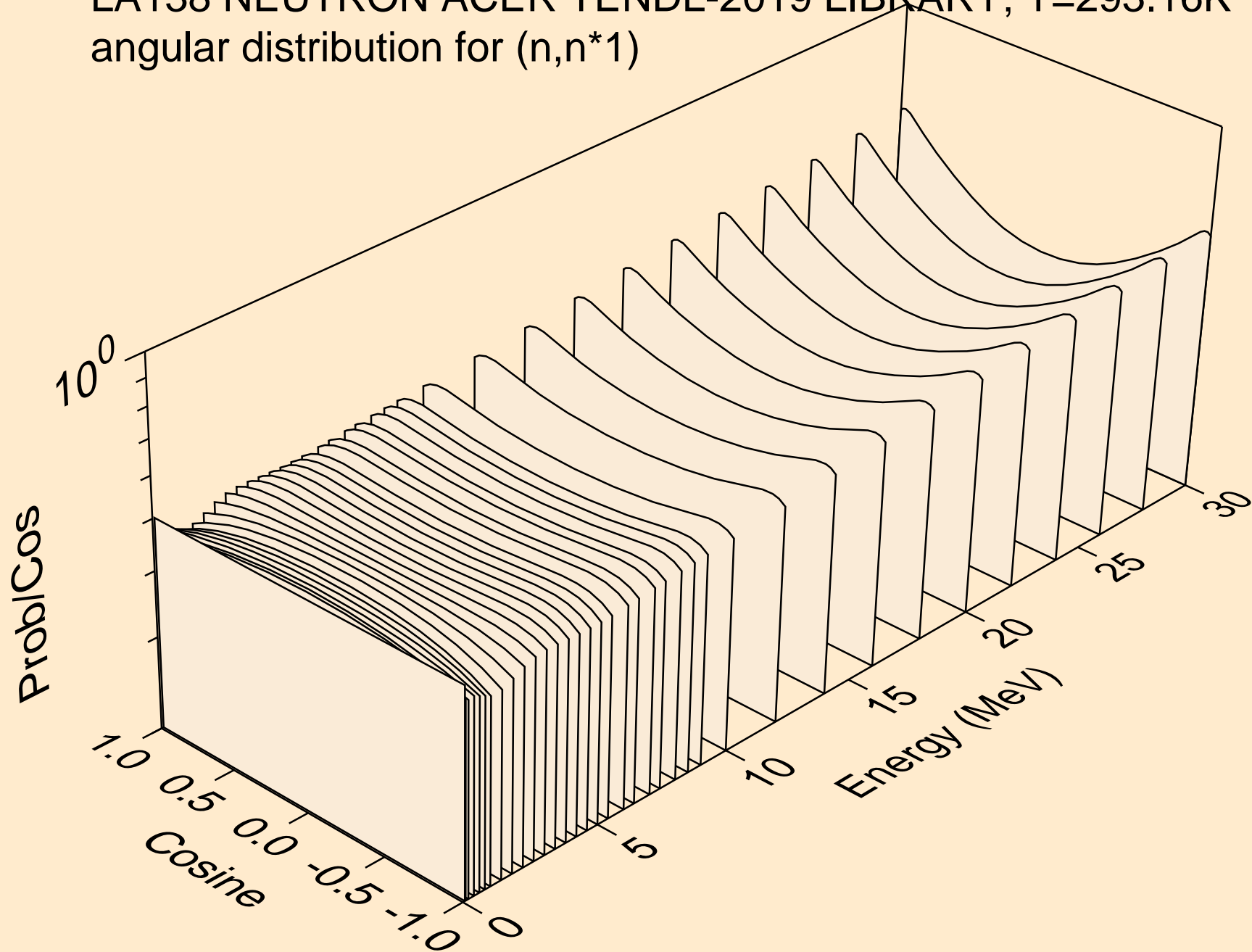

LA138 NEUTRON ACER TENDL-2019 LIBRARY; T=293.16K
angular distribution for (n,n*2)

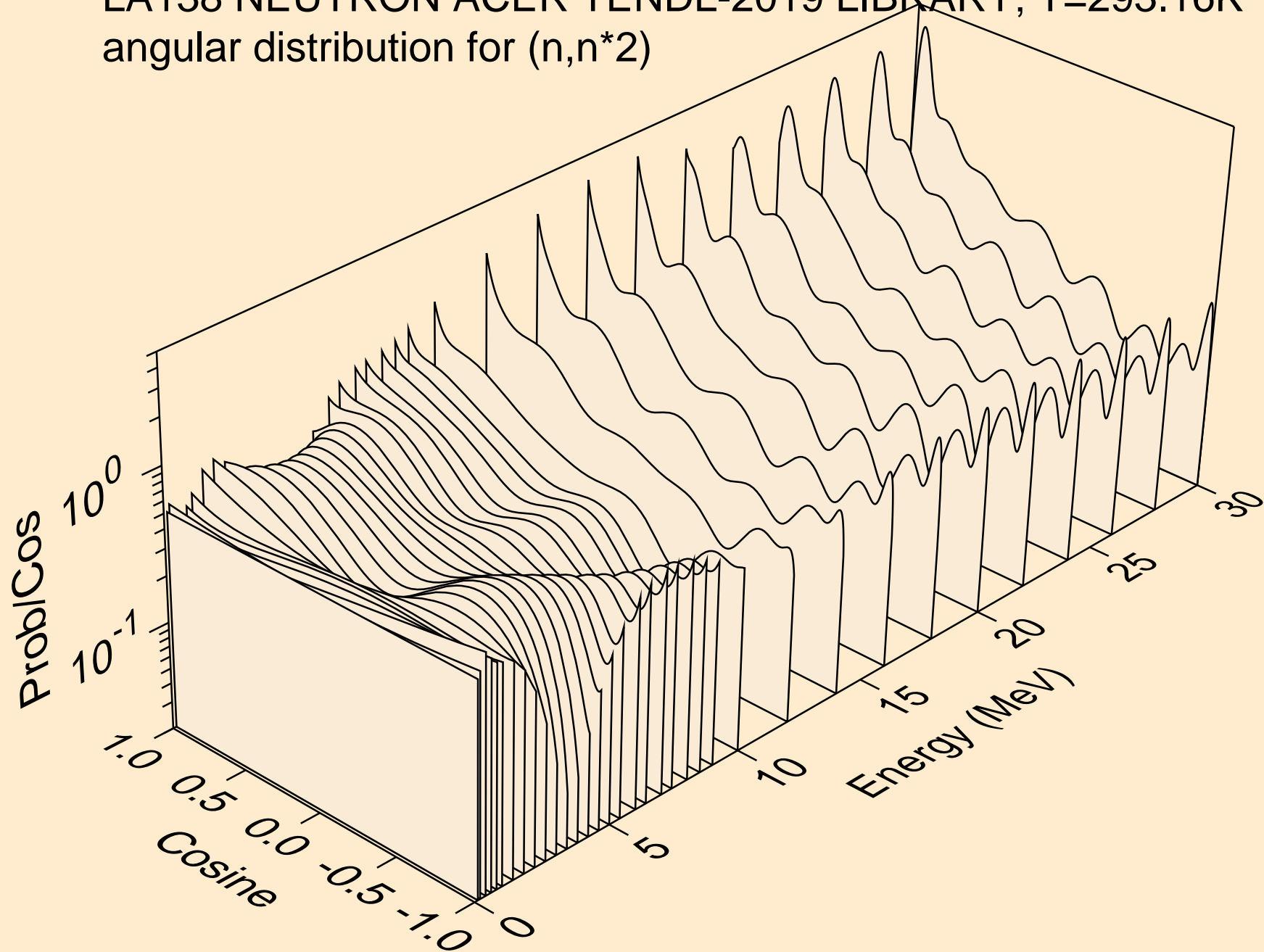

LA138 NEUTRON ACER TENDL-2019 LIBRARY; T=293.16K
angular distribution for (n,n*3)

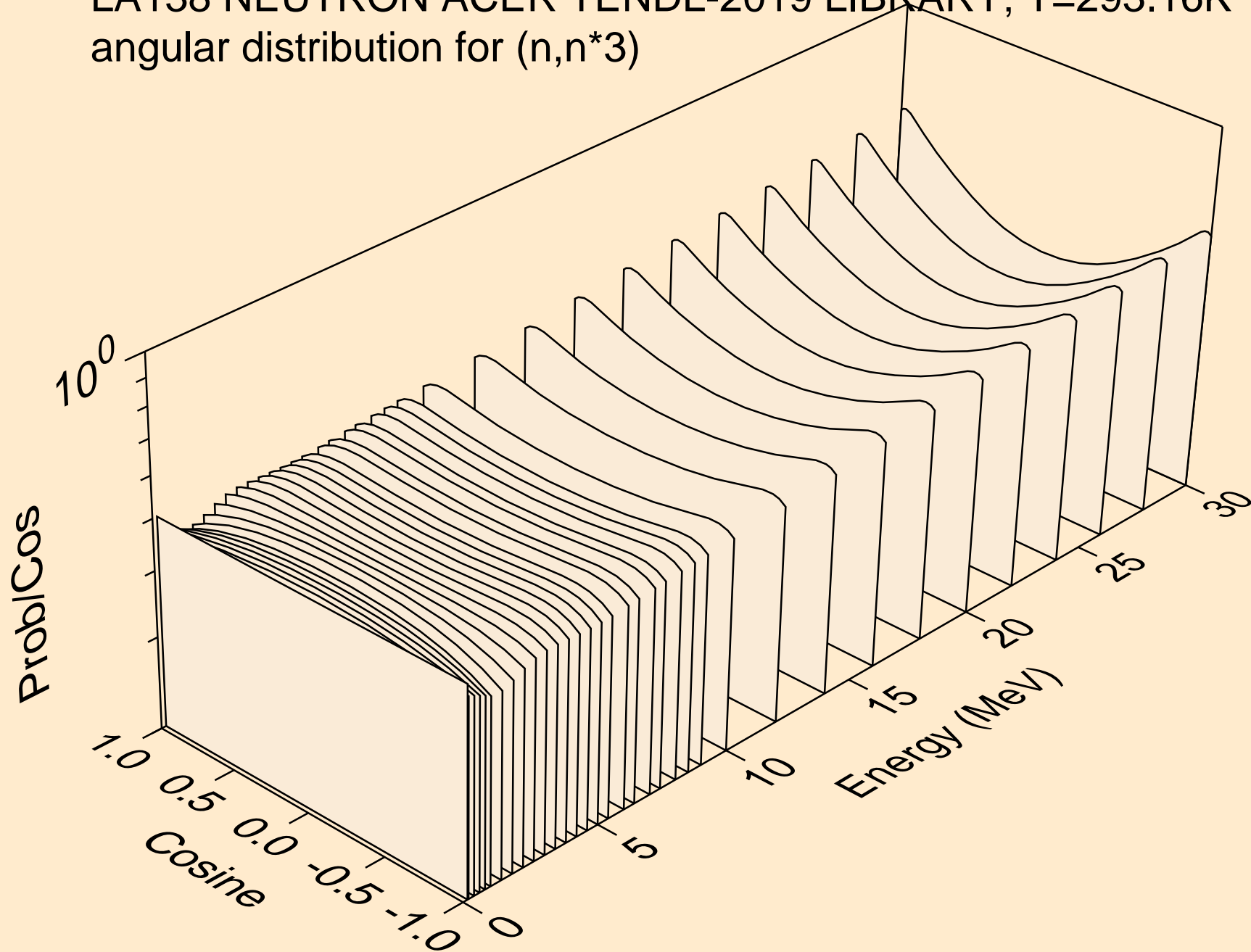

LA138 NEUTRON ACER TENDL-2019 LIBRARY; T=293.16K
angular distribution for (n,n*4)

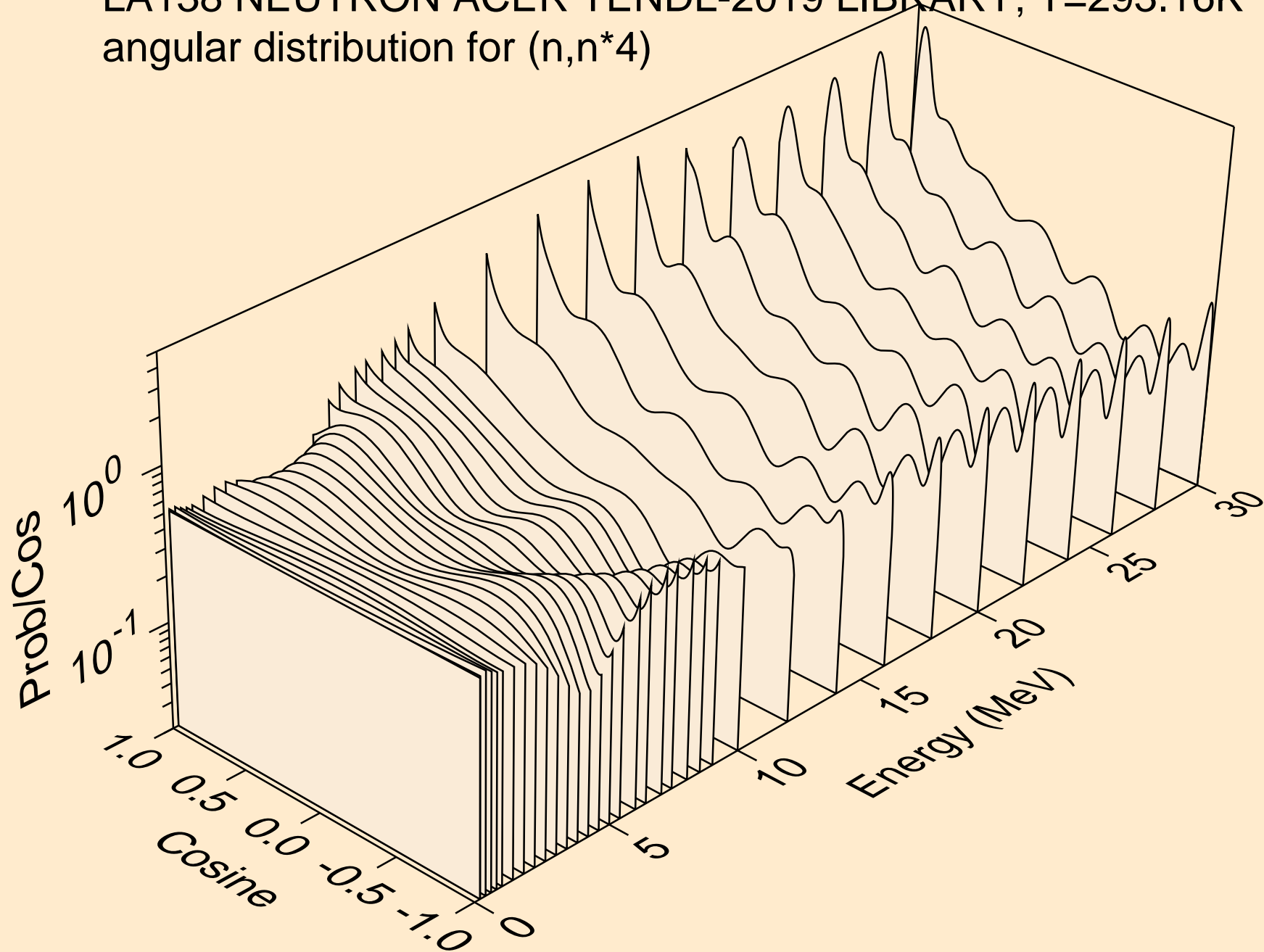

LA138 NEUTRON ACER TENDL-2019 LIBRARY; T=293.16K
angular distribution for (n,n*5)

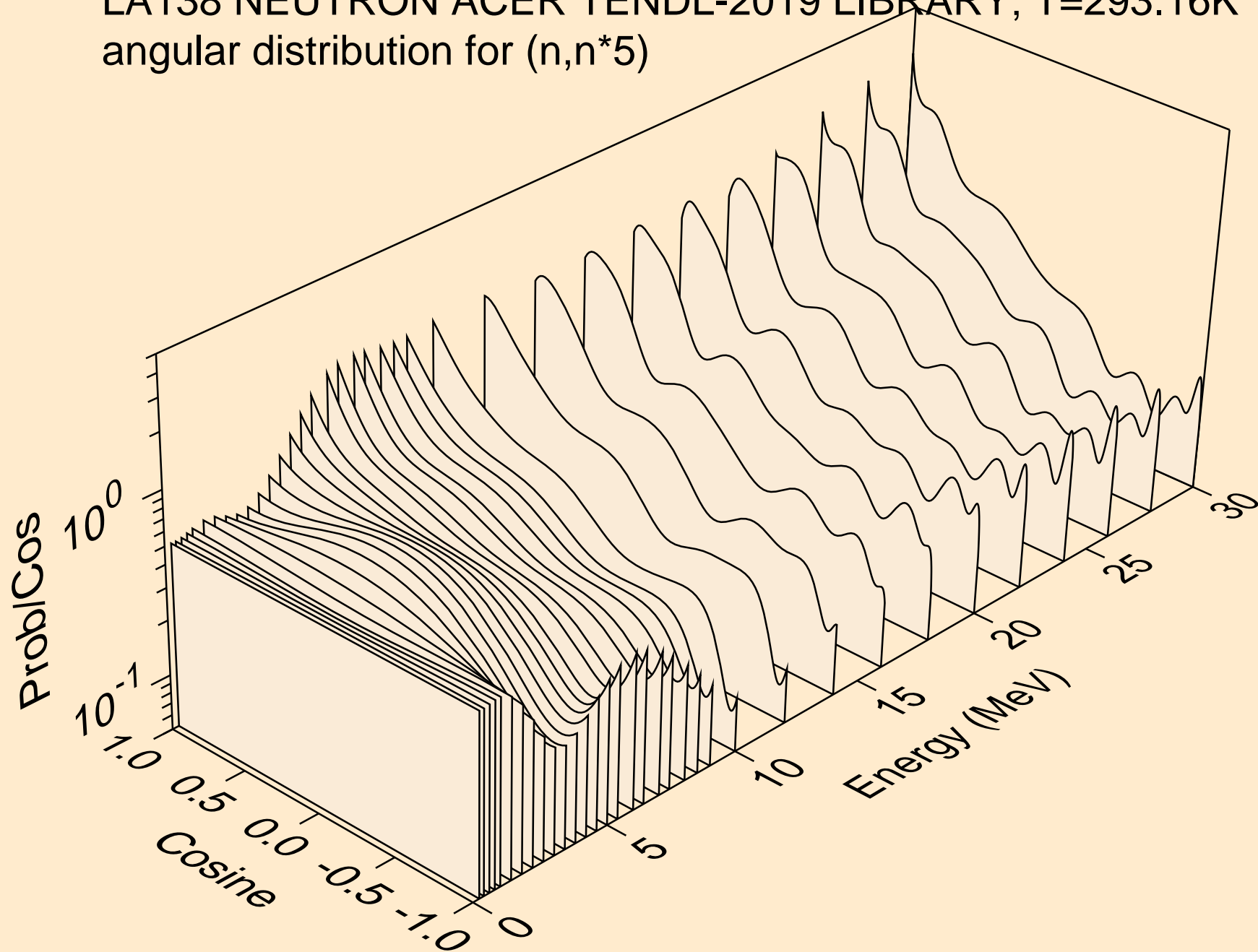

LA138 NEUTRON ACER TENDL-2019 LIBRARY; T=293.16K
angular distribution for (n,n*6)

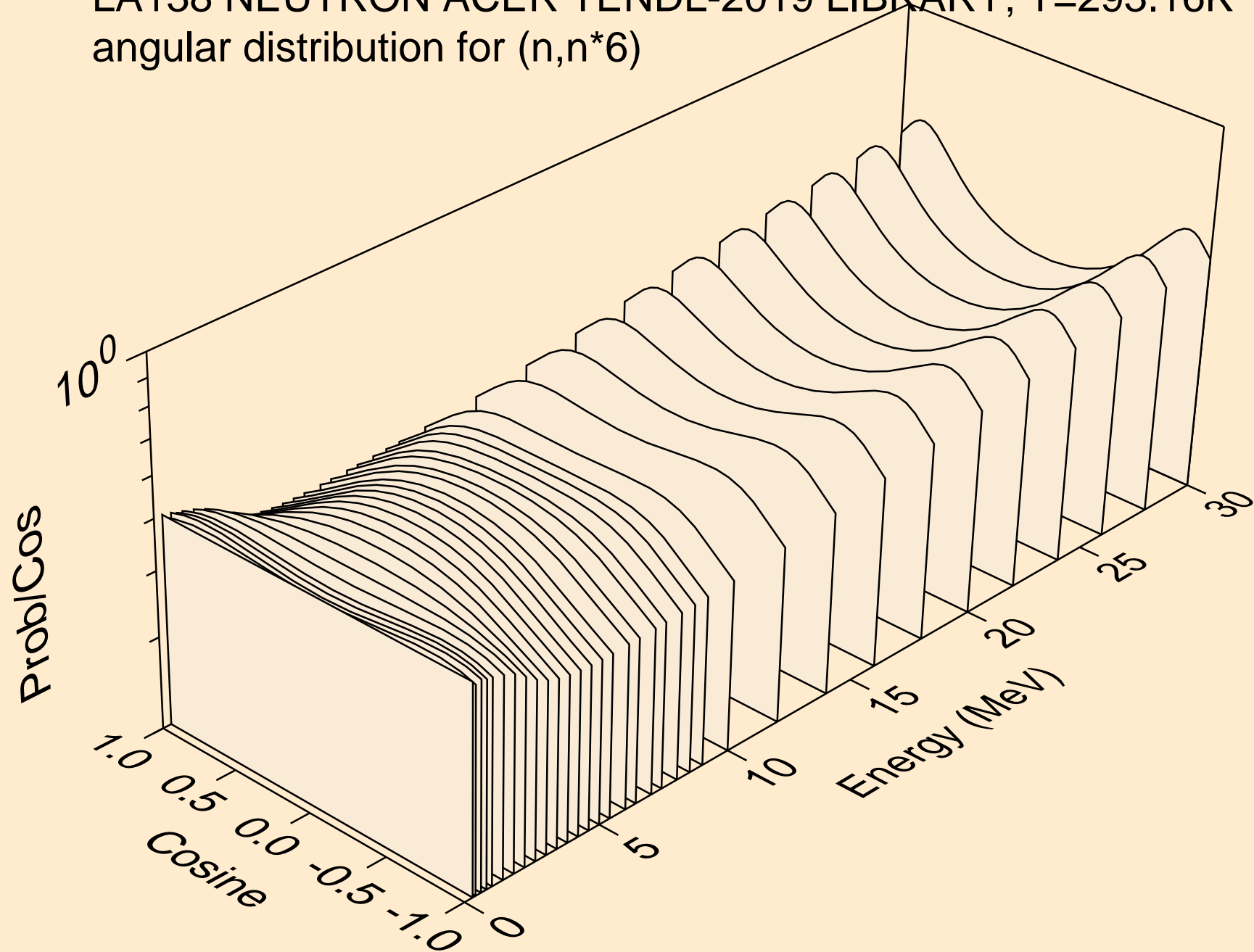

LA138 NEUTRON ACER TENDL-2019 LIBRARY; T=293.16K
angular distribution for (n,n*7)

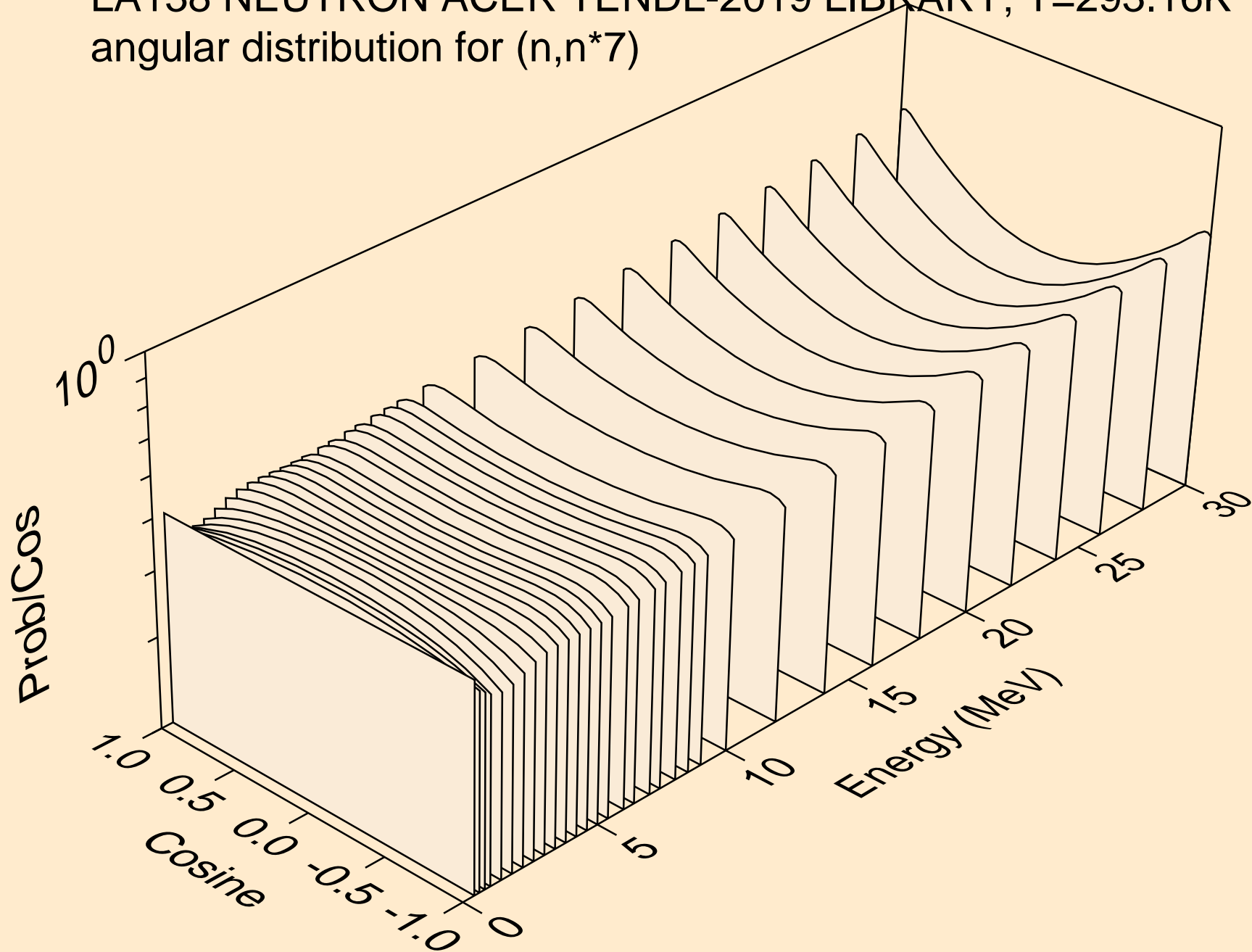

LA138 NEUTRON ACER TENDL-2019 LIBRARY; T=293.16K
angular distribution for (n,n*8)

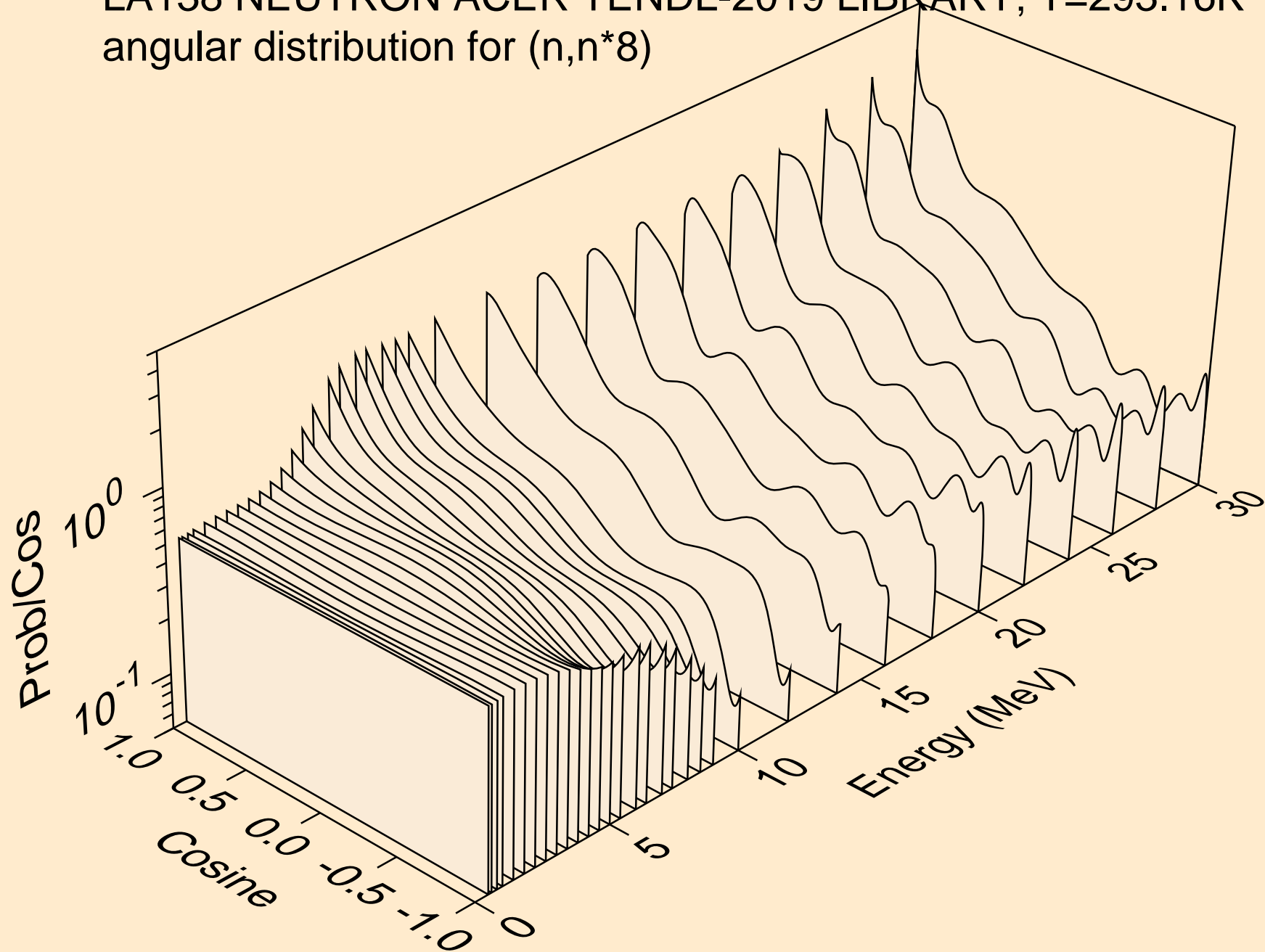

LA138 NEUTRON ACER TENDL-2019 LIBRARY; T=293.16K
angular distribution for (n,n*9)

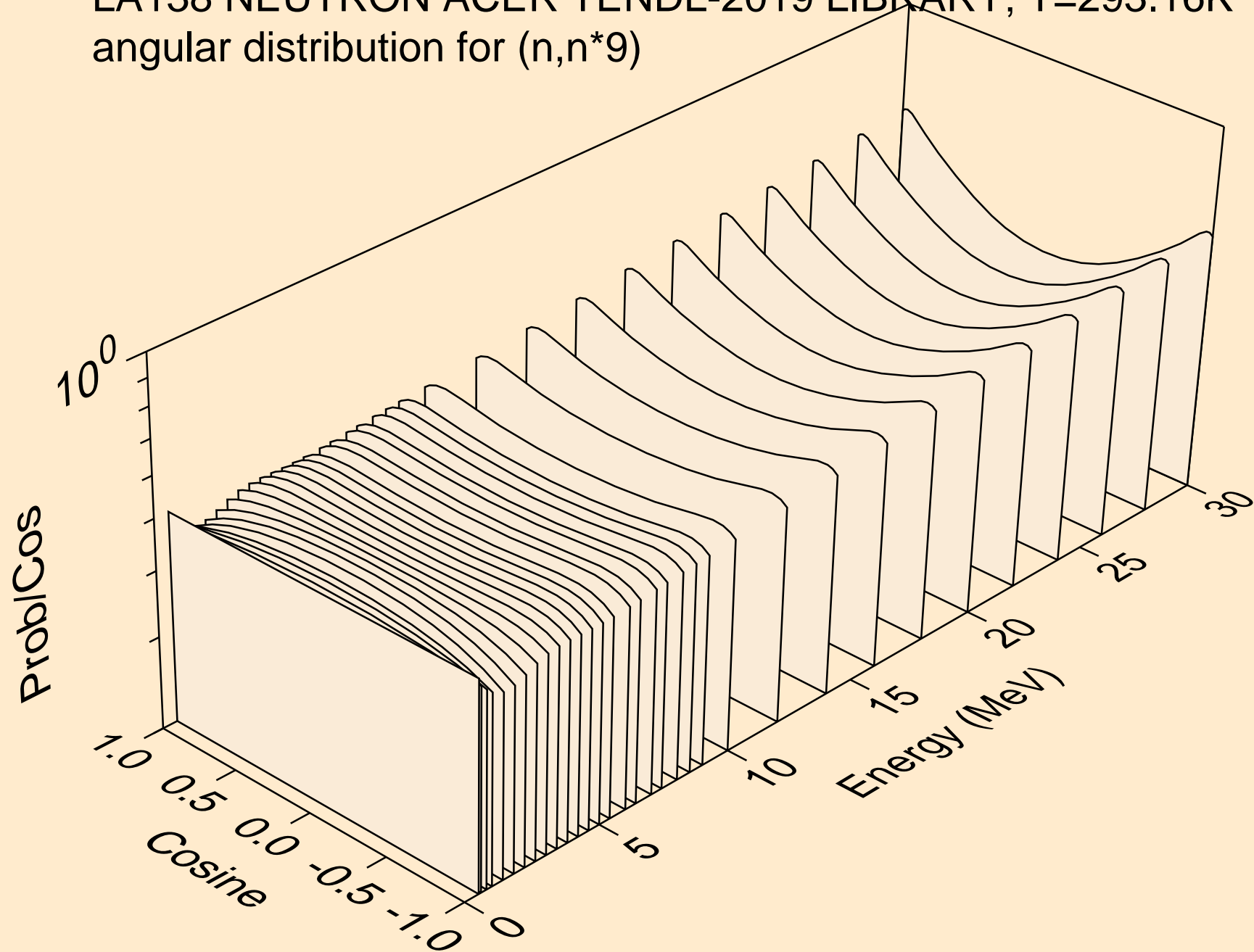

LA138 NEUTRON ACER TENDL-2019 LIBRARY; T=293.16K
angular distribution for (n,n*10)

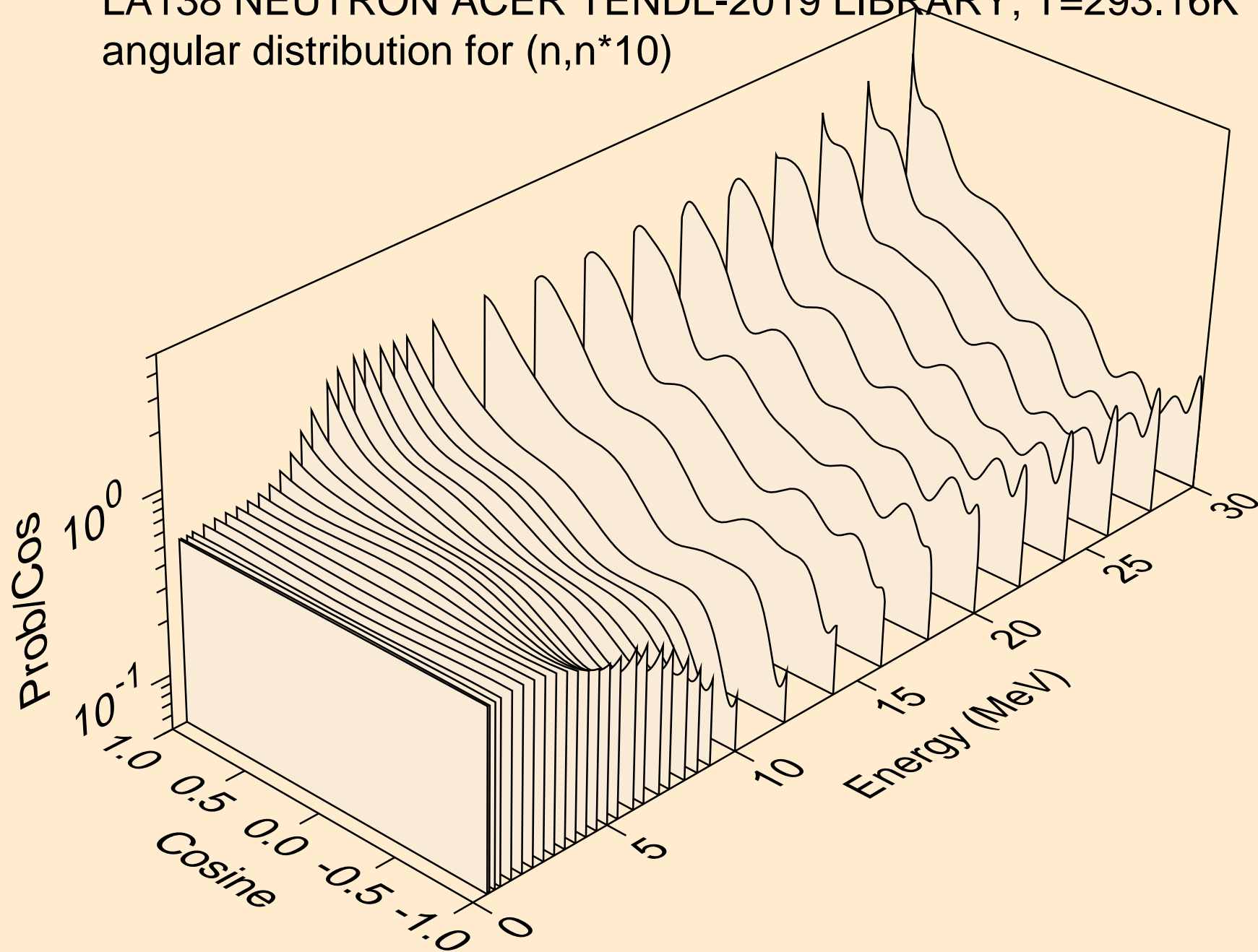

LA138 NEUTRON ACER TENDL-2019 LIBRARY; T=293.16K
angular distribution for (n,n*11)

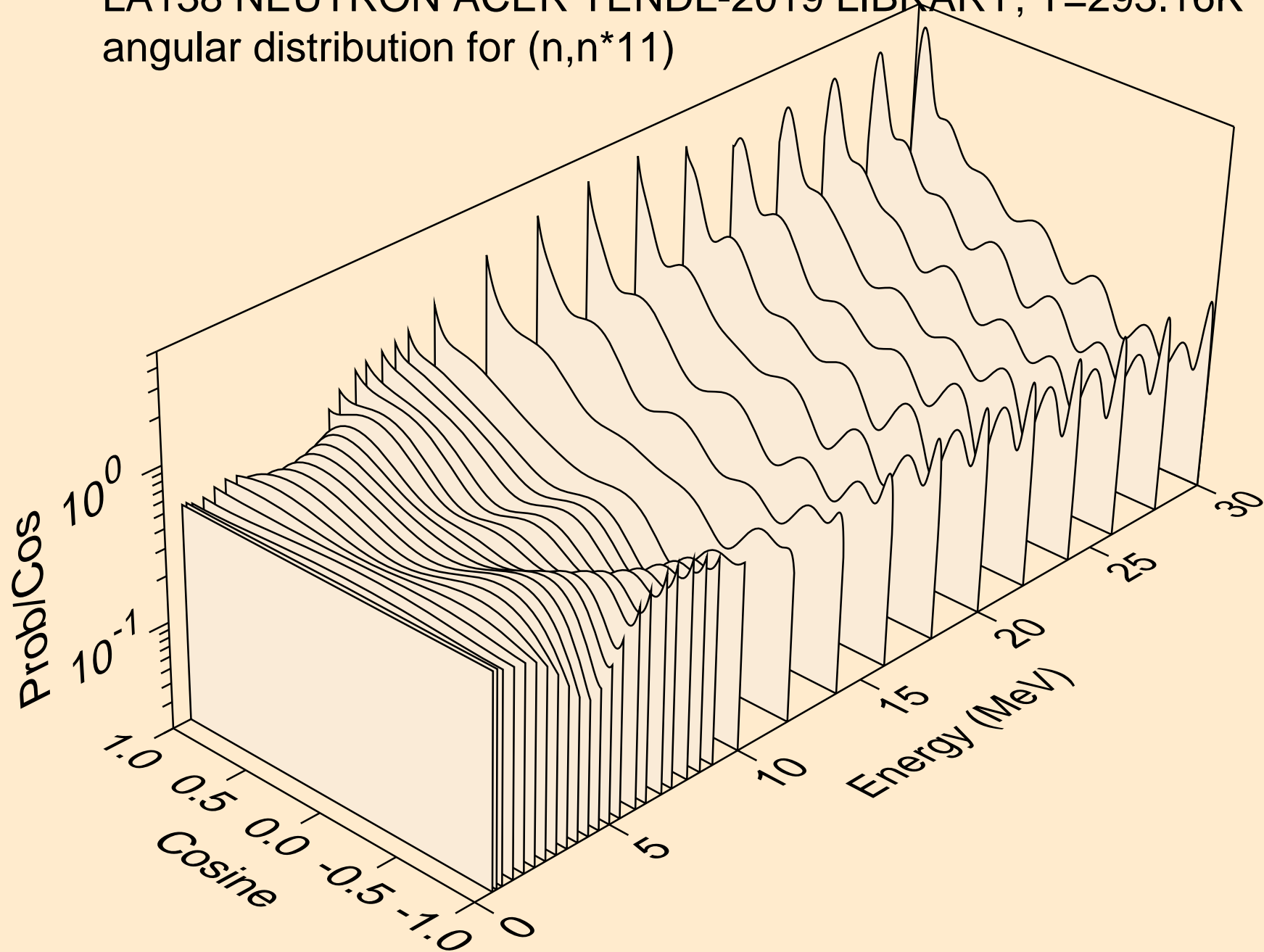

LA138 NEUTRON ACER TENDL-2019 LIBRARY; T=293.16K
angular distribution for (n,n*12)

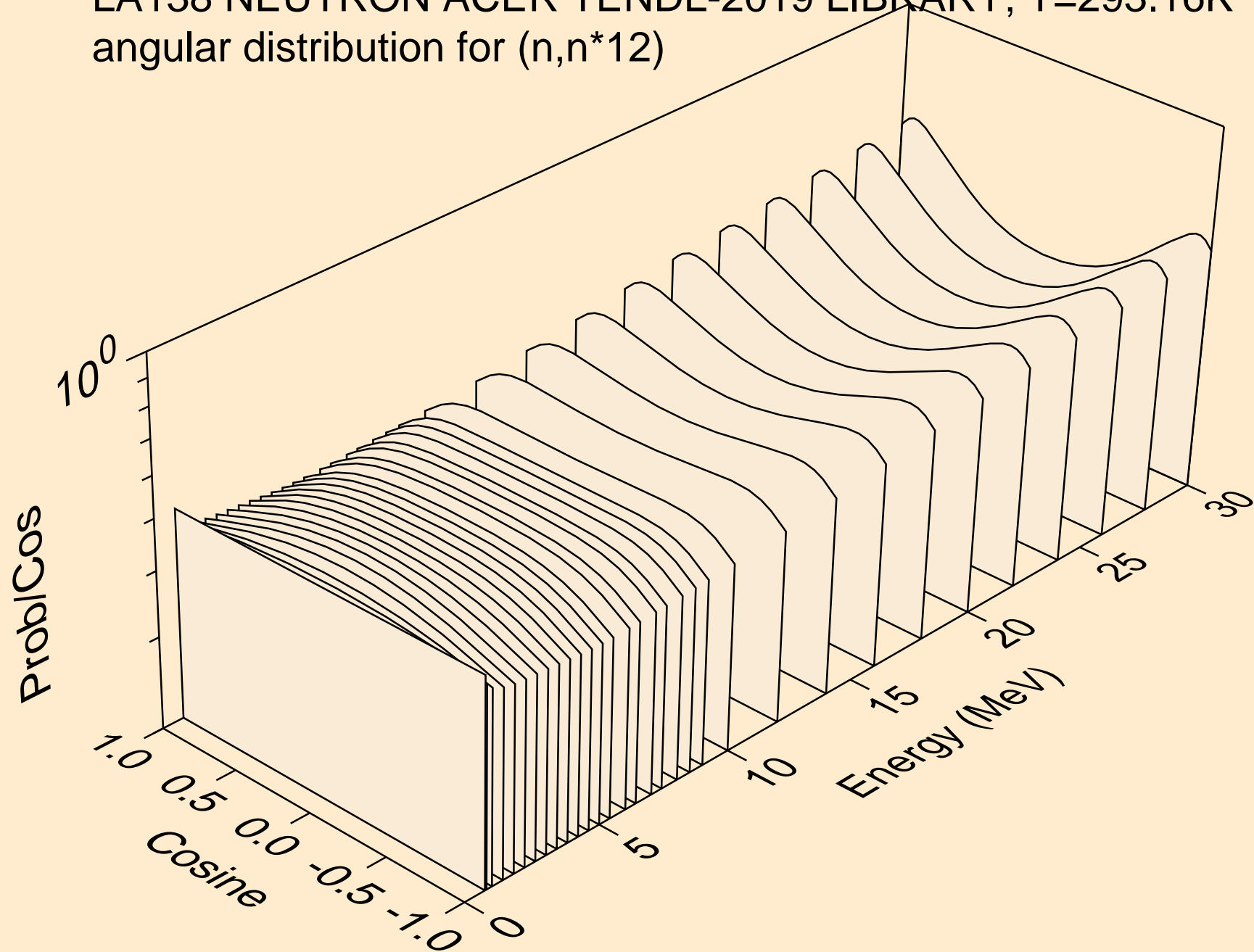

LA138 NEUTRON ACER TENDL-2019 LIBRARY; T=293.16K
angular distribution for (n,n*13)

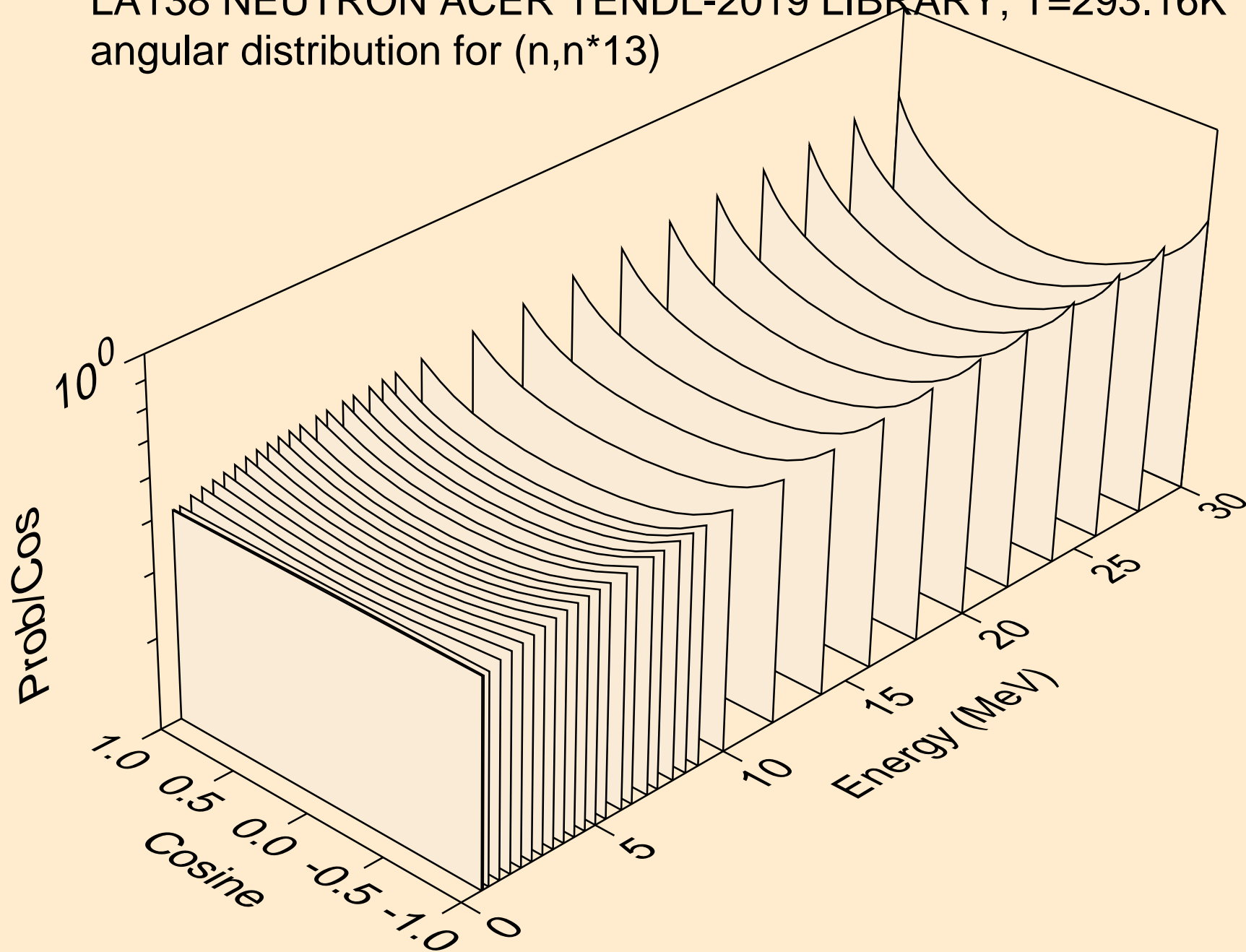

LA138 NEUTRON ACER TENDL-2019 LIBRARY; T=293.16K
angular distribution for (n,n*14)

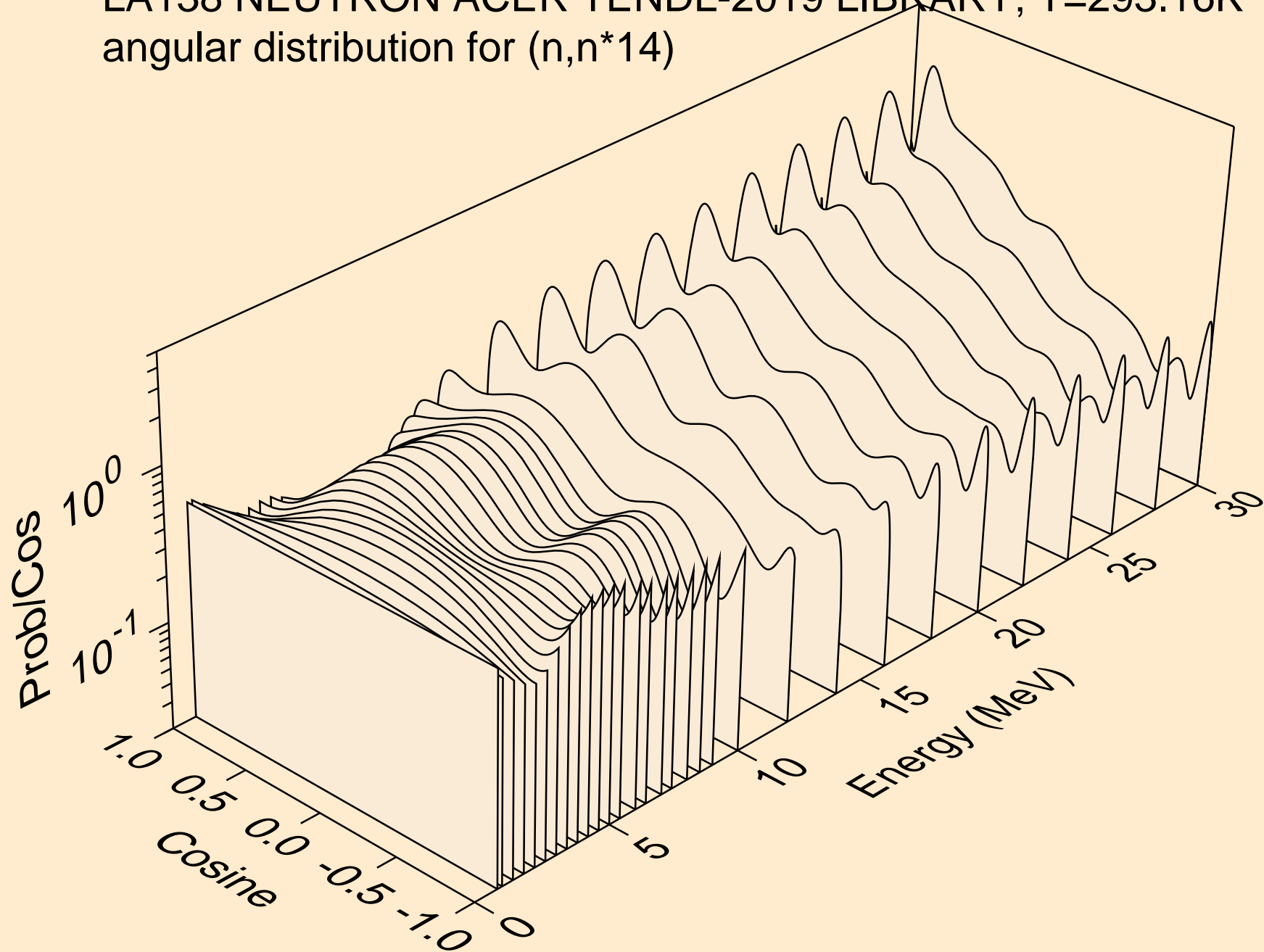

LA138 NEUTRON ACER TENDL-2019 LIBRARY; T=293.16K
angular distribution for (n,n*15)

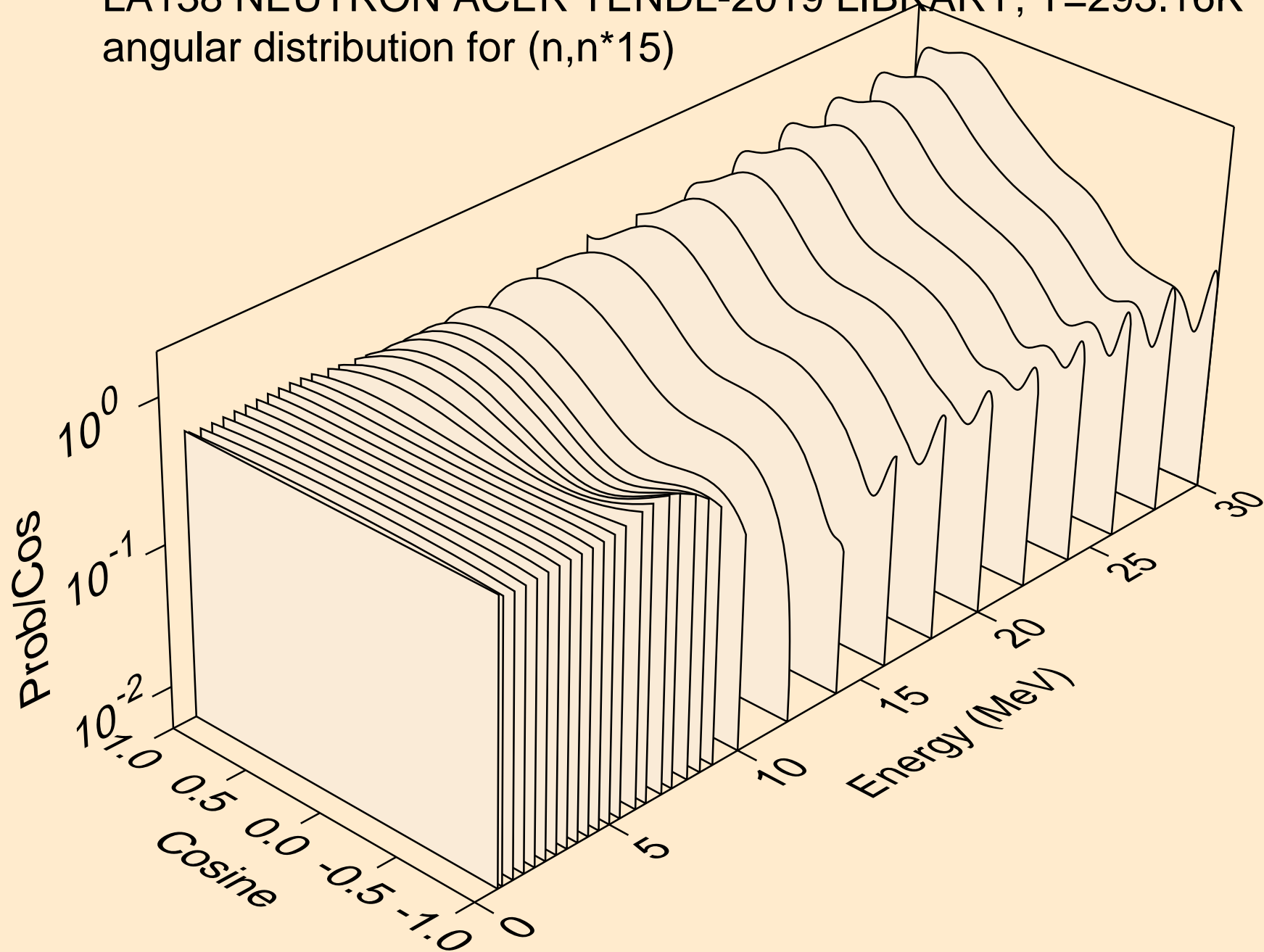

LA138 NEUTRON ACER TENDL-2019 LIBRARY; T=293.16K
angular distribution for (n,n*16)

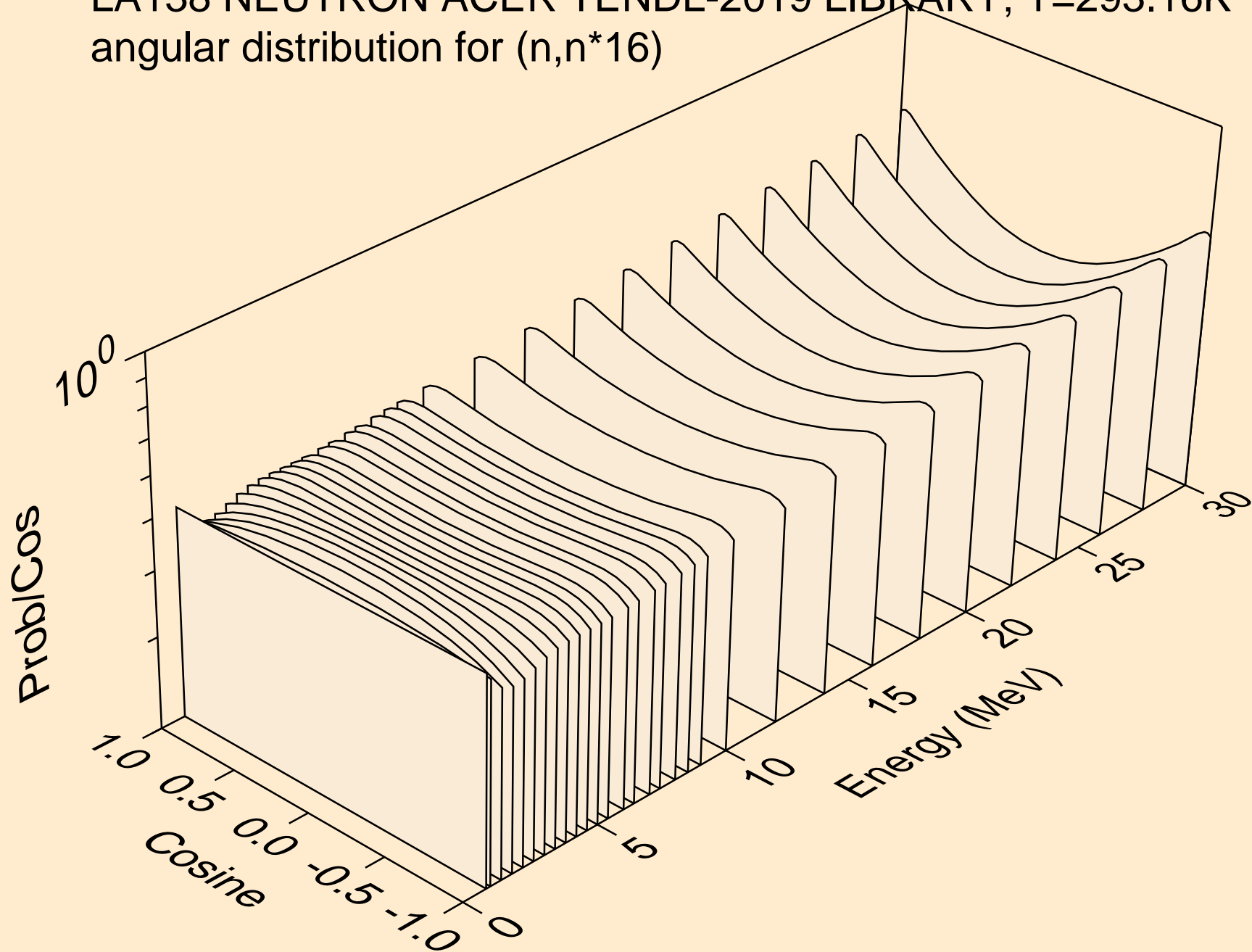

LA138 NEUTRON ACER TENDL-2019 LIBRARY; T=293.16K
angular distribution for (n,n*17)

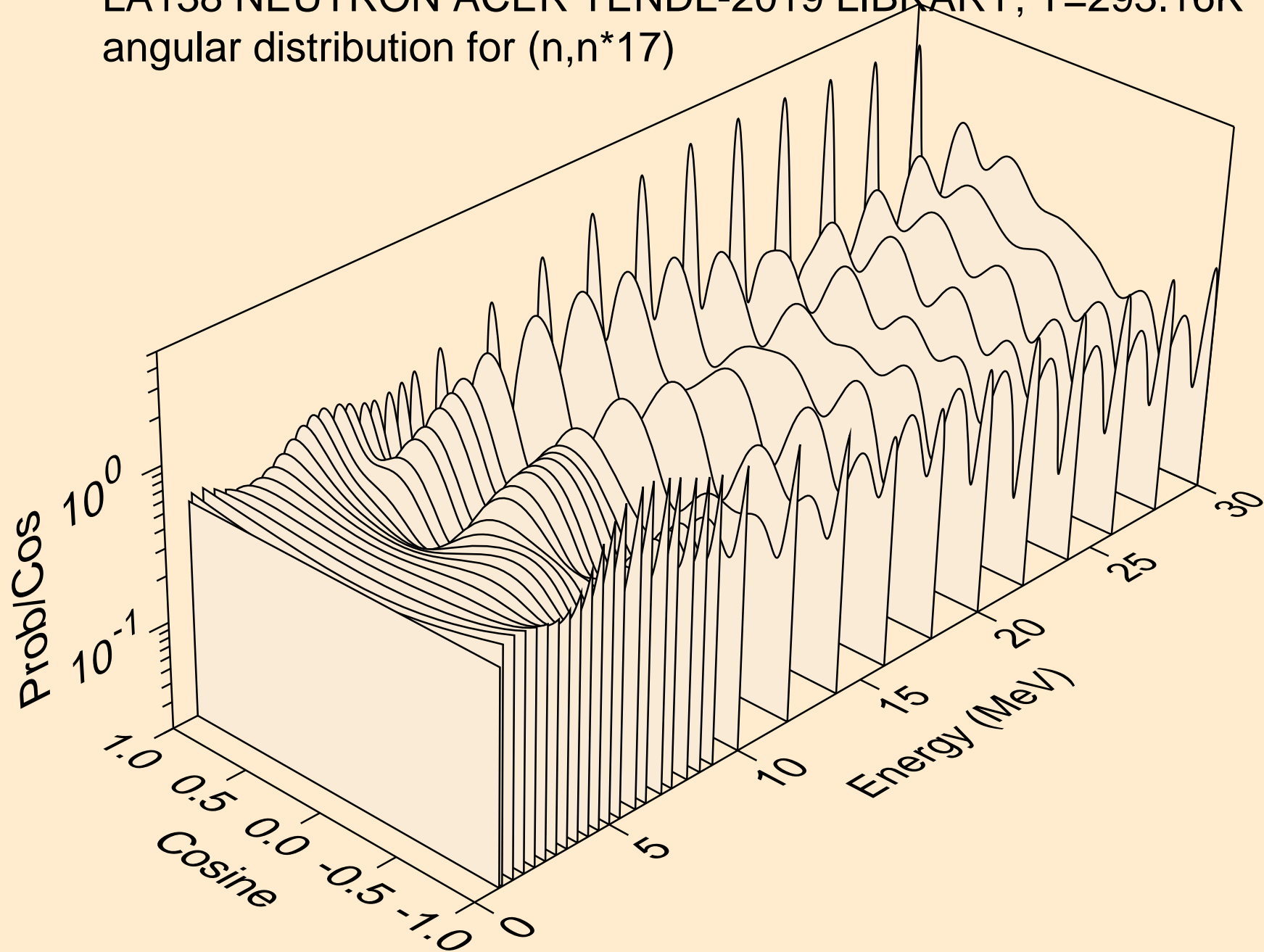

LA138 NEUTRON ACER TENDL-2019 LIBRARY; T=293.16K
angular distribution for (n,n*18)

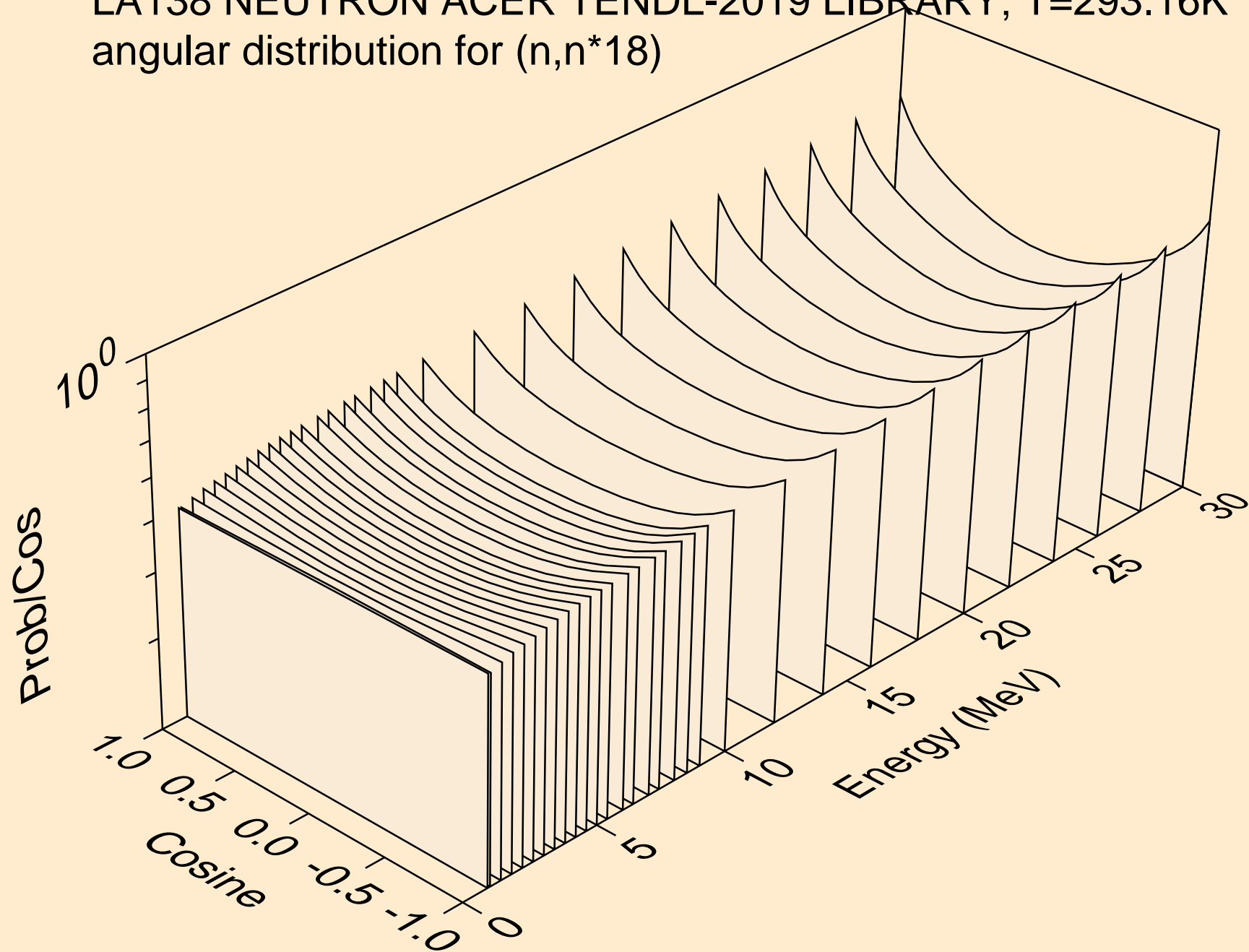

LA138 NEUTRON ACER TENDL-2019 LIBRARY; T=293.16K
angular distribution for (n,n*19)

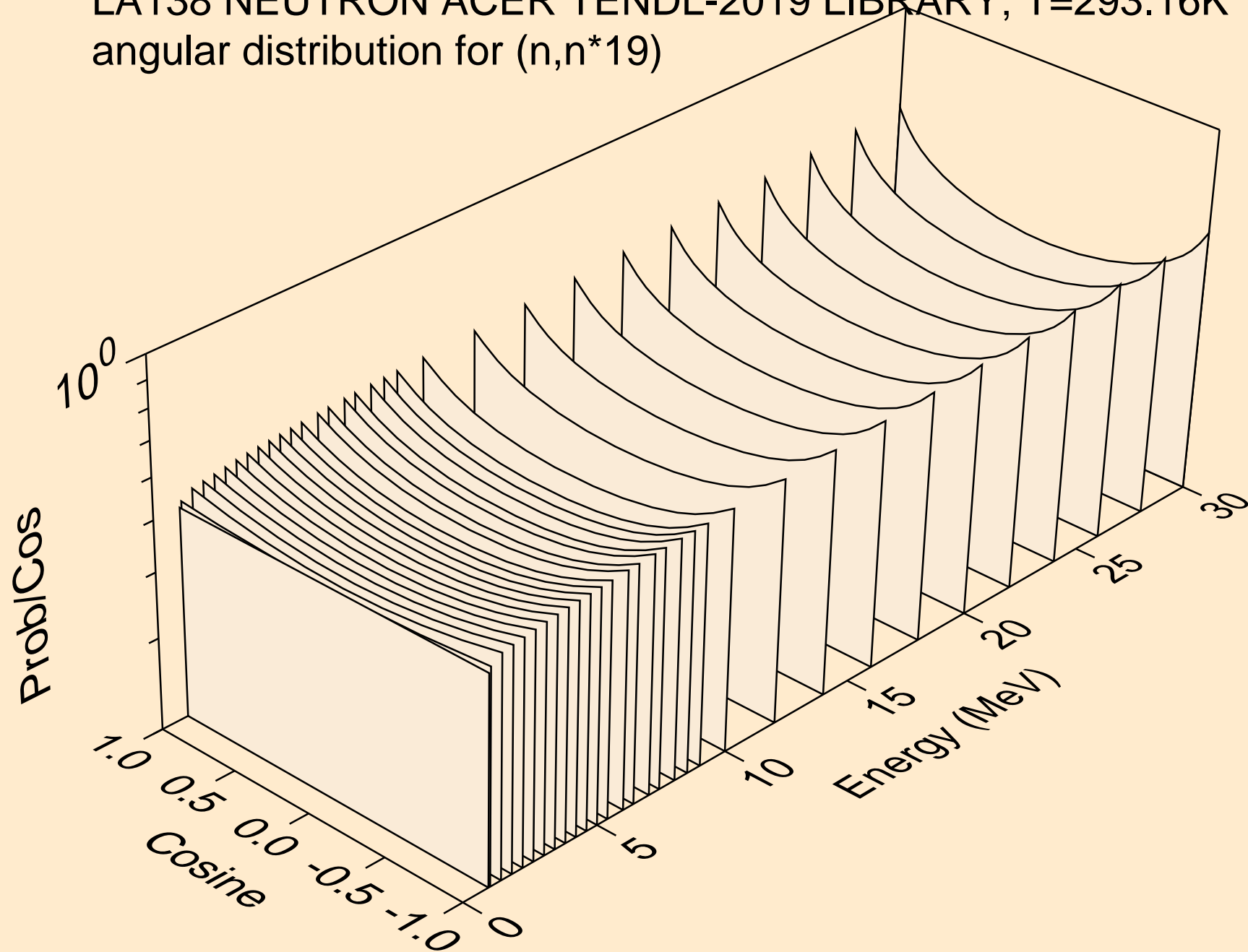

LA138 NEUTRON ACER TENDL-2019 LIBRARY; T=293.16K
angular distribution for (n,n*20)

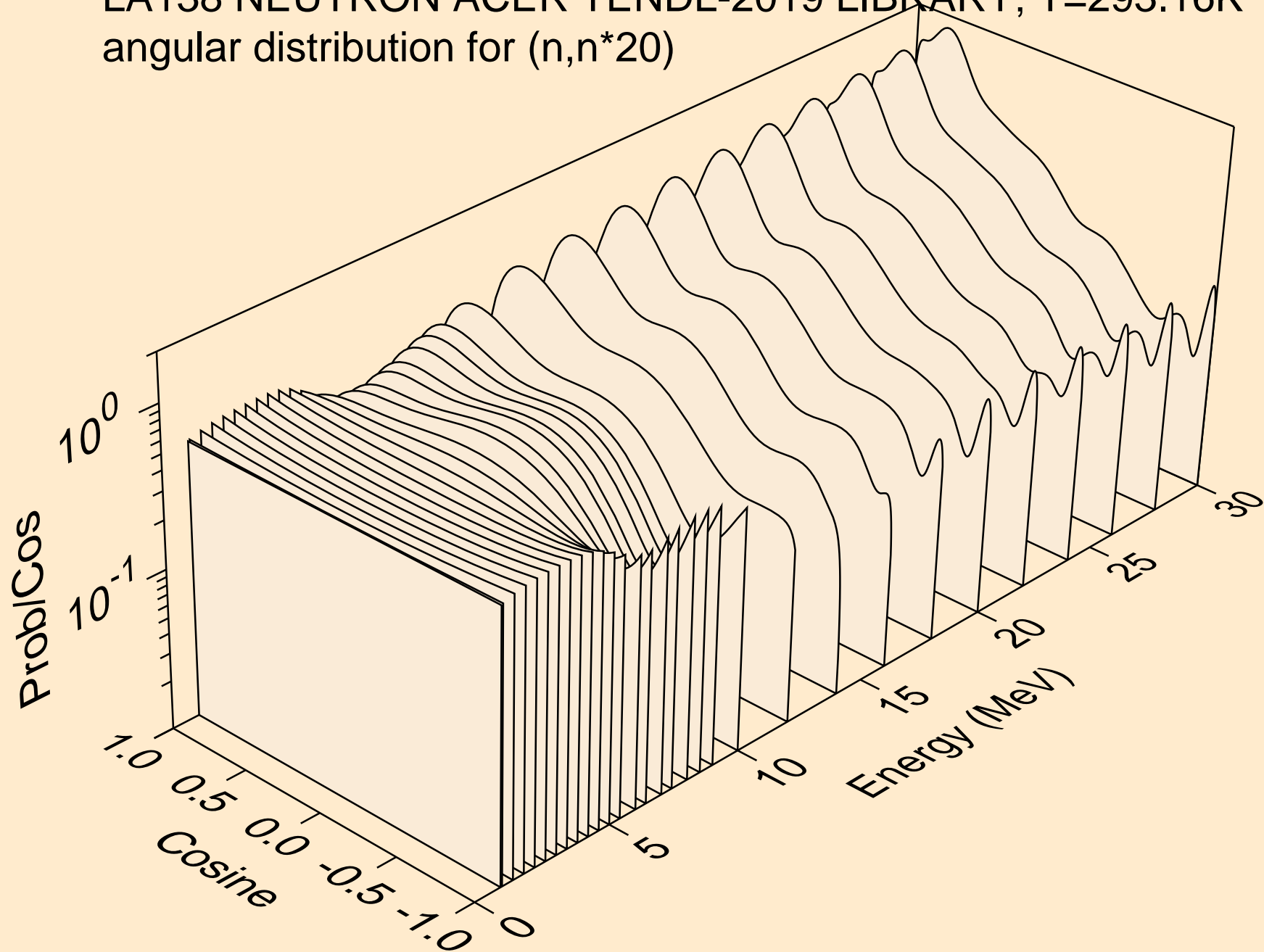

LA138 NEUTRON ACER TENDL-2019 LIBRARY; T=293.16K
angular distribution for (n,n*21)

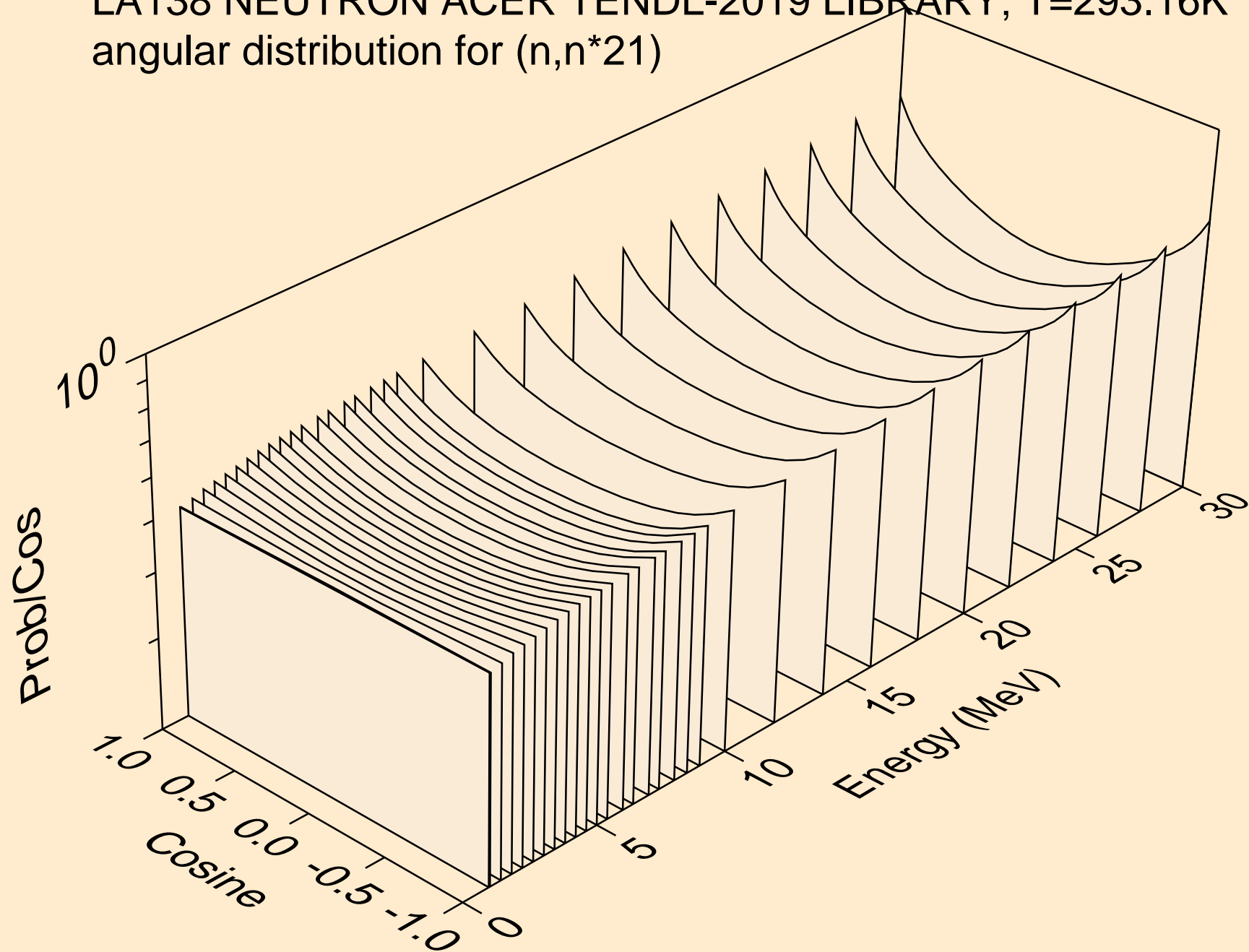

LA138 NEUTRON ACER TENDL-2019 LIBRARY; T=293.16K
angular distribution for (n,n*22)

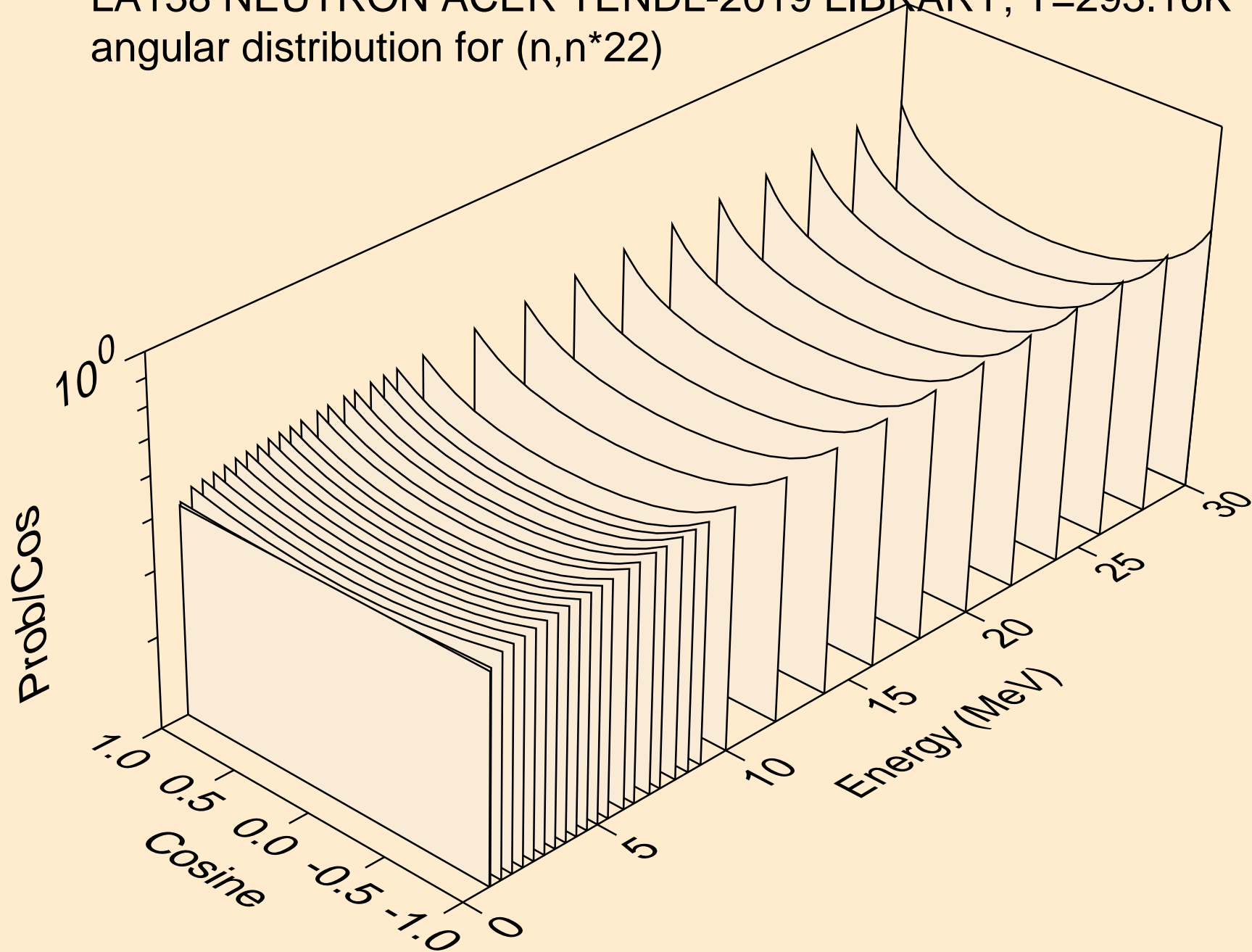

LA138 NEUTRON ACER TENDL-2019 LIBRARY; T=293.16K
angular distribution for (n,n*23)

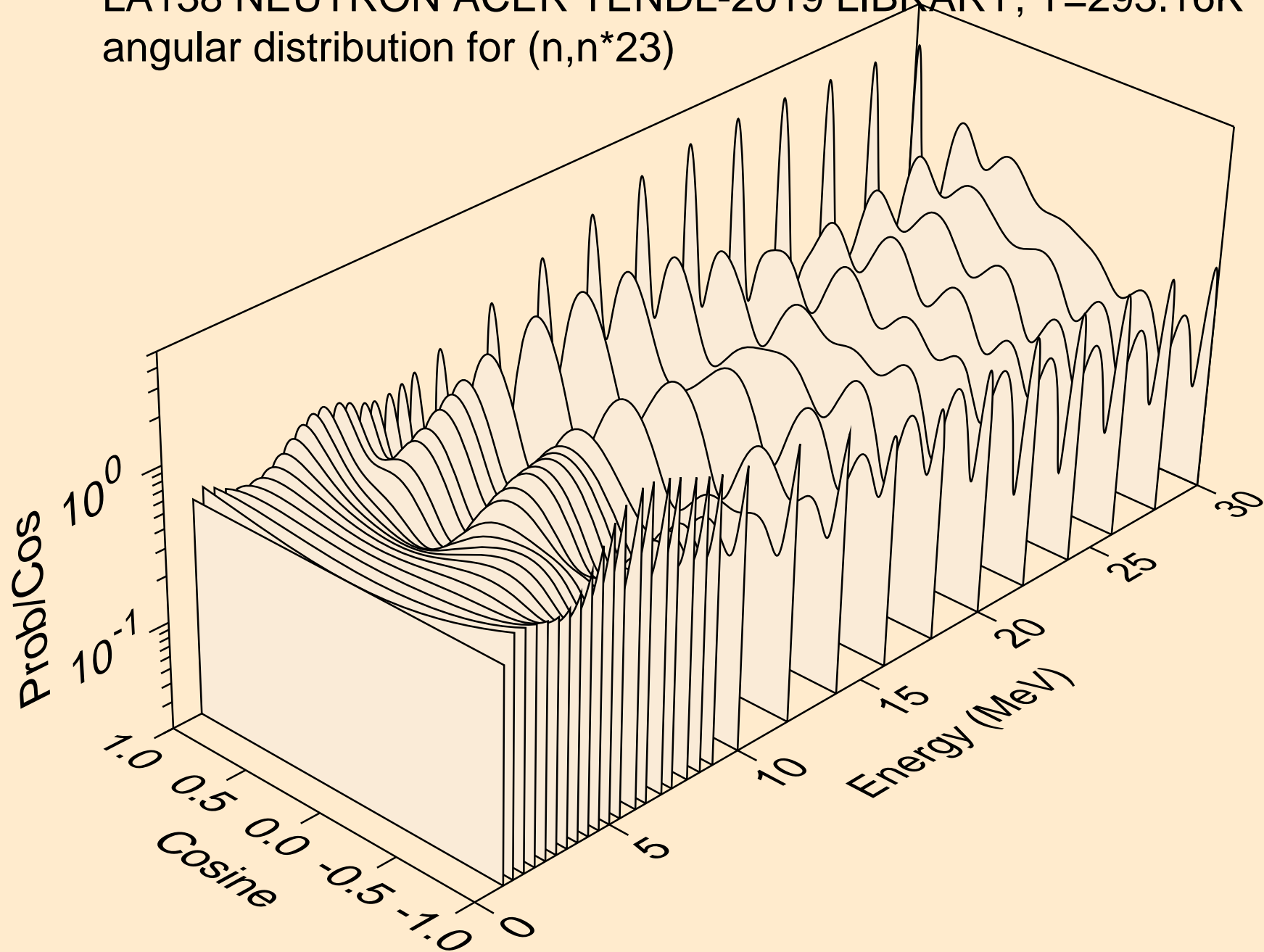

LA138 NEUTRON ACER TENDL-2019 LIBRARY; T=293.16K
angular distribution for (n,n*24)

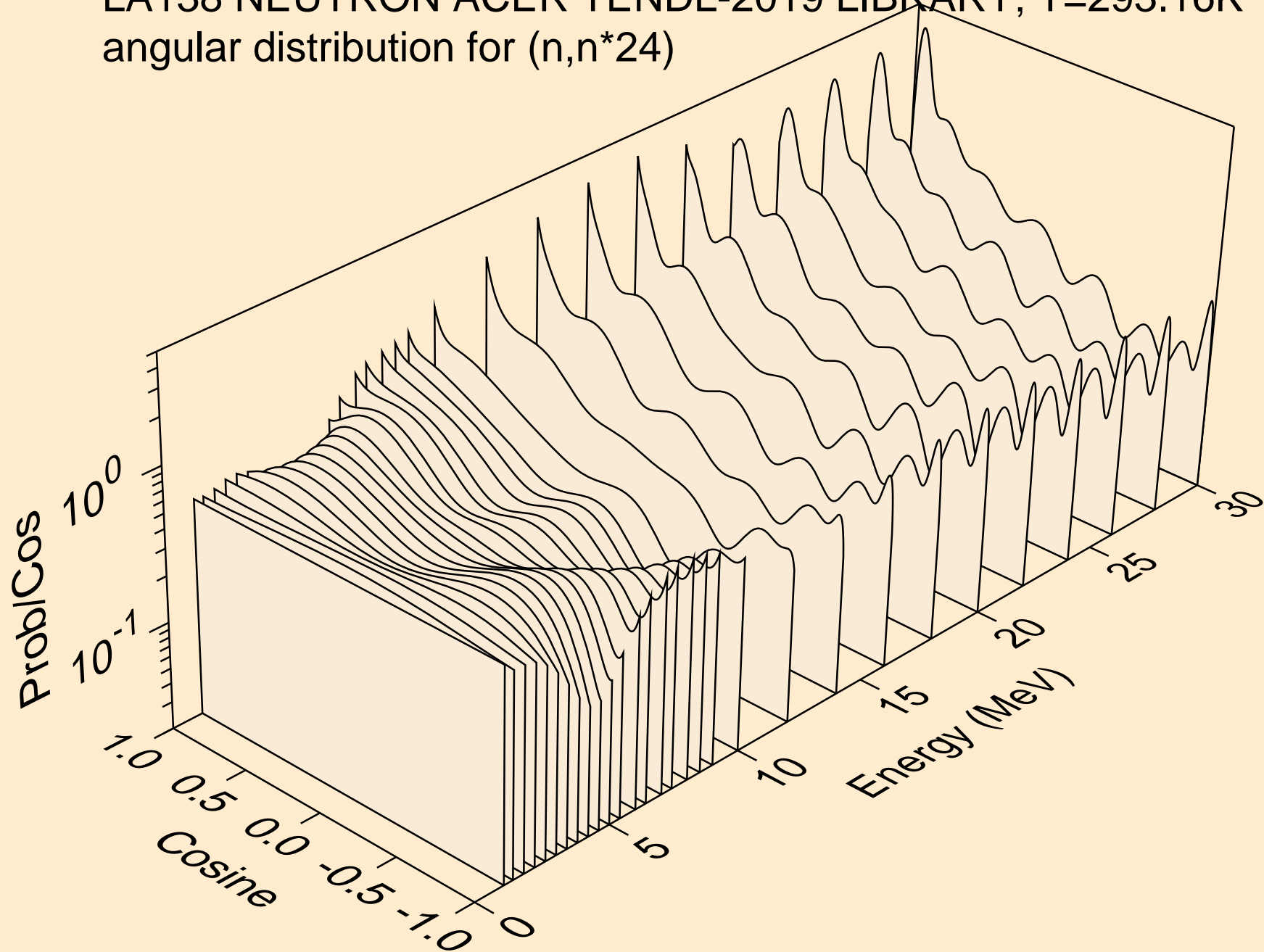

LA138 NEUTRON ACER TENDL-2019 LIBRARY; T=293.16K
angular distribution for (n,n*25)

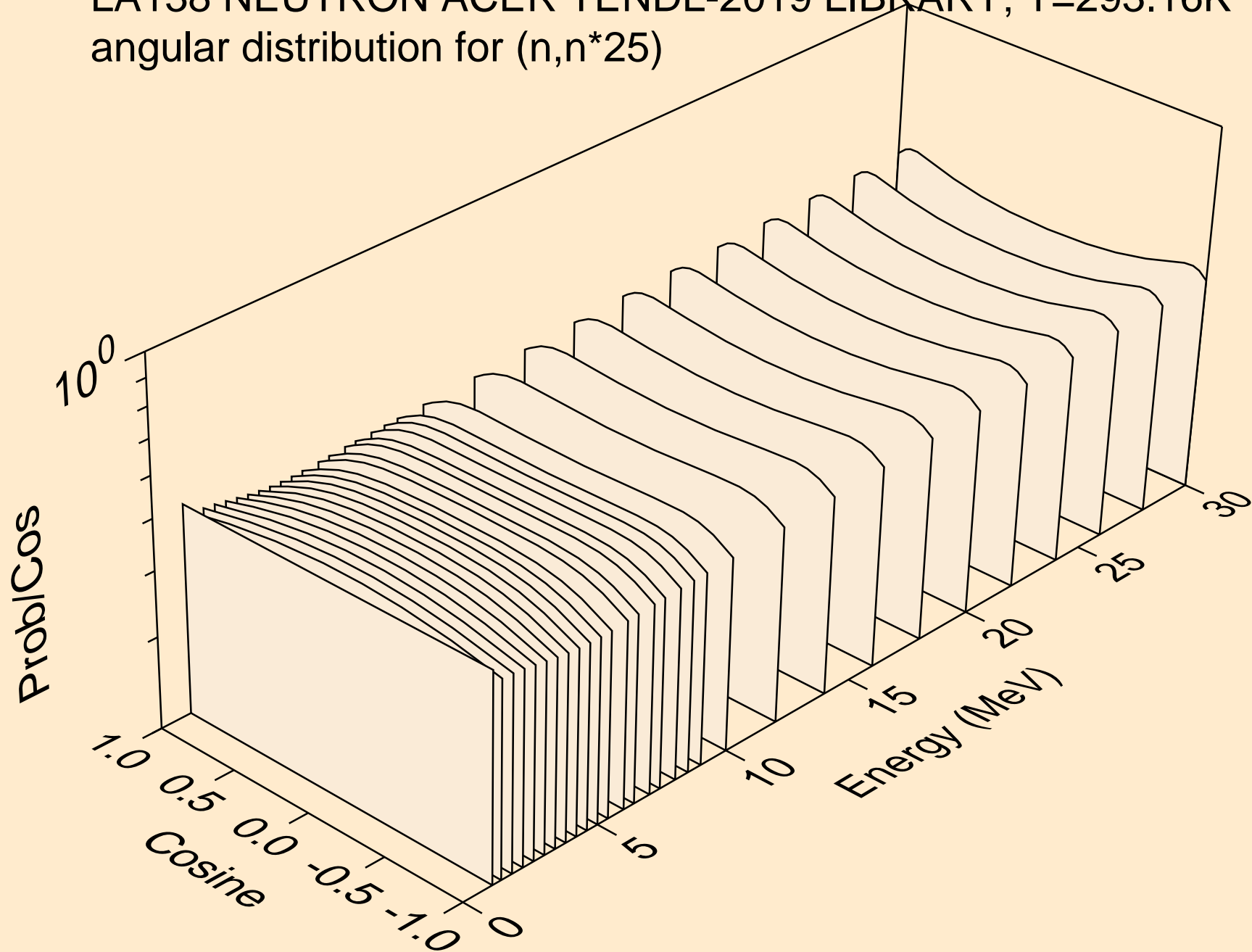

LA138 NEUTRON ACER TENDL-2019 LIBRARY; T=293.16K
angular distribution for (n,n*26)

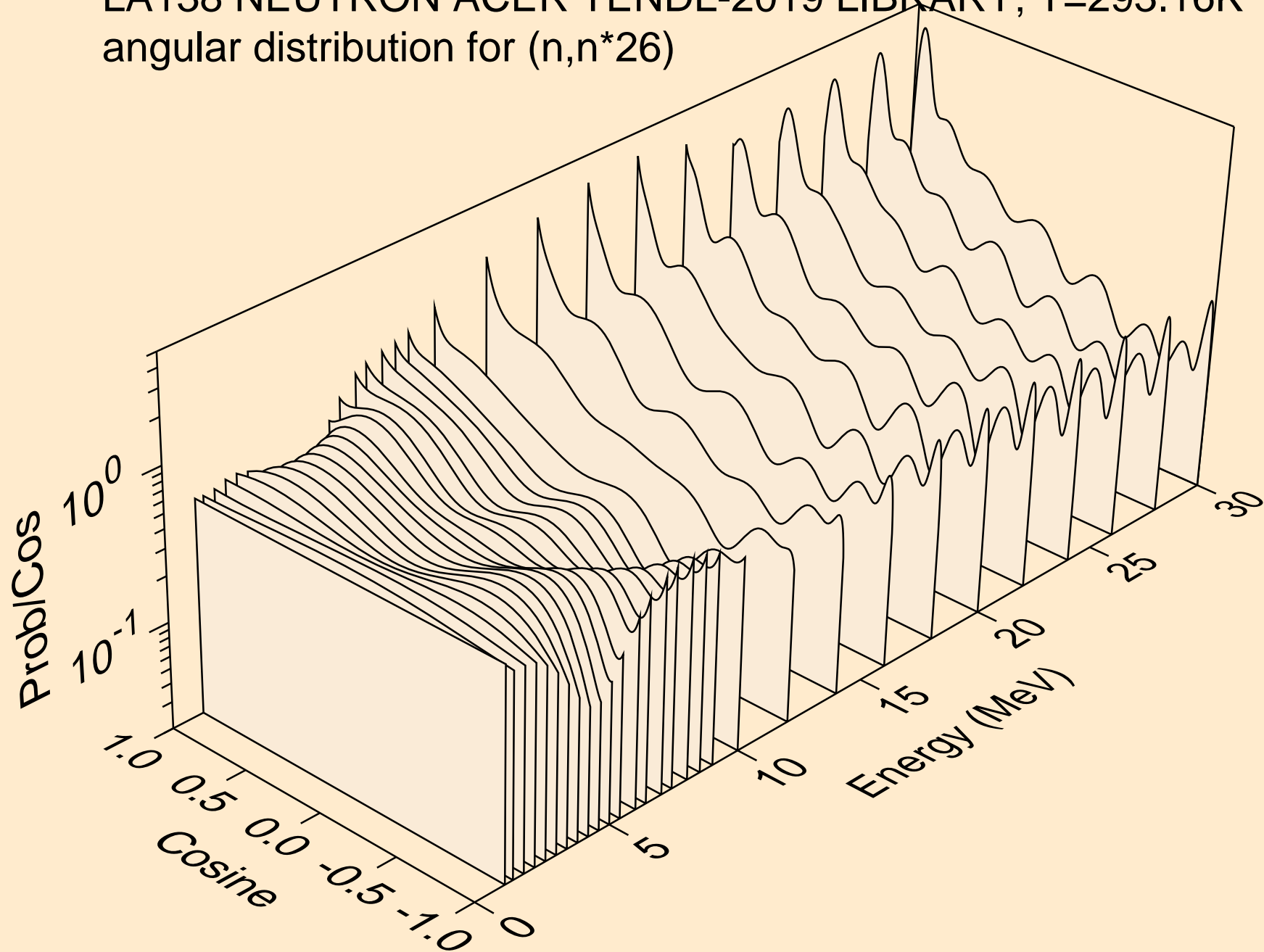

LA138 NEUTRON ACER TENDL-2019 LIBRARY; T=293.16K
angular distribution for (n,n*27)

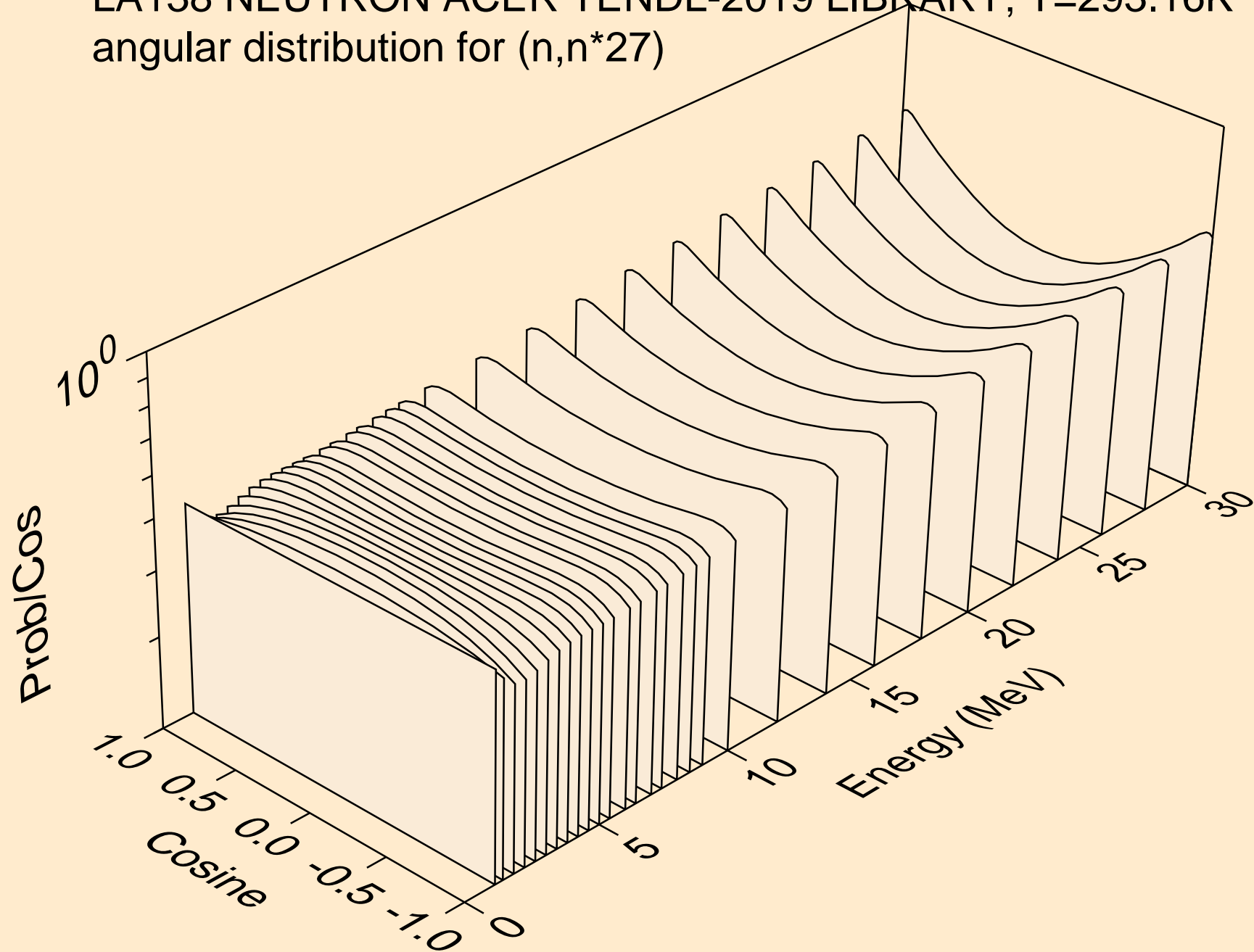

LA138 NEUTRON ACER TENDL-2019 LIBRARY; T=293.16K
angular distribution for (n,n*28)

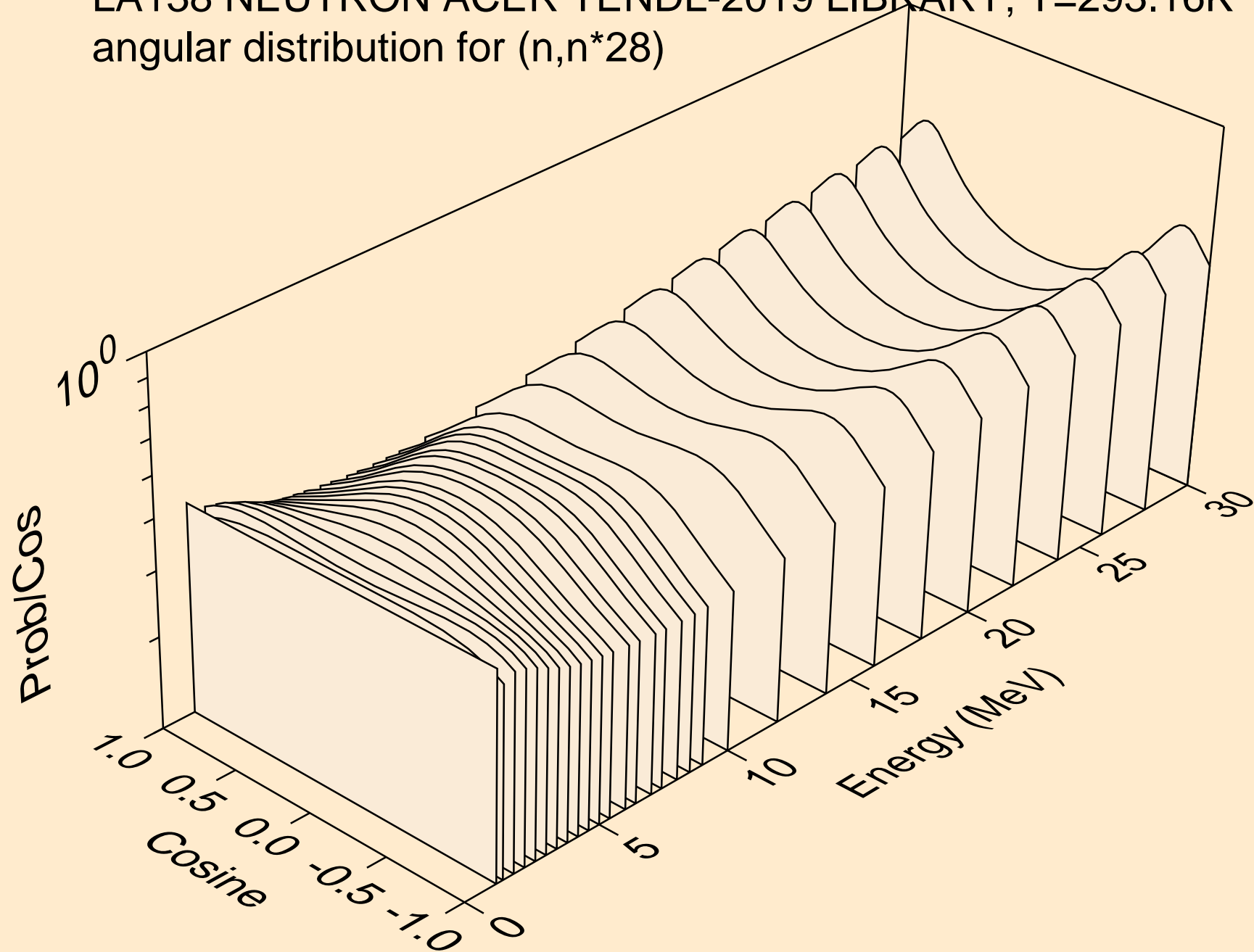

LA138 NEUTRON ACER TENDL-2019 LIBRARY; T=293.16K
angular distribution for (n,n*29)

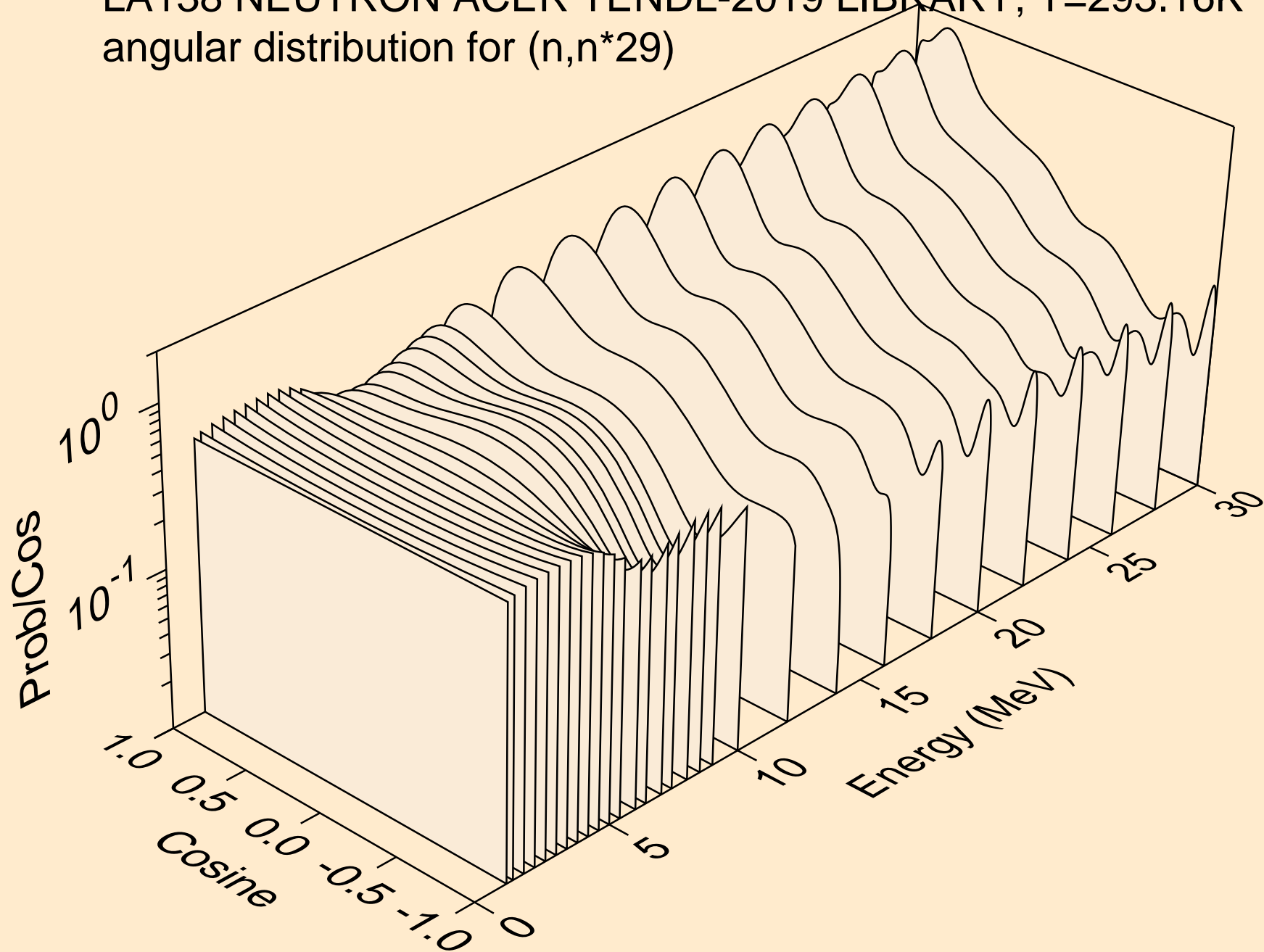

LA138 NEUTRON ACER TENDL-2019 LIBRARY; T=293.16K
angular distribution for (n,n*30)

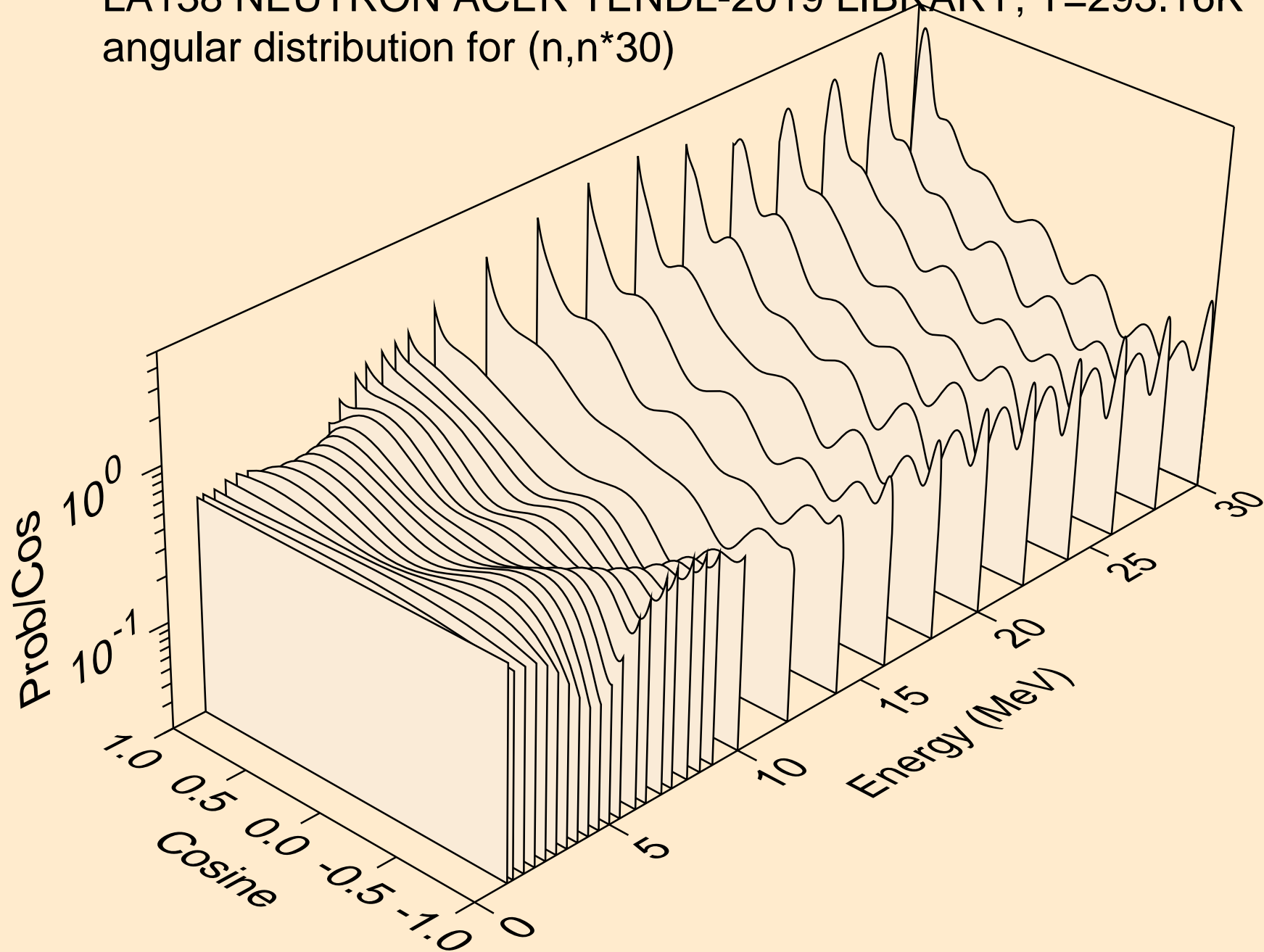

LA138 NEUTRON ACER TENDL-2019 LIBRARY; T=293.16K
Neutron emission for (n,x)

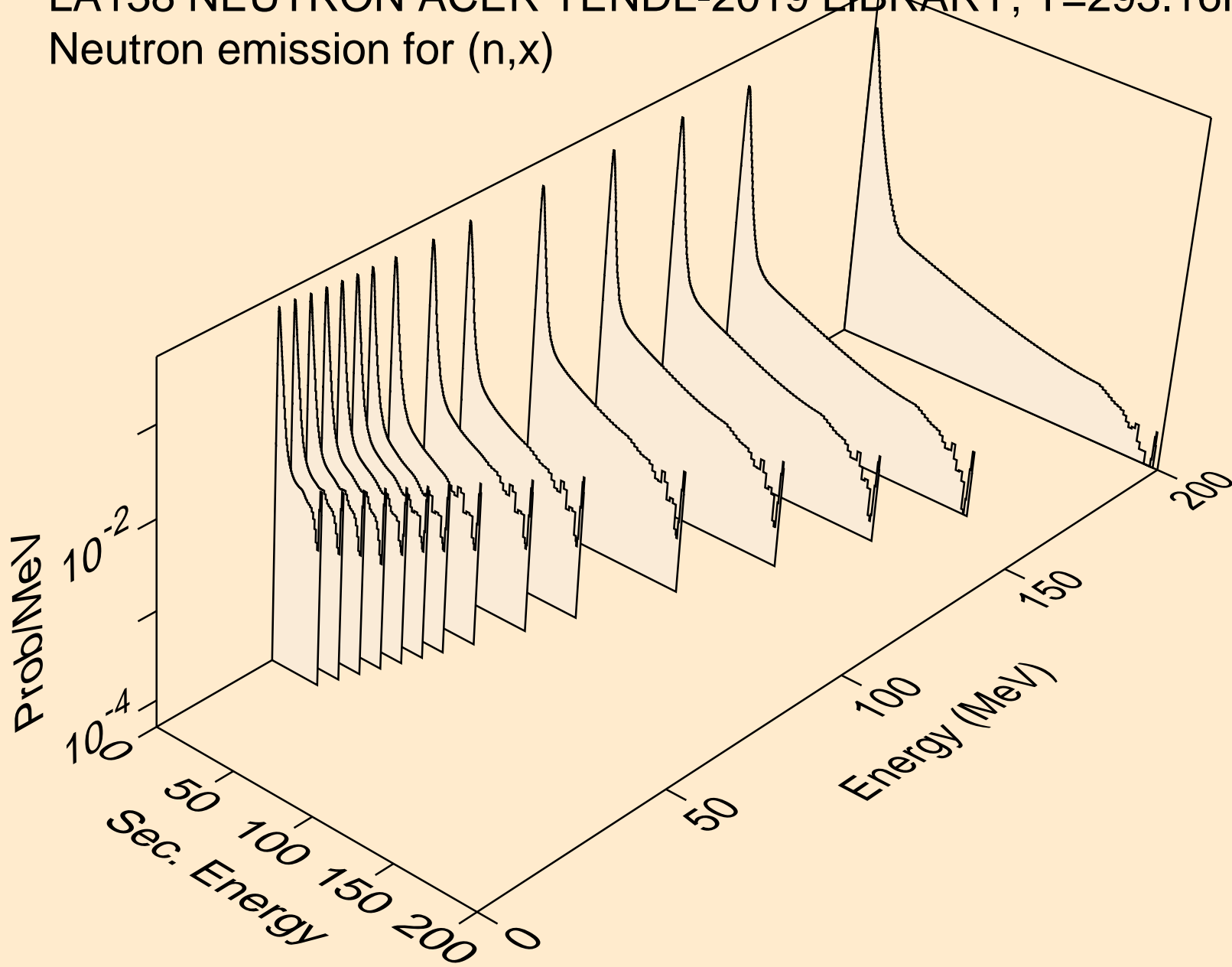

LA138 NEUTRON ACER TENDL-2019 LIBRARY; T=293.16K
Neutron emission for (n,2nd)

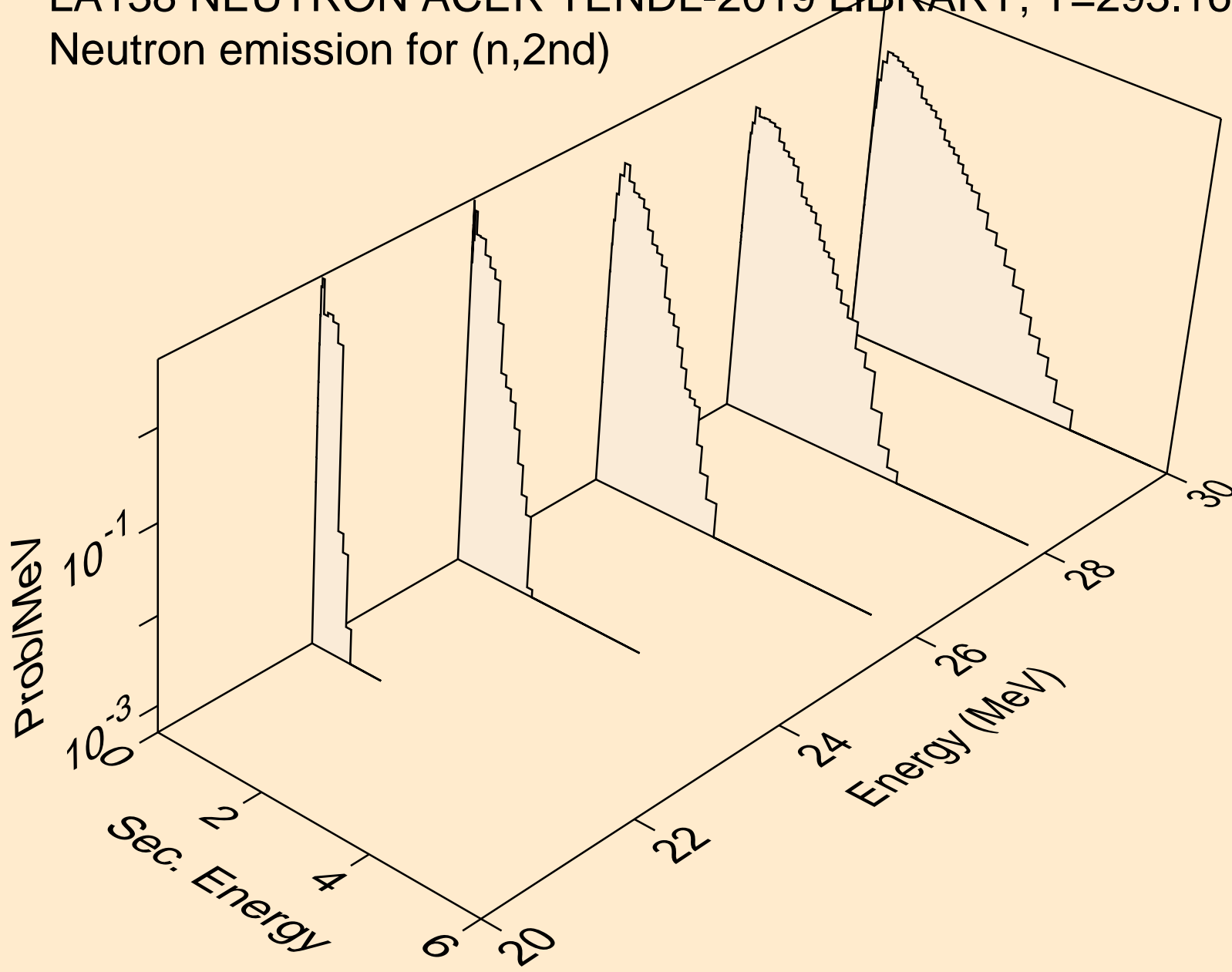

LA138 NEUTRON ACER TENDL-2019 LIBRARY; T=293.16K
Neutron emission for (n,2n)

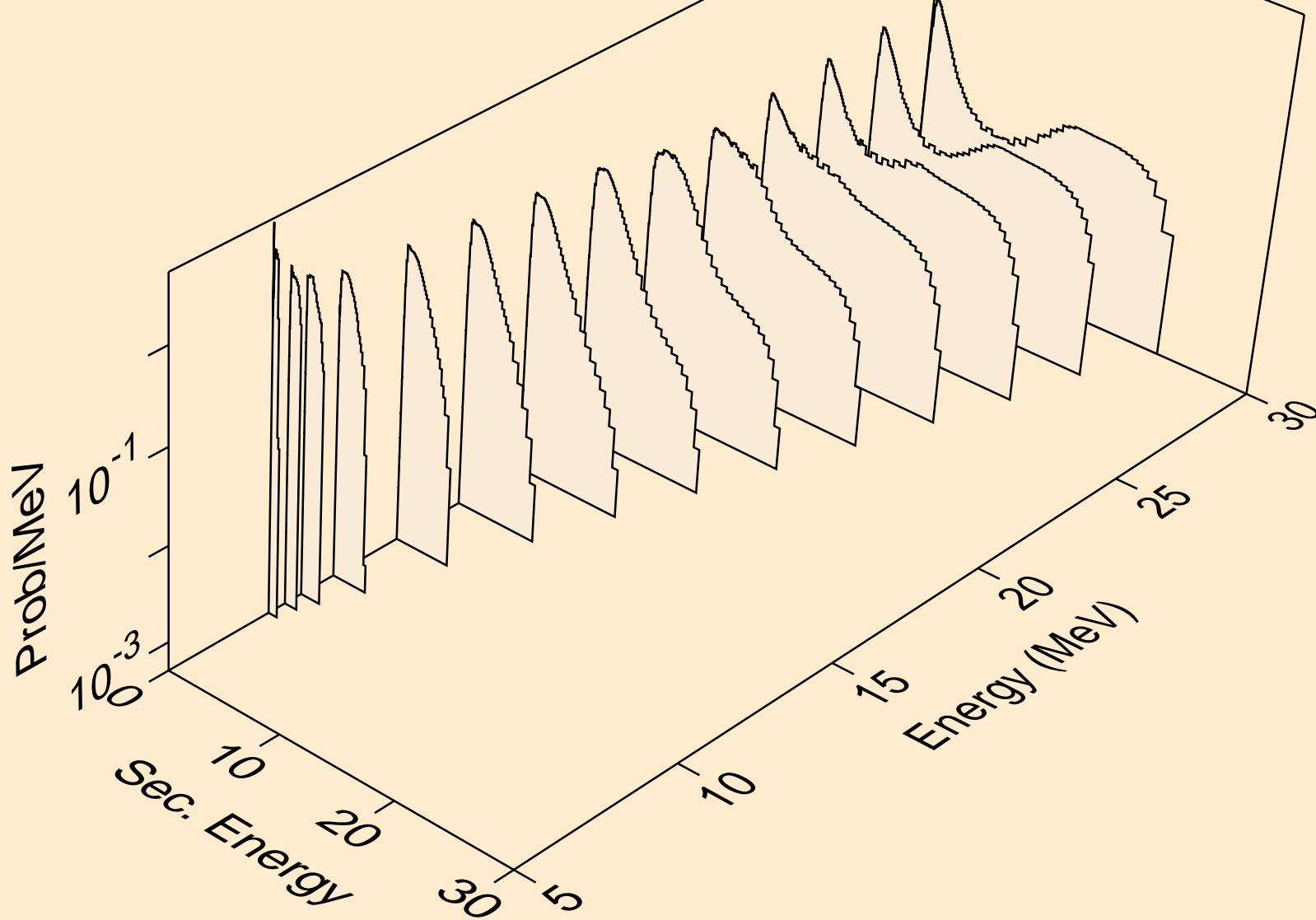

LA138 NEUTRON ACER TENDL-2019 LIBRARY; T=293.16K
Neutron emission for (n,3n)

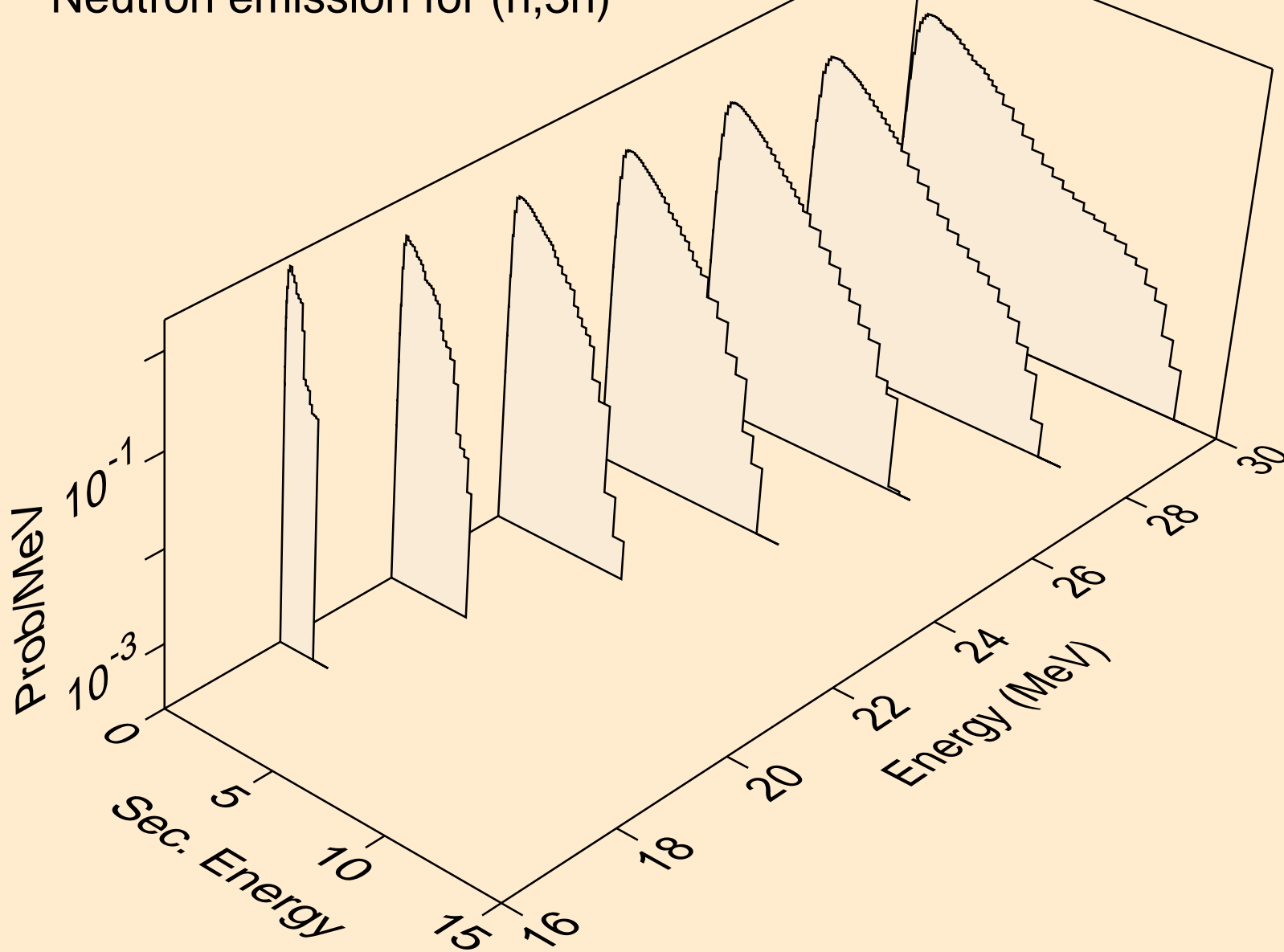

LA138 NEUTRON ACER TENDL-2019 LIBRARY; T=293.16K
Neutron emission for (n,n*)a

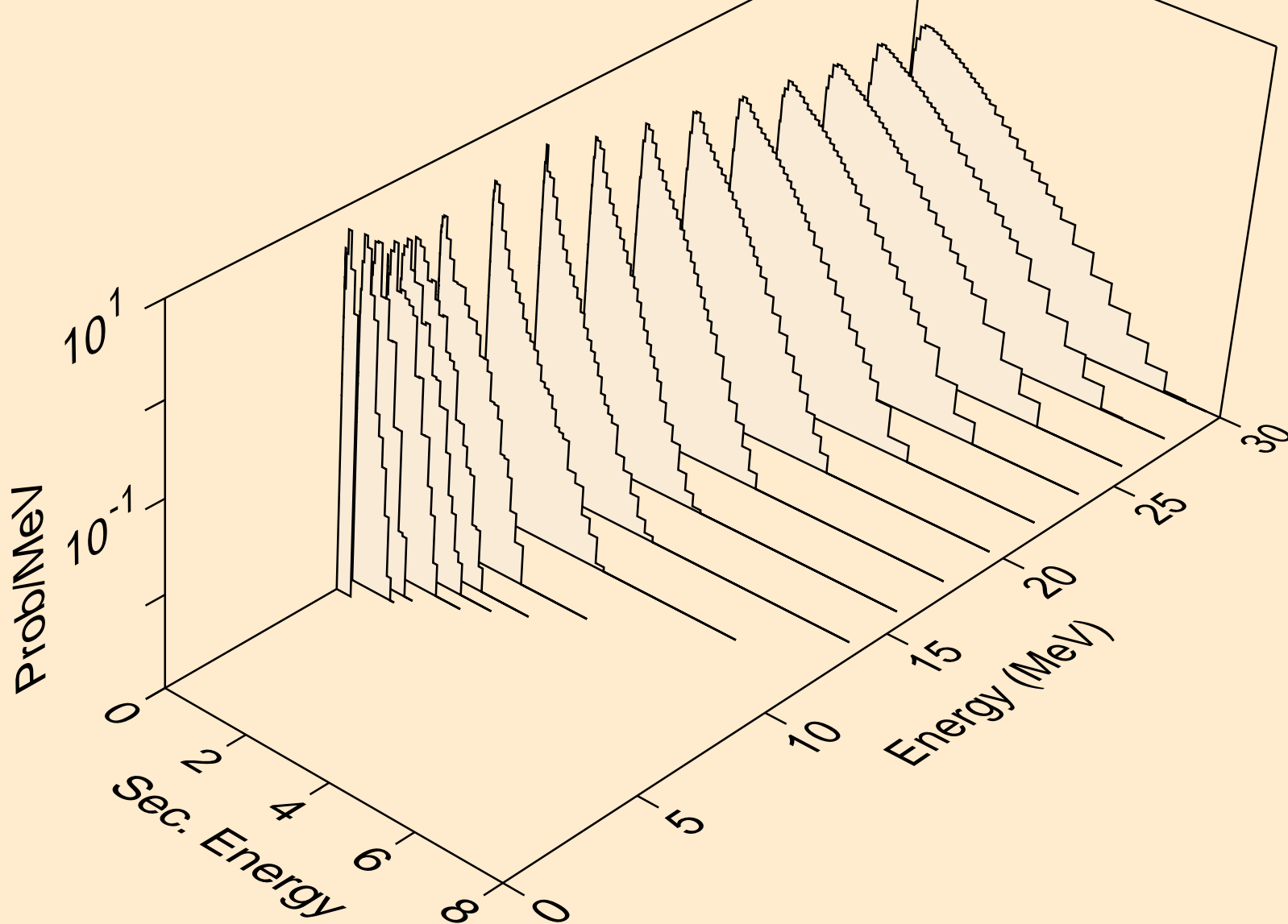

LA138 NEUTRON ACER TENDL-2019 LIBRARY; T=293.16K
Neutron emission for (n,2n)a

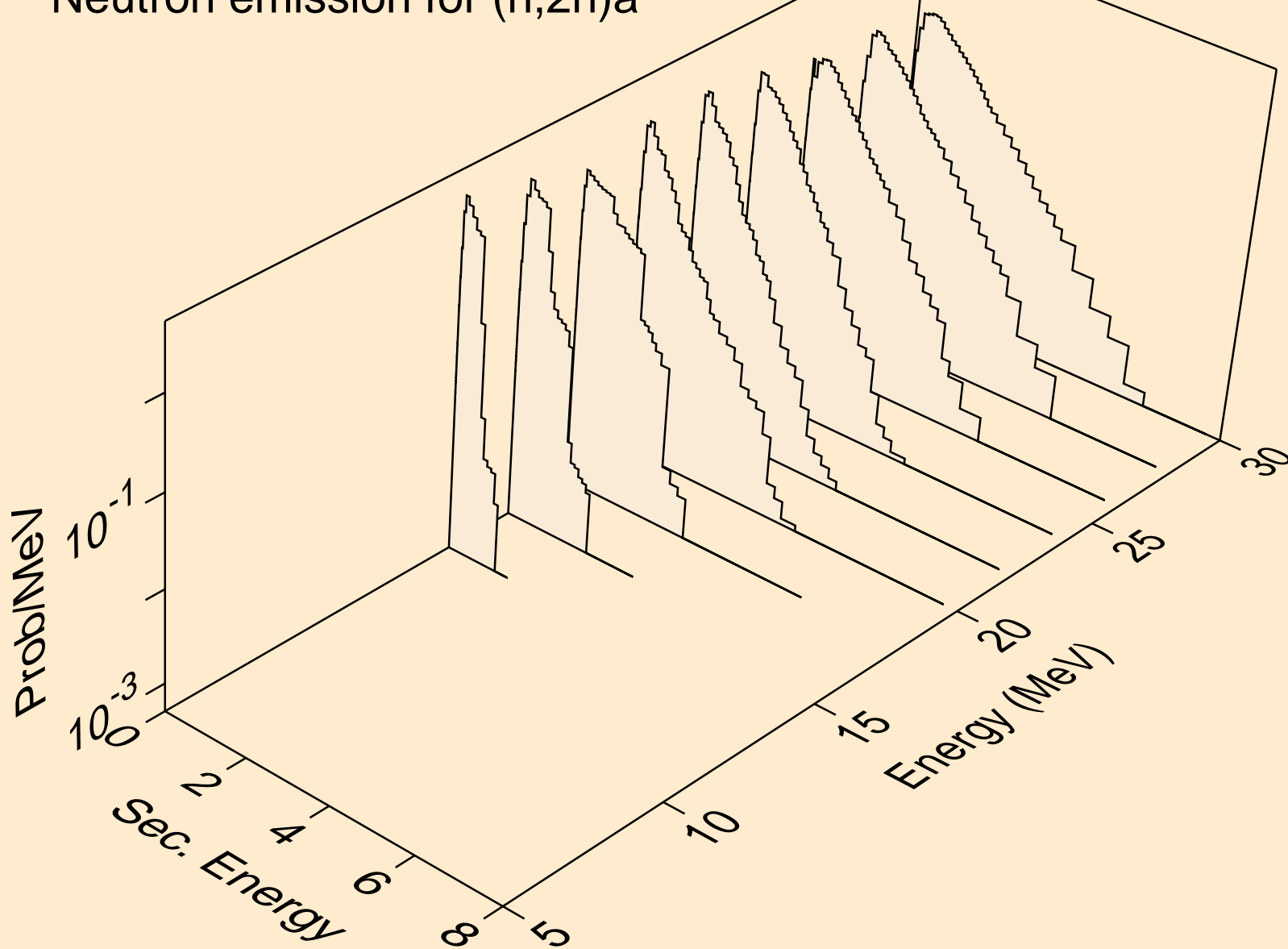

LA138 NEUTRON ACER TENDL-2019 LIBRARY; T=293.16K
Neutron emission for (n,3n)a

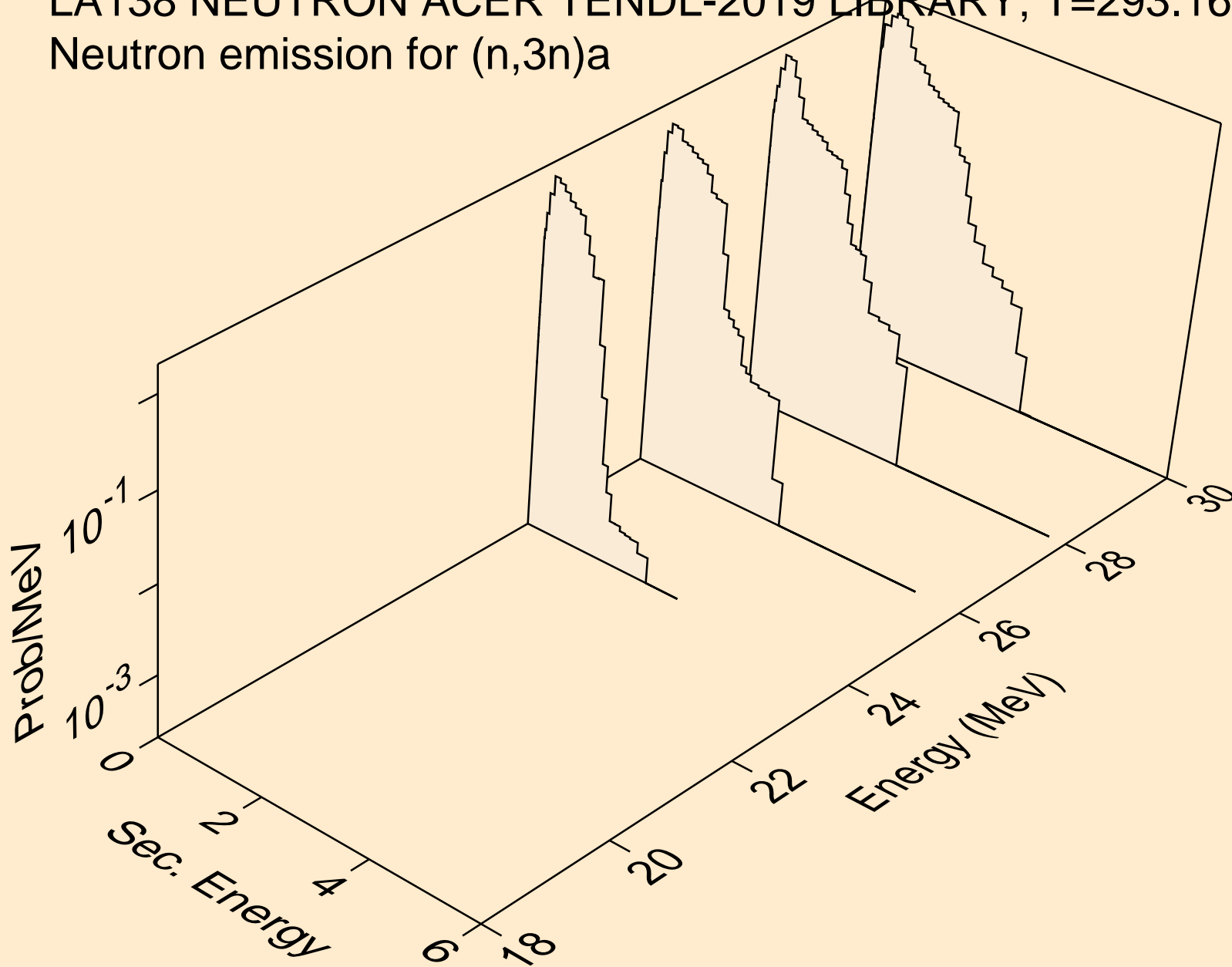

LA138 NEUTRON ACER TENDL-2019 LIBRARY; T=293.16K
Neutron emission for (n,n*)p

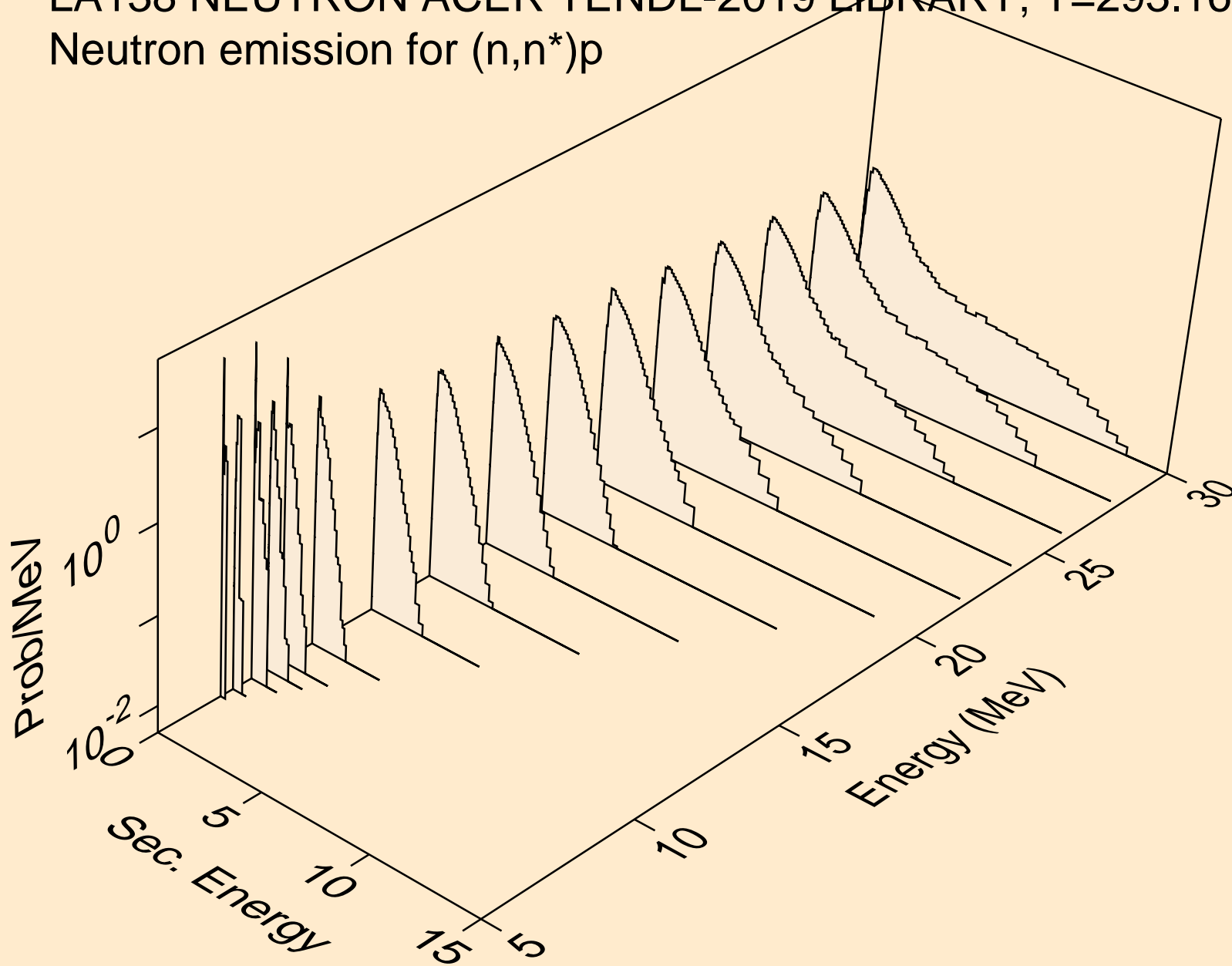

LA138 NEUTRON ACER TENDL-2019 LIBRARY; T=293.16K
Neutron emission for (n,n*)d

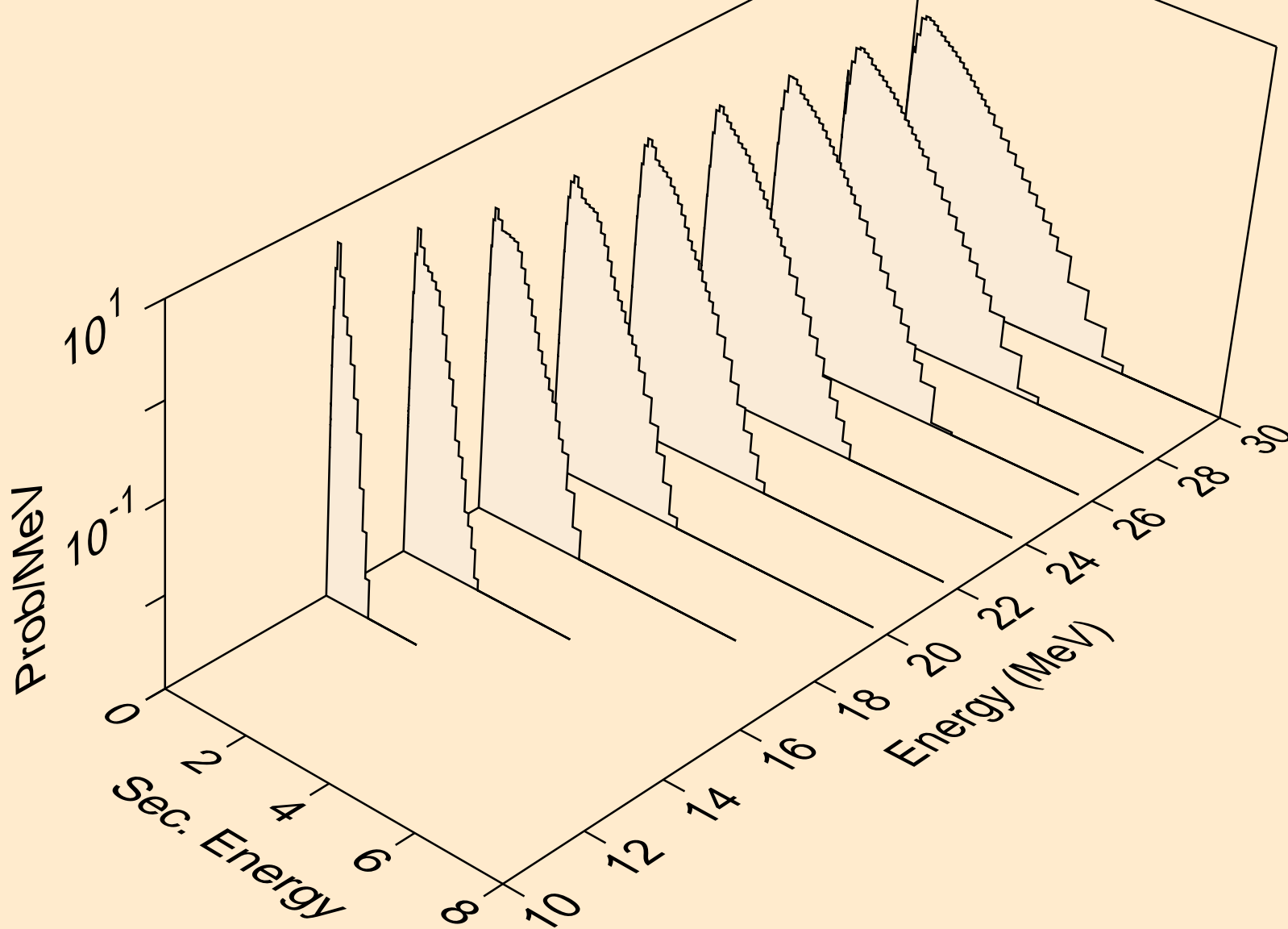

LA138 NEUTRON ACER TENDL-2019 LIBRARY; T=293.16K
Neutron emission for (n,n*)t

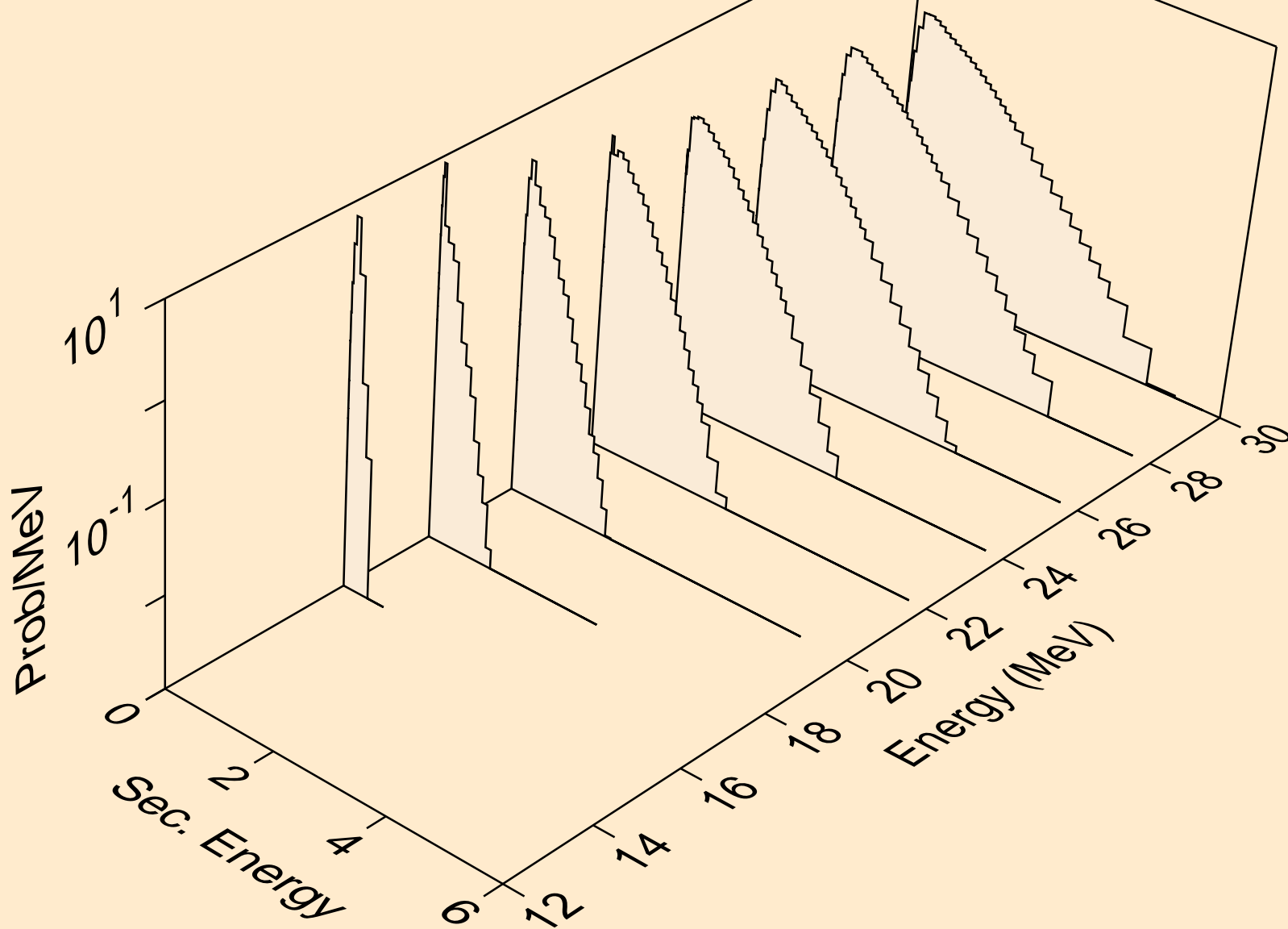

LA138 NEUTRON ACER TENDL-2019 LIBRARY; T=293.16K
Neutron emission for (n,n*)he3

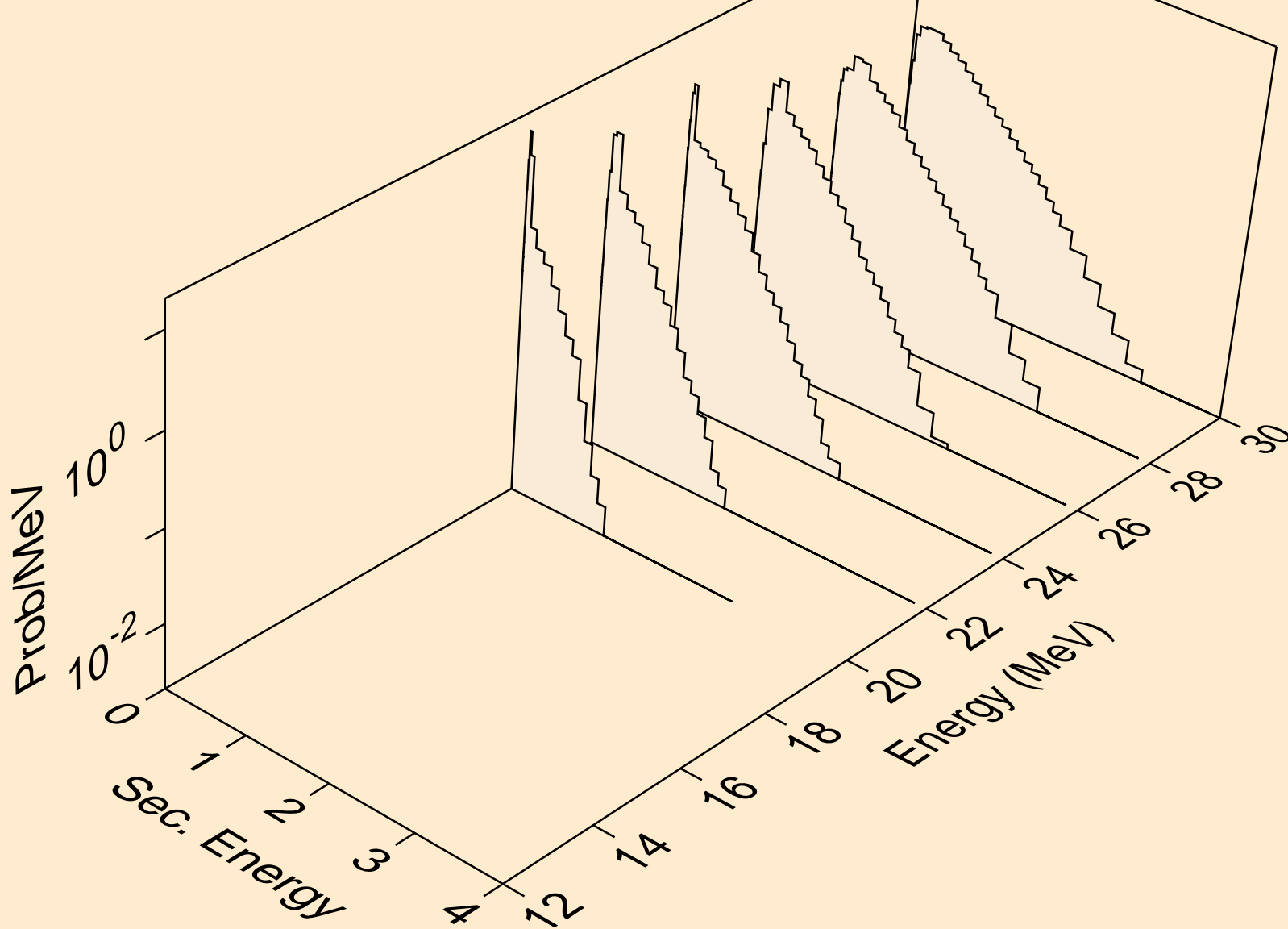

LA138 NEUTRON ACER TENDL-2019 LIBRARY; T=293.16K
Neutron emission for (n,4n)

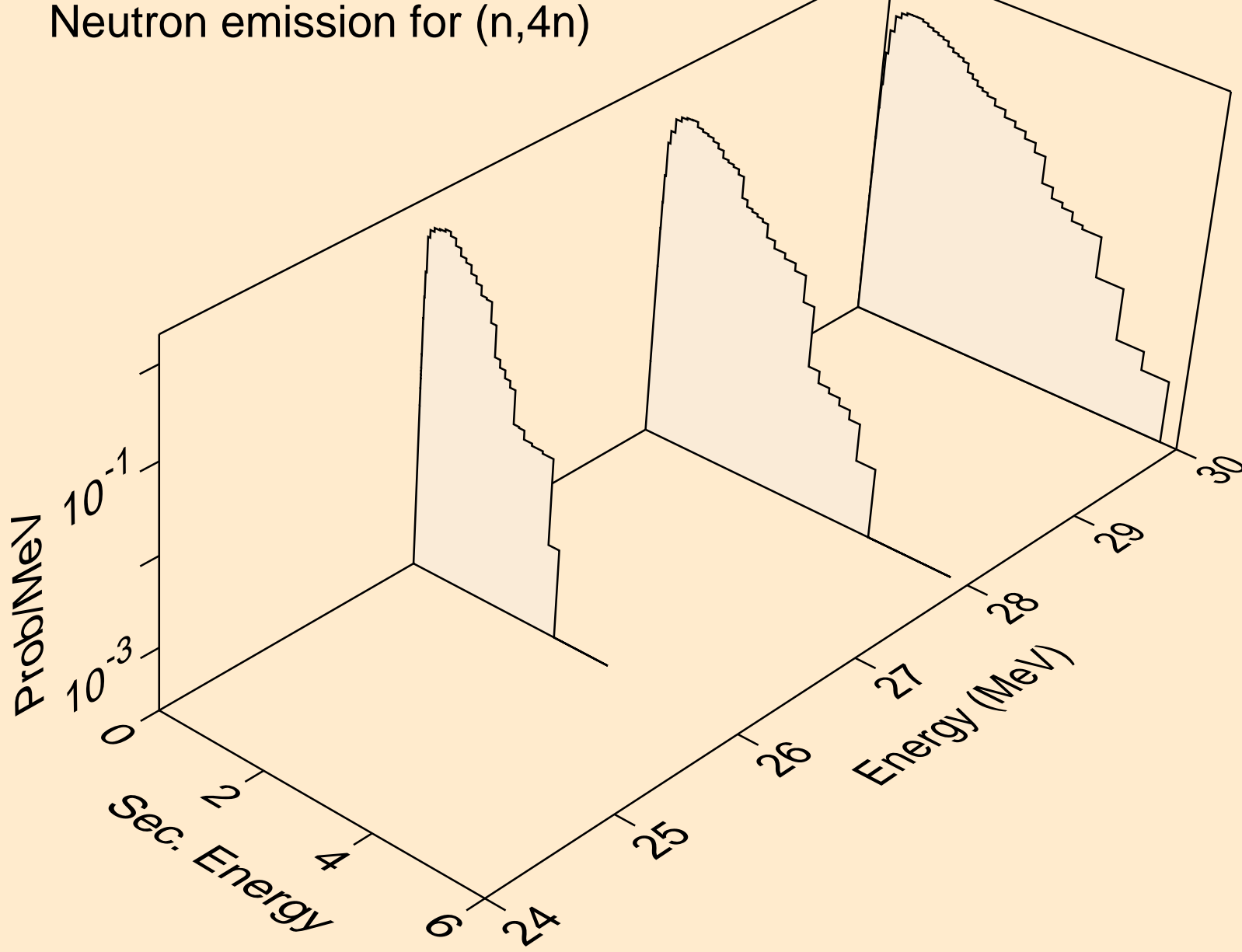

LA138 NEUTRON ACER TENDL-2019 LIBRARY; T=293.16K
Neutron emission for (n,2np)

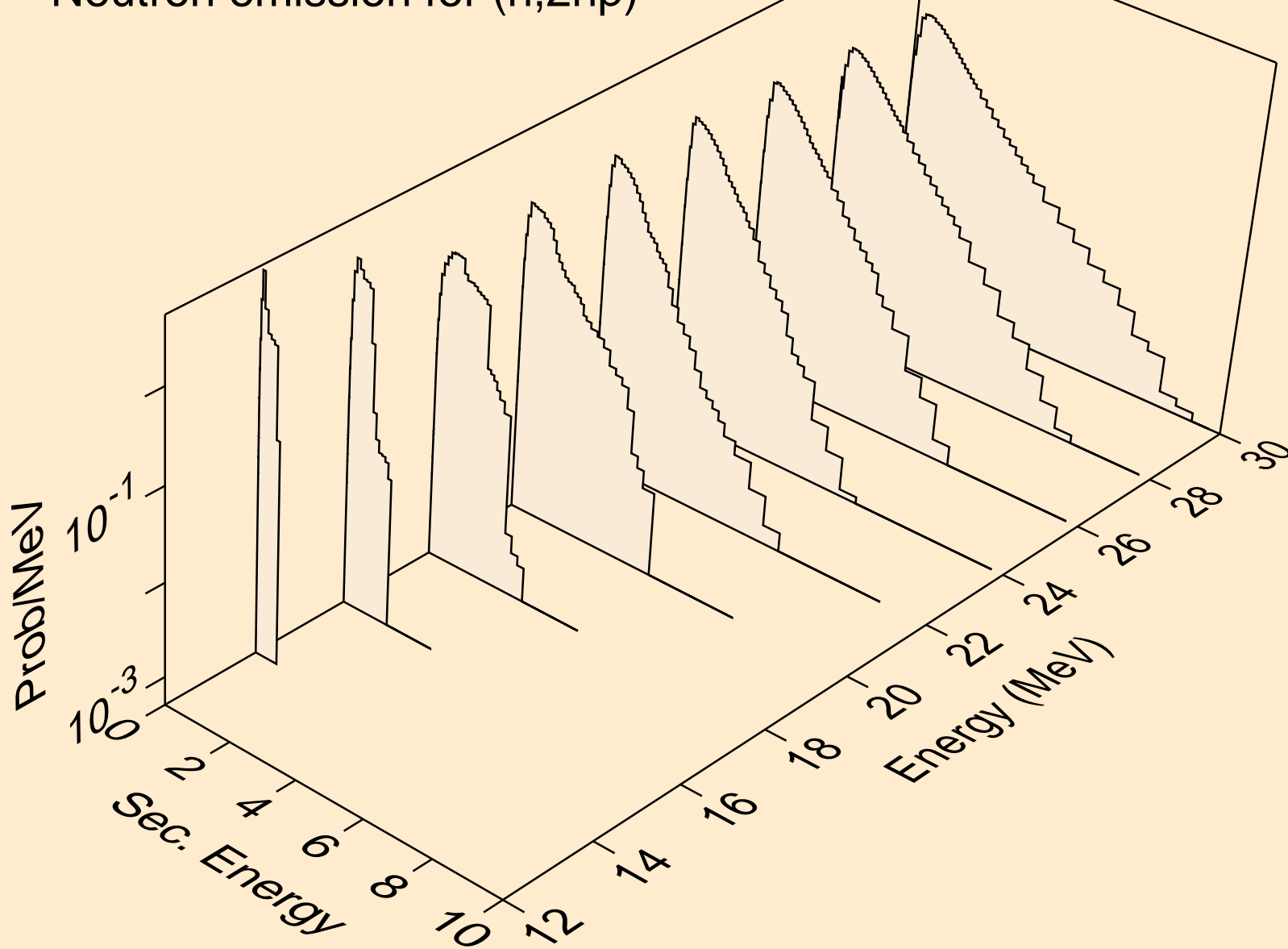

LA138 NEUTRON ACER TENDL-2019 LIBRARY; T=293.16K
Neutron emission for (n,3np)

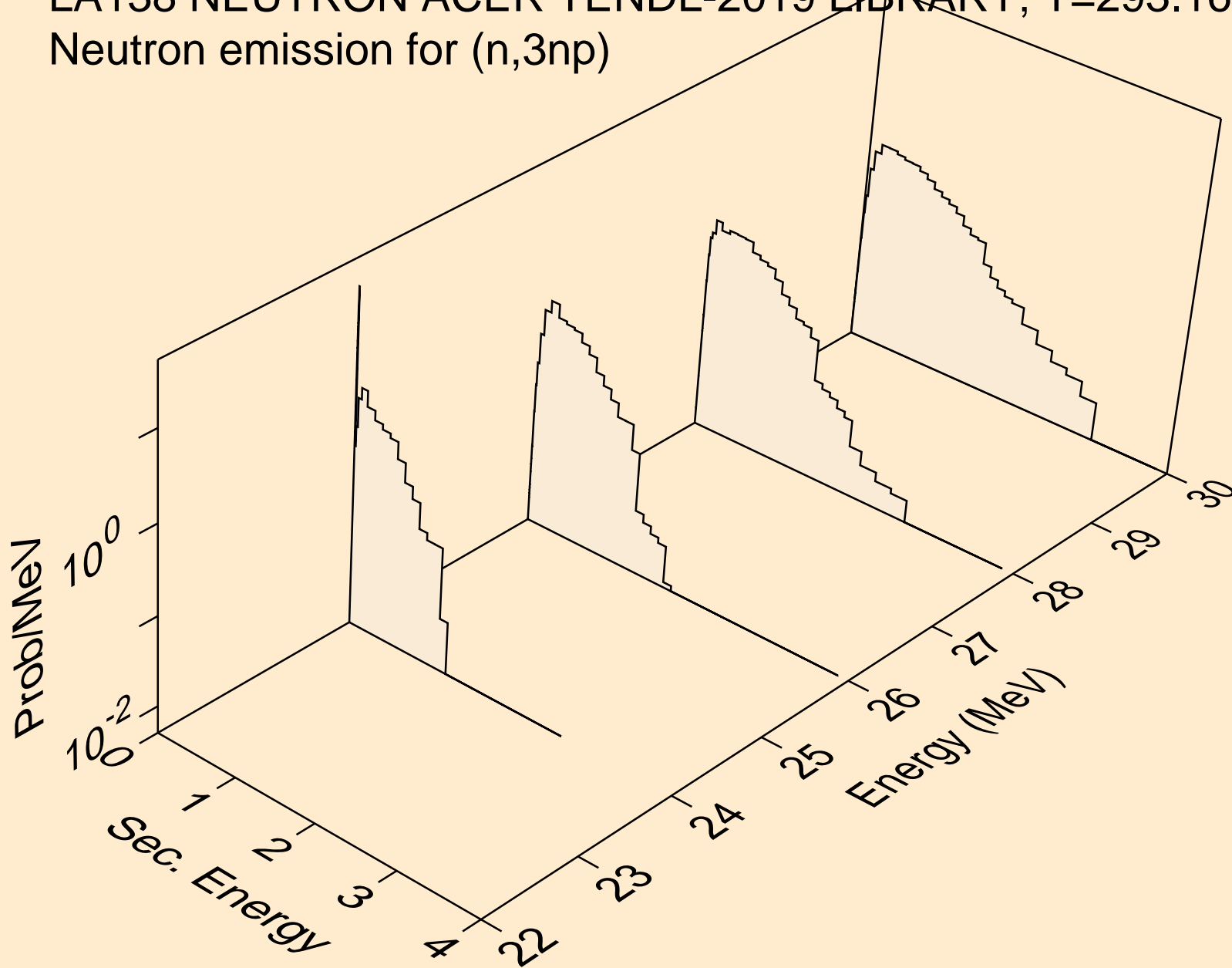

LA138 NEUTRON ACER TENDL-2019 LIBRARY; T=293.16K
Neutron emission for (n,2np)

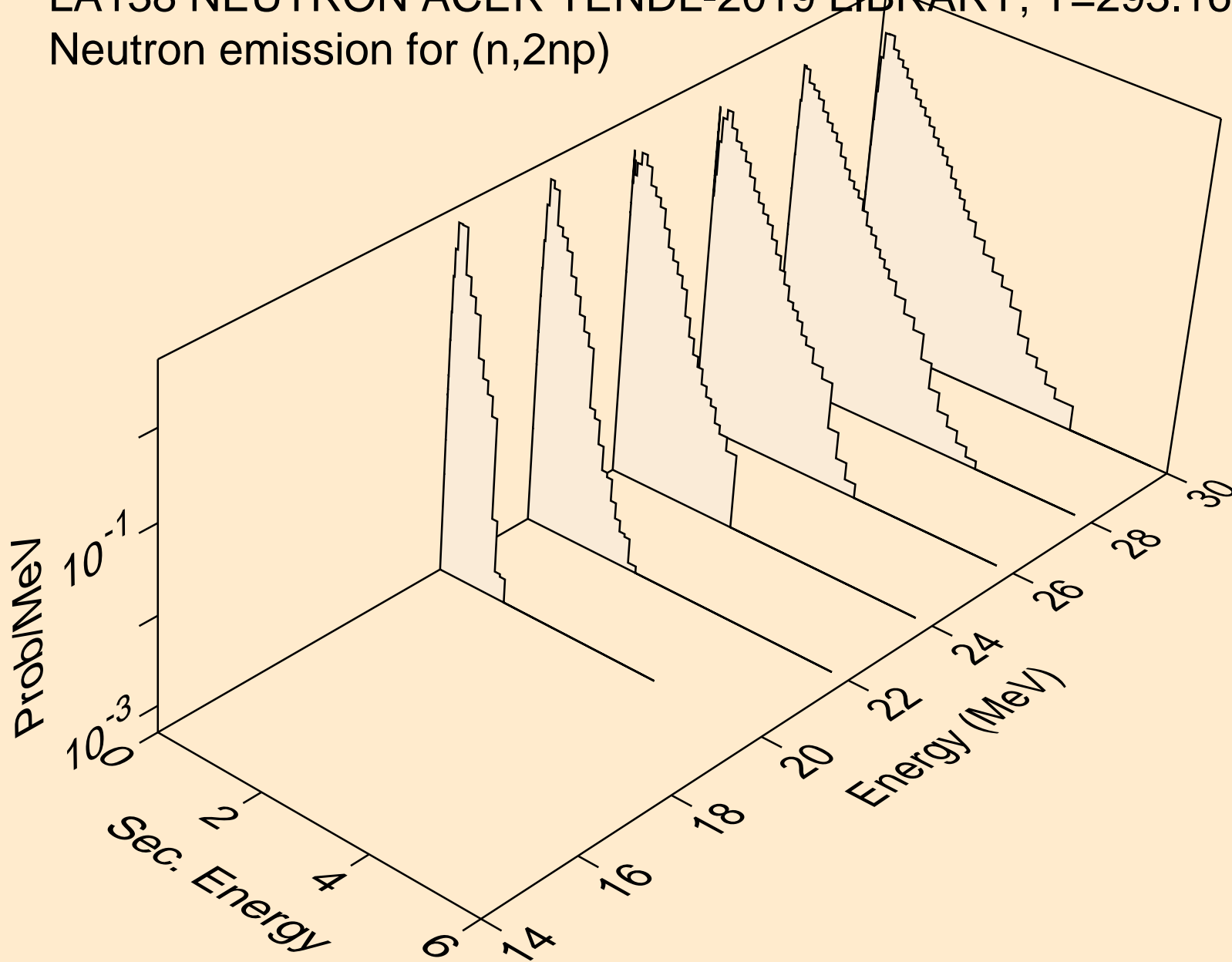

LA138 NEUTRON ACER TENDL-2019 LIBRARY; T=293.16K
Neutron emission for (n,npa)

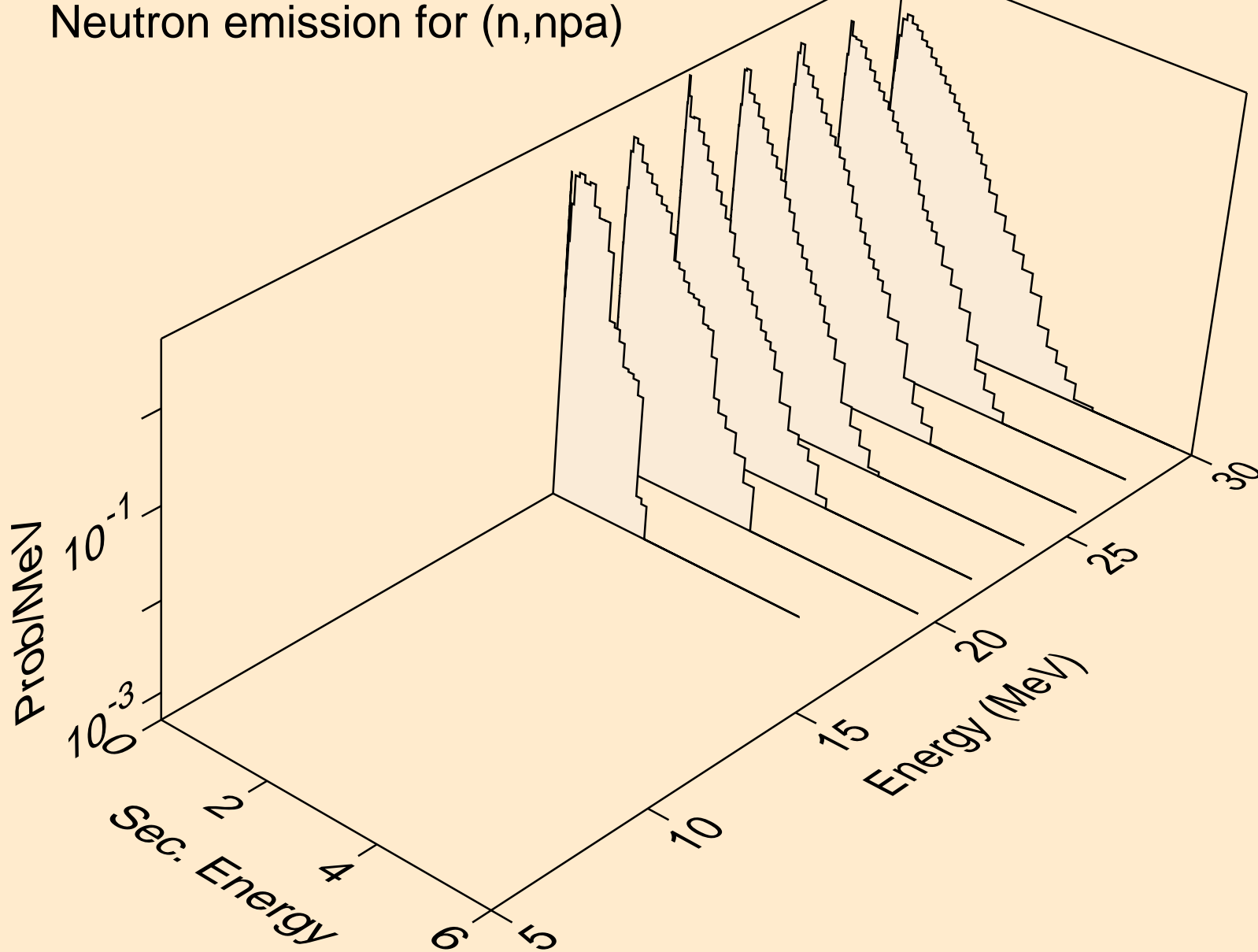

LA138 NEUTRON ACER TENDL-2019 LIBRARY; T=293.16K
Neutron emission for (n,n*c)

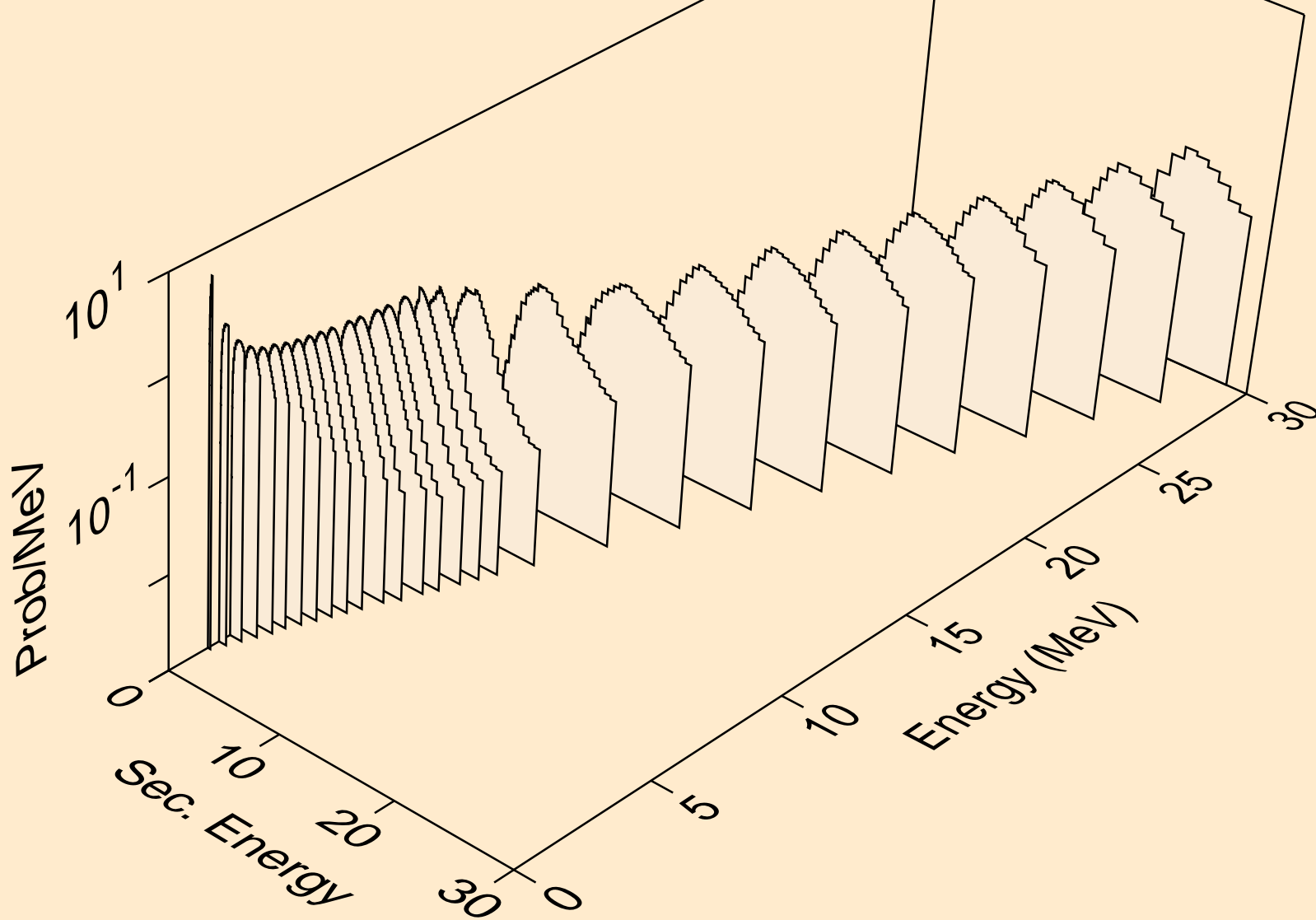

LA138 NEUTRON ACER TENDL-2019 LIBRARY; T=293.16K
Photon emission for (n,x)

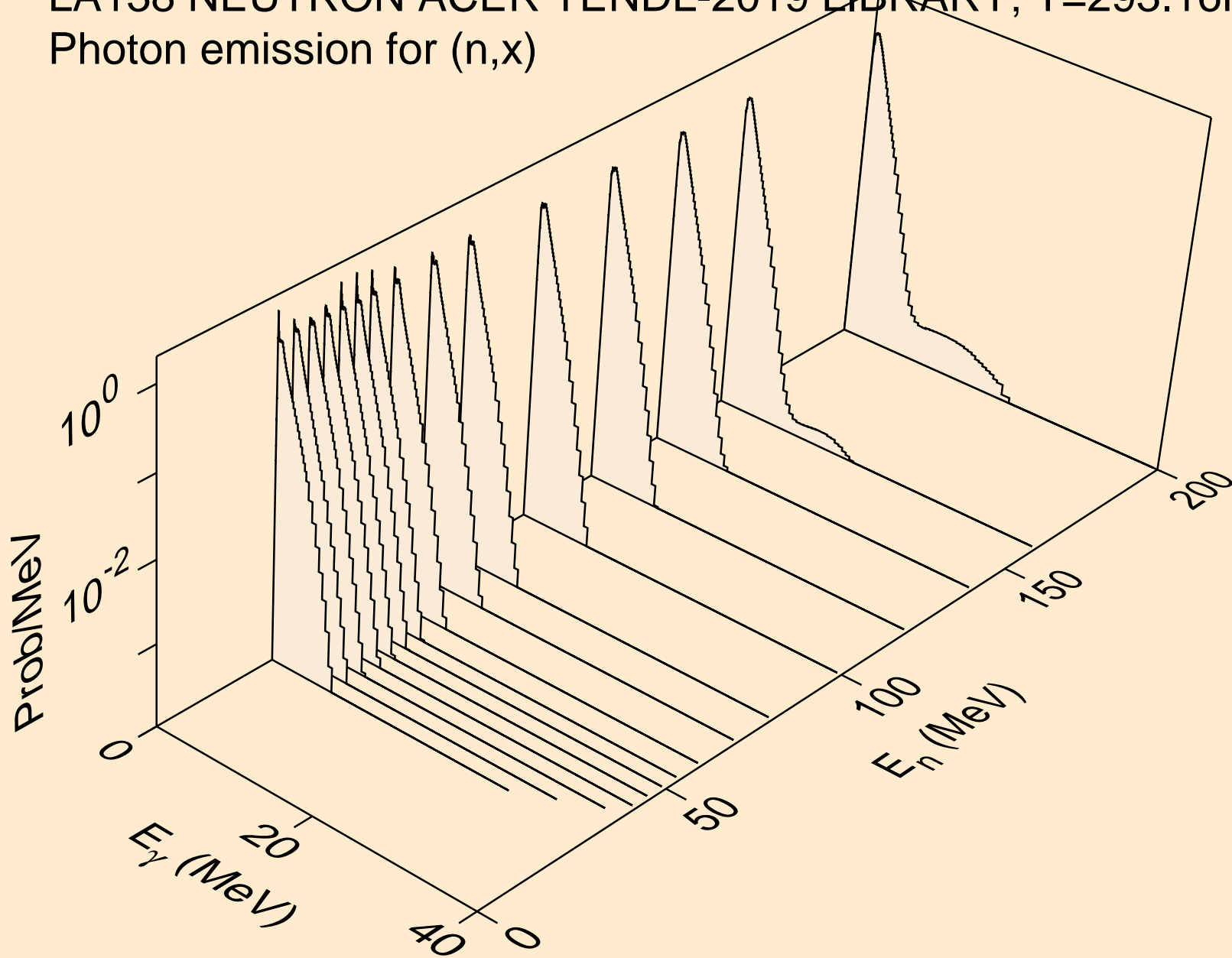

LA138 NEUTRON ACER TENDL-2019 LIBRARY; T=293.16K
Photon emission for (n,2nd)

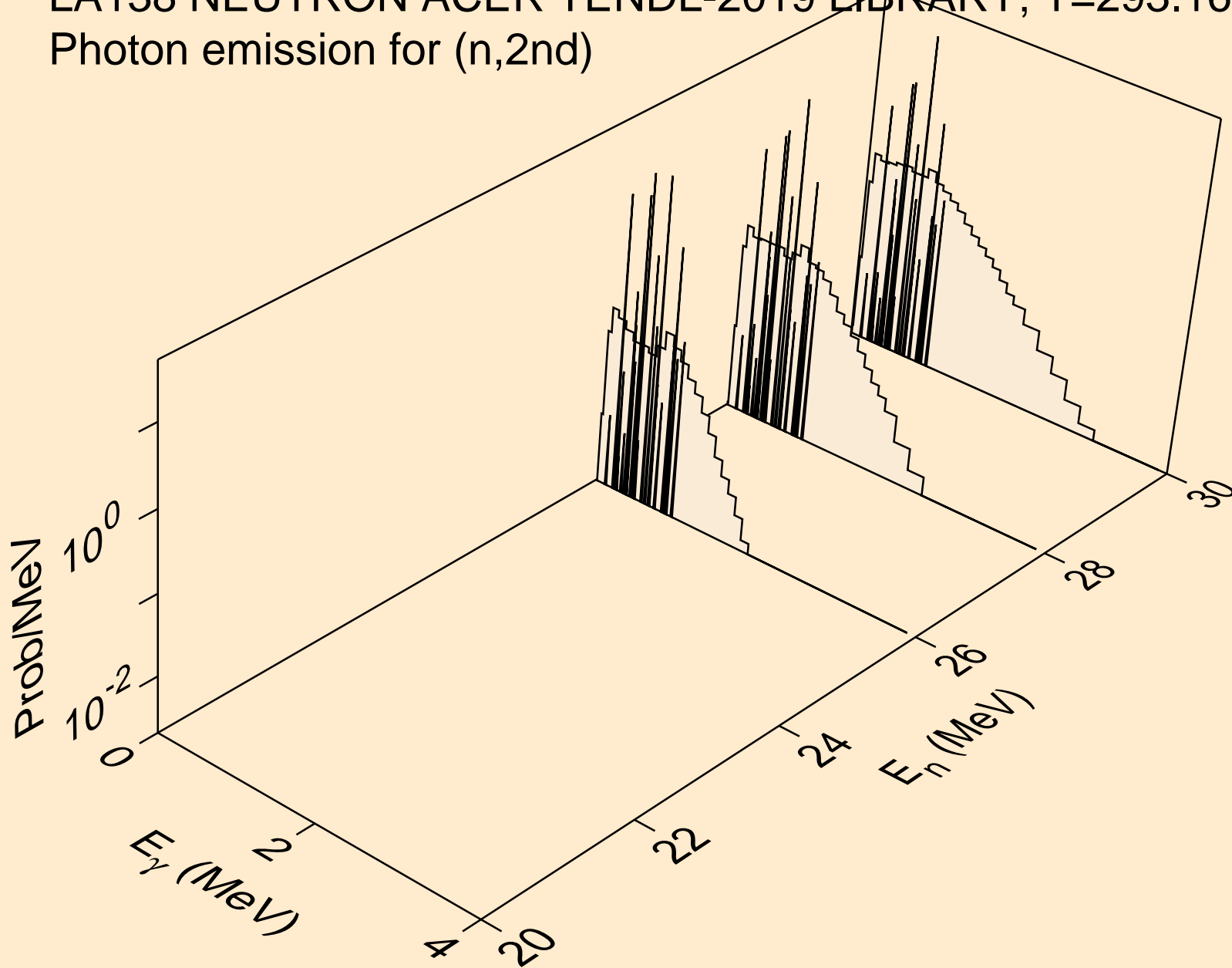

LA138 NEUTRON ACER TENDL-2019 LIBRARY; T=293.16K
Photon emission for (n,2n)

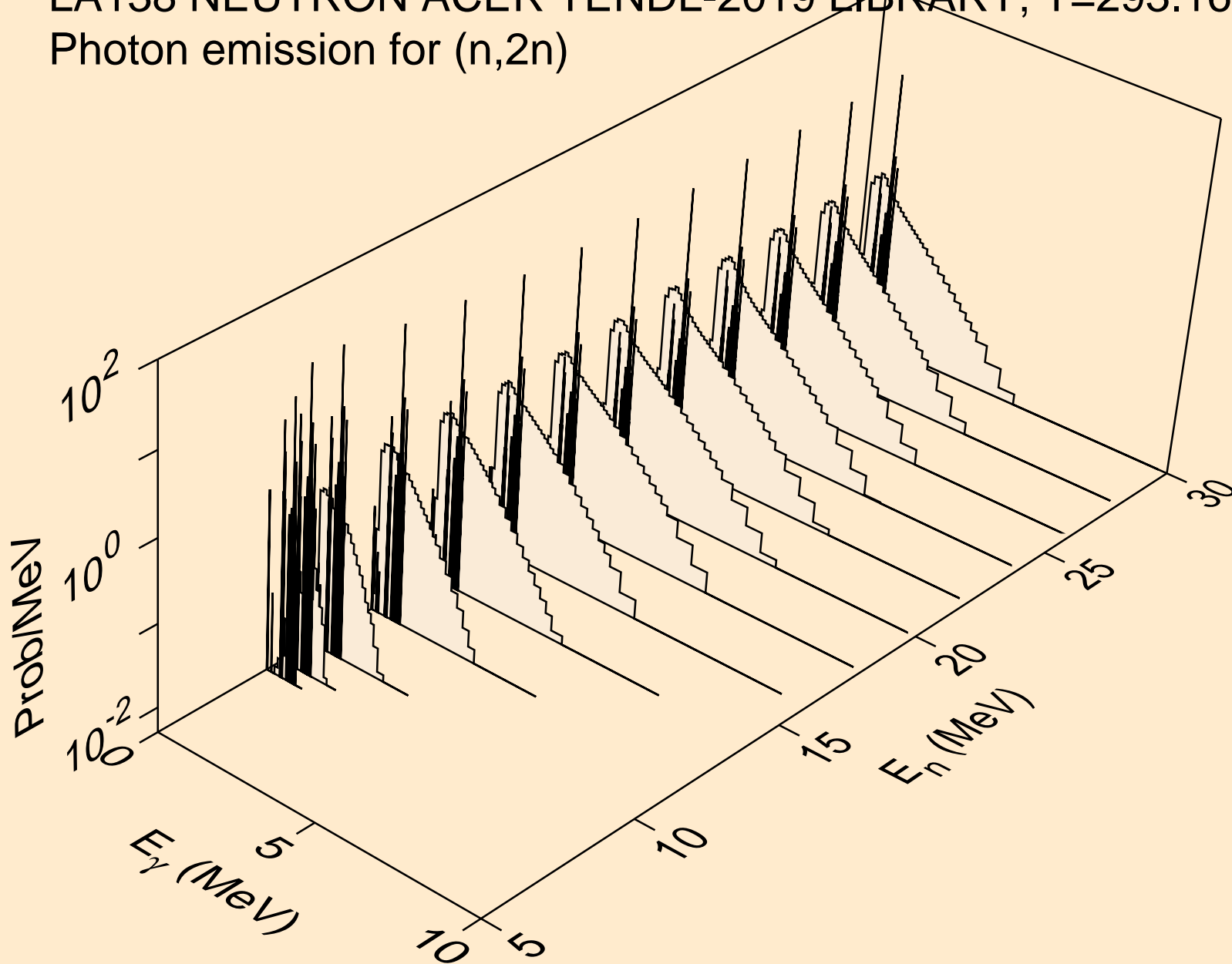

LA138 NEUTRON ACER TENDL-2019 LIBRARY; T=293.16K
Photon emission for (n,3n)

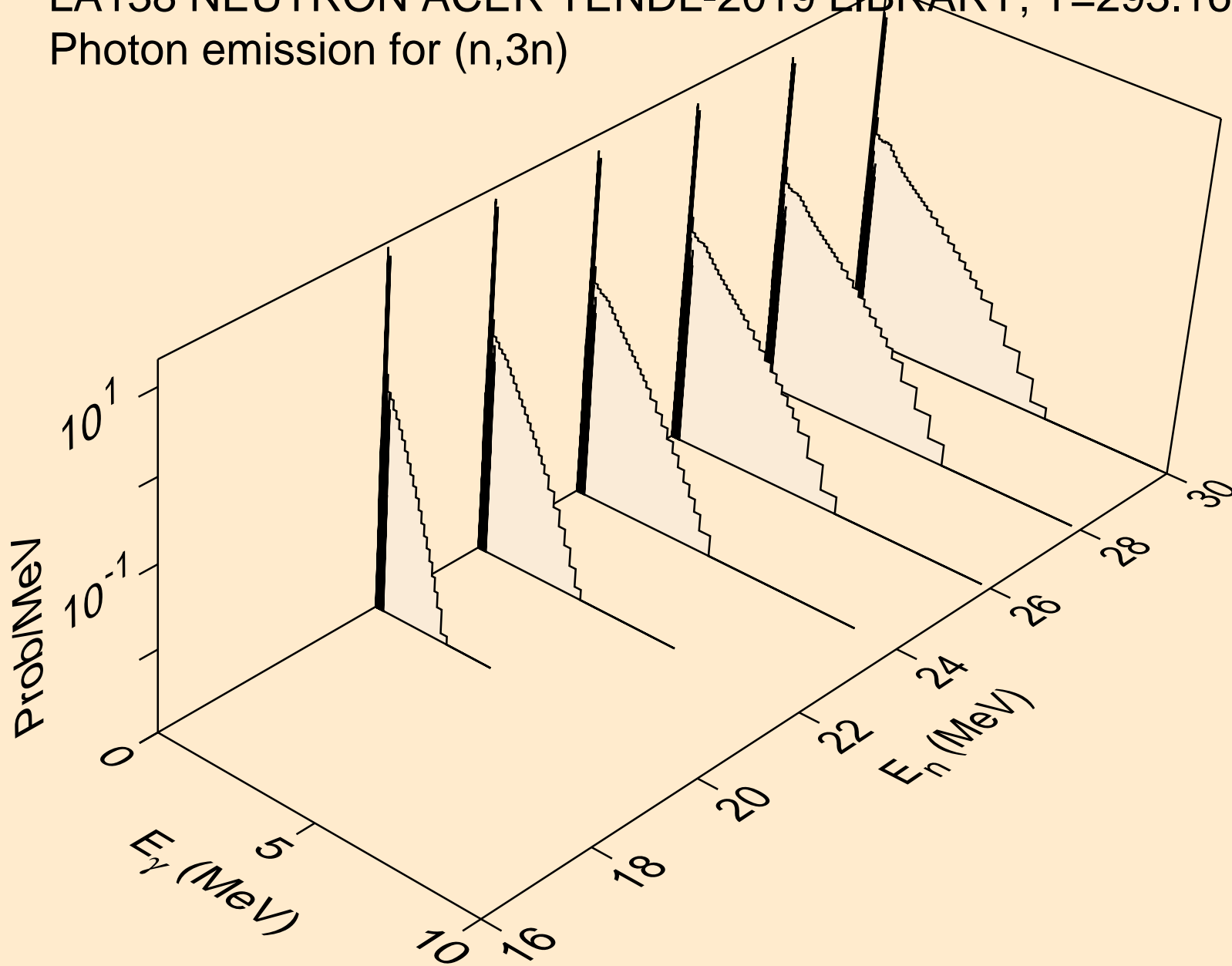

LA138 NEUTRON ACER TENDL-2019 LIBRARY; T=293.16K
Photon emission for (n,n*)a

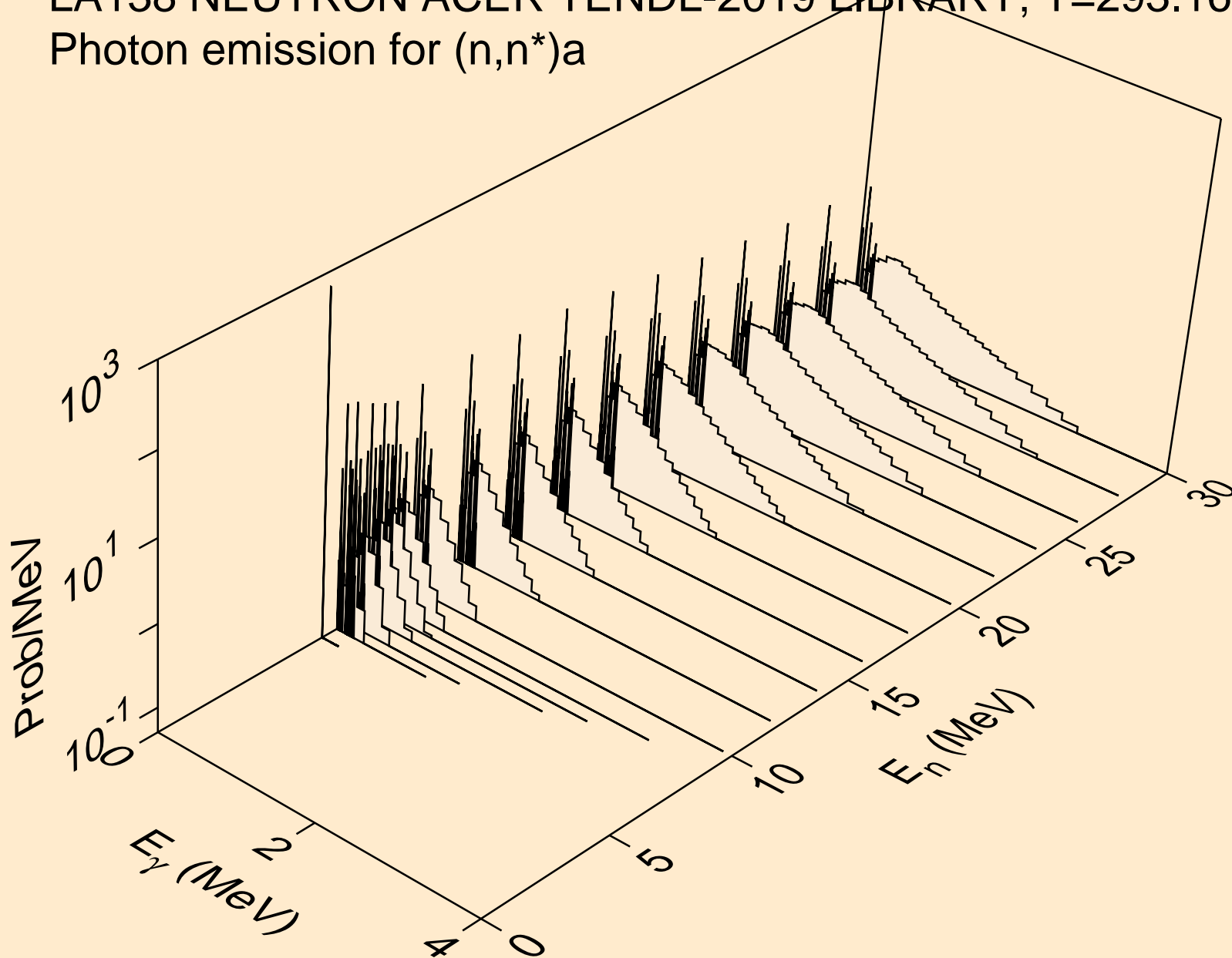

LA138 NEUTRON ACER TENDL-2019 LIBRARY; T=293.16K
Photon emission for (n,2n)a

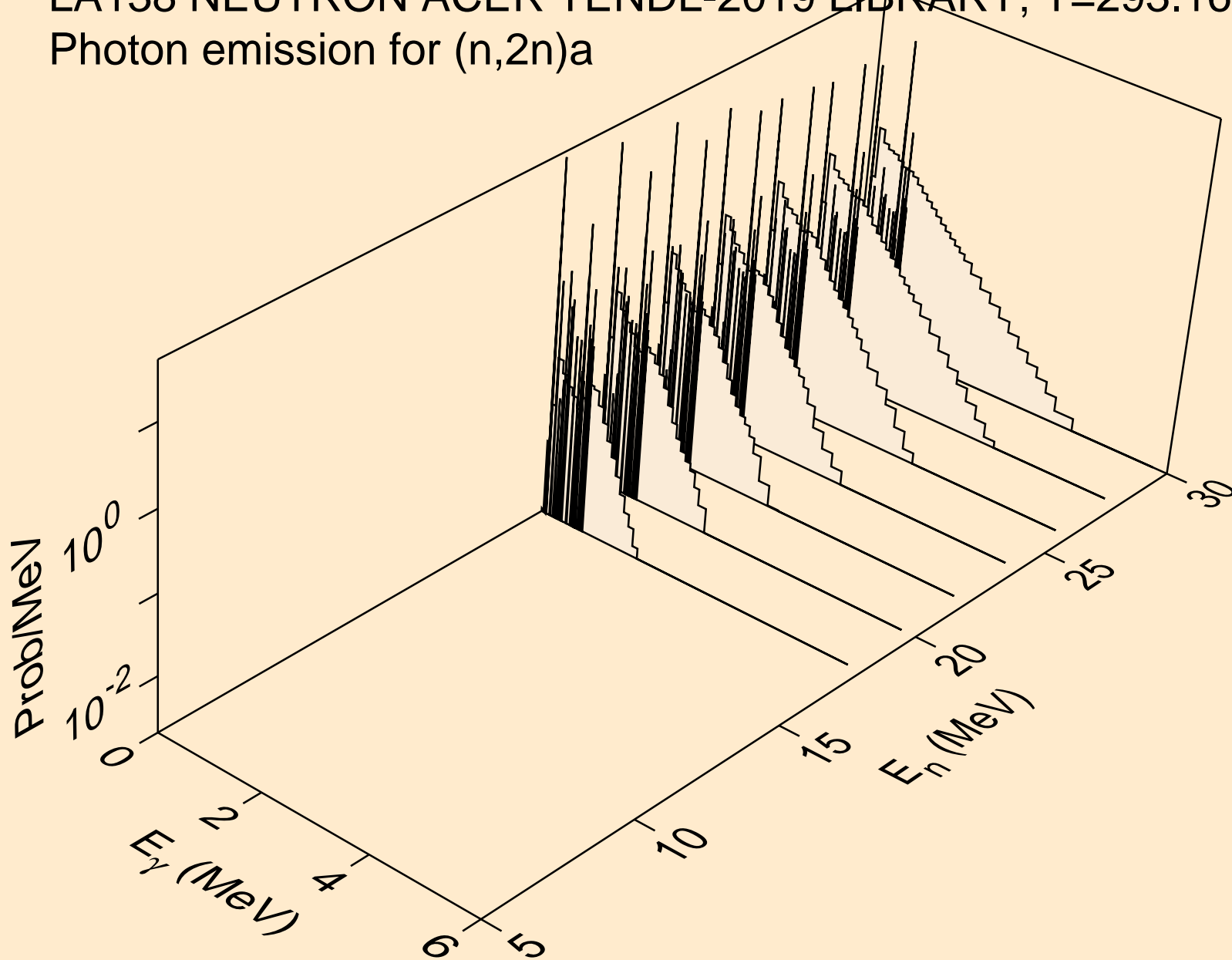

LA138 NEUTRON ACER TENDL-2019 LIBRARY; T=293.16K
Photon emission for (n,3n)a

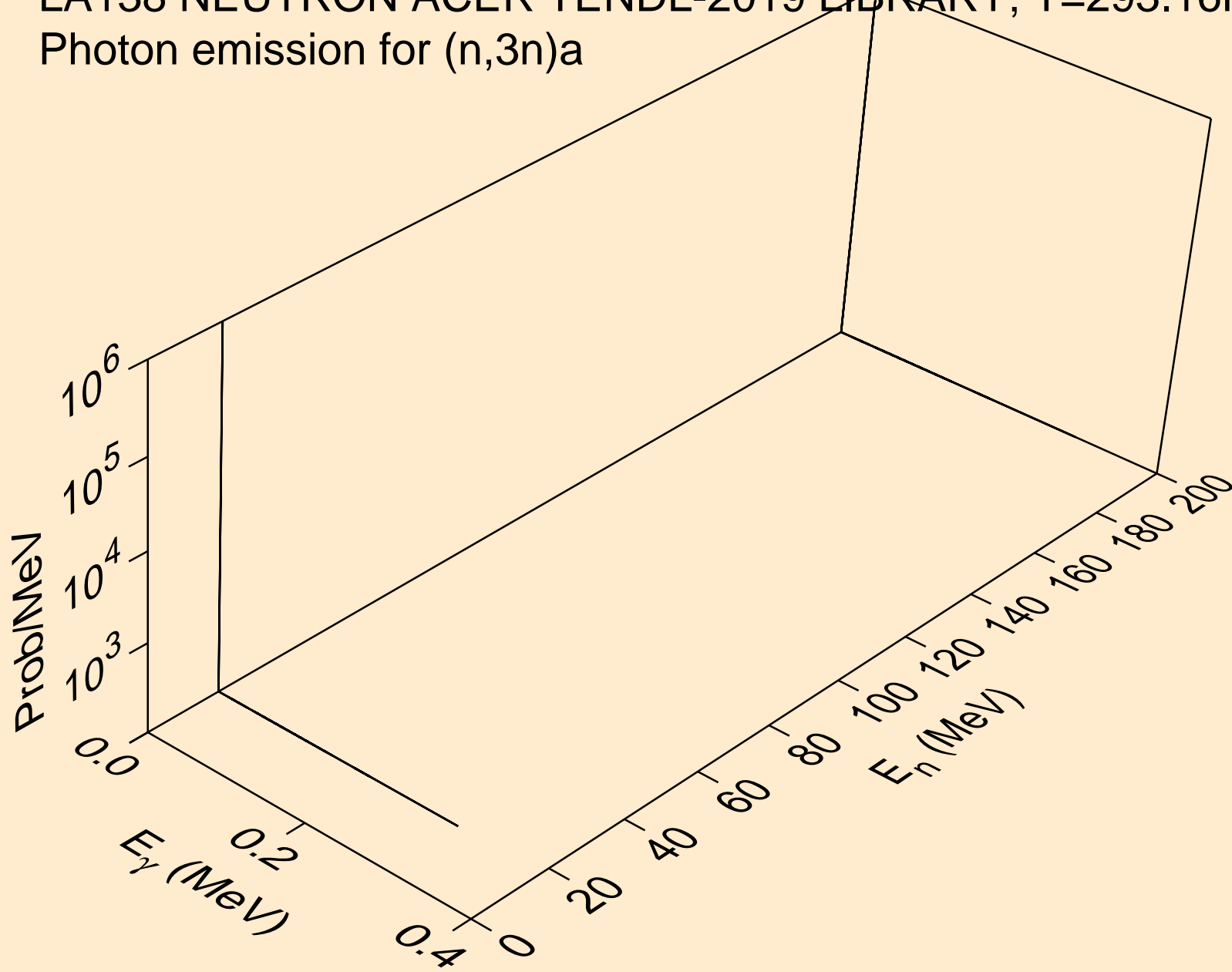

LA138 NEUTRON ACER TENDL-2019 LIBRARY; T=293.16K
Photon emission for (n,n*)p

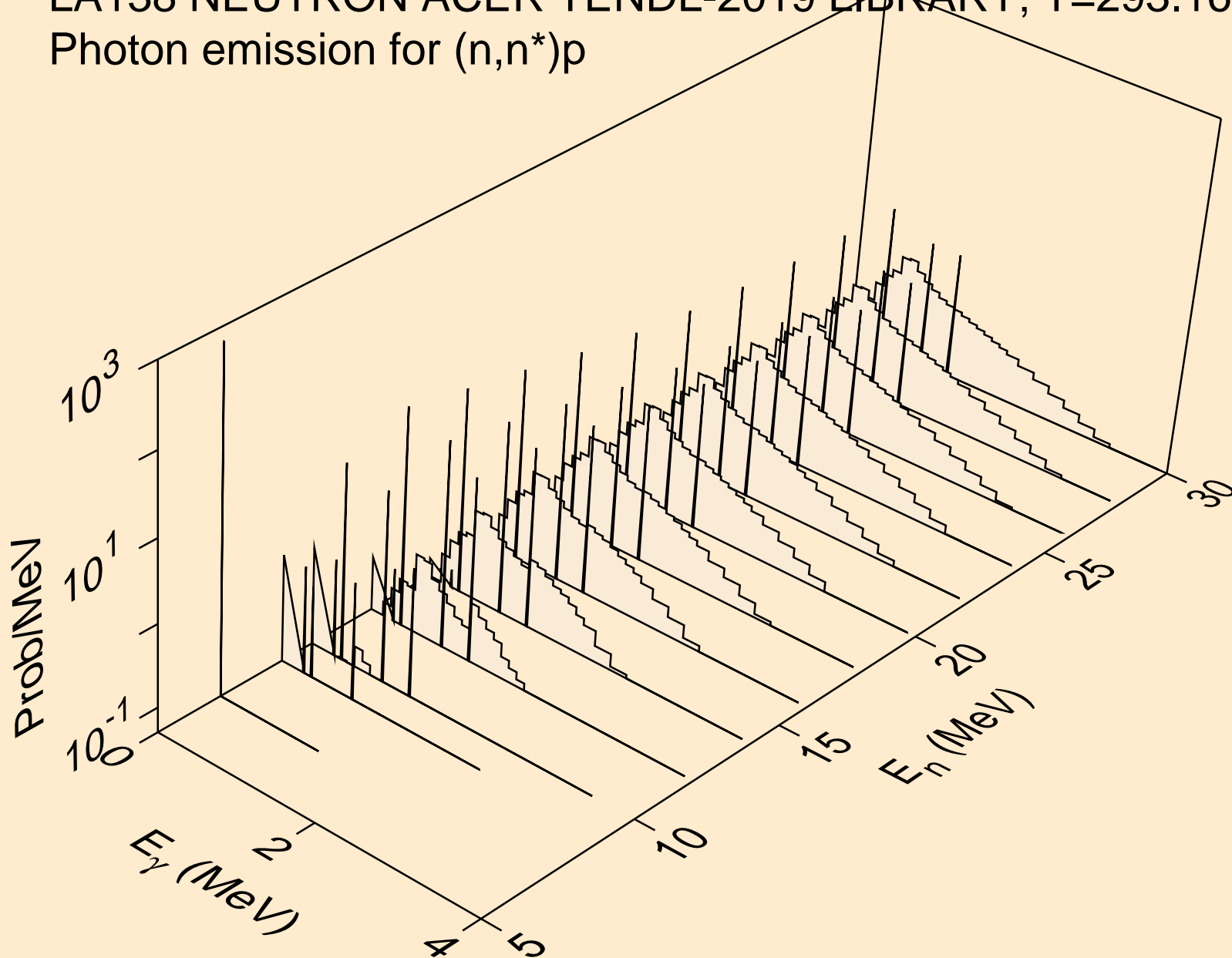

LA138 NEUTRON ACER TENDL-2019 LIBRARY; T=293.16K
Photon emission for (n,n*)d

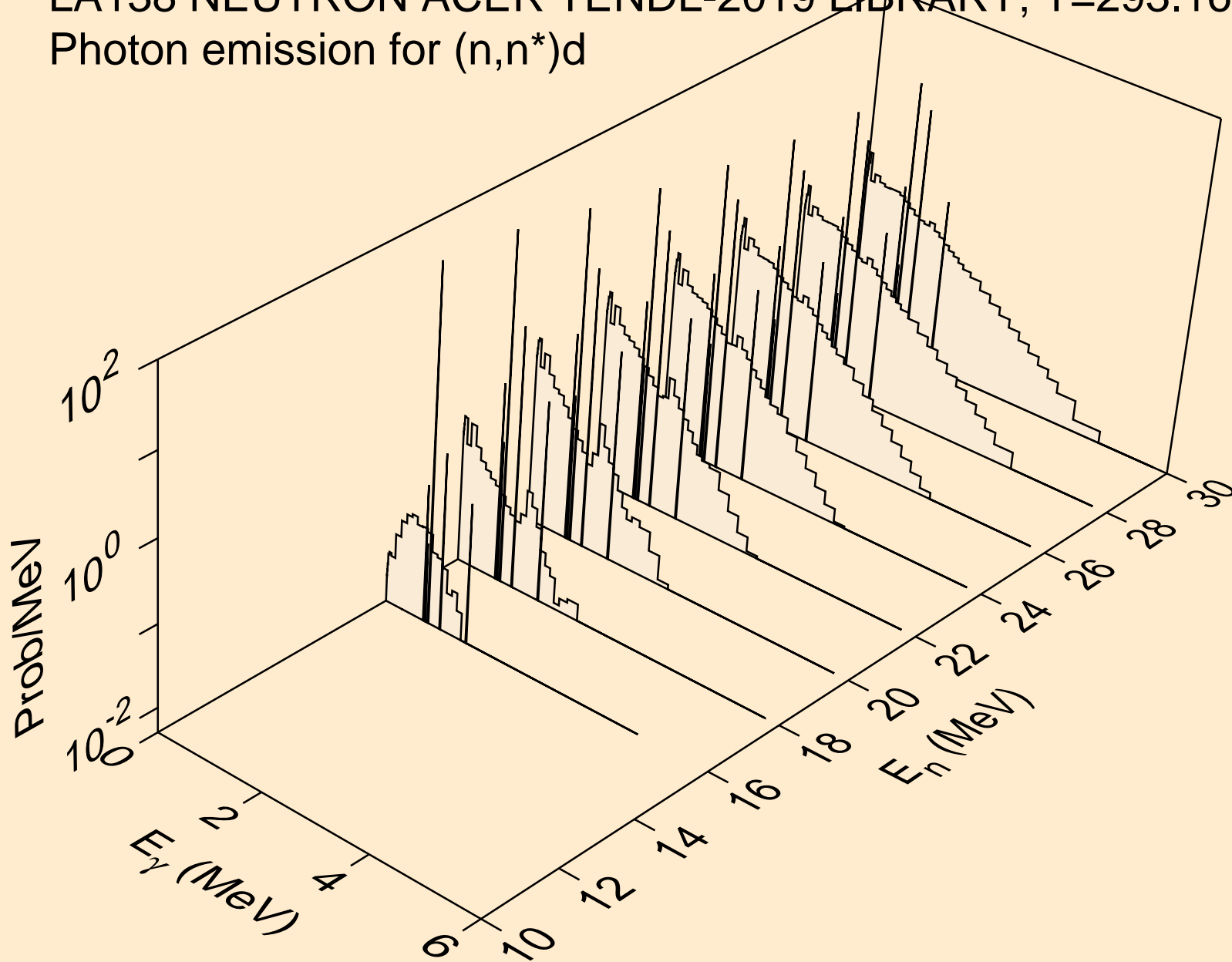

LA138 NEUTRON ACER TENDL-2019 LIBRARY; T=293.16K
Photon emission for (n,n*)t

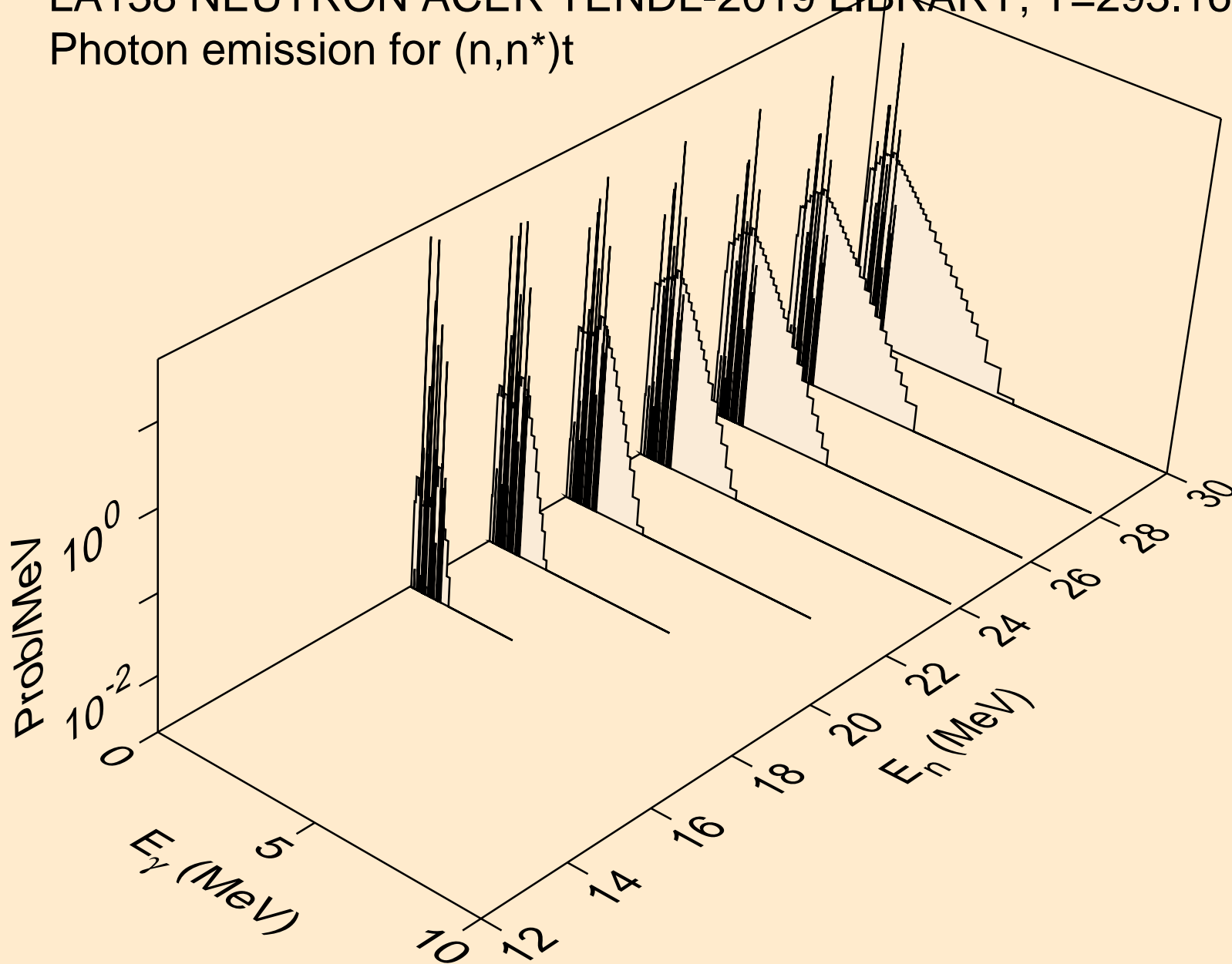

LA138 NEUTRON ACER TENDL-2019 LIBRARY; T=293.16K
Photon emission for (n,n*)he3

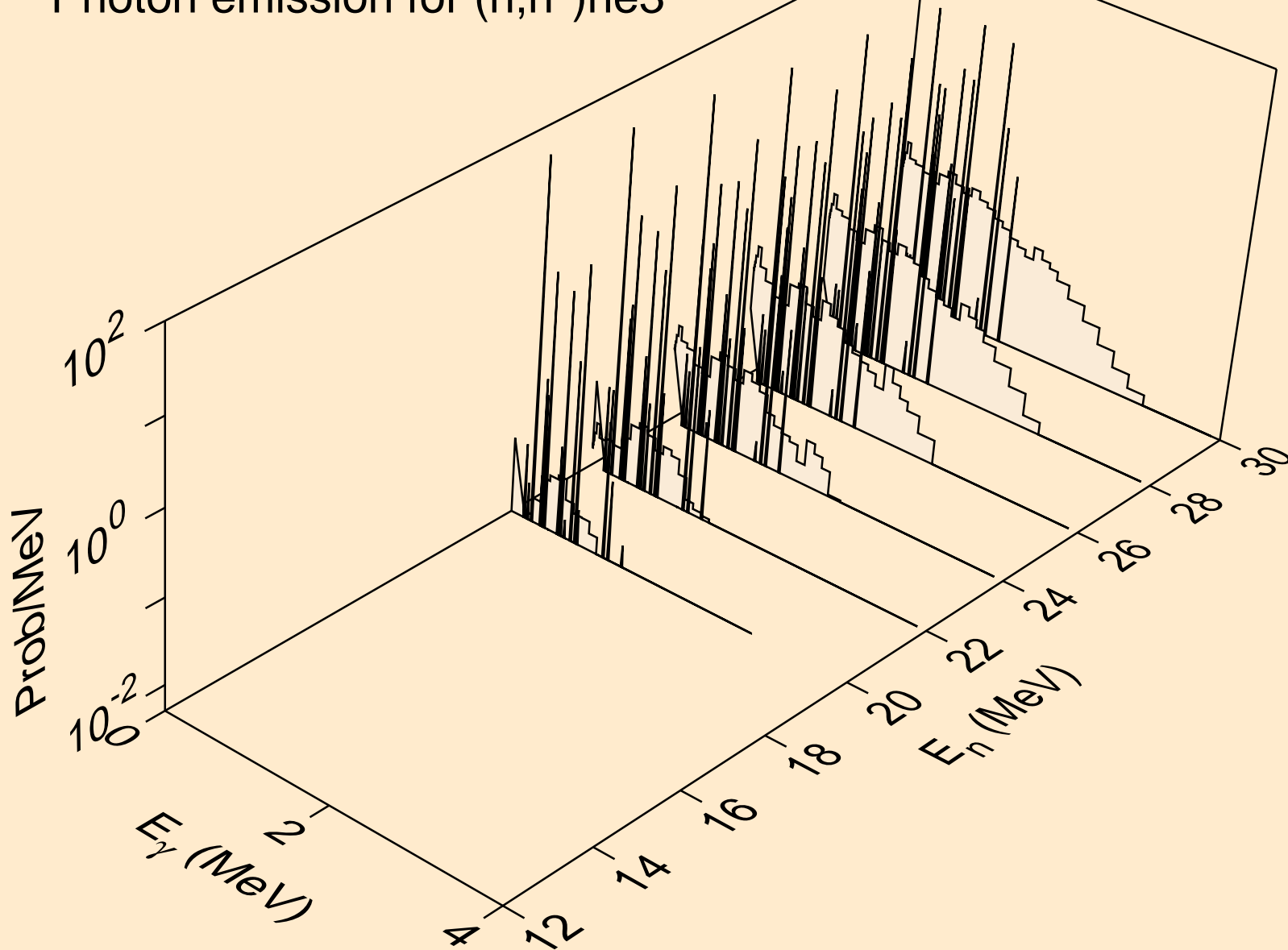

LA138 NEUTRON ACER TENDL-2019 LIBRARY; T=293.16K
Photon emission for (n,4n)

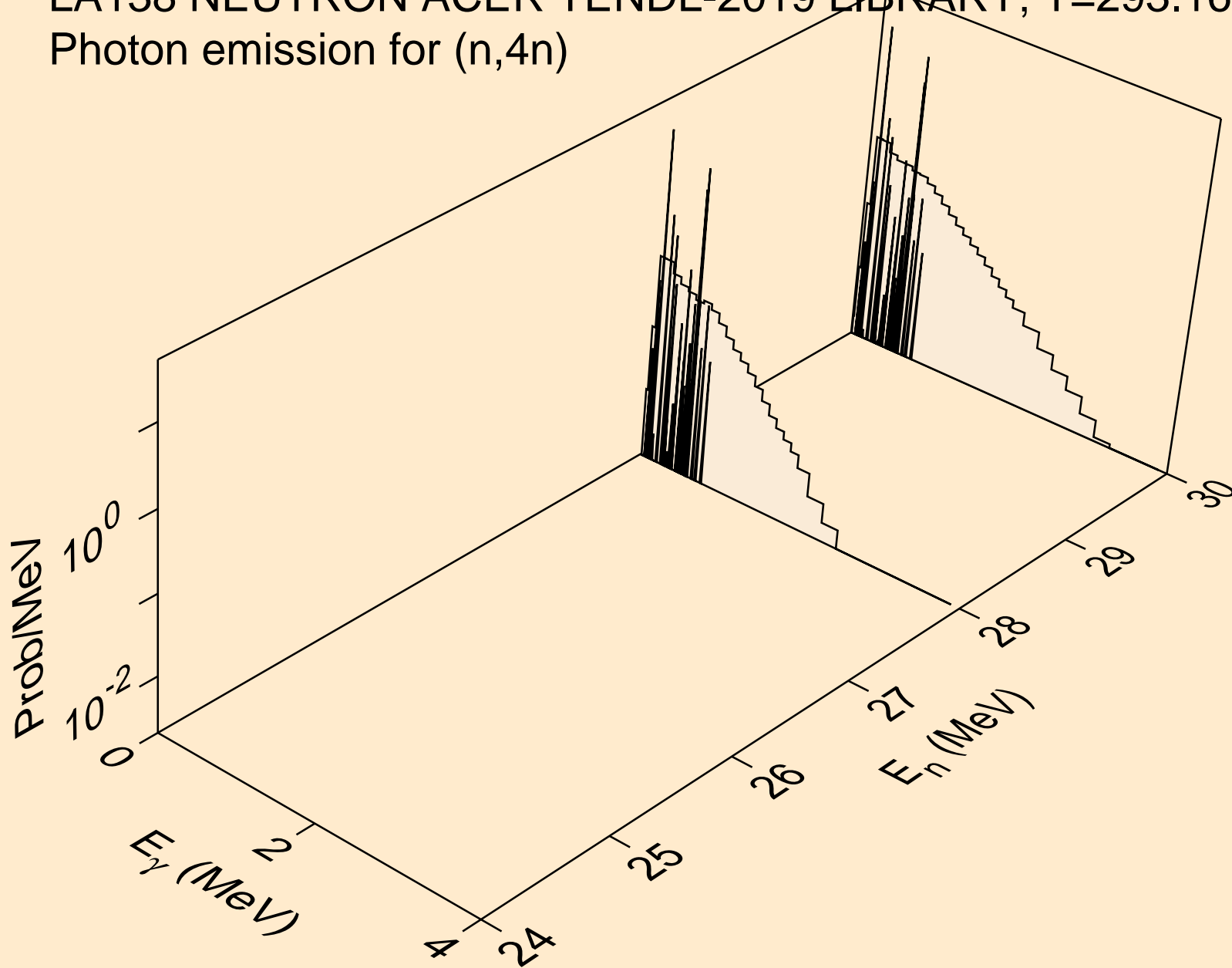

LA138 NEUTRON ACER TENDL-2019 LIBRARY; T=293.16K
Photon emission for (n,2np)

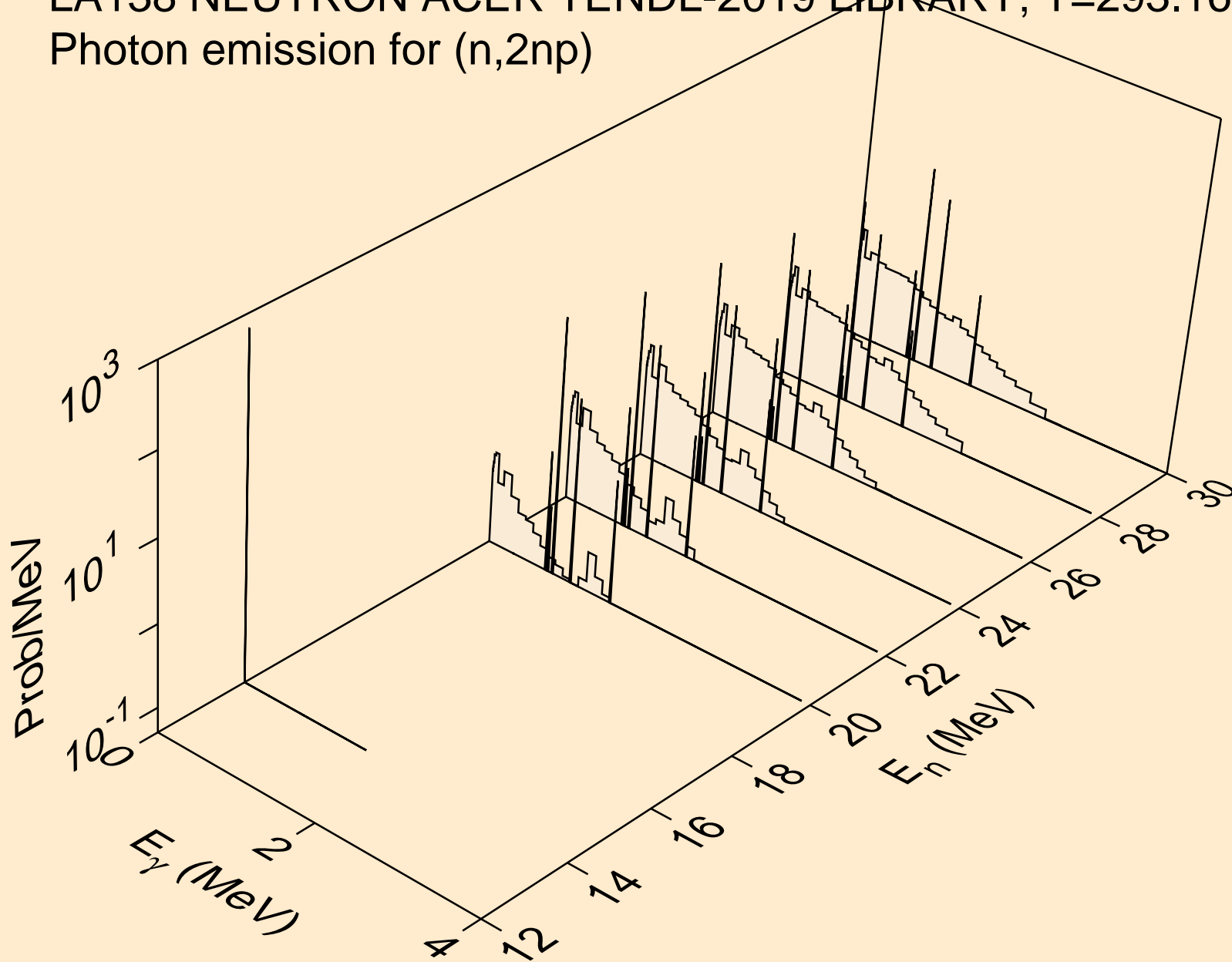

LA138 NEUTRON ACER TENDL-2019 LIBRARY; T=293.16K
Photon emission for (n,3np)

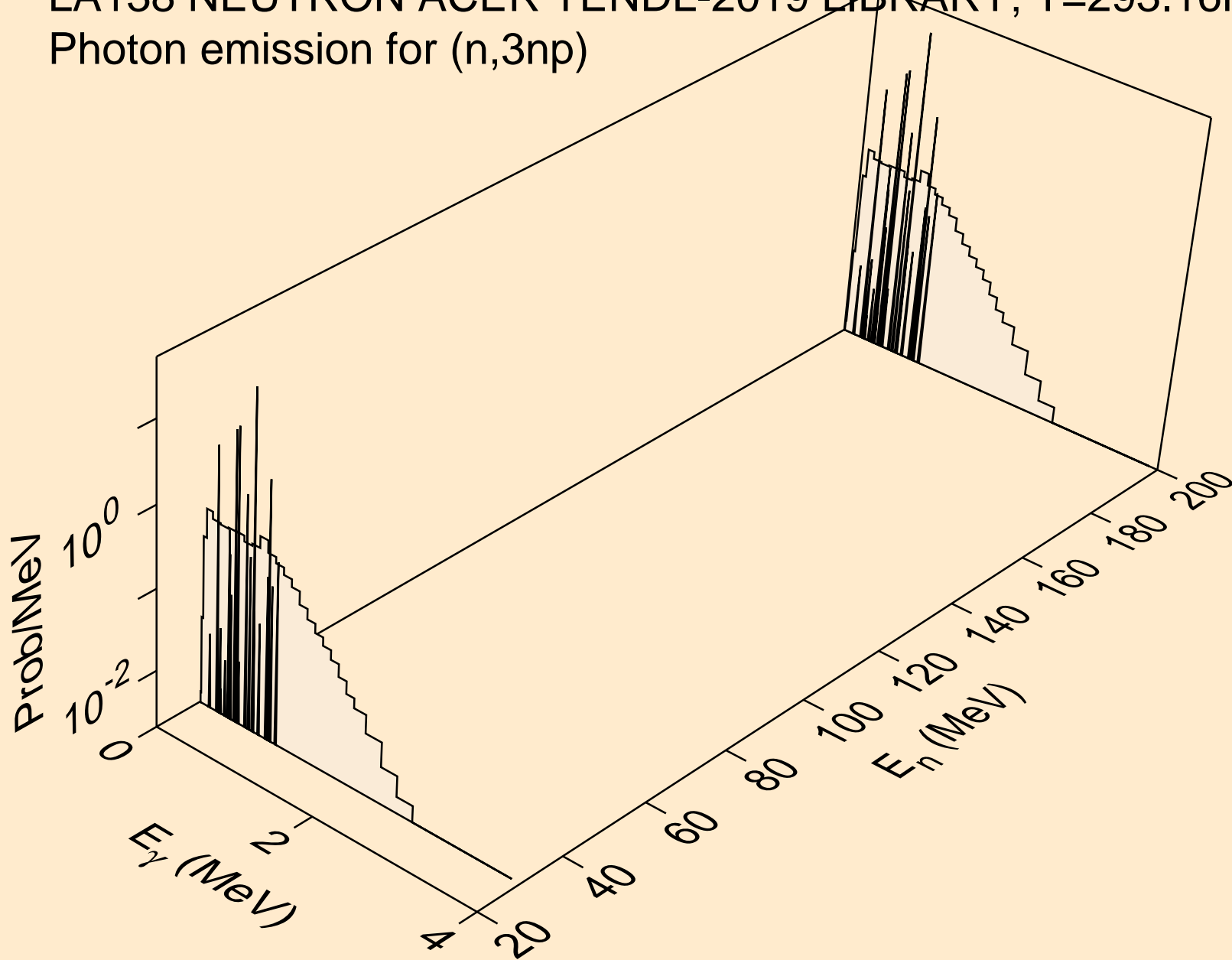

LA138 NEUTRON ACER TENDL-2019 LIBRARY; T=293.16K
Photon emission for (n,2np)

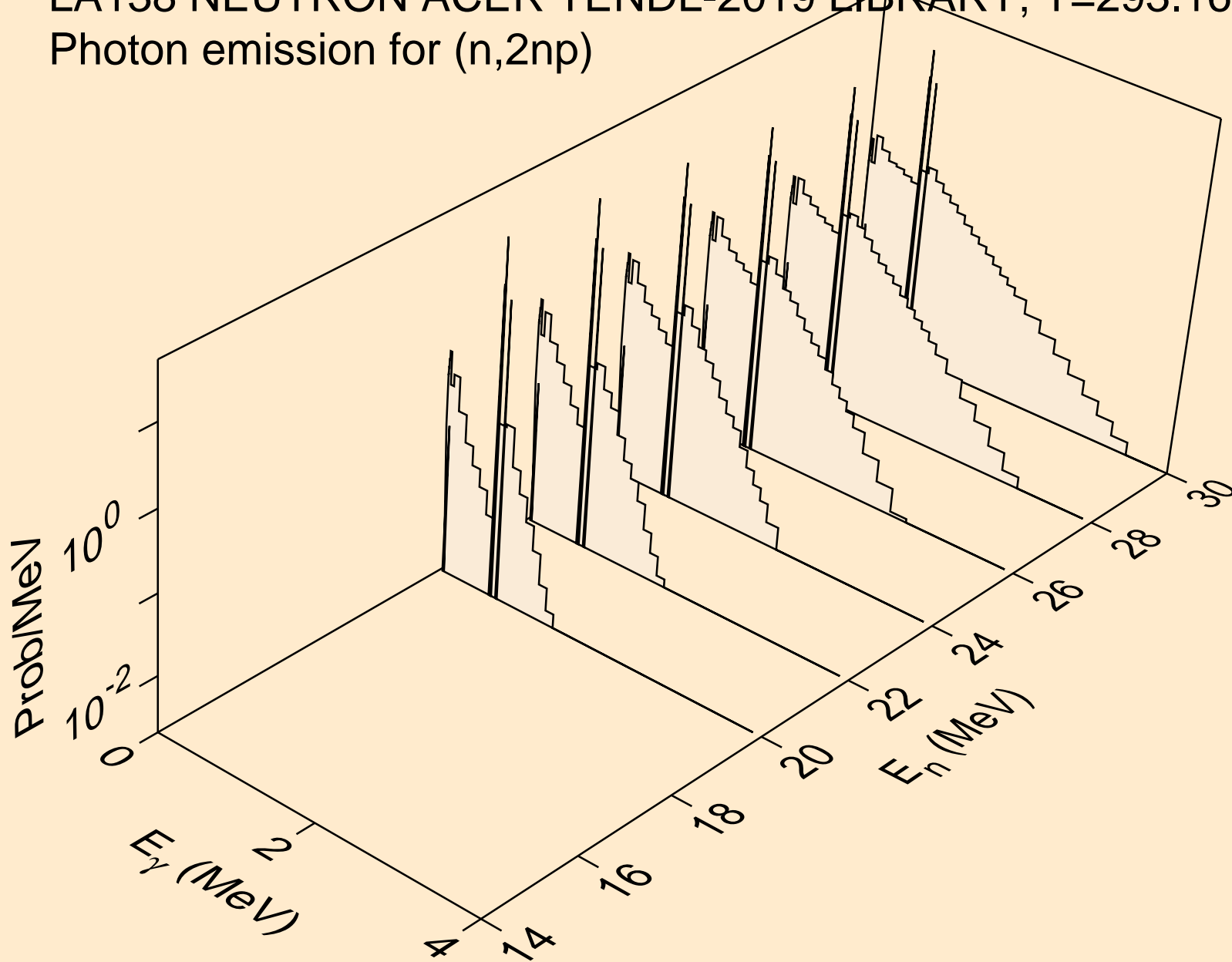

LA138 NEUTRON ACER TENDL-2019 LIBRARY; T=293.16K
Photon emission for (n,npa)

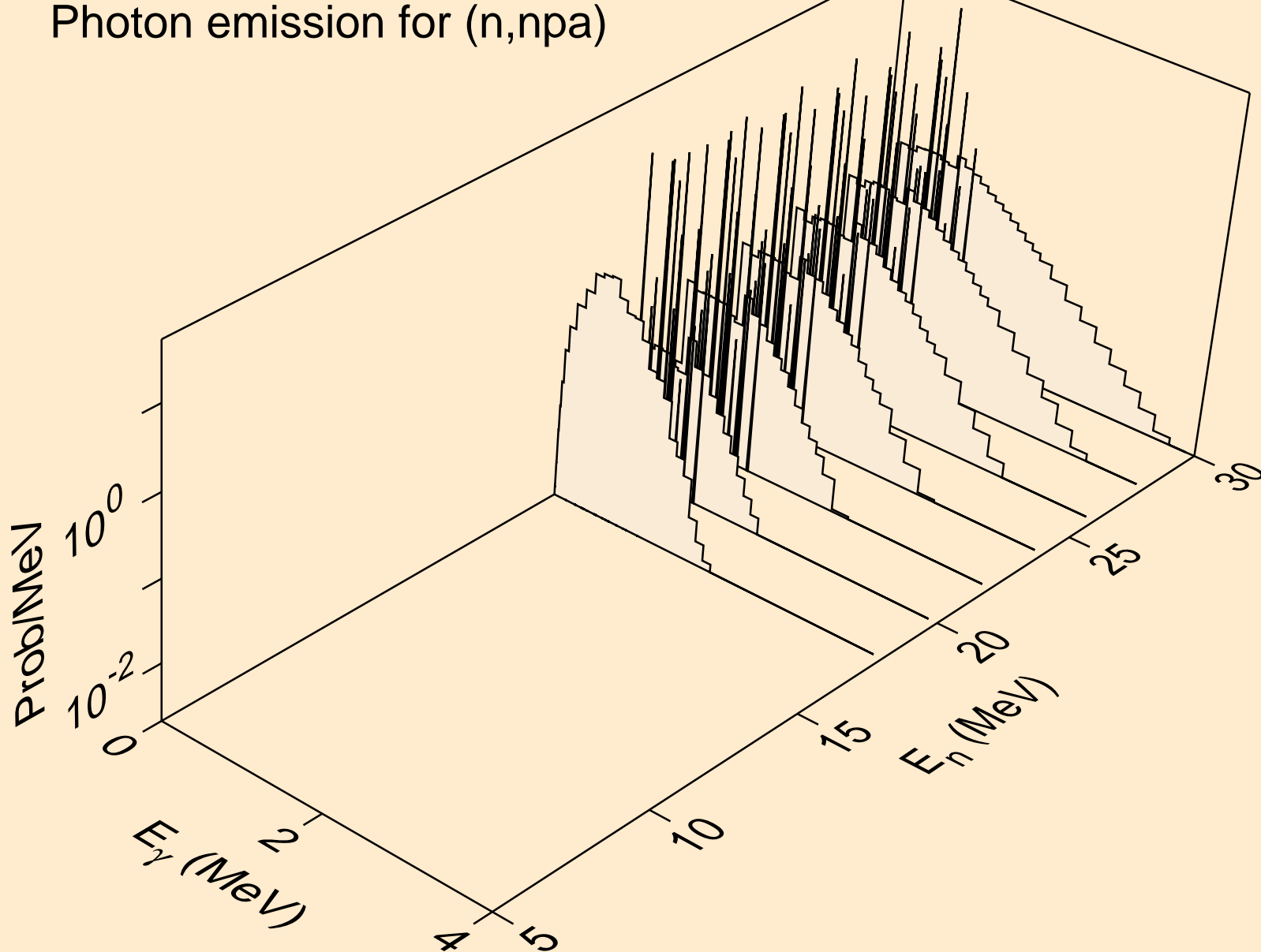

LA138 NEUTRON ACER TENDL-2019 LIBRARY; T=293.16K
Photon emission for (n,n*c)

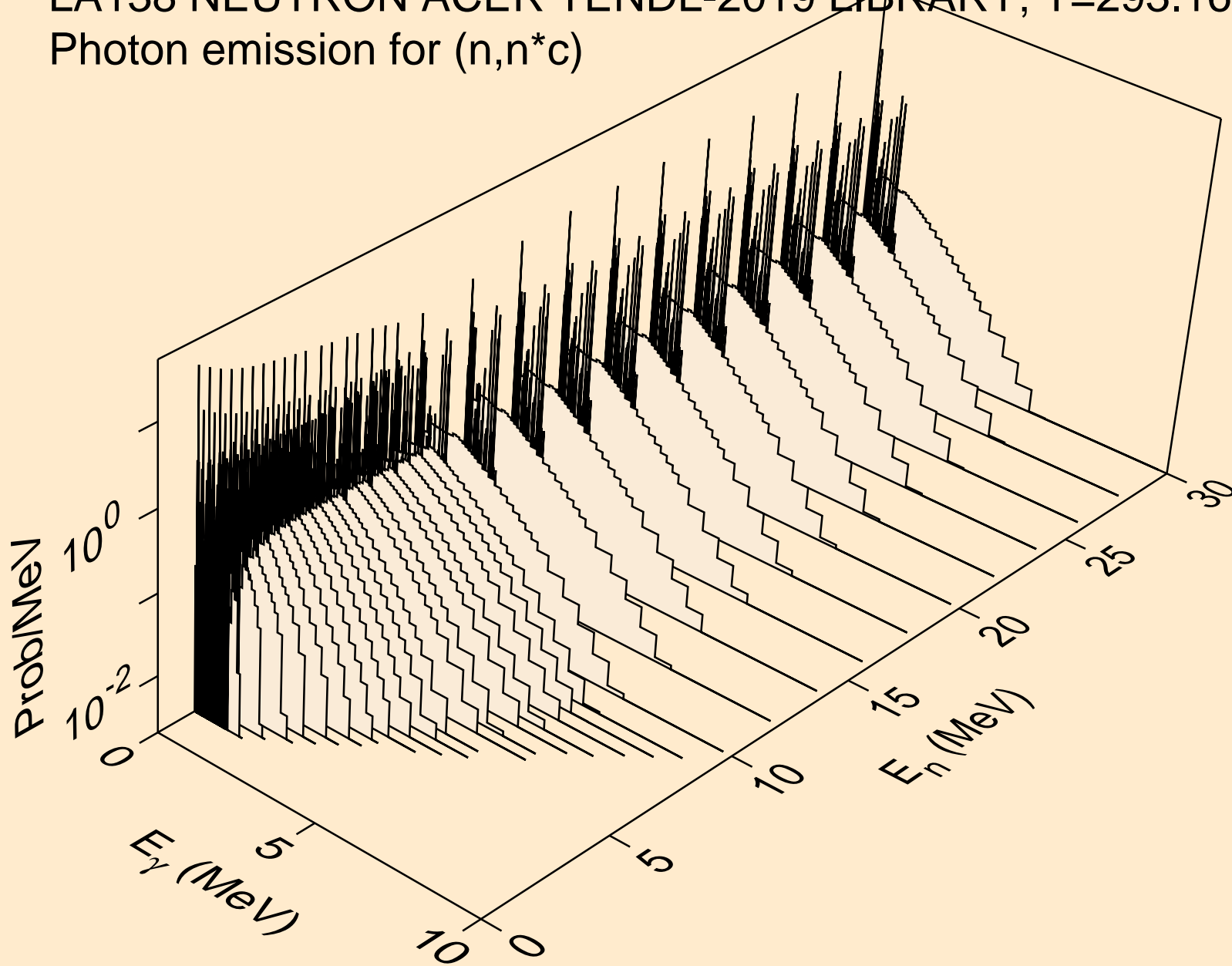

LA138 NEUTRON ACER TENDL-2019 LIBRARY; T=293.16K
Photon emission for (n,gma)

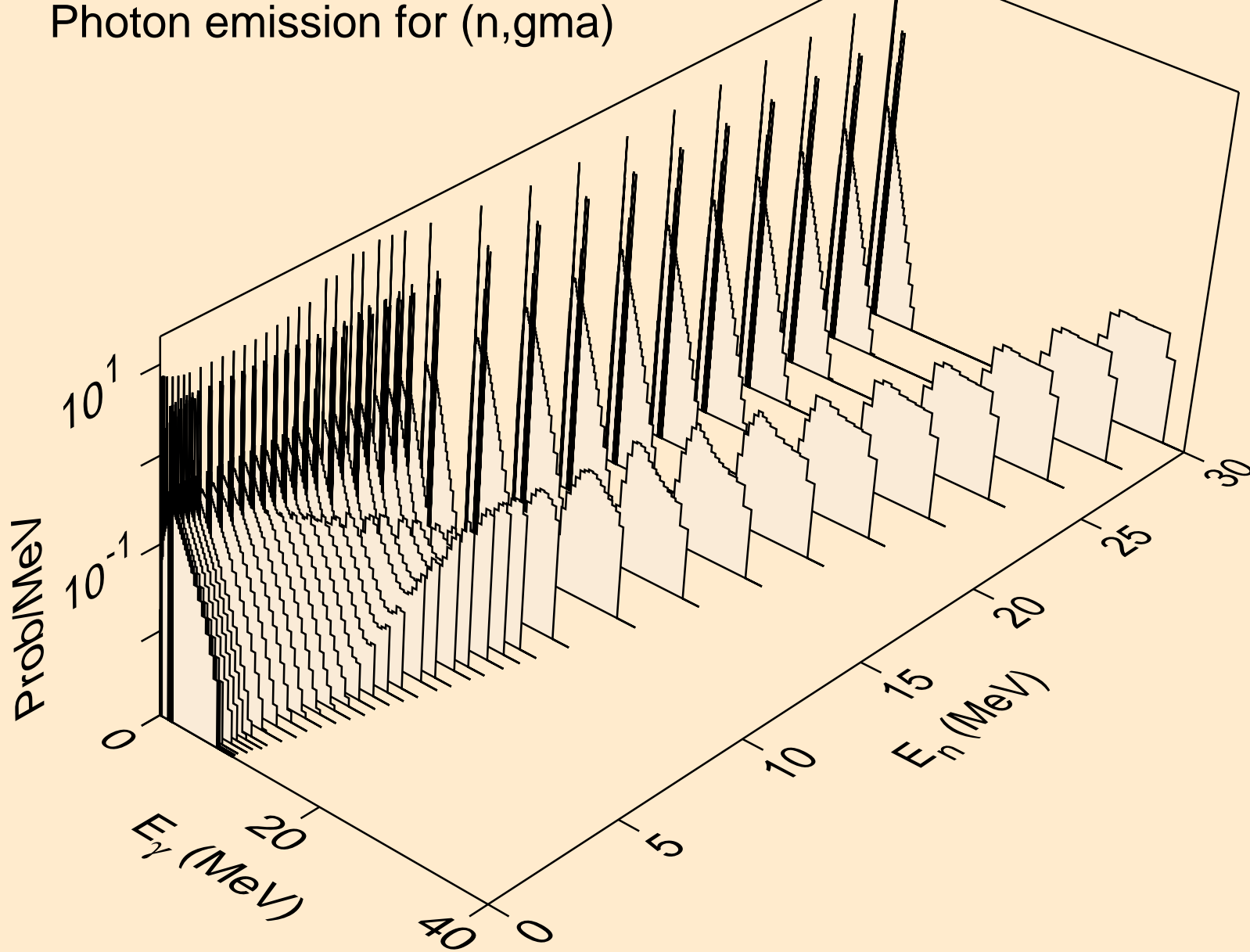

LA138 NEUTRON ACER TENDL-2019 LIBRARY; T=293.16K
Photon emission for (n,p)

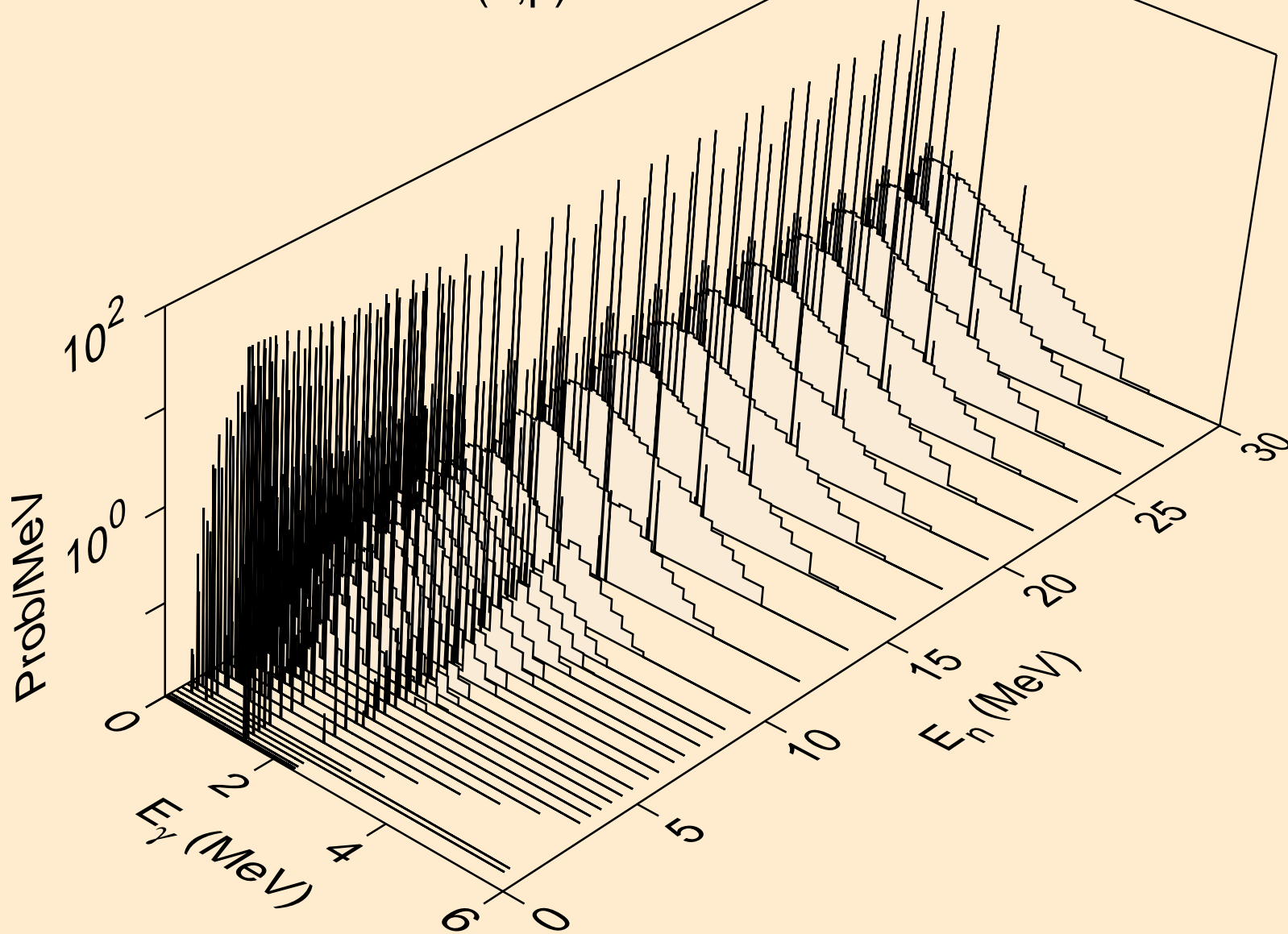

LA138 NEUTRON ACER TENDL-2019 LIBRARY; T=293.16K
Photon emission for (n,d)

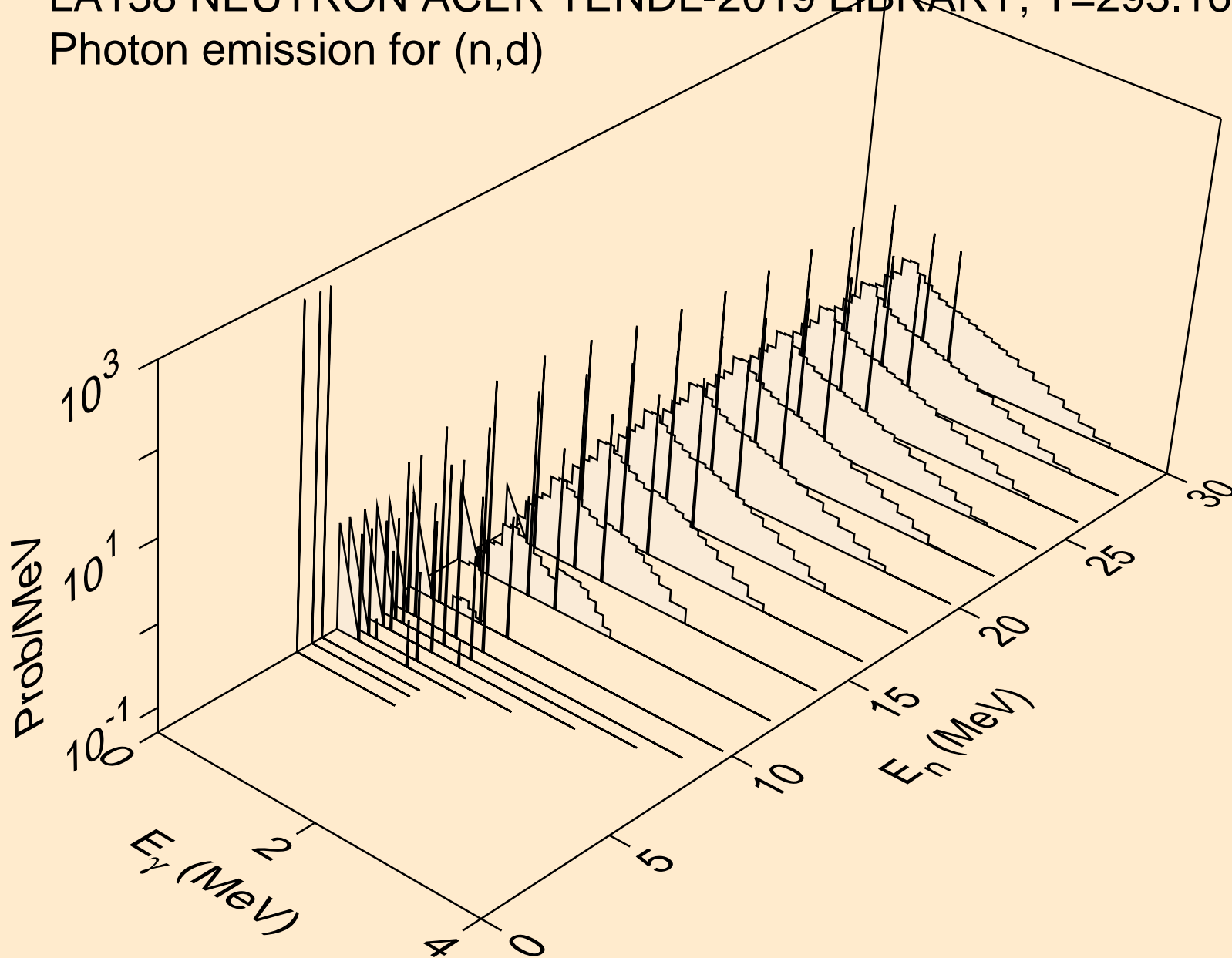

LA138 NEUTRON ACER TENDL-2019 LIBRARY; T=293.16K
Photon emission for (n,t)

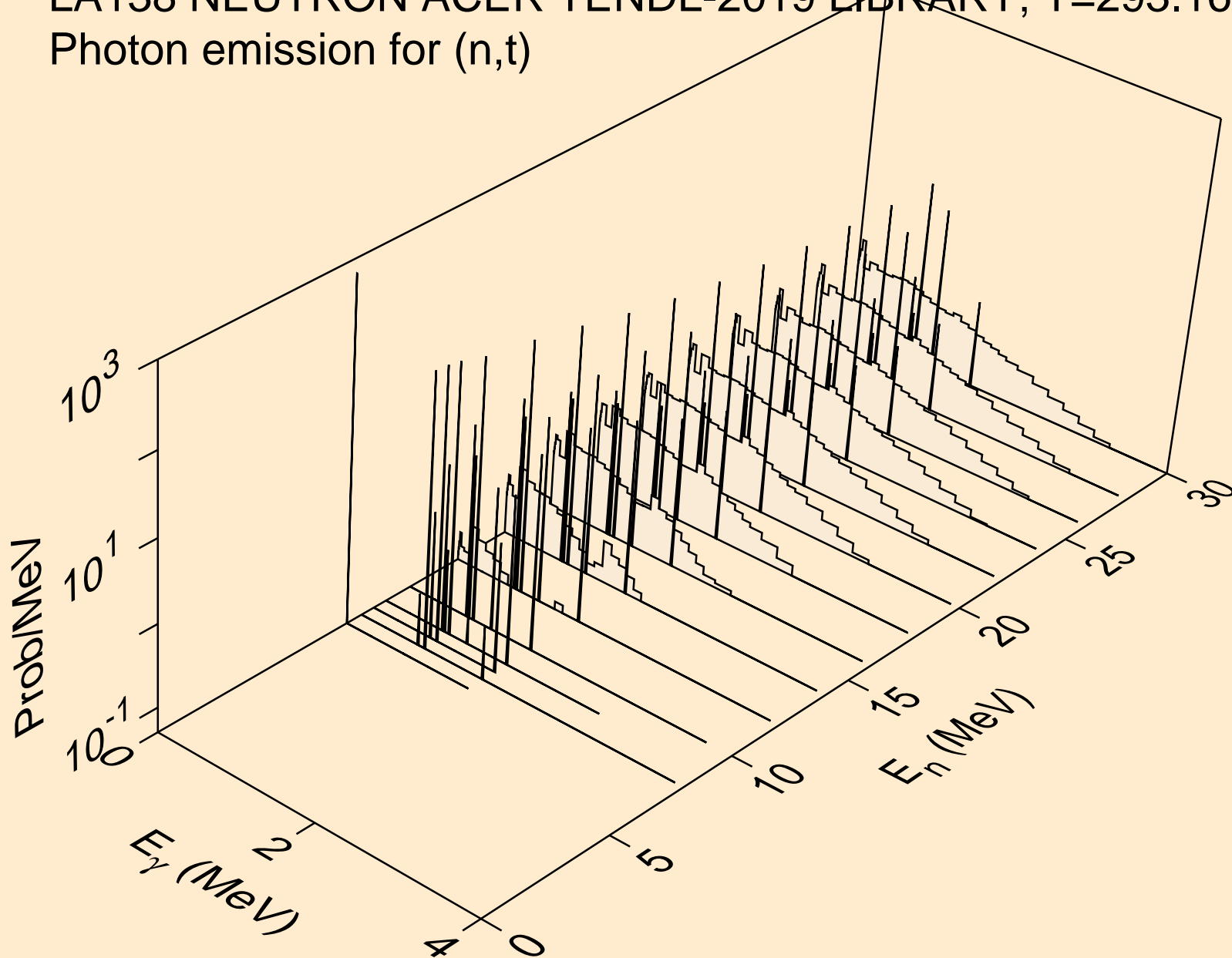

LA138 NEUTRON ACER TENDL-2019 LIBRARY; T=293.16K
Photon emission for (n,he3)

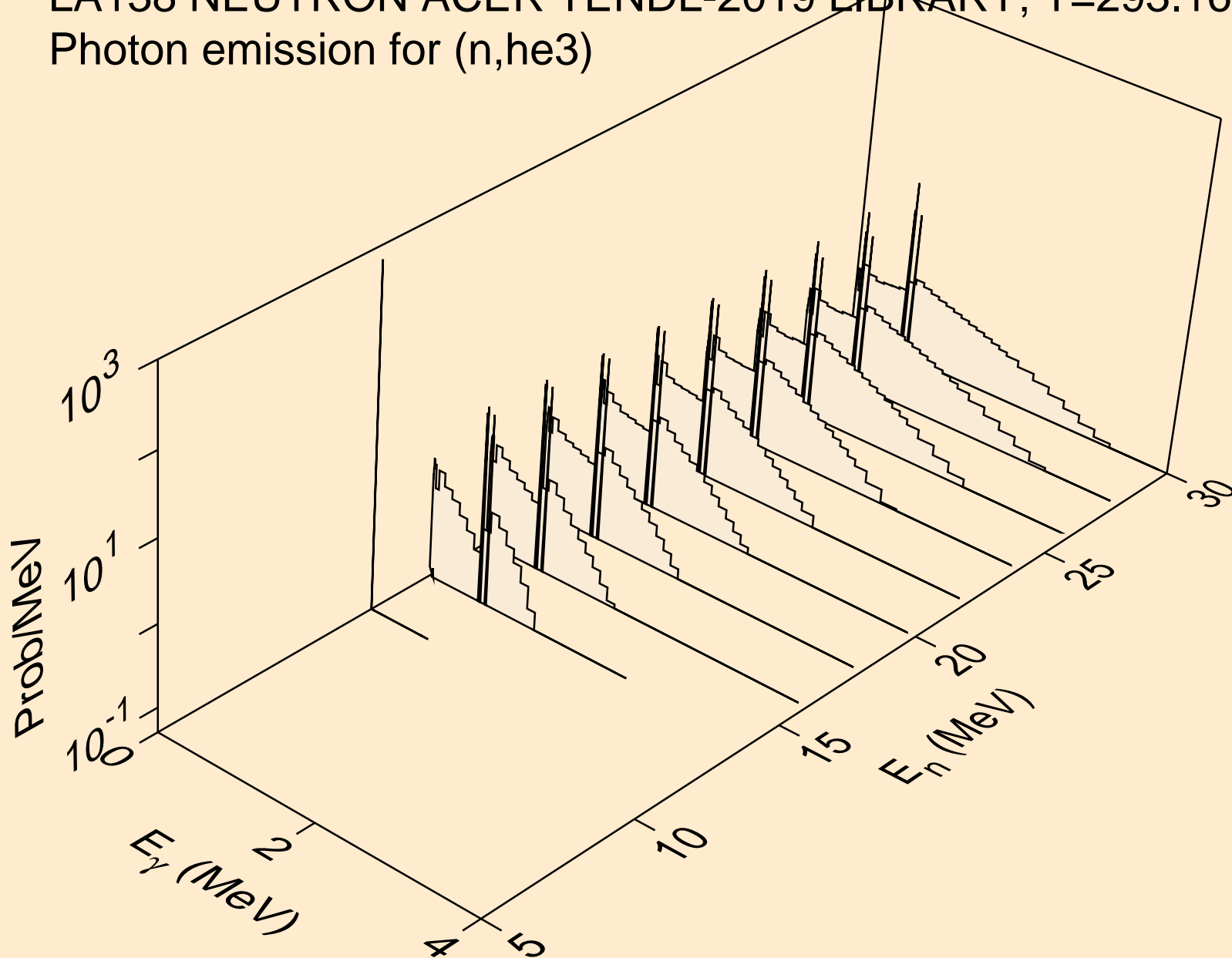

LA138 NEUTRON ACER TENDL-2019 LIBRARY; T=293.16K
Photon emission for (n,a)

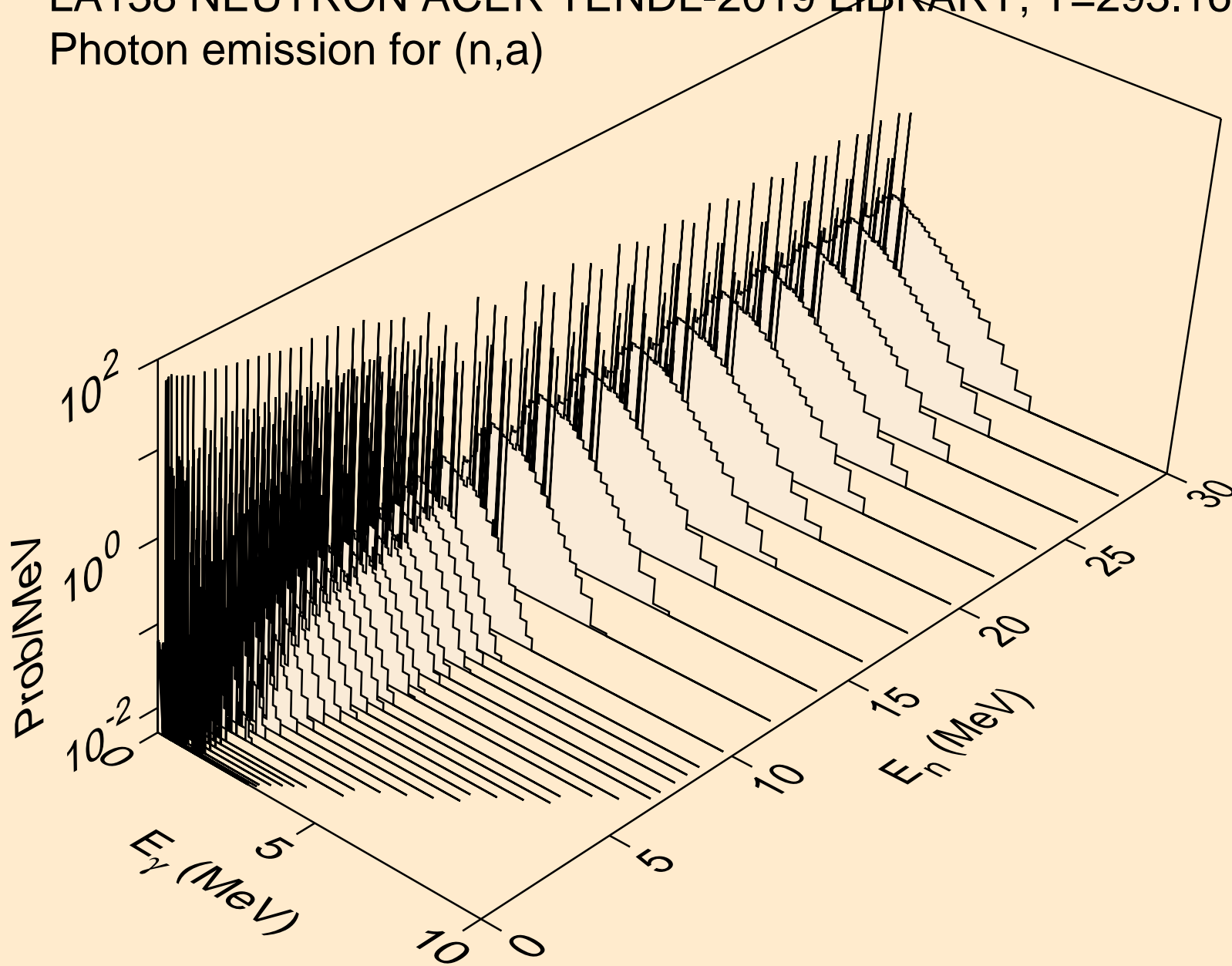

LA138 NEUTRON ACER TENDL-2019 LIBRARY; T=293.16K
Photon emission for (n,2a)

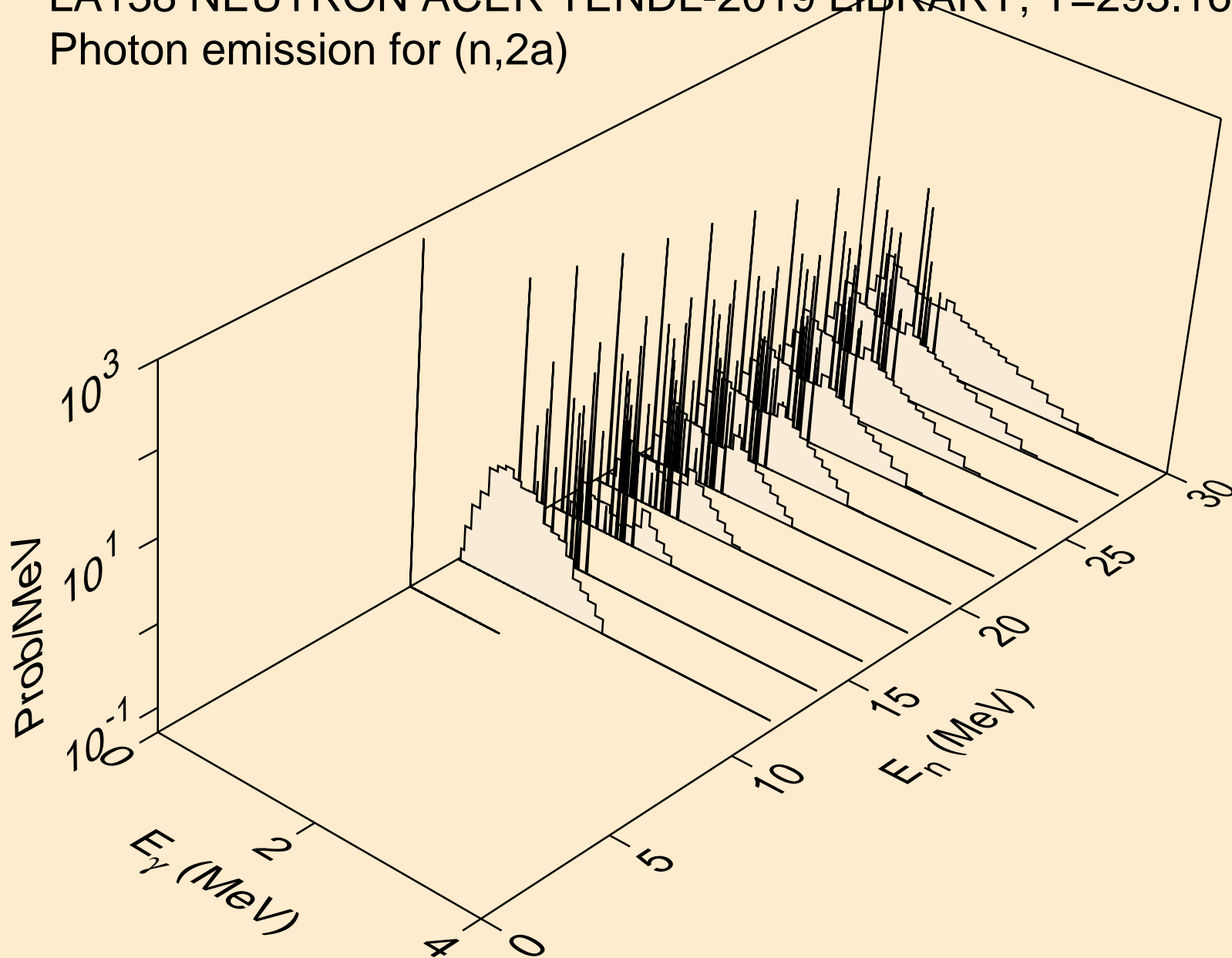

LA138 NEUTRON ACER TENDL-2019 LIBRARY; T=293.16K
Photon emission for (n,2p)

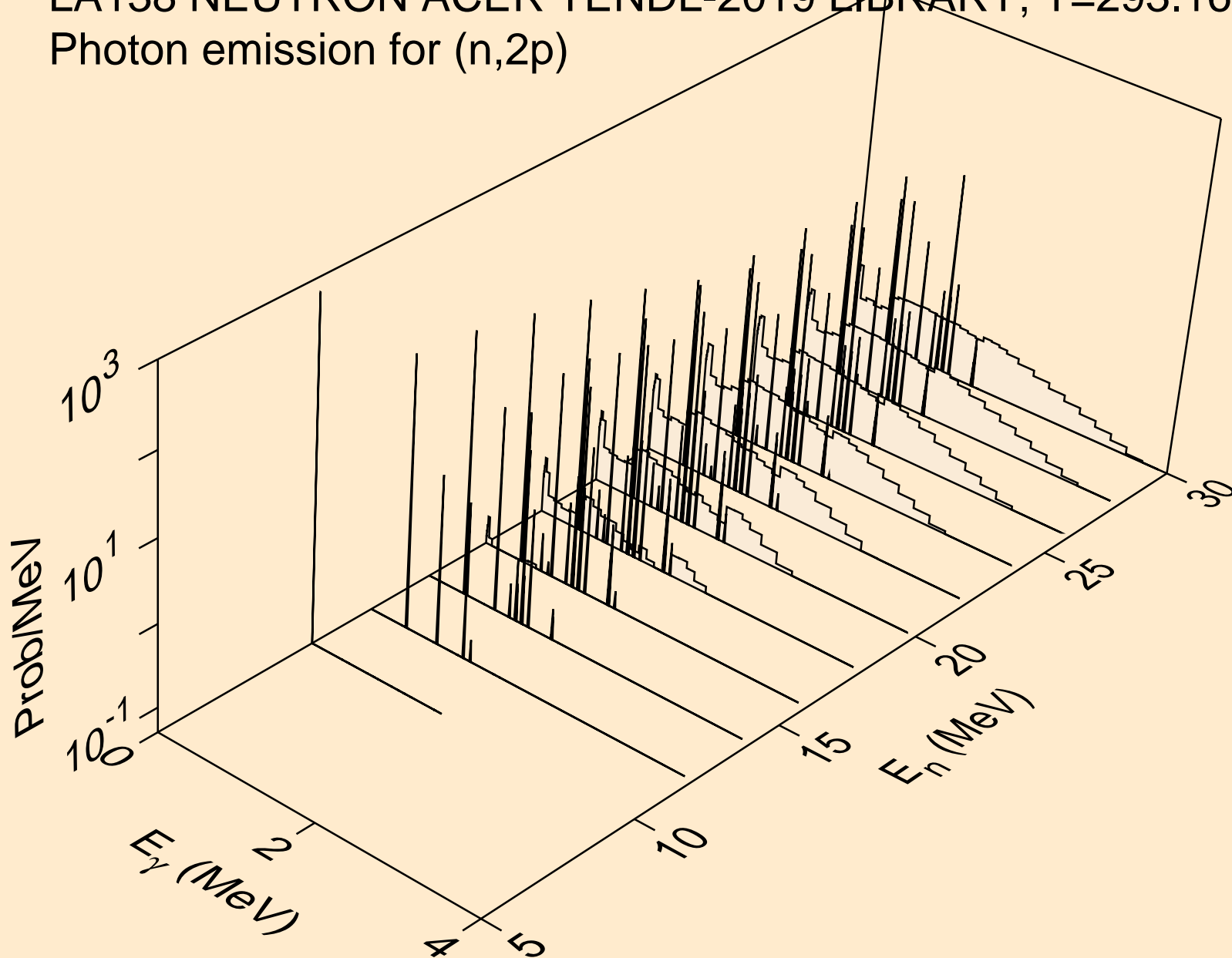

LA138 NEUTRON ACER TENDL-2019 LIBRARY; T=293.16K
Photon emission for (n,p α)

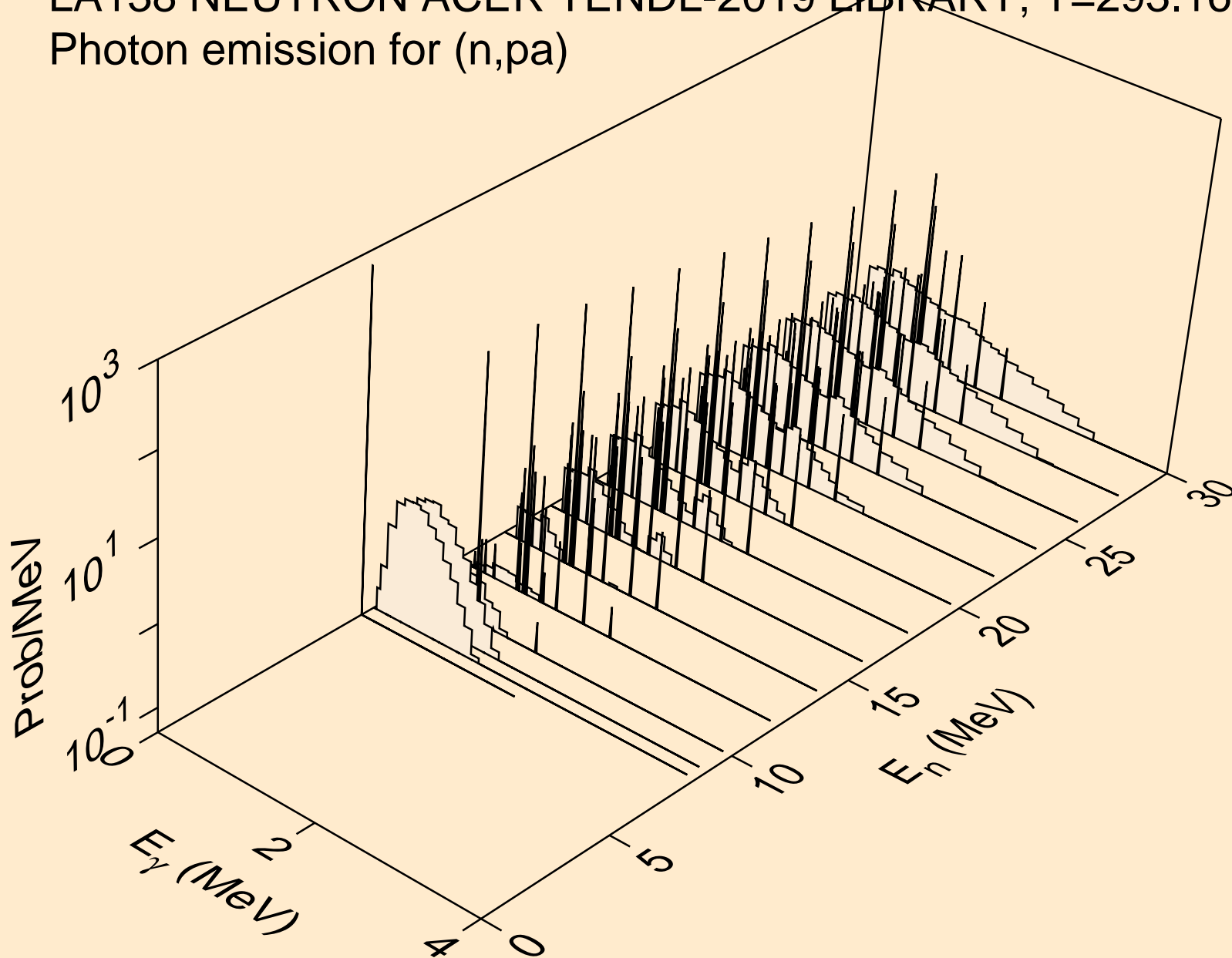

LA138 NEUTRON ACER TENDL-2019 LIBRARY; T=293.16K
Photon emission for (n,pd)

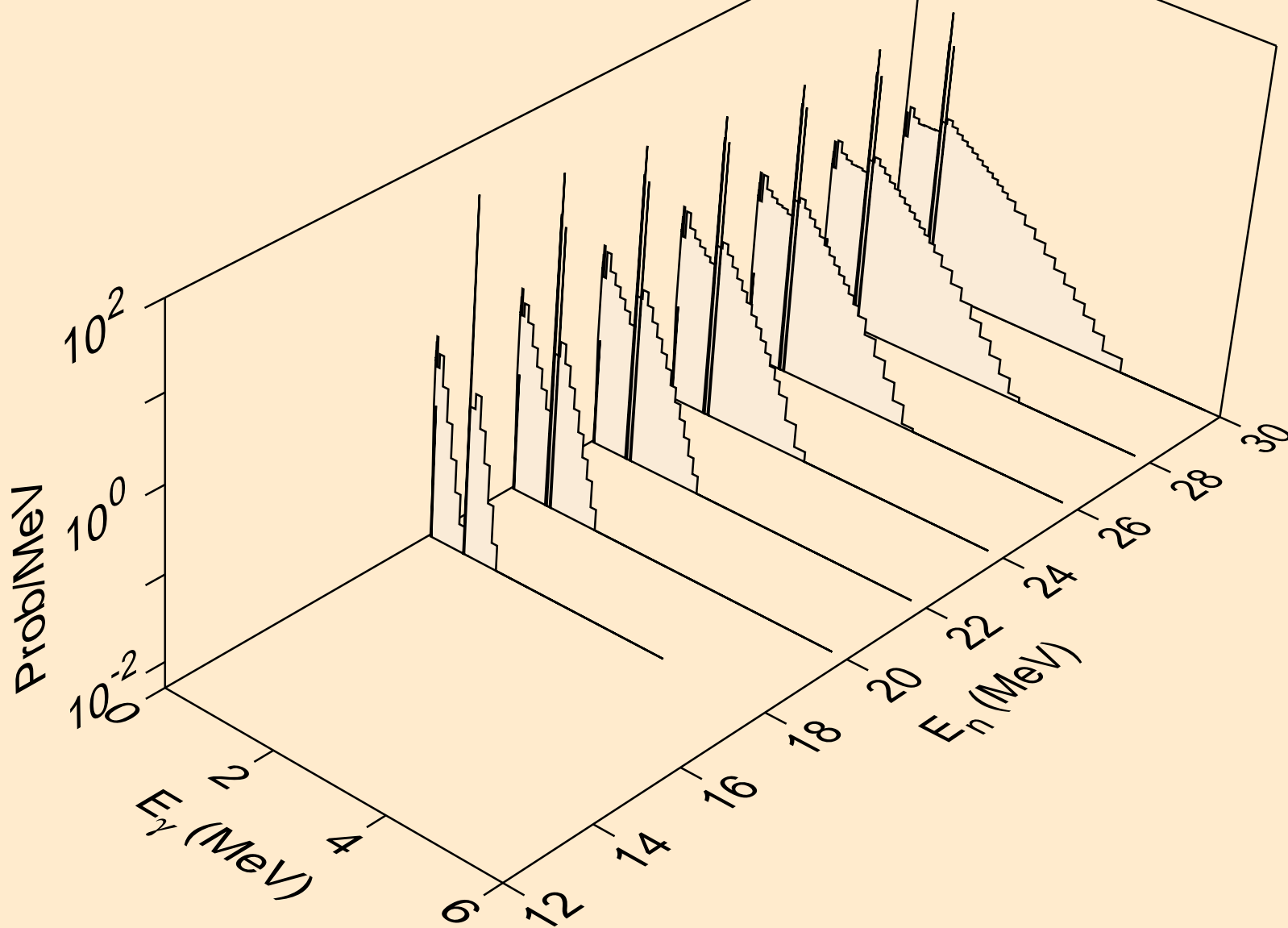

LA138 NEUTRON ACER TENDL-2019 LIBRARY; T=293.16K
Photon emission for (n,pt)

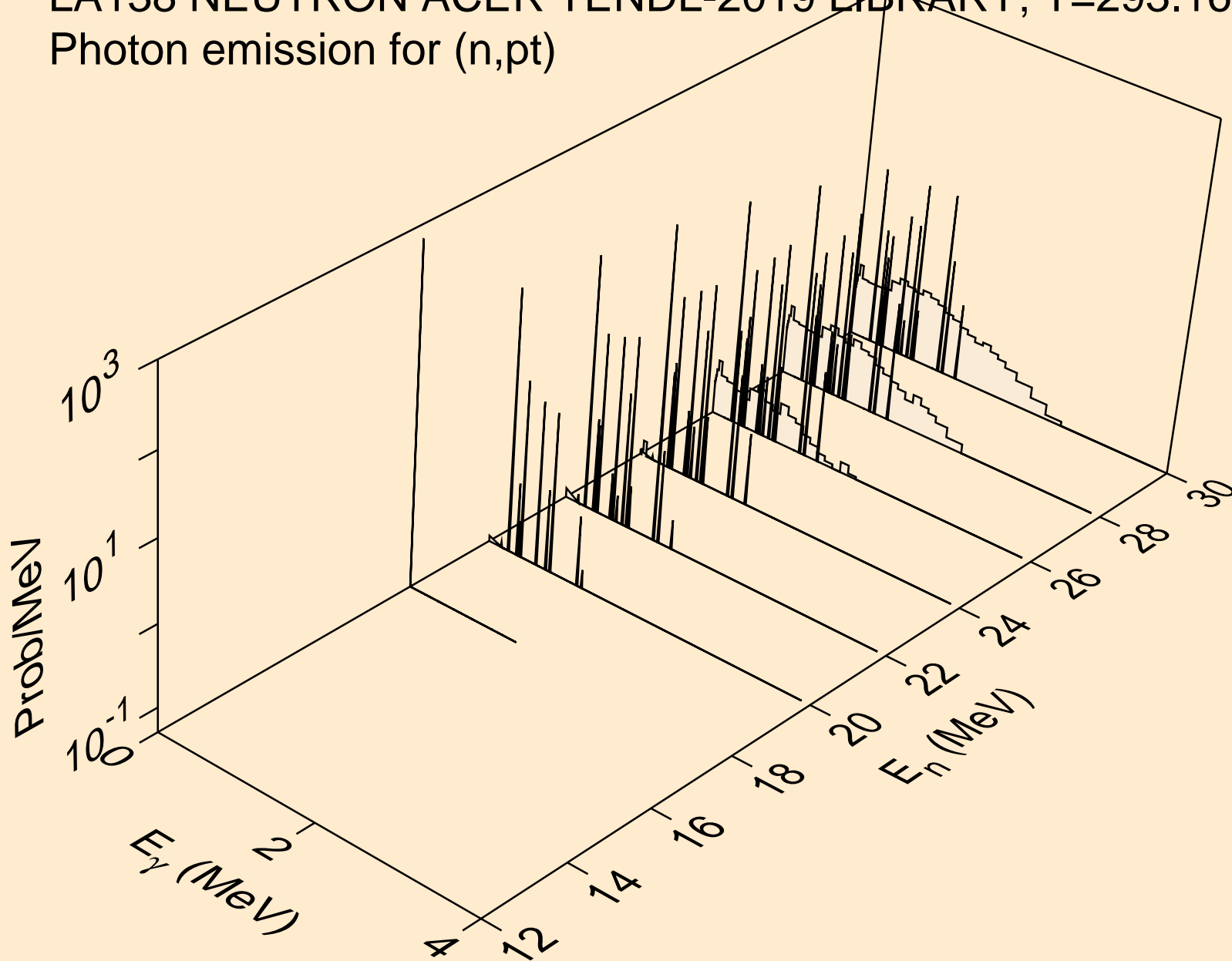

LA138 NEUTRON ACER TENDL-2019 LIBRARY; T=293.16K
Photon emission for (n,da)

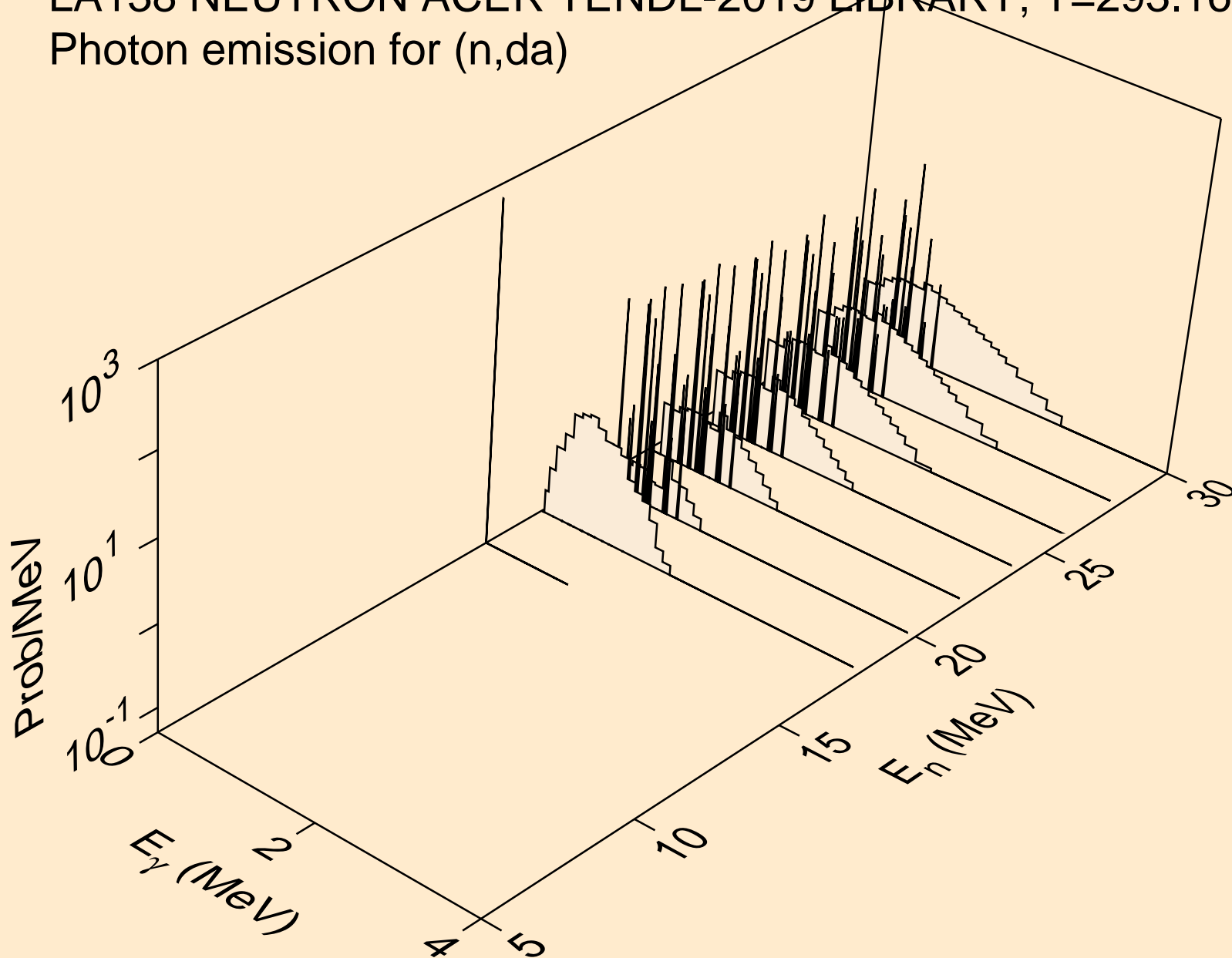

LA138 NEUTRON ACER TENDL-2019 LIBRARY; T=293.16K
thermal capture photon spectrum

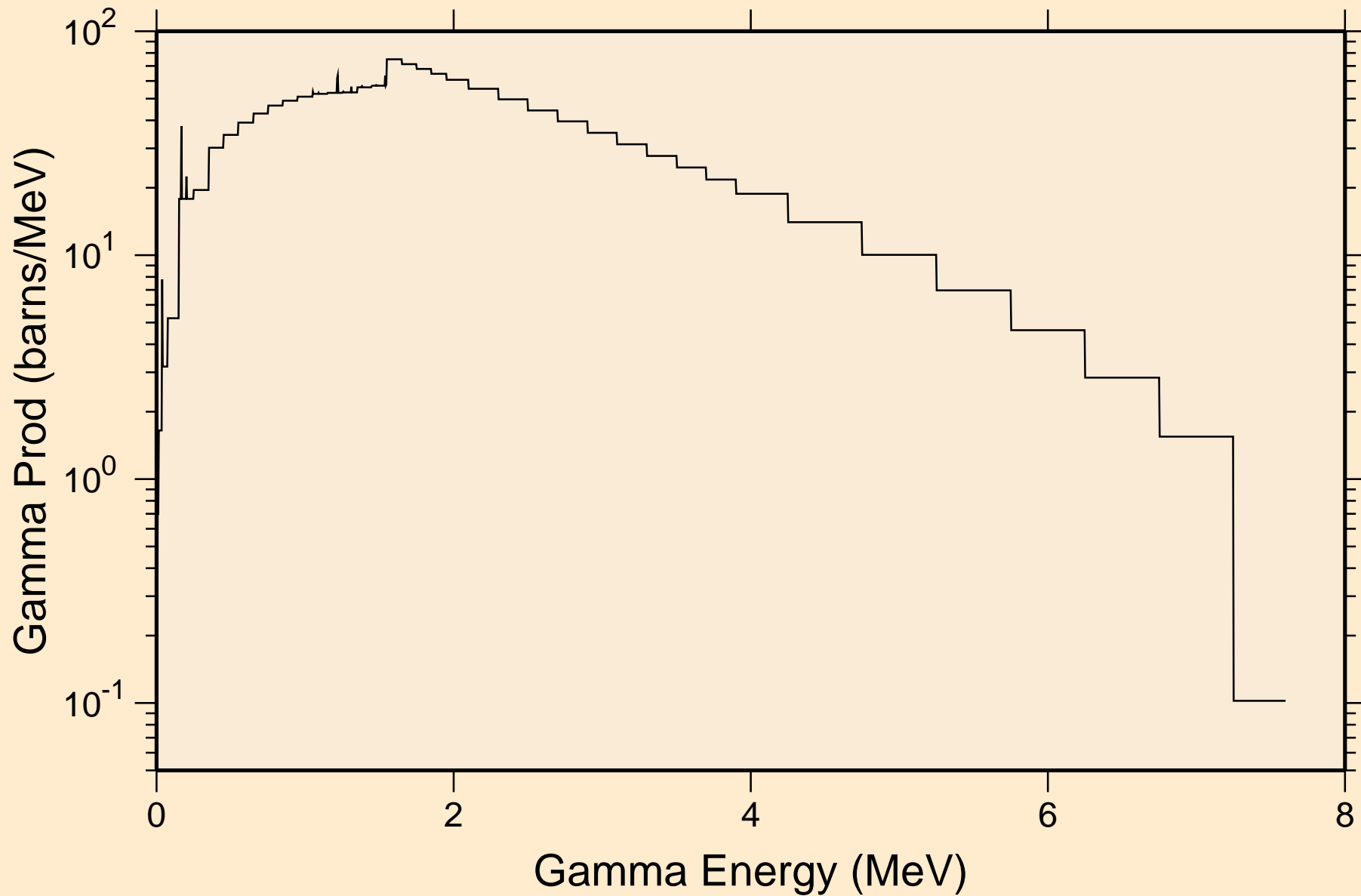

LA138 NEUTRON ACER TENDL-2019 LIBRARY; T=293.16K
14 MeV photon spectrum

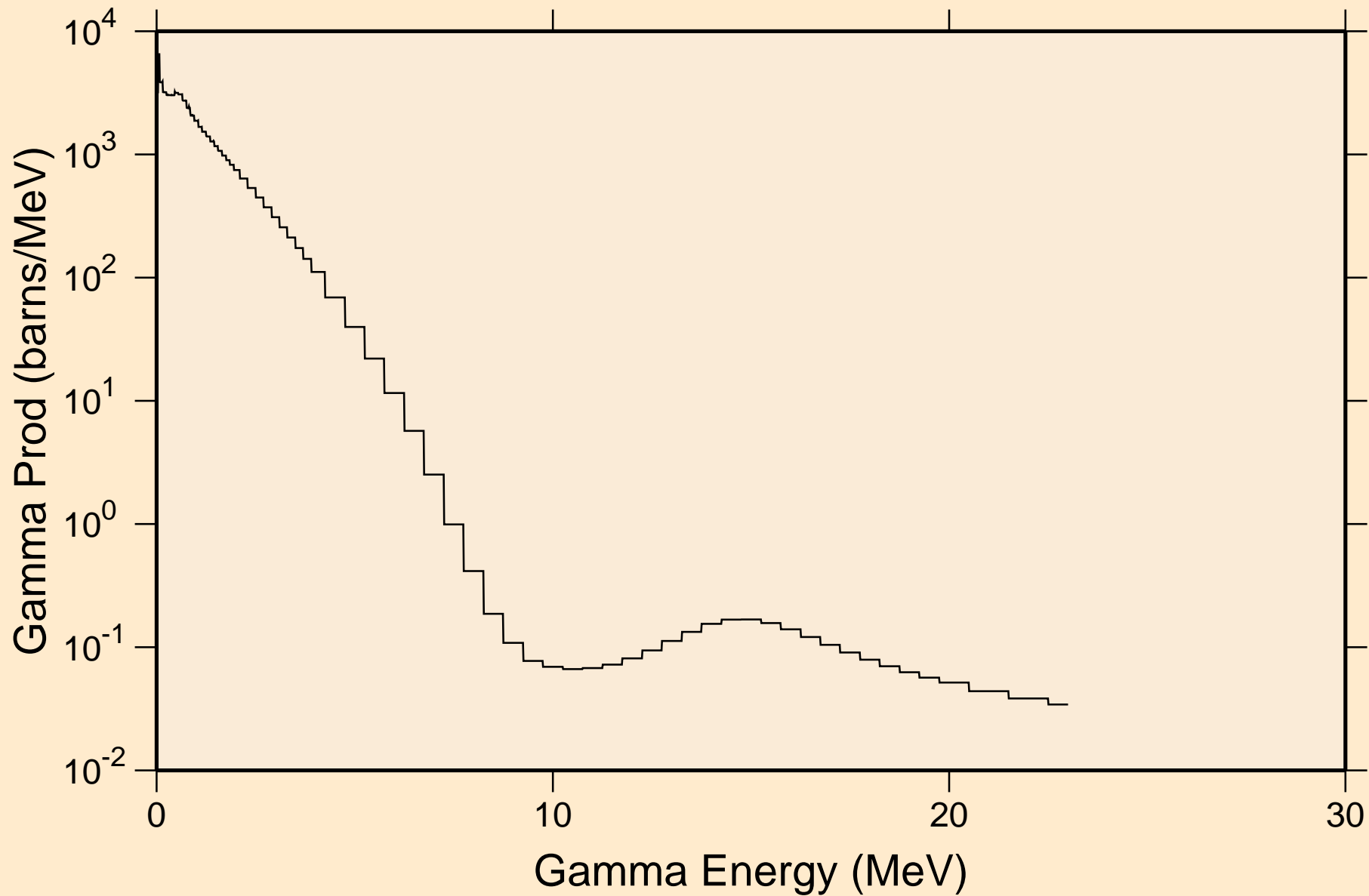

LA138 NEUTRON ACER TENDL-2019 LIBRARY; T=293.16K
Particle heating contributions

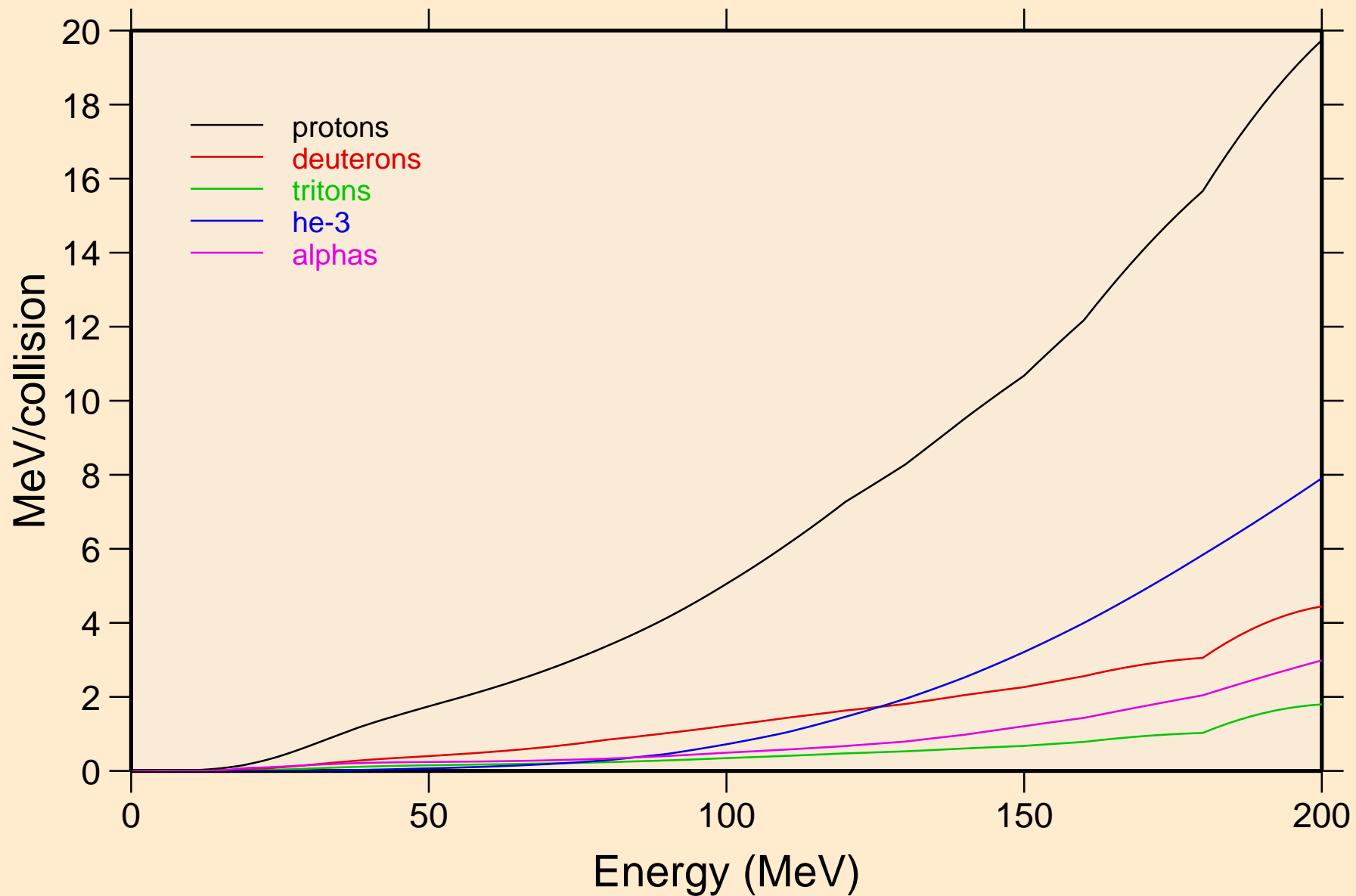

LA138 NEUTRON ACER TENDL-2019 LIBRARY; T=293.16K
Recoil Heating

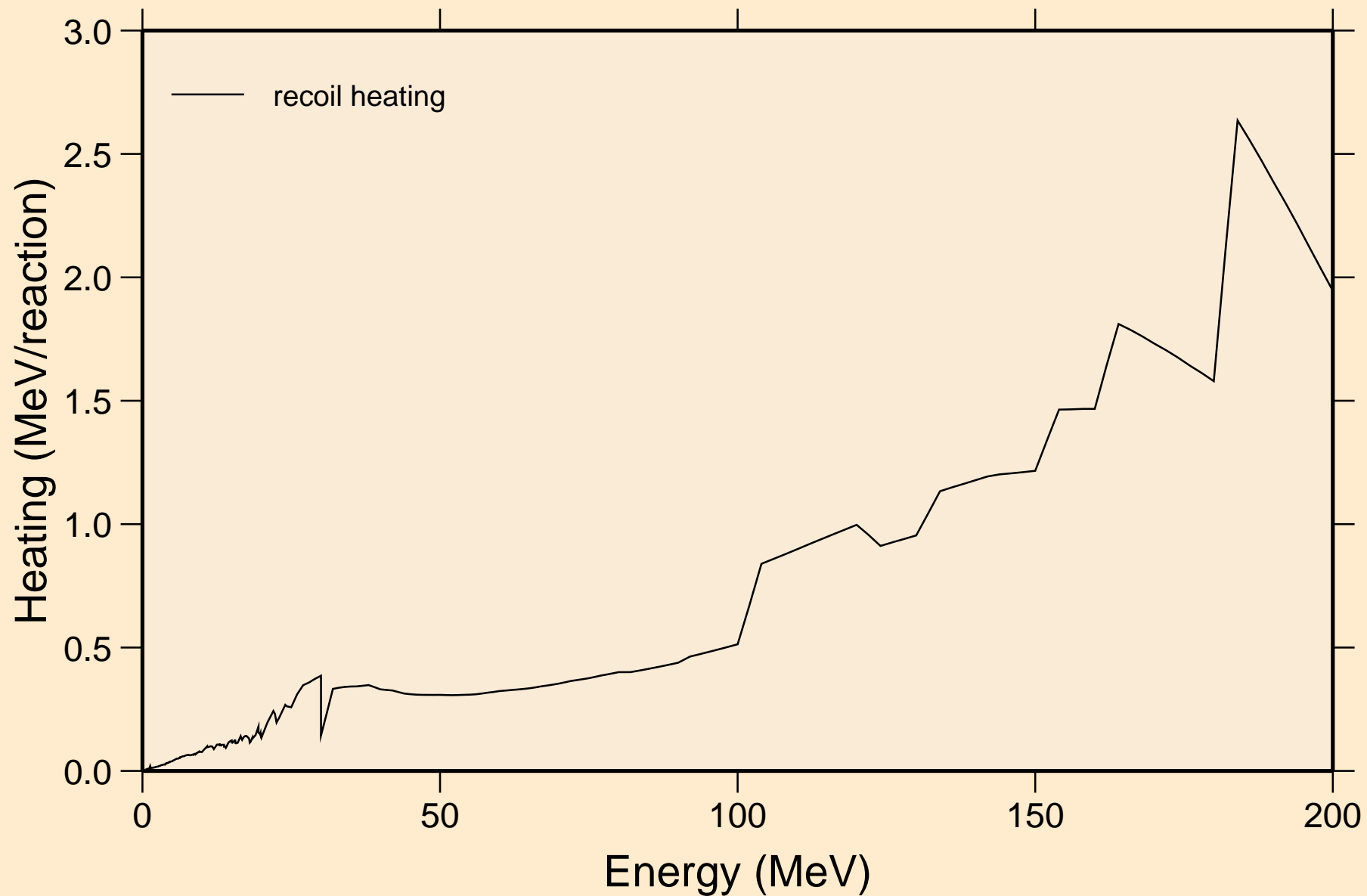

LA138 NEUTRON ACER TENDL-2019 LIBRARY; T=293.16K
Particle production cross sections

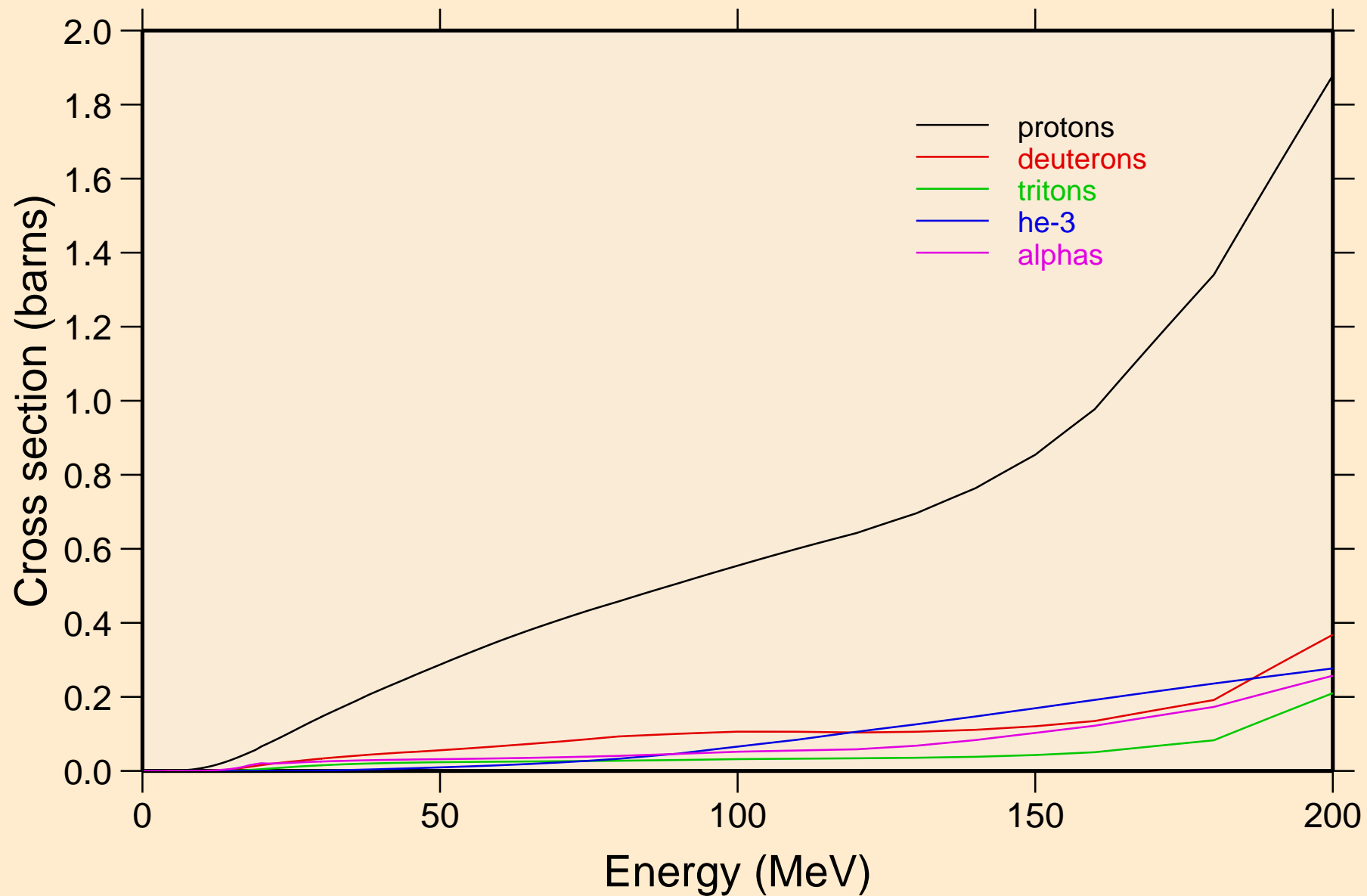

LA138 NEUTRON ACER TENDL-2019 LIBRARY; T=293.16K
protons from (n,x)

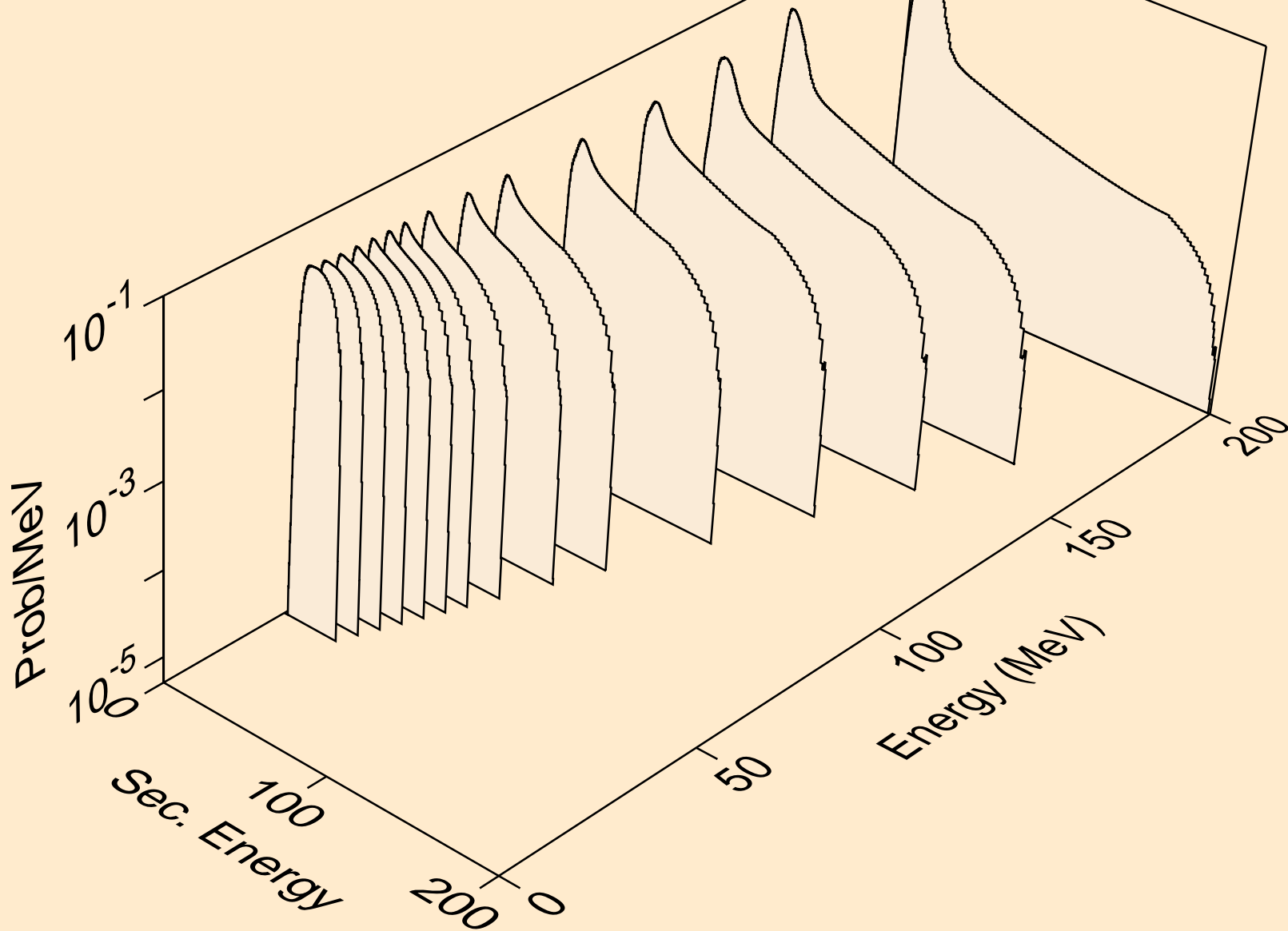

LA138 NEUTRON ACER TENDL-2019 LIBRARY; T=293.16K
protons from (n,n*)p

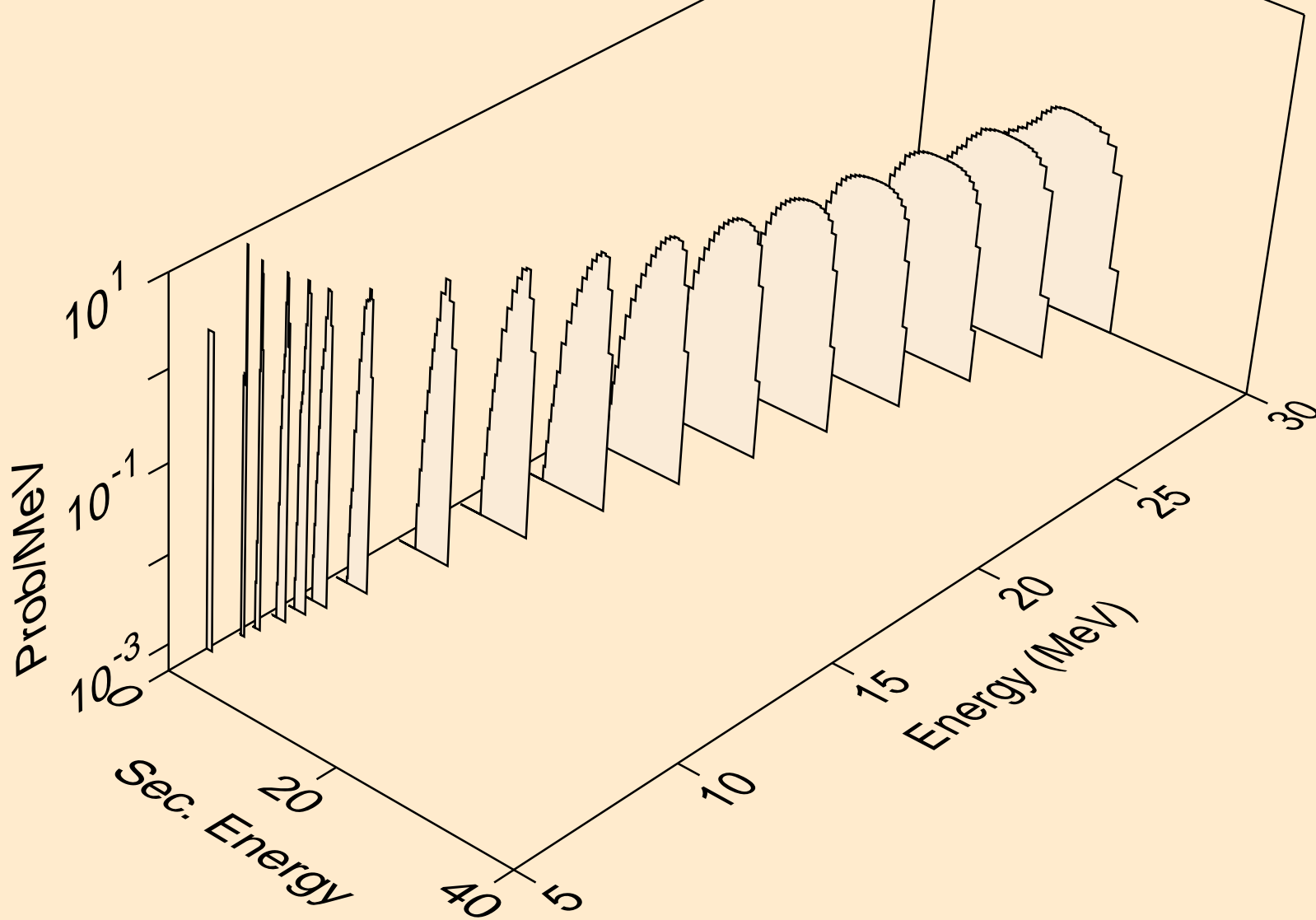

LA138 NEUTRON ACER TENDL-2019 LIBRARY; T=293.16K
protons from (n,2np)

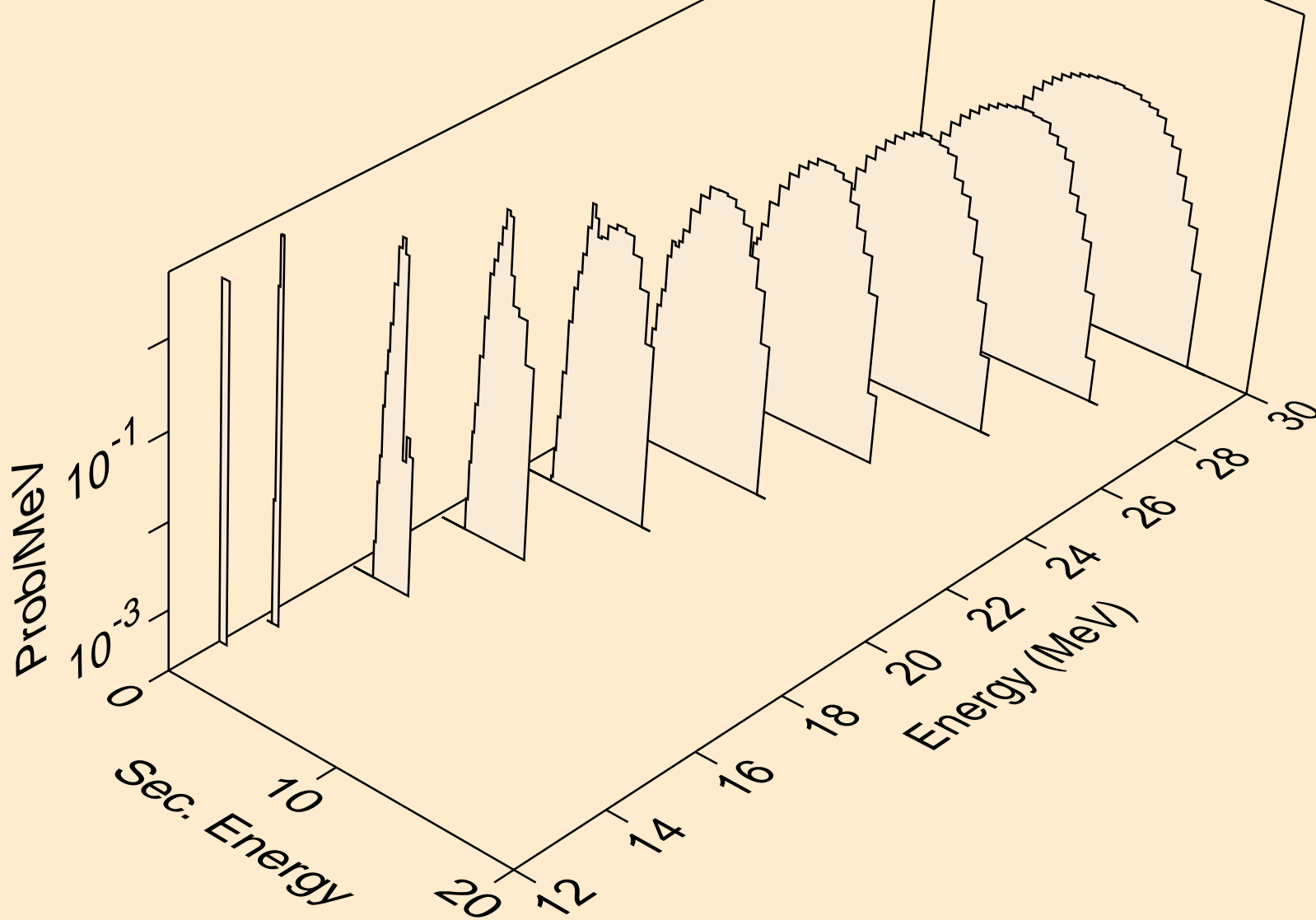

LA138 NEUTRON ACER TENDL-2019 LIBRARY; T=293.16K
protons from (n,3np)

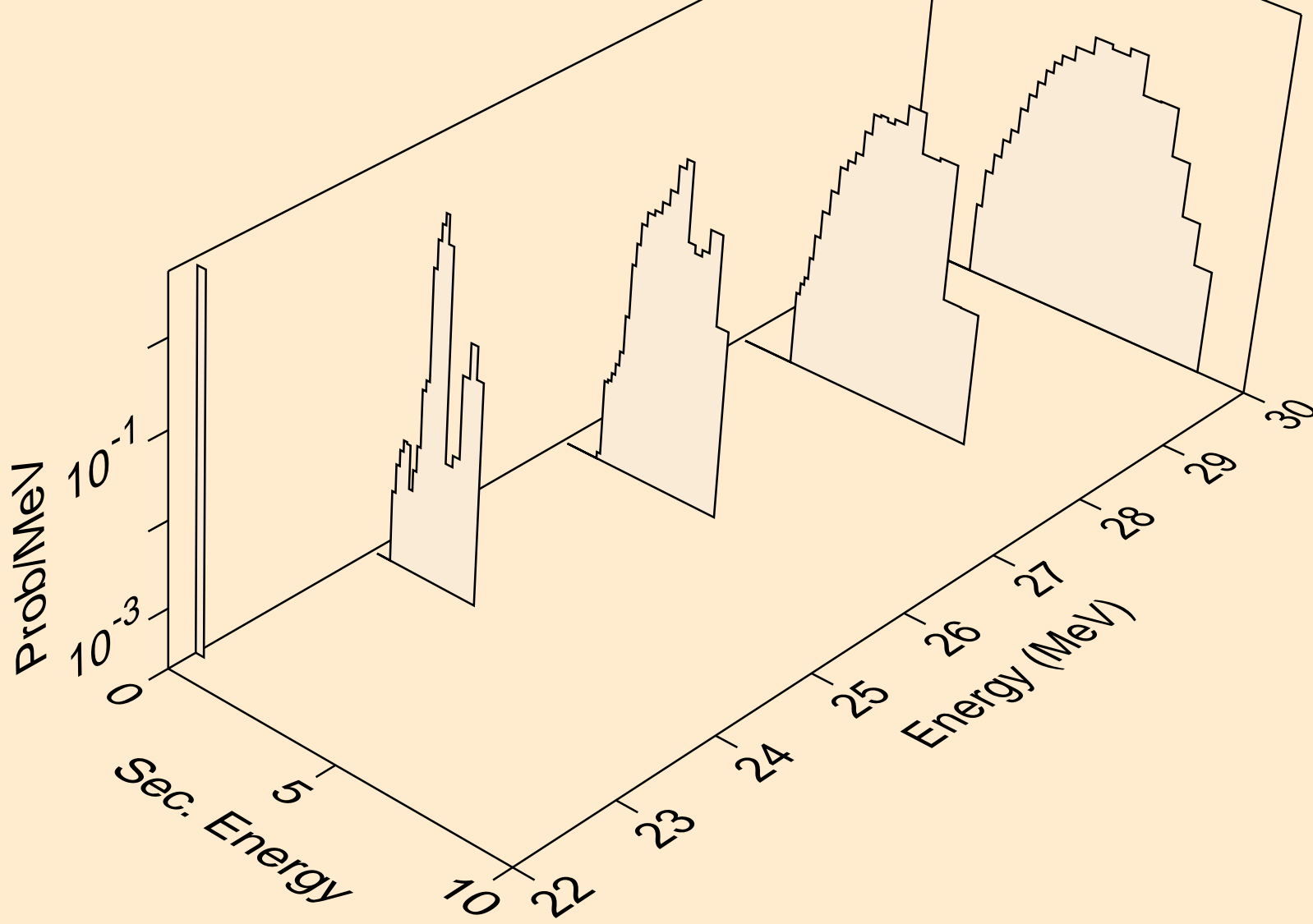

LA138 NEUTRON ACER TENDL-2019 LIBRARY; T=293.16K
protons from (n,2np)

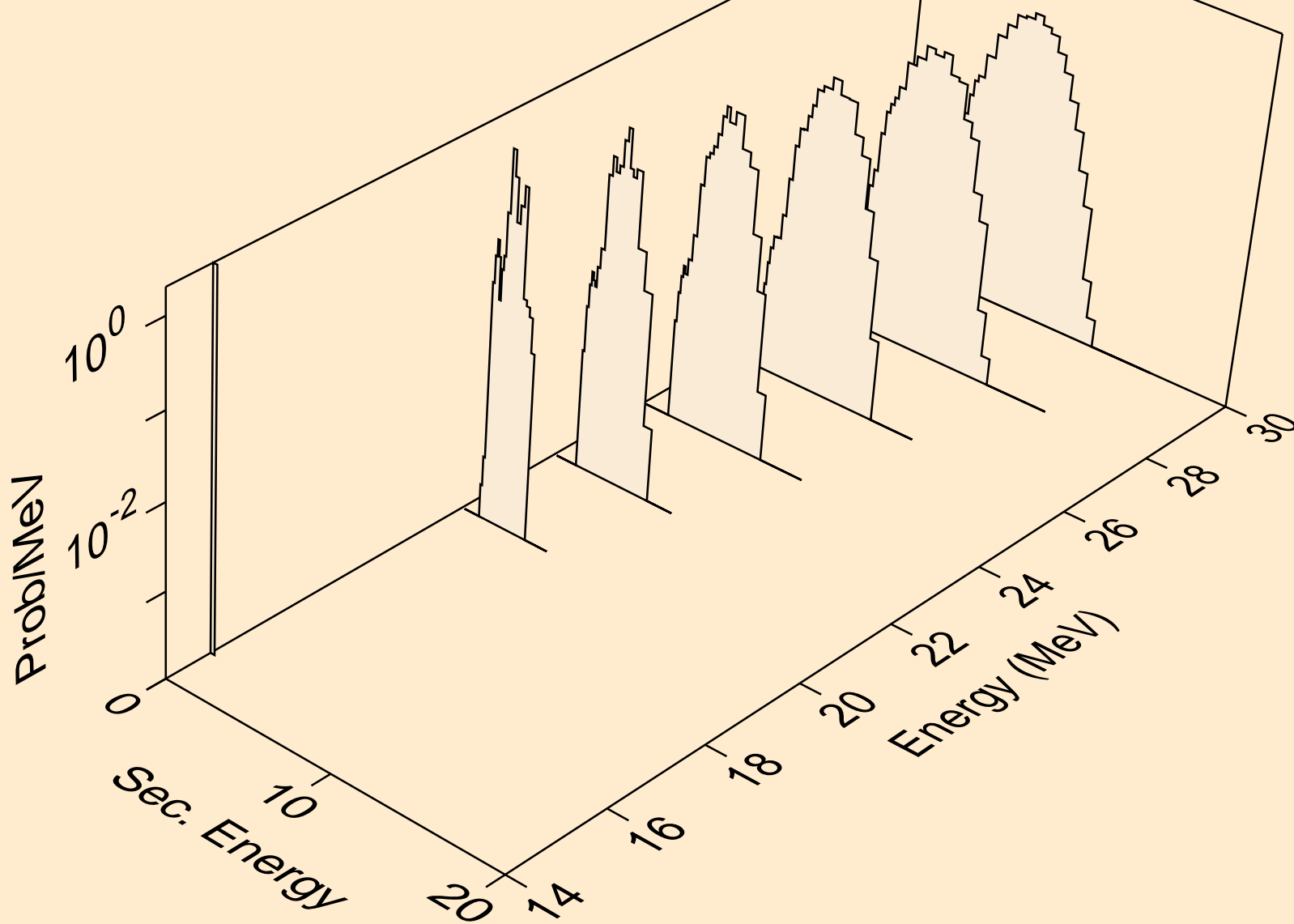

LA138 NEUTRON ACER TENDL-2019 LIBRARY; T=293.16K
protons from (n,npa)

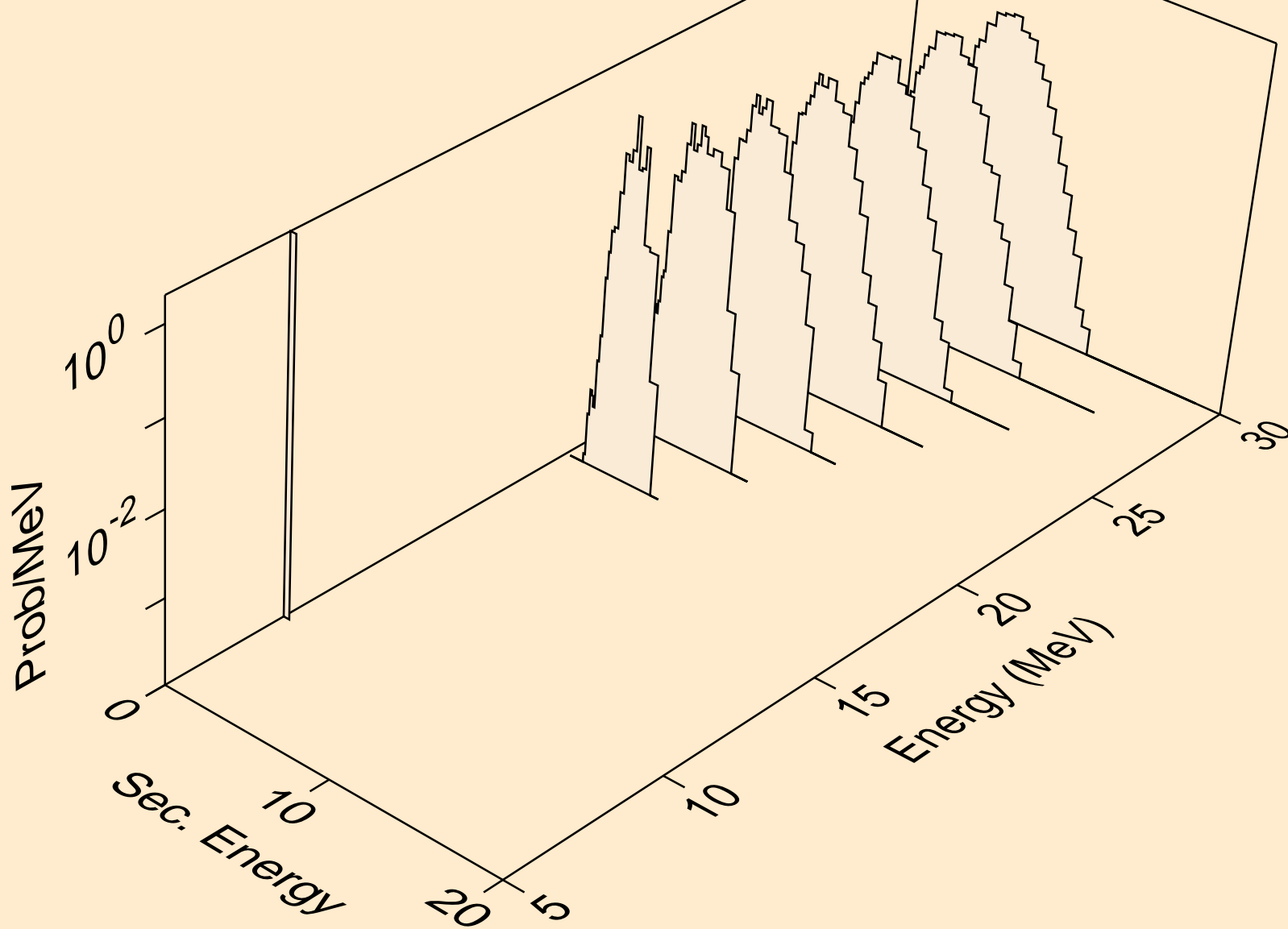

LA138 NEUTRON ACER TENDL-2019 LIBRARY; T=293.16K
protons from (n,p)

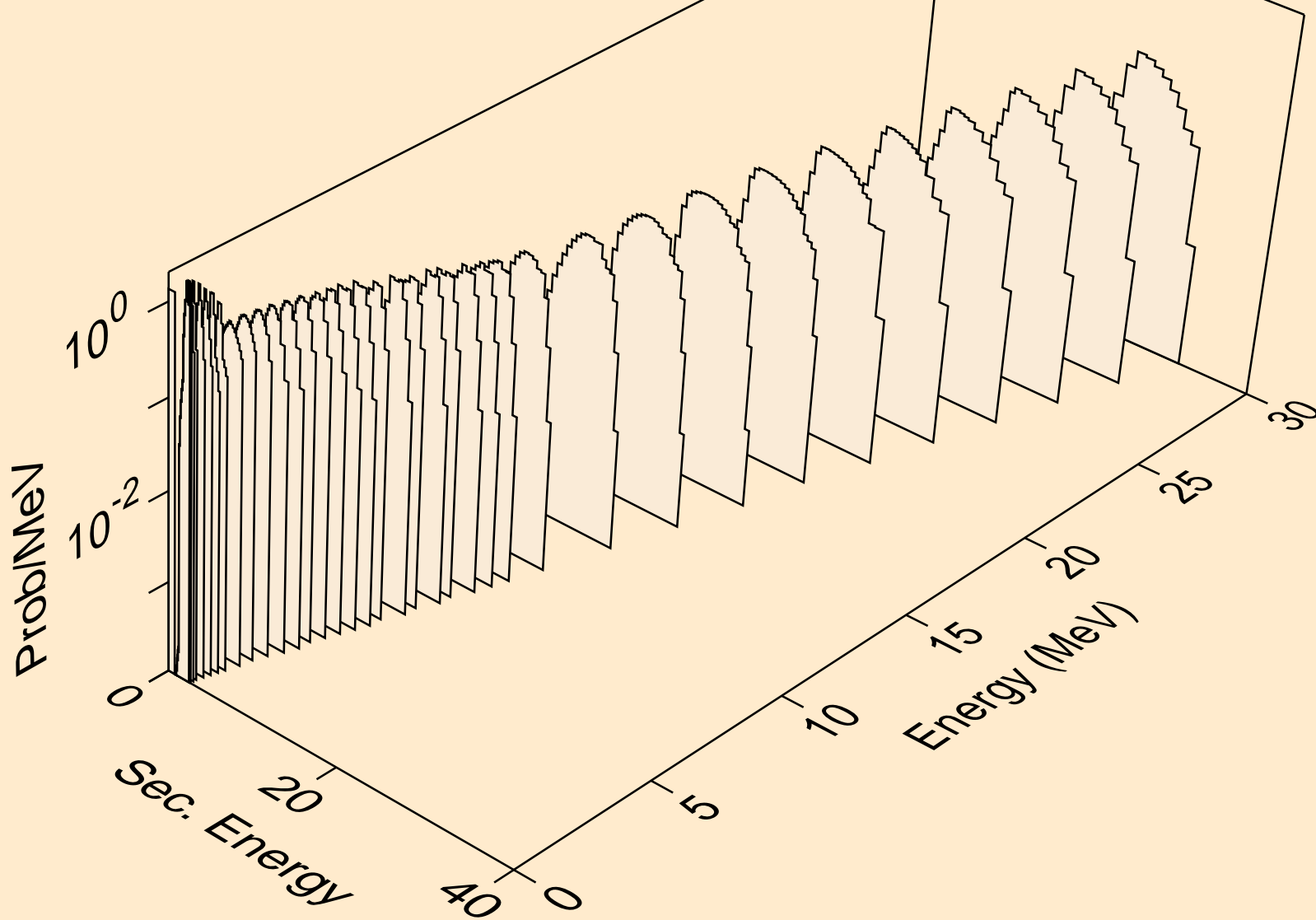

LA138 NEUTRON ACER TENDL-2019 LIBRARY; T=293.16K
protons from (n,2p)

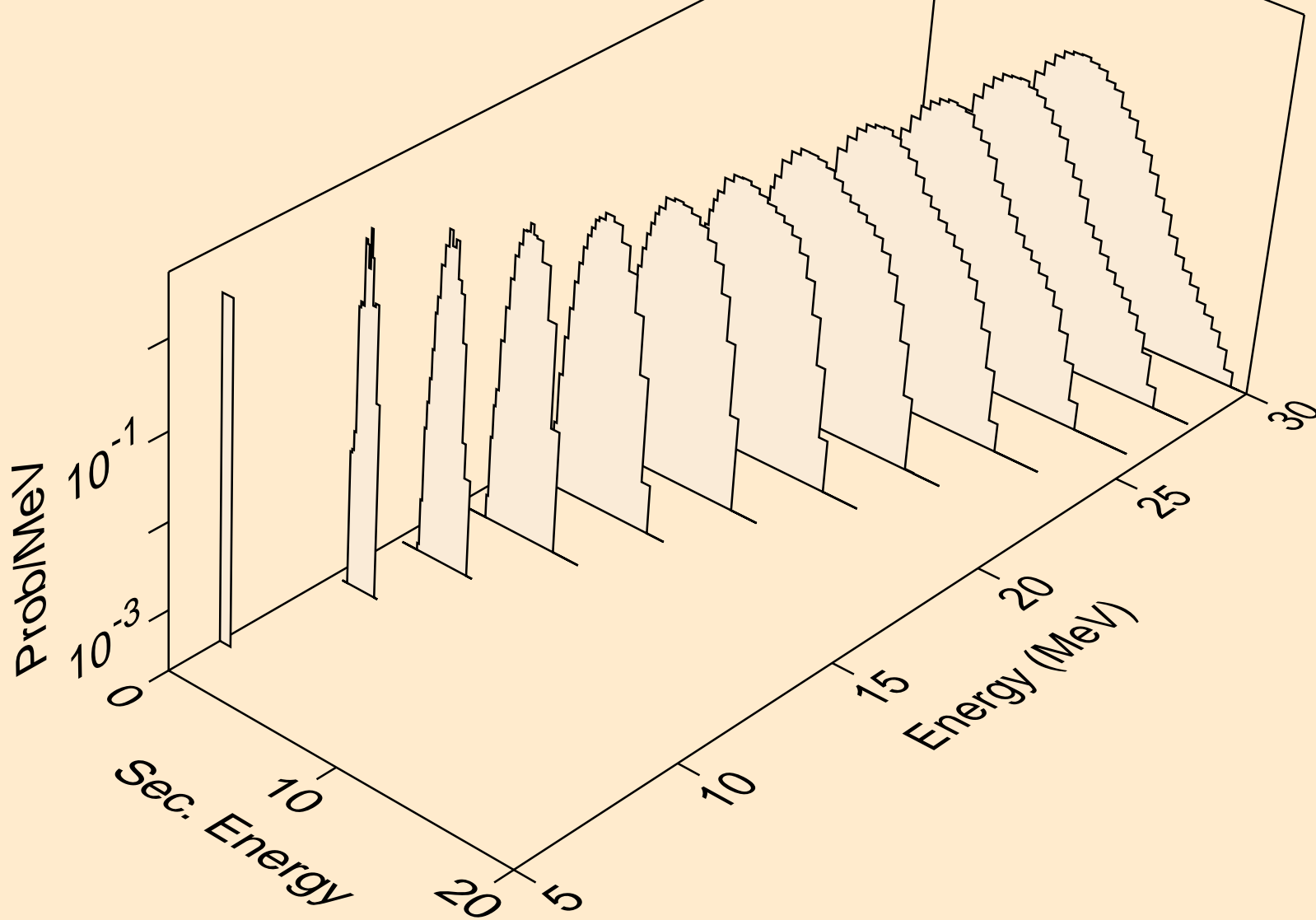

LA138 NEUTRON ACER TENDL-2019 LIBRARY; T=293.16K
protons from (n,p)

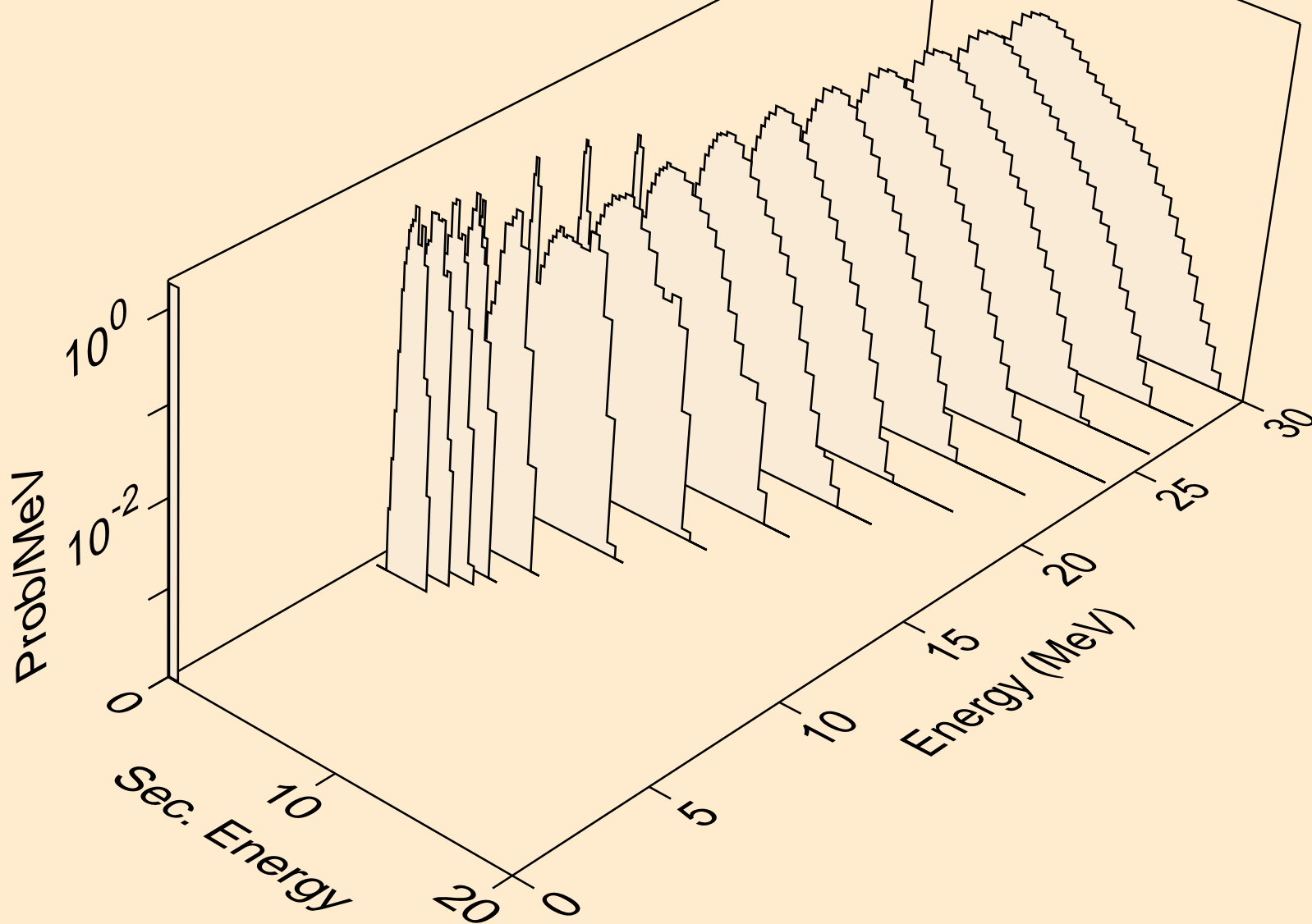

LA138 NEUTRON ACER TENDL-2019 LIBRARY; T=293.16K
protons from (n,pd)

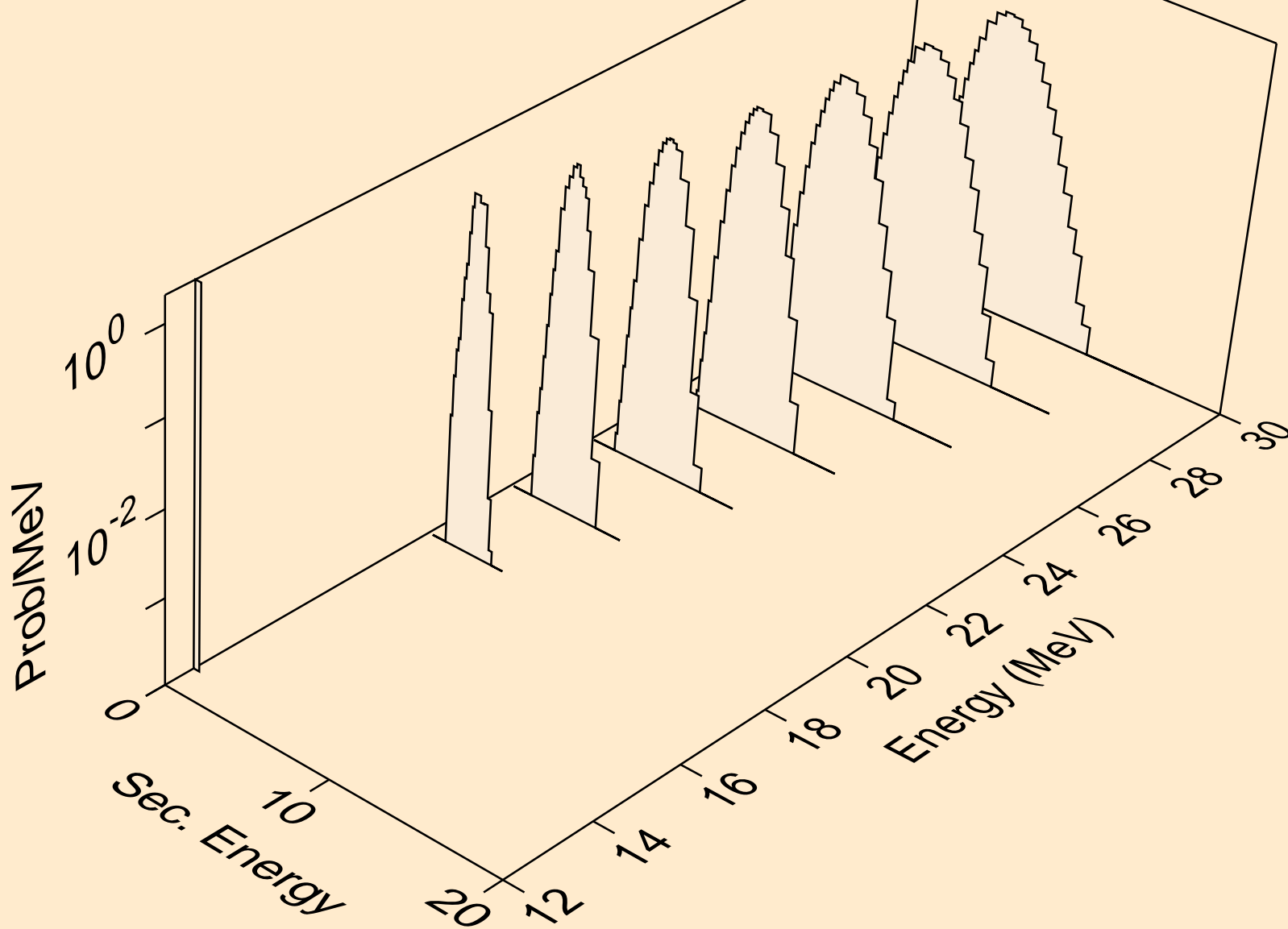

LA138 NEUTRON ACER TENDL-2019 LIBRARY; T=293.16K
protons from (n,pt)

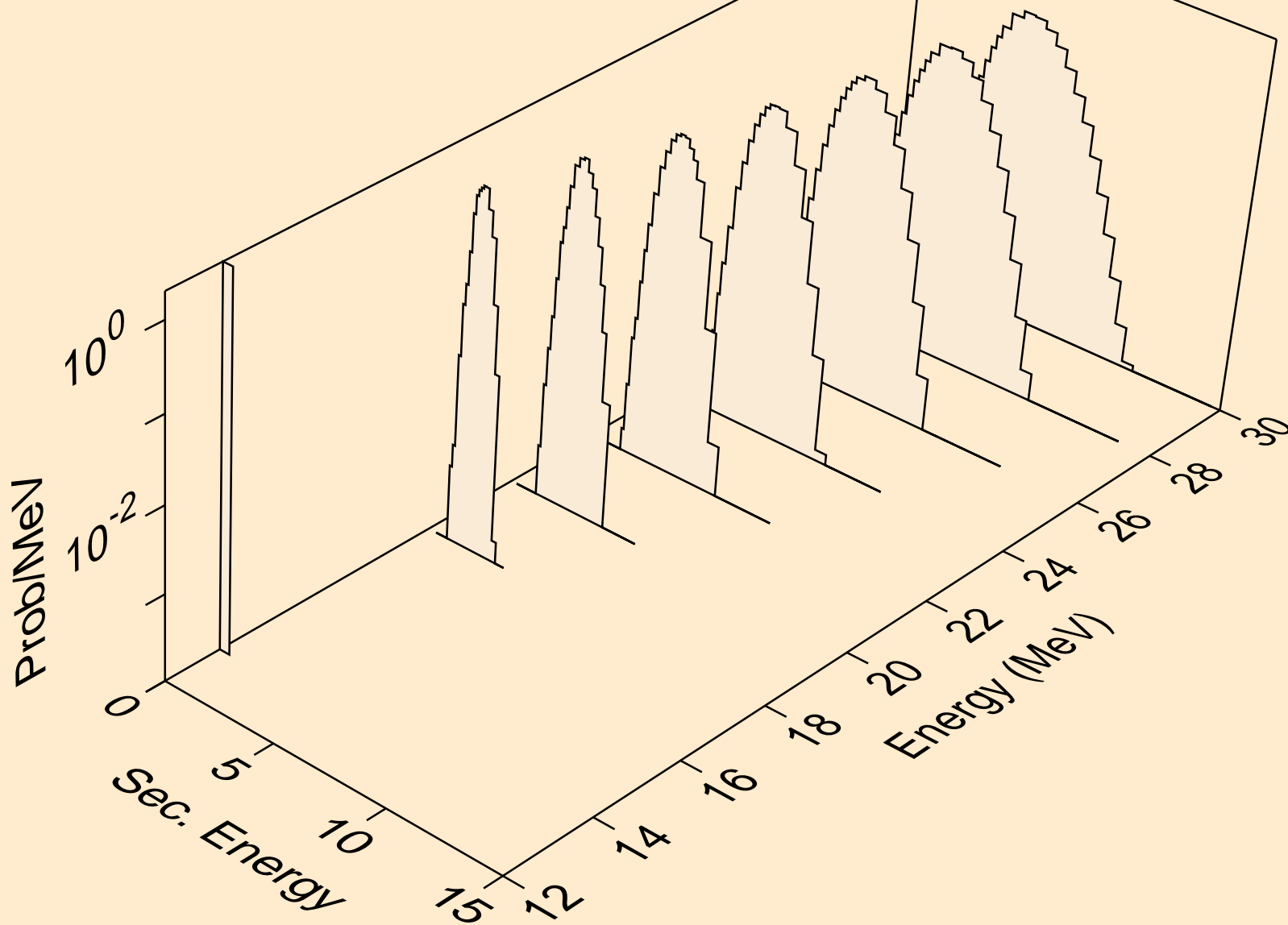

LA138 NEUTRON ACER TENDL-2019 LIBRARY; T=293.16K
deuterons from (n,x)

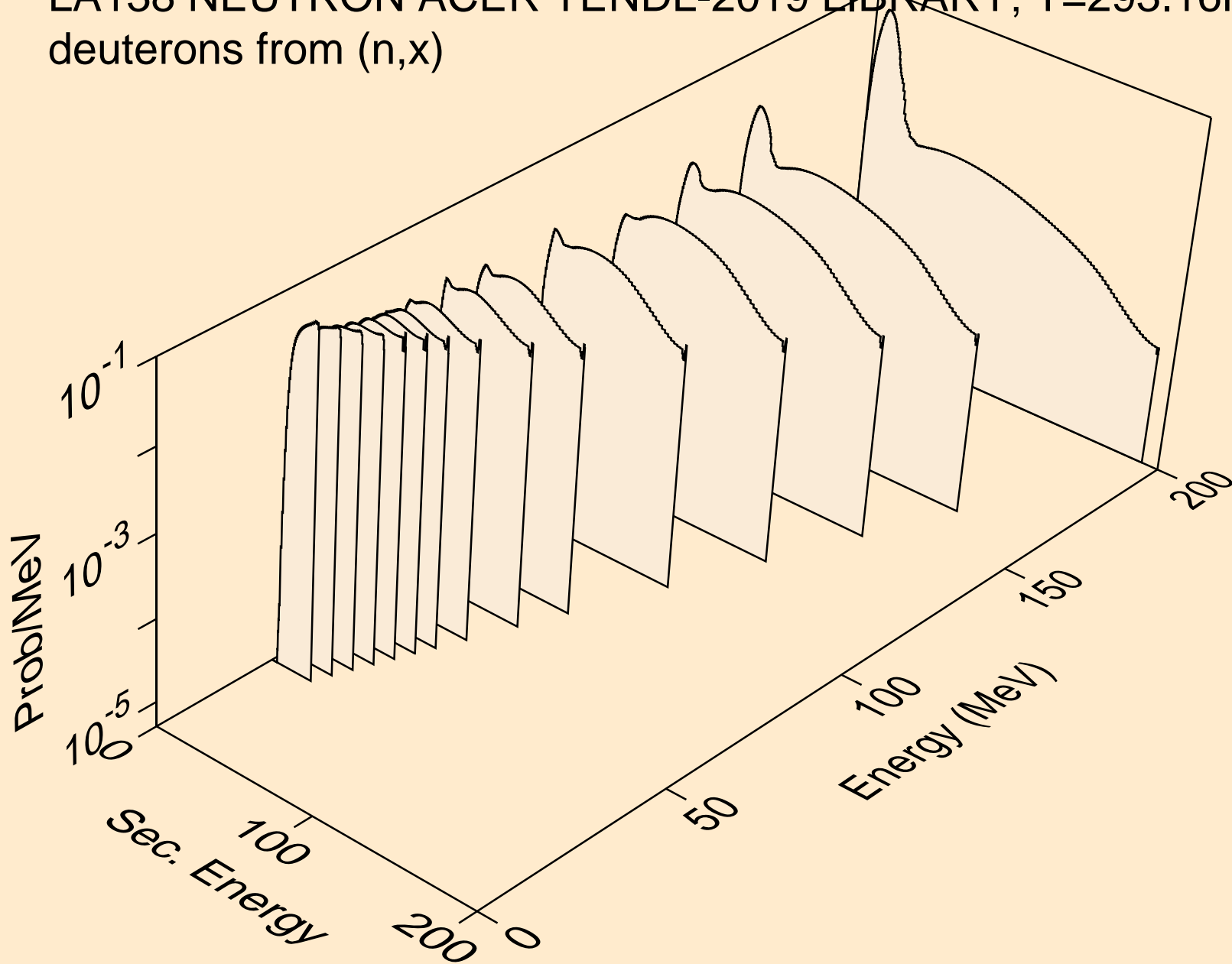

LA138 NEUTRON ACER TENDL-2019 LIBRARY; T=293.16K
deuterons from (n,2nd)

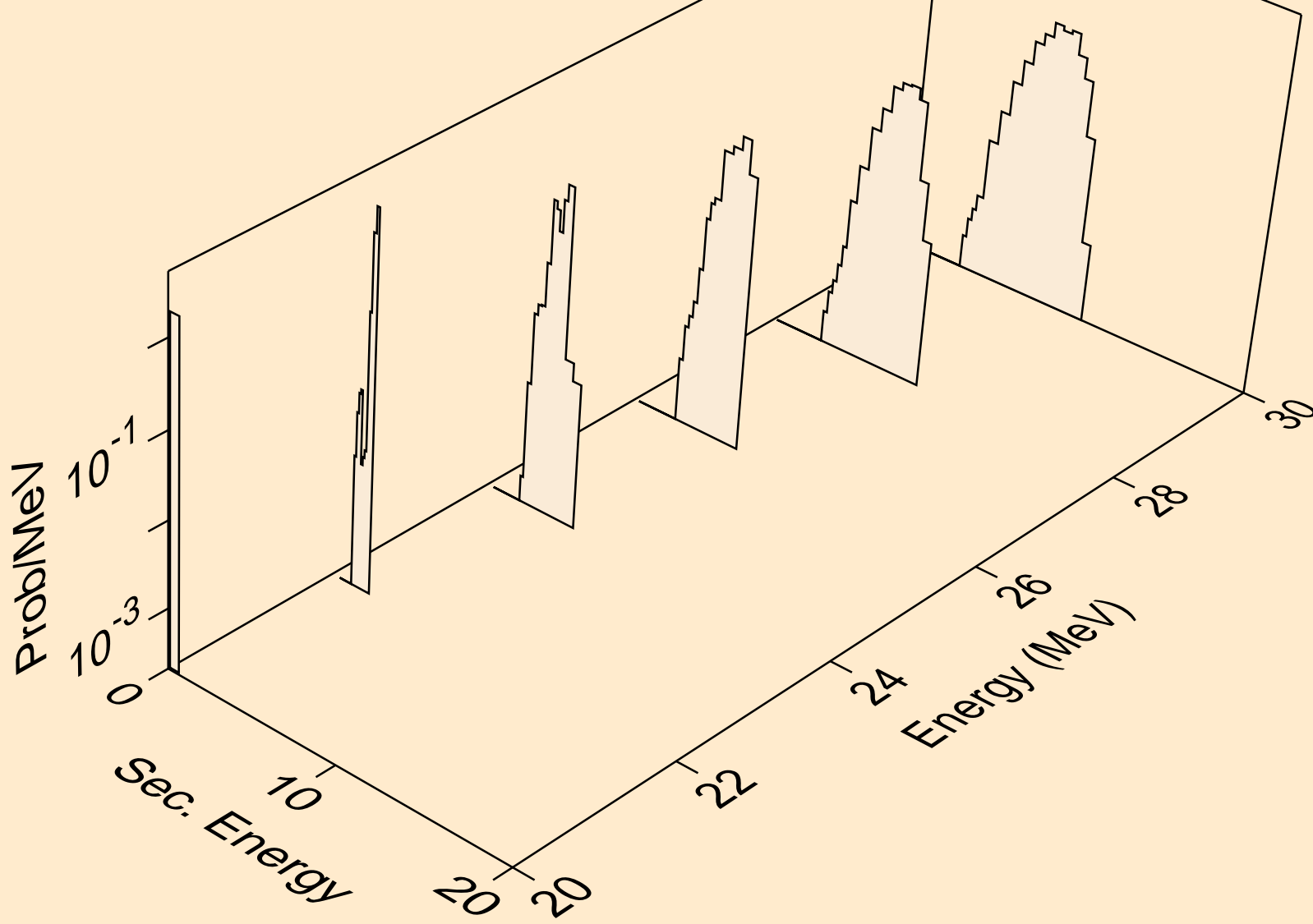

LA138 NEUTRON ACER TENDL-2019 LIBRARY; T=293.16K
deuterons from (n,n*)d

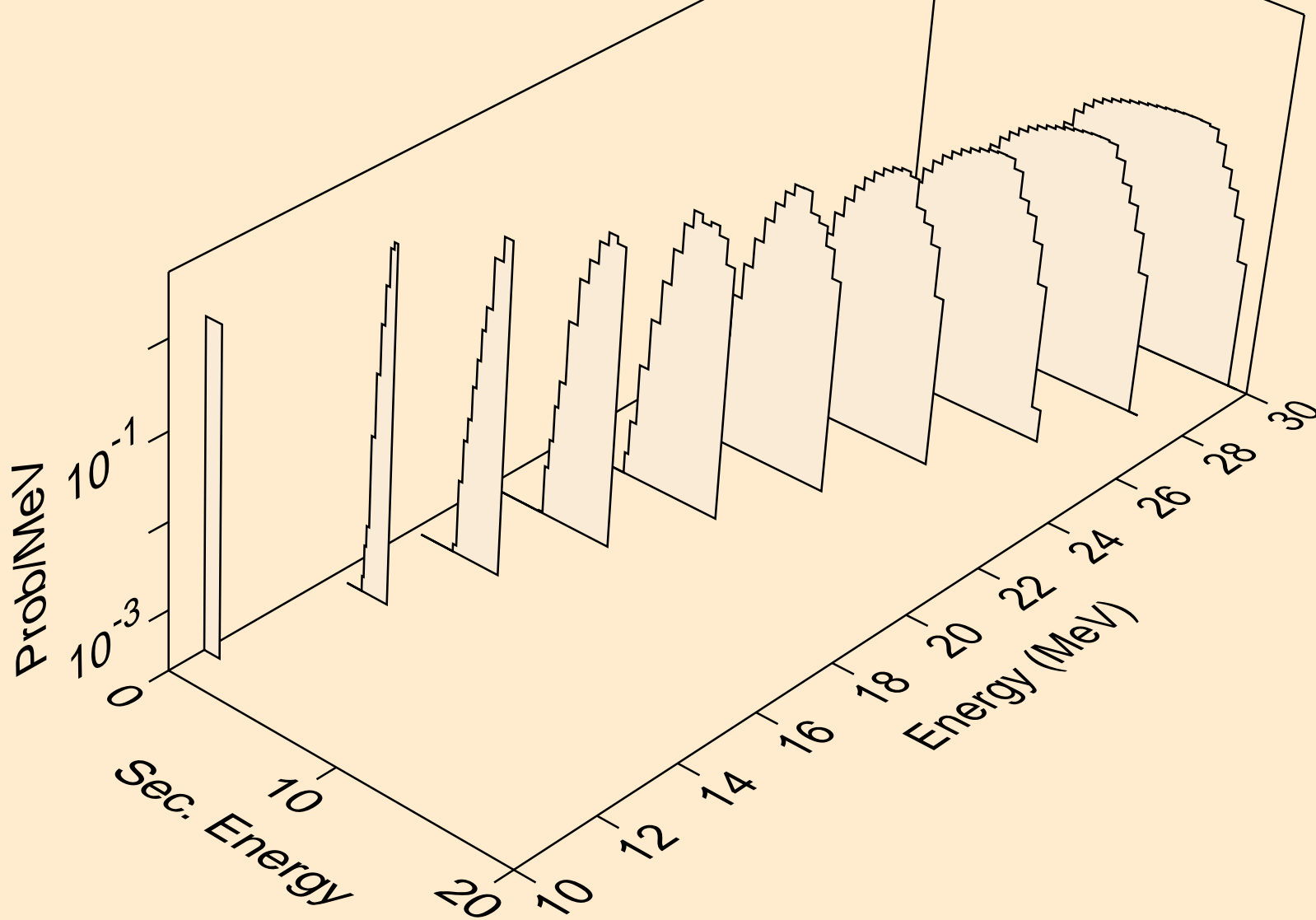

LA138 NEUTRON ACER TENDL-2019 LIBRARY; T=293.16K
deuterons from (n,d)

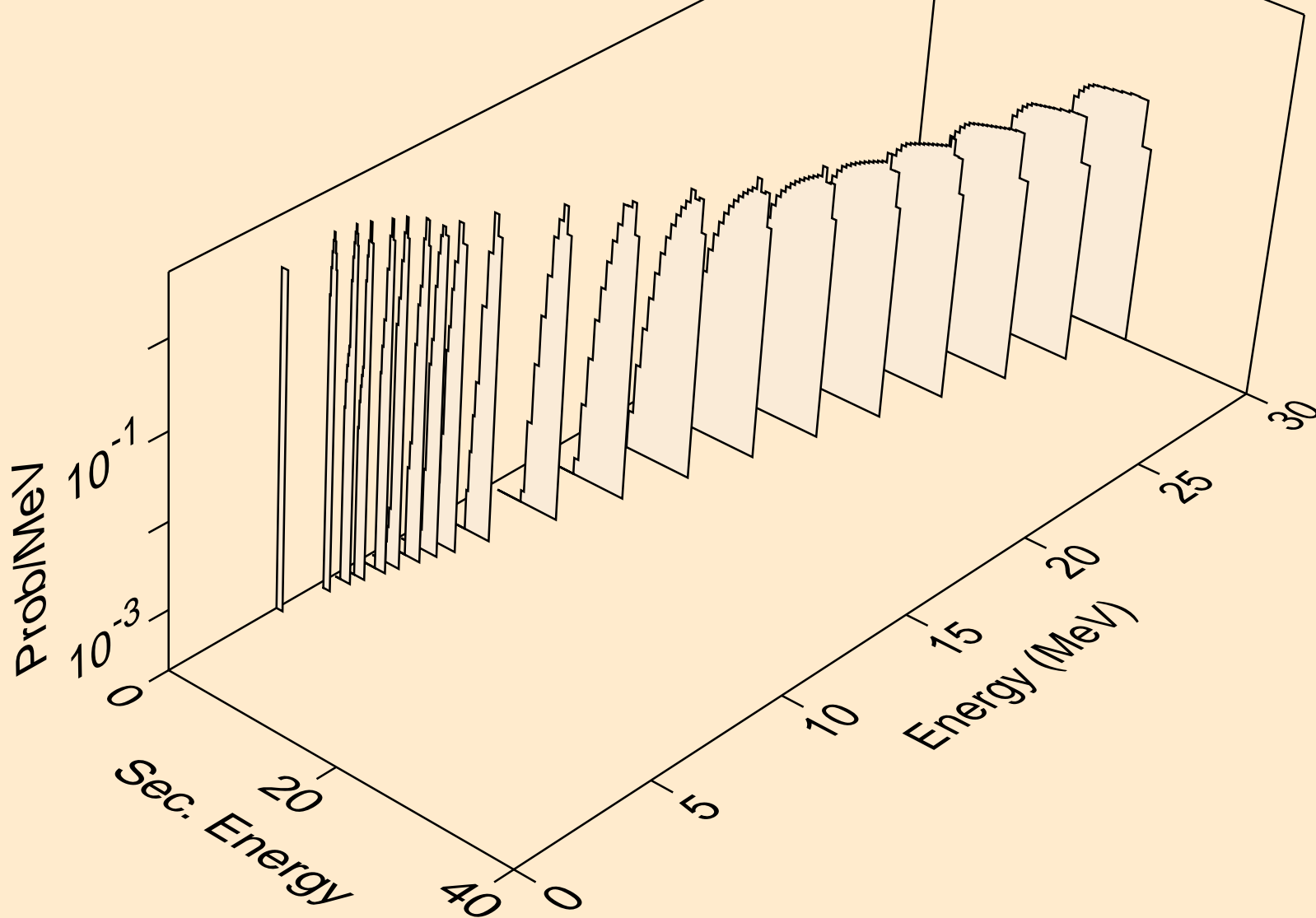

LA138 NEUTRON ACER TENDL-2019 LIBRARY; T=293.16K
deuterons from (n,pd)

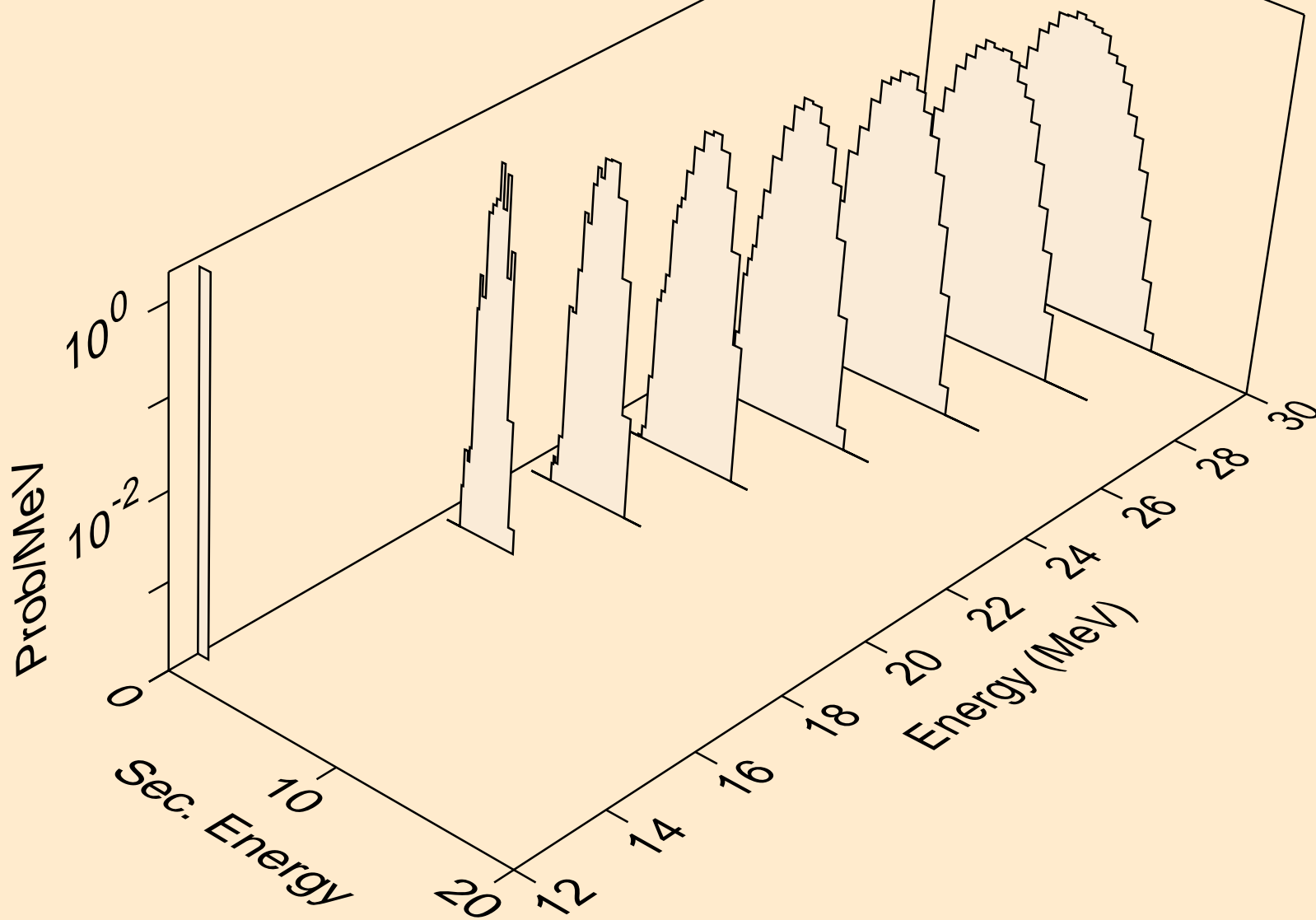

LA138 NEUTRON ACER TENDL-2019 LIBRARY; T=293.16K
deuterons from (n,da)

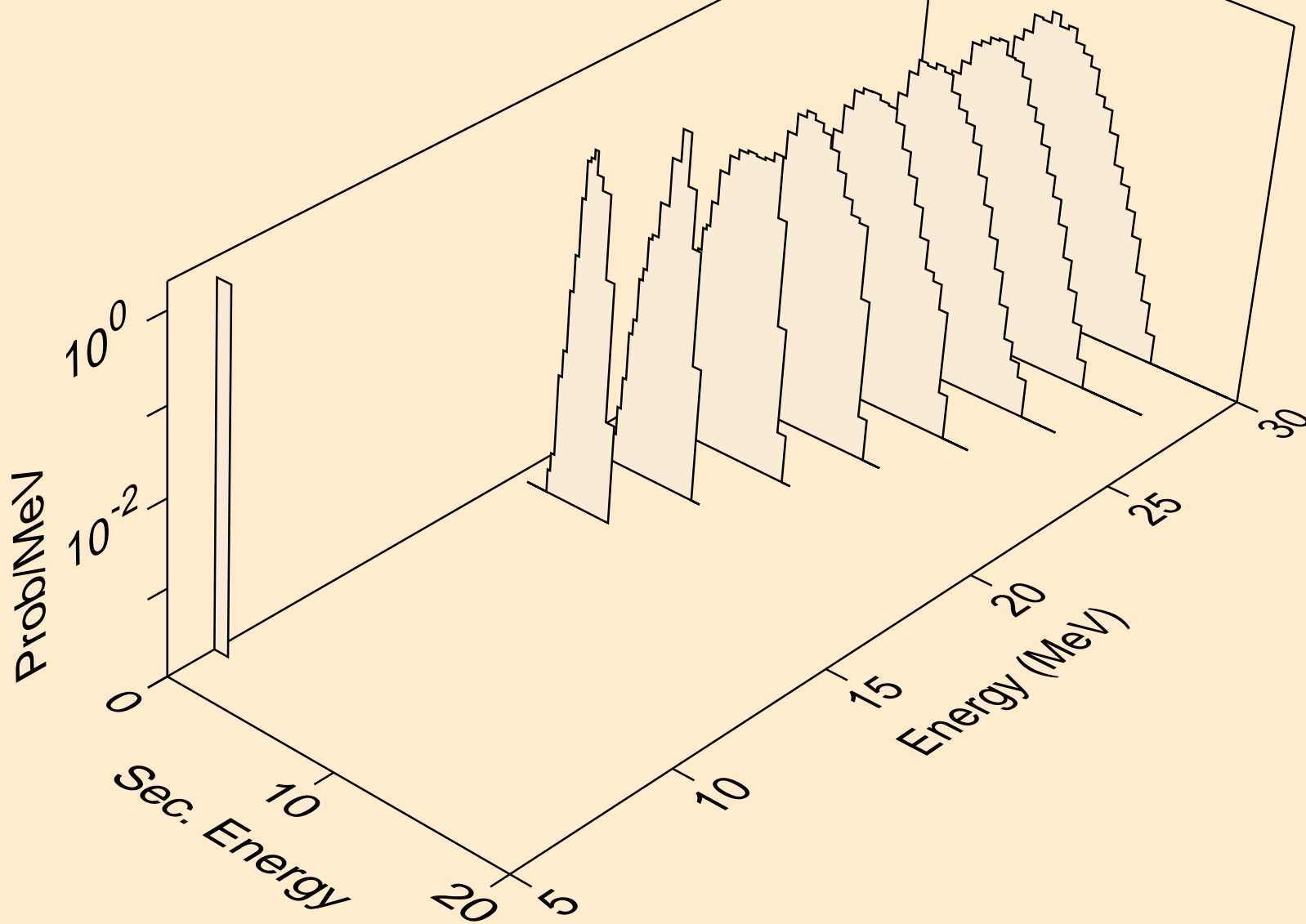

LA138 NEUTRON ACER TENDL-2019 LIBRARY; T=293.16K
tritons from (n,x)

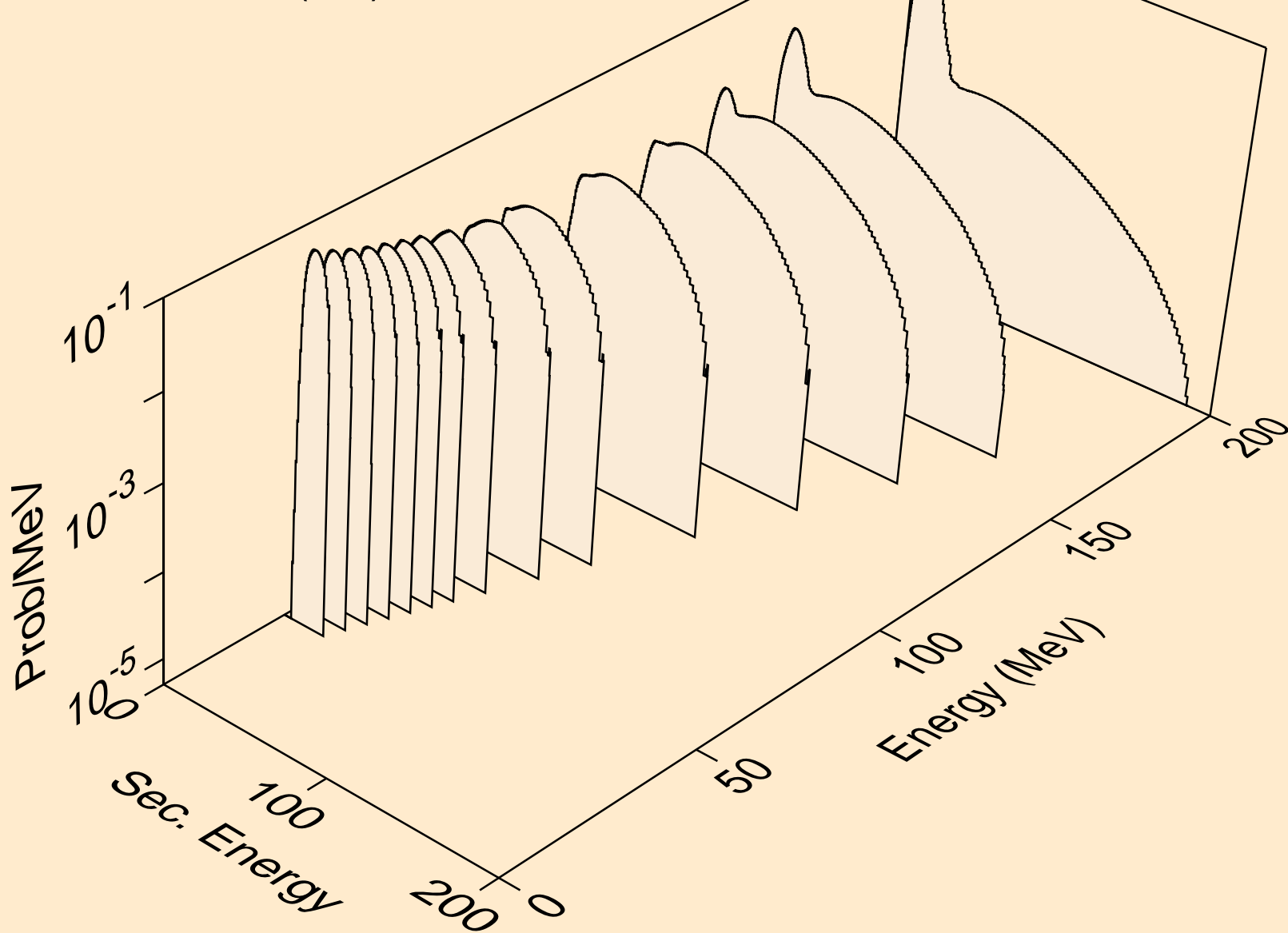

LA138 NEUTRON ACER TENDL-2019 LIBRARY; T=293.16K
tritons from (n,n*)t

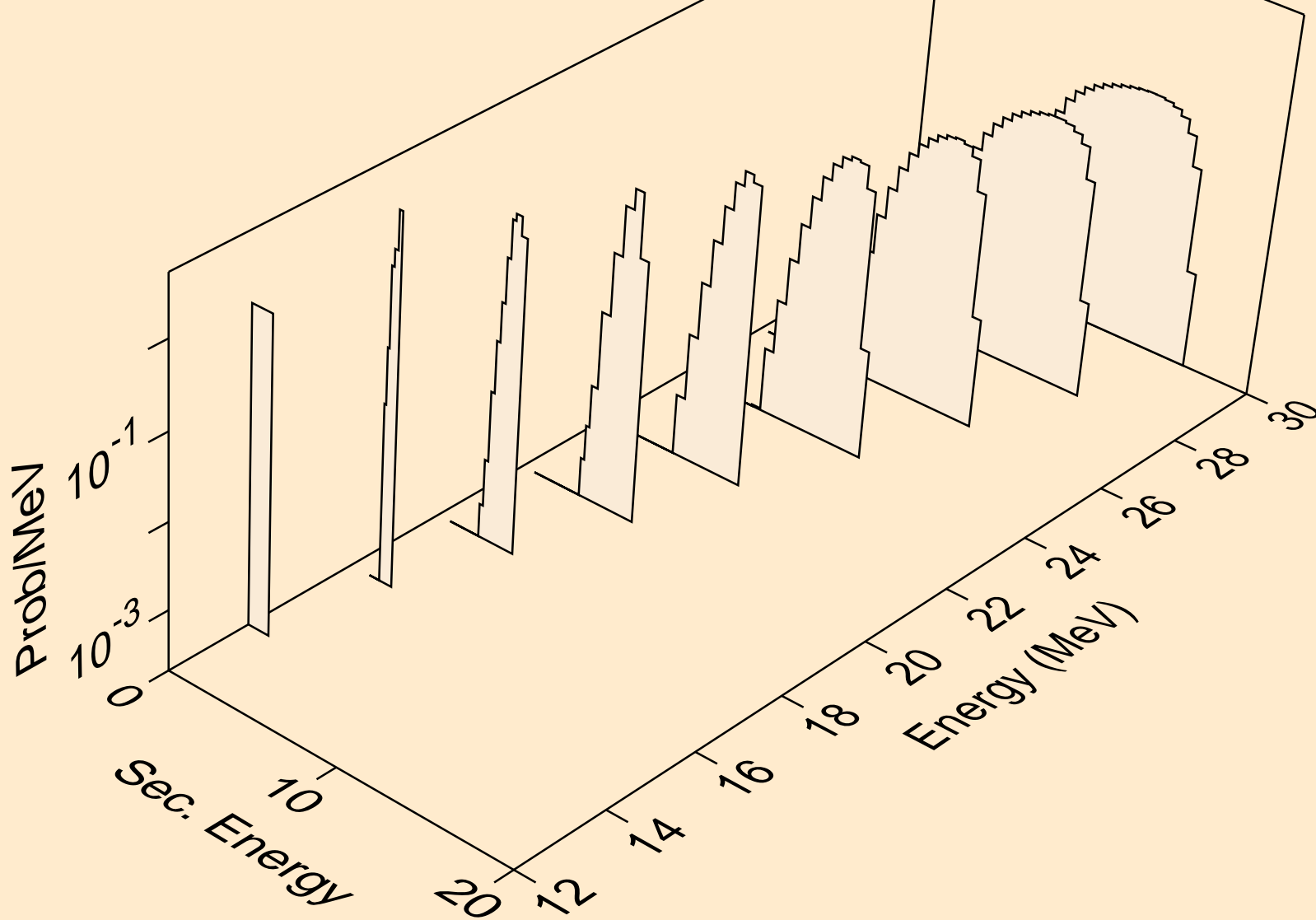

LA138 NEUTRON ACER TENDL-2019 LIBRARY; T=293.16K
tritons from (n,t)

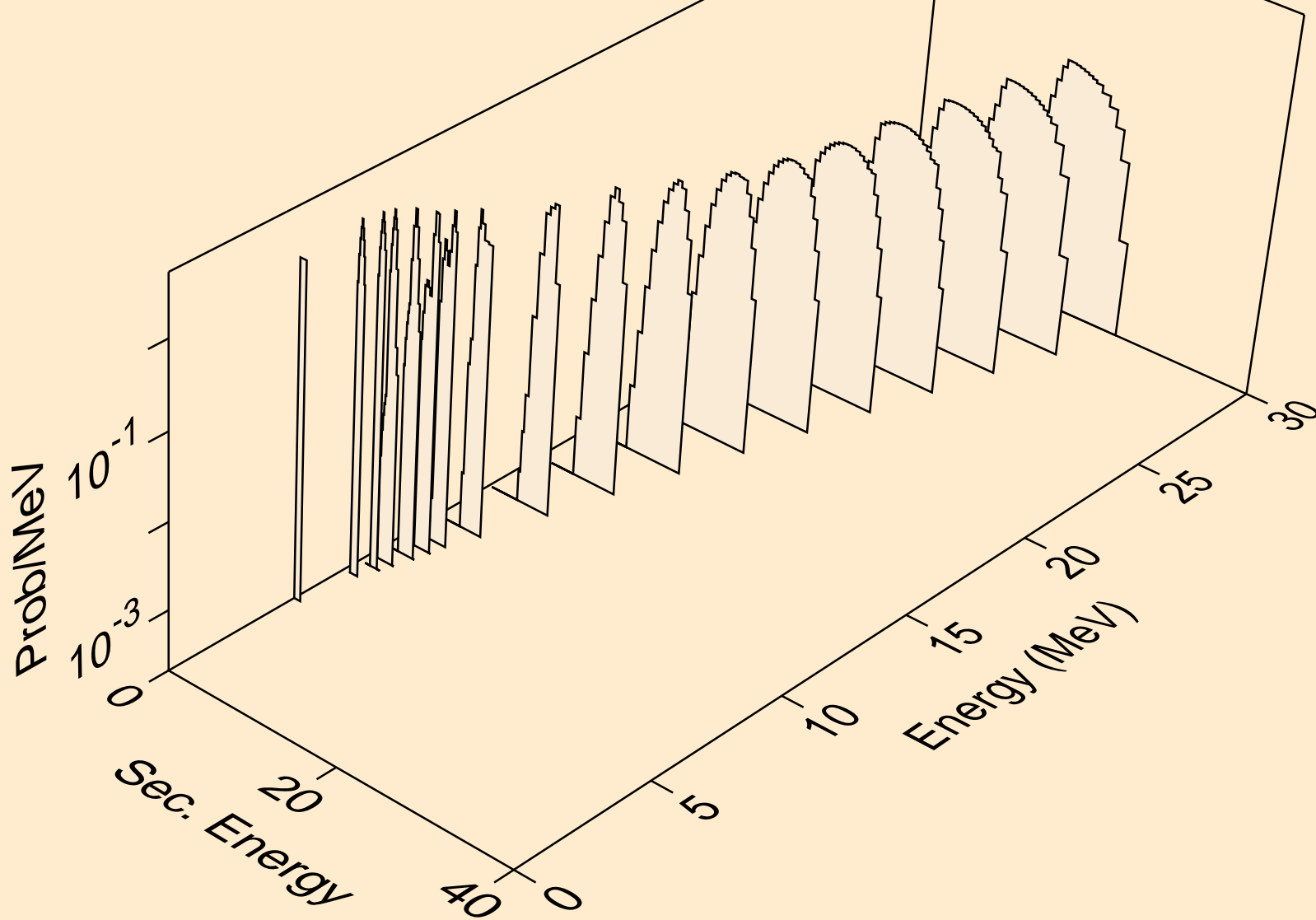

LA138 NEUTRON ACER TENDL-2019 LIBRARY; T=293.16K
tritons from (n,pt)

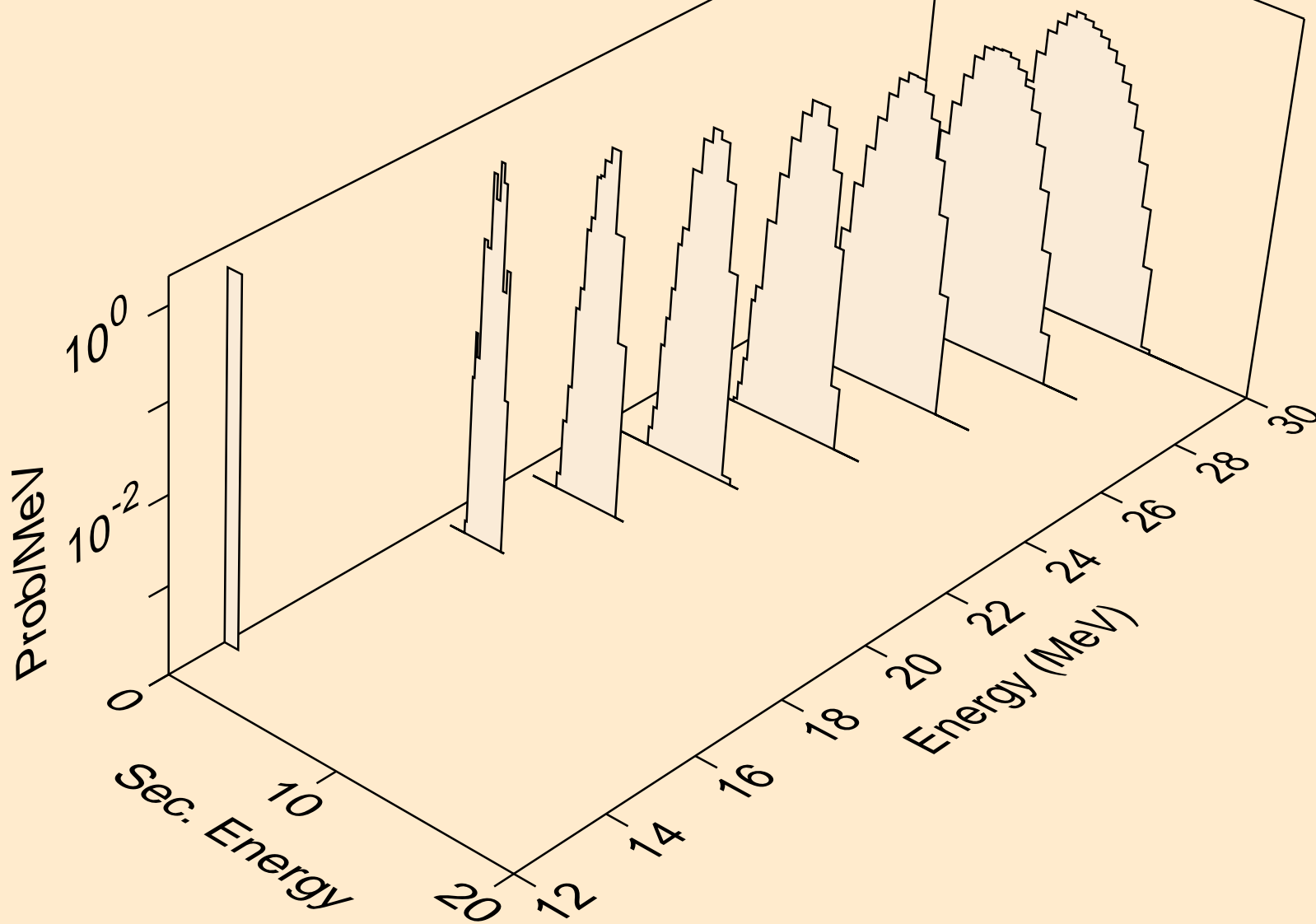

LA138 NEUTRON ACER TENDL-2019 LIBRARY; T=293.16K
he3s from (n,x)

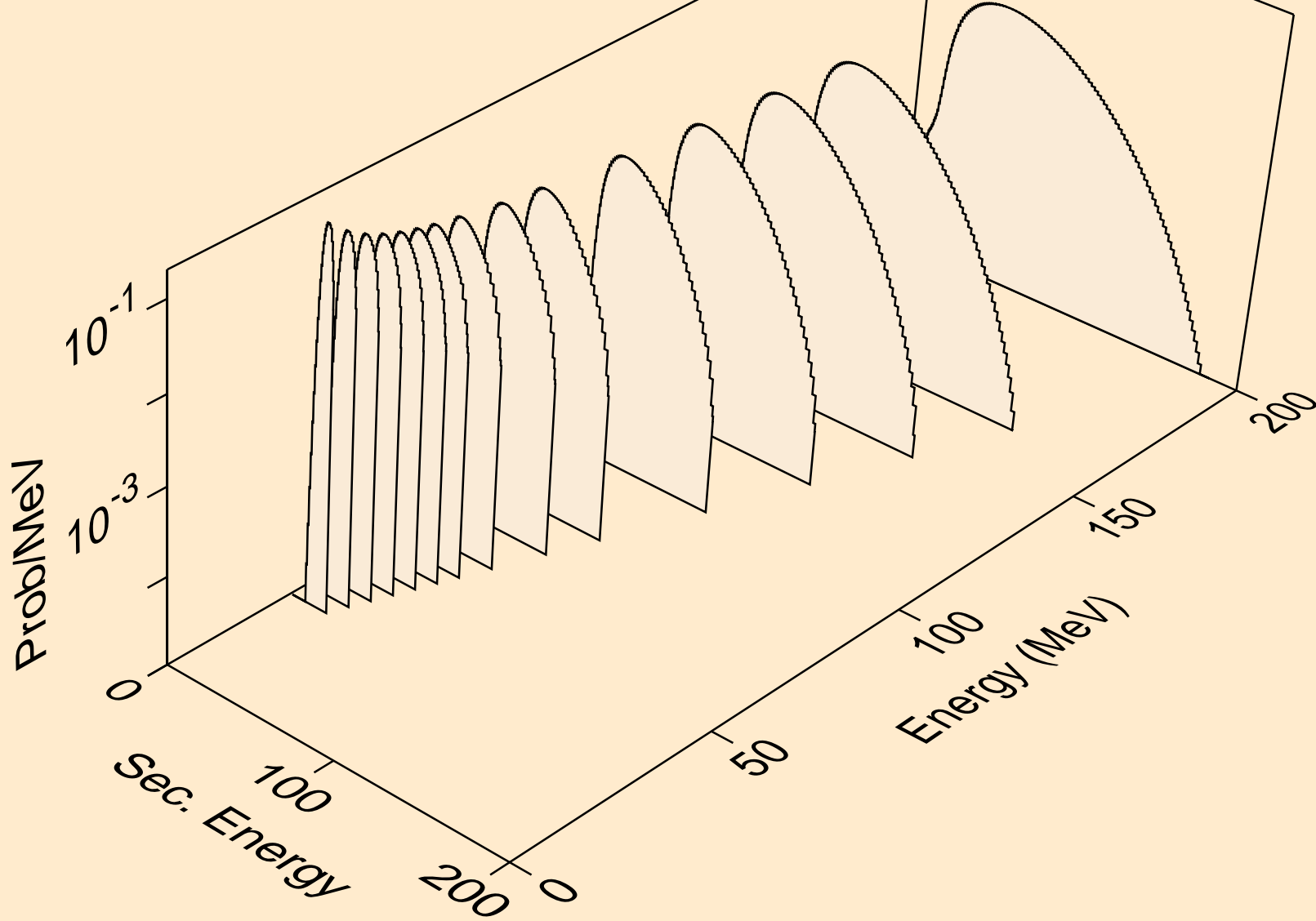

LA138 NEUTRON ACER TENDL-2019 LIBRARY; T=293.16K
he3s from (n,n*)he3

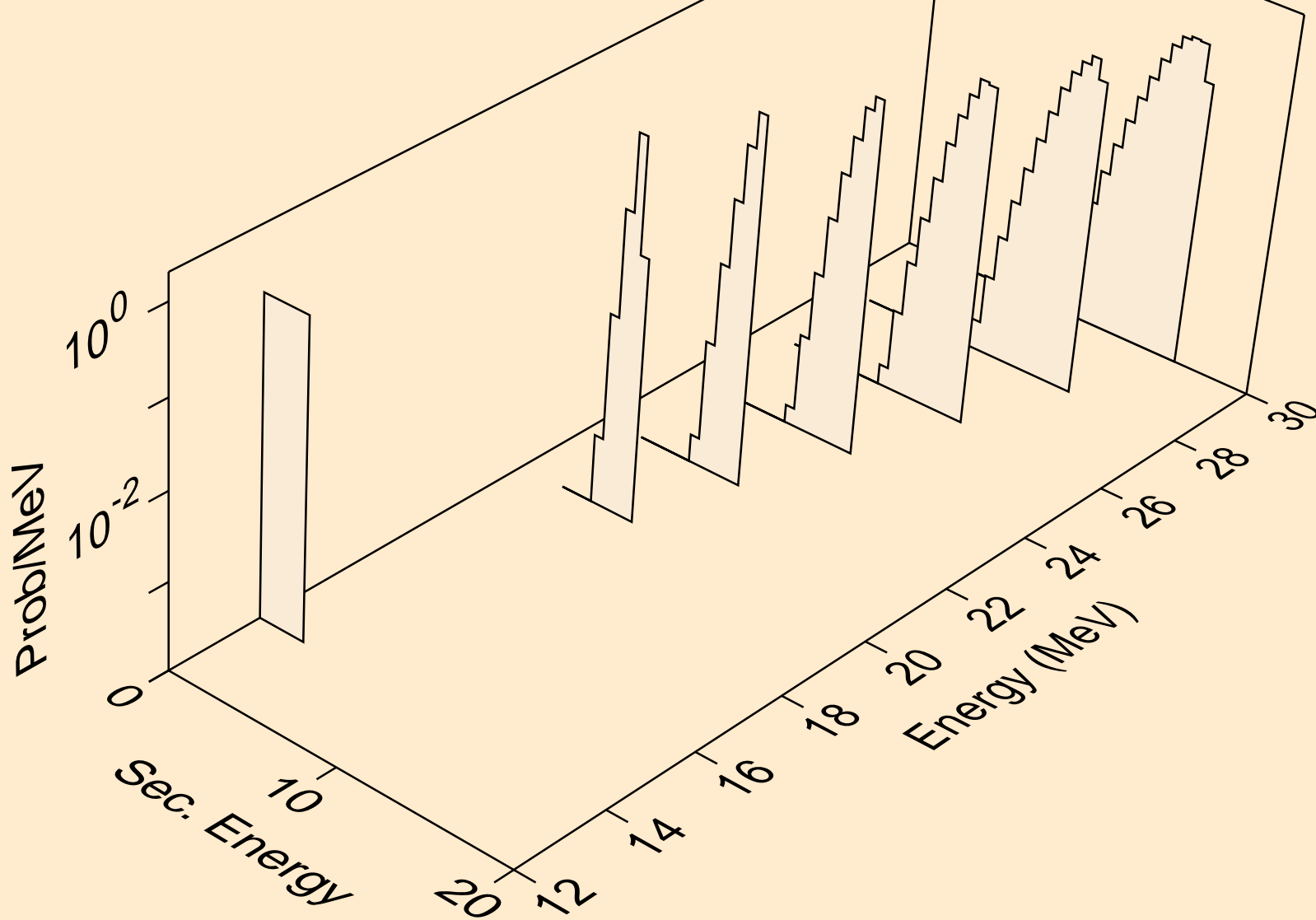

LA138 NEUTRON ACER TENDL-2019 LIBRARY; T=293.16K
he3s from (n,he3)

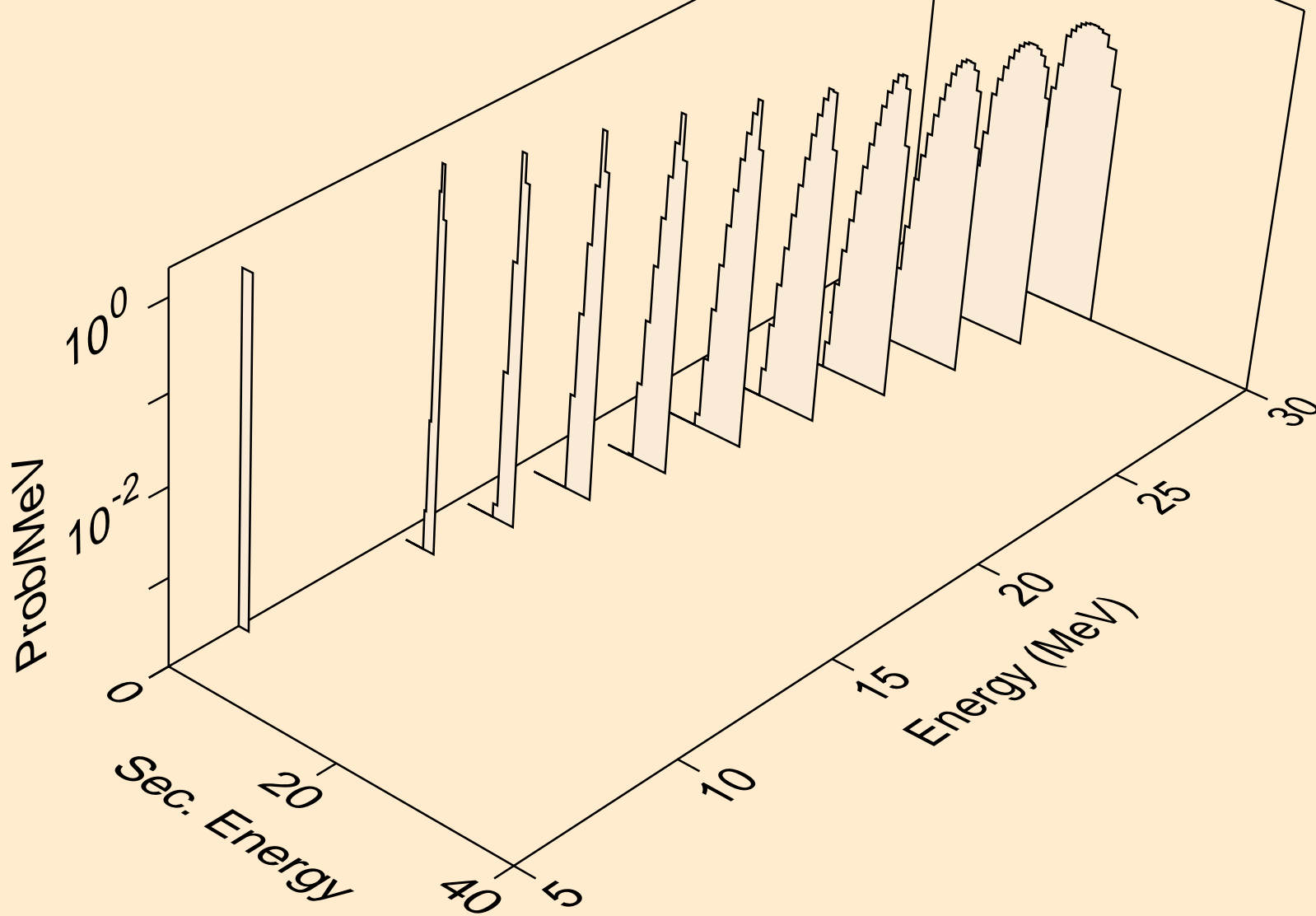

LA138 NEUTRON ACER TENDL-2019 LIBRARY; T=293.16K
alphas from (n,x)

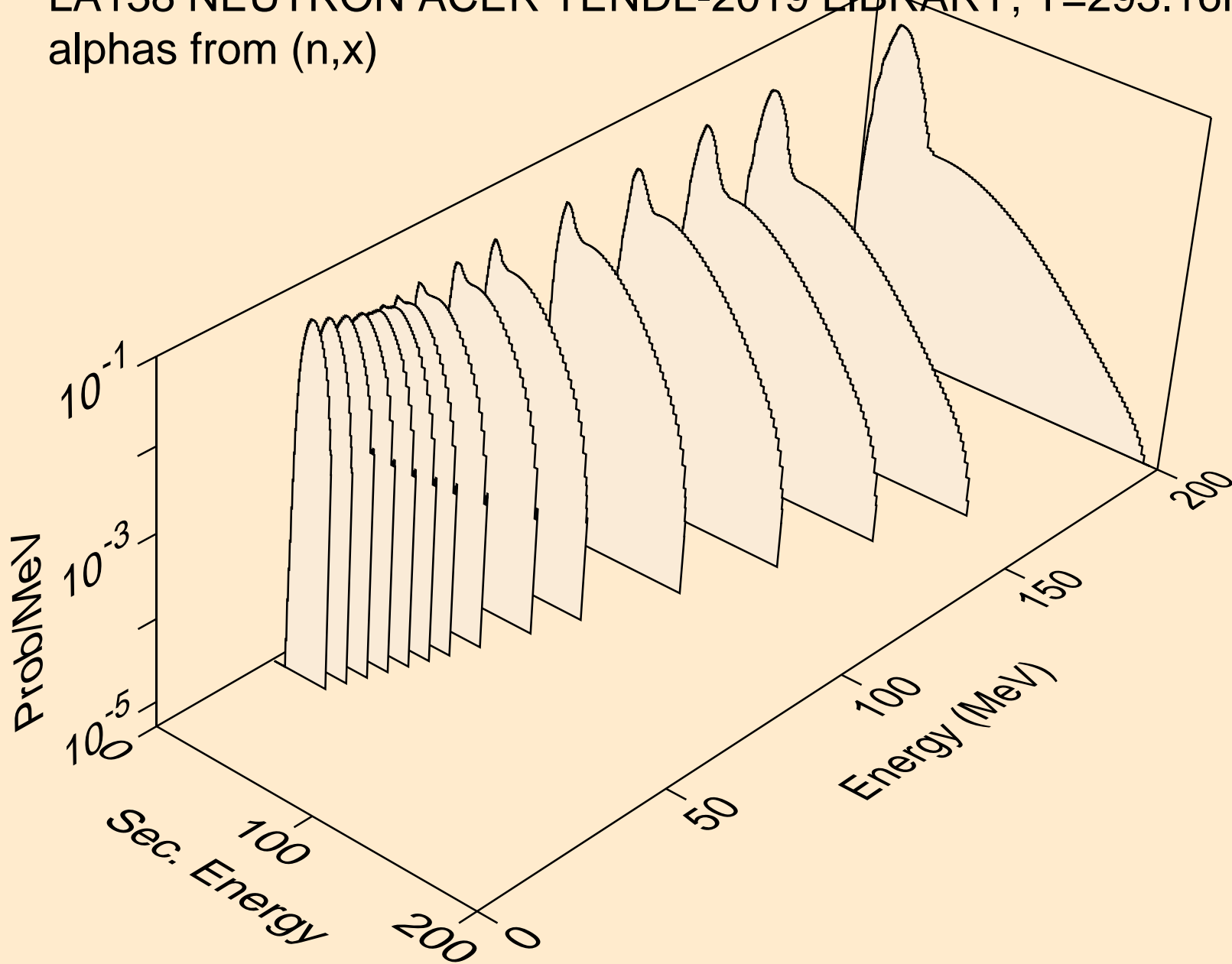

LA138 NEUTRON ACER TENDL-2019 LIBRARY; T=293.16K
alphas from (n,n*)a

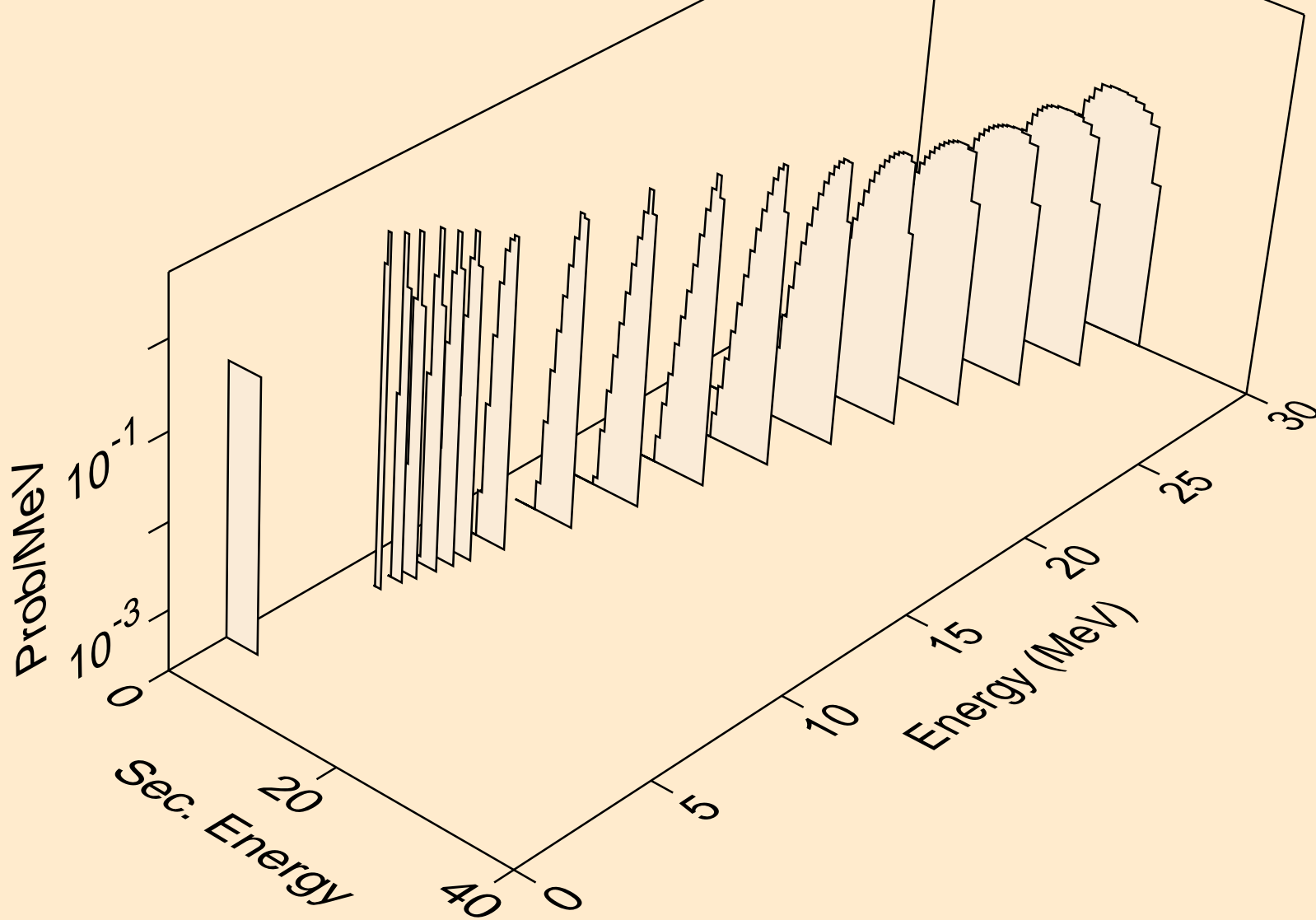

LA138 NEUTRON ACER TENDL-2019 LIBRARY; T=293.16K
alphas from (n,2n)a

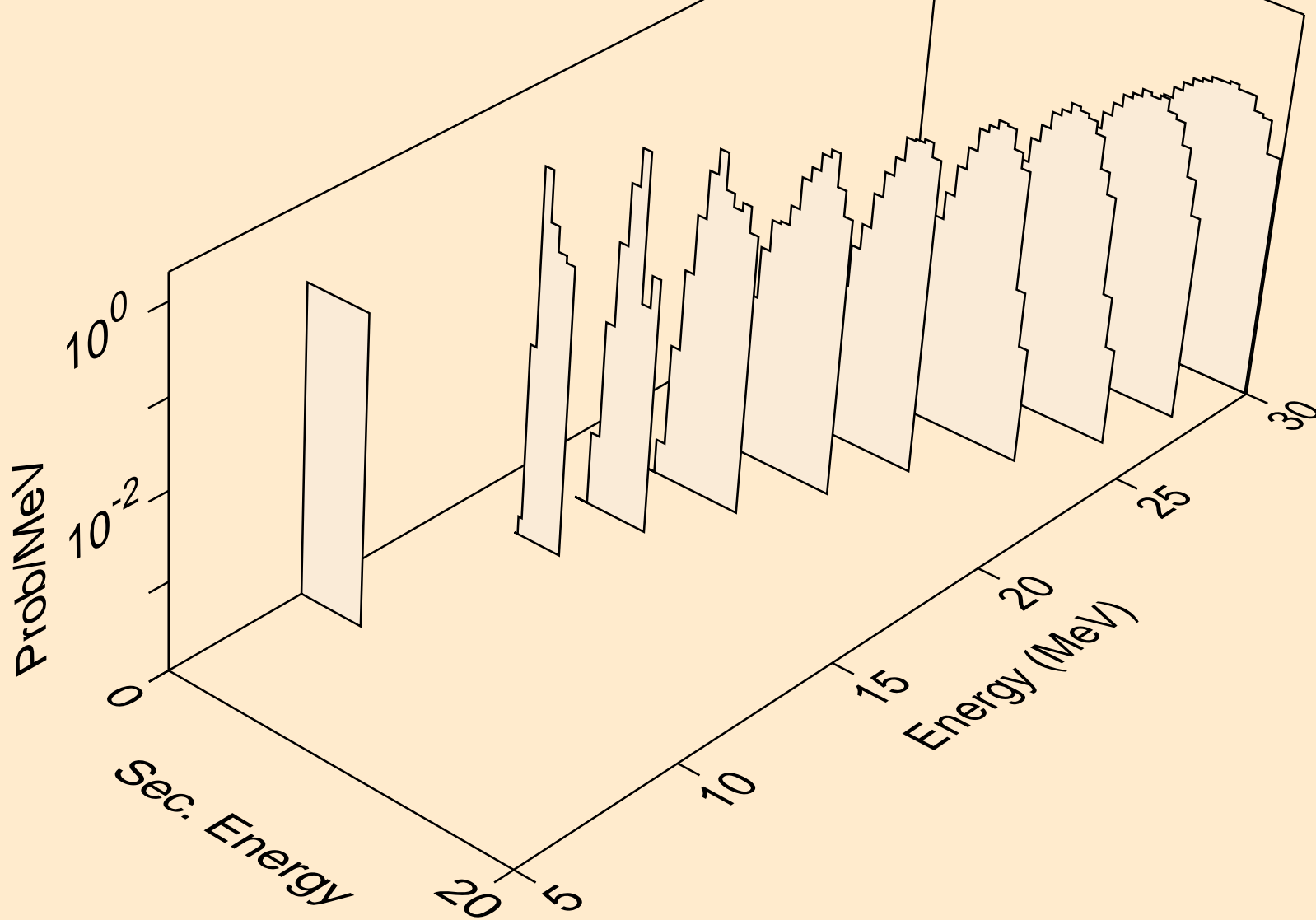

LA138 NEUTRON ACER TENDL-2019 LIBRARY; T=293.16K
alphas from (n,3n)a

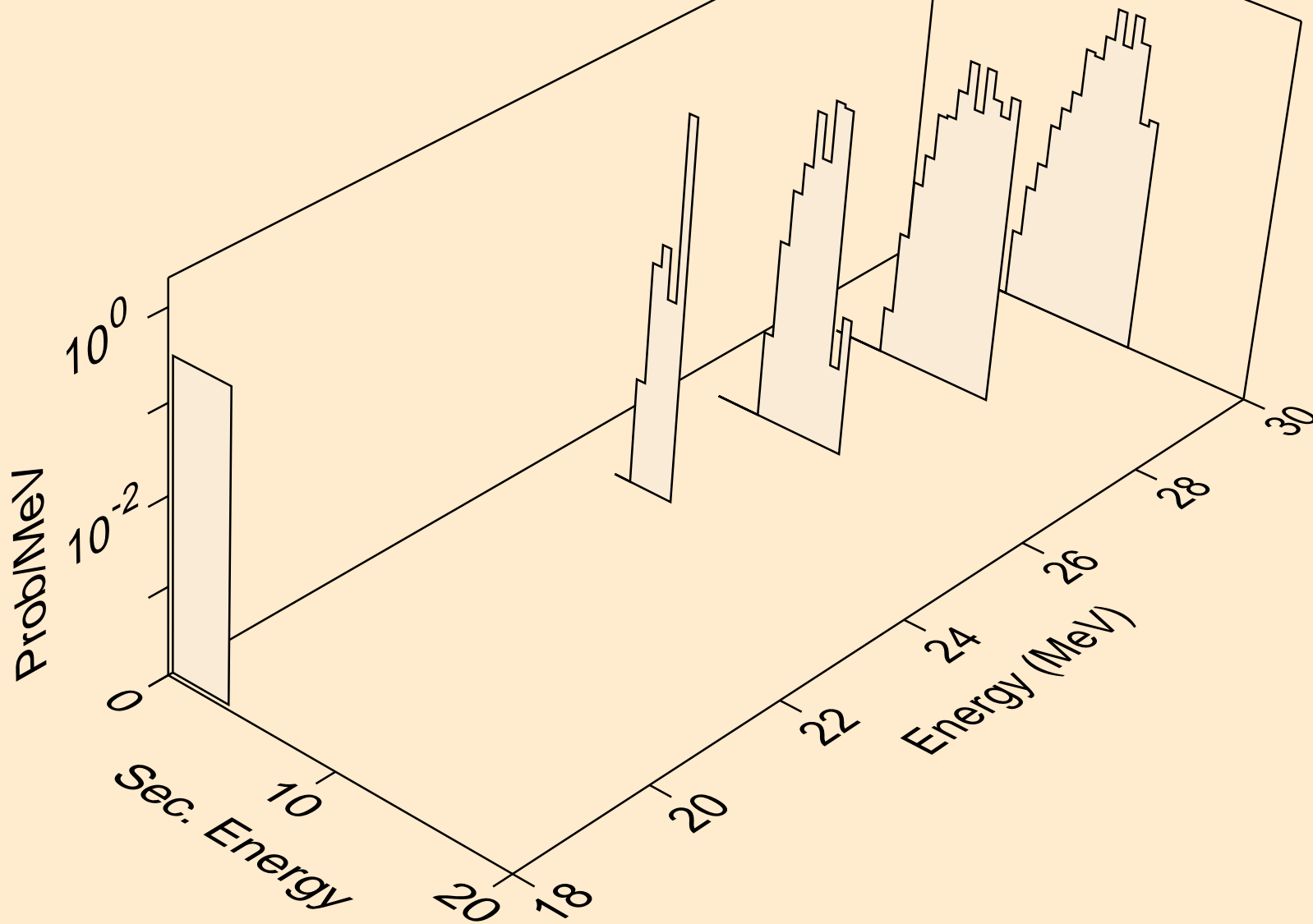

LA138 NEUTRON ACER TENDL-2019 LIBRARY; T=293.16K
alphas from (n,npa)

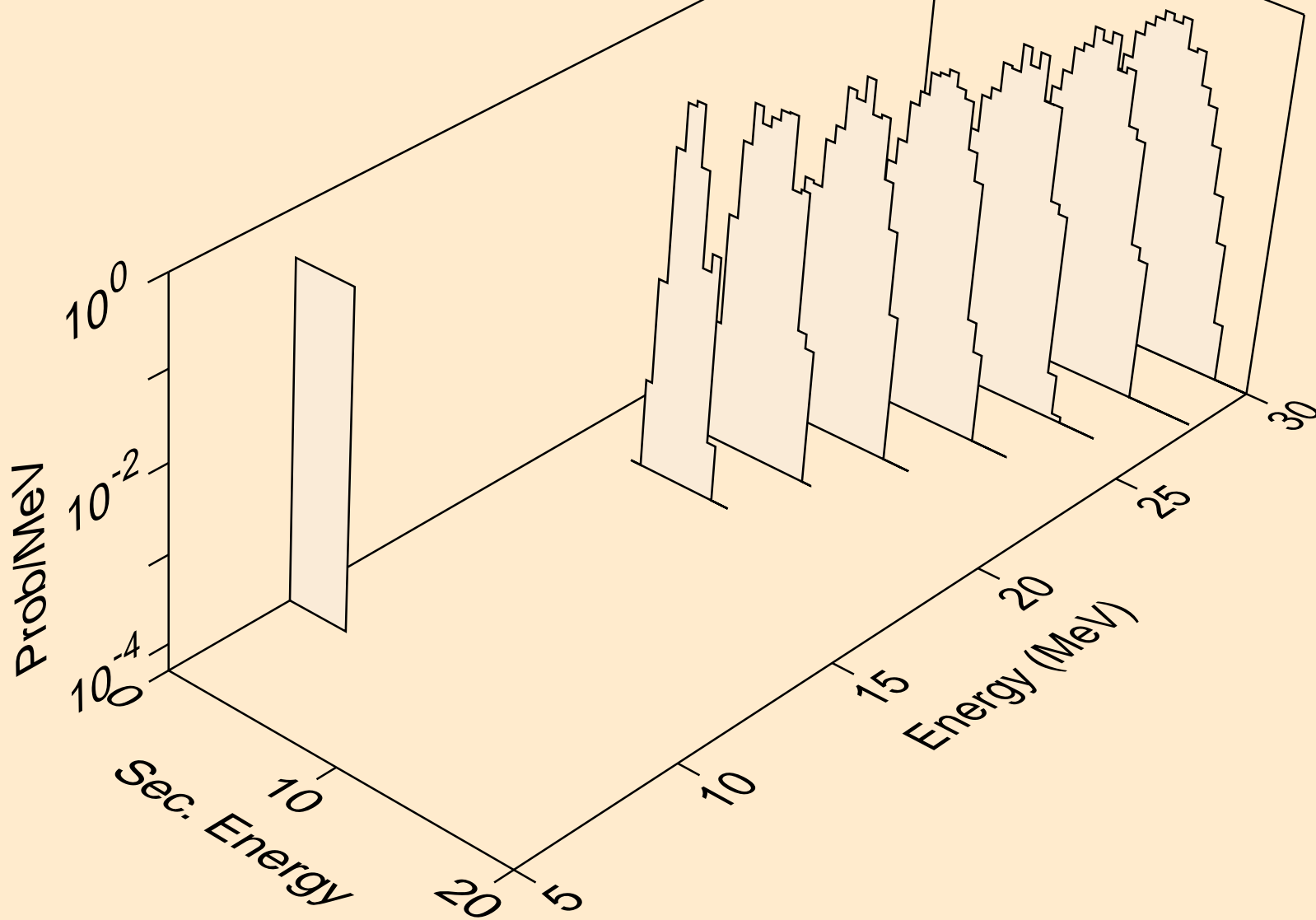

LA138 NEUTRON ACER TENDL-2019 LIBRARY; T=293.16K
alphas from (n,a)

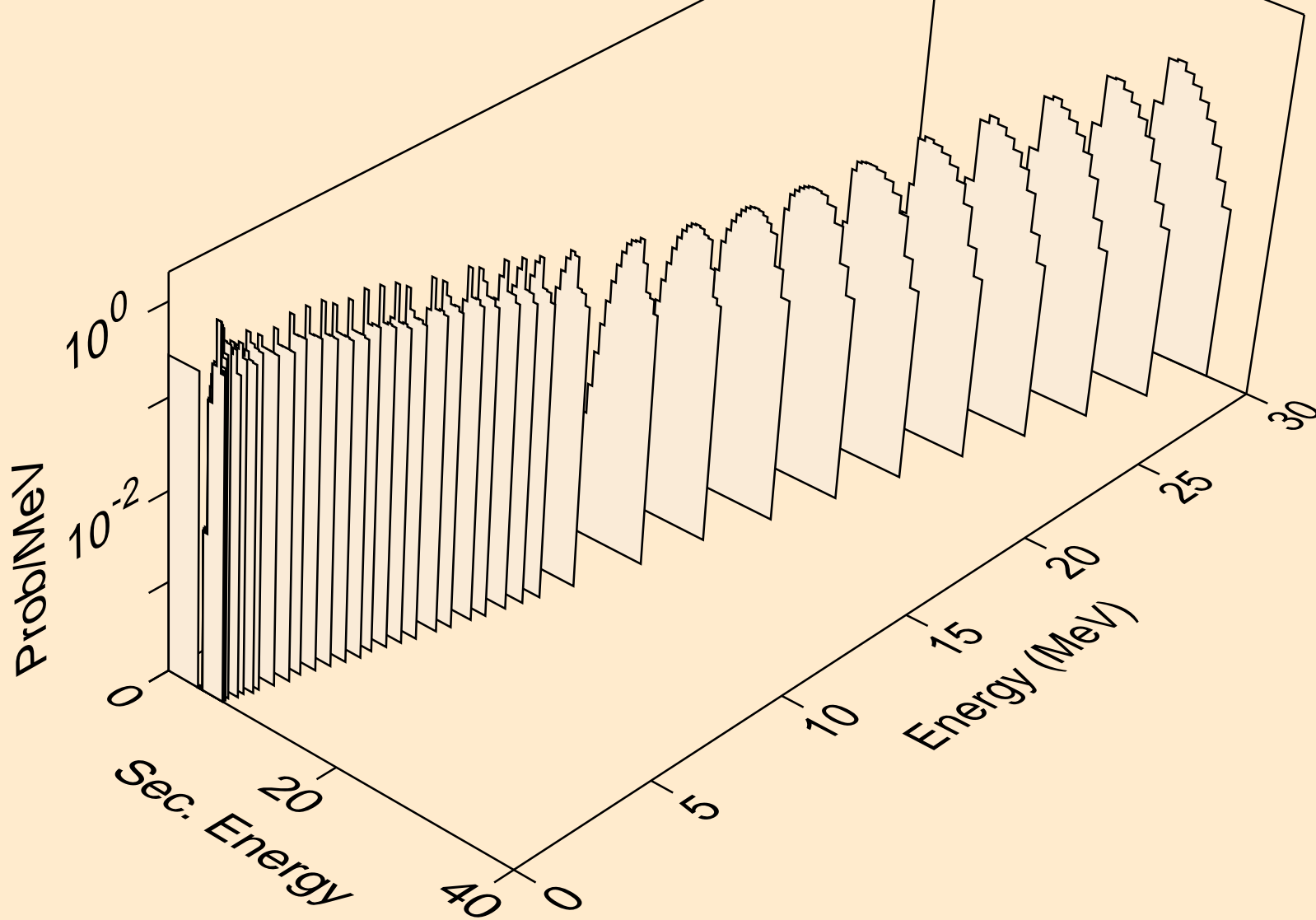

LA138 NEUTRON ACER TENDL-2019 LIBRARY; T=293.16K
alphas from (n,2a)

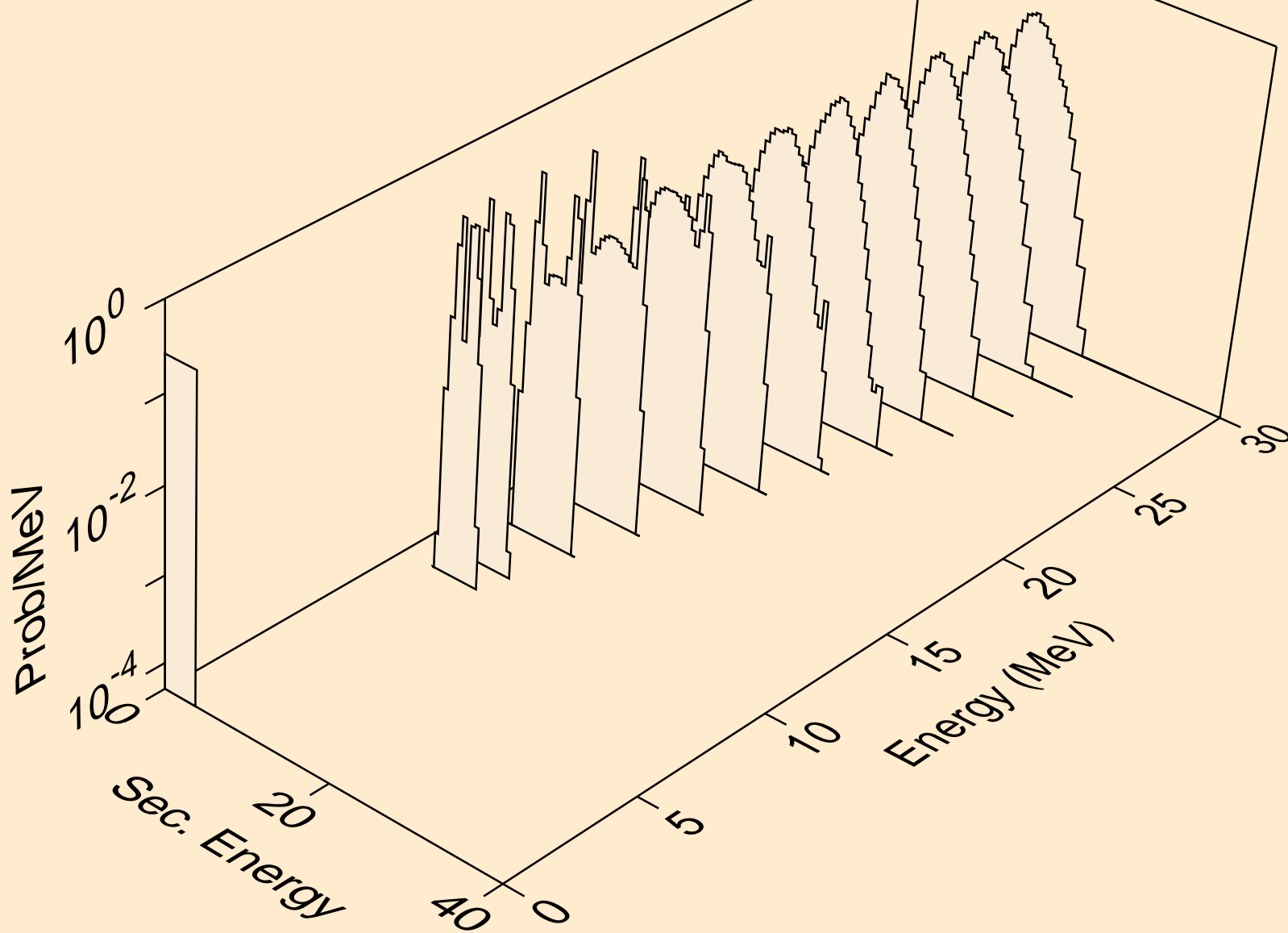

LA138 NEUTRON ACER TENDL-2019 LIBRARY; T=293.16K
alphas from (n,pa)

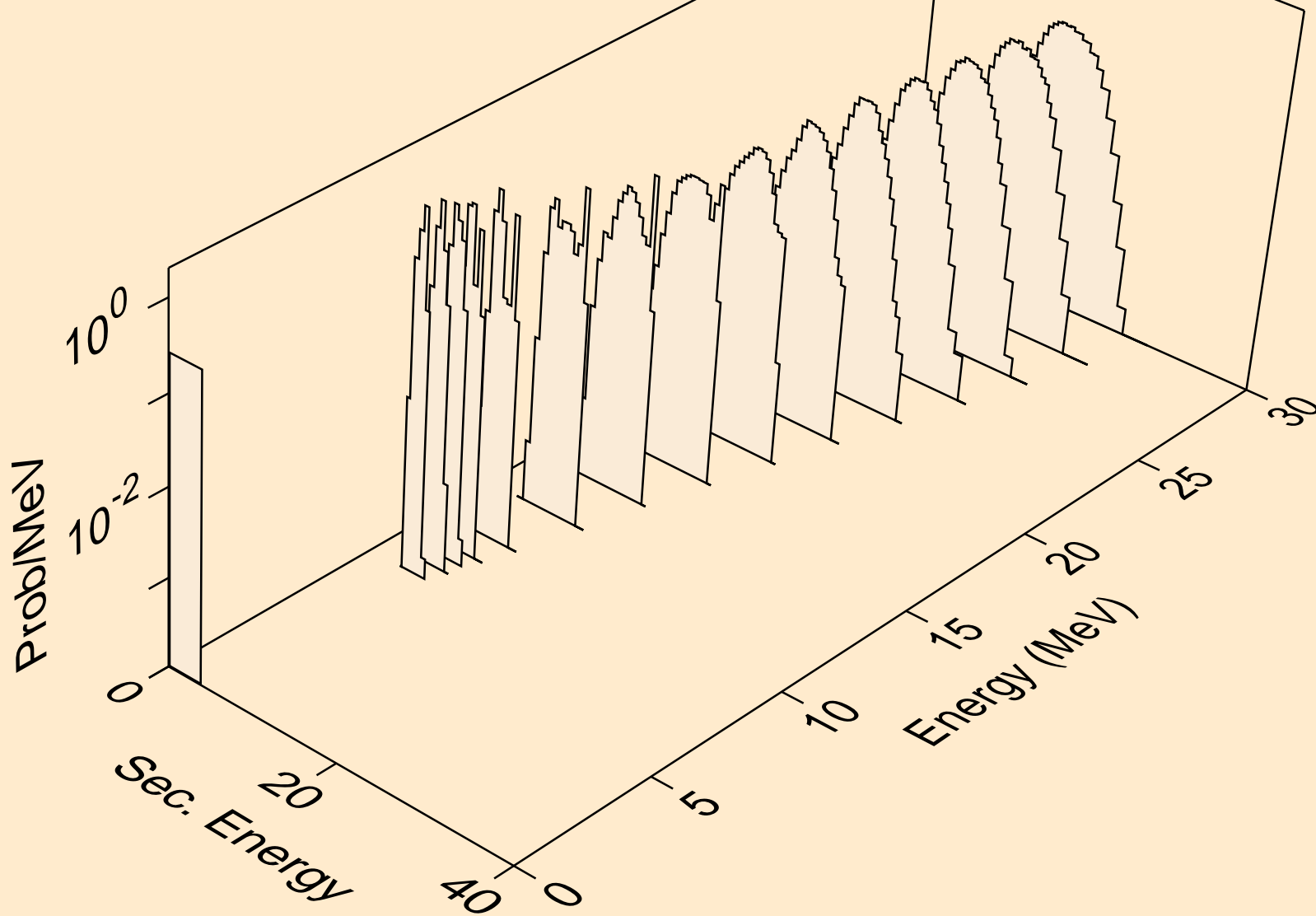

LA138 NEUTRON ACER TENDL-2019 LIBRARY; T=293.16K
alphas from (n,da)

