

LR256 NEUTRON ACER TENDL-2019 LIBRARY; T=293.16K
Principal cross sections

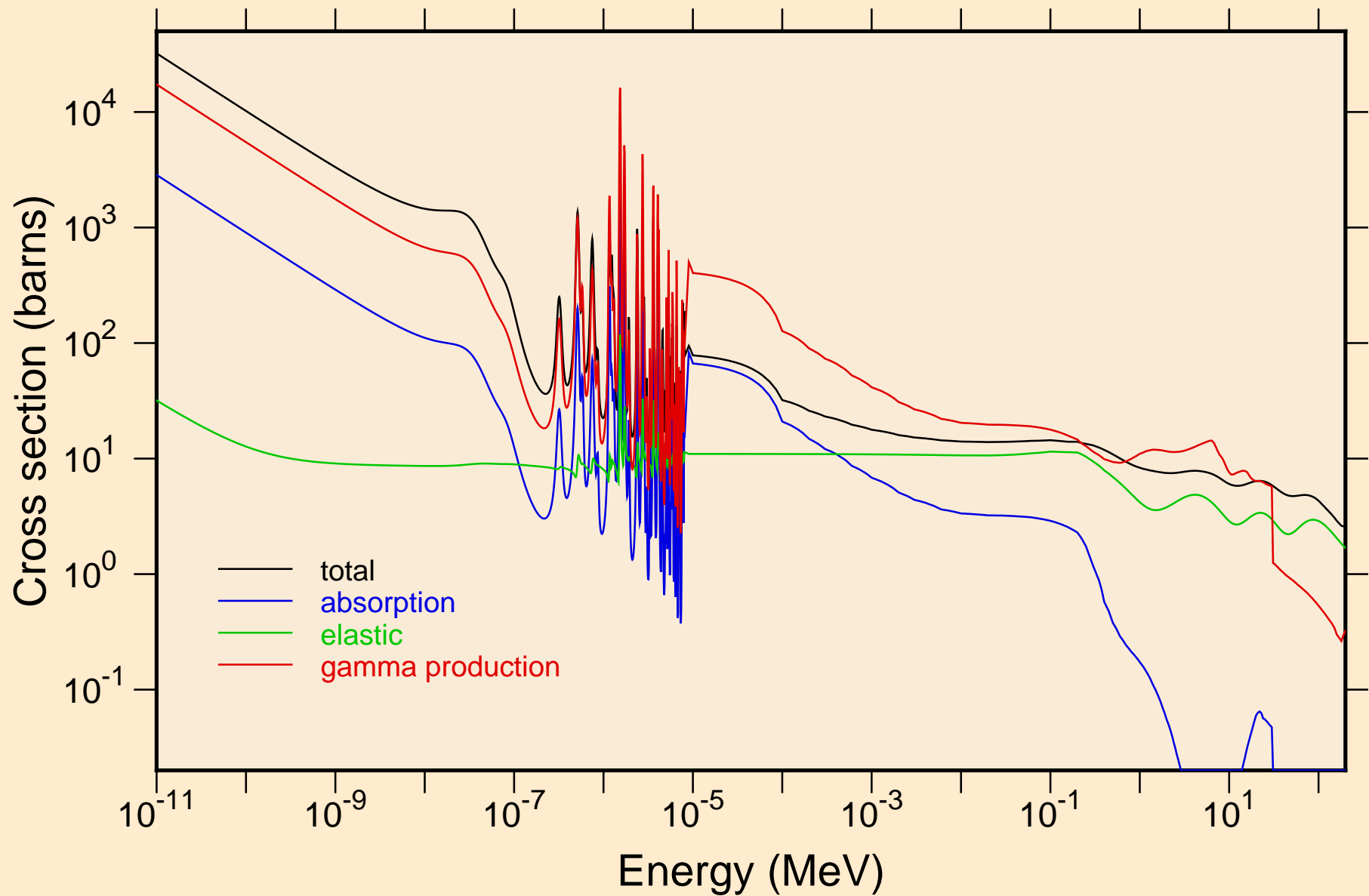

LR256 NEUTRON ACER TENDL-2019 LIBRARY; T=293.16K
resonance total cross section

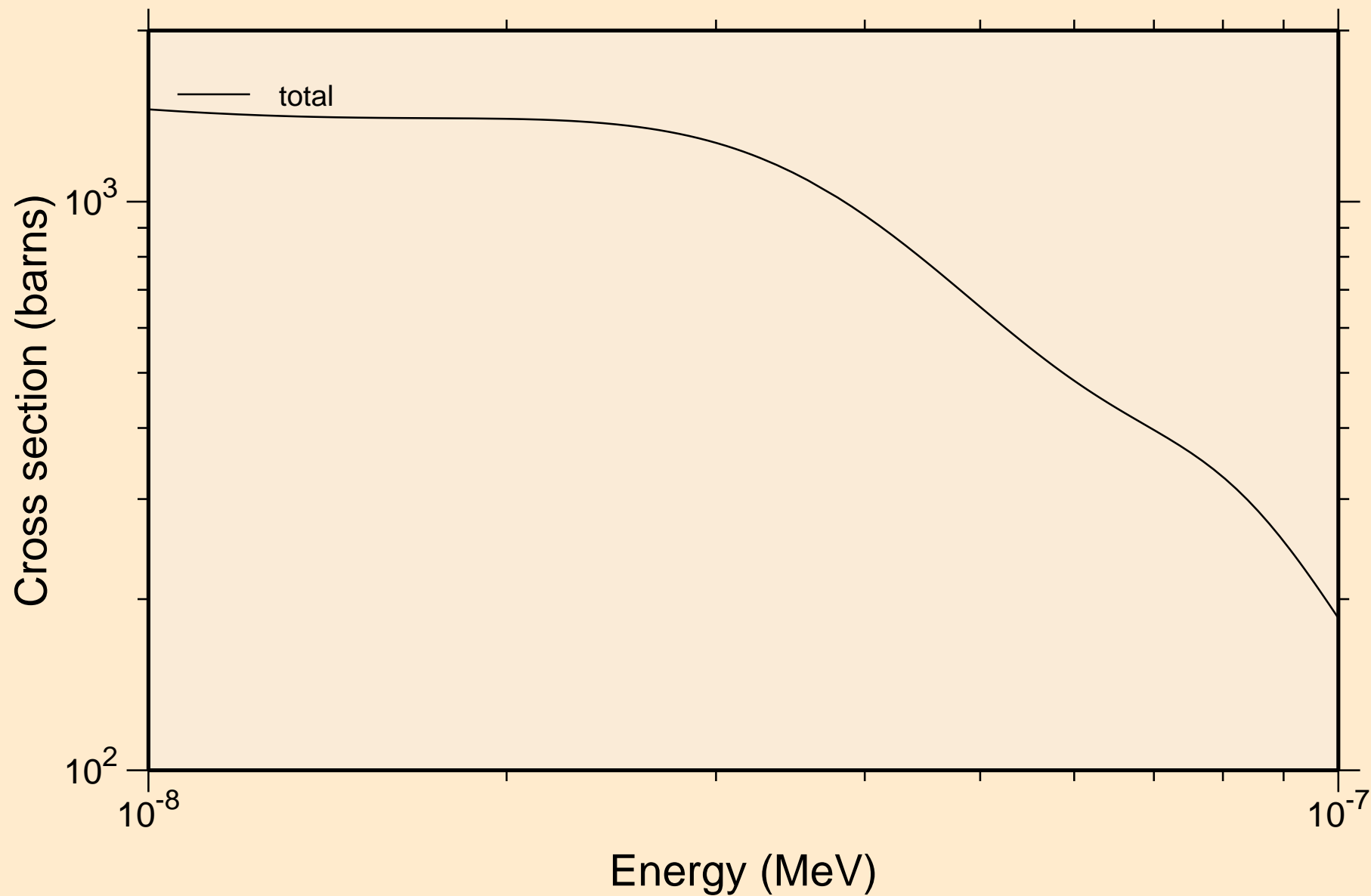

LR256 NEUTRON ACER TENDL-2019 LIBRARY; T=293.16K
resonance total cross section

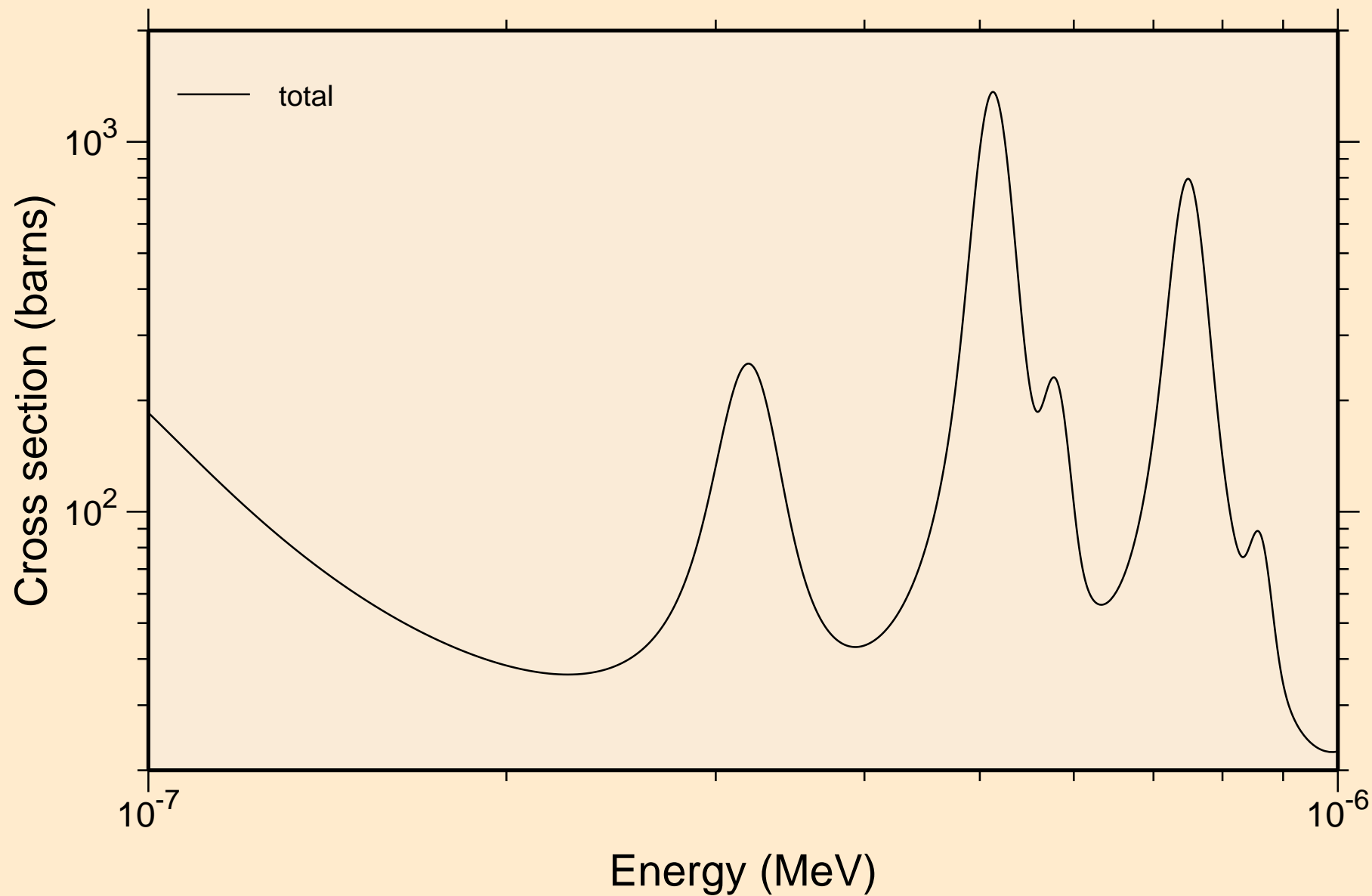

LR256 NEUTRON ACER TENDL-2019 LIBRARY; T=293.16K
resonance total cross section

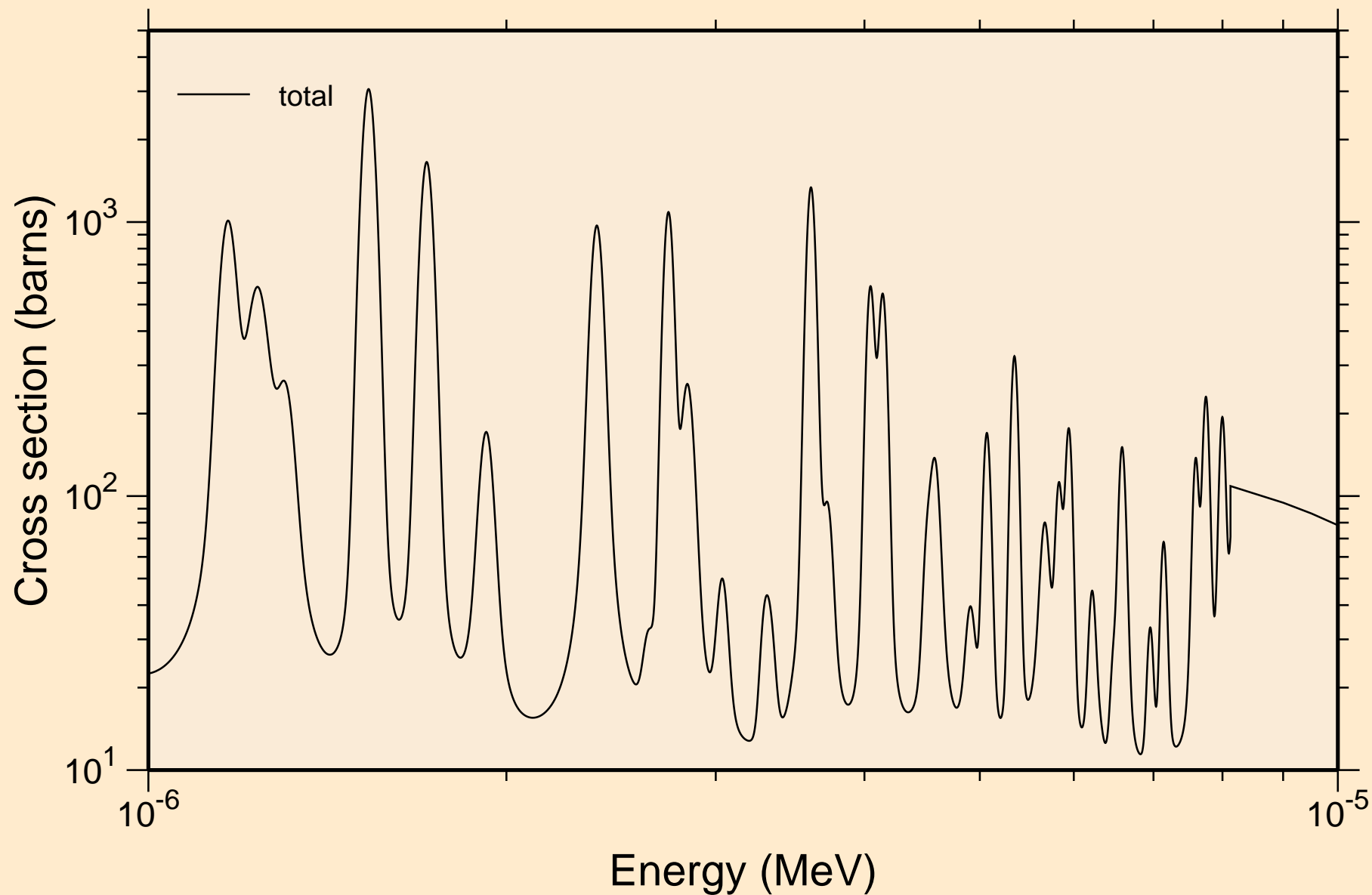

LR256 NEUTRON ACER TENDL-2019 LIBRARY; T=293.16K
resonance total cross section

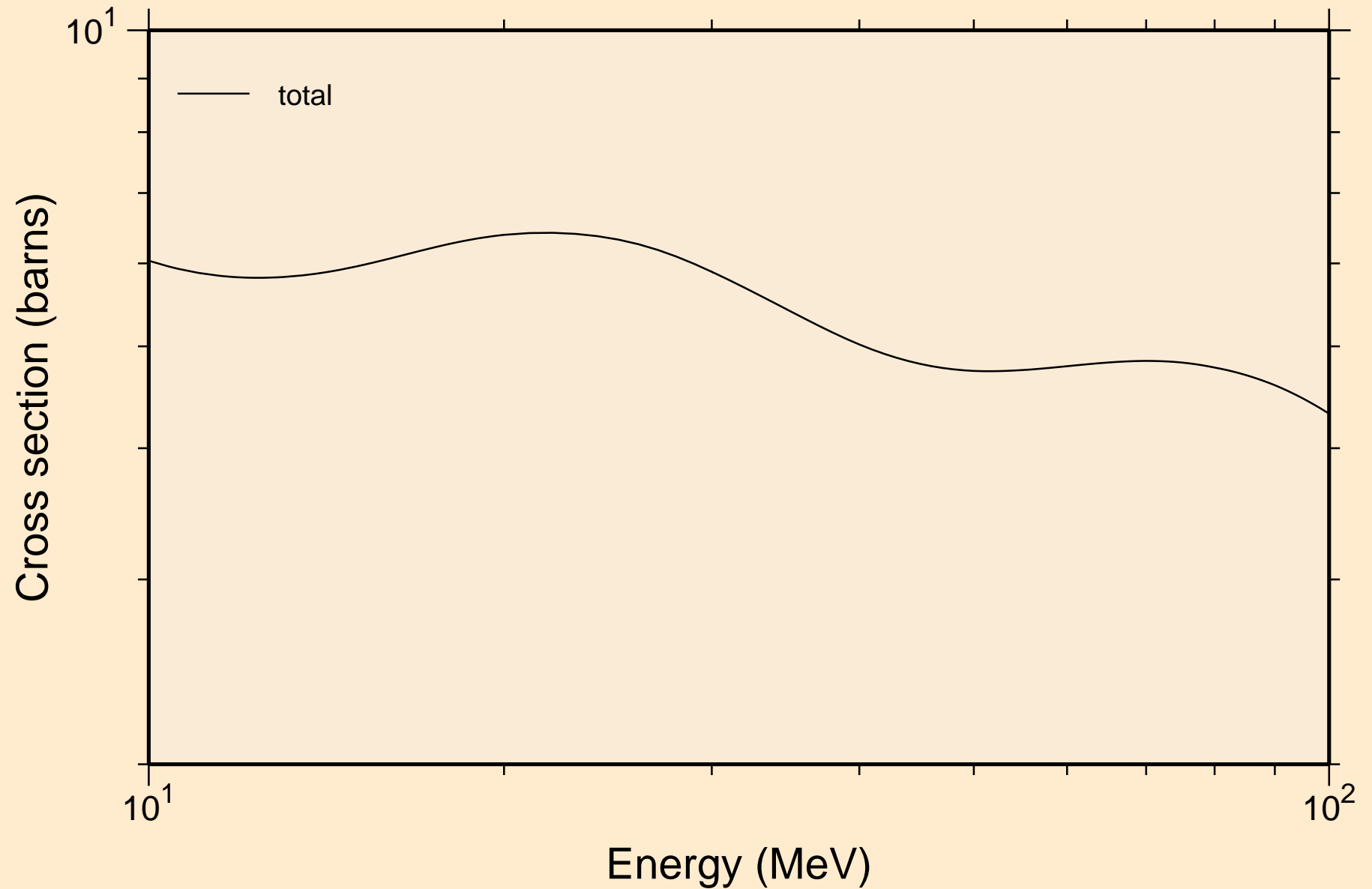

LR256 NEUTRON ACER TENDL-2019 LIBRARY; T=293.16K
resonance absorption cross sections

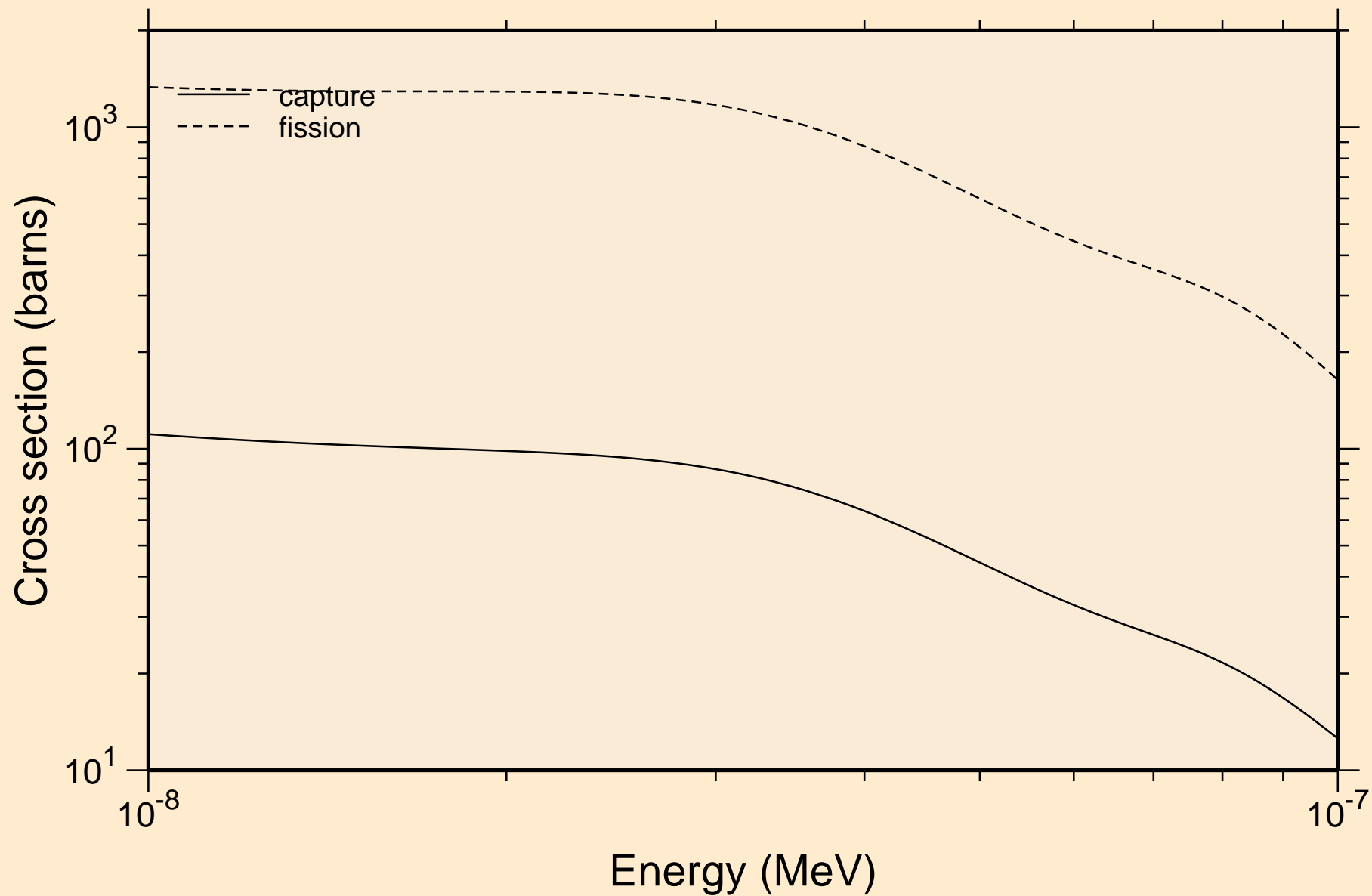

LR256 NEUTRON ACER TENDL-2019 LIBRARY; T=293.16K
resonance absorption cross sections

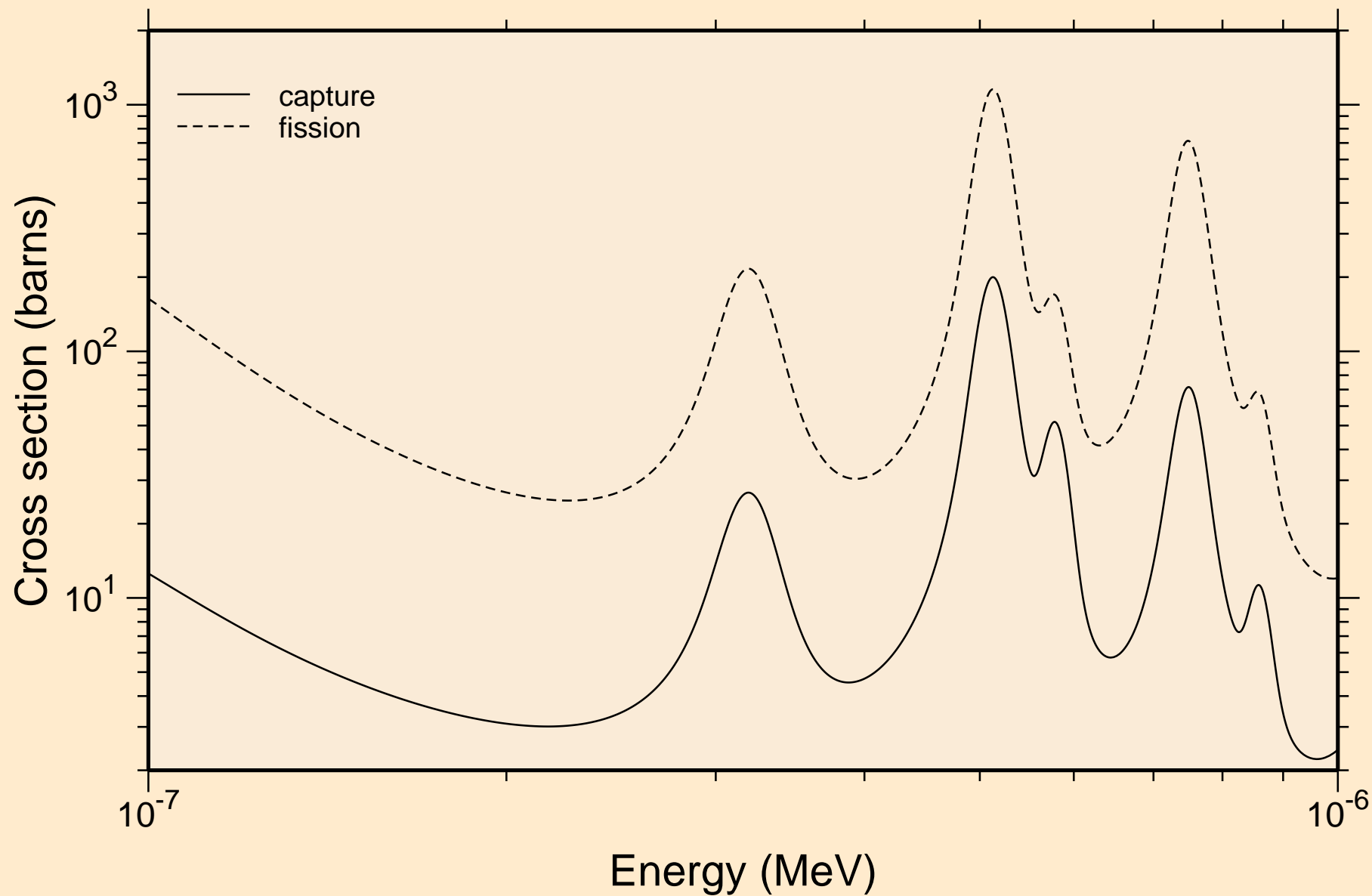

LR256 NEUTRON ACER TENDL-2019 LIBRARY; T=293.16K
resonance absorption cross sections

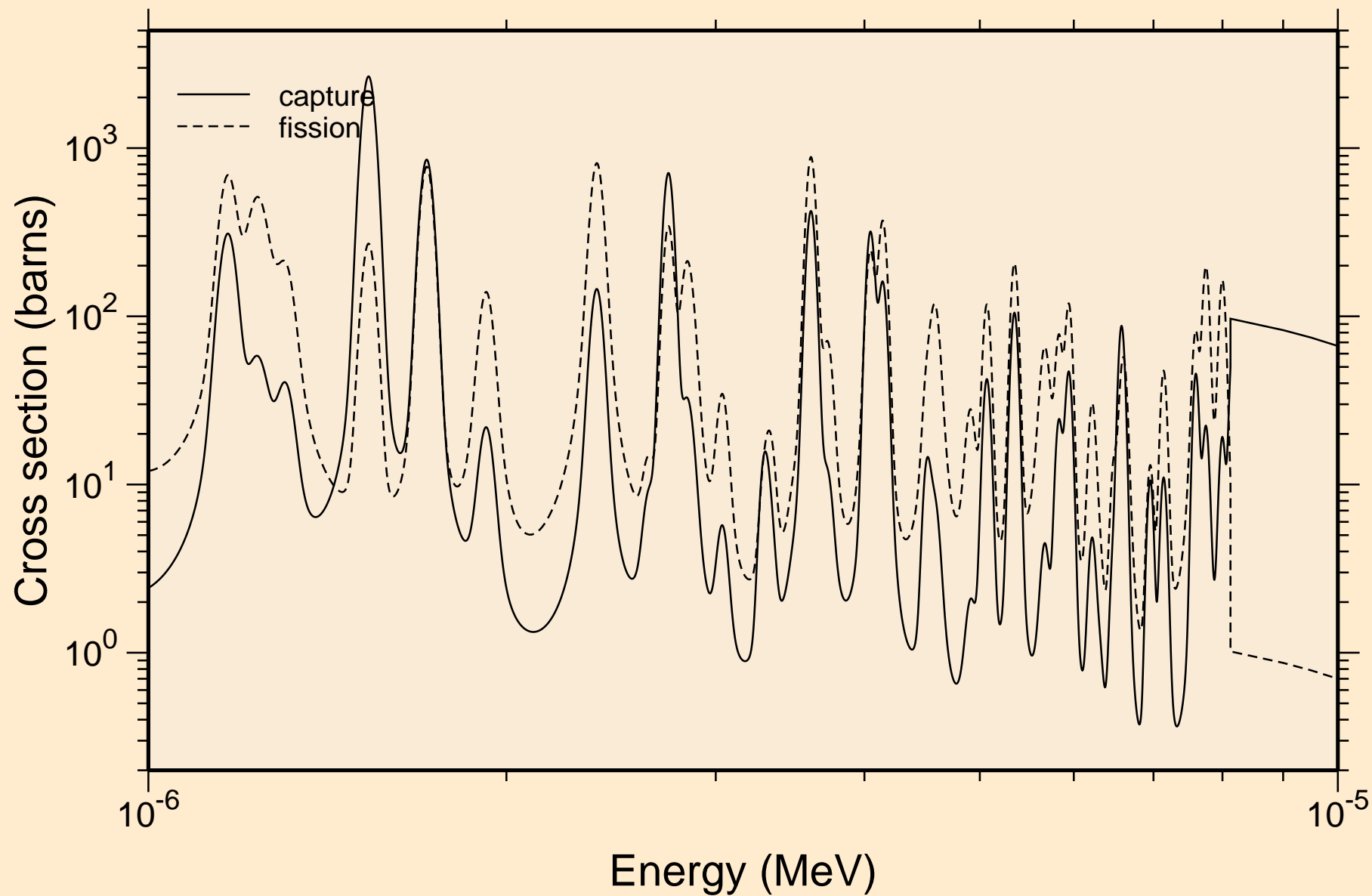

LR256 NEUTRON ACER TENDL-2019 LIBRARY; T=293.16K
resonance absorption cross sections

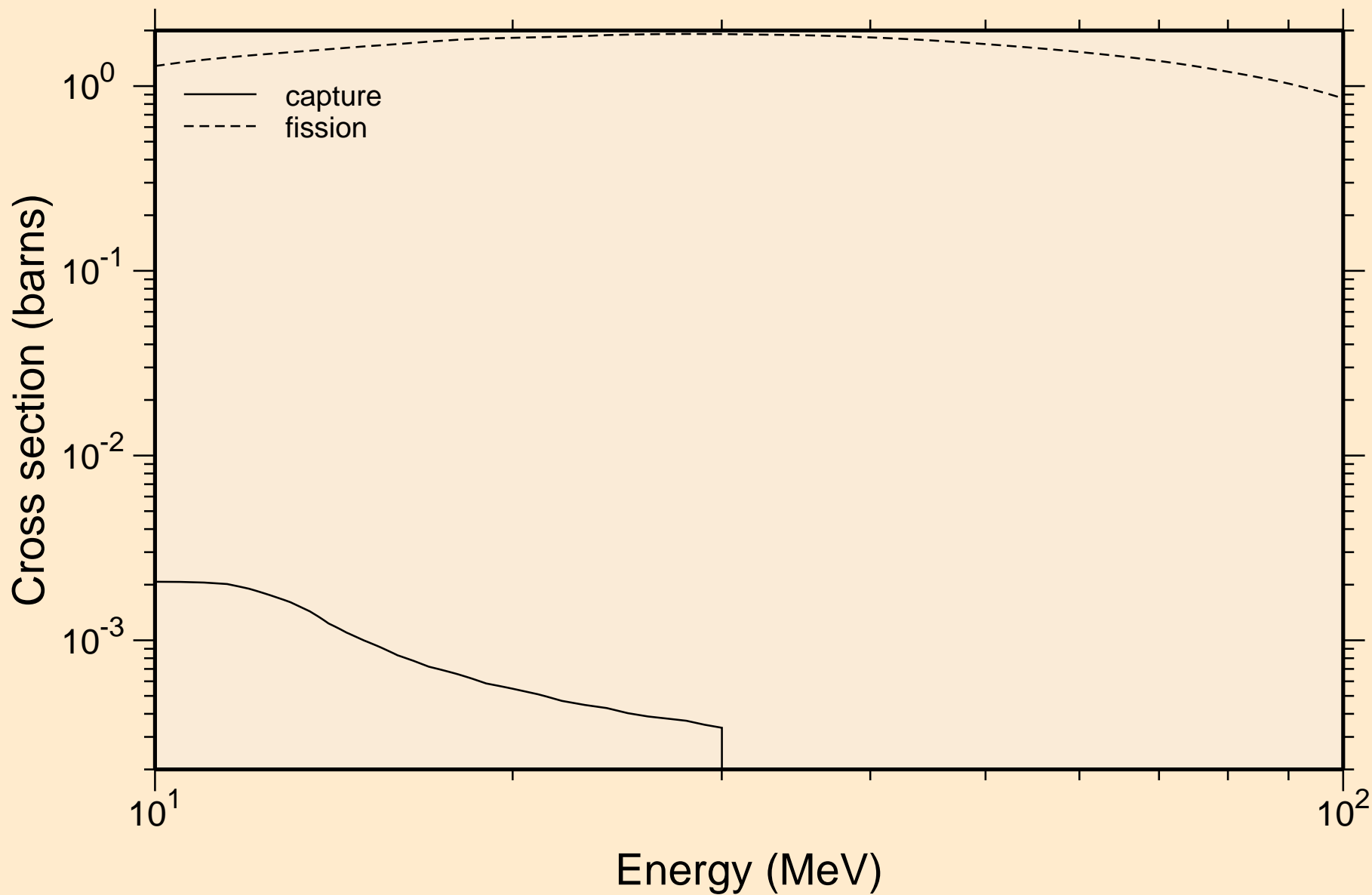

LR256 NEUTRON ACER TENDL-2019 LIBRARY; T=293.16K
Heating

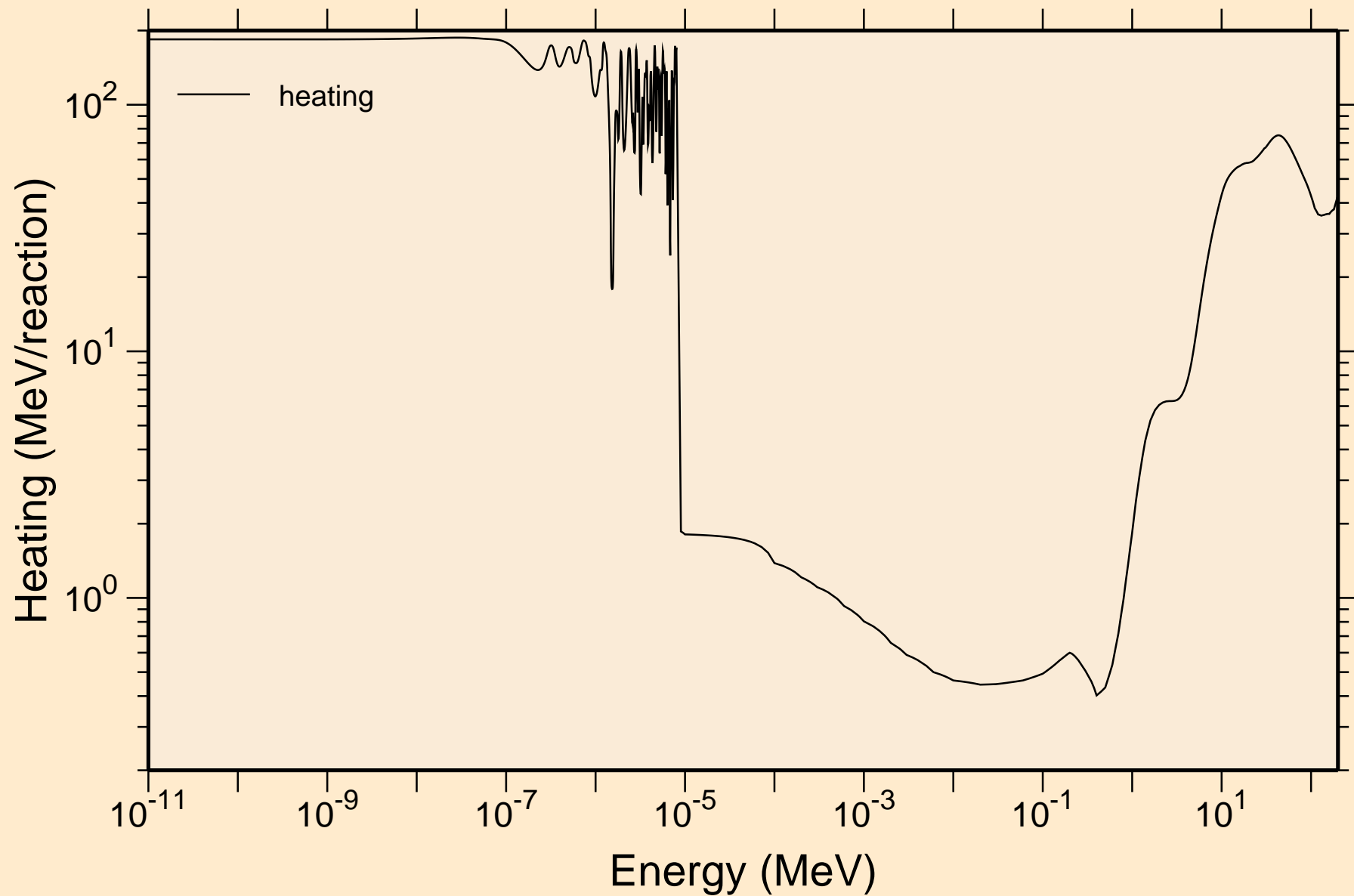

LR256 NEUTRON ACER TENDL-2019 LIBRARY; T=293.16K
Damage

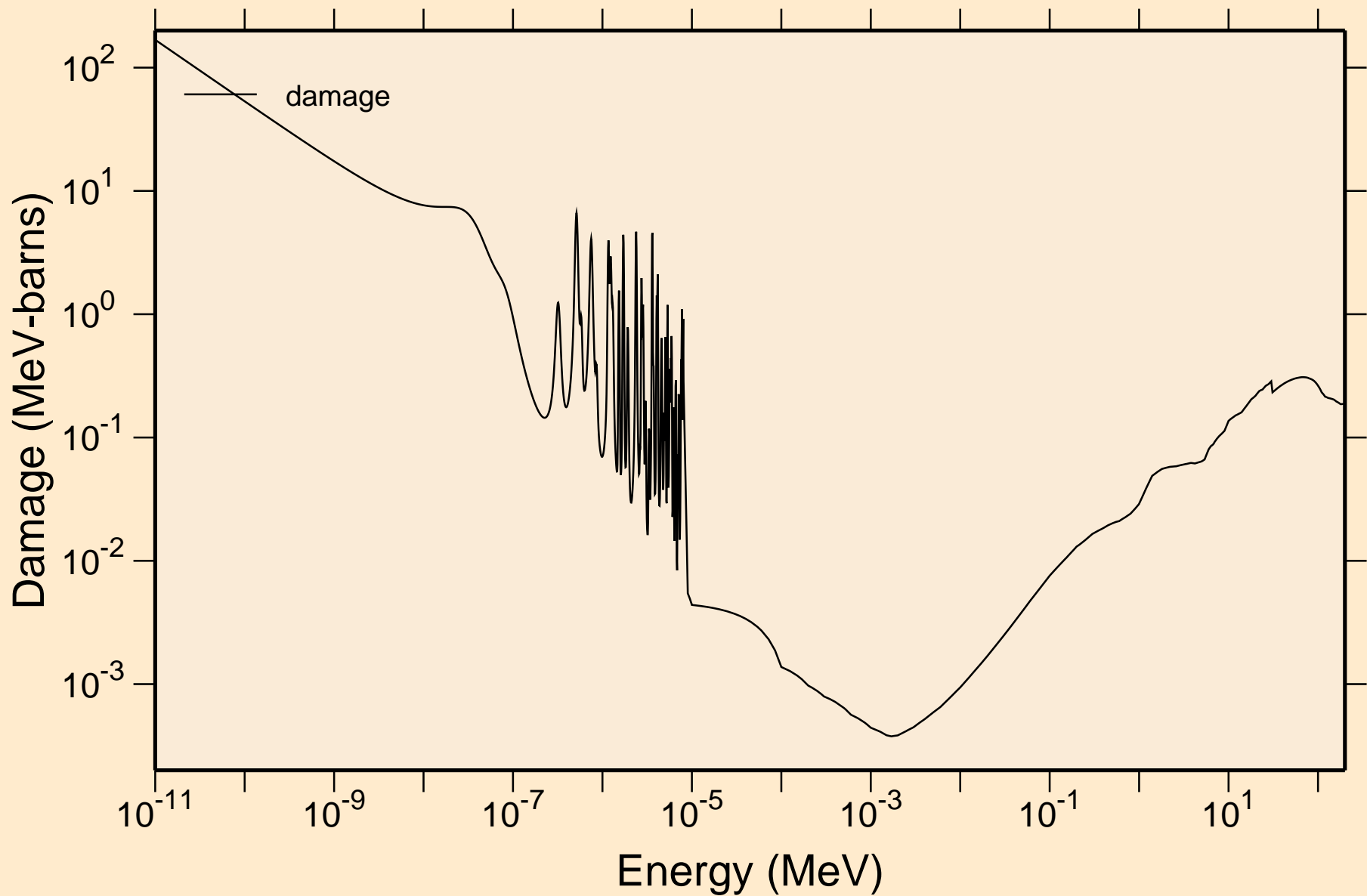

LR256 NEUTRON ACER TENDL-2019 LIBRARY; T=293.16K
Non-threshold reactions

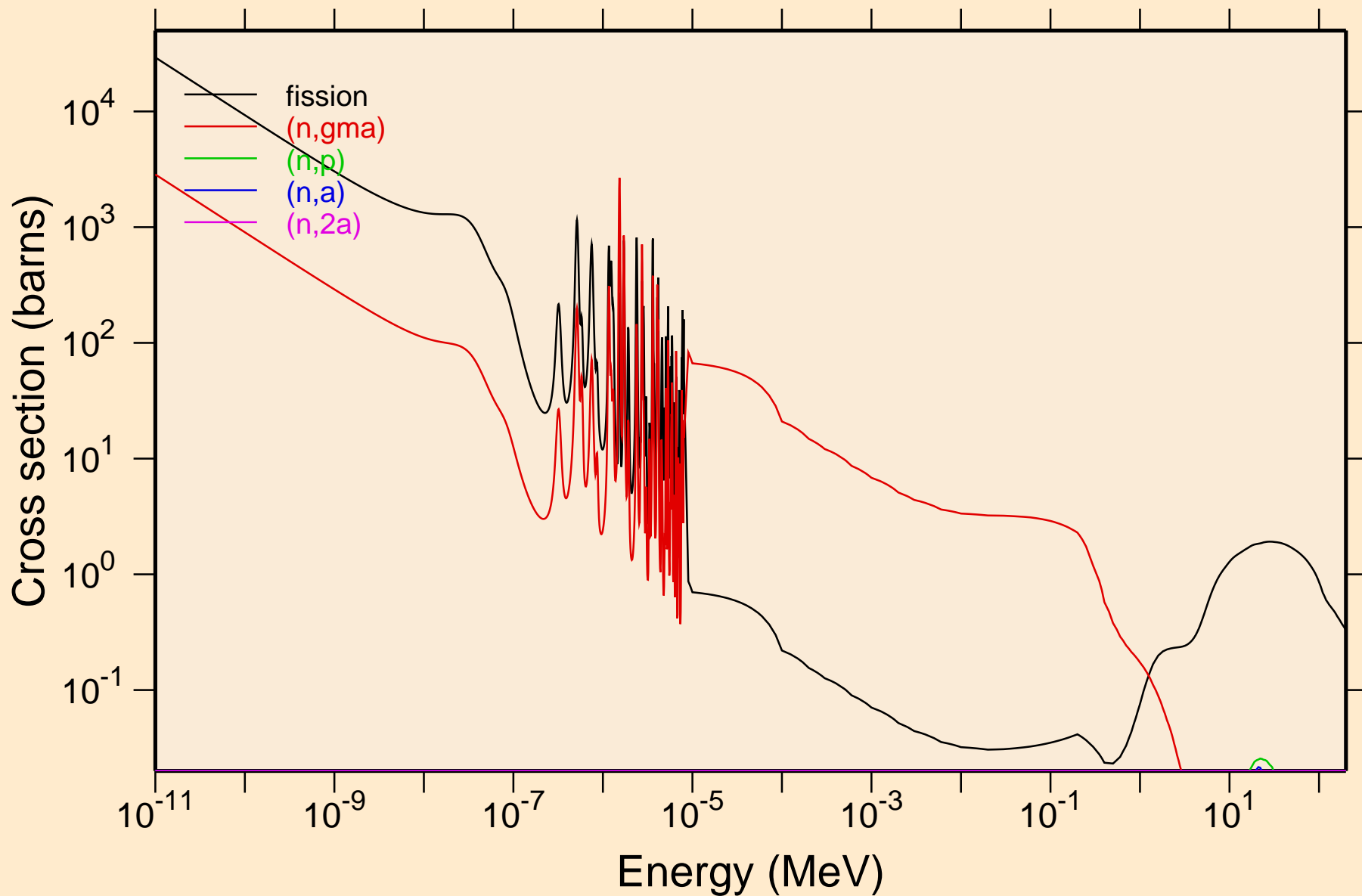

LR256 NEUTRON ACER TENDL-2019 LIBRARY; T=293.16K
Non-threshold reactions

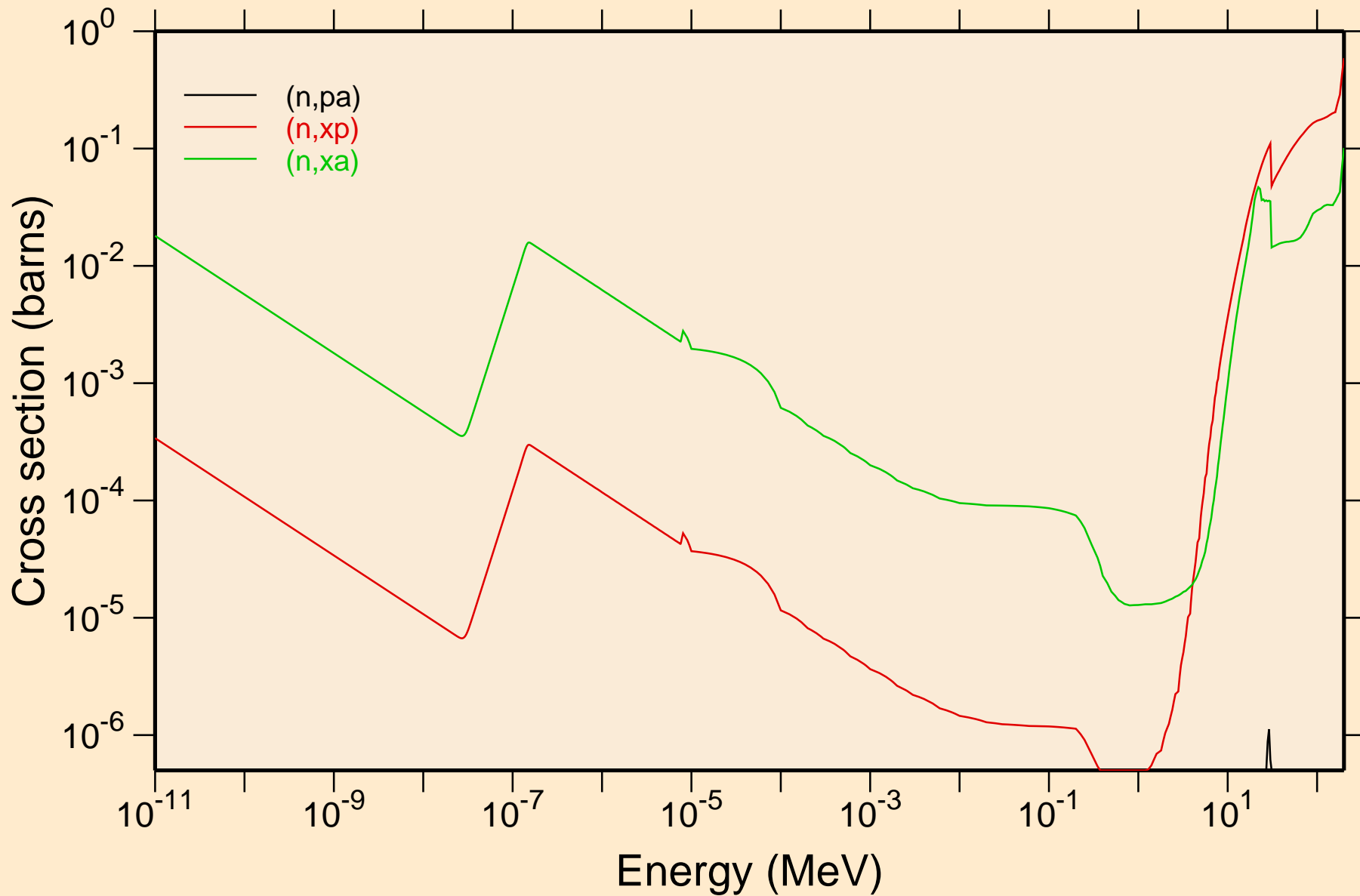

LR256 NEUTRON ACER TENDL-2019 LIBRARY; T=293.16K
Principal cross sections

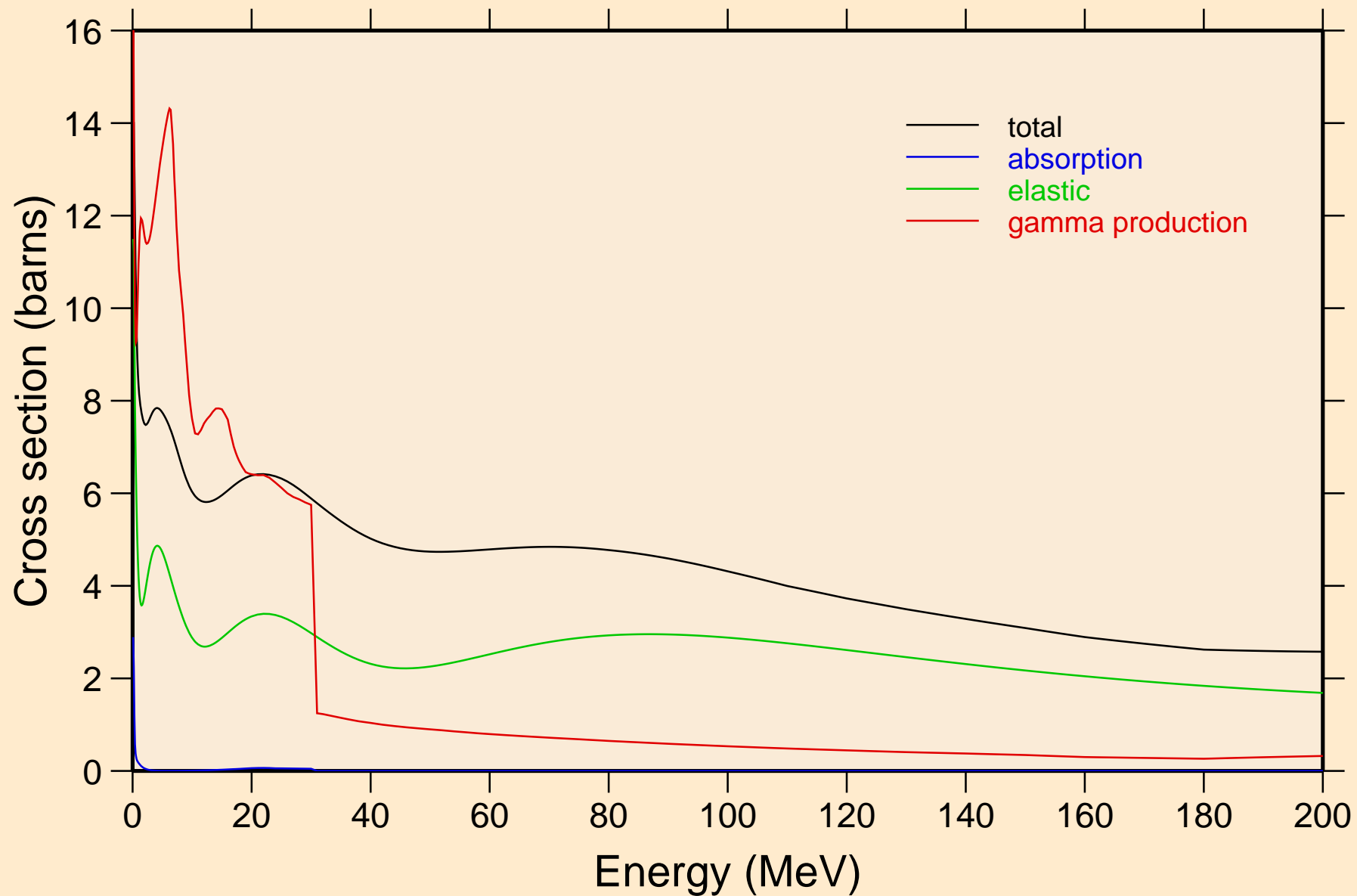

LR256 NEUTRON ACER TENDL-2019 LIBRARY; T=293.16K
Heating

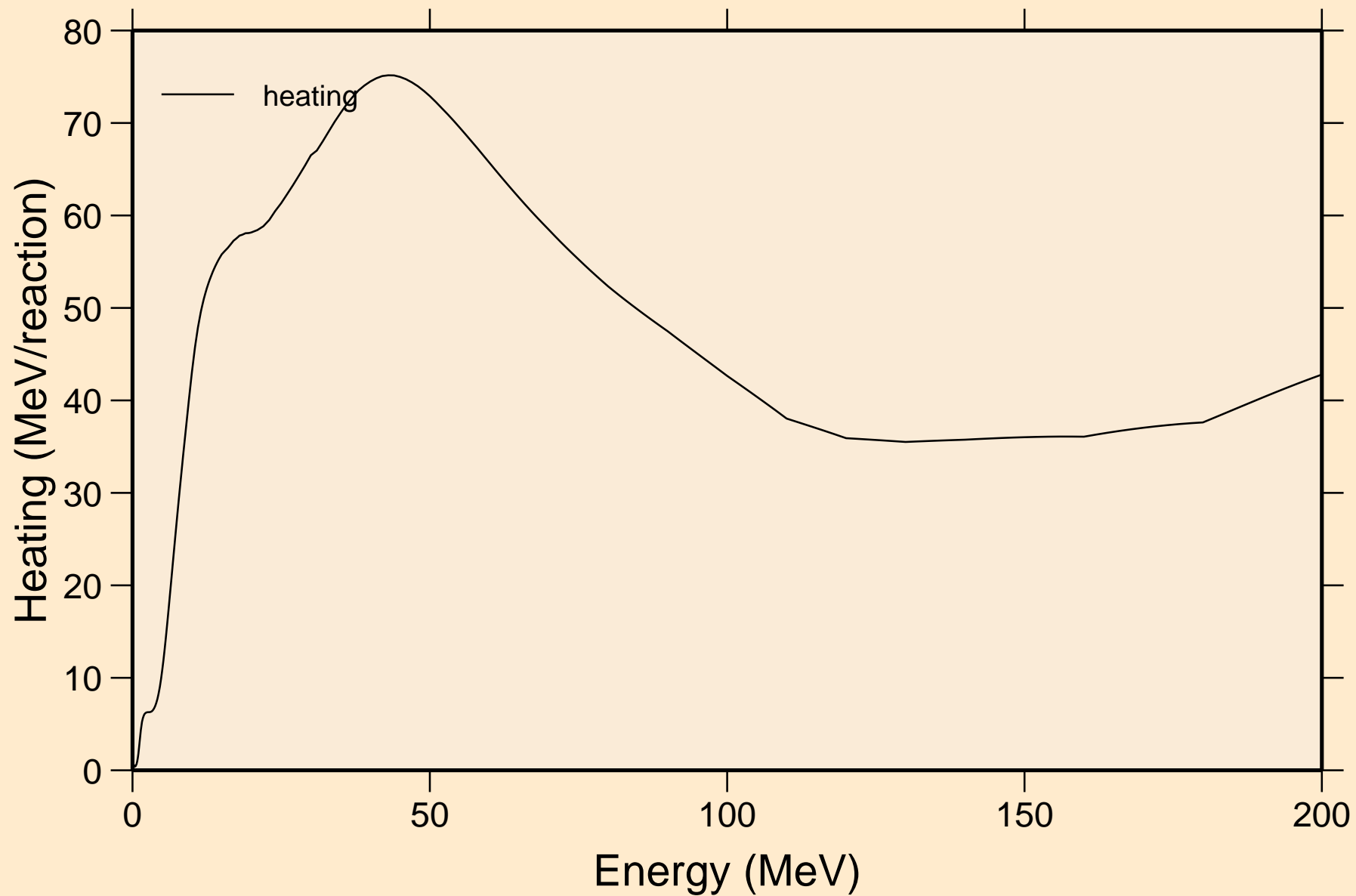

LR256 NEUTRON ACER TENDL-2019 LIBRARY; T=293.16K
Damage

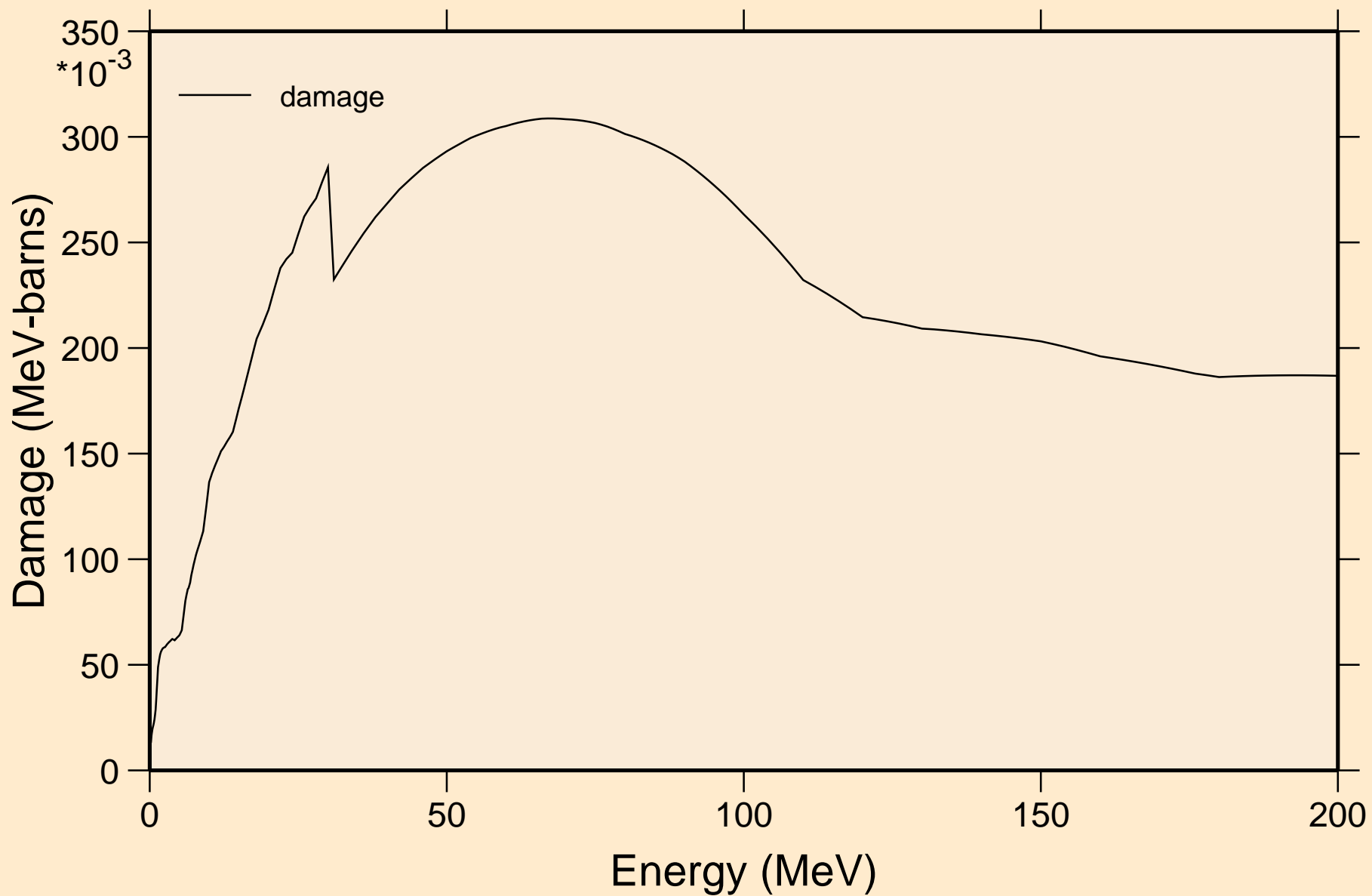

LR256 NEUTRON ACER TENDL-2019 LIBRARY; T=293.16K
Non-threshold reactions

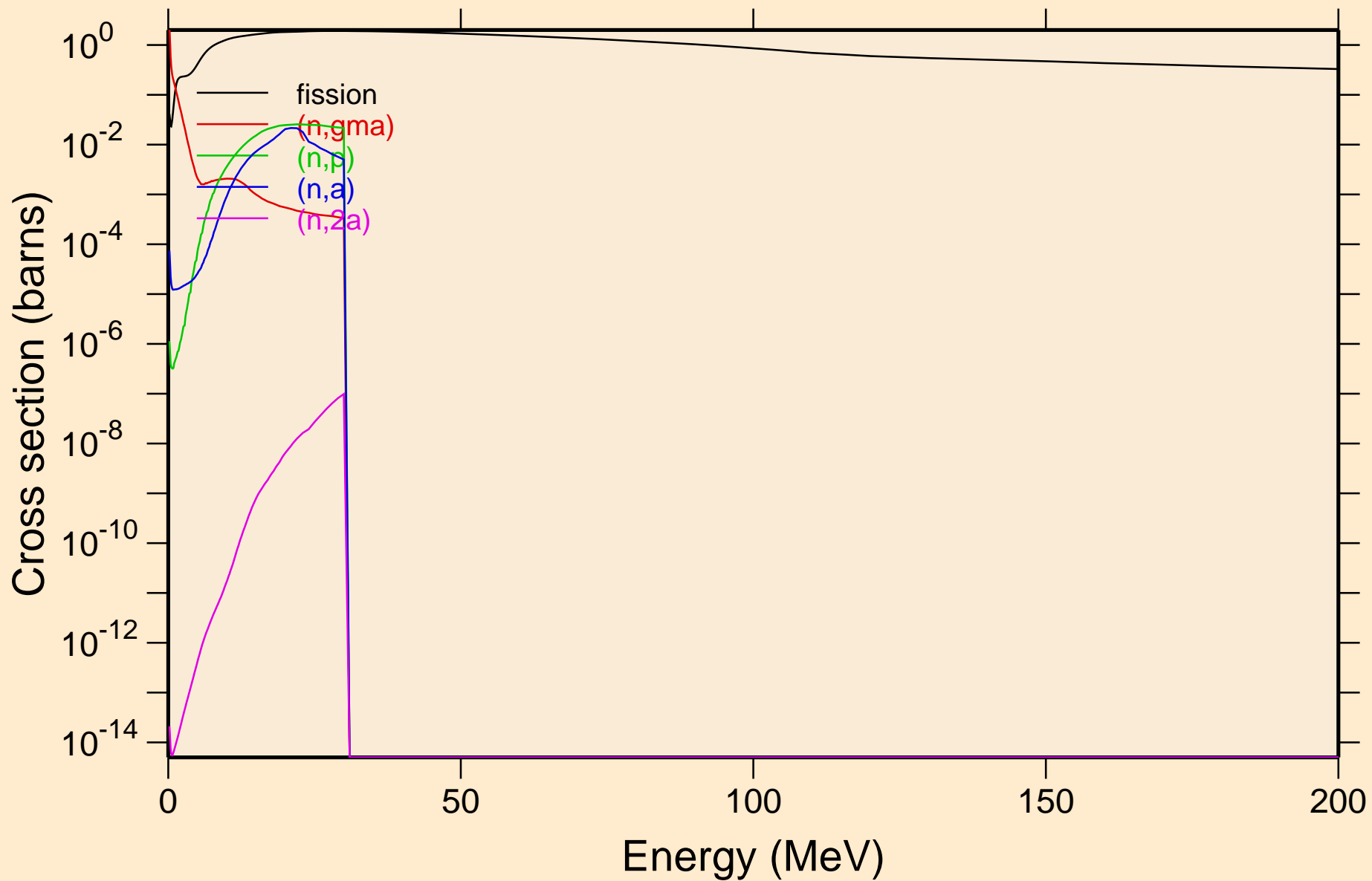

LR256 NEUTRON ACER TENDL-2019 LIBRARY; T=293.16K
Non-threshold reactions

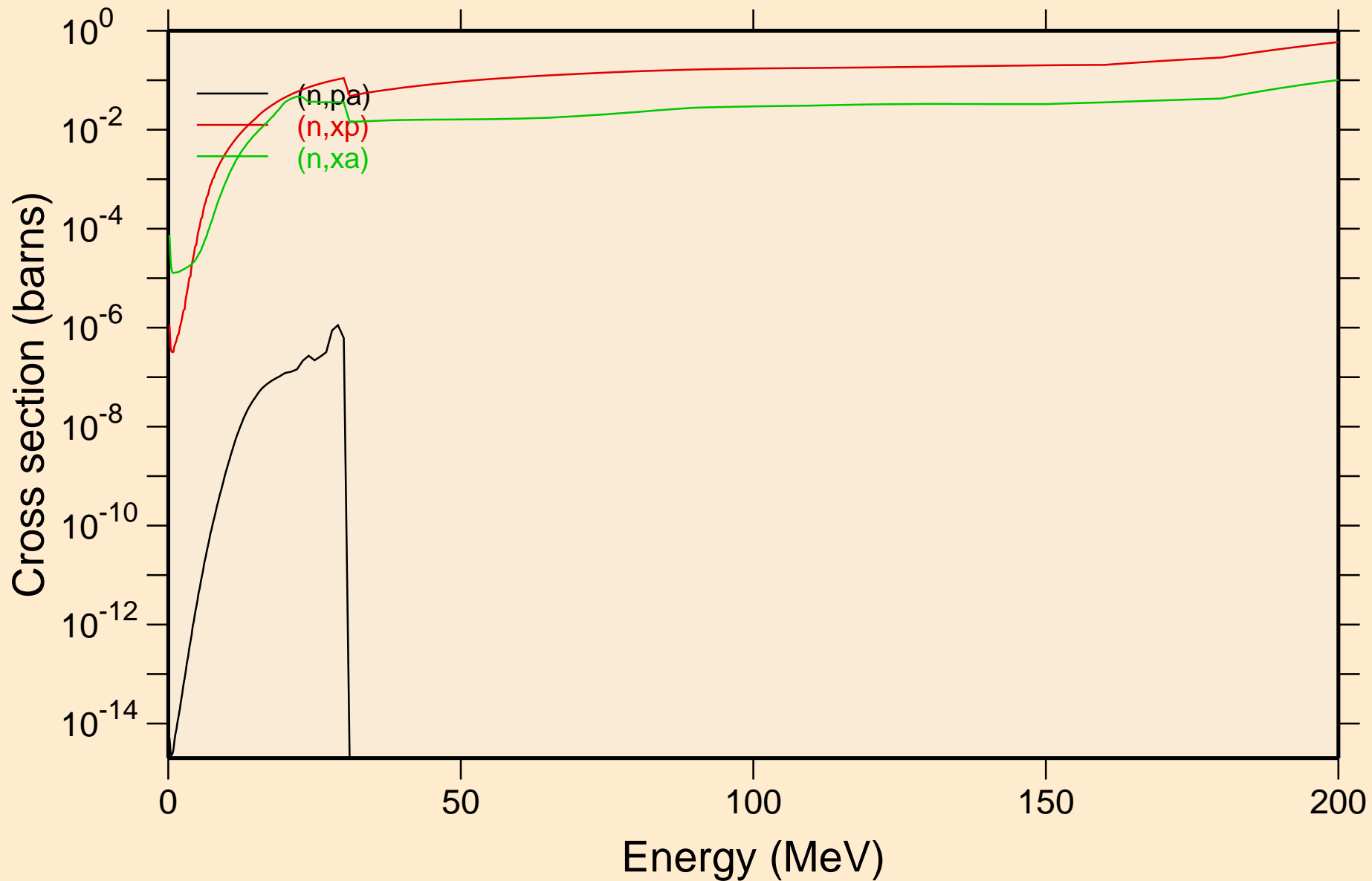

LR256 NEUTRON ACER TENDL-2019 LIBRARY; T=293.16K
Inelastic levels

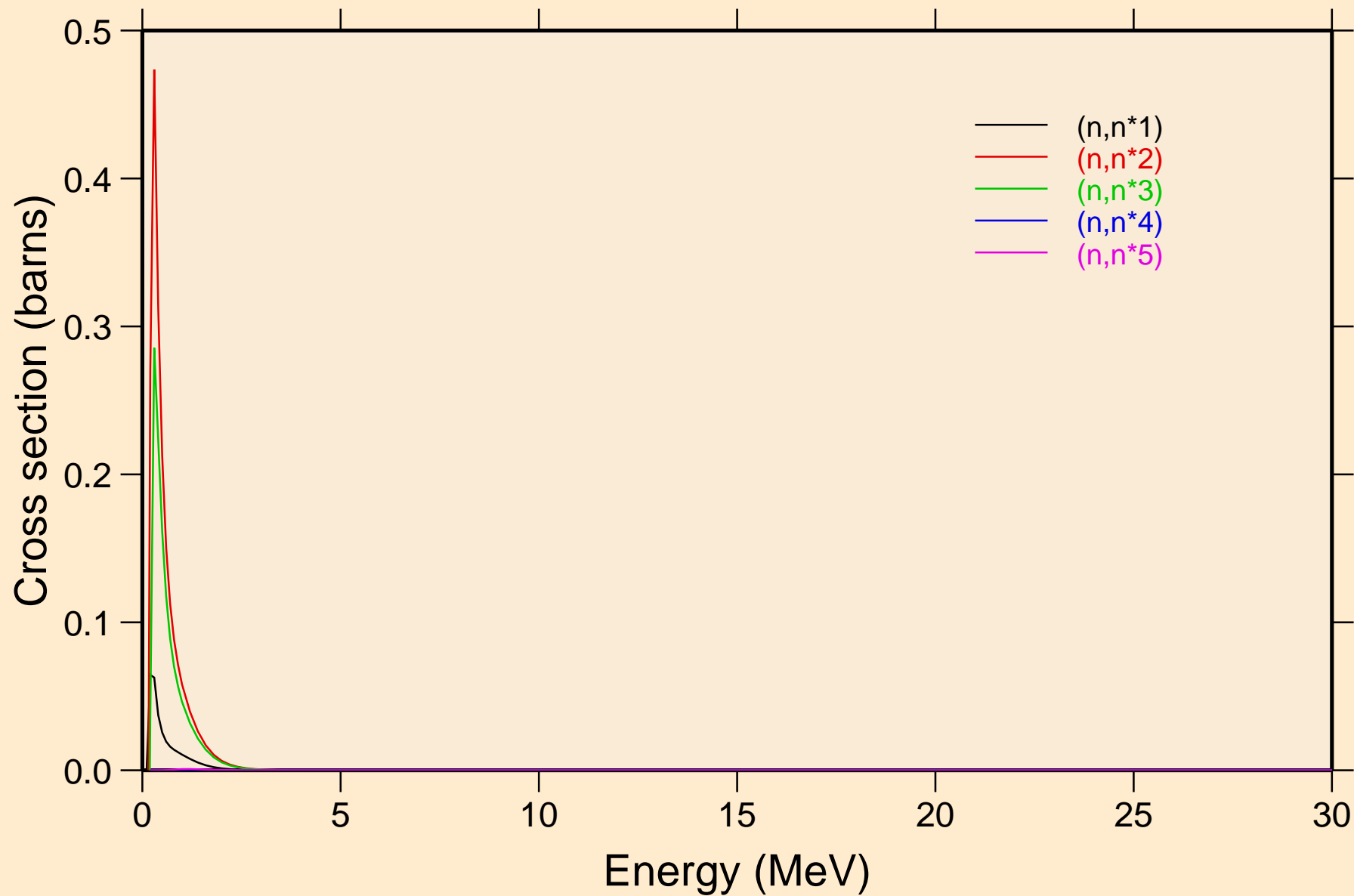

LR256 NEUTRON ACER TENDL-2019 LIBRARY; T=293.16K
Inelastic levels

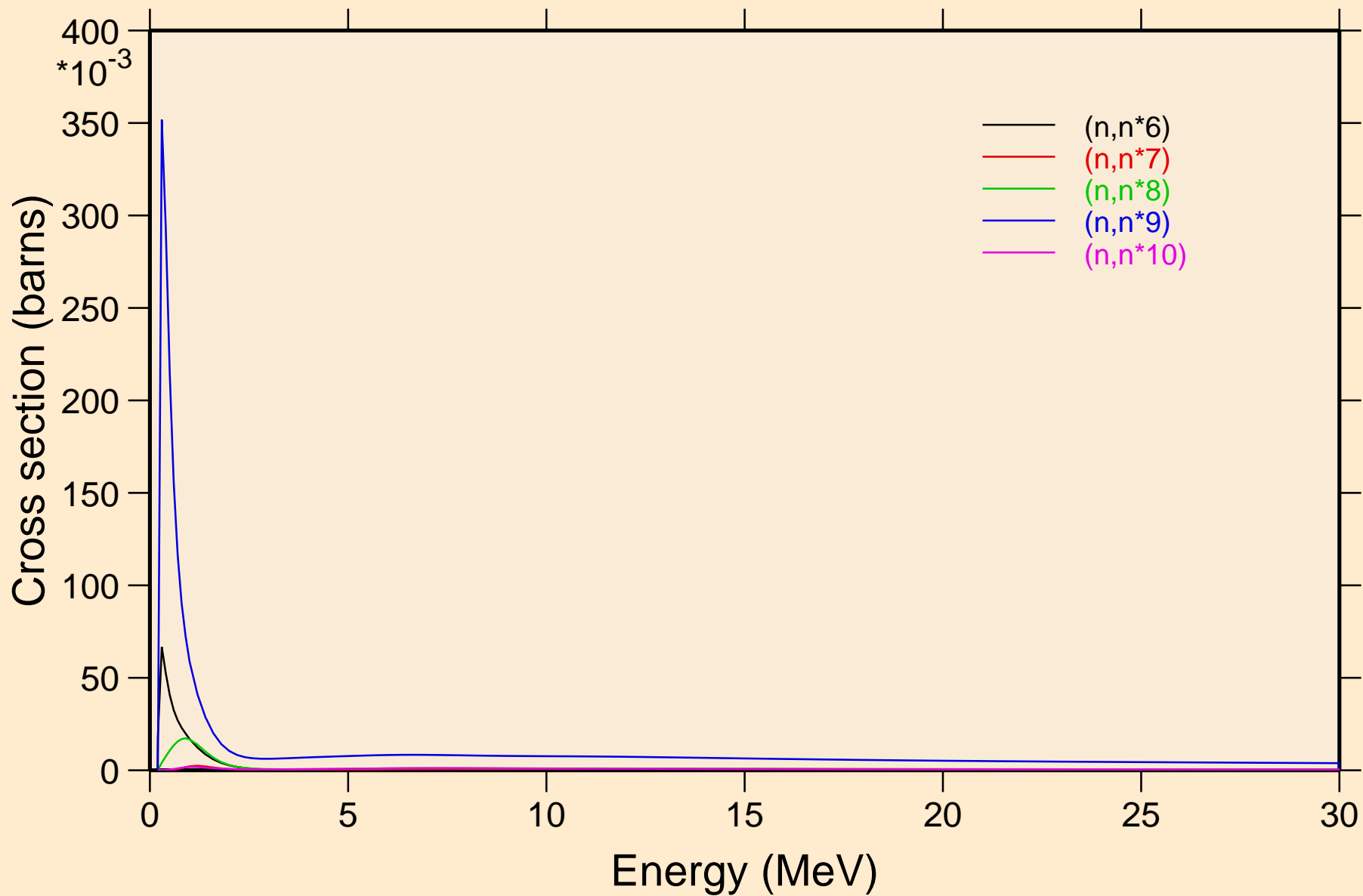

LR256 NEUTRON ACER TENDL-2019 LIBRARY; T=293.16K
Inelastic levels

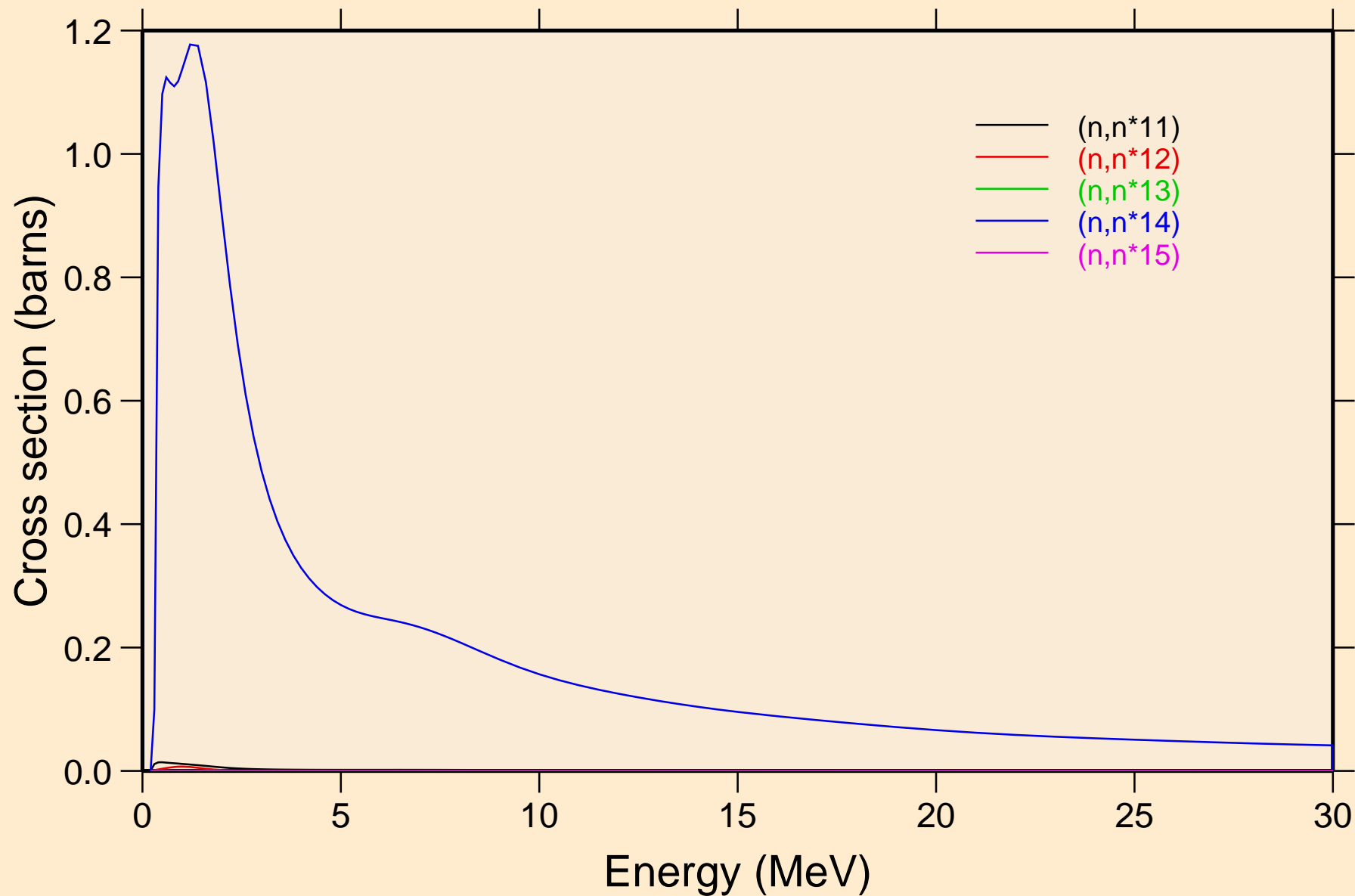

LR256 NEUTRON ACER TENDL-2019 LIBRARY; T=293.16K
Inelastic levels

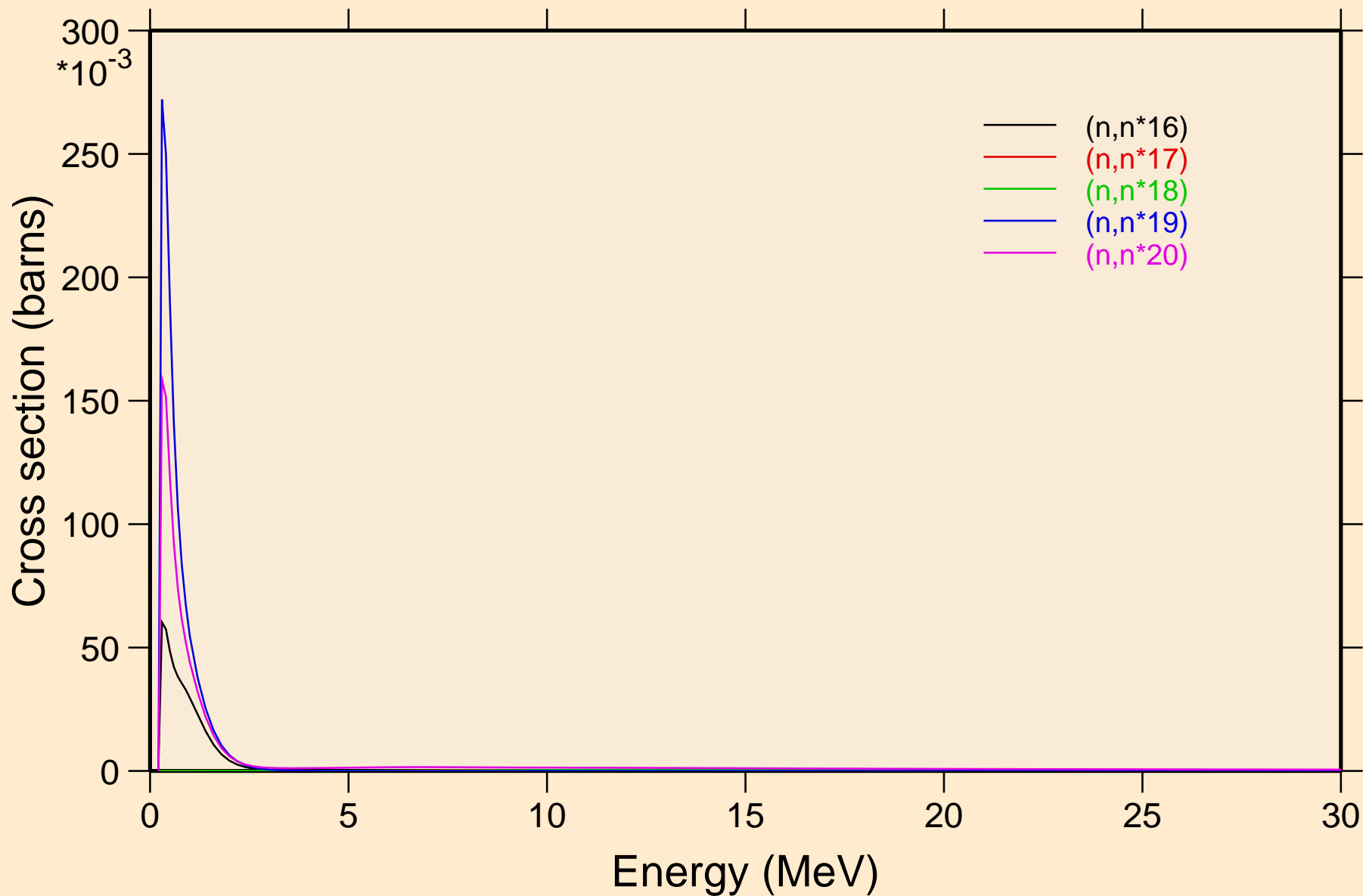

LR256 NEUTRON ACER TENDL-2019 LIBRARY; T=293.16K
Inelastic levels

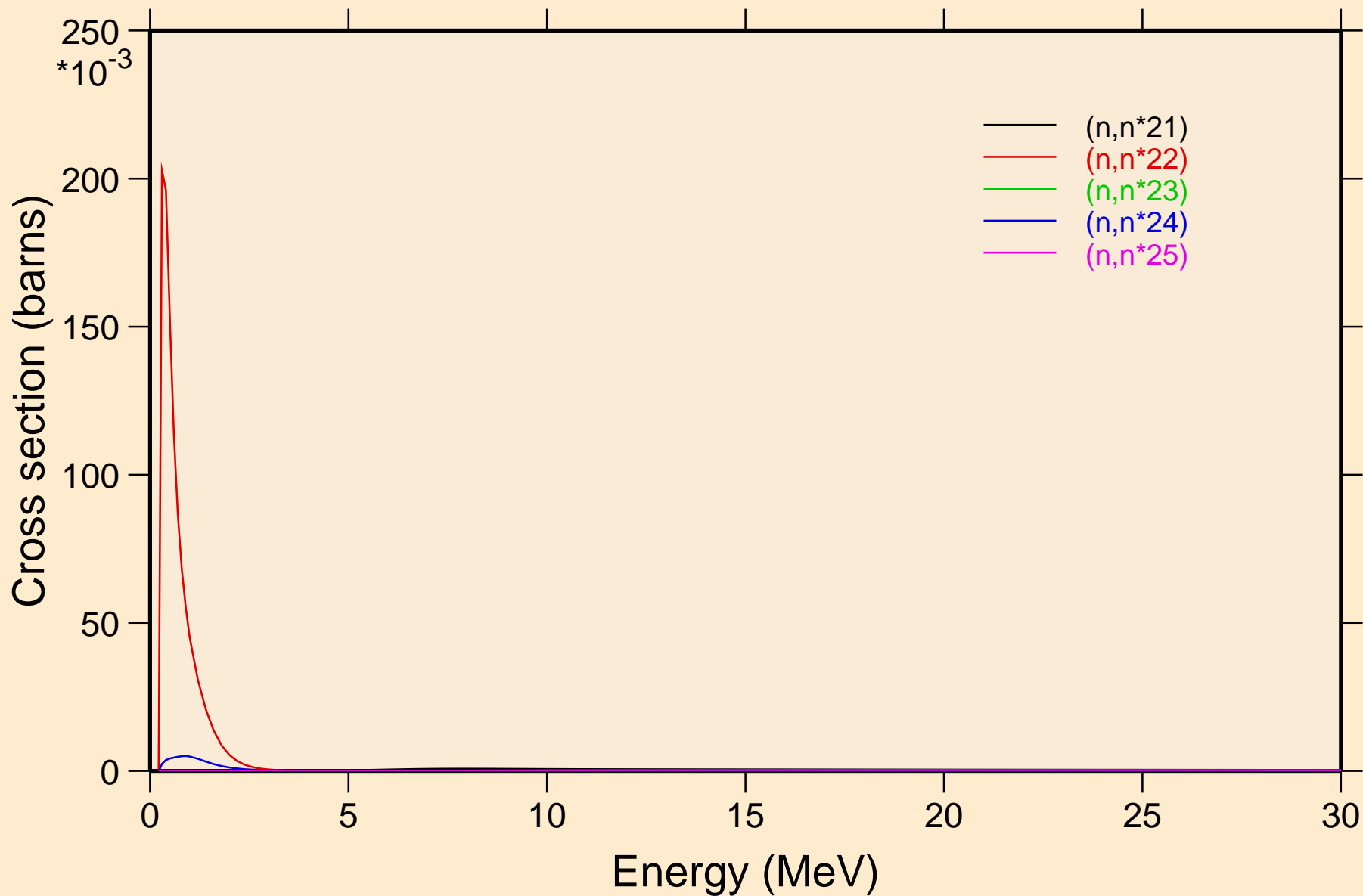

LR256 NEUTRON ACER TENDL-2019 LIBRARY; T=293.16K
Inelastic levels

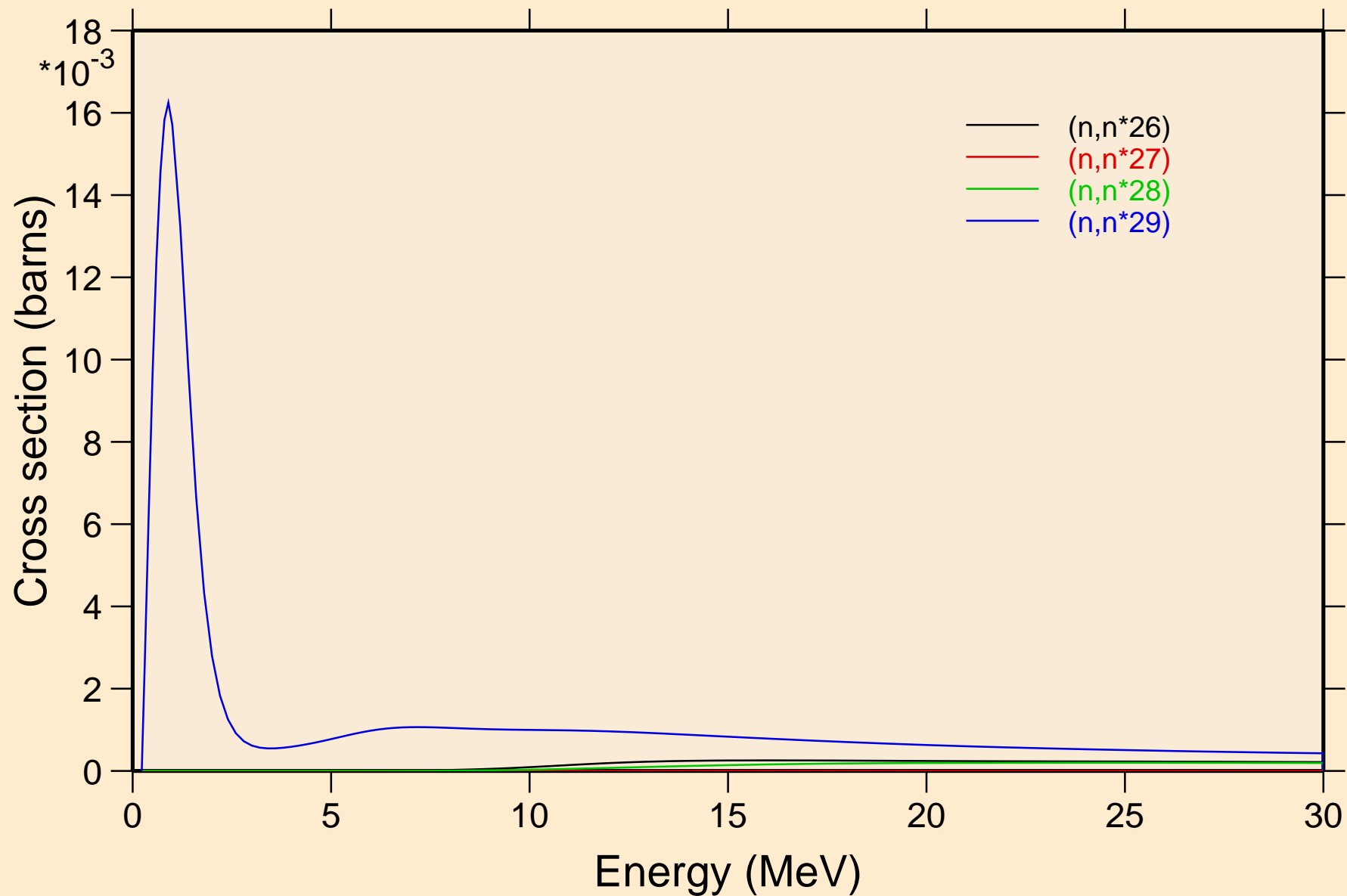

LR256 NEUTRON ACER TENDL-2019 LIBRARY; T=293.16K
Threshold reactions

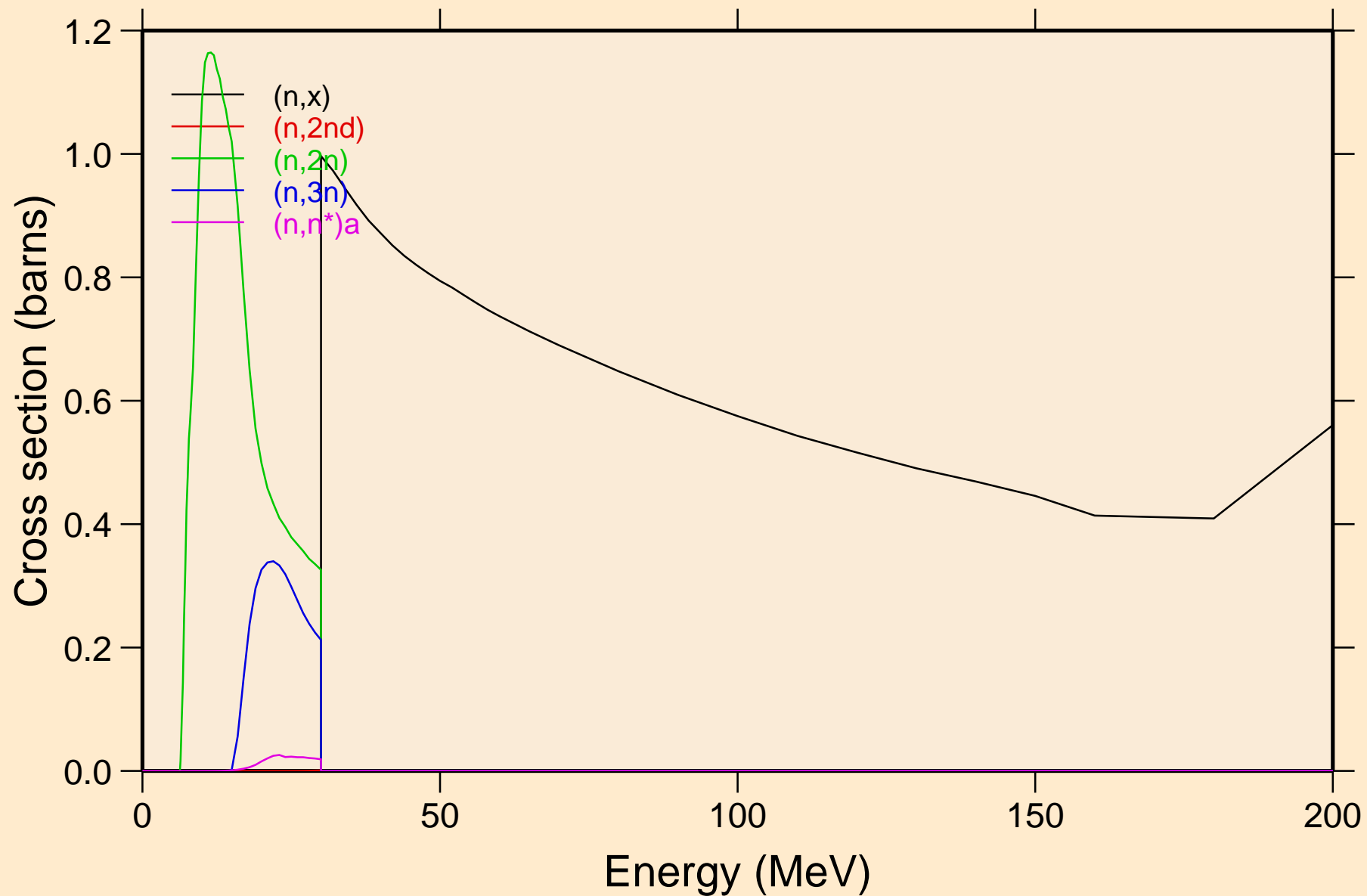

LR256 NEUTRON ACER TENDL-2019 LIBRARY; T=293.16K
Threshold reactions

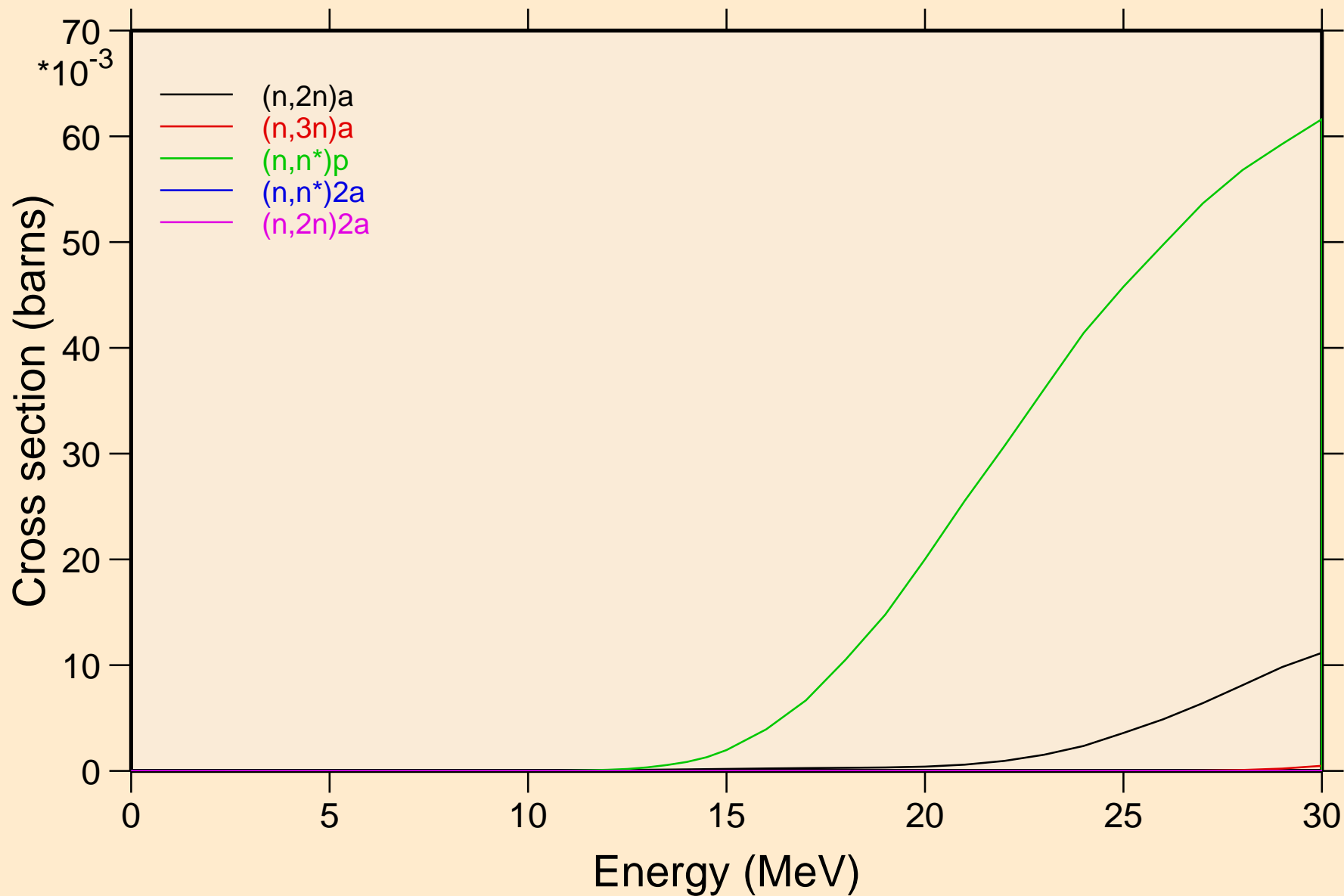

LR256 NEUTRON ACER TENDL-2019 LIBRARY; T=293.16K
Threshold reactions

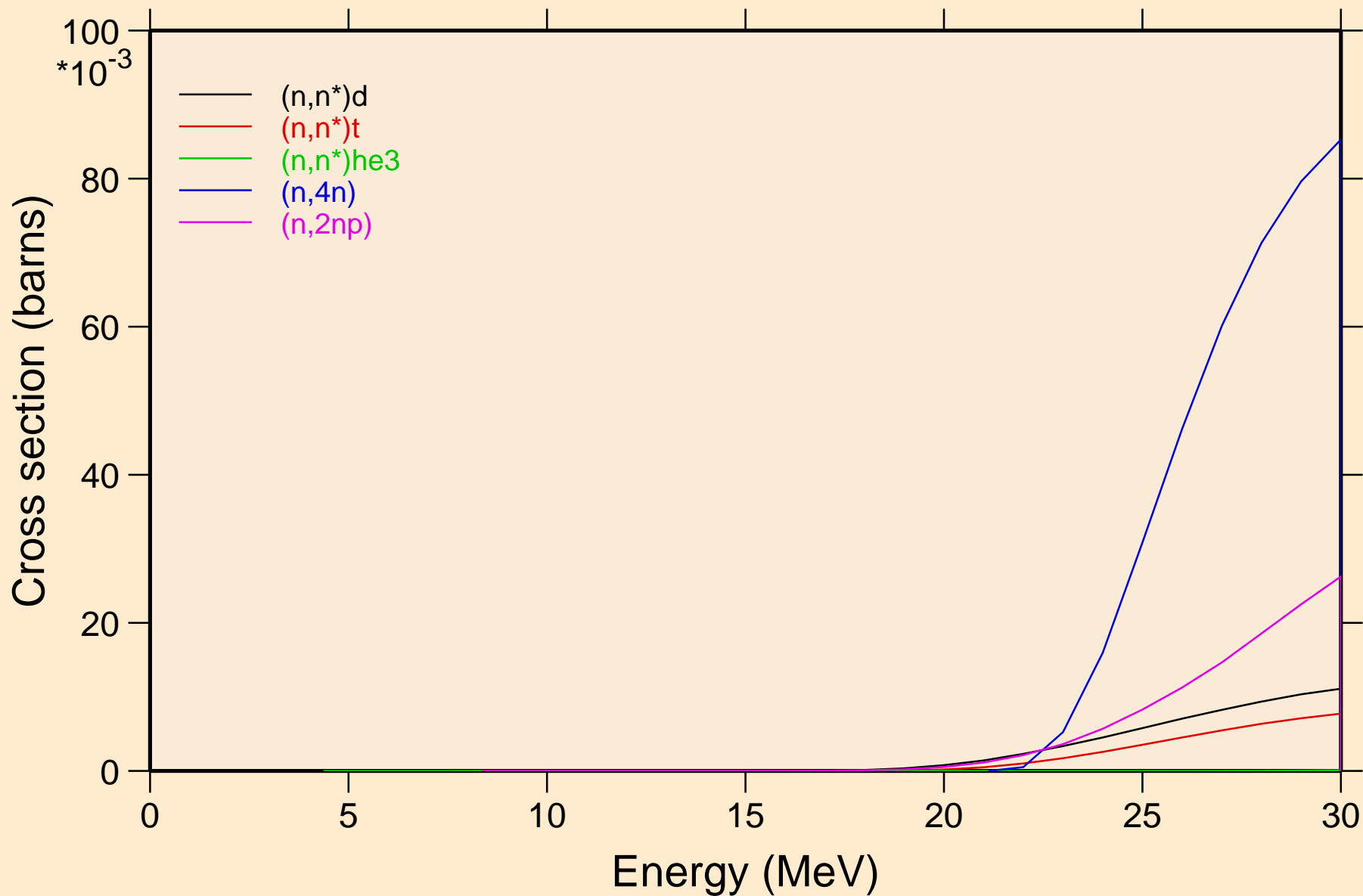

LR256 NEUTRON ACER TENDL-2019 LIBRARY; T=293.16K
Threshold reactions

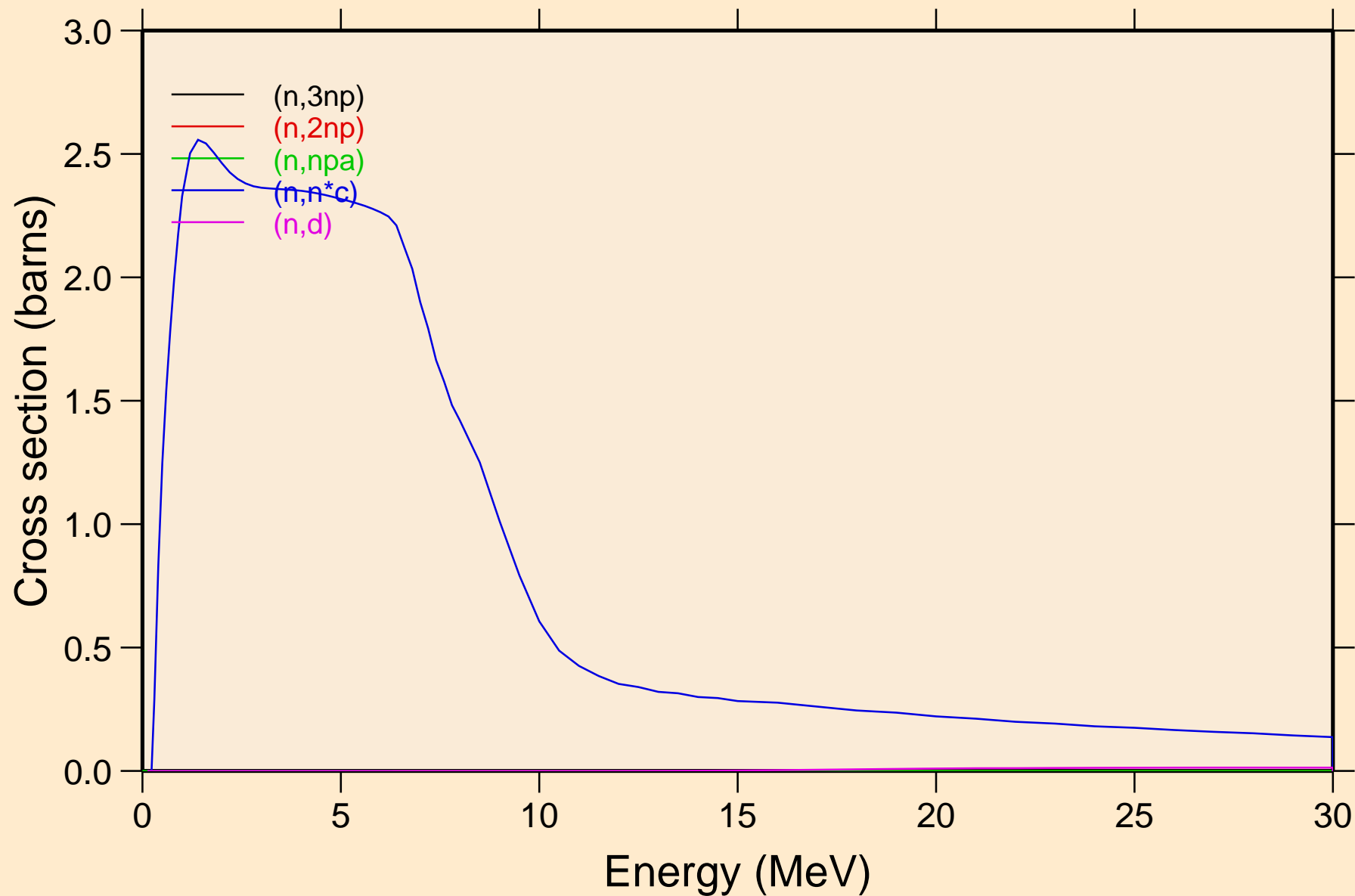

LR256 NEUTRON ACER TENDL-2019 LIBRARY; T=293.16K
Threshold reactions

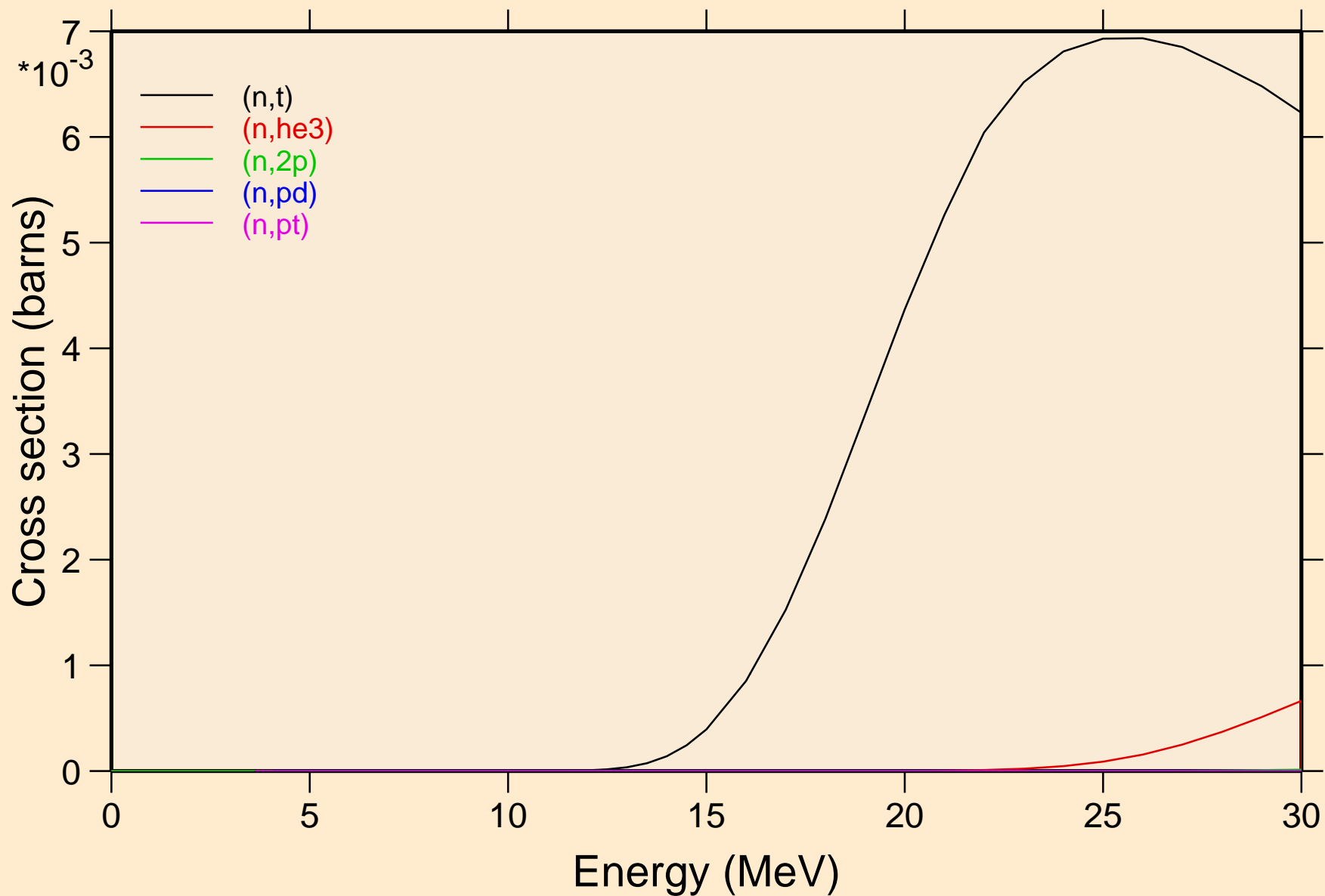

LR256 NEUTRON ACER TENDL-2019 LIBRARY; T=293.16K
Threshold reactions

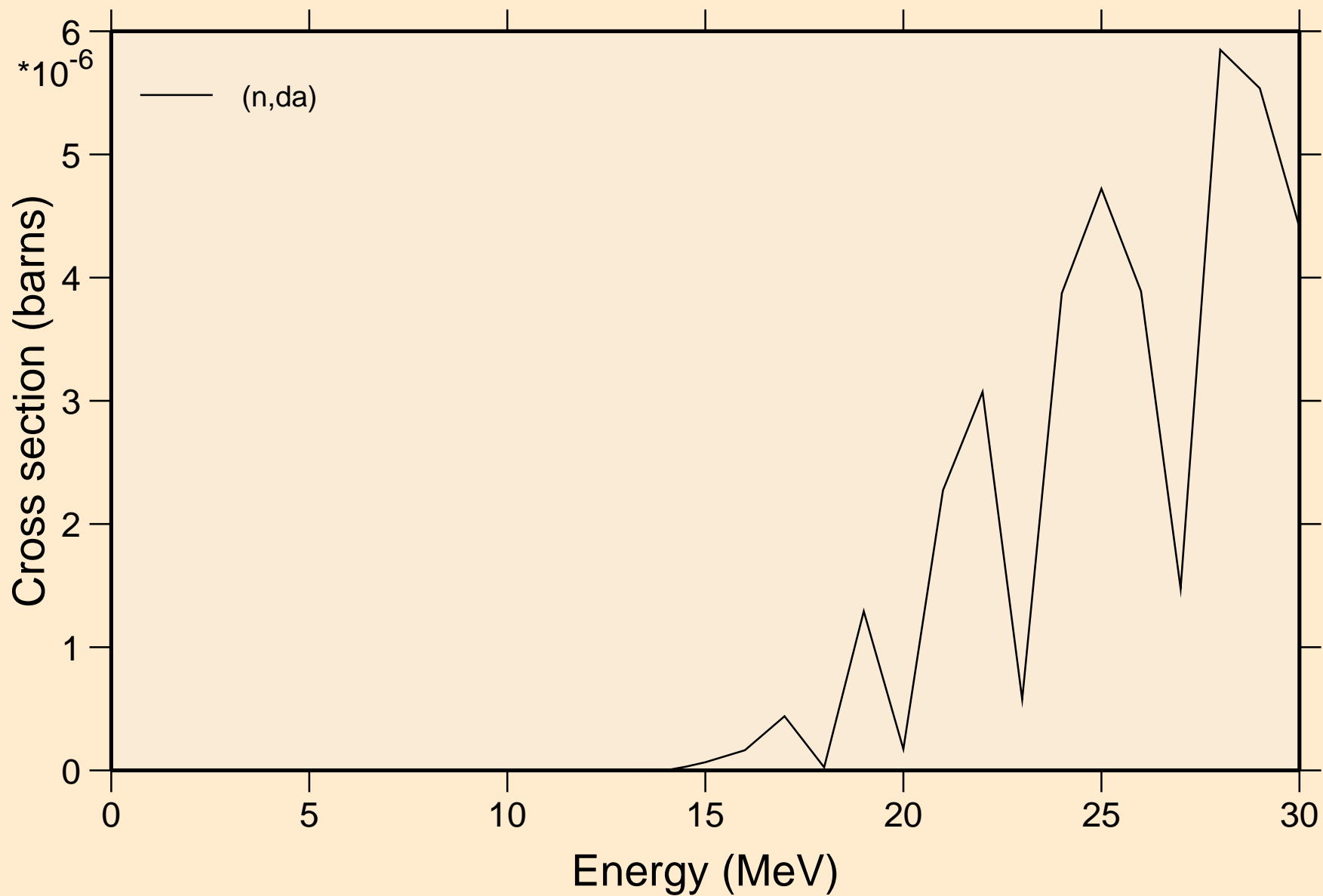

LR256 NEUTRON ACER TENDL-2019 LIBRARY; T=293.16K

Threshold reactions

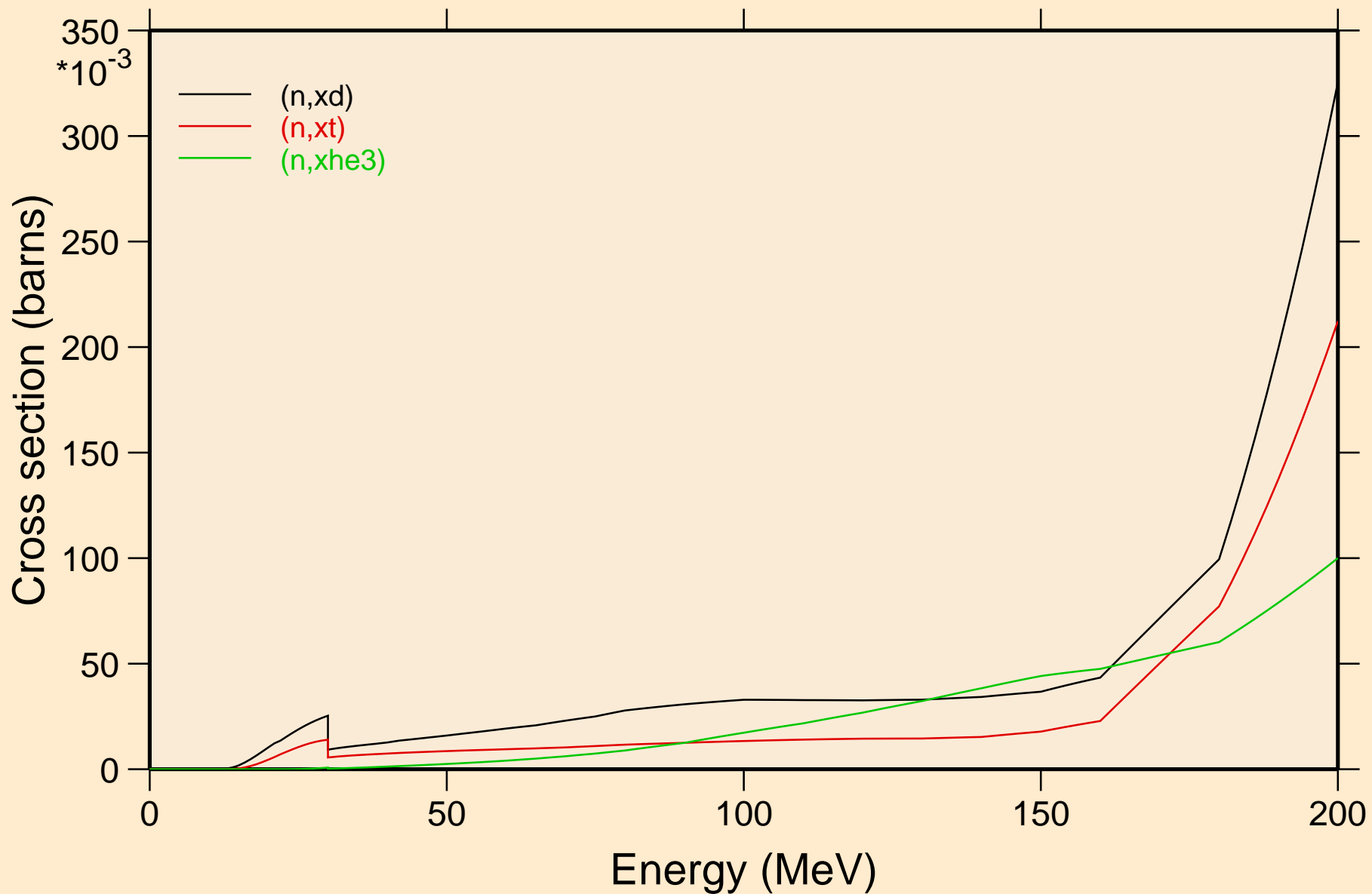

LR256 NEUTRON ACER TENDL-2019 LIBRARY; T=293.16K
angular distribution for elastic

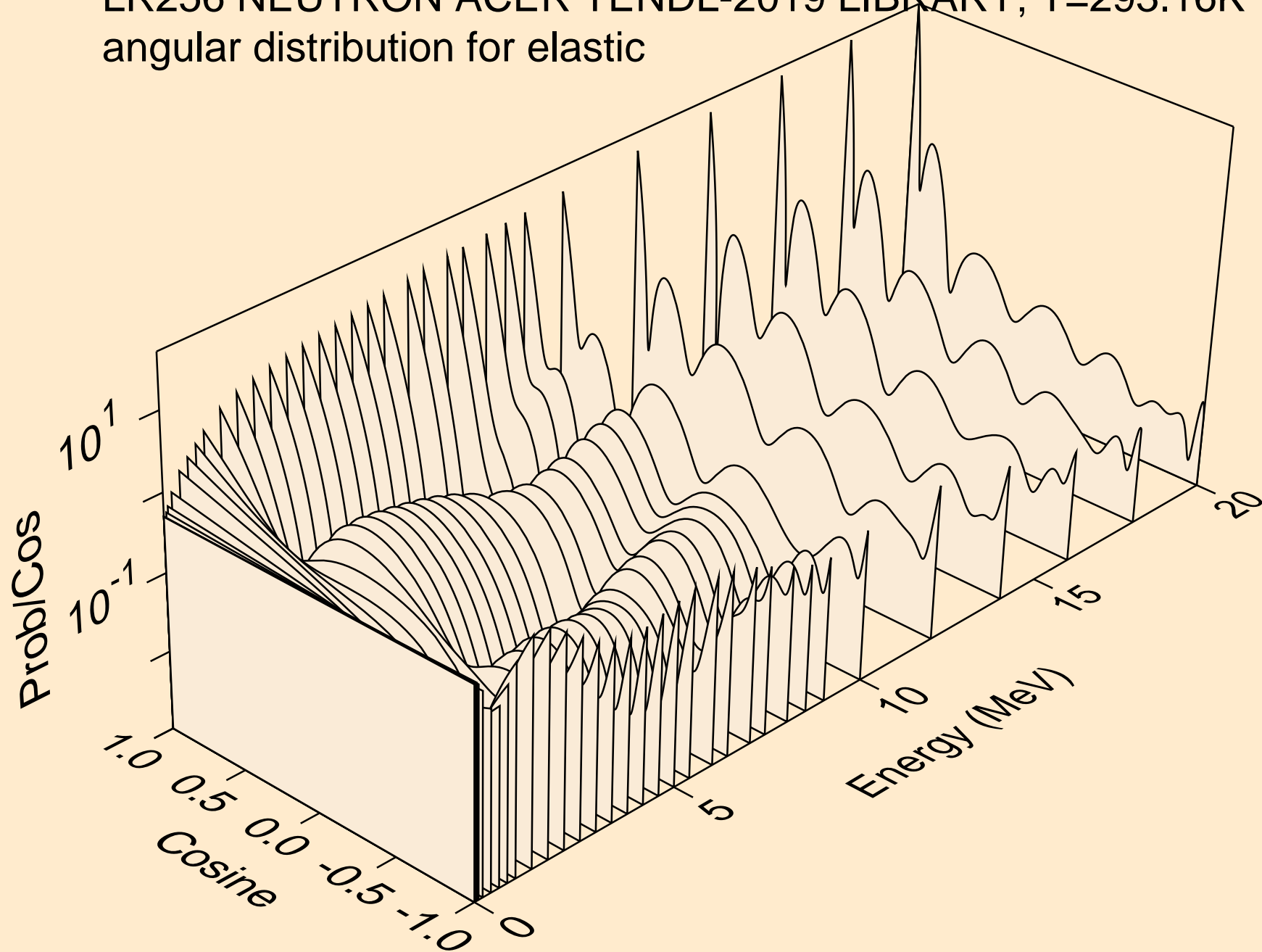

LR256 NEUTRON ACER TENDL-2019 LIBRARY; T=293.16K
angular distribution for elastic

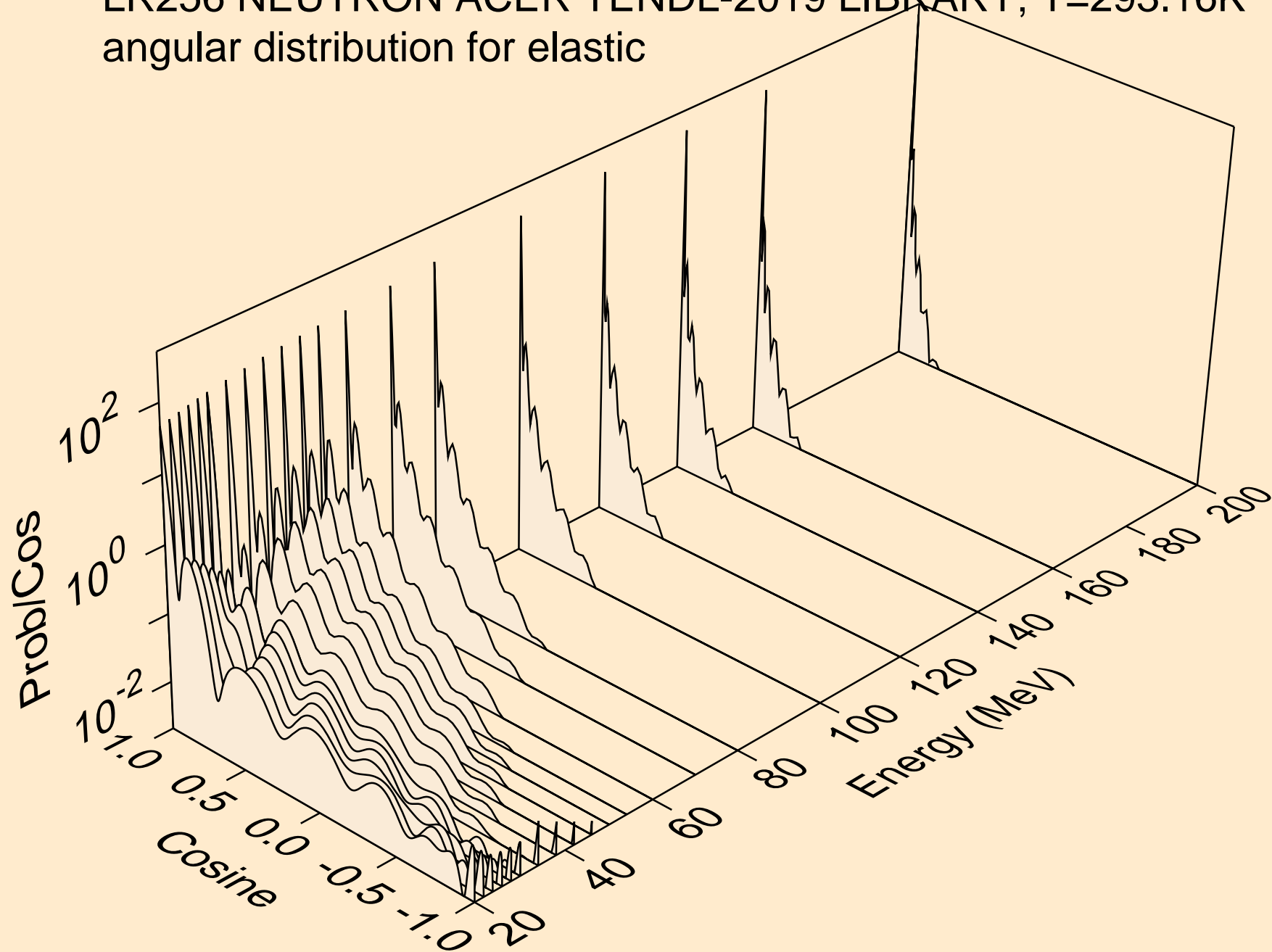

LR256 NEUTRON ACER TENDL-2019 LIBRARY; T=293.16K
angular distribution for (n,n*1)

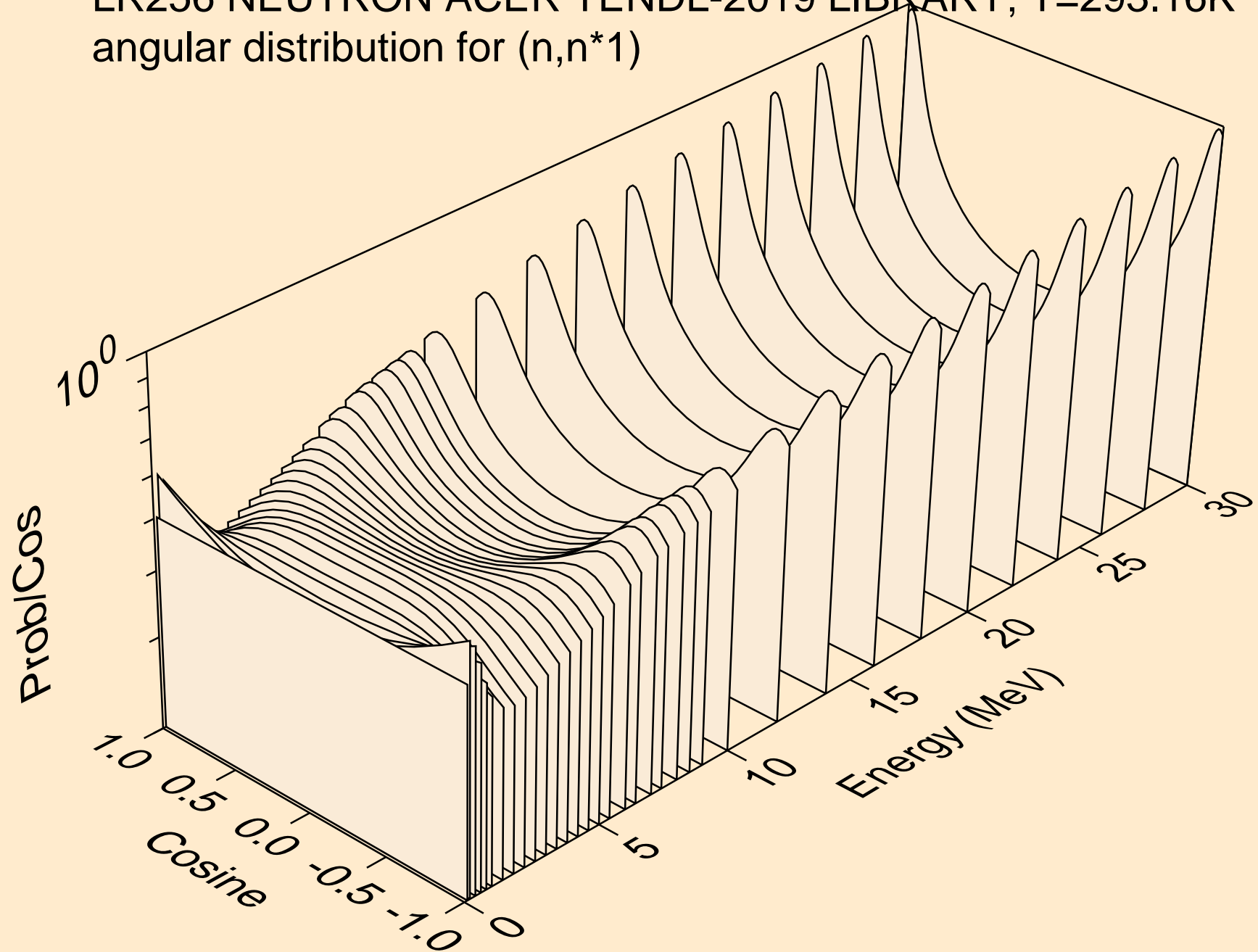

LR256 NEUTRON ACER TENDL-2019 LIBRARY; T=293.16K
angular distribution for (n,n*2)

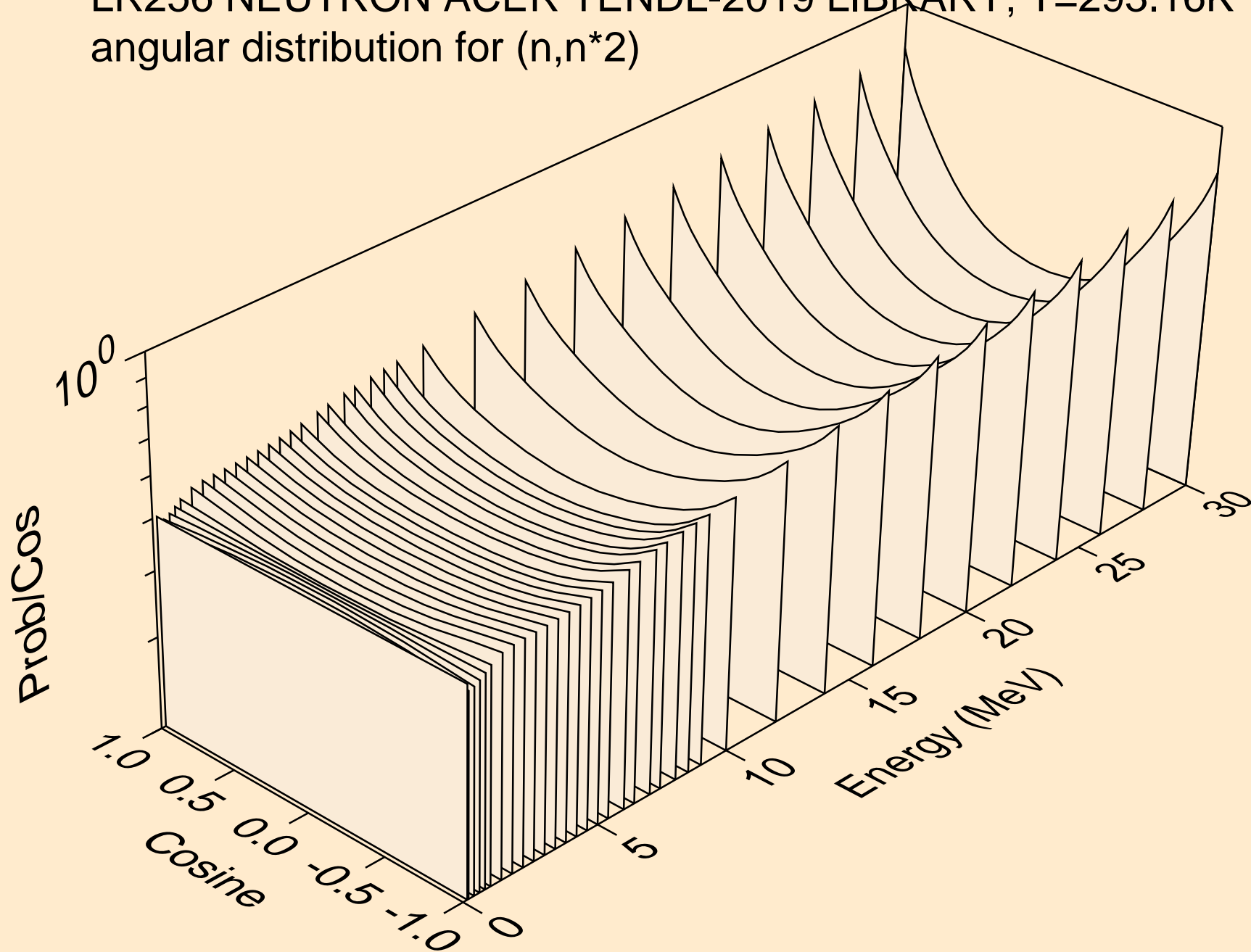

LR256 NEUTRON ACER TENDL-2019 LIBRARY; T=293.16K
angular distribution for (n,n*3)

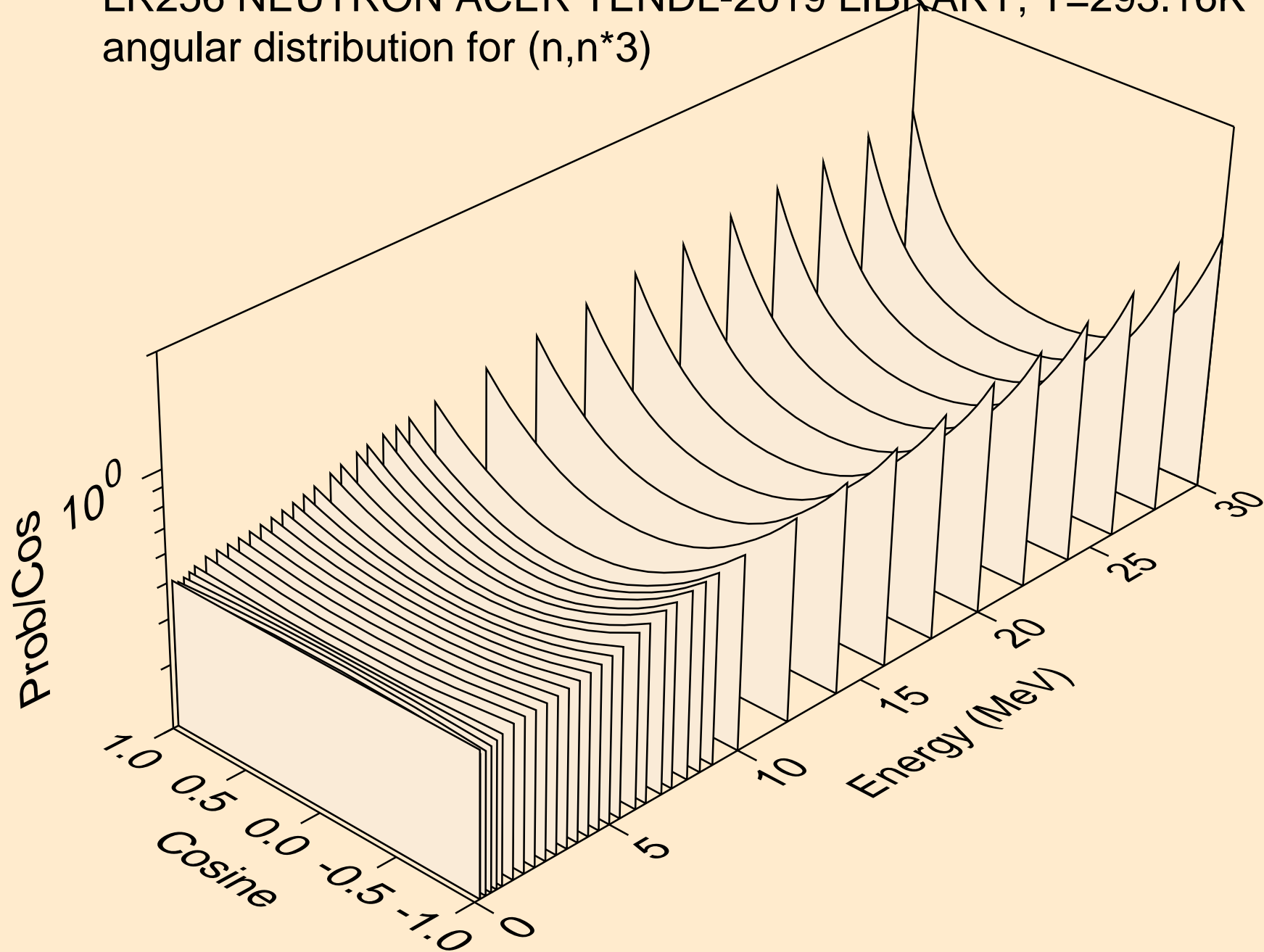

LR256 NEUTRON ACER TENDL-2019 LIBRARY; T=293.16K
angular distribution for (n,n*4)

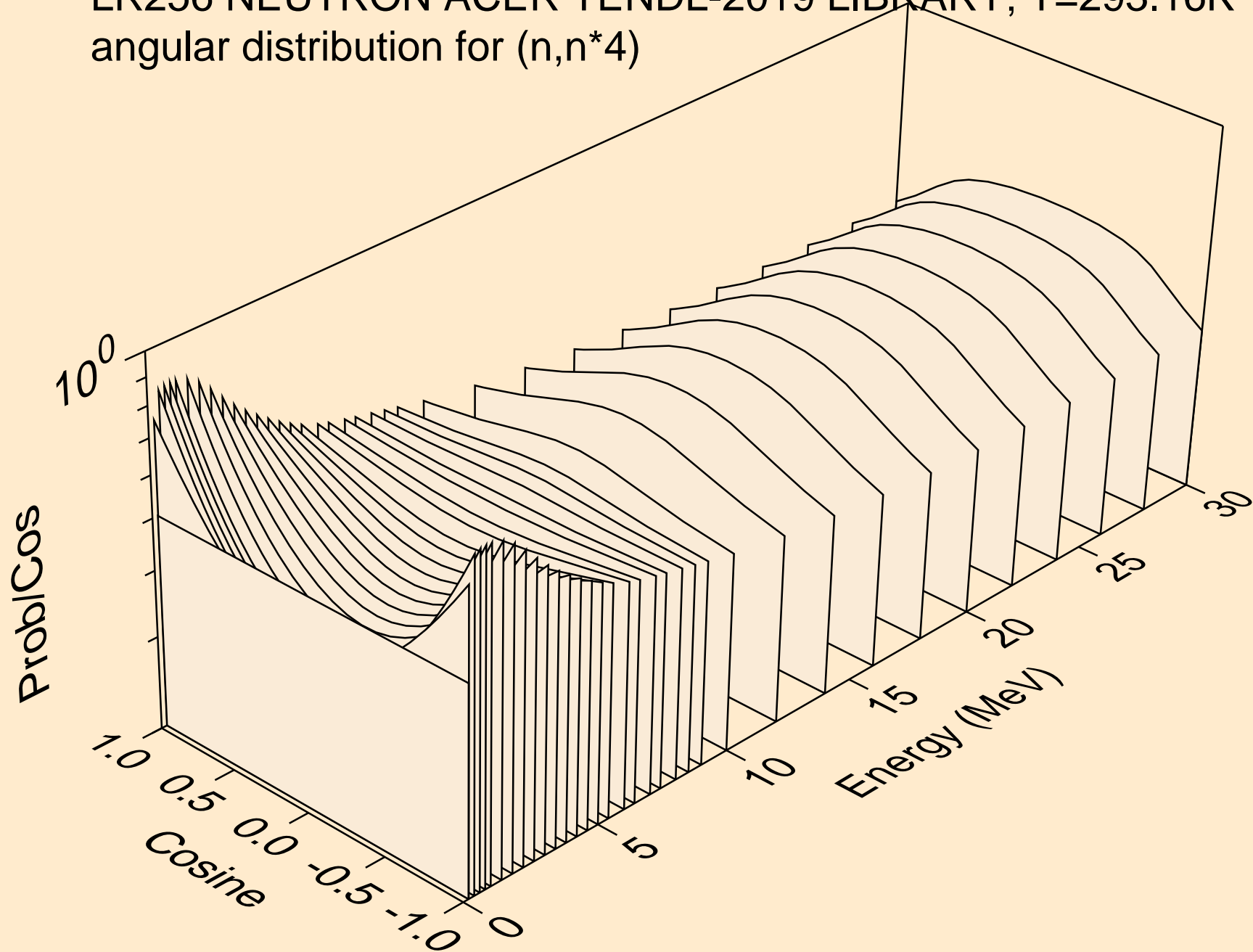

LR256 NEUTRON ACER TENDL-2019 LIBRARY; T=293.16K
angular distribution for (n,n*5)

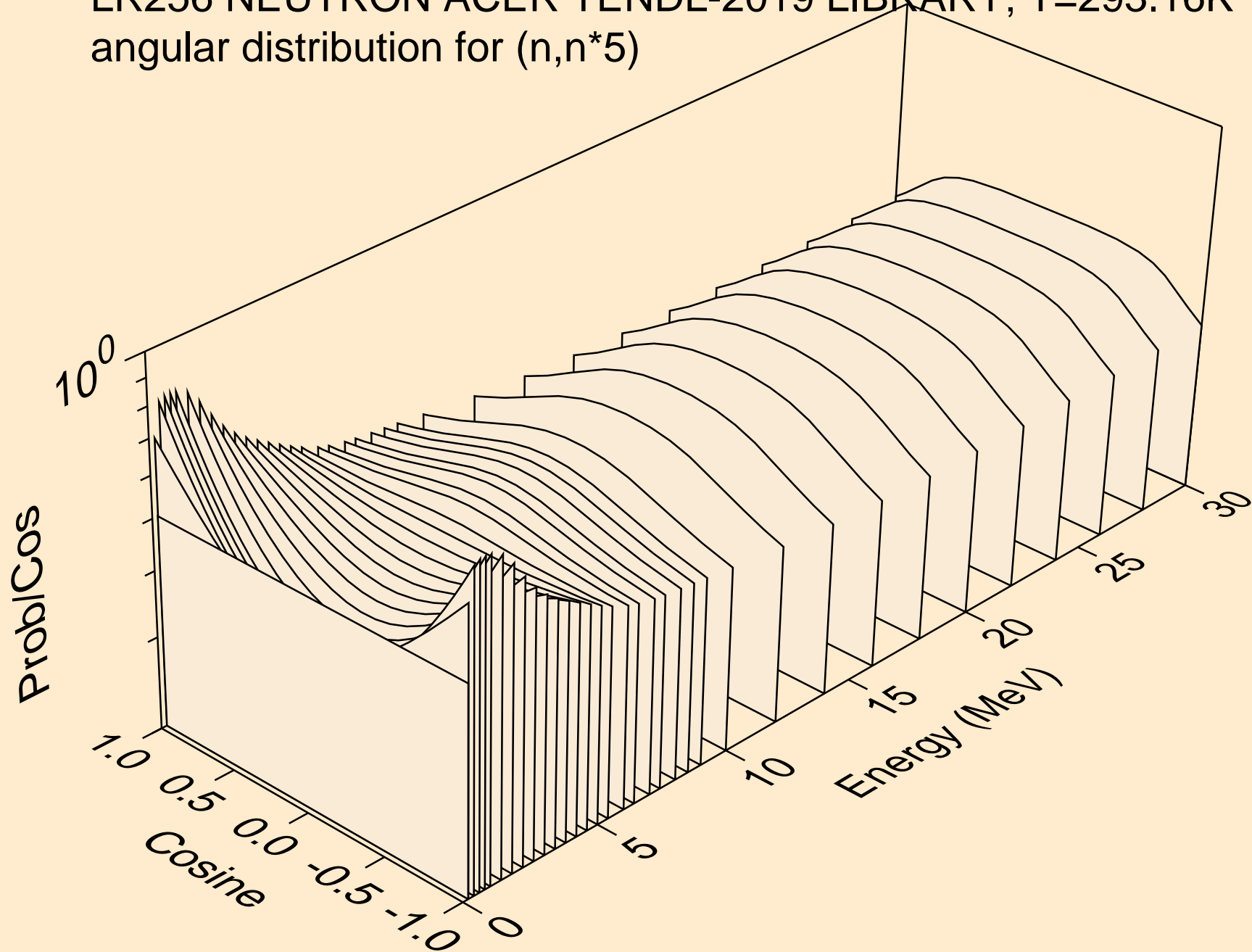

LR256 NEUTRON ACER TENDL-2019 LIBRARY; T=293.16K
angular distribution for (n,n*6)

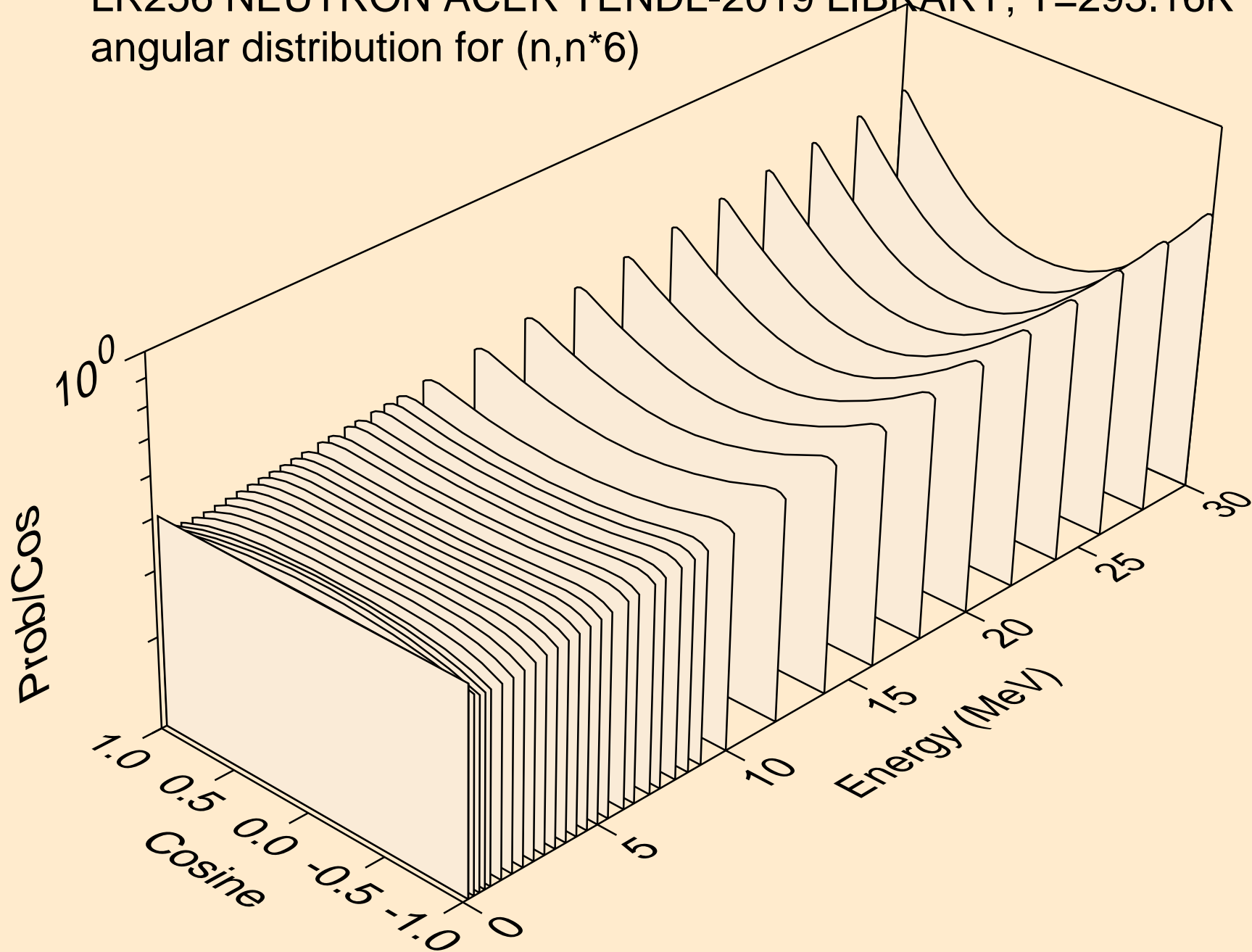

LR256 NEUTRON ACER TENDL-2019 LIBRARY; T=293.16K
angular distribution for (n,n*7)

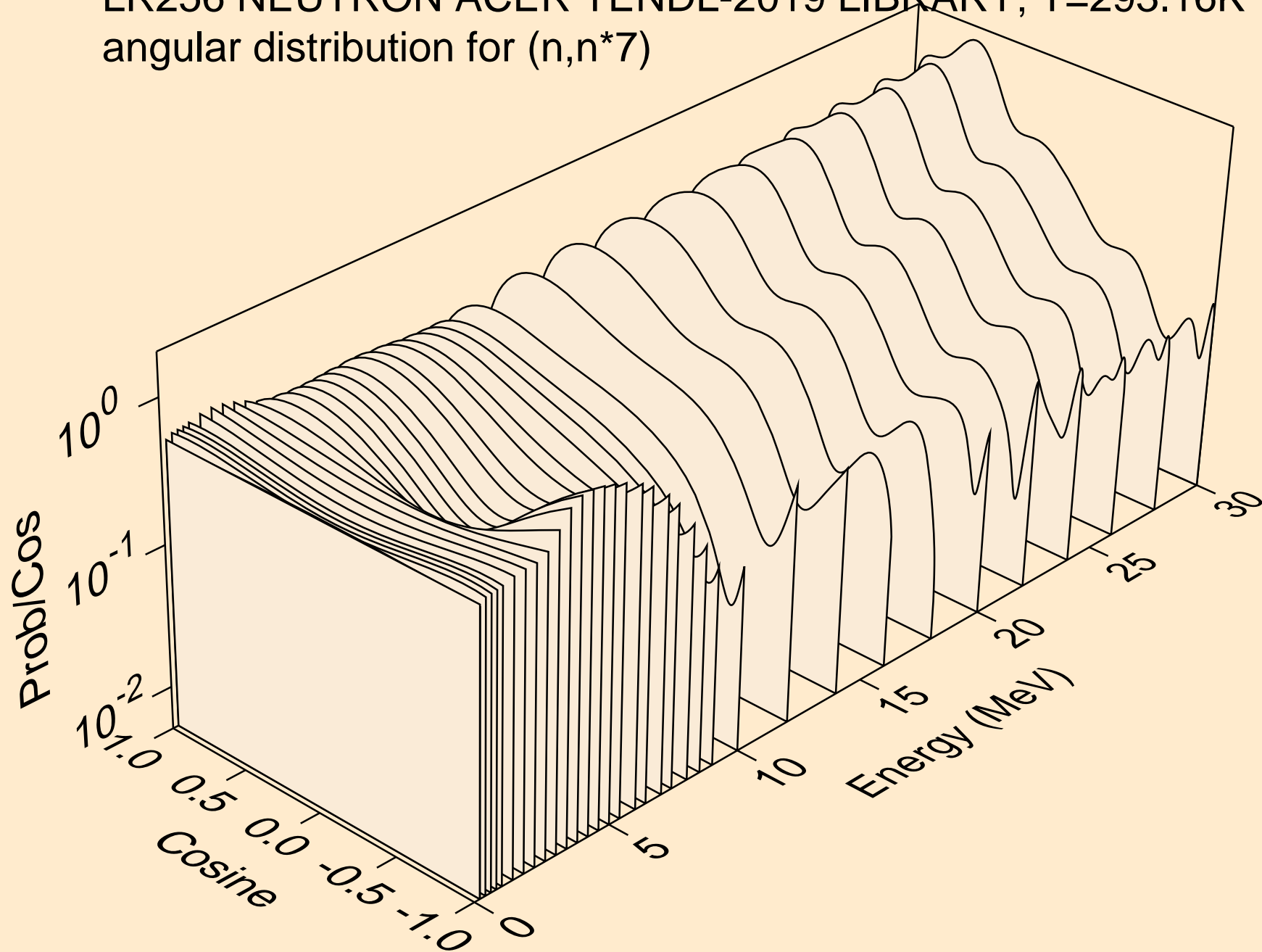

LR256 NEUTRON ACER TENDL-2019 LIBRARY; T=293.16K
angular distribution for (n,n*8)

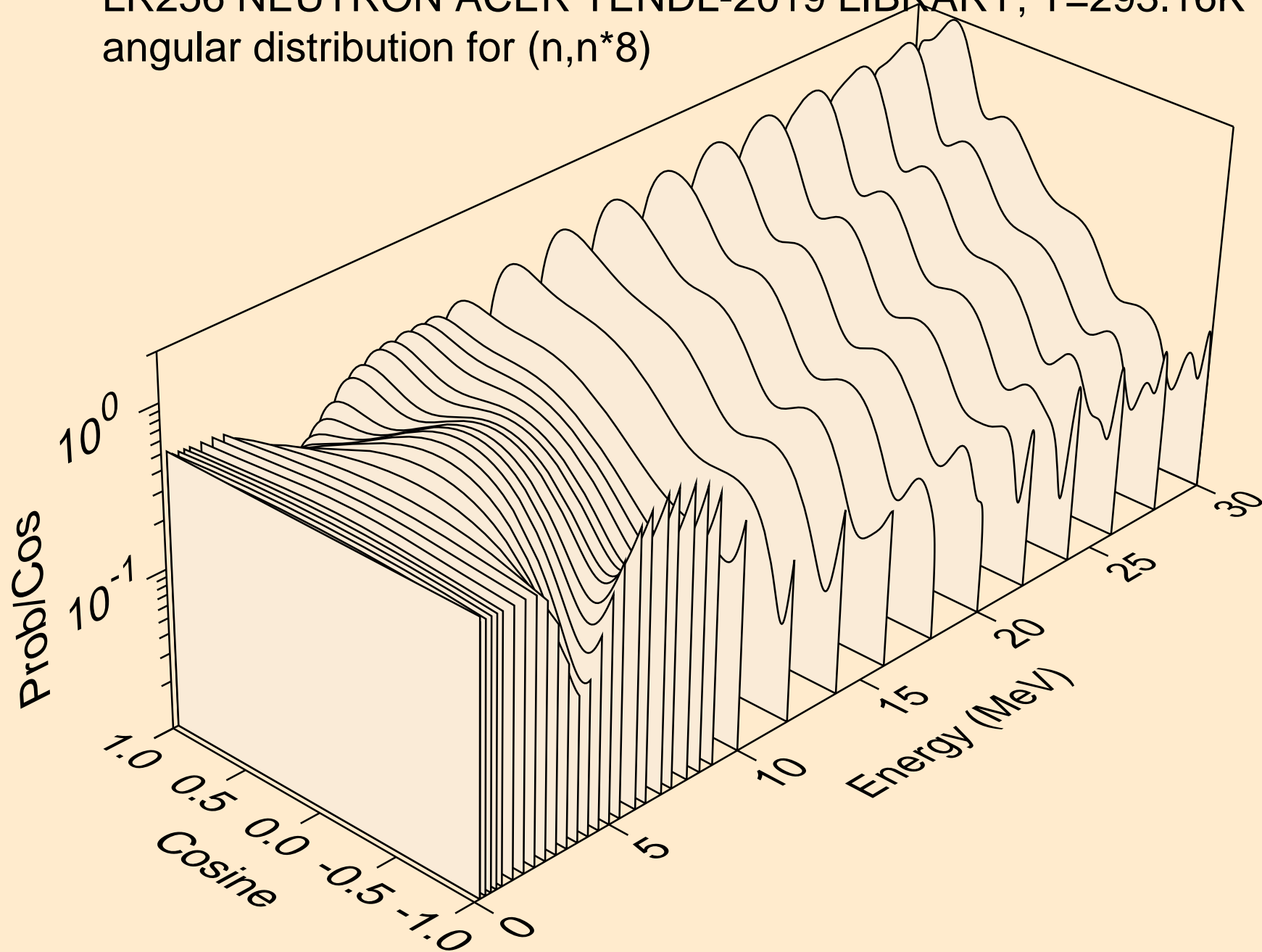

LR256 NEUTRON ACER TENDL-2019 LIBRARY; T=293.16K
angular distribution for (n,n*9)

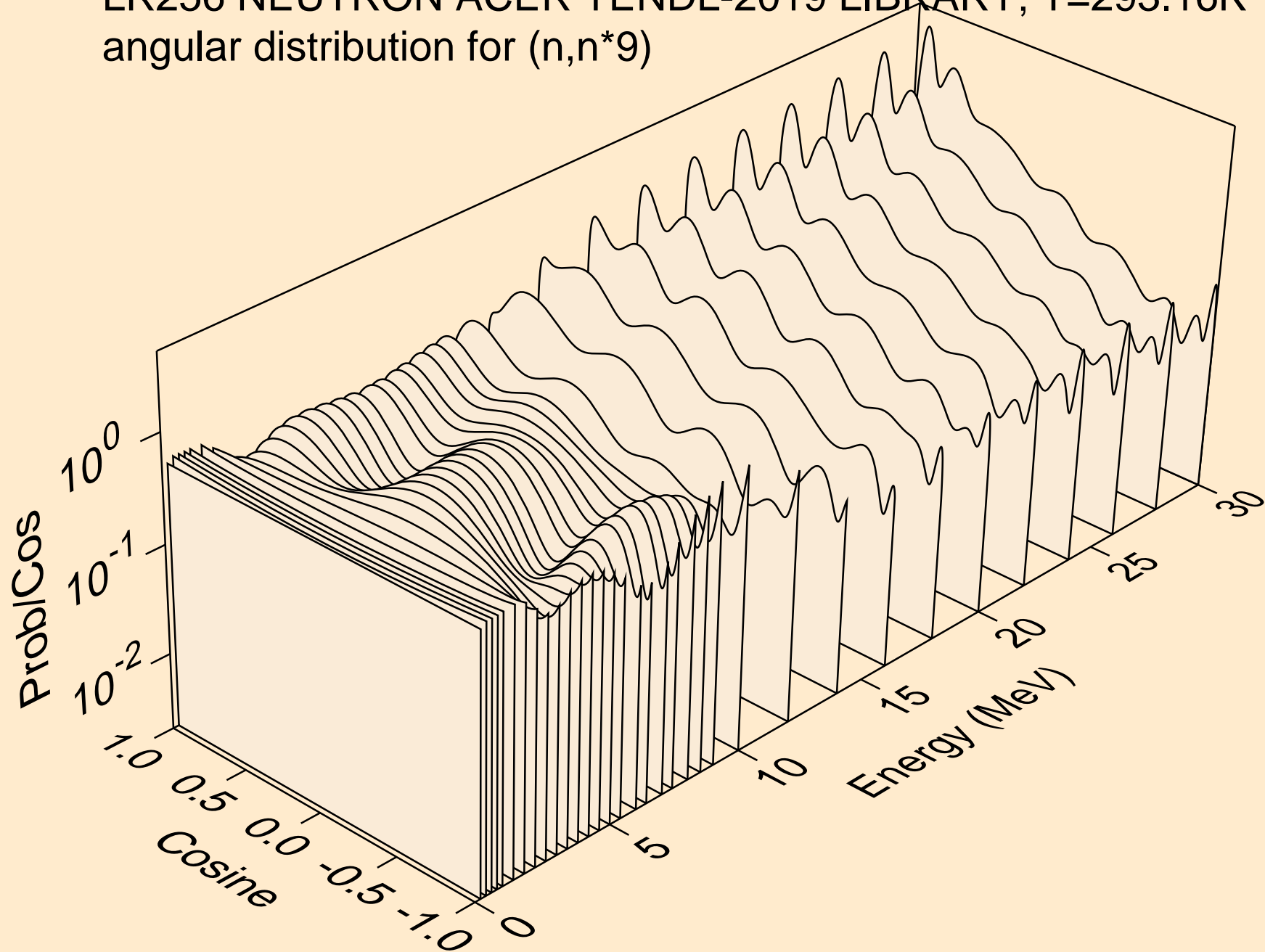

LR256 NEUTRON ACER TENDL-2019 LIBRARY; T=293.16K
angular distribution for (n,n*10)

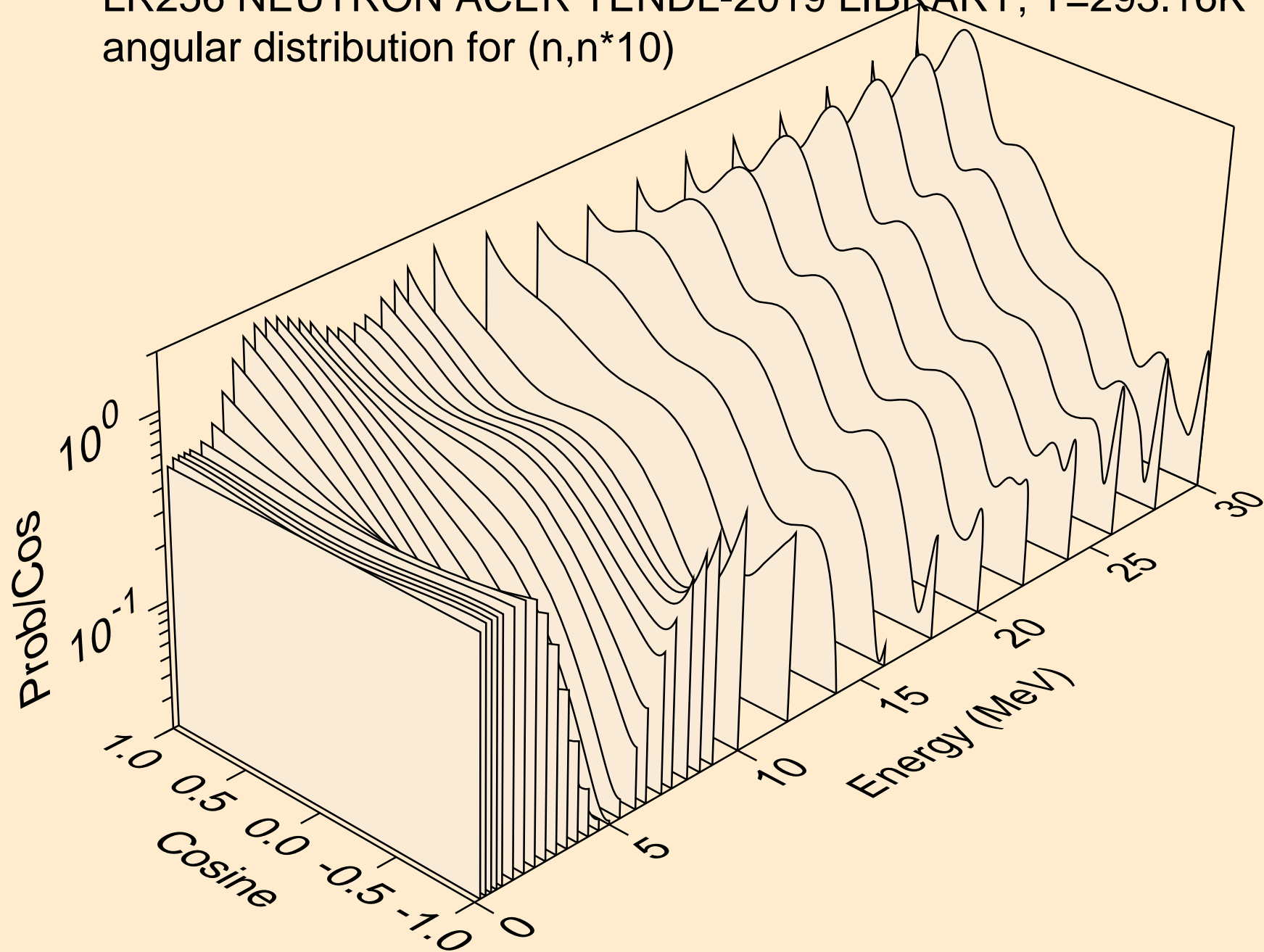

LR256 NEUTRON ACER TENDL-2019 LIBRARY; T=293.16K
angular distribution for (n,n*11)

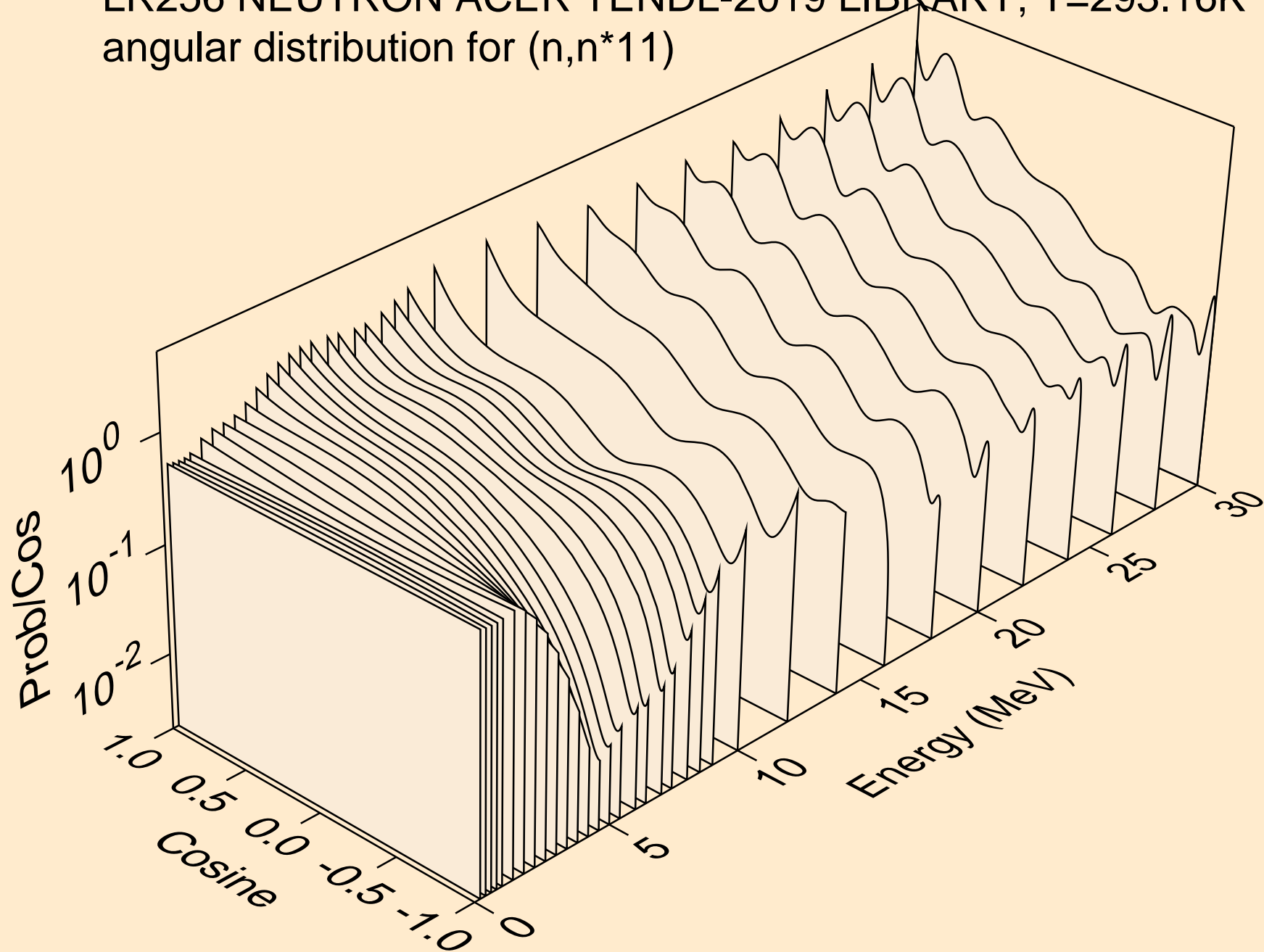

LR256 NEUTRON ACER TENDL-2019 LIBRARY; T=293.16K
angular distribution for (n,n*12)

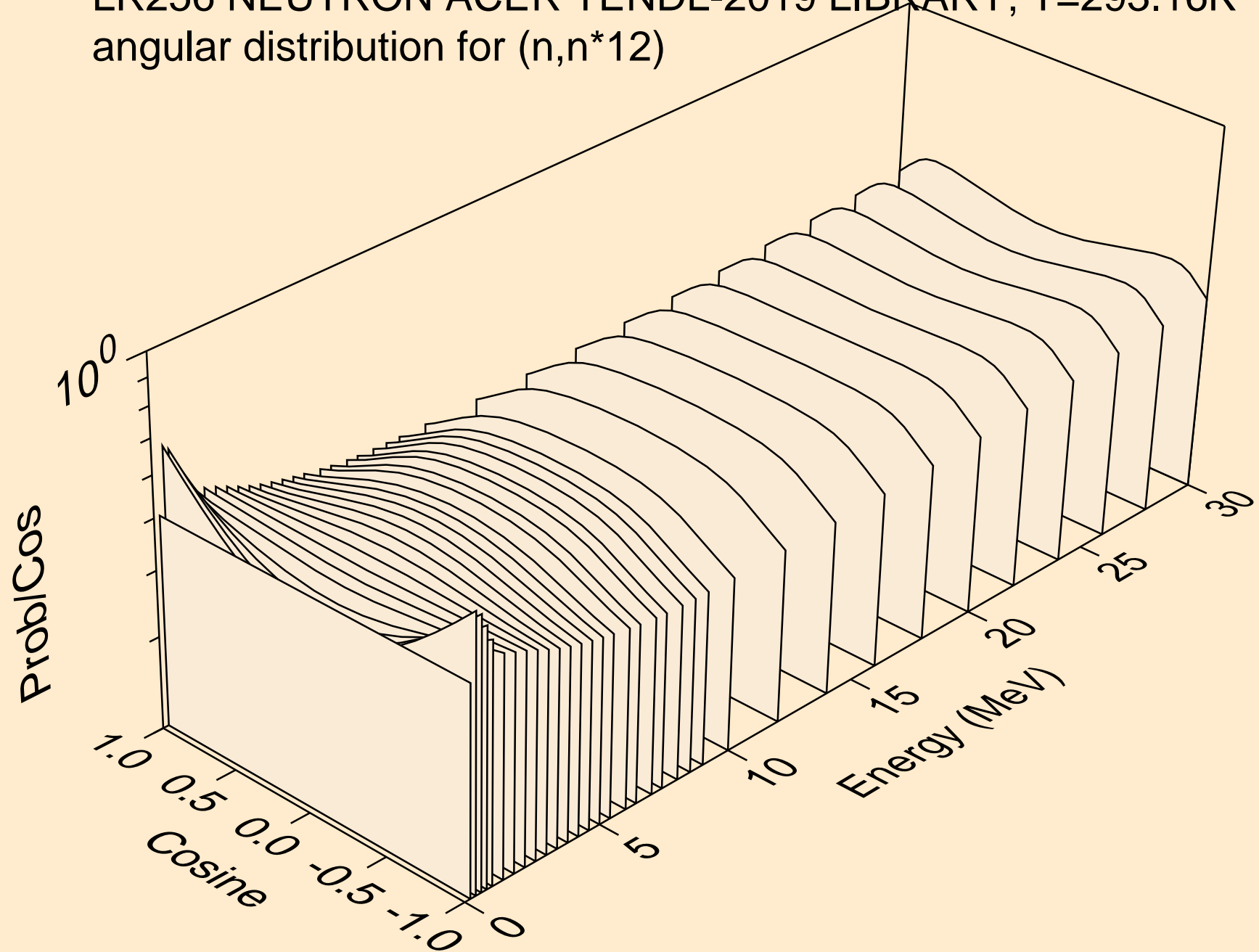

LR256 NEUTRON ACER TENDL-2019 LIBRARY; T=293.16K
angular distribution for (n,n*13)

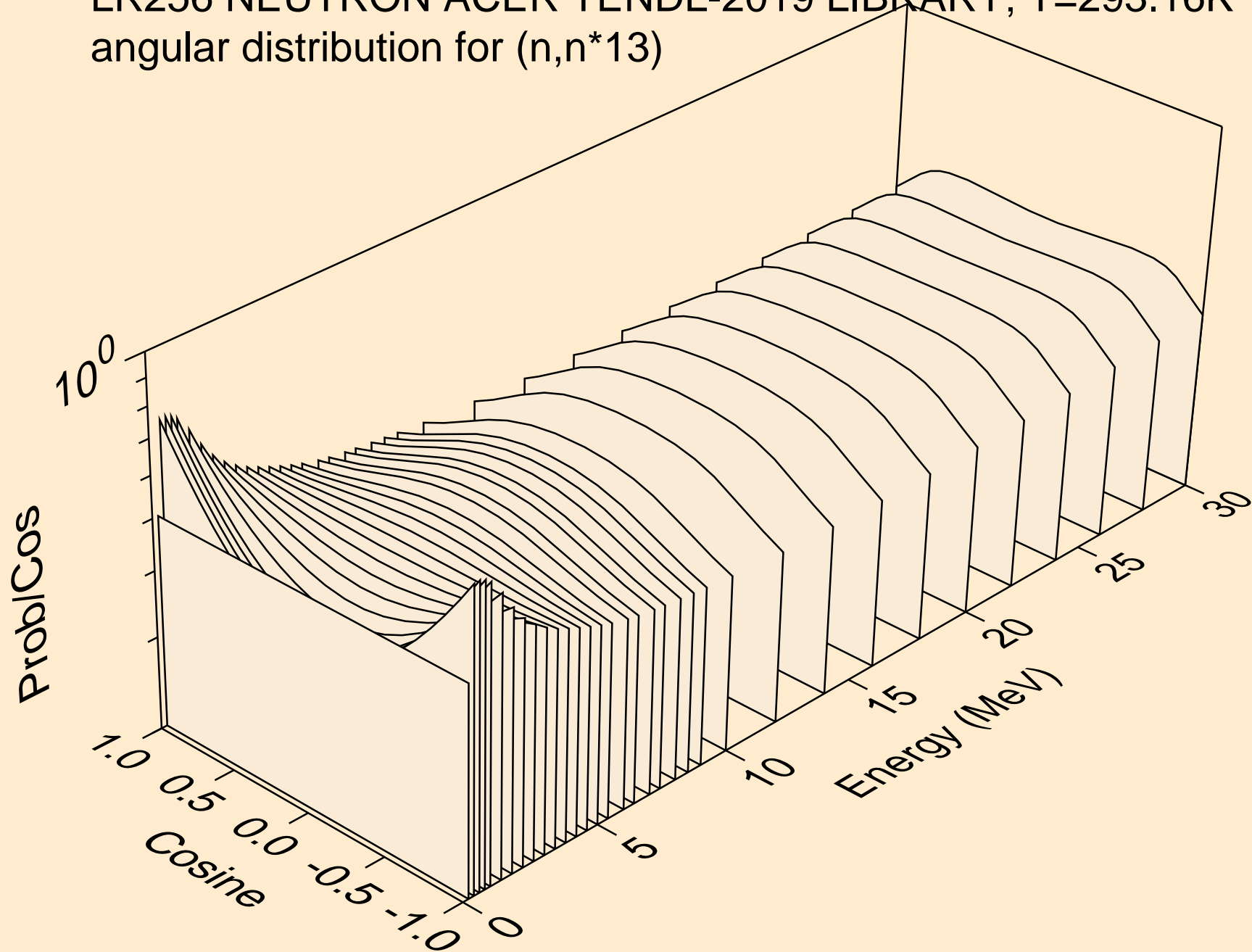

LR256 NEUTRON ACER TENDL-2019 LIBRARY; T=293.16K
angular distribution for (n,n*14)

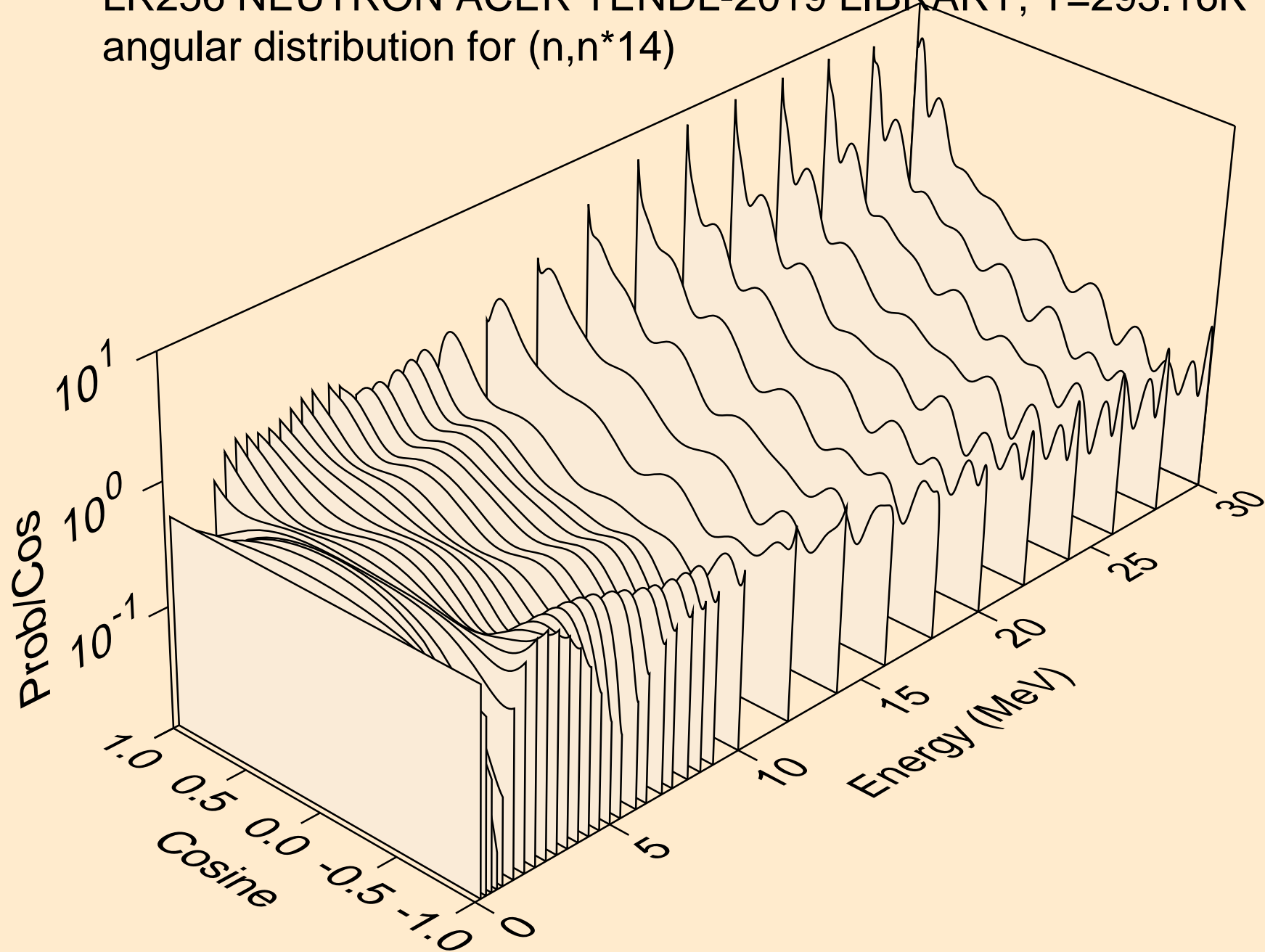

LR256 NEUTRON ACER TENDL-2019 LIBRARY; T=293.16K
angular distribution for (n,n*15)

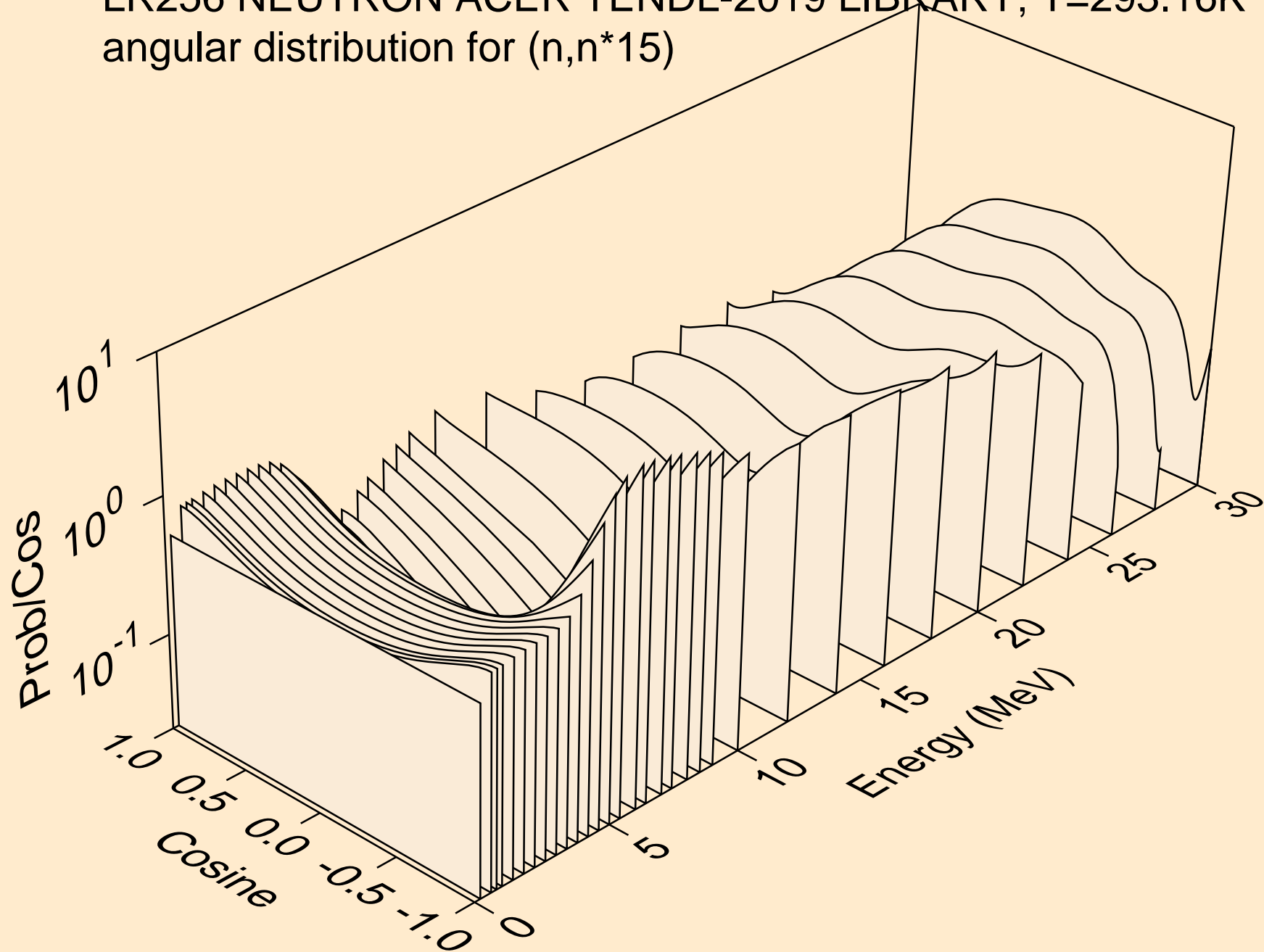

LR256 NEUTRON ACER TENDL-2019 LIBRARY; T=293.16K
angular distribution for (n,n*16)

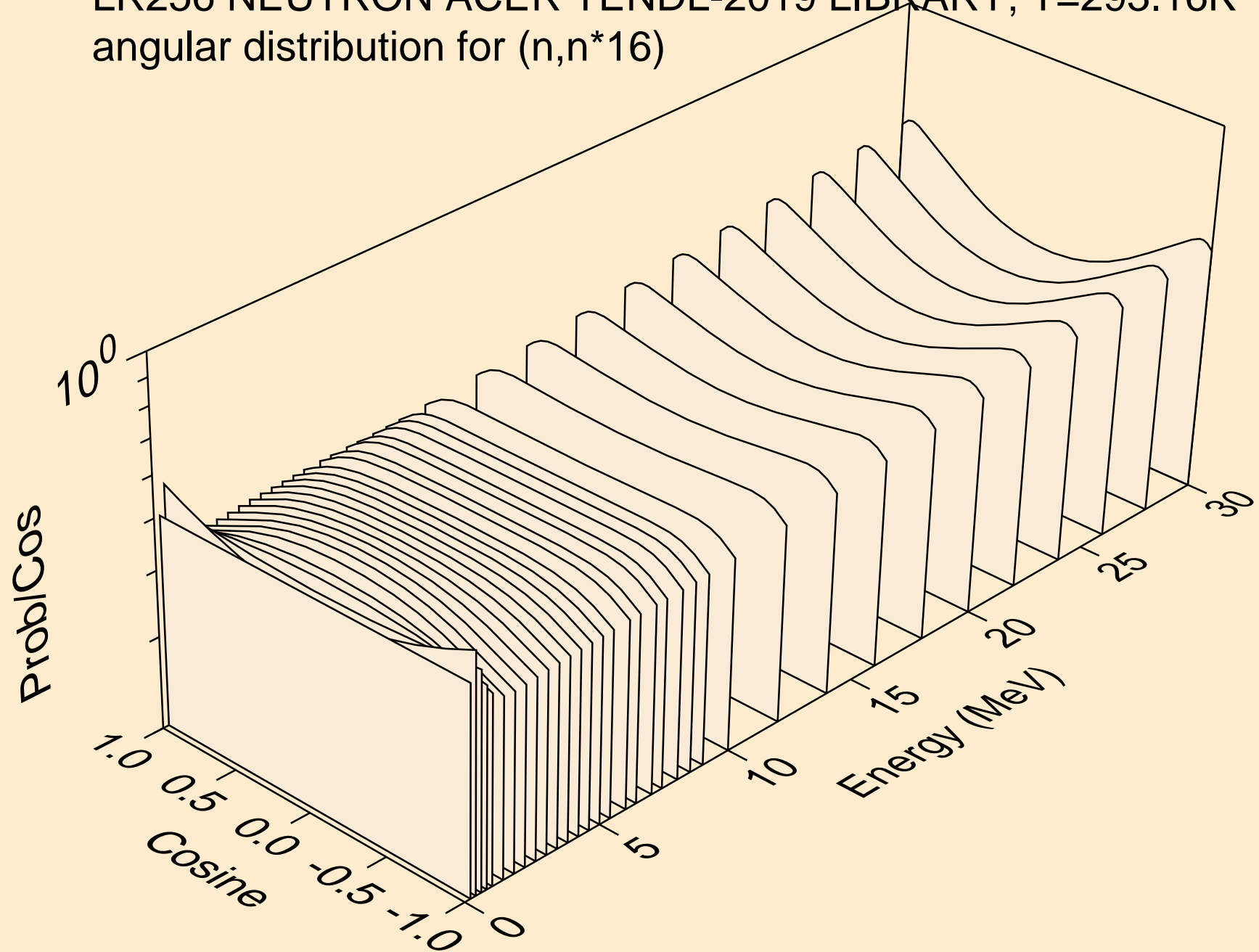

LR256 NEUTRON ACER TENDL-2019 LIBRARY; T=293.16K
angular distribution for (n,n*17)

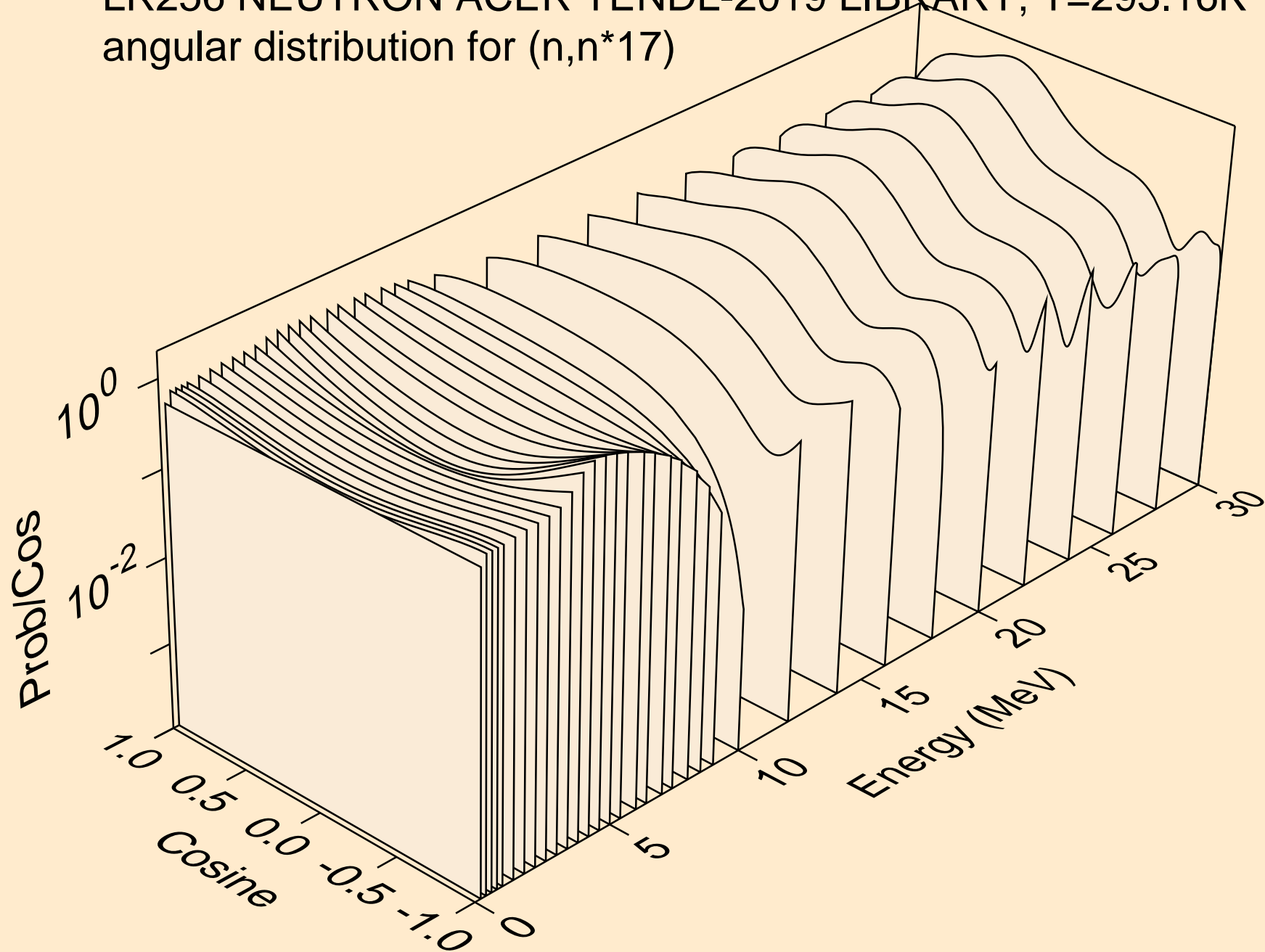

LR256 NEUTRON ACER TENDL-2019 LIBRARY; T=293.16K
angular distribution for (n,n*18)

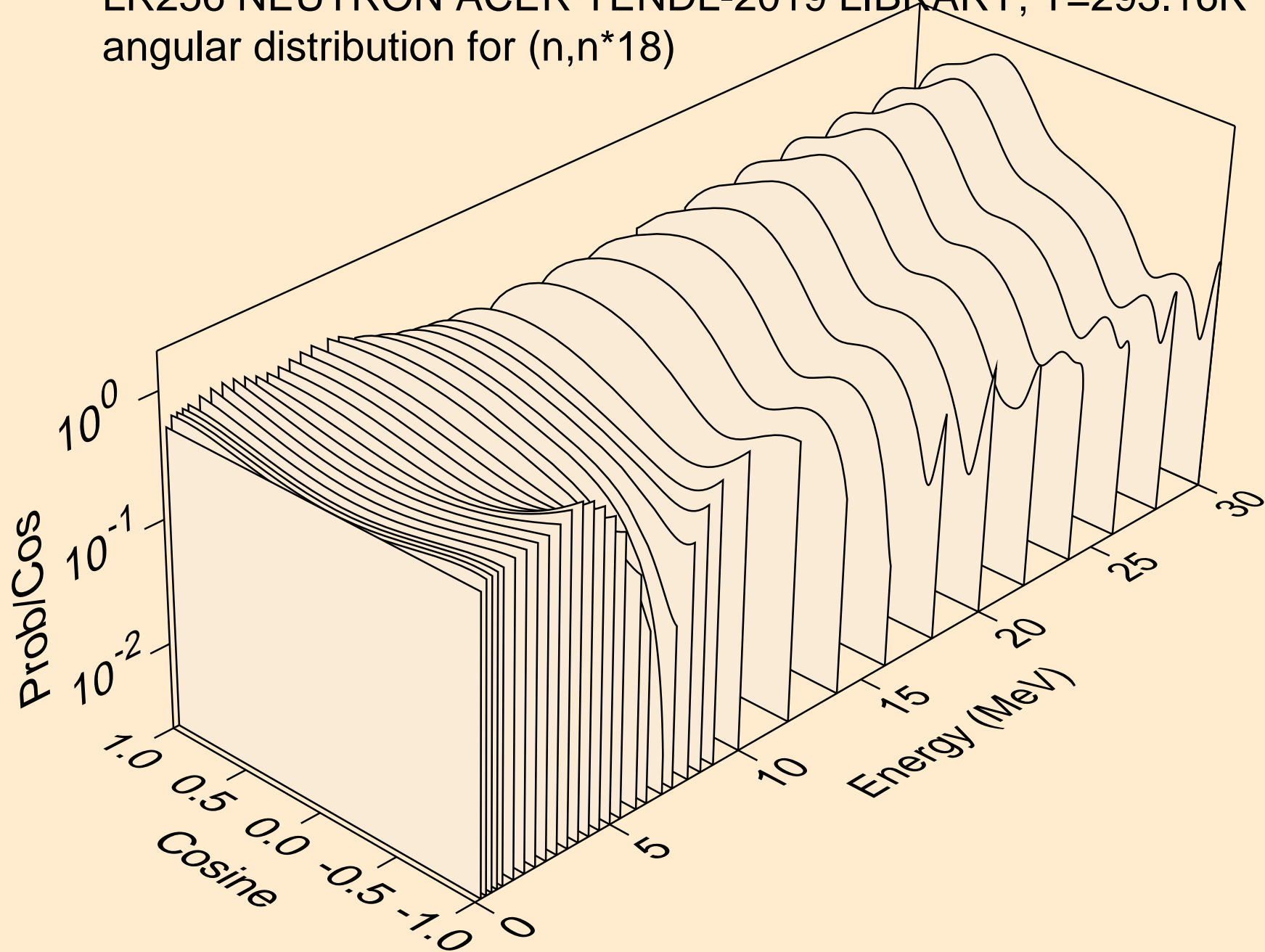

LR256 NEUTRON ACER TENDL-2019 LIBRARY; T=293.16K
angular distribution for (n,n*19)

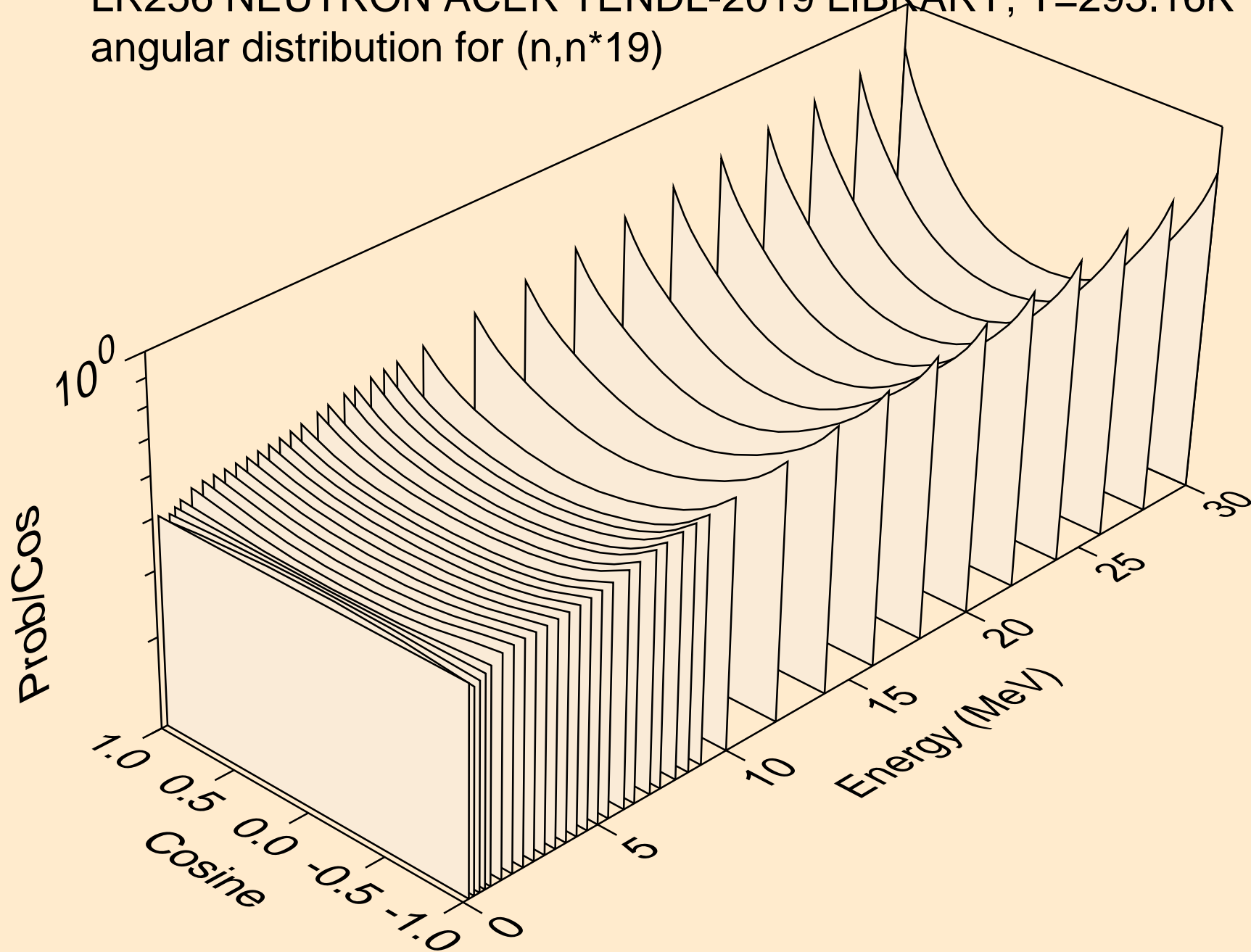

LR256 NEUTRON ACER TENDL-2019 LIBRARY; T=293.16K
angular distribution for (n,n*20)

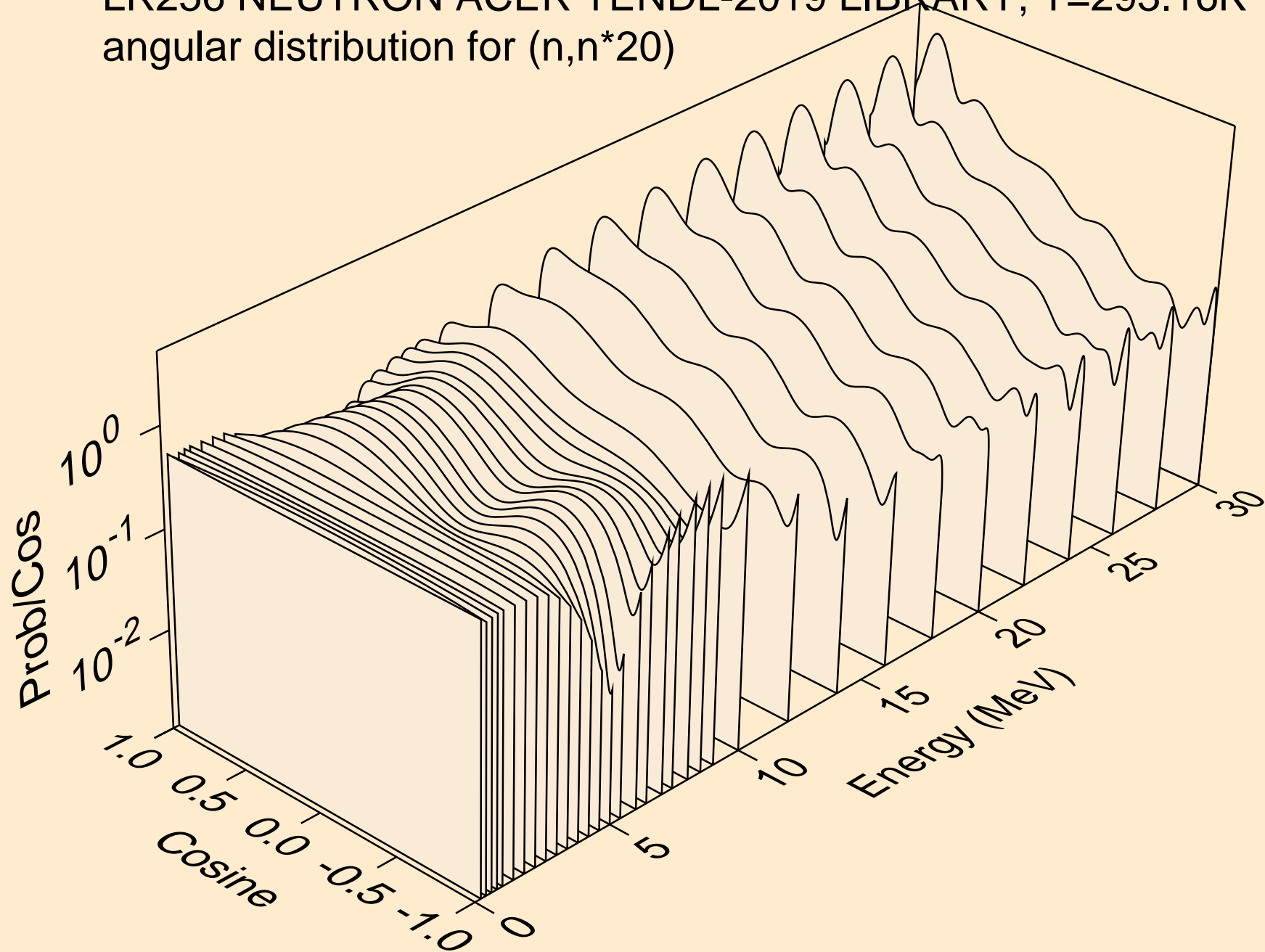

LR256 NEUTRON ACER TENDL-2019 LIBRARY; T=293.16K
angular distribution for (n,n*21)

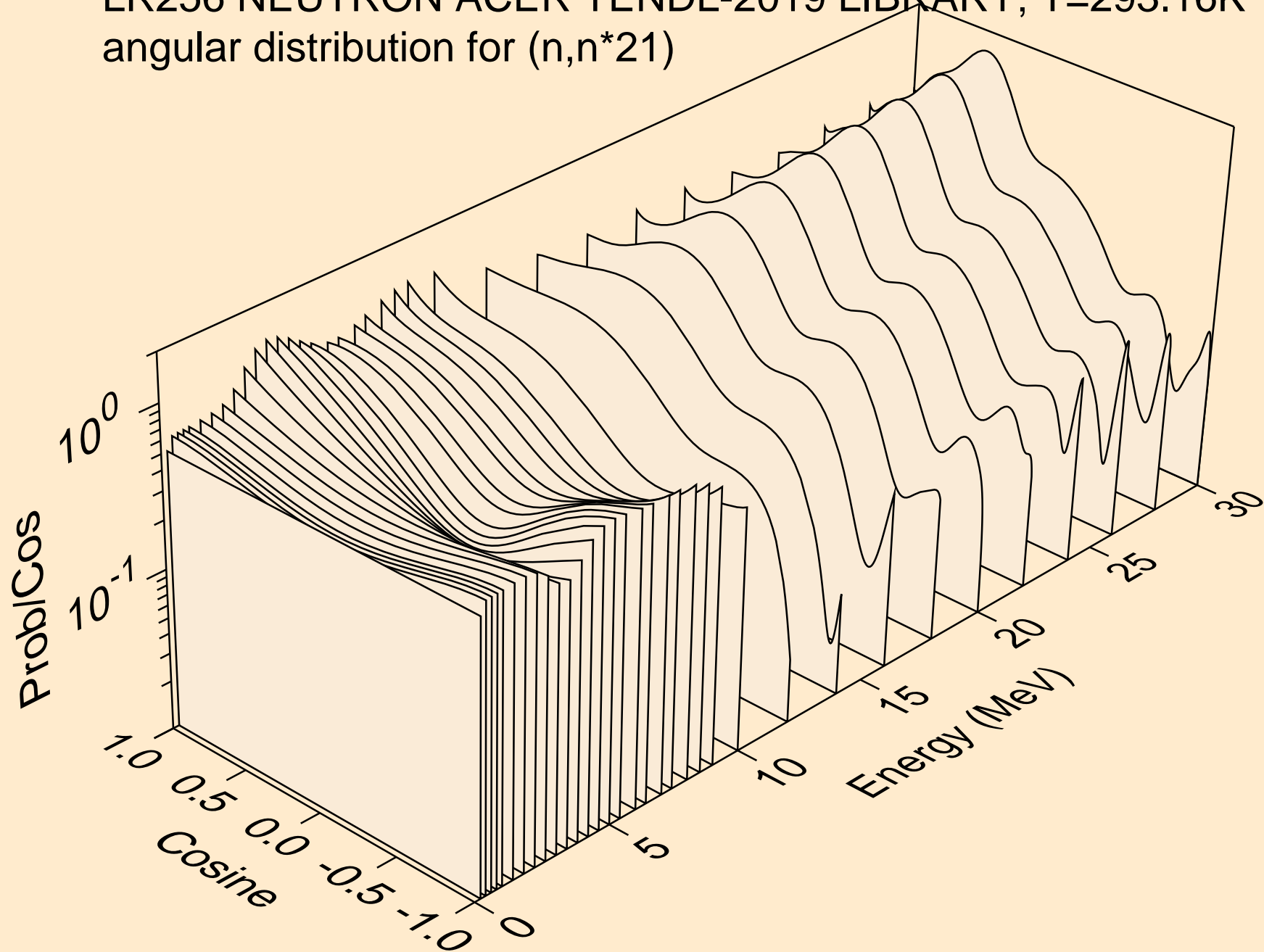

LR256 NEUTRON ACER TENDL-2019 LIBRARY; T=293.16K
angular distribution for (n,n*22)

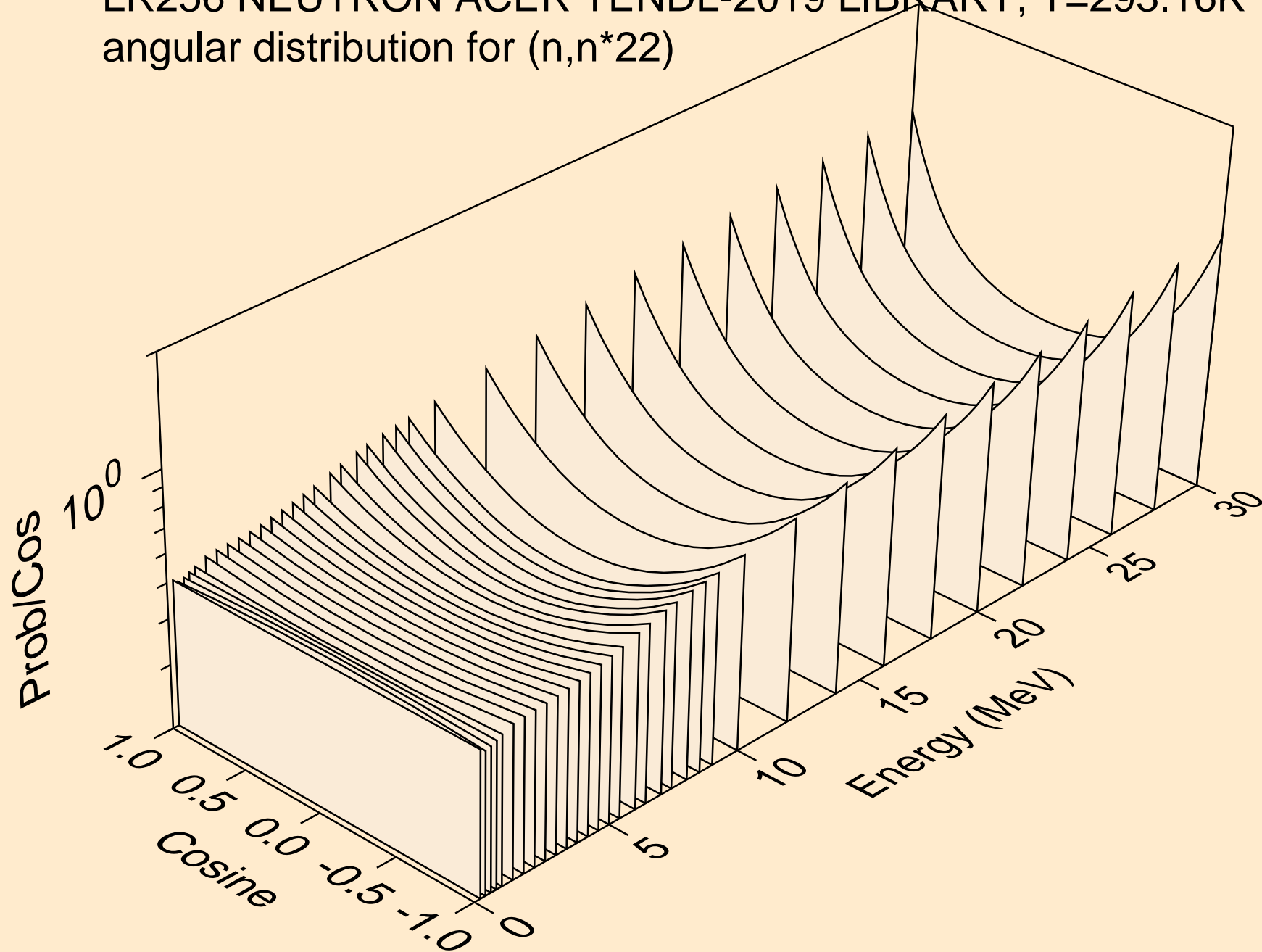

LR256 NEUTRON ACER TENDL-2019 LIBRARY; T=293.16K
angular distribution for (n,n*23)

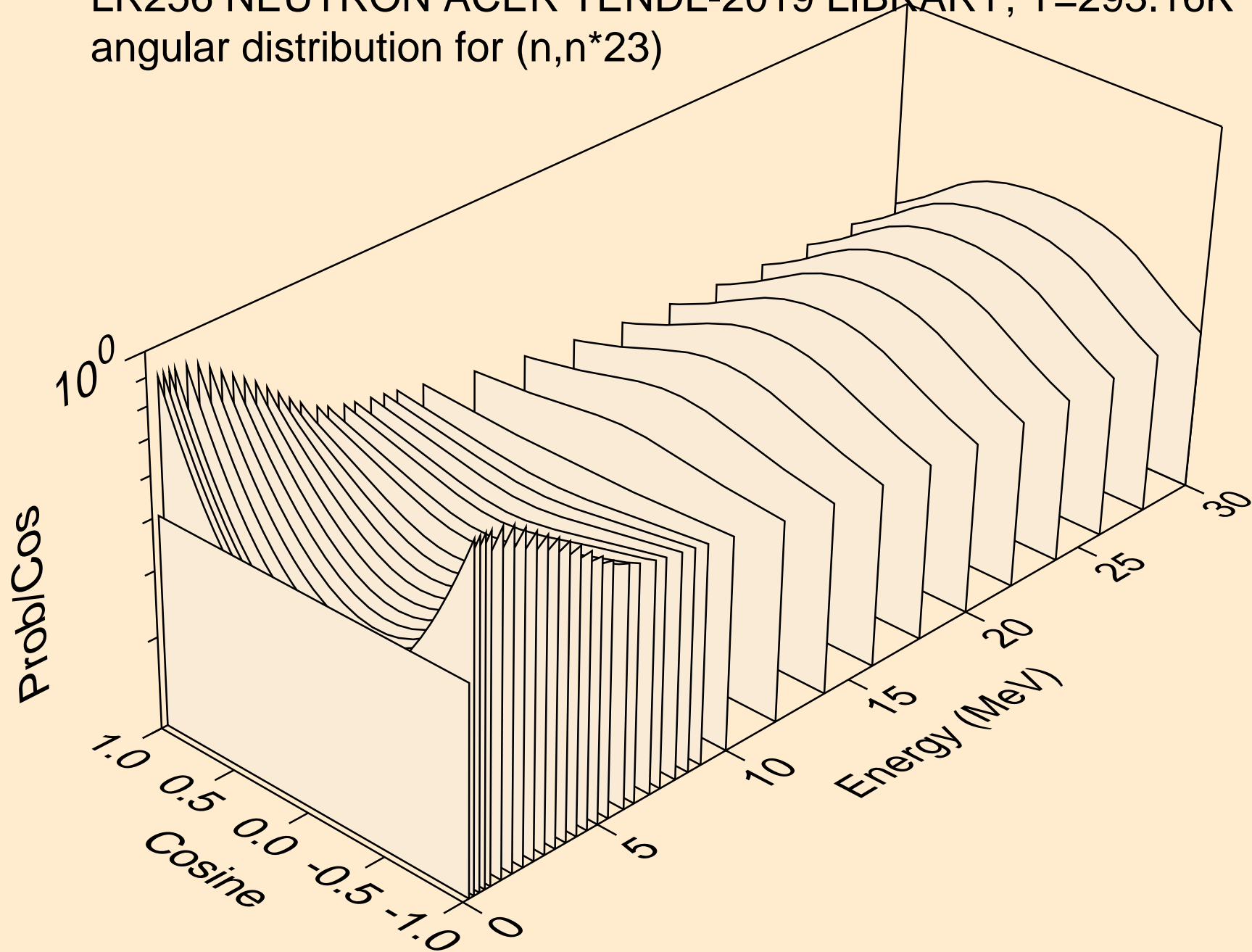

LR256 NEUTRON ACER TENDL-2019 LIBRARY; T=293.16K
angular distribution for (n,n*24)

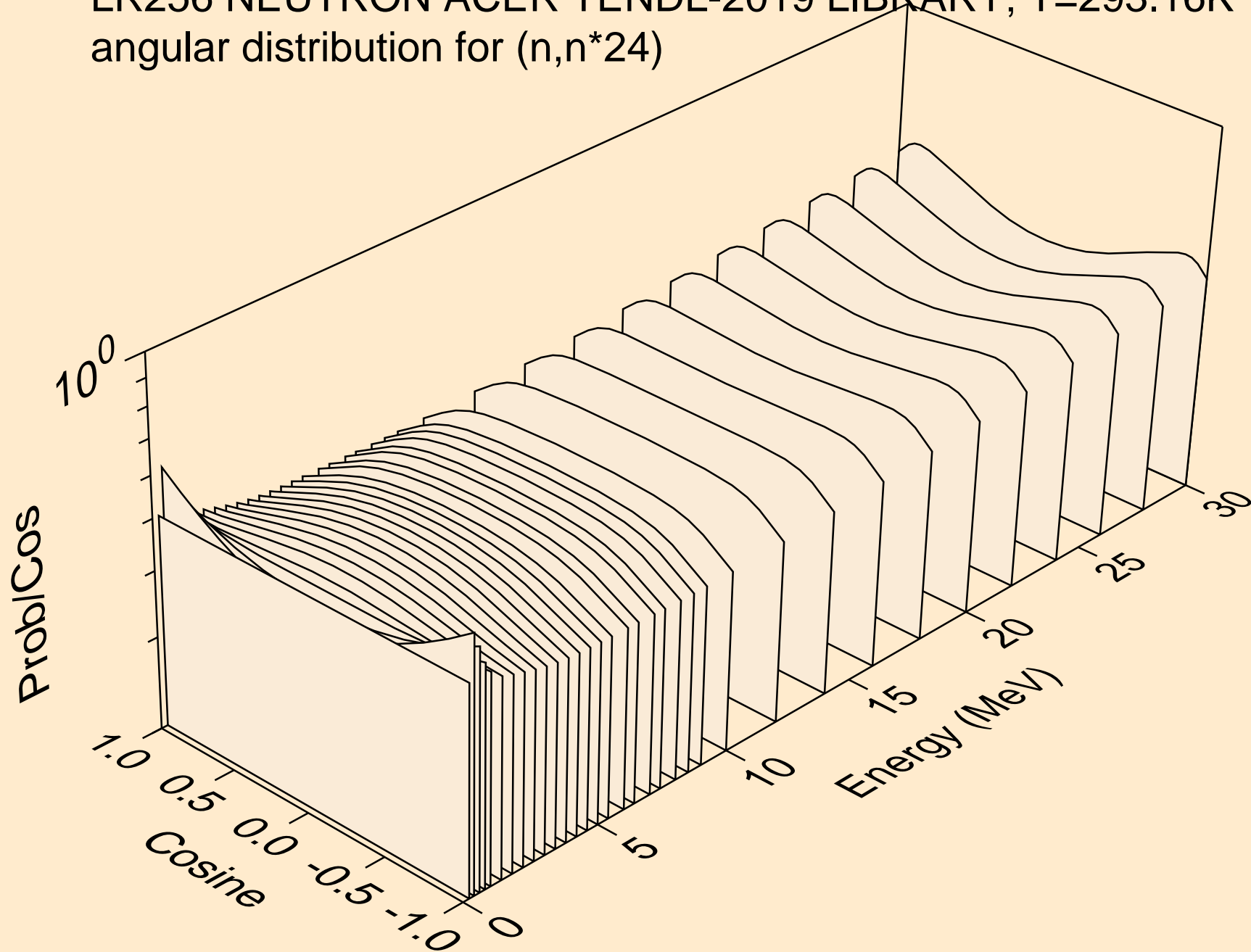

LR256 NEUTRON ACER TENDL-2019 LIBRARY; T=293.16K
angular distribution for (n,n*25)

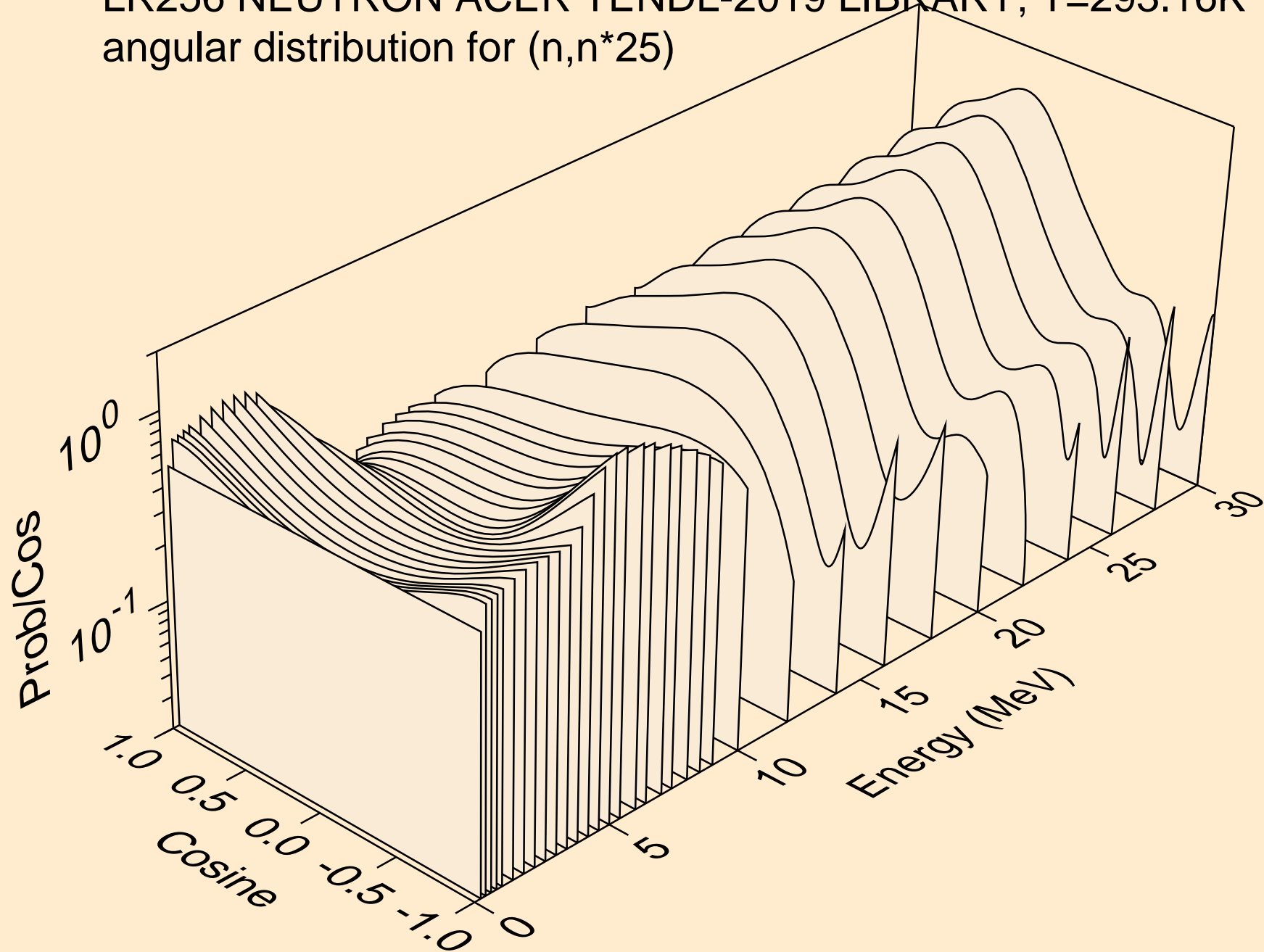

LR256 NEUTRON ACER TENDL-2019 LIBRARY; T=293.16K
angular distribution for (n,n*26)

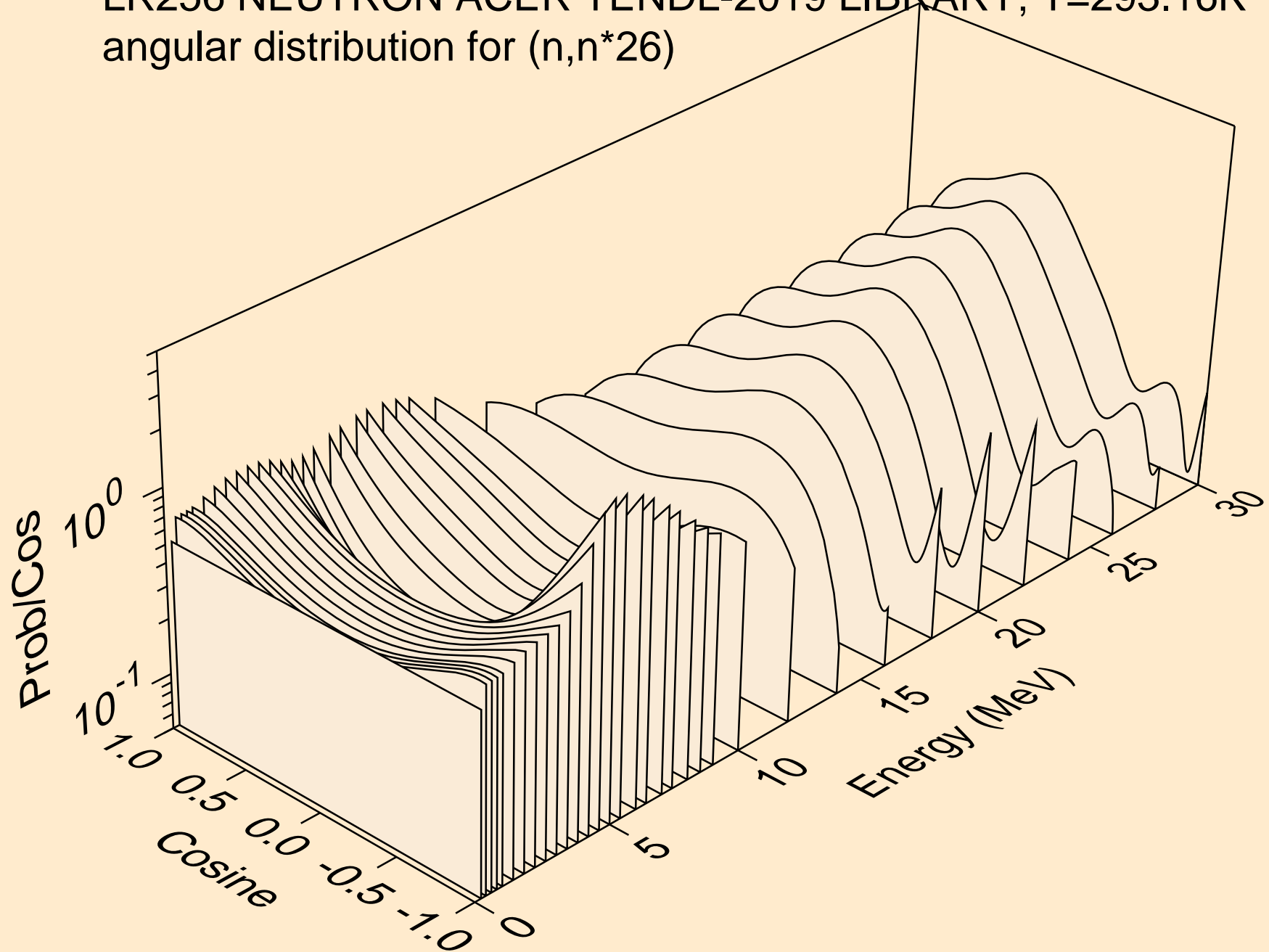

LR256 NEUTRON ACER TENDL-2019 LIBRARY; T=293.16K
angular distribution for (n,n*27)

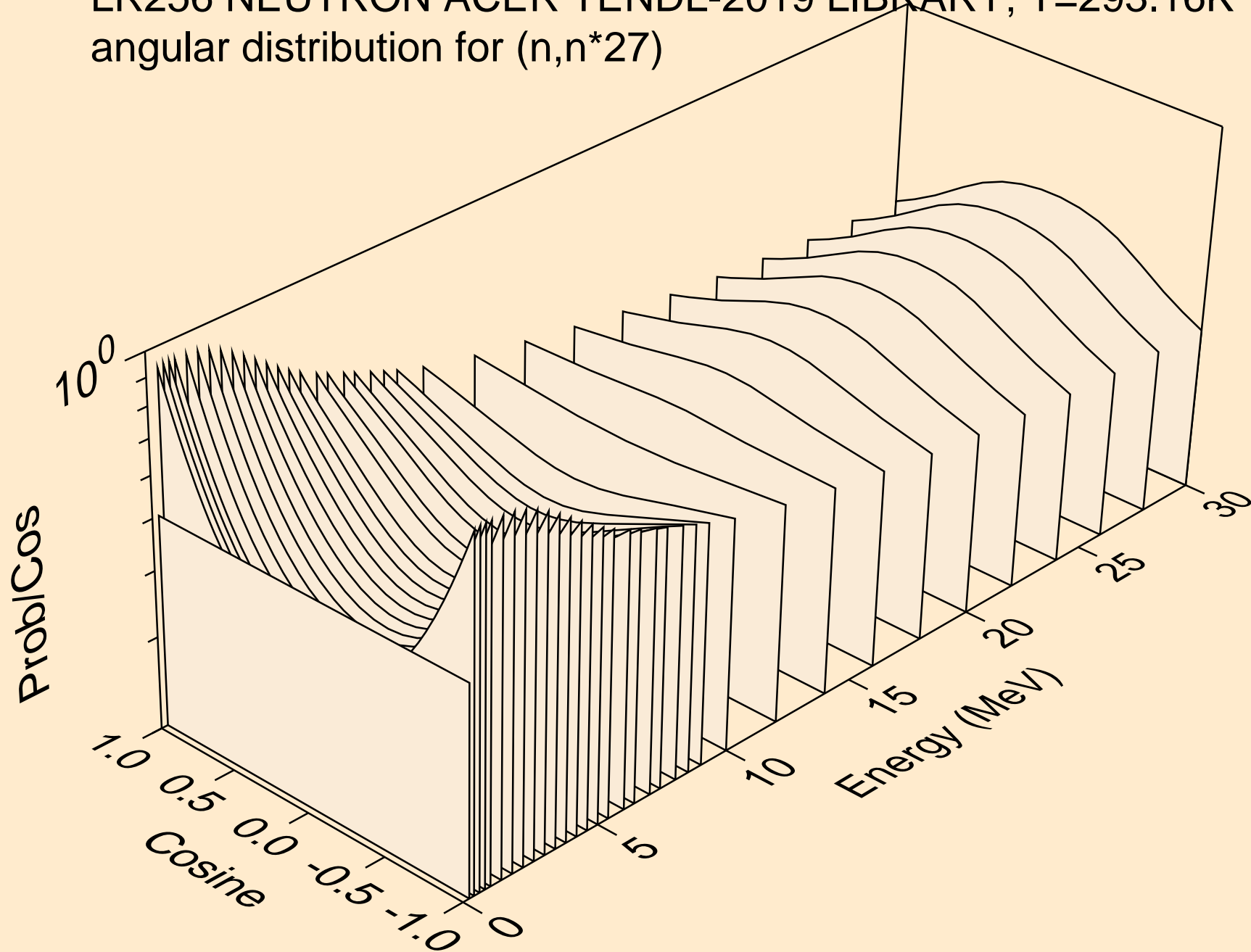

LR256 NEUTRON ACER TENDL-2019 LIBRARY; T=293.16K
angular distribution for (n,n*28)

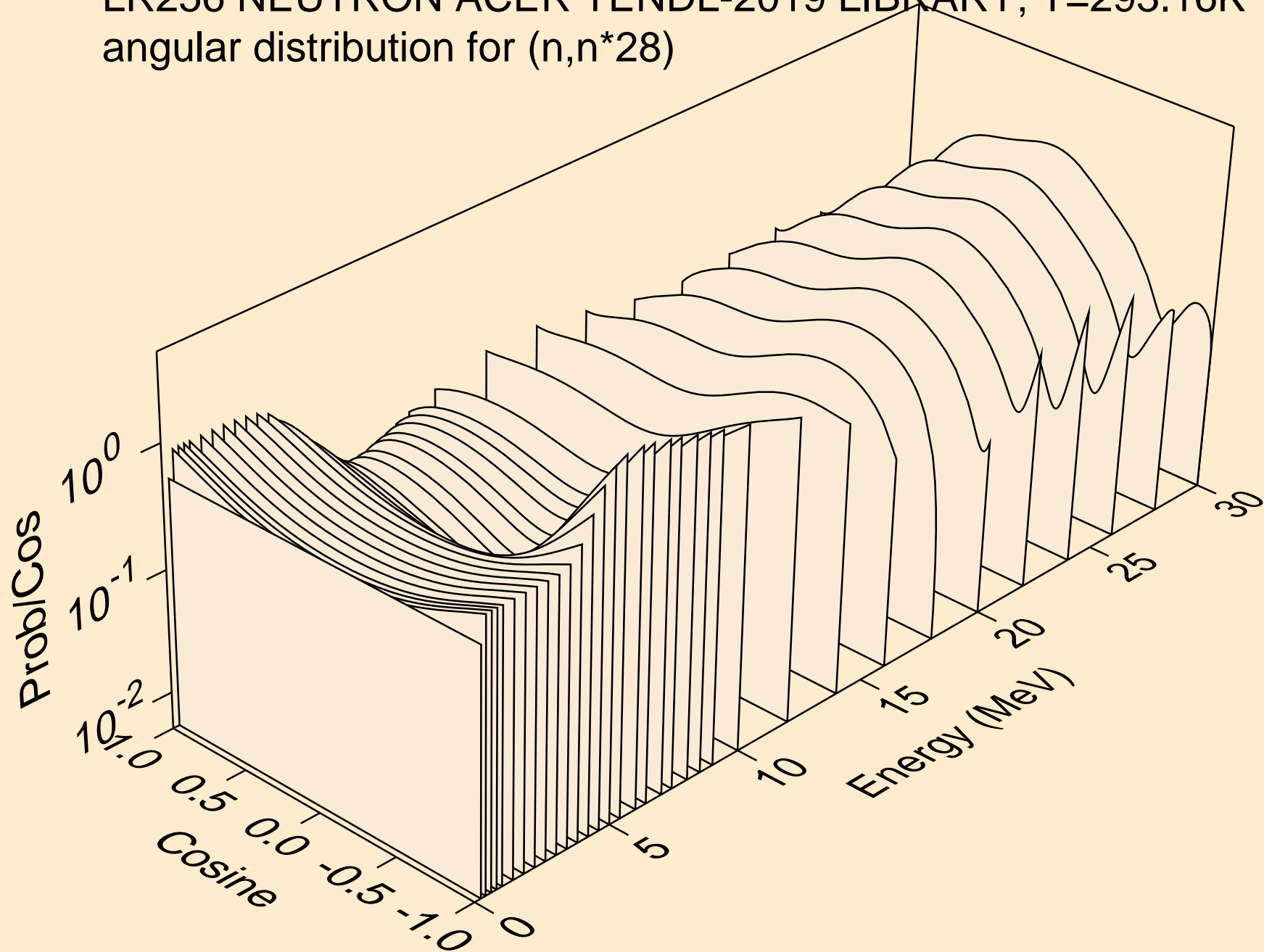

LR256 NEUTRON ACER TENDL-2019 LIBRARY; T=293.16K
angular distribution for (n,n*29)

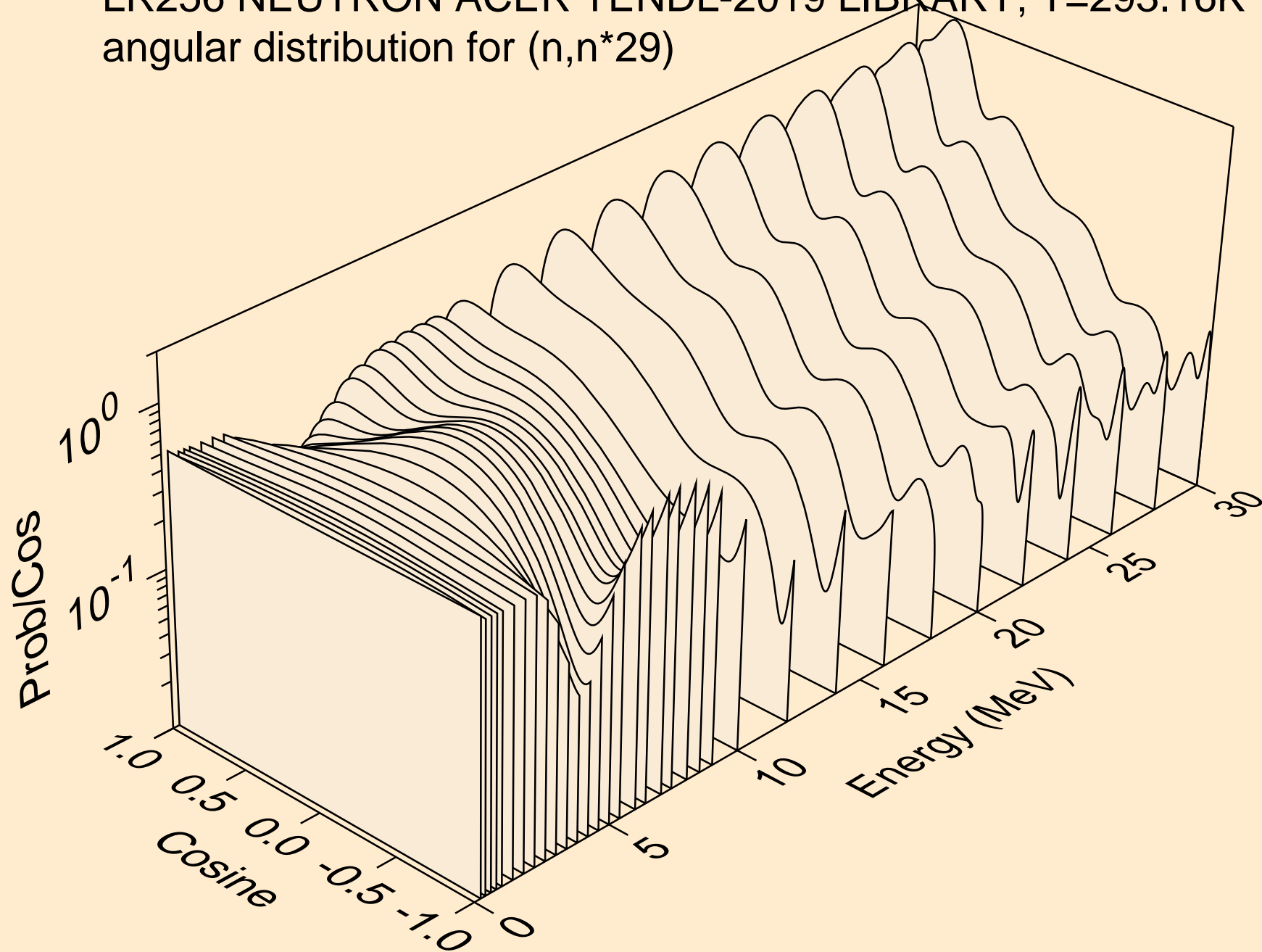

LR256 NEUTRON ACER TENDL-2019 LIBRARY; T=293.16K
Total fission nubar

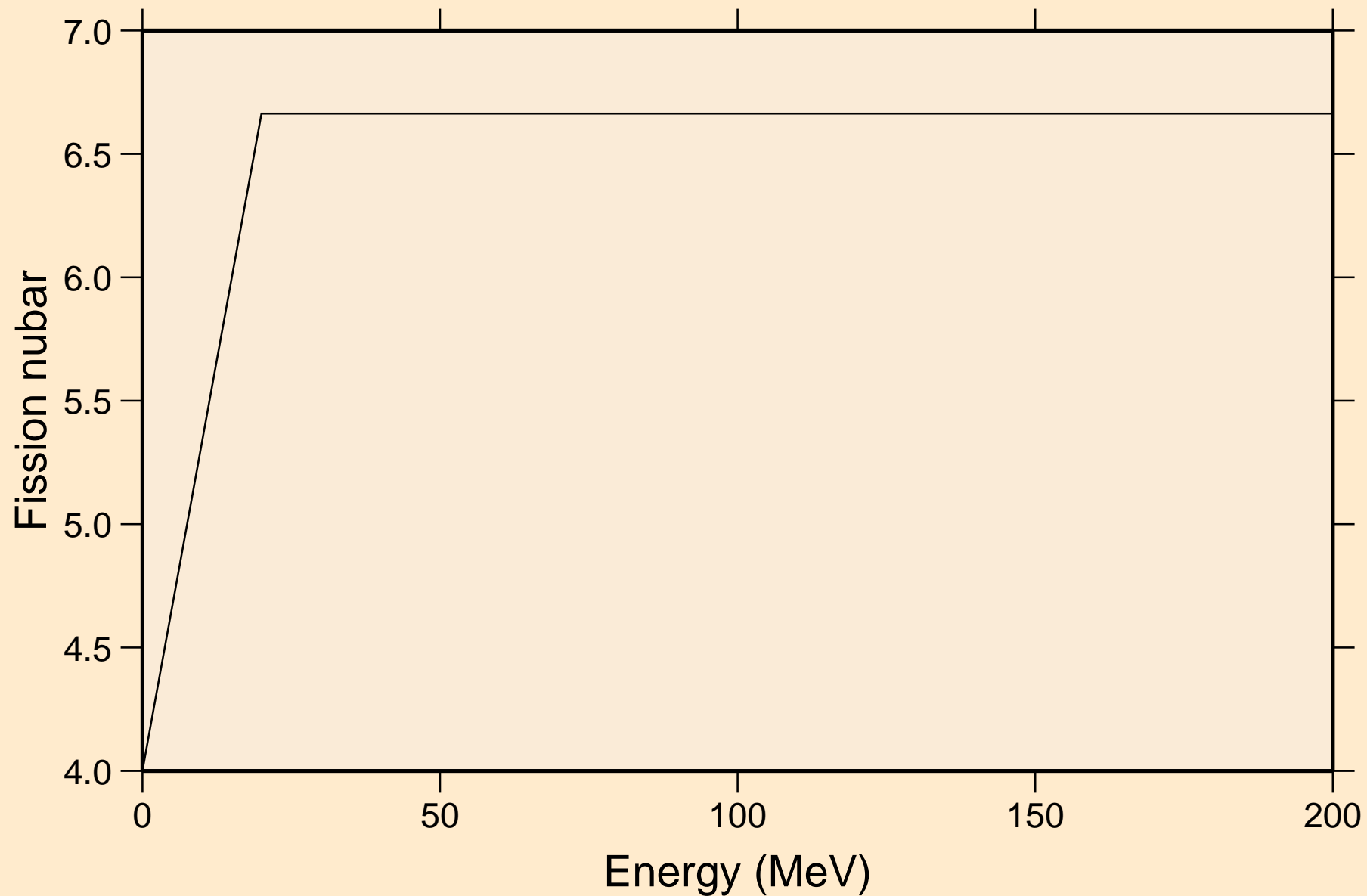

LR256 NEUTRON ACER TENDL-2019 LIBRARY; T=293.16K
Neutron emission for (n,x)

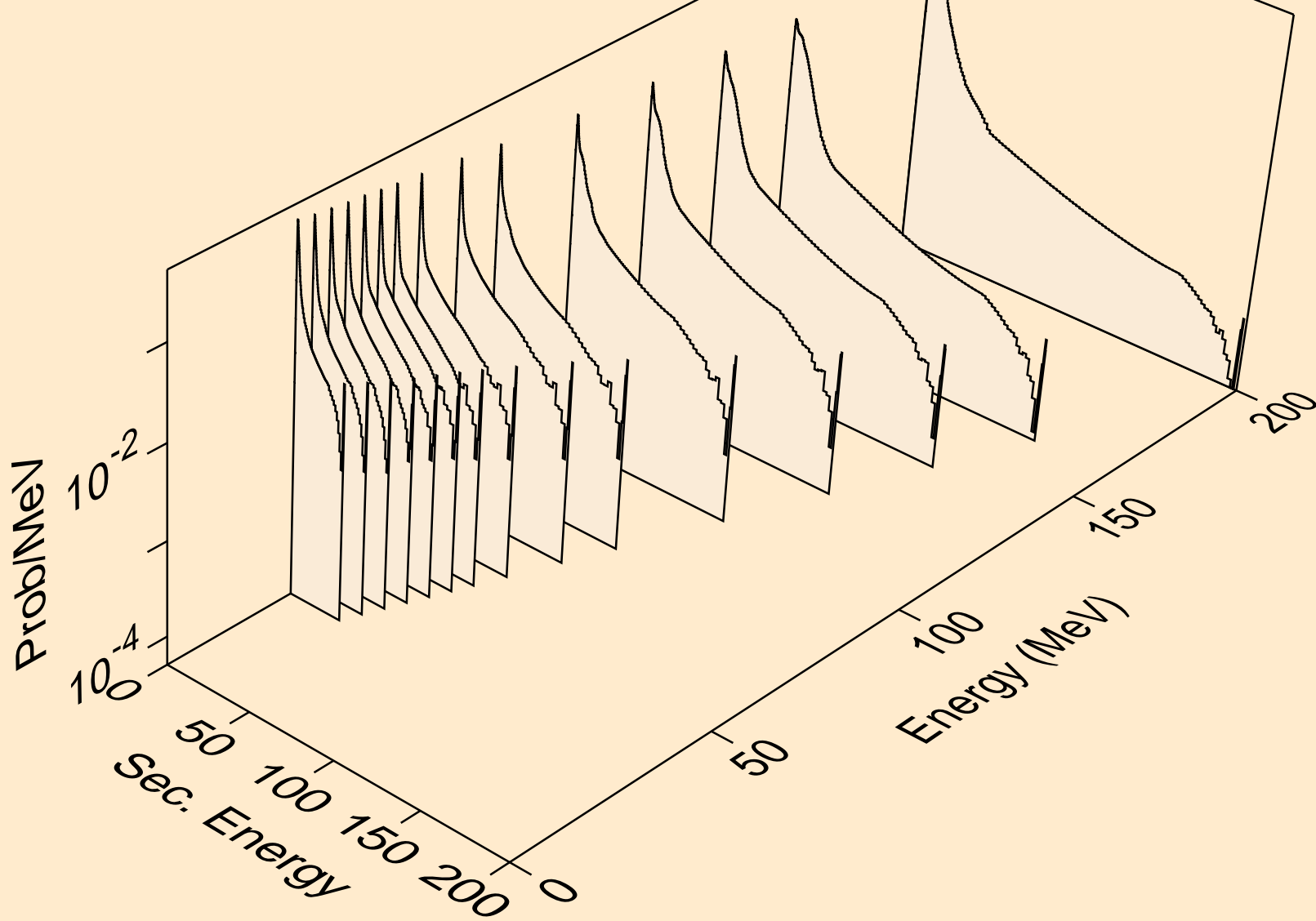

LR256 NEUTRON ACER TENDL-2019 LIBRARY; T=293.16K
Neutron emission for (n,2nd)

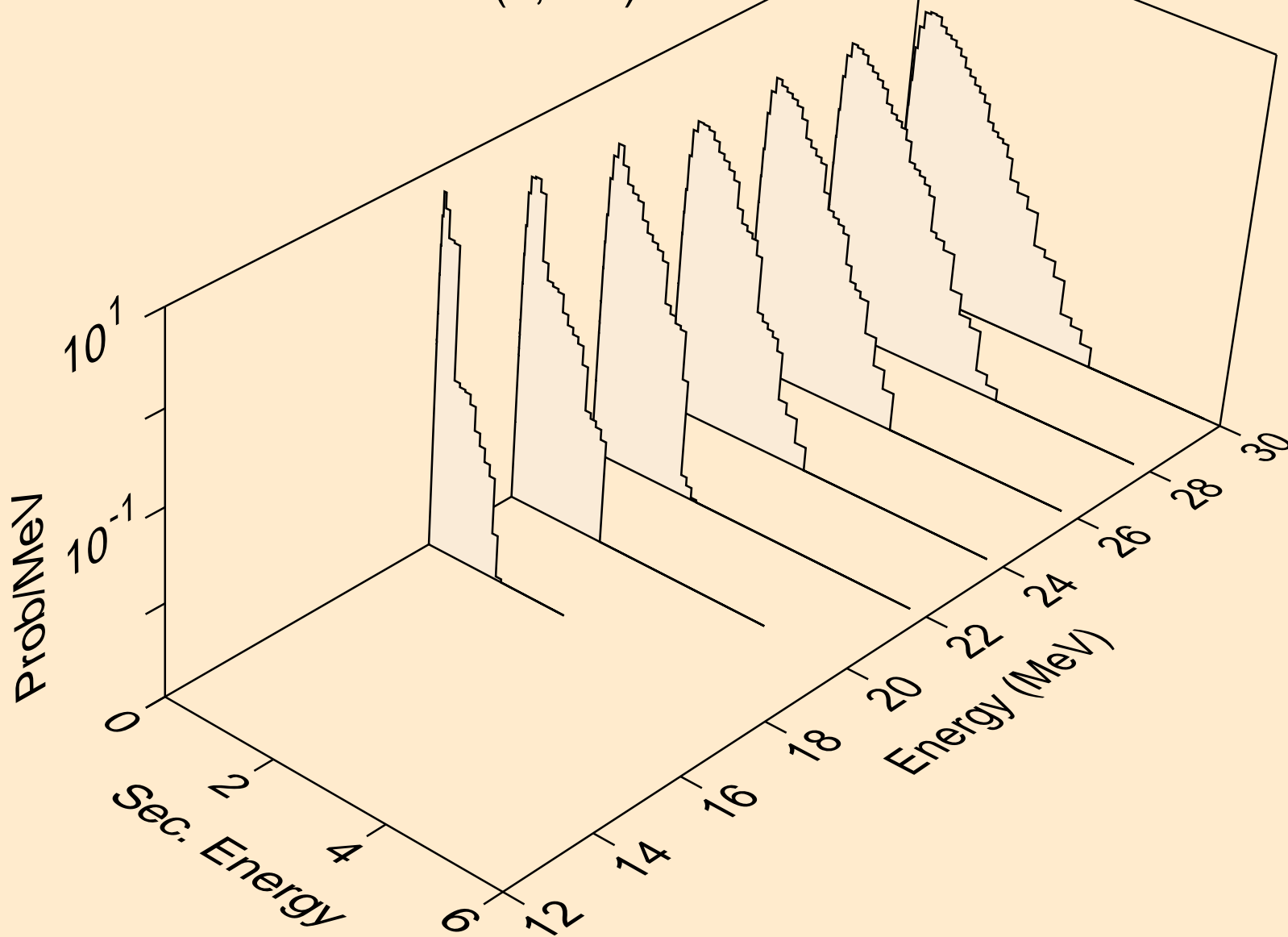

LR256 NEUTRON ACER TENDL-2019 LIBRARY; T=293.16K
Neutron emission for (n,2n)

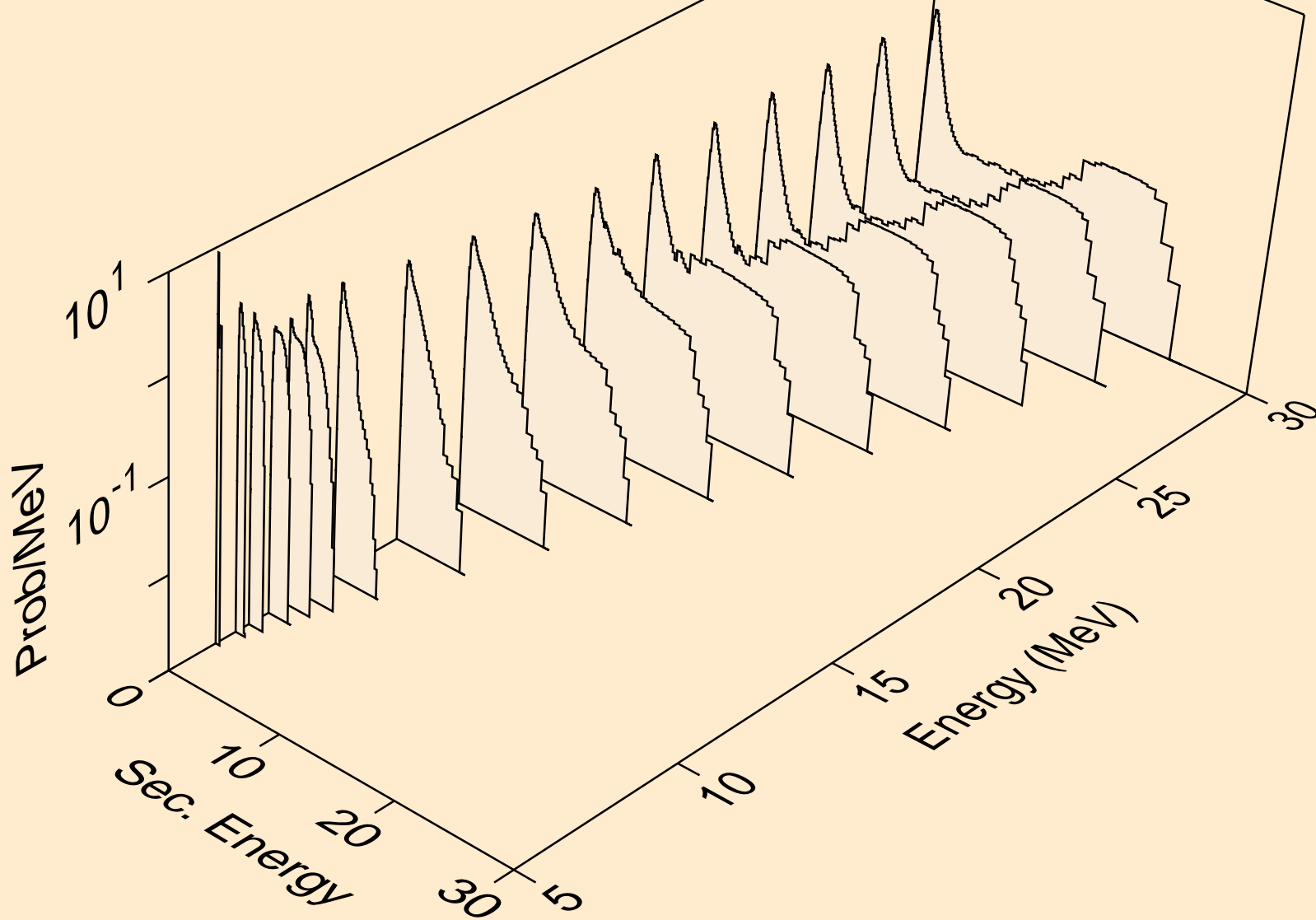

LR256 NEUTRON ACER TENDL-2019 LIBRARY; T=293.16K
Neutron emission for (n,3n)

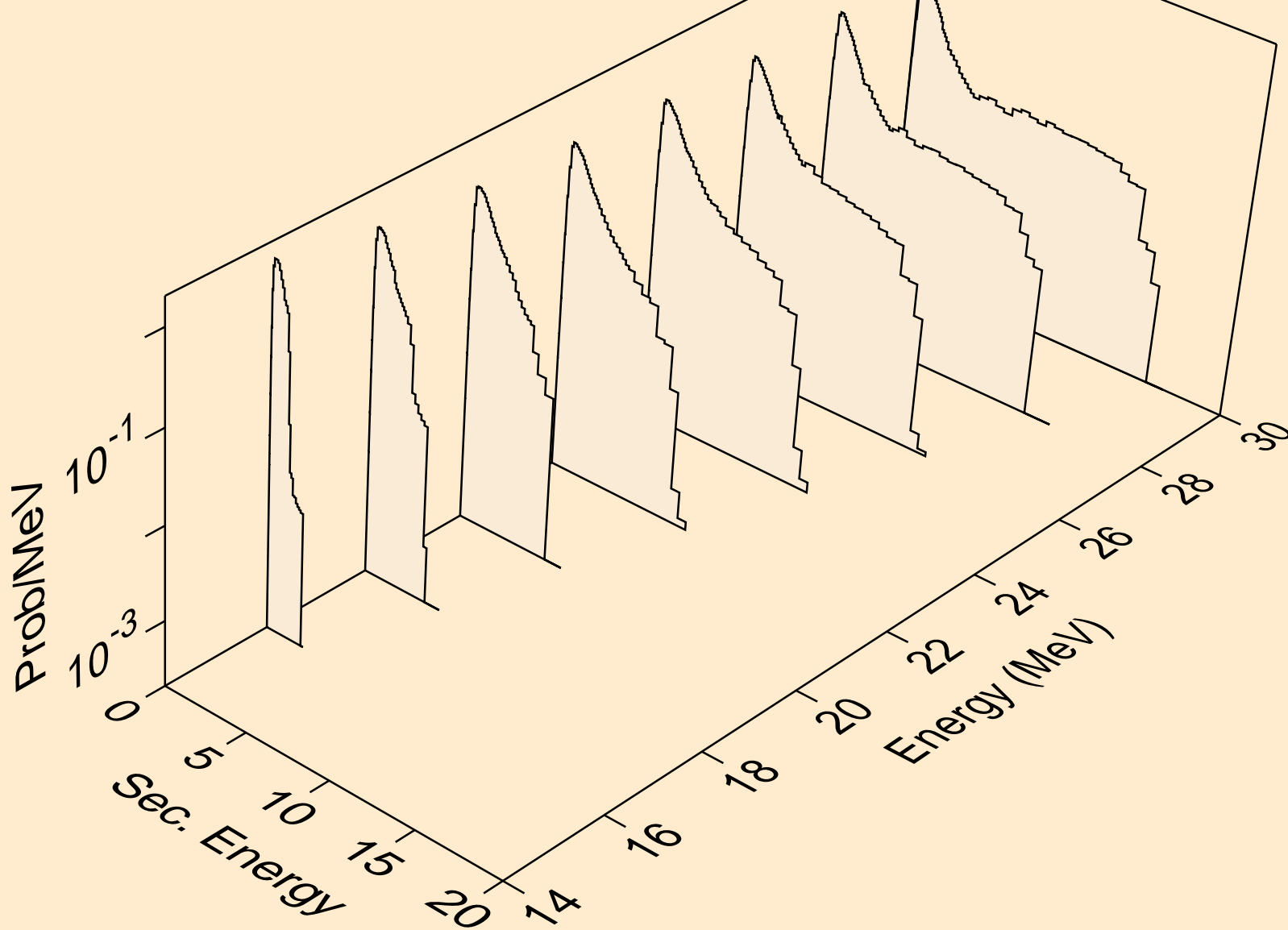

LR256 NEUTRON ACER TENDL-2019 LIBRARY; T=293.16K
Neutron emission for fission

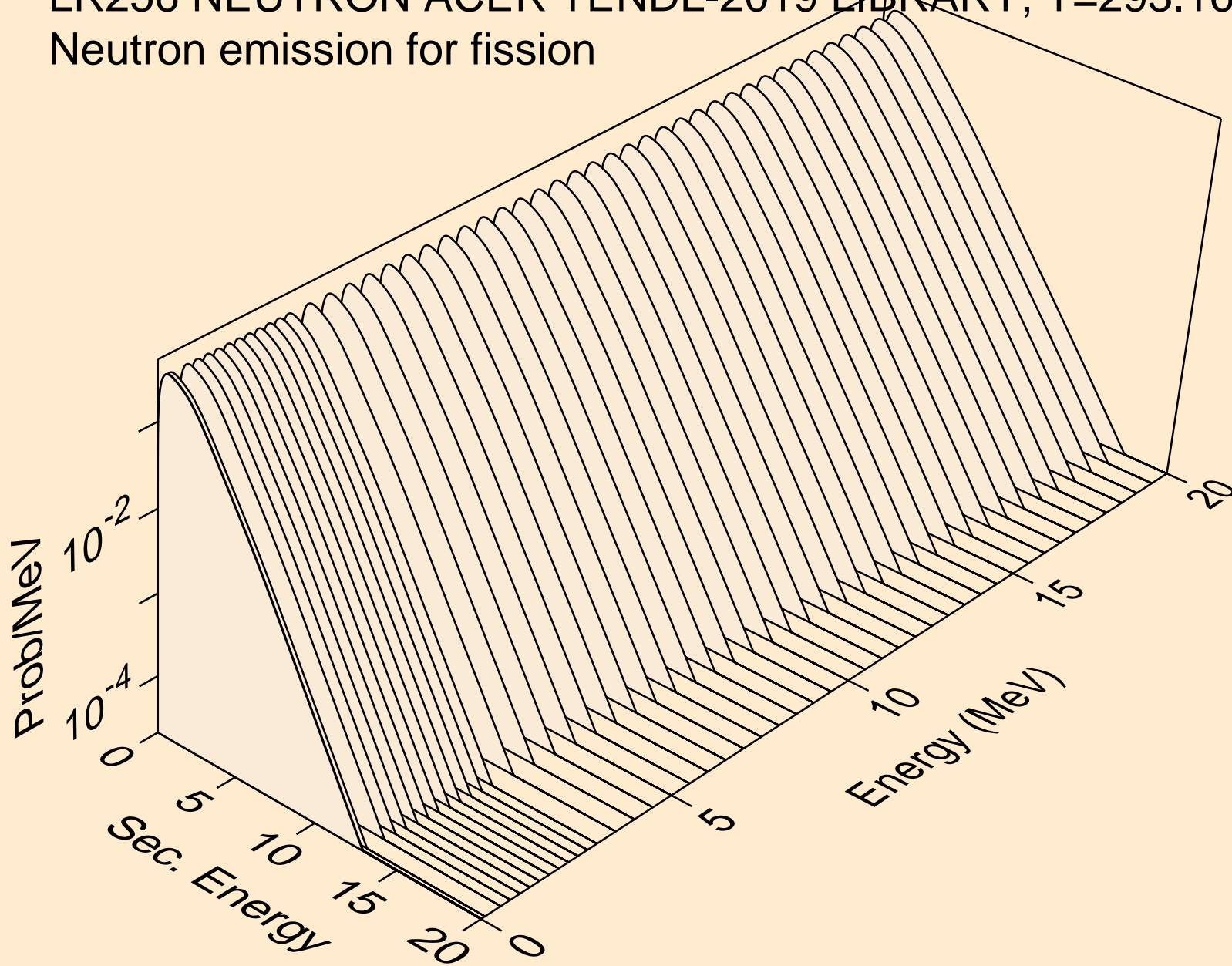

LR256 NEUTRON ACER TENDL-2019 LIBRARY; T=293.16K
Neutron emission for (n,n*)a

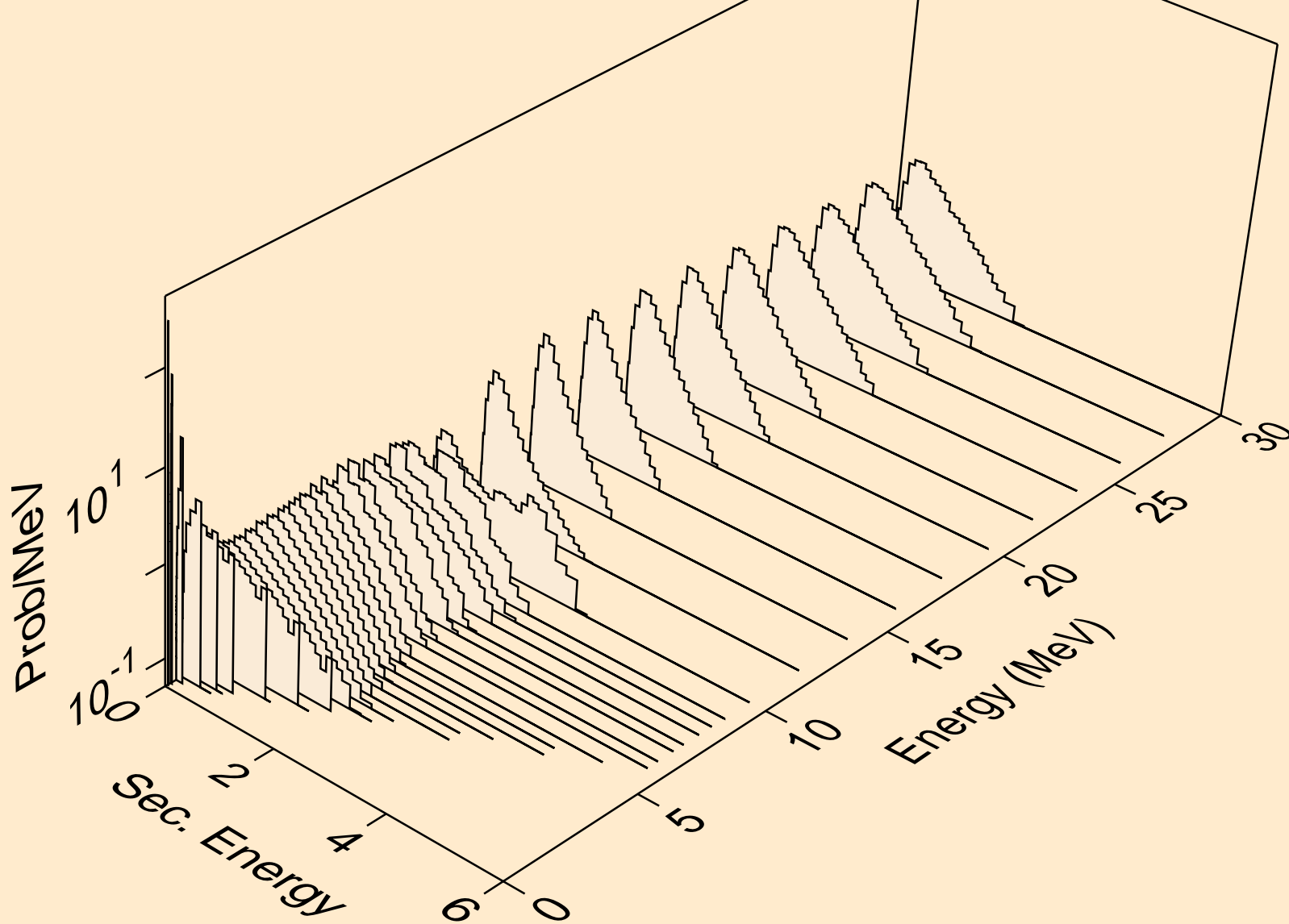

LR256 NEUTRON ACER TENDL-2019 LIBRARY; T=293.16K
Neutron emission for (n,2n)a

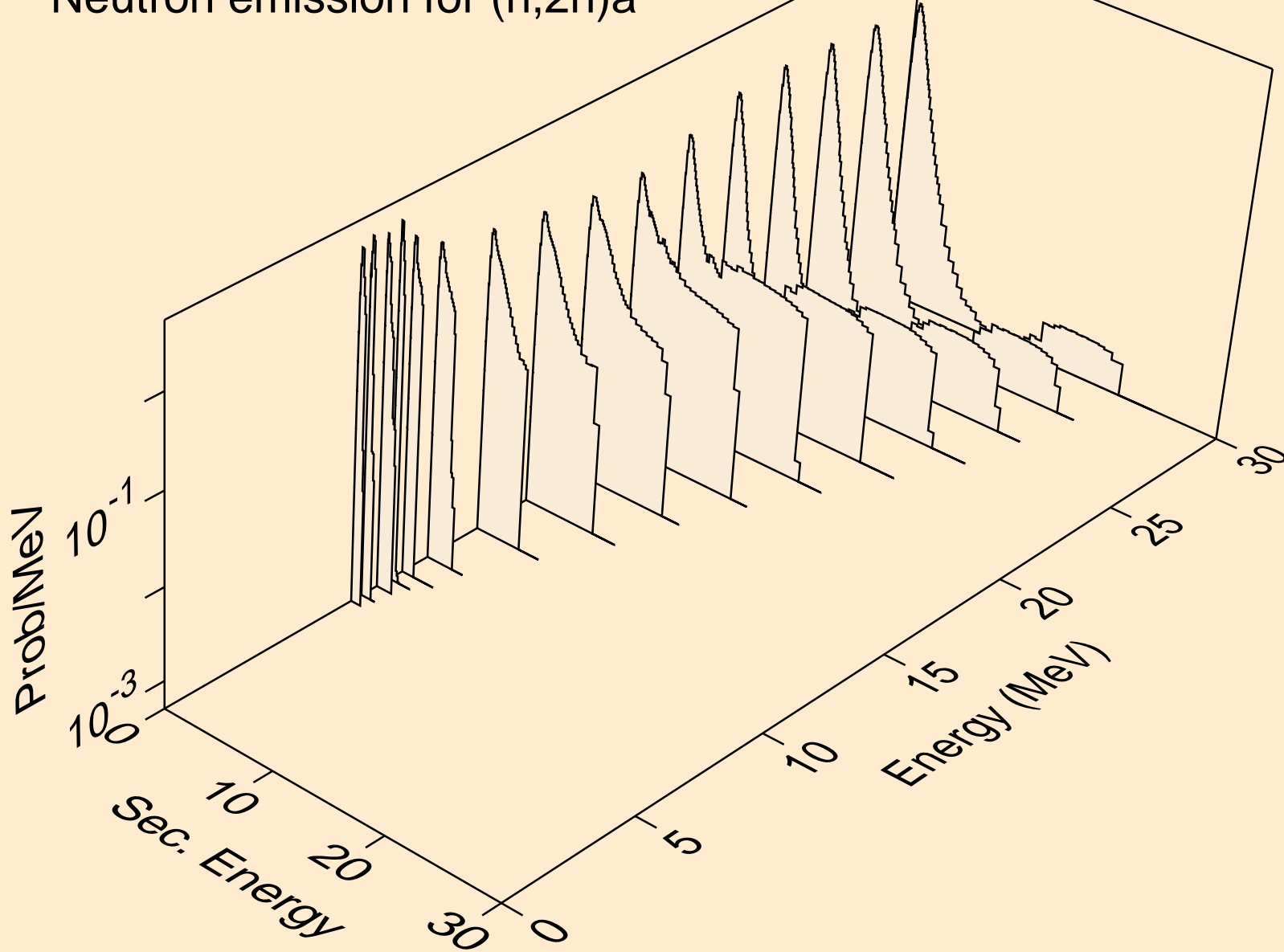

LR256 NEUTRON ACER TENDL-2019 LIBRARY; T=293.16K
Neutron emission for (n,3n)a

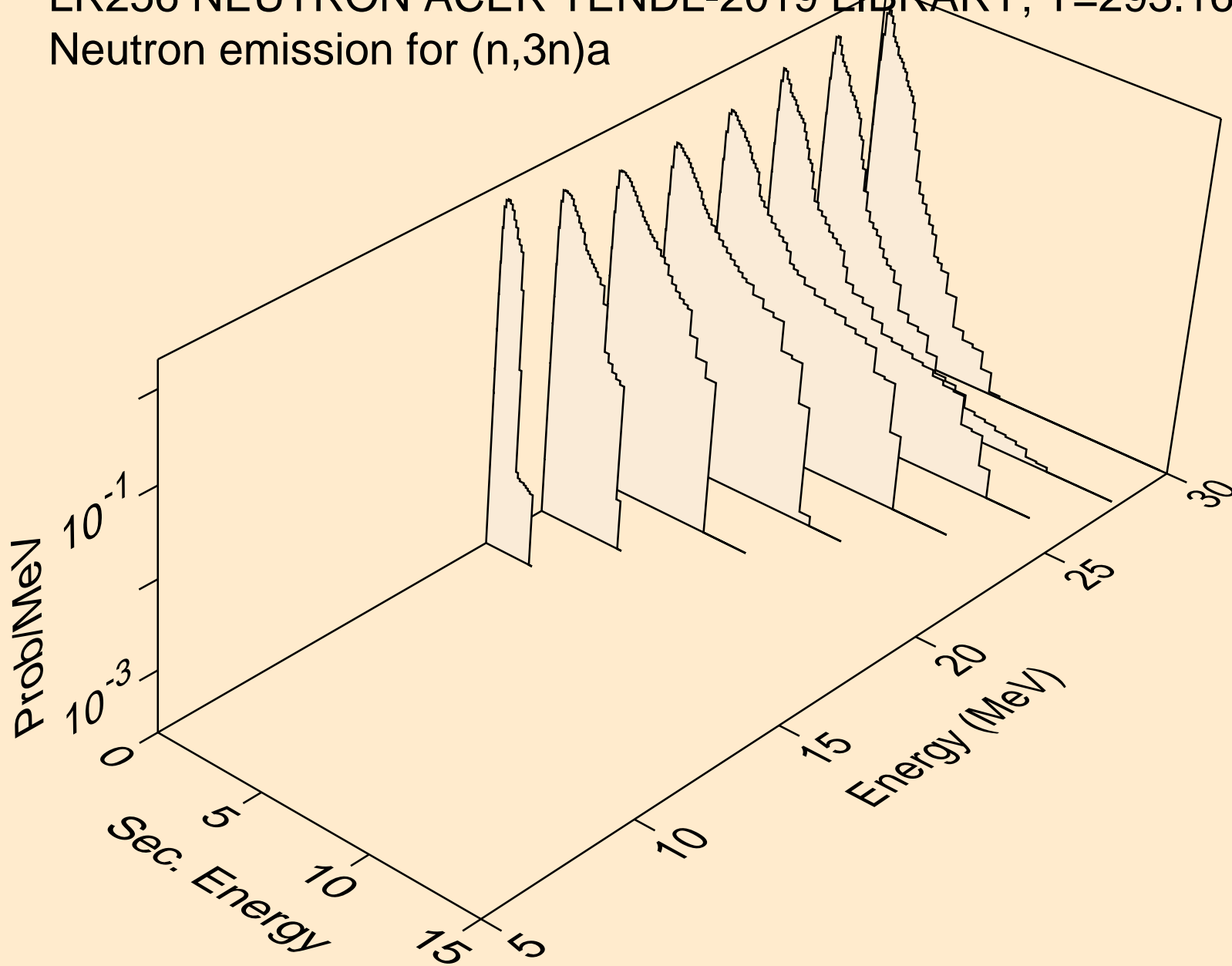

LR256 NEUTRON ACER TENDL-2019 LIBRARY; T=293.16K
Neutron emission for (n,n*)p

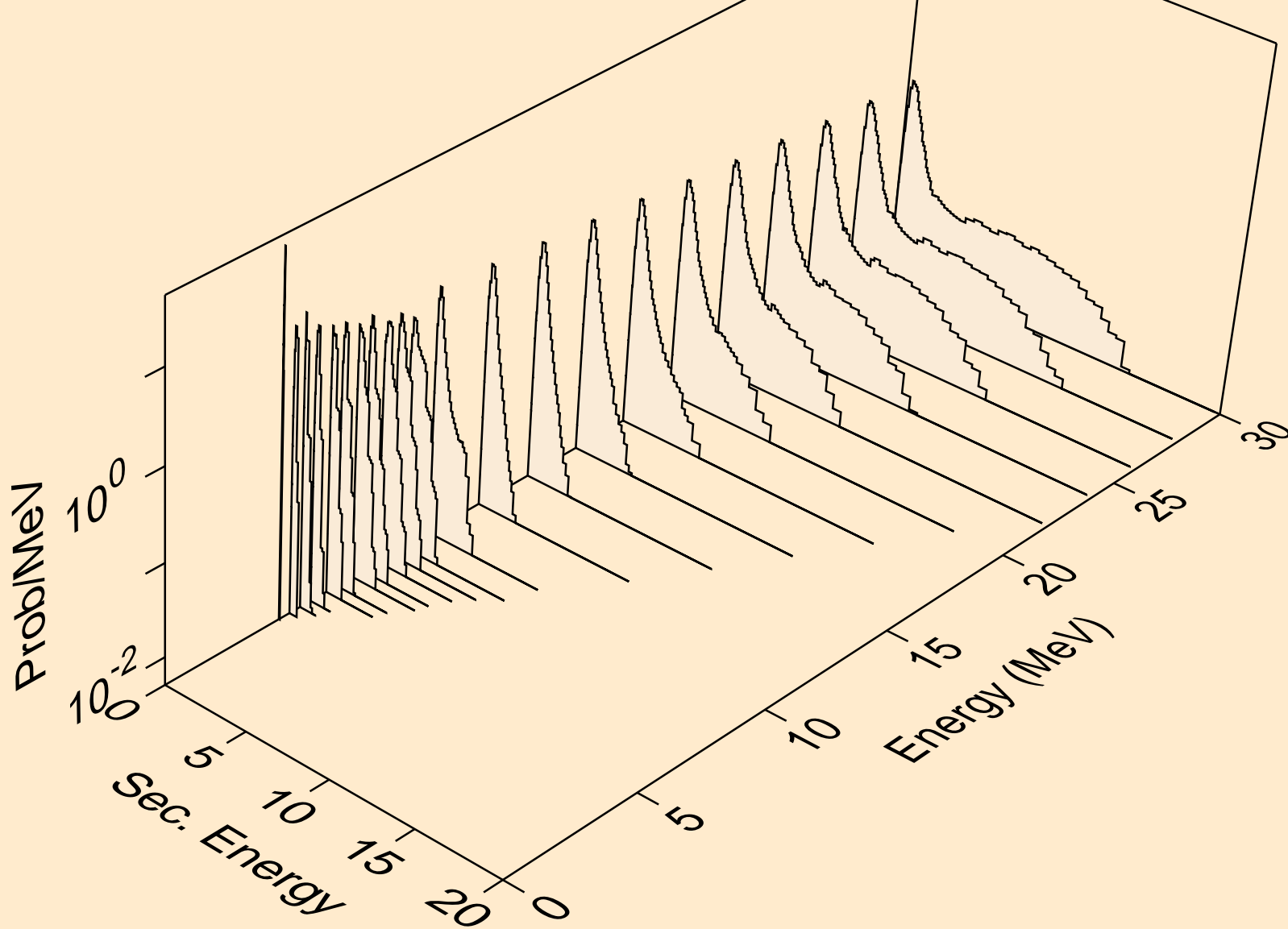

LR256 NEUTRON ACER TENDL-2019 LIBRARY; T=293.16K
Neutron emission for (n,n*)2a

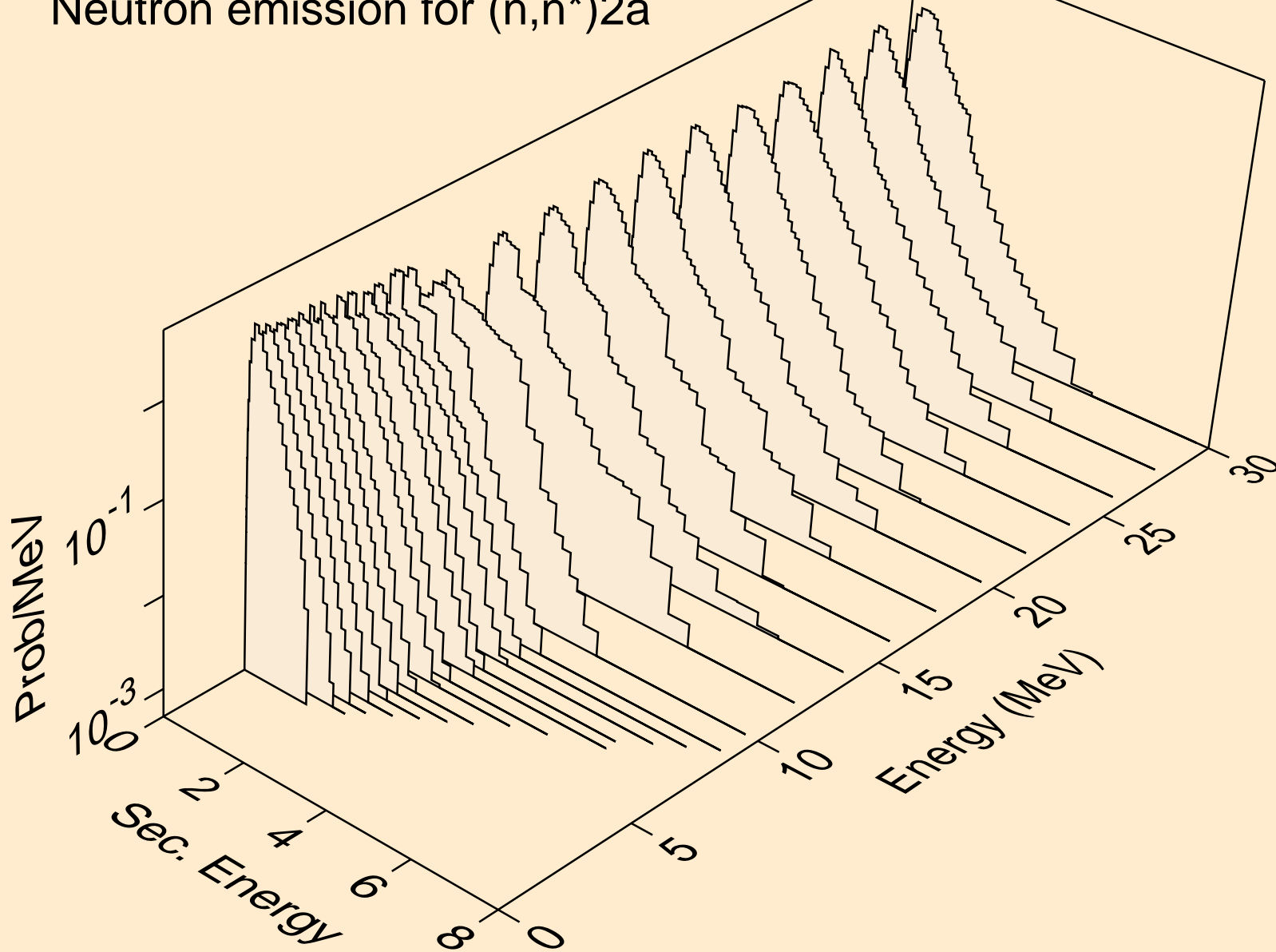

LR256 NEUTRON ACER TENDL-2019 LIBRARY; T=293.16K
Neutron emission for (n,2n)2a

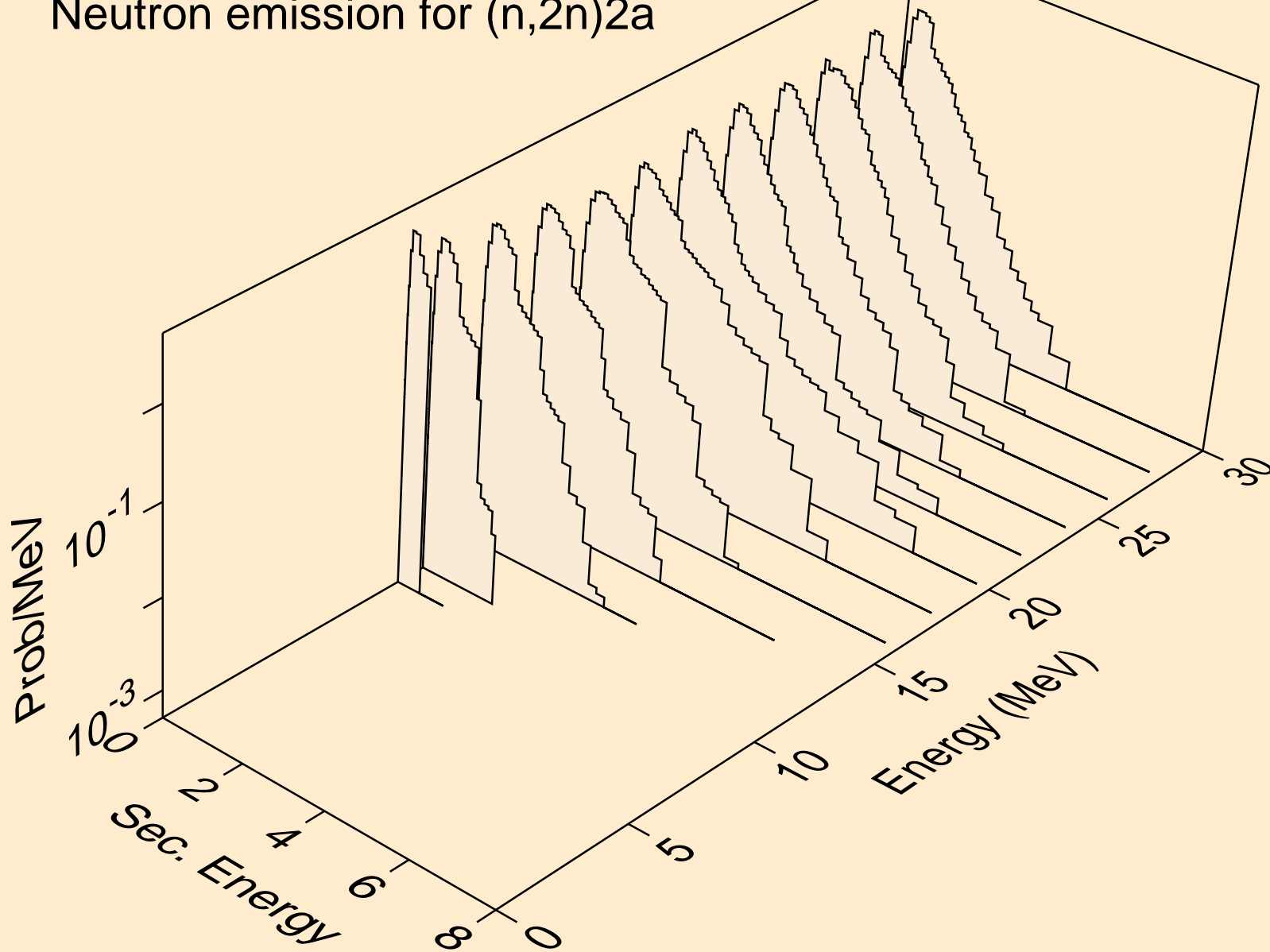

LR256 NEUTRON ACER TENDL-2019 LIBRARY; T=293.16K
Neutron emission for (n,n*)d

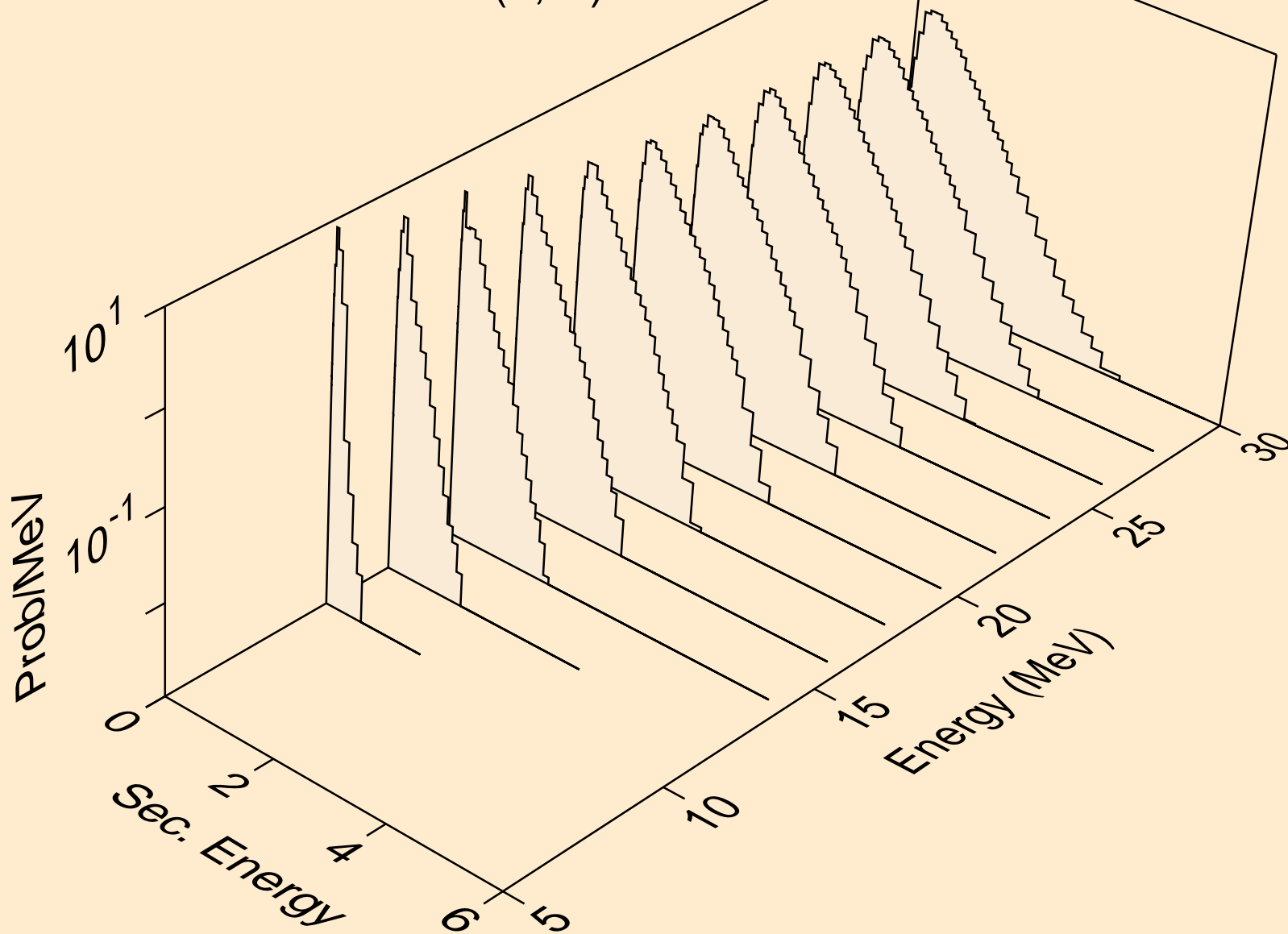

LR256 NEUTRON ACER TENDL-2019 LIBRARY; T=293.16K
Neutron emission for (n,n*)t

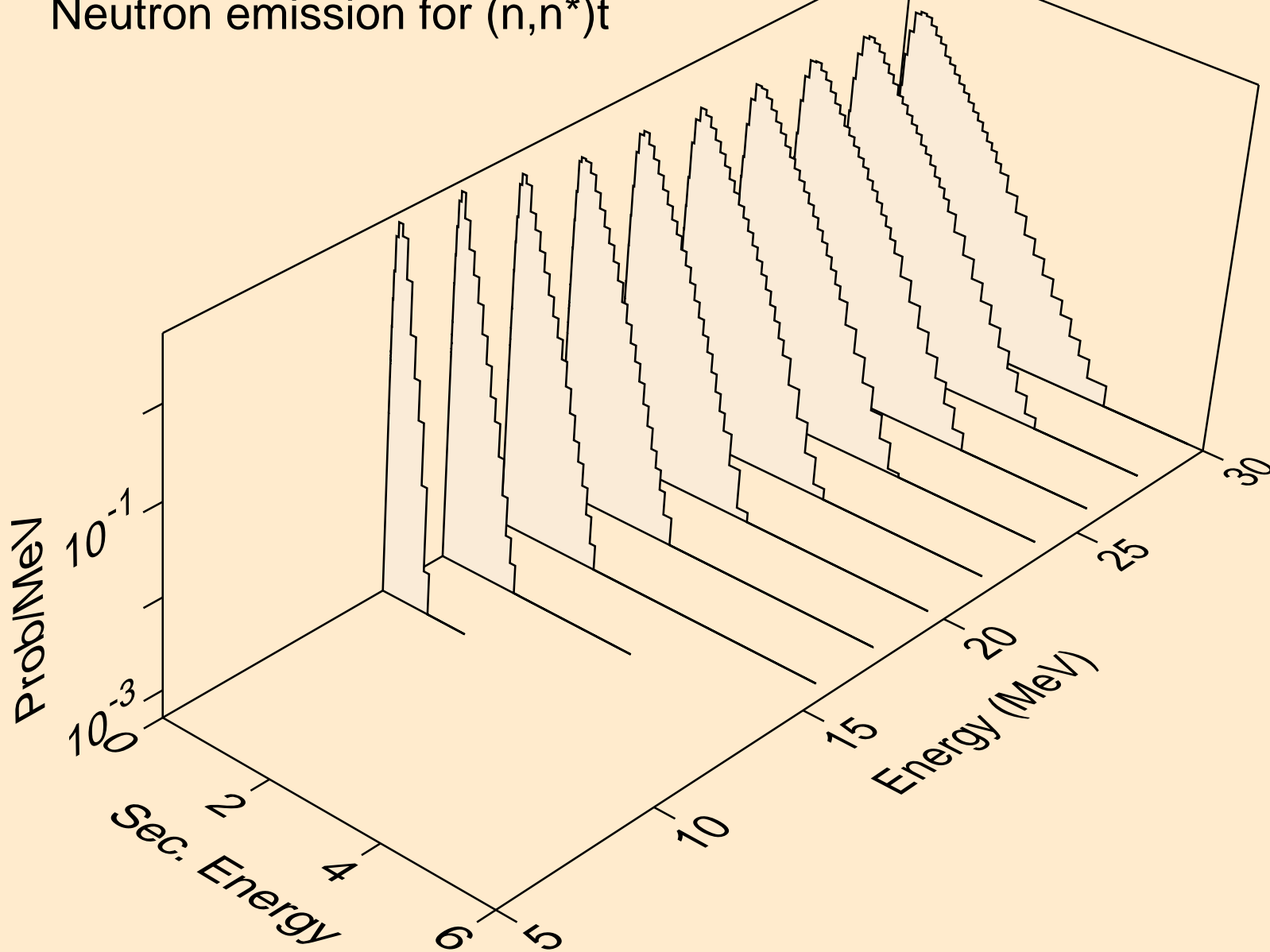

LR256 NEUTRON ACER TENDL-2019 LIBRARY; T=293.16K
Neutron emission for (n,n*)he3

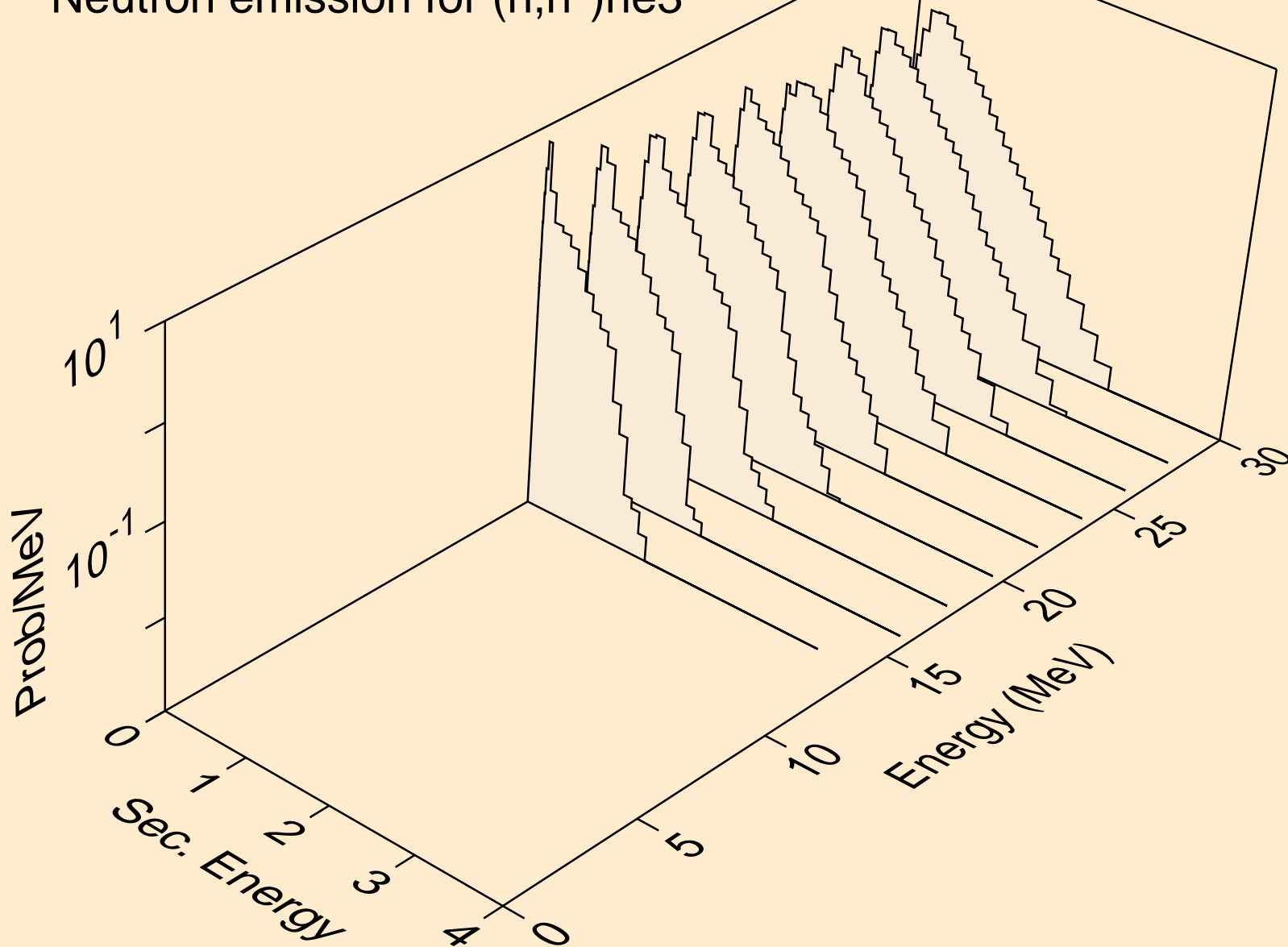

LR256 NEUTRON ACER TENDL-2019 LIBRARY; T=293.16K
Neutron emission for (n,4n)

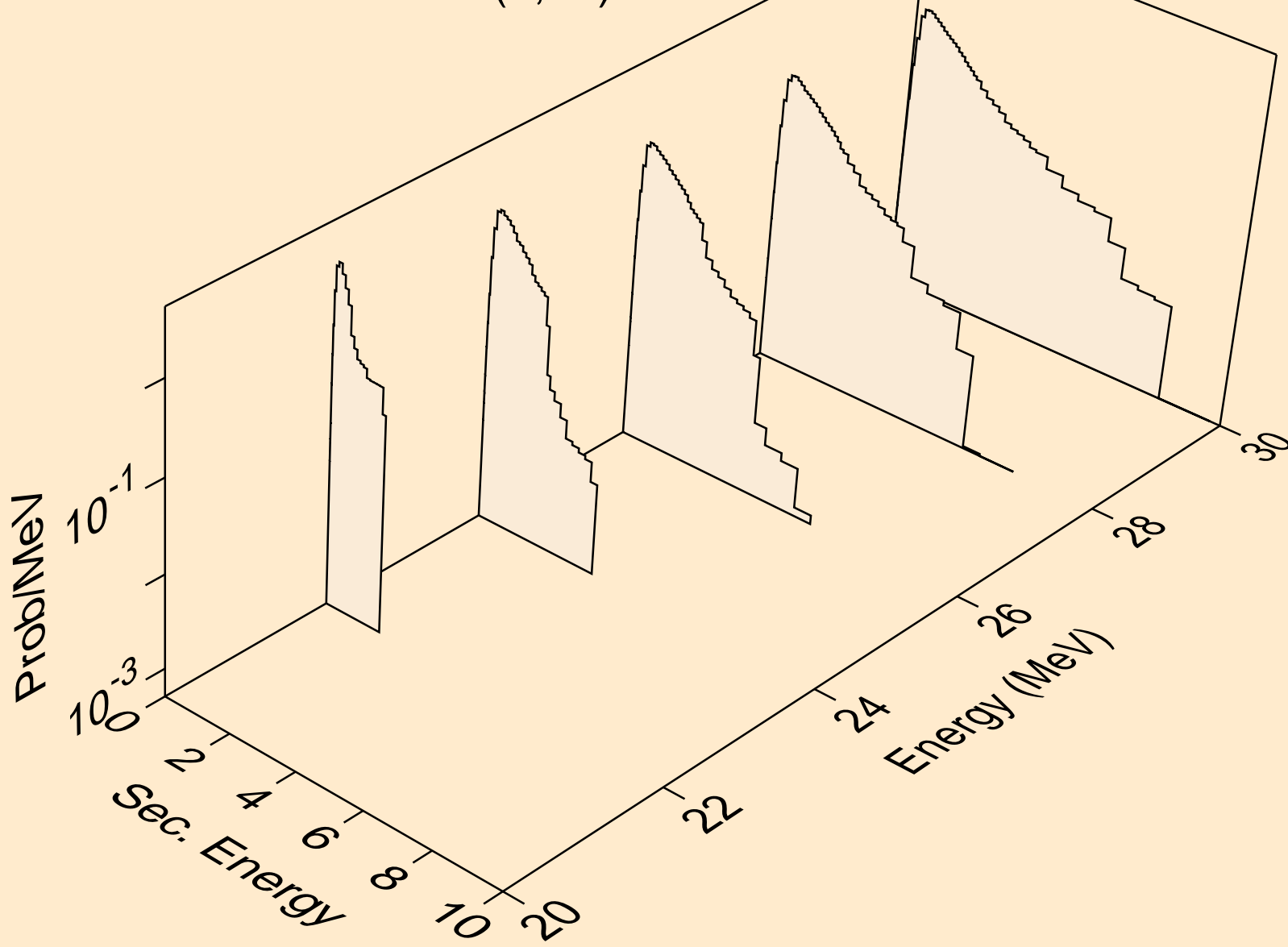

LR256 NEUTRON ACER TENDL-2019 LIBRARY; T=293.16K
Neutron emission for (n,2np)

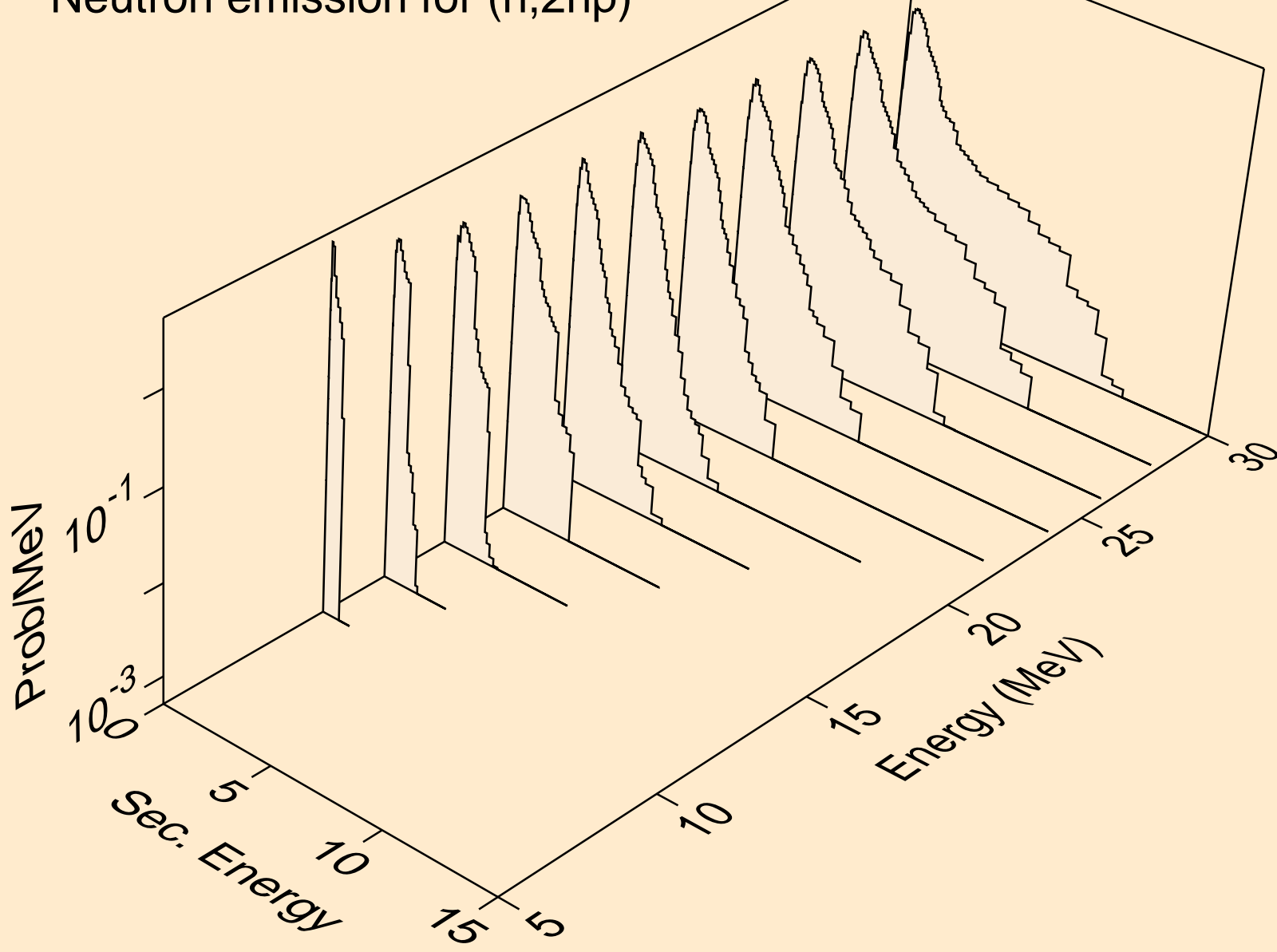

LR256 NEUTRON ACER TENDL-2019 LIBRARY; T=293.16K
Neutron emission for (n,3np)

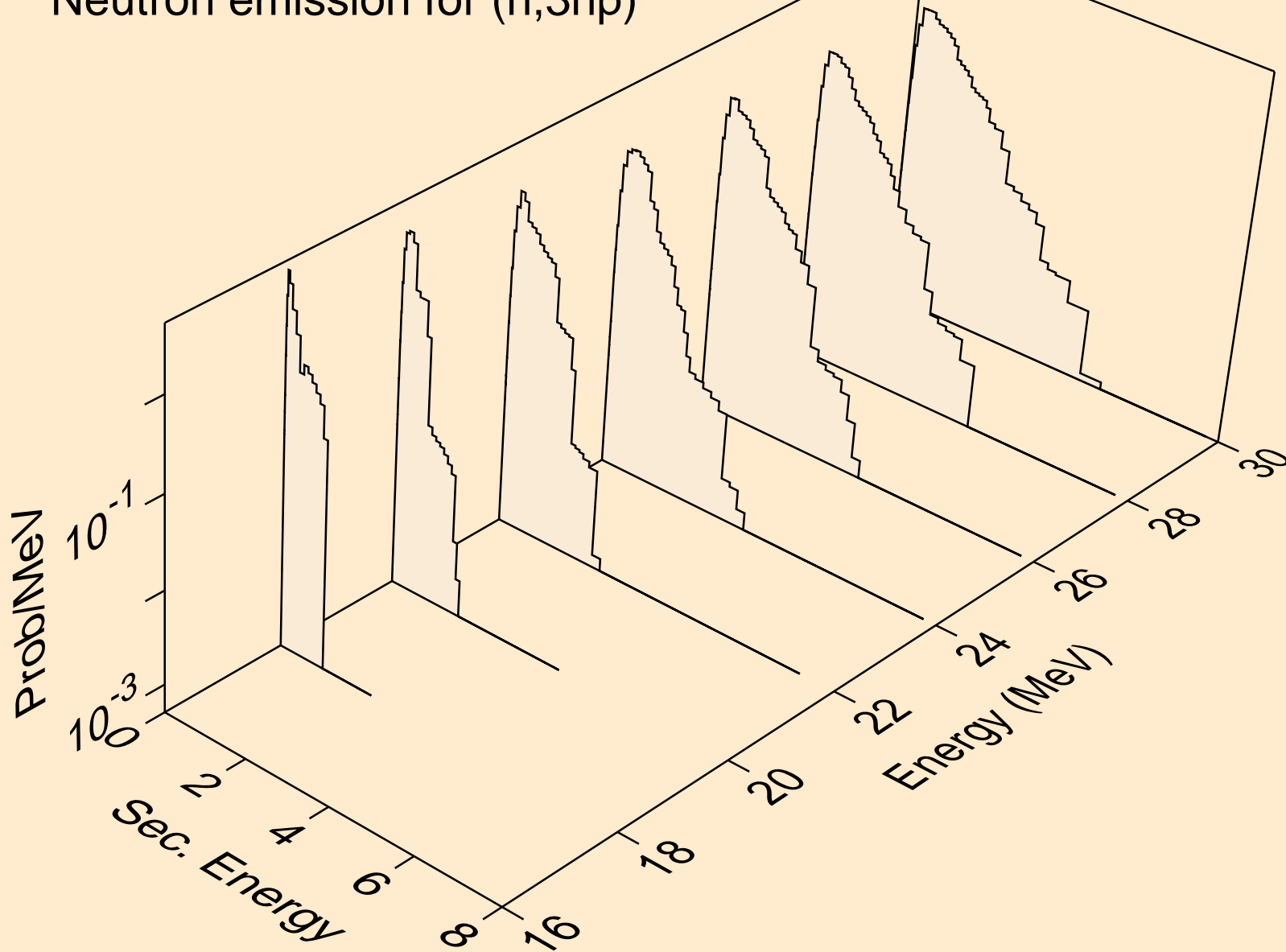

LR256 NEUTRON ACER TENDL-2019 LIBRARY; T=293.16K
Neutron emission for (n,2np)

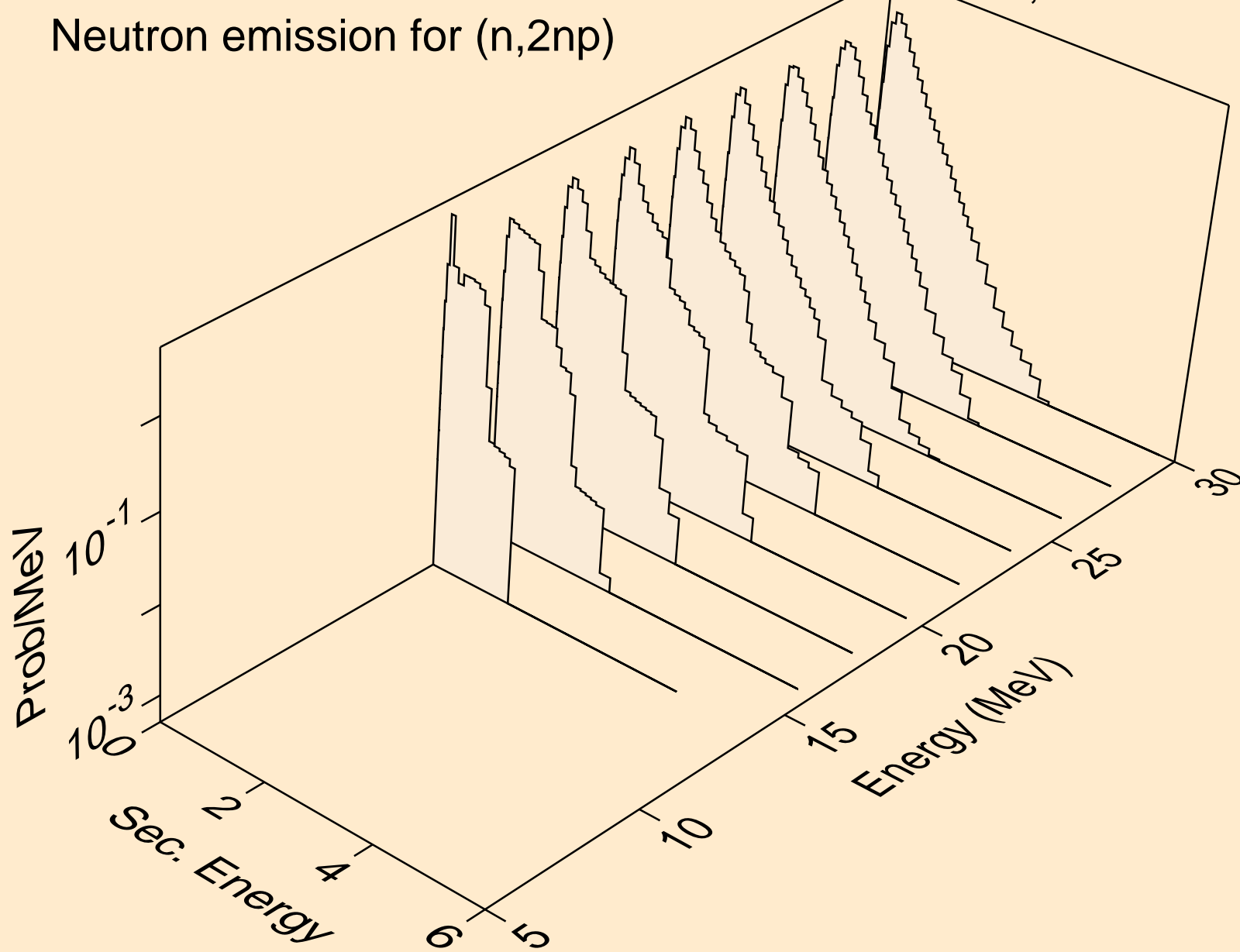

LR256 NEUTRON ACER TENDL-2019 LIBRARY; T=293.16K
Neutron emission for (n,npa)

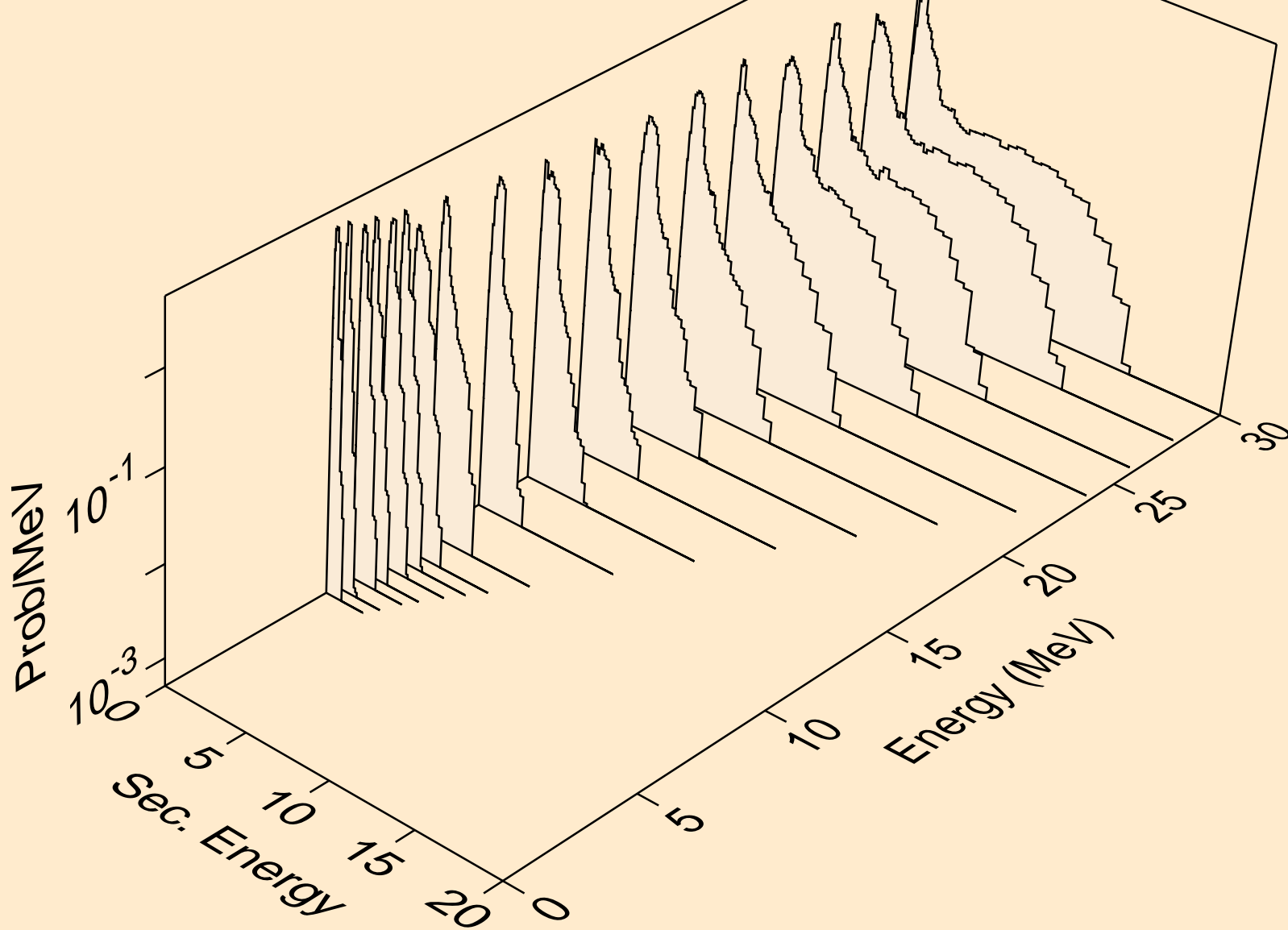

LR256 NEUTRON ACER TENDL-2019 LIBRARY; T=293.16K
Neutron emission for (n,n*c)

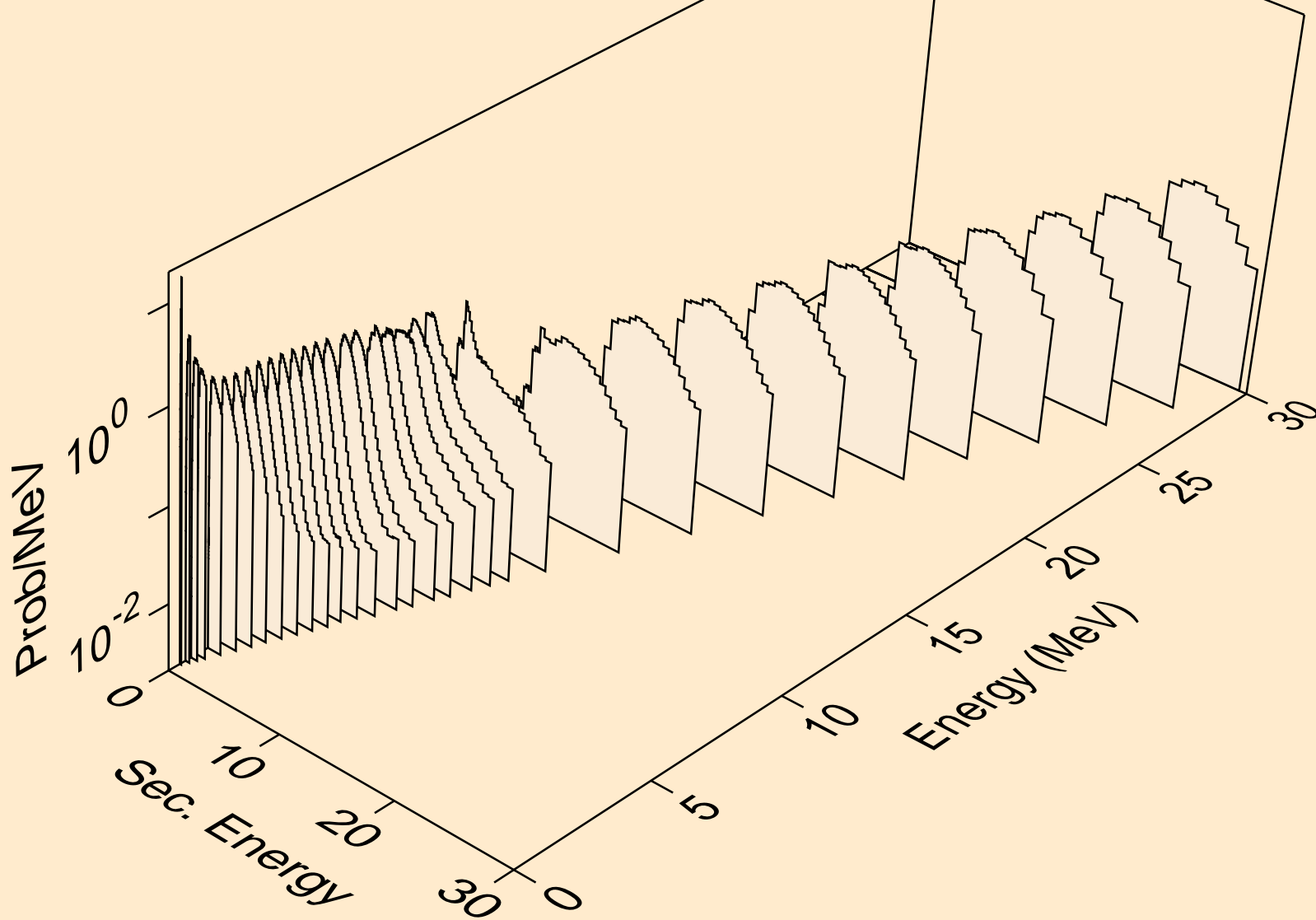

LR256 NEUTRON ACER TENDL-2019 LIBRARY; T=293.16K

Delayed nubar

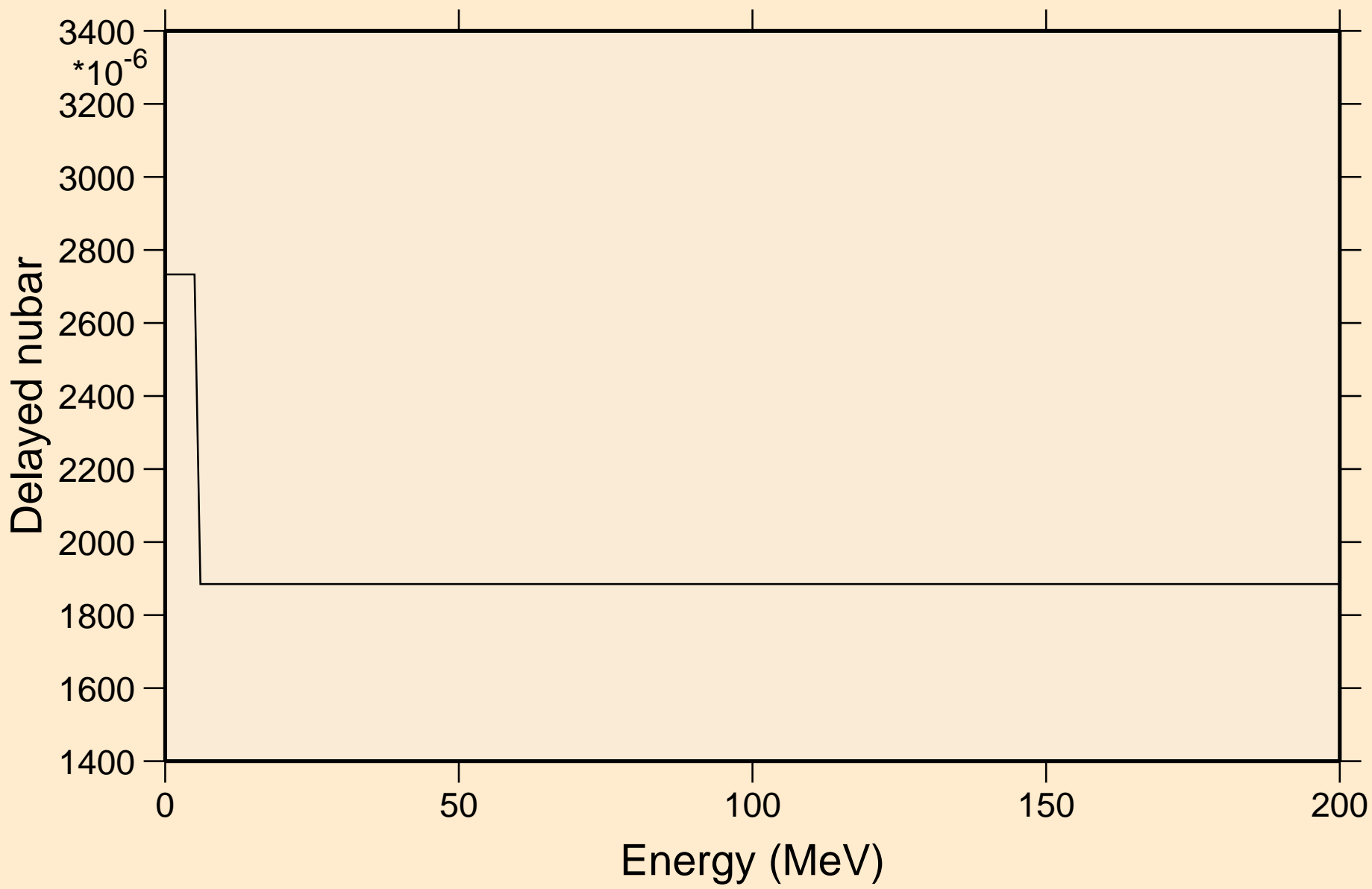

LR256 NEUTRON ACER TENDL-2019 LIBRARY; T=293.16K

Delayed neutron spectra

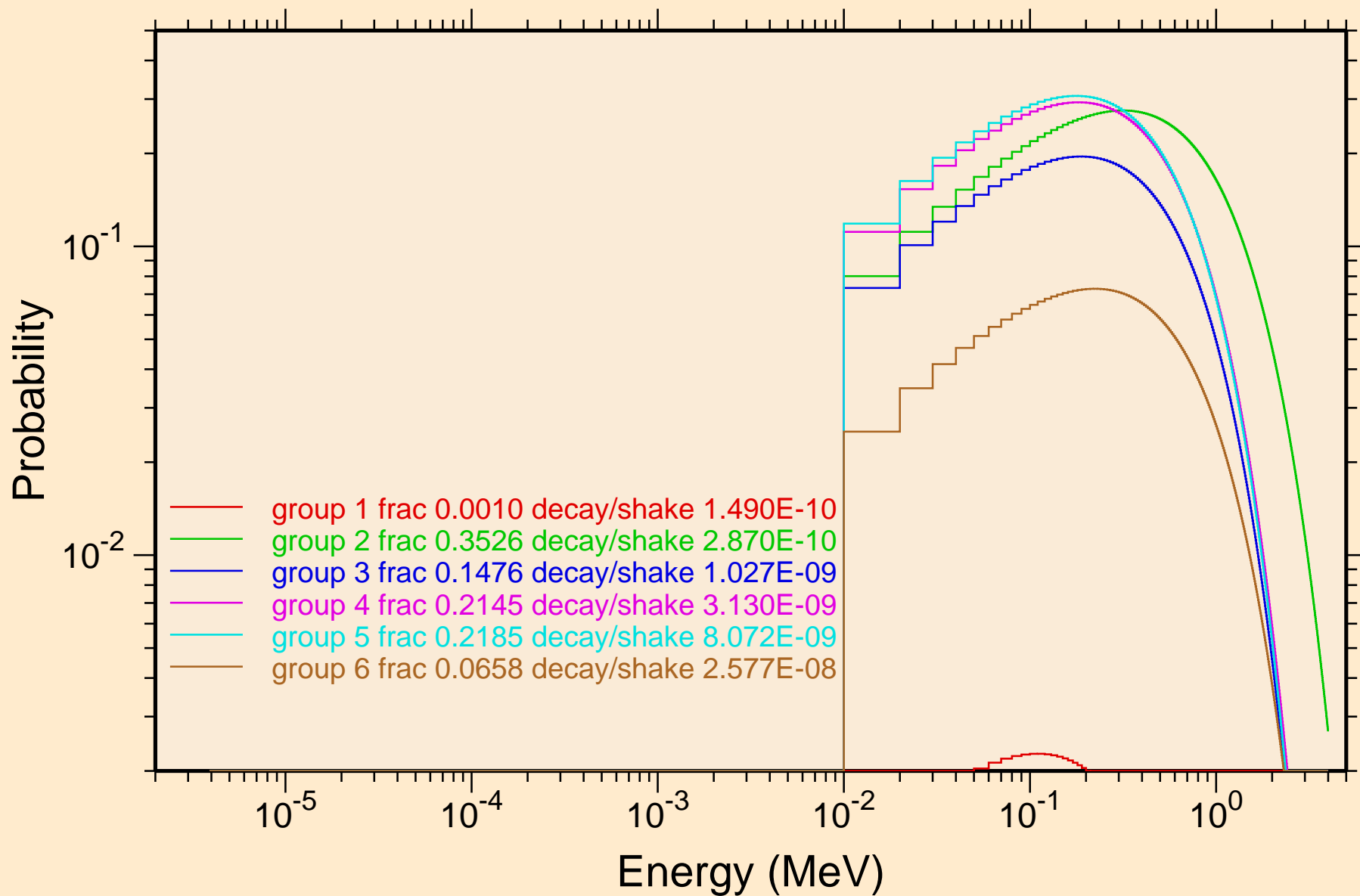

LR256 NEUTRON ACER TENDL-2019 LIBRARY; T=293.16K
Photon emission for (n,x)

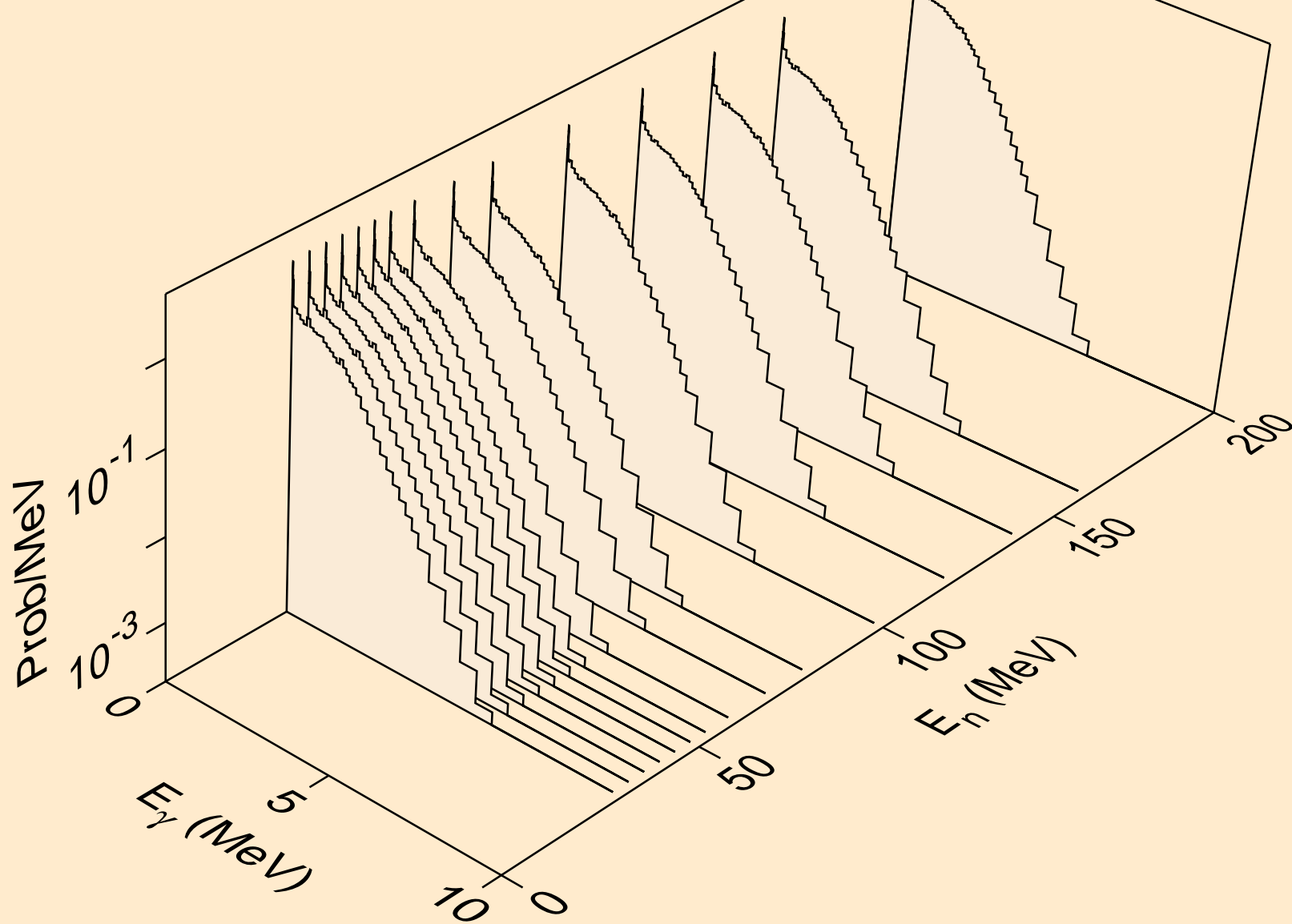

LR256 NEUTRON ACER TENDL-2019 LIBRARY; T=293.16K
Photon emission for (n,2nd)

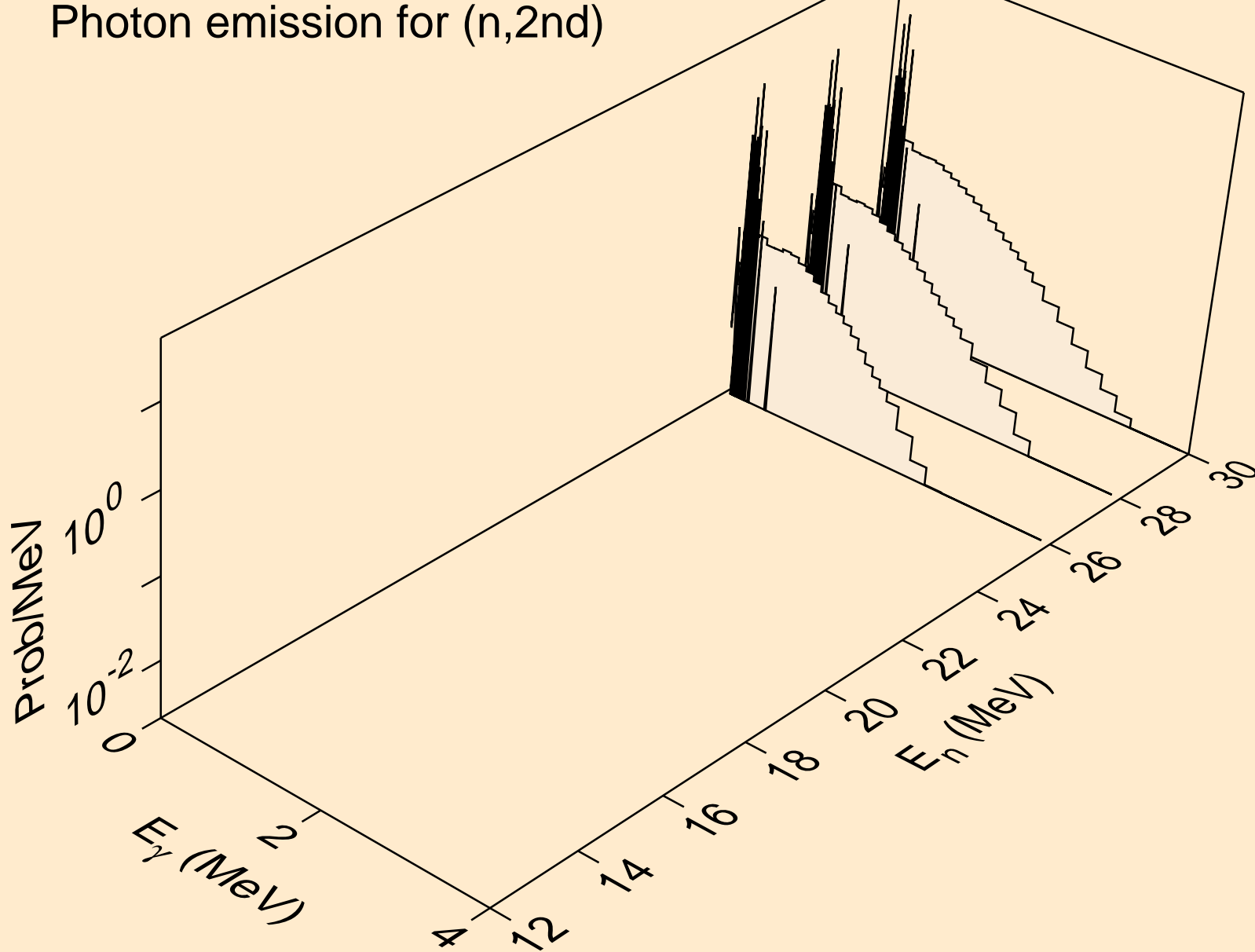

LR256 NEUTRON ACER TENDL-2019 LIBRARY; T=293.16K
Photon emission for (n,2n)

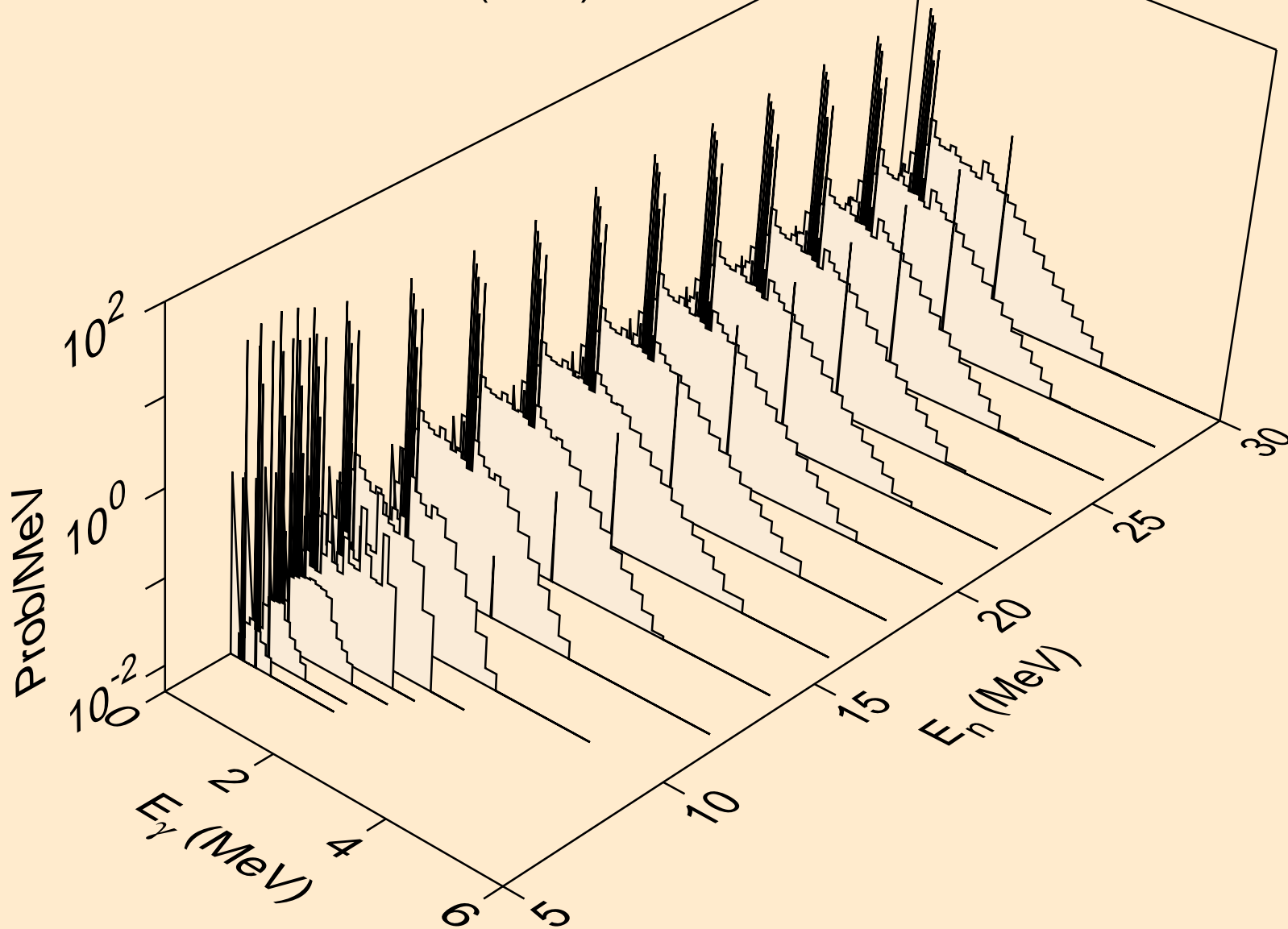

LR256 NEUTRON ACER TENDL-2019 LIBRARY; T=293.16K
Photon emission for (n,3n)

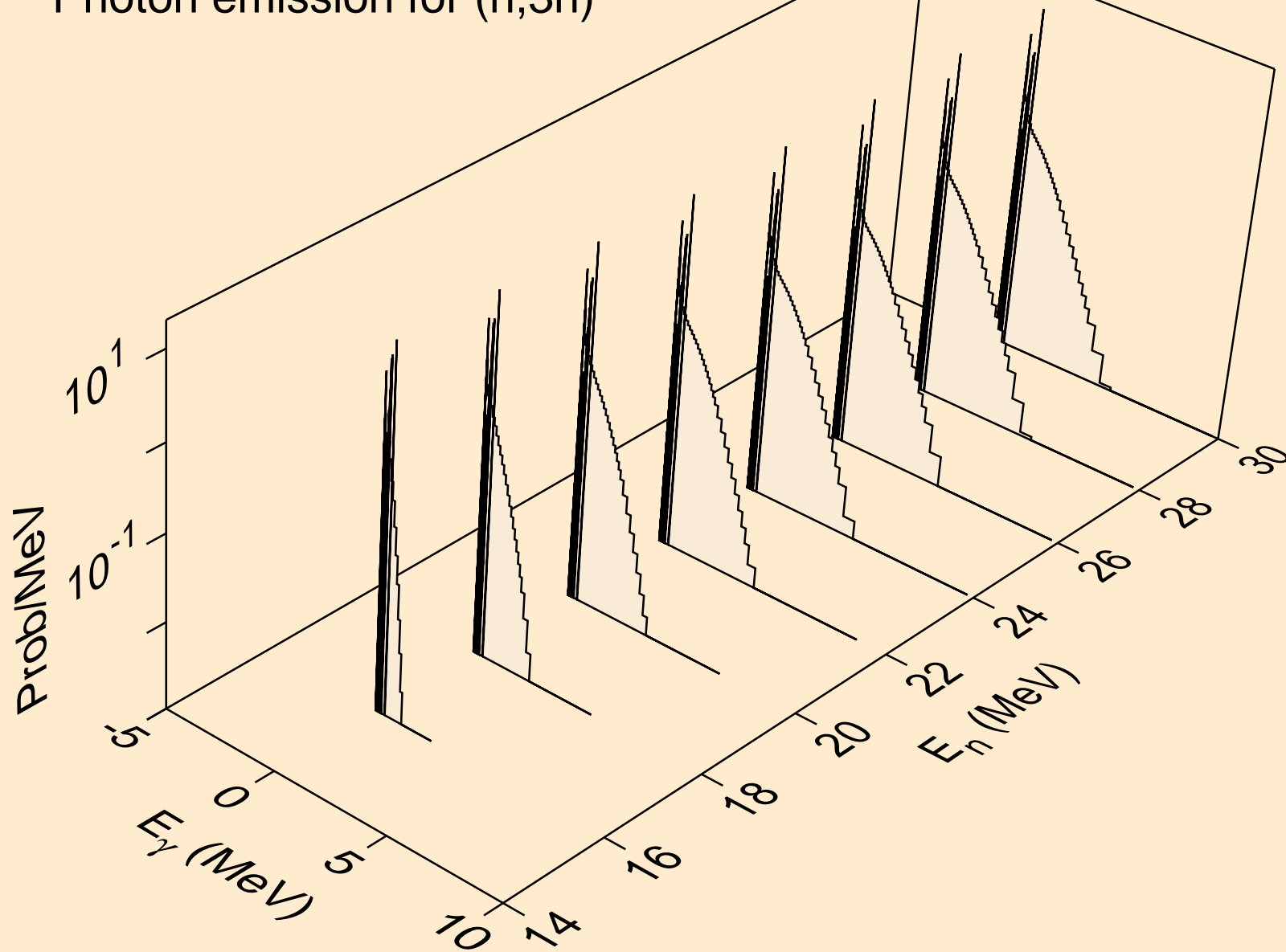

LR256 NEUTRON ACER TENDL-2019 LIBRARY; T=293.16K
Photon emission for (n,n*)a

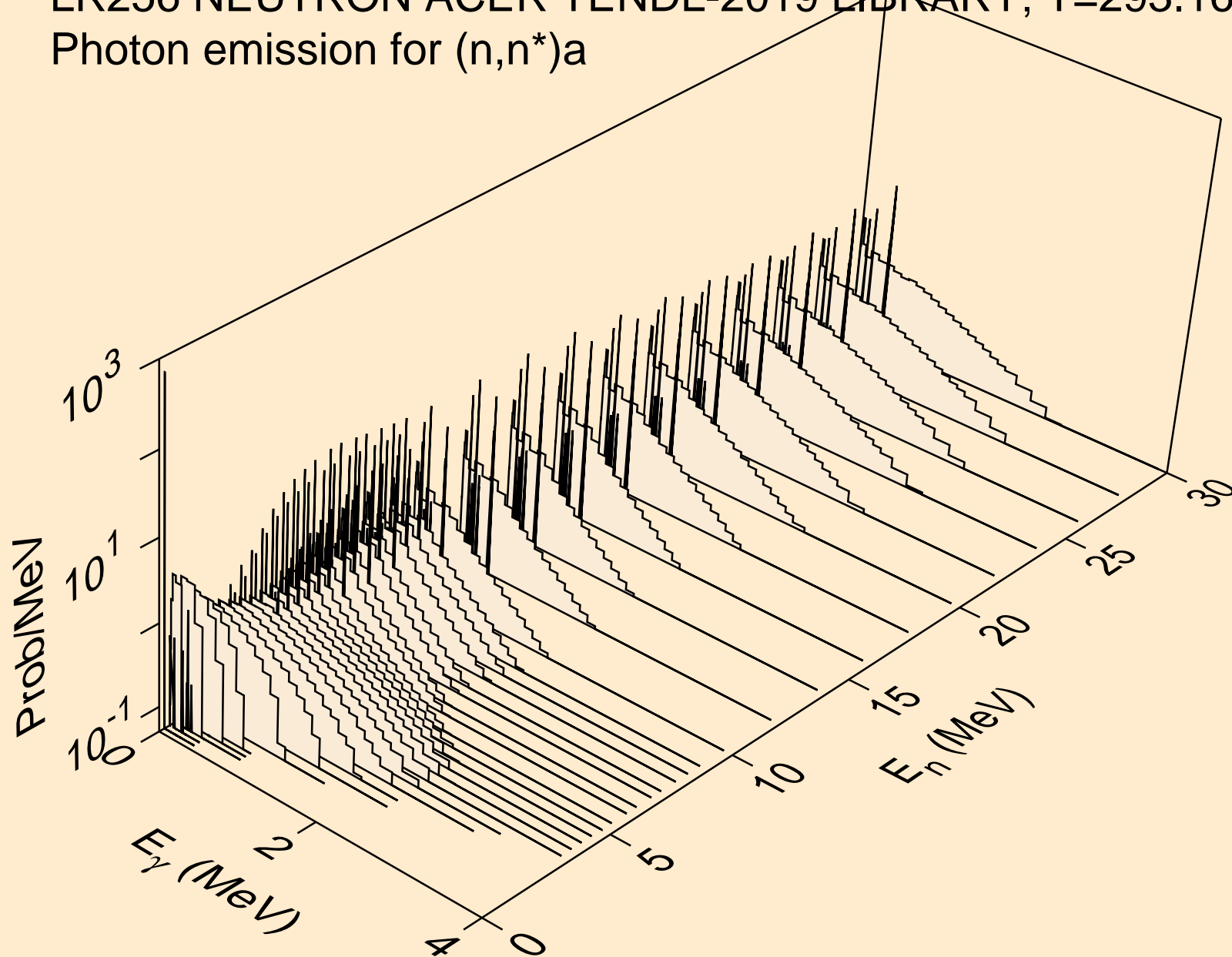

LR256 NEUTRON ACER TENDL-2019 LIBRARY; T=293.16K
Photon emission for (n,2n)a

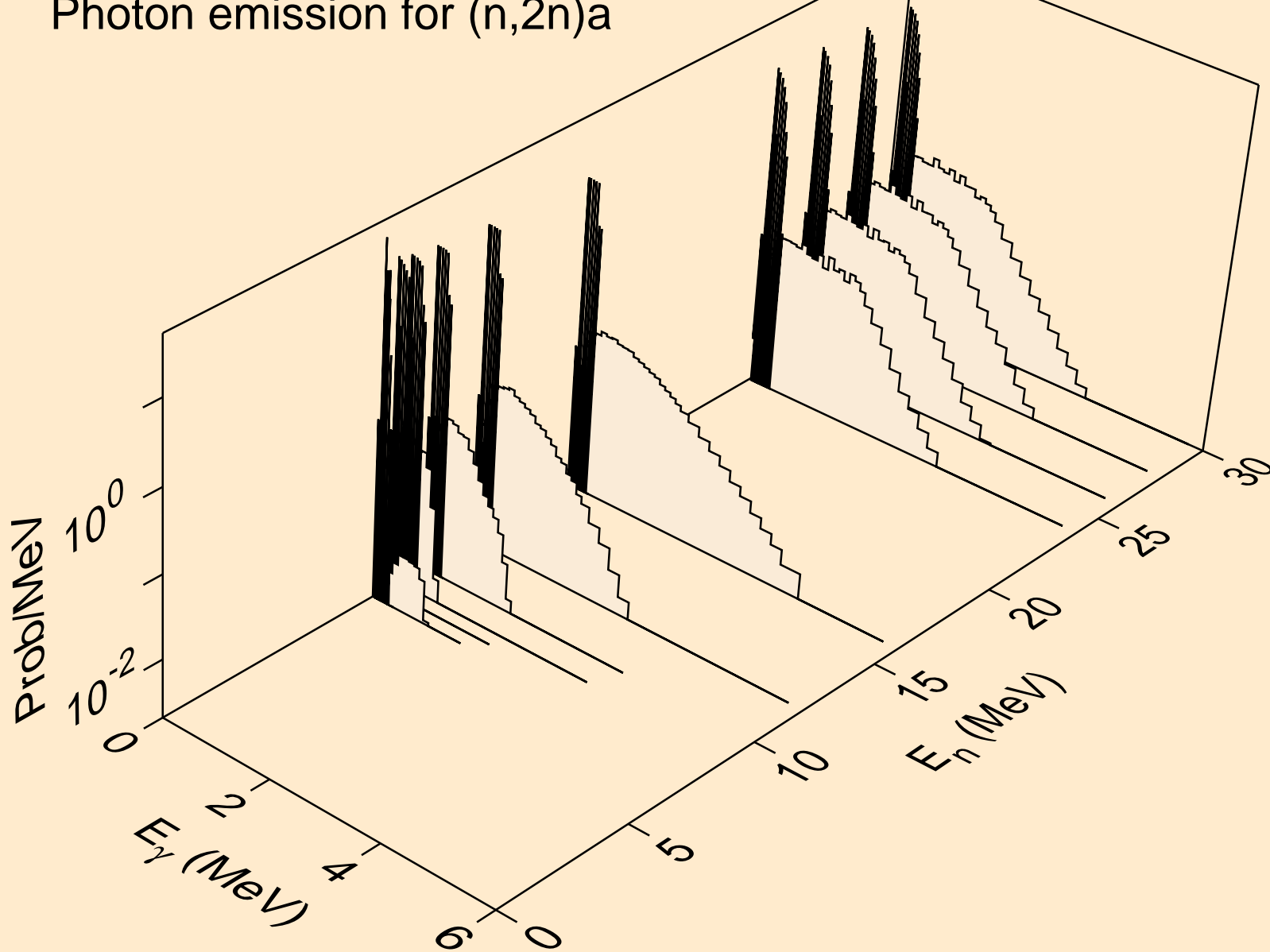

LR256 NEUTRON ACER TENDL-2019 LIBRARY; T=293.16K
Photon emission for (n,3n)a

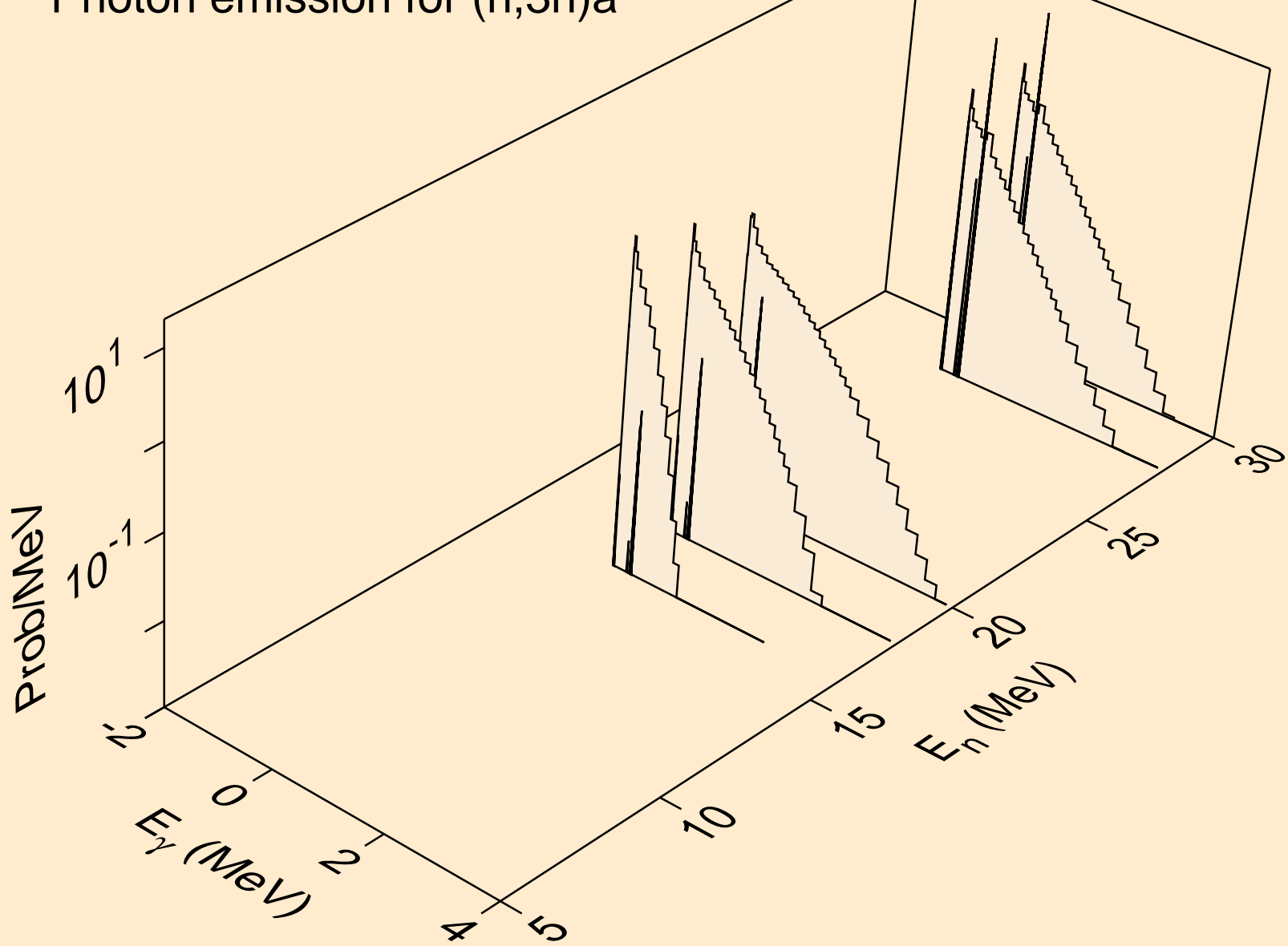

LR256 NEUTRON ACER TENDL-2019 LIBRARY; T=293.16K
Photon emission for (n,n*)p

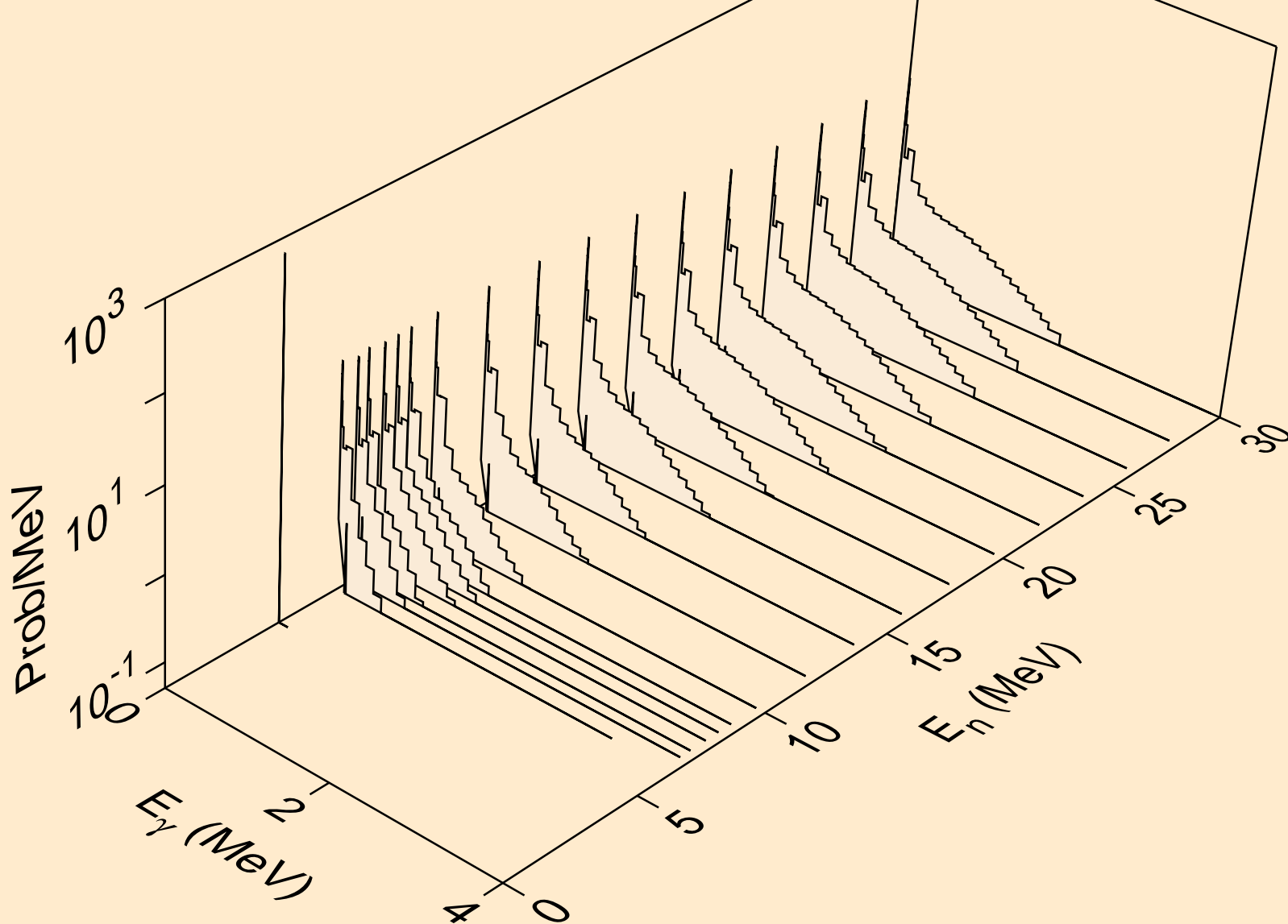

LR256 NEUTRON ACER TENDL-2019 LIBRARY; T=293.16K
Photon emission for (n,n*)2a

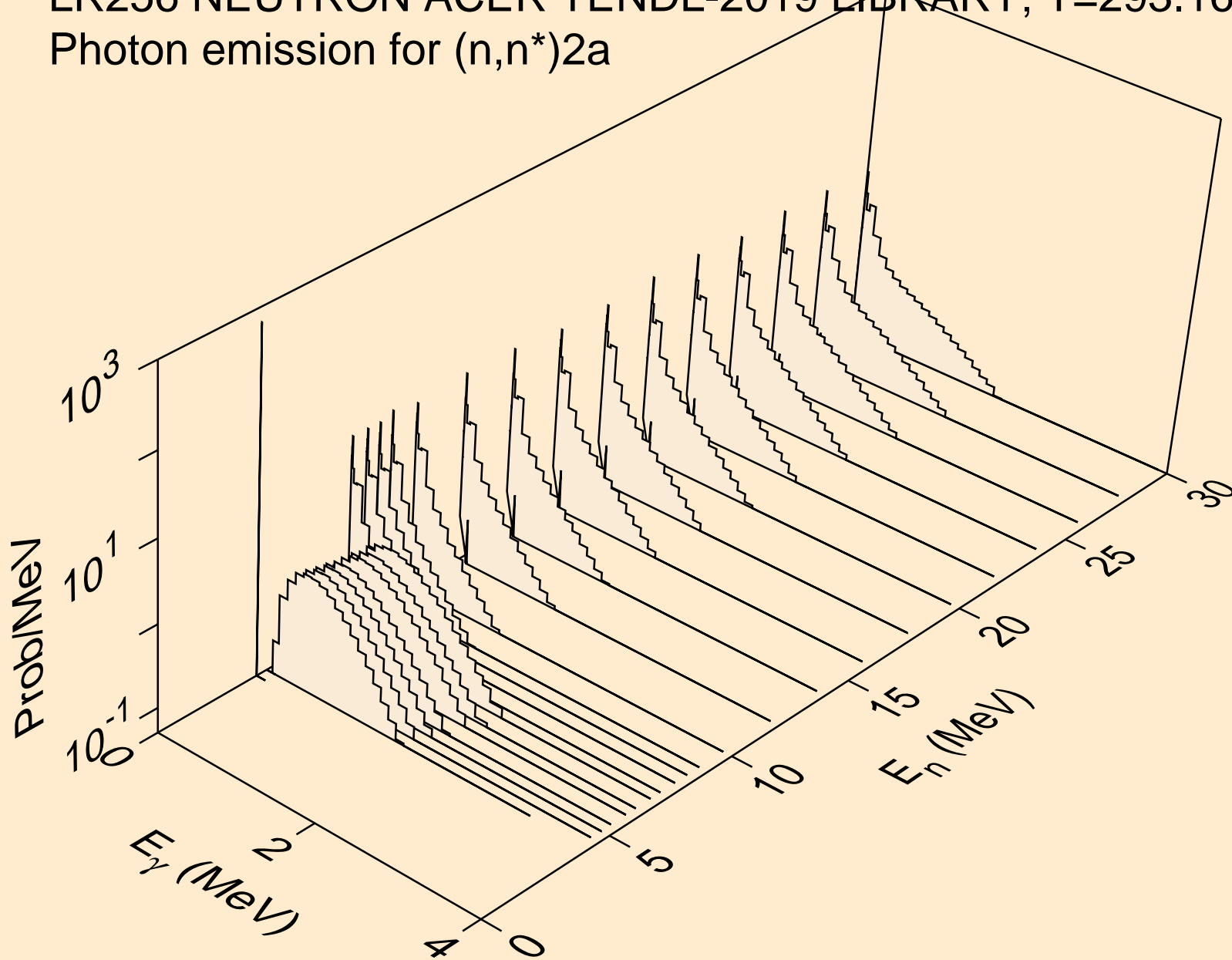

LR256 NEUTRON ACER TENDL-2019 LIBRARY; T=293.16K
Photon emission for (n,2n)2a

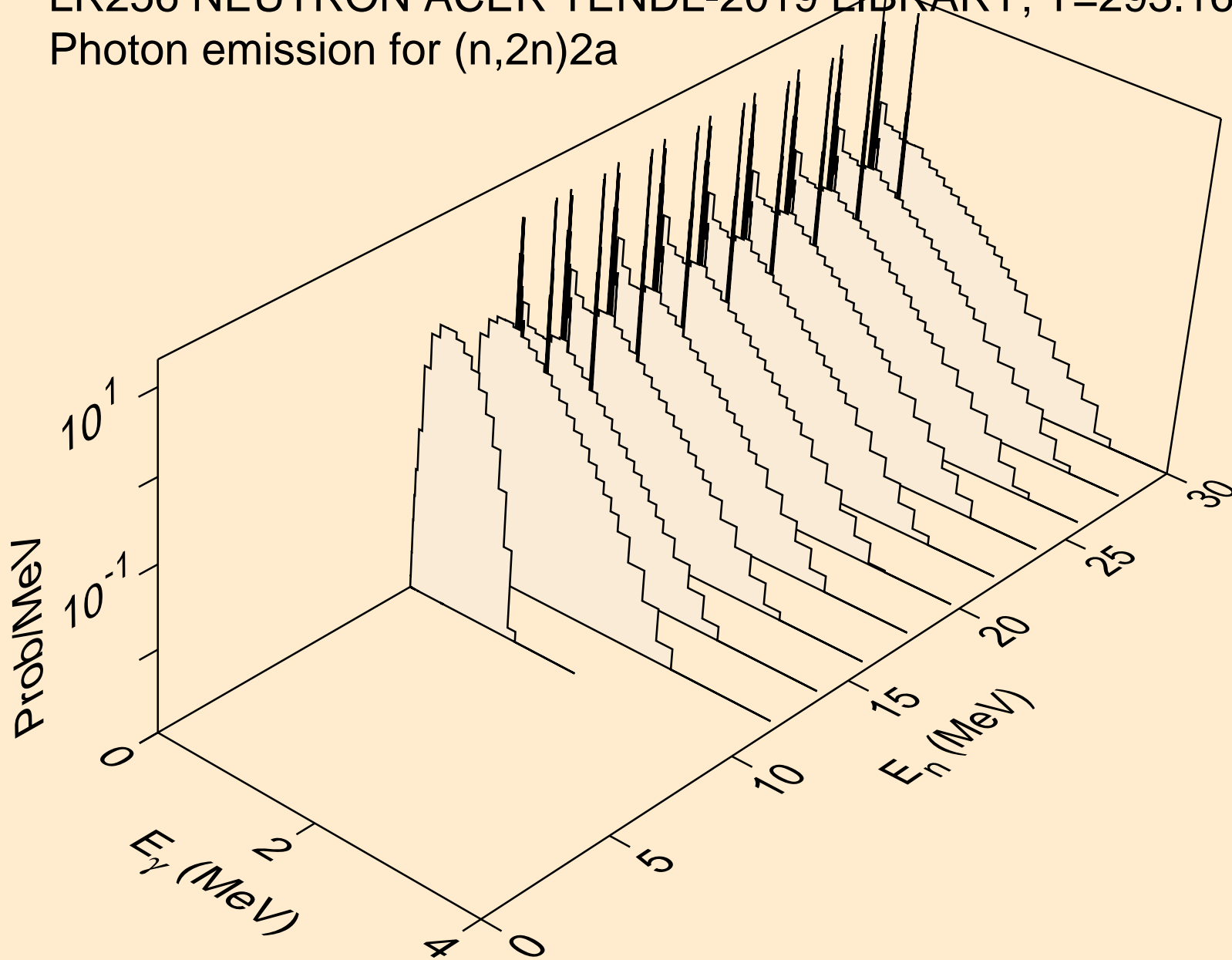

LR256 NEUTRON ACER TENDL-2019 LIBRARY; T=293.16K
Photon emission for (n,n*)d

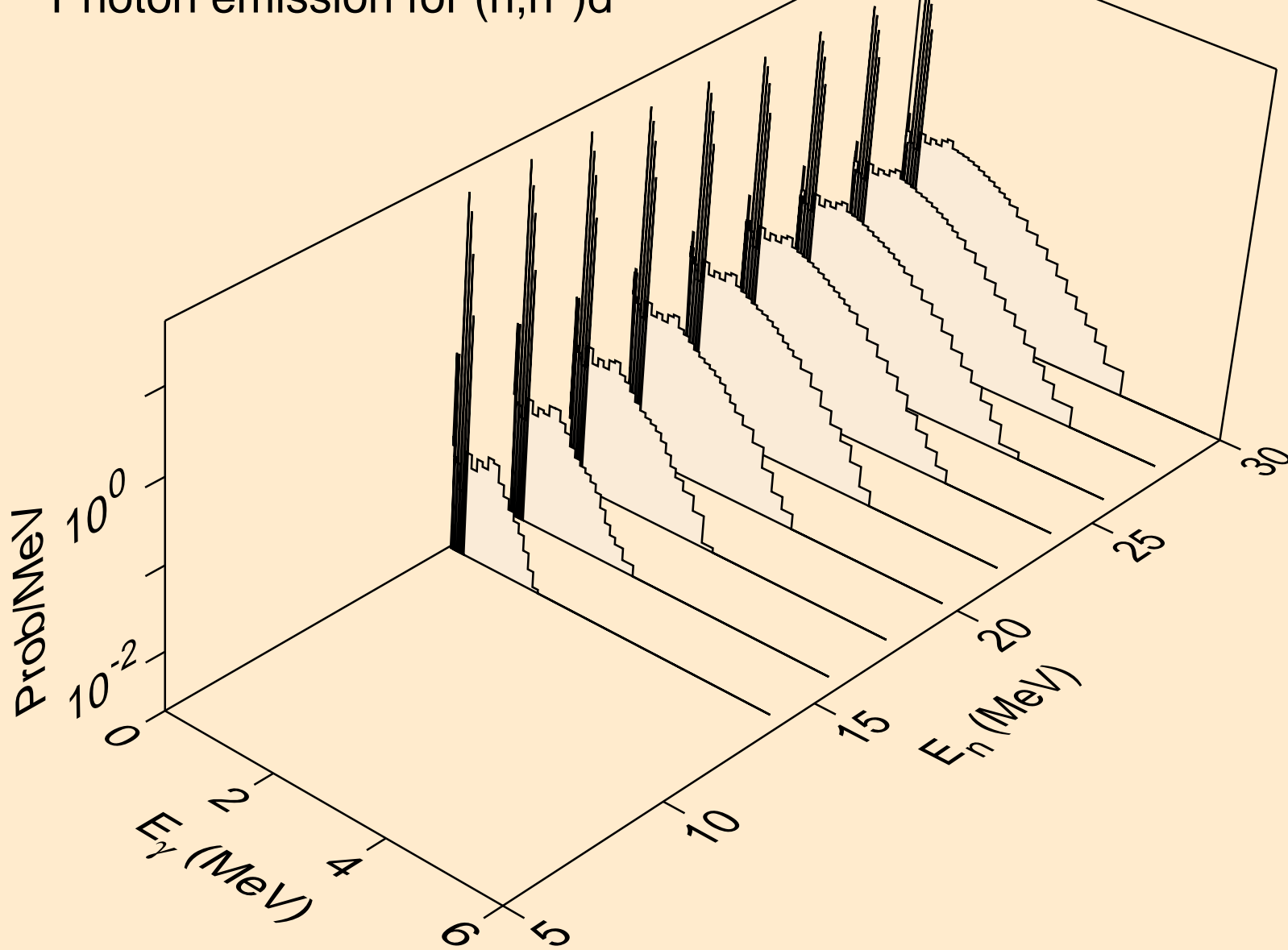

LR256 NEUTRON ACER TENDL-2019 LIBRARY; T=293.16K
Photon emission for (n,n*)t

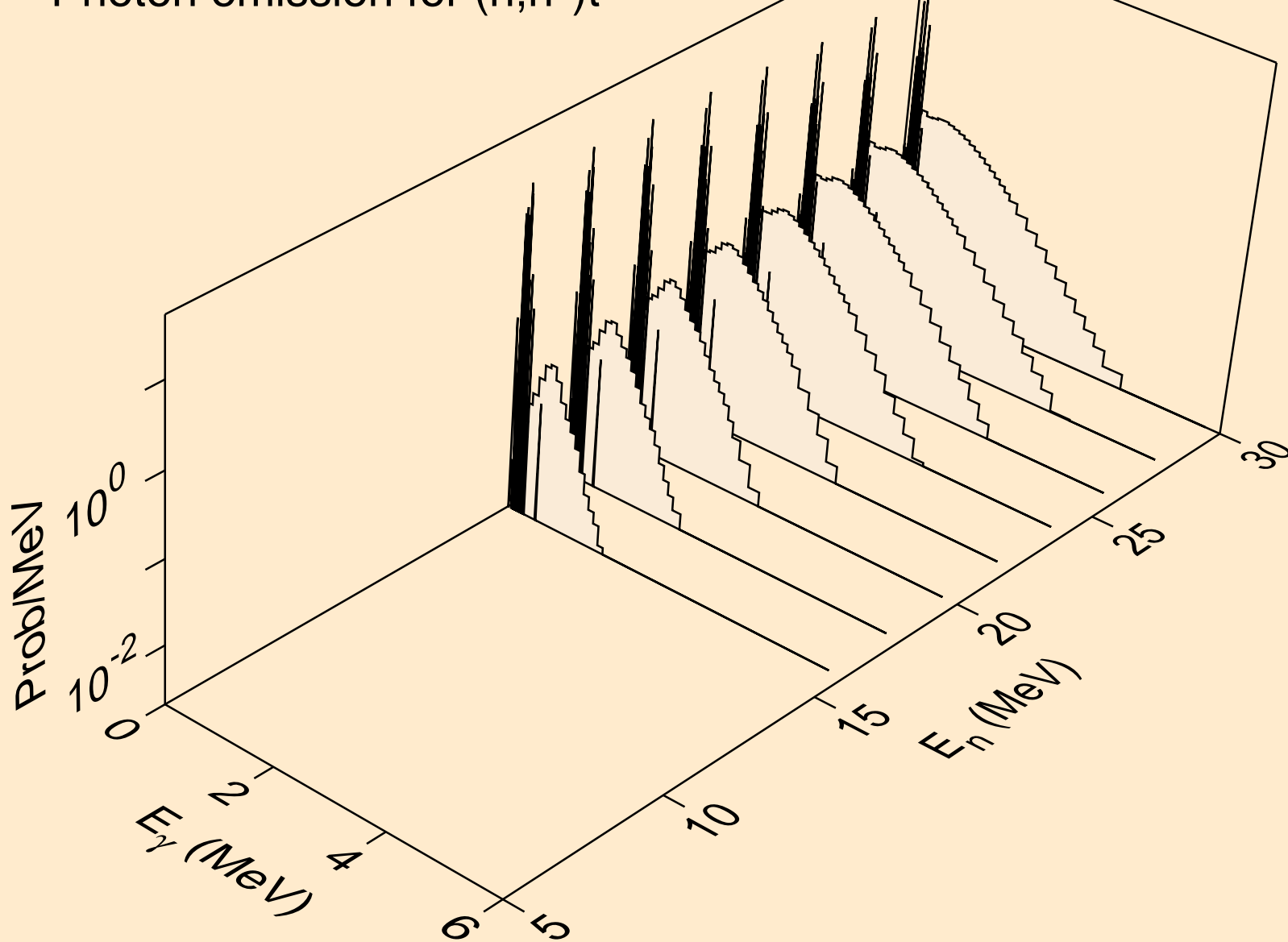

LR256 NEUTRON ACER TENDL-2019 LIBRARY; T=293.16K
Photon emission for (n,n*)he3

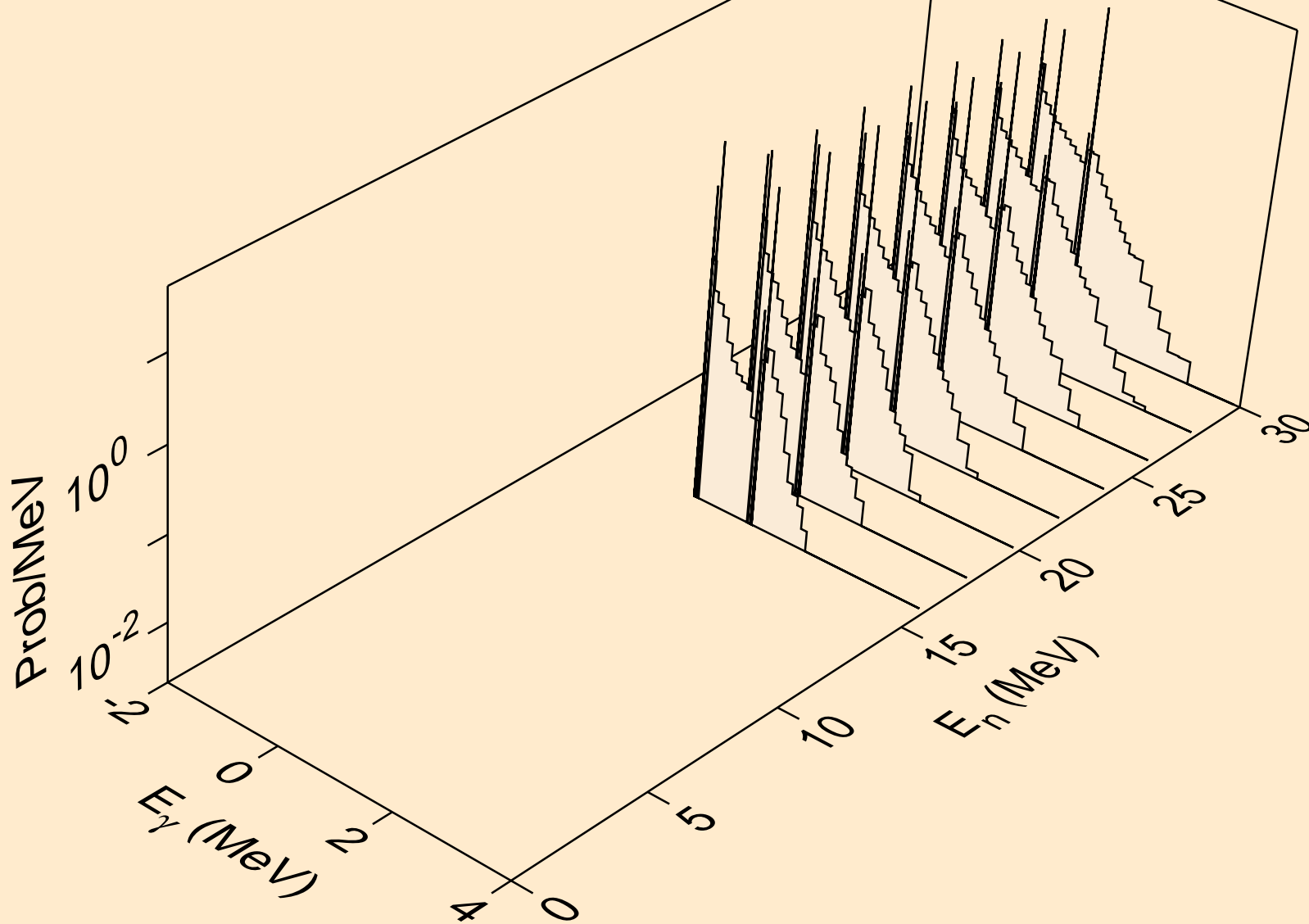

LR256 NEUTRON ACER TENDL-2019 LIBRARY; T=293.16K
Photon emission for (n,4n)

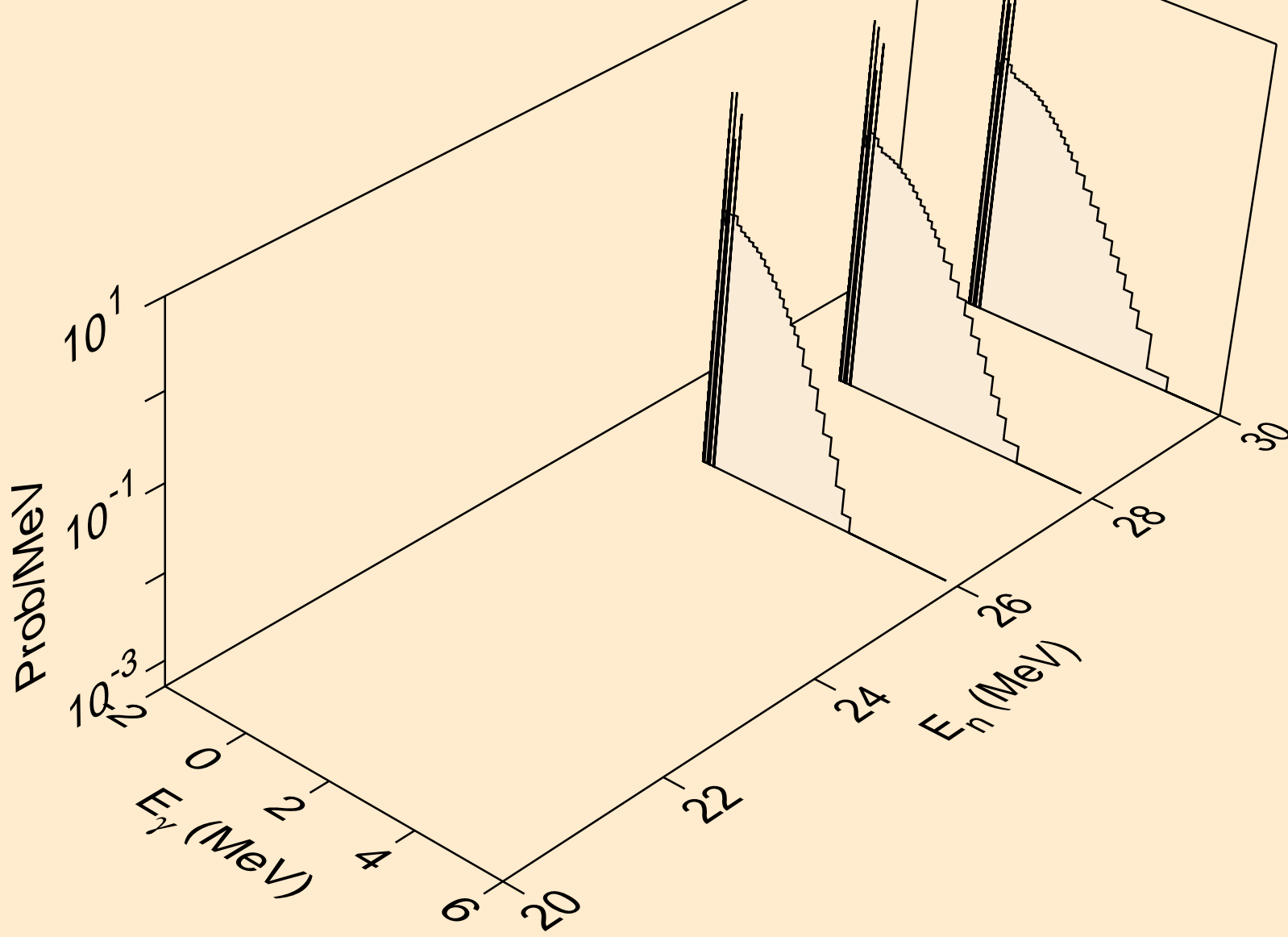

LR256 NEUTRON ACER TENDL-2019 LIBRARY; T=293.16K
Photon emission for (n,2np)

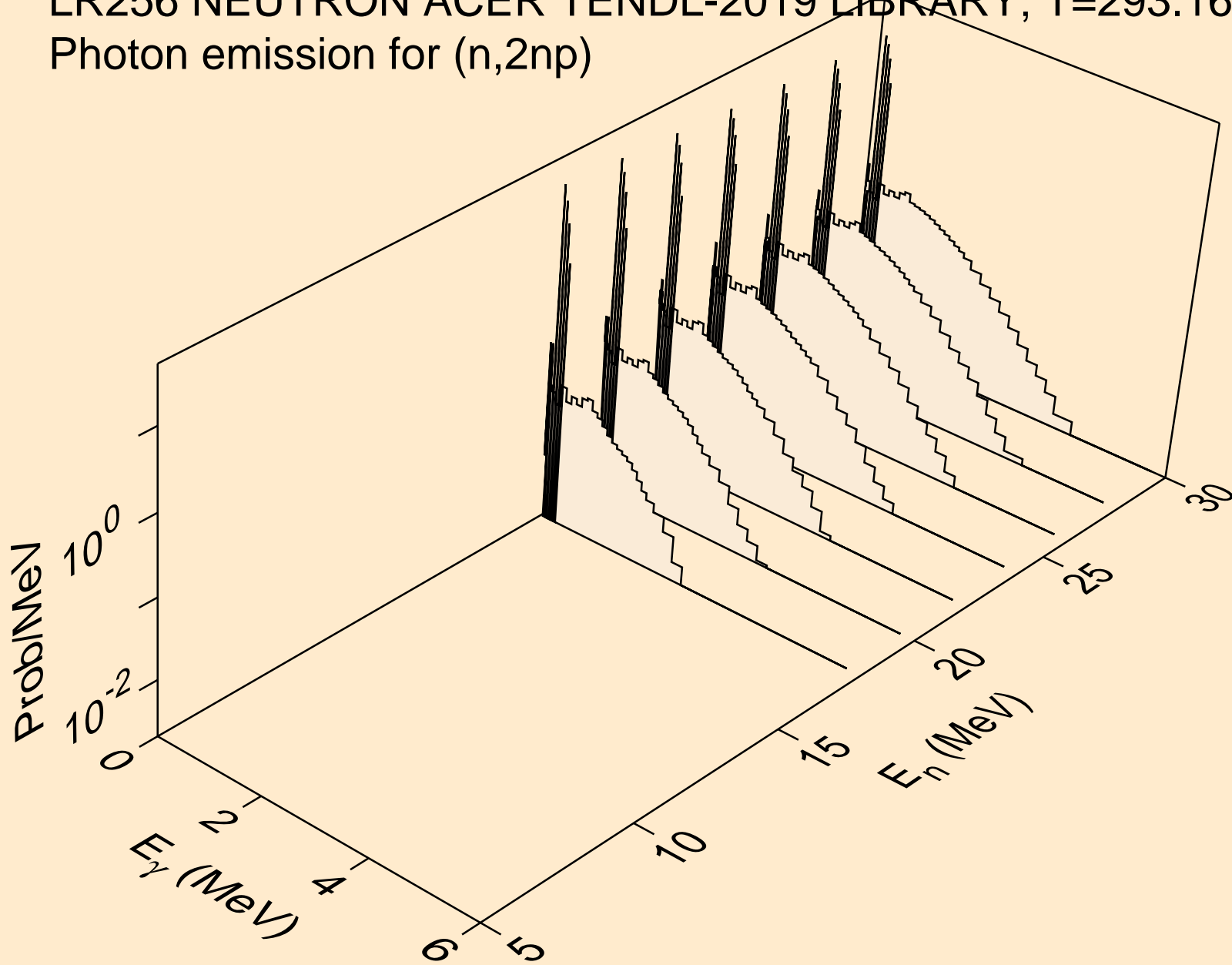

LR256 NEUTRON ACER TENDL-2019 LIBRARY; T=293.16K
Photon emission for (n,3np)

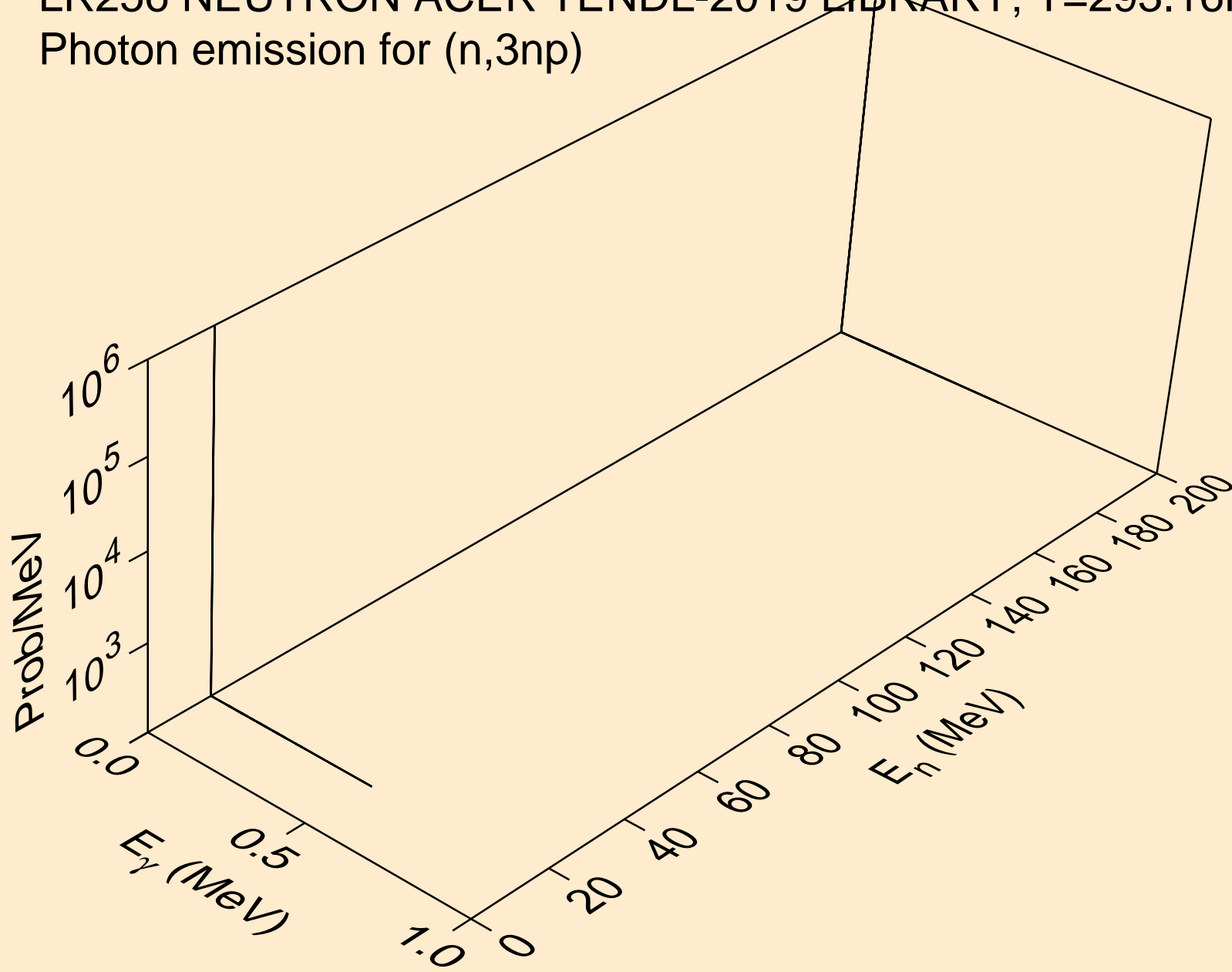

LR256 NEUTRON ACER TENDL-2019 LIBRARY; T=293.16K
Photon emission for (n,2np)

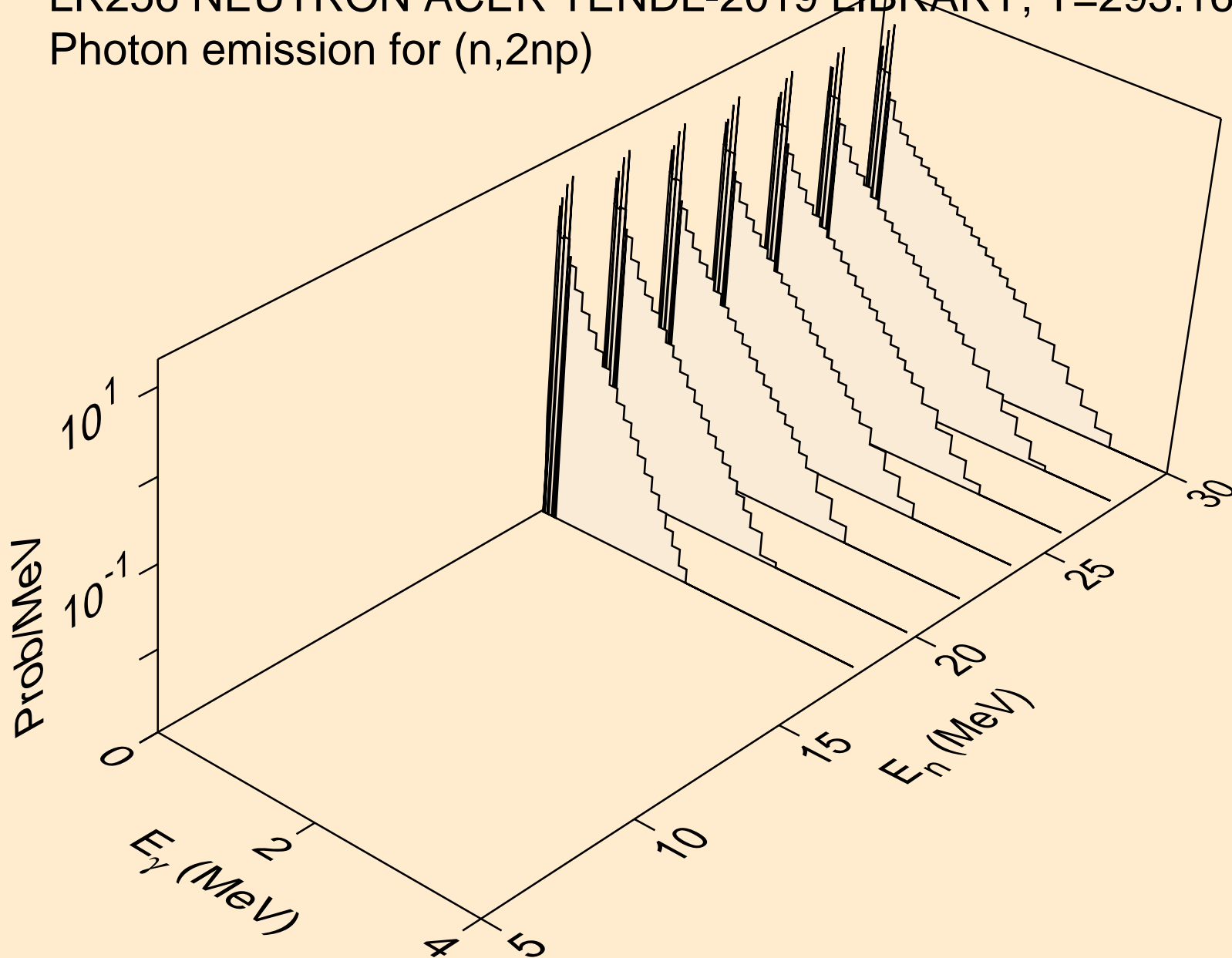

LR256 NEUTRON ACER TENDL-2019 LIBRARY; T=293.16K
Photon emission for (n,npa)

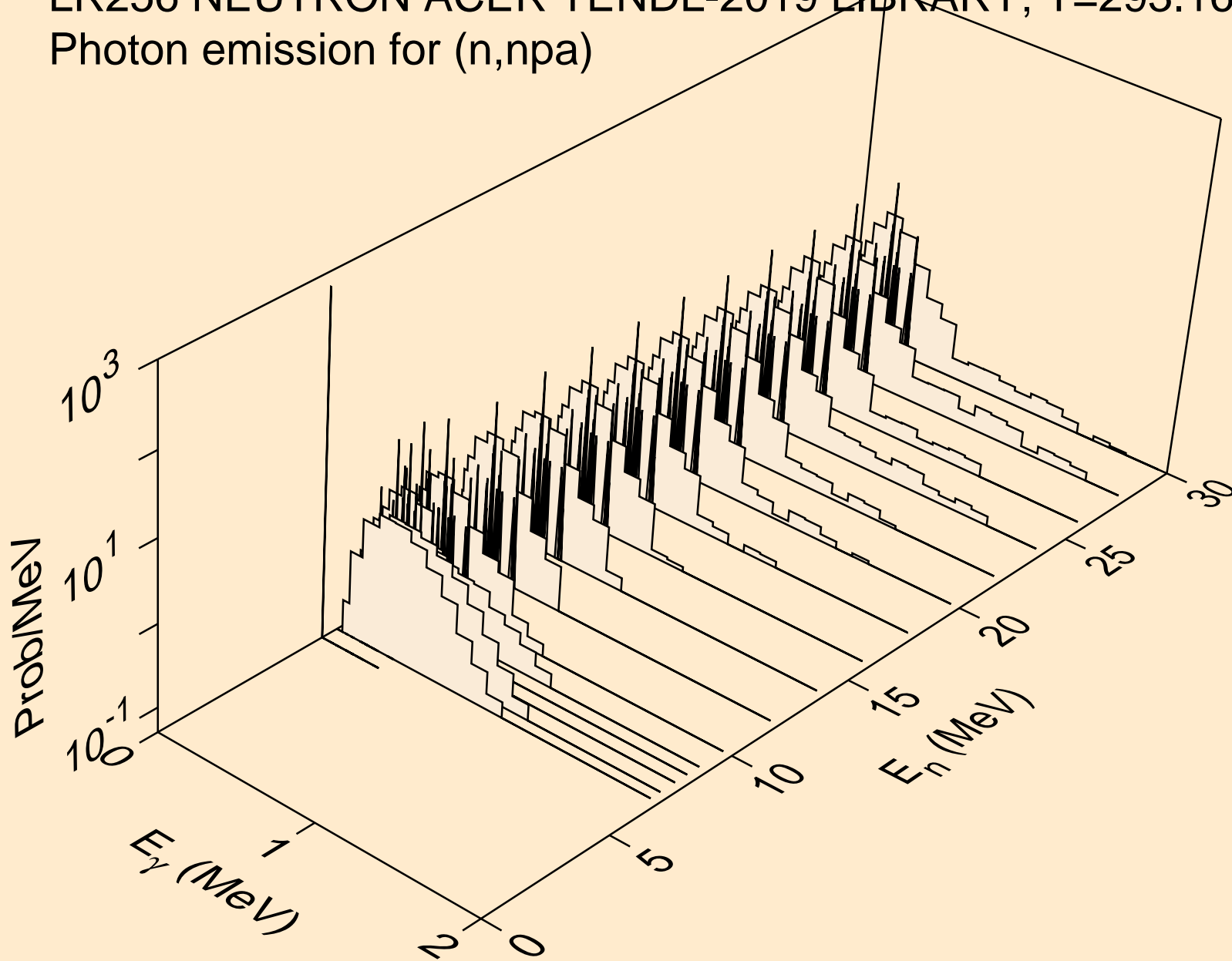

LR256 NEUTRON ACER TENDL-2019 LIBRARY; T=293.16K
Photon emission for (n,n*c)

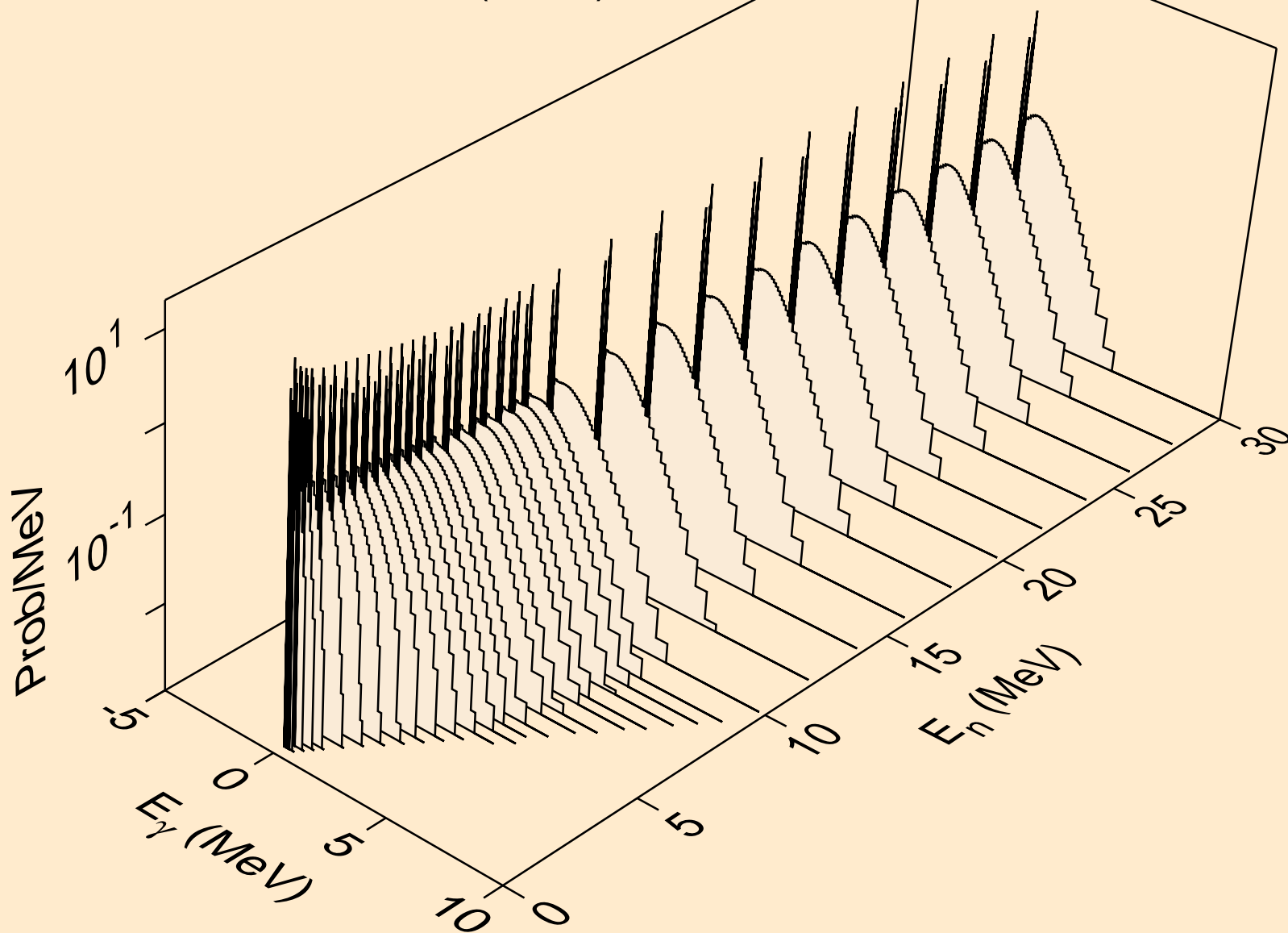

LR256 NEUTRON ACER TENDL-2019 LIBRARY; T=293.16K
Photon emission for (n,gma)

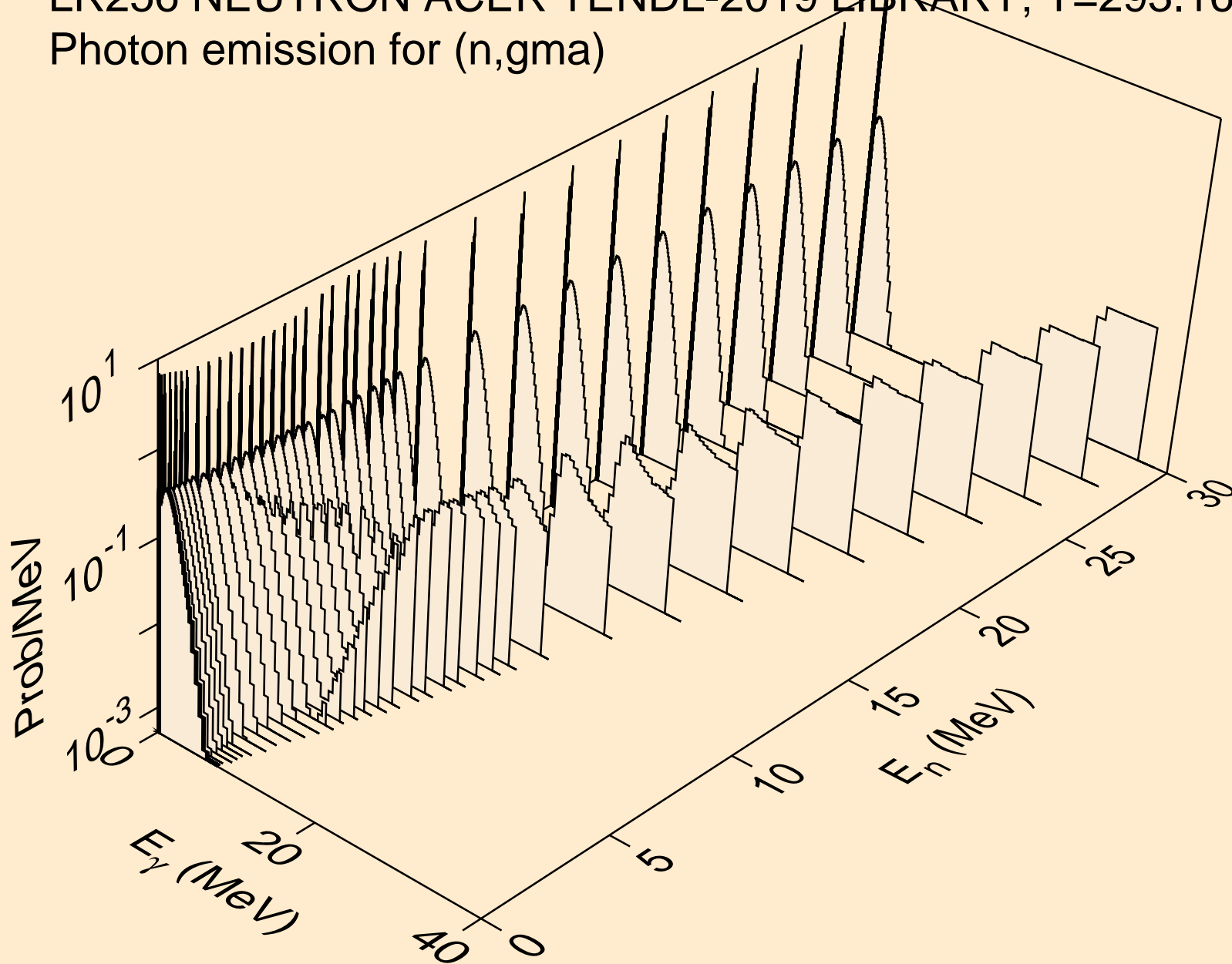

LR256 NEUTRON ACER TENDL-2019 LIBRARY; T=293.16K
Photon emission for (n,p)

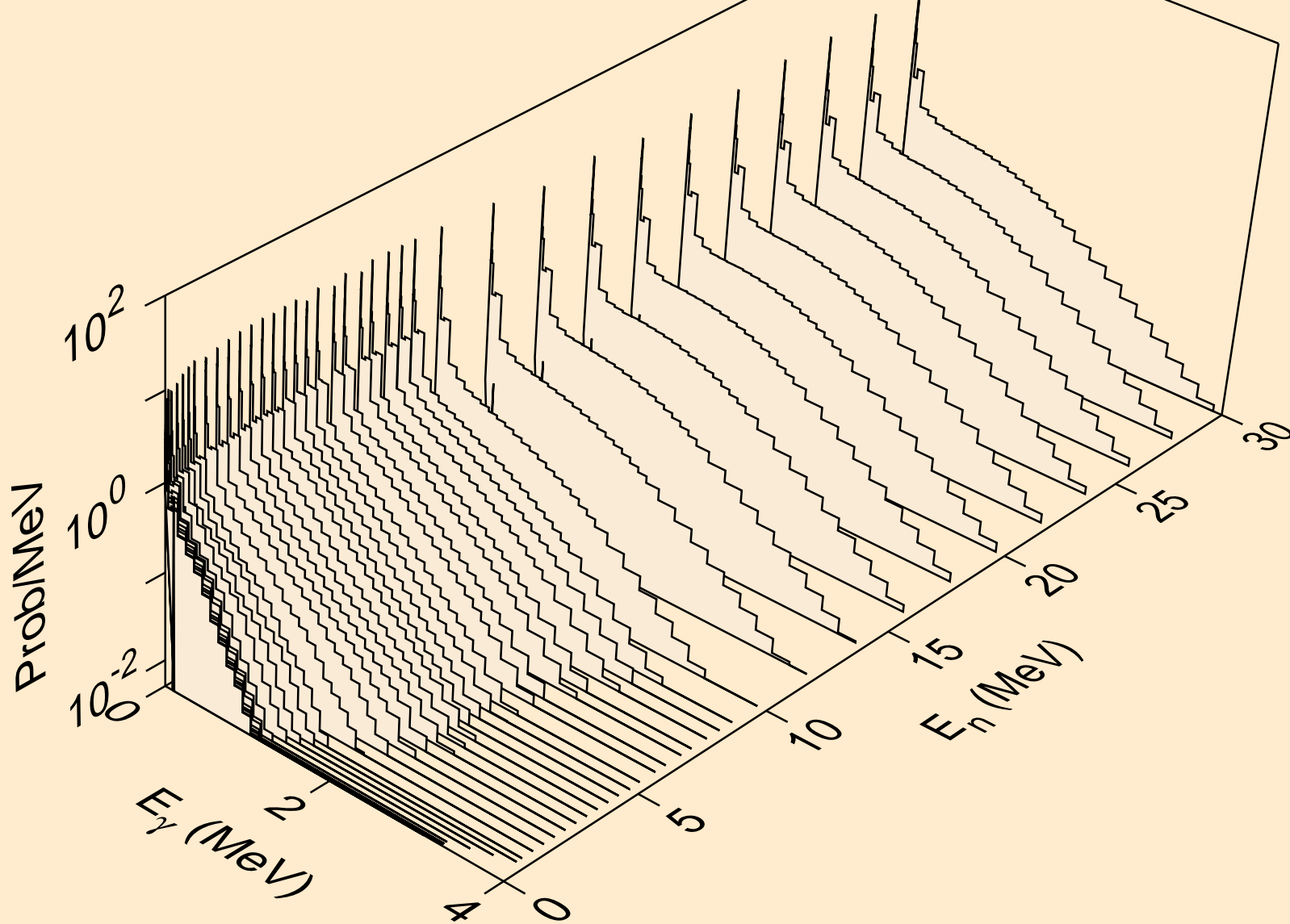

LR256 NEUTRON ACER TENDL-2019 LIBRARY; T=293.16K
Photon emission for (n,d)

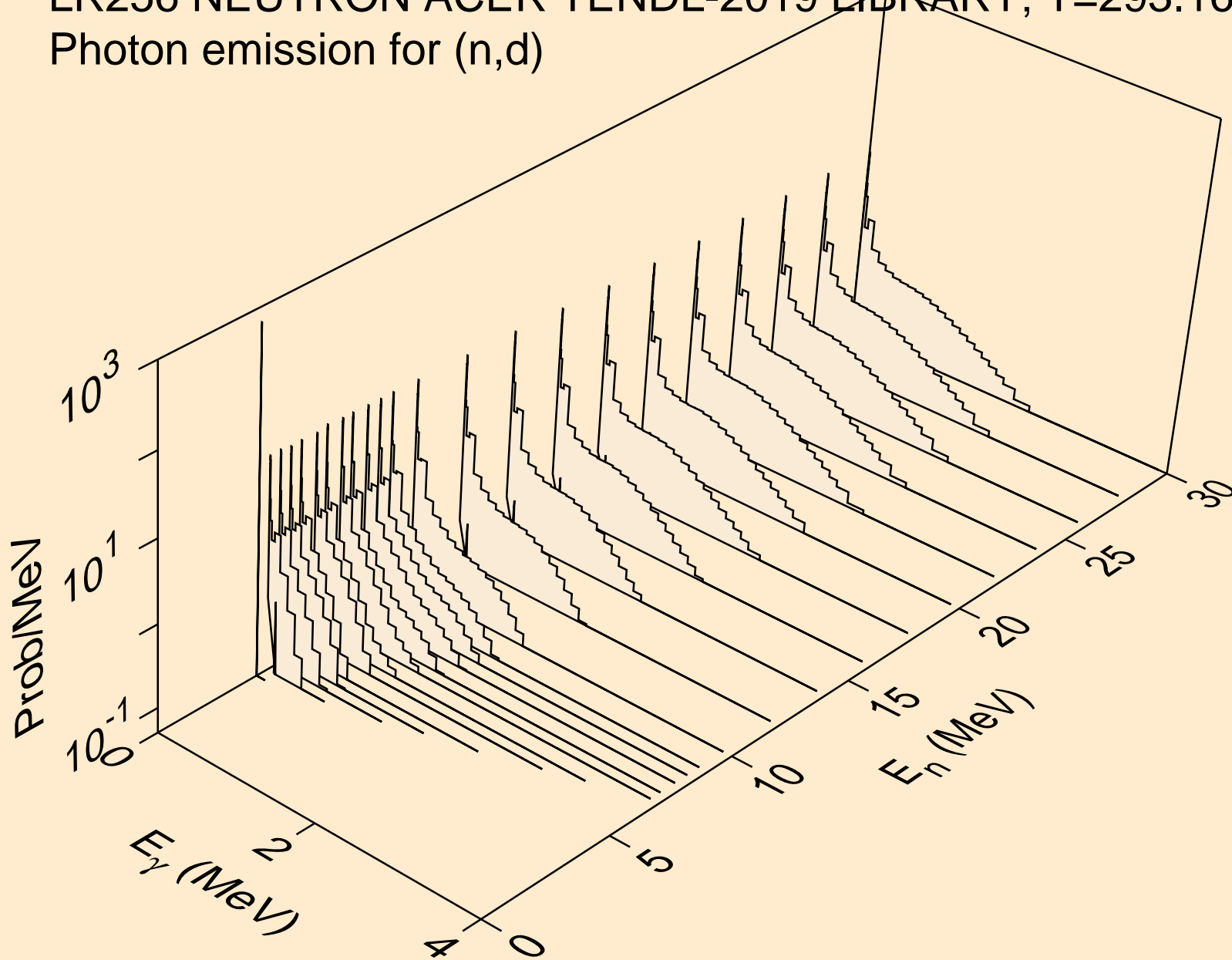

LR256 NEUTRON ACER TENDL-2019 LIBRARY; T=293.16K
Photon emission for (n,t)

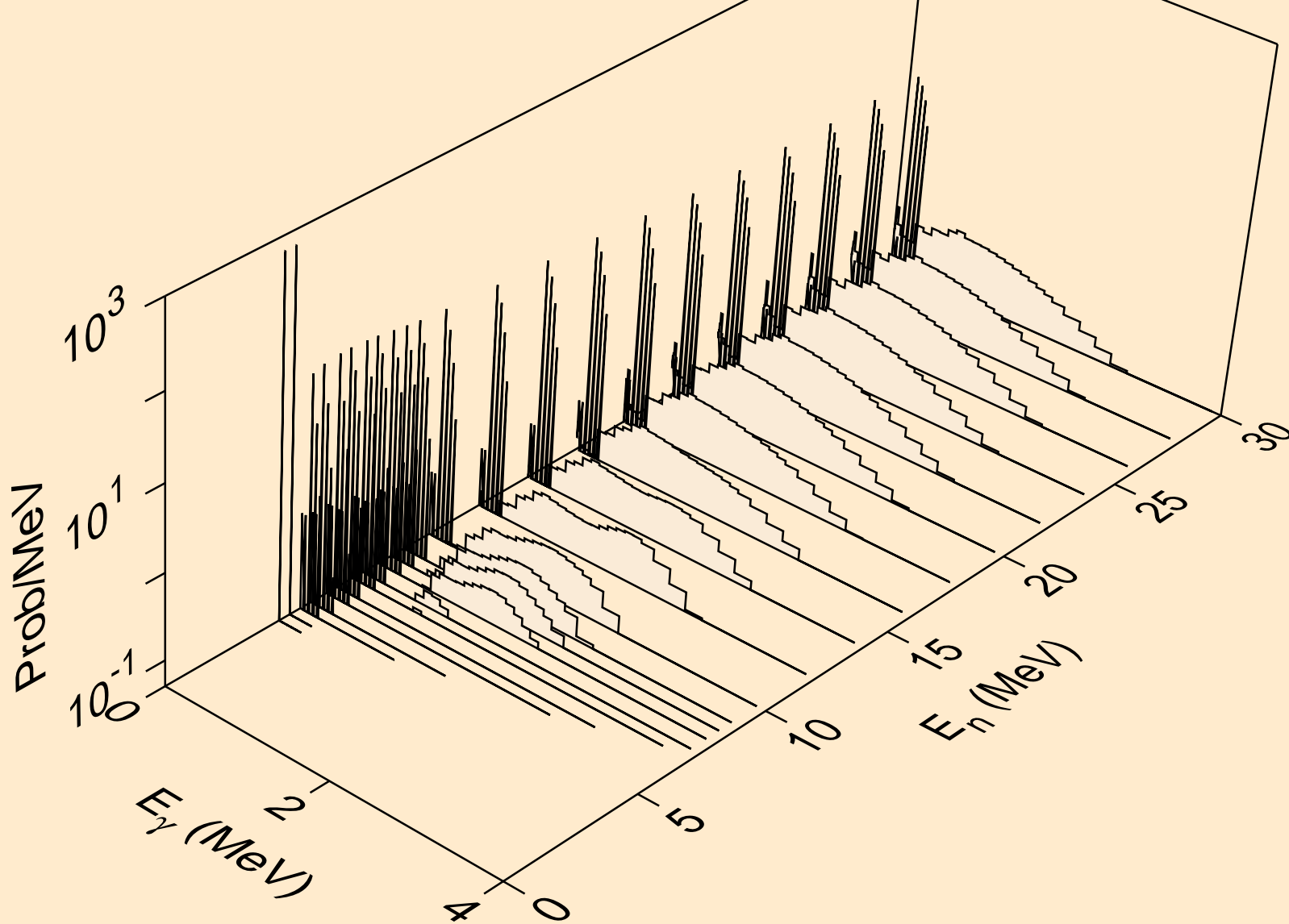

LR256 NEUTRON ACER TENDL-2019 LIBRARY; T=293.16K
Photon emission for (n,he3)

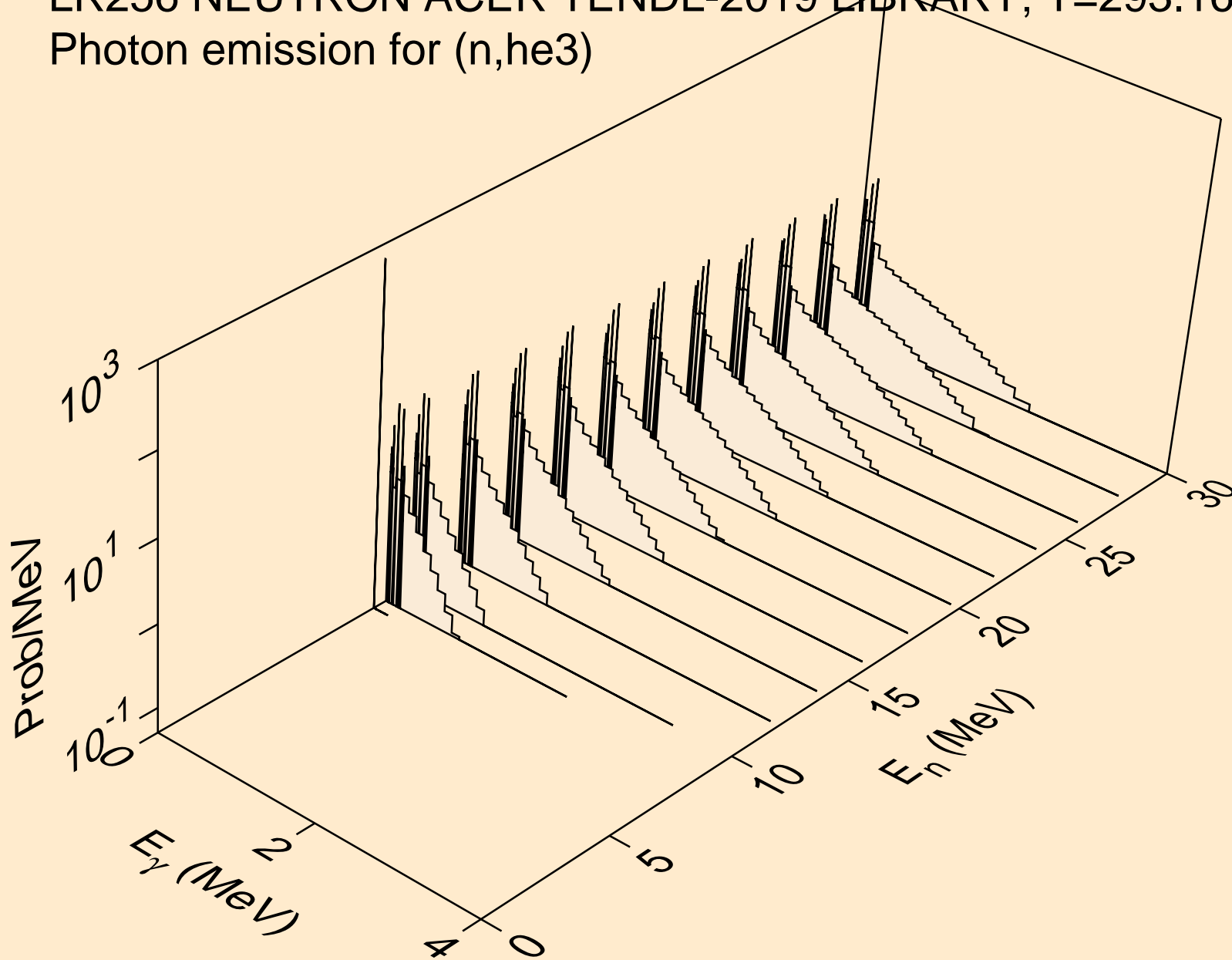

LR256 NEUTRON ACER TENDL-2019 LIBRARY; T=293.16K
Photon emission for (n,a)

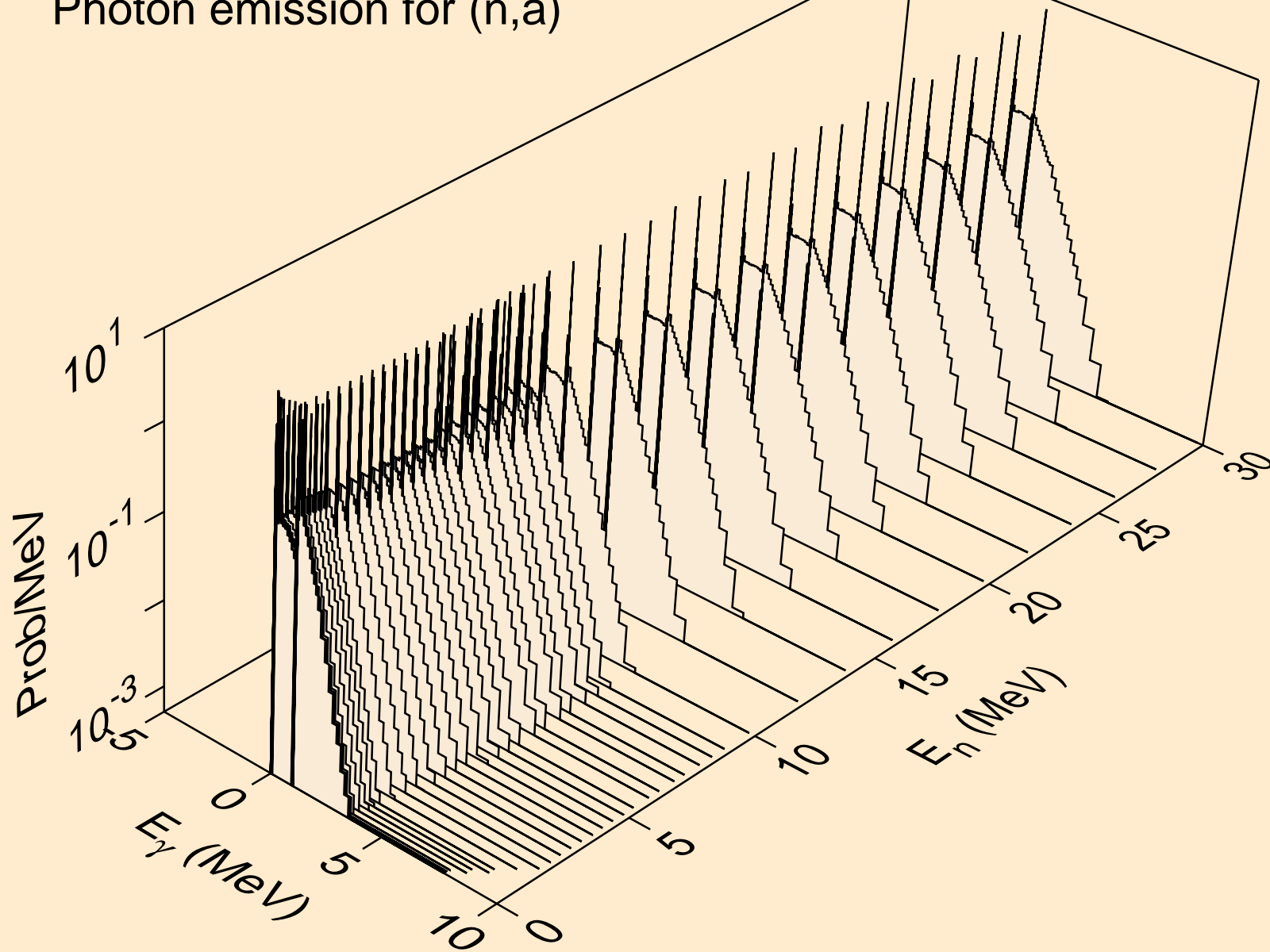

LR256 NEUTRON ACER TENDL-2019 LIBRARY; T=293.16K
Photon emission for (n,2a)

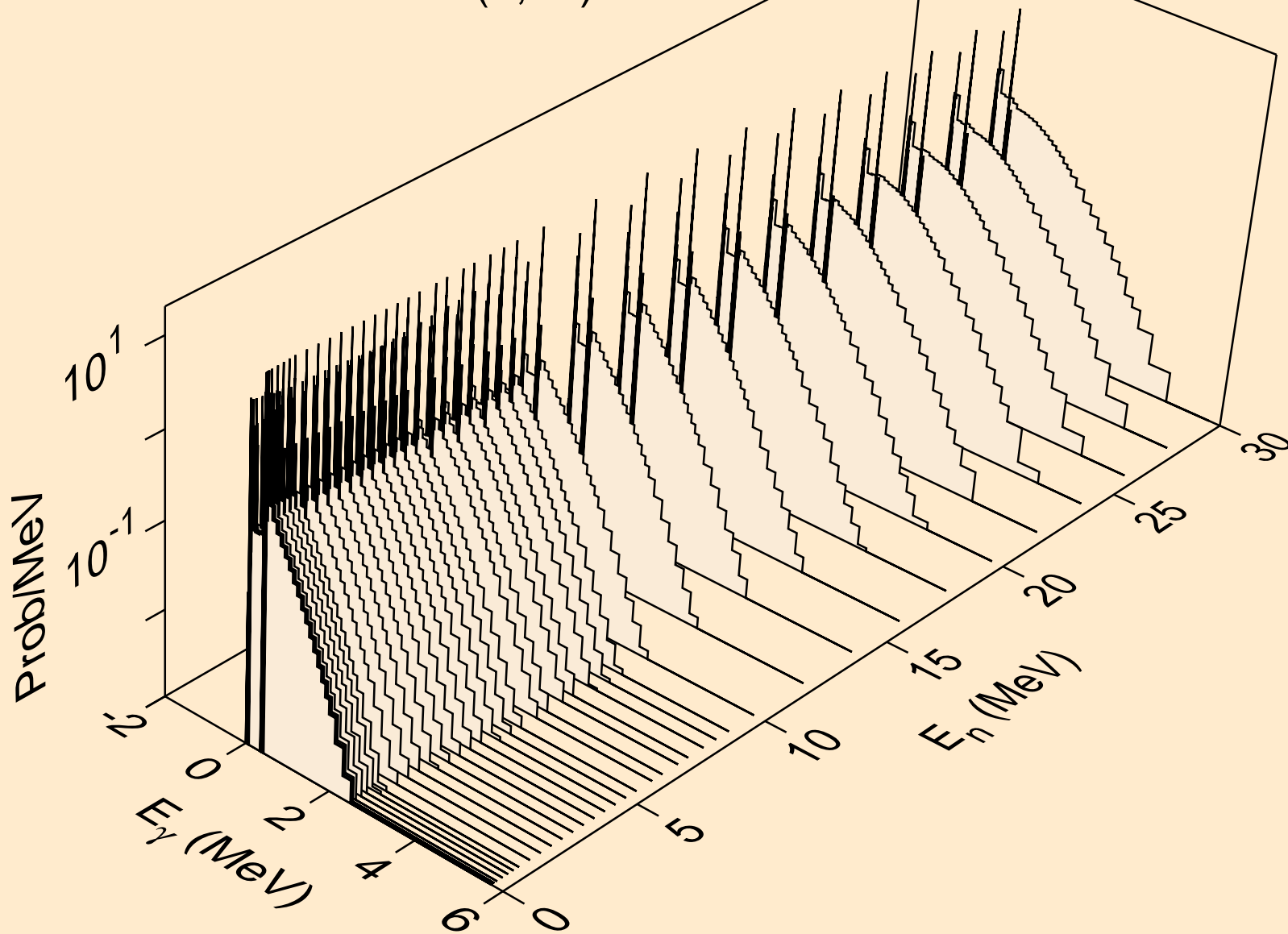

LR256 NEUTRON ACER TENDL-2019 LIBRARY; T=293.16K
Photon emission for (n,2p)

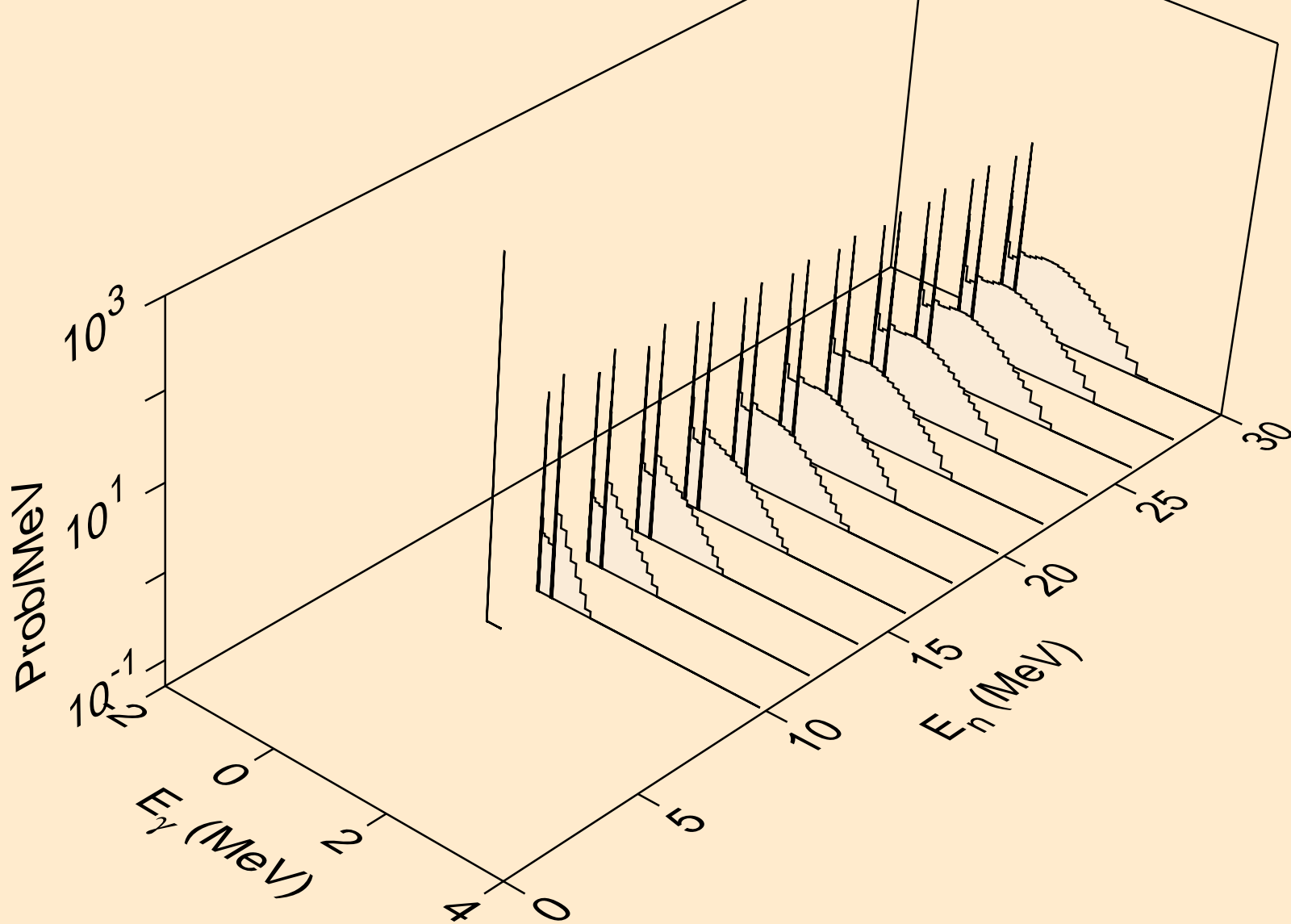

LR256 NEUTRON ACER TENDL-2019 LIBRARY; T=293.16K
Photon emission for (n,p α)

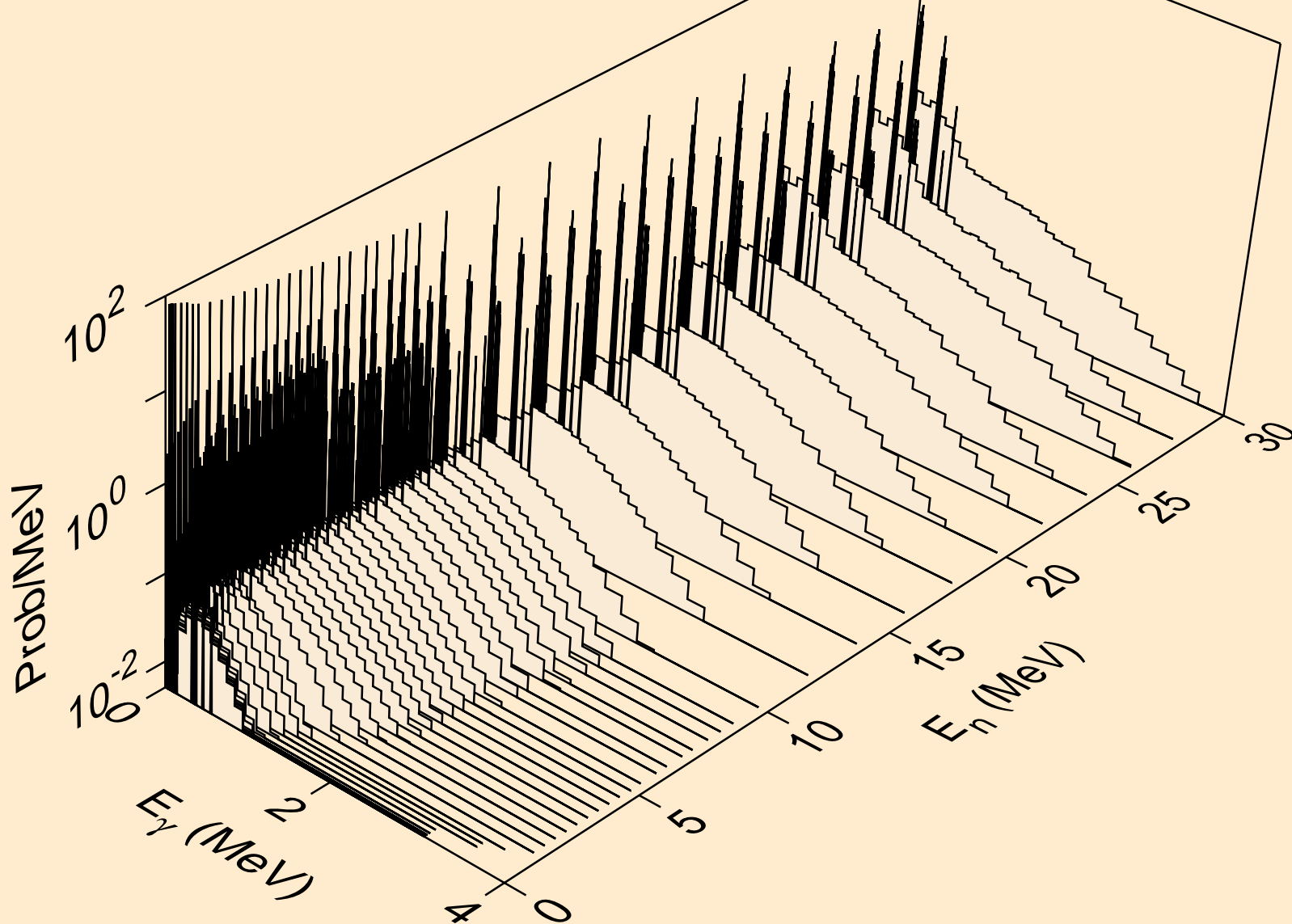

LR256 NEUTRON ACER TENDL-2019 LIBRARY; T=293.16K
Photon emission for (n,pd)

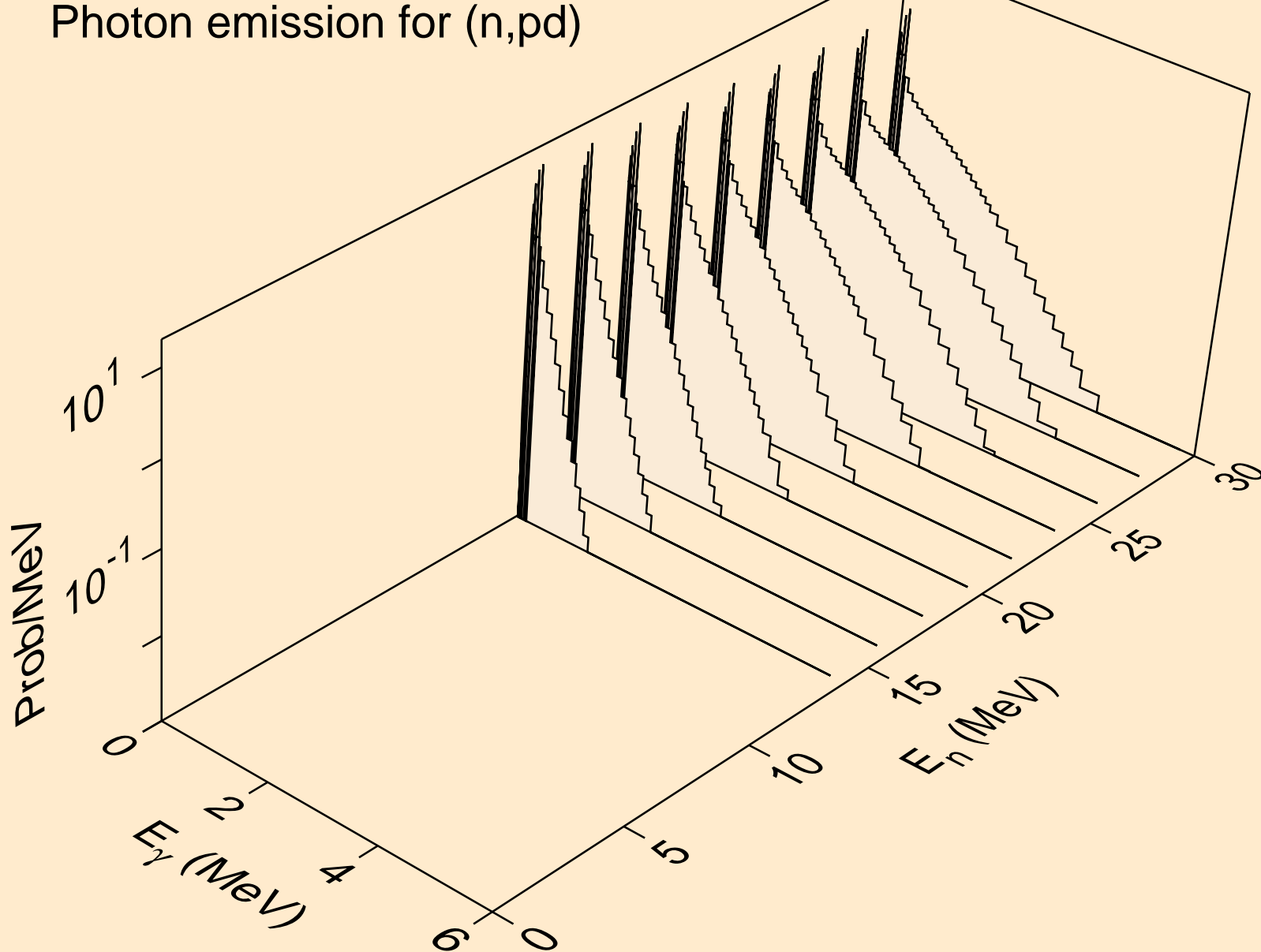

LR256 NEUTRON ACER TENDL-2019 LIBRARY; T=293.16K
Photon emission for (n,pt)

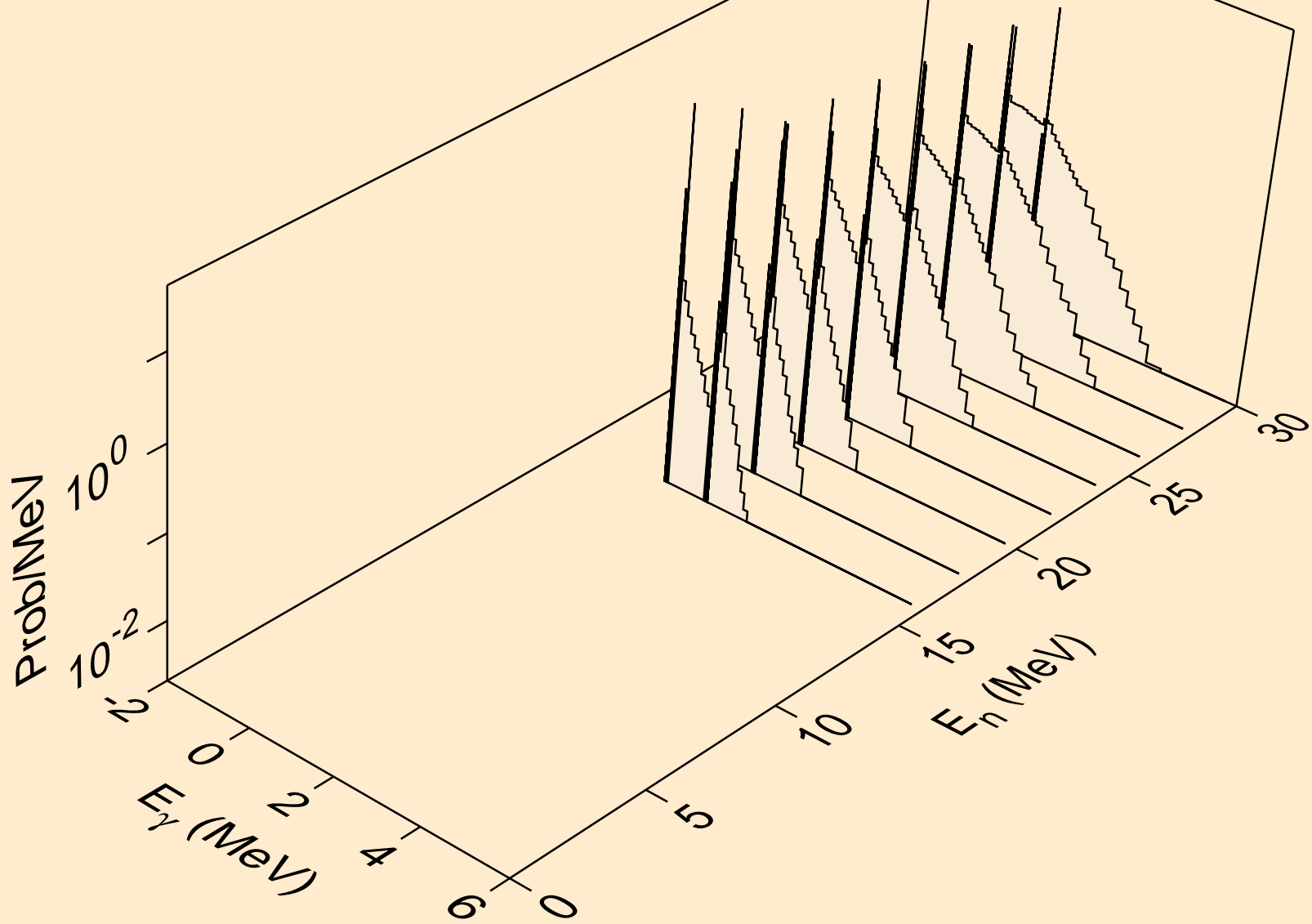

LR256 NEUTRON ACER TENDL-2019 LIBRARY; T=293.16K
Photon emission for (n,da)

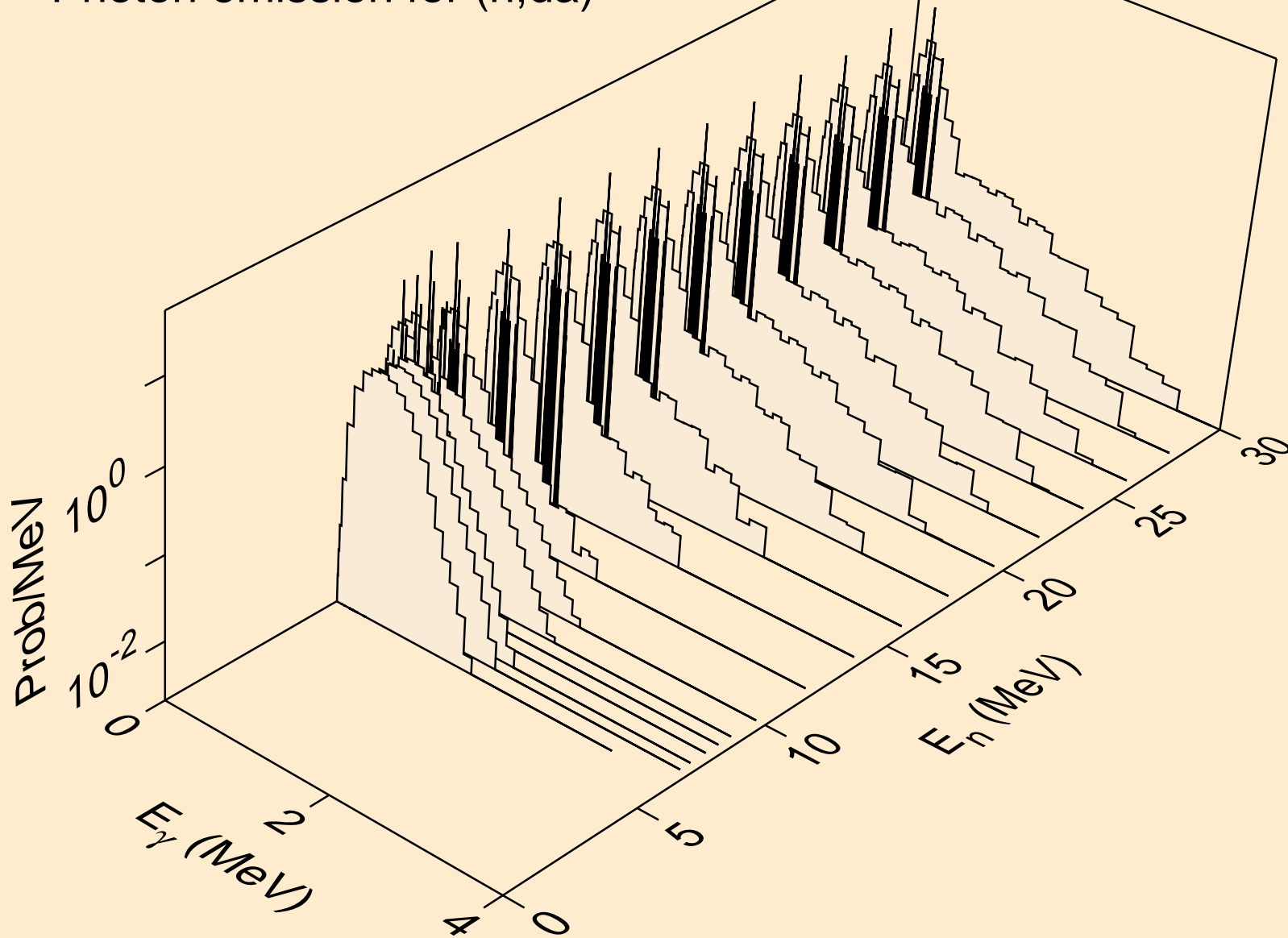

LR256 NEUTRON ACER TENDL-2019 LIBRARY; T=293.16K
thermal capture photon spectrum

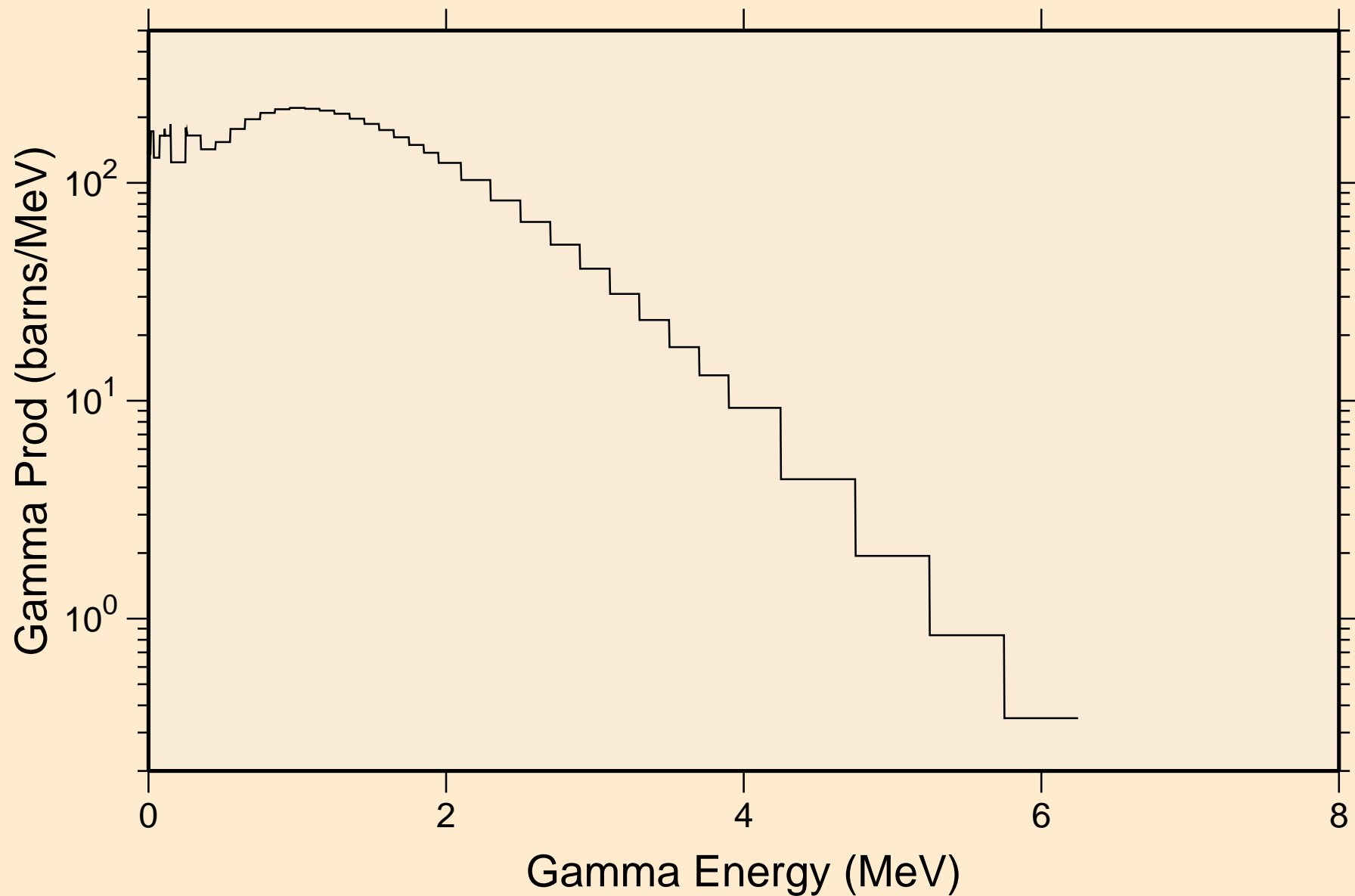

LR256 NEUTRON ACER TENDL-2019 LIBRARY; T=293.16K
14 MeV photon spectrum

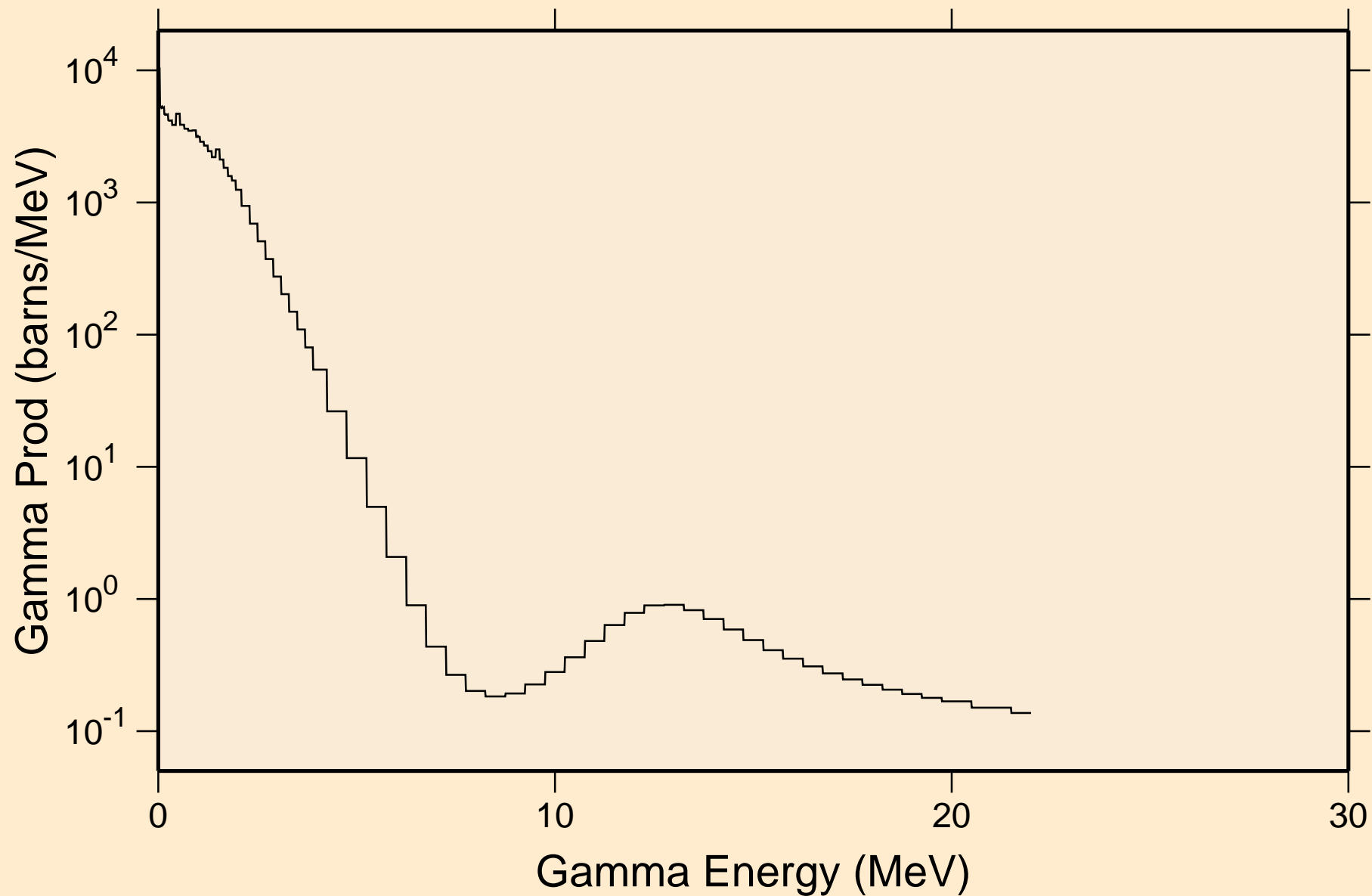

LR256 NEUTRON ACER TENDL-2019 LIBRARY; T=293.16K
Particle heating contributions

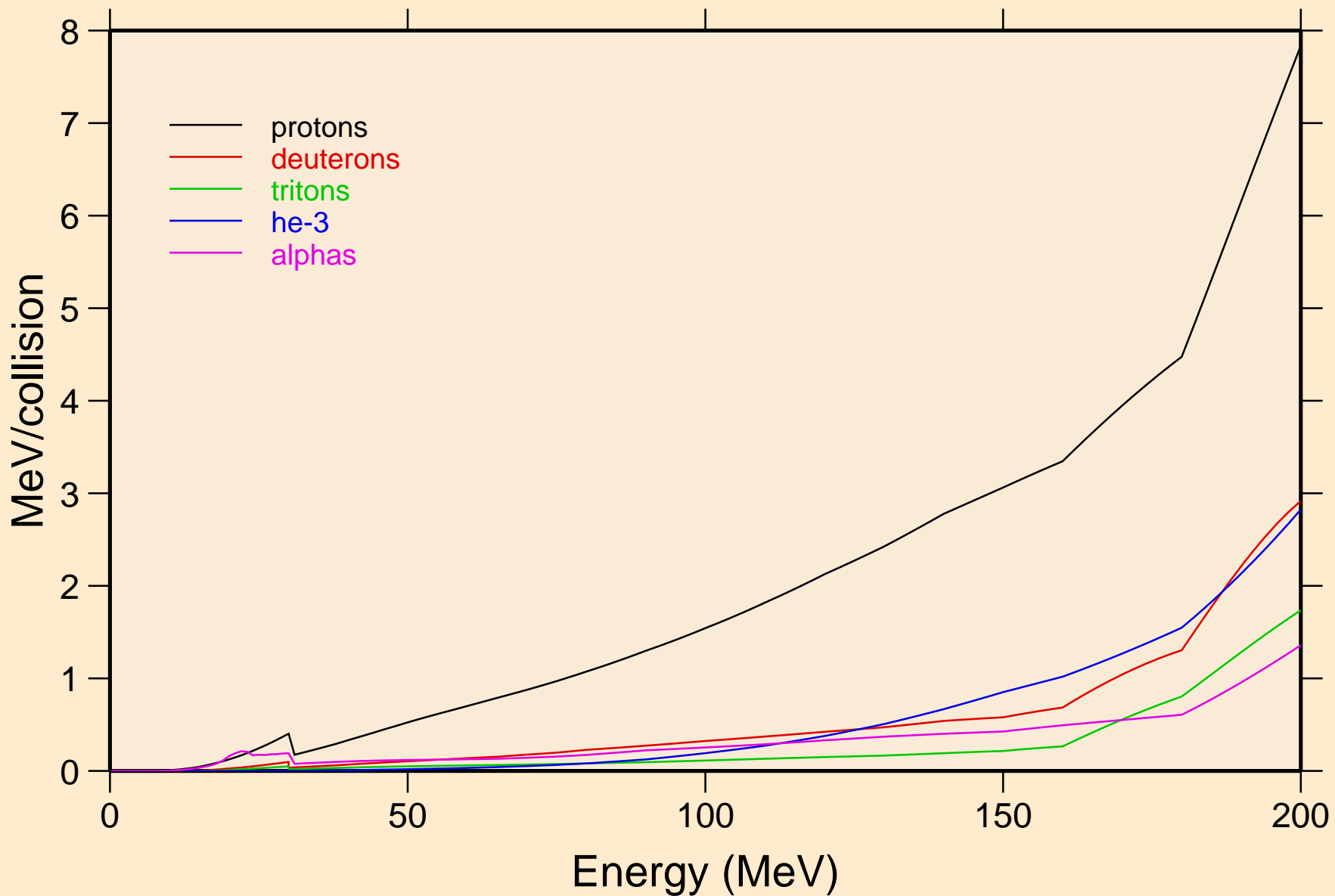

LR256 NEUTRON ACER TENDL-2019 LIBRARY; T=293.16K
Recoil Heating

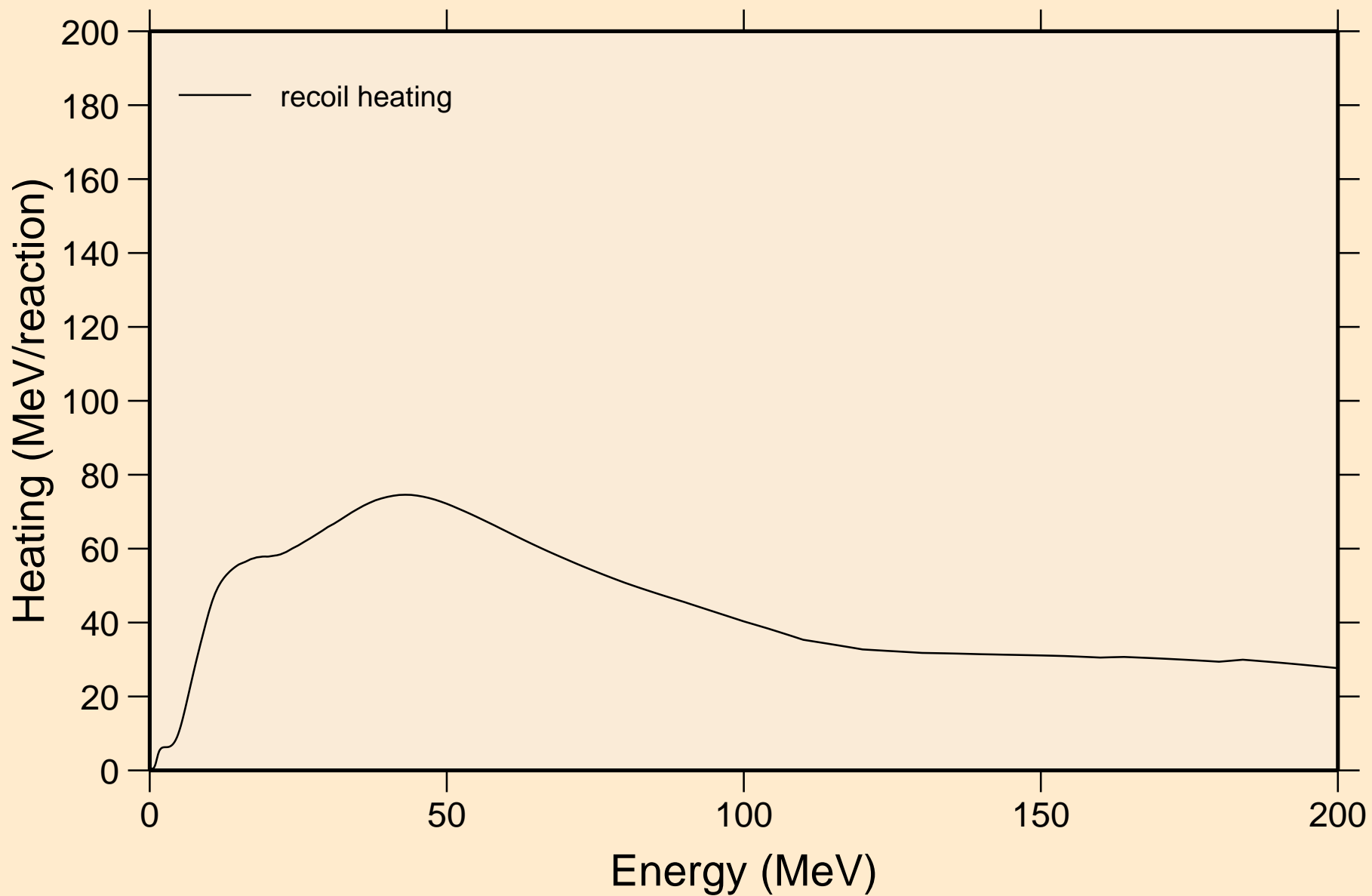

LR256 NEUTRON ACER TENDL-2019 LIBRARY; T=293.16K
Particle production cross sections

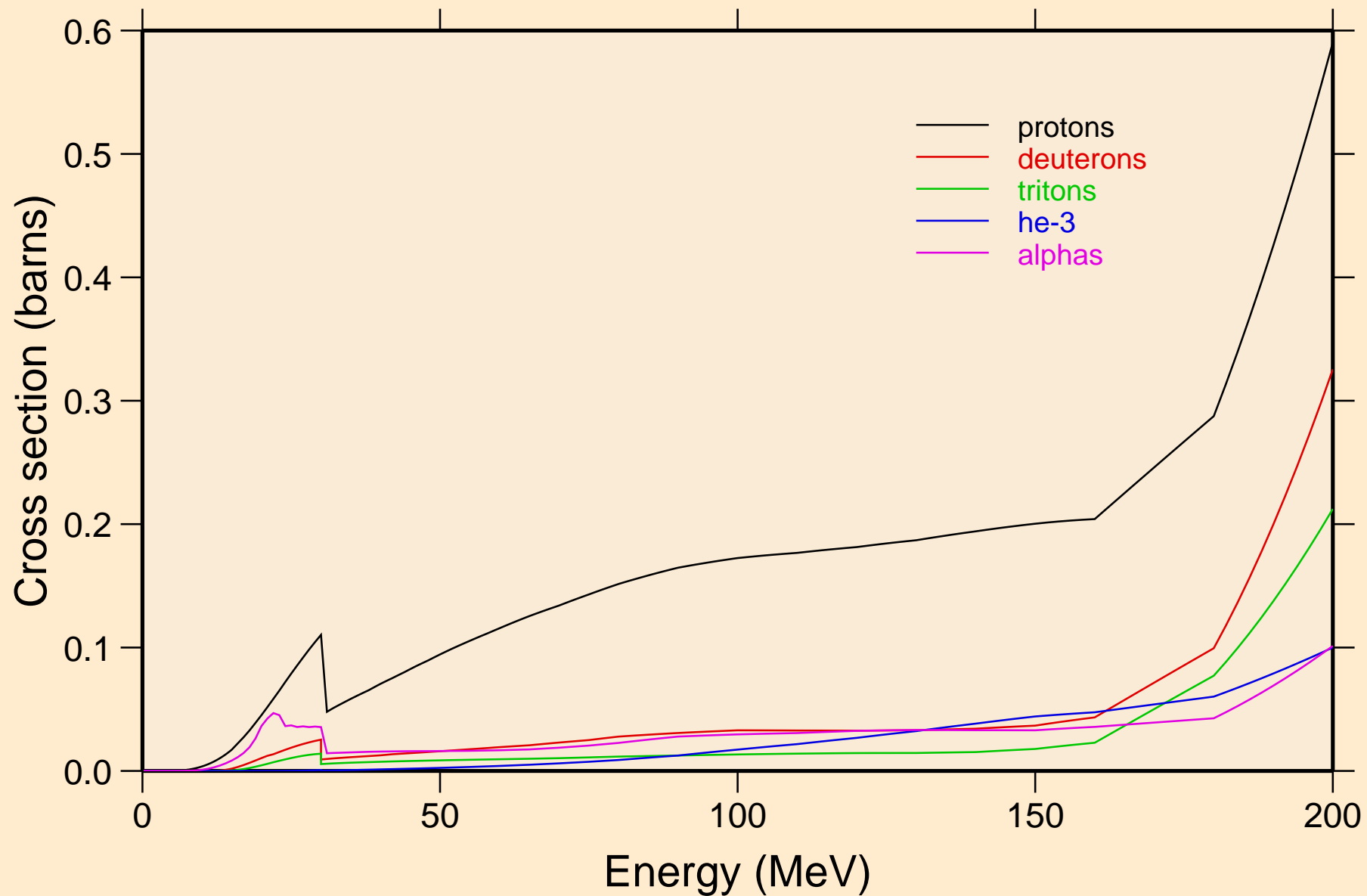

LR256 NEUTRON ACER TENDL-2019 LIBRARY; T=293.16K
protons from (n,x)

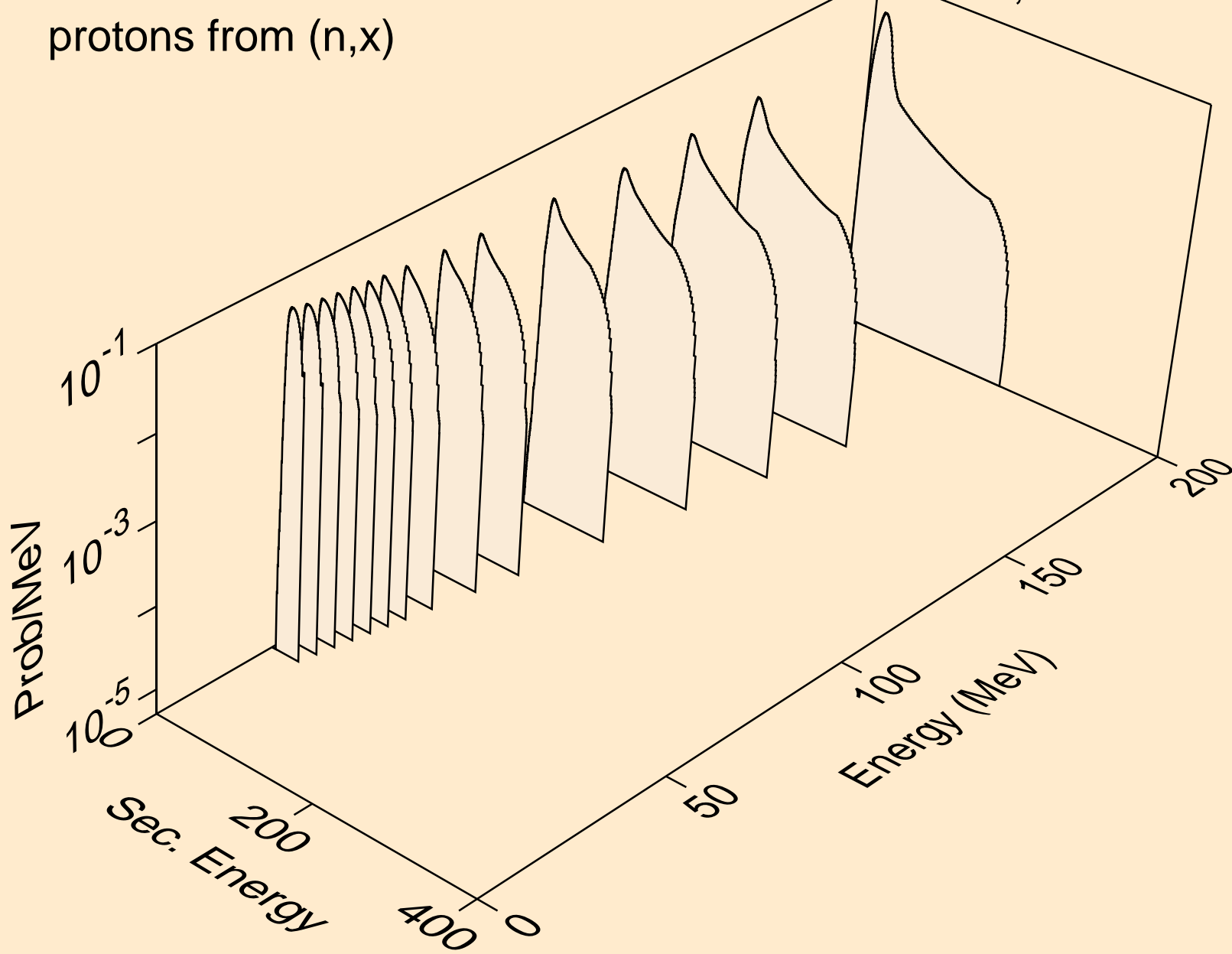

LR256 NEUTRON ACER TENDL-2019 LIBRARY; T=293.16K
protons from (n,n*)p

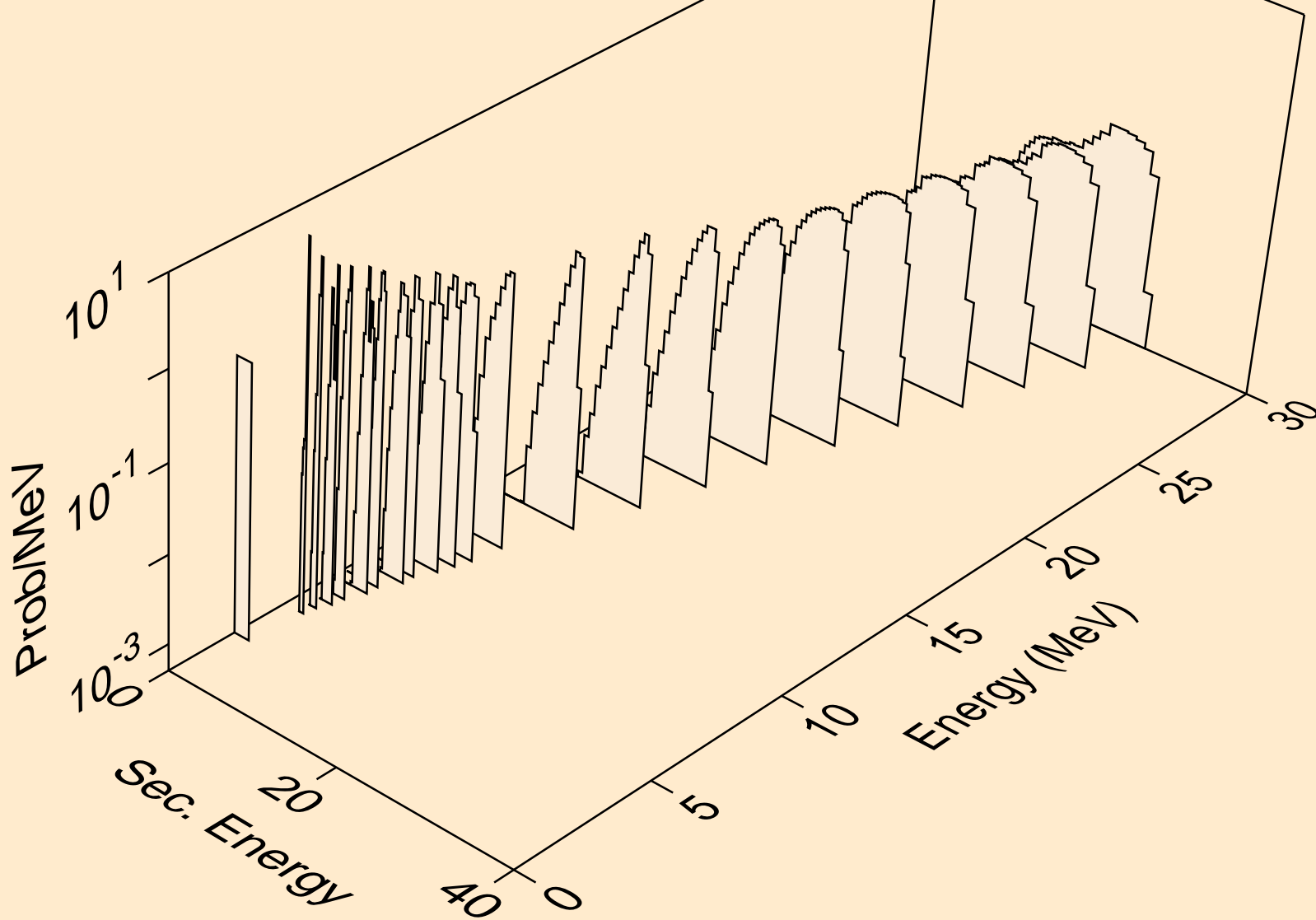

LR256 NEUTRON ACER TENDL-2019 LIBRARY; T=293.16K
protons from (n,2np)

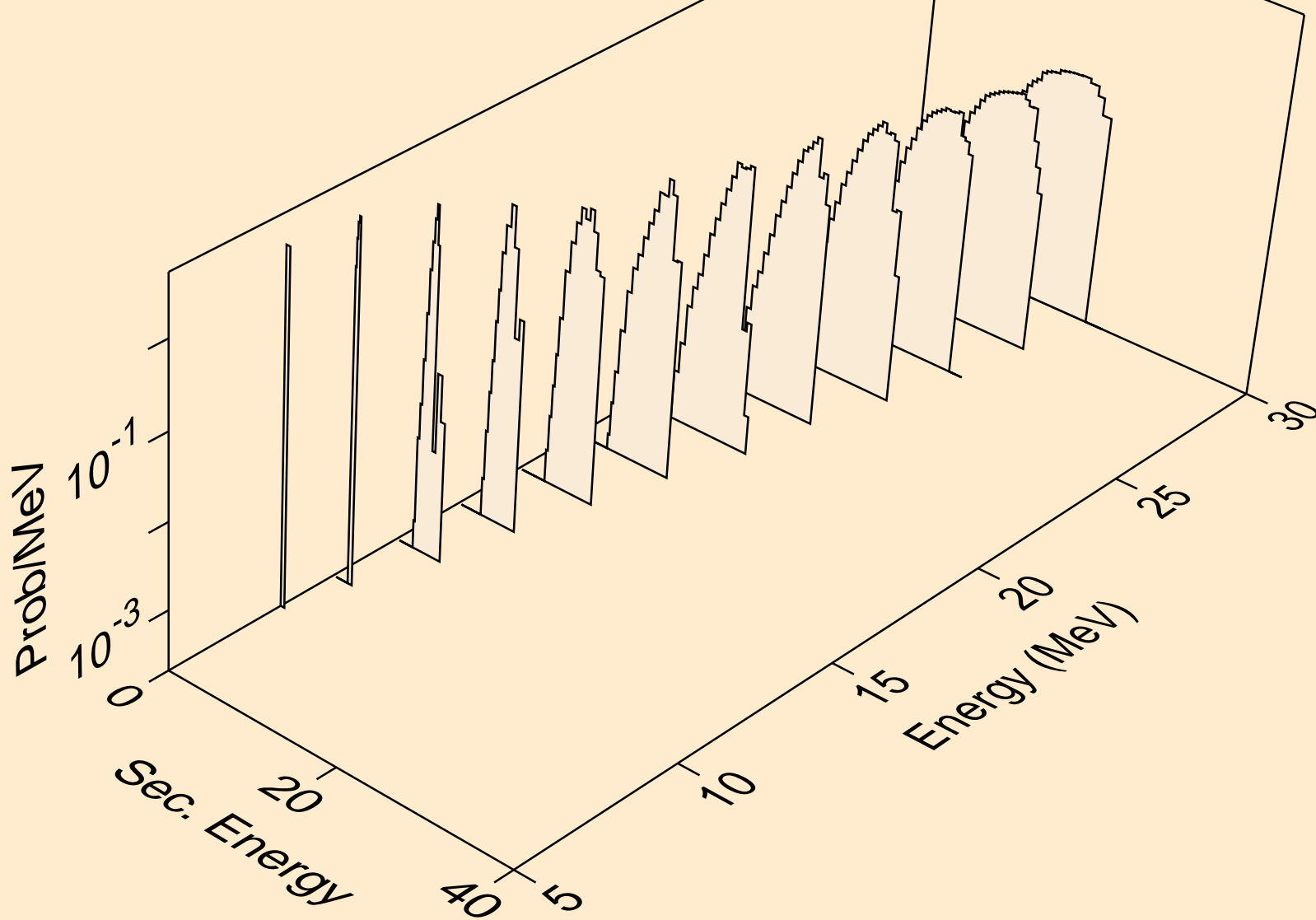

LR256 NEUTRON ACER TENDL-2019 LIBRARY; T=293.16K
protons from (n,3np)

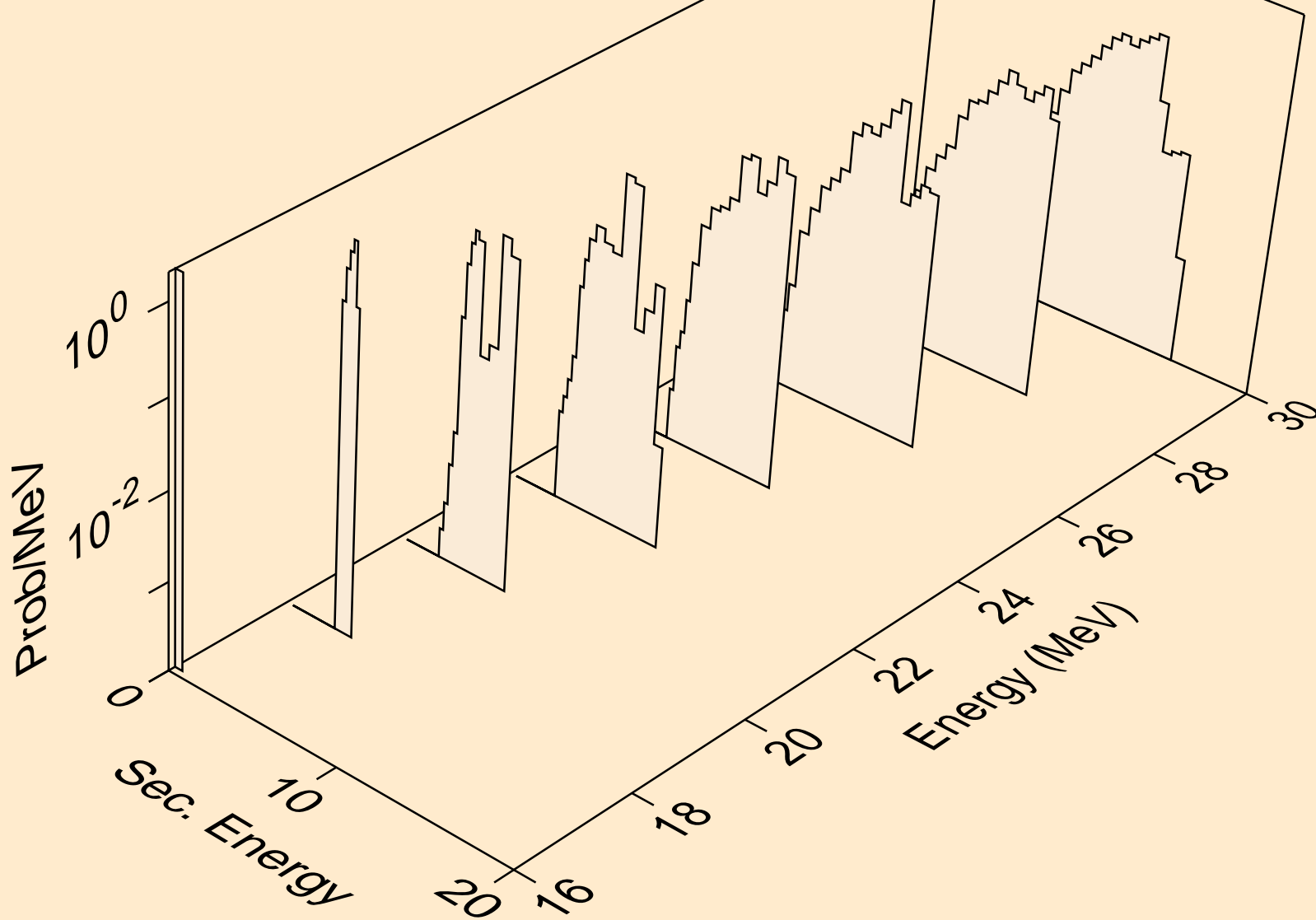

LR256 NEUTRON ACER TENDL-2019 LIBRARY; T=293.16K
protons from (n,2np)

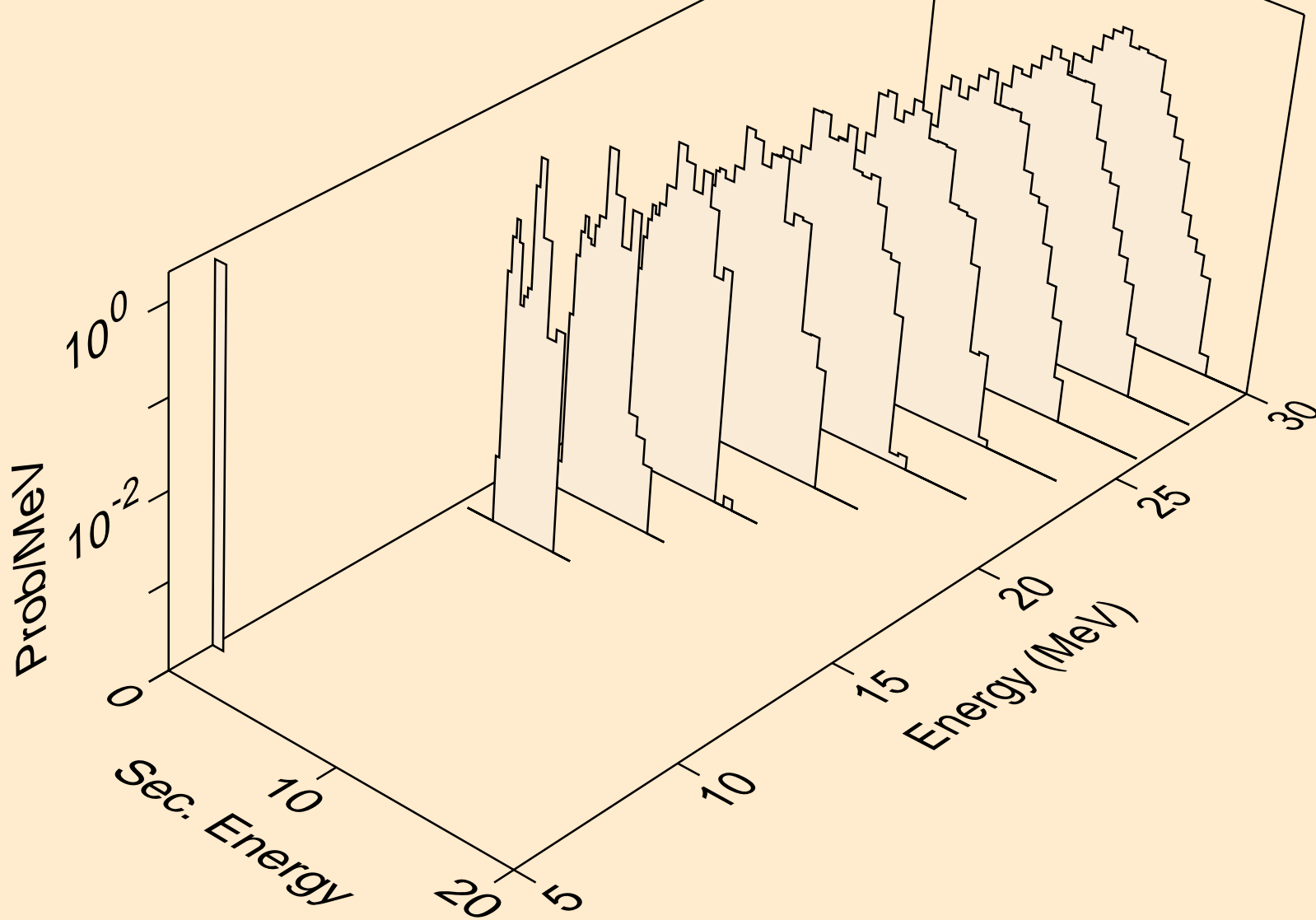

LR256 NEUTRON ACER TENDL-2019 LIBRARY; T=293.16K
protons from (n,npa)

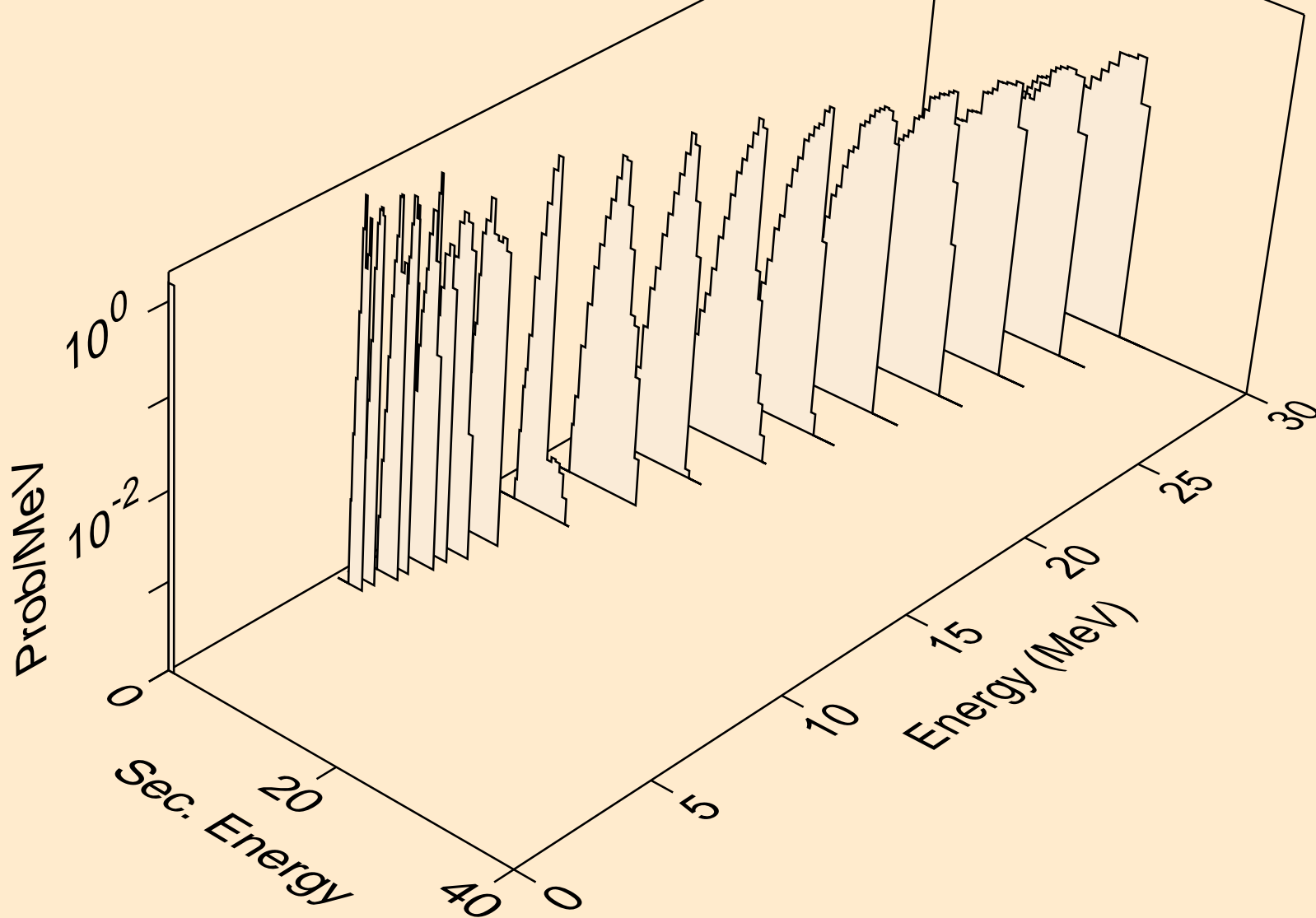

LR256 NEUTRON ACER TENDL-2019 LIBRARY; T=293.16K
protons from (n,p)

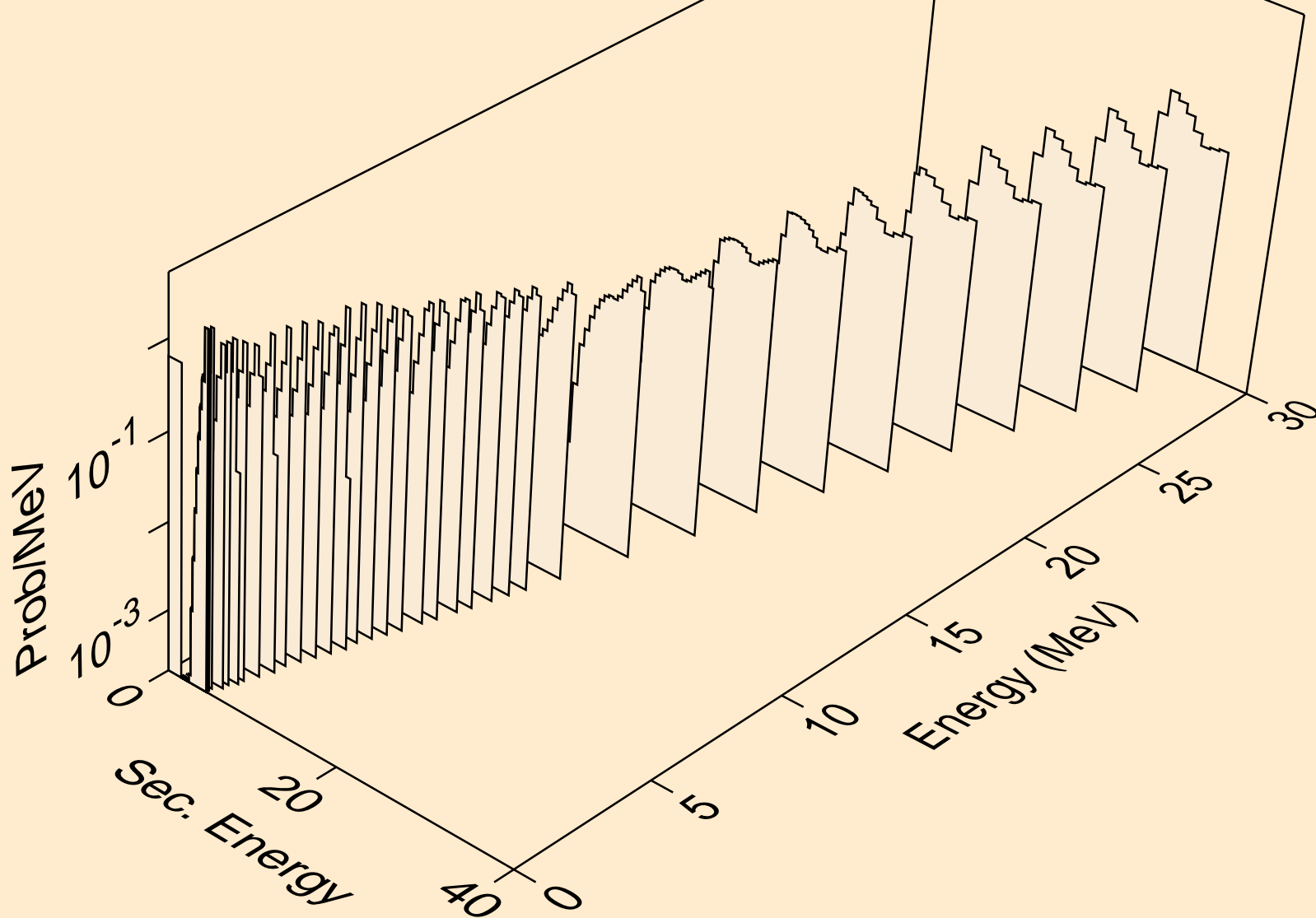

LR256 NEUTRON ACER TENDL-2019 LIBRARY; T=293.16K
protons from (n,2p)

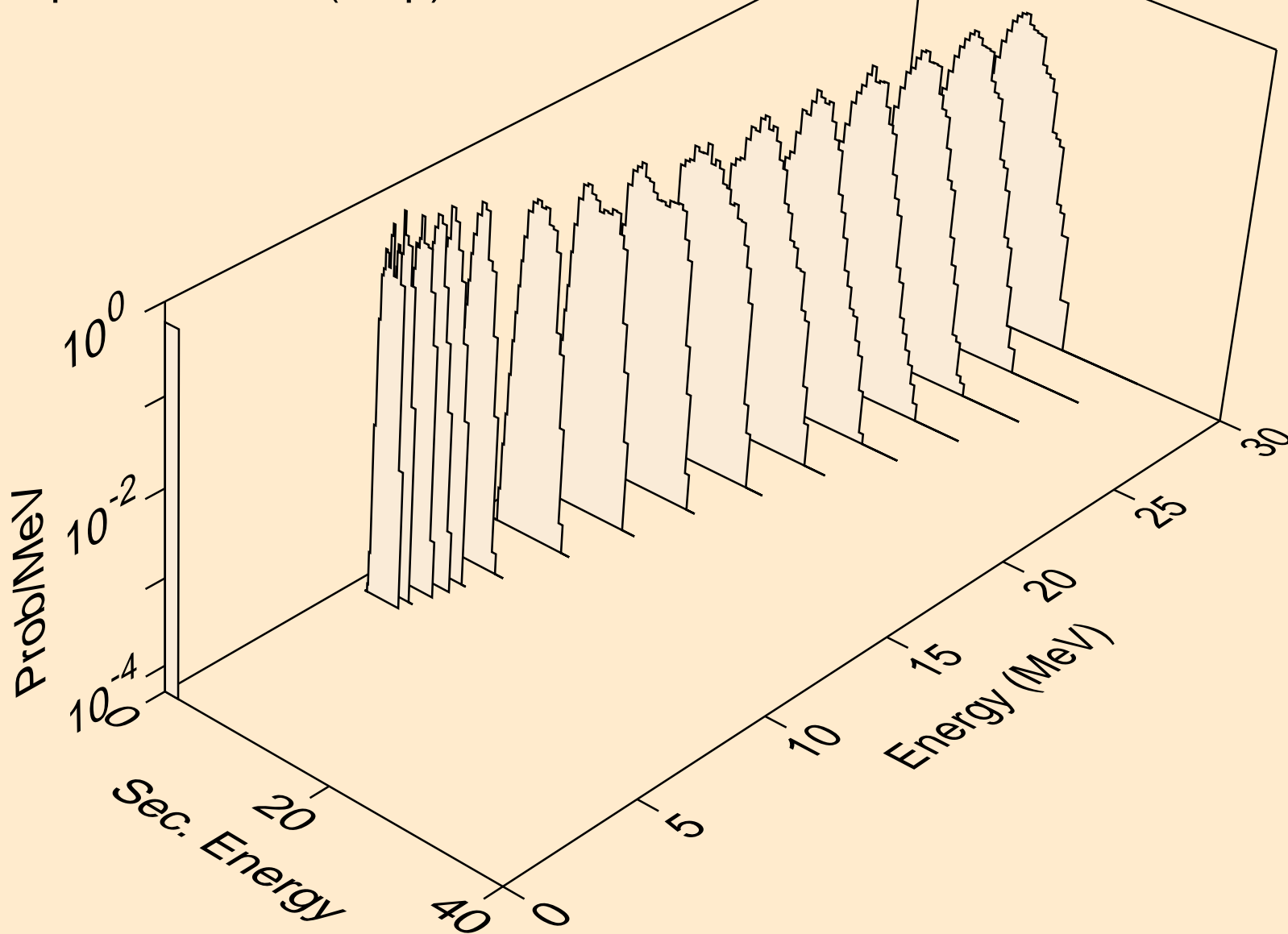

LR256 NEUTRON ACER TENDL-2019 LIBRARY; T=293.16K
protons from (n,p)

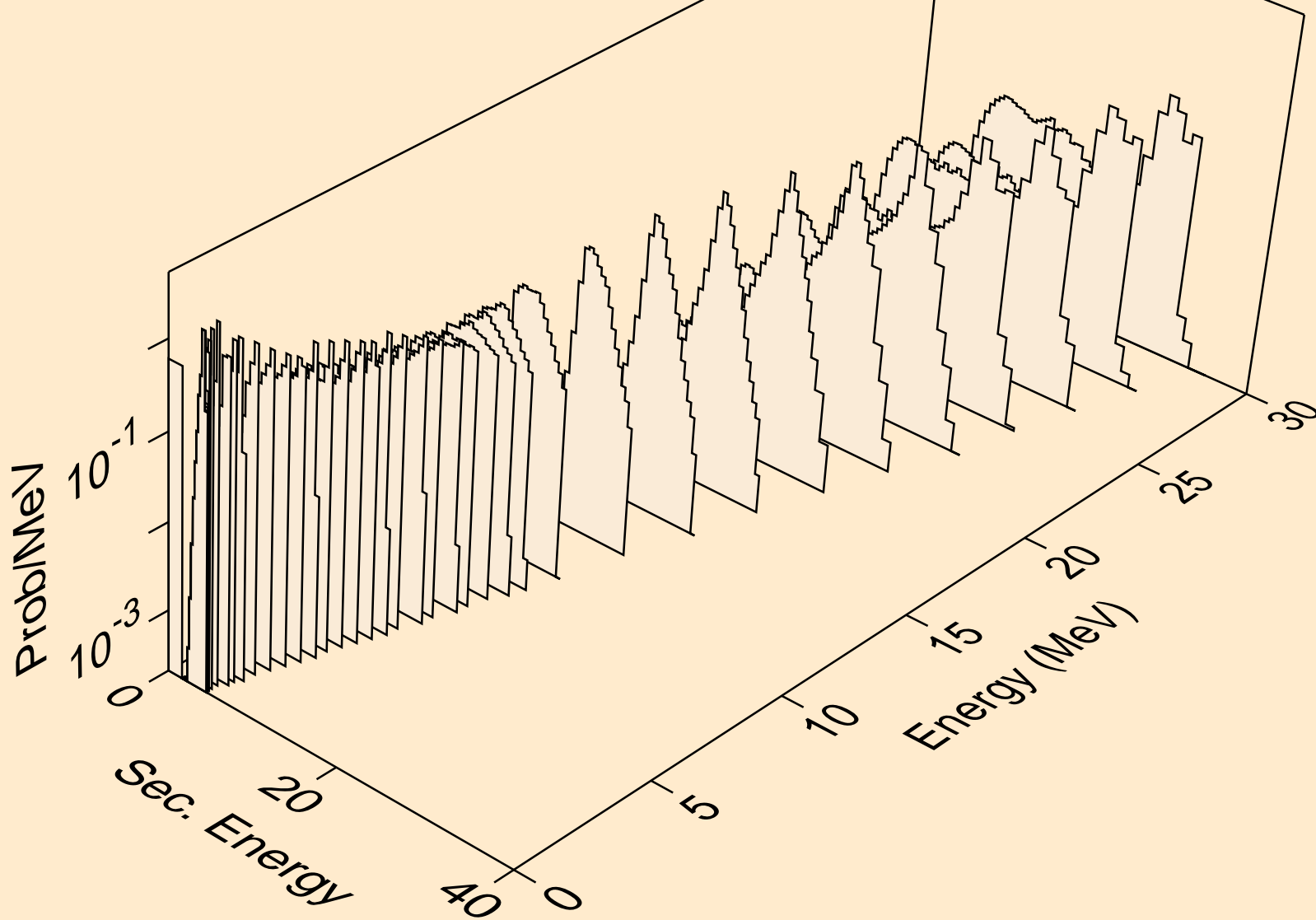

LR256 NEUTRON ACER TENDL-2019 LIBRARY; T=293.16K
protons from (n,pd)

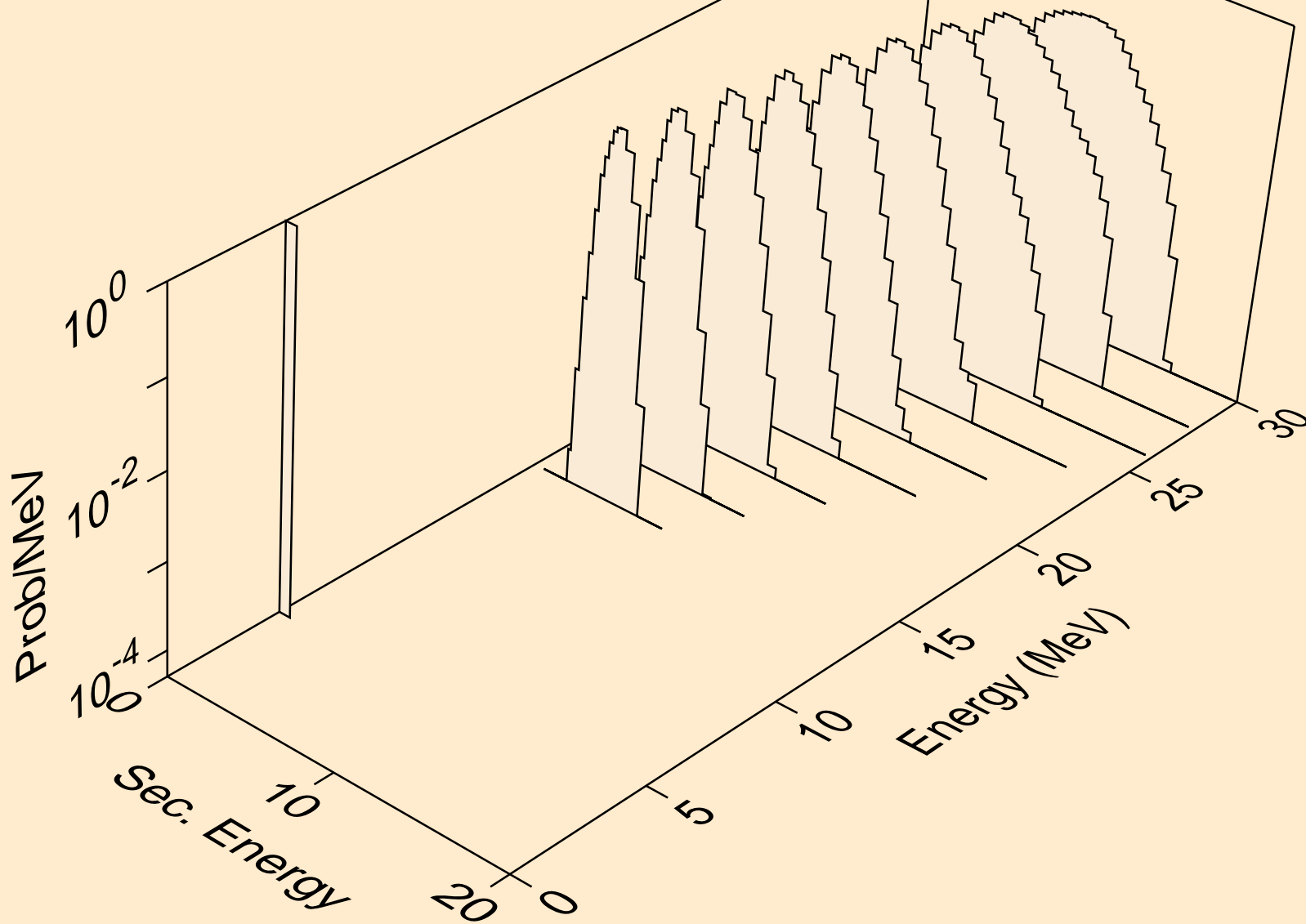

LR256 NEUTRON ACER TENDL-2019 LIBRARY; T=293.16K
protons from (n,pt)

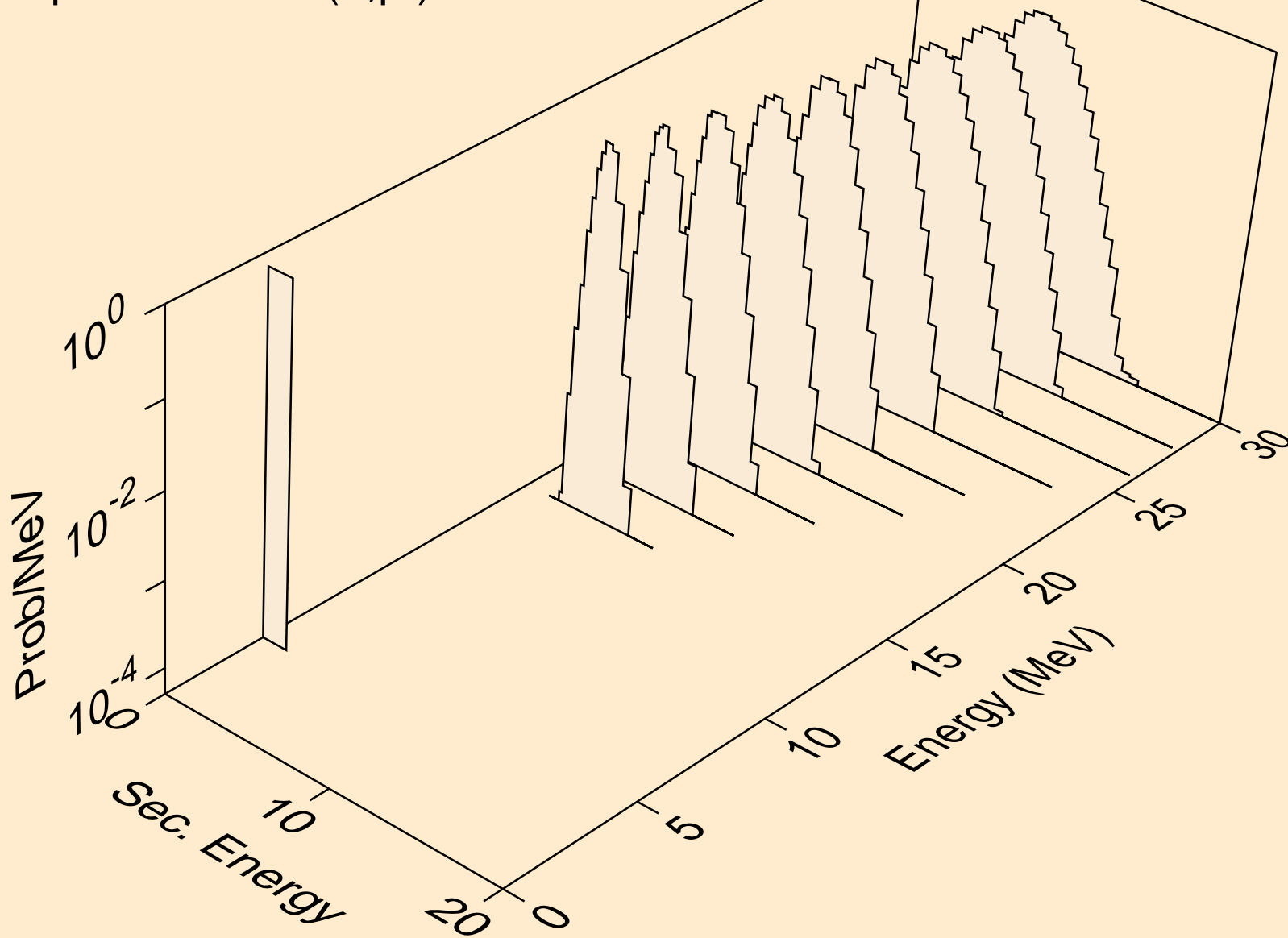

LR256 NEUTRON ACER TENDL-2019 LIBRARY; T=293.16K
deuterons from (n,x)

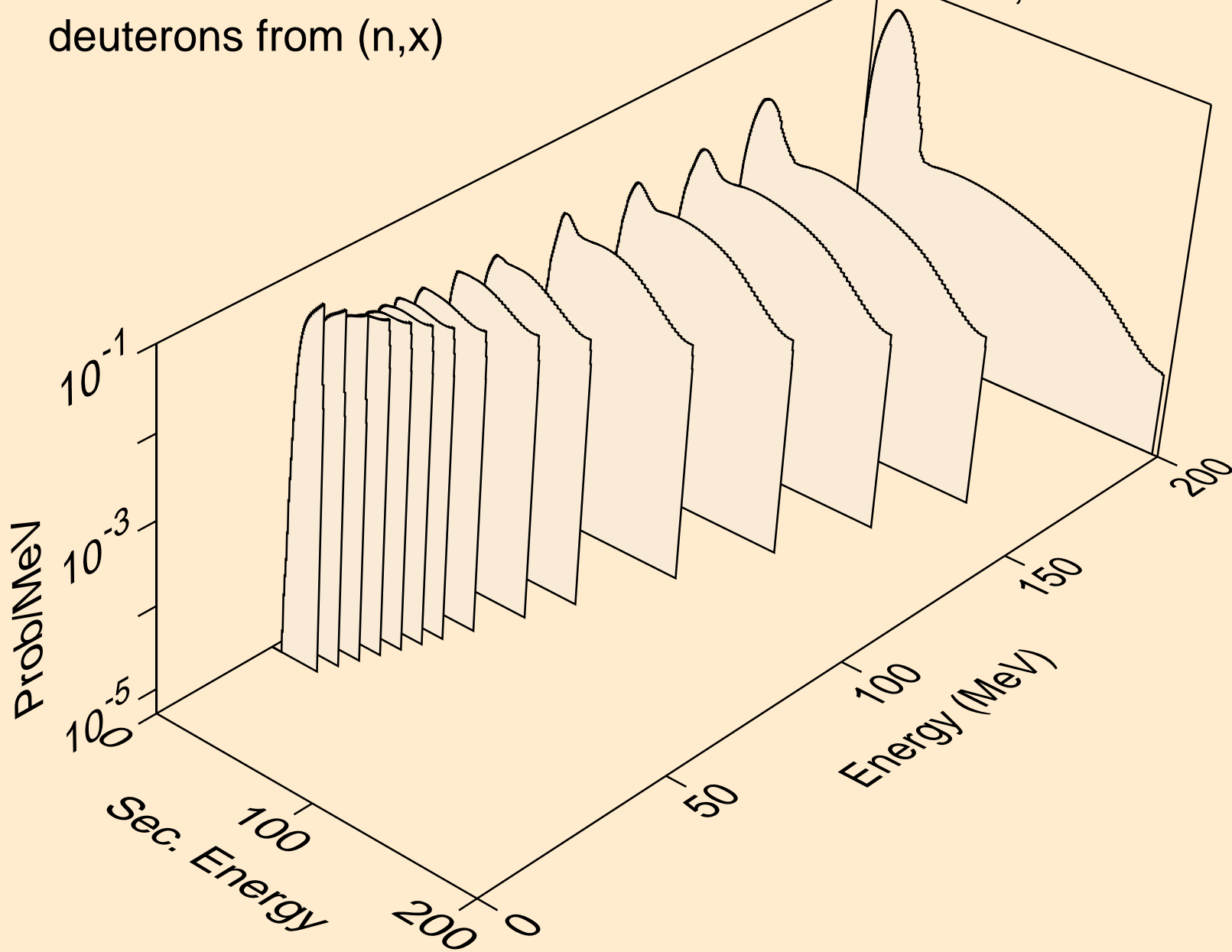

LR256 NEUTRON ACER TENDL-2019 LIBRARY; T=293.16K
deuterons from (n,2nd)

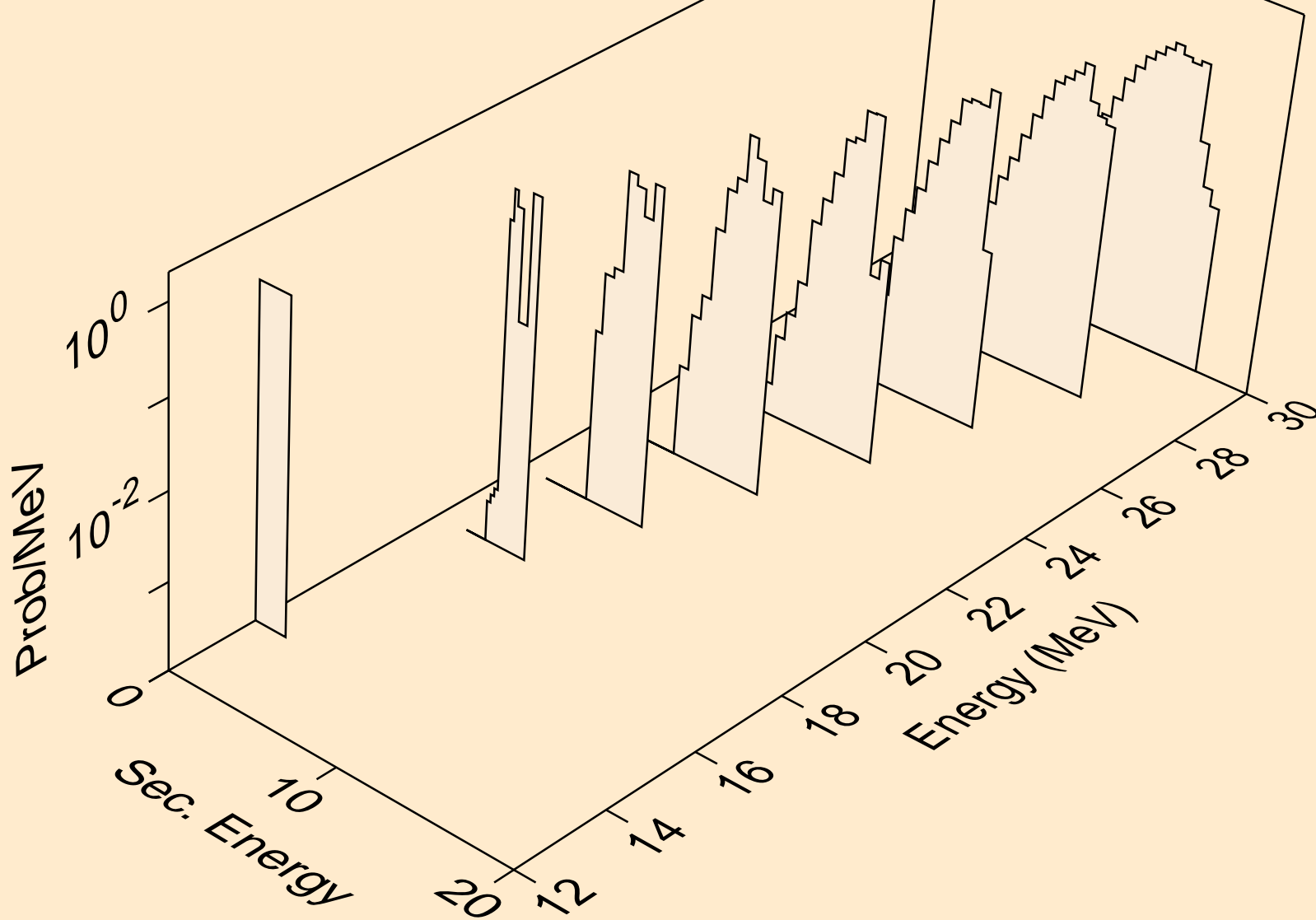

LR256 NEUTRON ACER TENDL-2019 LIBRARY; T=293.16K
deuterons from (n,n*)d

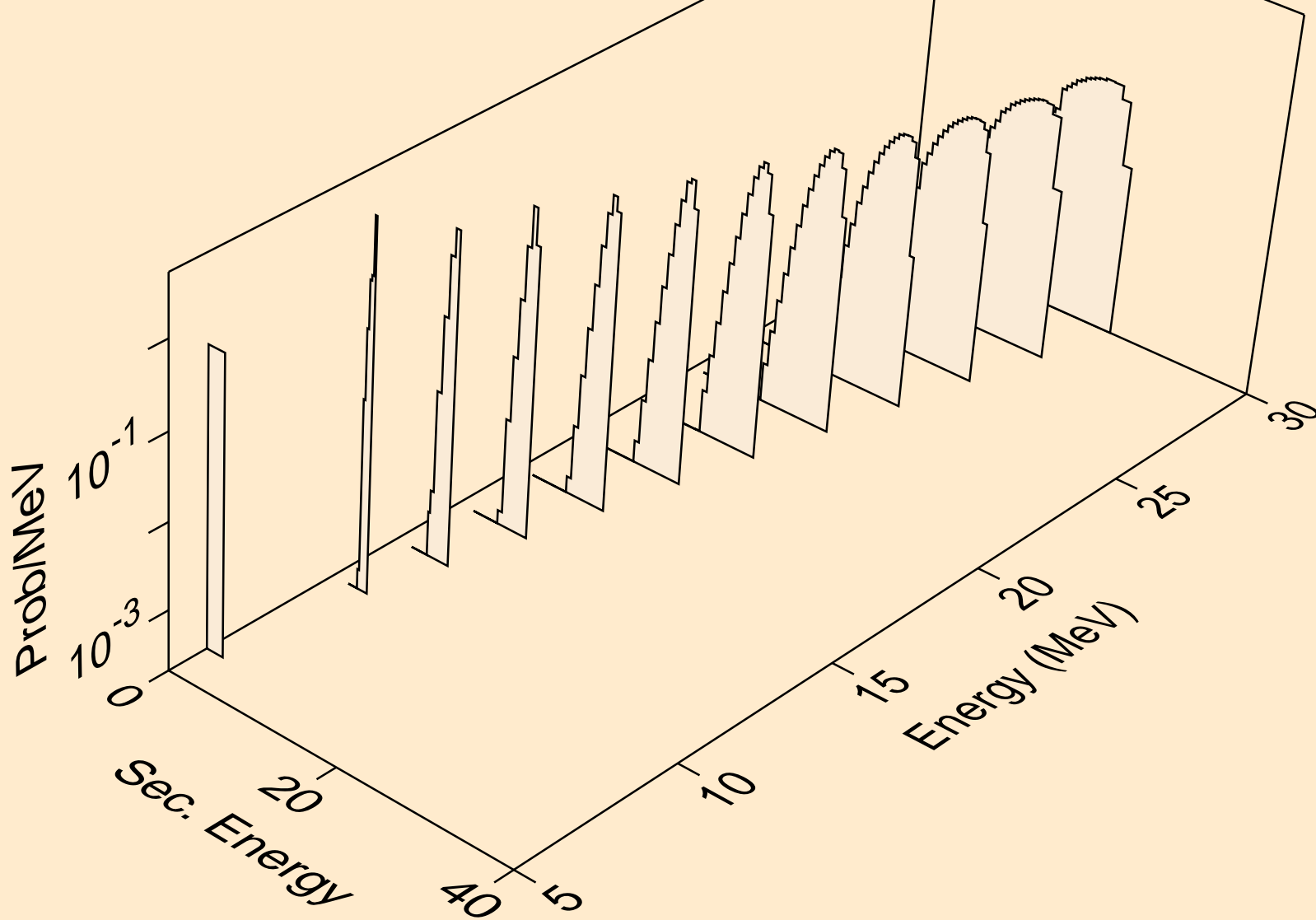

LR256 NEUTRON ACER TENDL-2019 LIBRARY; T=293.16K
deuterons from (n,d)

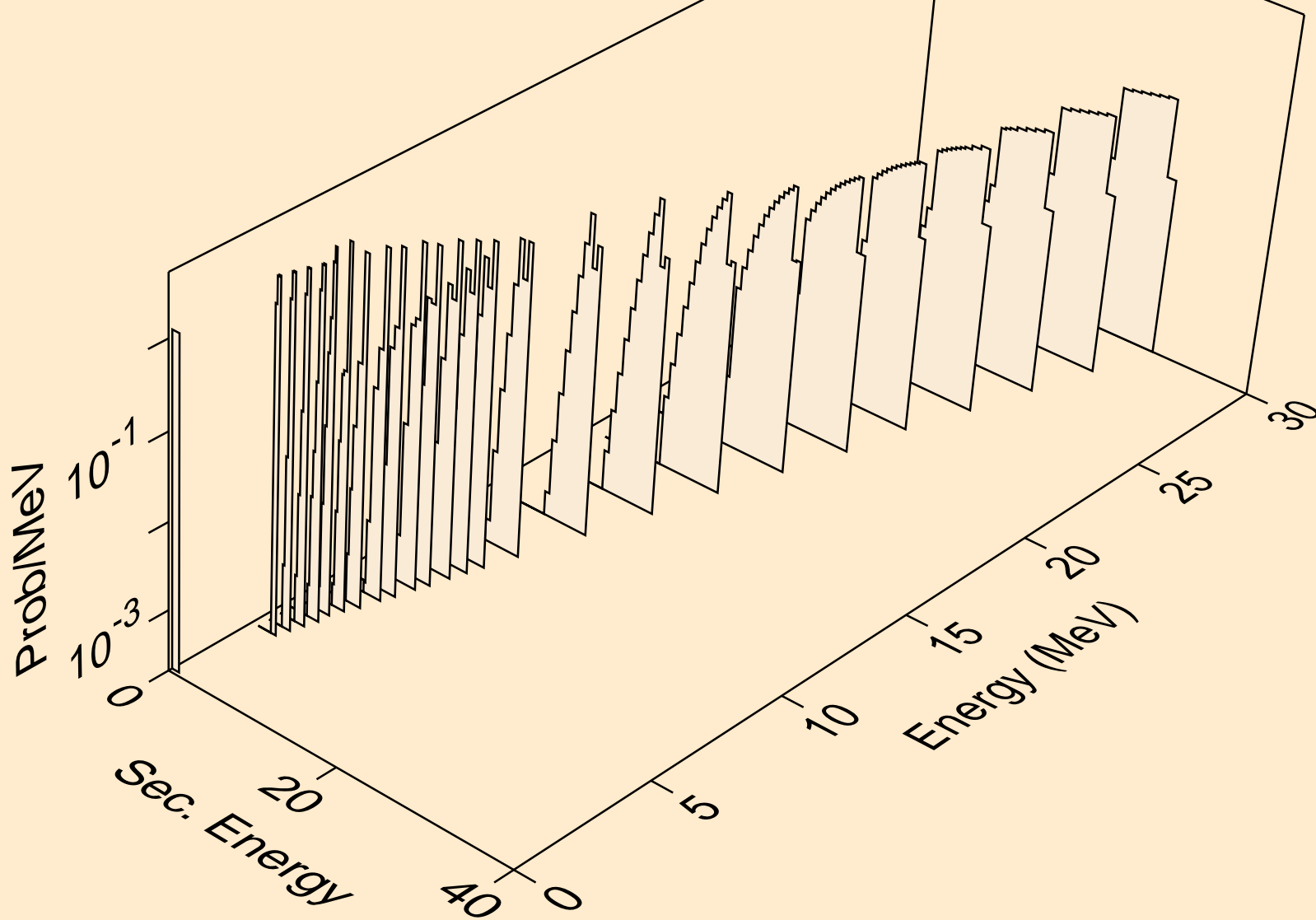

LR256 NEUTRON ACER TENDL-2019 LIBRARY; T=293.16K
deuterons from (n,pd)

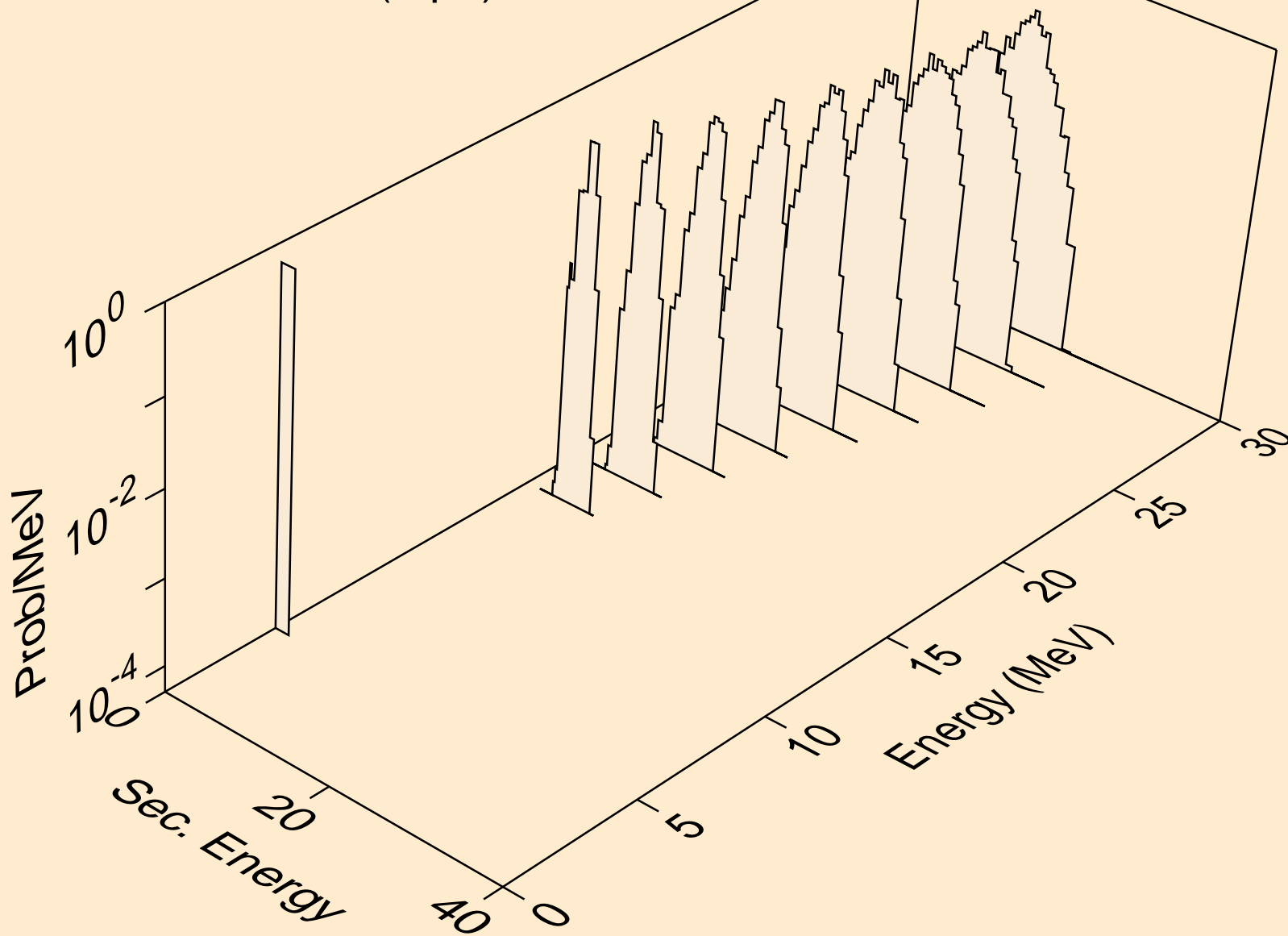

LR256 NEUTRON ACER TENDL-2019 LIBRARY; T=293.16K
deuterons from (n,da)

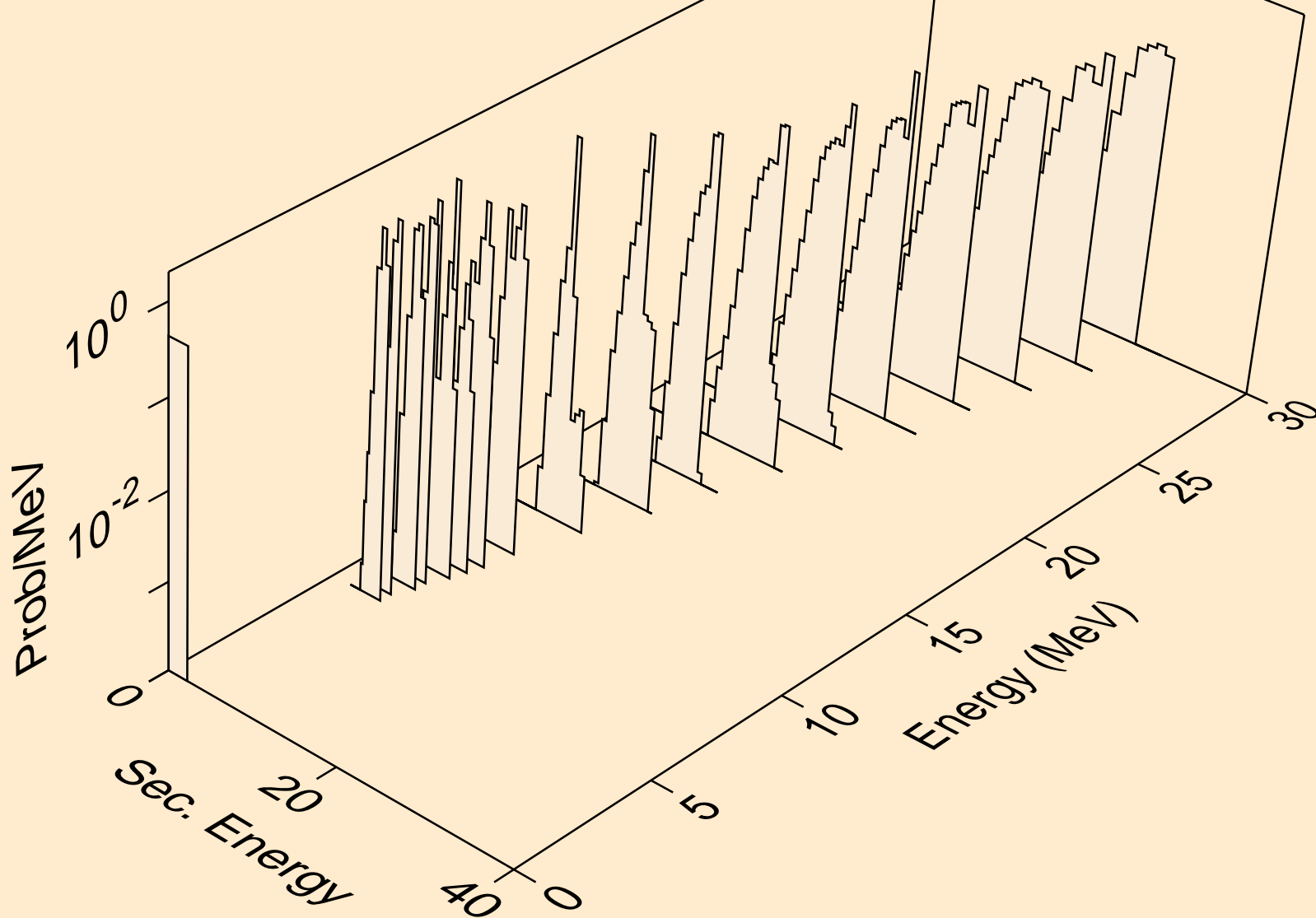

LR256 NEUTRON ACER TENDL-2019 LIBRARY; T=293.16K
tritons from (n,x)

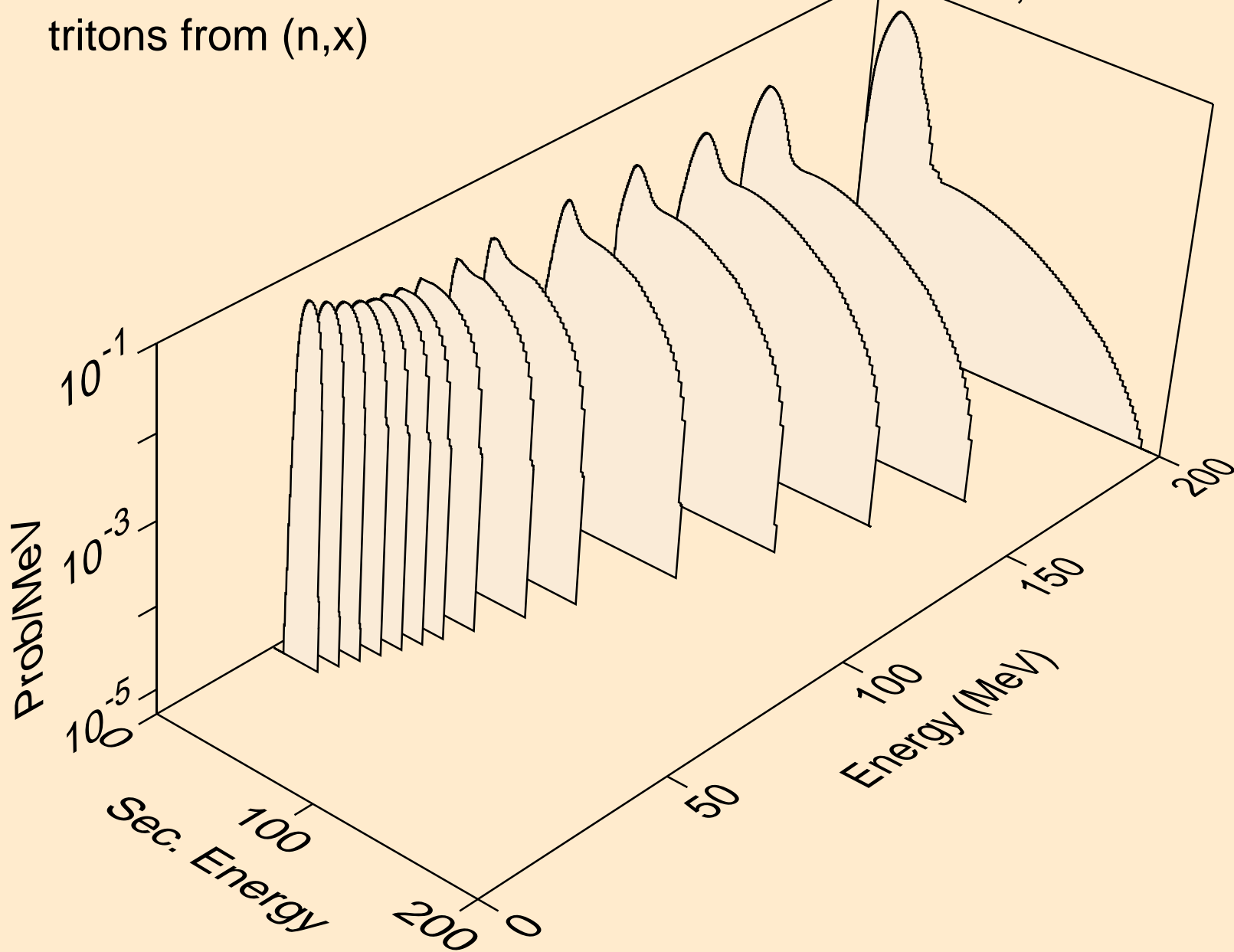

LR256 NEUTRON ACER TENDL-2019 LIBRARY; T=293.16K
tritons from (n,n*)t

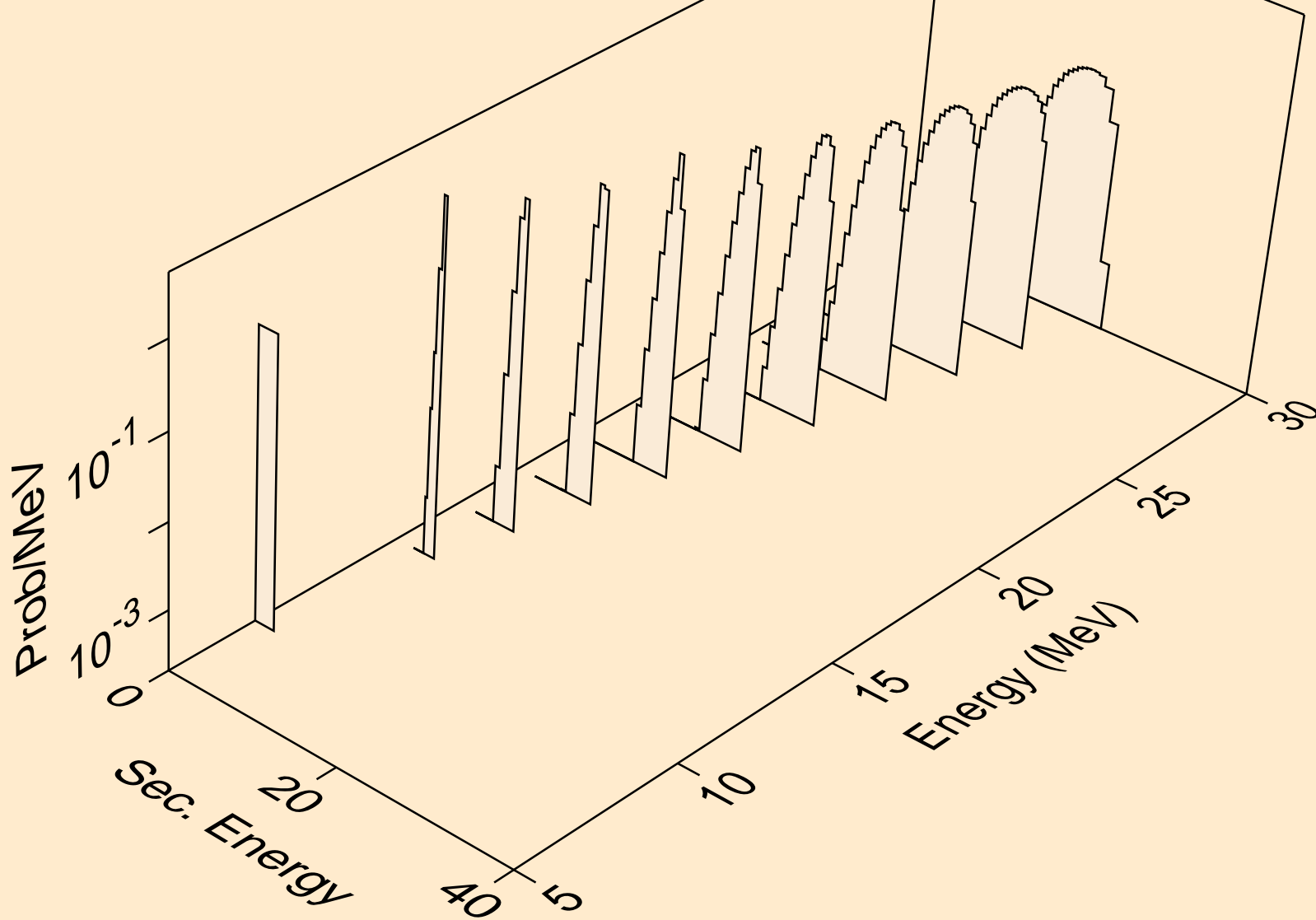

LR256 NEUTRON ACER TENDL-2019 LIBRARY; T=293.16K
tritons from (n,t)

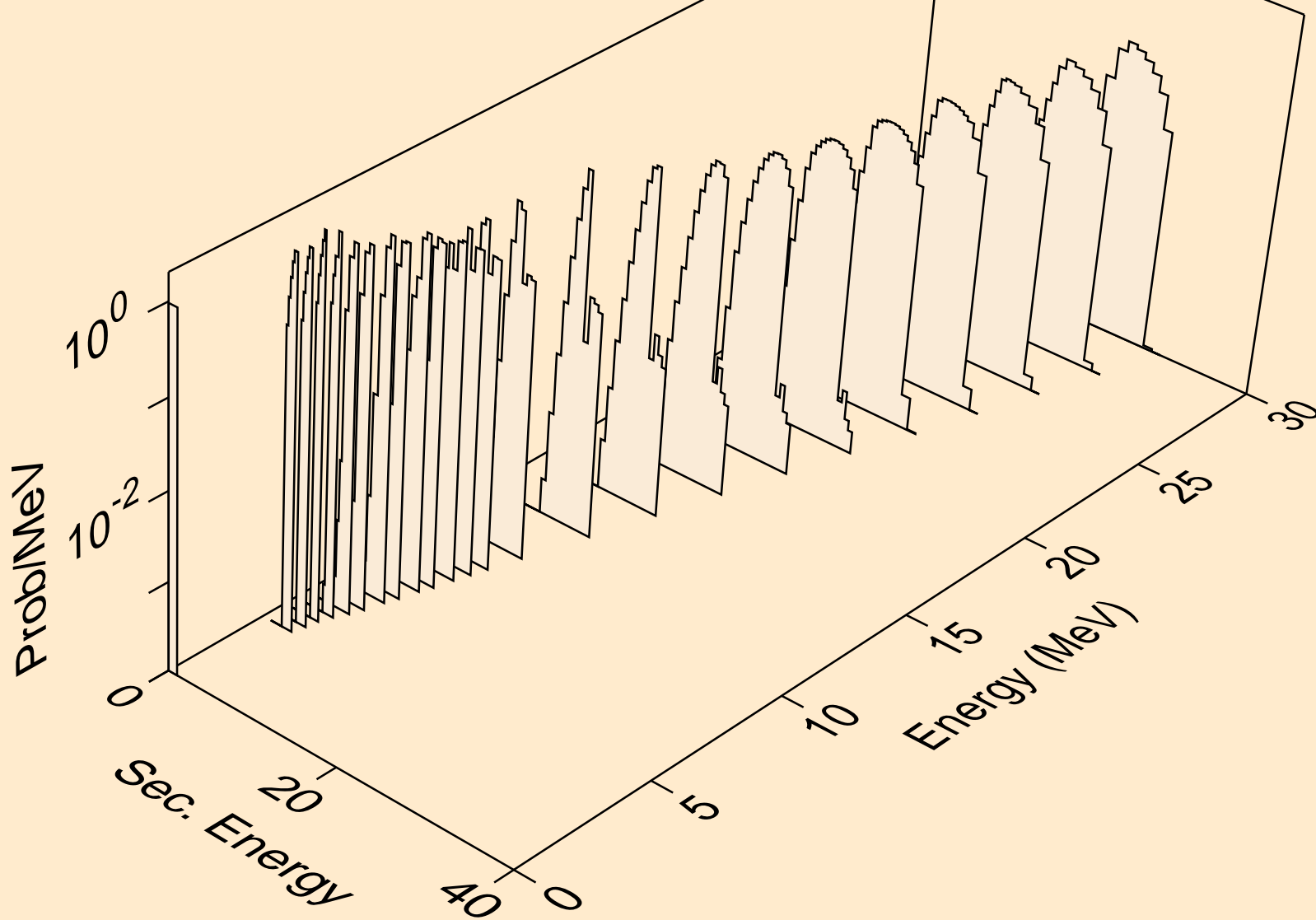

LR256 NEUTRON ACER TENDL-2019 LIBRARY; T=293.16K
tritons from (n,pt)

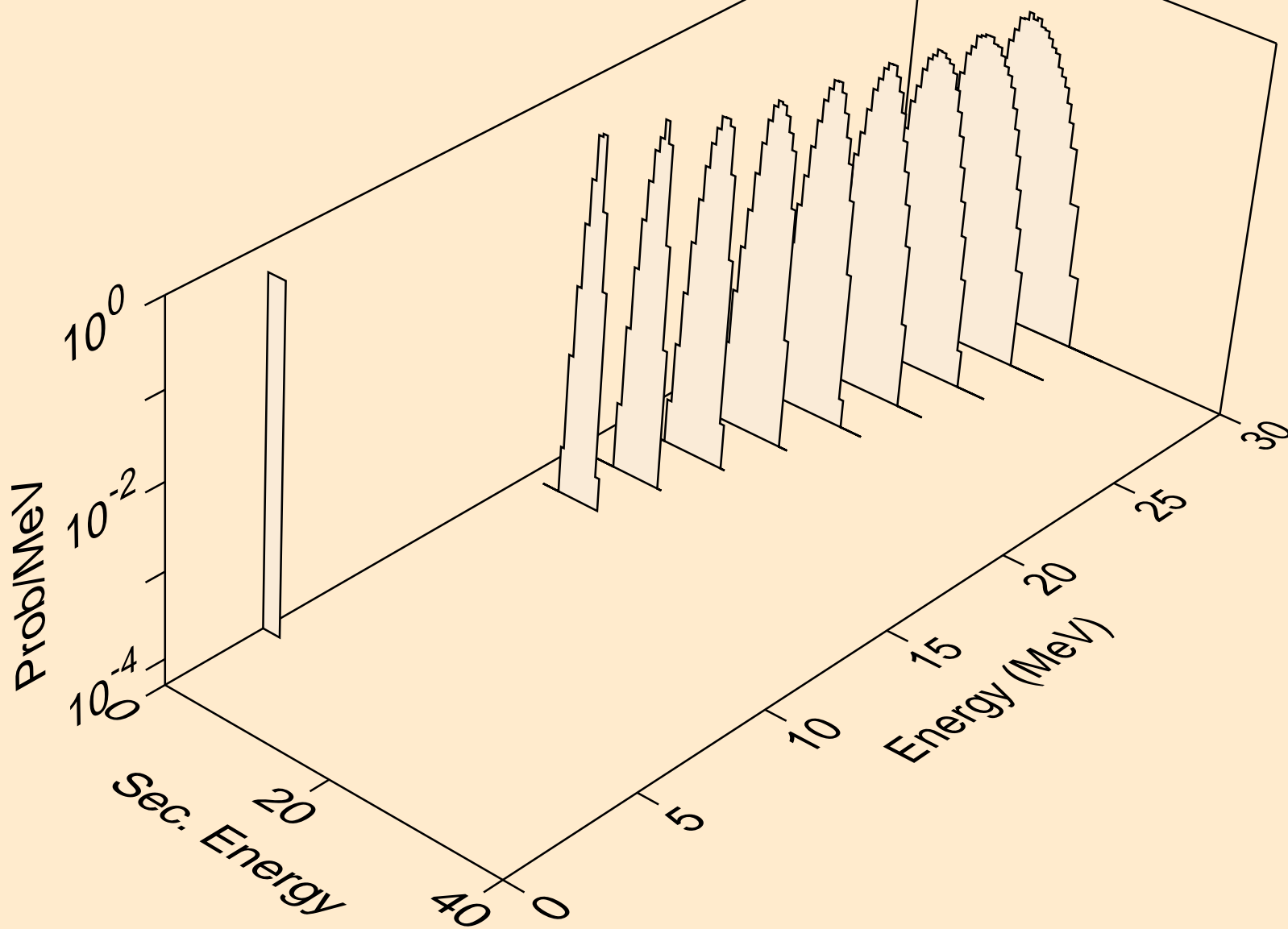

LR256 NEUTRON ACER TENDL-2019 LIBRARY; T=293.16K
he3s from (n,x)

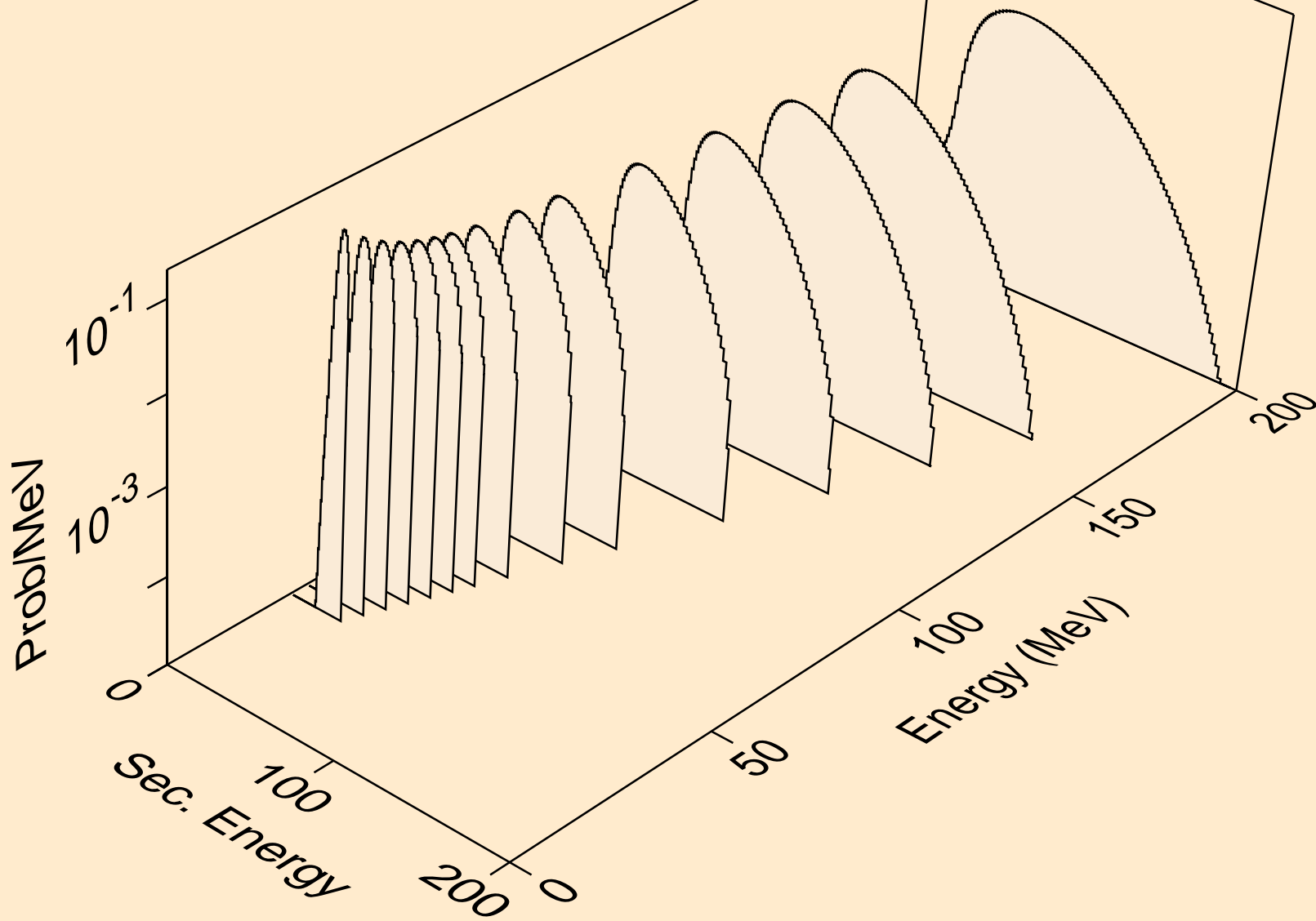

LR256 NEUTRON ACER TENDL-2019 LIBRARY; T=293.16K
he3s from (n,n*)he3

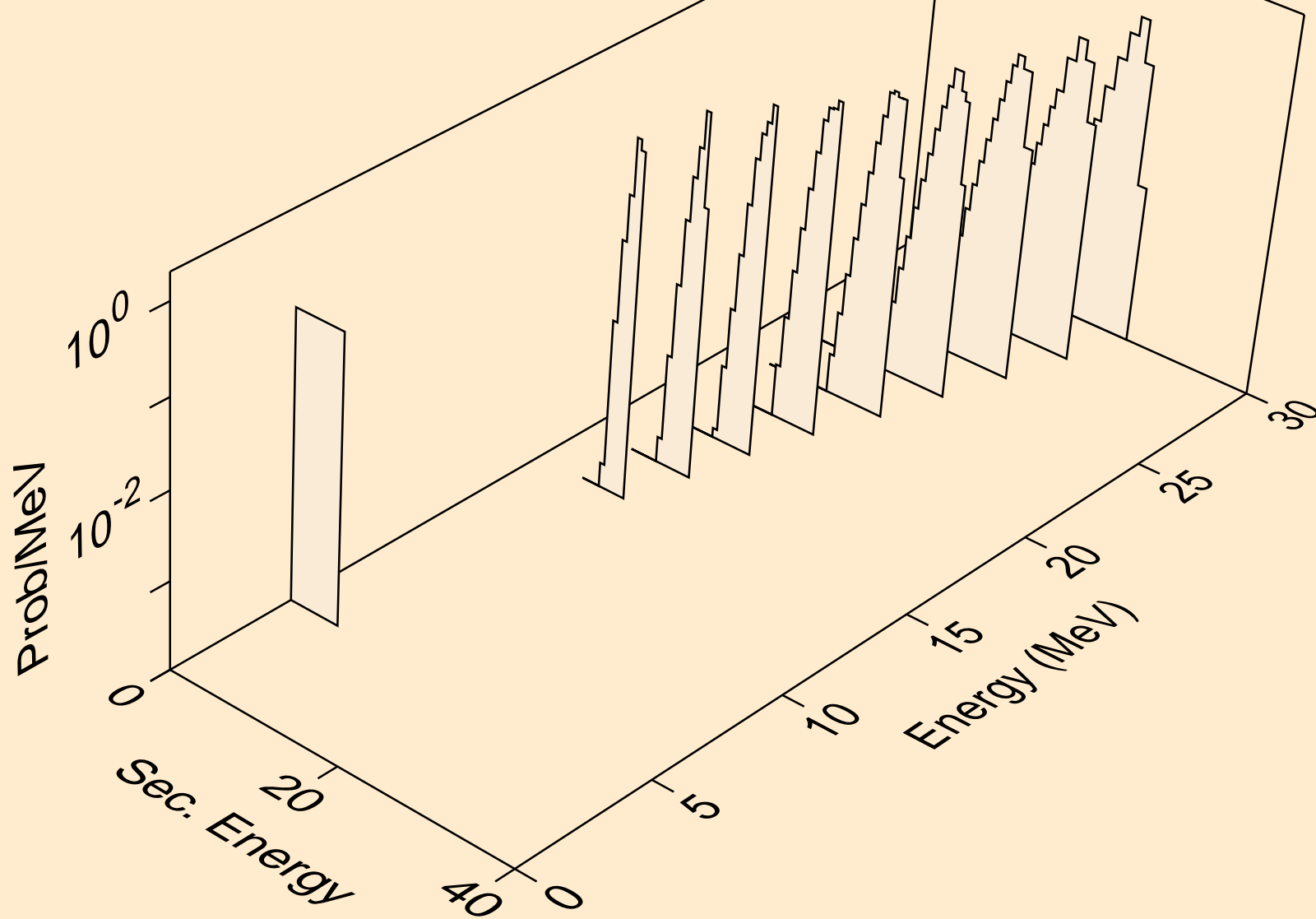

LR256 NEUTRON ACER TENDL-2019 LIBRARY; T=293.16K
he3s from (n,he3)

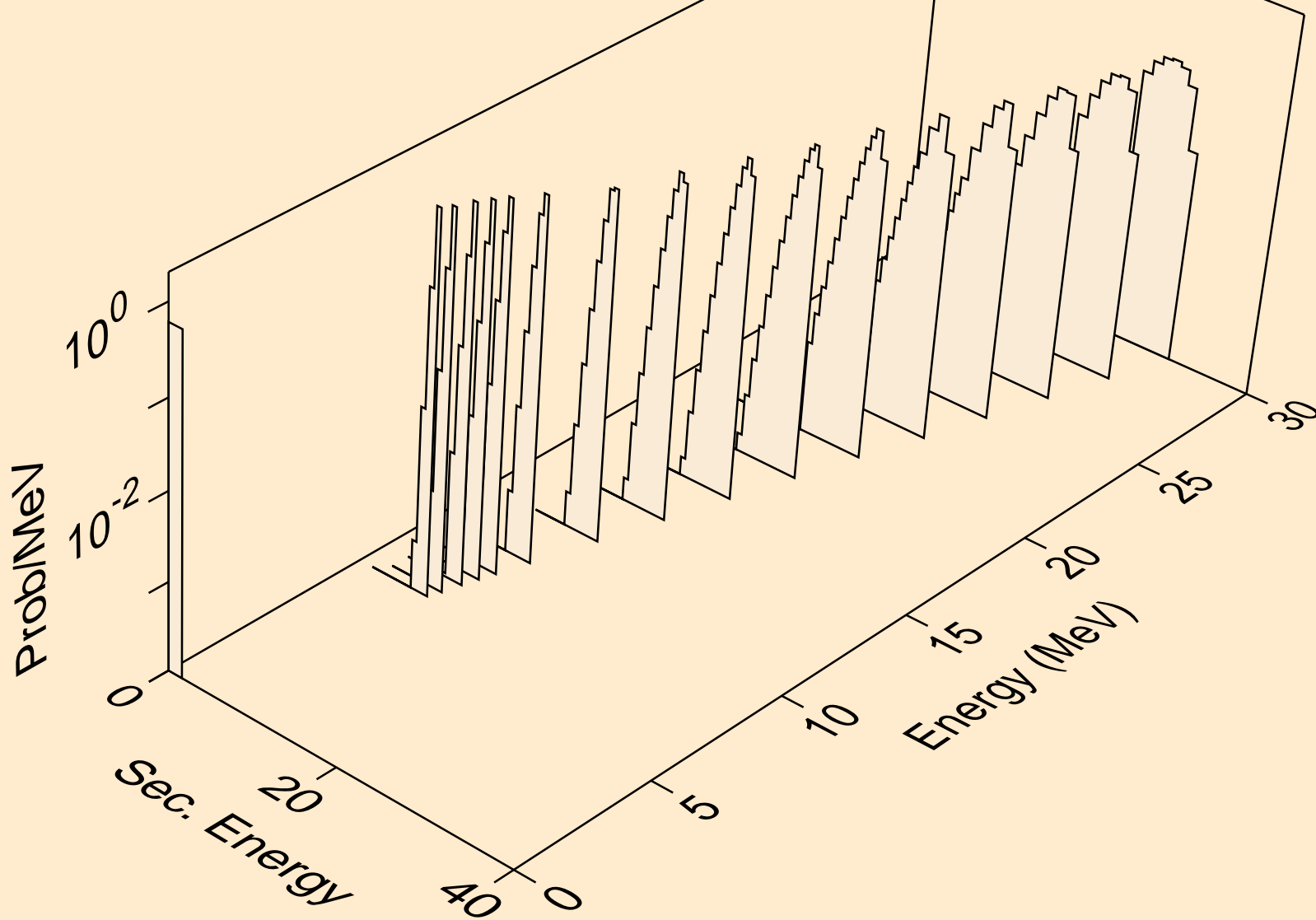

LR256 NEUTRON ACER TENDL-2019 LIBRARY; T=293.16K
alphas from (n,x)

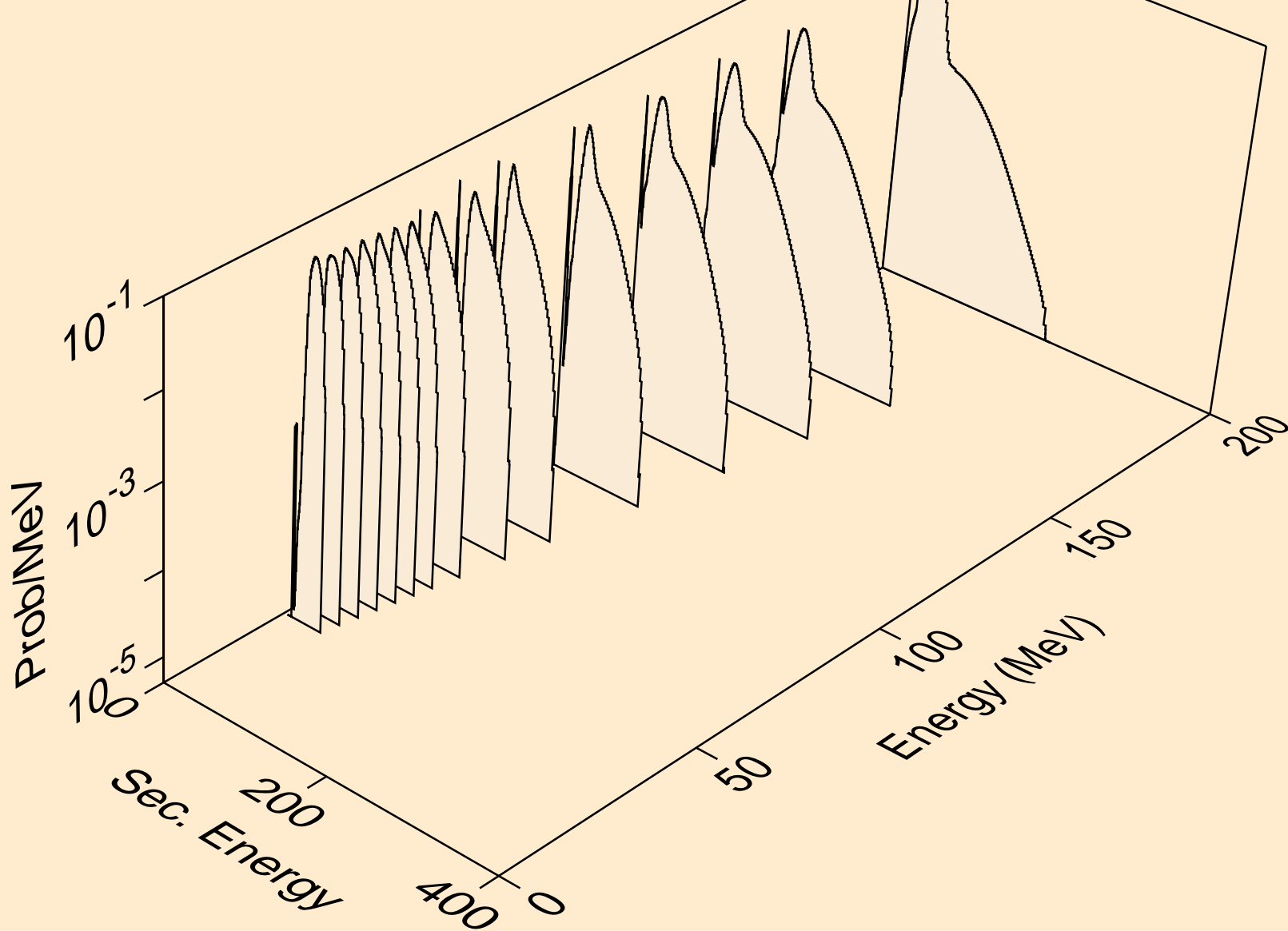

LR256 NEUTRON ACER TENDL-2019 LIBRARY; T=293.16K
alphas from (n,n*)a

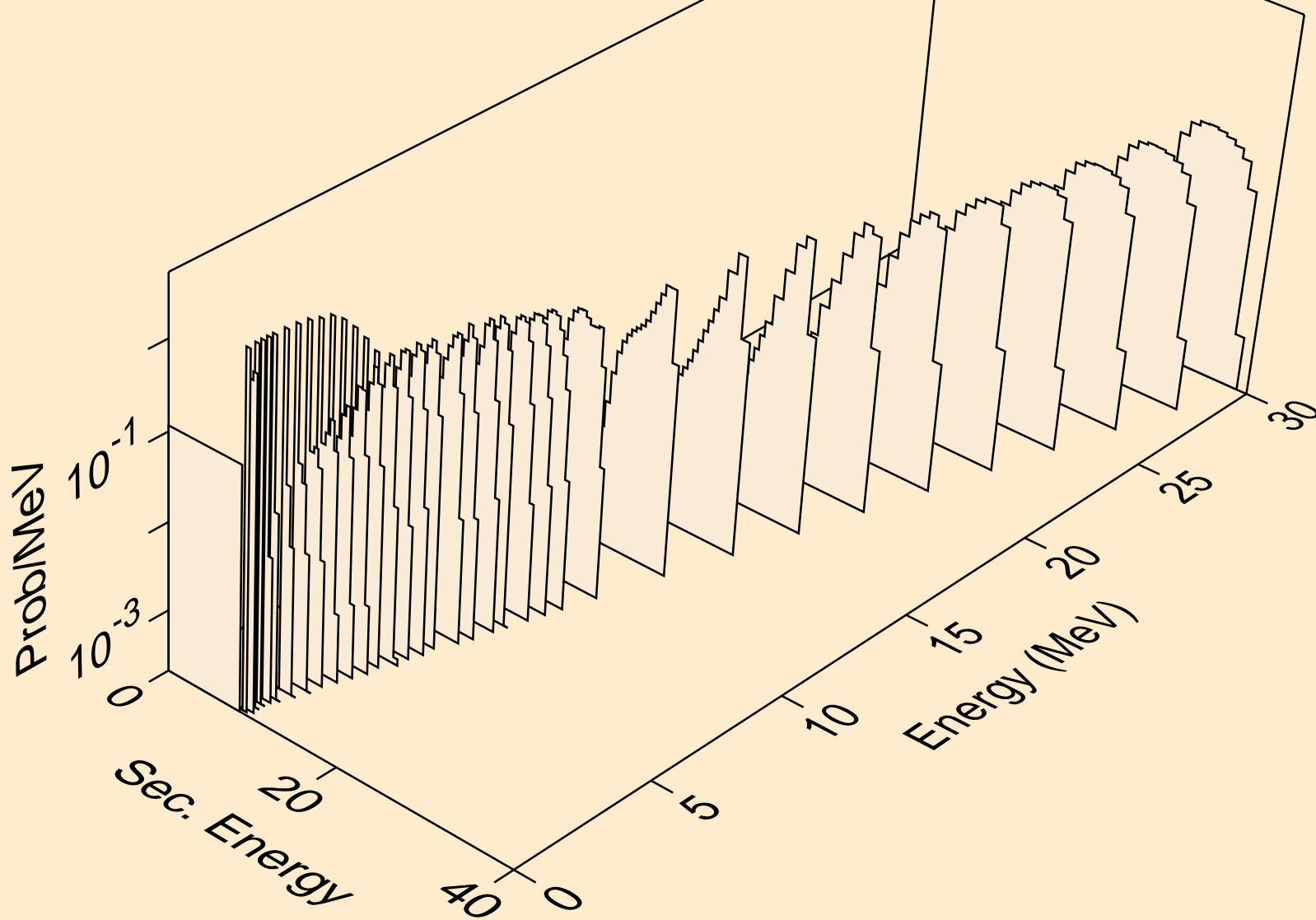

LR256 NEUTRON ACER TENDL-2019 LIBRARY; T=293.16K
alphas from (n,2n)a

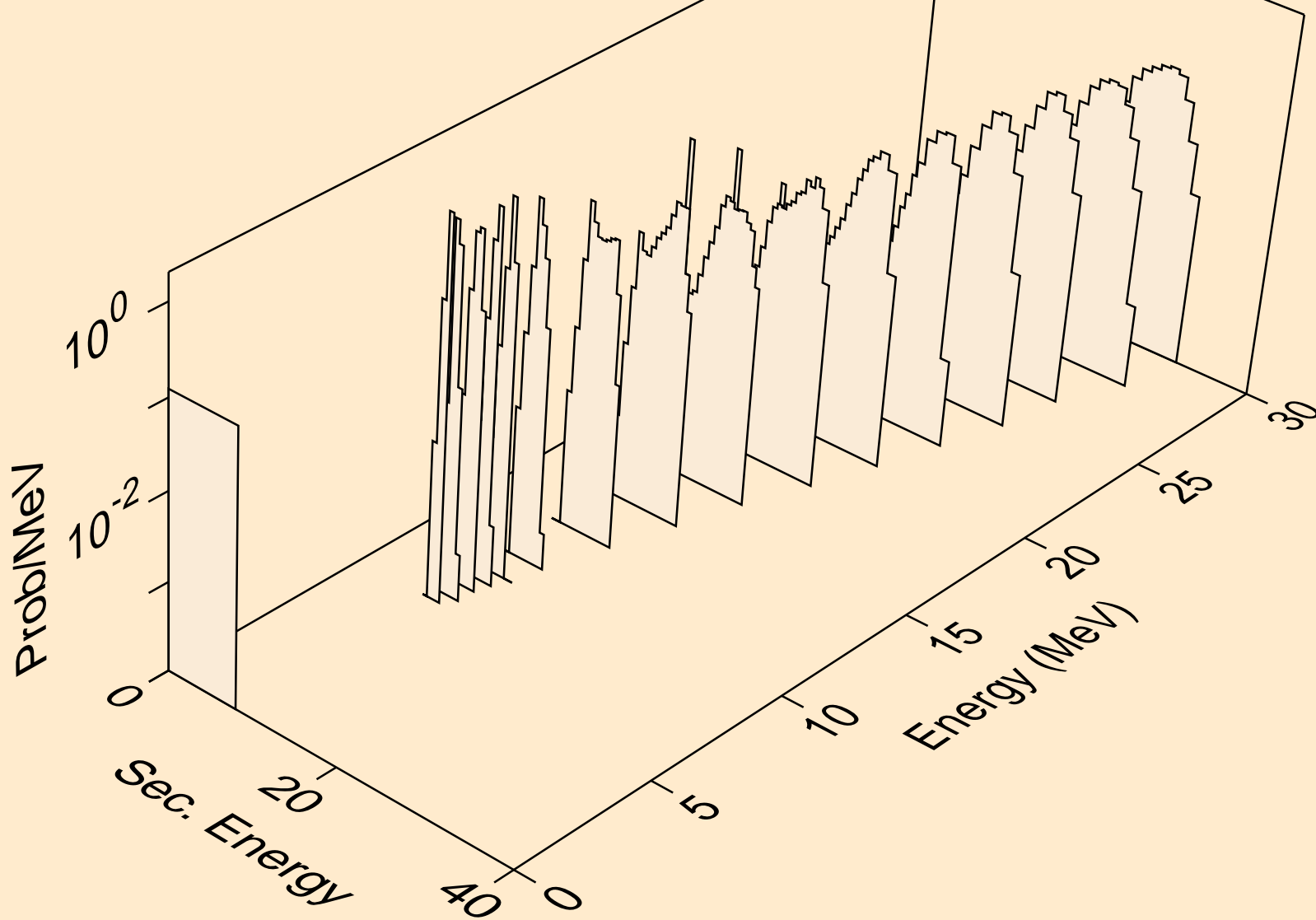

LR256 NEUTRON ACER TENDL-2019 LIBRARY; T=293.16K
alphas from (n,3n)a

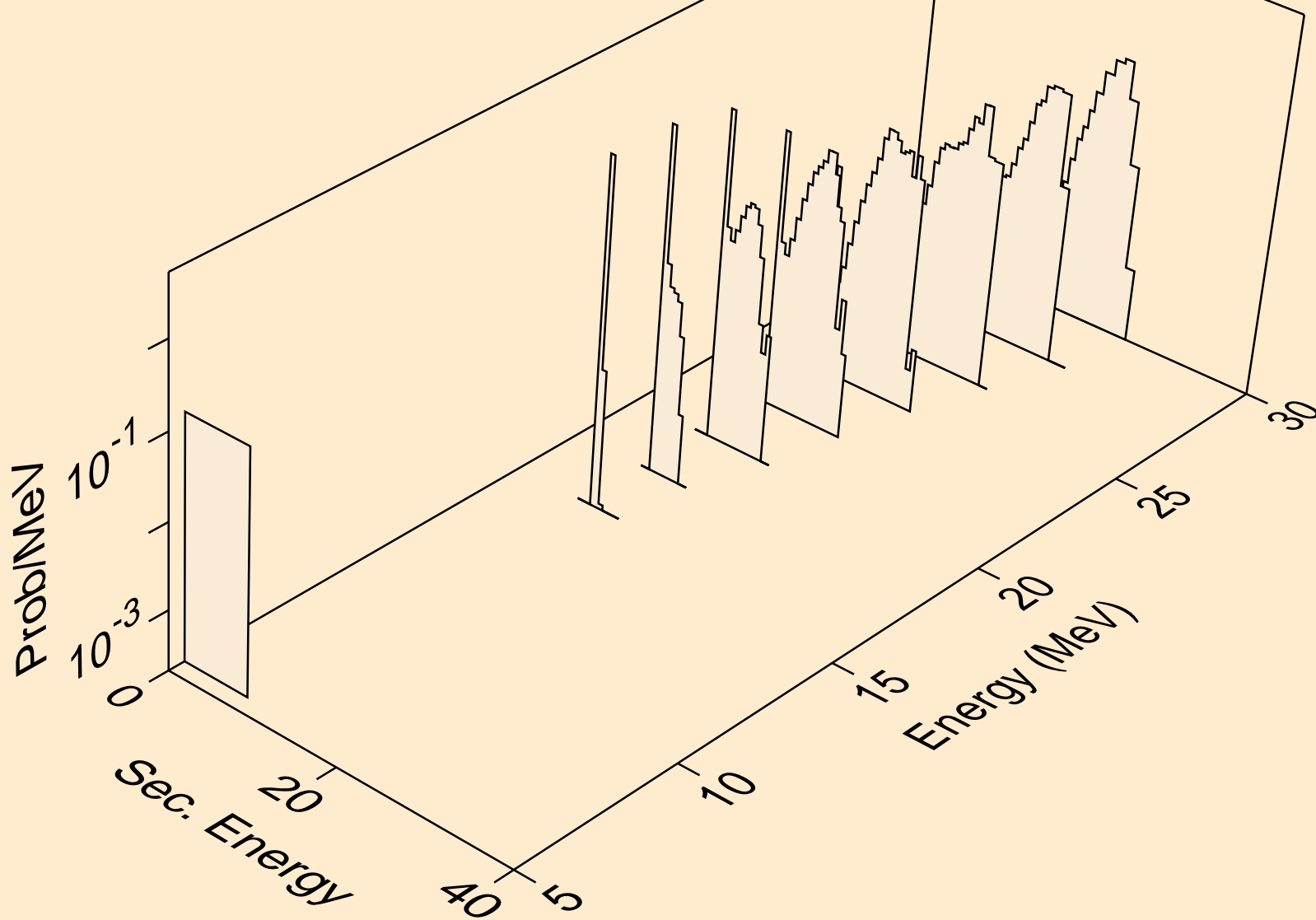

LR256 NEUTRON ACER TENDL-2019 LIBRARY; T=293.16K
alphas from (n,n*)2a

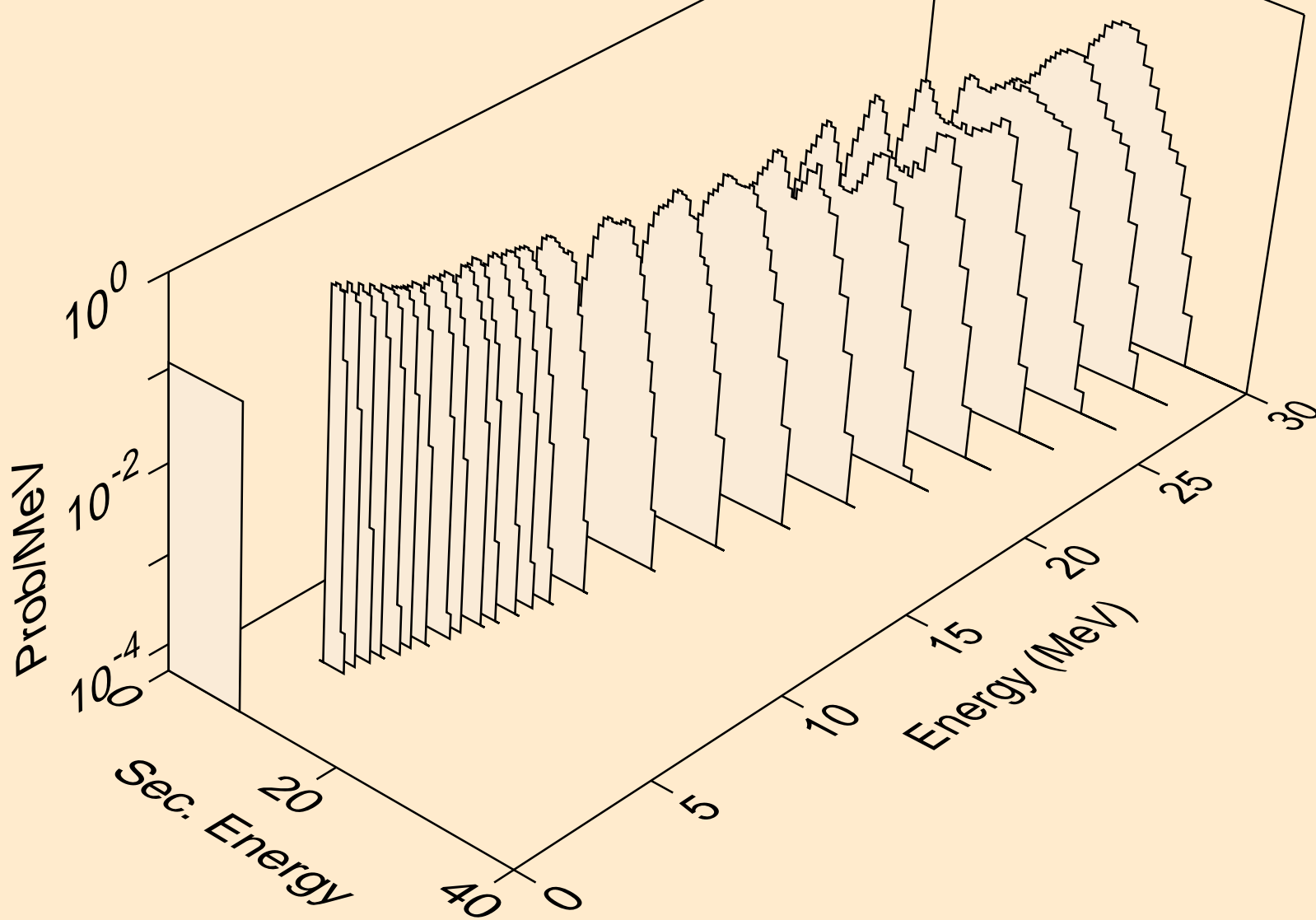

LR256 NEUTRON ACER TENDL-2019 LIBRARY; T=293.16K
alphas from (n,2n)2a

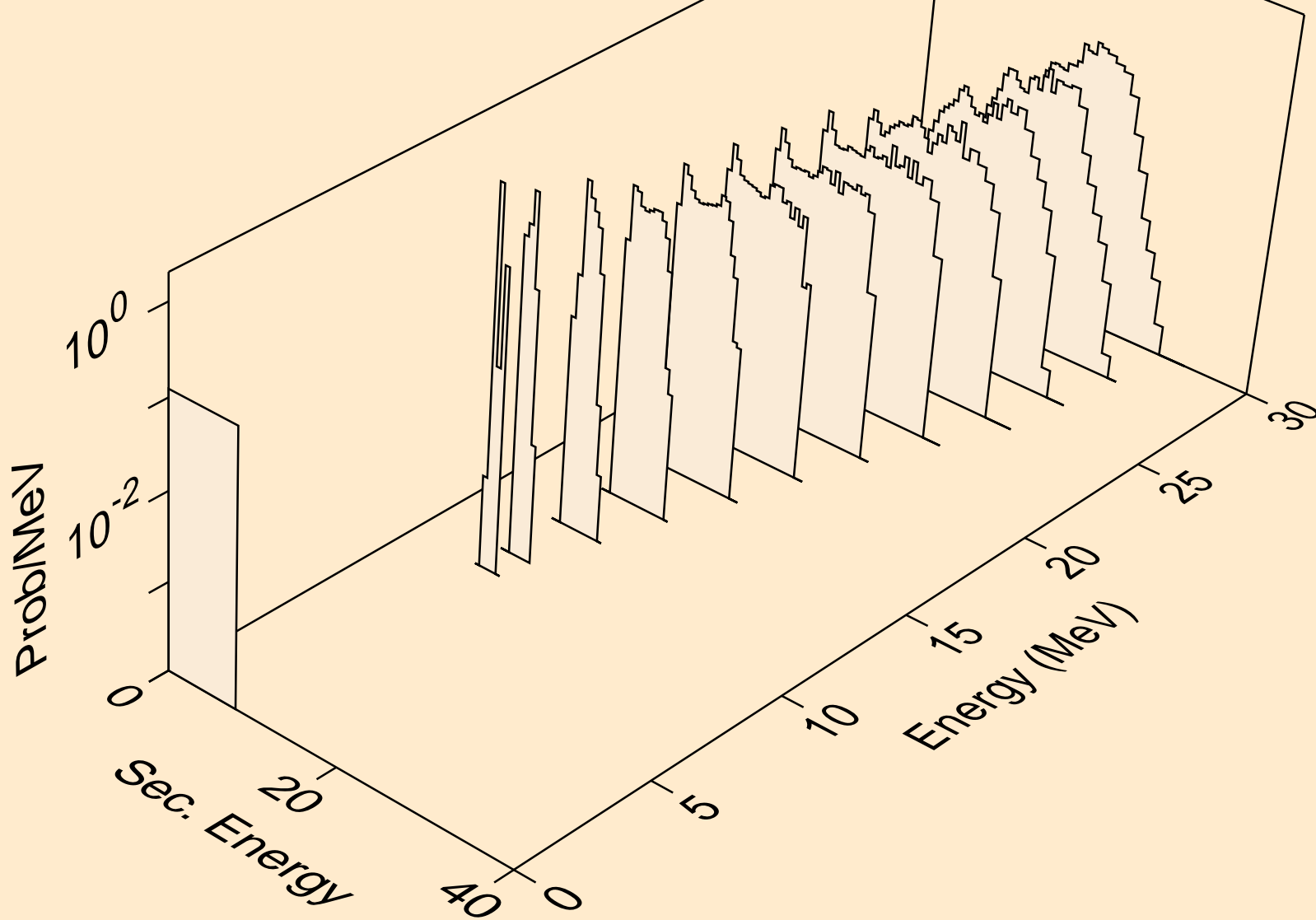

LR256 NEUTRON ACER TENDL-2019 LIBRARY; T=293.16K
alphas from (n,npa)

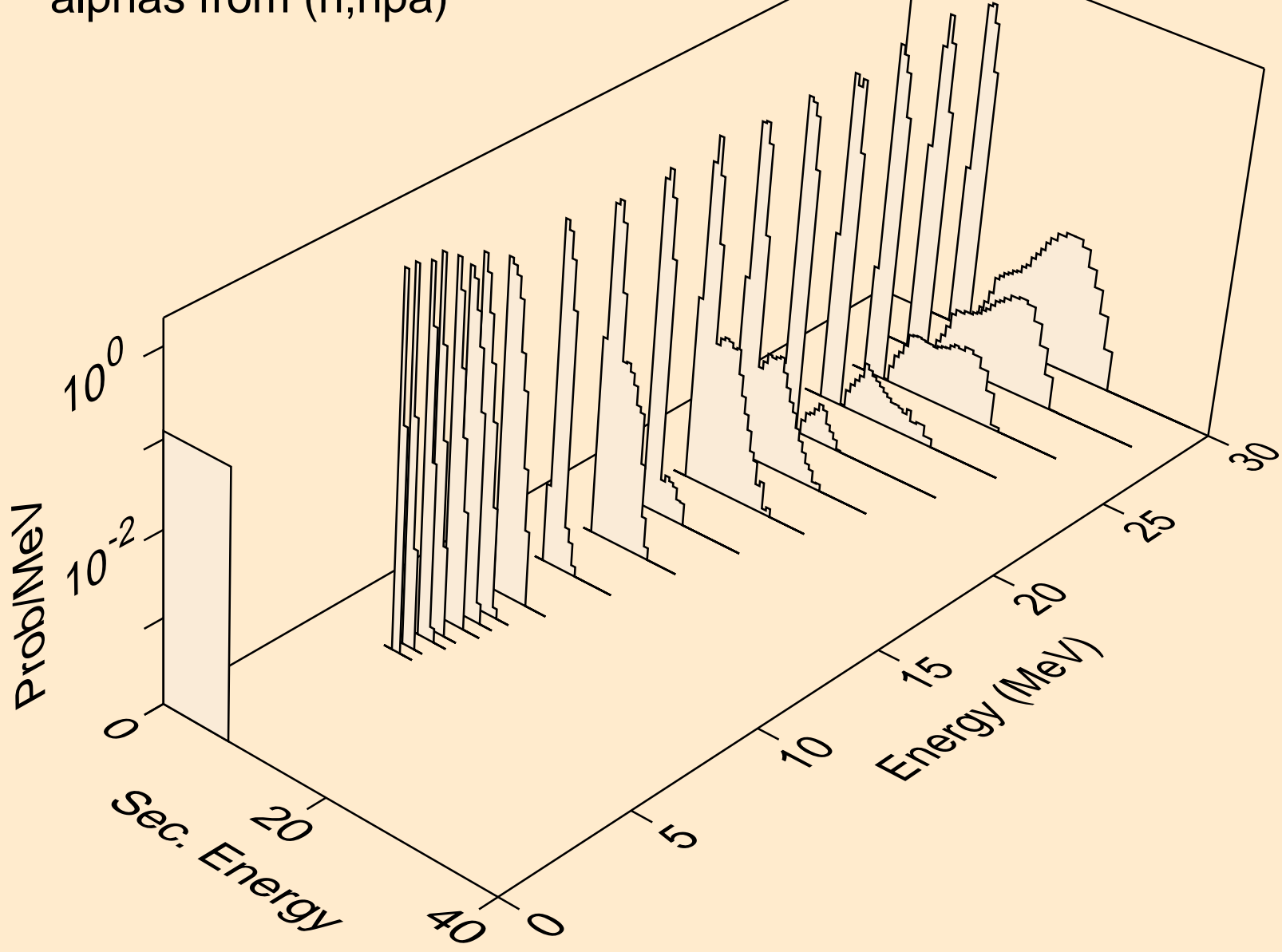

LR256 NEUTRON ACER TENDL-2019 LIBRARY; T=293.16K
alphas from (n,a)

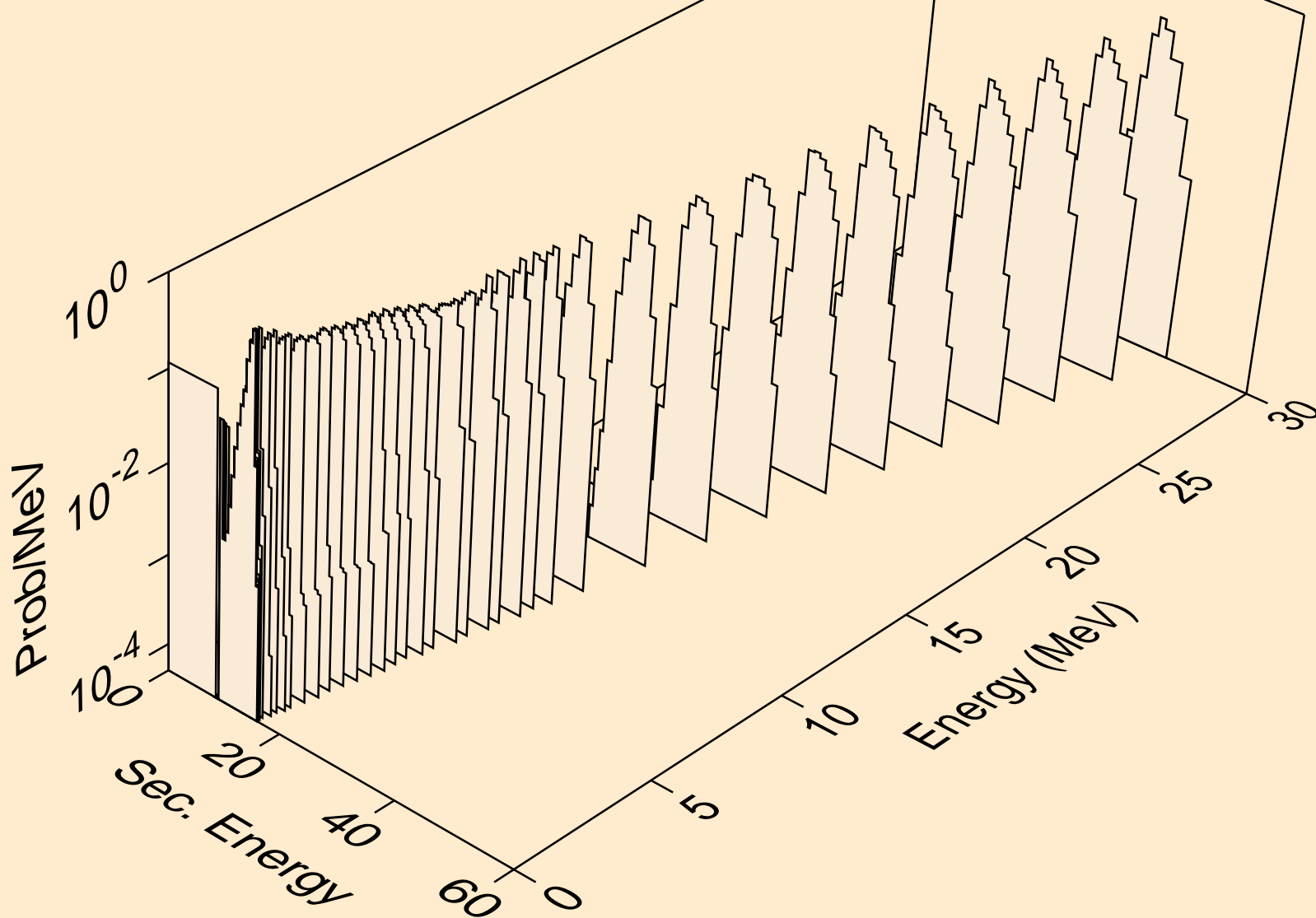

LR256 NEUTRON ACER TENDL-2019 LIBRARY; T=293.16K
alphas from (n,2a)

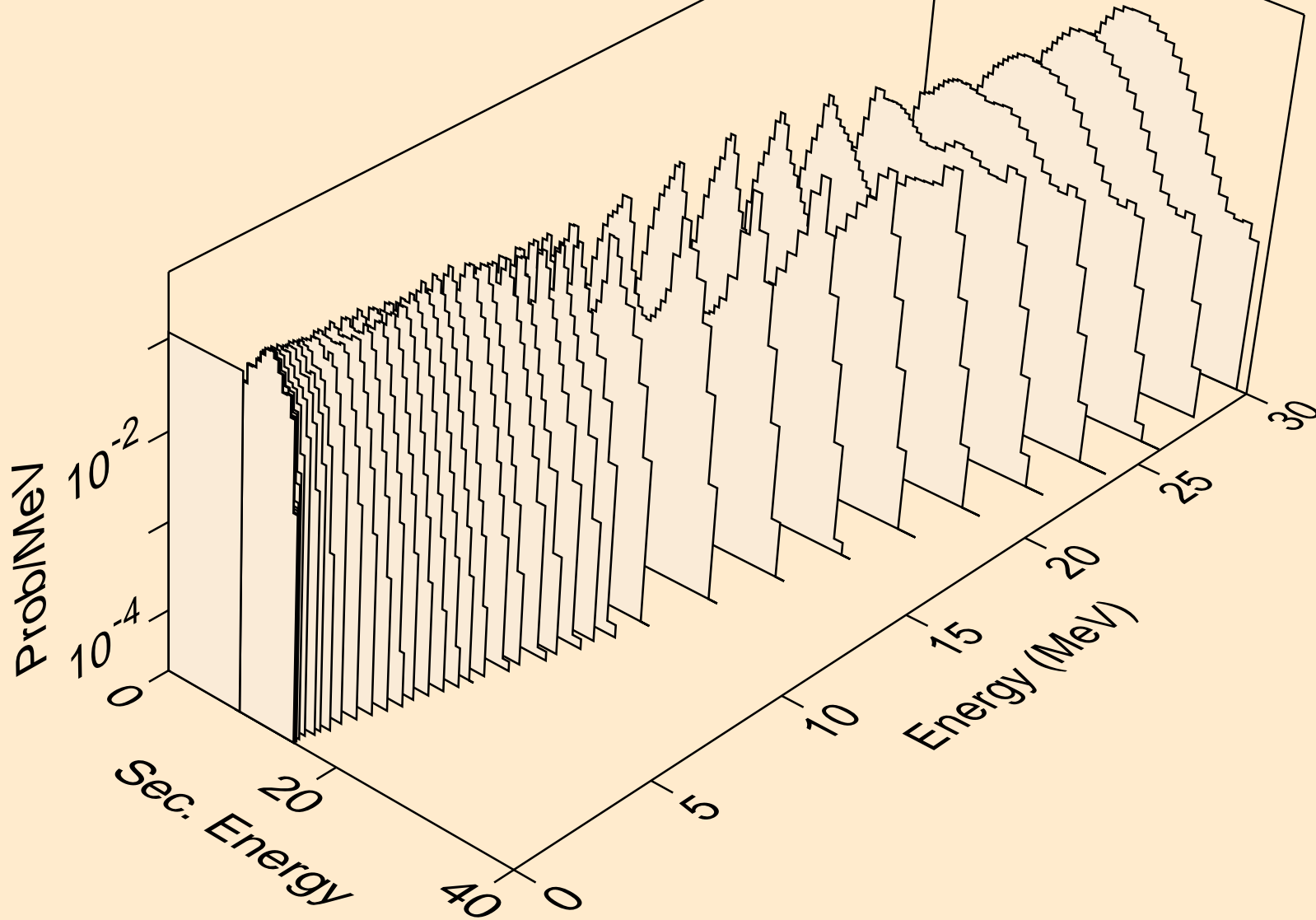

LR256 NEUTRON ACER TENDL-2019 LIBRARY; T=293.16K
alphas from (n,pa)

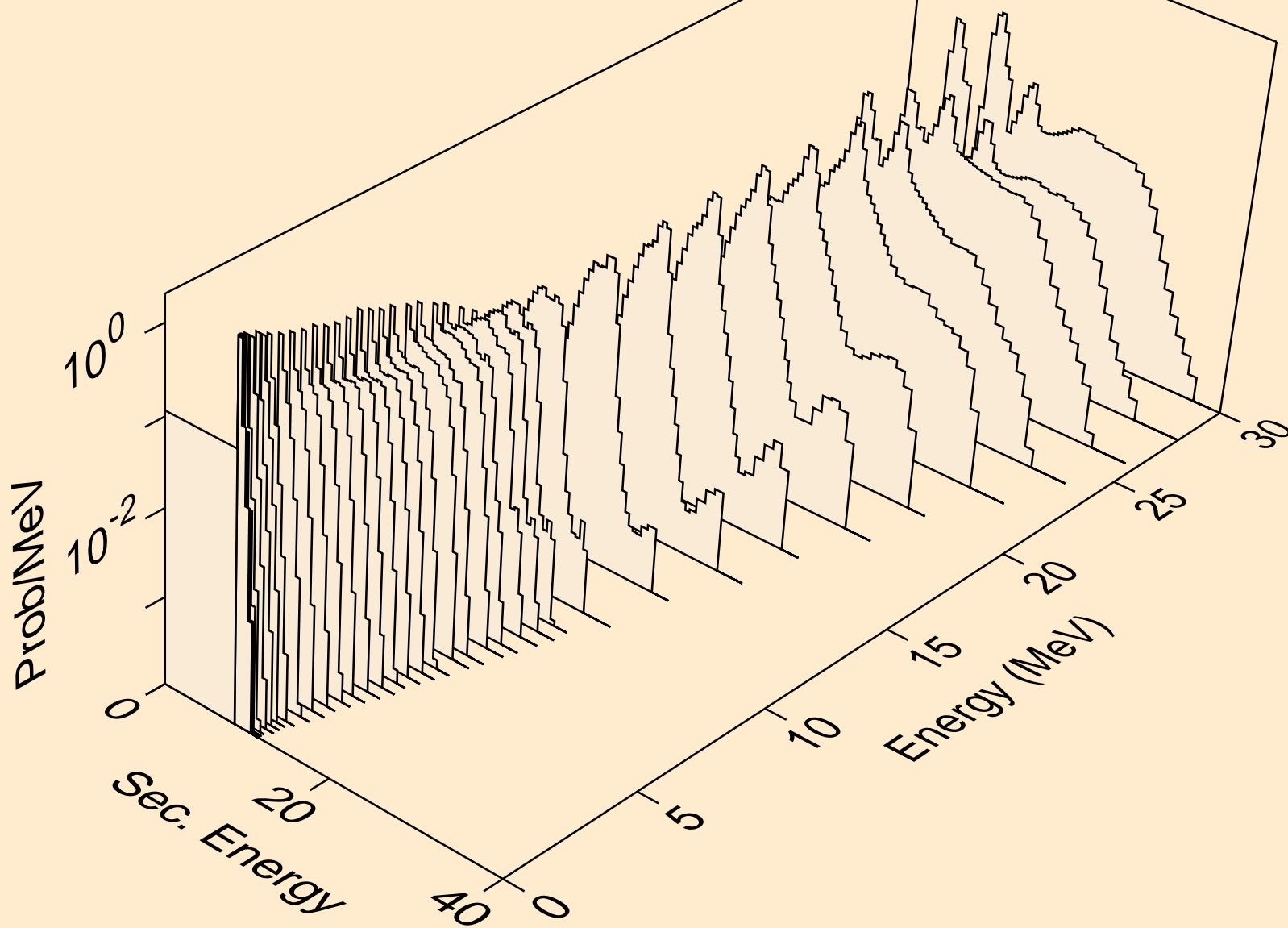

LR256 NEUTRON ACER TENDL-2019 LIBRARY; T=293.16K
alphas from (n,da)

