

LU162N NEUTRON ACER TENDL-2019 LIBRARY; T=293.16K  
Principal cross sections

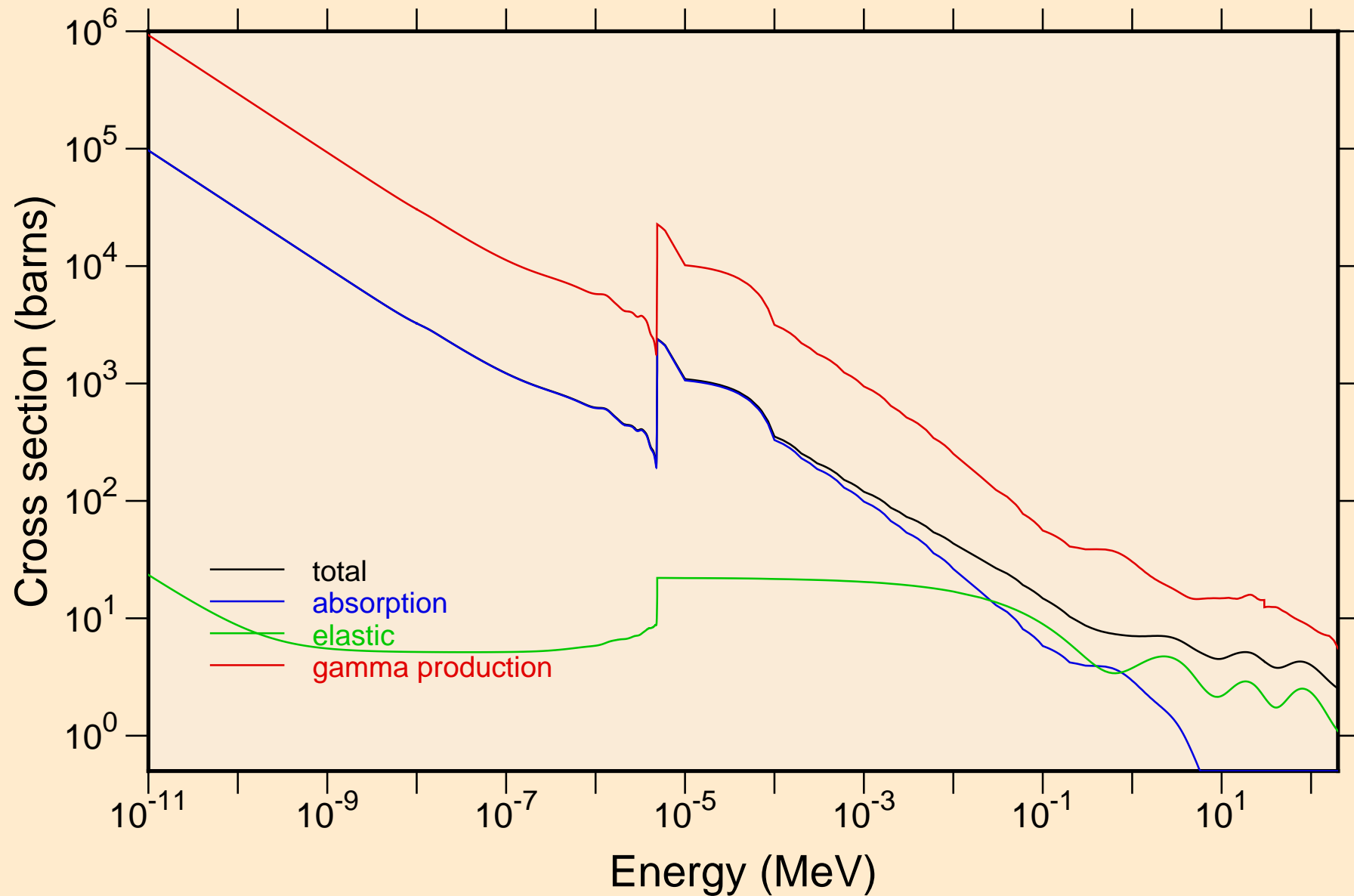

LU162N NEUTRON ACER TENDL-2019 LIBRARY; T=293.16K  
resonance total cross section

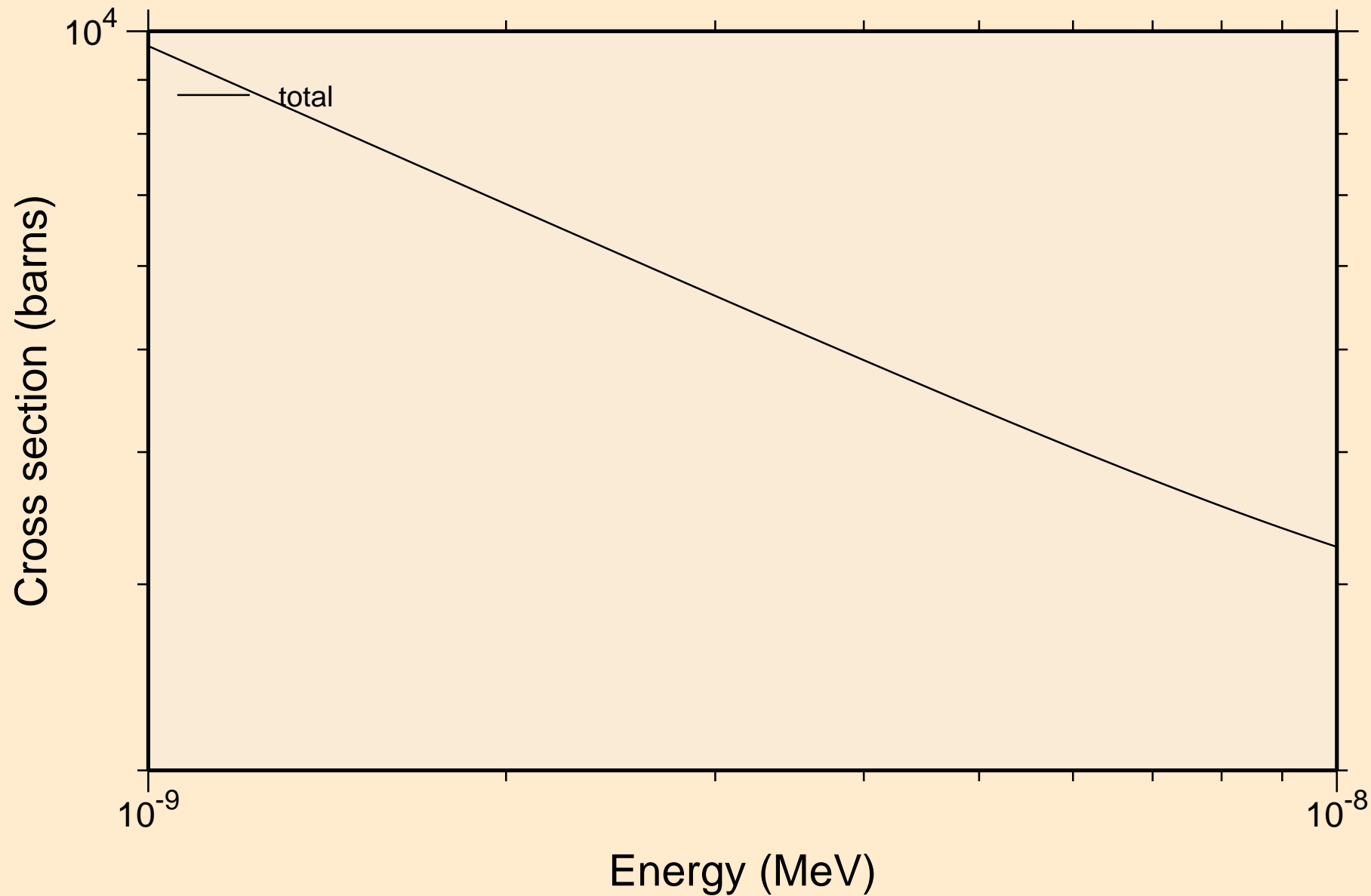

LU162N NEUTRON ACER TENDL-2019 LIBRARY; T=293.16K  
resonance total cross section

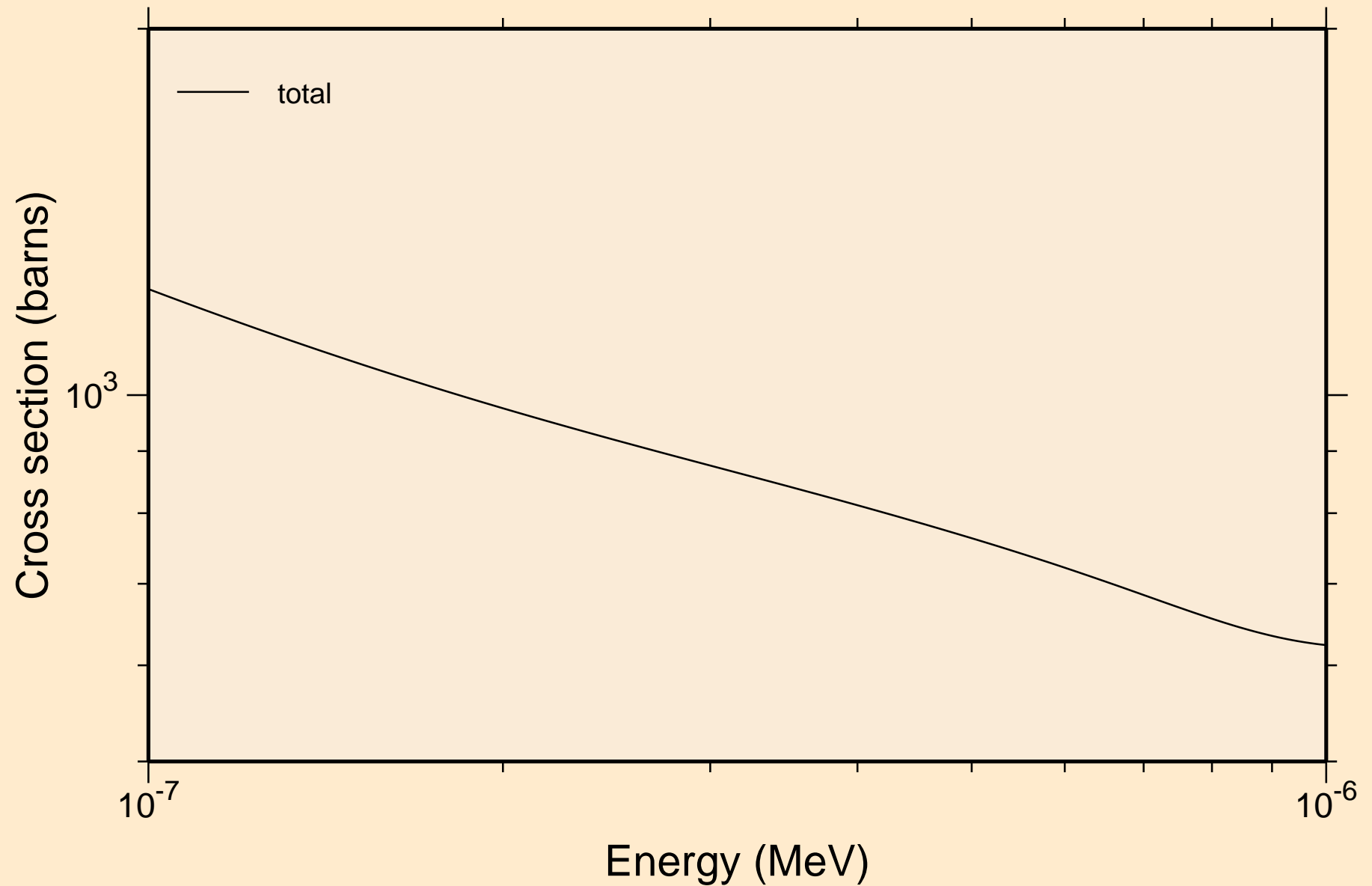

LU162N NEUTRON ACER TENDL-2019 LIBRARY; T=293.16K  
resonance total cross section

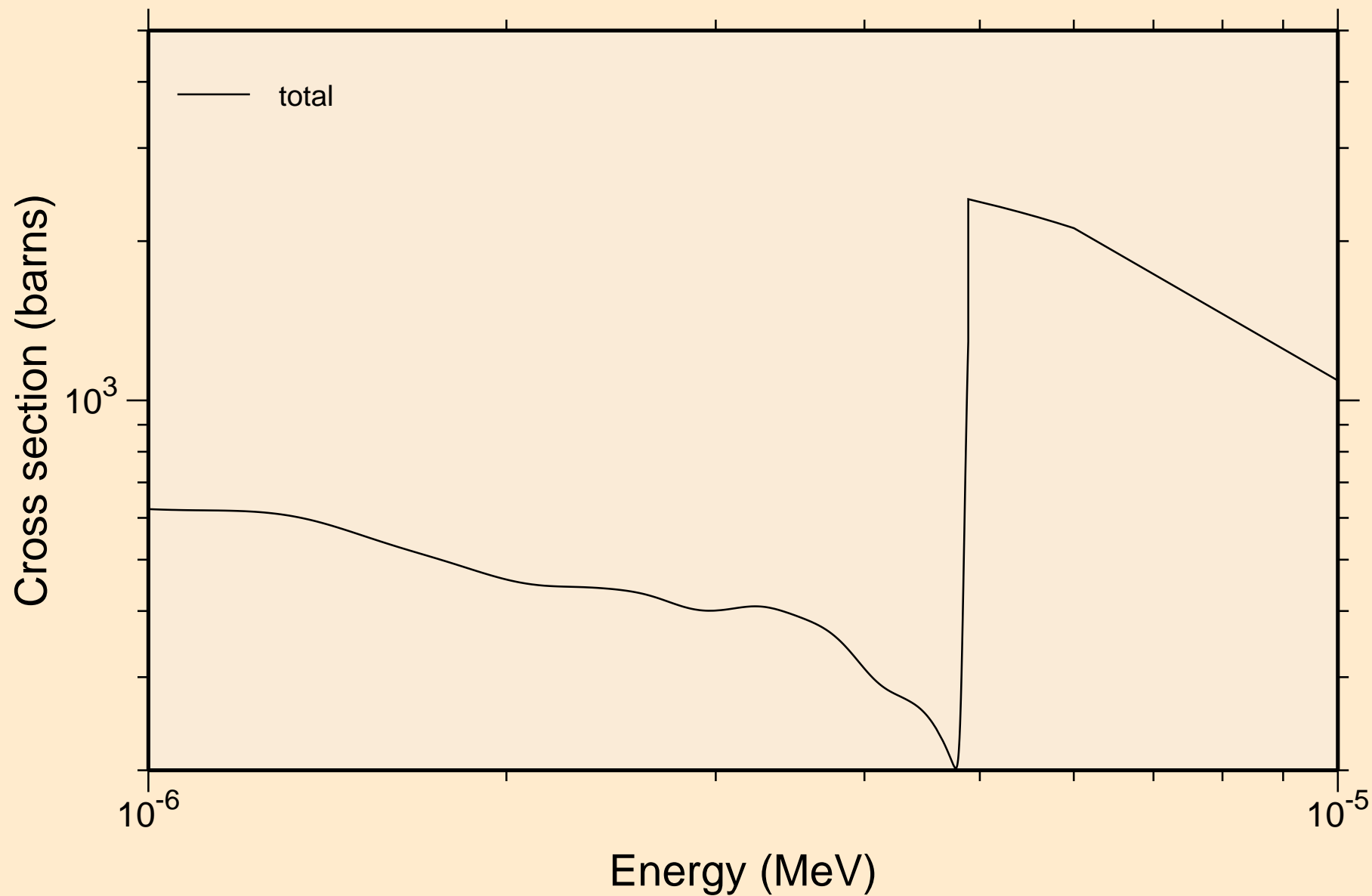

LU162N NEUTRON ACER TENDL-2019 LIBRARY; T=293.16K  
resonance total cross section

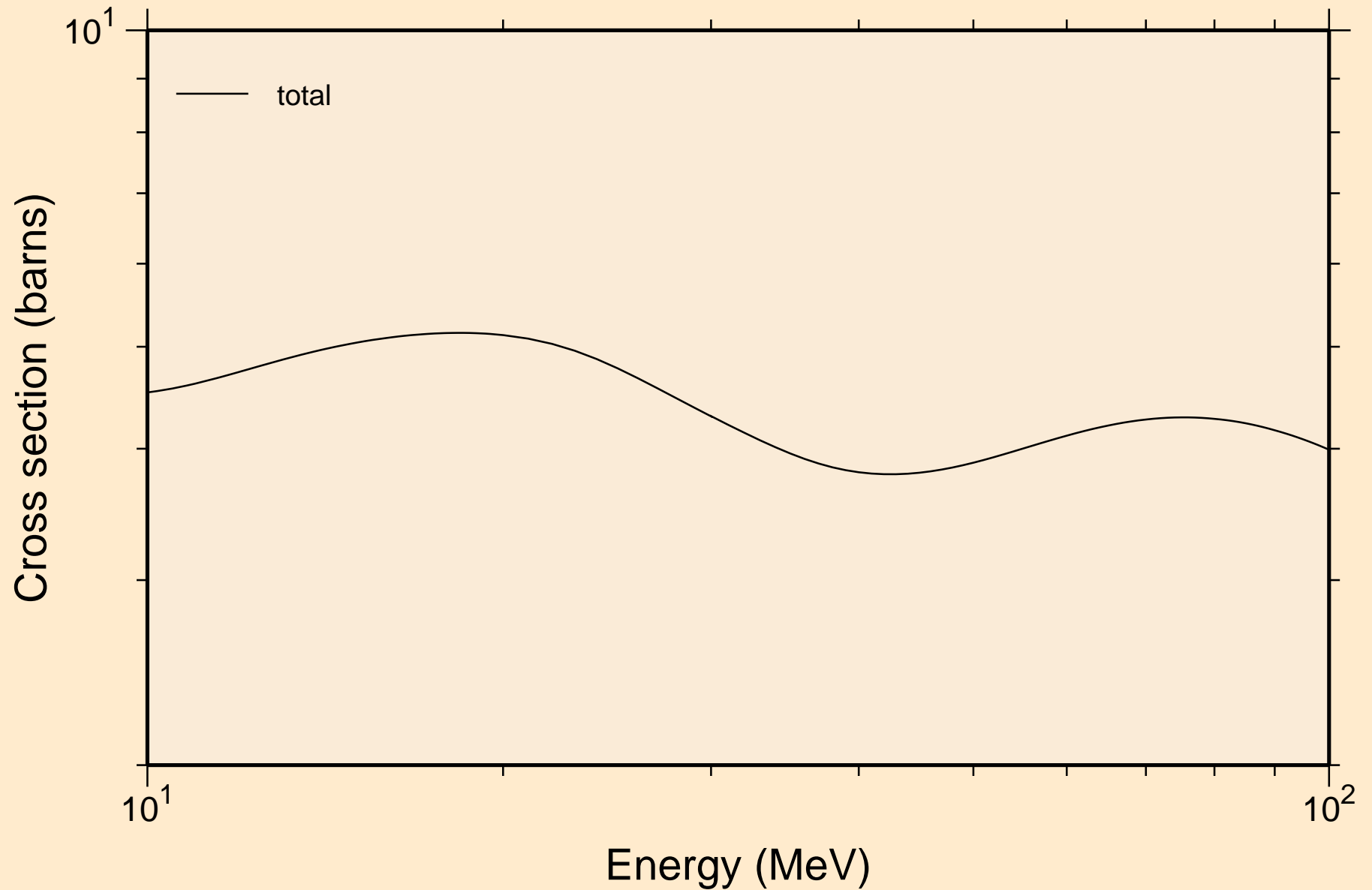

LU162N NEUTRON ACER TENDL-2019 LIBRARY; T=293.16K  
resonance absorption cross sections

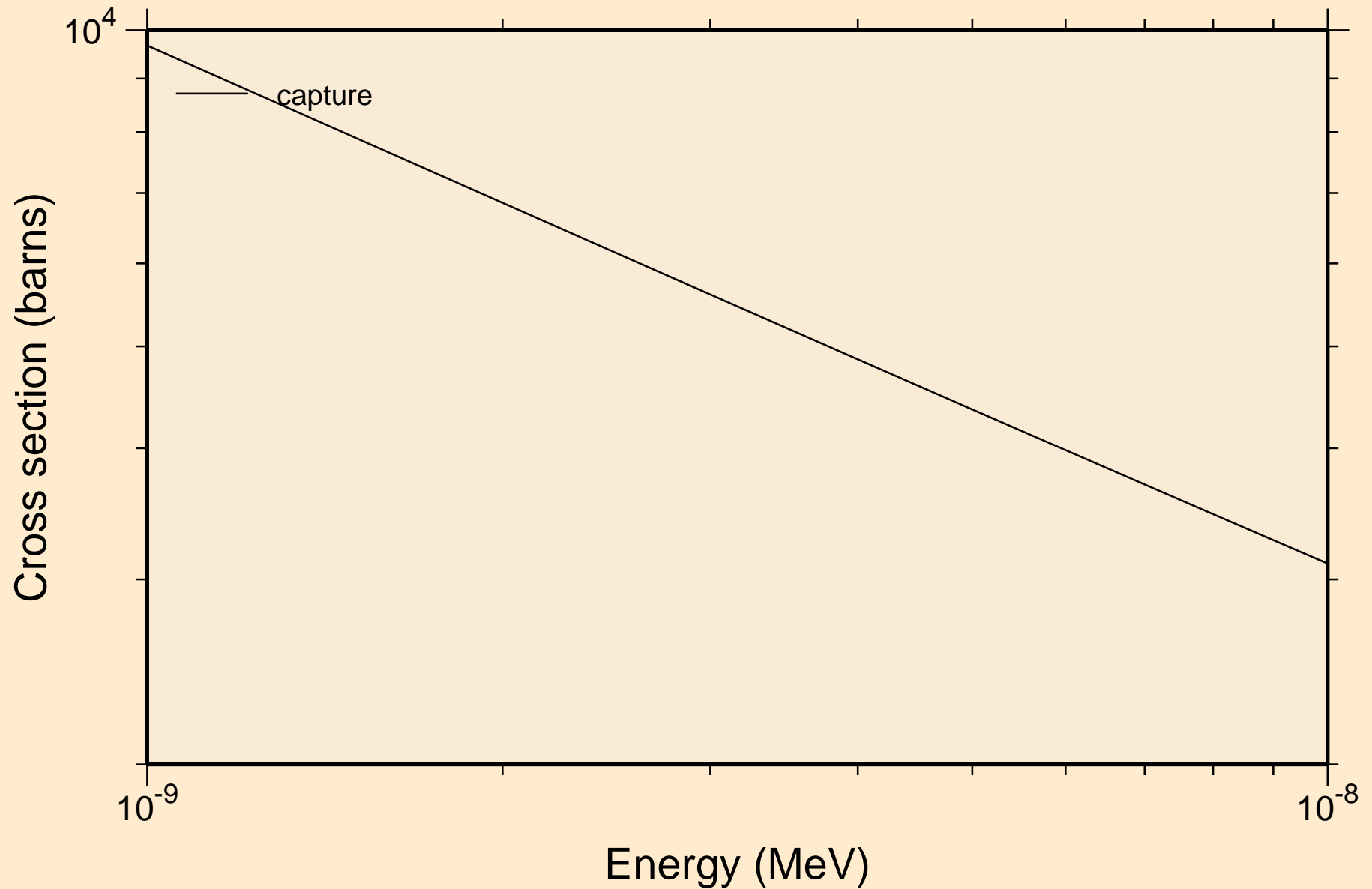

LU162N NEUTRON ACER TENDL-2019 LIBRARY; T=293.16K  
resonance absorption cross sections

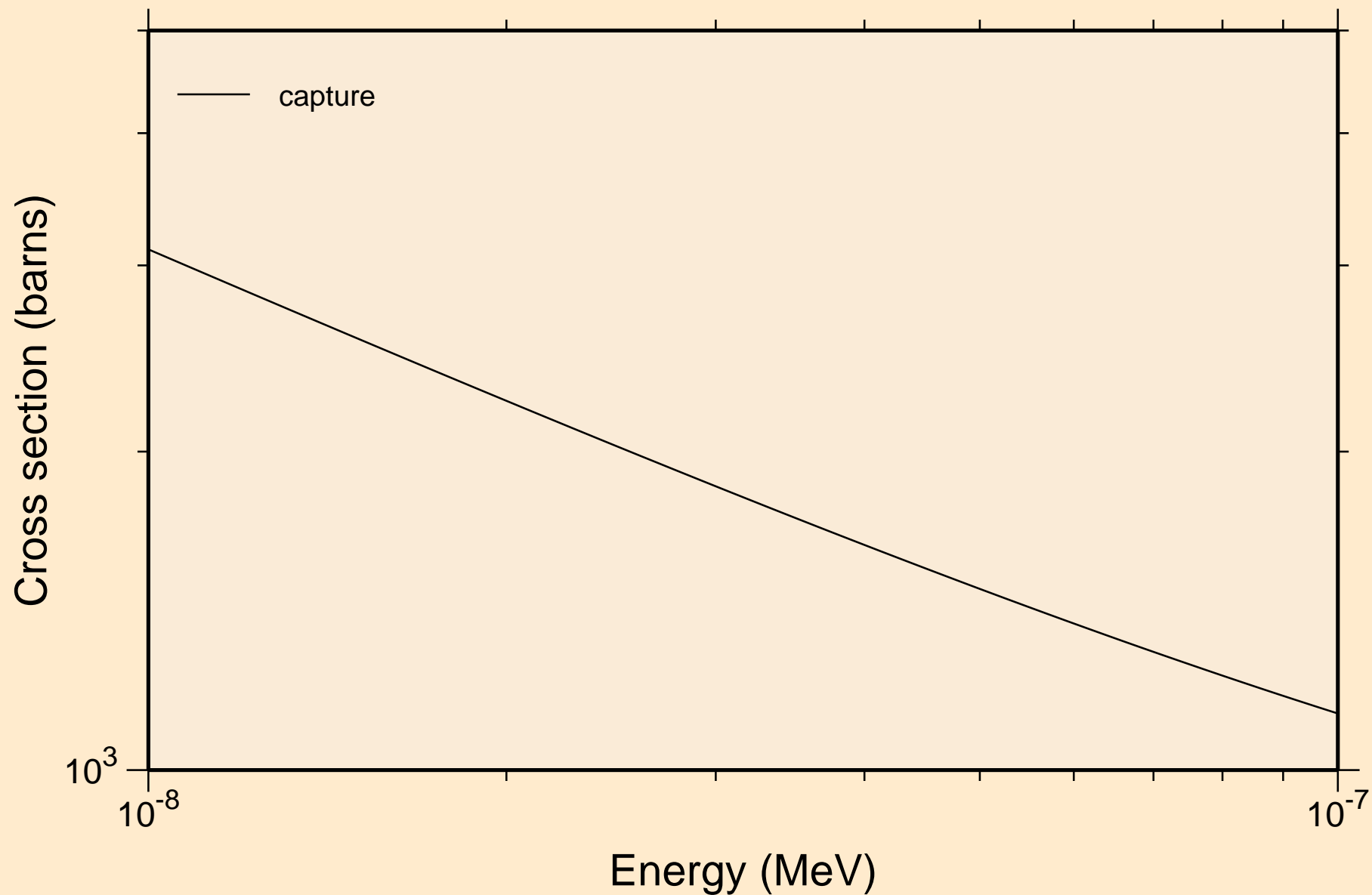

LU162N NEUTRON ACER TENDL-2019 LIBRARY; T=293.16K  
resonance absorption cross sections

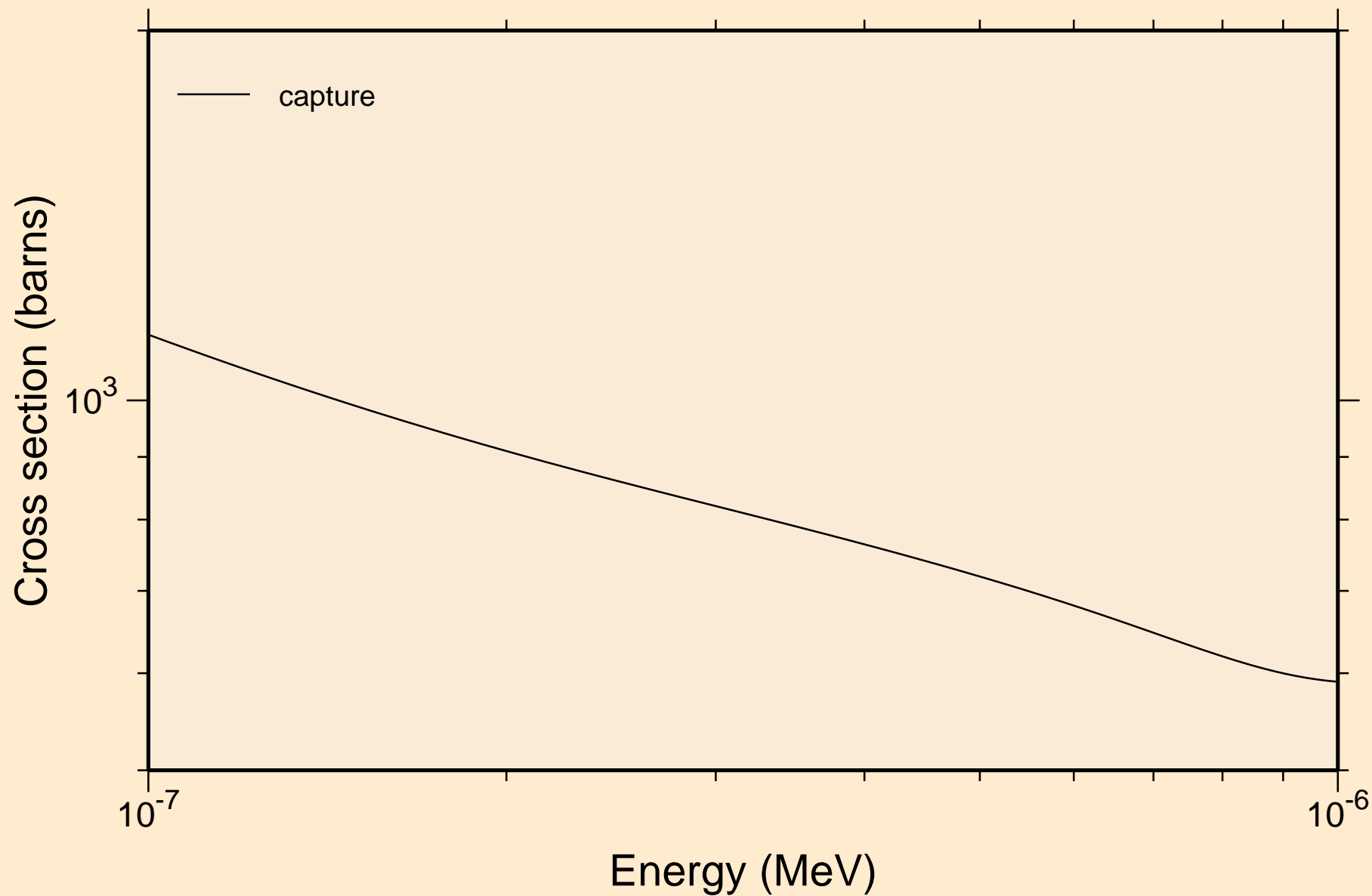



LU162N NEUTRON ACER TENDL-2019 LIBRARY; T=293.16K  
resonance absorption cross sections

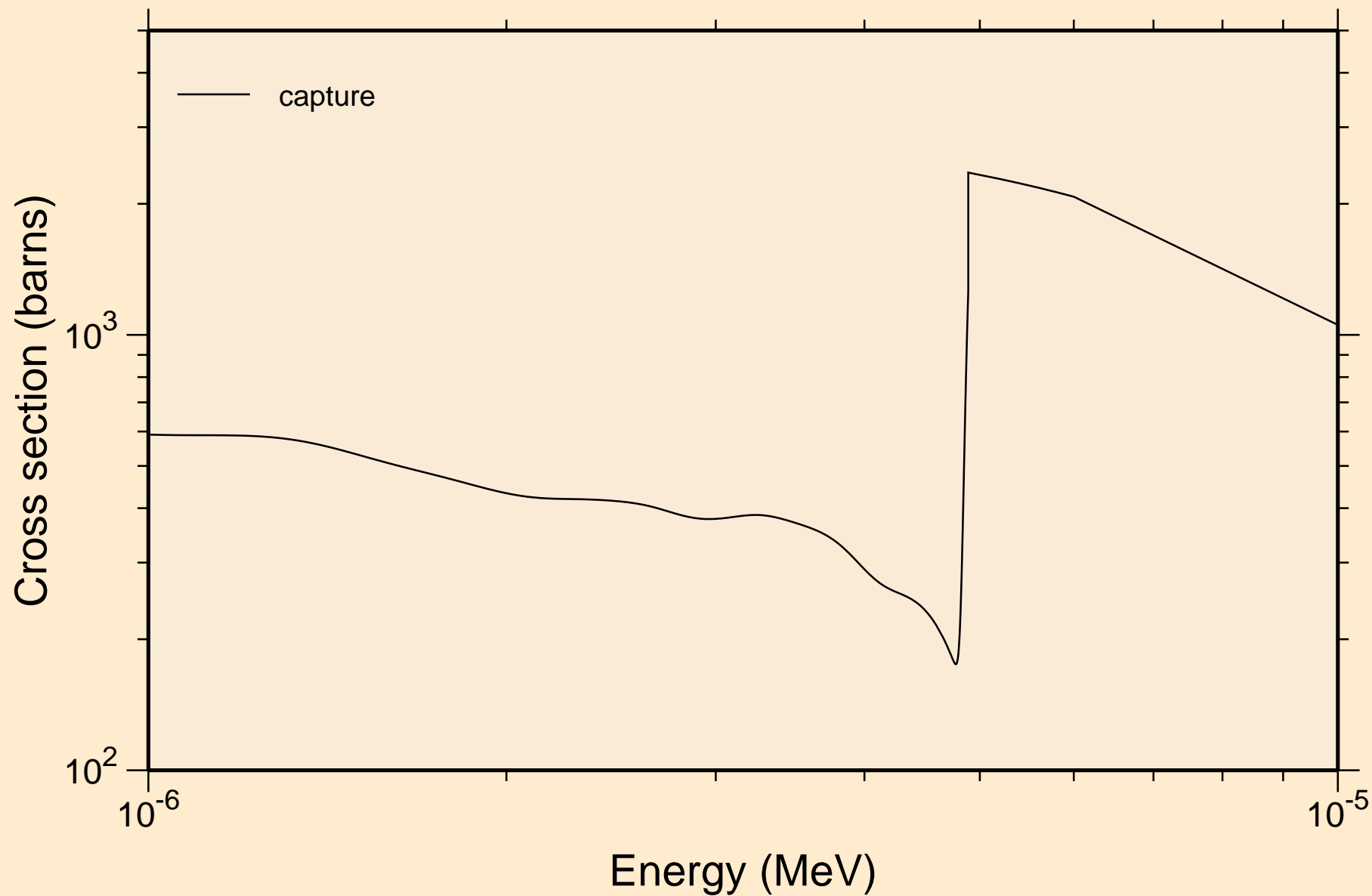

LU162N NEUTRON ACER TENDL-2019 LIBRARY; T=293.16K  
resonance absorption cross sections

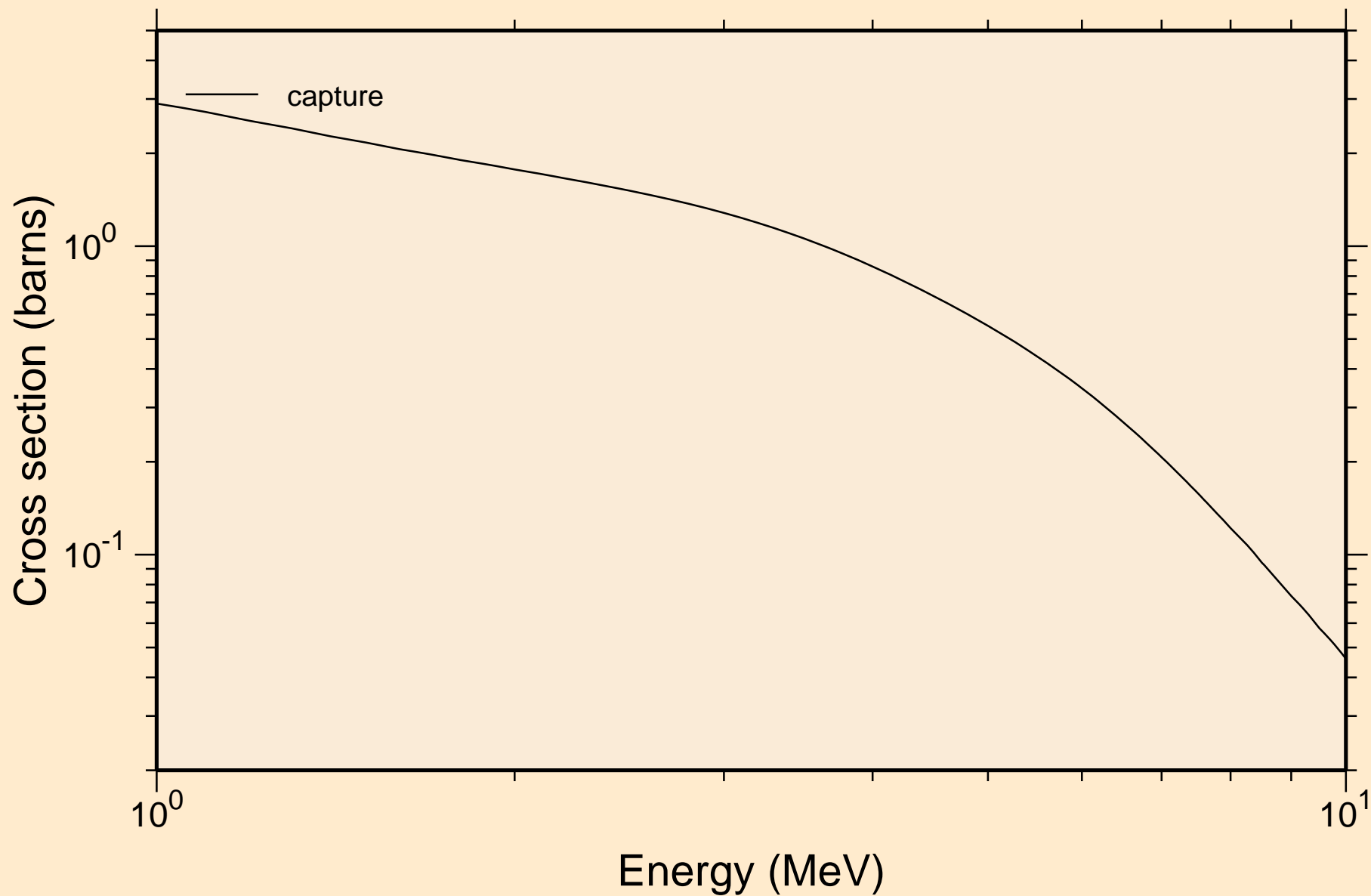

LU162N NEUTRON ACER TENDL-2019 LIBRARY; T=293.16K  
Heating

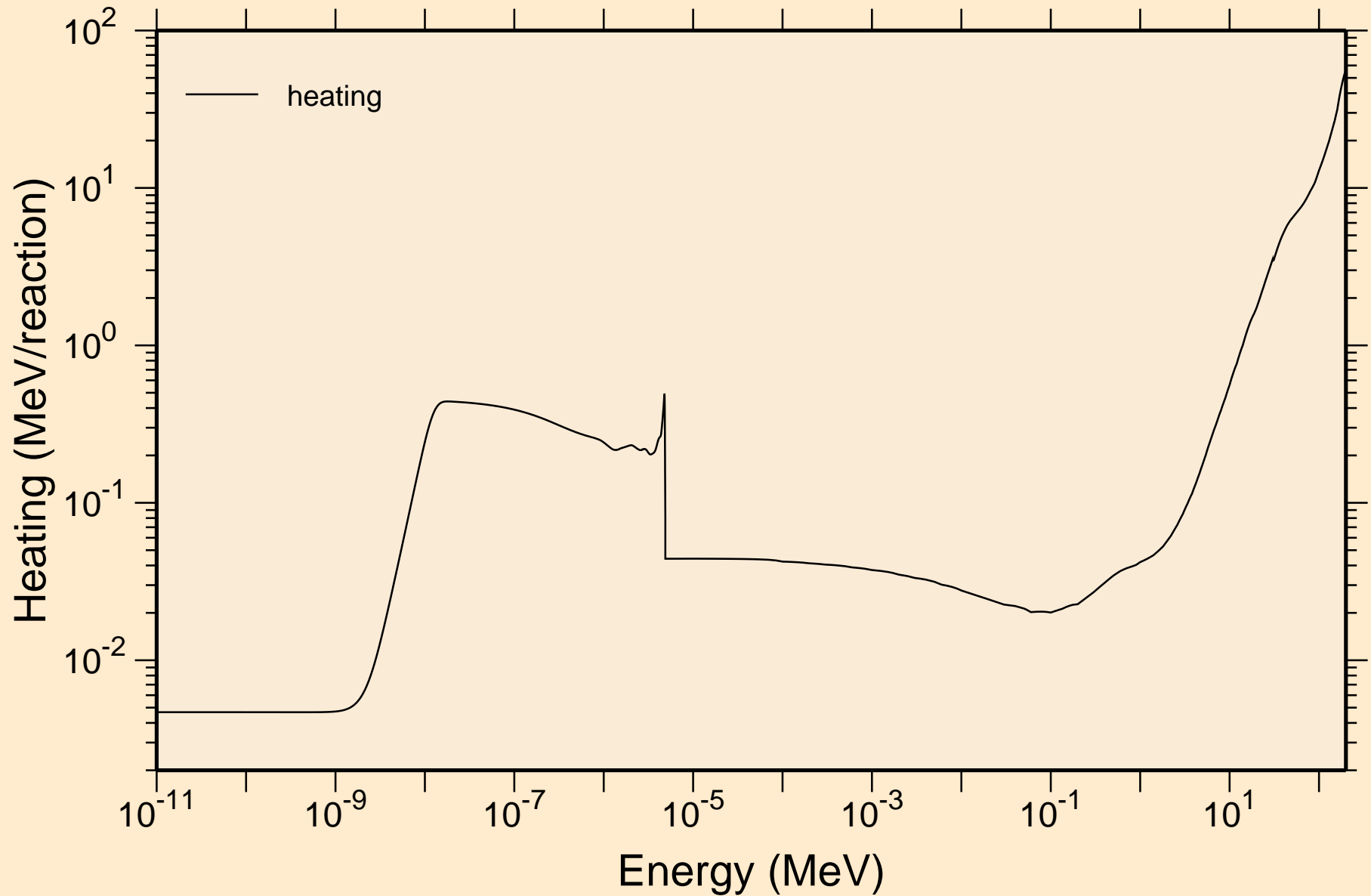

LU162N NEUTRON ACER TENDL-2019 LIBRARY; T=293.16K  
Damage

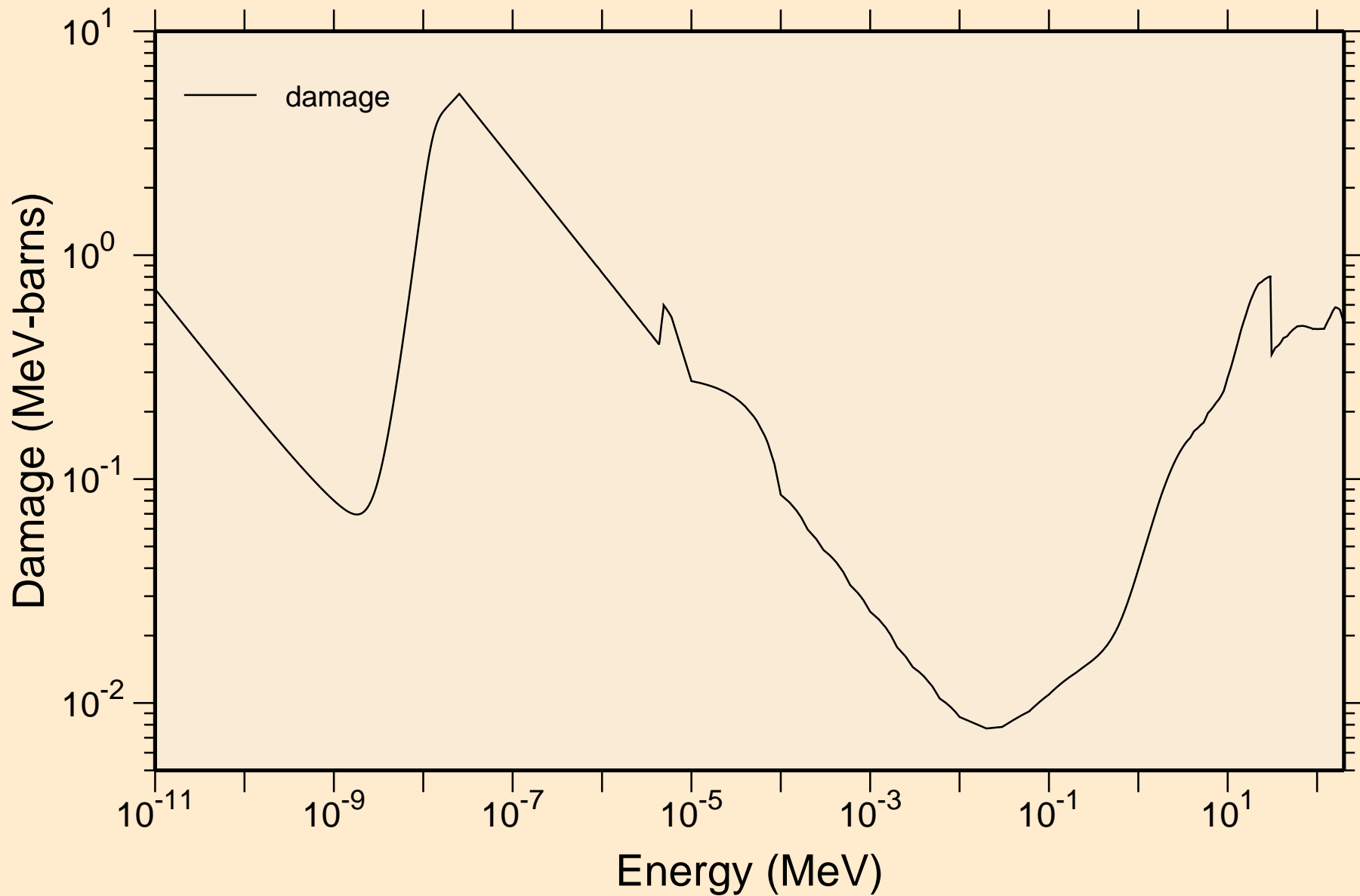

LU162N NEUTRON ACER TENDL-2019 LIBRARY; T=293.16K  
Non-threshold reactions

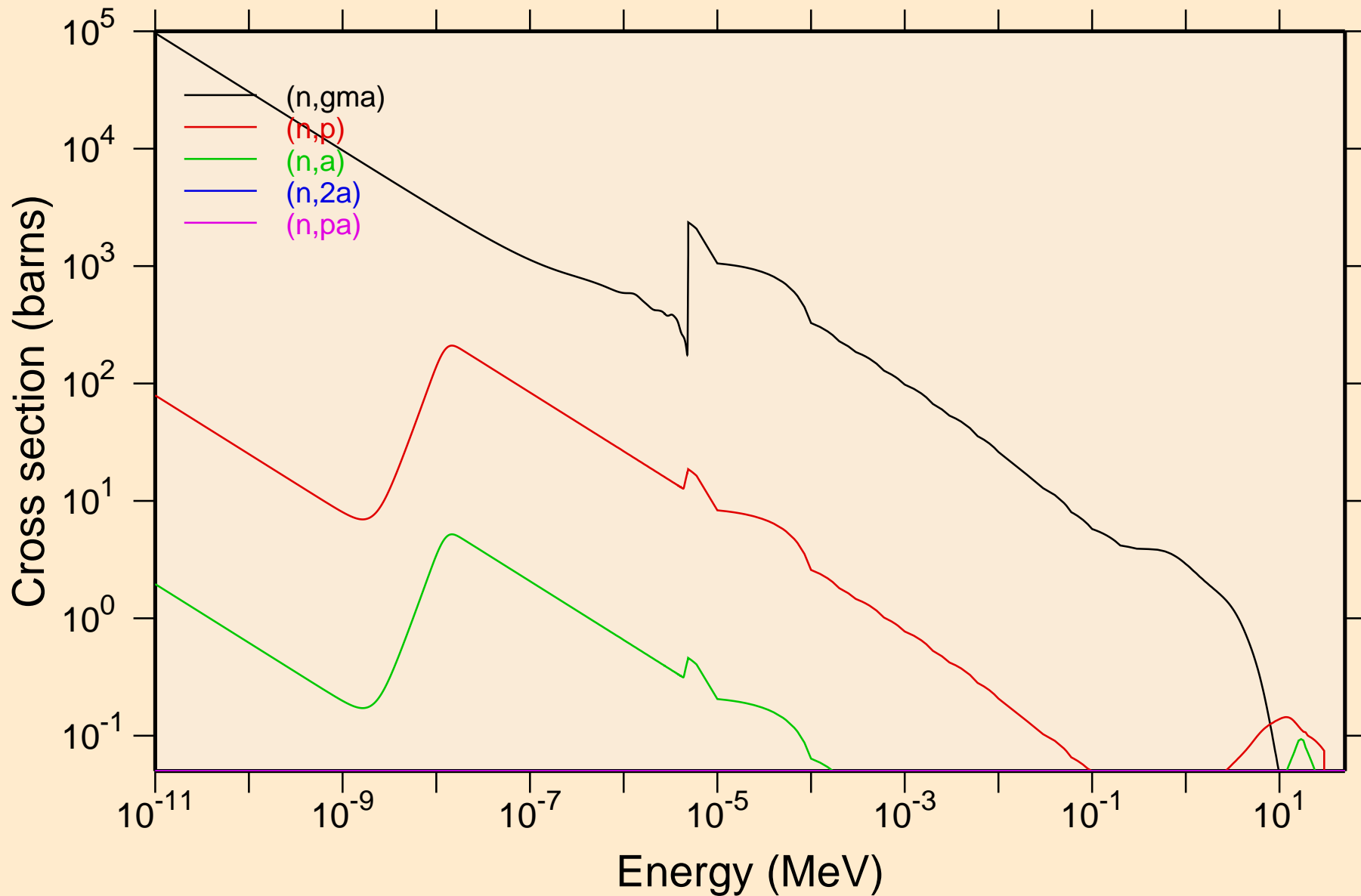

LU162N NEUTRON ACER TENDL-2019 LIBRARY; T=293.16K  
Non-threshold reactions

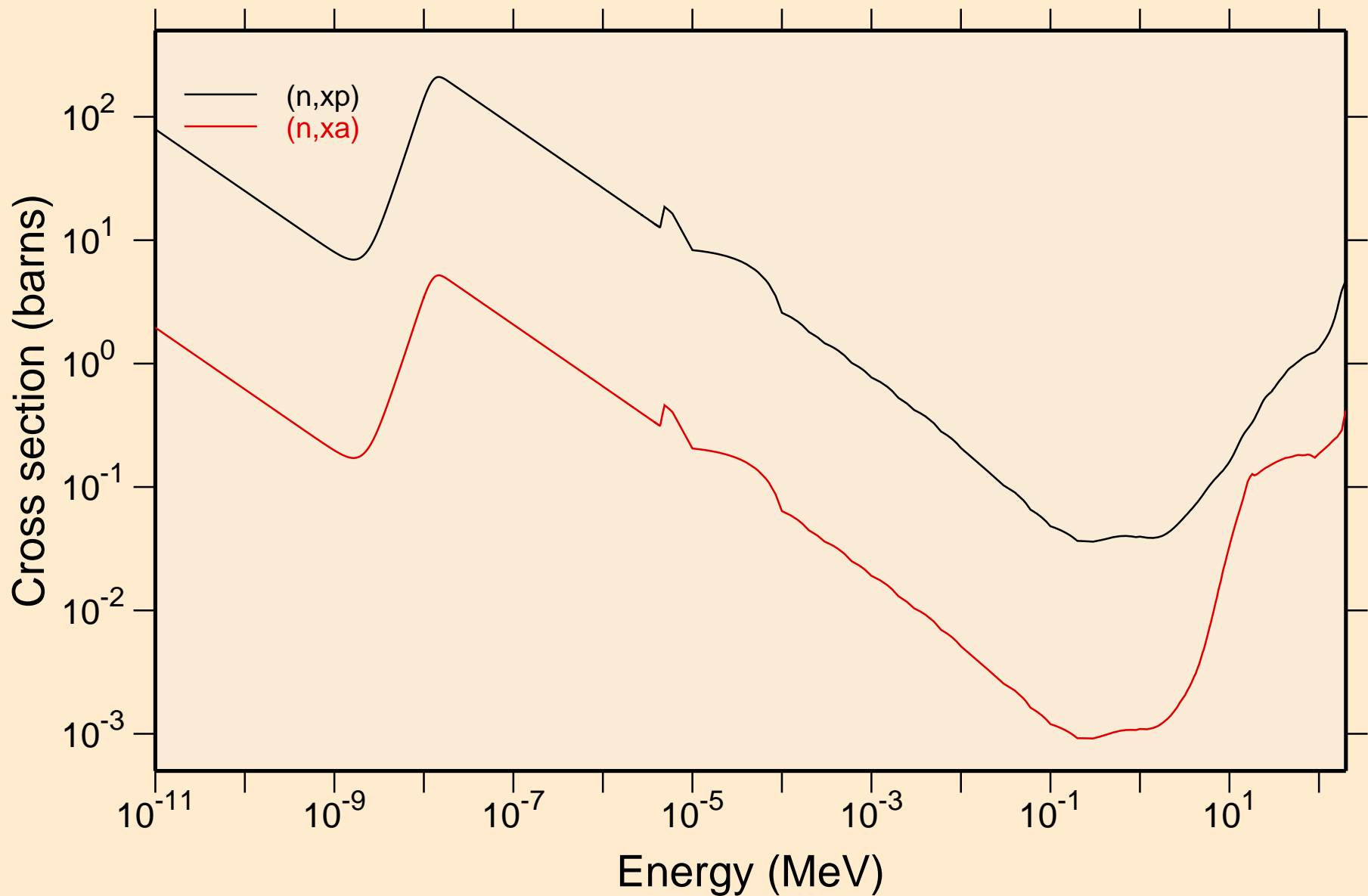

LU162N NEUTRON ACER TENDL-2019 LIBRARY; T=293.16K  
Principal cross sections

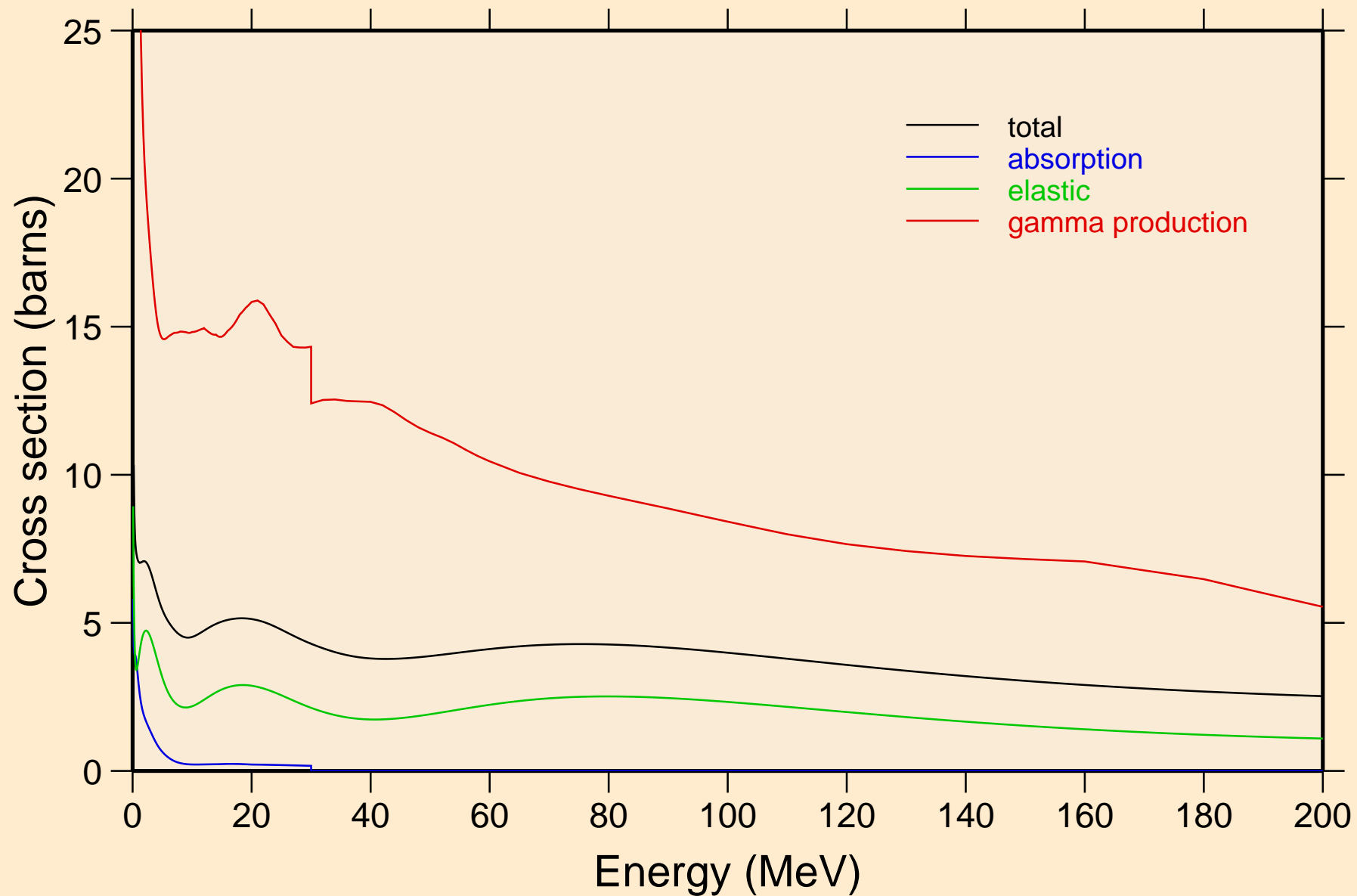

LU162N NEUTRON ACER TENDL-2019 LIBRARY; T=293.16K  
Heating

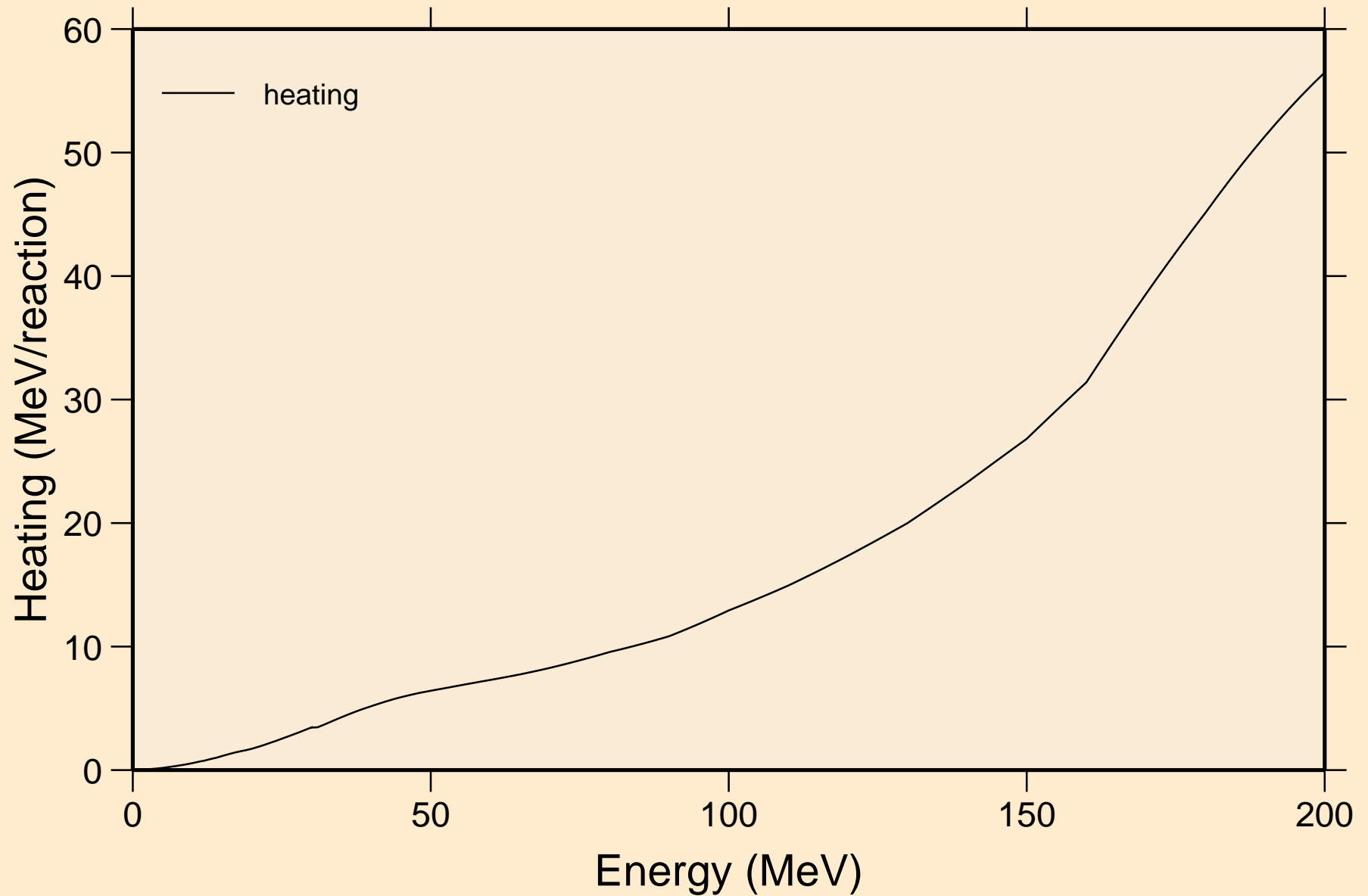



LU162N NEUTRON ACER TENDL-2019 LIBRARY; T=293.16K  
Damage

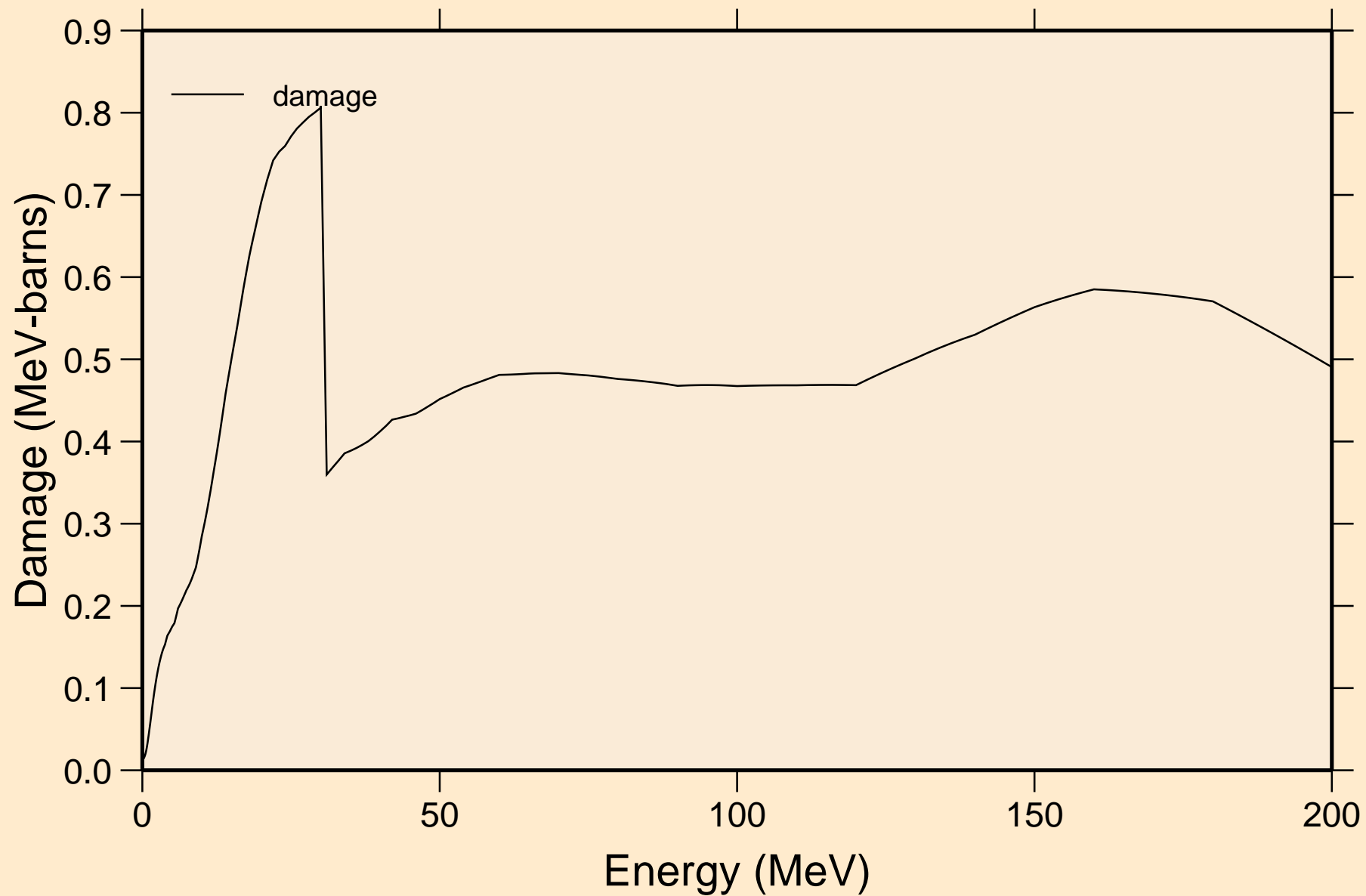

LU162N NEUTRON ACER TENDL-2019 LIBRARY; T=293.16K  
Non-threshold reactions

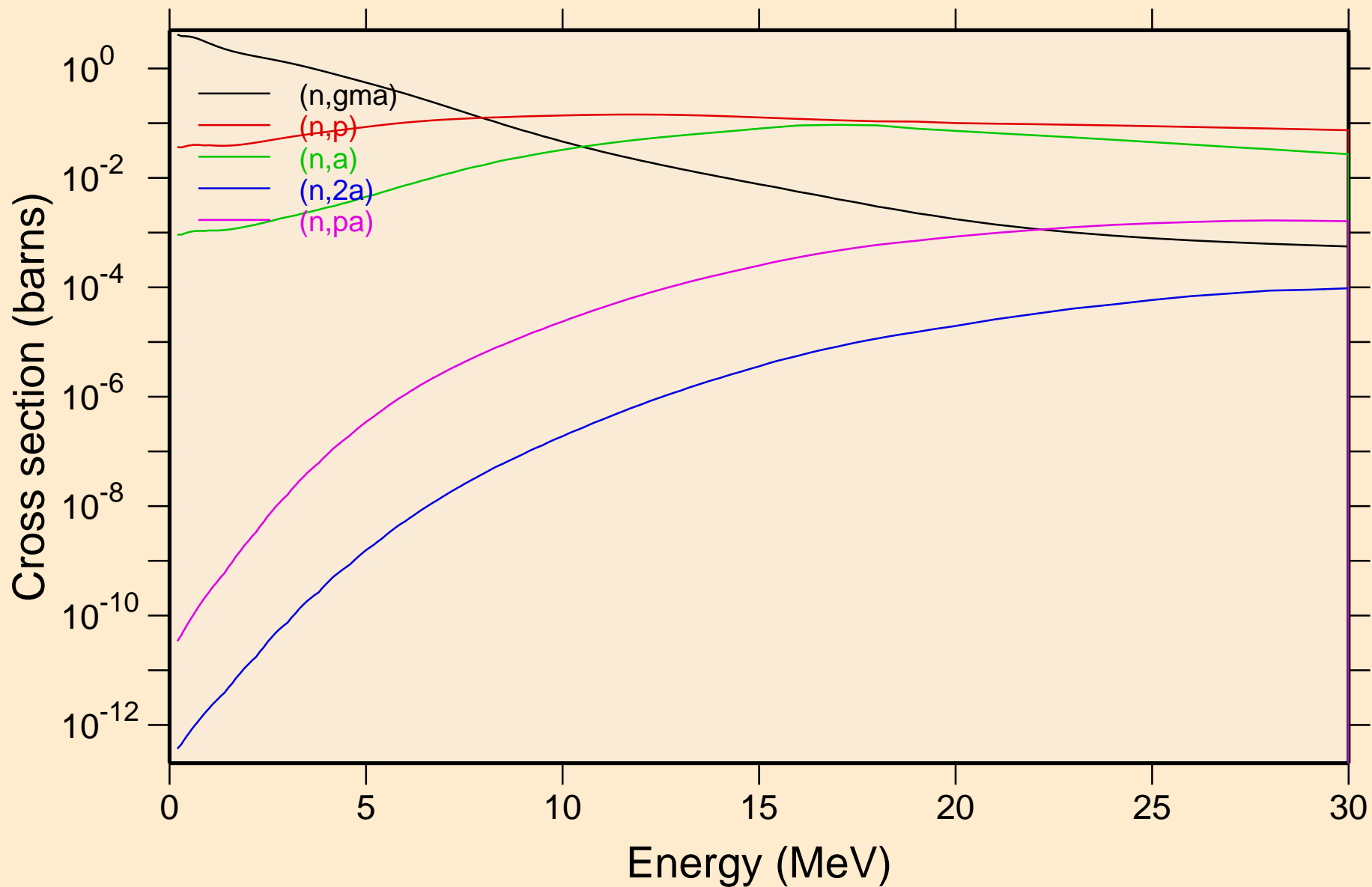

LU162N NEUTRON ACER TENDL-2019 LIBRARY; T=293.16K  
Non-threshold reactions

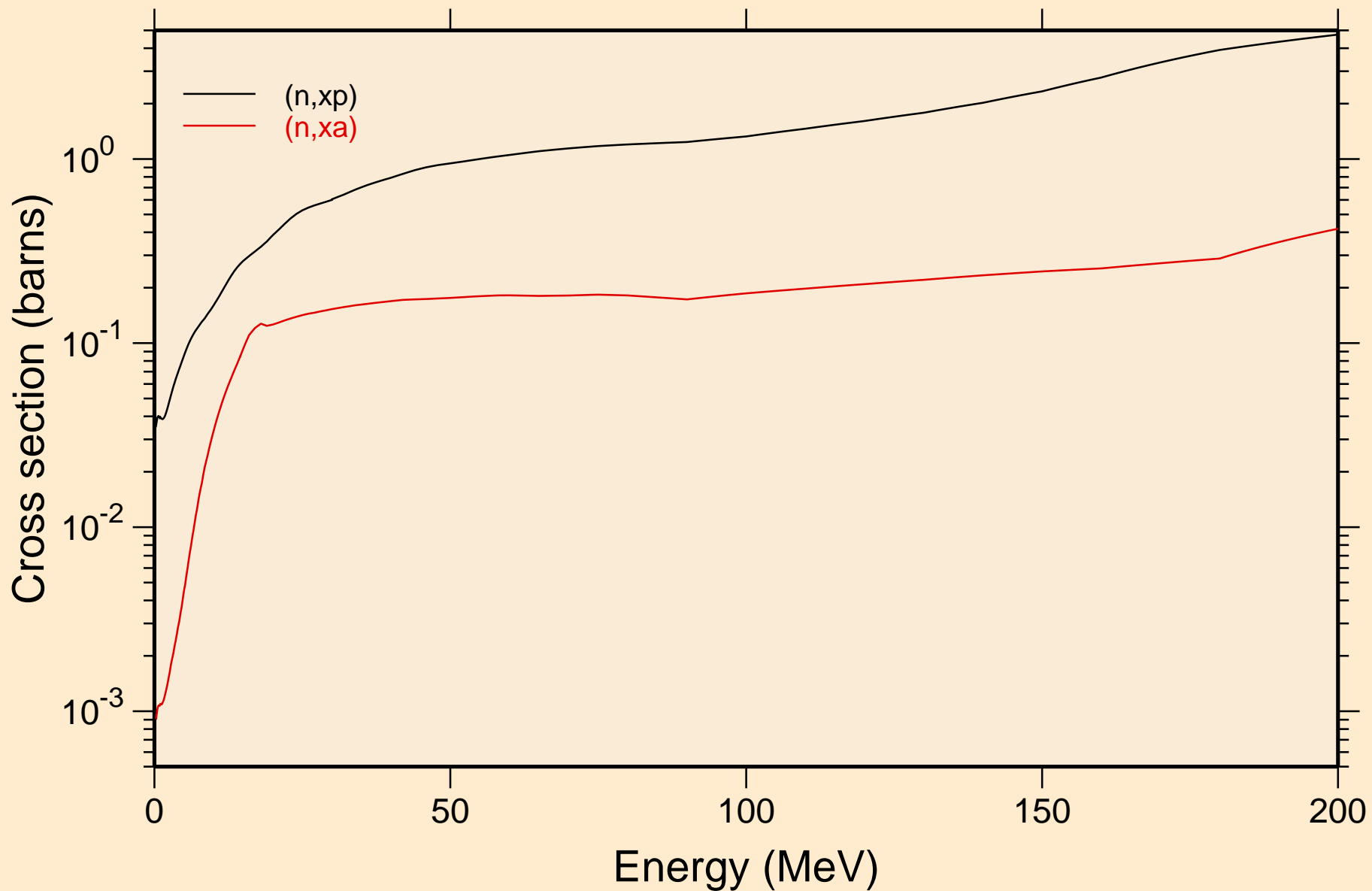

LU162N NEUTRON ACER TENDL-2019 LIBRARY; T=293.16K  
Inelastic levels

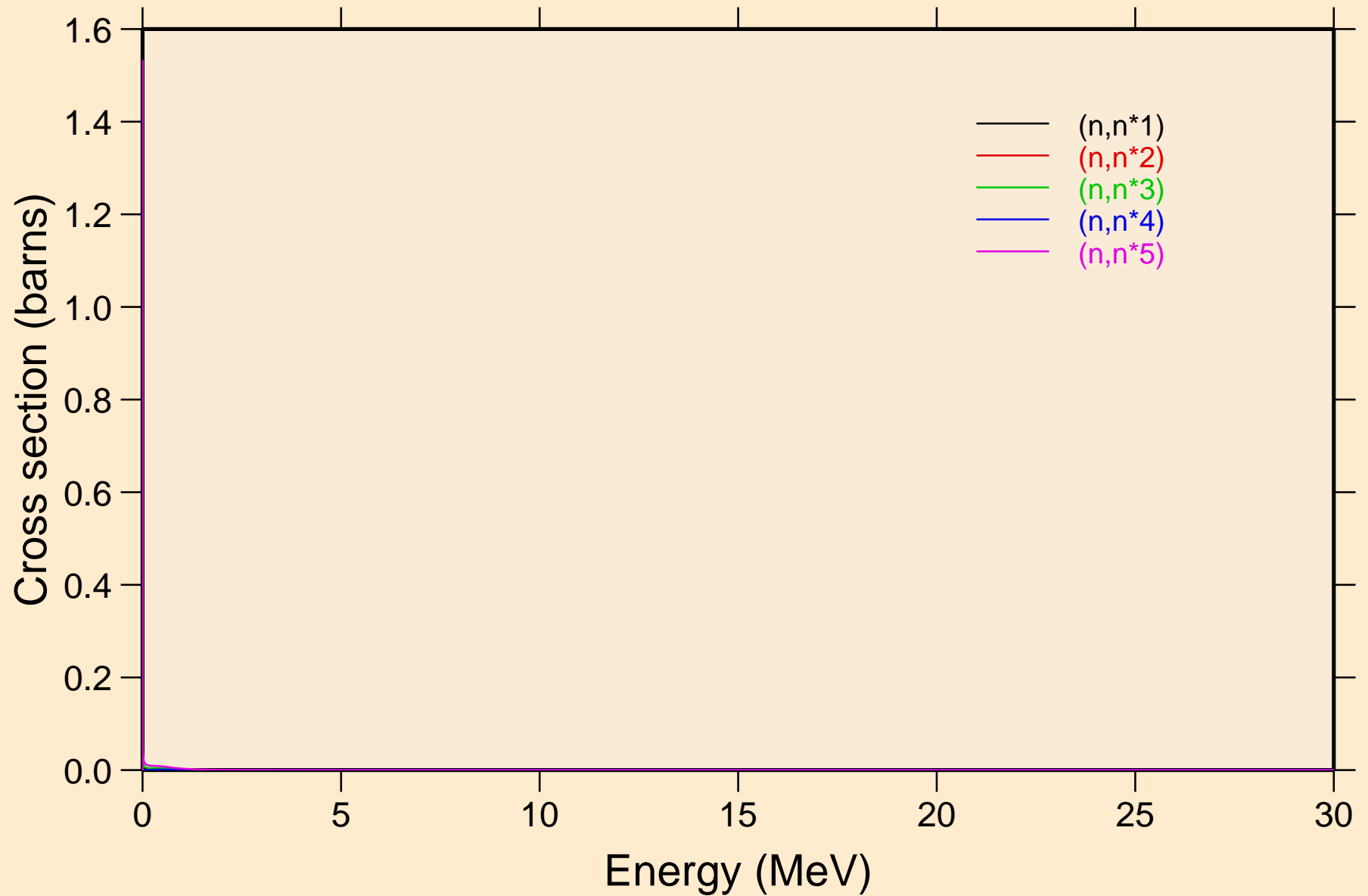

LU162N NEUTRON ACER TENDL-2019 LIBRARY; T=293.16K  
Inelastic levels

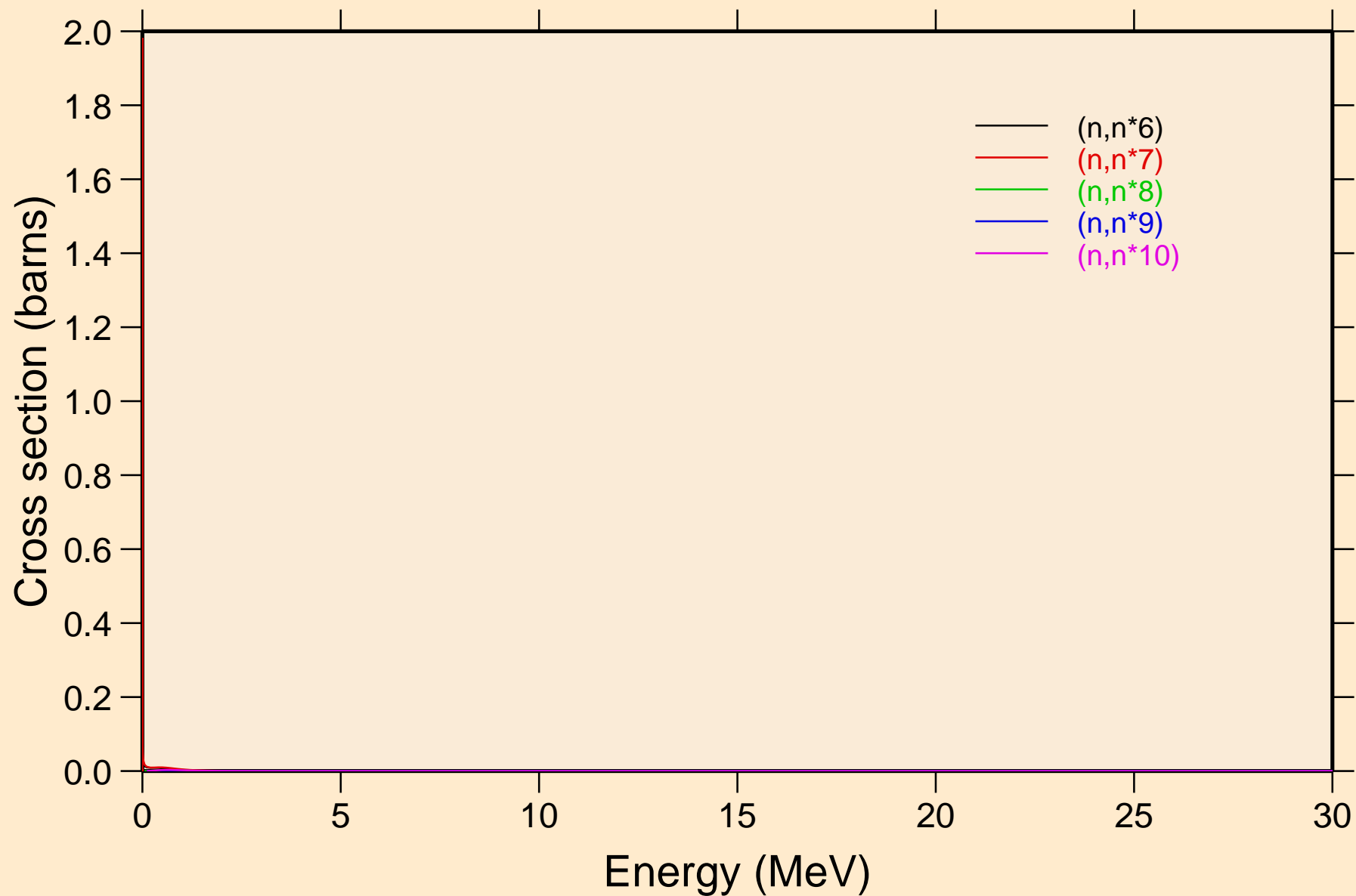

LU162N NEUTRON ACER TENDL-2019 LIBRARY; T=293.16K  
Inelastic levels

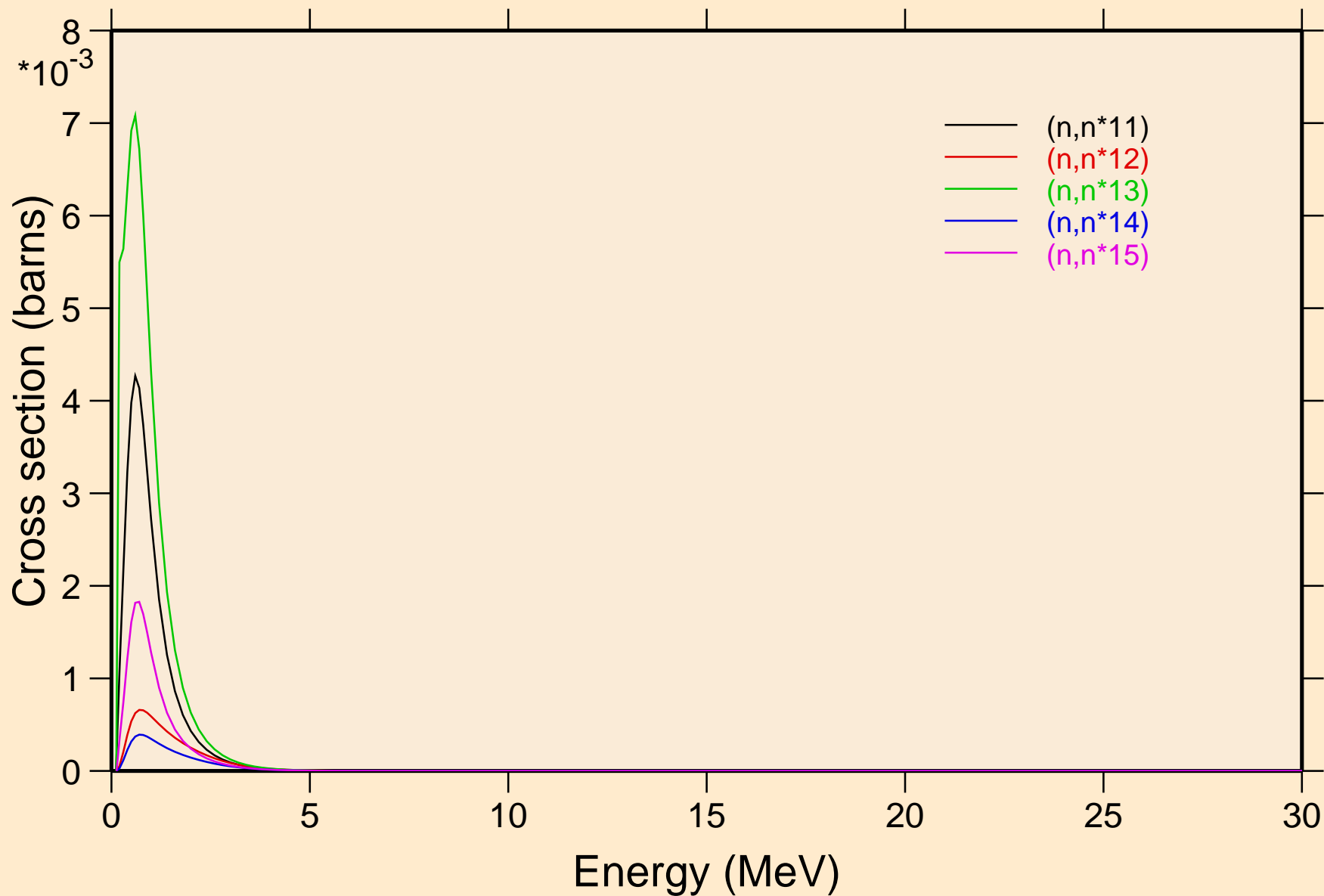

LU162N NEUTRON ACER TENDL-2019 LIBRARY; T=293.16K  
Inelastic levels

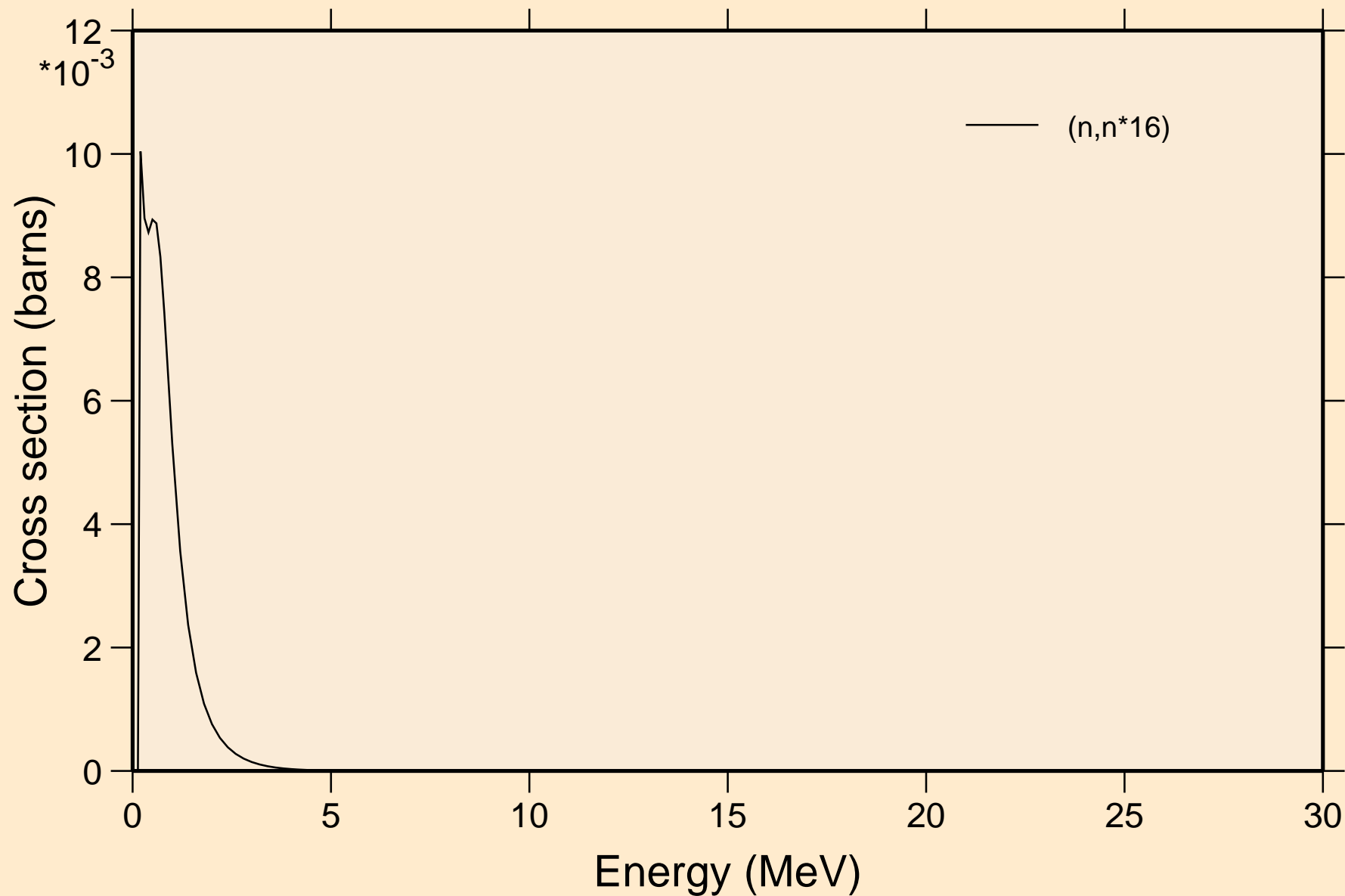

LU162N NEUTRON ACER TENDL-2019 LIBRARY; T=293.16K  
Threshold reactions

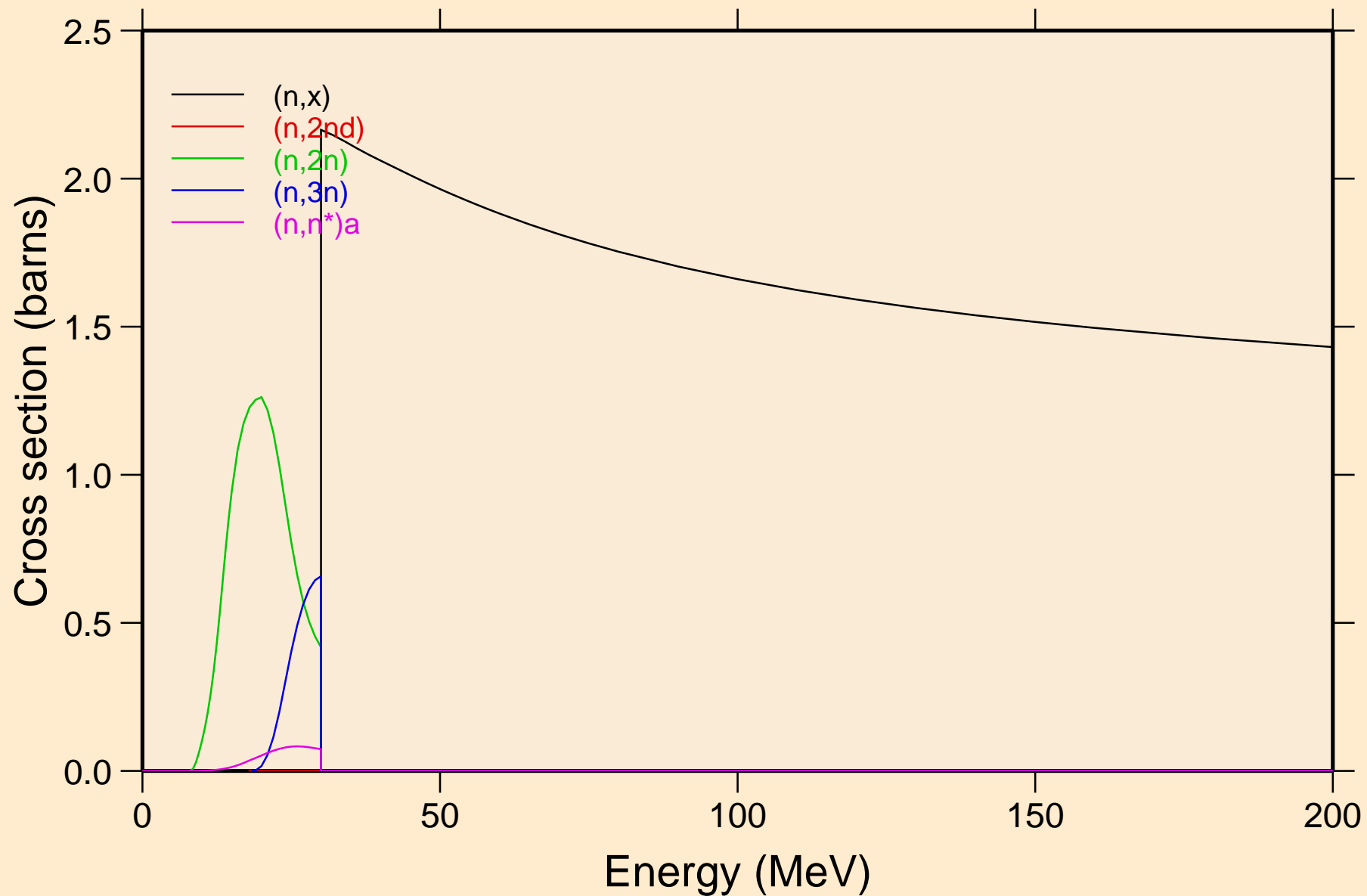



LU162N NEUTRON ACER TENDL-2019 LIBRARY; T=293.16K  
Threshold reactions

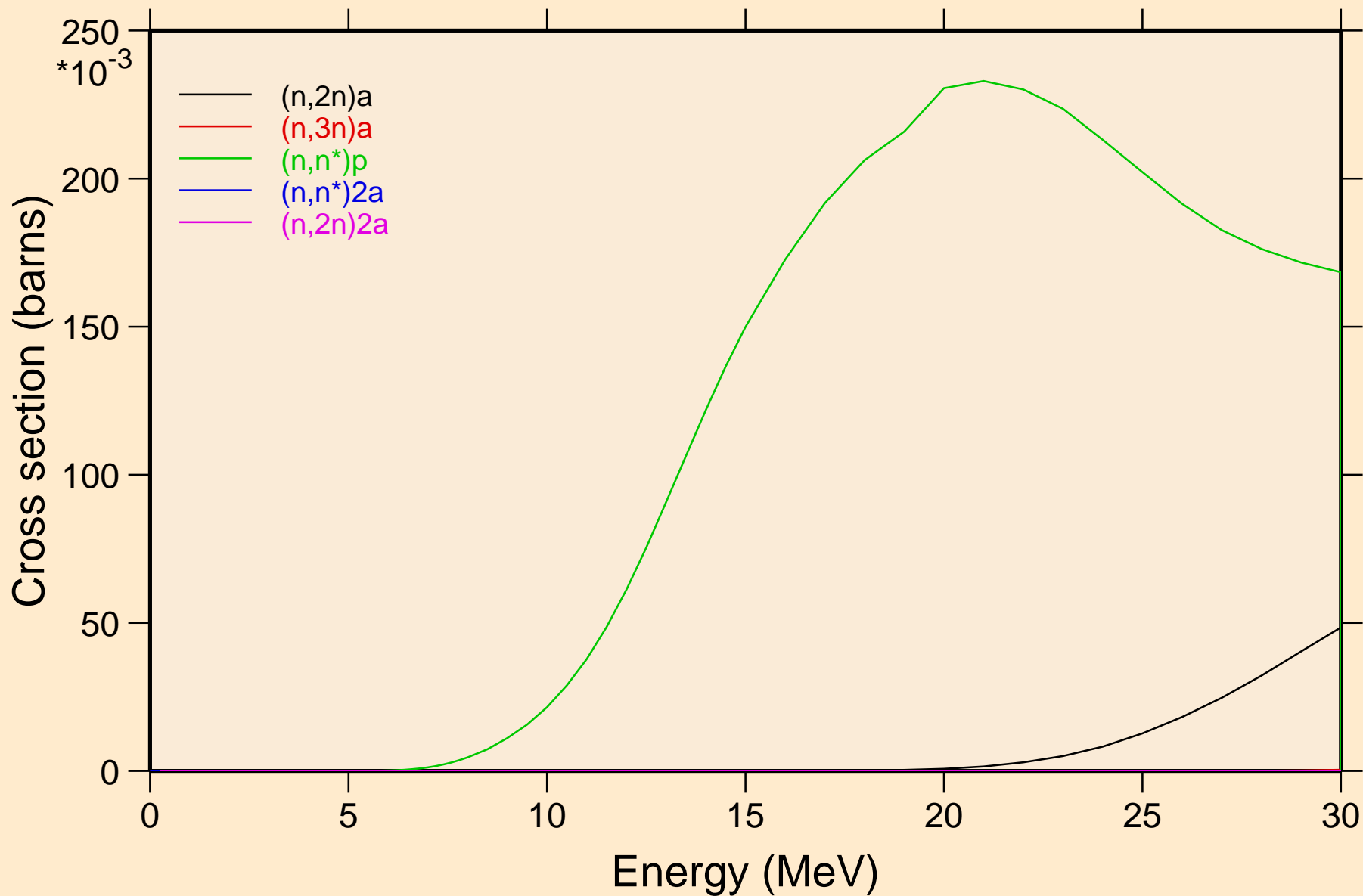

LU162N NEUTRON ACER TENDL-2019 LIBRARY; T=293.16K  
Threshold reactions

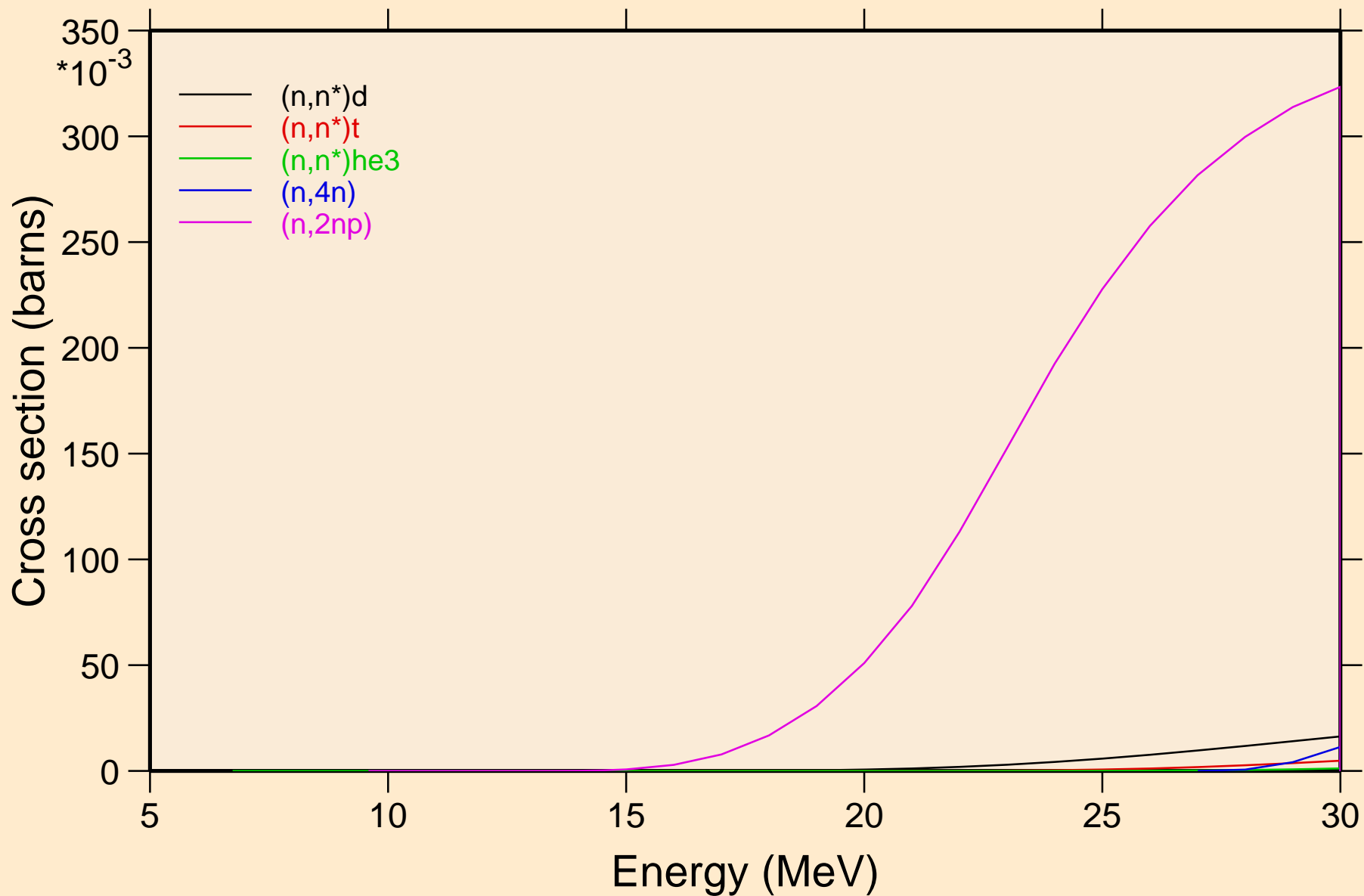

LU162N NEUTRON ACER TENDL-2019 LIBRARY; T=293.16K  
Threshold reactions

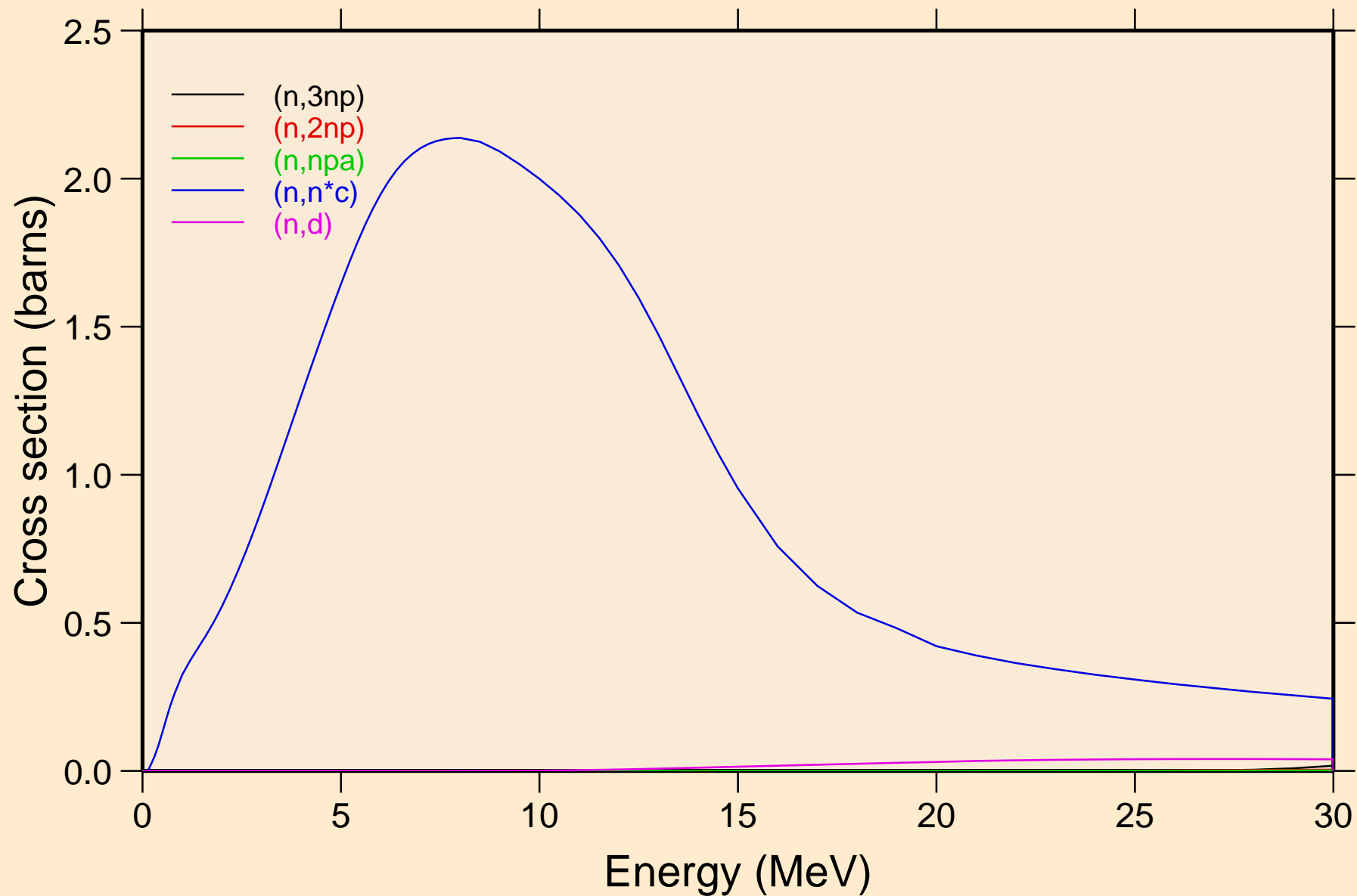

LU162N NEUTRON ACER TENDL-2019 LIBRARY; T=293.16K  
Threshold reactions

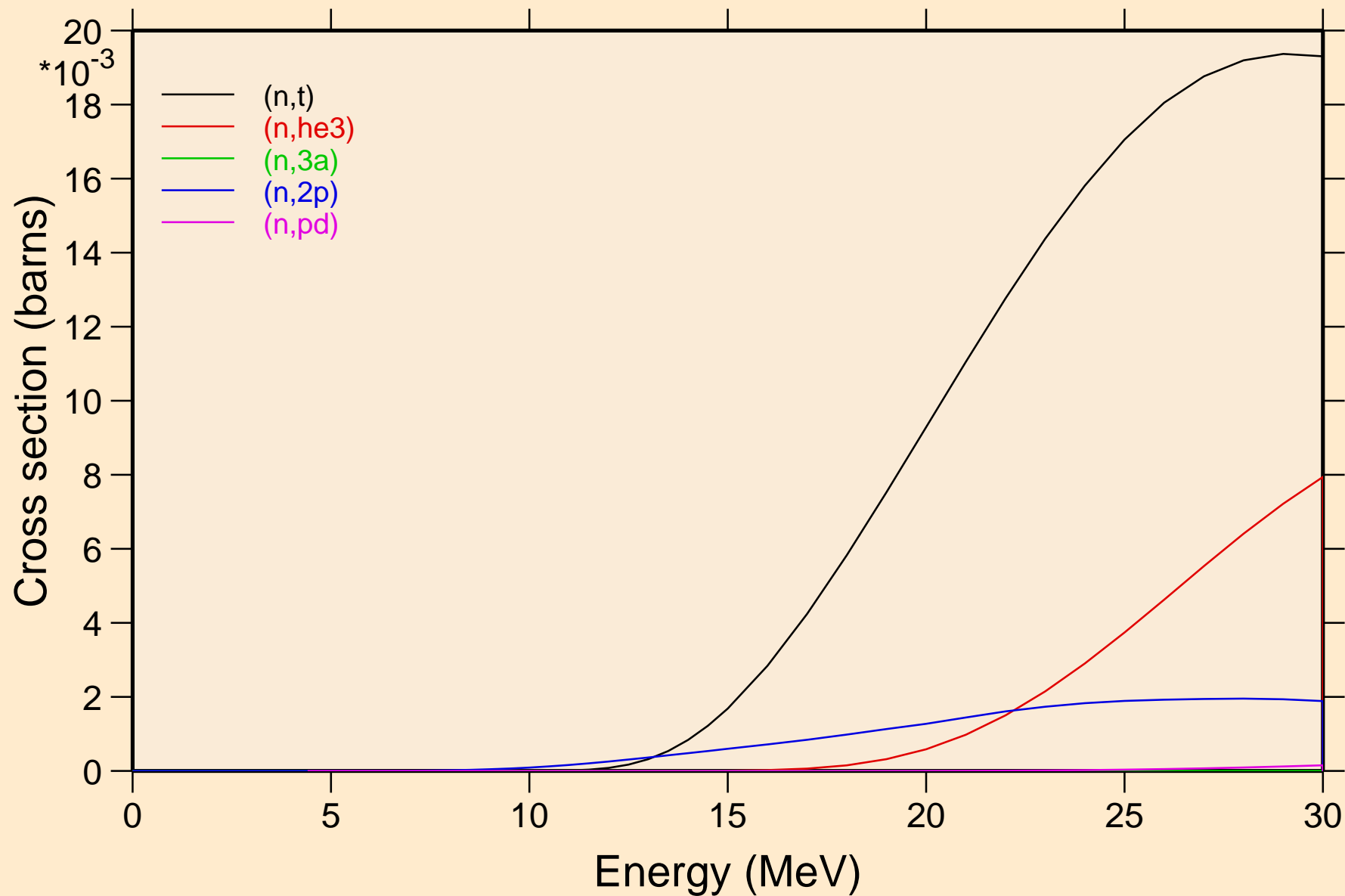

LU162N NEUTRON ACER TENDL-2019 LIBRARY; T=293.16K  
Threshold reactions

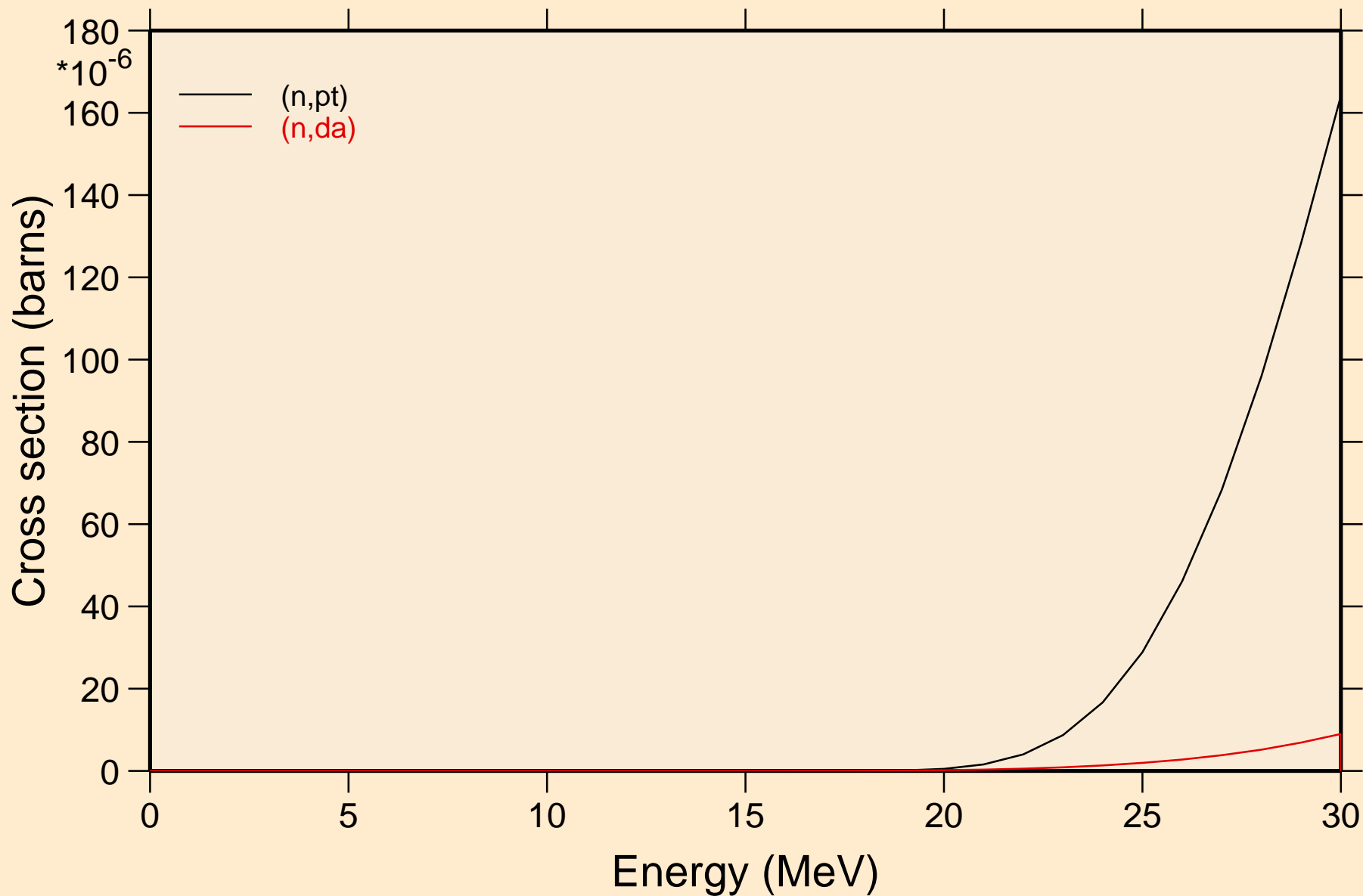

LU162N NEUTRON ACER TENDL-2019 LIBRARY; T=293.16K  
Threshold reactions

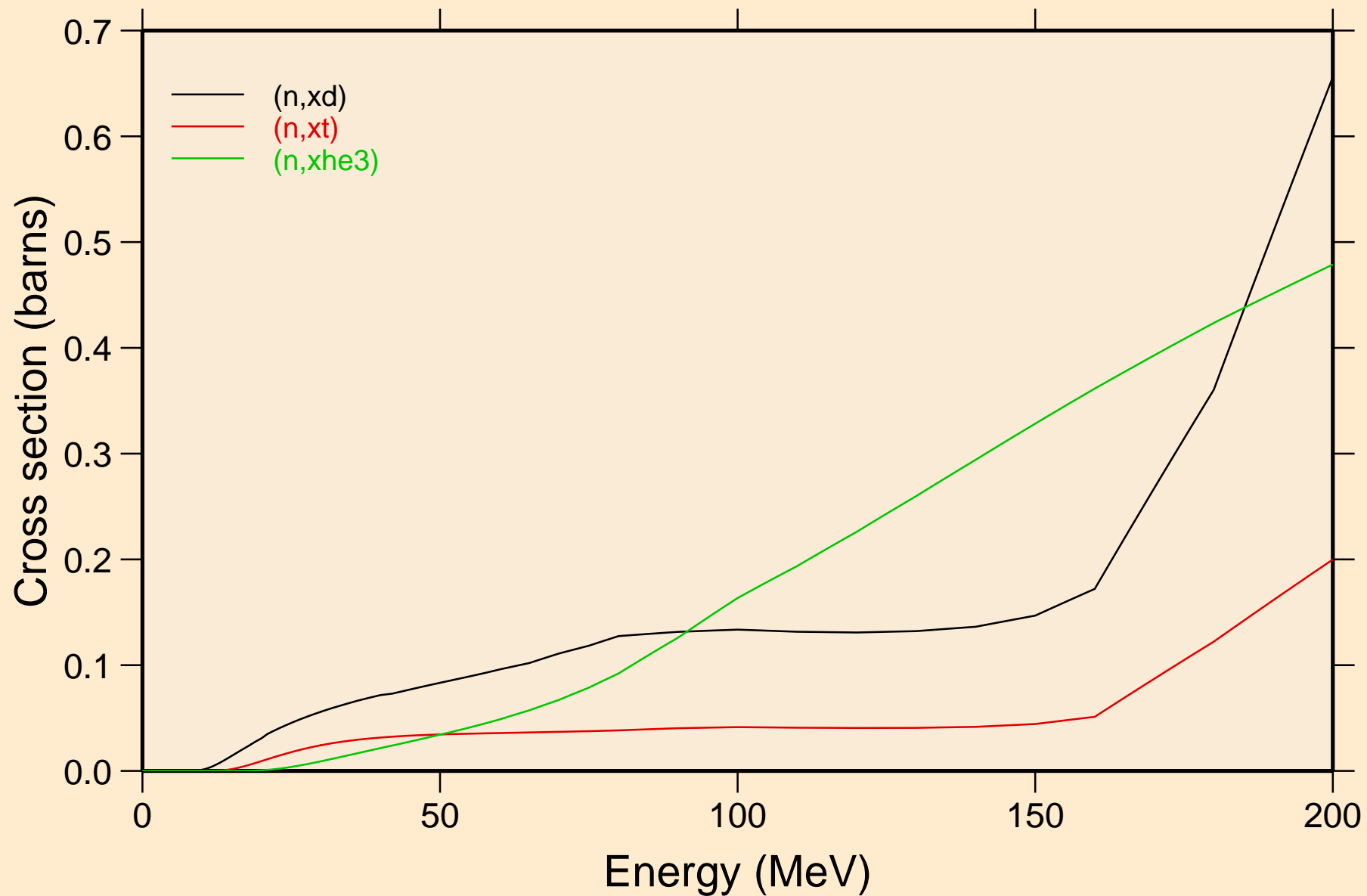

LU162N NEUTRON ACER TENDL-2019 LIBRARY; T=293.16K  
angular distribution for elastic

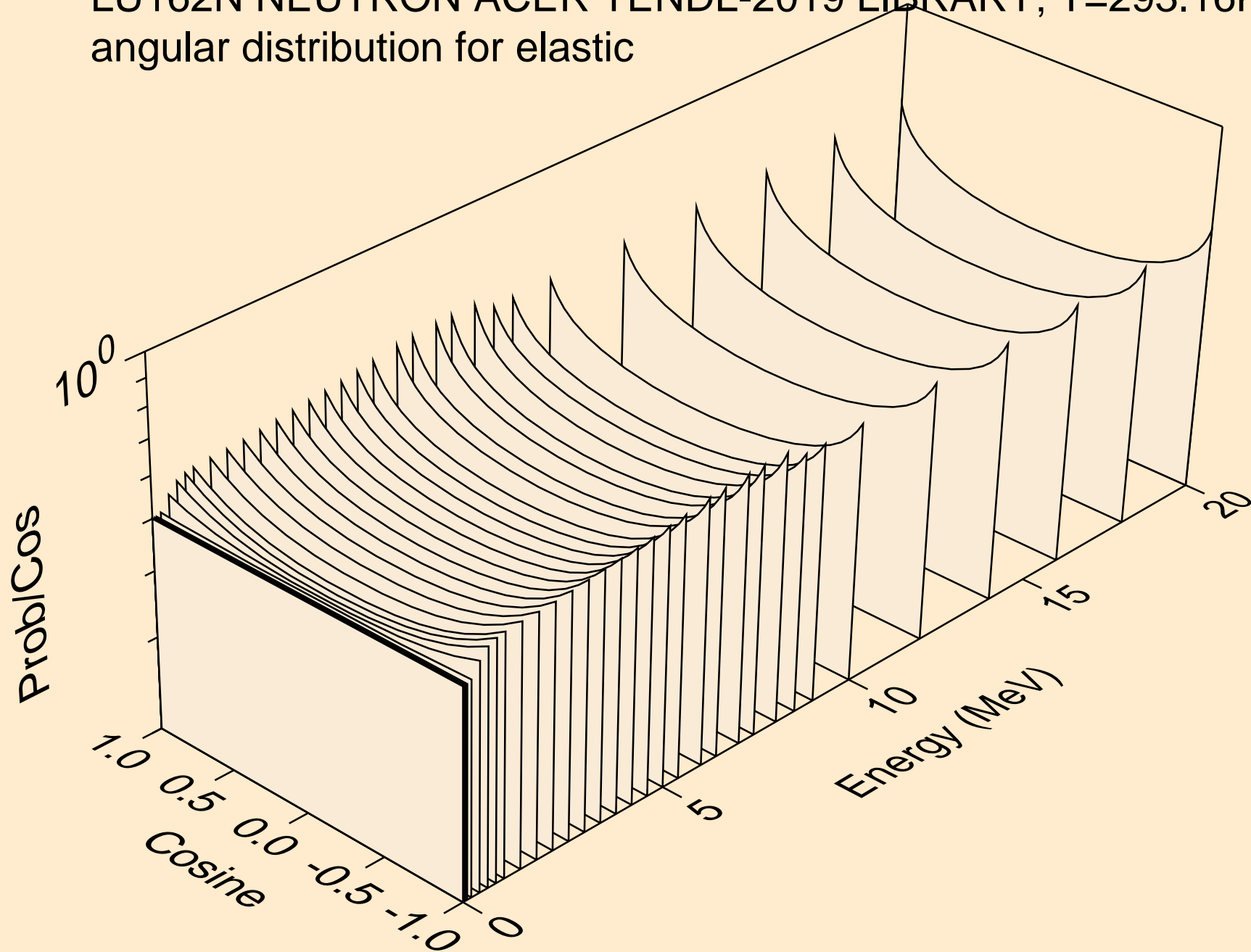

LU162N NEUTRON ACER TENDL-2019 LIBRARY; T=293.16K  
angular distribution for elastic

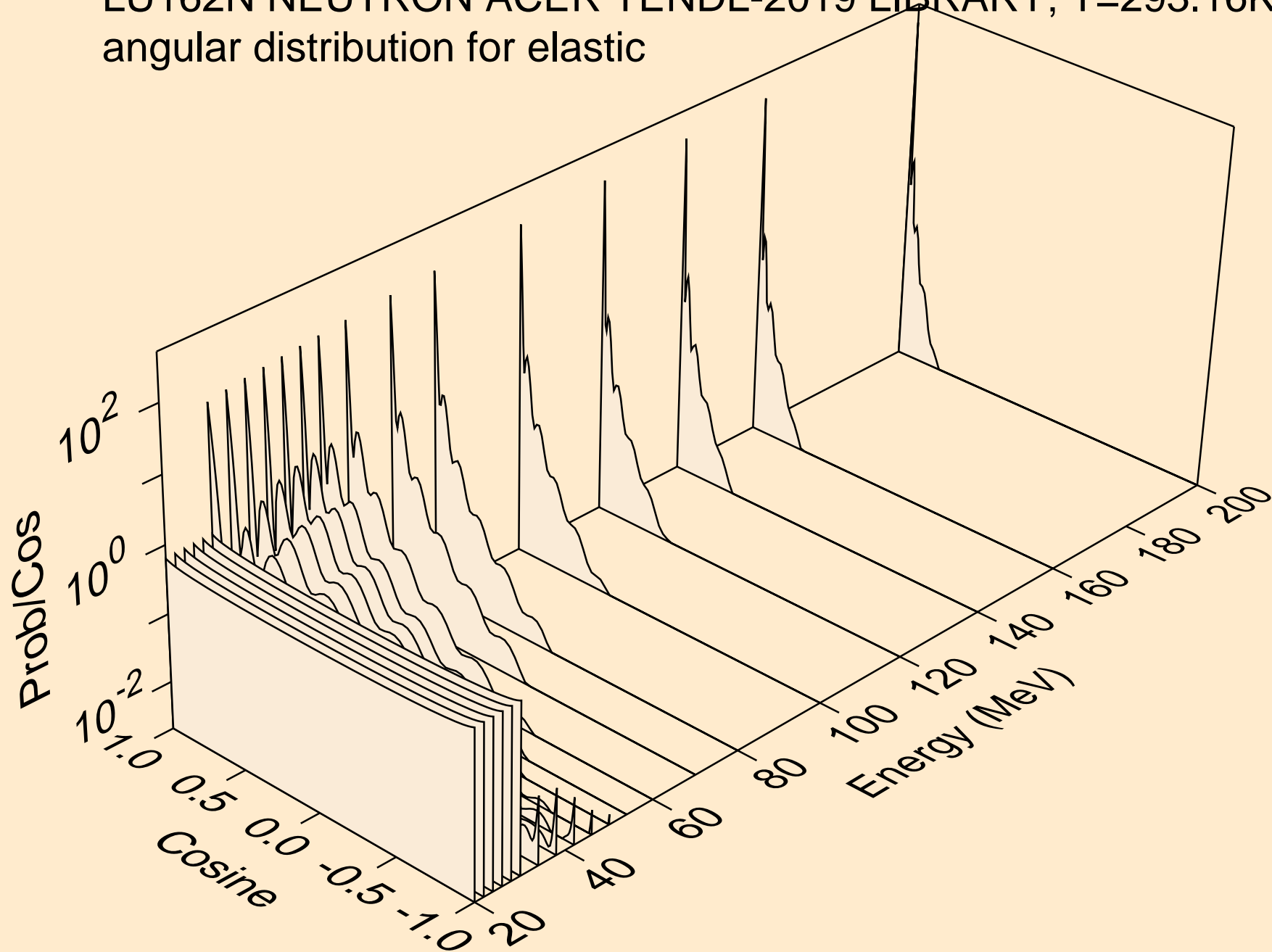



LU162N NEUTRON ACER TENDL-2019 LIBRARY; T=293.16K  
angular distribution for (n,n\*1)

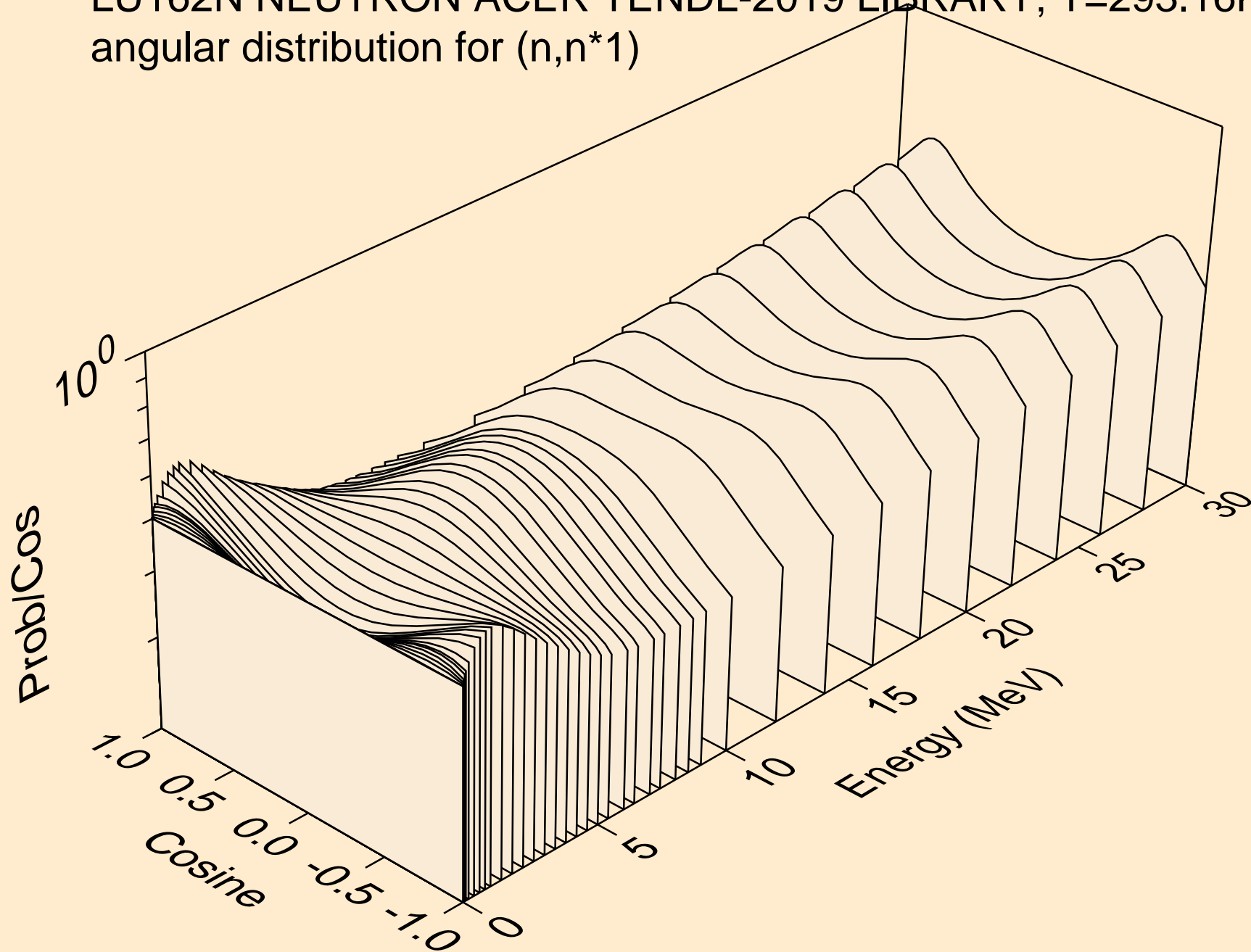

LU162N NEUTRON ACER TENDL-2019 LIBRARY; T=293.16K  
angular distribution for (n,n\*2)

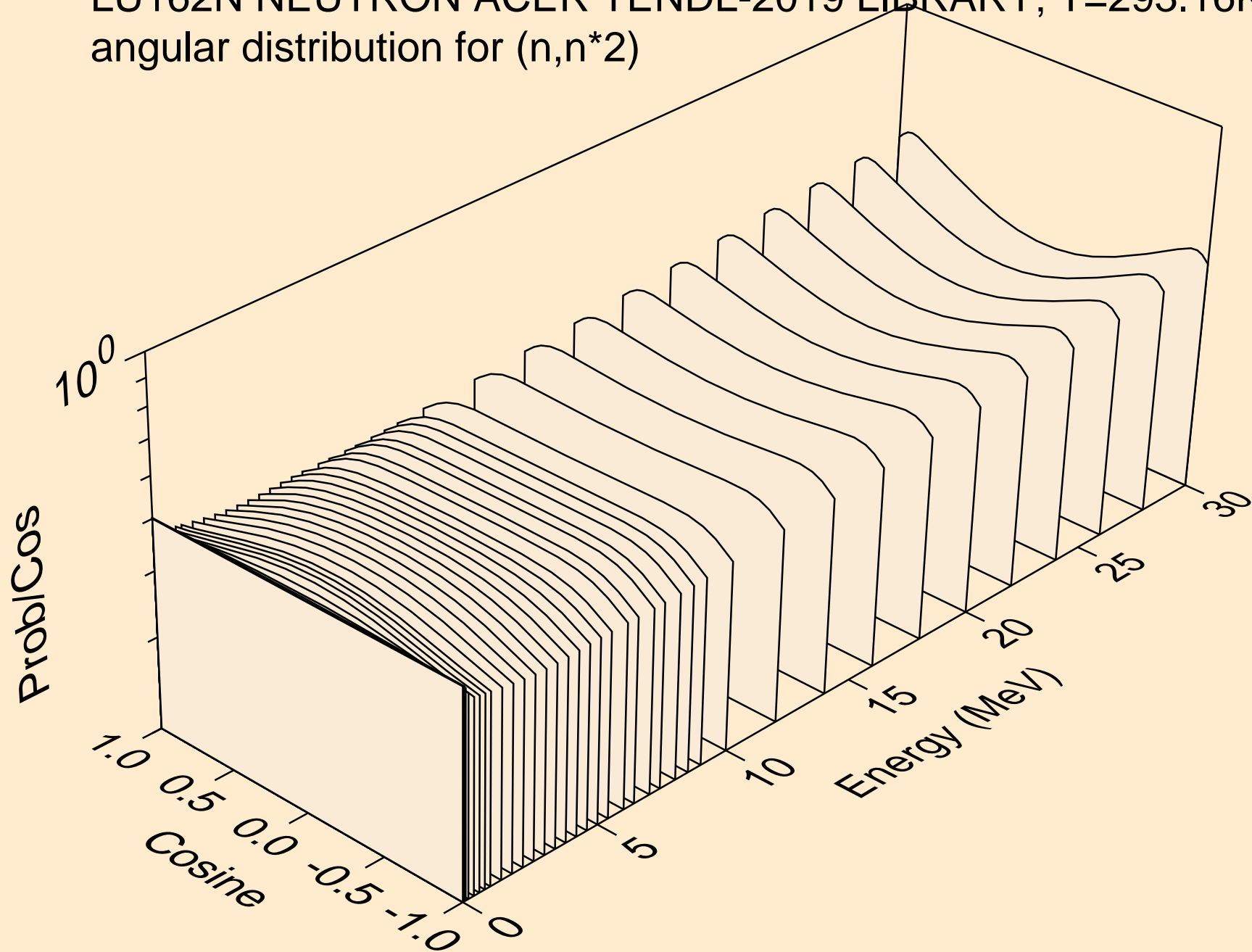

LU162N NEUTRON ACER TENDL-2019 LIBRARY; T=293.16K  
angular distribution for (n,n\*3)

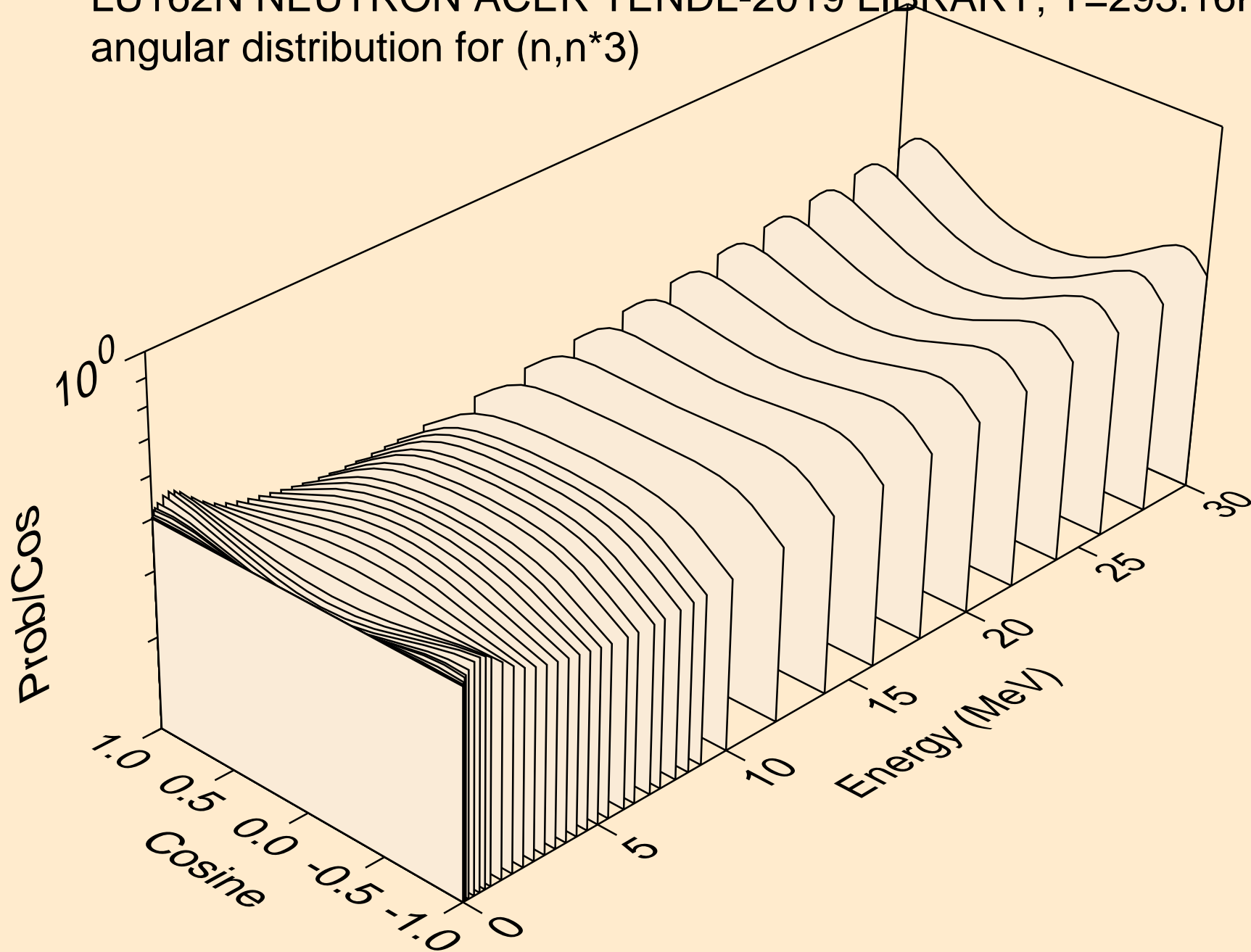

LU162N NEUTRON ACER TENDL-2019 LIBRARY; T=293.16K  
angular distribution for (n,n\*4)

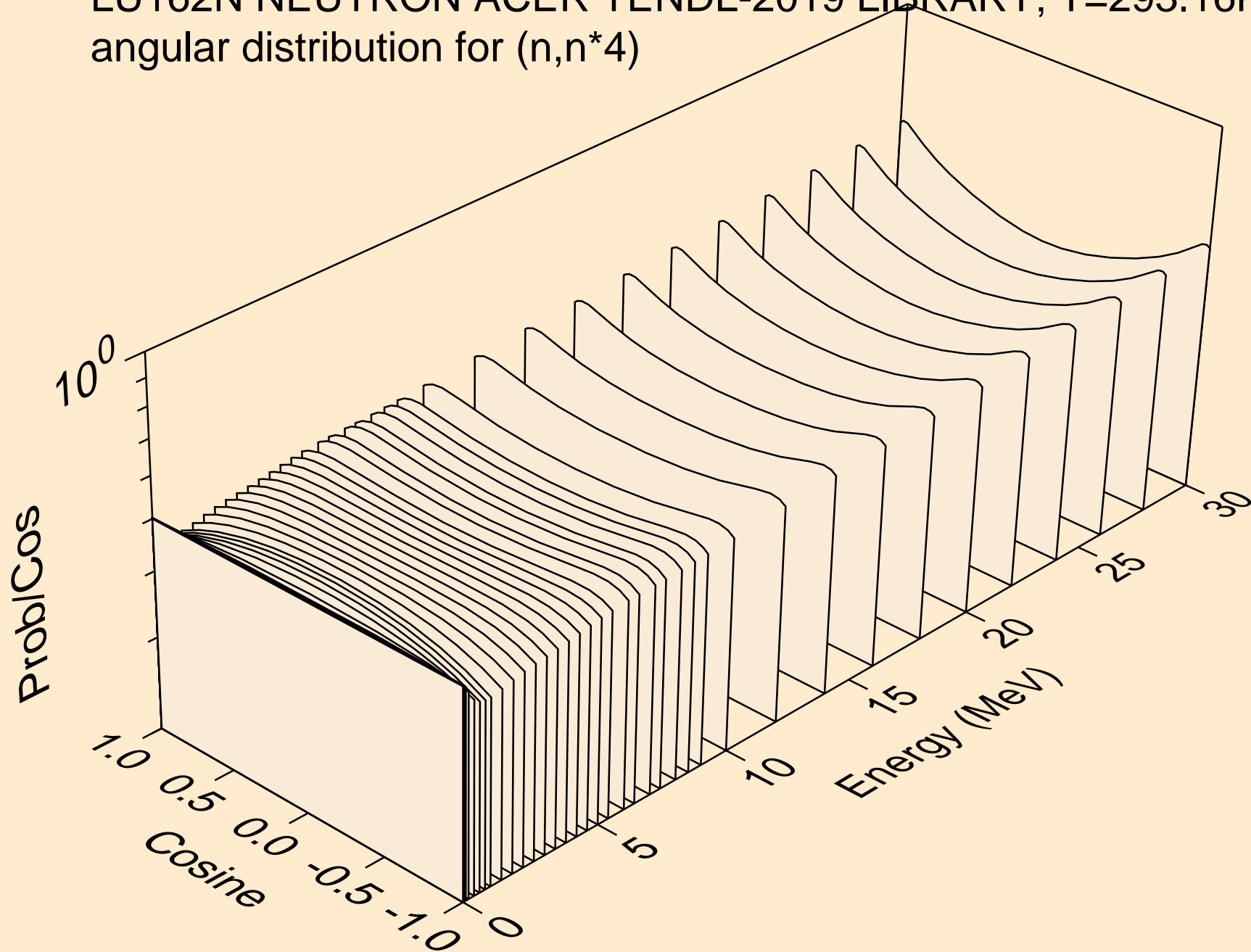

LU162N NEUTRON ACER TENDL-2019 LIBRARY; T=293.16K  
angular distribution for (n,n\*5)

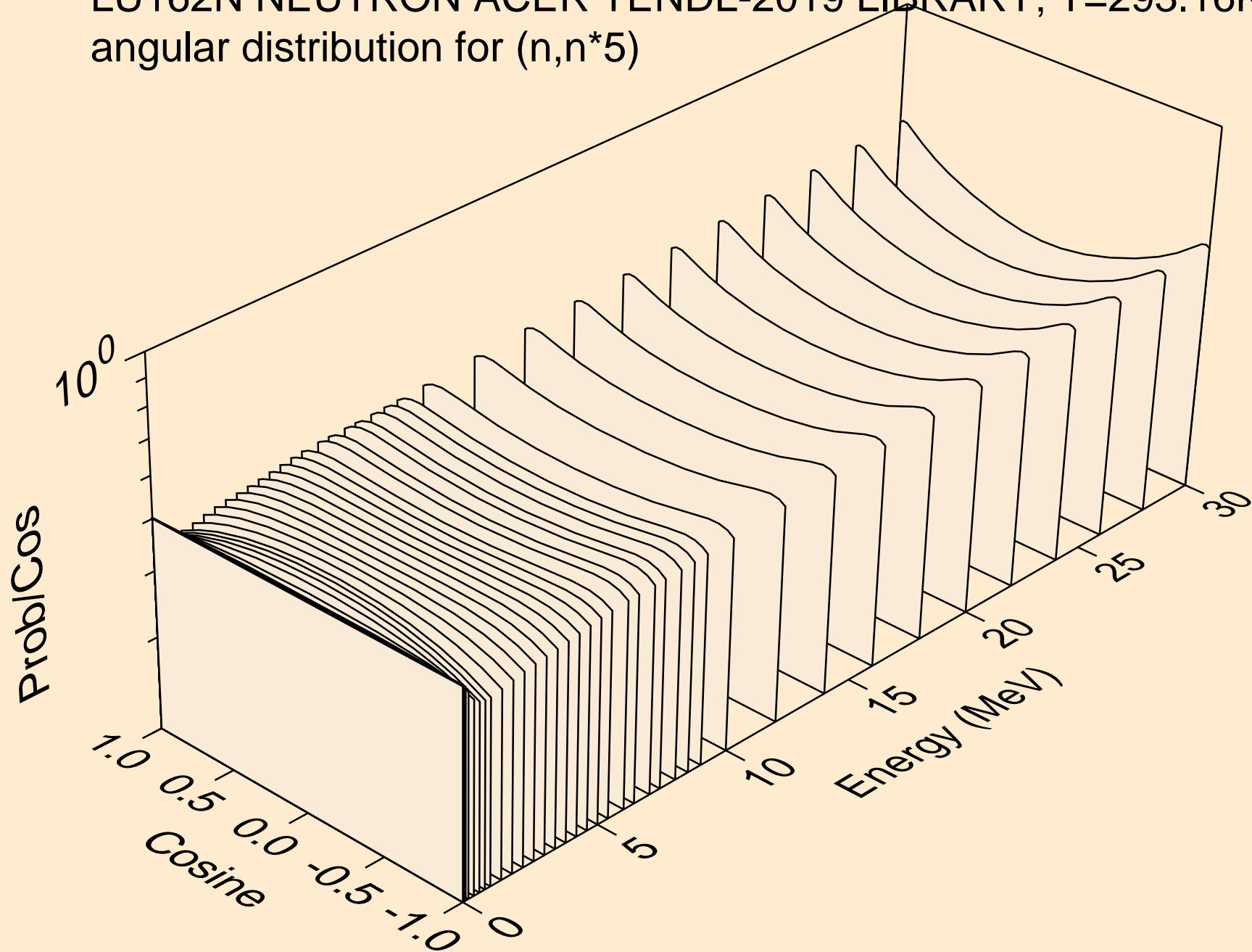

LU162N NEUTRON ACER TENDL-2019 LIBRARY; T=293.16K  
angular distribution for (n,n\*6)

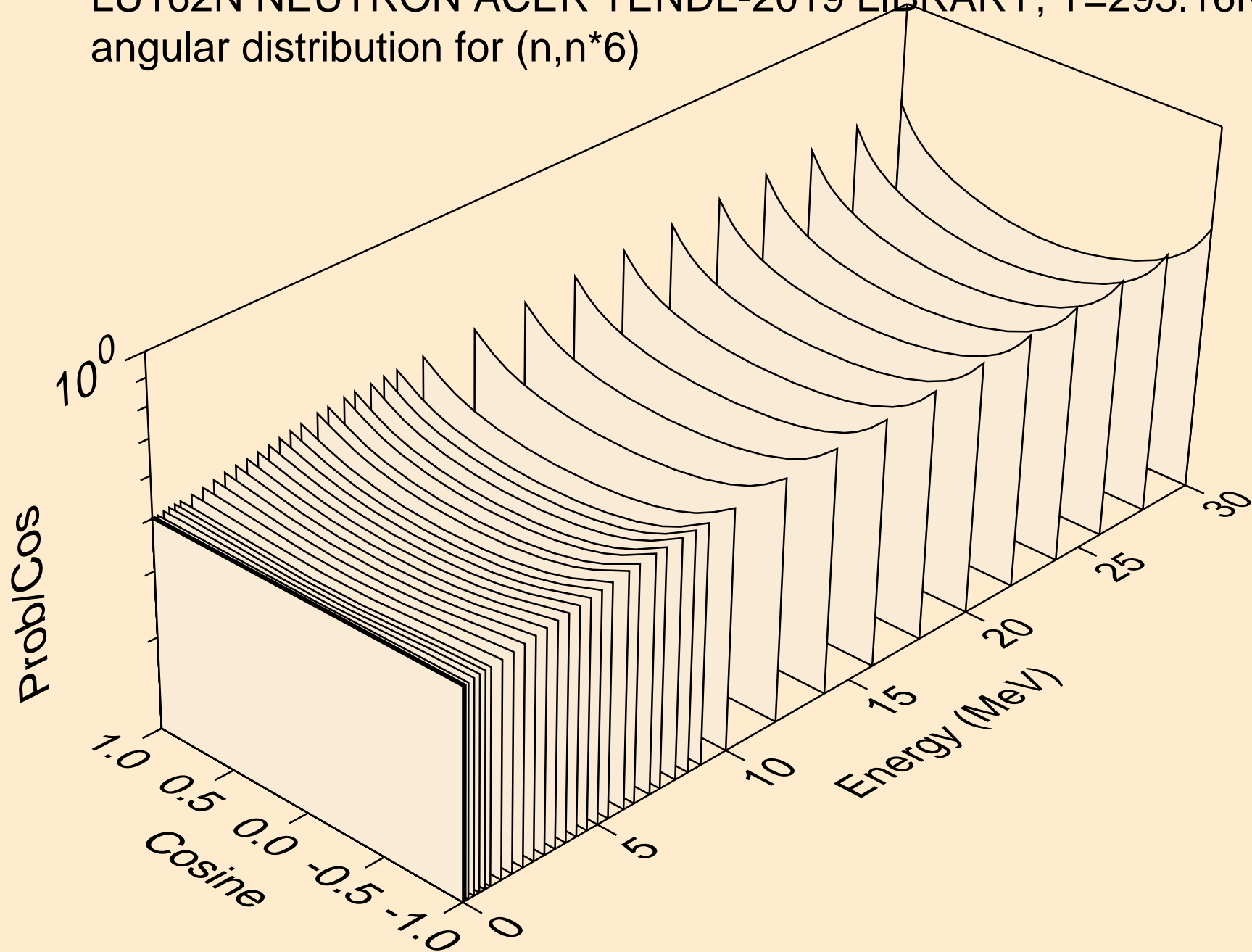

LU162N NEUTRON ACER TENDL-2019 LIBRARY; T=293.16K  
angular distribution for (n,n\*7)

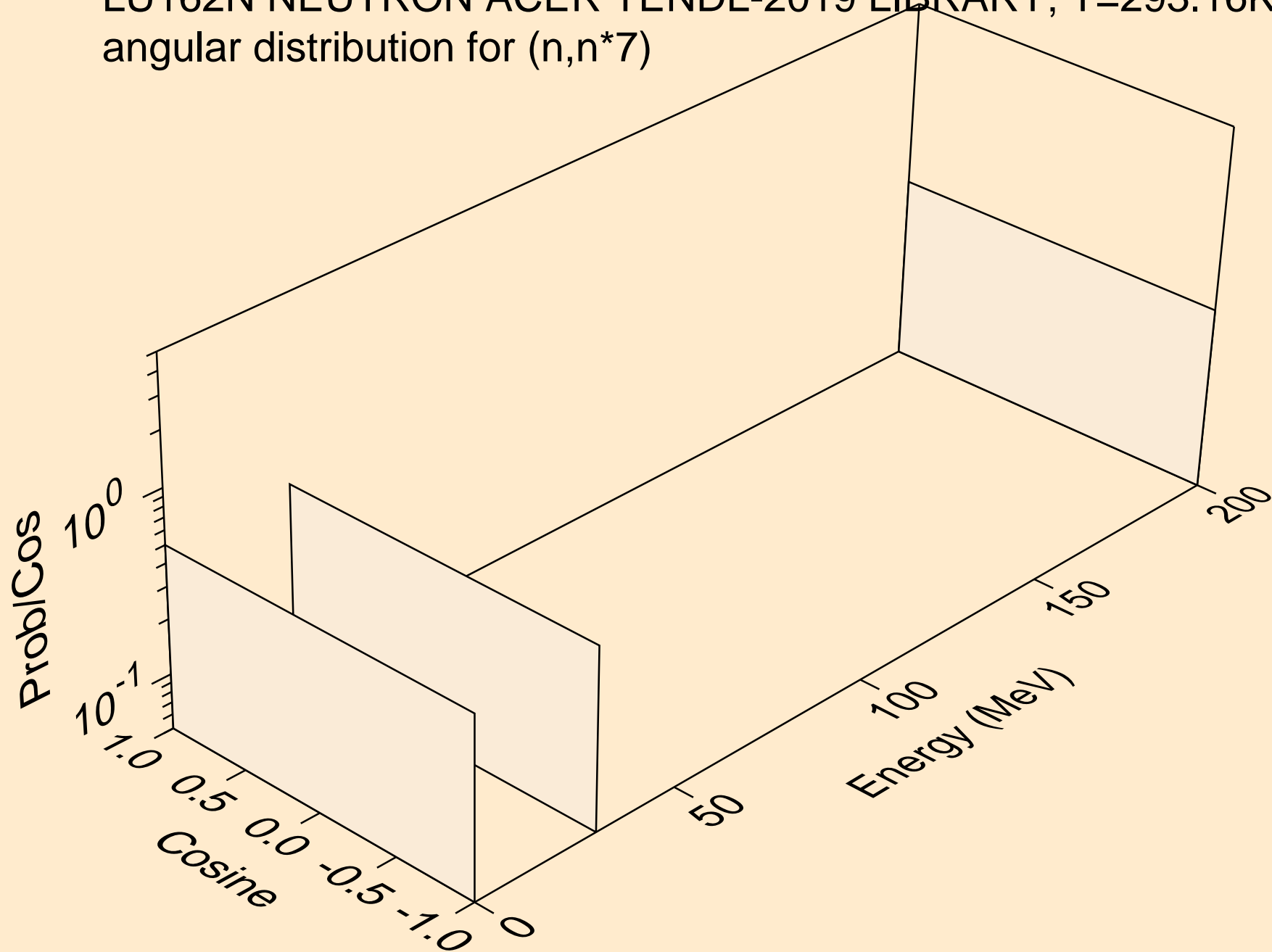

LU162N NEUTRON ACER TENDL-2019 LIBRARY; T=293.16K  
angular distribution for (n,n\*8)

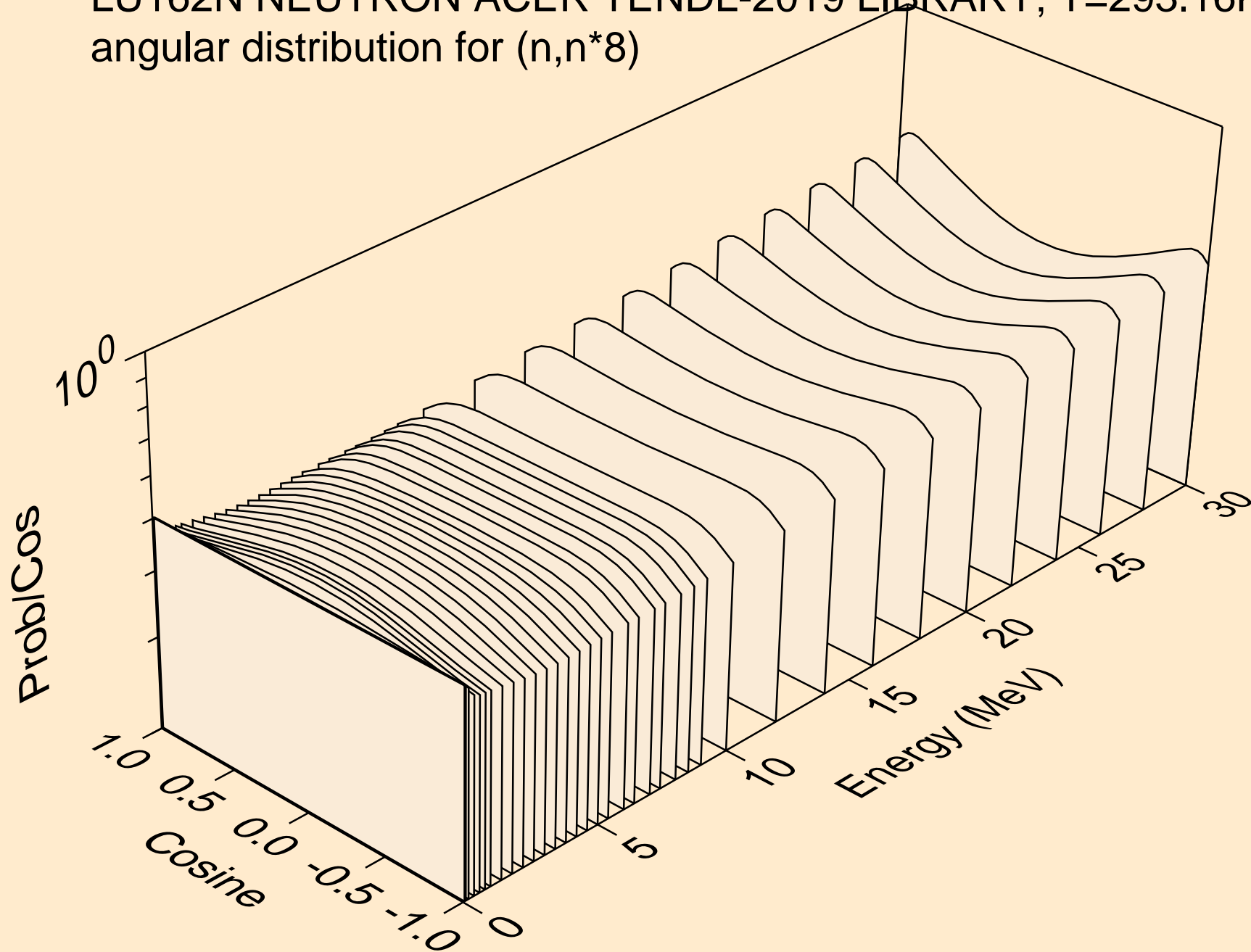



LU162N NEUTRON ACER TENDL-2019 LIBRARY; T=293.16K  
angular distribution for (n,n\*9)

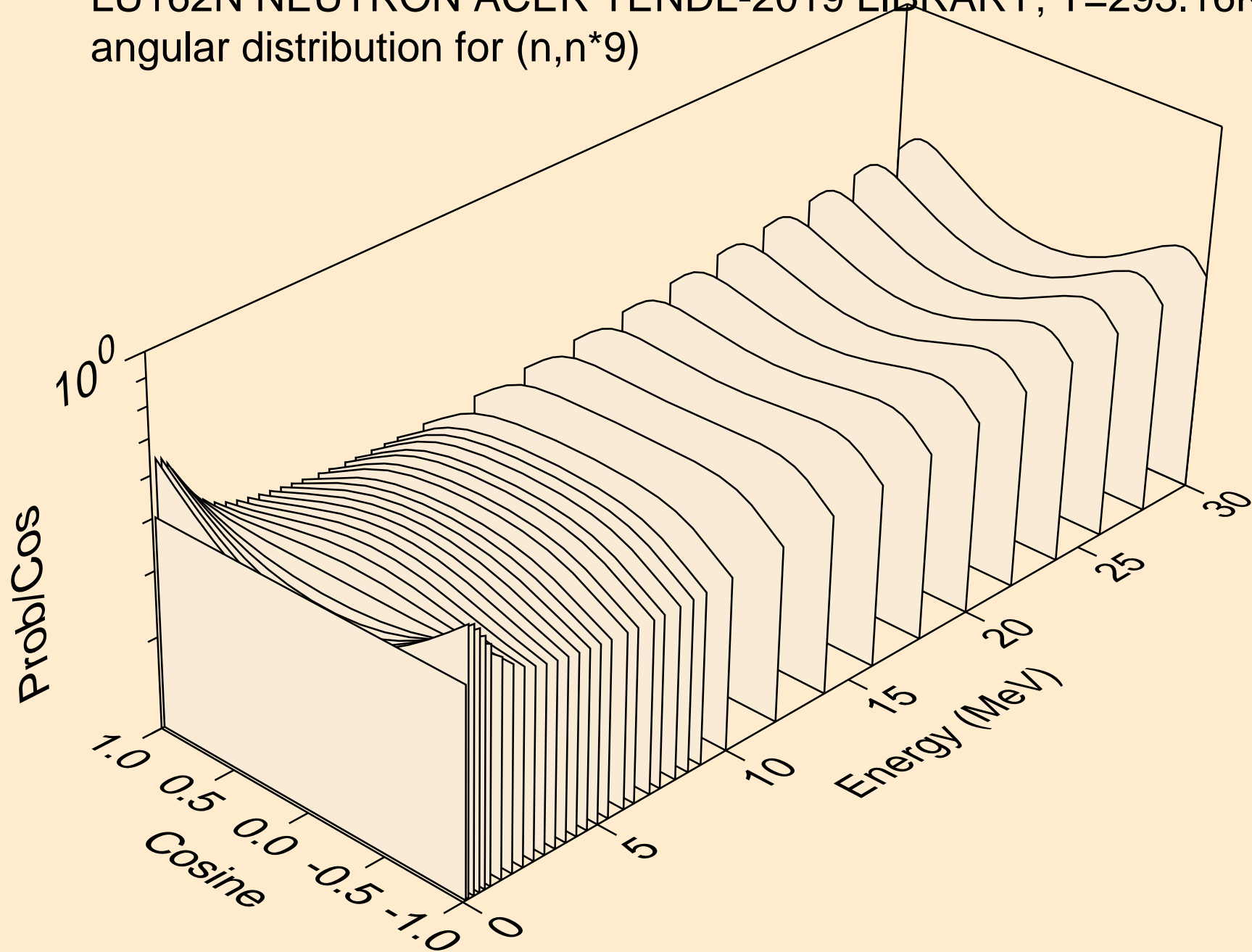

LU162N NEUTRON ACER TENDL-2019 LIBRARY; T=293.16K  
angular distribution for (n,n\*10)

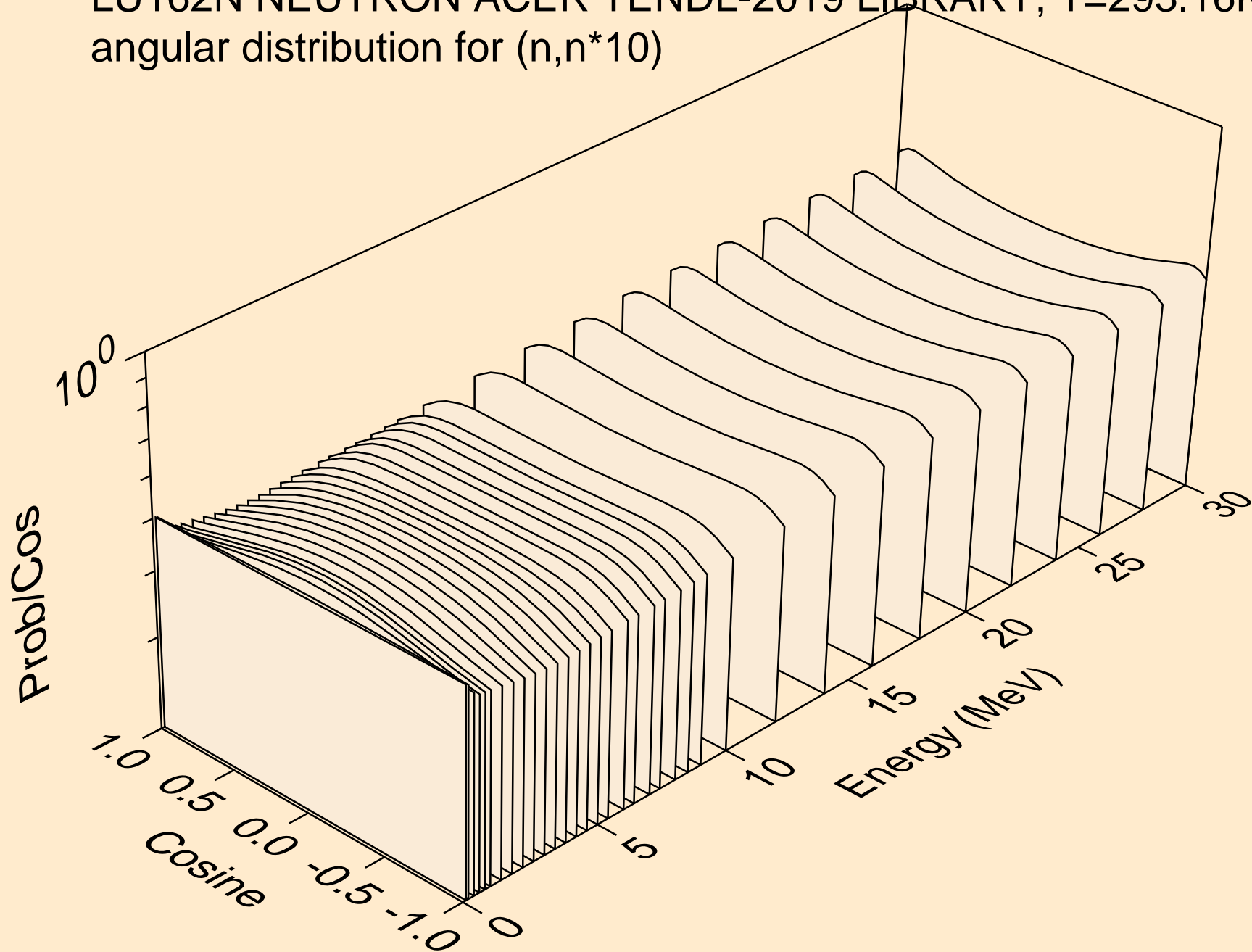

LU162N NEUTRON ACER TENDL-2019 LIBRARY; T=293.16K  
angular distribution for (n,n\*11)

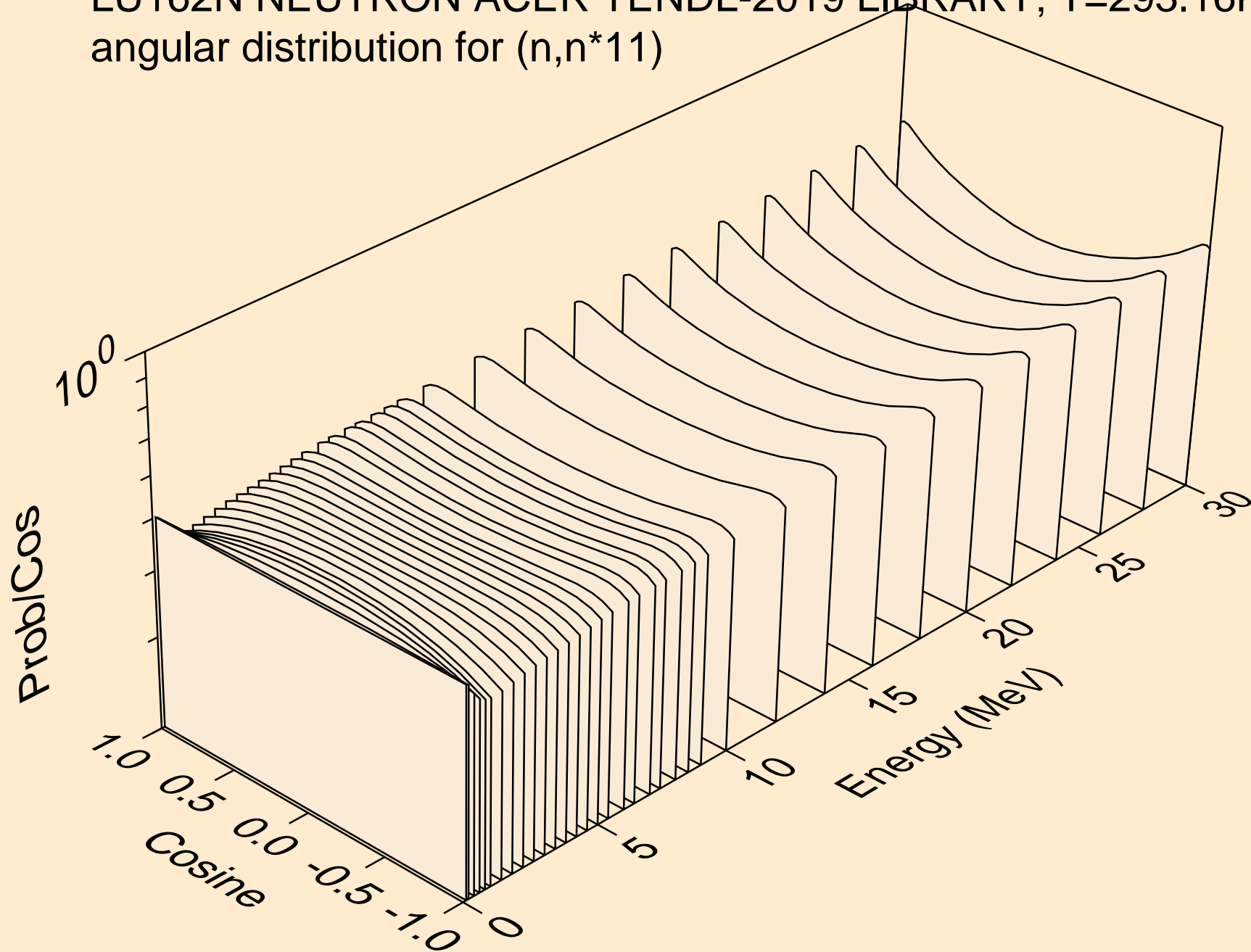

LU162N NEUTRON ACER TENDL-2019 LIBRARY; T=293.16K  
angular distribution for (n,n\*12)

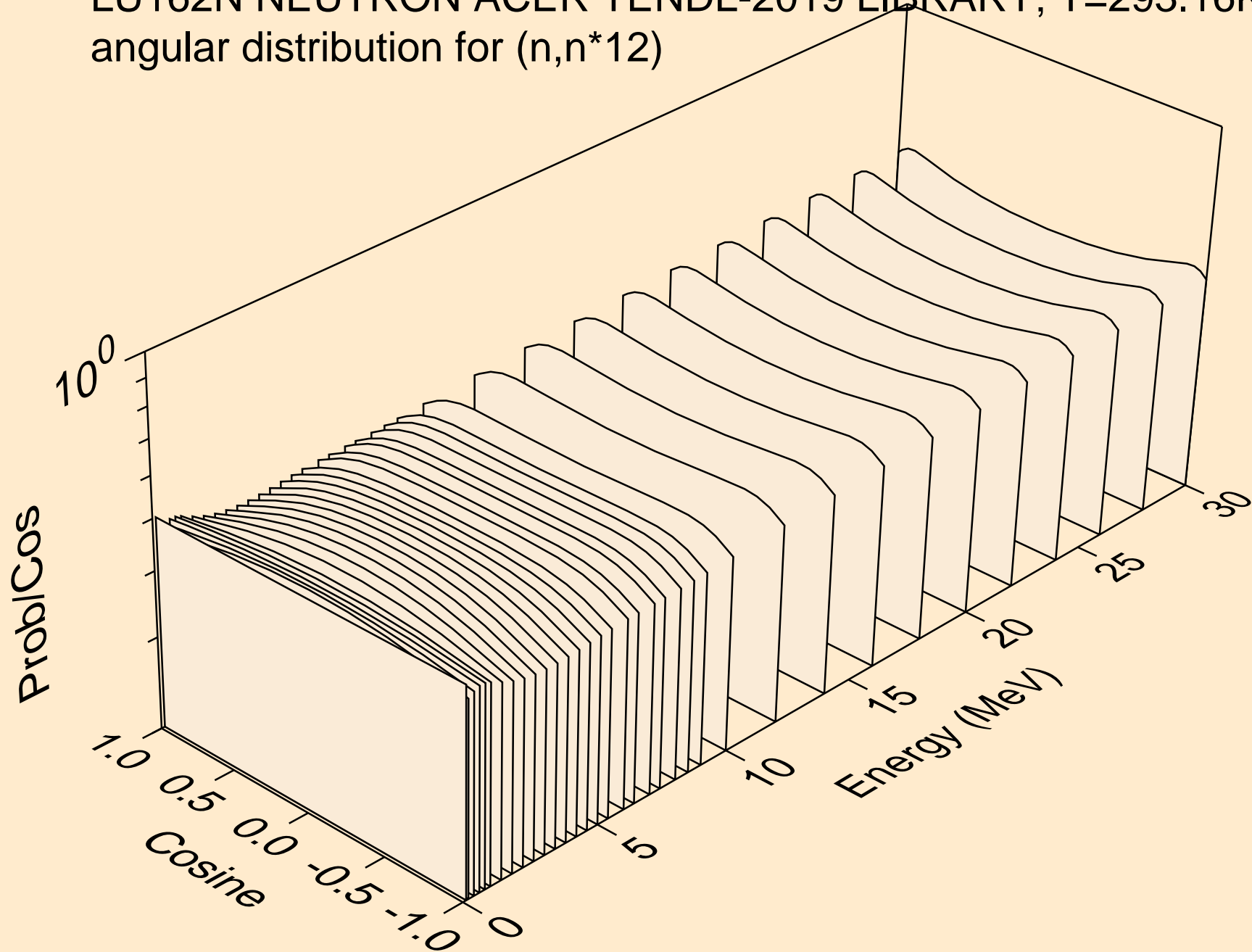

LU162N NEUTRON ACER TENDL-2019 LIBRARY; T=293.16K  
angular distribution for (n,n\*13)

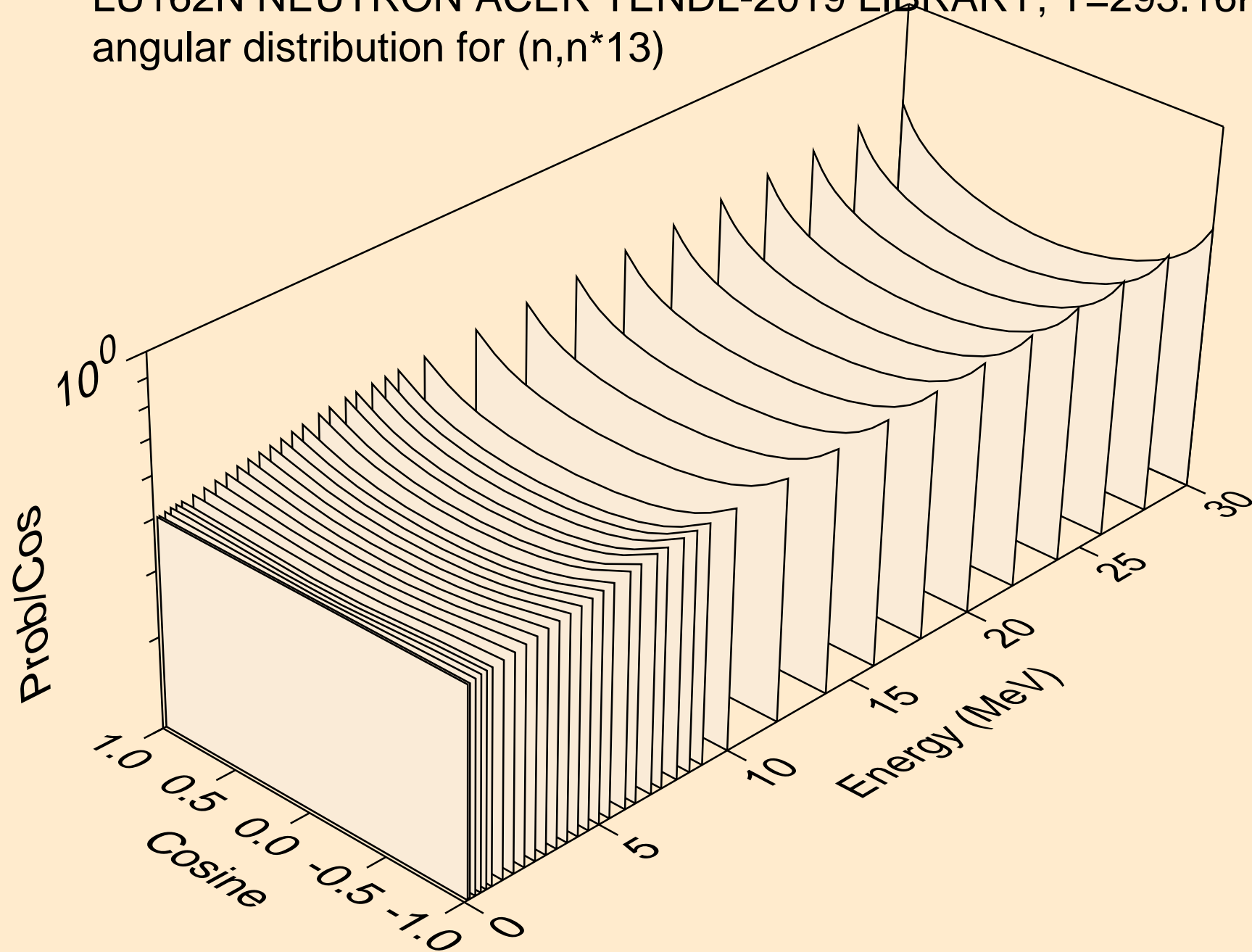

LU162N NEUTRON ACER TENDL-2019 LIBRARY; T=293.16K  
angular distribution for (n,n\*14)

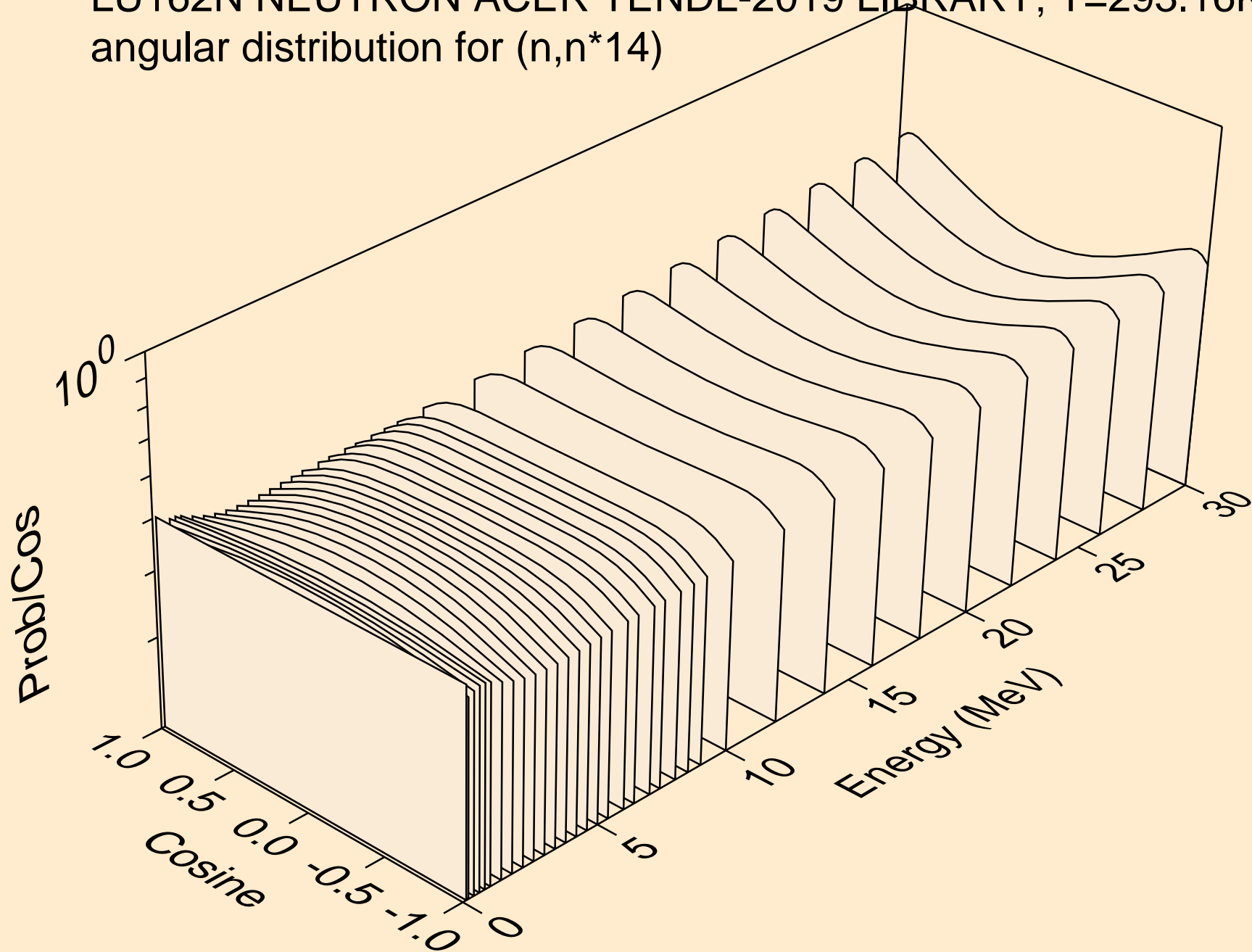

LU162N NEUTRON ACER TENDL-2019 LIBRARY; T=293.16K  
angular distribution for (n,n\*15)

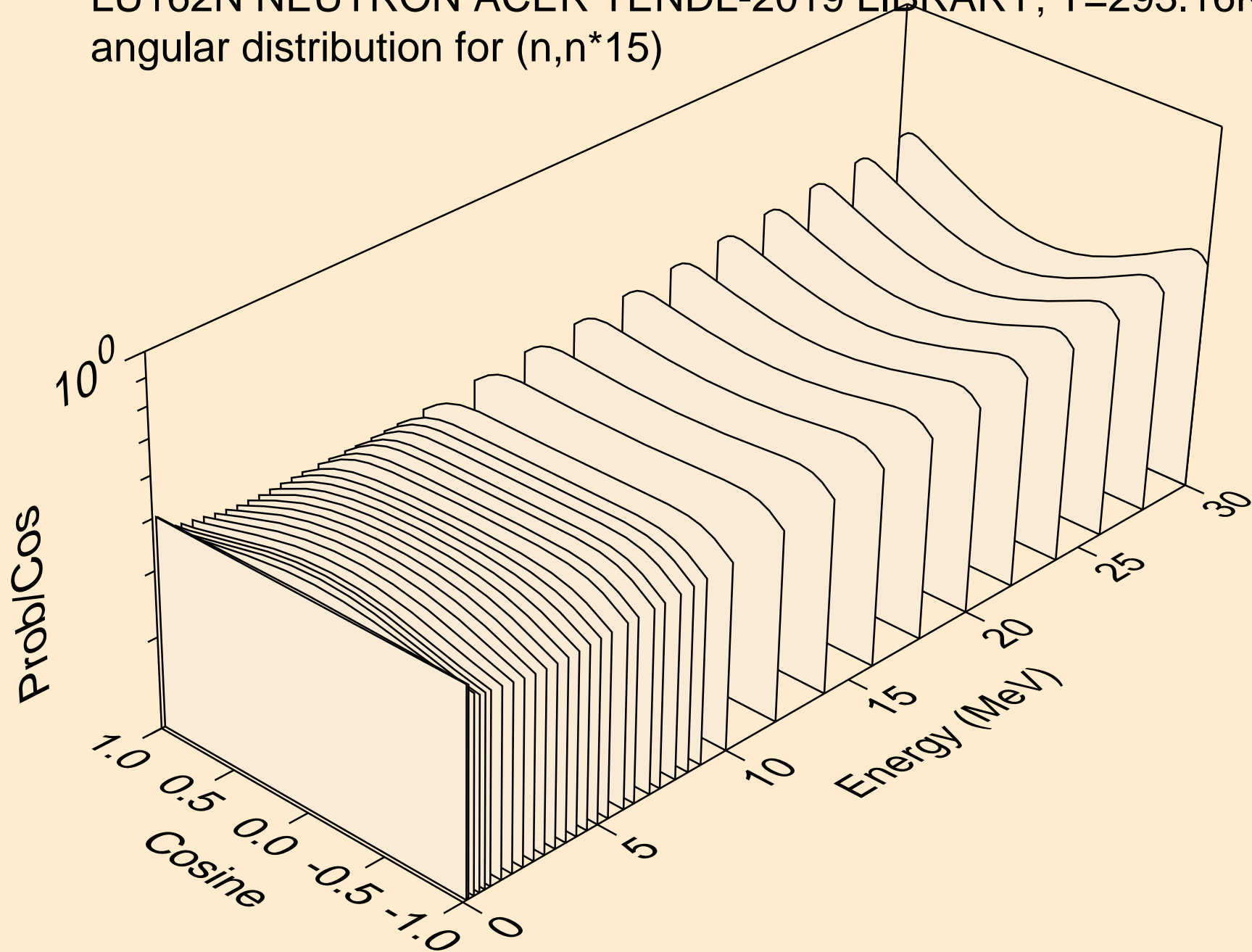

LU162N NEUTRON ACER TENDL-2019 LIBRARY; T=293.16K  
angular distribution for (n,n\*16)

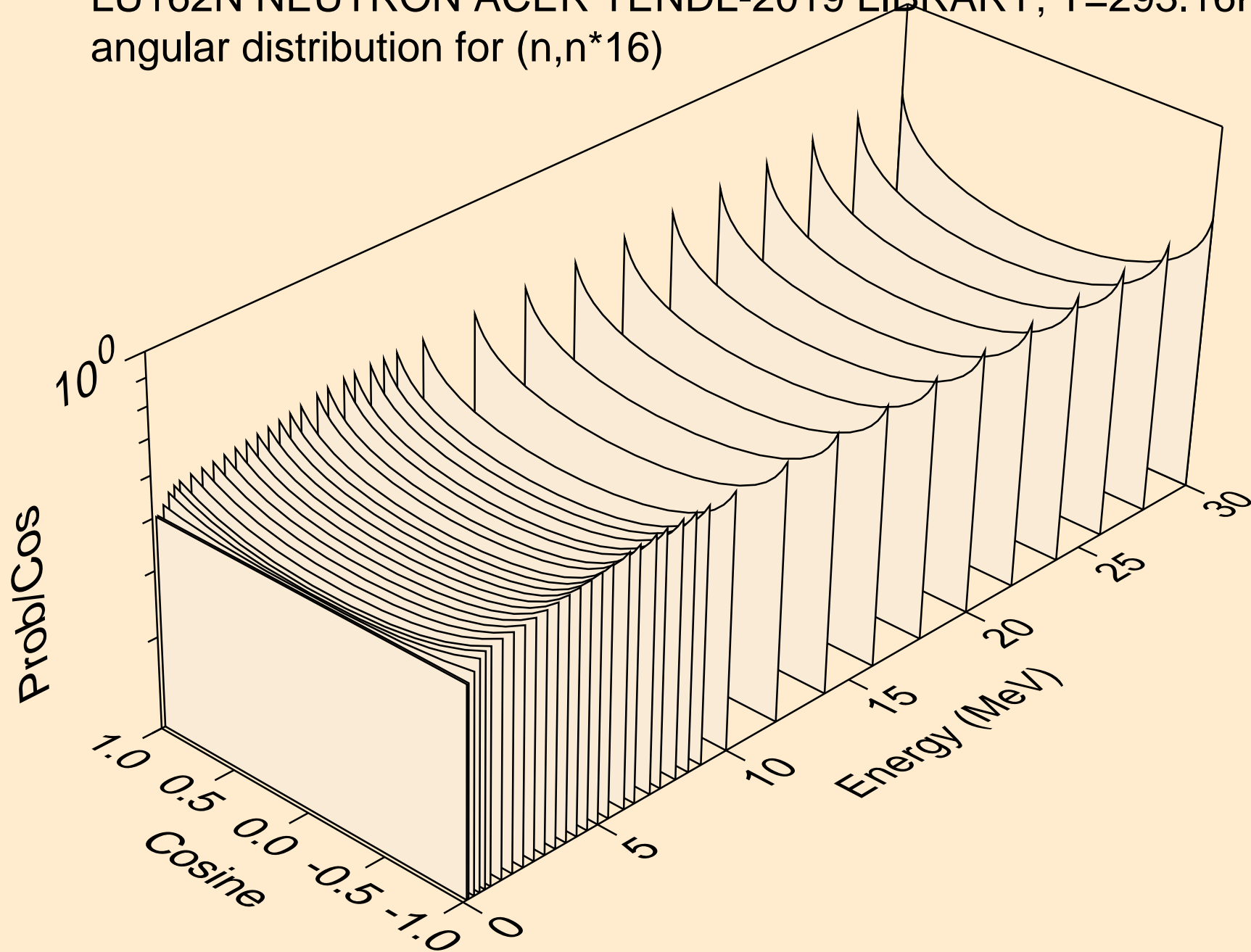



LU162N NEUTRON ACER TENDL-2019 LIBRARY; T=293.16K  
Neutron emission for (n,x)

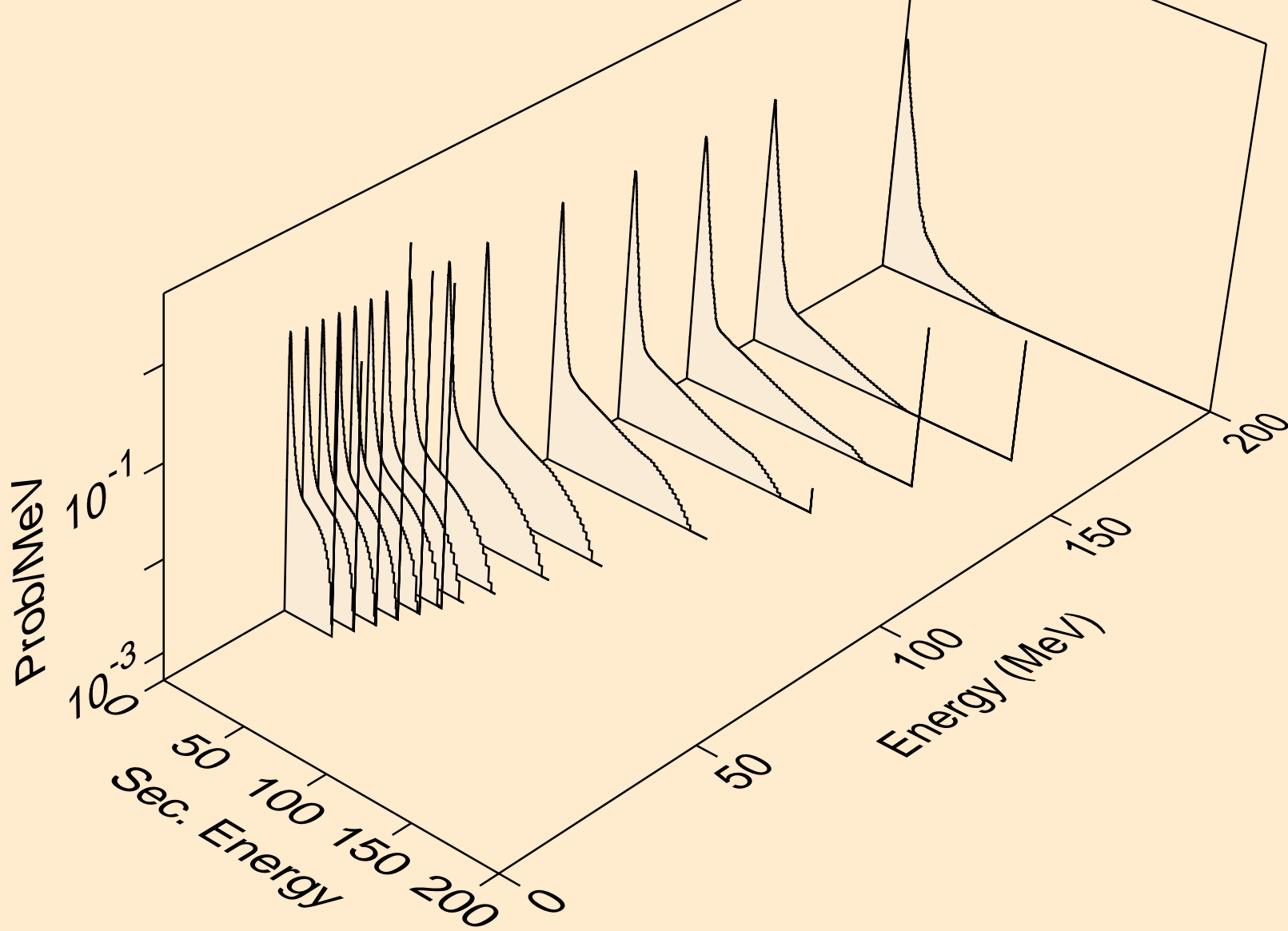

LU162N NEUTRON ACER TENDL-2019 LIBRARY; T=293.16K  
Neutron emission for (n,2nd)

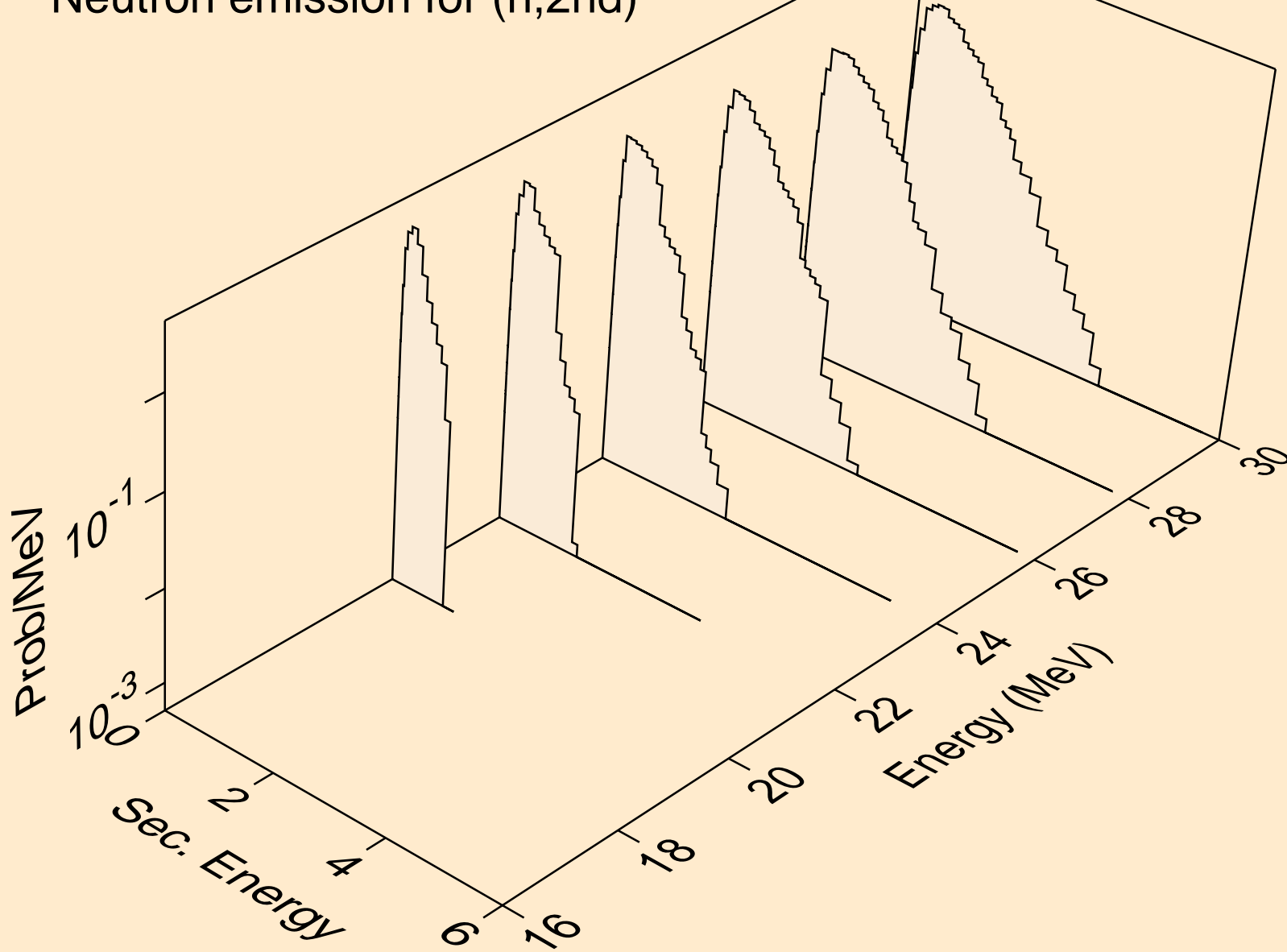

LU162N NEUTRON ACER TENDL-2019 LIBRARY; T=293.16K  
Neutron emission for (n,2n)

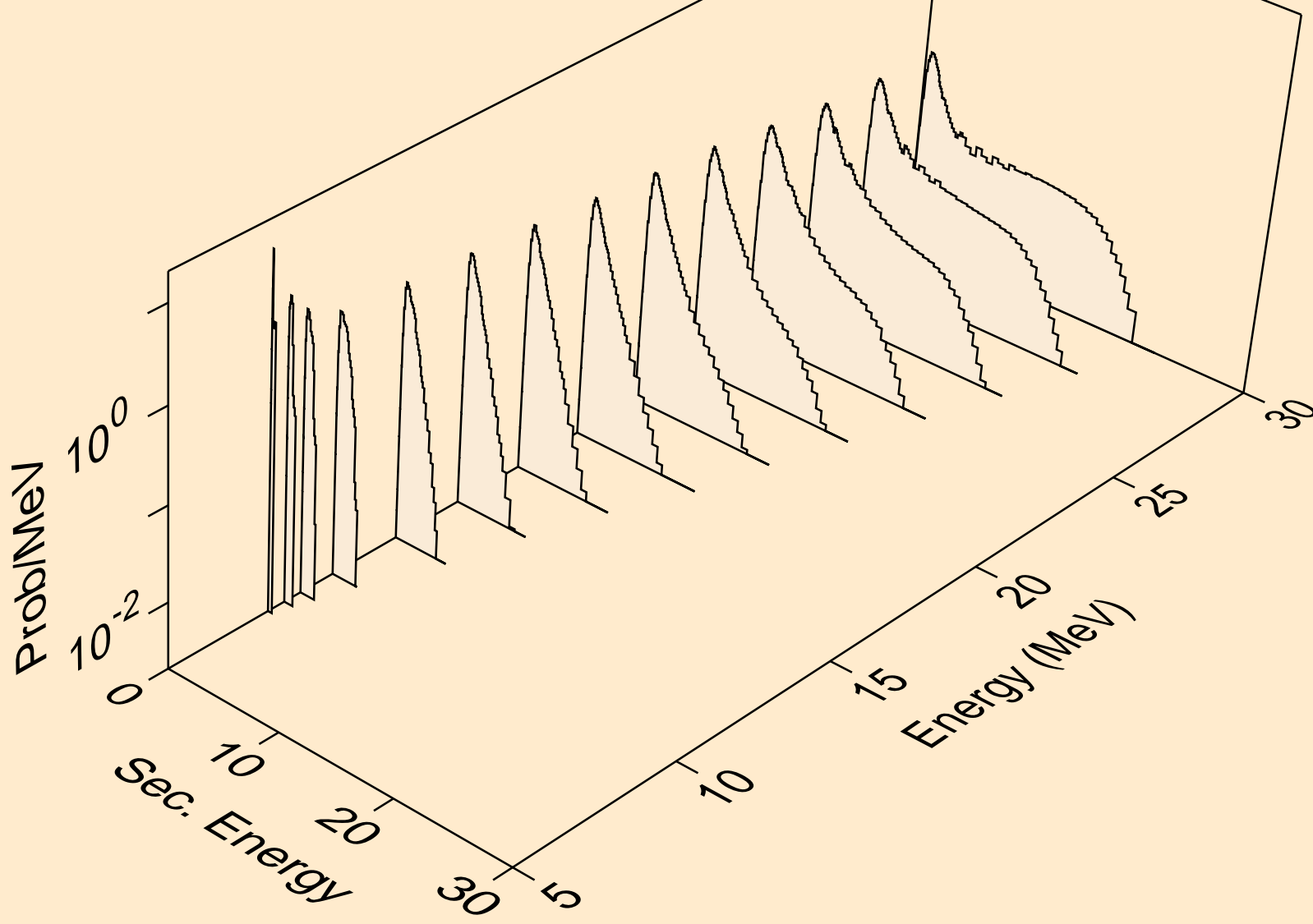

LU162N NEUTRON ACER TENDL-2019 LIBRARY; T=293.16K  
Neutron emission for (n,3n)

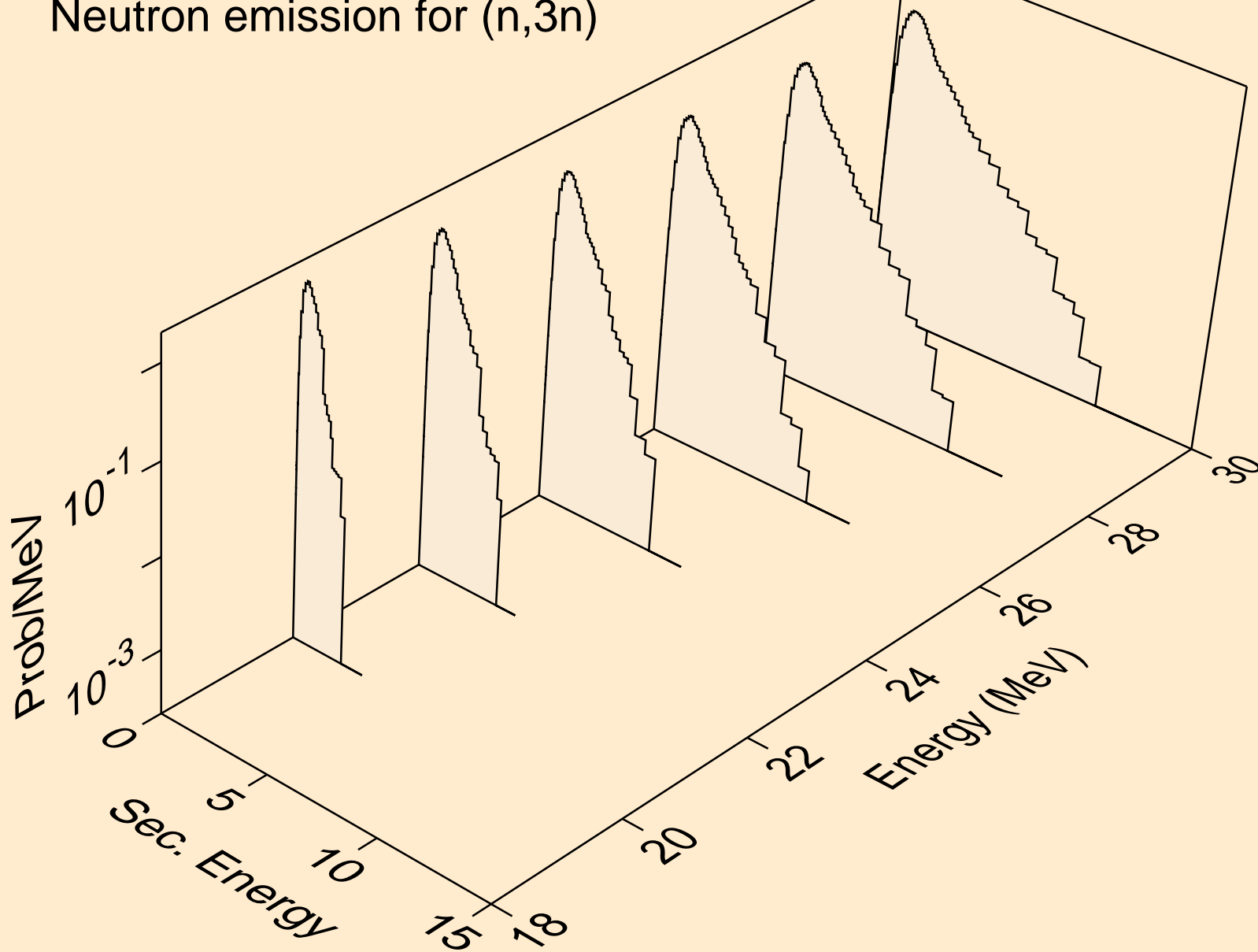

LU162N NEUTRON ACER TENDL-2019 LIBRARY; T=293.16K  
Neutron emission for (n,n\*)a

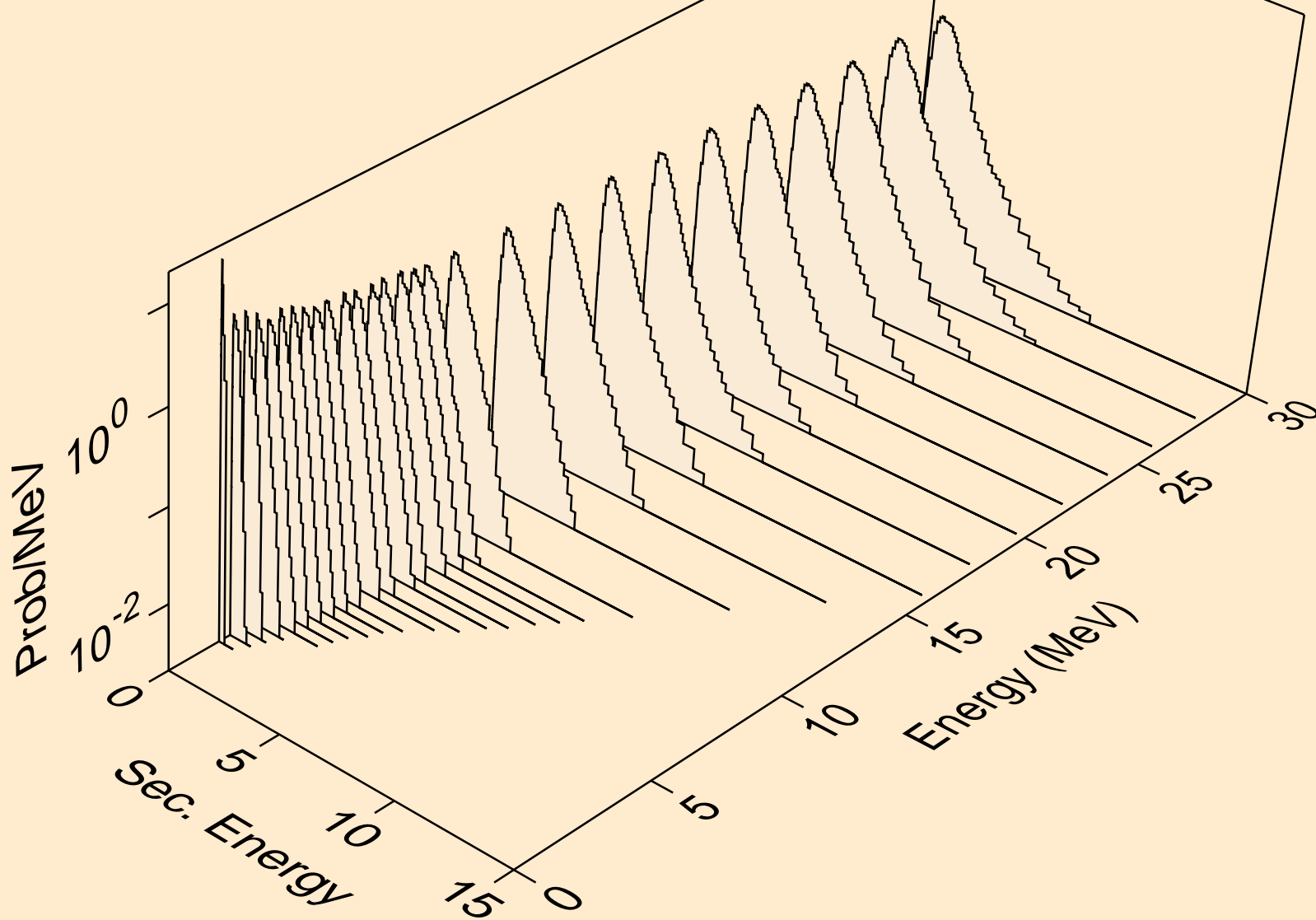

LU162N NEUTRON ACER TENDL-2019 LIBRARY; T=293.16K  
Neutron emission for (n,2n)a

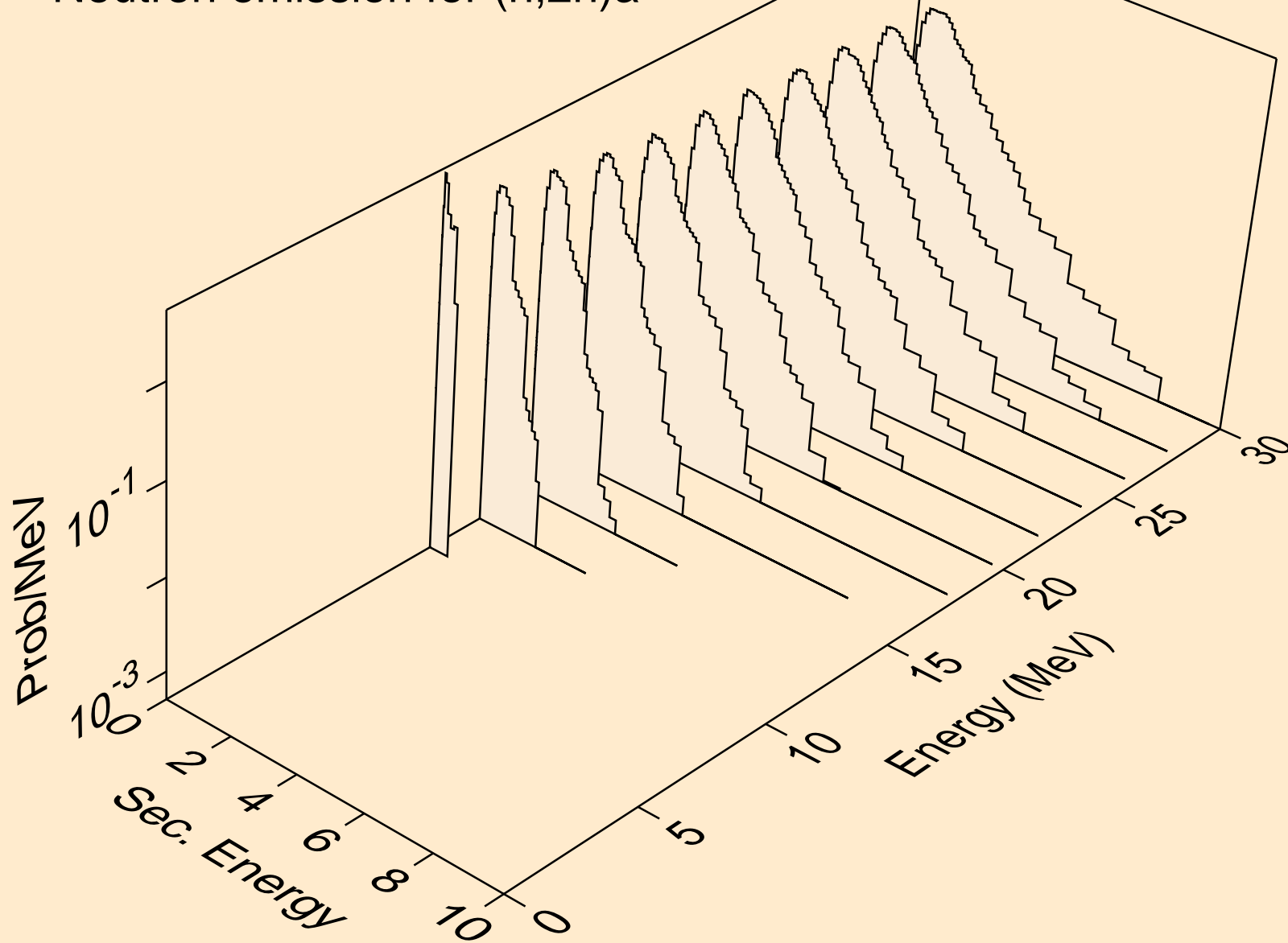

LU162N NEUTRON ACER TENDL-2019 LIBRARY; T=293.16K  
Neutron emission for (n,3n)a

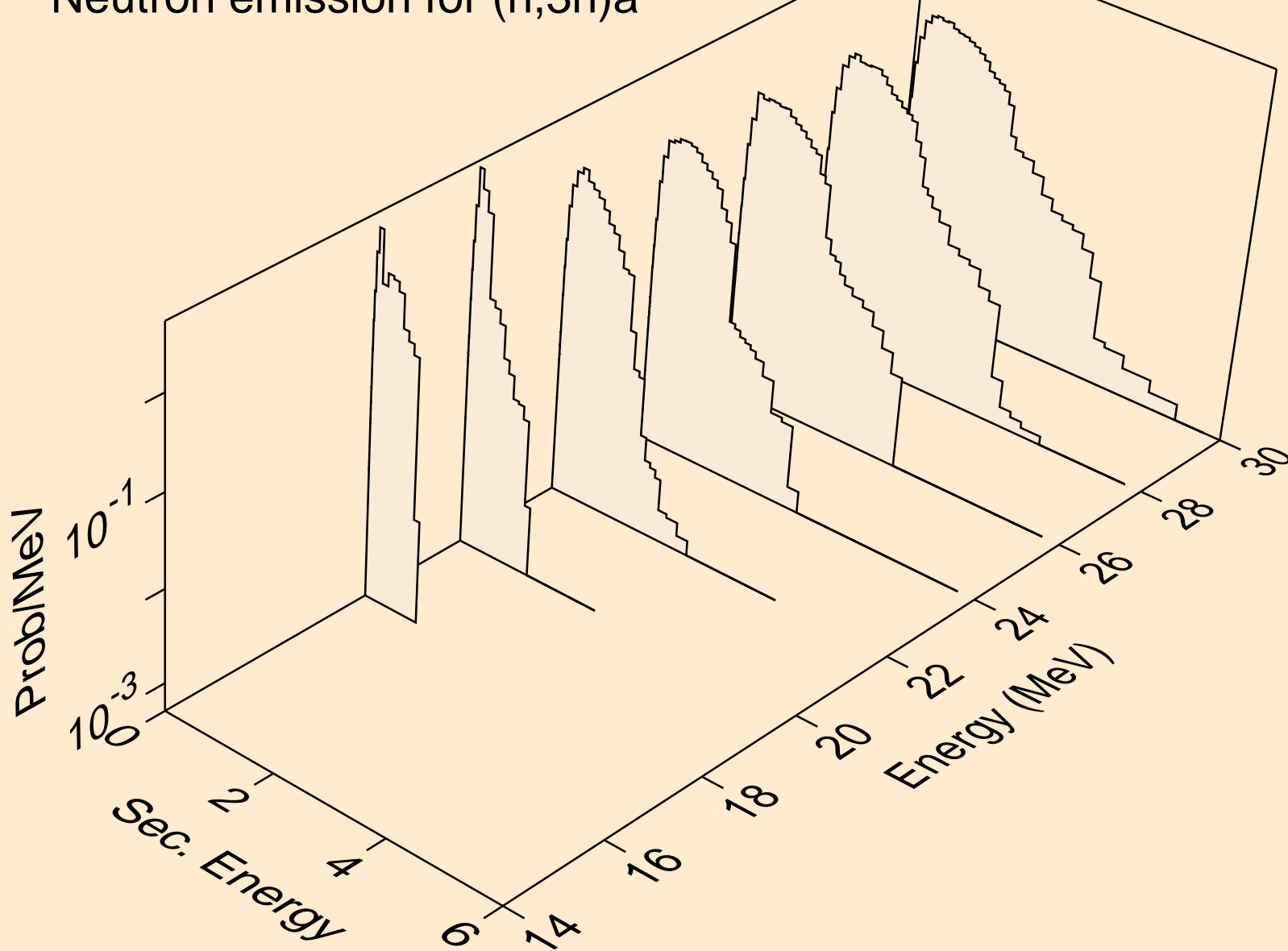

LU162N NEUTRON ACER TENDL-2019 LIBRARY; T=293.16K  
Neutron emission for (n,n\*)p

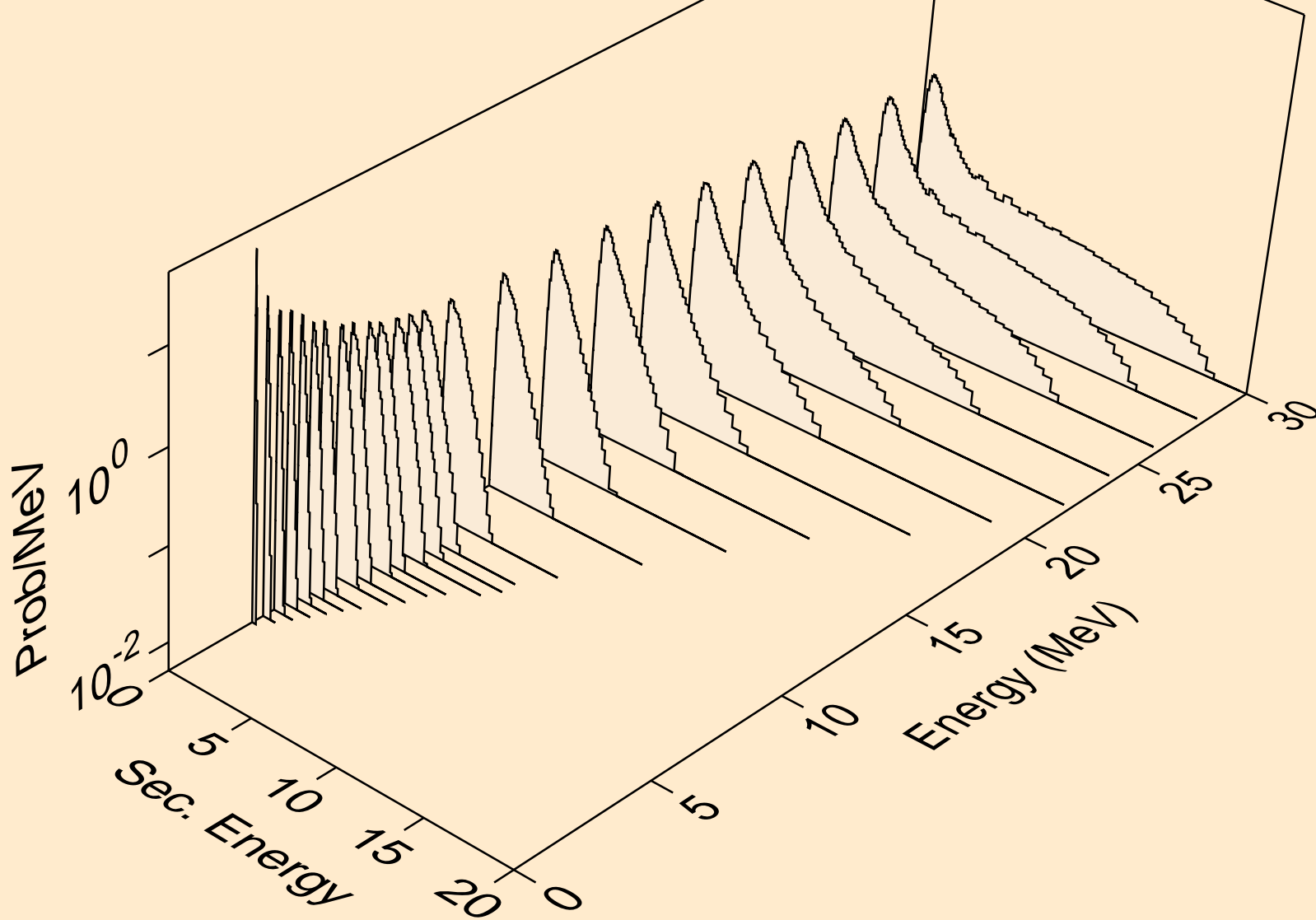



LU162N NEUTRON ACER TENDL-2019 LIBRARY; T=293.16K  
Neutron emission for (n,n\*)2a

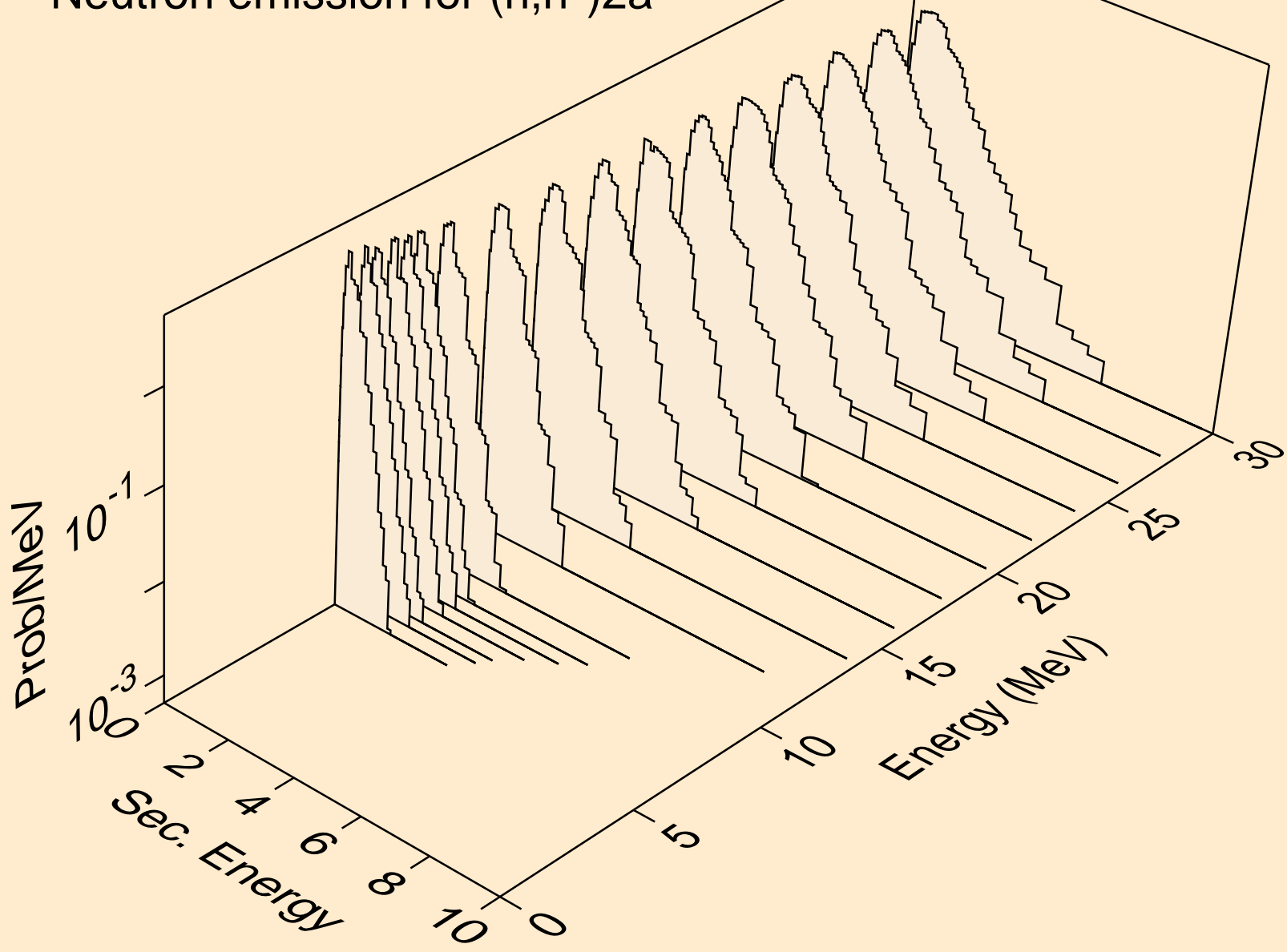

LU162N NEUTRON ACER TENDL-2019 LIBRARY; T=293.16K  
Neutron emission for (n,2n)2a

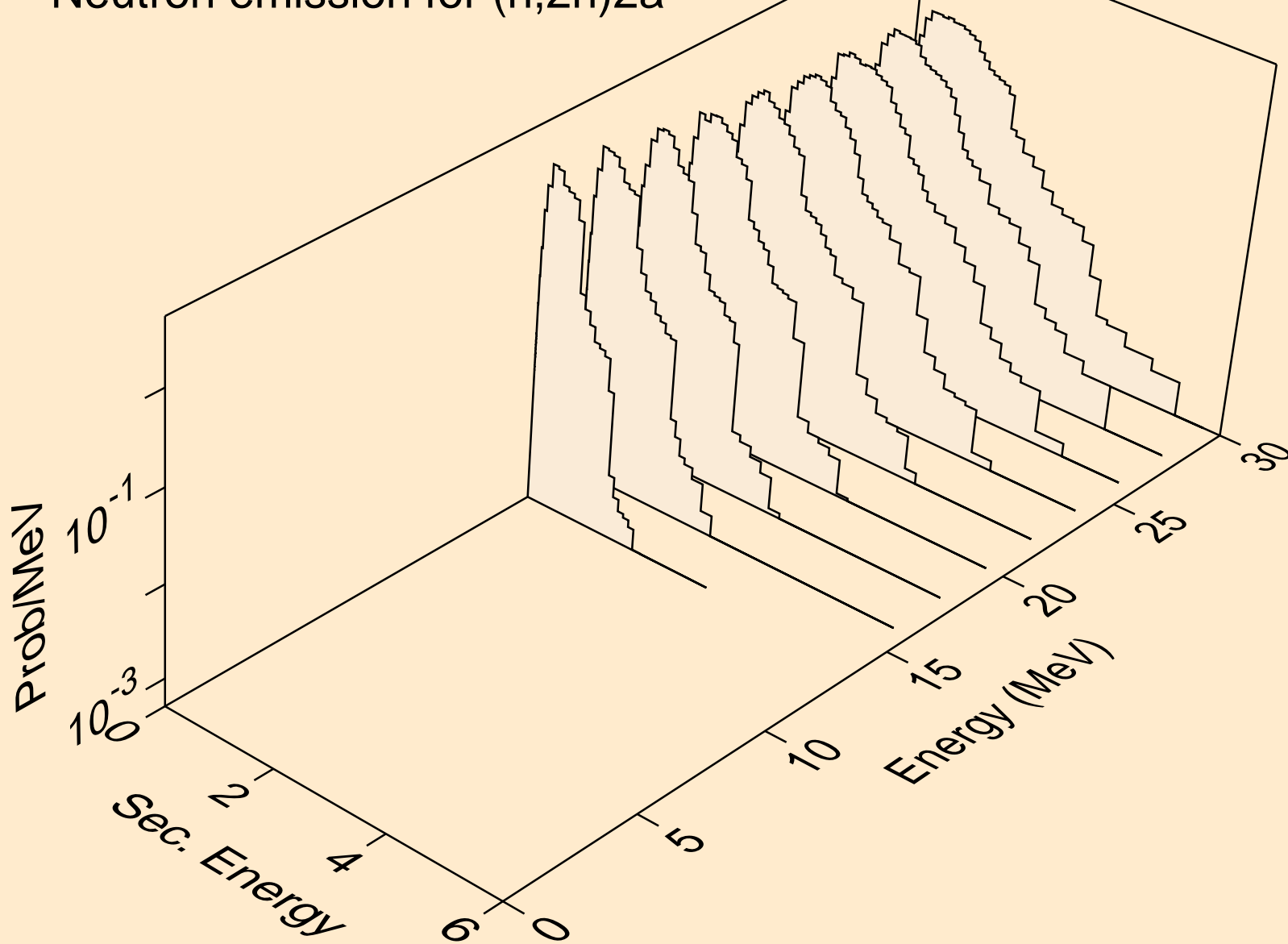

LU162N NEUTRON ACER TENDL-2019 LIBRARY; T=293.16K  
Neutron emission for (n,n\*)d

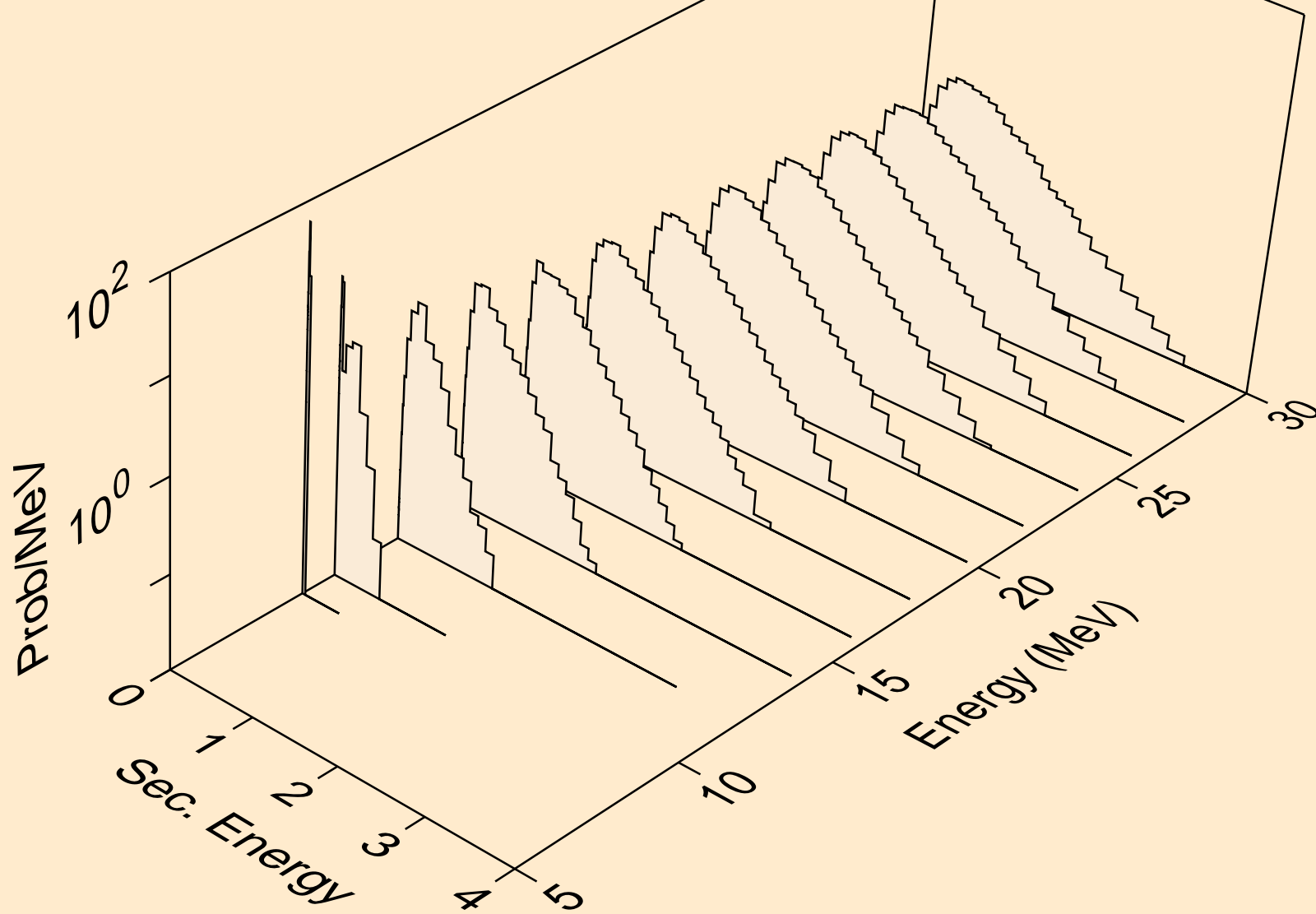

LU162N NEUTRON ACER TENDL-2019 LIBRARY; T=293.16K  
Neutron emission for (n,n\*)t

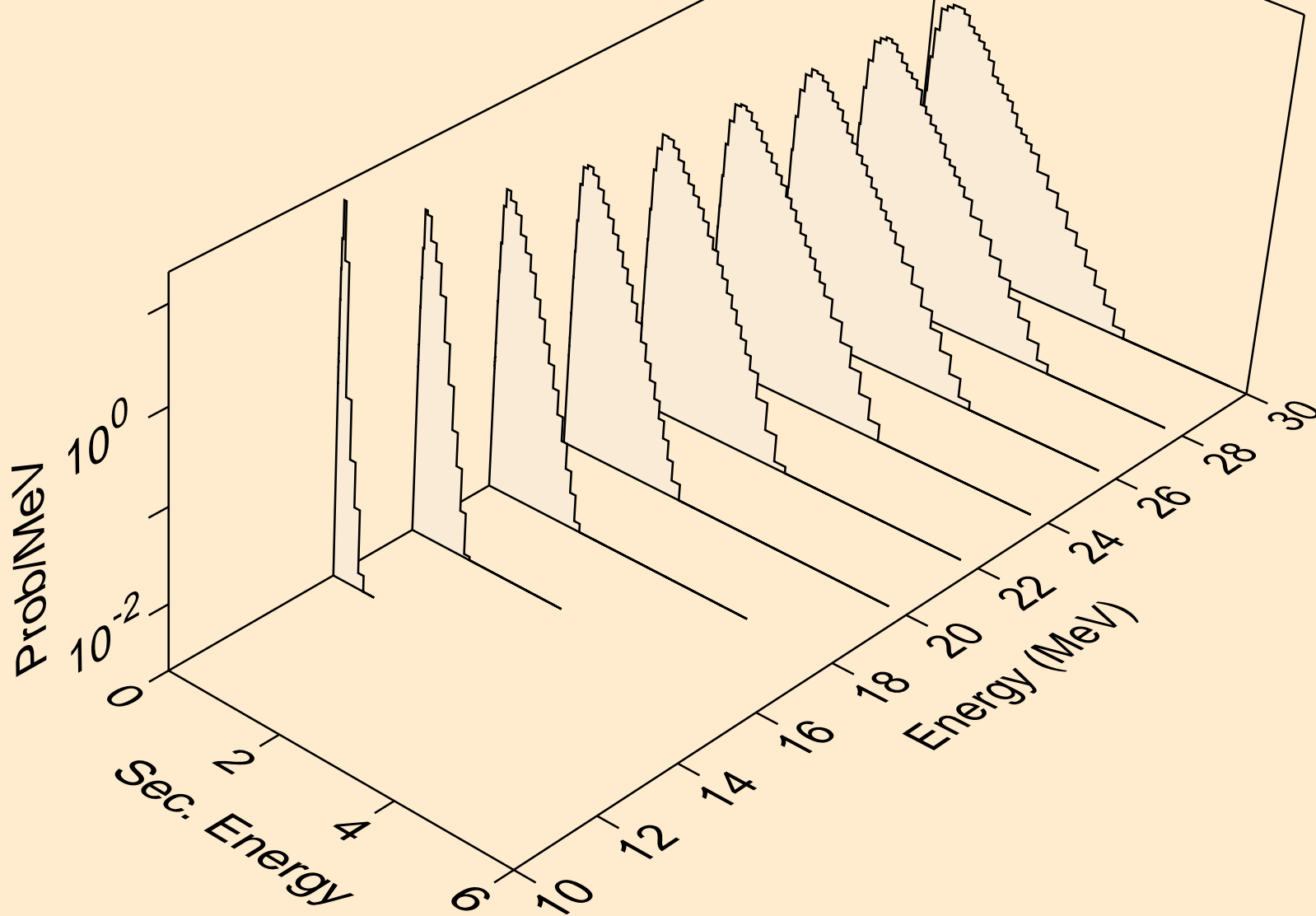

LU162N NEUTRON ACER TENDL-2019 LIBRARY; T=293.16K  
Neutron emission for (n,n\*)he3

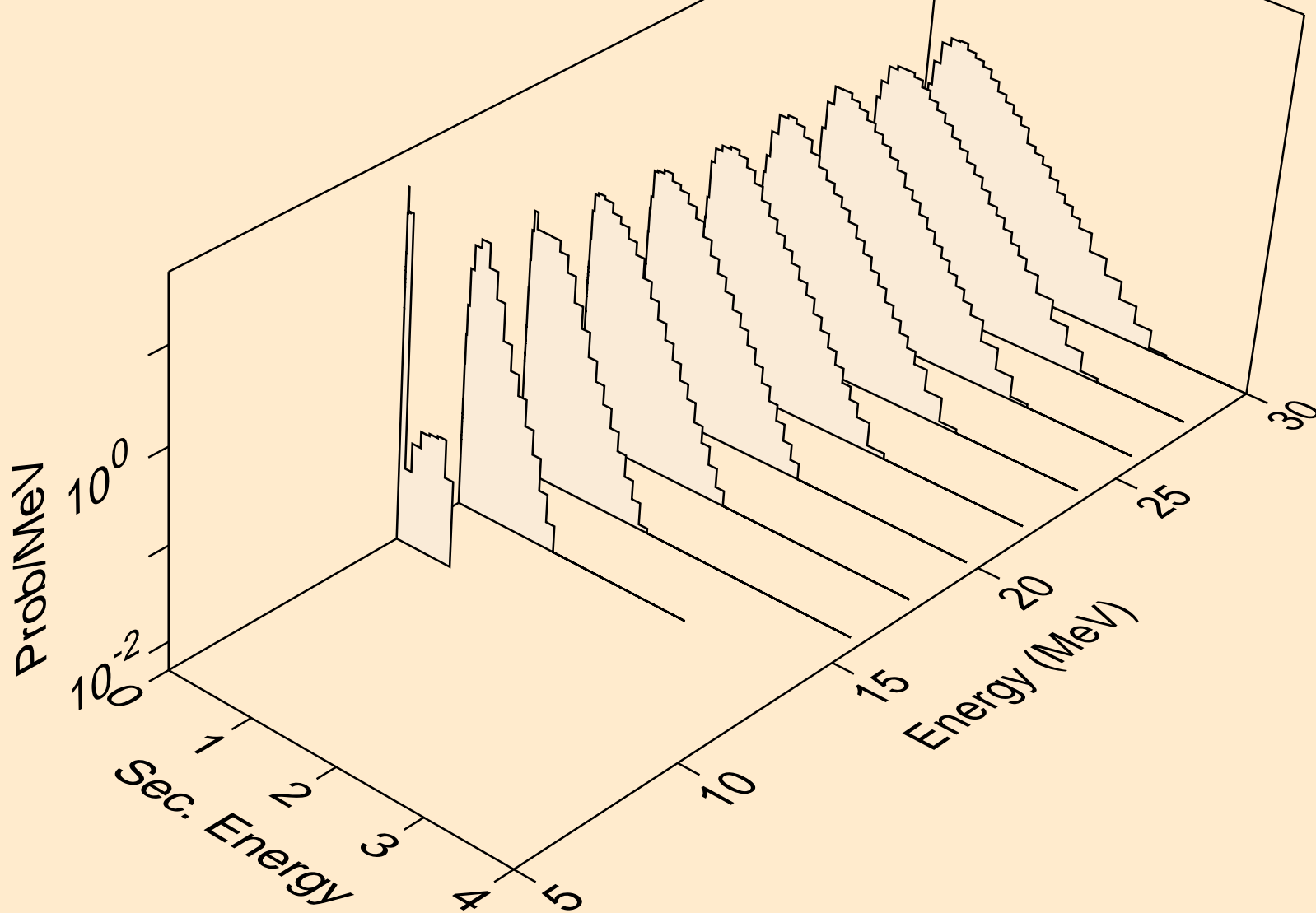

LU162N NEUTRON ACER TENDL-2019 LIBRARY; T=293.16K  
Neutron emission for (n,4n)

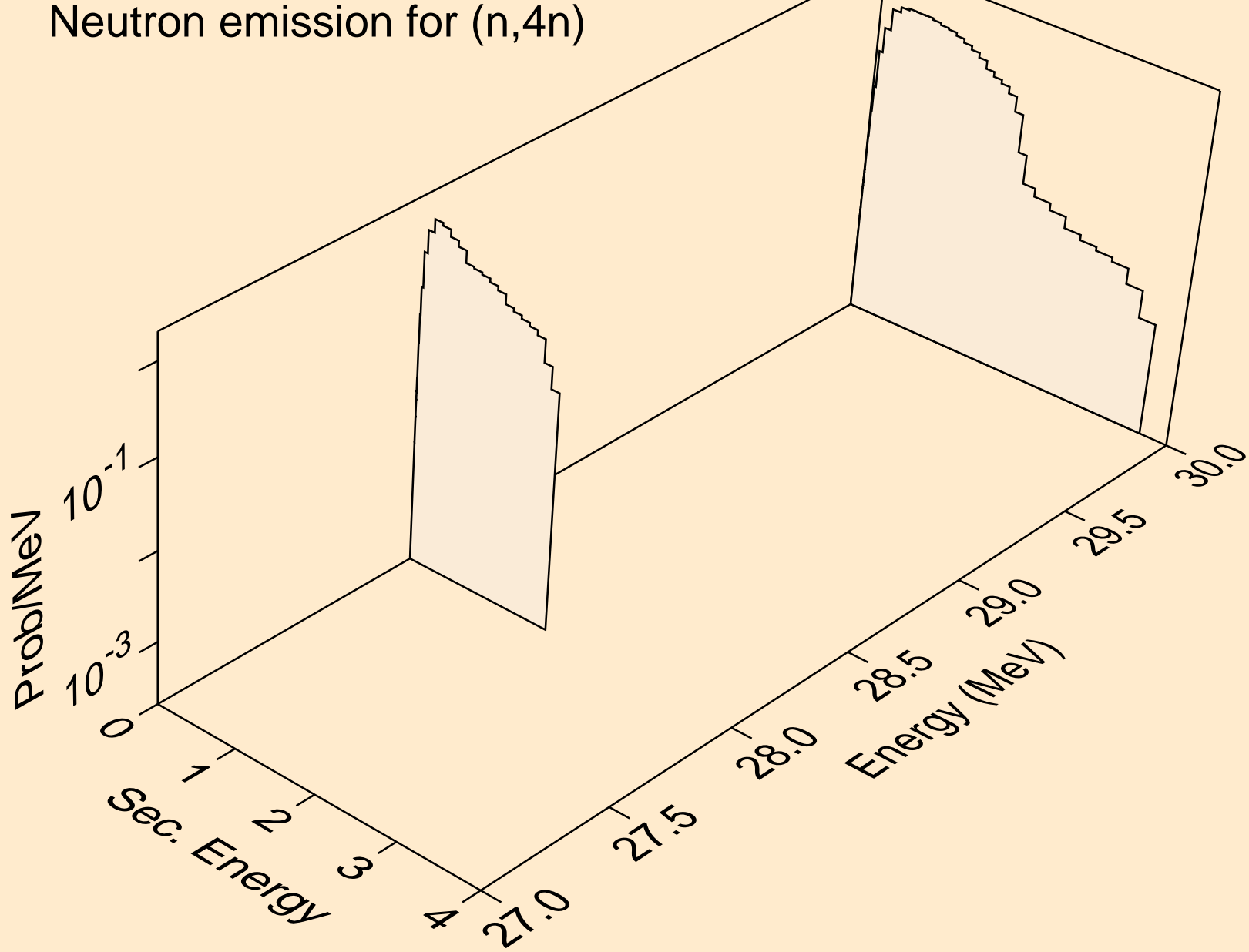

LU162N NEUTRON ACER TENDL-2019 LIBRARY; T=293.16K  
Neutron emission for (n,2np)

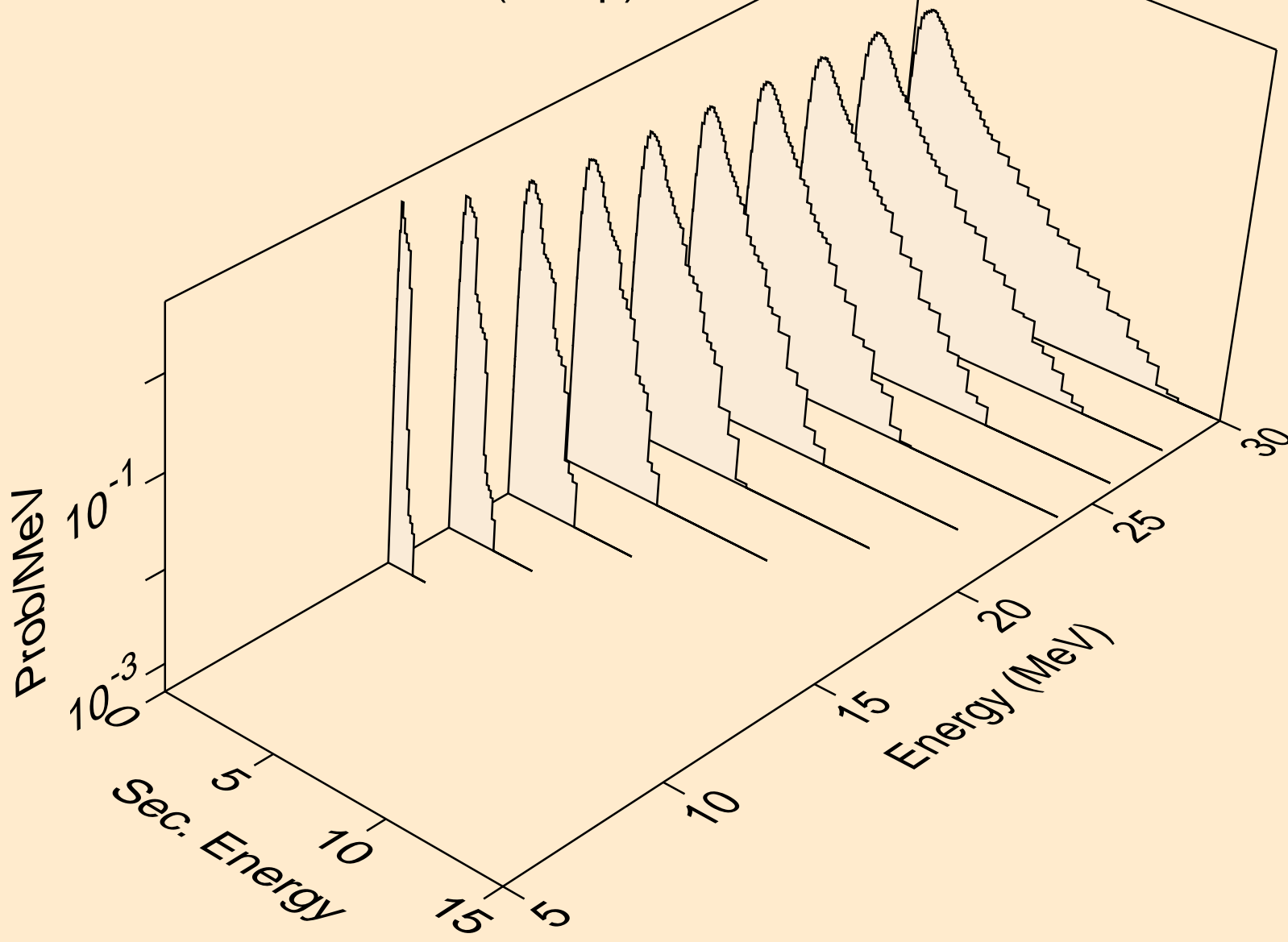

LU162N NEUTRON ACER TENDL-2019 LIBRARY; T=293.16K  
Neutron emission for (n,3np)

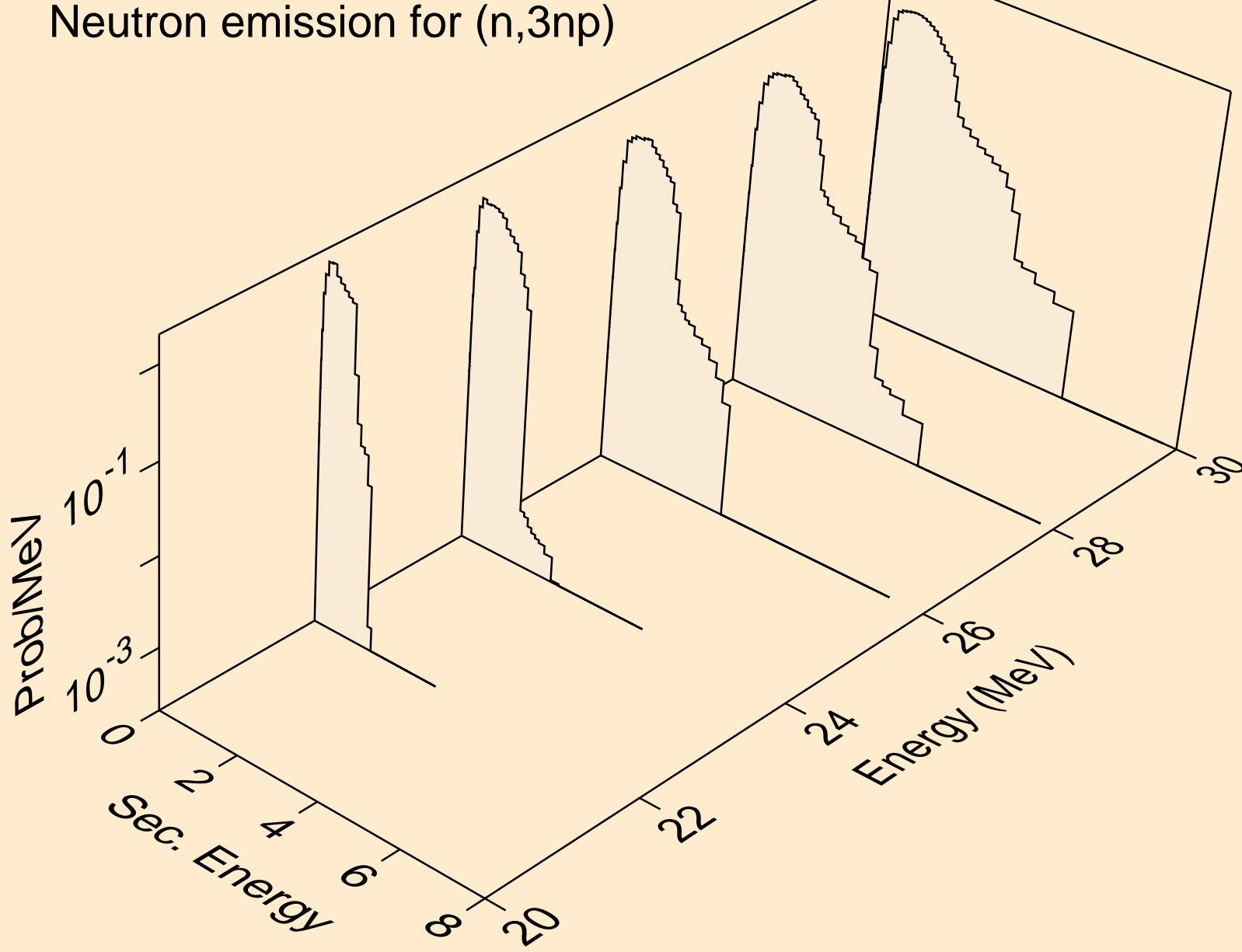



LU162N NEUTRON ACER TENDL-2019 LIBRARY; T=293.16K  
Neutron emission for (n,2np)

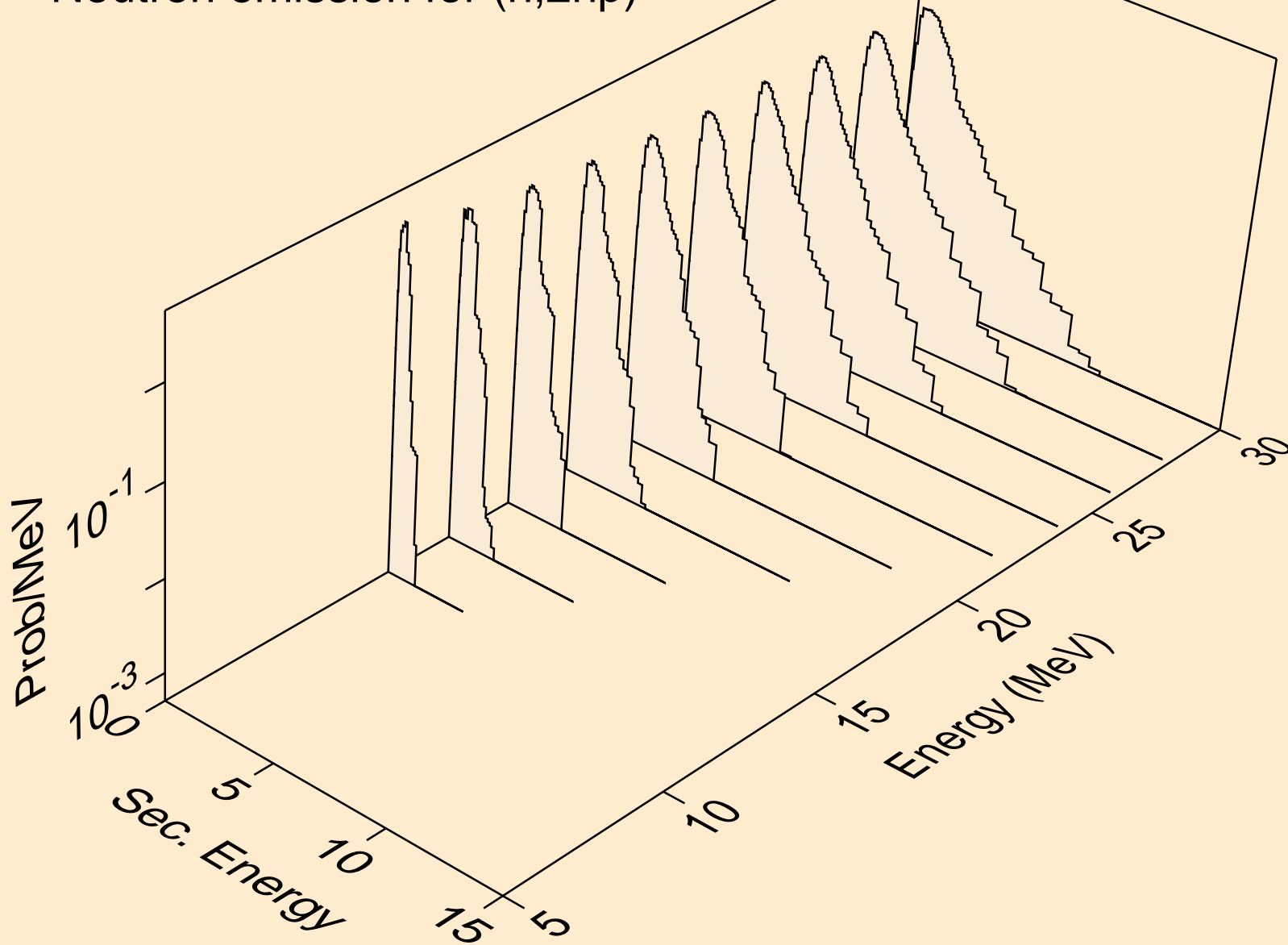

LU162N NEUTRON ACER TENDL-2019 LIBRARY; T=293.16K  
Neutron emission for (n,npa)

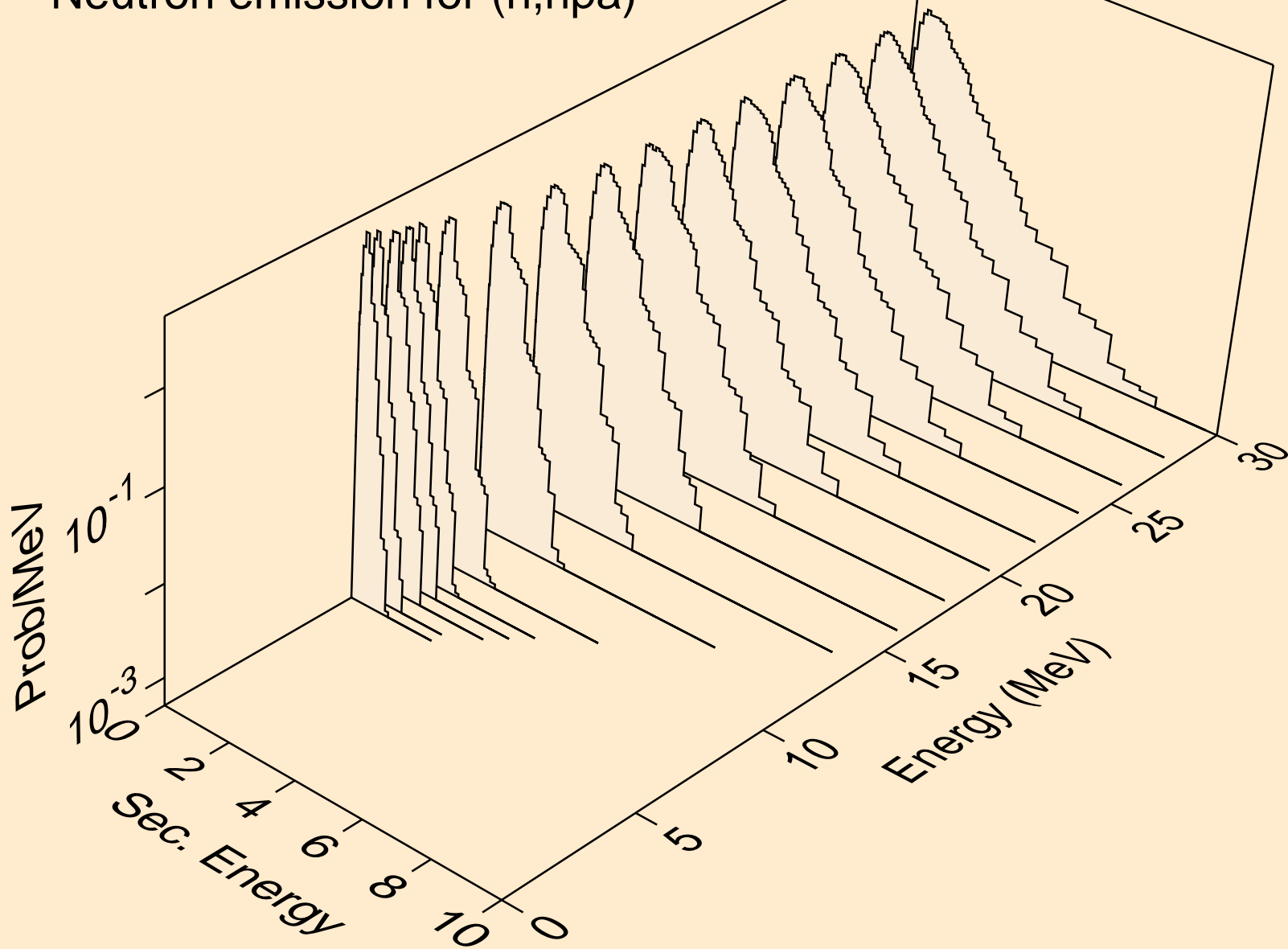

LU162N NEUTRON ACER TENDL-2019 LIBRARY; T=293.16K  
Neutron emission for (n,n\*c)

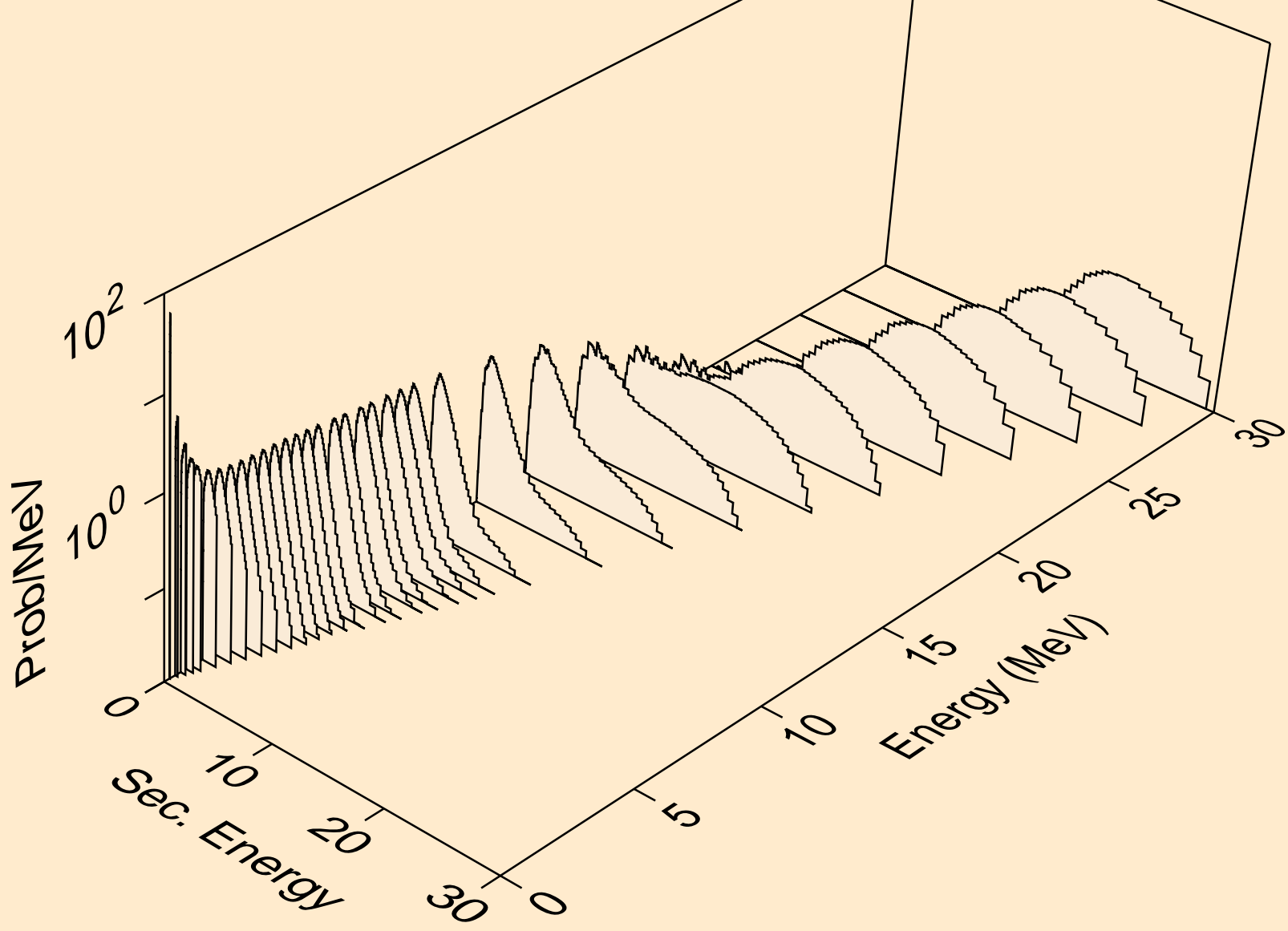

LU162N NEUTRON ACER TENDL-2019 LIBRARY; T=293.16K  
Photon emission for (n,x)

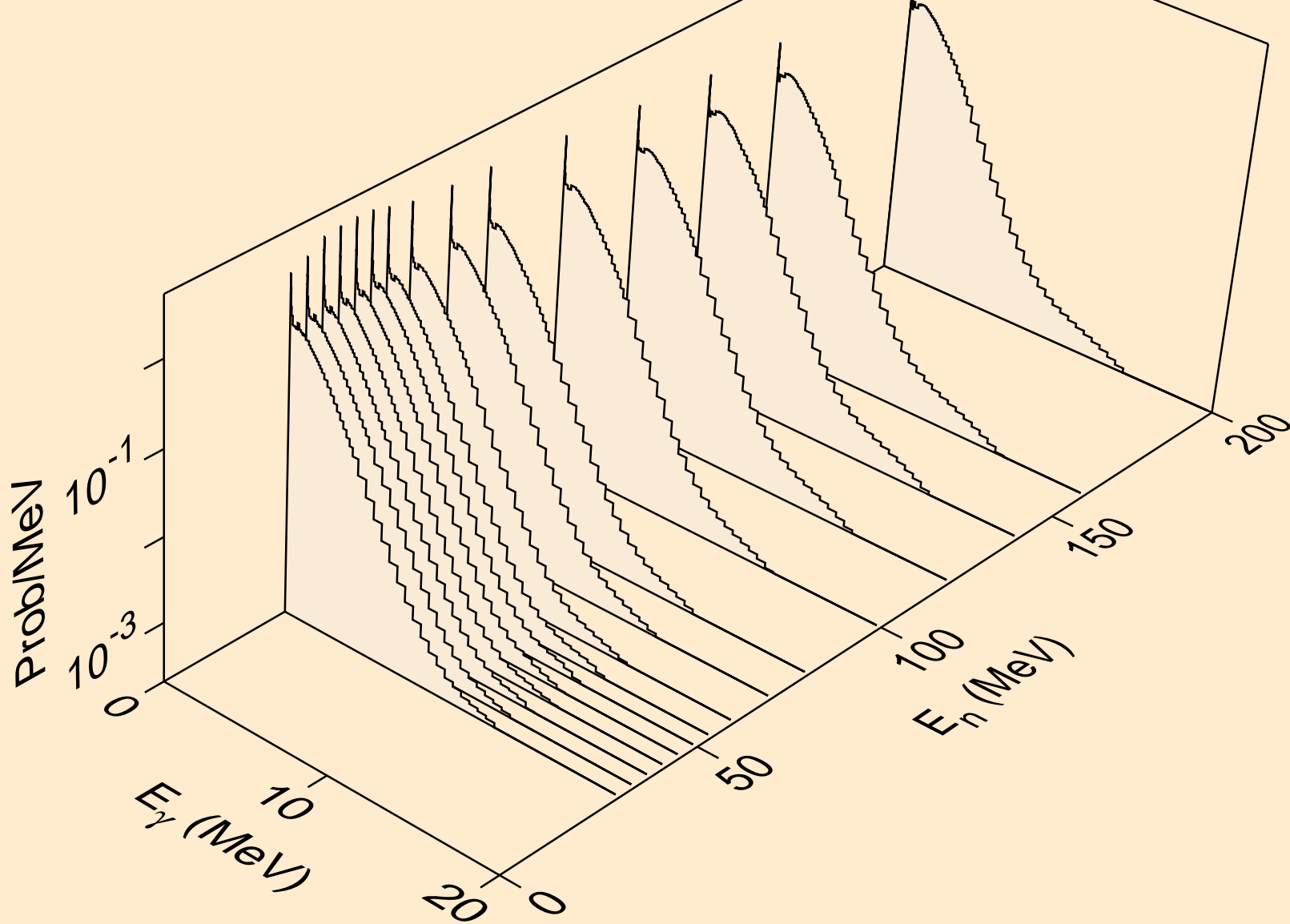

LU162N NEUTRON ACER TENDL-2019 LIBRARY; T=293.16K  
Photon emission for (n,2nd)

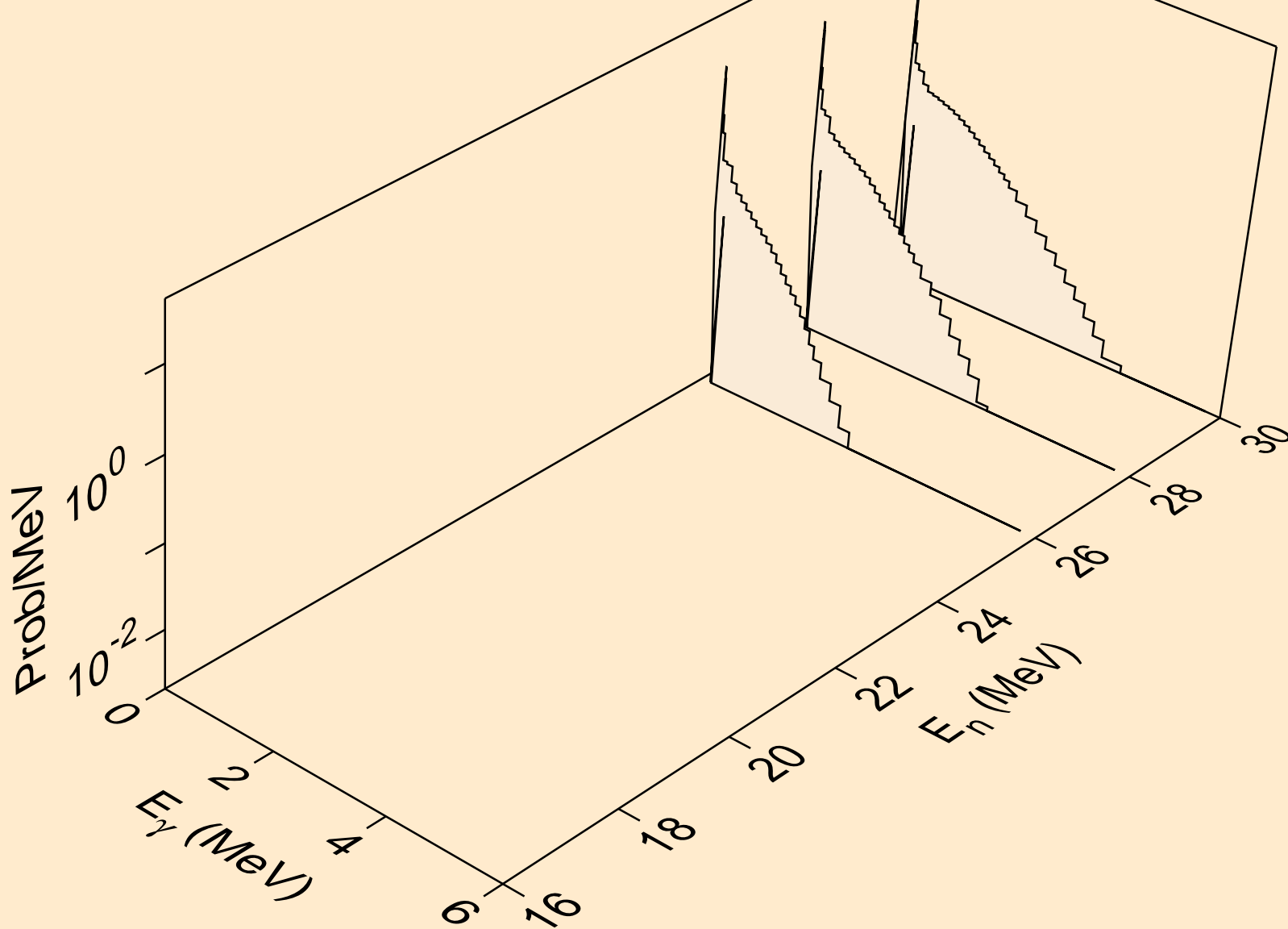

LU162N NEUTRON ACER TENDL-2019 LIBRARY; T=293.16K  
Photon emission for (n,2n)

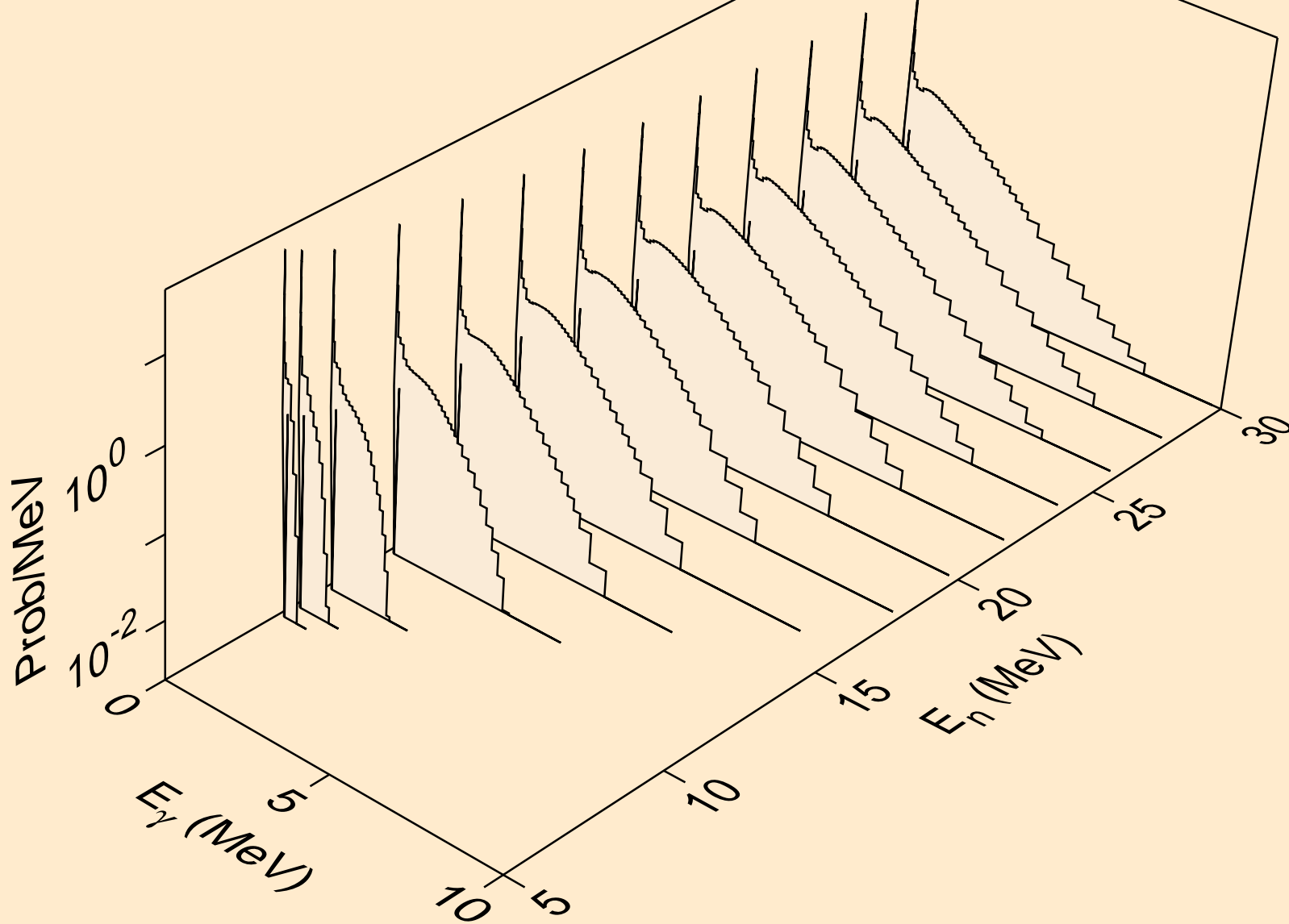

LU162N NEUTRON ACER TENDL-2019 LIBRARY; T=293.16K  
Photon emission for (n,3n)

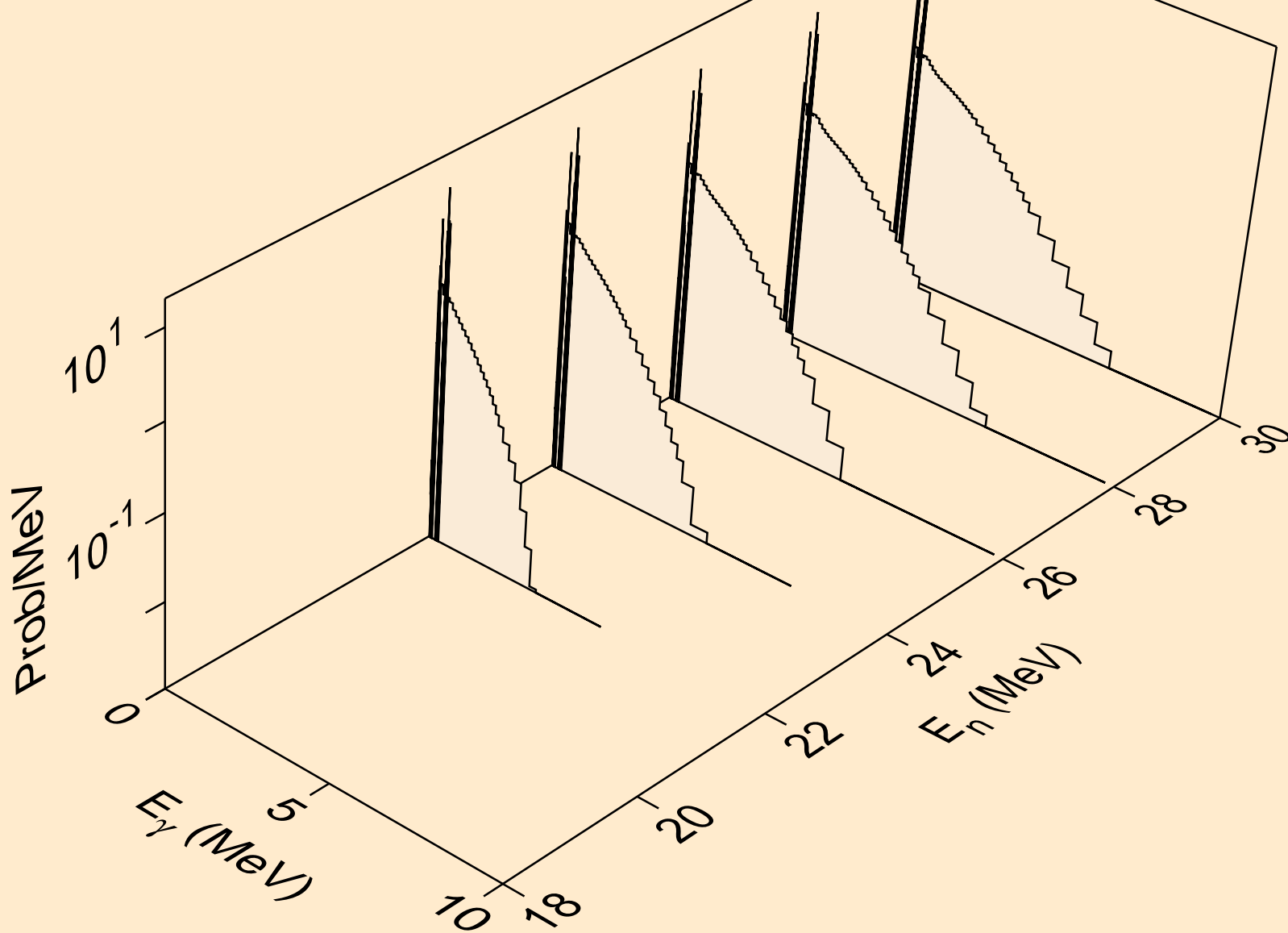

LU162N NEUTRON ACER TENDL-2019 LIBRARY; T=293.16K  
Photon emission for (n,n\*)a

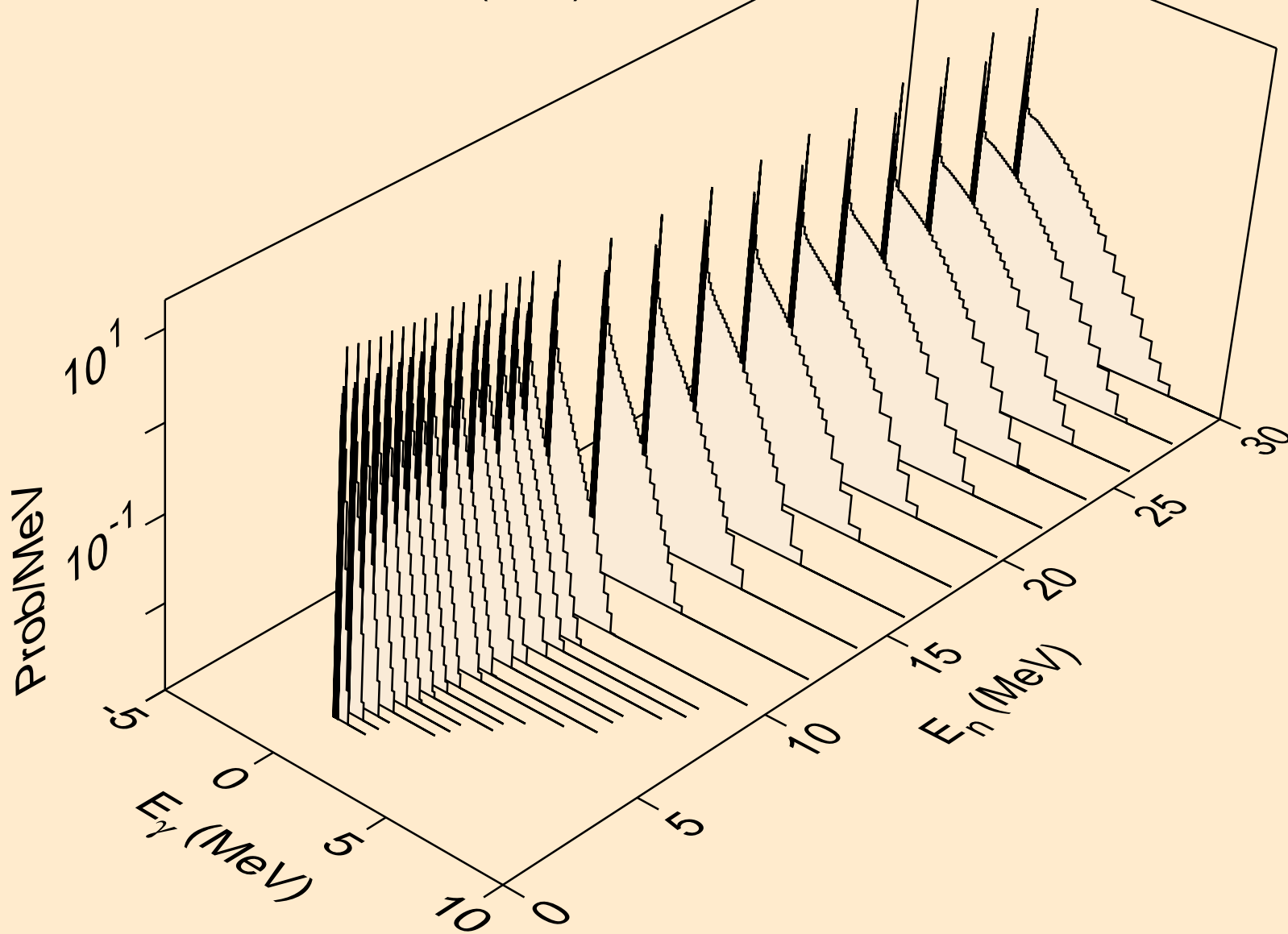



LU162N NEUTRON ACER TENDL-2019 LIBRARY; T=293.16K  
Photon emission for (n,2n)a

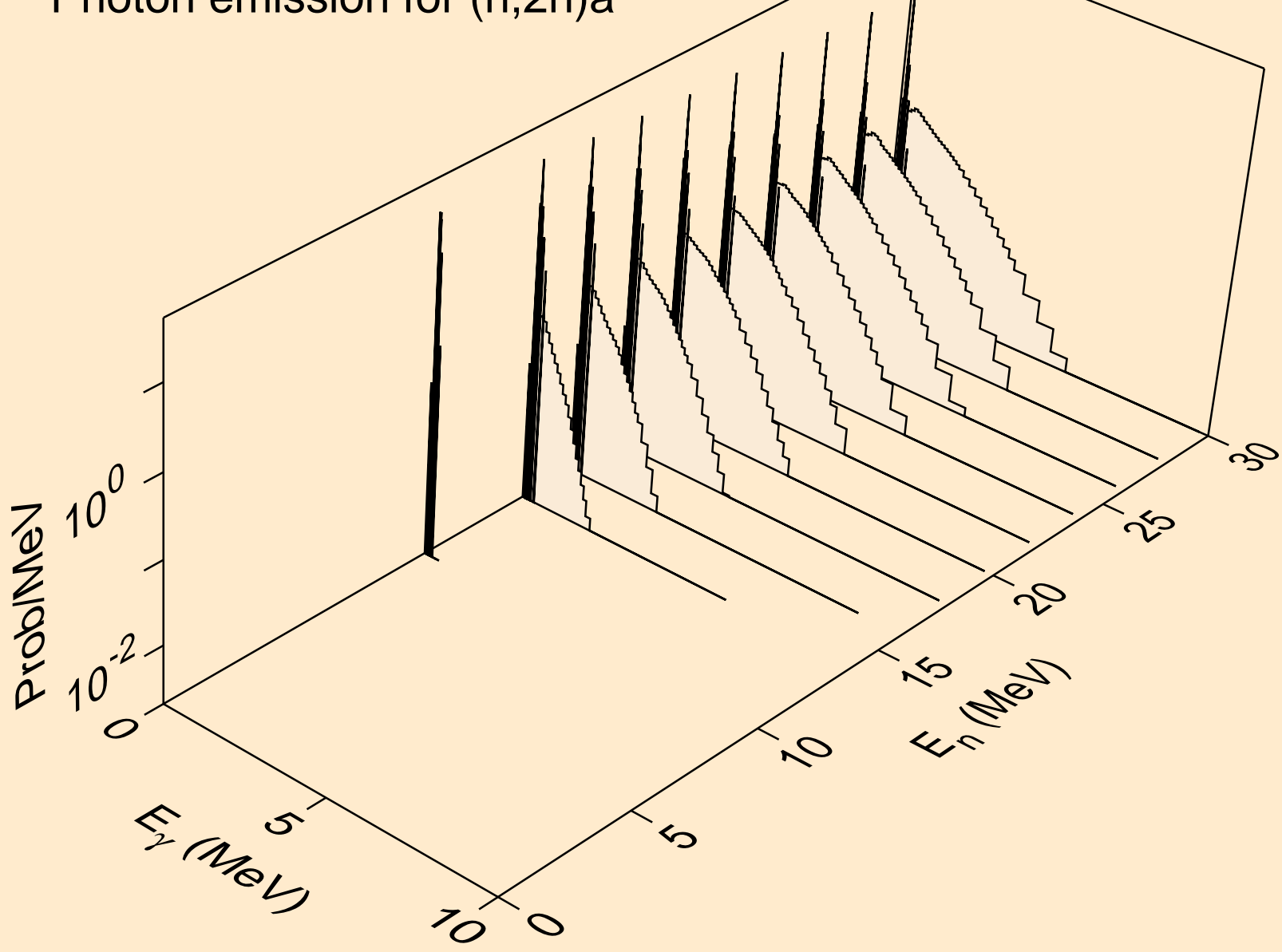

LU162N NEUTRON ACER TENDL-2019 LIBRARY; T=293.16K  
Photon emission for (n,3n)a

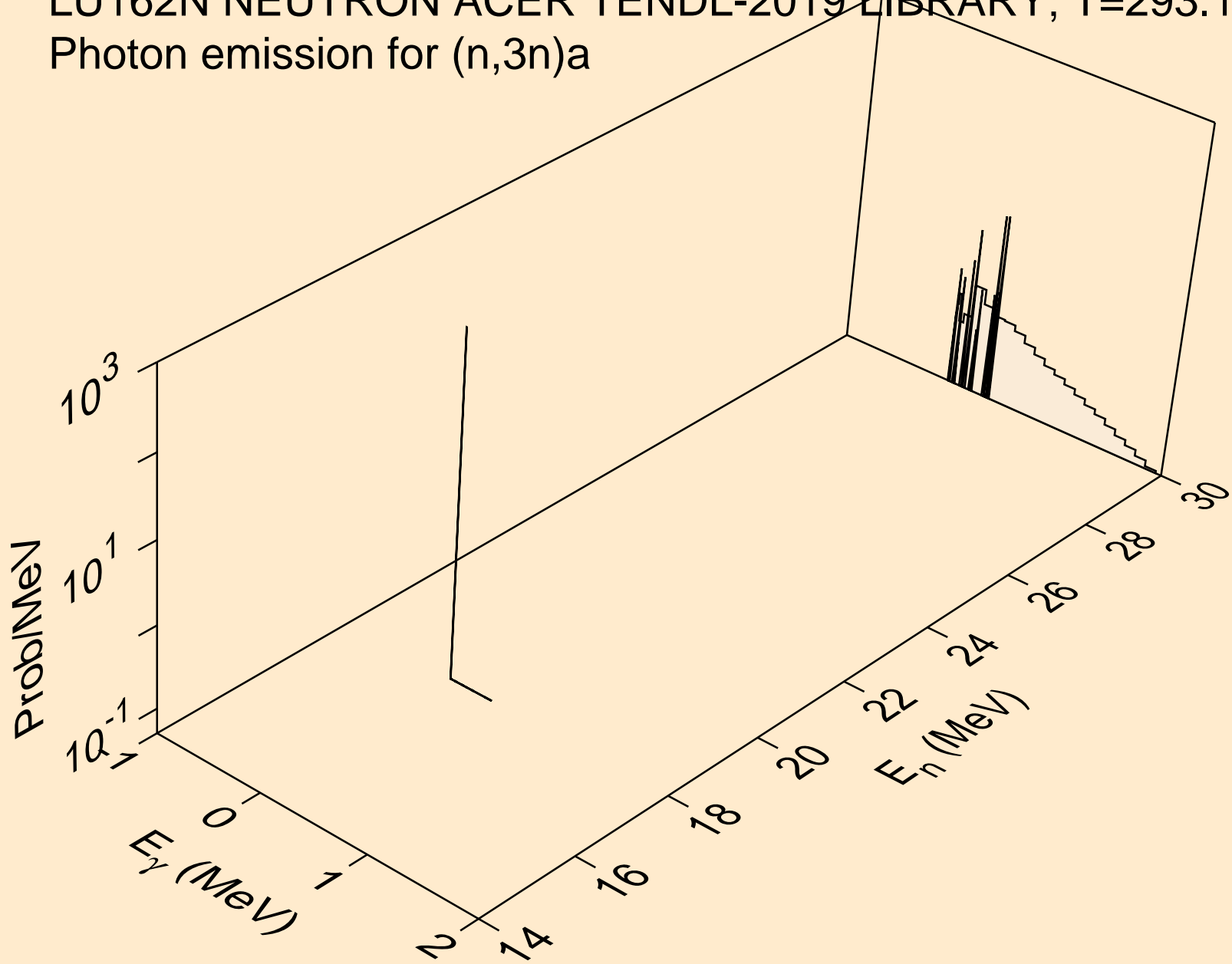

LU162N NEUTRON ACER TENDL-2019 LIBRARY; T=293.16K  
Photon emission for (n,n\*)p

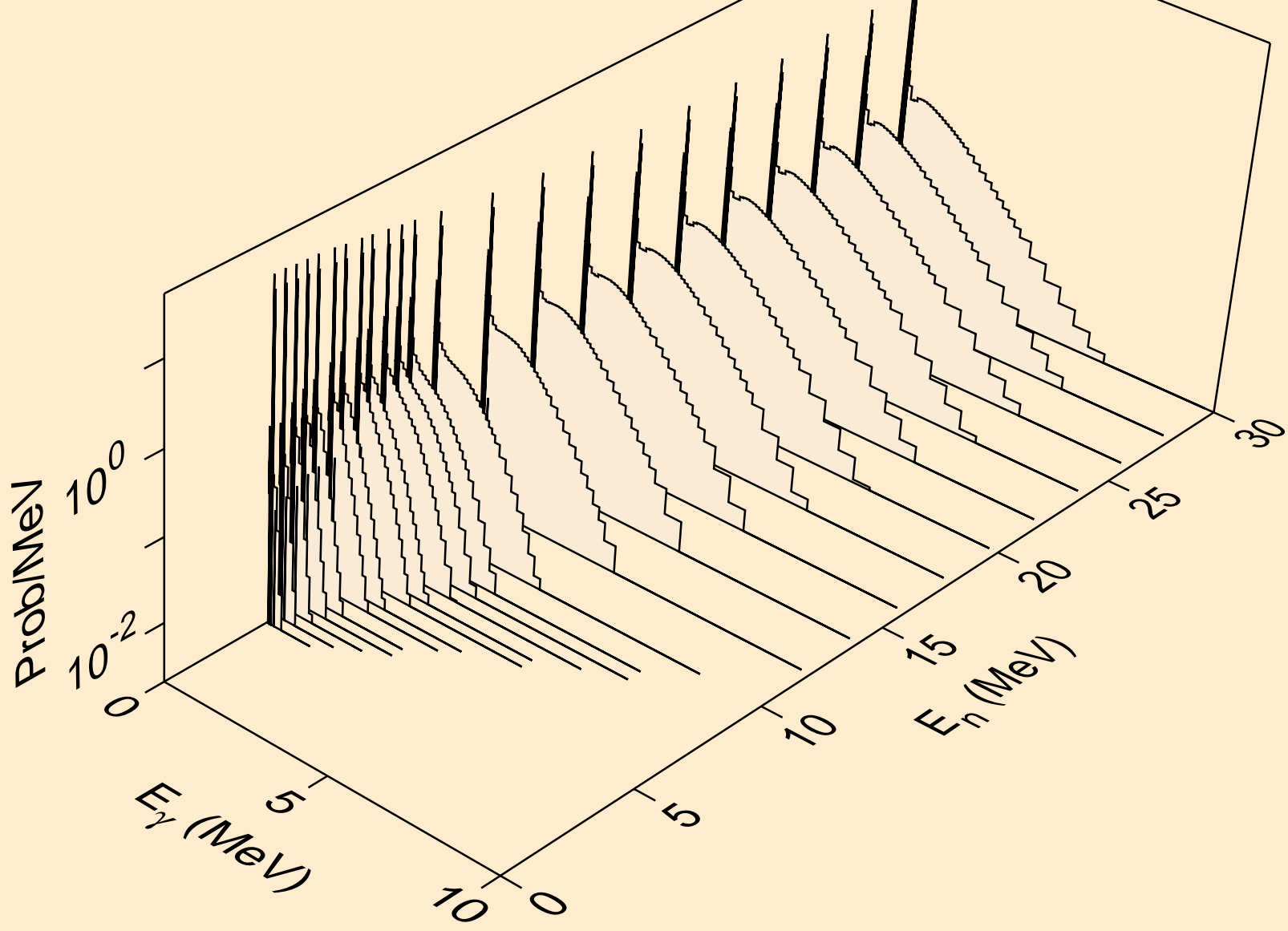

LU162N NEUTRON ACER TENDL-2019 LIBRARY; T=293.16K  
Photon emission for (n,n\*)2a

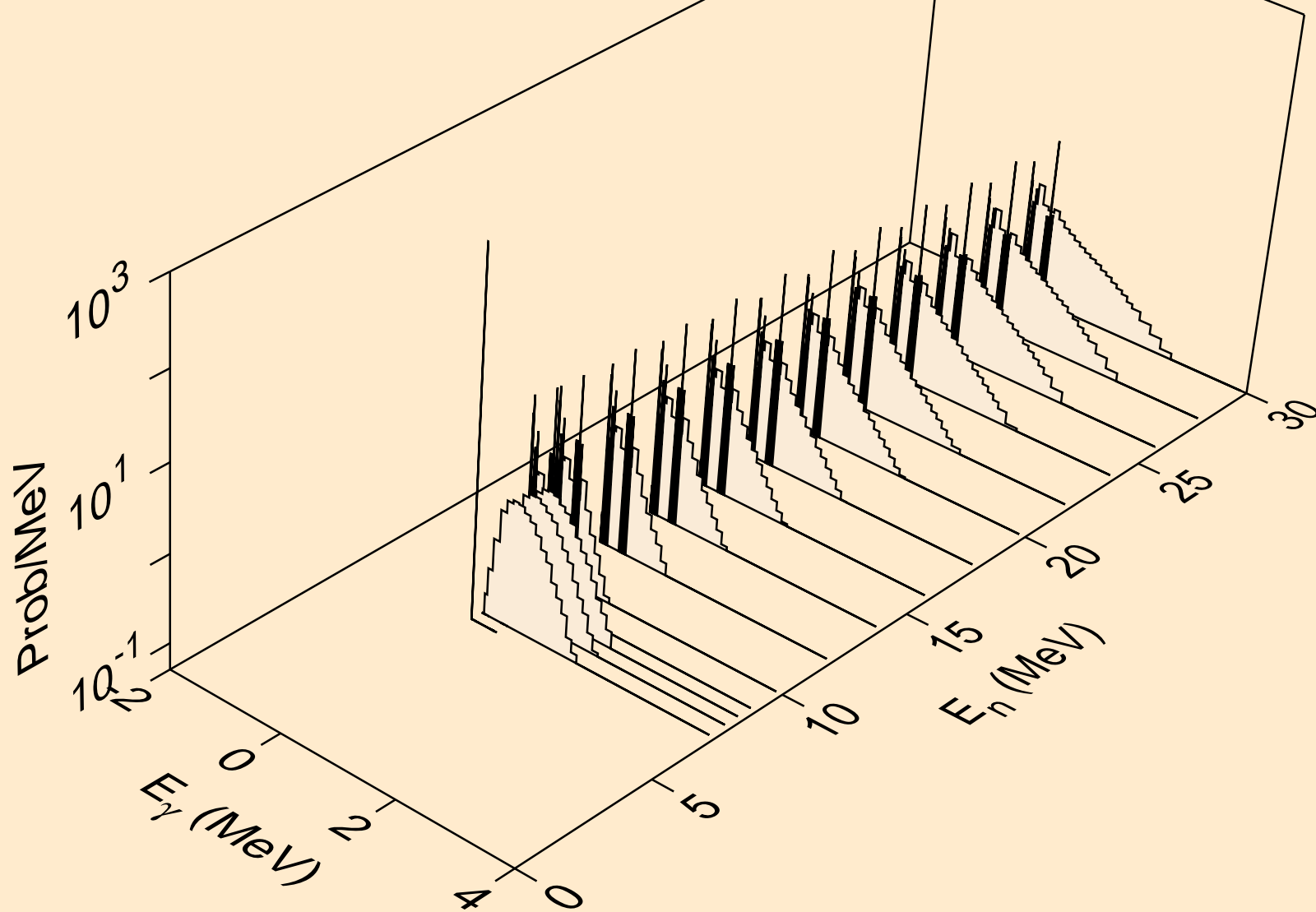

LU162N NEUTRON ACER TENDL-2019 LIBRARY; T=293.16K  
Photon emission for (n,2n)2a

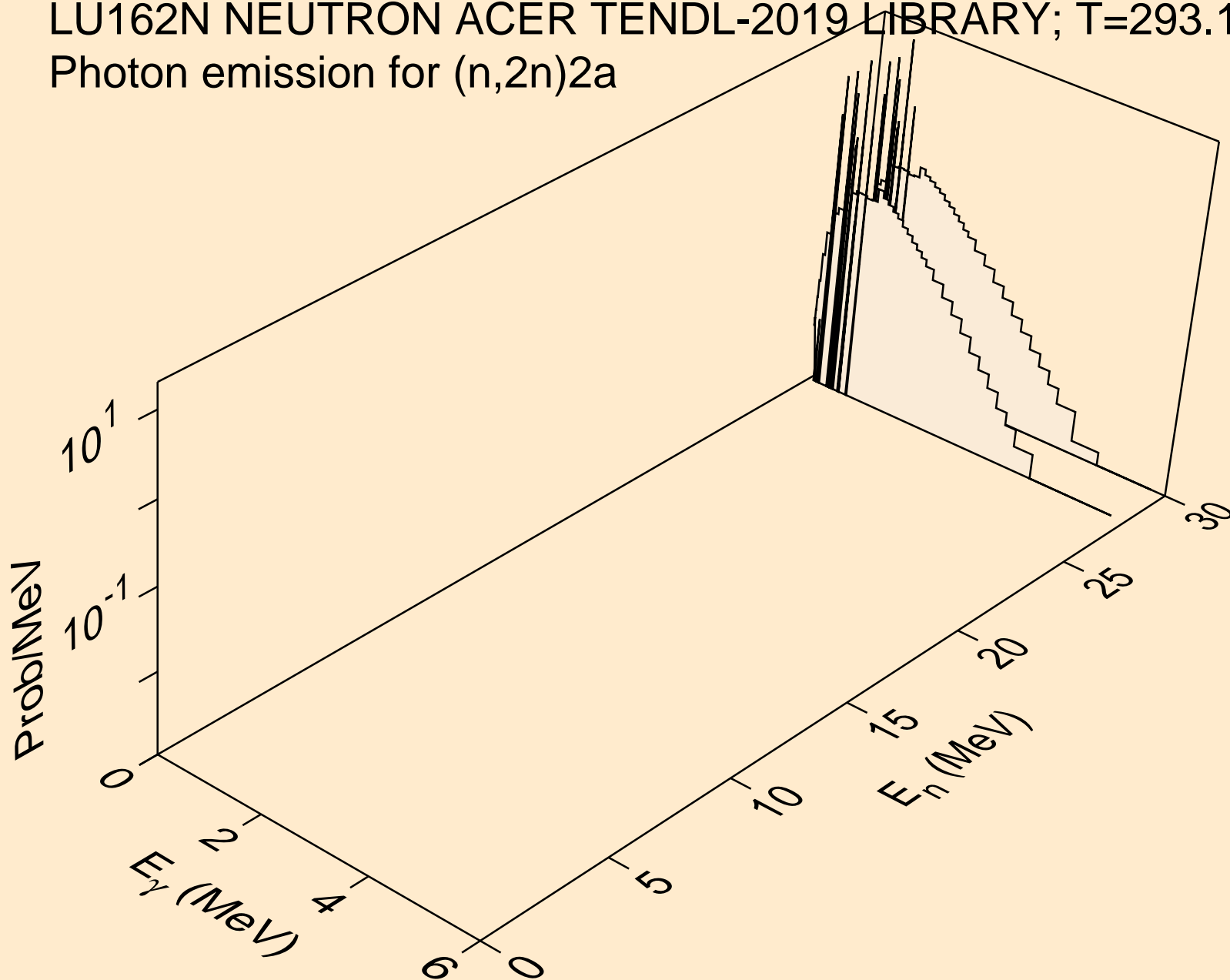

LU162N NEUTRON ACER TENDL-2019 LIBRARY; T=293.16K  
Photon emission for (n,n\*)d

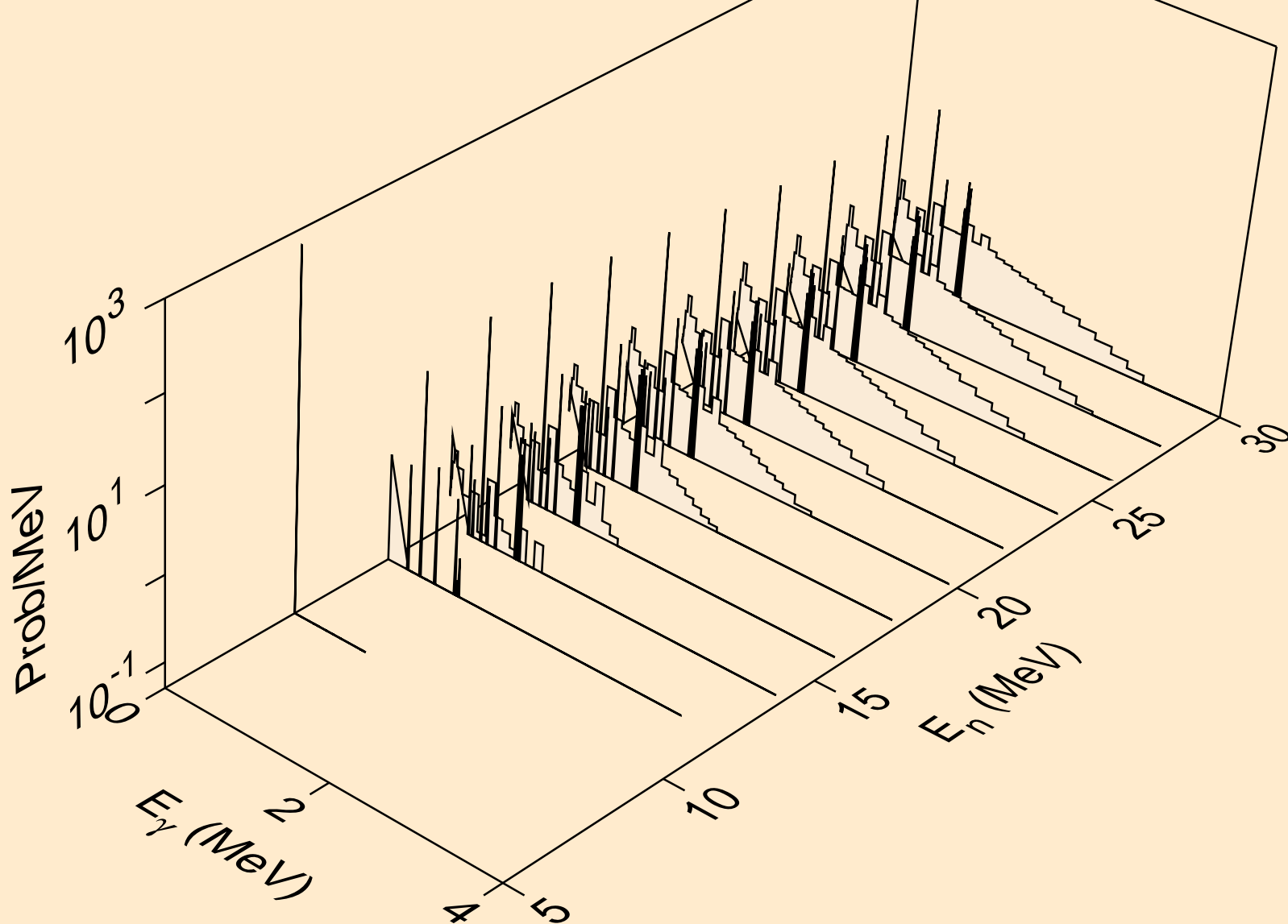

LU162N NEUTRON ACER TENDL-2019 LIBRARY; T=293.16K  
Photon emission for (n,n\*)t

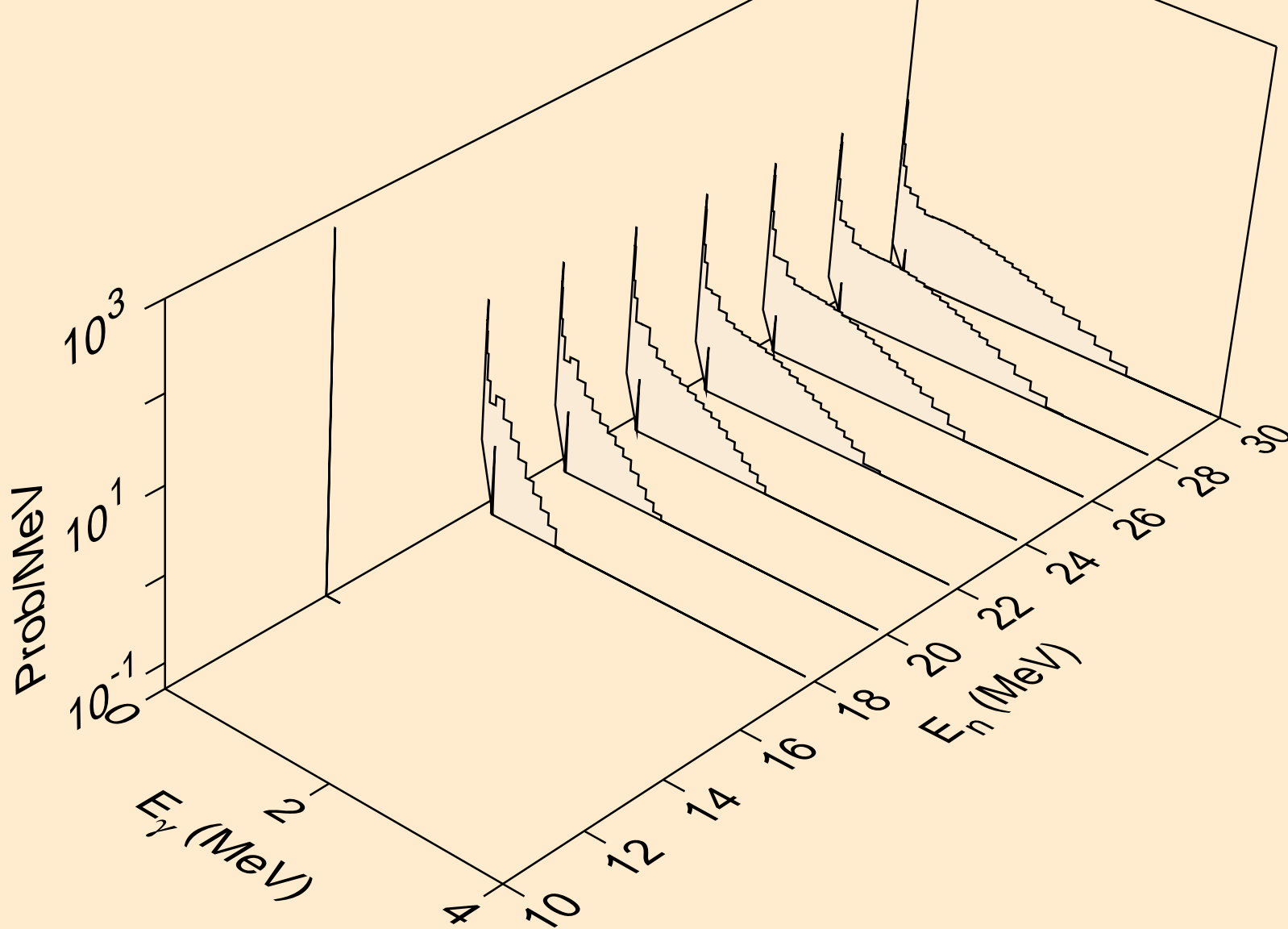

LU162N NEUTRON ACER TENDL-2019 LIBRARY; T=293.16K  
Photon emission for (n,n\*)he3

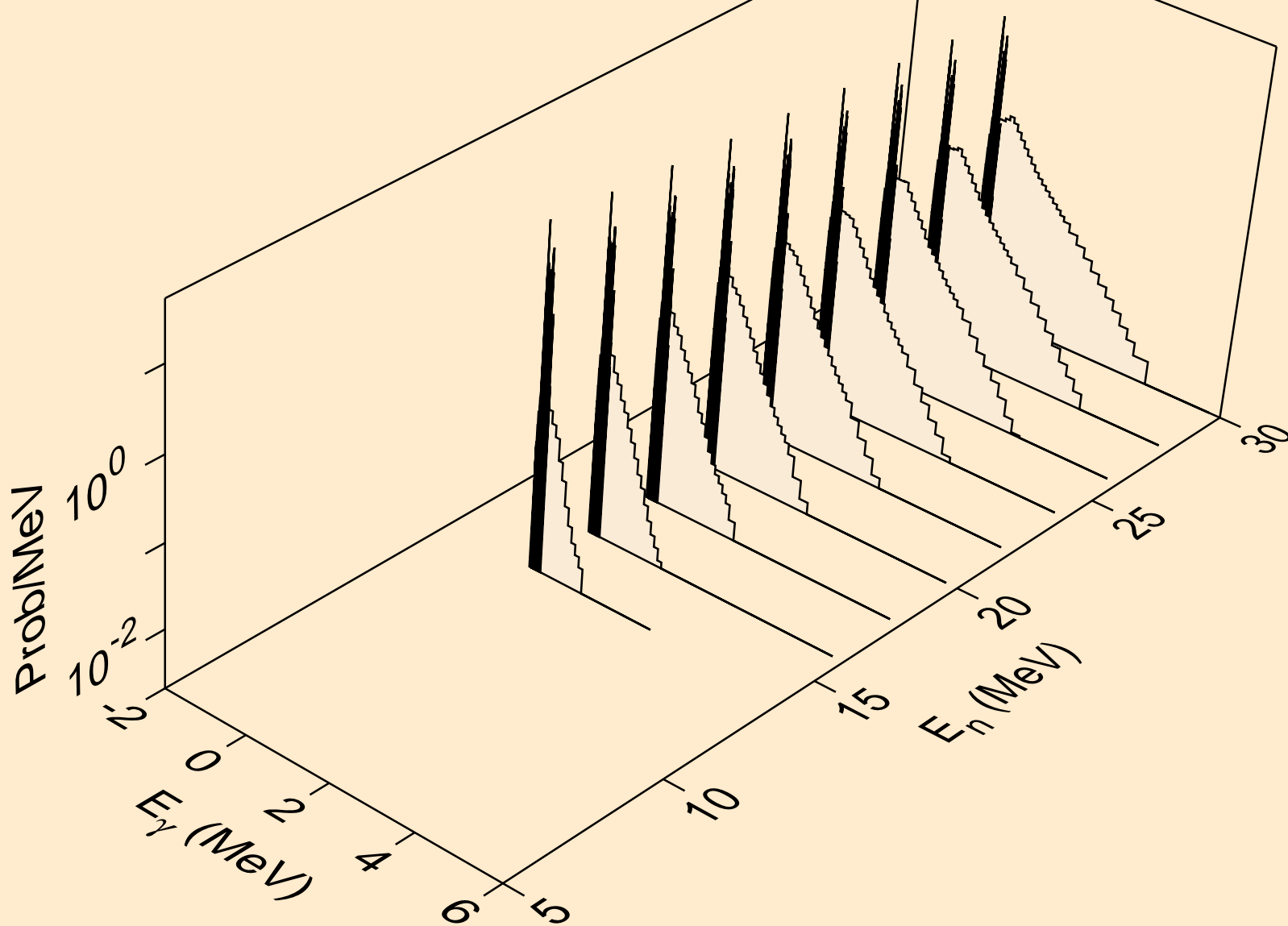



LU162N NEUTRON ACER TENDL-2019 LIBRARY; T=293.16K  
Photon emission for (n,4n)

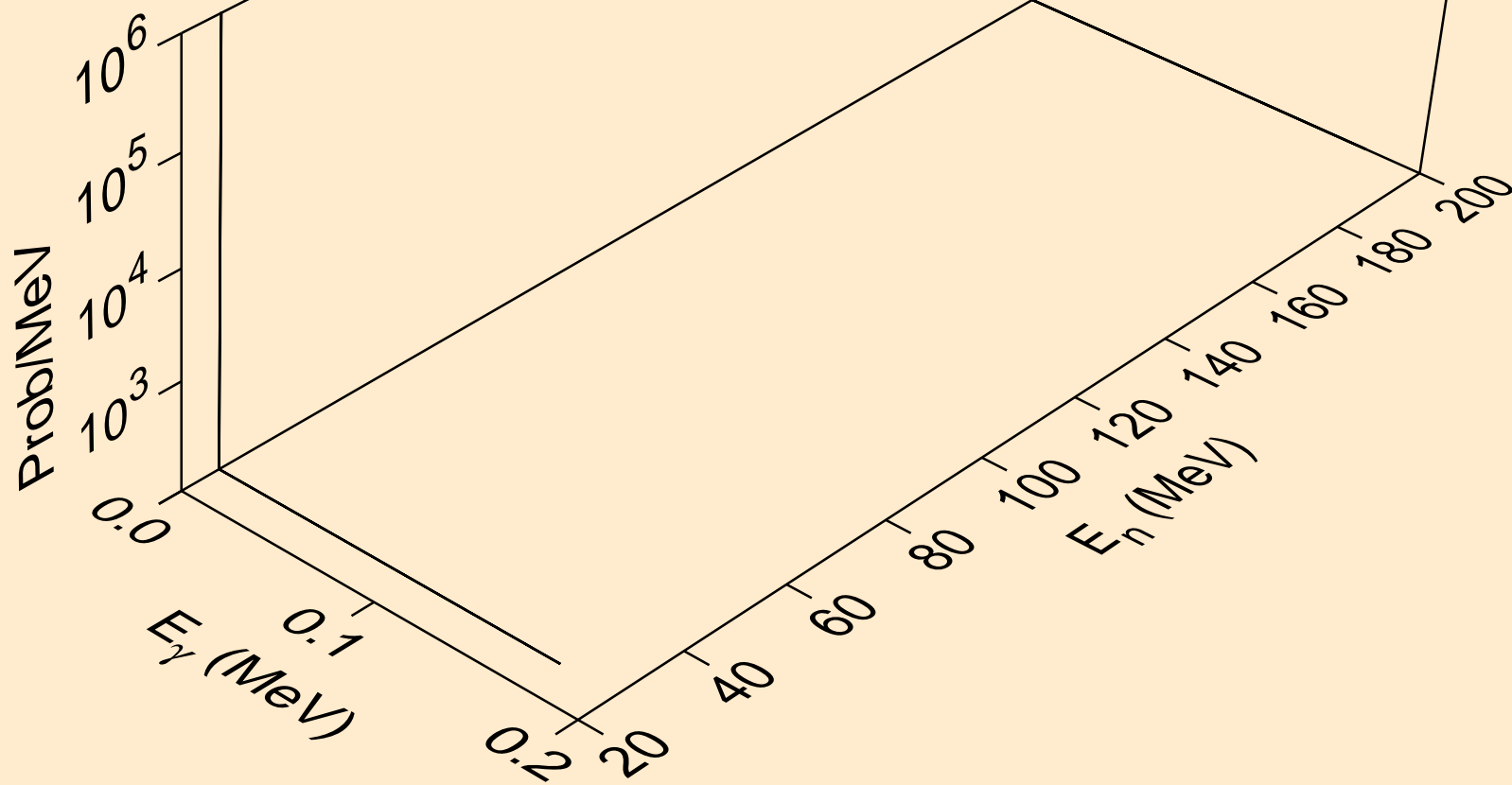

LU162N NEUTRON ACER TENDL-2019 LIBRARY; T=293.16K  
Photon emission for (n,2np)

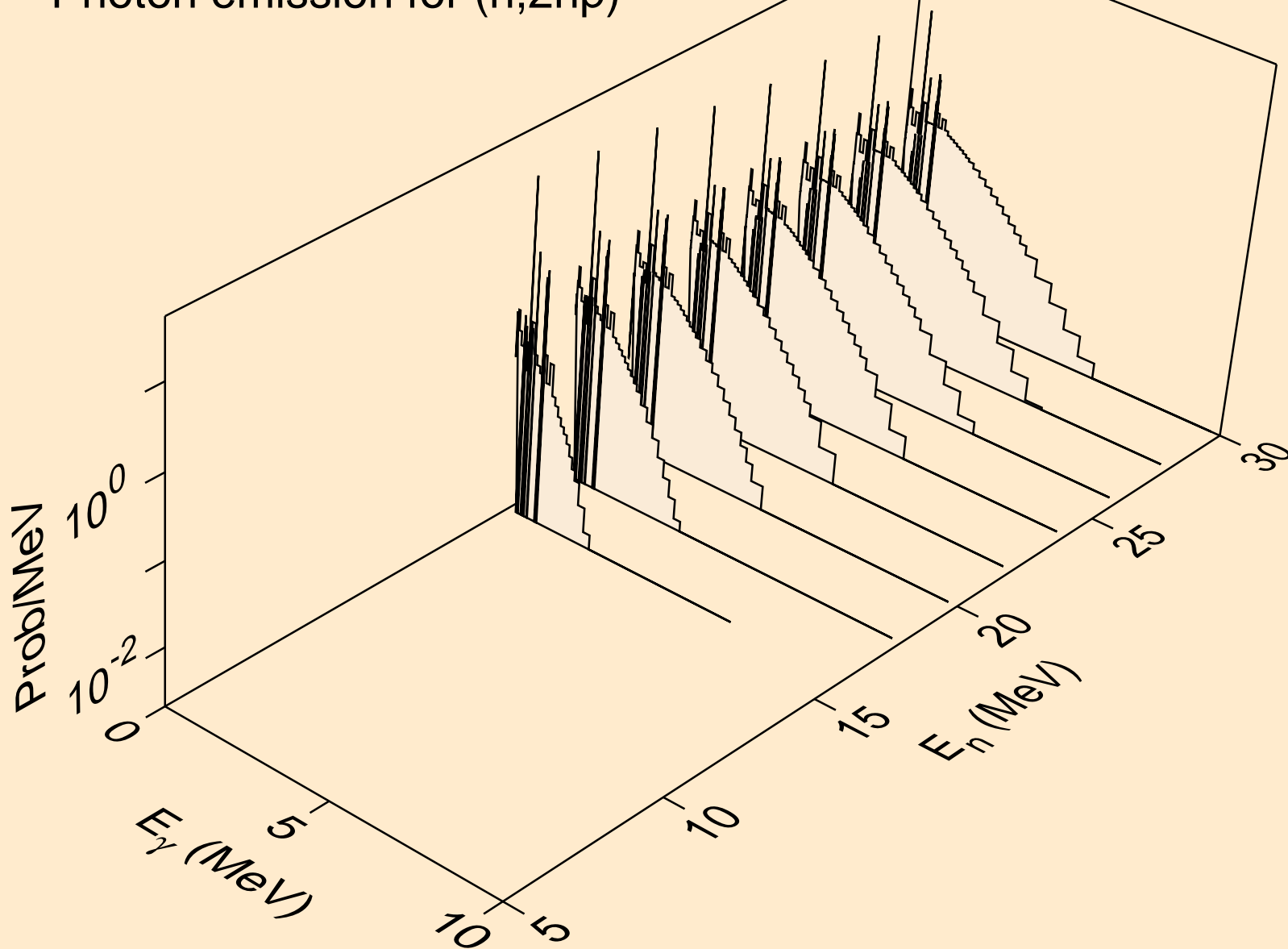

LU162N NEUTRON ACER TENDL-2019 LIBRARY; T=293.16K  
Photon emission for (n,3np)

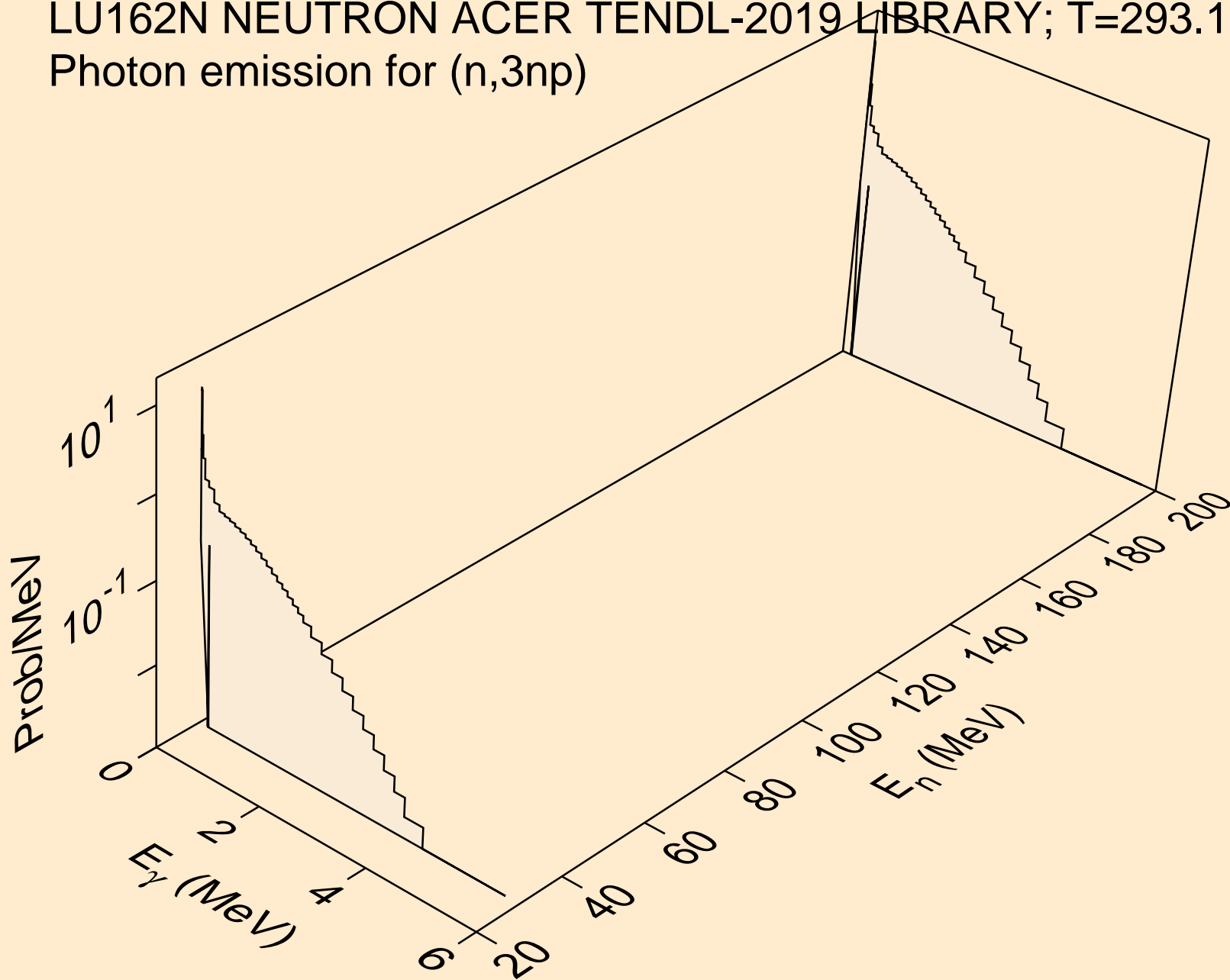

LU162N NEUTRON ACER TENDL-2019 LIBRARY; T=293.16K  
Photon emission for (n,2np)

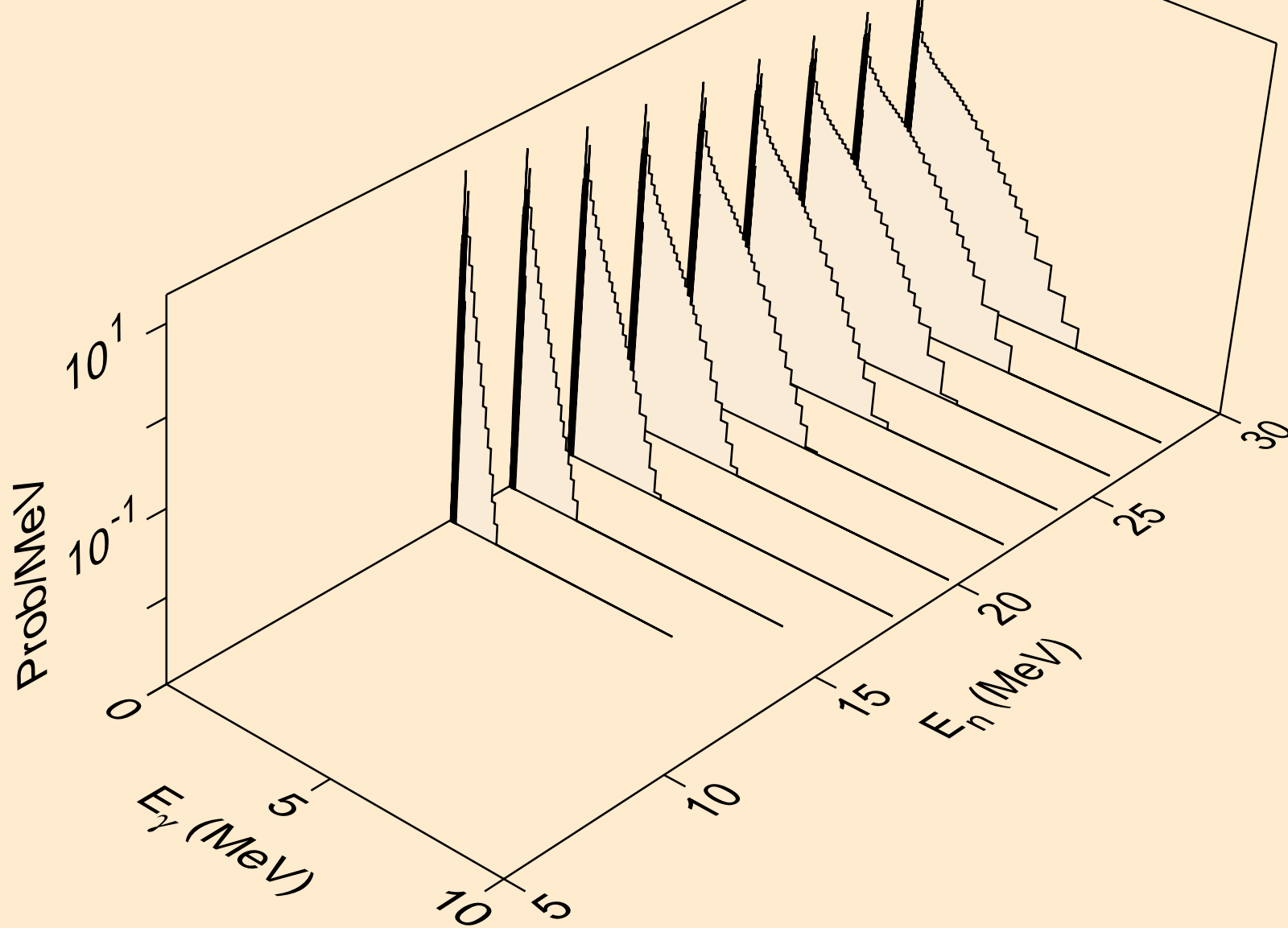

LU162N NEUTRON ACER TENDL-2019 LIBRARY; T=293.16K  
Photon emission for (n,npa)

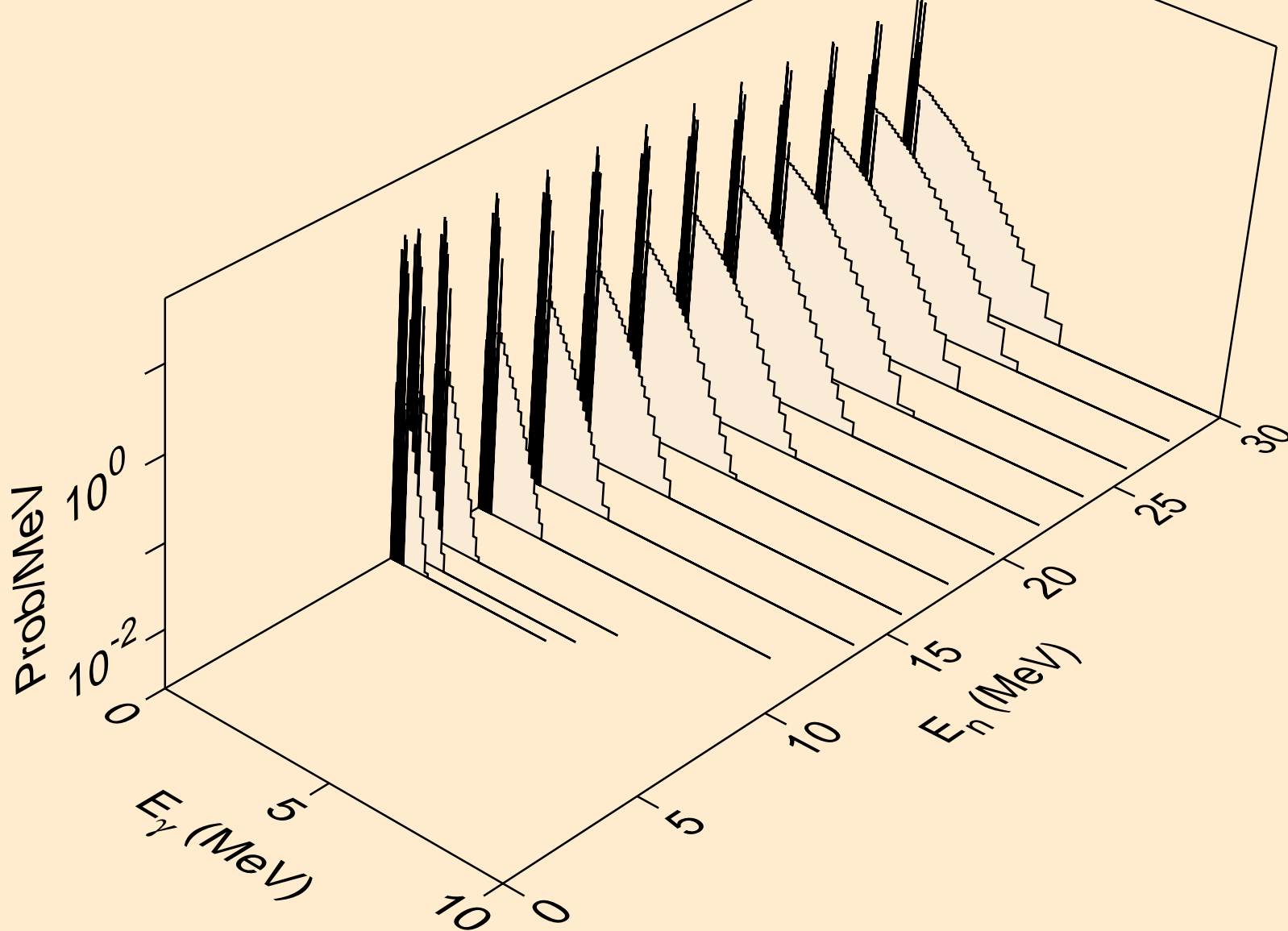

LU162N NEUTRON ACER TENDL-2019 LIBRARY; T=293.16K  
Photon emission for (n,n\*1)

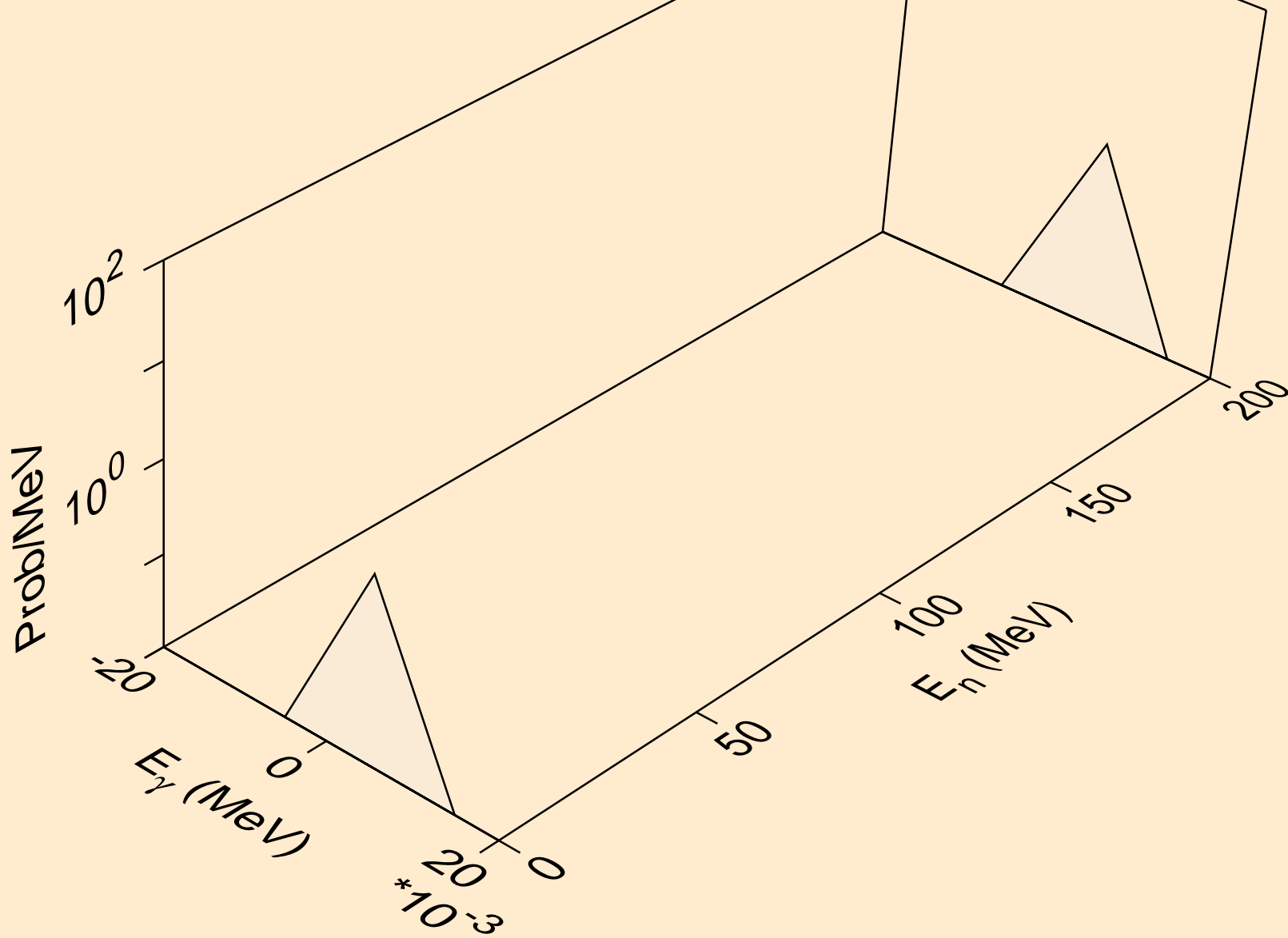

LU162N NEUTRON ACER TENDL-2019 LIBRARY; T=293.16K  
Photon emission for (n,n\*2)

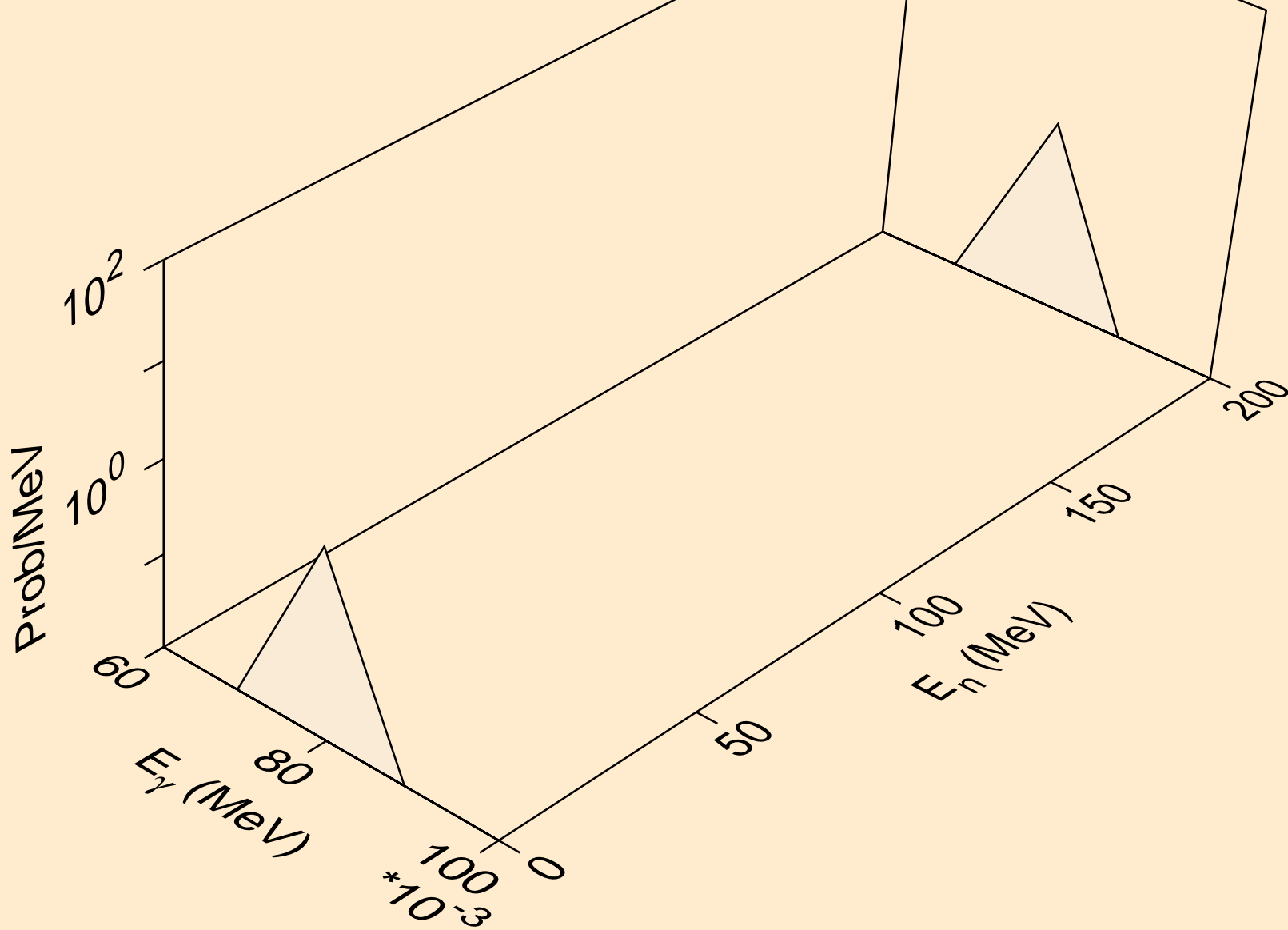

LU162N NEUTRON ACER TENDL-2019 LIBRARY; T=293.16K  
Photon emission for (n,n\*3)

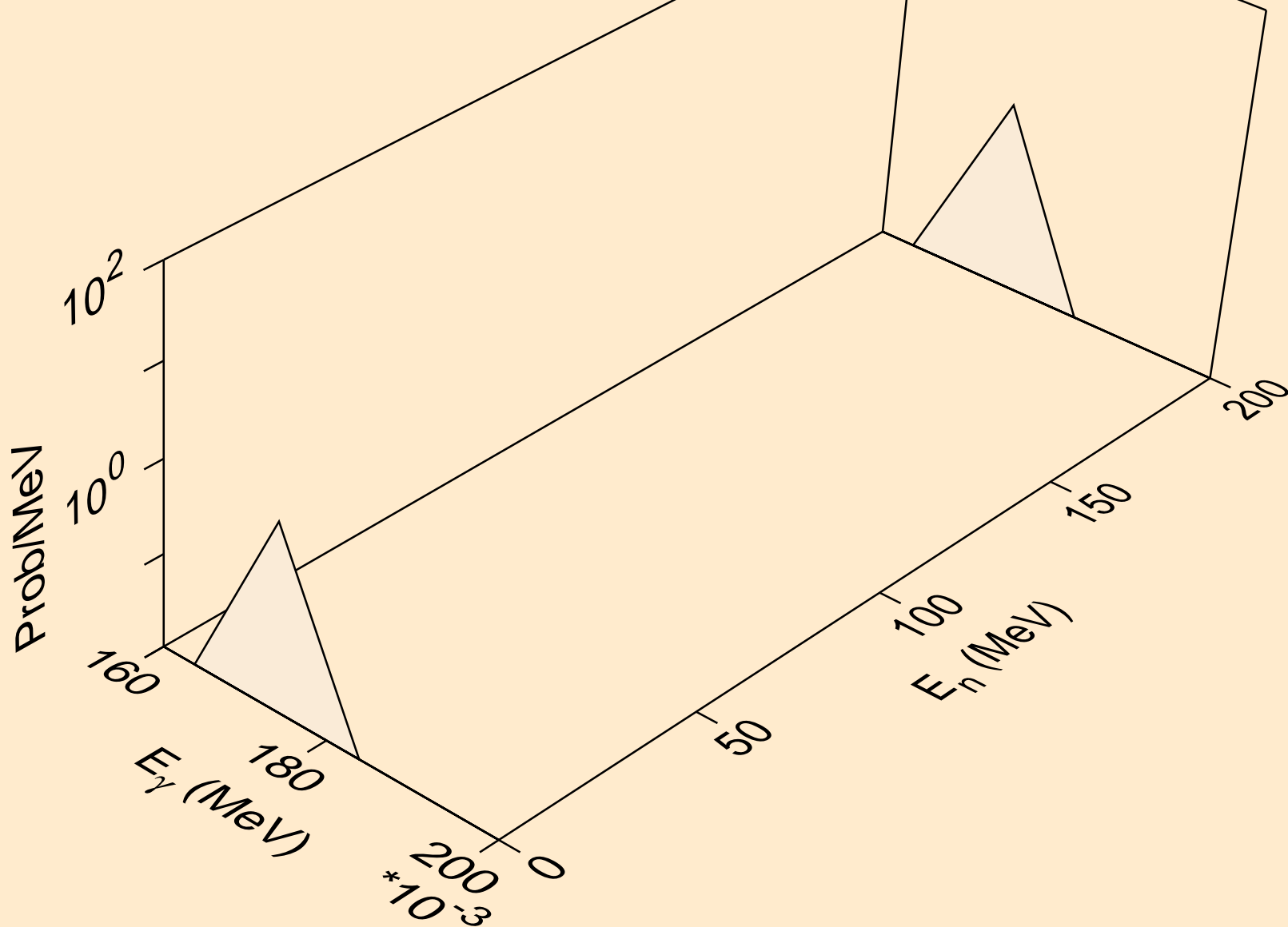



LU162N NEUTRON ACER TENDL-2019 LIBRARY; T=293.16K  
Photon emission for (n,n\*4)

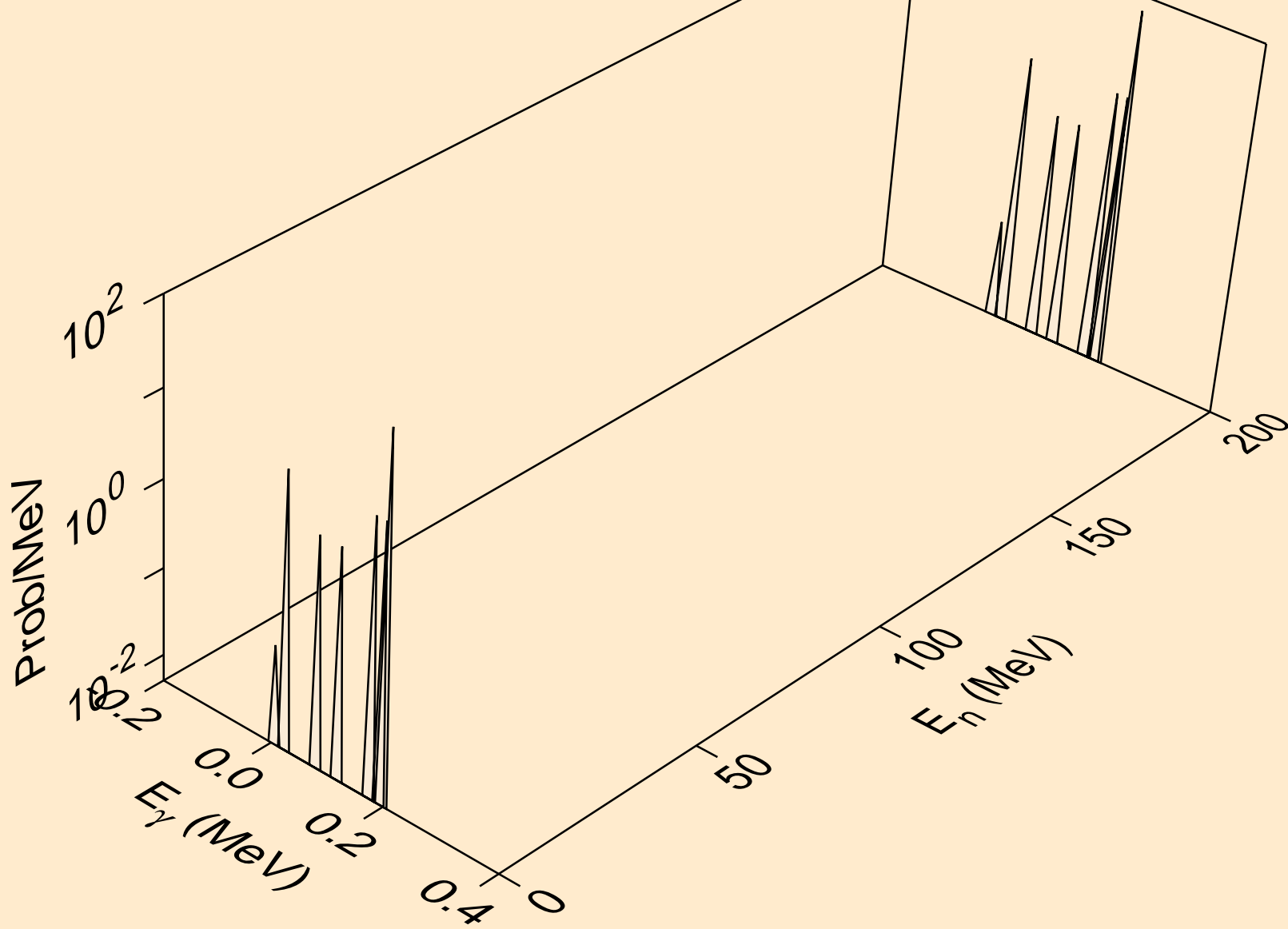

LU162N NEUTRON ACER TENDL-2019 LIBRARY; T=293.16K  
Photon emission for (n,n\*6)

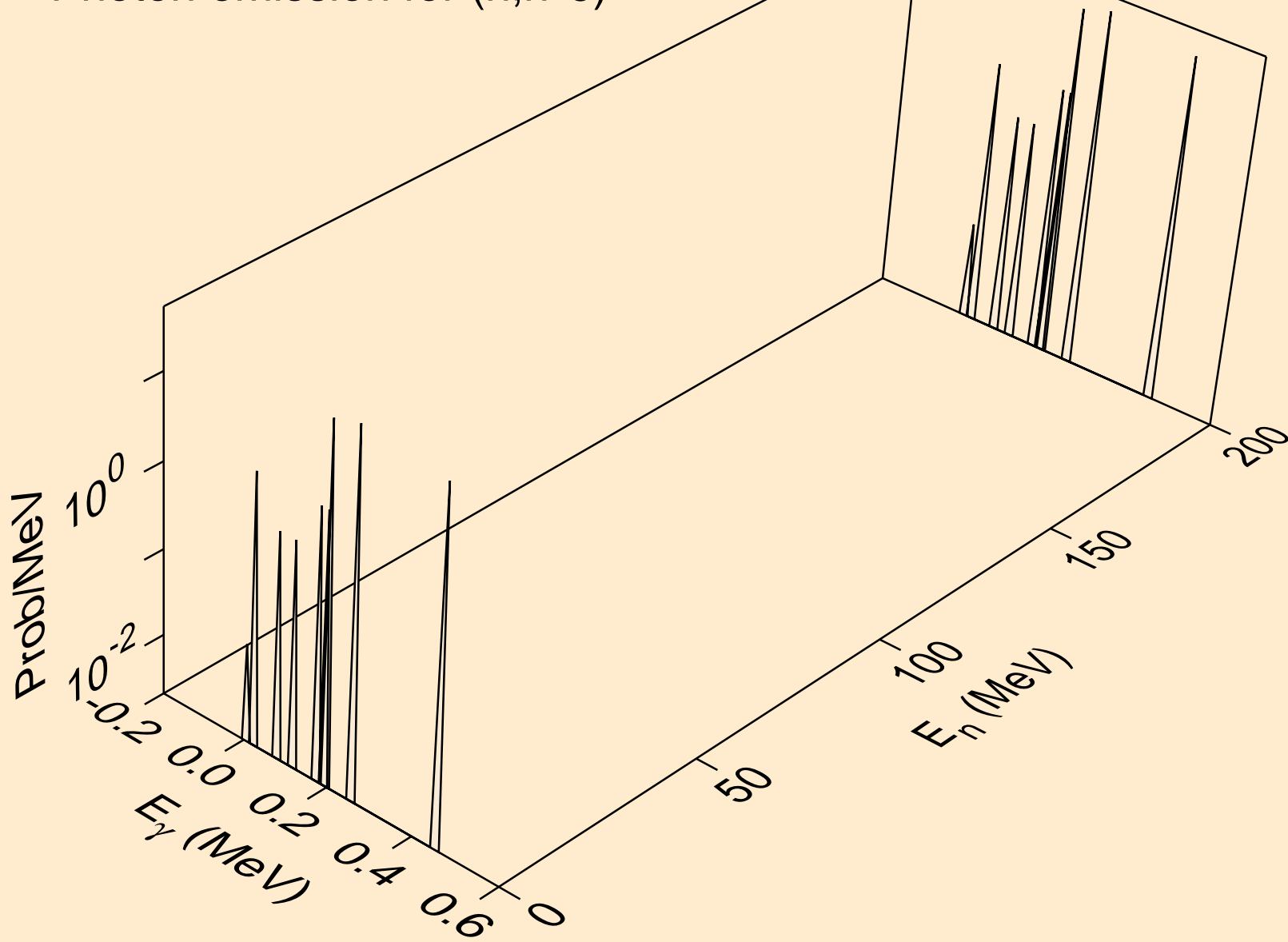

LU162N NEUTRON ACER TENDL-2019 LIBRARY; T=293.16K  
Photon emission for (n,n\*8)

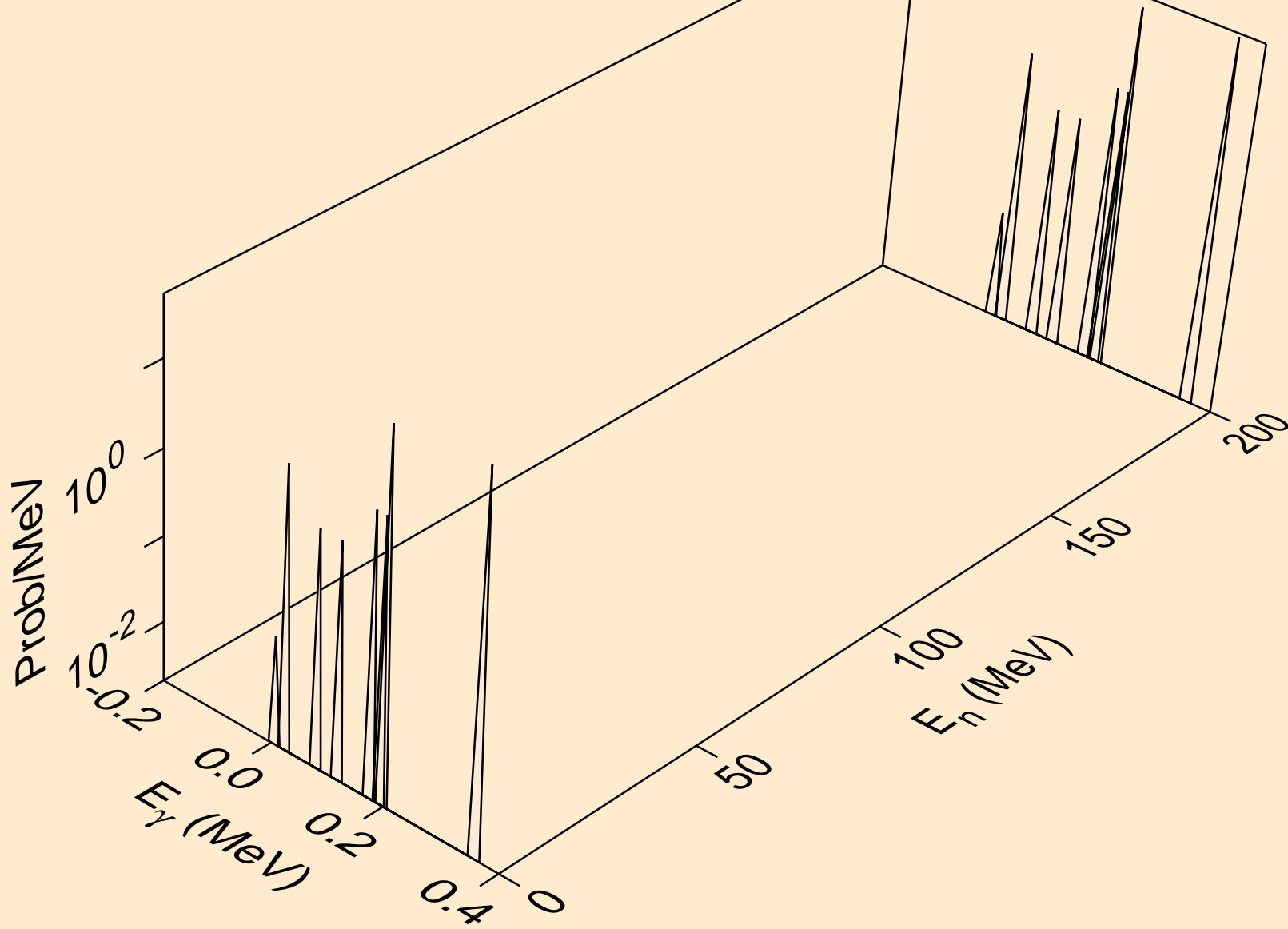

LU162N NEUTRON ACER TENDL-2019 LIBRARY; T=293.16K  
Photon emission for (n,n\*9)

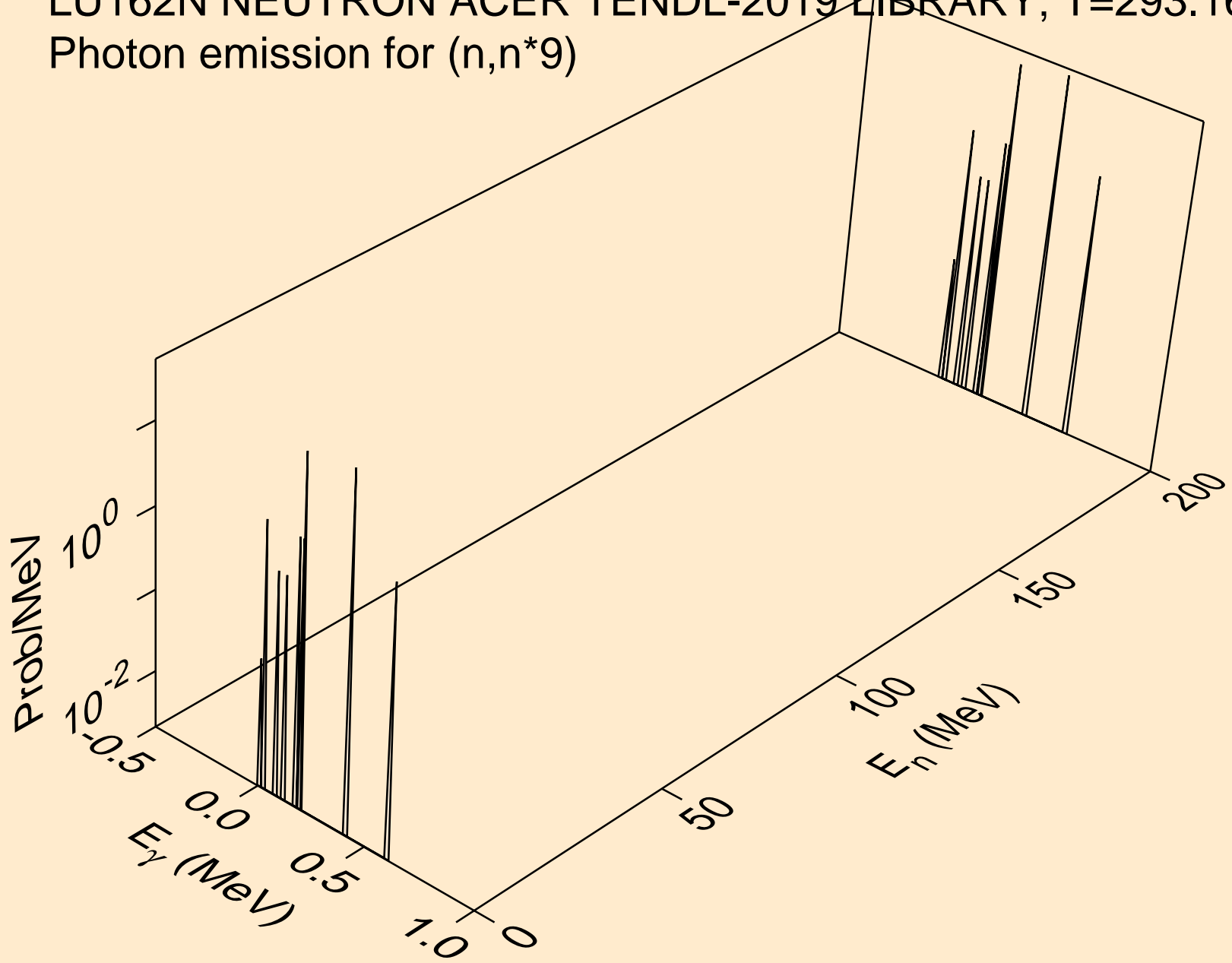

LU162N NEUTRON ACER TENDL-2019 LIBRARY; T=293.16K  
Photon emission for (n,n\*10)

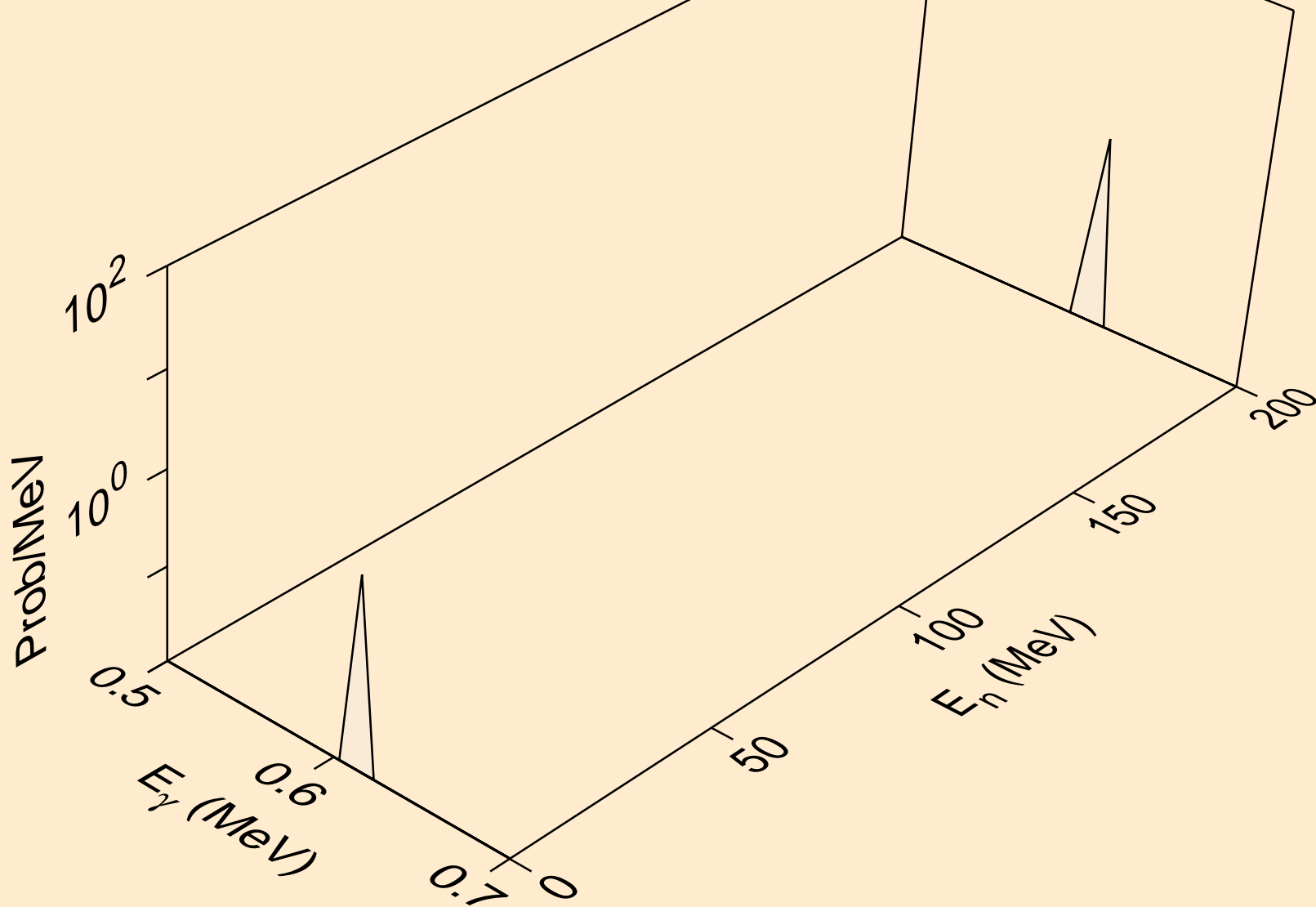

LU162N NEUTRON ACER TENDL-2019 LIBRARY; T=293.16K  
Photon emission for (n,n\*11)

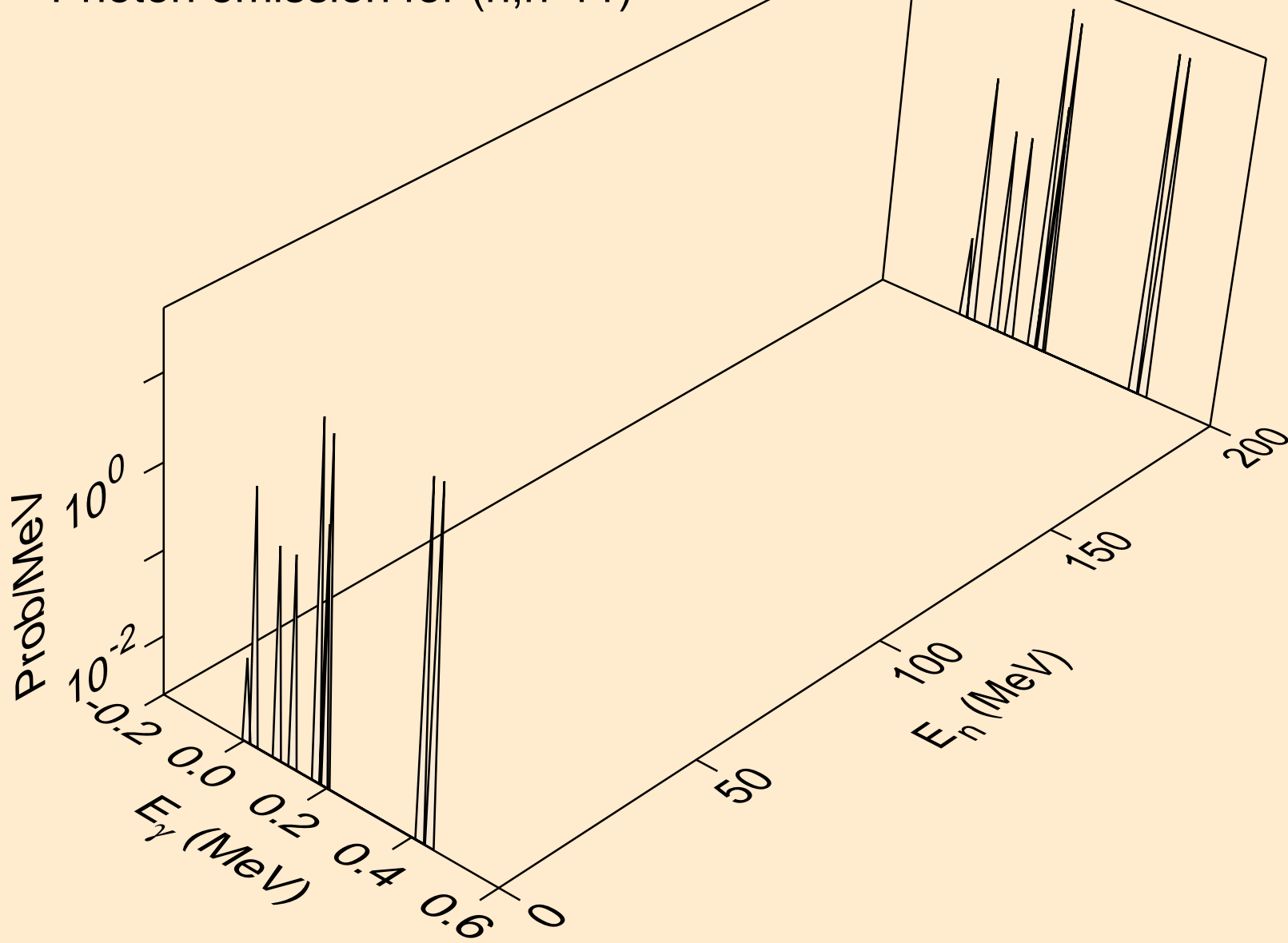

LU162N NEUTRON ACER TENDL-2019 LIBRARY; T=293.16K  
Photon emission for (n,n\*12)

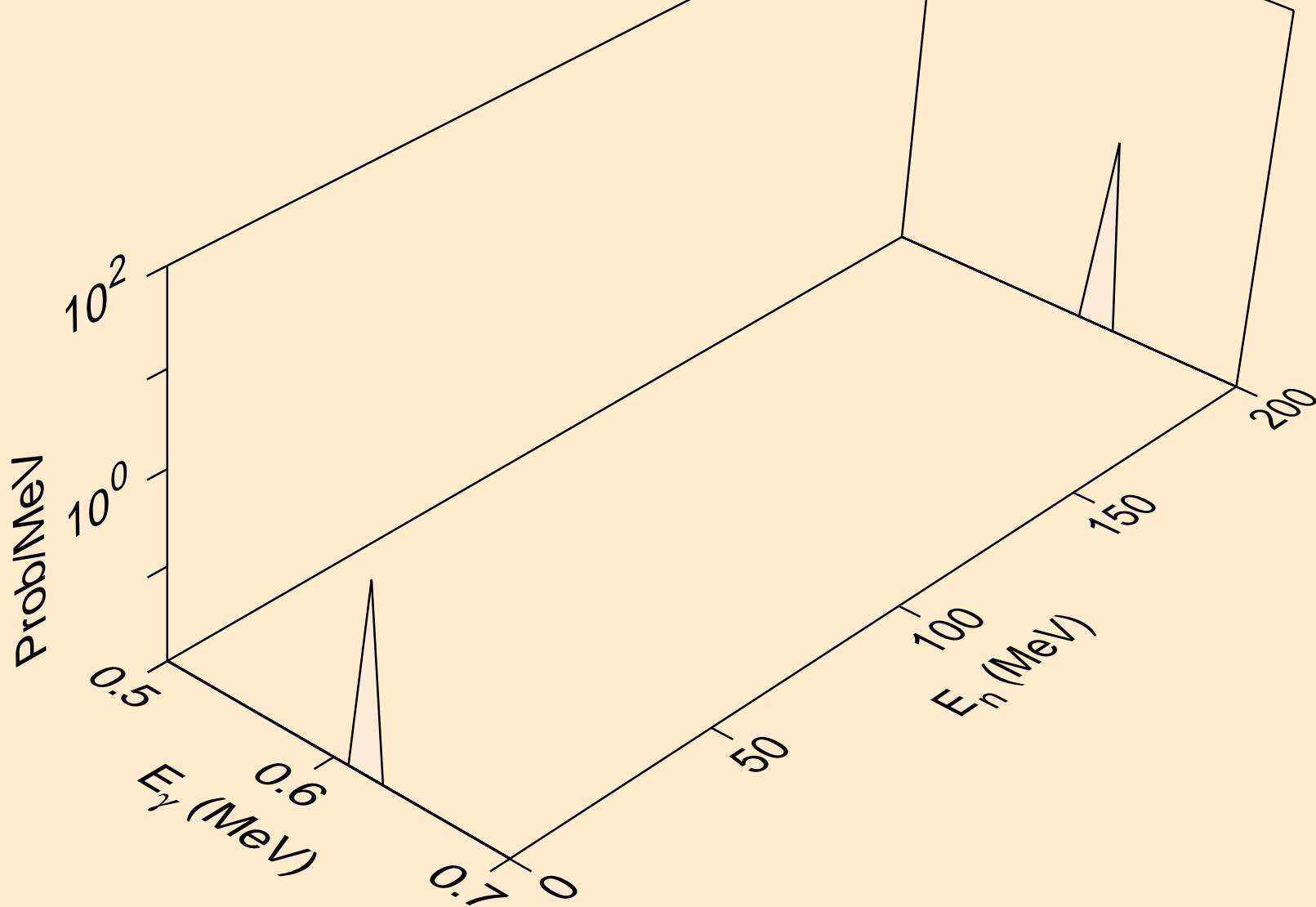

LU162N NEUTRON ACER TENDL-2019 LIBRARY; T=293.16K  
Photon emission for (n,n\*13)

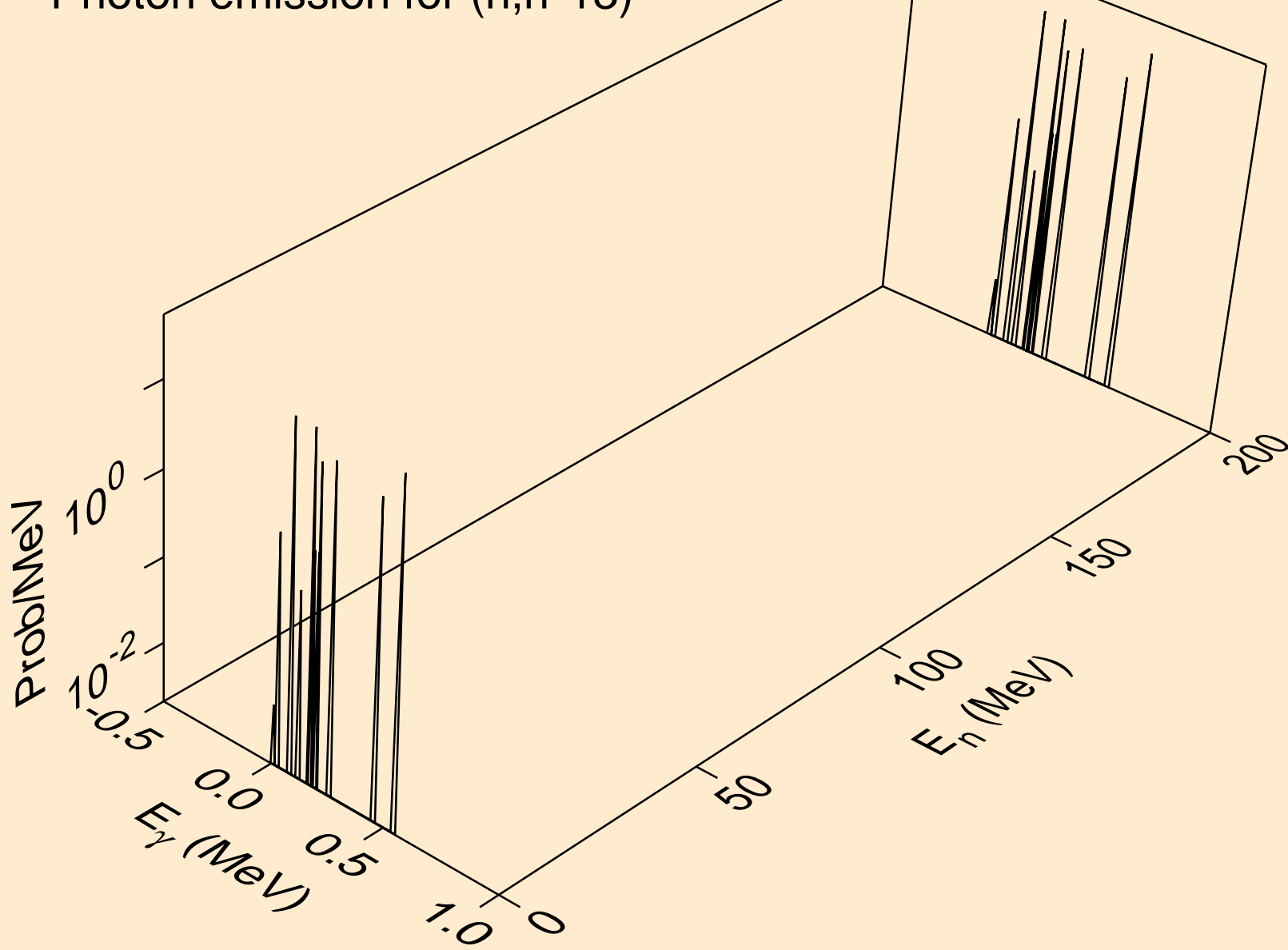



LU162N NEUTRON ACER TENDL-2019 LIBRARY; T=293.16K  
Photon emission for (n,n\*14)

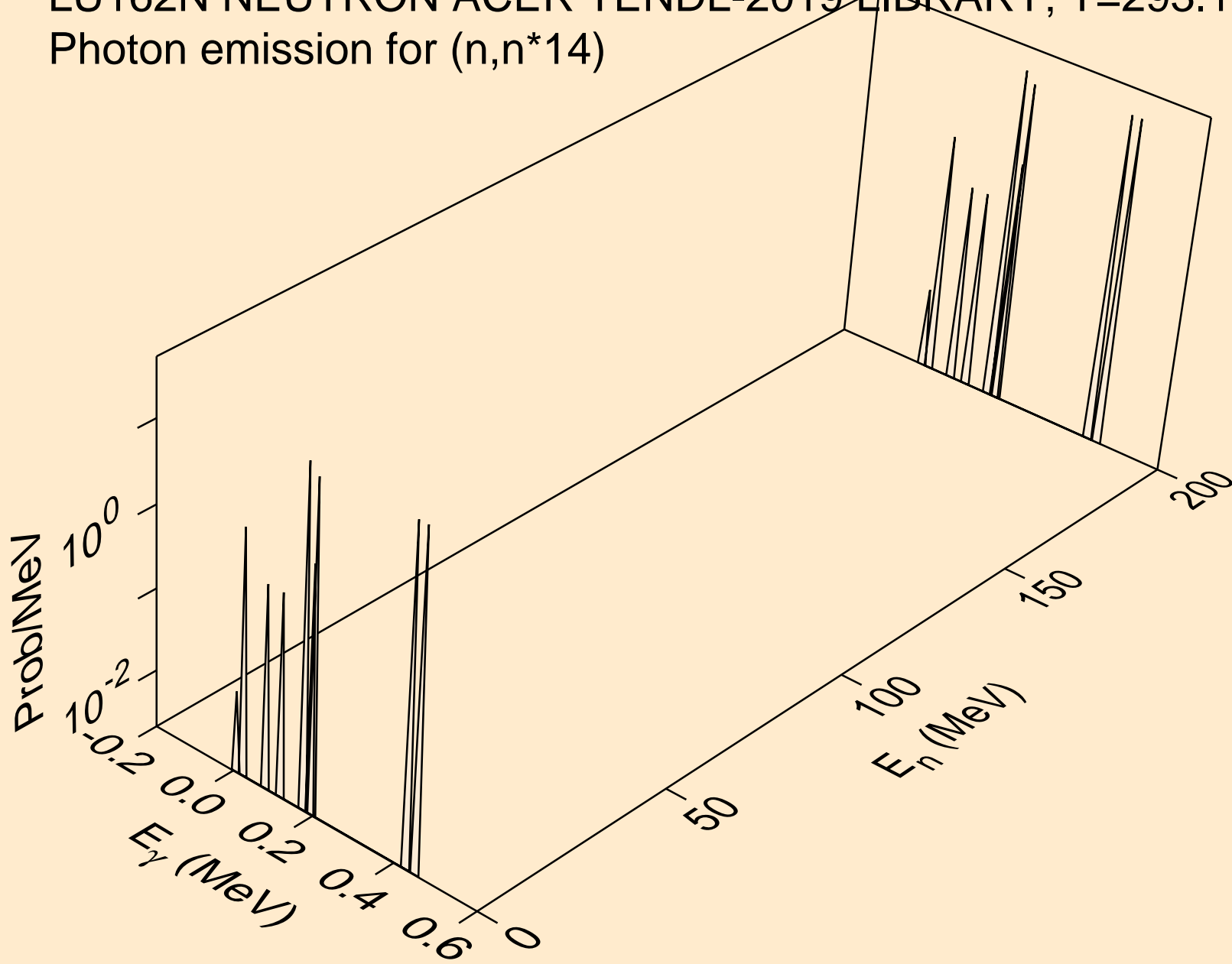

LU162N NEUTRON ACER TENDL-2019 LIBRARY; T=293.16K  
Photon emission for (n,n\*15)

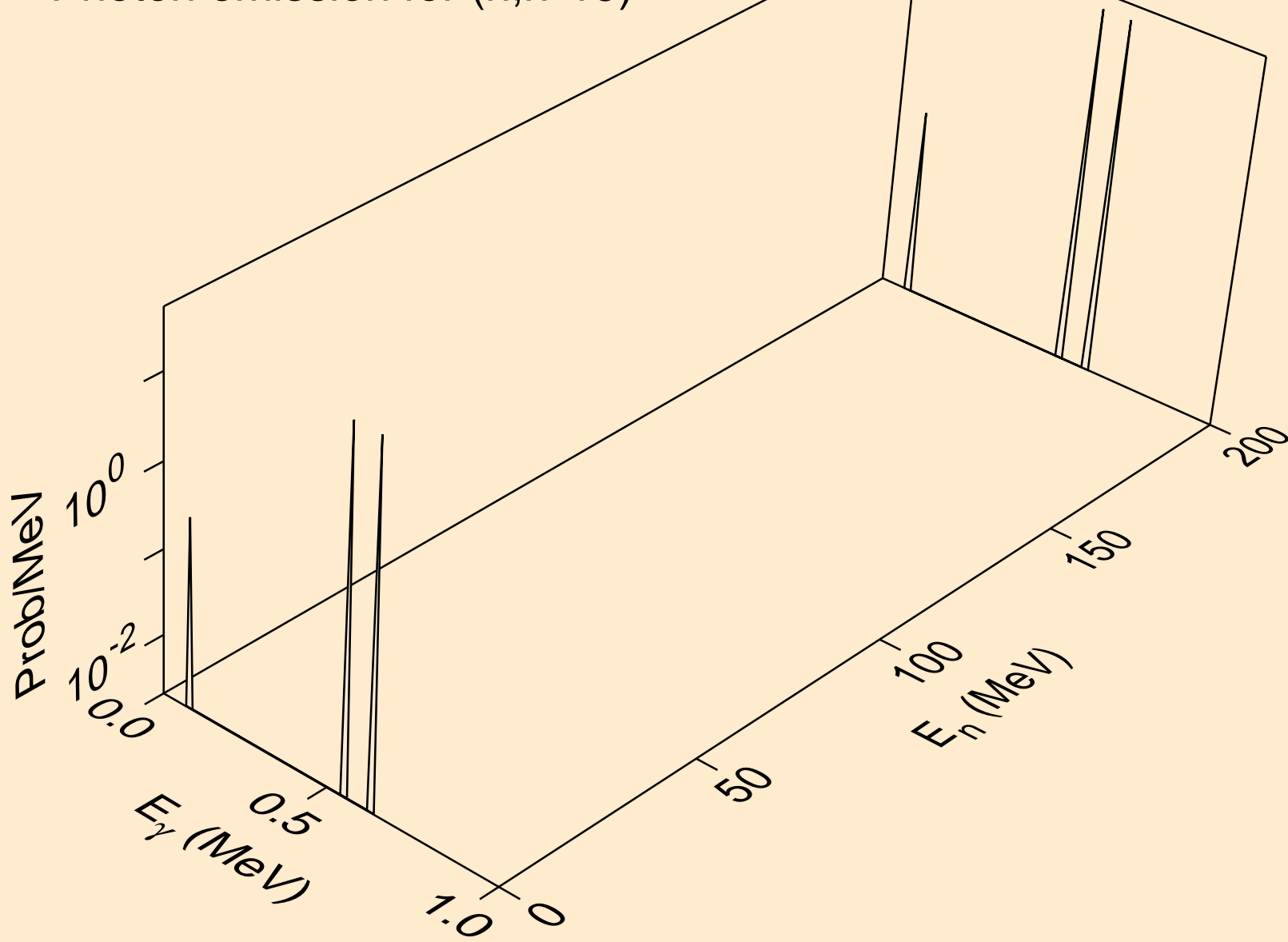

LU162N NEUTRON ACER TENDL-2019 LIBRARY; T=293.16K  
Photon emission for (n,n\*16)

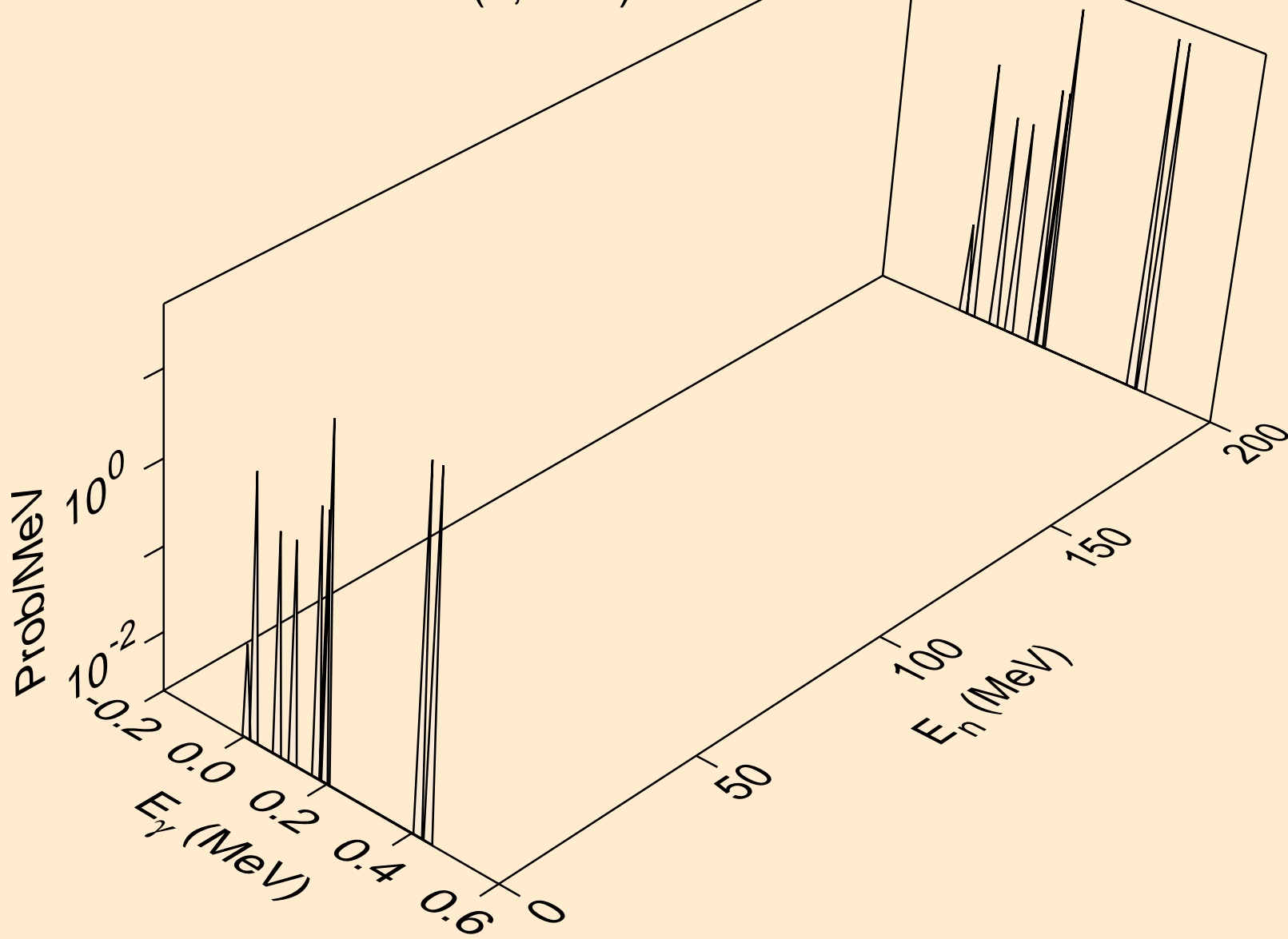

LU162N NEUTRON ACER TENDL-2019 LIBRARY; T=293.16K  
Photon emission for (n,n\*c)

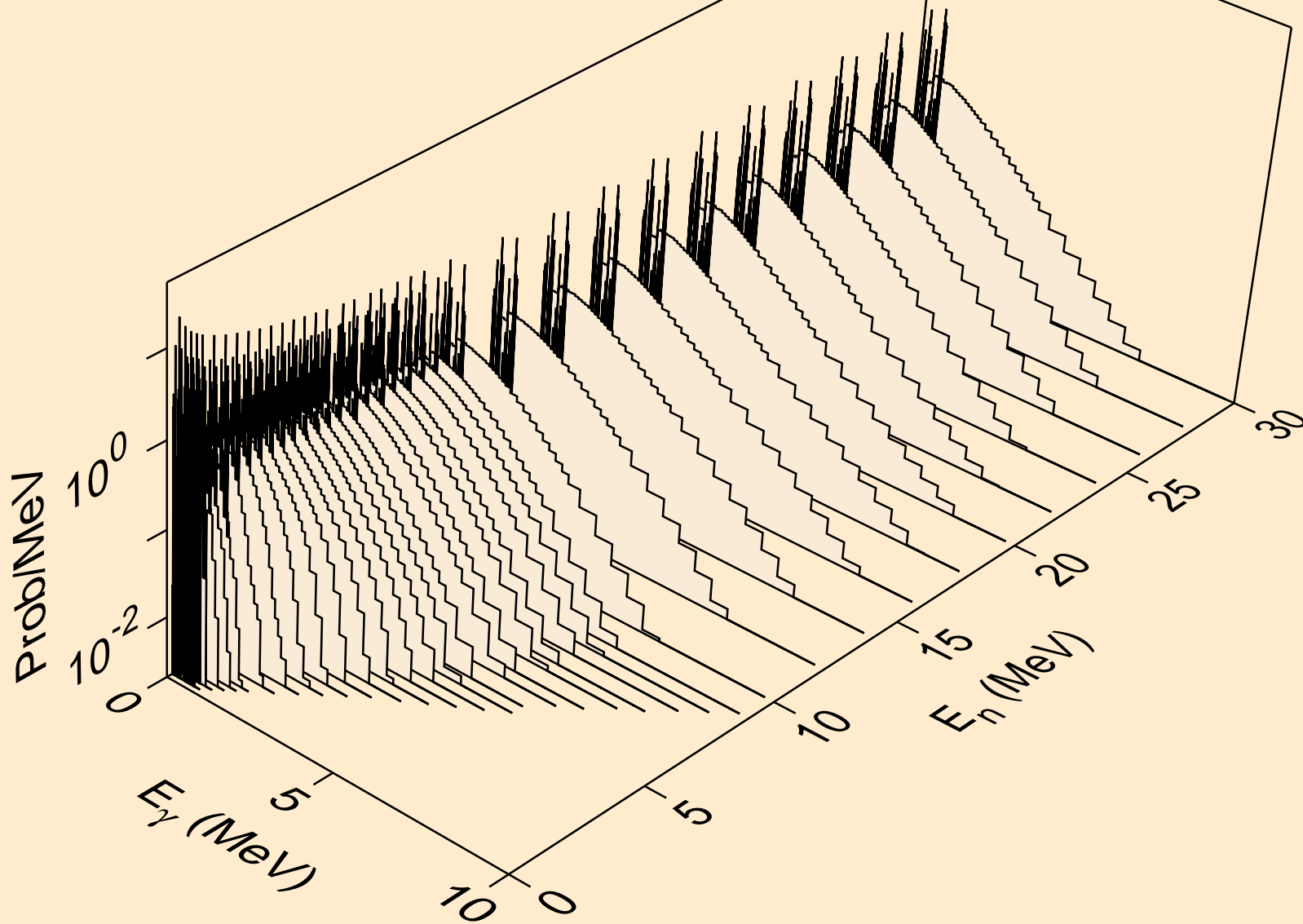

LU162N NEUTRON ACER TENDL-2019 LIBRARY; T=293.16K  
Photon emission for (n,gma)

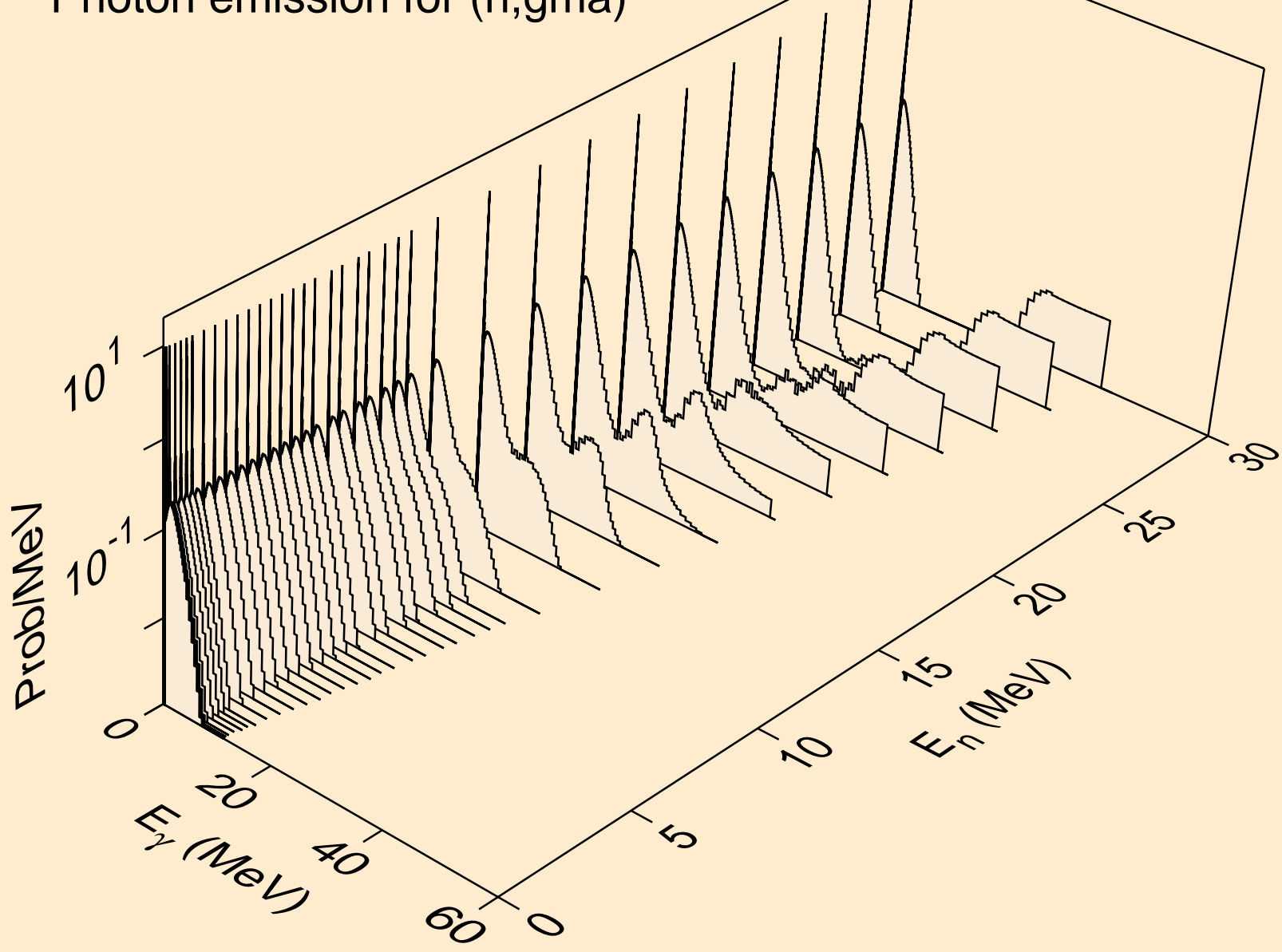

LU162N NEUTRON ACER TENDL-2019 LIBRARY; T=293.16K  
Photon emission for (n,p)

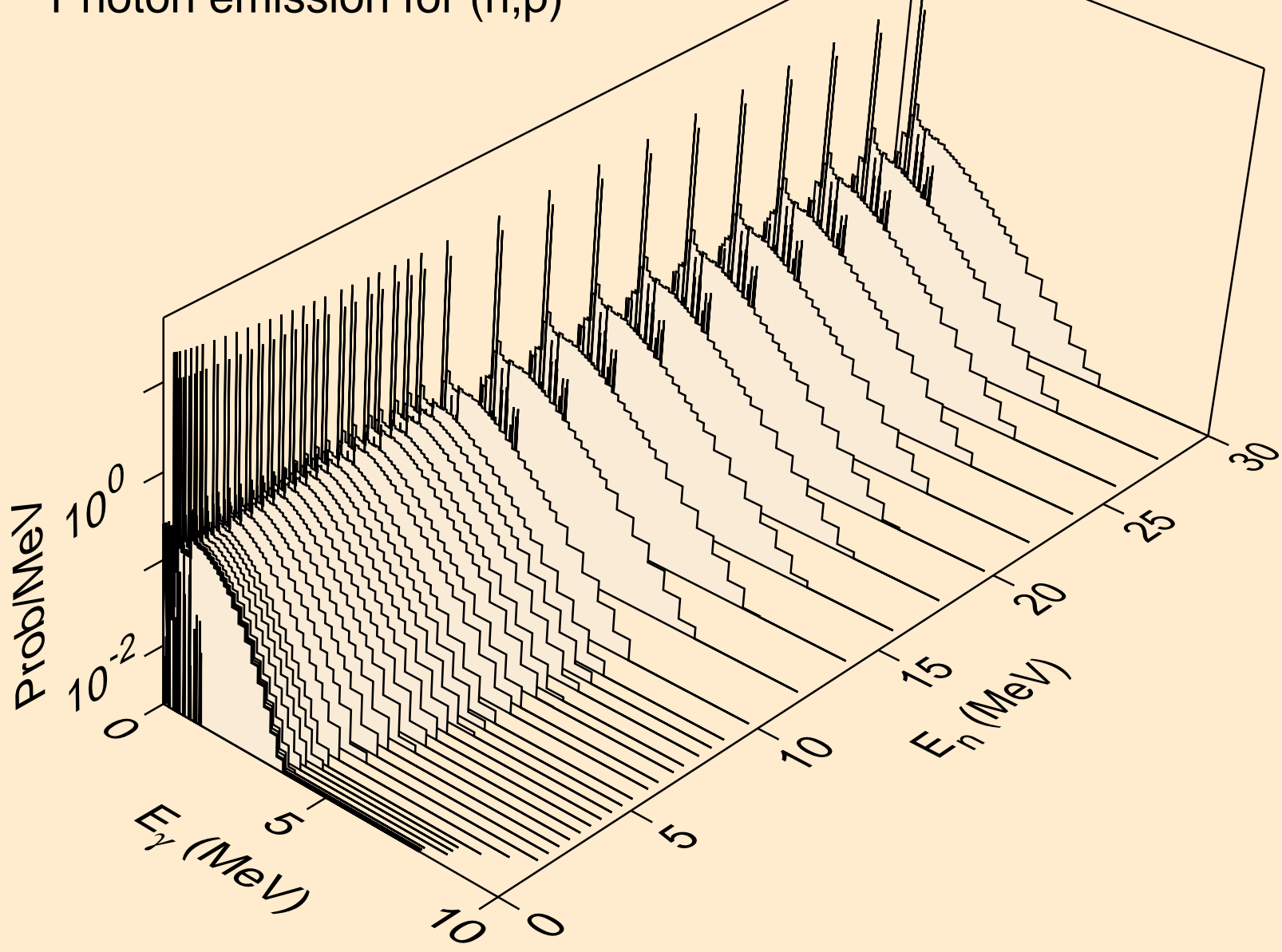

LU162N NEUTRON ACER TENDL-2019 LIBRARY; T=293.16K  
Photon emission for (n,d)

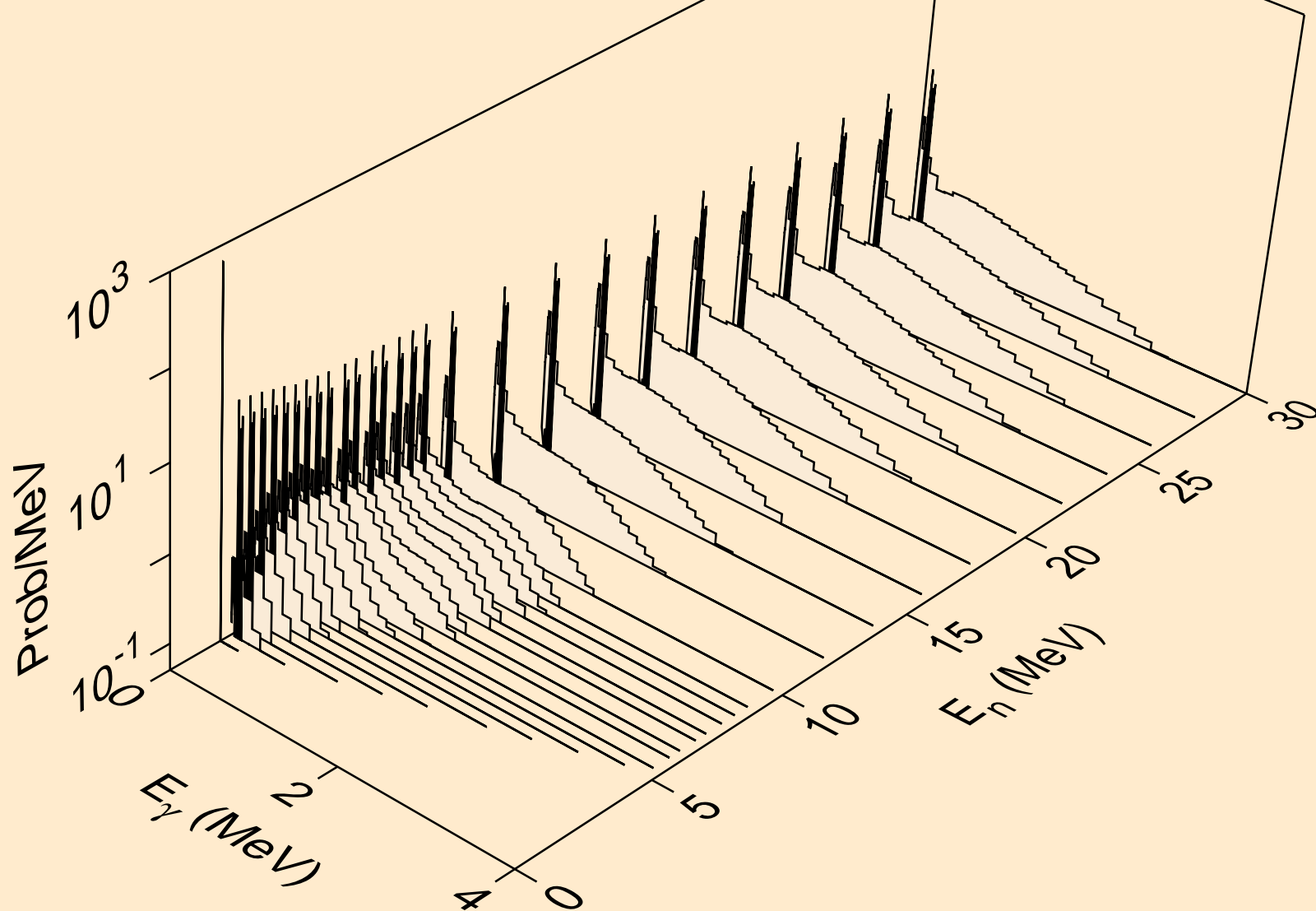

LU162N NEUTRON ACER TENDL-2019 LIBRARY; T=293.16K  
Photon emission for (n,t)

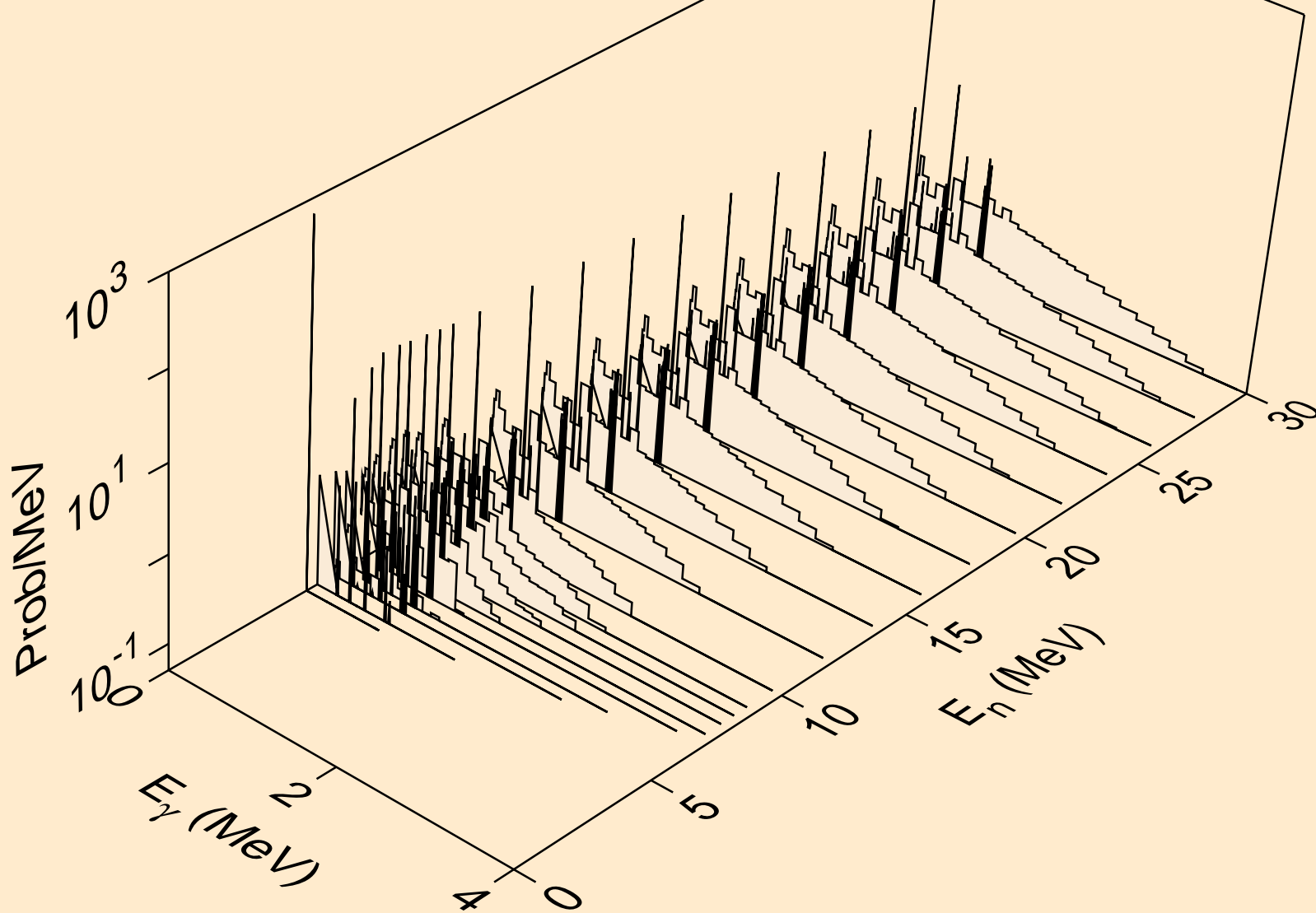



LU162N NEUTRON ACER TENDL-2019 LIBRARY; T=293.16K  
Photon emission for (n,he3)

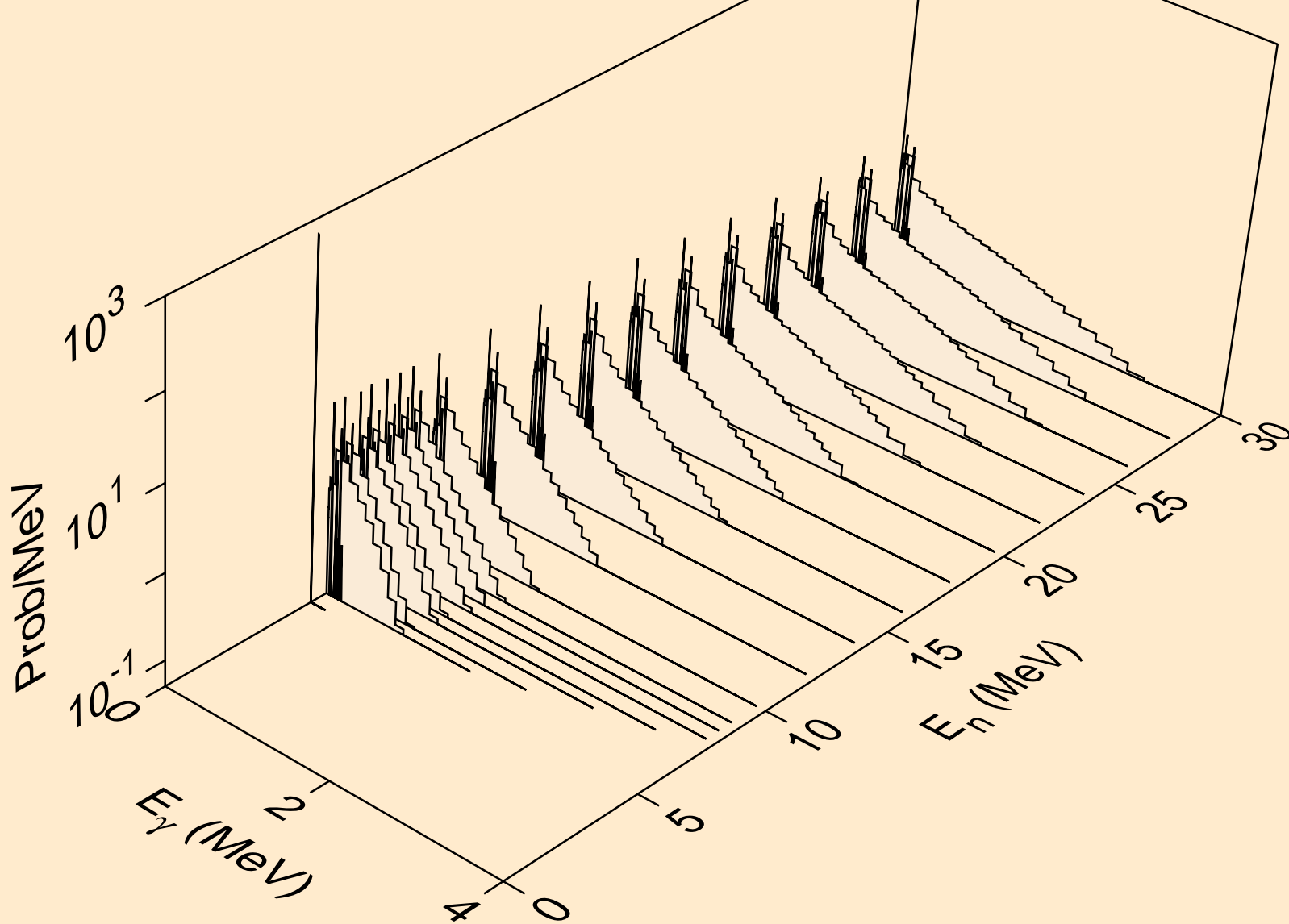

LU162N NEUTRON ACER TENDL-2019 LIBRARY; T=293.16K  
Photon emission for (n,a)

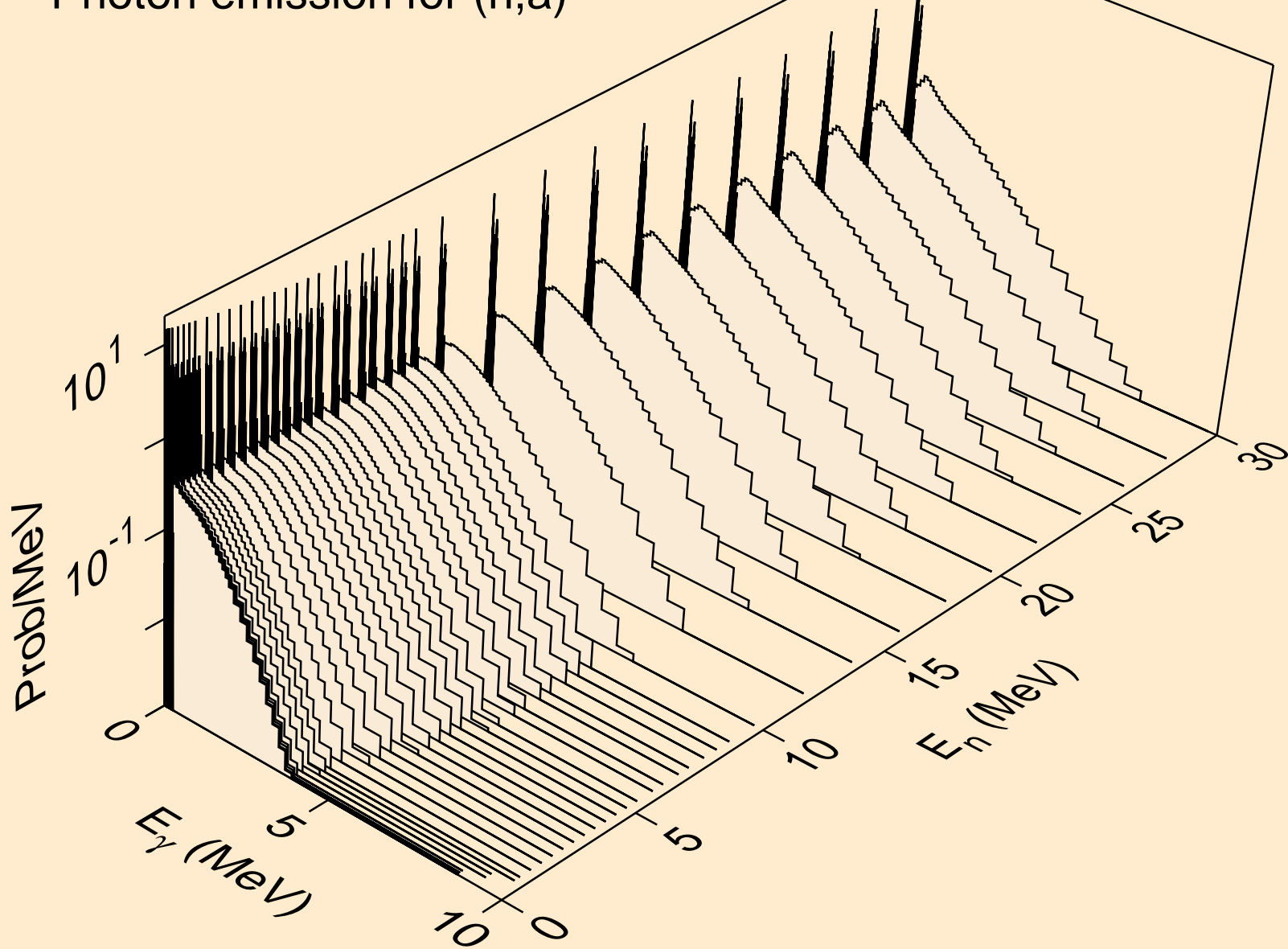

LU162N NEUTRON ACER TENDL-2019 LIBRARY; T=293.16K  
Photon emission for (n,2a)

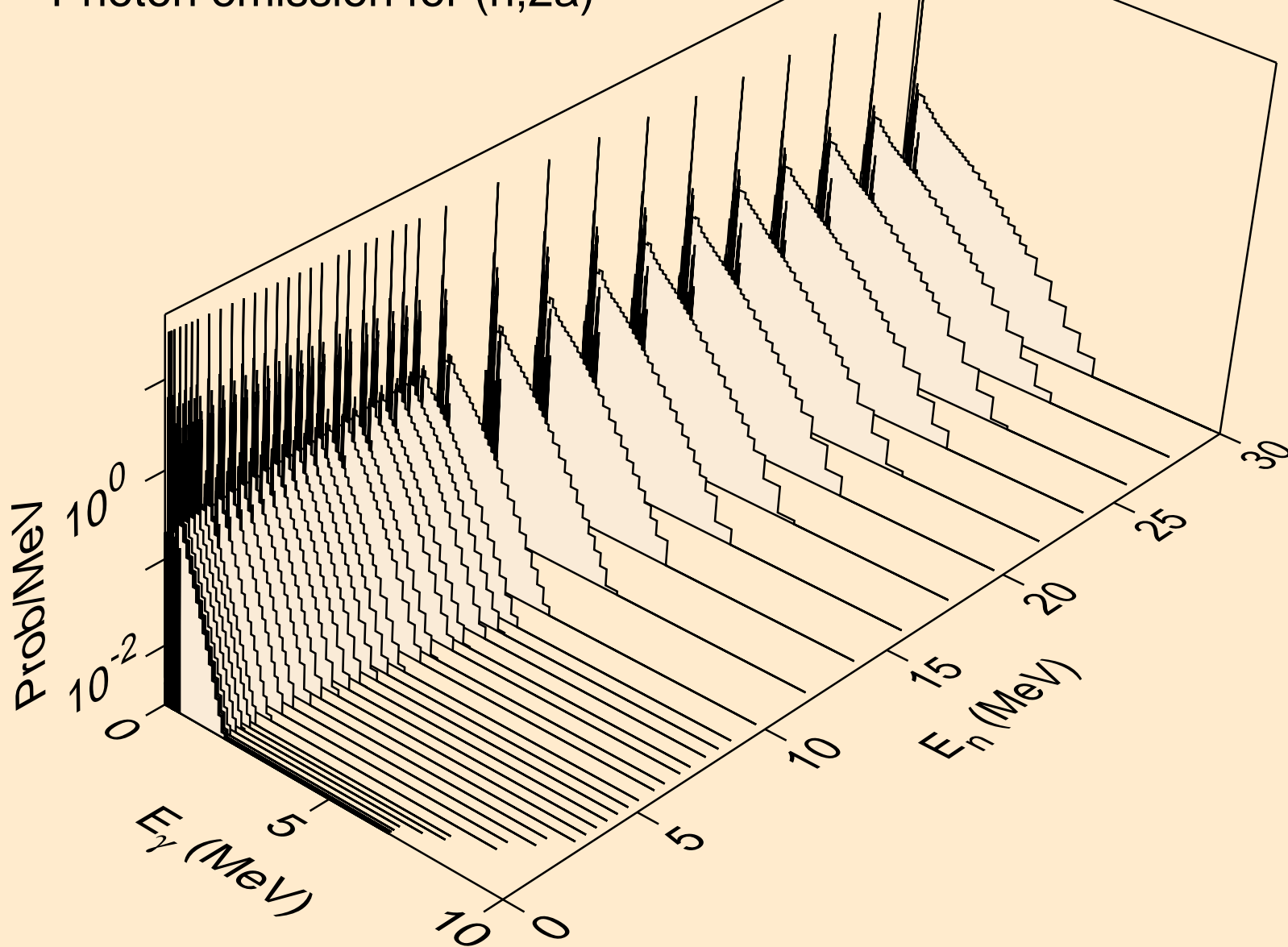

LU162N NEUTRON ACER TENDL-2019 LIBRARY; T=293.16K  
Photon emission for (n,3a)

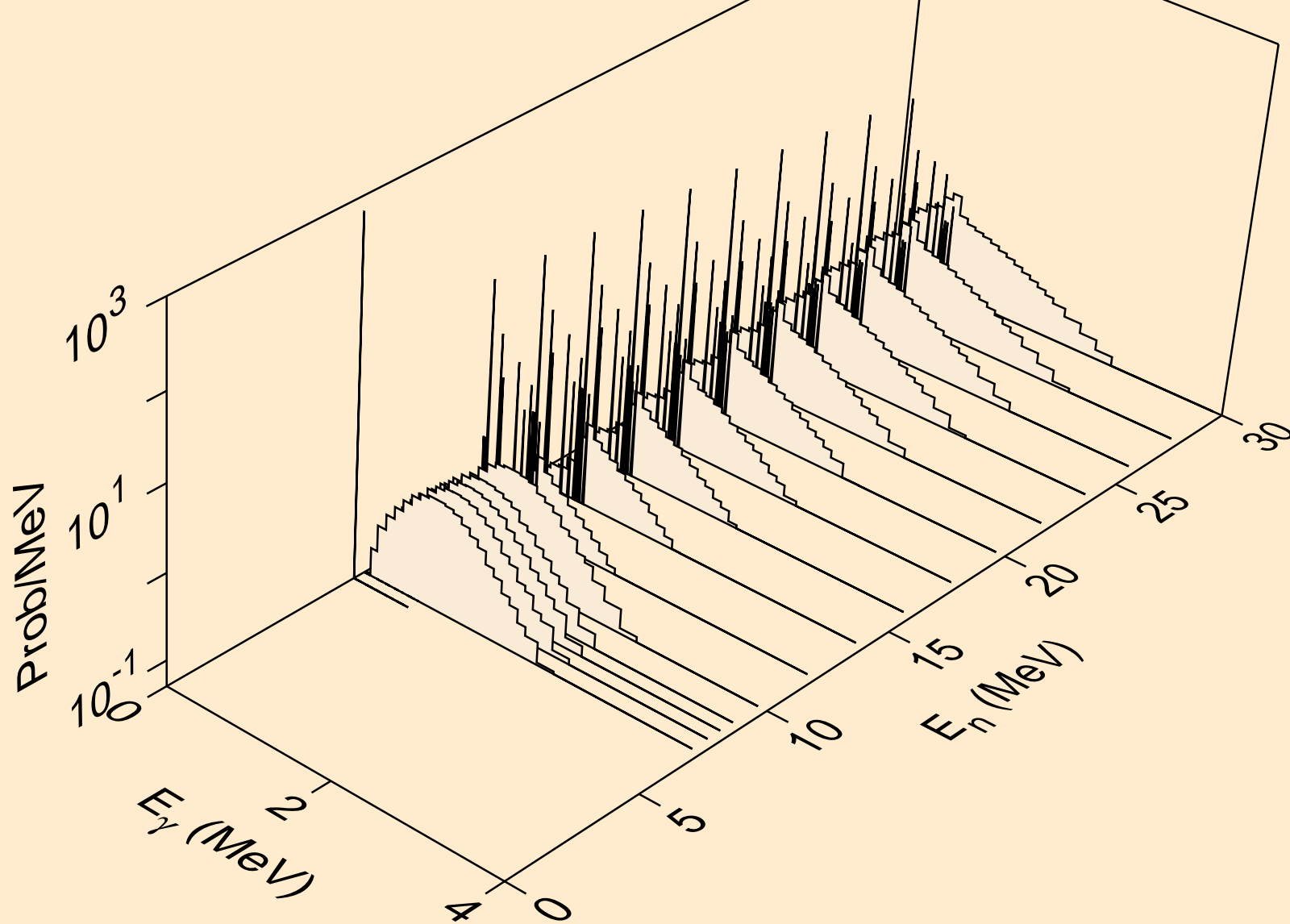

LU162N NEUTRON ACER TENDL-2019 LIBRARY; T=293.16K  
Photon emission for (n,2p)

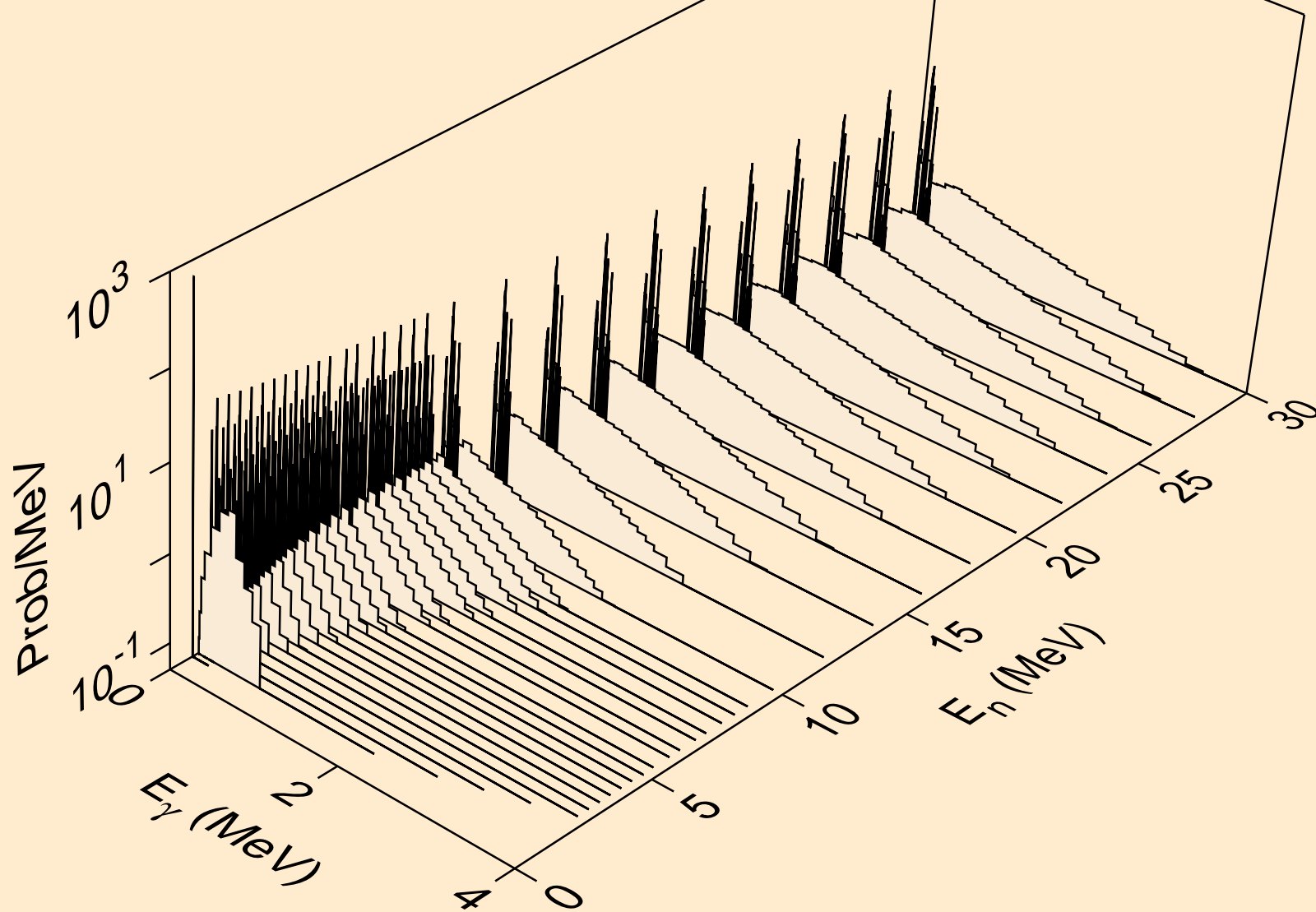

LU162N NEUTRON ACER TENDL-2019 LIBRARY; T=293.16K  
Photon emission for (n,p $\alpha$ )

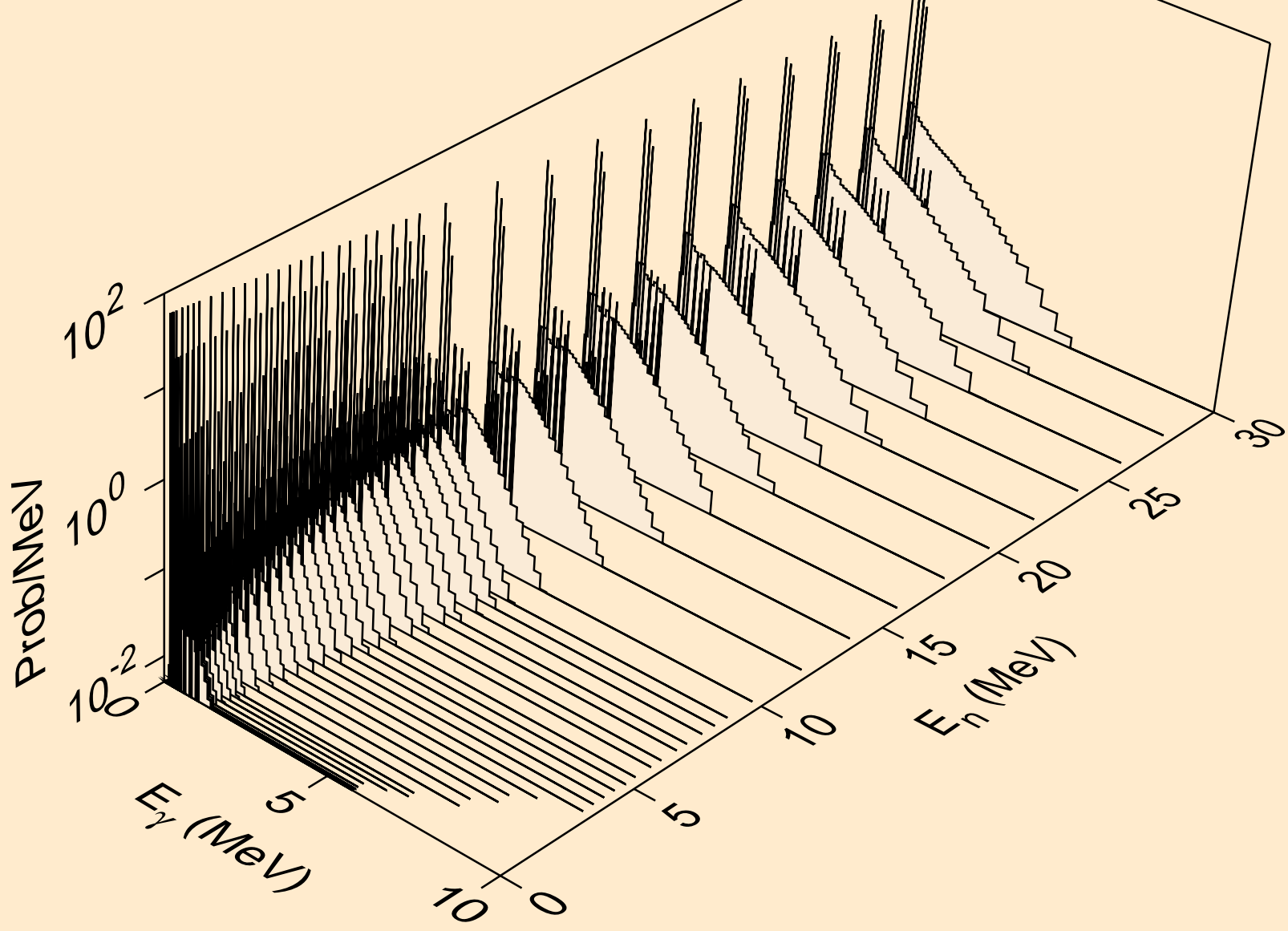

LU162N NEUTRON ACER TENDL-2019 LIBRARY; T=293.16K  
Photon emission for (n,pd)

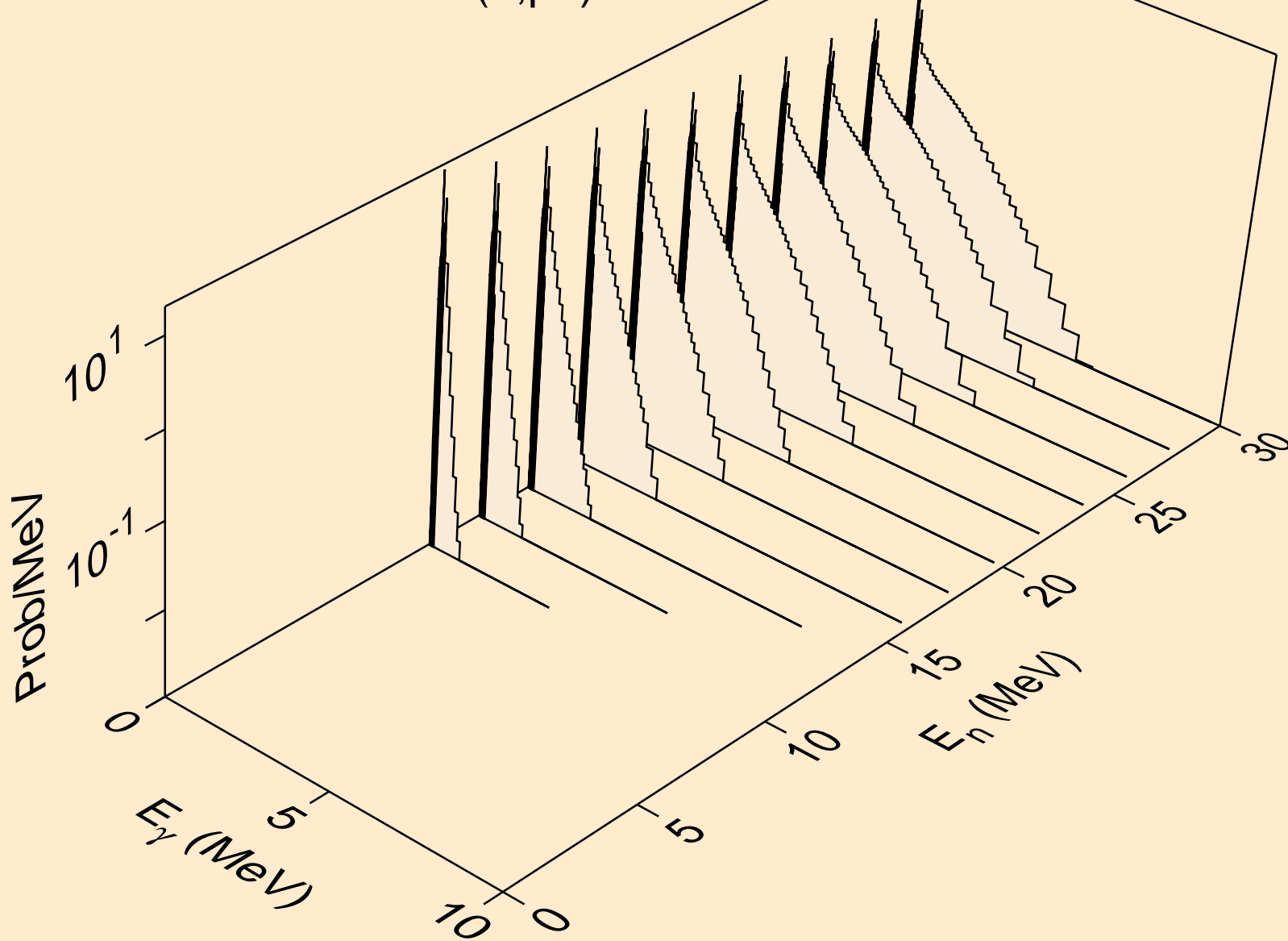

LU162N NEUTRON ACER TENDL-2019 LIBRARY; T=293.16K  
Photon emission for (n,pt)

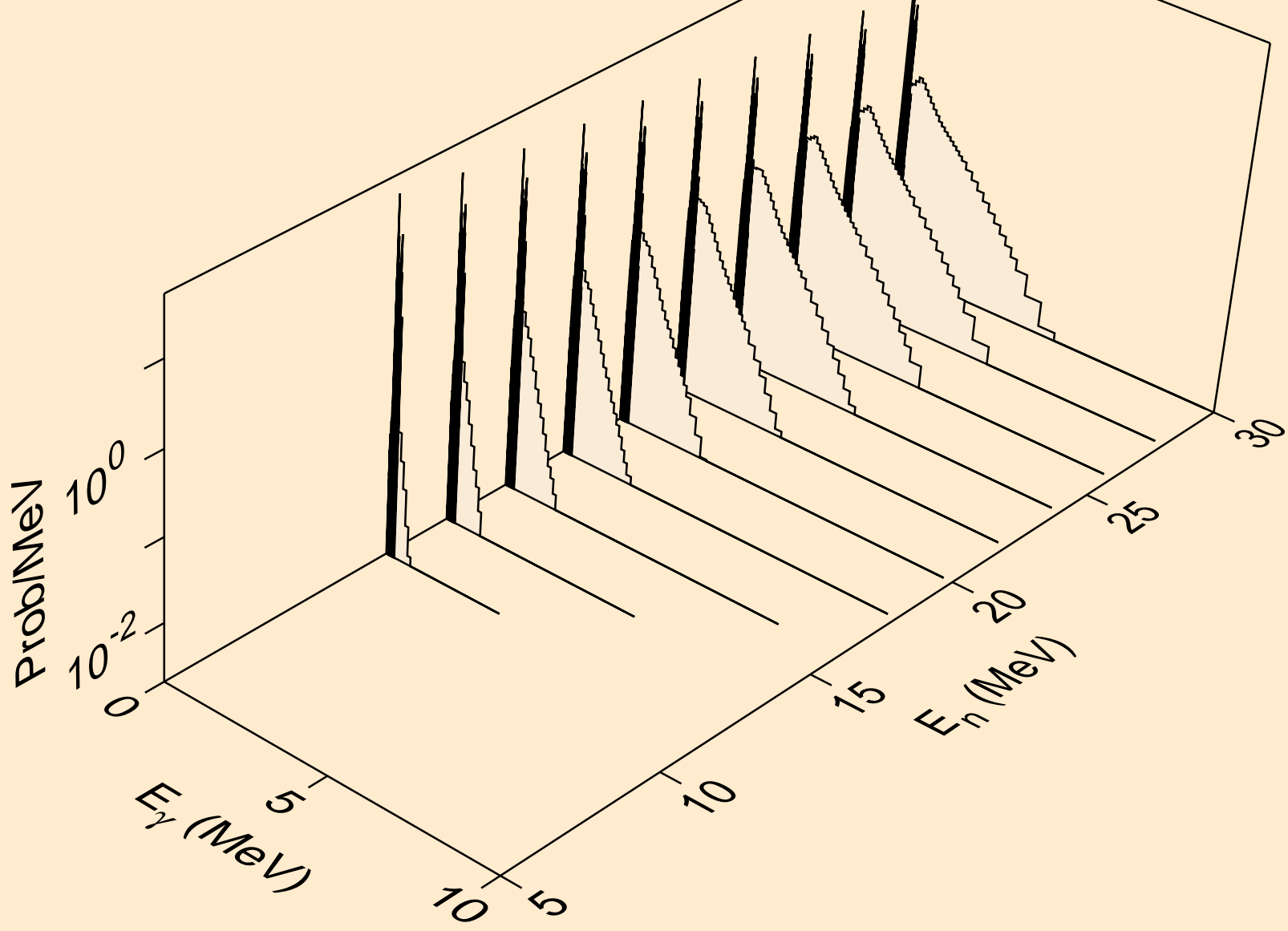



LU162N NEUTRON ACER TENDL-2019 LIBRARY; T=293.16K  
Photon emission for (n,da)

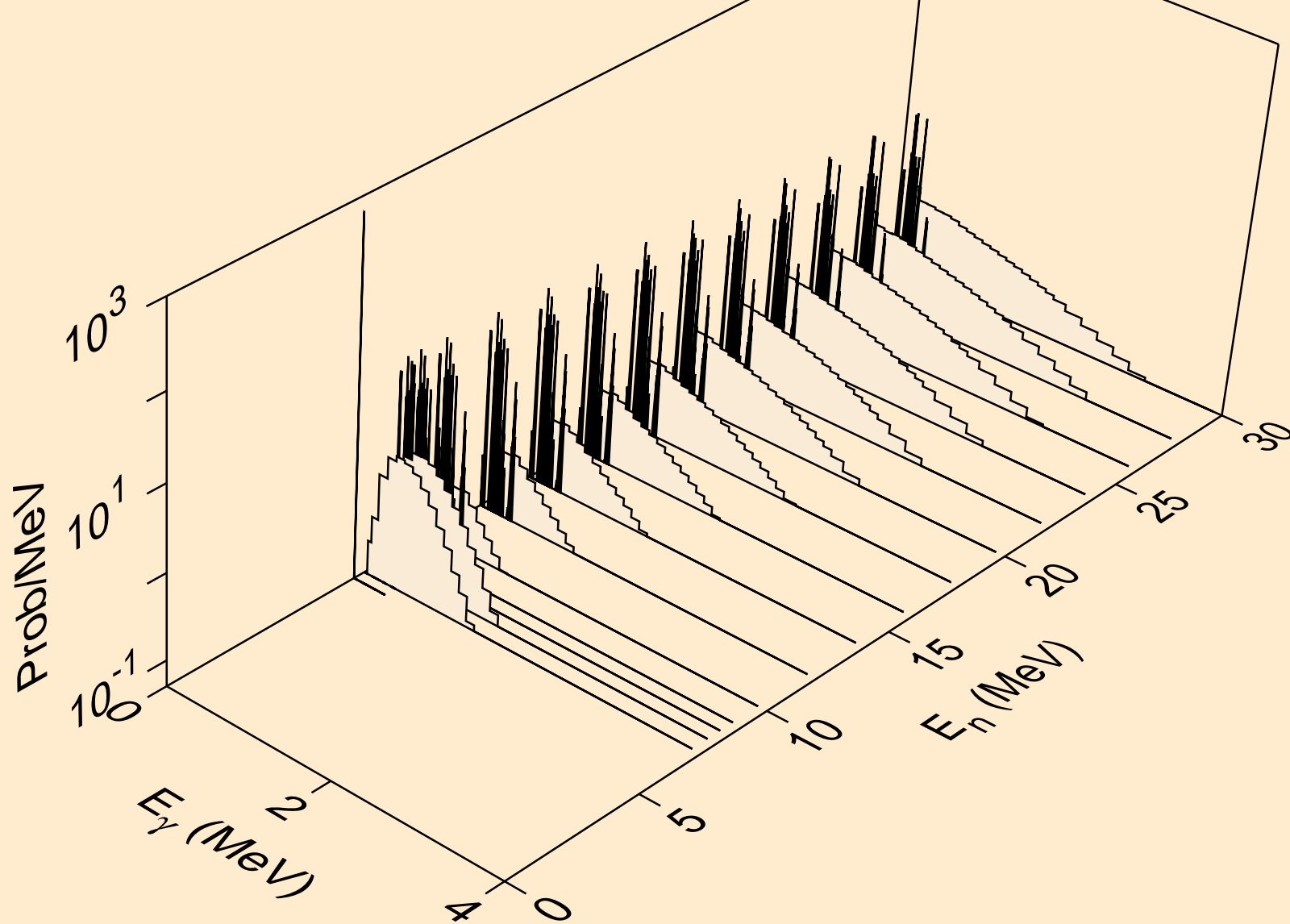

LU162N NEUTRON ACER TENDL-2019 LIBRARY; T=293.16K  
thermal capture photon spectrum

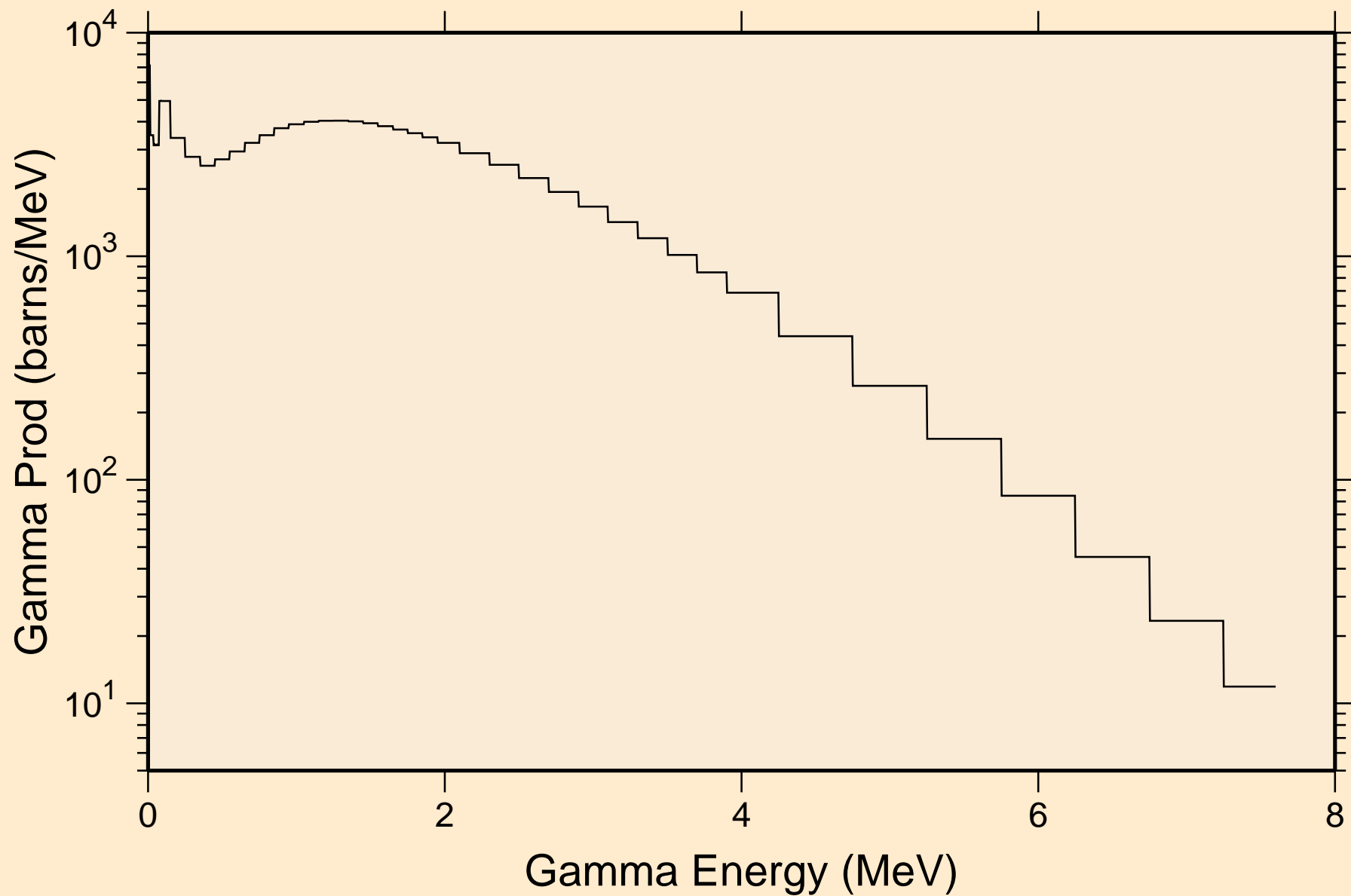

LU162N NEUTRON ACER TENDL-2019 LIBRARY; T=293.16K  
14 MeV photon spectrum

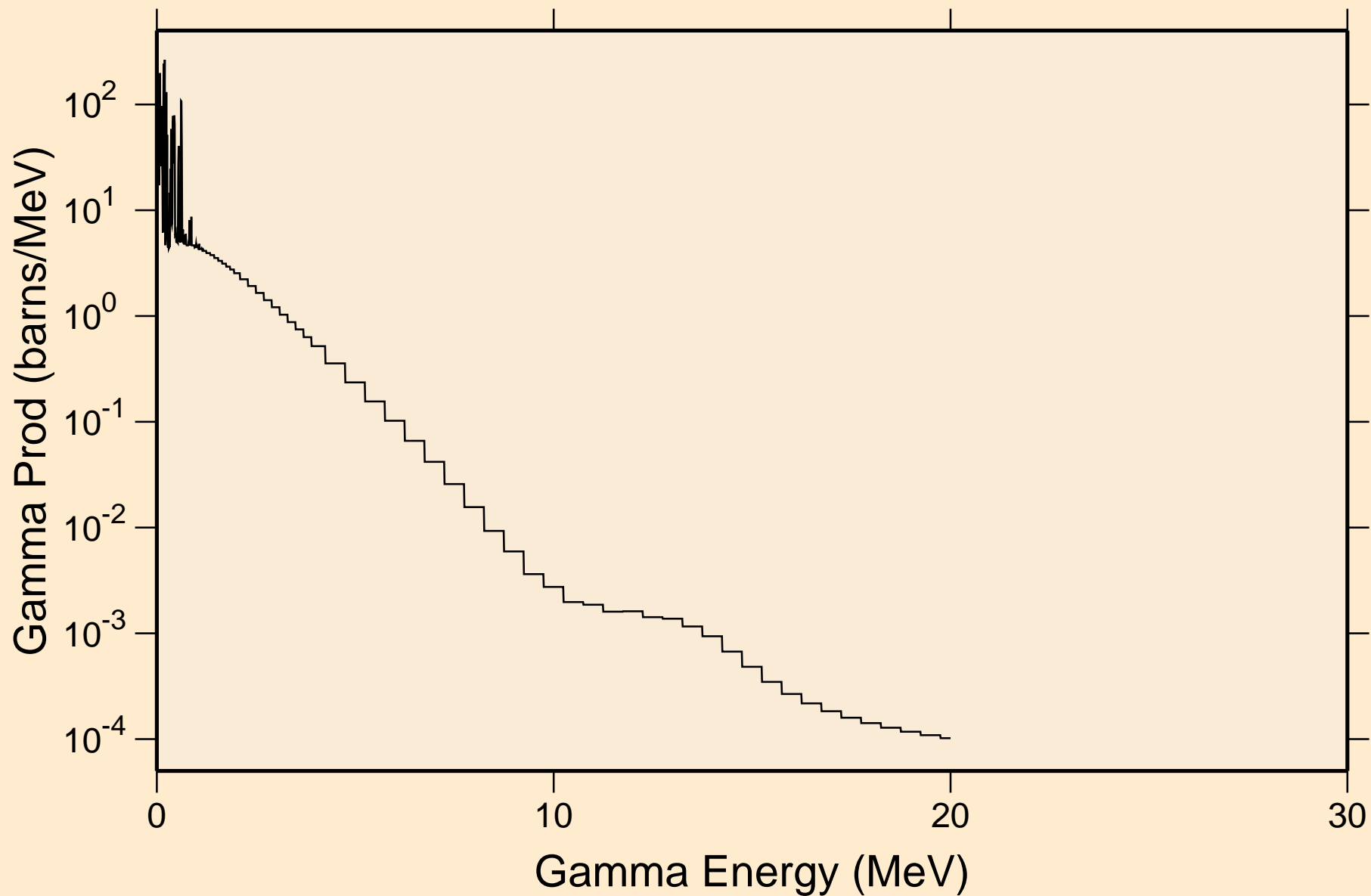

LU162N NEUTRON ACER TENDL-2019 LIBRARY; T=293.16K  
Particle heating contributions

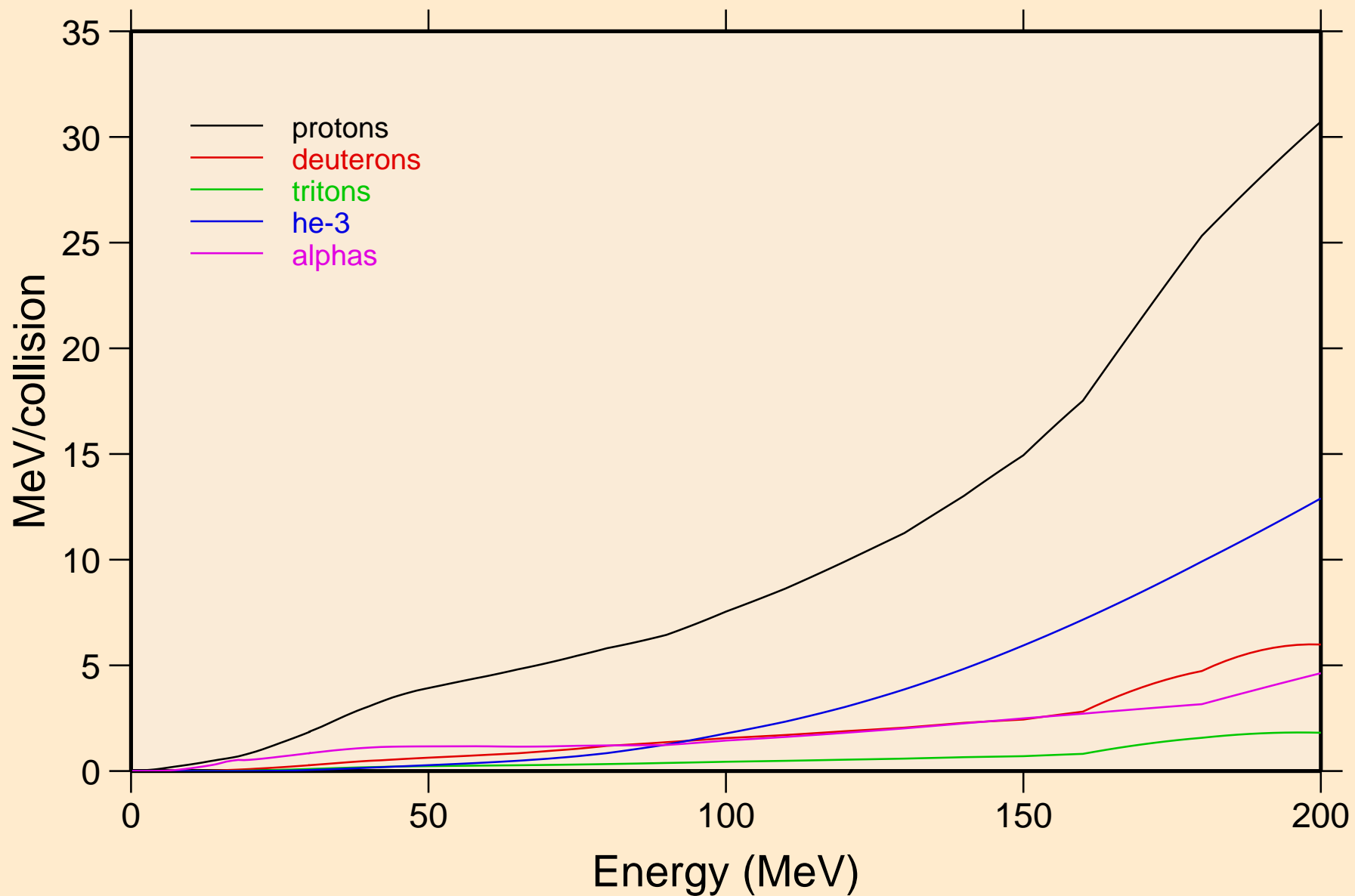

LU162N NEUTRON ACER TENDL-2019 LIBRARY; T=293.16K  
Recoil Heating

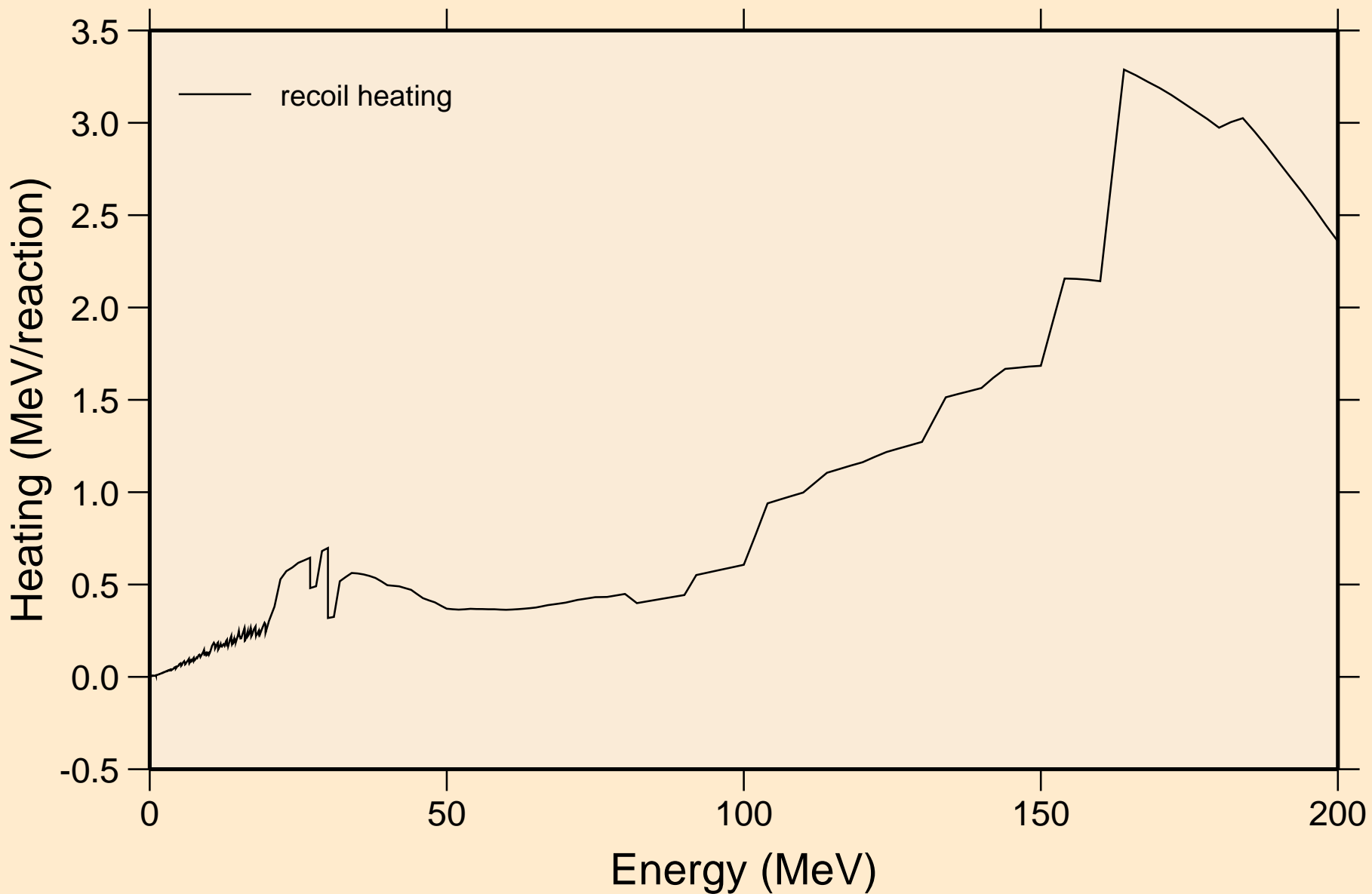

LU162N NEUTRON ACER TENDL-2019 LIBRARY; T=293.16K  
Particle production cross sections

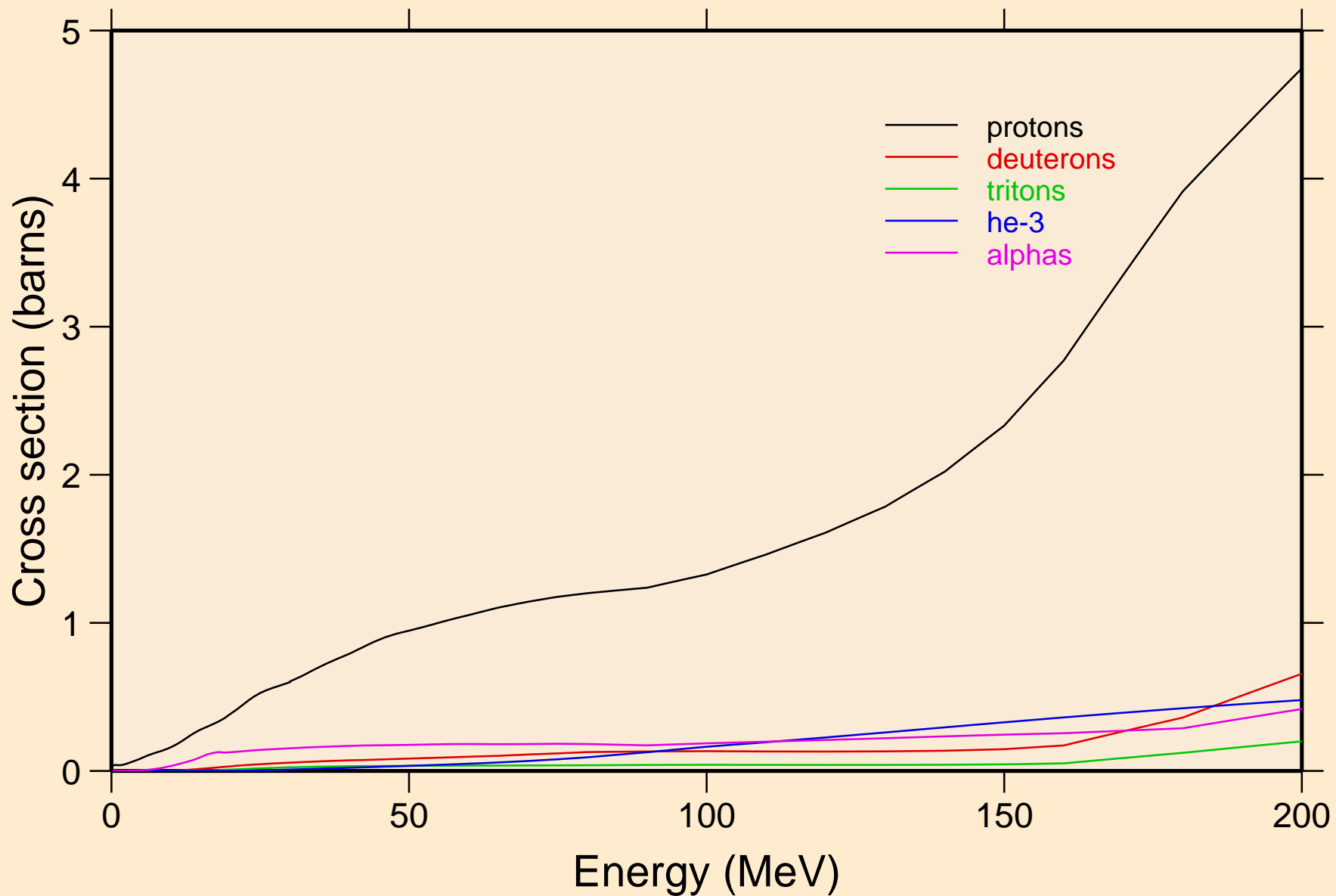

LU162N NEUTRON ACER TENDL-2019 LIBRARY; T=293.16K  
protons from (n,x)

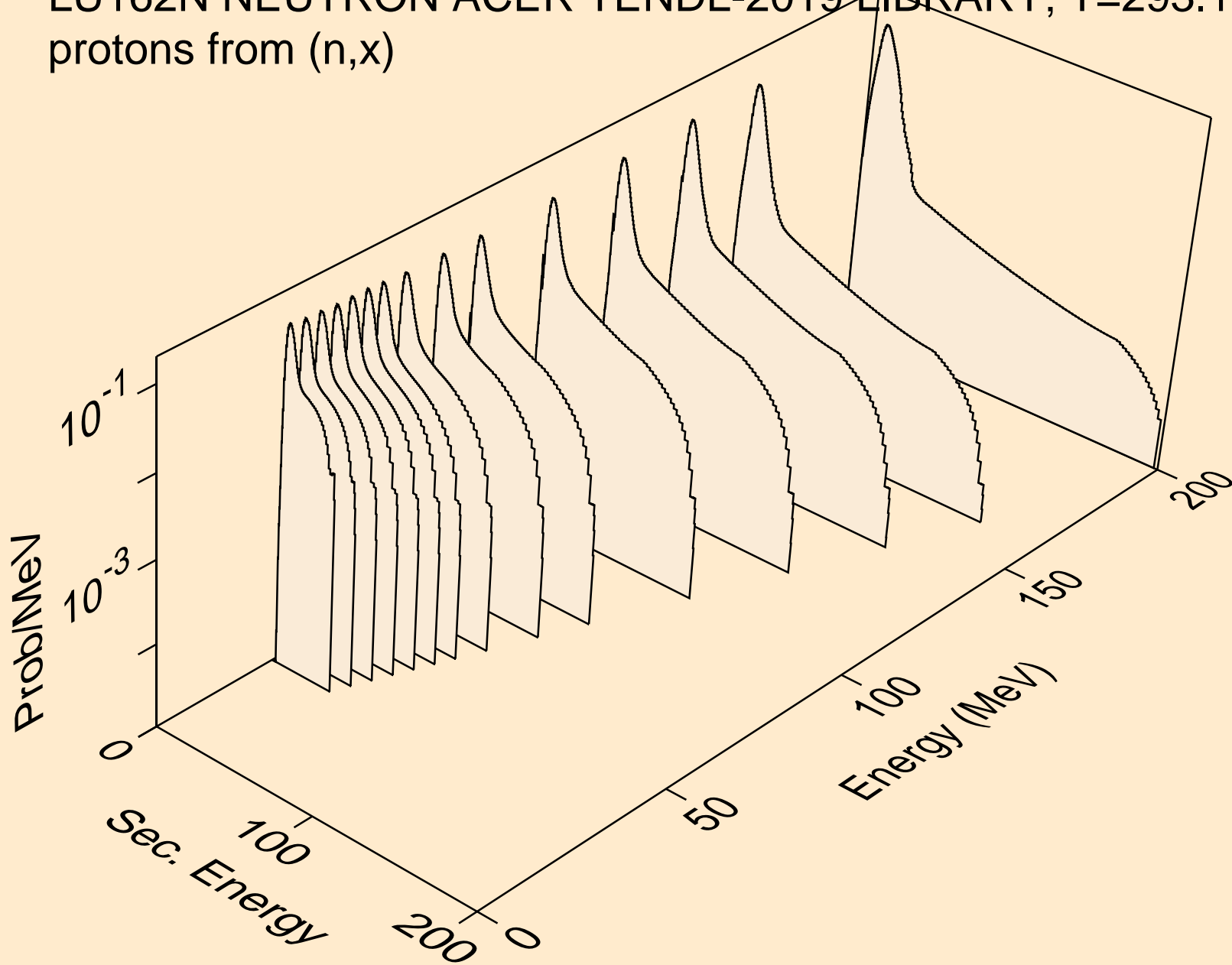

LU162N NEUTRON ACER TENDL-2019 LIBRARY; T=293.16K  
protons from (n,n\*)p

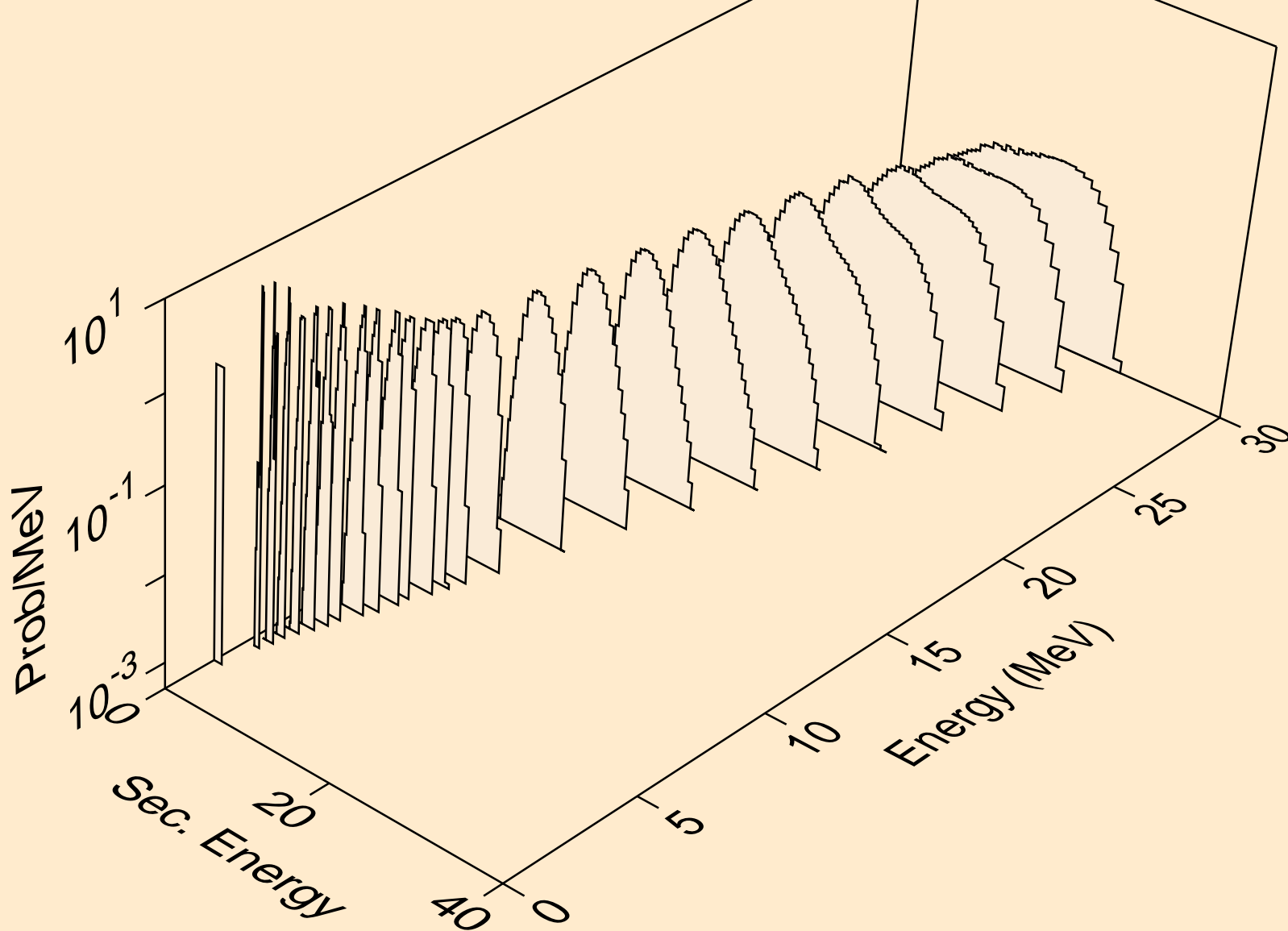



LU162N NEUTRON ACER TENDL-2019 LIBRARY; T=293.16K  
protons from (n,2np)

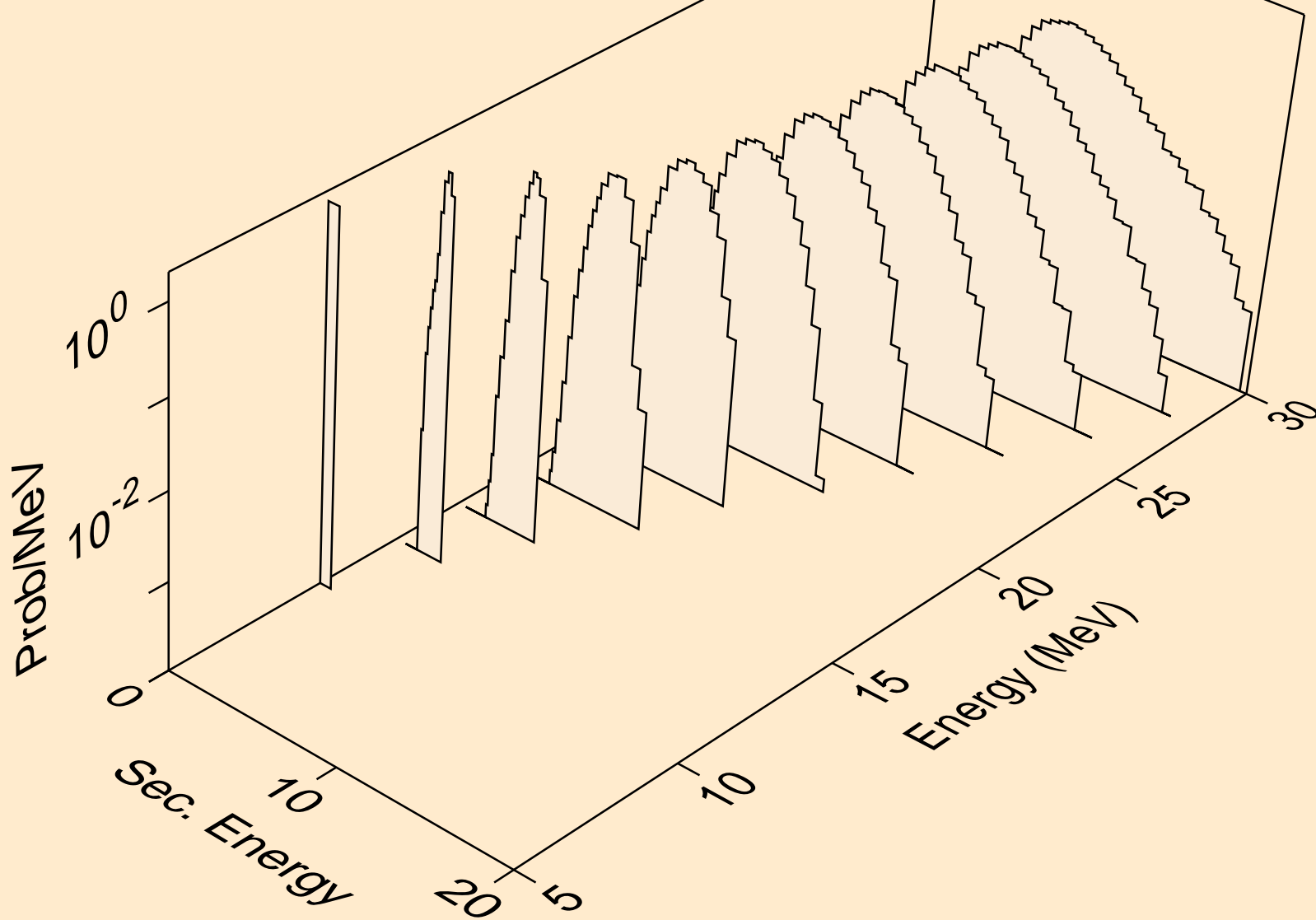

LU162N NEUTRON ACER TENDL-2019 LIBRARY; T=293.16K  
protons from (n,3np)

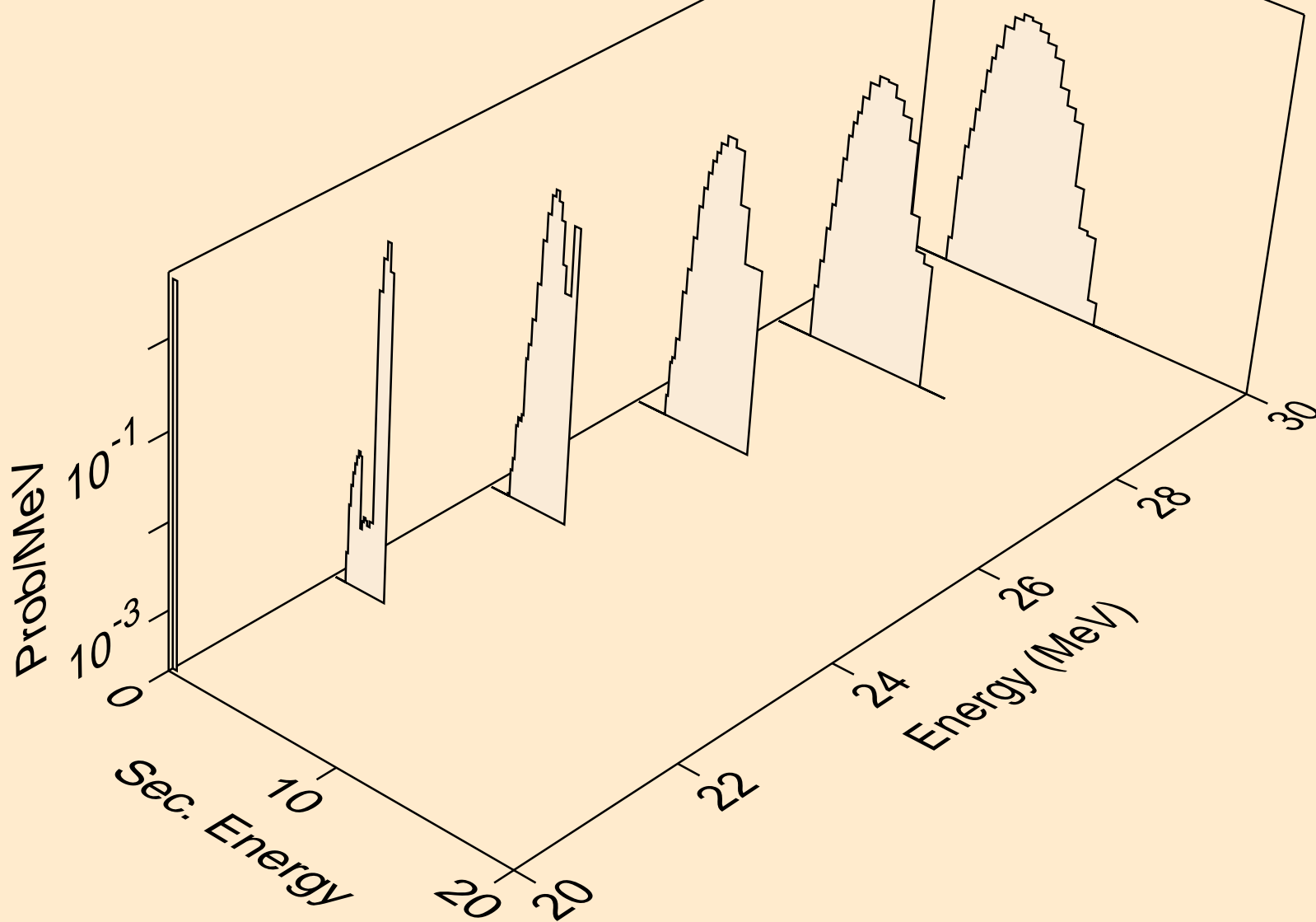

LU162N NEUTRON ACER TENDL-2019 LIBRARY; T=293.16K  
protons from (n,2np)

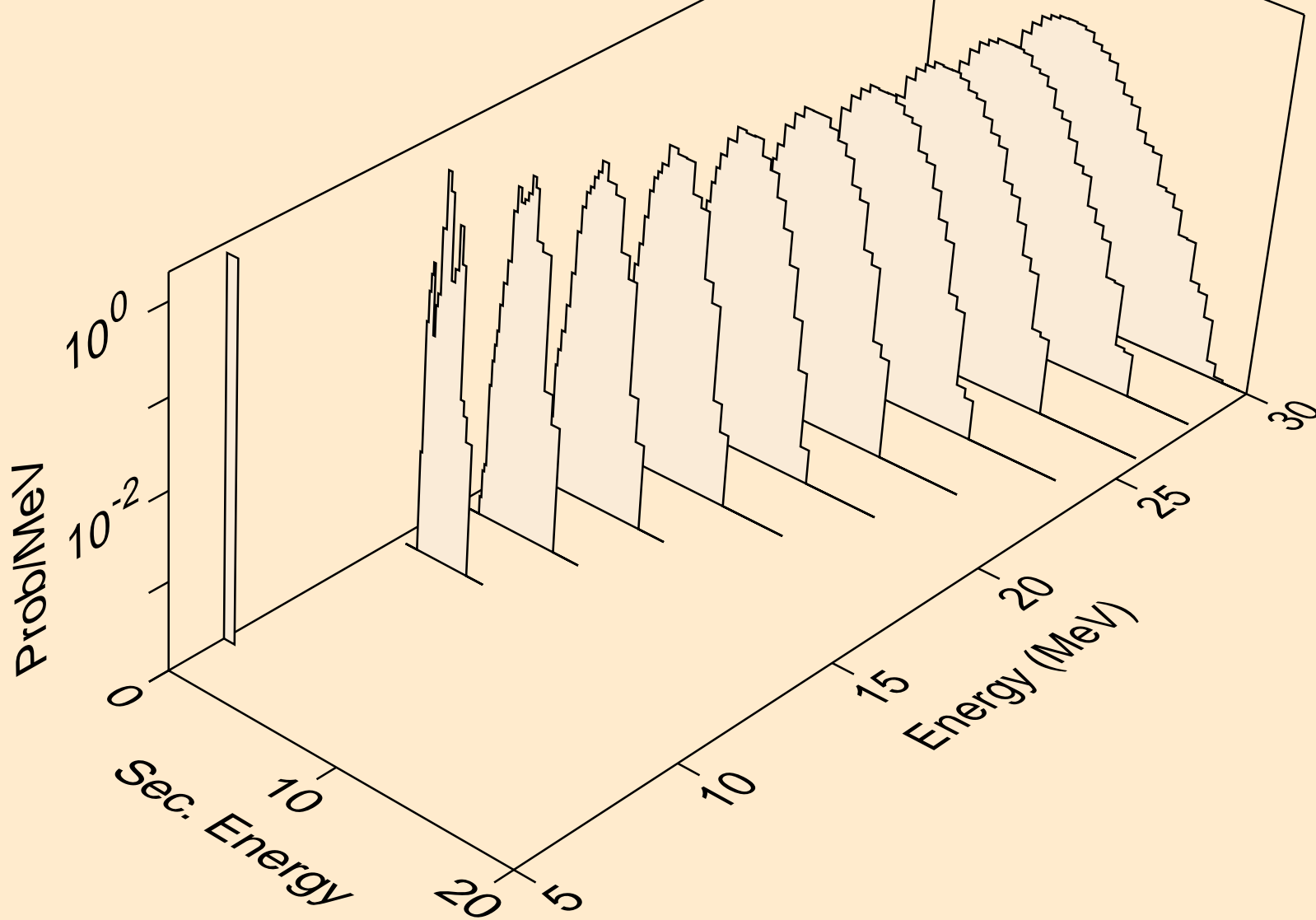

LU162N NEUTRON ACER TENDL-2019 LIBRARY; T=293.16K  
protons from (n,npa)

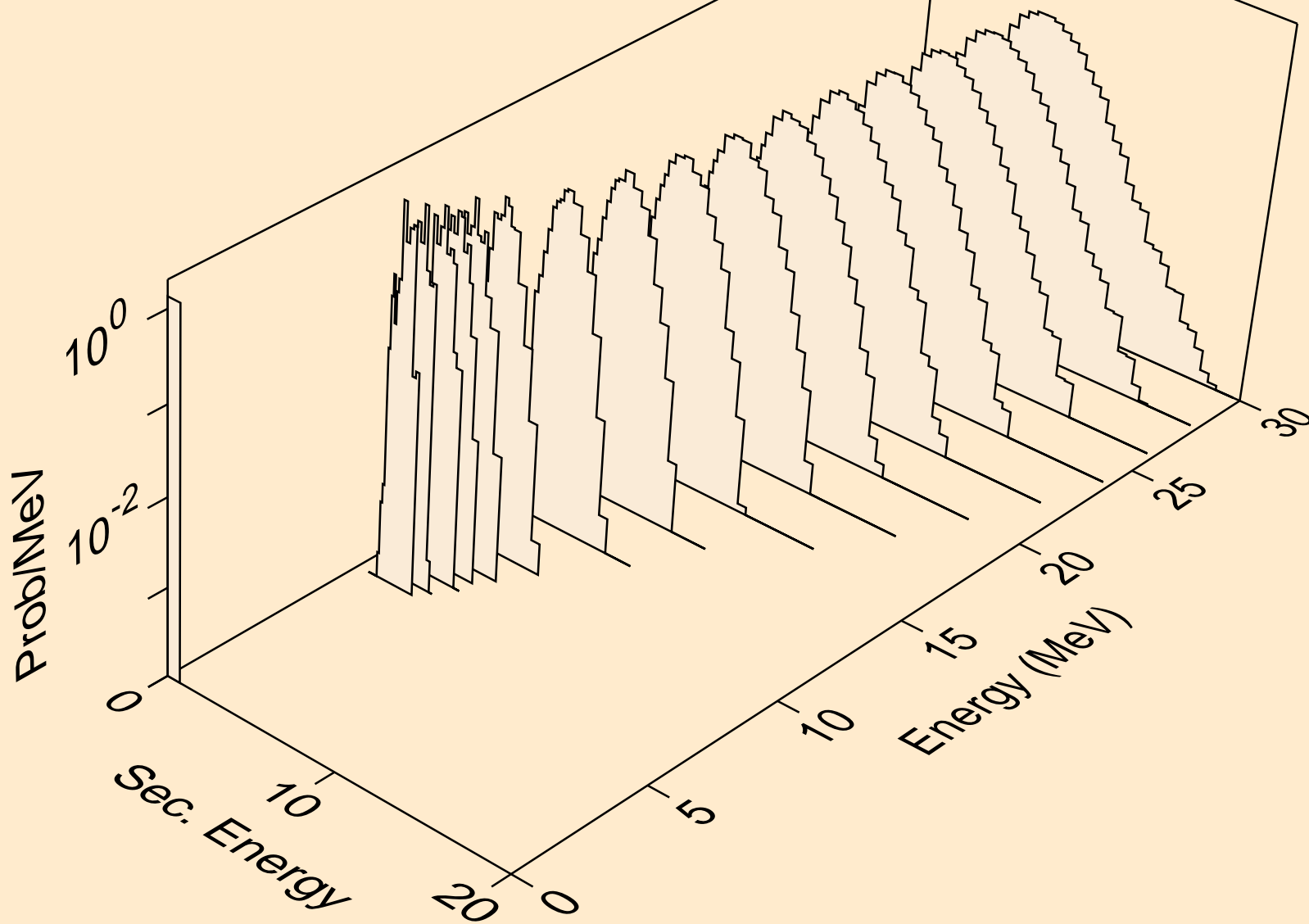

LU162N NEUTRON ACER TENDL-2019 LIBRARY; T=293.16K  
protons from (n,p)

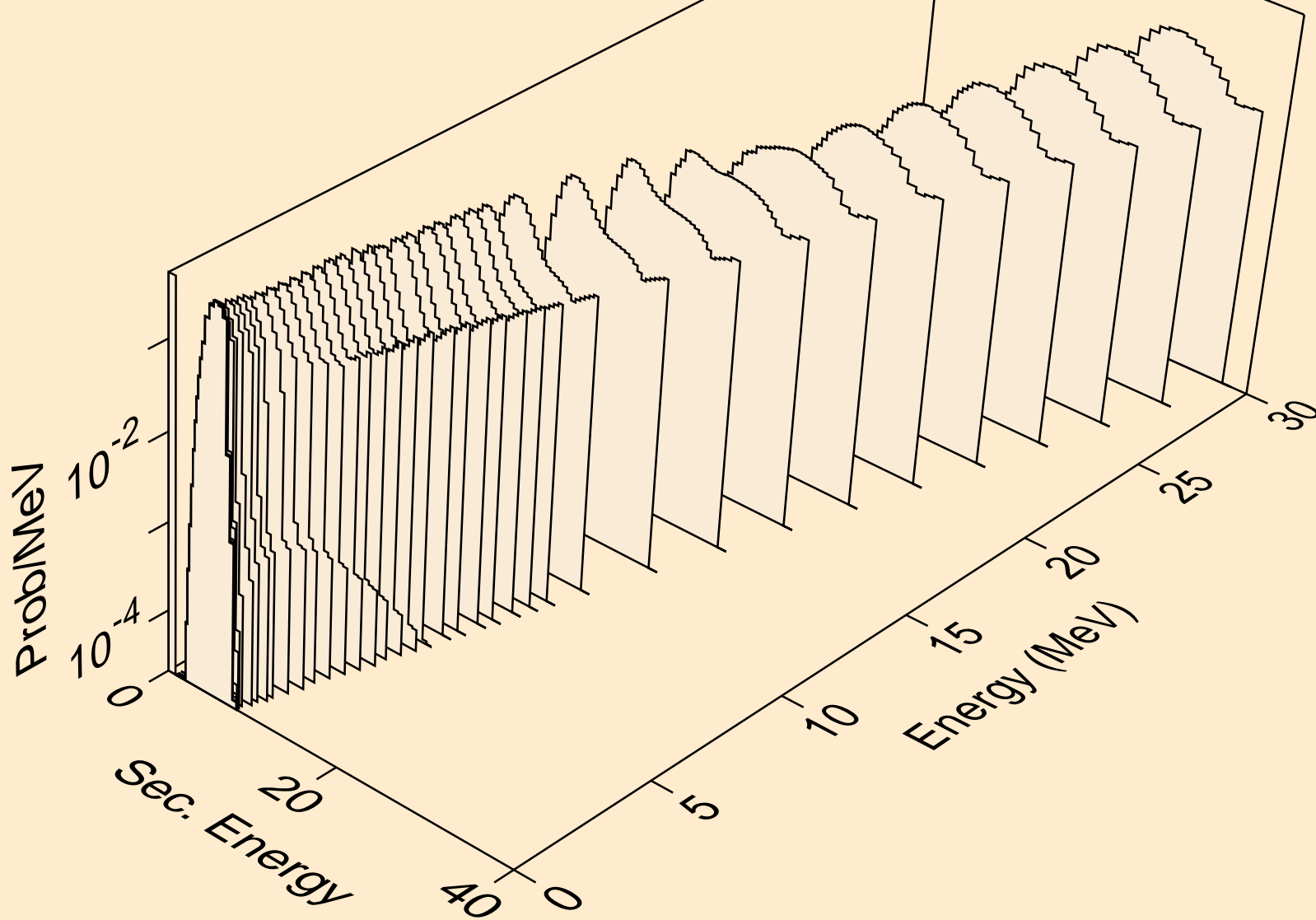

LU162N NEUTRON ACER TENDL-2019 LIBRARY; T=293.16K  
protons from (n,2p)

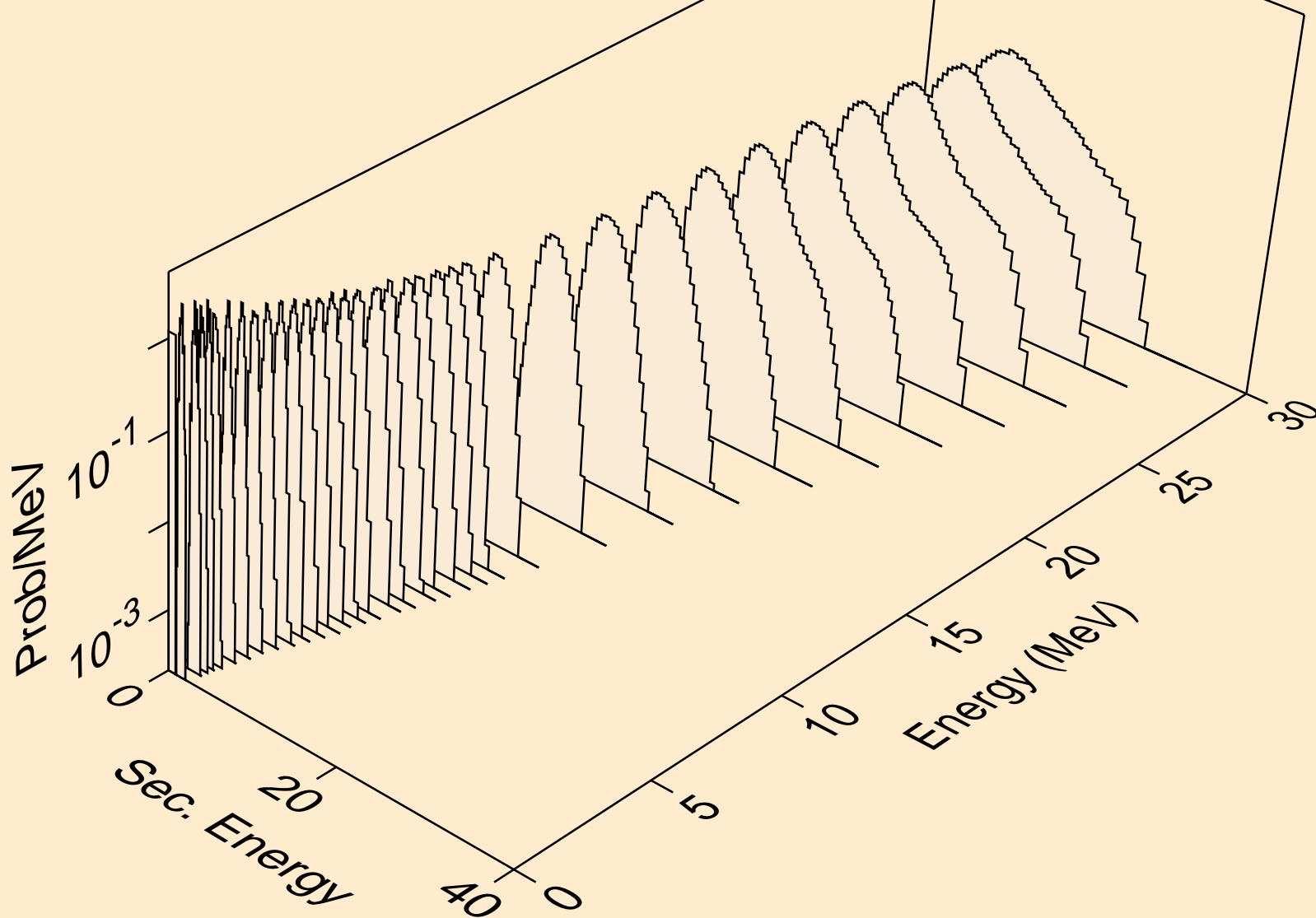

LU162N NEUTRON ACER TENDL-2019 LIBRARY; T=293.16K  
protons from (n,p)

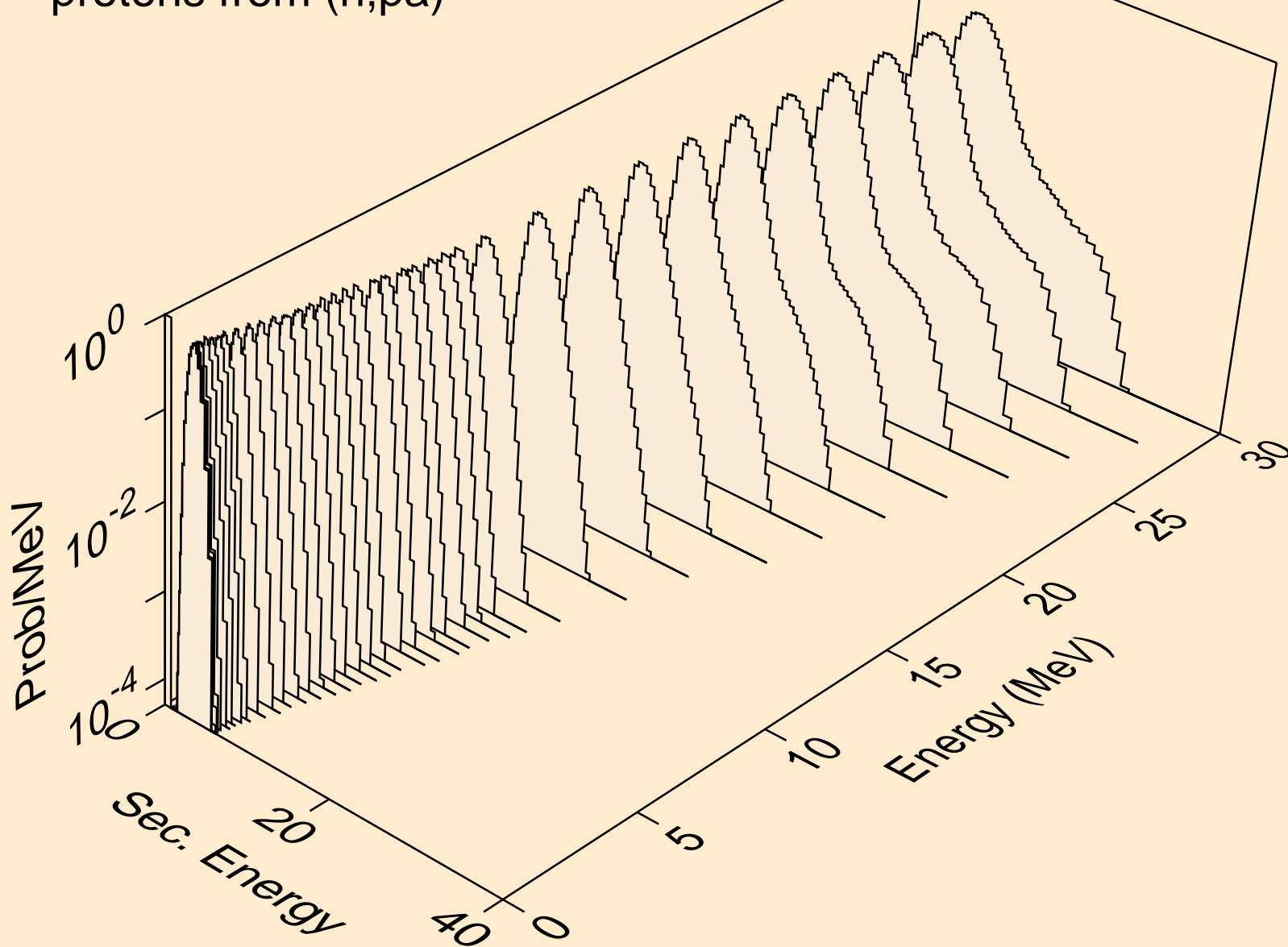

LU162N NEUTRON ACER TENDL-2019 LIBRARY; T=293.16K  
protons from (n,pd)

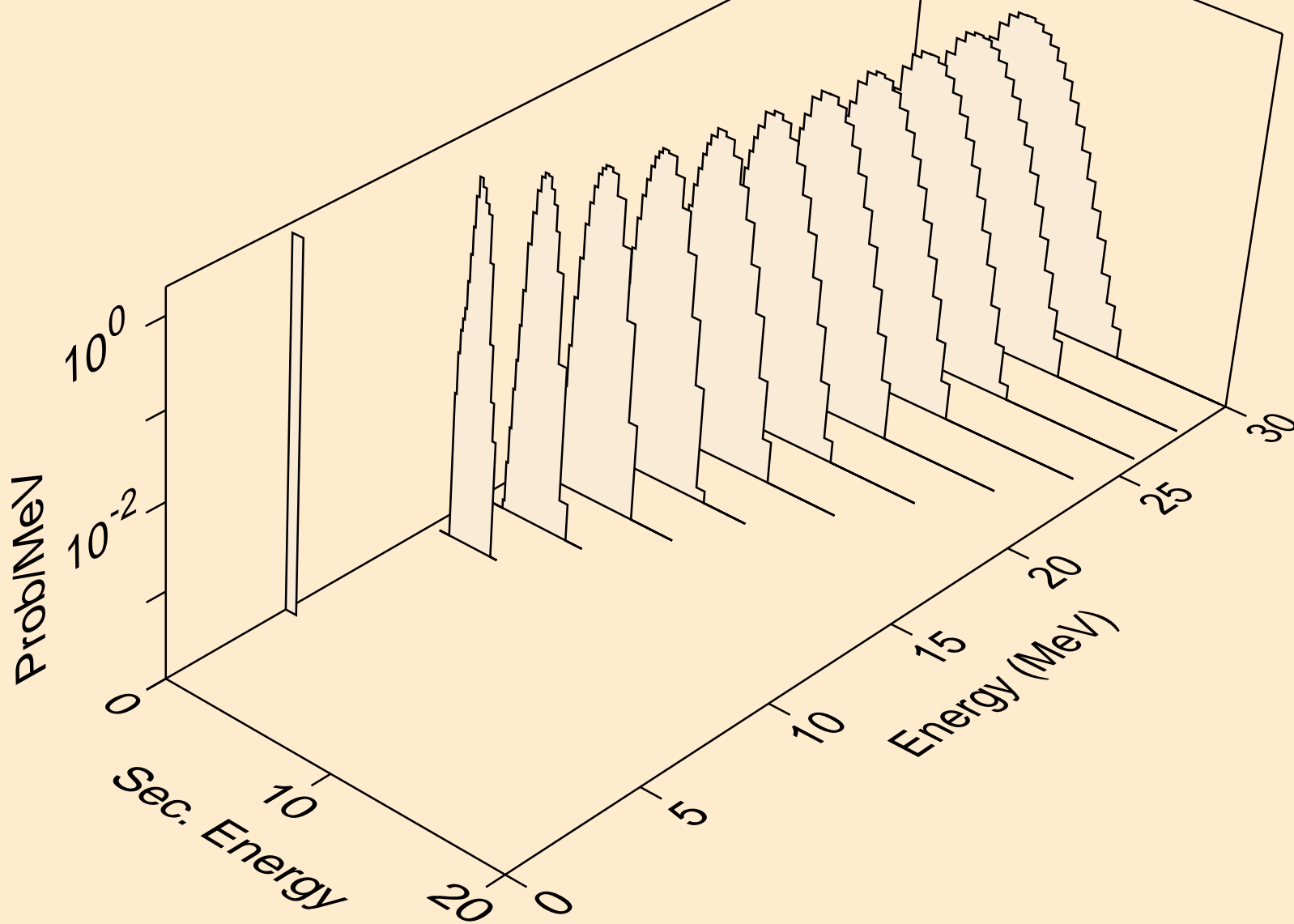



LU162N NEUTRON ACER TENDL-2019 LIBRARY; T=293.16K  
protons from (n,pt)

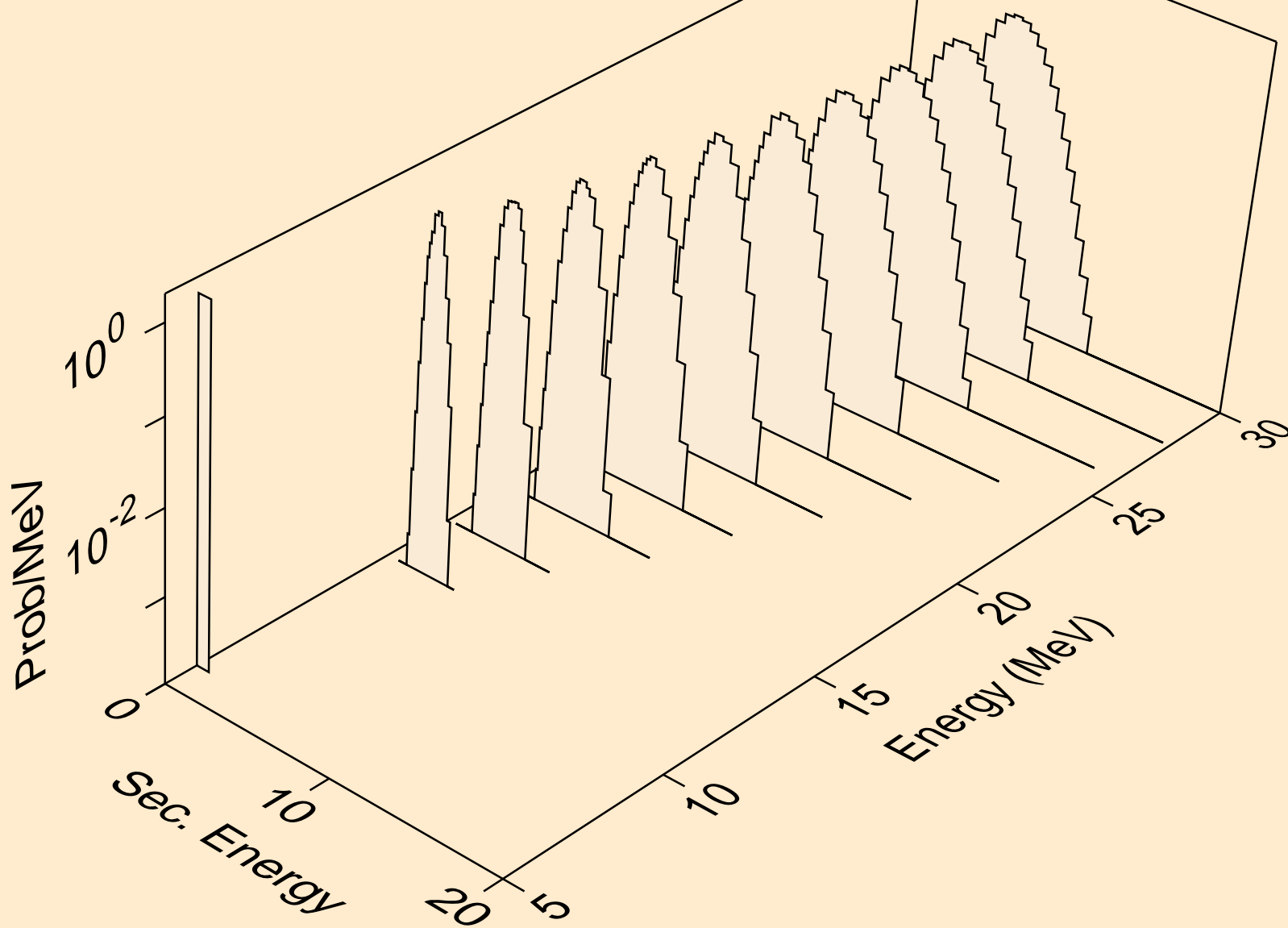

LU162N NEUTRON ACER TENDL-2019 LIBRARY; T=293.16K  
deuterons from (n,x)

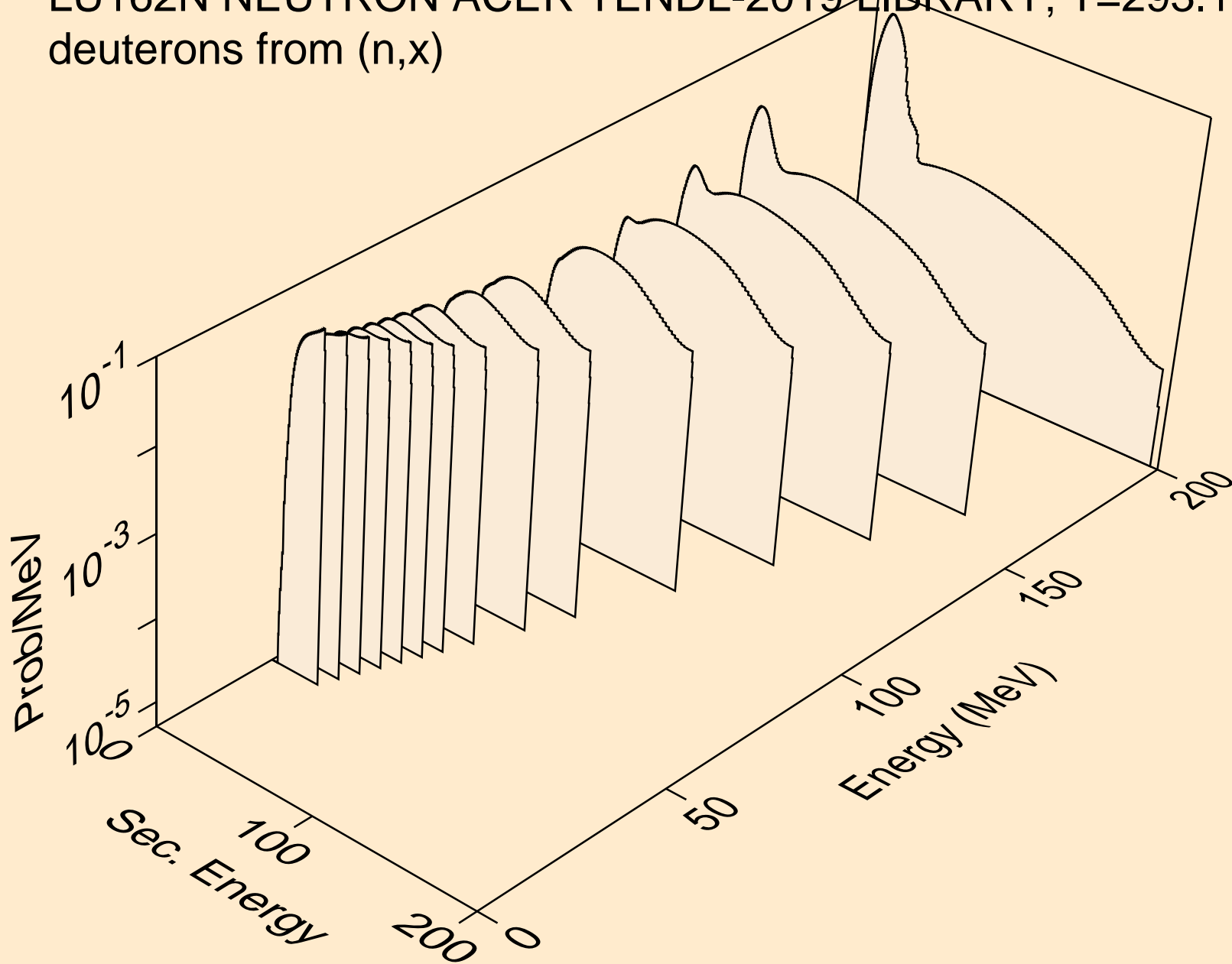

LU162N NEUTRON ACER TENDL-2019 LIBRARY; T=293.16K  
deuterons from (n,2nd)

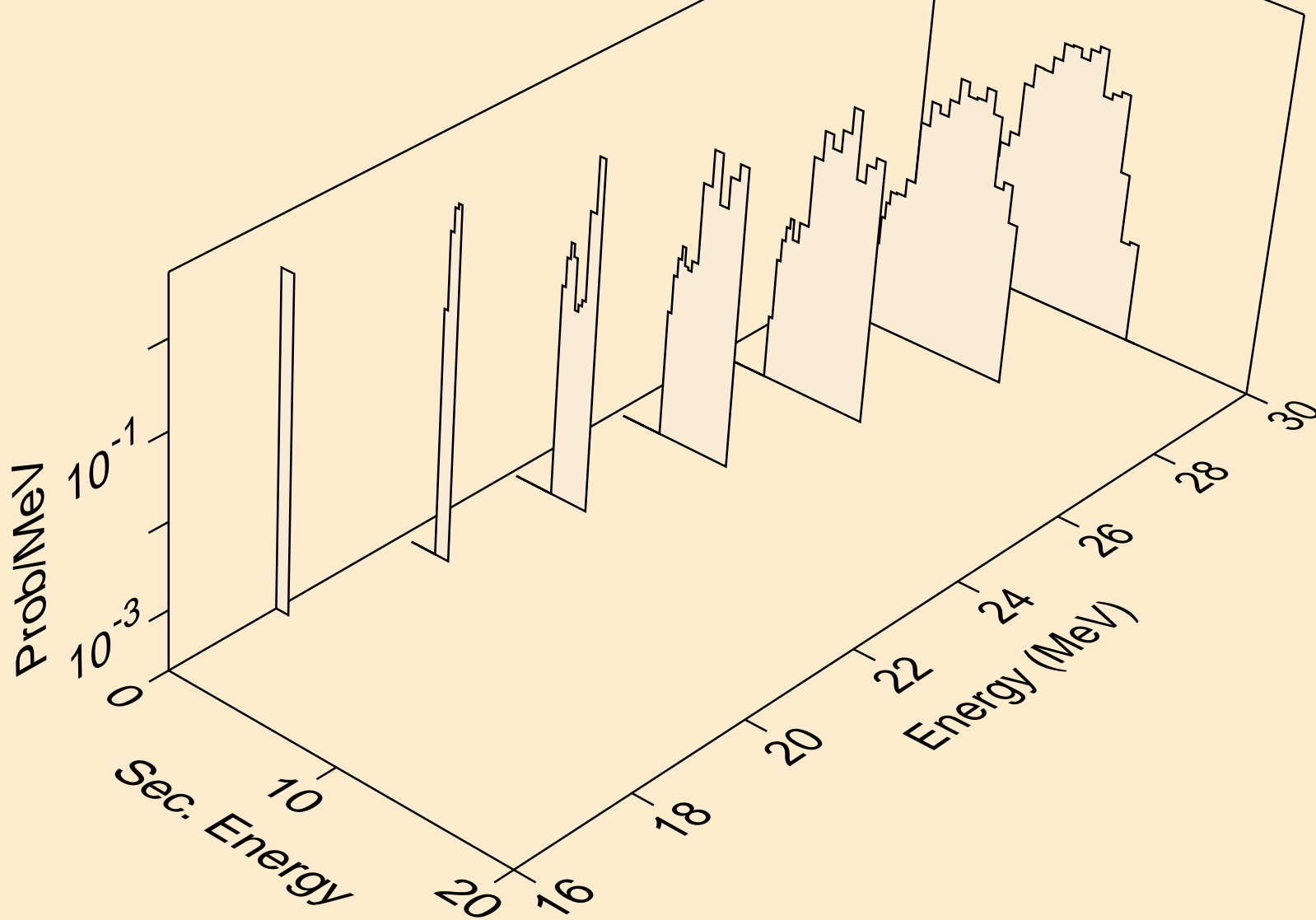

LU162N NEUTRON ACER TENDL-2019 LIBRARY; T=293.16K  
deuterons from (n,n\*)d

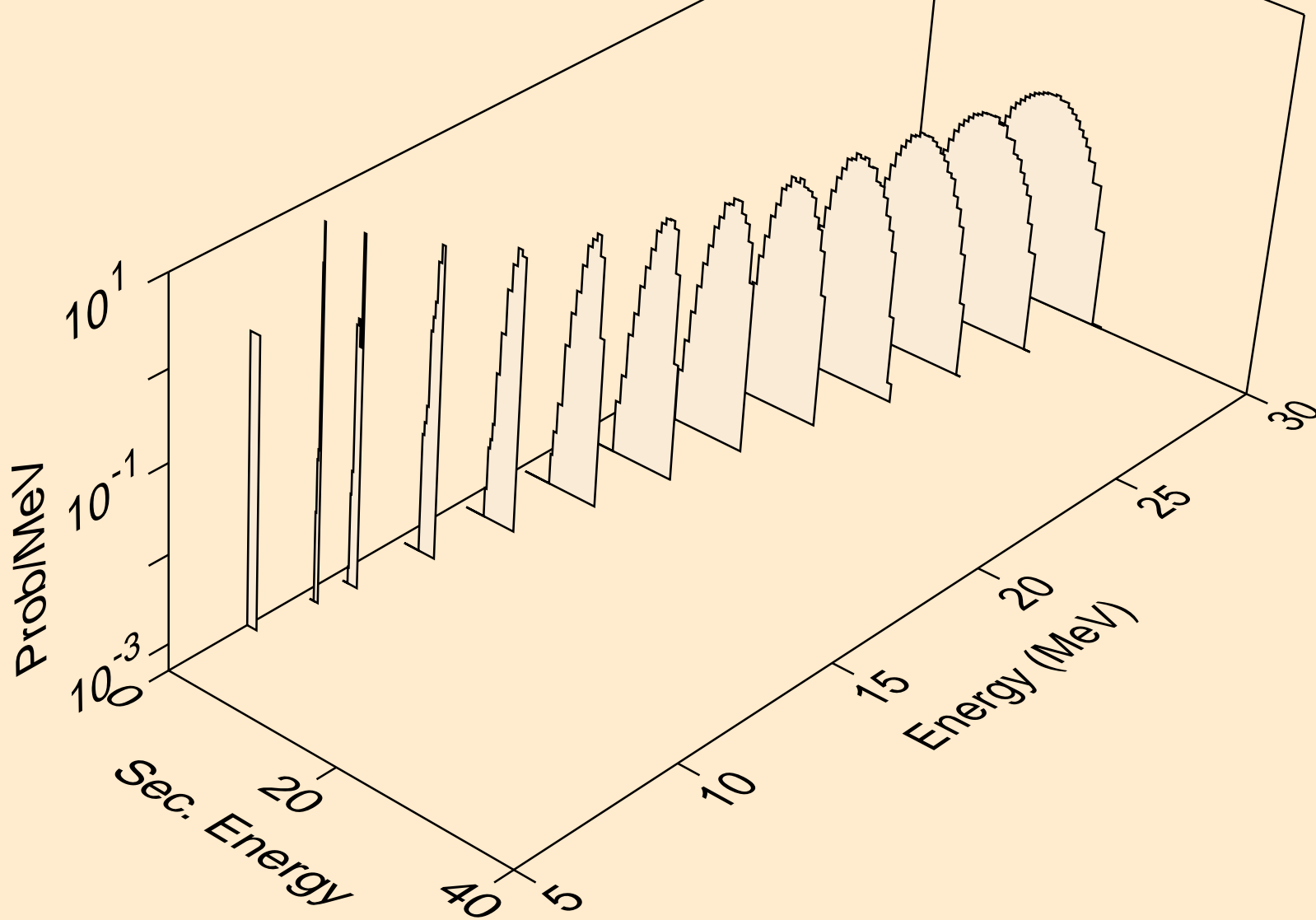

LU162N NEUTRON ACER TENDL-2019 LIBRARY; T=293.16K  
deuterons from (n,d)

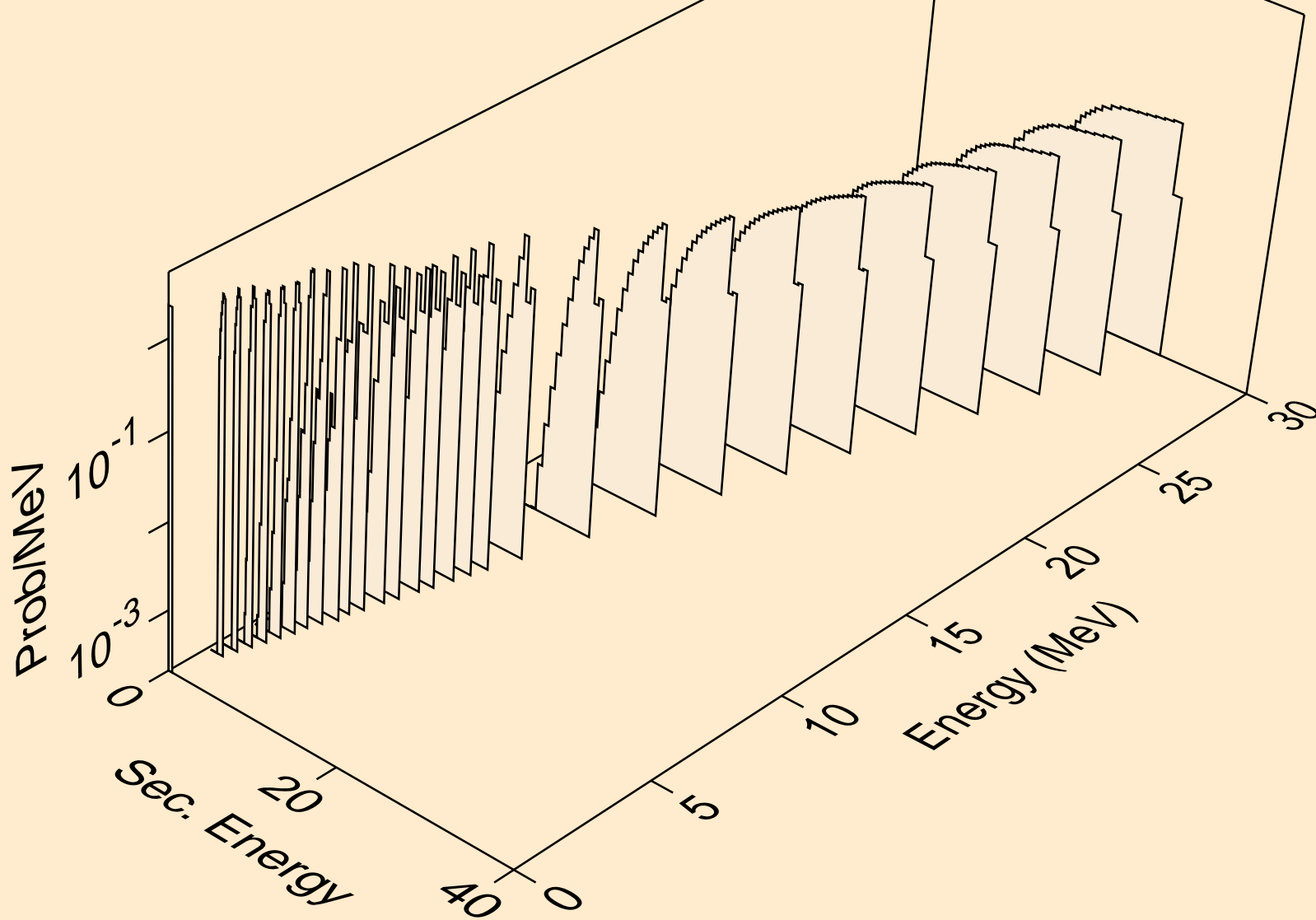

LU162N NEUTRON ACER TENDL-2019 LIBRARY; T=293.16K  
deuterons from (n,pd)

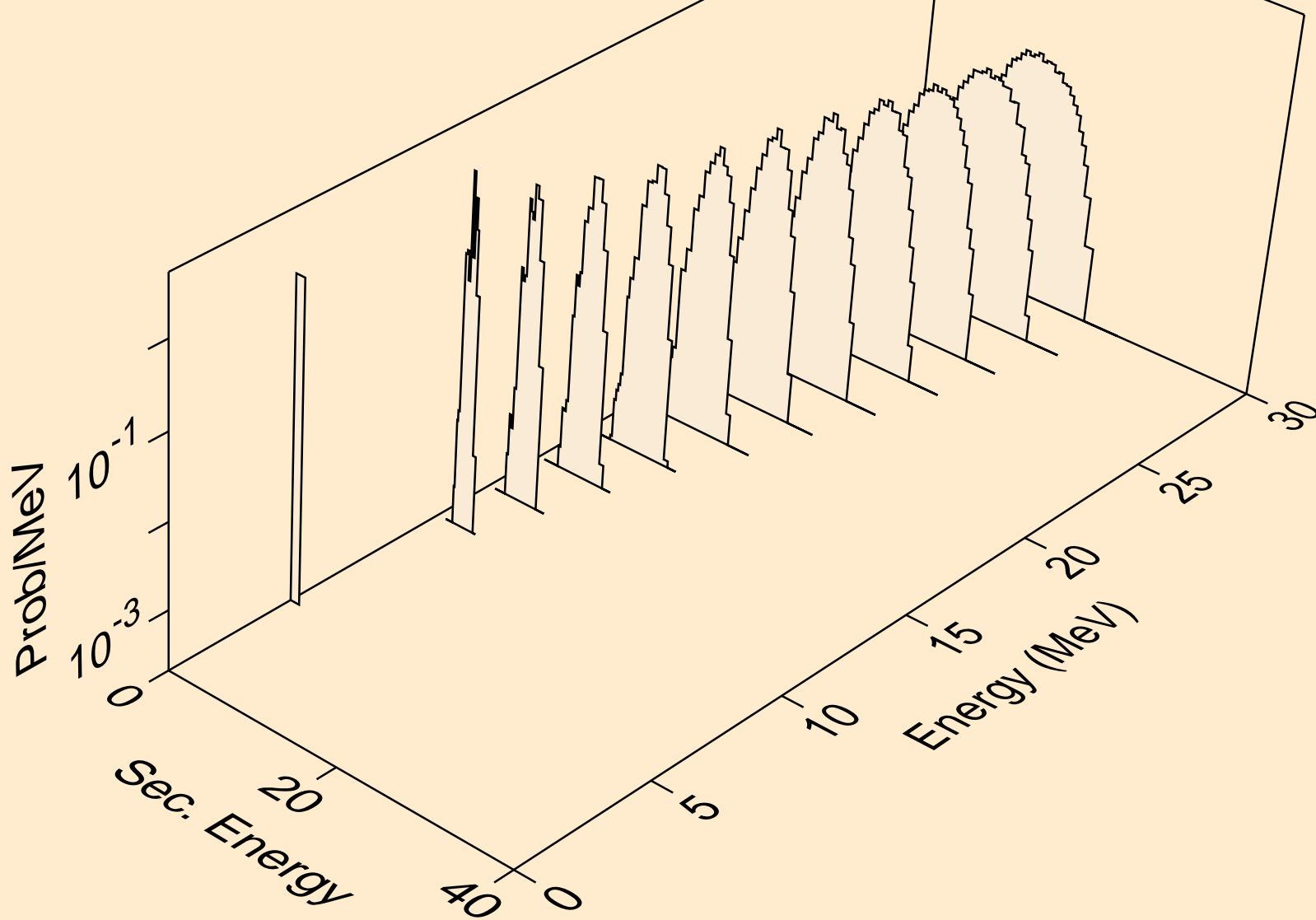

LU162N NEUTRON ACER TENDL-2019 LIBRARY; T=293.16K  
deuterons from (n,da)

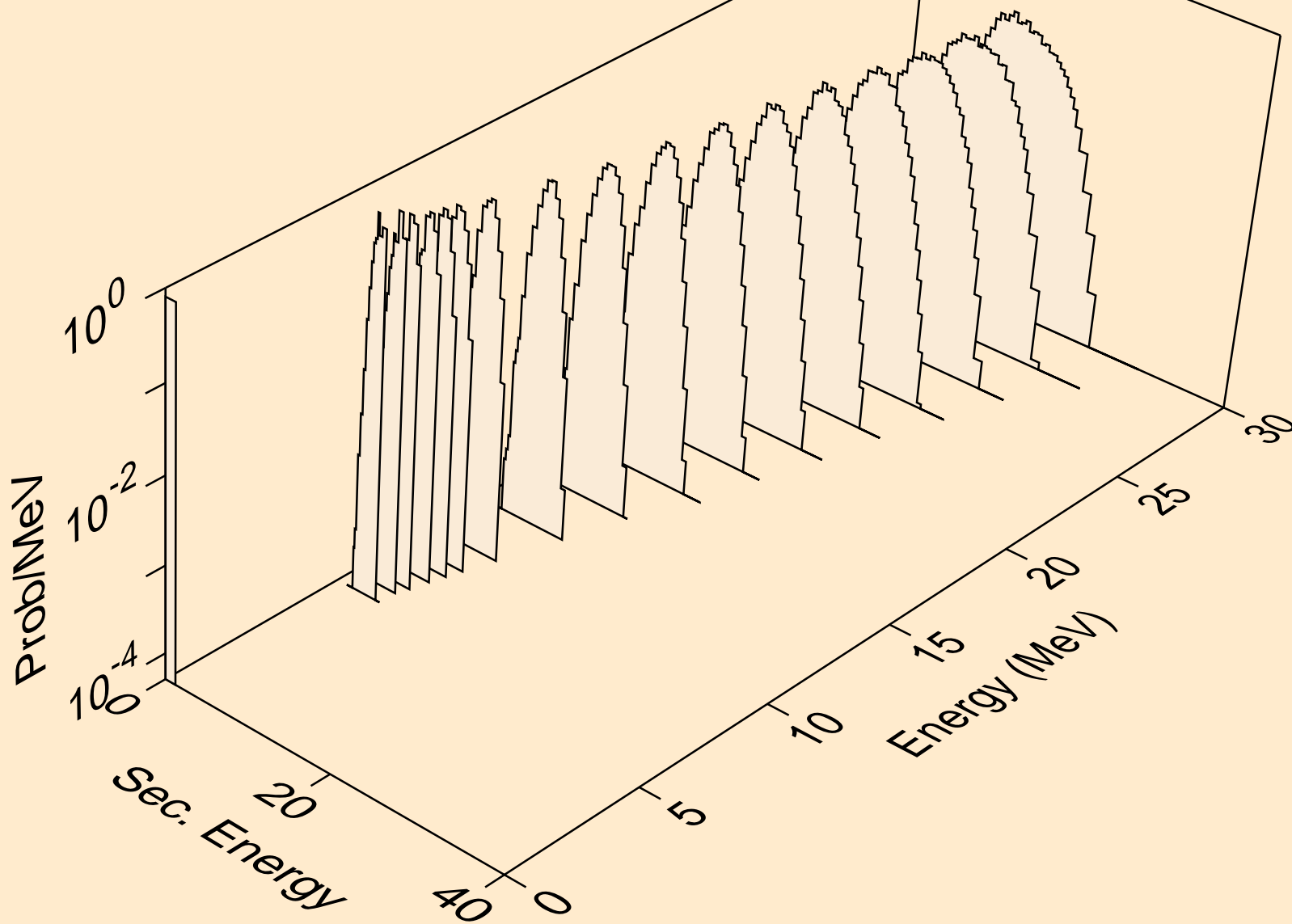

LU162N NEUTRON ACER TENDL-2019 LIBRARY; T=293.16K  
tritons from (n,x)

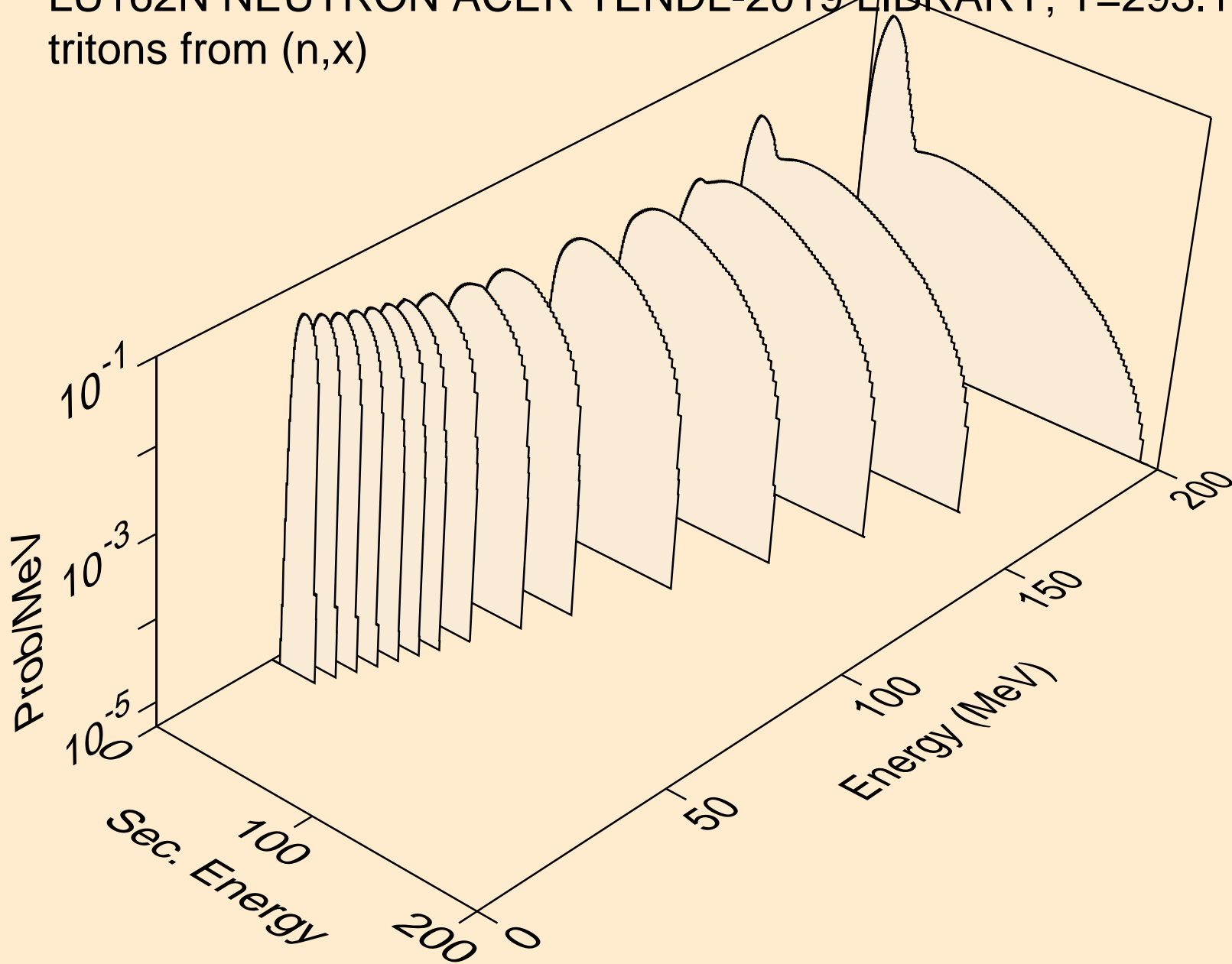



LU162N NEUTRON ACER TENDL-2019 LIBRARY; T=293.16K  
tritons from (n,n\*)t

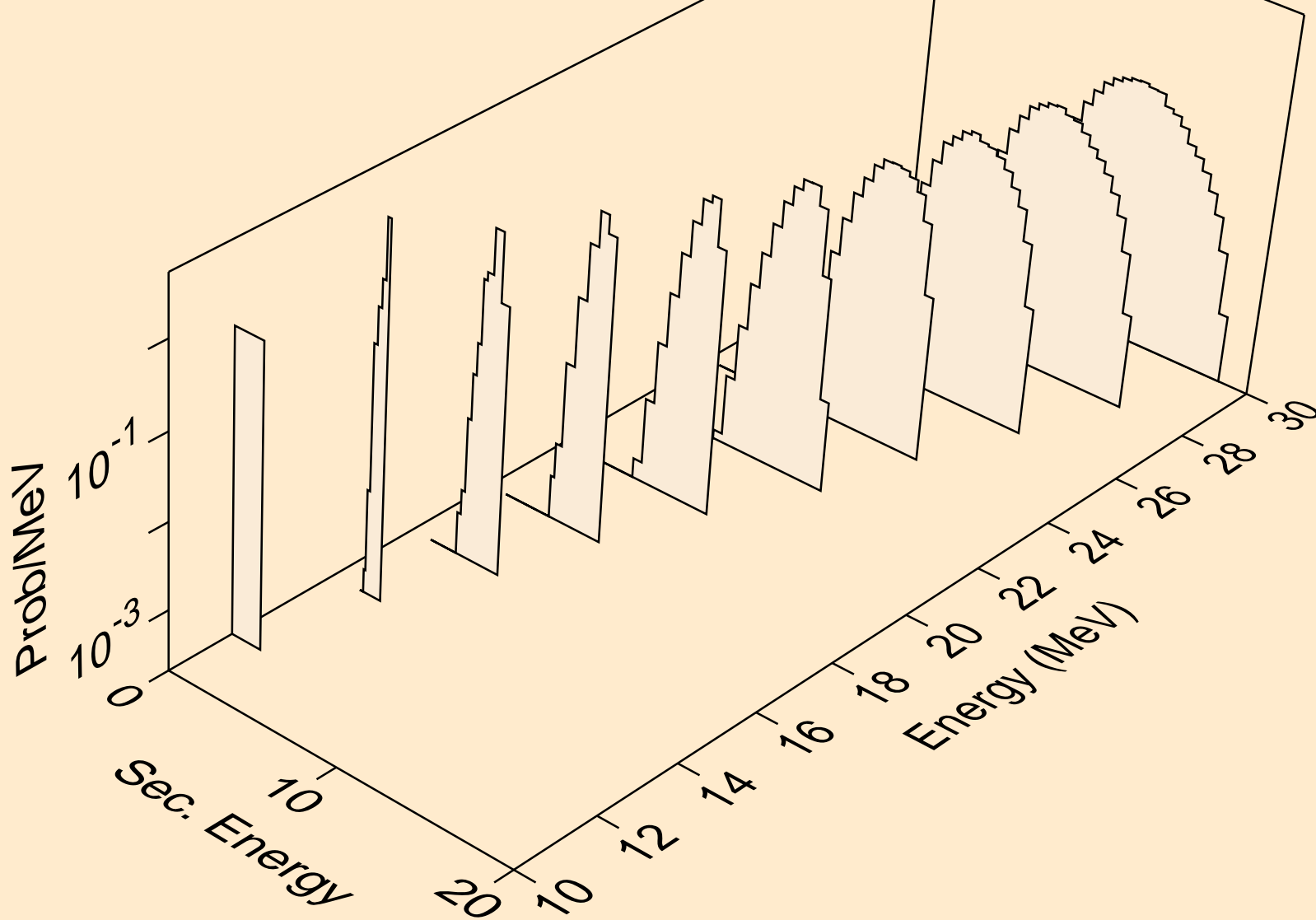

LU162N NEUTRON ACER TENDL-2019 LIBRARY; T=293.16K  
tritons from (n,t)

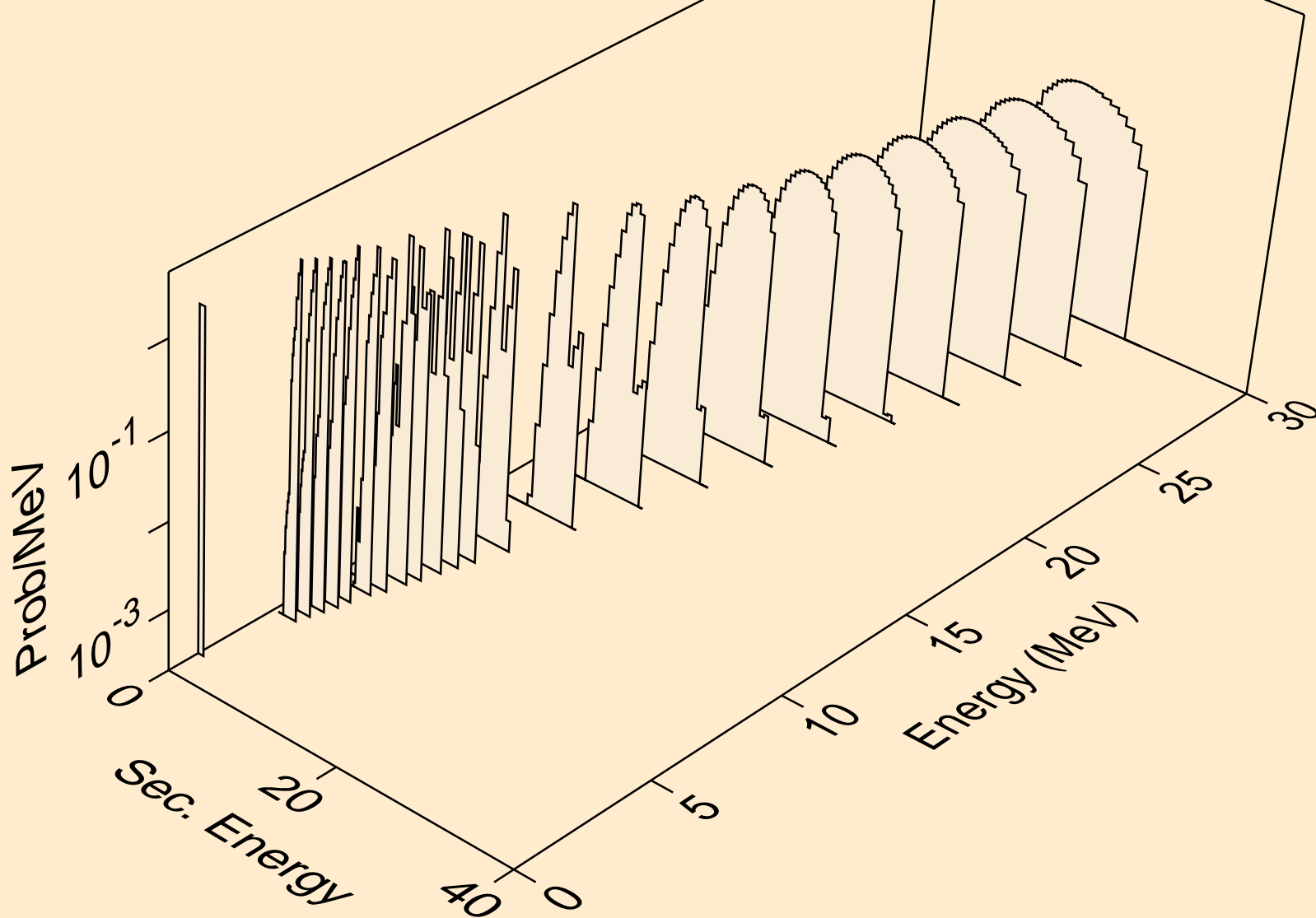

LU162N NEUTRON ACER TENDL-2019 LIBRARY; T=293.16K  
tritons from (n,pt)

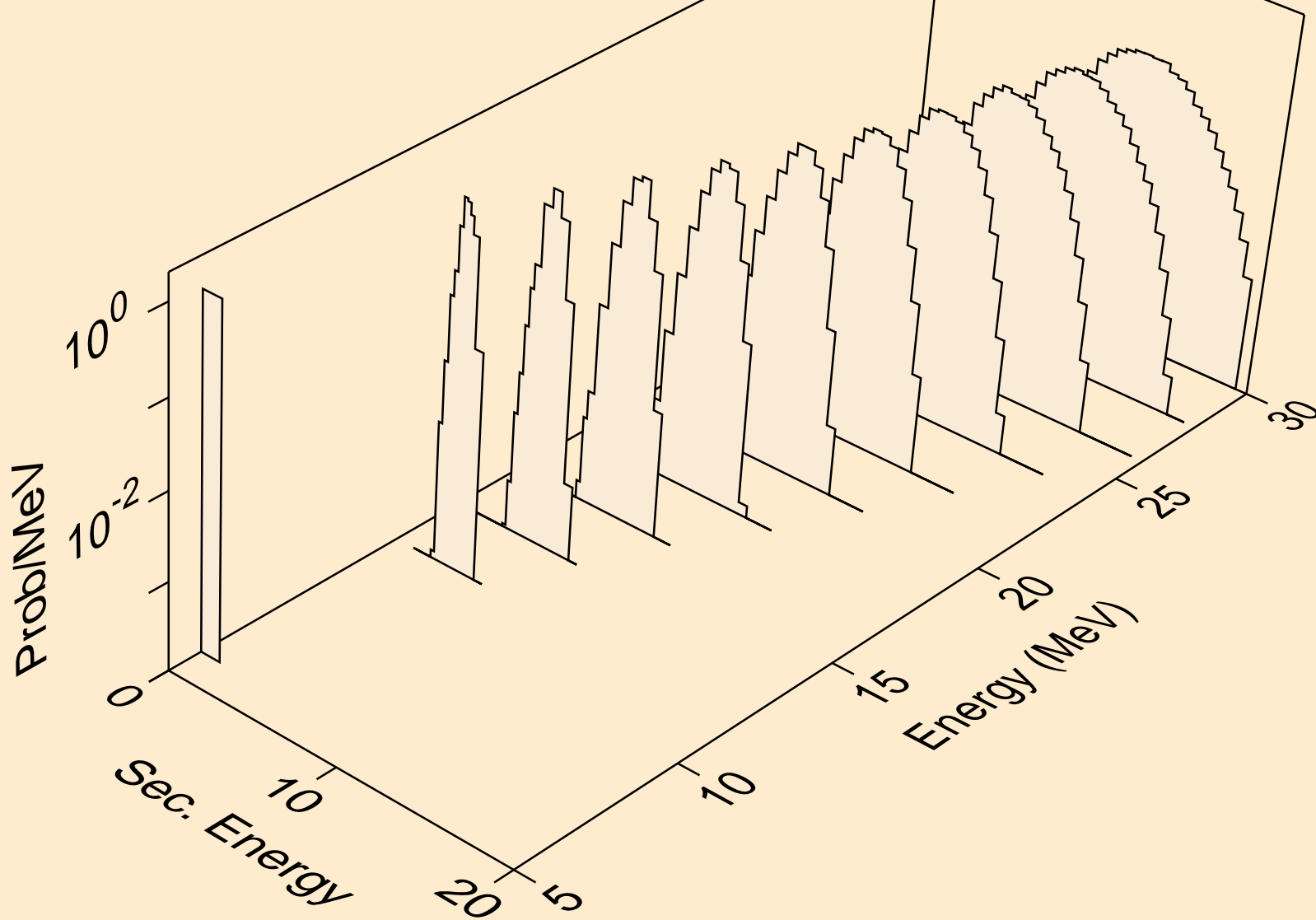

LU162N NEUTRON ACER TENDL-2019 LIBRARY; T=293.16K  
he3s from (n,x)

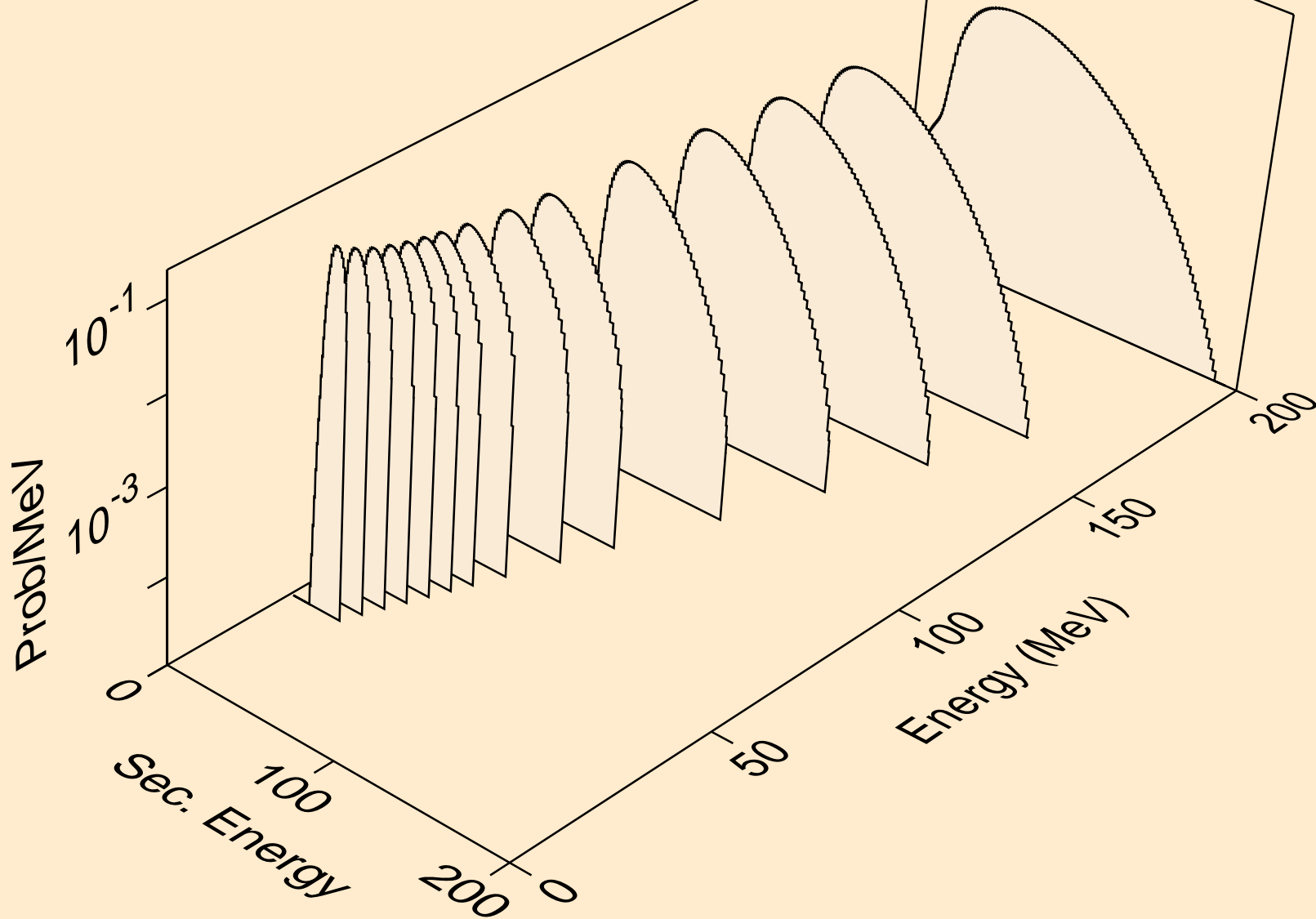

LU162N NEUTRON ACER TENDL-2019 LIBRARY; T=293.16K  
he3s from (n,n\*)he3

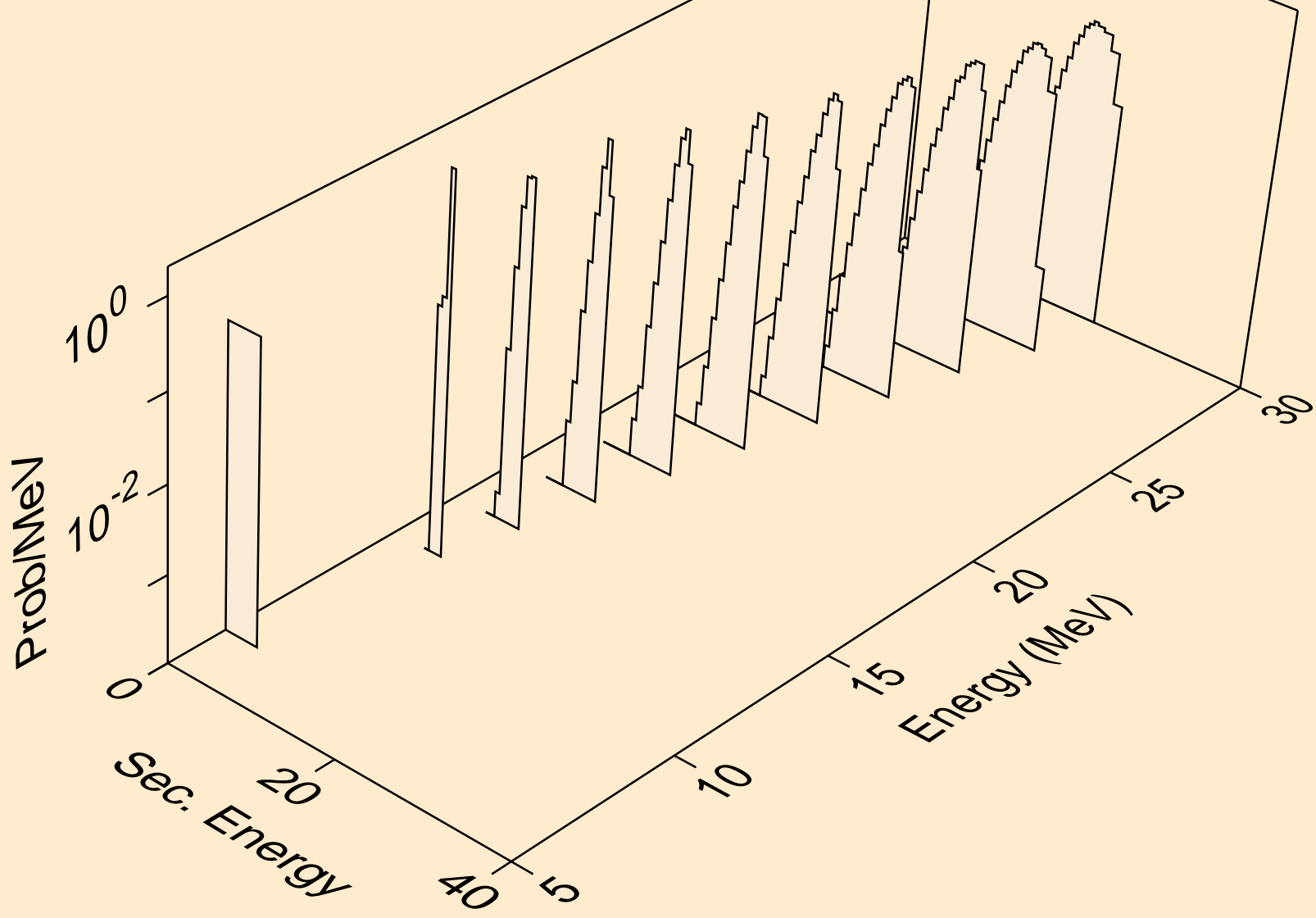

LU162N NEUTRON ACER TENDL-2019 LIBRARY; T=293.16K  
he3s from (n,he3)

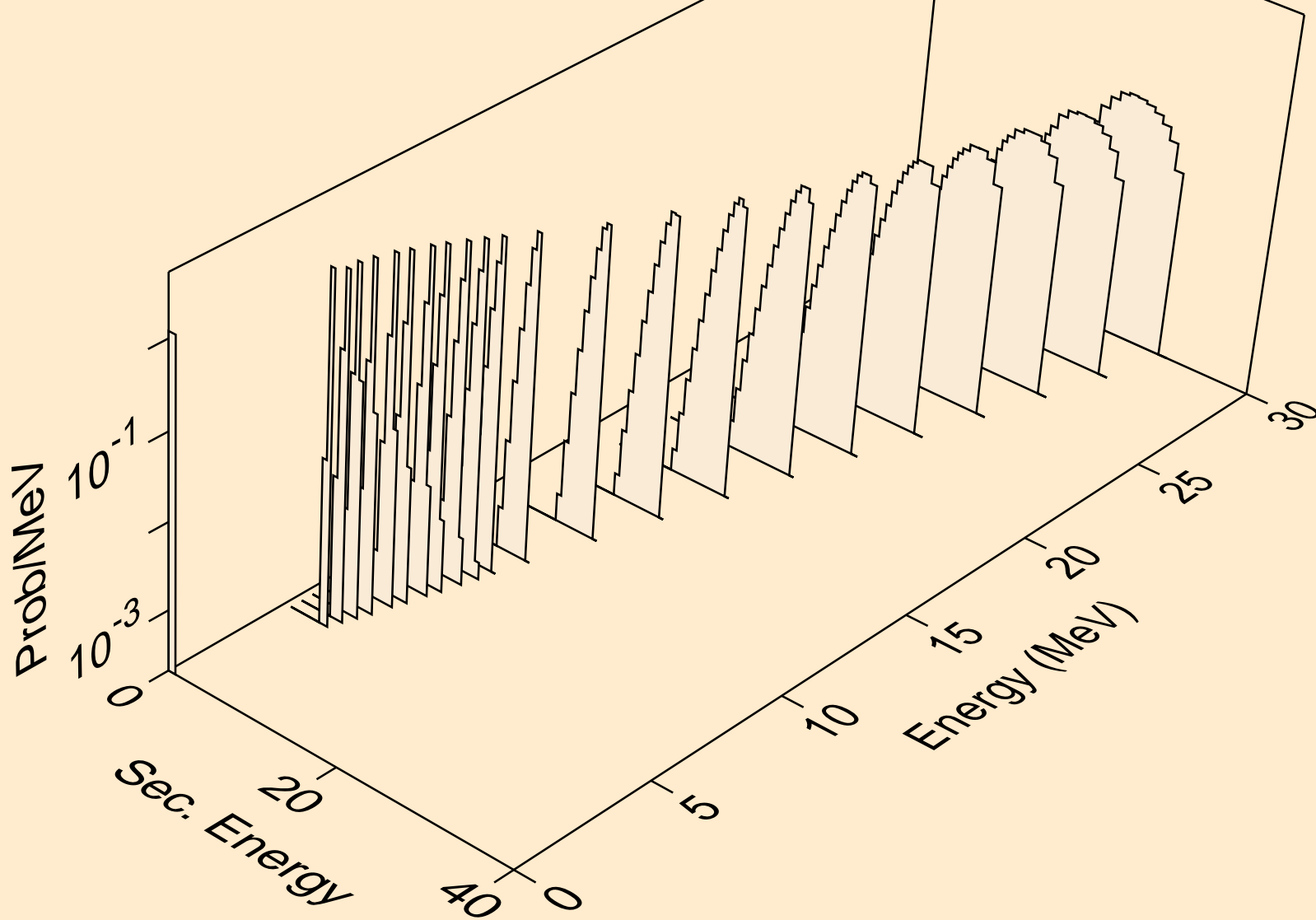

LU162N NEUTRON ACER TENDL-2019 LIBRARY; T=293.16K  
alphas from (n,x)

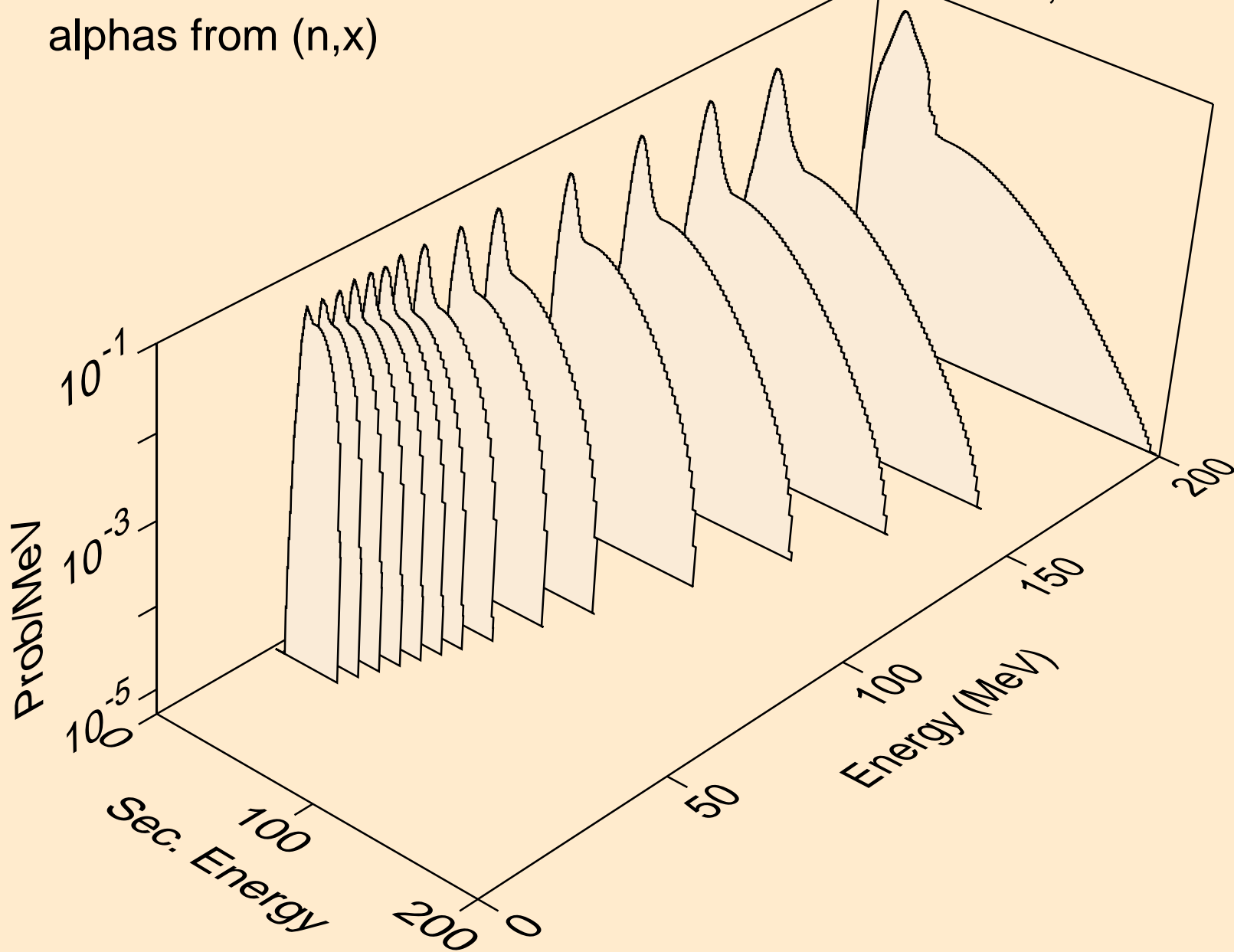

LU162N NEUTRON ACER TENDL-2019 LIBRARY; T=293.16K  
alphas from (n,n\*)a

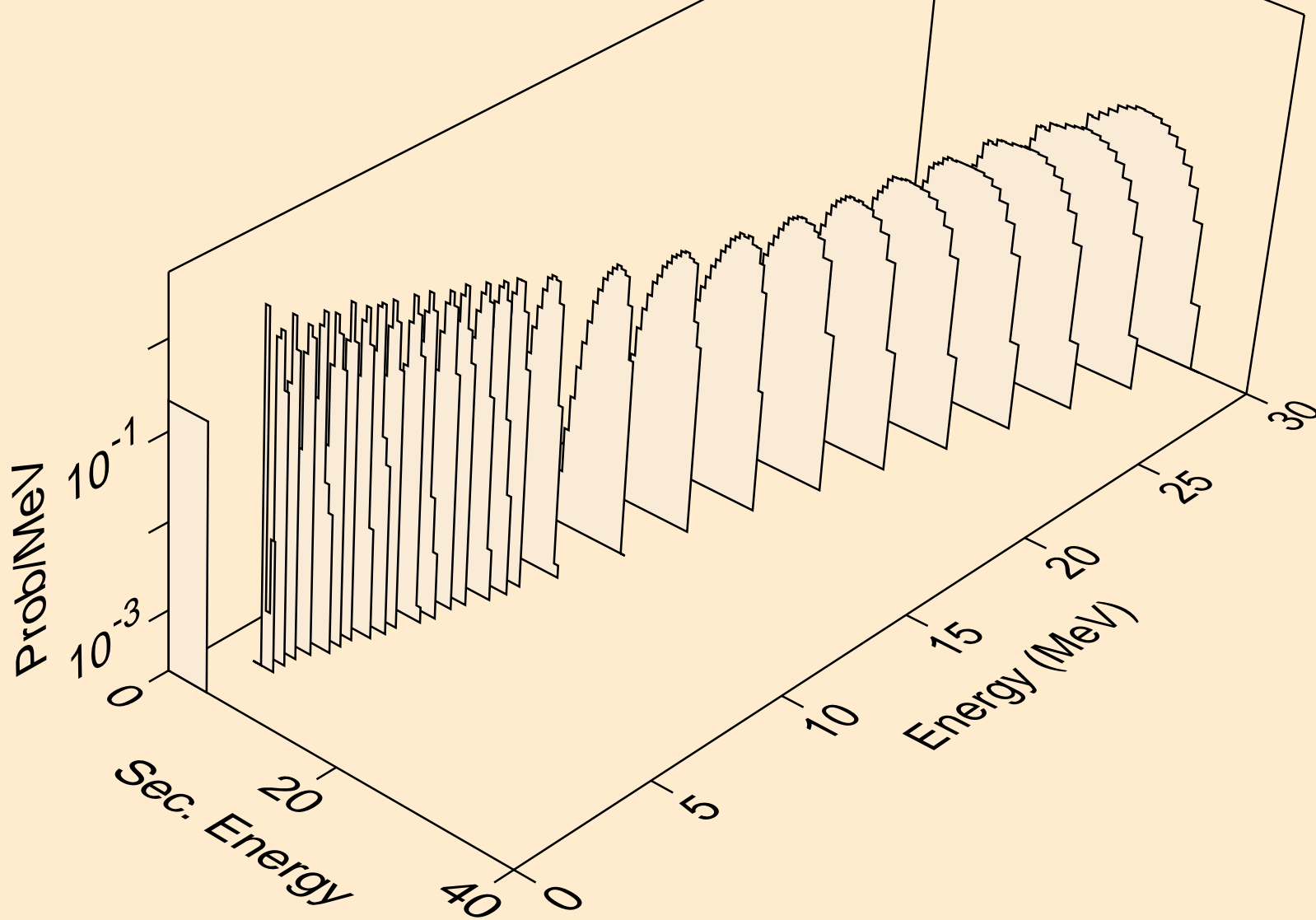



LU162N NEUTRON ACER TENDL-2019 LIBRARY; T=293.16K  
alphas from (n,2n)a

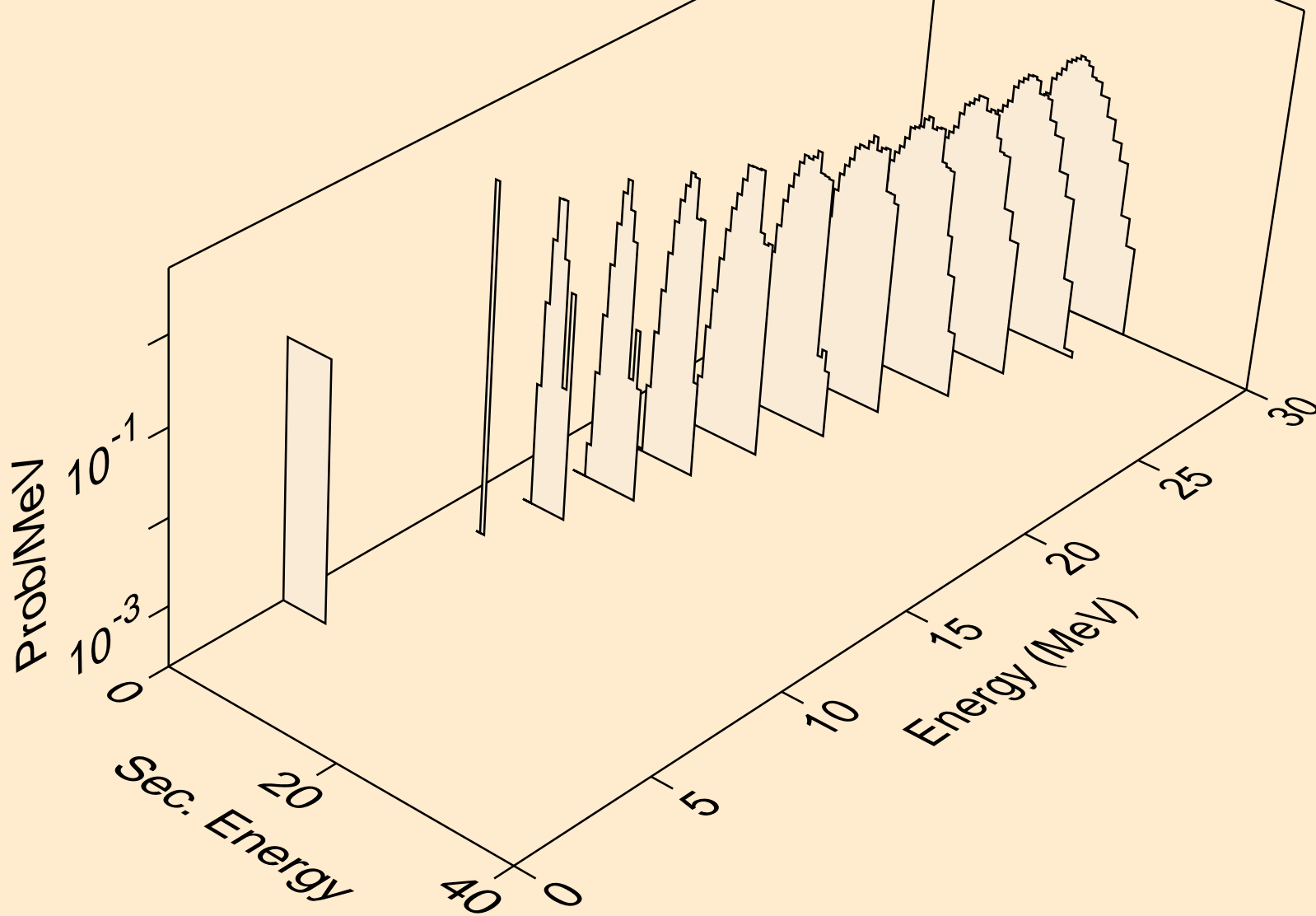

LU162N NEUTRON ACER TENDL-2019 LIBRARY; T=293.16K  
alphas from (n,3n)a

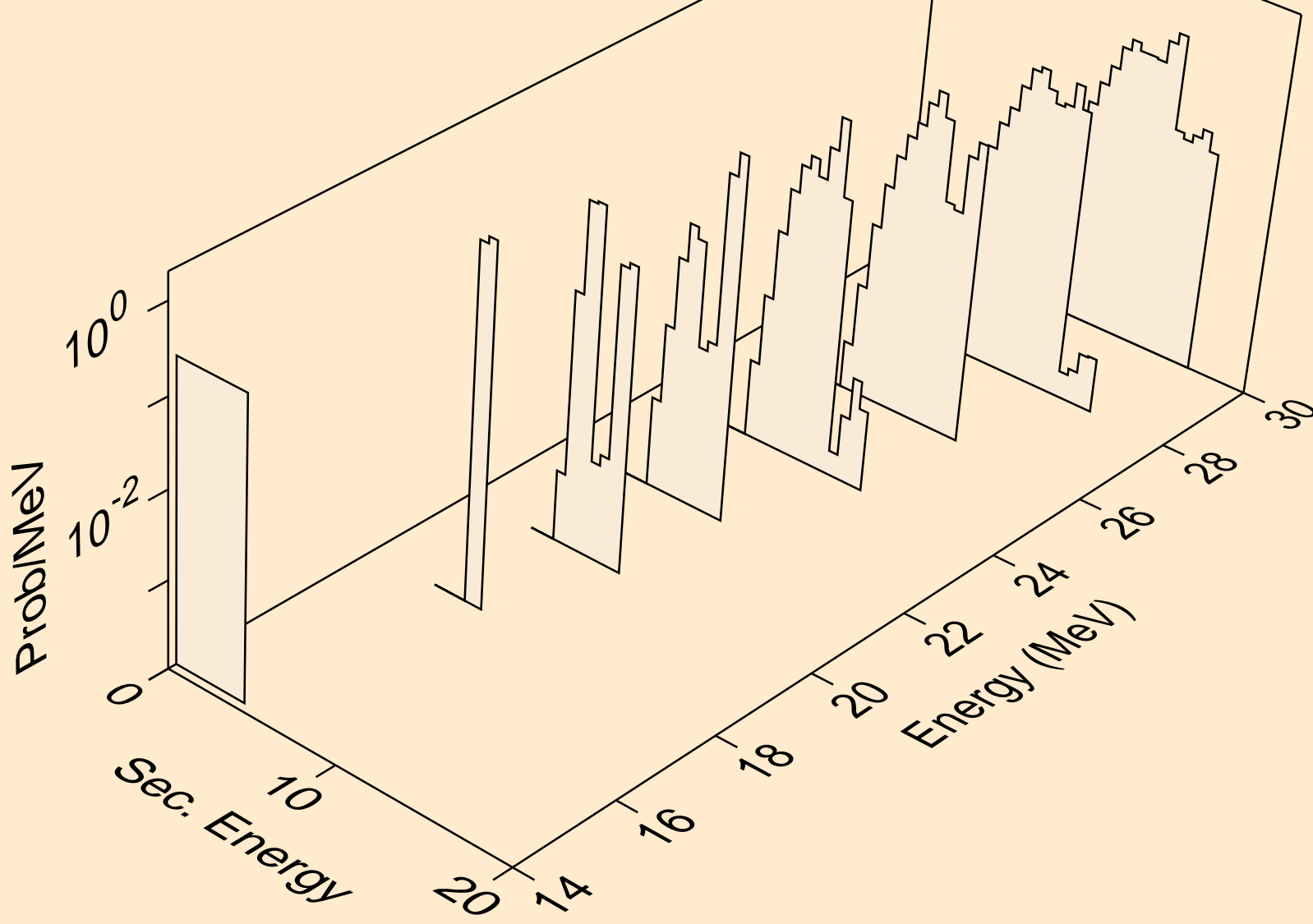

LU162N NEUTRON ACER TENDL-2019 LIBRARY; T=293.16K  
alphas from (n,n\*)2a

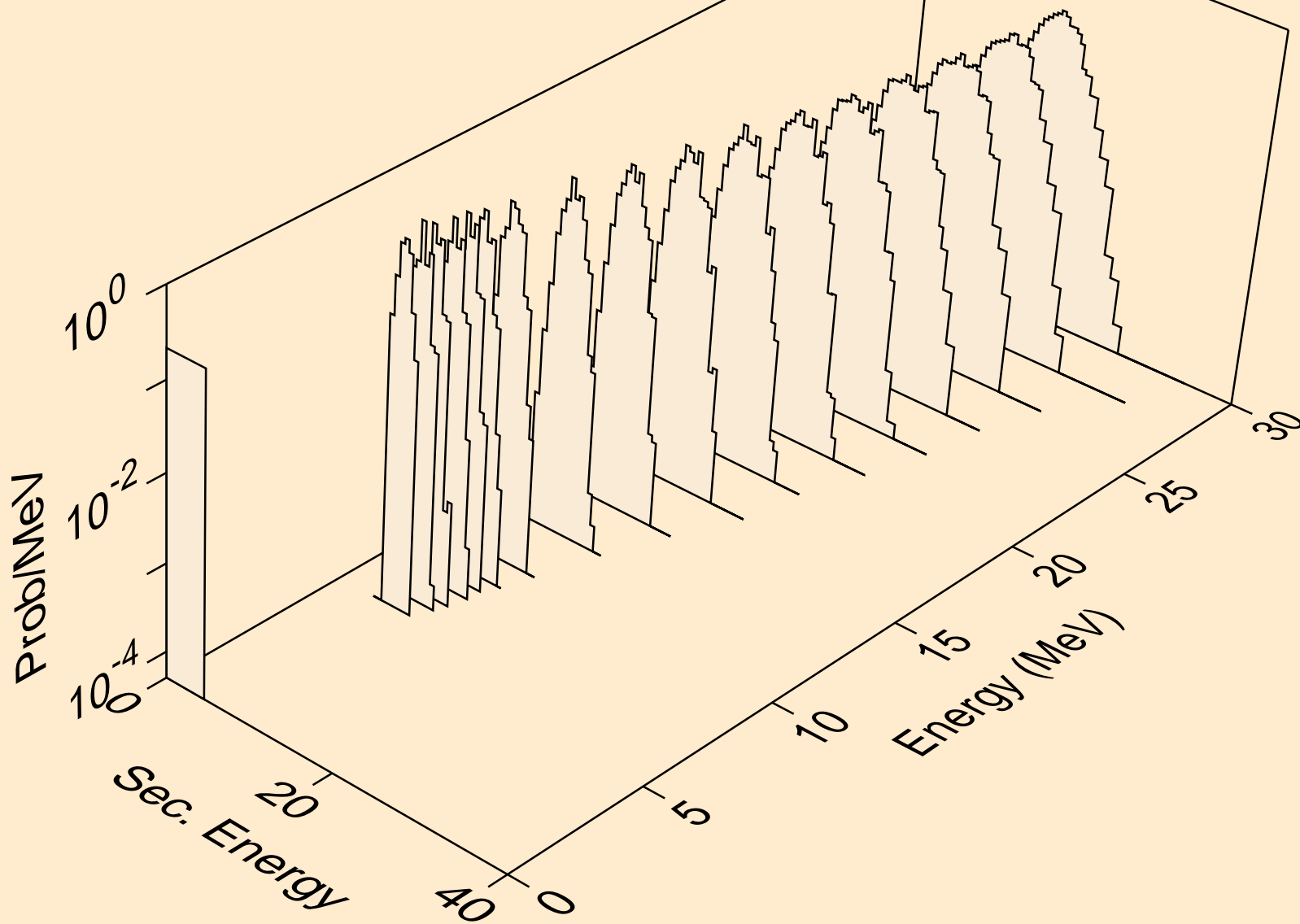

LU162N NEUTRON ACER TENDL-2019 LIBRARY; T=293.16K  
alphas from (n,2n)2a

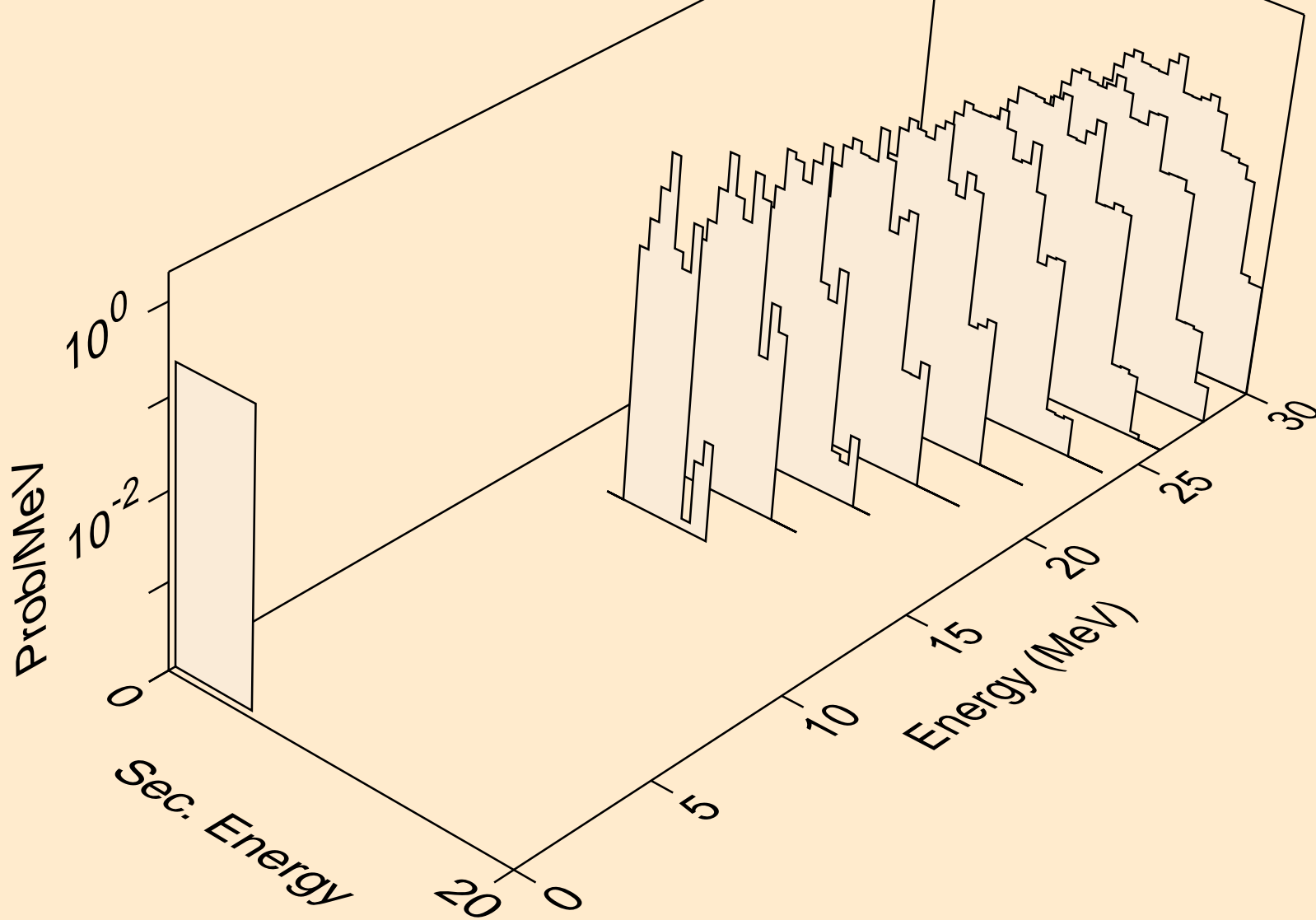

LU162N NEUTRON ACER TENDL-2019 LIBRARY; T=293.16K  
alphas from (n,npa)

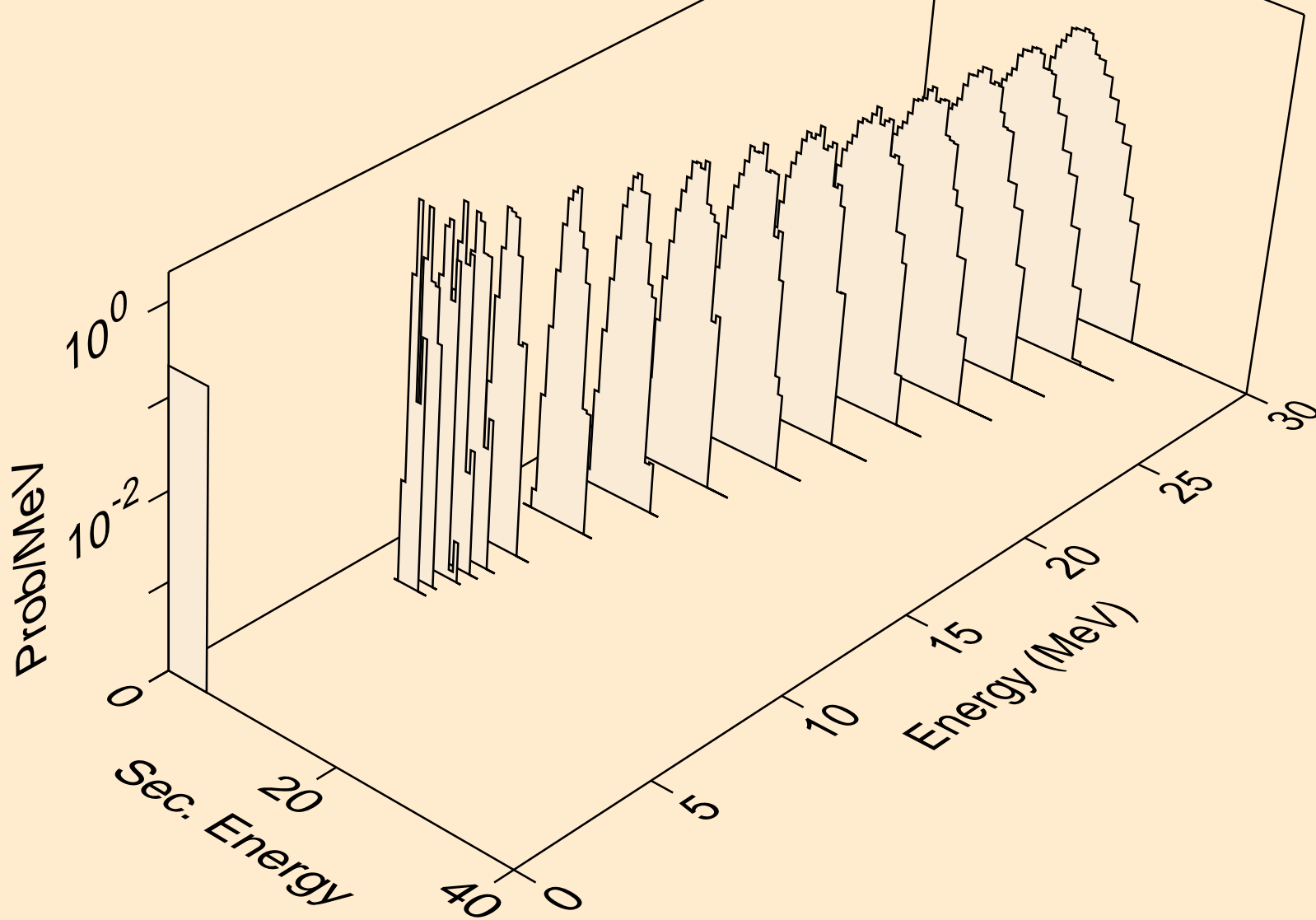

LU162N NEUTRON ACER TENDL-2019 LIBRARY; T=293.16K  
alphas from (n,a)

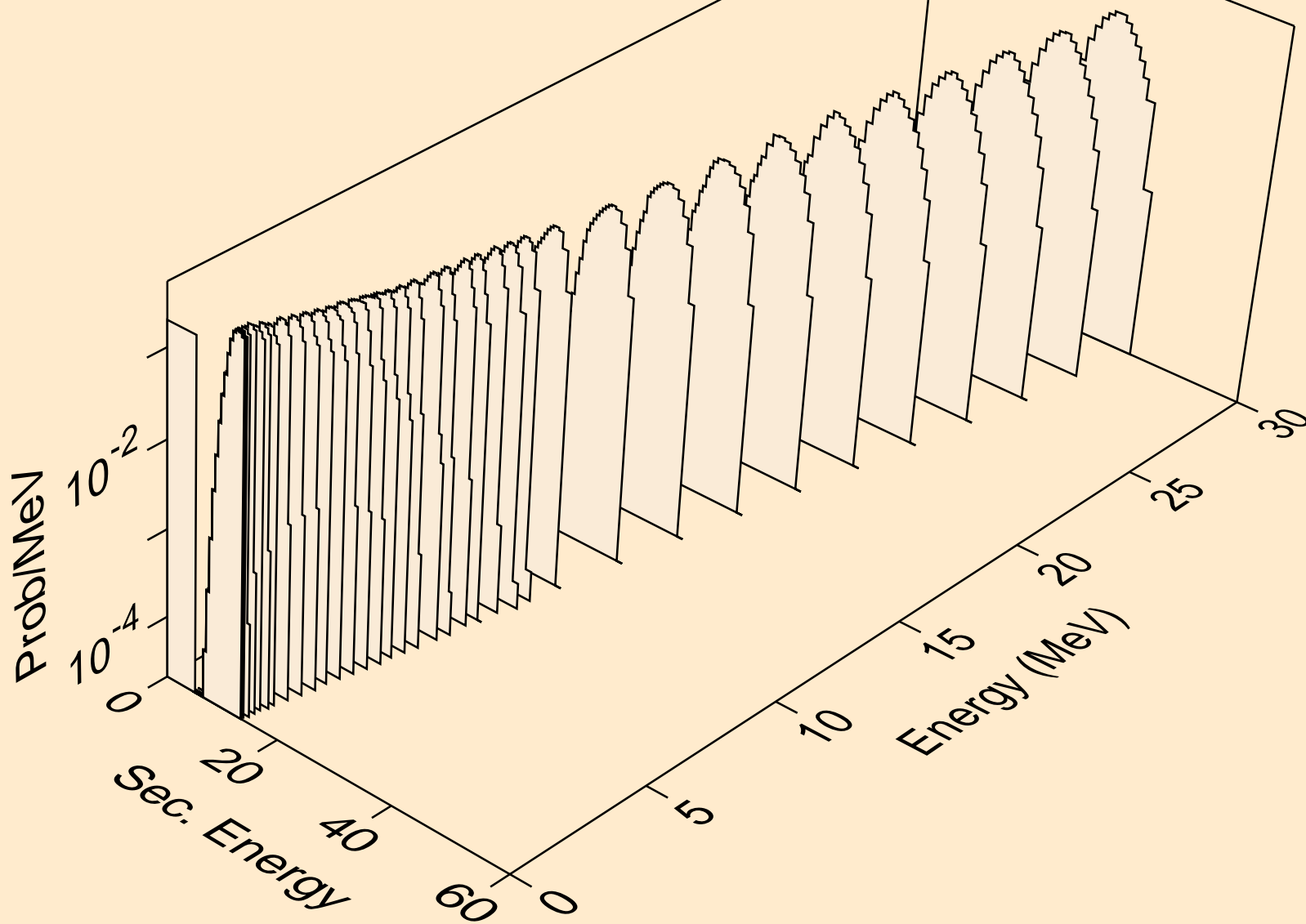

LU162N NEUTRON ACER TENDL-2019 LIBRARY; T=293.16K  
alphas from (n,2a)

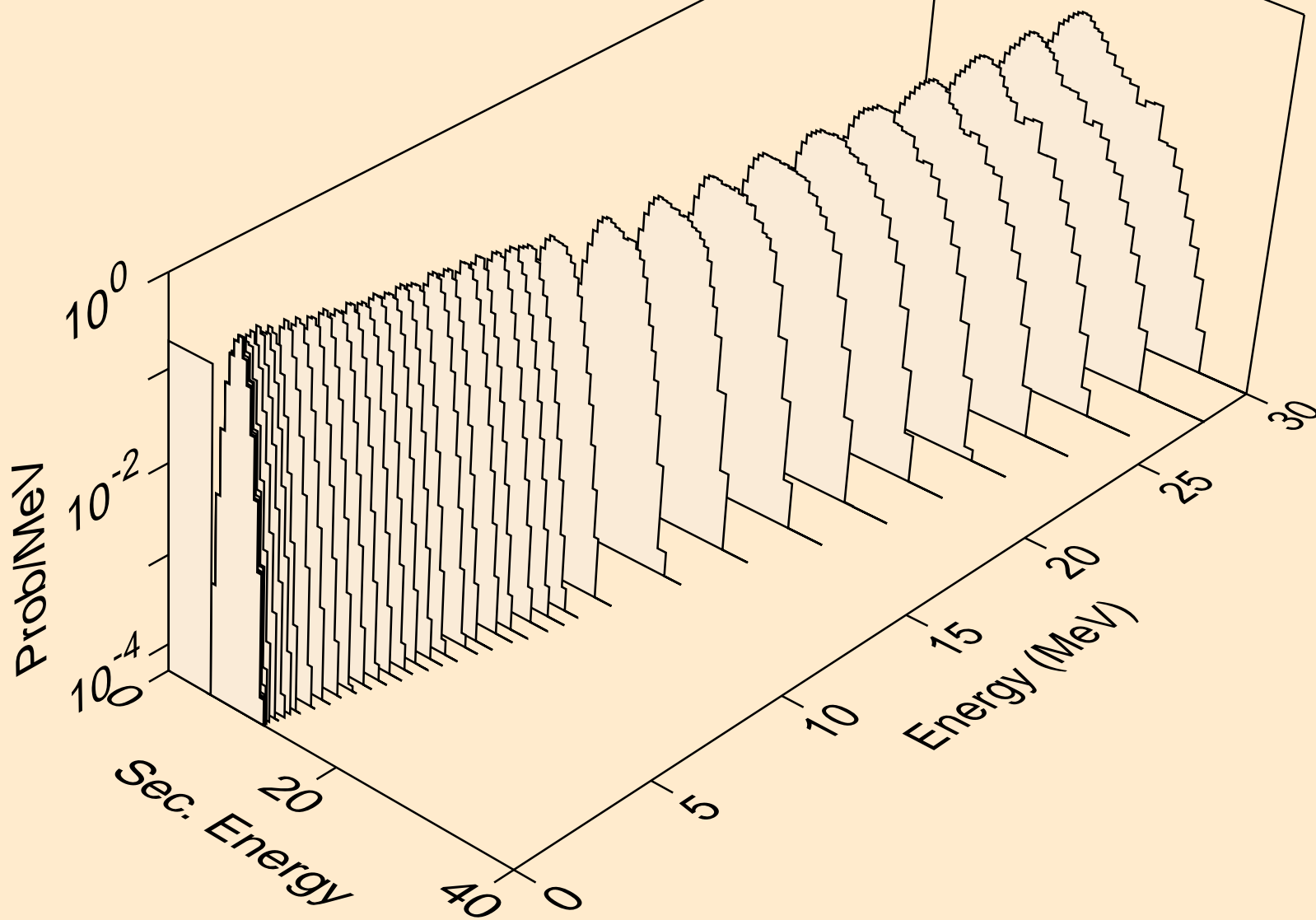

LU162N NEUTRON ACER TENDL-2019 LIBRARY; T=293.16K  
alphas from (n,3a)

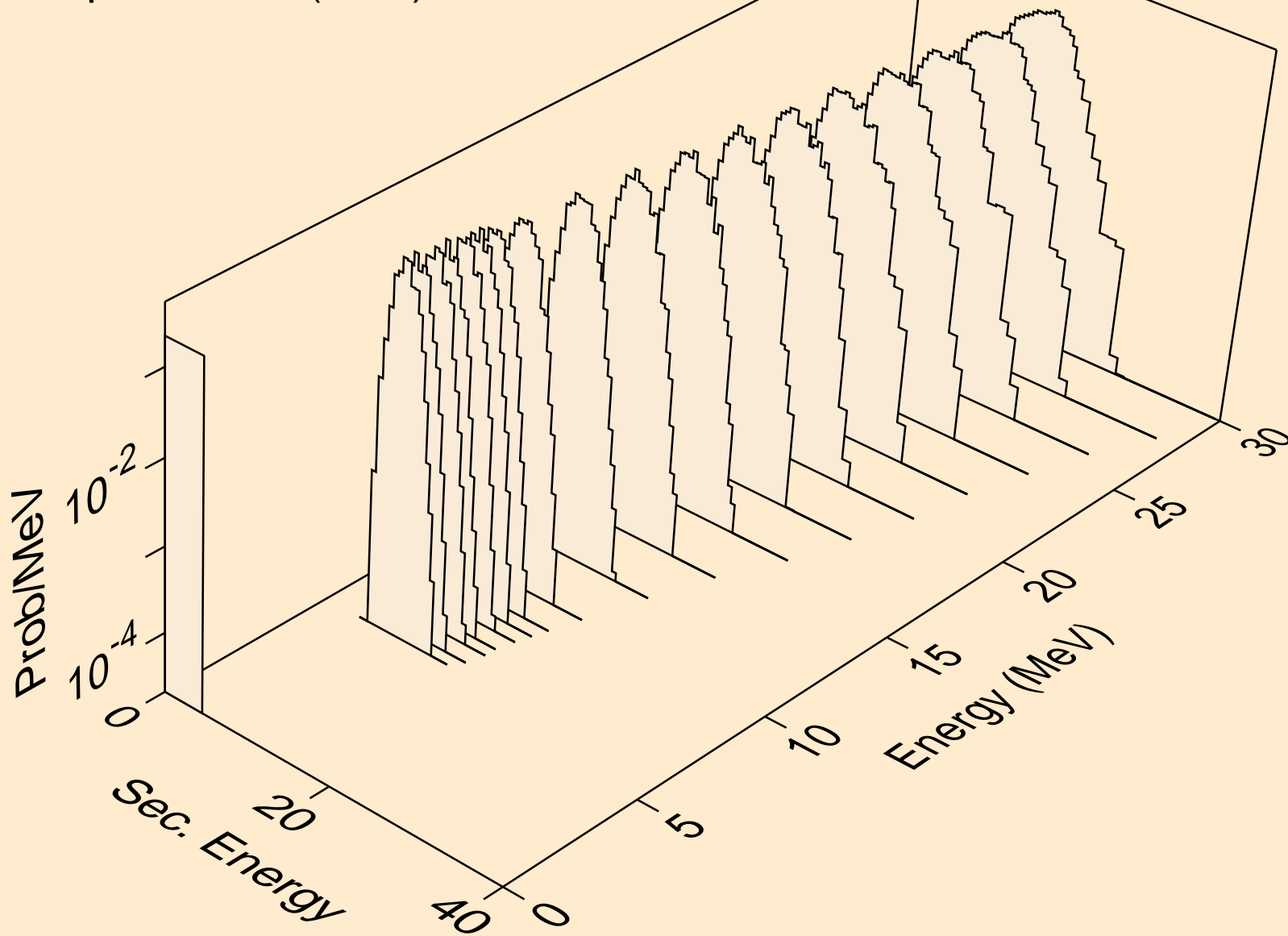



LU162N NEUTRON ACER TENDL-2019 LIBRARY; T=293.16K  
alphas from (n,pa)

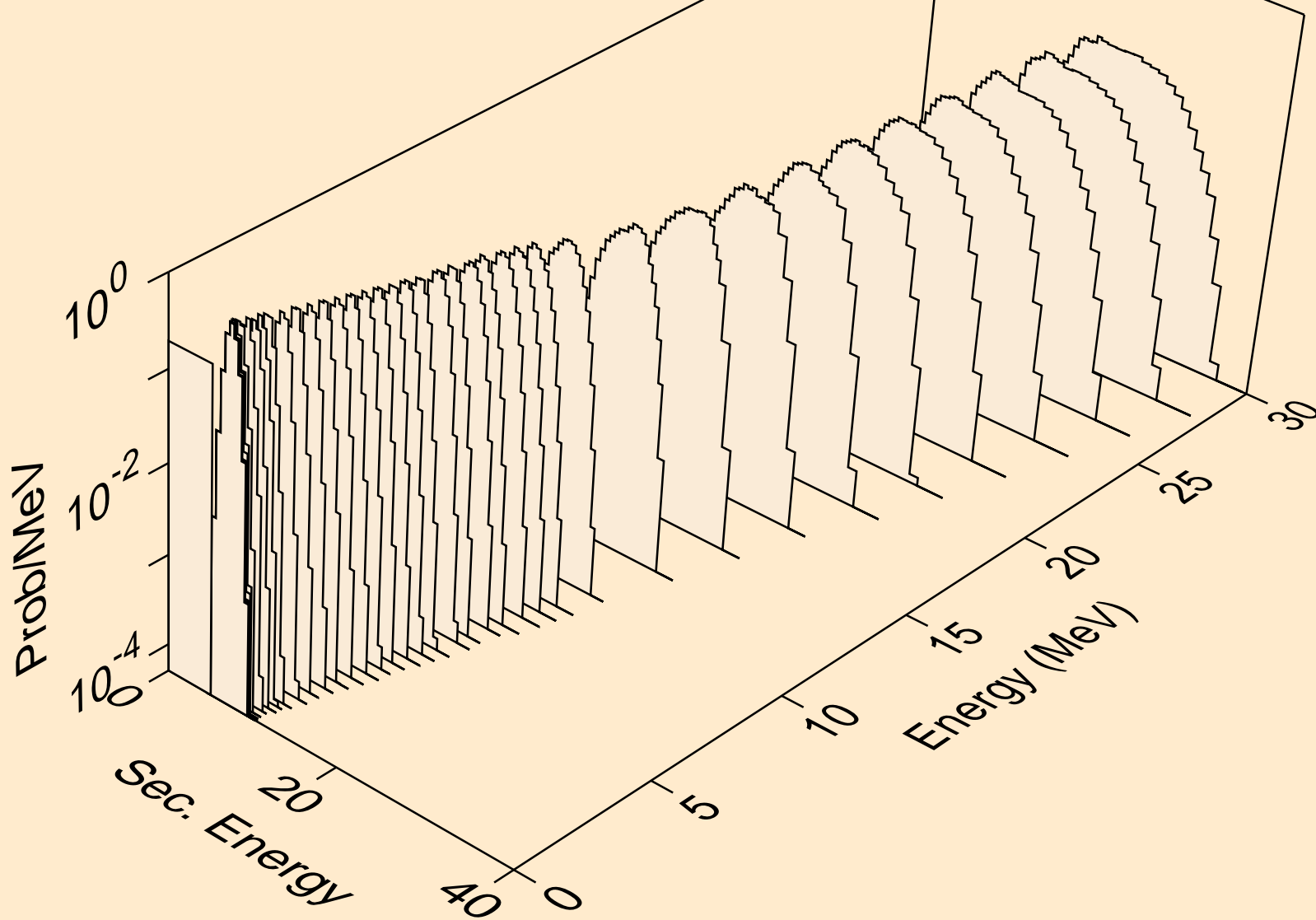

LU162N NEUTRON ACER TENDL-2019 LIBRARY; T=293.16K  
alphas from (n,da)

