

LU166 NEUTRON ACER TENDL-2019 LIBRARY; T=293.16K  
Principal cross sections

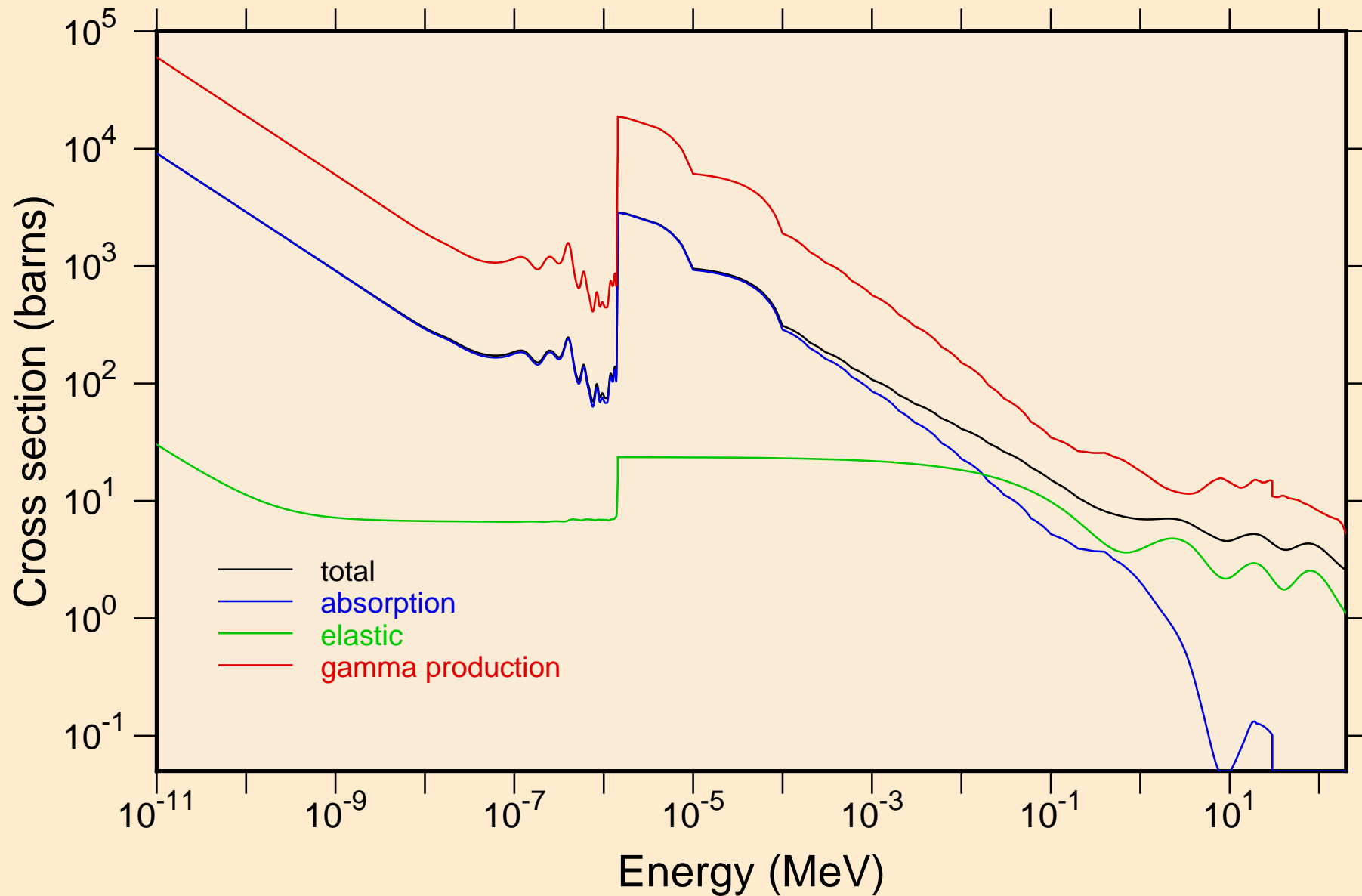

LU166 NEUTRON ACER TENDL-2019 LIBRARY; T=293.16K  
Heating

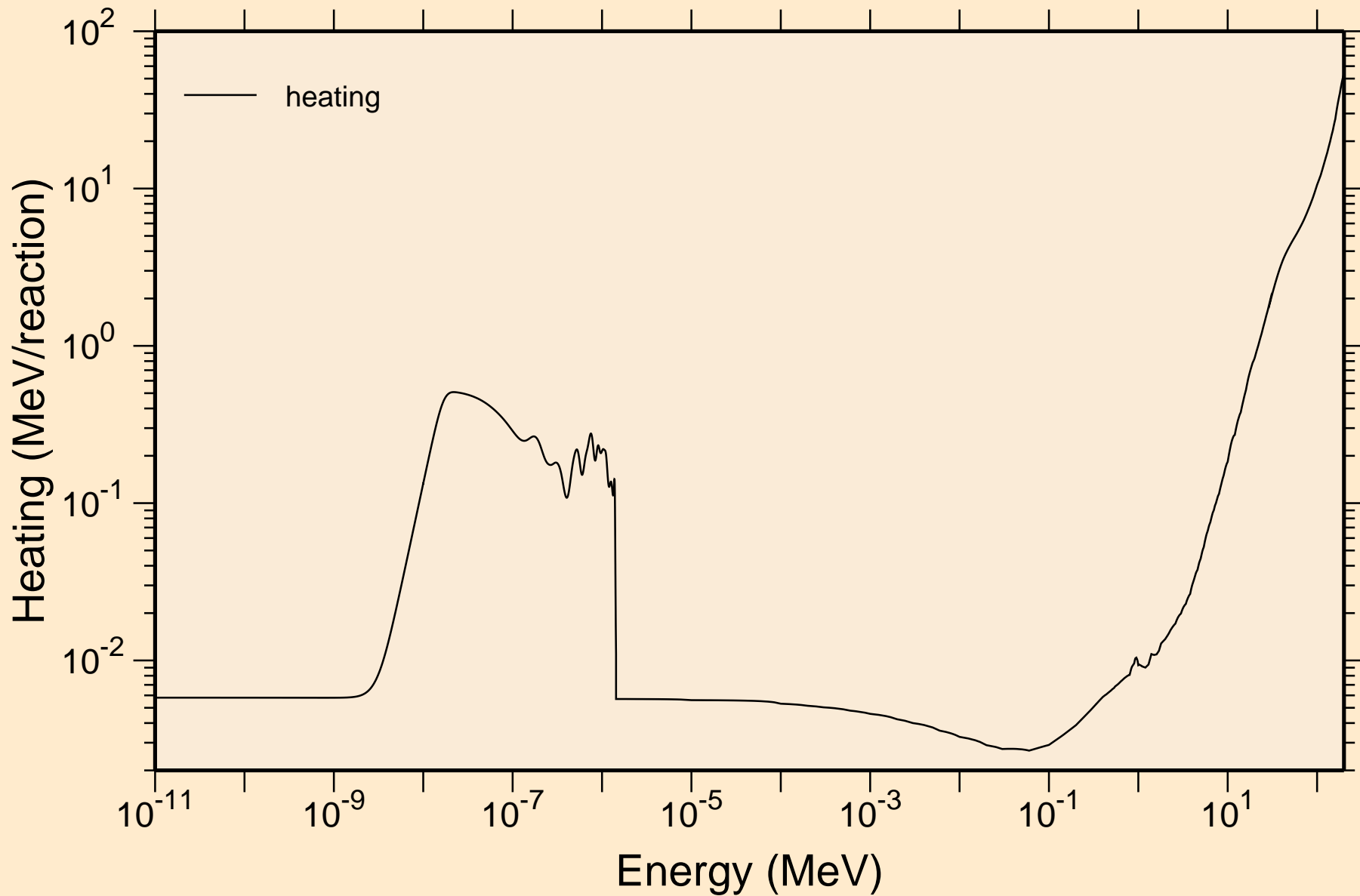

LU166 NEUTRON ACER TENDL-2019 LIBRARY; T=293.16K  
Damage

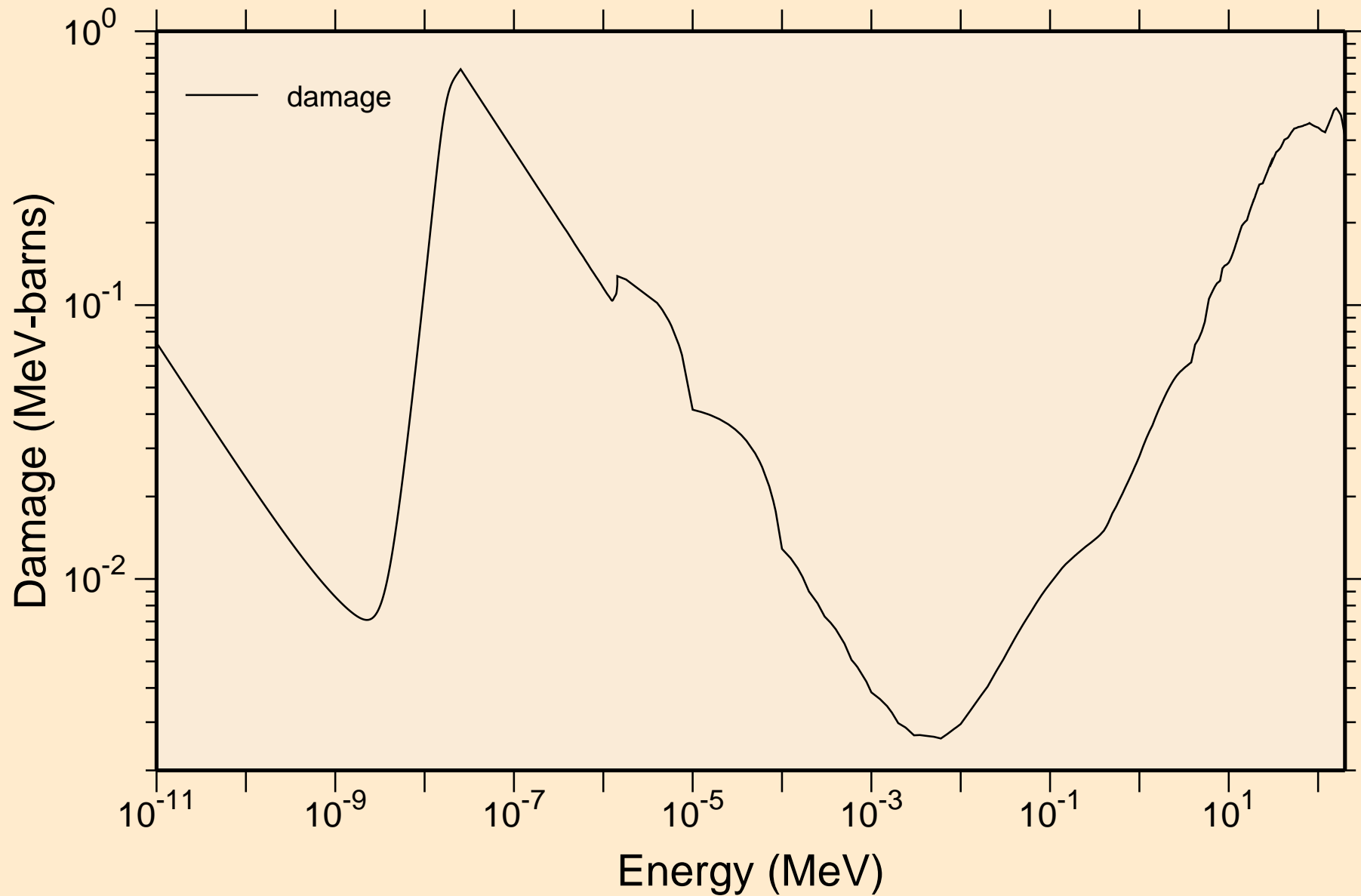

LU166 NEUTRON ACER TENDL-2019 LIBRARY; T=293.16K  
Non-threshold reactions

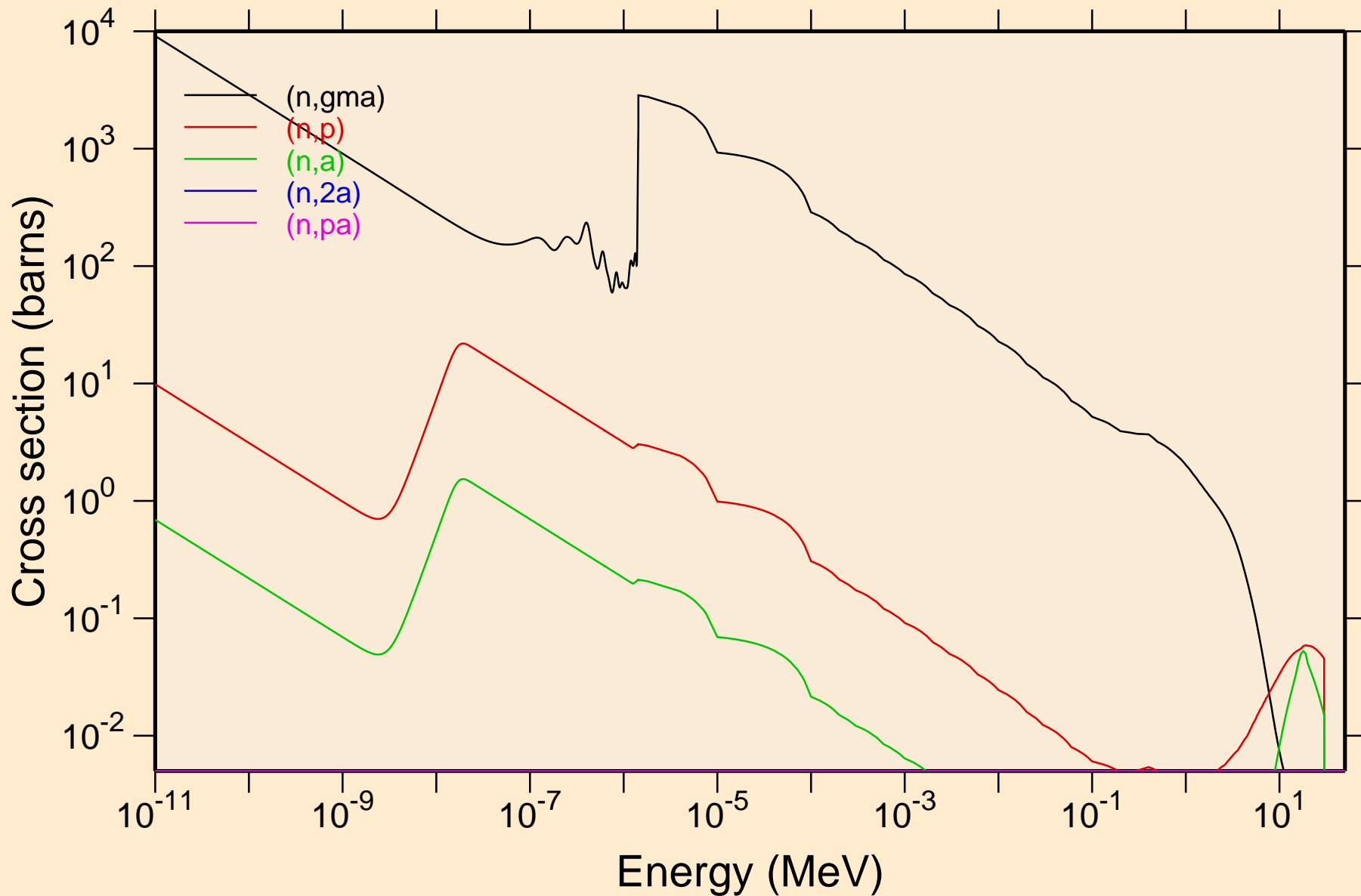

LU166 NEUTRON ACER TENDL-2019 LIBRARY; T=293.16K  
Non-threshold reactions

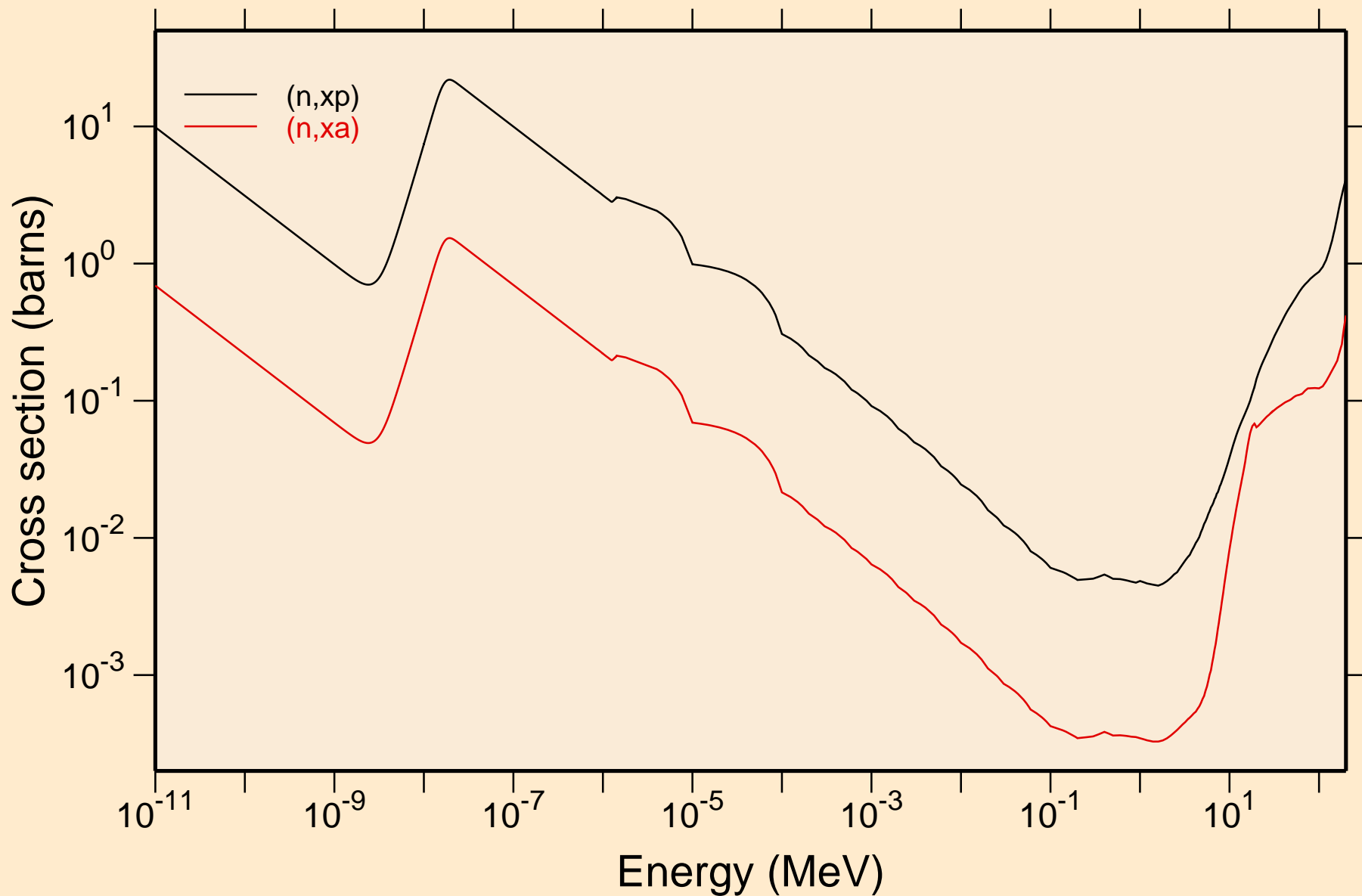

LU166 NEUTRON ACER TENDL-2019 LIBRARY; T=293.16K  
Principal cross sections

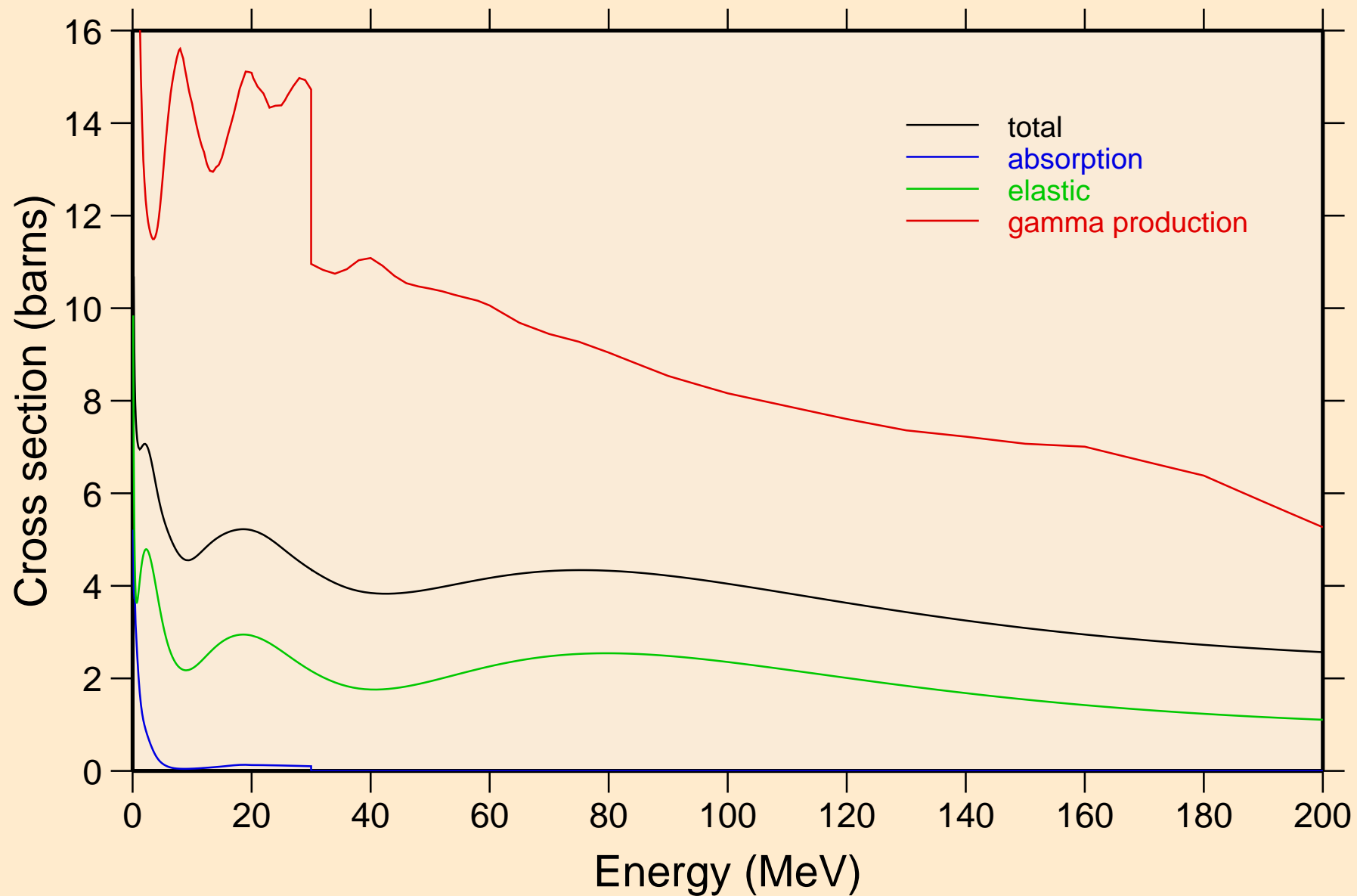

LU166 NEUTRON ACER TENDL-2019 LIBRARY; T=293.16K  
Heating

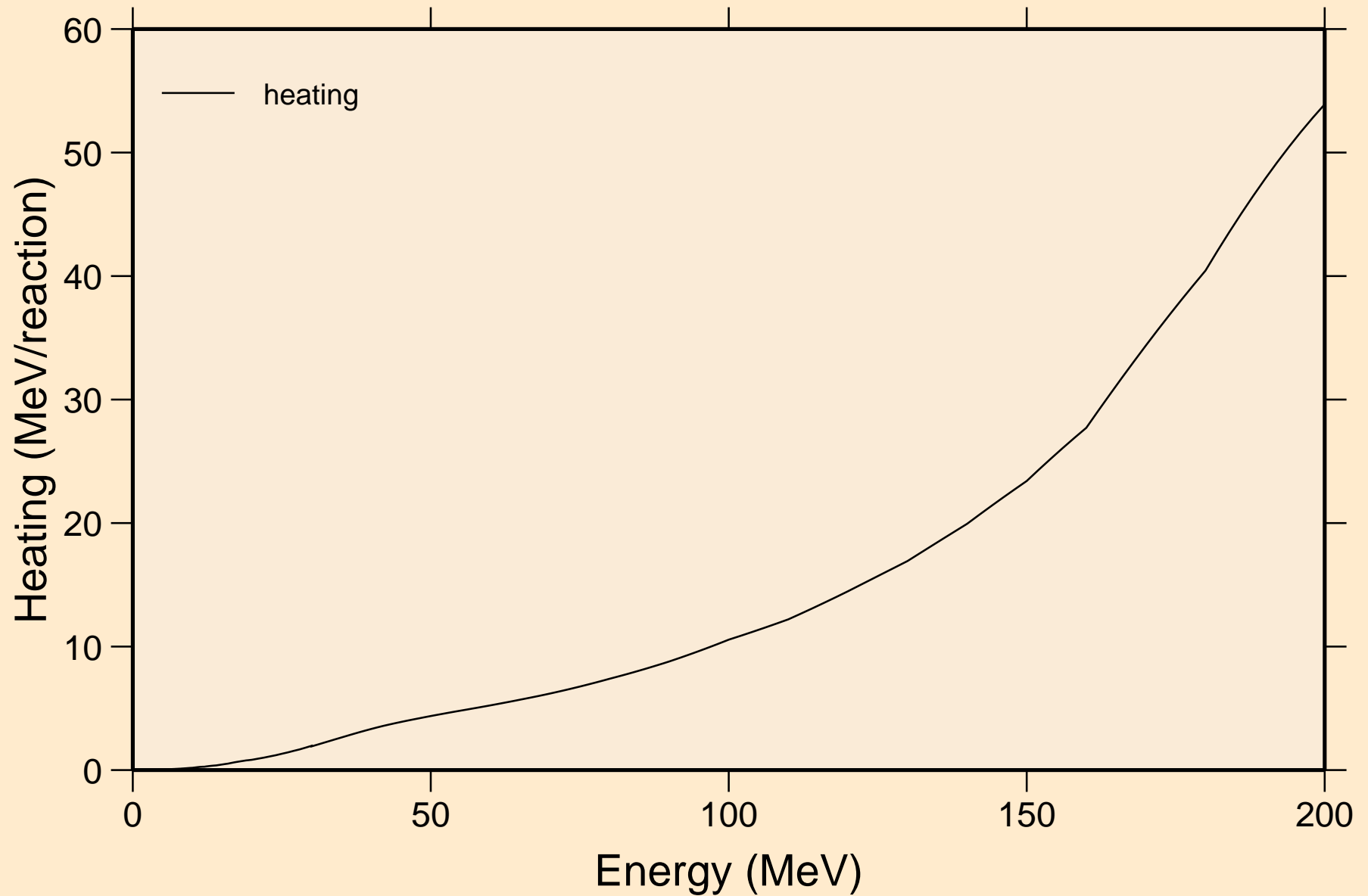

LU166 NEUTRON ACER TENDL-2019 LIBRARY; T=293.16K  
Damage

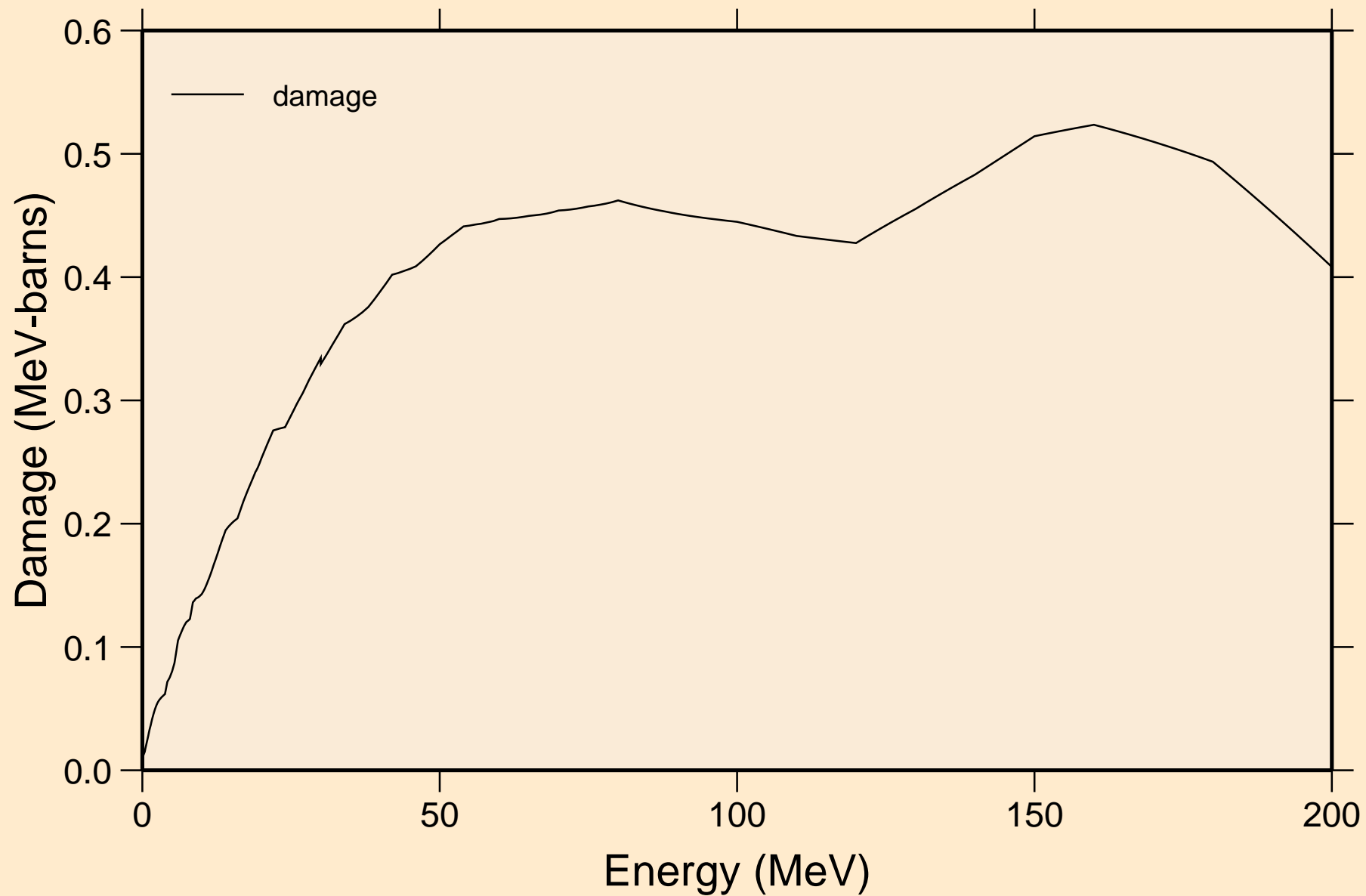



LU166 NEUTRON ACER TENDL-2019 LIBRARY; T=293.16K  
Non-threshold reactions

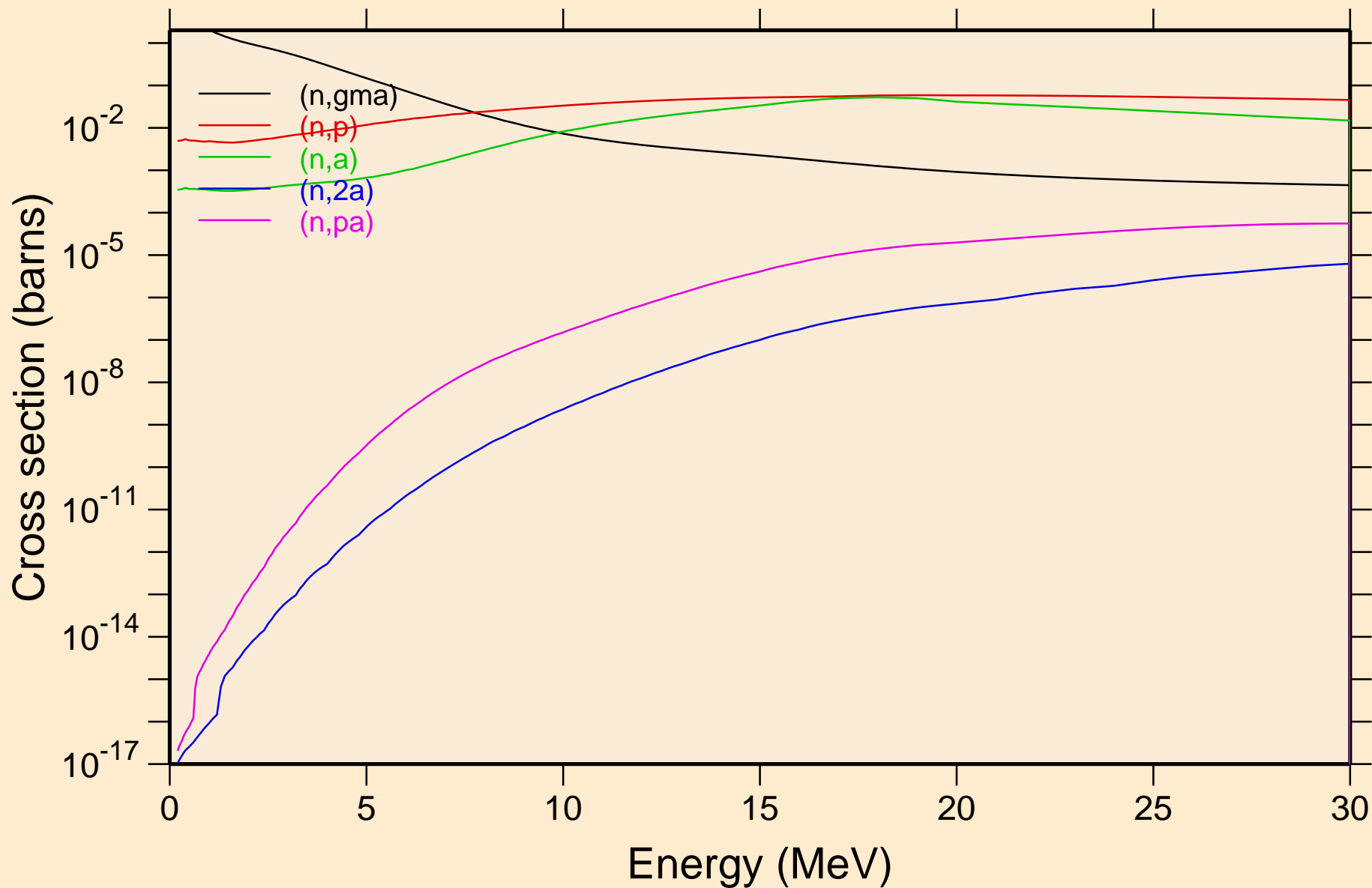

LU166 NEUTRON ACER TENDL-2019 LIBRARY; T=293.16K  
Non-threshold reactions

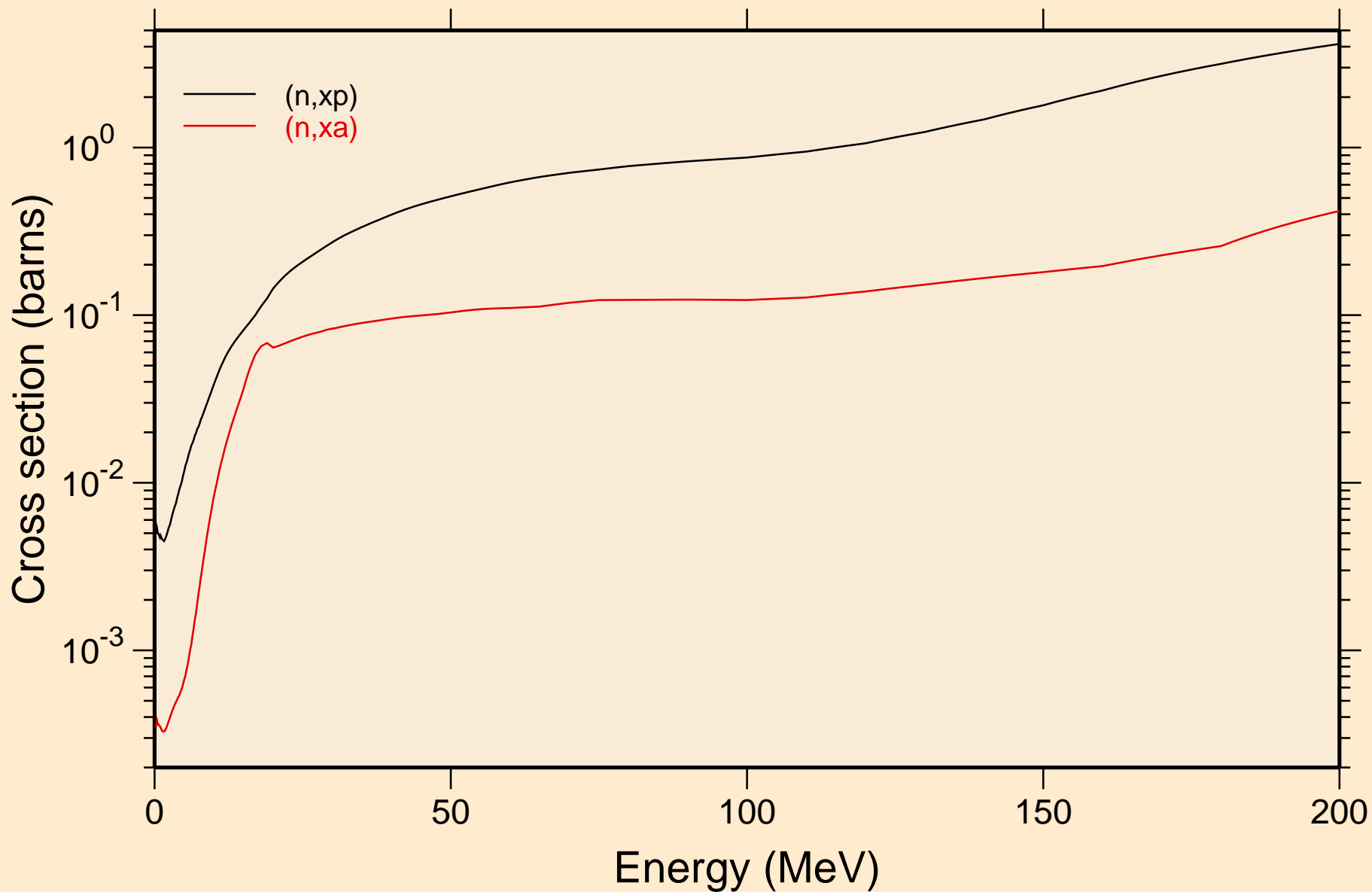

LU166 NEUTRON ACER TENDL-2019 LIBRARY; T=293.16K  
Inelastic levels

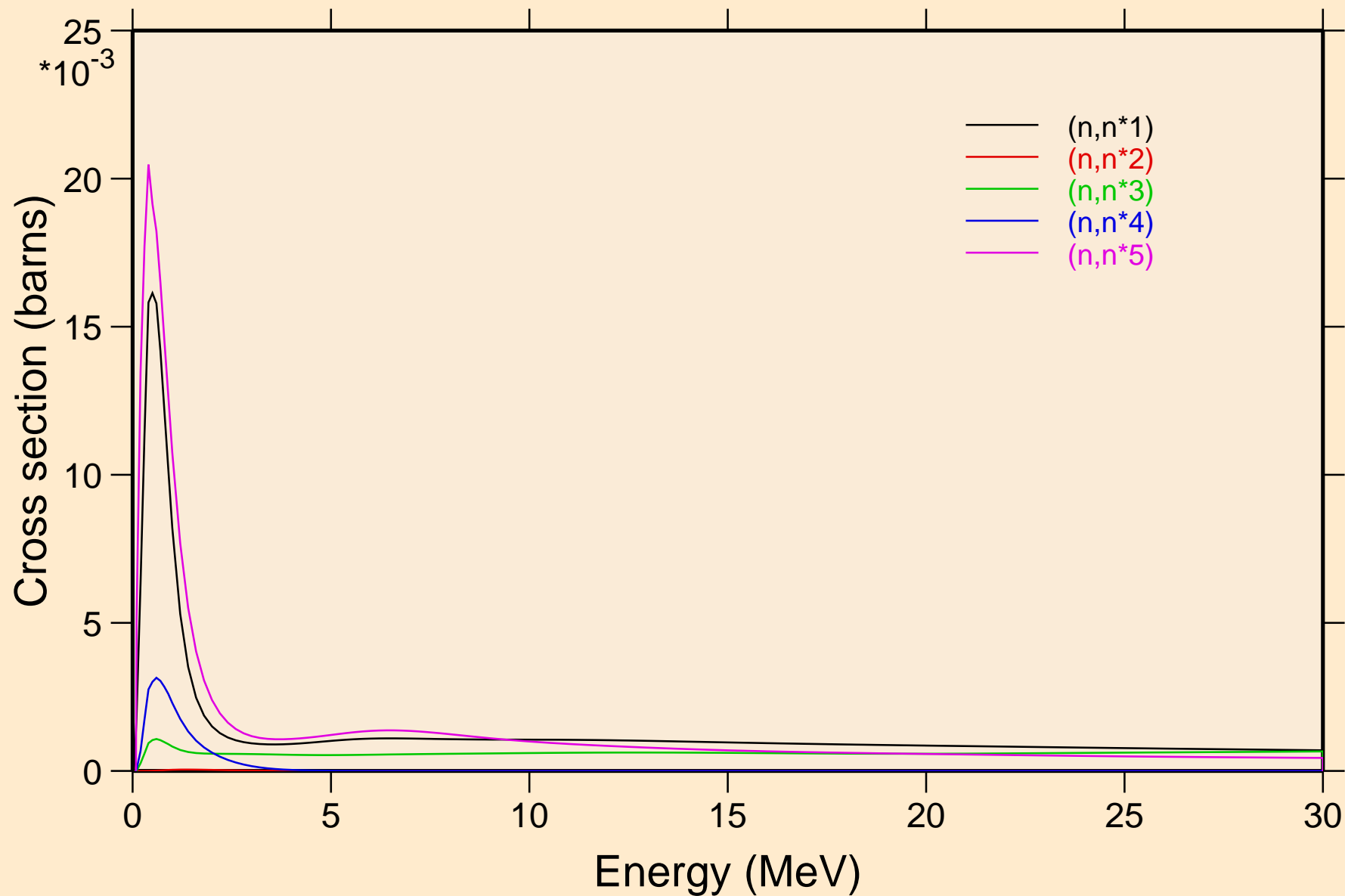

LU166 NEUTRON ACER TENDL-2019 LIBRARY; T=293.16K  
Inelastic levels

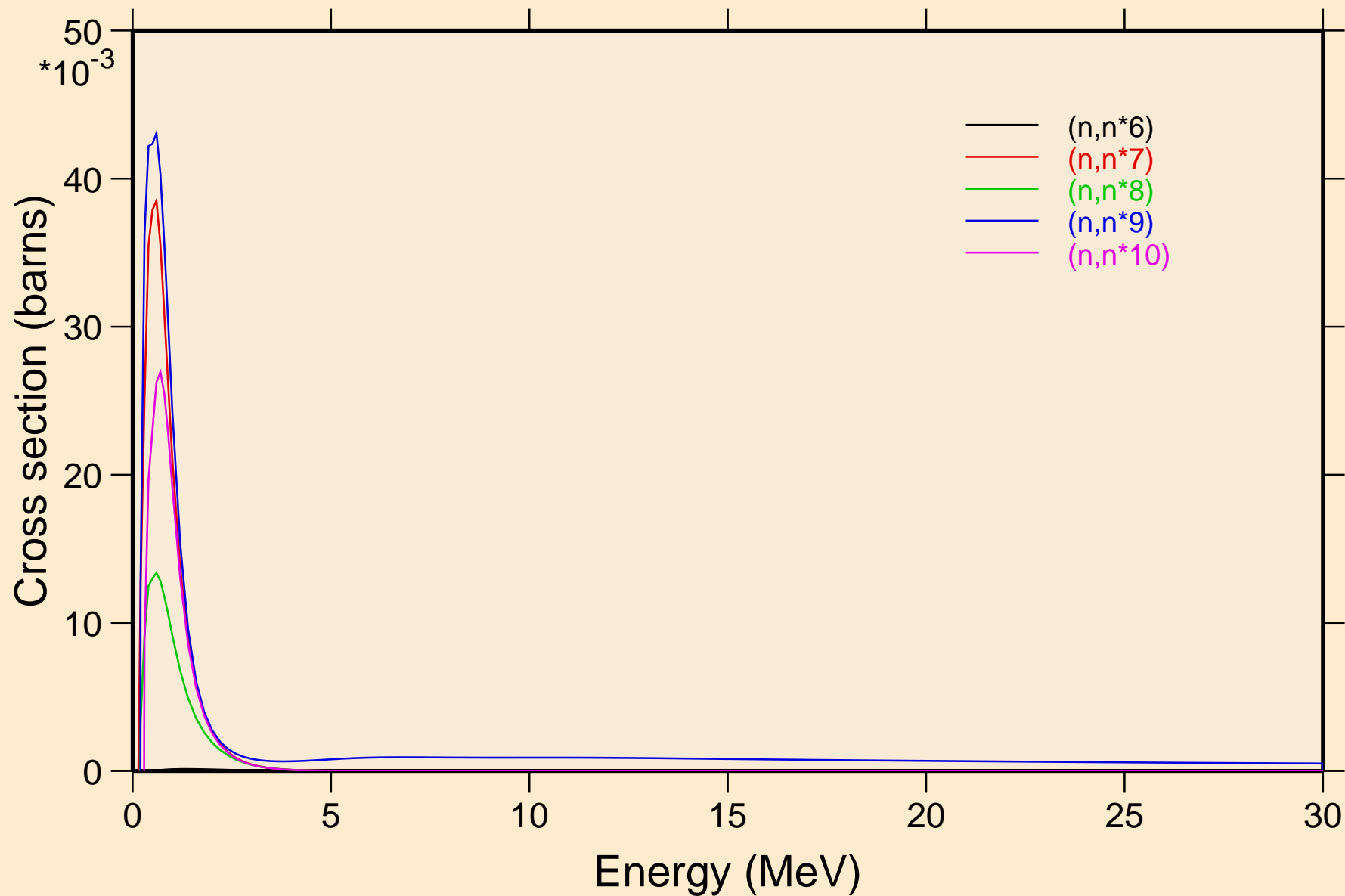

LU166 NEUTRON ACER TENDL-2019 LIBRARY; T=293.16K  
Inelastic levels

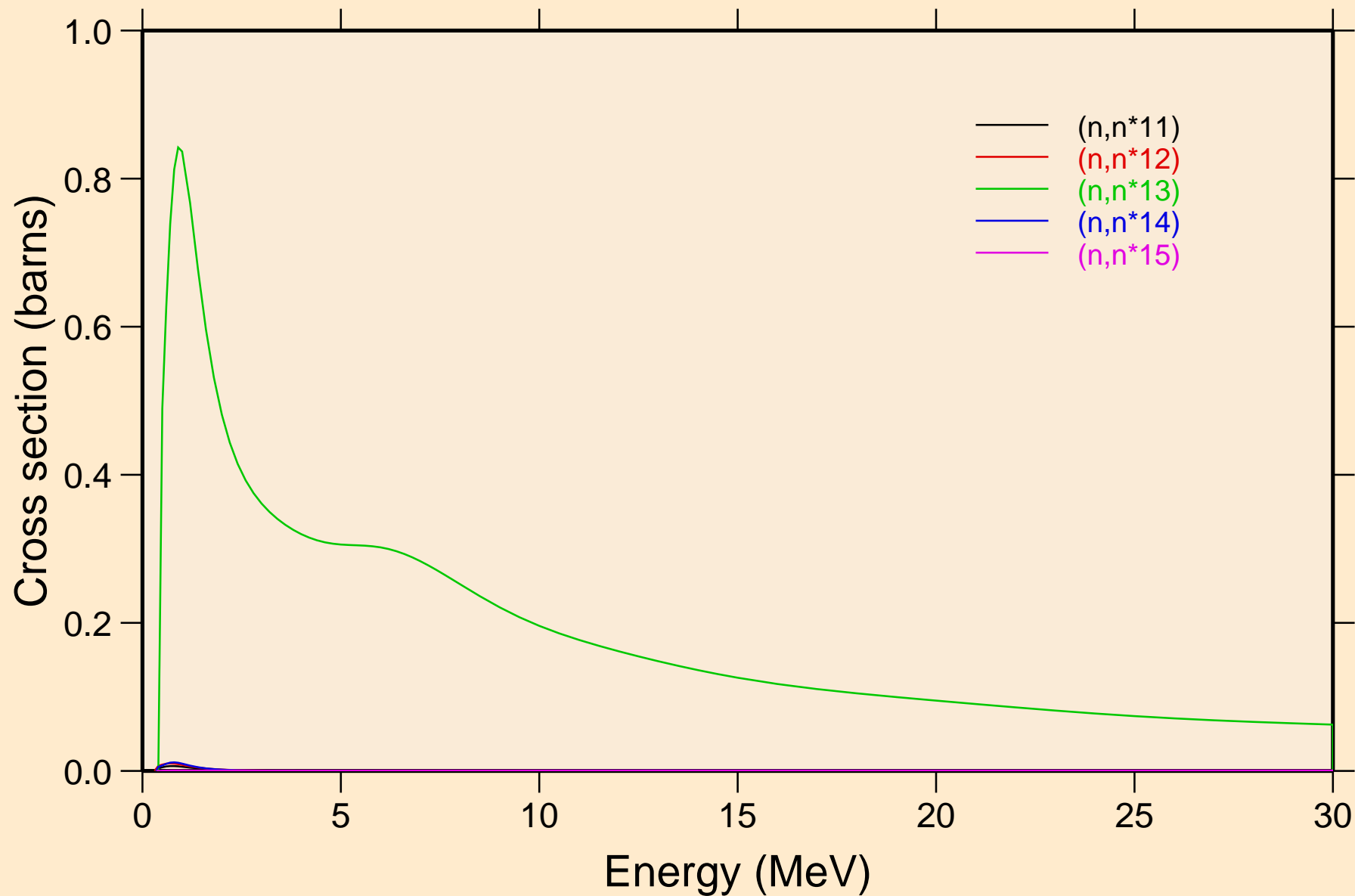

LU166 NEUTRON ACER TENDL-2019 LIBRARY; T=293.16K  
Inelastic levels

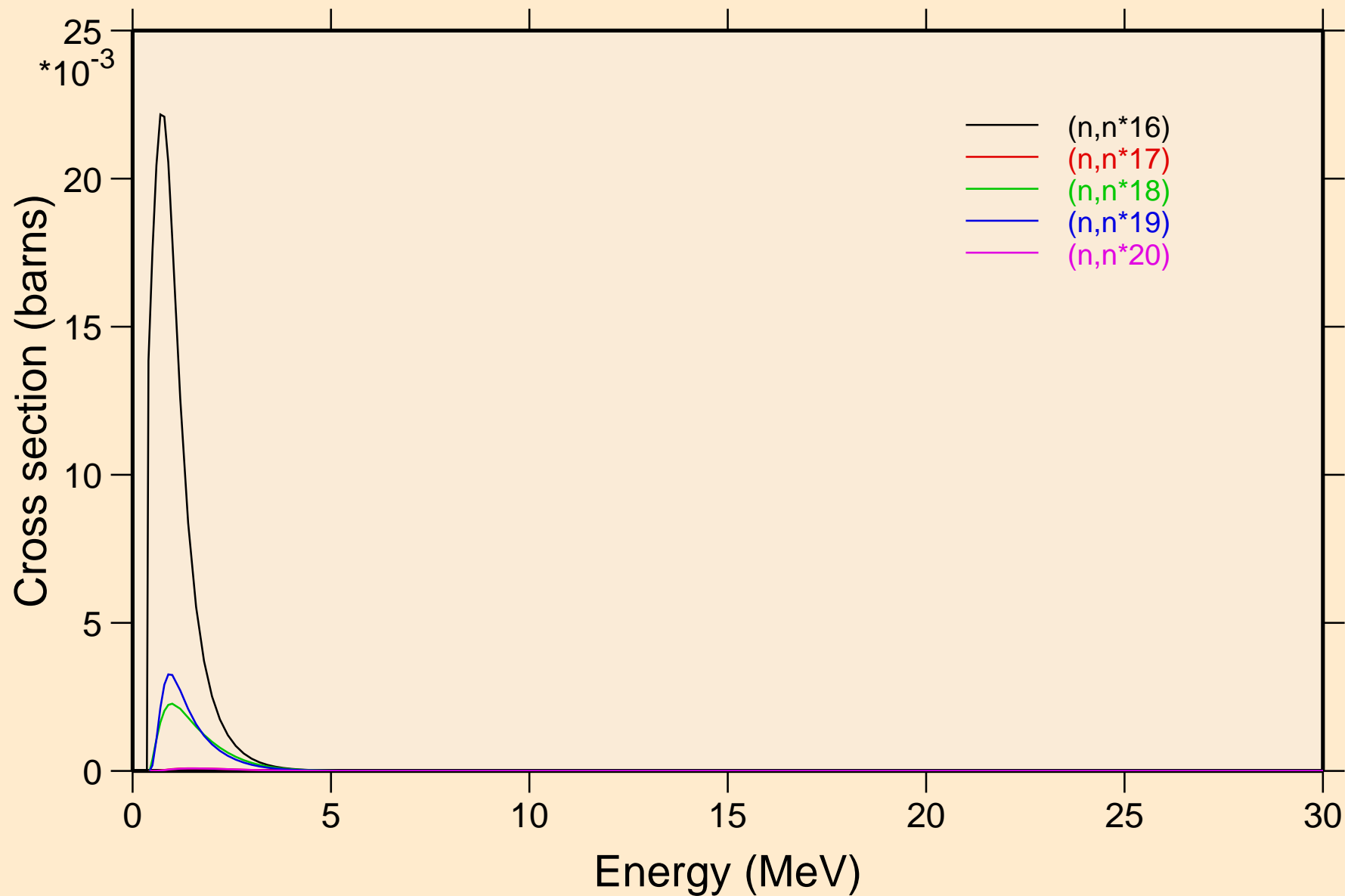

LU166 NEUTRON ACER TENDL-2019 LIBRARY; T=293.16K  
Inelastic levels

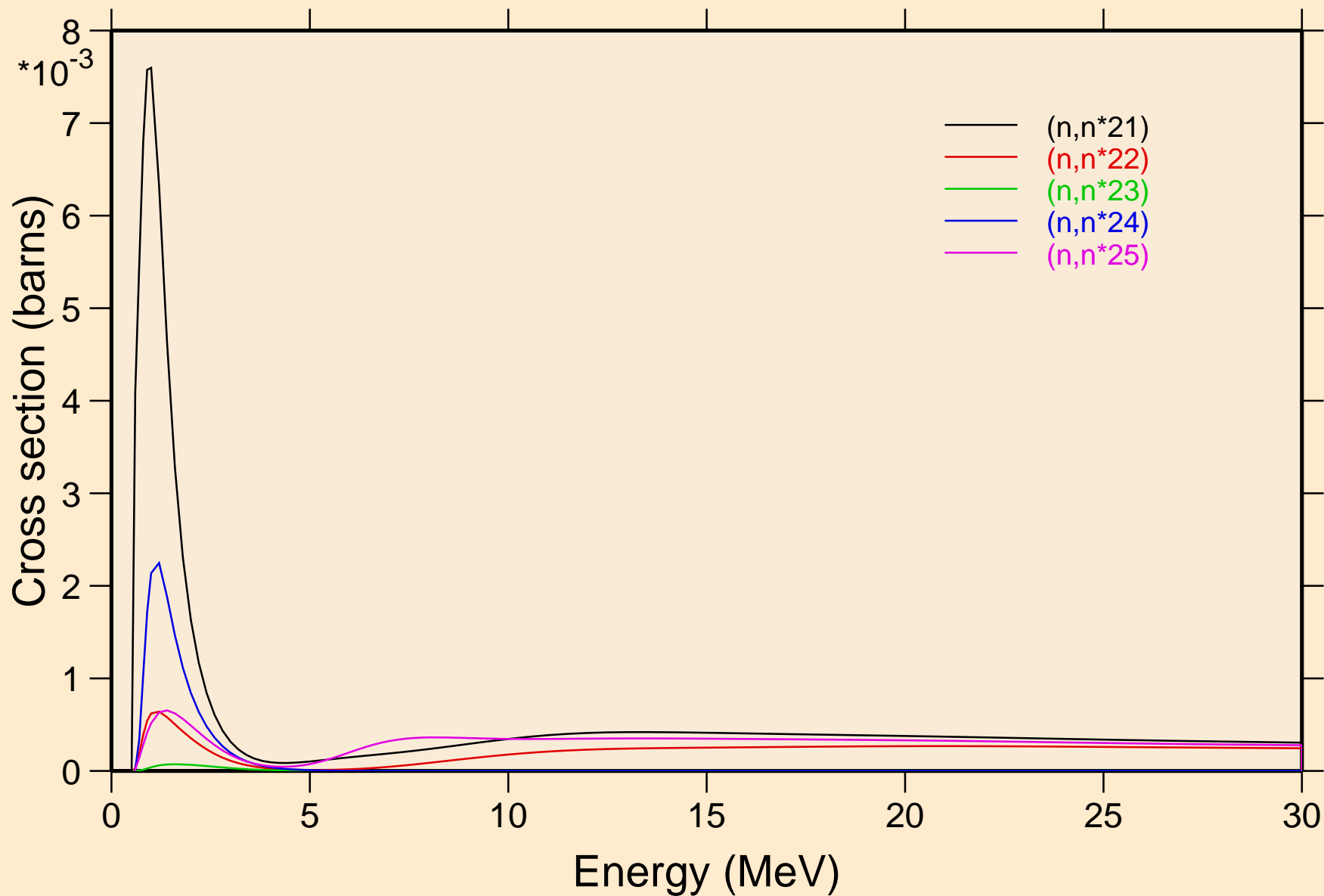

LU166 NEUTRON ACER TENDL-2019 LIBRARY; T=293.16K  
Inelastic levels

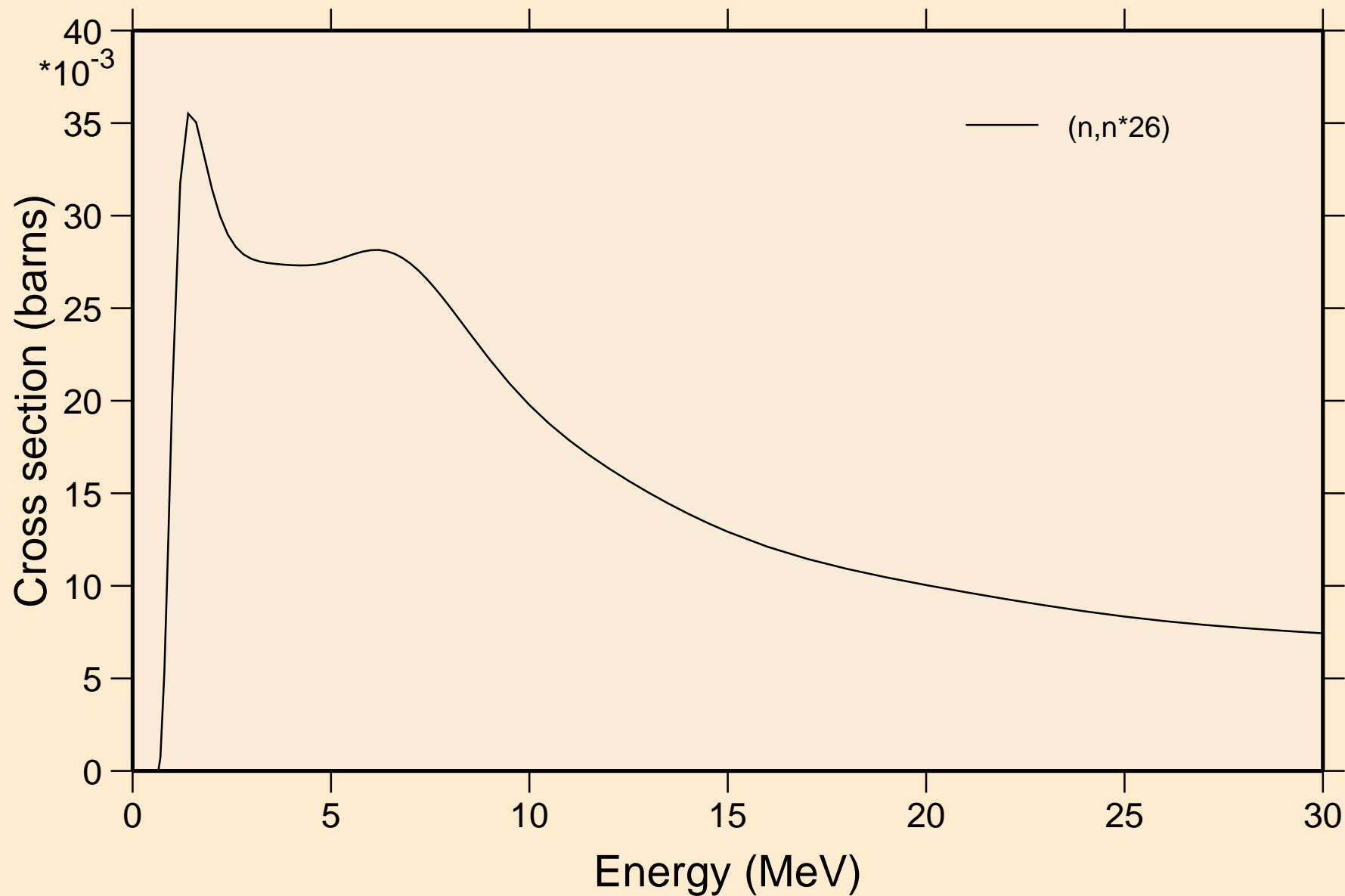



LU166 NEUTRON ACER TENDL-2019 LIBRARY; T=293.16K  
Threshold reactions

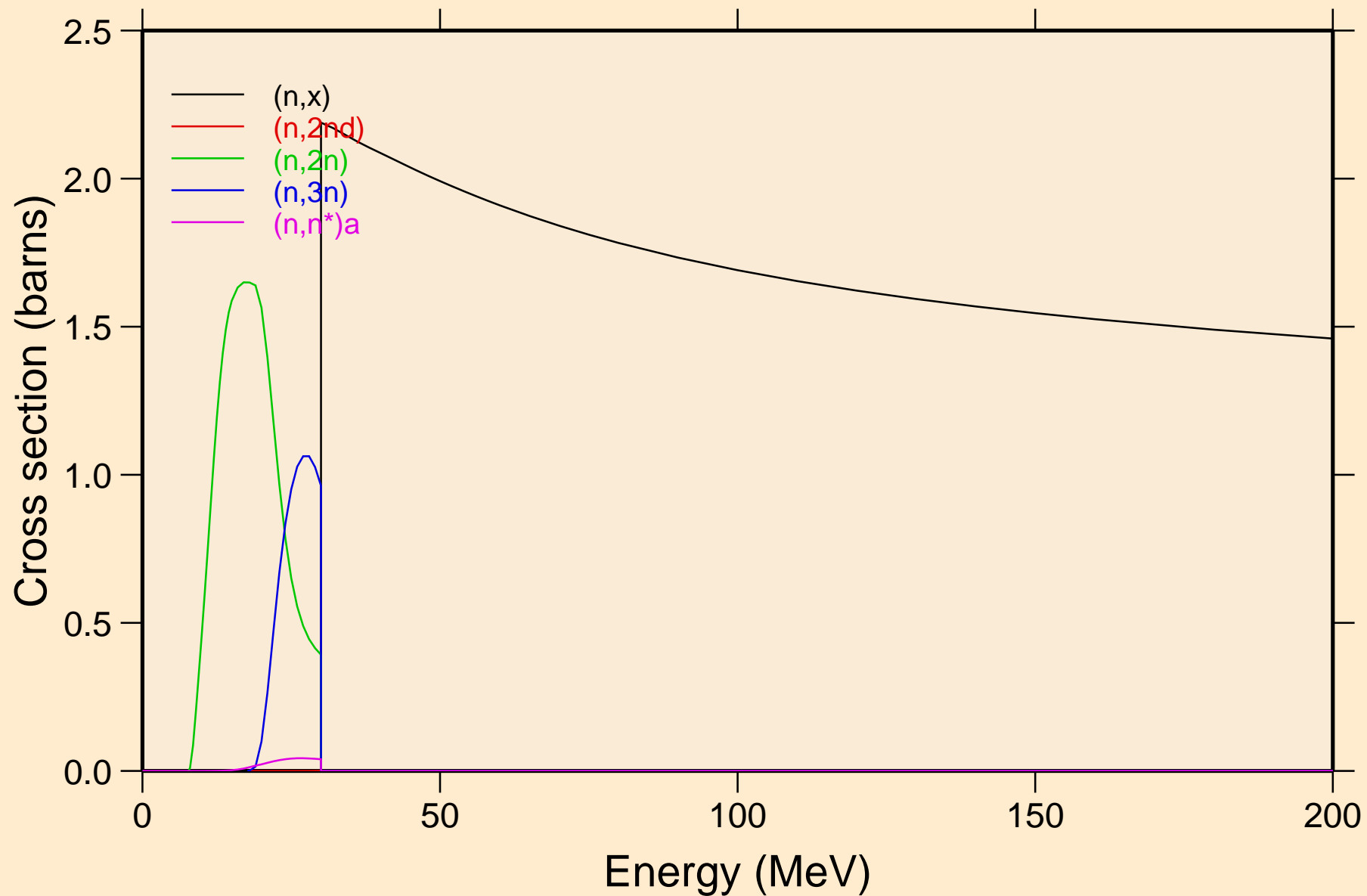

LU166 NEUTRON ACER TENDL-2019 LIBRARY; T=293.16K  
Threshold reactions

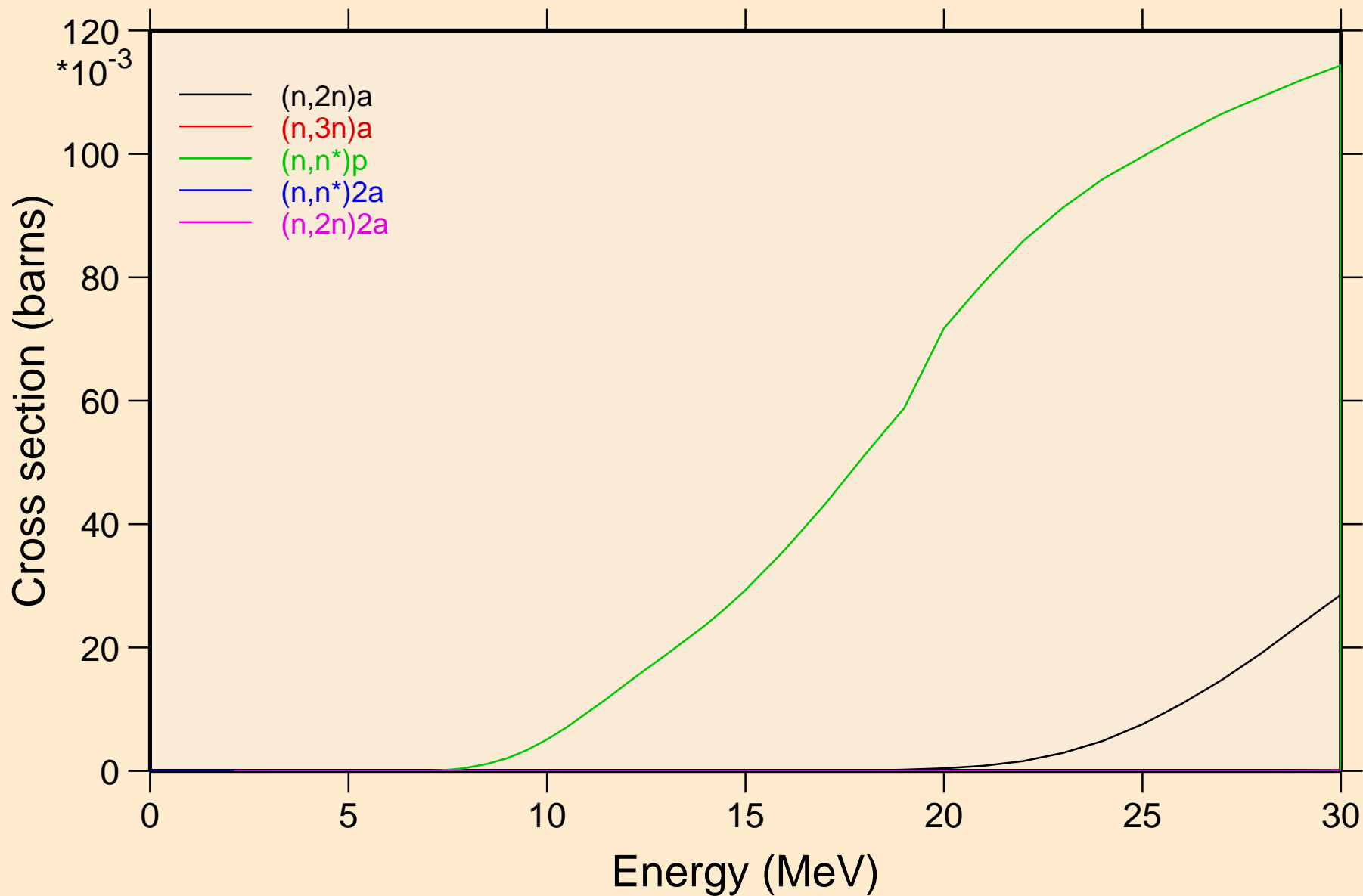

LU166 NEUTRON ACER TENDL-2019 LIBRARY; T=293.16K  
Threshold reactions

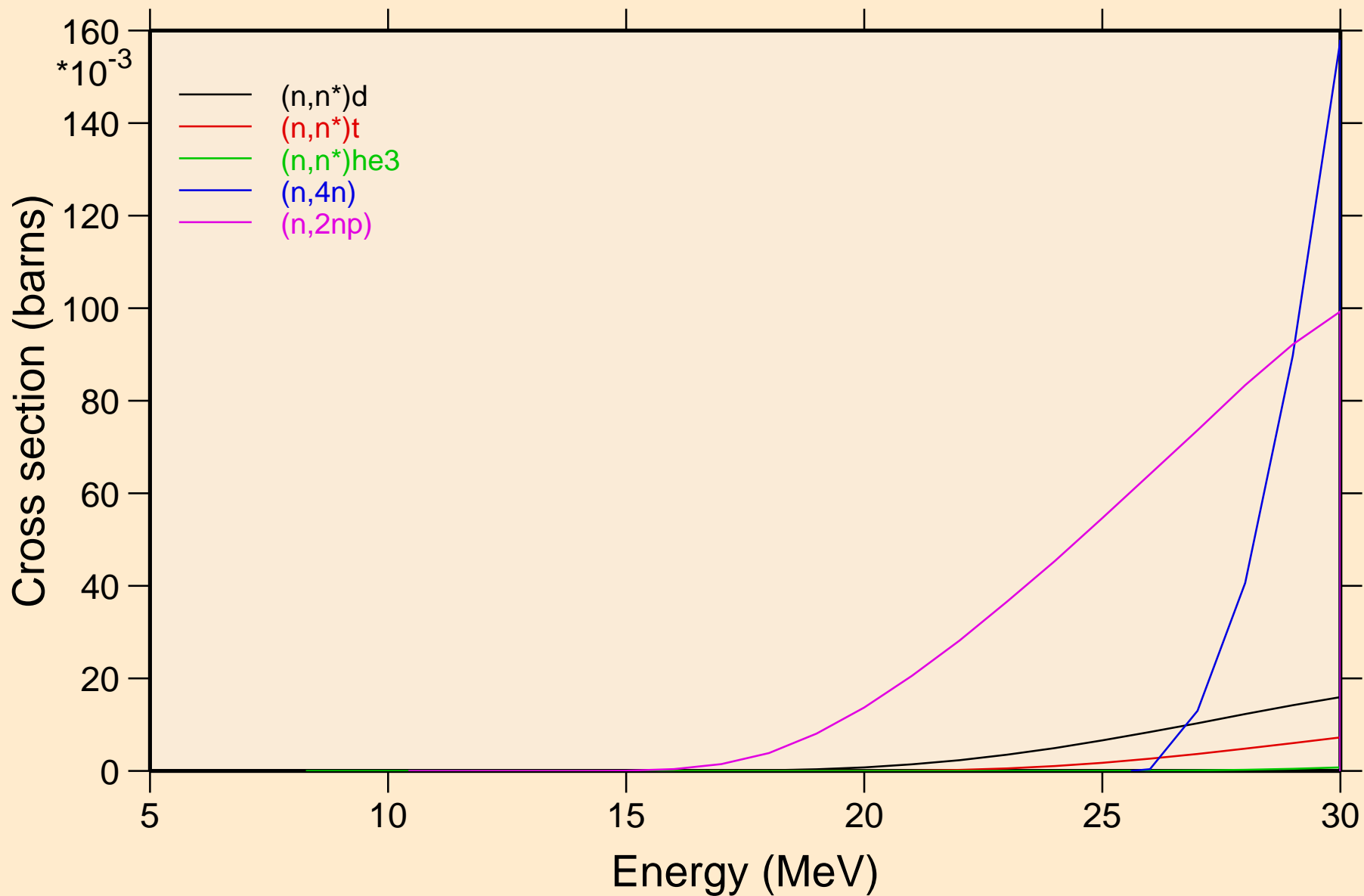

LU166 NEUTRON ACER TENDL-2019 LIBRARY; T=293.16K  
Threshold reactions

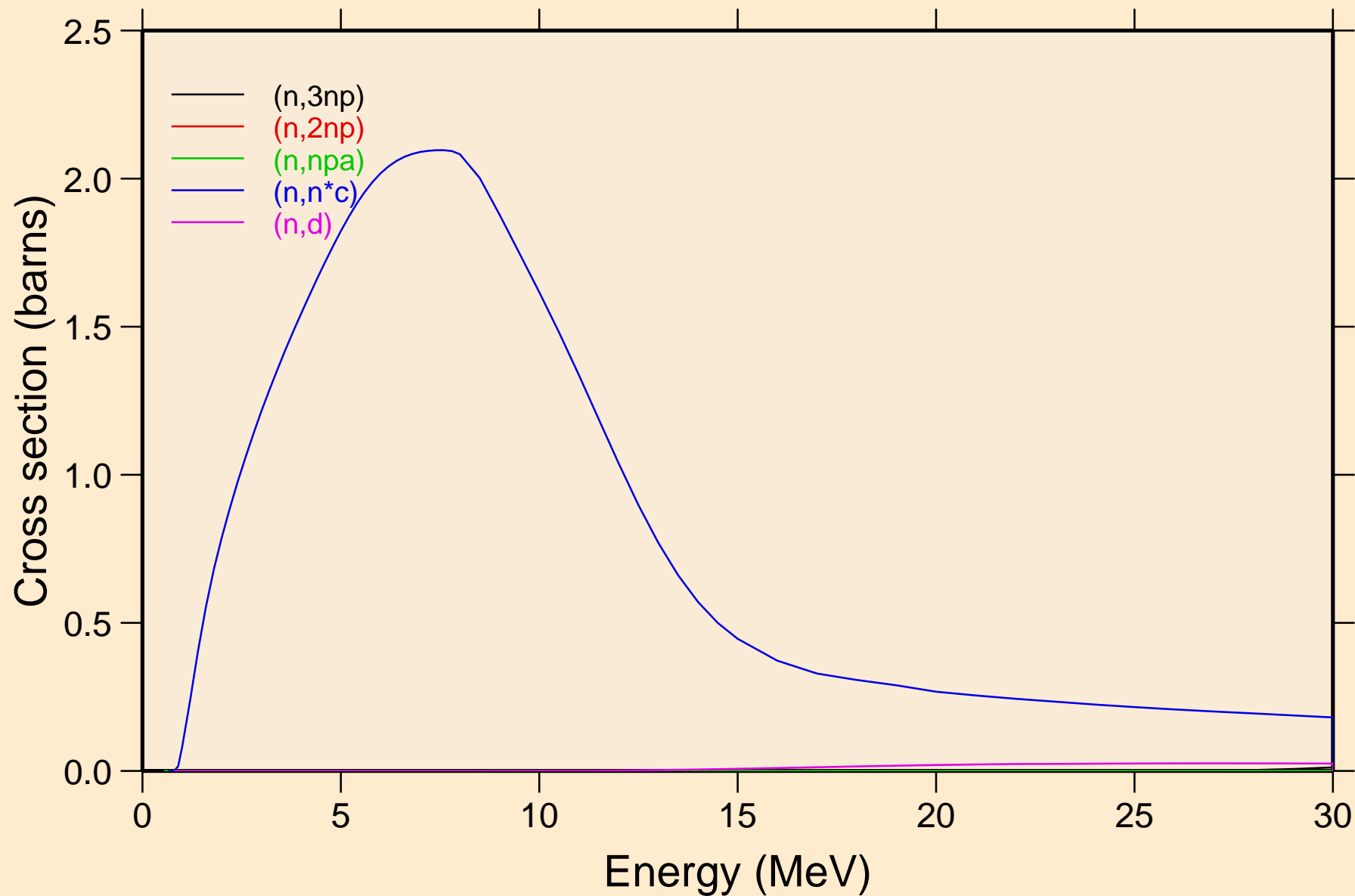

LU166 NEUTRON ACER TENDL-2019 LIBRARY; T=293.16K  
Threshold reactions

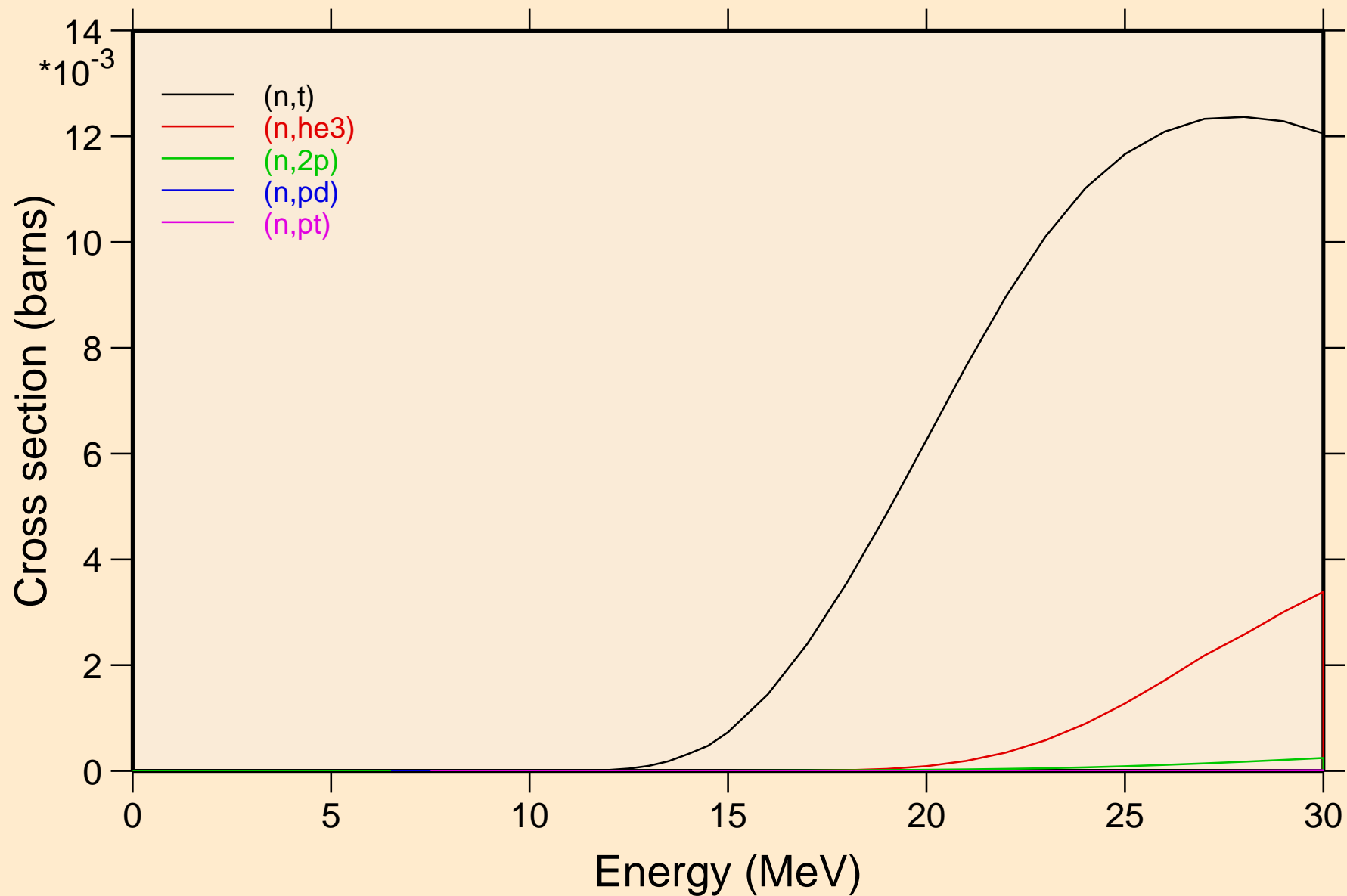

LU166 NEUTRON ACER TENDL-2019 LIBRARY; T=293.16K  
Threshold reactions

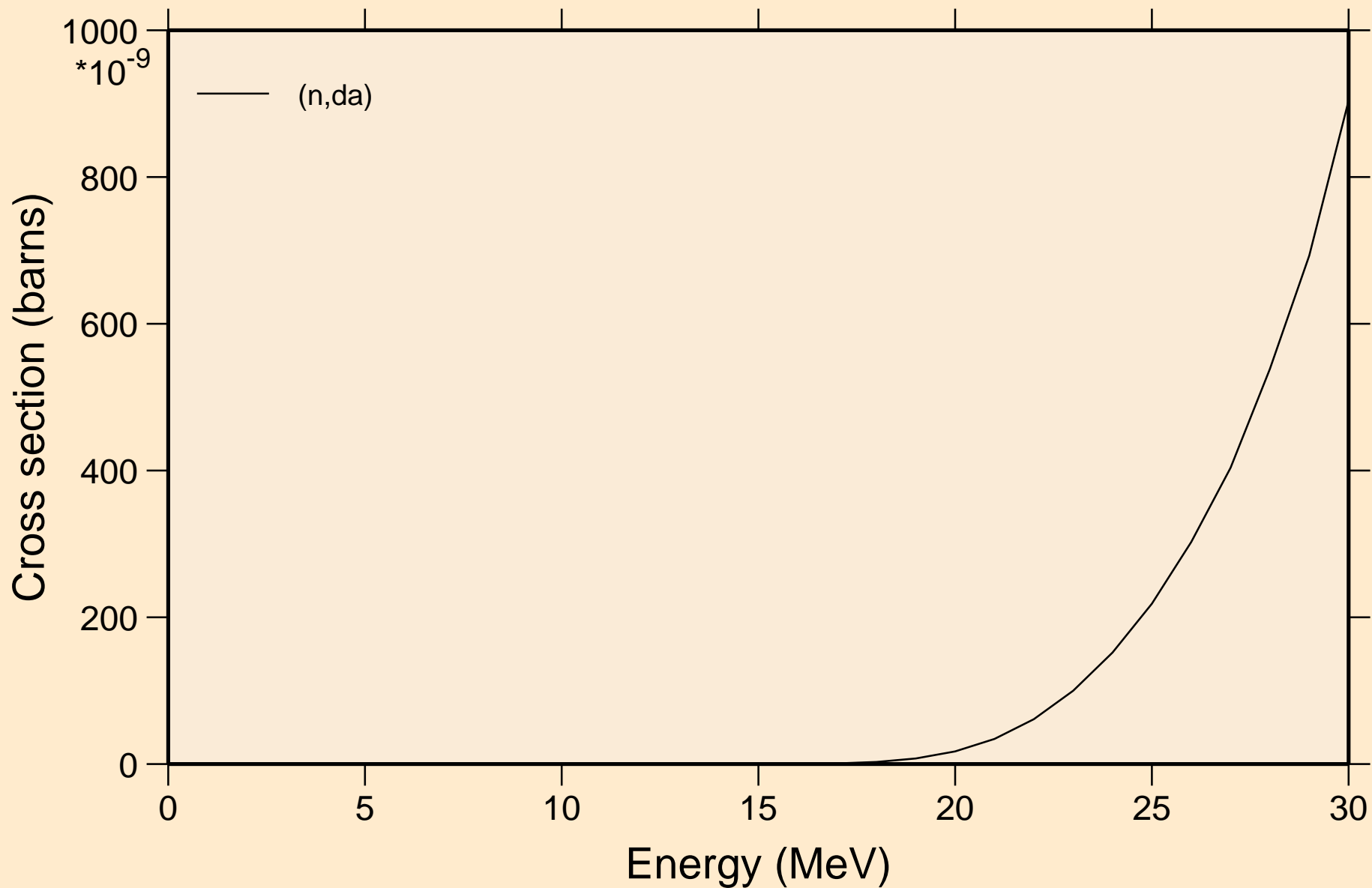

LU166 NEUTRON ACER TENDL-2019 LIBRARY; T=293.16K  
Threshold reactions

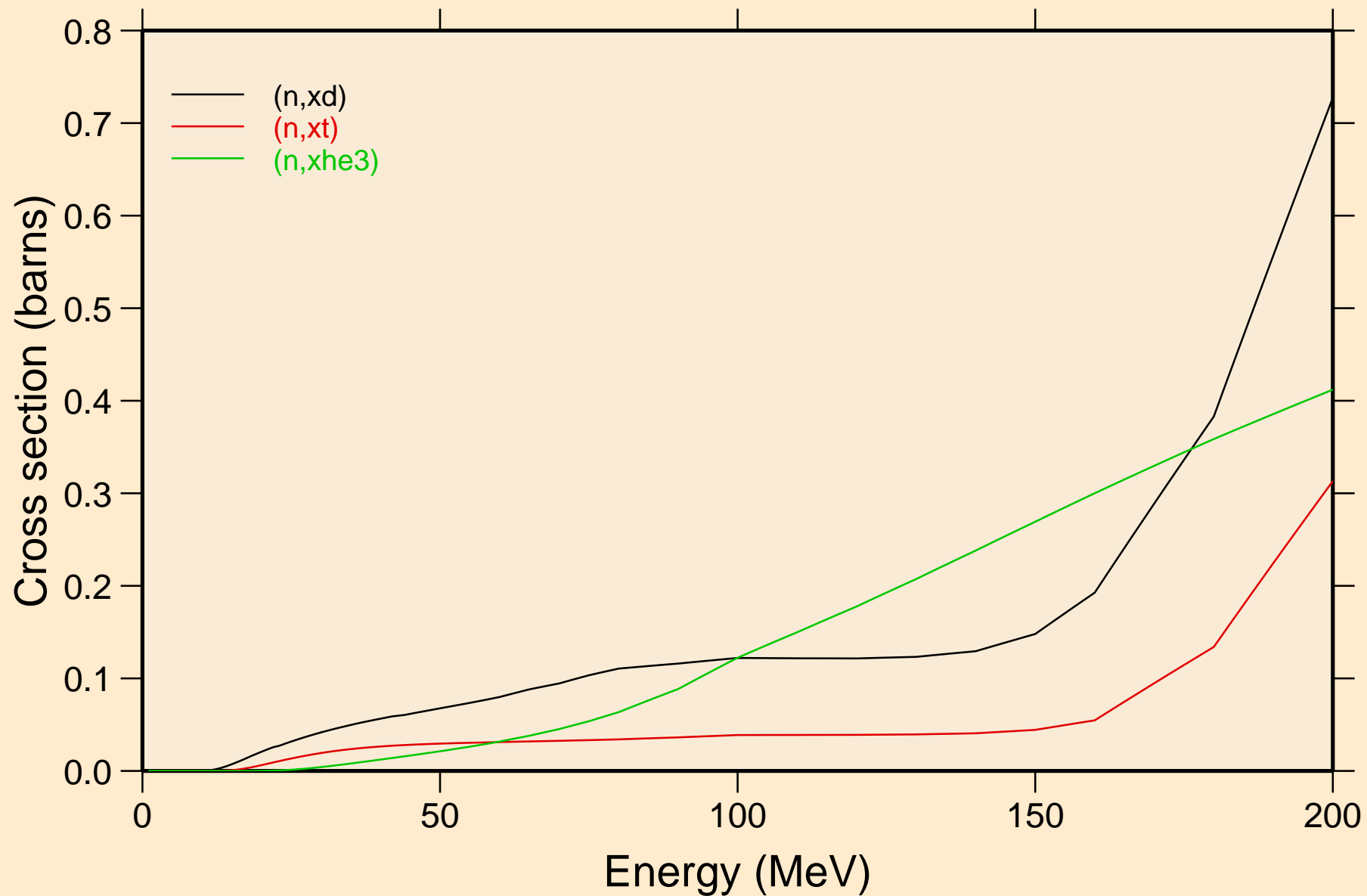

LU166 NEUTRON ACER TENDL-2019 LIBRARY; T=293.16K  
angular distribution for elastic

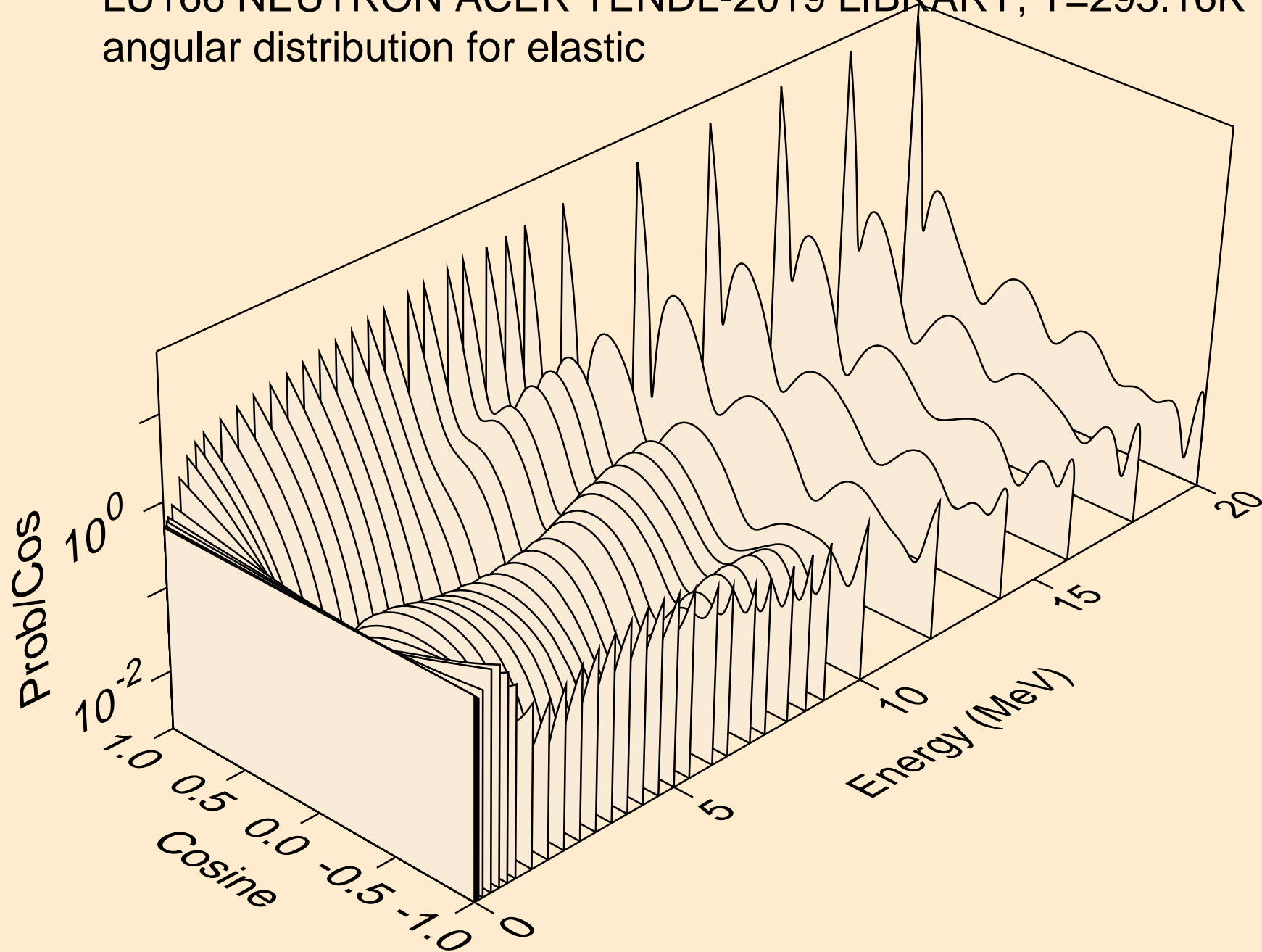



LU166 NEUTRON ACER TENDL-2019 LIBRARY; T=293.16K  
angular distribution for elastic

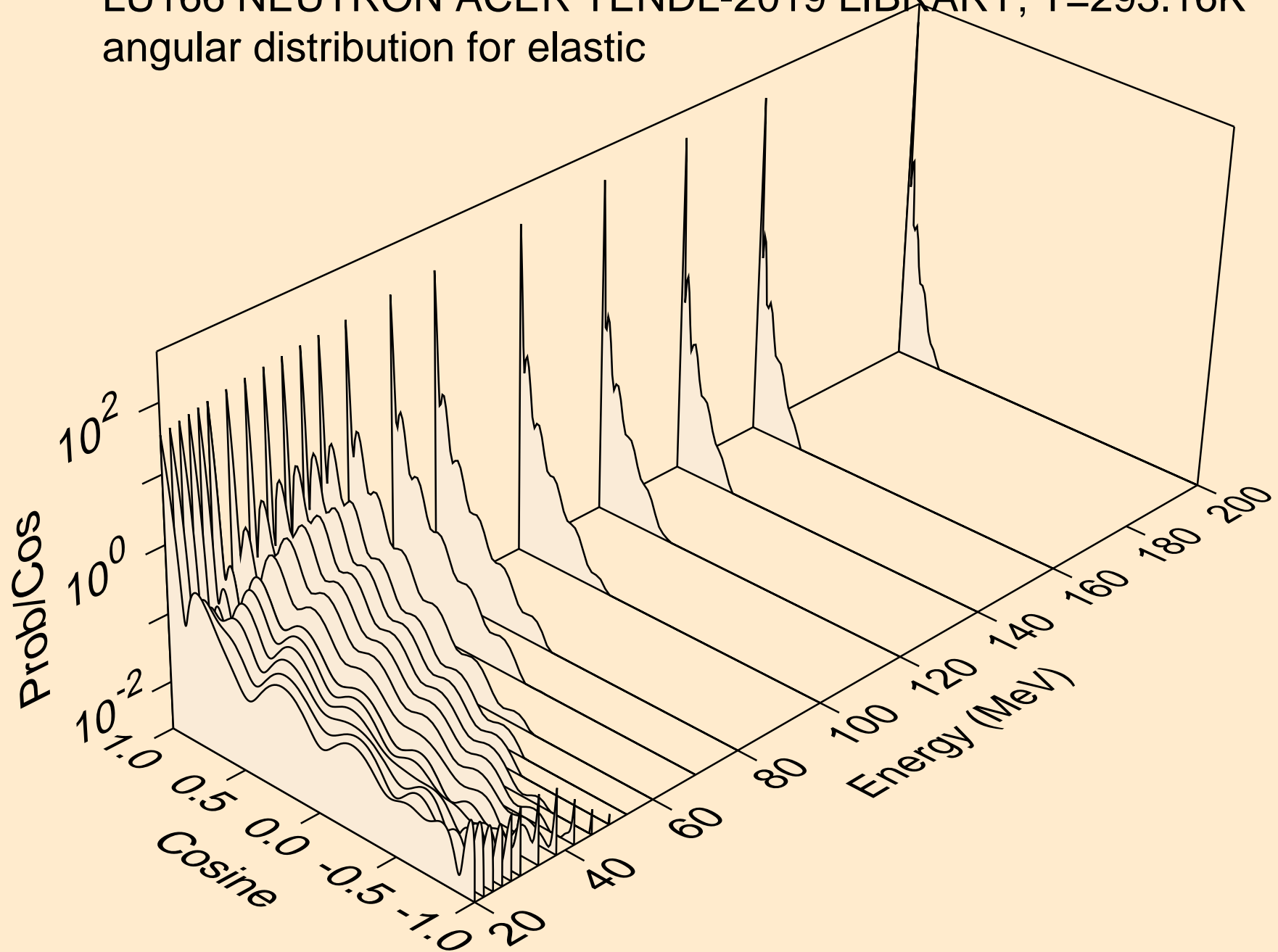

LU166 NEUTRON ACER TENDL-2019 LIBRARY; T=293.16K  
angular distribution for (n,n\*1)

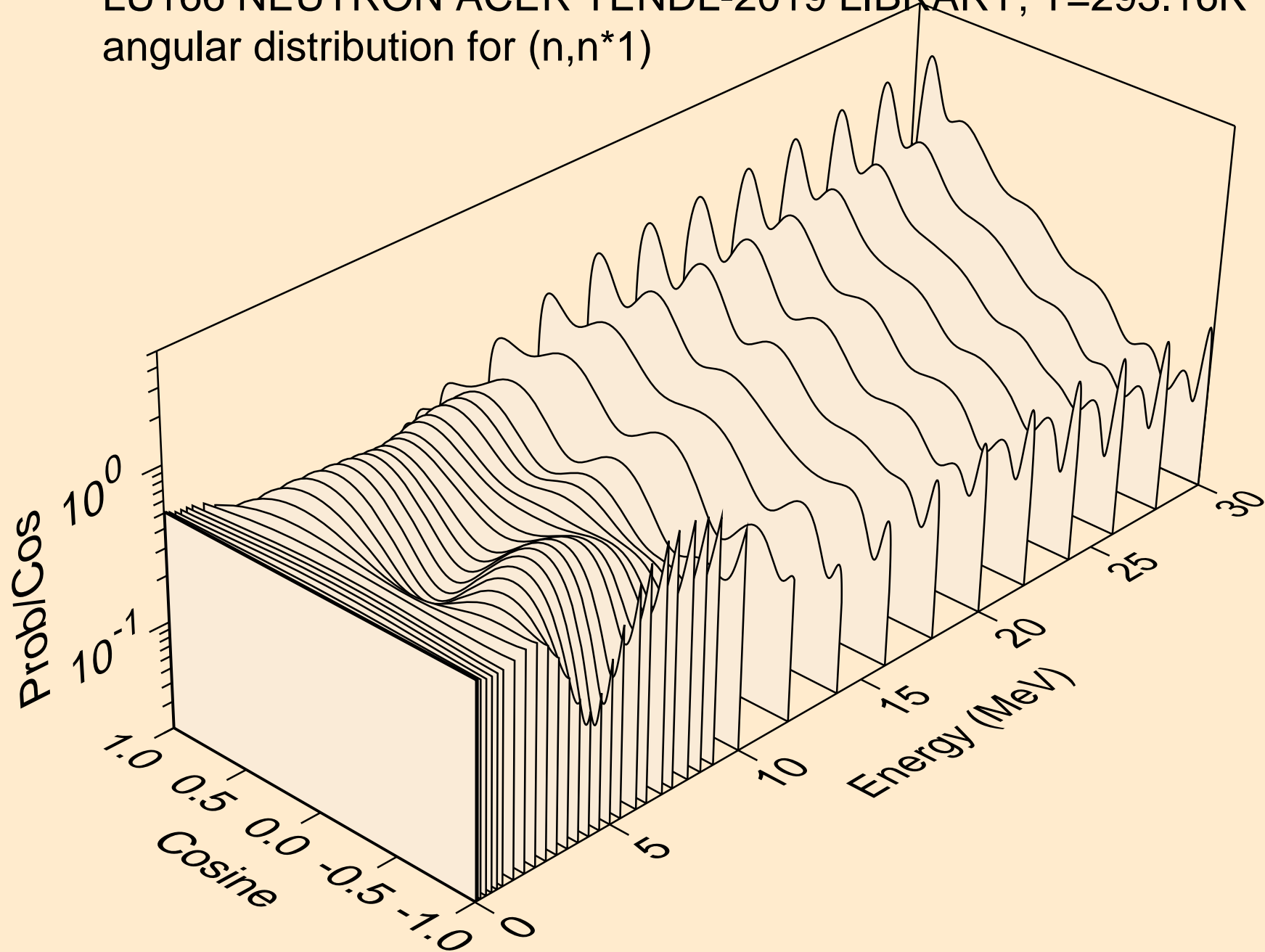

LU166 NEUTRON ACER TENDL-2019 LIBRARY; T=293.16K  
angular distribution for (n,n\*2)

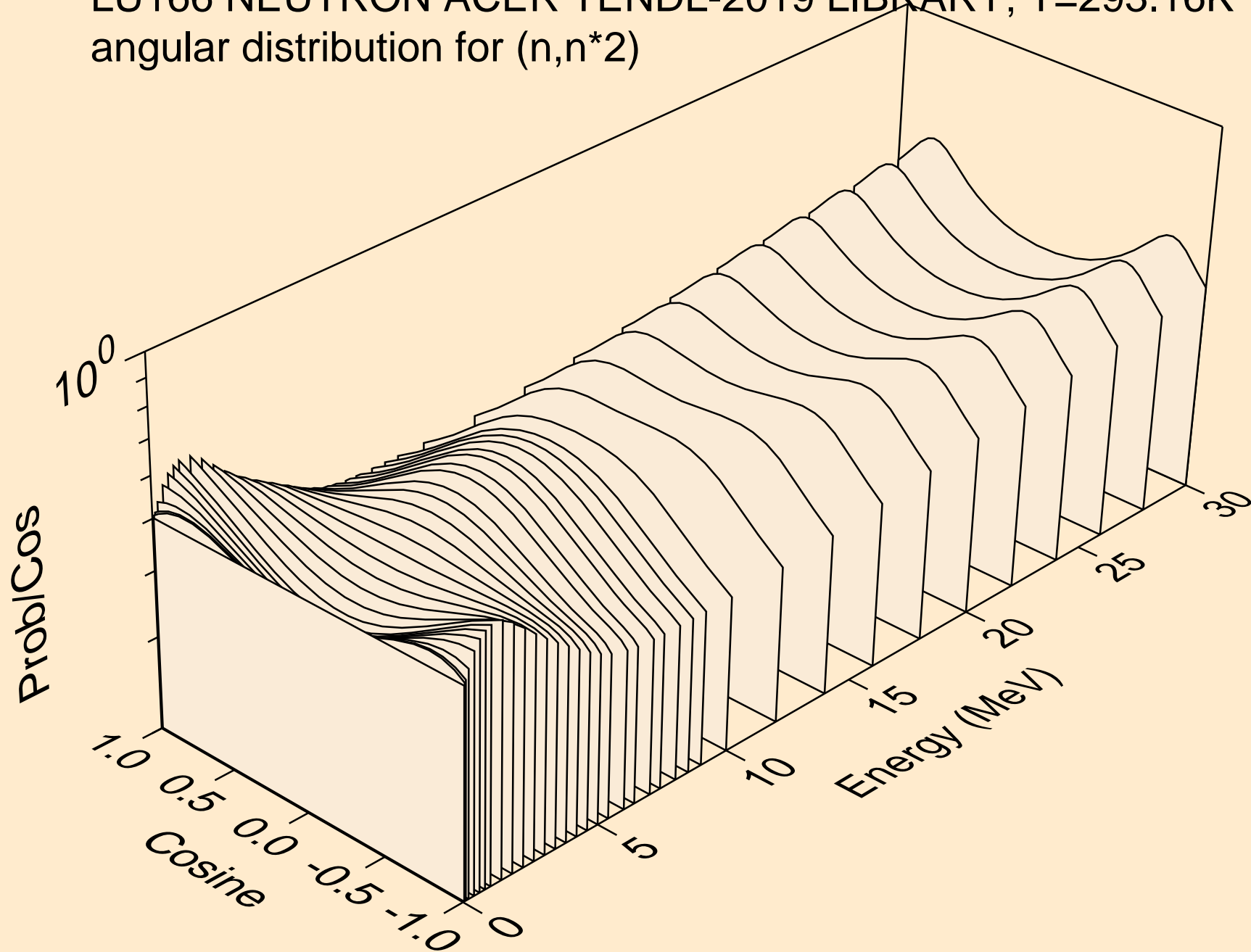

LU166 NEUTRON ACER TENDL-2019 LIBRARY; T=293.16K  
angular distribution for (n,n\*3)

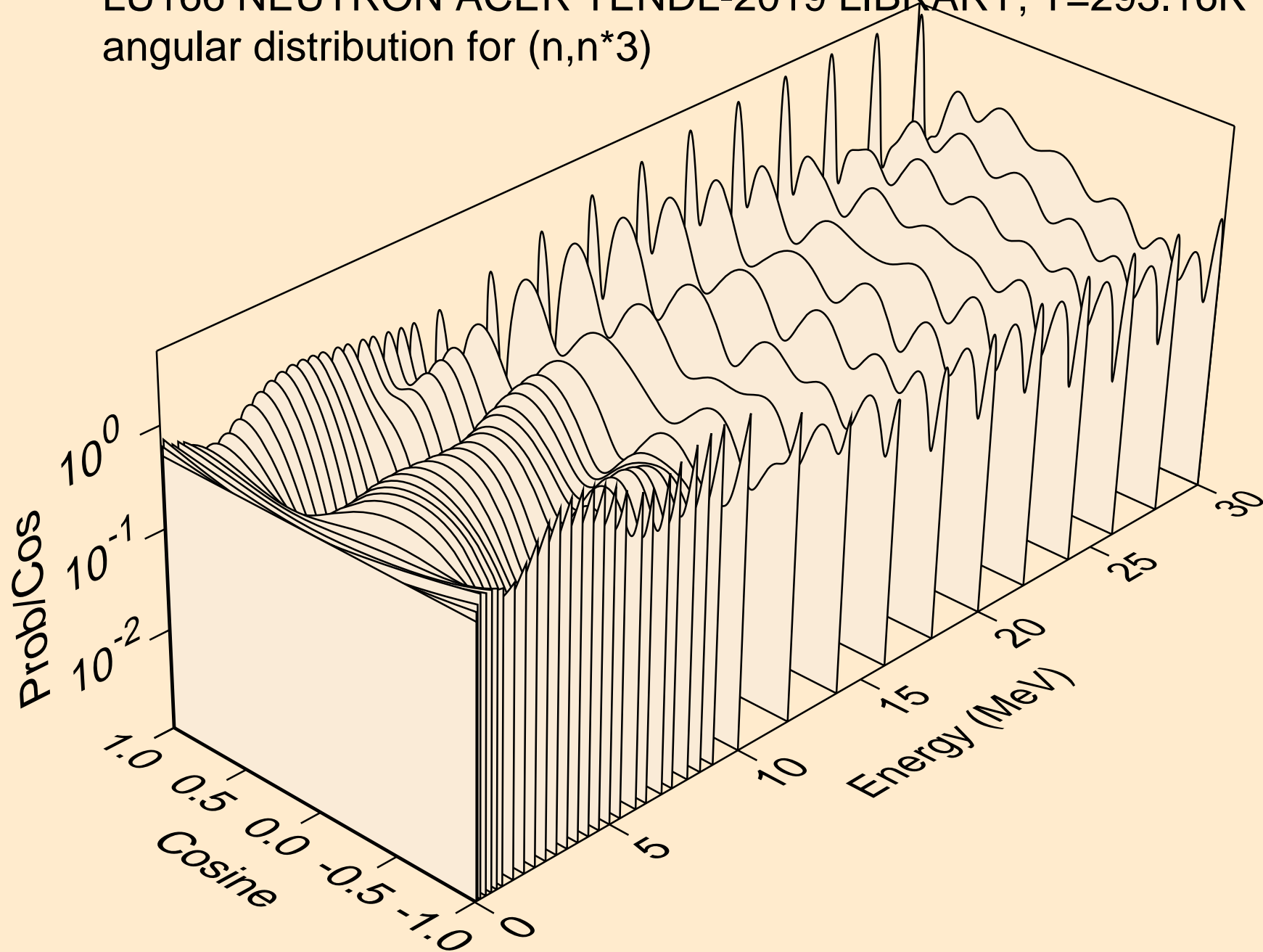

LU166 NEUTRON ACER TENDL-2019 LIBRARY; T=293.16K  
angular distribution for (n,n\*4)

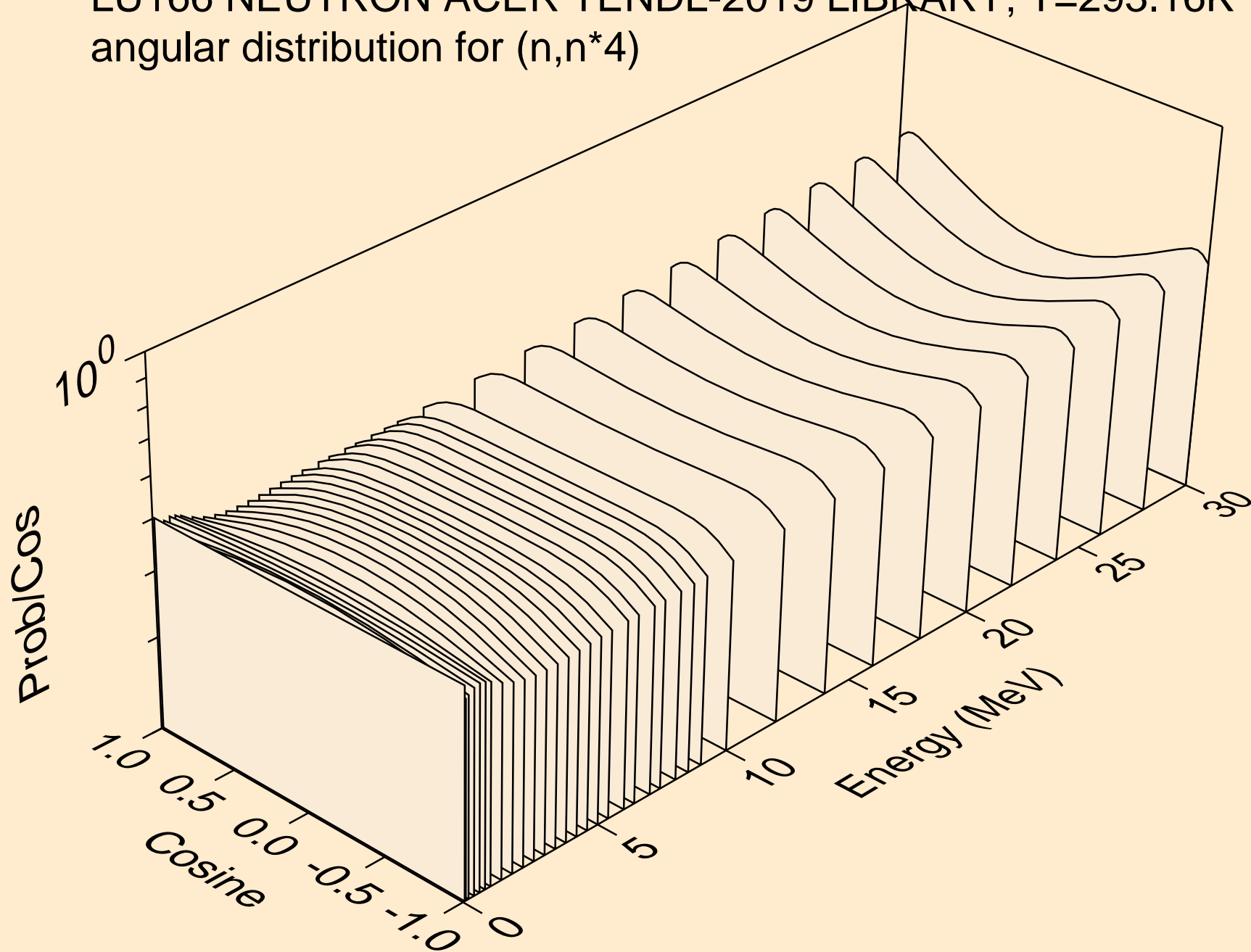

LU166 NEUTRON ACER TENDL-2019 LIBRARY; T=293.16K  
angular distribution for (n,n\*5)

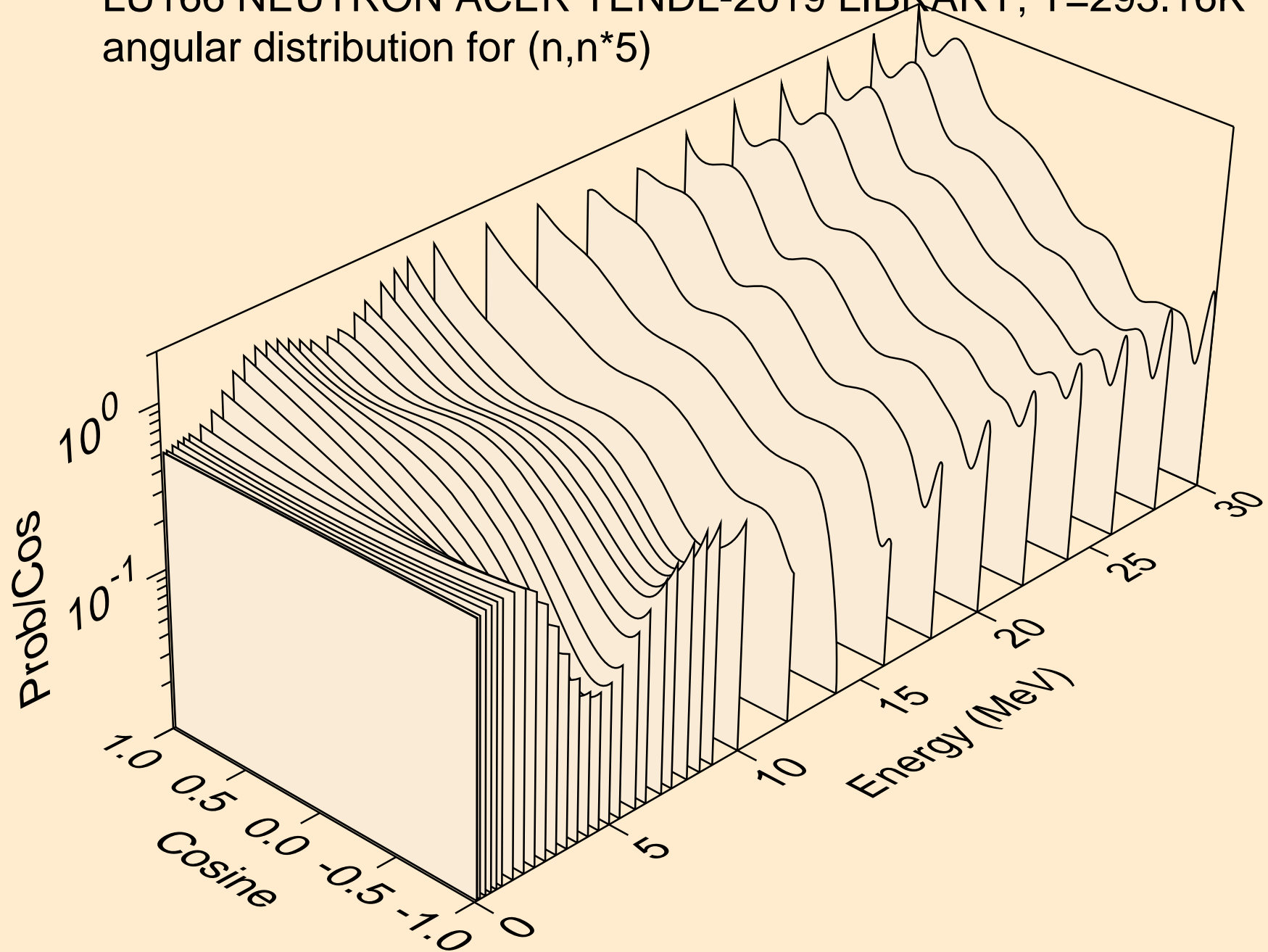

LU166 NEUTRON ACER TENDL-2019 LIBRARY; T=293.16K  
angular distribution for (n,n\*6)

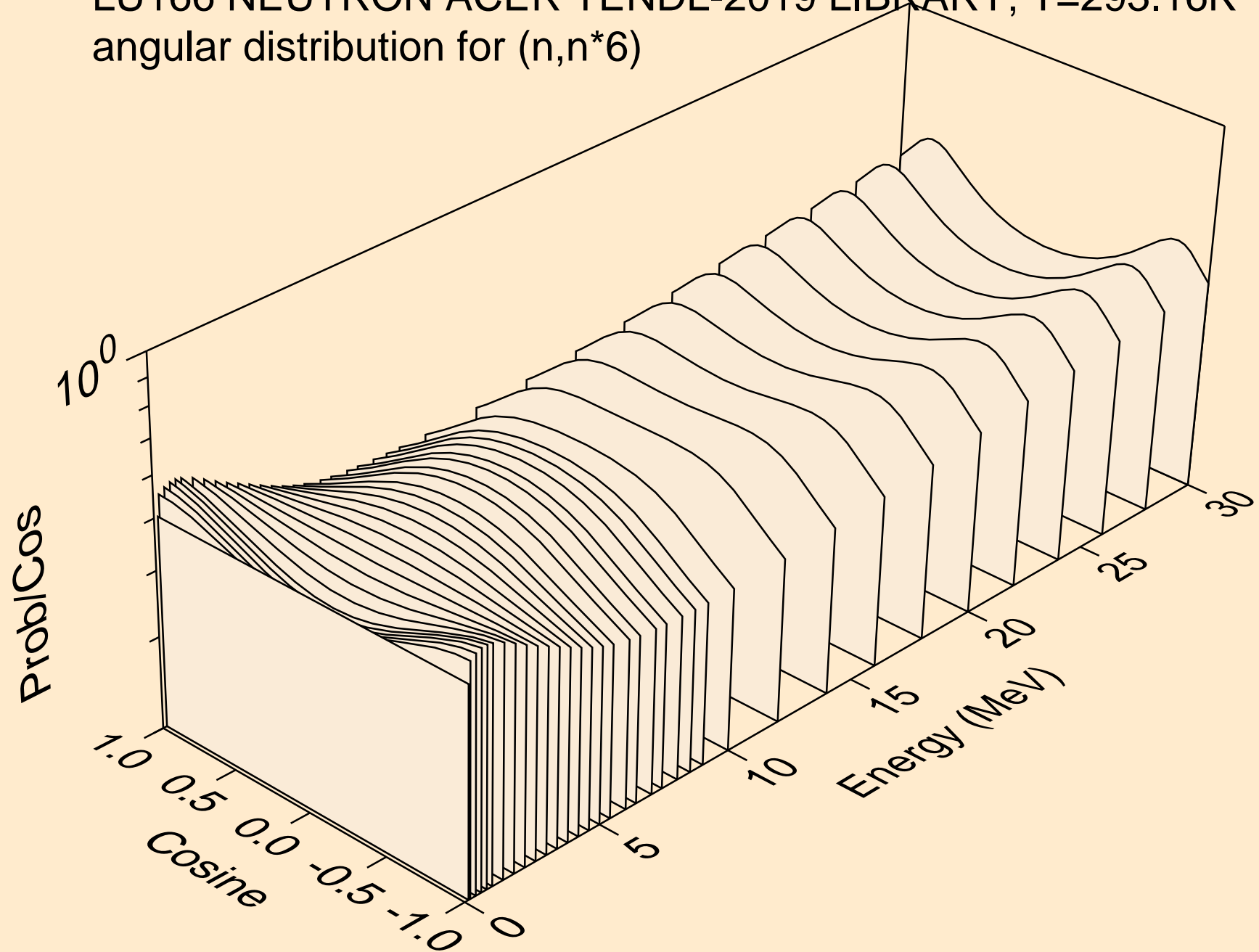

LU166 NEUTRON ACER TENDL-2019 LIBRARY; T=293.16K  
angular distribution for (n,n\*7)

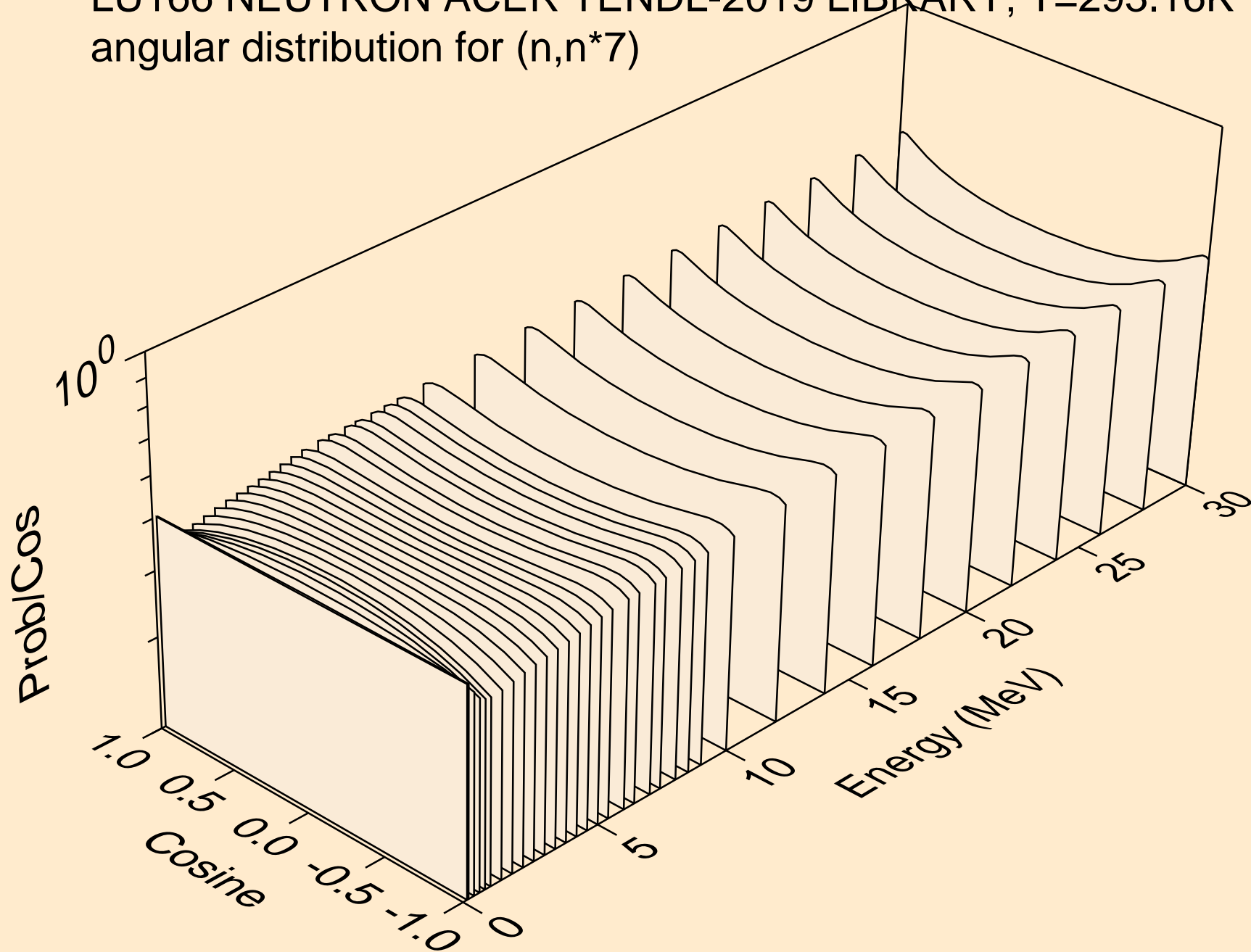



LU166 NEUTRON ACER TENDL-2019 LIBRARY; T=293.16K  
angular distribution for (n,n\*8)

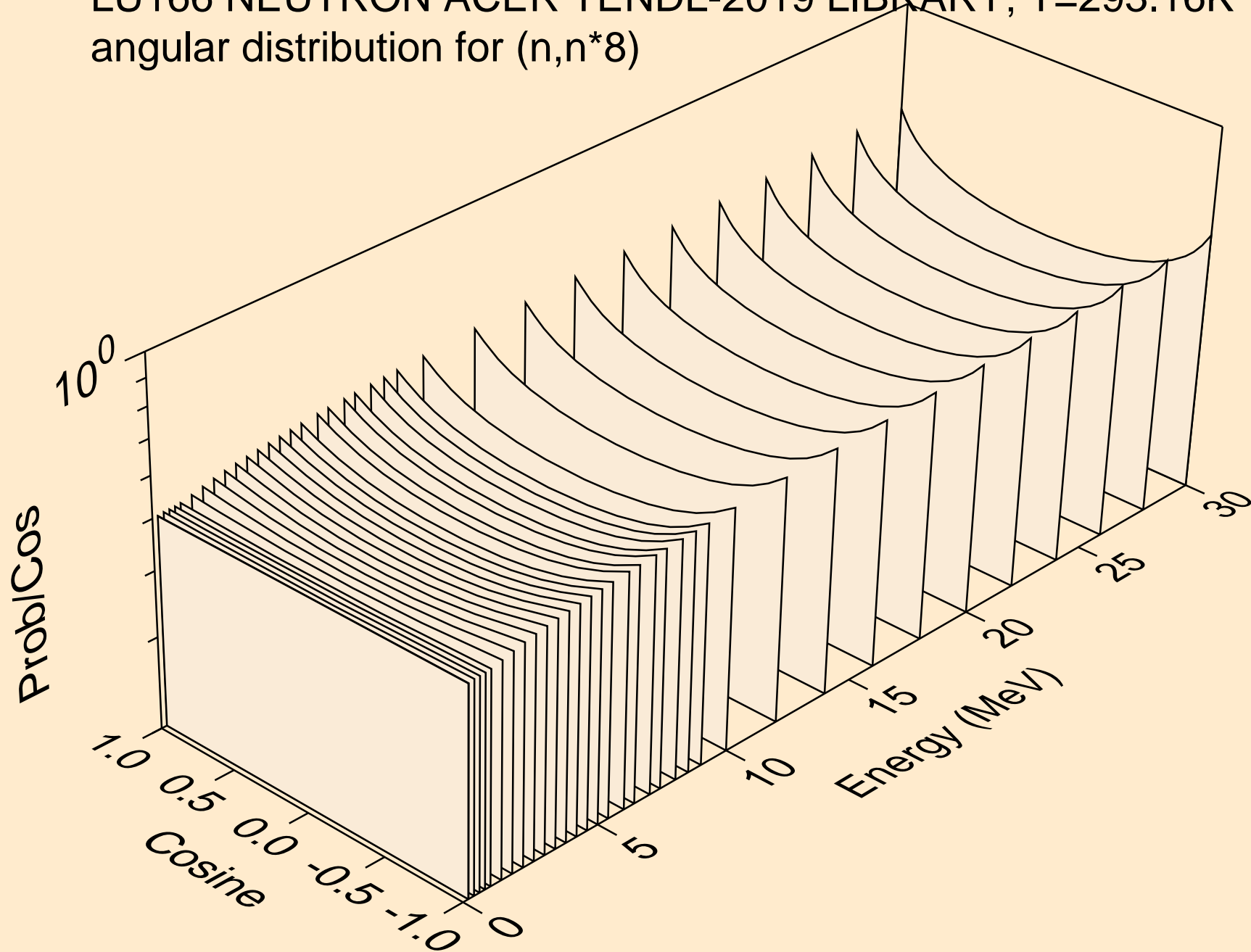

LU166 NEUTRON ACER TENDL-2019 LIBRARY; T=293.16K  
angular distribution for (n,n\*9)

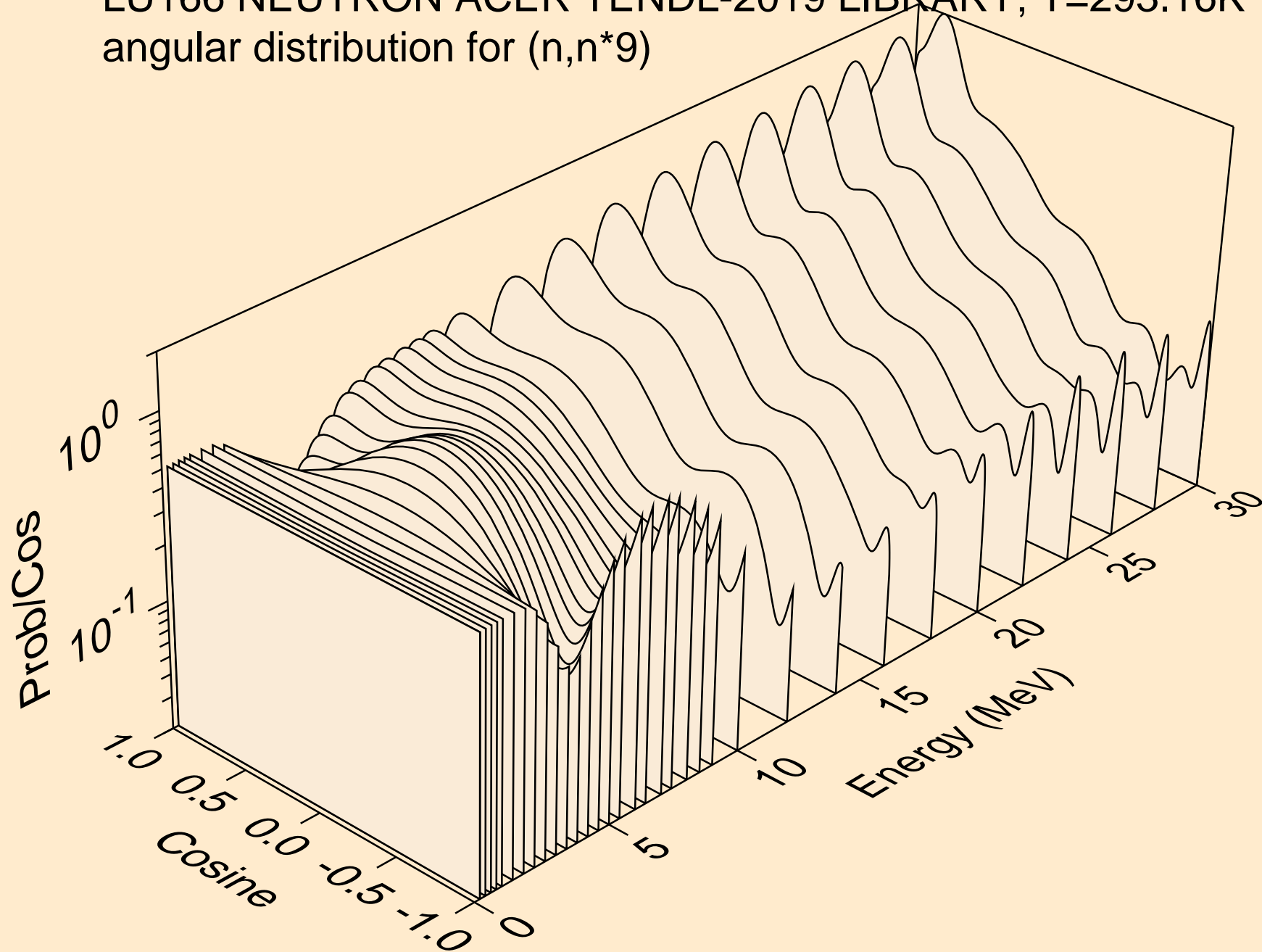

LU166 NEUTRON ACER TENDL-2019 LIBRARY; T=293.16K  
angular distribution for (n,n\*10)

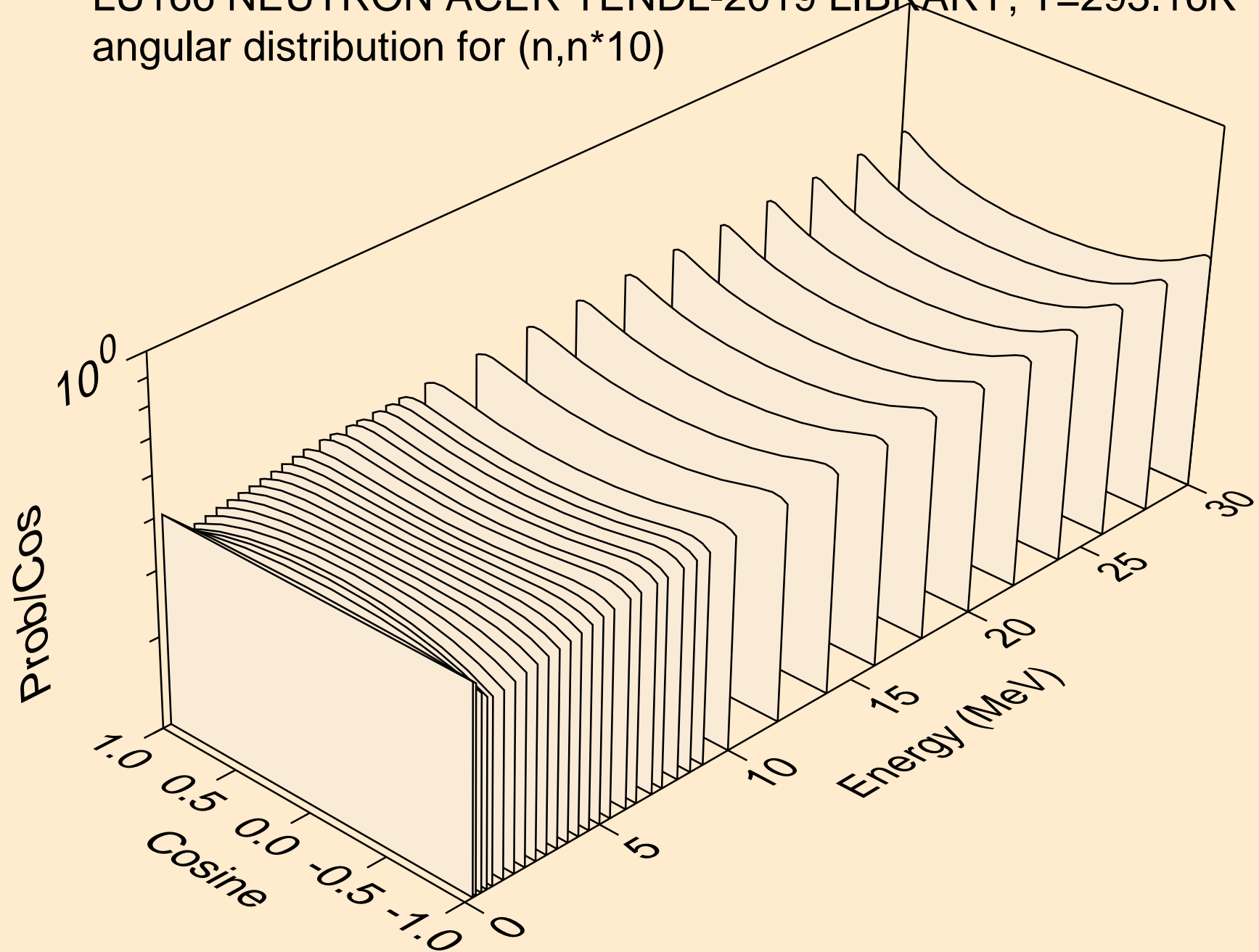

LU166 NEUTRON ACER TENDL-2019 LIBRARY; T=293.16K  
angular distribution for (n,n\*11)

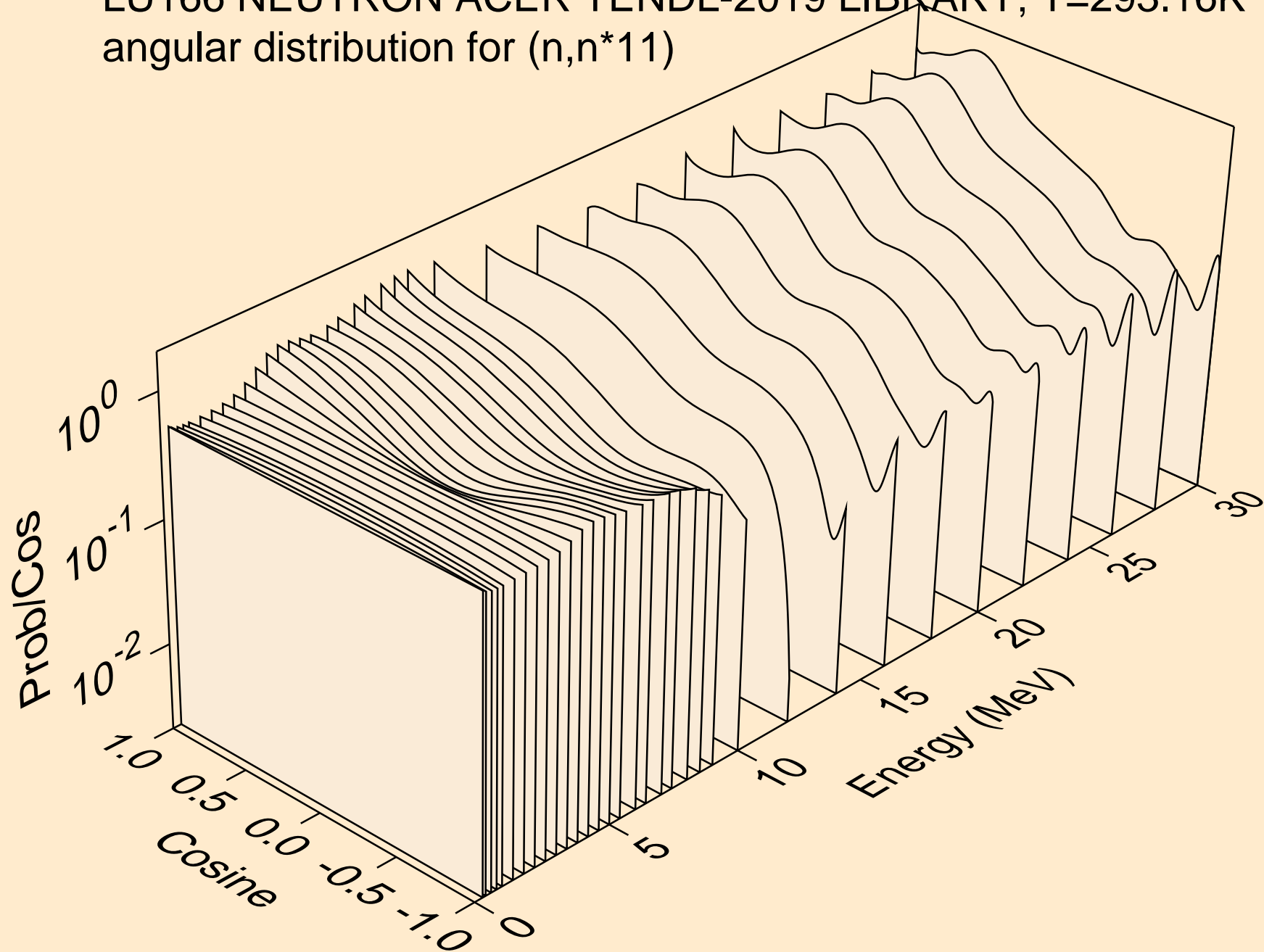

LU166 NEUTRON ACER TENDL-2019 LIBRARY; T=293.16K  
angular distribution for (n,n\*12)

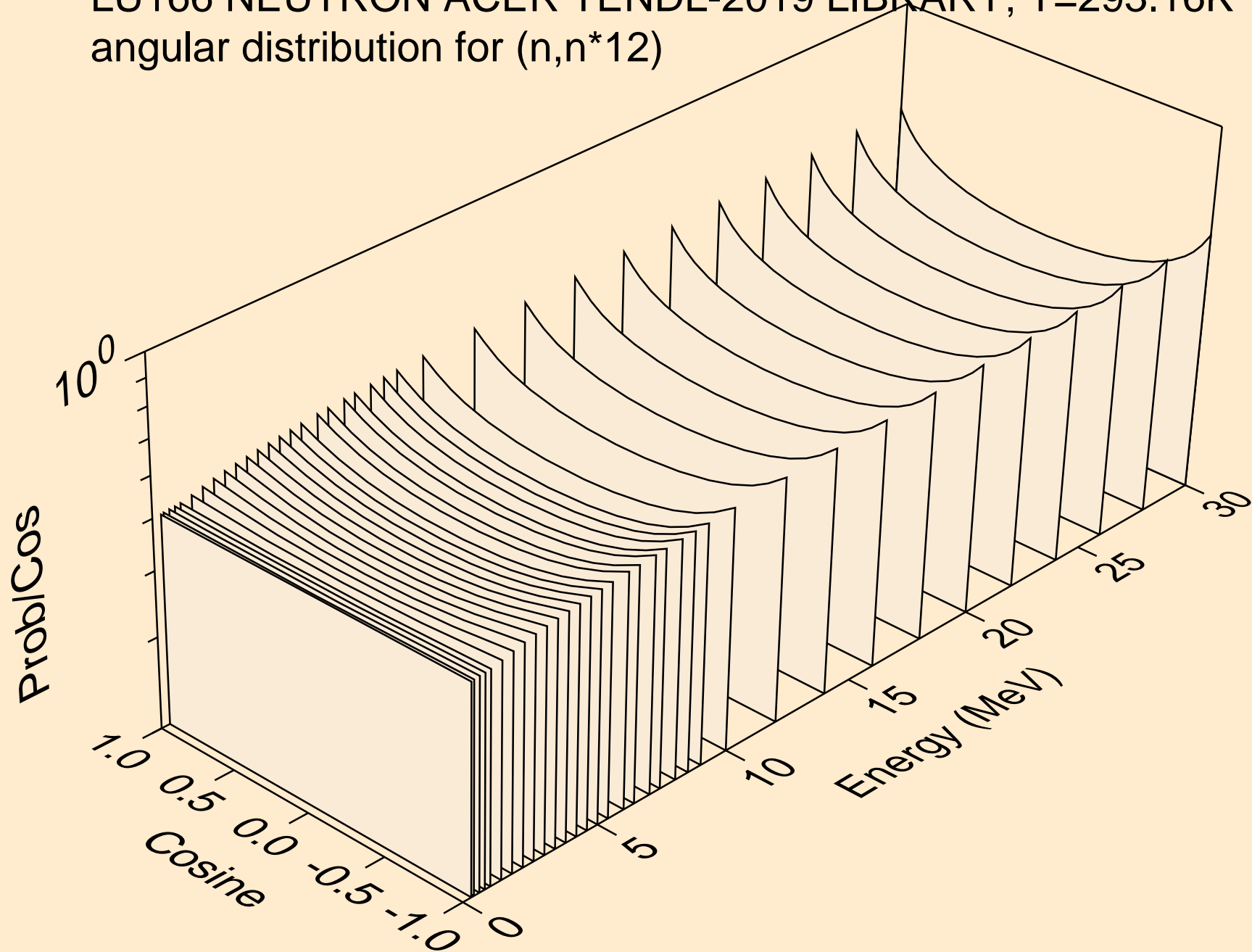

LU166 NEUTRON ACER TENDL-2019 LIBRARY; T=293.16K  
angular distribution for (n,n\*13)

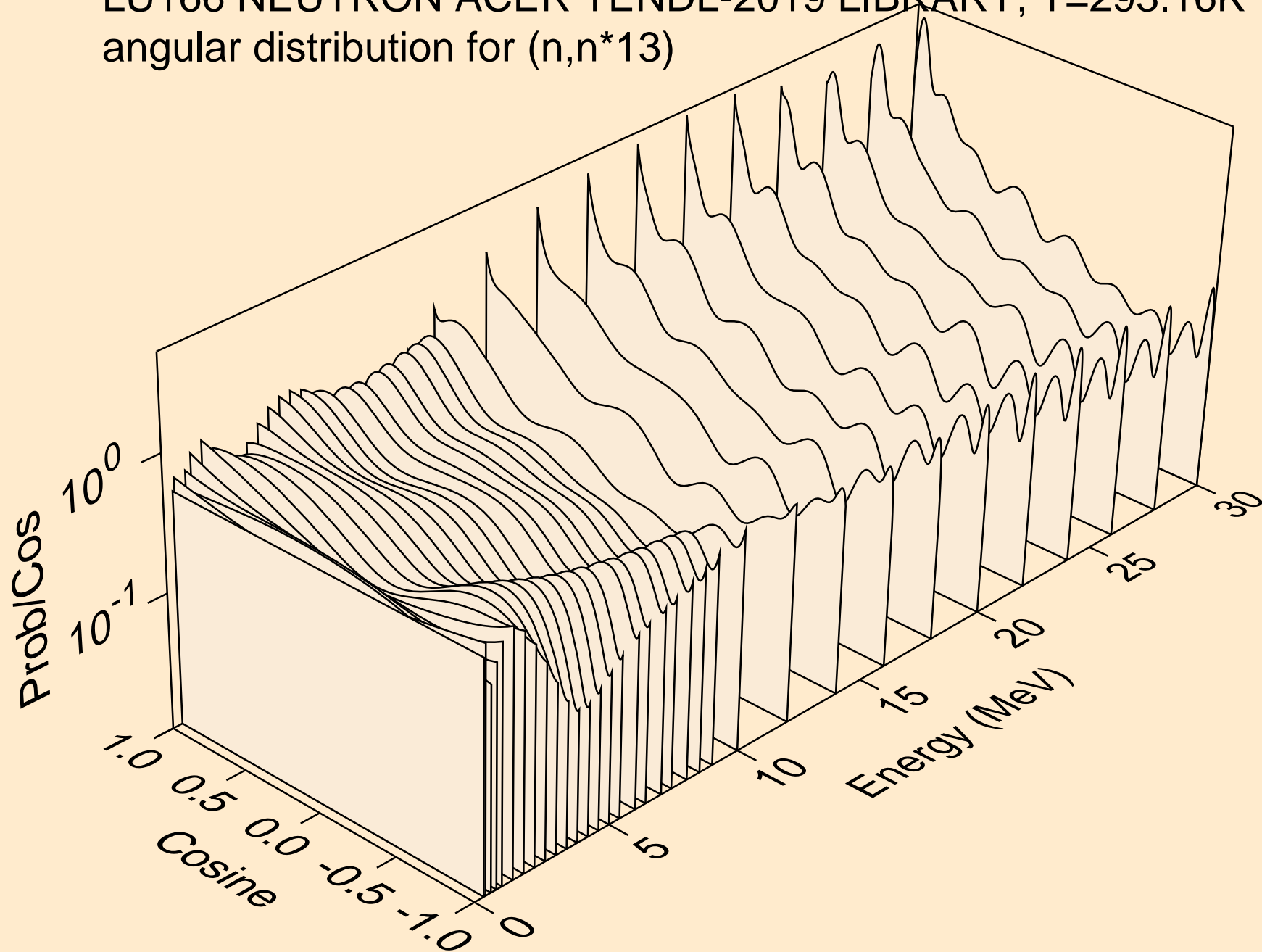

LU166 NEUTRON ACER TENDL-2019 LIBRARY; T=293.16K  
angular distribution for (n,n\*14)

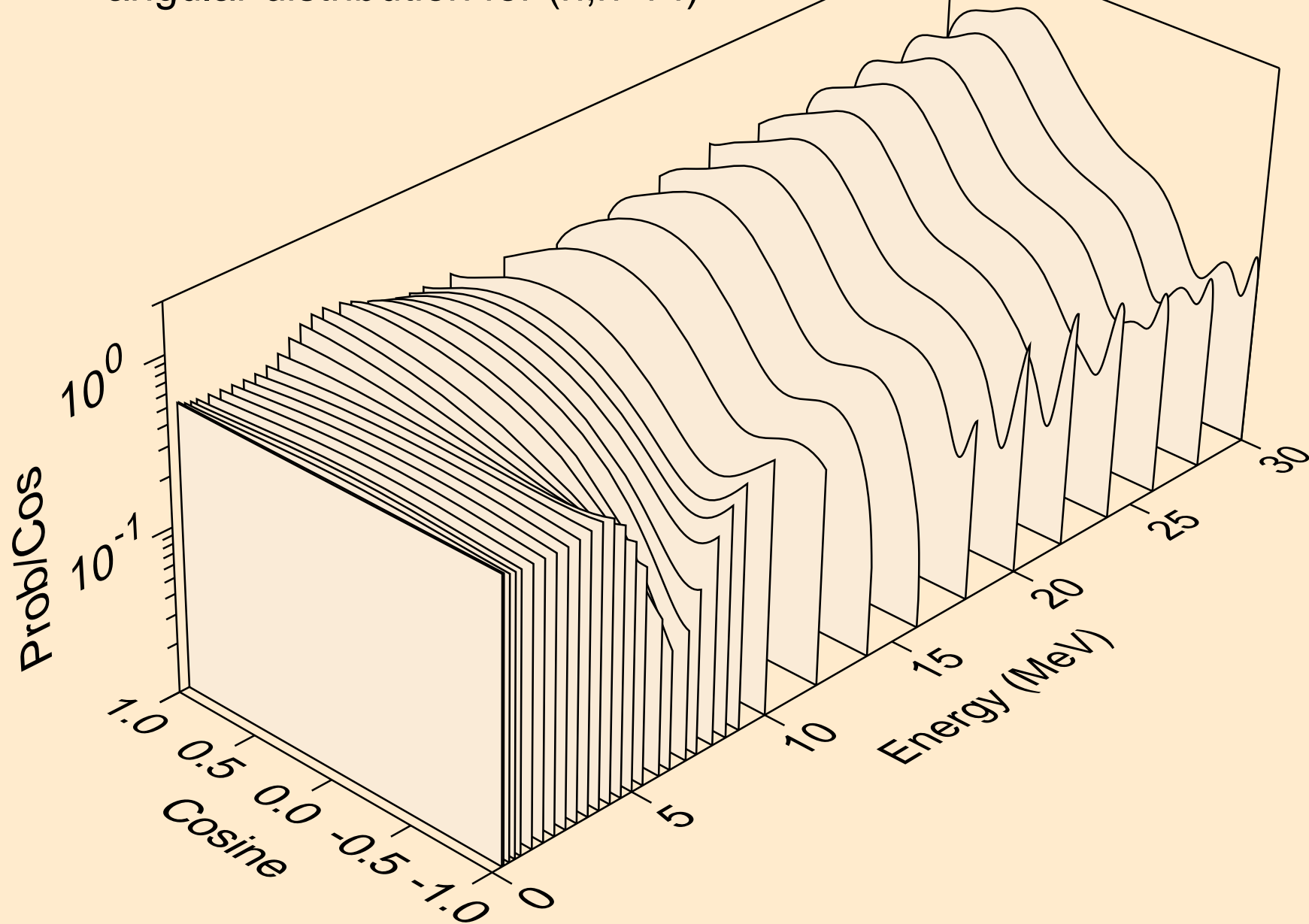

LU166 NEUTRON ACER TENDL-2019 LIBRARY; T=293.16K  
angular distribution for (n,n\*15)

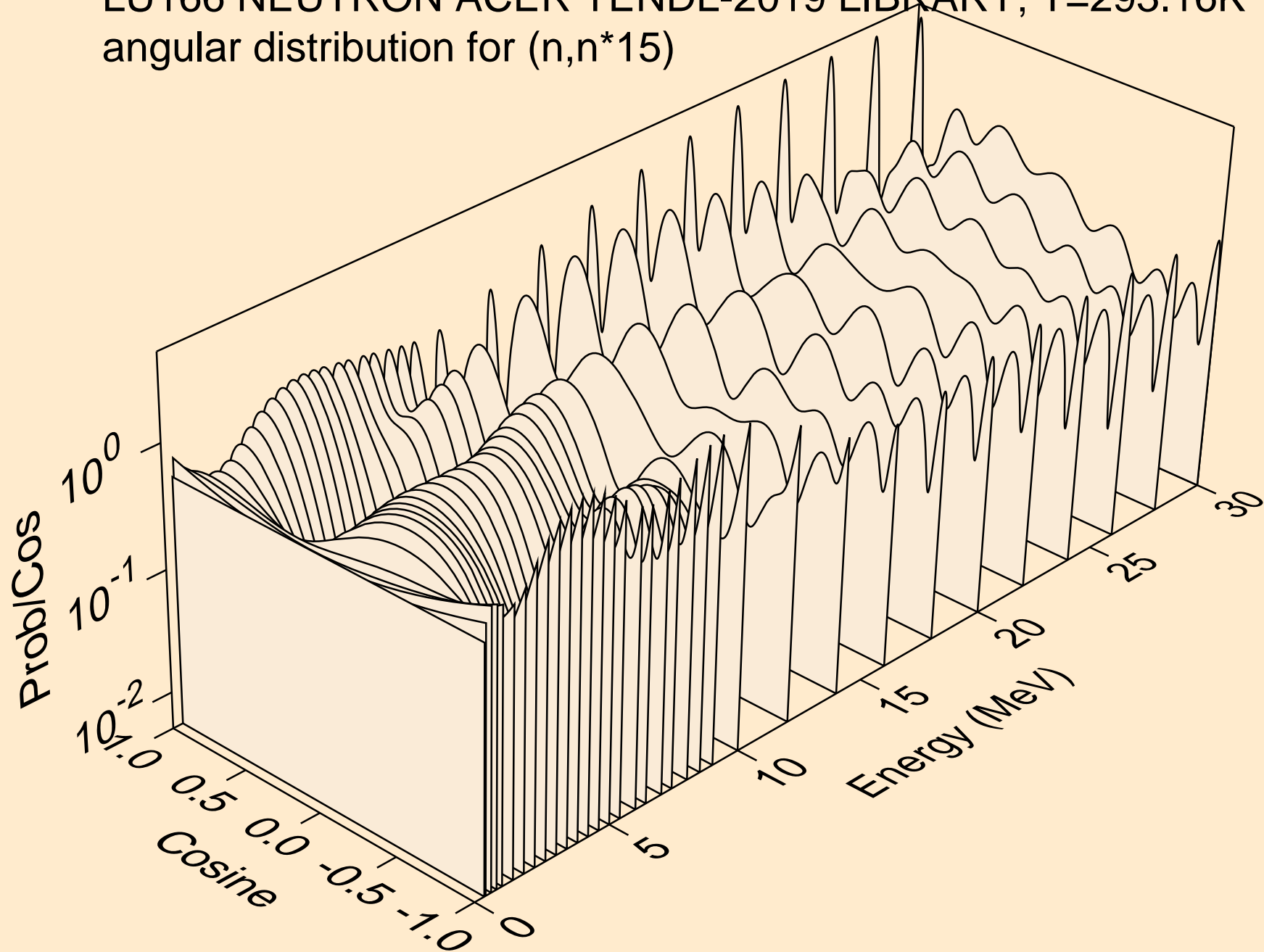



LU166 NEUTRON ACER TENDL-2019 LIBRARY; T=293.16K  
angular distribution for (n,n\*16)

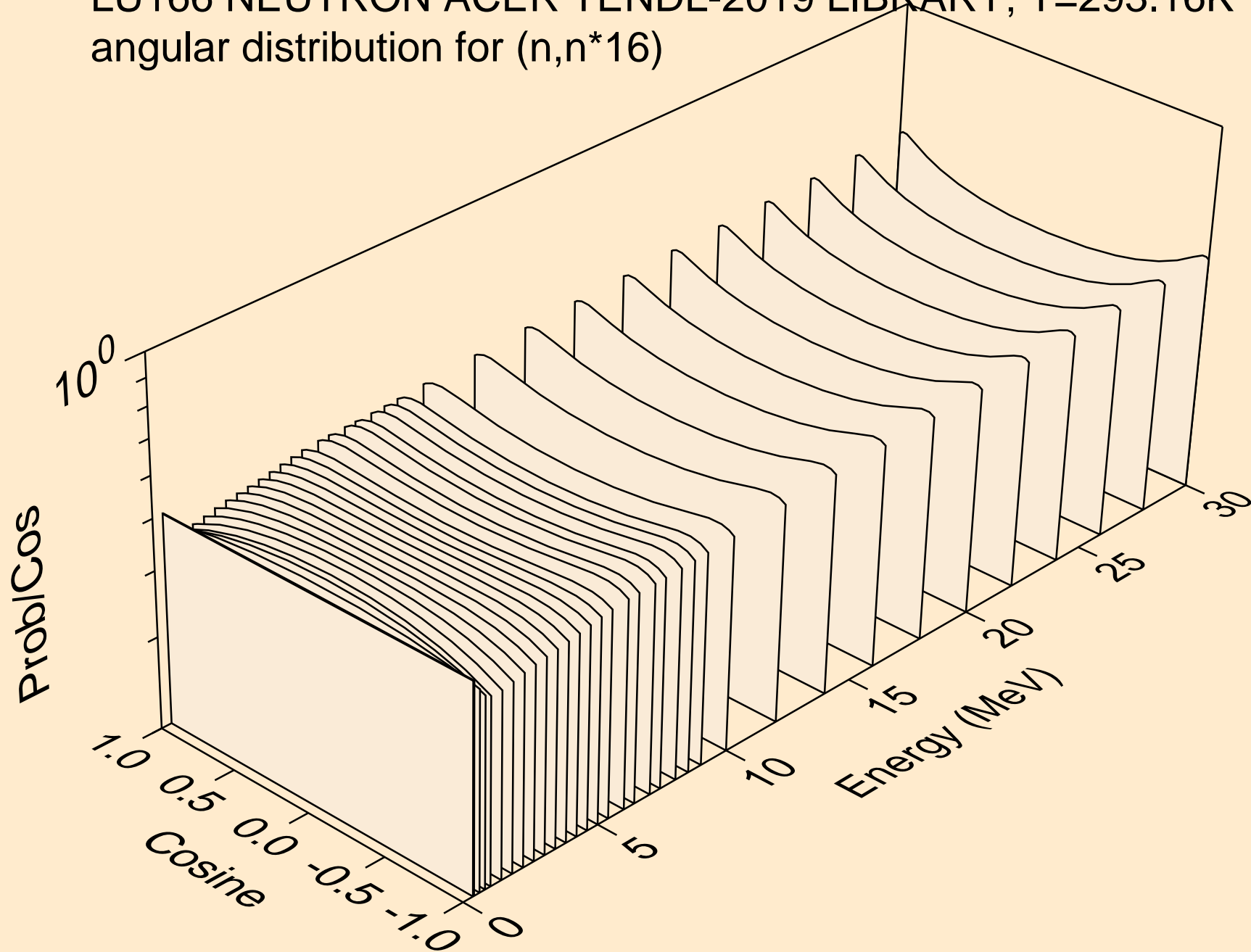

LU166 NEUTRON ACER TENDL-2019 LIBRARY; T=293.16K  
angular distribution for (n,n\*17)

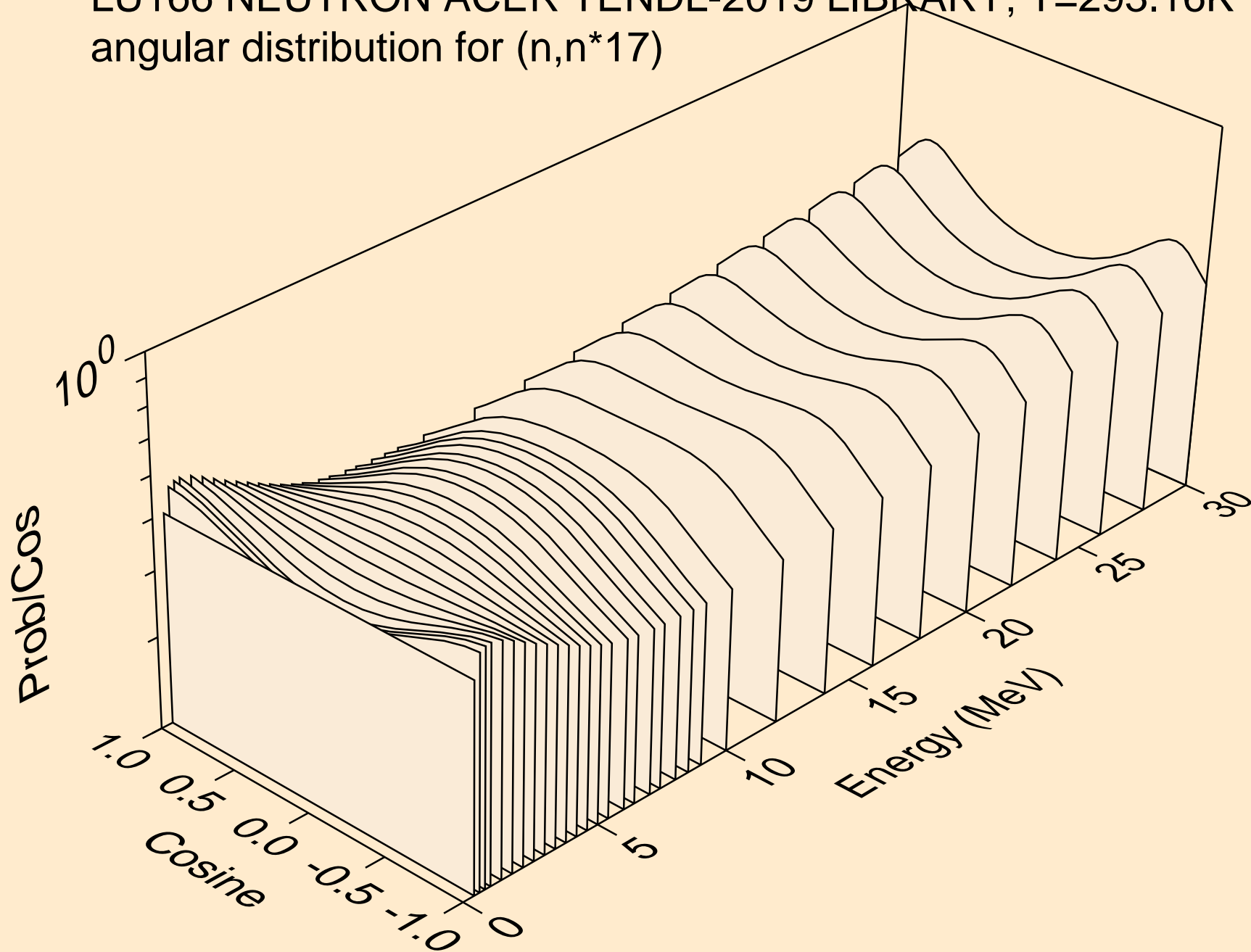

LU166 NEUTRON ACER TENDL-2019 LIBRARY; T=293.16K  
angular distribution for (n,n\*18)

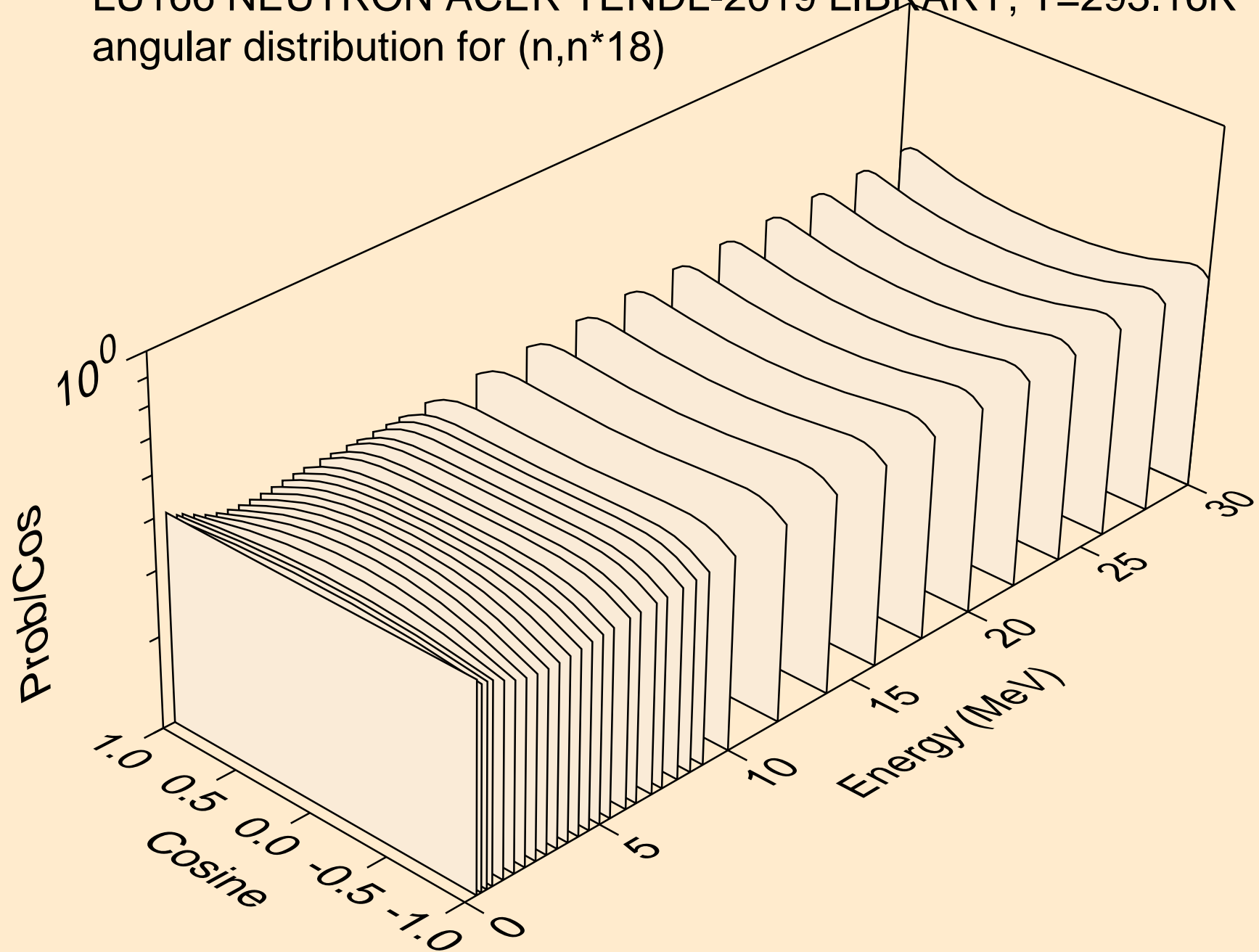

LU166 NEUTRON ACER TENDL-2019 LIBRARY; T=293.16K  
angular distribution for (n,n\*19)

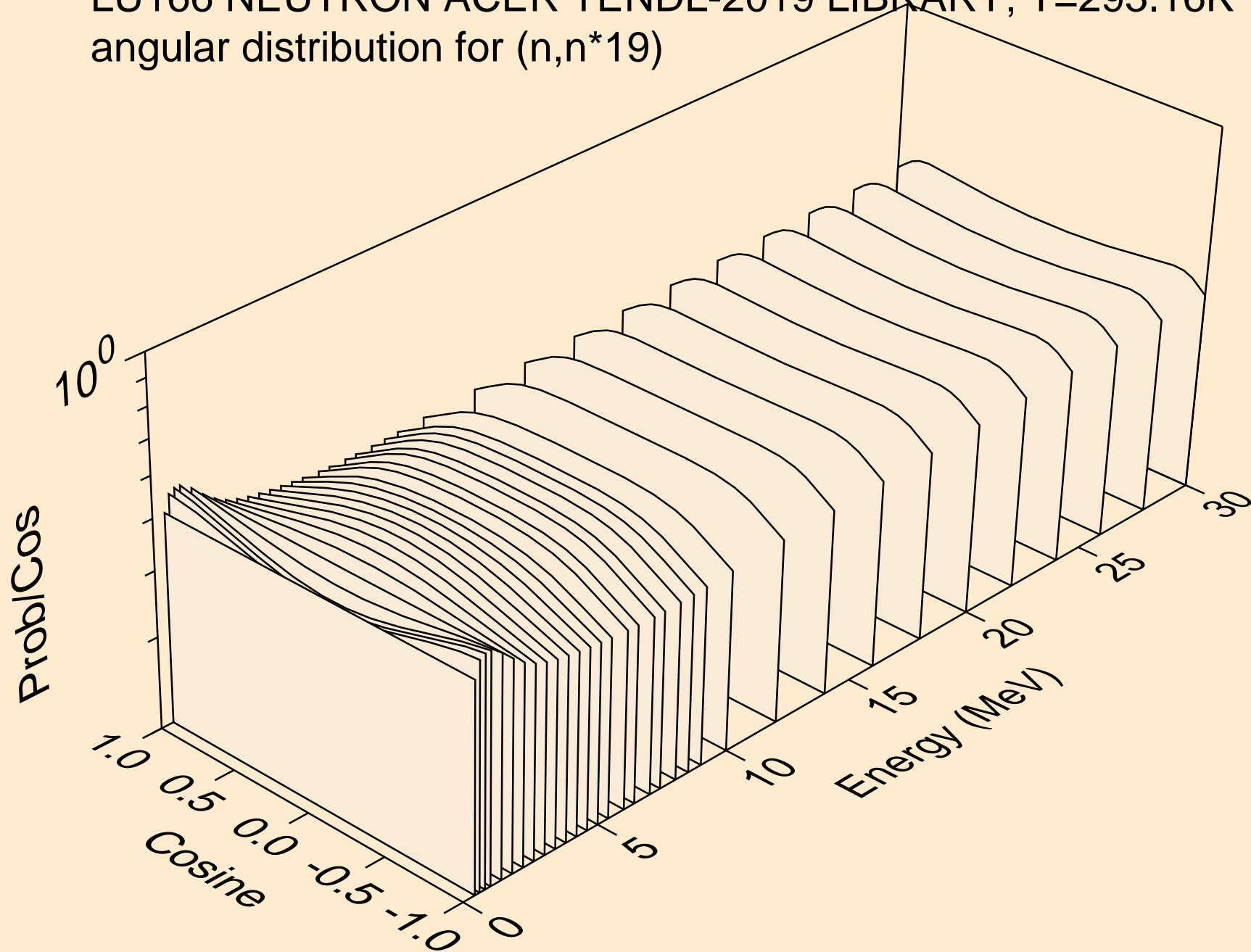

LU166 NEUTRON ACER TENDL-2019 LIBRARY; T=293.16K  
angular distribution for (n,n\*20)

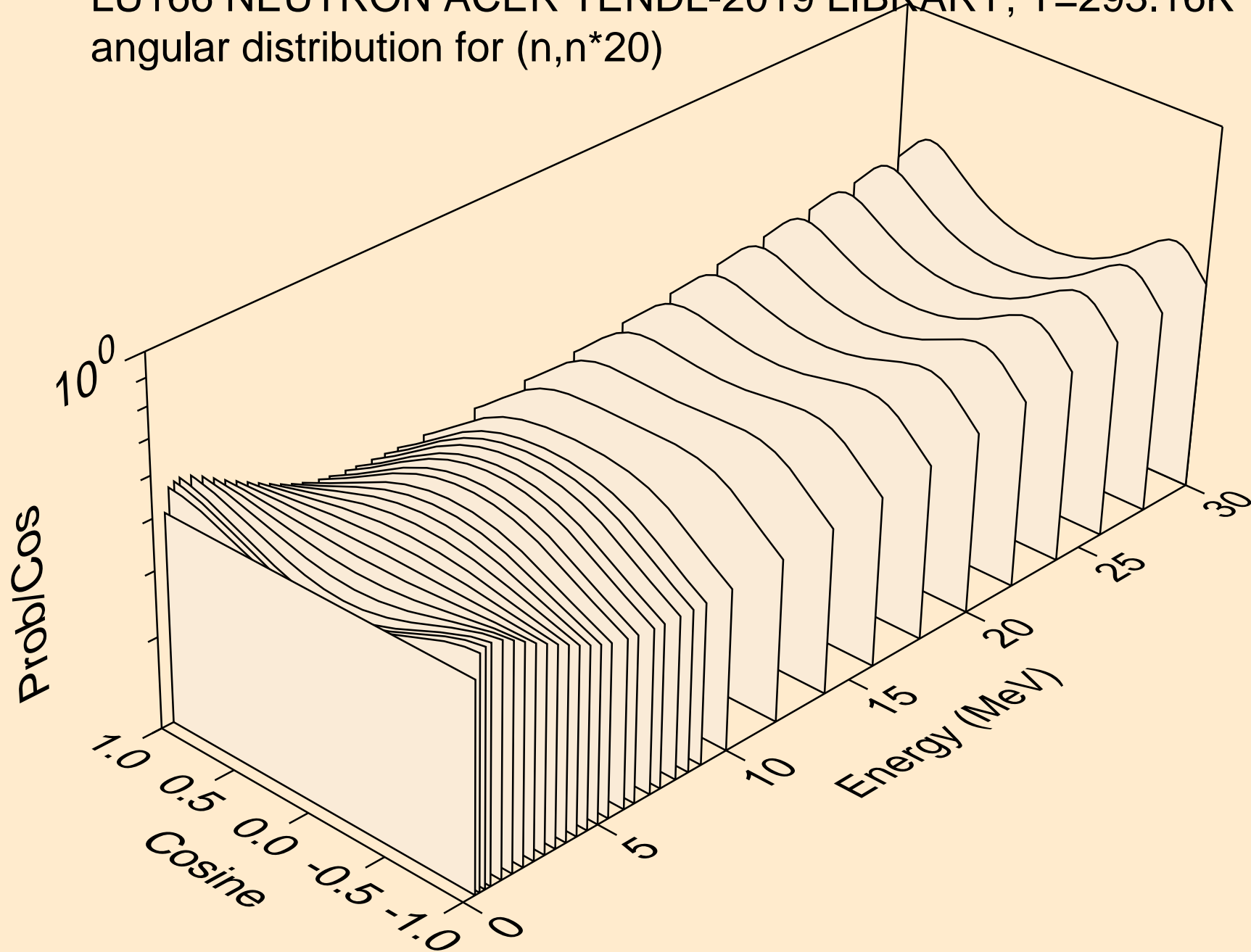

LU166 NEUTRON ACER TENDL-2019 LIBRARY; T=293.16K  
angular distribution for (n,n\*21)

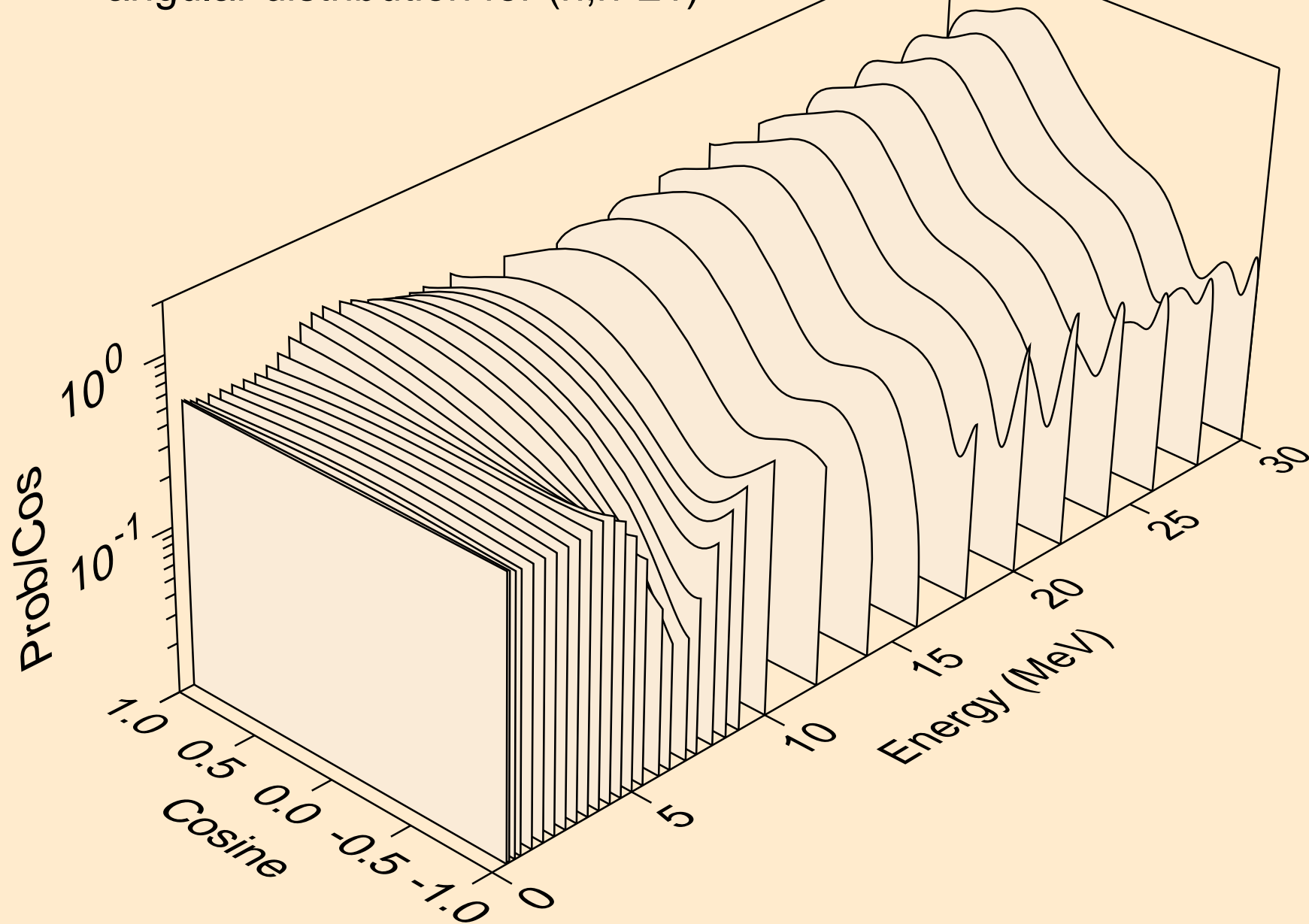

LU166 NEUTRON ACER TENDL-2019 LIBRARY; T=293.16K  
angular distribution for (n,n\*22)

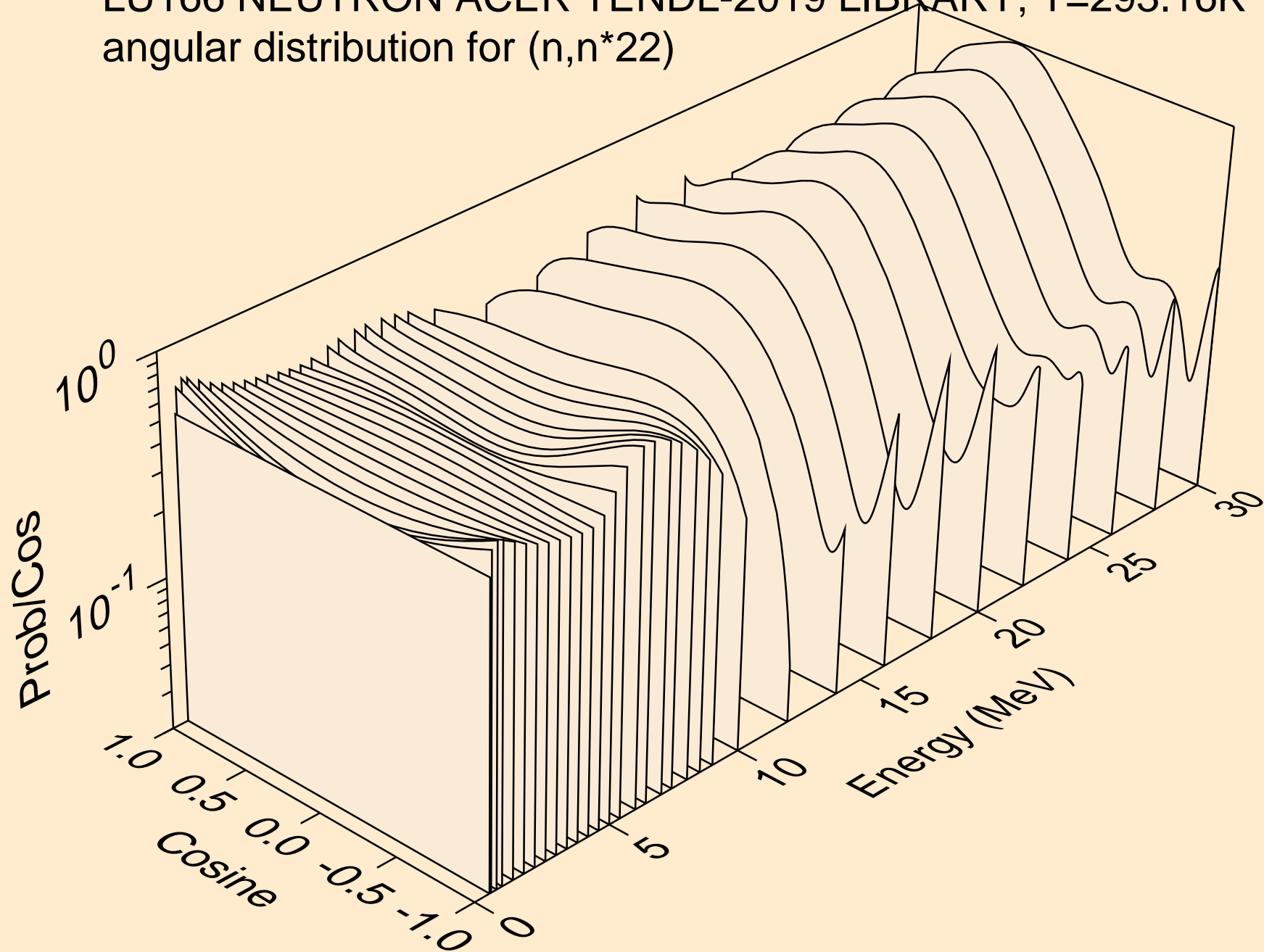

LU166 NEUTRON ACER TENDL-2019 LIBRARY; T=293.16K  
angular distribution for (n,n\*23)

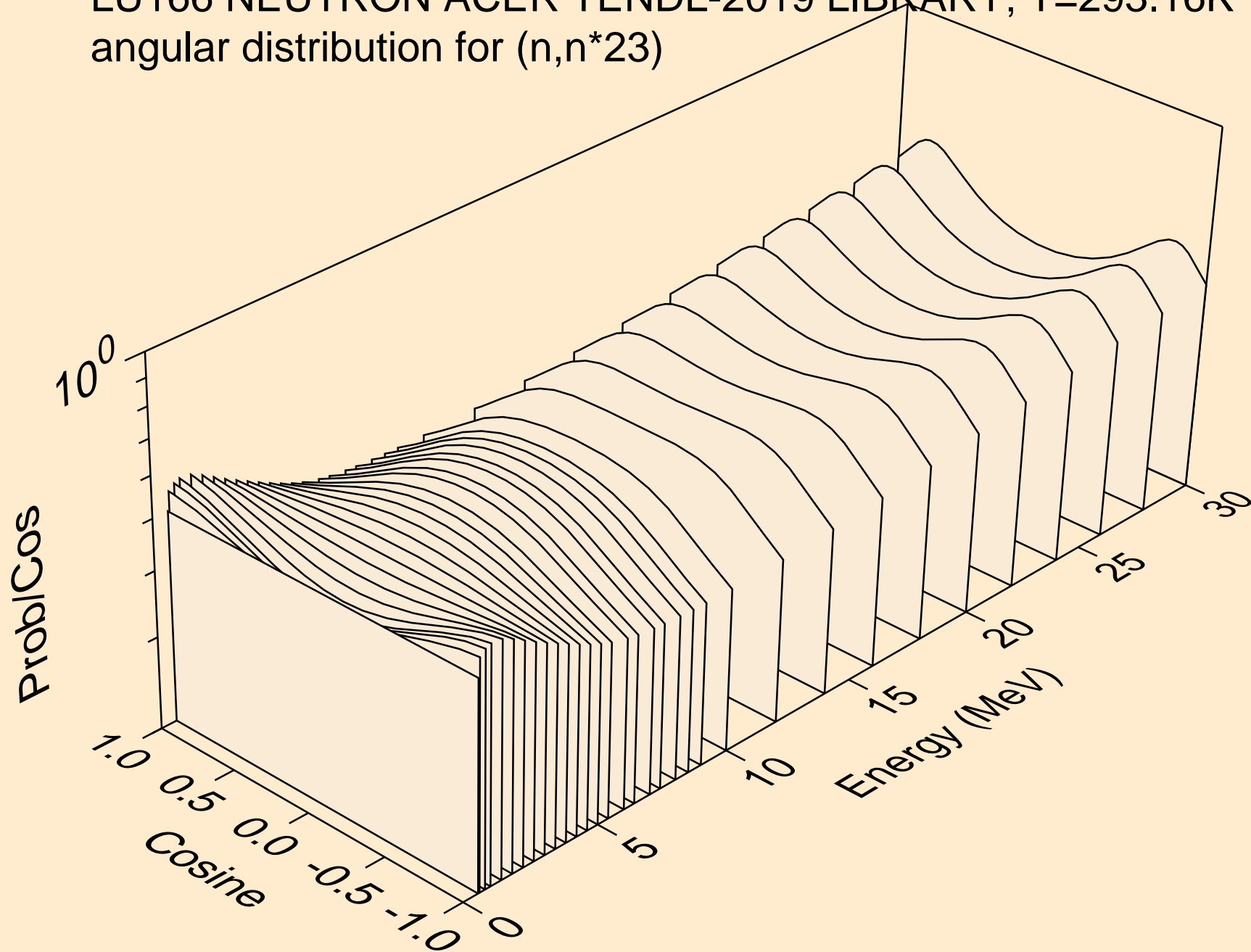



LU166 NEUTRON ACER TENDL-2019 LIBRARY; T=293.16K  
angular distribution for (n,n\*24)

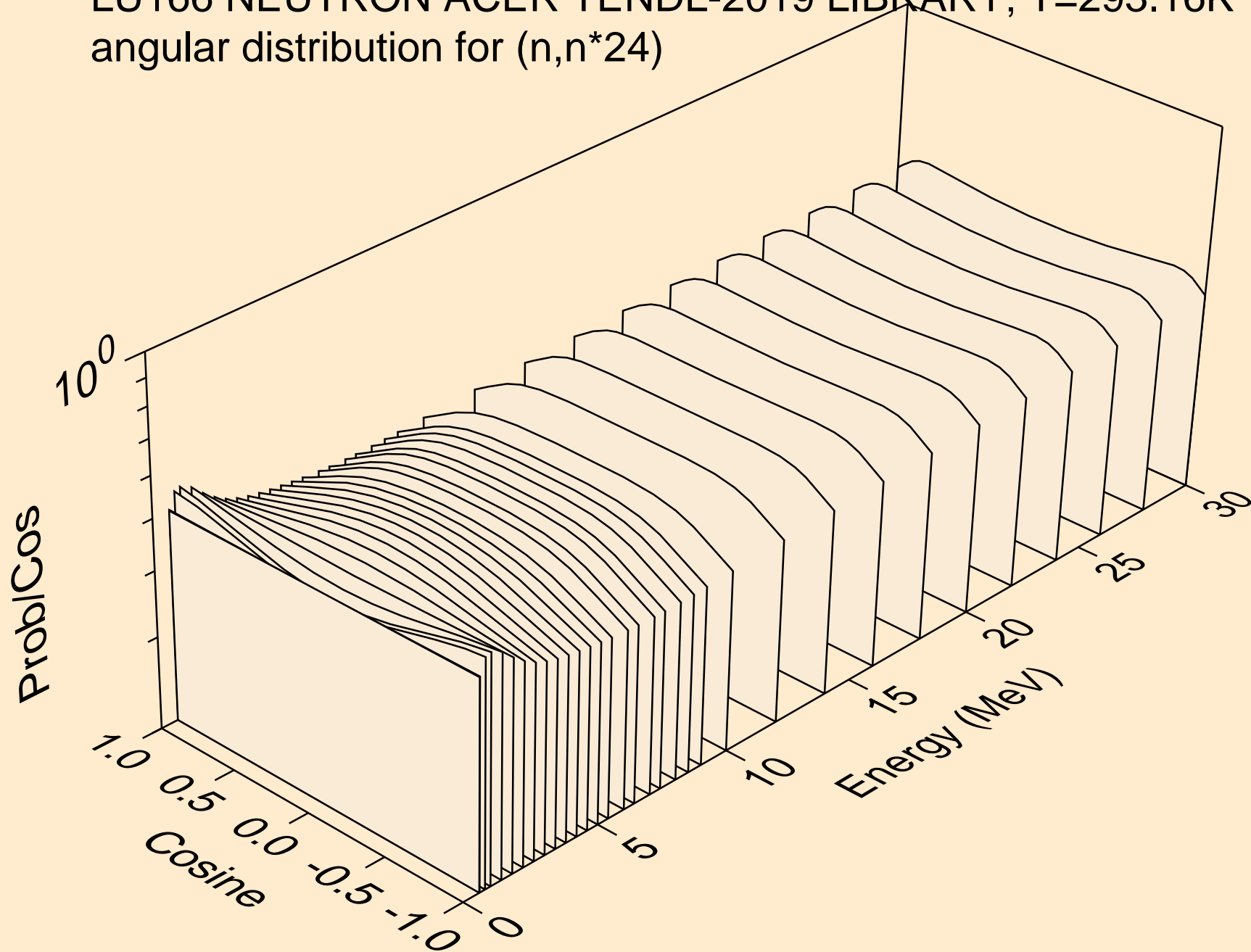

LU166 NEUTRON ACER TENDL-2019 LIBRARY; T=293.16K  
angular distribution for (n,n\*25)

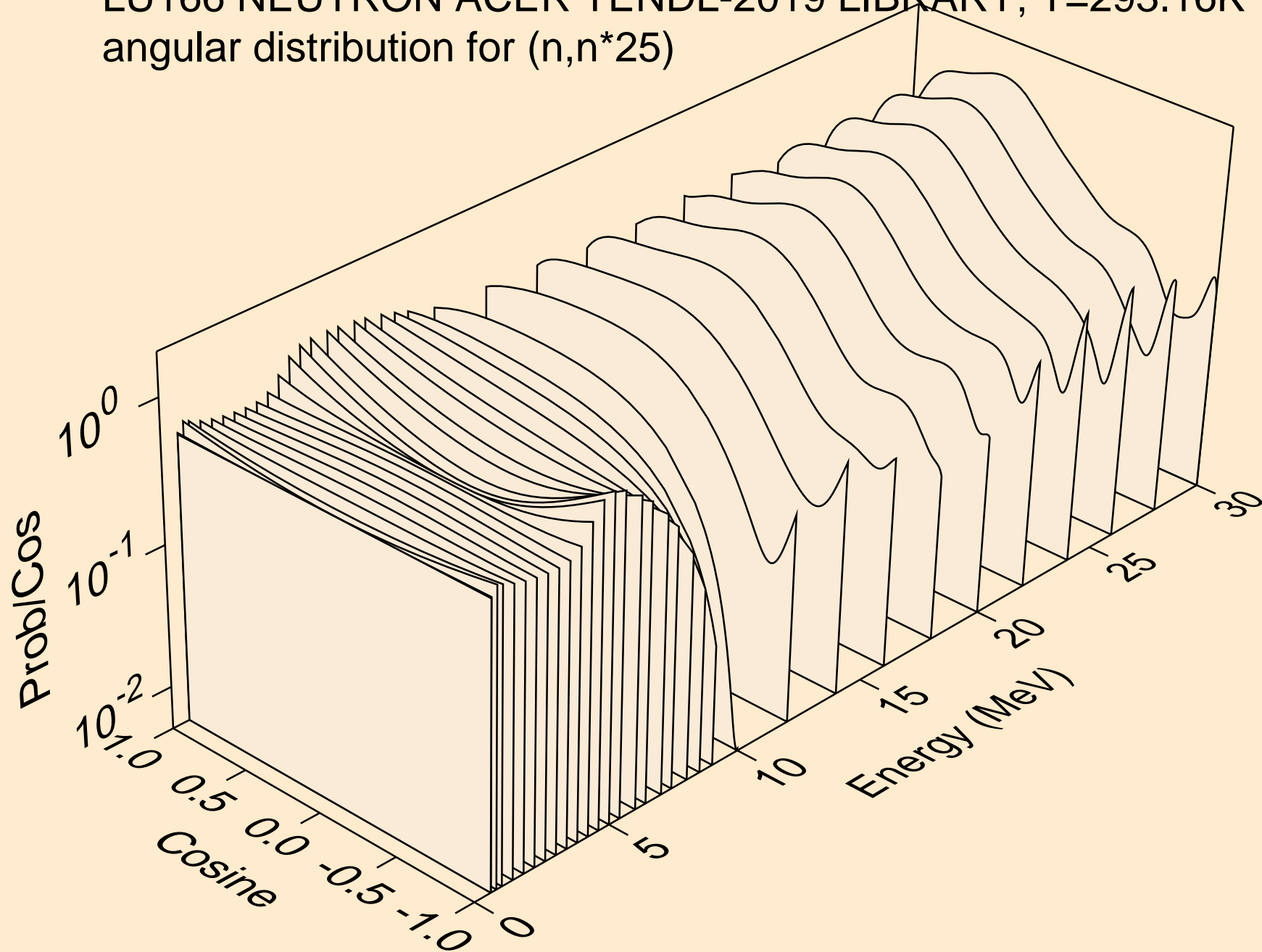

LU166 NEUTRON ACER TENDL-2019 LIBRARY; T=293.16K  
angular distribution for (n,n\*26)

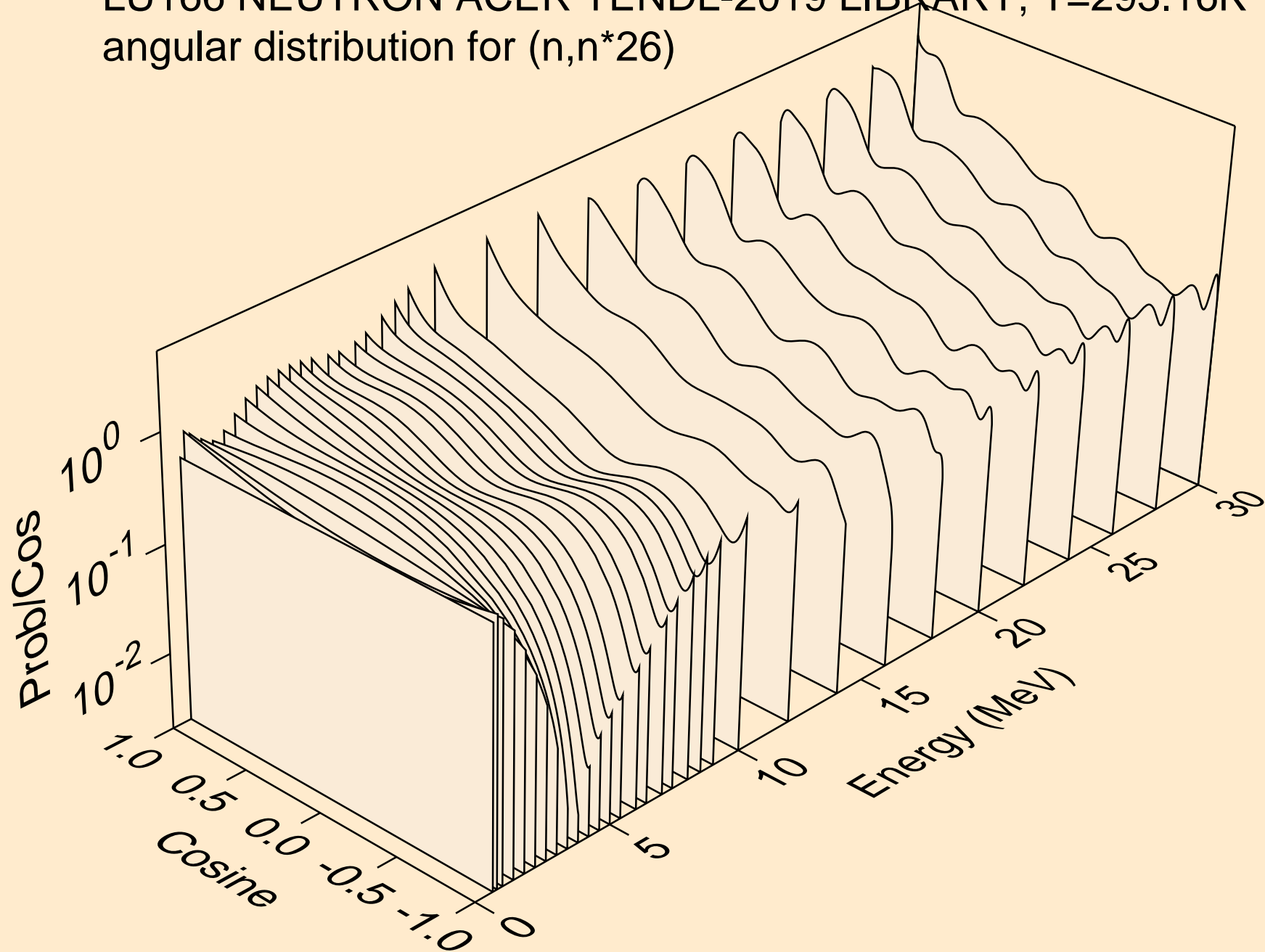

LU166 NEUTRON ACER TENDL-2019 LIBRARY; T=293.16K  
Neutron emission for (n,x)

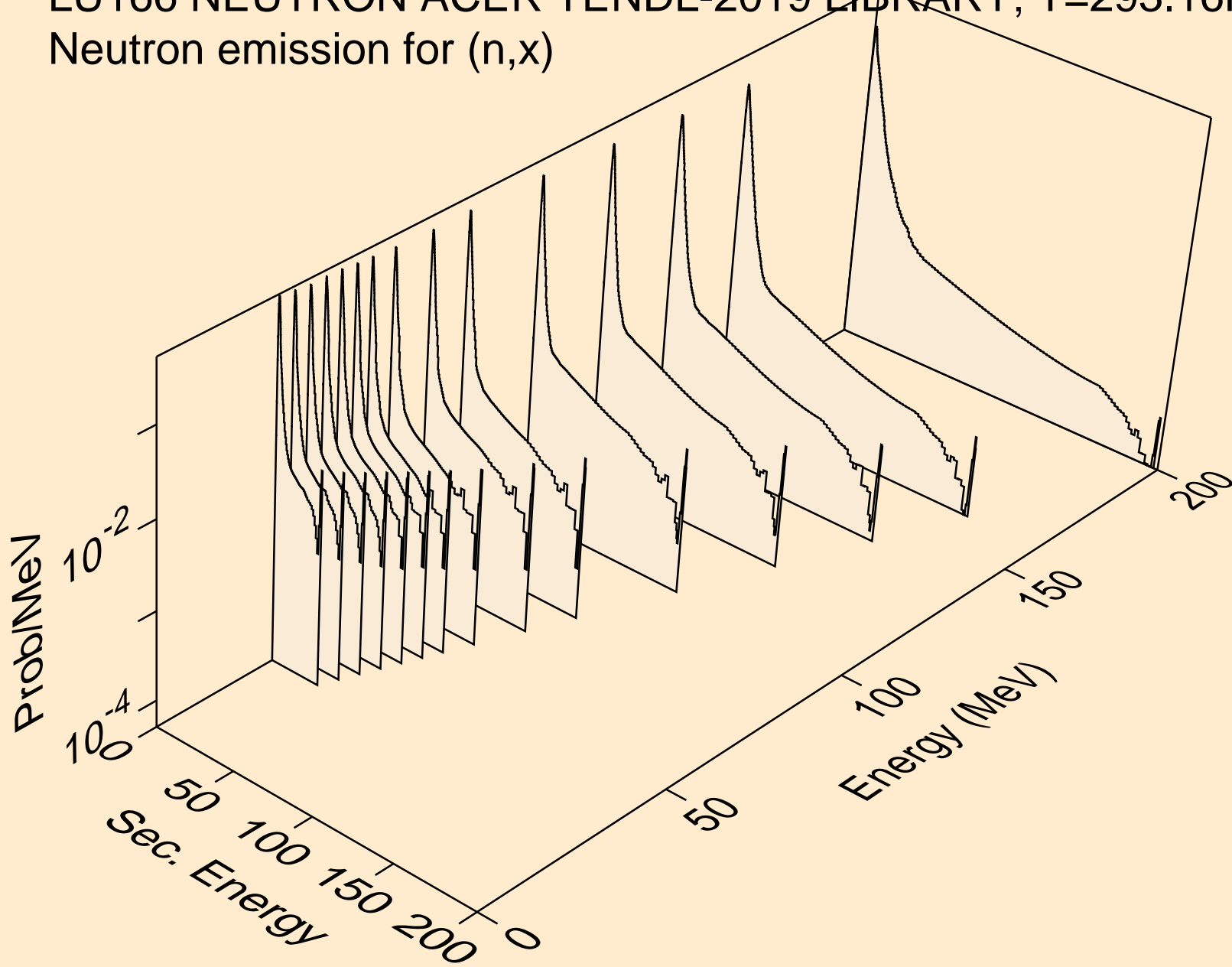

LU166 NEUTRON ACER TENDL-2019 LIBRARY; T=293.16K  
Neutron emission for (n,2nd)

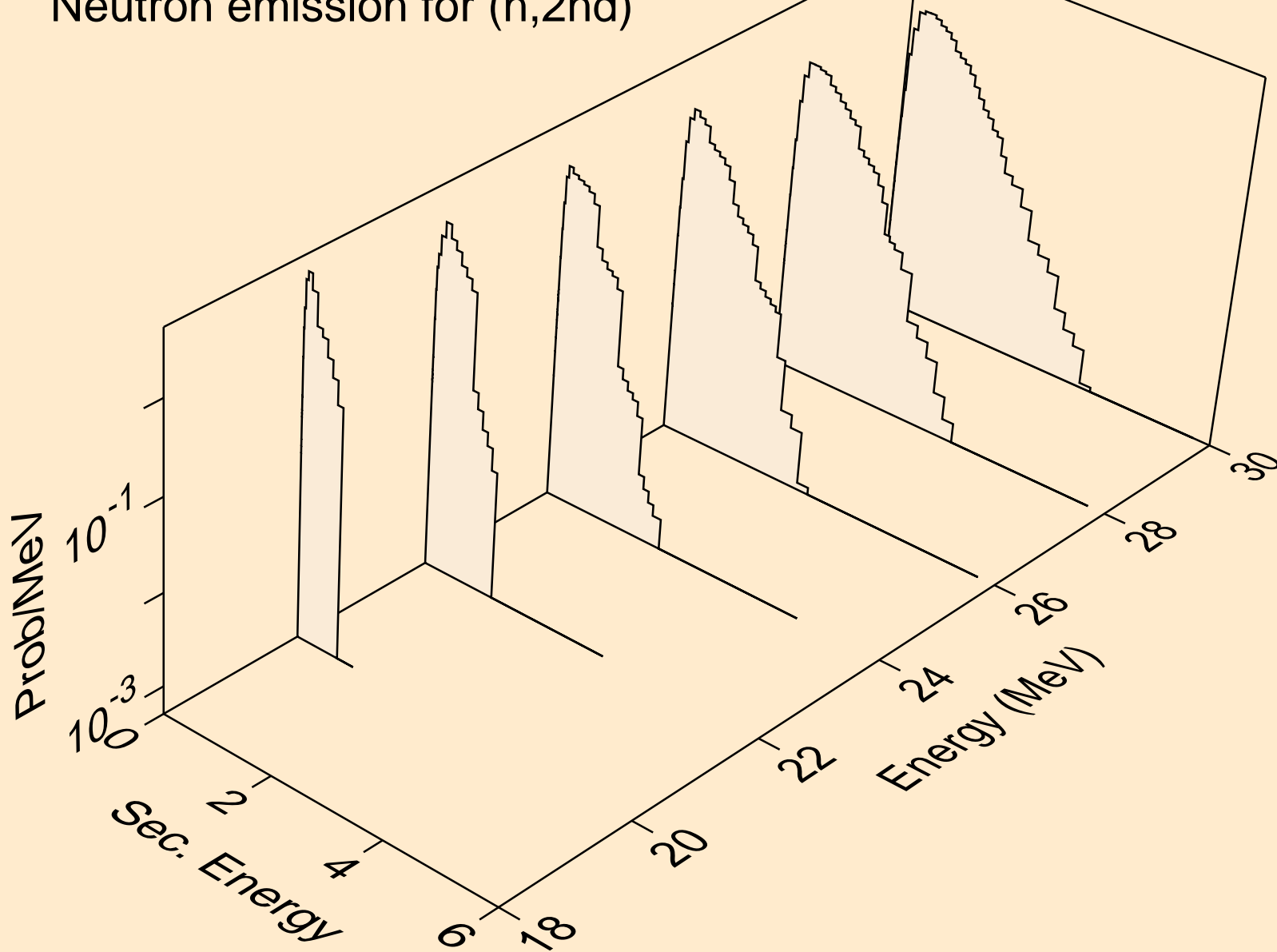

LU166 NEUTRON ACER TENDL-2019 LIBRARY; T=293.16K  
Neutron emission for (n,2n)

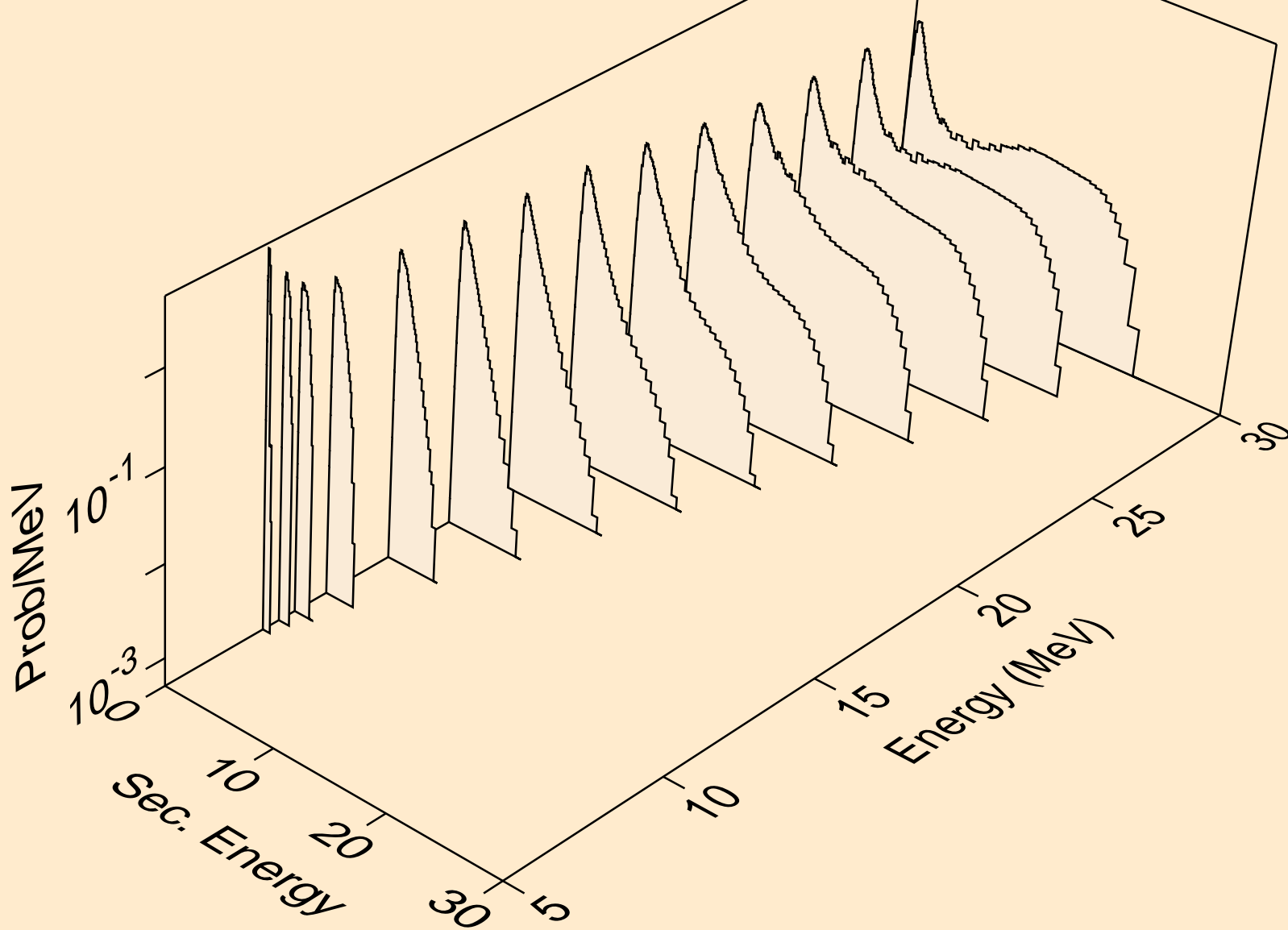

LU166 NEUTRON ACER TENDL-2019 LIBRARY; T=293.16K  
Neutron emission for (n,3n)

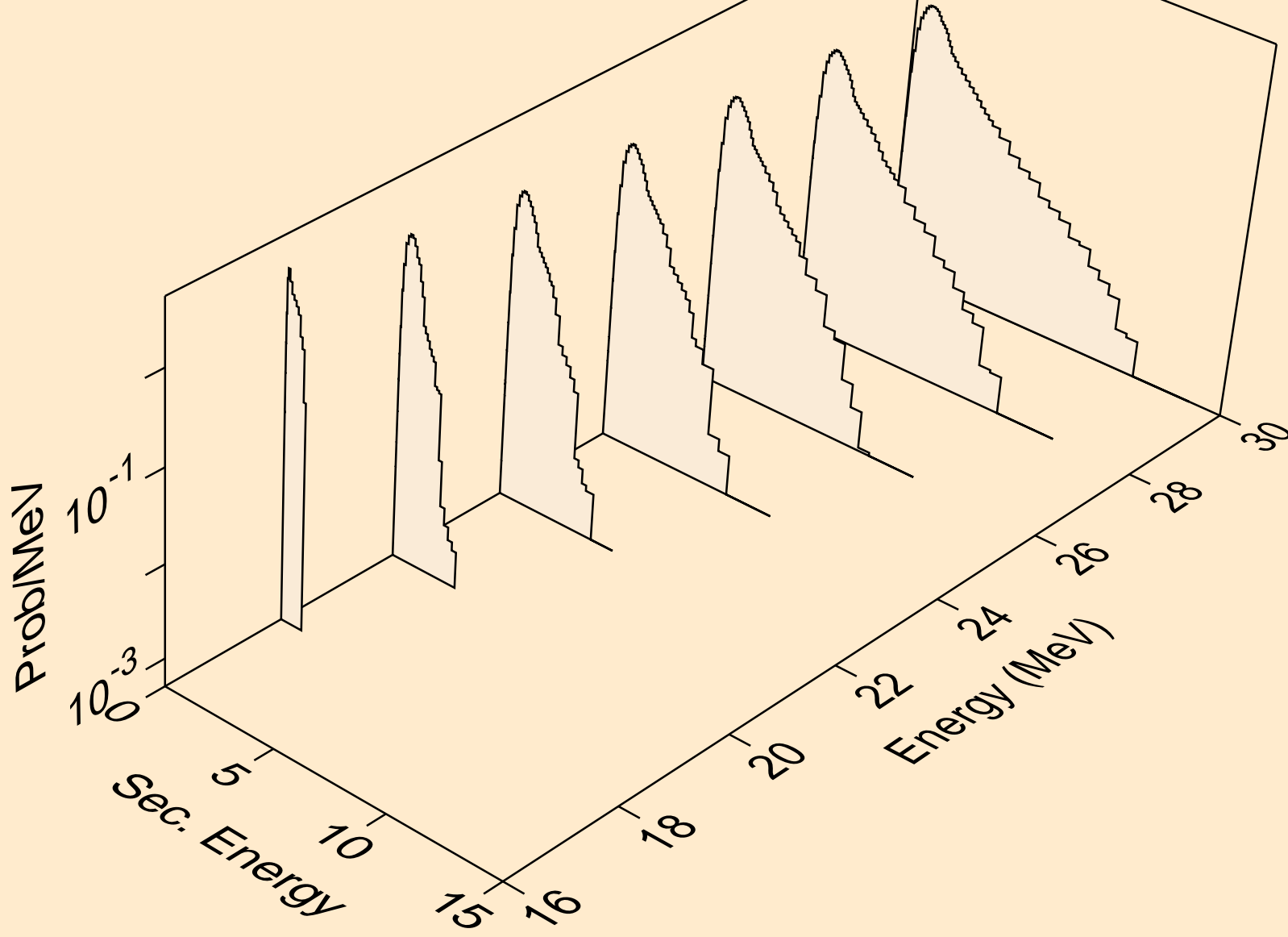

LU166 NEUTRON ACER TENDL-2019 LIBRARY; T=293.16K  
Neutron emission for (n,n\*)a

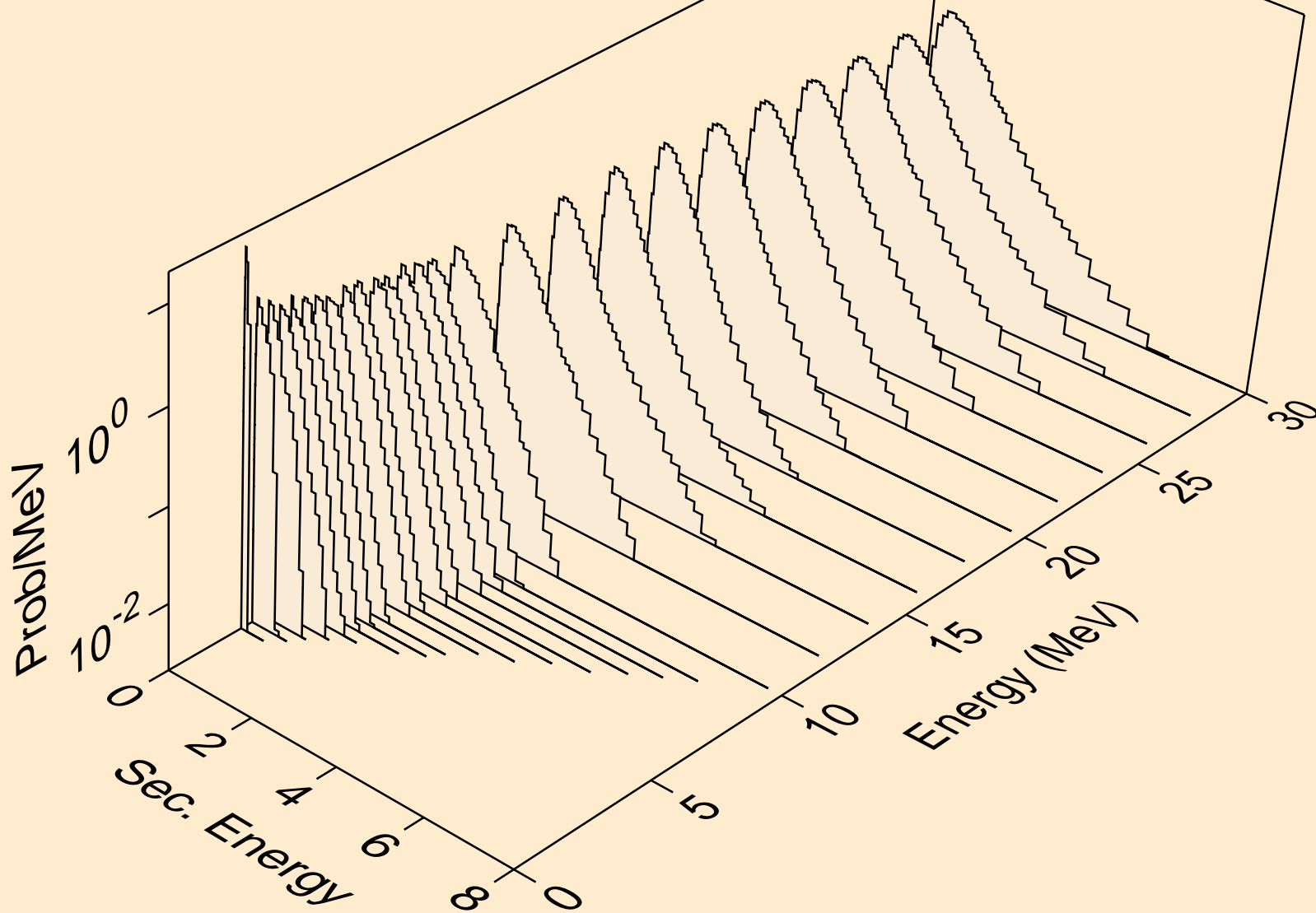



LU166 NEUTRON ACER TENDL-2019 LIBRARY; T=293.16K  
Neutron emission for (n,2n)<sub>a</sub>

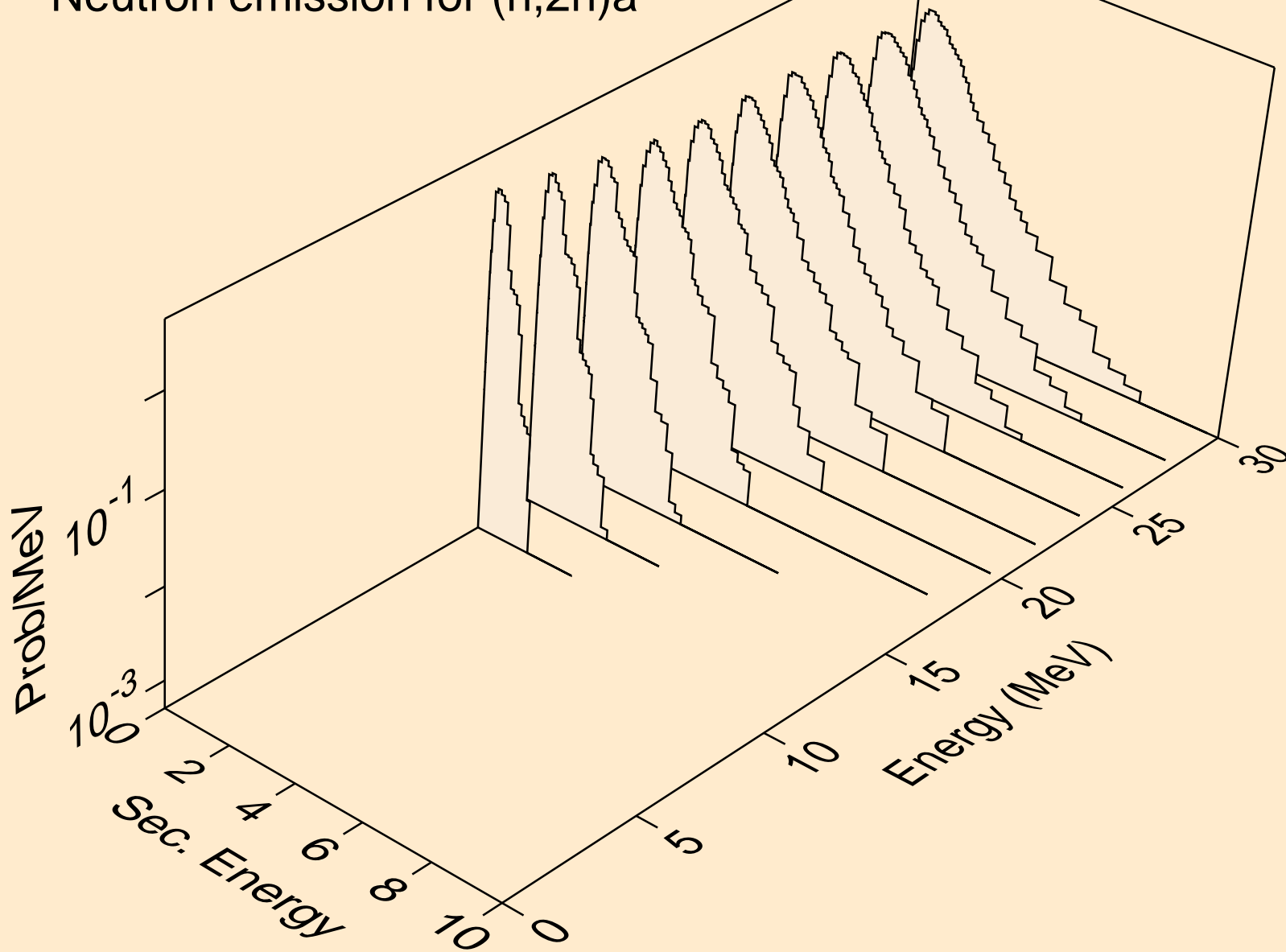

LU166 NEUTRON ACER TENDL-2019 LIBRARY; T=293.16K  
Neutron emission for (n,3n)a

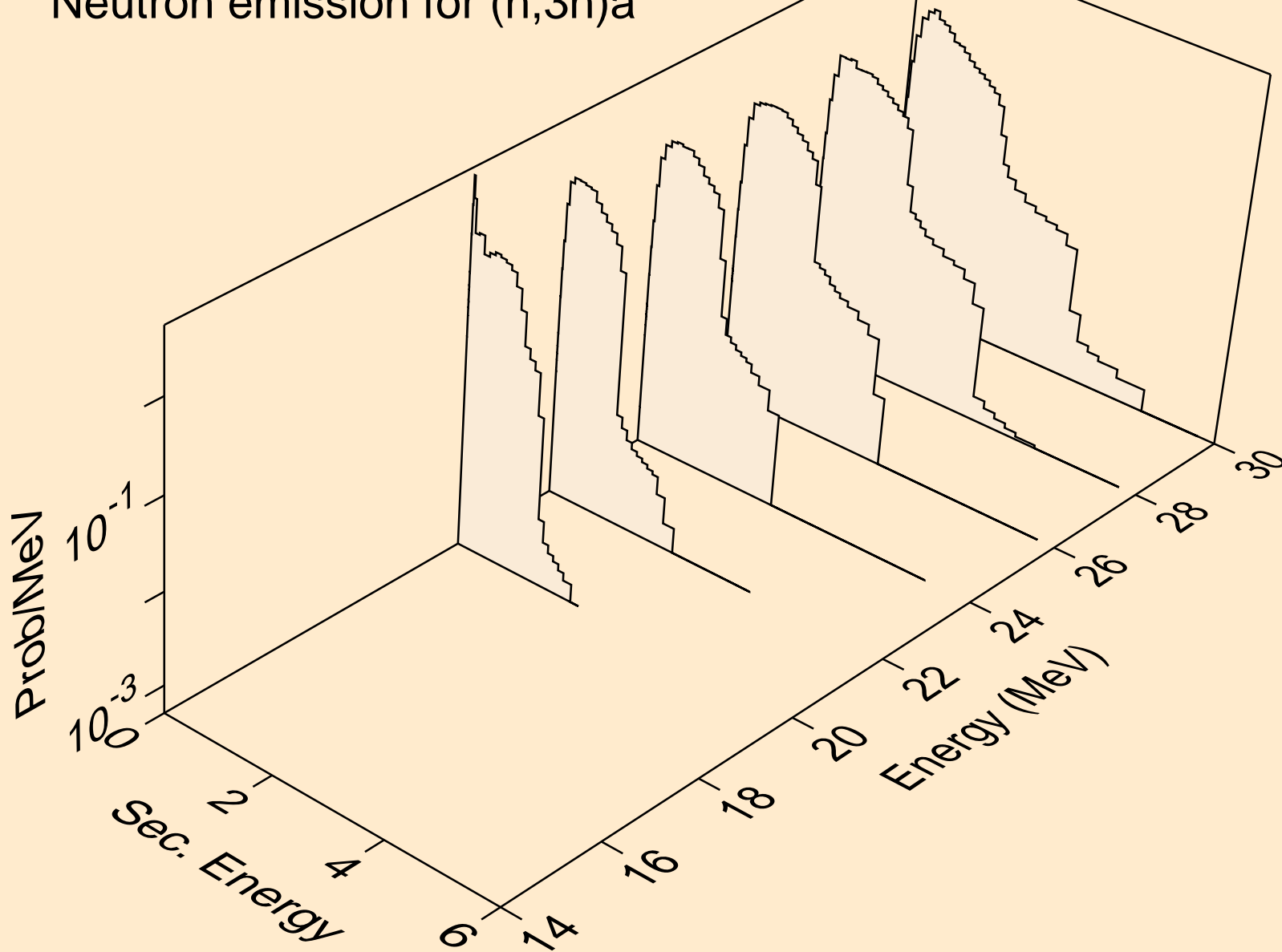

LU166 NEUTRON ACER TENDL-2019 LIBRARY; T=293.16K  
Neutron emission for (n,n\*)p

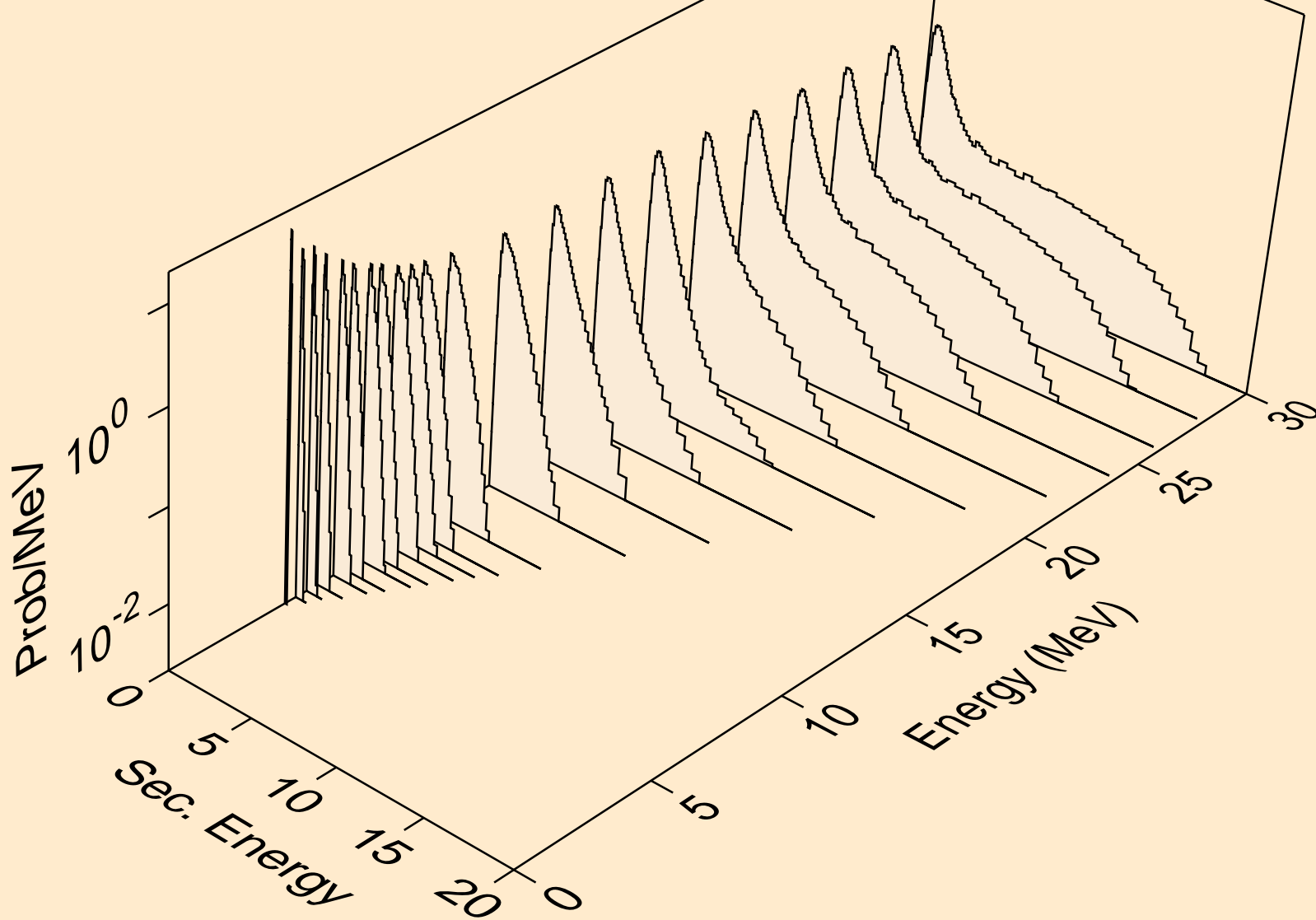

LU166 NEUTRON ACER TENDL-2019 LIBRARY; T=293.16K  
Neutron emission for (n,n\*)2a

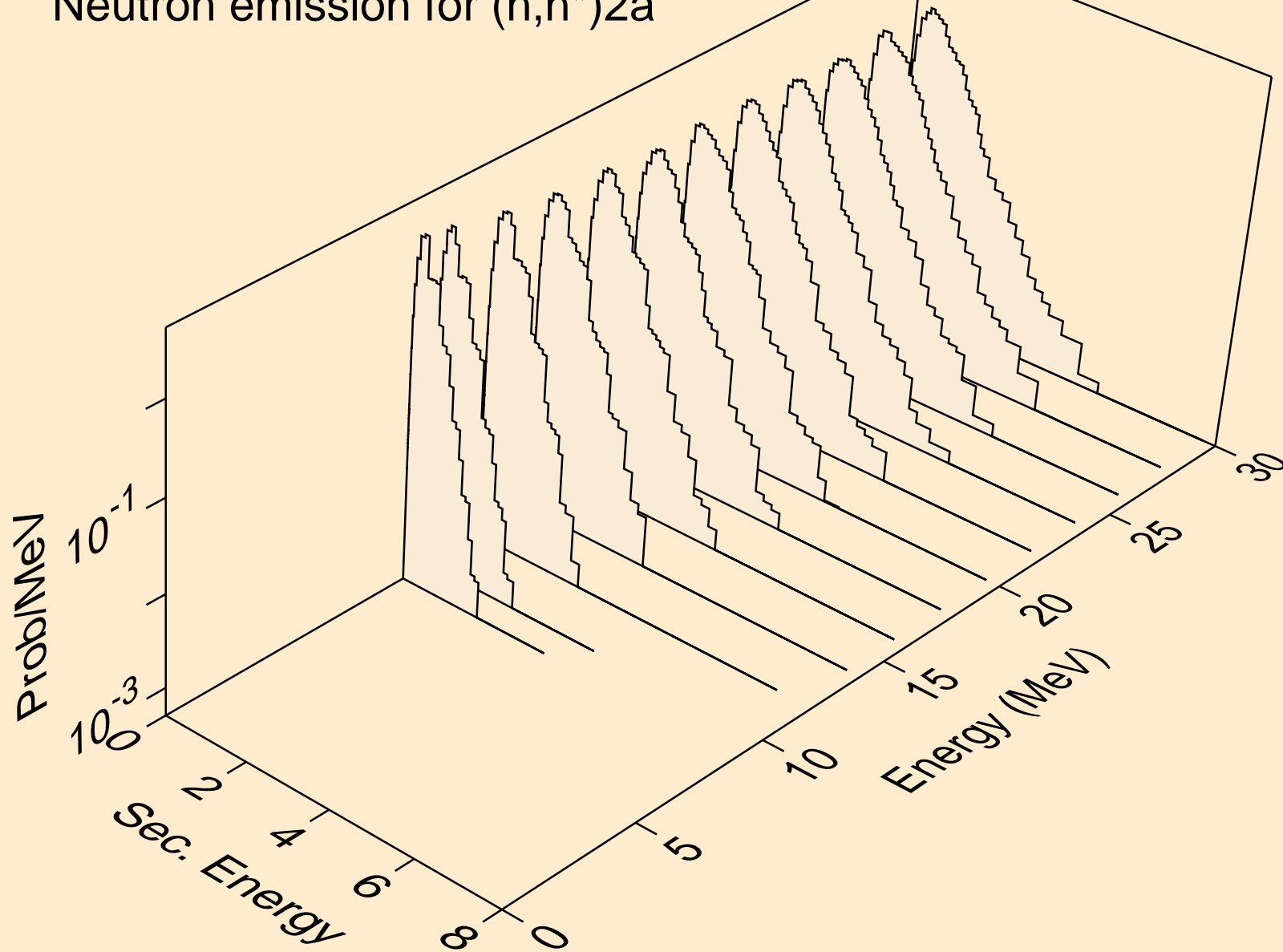

LU166 NEUTRON ACER TENDL-2019 LIBRARY; T=293.16K  
Neutron emission for (n,2n)2a

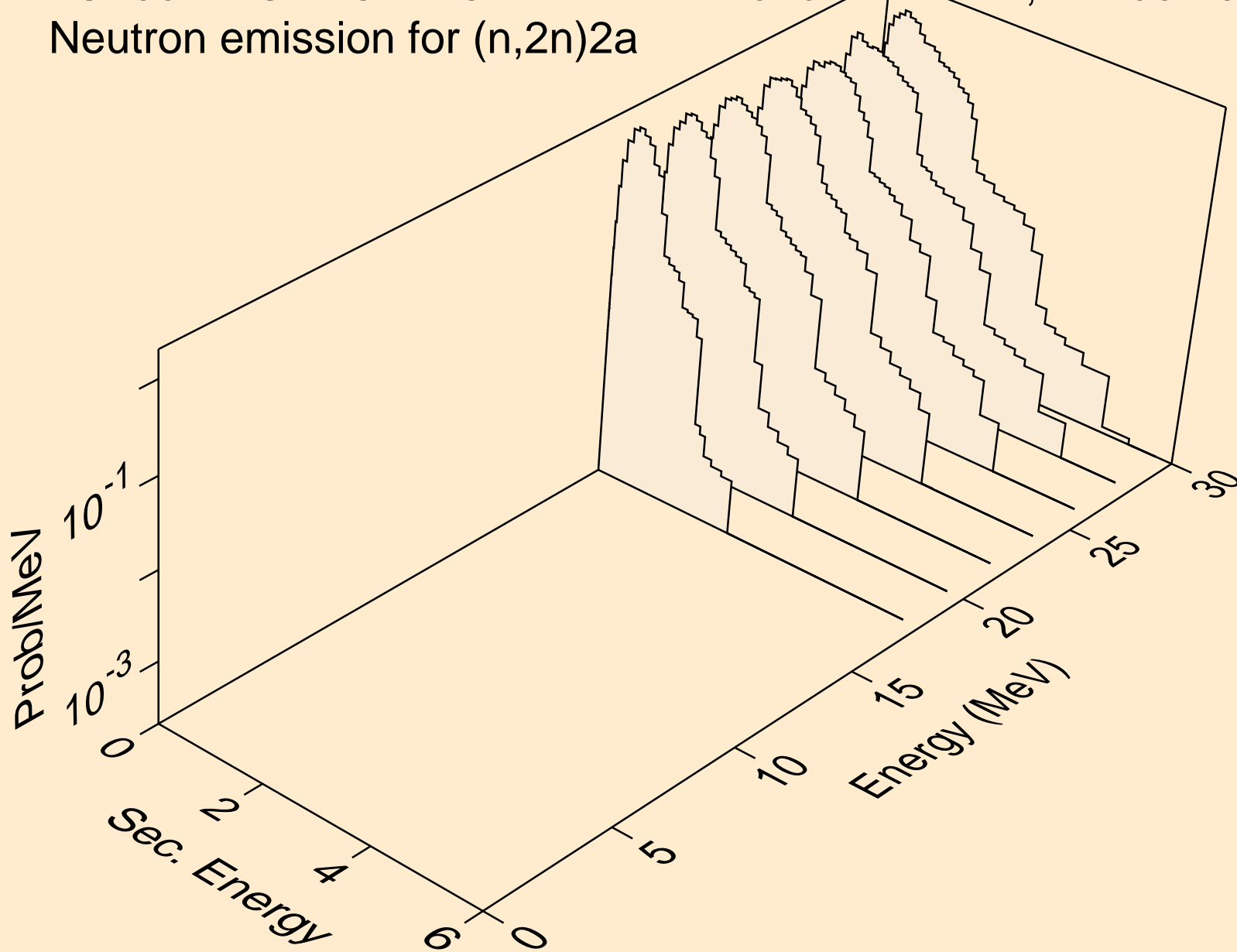

LU166 NEUTRON ACER TENDL-2019 LIBRARY; T=293.16K  
Neutron emission for (n,n\*)d

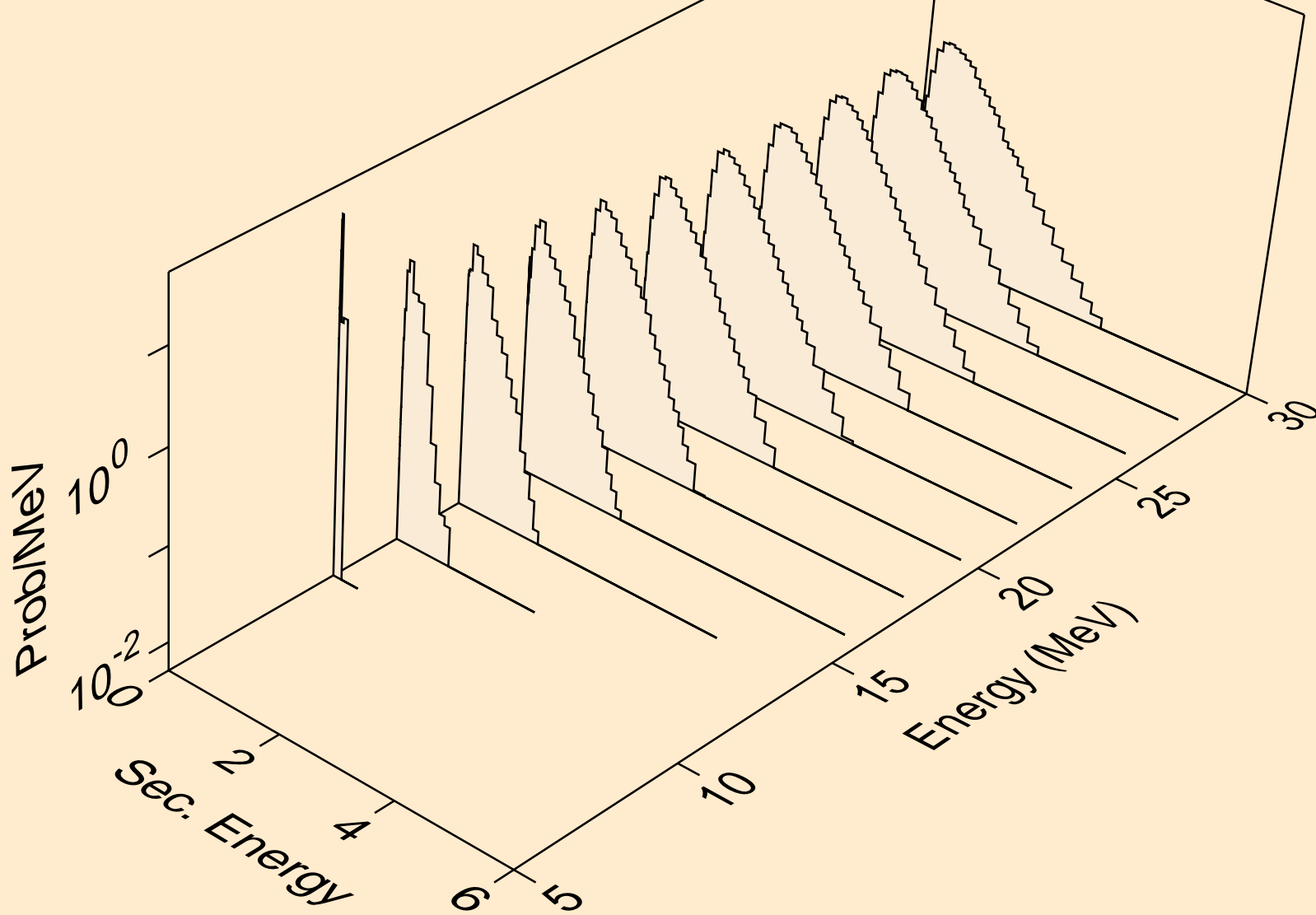

LU166 NEUTRON ACER TENDL-2019 LIBRARY; T=293.16K  
Neutron emission for (n,n\*)t

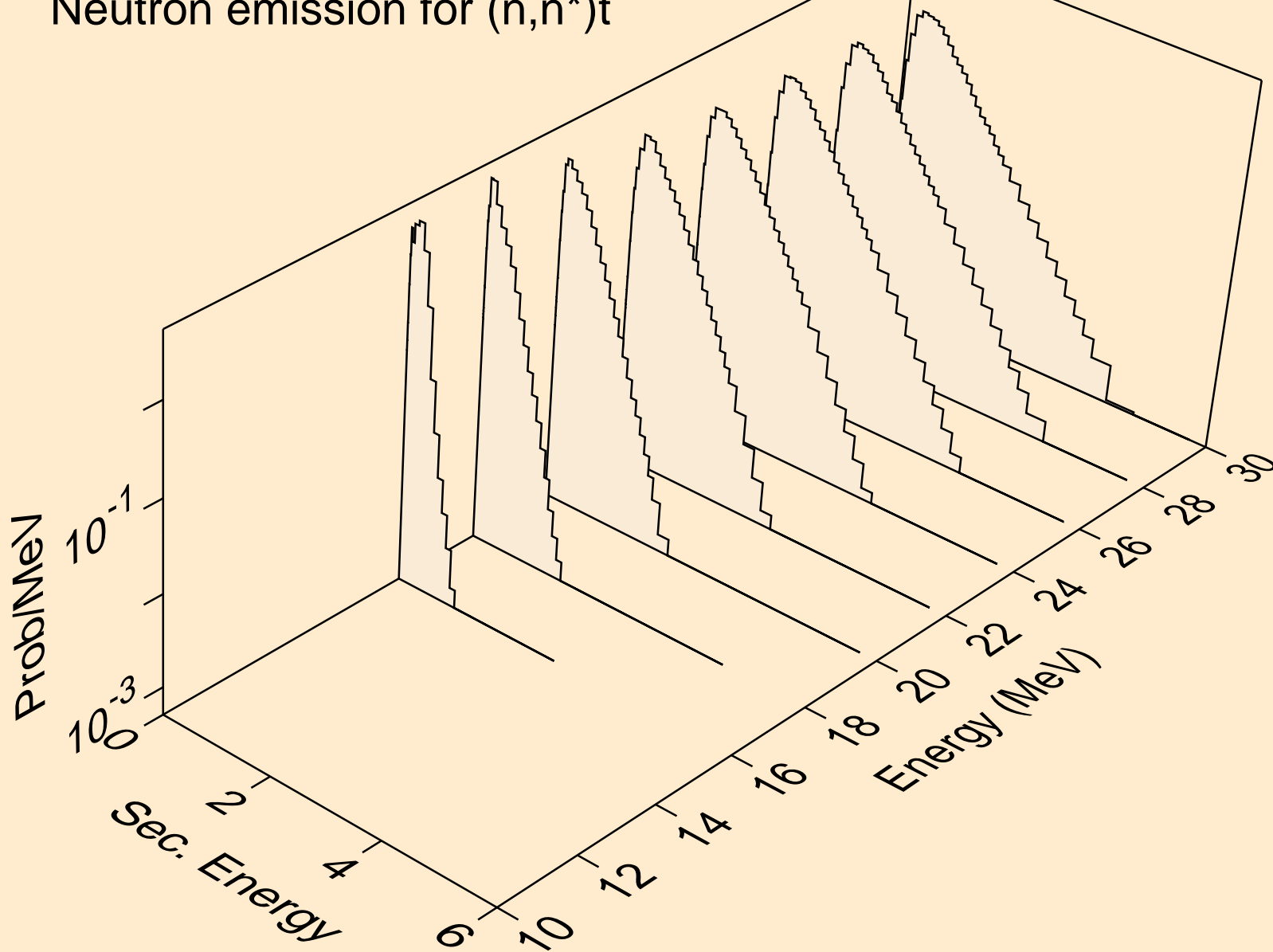

LU166 NEUTRON ACER TENDL-2019 LIBRARY; T=293.16K  
Neutron emission for (n,n\*)he3

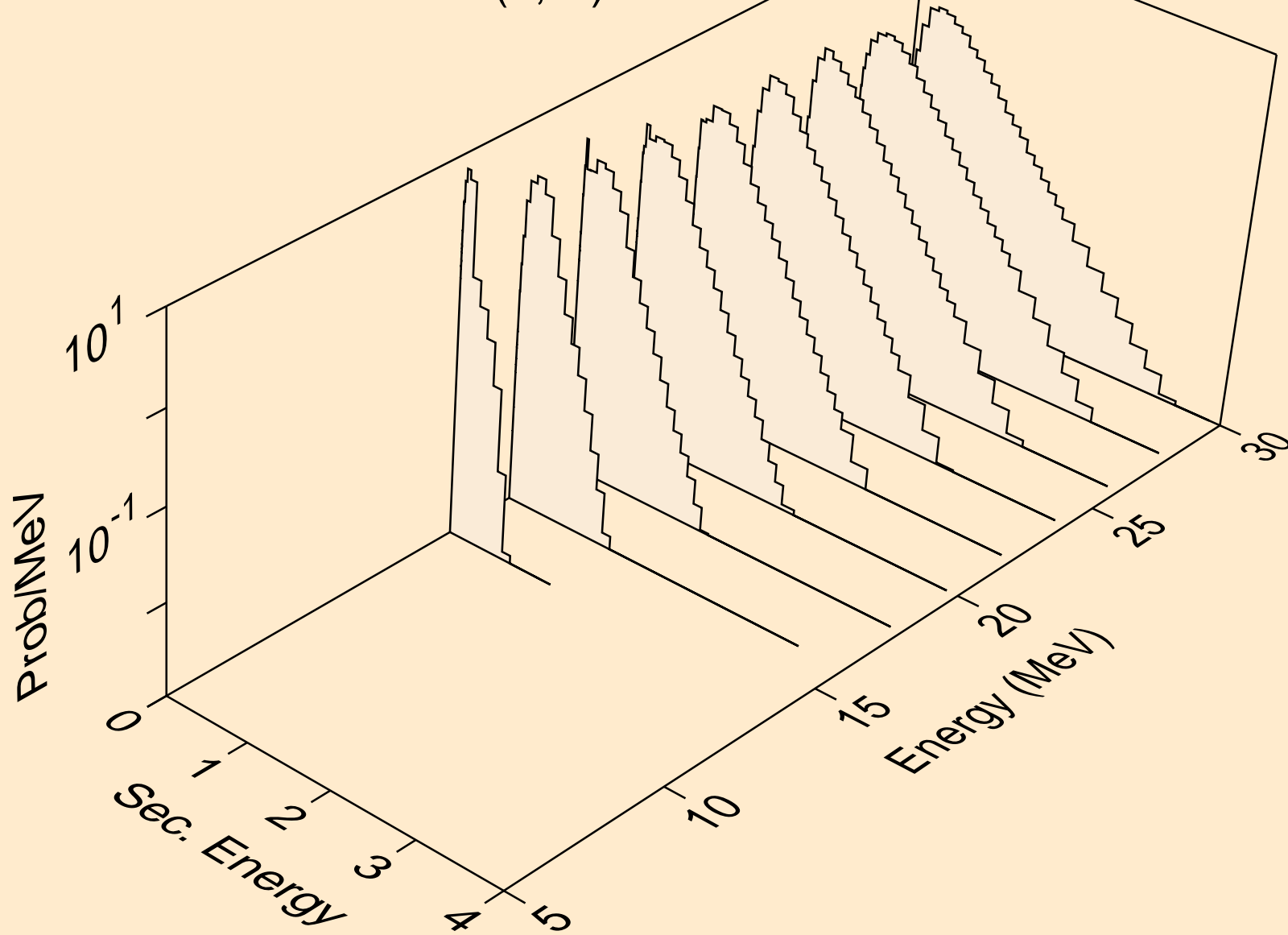



LU166 NEUTRON ACER TENDL-2019 LIBRARY; T=293.16K  
Neutron emission for (n,4n)

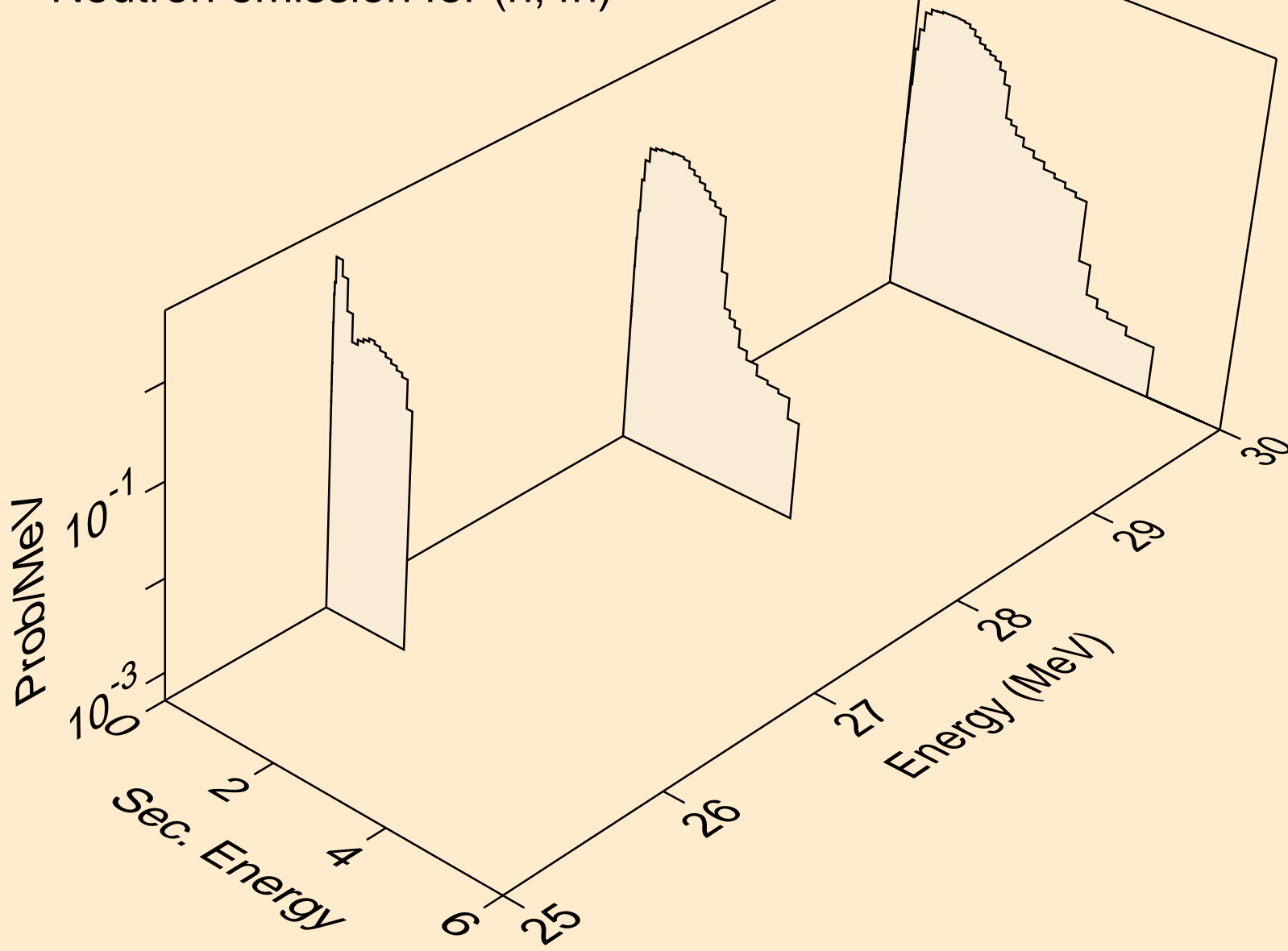

LU166 NEUTRON ACER TENDL-2019 LIBRARY; T=293.16K  
Neutron emission for (n,2np)

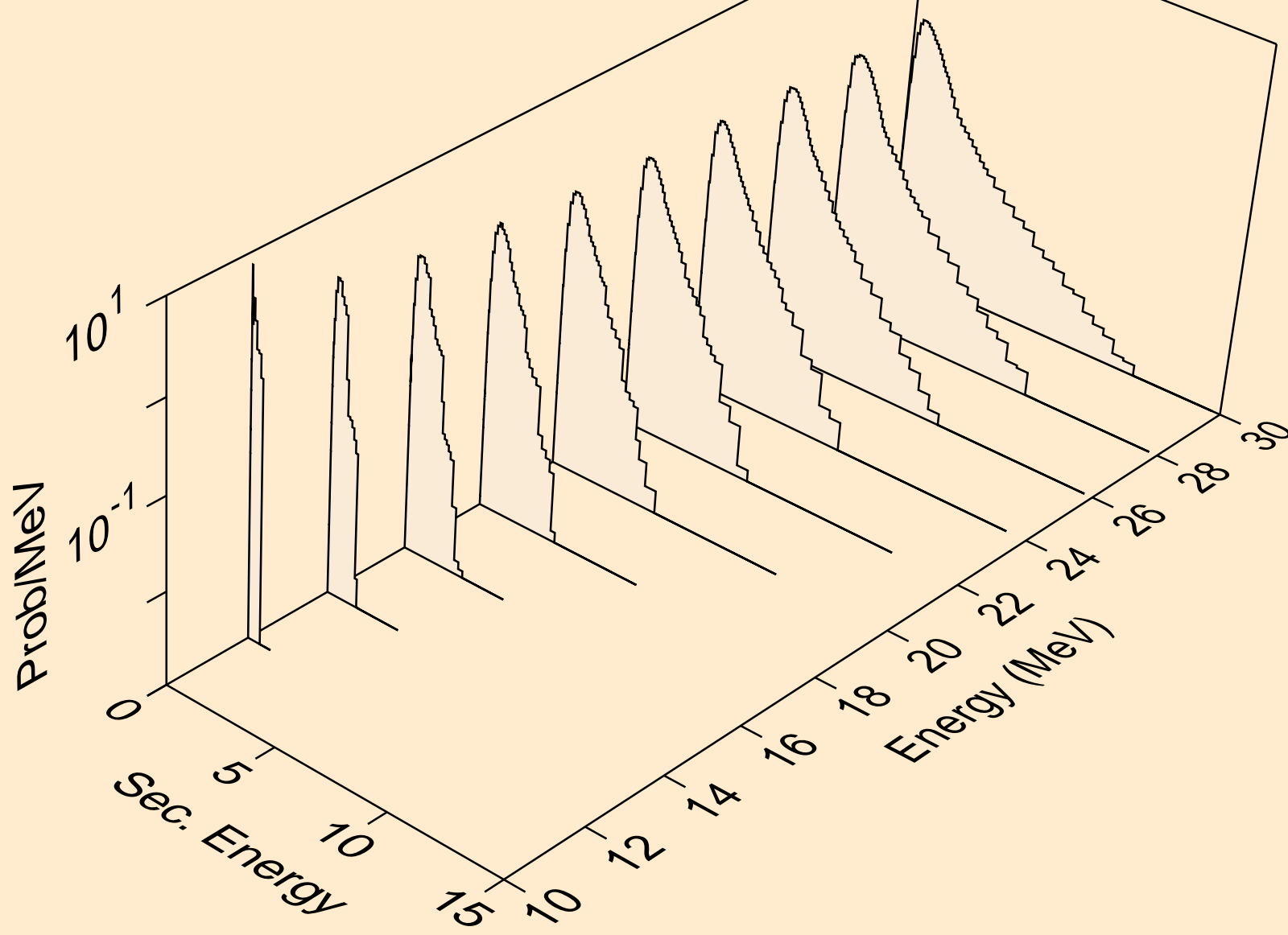

LU166 NEUTRON ACER TENDL-2019 LIBRARY; T=293.16K  
Neutron emission for (n,3np)

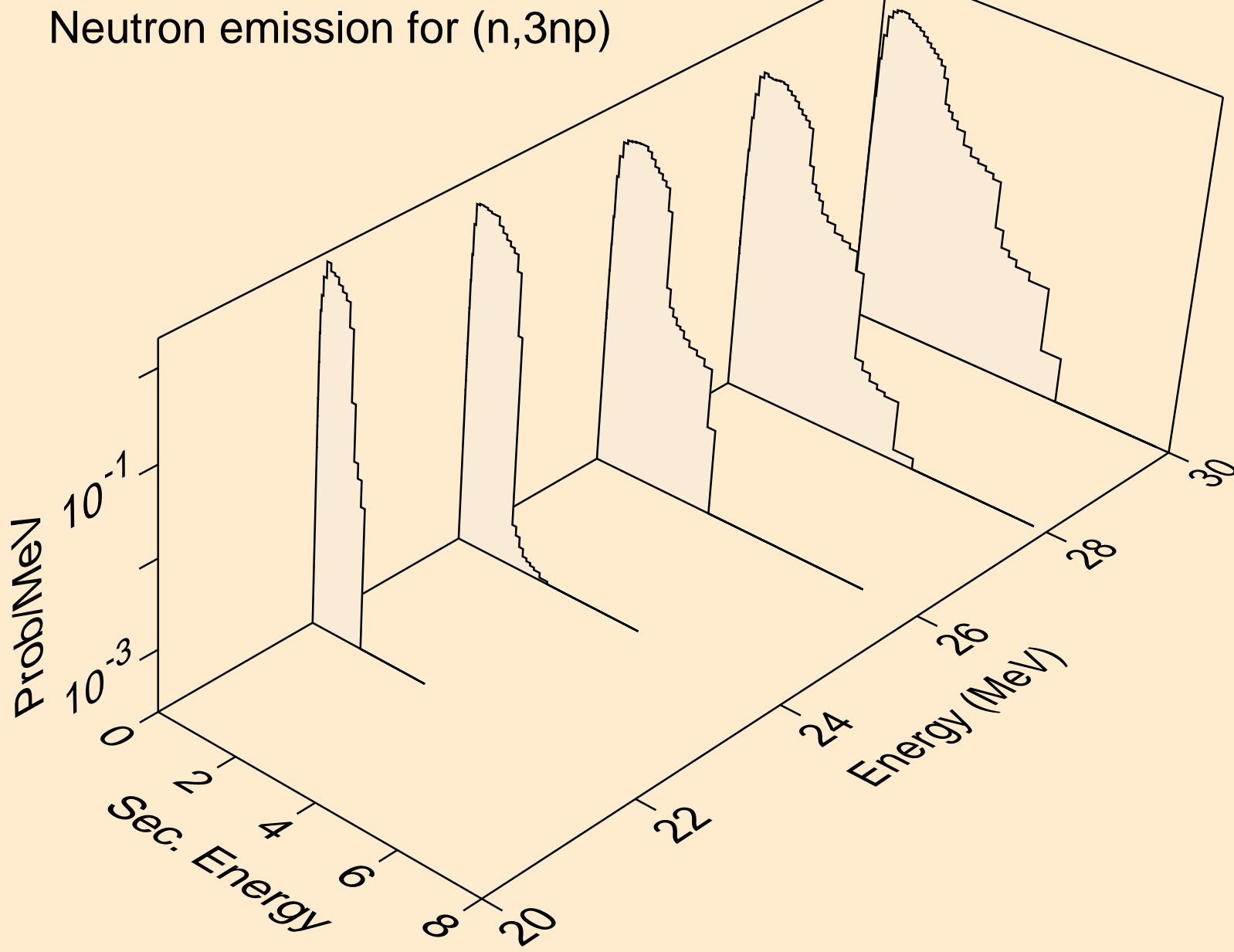

LU166 NEUTRON ACER TENDL-2019 LIBRARY; T=293.16K  
Neutron emission for (n,2np)

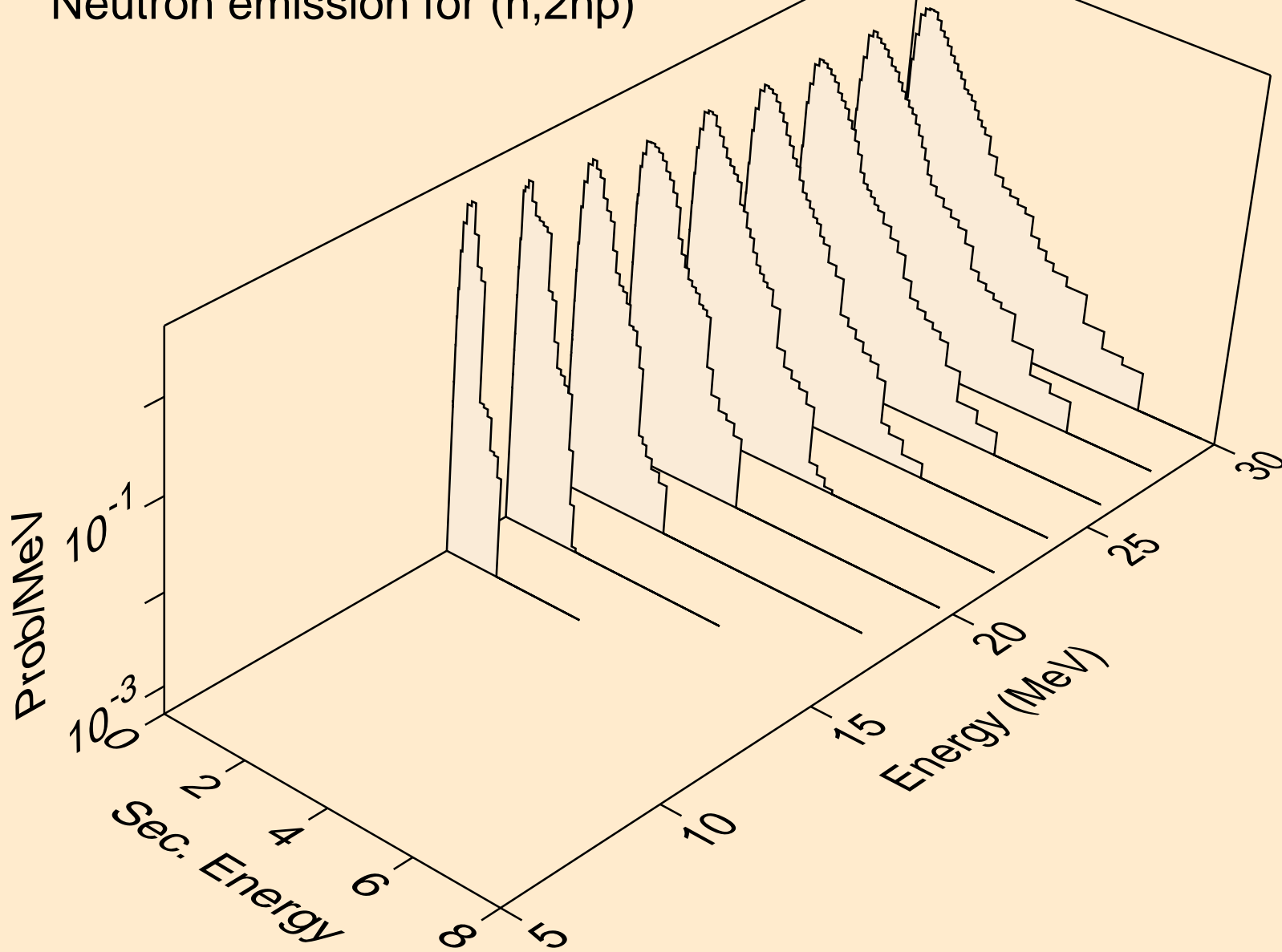

LU166 NEUTRON ACER TENDL-2019 LIBRARY; T=293.16K  
Neutron emission for (n,npa)

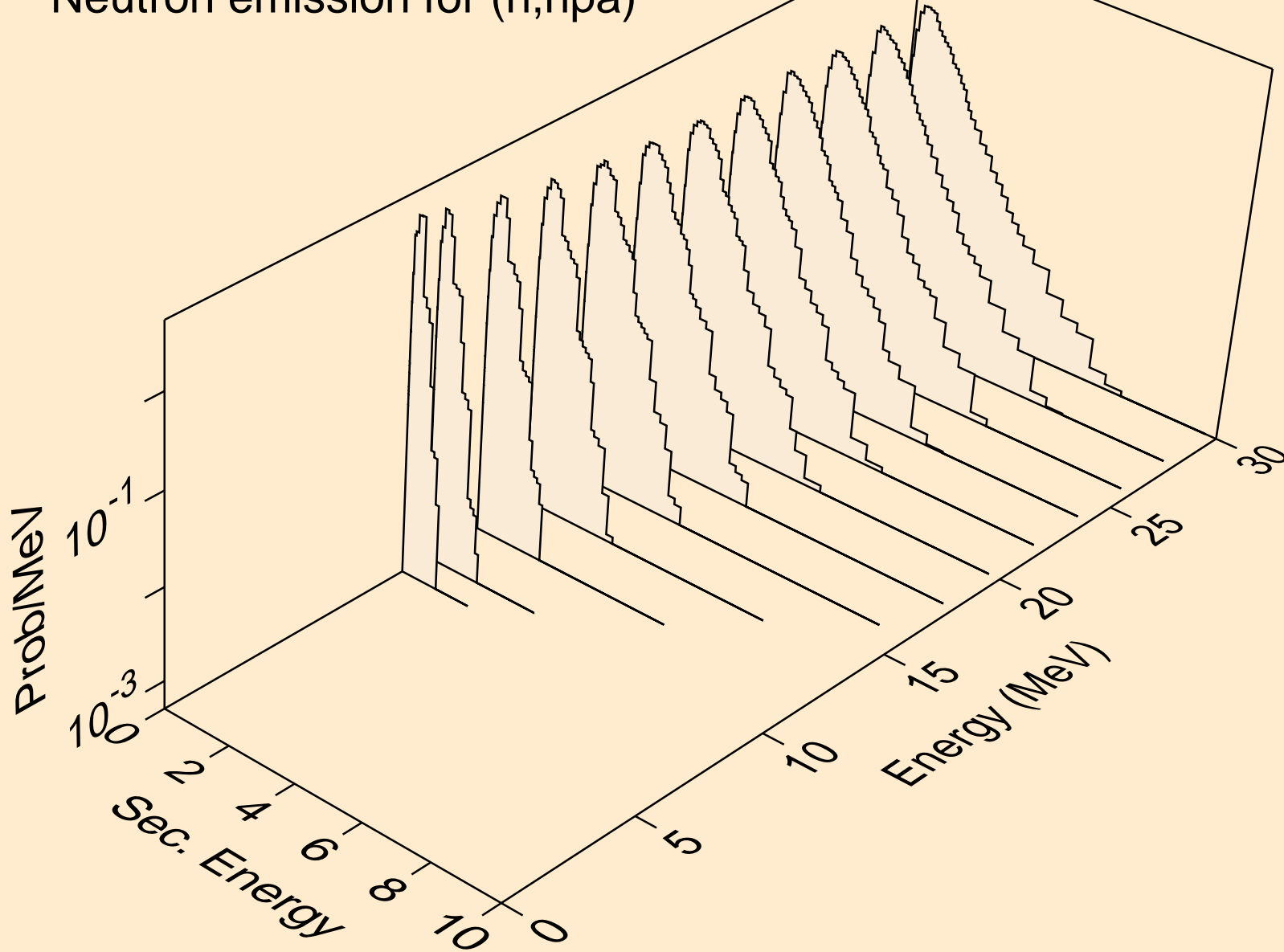

LU166 NEUTRON ACER TENDL-2019 LIBRARY; T=293.16K  
Neutron emission for (n,n\*c)

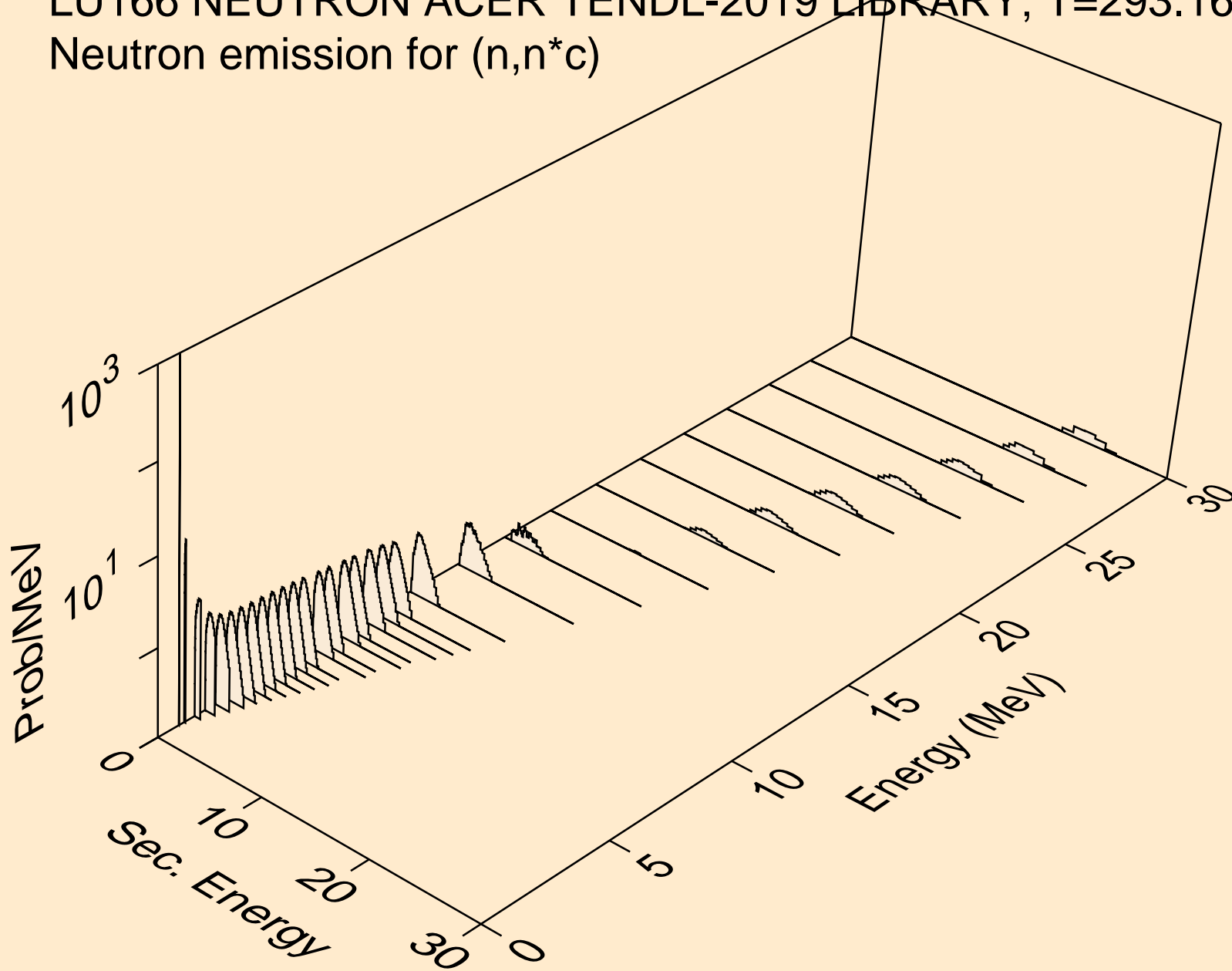

LU166 NEUTRON ACER TENDL-2019 LIBRARY; T=293.16K  
Photon emission for (n,x)

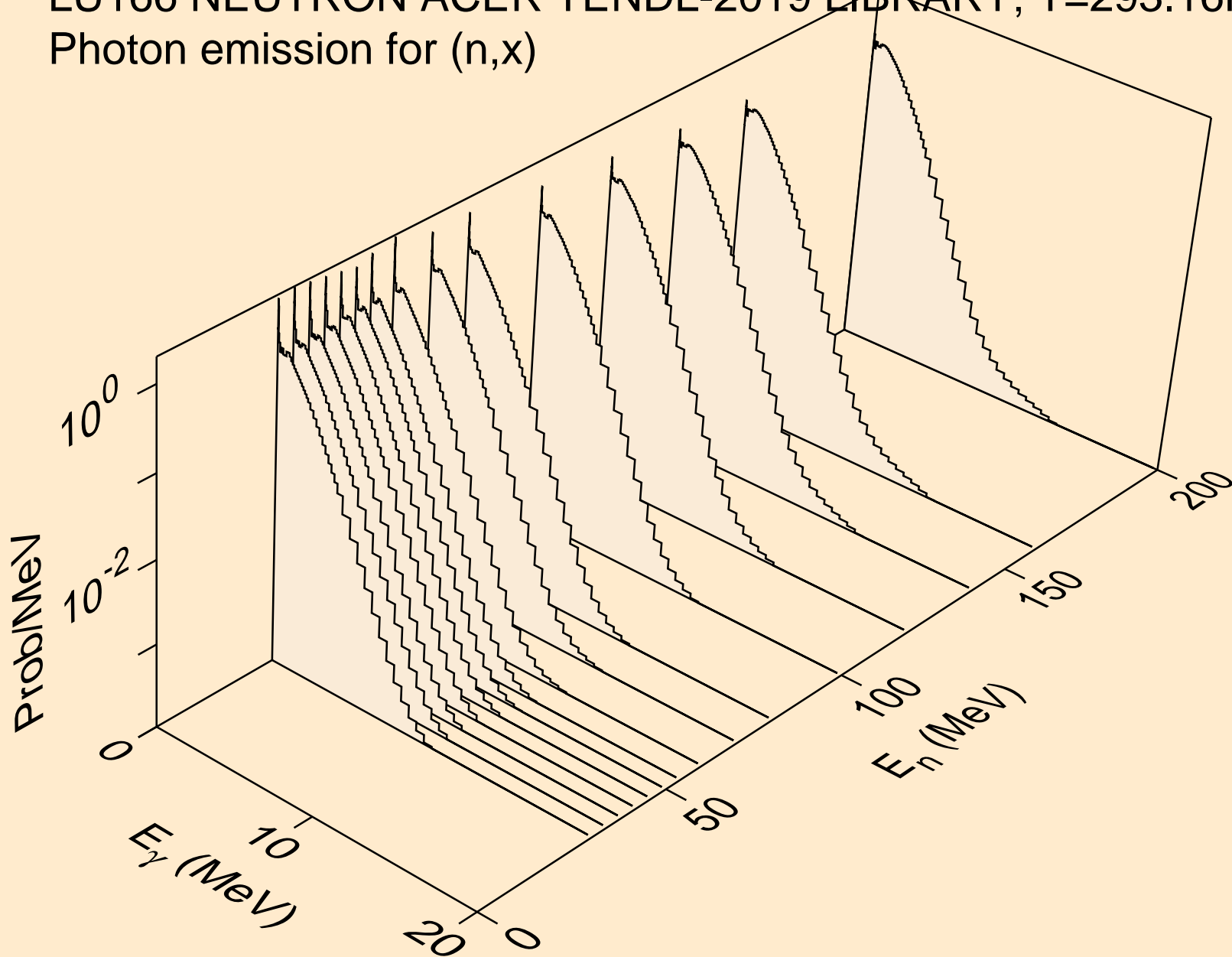

LU166 NEUTRON ACER TENDL-2019 LIBRARY; T=293.16K  
Photon emission for (n,2nd)

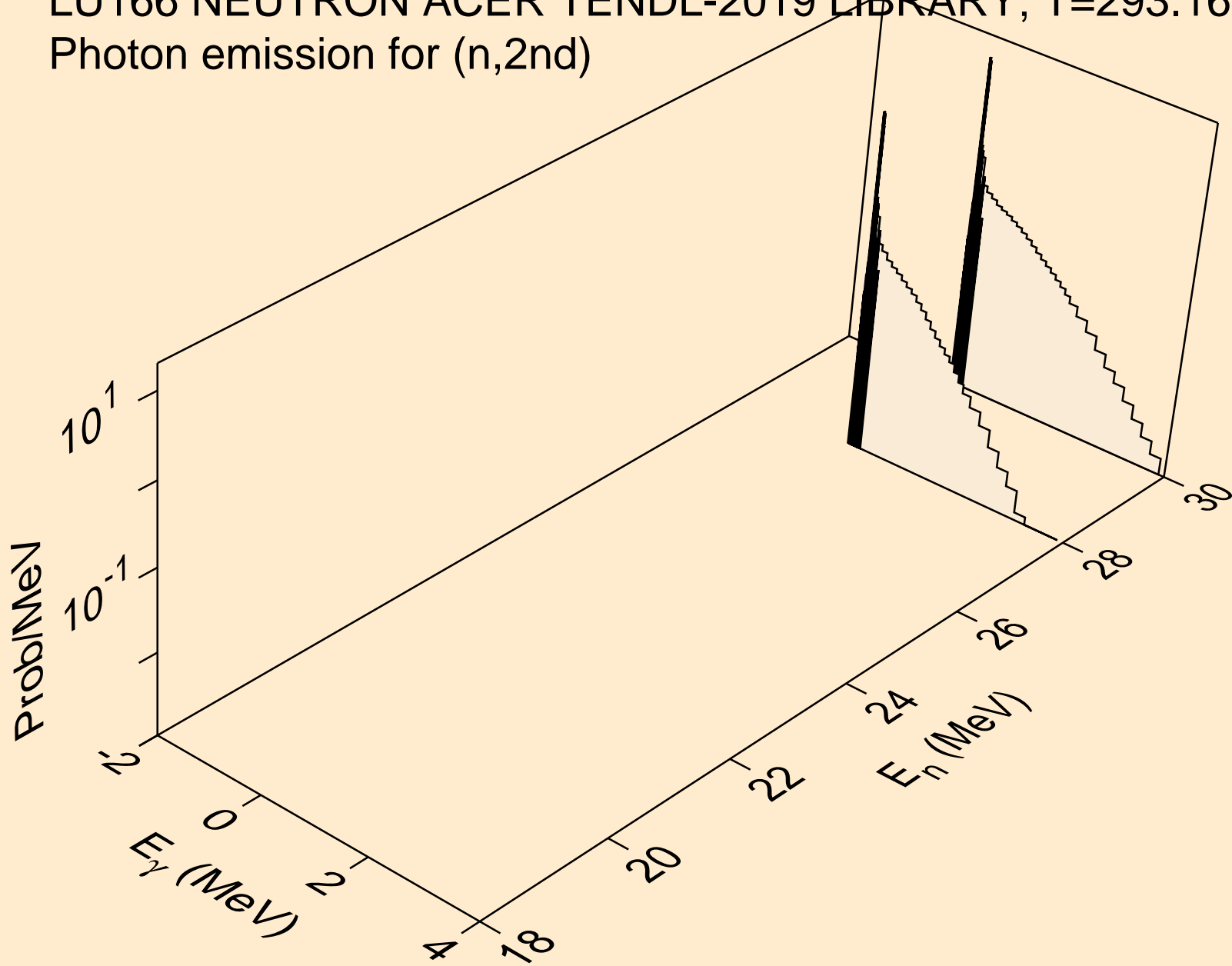



LU166 NEUTRON ACER TENDL-2019 LIBRARY; T=293.16K  
Photon emission for (n,2n)

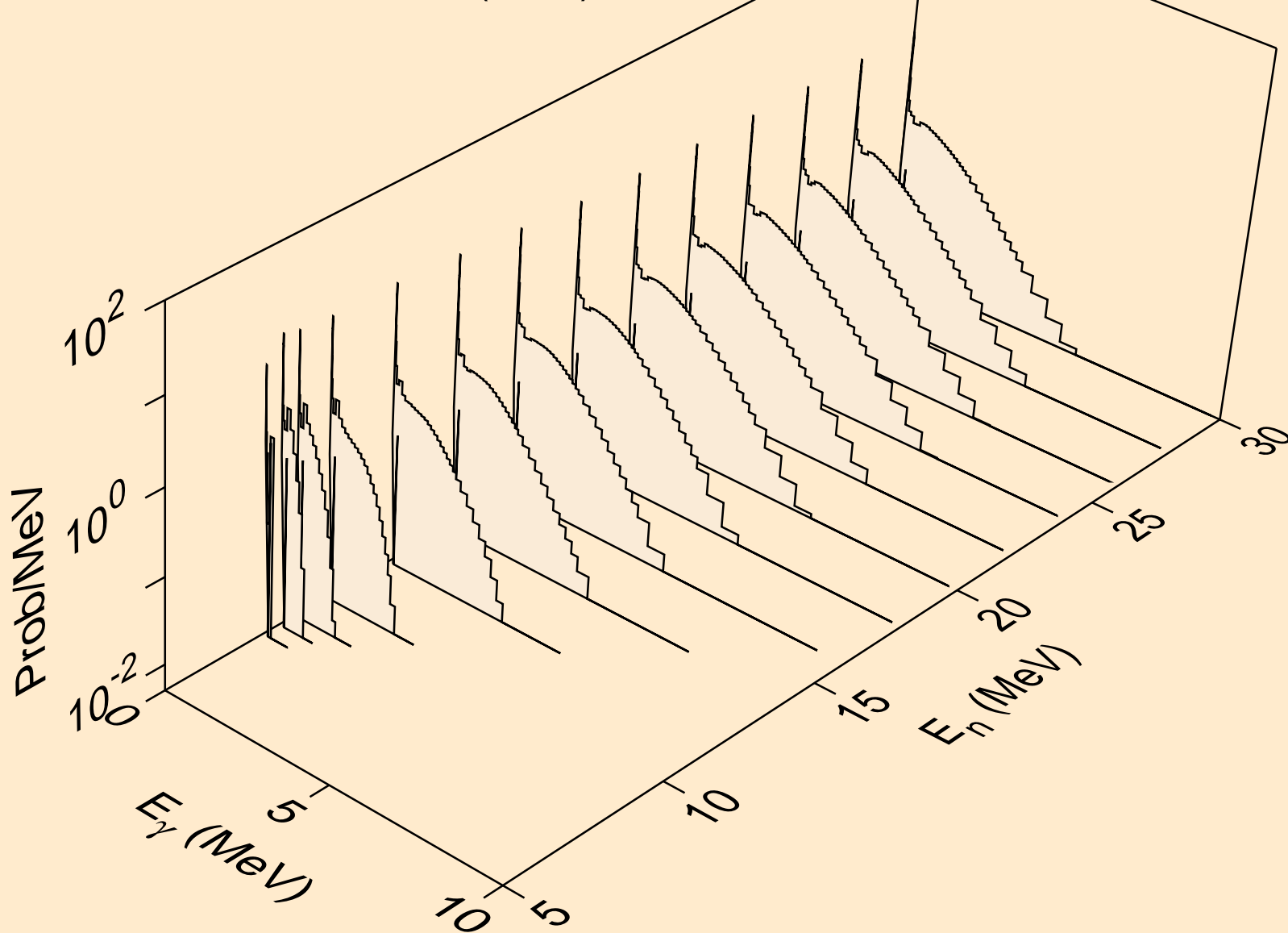

LU166 NEUTRON ACER TENDL-2019 LIBRARY; T=293.16K  
Photon emission for (n,3n)

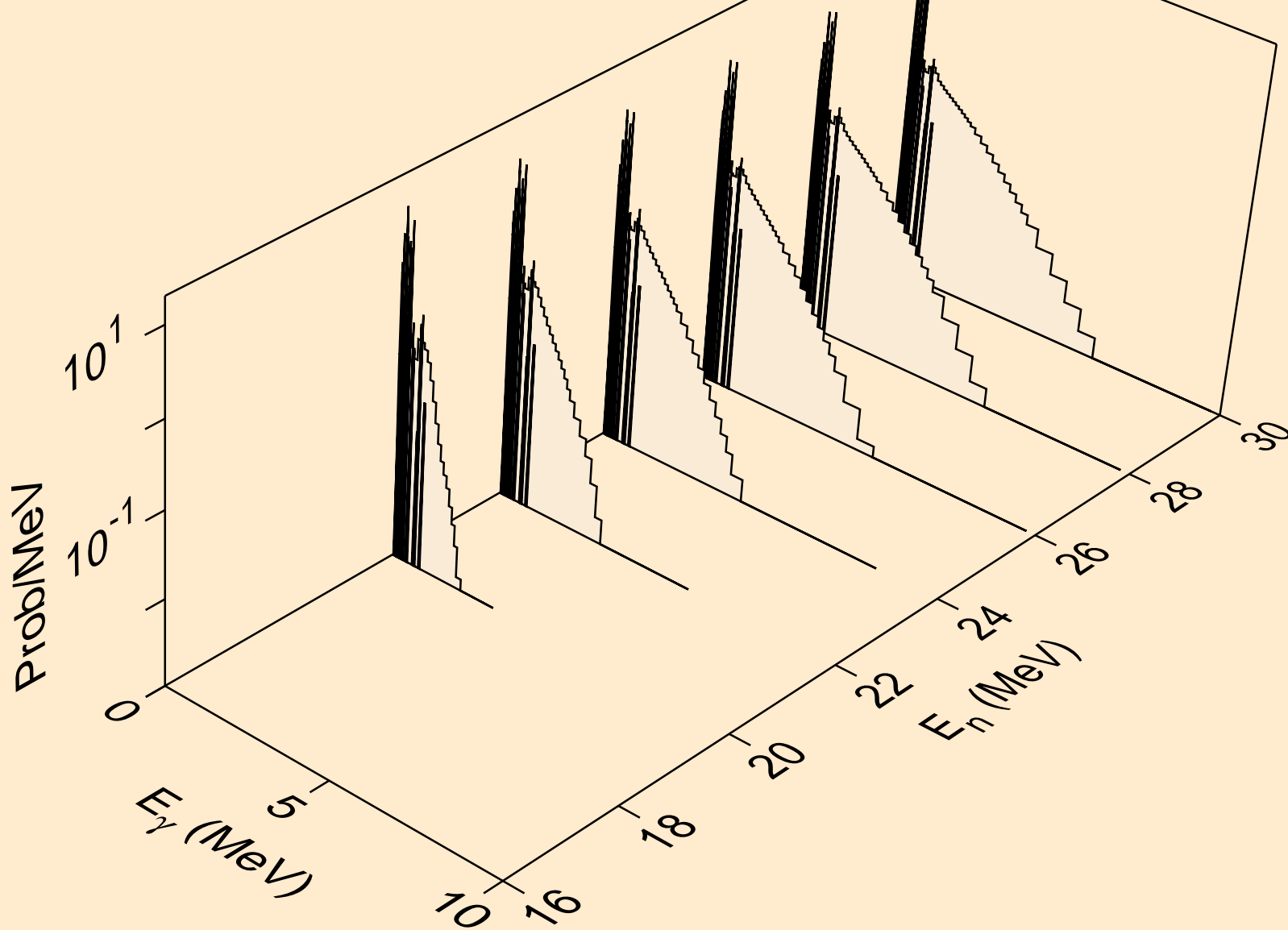

LU166 NEUTRON ACER TENDL-2019 LIBRARY; T=293.16K  
Photon emission for (n,n\*)a

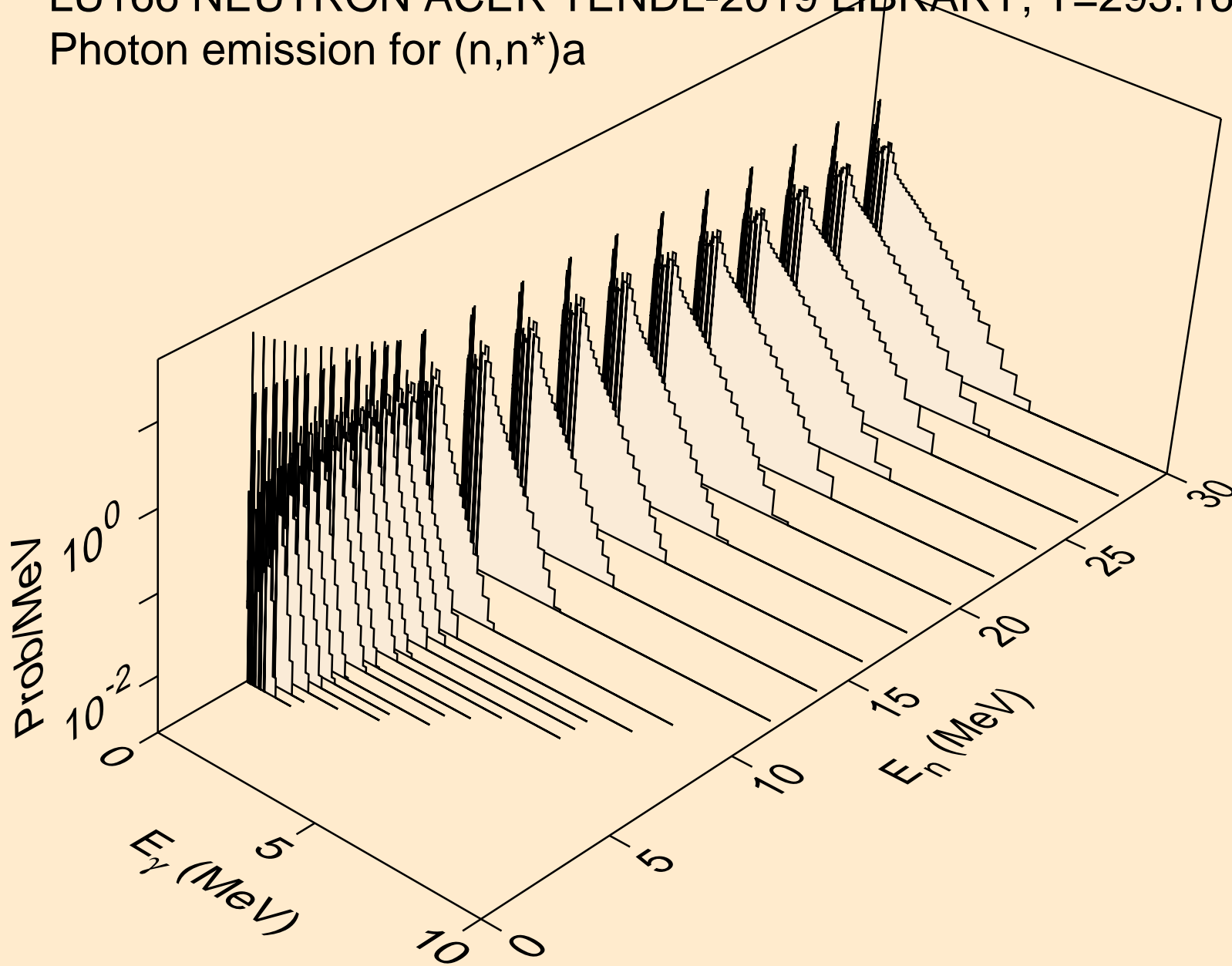

LU166 NEUTRON ACER TENDL-2019 LIBRARY; T=293.16K  
Photon emission for (n,2n)a

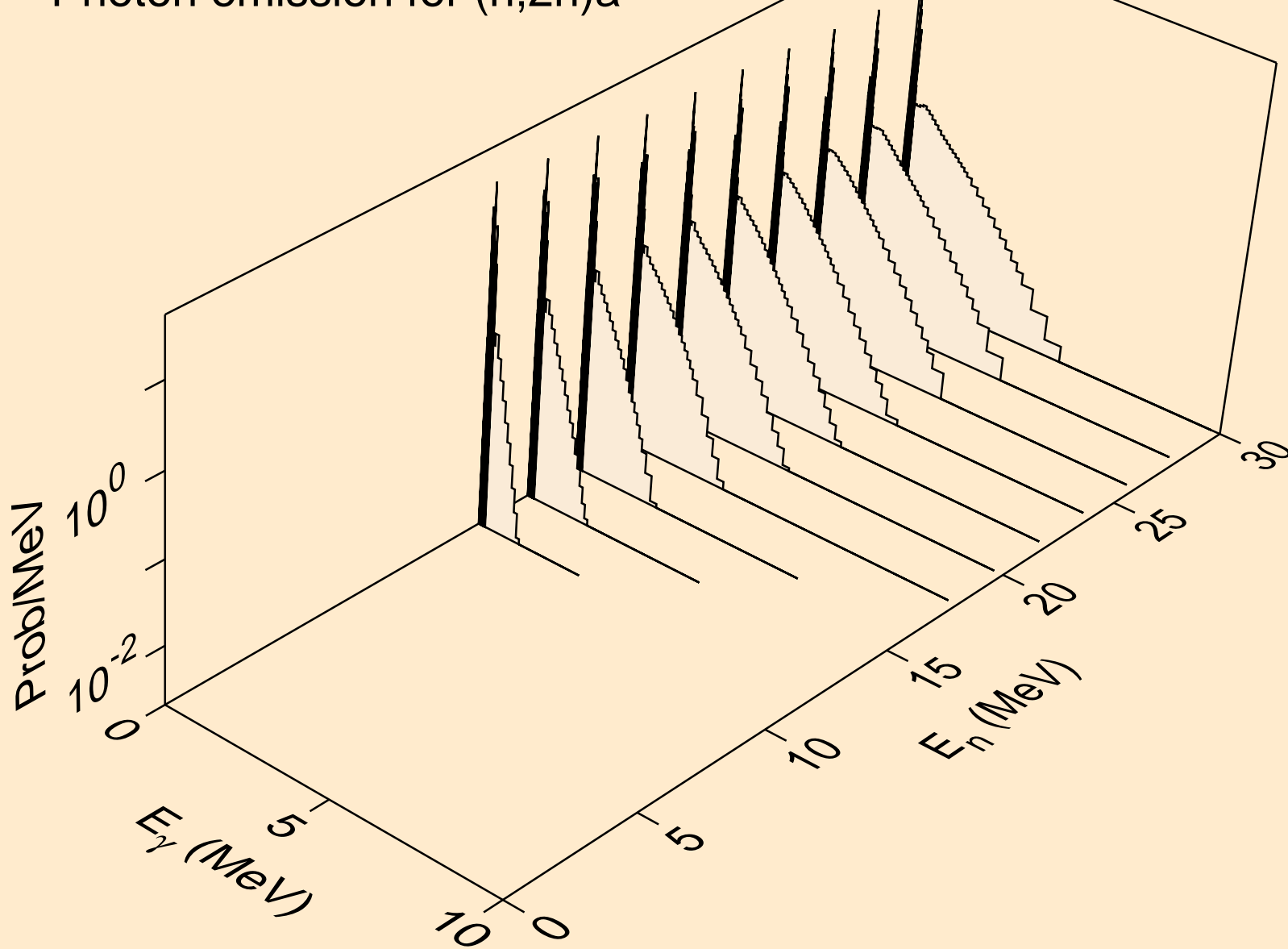

LU166 NEUTRON ACER TENDL-2019 LIBRARY; T=293.16K  
Photon emission for (n,3n)a

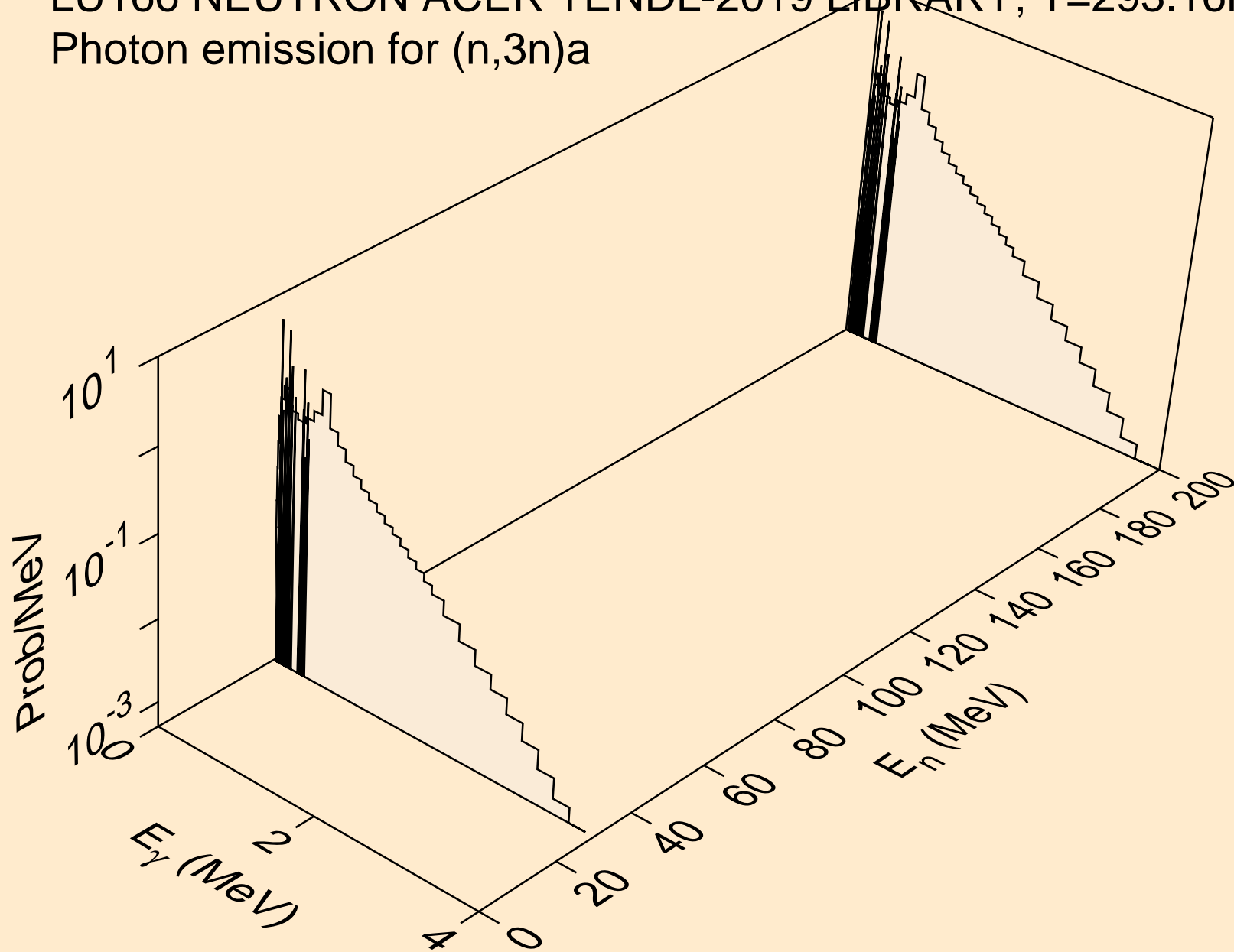

LU166 NEUTRON ACER TENDL-2019 LIBRARY; T=293.16K  
Photon emission for (n,n\*)p

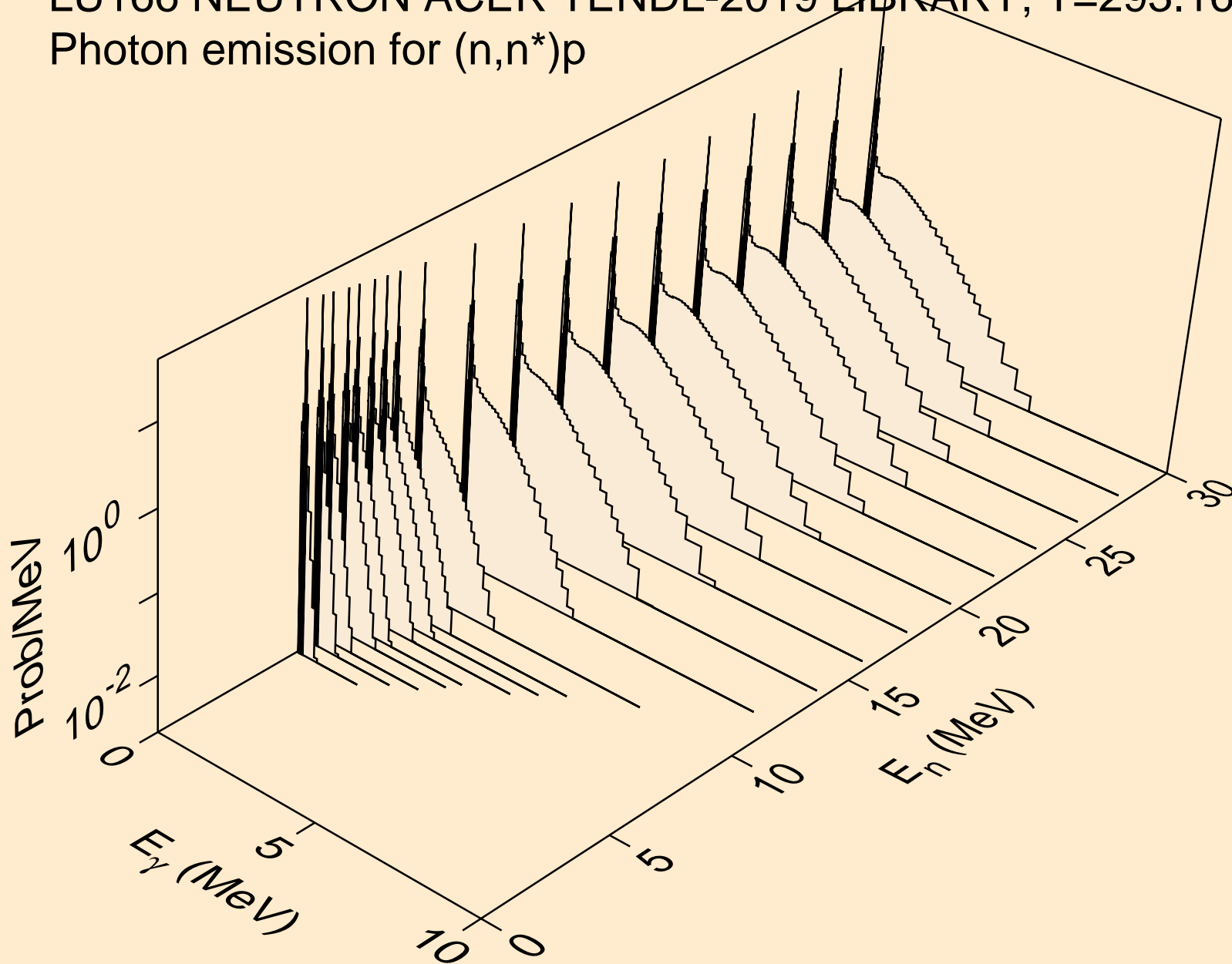

LU166 NEUTRON ACER TENDL-2019 LIBRARY; T=293.16K  
Photon emission for (n,n\*)2a

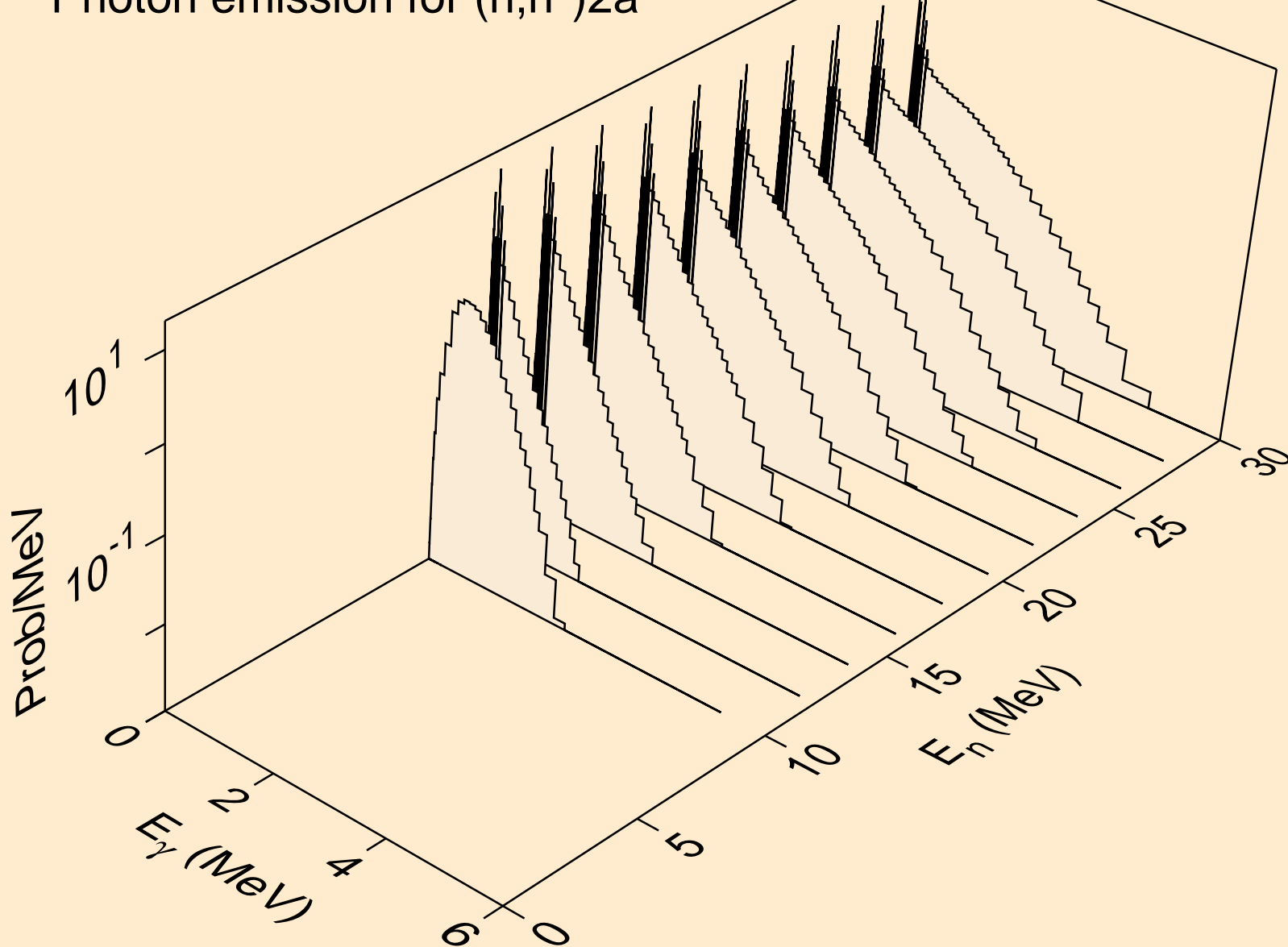

LU166 NEUTRON ACER TENDL-2019 LIBRARY; T=293.16K  
Photon emission for (n,2n)2a

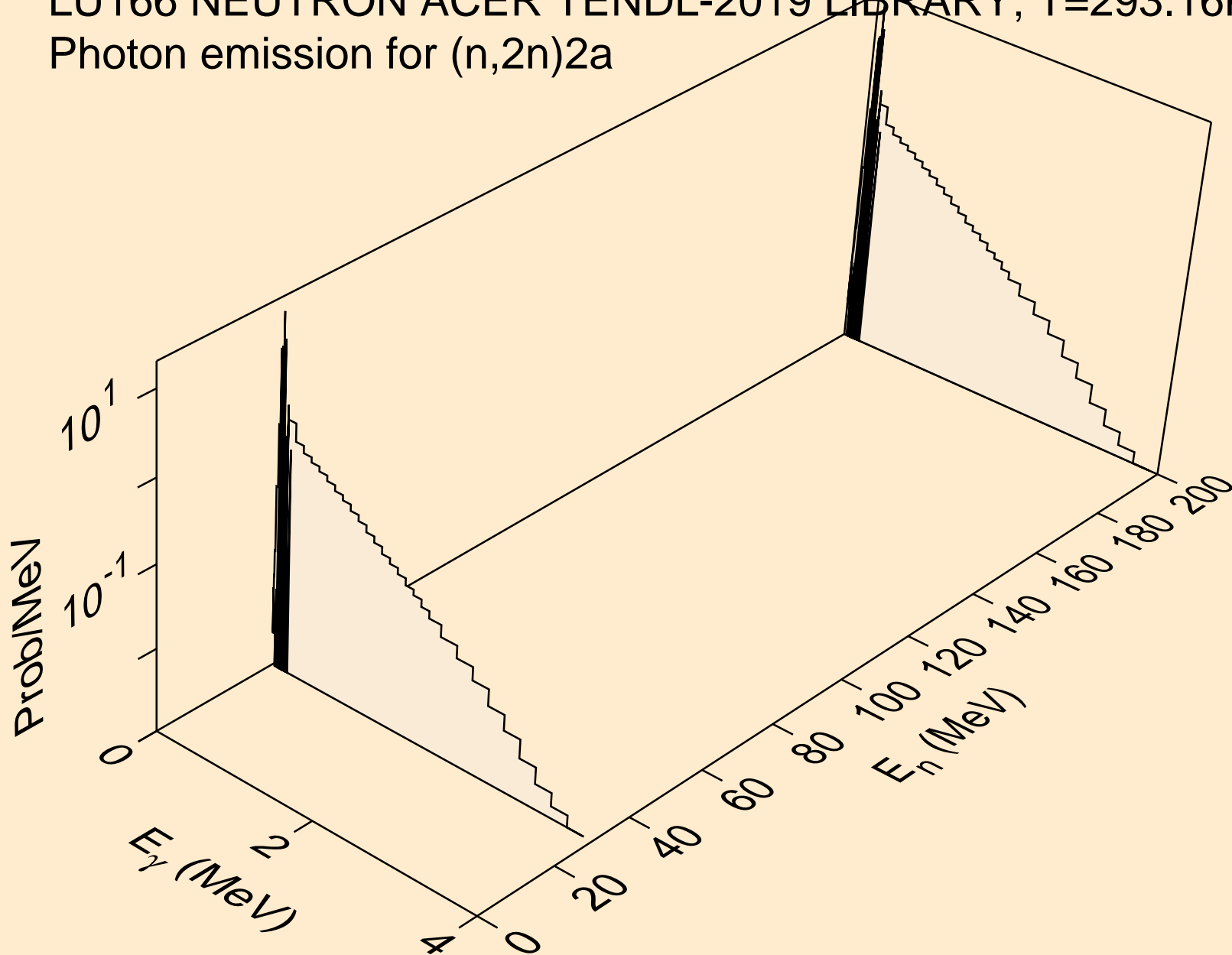



LU166 NEUTRON ACER TENDL-2019 LIBRARY; T=293.16K  
Photon emission for (n,n\*)d

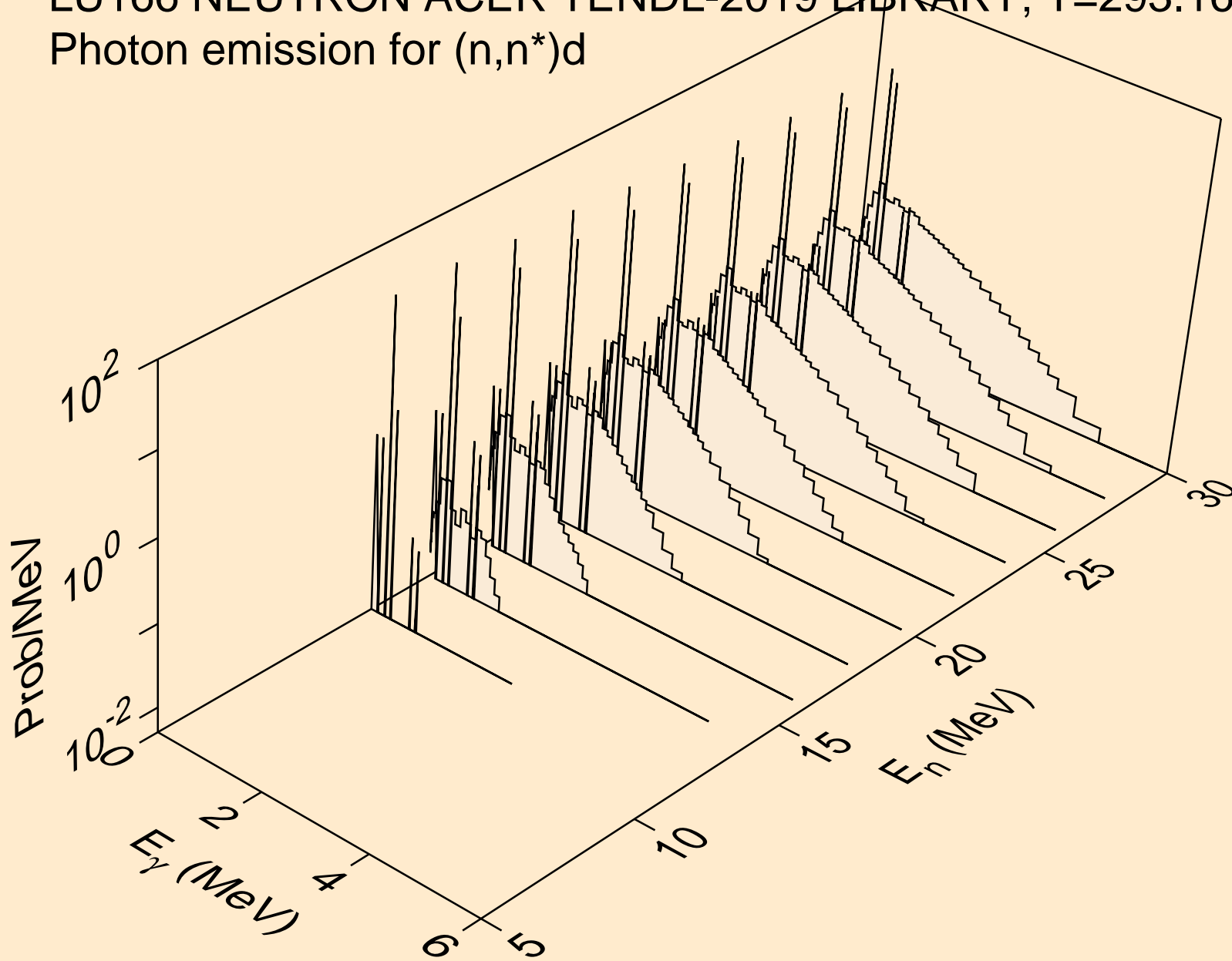

LU166 NEUTRON ACER TENDL-2019 LIBRARY; T=293.16K  
Photon emission for (n,n\*)t

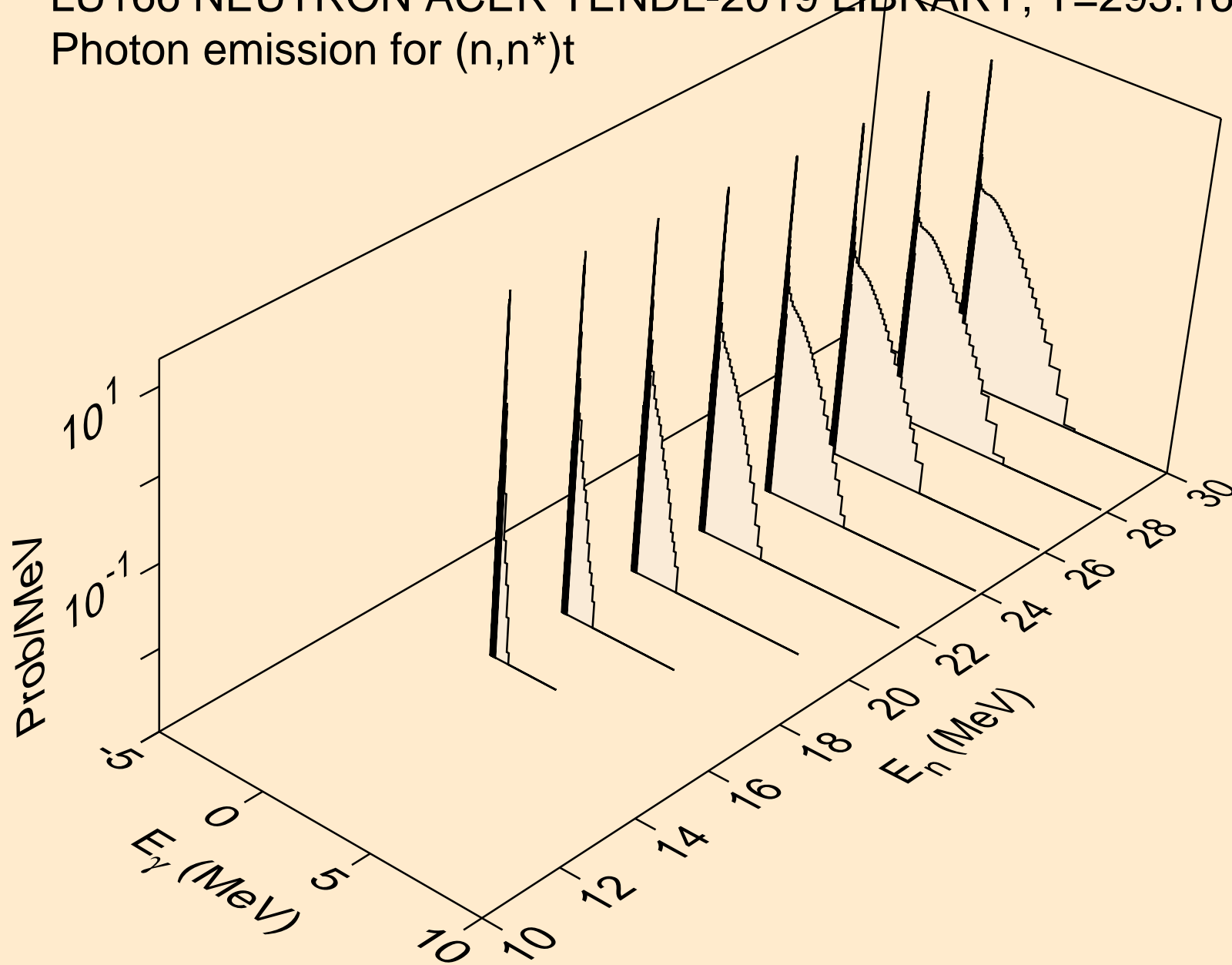

LU166 NEUTRON ACER TENDL-2019 LIBRARY; T=293.16K  
Photon emission for (n,n\*)he3

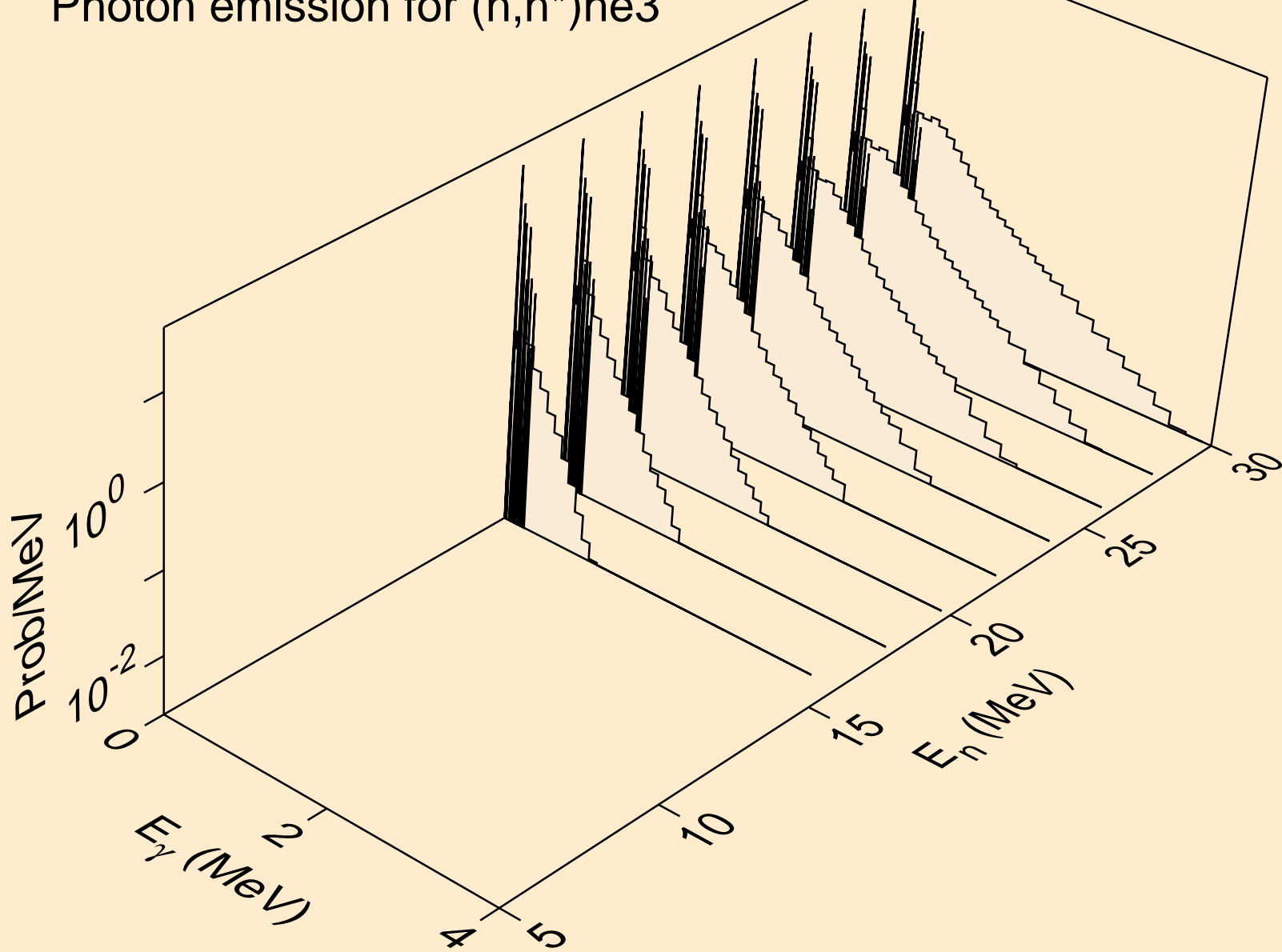

LU166 NEUTRON ACER TENDL-2019 LIBRARY; T=293.16K  
Photon emission for (n,4n)

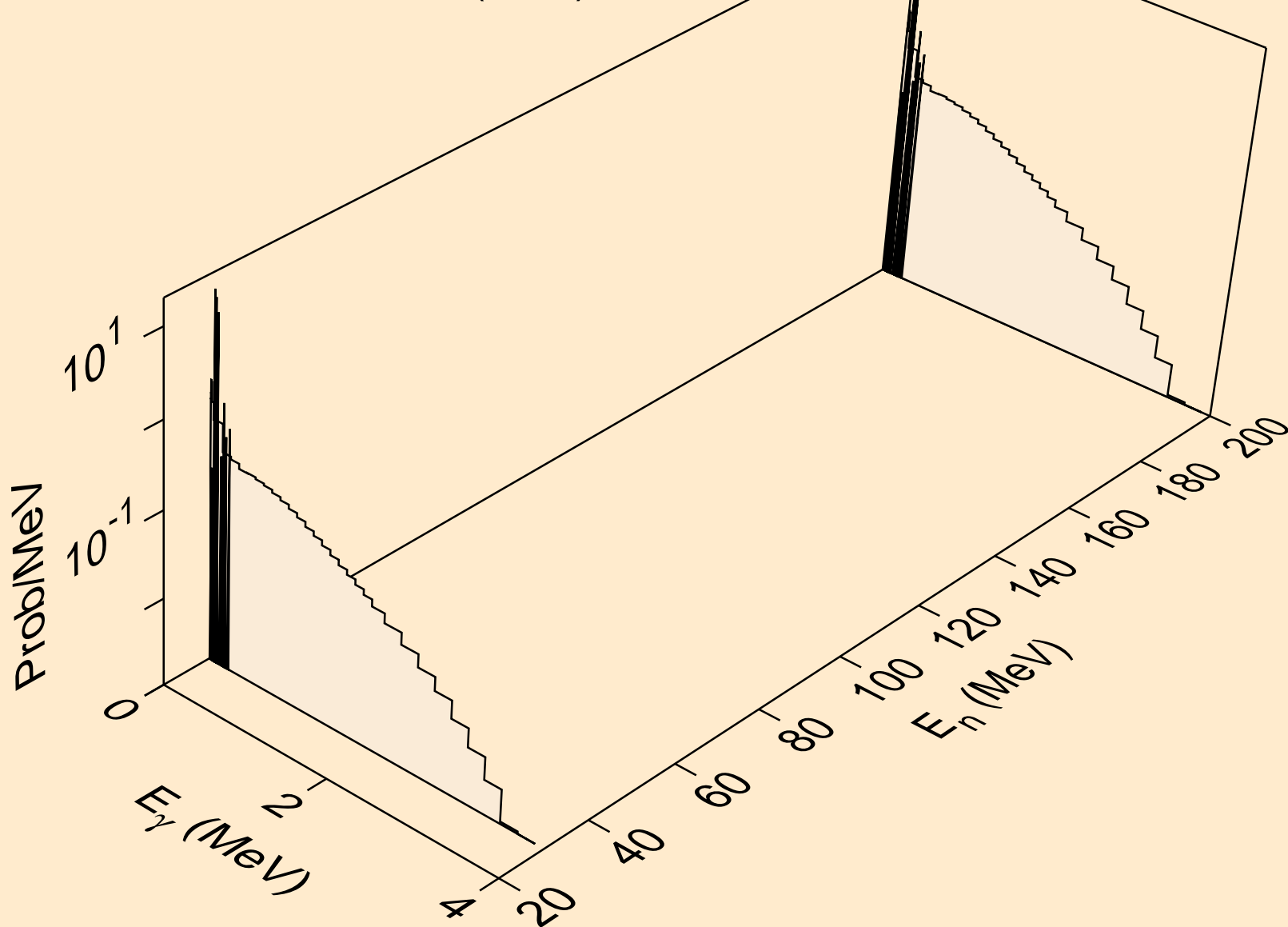

LU166 NEUTRON ACER TENDL-2019 LIBRARY; T=293.16K  
Photon emission for (n,2np)

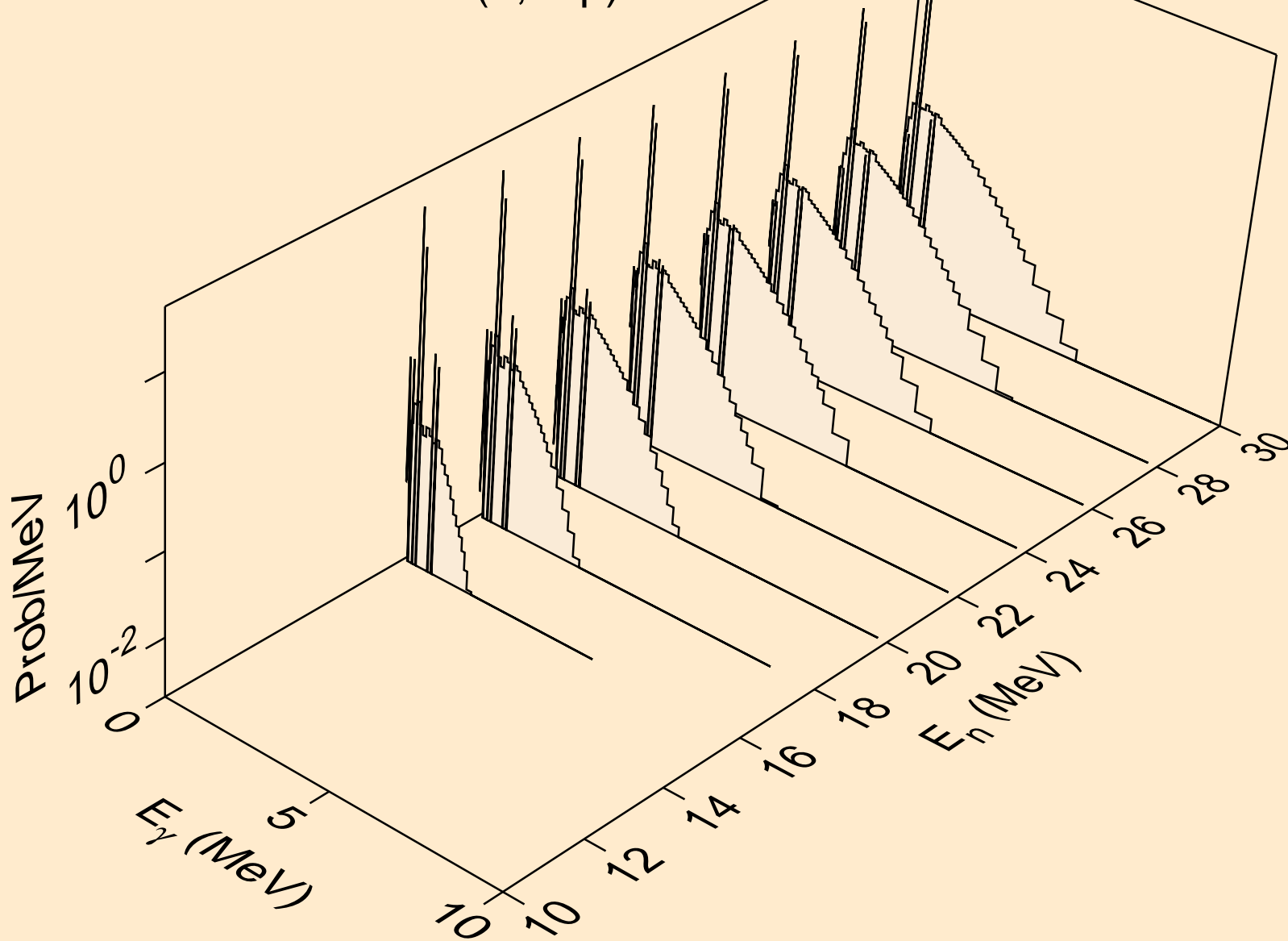

LU166 NEUTRON ACER TENDL-2019 LIBRARY; T=293.16K  
Photon emission for (n,3np)

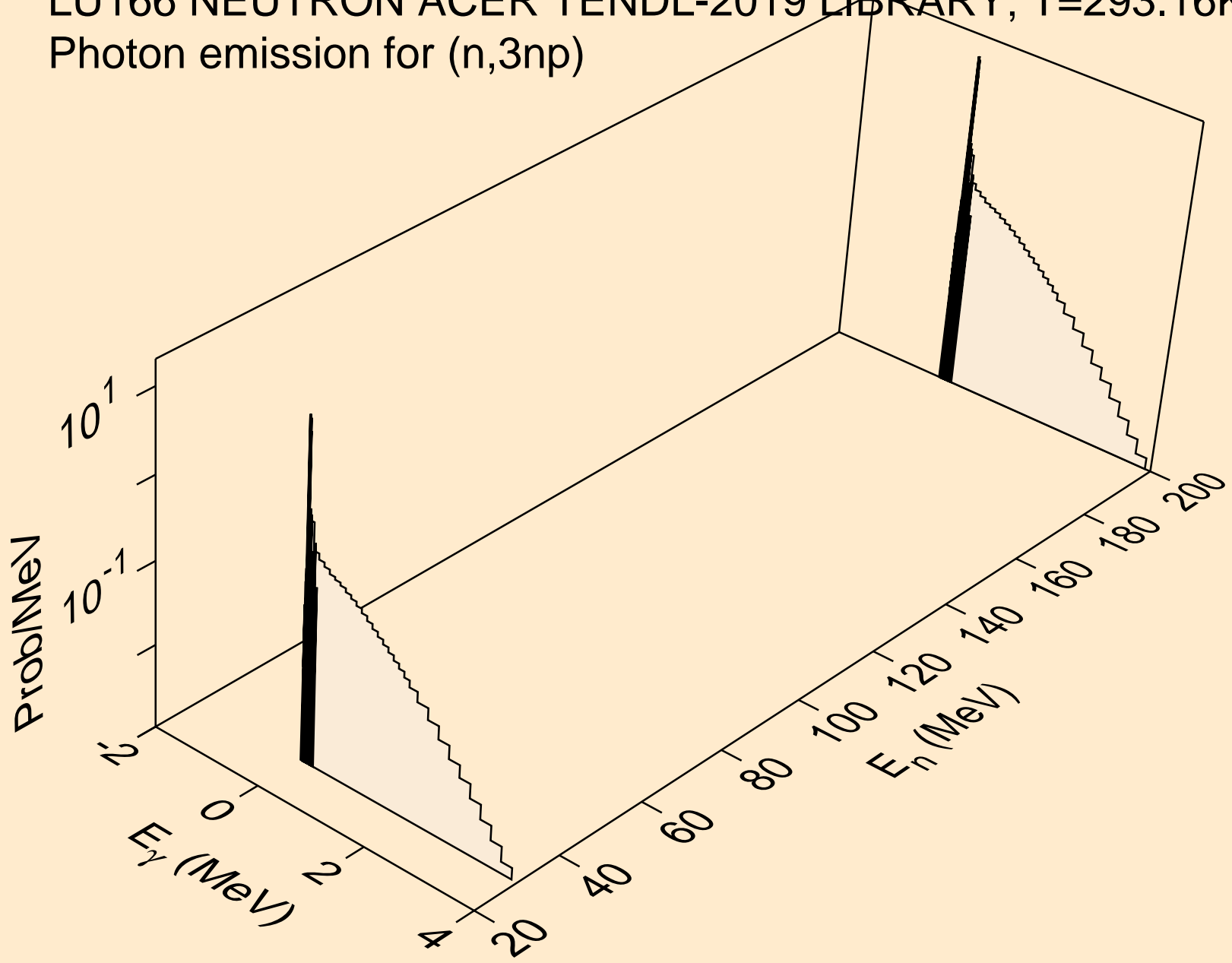

LU166 NEUTRON ACER TENDL-2019 LIBRARY; T=293.16K  
Photon emission for (n,2np)

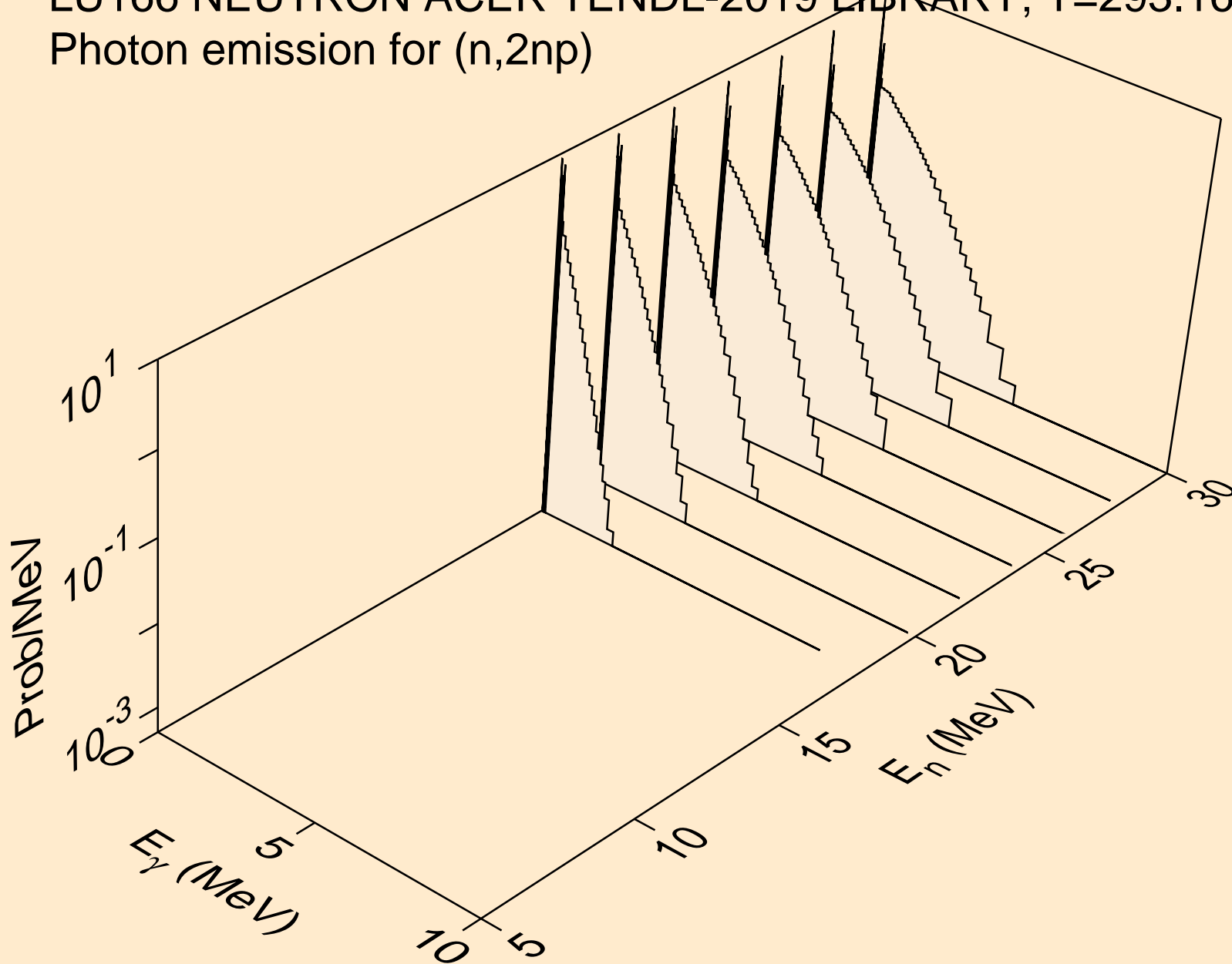

LU166 NEUTRON ACER TENDL-2019 LIBRARY; T=293.16K  
Photon emission for (n,npa)

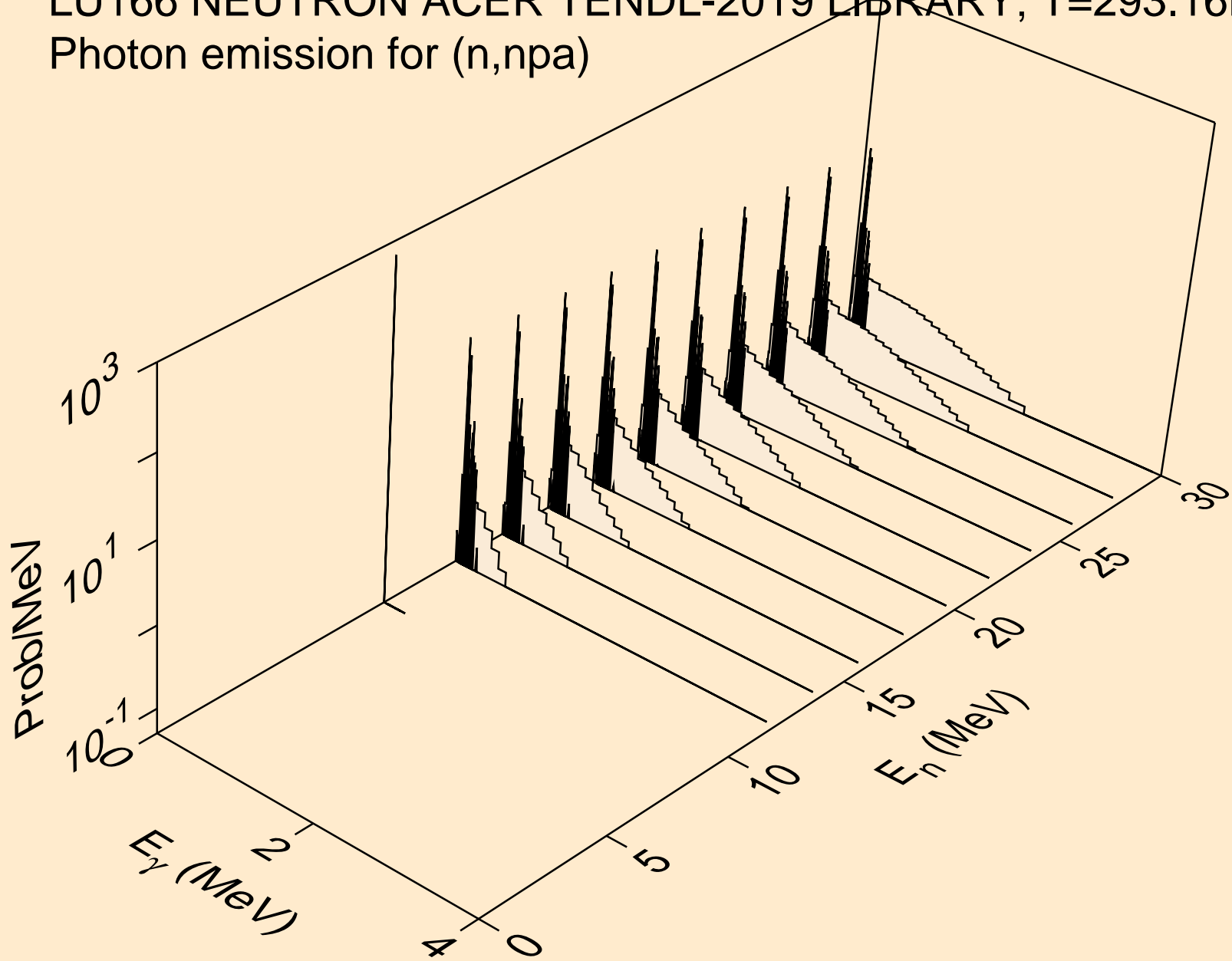



LU166 NEUTRON ACER TENDL-2019 LIBRARY; T=293.16K  
Photon emission for (n,n\*c)

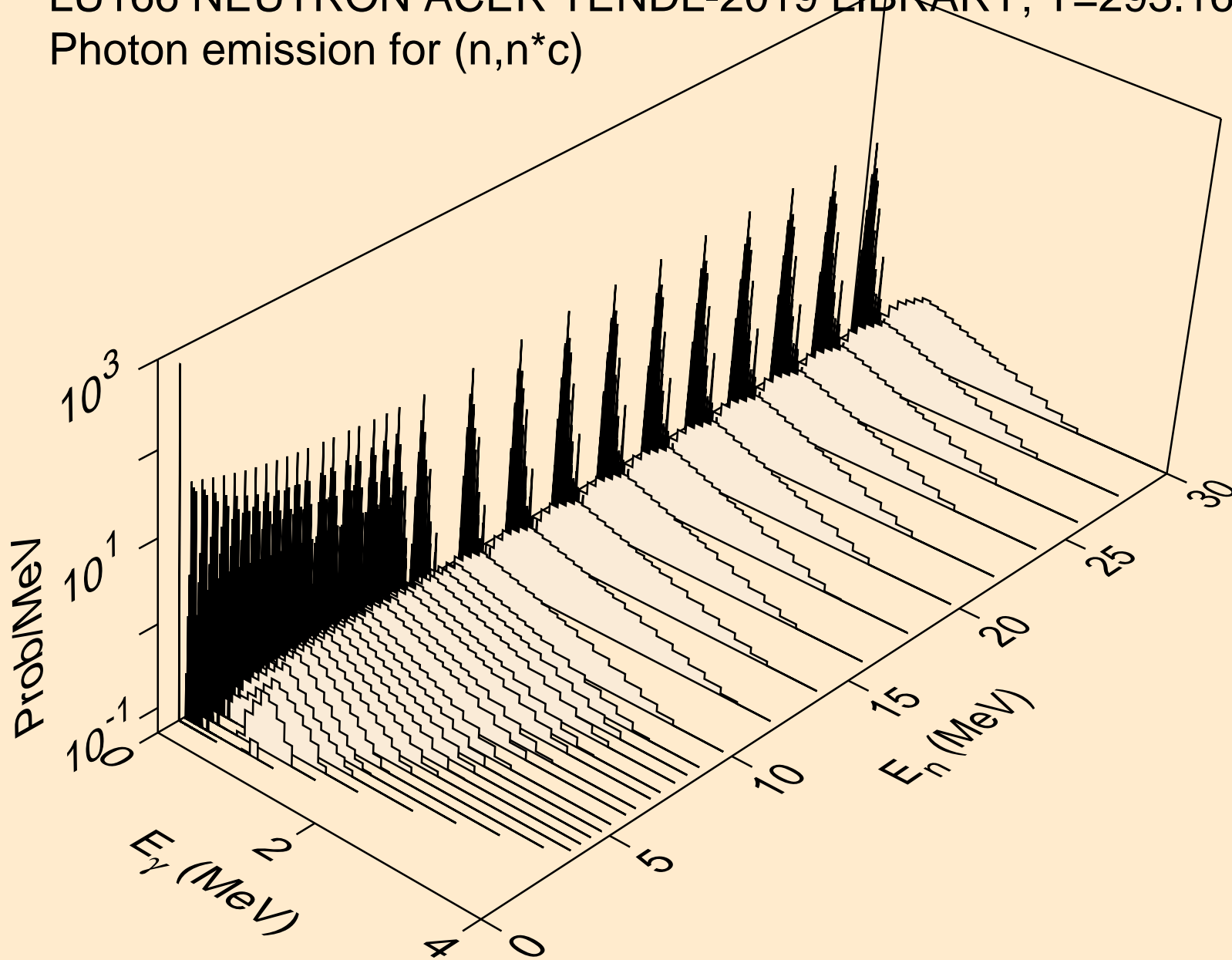

LU166 NEUTRON ACER TENDL-2019 LIBRARY; T=293.16K  
Photon emission for (n,gma)

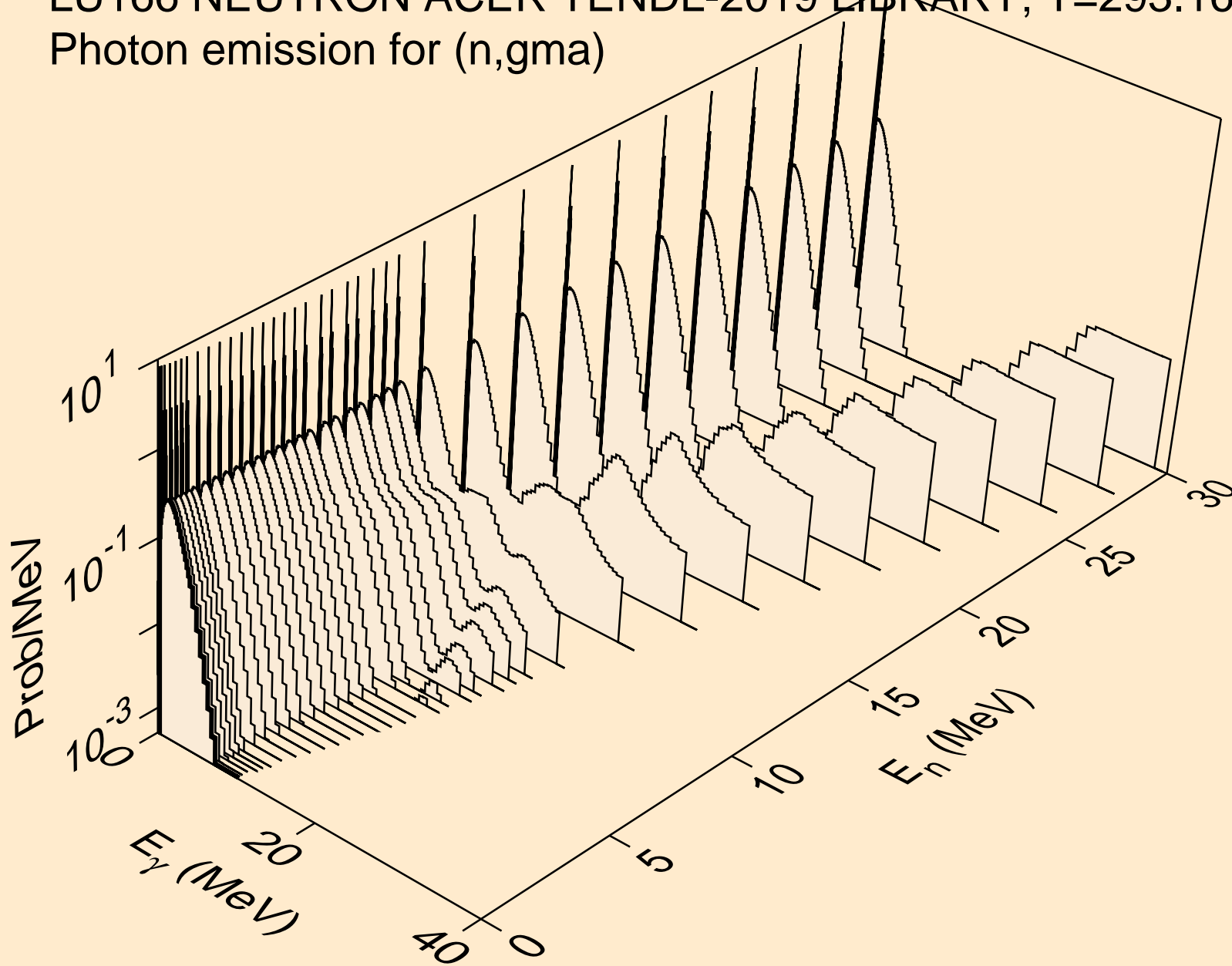

LU166 NEUTRON ACER TENDL-2019 LIBRARY; T=293.16K  
Photon emission for (n,p)

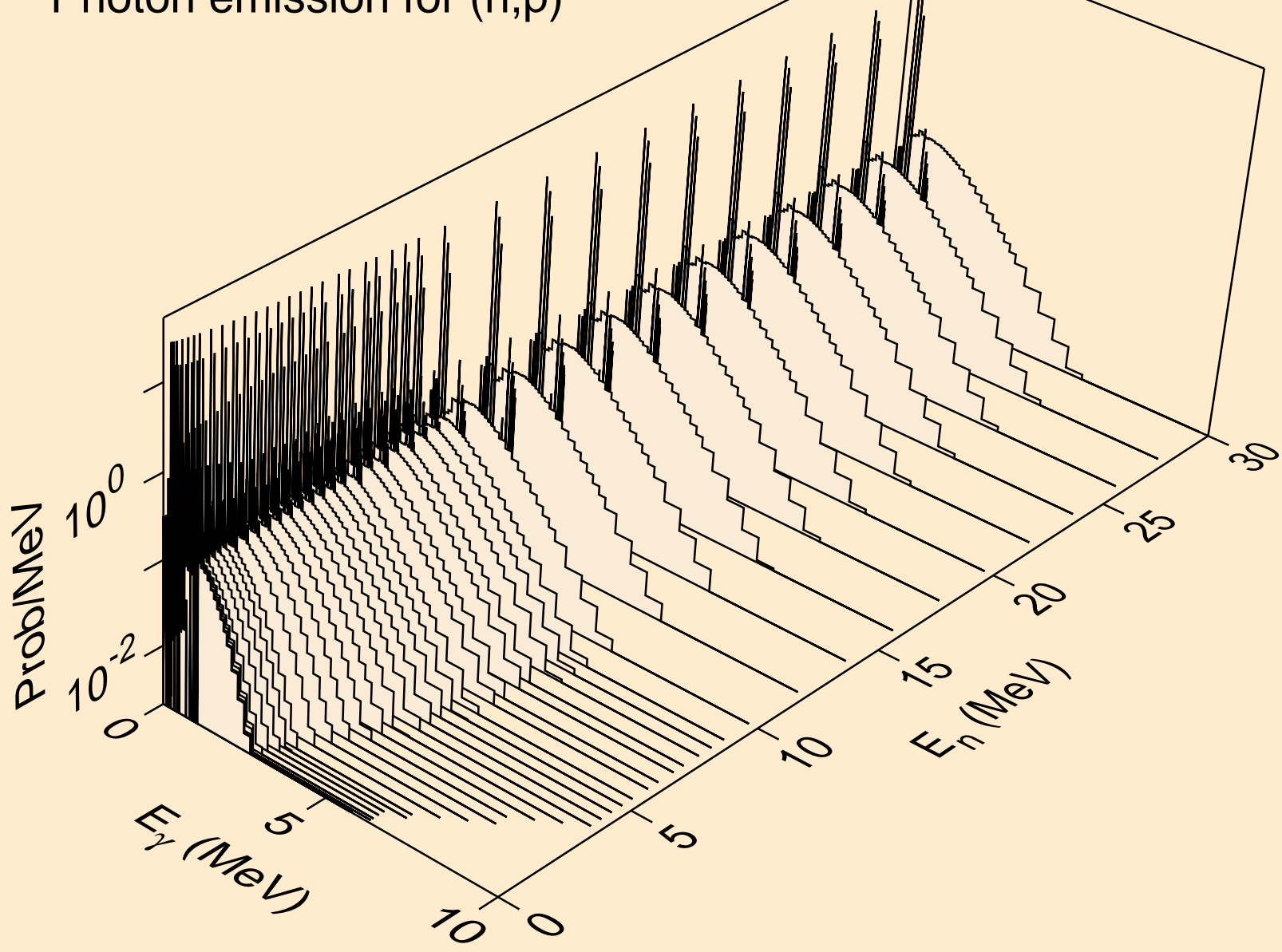

LU166 NEUTRON ACER TENDL-2019 LIBRARY; T=293.16K  
Photon emission for (n,d)

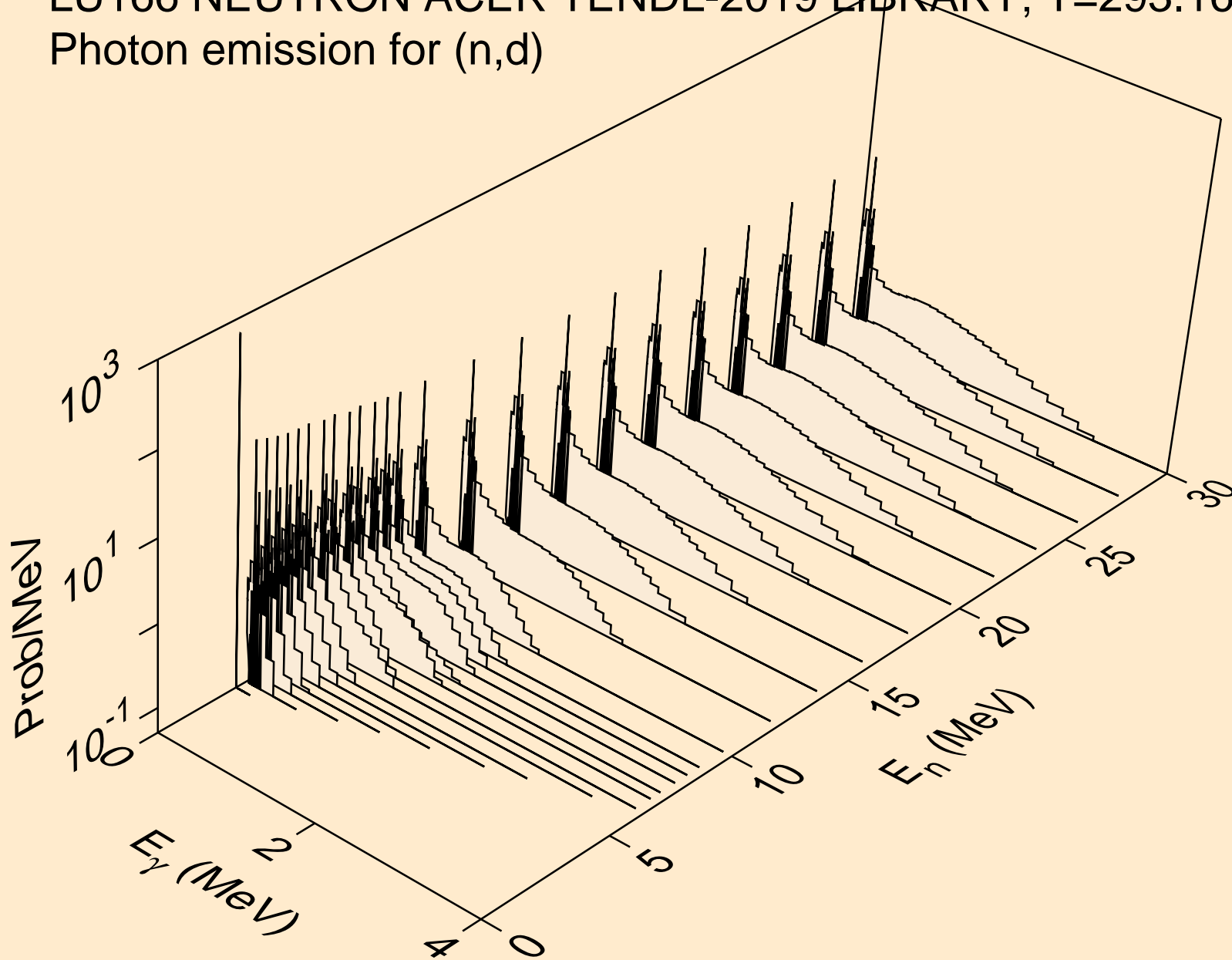

LU166 NEUTRON ACER TENDL-2019 LIBRARY; T=293.16K  
Photon emission for (n,t)

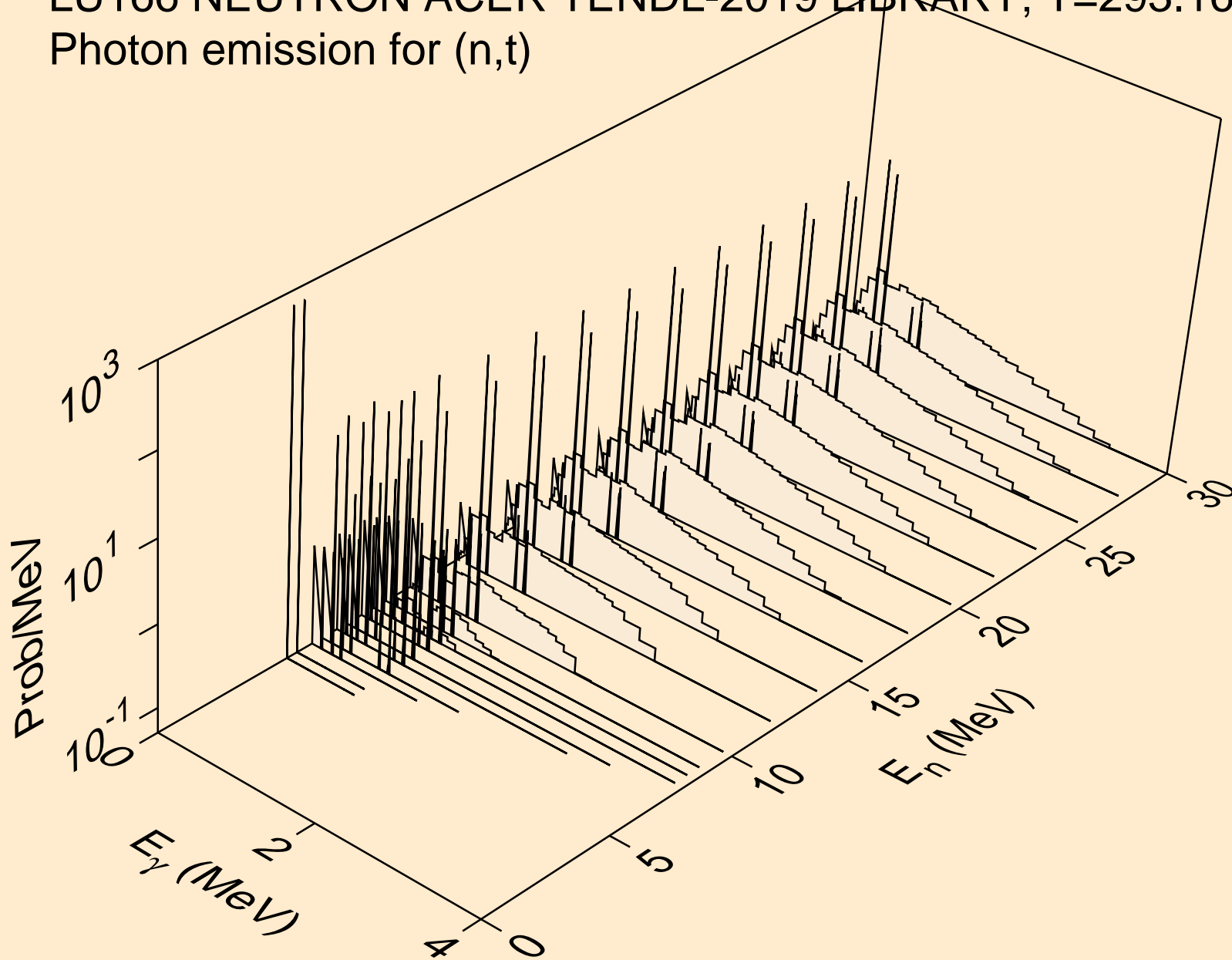

LU166 NEUTRON ACER TENDL-2019 LIBRARY; T=293.16K  
Photon emission for (n,he3)

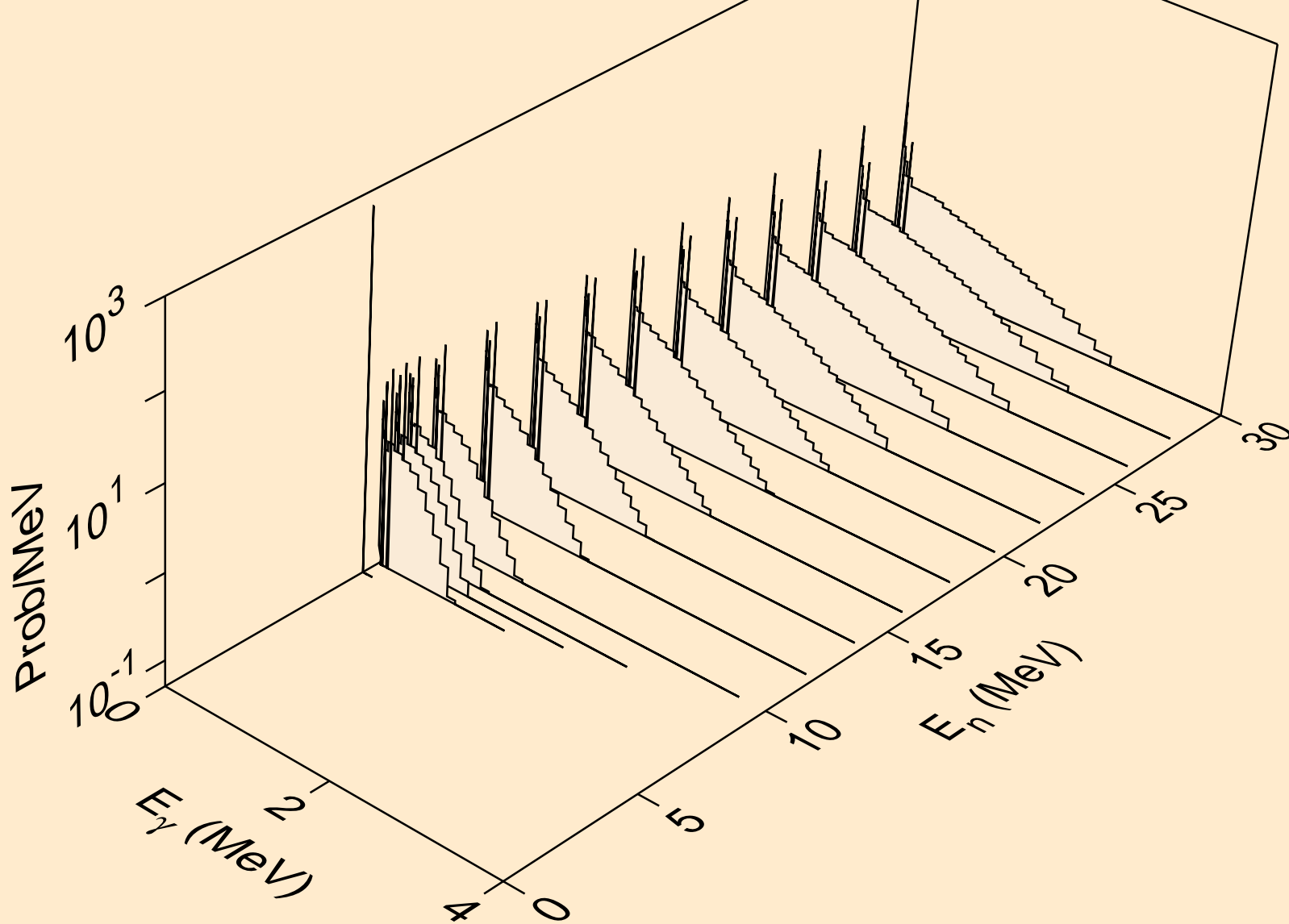

LU166 NEUTRON ACER TENDL-2019 LIBRARY; T=293.16K  
Photon emission for (n,a)

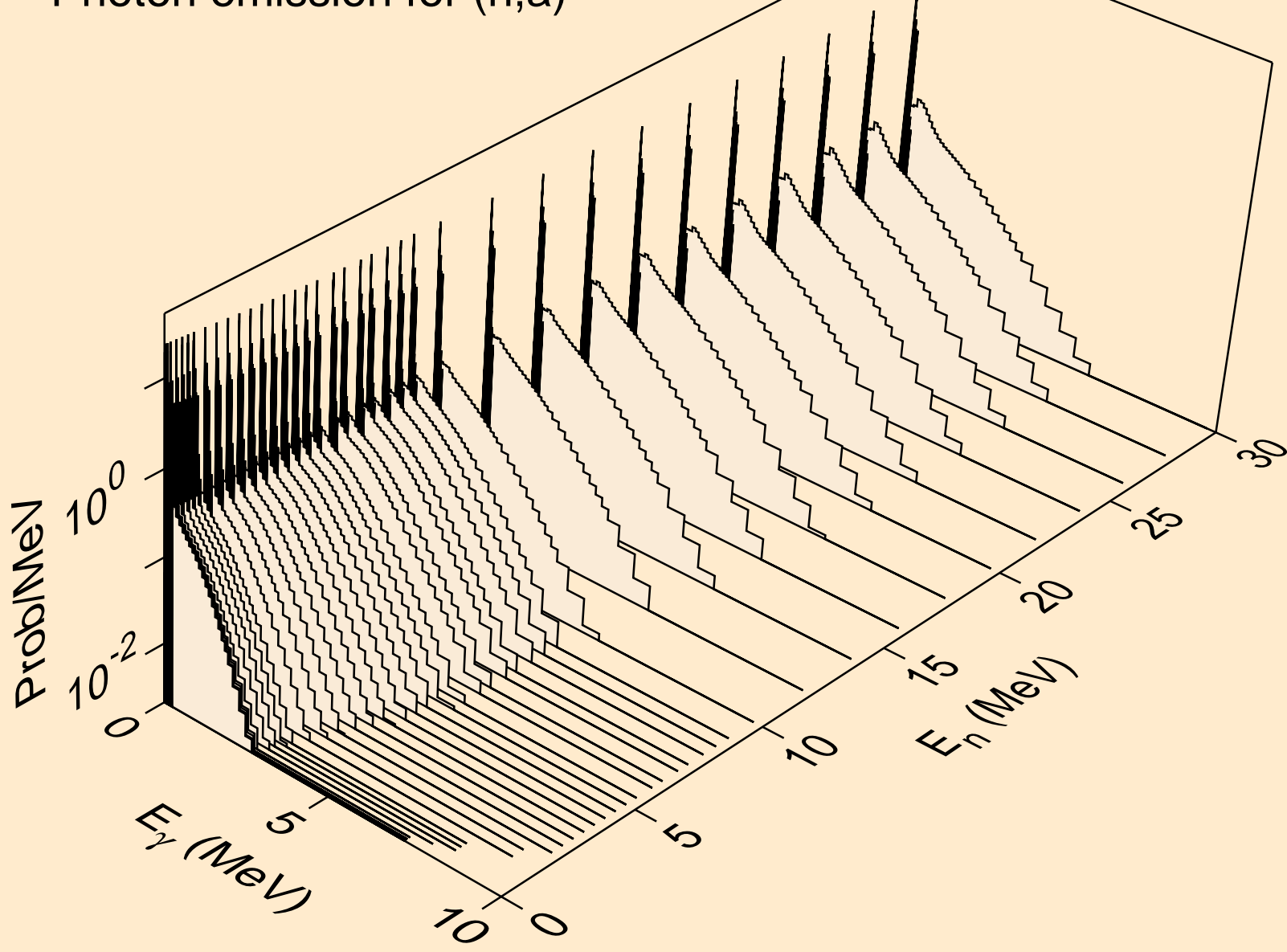

LU166 NEUTRON ACER TENDL-2019 LIBRARY; T=293.16K  
Photon emission for (n,2a)

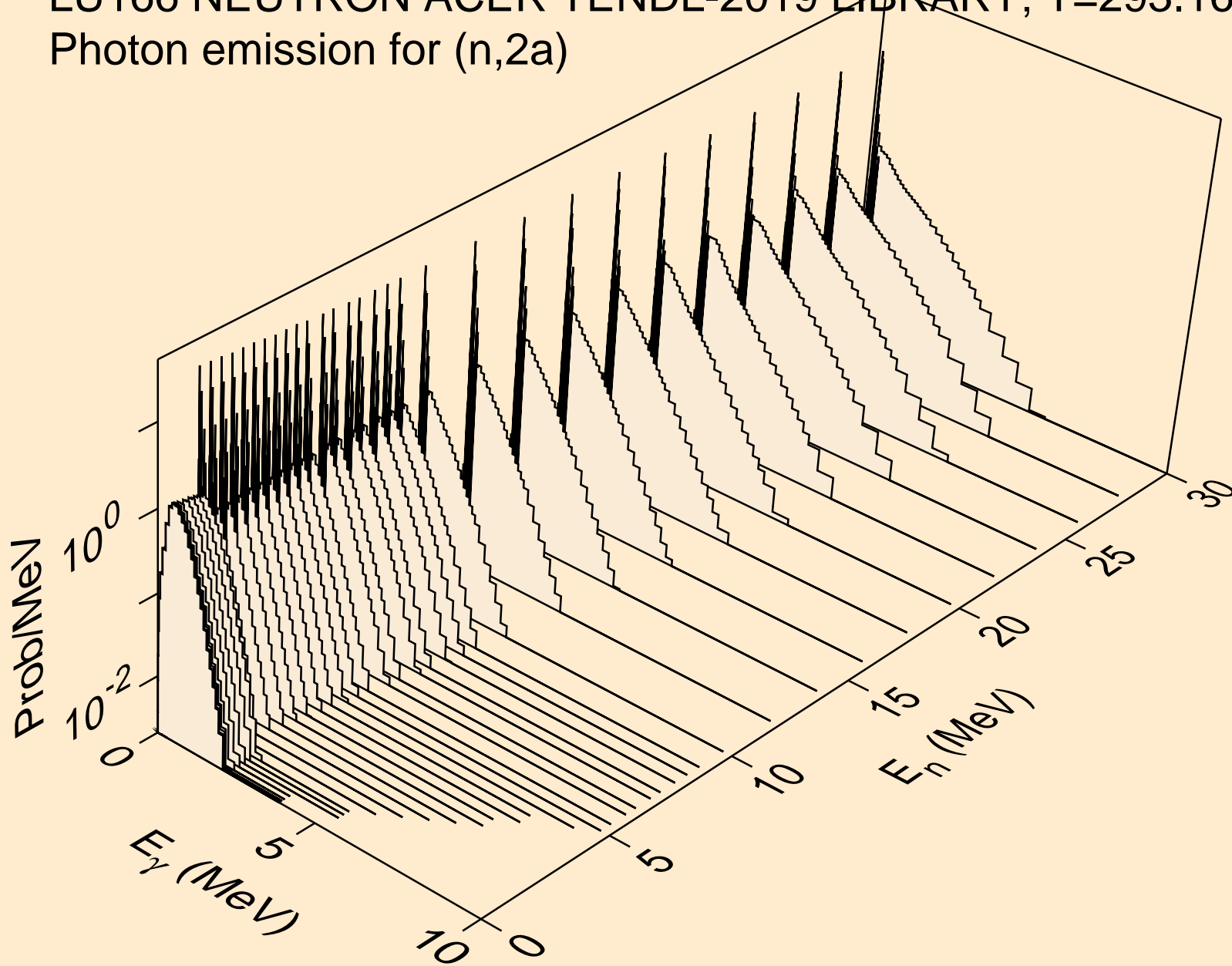



LU166 NEUTRON ACER TENDL-2019 LIBRARY; T=293.16K  
Photon emission for (n,2p)

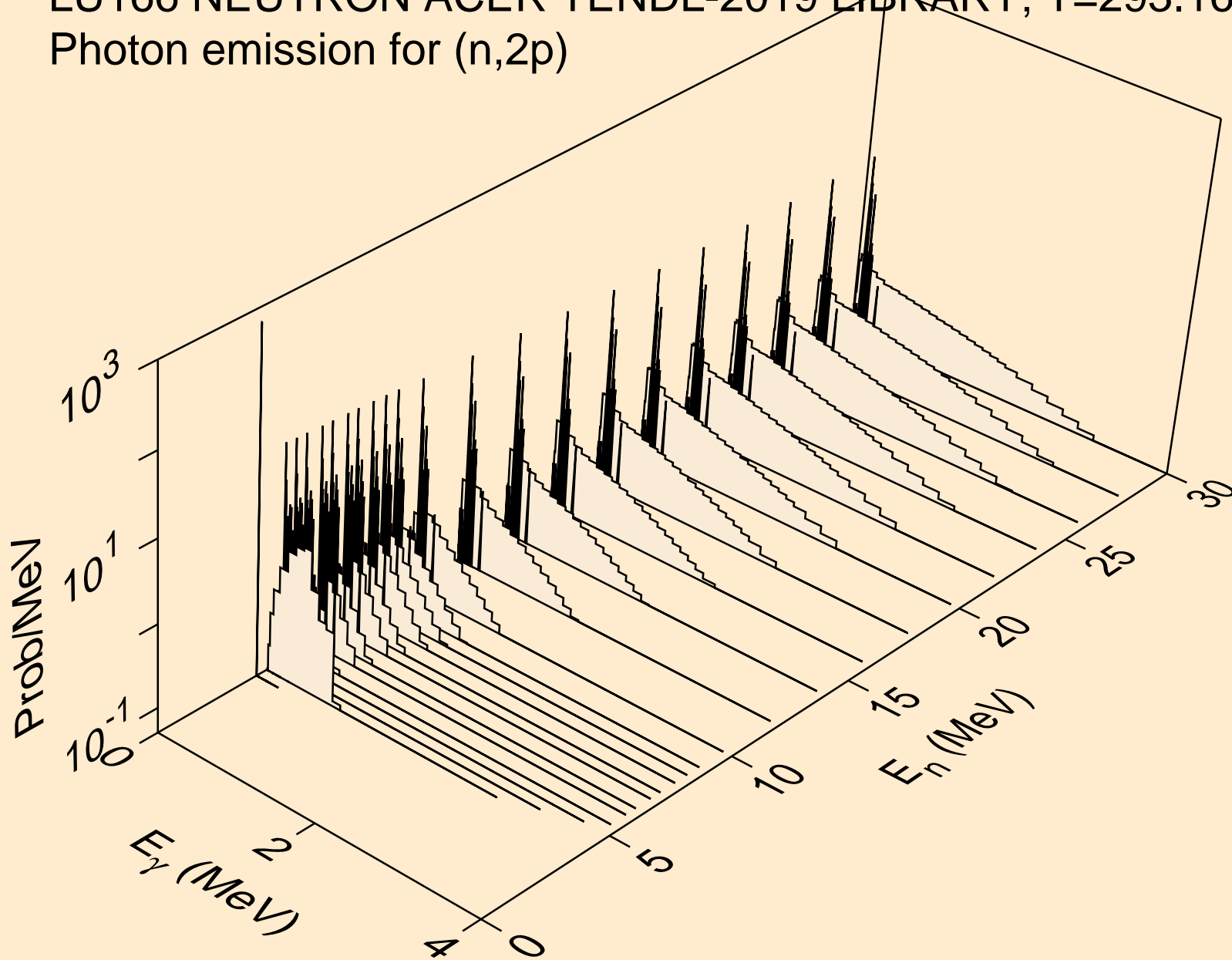

LU166 NEUTRON ACER TENDL-2019 LIBRARY; T=293.16K  
Photon emission for (n,p $\alpha$ )

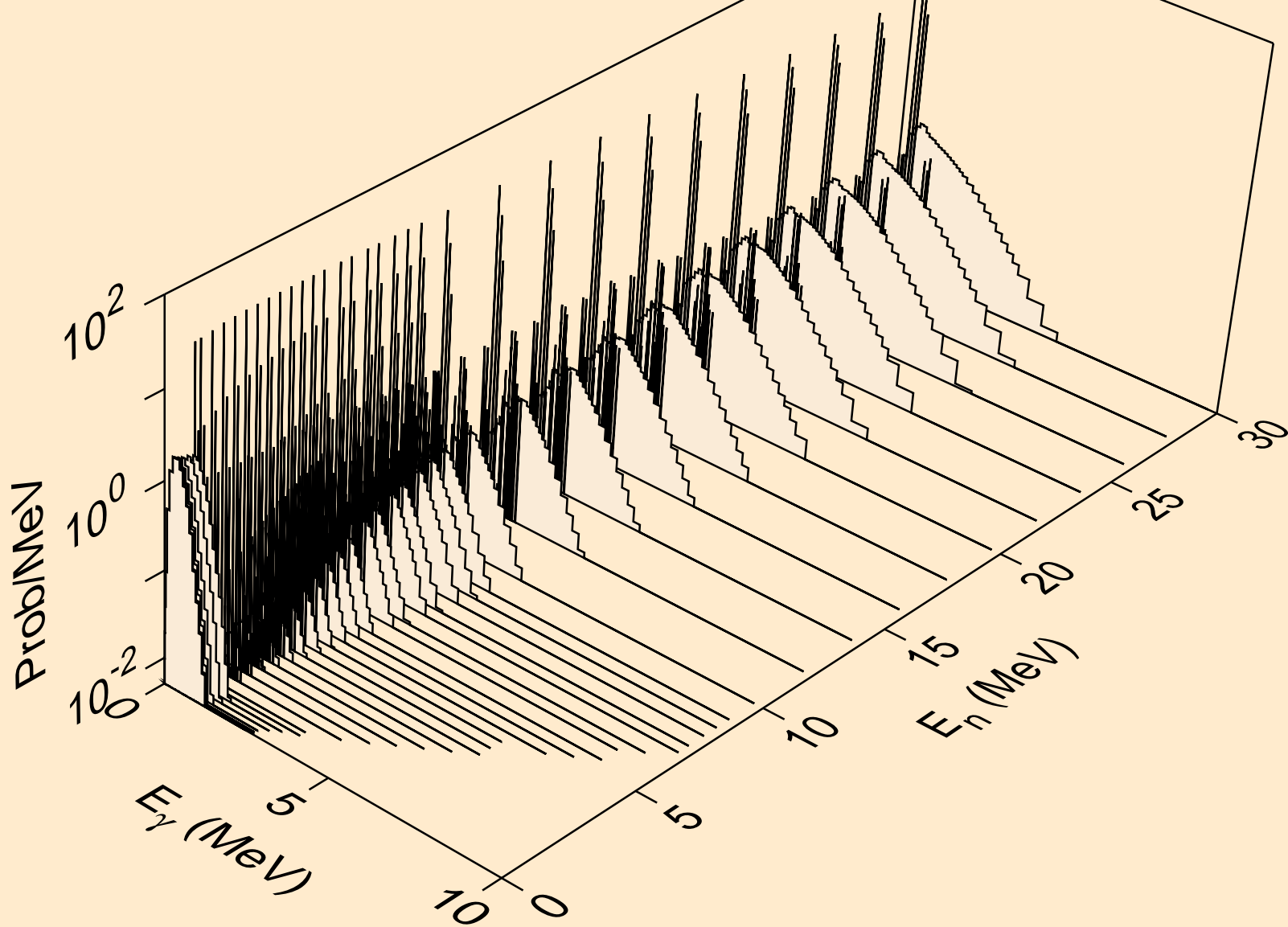

LU166 NEUTRON ACER TENDL-2019 LIBRARY; T=293.16K  
Photon emission for (n,pd)

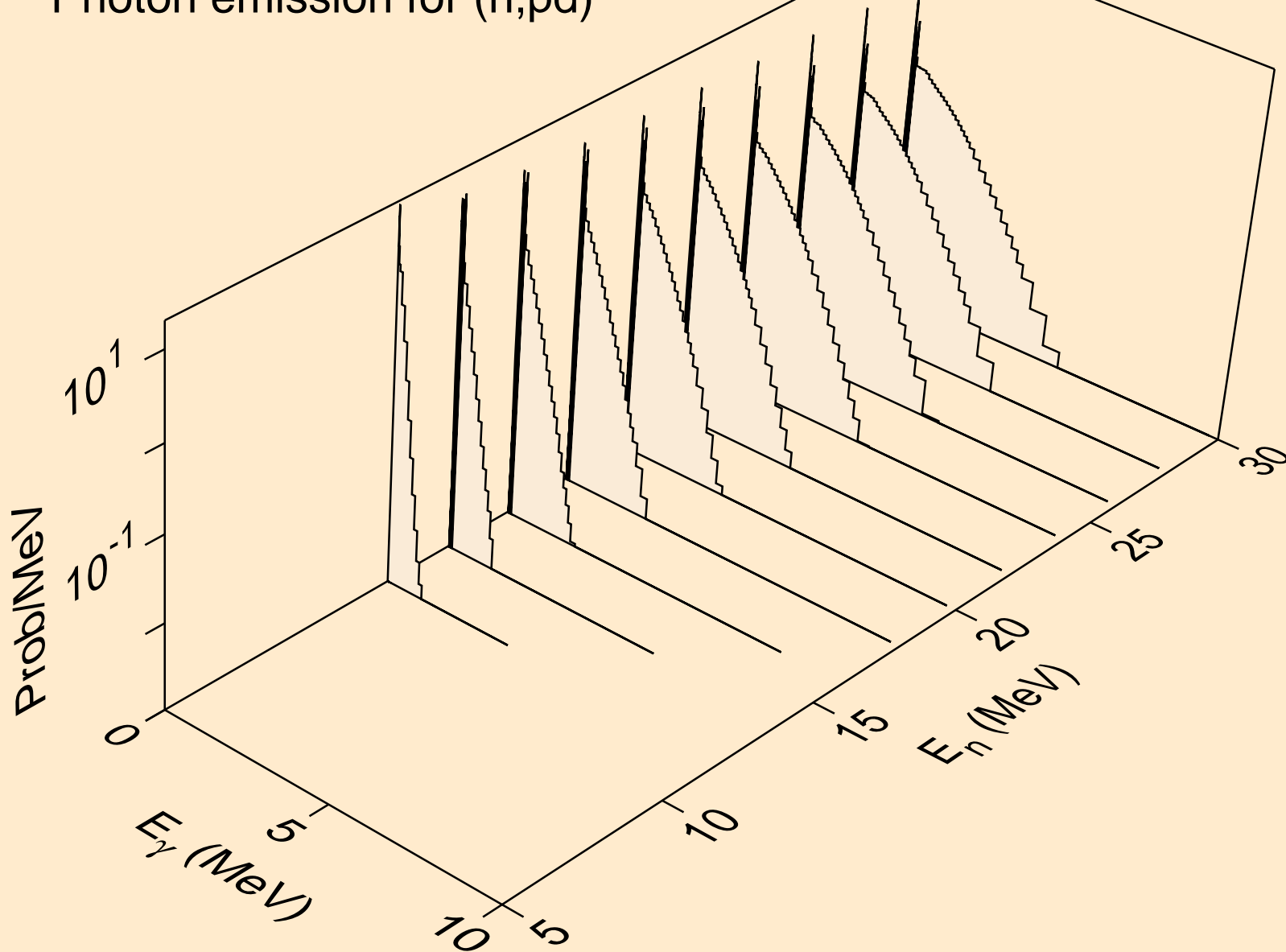

LU166 NEUTRON ACER TENDL-2019 LIBRARY; T=293.16K  
Photon emission for (n,pt)

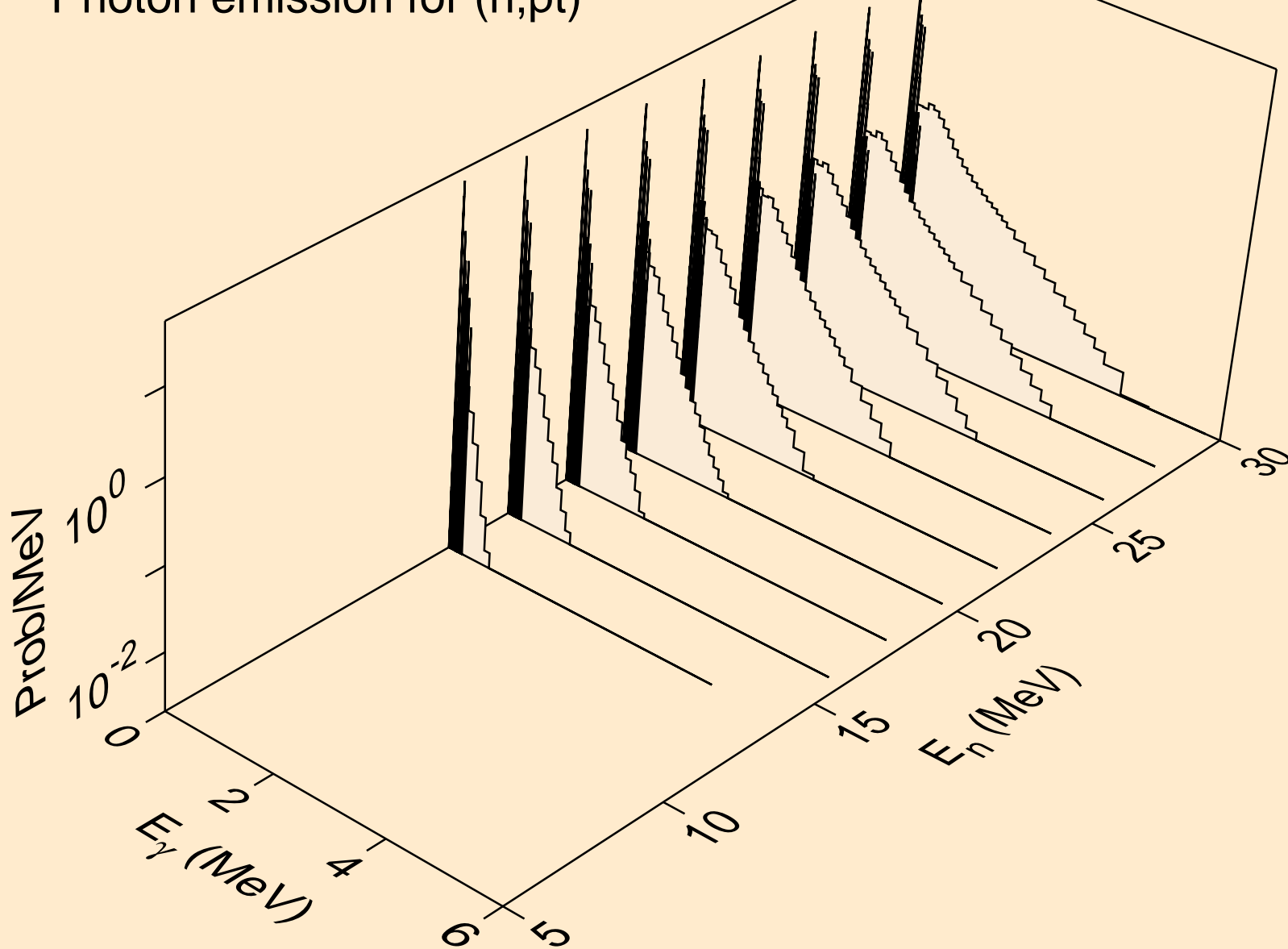

LU166 NEUTRON ACER TENDL-2019 LIBRARY; T=293.16K  
Photon emission for (n,da)

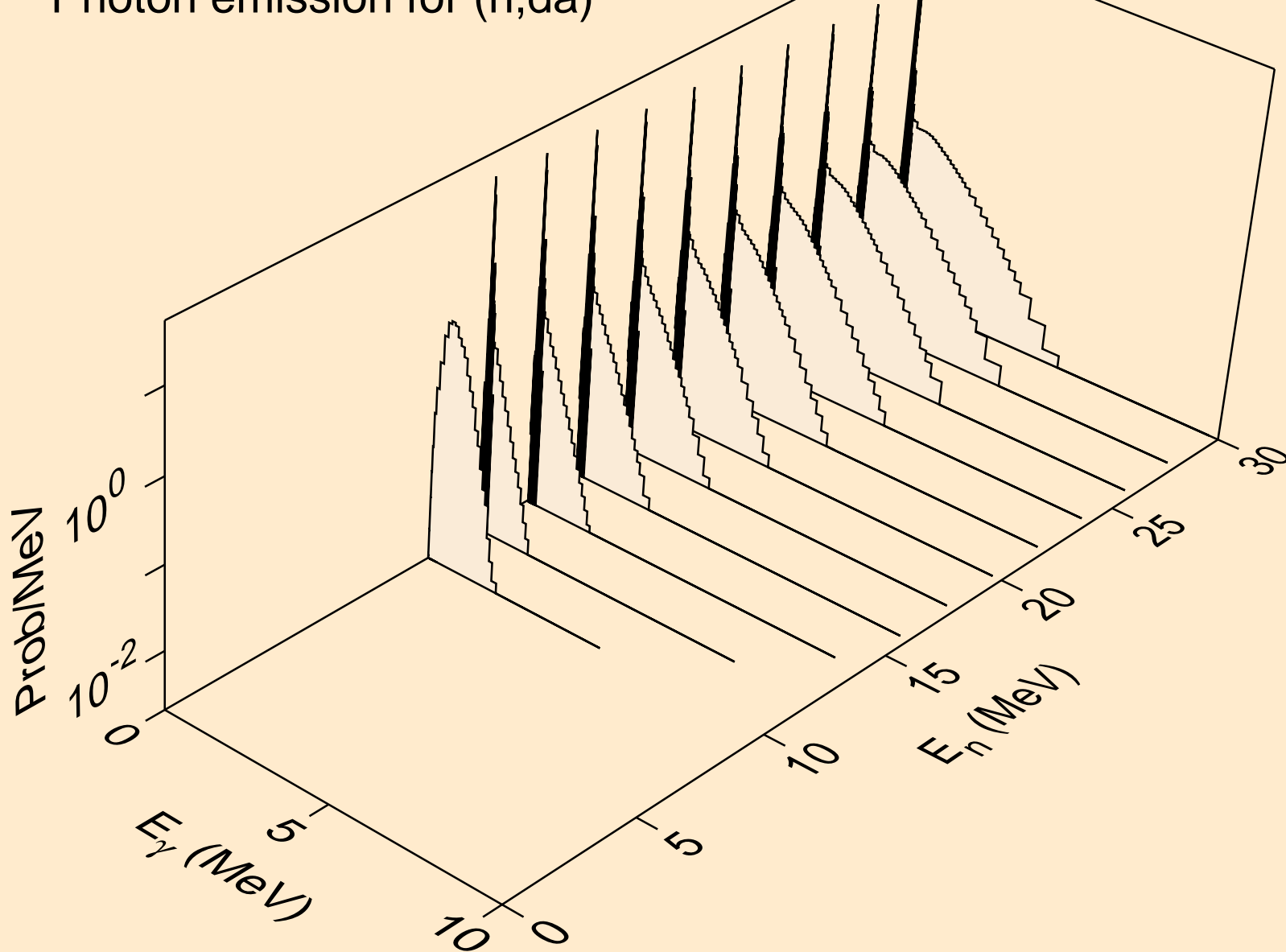

LU166 NEUTRON ACER TENDL-2019 LIBRARY; T=293.16K  
thermal capture photon spectrum

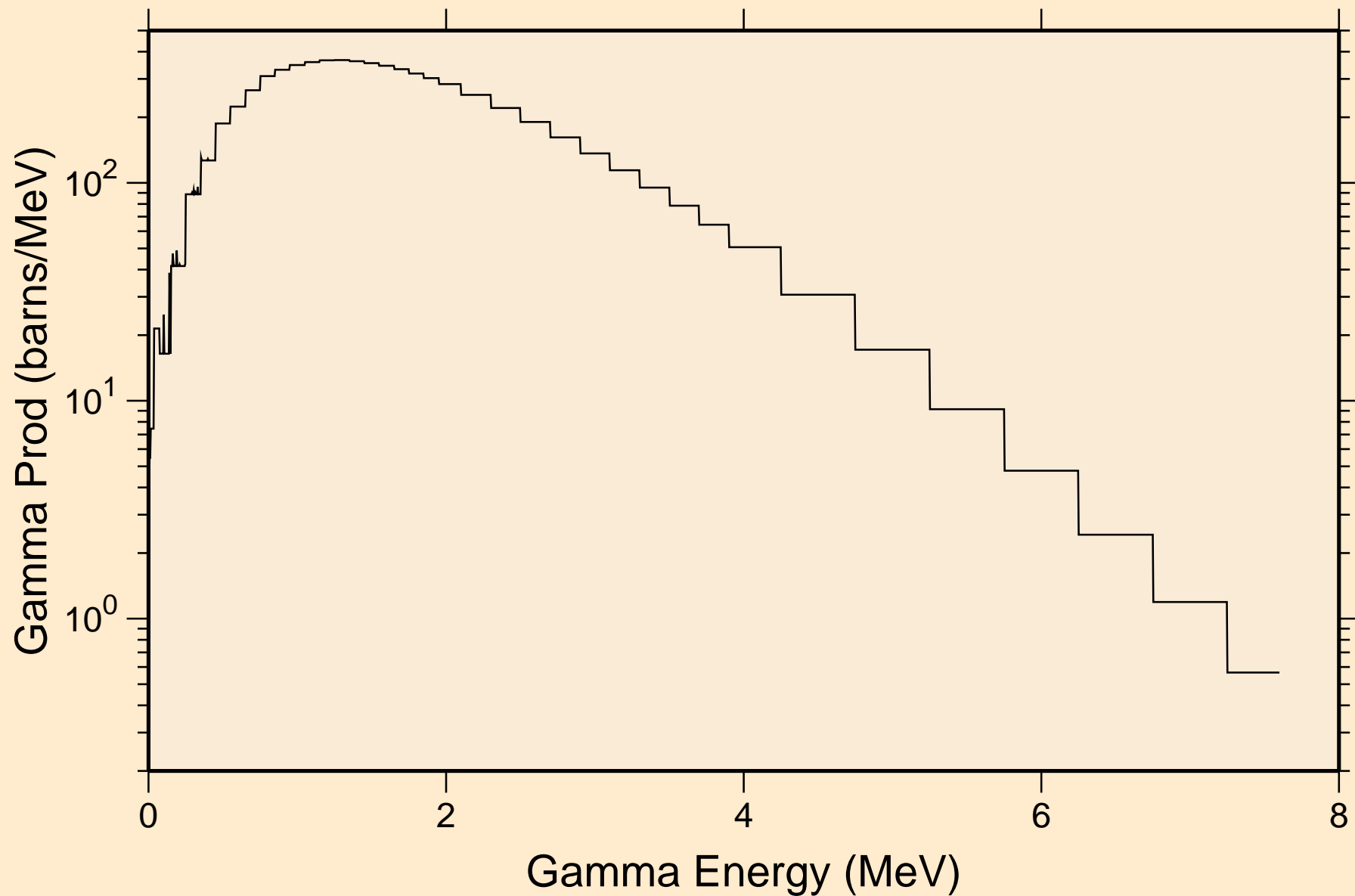

LU166 NEUTRON ACER TENDL-2019 LIBRARY; T=293.16K  
14 MeV photon spectrum

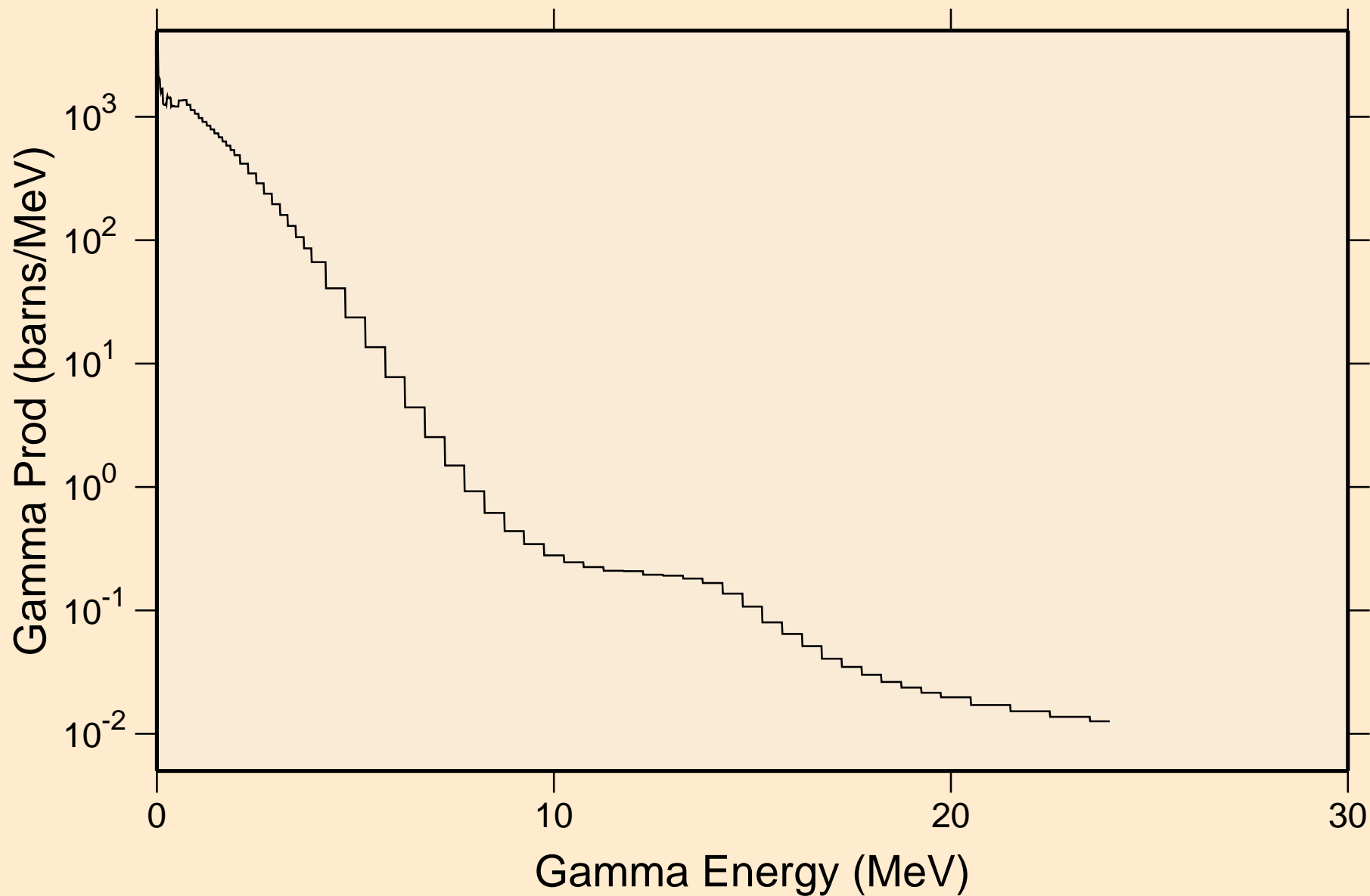

# LU166 NEUTRON ACER TENDL-2019 LIBRARY; T=293.16K

## Particle heating contributions

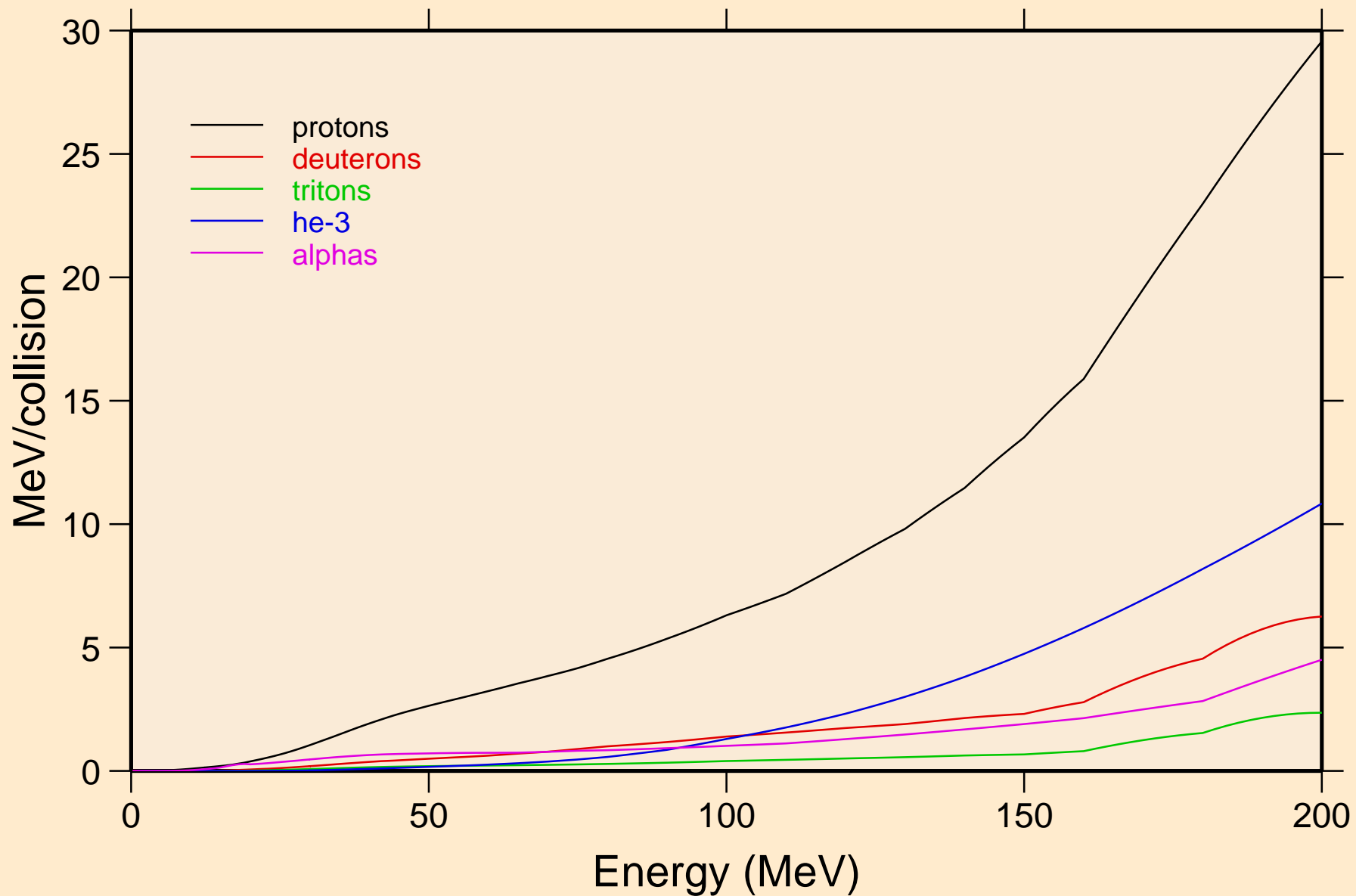



LU166 NEUTRON ACER TENDL-2019 LIBRARY; T=293.16K  
Recoil Heating

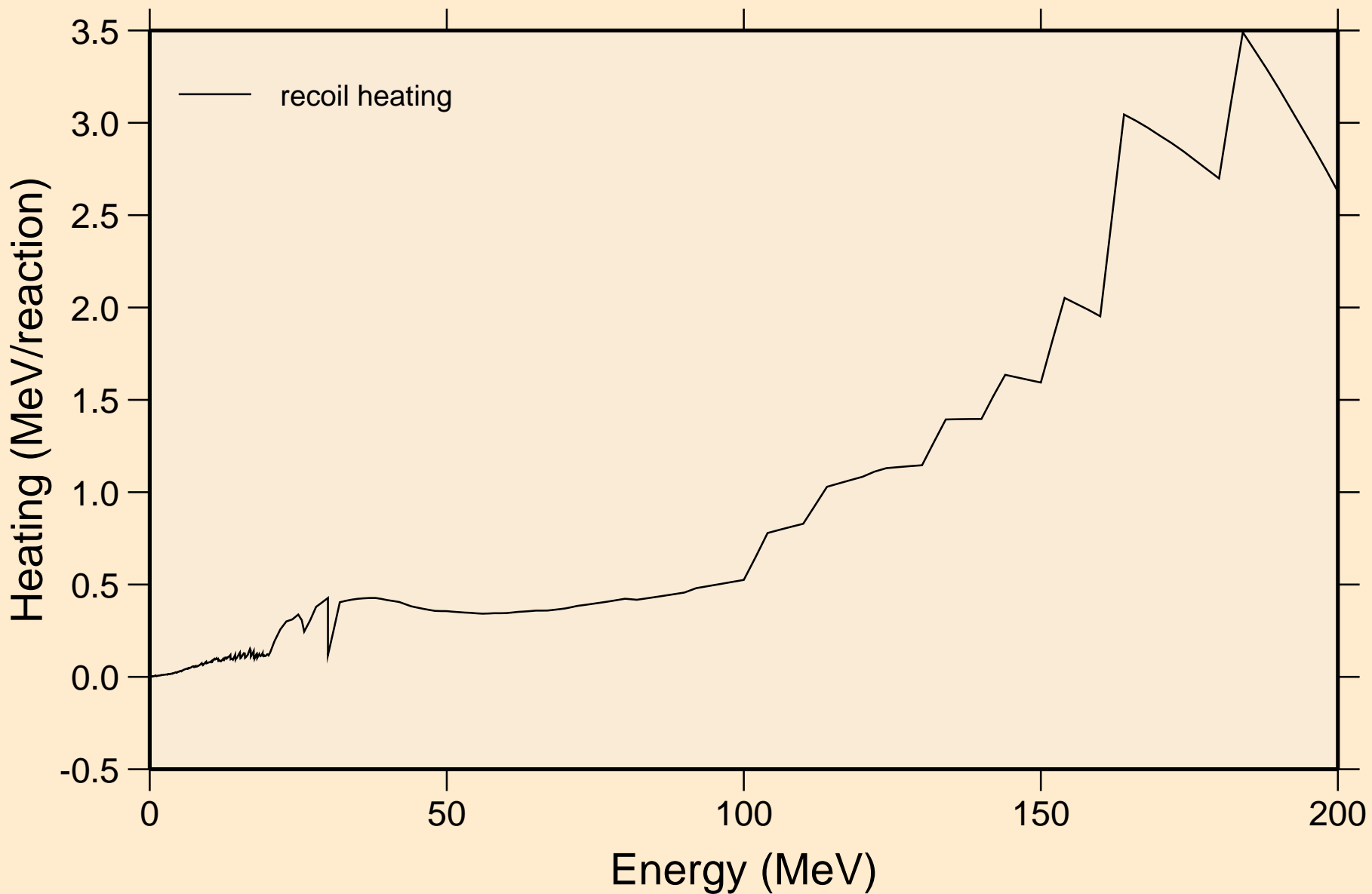

LU166 NEUTRON ACER TENDL-2019 LIBRARY; T=293.16K  
Particle production cross sections

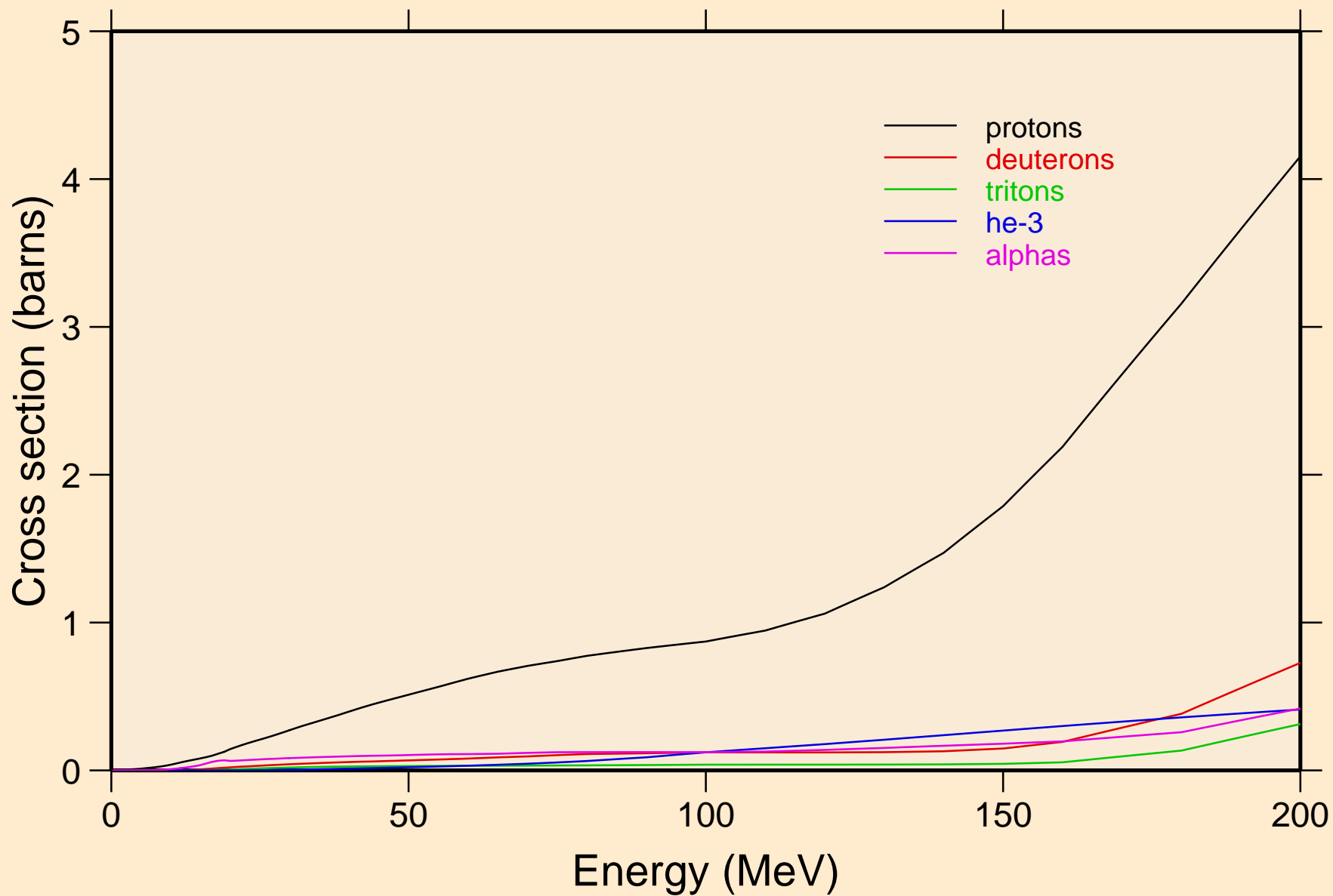

LU166 NEUTRON ACER TENDL-2019 LIBRARY; T=293.16K  
protons from (n,x)

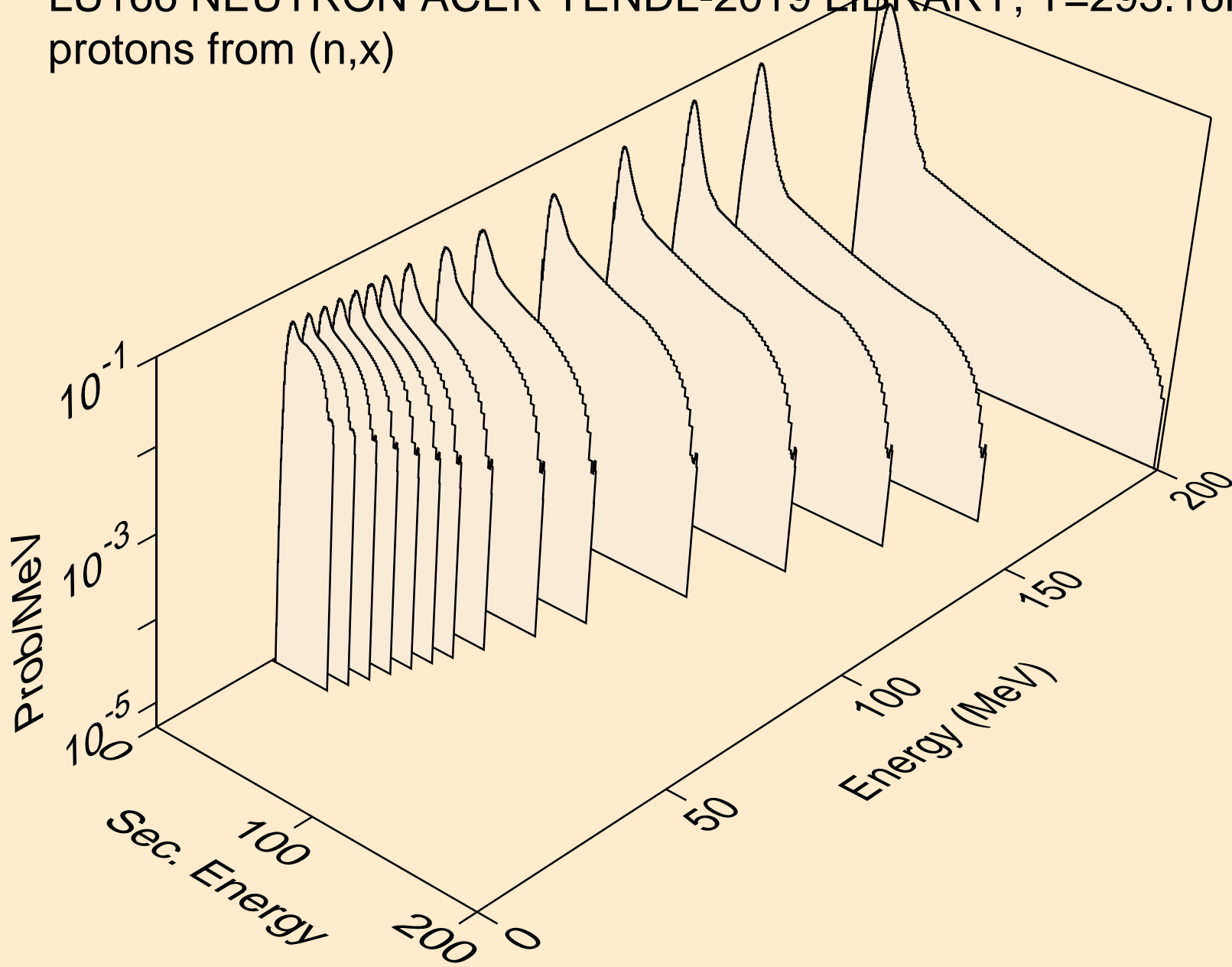

LU166 NEUTRON ACER TENDL-2019 LIBRARY; T=293.16K  
protons from (n,n\*)p

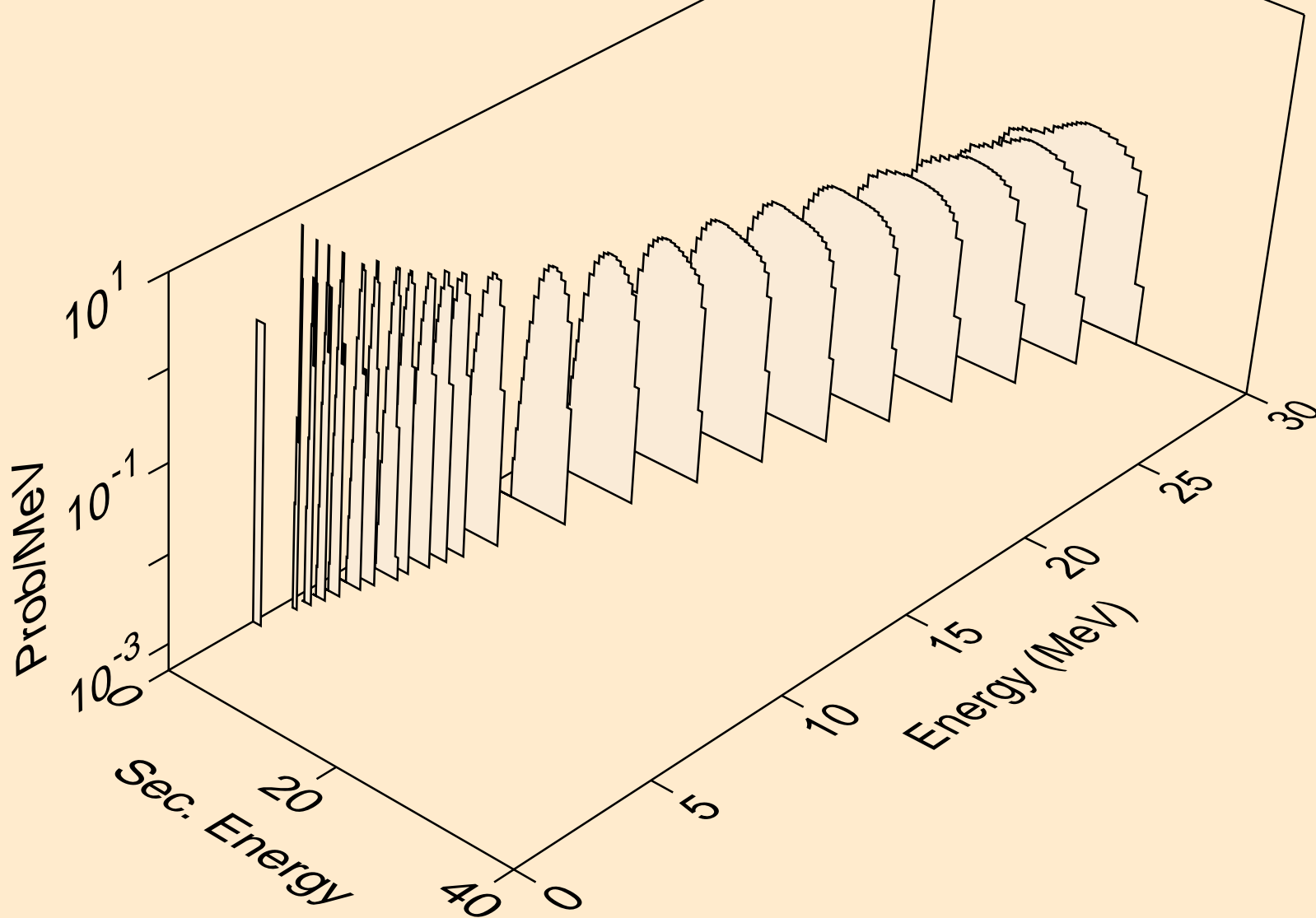

LU166 NEUTRON ACER TENDL-2019 LIBRARY; T=293.16K  
protons from (n,2np)

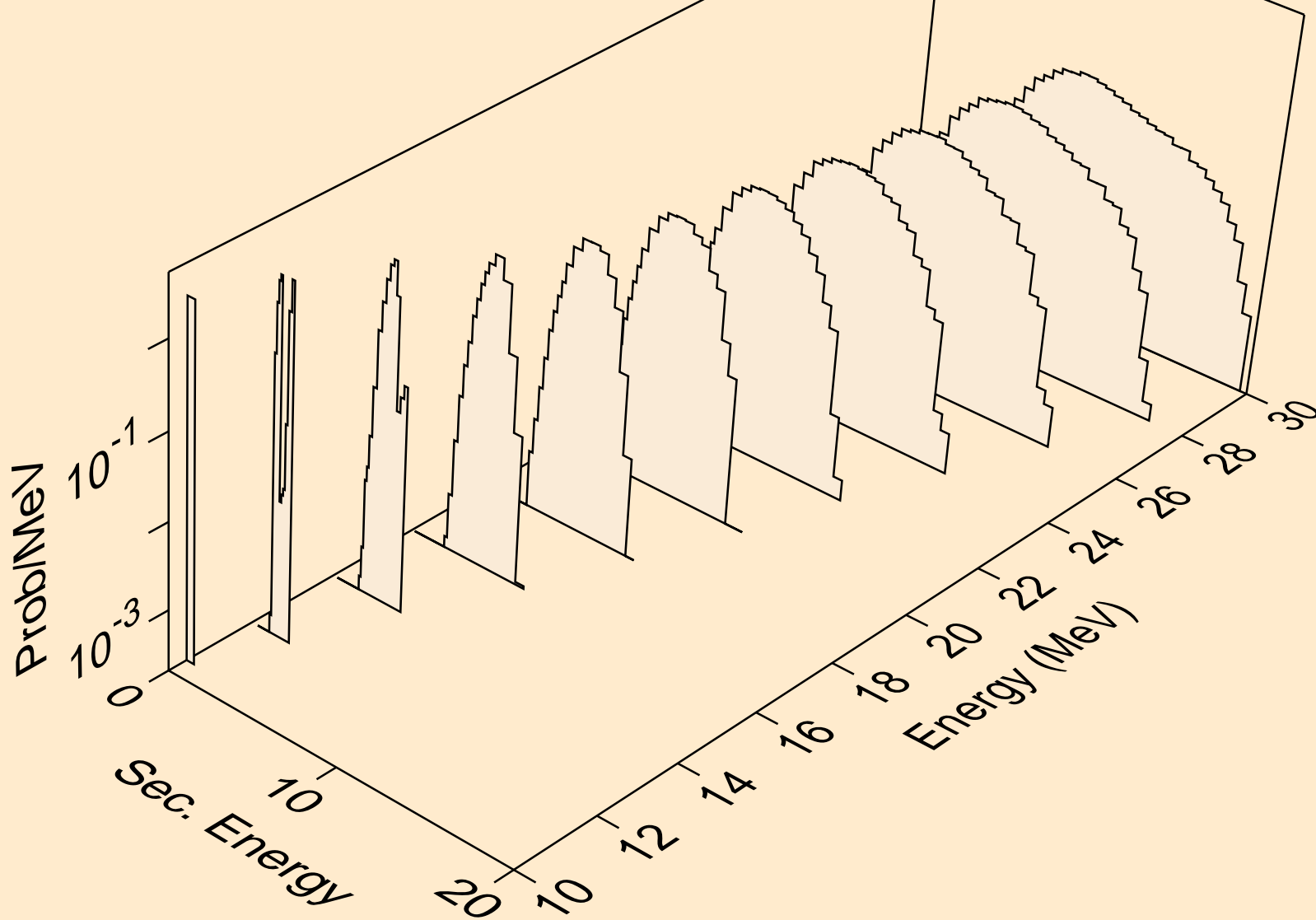

LU166 NEUTRON ACER TENDL-2019 LIBRARY; T=293.16K  
protons from (n,3np)

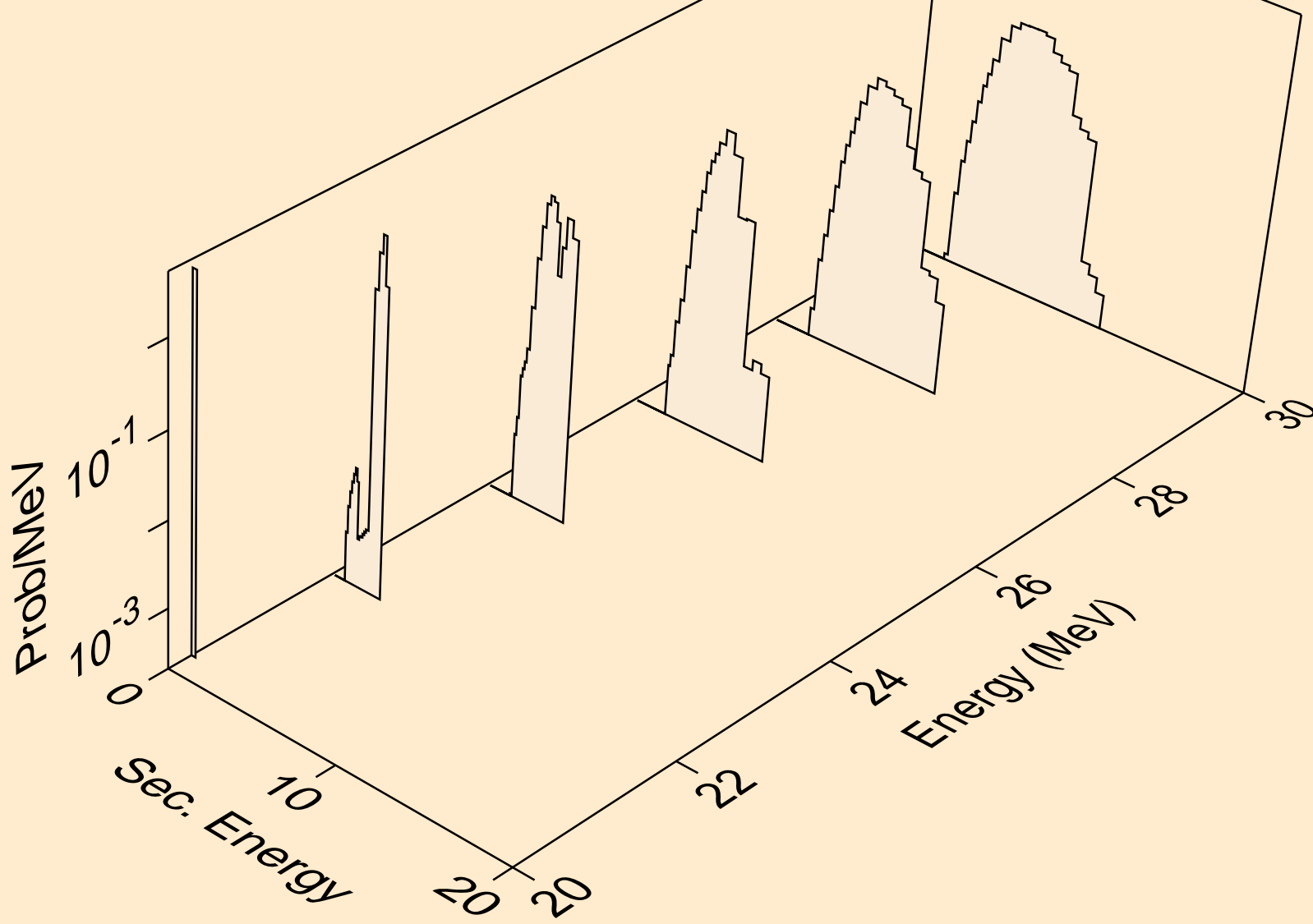

LU166 NEUTRON ACER TENDL-2019 LIBRARY; T=293.16K  
protons from (n,2np)

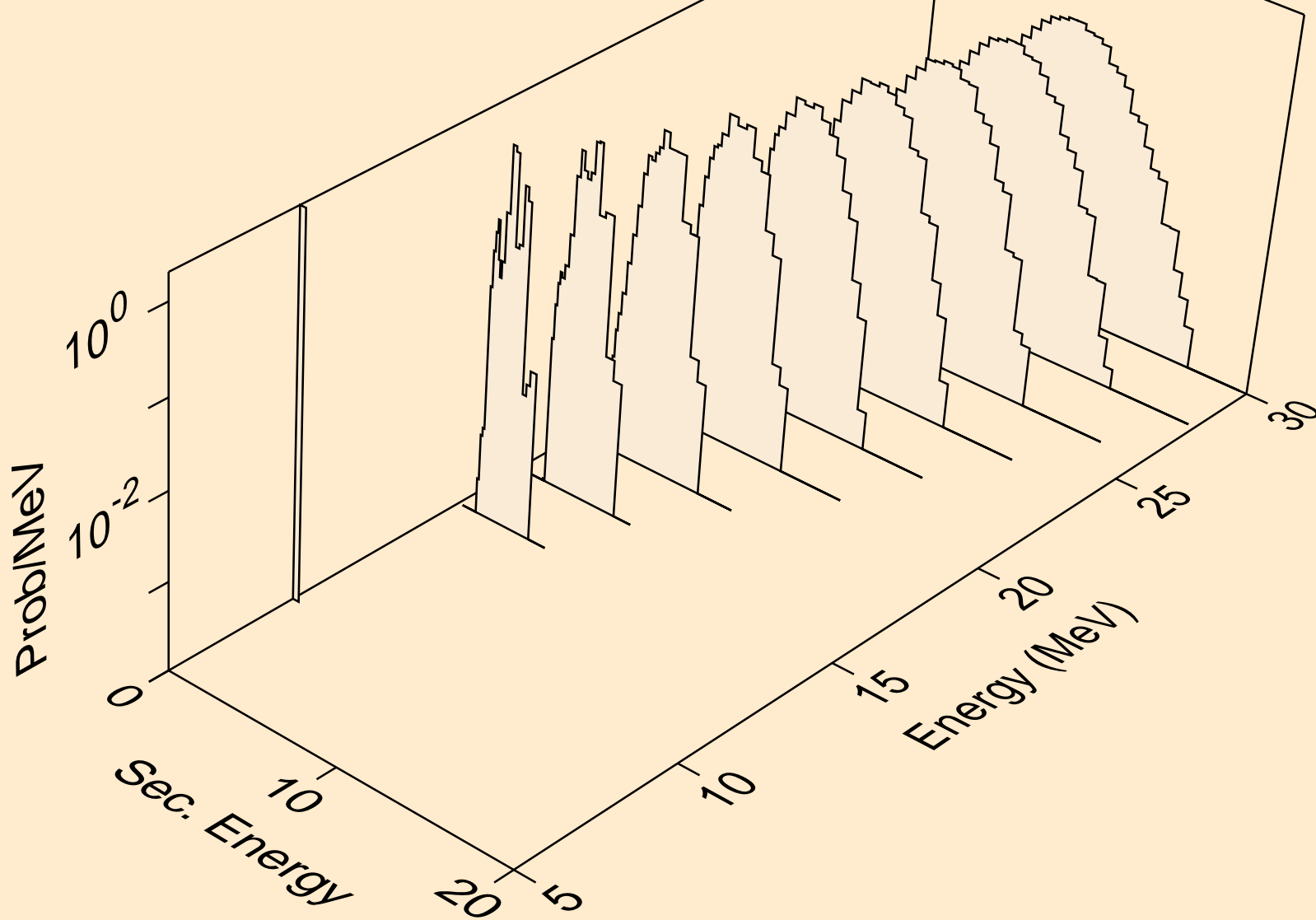

LU166 NEUTRON ACER TENDL-2019 LIBRARY; T=293.16K  
protons from (n,npa)

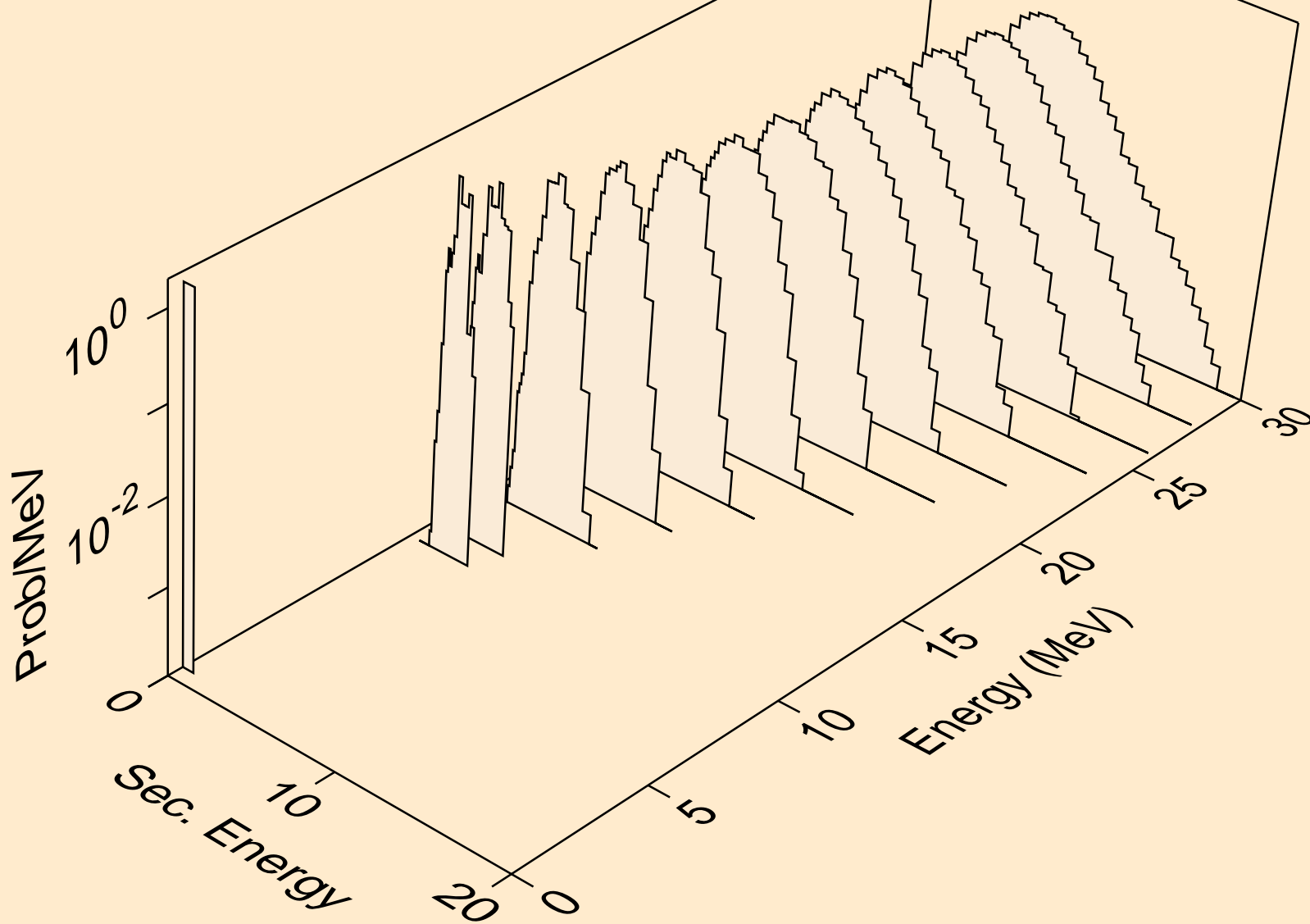



LU166 NEUTRON ACER TENDL-2019 LIBRARY; T=293.16K  
protons from (n,p)

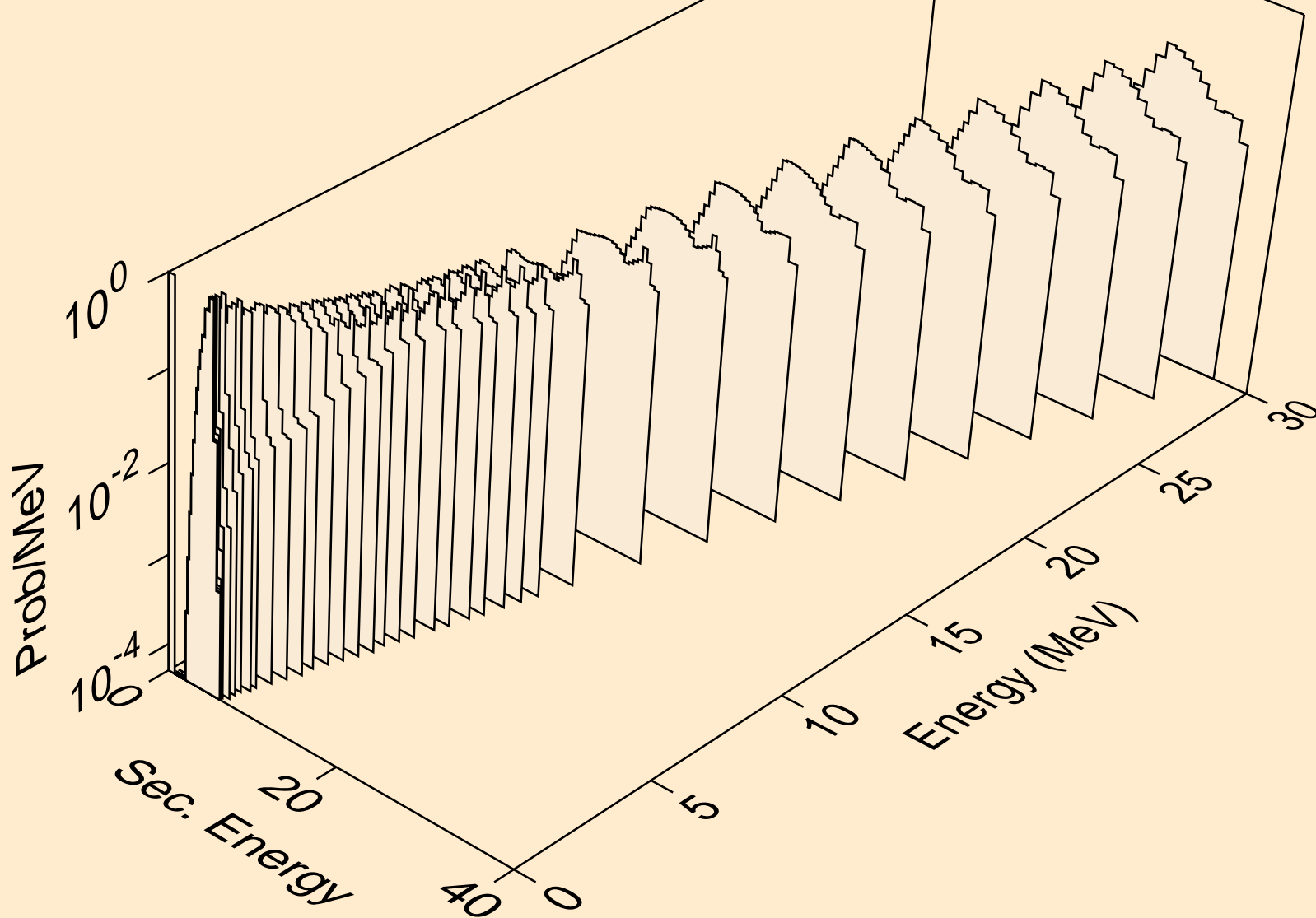

LU166 NEUTRON ACER TENDL-2019 LIBRARY; T=293.16K  
protons from (n,2p)

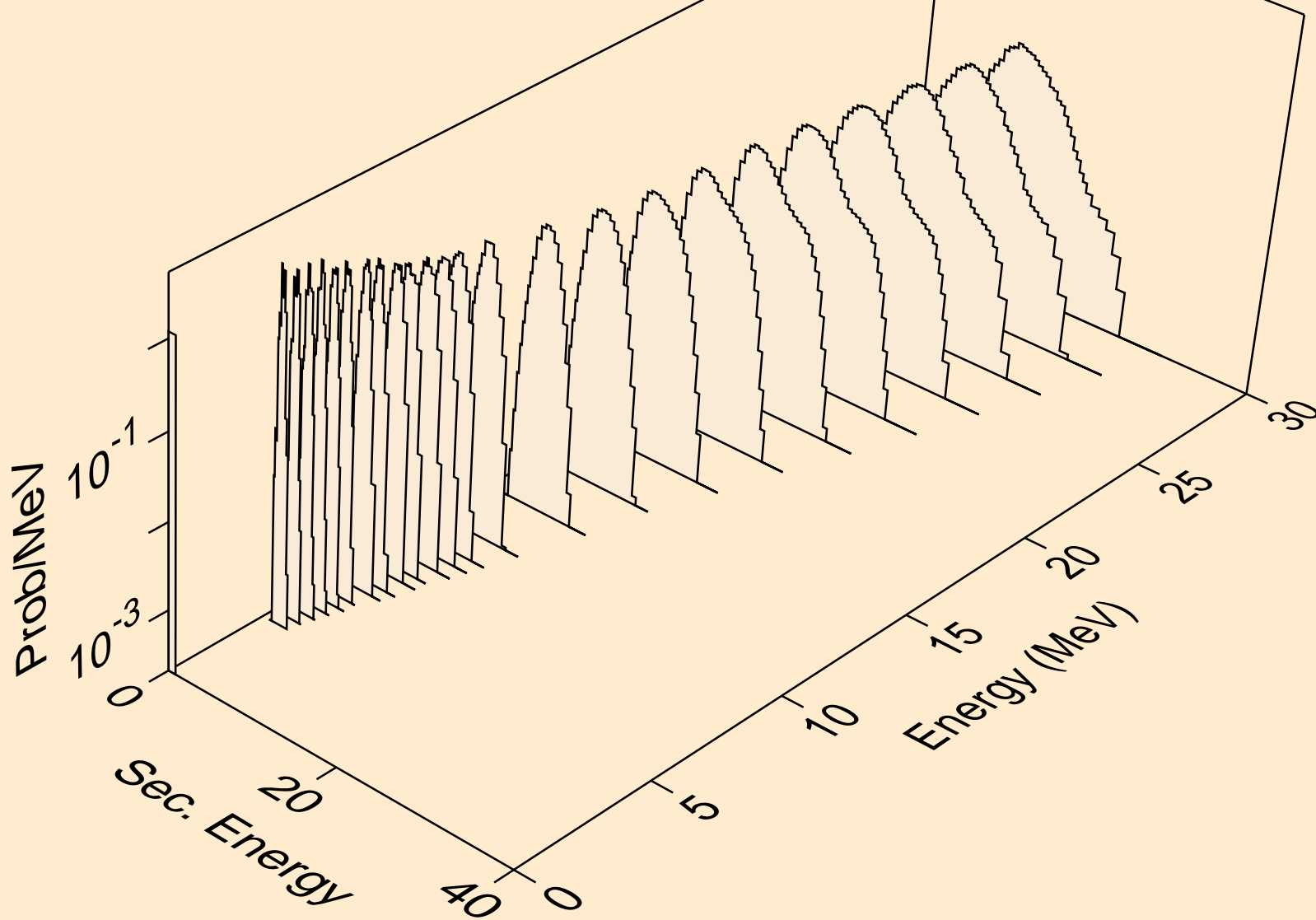

LU166 NEUTRON ACER TENDL-2019 LIBRARY; T=293.16K  
protons from (n,p)

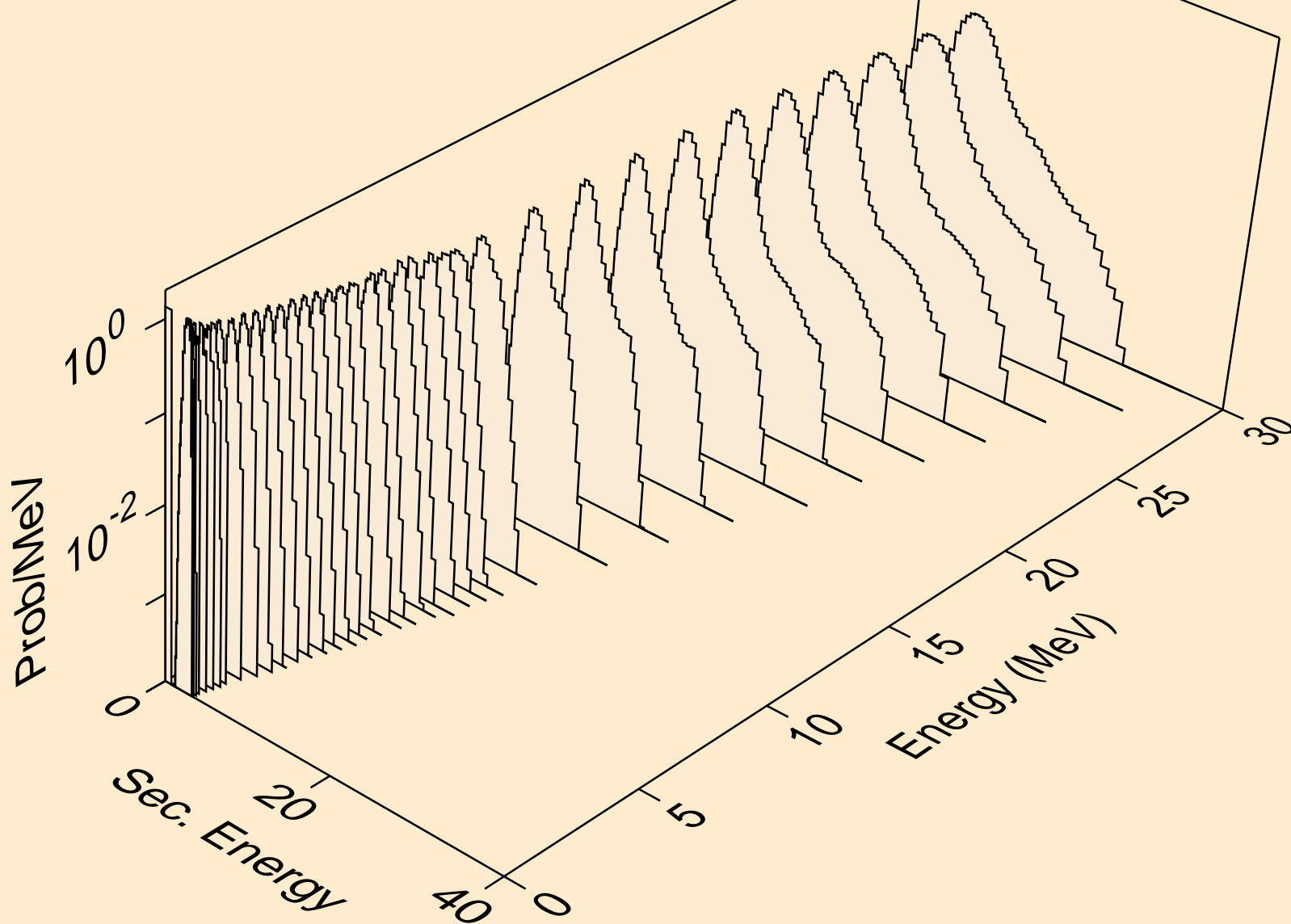

LU166 NEUTRON ACER TENDL-2019 LIBRARY; T=293.16K  
protons from (n,pd)

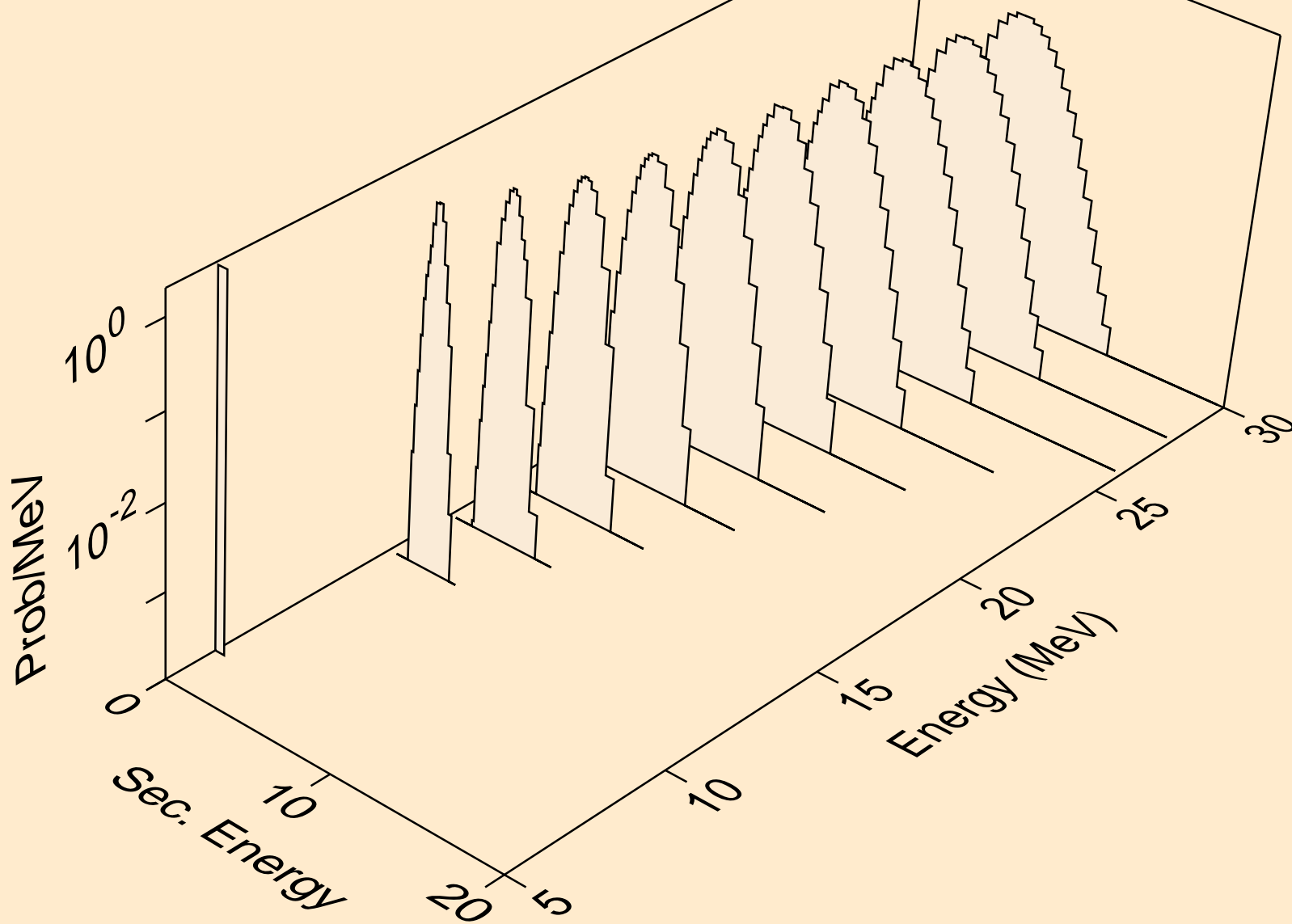

LU166 NEUTRON ACER TENDL-2019 LIBRARY; T=293.16K  
protons from (n,pt)

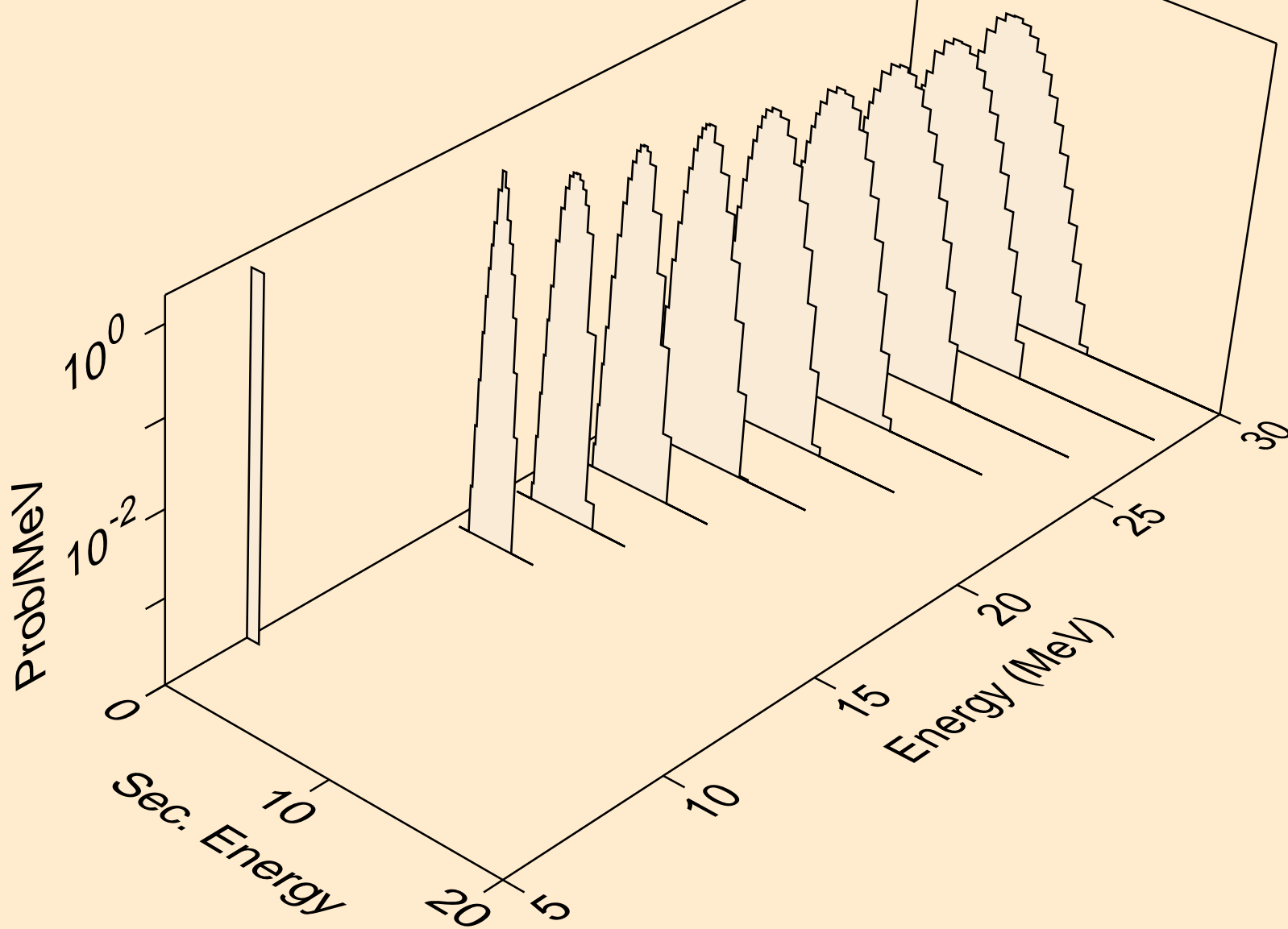

LU166 NEUTRON ACER TENDL-2019 LIBRARY; T=293.16K  
deuterons from (n,x)

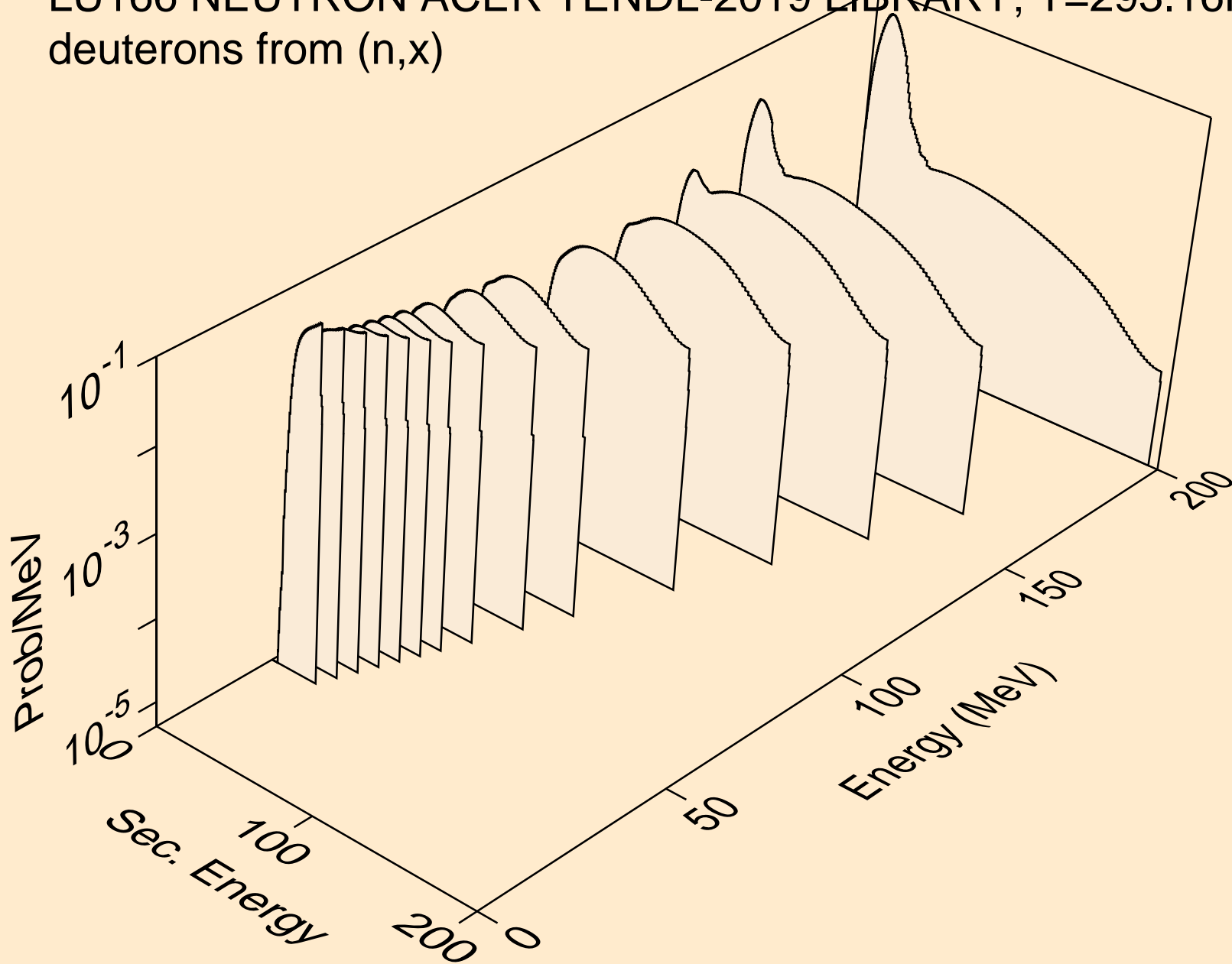

LU166 NEUTRON ACER TENDL-2019 LIBRARY; T=293.16K  
deuterons from (n,2nd)

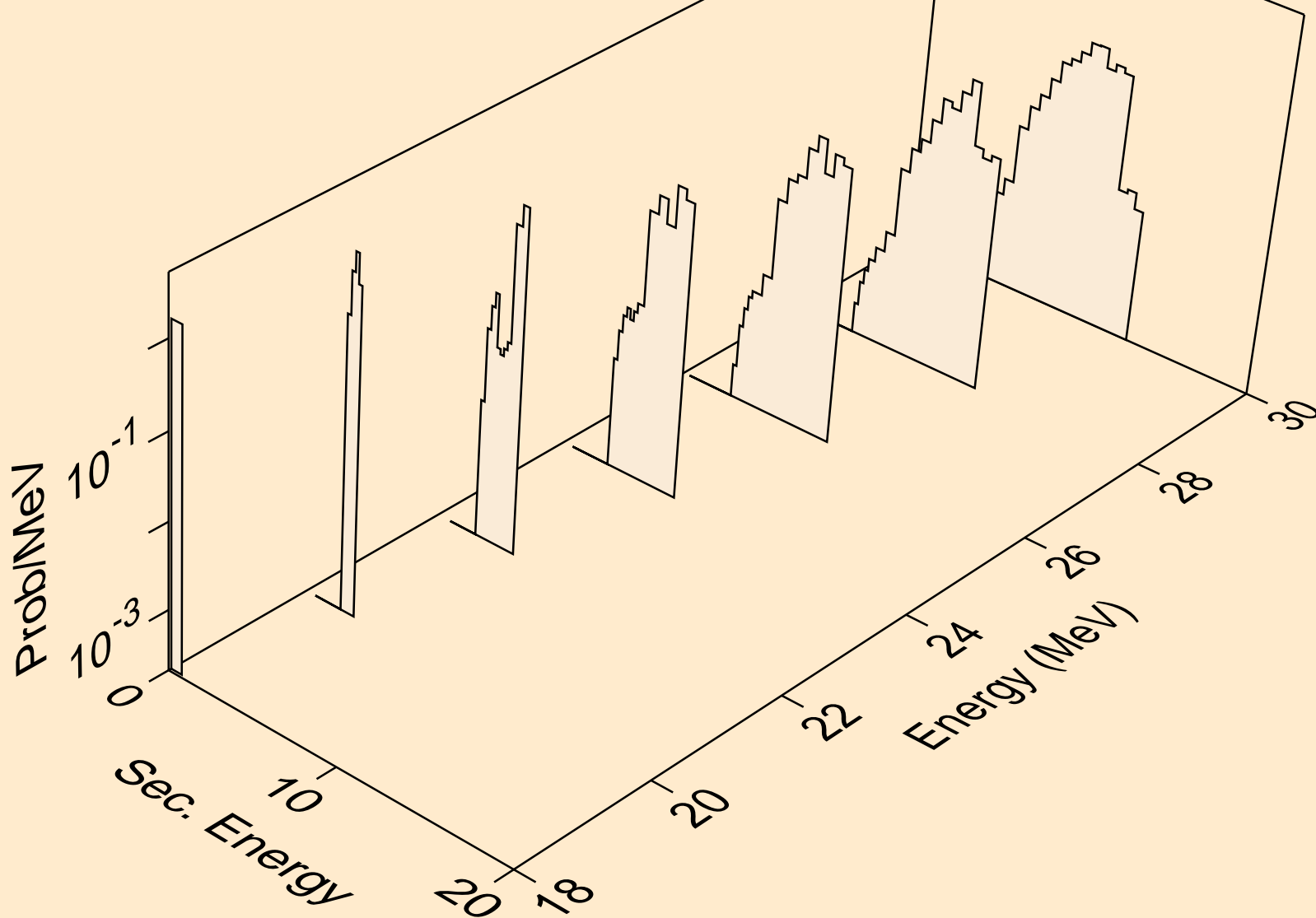

LU166 NEUTRON ACER TENDL-2019 LIBRARY; T=293.16K  
deuterons from (n,n\*)d

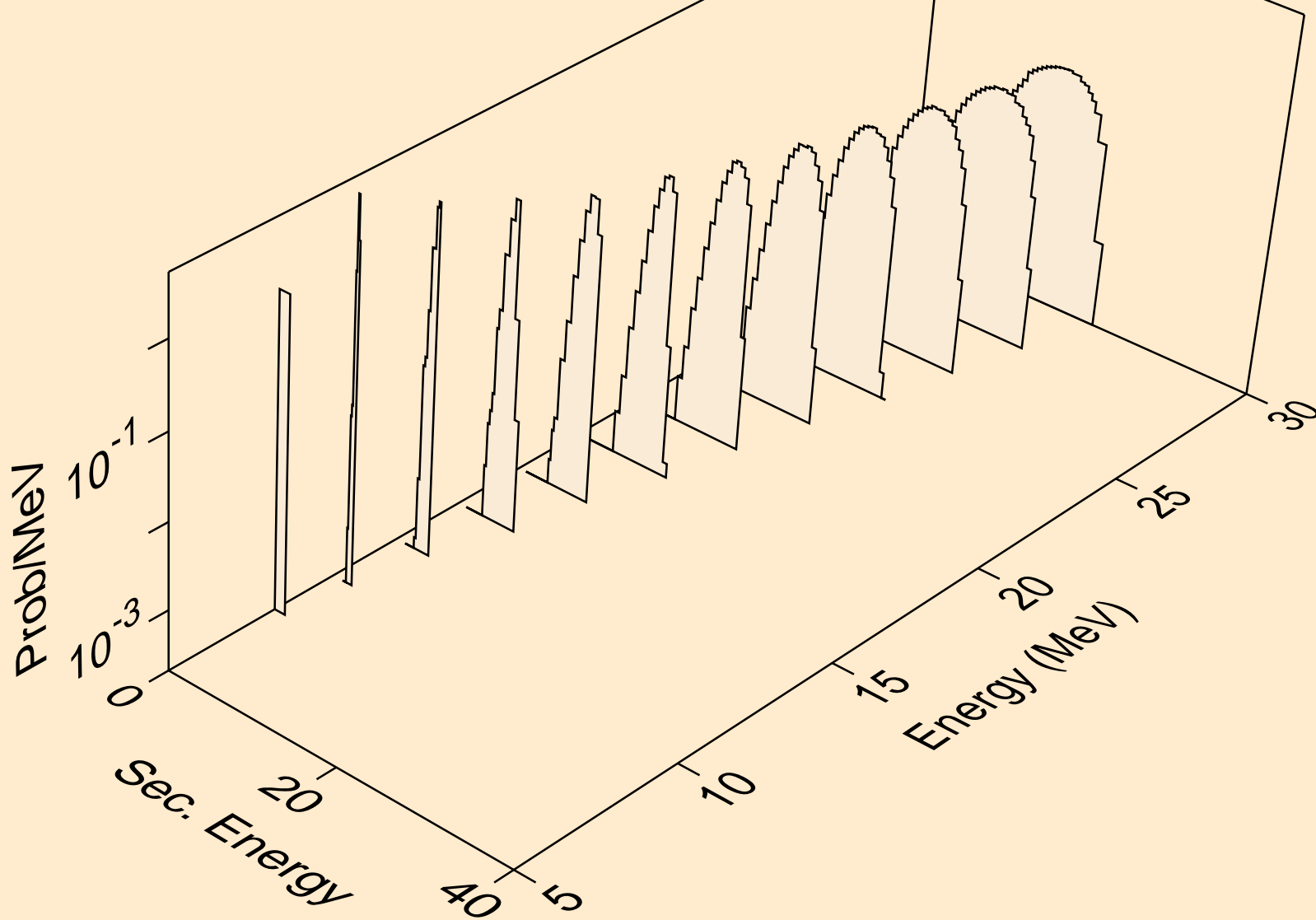



LU166 NEUTRON ACER TENDL-2019 LIBRARY; T=293.16K  
deuterons from (n,d)

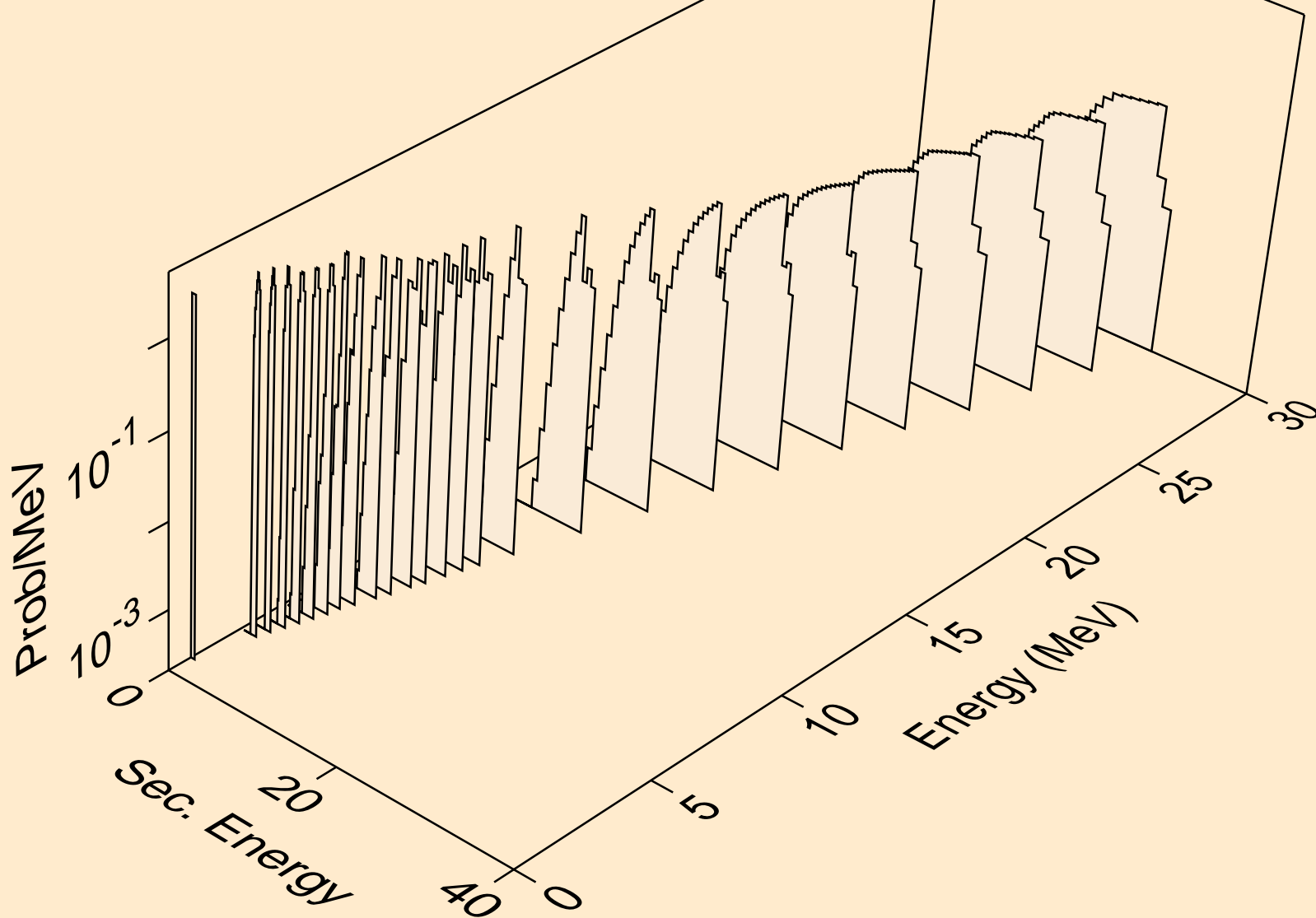

LU166 NEUTRON ACER TENDL-2019 LIBRARY; T=293.16K  
deuterons from (n,pd)

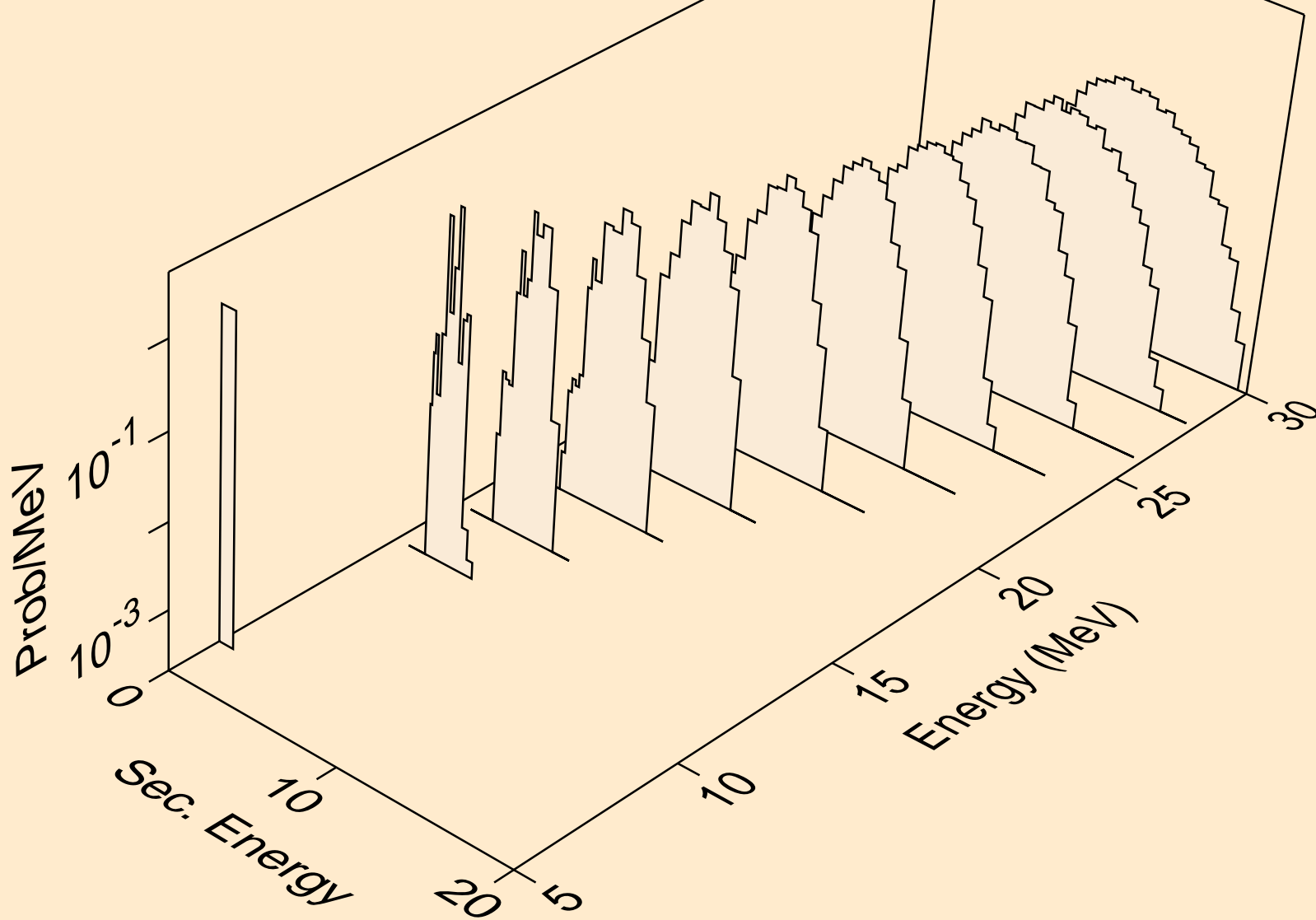

LU166 NEUTRON ACER TENDL-2019 LIBRARY; T=293.16K  
deuterons from (n,da)

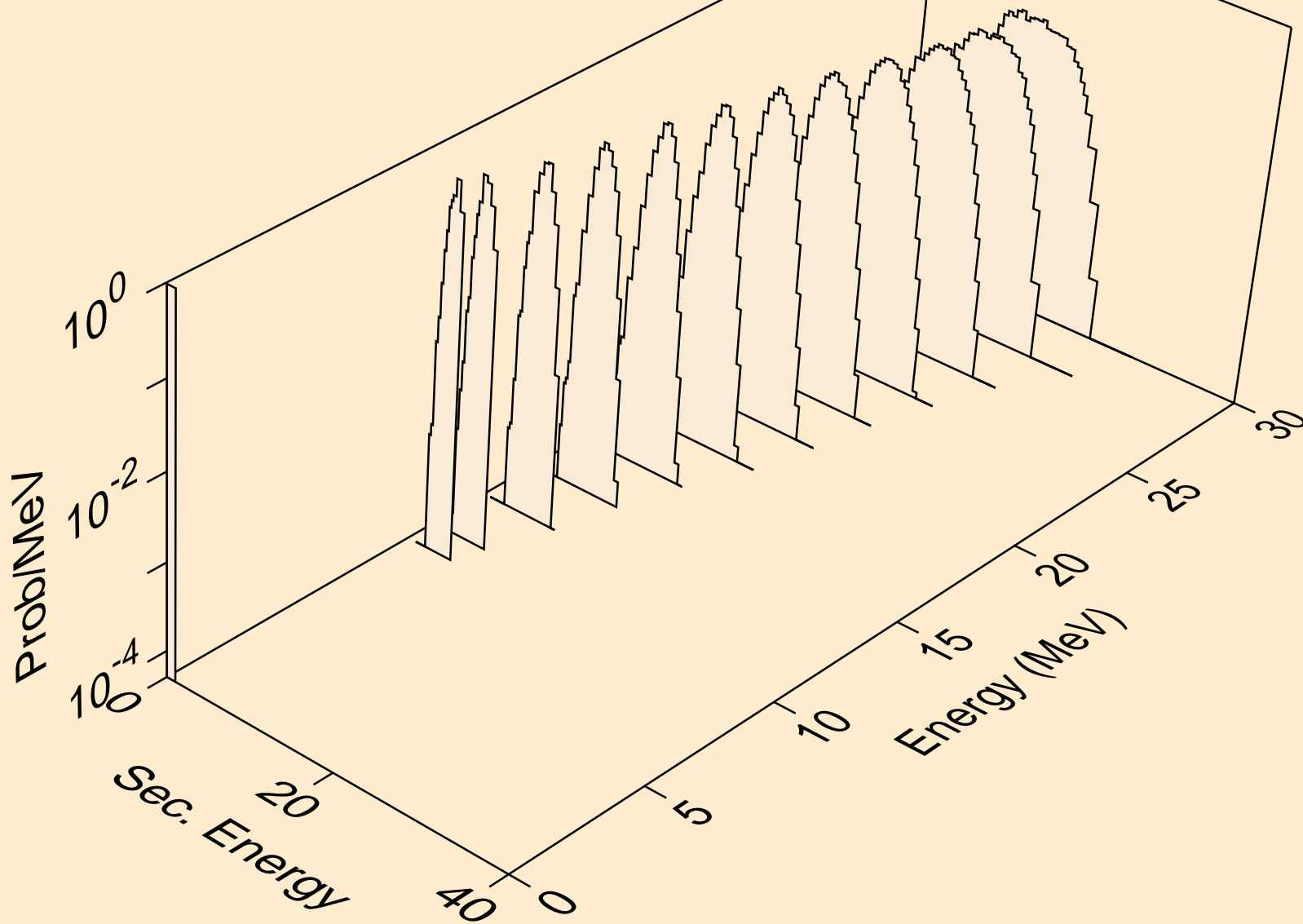

LU166 NEUTRON ACER TENDL-2019 LIBRARY; T=293.16K  
tritons from (n,x)

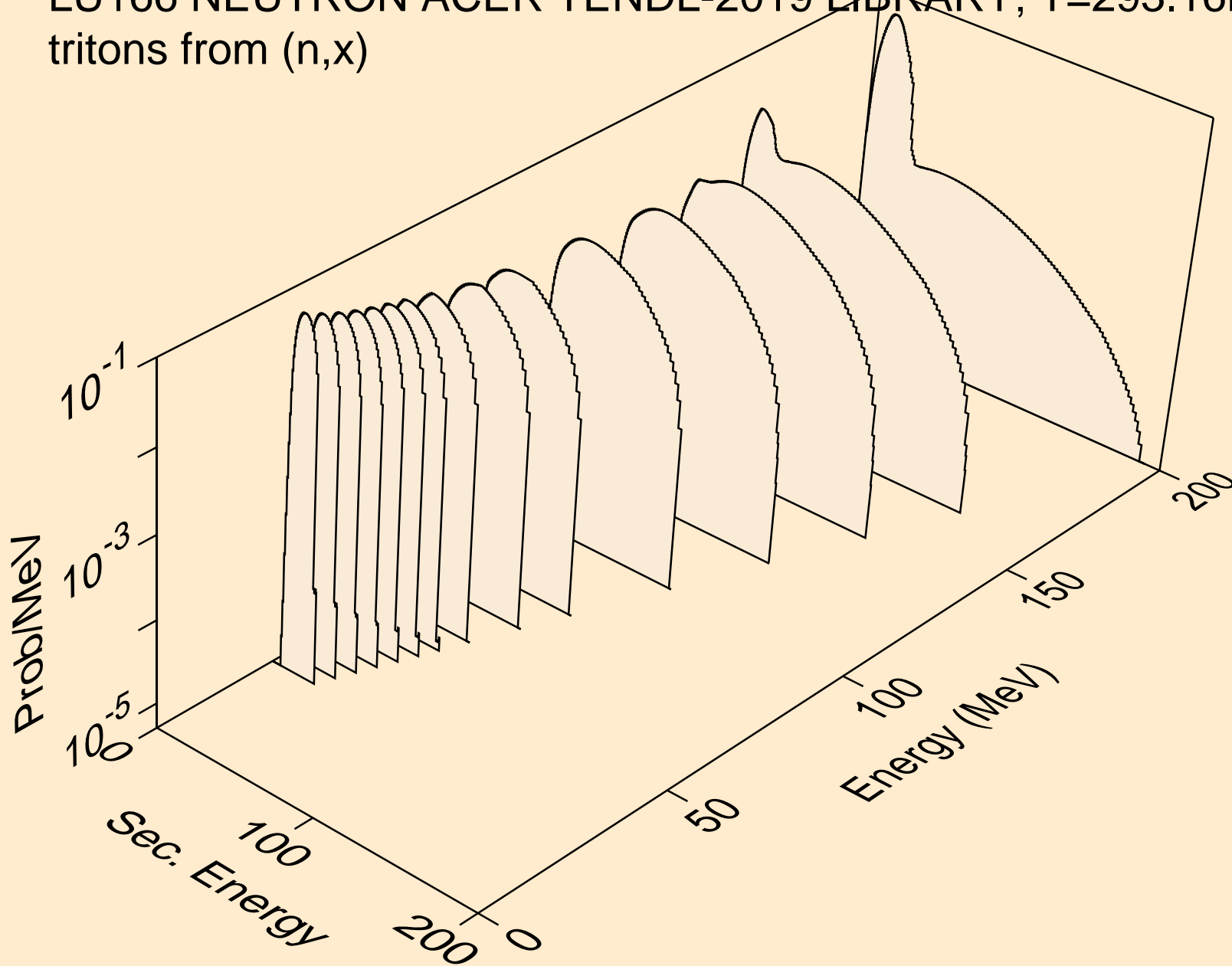

LU166 NEUTRON ACER TENDL-2019 LIBRARY; T=293.16K  
tritons from (n,n\*)t

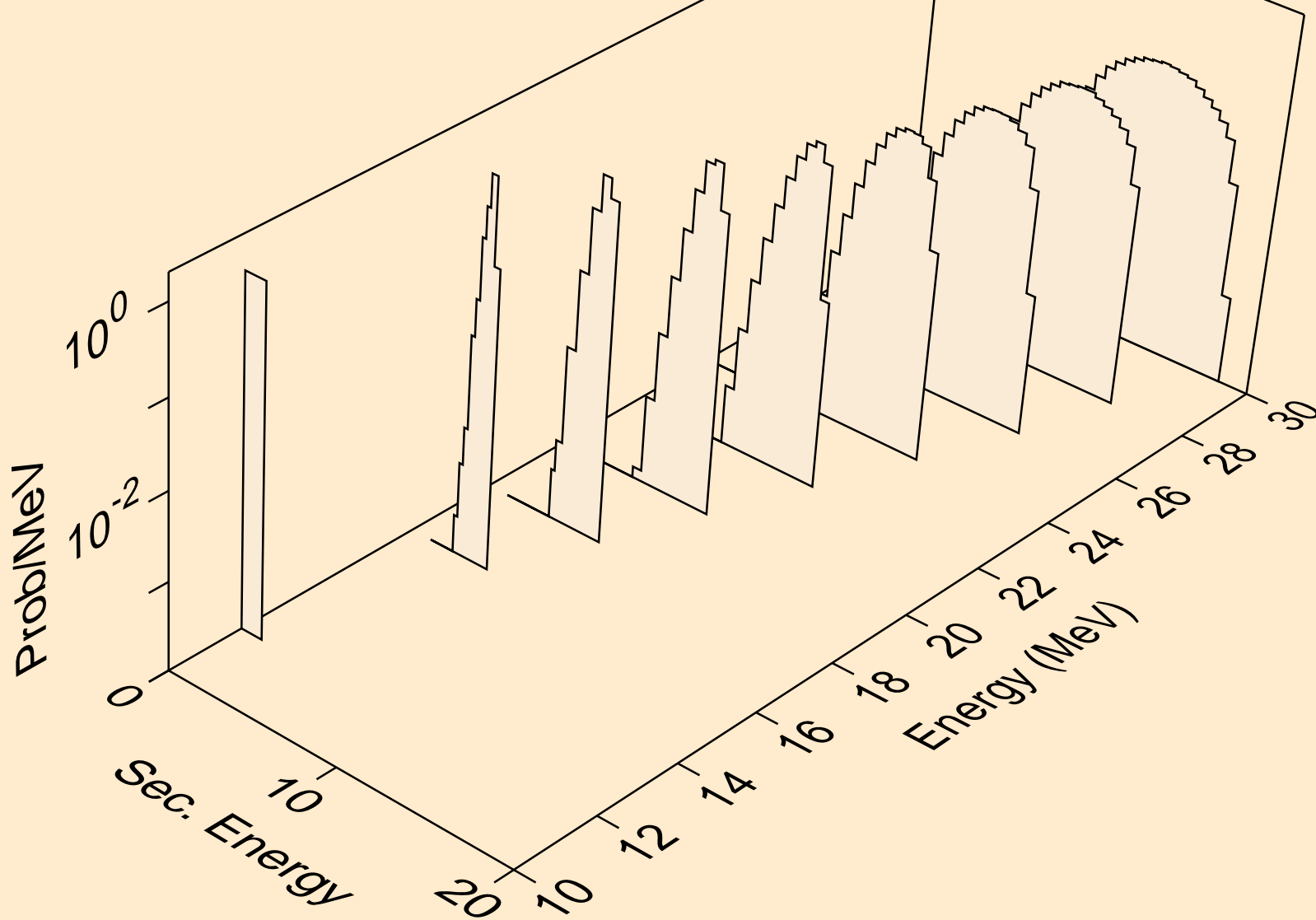

LU166 NEUTRON ACER TENDL-2019 LIBRARY; T=293.16K  
tritons from (n,t)

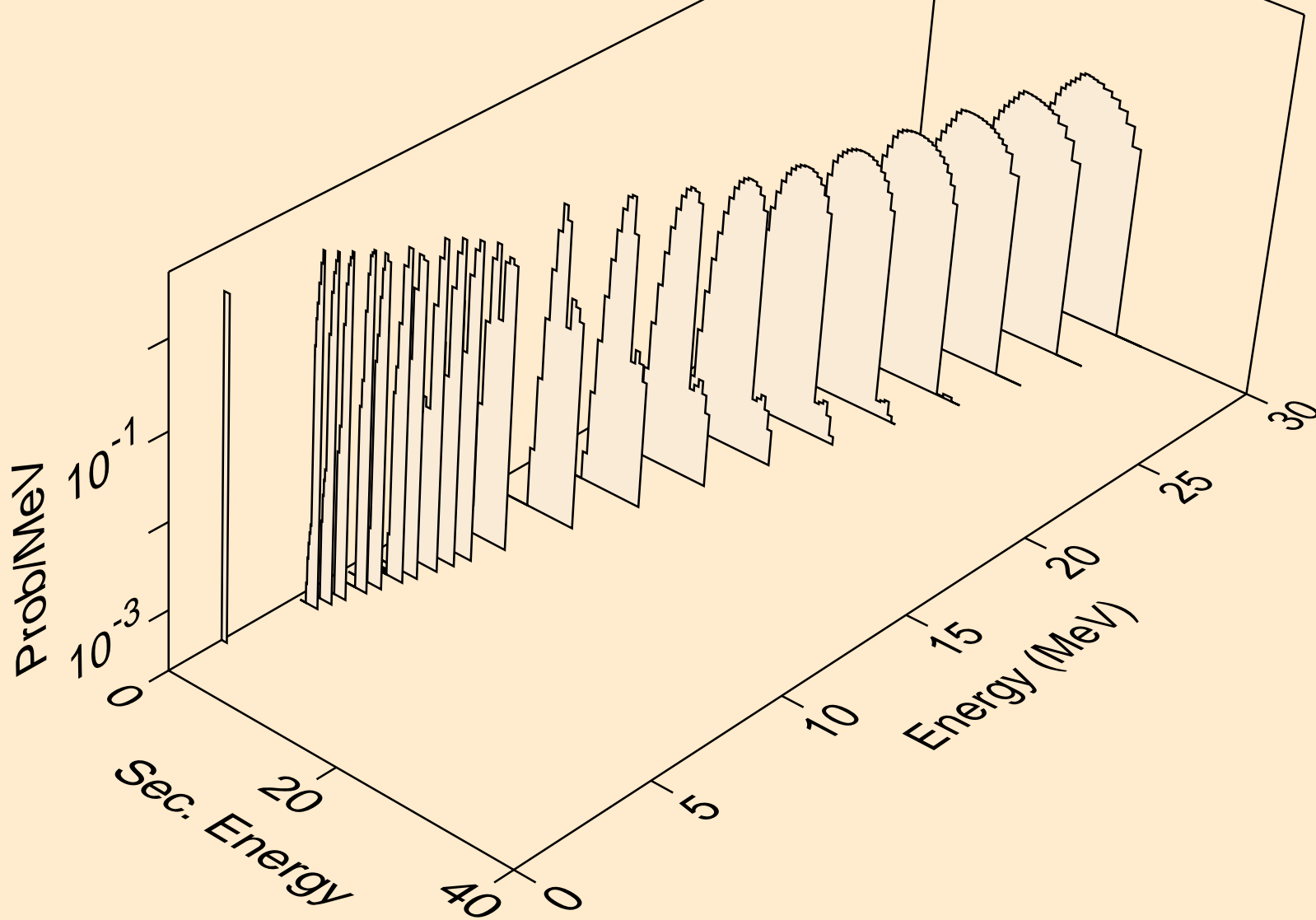

LU166 NEUTRON ACER TENDL-2019 LIBRARY; T=293.16K  
tritons from (n,pt)

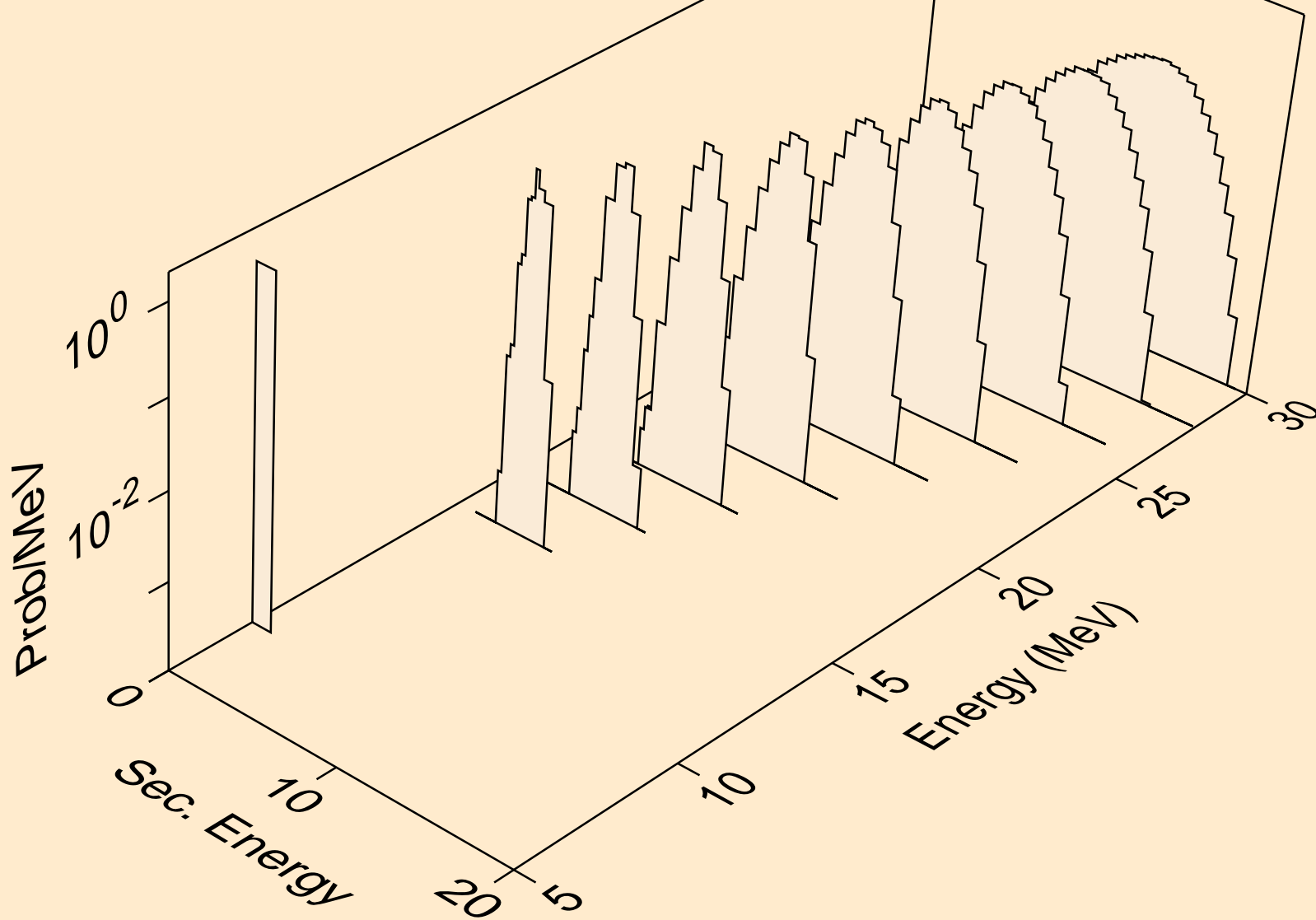

LU166 NEUTRON ACER TENDL-2019 LIBRARY; T=293.16K  
he3s from (n,x)

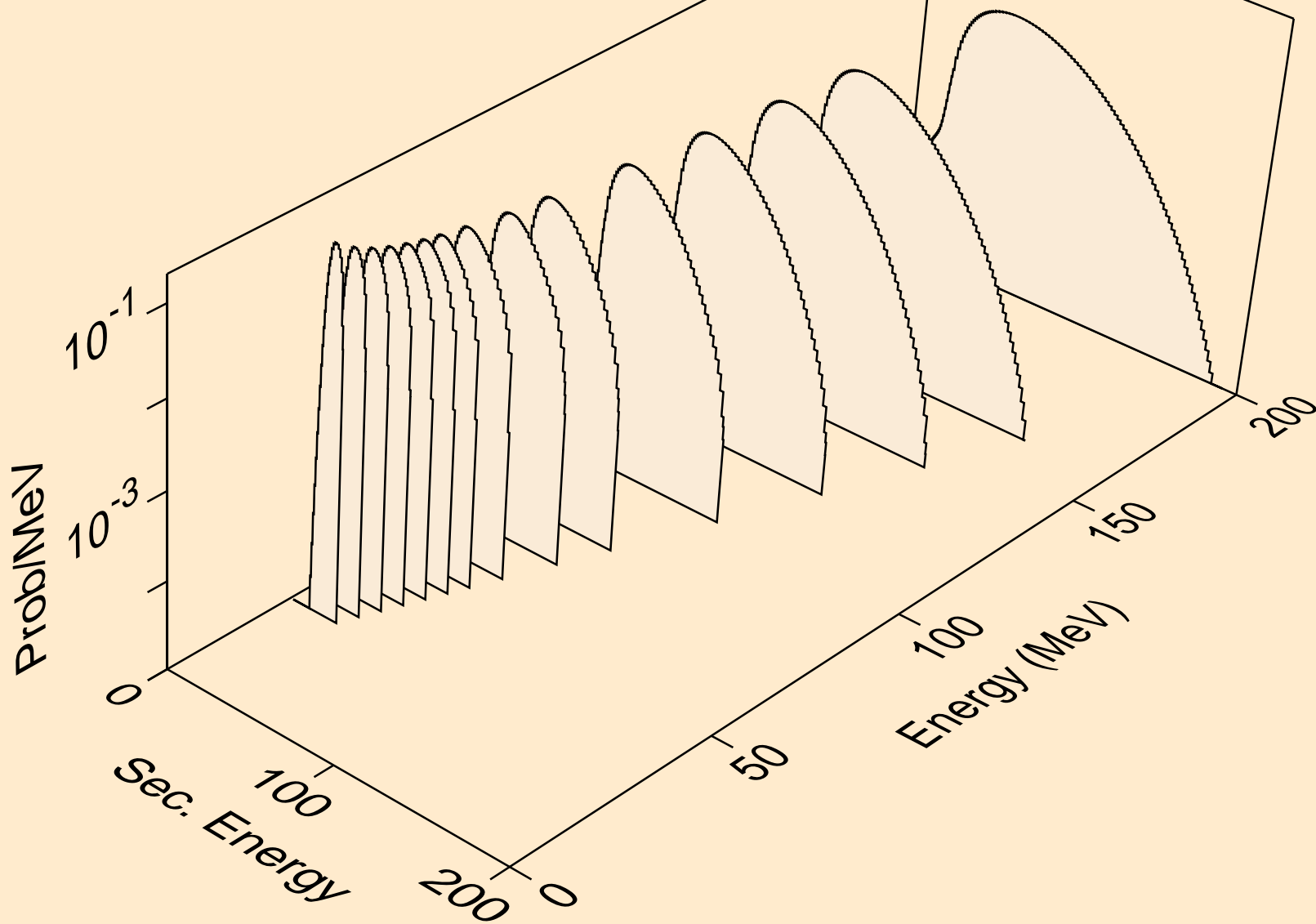



LU166 NEUTRON ACER TENDL-2019 LIBRARY; T=293.16K  
he3s from (n,n\*)he3

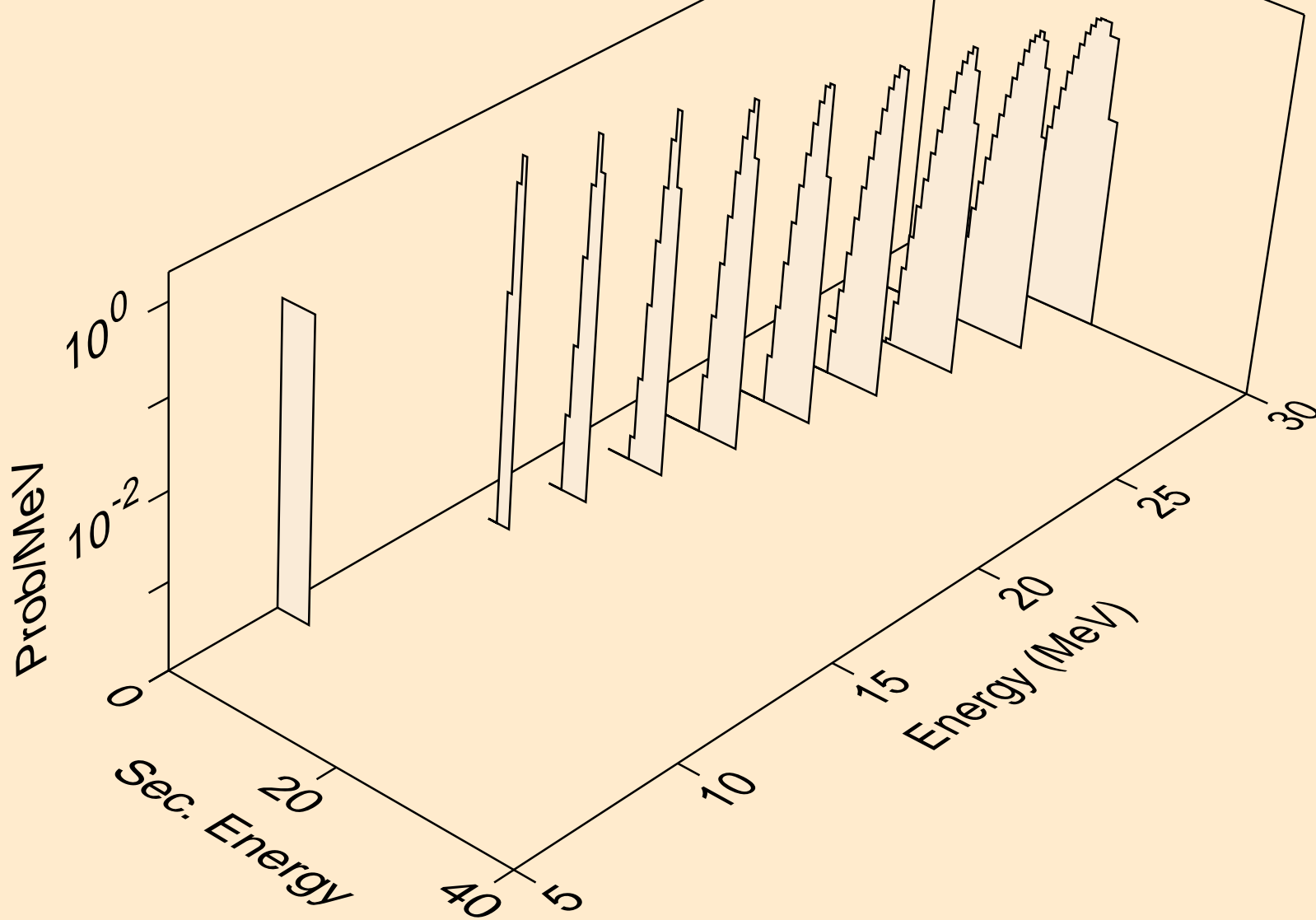

LU166 NEUTRON ACER TENDL-2019 LIBRARY; T=293.16K  
he3s from (n,he3)

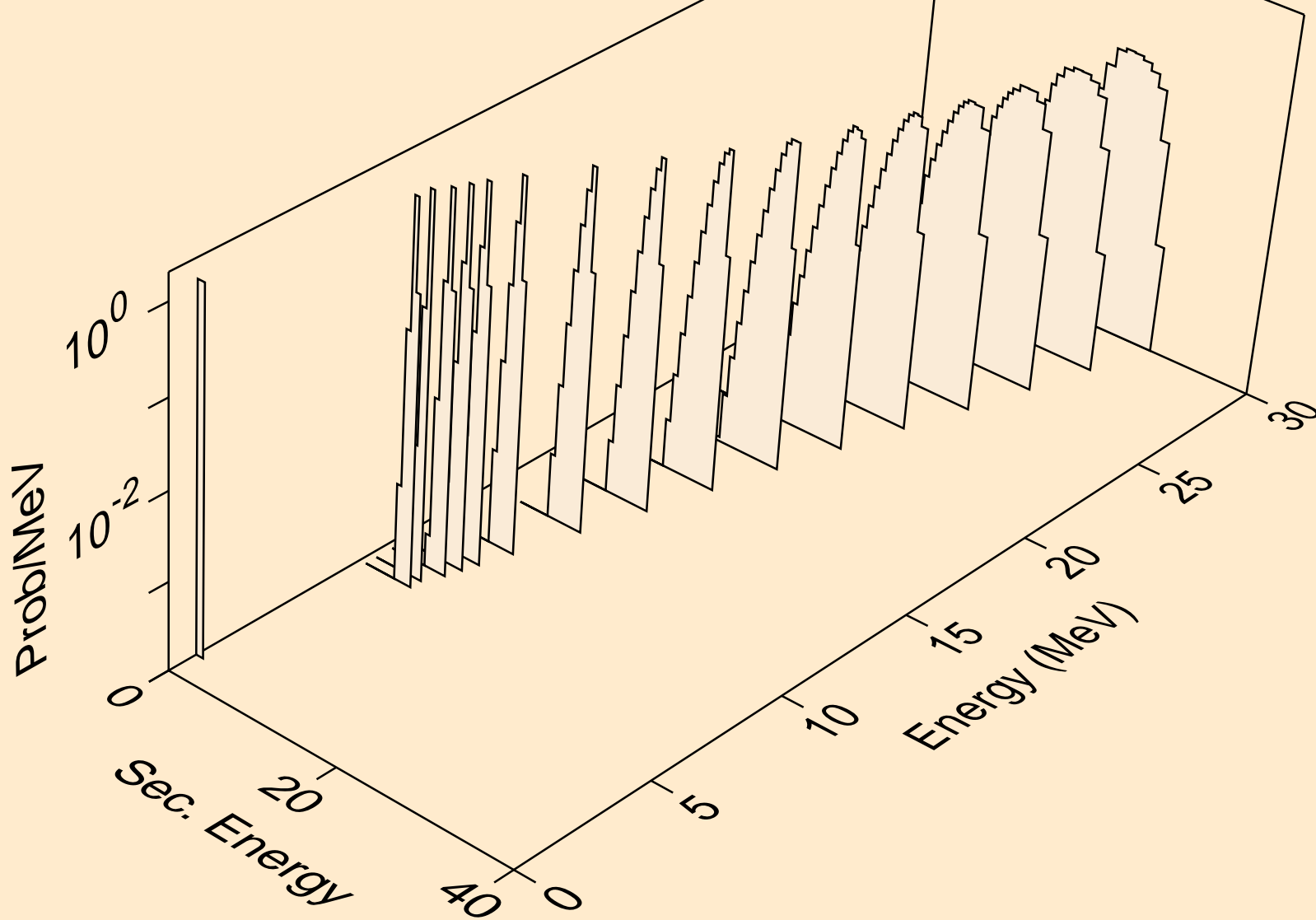

LU166 NEUTRON ACER TENDL-2019 LIBRARY; T=293.16K  
alphas from (n,x)

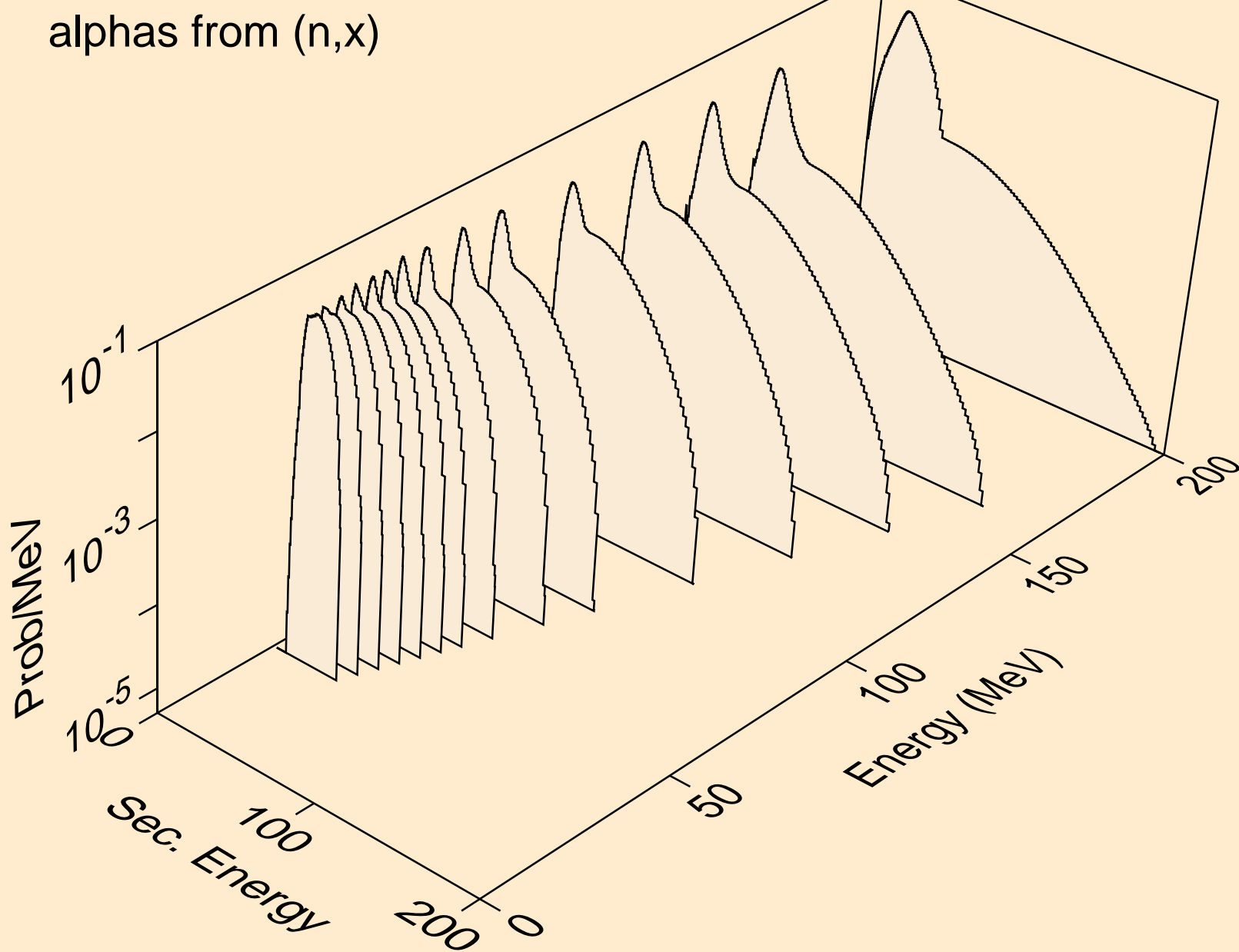

LU166 NEUTRON ACER TENDL-2019 LIBRARY; T=293.16K  
alphas from (n,n\*)a

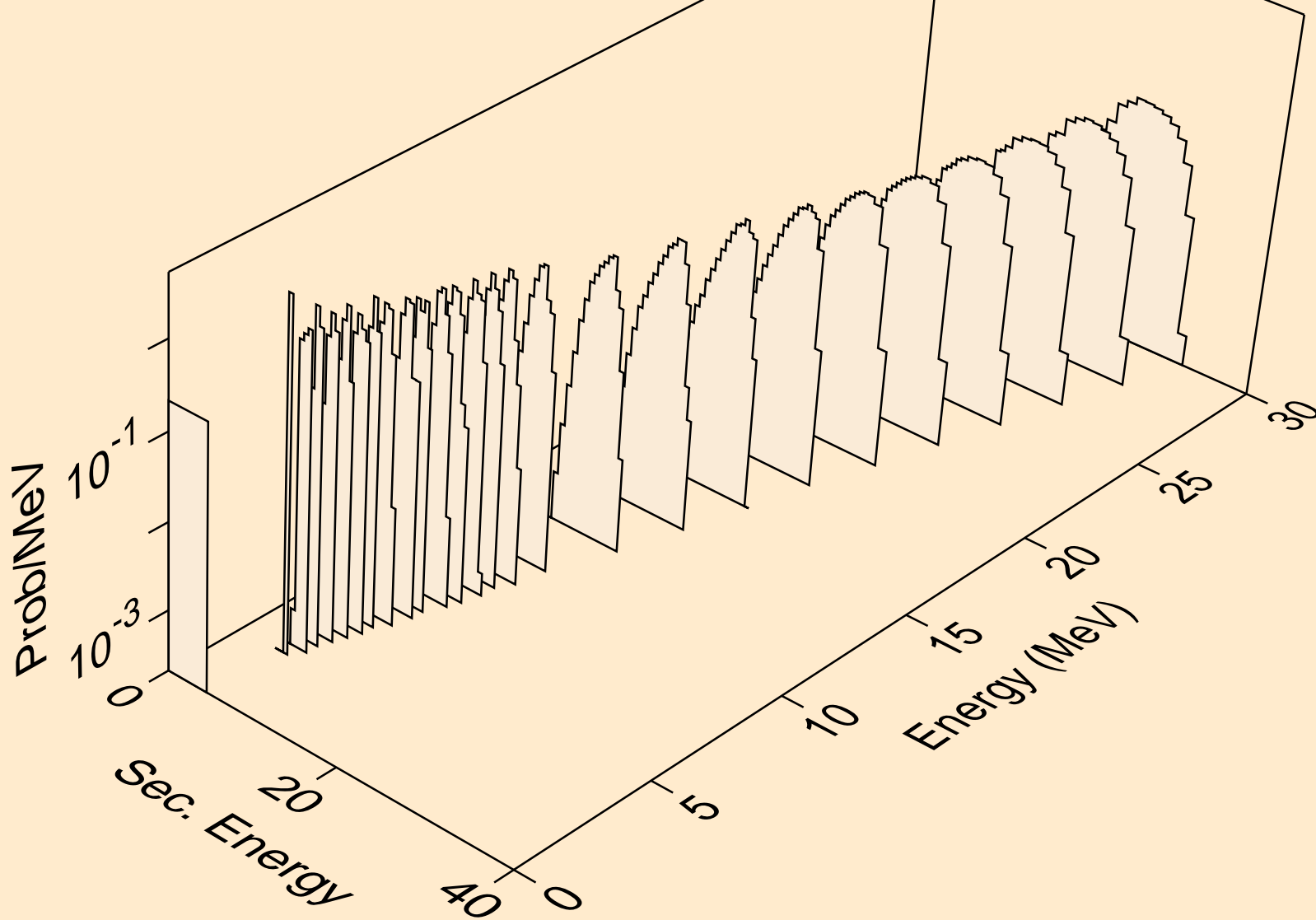

LU166 NEUTRON ACER TENDL-2019 LIBRARY; T=293.16K  
alphas from (n,2n)a

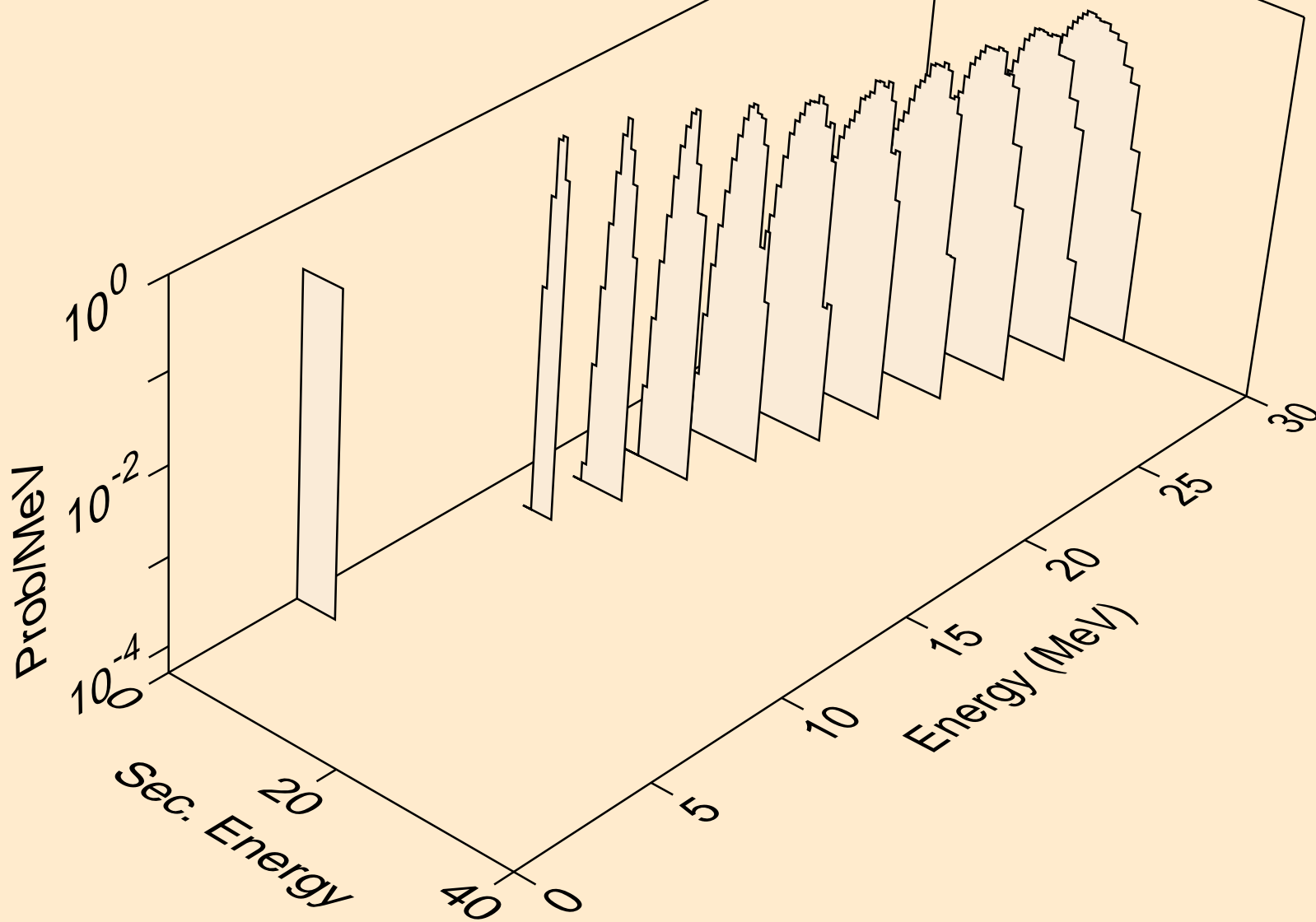

LU166 NEUTRON ACER TENDL-2019 LIBRARY; T=293.16K  
alphas from (n,3n)a

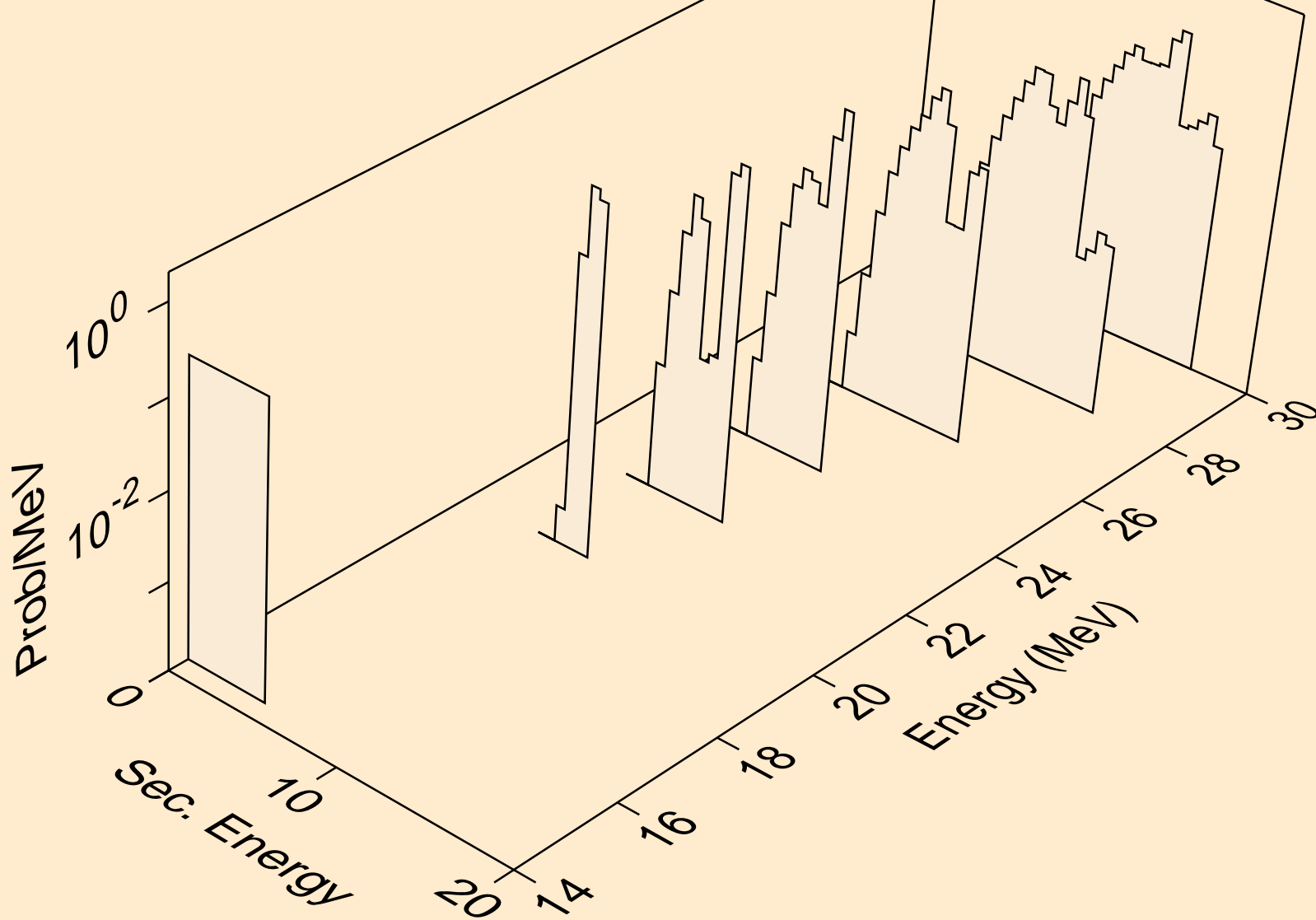

LU166 NEUTRON ACER TENDL-2019 LIBRARY; T=293.16K  
alphas from (n,n\*)2a

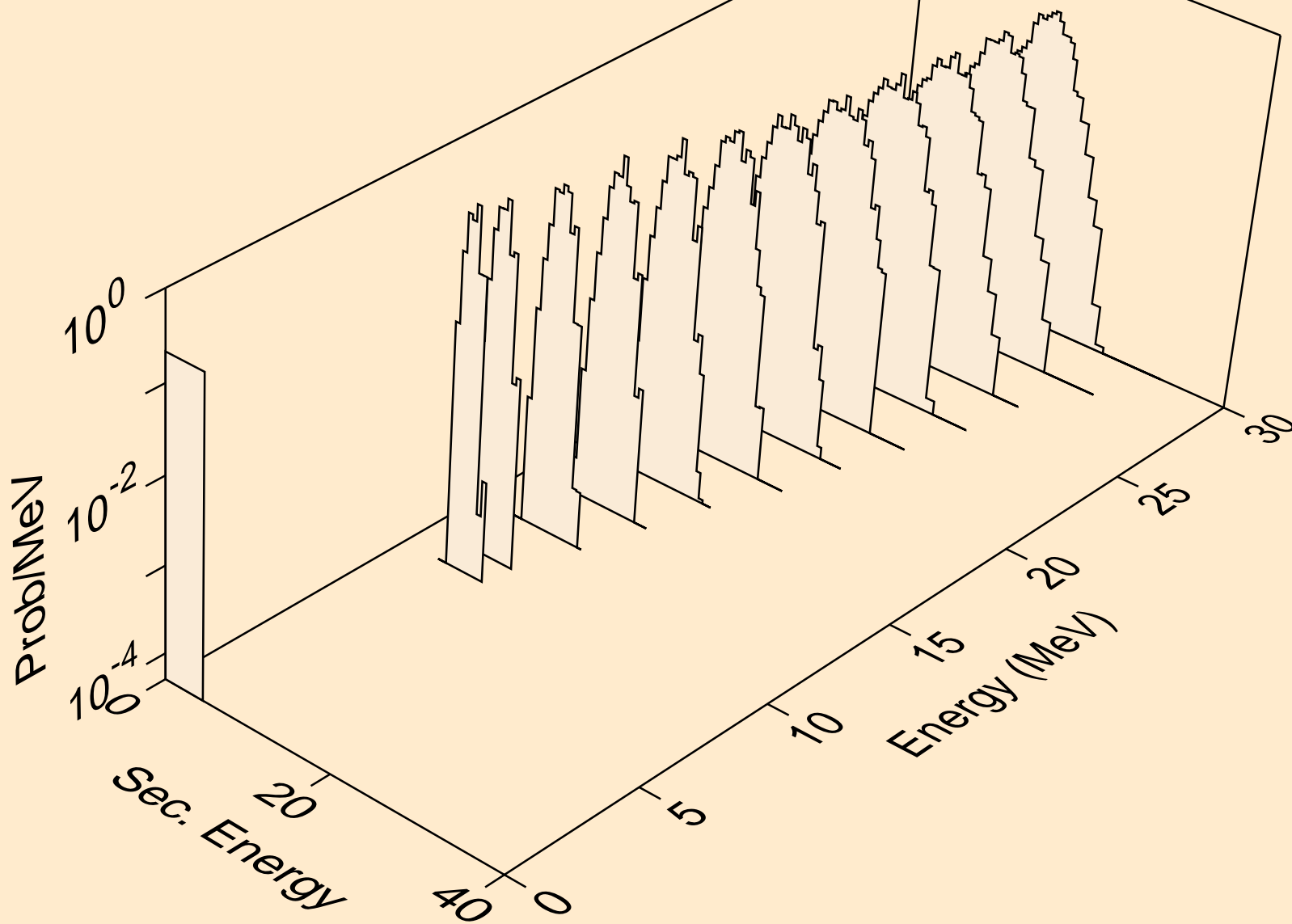

LU166 NEUTRON ACER TENDL-2019 LIBRARY; T=293.16K  
alphas from (n,2n)2a

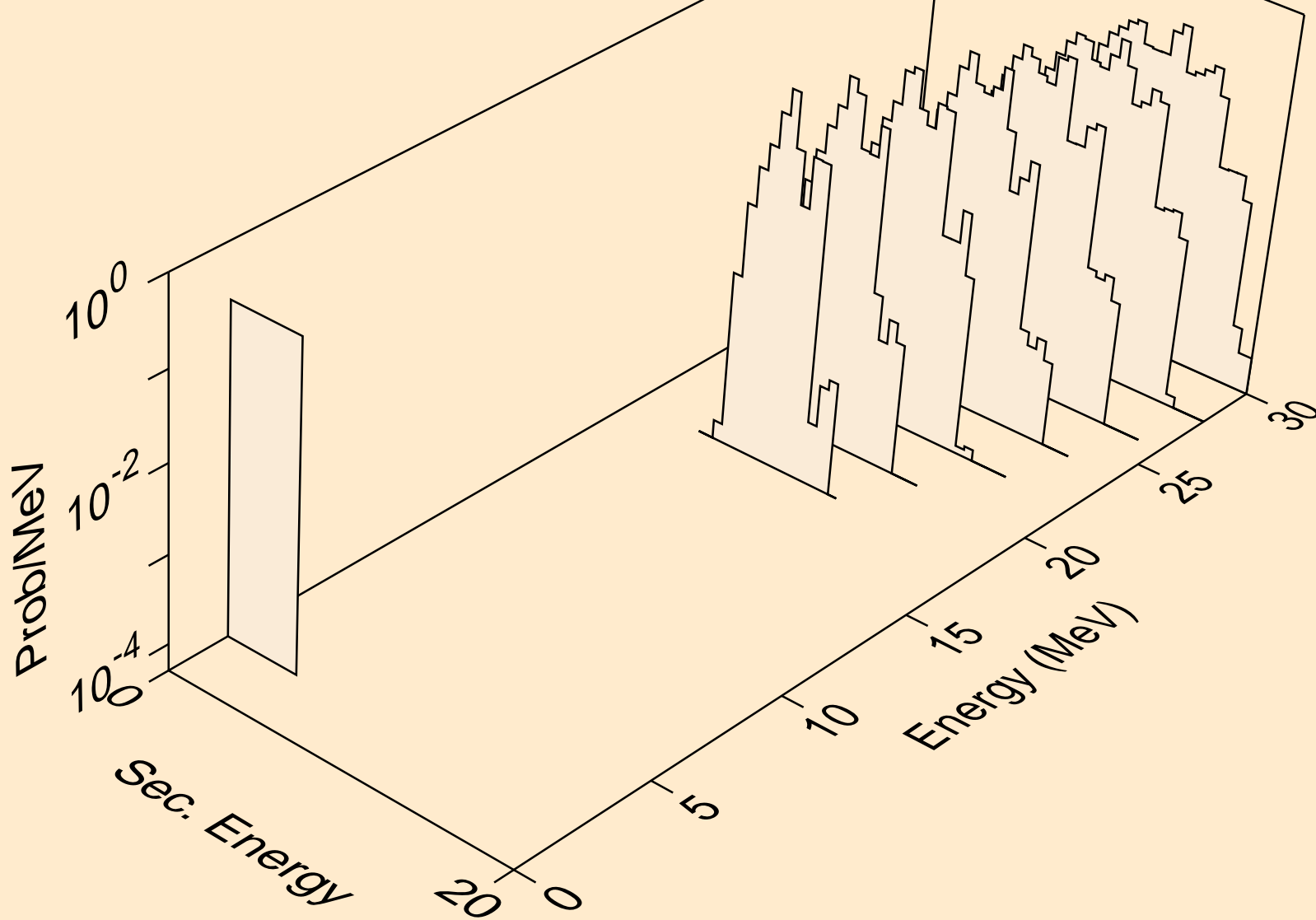



LU166 NEUTRON ACER TENDL-2019 LIBRARY; T=293.16K  
alphas from (n,npa)

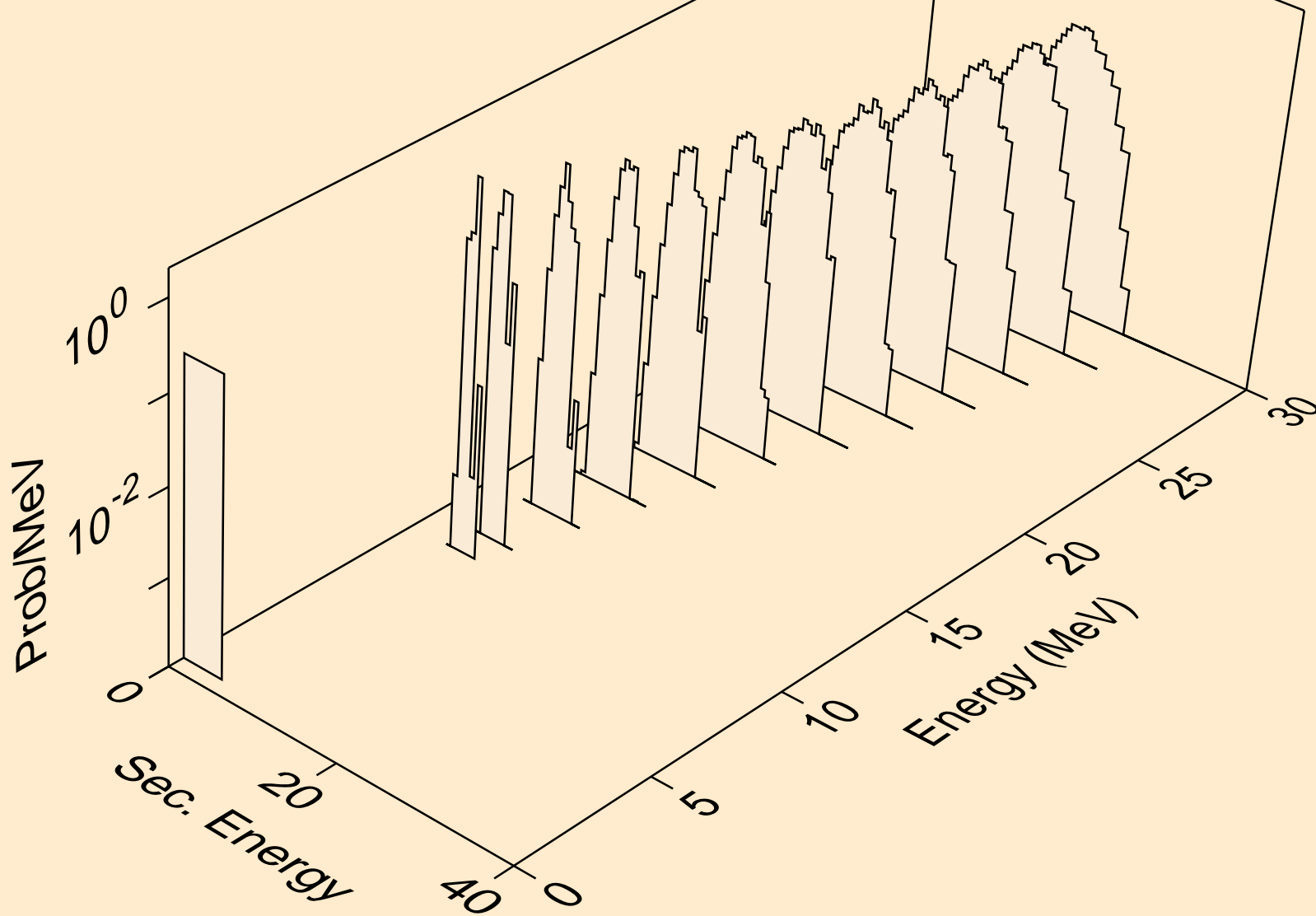

LU166 NEUTRON ACER TENDL-2019 LIBRARY; T=293.16K  
alphas from (n,a)

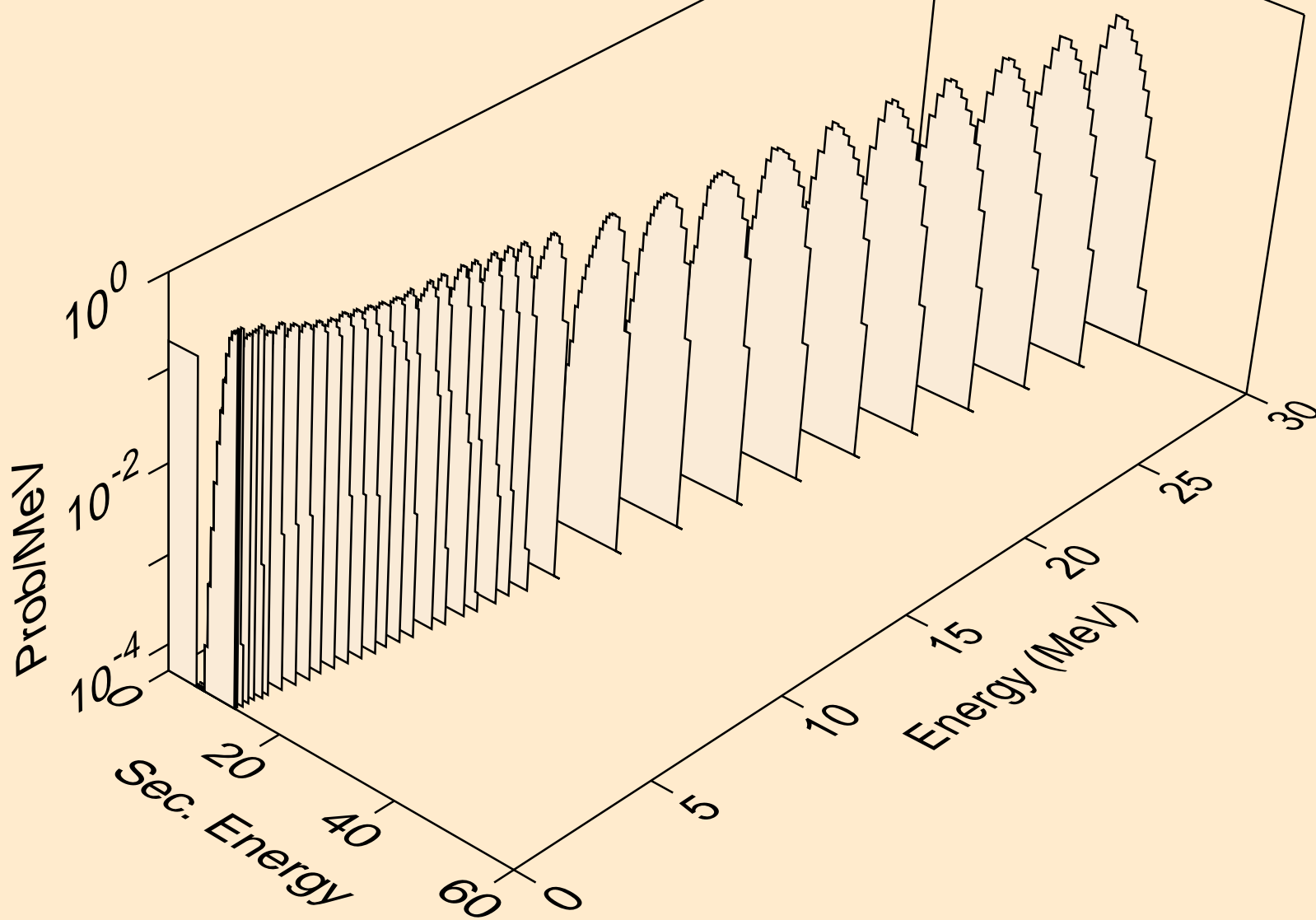

LU166 NEUTRON ACER TENDL-2019 LIBRARY; T=293.16K  
alphas from (n,2a)

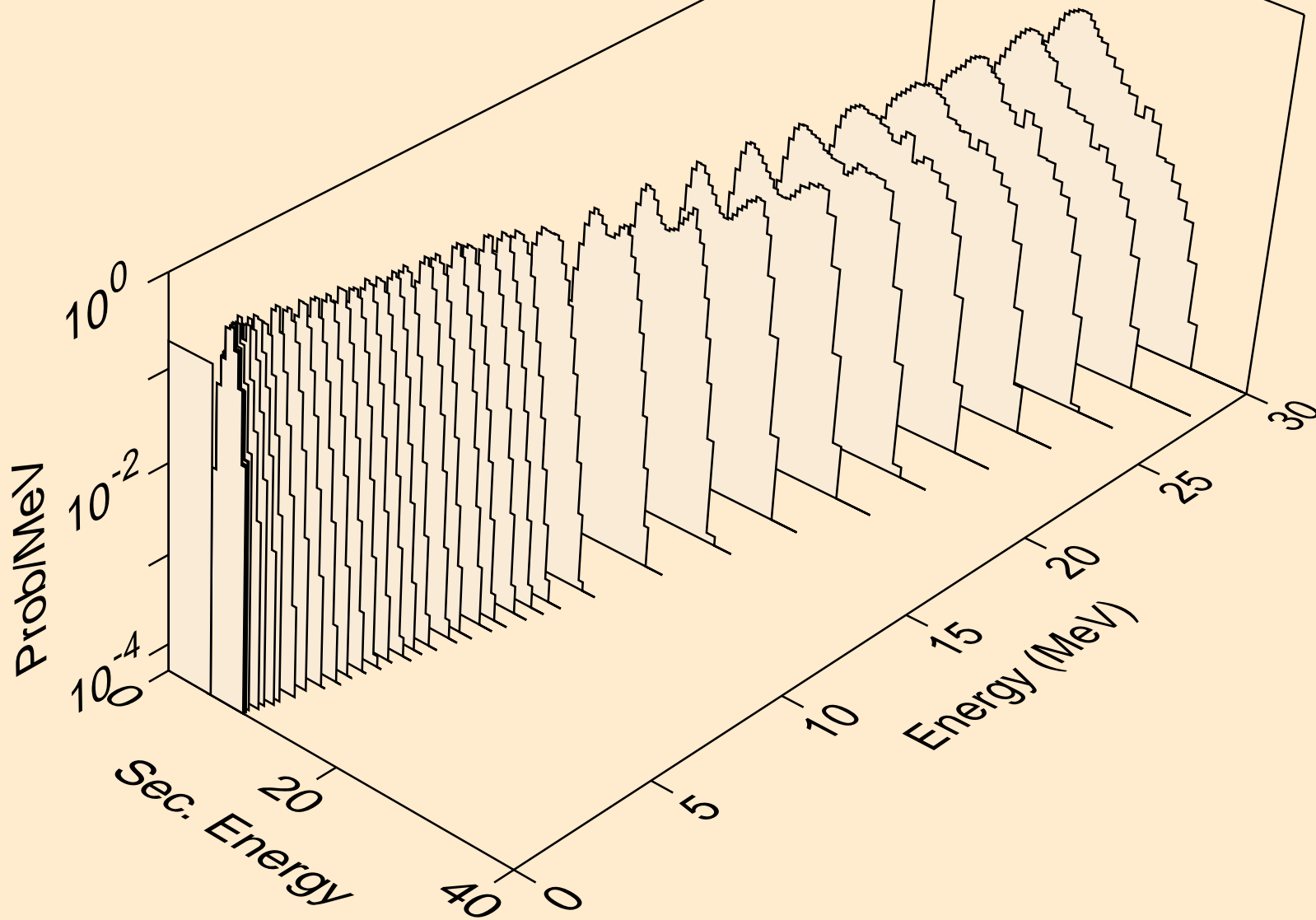

LU166 NEUTRON ACER TENDL-2019 LIBRARY; T=293.16K  
alphas from (n,pa)

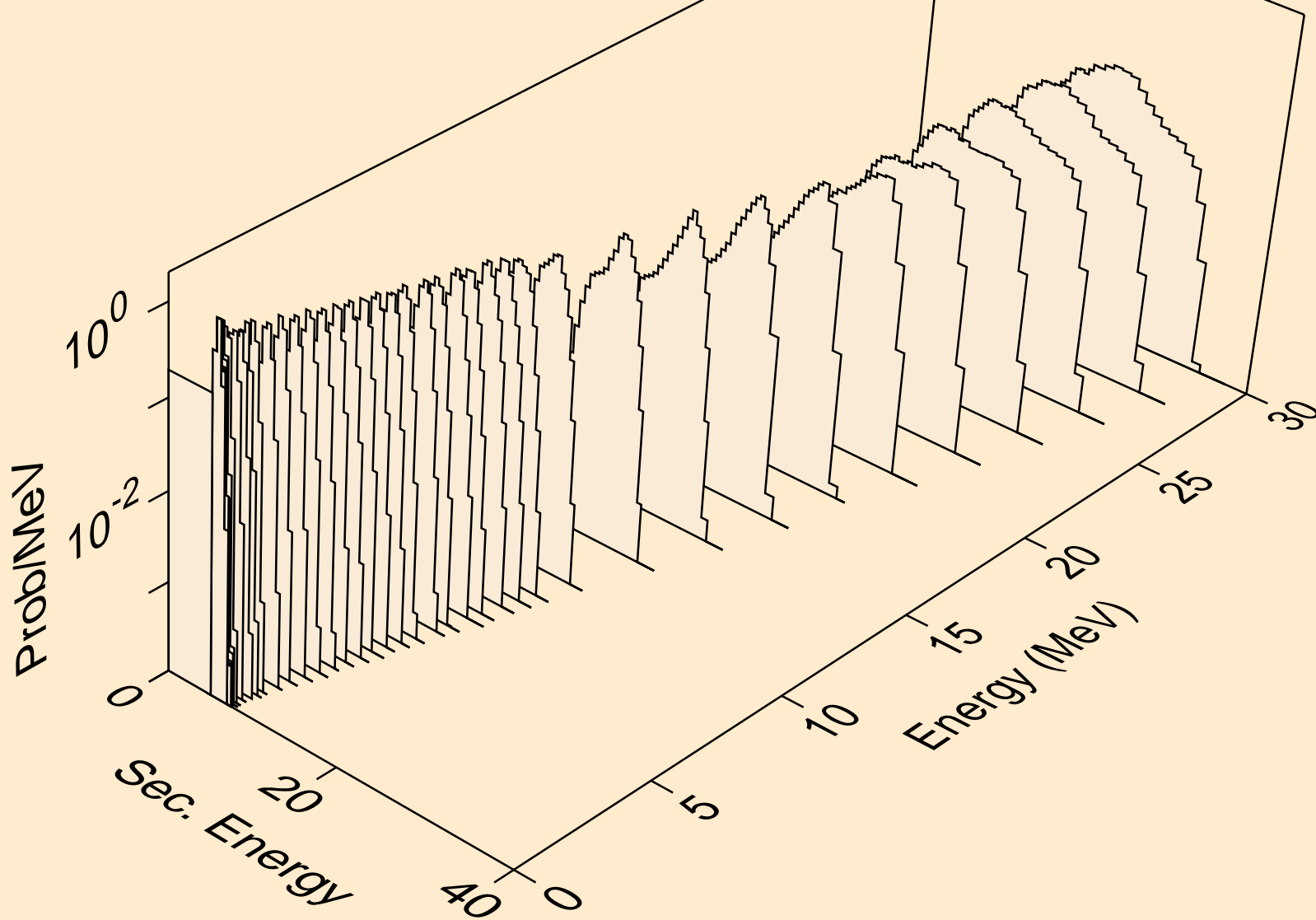

LU166 NEUTRON ACER TENDL-2019 LIBRARY; T=293.16K  
alphas from (n,da)

