

LU168 NEUTRON ACER TENDL-2019 LIBRARY; T=293.16K  
Principal cross sections

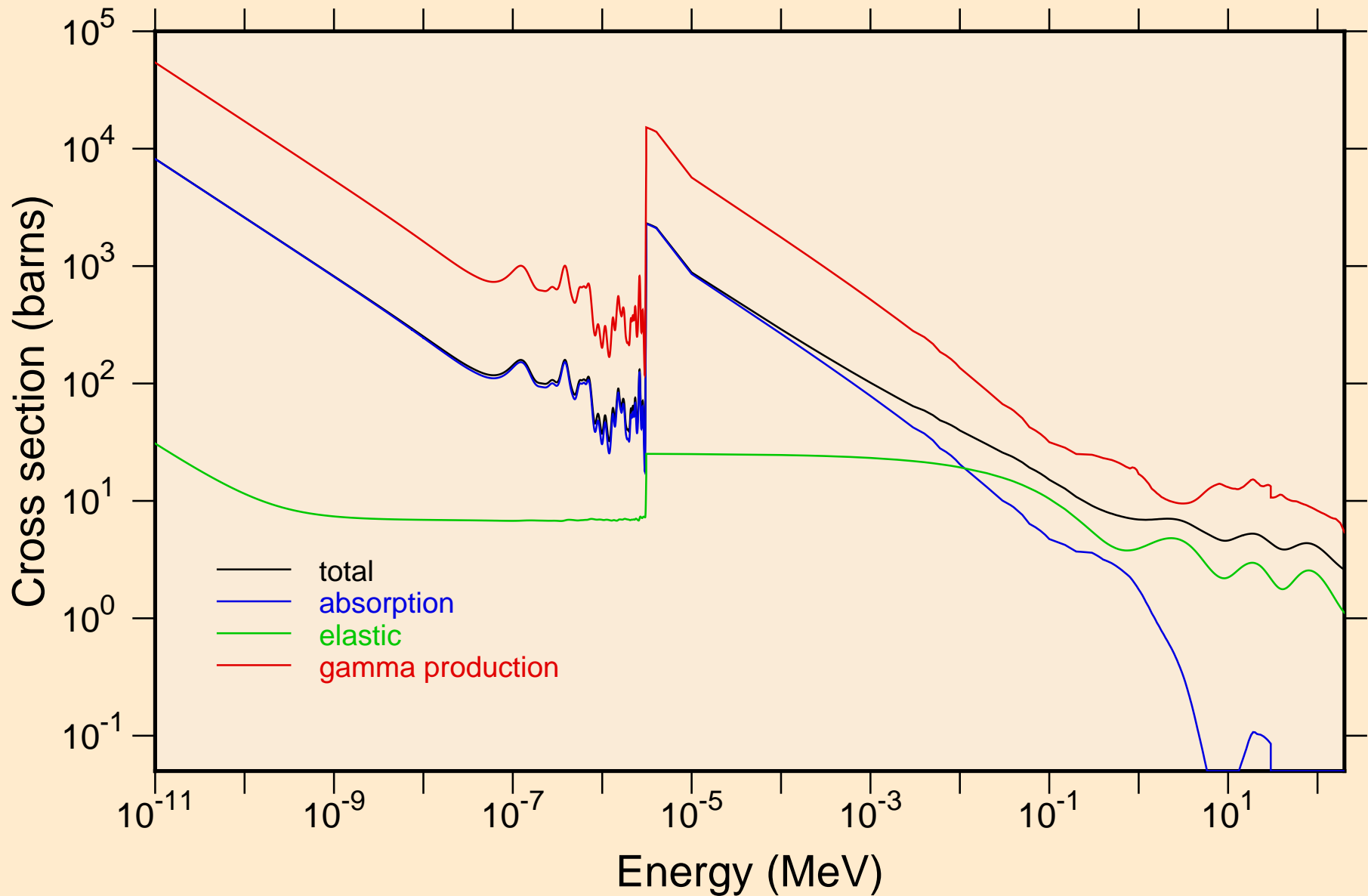

LU168 NEUTRON ACER TENDL-2019 LIBRARY; T=293.16K  
resonance total cross section

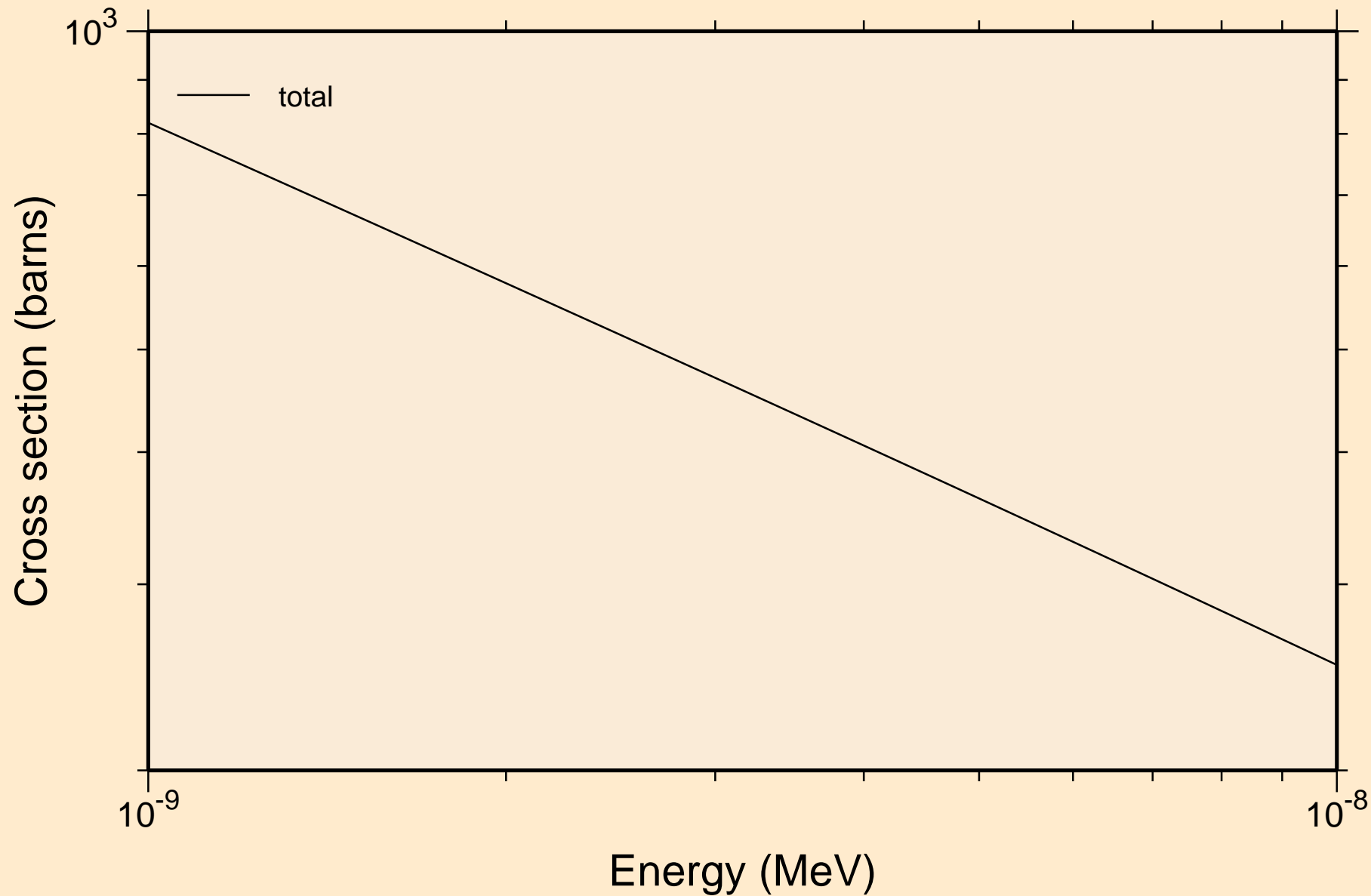

LU168 NEUTRON ACER TENDL-2019 LIBRARY; T=293.16K  
resonance total cross section

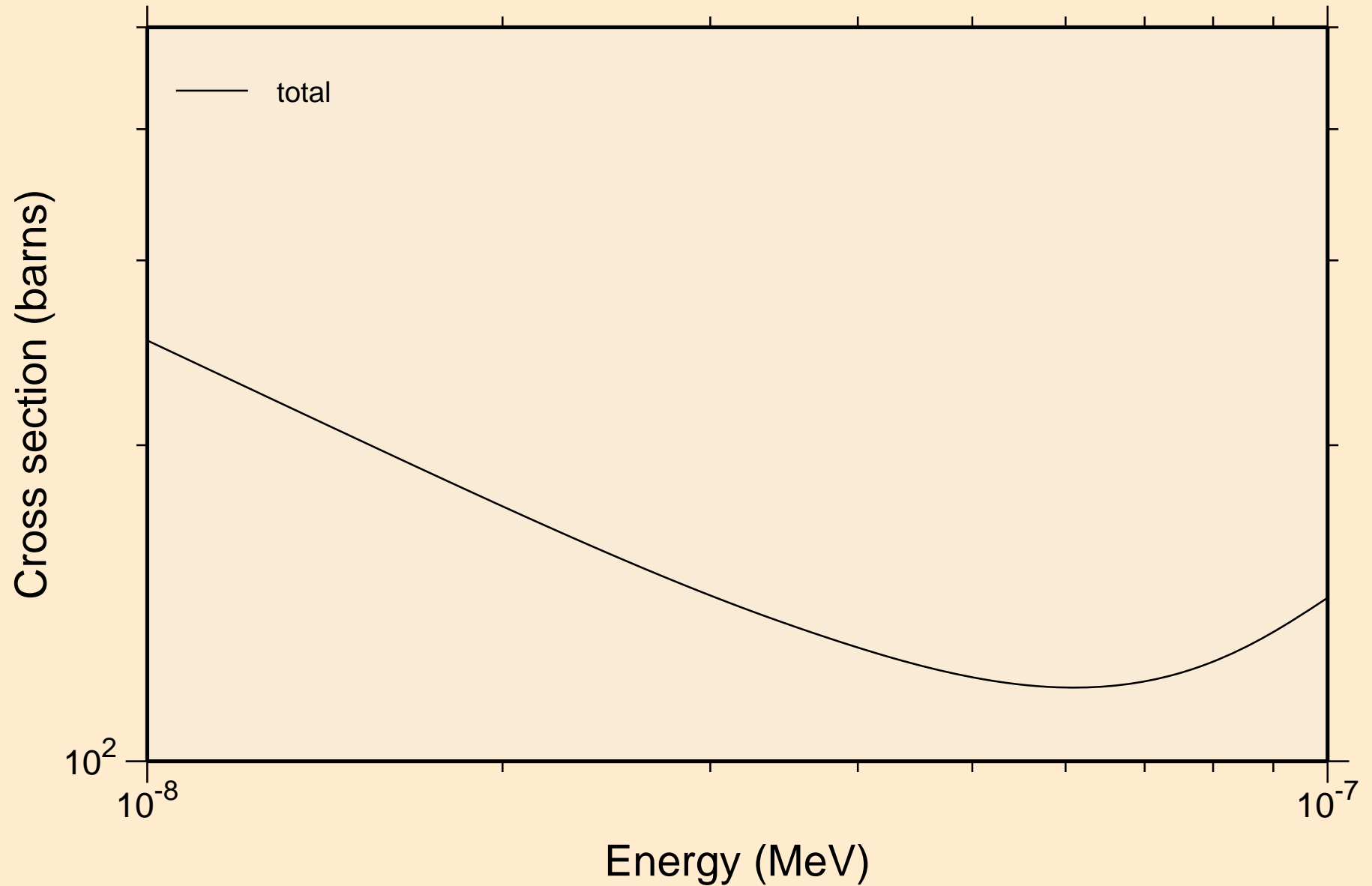

LU168 NEUTRON ACER TENDL-2019 LIBRARY; T=293.16K  
resonance total cross section

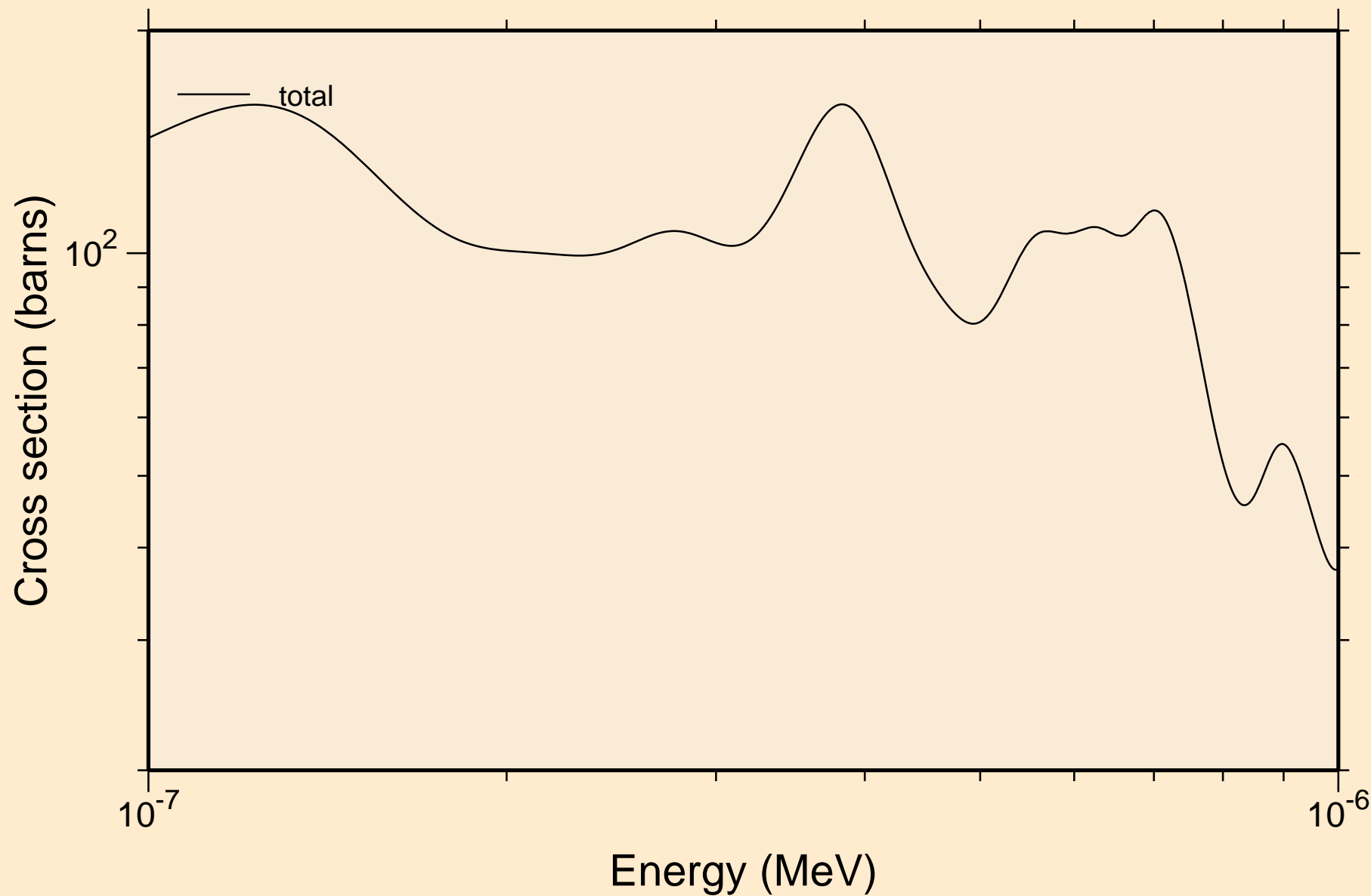

LU168 NEUTRON ACER TENDL-2019 LIBRARY; T=293.16K  
resonance total cross section

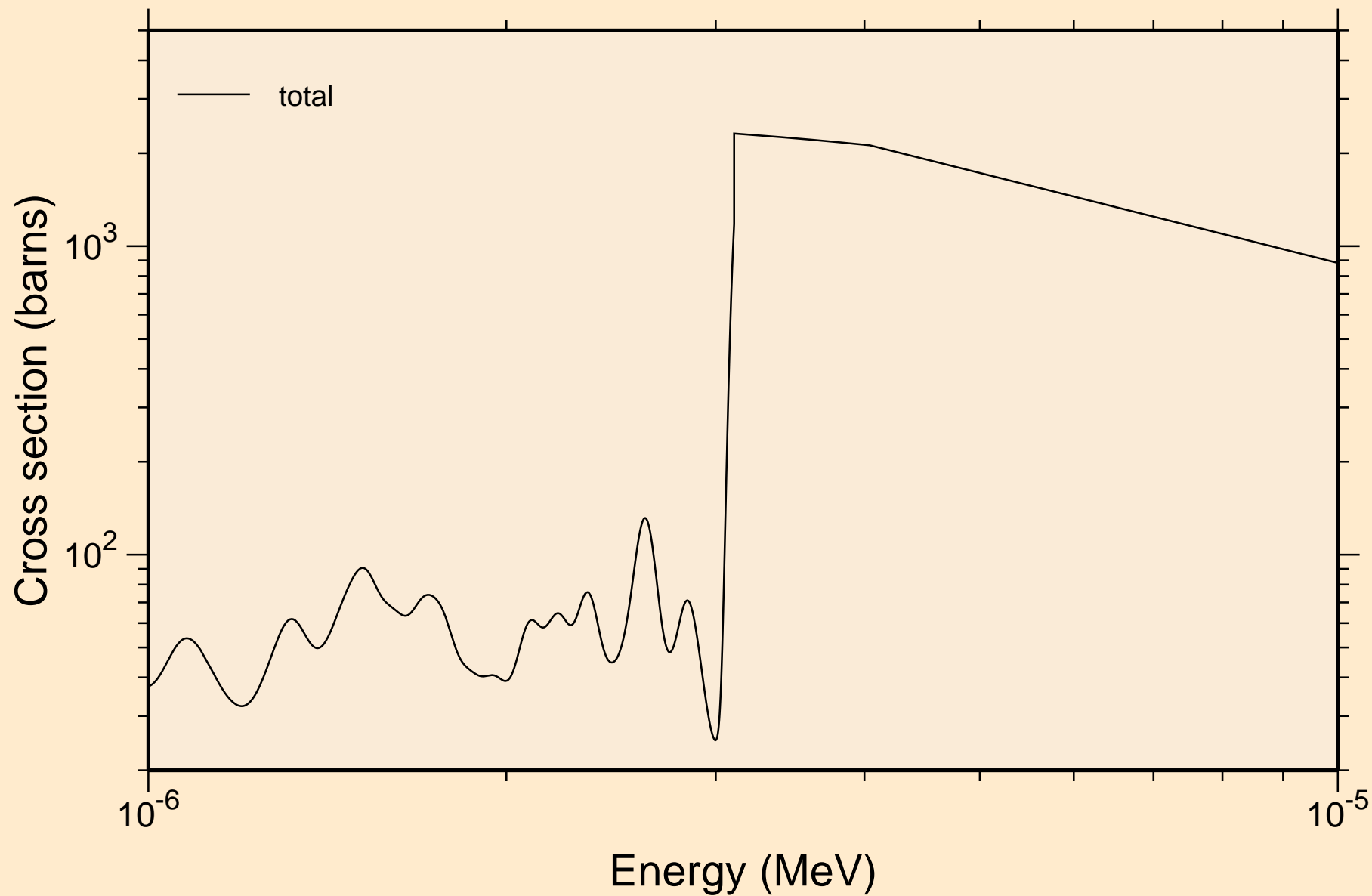

LU168 NEUTRON ACER TENDL-2019 LIBRARY; T=293.16K  
resonance total cross section

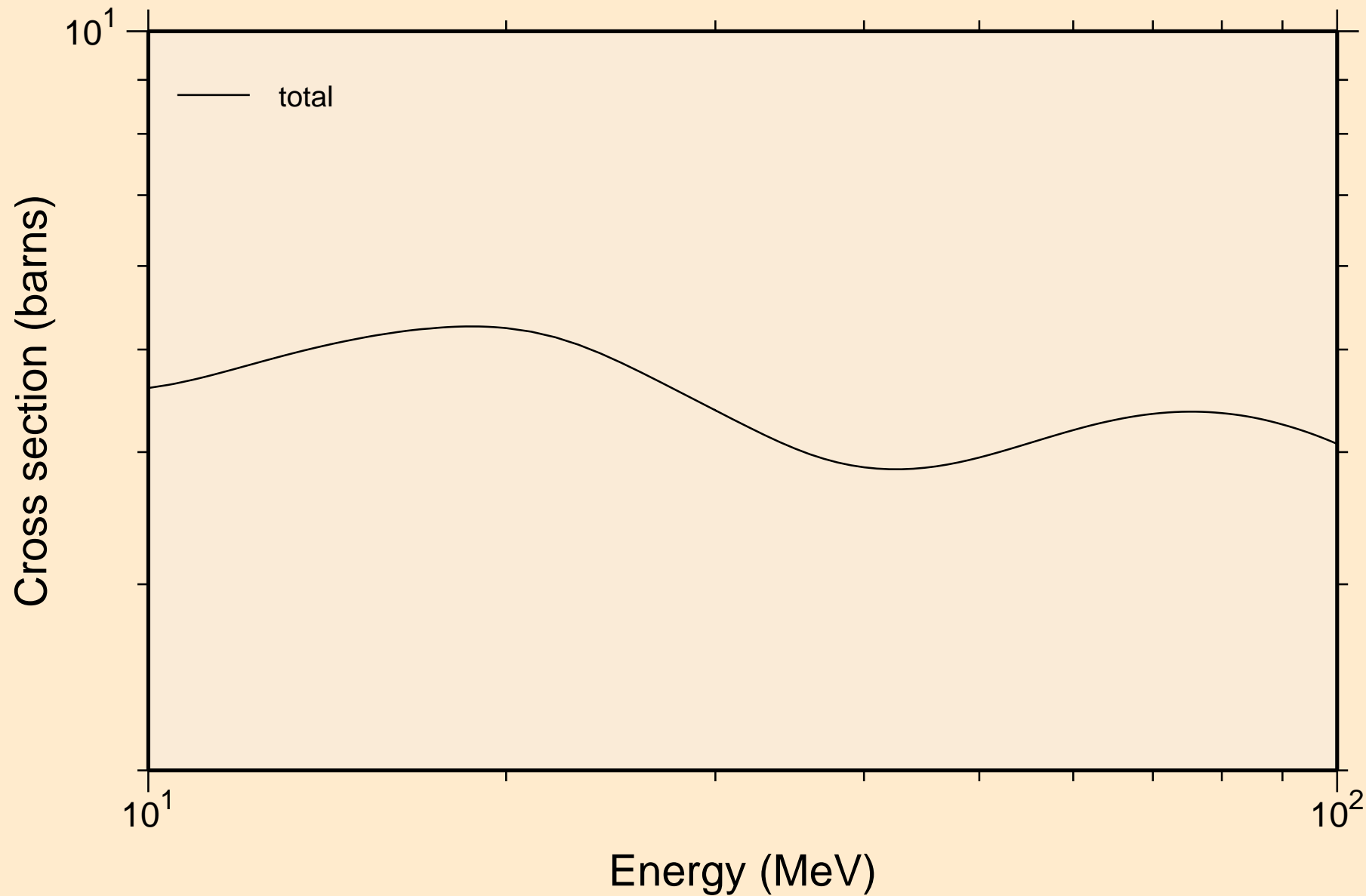

LU168 NEUTRON ACER TENDL-2019 LIBRARY; T=293.16K  
resonance absorption cross sections

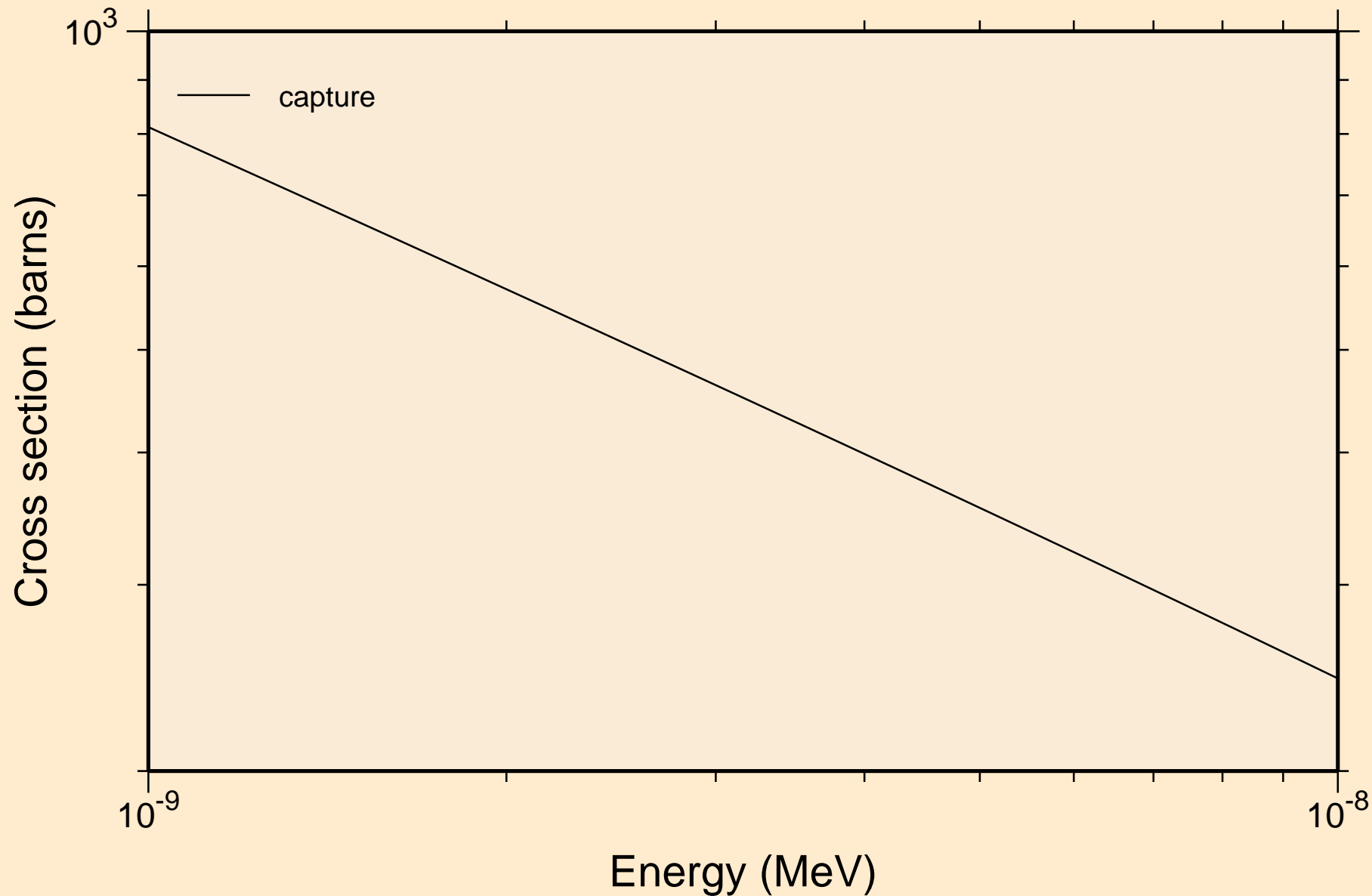

LU168 NEUTRON ACER TENDL-2019 LIBRARY; T=293.16K  
resonance absorption cross sections

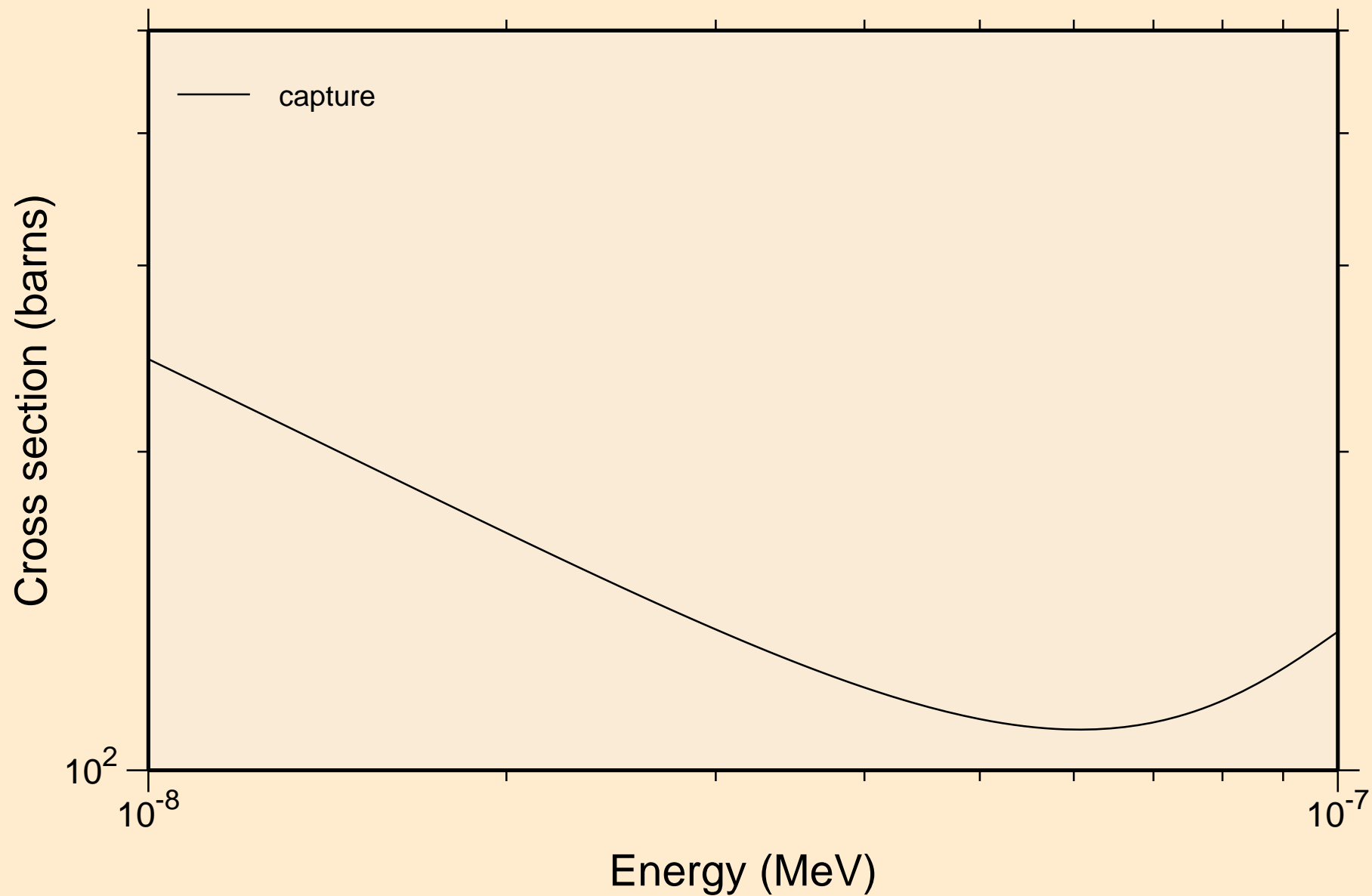



LU168 NEUTRON ACER TENDL-2019 LIBRARY; T=293.16K  
resonance absorption cross sections

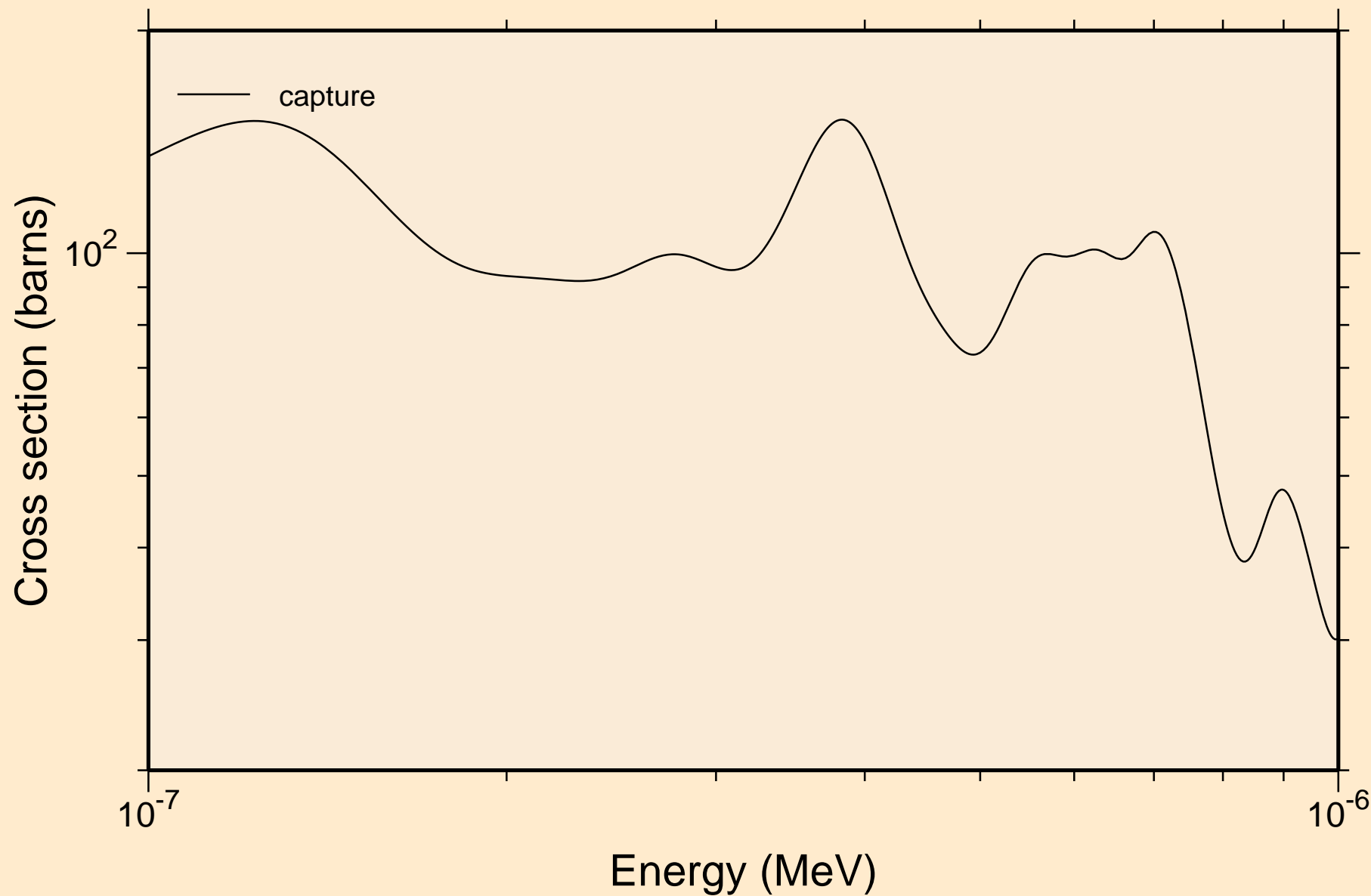

LU168 NEUTRON ACER TENDL-2019 LIBRARY; T=293.16K  
resonance absorption cross sections

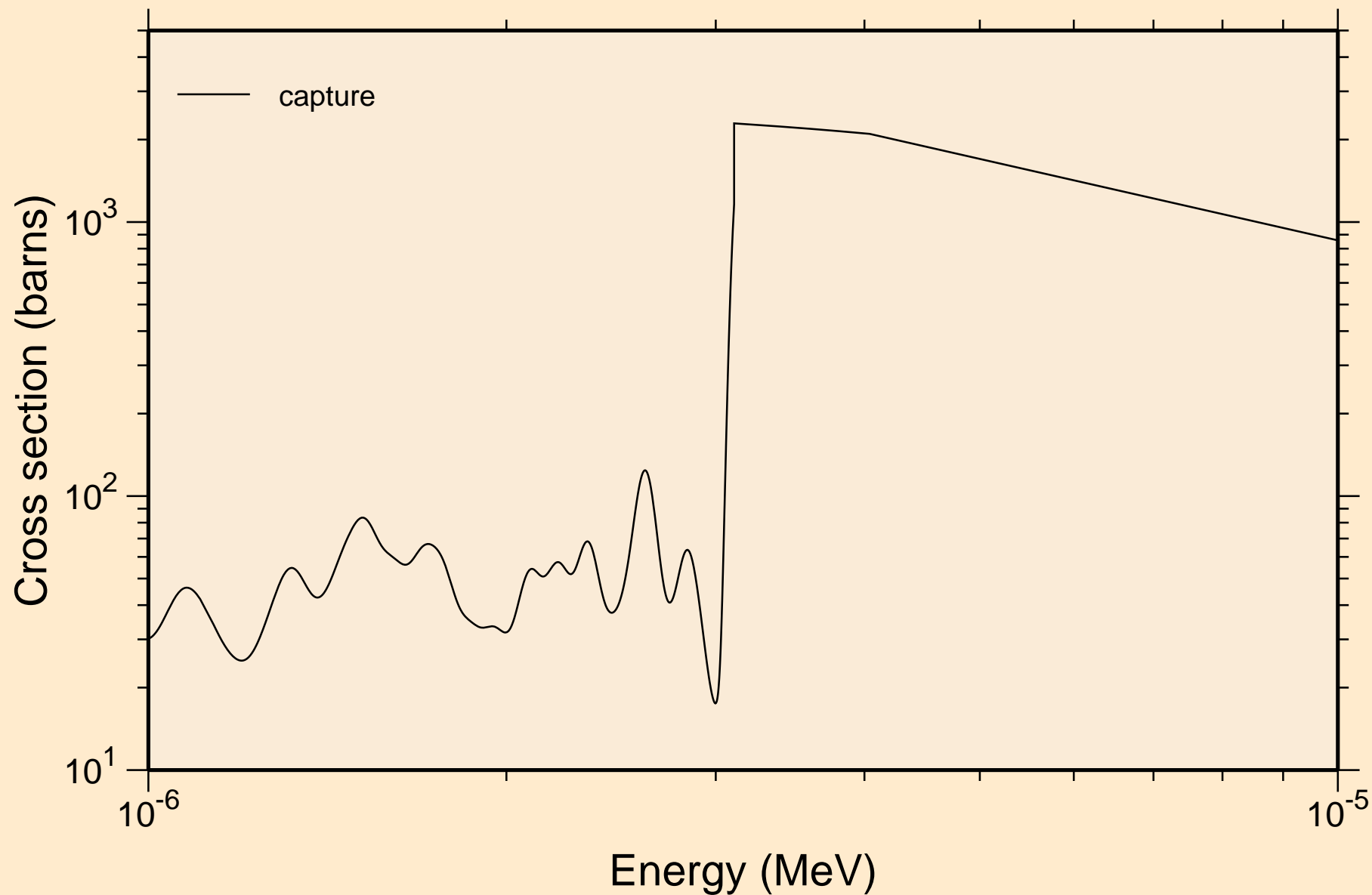

LU168 NEUTRON ACER TENDL-2019 LIBRARY; T=293.16K  
resonance absorption cross sections

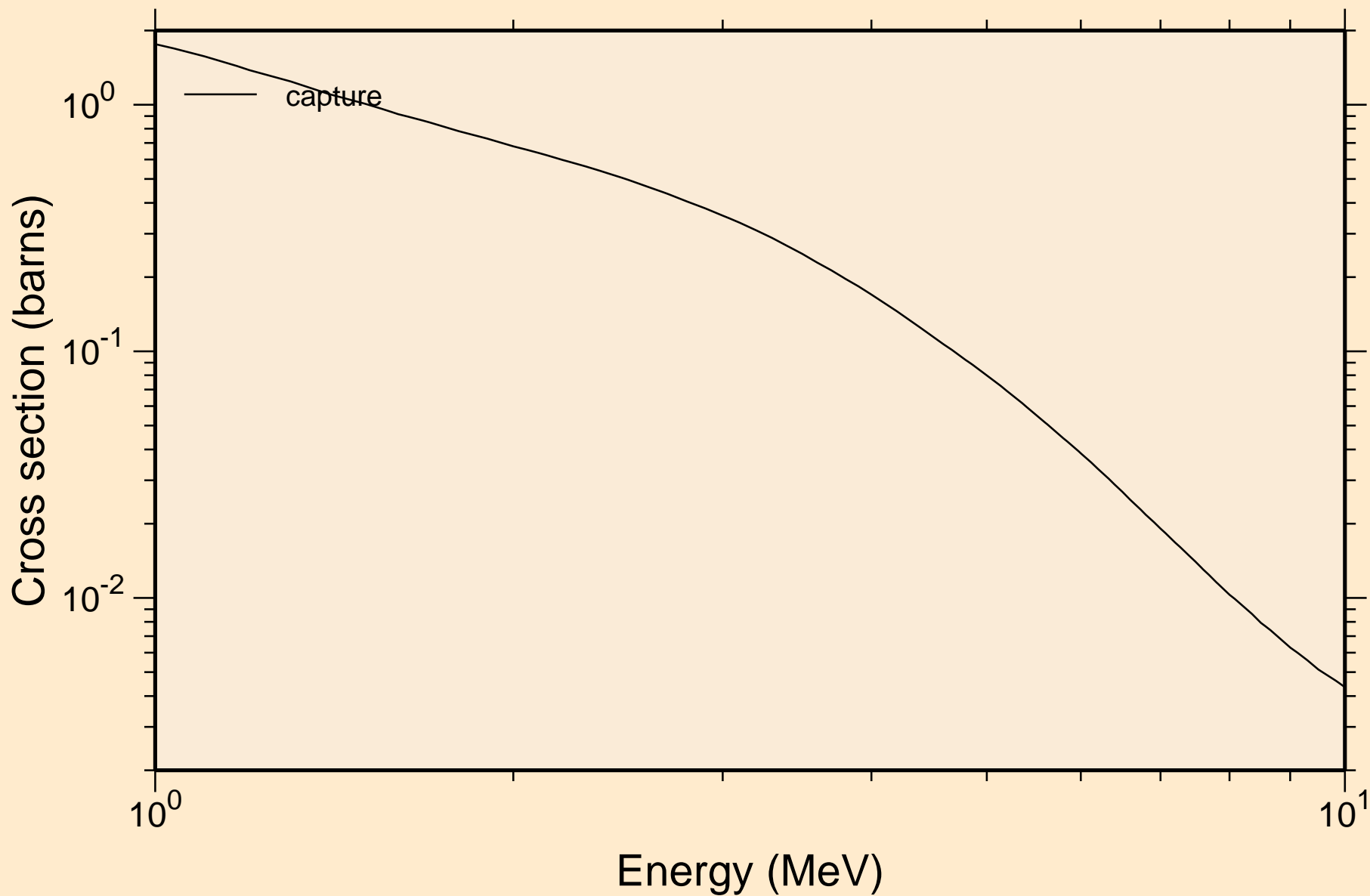

LU168 NEUTRON ACER TENDL-2019 LIBRARY; T=293.16K  
Heating

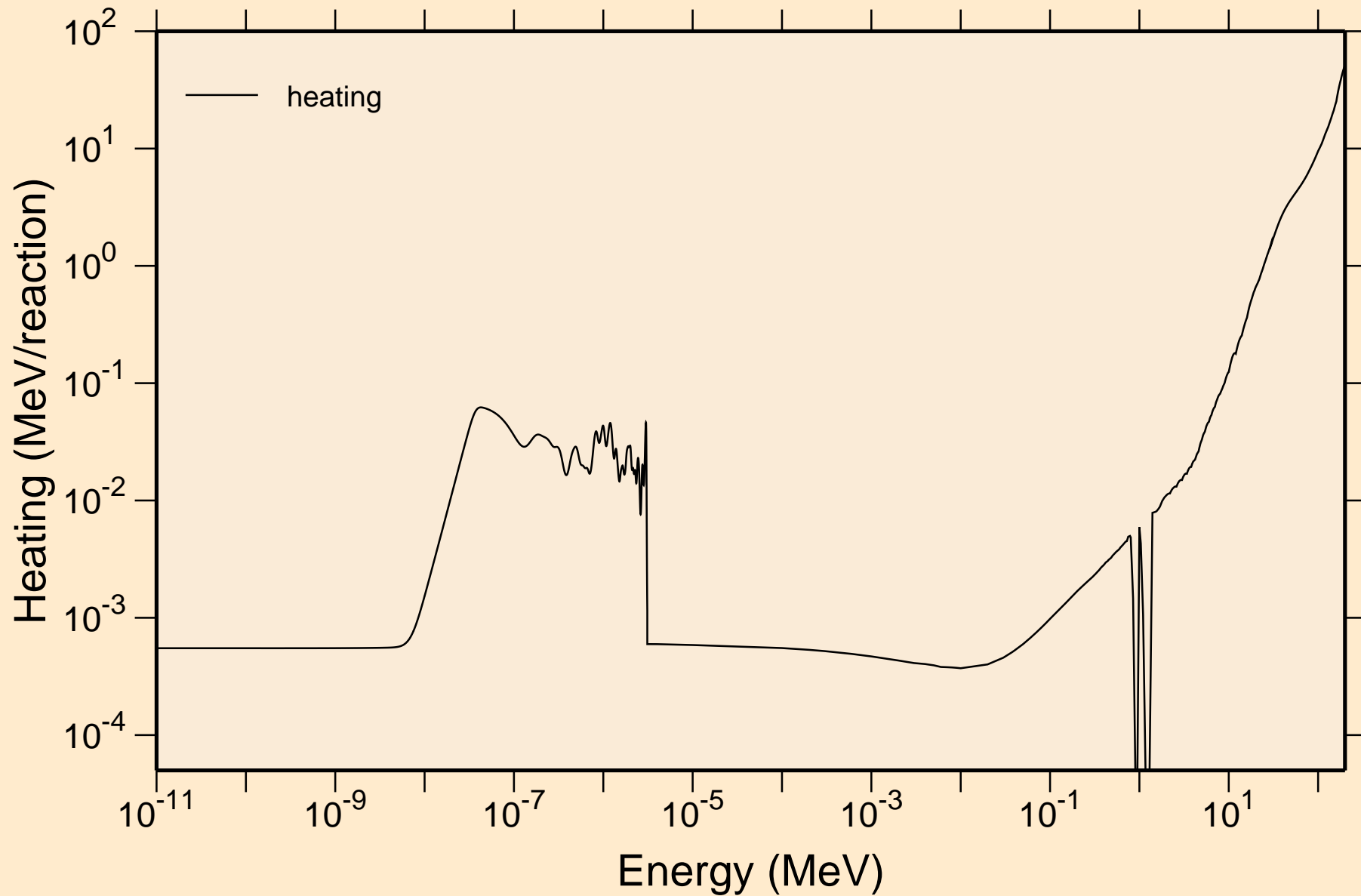

LU168 NEUTRON ACER TENDL-2019 LIBRARY; T=293.16K  
Damage

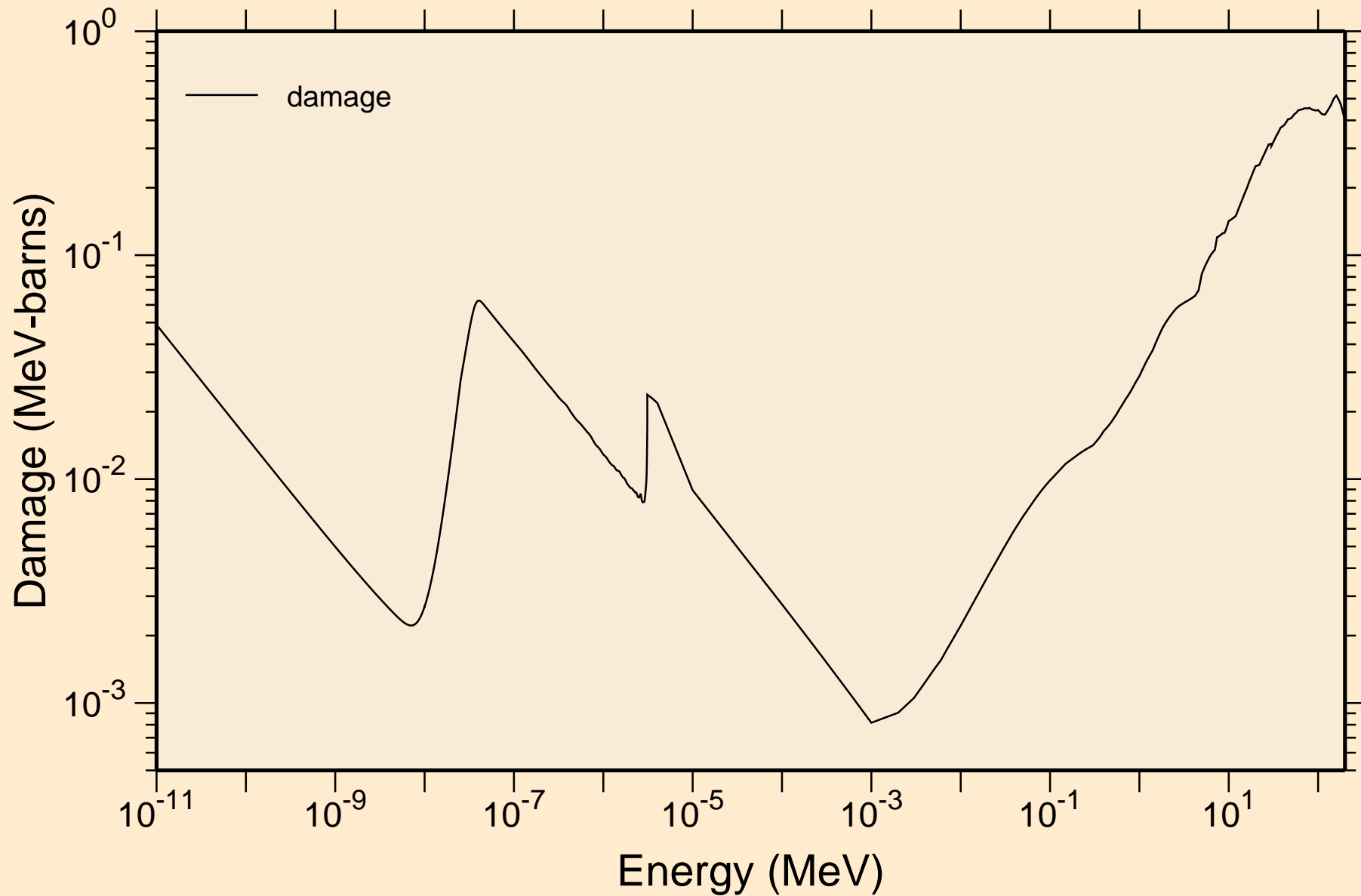

LU168 NEUTRON ACER TENDL-2019 LIBRARY; T=293.16K  
Non-threshold reactions

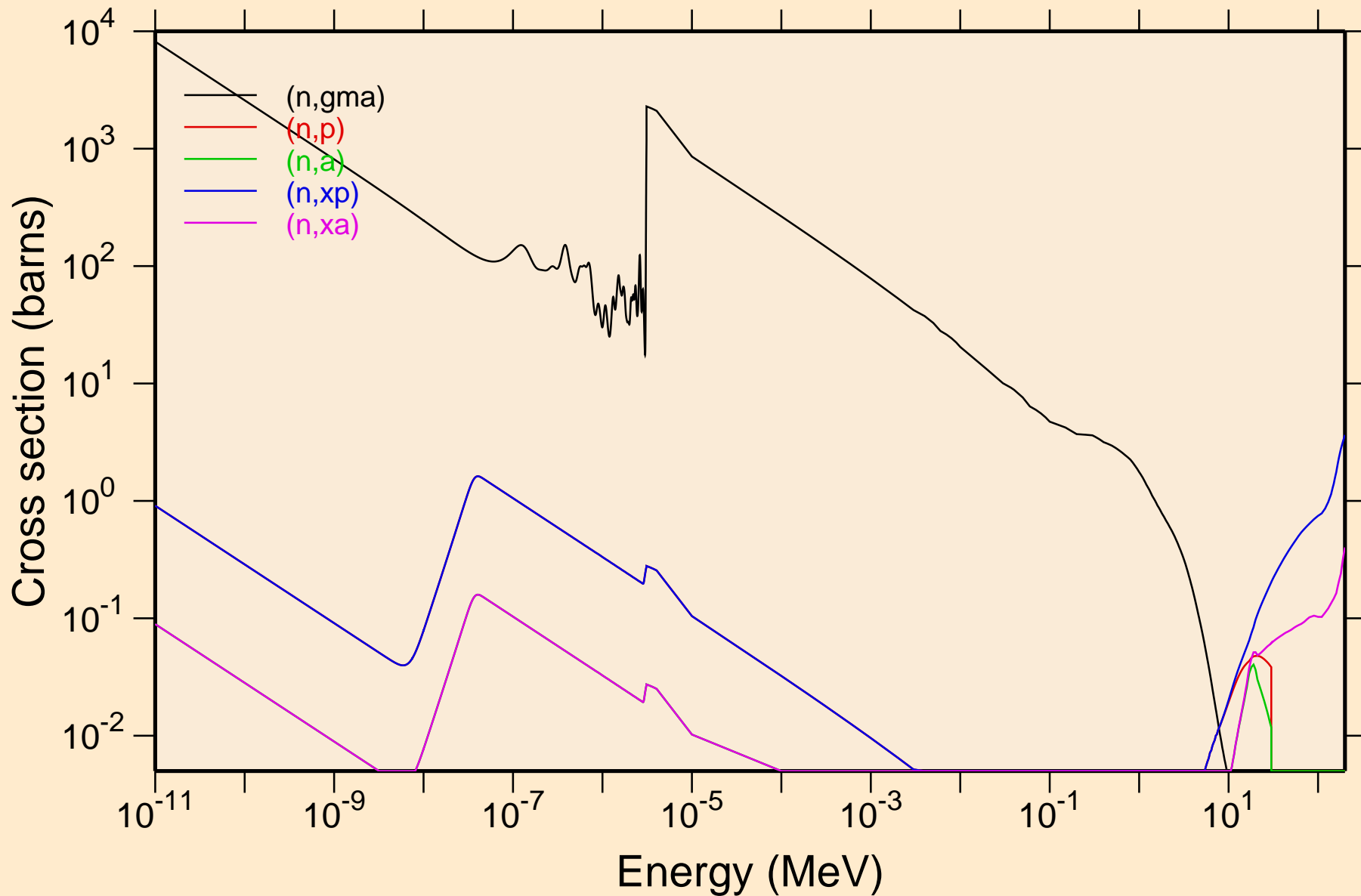

LU168 NEUTRON ACER TENDL-2019 LIBRARY; T=293.16K  
Principal cross sections

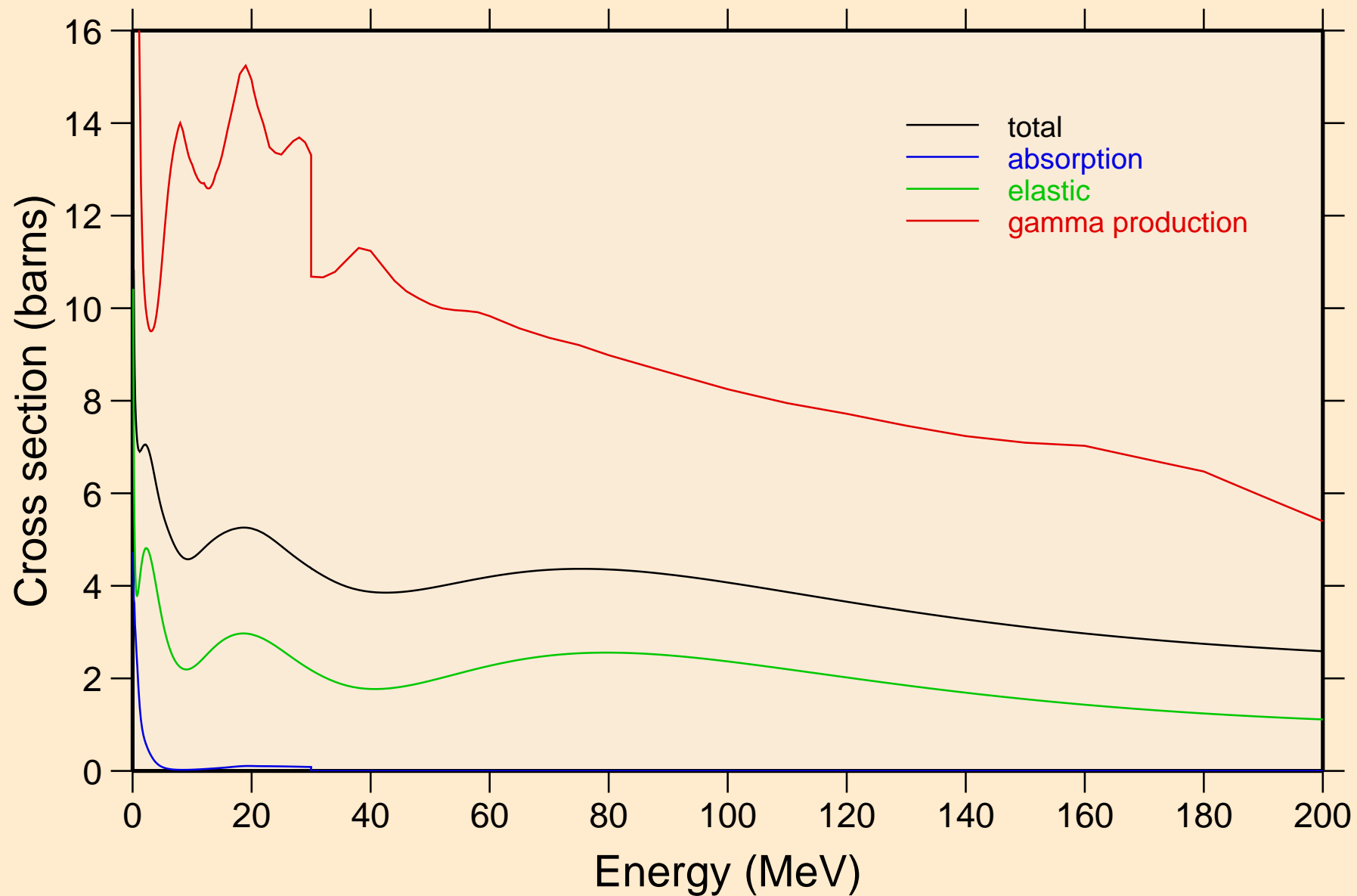

LU168 NEUTRON ACER TENDL-2019 LIBRARY; T=293.16K  
Heating

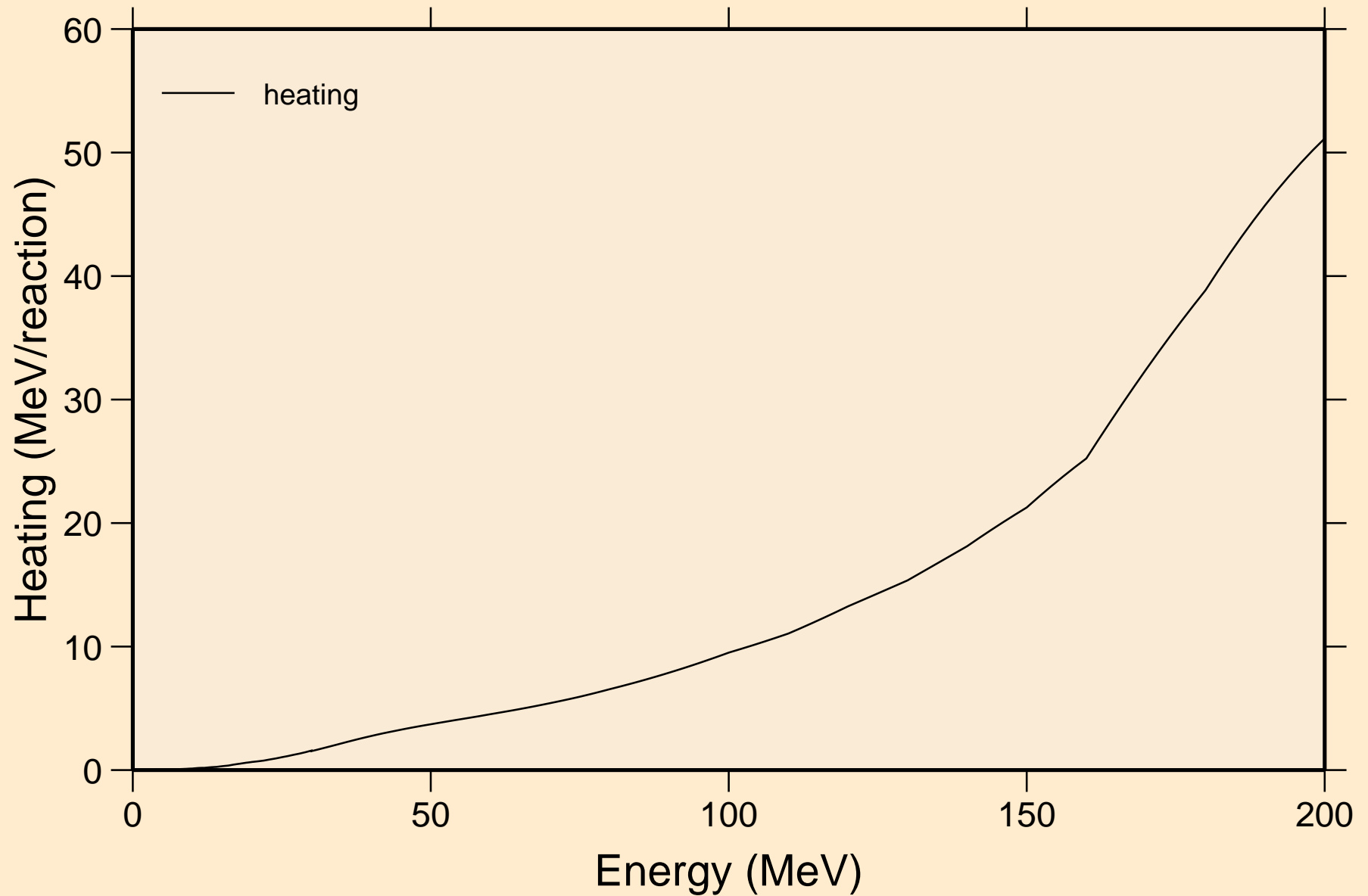



LU168 NEUTRON ACER TENDL-2019 LIBRARY; T=293.16K  
Damage

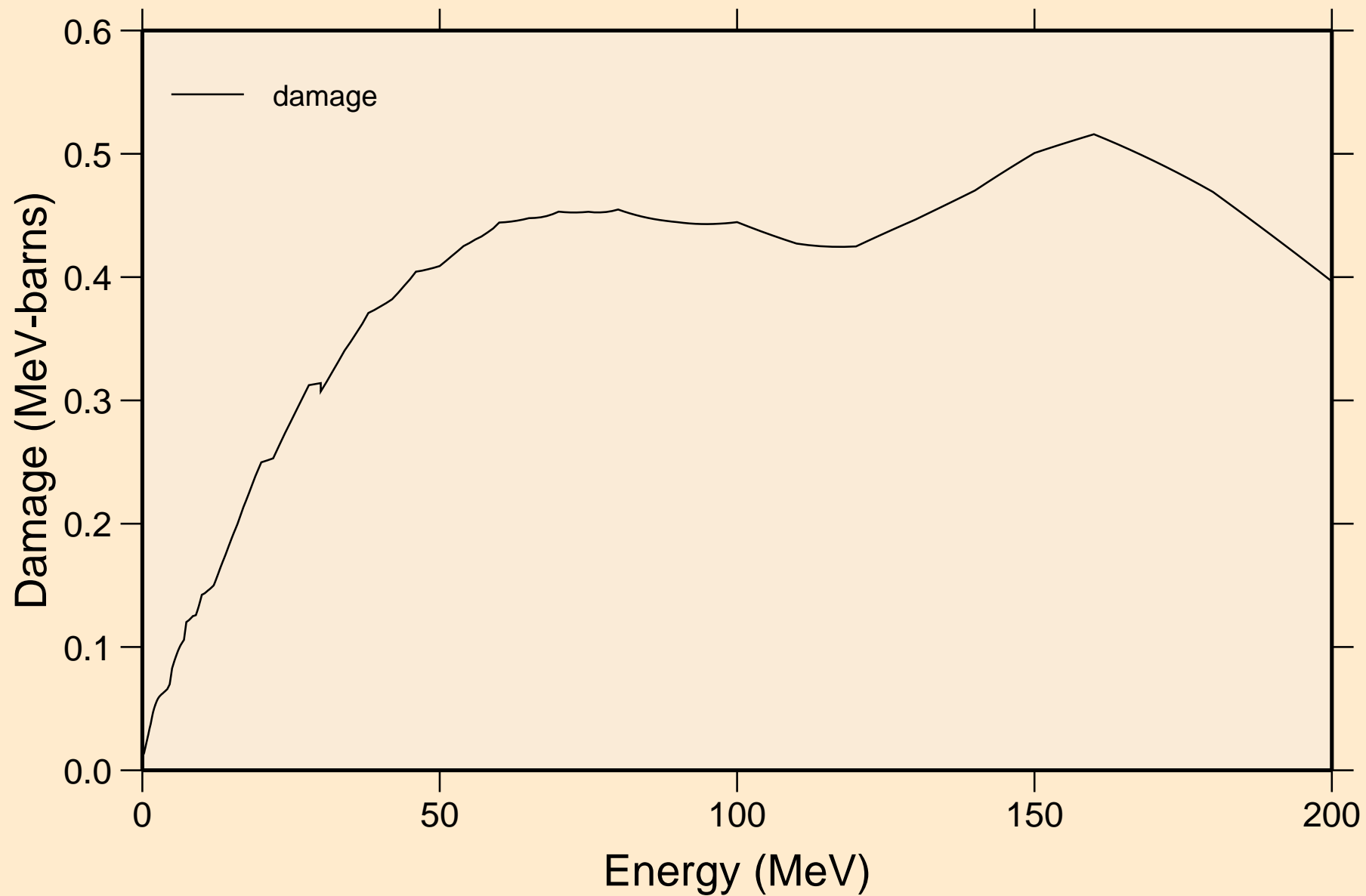

LU168 NEUTRON ACER TENDL-2019 LIBRARY; T=293.16K  
Non-threshold reactions

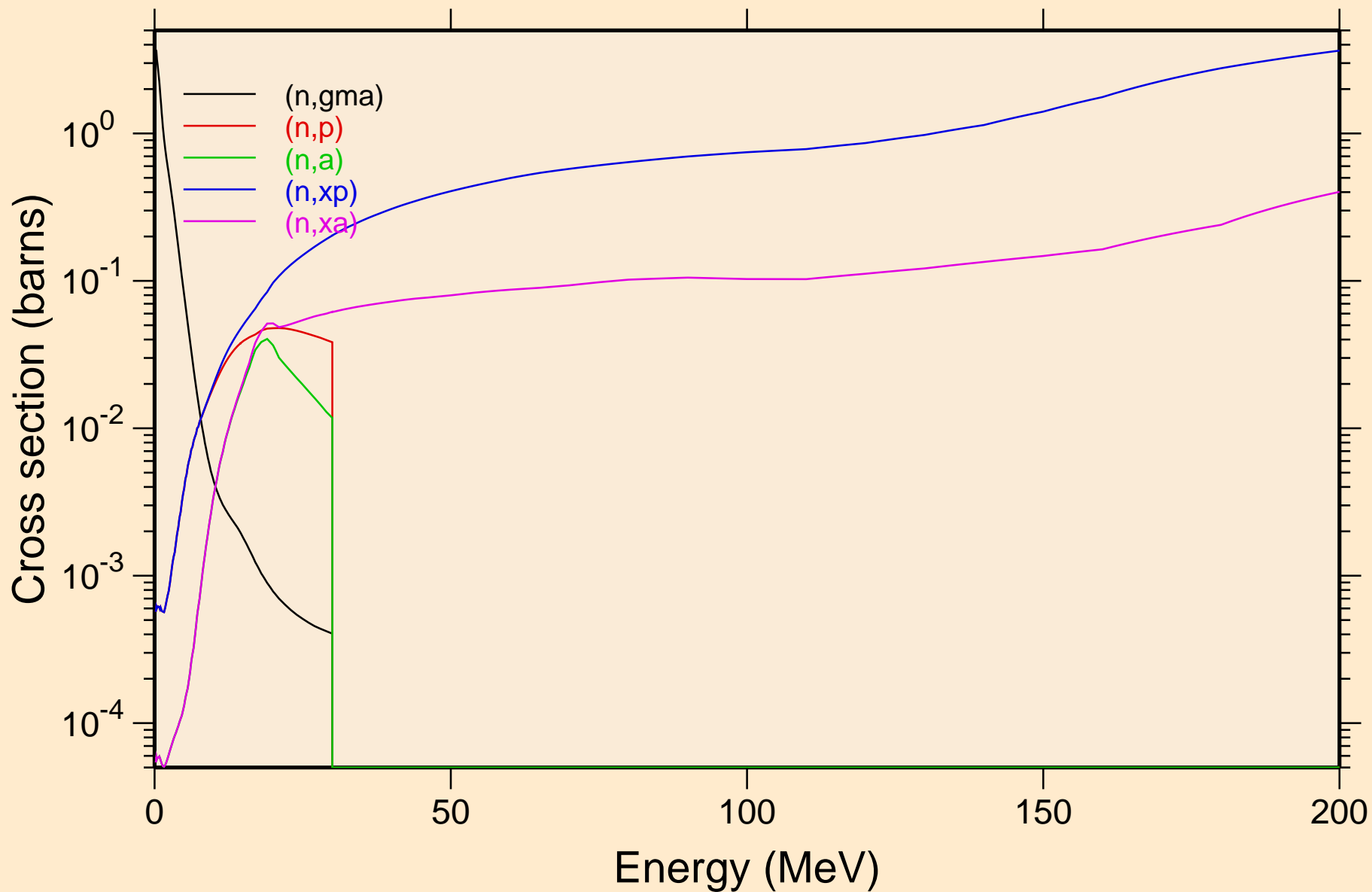

LU168 NEUTRON ACER TENDL-2019 LIBRARY; T=293.16K  
Inelastic levels

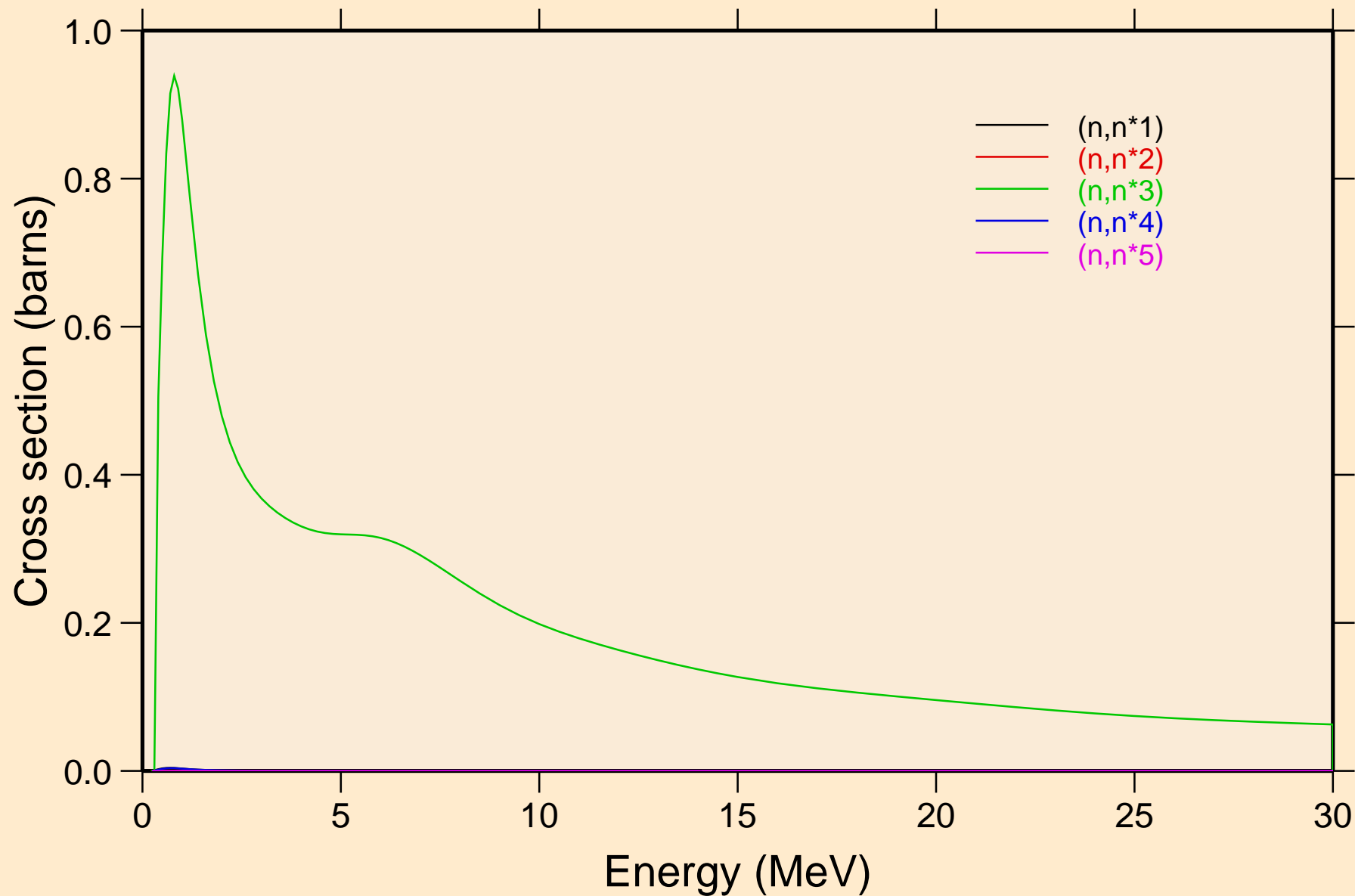

LU168 NEUTRON ACER TENDL-2019 LIBRARY; T=293.16K  
Inelastic levels

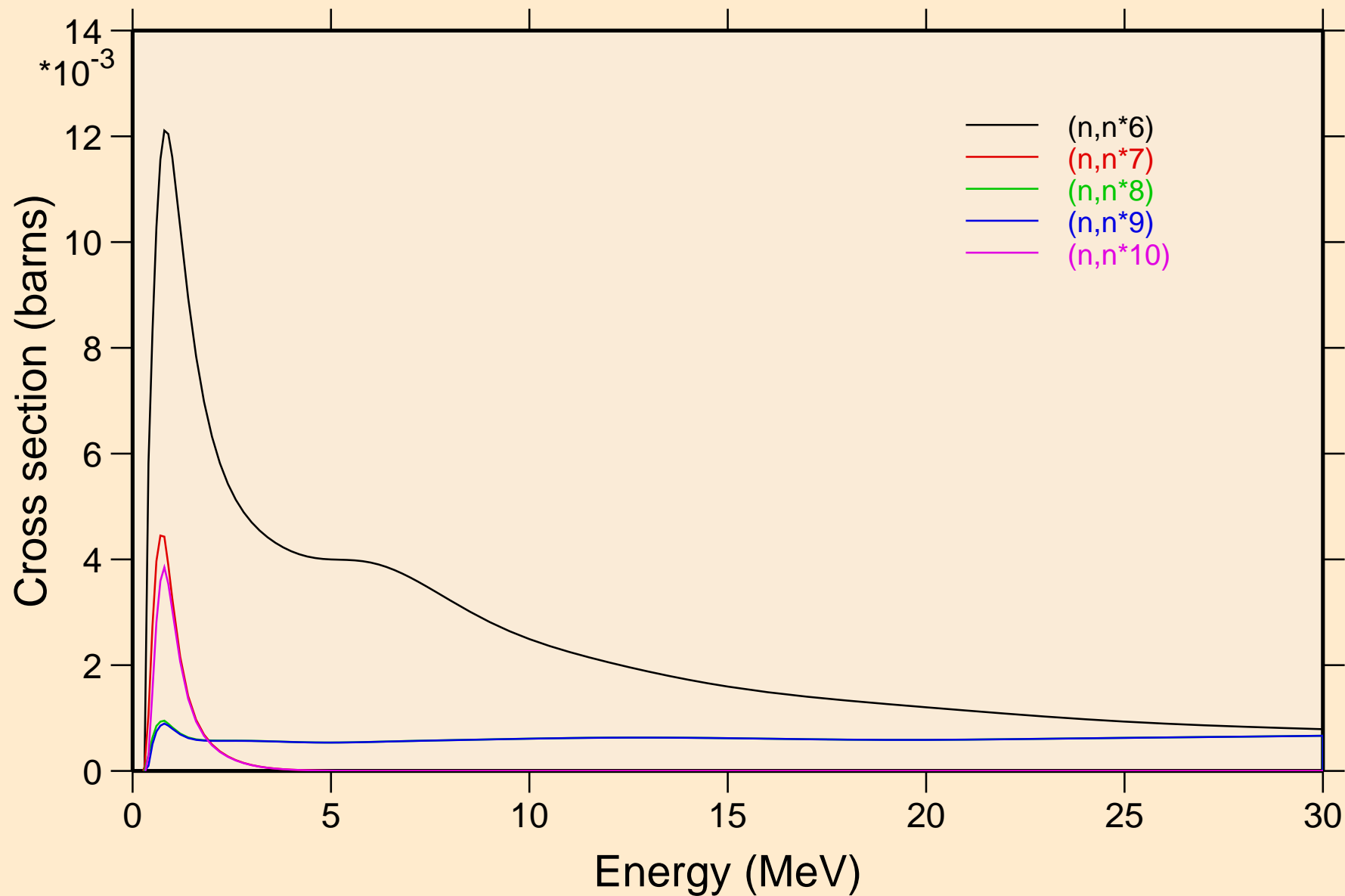

LU168 NEUTRON ACER TENDL-2019 LIBRARY; T=293.16K  
Inelastic levels

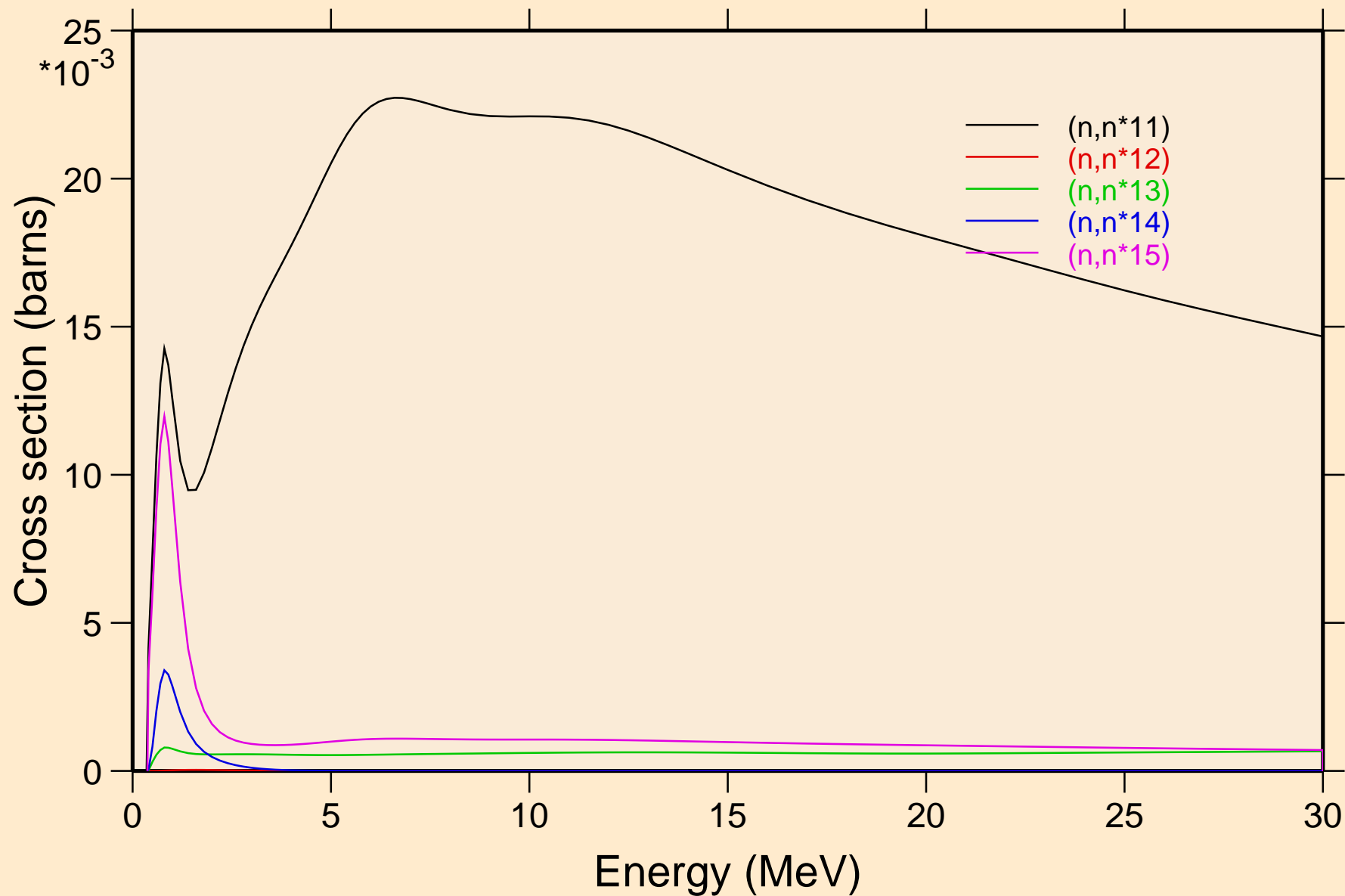

LU168 NEUTRON ACER TENDL-2019 LIBRARY; T=293.16K  
Inelastic levels

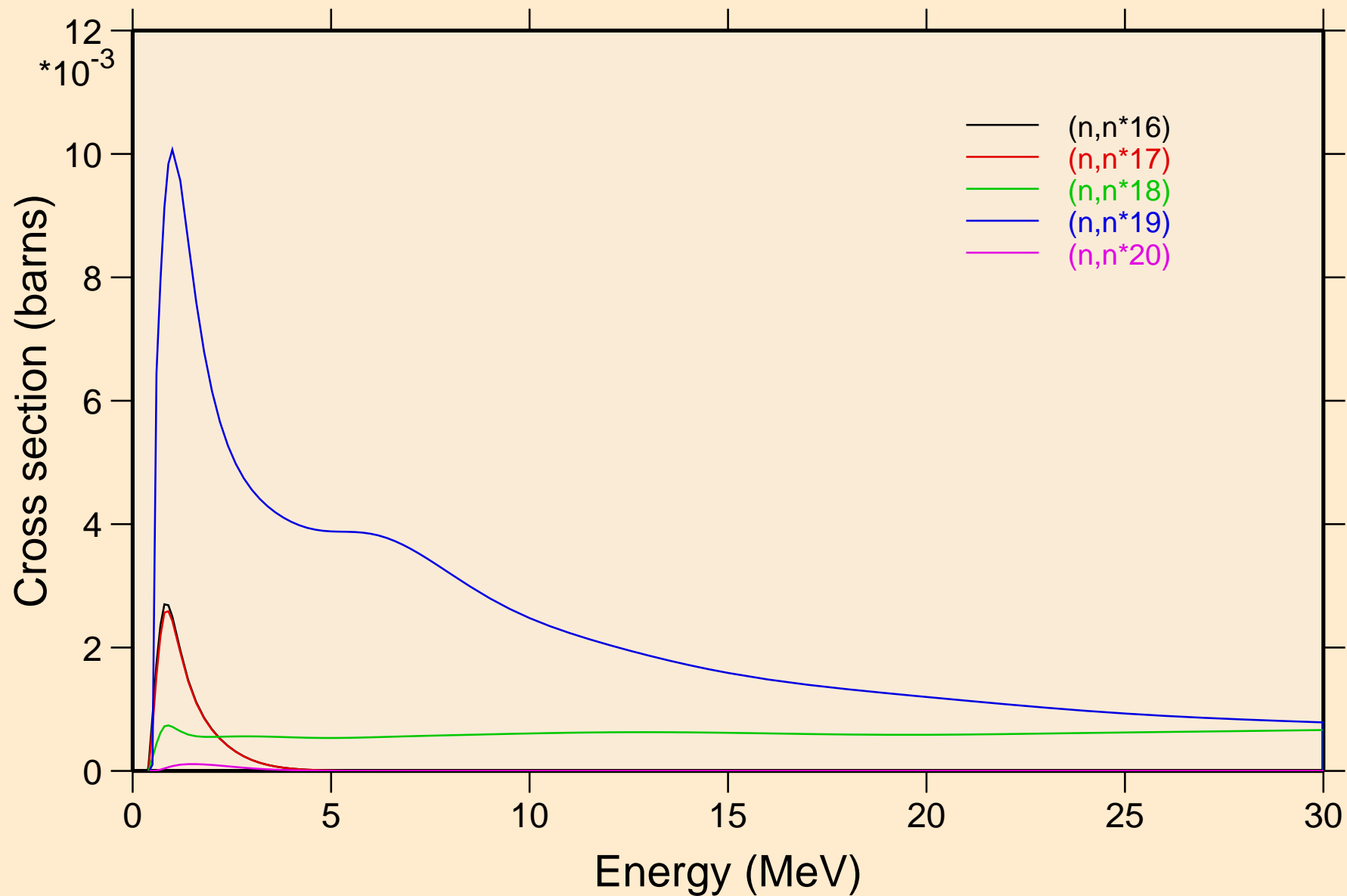

LU168 NEUTRON ACER TENDL-2019 LIBRARY; T=293.16K  
Inelastic levels

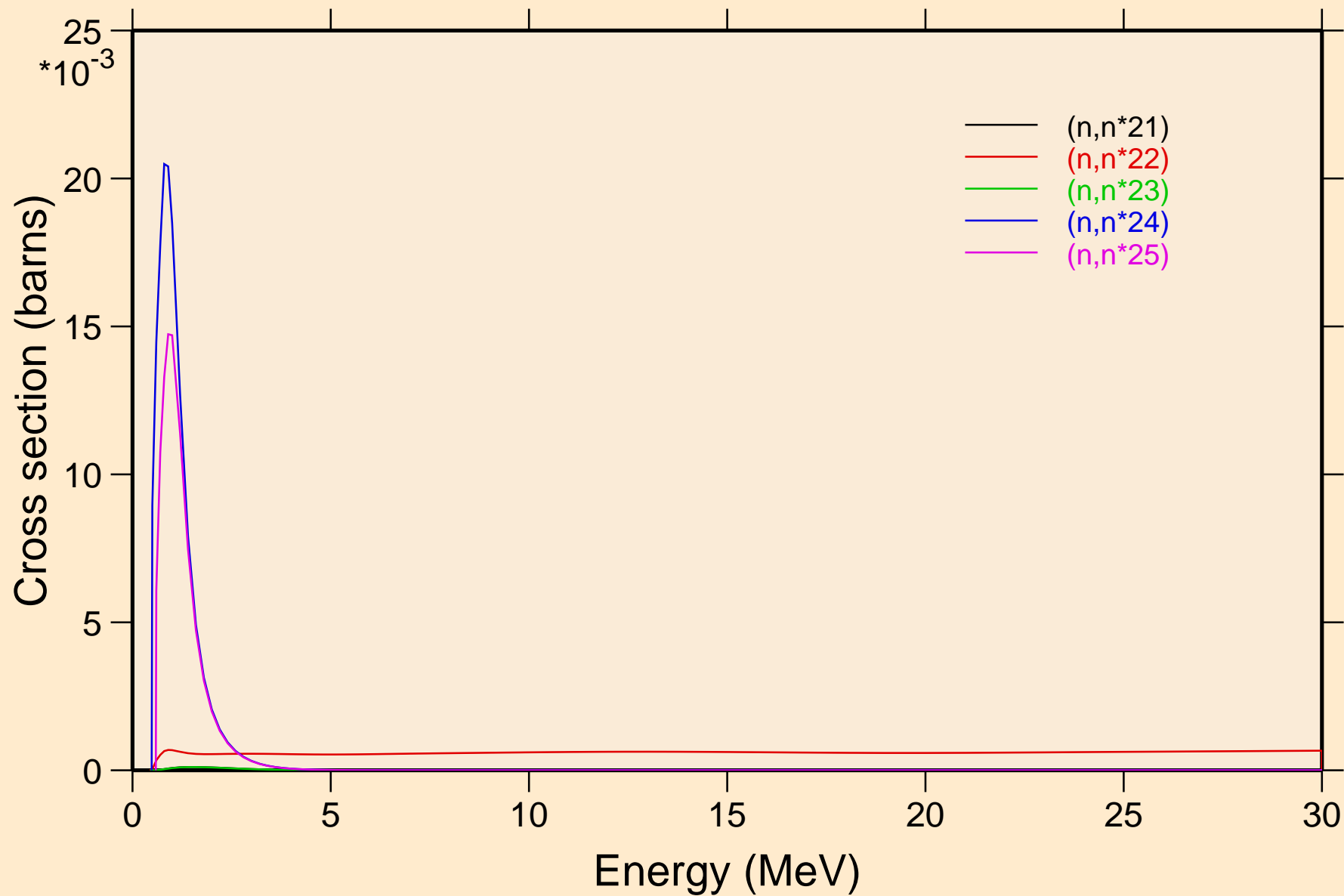

LU168 NEUTRON ACER TENDL-2019 LIBRARY; T=293.16K  
Inelastic levels

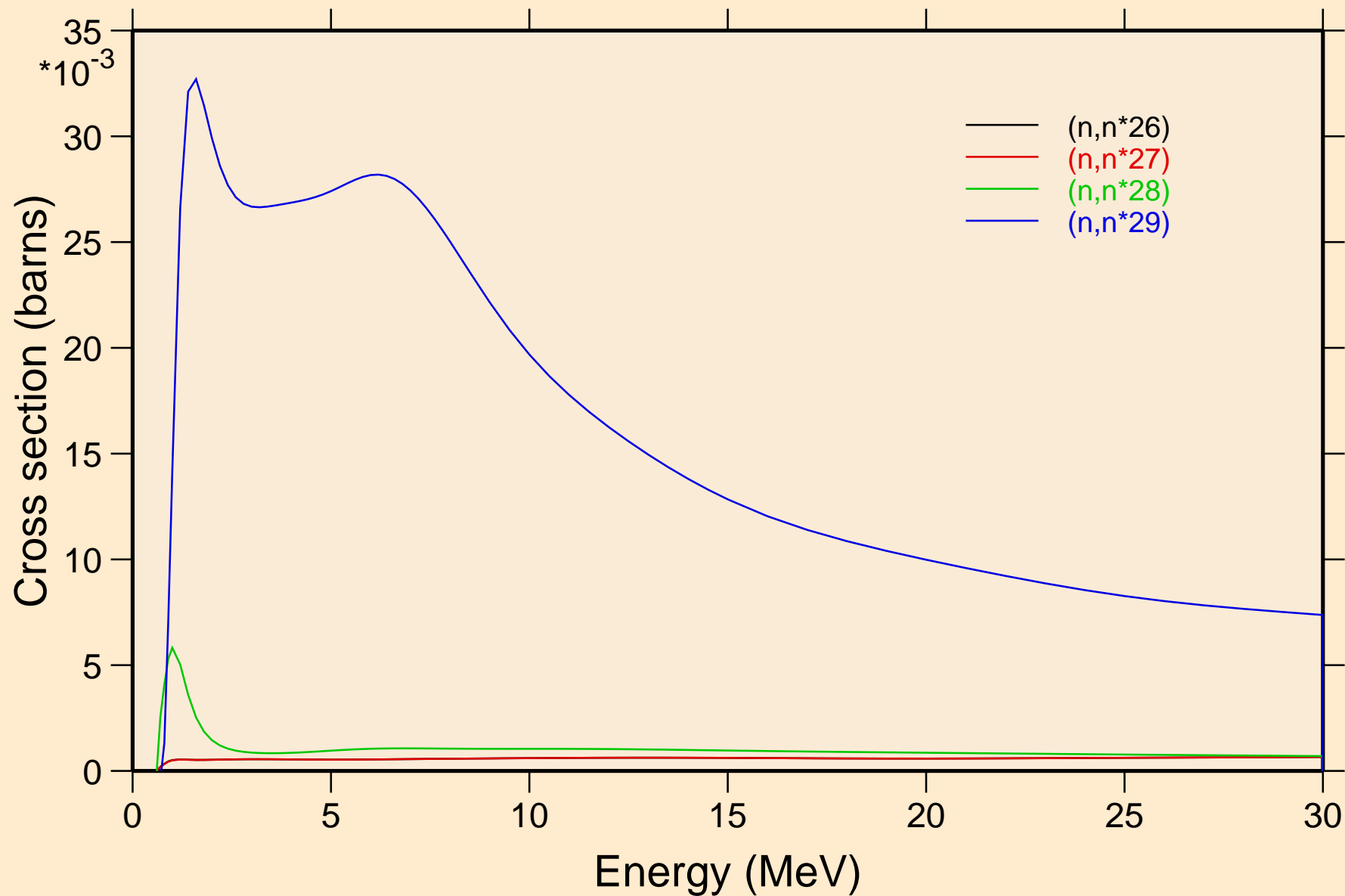



# LU168 NEUTRON ACER TENDL-2019 LIBRARY; T=293.16K

## Threshold reactions

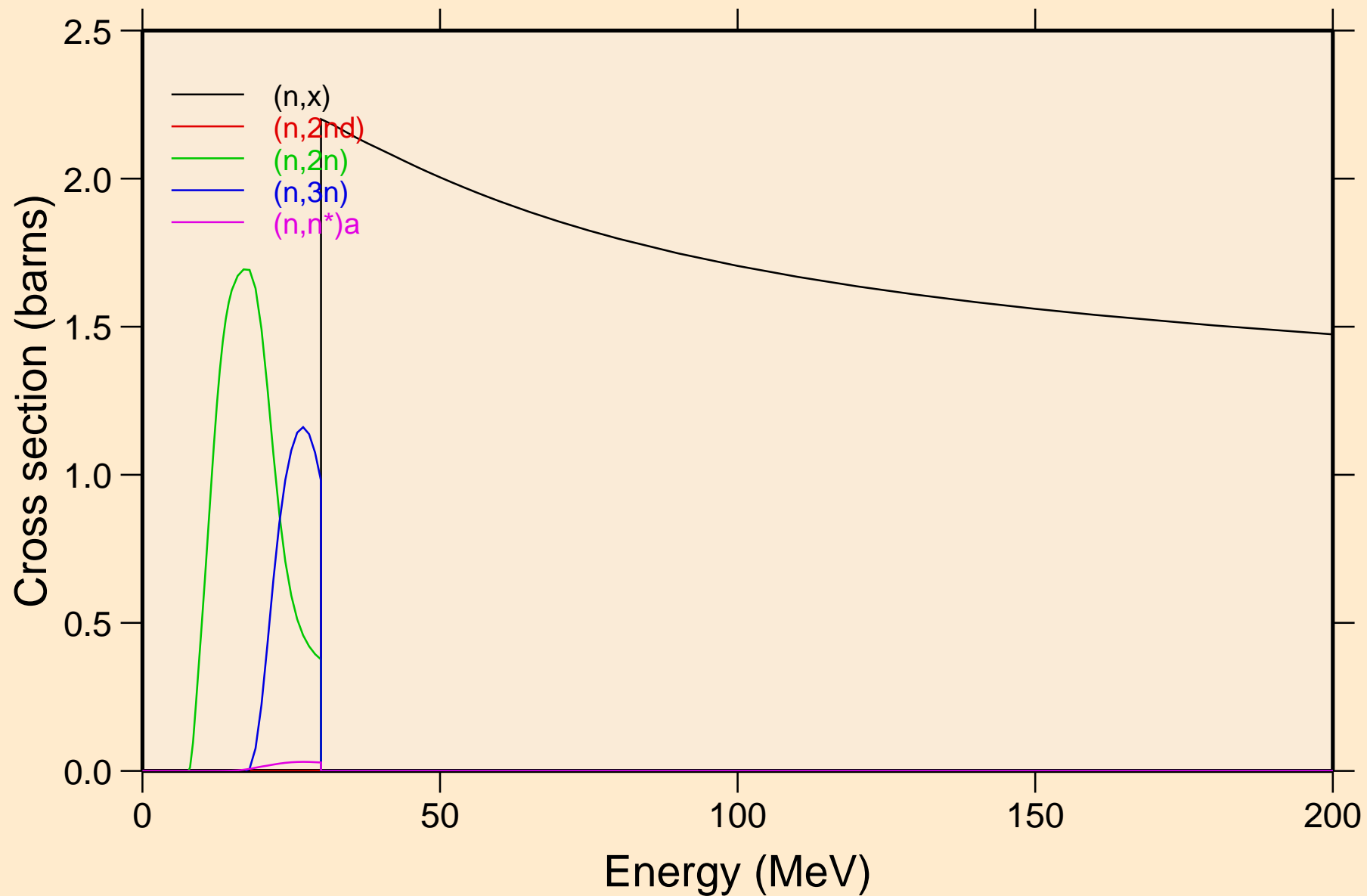

LU168 NEUTRON ACER TENDL-2019 LIBRARY; T=293.16K  
Threshold reactions

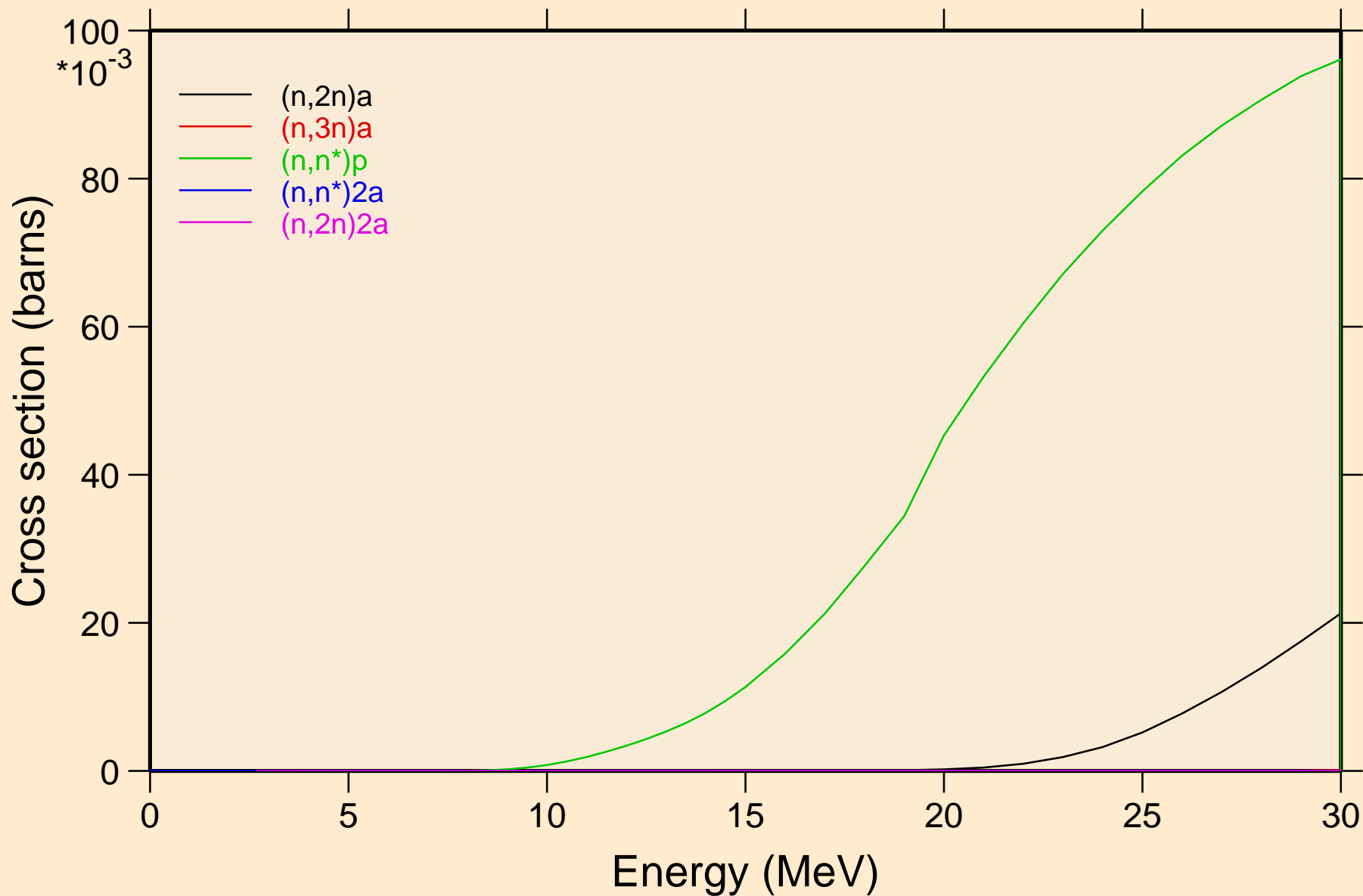

LU168 NEUTRON ACER TENDL-2019 LIBRARY; T=293.16K  
Threshold reactions

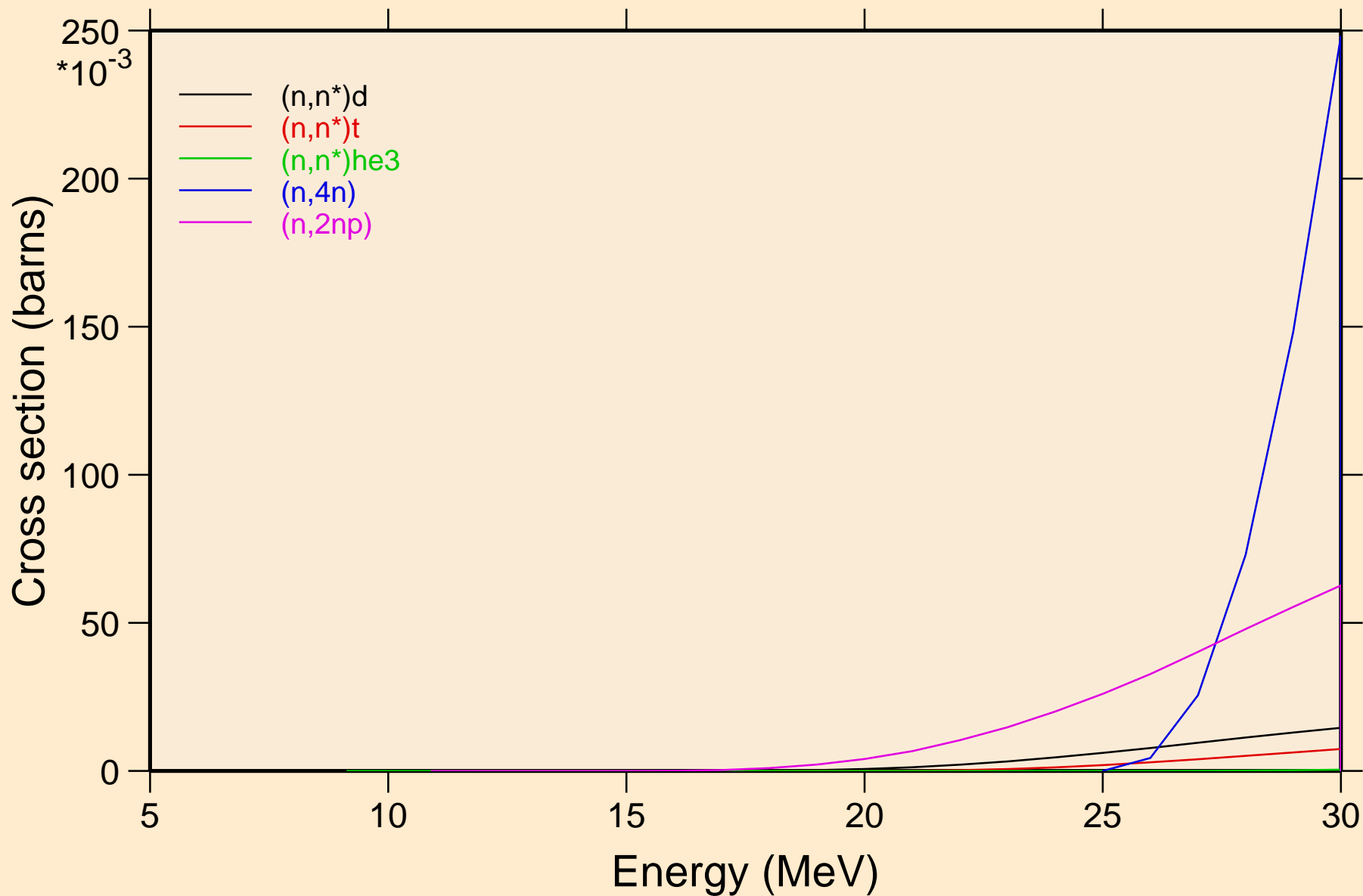

LU168 NEUTRON ACER TENDL-2019 LIBRARY; T=293.16K  
Threshold reactions

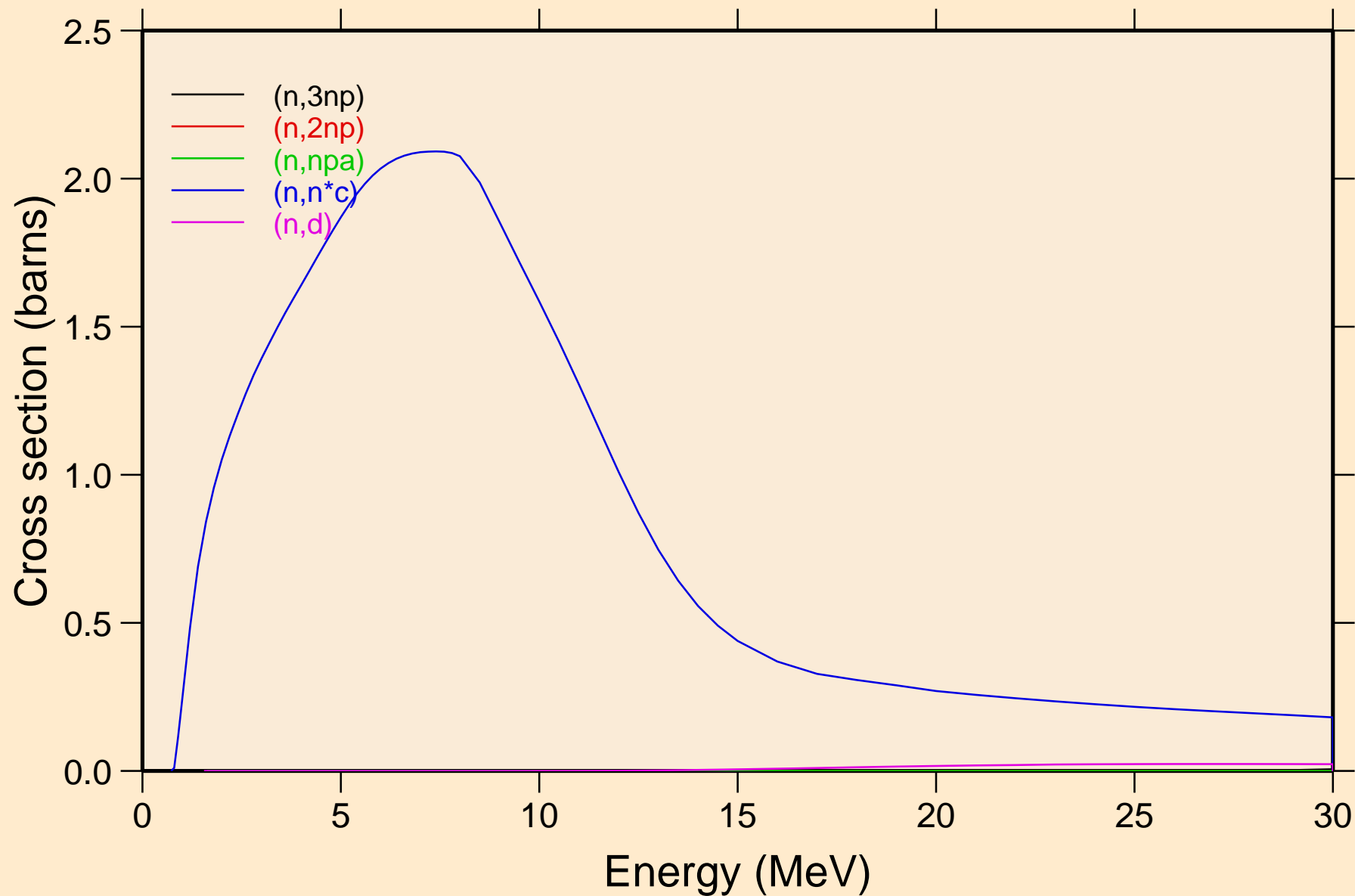

LU168 NEUTRON ACER TENDL-2019 LIBRARY; T=293.16K  
Threshold reactions

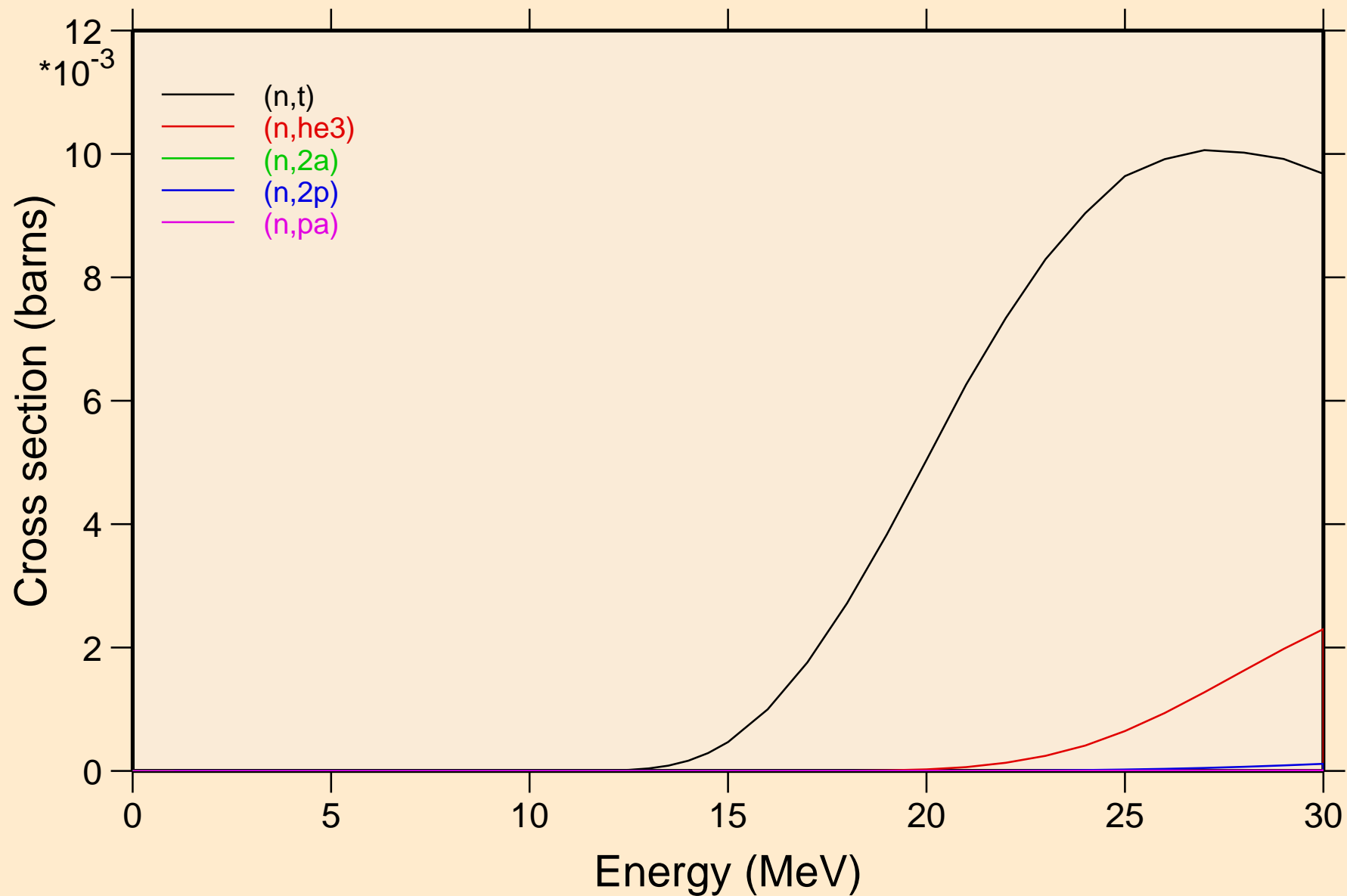

LU168 NEUTRON ACER TENDL-2019 LIBRARY; T=293.16K  
Threshold reactions

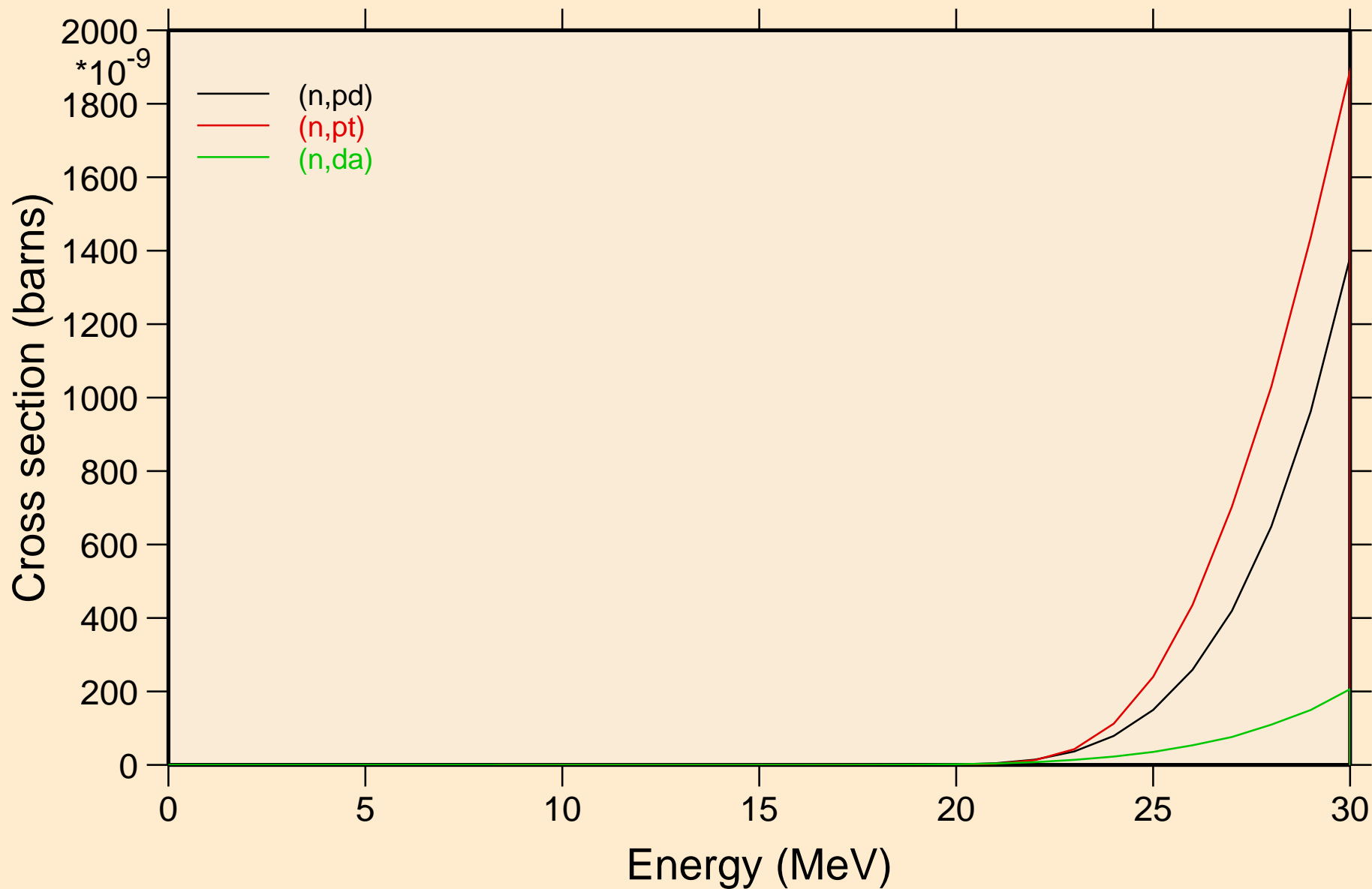

LU168 NEUTRON ACER TENDL-2019 LIBRARY; T=293.16K  
Threshold reactions

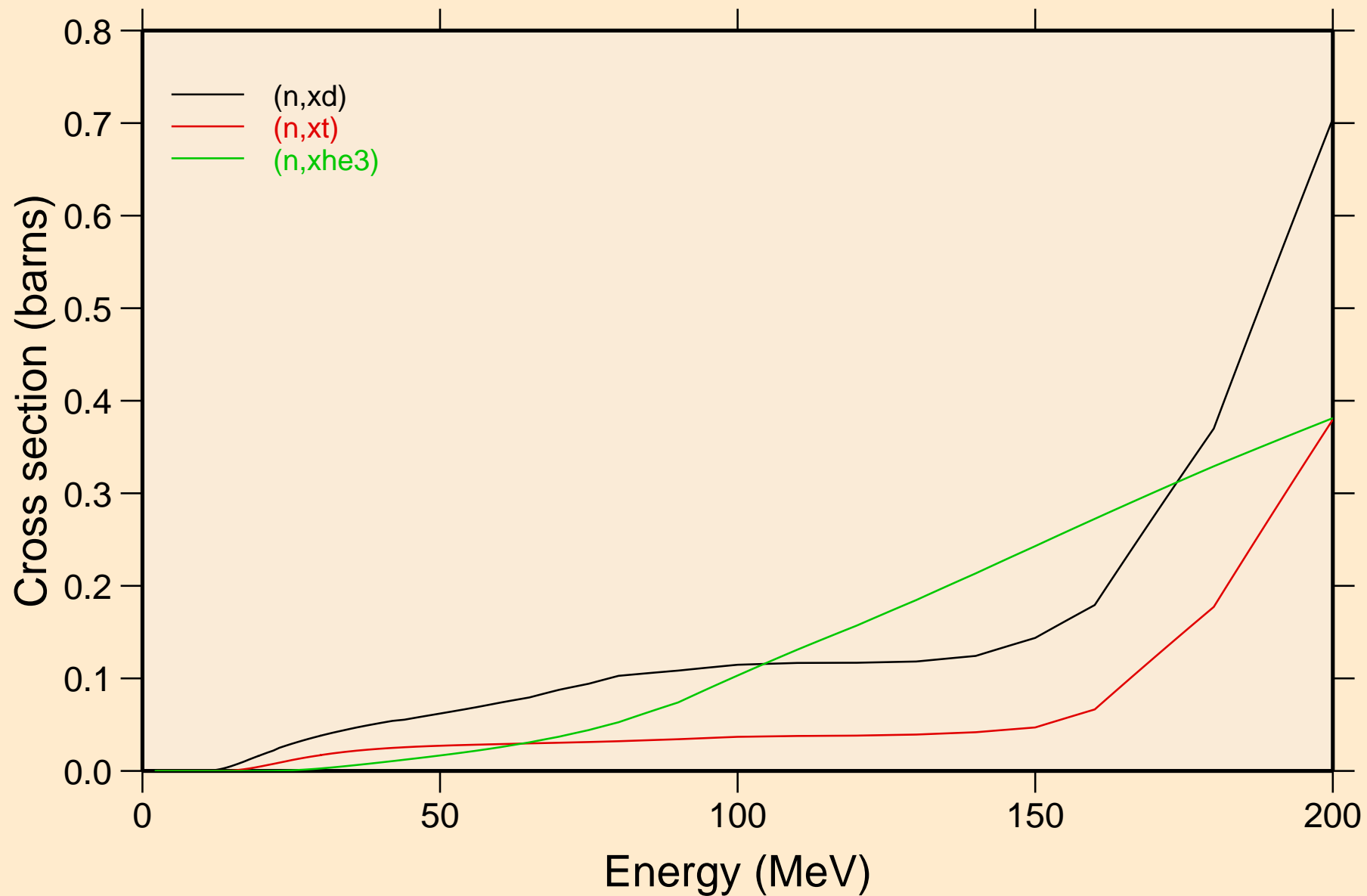

LU168 NEUTRON ACER TENDL-2019 LIBRARY; T=293.16K  
angular distribution for elastic

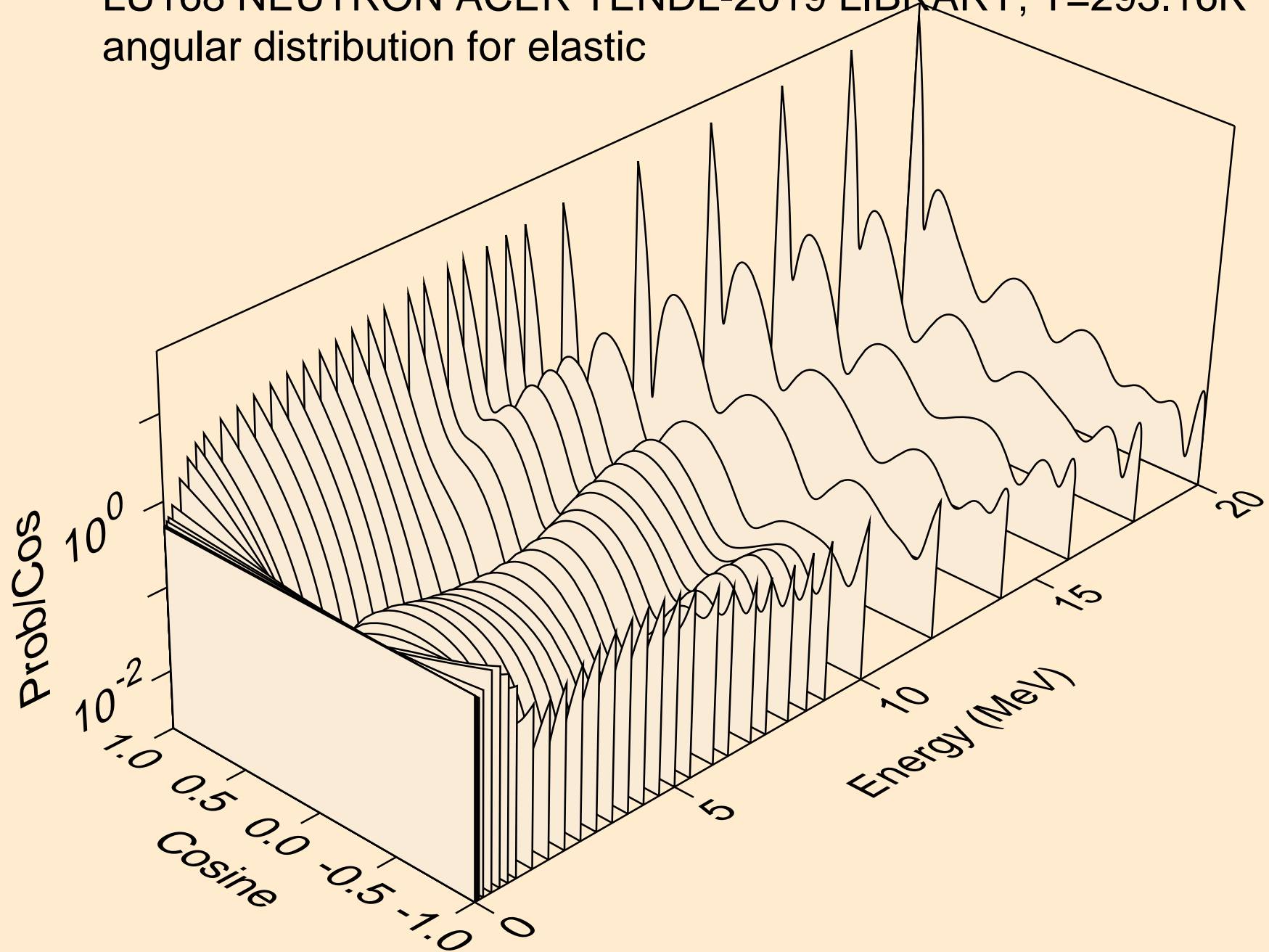



LU168 NEUTRON ACER TENDL-2019 LIBRARY; T=293.16K  
angular distribution for elastic

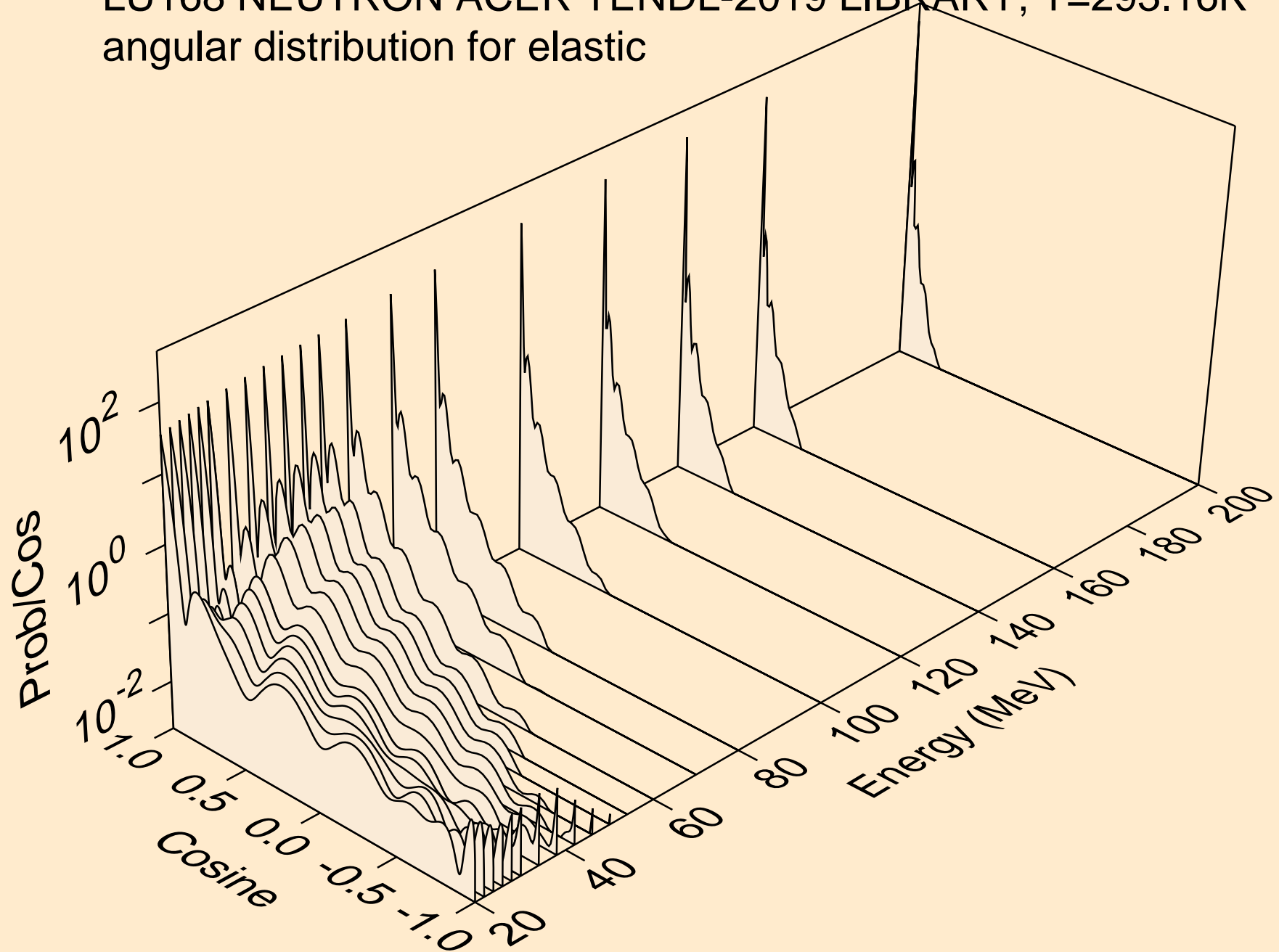

LU168 NEUTRON ACER TENDL-2019 LIBRARY; T=293.16K  
angular distribution for (n,n\*1)

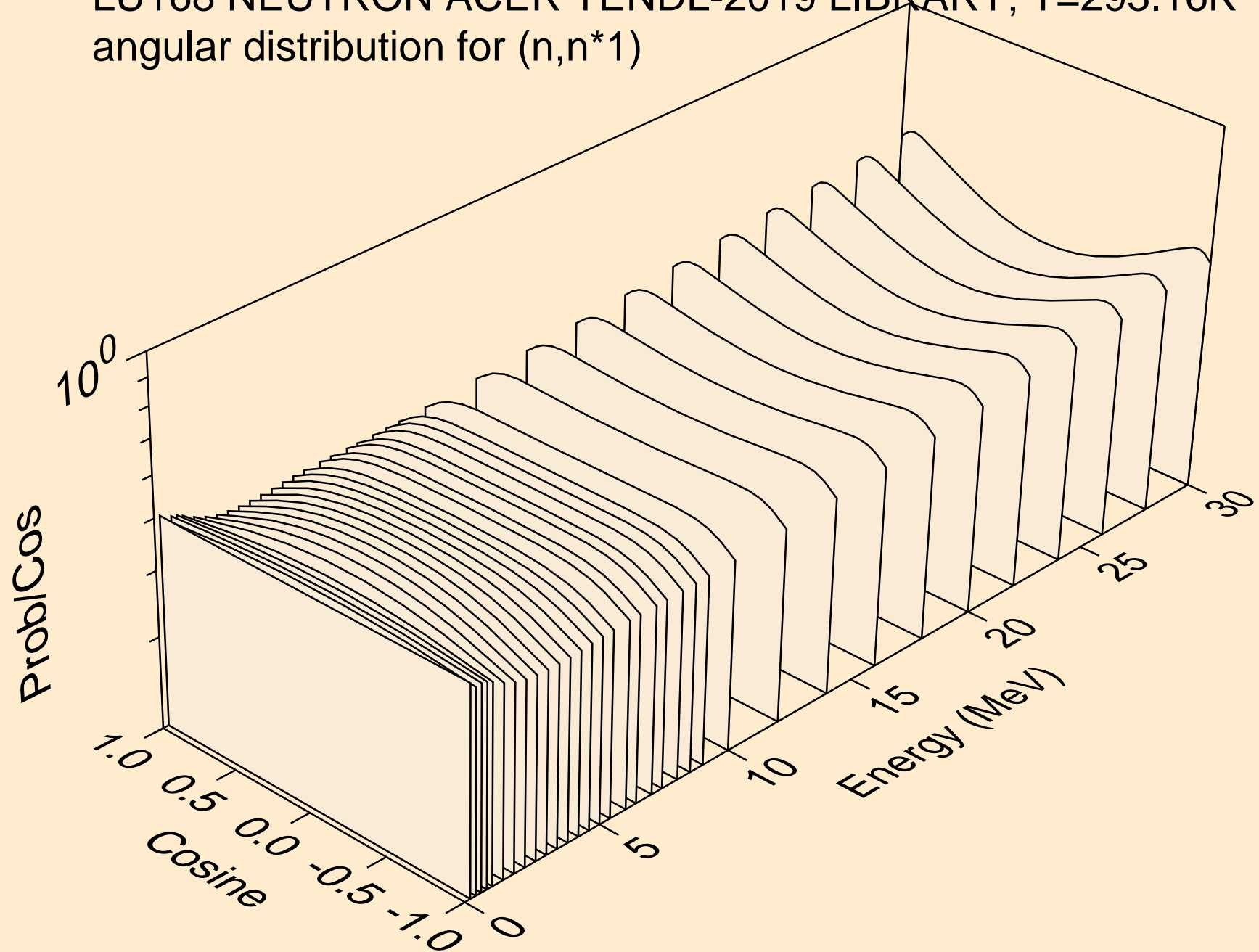

LU168 NEUTRON ACER TENDL-2019 LIBRARY; T=293.16K  
angular distribution for (n,n\*2)

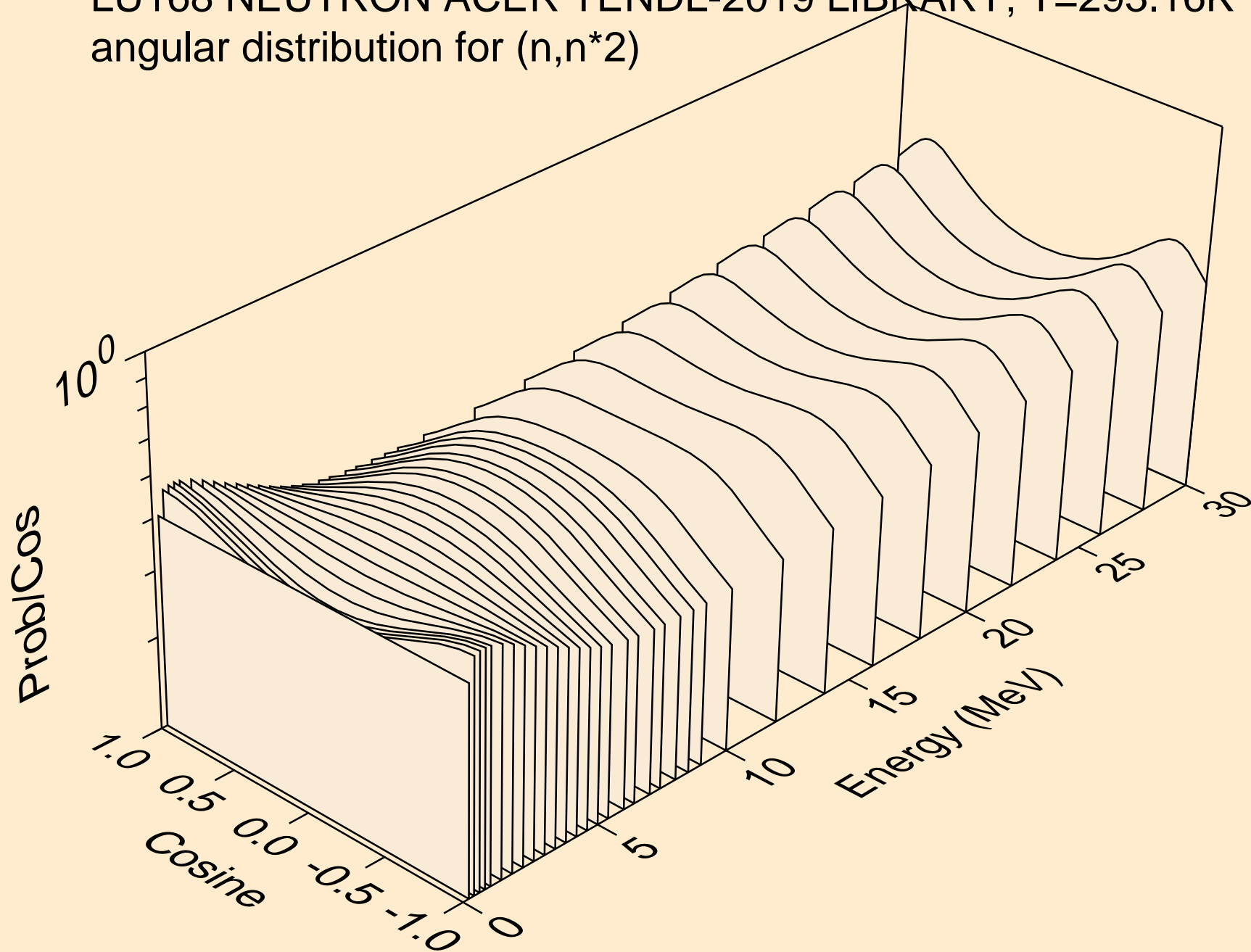

LU168 NEUTRON ACER TENDL-2019 LIBRARY; T=293.16K  
angular distribution for (n,n\*3)

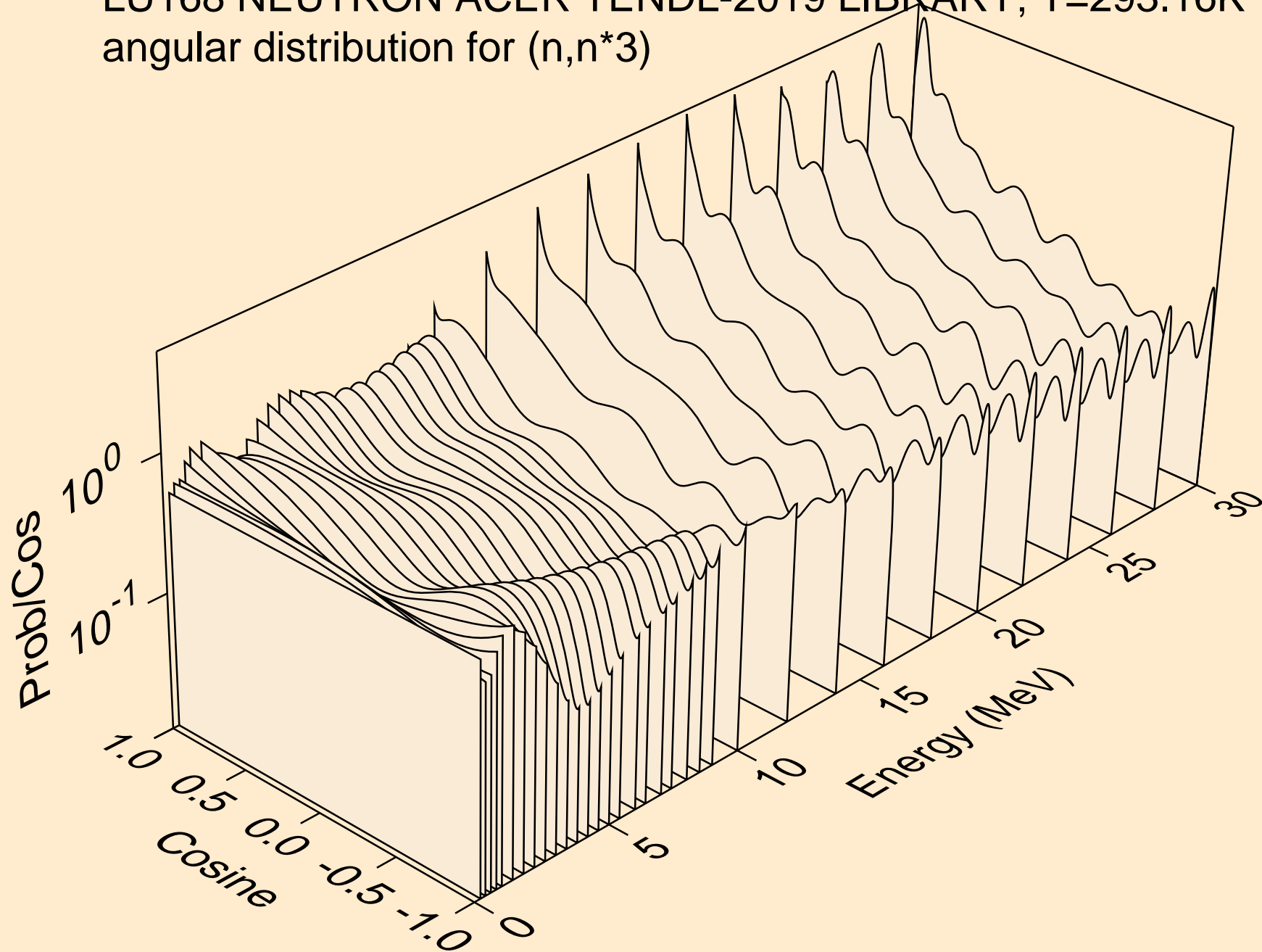

LU168 NEUTRON ACER TENDL-2019 LIBRARY; T=293.16K  
angular distribution for (n,n\*4)

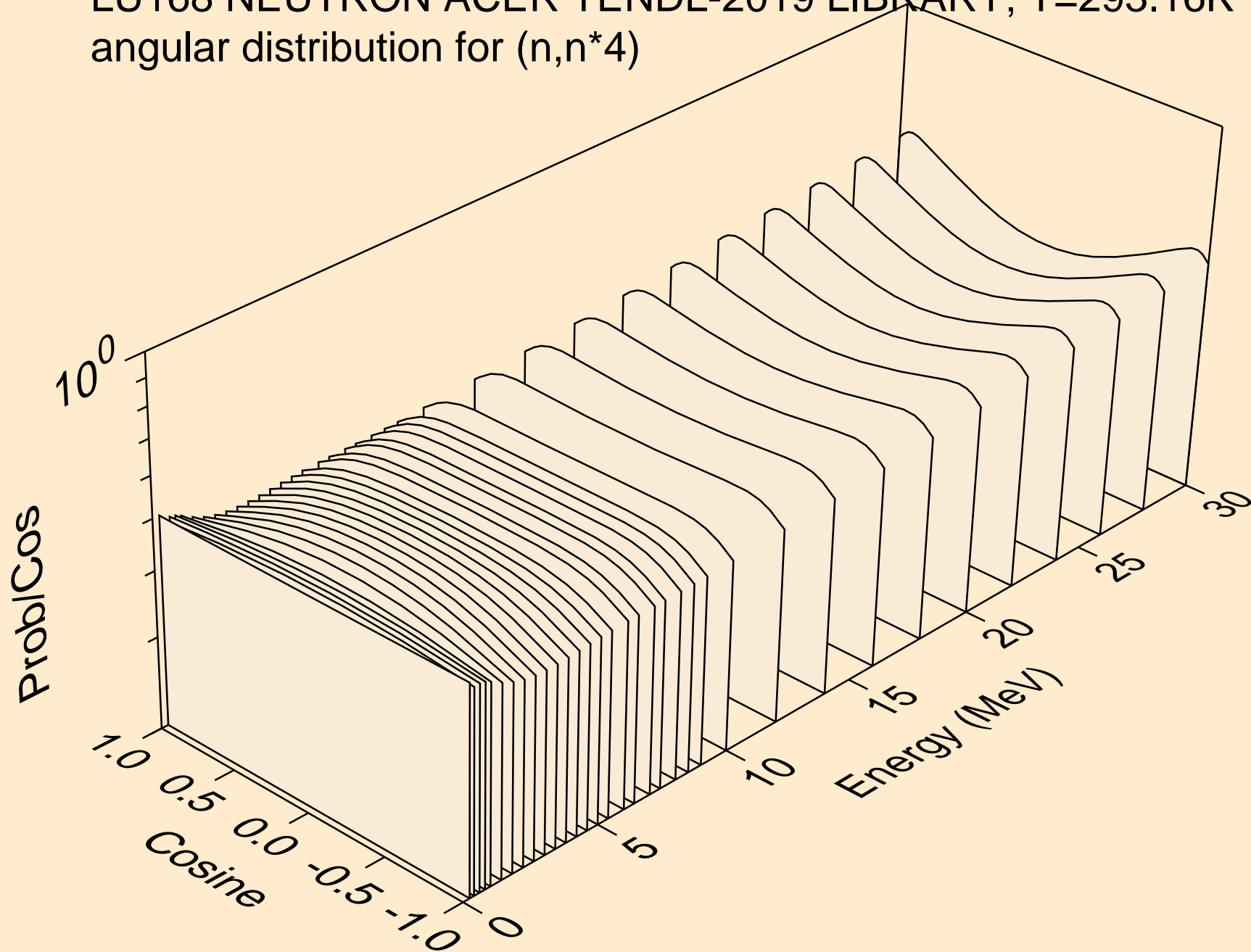

LU168 NEUTRON ACER TENDL-2019 LIBRARY; T=293.16K  
angular distribution for (n,n\*5)

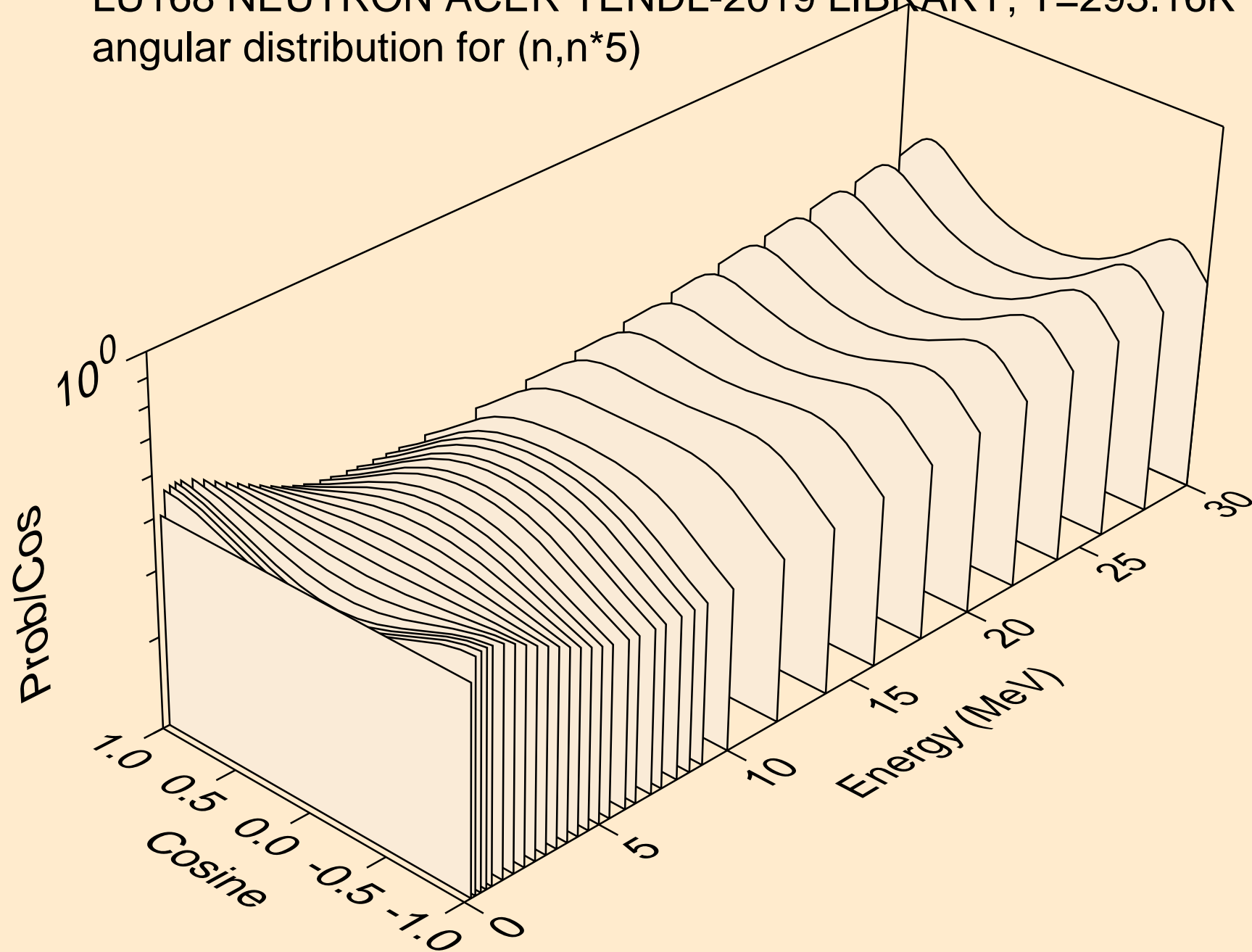

LU168 NEUTRON ACER TENDL-2019 LIBRARY; T=293.16K  
angular distribution for (n,n\*6)

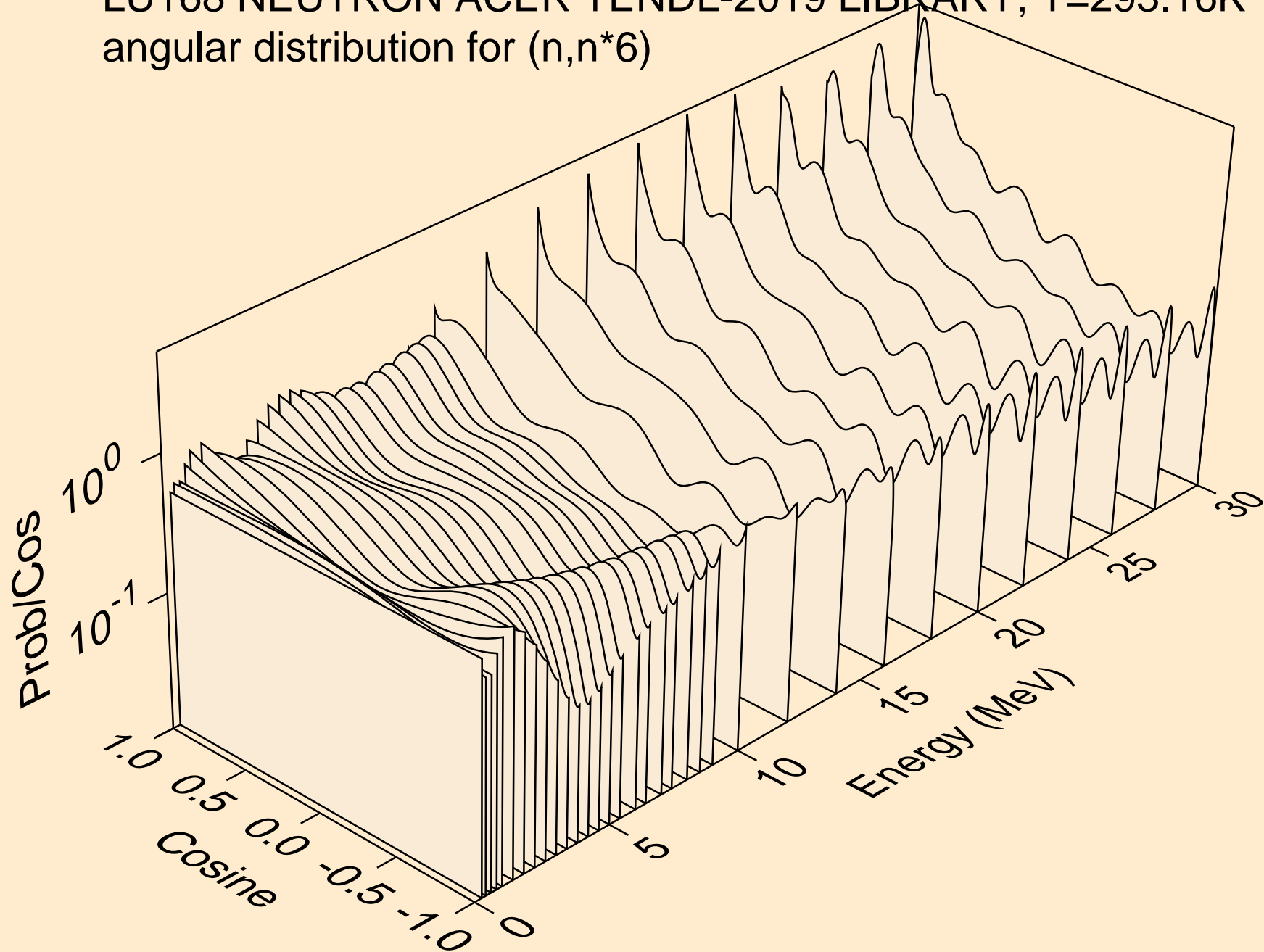

LU168 NEUTRON ACER TENDL-2019 LIBRARY; T=293.16K  
angular distribution for (n,n\*7)

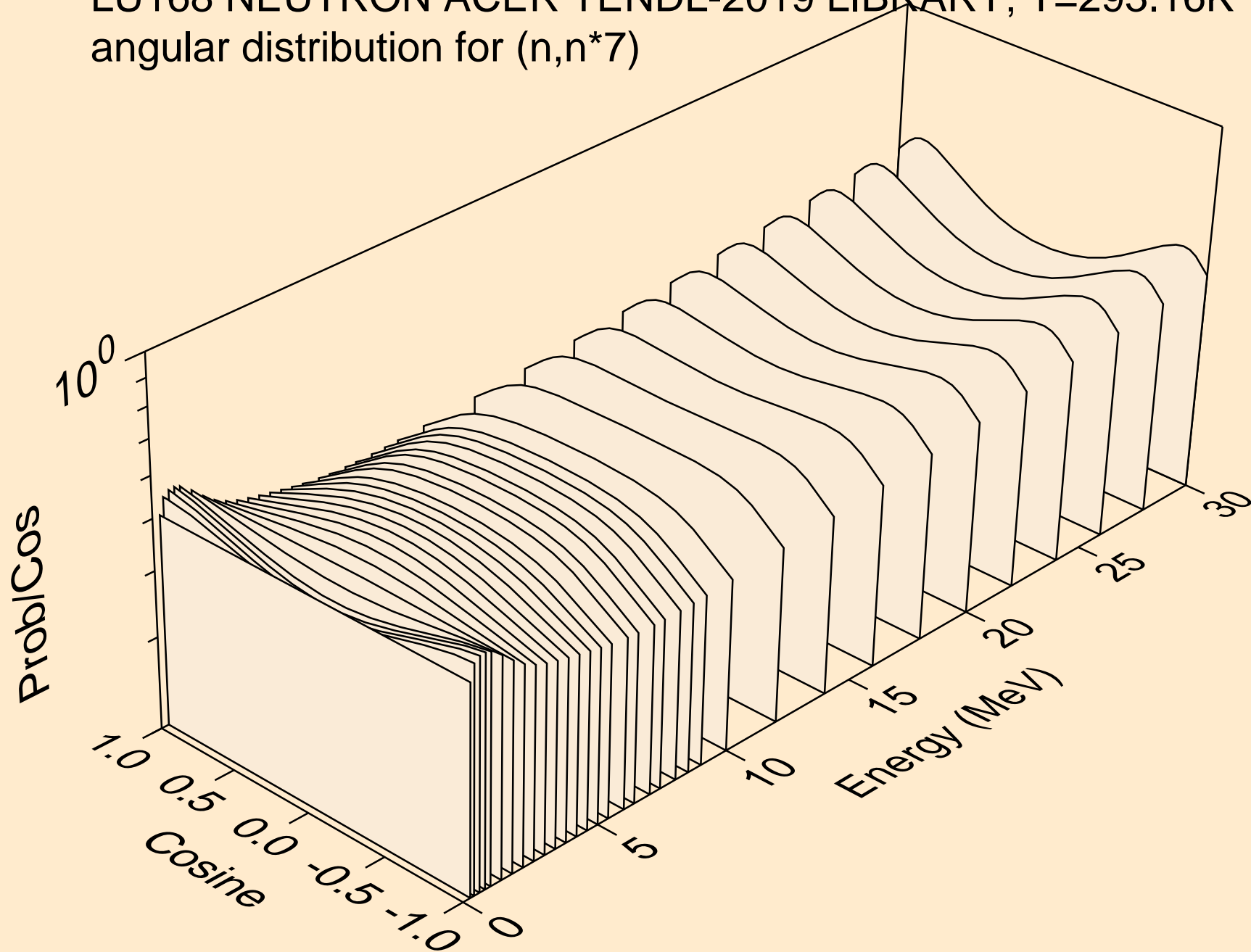



LU168 NEUTRON ACER TENDL-2019 LIBRARY; T=293.16K  
angular distribution for (n,n\*8)

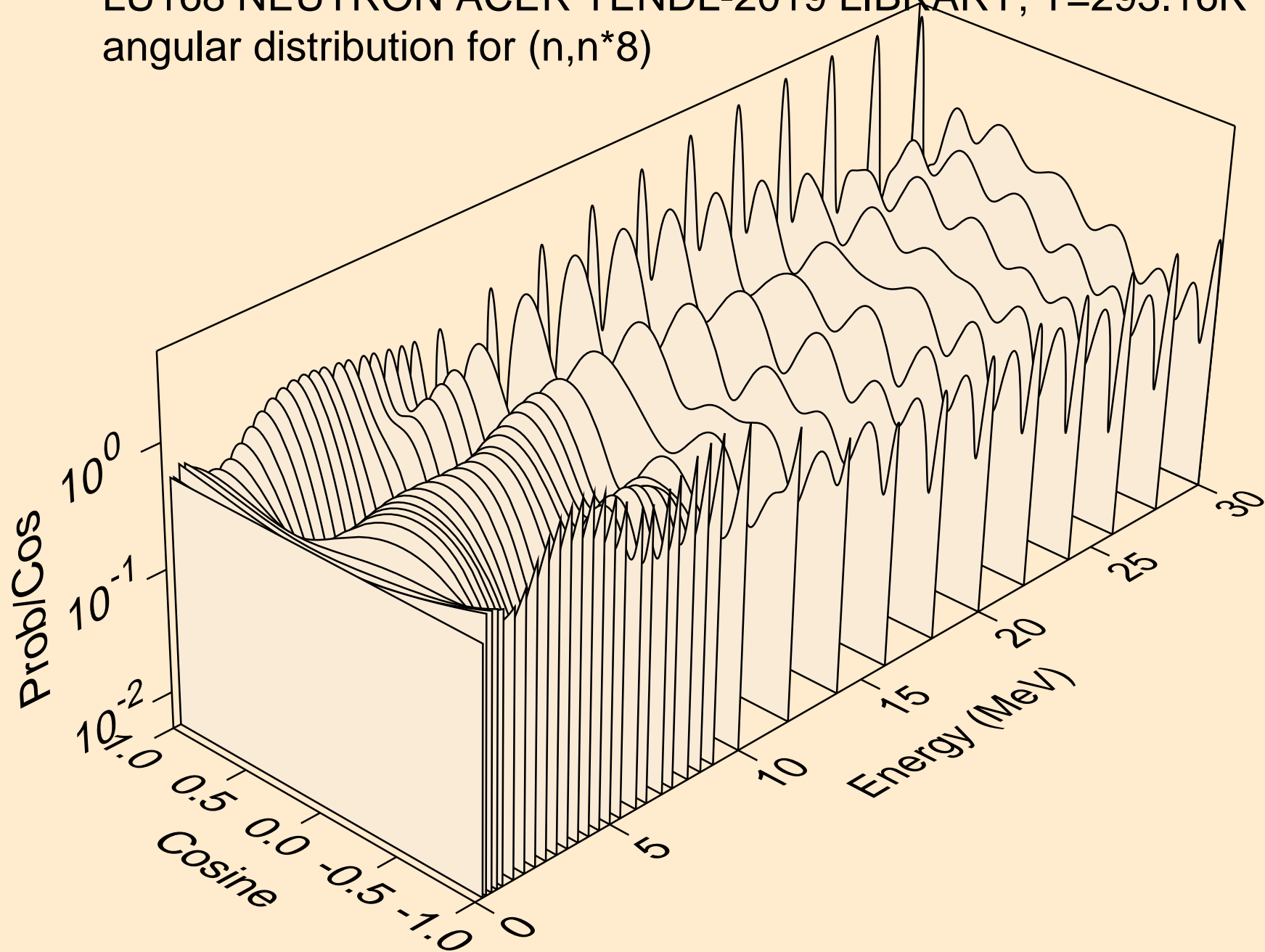

LU168 NEUTRON ACER TENDL-2019 LIBRARY; T=293.16K  
angular distribution for (n,n\*9)

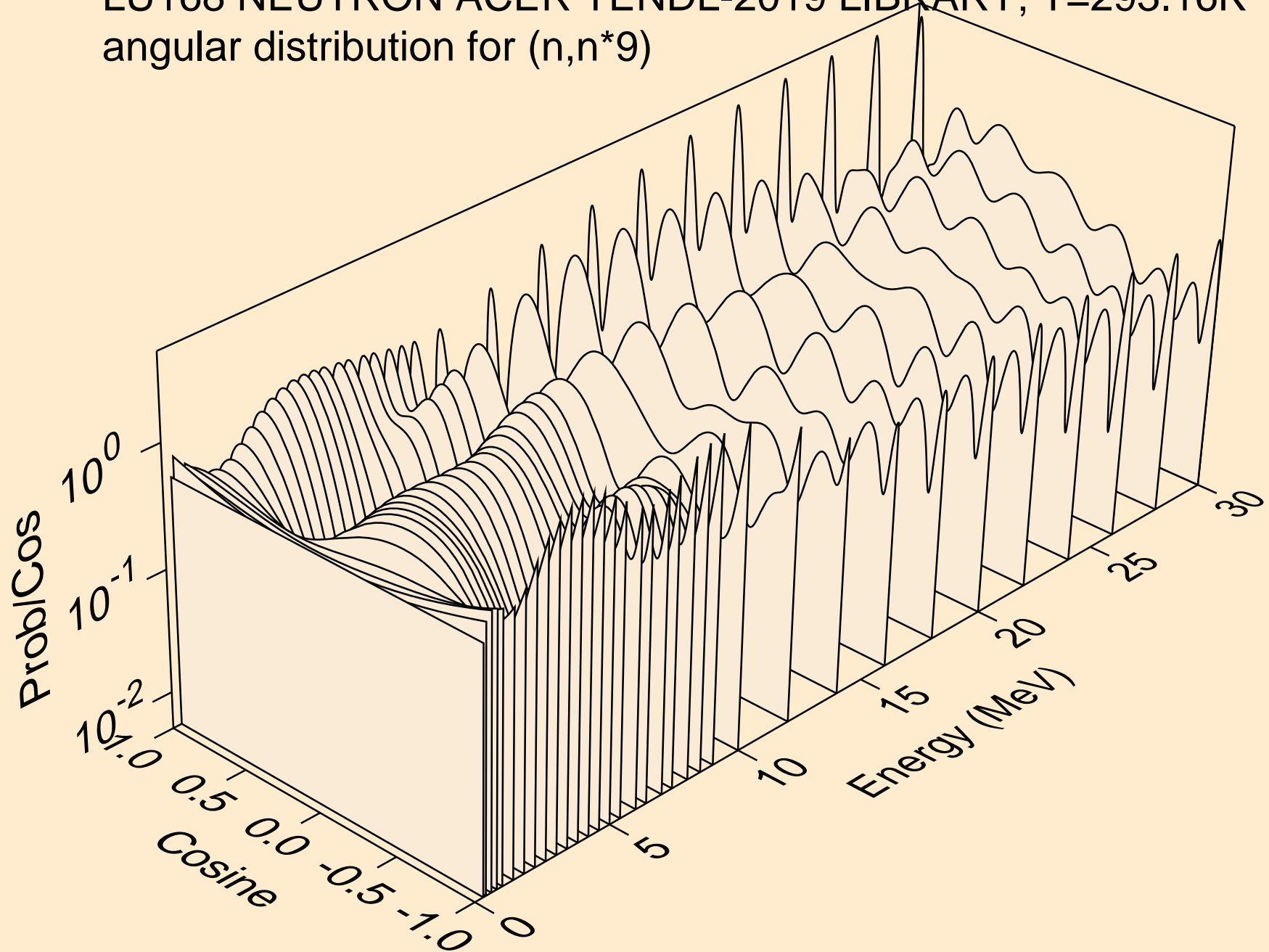

LU168 NEUTRON ACER TENDL-2019 LIBRARY; T=293.16K  
angular distribution for (n,n\*10)

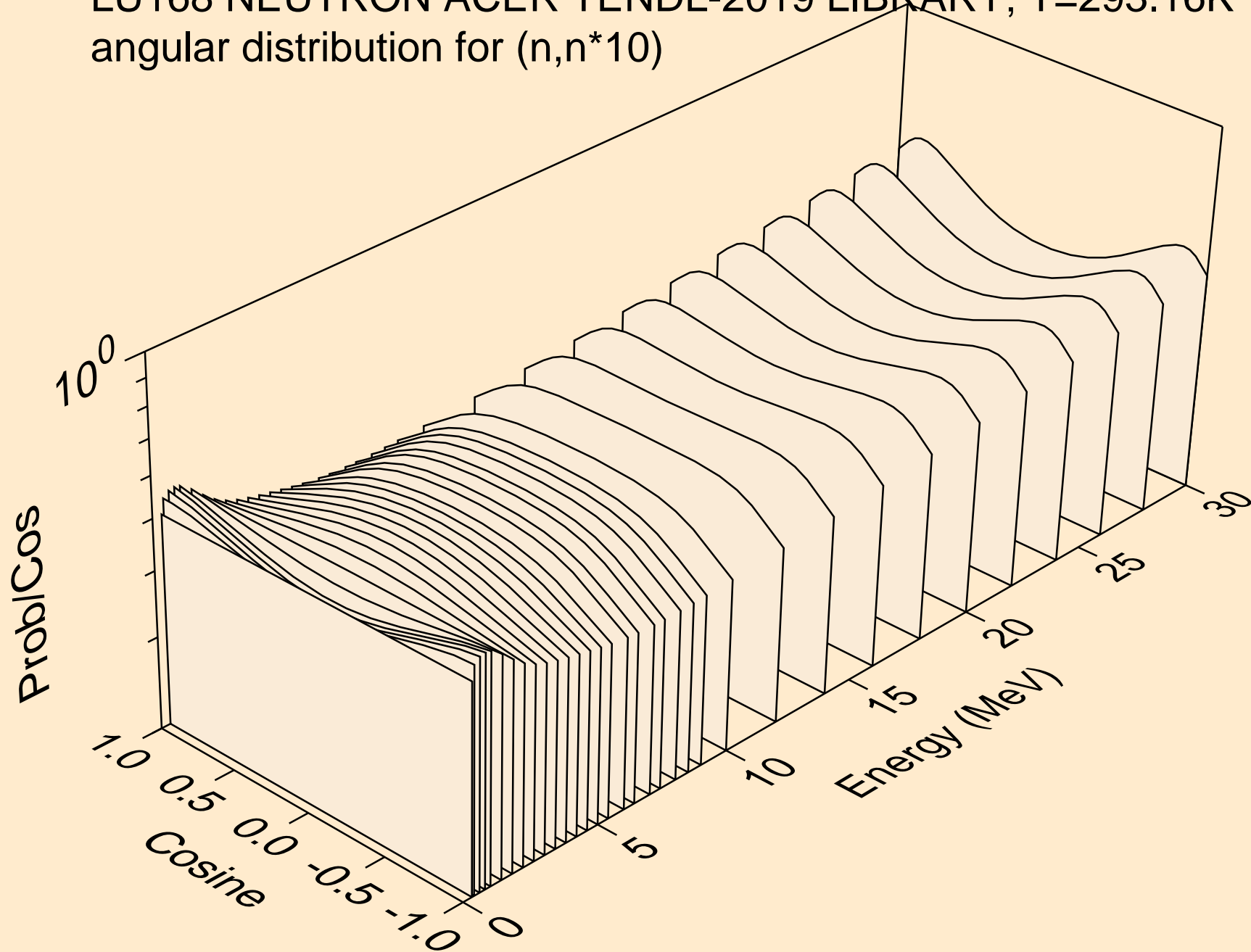

LU168 NEUTRON ACER TENDL-2019 LIBRARY; T=293.16K  
angular distribution for (n,n\*11)

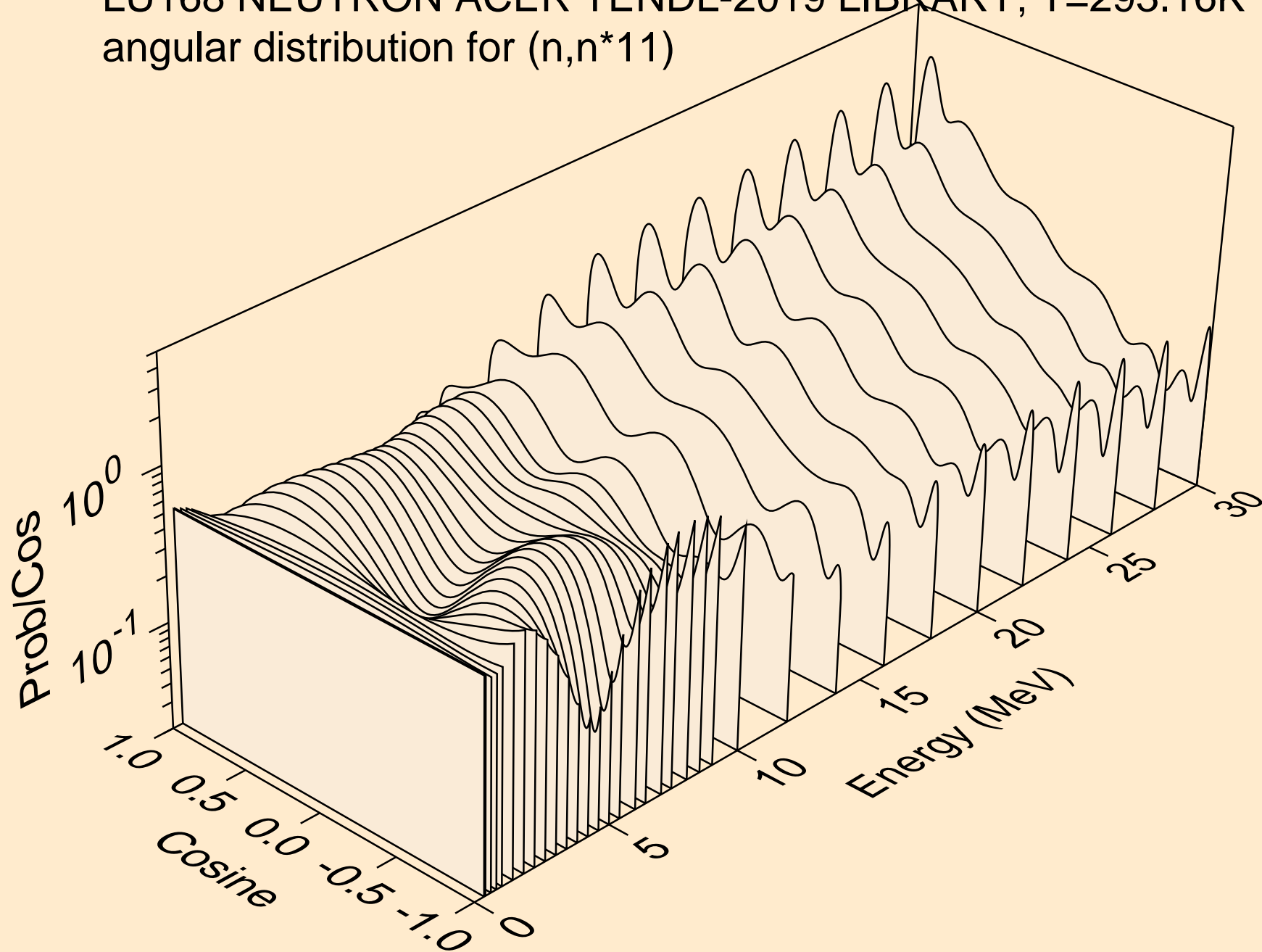

LU168 NEUTRON ACER TENDL-2019 LIBRARY; T=293.16K  
angular distribution for (n,n\*12)

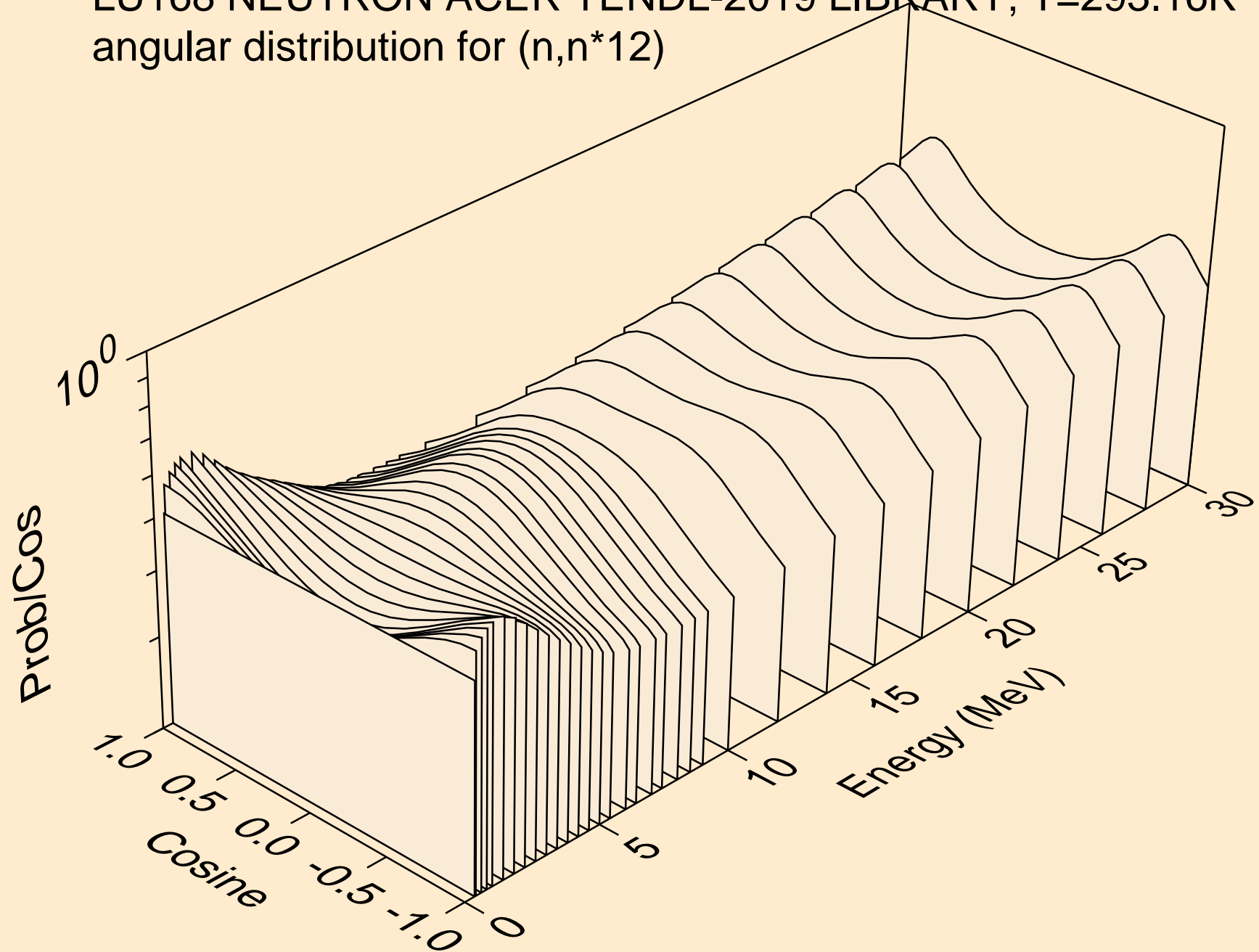

LU168 NEUTRON ACER TENDL-2019 LIBRARY; T=293.16K  
angular distribution for (n,n\*13)

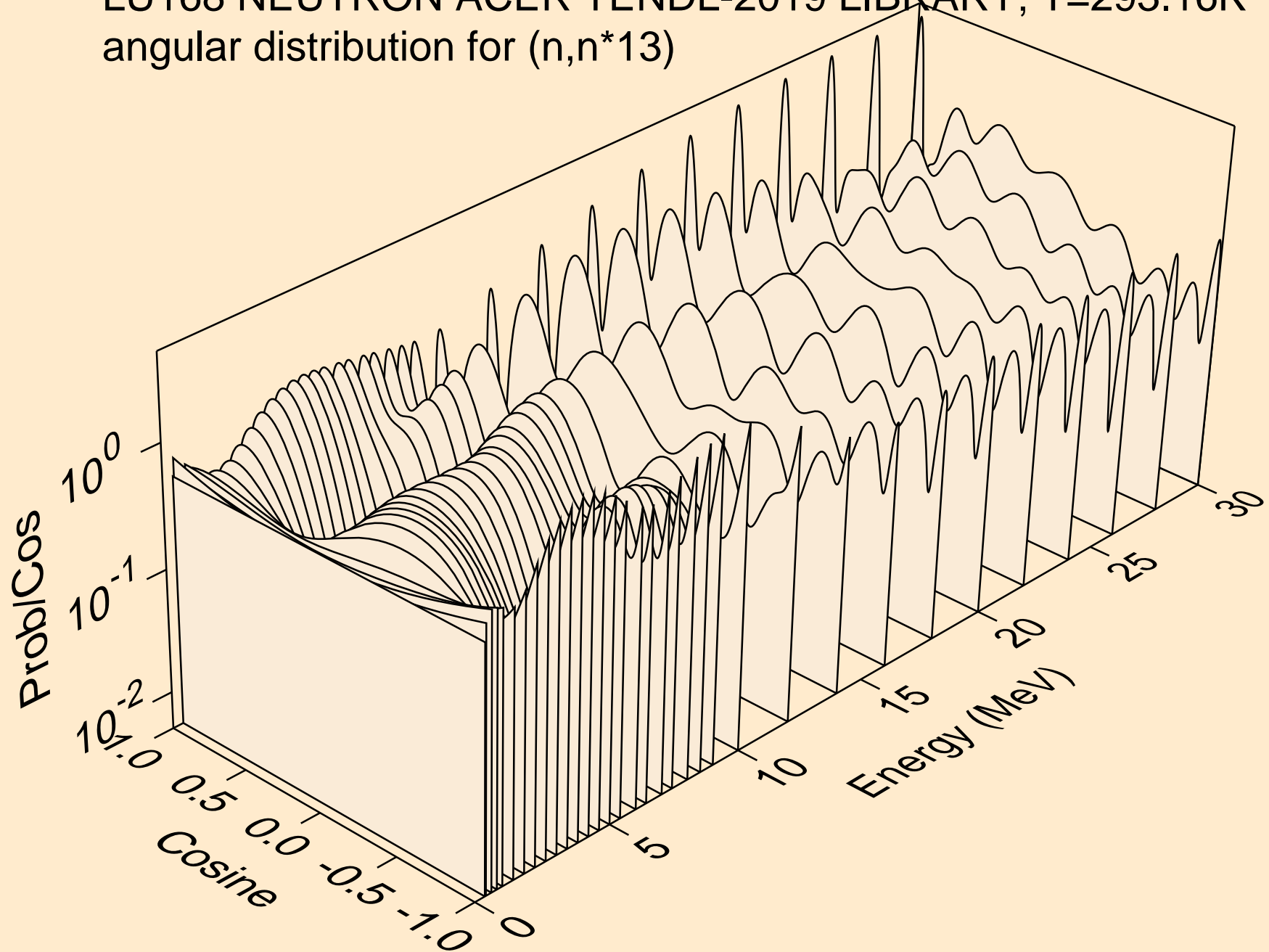

LU168 NEUTRON ACER TENDL-2019 LIBRARY; T=293.16K  
angular distribution for (n,n\*14)

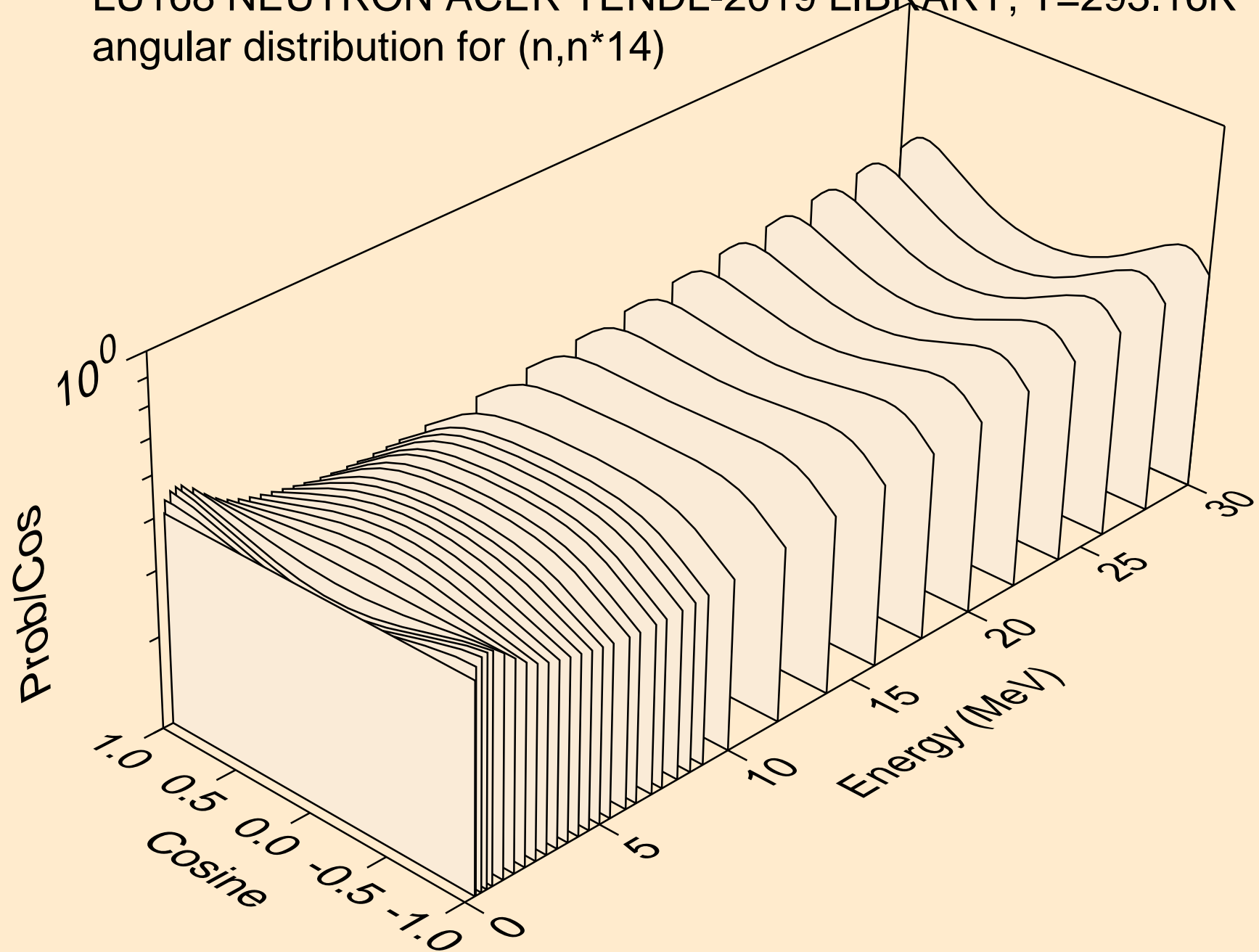

LU168 NEUTRON ACER TENDL-2019 LIBRARY; T=293.16K  
angular distribution for (n,n\*15)

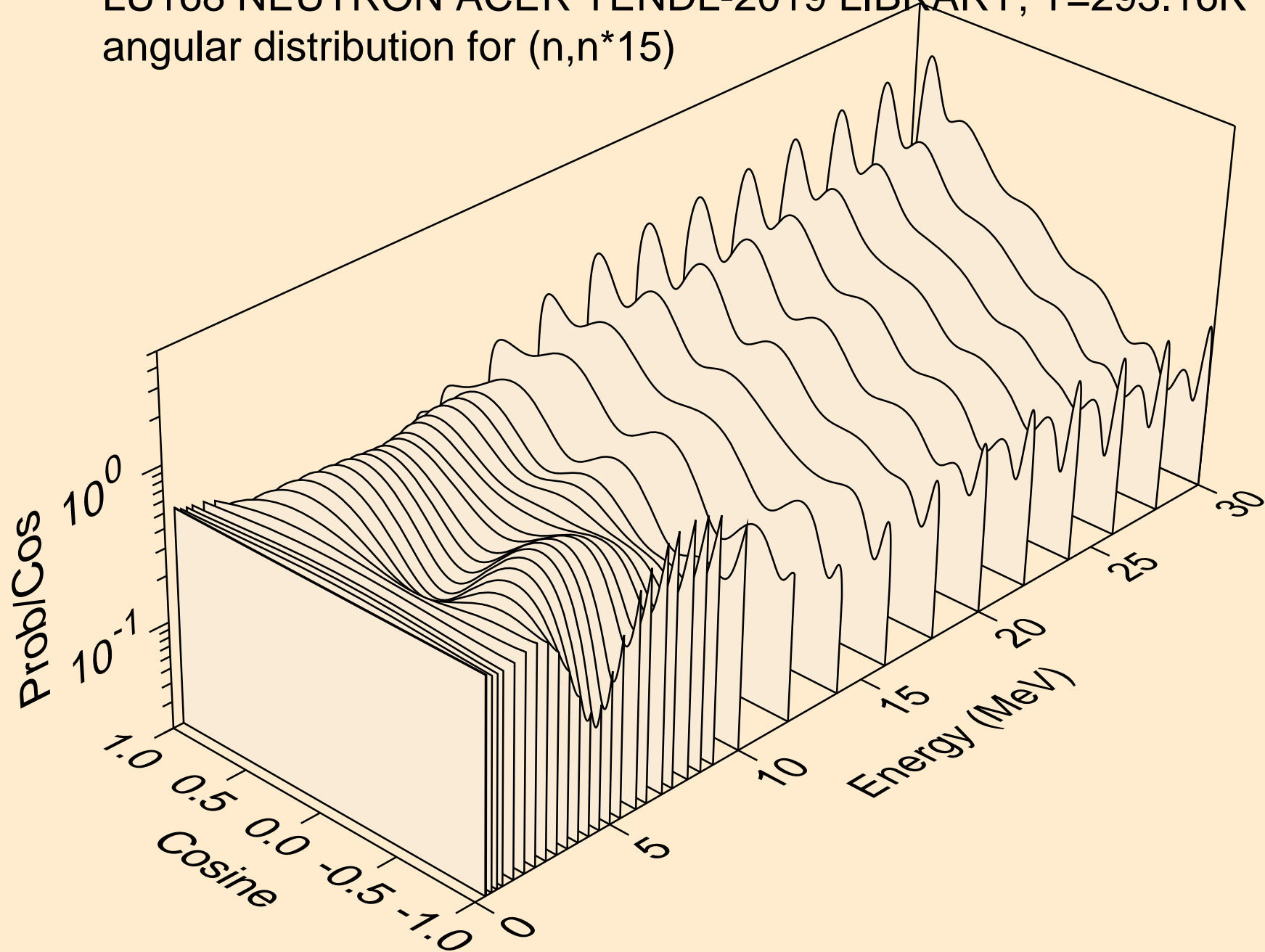



LU168 NEUTRON ACER TENDL-2019 LIBRARY; T=293.16K  
angular distribution for (n,n\*16)

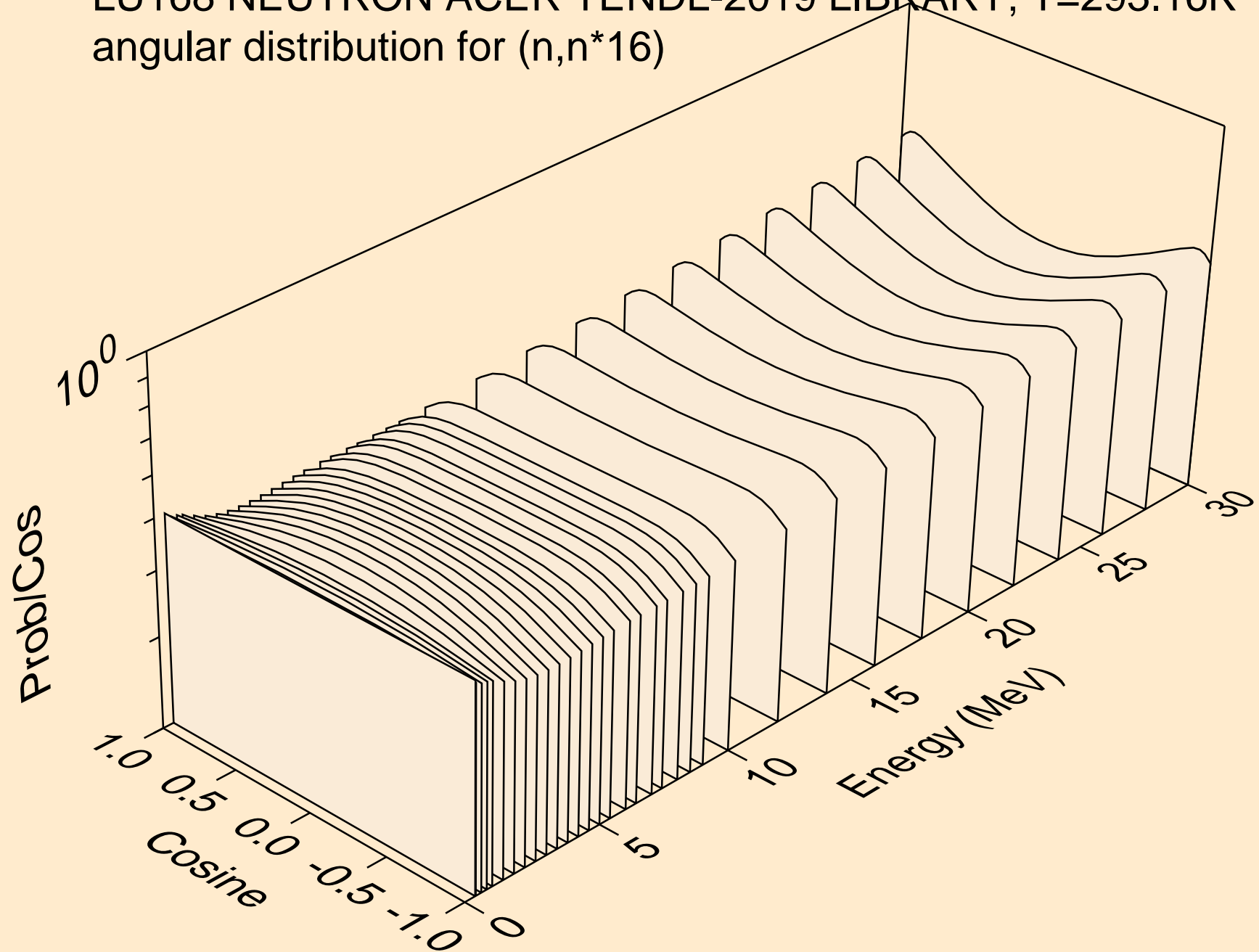

LU168 NEUTRON ACER TENDL-2019 LIBRARY; T=293.16K  
angular distribution for (n,n\*17)

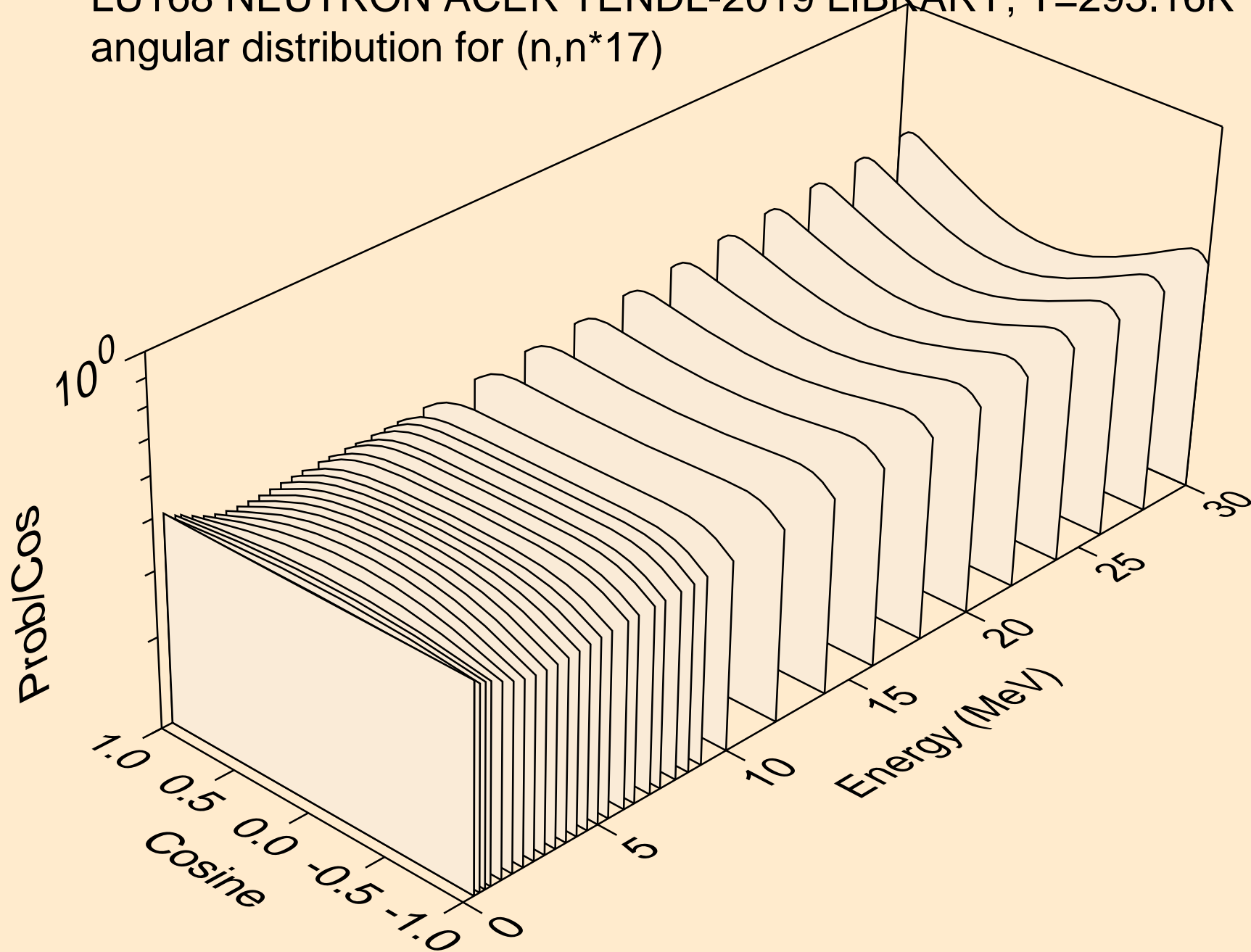

LU168 NEUTRON ACER TENDL-2019 LIBRARY; T=293.16K  
angular distribution for (n,n\*18)

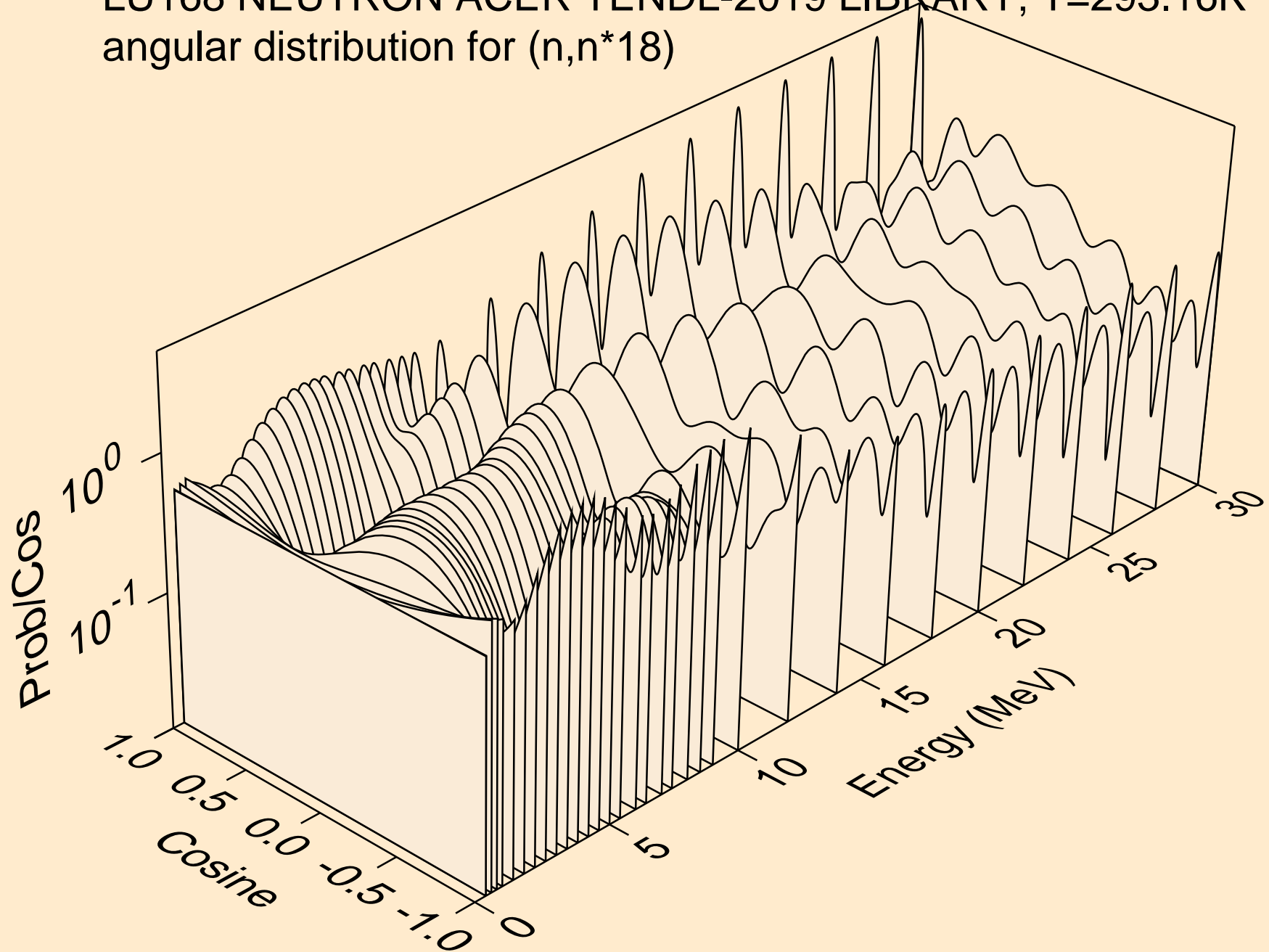

LU168 NEUTRON ACER TENDL-2019 LIBRARY; T=293.16K  
angular distribution for (n,n\*19)

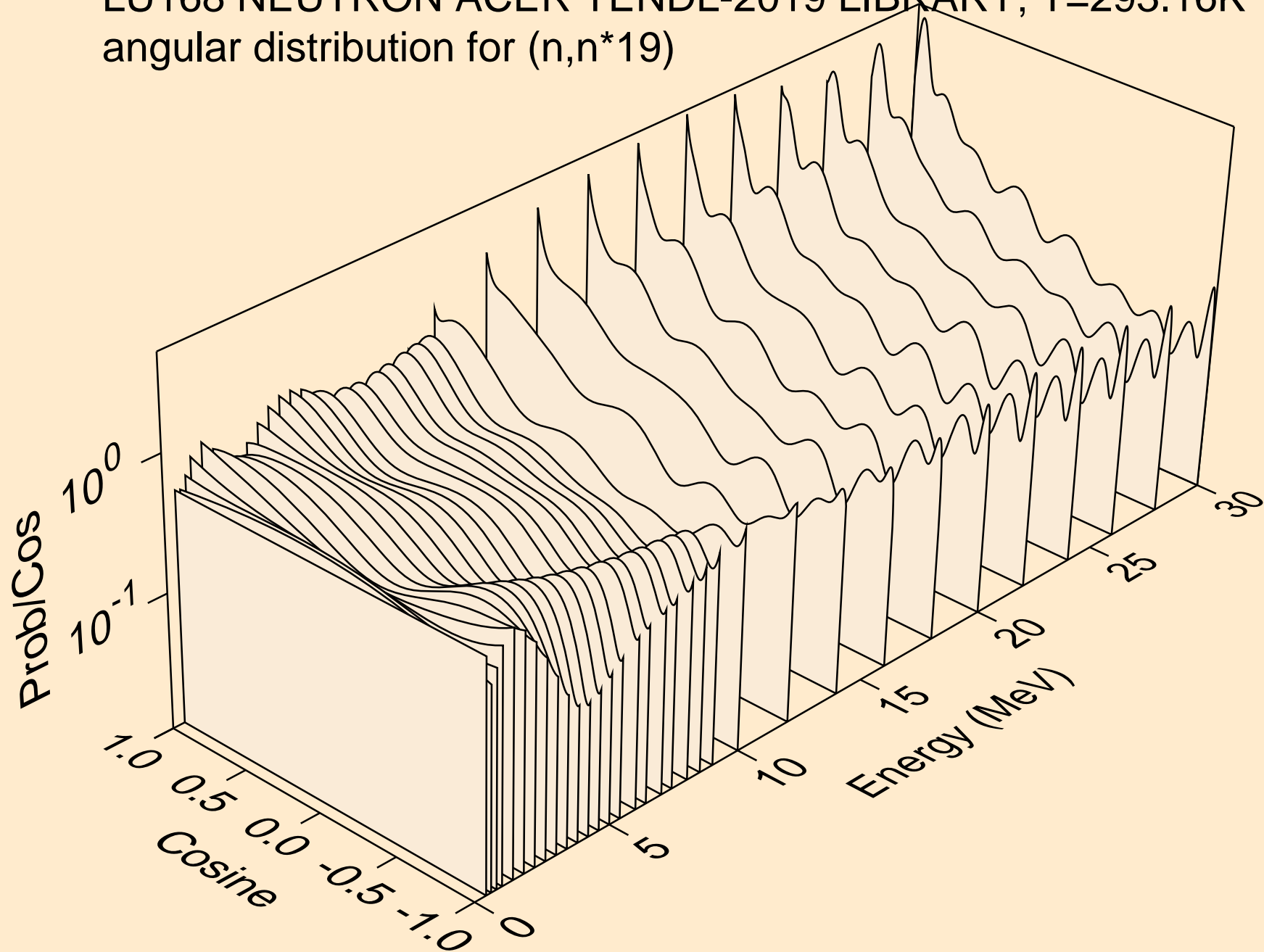

LU168 NEUTRON ACER TENDL-2019 LIBRARY; T=293.16K  
angular distribution for (n,n\*20)

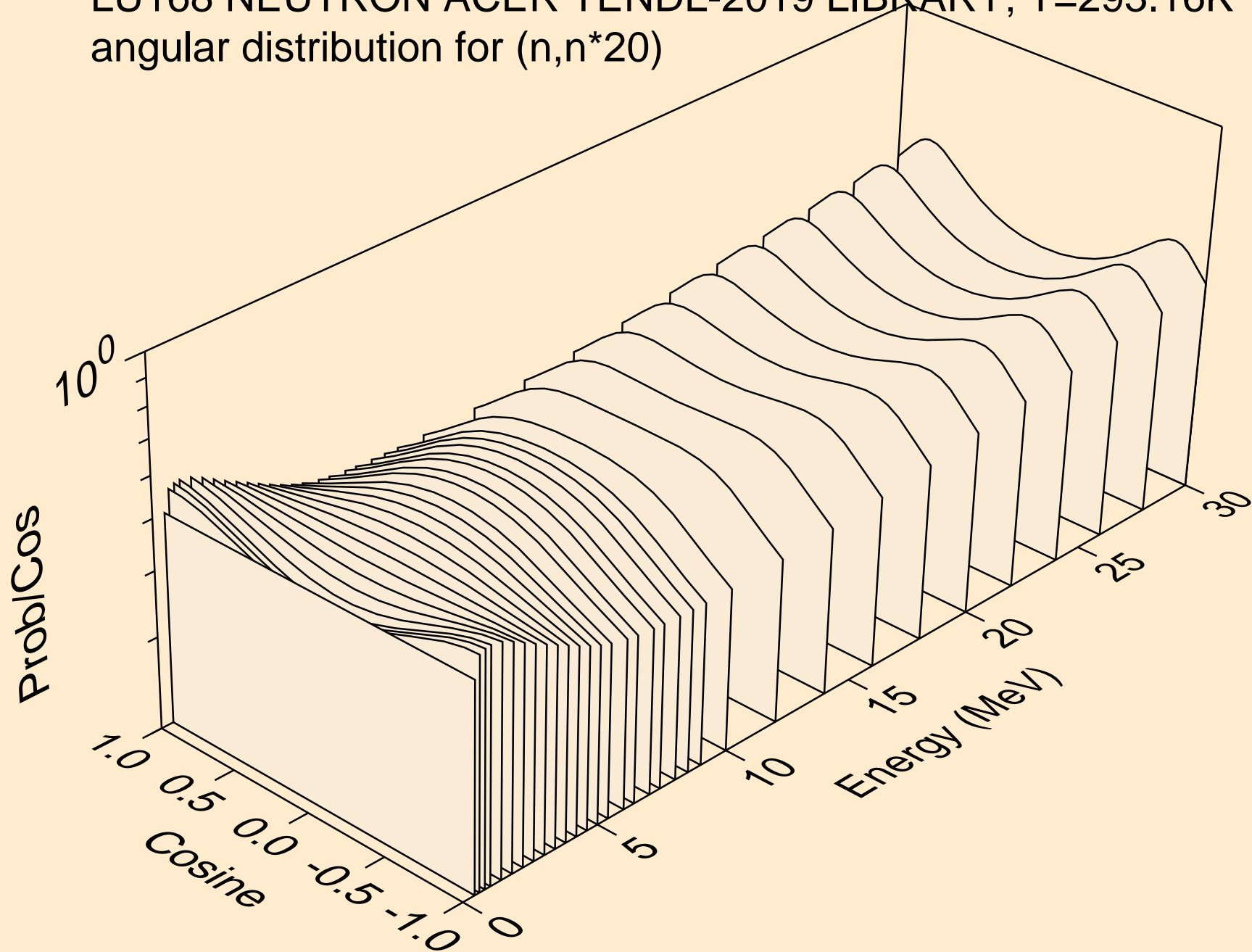

LU168 NEUTRON ACER TENDL-2019 LIBRARY; T=293.16K  
angular distribution for (n,n\*21)

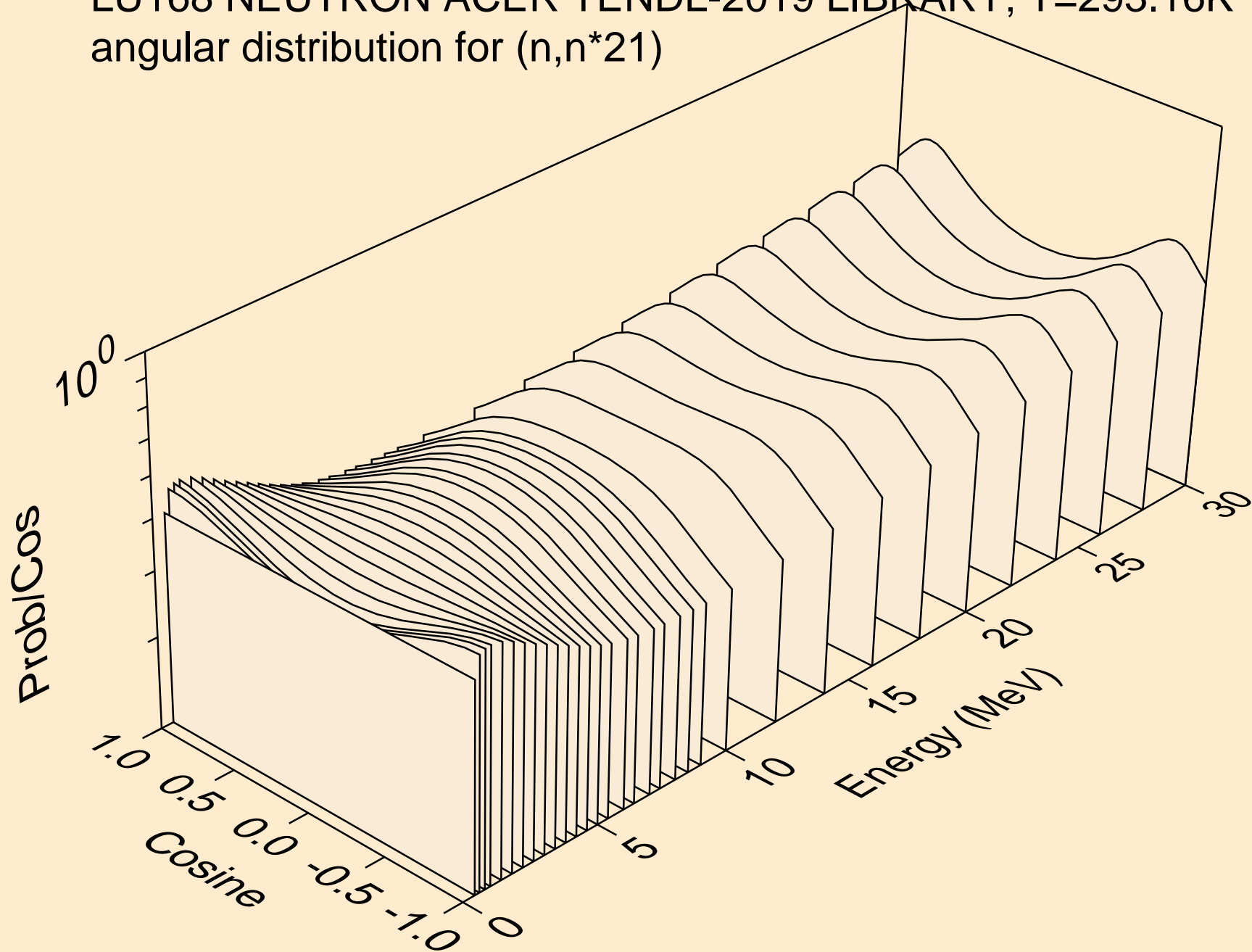

LU168 NEUTRON ACER TENDL-2019 LIBRARY; T=293.16K  
angular distribution for (n,n\*22)

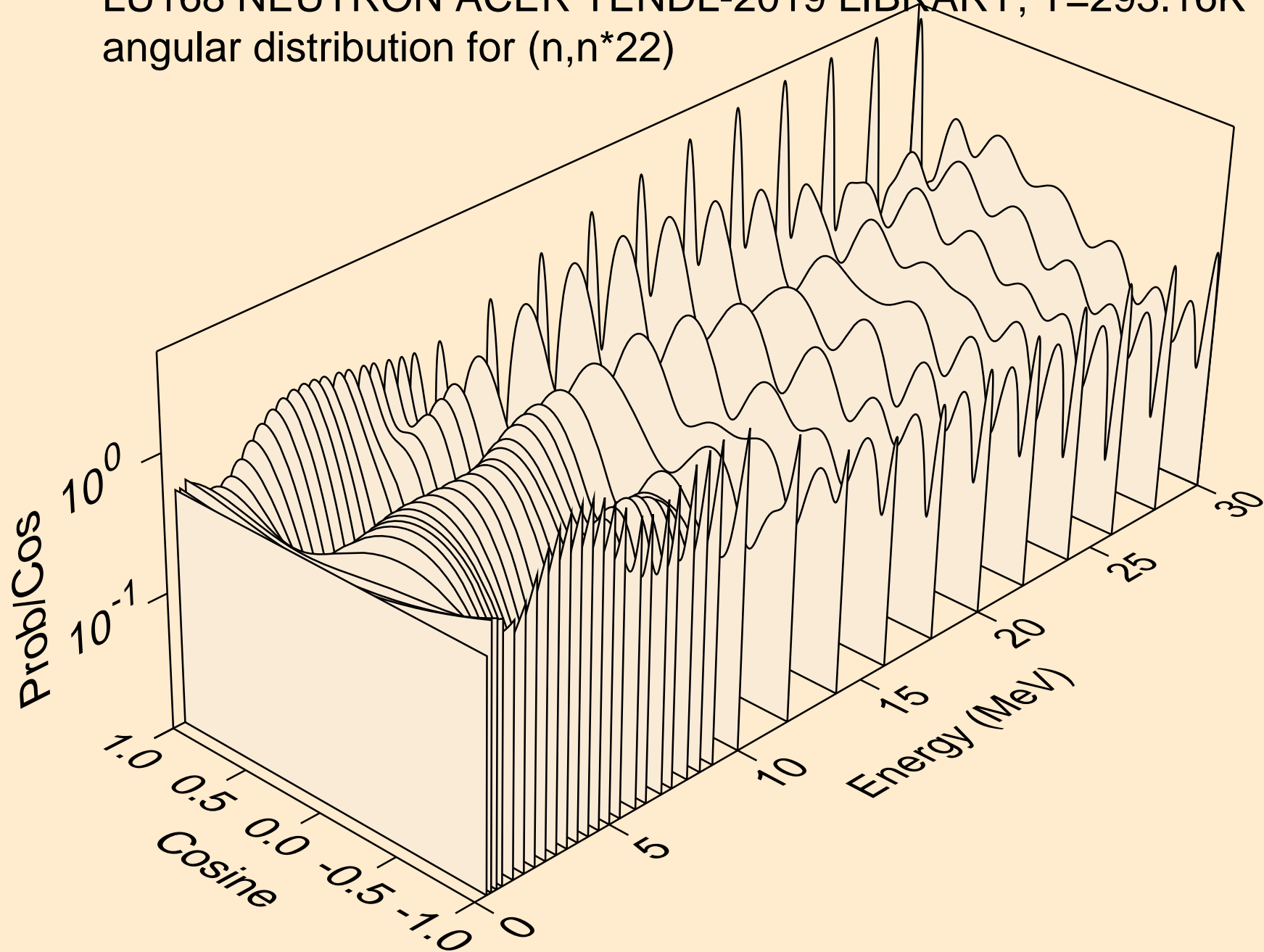

LU168 NEUTRON ACER TENDL-2019 LIBRARY; T=293.16K  
angular distribution for (n,n\*23)

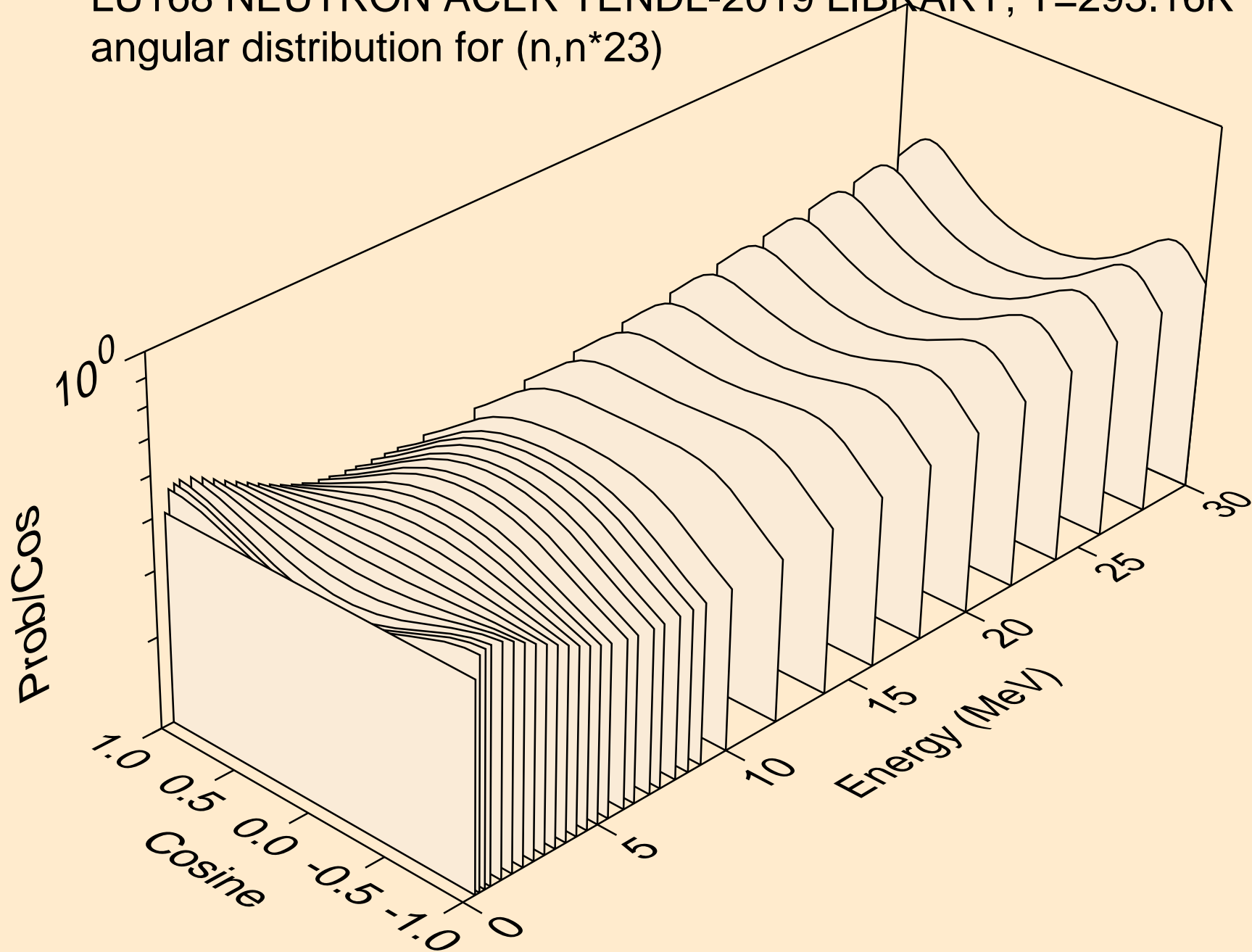



LU168 NEUTRON ACER TENDL-2019 LIBRARY; T=293.16K  
angular distribution for (n,n\*24)

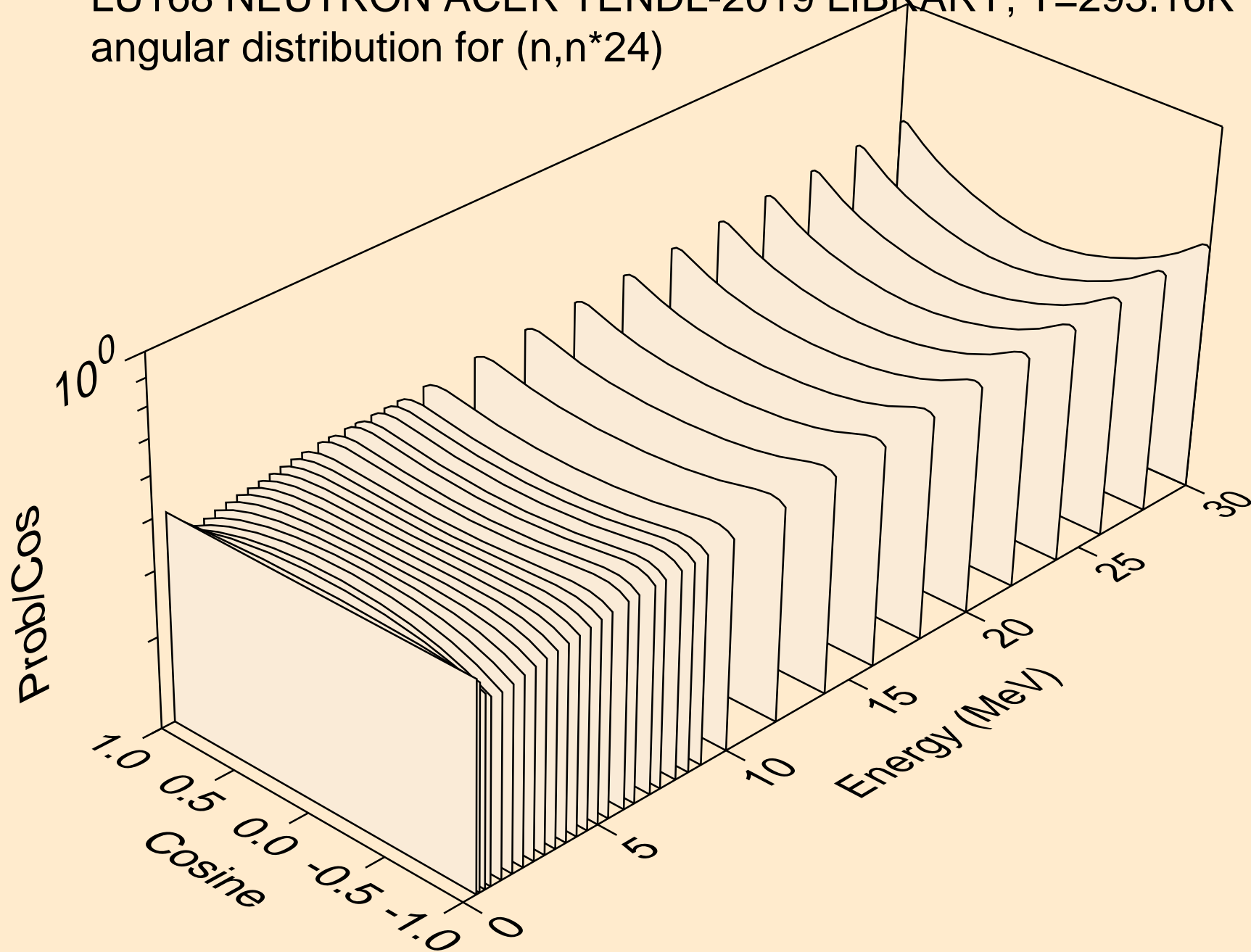

LU168 NEUTRON ACER TENDL-2019 LIBRARY; T=293.16K  
angular distribution for (n,n\*25)

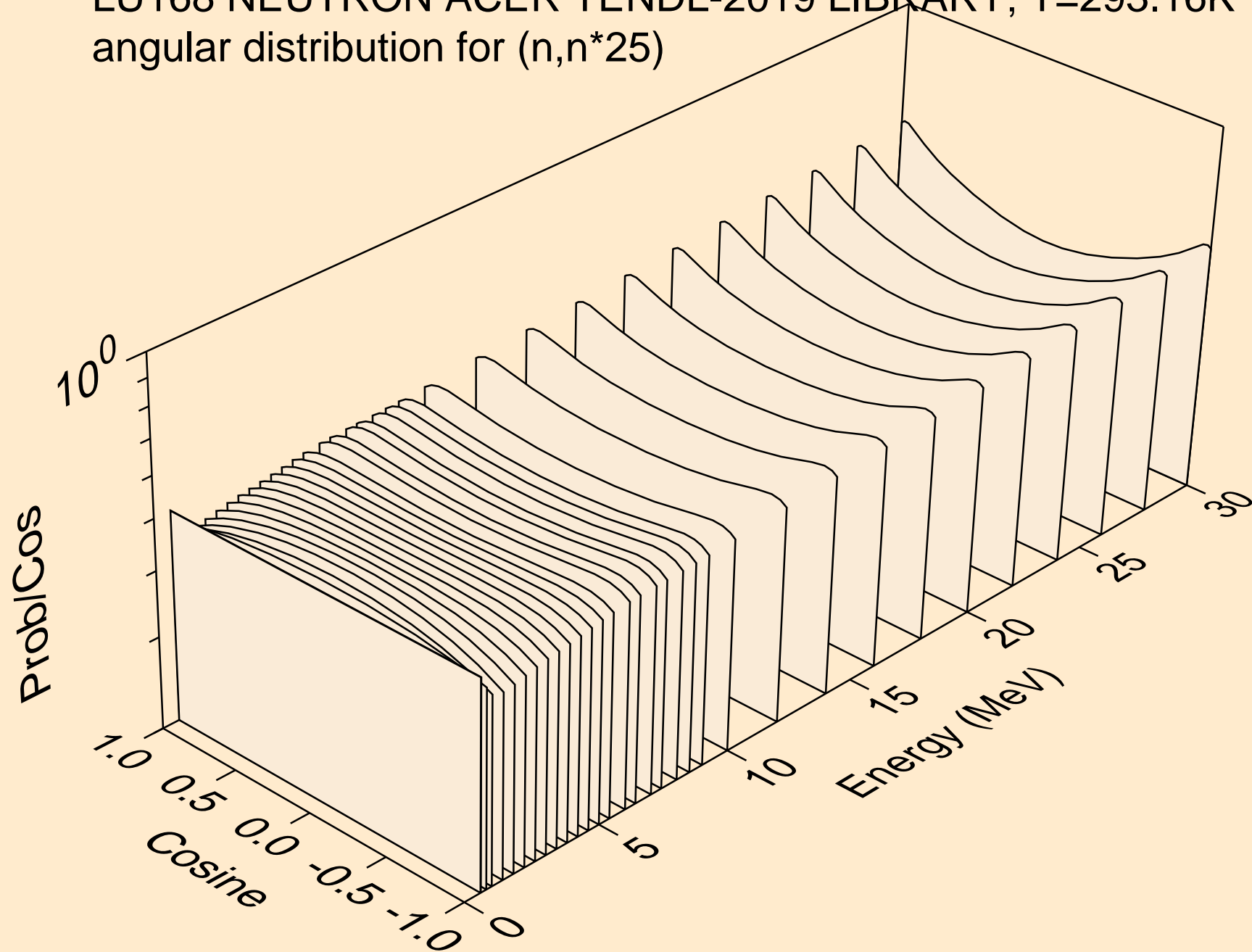

LU168 NEUTRON ACER TENDL-2019 LIBRARY; T=293.16K  
angular distribution for (n,n\*26)

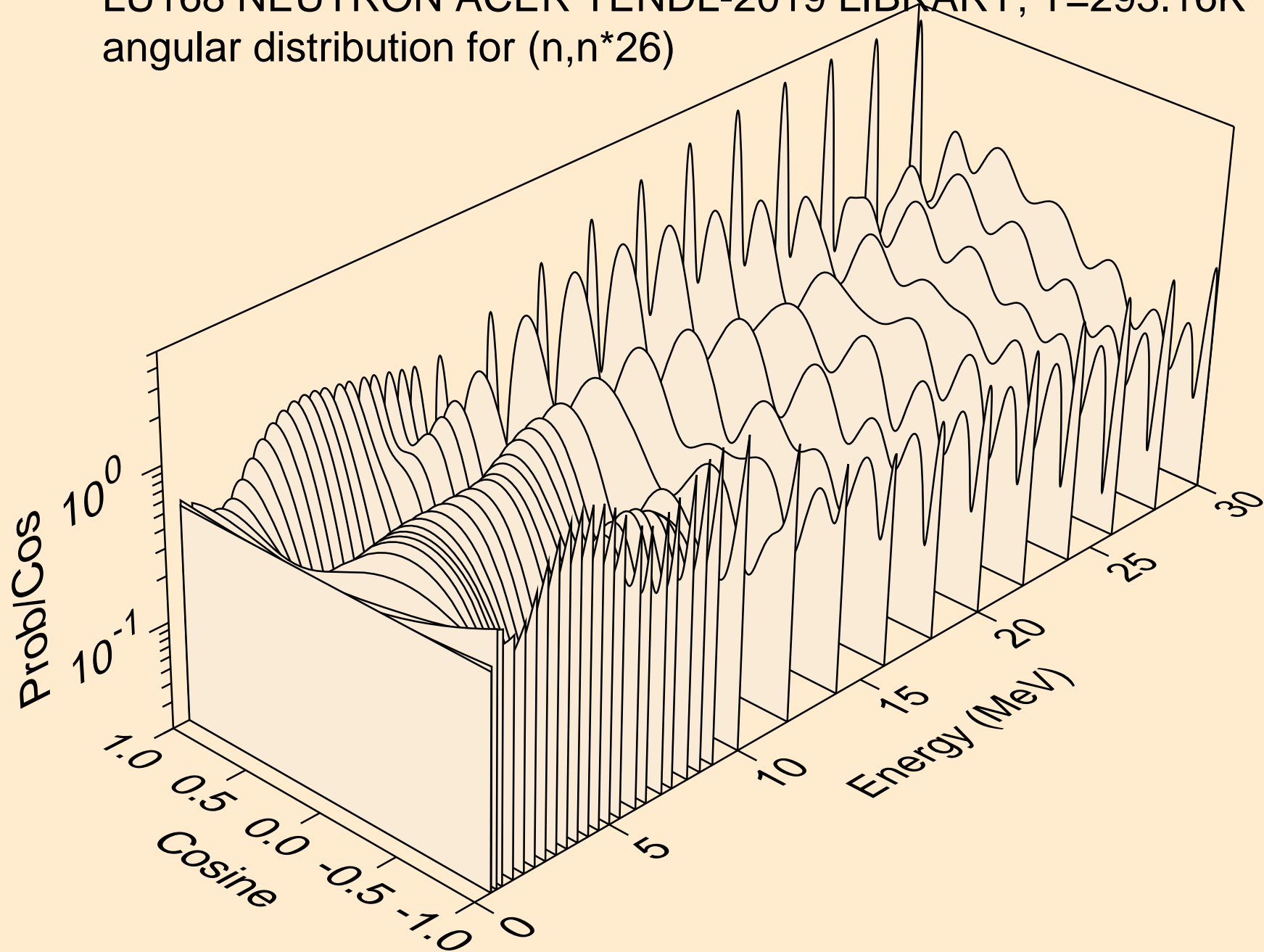

LU168 NEUTRON ACER TENDL-2019 LIBRARY; T=293.16K  
angular distribution for (n,n\*27)

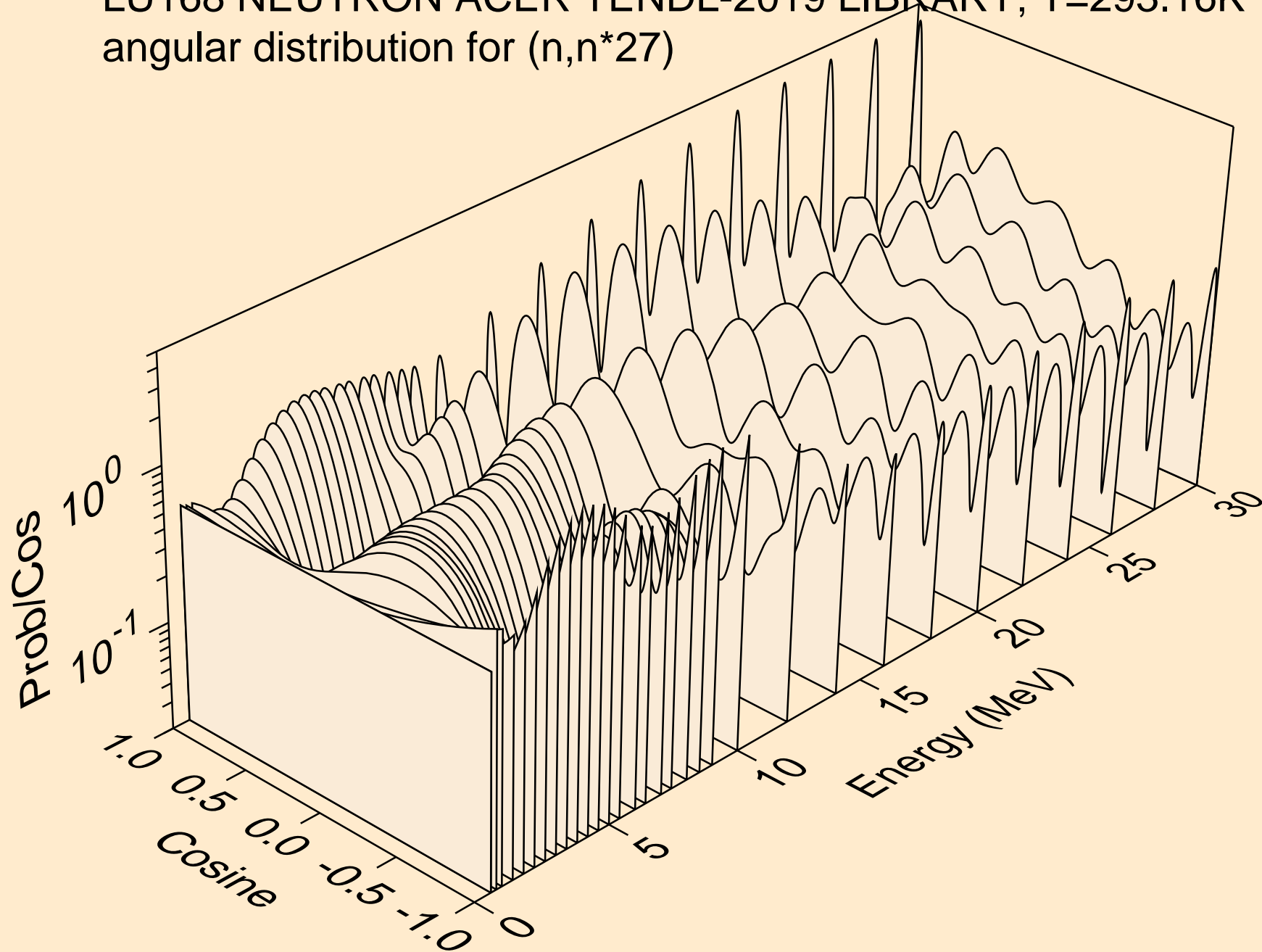

LU168 NEUTRON ACER TENDL-2019 LIBRARY; T=293.16K  
angular distribution for (n,n\*28)

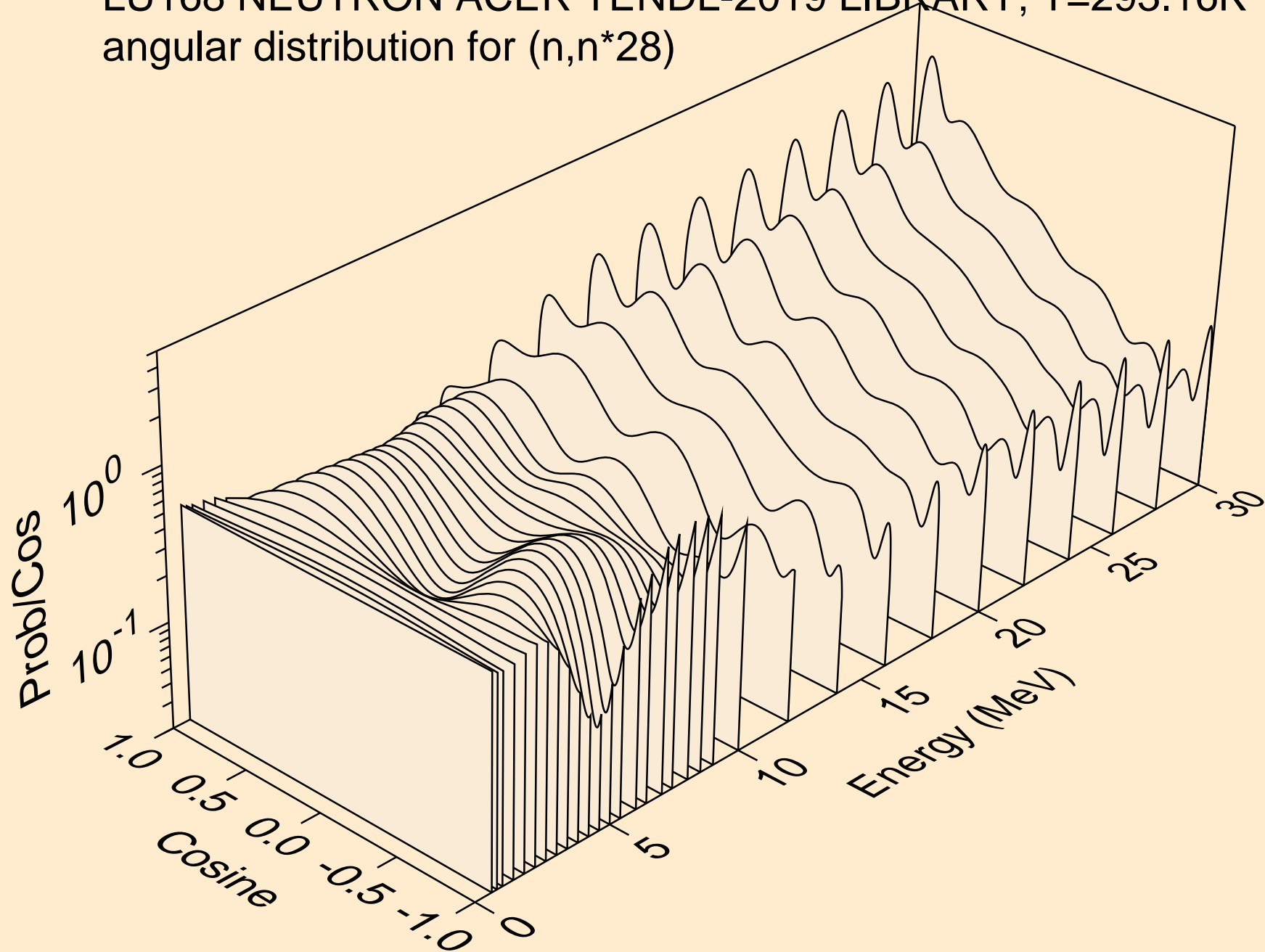

LU168 NEUTRON ACER TENDL-2019 LIBRARY; T=293.16K  
angular distribution for (n,n\*29)

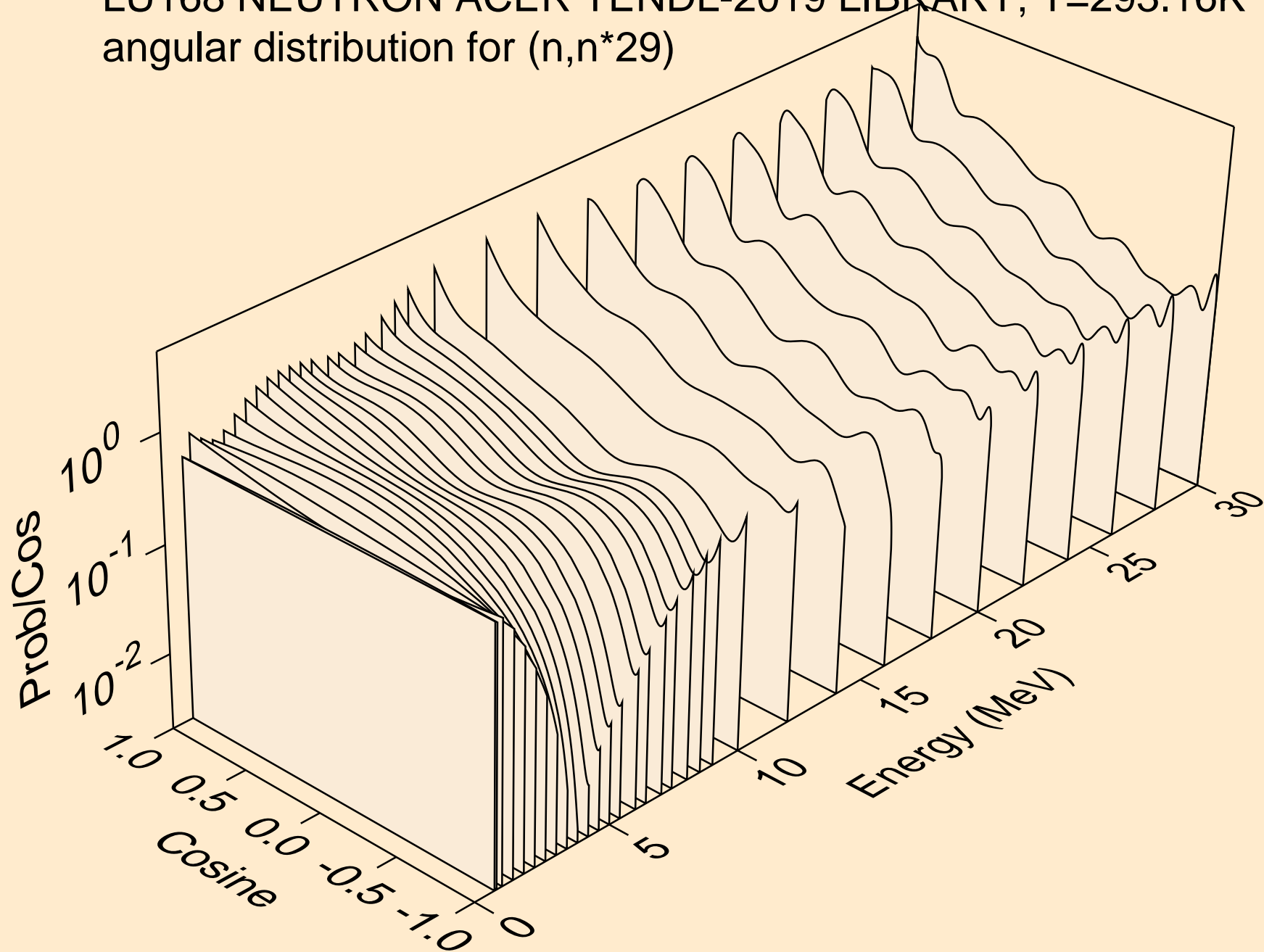

LU168 NEUTRON ACER TENDL-2019 LIBRARY; T=293.16K  
Neutron emission for (n,x)

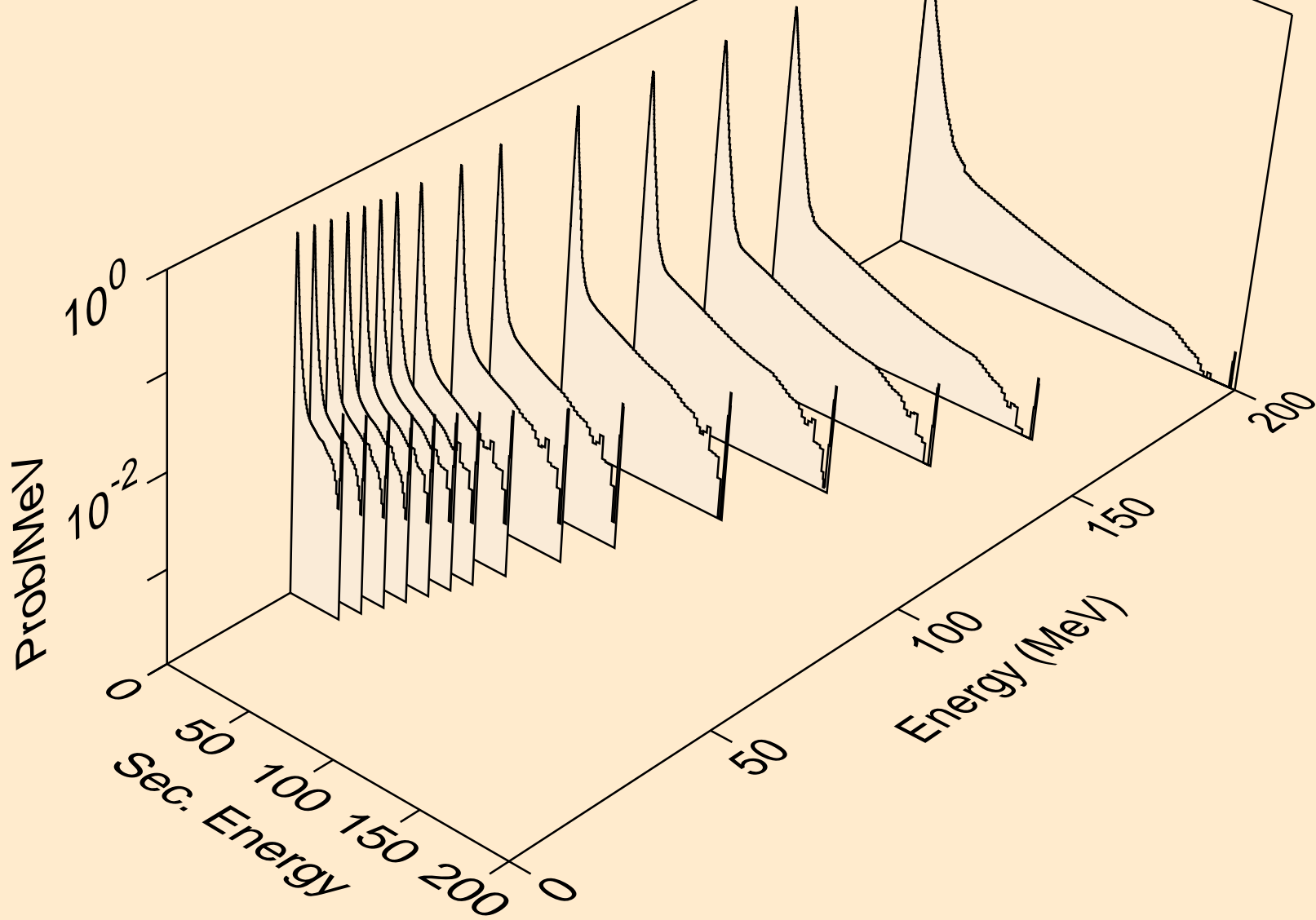

LU168 NEUTRON ACER TENDL-2019 LIBRARY; T=293.16K  
Neutron emission for (n,2nd)

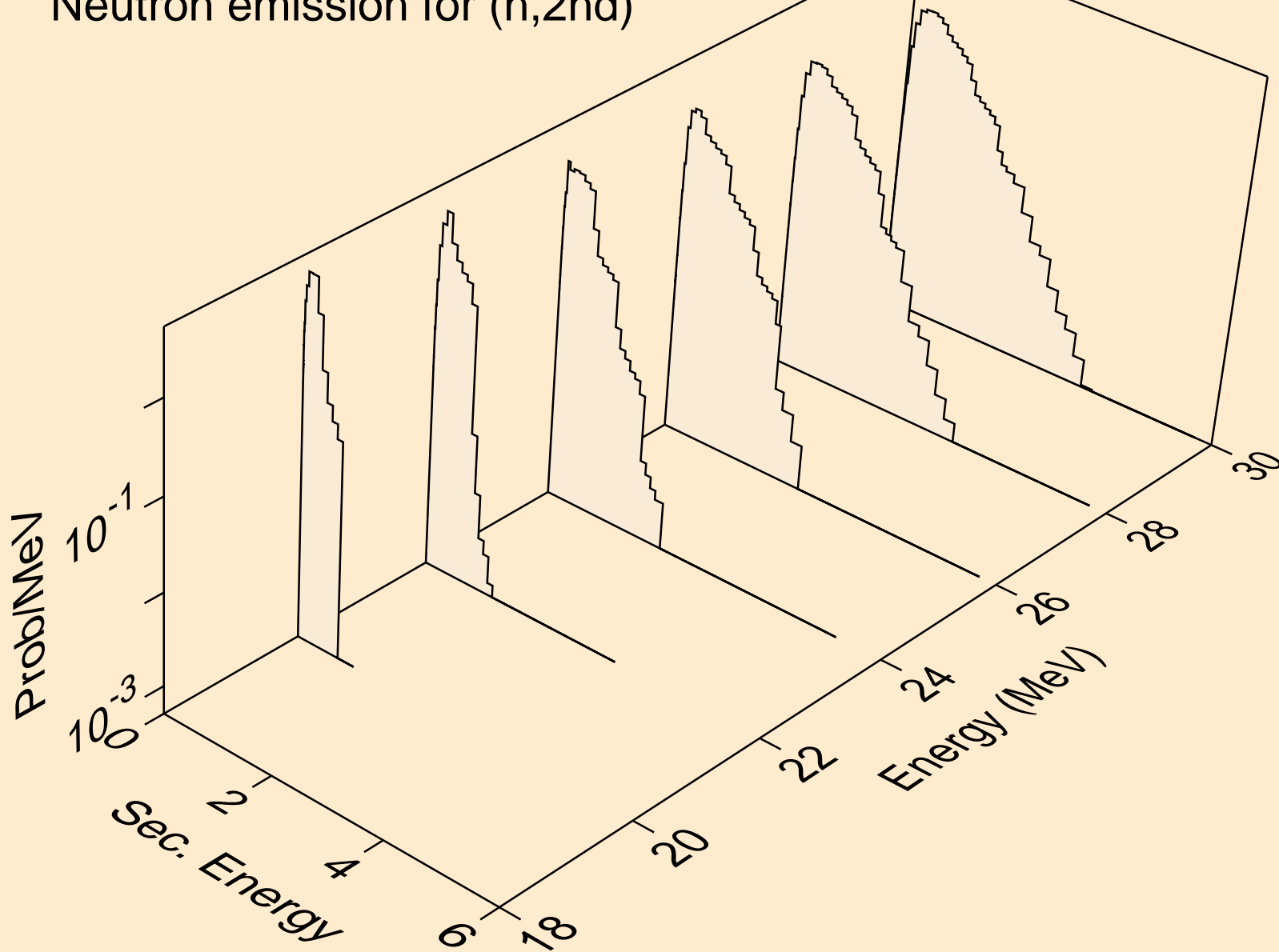



LU168 NEUTRON ACER TENDL-2019 LIBRARY; T=293.16K  
Neutron emission for (n,2n)

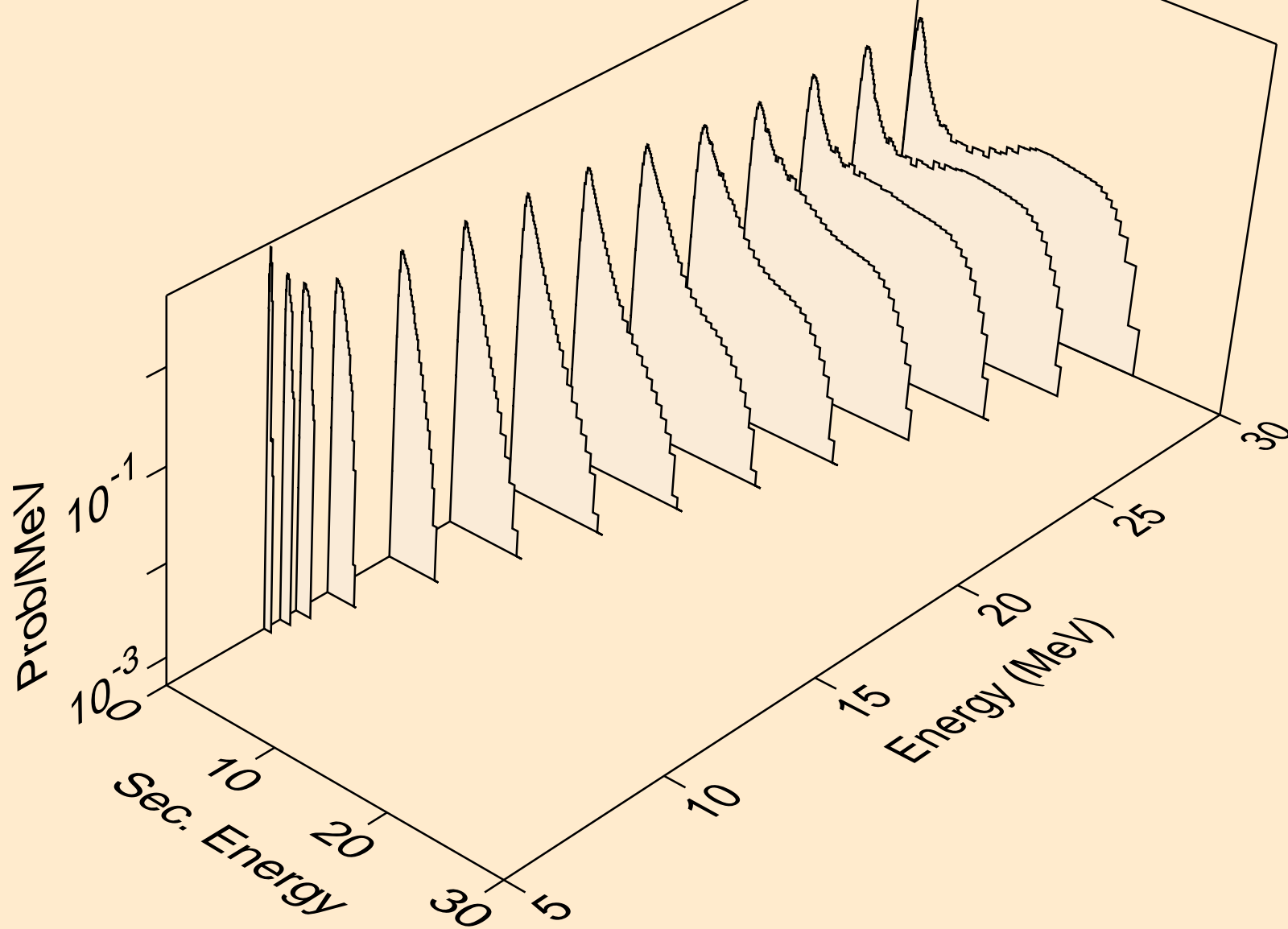

LU168 NEUTRON ACER TENDL-2019 LIBRARY; T=293.16K  
Neutron emission for (n,3n)

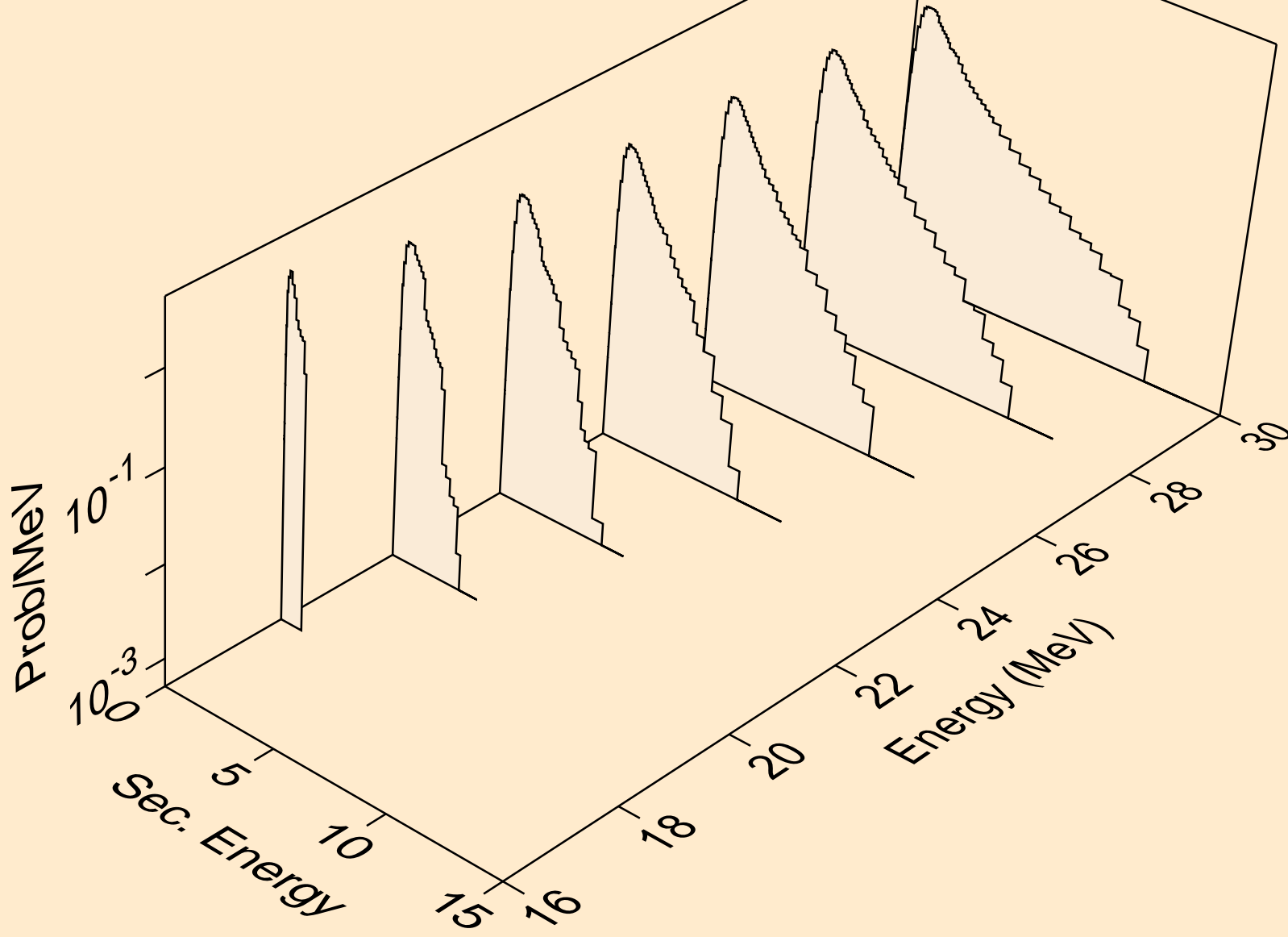

LU168 NEUTRON ACER TENDL-2019 LIBRARY; T=293.16K  
Neutron emission for (n,n\*)a

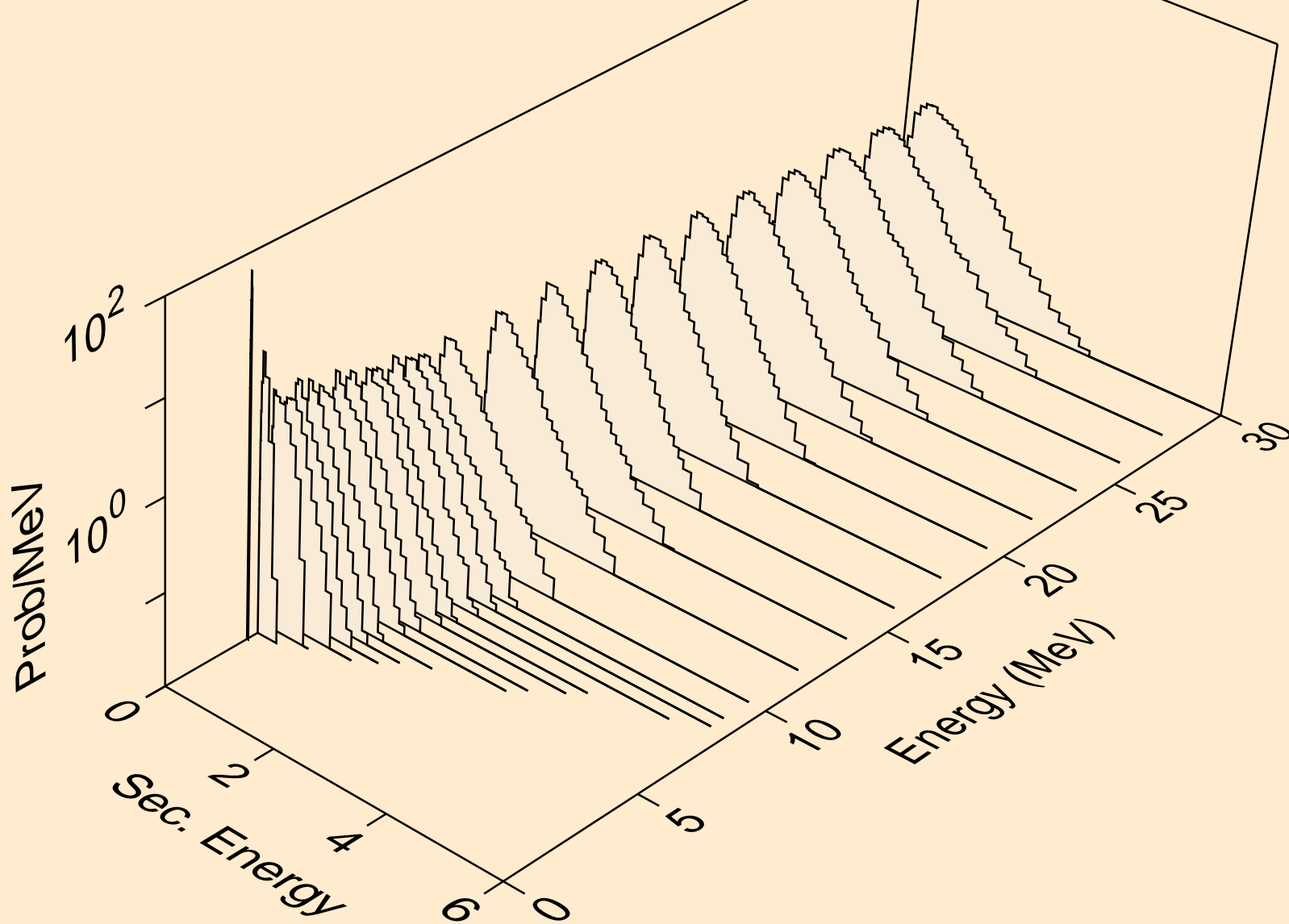

LU168 NEUTRON ACER TENDL-2019 LIBRARY; T=293.16K  
Neutron emission for (n,2n)a

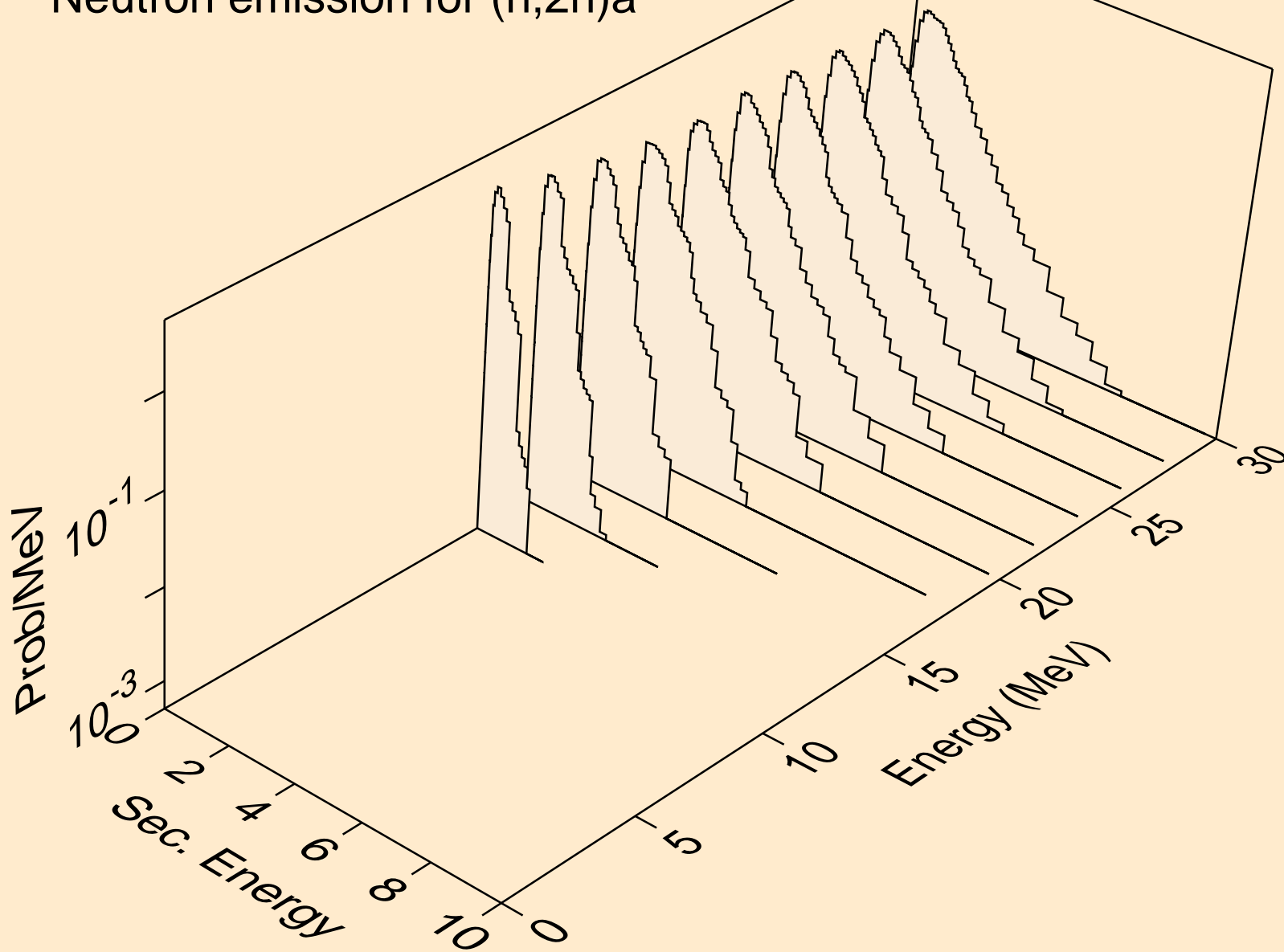

LU168 NEUTRON ACER TENDL-2019 LIBRARY; T=293.16K  
Neutron emission for (n,3n)a

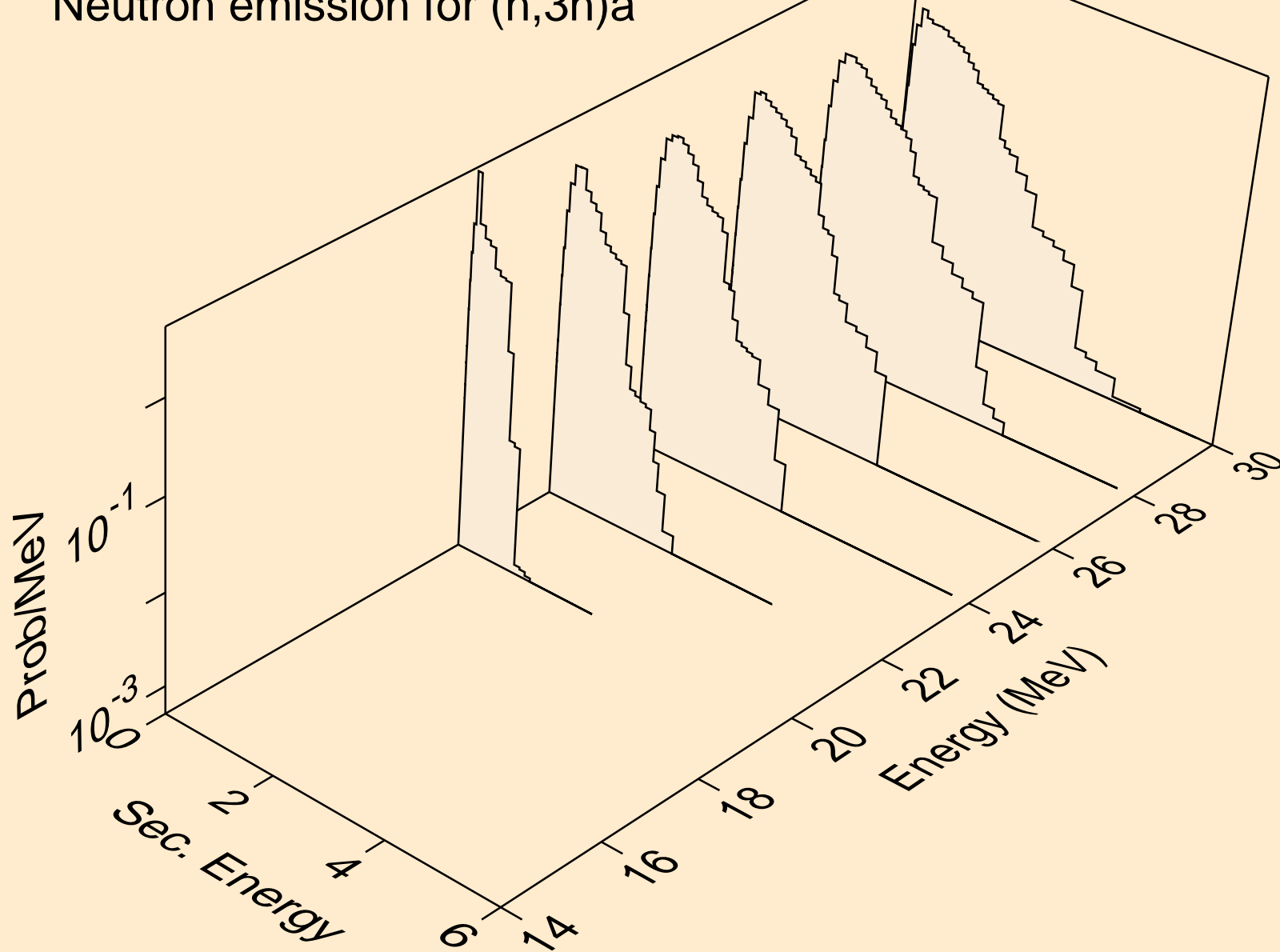

LU168 NEUTRON ACER TENDL-2019 LIBRARY; T=293.16K  
Neutron emission for (n,n\*)p

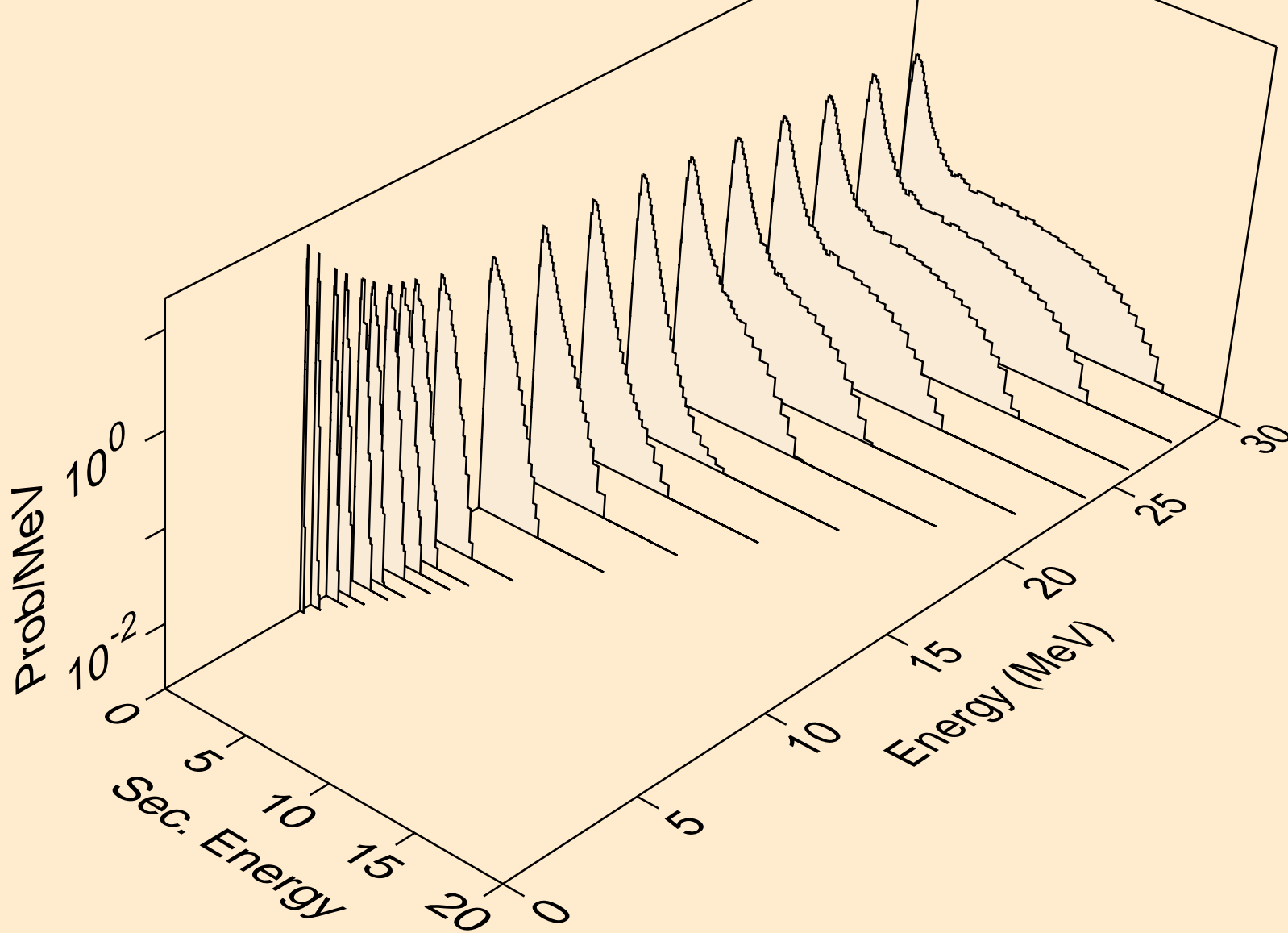

LU168 NEUTRON ACER TENDL-2019 LIBRARY; T=293.16K  
Neutron emission for (n,n\*)2a

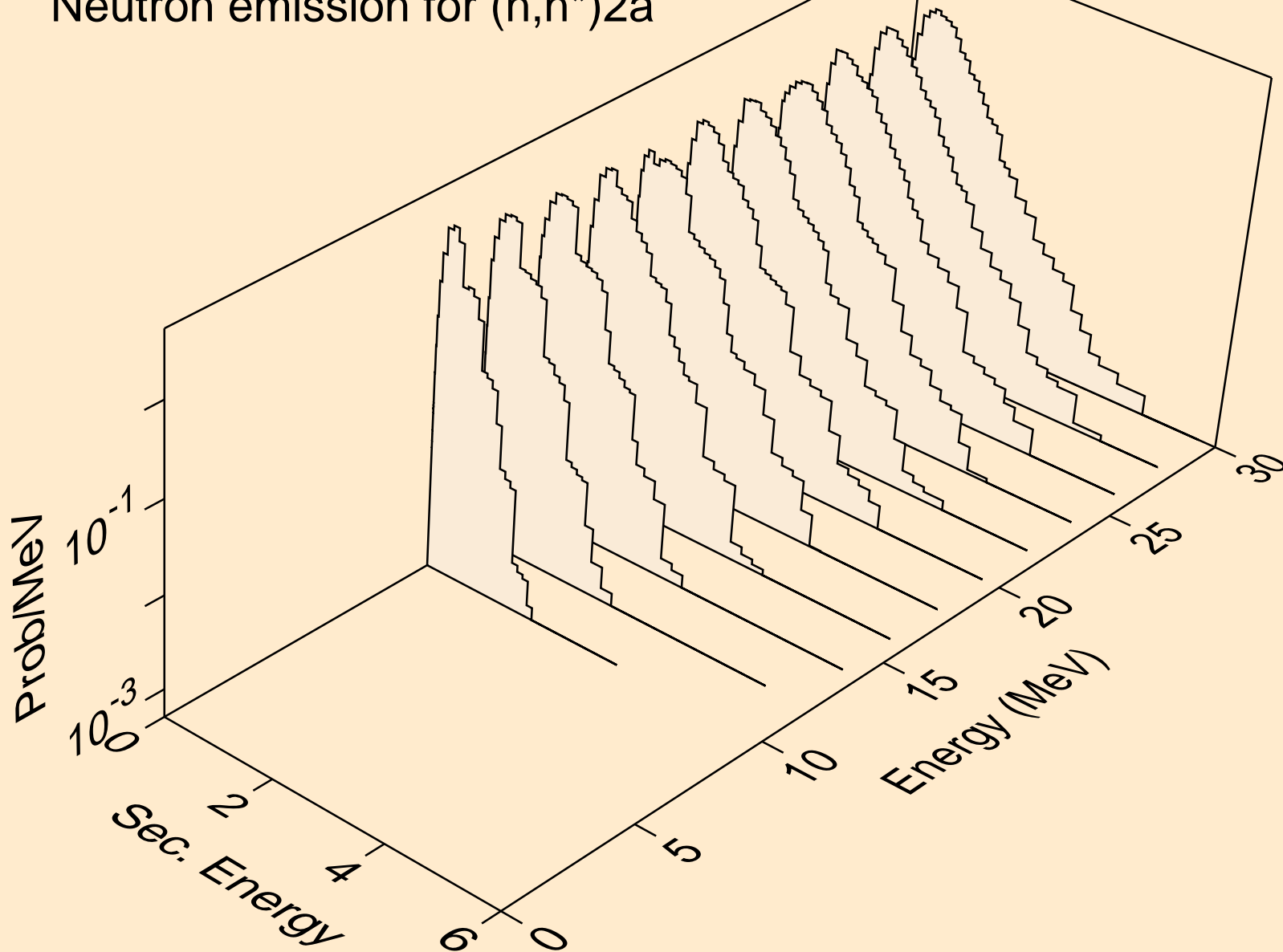

LU168 NEUTRON ACER TENDL-2019 LIBRARY; T=293.16K  
Neutron emission for (n,2n)2a

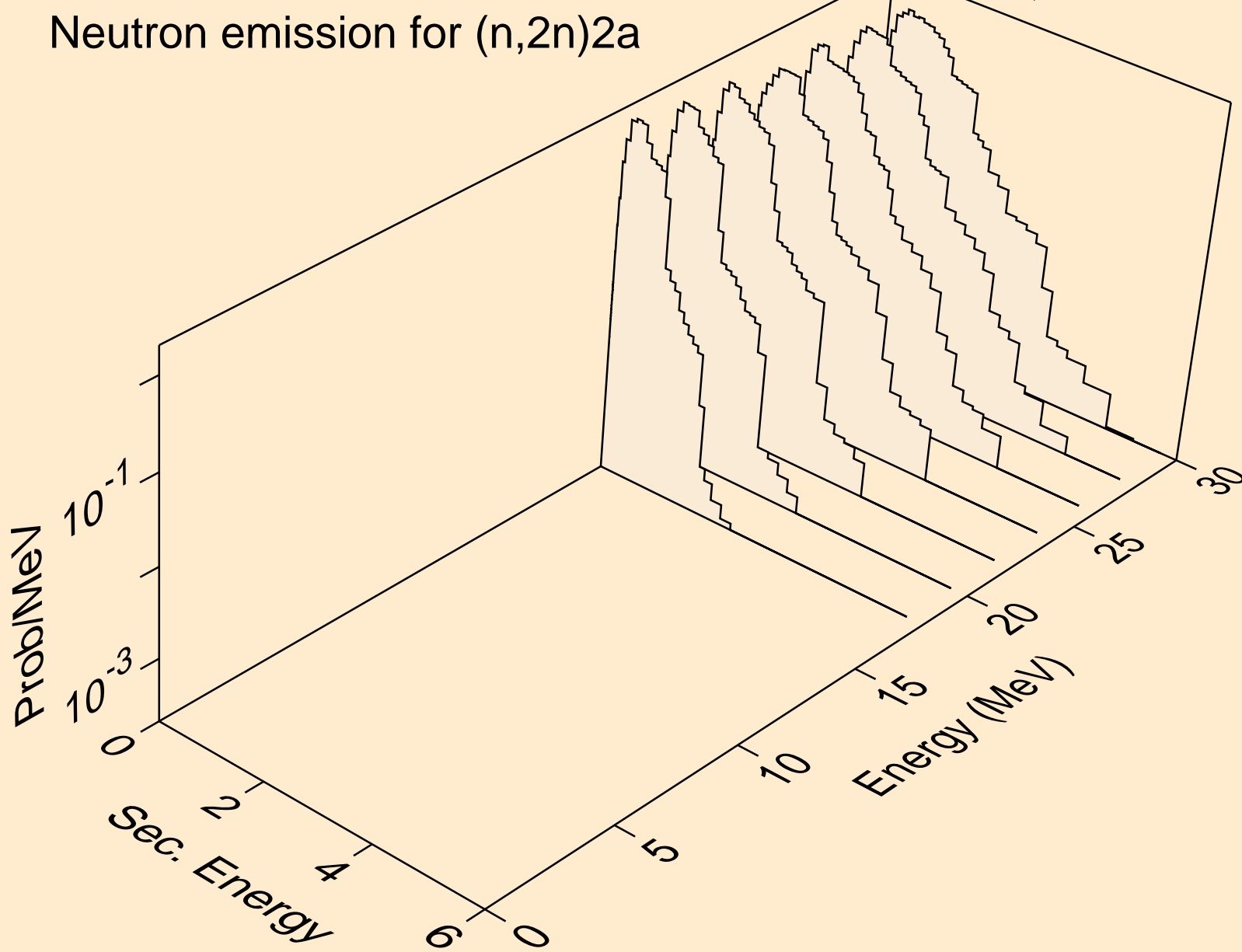



LU168 NEUTRON ACER TENDL-2019 LIBRARY; T=293.16K  
Neutron emission for (n,n\*)d

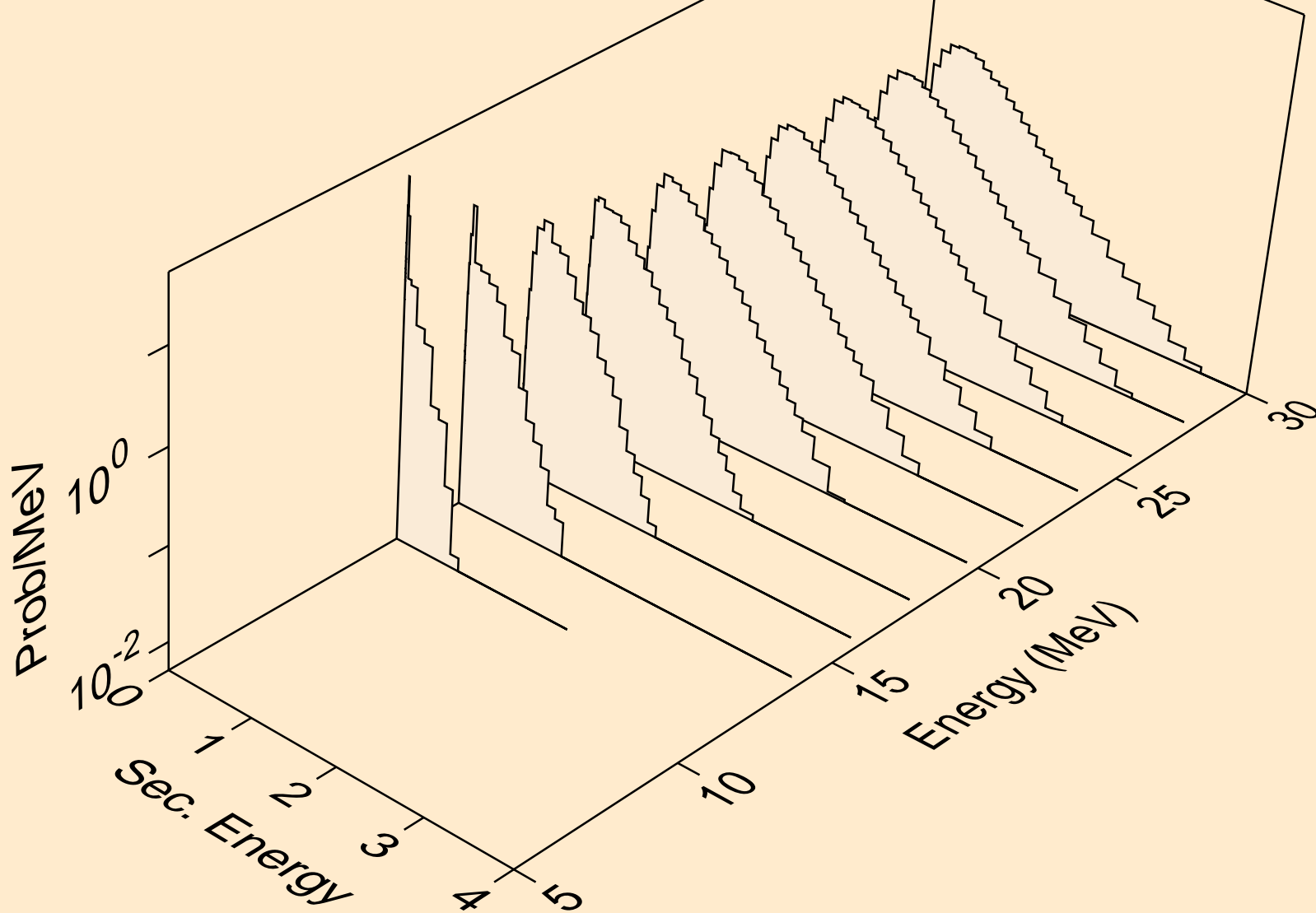

LU168 NEUTRON ACER TENDL-2019 LIBRARY; T=293.16K  
Neutron emission for (n,n\*)t

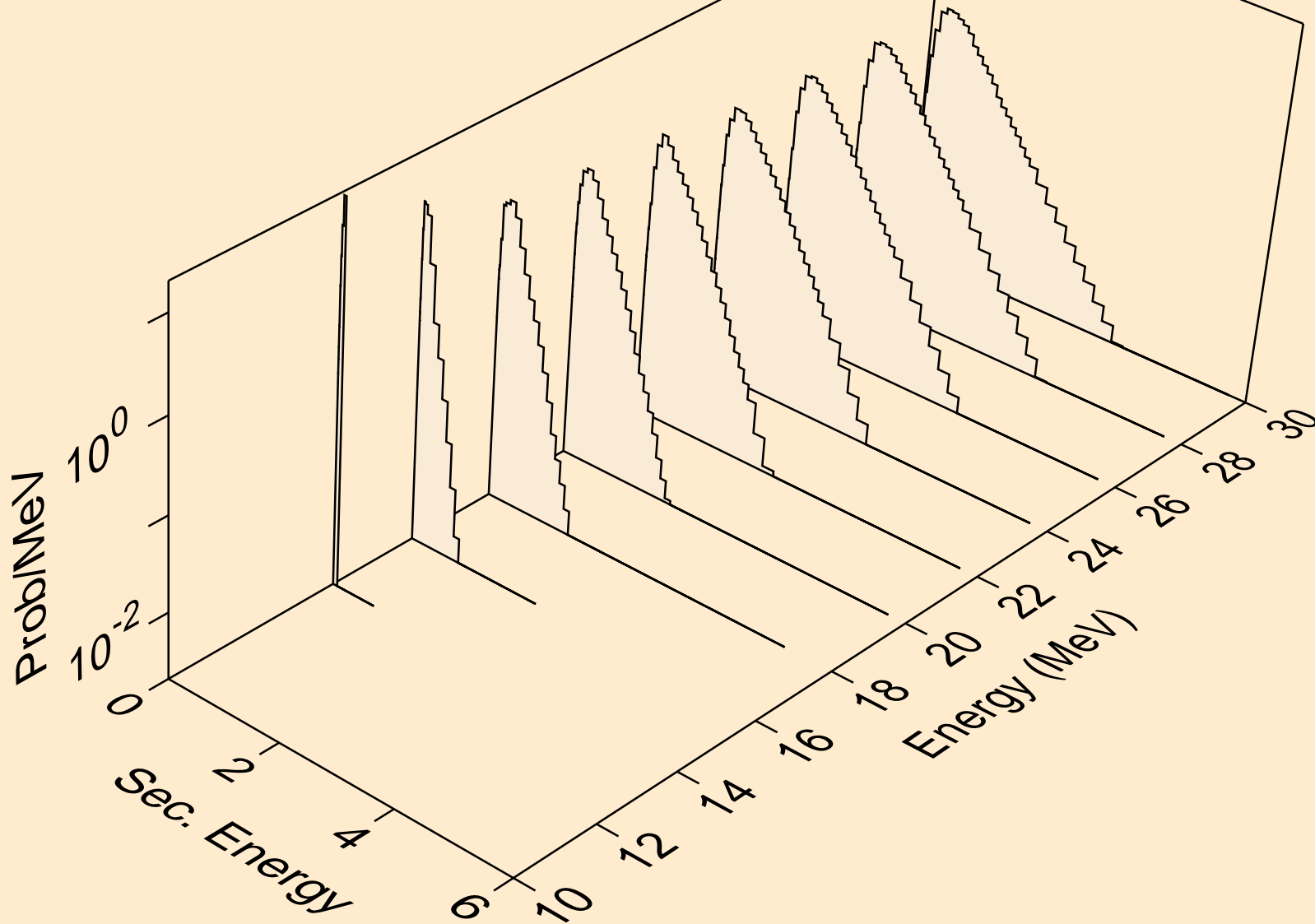

LU168 NEUTRON ACER TENDL-2019 LIBRARY; T=293.16K  
Neutron emission for (n,n\*)he3

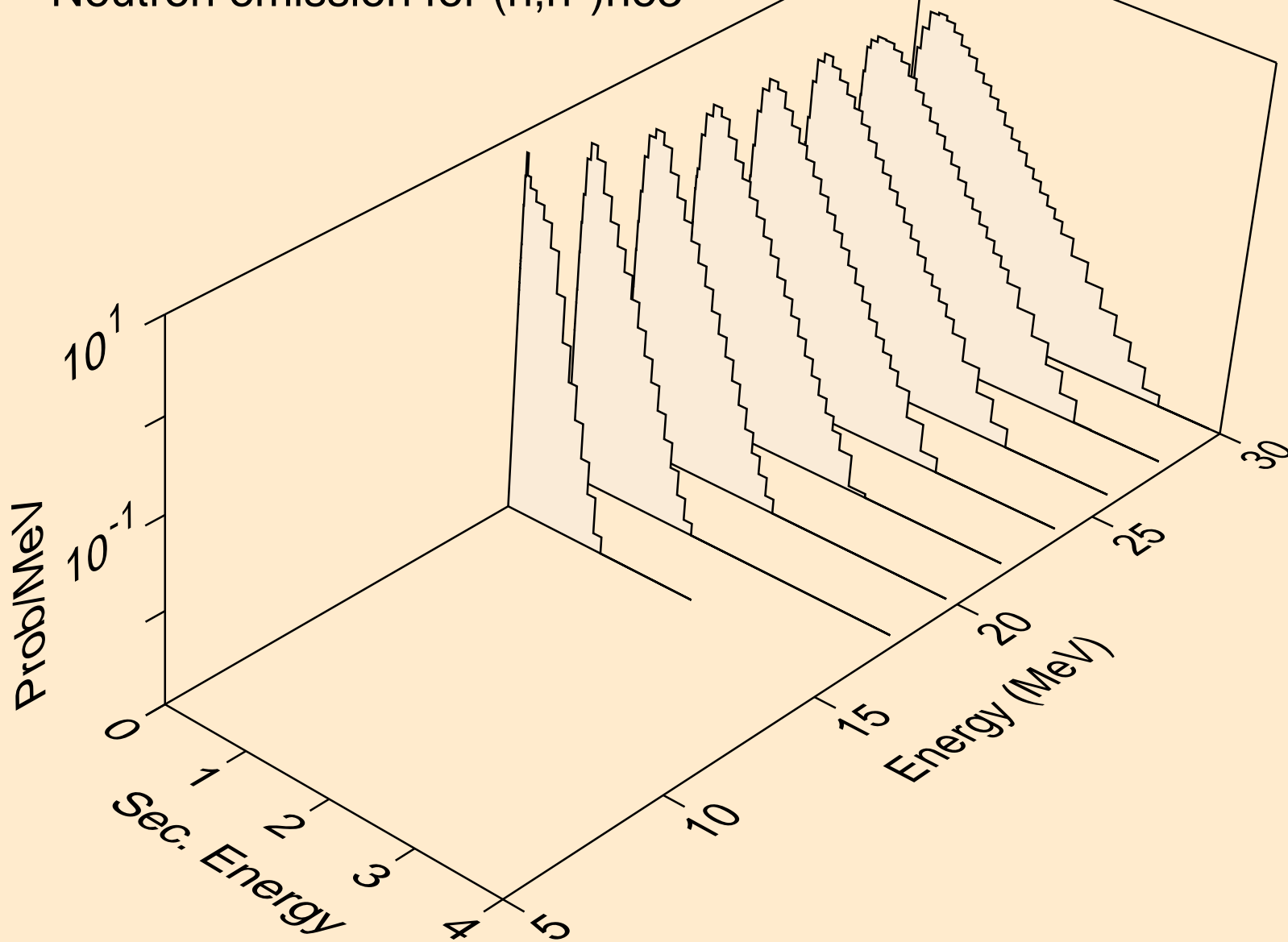

LU168 NEUTRON ACER TENDL-2019 LIBRARY; T=293.16K  
Neutron emission for (n,4n)

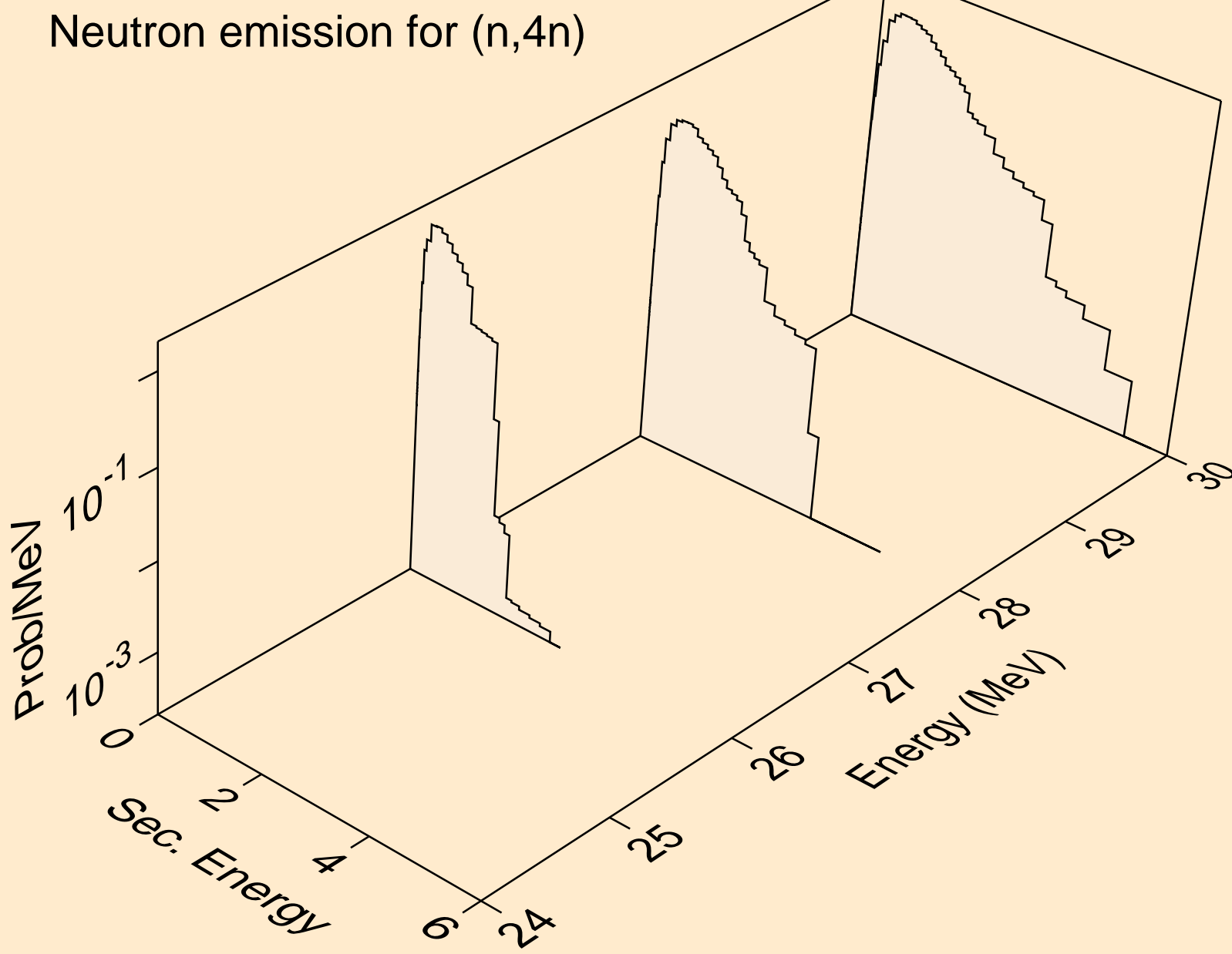

LU168 NEUTRON ACER TENDL-2019 LIBRARY; T=293.16K  
Neutron emission for (n,2np)

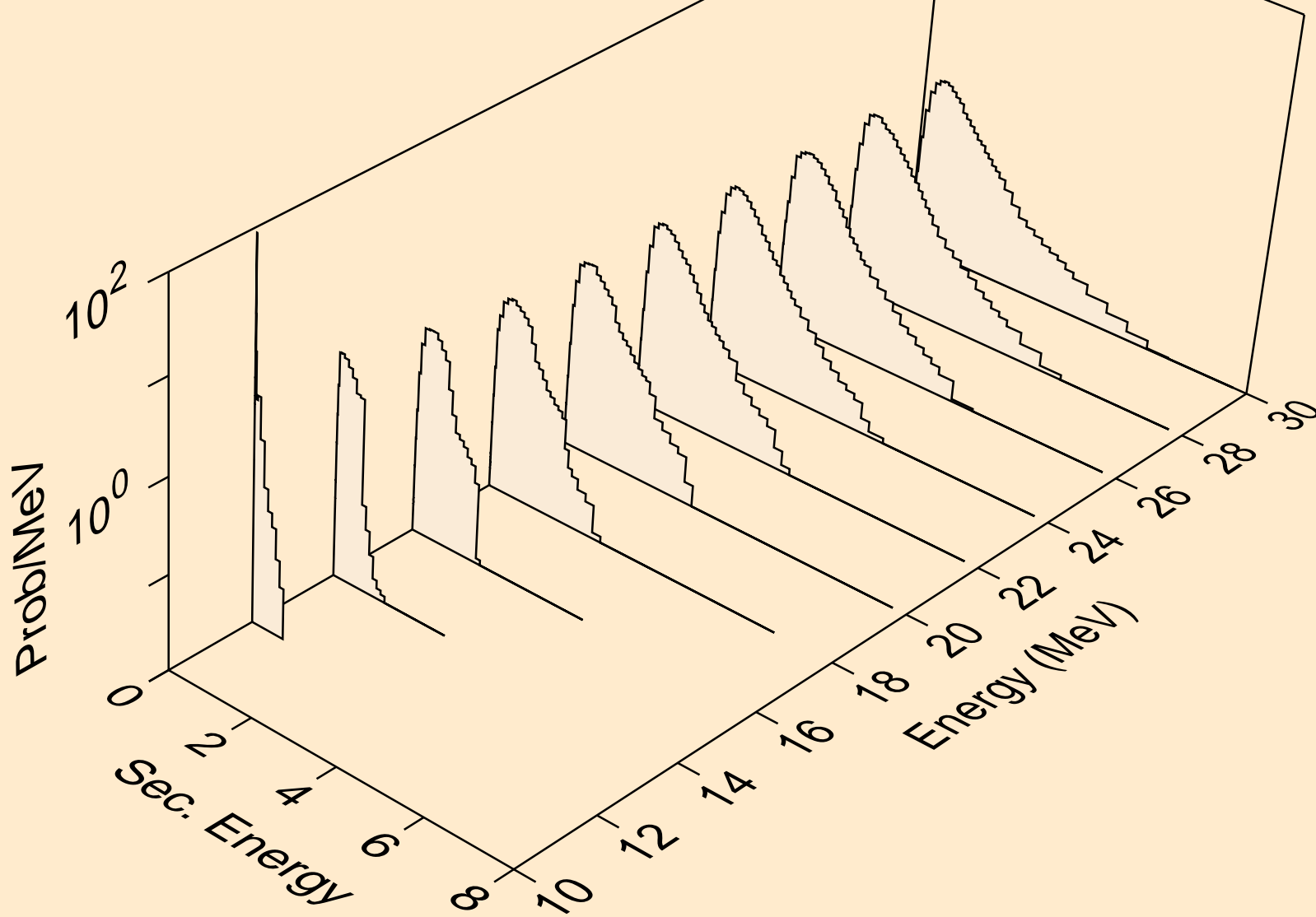

LU168 NEUTRON ACER TENDL-2019 LIBRARY; T=293.16K  
Neutron emission for (n,3np)

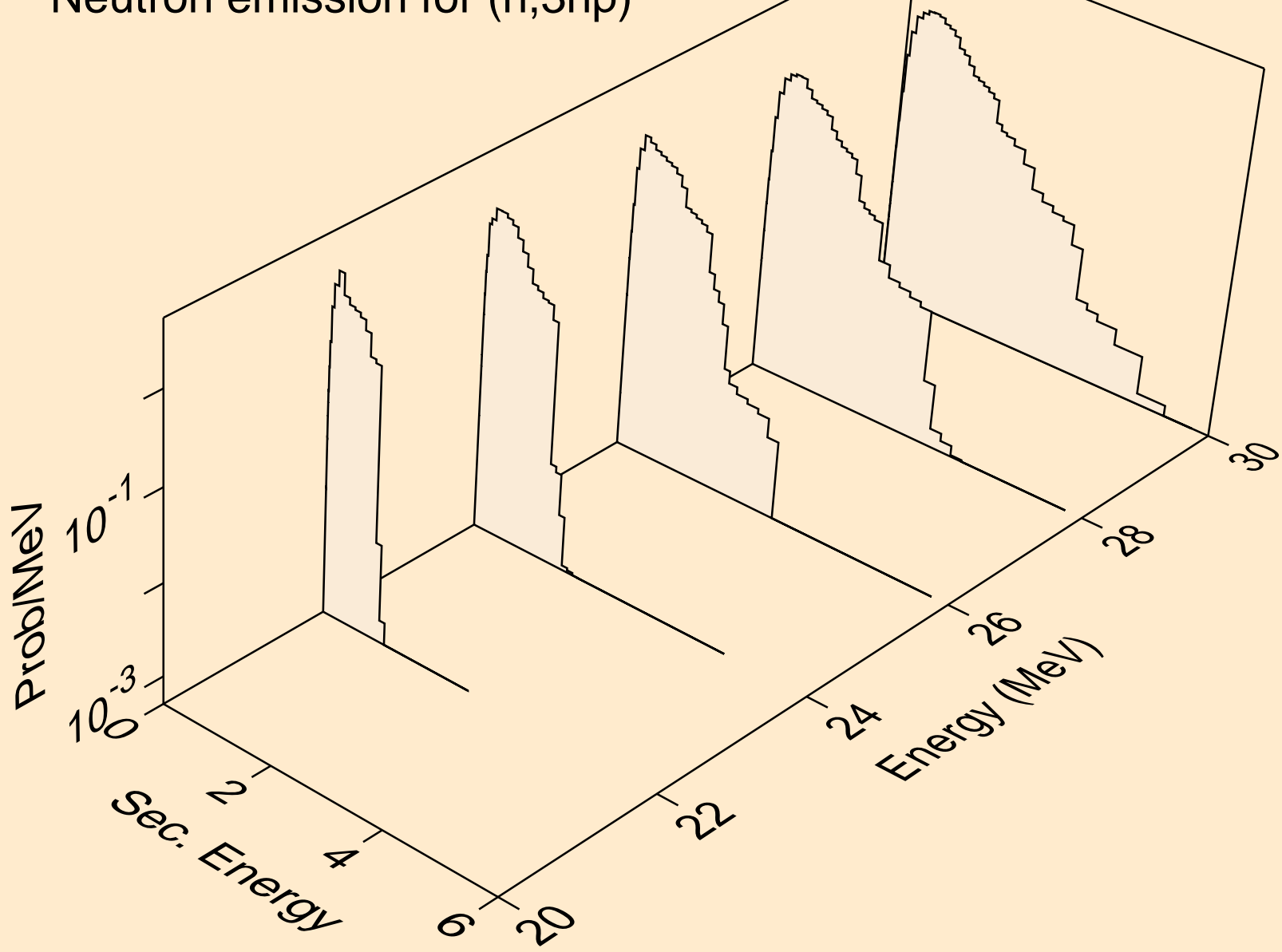

LU168 NEUTRON ACER TENDL-2019 LIBRARY; T=293.16K  
Neutron emission for (n,2np)

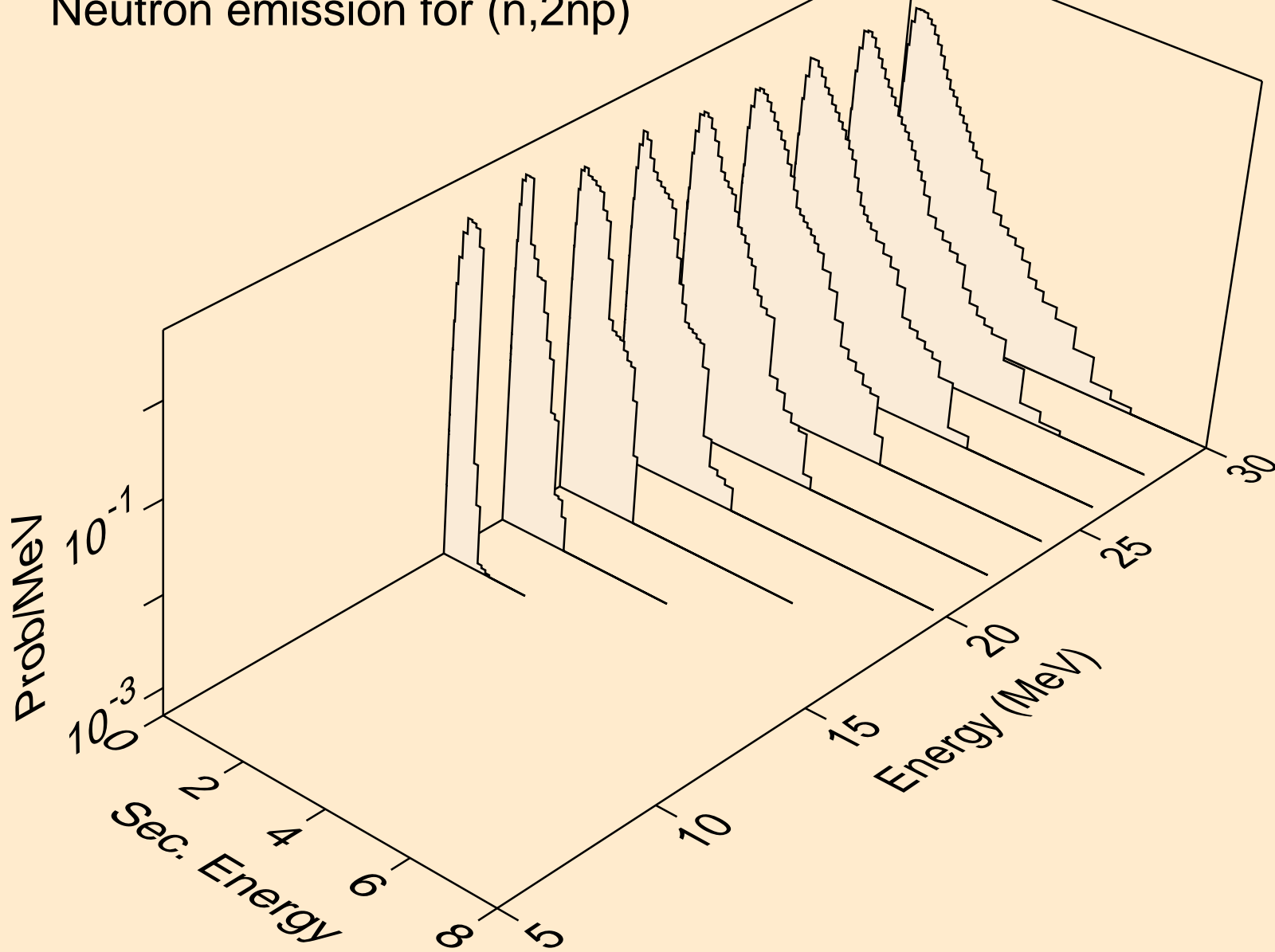

LU168 NEUTRON ACER TENDL-2019 LIBRARY; T=293.16K  
Neutron emission for (n,npa)

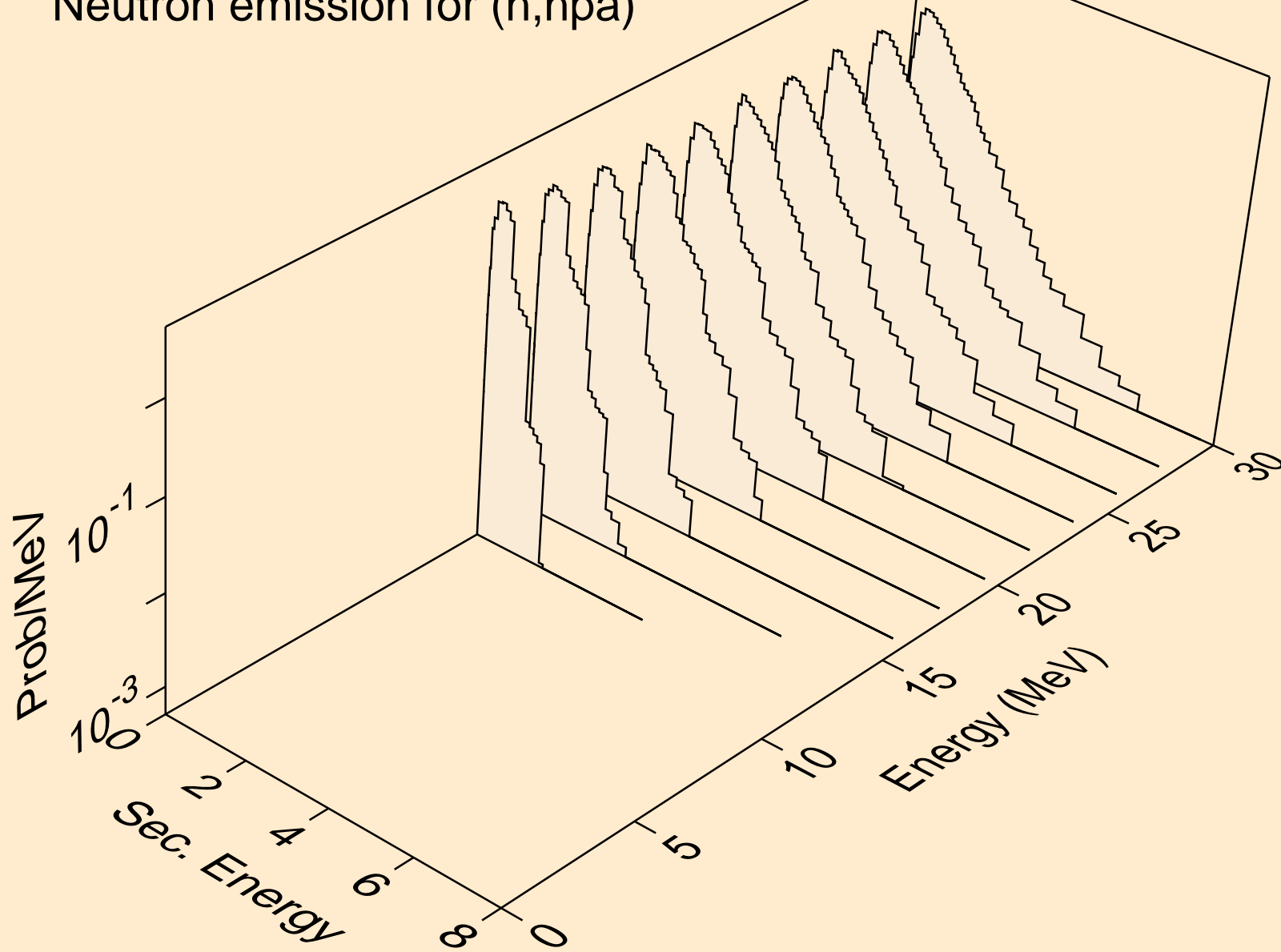



LU168 NEUTRON ACER TENDL-2019 LIBRARY; T=293.16K  
Neutron emission for (n,n\*c)

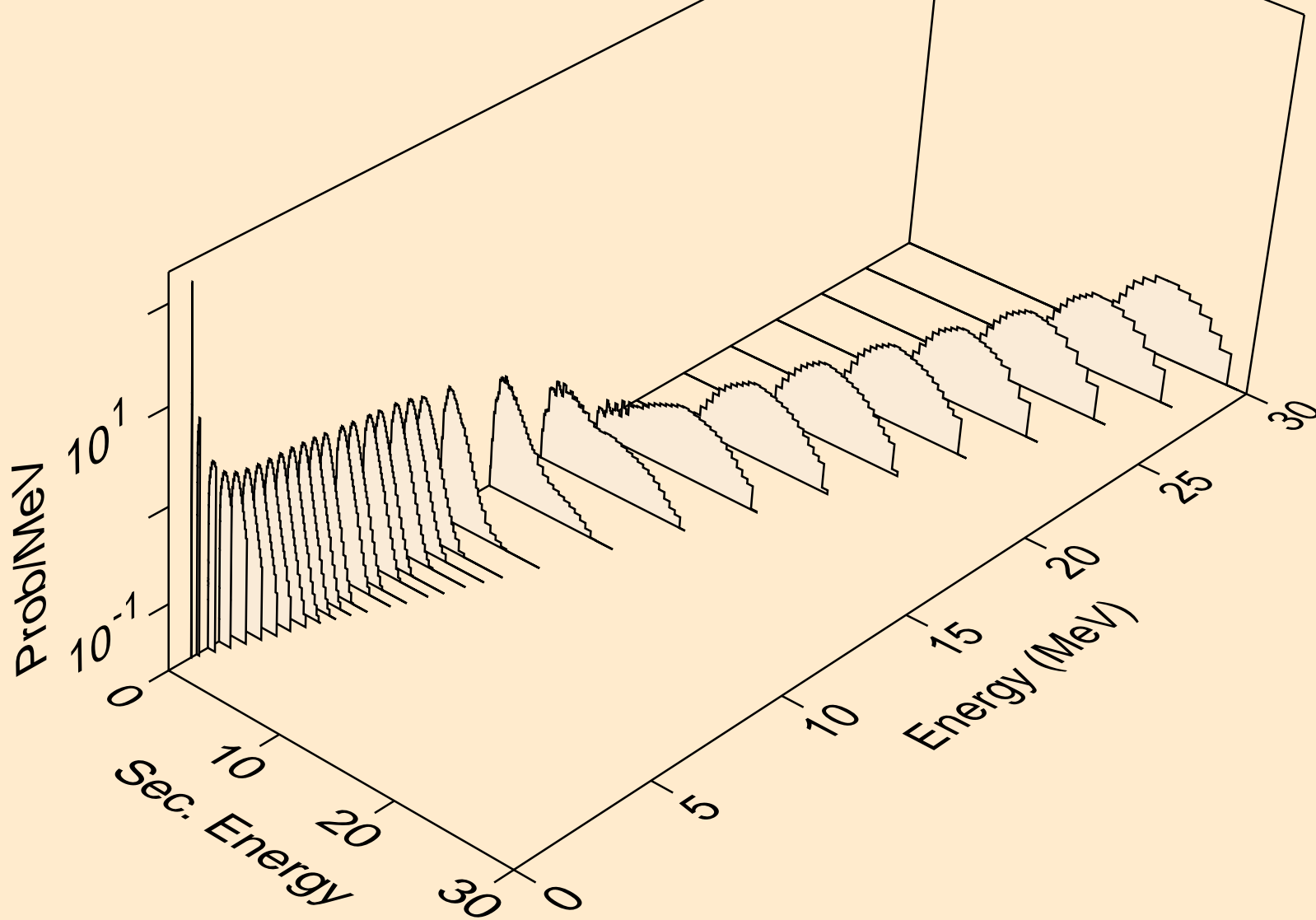

LU168 NEUTRON ACER TENDL-2019 LIBRARY; T=293.16K  
Photon emission for (n,x)

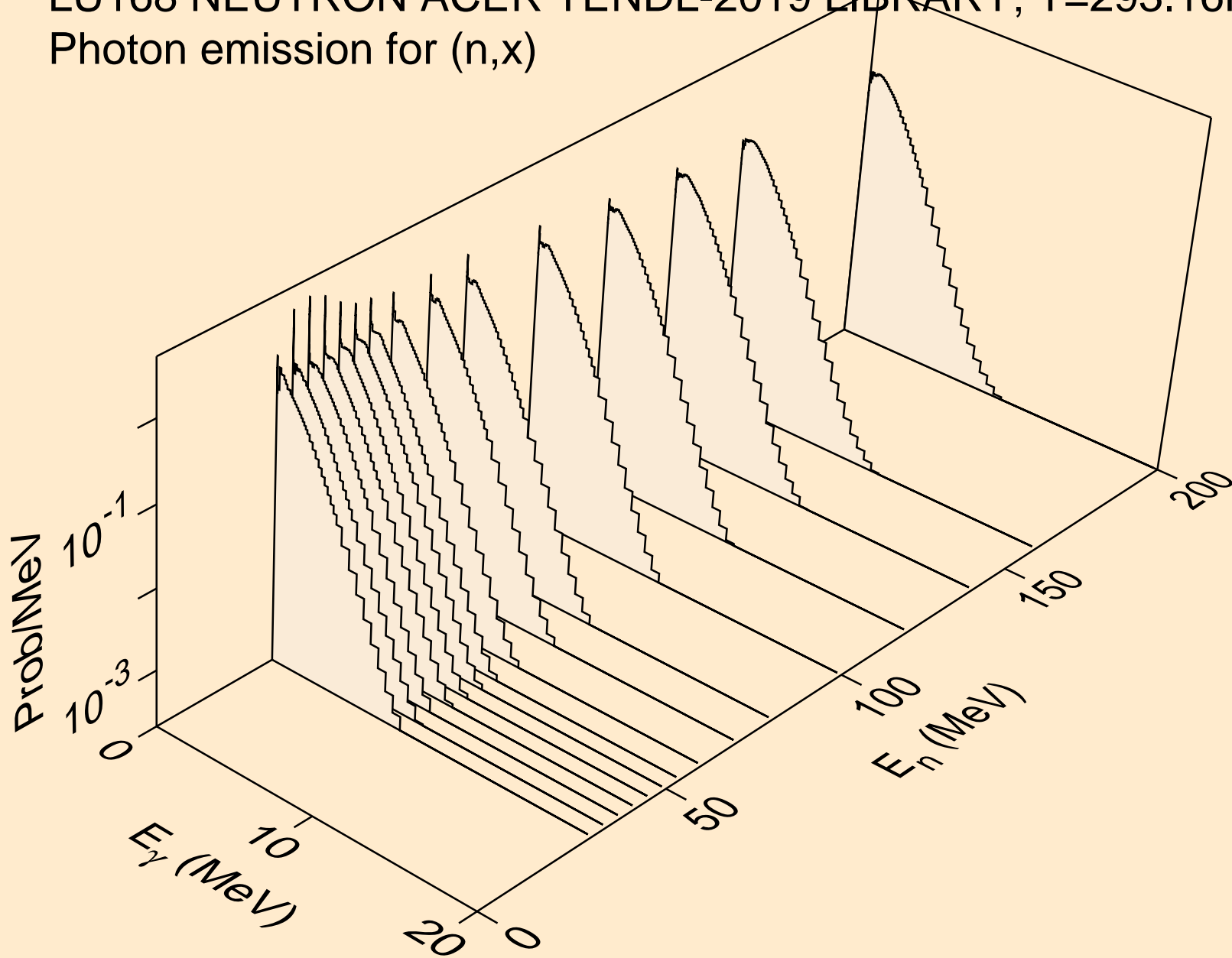

LU168 NEUTRON ACER TENDL-2019 LIBRARY; T=293.16K  
Photon emission for (n,2nd)

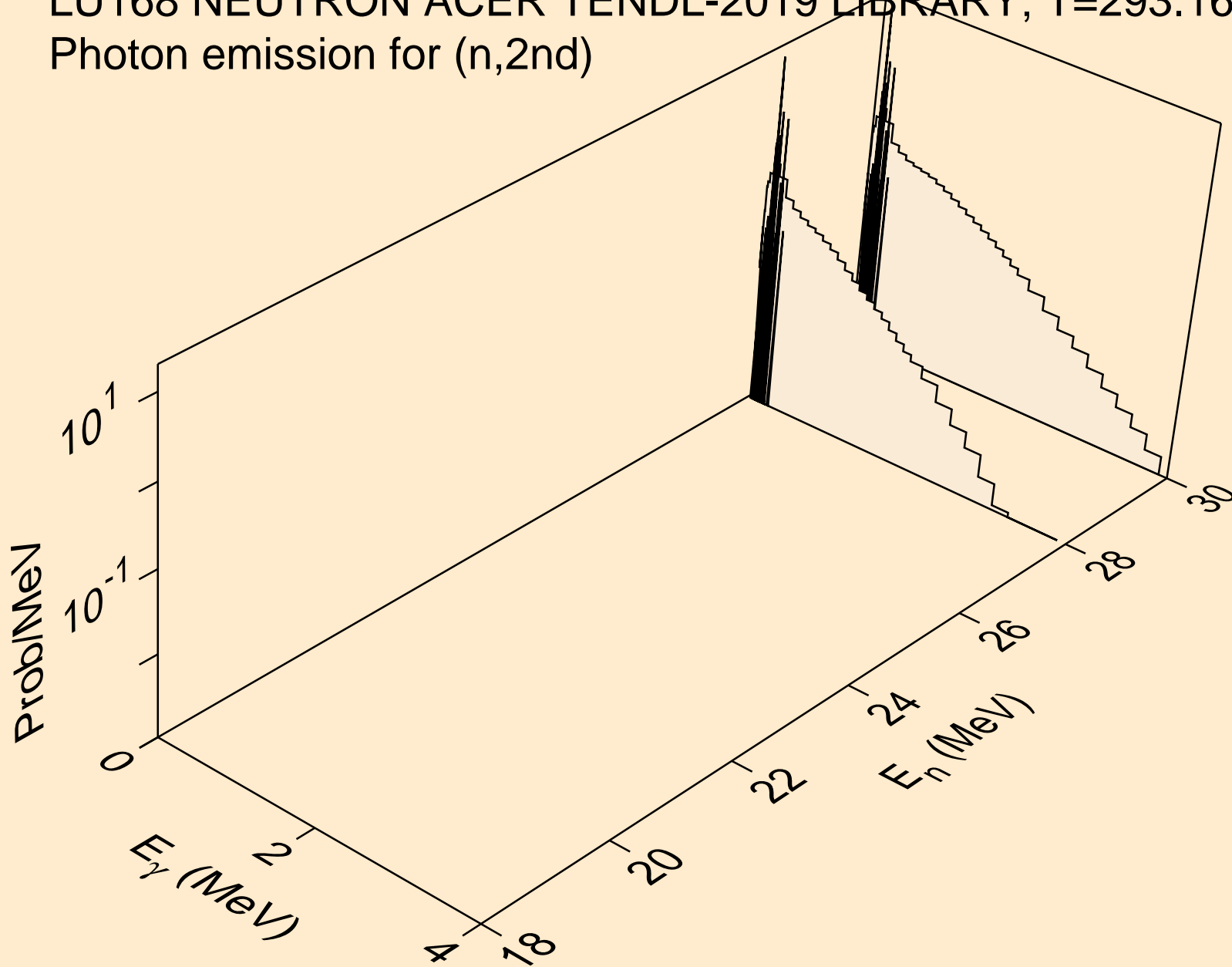

LU168 NEUTRON ACER TENDL-2019 LIBRARY; T=293.16K  
Photon emission for (n,2n)

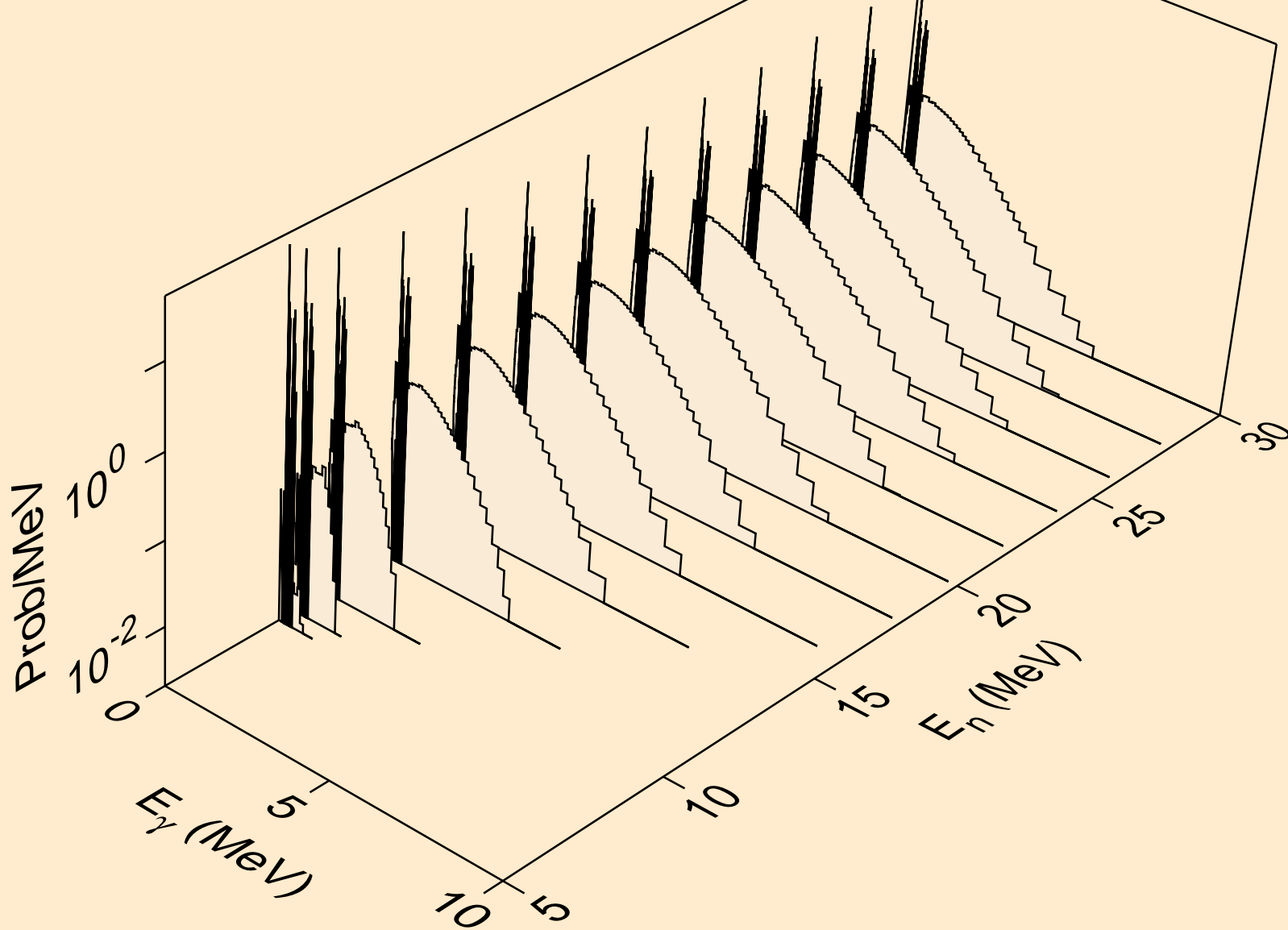

LU168 NEUTRON ACER TENDL-2019 LIBRARY; T=293.16K  
Photon emission for (n,3n)

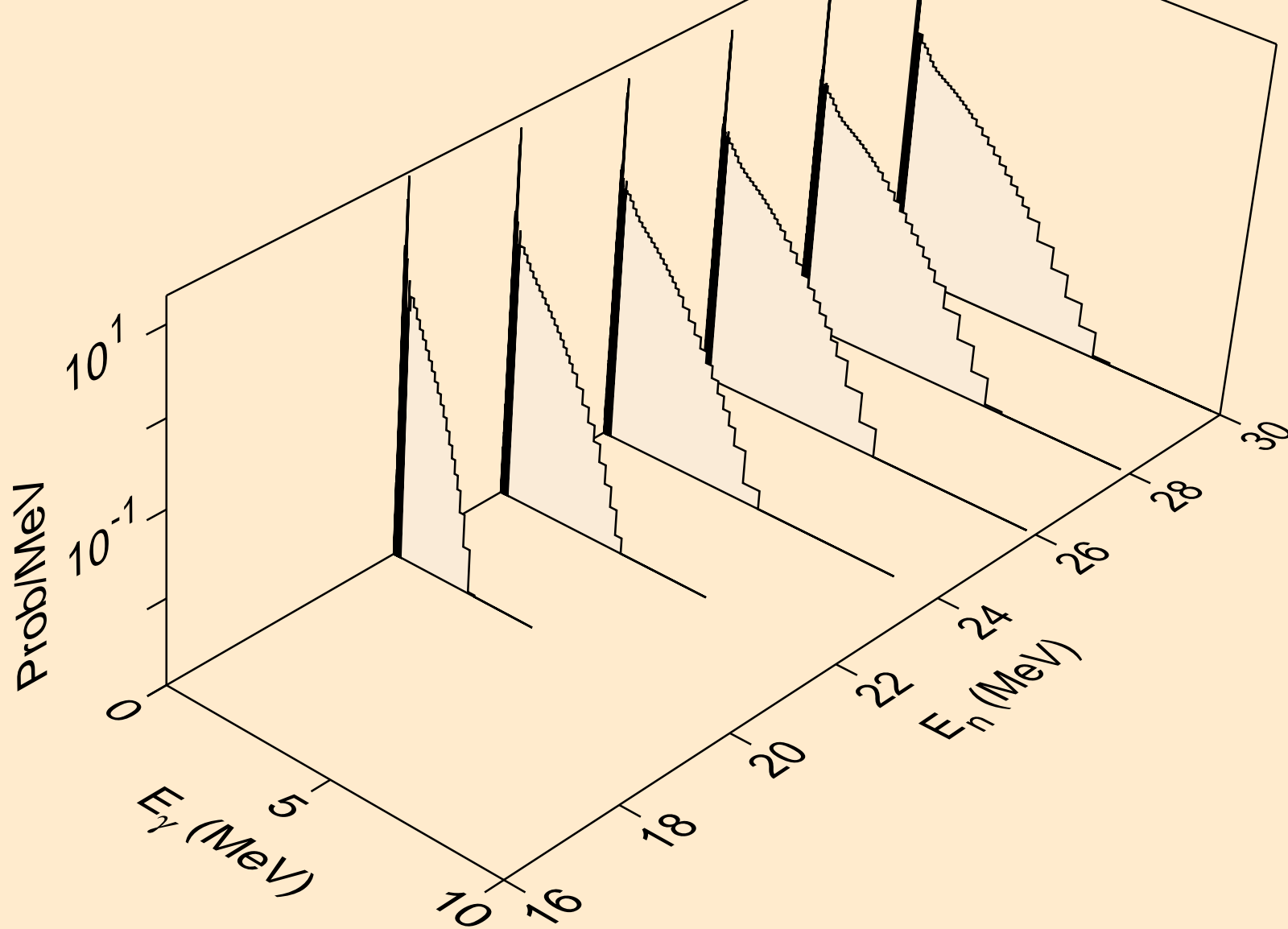

LU168 NEUTRON ACER TENDL-2019 LIBRARY; T=293.16K  
Photon emission for (n,n\*)a

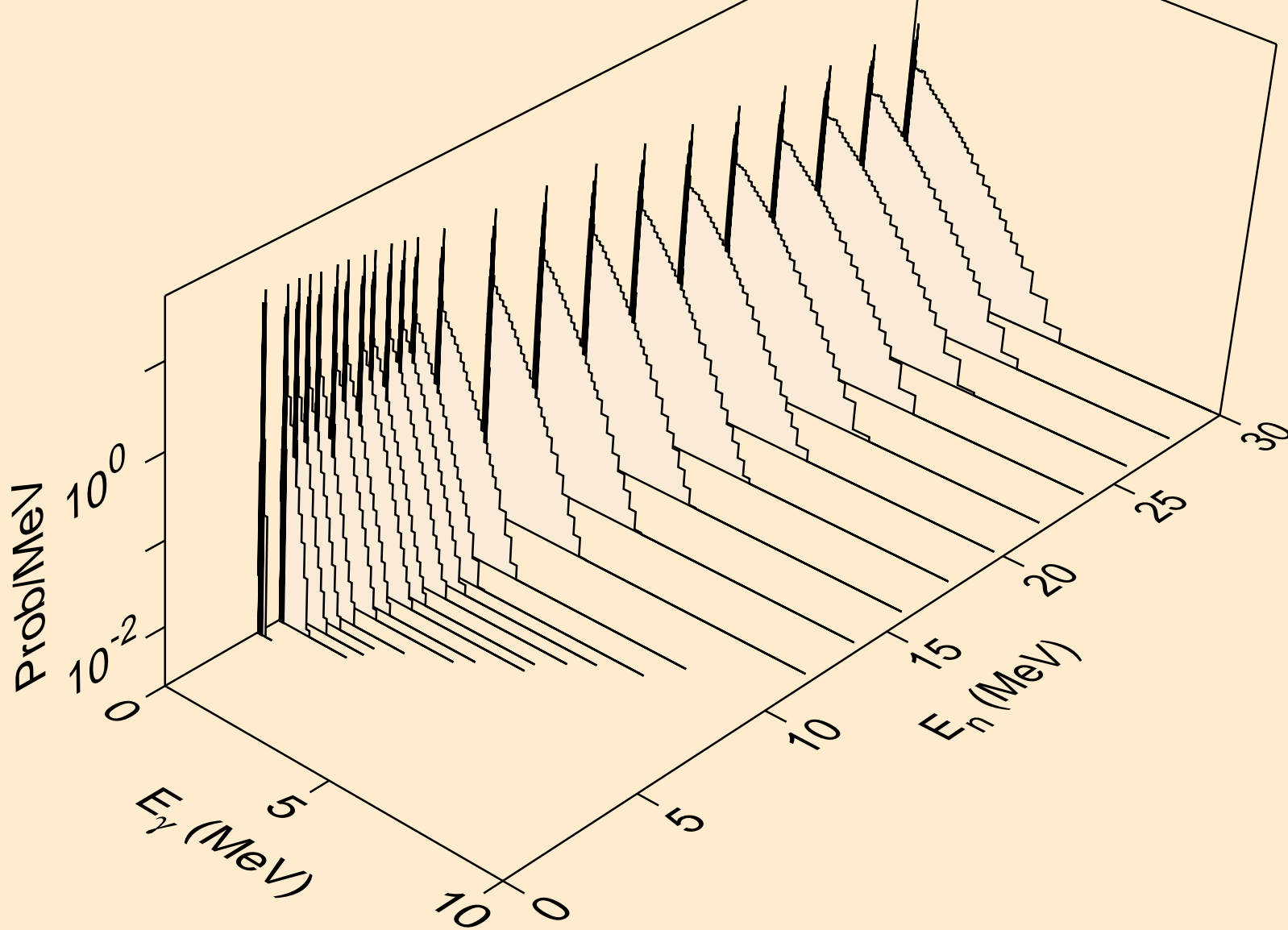

LU168 NEUTRON ACER TENDL-2019 LIBRARY; T=293.16K  
Photon emission for (n,2n)a

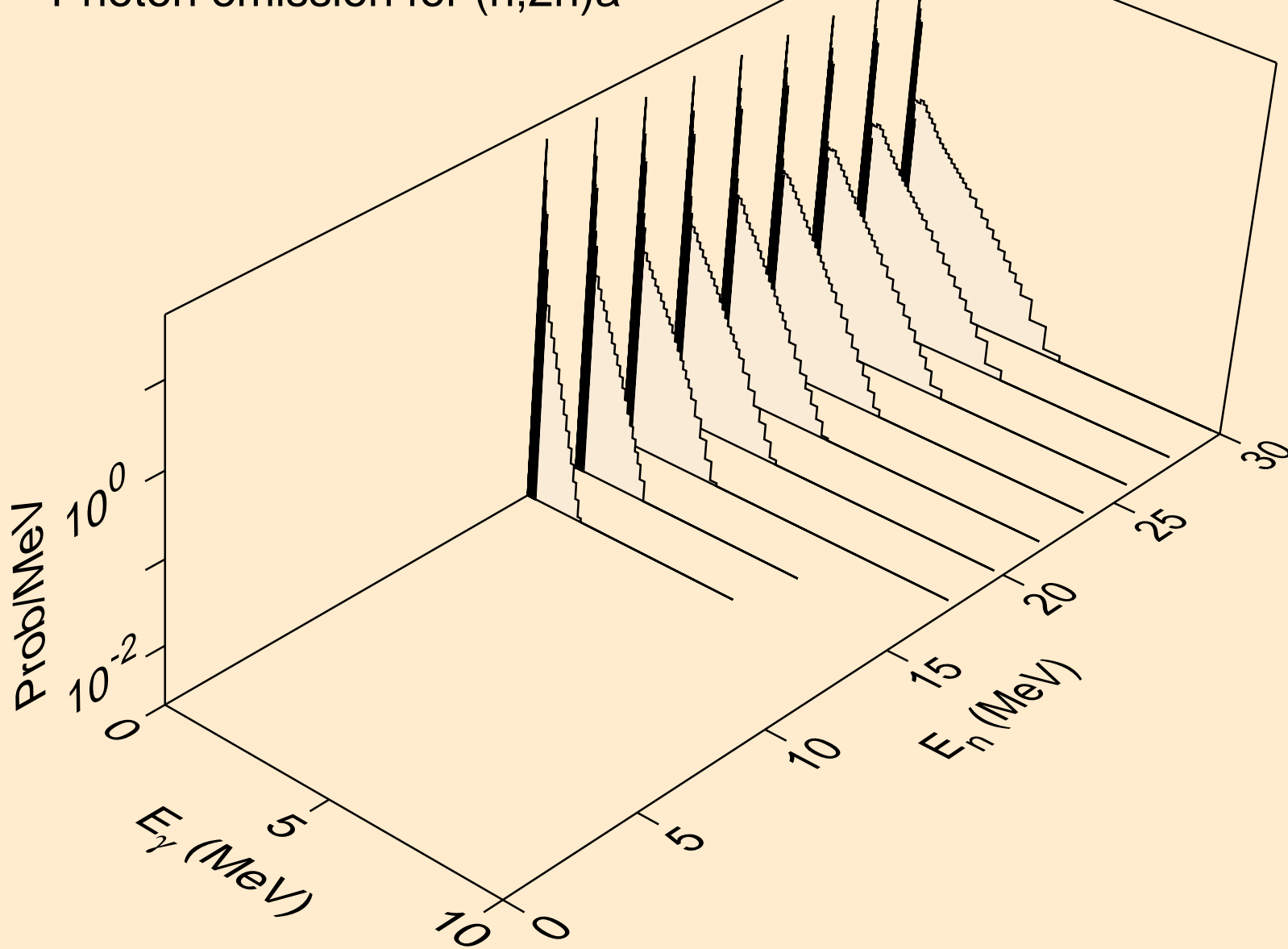

LU168 NEUTRON ACER TENDL-2019 LIBRARY; T=293.16K  
Photon emission for (n,3n)a

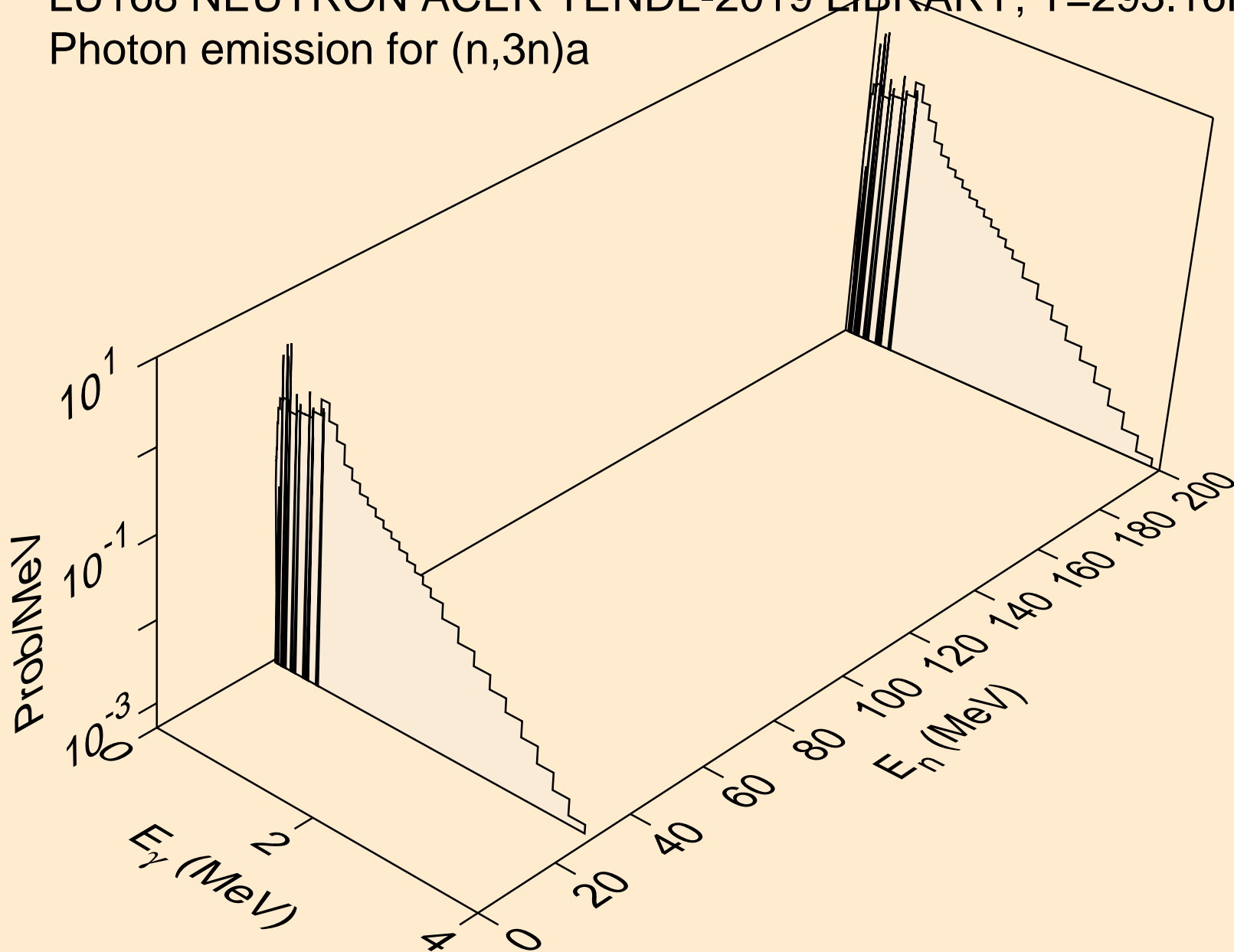



LU168 NEUTRON ACER TENDL-2019 LIBRARY; T=293.16K  
Photon emission for (n,n\*)p

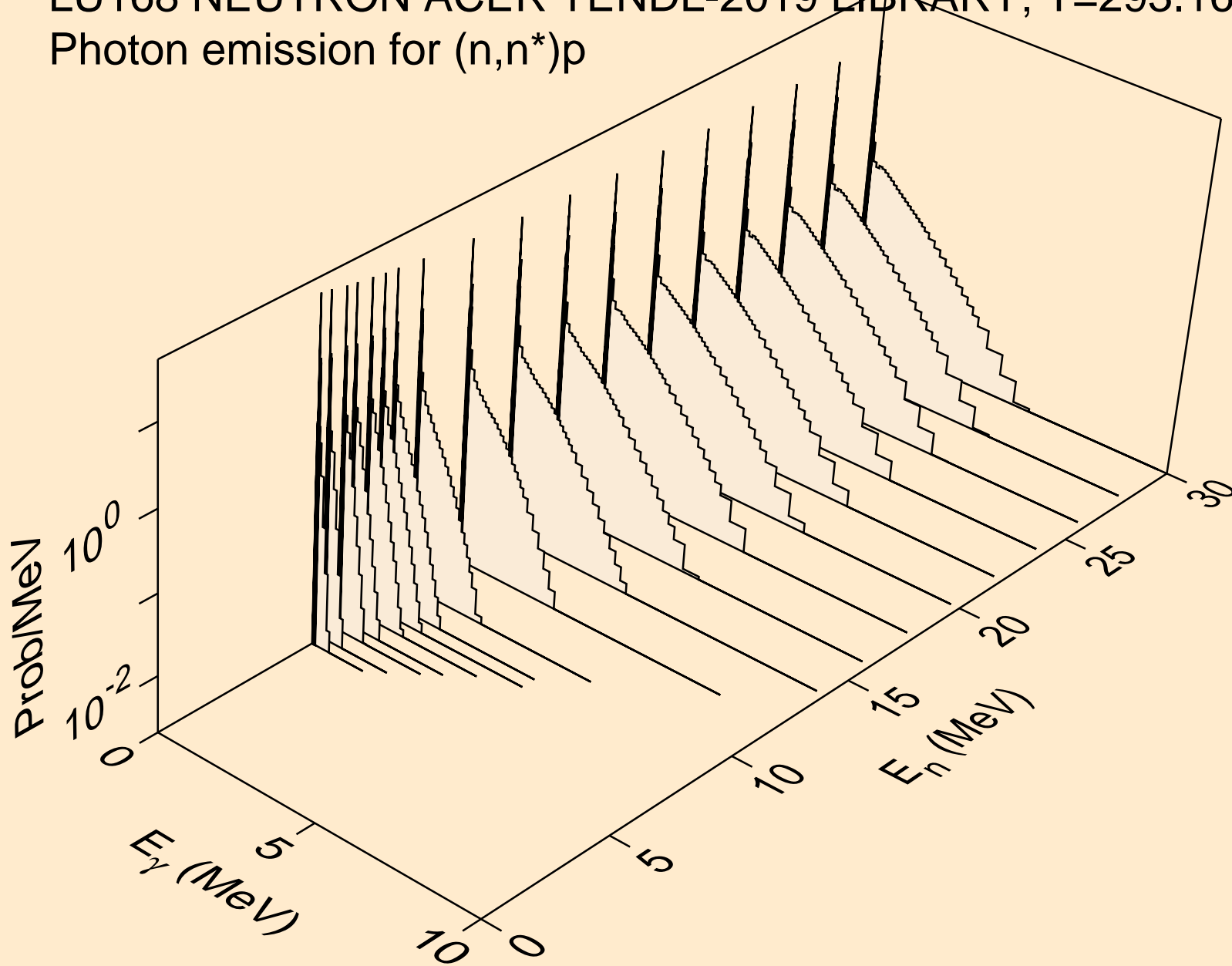

LU168 NEUTRON ACER TENDL-2019 LIBRARY; T=293.16K  
Photon emission for (n,n\*)2a

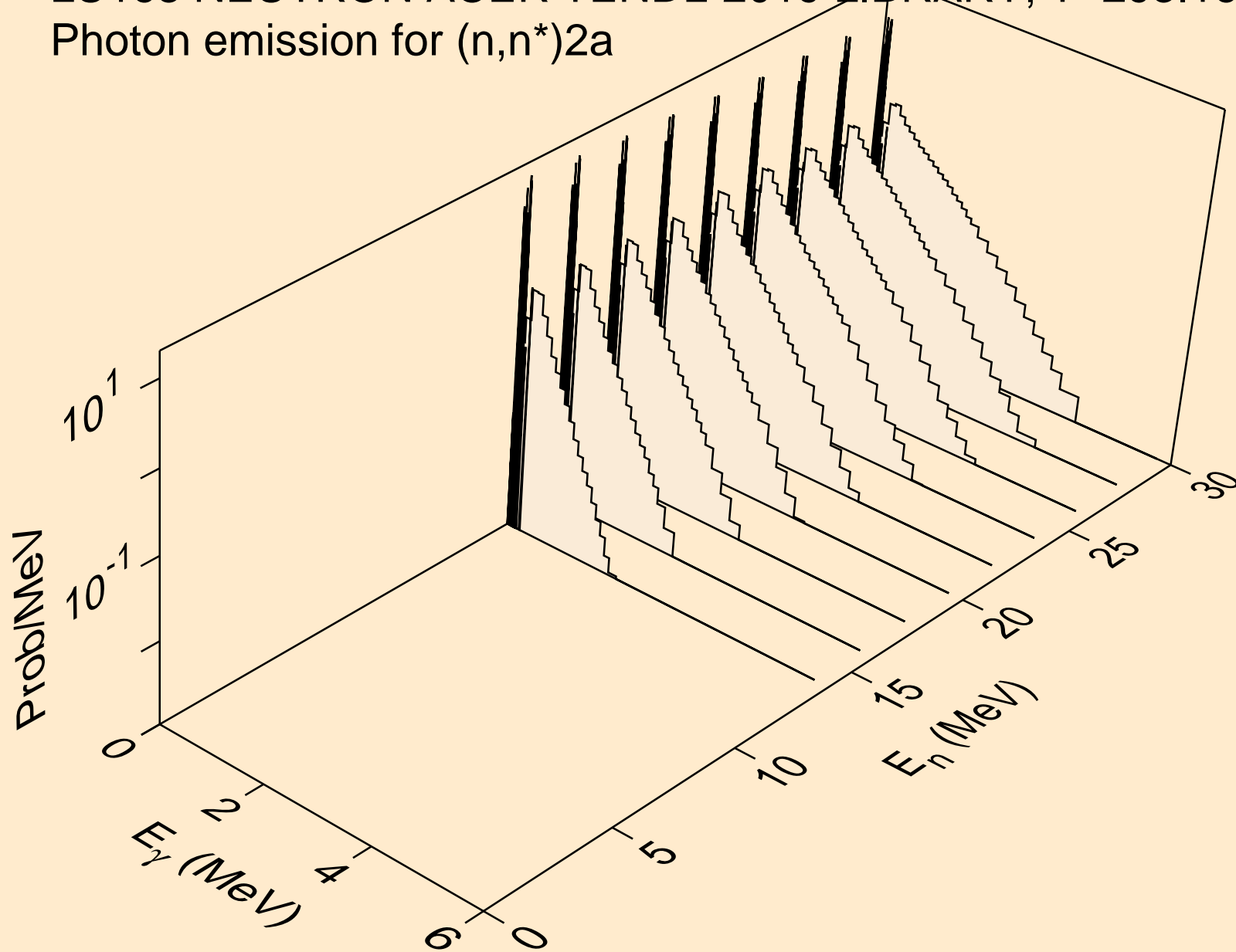

LU168 NEUTRON ACER TENDL-2019 LIBRARY; T=293.16K  
Photon emission for (n,2n)2a

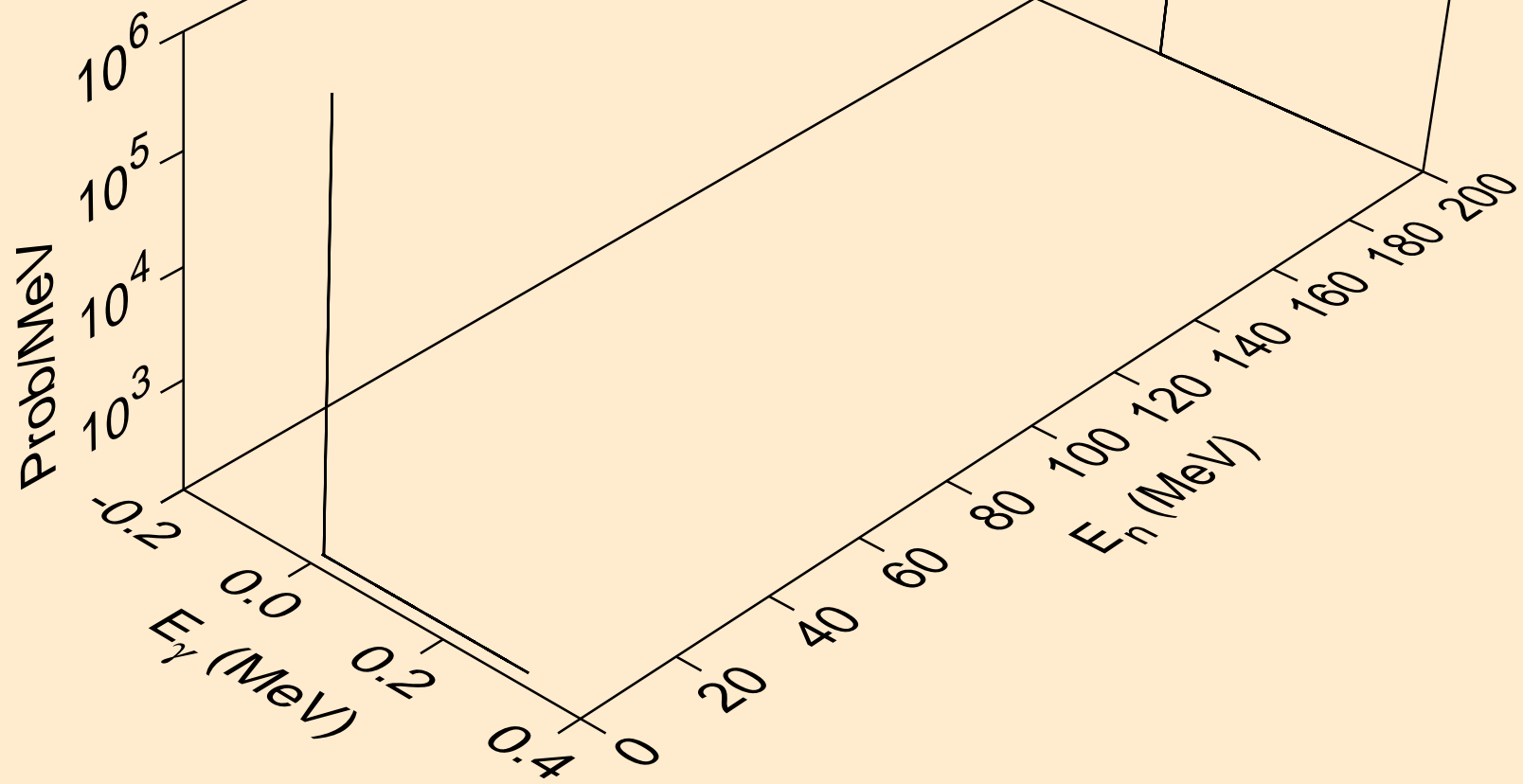

LU168 NEUTRON ACER TENDL-2019 LIBRARY; T=293.16K  
Photon emission for (n,n\*)d

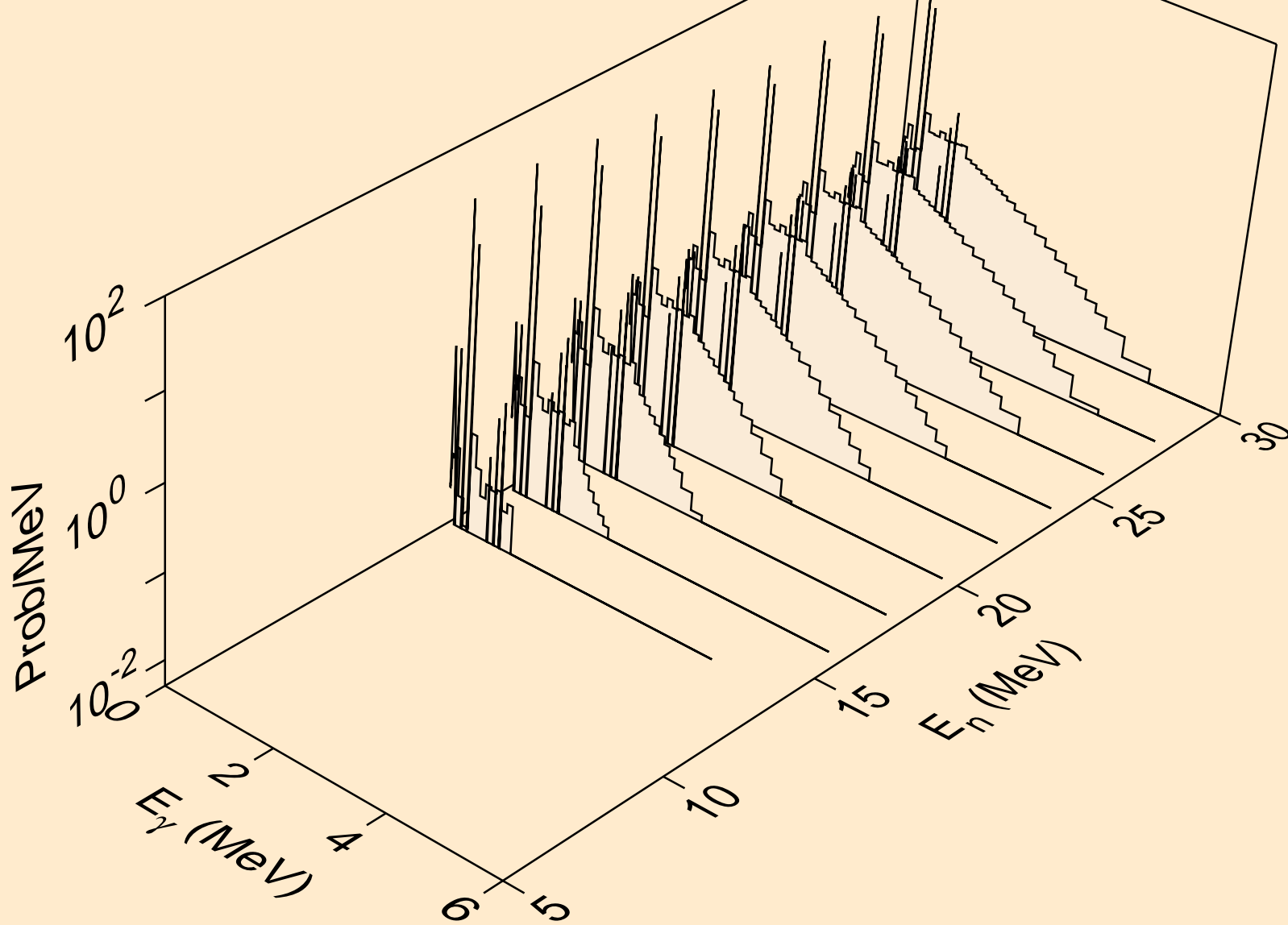

LU168 NEUTRON ACER TENDL-2019 LIBRARY; T=293.16K  
Photon emission for (n,n\*)t

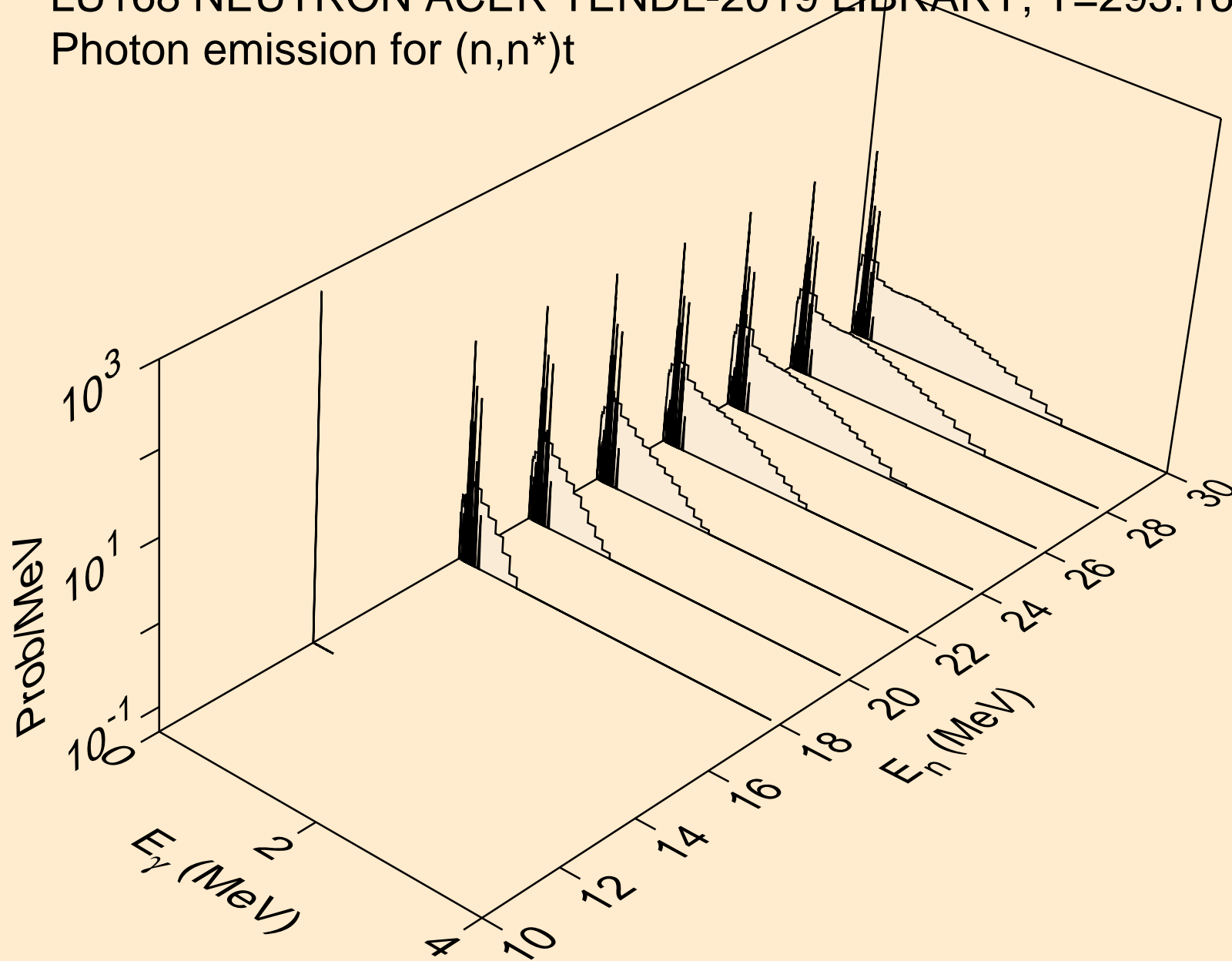

LU168 NEUTRON ACER TENDL-2019 LIBRARY; T=293.16K  
Photon emission for (n,n\*)he3

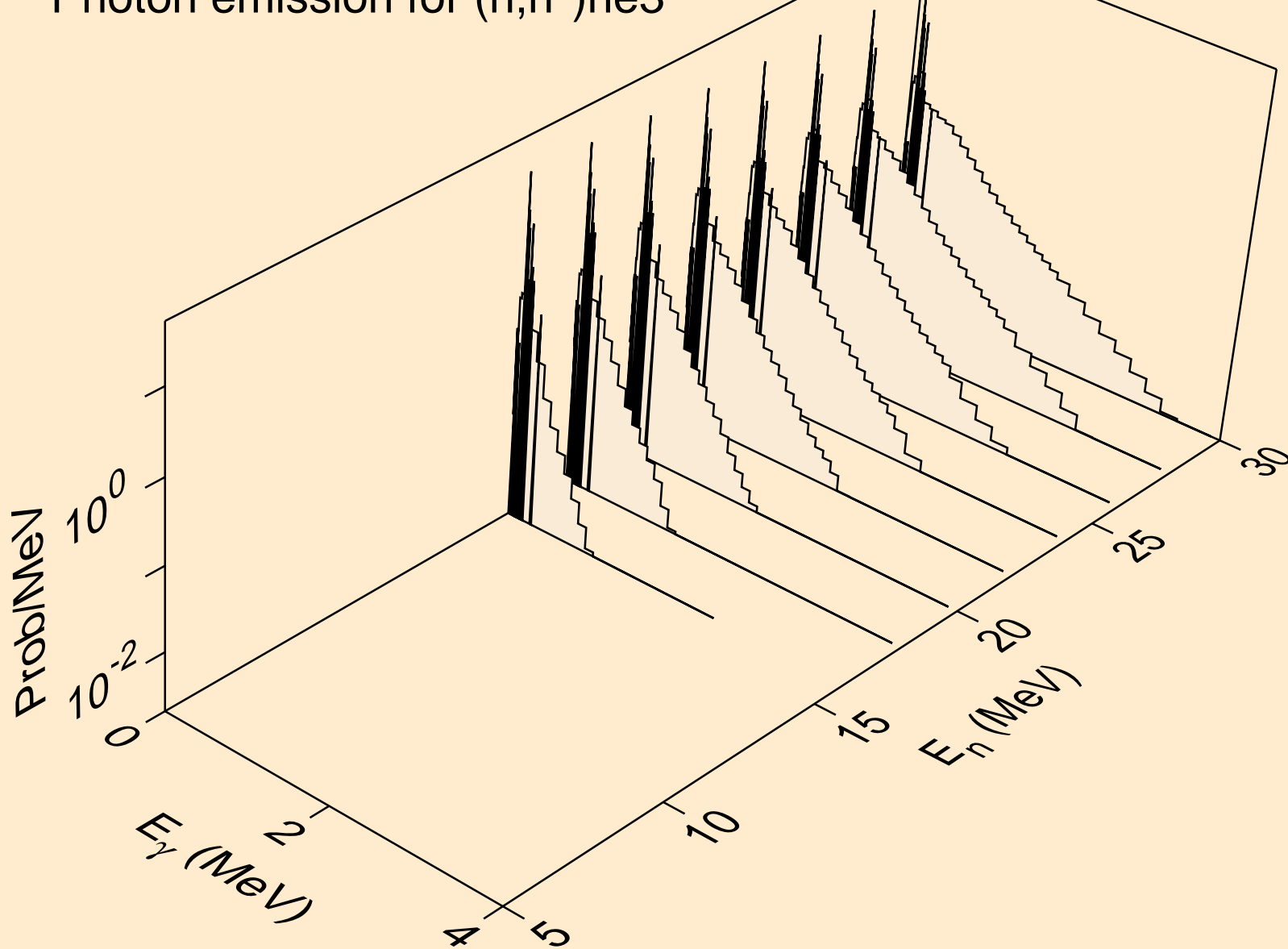

LU168 NEUTRON ACER TENDL-2019 LIBRARY; T=293.16K  
Photon emission for (n,4n)

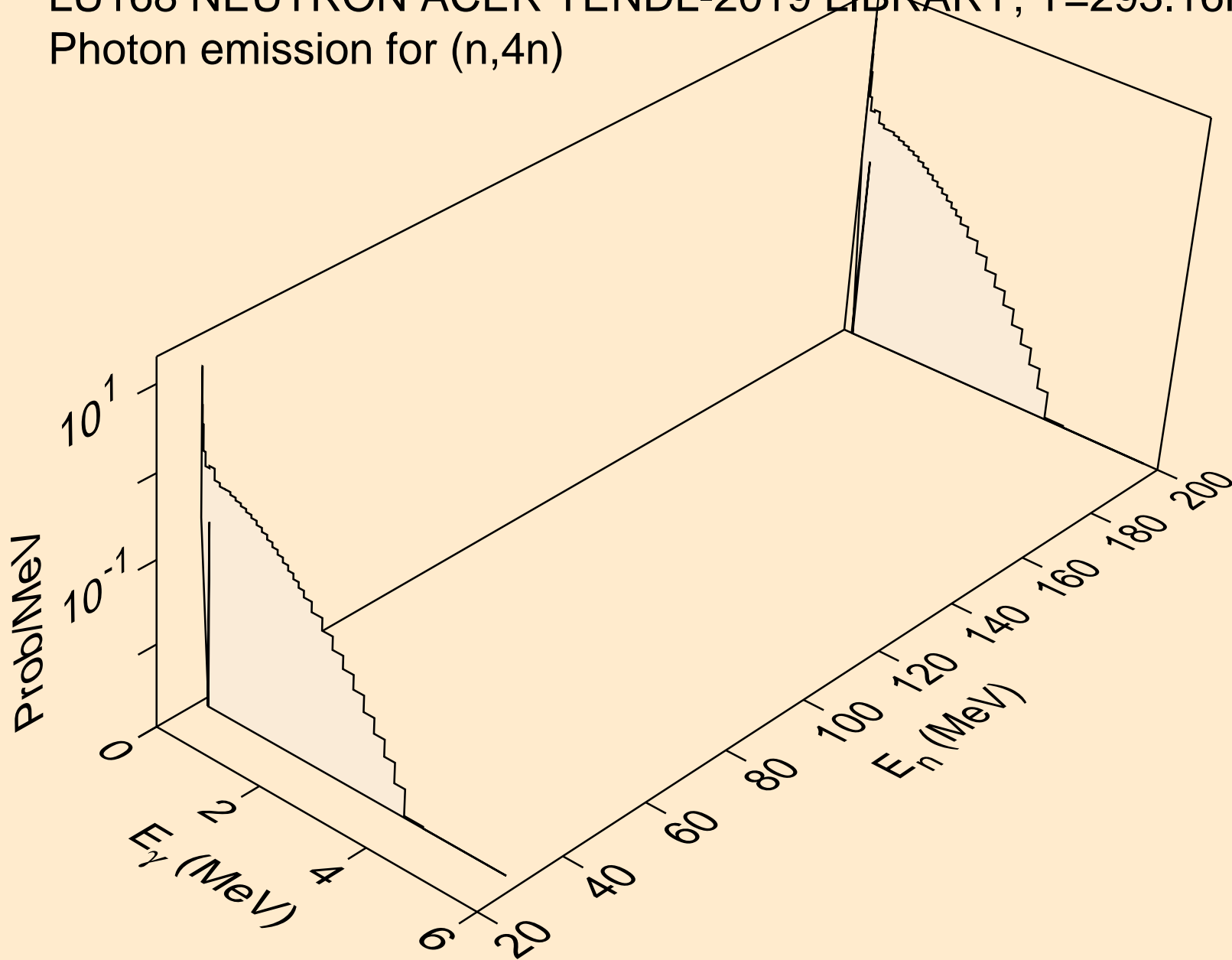

LU168 NEUTRON ACER TENDL-2019 LIBRARY; T=293.16K  
Photon emission for (n,2np)

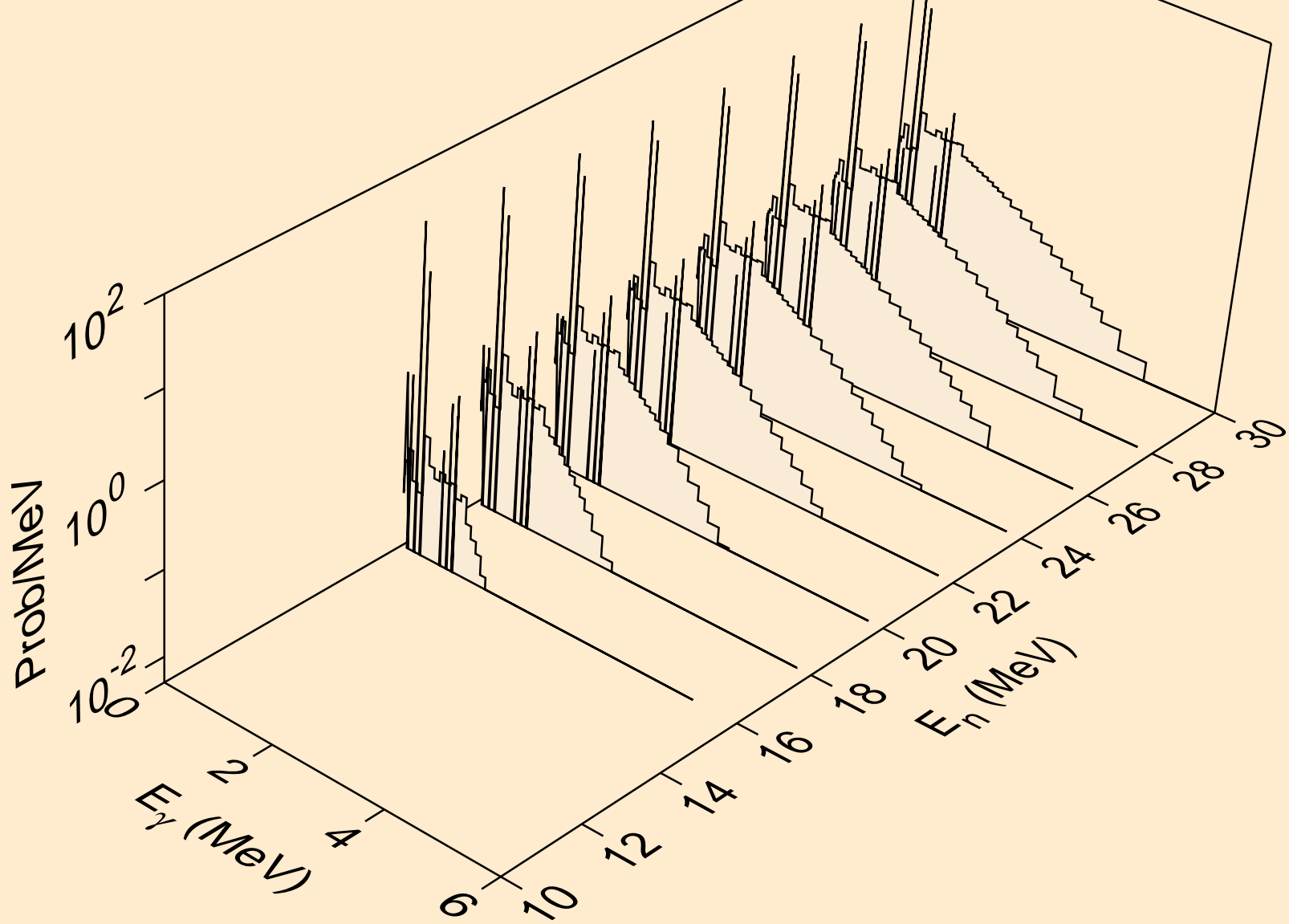



LU168 NEUTRON ACER TENDL-2019 LIBRARY; T=293.16K  
Photon emission for (n,3np)

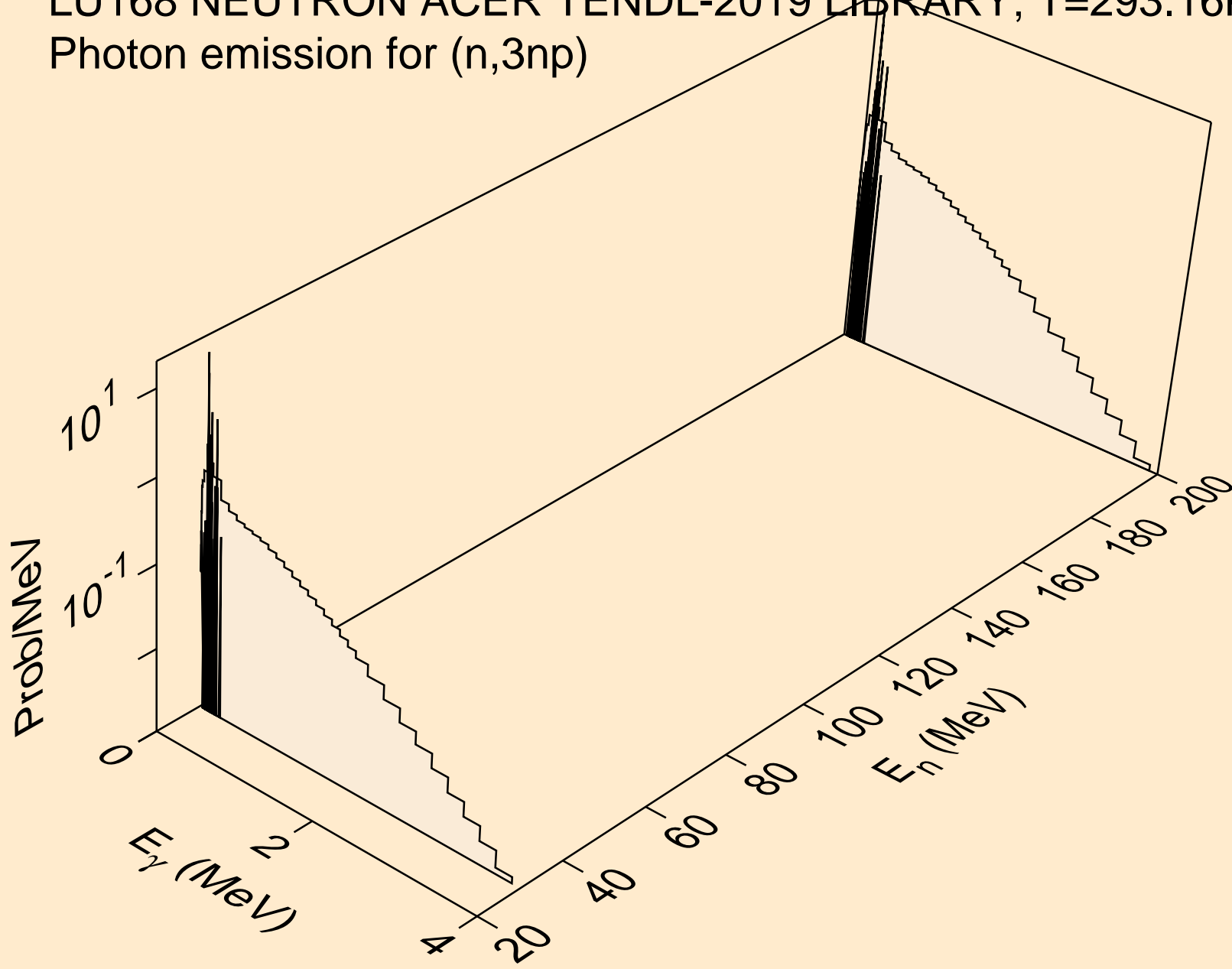

LU168 NEUTRON ACER TENDL-2019 LIBRARY; T=293.16K  
Photon emission for (n,2np)

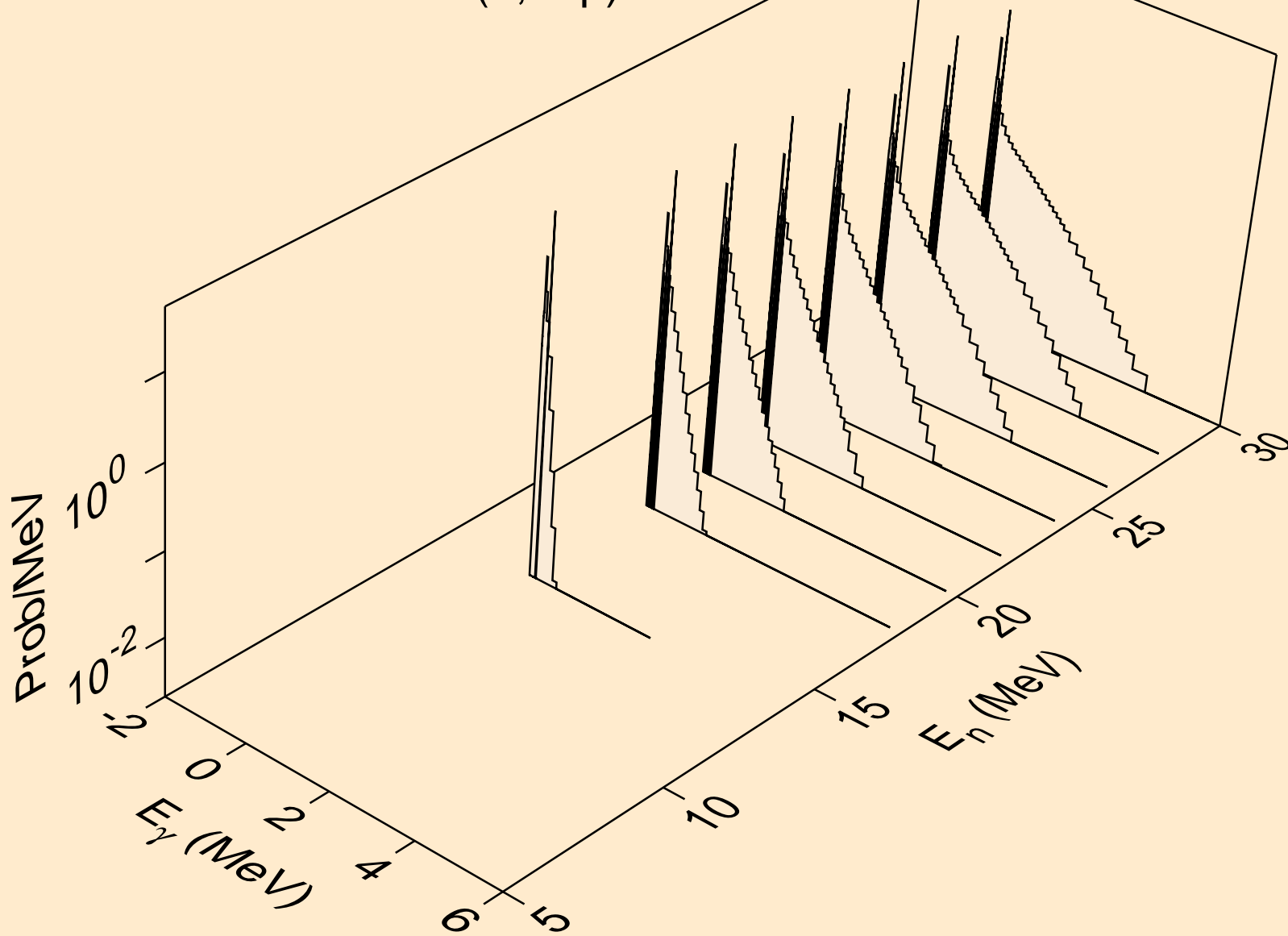

LU168 NEUTRON ACER TENDL-2019 LIBRARY; T=293.16K  
Photon emission for (n,npa)

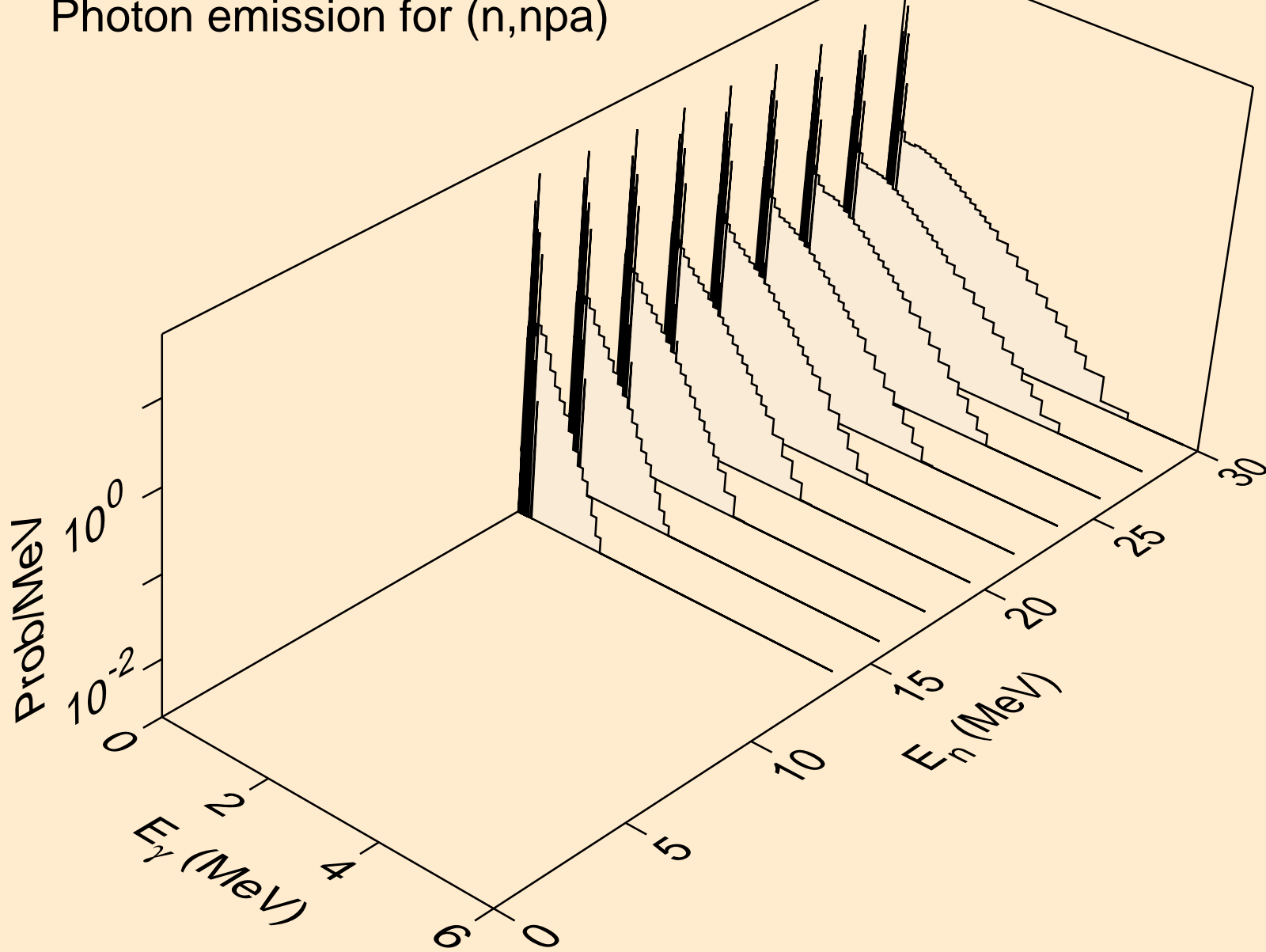

LU168 NEUTRON ACER TENDL-2019 LIBRARY; T=293.16K  
Photon emission for (n,n\*c)

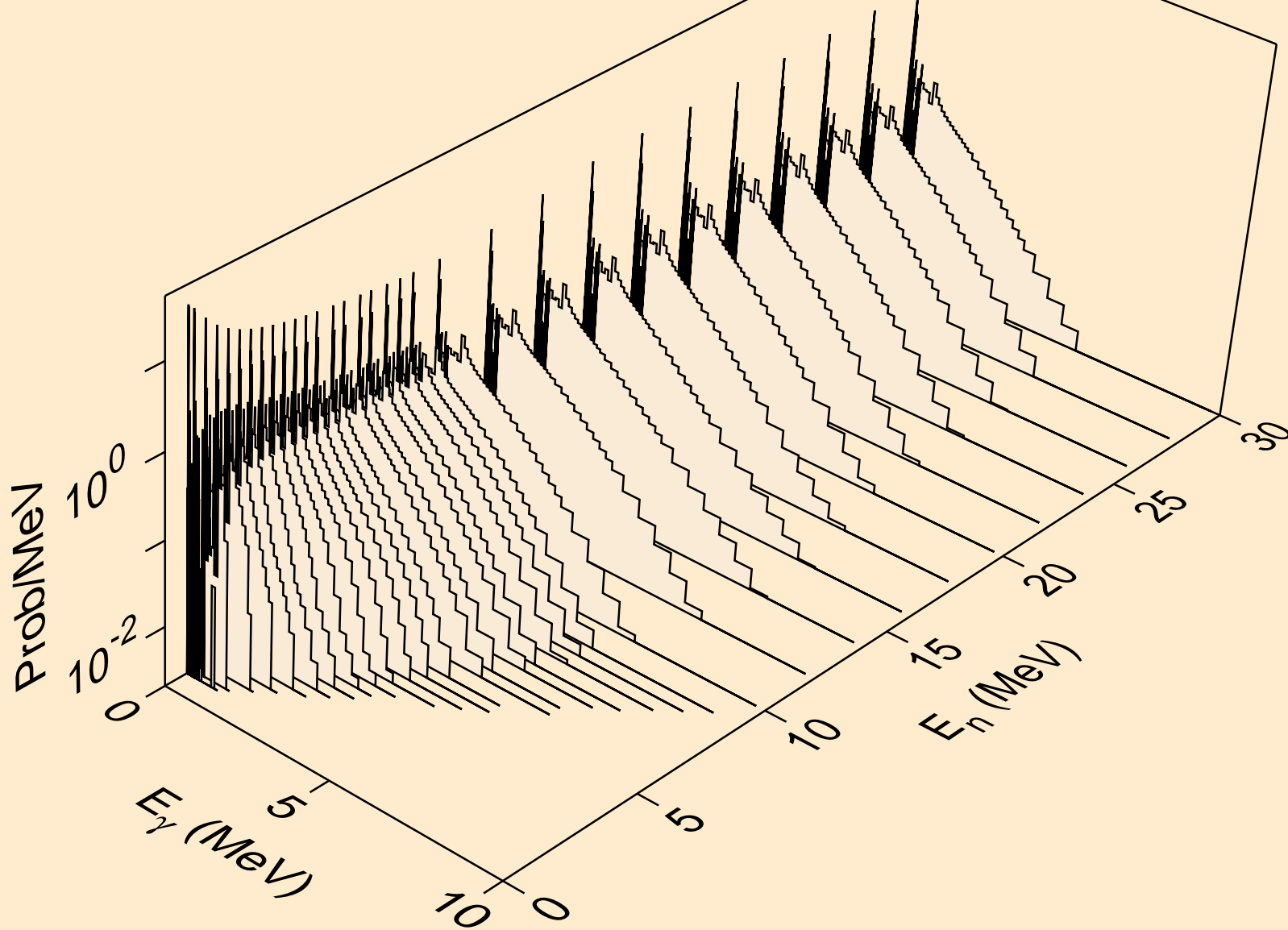

LU168 NEUTRON ACER TENDL-2019 LIBRARY; T=293.16K  
Photon emission for (n,gma)

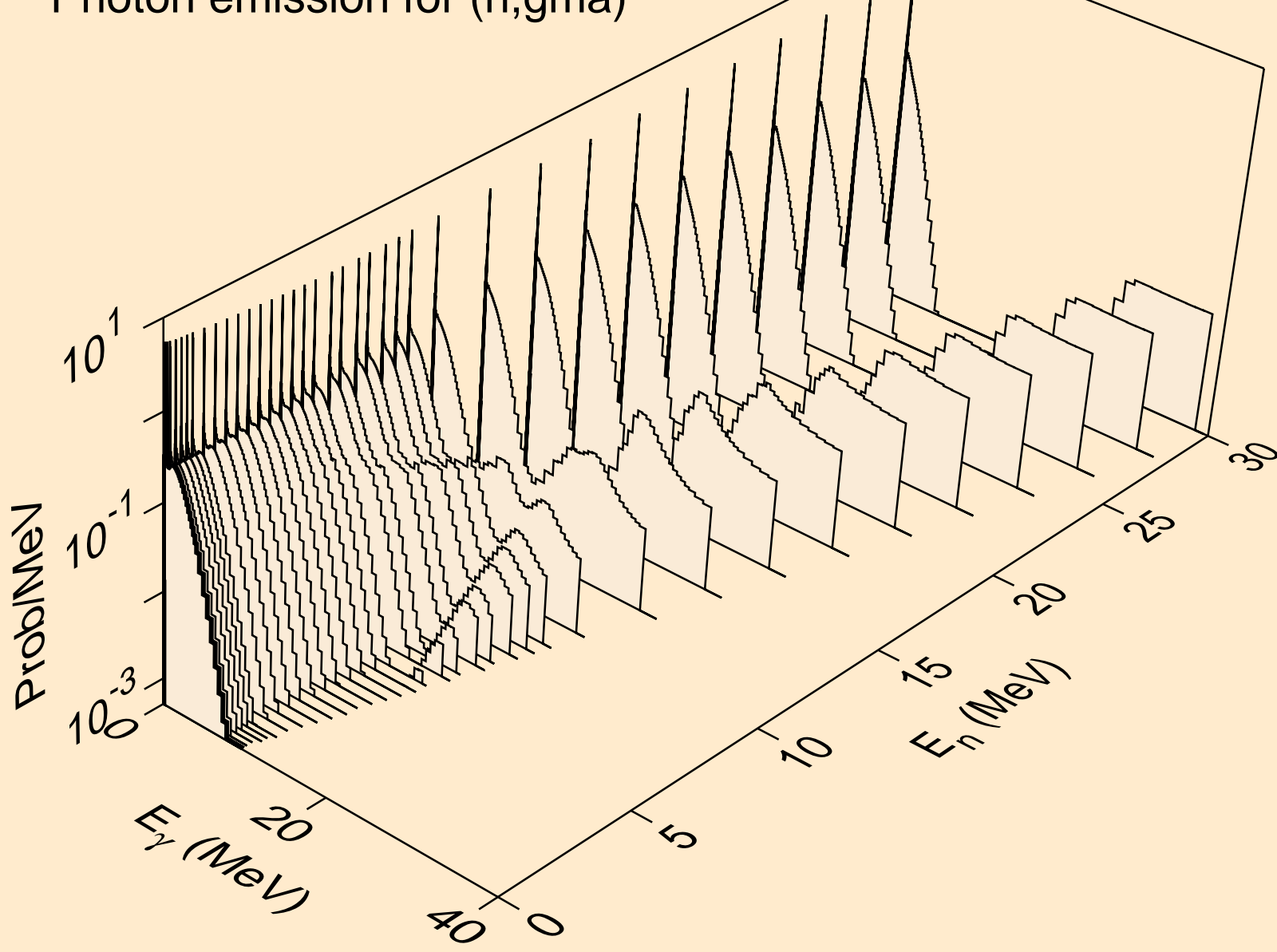

LU168 NEUTRON ACER TENDL-2019 LIBRARY; T=293.16K  
Photon emission for (n,p)

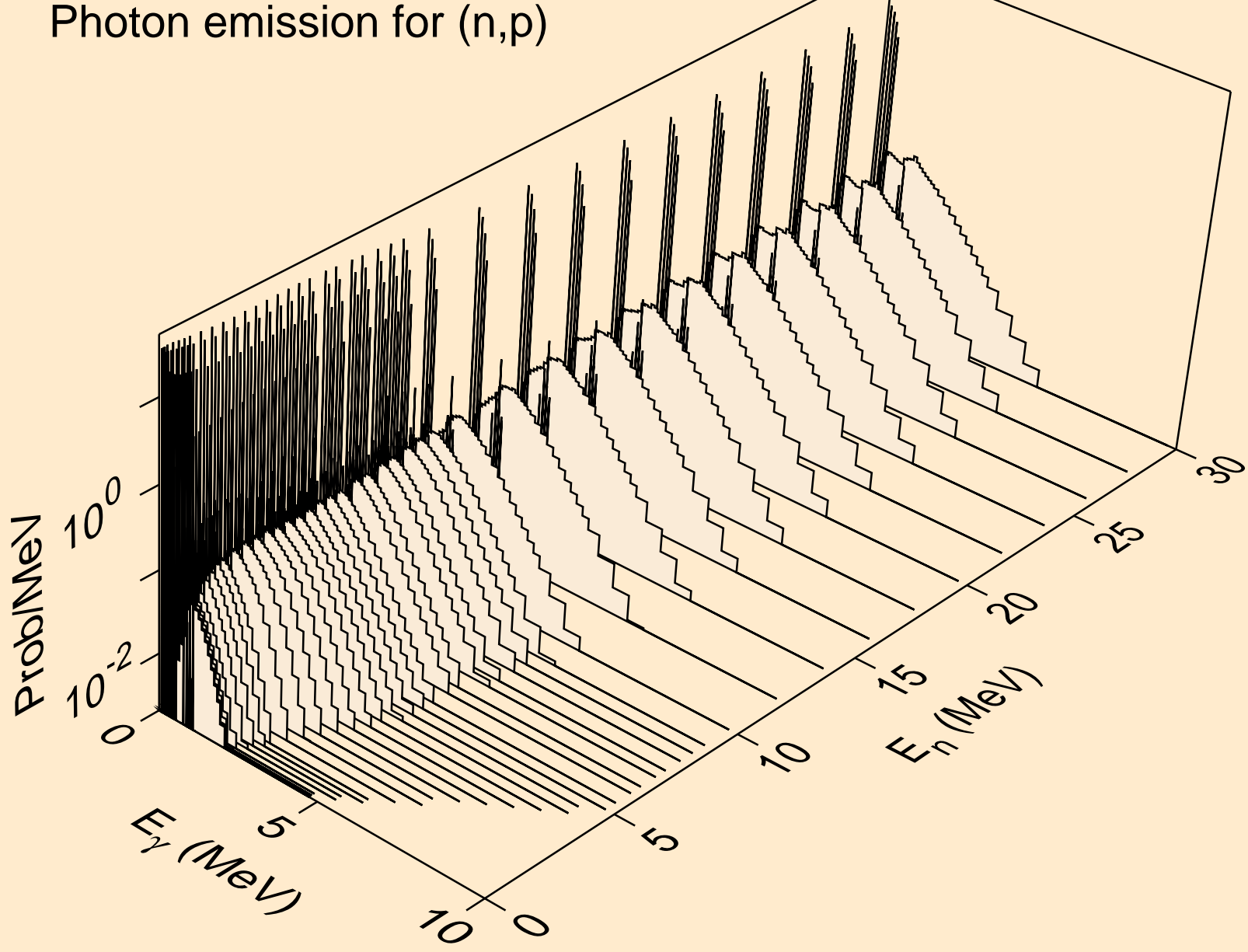

LU168 NEUTRON ACER TENDL-2019 LIBRARY; T=293.16K  
Photon emission for (n,d)

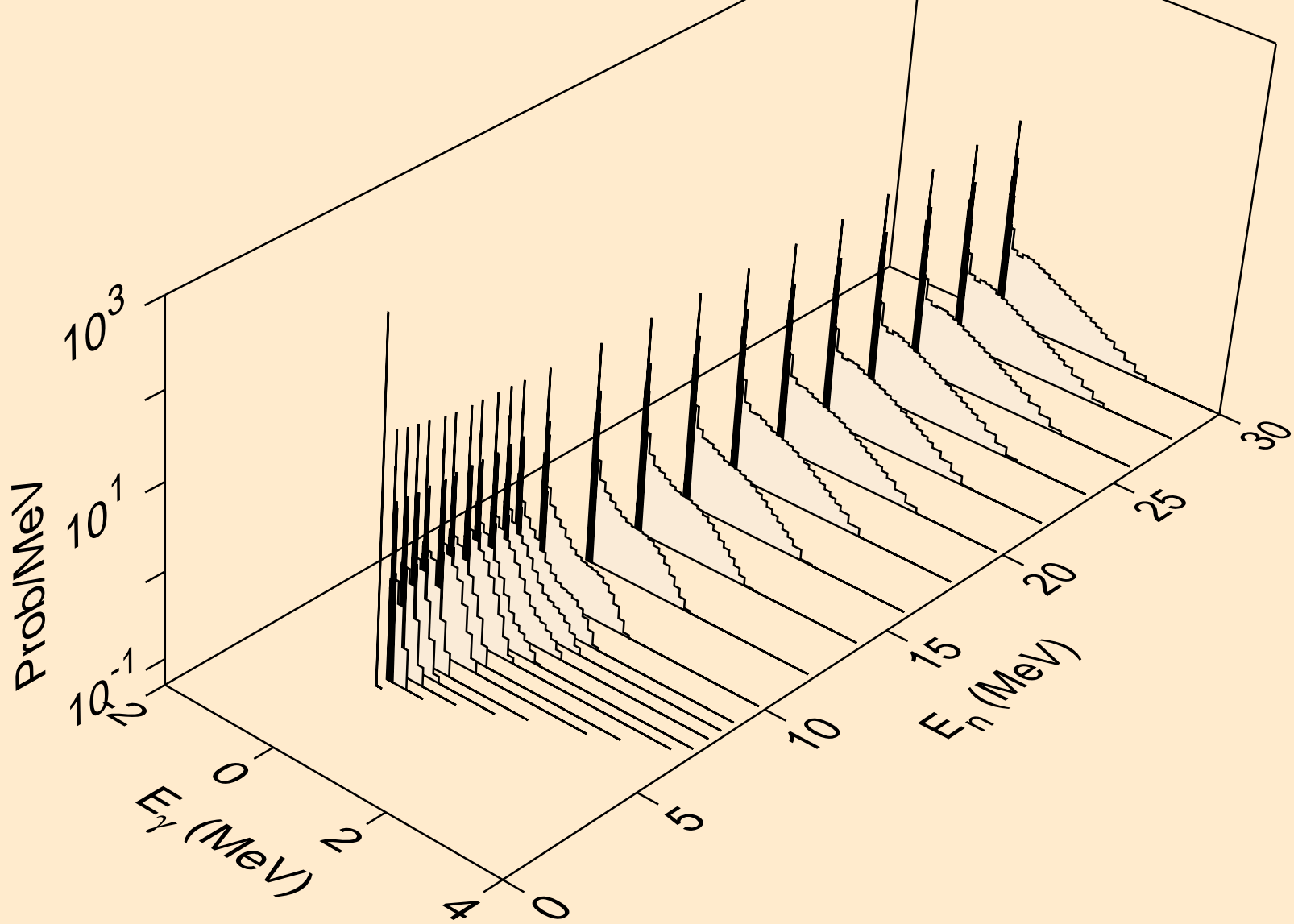

LU168 NEUTRON ACER TENDL-2019 LIBRARY; T=293.16K  
Photon emission for (n,t)

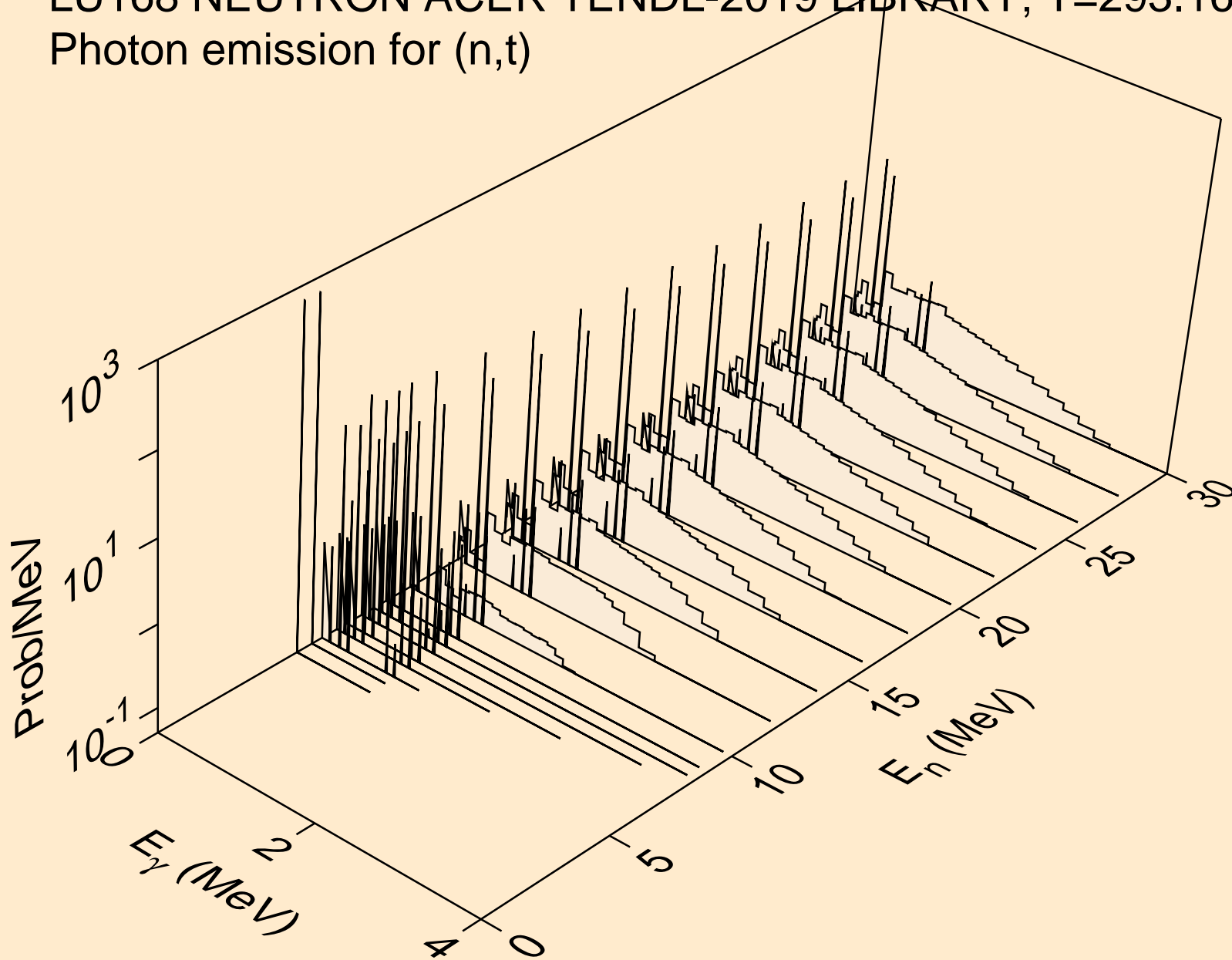



LU168 NEUTRON ACER TENDL-2019 LIBRARY; T=293.16K  
Photon emission for (n,he3)

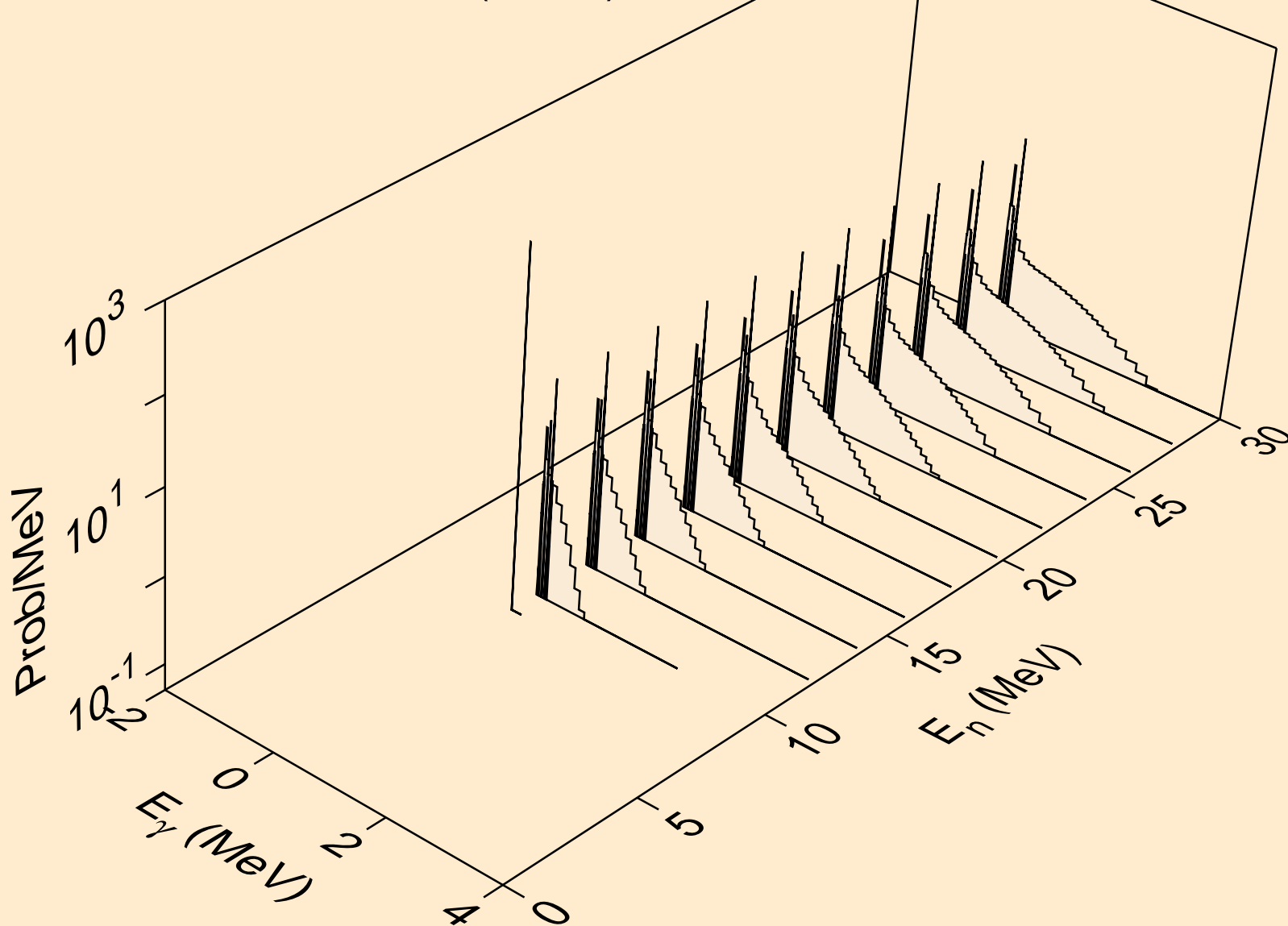

LU168 NEUTRON ACER TENDL-2019 LIBRARY; T=293.16K  
Photon emission for (n,a)

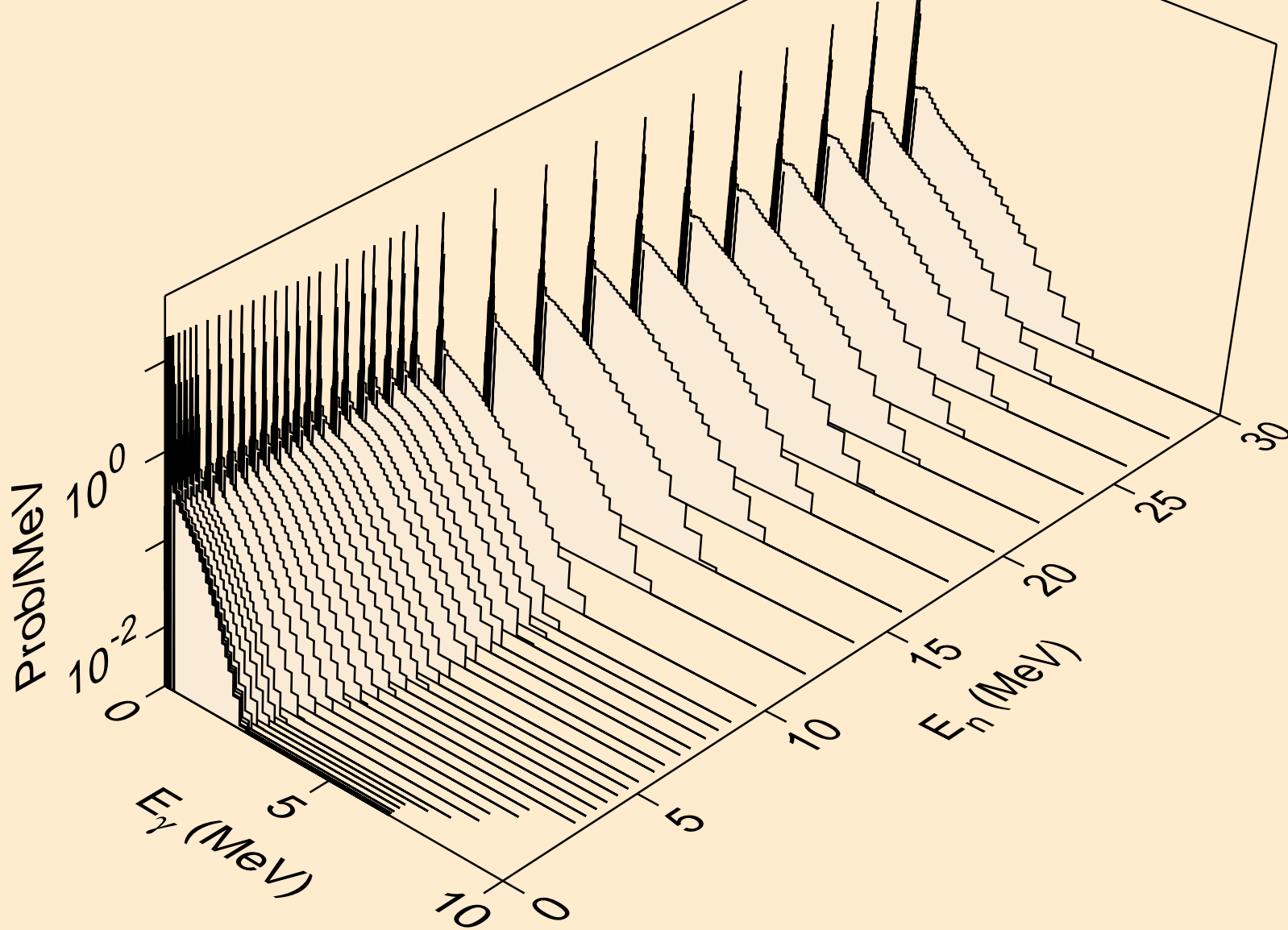

LU168 NEUTRON ACER TENDL-2019 LIBRARY; T=293.16K  
Photon emission for (n,2a)

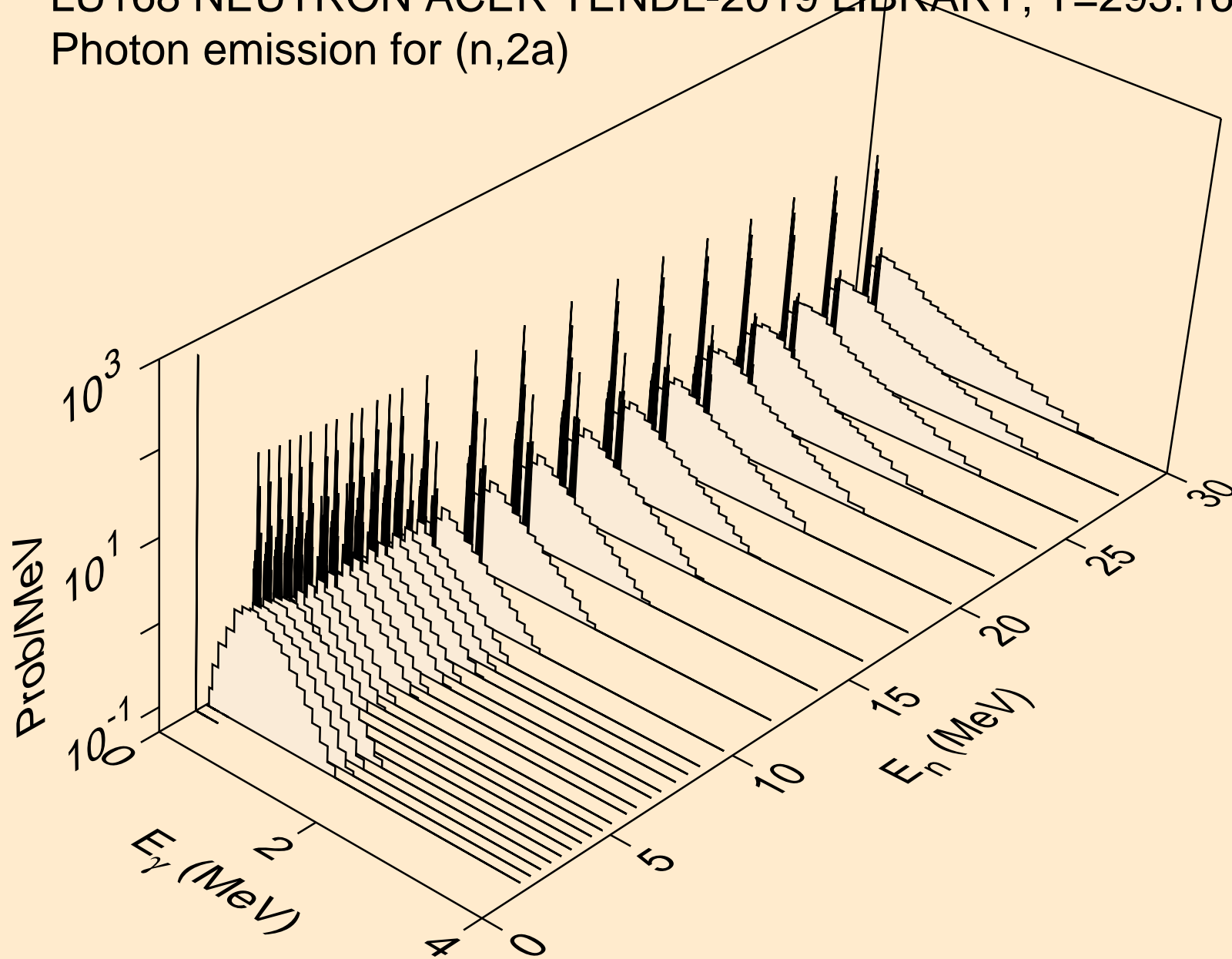

LU168 NEUTRON ACER TENDL-2019 LIBRARY; T=293.16K  
Photon emission for (n,2p)

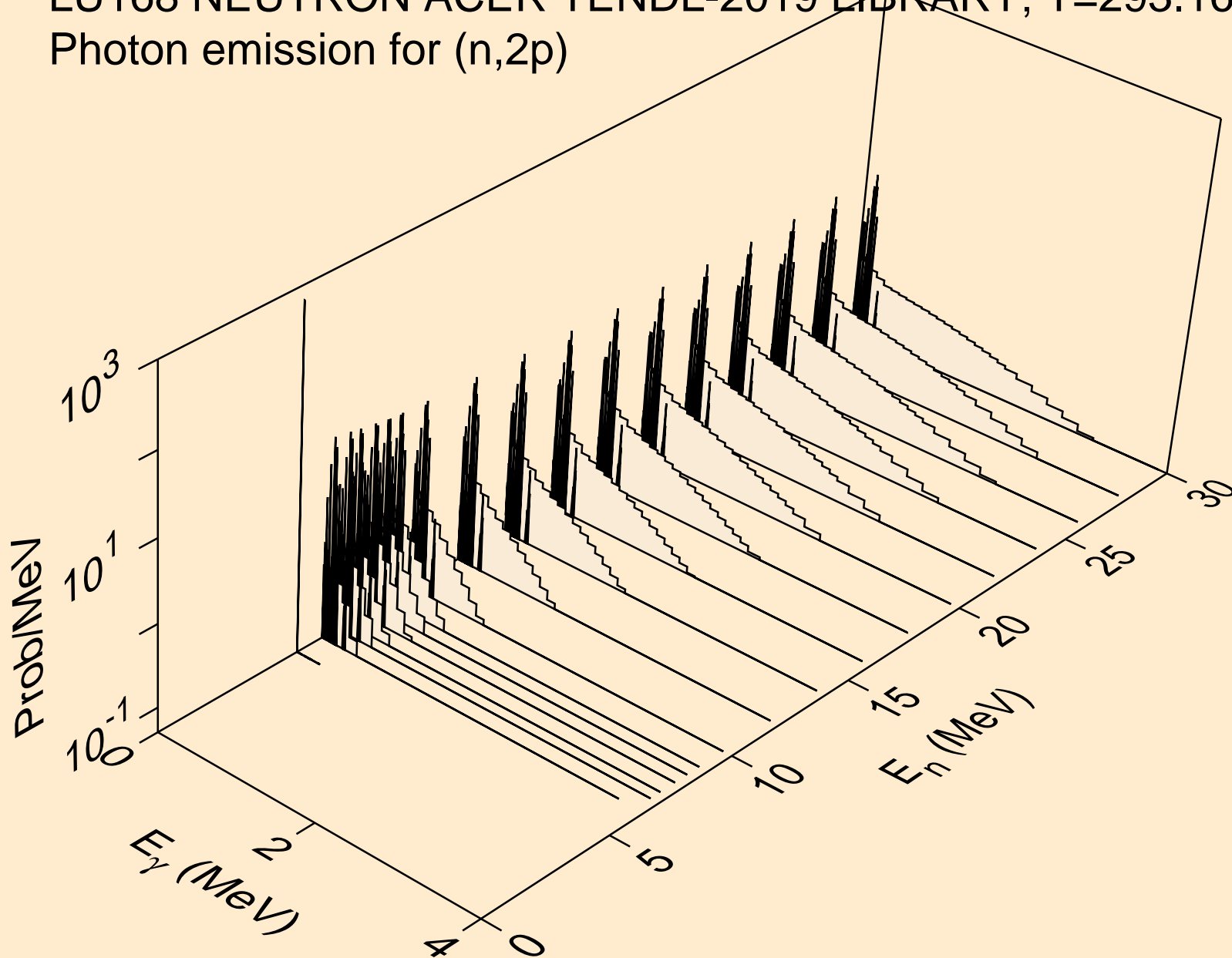

LU168 NEUTRON ACER TENDL-2019 LIBRARY; T=293.16K  
Photon emission for (n,p $\alpha$ )

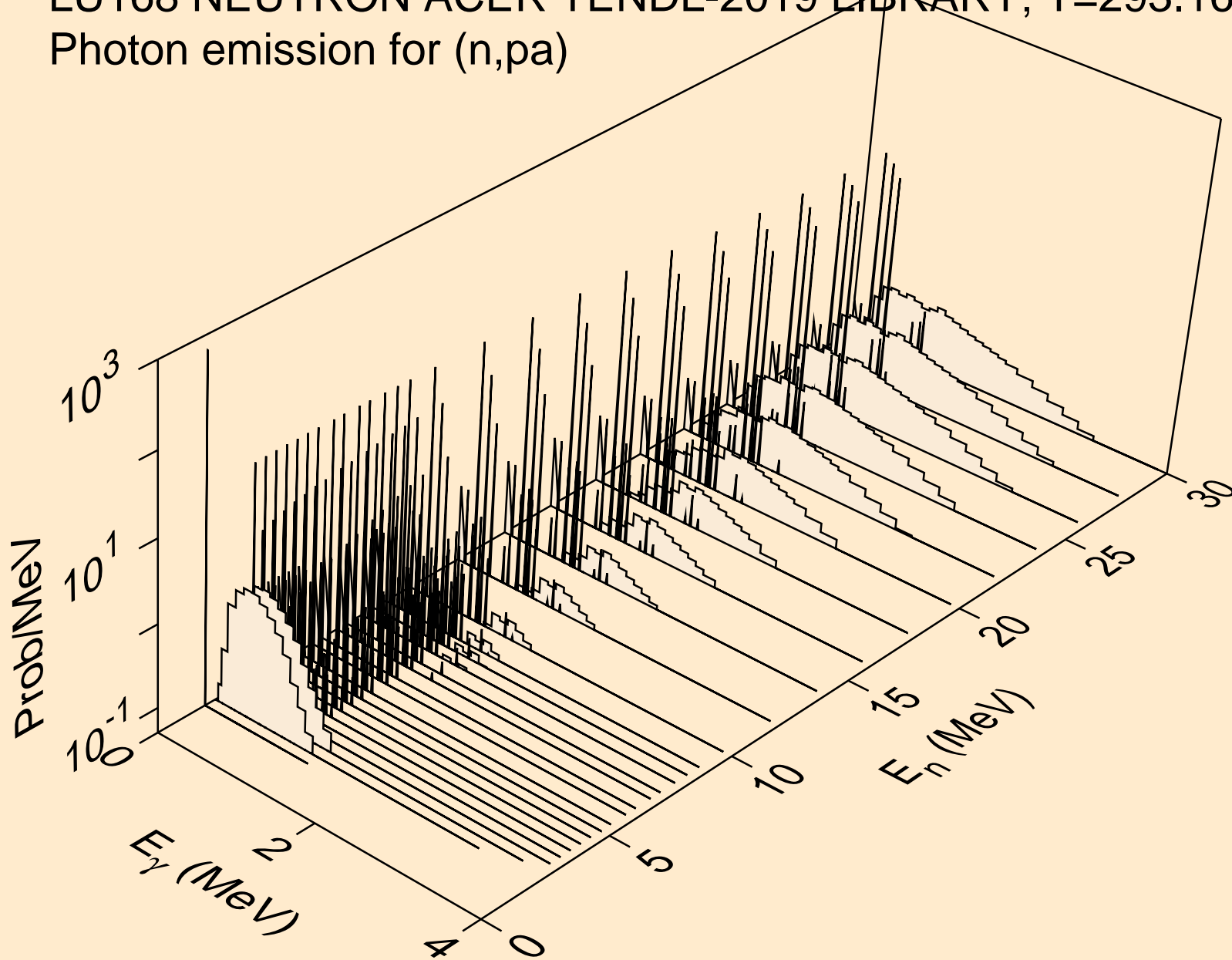

LU168 NEUTRON ACER TENDL-2019 LIBRARY; T=293.16K  
Photon emission for (n,pd)

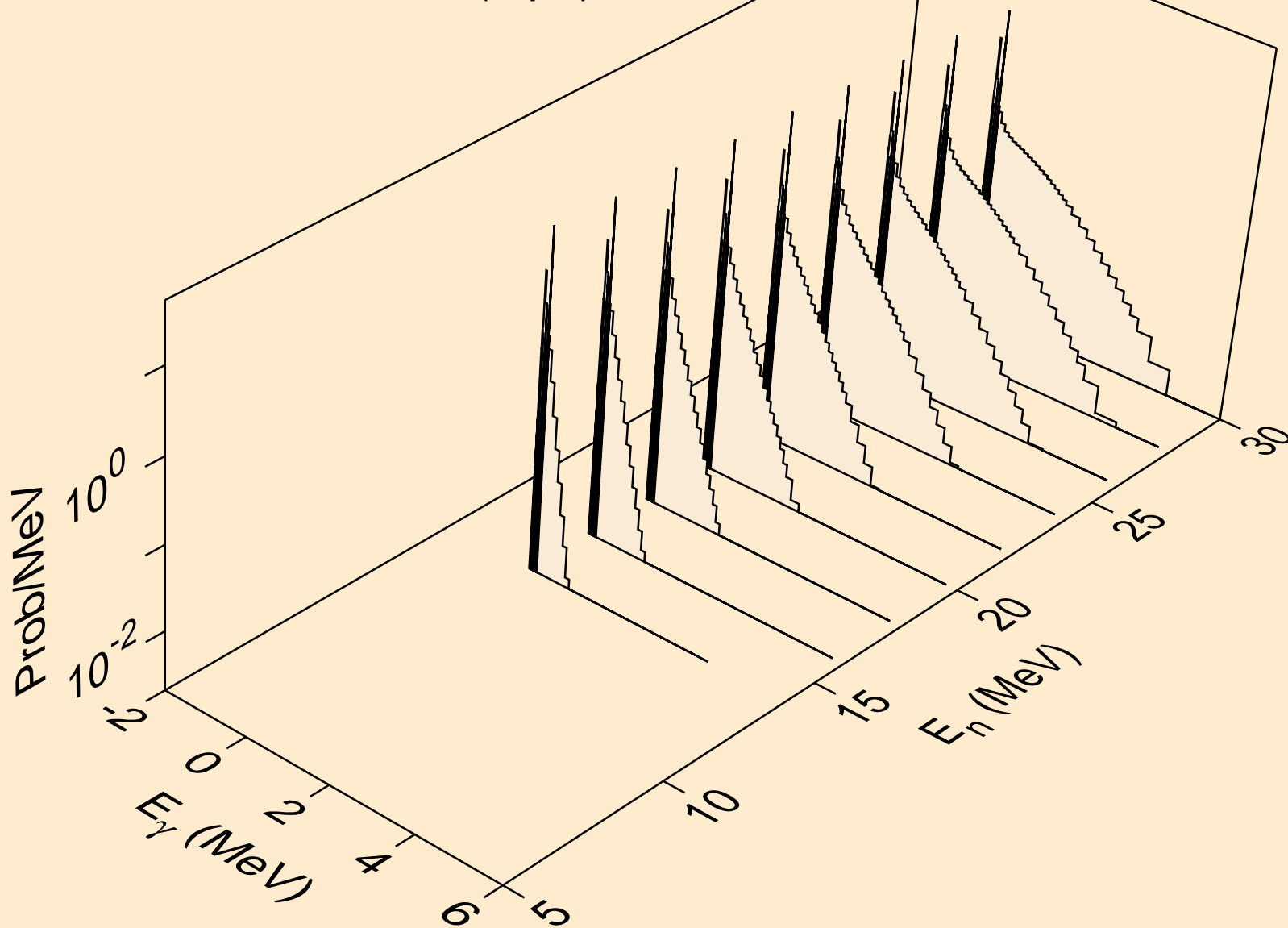

LU168 NEUTRON ACER TENDL-2019 LIBRARY; T=293.16K  
Photon emission for (n,pt)

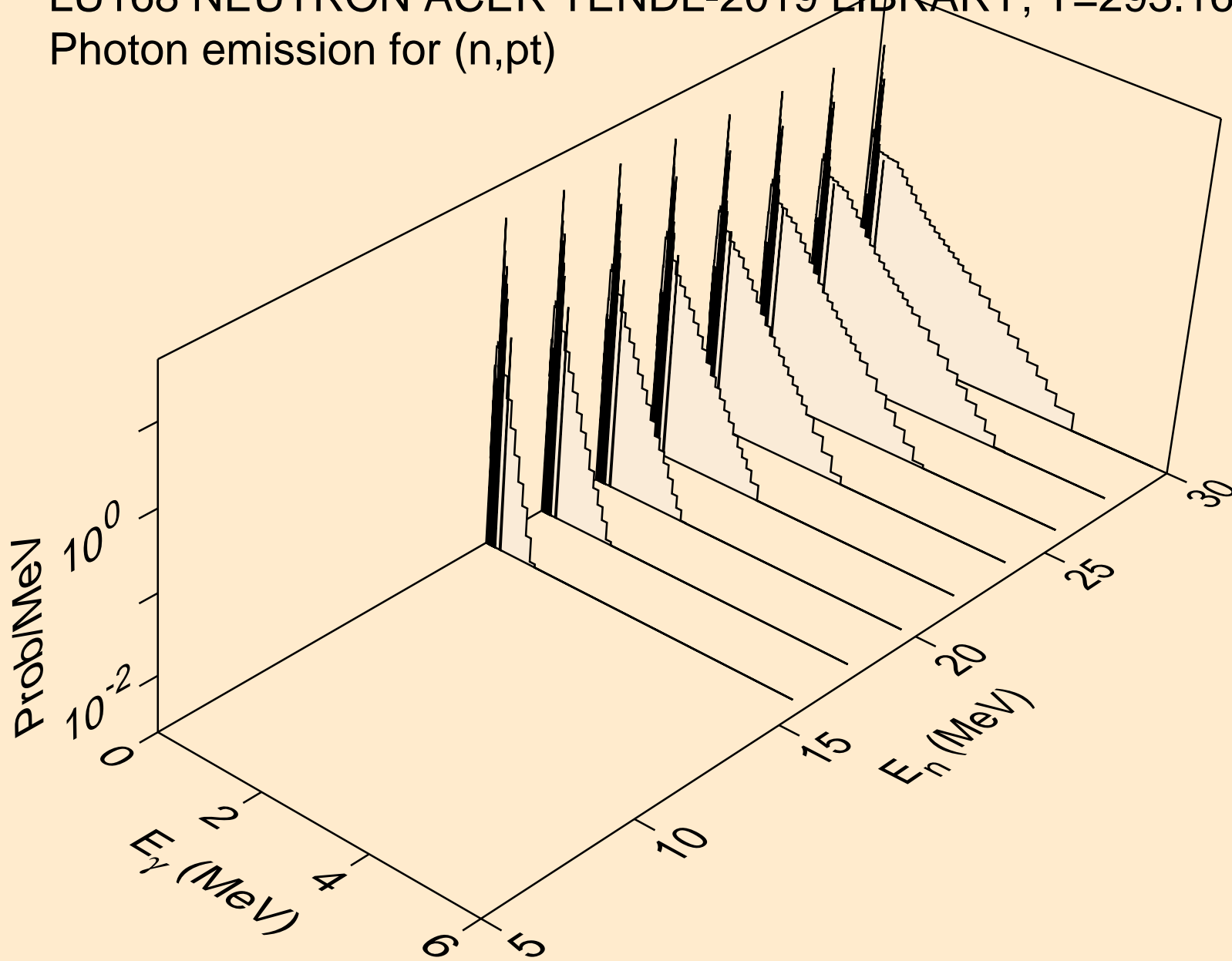

LU168 NEUTRON ACER TENDL-2019 LIBRARY; T=293.16K  
Photon emission for (n,da)

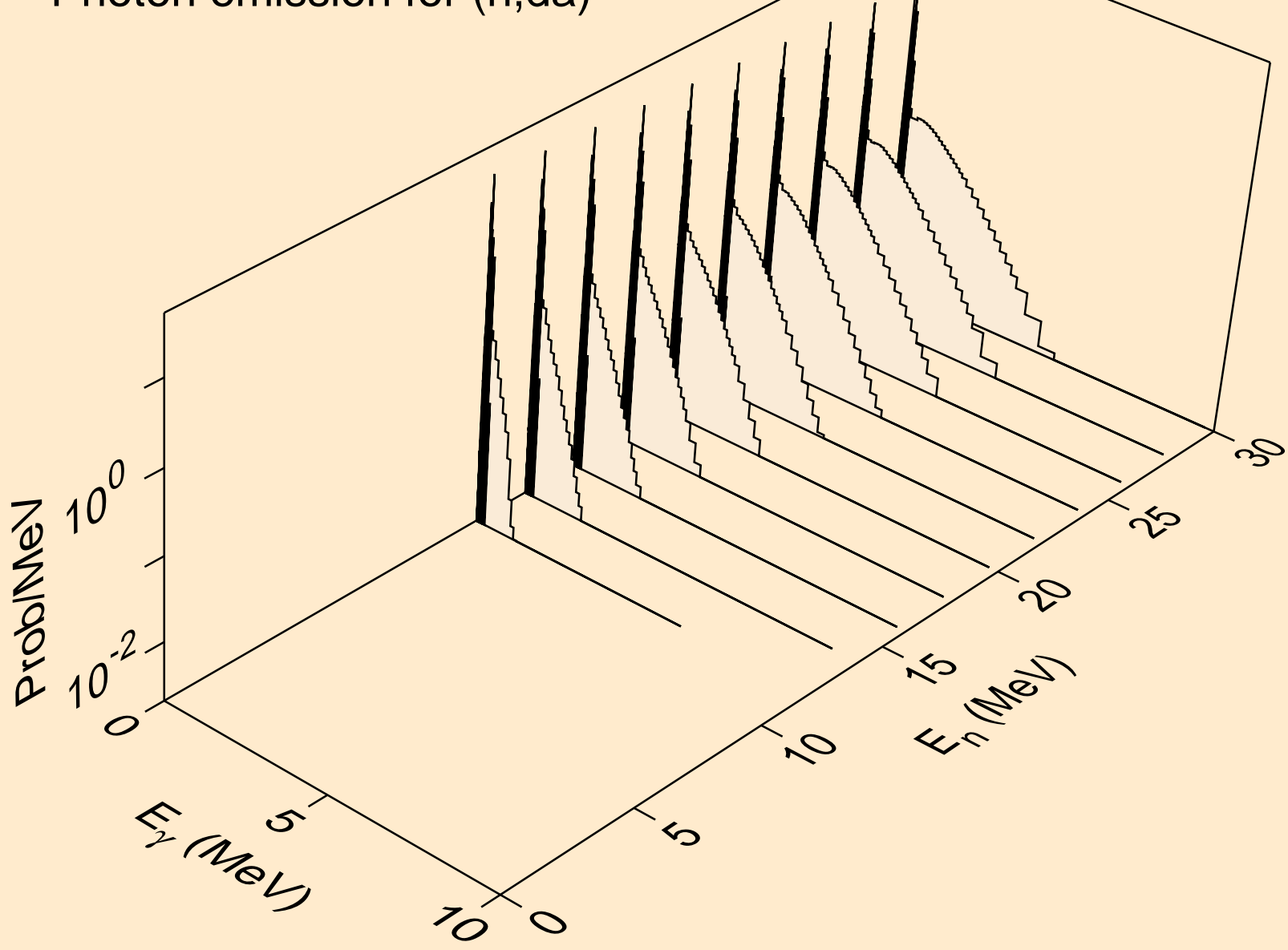



LU168 NEUTRON ACER TENDL-2019 LIBRARY; T=293.16K  
thermal capture photon spectrum

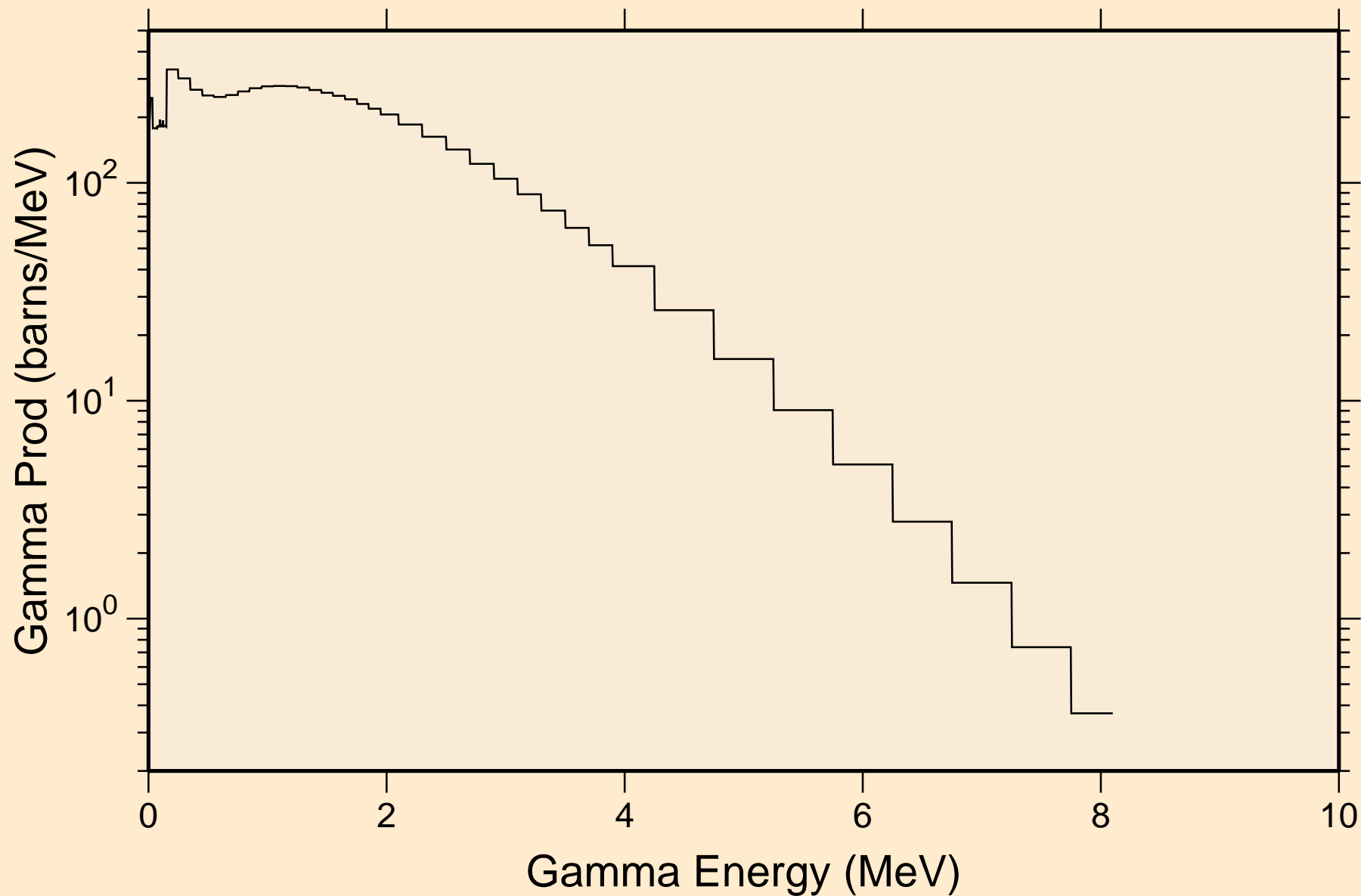

LU168 NEUTRON ACER TENDL-2019 LIBRARY; T=293.16K  
14 MeV photon spectrum

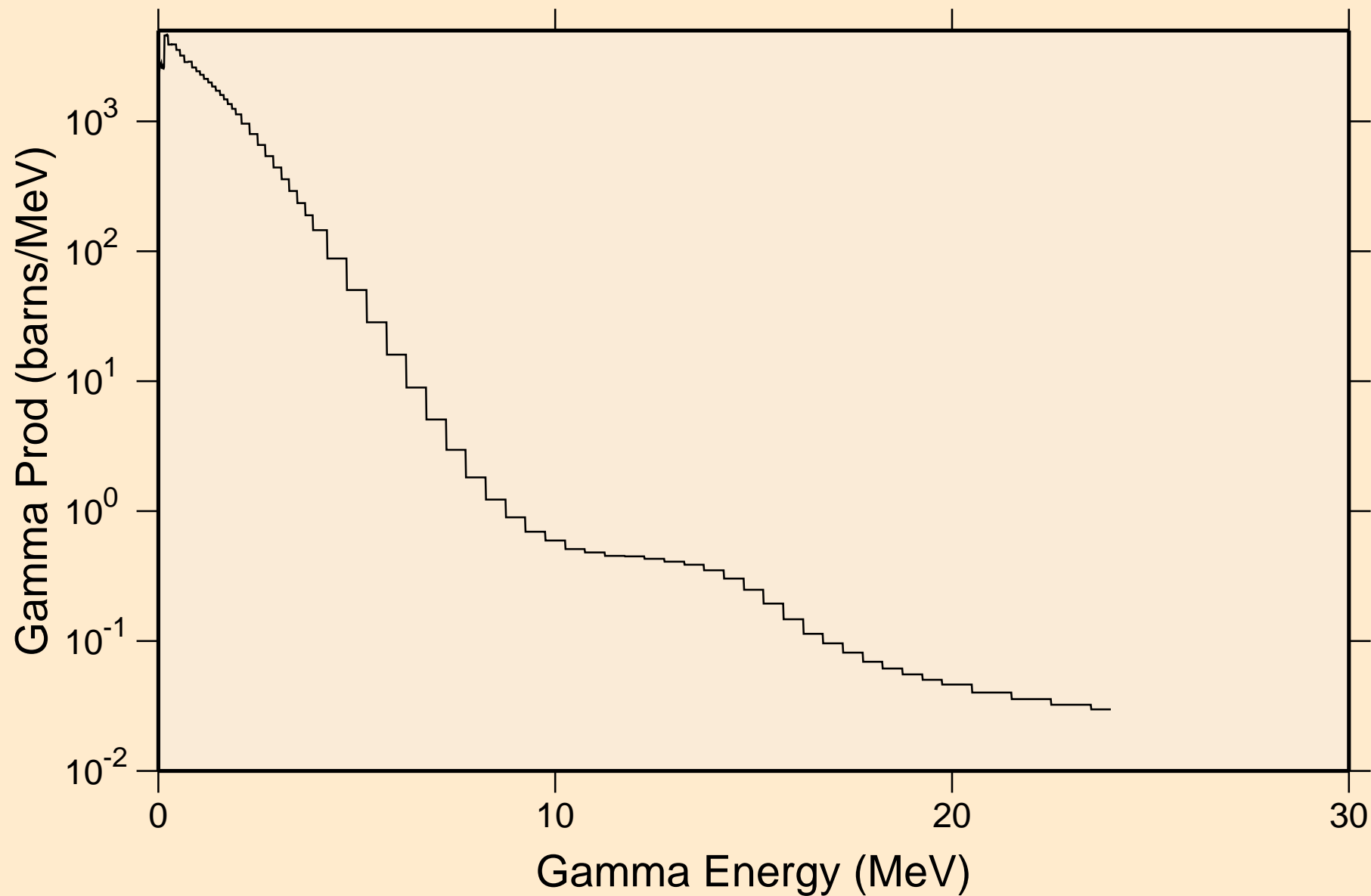

LU168 NEUTRON ACER TENDL-2019 LIBRARY; T=293.16K  
Particle heating contributions

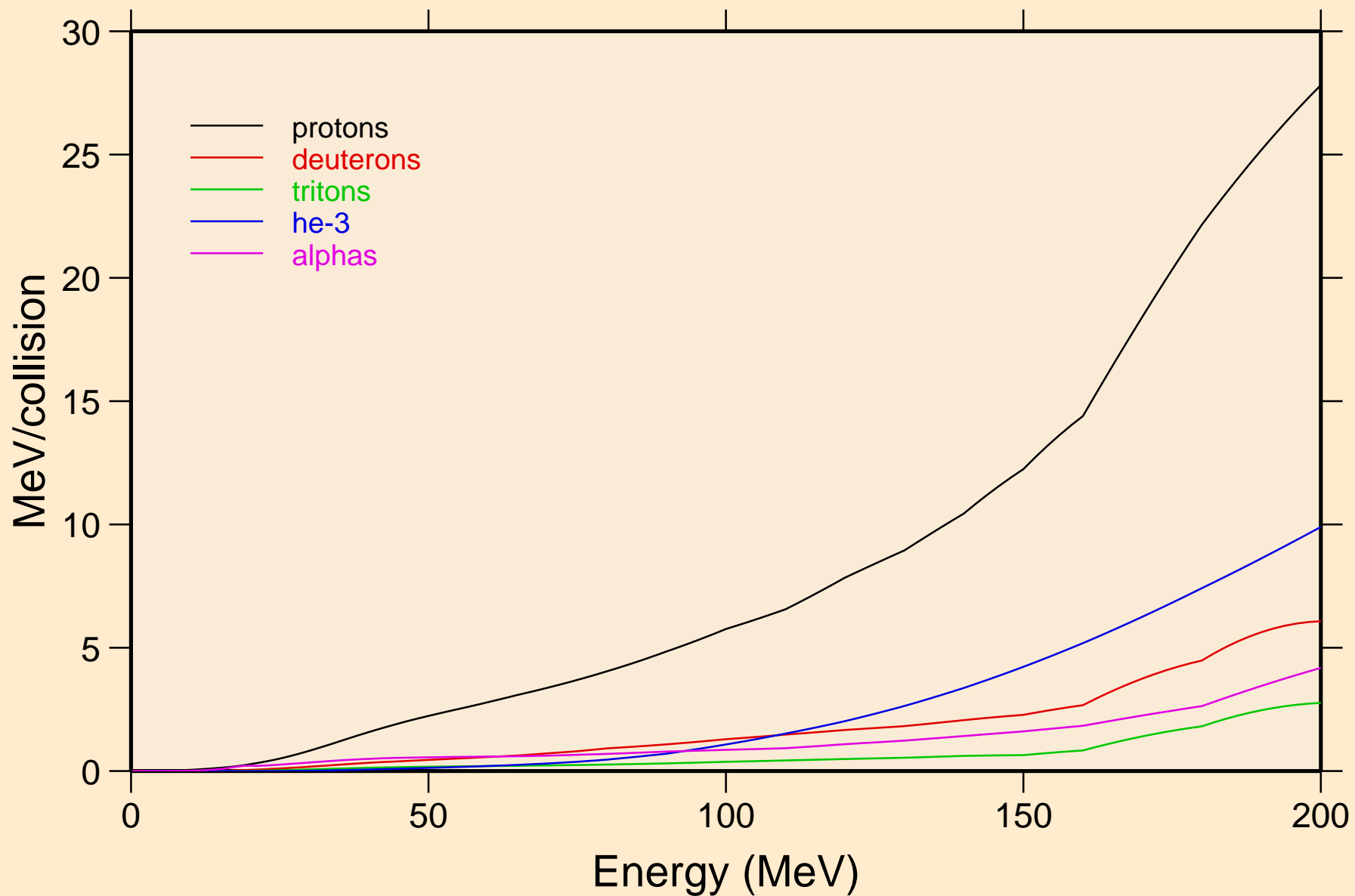

LU168 NEUTRON ACER TENDL-2019 LIBRARY; T=293.16K  
Recoil Heating

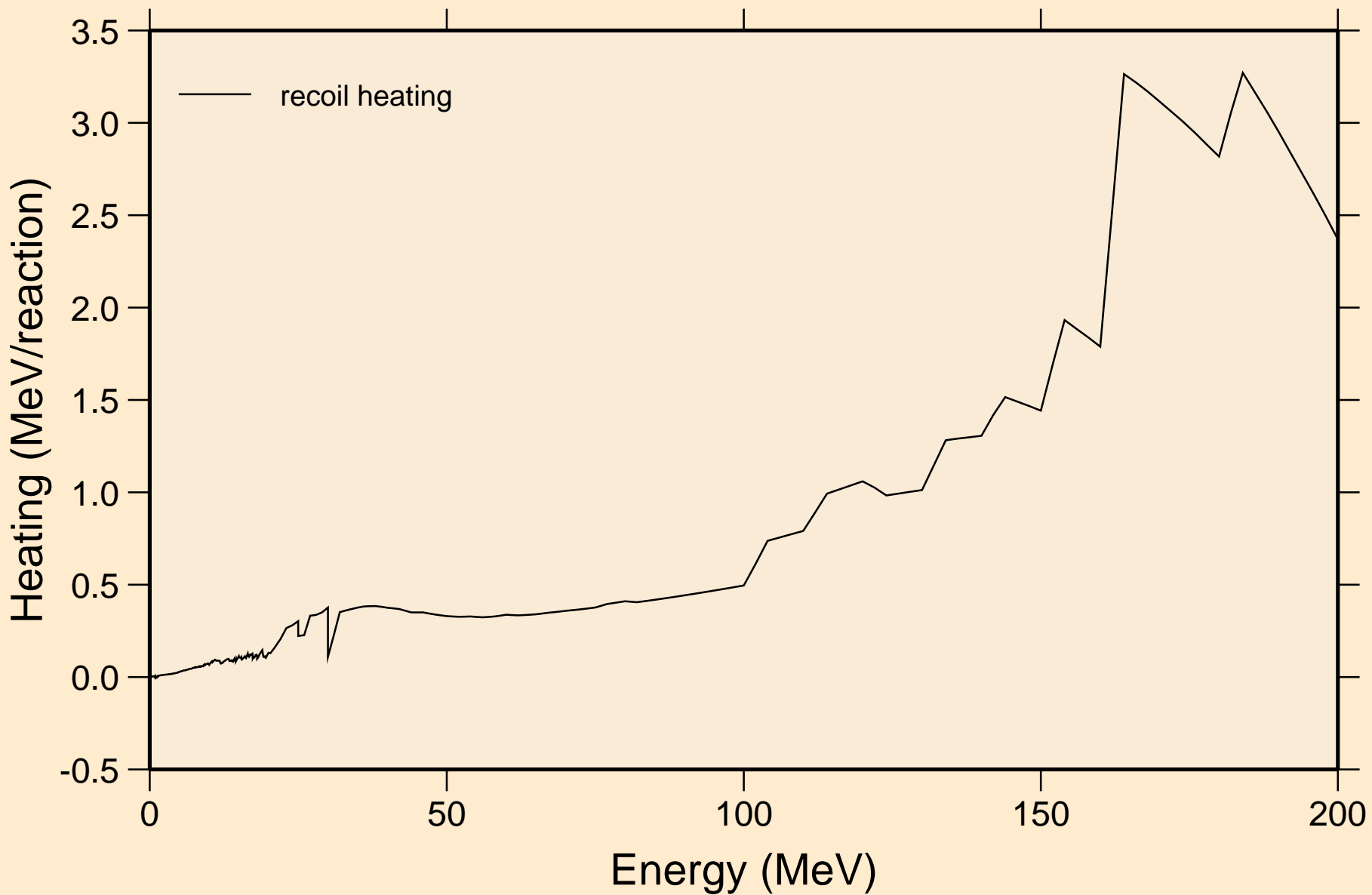

LU168 NEUTRON ACER TENDL-2019 LIBRARY; T=293.16K  
Particle production cross sections

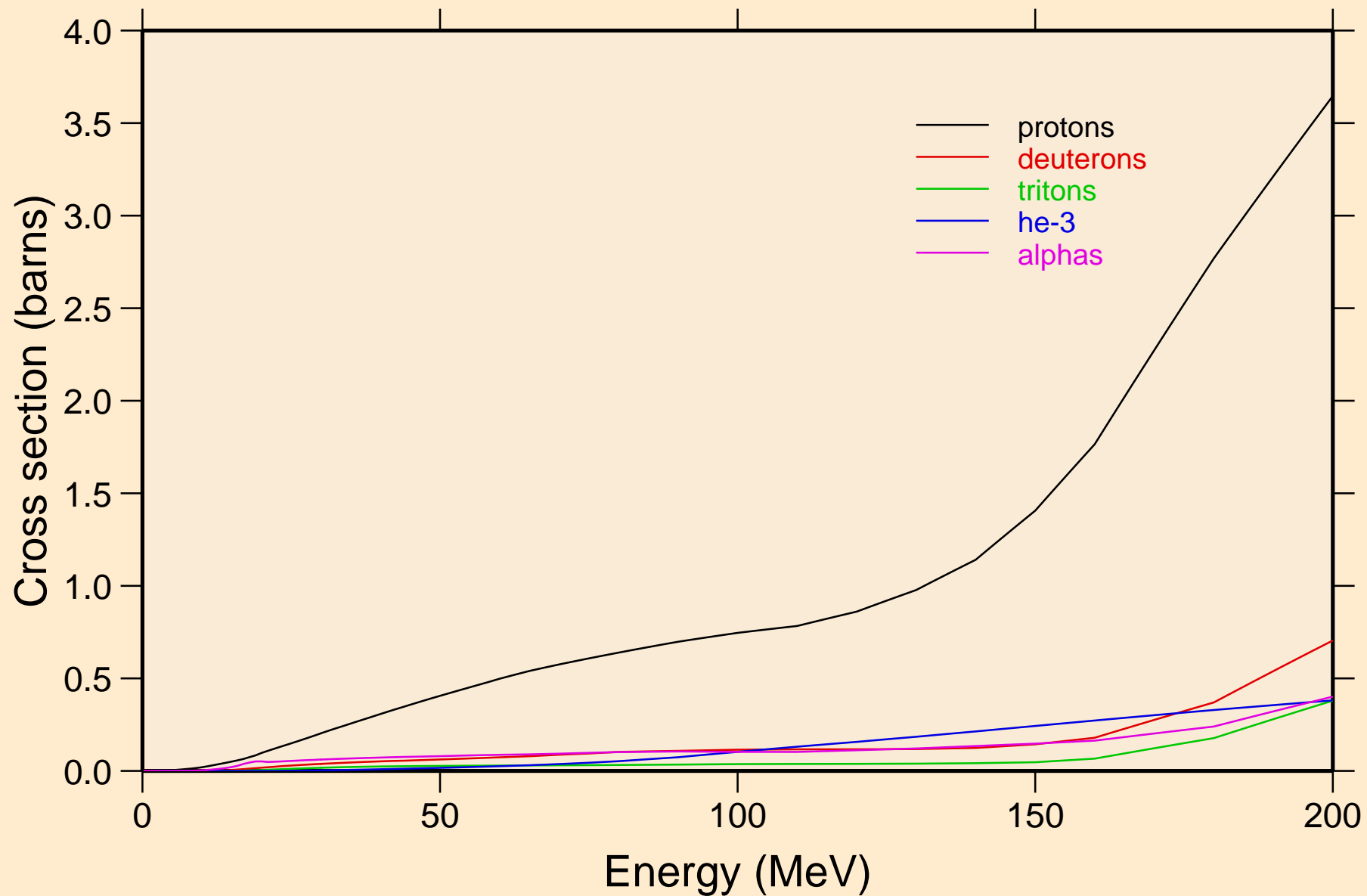

LU168 NEUTRON ACER TENDL-2019 LIBRARY; T=293.16K  
protons from (n,x)

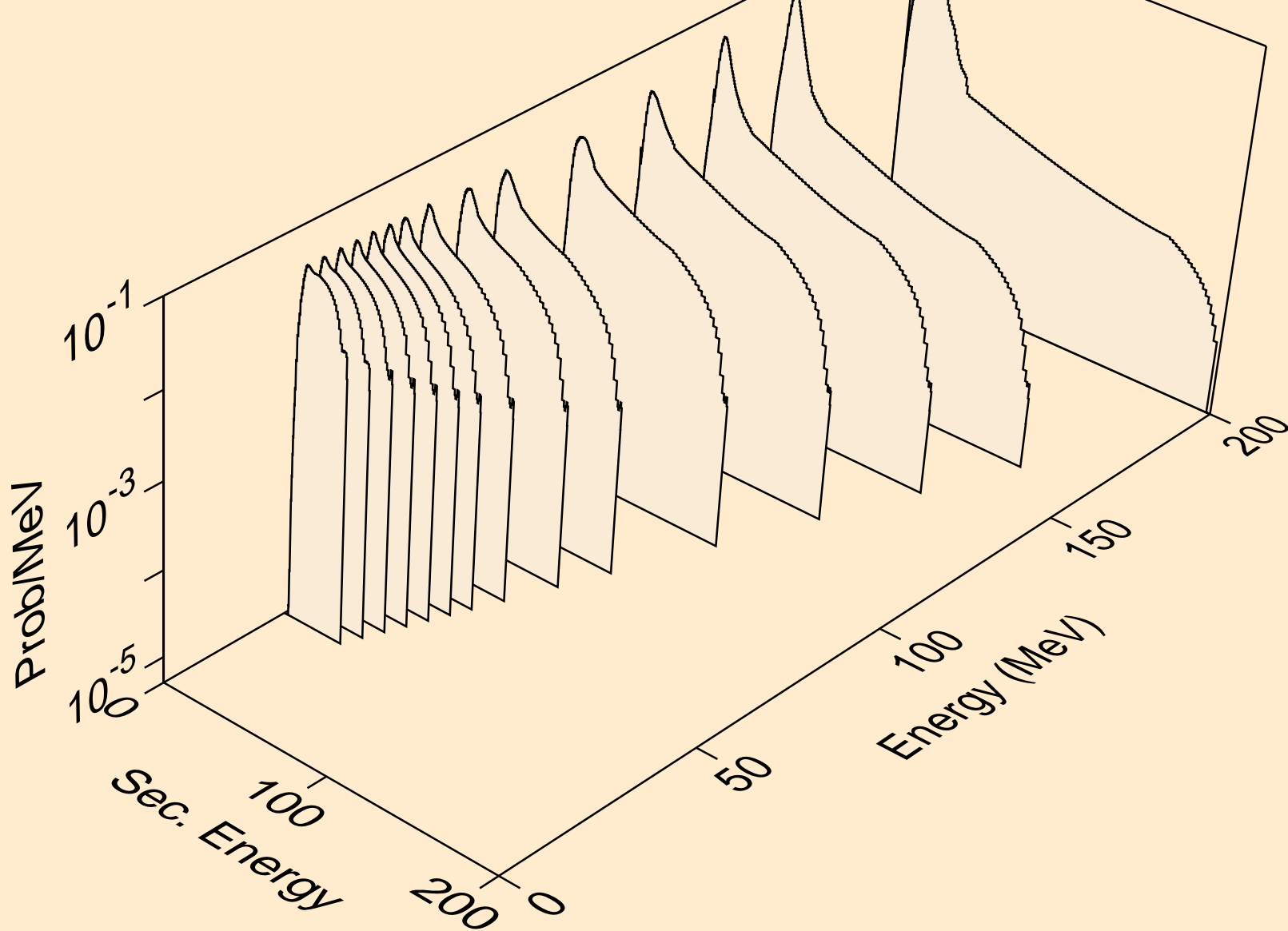

LU168 NEUTRON ACER TENDL-2019 LIBRARY; T=293.16K  
protons from (n,n\*)p

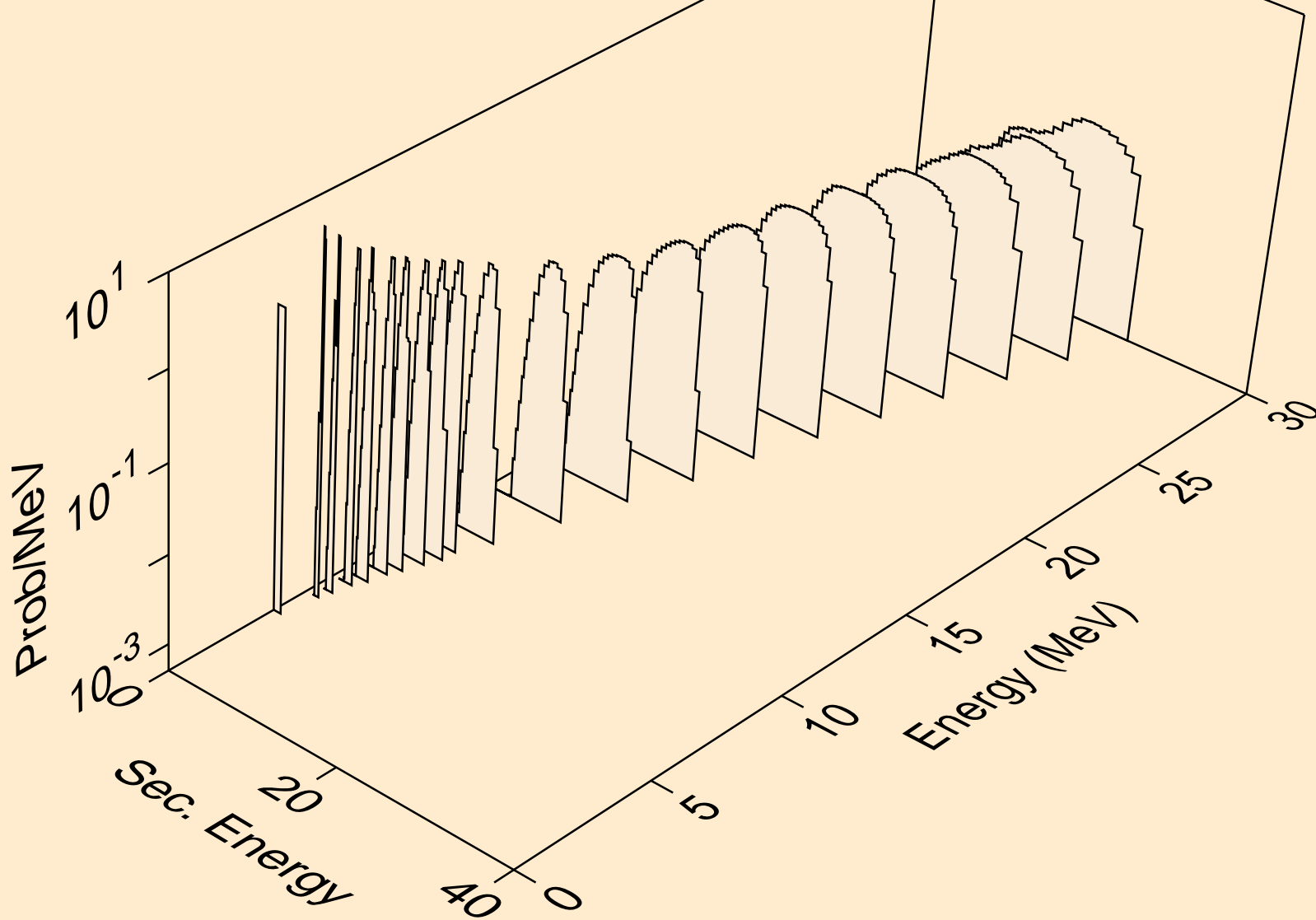

LU168 NEUTRON ACER TENDL-2019 LIBRARY; T=293.16K  
protons from (n,2np)

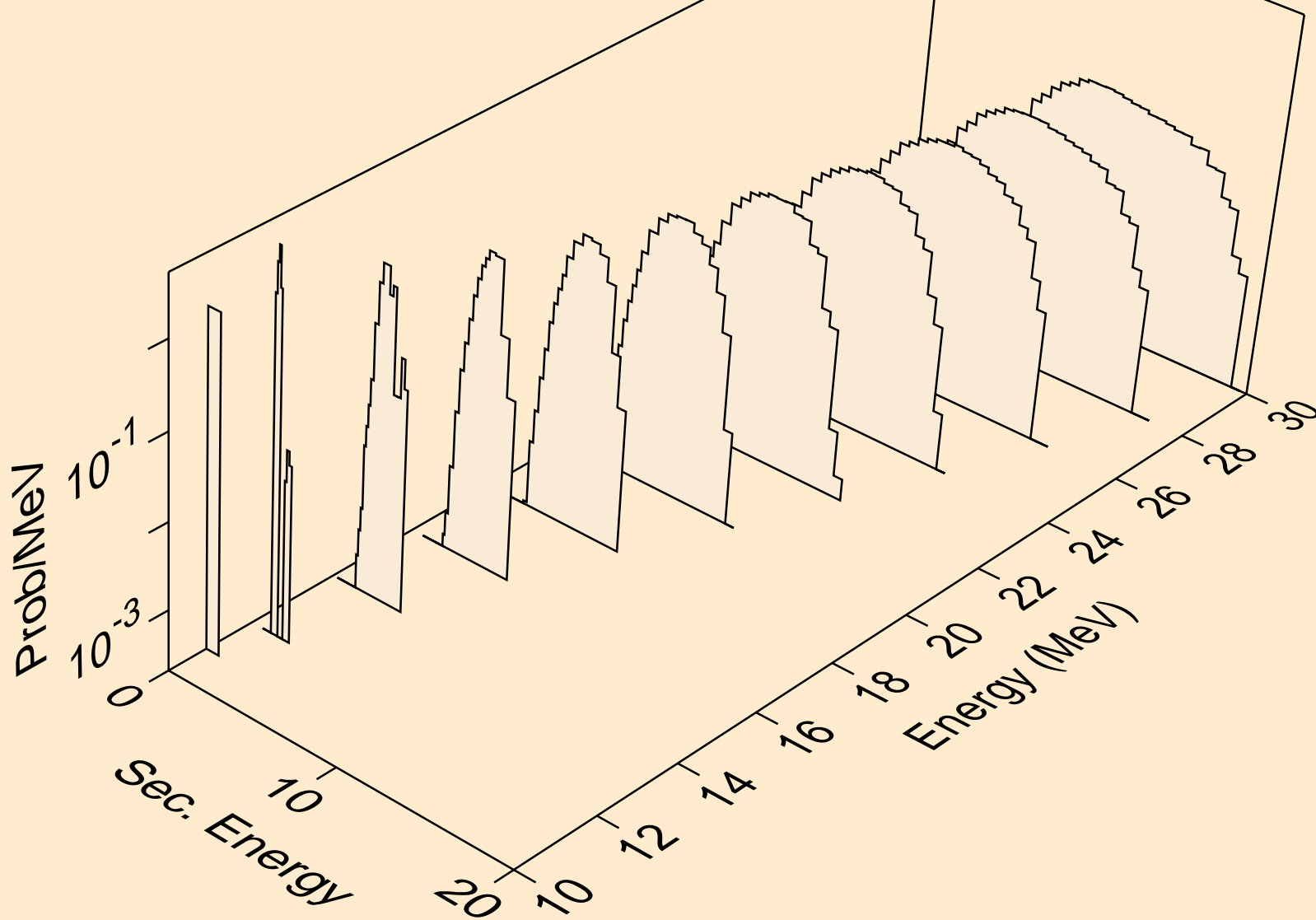



LU168 NEUTRON ACER TENDL-2019 LIBRARY; T=293.16K  
protons from (n,3np)

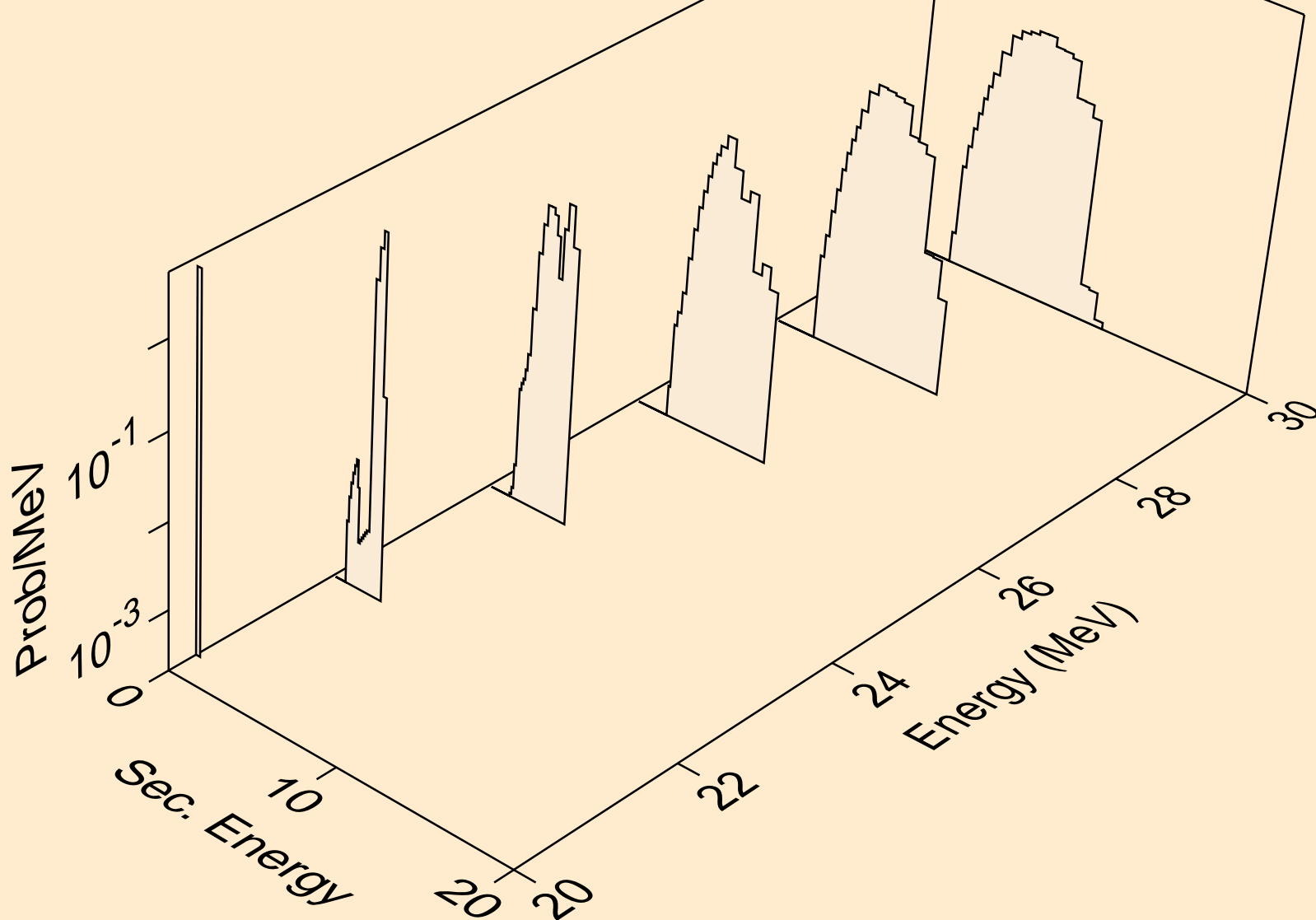

LU168 NEUTRON ACER TENDL-2019 LIBRARY; T=293.16K  
protons from (n,2np)

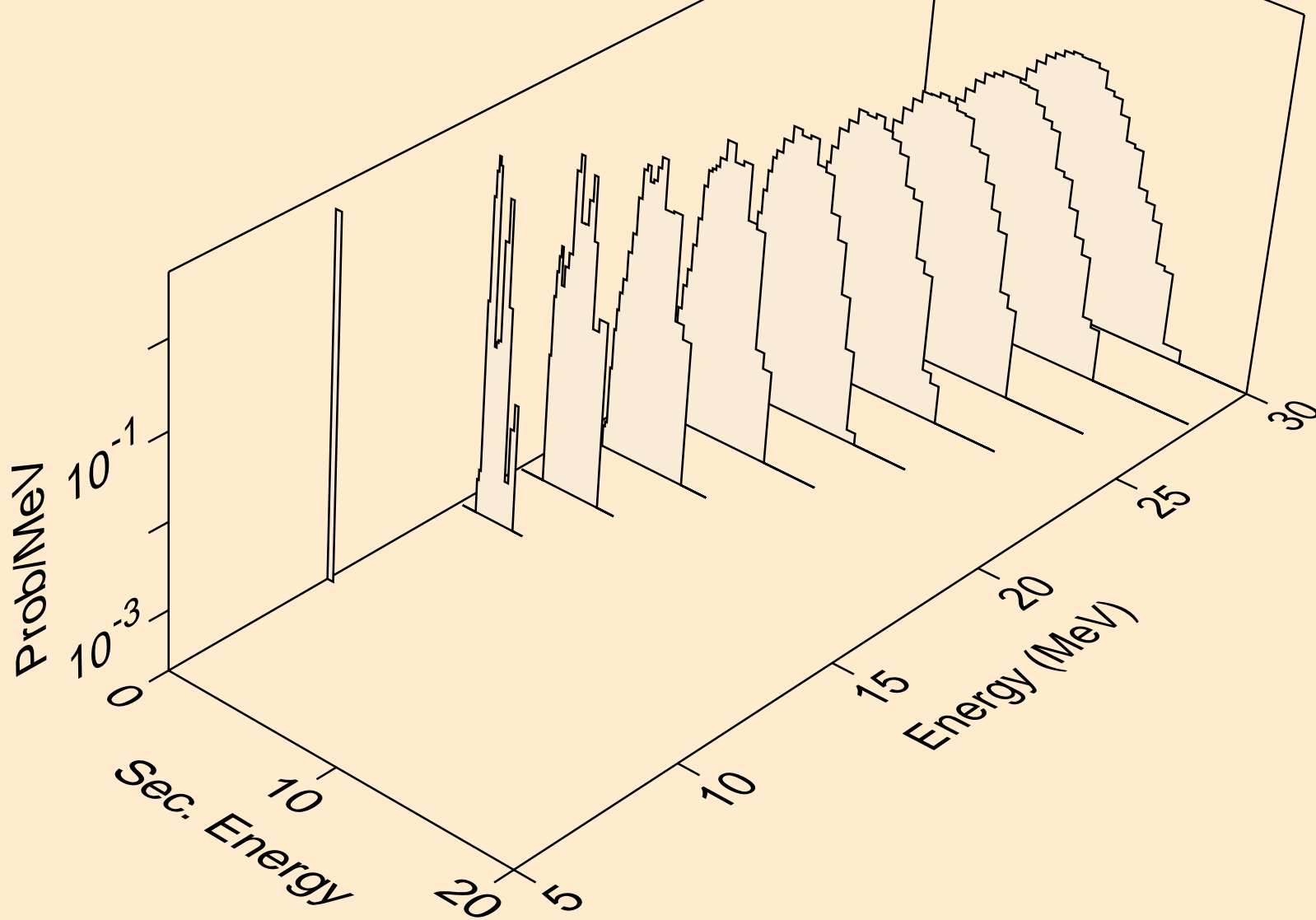

LU168 NEUTRON ACER TENDL-2019 LIBRARY; T=293.16K  
protons from (n,npa)

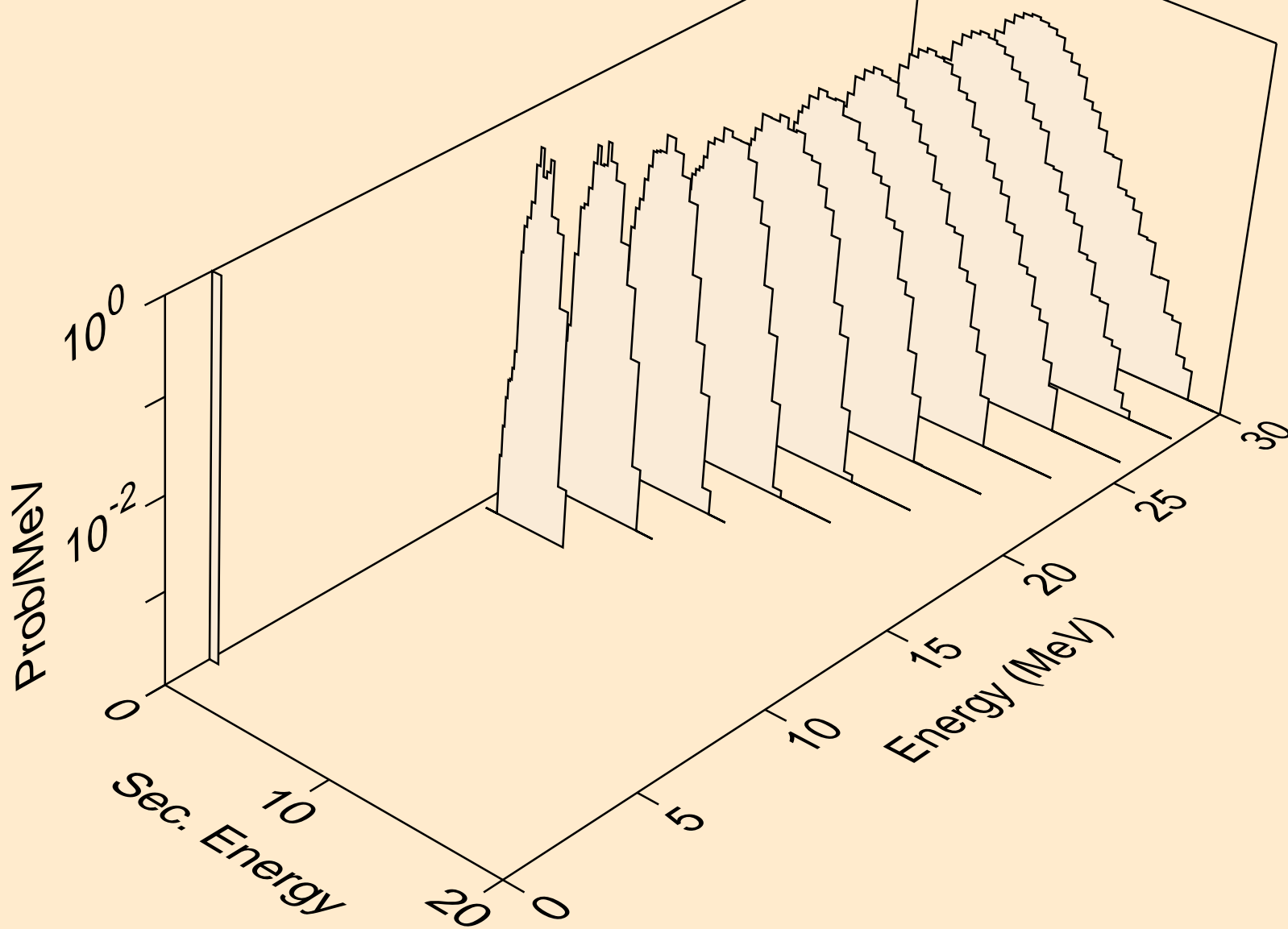

LU168 NEUTRON ACER TENDL-2019 LIBRARY; T=293.16K  
protons from (n,p)

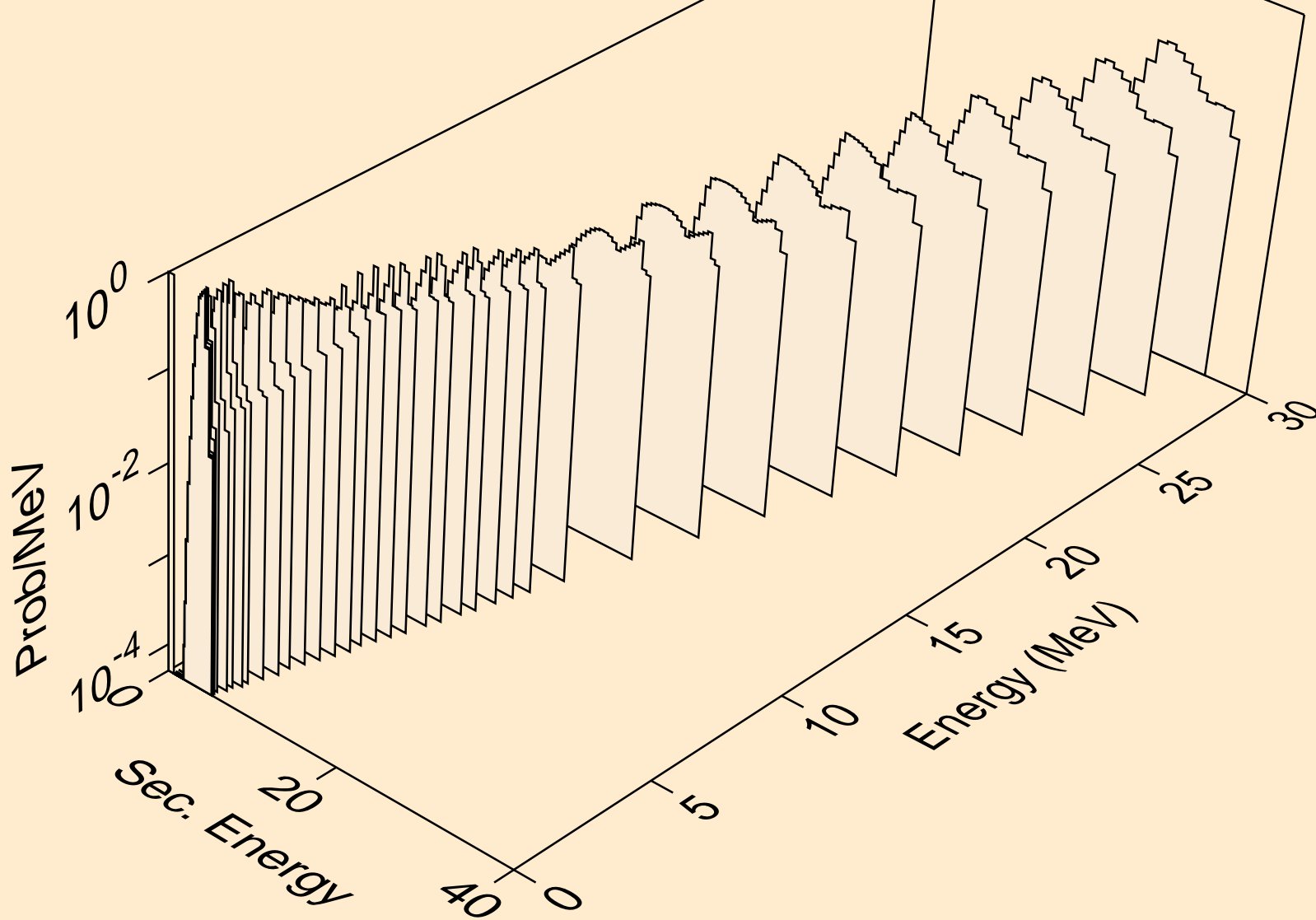

LU168 NEUTRON ACER TENDL-2019 LIBRARY; T=293.16K  
protons from (n,2p)

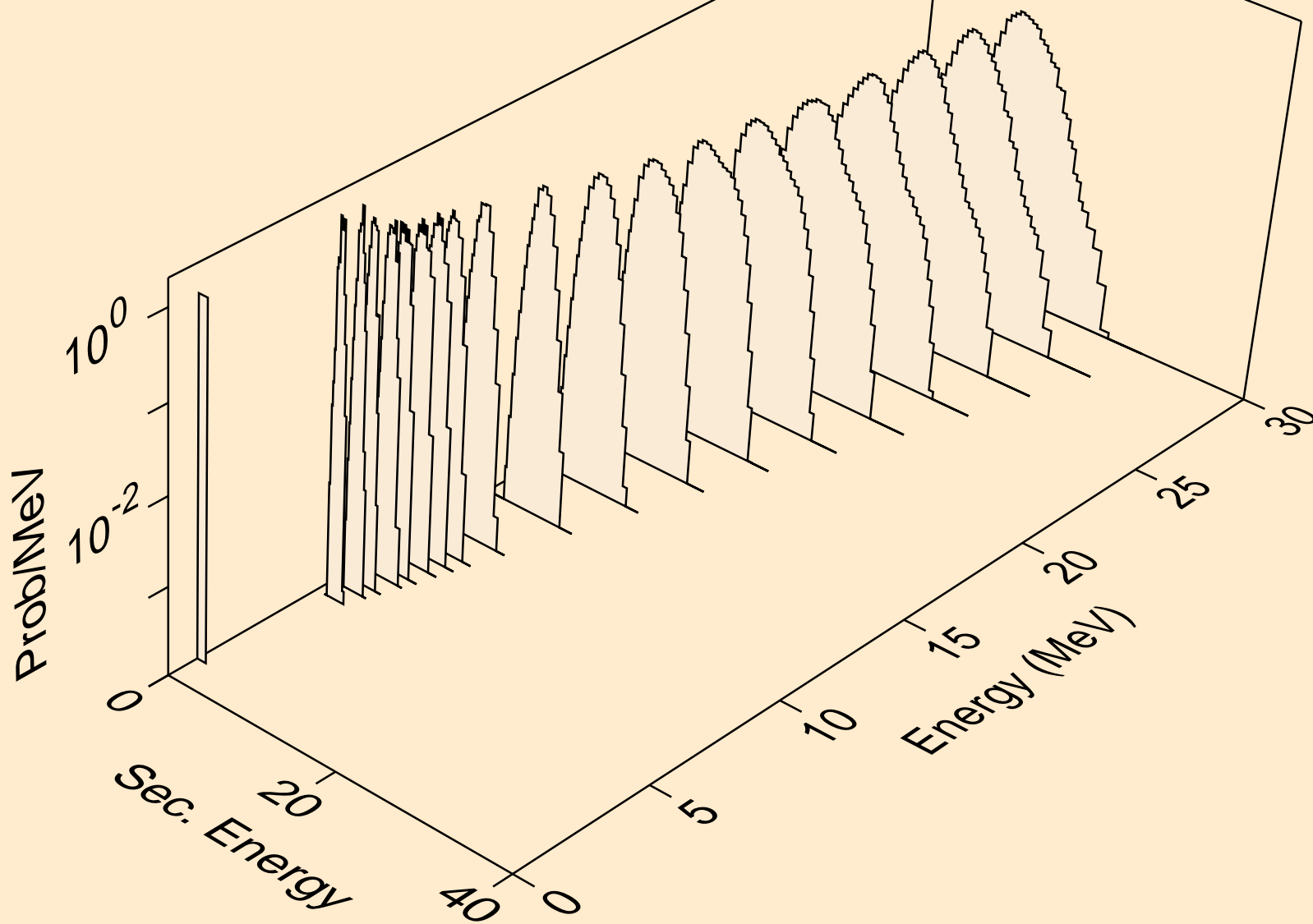

LU168 NEUTRON ACER TENDL-2019 LIBRARY; T=293.16K  
protons from (n,p)

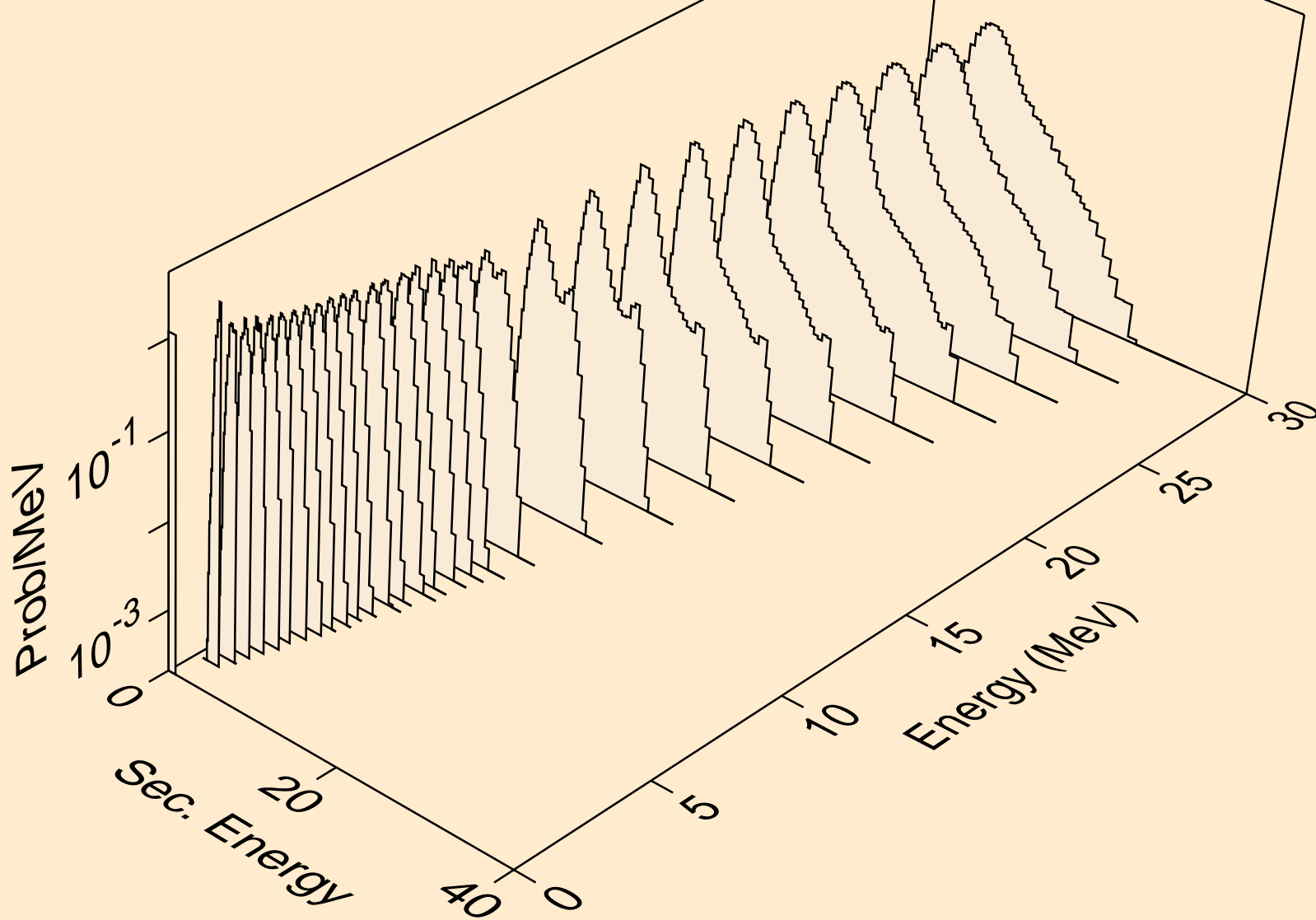

LU168 NEUTRON ACER TENDL-2019 LIBRARY; T=293.16K  
protons from (n,pd)

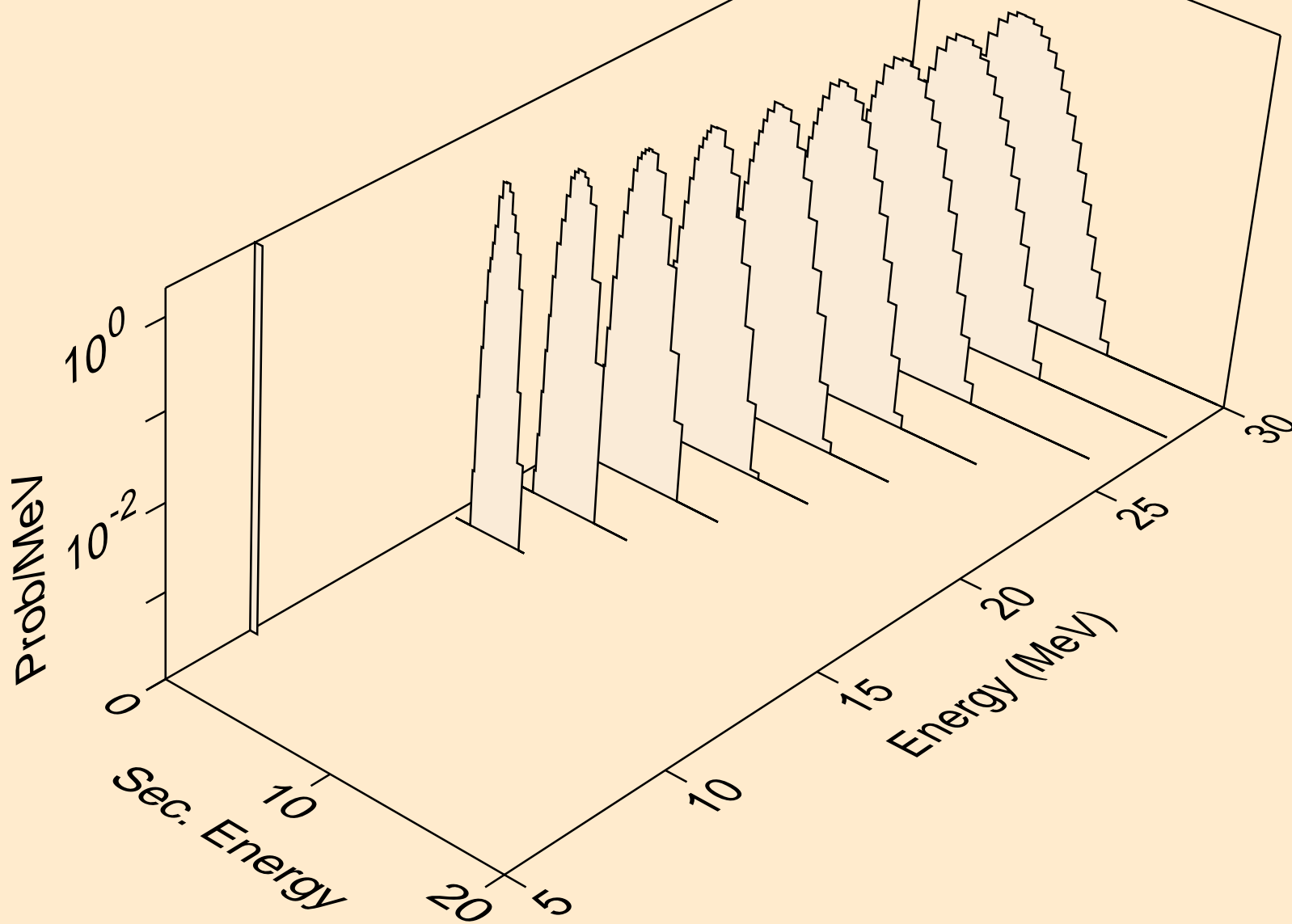

LU168 NEUTRON ACER TENDL-2019 LIBRARY; T=293.16K  
protons from (n,pt)

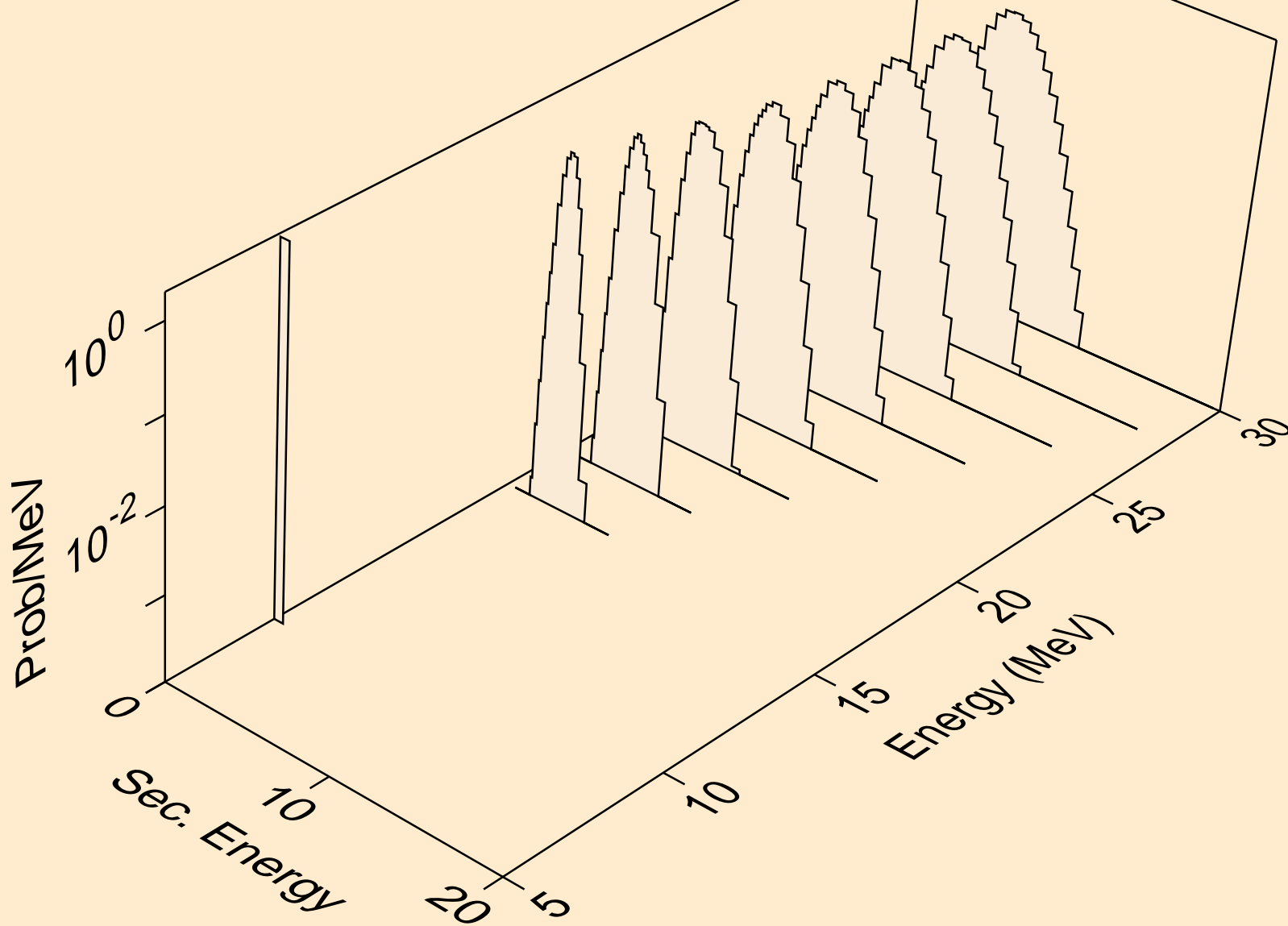



LU168 NEUTRON ACER TENDL-2019 LIBRARY; T=293.16K  
deuterons from (n,x)

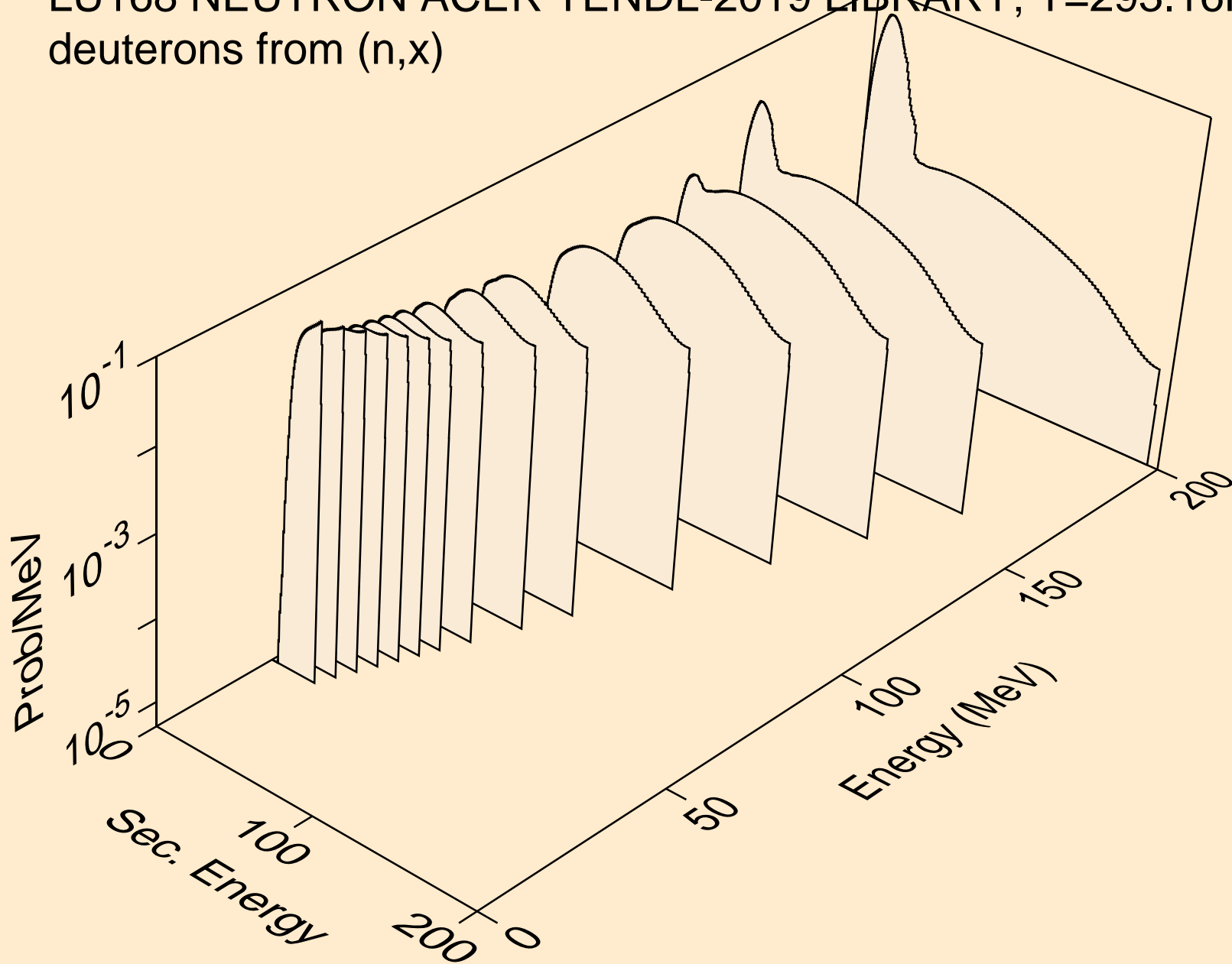

LU168 NEUTRON ACER TENDL-2019 LIBRARY; T=293.16K  
deuterons from (n,2nd)

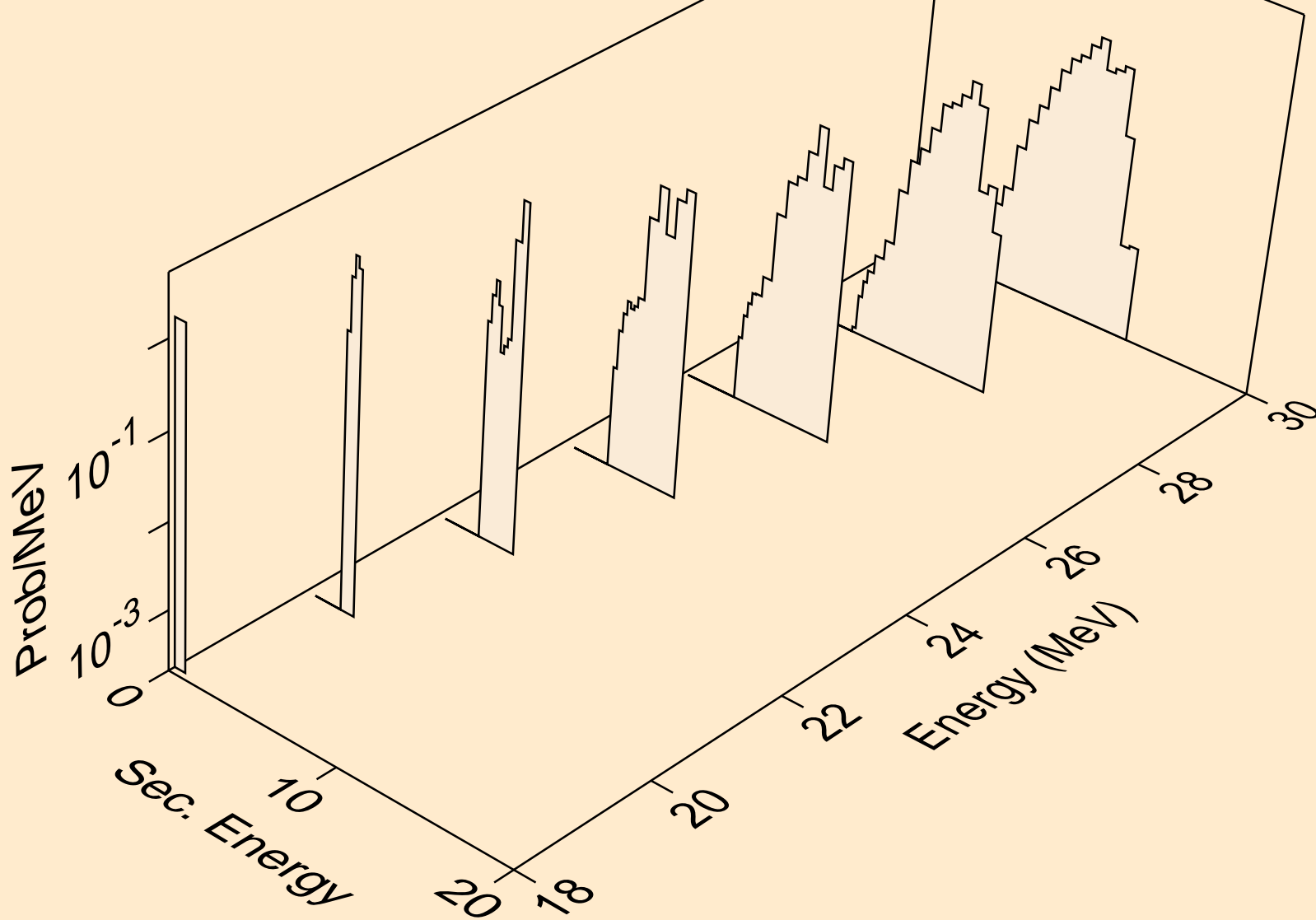

LU168 NEUTRON ACER TENDL-2019 LIBRARY; T=293.16K  
deuterons from (n,n\*)d

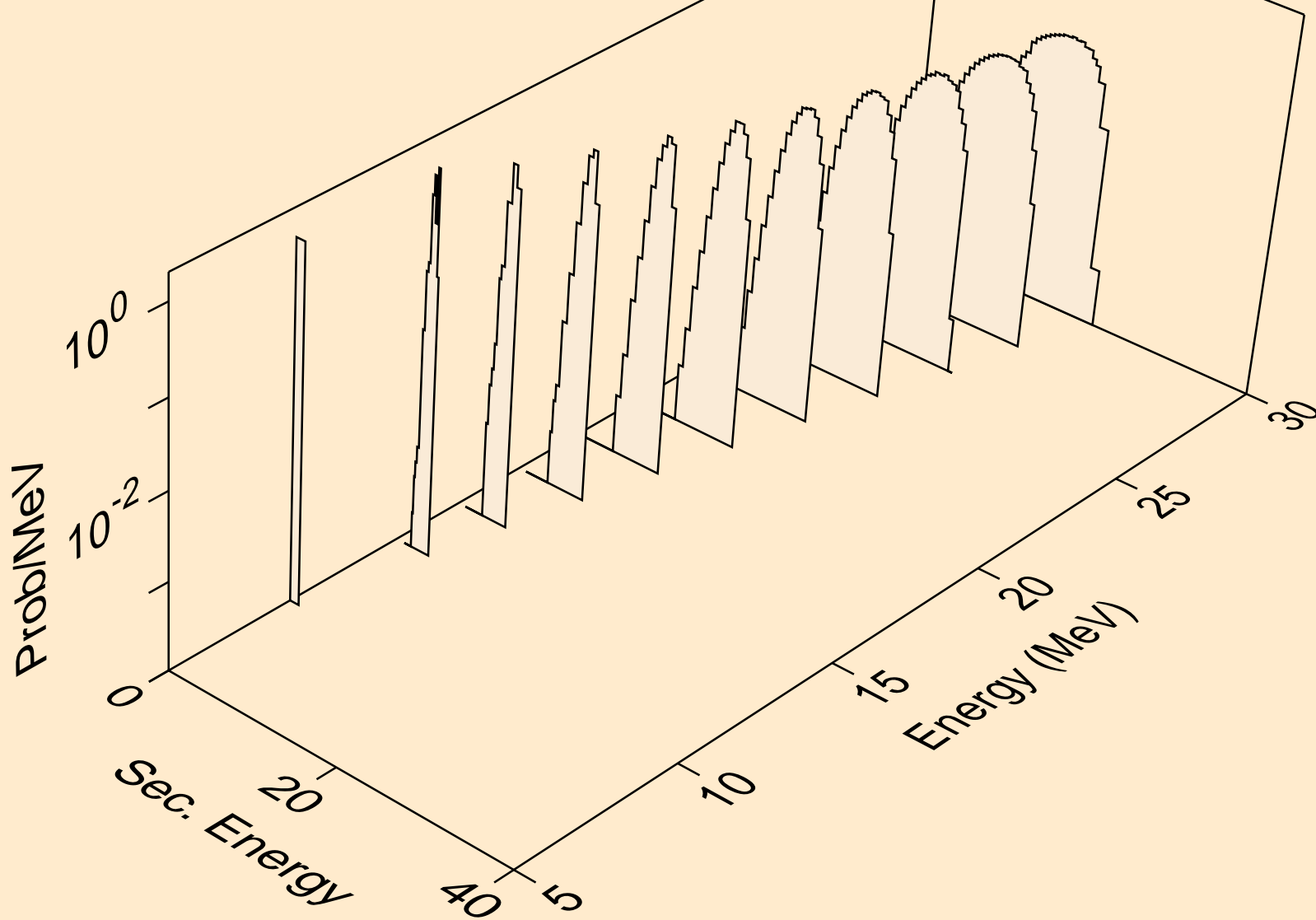

LU168 NEUTRON ACER TENDL-2019 LIBRARY; T=293.16K  
deuterons from (n,d)

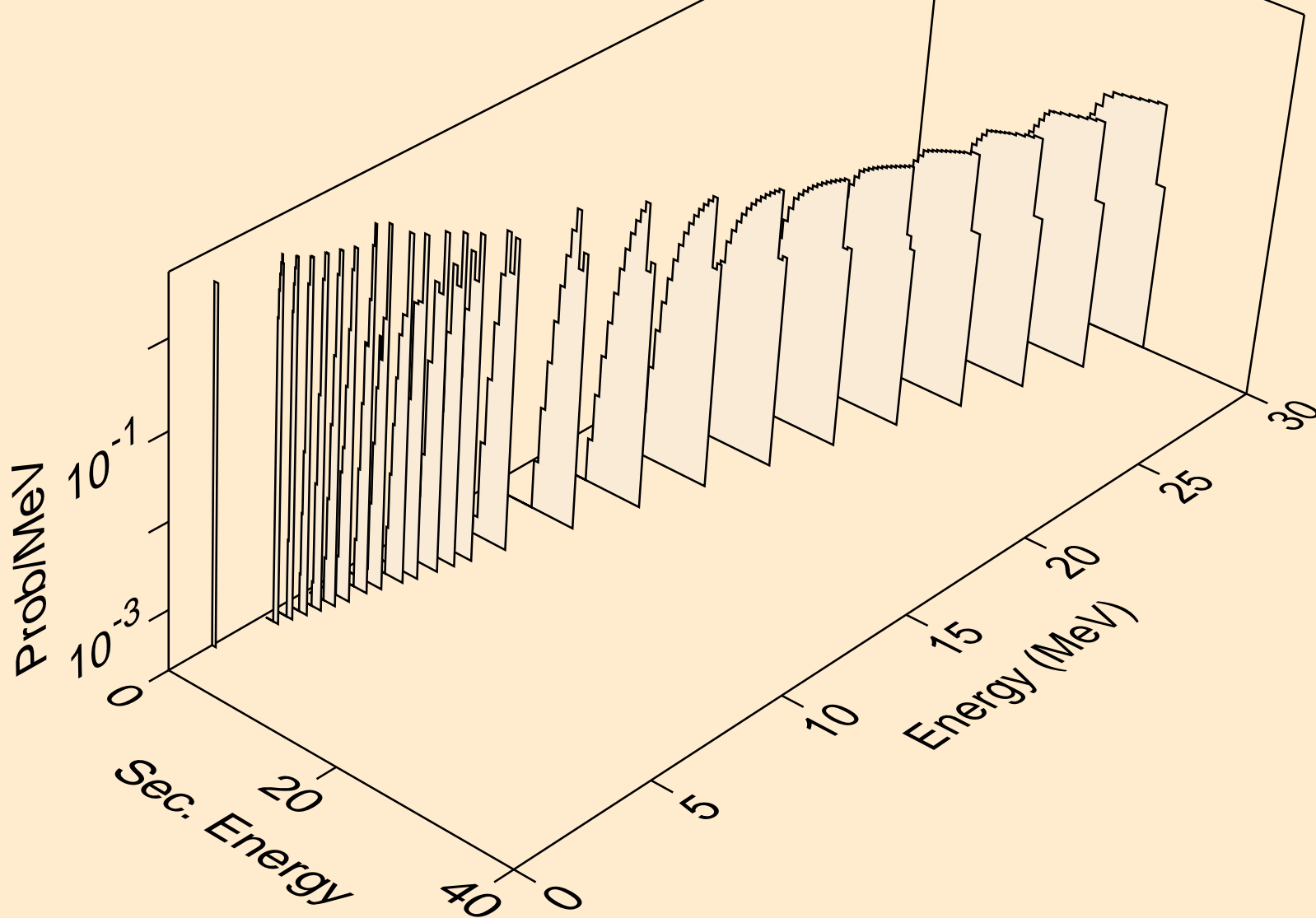

LU168 NEUTRON ACER TENDL-2019 LIBRARY; T=293.16K  
deuterons from (n,pd)

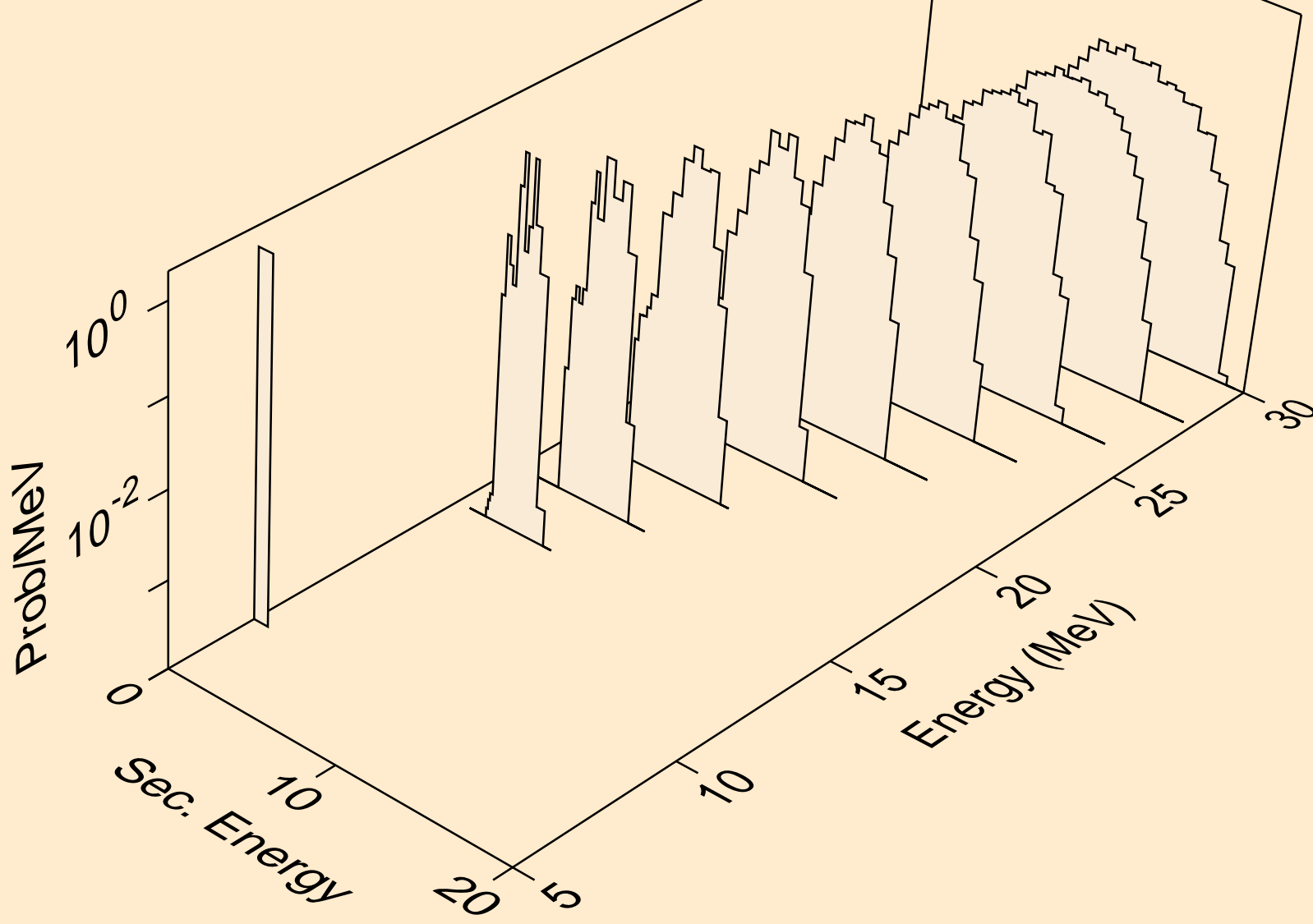

LU168 NEUTRON ACER TENDL-2019 LIBRARY; T=293.16K  
deuterons from (n,da)

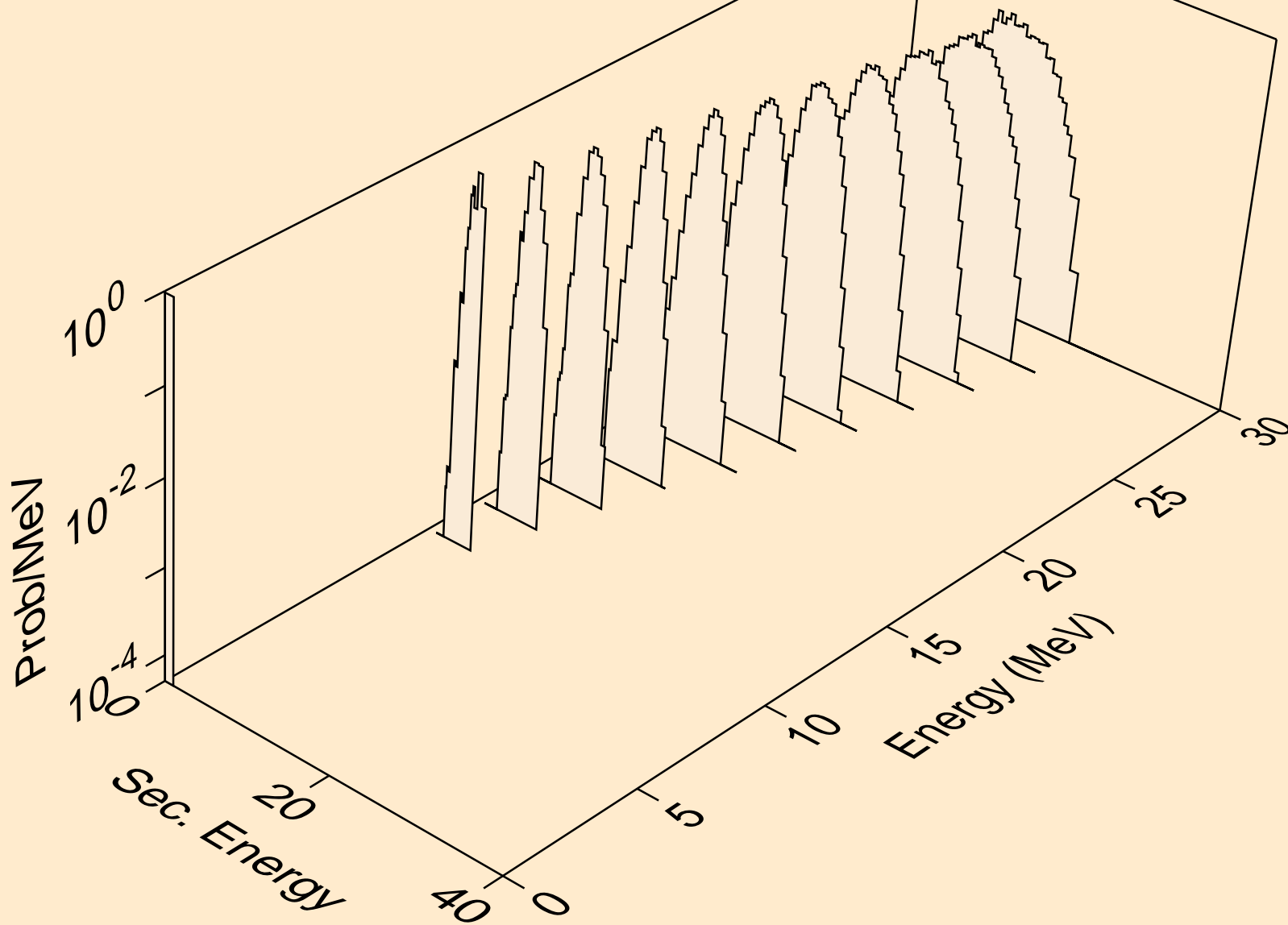

LU168 NEUTRON ACER TENDL-2019 LIBRARY; T=293.16K  
tritons from (n,x)

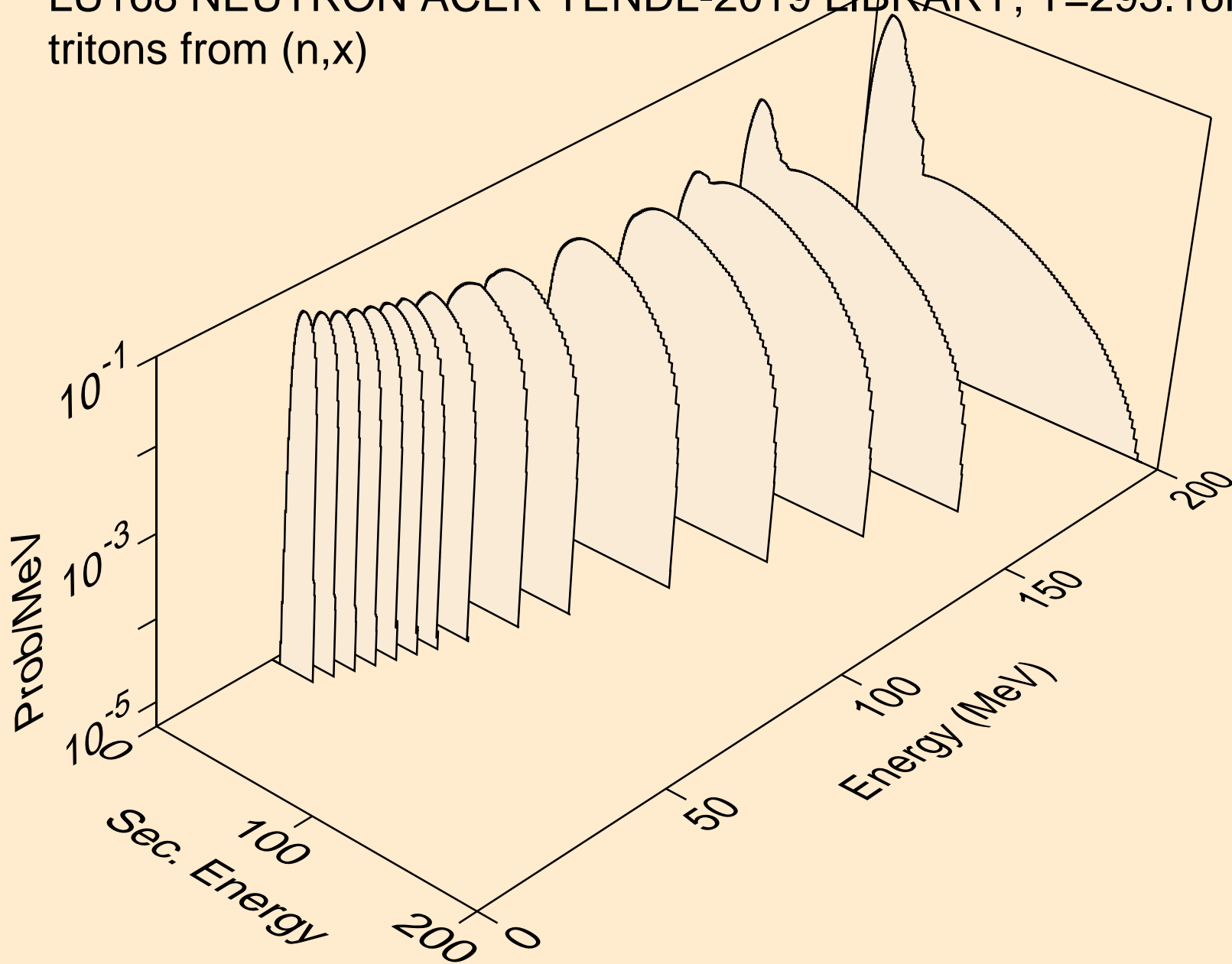

LU168 NEUTRON ACER TENDL-2019 LIBRARY; T=293.16K  
tritons from (n,n\*)t

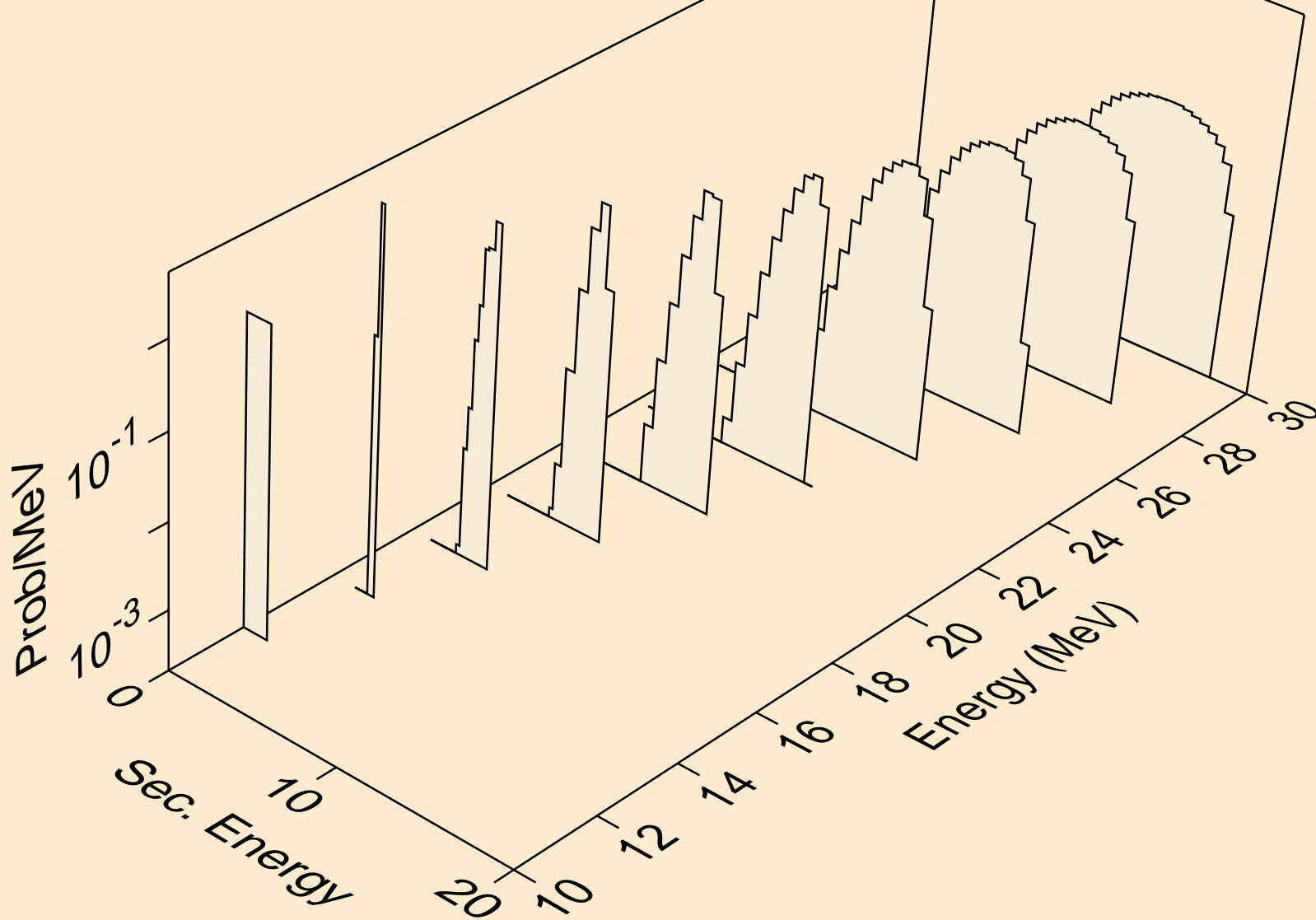



LU168 NEUTRON ACER TENDL-2019 LIBRARY; T=293.16K  
tritons from (n,t)

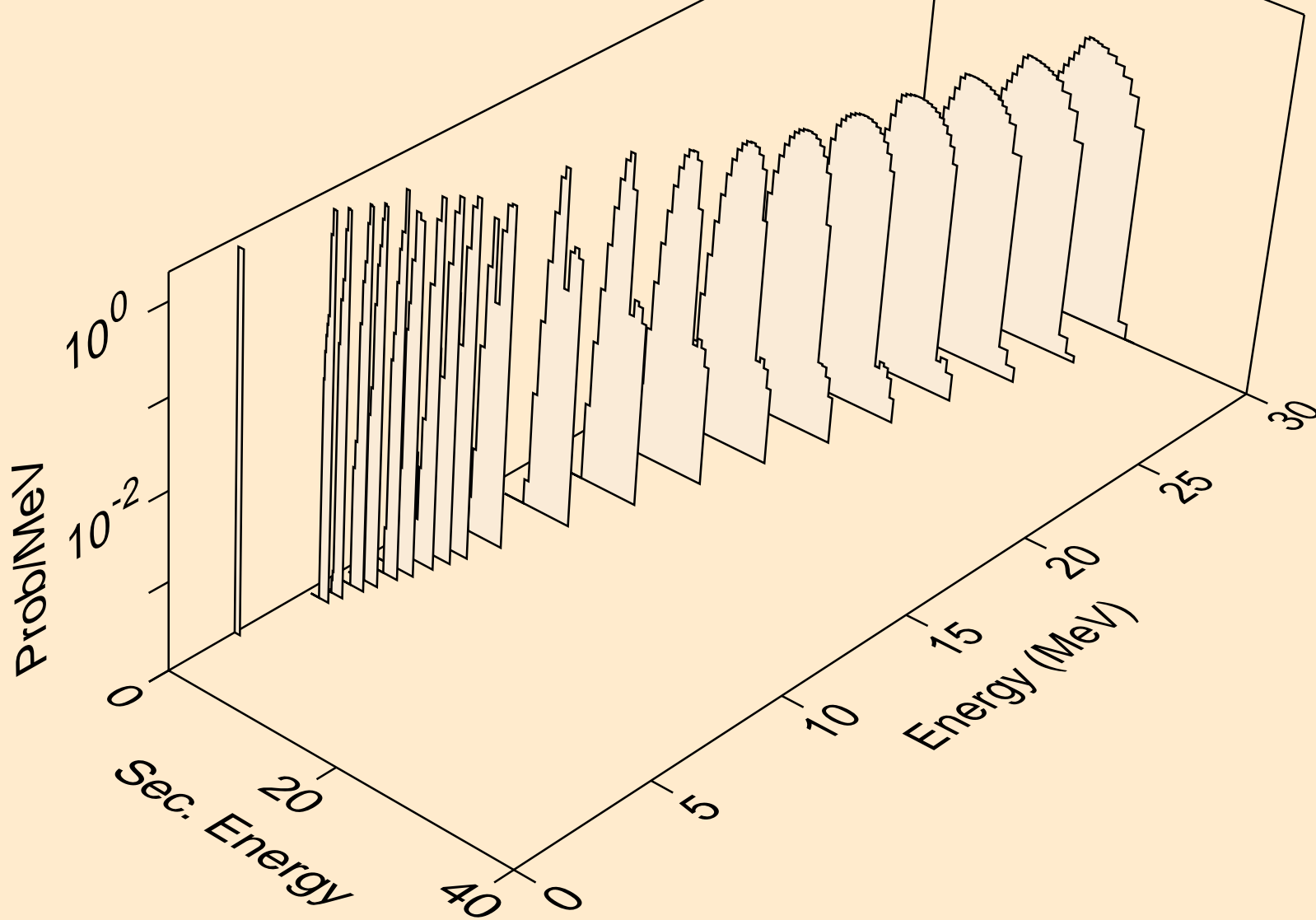

LU168 NEUTRON ACER TENDL-2019 LIBRARY; T=293.16K  
tritons from (n,pt)

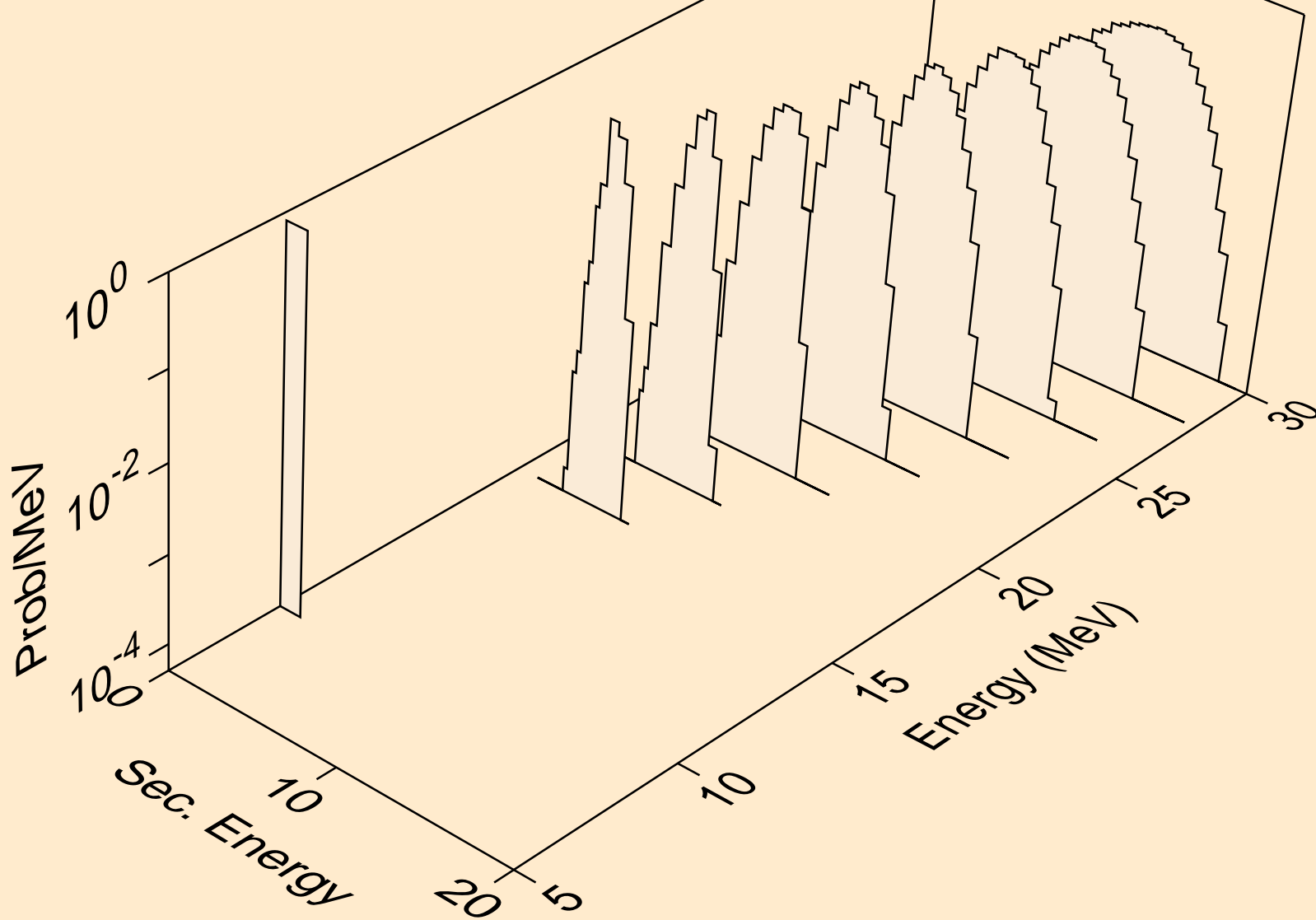

LU168 NEUTRON ACER TENDL-2019 LIBRARY; T=293.16K  
he3s from (n,x)

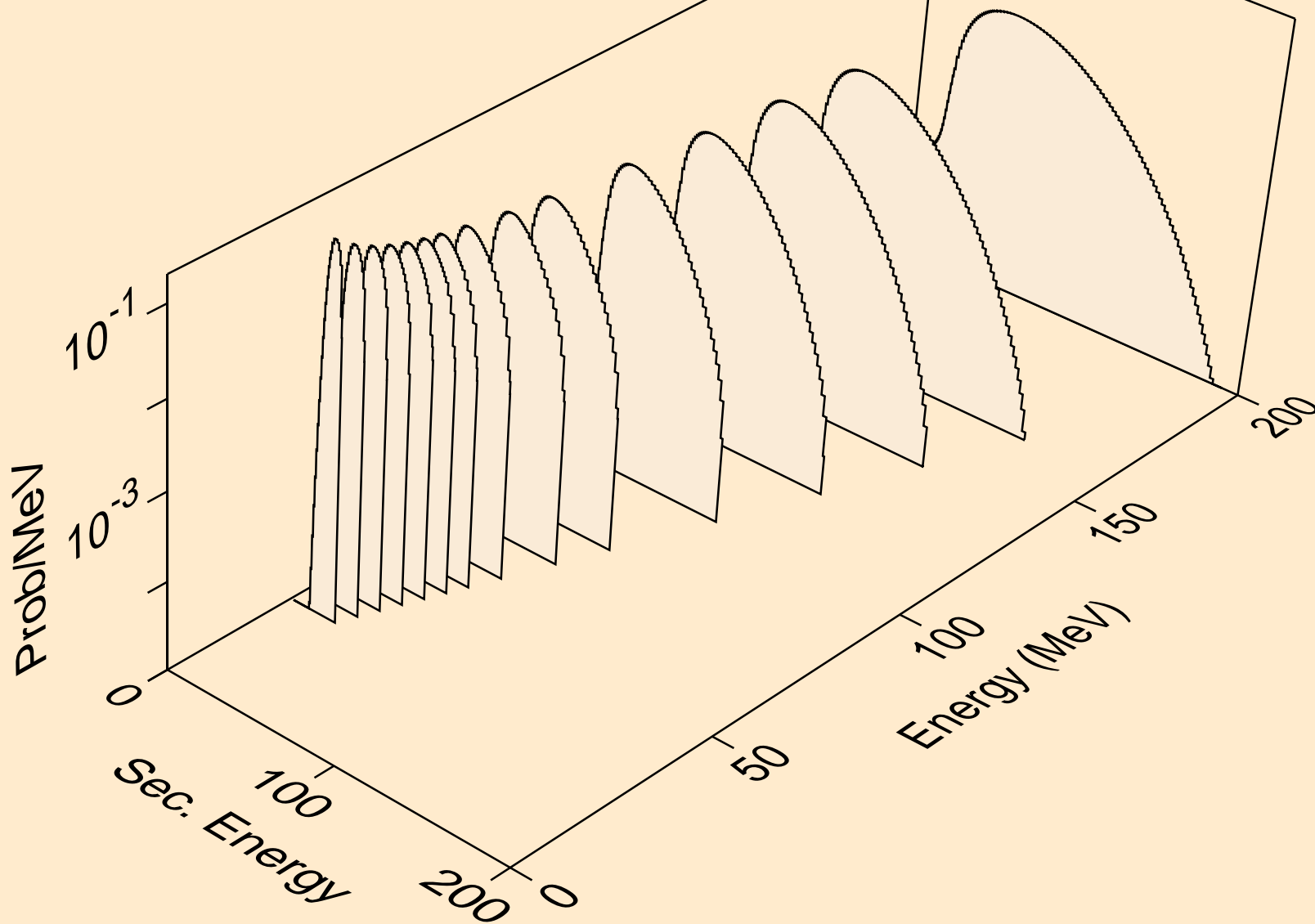

LU168 NEUTRON ACER TENDL-2019 LIBRARY; T=293.16K  
he3s from (n,n\*)he3

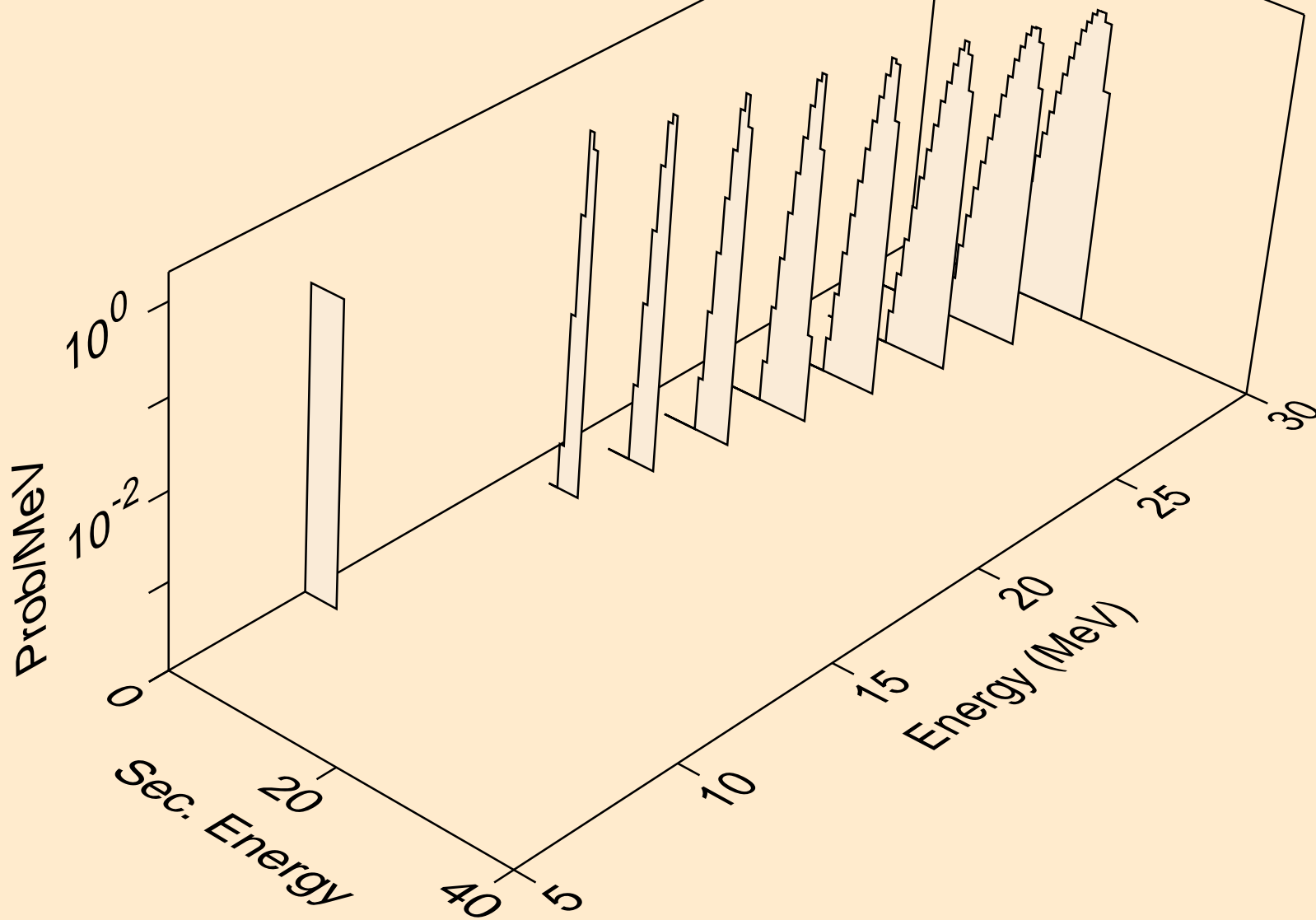

LU168 NEUTRON ACER TENDL-2019 LIBRARY; T=293.16K  
he3s from (n,he3)

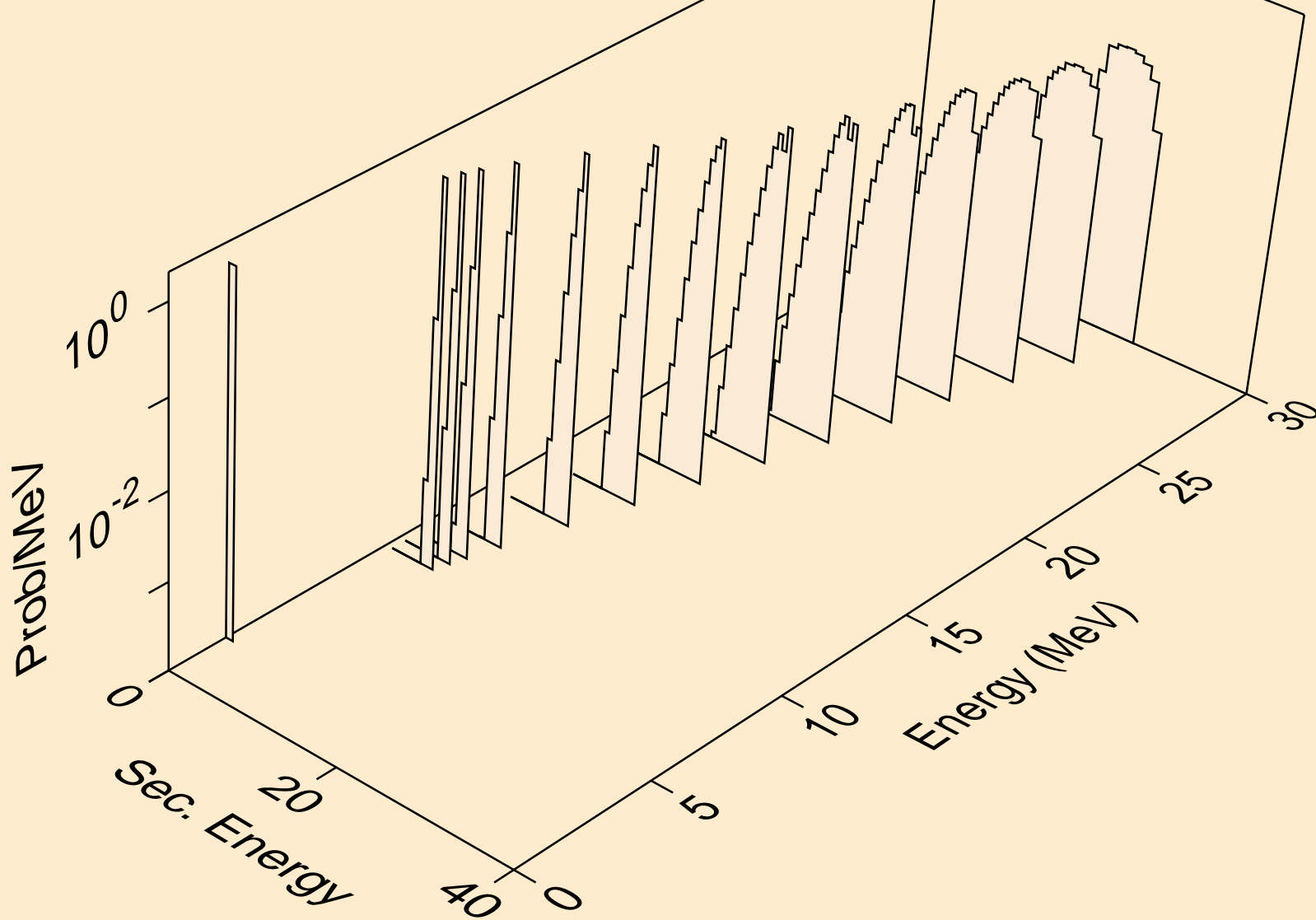

LU168 NEUTRON ACER TENDL-2019 LIBRARY; T=293.16K  
alphas from (n,x)

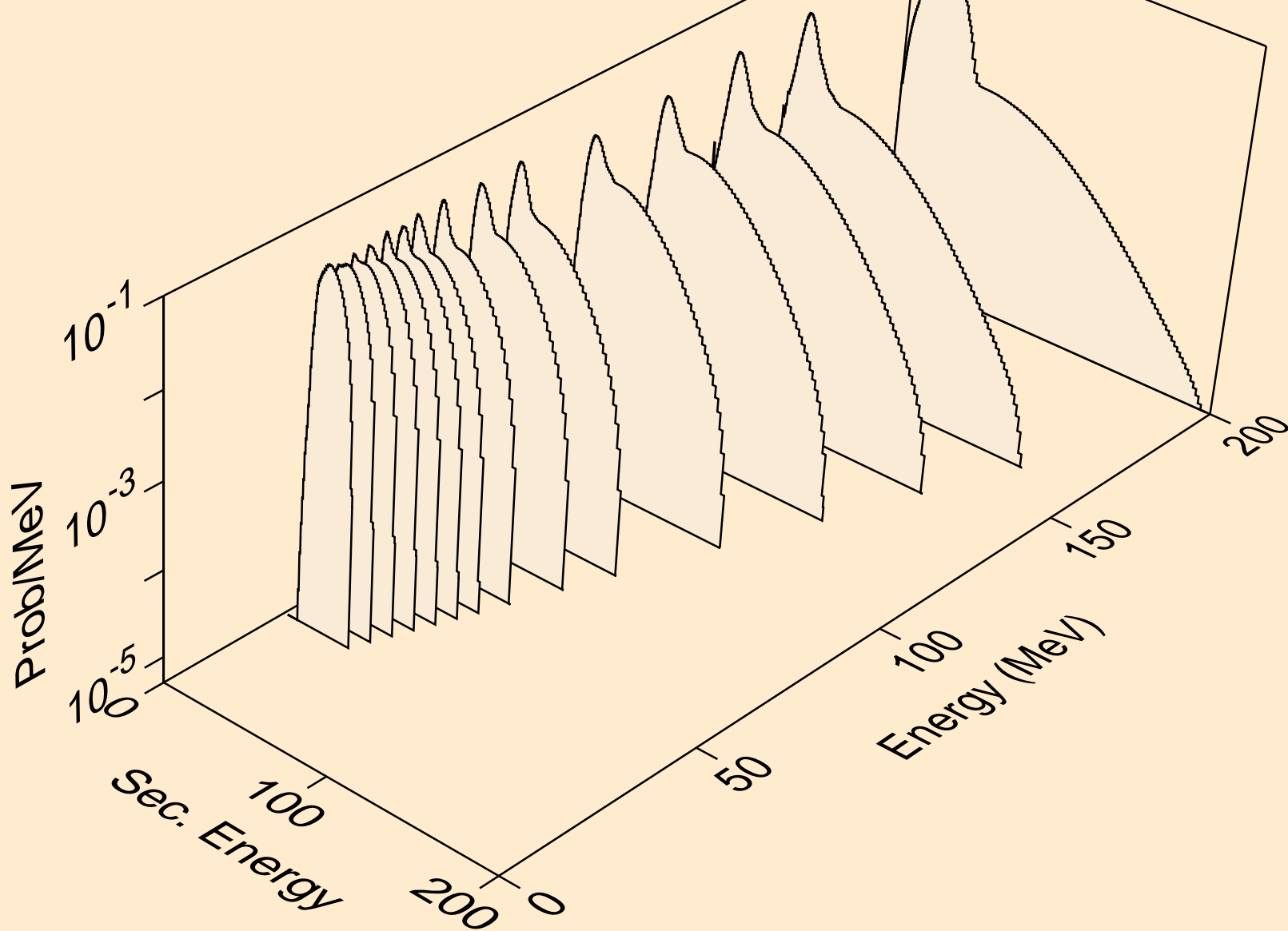

LU168 NEUTRON ACER TENDL-2019 LIBRARY; T=293.16K  
alphas from (n,n\*)a

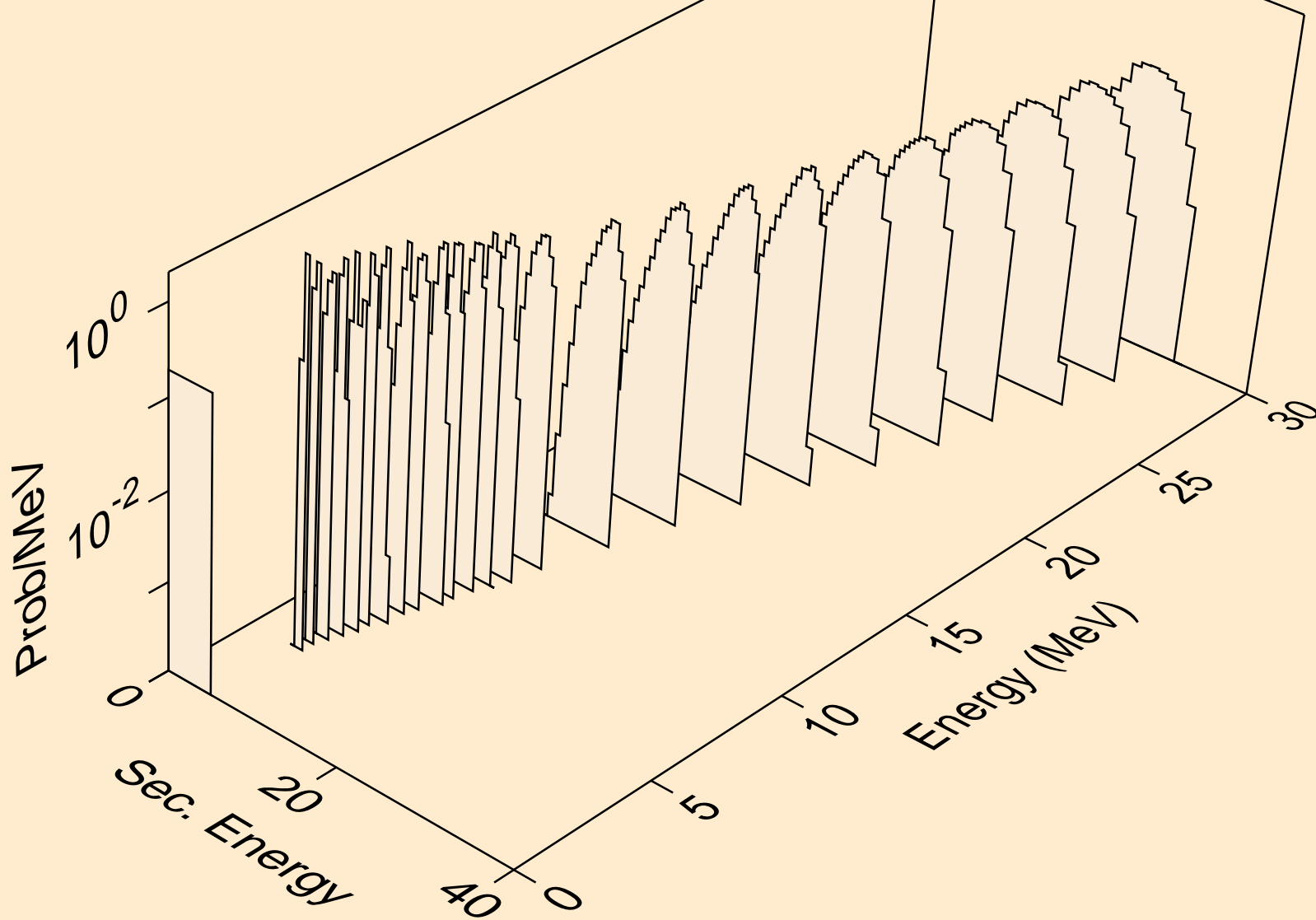

LU168 NEUTRON ACER TENDL-2019 LIBRARY; T=293.16K  
alphas from (n,2n)a

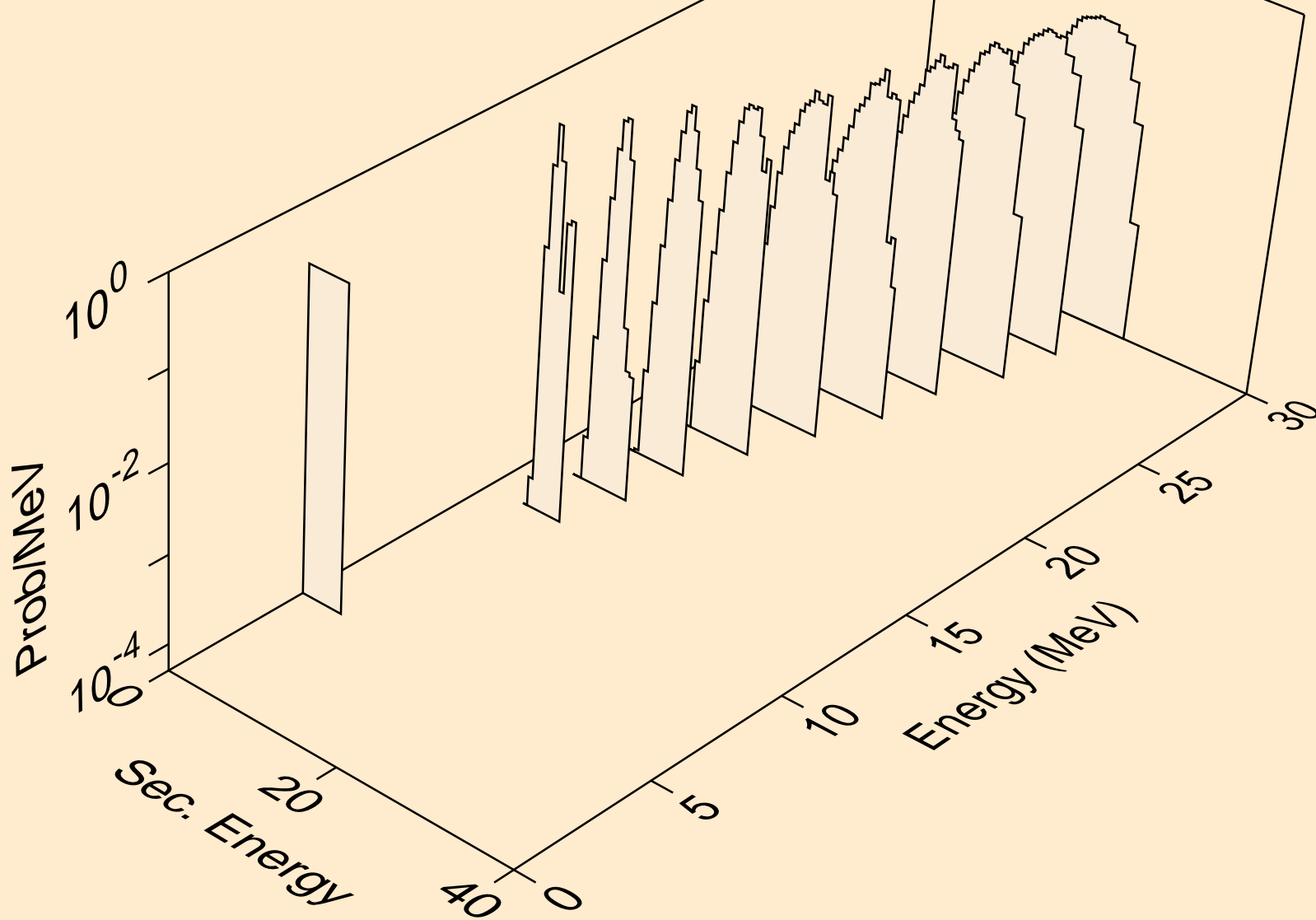



LU168 NEUTRON ACER TENDL-2019 LIBRARY; T=293.16K  
alphas from (n,3n)a

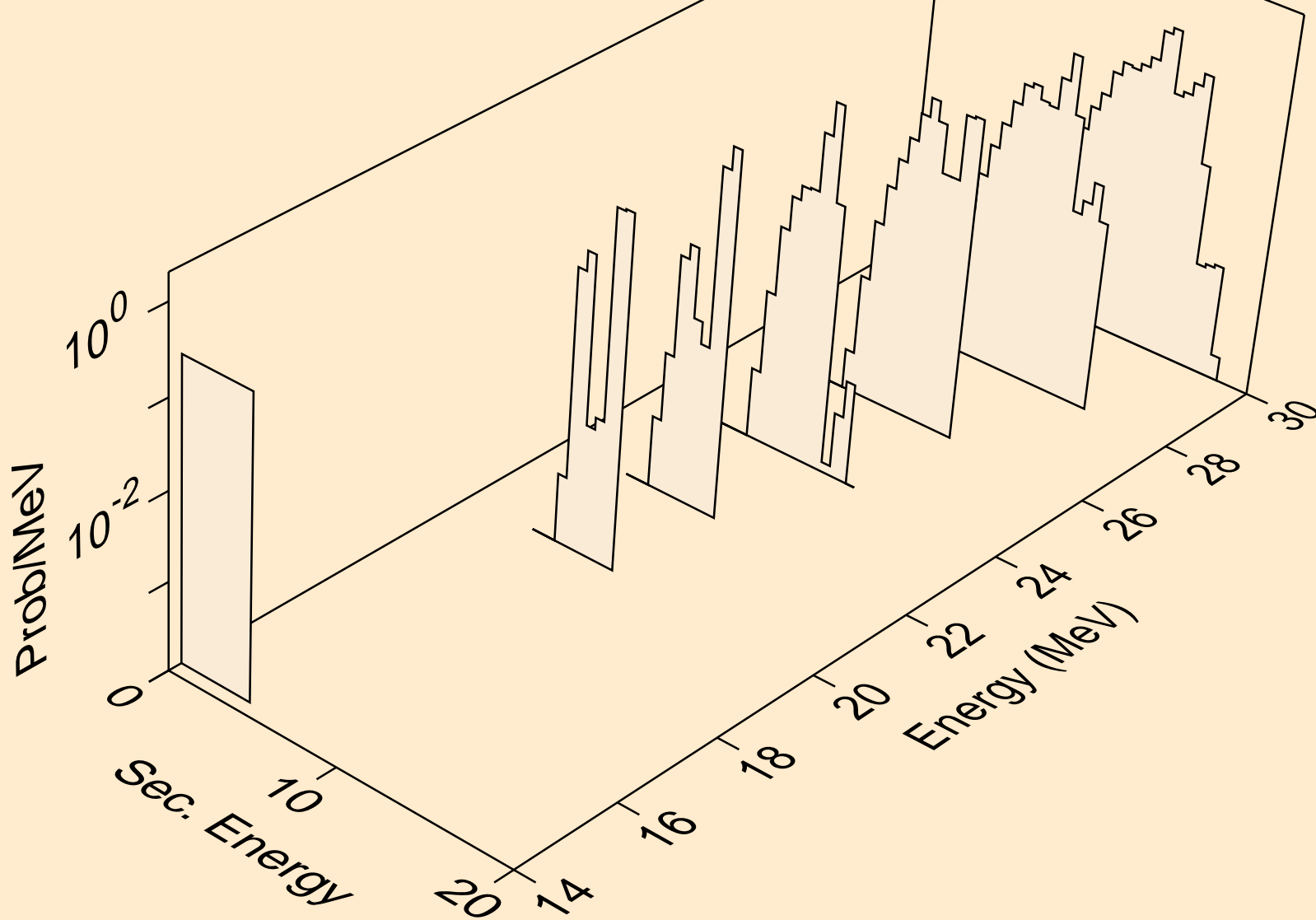

LU168 NEUTRON ACER TENDL-2019 LIBRARY; T=293.16K  
alphas from (n,n\*)2a

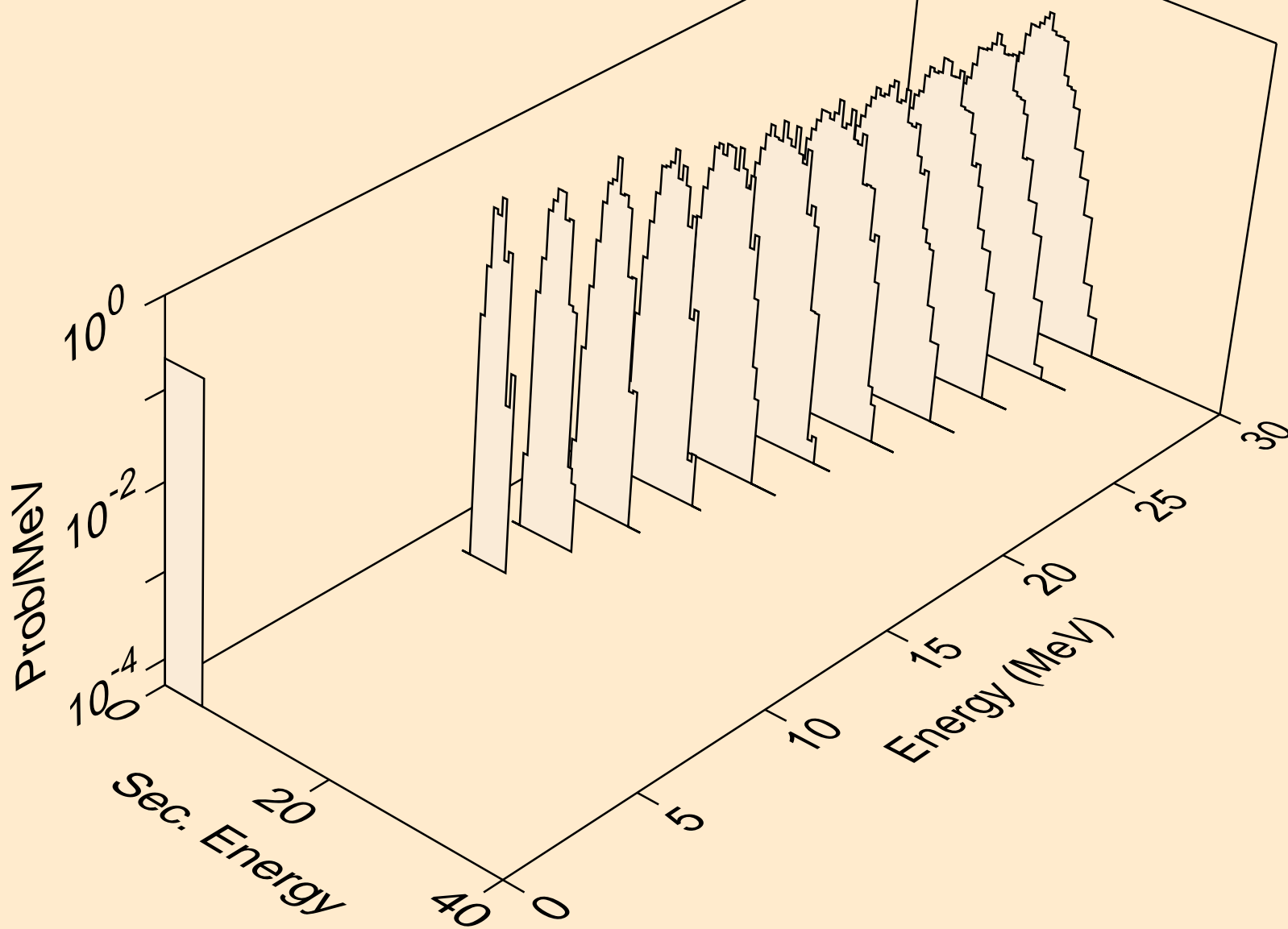

LU168 NEUTRON ACER TENDL-2019 LIBRARY; T=293.16K  
alphas from (n,2n)2a

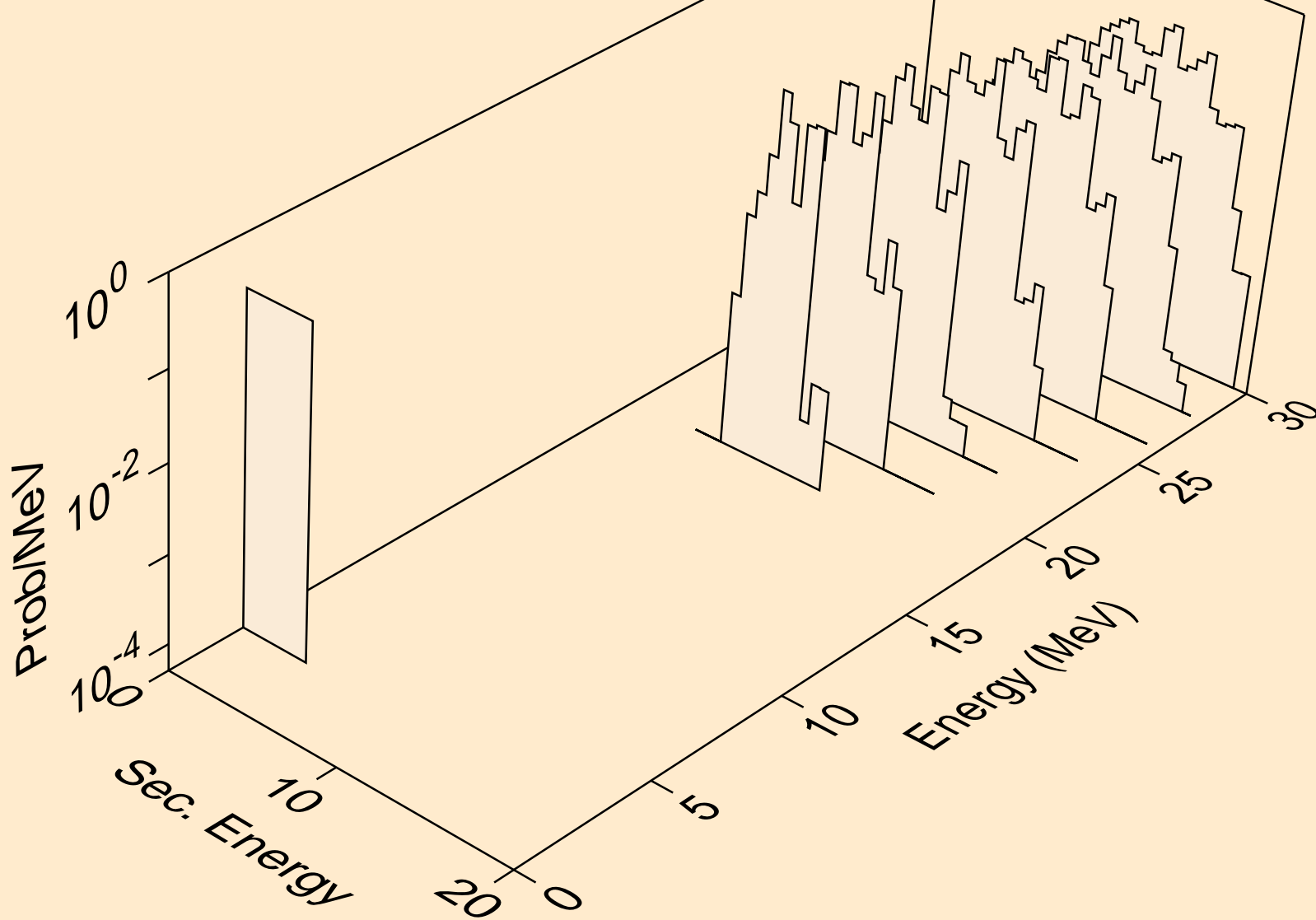

LU168 NEUTRON ACER TENDL-2019 LIBRARY; T=293.16K  
alphas from (n,npa)

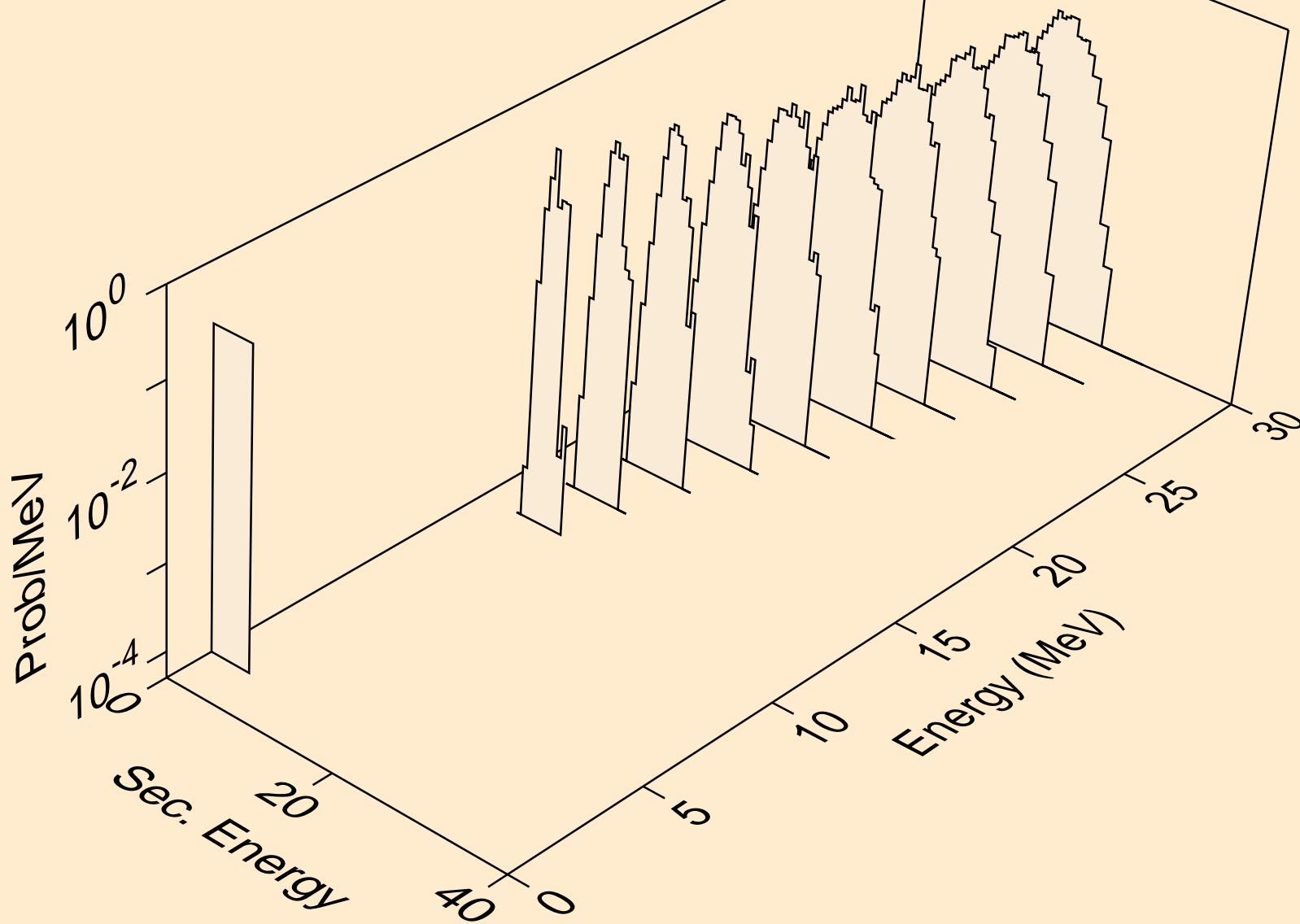

LU168 NEUTRON ACER TENDL-2019 LIBRARY; T=293.16K  
alphas from (n,a)

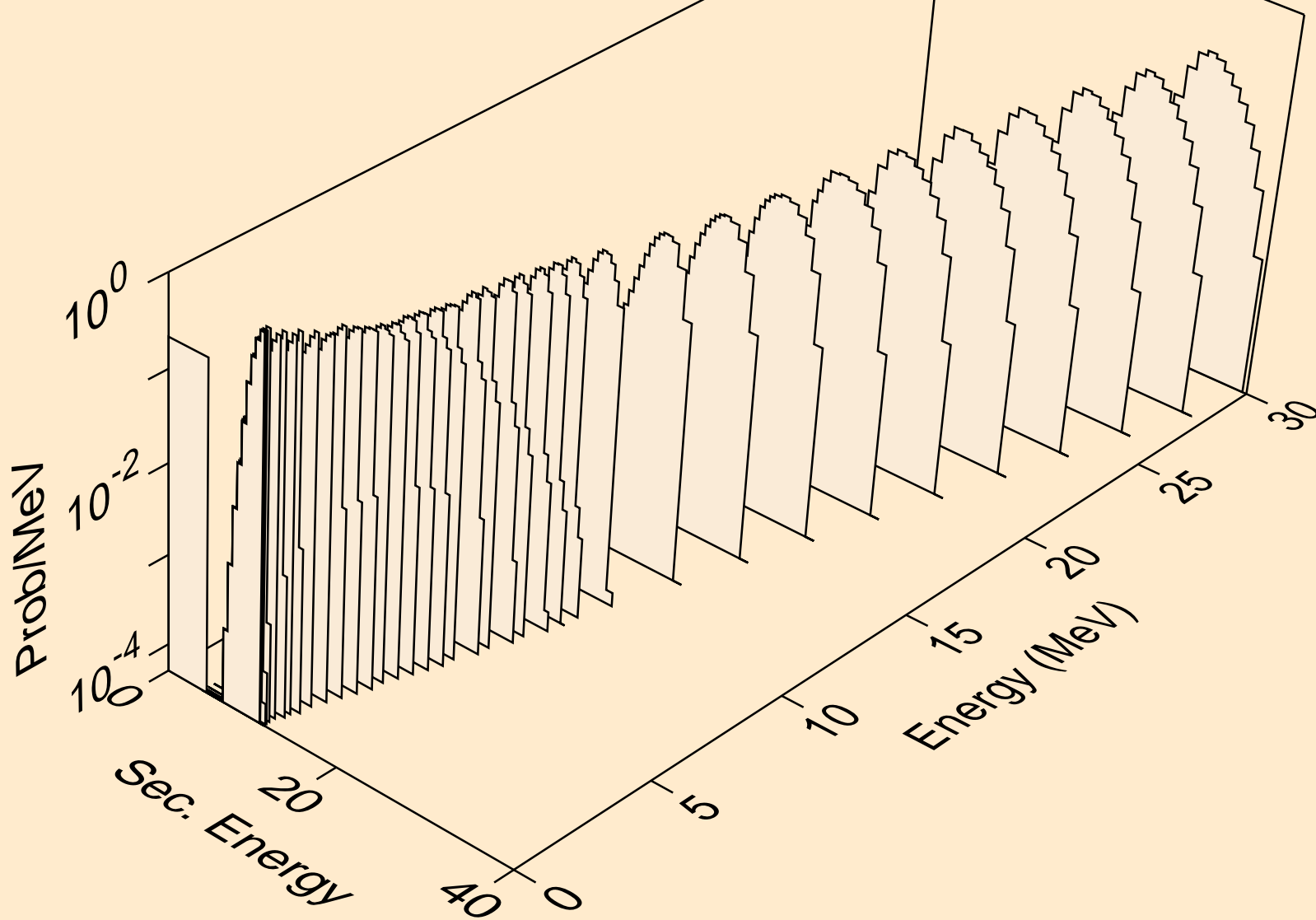

LU168 NEUTRON ACER TENDL-2019 LIBRARY; T=293.16K  
alphas from (n,2a)

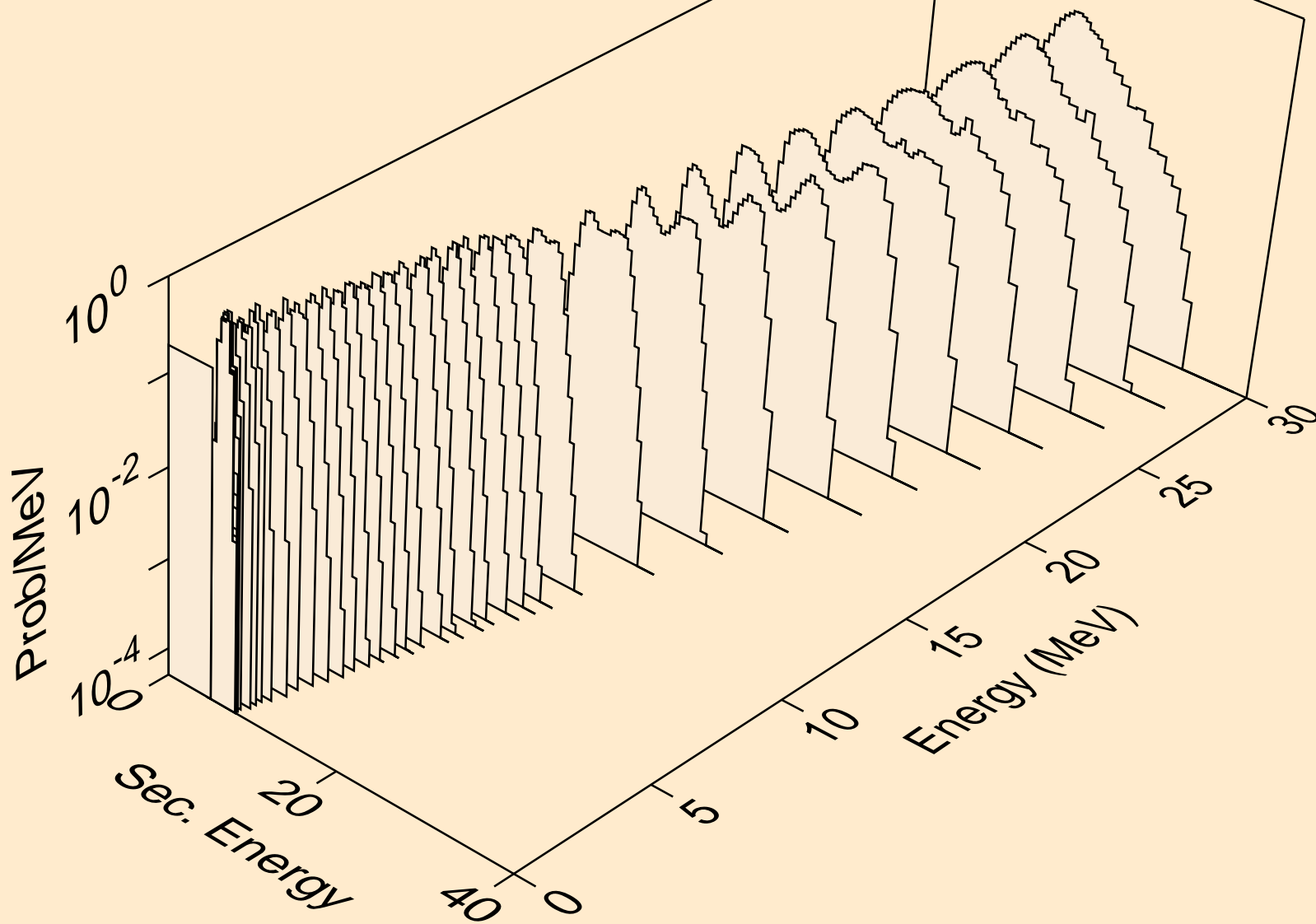

LU168 NEUTRON ACER TENDL-2019 LIBRARY; T=293.16K  
alphas from (n,pa)

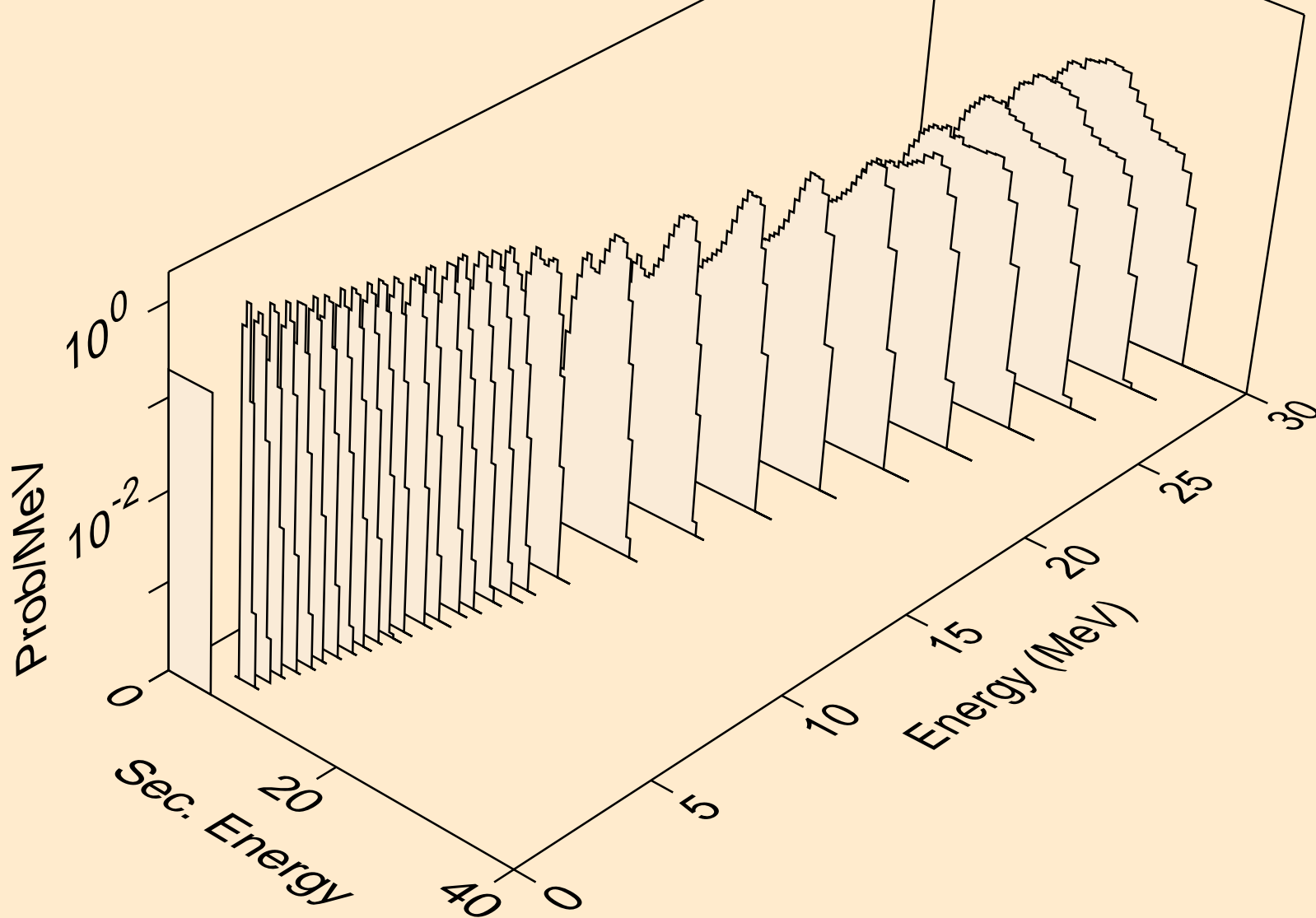

LU168 NEUTRON ACER TENDL-2019 LIBRARY; T=293.16K  
alphas from (n,da)

