

LU169 NEUTRON ACER TENDL-2019 LIBRARY; T=293.16K
Principal cross sections

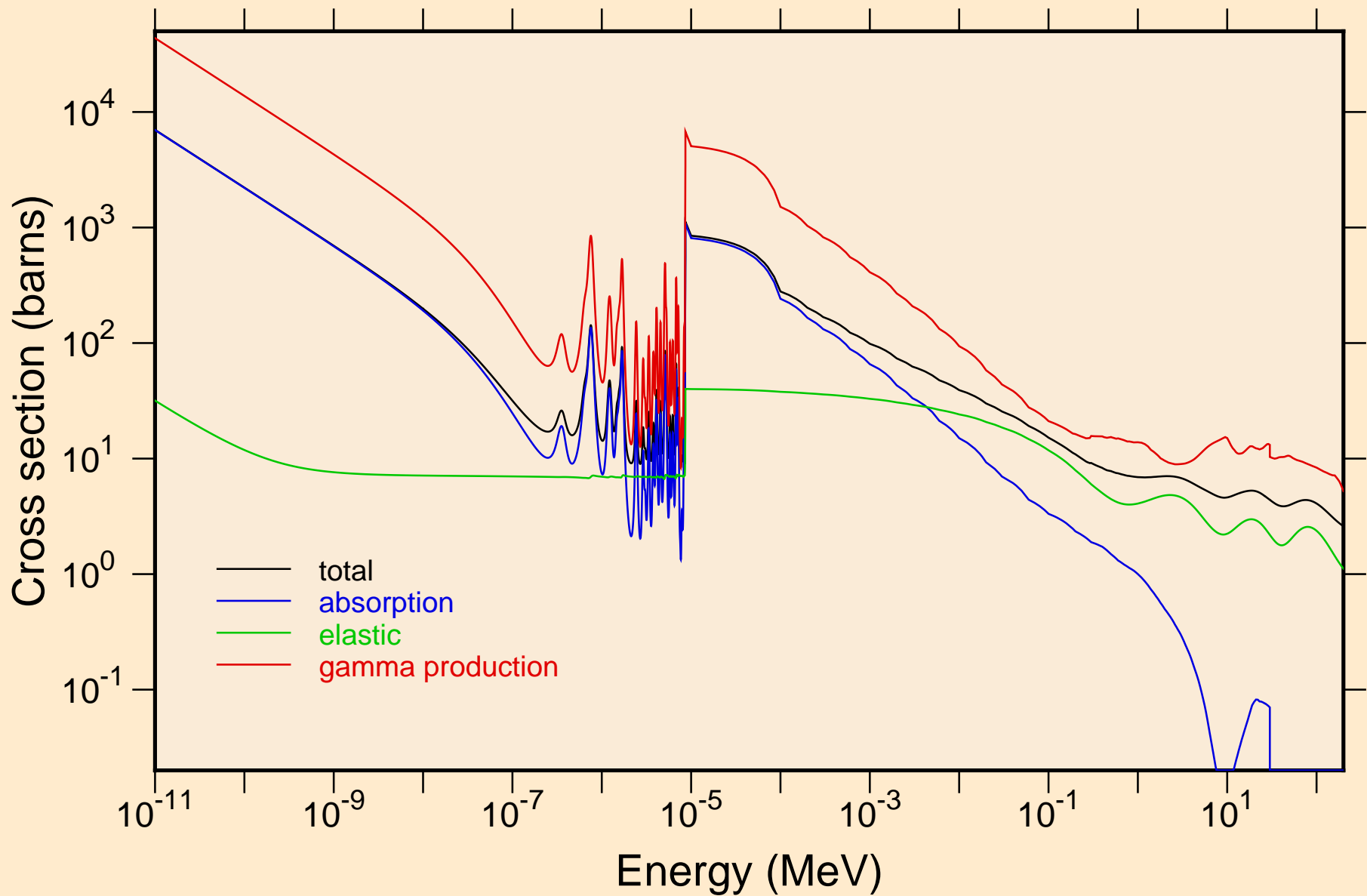

LU169 NEUTRON ACER TENDL-2019 LIBRARY; T=293.16K
resonance total cross section

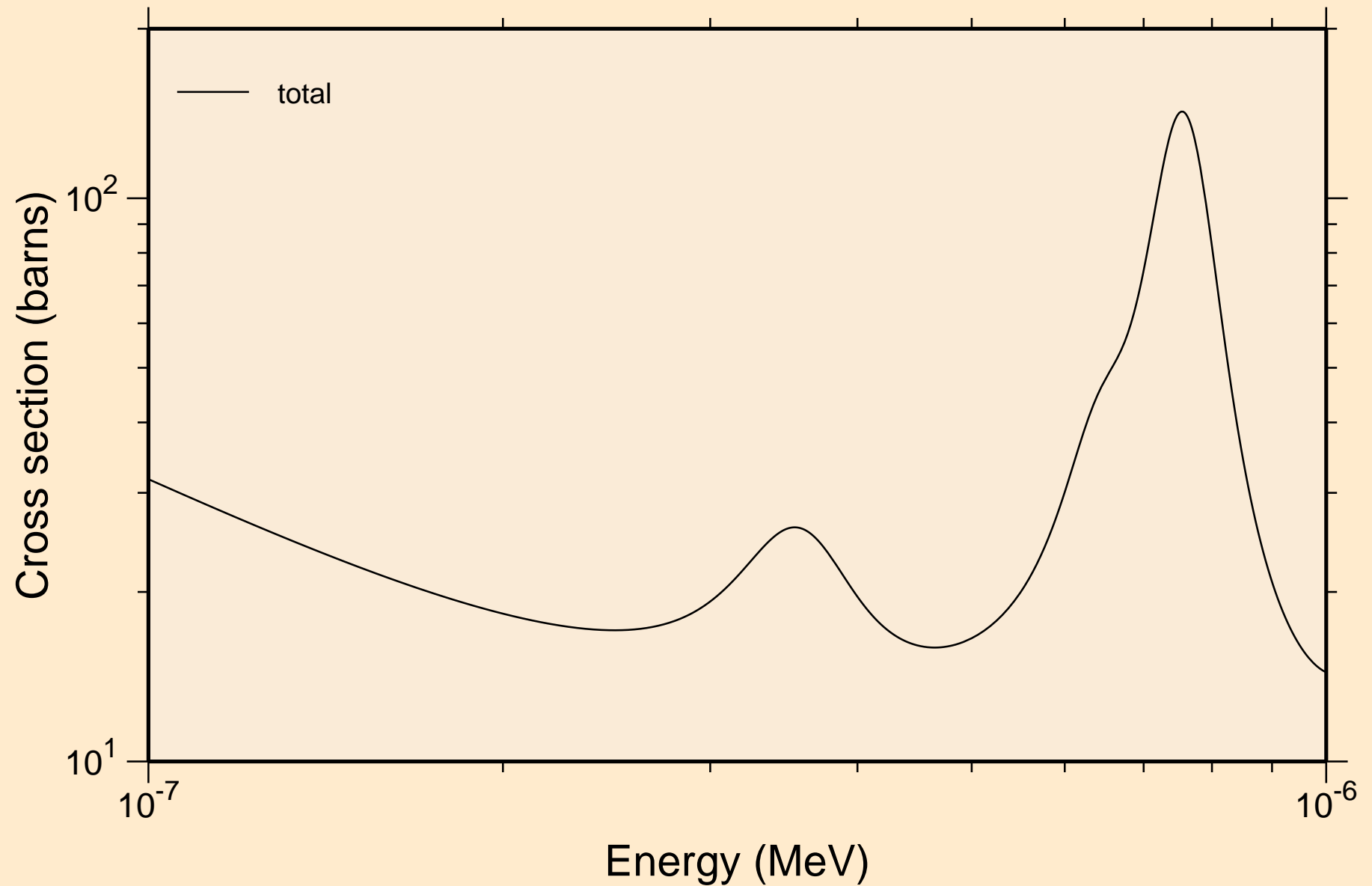

LU169 NEUTRON ACER TENDL-2019 LIBRARY; T=293.16K
resonance total cross section

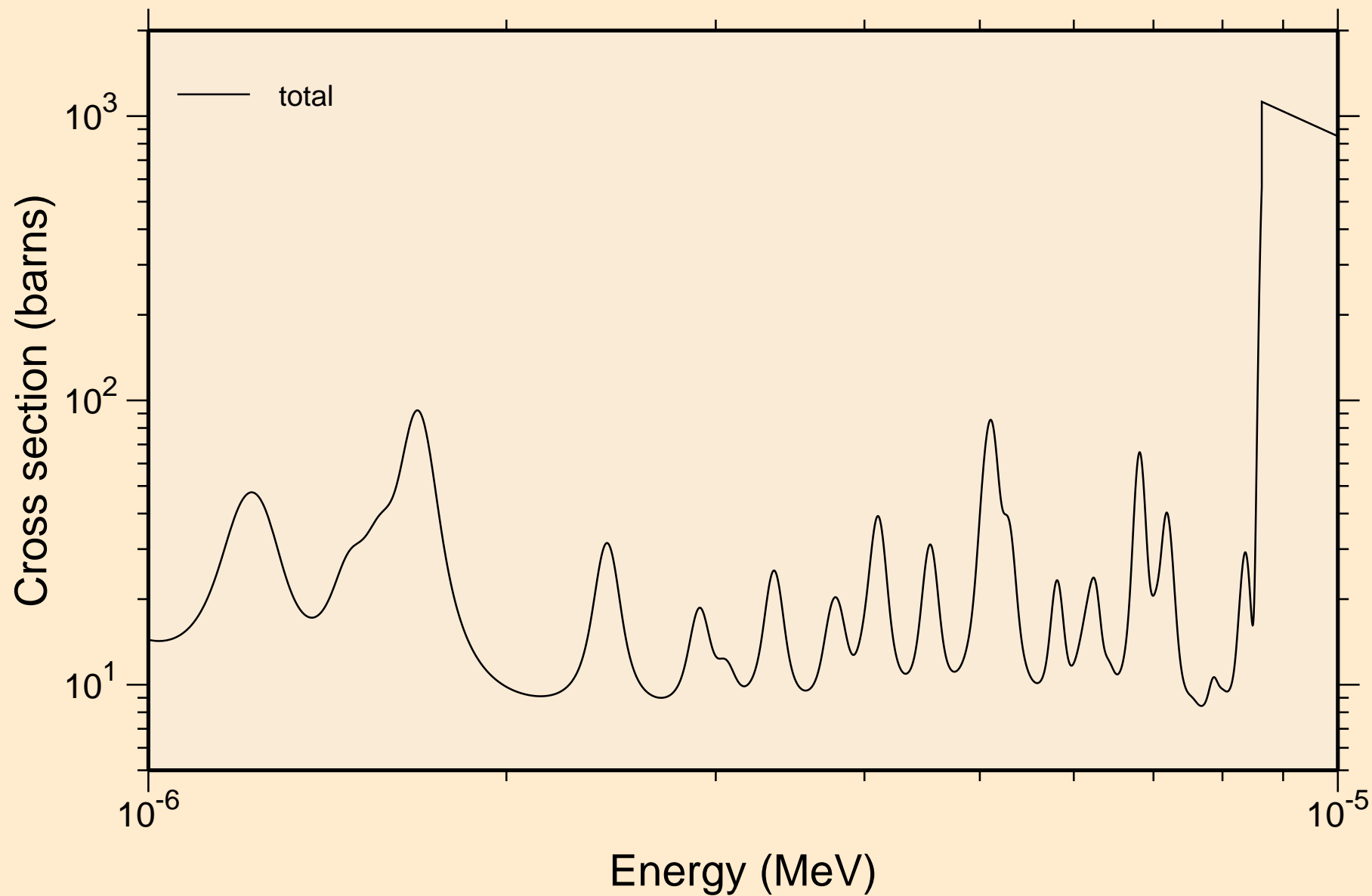

LU169 NEUTRON ACER TENDL-2019 LIBRARY; T=293.16K
resonance total cross section

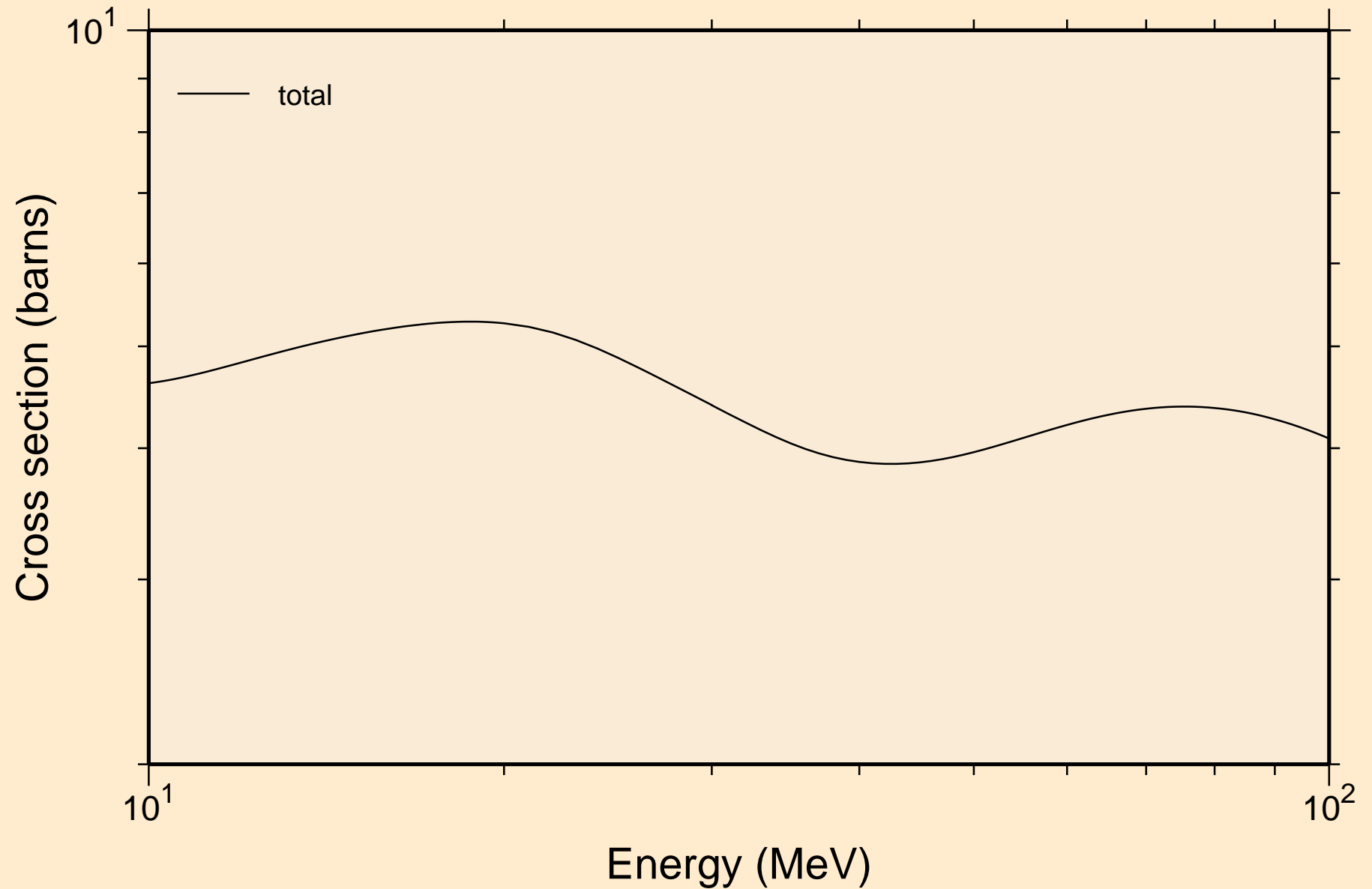

LU169 NEUTRON ACER TENDL-2019 LIBRARY; T=293.16K
resonance absorption cross sections

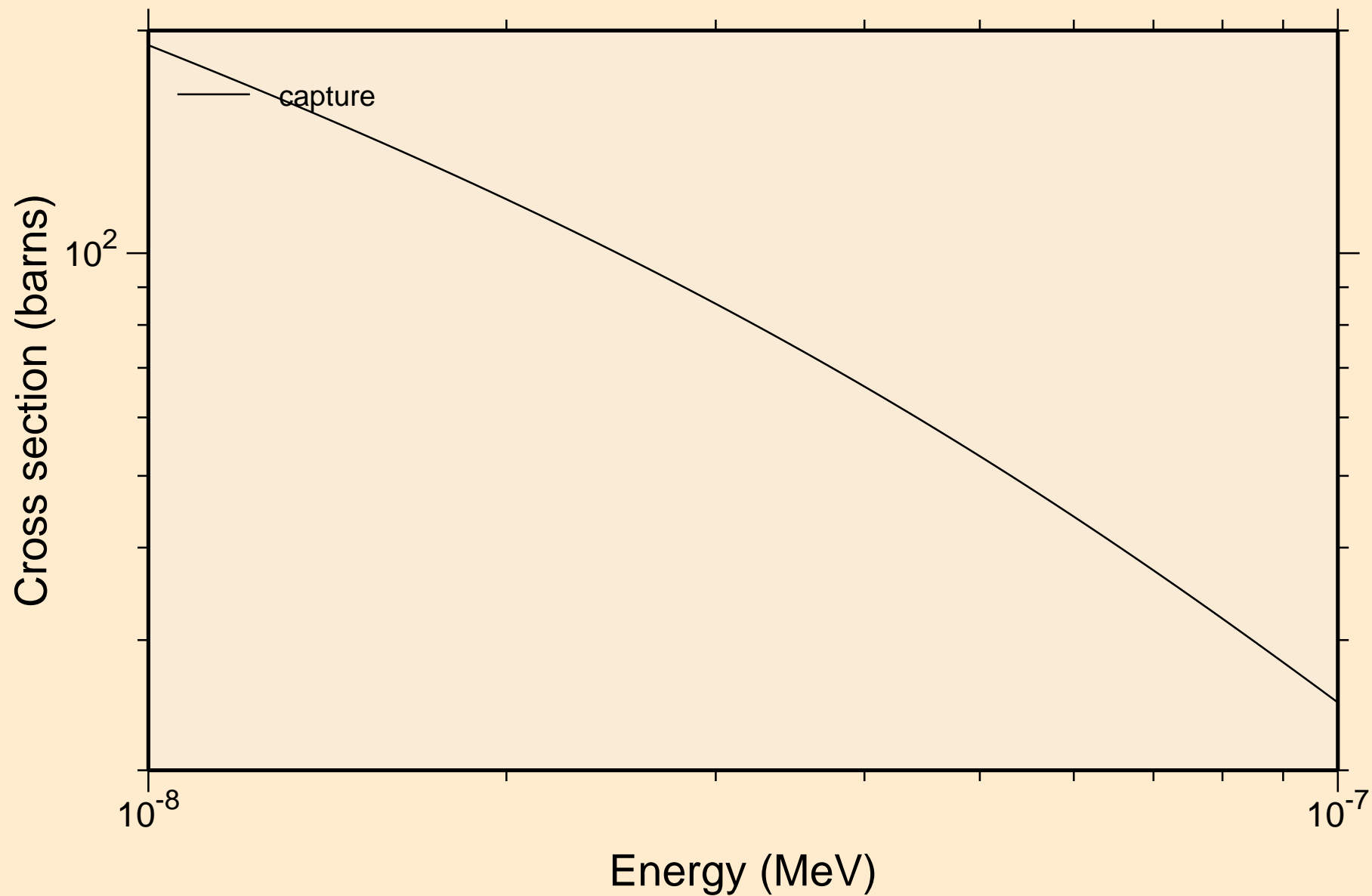

LU169 NEUTRON ACER TENDL-2019 LIBRARY; T=293.16K
resonance absorption cross sections

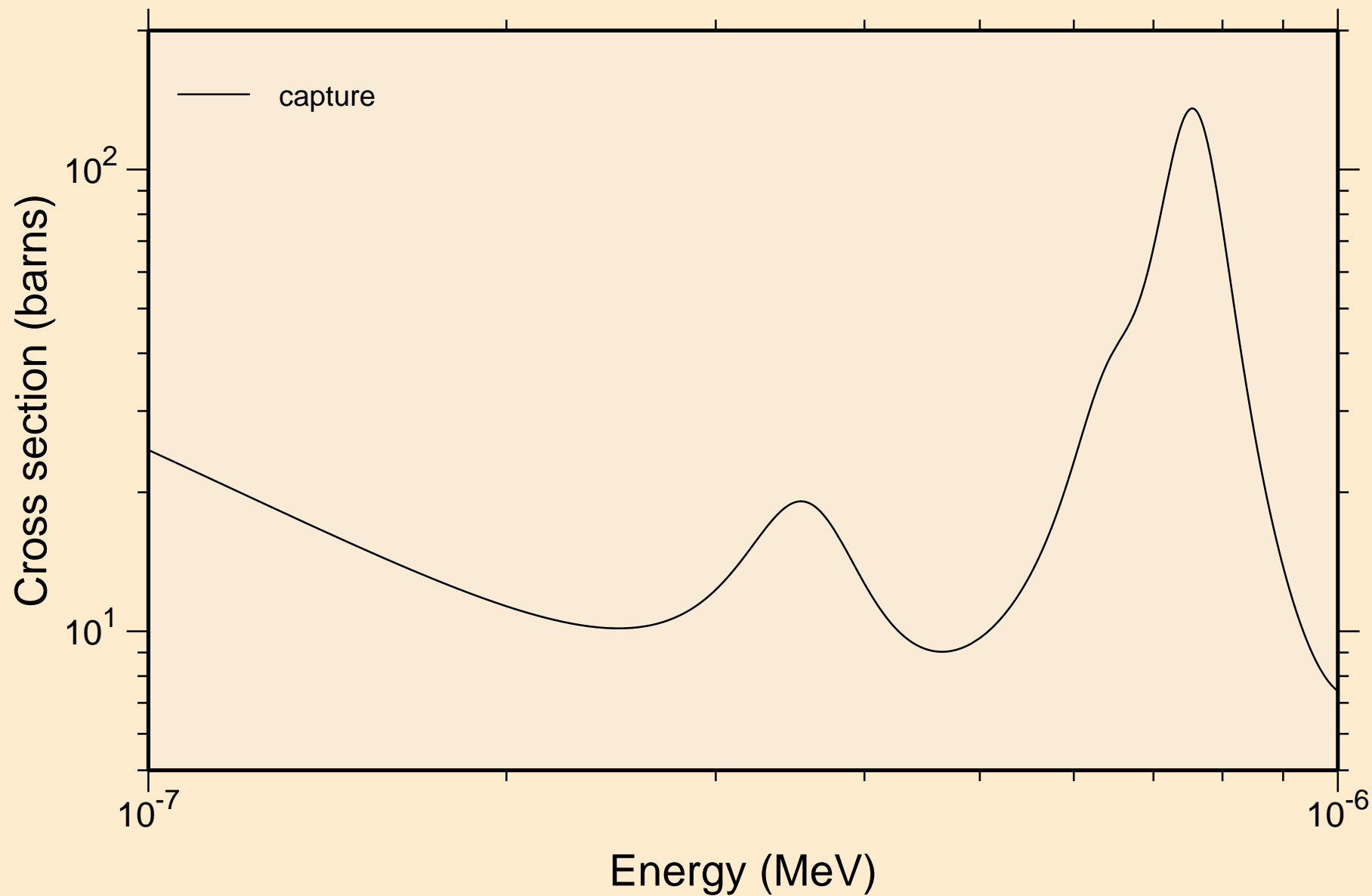

LU169 NEUTRON ACER TENDL-2019 LIBRARY; T=293.16K
resonance absorption cross sections

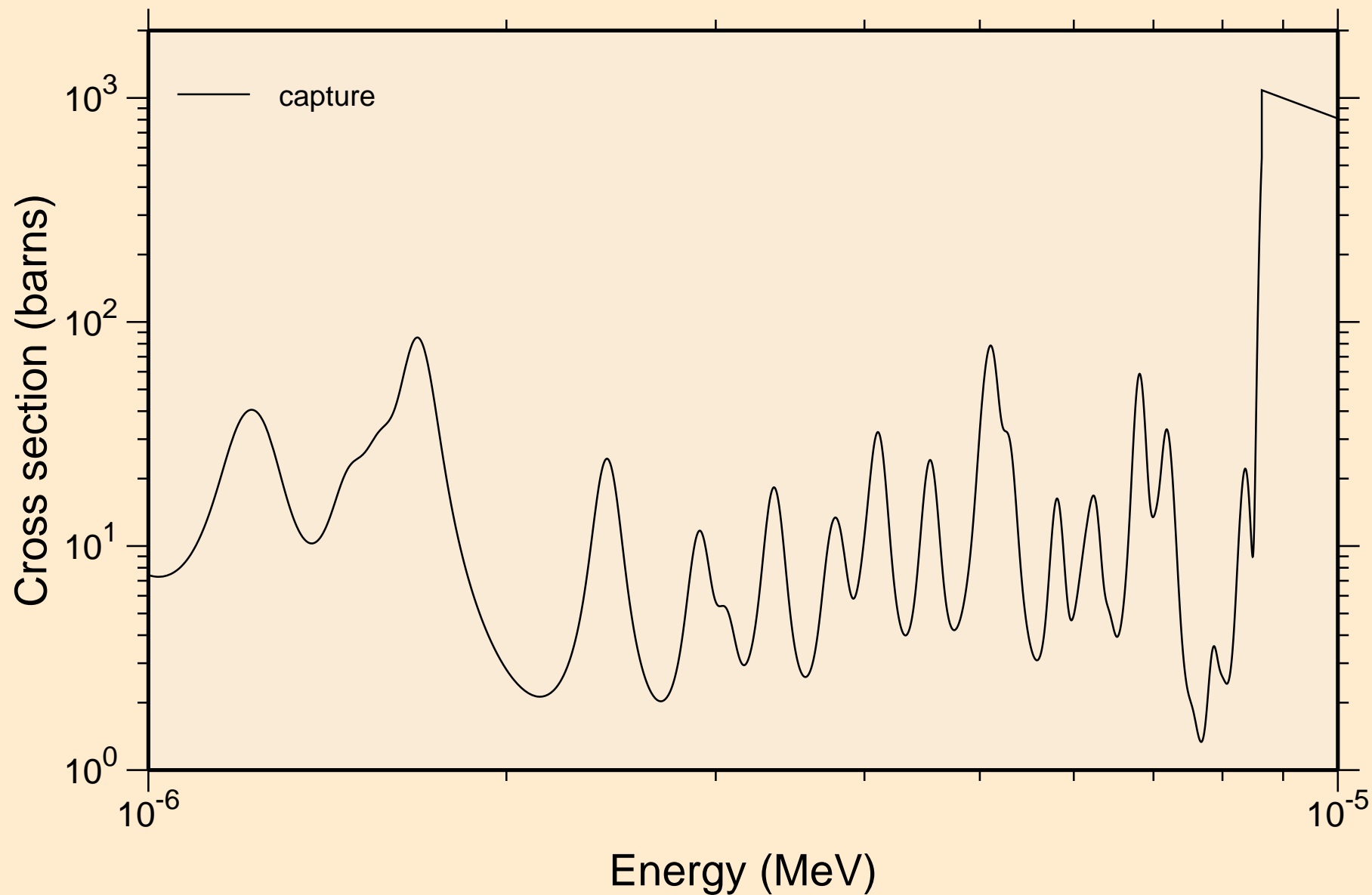

LU169 NEUTRON ACER TENDL-2019 LIBRARY; T=293.16K
resonance absorption cross sections

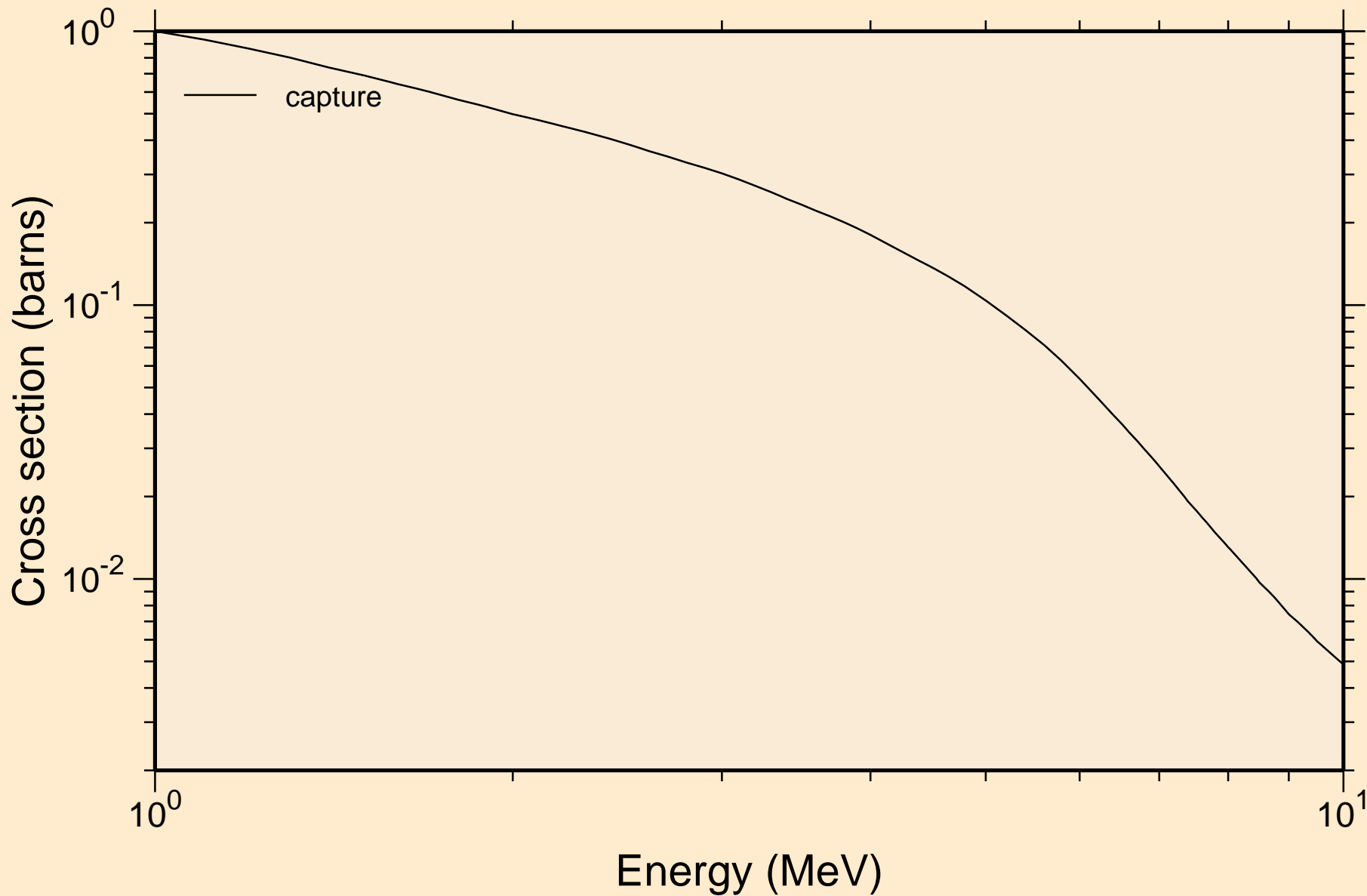

LU169 NEUTRON ACER TENDL-2019 LIBRARY; T=293.16K
Heating

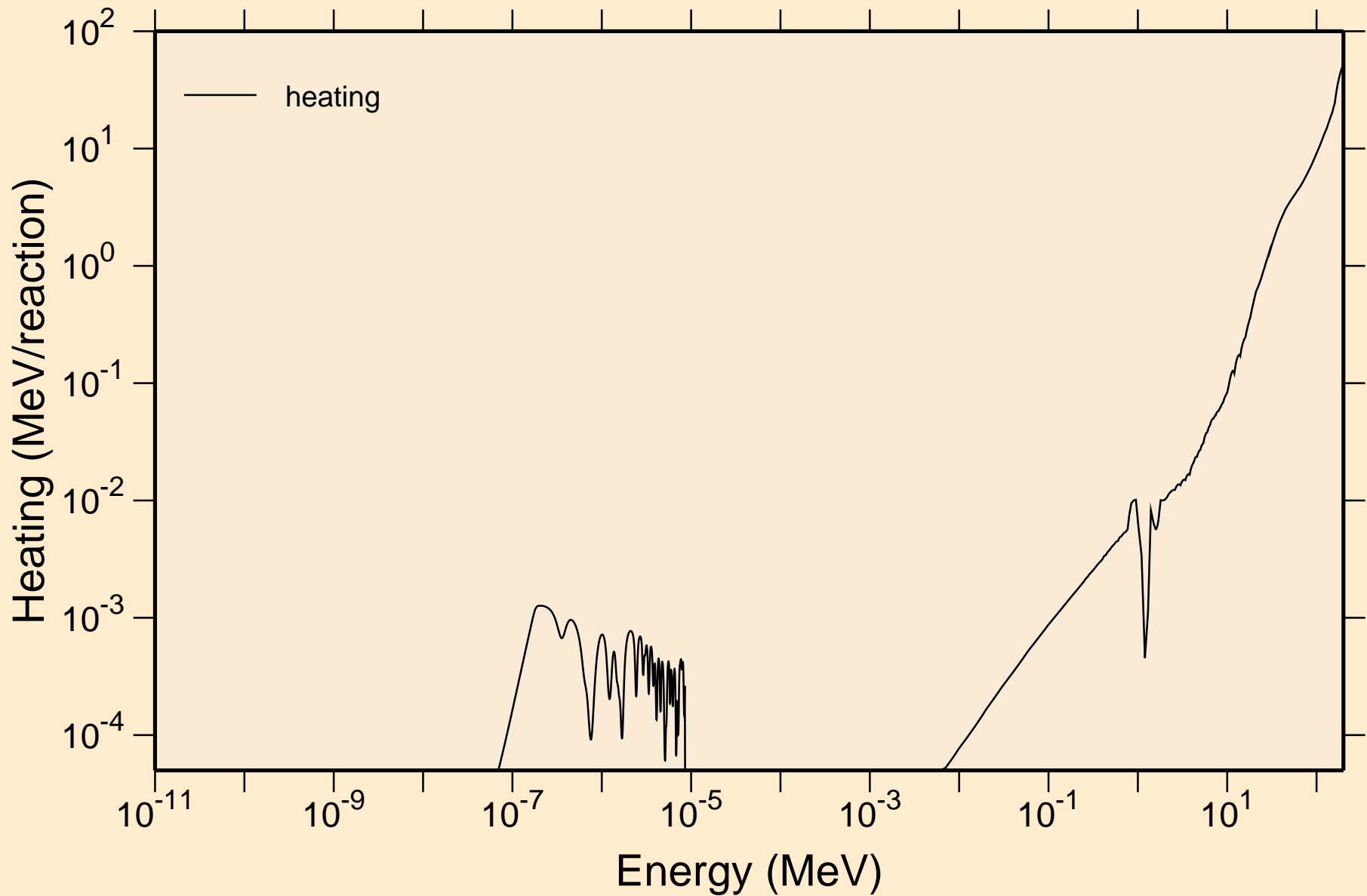

LU169 NEUTRON ACER TENDL-2019 LIBRARY; T=293.16K
Damage

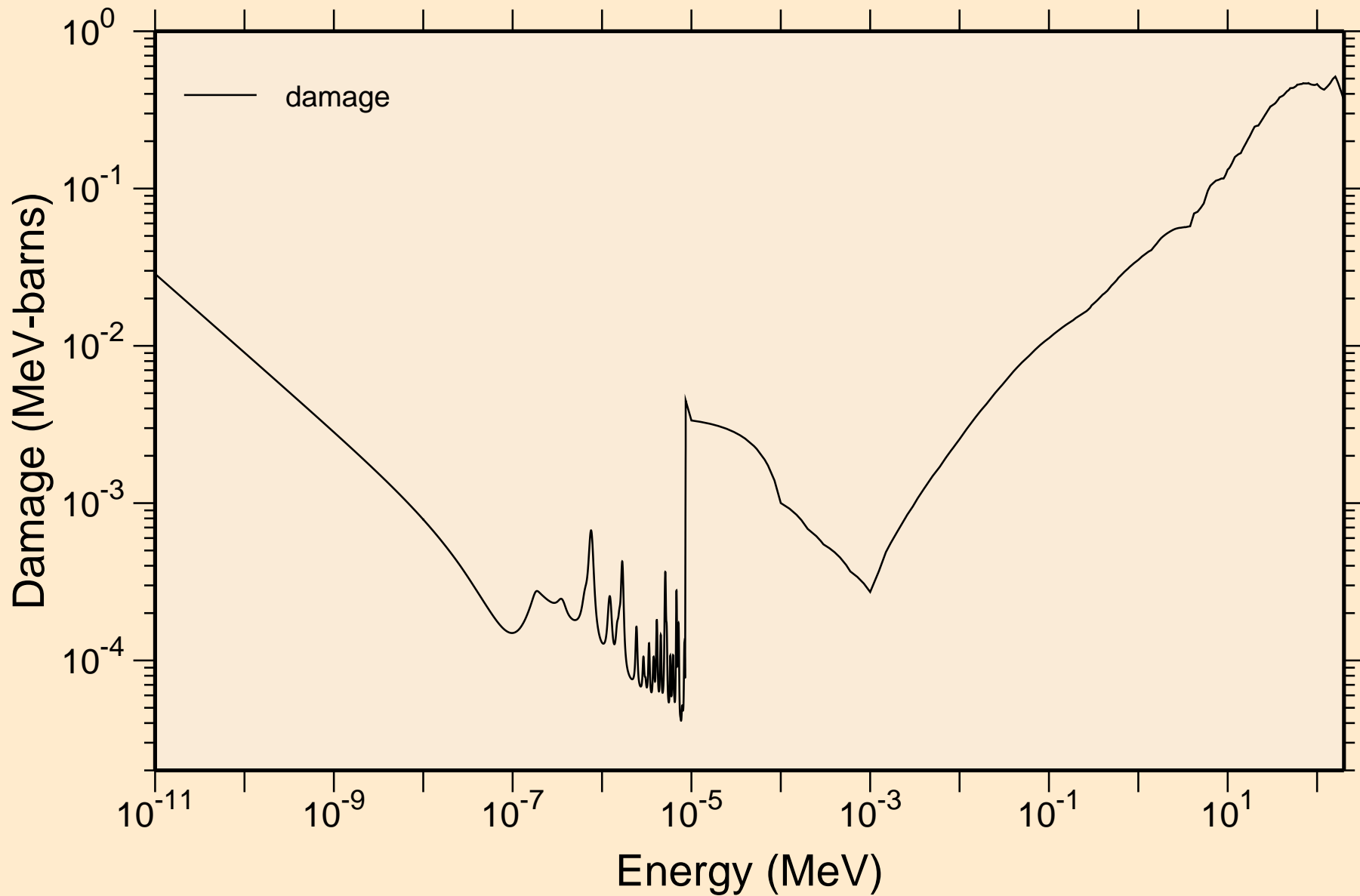

LU169 NEUTRON ACER TENDL-2019 LIBRARY; T=293.16K
Non-threshold reactions

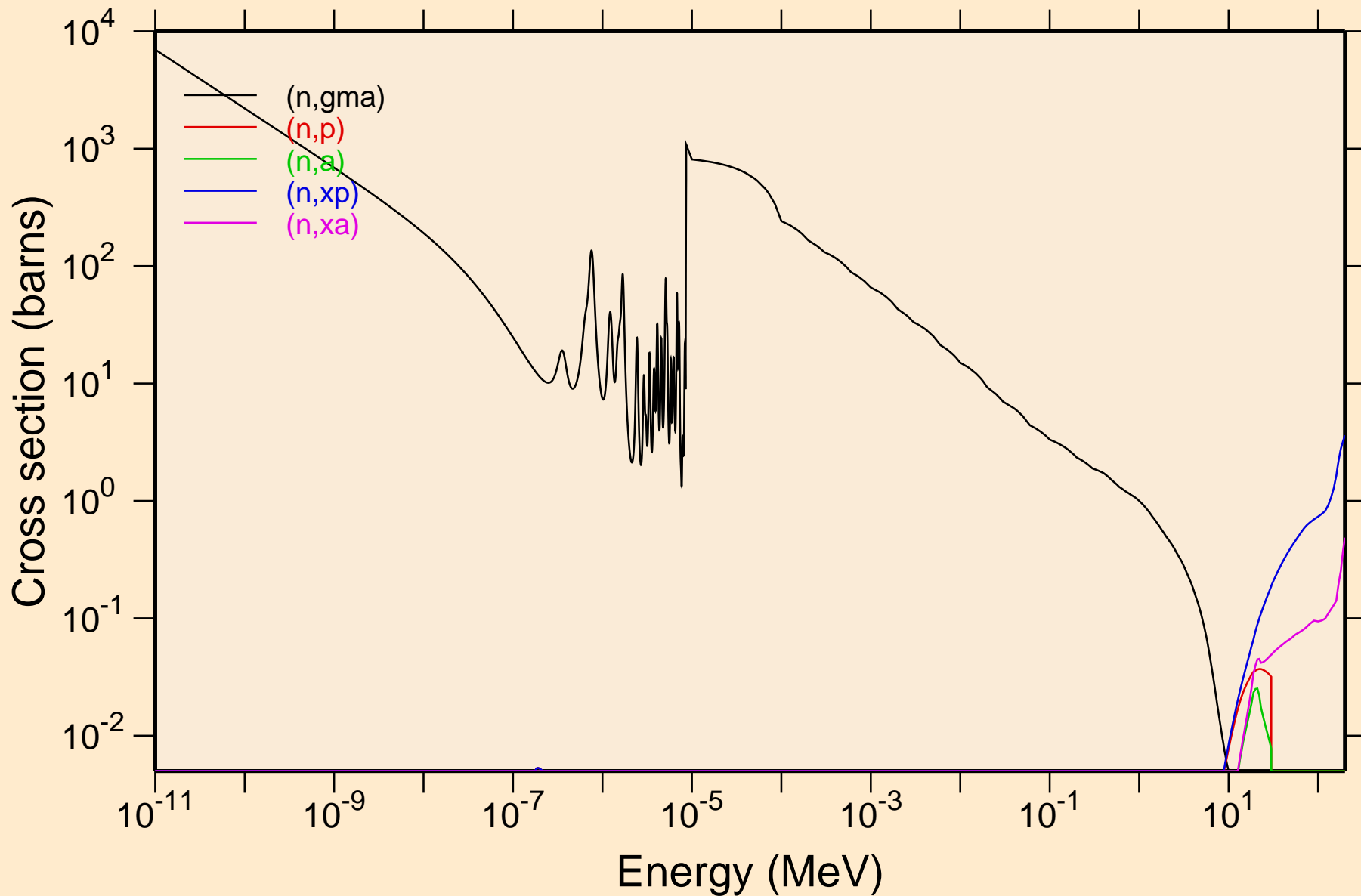

LU169 NEUTRON ACER TENDL-2019 LIBRARY; T=293.16K
Principal cross sections

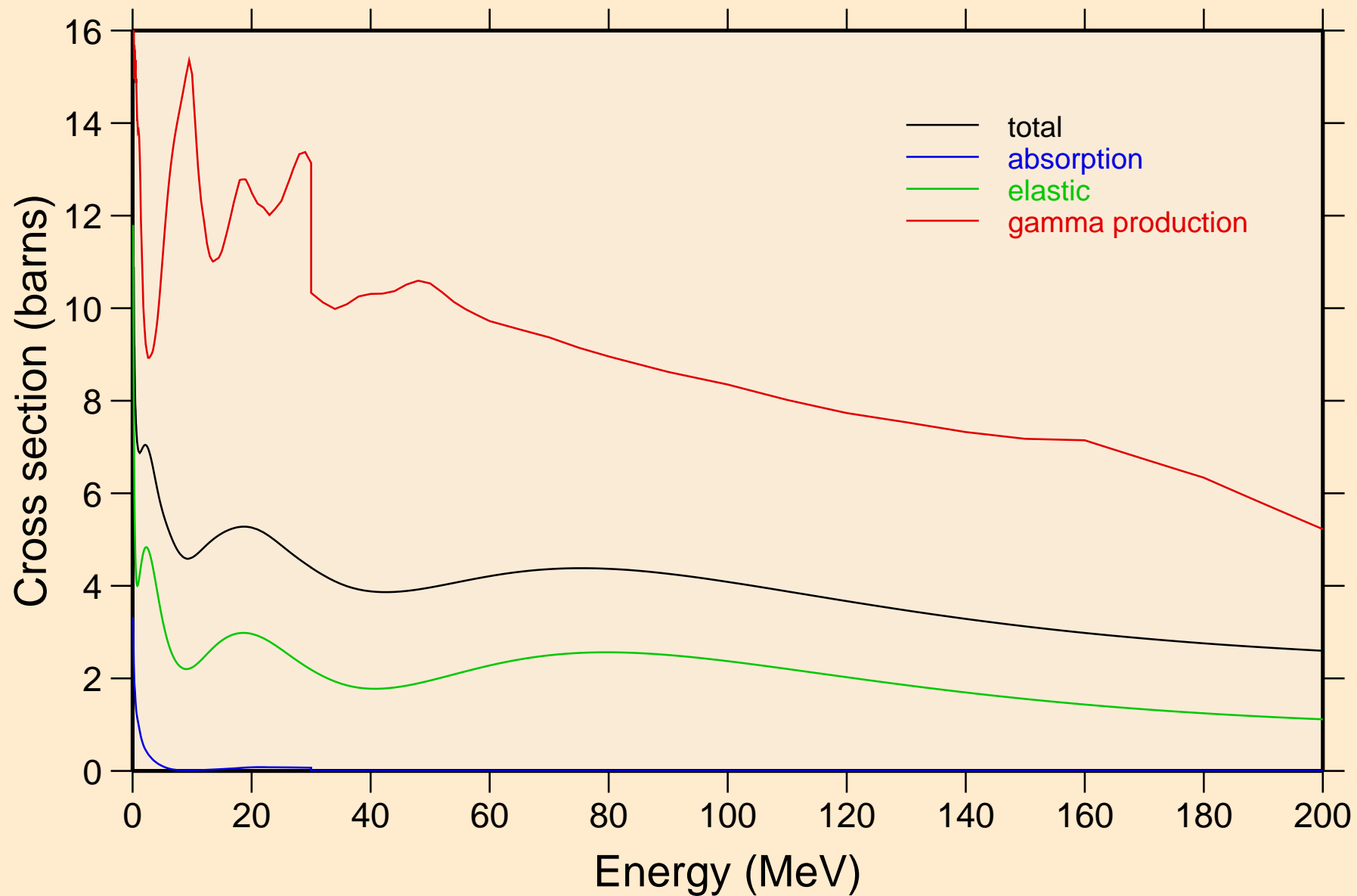

LU169 NEUTRON ACER TENDL-2019 LIBRARY; T=293.16K
Heating

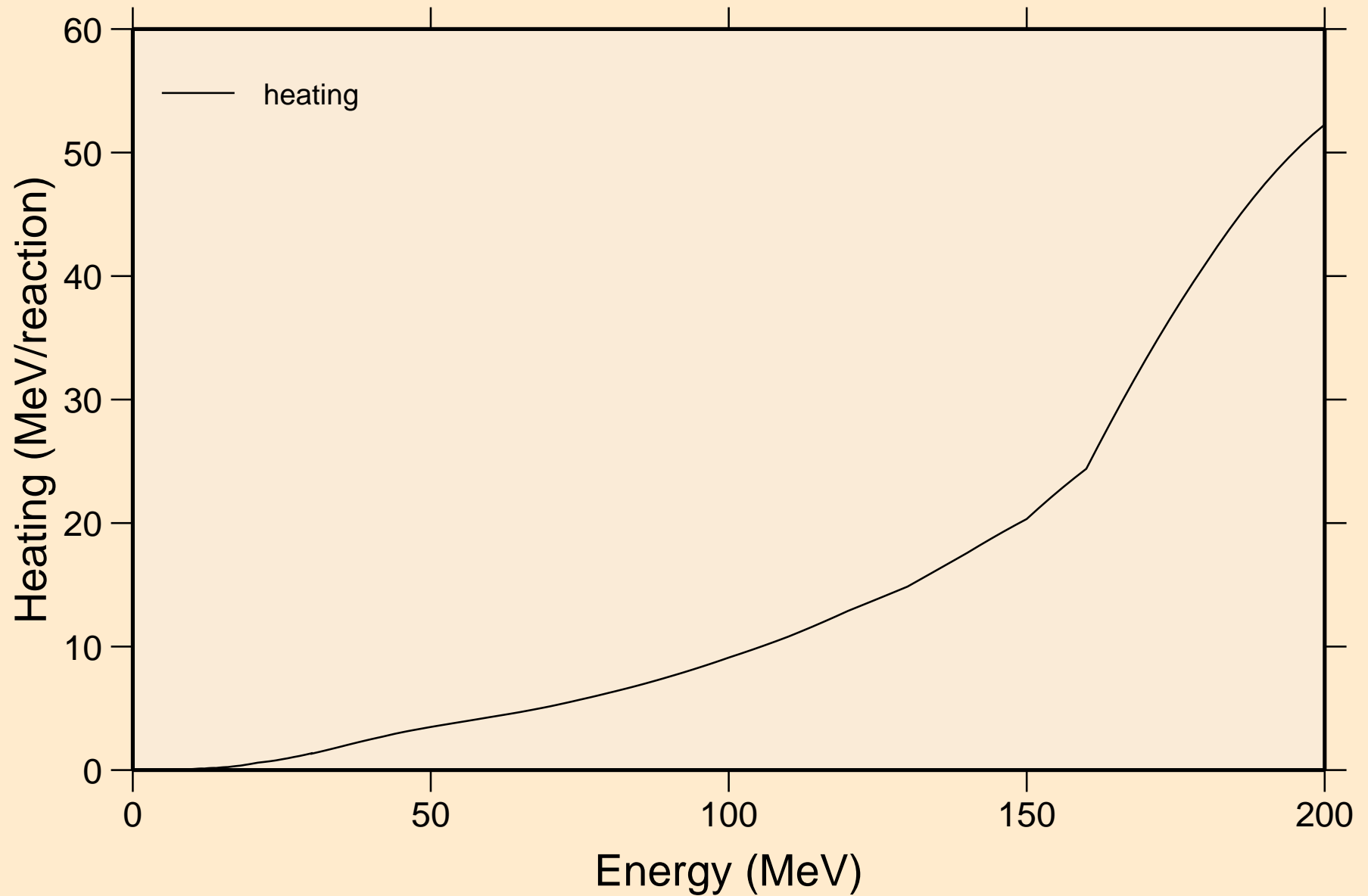

LU169 NEUTRON ACER TENDL-2019 LIBRARY; T=293.16K
Damage

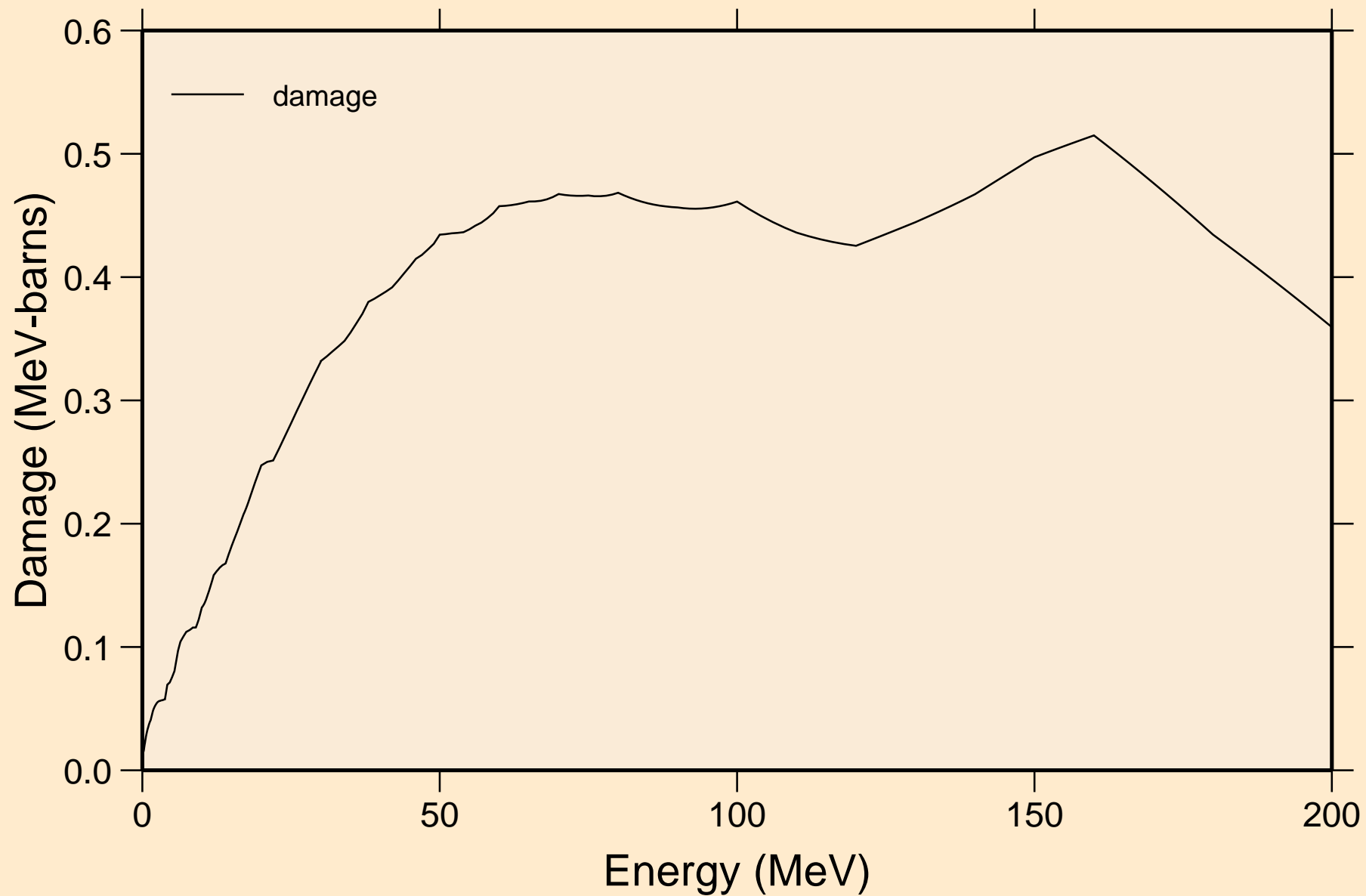

LU169 NEUTRON ACER TENDL-2019 LIBRARY; T=293.16K
Non-threshold reactions

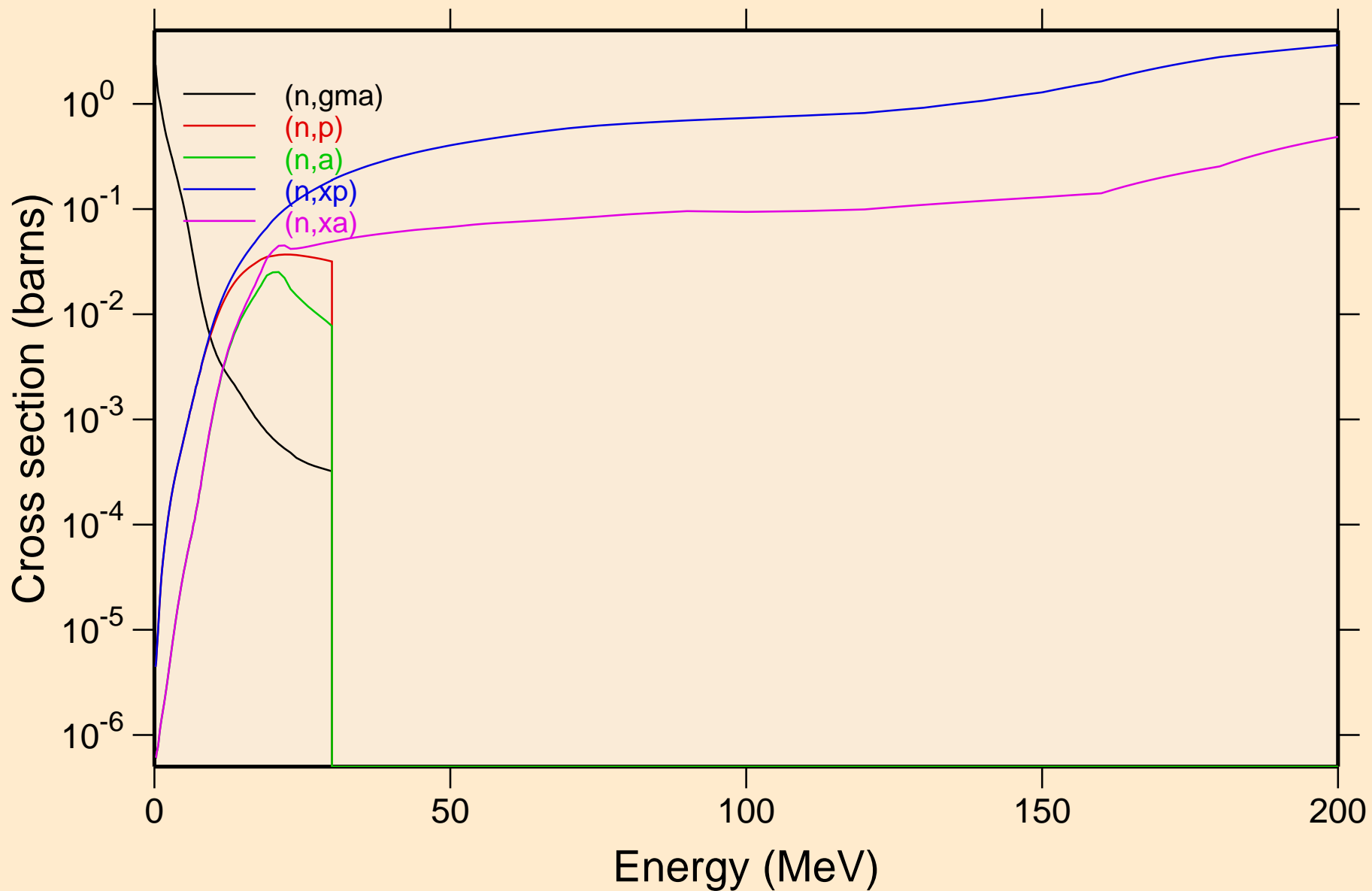

LU169 NEUTRON ACER TENDL-2019 LIBRARY; T=293.16K
Inelastic levels

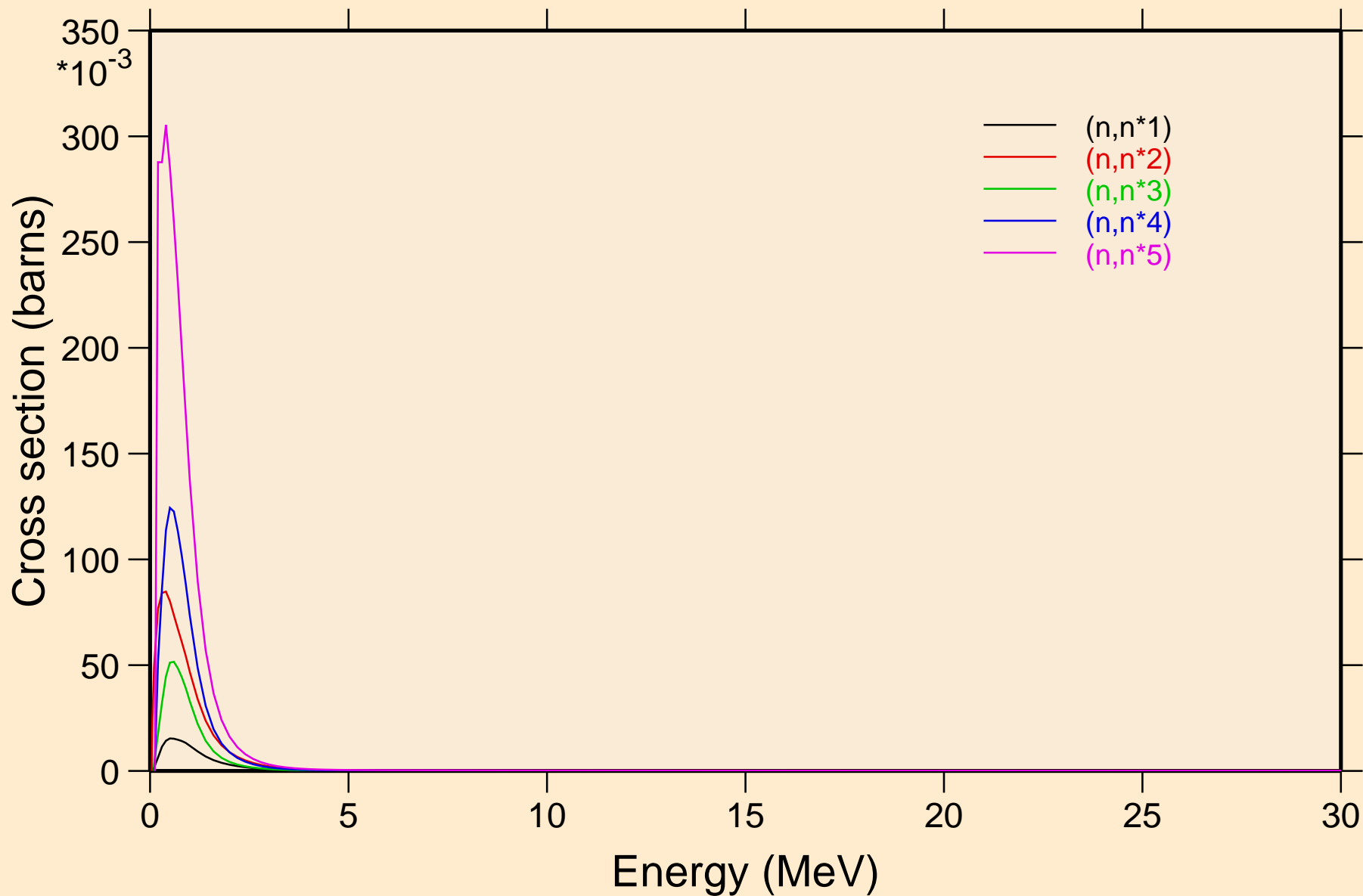

LU169 NEUTRON ACER TENDL-2019 LIBRARY; T=293.16K
Inelastic levels

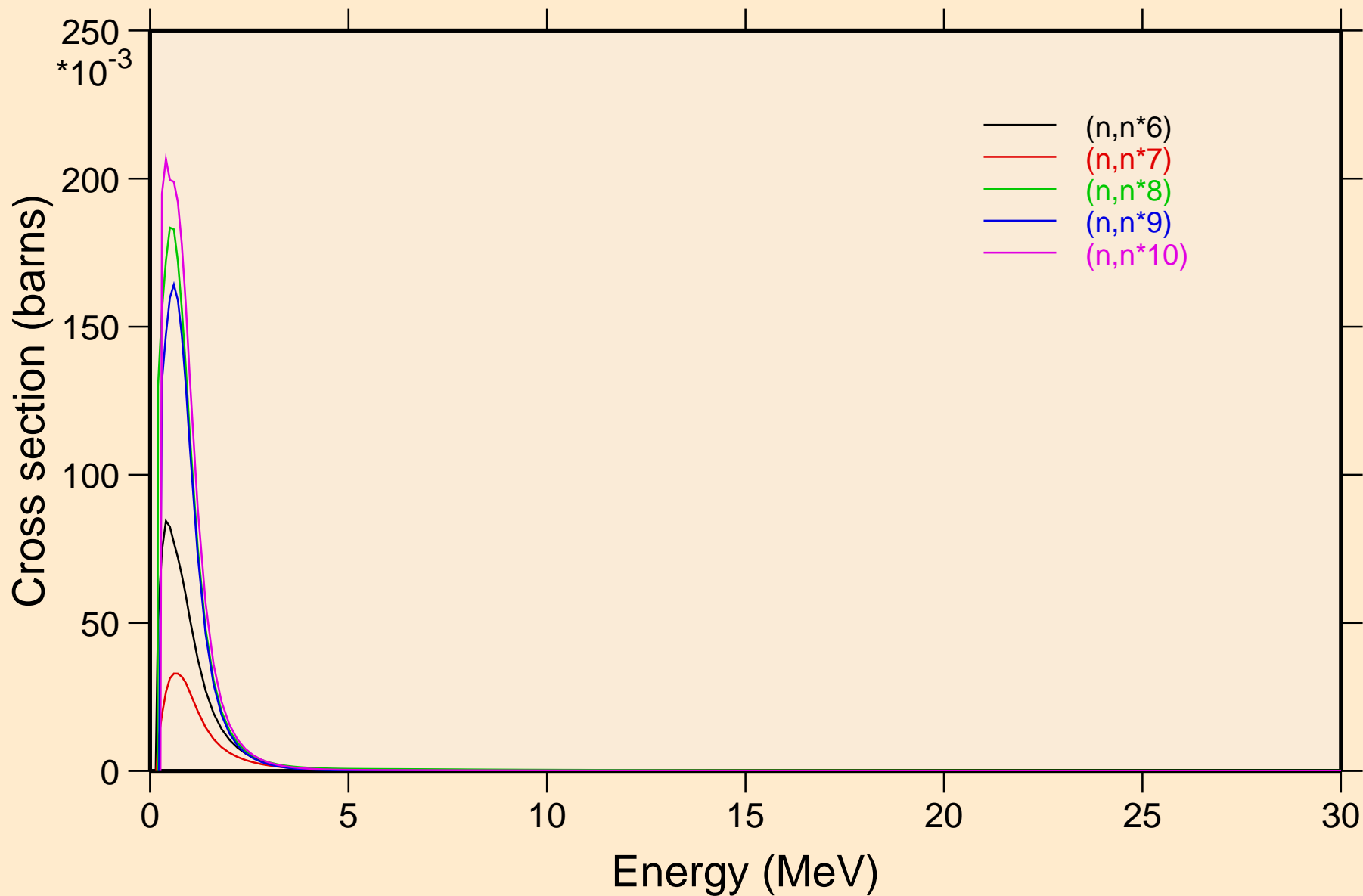

LU169 NEUTRON ACER TENDL-2019 LIBRARY; T=293.16K
Inelastic levels

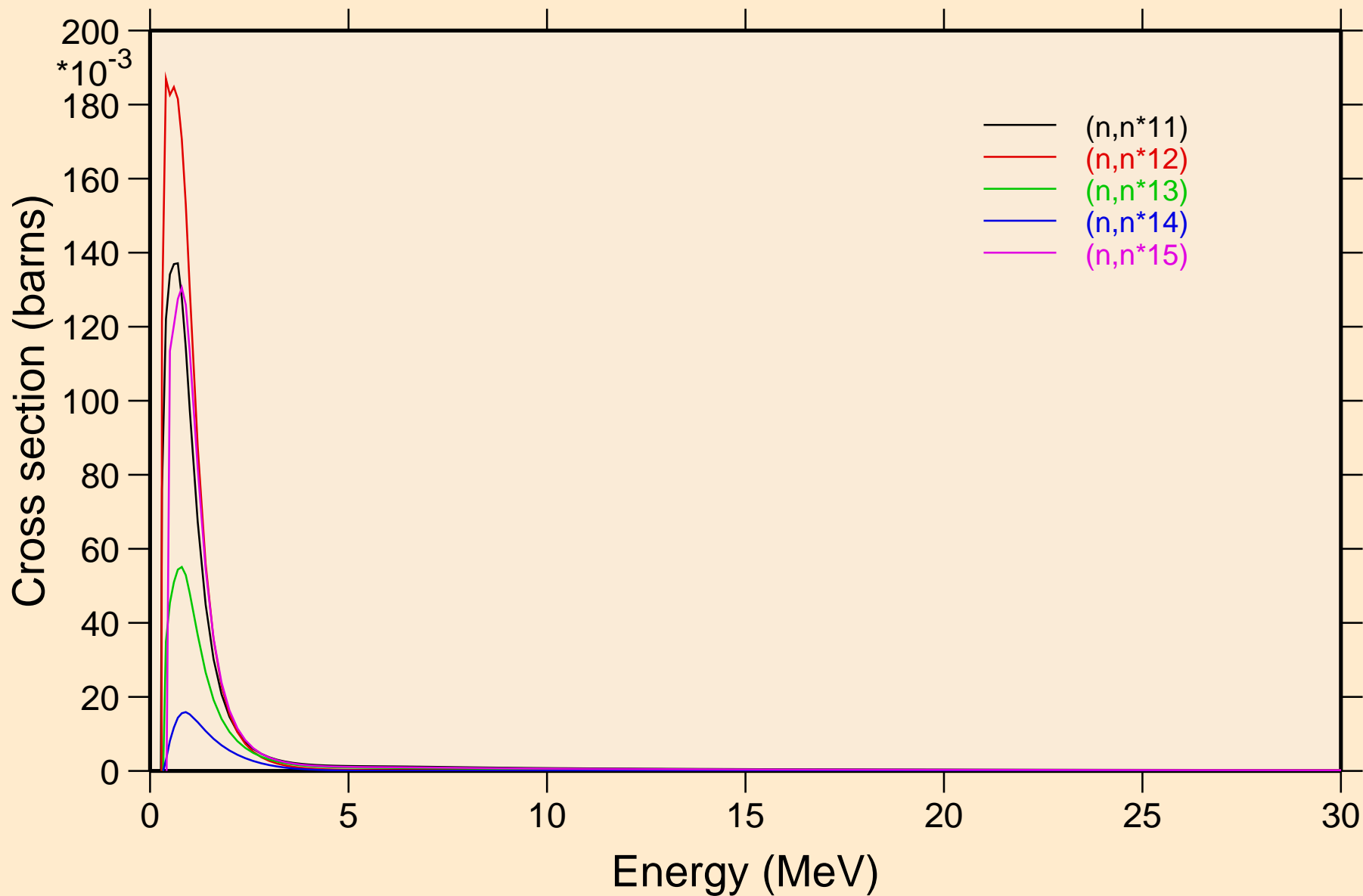

LU169 NEUTRON ACER TENDL-2019 LIBRARY; T=293.16K
Inelastic levels

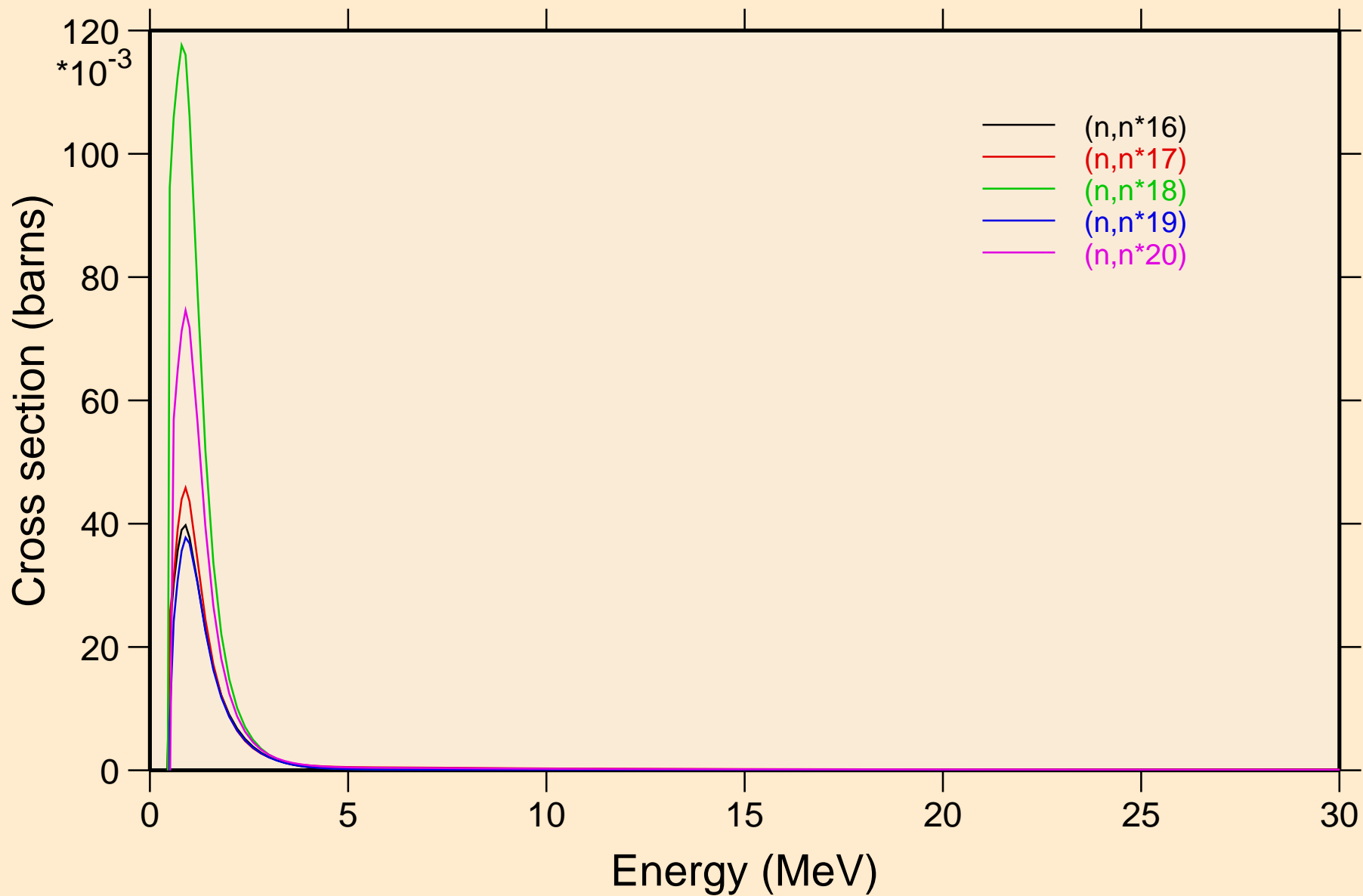

LU169 NEUTRON ACER TENDL-2019 LIBRARY; T=293.16K
Inelastic levels

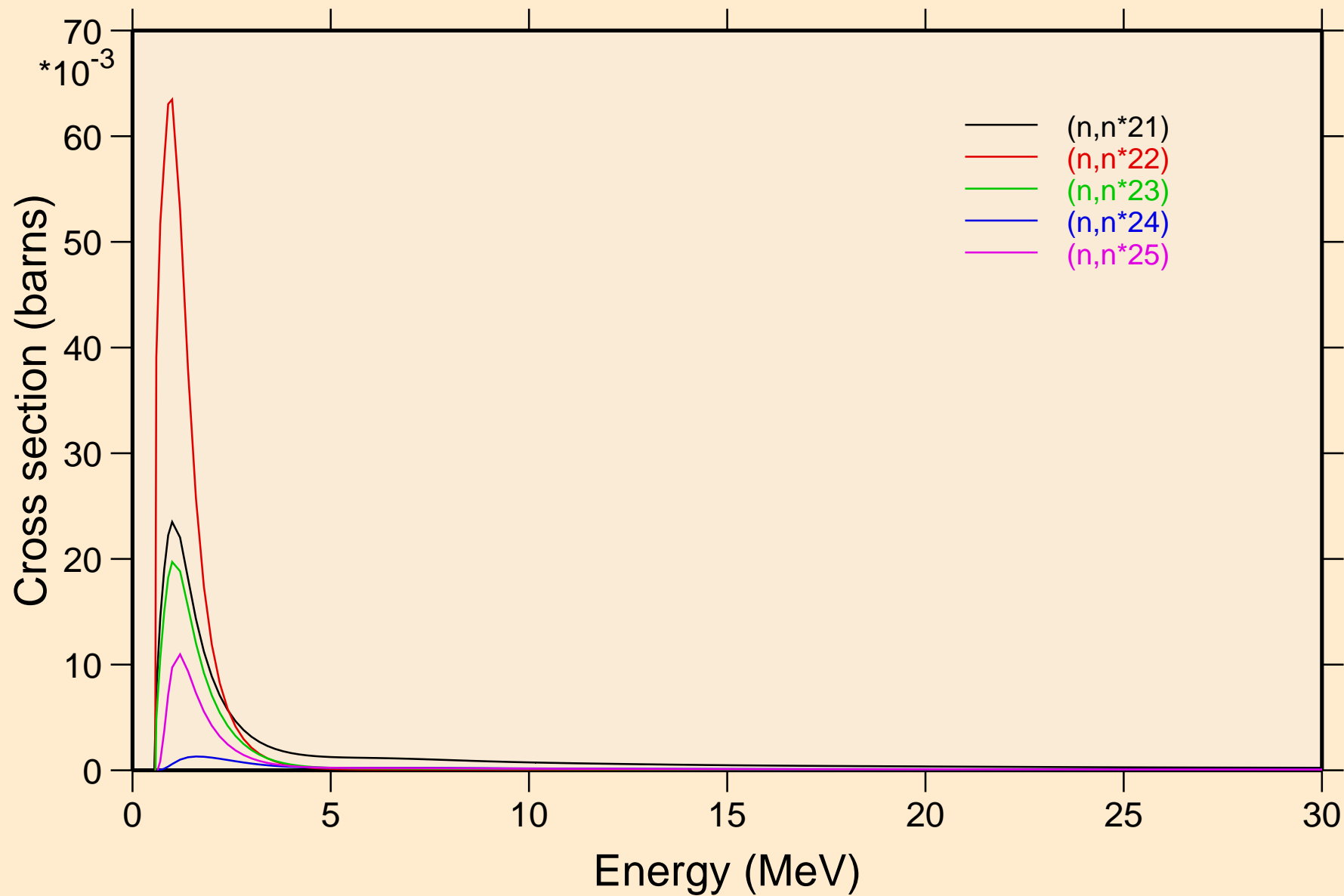

LU169 NEUTRON ACER TENDL-2019 LIBRARY; T=293.16K
Inelastic levels

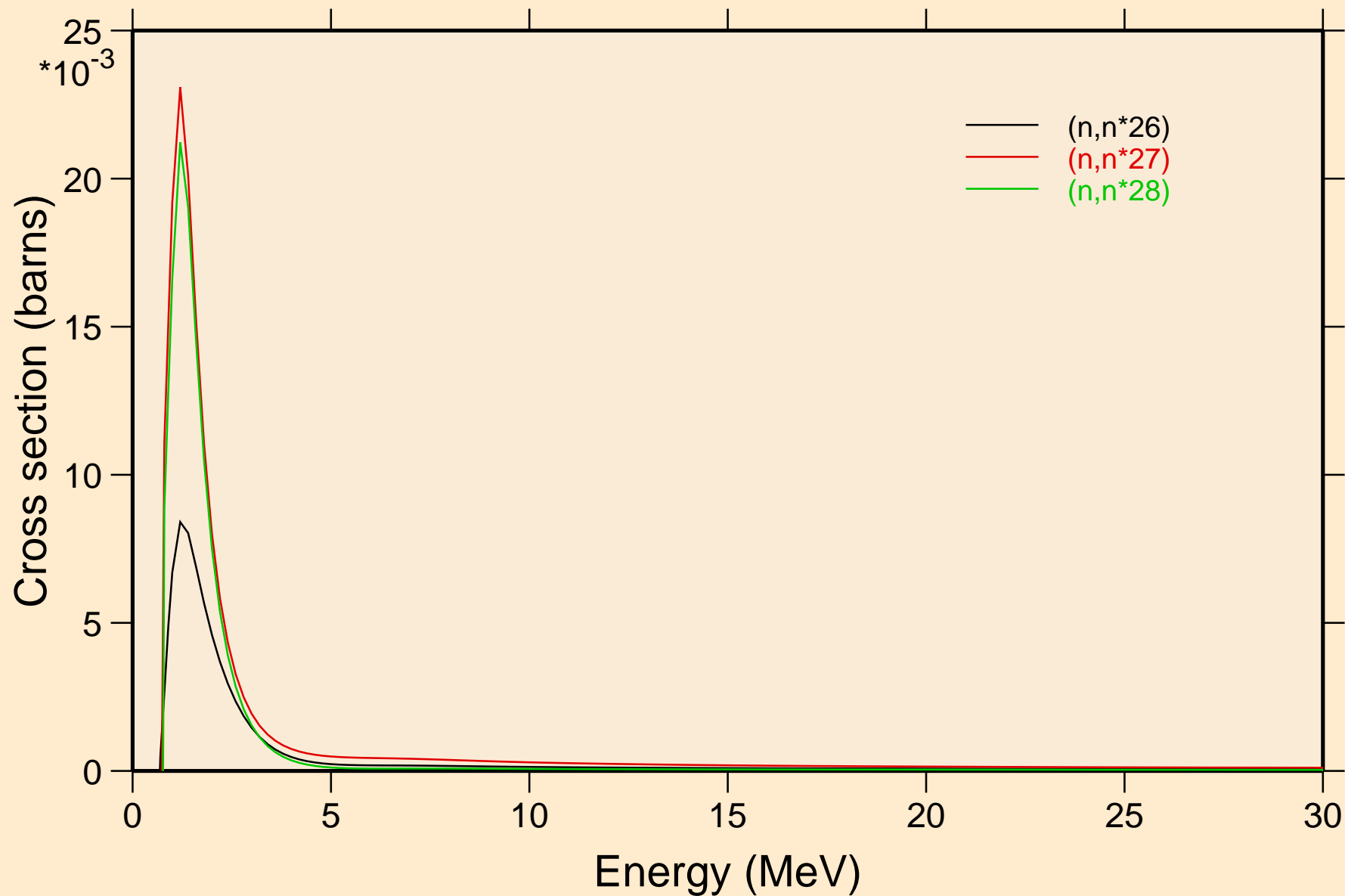

LU169 NEUTRON ACER TENDL-2019 LIBRARY; T=293.16K
Threshold reactions

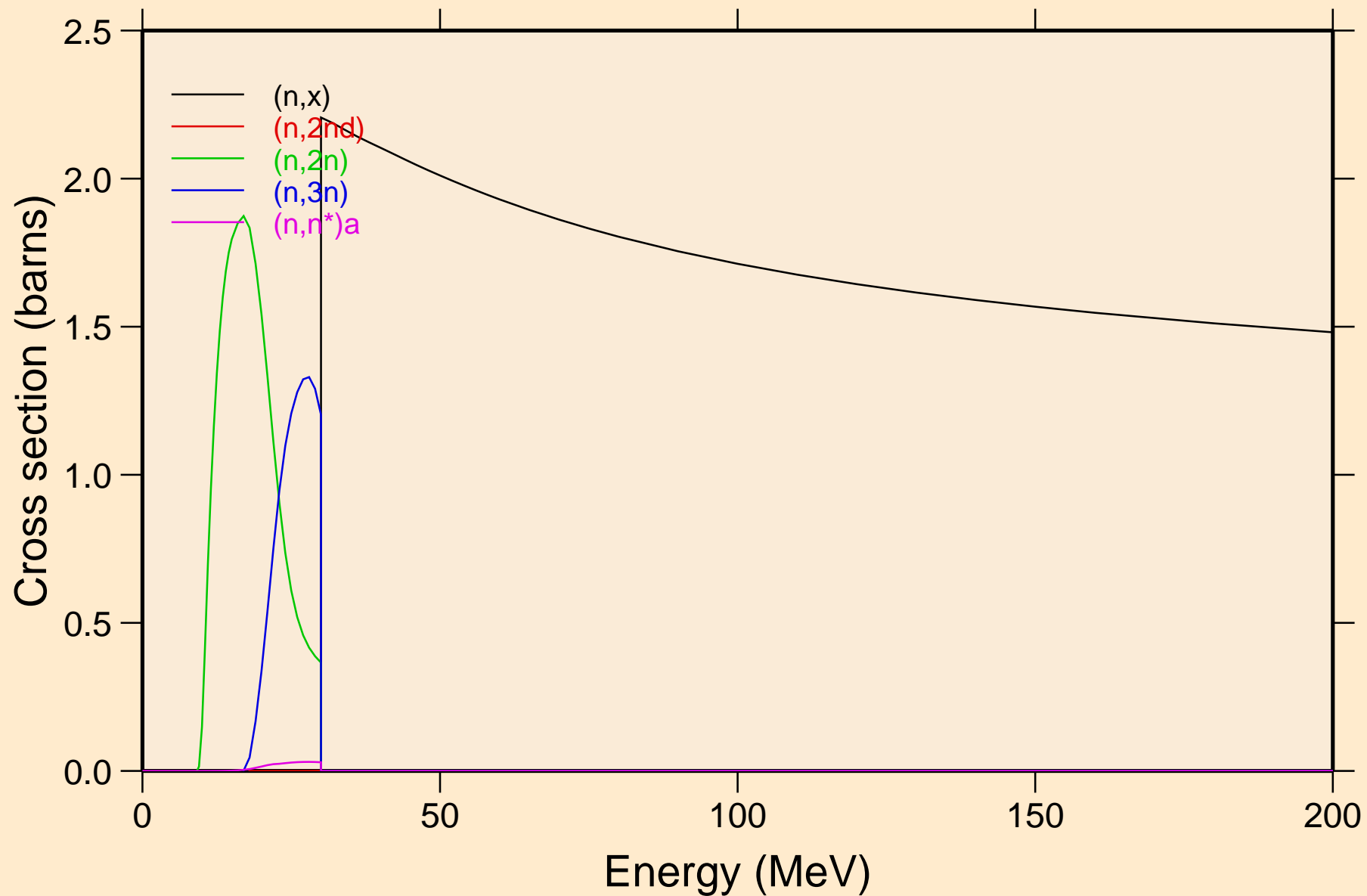

LU169 NEUTRON ACER TENDL-2019 LIBRARY; T=293.16K
Threshold reactions

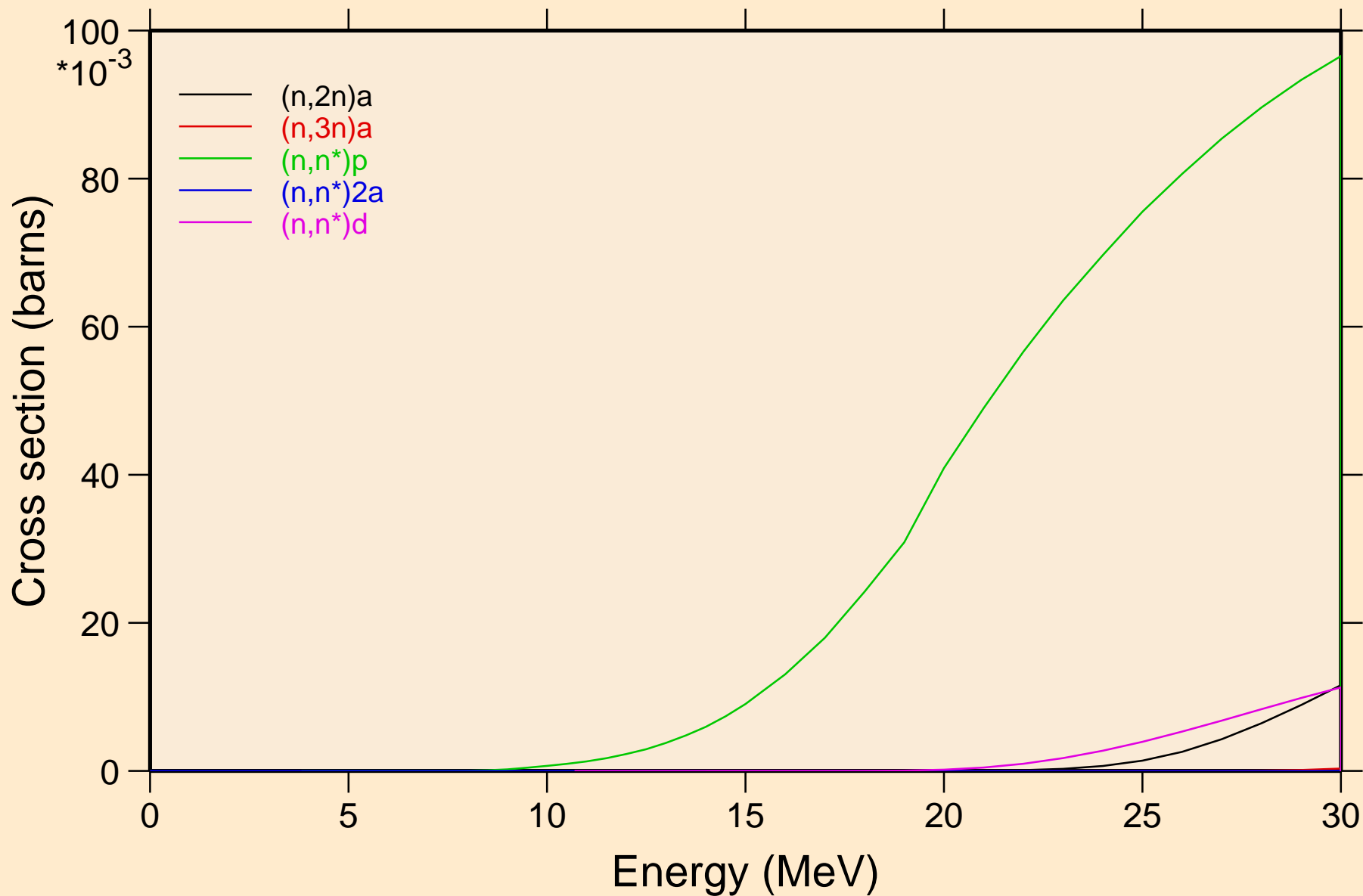

LU169 NEUTRON ACER TENDL-2019 LIBRARY; T=293.16K
Threshold reactions

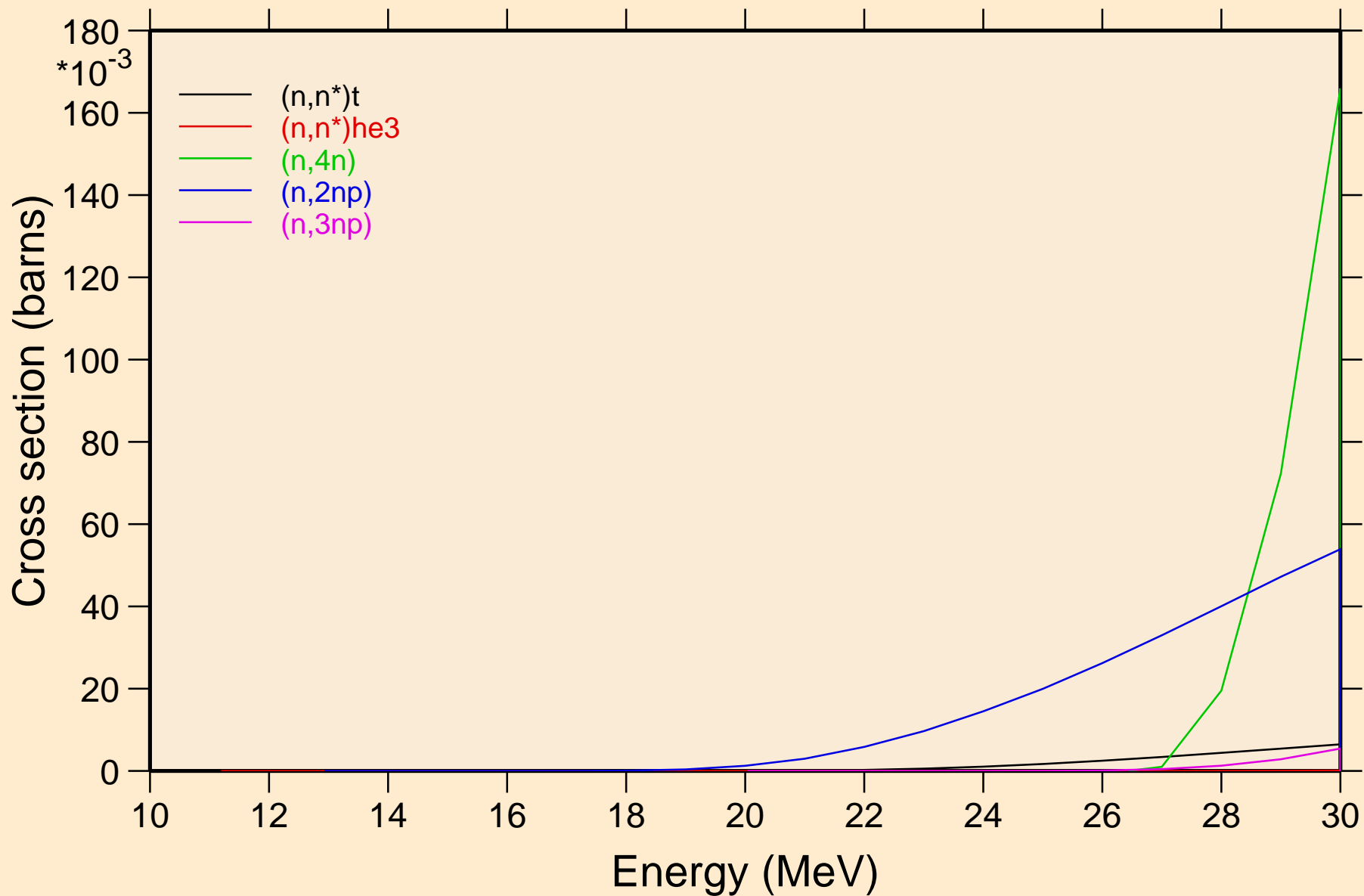

LU169 NEUTRON ACER TENDL-2019 LIBRARY; T=293.16K
Threshold reactions

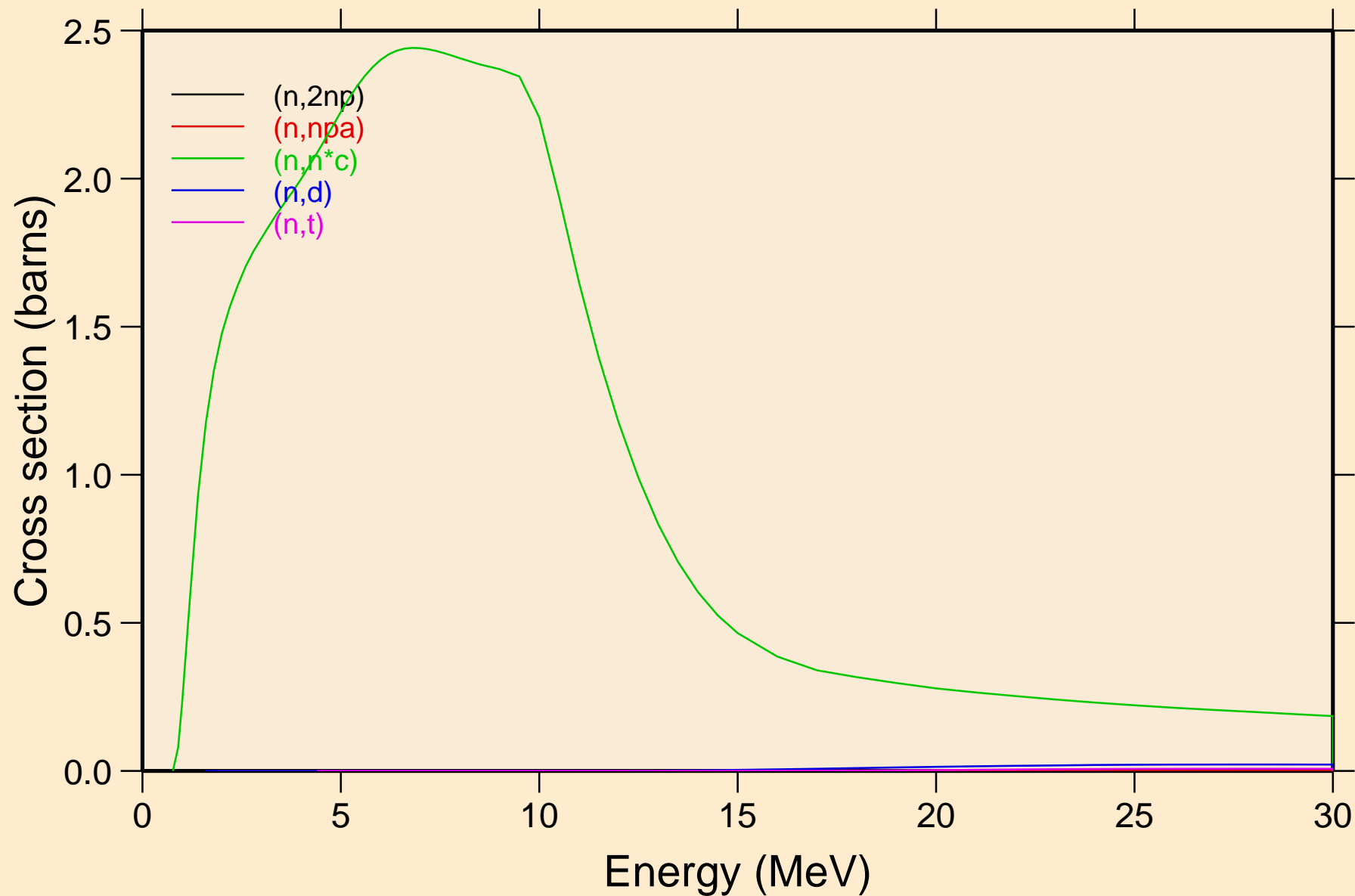

LU169 NEUTRON ACER TENDL-2019 LIBRARY; T=293.16K
Threshold reactions

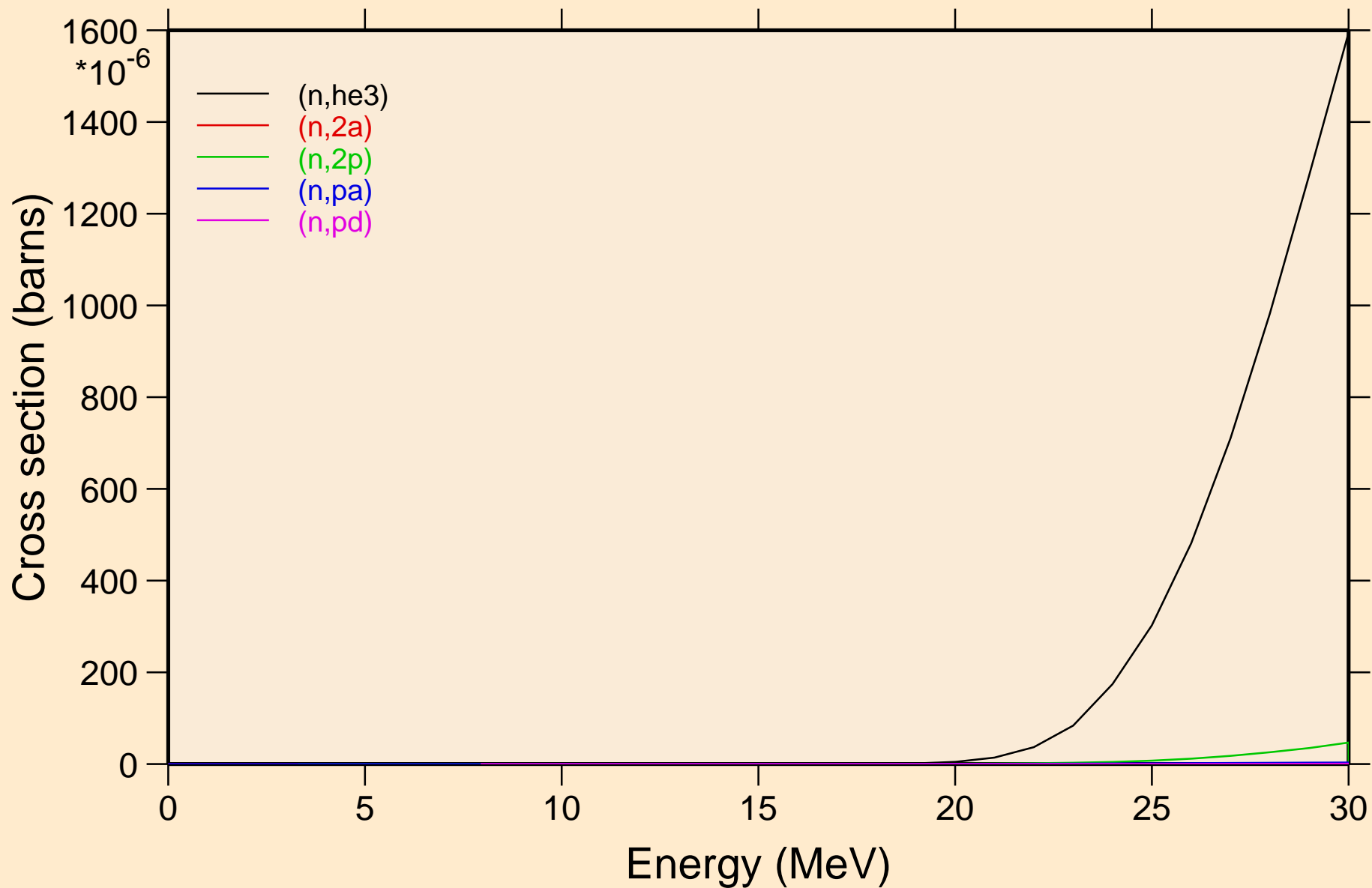

LU169 NEUTRON ACER TENDL-2019 LIBRARY; T=293.16K
Threshold reactions

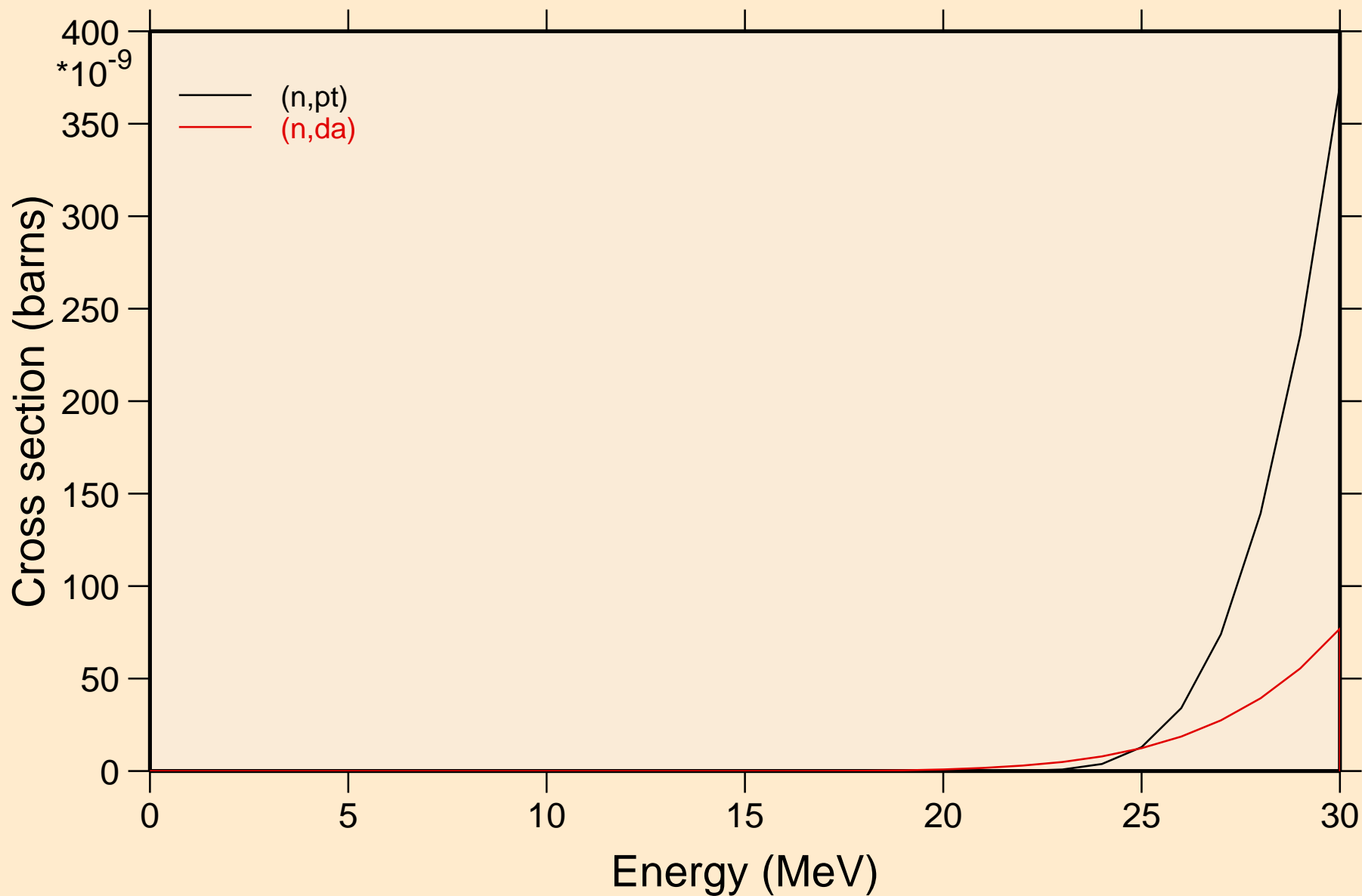

LU169 NEUTRON ACER TENDL-2019 LIBRARY; T=293.16K
Threshold reactions

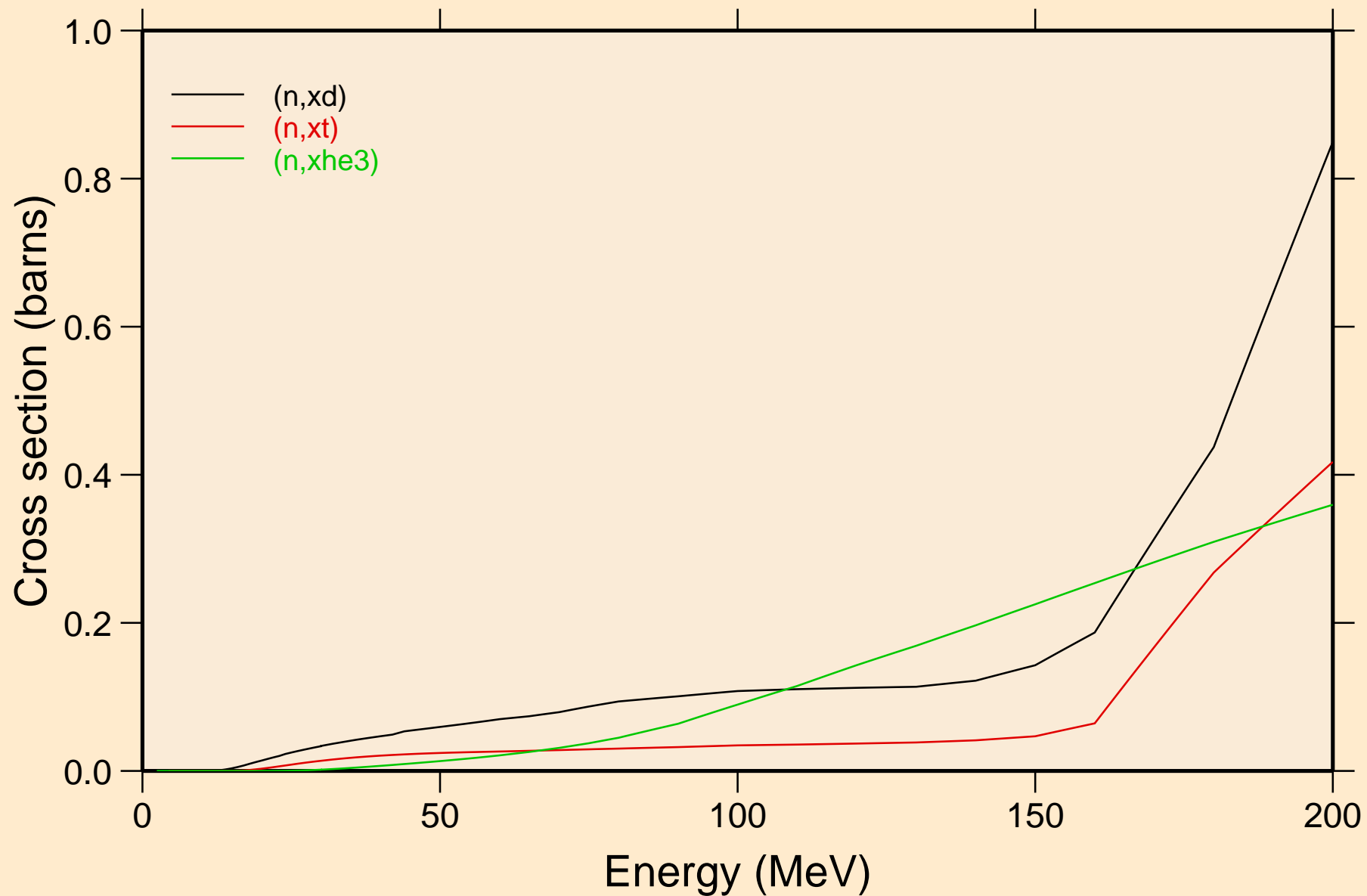

LU169 NEUTRON ACER TENDL-2019 LIBRARY; T=293.16K
angular distribution for elastic

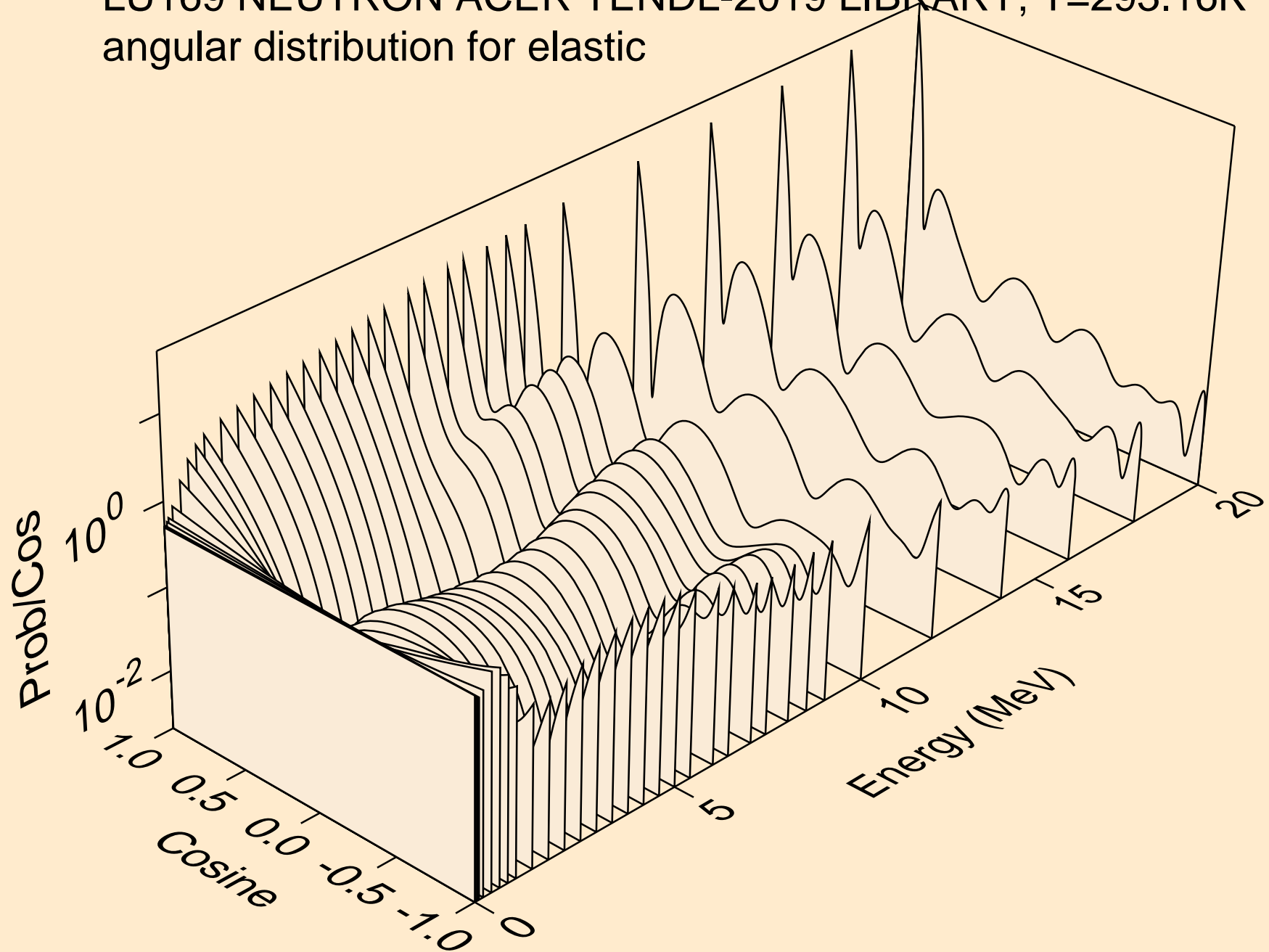

LU169 NEUTRON ACER TENDL-2019 LIBRARY; T=293.16K
angular distribution for elastic

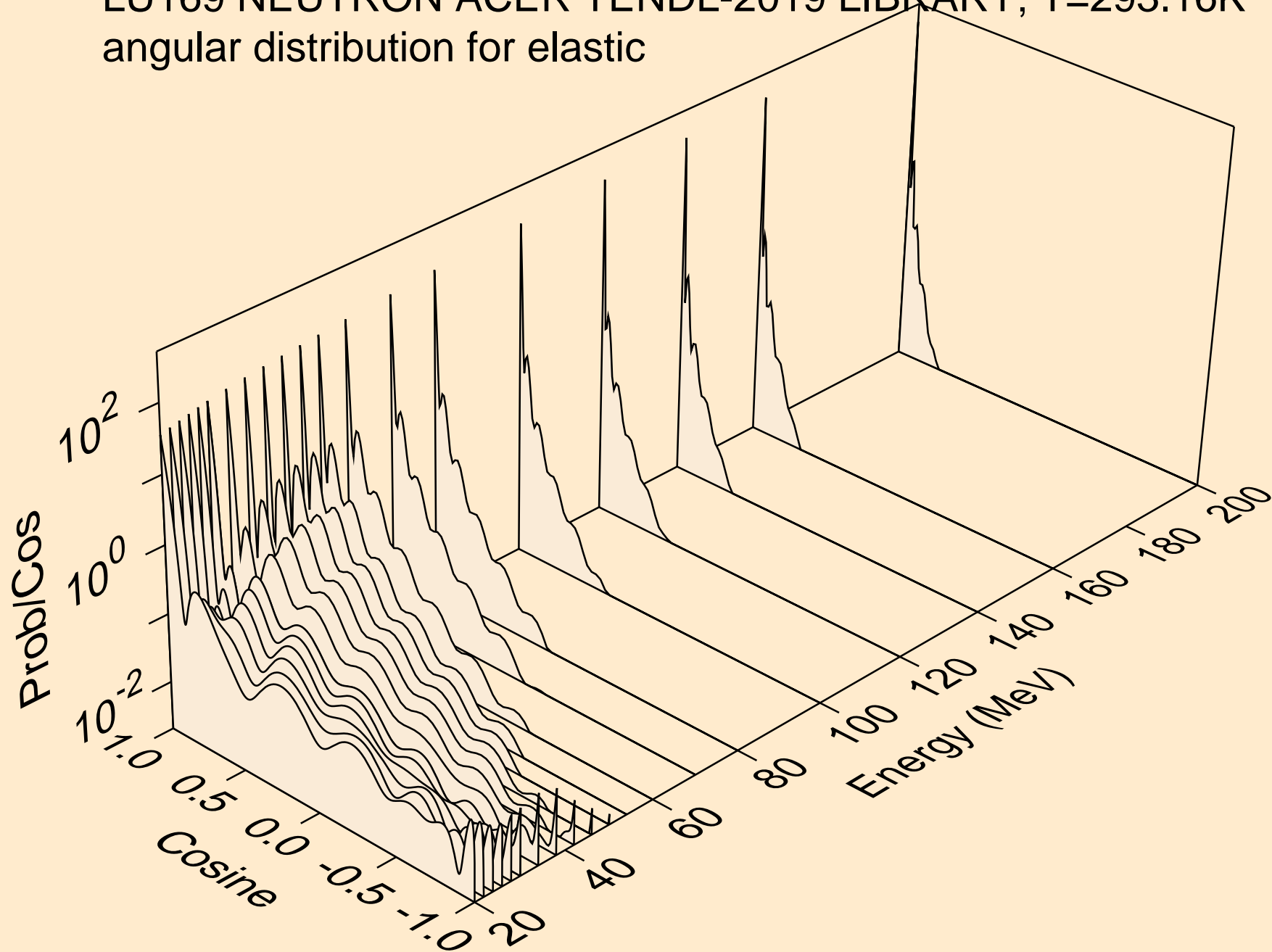

LU169 NEUTRON ACER TENDL-2019 LIBRARY; T=293.16K
angular distribution for (n,n*1)

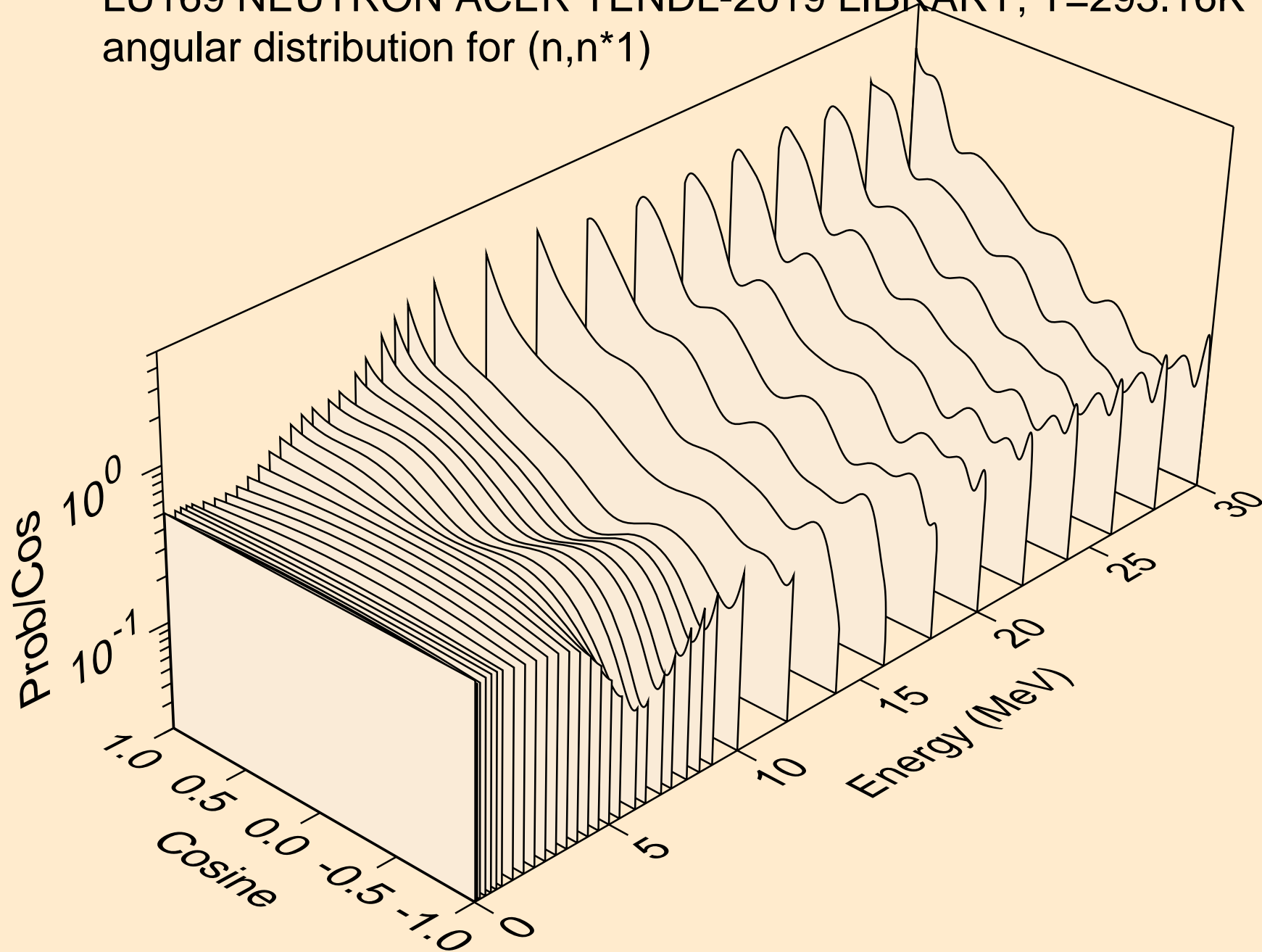

LU169 NEUTRON ACER TENDL-2019 LIBRARY; T=293.16K
angular distribution for (n,n*2)

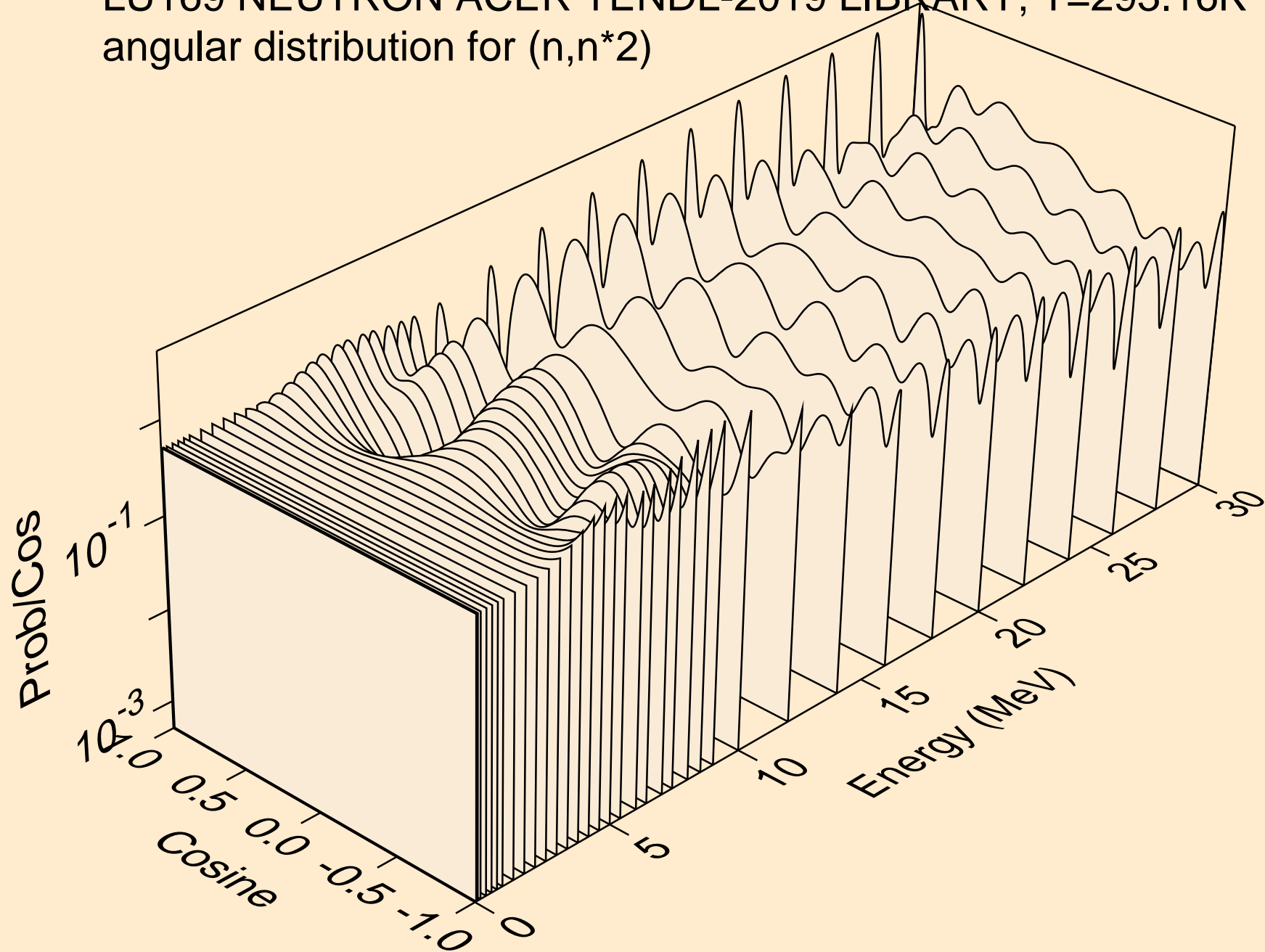

LU169 NEUTRON ACER TENDL-2019 LIBRARY; T=293.16K
angular distribution for (n,n*3)

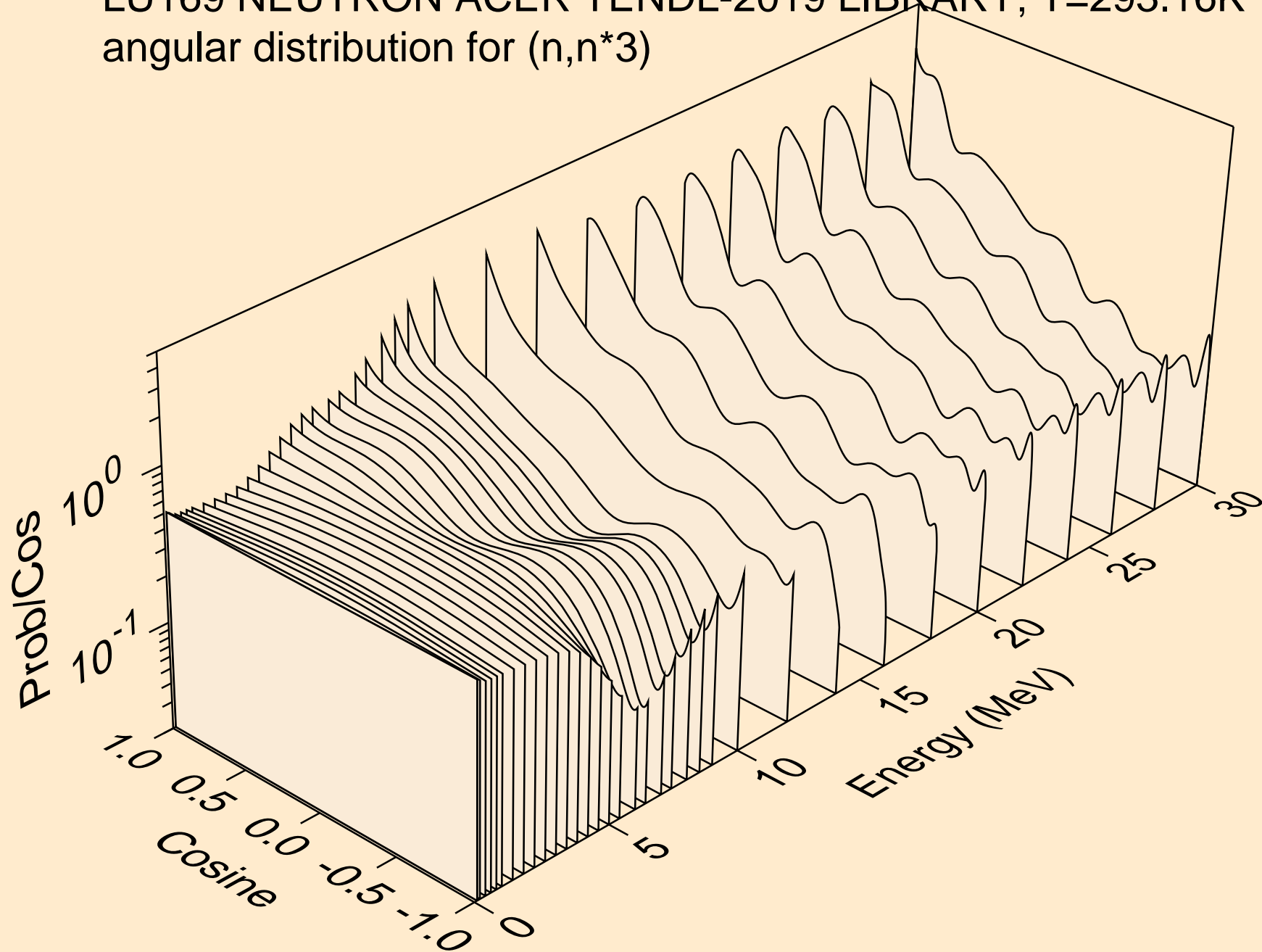

LU169 NEUTRON ACER TENDL-2019 LIBRARY; T=293.16K
angular distribution for (n,n*4)

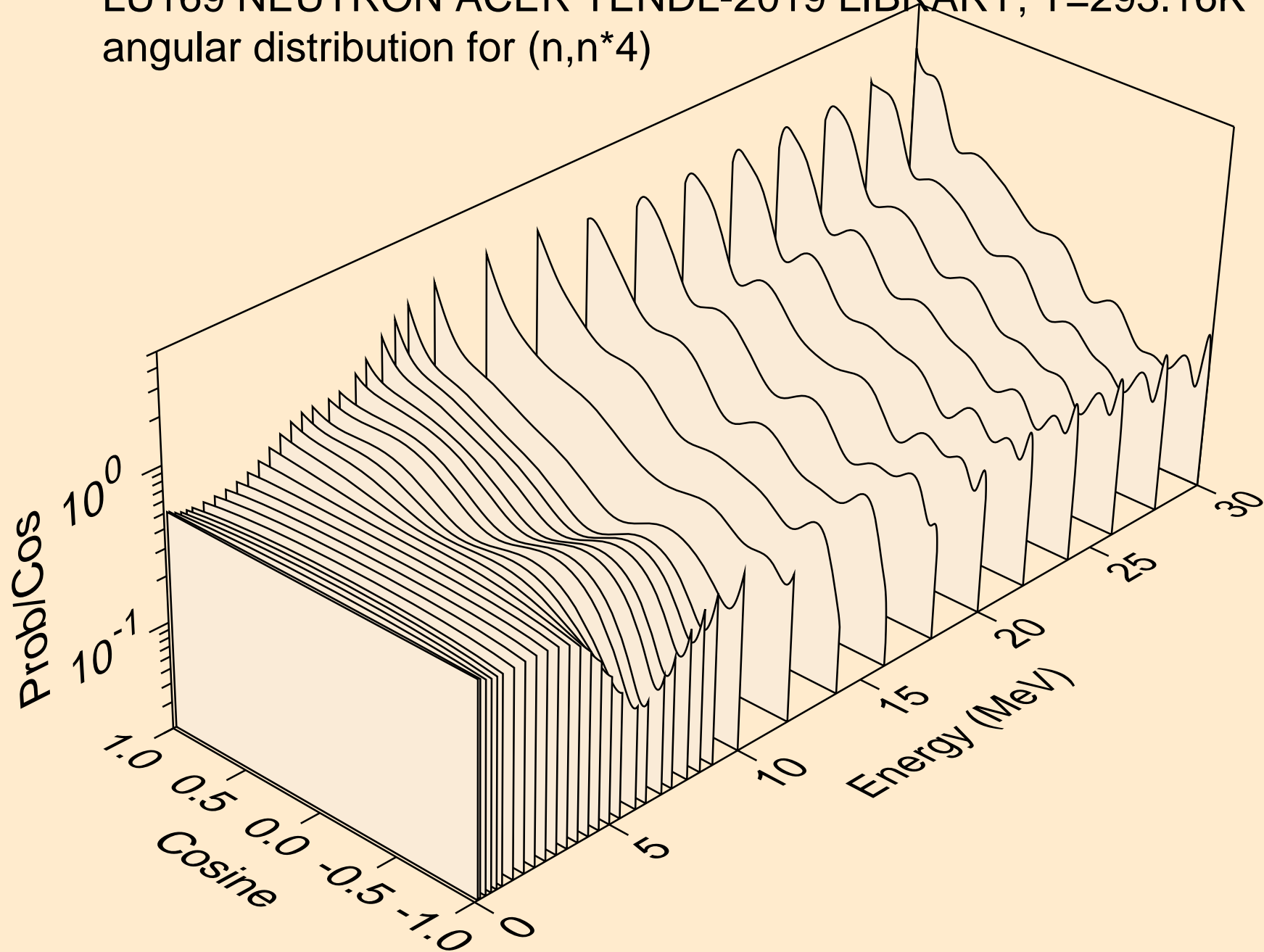

LU169 NEUTRON ACER TENDL-2019 LIBRARY; T=293.16K
angular distribution for (n,n*5)

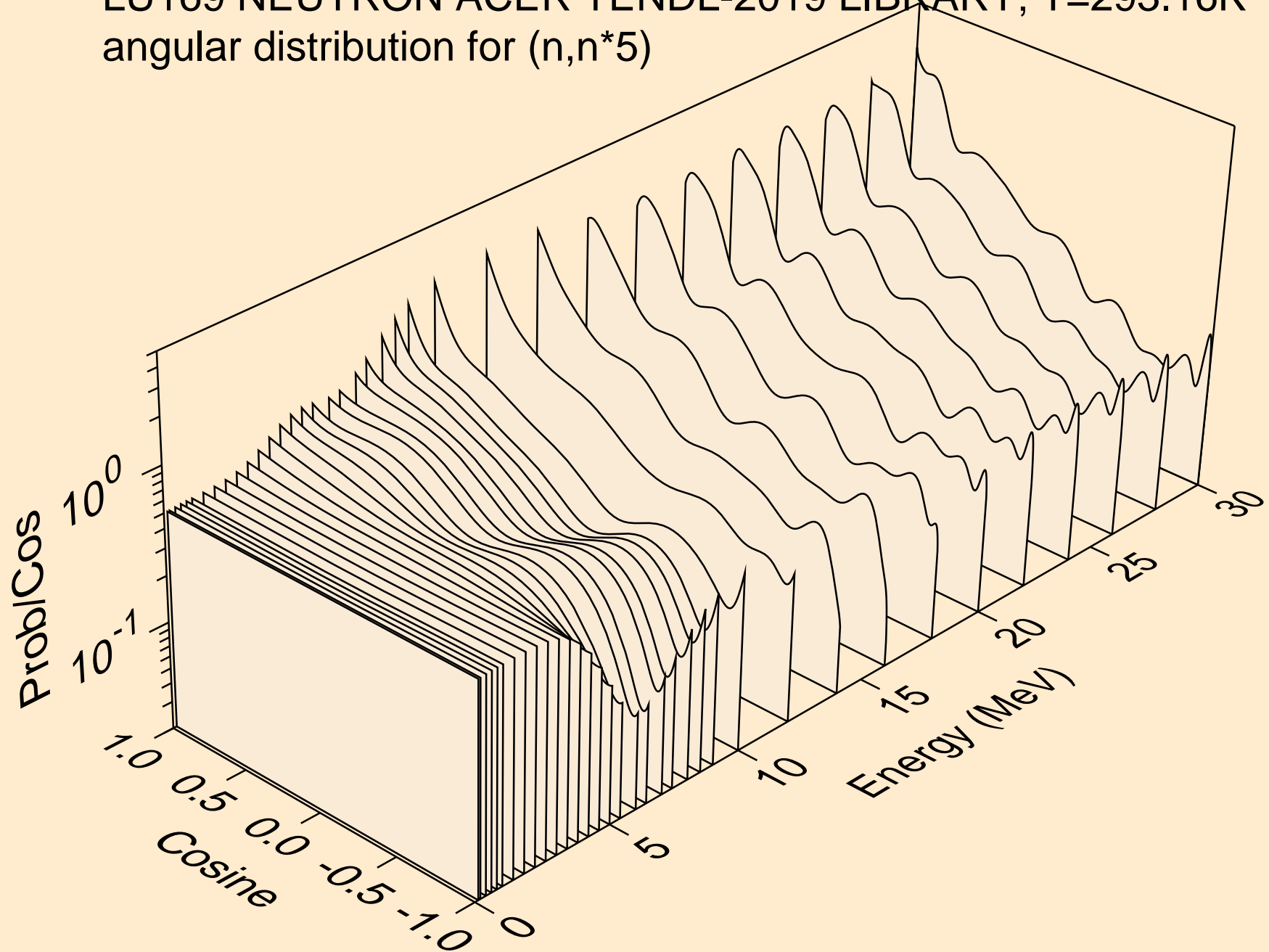

LU169 NEUTRON ACER TENDL-2019 LIBRARY; T=293.16K
angular distribution for (n,n*6)

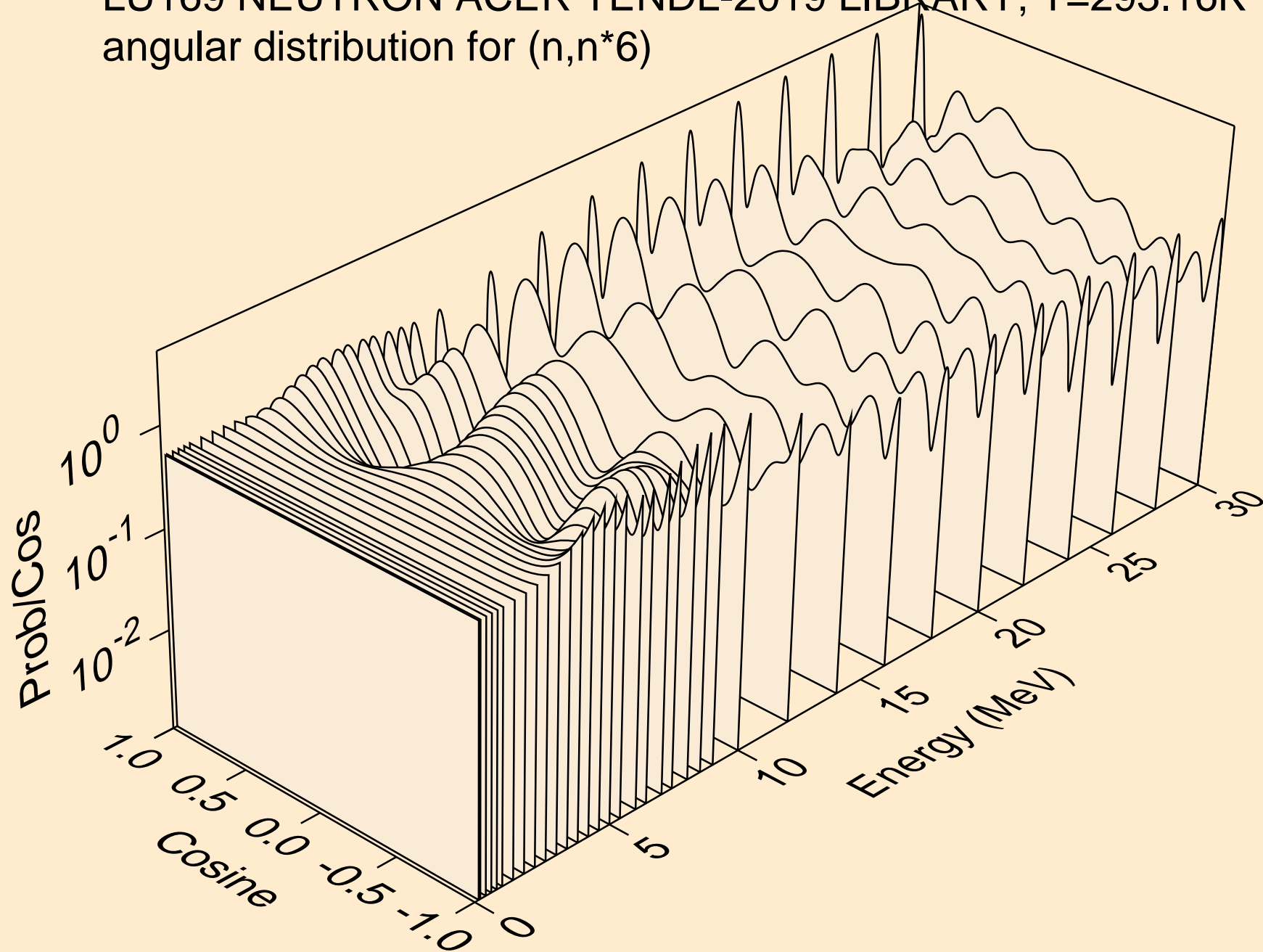

LU169 NEUTRON ACER TENDL-2019 LIBRARY; T=293.16K
angular distribution for (n,n*7)

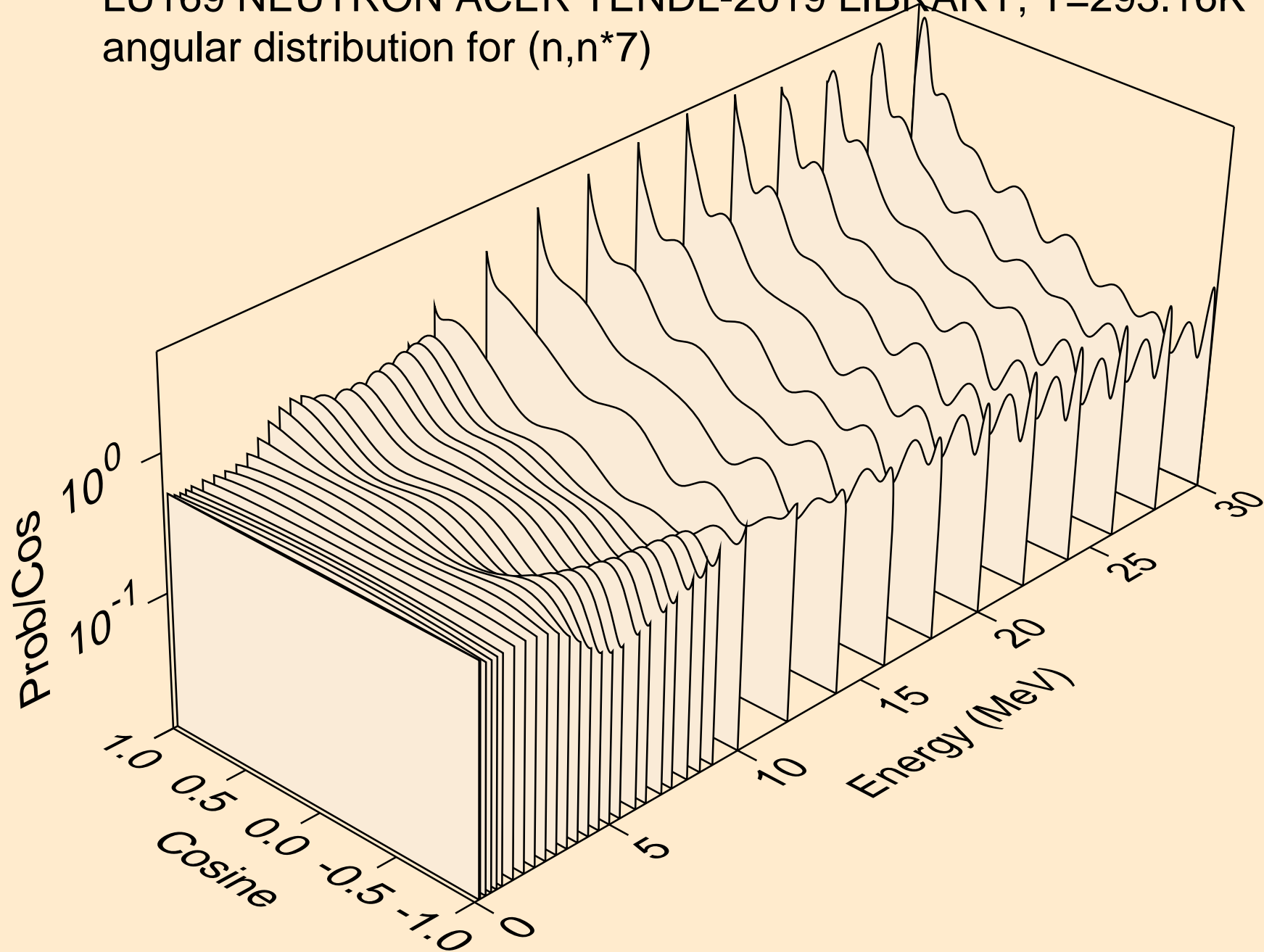

LU169 NEUTRON ACER TENDL-2019 LIBRARY; T=293.16K
angular distribution for (n,n*8)

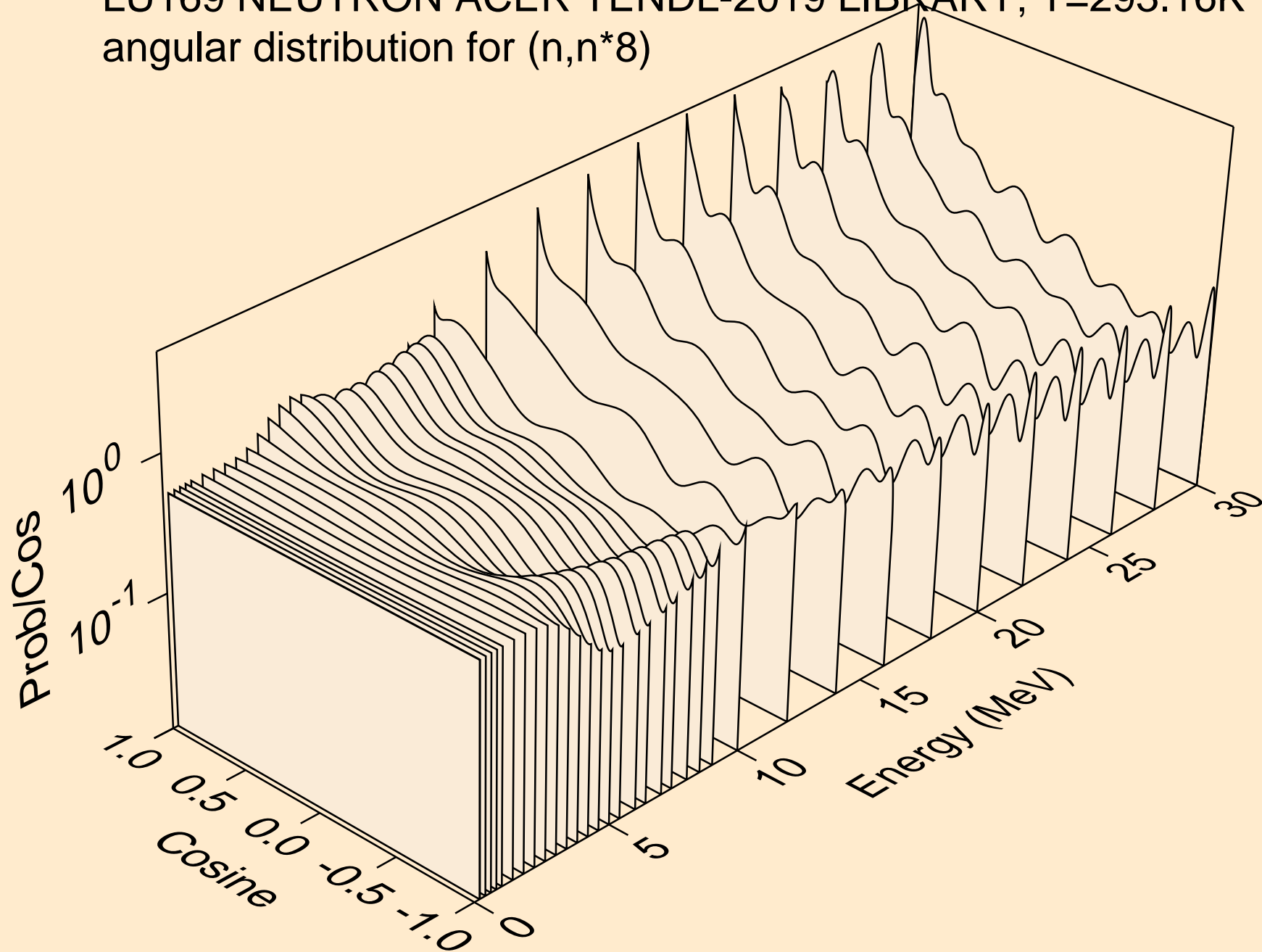

LU169 NEUTRON ACER TENDL-2019 LIBRARY; T=293.16K
angular distribution for (n,n*9)

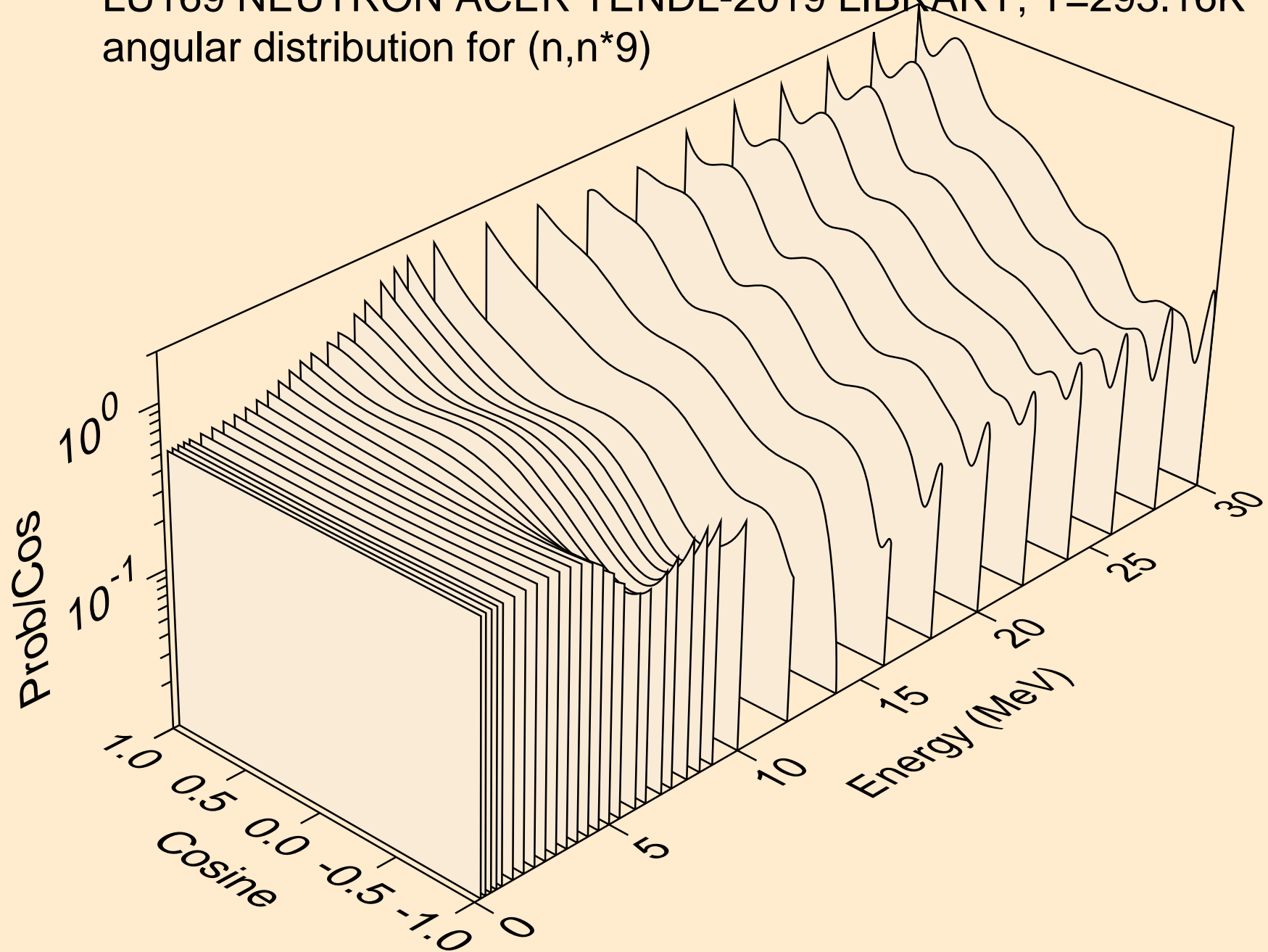

LU169 NEUTRON ACER TENDL-2019 LIBRARY; T=293.16K
angular distribution for (n,n*10)

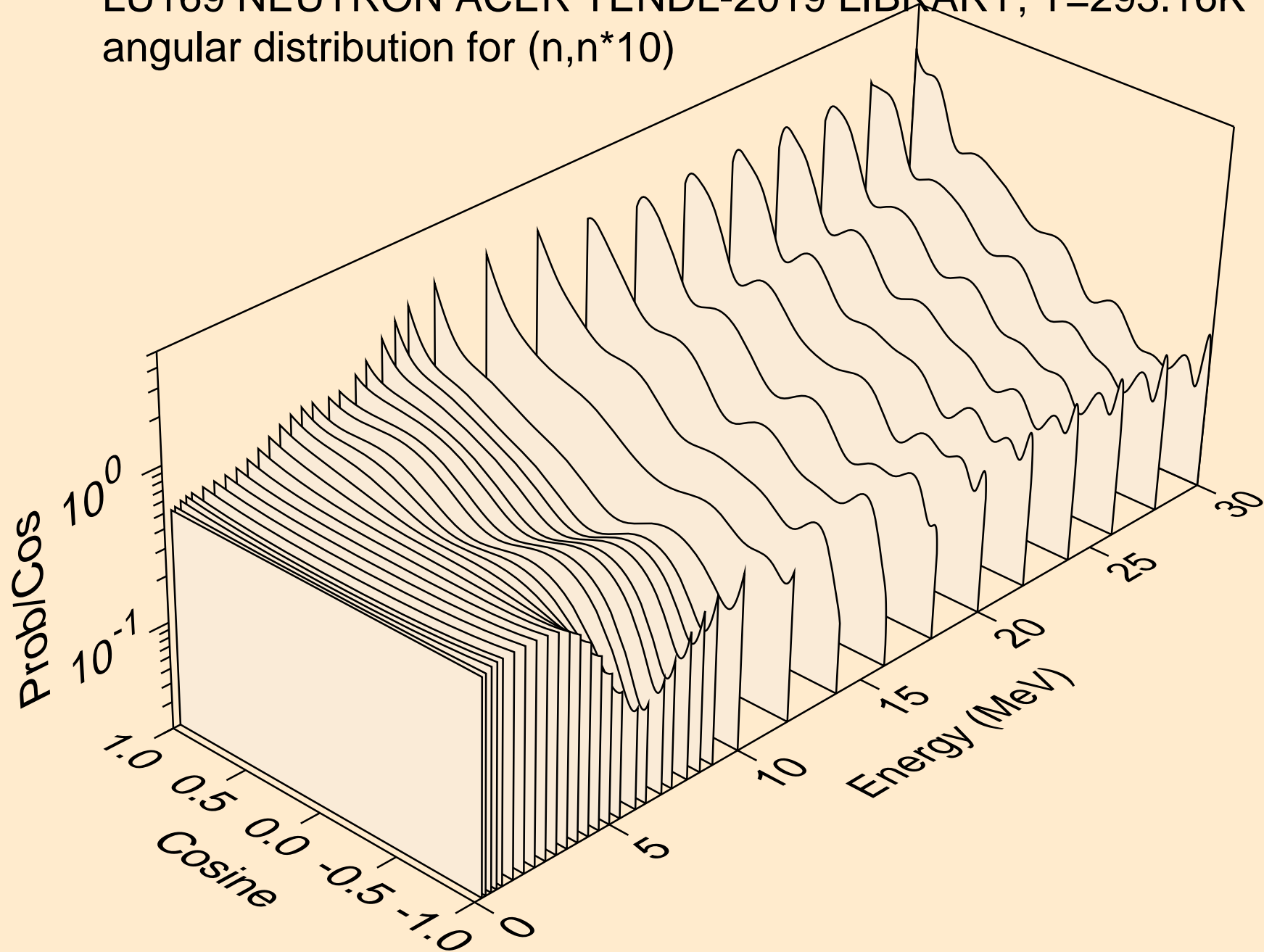

LU169 NEUTRON ACER TENDL-2019 LIBRARY; T=293.16K
angular distribution for (n,n*11)

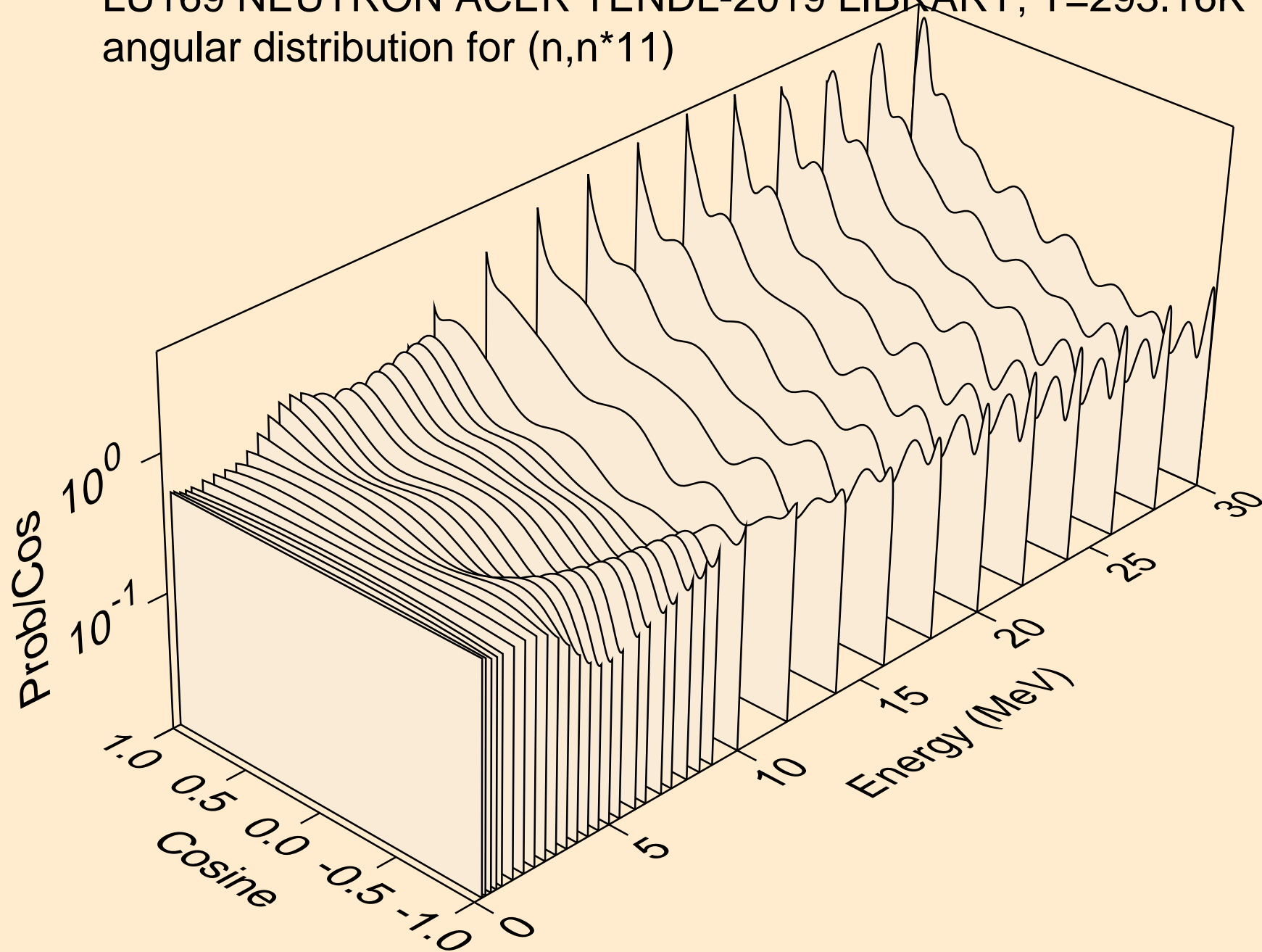

LU169 NEUTRON ACER TENDL-2019 LIBRARY; T=293.16K
angular distribution for (n,n*12)

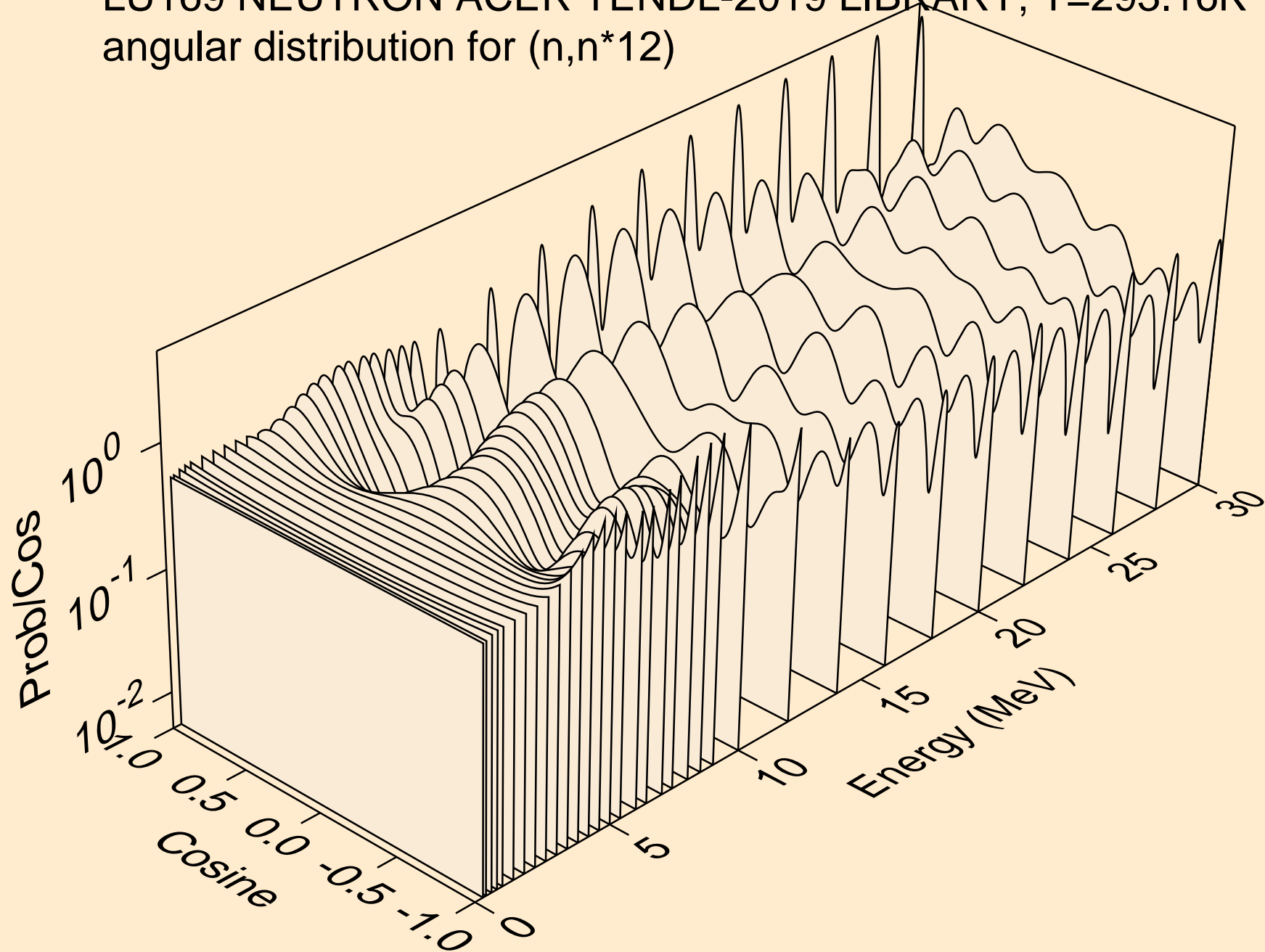

LU169 NEUTRON ACER TENDL-2019 LIBRARY; T=293.16K
angular distribution for (n,n*13)

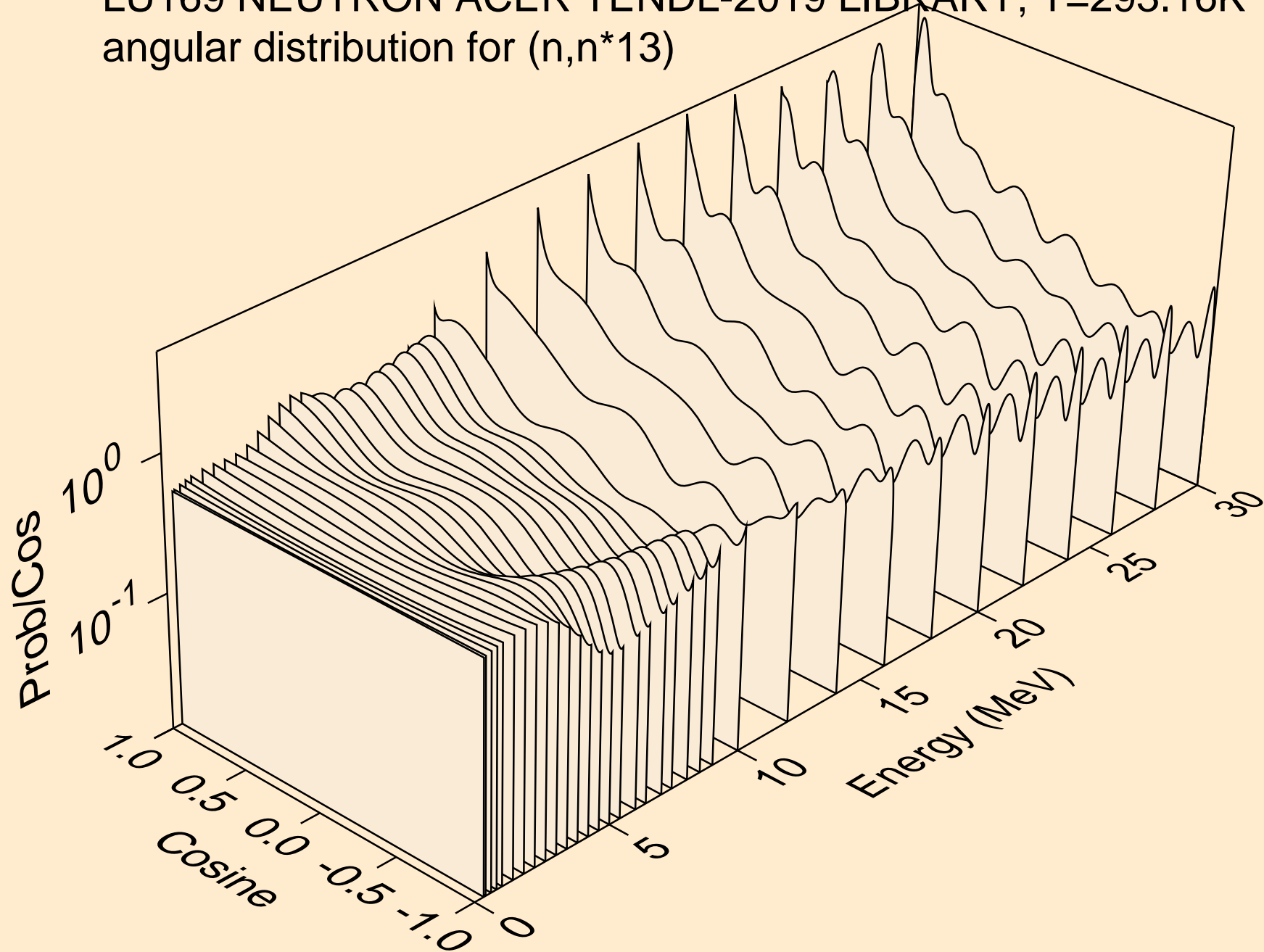

LU169 NEUTRON ACER TENDL-2019 LIBRARY; T=293.16K
angular distribution for (n,n*14)

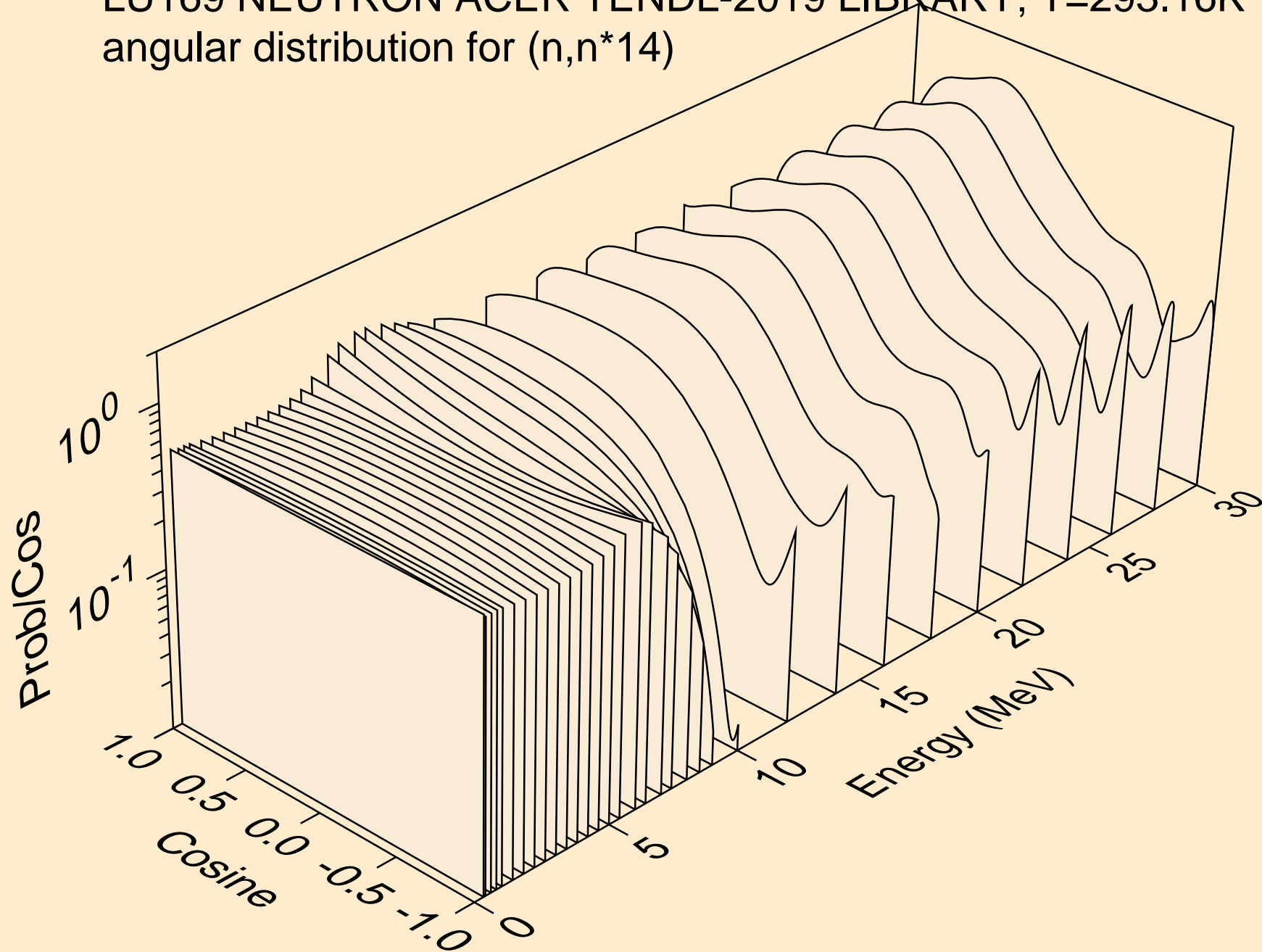

LU169 NEUTRON ACER TENDL-2019 LIBRARY; T=293.16K
angular distribution for (n,n*15)

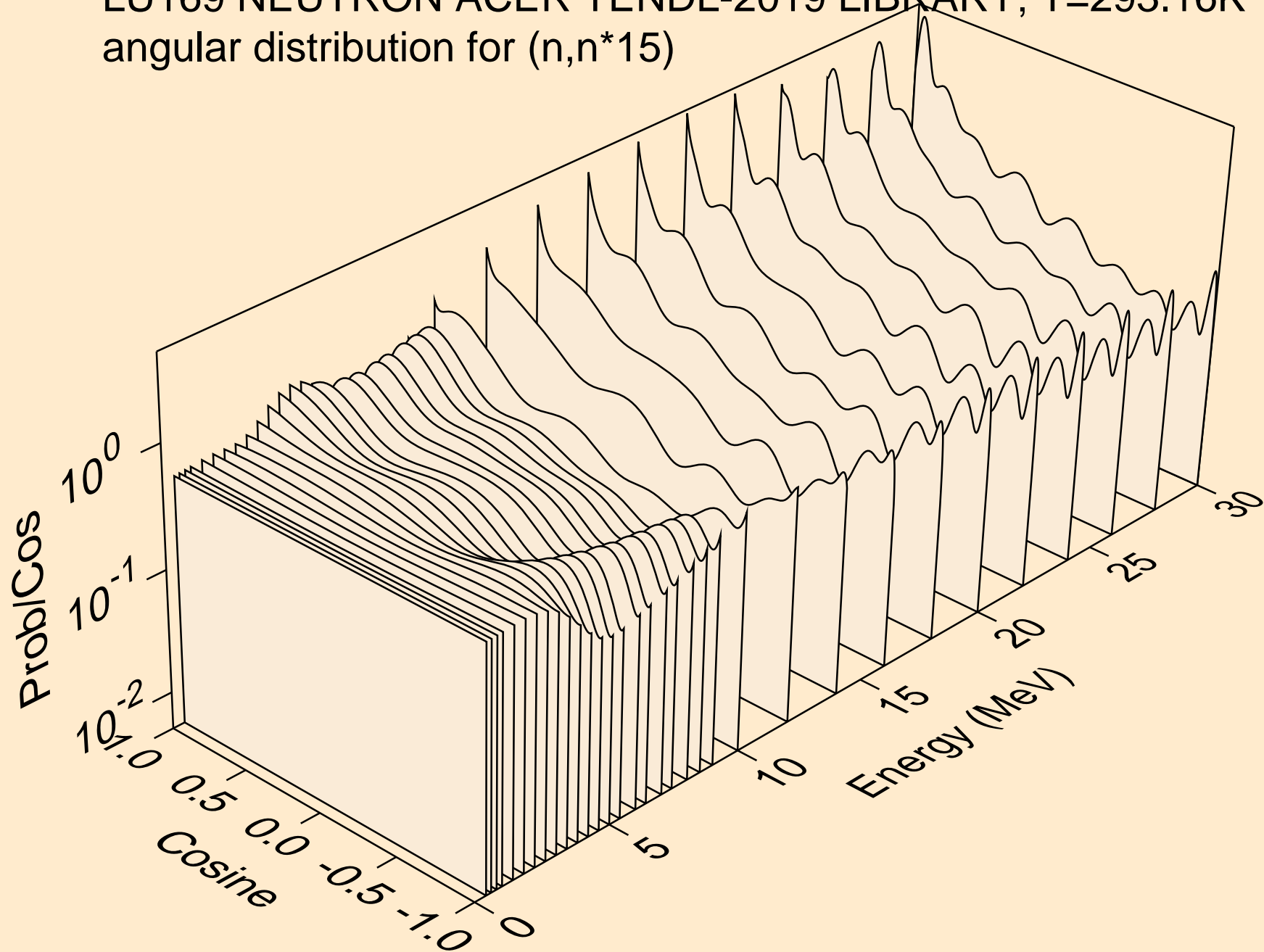

LU169 NEUTRON ACER TENDL-2019 LIBRARY; T=293.16K
angular distribution for (n,n*16)

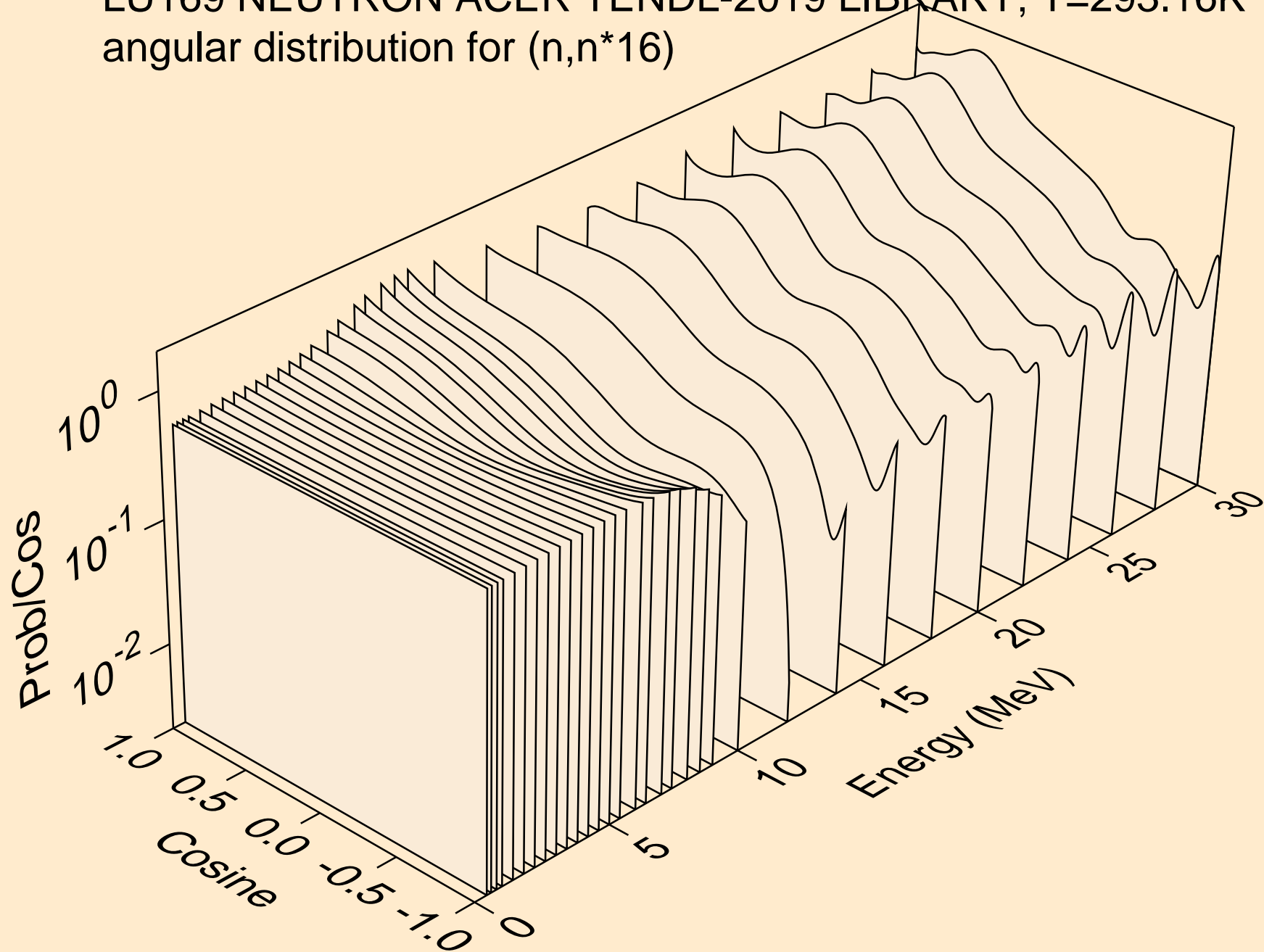

LU169 NEUTRON ACER TENDL-2019 LIBRARY; T=293.16K
angular distribution for (n,n*17)

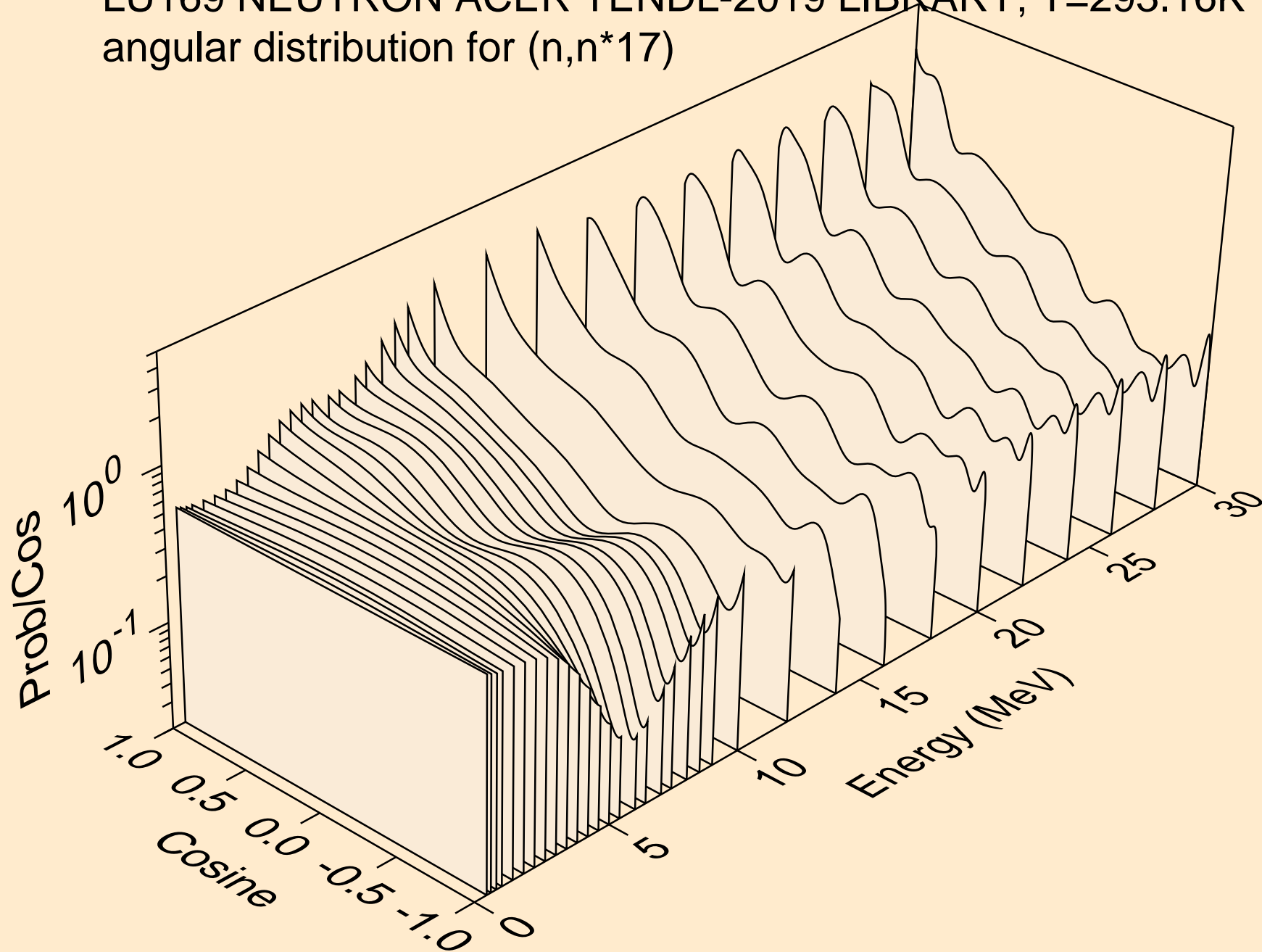

LU169 NEUTRON ACER TENDL-2019 LIBRARY; T=293.16K
angular distribution for (n,n*18)

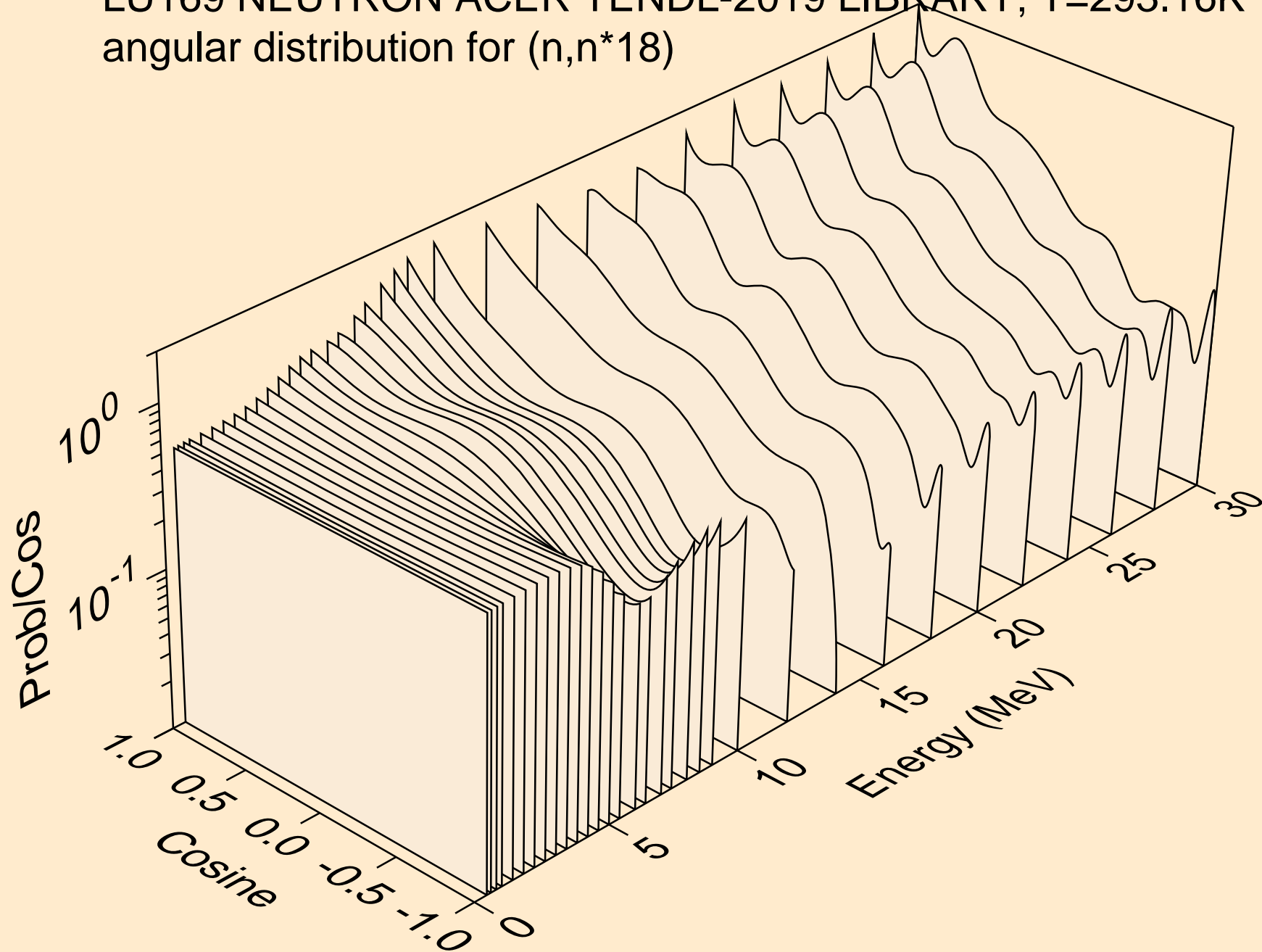

LU169 NEUTRON ACER TENDL-2019 LIBRARY; T=293.16K
angular distribution for (n,n*19)

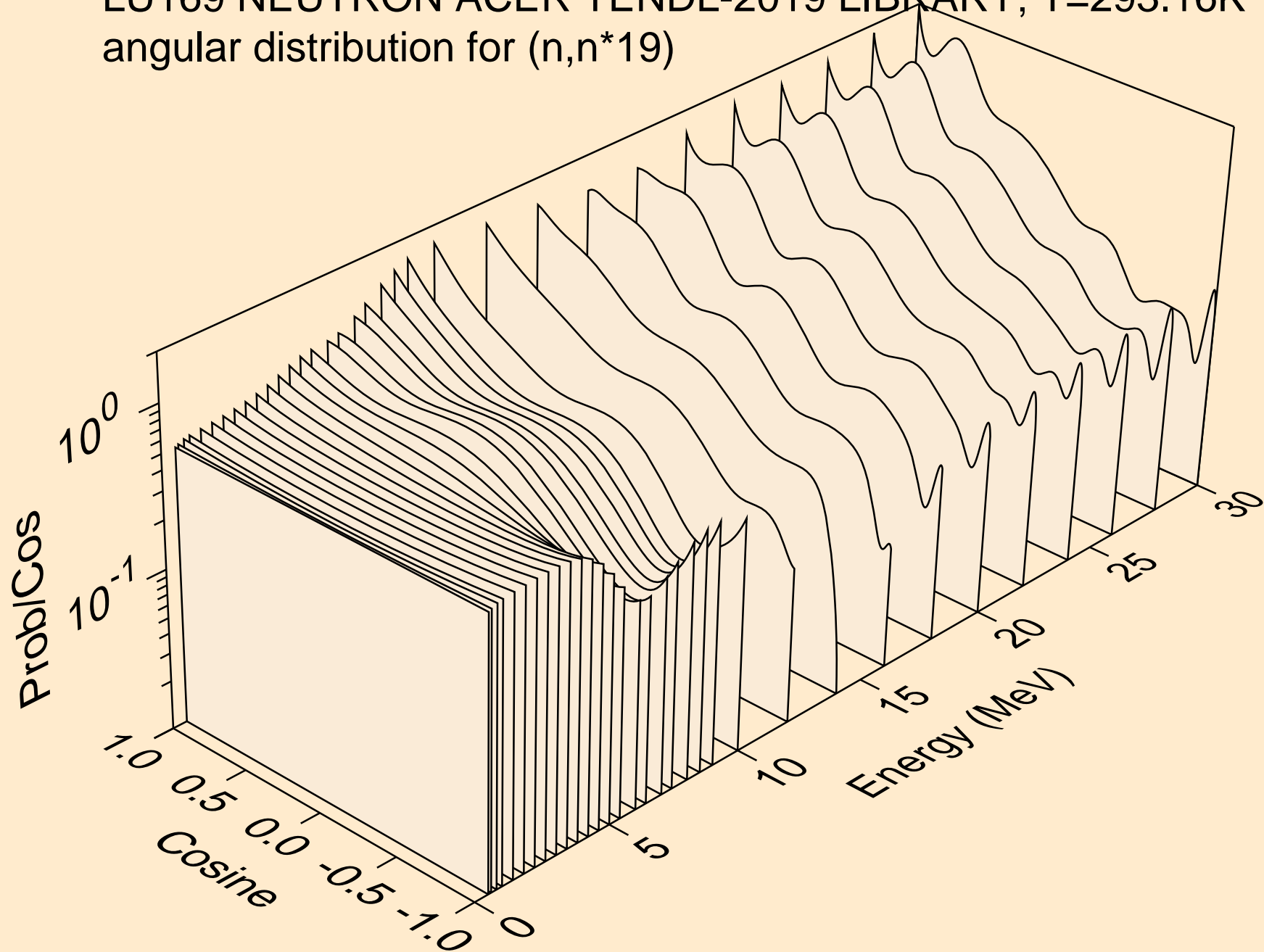

LU169 NEUTRON ACER TENDL-2019 LIBRARY; T=293.16K
angular distribution for (n,n*20)

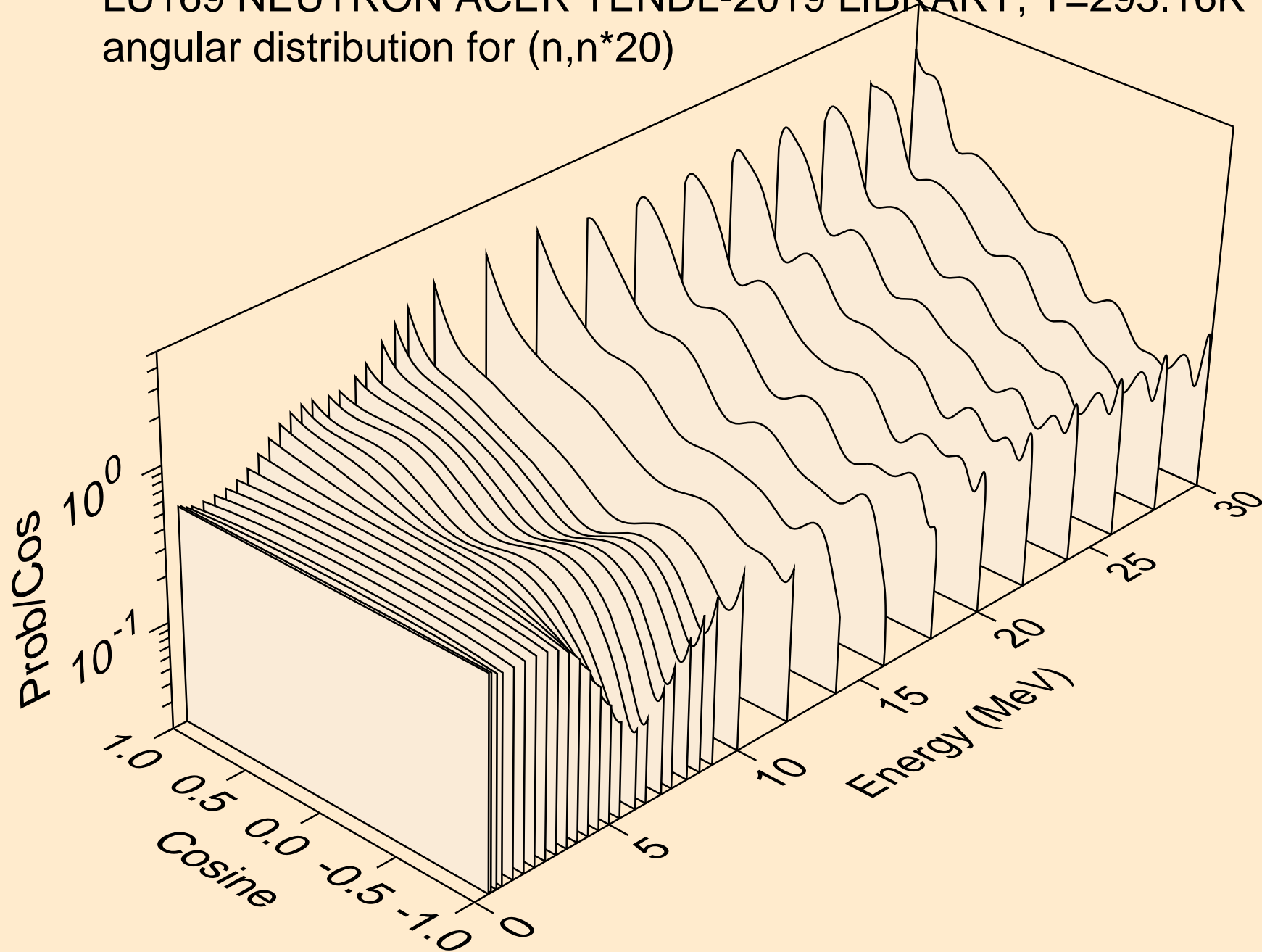

LU169 NEUTRON ACER TENDL-2019 LIBRARY; T=293.16K
angular distribution for (n,n*21)

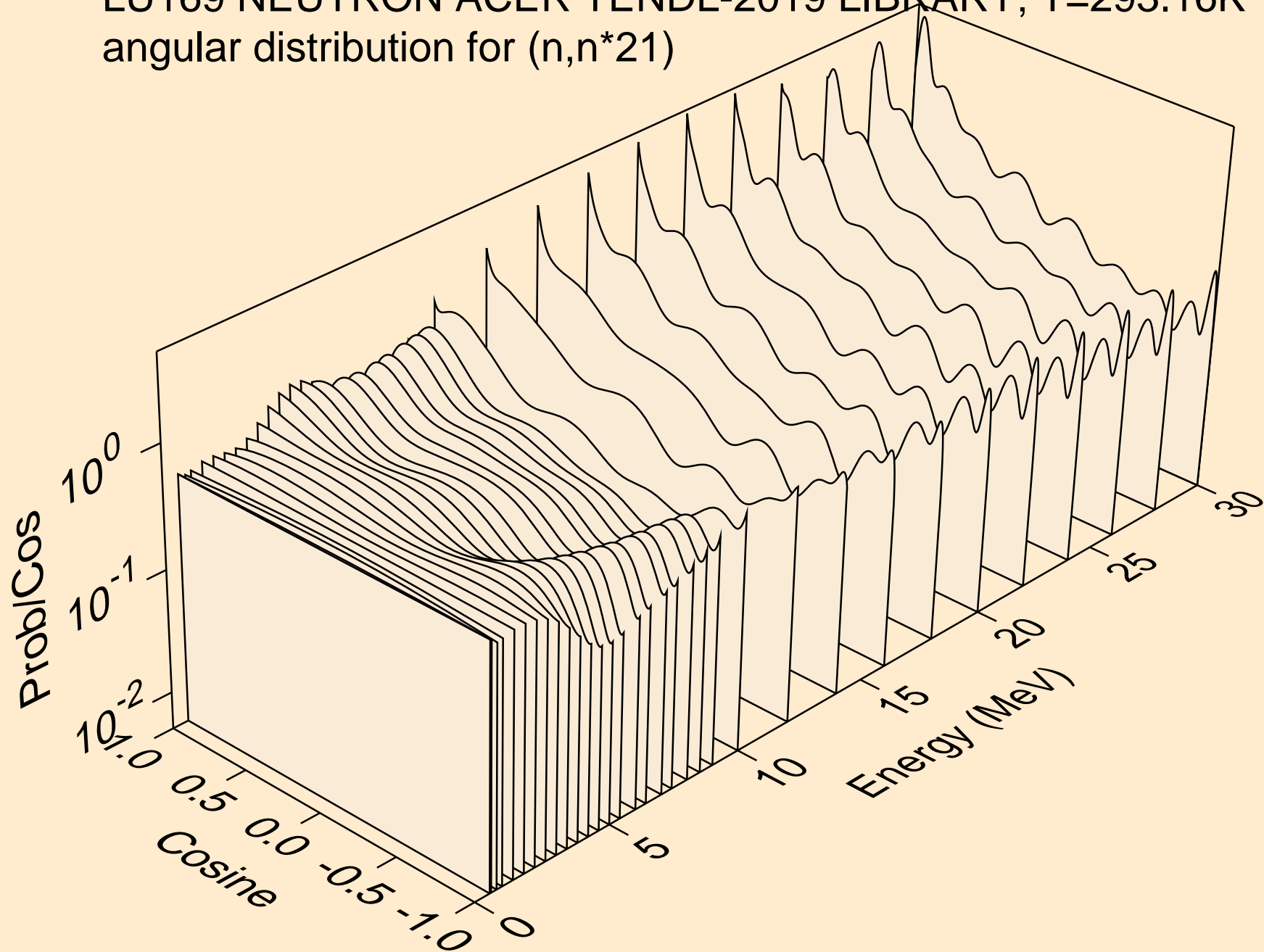

LU169 NEUTRON ACER TENDL-2019 LIBRARY; T=293.16K
angular distribution for (n,n*22)

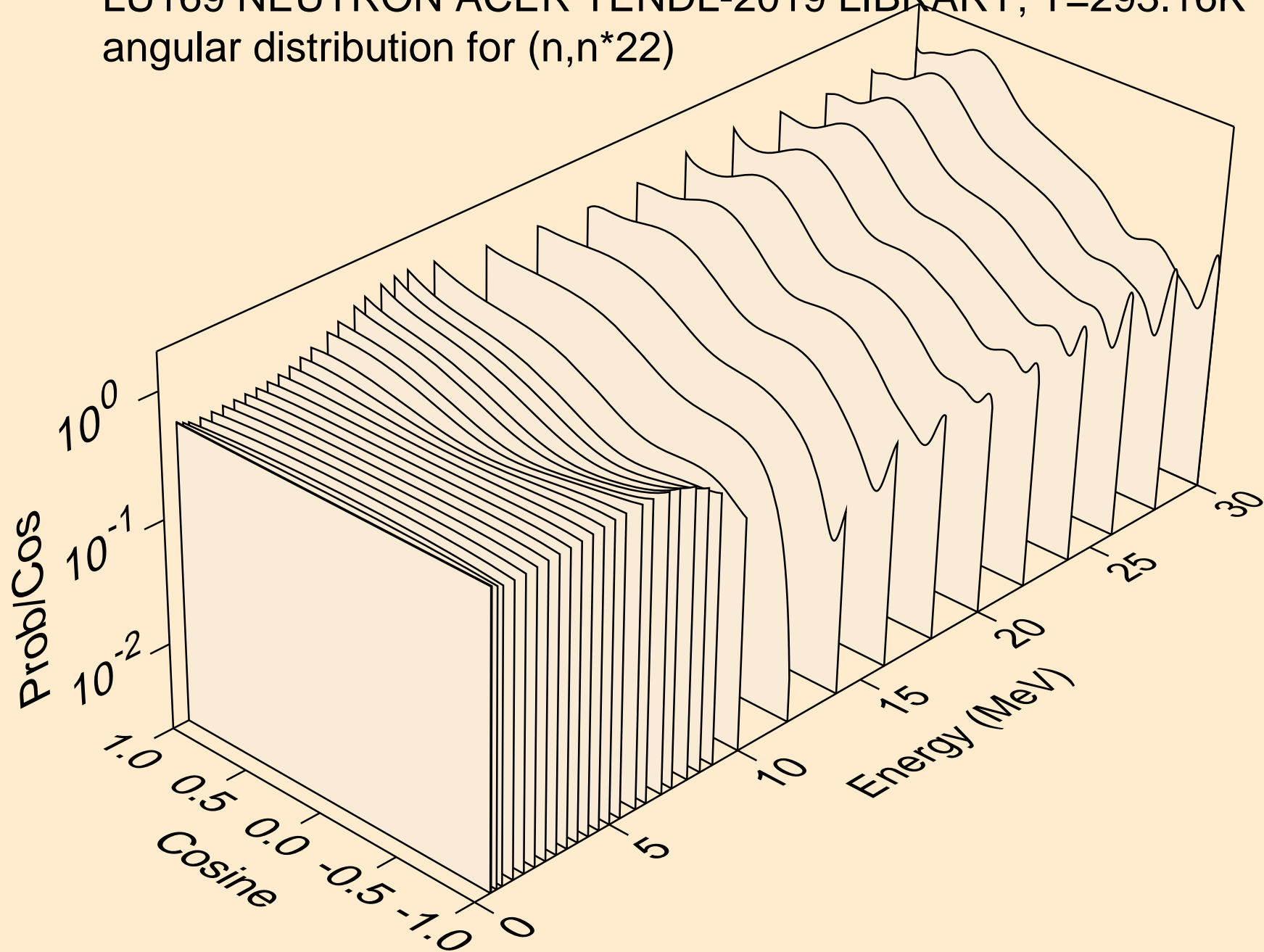

LU169 NEUTRON ACER TENDL-2019 LIBRARY; T=293.16K
angular distribution for (n,n*23)

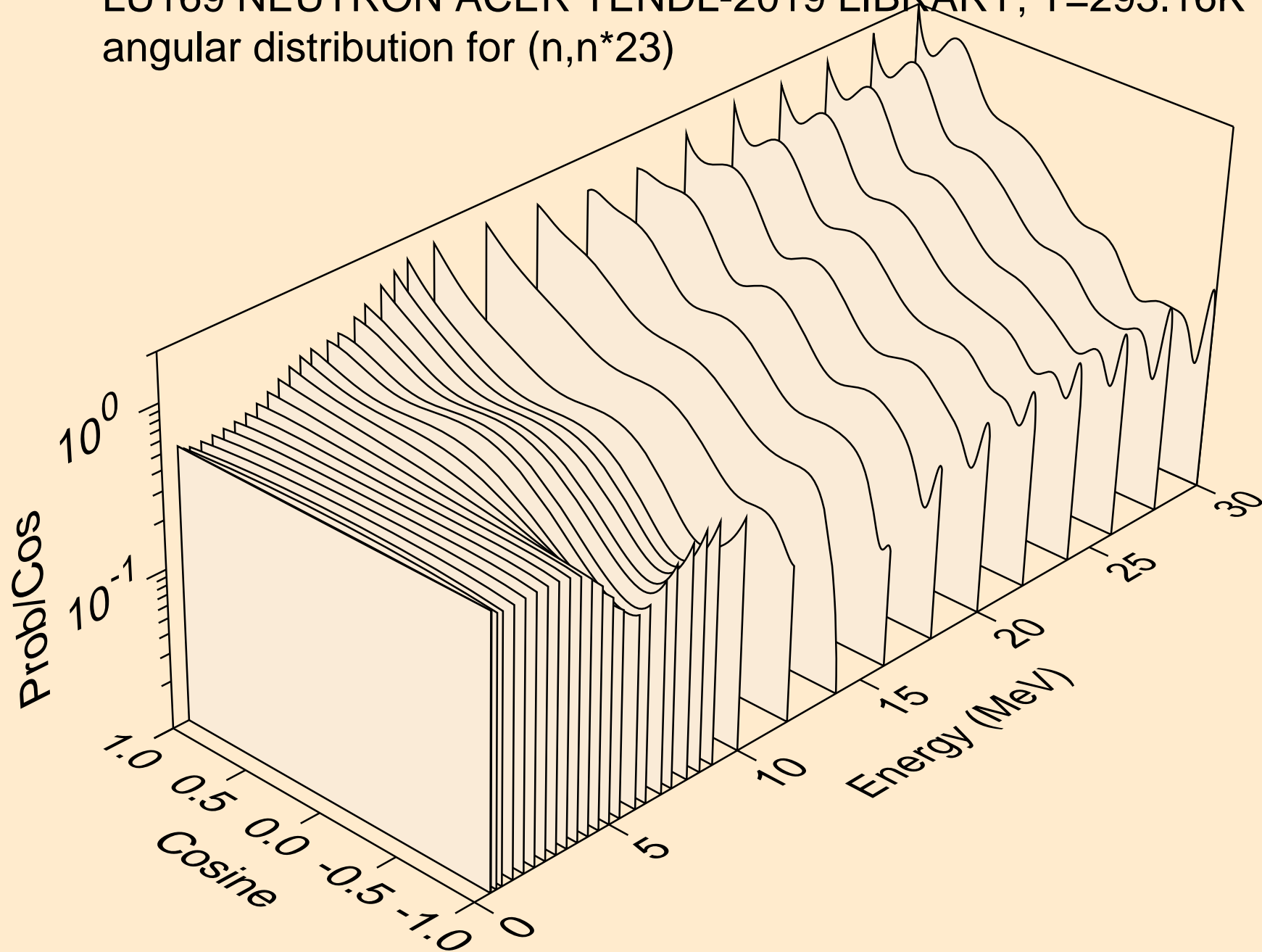

LU169 NEUTRON ACER TENDL-2019 LIBRARY; T=293.16K
angular distribution for (n,n*24)

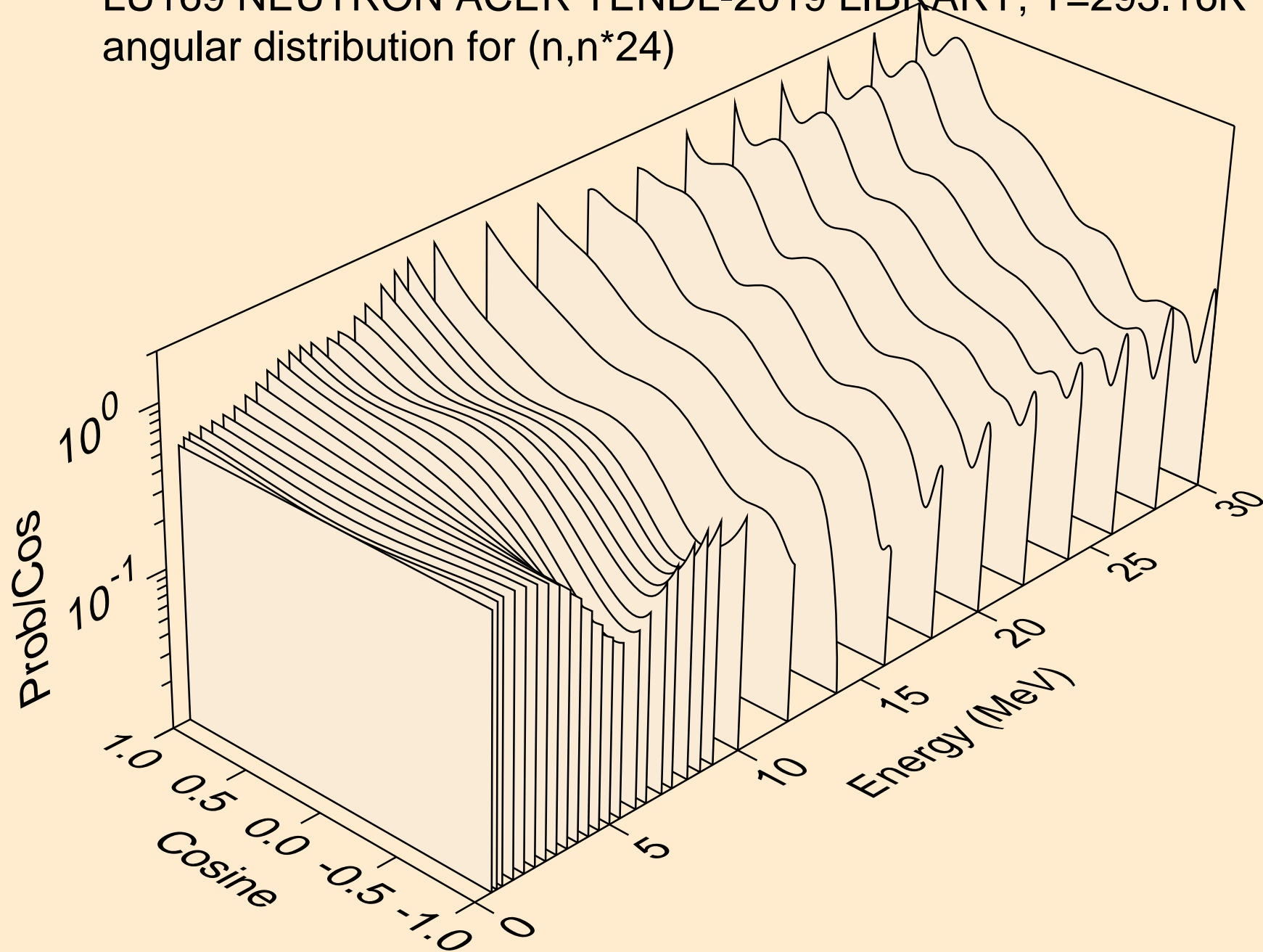

LU169 NEUTRON ACER TENDL-2019 LIBRARY; T=293.16K
angular distribution for (n,n*25)

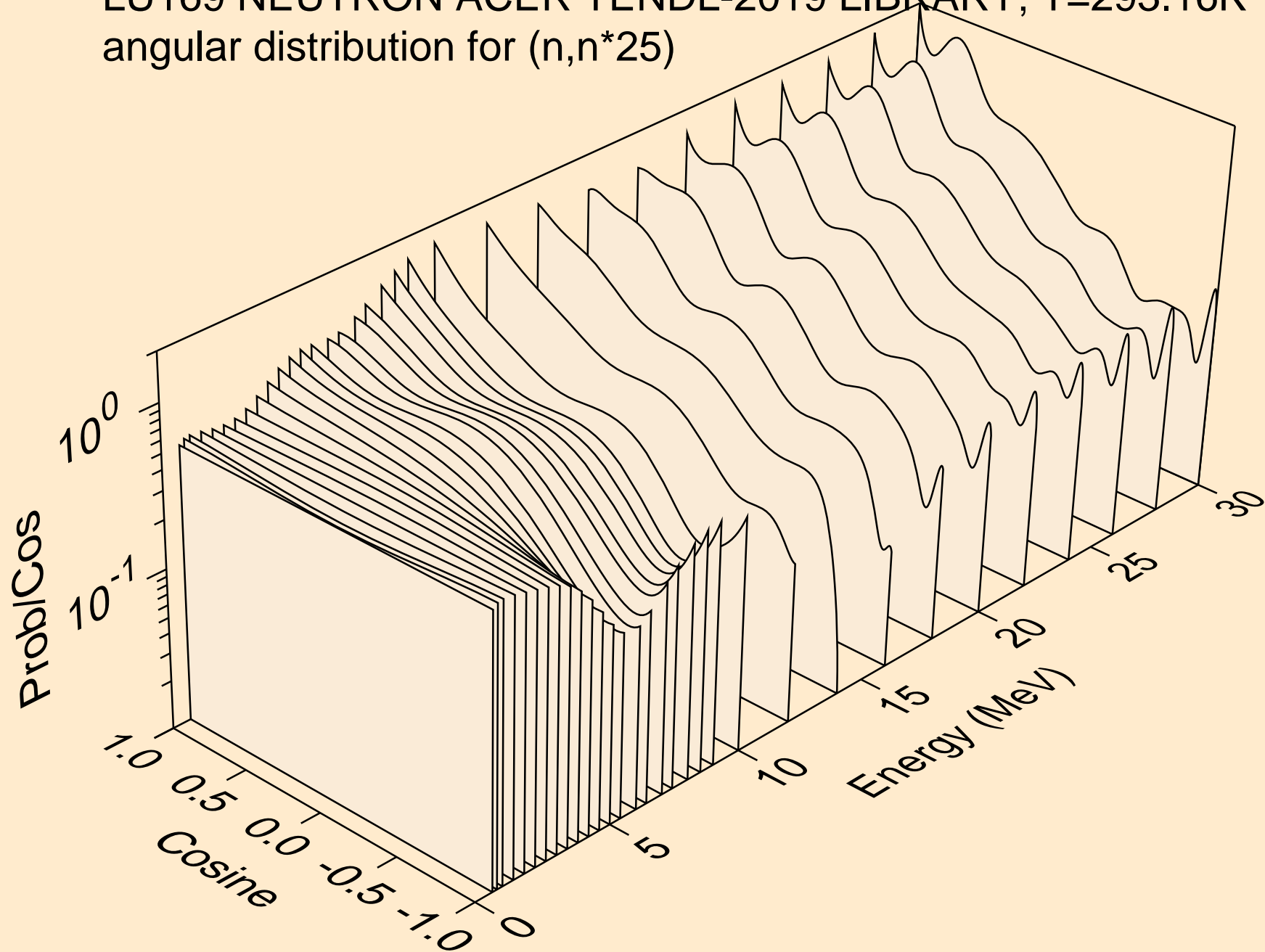

LU169 NEUTRON ACER TENDL-2019 LIBRARY; T=293.16K
angular distribution for (n,n*26)

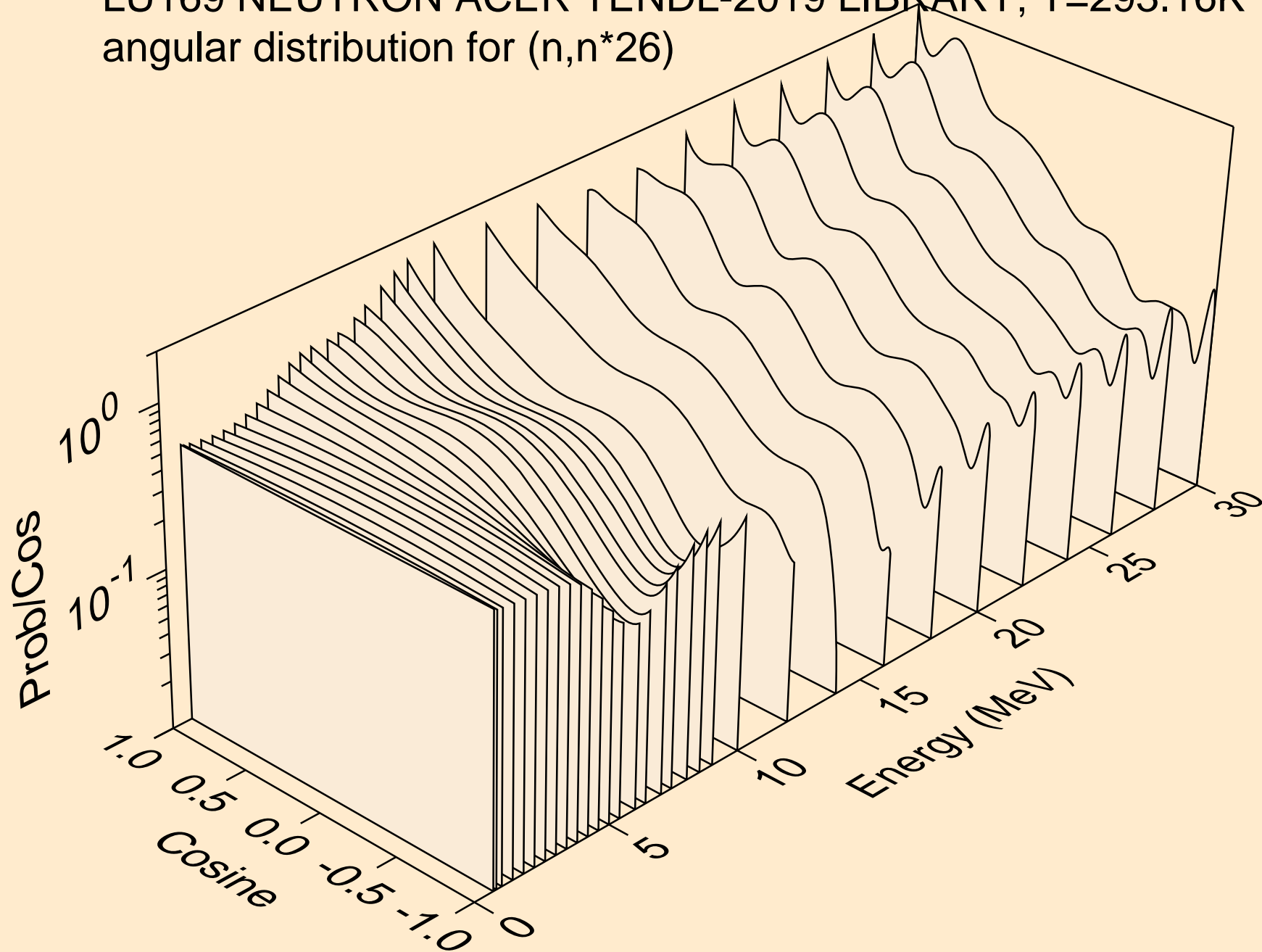

LU169 NEUTRON ACER TENDL-2019 LIBRARY; T=293.16K
angular distribution for (n,n*27)

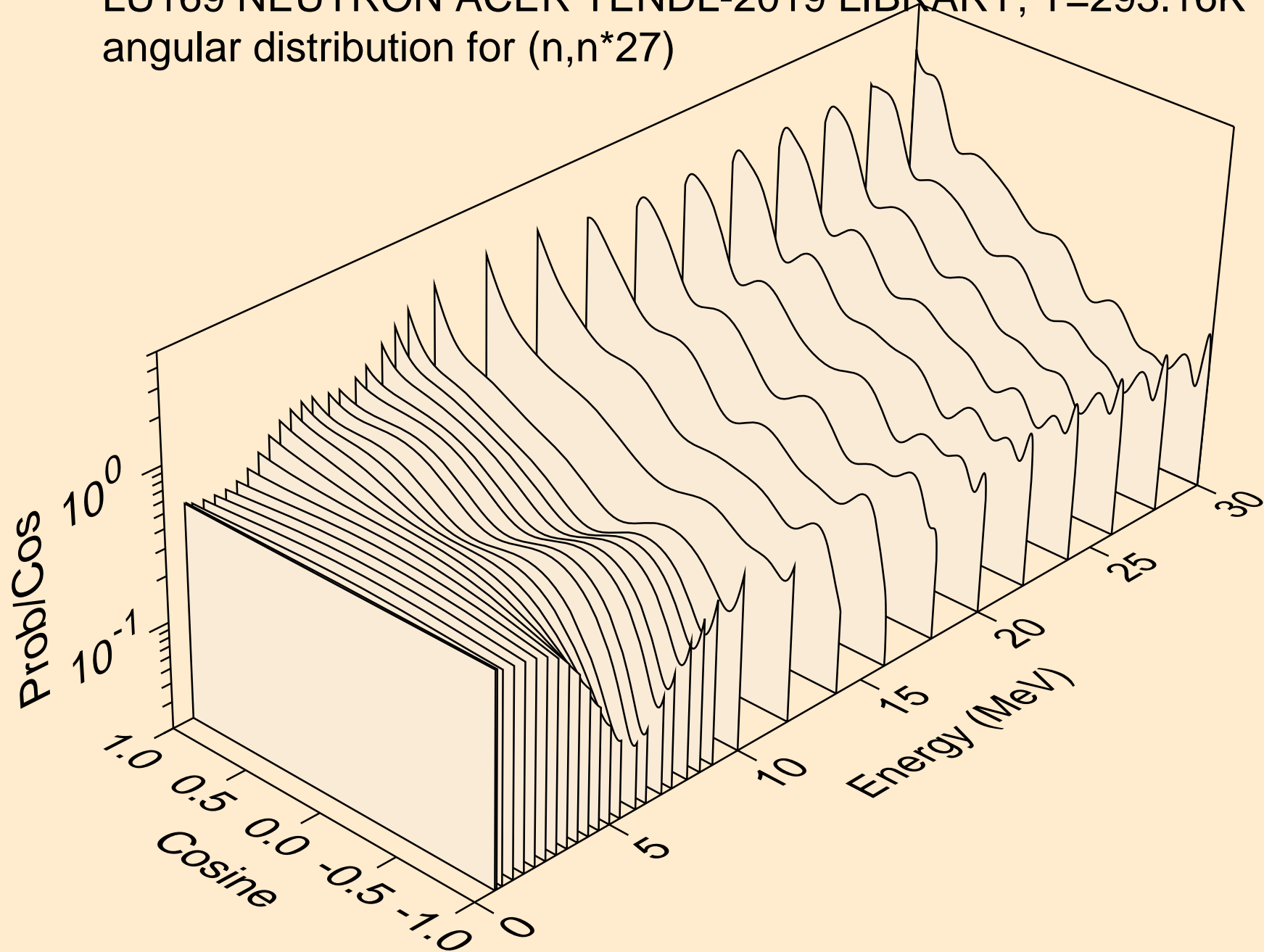

LU169 NEUTRON ACER TENDL-2019 LIBRARY; T=293.16K
angular distribution for (n,n*28)

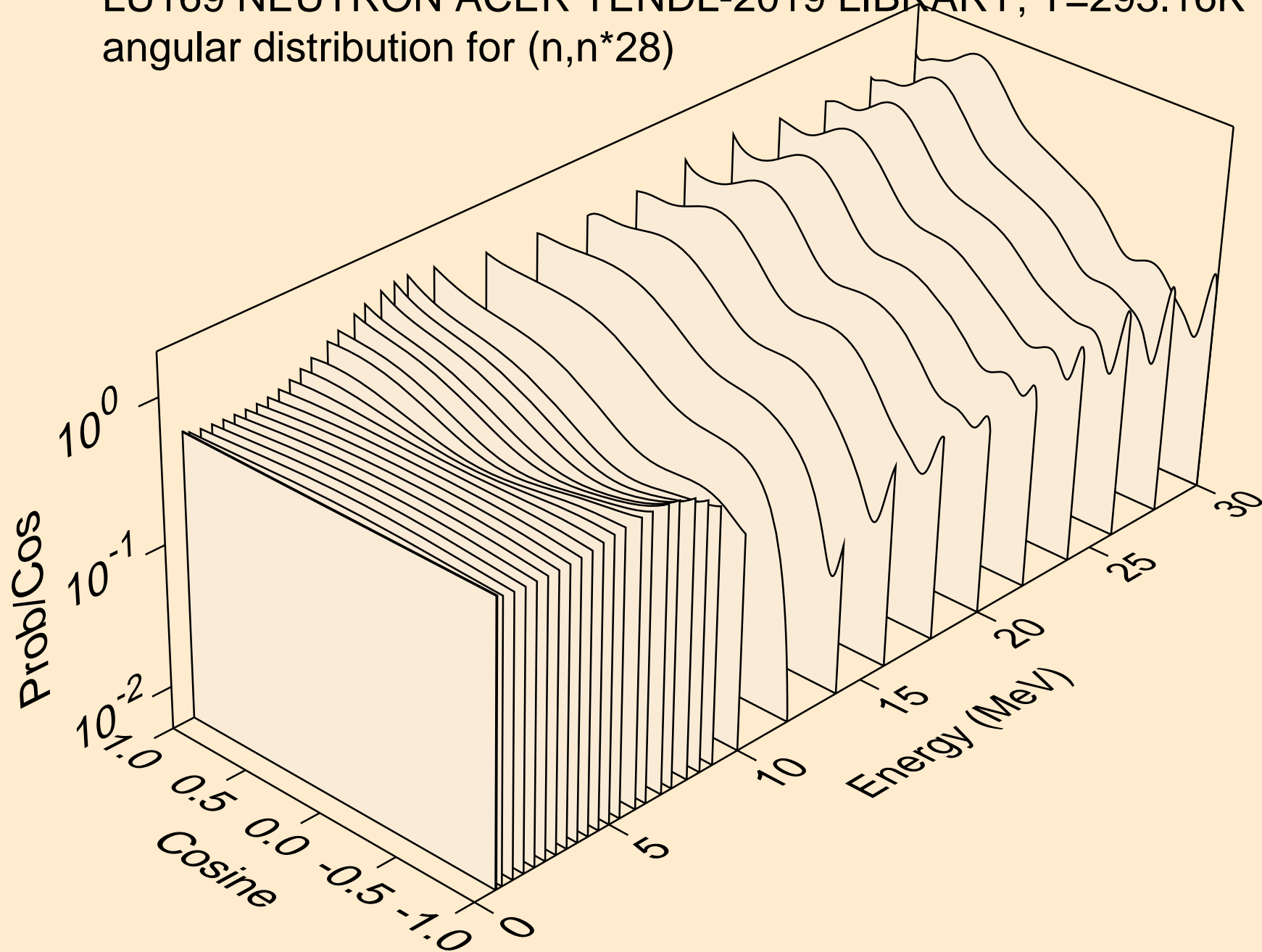

LU169 NEUTRON ACER TENDL-2019 LIBRARY; T=293.16K
Neutron emission for (n,x)

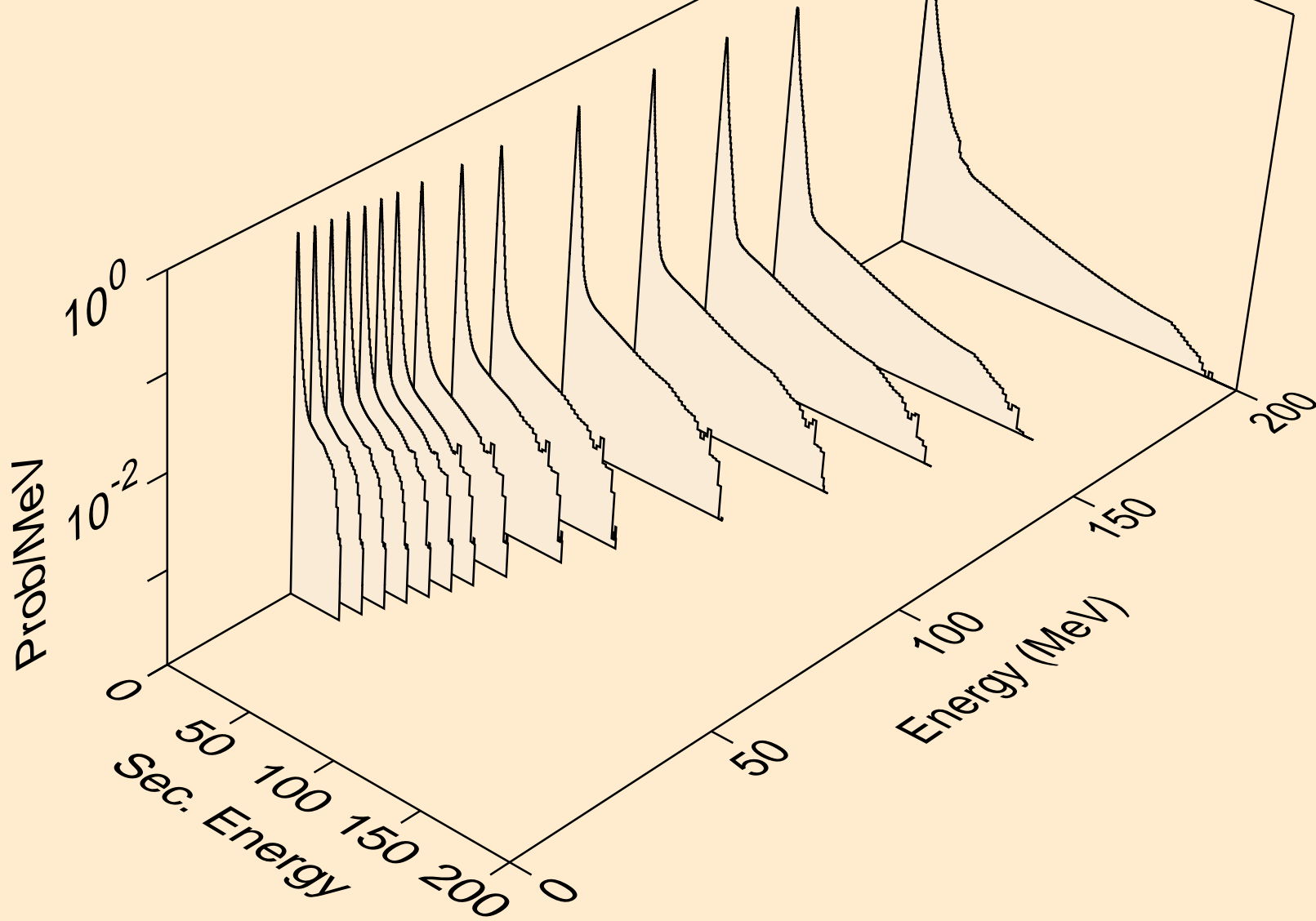

LU169 NEUTRON ACER TENDL-2019 LIBRARY; T=293.16K
Neutron emission for (n,2nd)

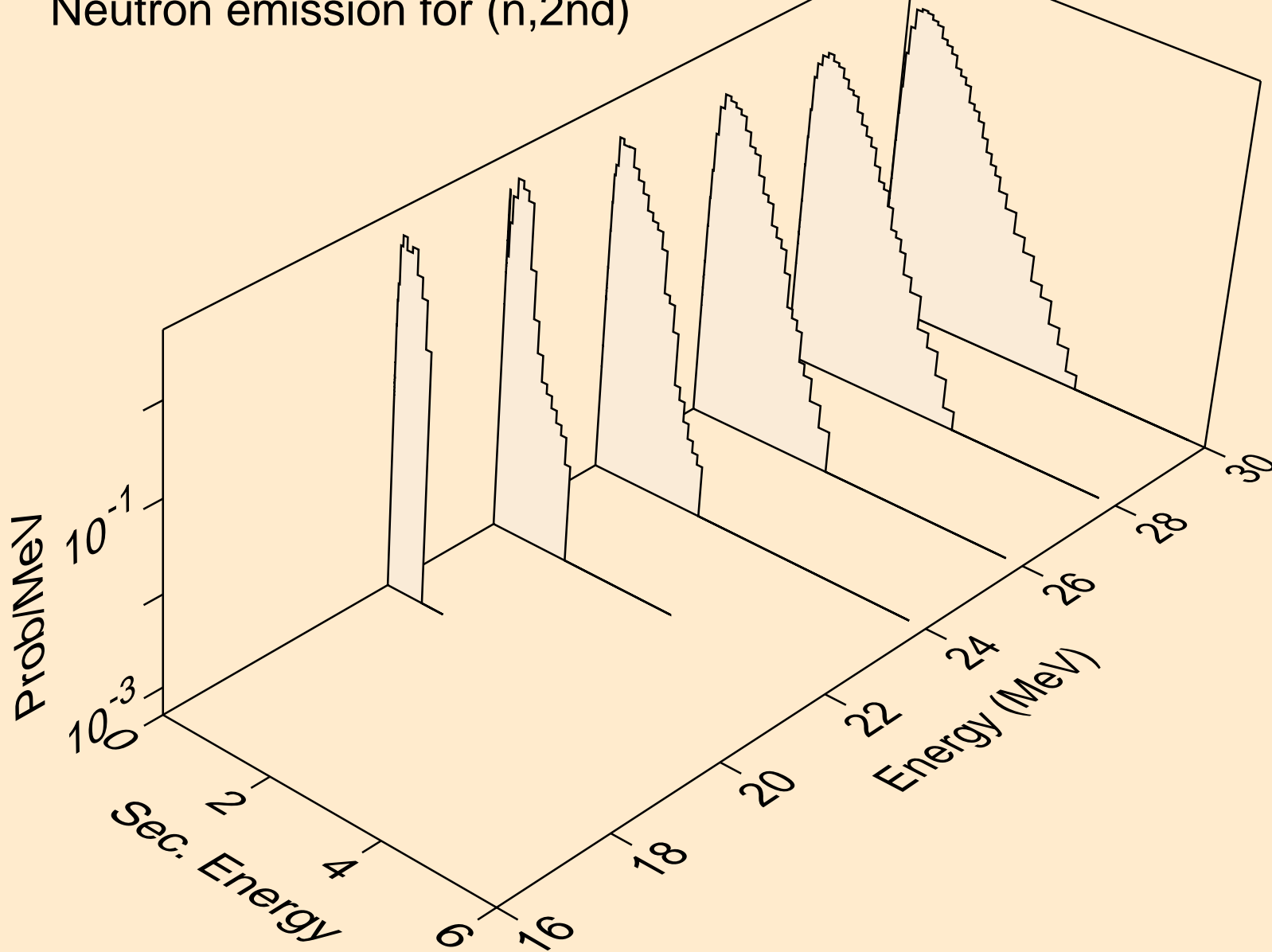

LU169 NEUTRON ACER TENDL-2019 LIBRARY; T=293.16K
Neutron emission for (n,2n)

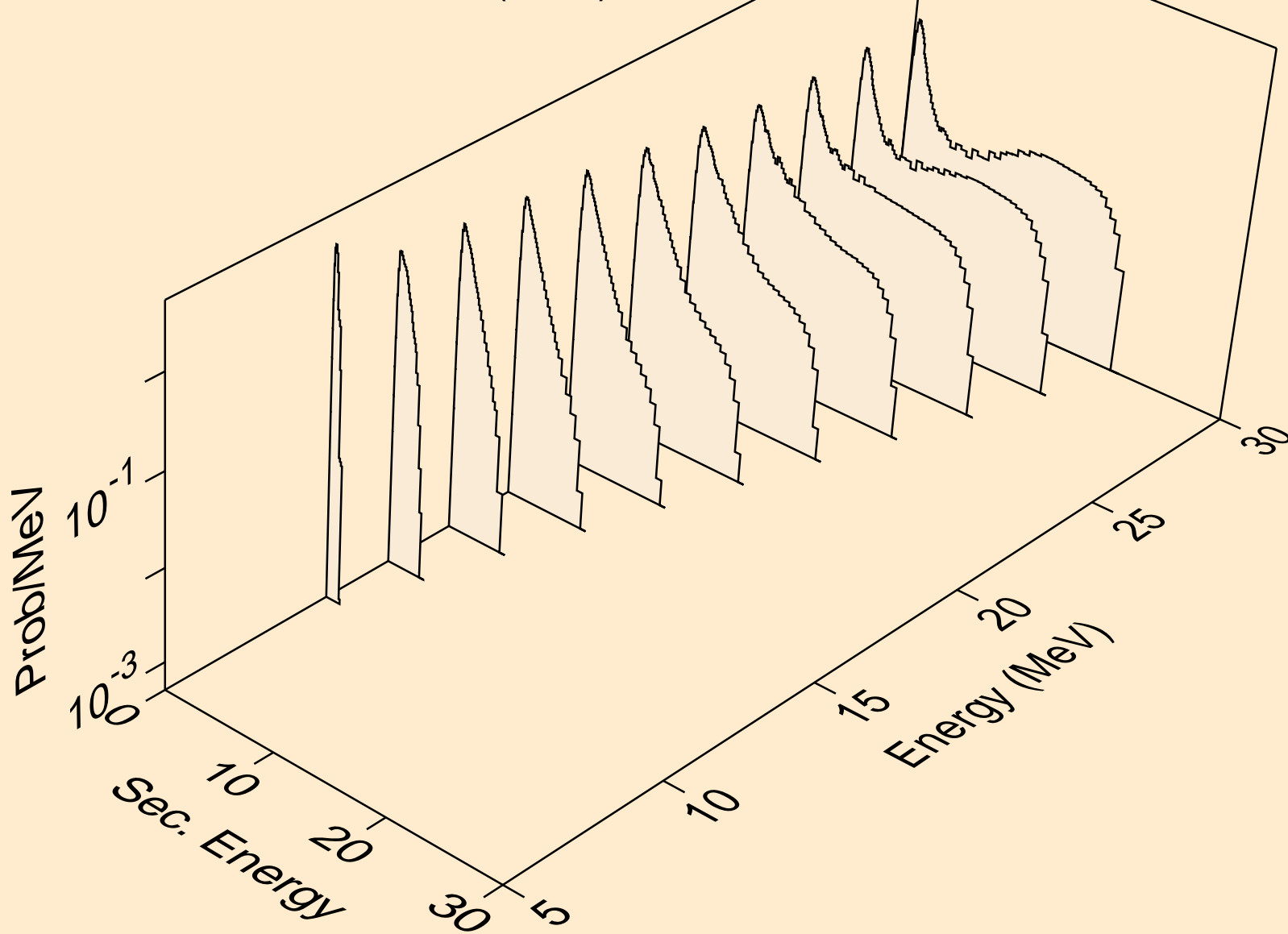

LU169 NEUTRON ACER TENDL-2019 LIBRARY; T=293.16K
Neutron emission for (n,3n)

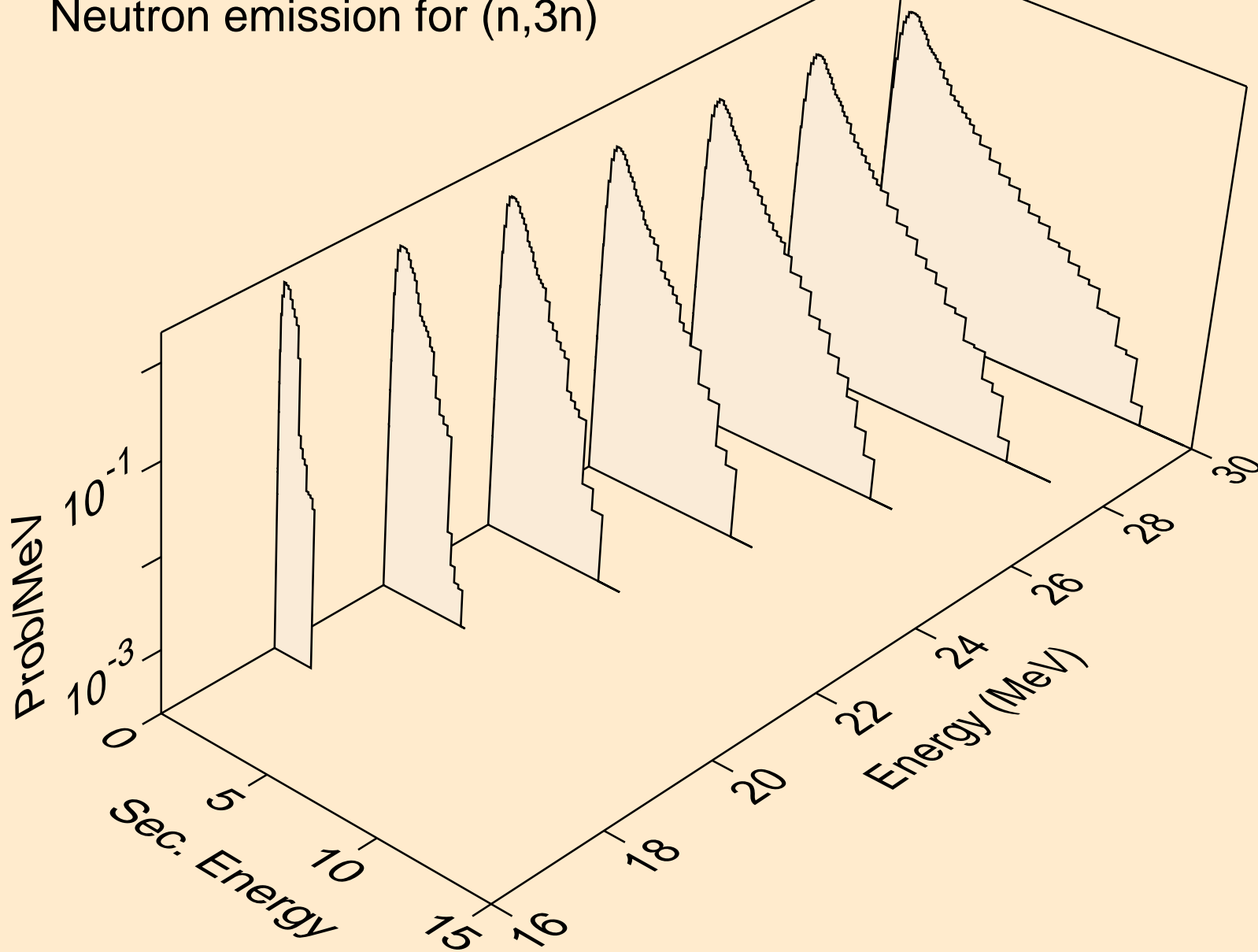

LU169 NEUTRON ACER TENDL-2019 LIBRARY; T=293.16K
Neutron emission for (n,n*)a

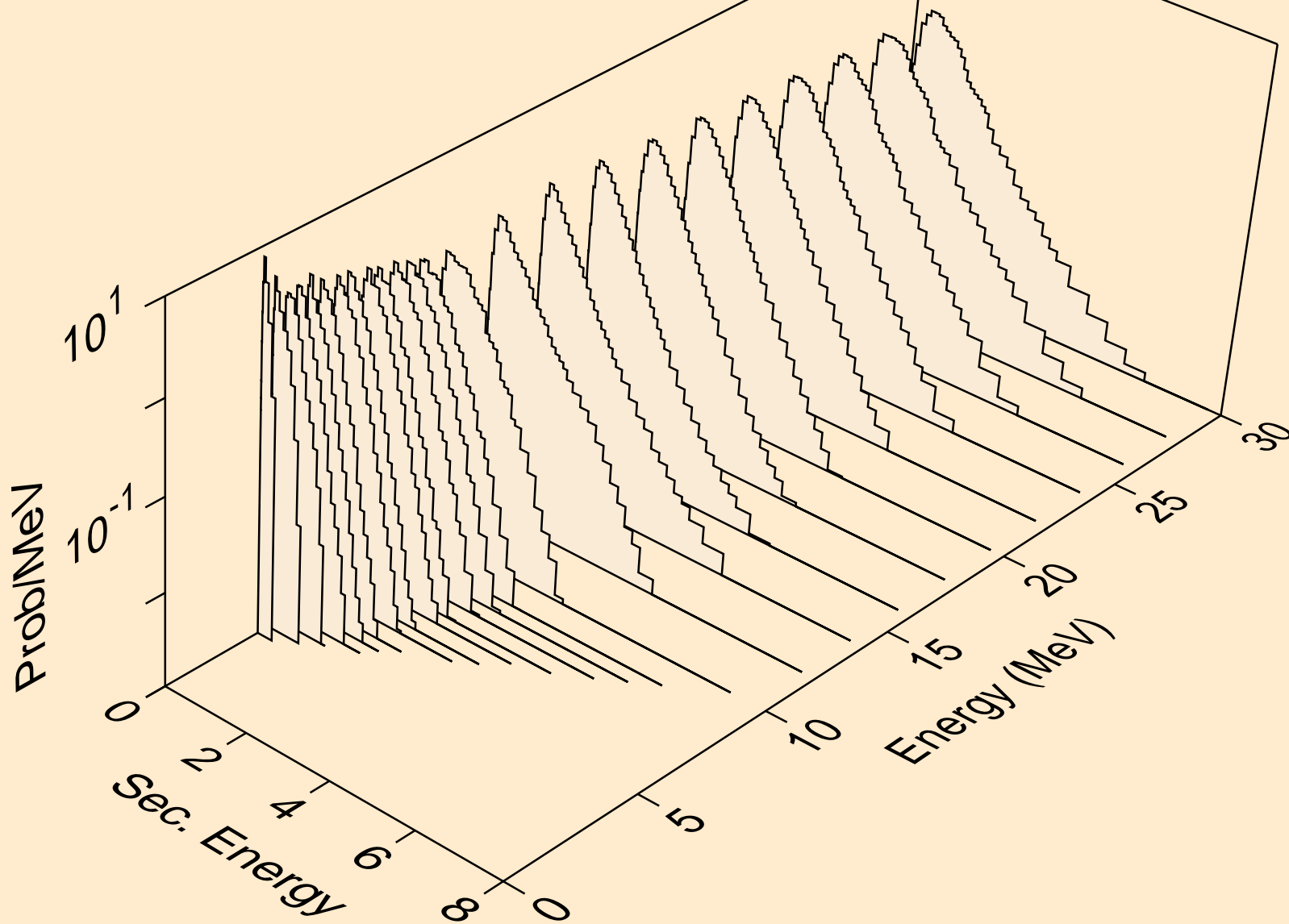

LU169 NEUTRON ACER TENDL-2019 LIBRARY; T=293.16K
Neutron emission for (n,2n)a

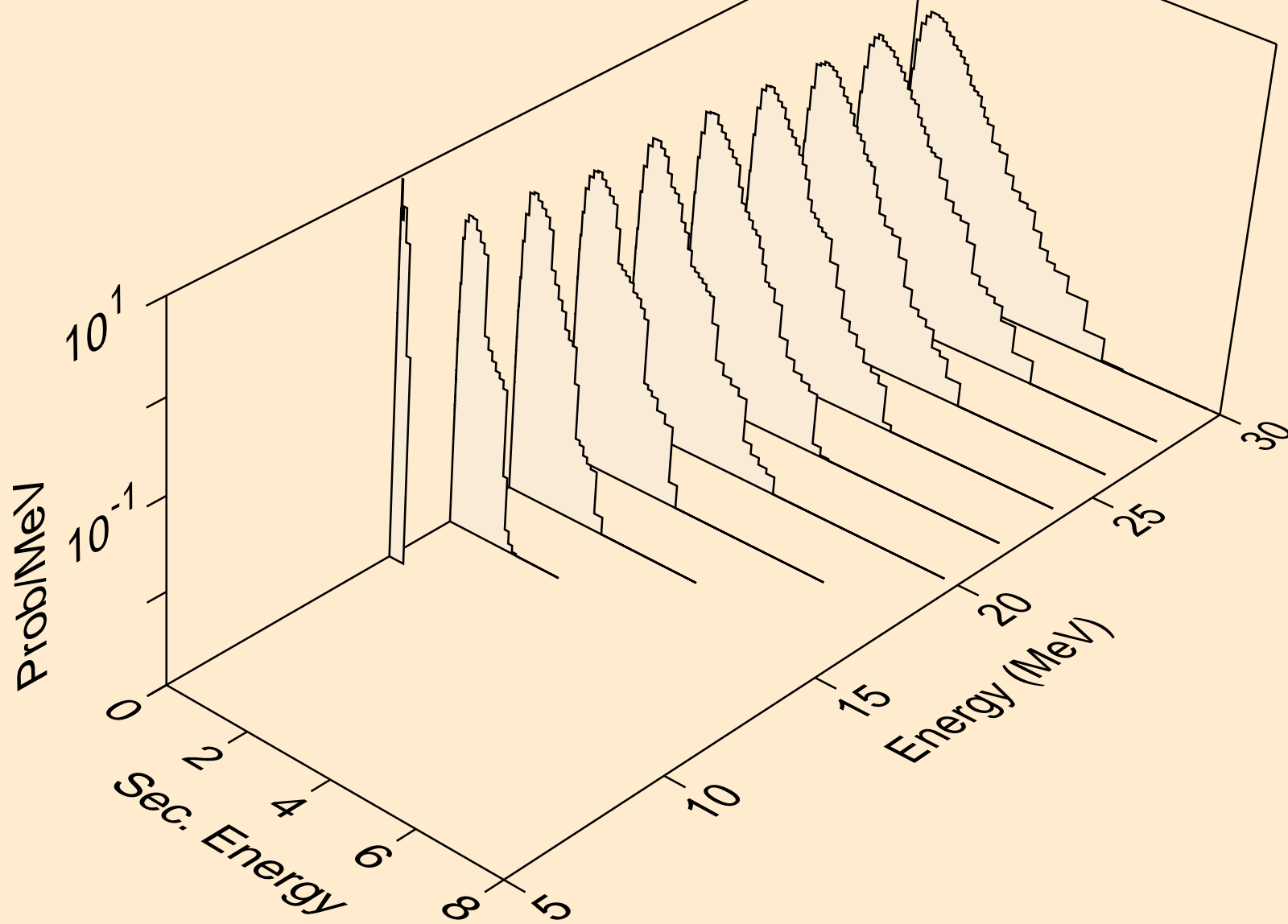

LU169 NEUTRON ACER TENDL-2019 LIBRARY; T=293.16K
Neutron emission for (n,3n)a

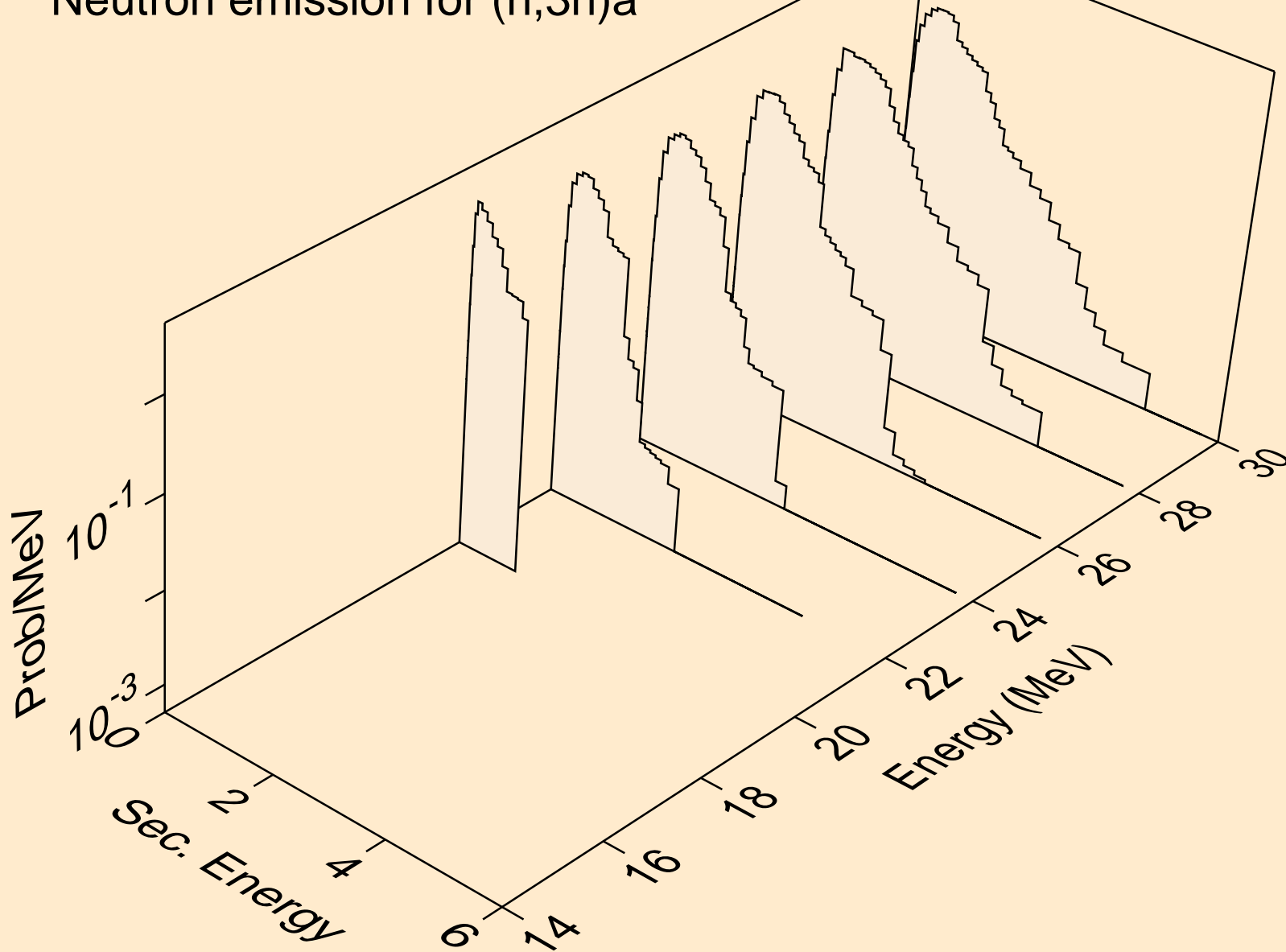

LU169 NEUTRON ACER TENDL-2019 LIBRARY; T=293.16K
Neutron emission for (n,n*)p

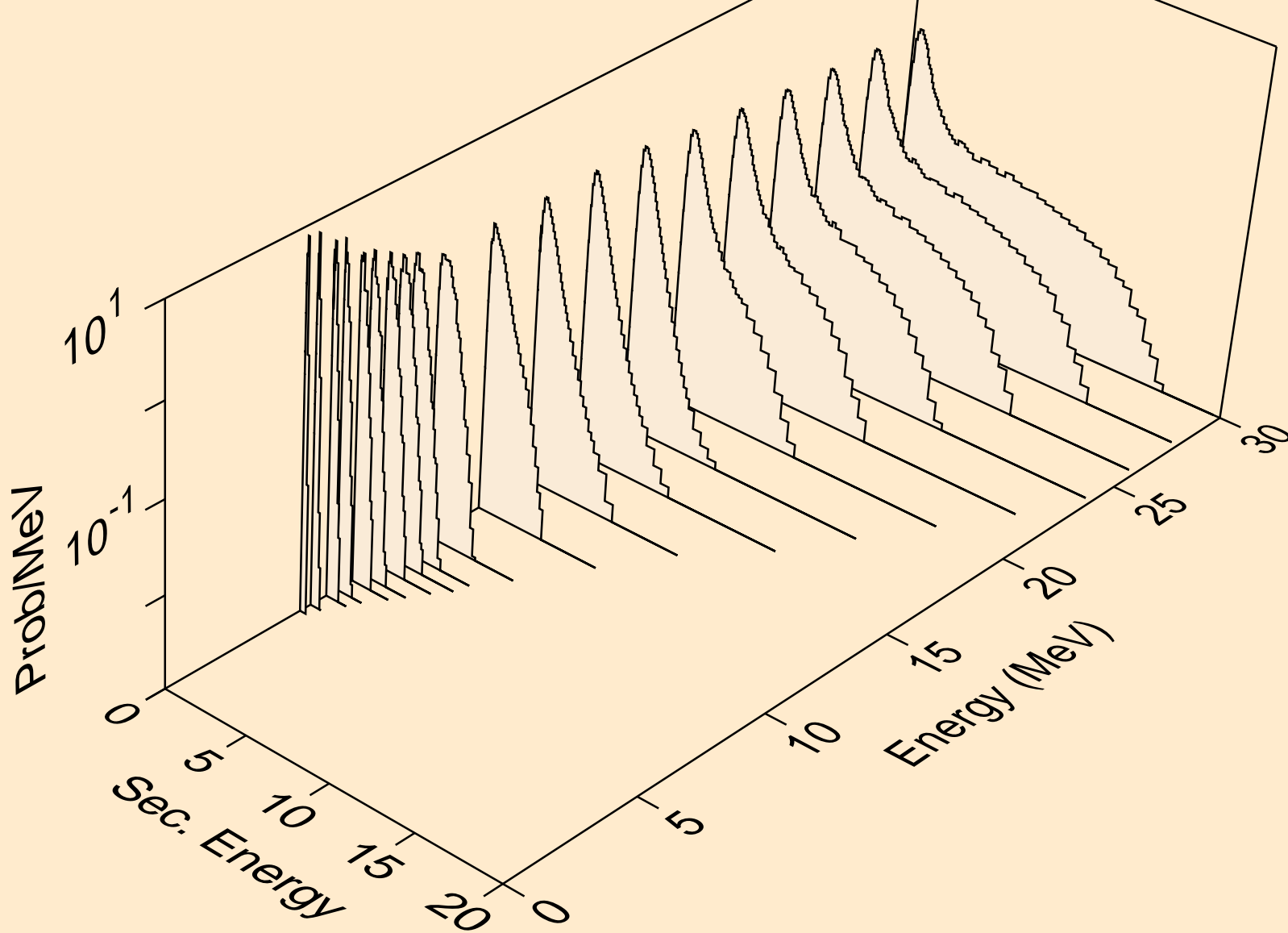

LU169 NEUTRON ACER TENDL-2019 LIBRARY; T=293.16K
Neutron emission for (n,n*)2a

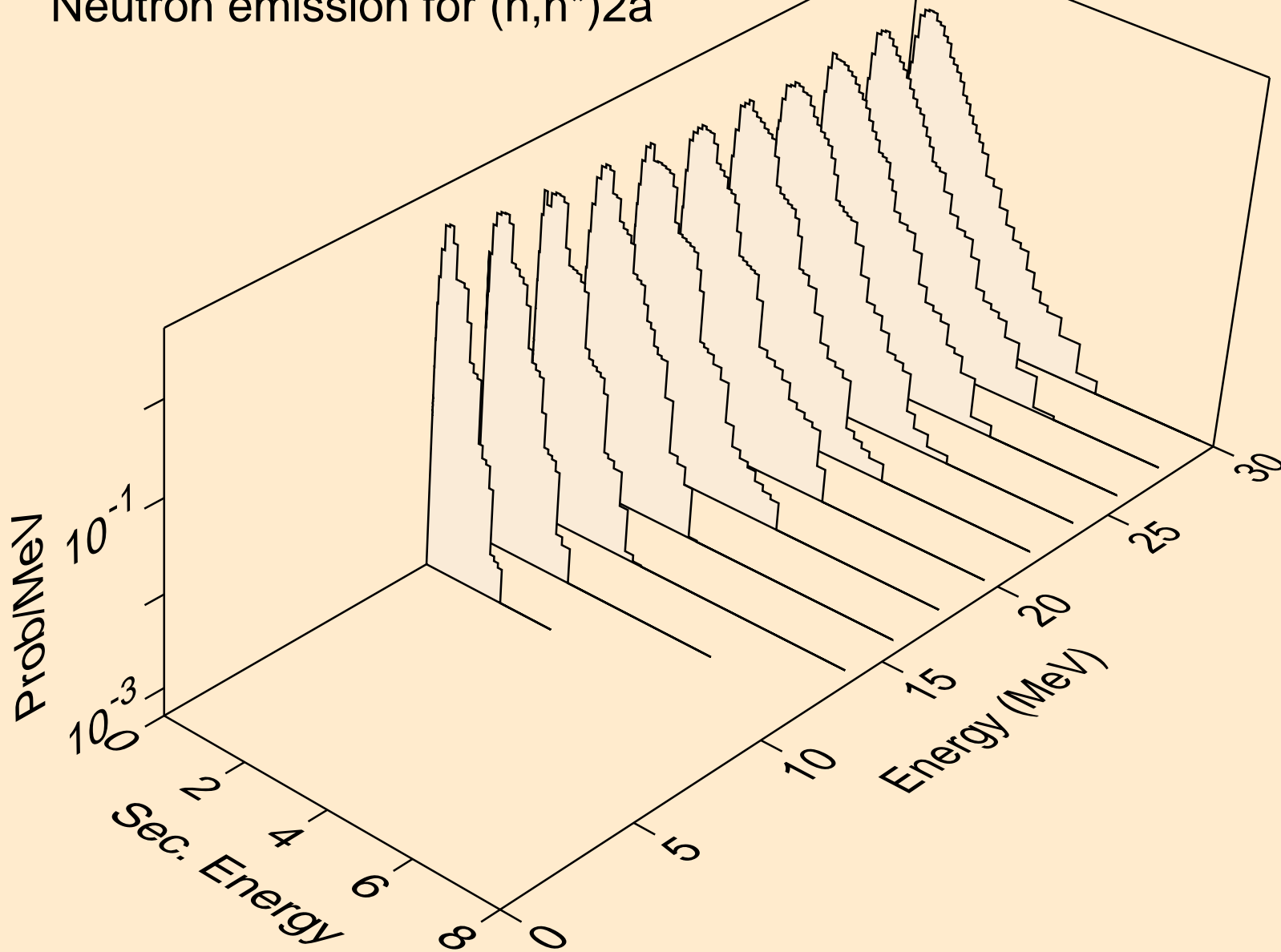

LU169 NEUTRON ACER TENDL-2019 LIBRARY; T=293.16K
Neutron emission for (n,n*)d

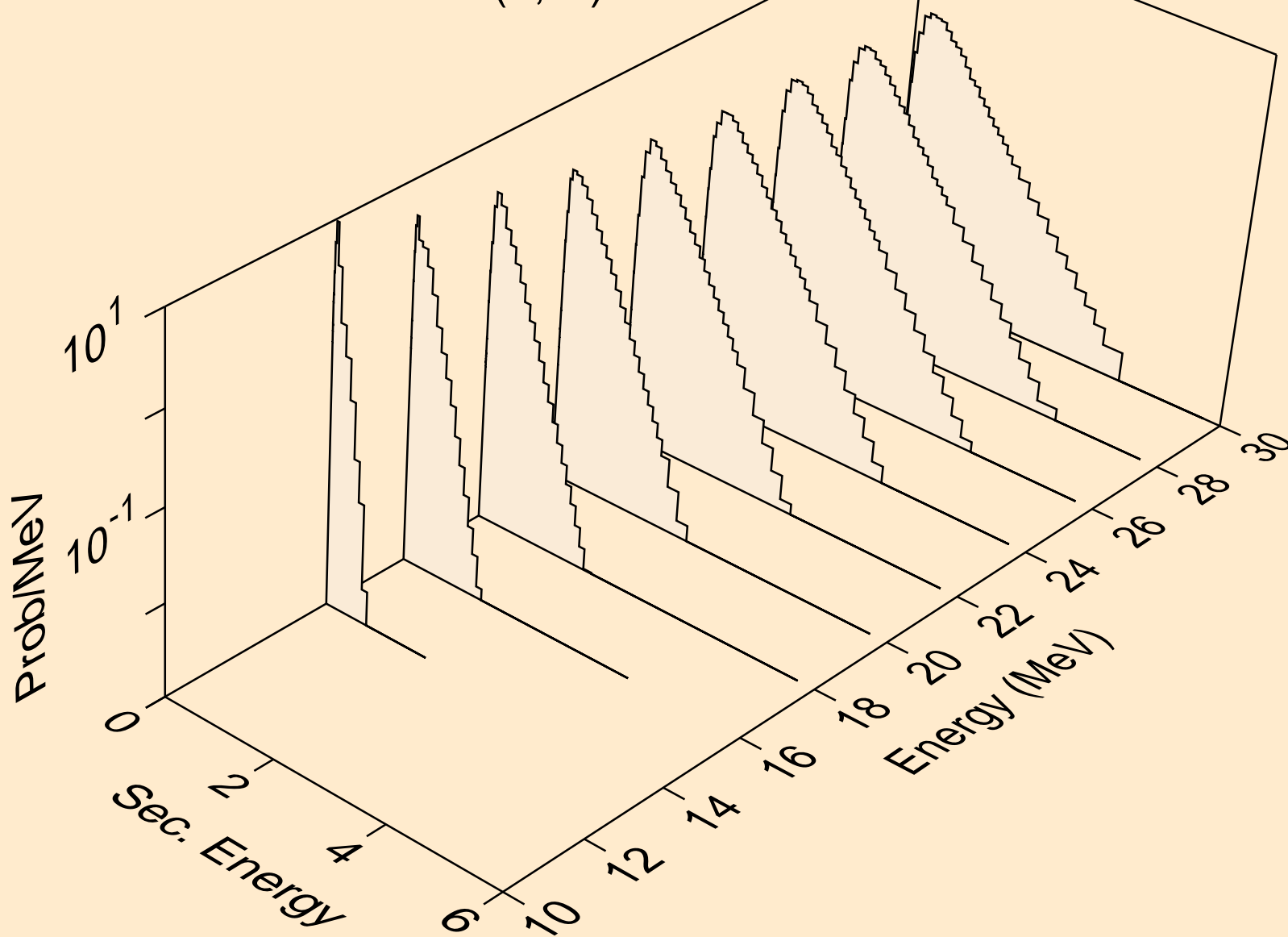

LU169 NEUTRON ACER TENDL-2019 LIBRARY; T=293.16K
Neutron emission for (n,n*)t

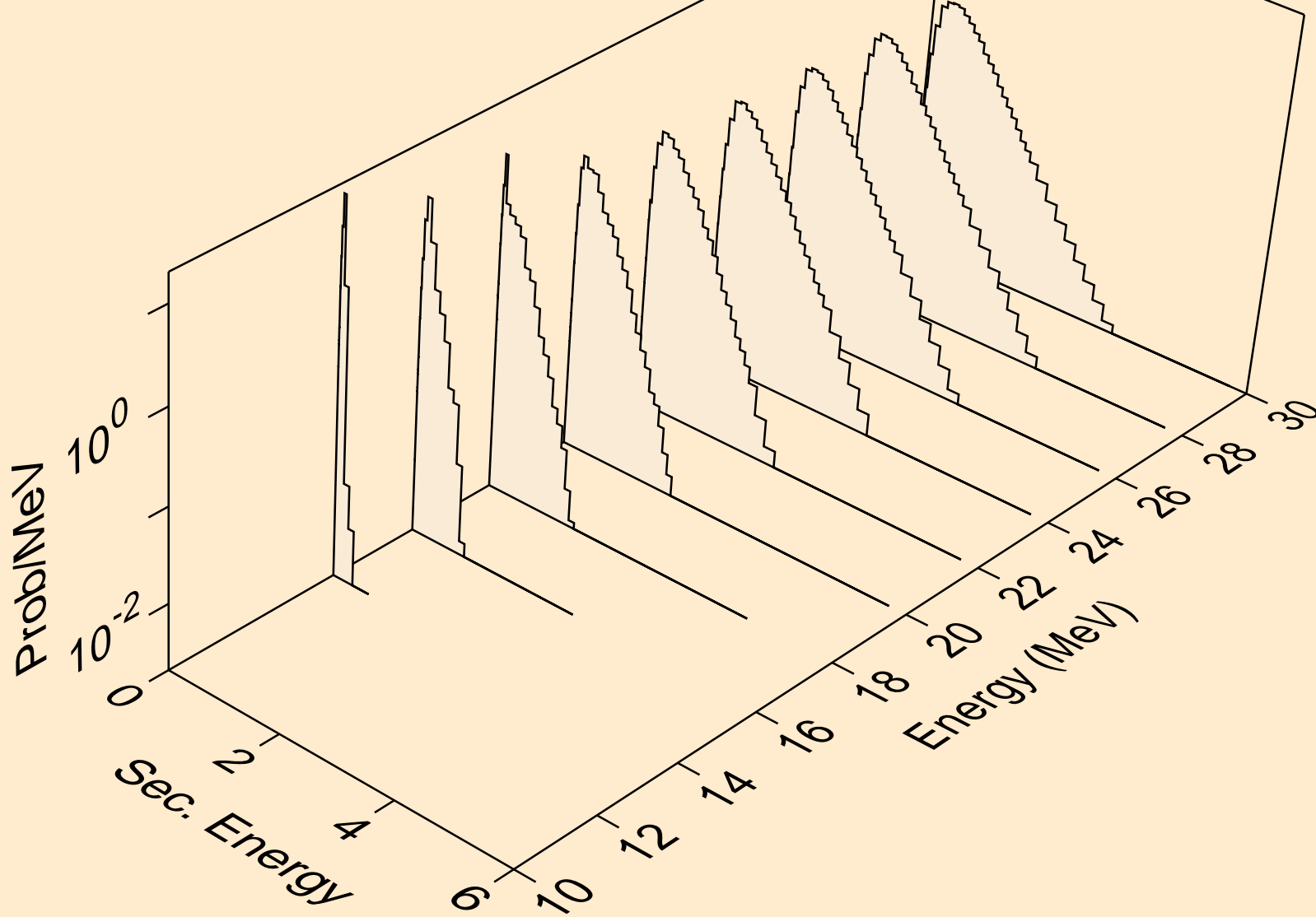

LU169 NEUTRON ACER TENDL-2019 LIBRARY; T=293.16K
Neutron emission for (n,n*)he3

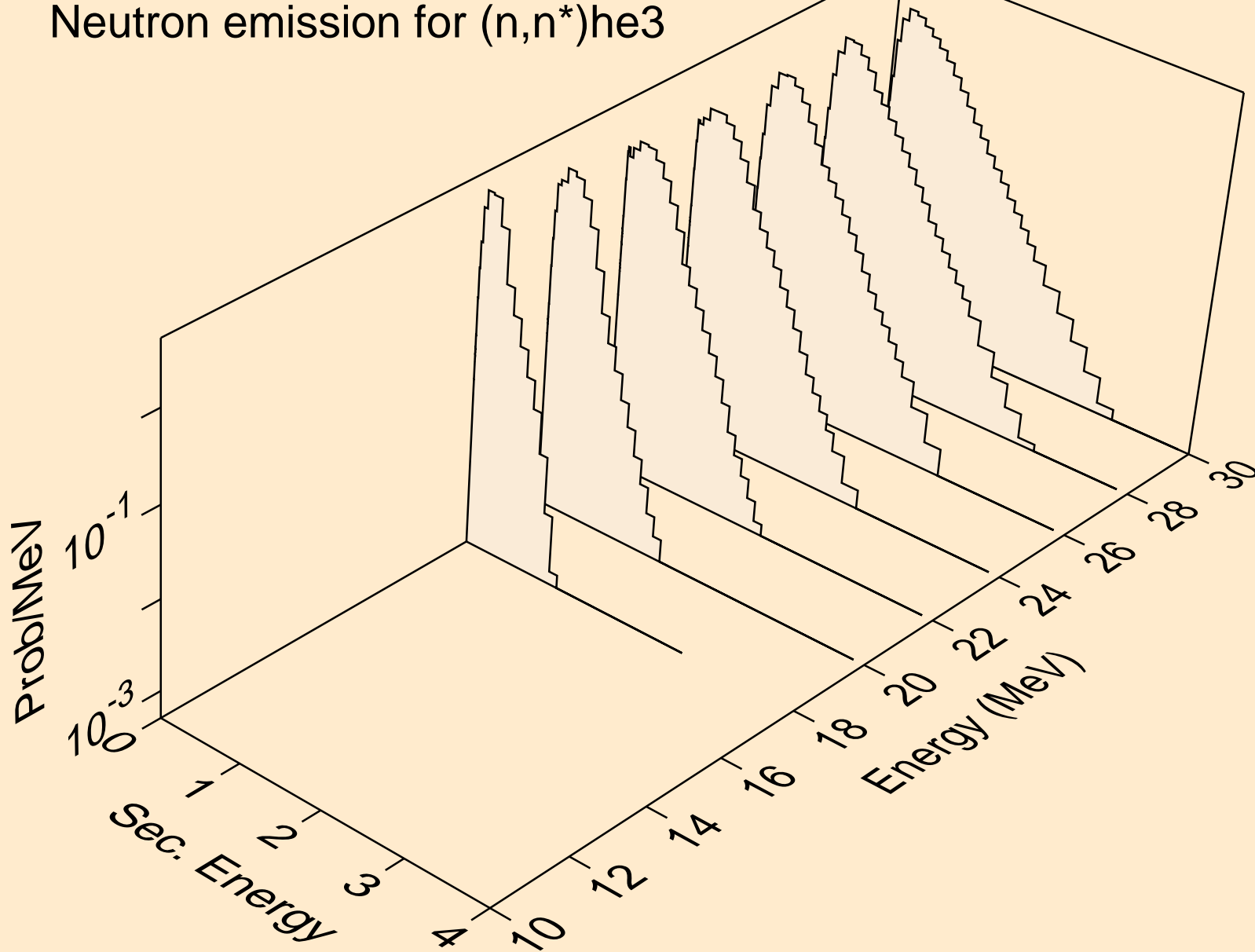

LU169 NEUTRON ACER TENDL-2019 LIBRARY; T=293.16K
Neutron emission for (n,4n)

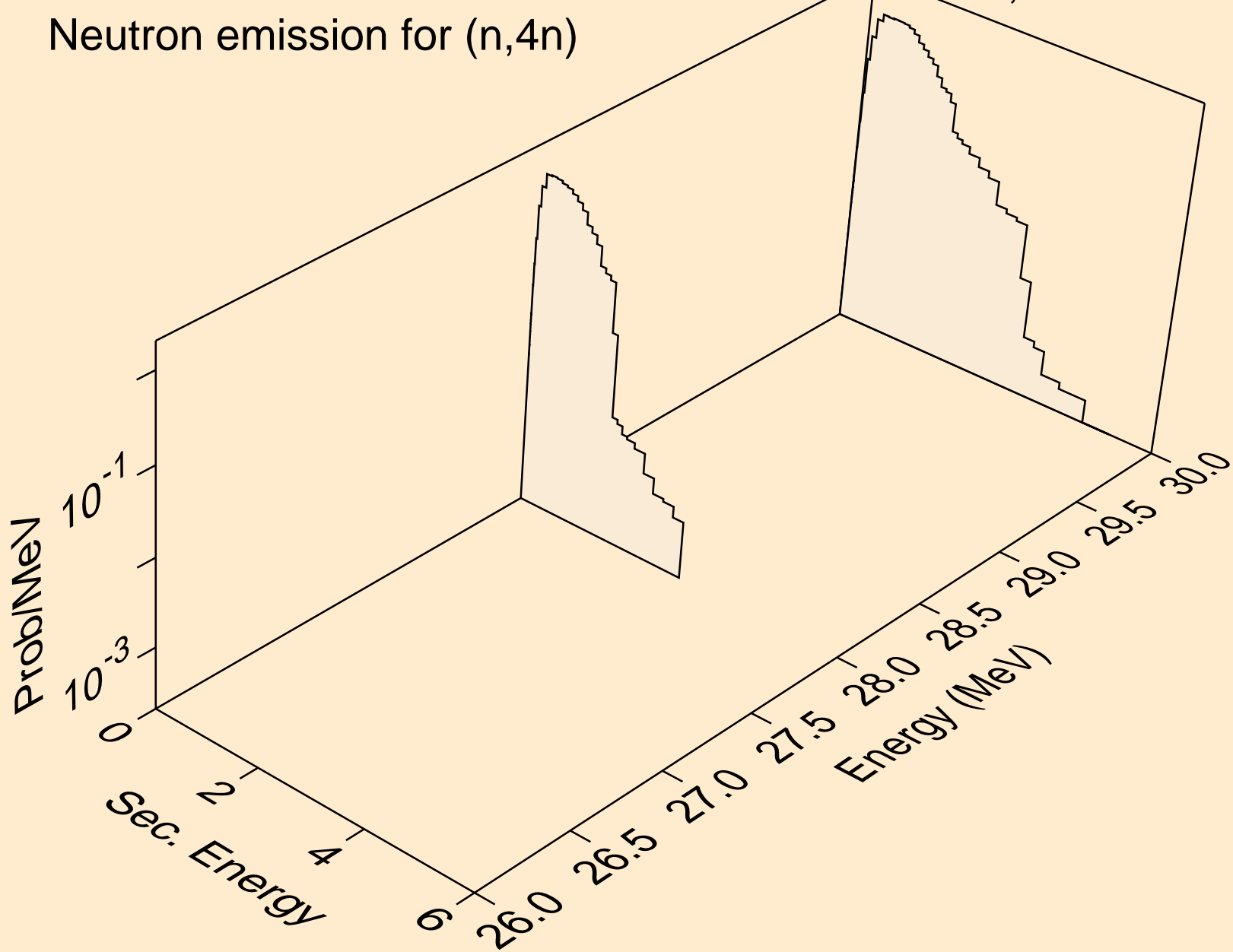

LU169 NEUTRON ACER TENDL-2019 LIBRARY; T=293.16K
Neutron emission for (n,2np)

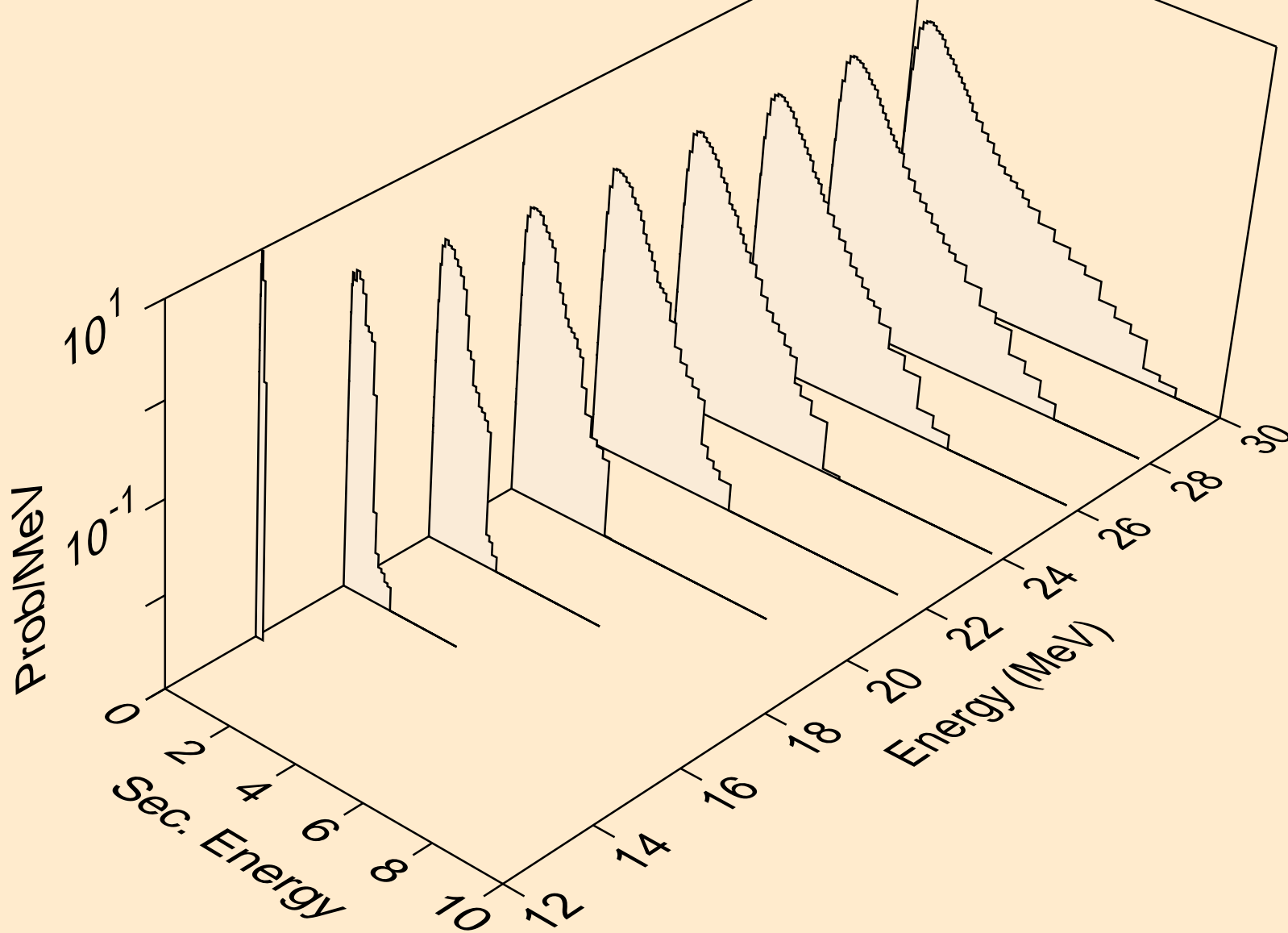

LU169 NEUTRON ACER TENDL-2019 LIBRARY; T=293.16K
Neutron emission for (n,3np)

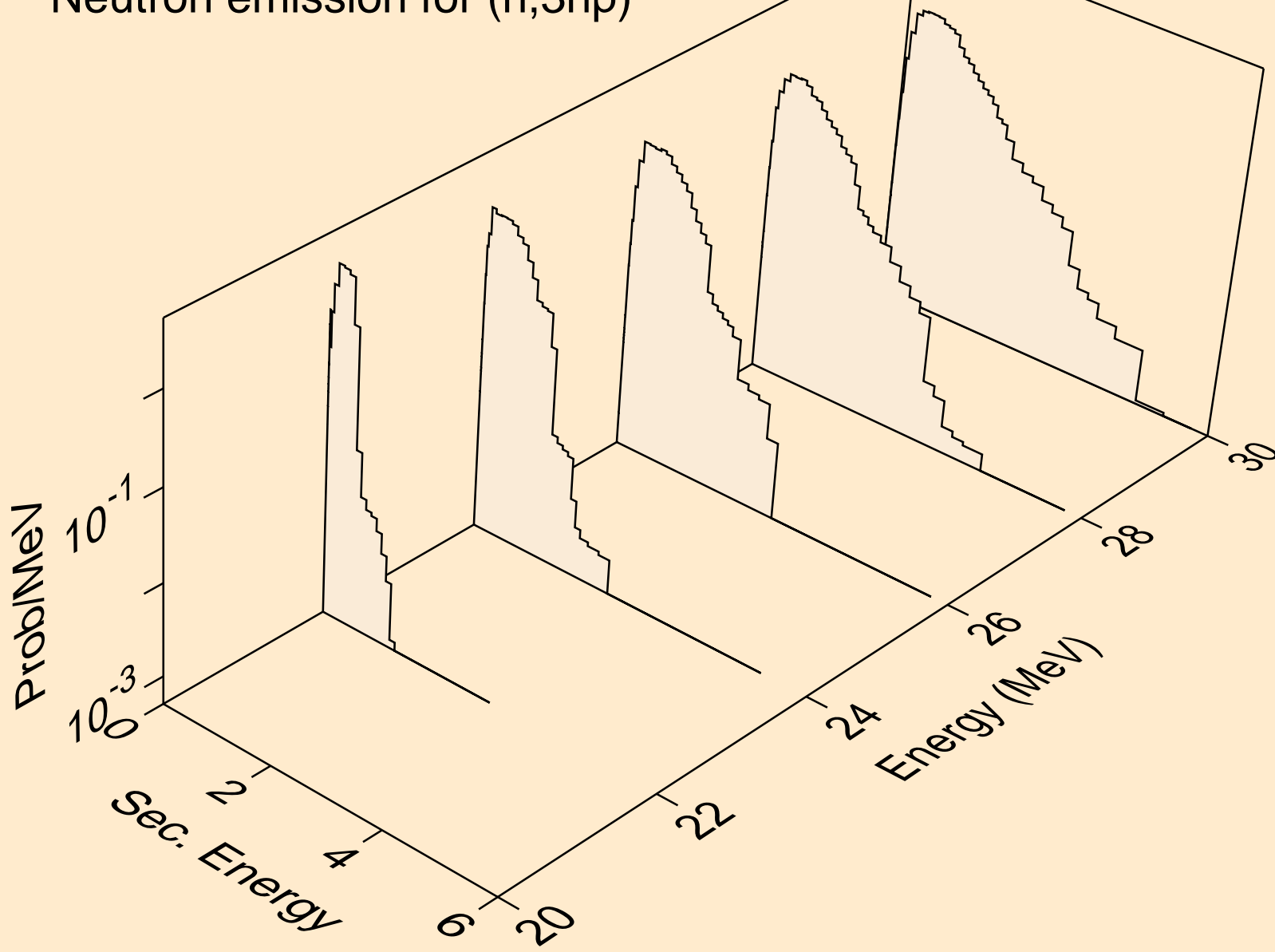

LU169 NEUTRON ACER TENDL-2019 LIBRARY; T=293.16K
Neutron emission for (n,2np)

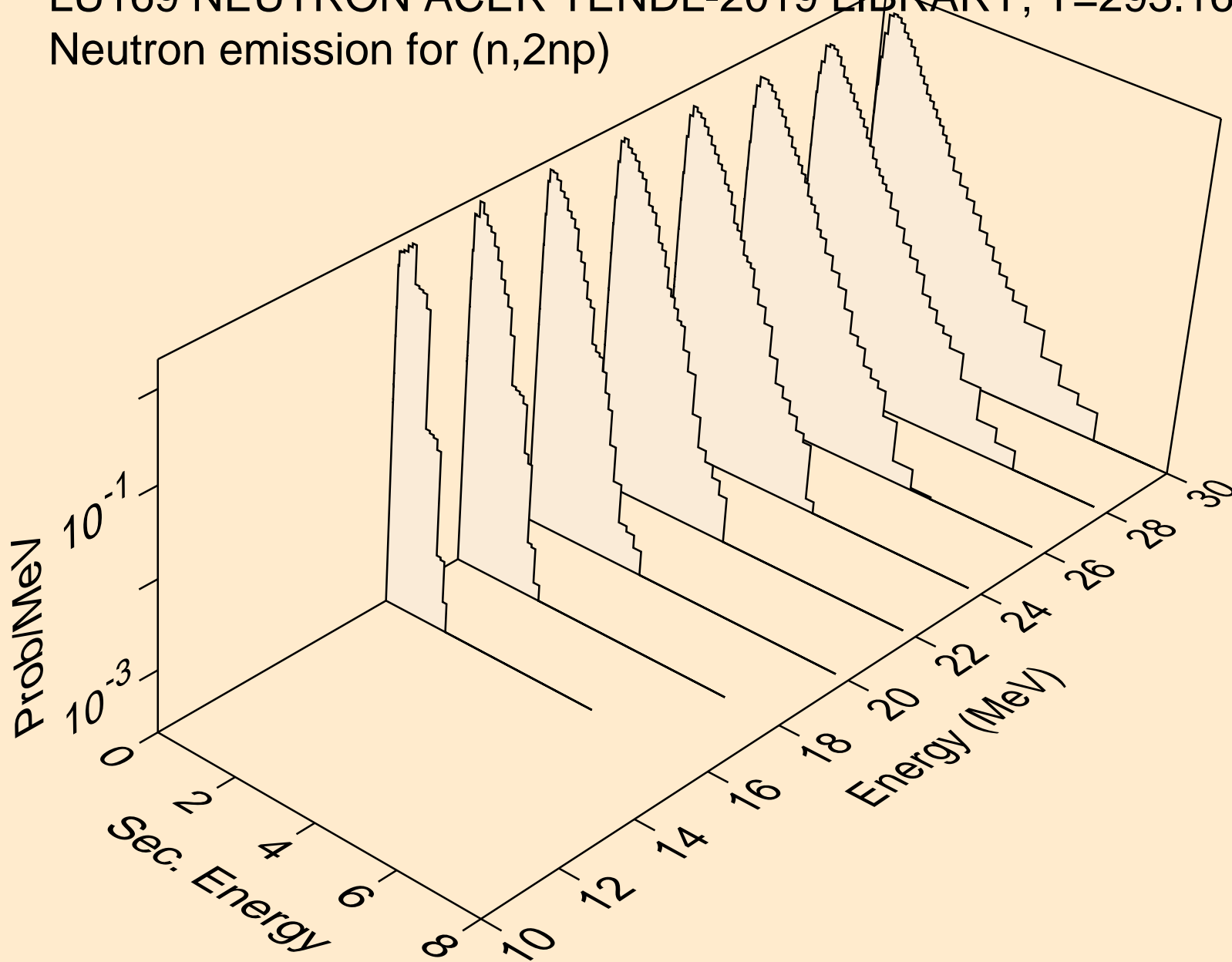

LU169 NEUTRON ACER TENDL-2019 LIBRARY; T=293.16K
Neutron emission for (n,npa)

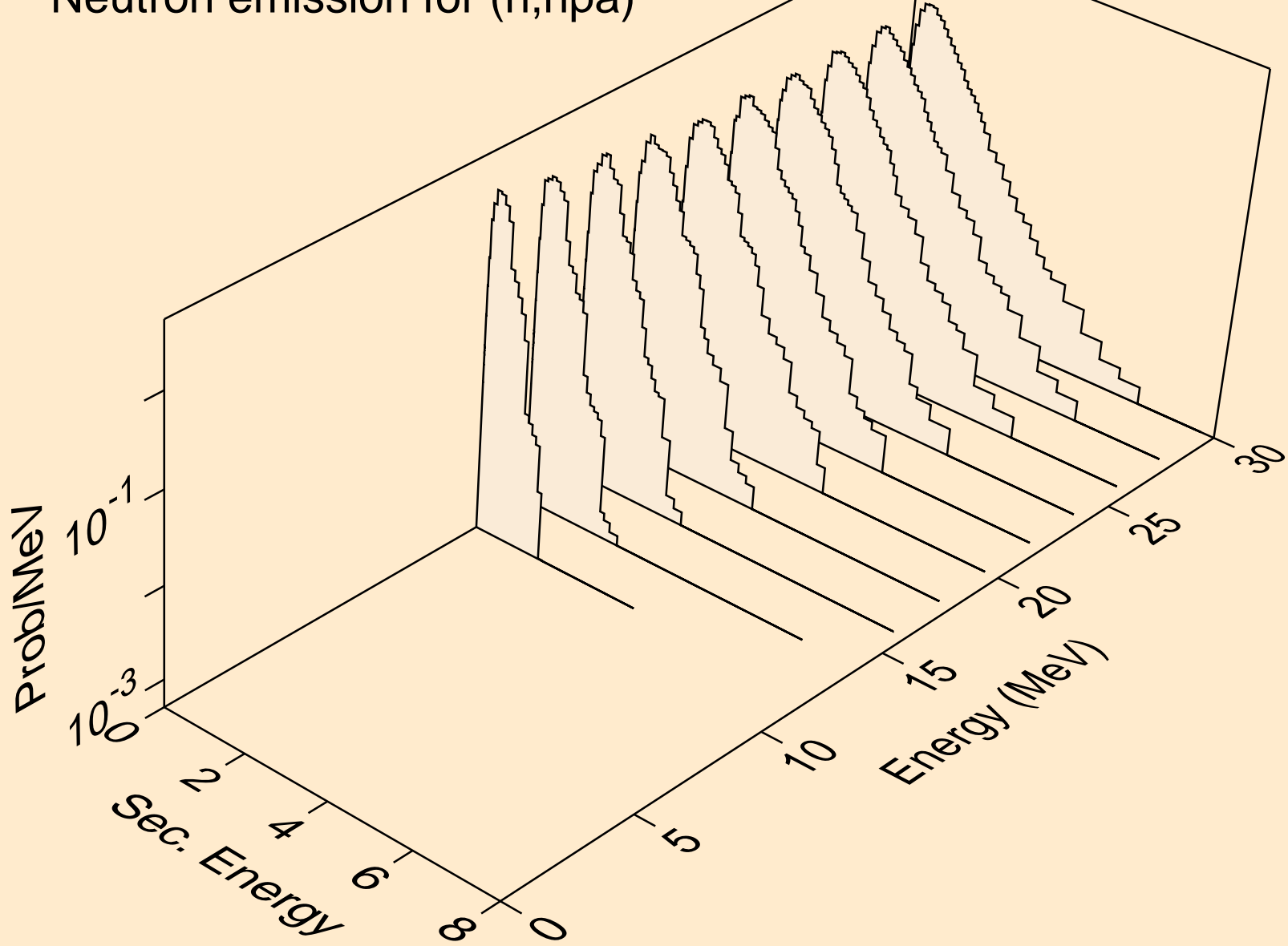

LU169 NEUTRON ACER TENDL-2019 LIBRARY; T=293.16K
Neutron emission for (n,n*c)

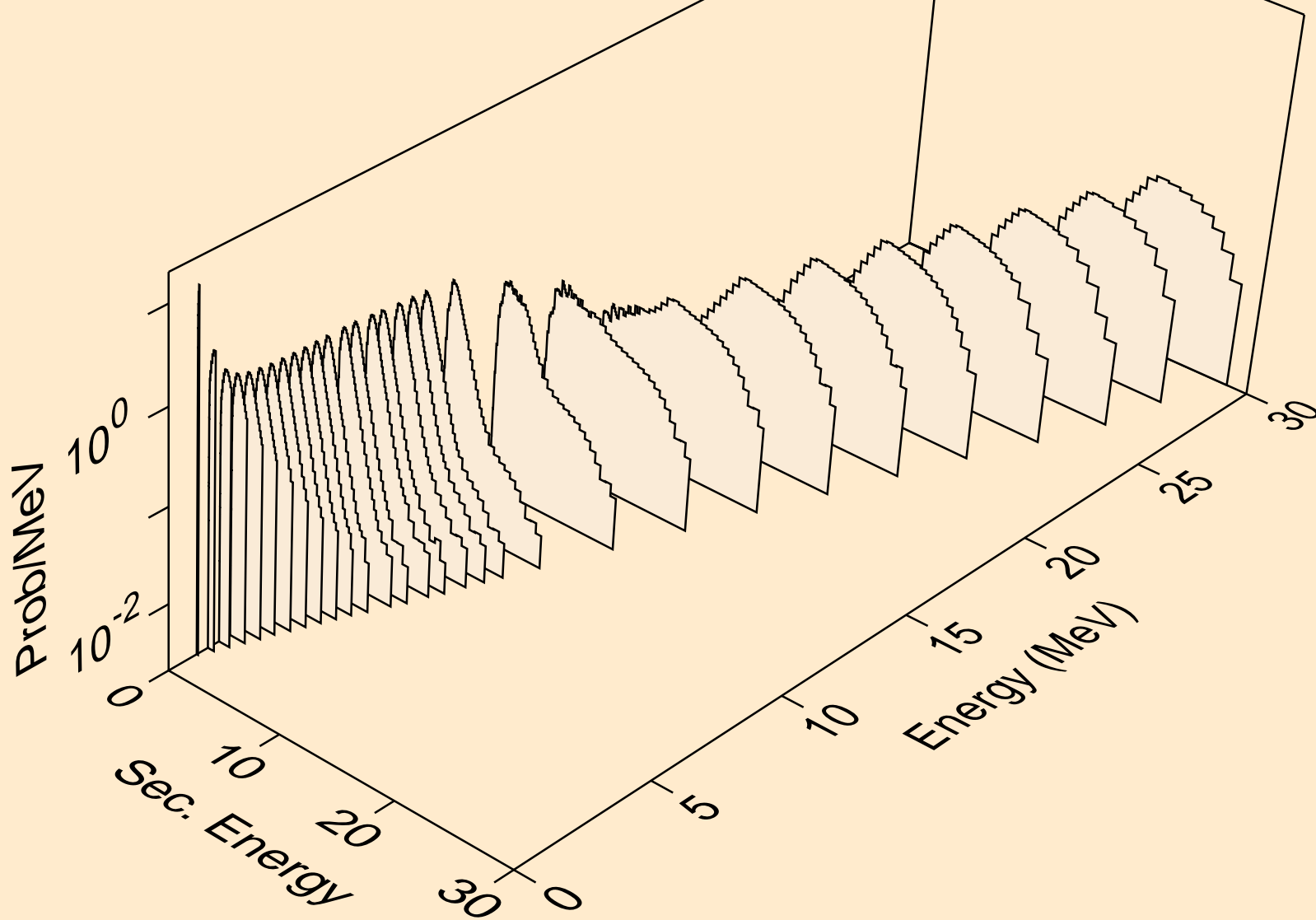

LU169 NEUTRON ACER TENDL-2019 LIBRARY; T=293.16K
Photon emission for (n,x)

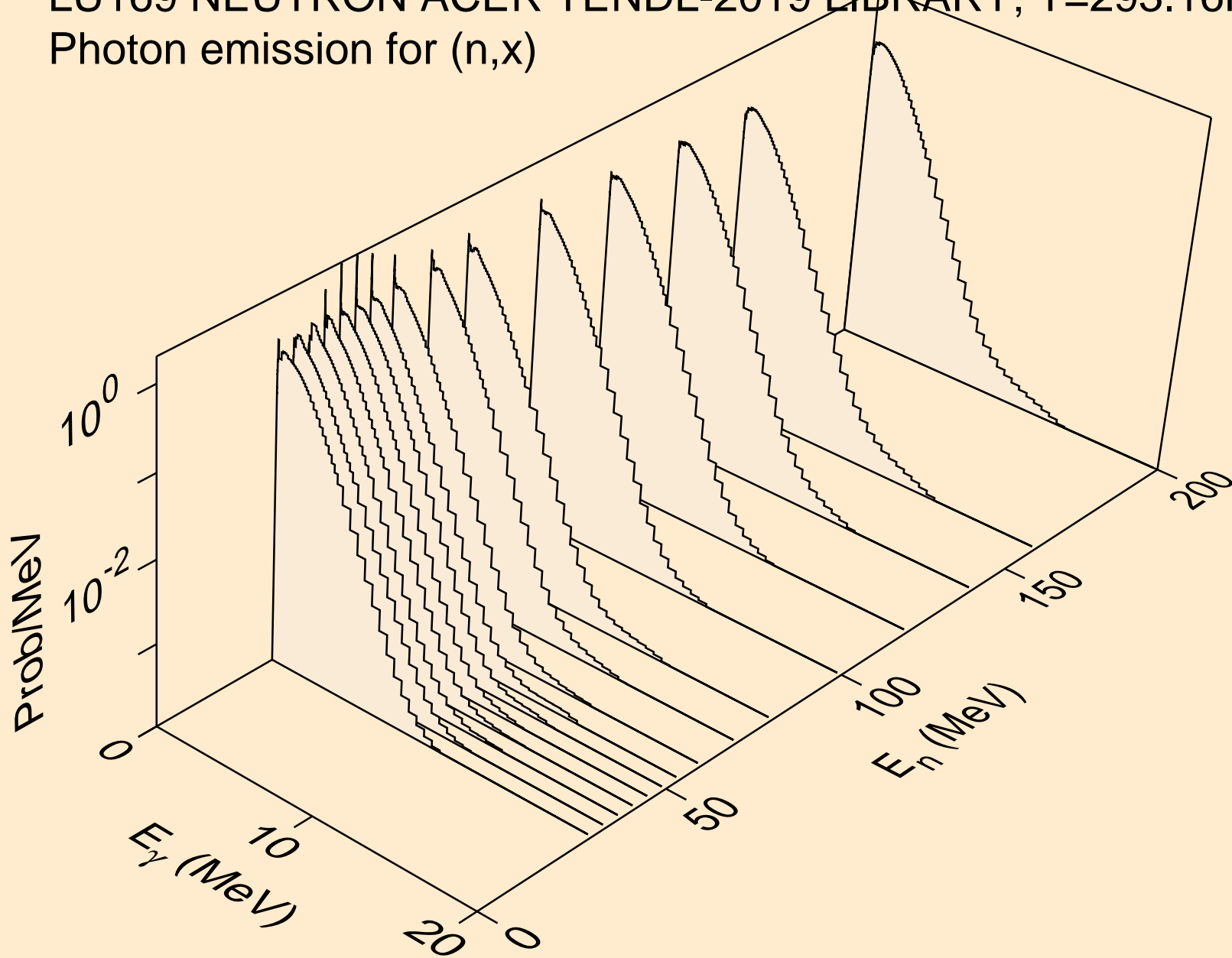

LU169 NEUTRON ACER TENDL-2019 LIBRARY; T=293.16K
Photon emission for (n,2nd)

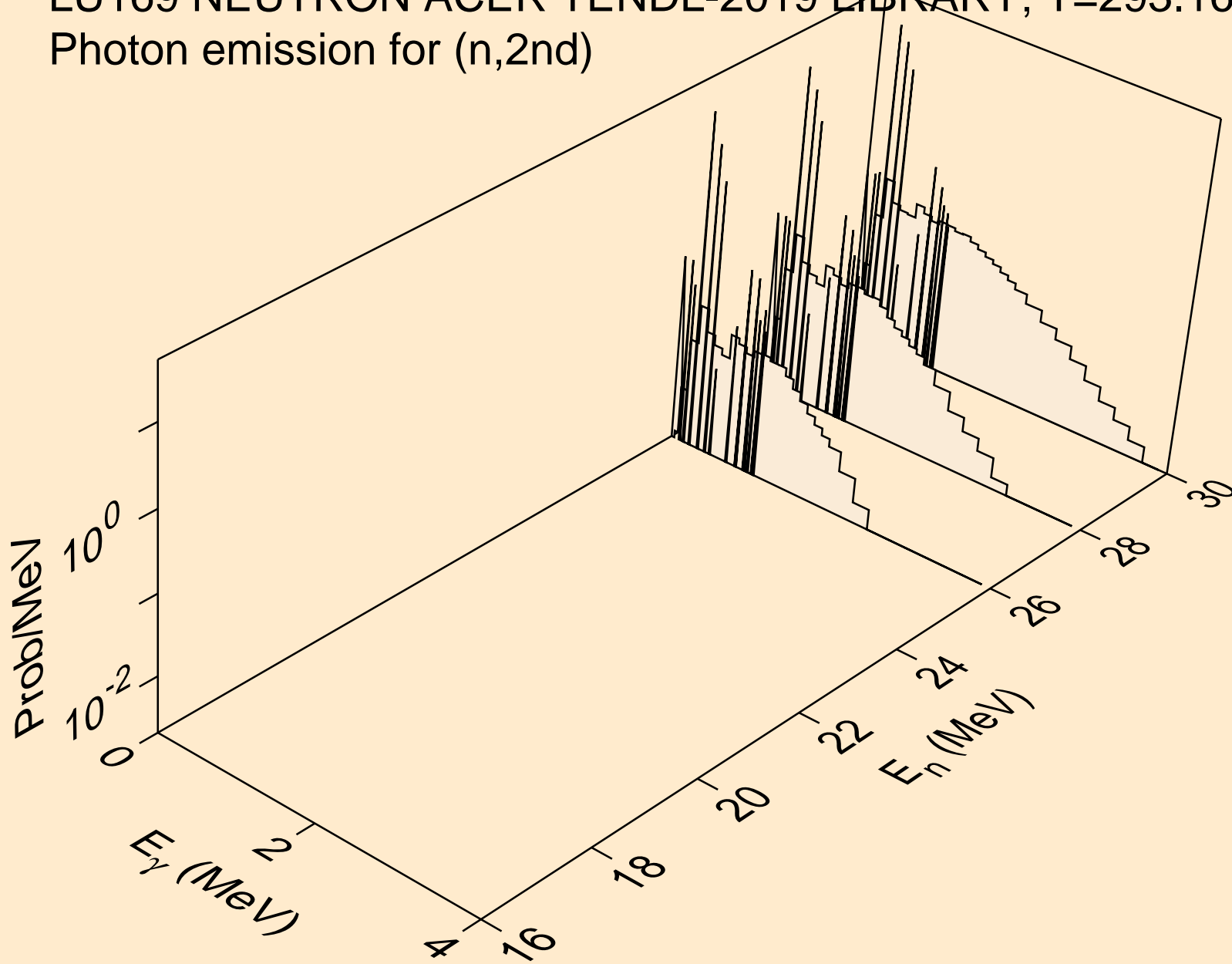

LU169 NEUTRON ACER TENDL-2019 LIBRARY; T=293.16K
Photon emission for (n,2n)

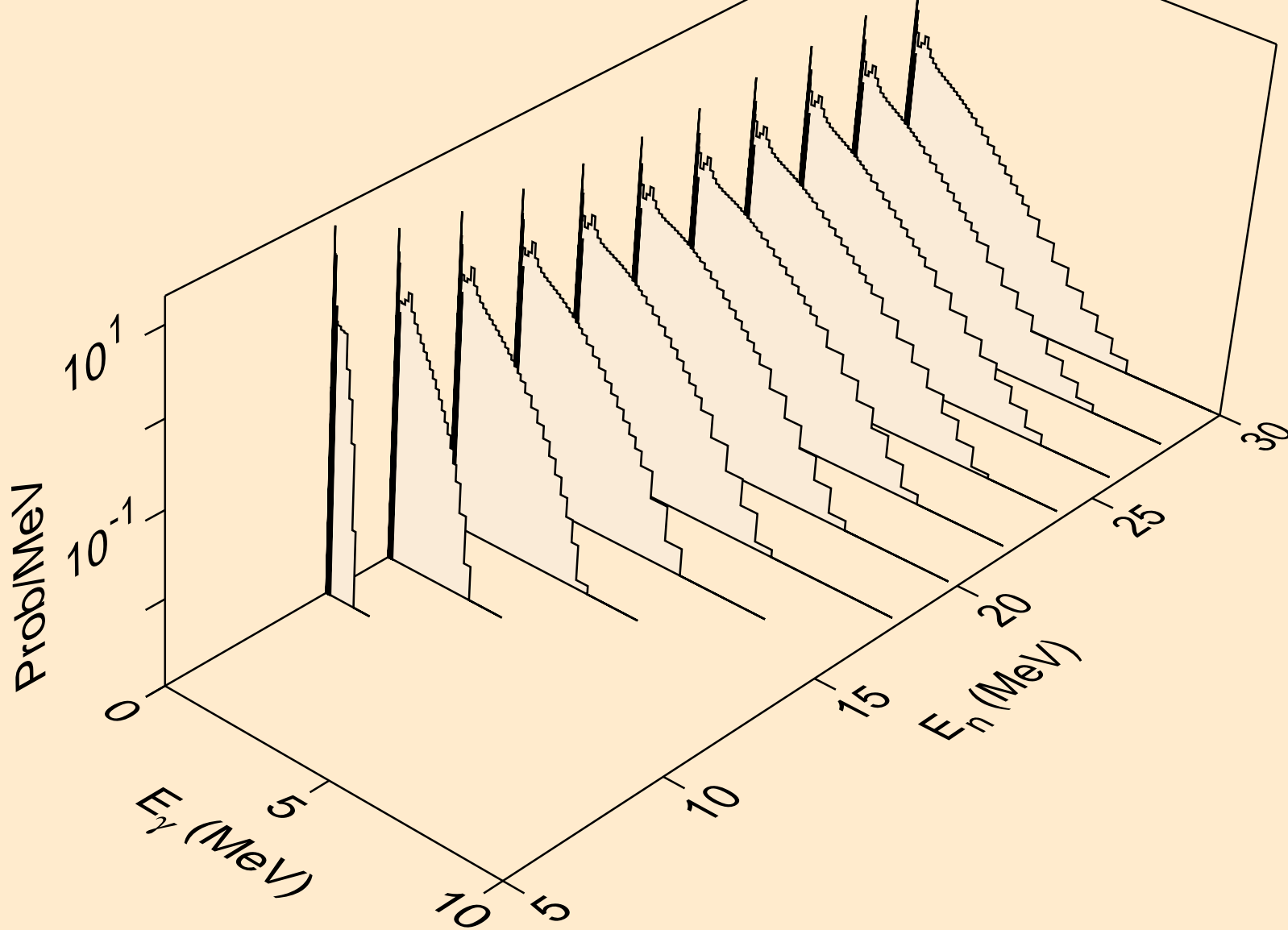

LU169 NEUTRON ACER TENDL-2019 LIBRARY; T=293.16K
Photon emission for (n,3n)

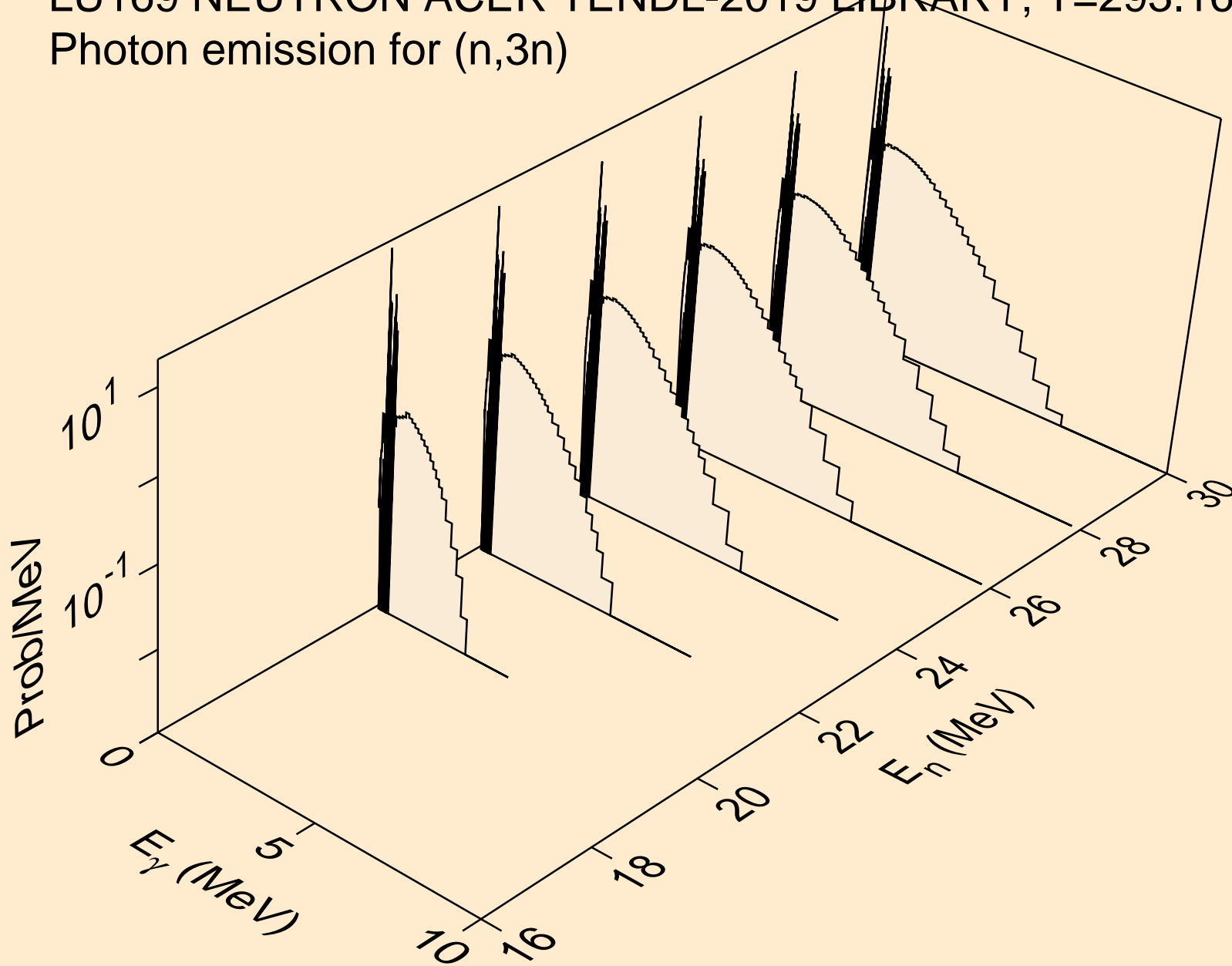

LU169 NEUTRON ACER TENDL-2019 LIBRARY; T=293.16K
Photon emission for (n,n*)a

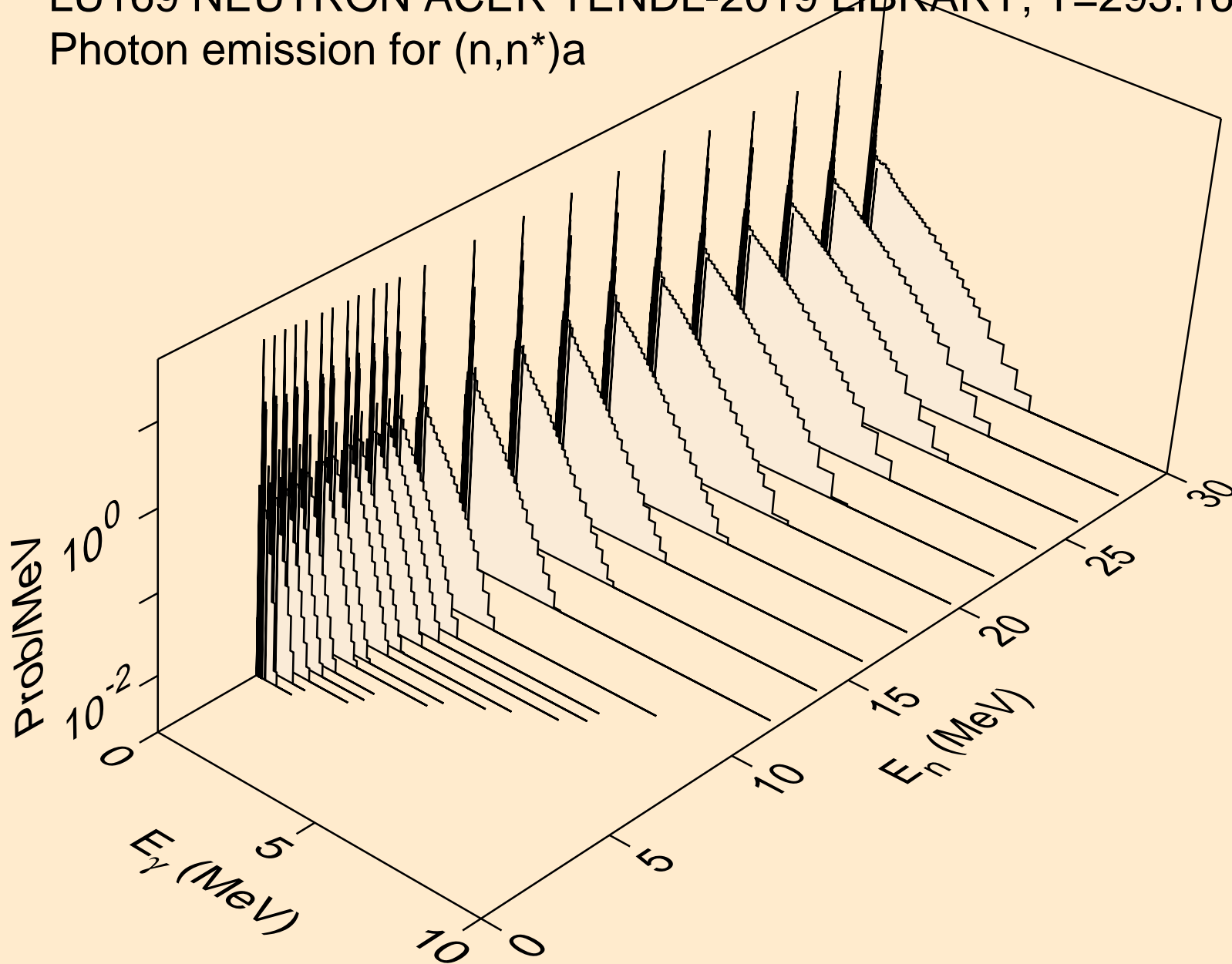

LU169 NEUTRON ACER TENDL-2019 LIBRARY; T=293.16K
Photon emission for (n,2n)a

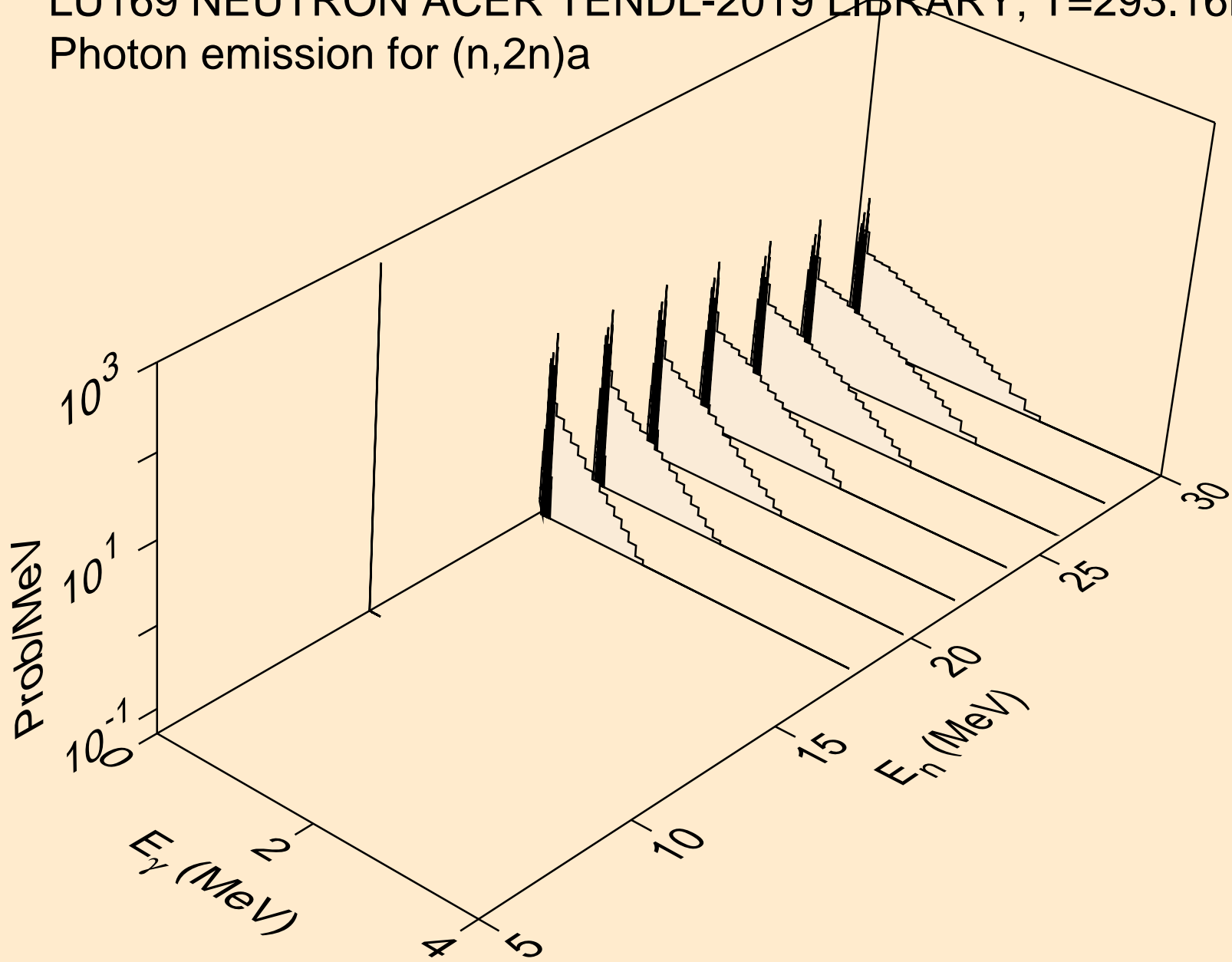

LU169 NEUTRON ACER TENDL-2019 LIBRARY; T=293.16K
Photon emission for (n,3n)a

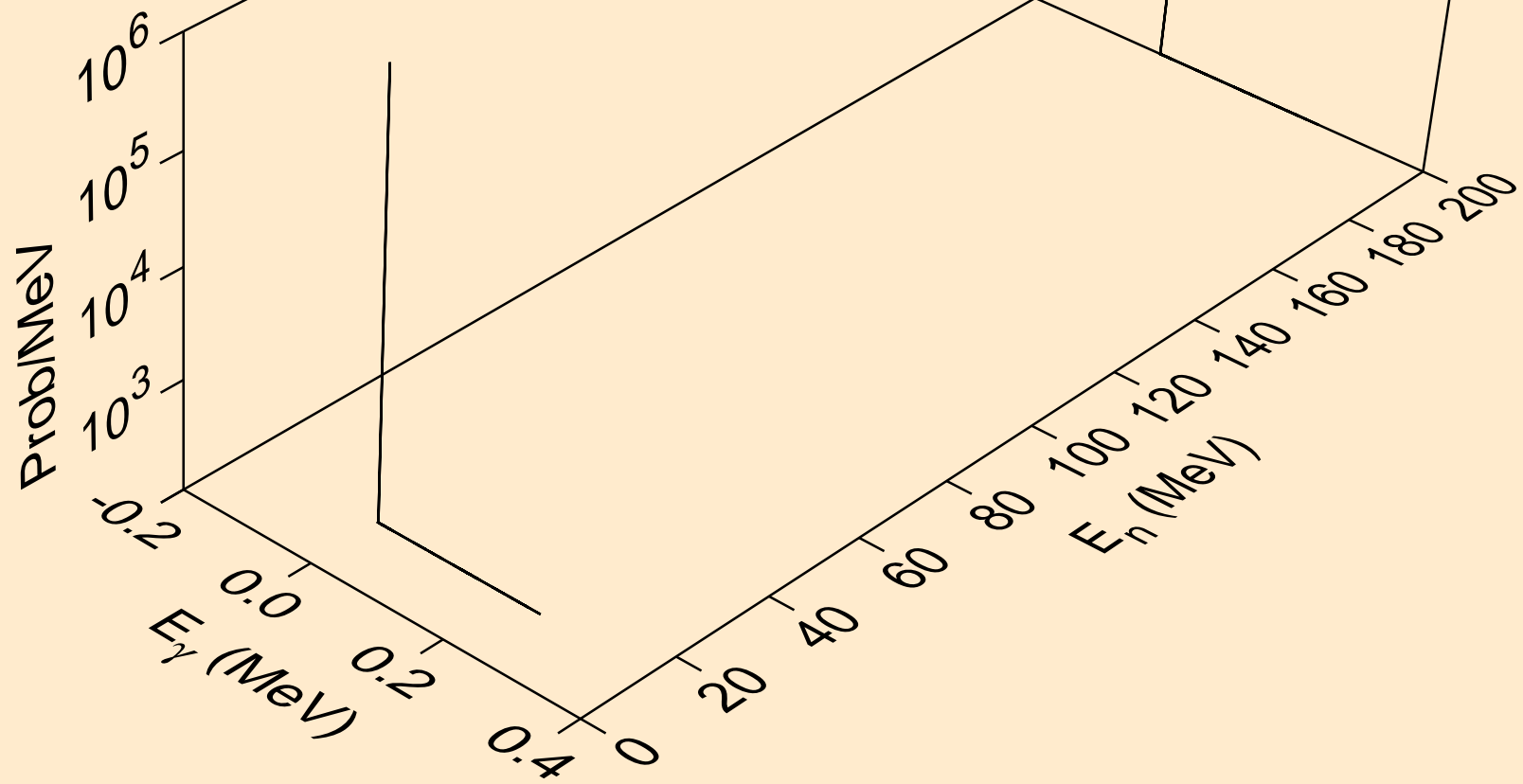

LU169 NEUTRON ACER TENDL-2019 LIBRARY; T=293.16K
Photon emission for (n,n*)p

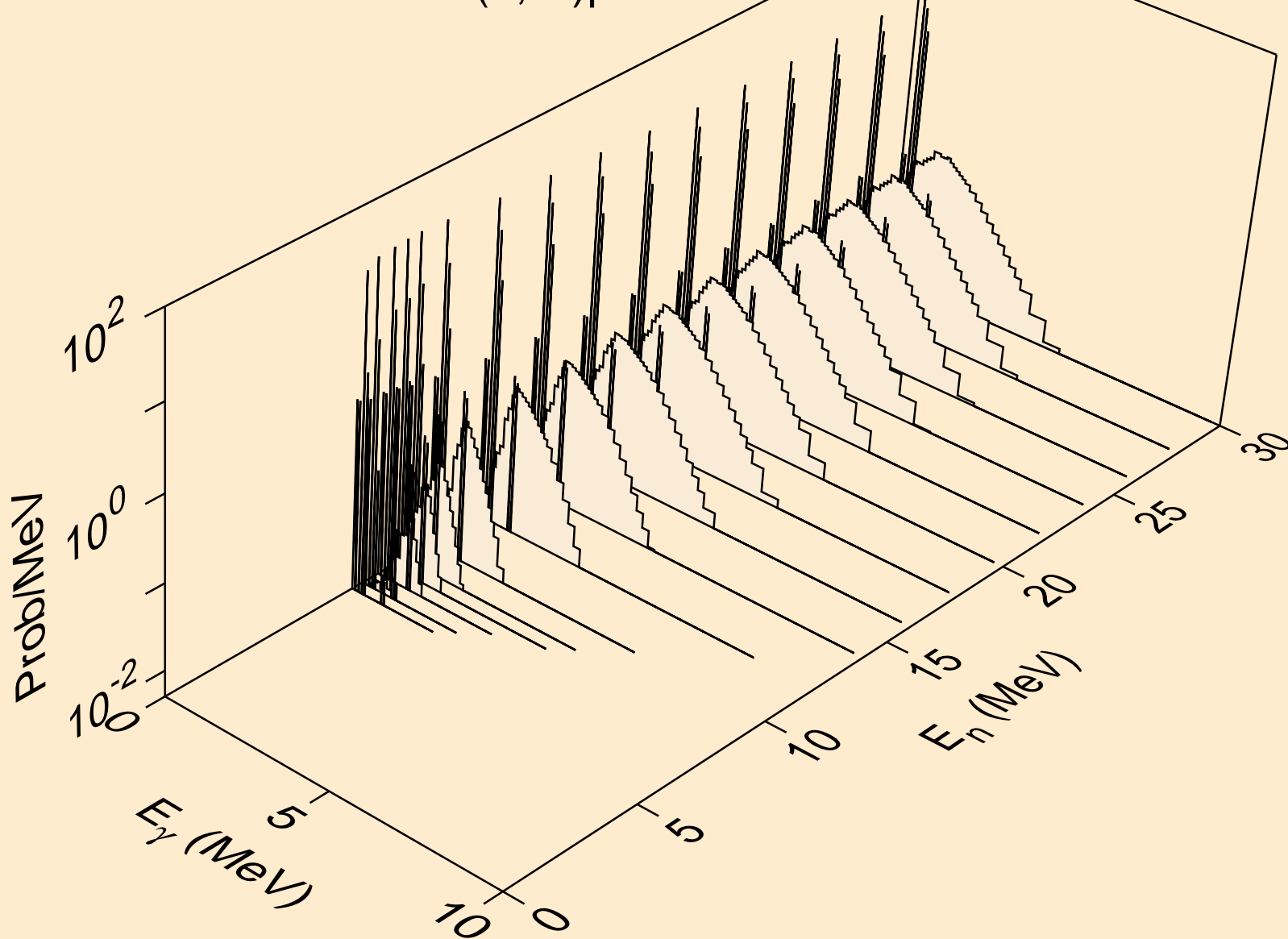

LU169 NEUTRON ACER TENDL-2019 LIBRARY; T=293.16K
Photon emission for (n,n*)2a

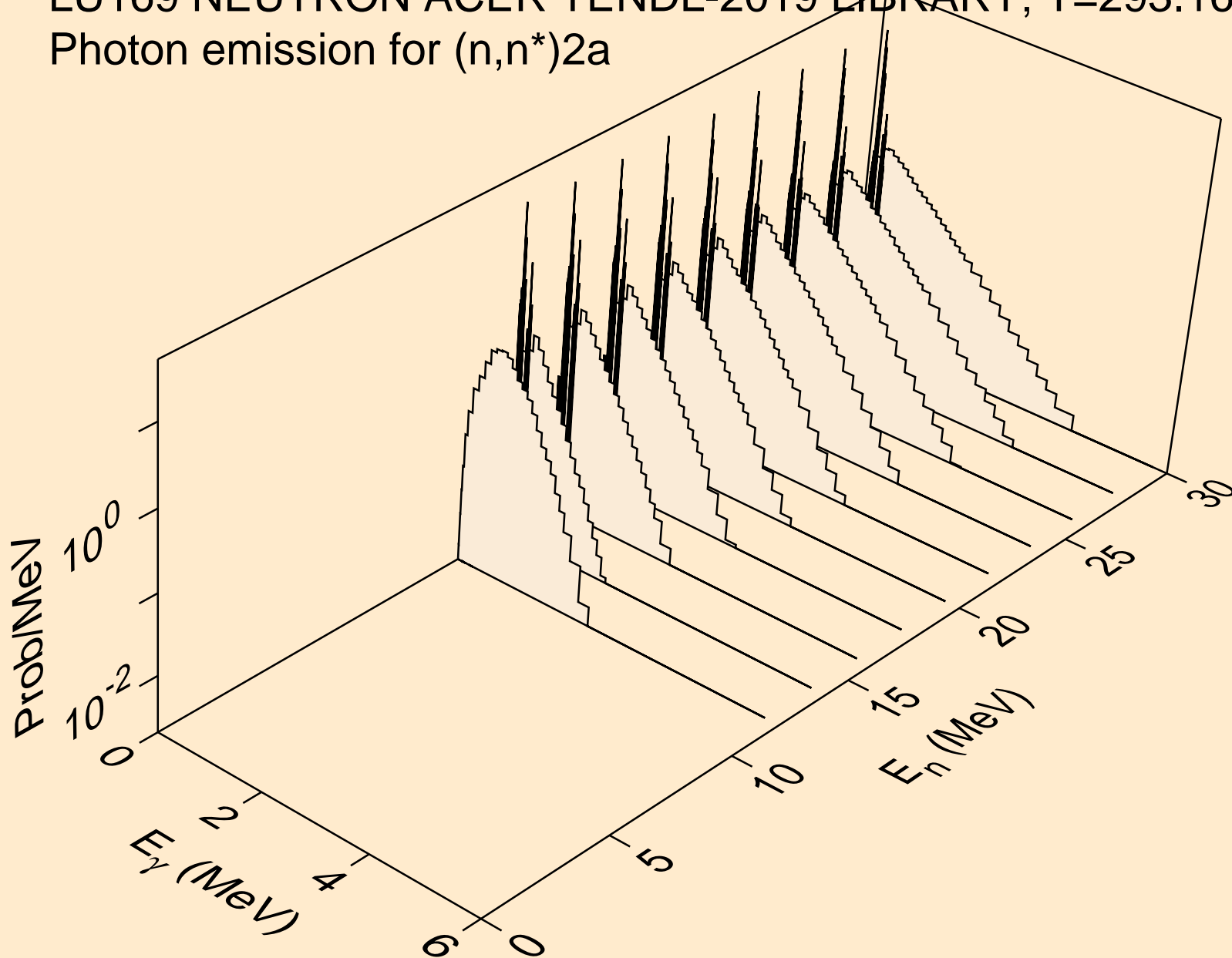

LU169 NEUTRON ACER TENDL-2019 LIBRARY; T=293.16K
Photon emission for (n,n*)d

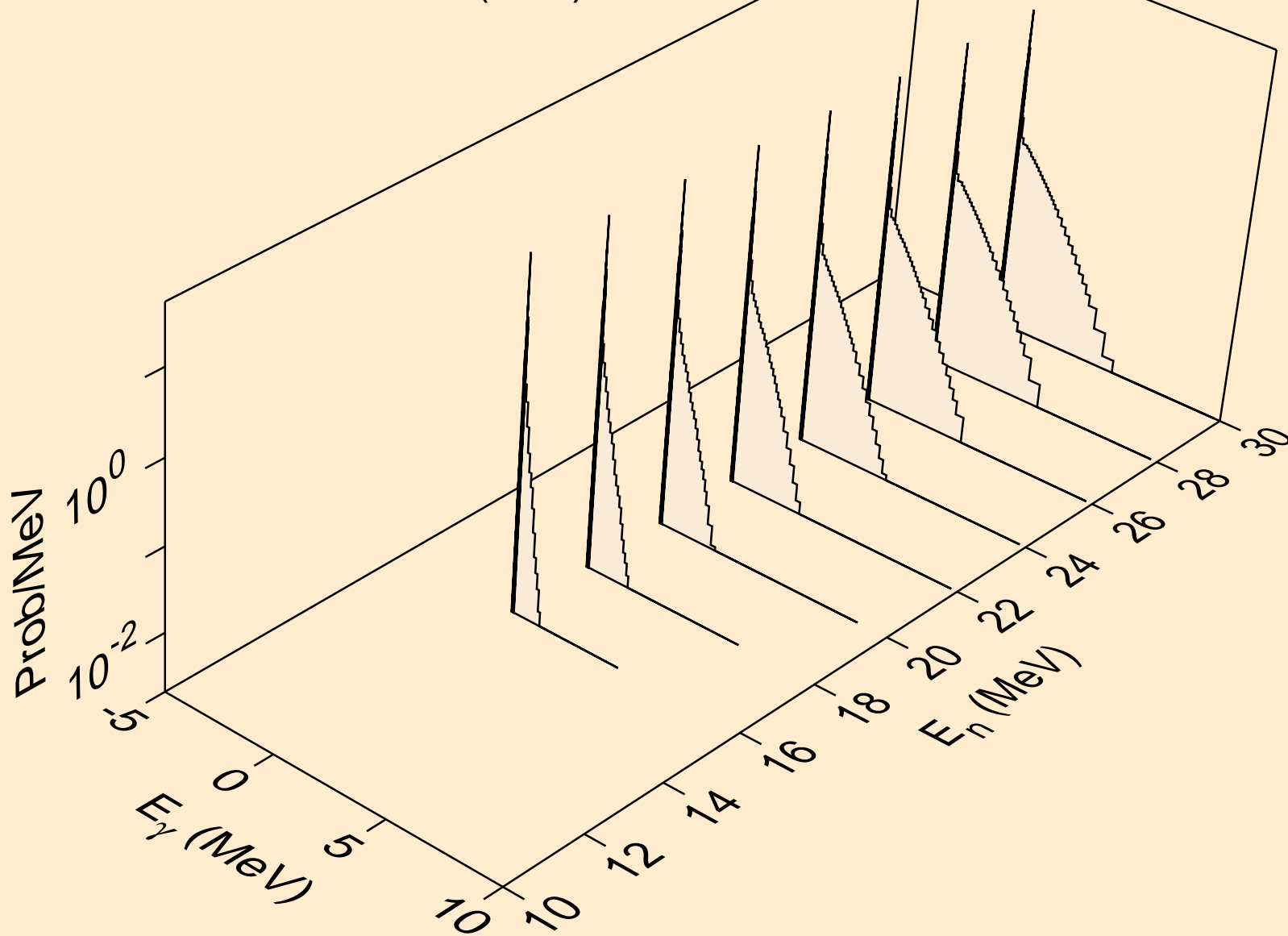

LU169 NEUTRON ACER TENDL-2019 LIBRARY; T=293.16K
Photon emission for (n,n*)t

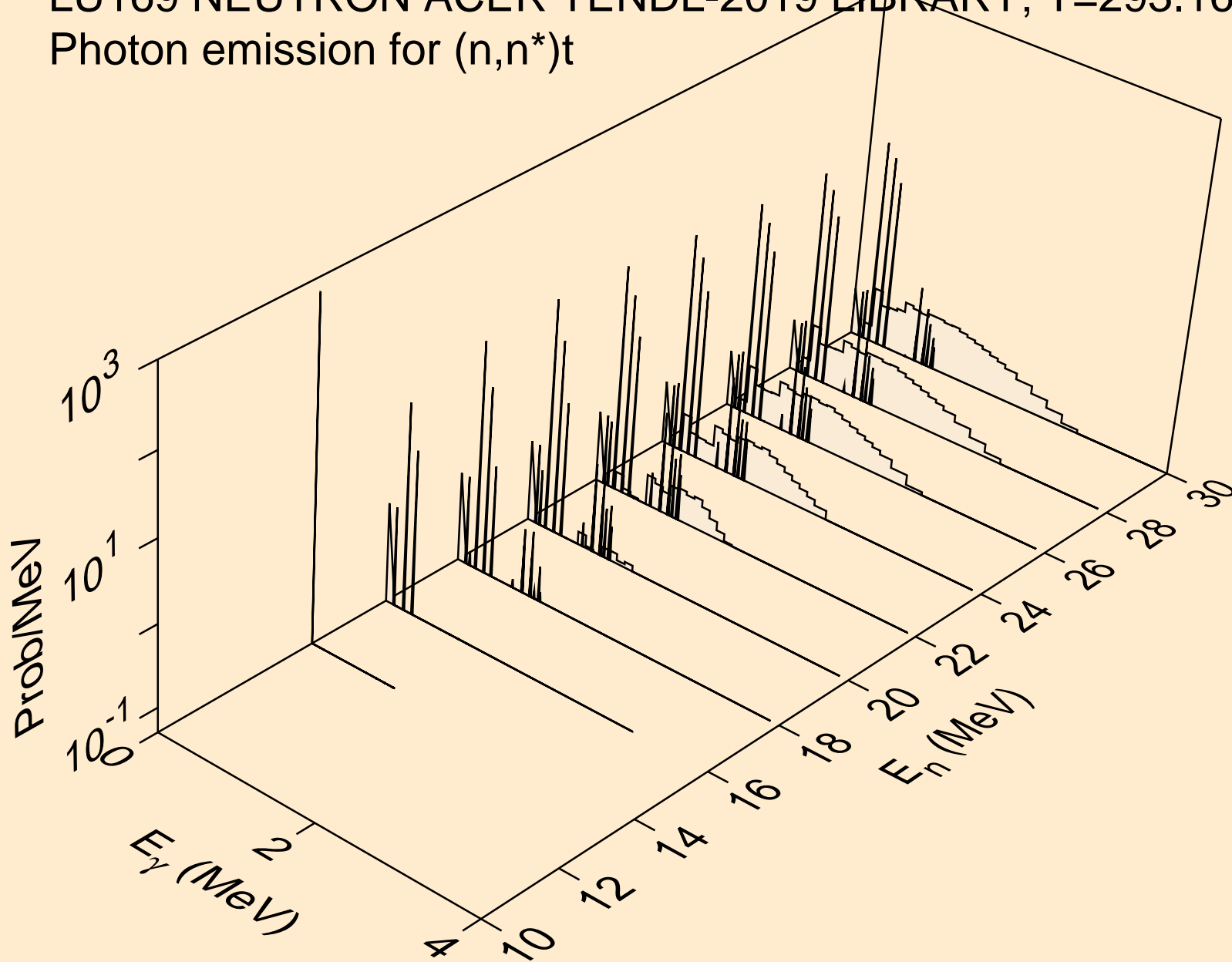

LU169 NEUTRON ACER TENDL-2019 LIBRARY; T=293.16K
Photon emission for (n,n*)he3

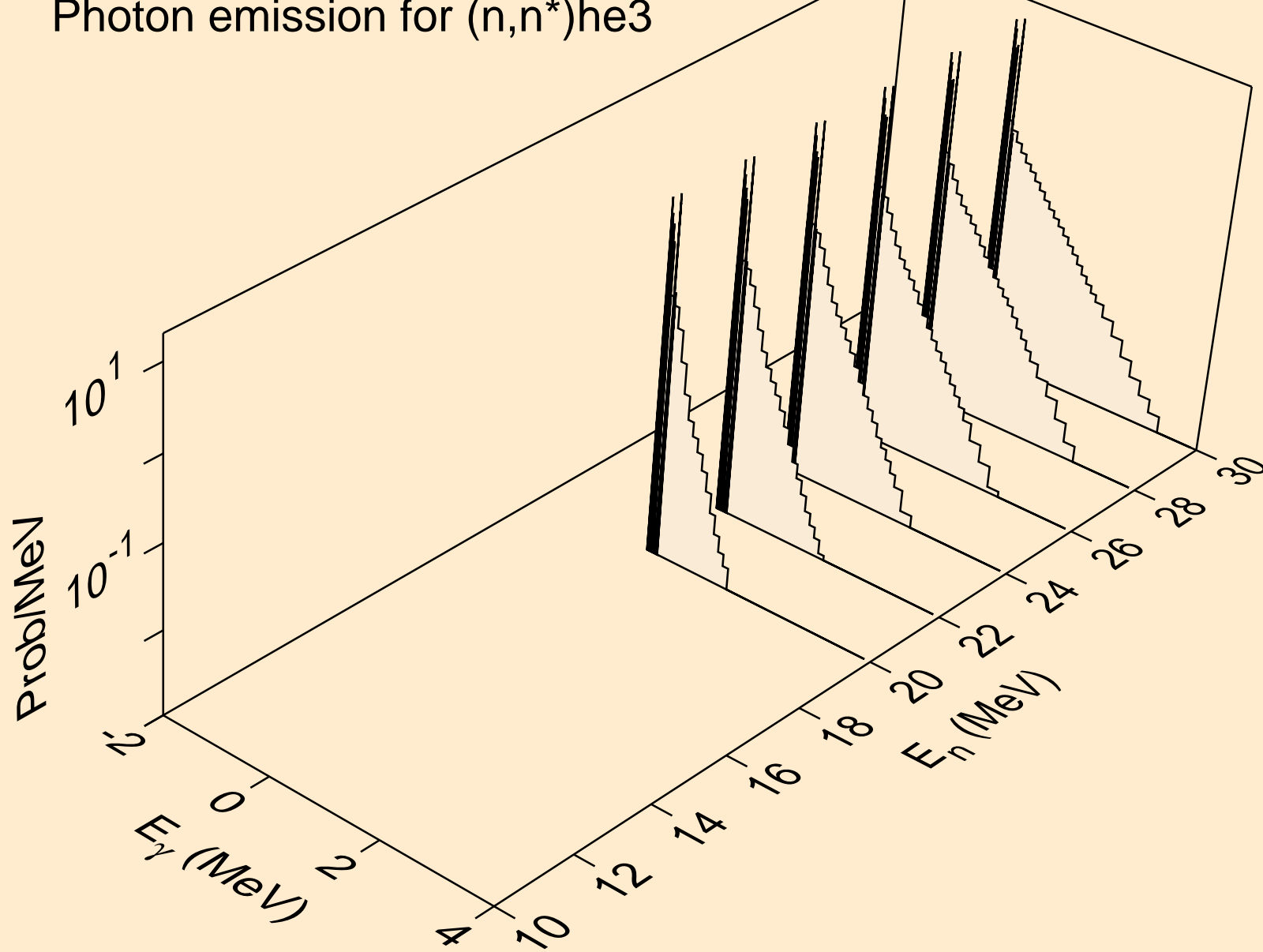

LU169 NEUTRON ACER TENDL-2019 LIBRARY; T=293.16K
Photon emission for (n,4n)

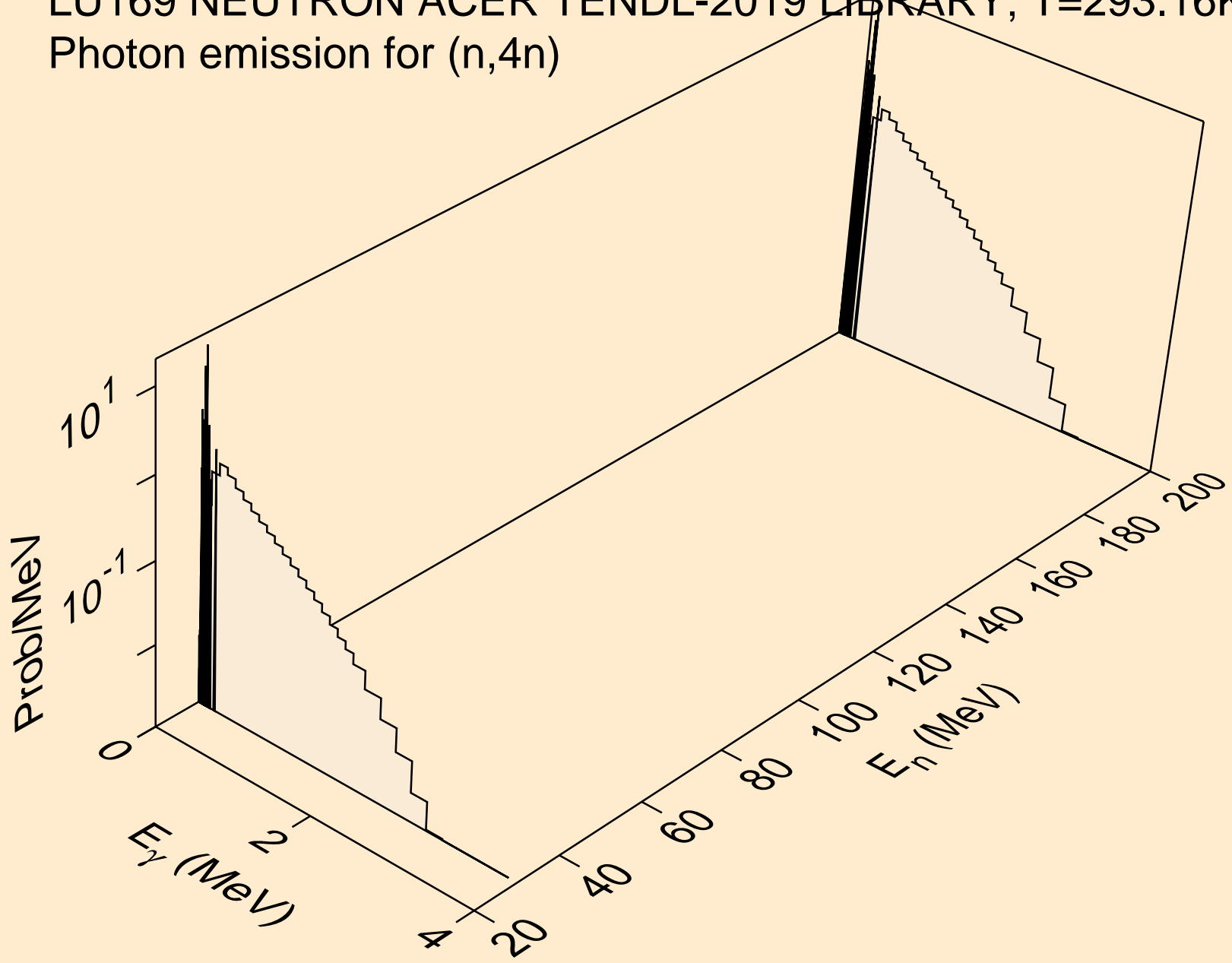

LU169 NEUTRON ACER TENDL-2019 LIBRARY; T=293.16K
Photon emission for (n,2np)

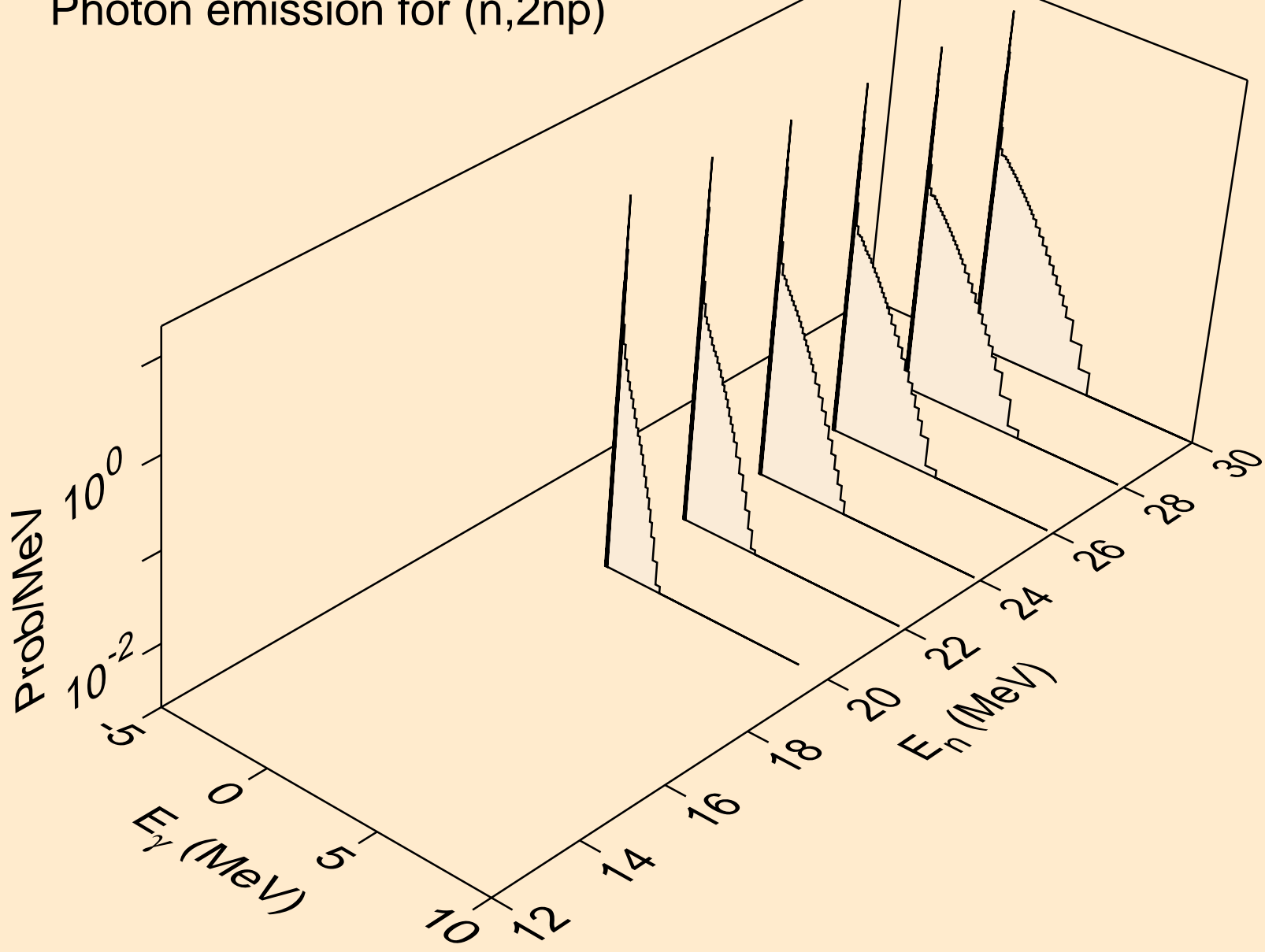

LU169 NEUTRON ACER TENDL-2019 LIBRARY; T=293.16K
Photon emission for (n,3np)

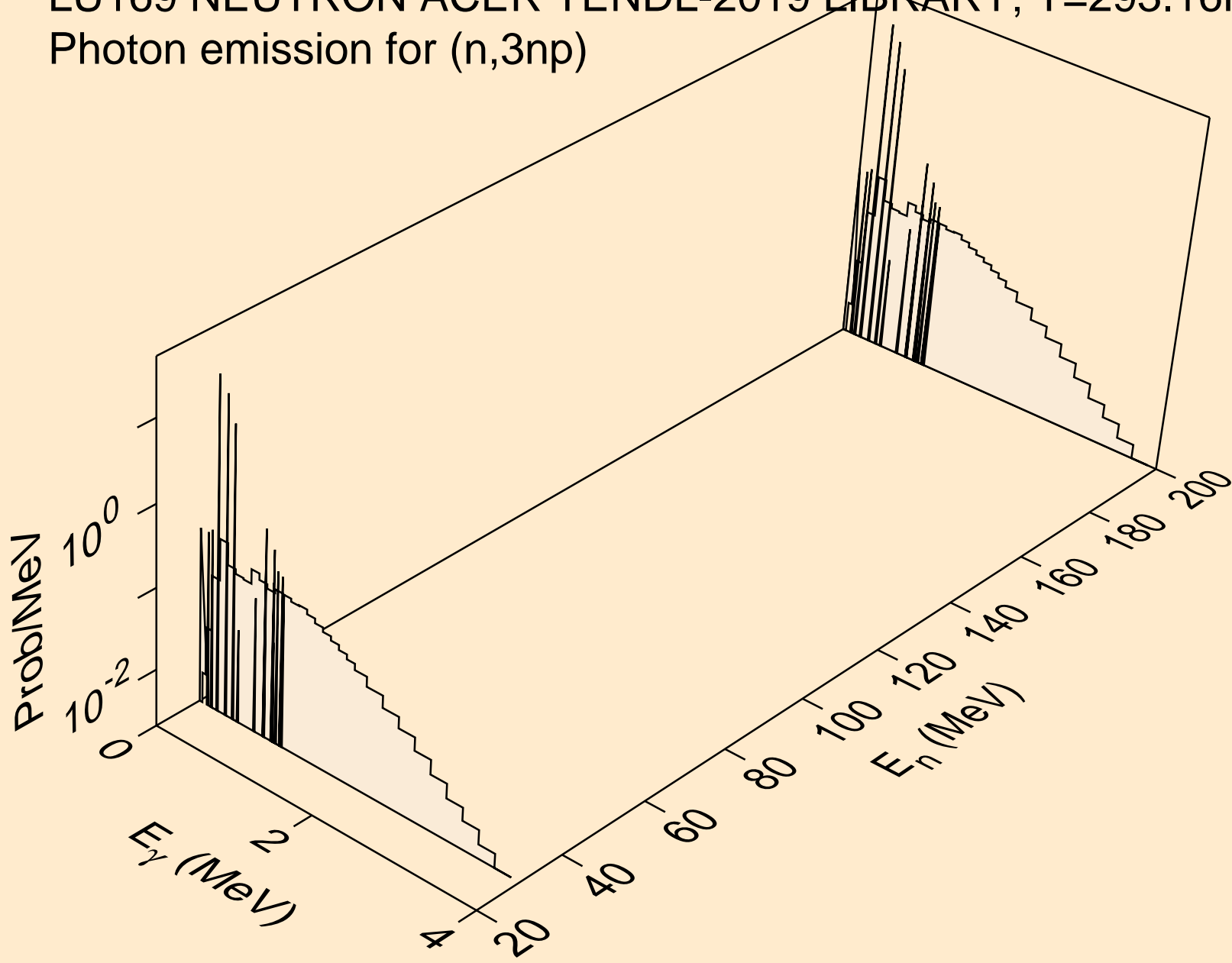

LU169 NEUTRON ACER TENDL-2019 LIBRARY; T=293.16K
Photon emission for (n,2np)

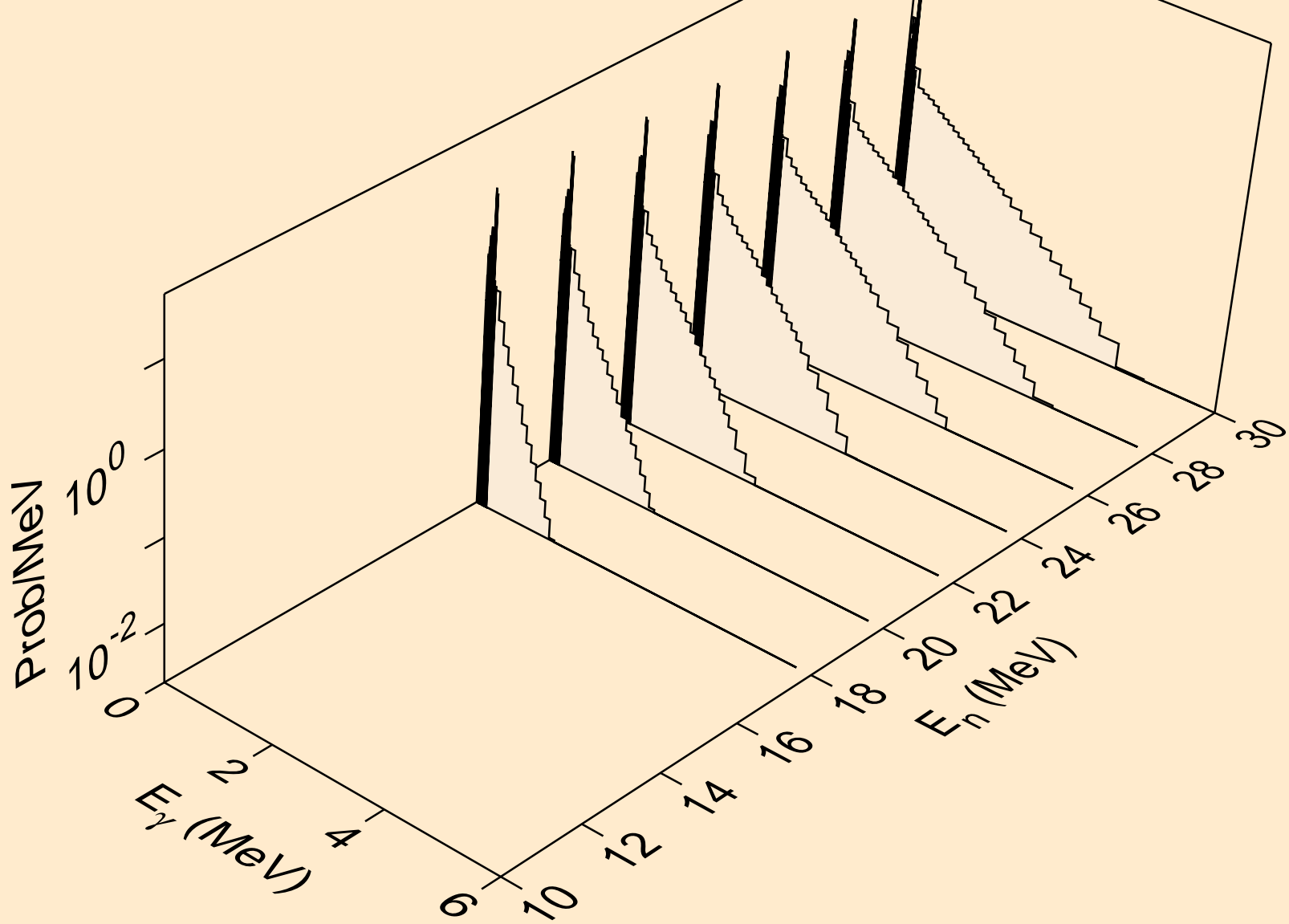

LU169 NEUTRON ACER TENDL-2019 LIBRARY; T=293.16K
Photon emission for (n,npa)

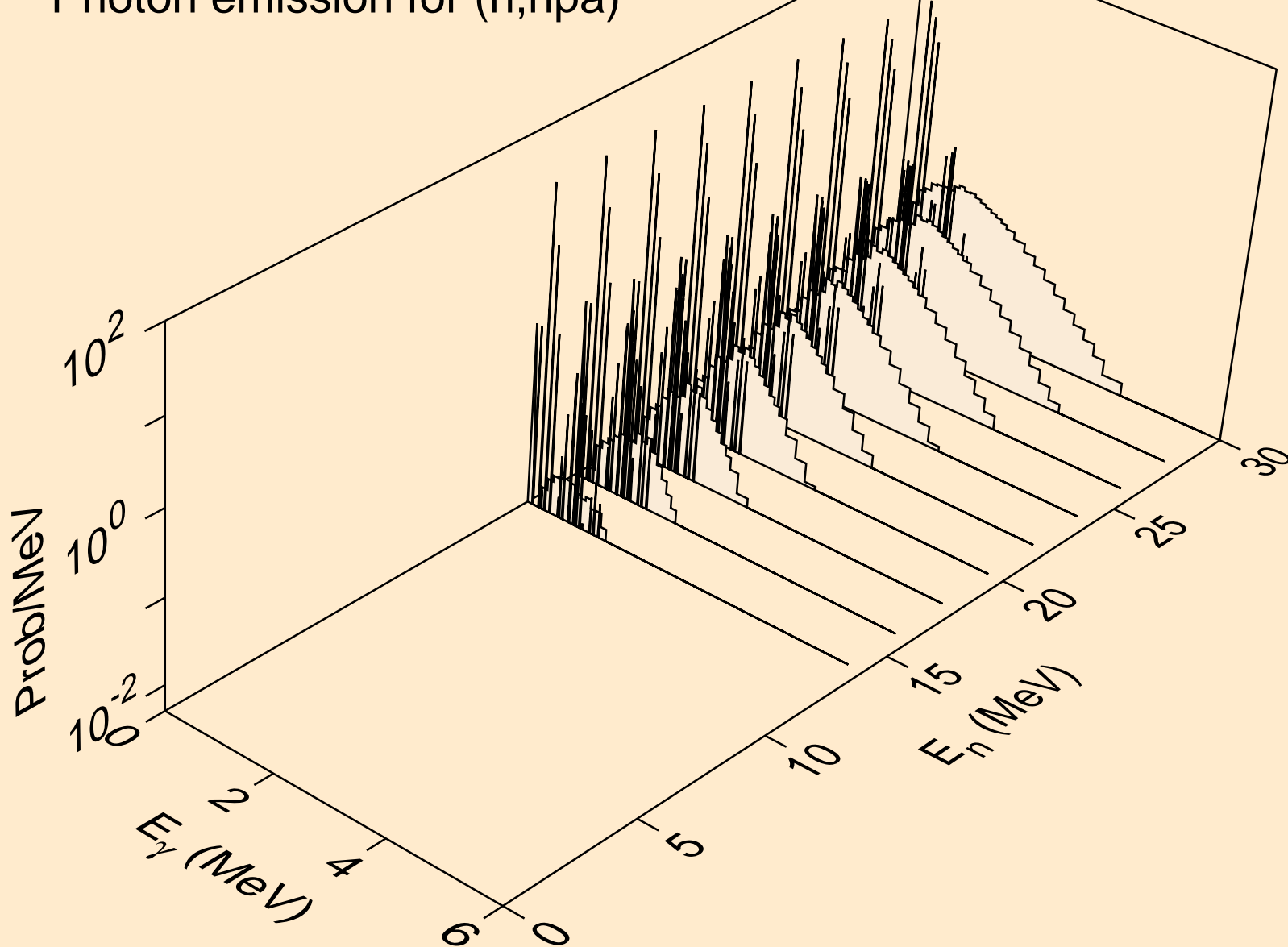

LU169 NEUTRON ACER TENDL-2019 LIBRARY; T=293.16K
Photon emission for (n,n*c)

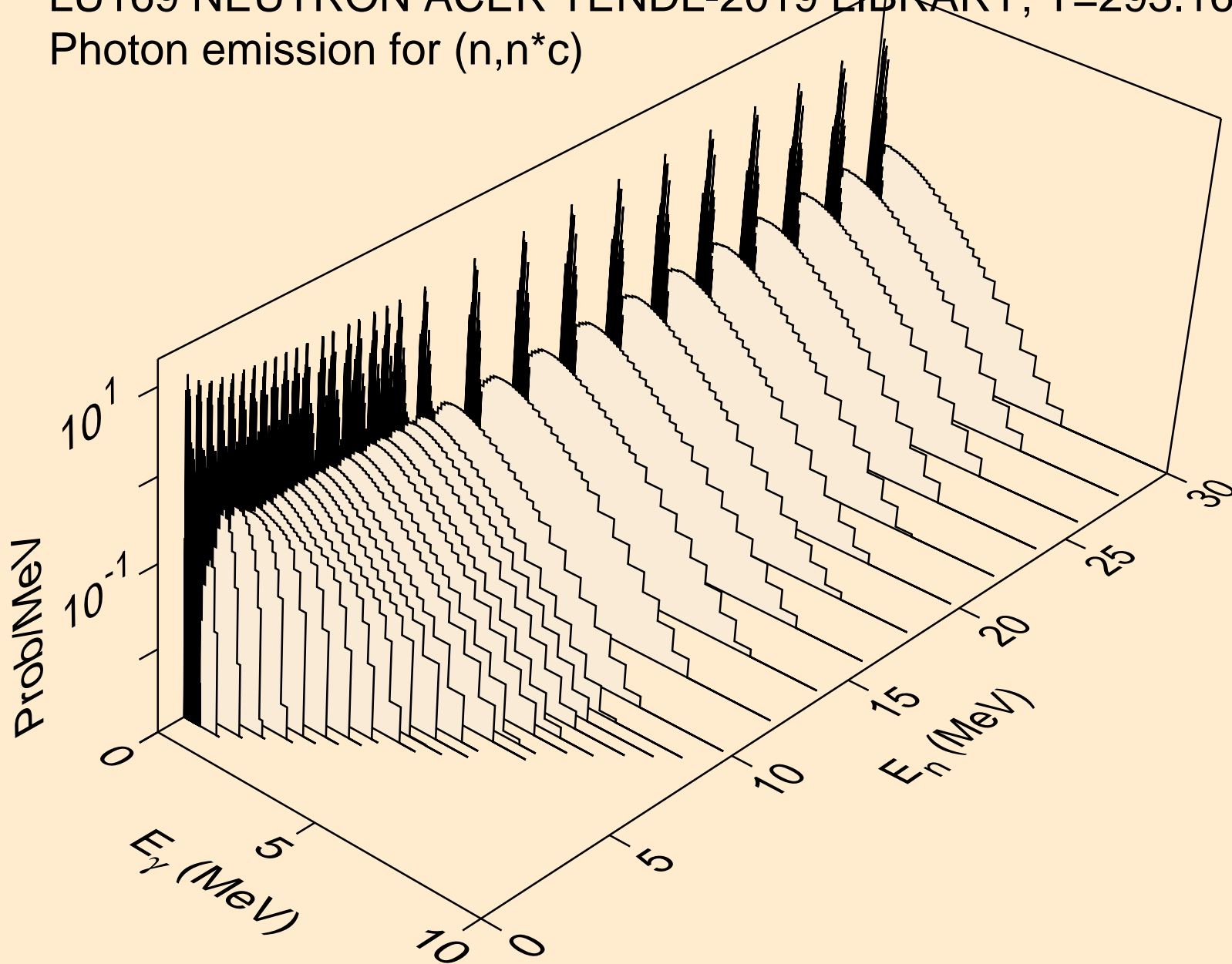

LU169 NEUTRON ACER TENDL-2019 LIBRARY; T=293.16K
Photon emission for (n,gma)

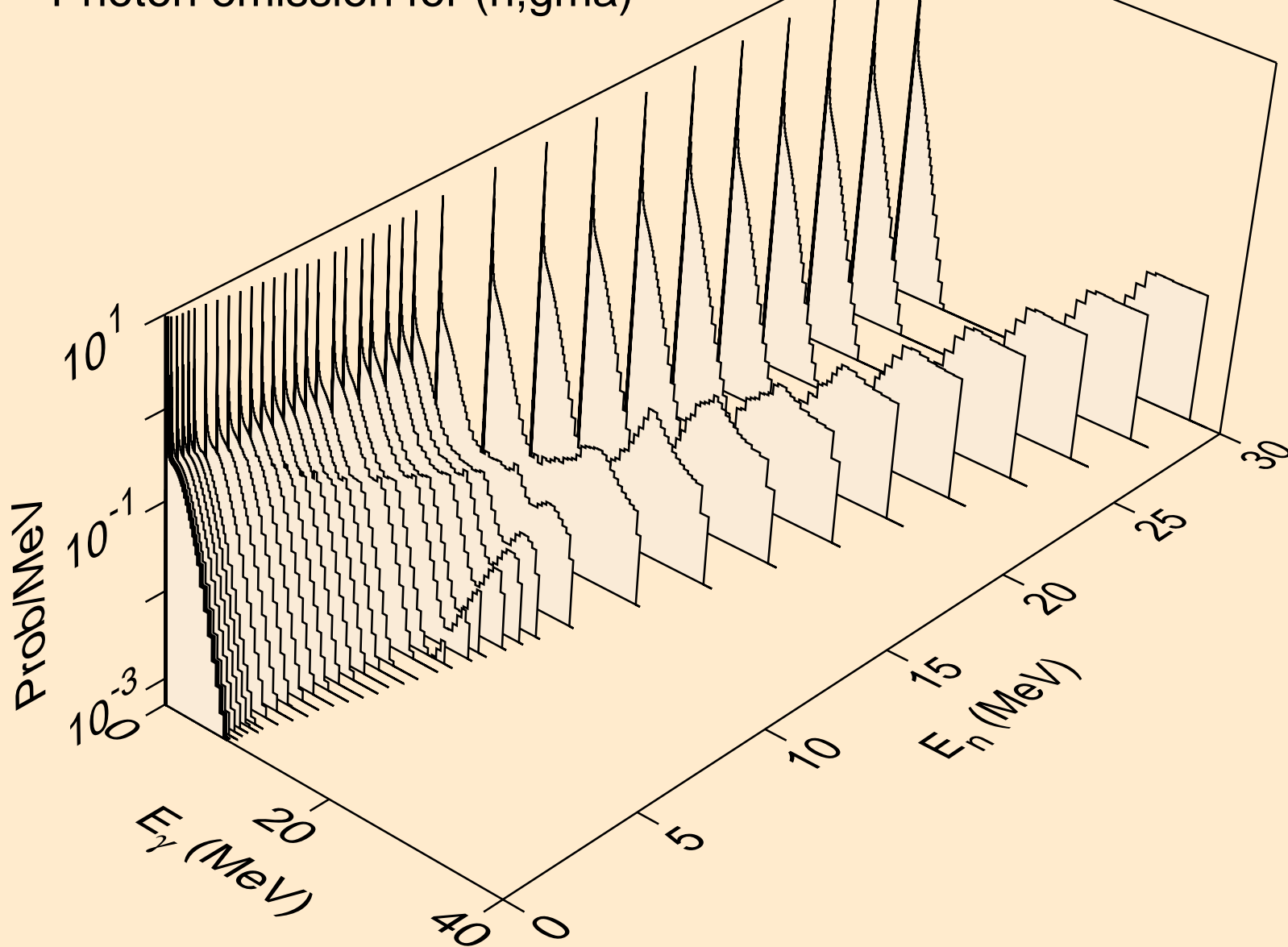

LU169 NEUTRON ACER TENDL-2019 LIBRARY; T=293.16K
Photon emission for (n,p)

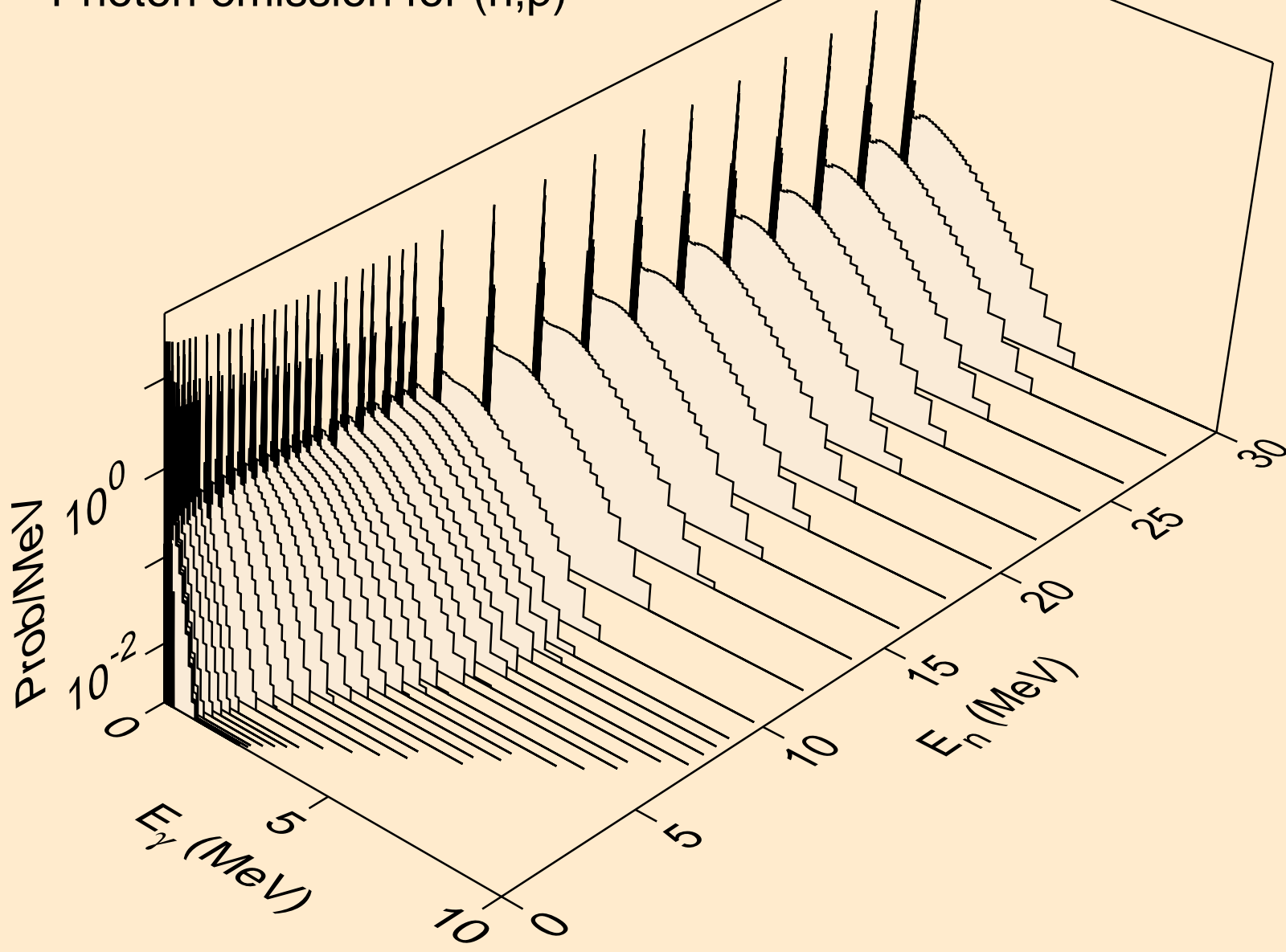

LU169 NEUTRON ACER TENDL-2019 LIBRARY; T=293.16K
Photon emission for (n,d)

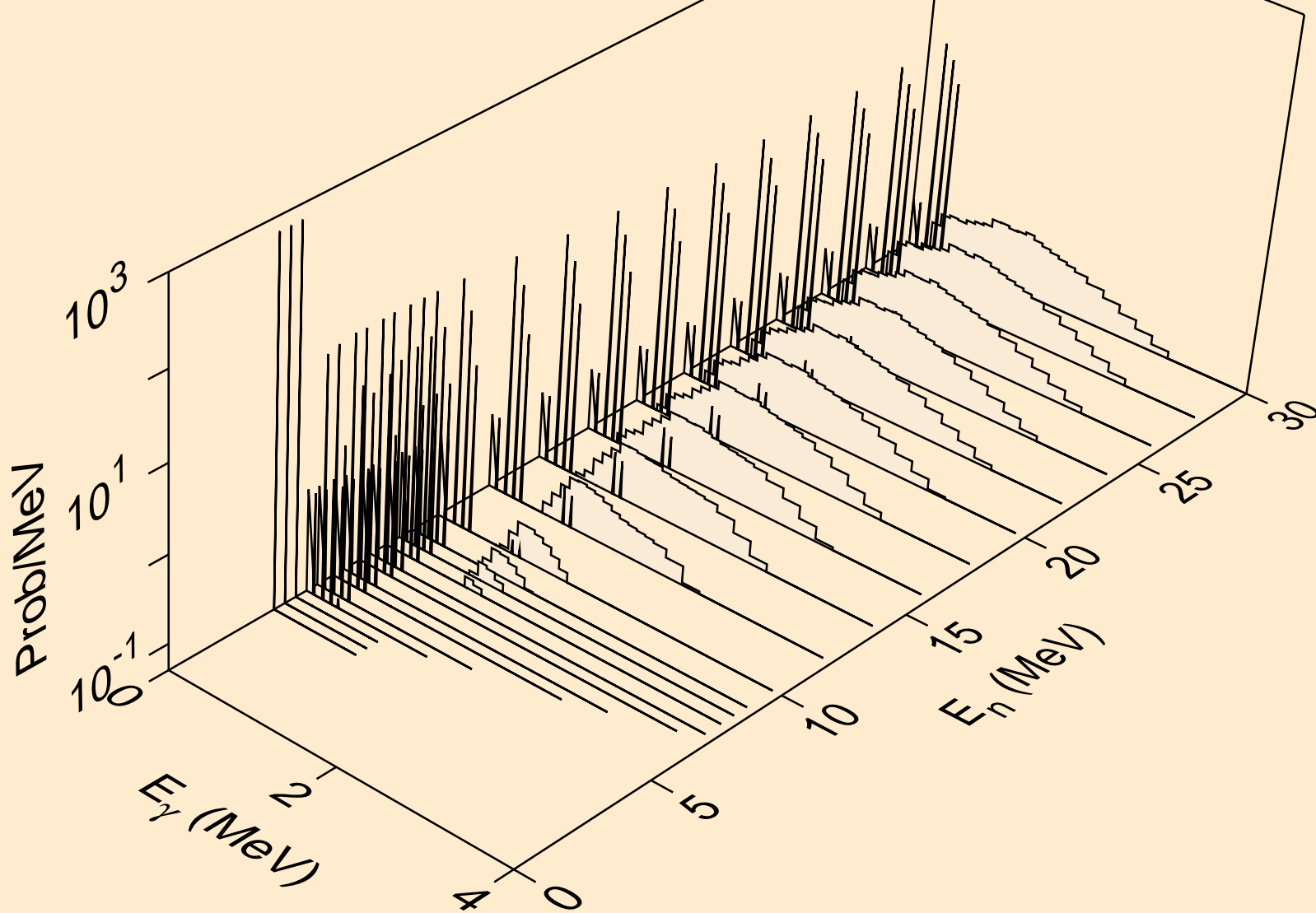

LU169 NEUTRON ACER TENDL-2019 LIBRARY; T=293.16K
Photon emission for (n,t)

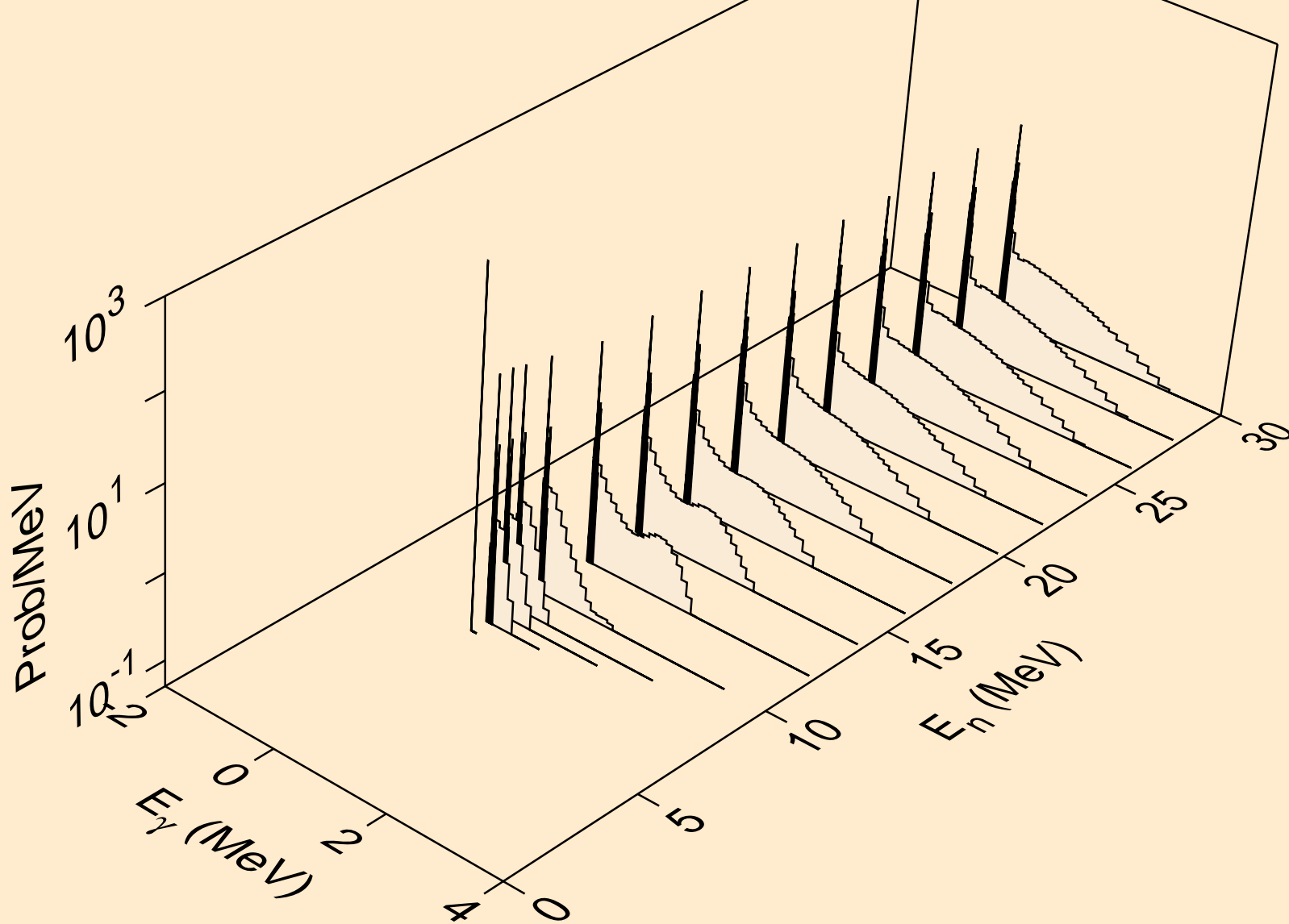

LU169 NEUTRON ACER TENDL-2019 LIBRARY; T=293.16K
Photon emission for (n,he3)

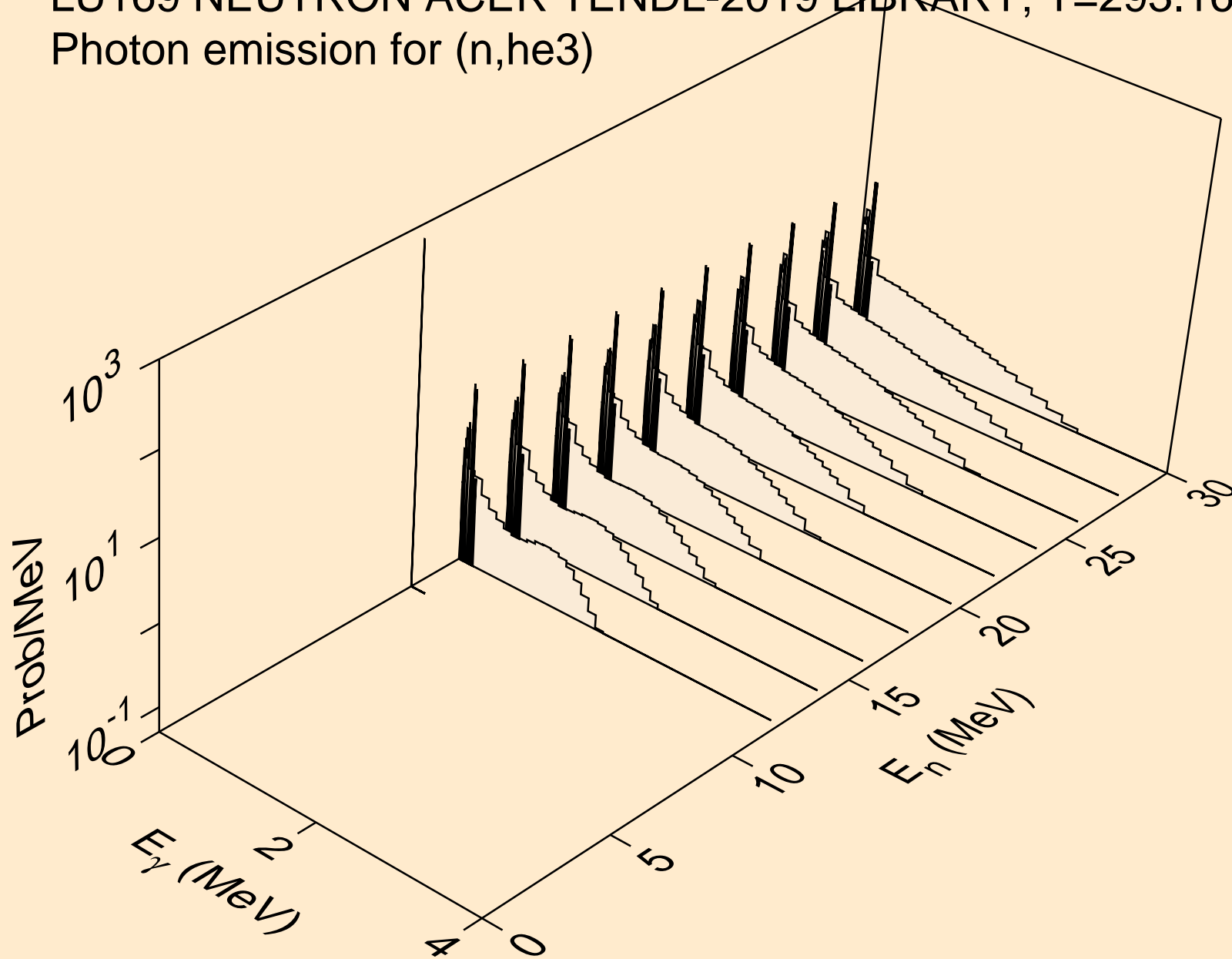

LU169 NEUTRON ACER TENDL-2019 LIBRARY; T=293.16K
Photon emission for (n,a)

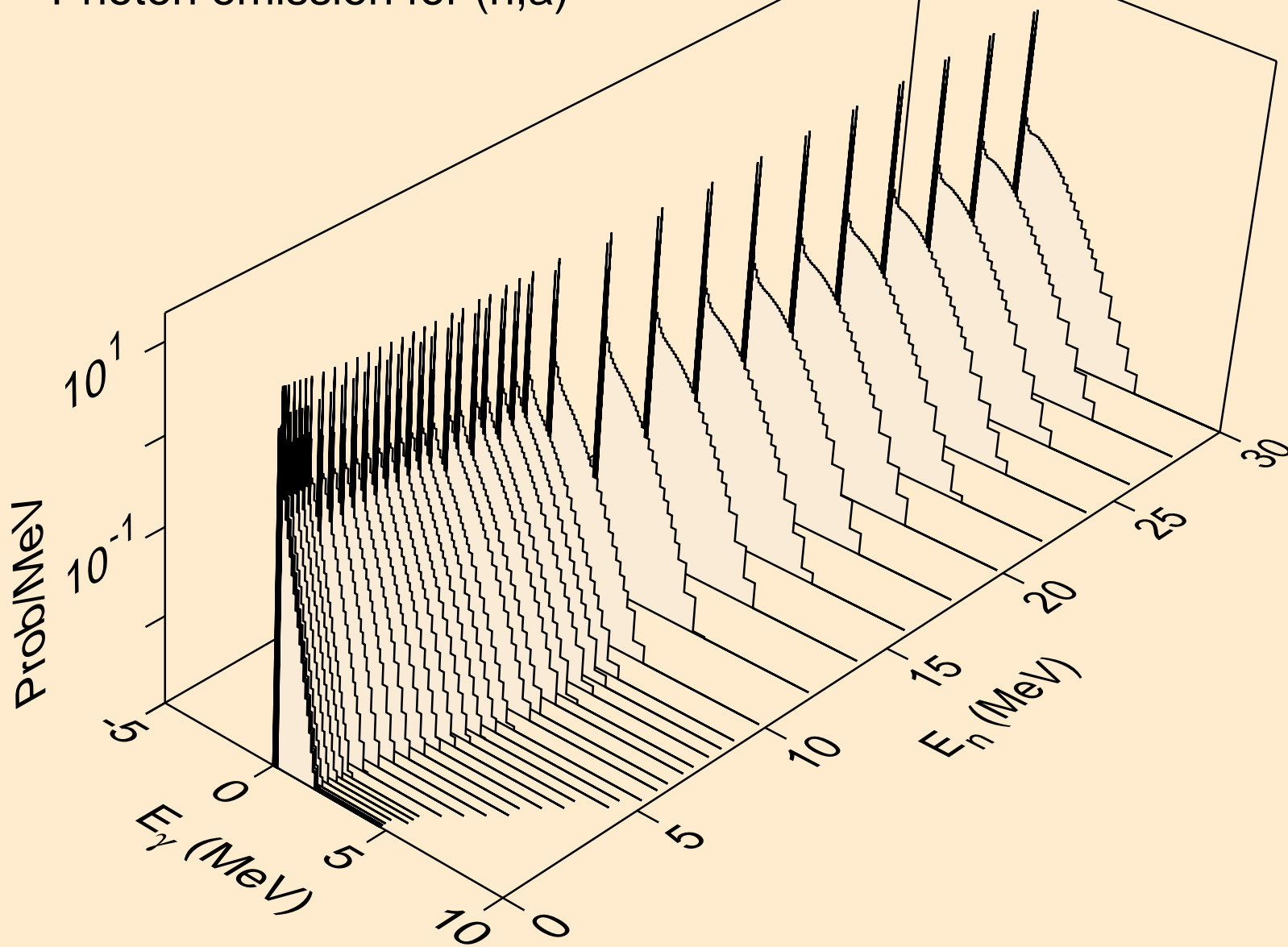

LU169 NEUTRON ACER TENDL-2019 LIBRARY; T=293.16K
Photon emission for (n,2a)

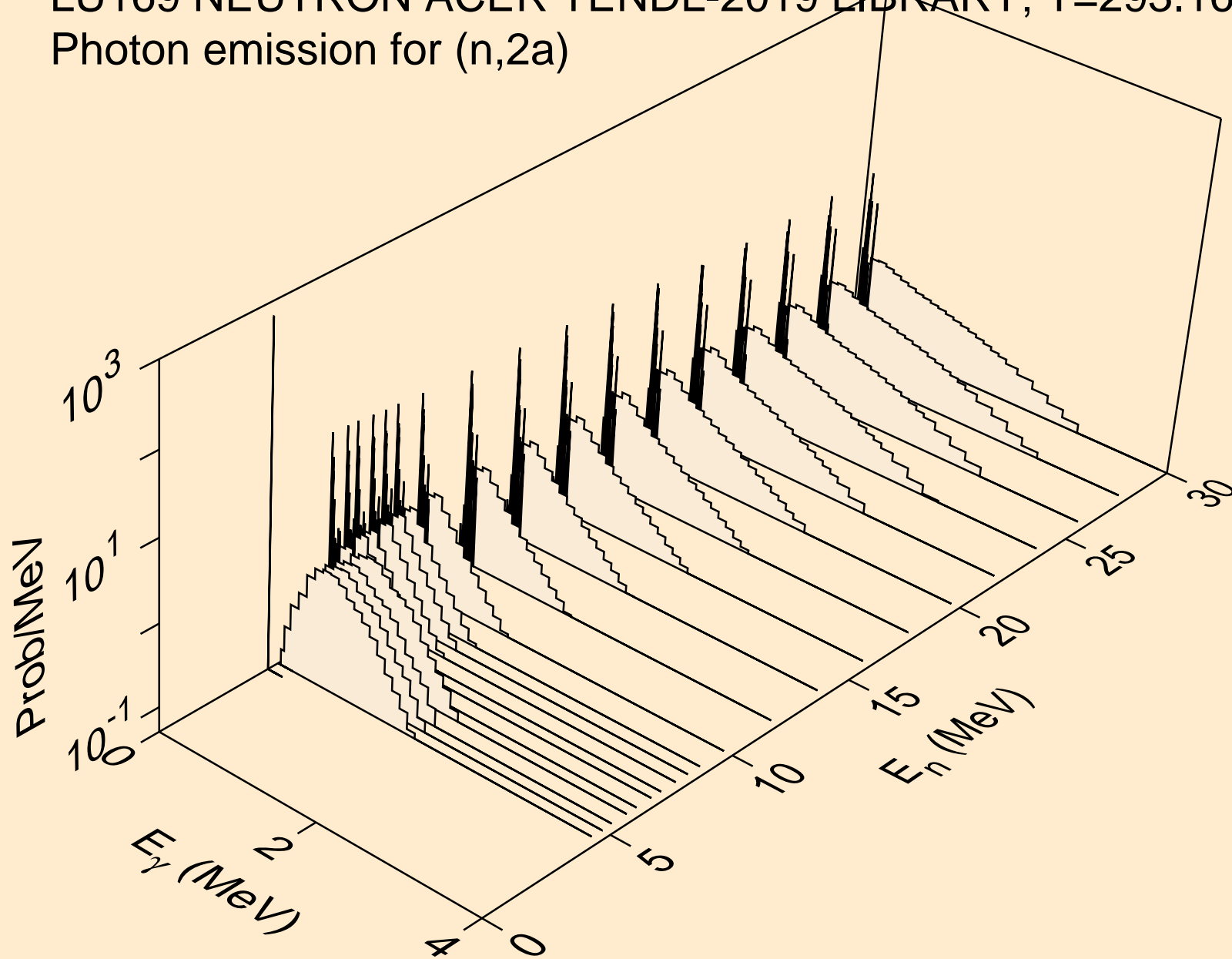

LU169 NEUTRON ACER TENDL-2019 LIBRARY; T=293.16K
Photon emission for (n,2p)

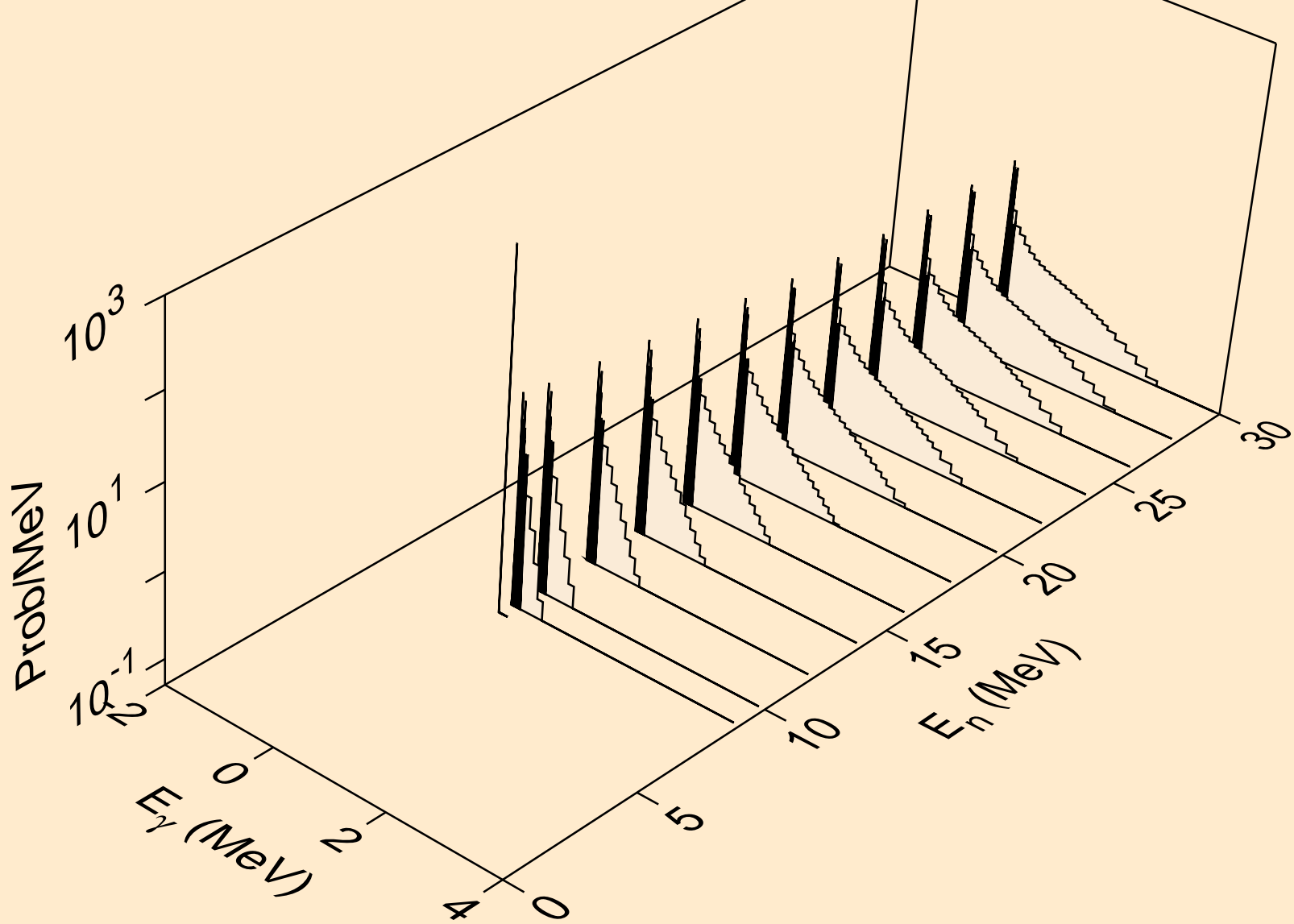

LU169 NEUTRON ACER TENDL-2019 LIBRARY; T=293.16K
Photon emission for (n,p α)

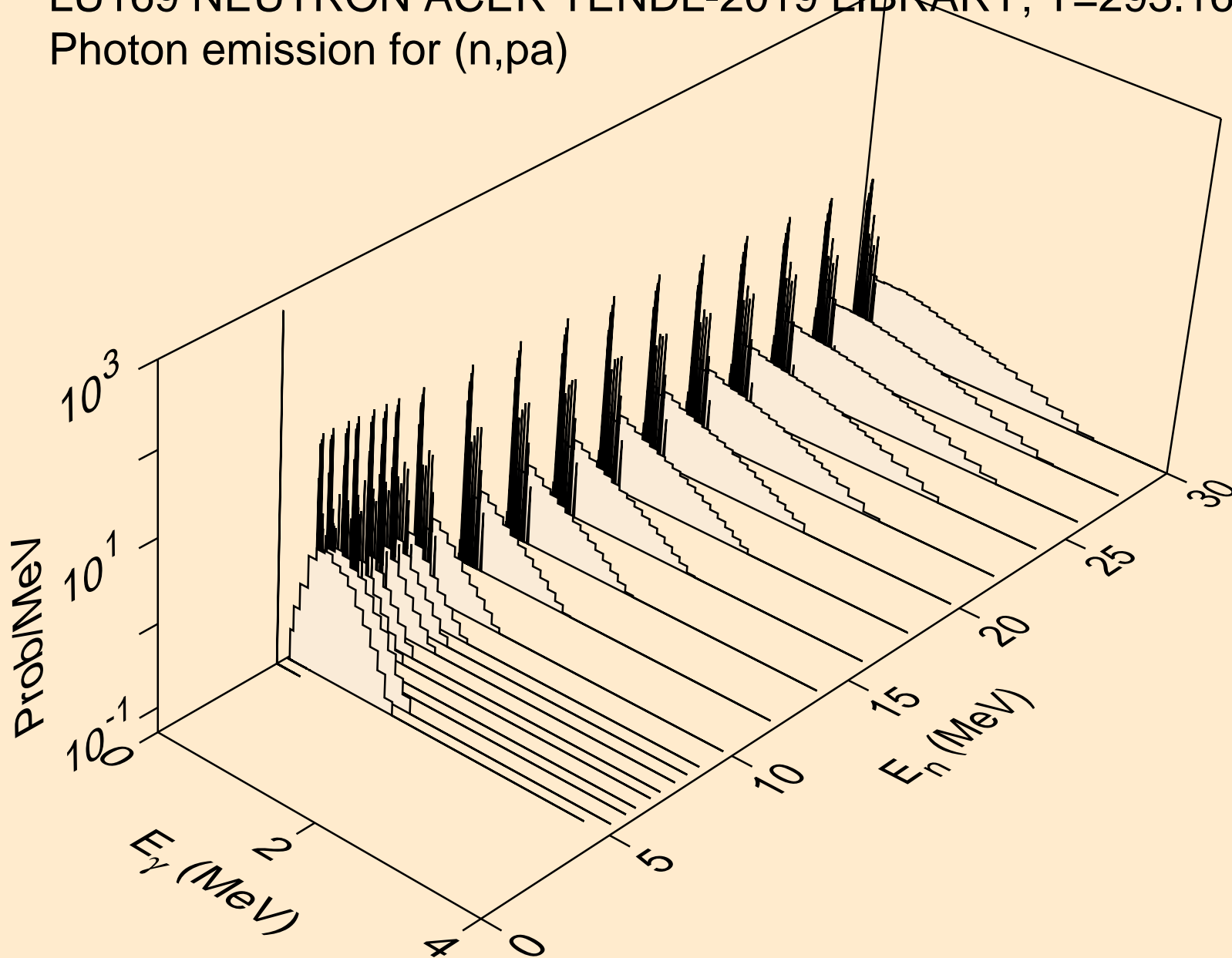

LU169 NEUTRON ACER TENDL-2019 LIBRARY; T=293.16K
Photon emission for (n,pd)

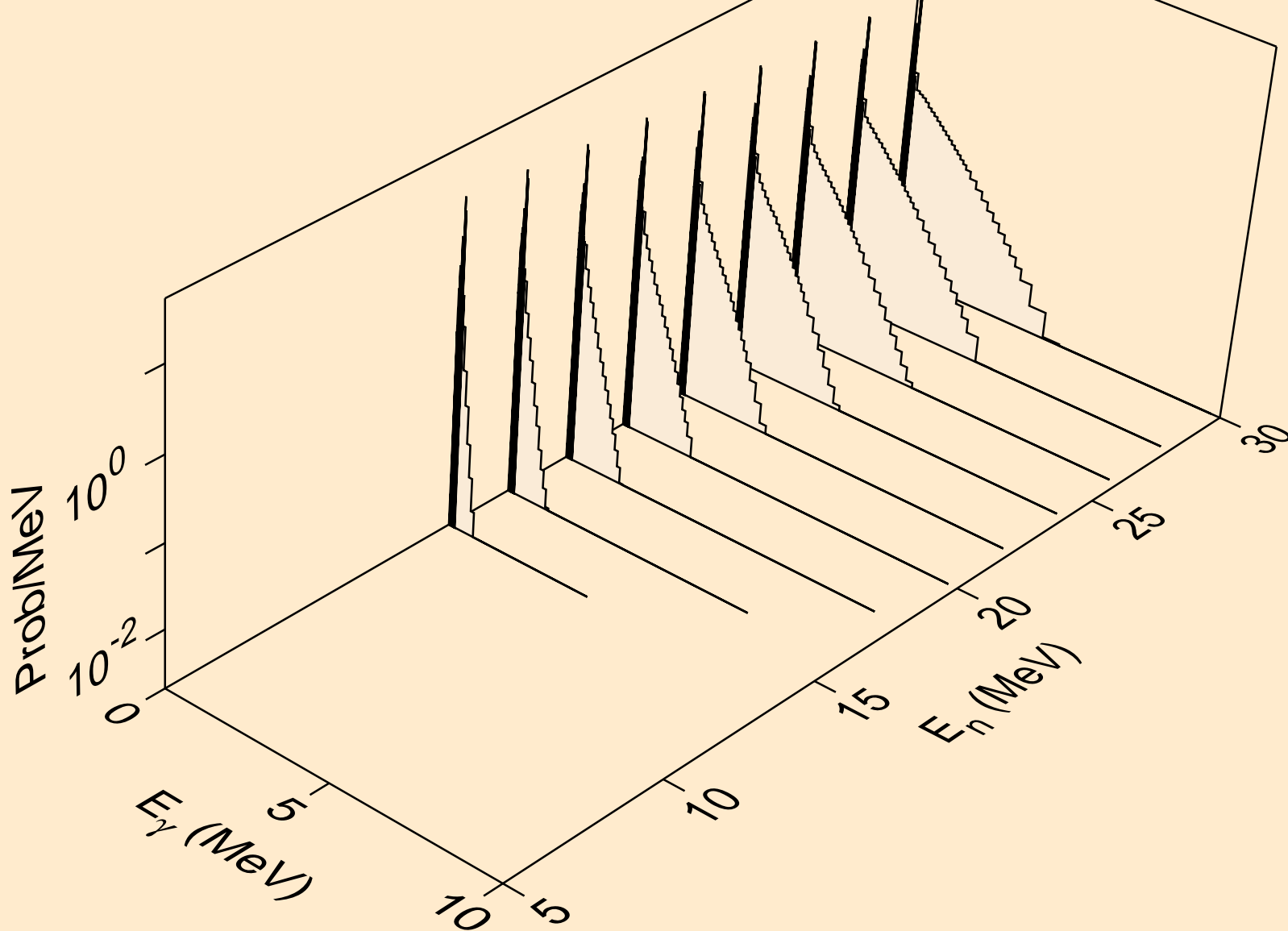

LU169 NEUTRON ACER TENDL-2019 LIBRARY; T=293.16K
Photon emission for (n,pt)

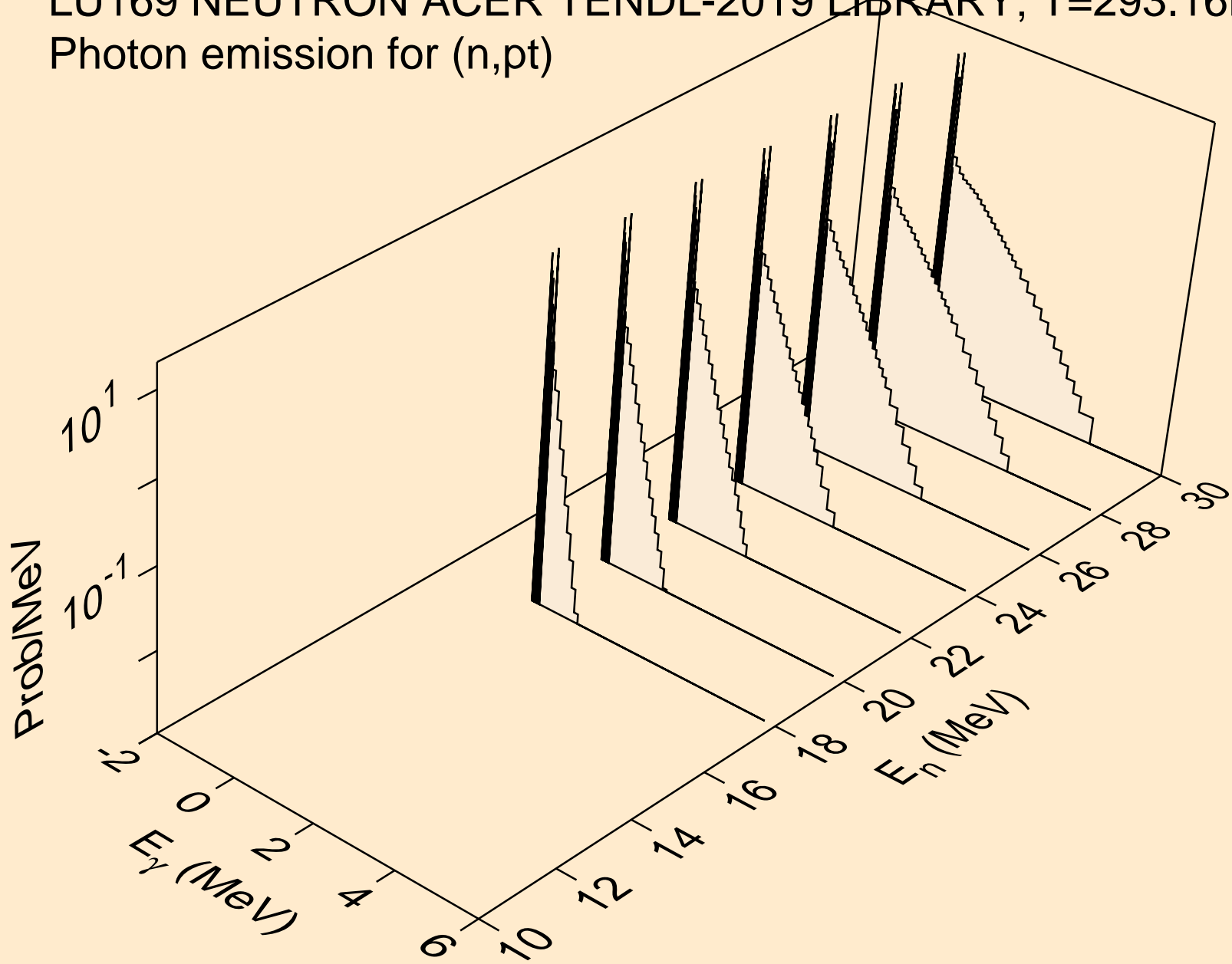

LU169 NEUTRON ACER TENDL-2019 LIBRARY; T=293.16K
Photon emission for (n,da)

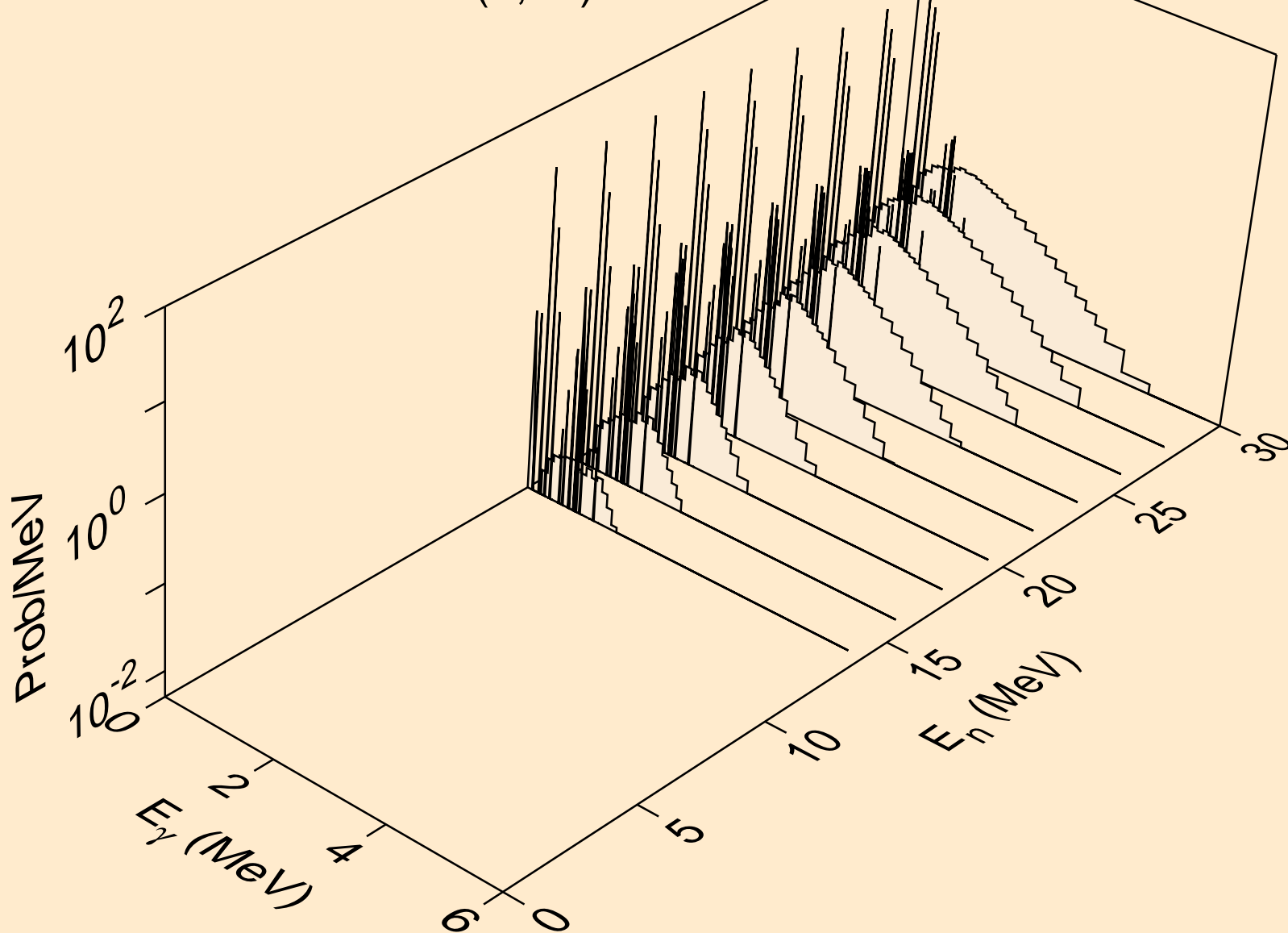

LU169 NEUTRON ACER TENDL-2019 LIBRARY; T=293.16K
thermal capture photon spectrum

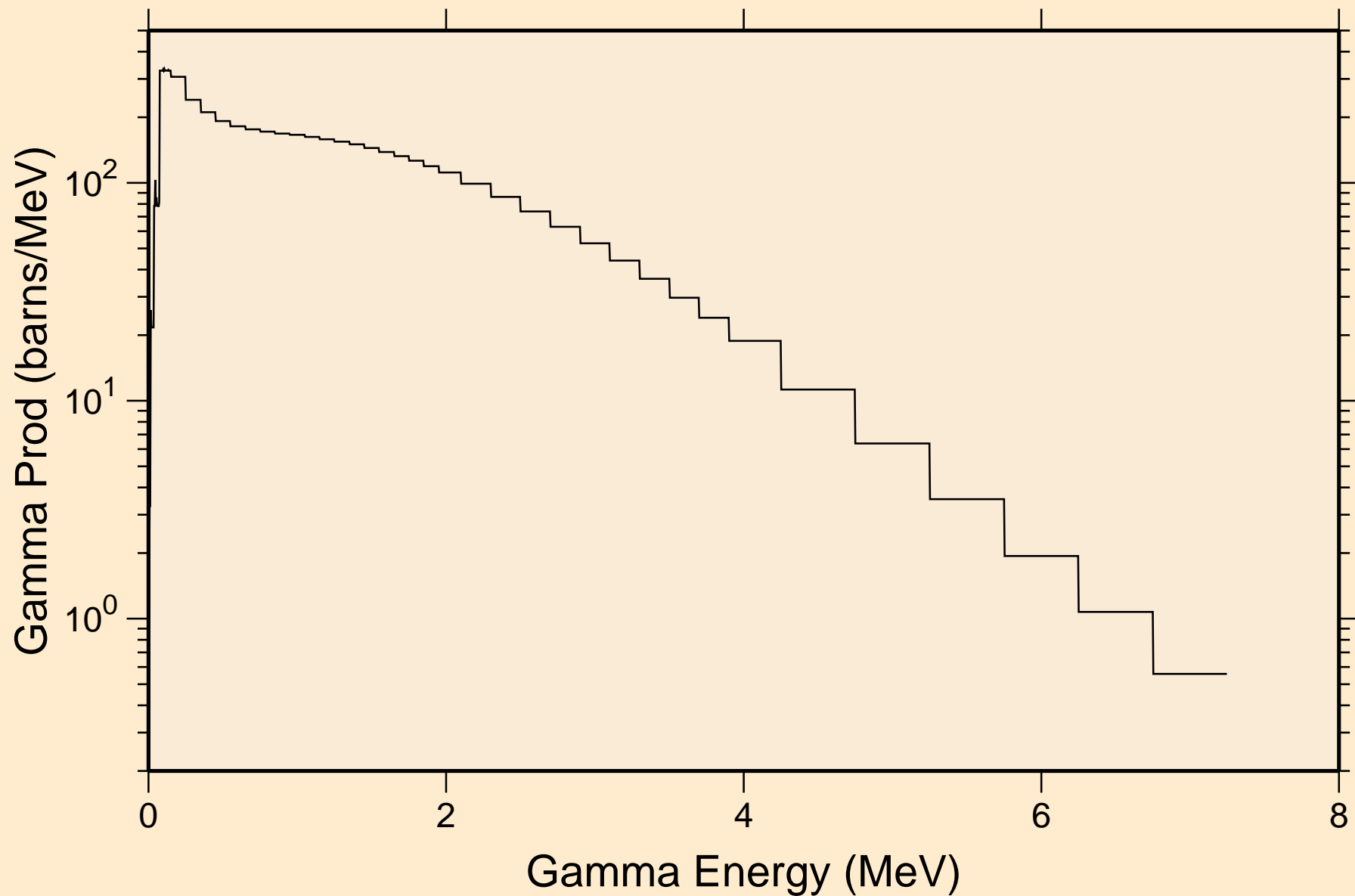

LU169 NEUTRON ACER TENDL-2019 LIBRARY; T=293.16K
14 MeV photon spectrum

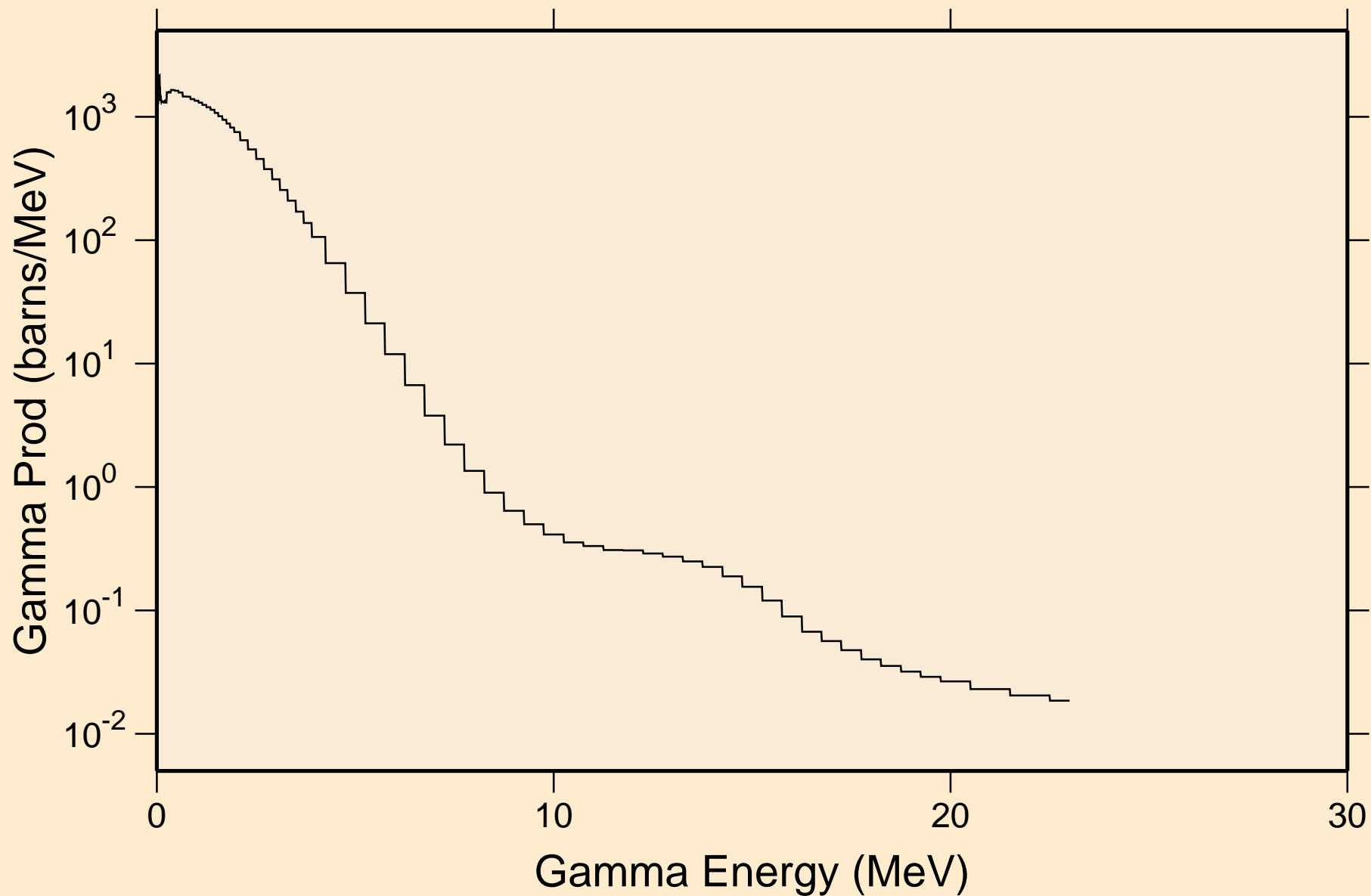

LU169 NEUTRON ACER TENDL-2019 LIBRARY; T=293.16K
Particle heating contributions

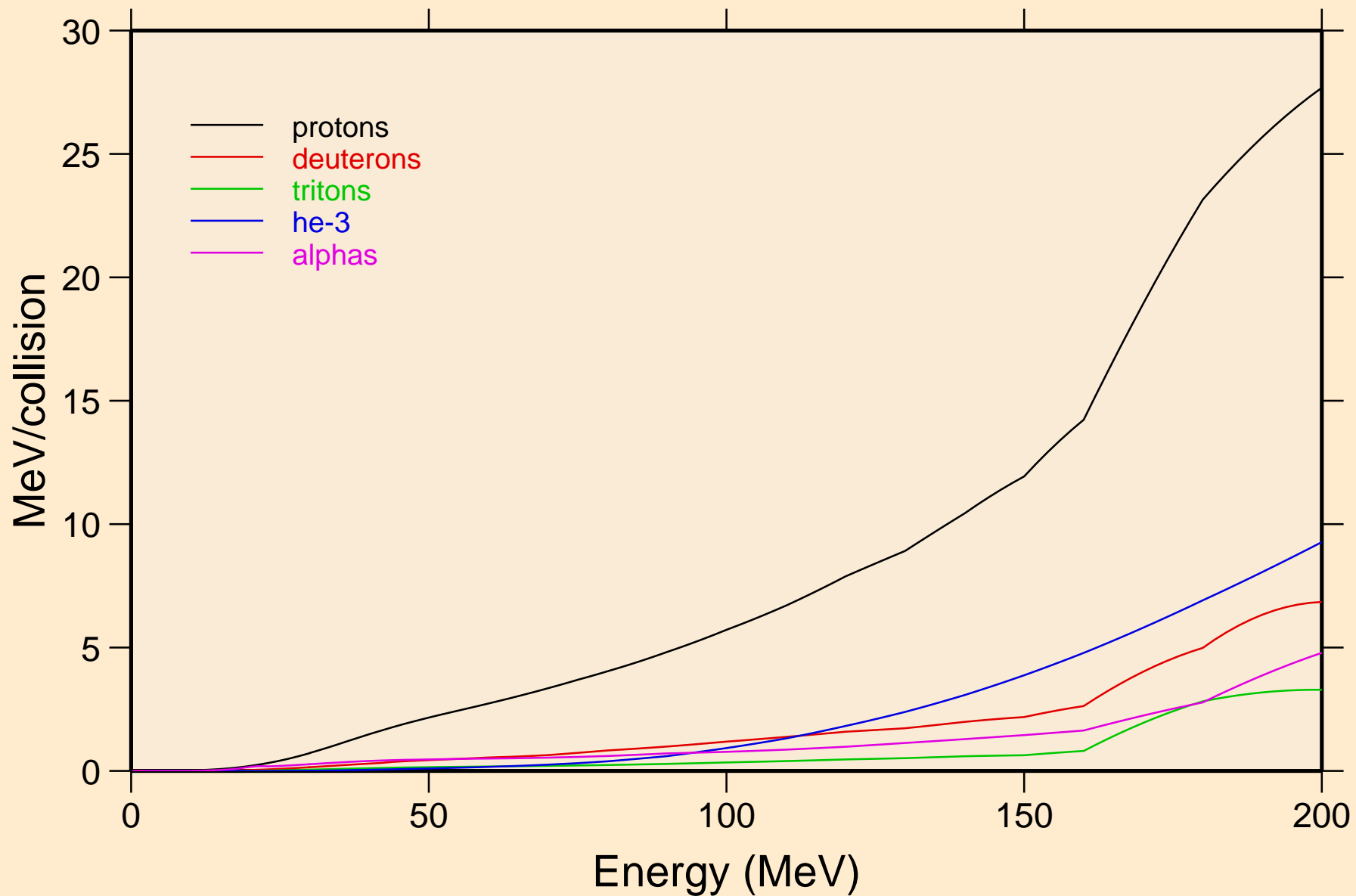

LU169 NEUTRON ACER TENDL-2019 LIBRARY; T=293.16K
Recoil Heating

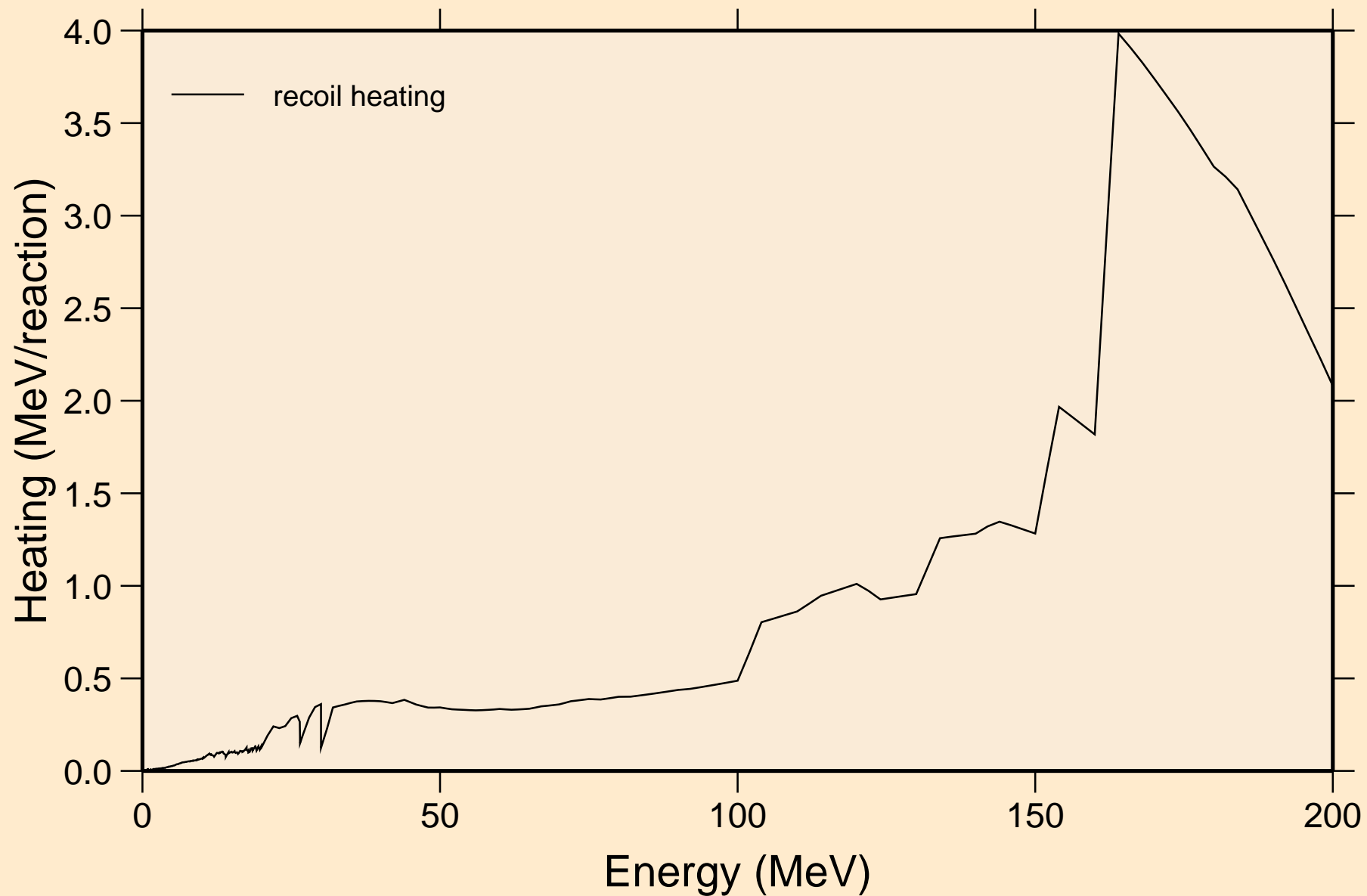

LU169 NEUTRON ACER TENDL-2019 LIBRARY; T=293.16K
Particle production cross sections

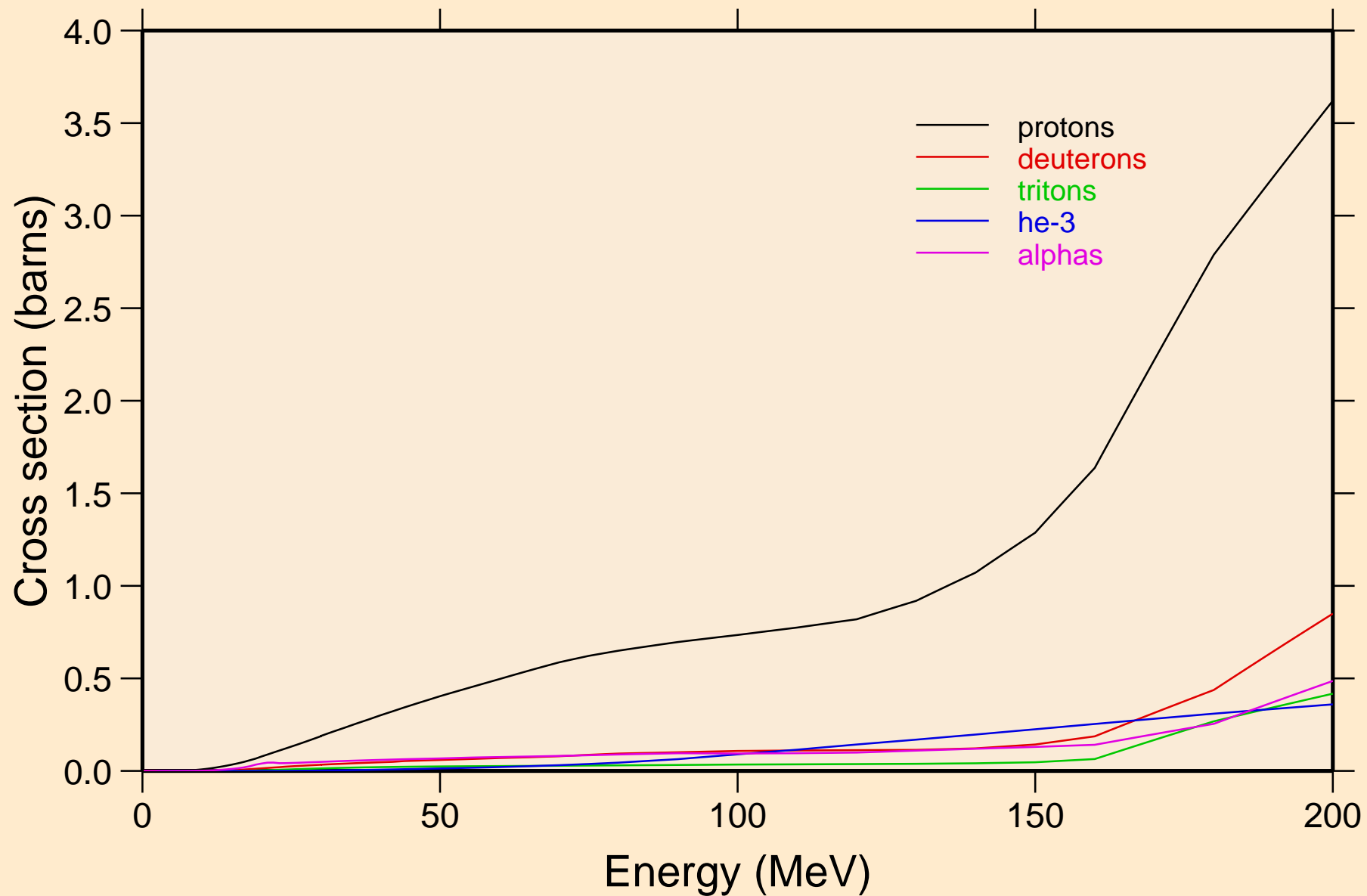

LU169 NEUTRON ACER TENDL-2019 LIBRARY; T=293.16K
protons from (n,x)

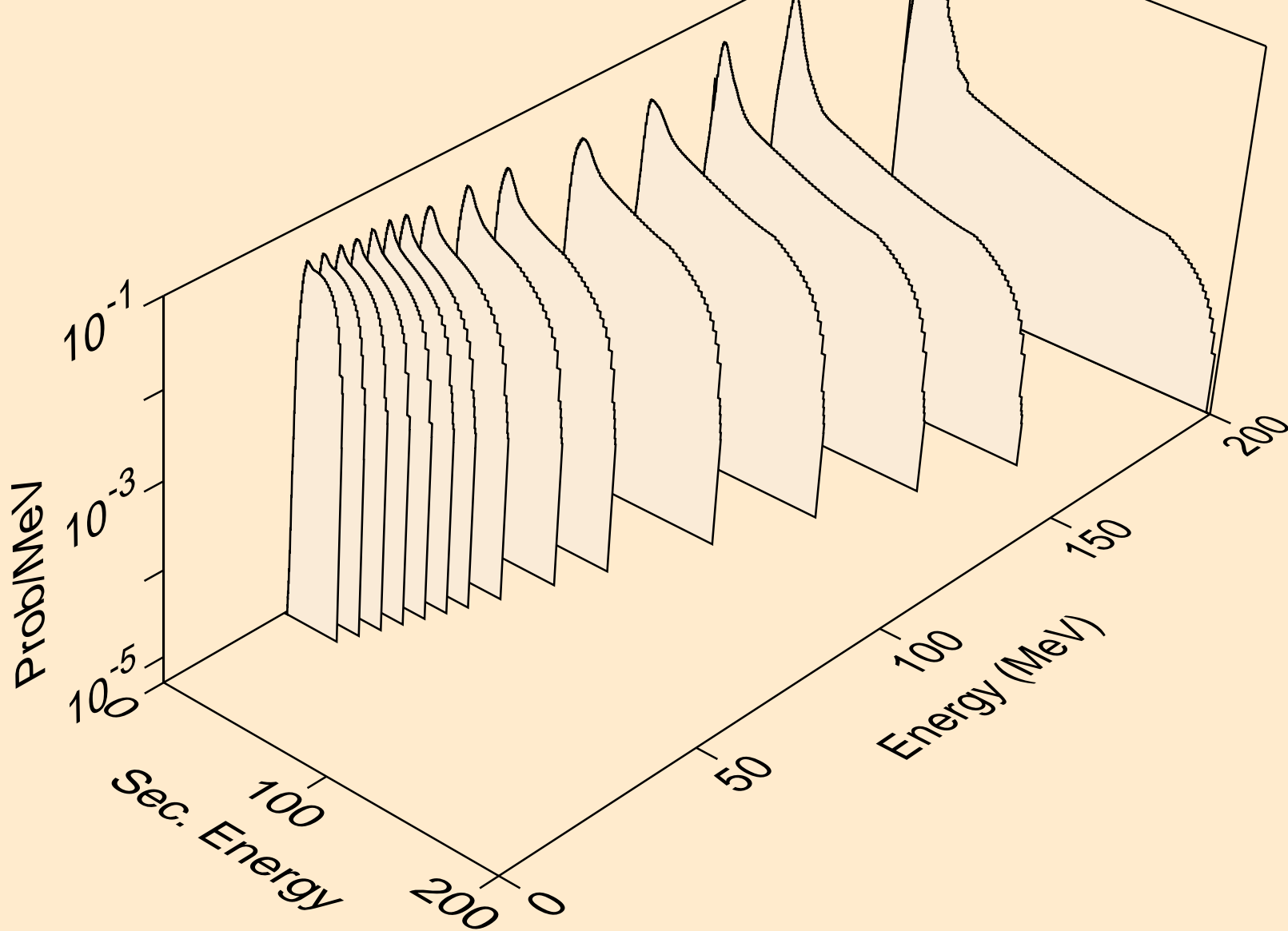

LU169 NEUTRON ACER TENDL-2019 LIBRARY; T=293.16K
protons from (n,n*)p

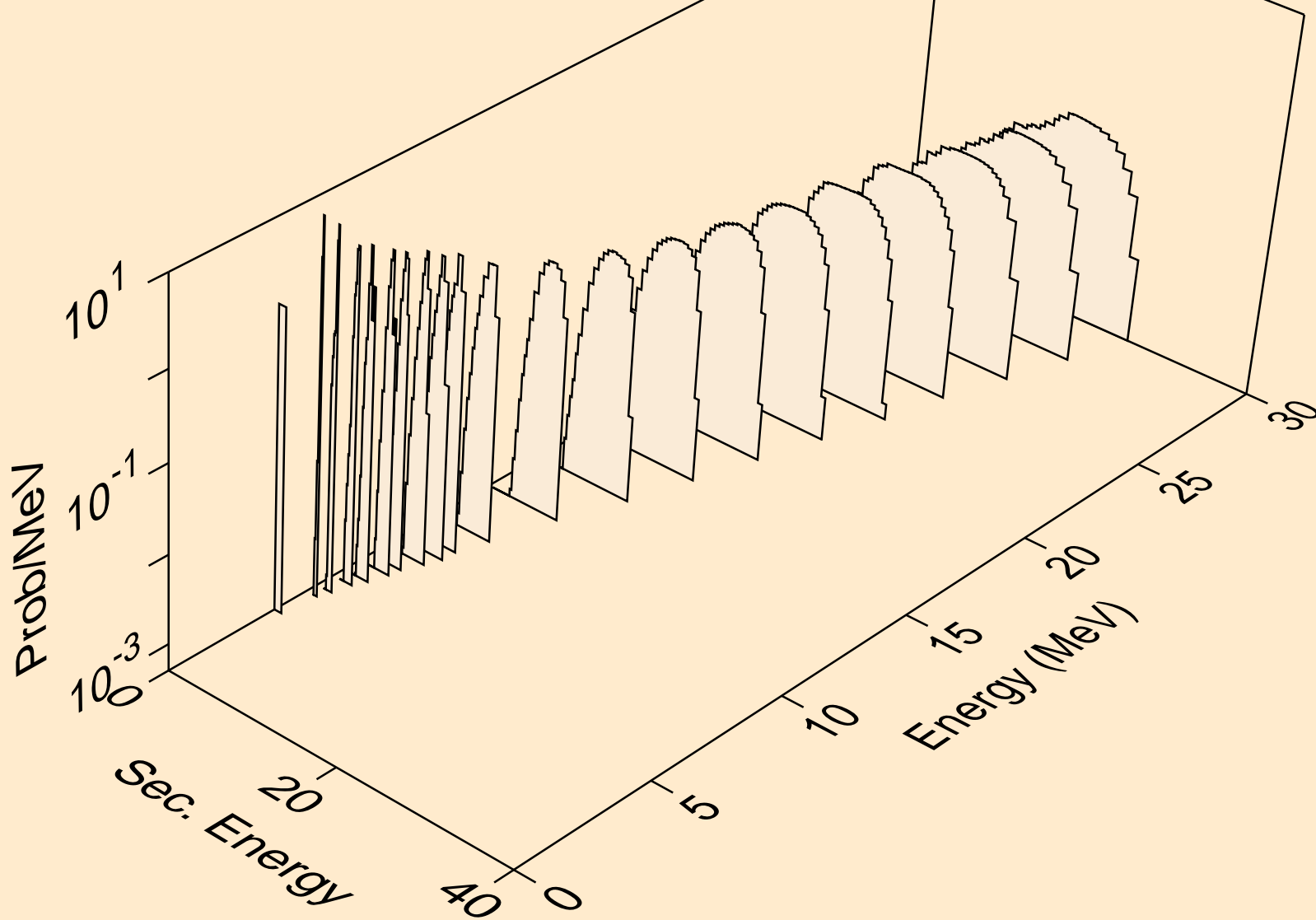

LU169 NEUTRON ACER TENDL-2019 LIBRARY; T=293.16K
protons from (n,2np)

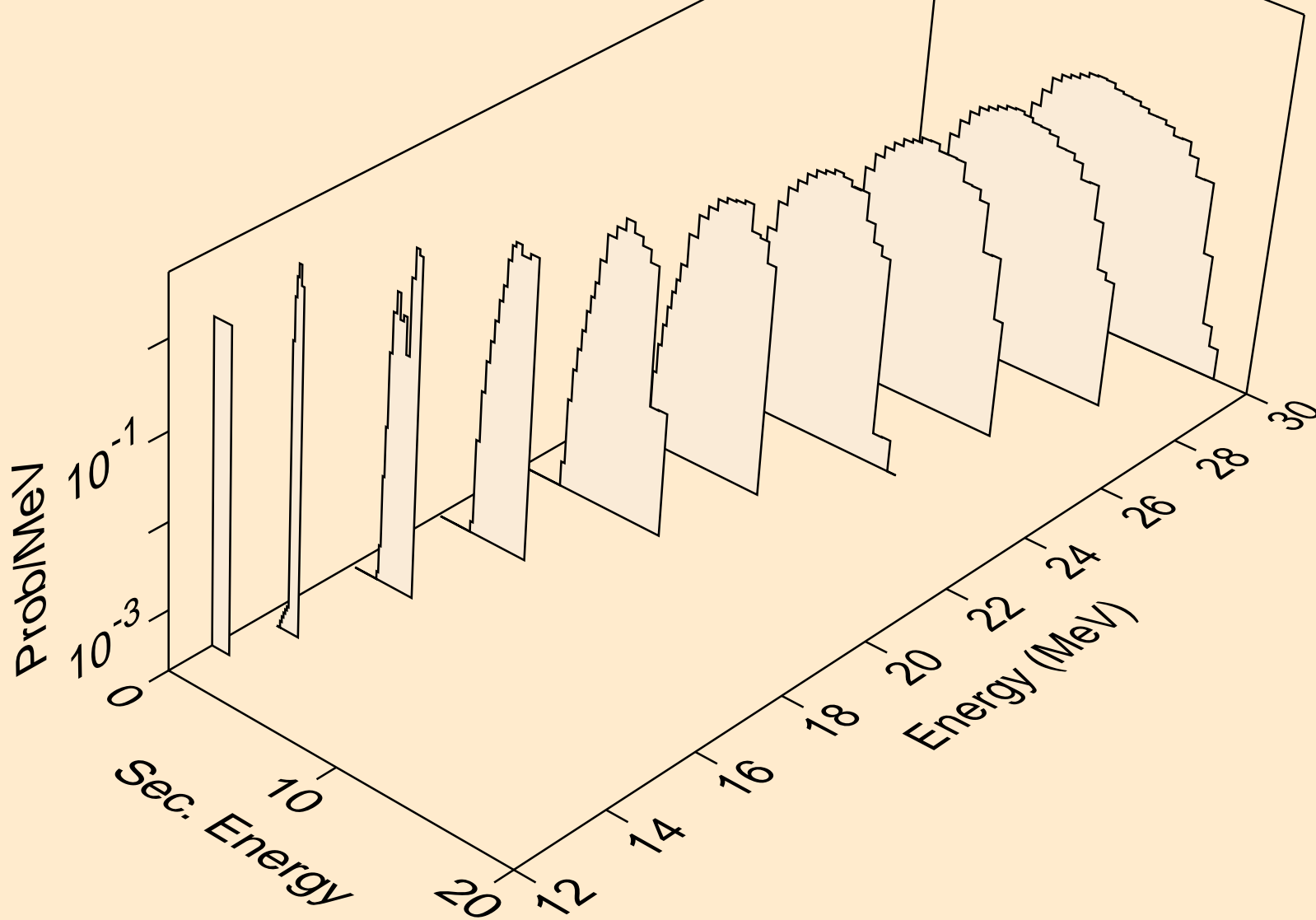

LU169 NEUTRON ACER TENDL-2019 LIBRARY; T=293.16K
protons from (n,3np)

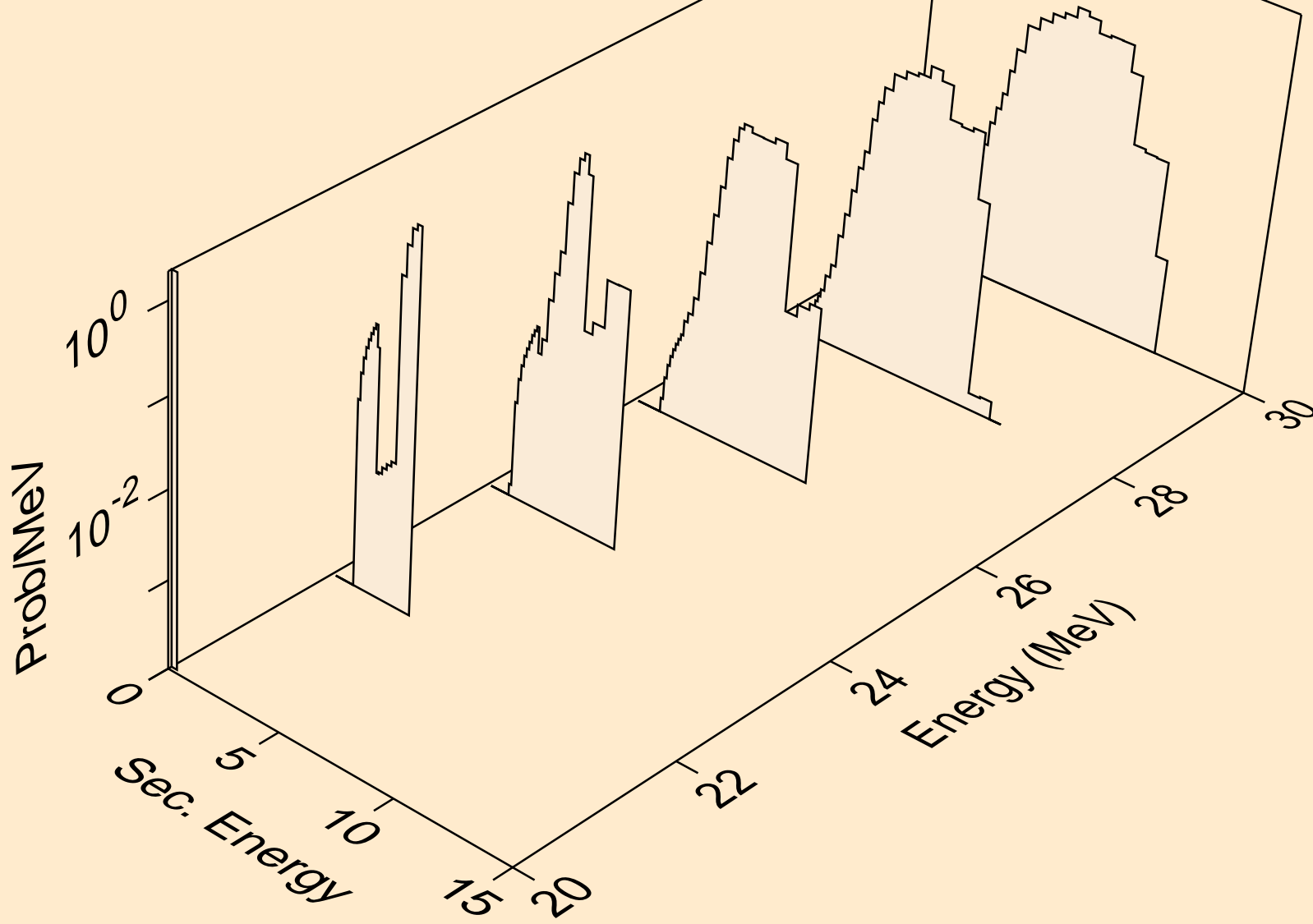

LU169 NEUTRON ACER TENDL-2019 LIBRARY; T=293.16K
protons from (n,2np)

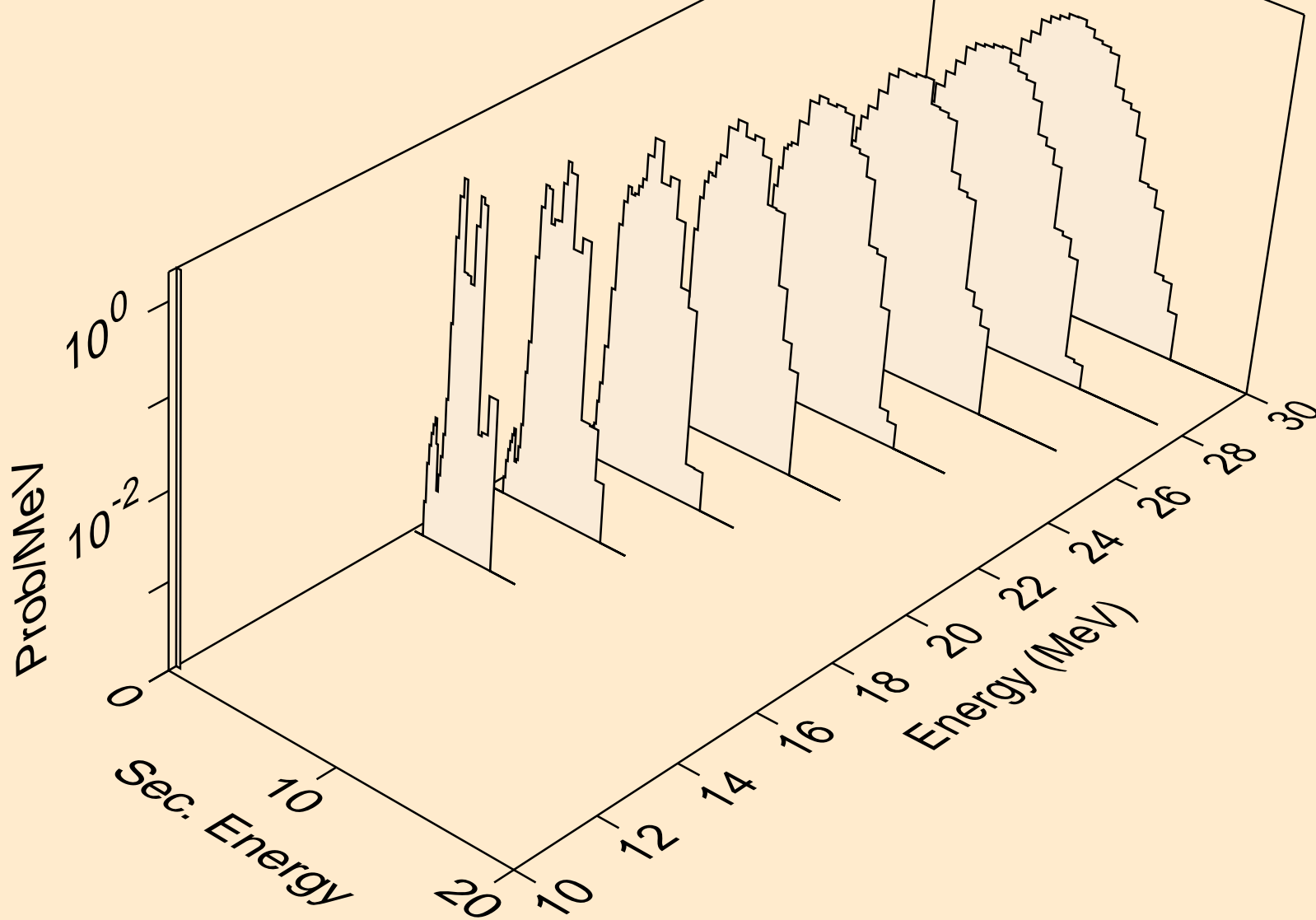

LU169 NEUTRON ACER TENDL-2019 LIBRARY; T=293.16K
protons from (n,npa)

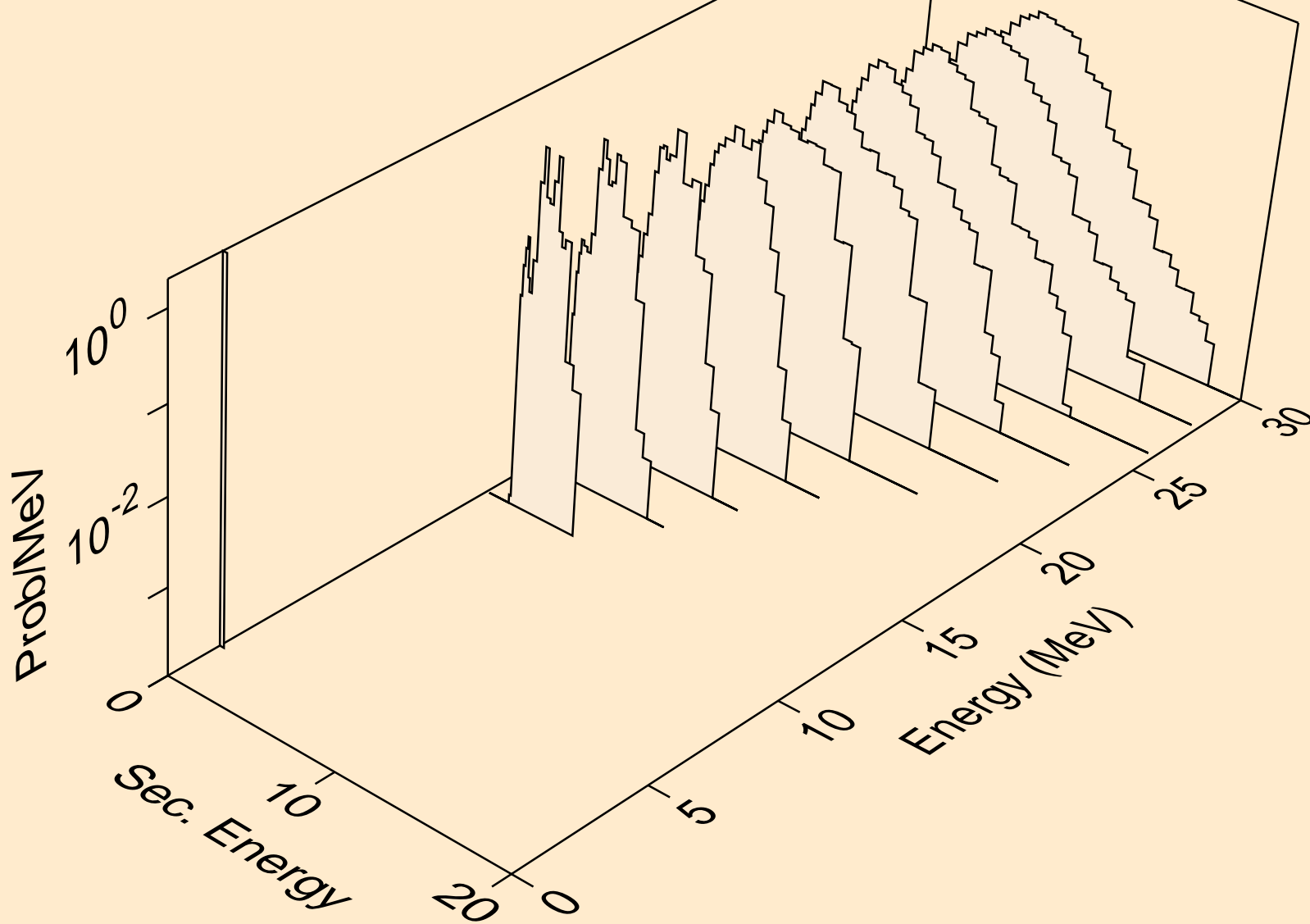

LU169 NEUTRON ACER TENDL-2019 LIBRARY; T=293.16K
protons from (n,p)

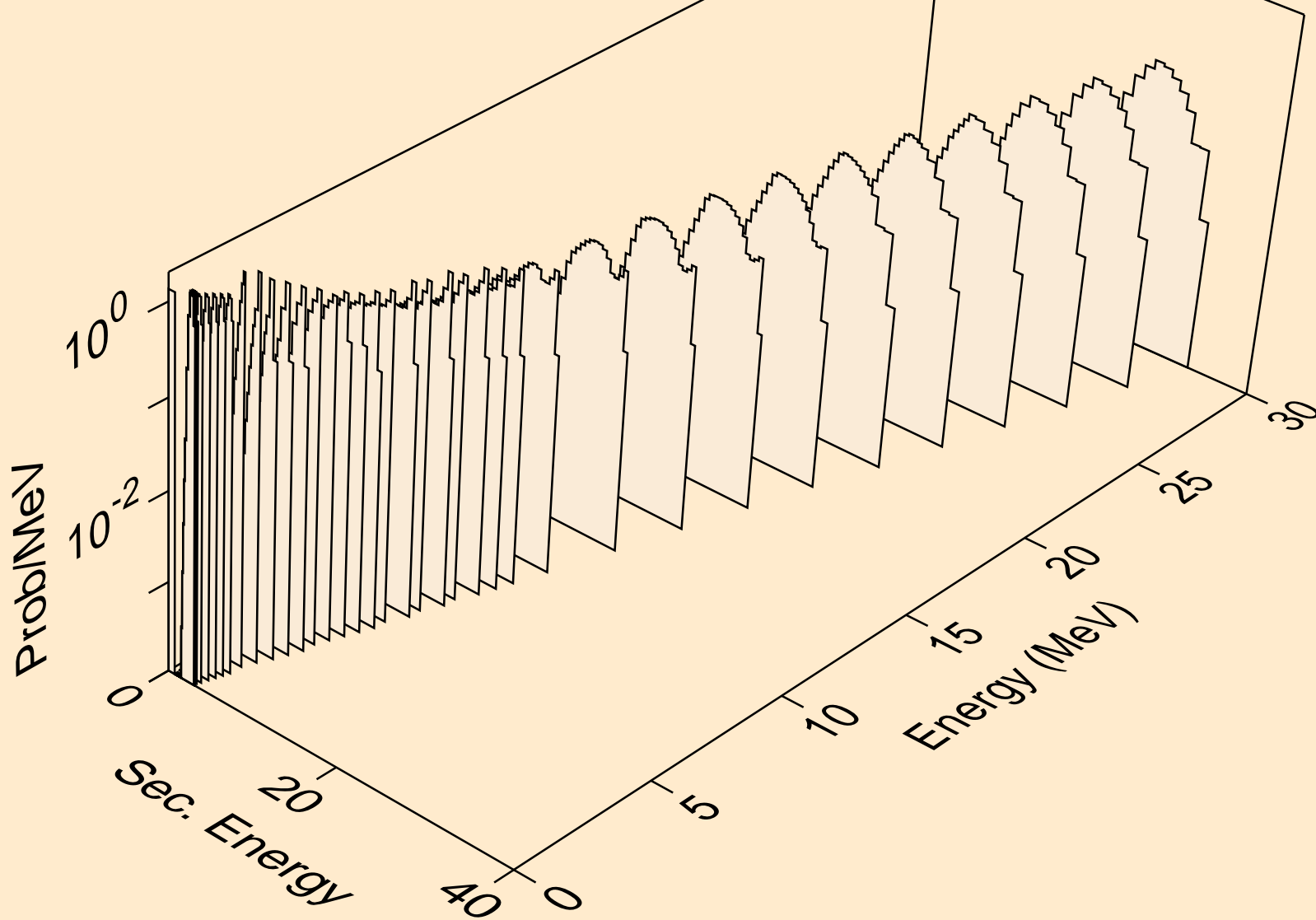

LU169 NEUTRON ACER TENDL-2019 LIBRARY; T=293.16K
protons from (n,2p)

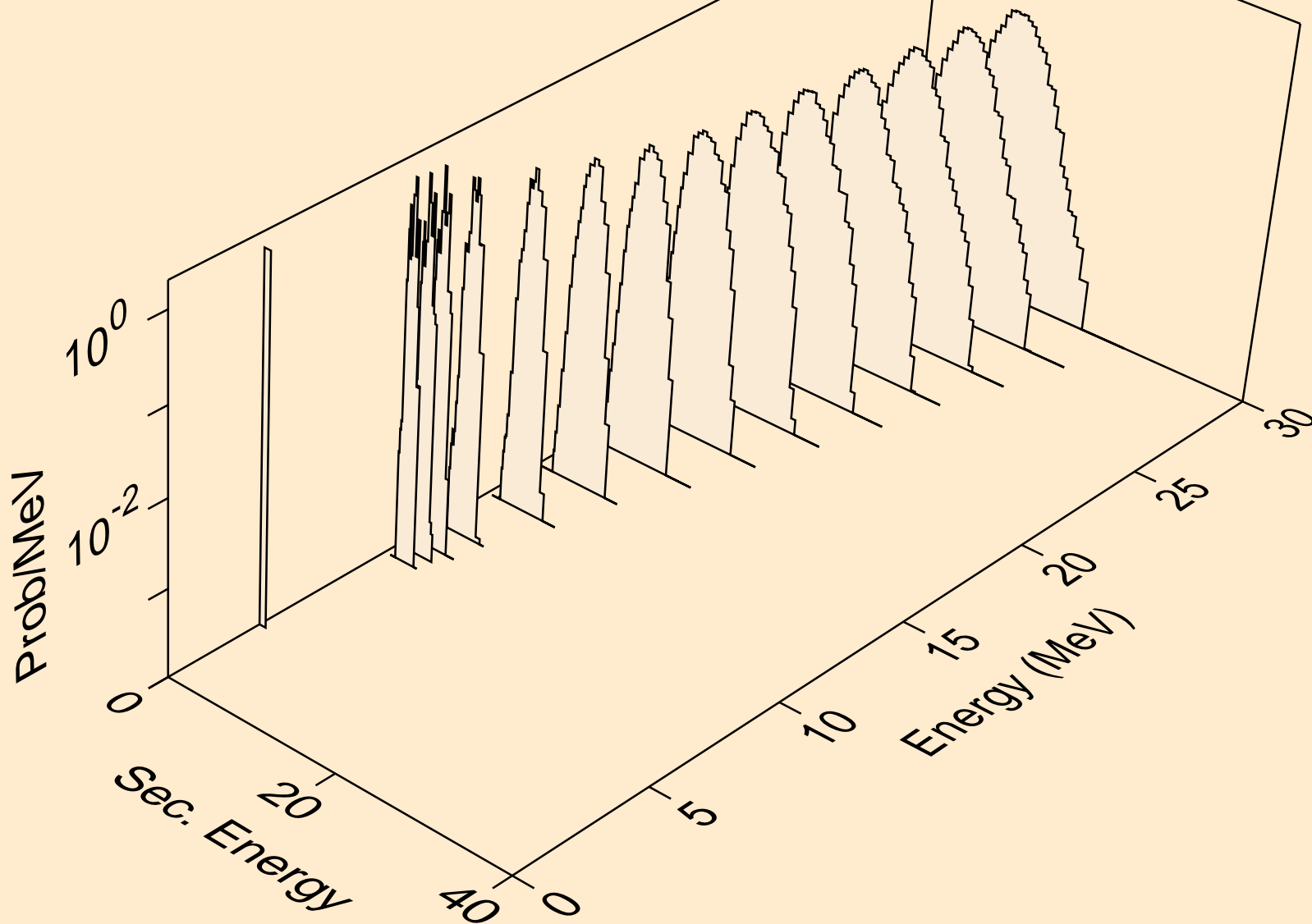

LU169 NEUTRON ACER TENDL-2019 LIBRARY; T=293.16K
protons from (n,p)

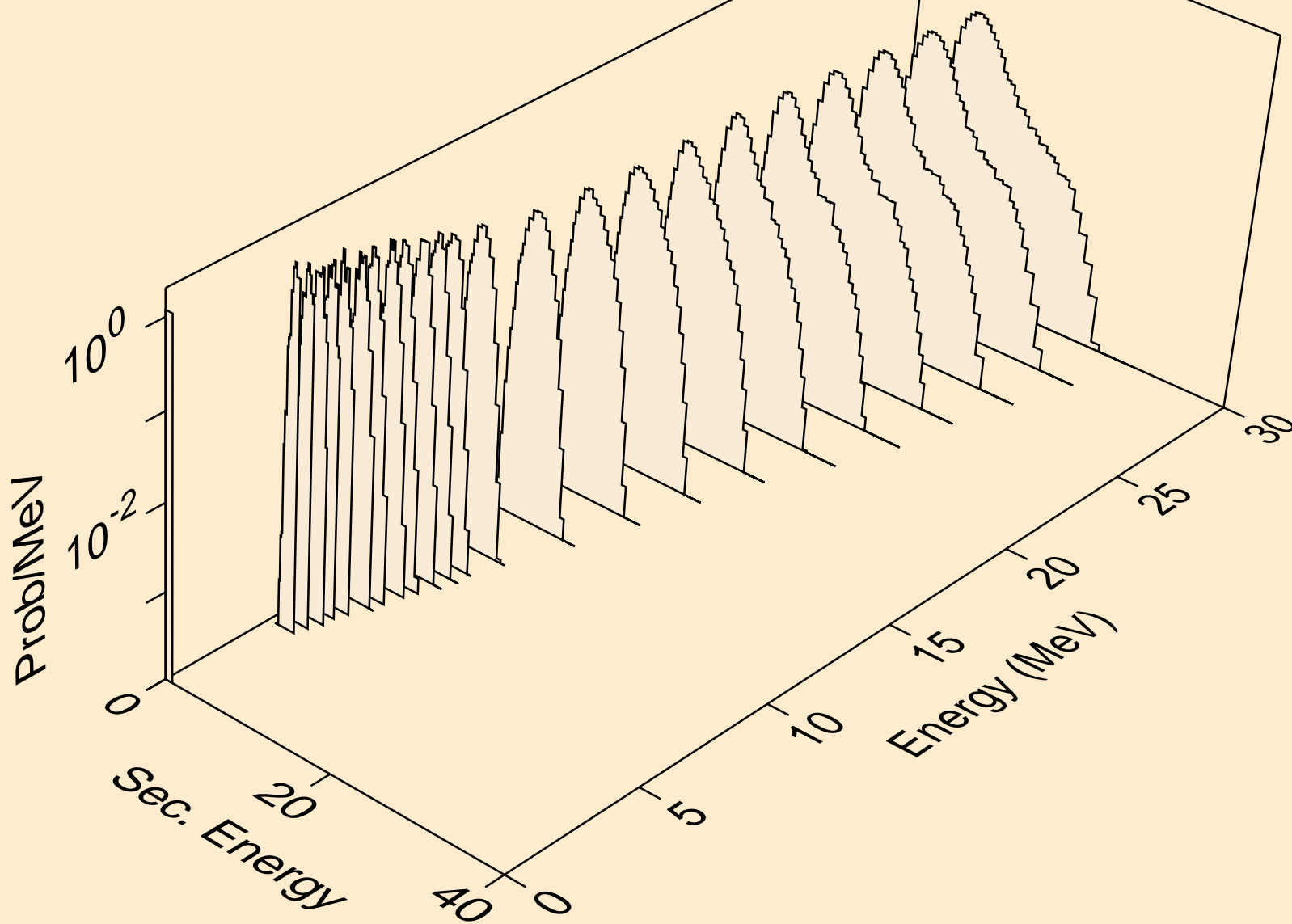

LU169 NEUTRON ACER TENDL-2019 LIBRARY; T=293.16K
protons from (n,pd)

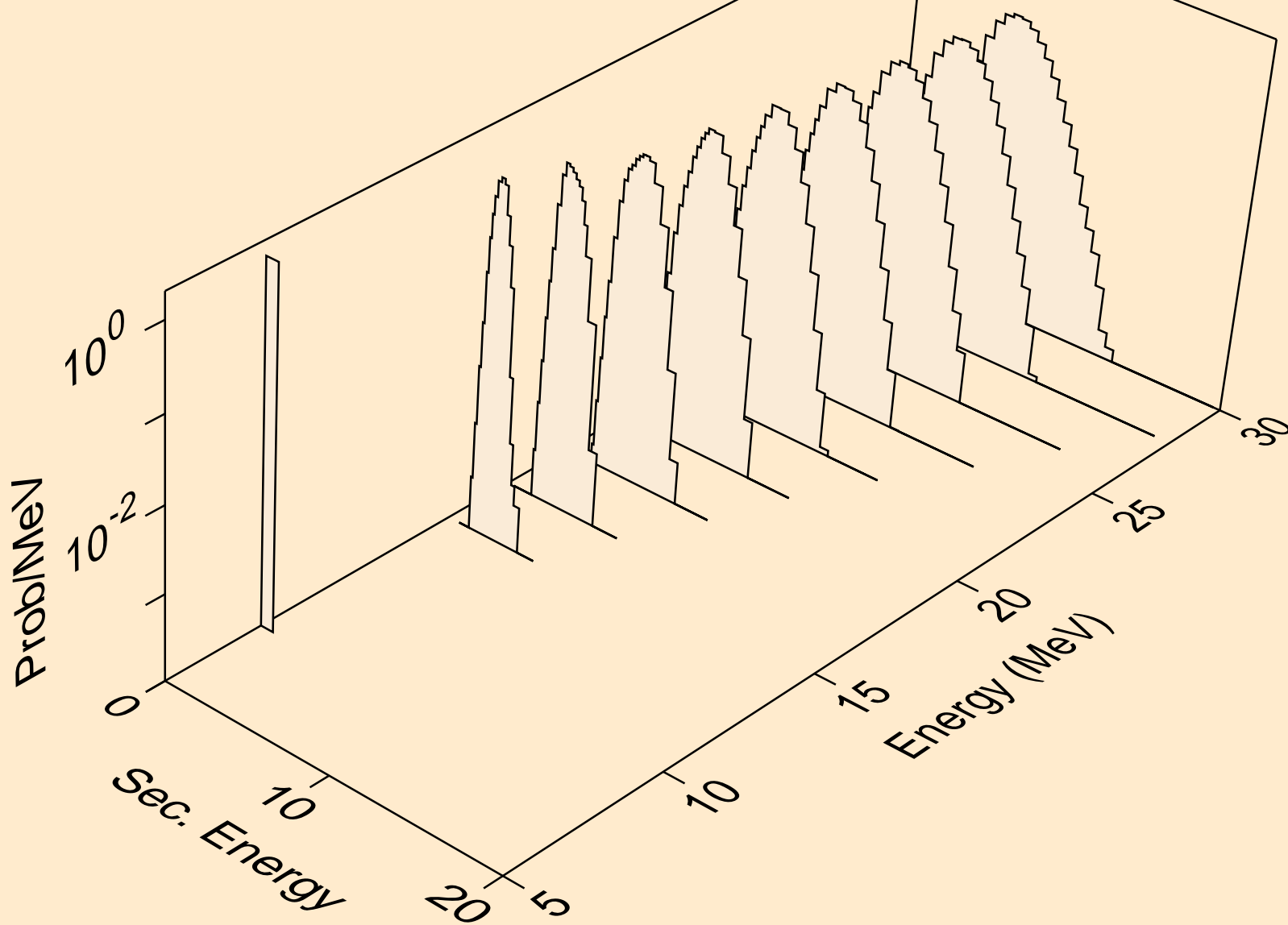

LU169 NEUTRON ACER TENDL-2019 LIBRARY; T=293.16K
protons from (n,pt)

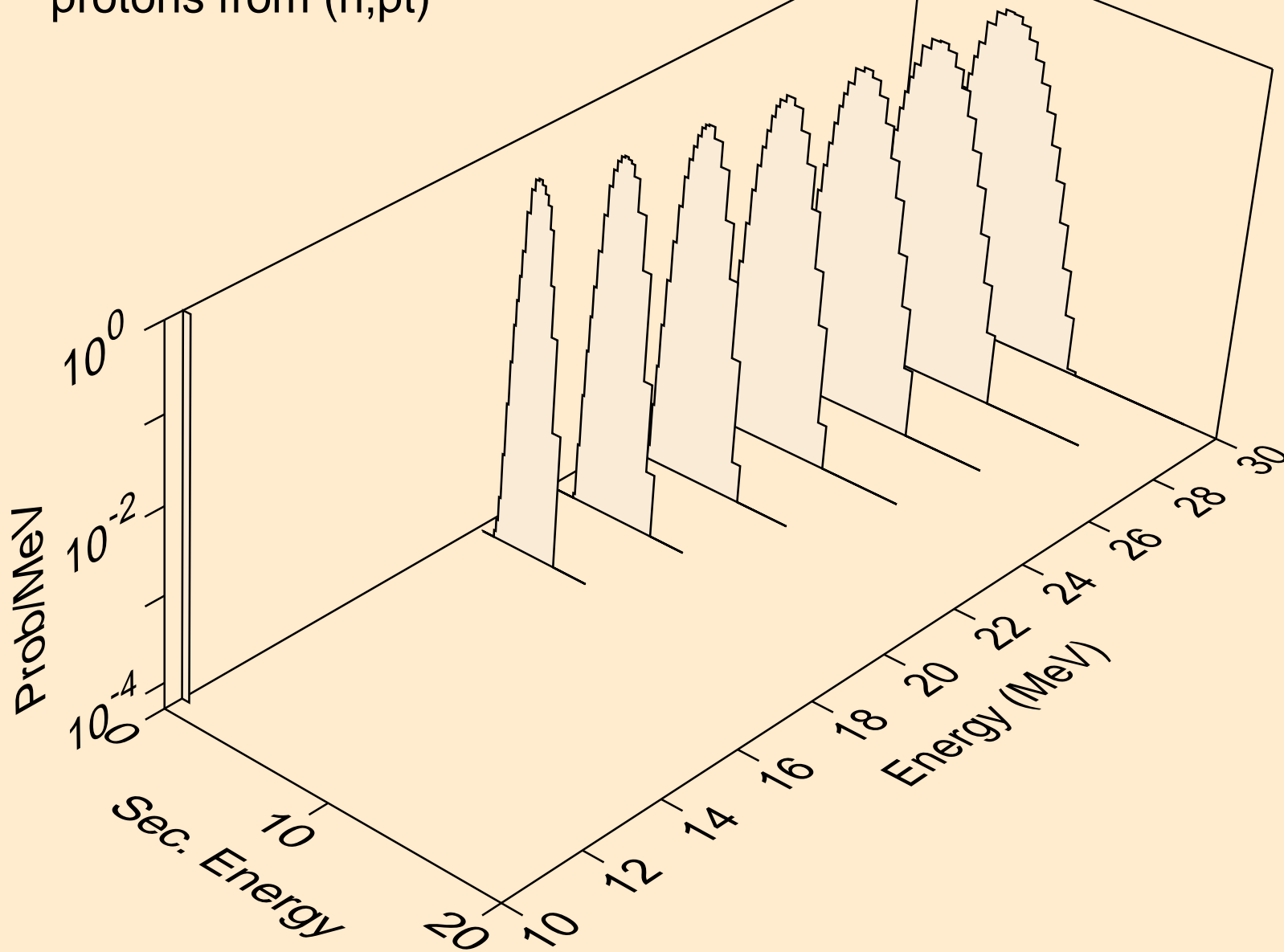

LU169 NEUTRON ACER TENDL-2019 LIBRARY; T=293.16K
deuterons from (n,x)

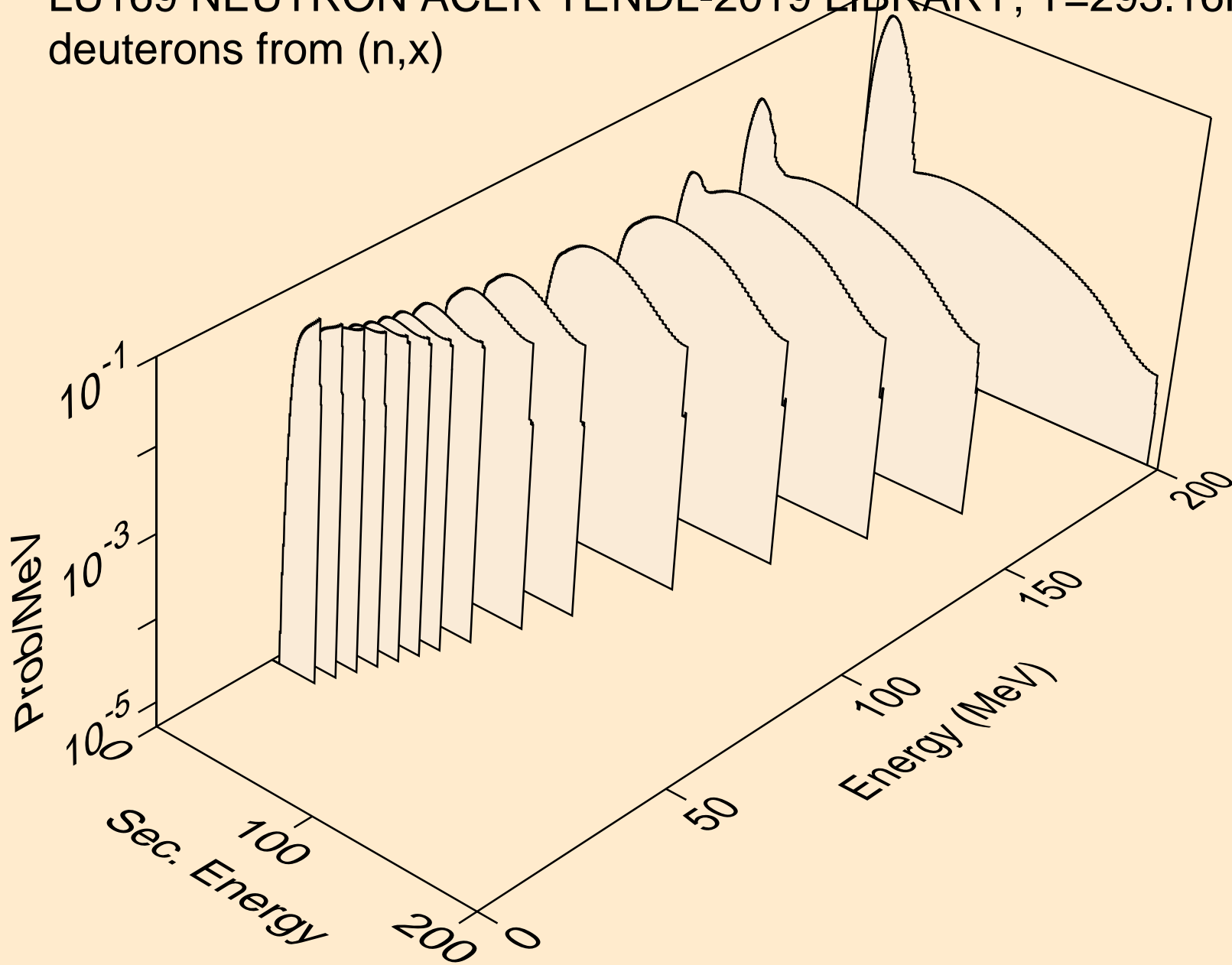

LU169 NEUTRON ACER TENDL-2019 LIBRARY; T=293.16K
deuterons from (n,2nd)

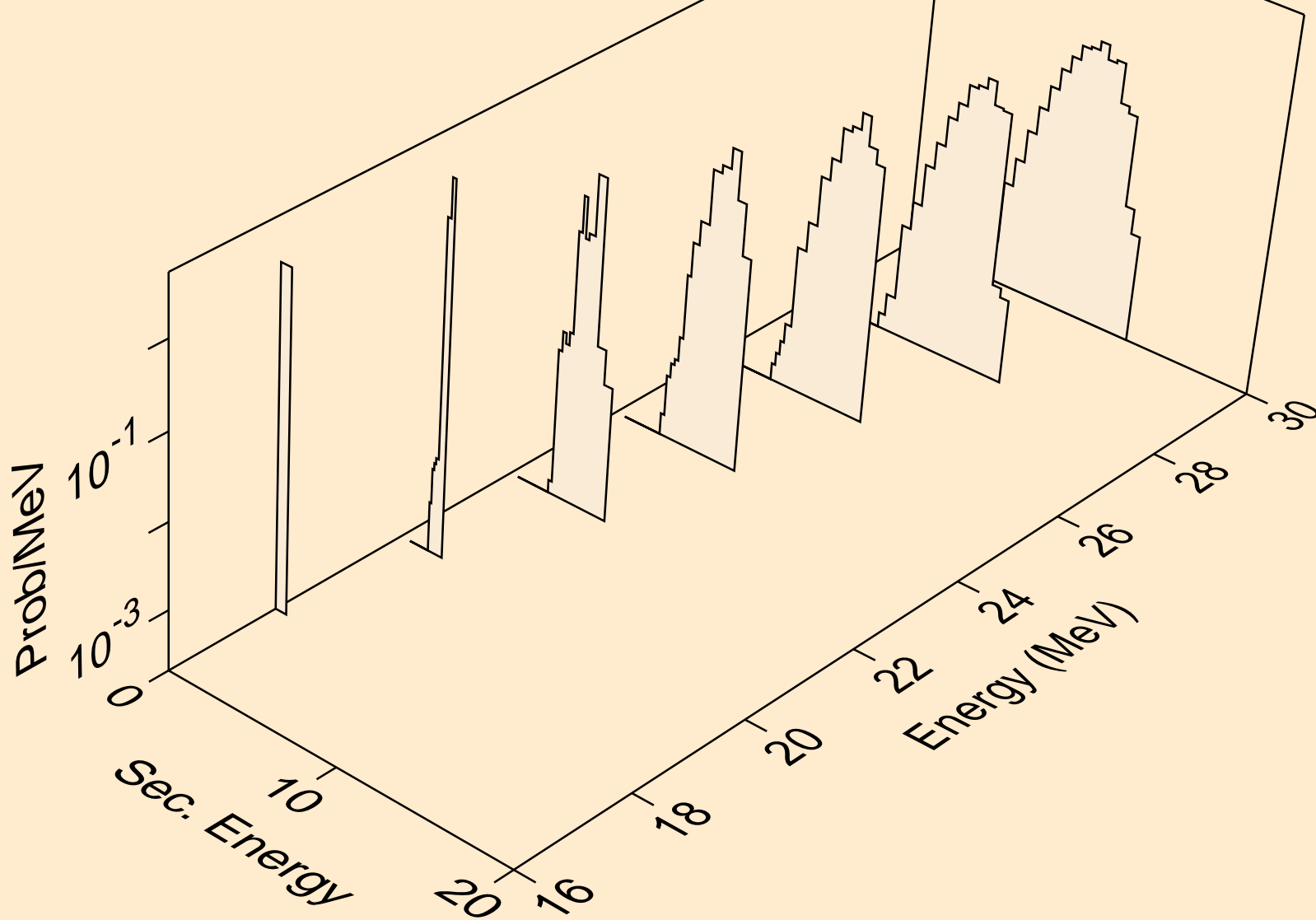

LU169 NEUTRON ACER TENDL-2019 LIBRARY; T=293.16K
deuterons from (n,n*)d

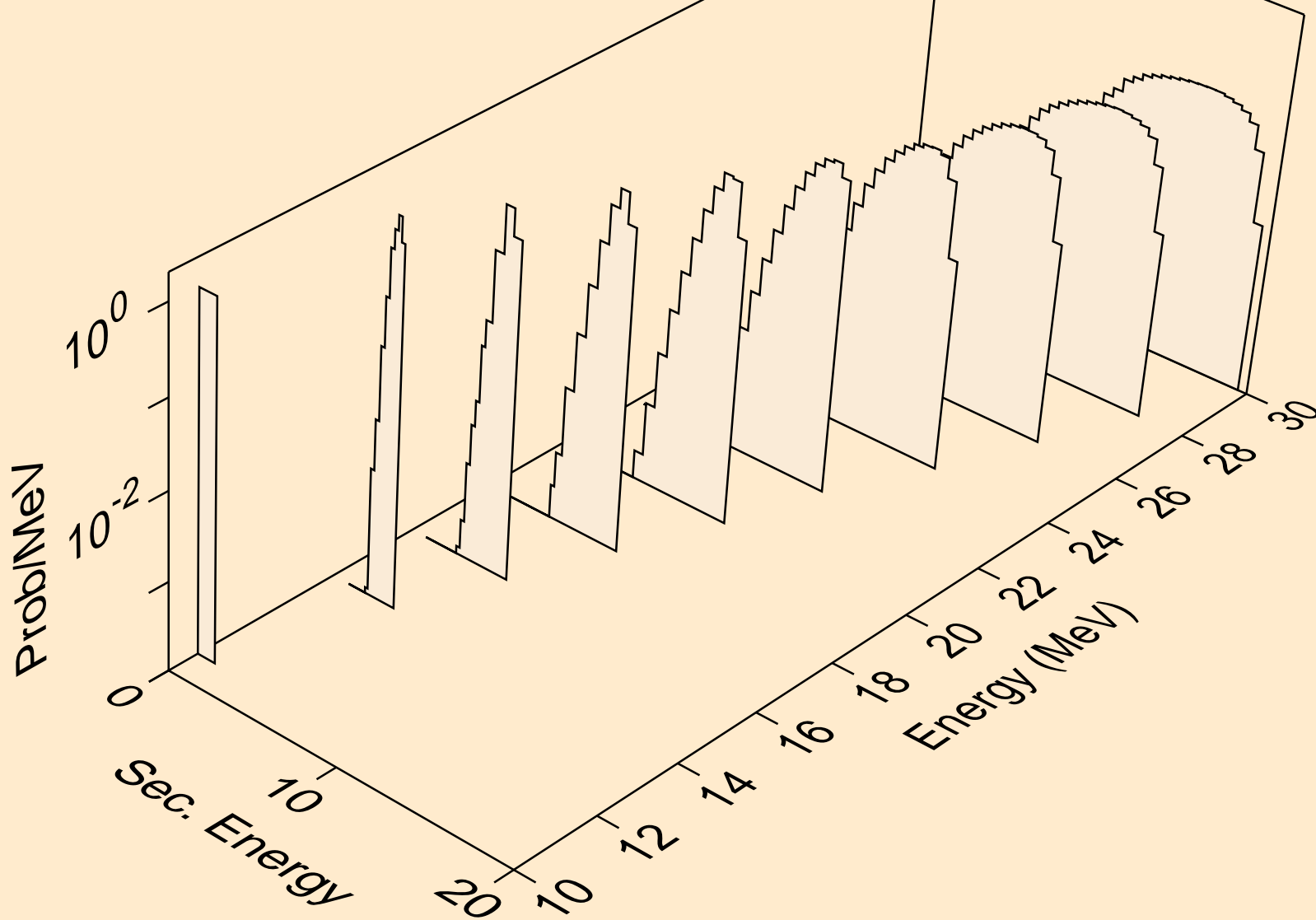

LU169 NEUTRON ACER TENDL-2019 LIBRARY; T=293.16K
deuterons from (n,d)

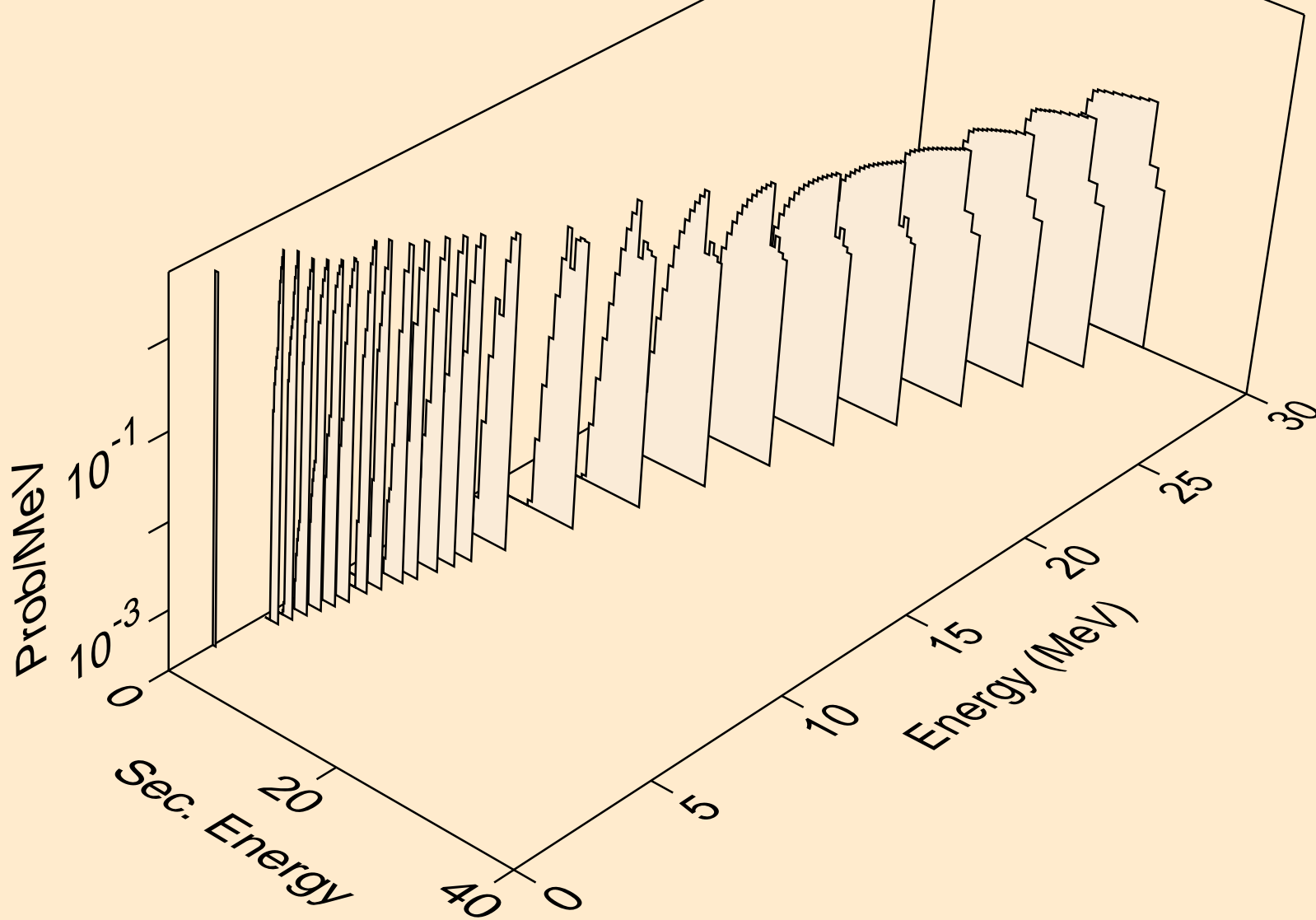

LU169 NEUTRON ACER TENDL-2019 LIBRARY; T=293.16K
deuterons from (n,pd)

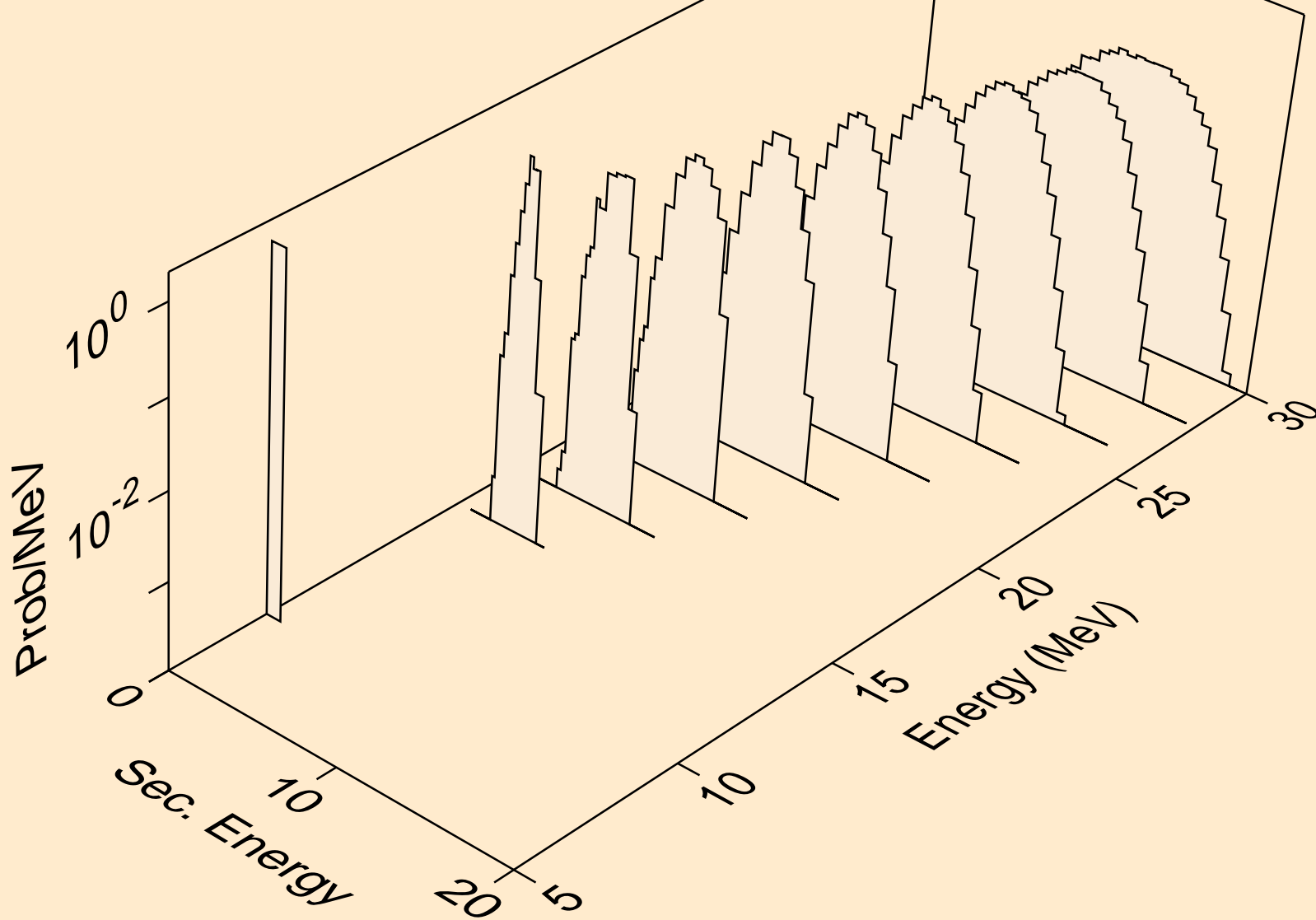

LU169 NEUTRON ACER TENDL-2019 LIBRARY; T=293.16K
deuterons from (n,da)

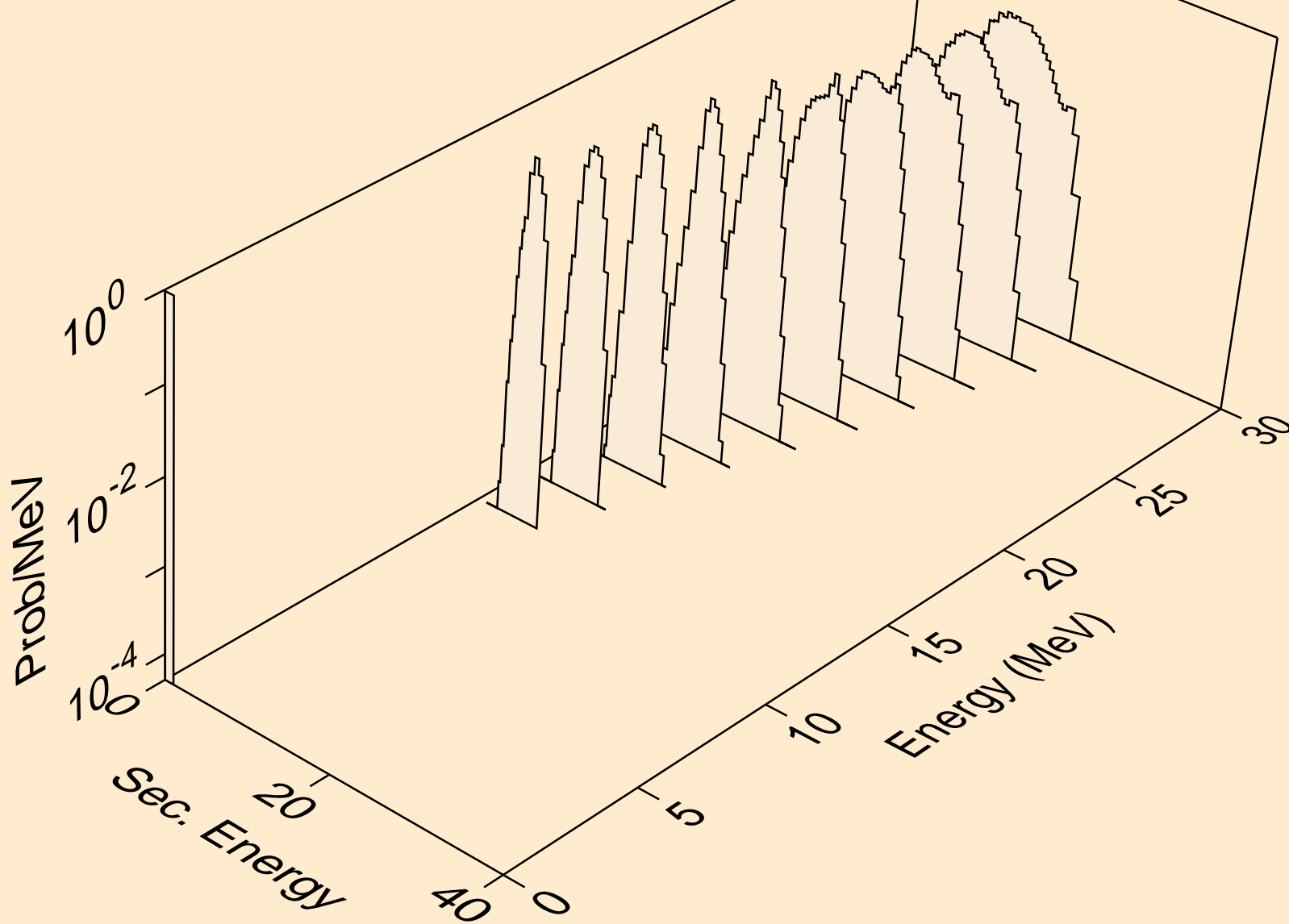

LU169 NEUTRON ACER TENDL-2019 LIBRARY; T=293.16K
tritons from (n,x)

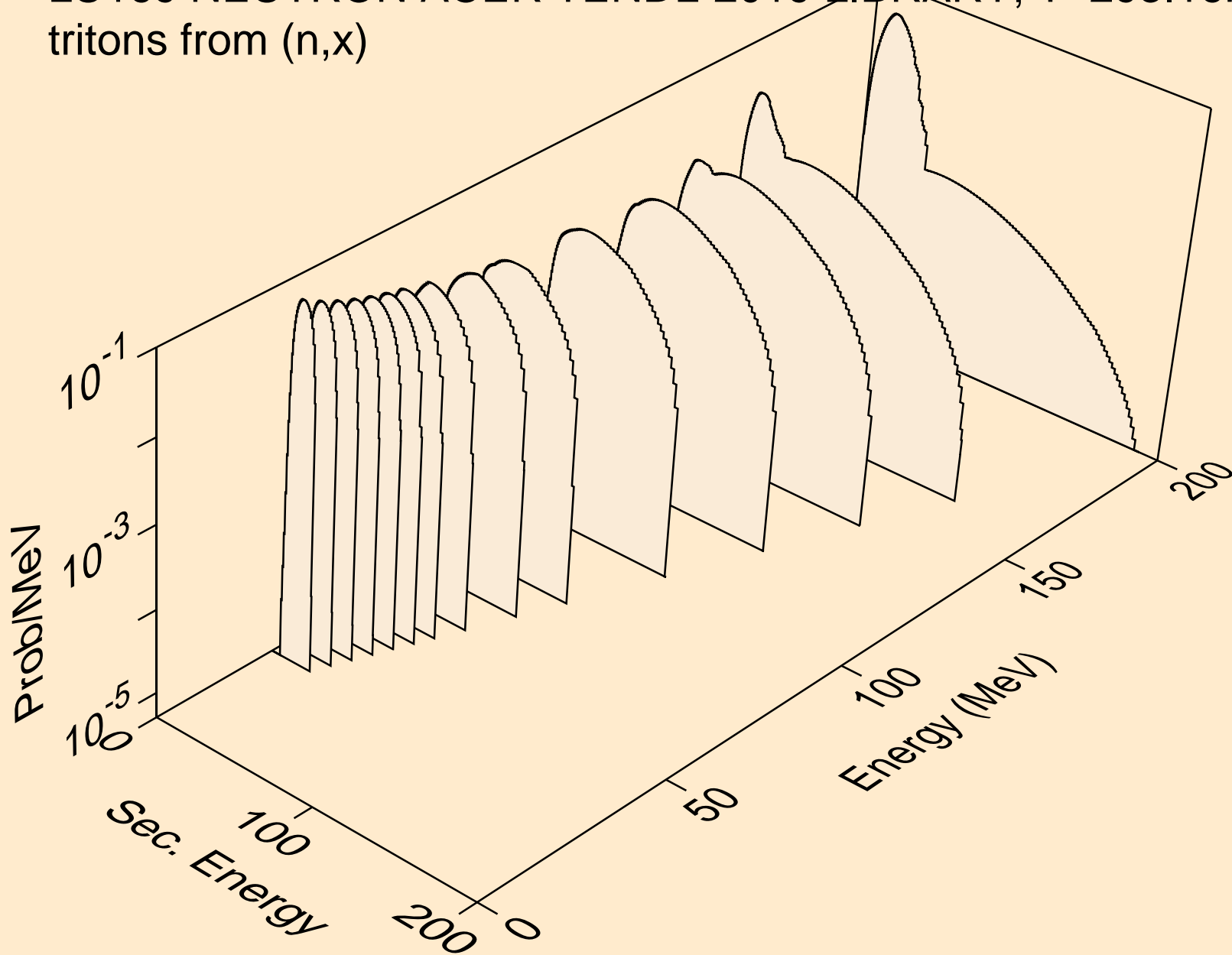

LU169 NEUTRON ACER TENDL-2019 LIBRARY; T=293.16K
tritons from (n,n*)t

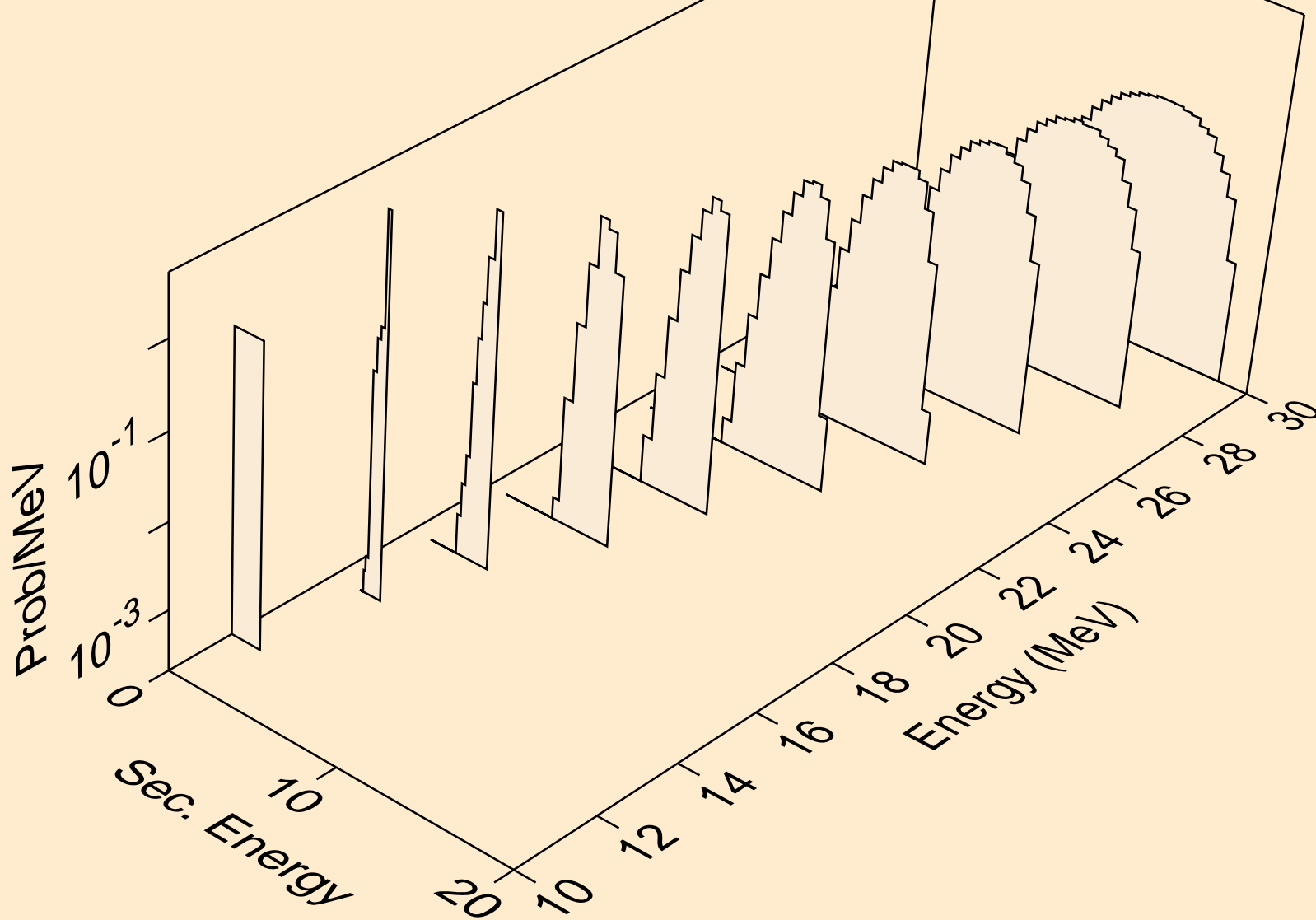

LU169 NEUTRON ACER TENDL-2019 LIBRARY; T=293.16K
tritons from (n,t)

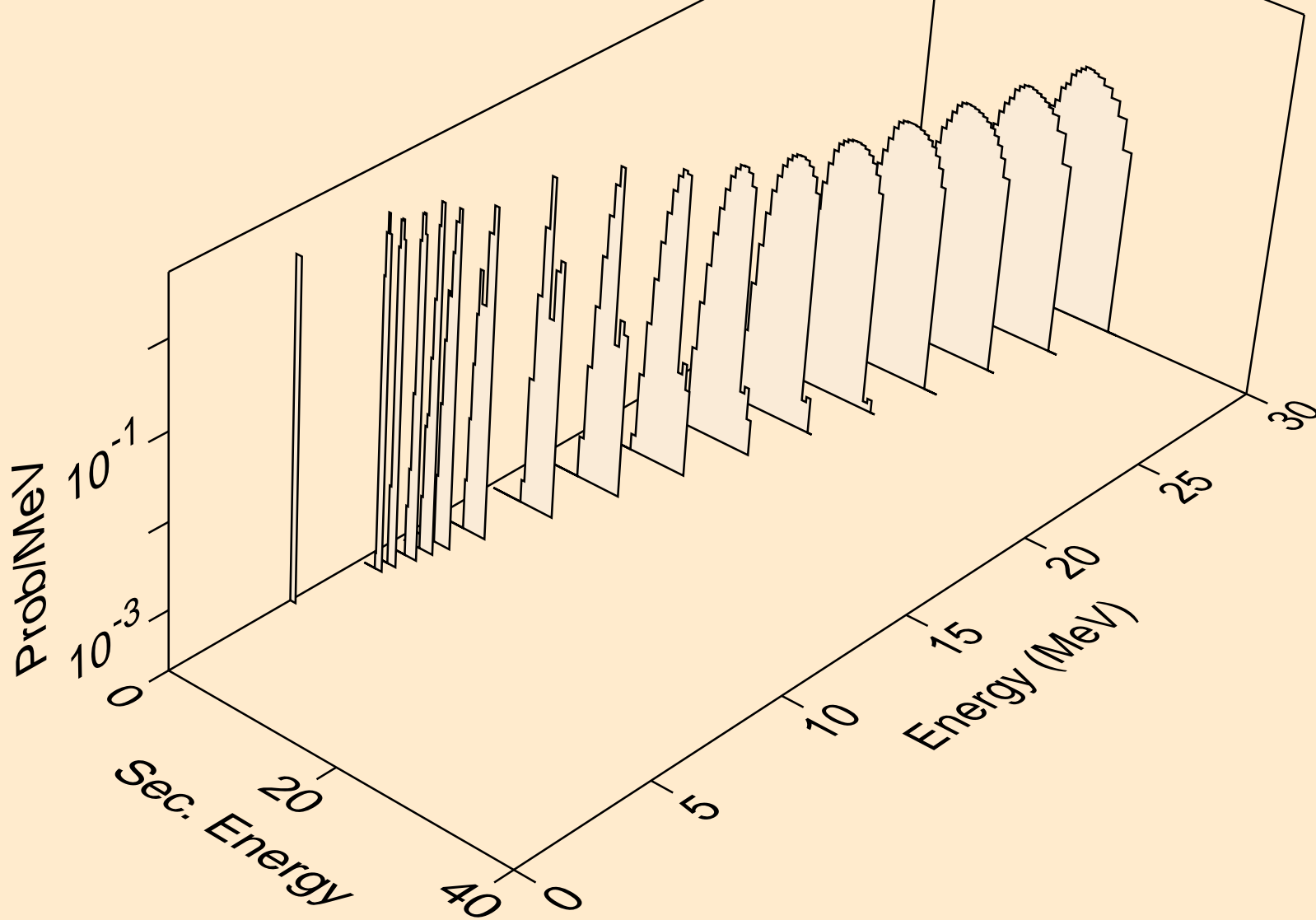

LU169 NEUTRON ACER TENDL-2019 LIBRARY; T=293.16K
tritons from (n,pt)

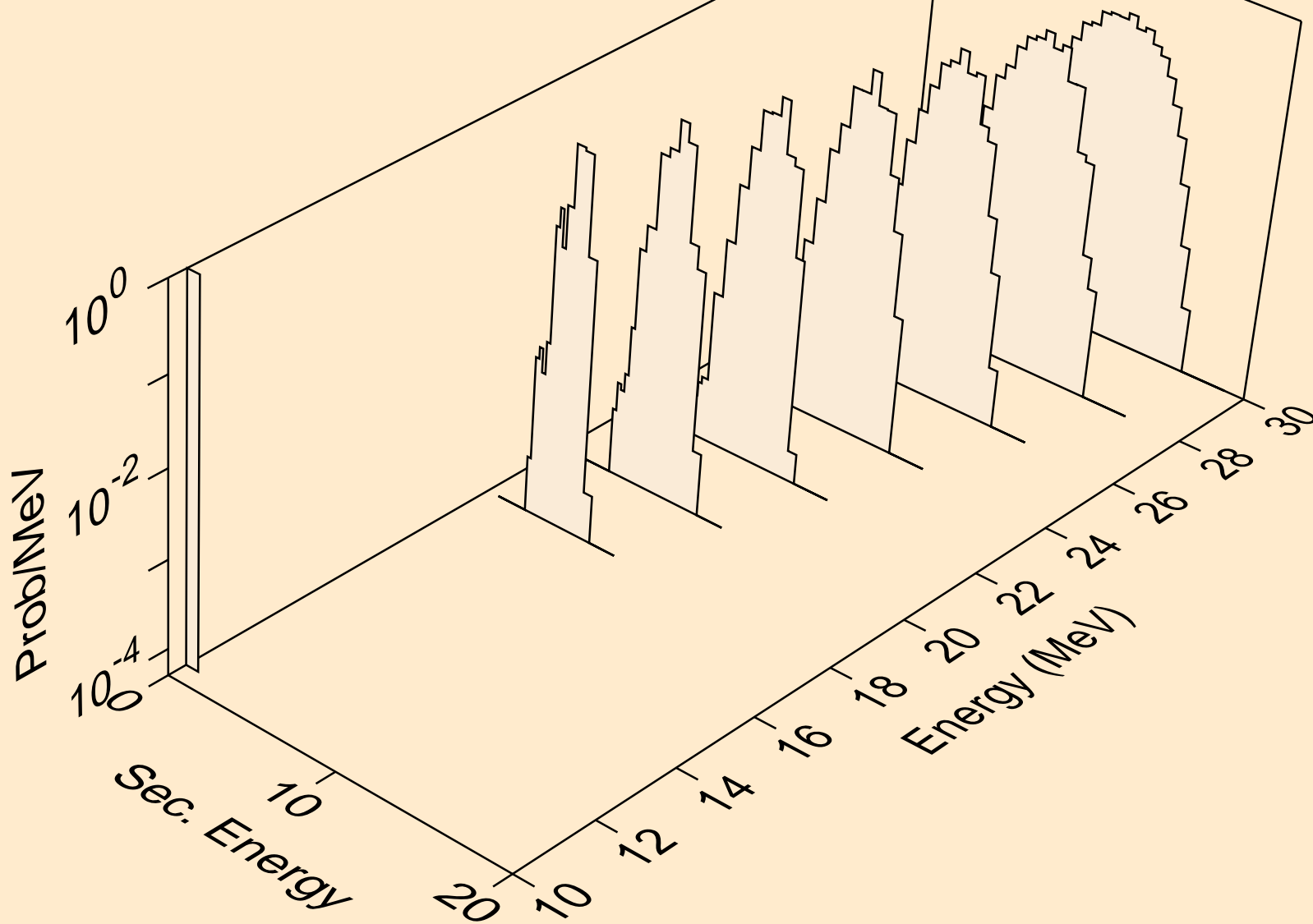

LU169 NEUTRON ACER TENDL-2019 LIBRARY; T=293.16K
he3s from (n,x)

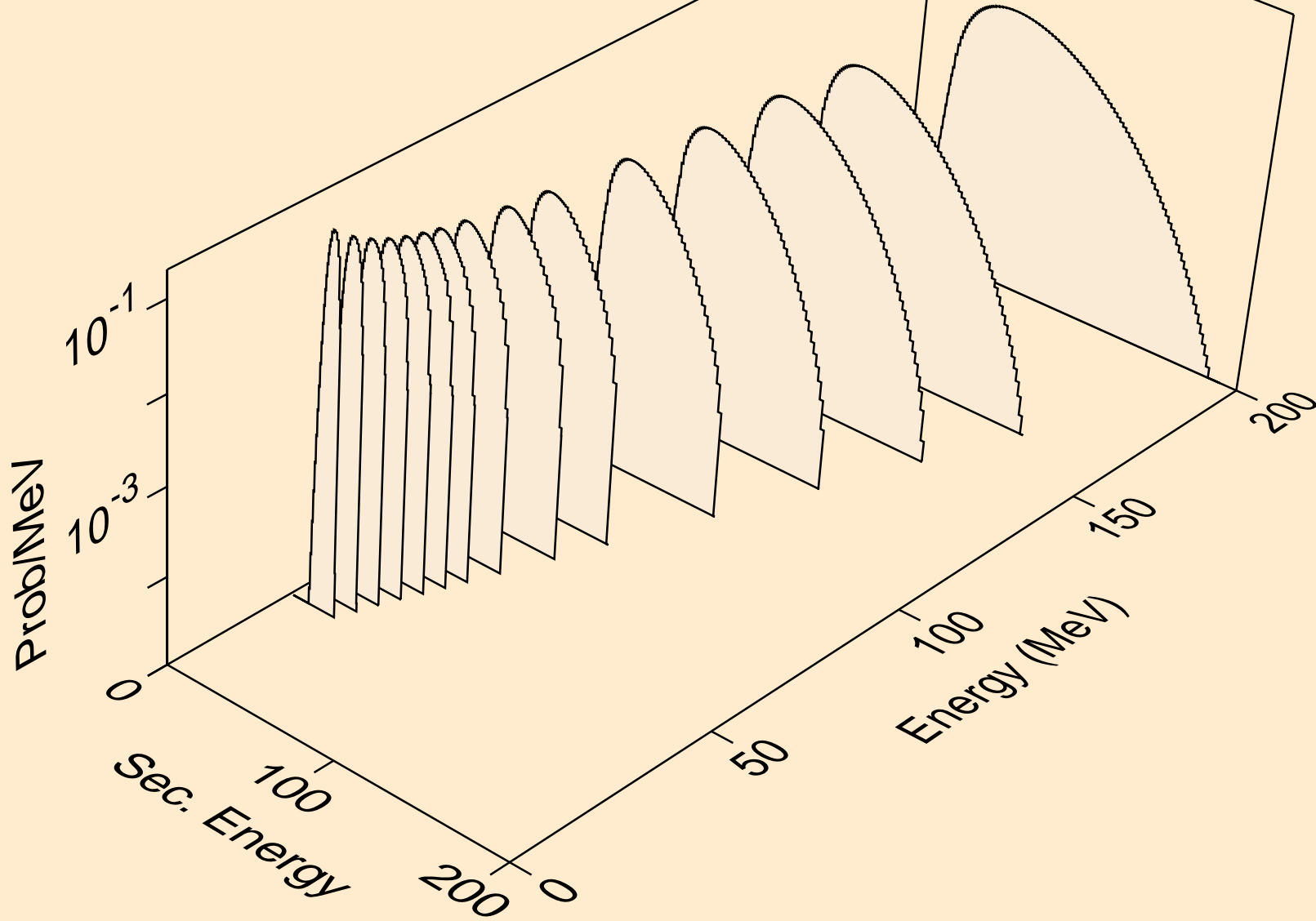

LU169 NEUTRON ACER TENDL-2019 LIBRARY; T=293.16K
he3s from (n,n*)he3

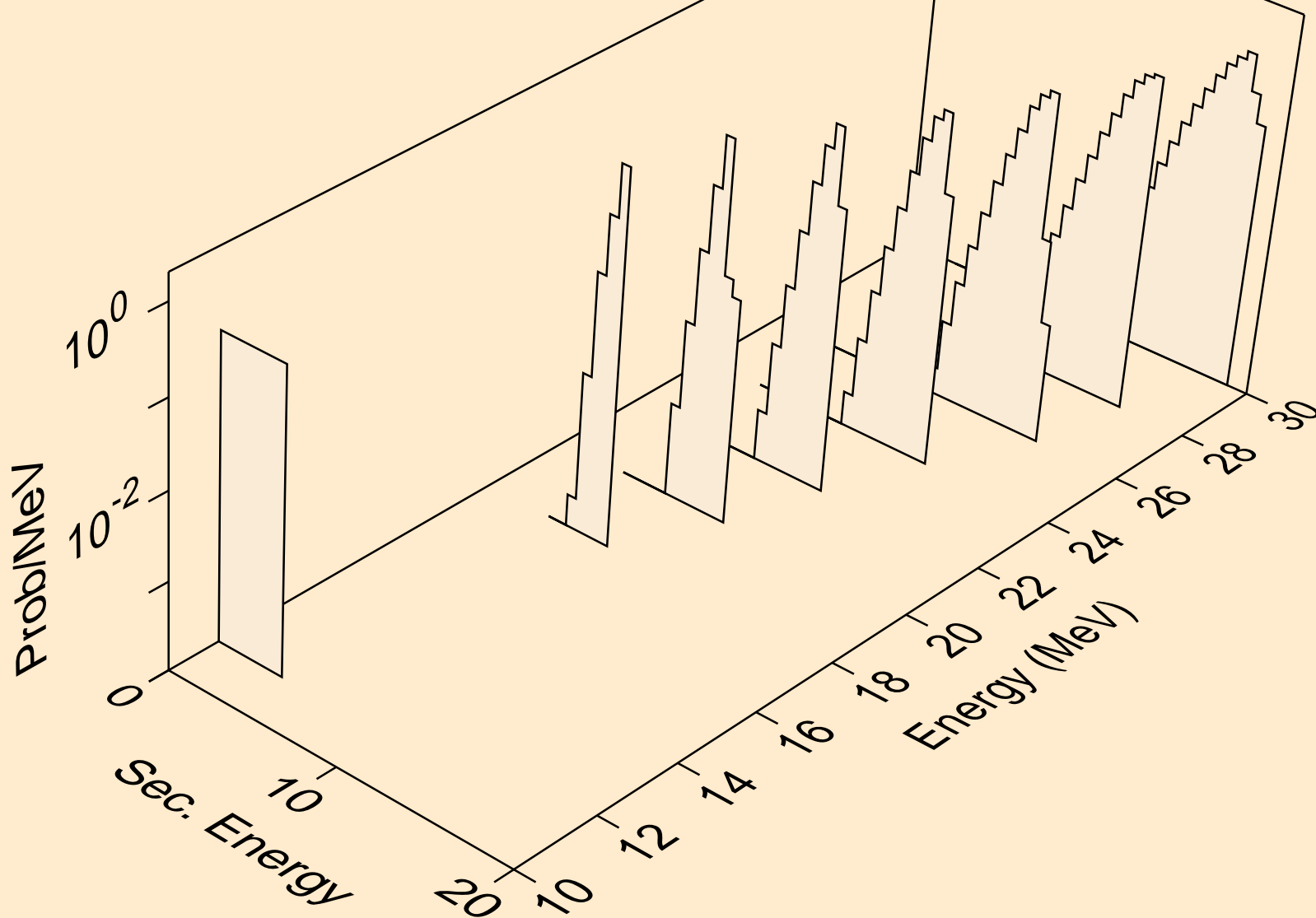

LU169 NEUTRON ACER TENDL-2019 LIBRARY; T=293.16K
he3s from (n,he3)

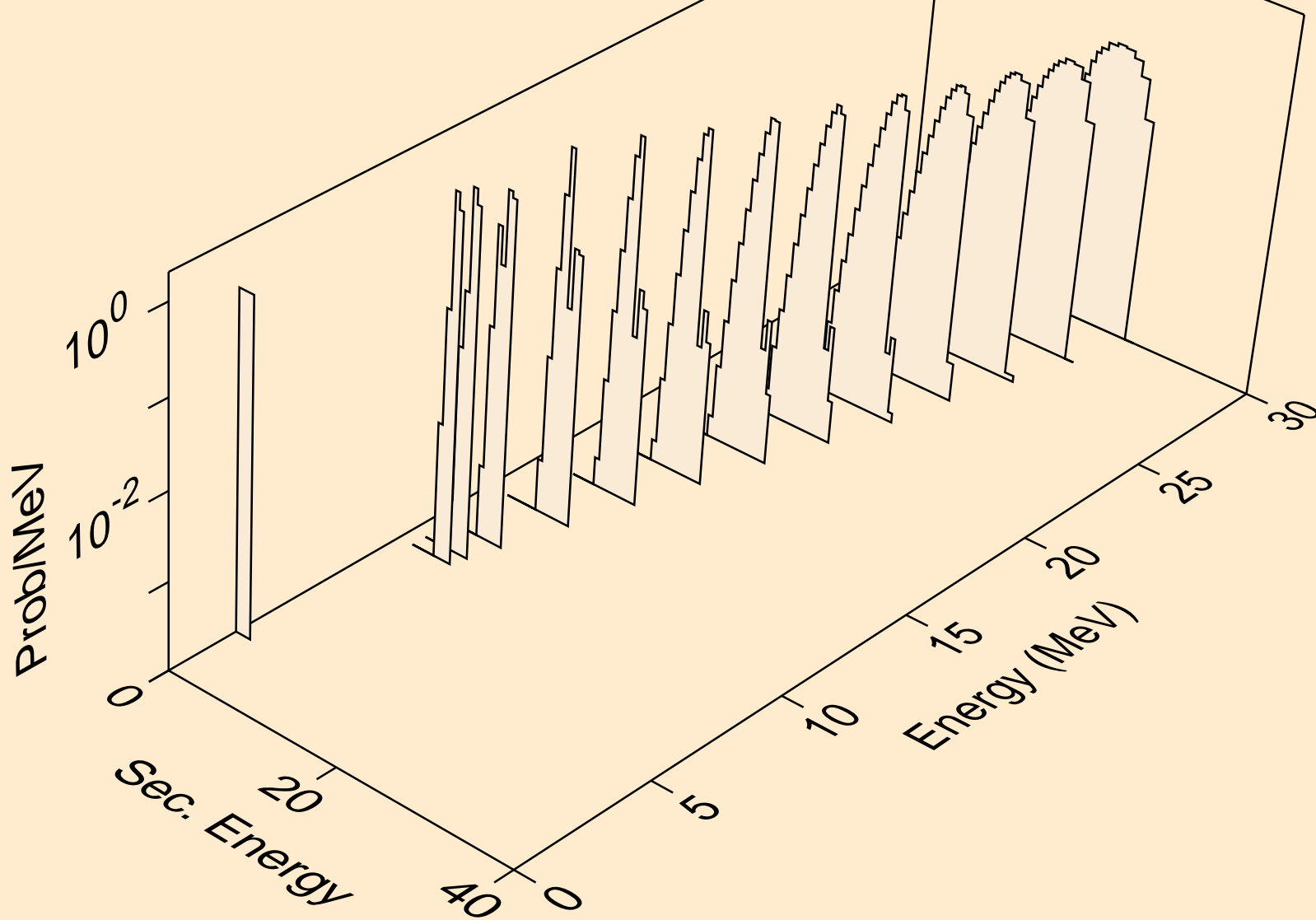

LU169 NEUTRON ACER TENDL-2019 LIBRARY; T=293.16K
alphas from (n,x)

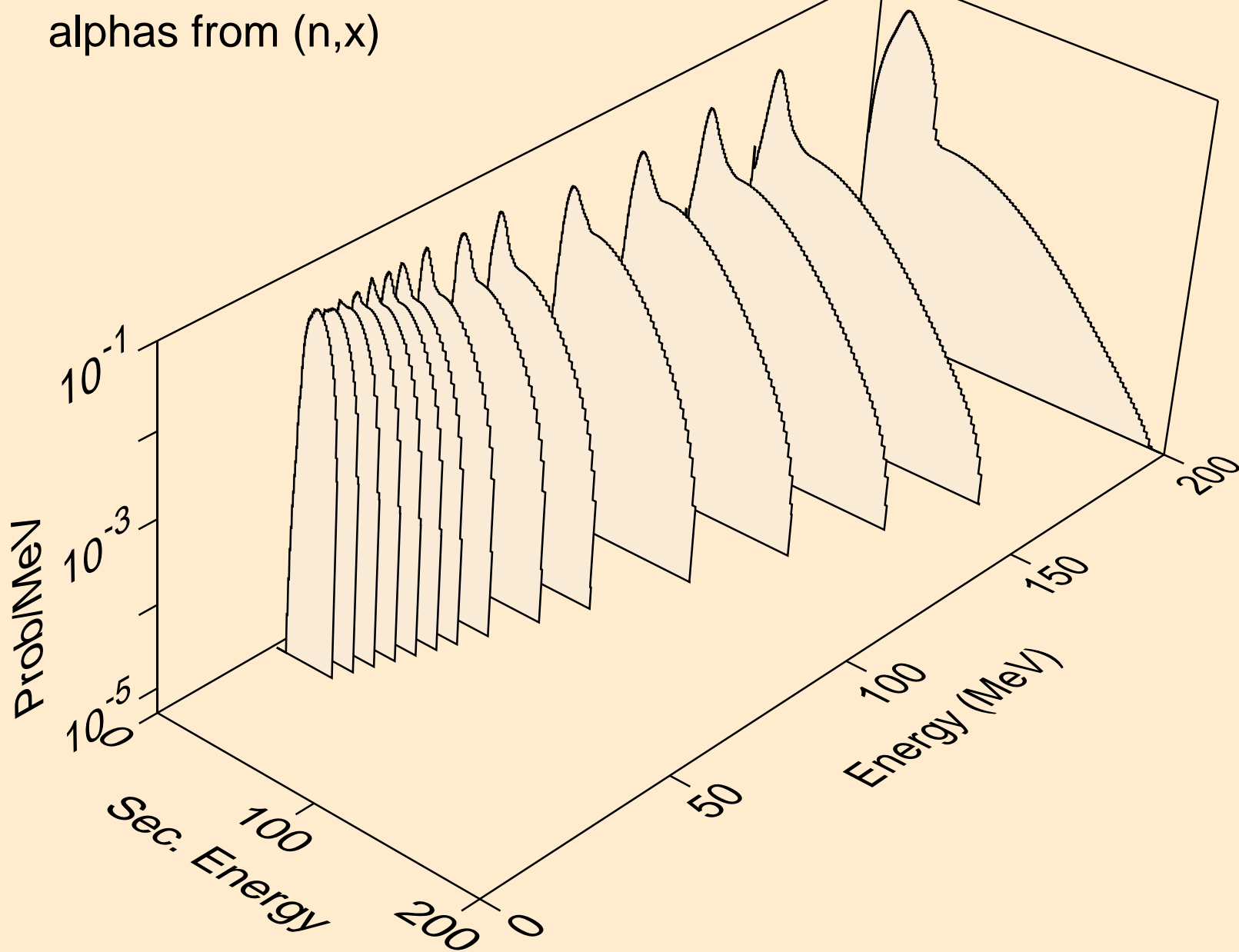

LU169 NEUTRON ACER TENDL-2019 LIBRARY; T=293.16K
alphas from (n,n*)a

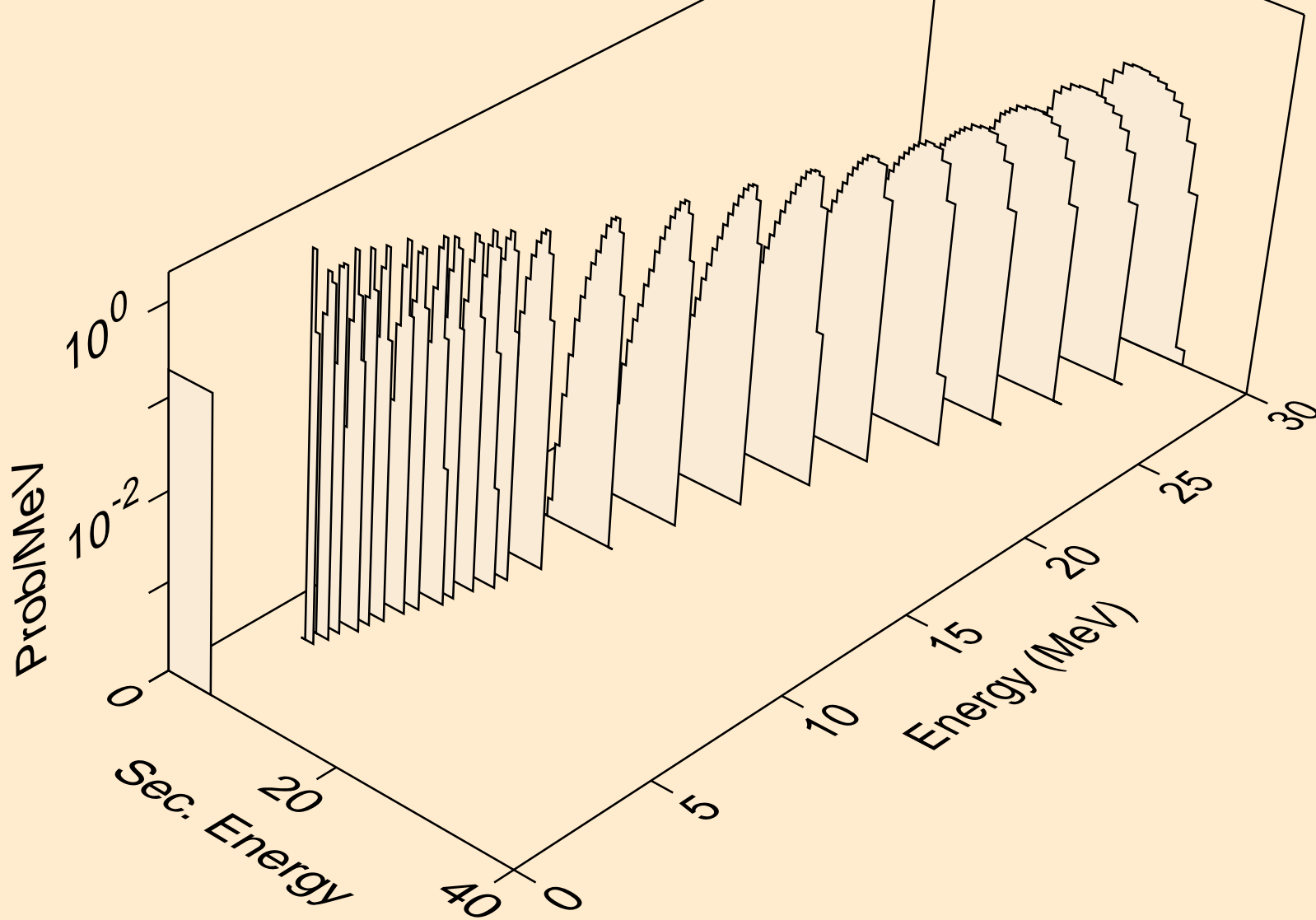

LU169 NEUTRON ACER TENDL-2019 LIBRARY; T=293.16K
alphas from (n,2n)a

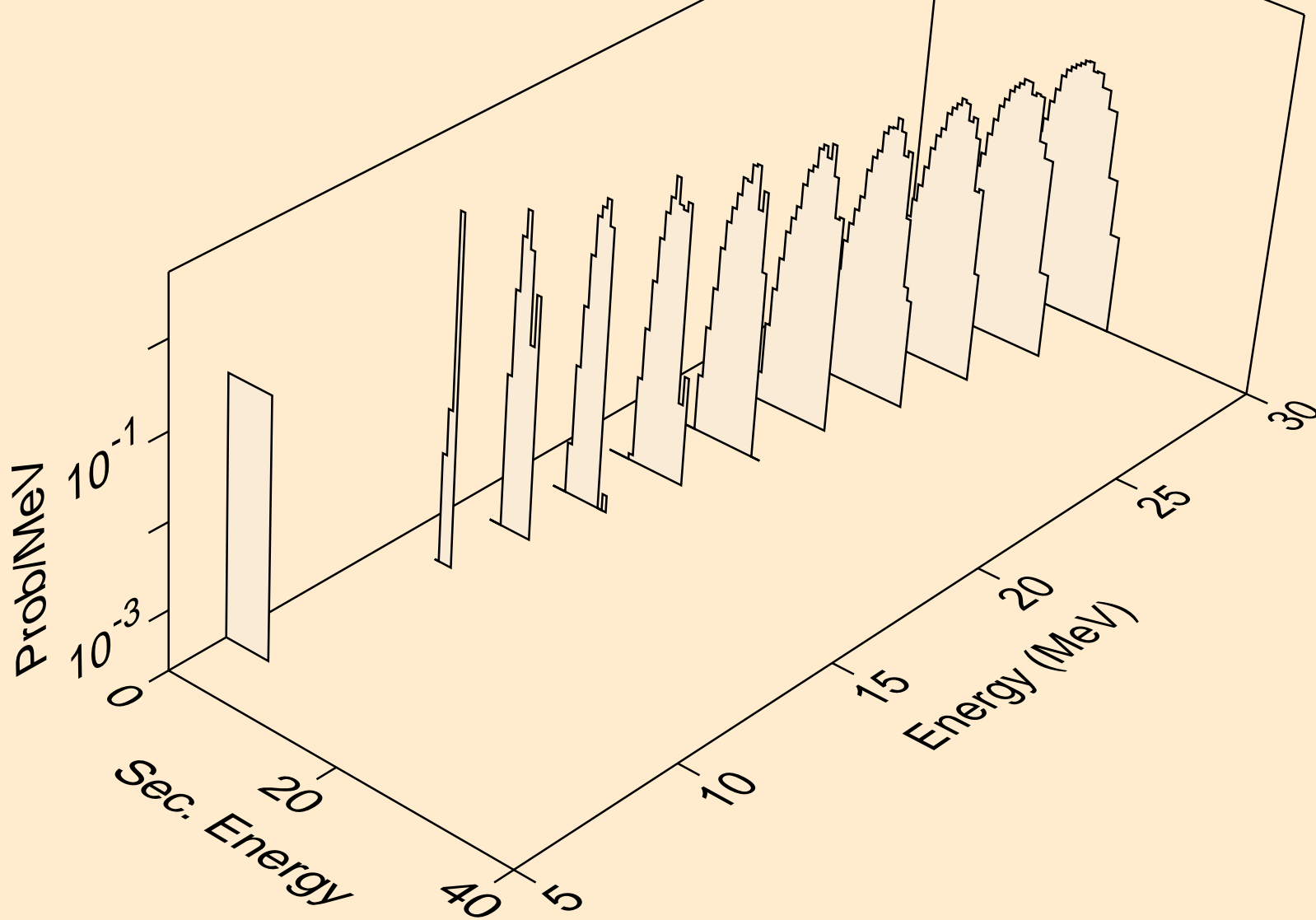

LU169 NEUTRON ACER TENDL-2019 LIBRARY; T=293.16K
alphas from (n,3n)a

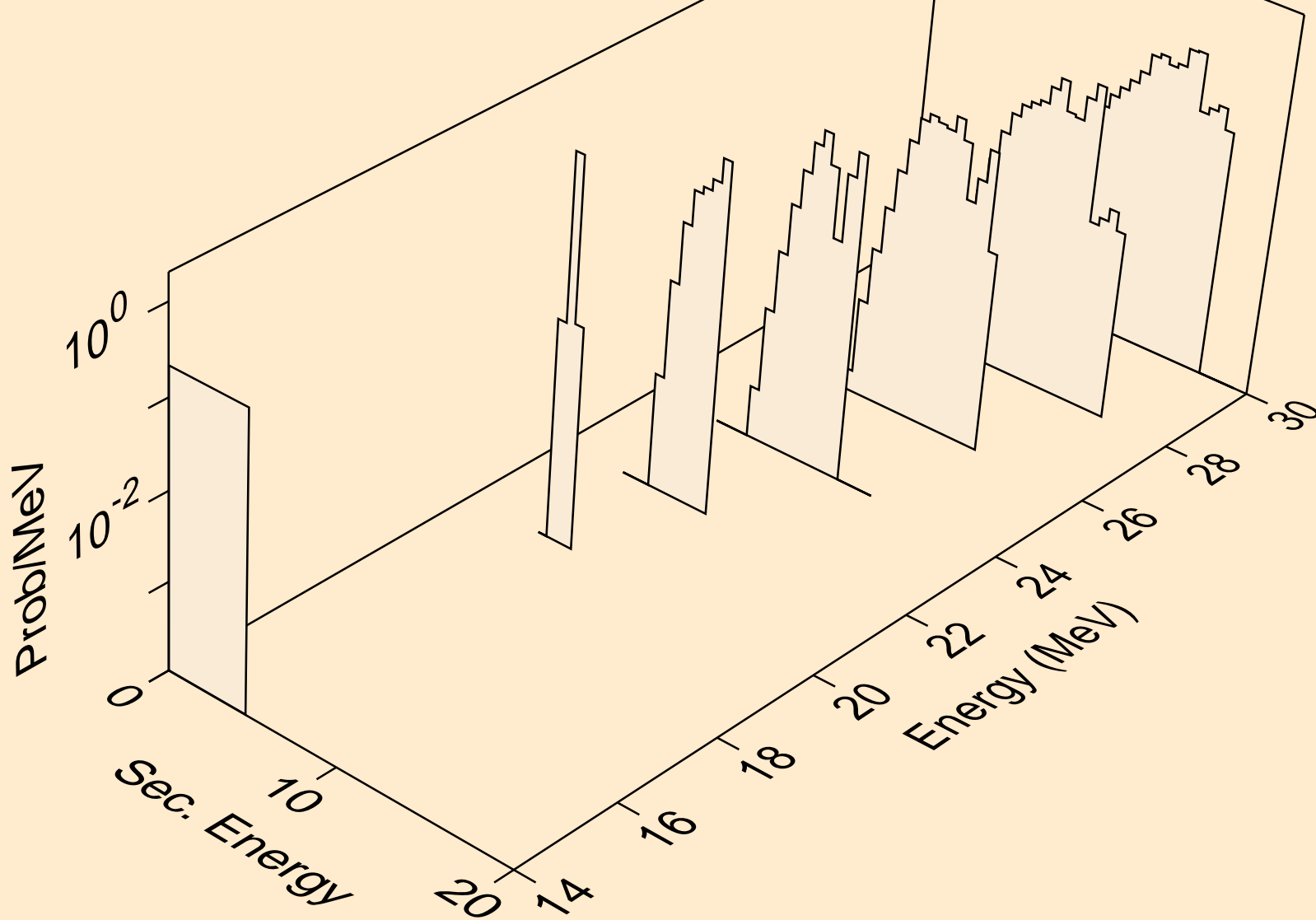

LU169 NEUTRON ACER TENDL-2019 LIBRARY; T=293.16K
alphas from (n,n*)2a

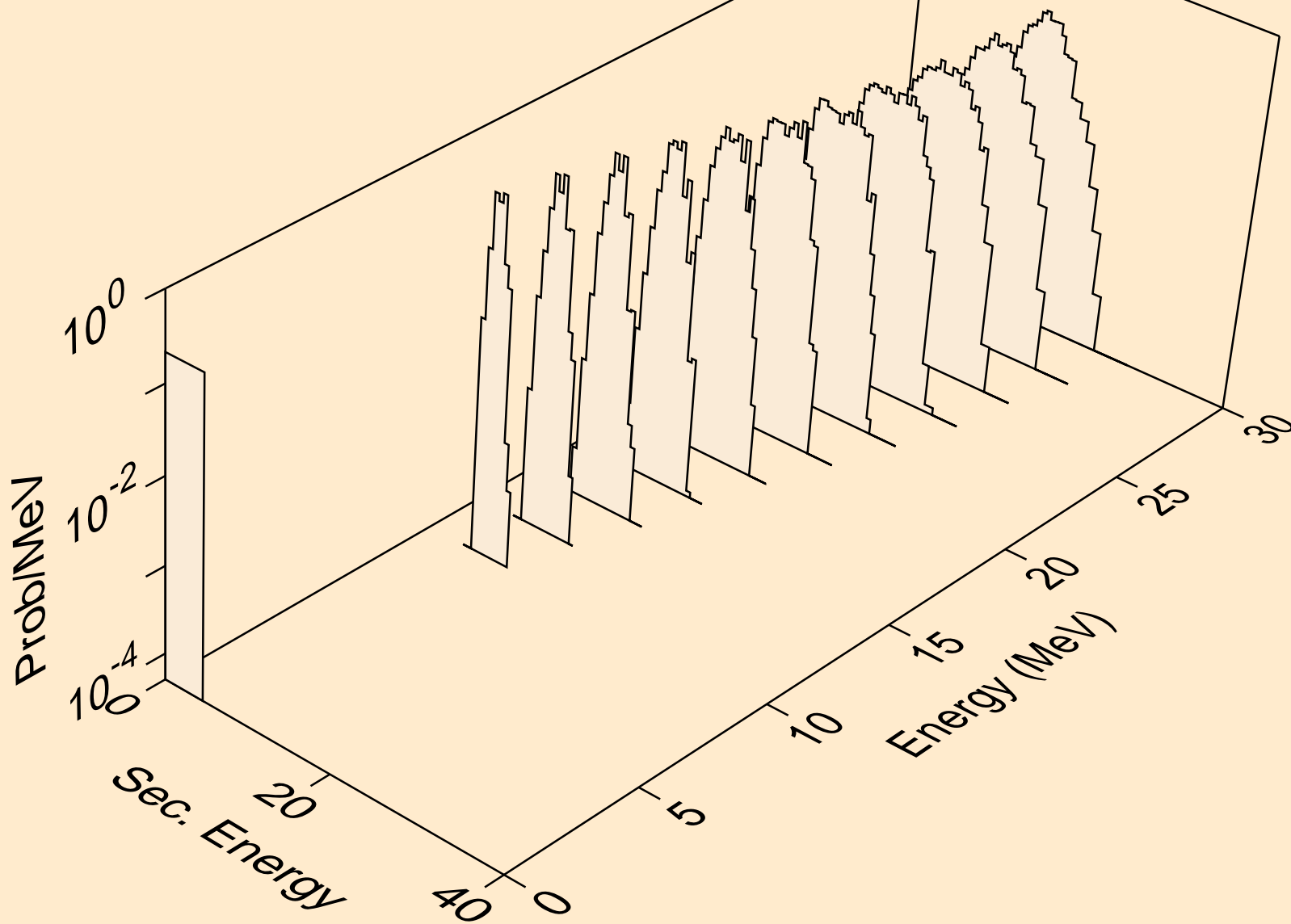

LU169 NEUTRON ACER TENDL-2019 LIBRARY; T=293.16K
alphas from (n,npa)

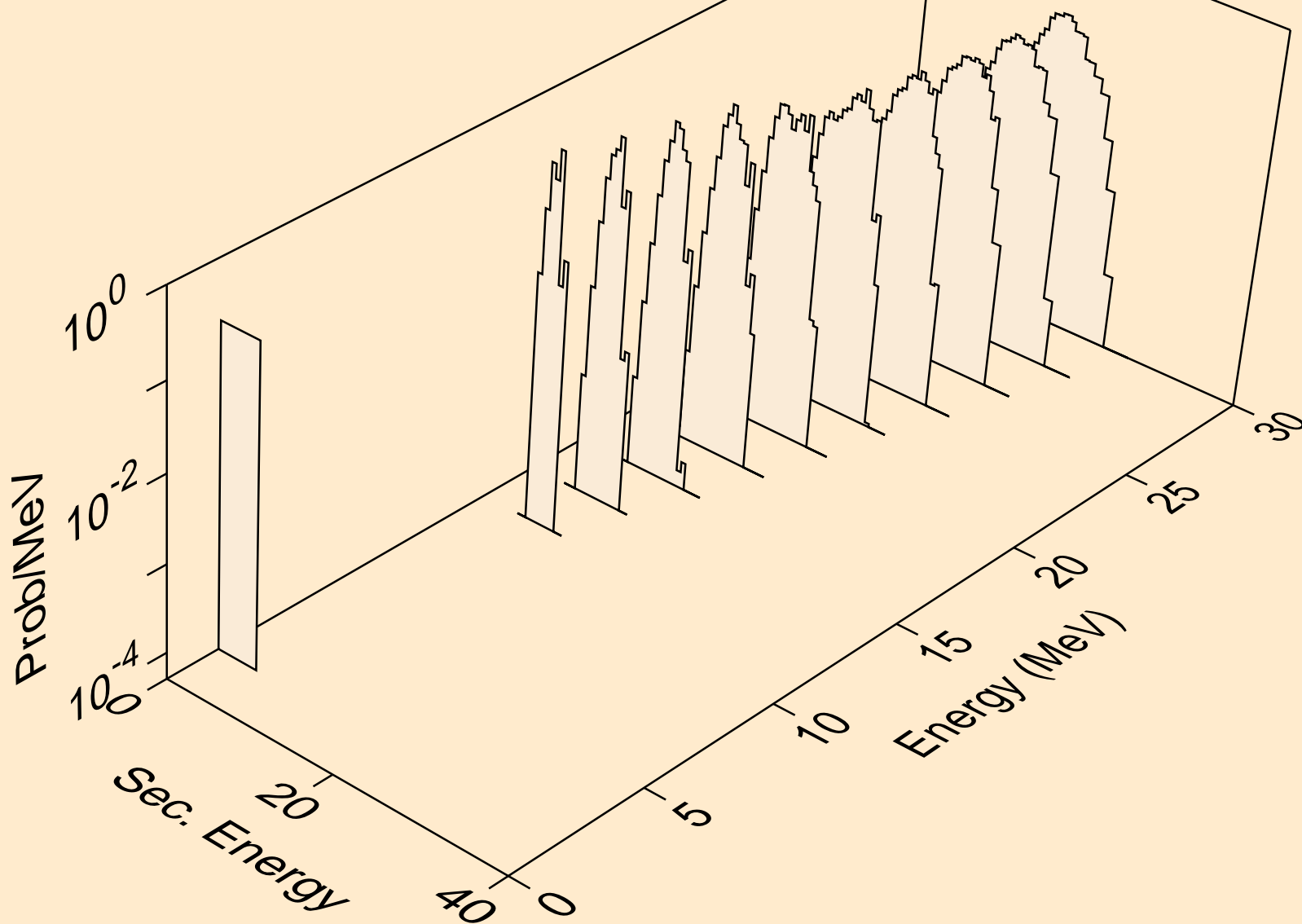

LU169 NEUTRON ACER TENDL-2019 LIBRARY; T=293.16K
alphas from (n,a)

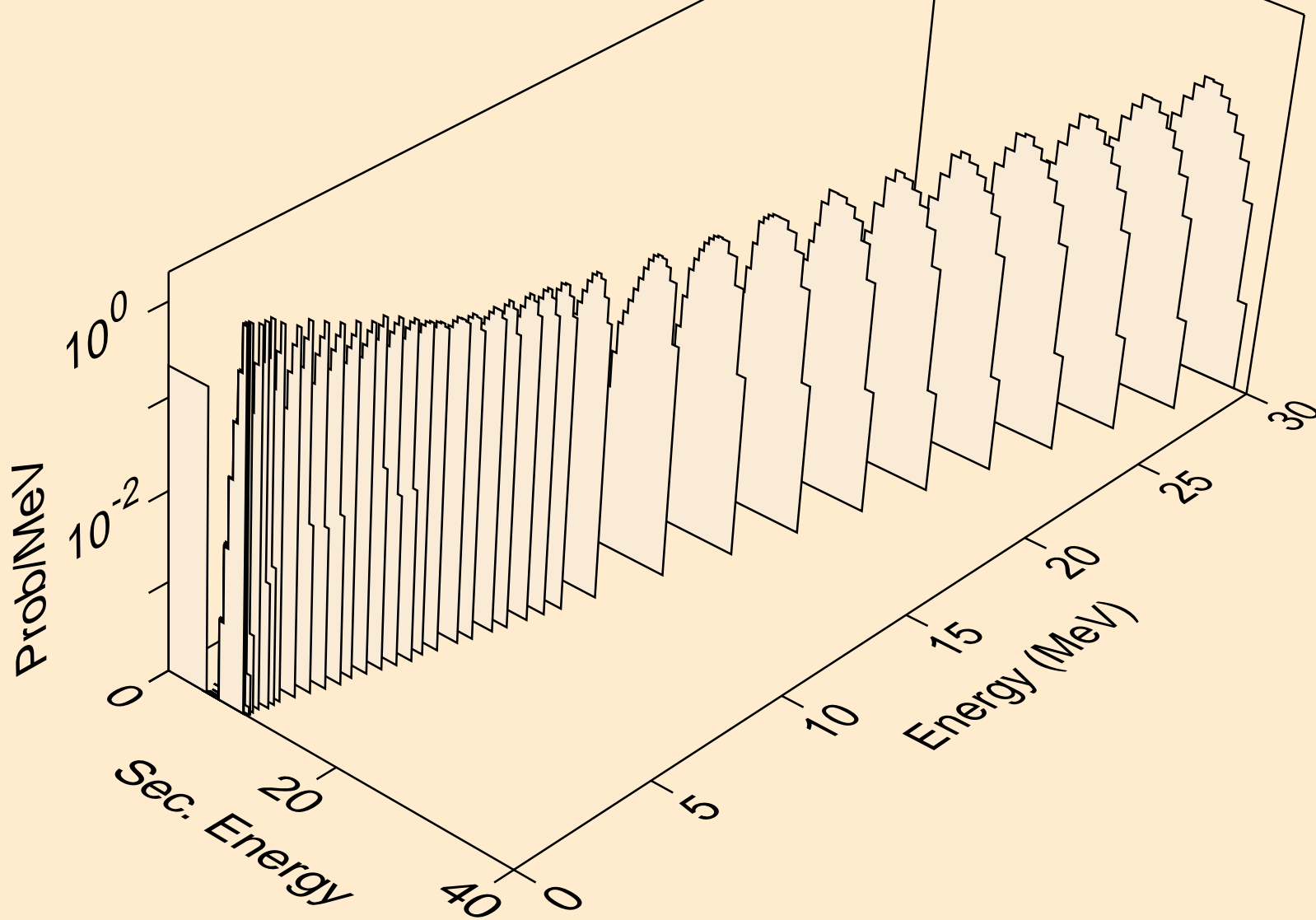

LU169 NEUTRON ACER TENDL-2019 LIBRARY; T=293.16K
alphas from (n,2a)

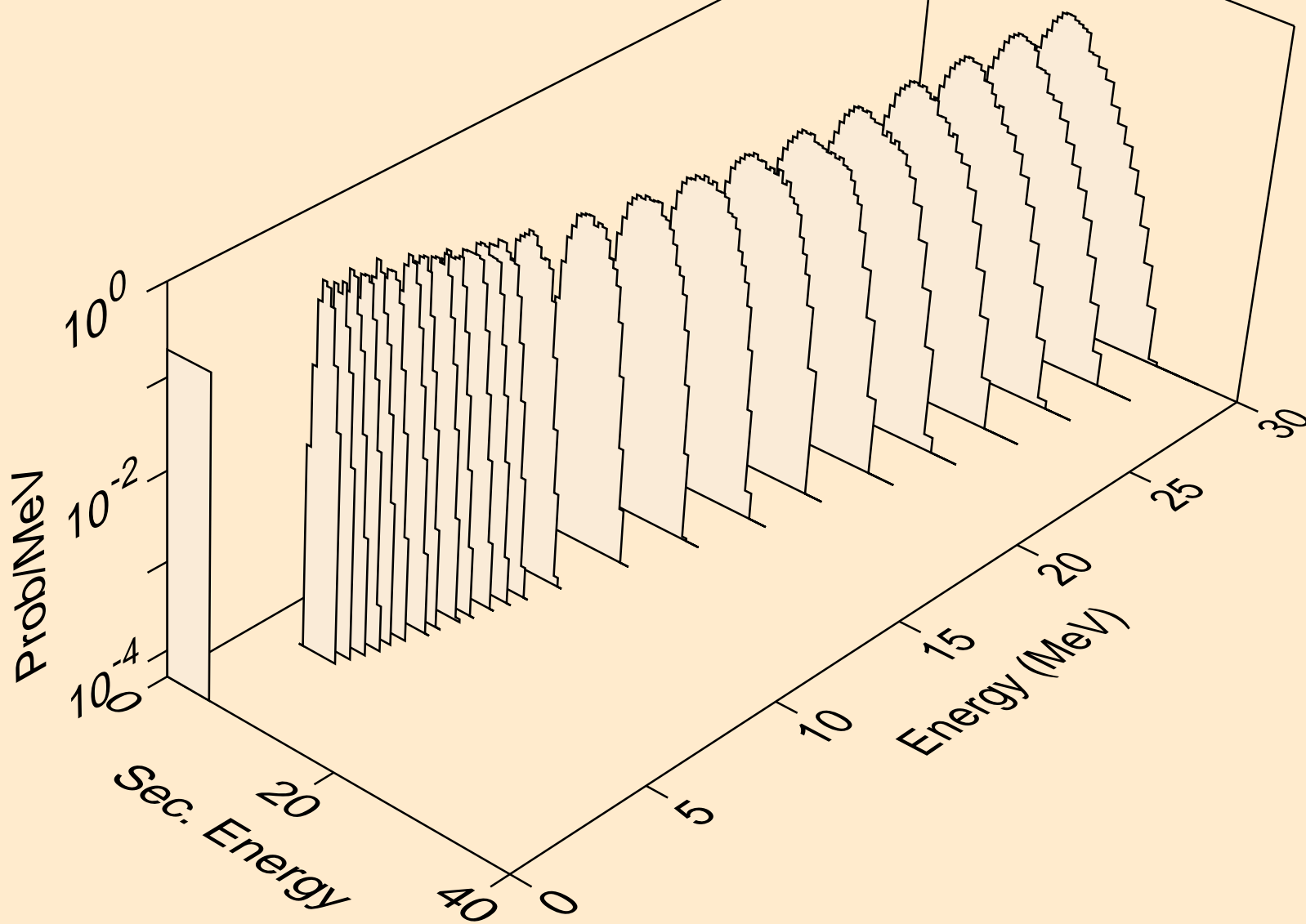

LU169 NEUTRON ACER TENDL-2019 LIBRARY; T=293.16K
alphas from (n,pa)

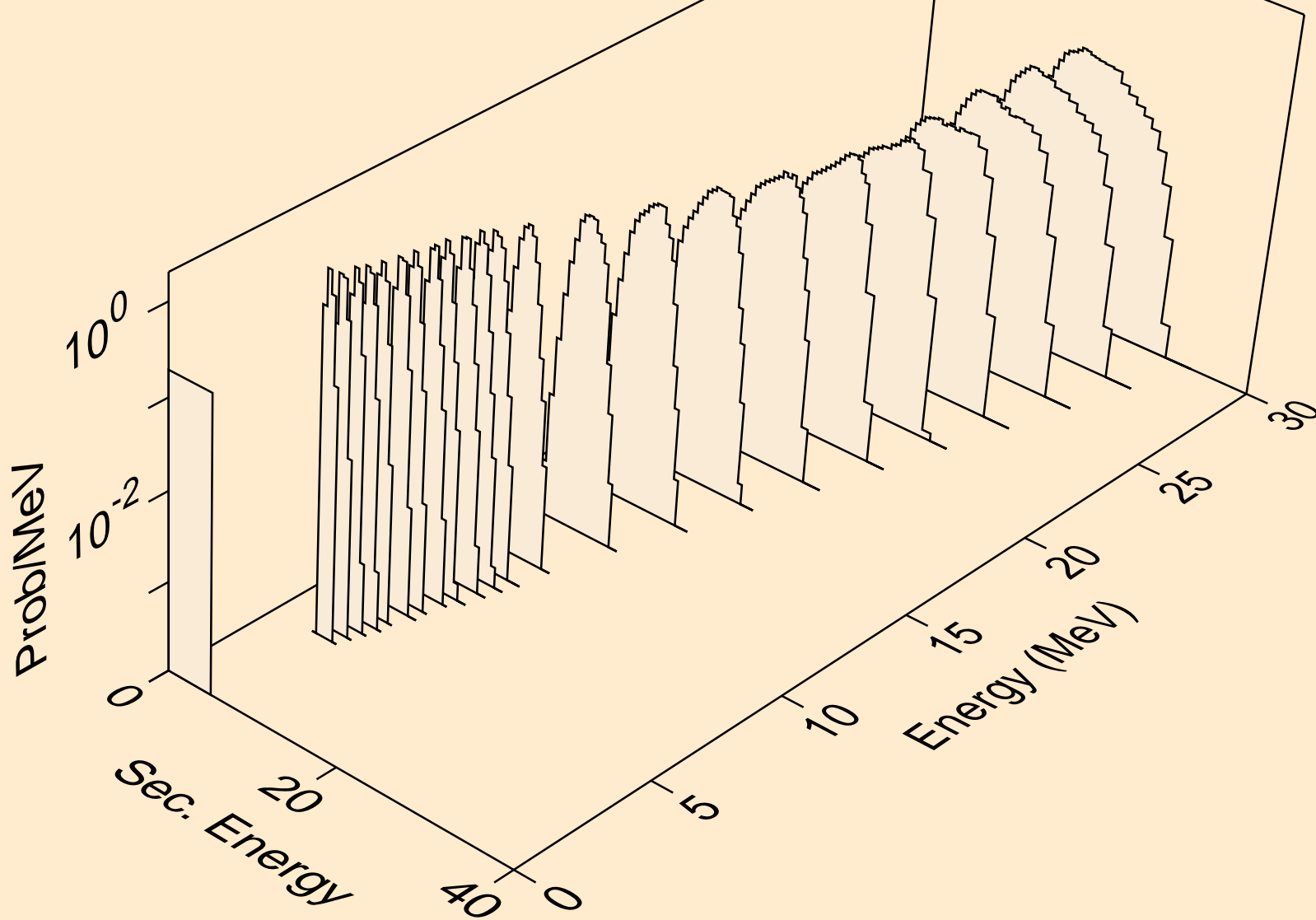

LU169 NEUTRON ACER TENDL-2019 LIBRARY; T=293.16K
alphas from (n,da)

