

LU176 NEUTRON ACER TENDL-2019 LIBRARY; T=293.16K  
Principal cross sections

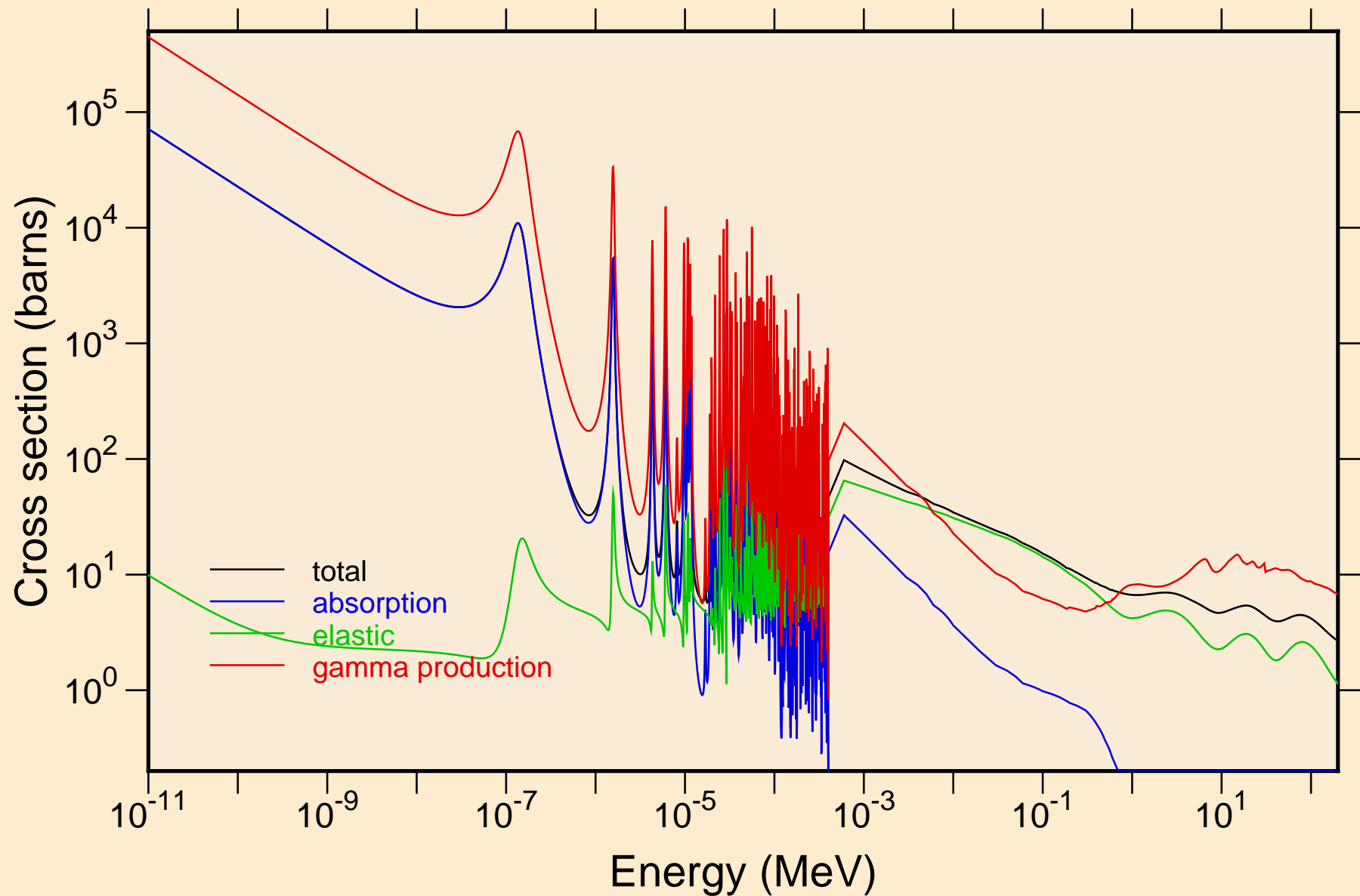

LU176 NEUTRON ACER TENDL-2019 LIBRARY; T=293.16K  
resonance total cross section

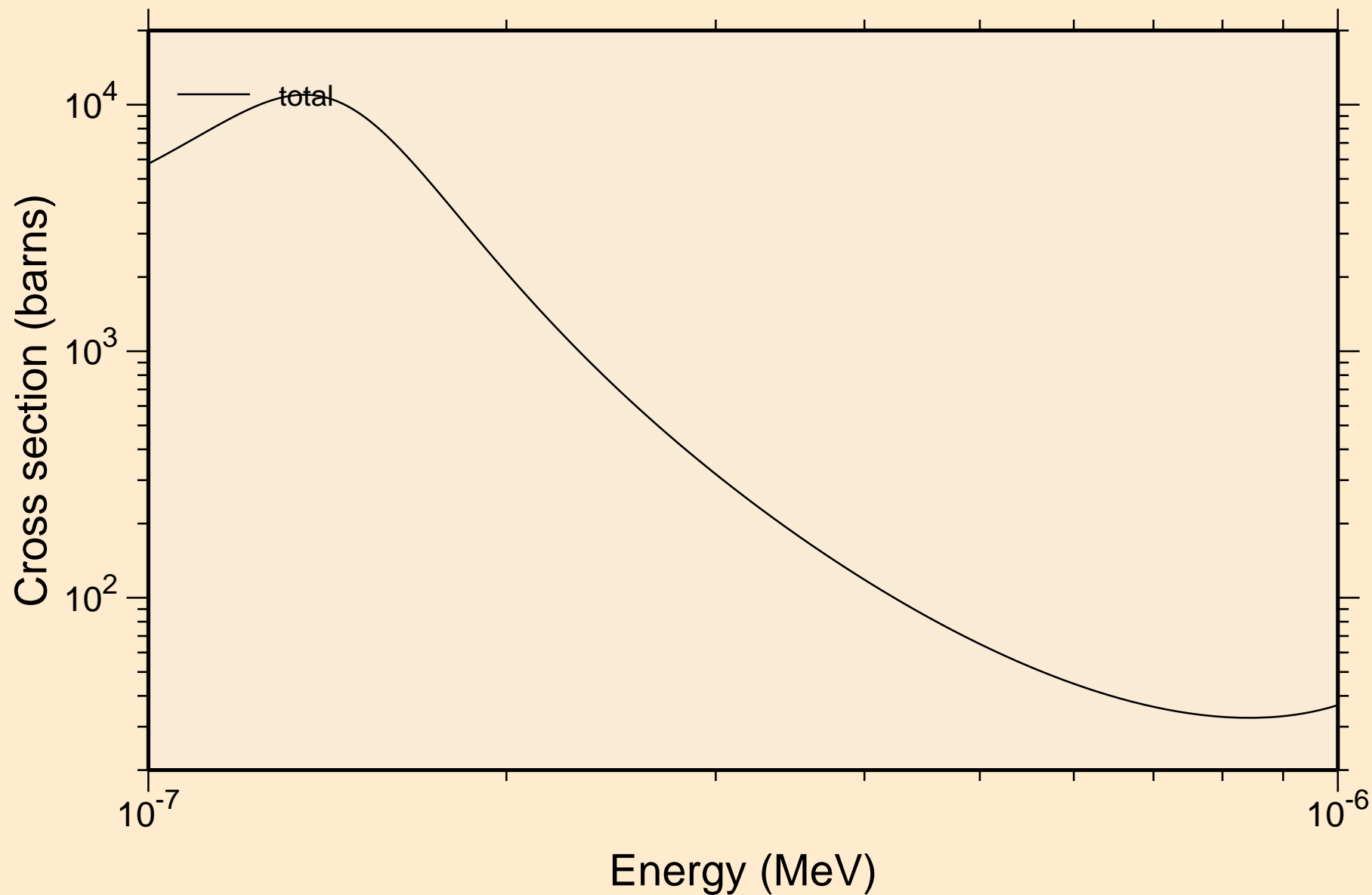

LU176 NEUTRON ACER TENDL-2019 LIBRARY; T=293.16K  
resonance total cross section

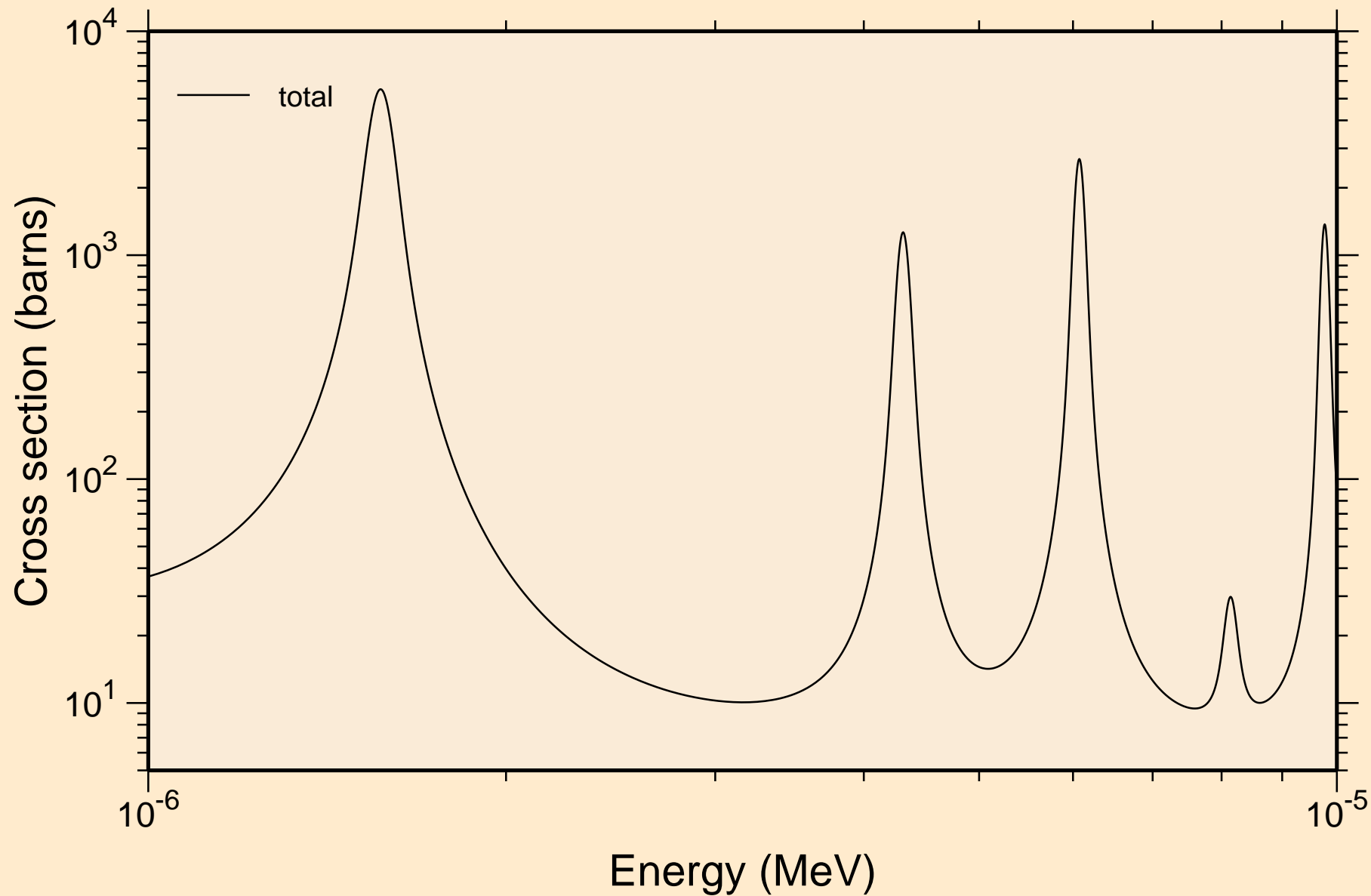

LU176 NEUTRON ACER TENDL-2019 LIBRARY; T=293.16K  
resonance total cross section

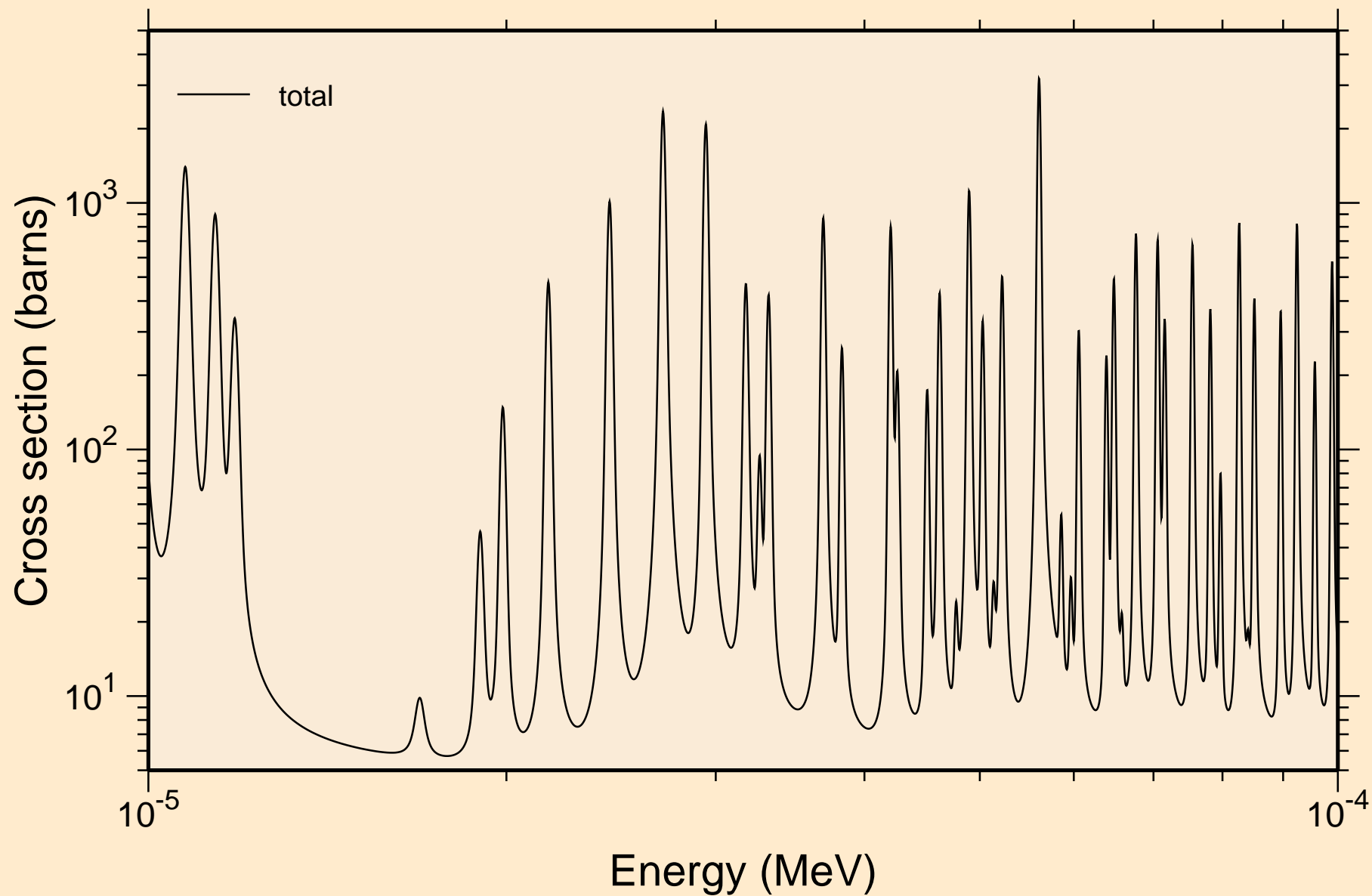

LU176 NEUTRON ACER TENDL-2019 LIBRARY; T=293.16K  
resonance total cross section

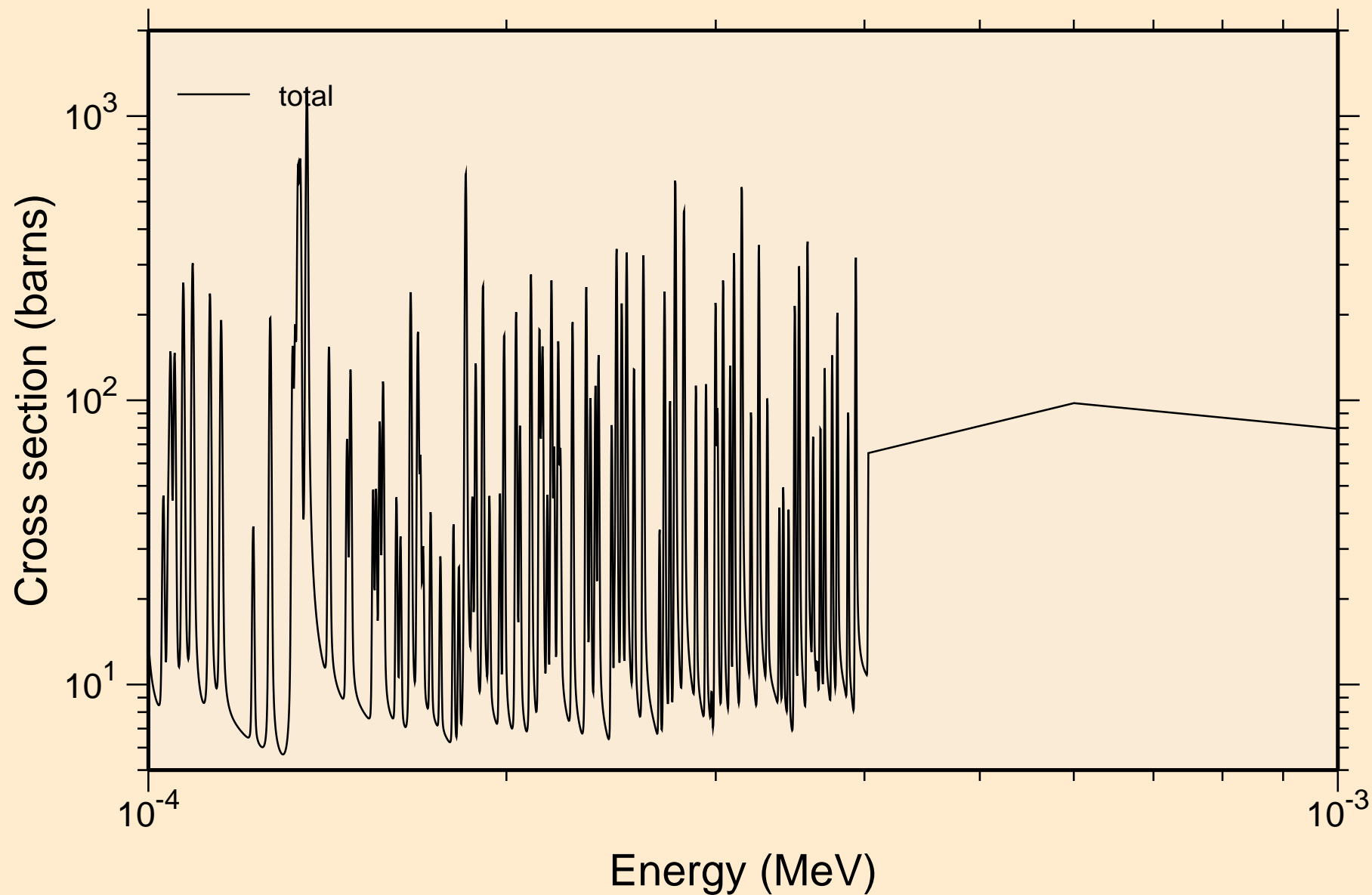

LU176 NEUTRON ACER TENDL-2019 LIBRARY; T=293.16K  
resonance total cross section

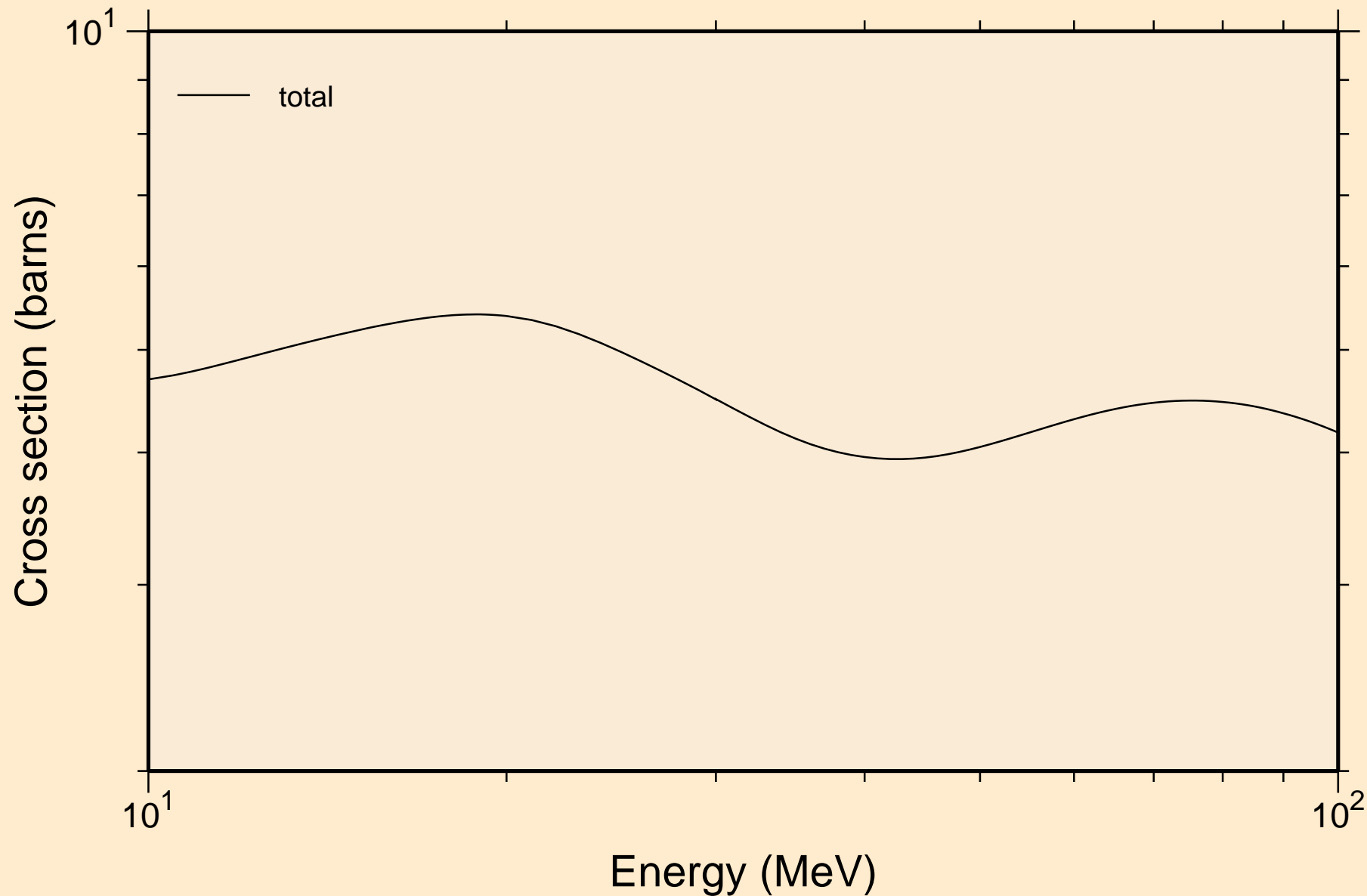

LU176 NEUTRON ACER TENDL-2019 LIBRARY; T=293.16K  
resonance absorption cross sections

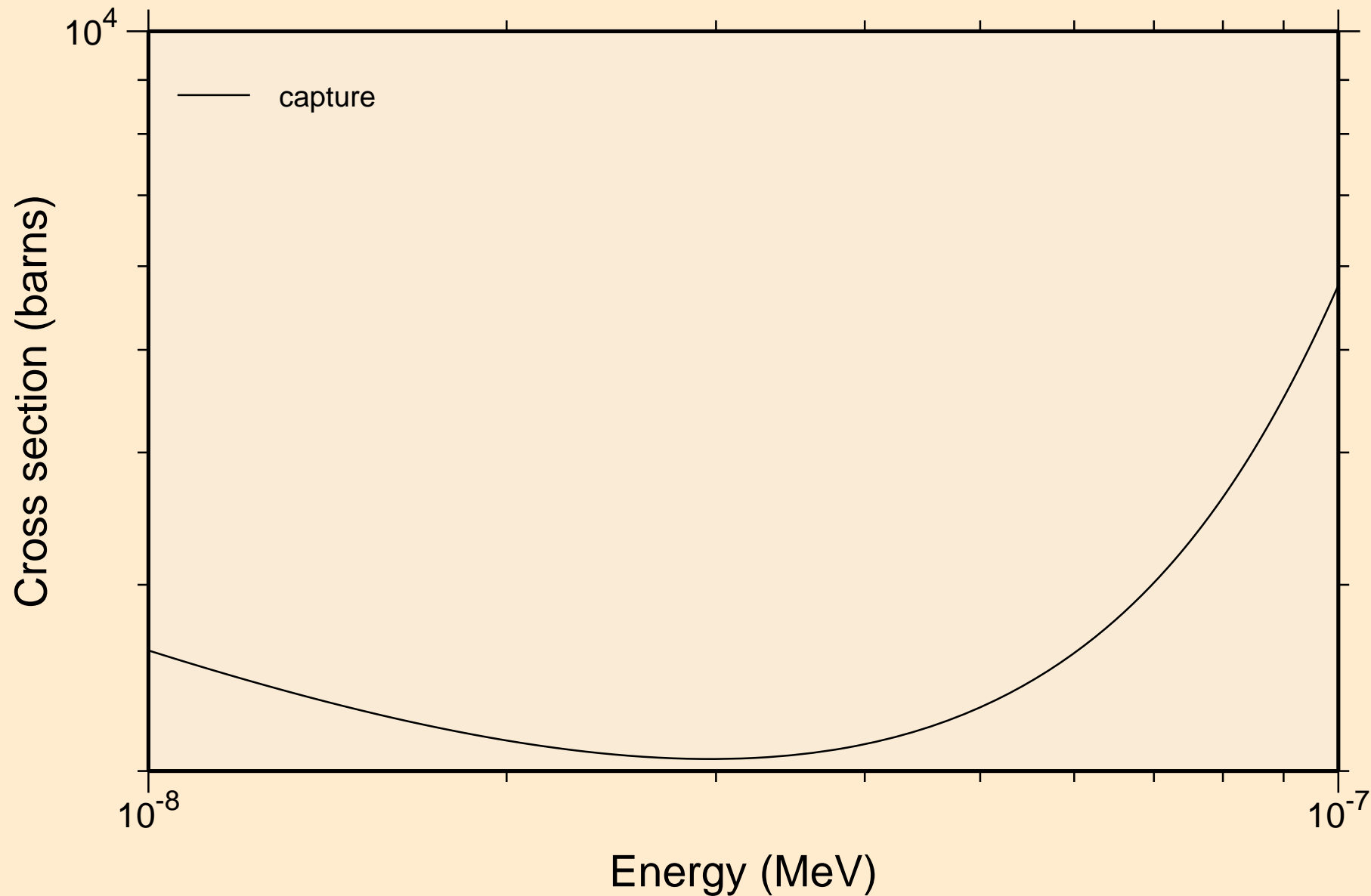

LU176 NEUTRON ACER TENDL-2019 LIBRARY; T=293.16K  
resonance absorption cross sections

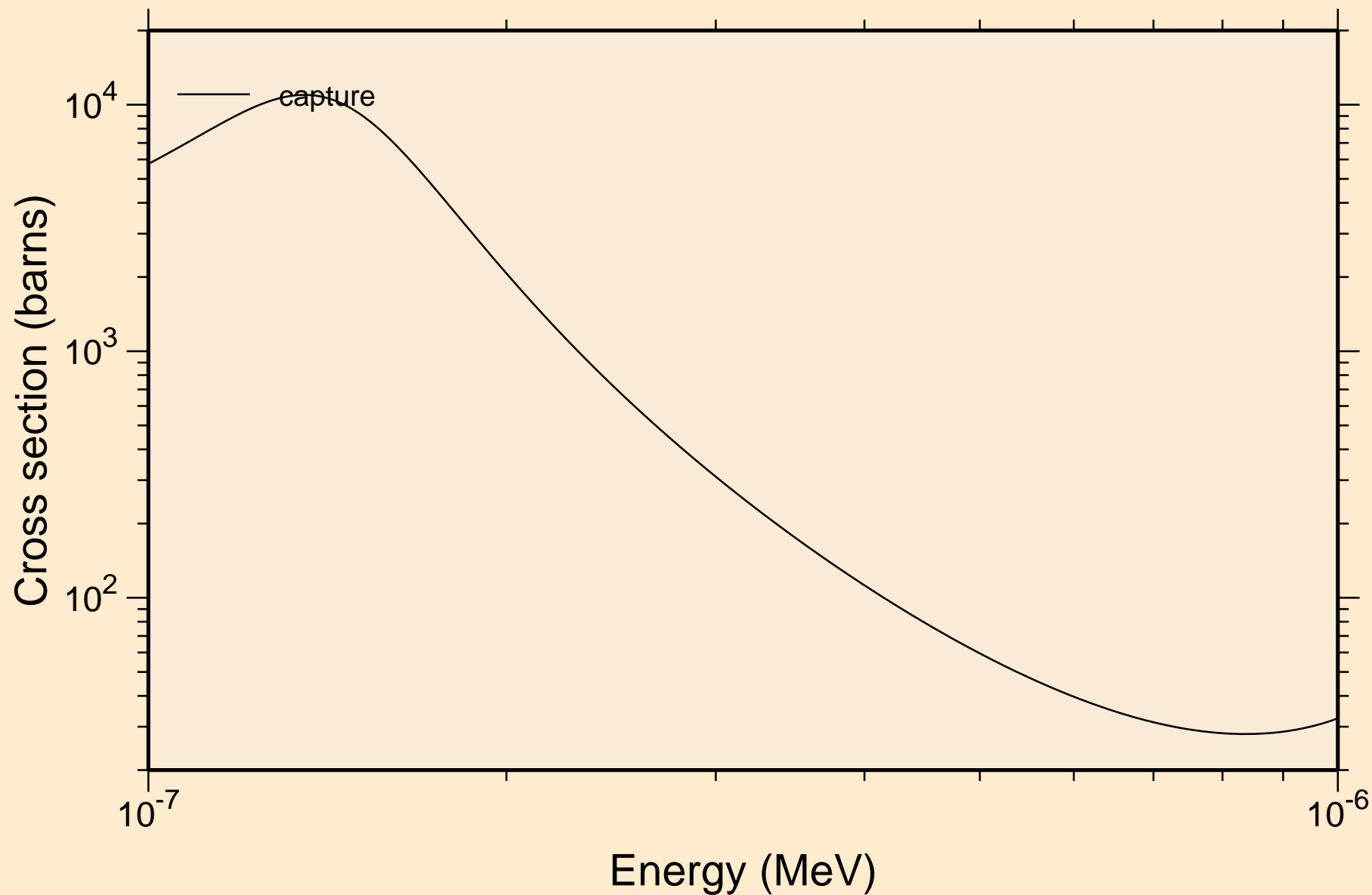



LU176 NEUTRON ACER TENDL-2019 LIBRARY; T=293.16K  
resonance absorption cross sections

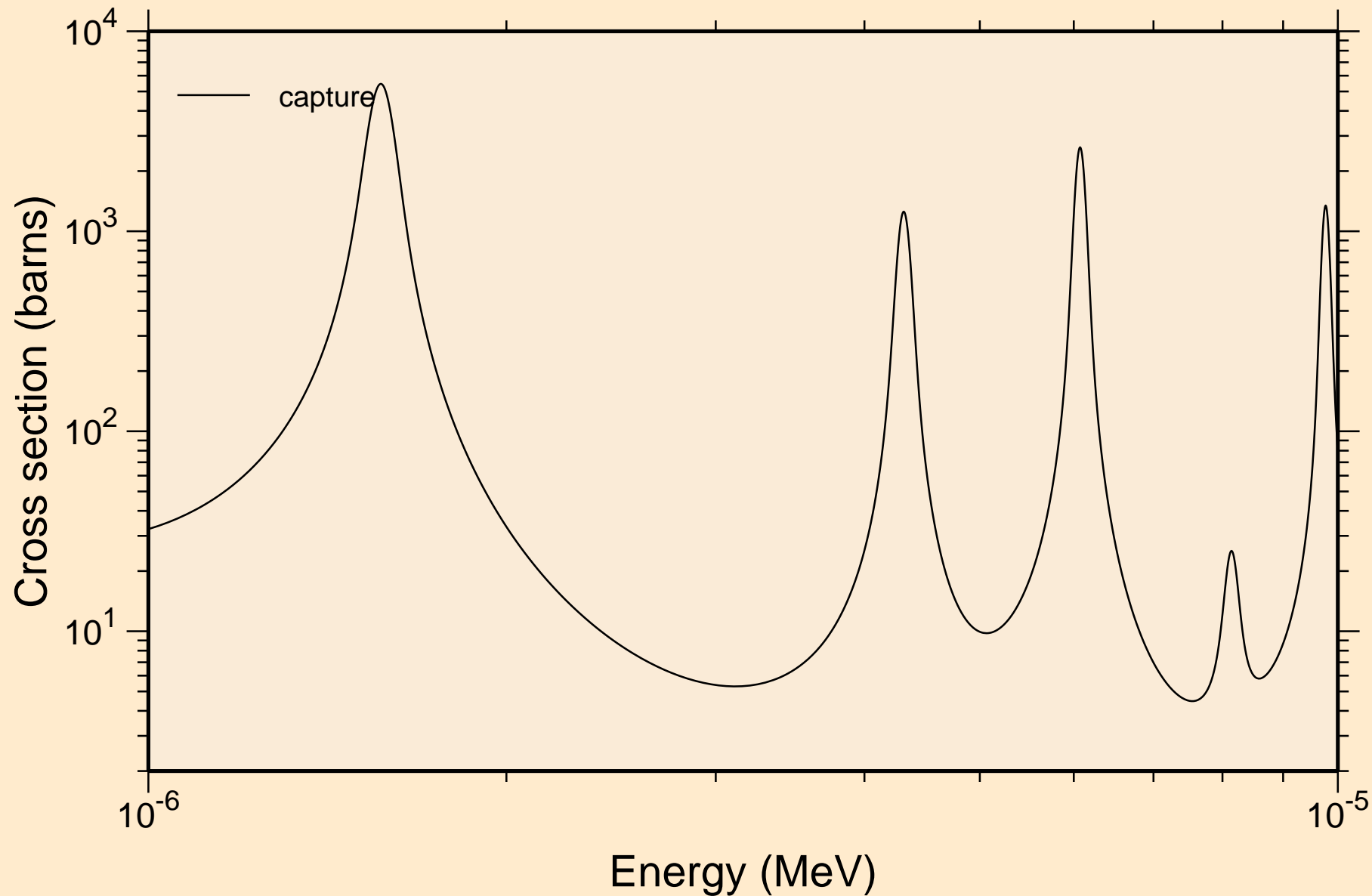

LU176 NEUTRON ACER TENDL-2019 LIBRARY; T=293.16K  
resonance absorption cross sections

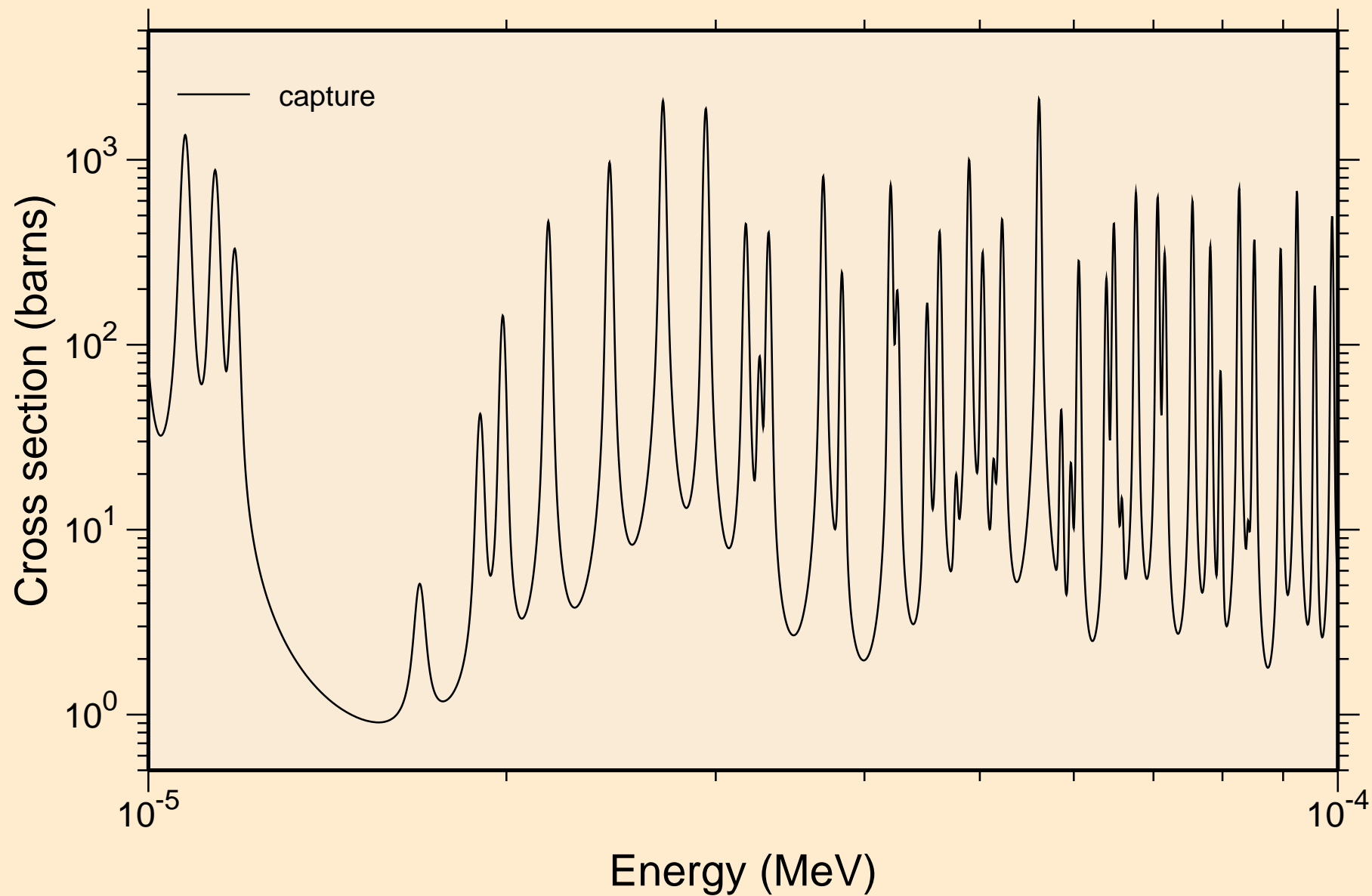

LU176 NEUTRON ACER TENDL-2019 LIBRARY; T=293.16K  
resonance absorption cross sections

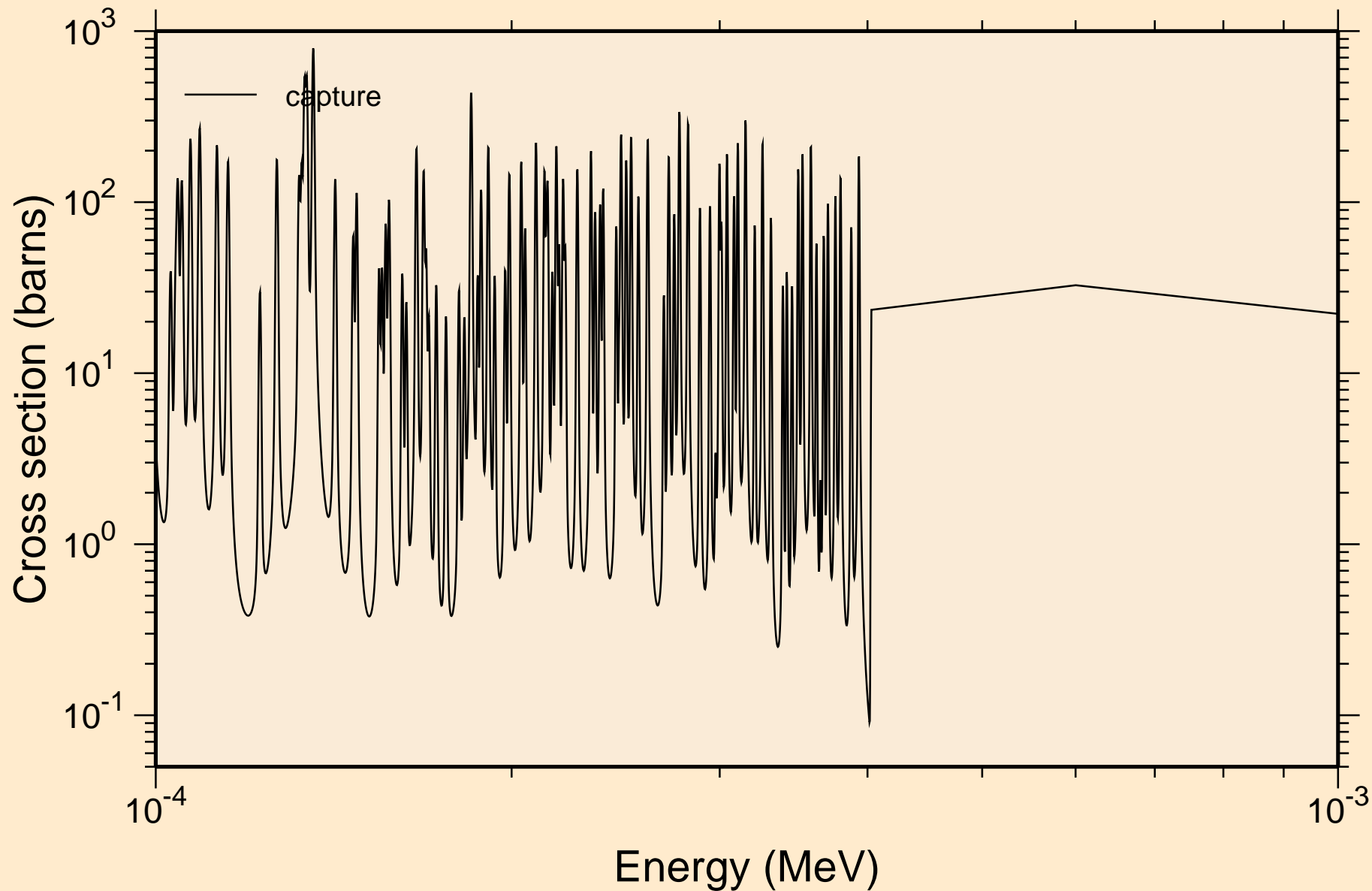

LU176 NEUTRON ACER TENDL-2019 LIBRARY; T=293.16K  
resonance absorption cross sections

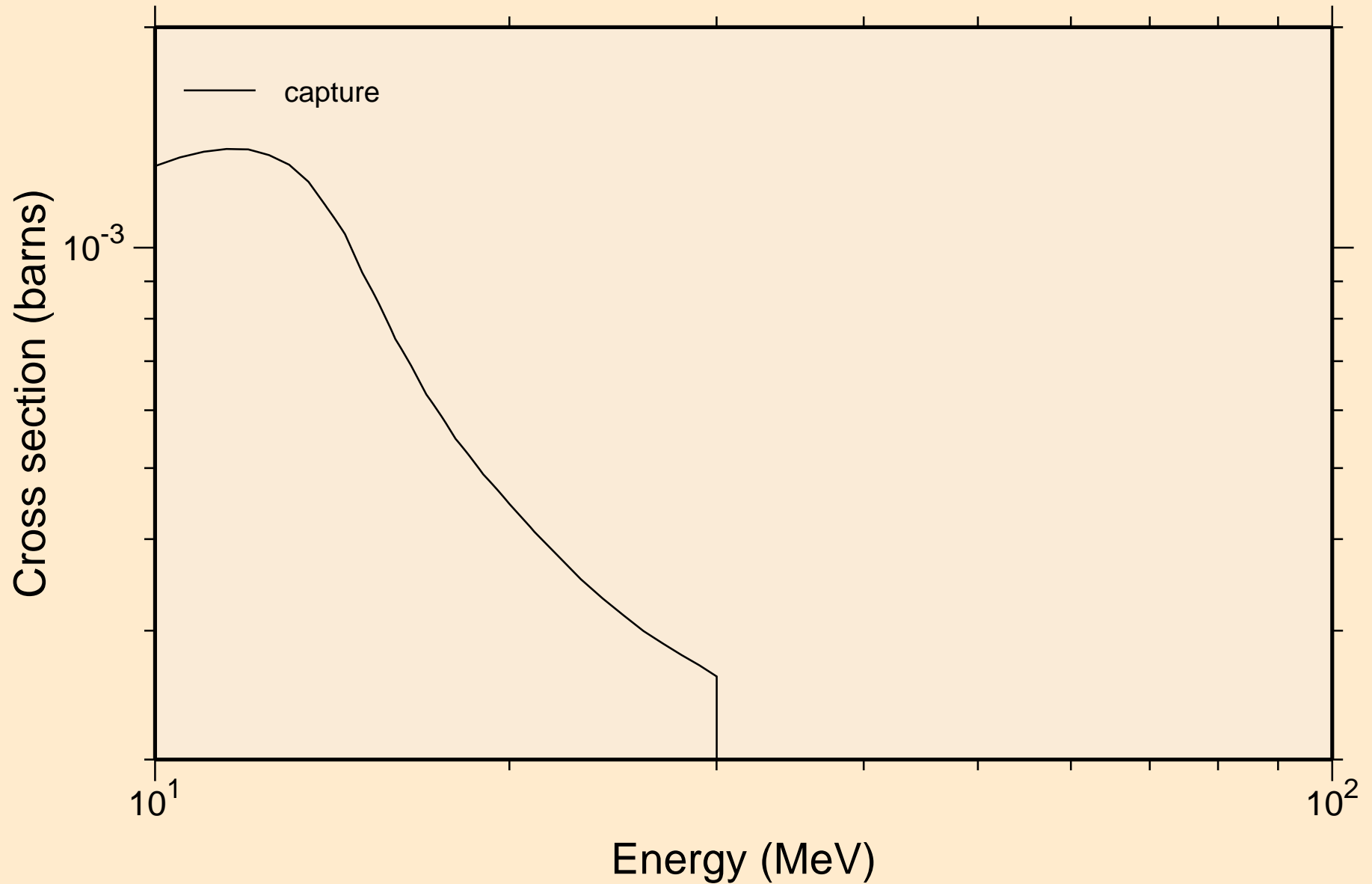

LU176 NEUTRON ACER TENDL-2019 LIBRARY; T=293.16K  
Heating

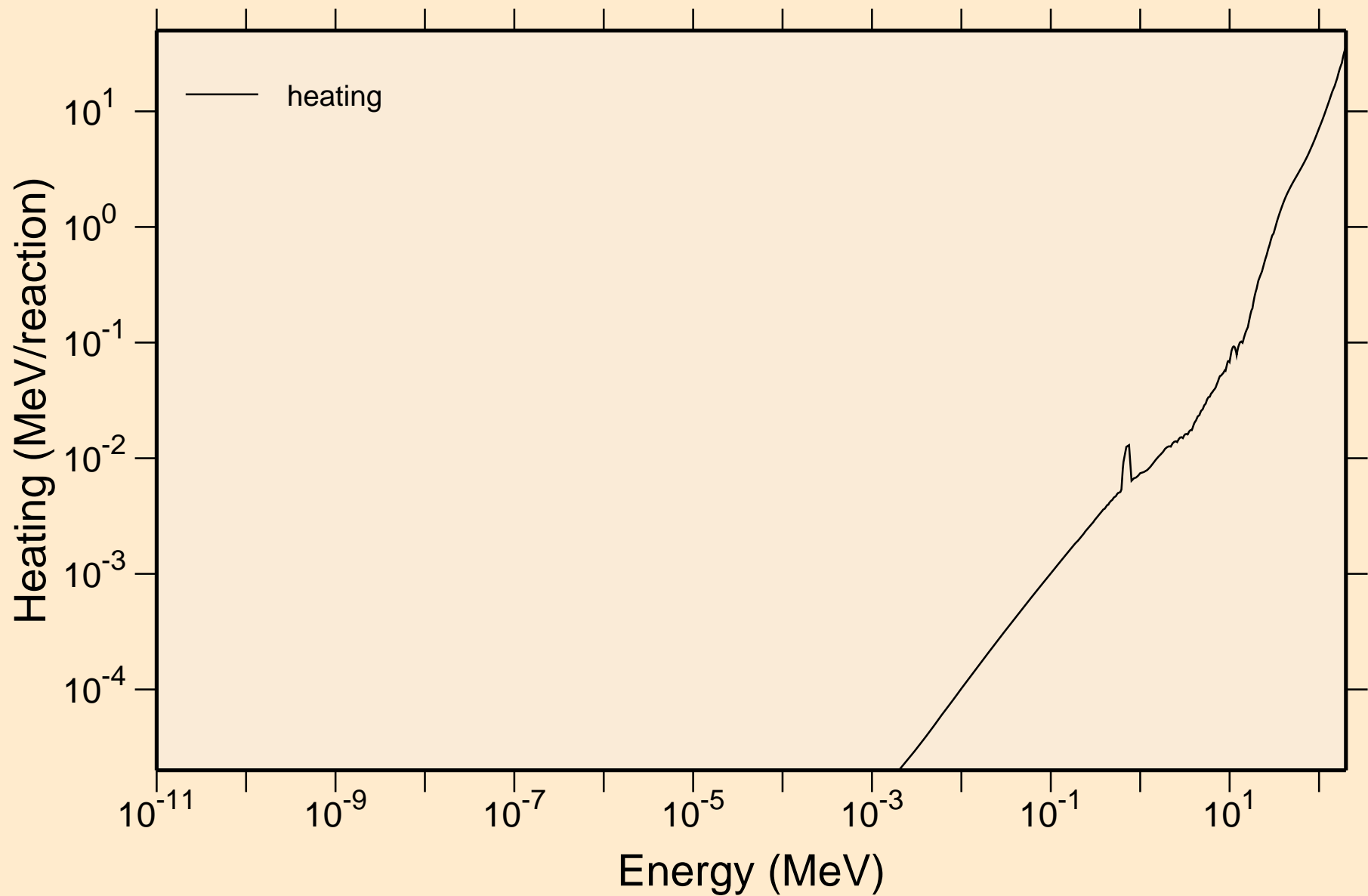

LU176 NEUTRON ACER TENDL-2019 LIBRARY; T=293.16K  
Damage

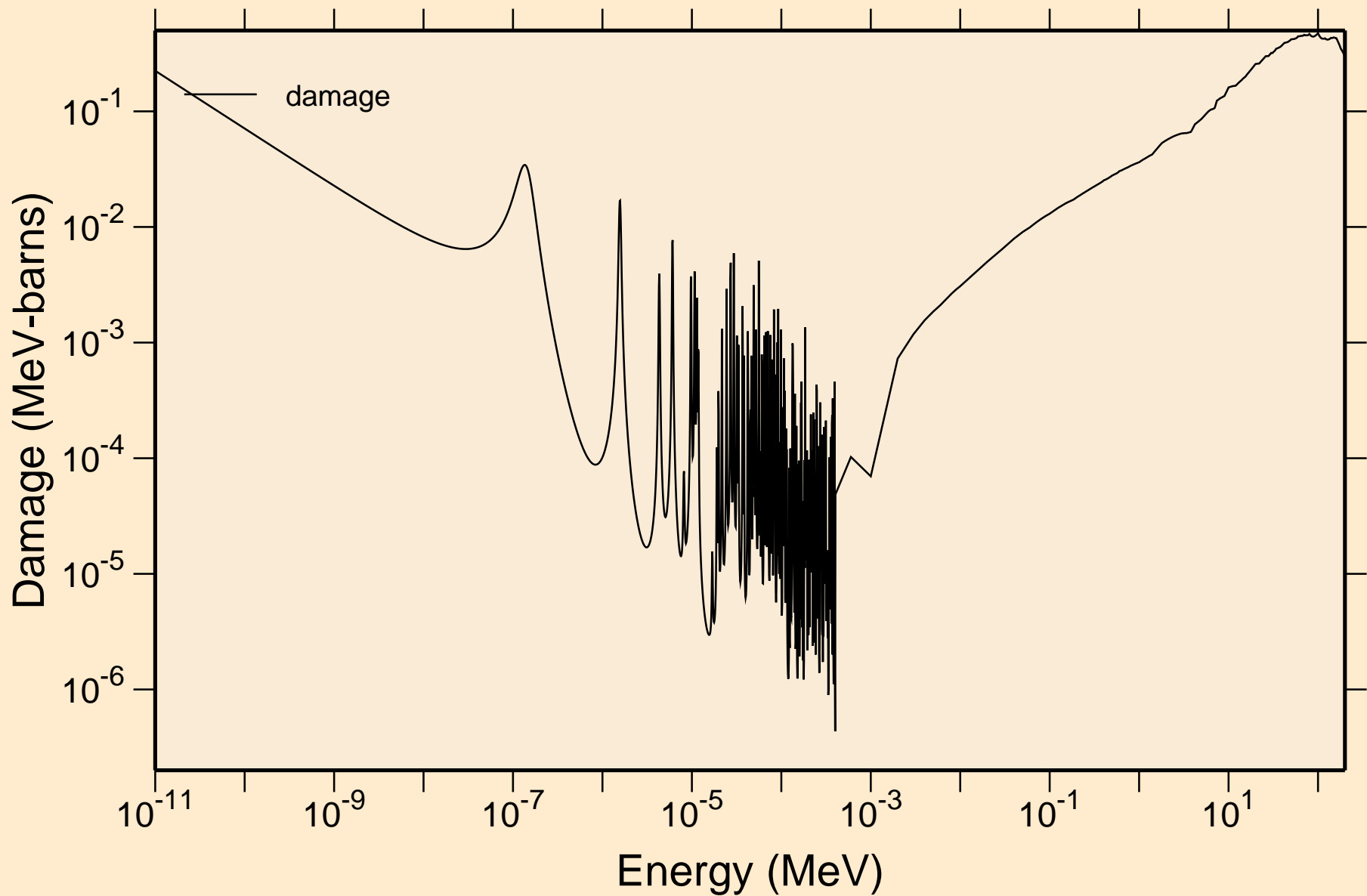

LU176 NEUTRON ACER TENDL-2019 LIBRARY; T=293.16K  
Non-threshold reactions

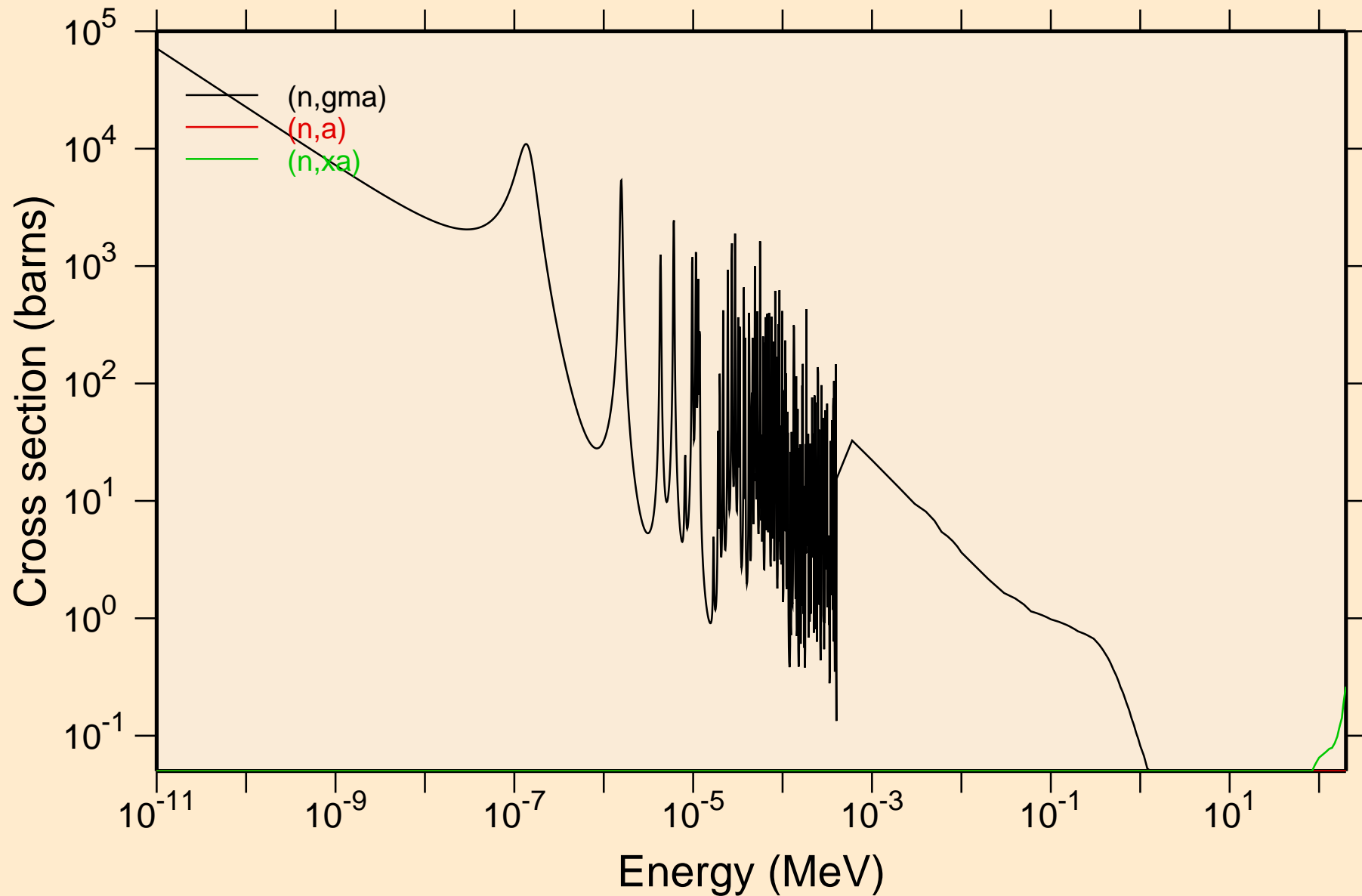

LU176 NEUTRON ACER TENDL-2019 LIBRARY; T=293.16K  
Principal cross sections

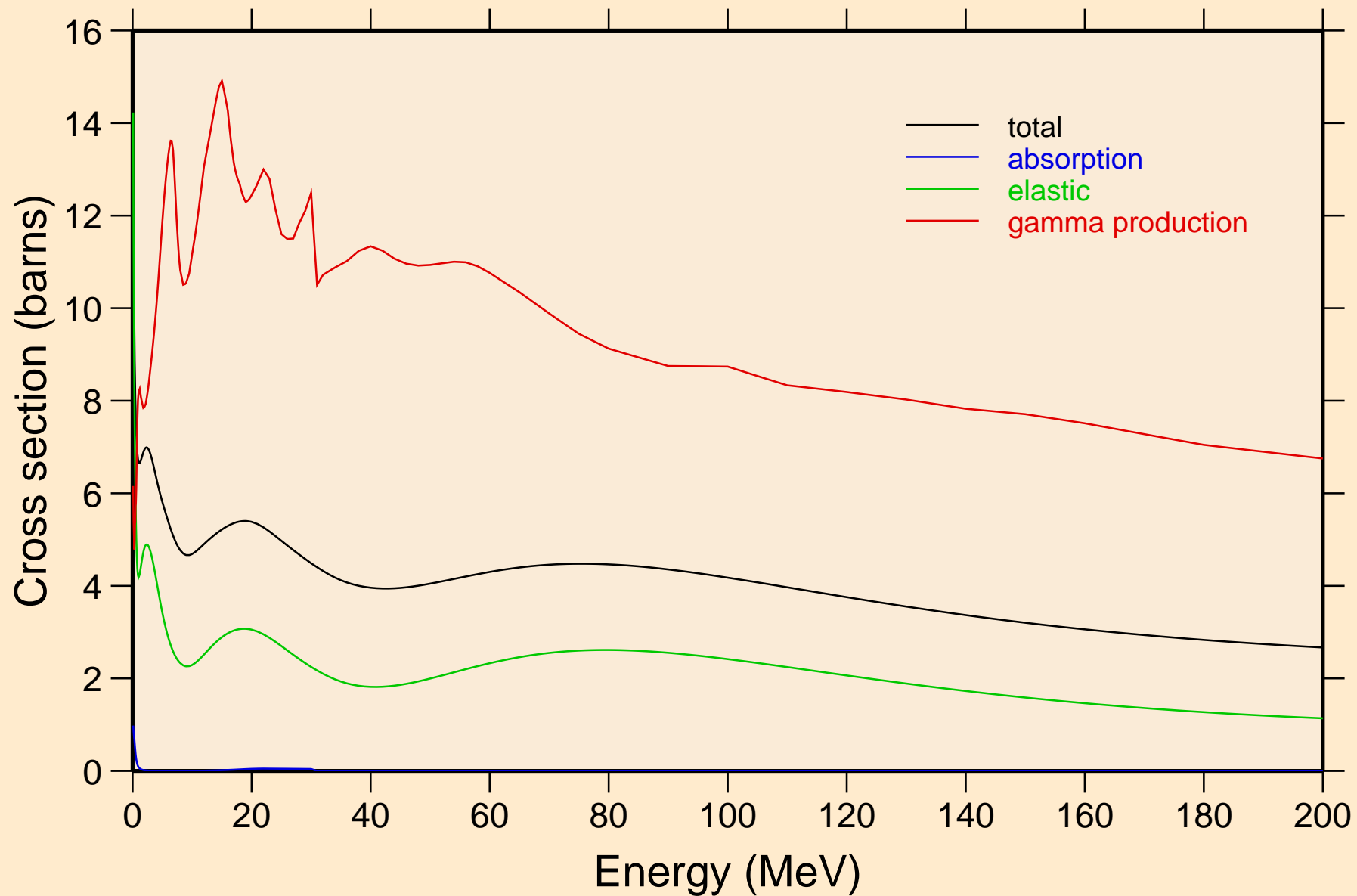



LU176 NEUTRON ACER TENDL-2019 LIBRARY; T=293.16K  
Heating

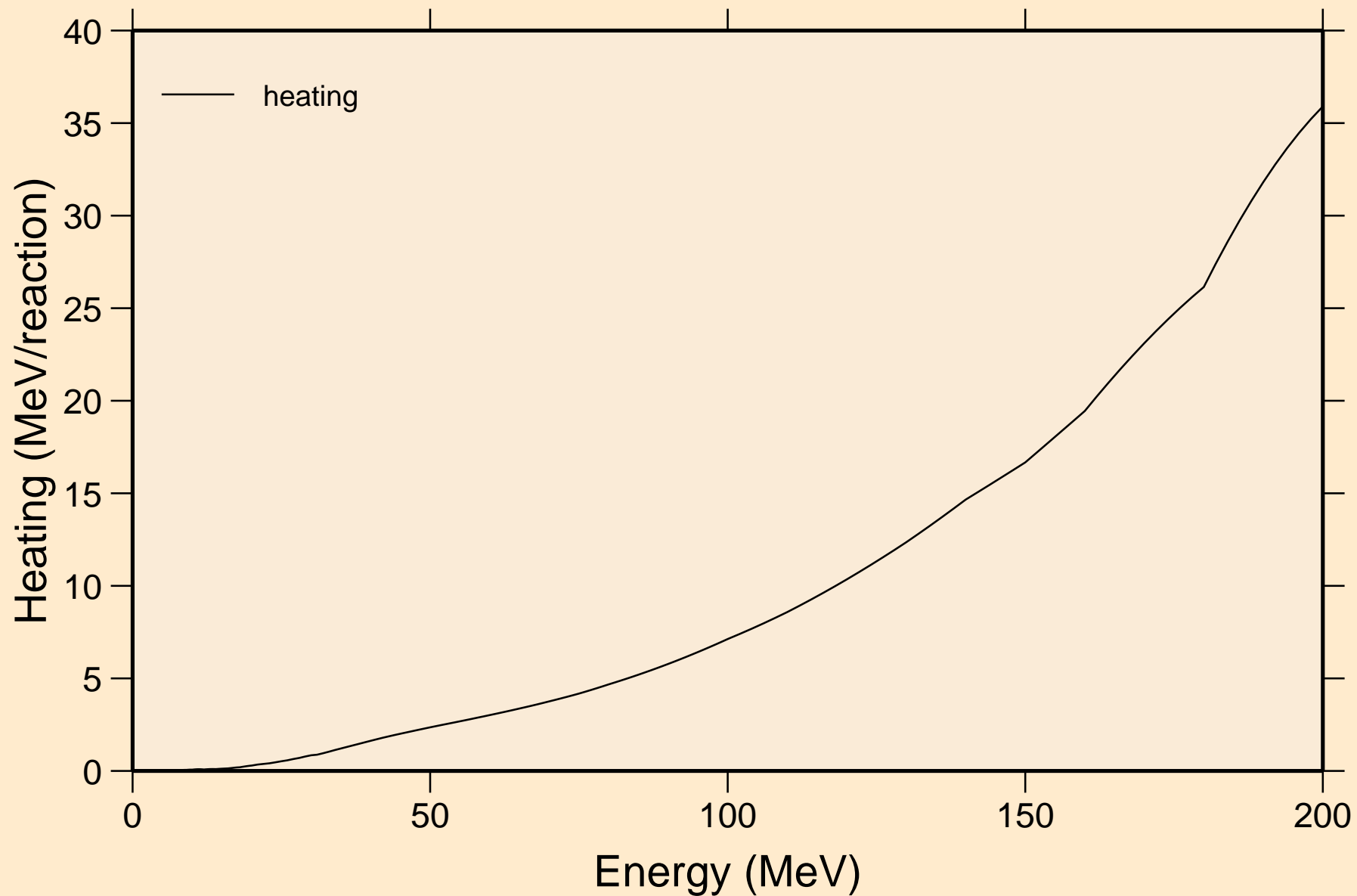

LU176 NEUTRON ACER TENDL-2019 LIBRARY; T=293.16K  
Damage

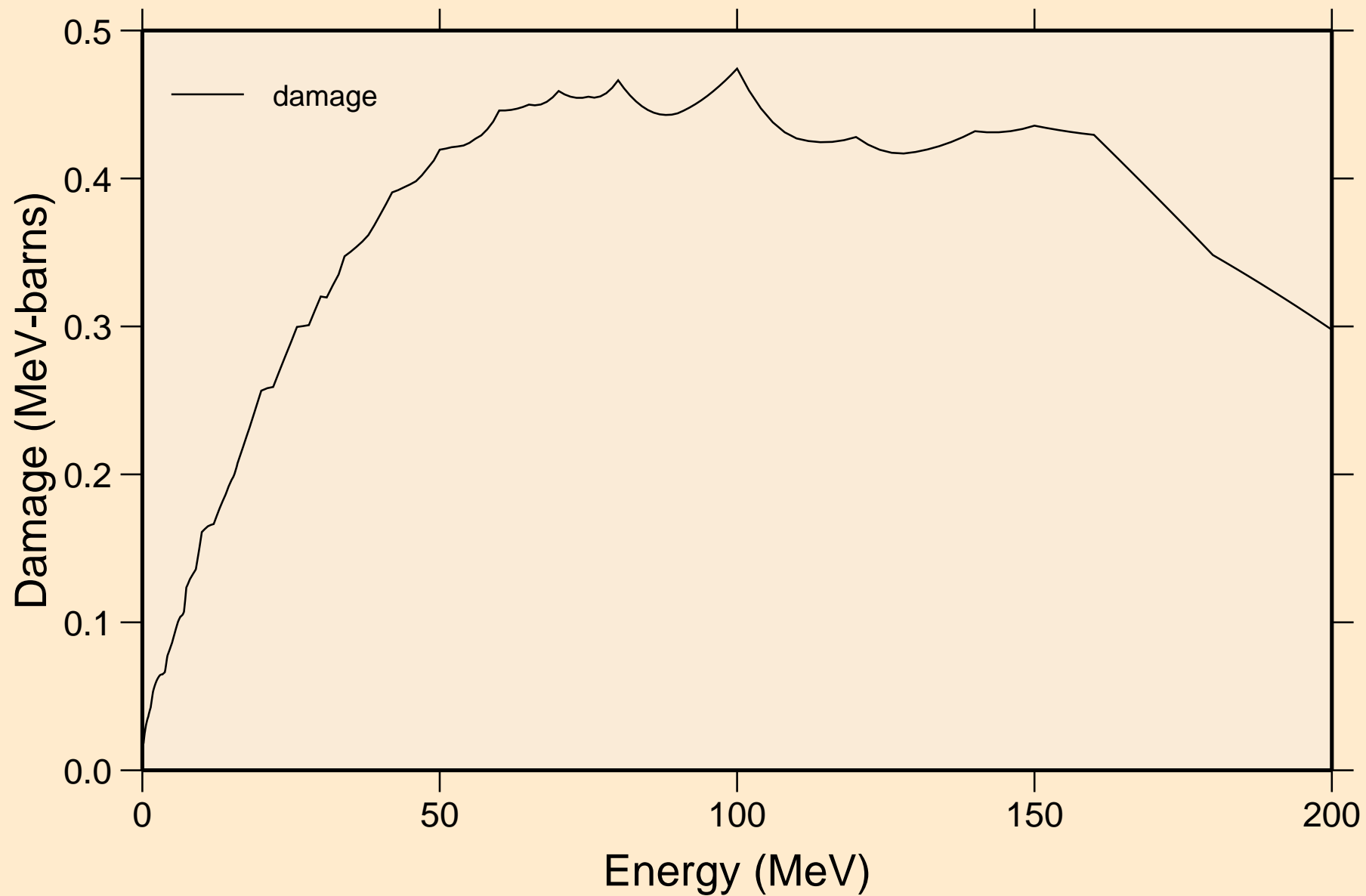

LU176 NEUTRON ACER TENDL-2019 LIBRARY; T=293.16K  
Non-threshold reactions

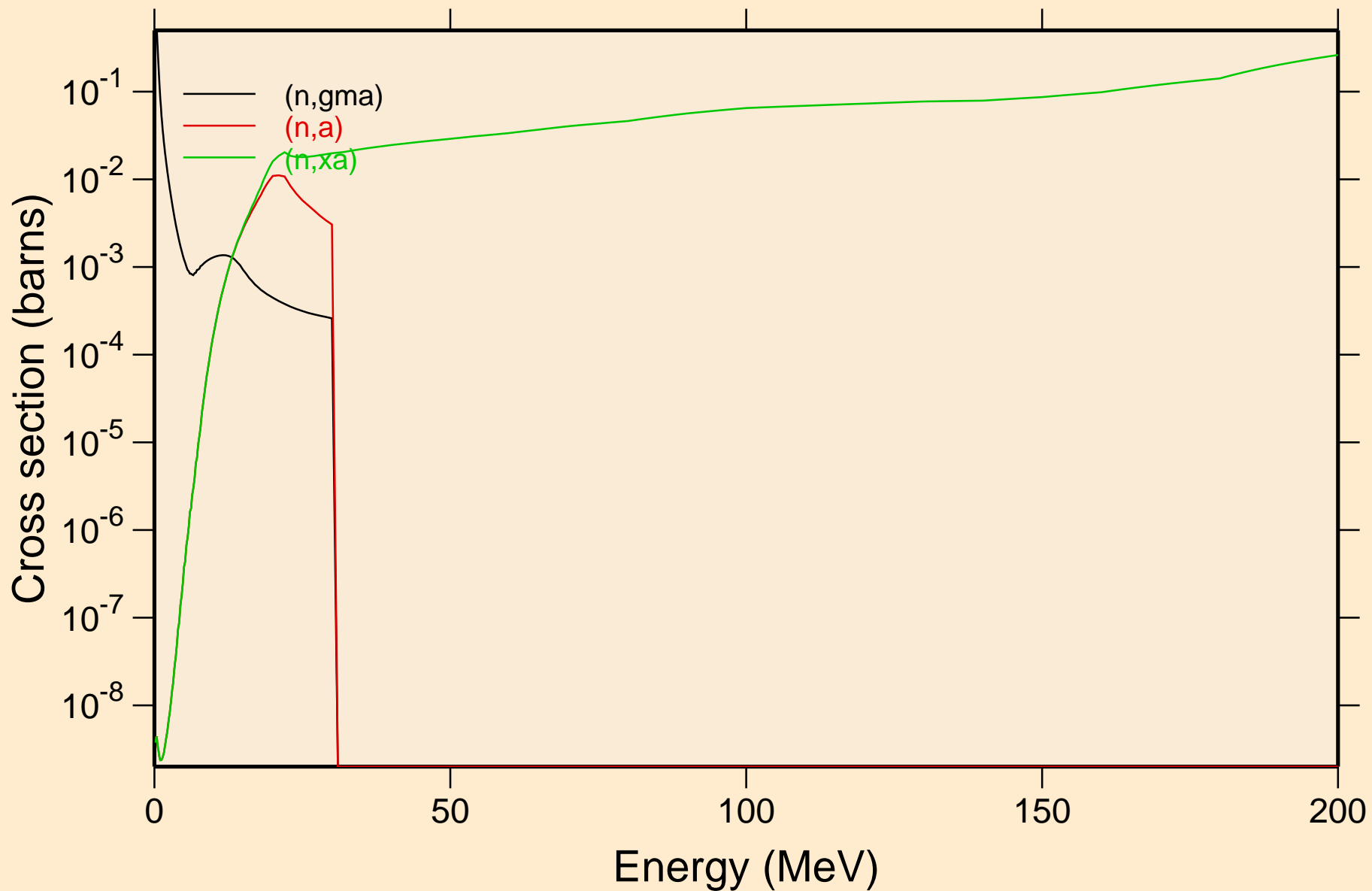

LU176 NEUTRON ACER TENDL-2019 LIBRARY; T=293.16K  
Inelastic levels

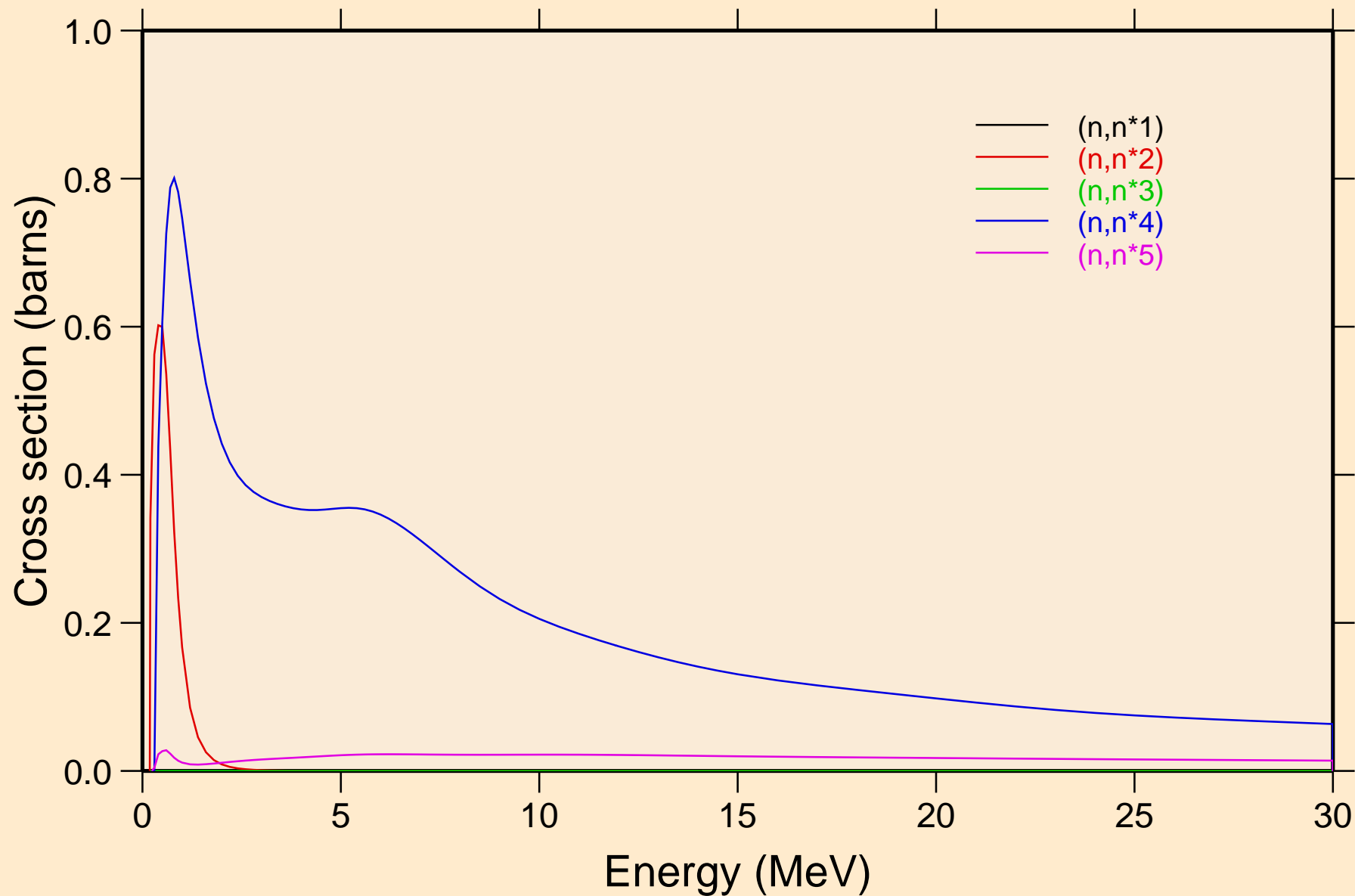

LU176 NEUTRON ACER TENDL-2019 LIBRARY; T=293.16K  
Inelastic levels

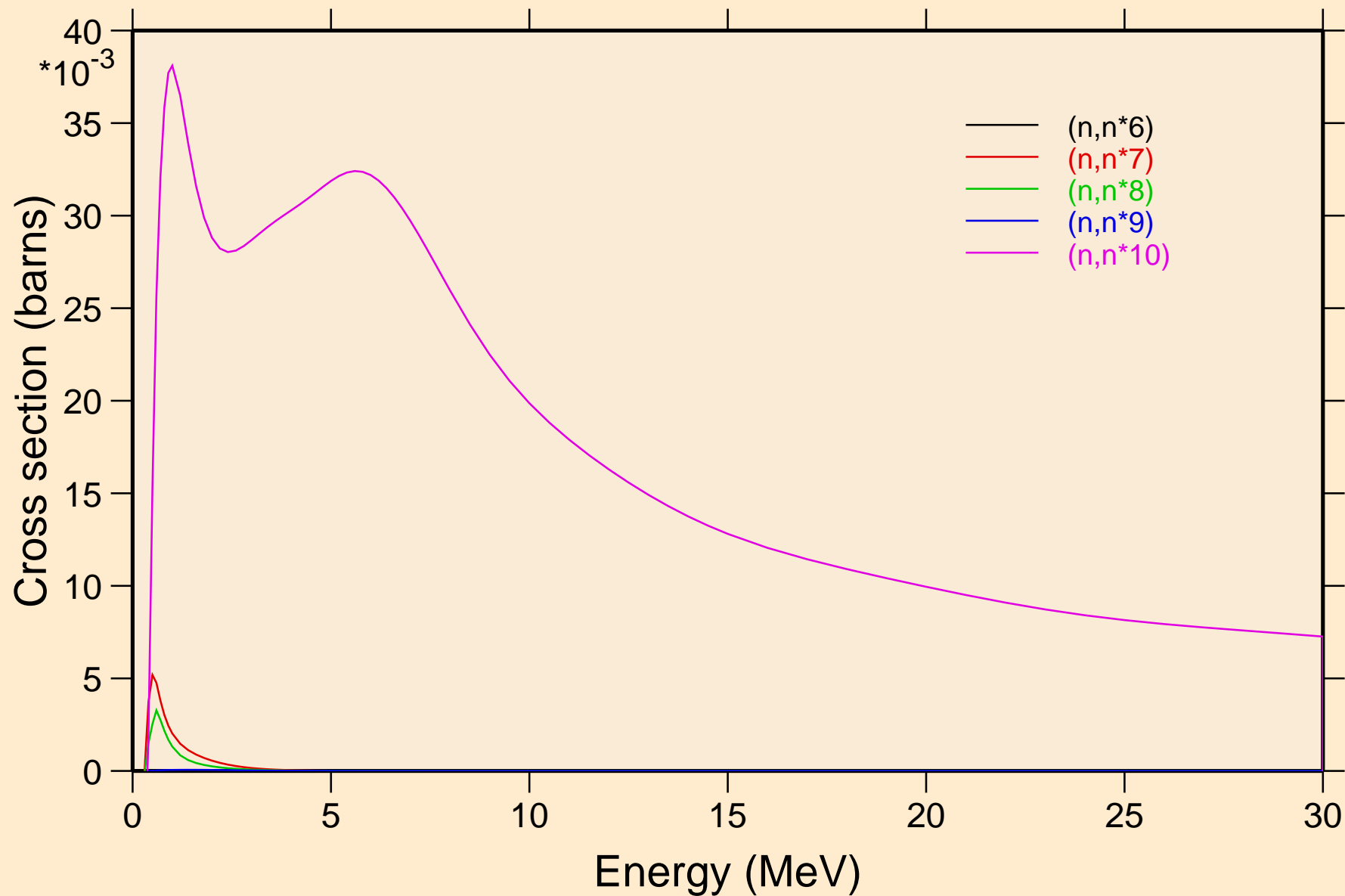

LU176 NEUTRON ACER TENDL-2019 LIBRARY; T=293.16K  
Inelastic levels

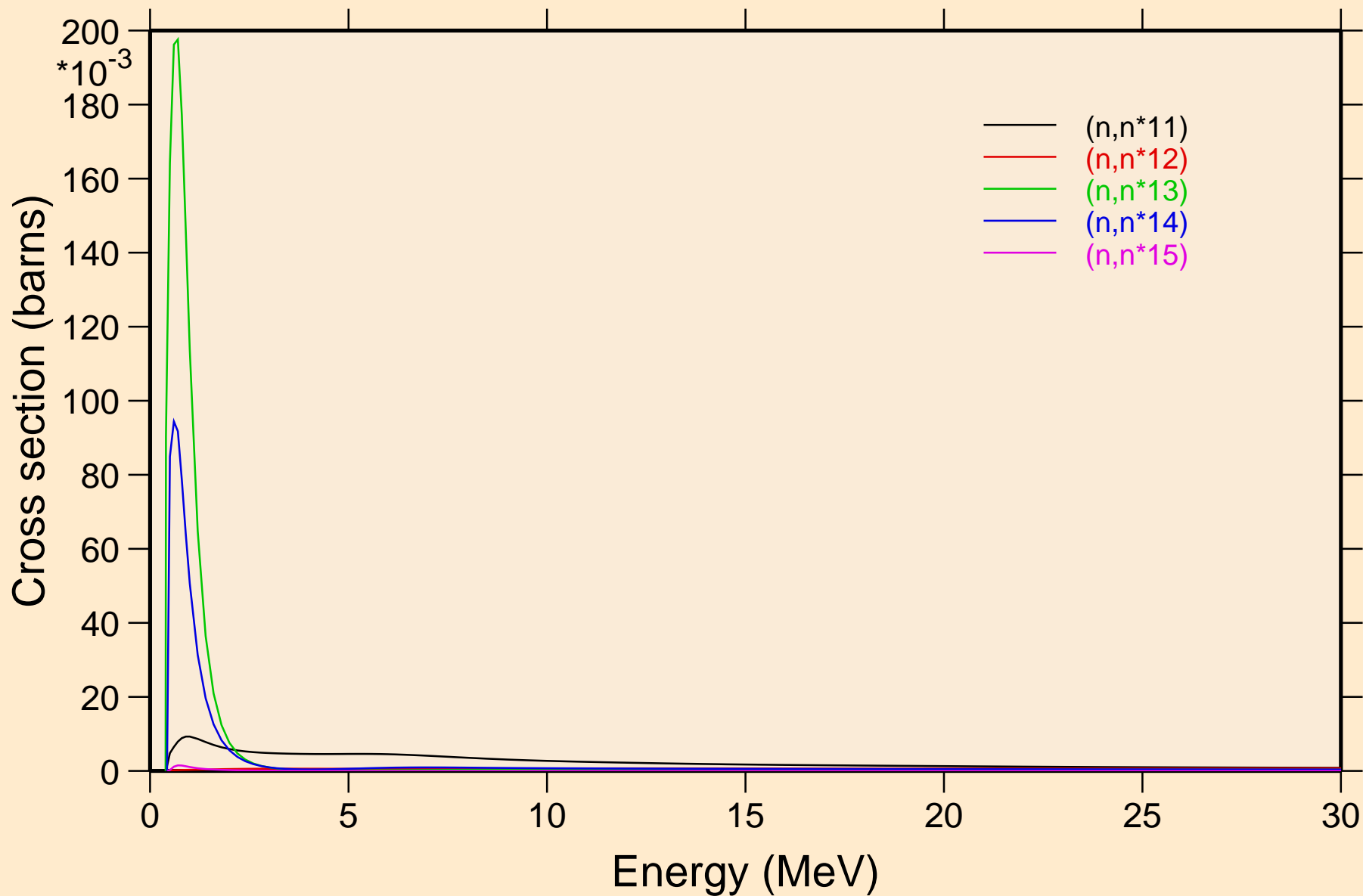

LU176 NEUTRON ACER TENDL-2019 LIBRARY; T=293.16K  
Inelastic levels

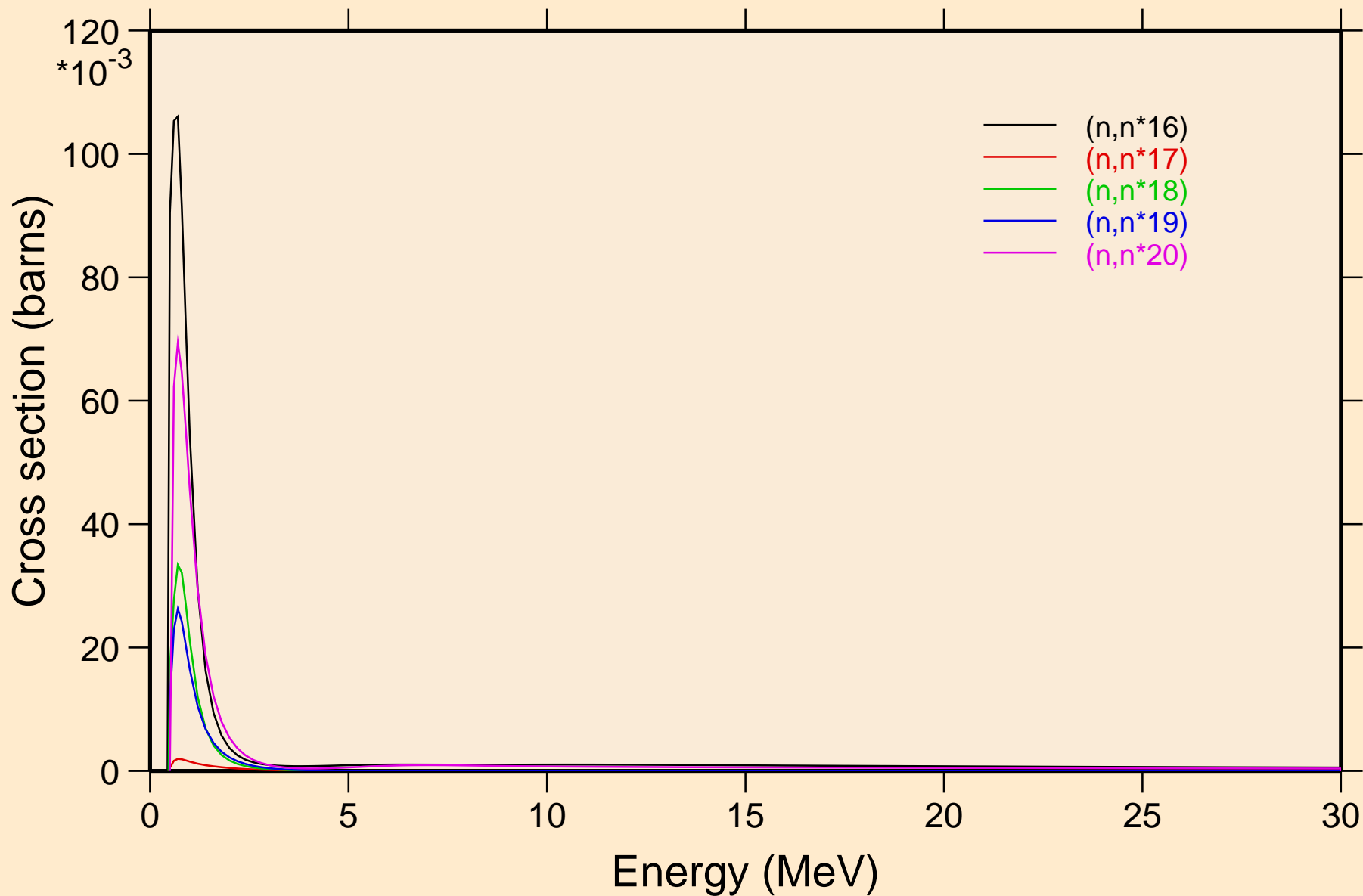

LU176 NEUTRON ACER TENDL-2019 LIBRARY; T=293.16K  
Inelastic levels

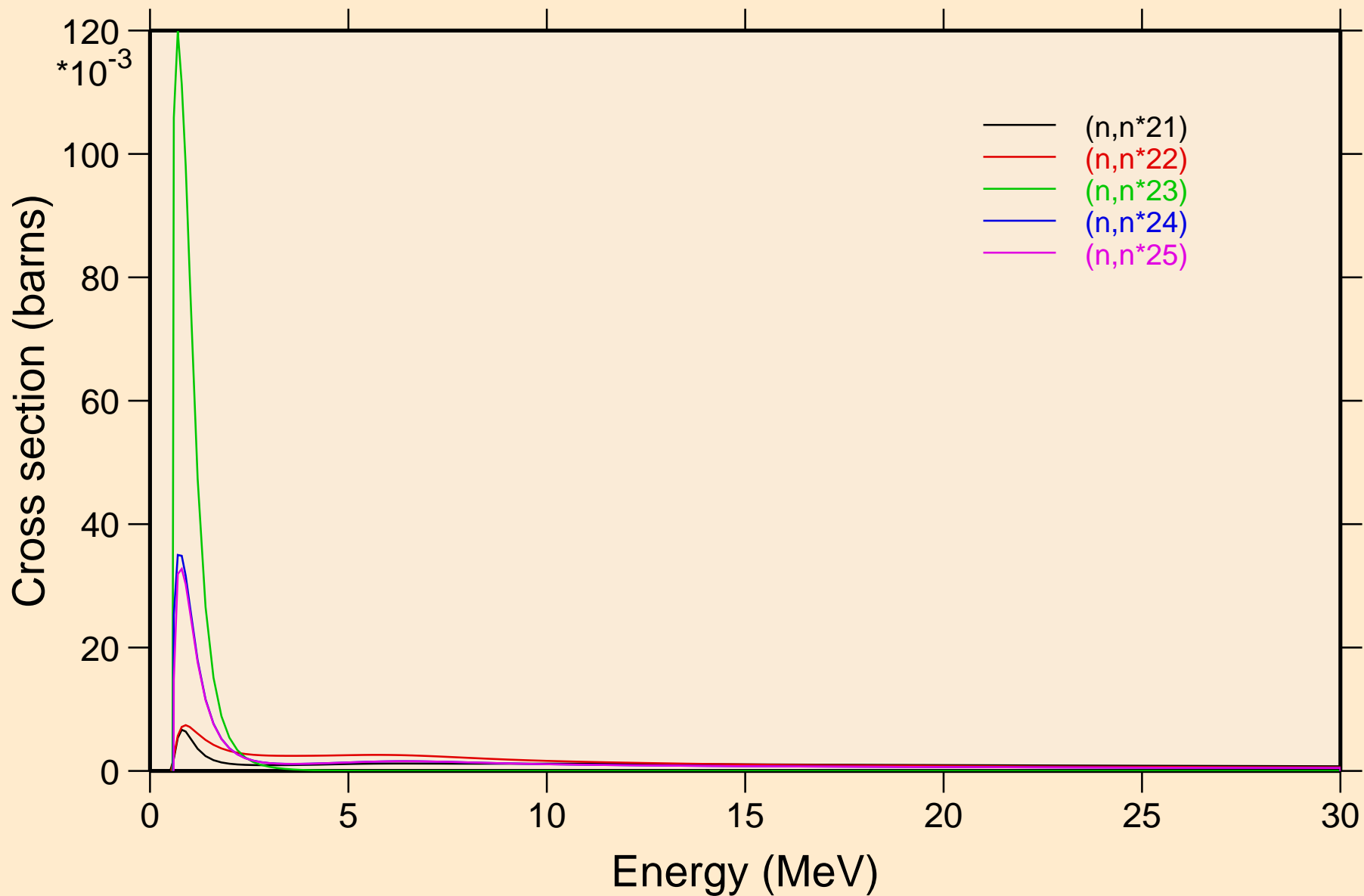



LU176 NEUTRON ACER TENDL-2019 LIBRARY; T=293.16K  
Inelastic levels

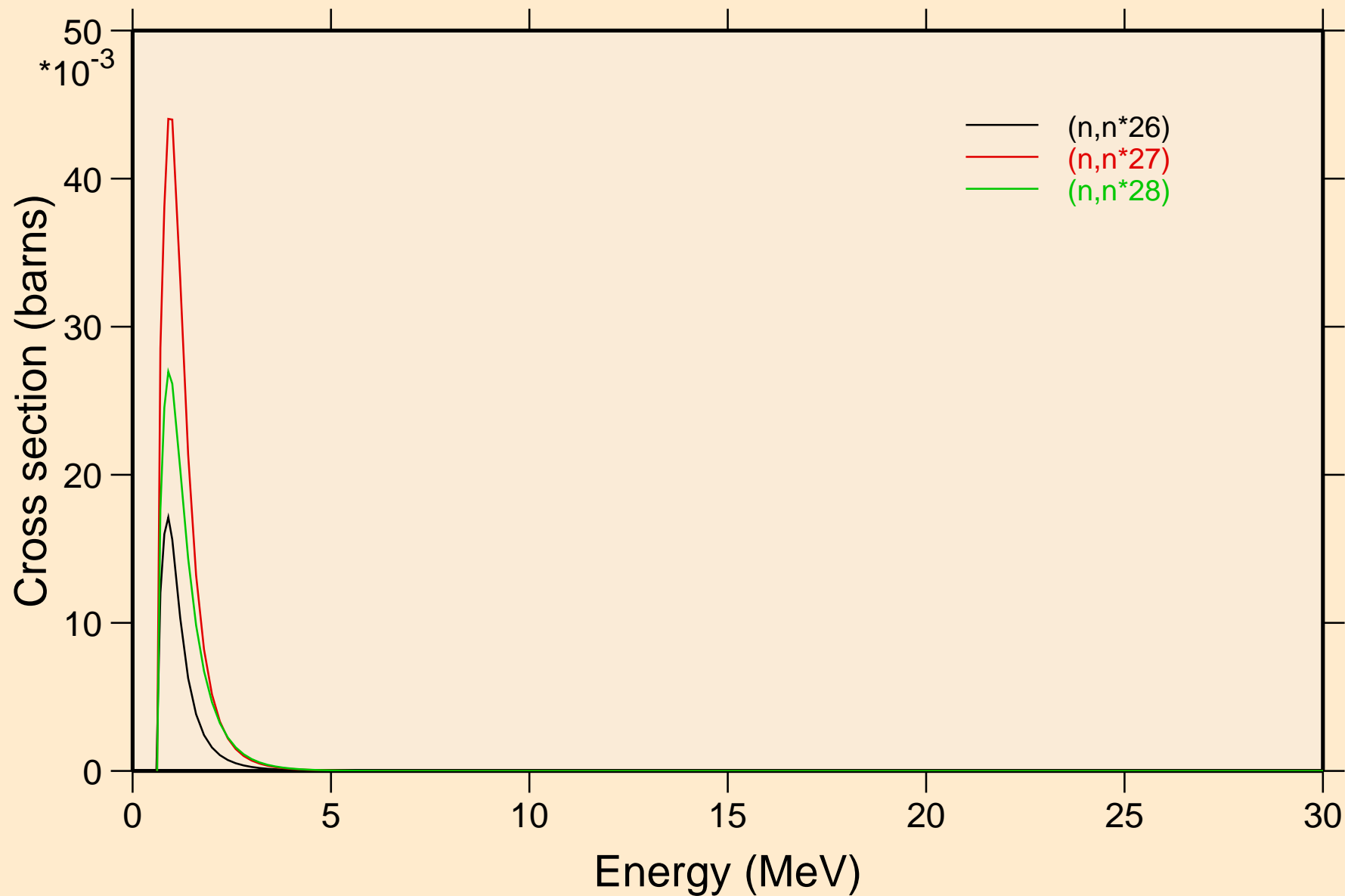

LU176 NEUTRON ACER TENDL-2019 LIBRARY; T=293.16K  
Threshold reactions

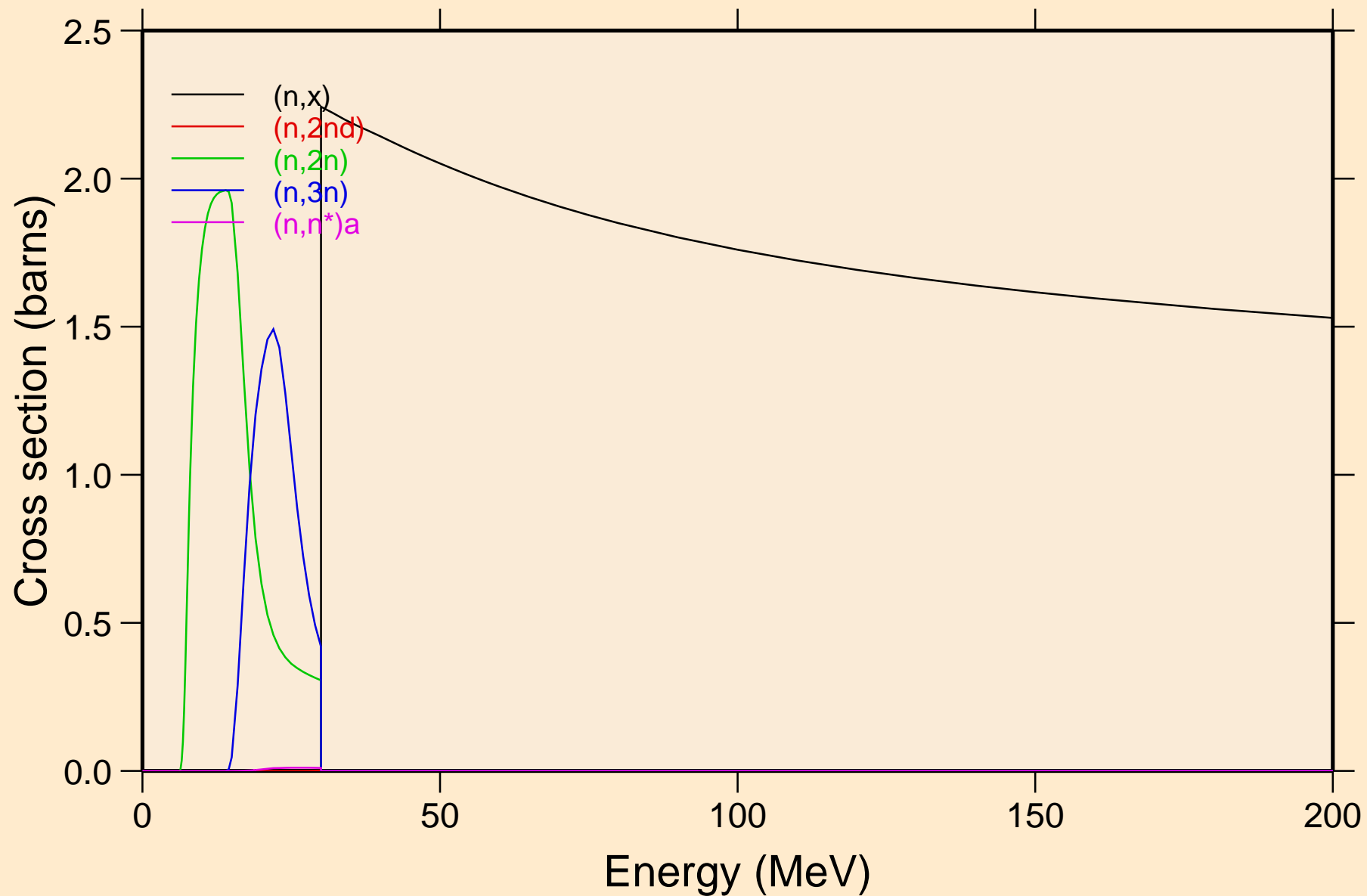

LU176 NEUTRON ACER TENDL-2019 LIBRARY; T=293.16K  
Threshold reactions

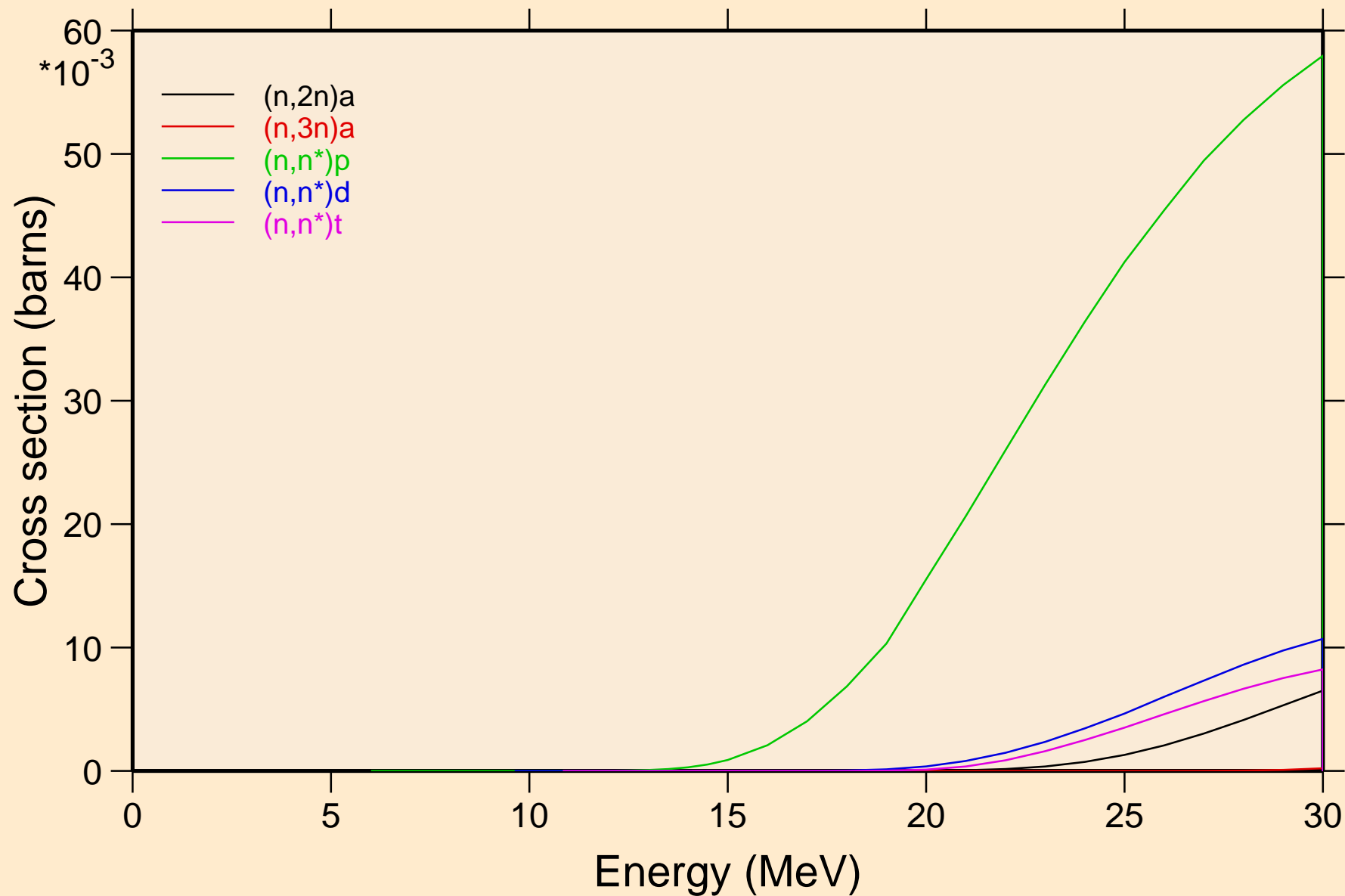

LU176 NEUTRON ACER TENDL-2019 LIBRARY; T=293.16K  
Threshold reactions

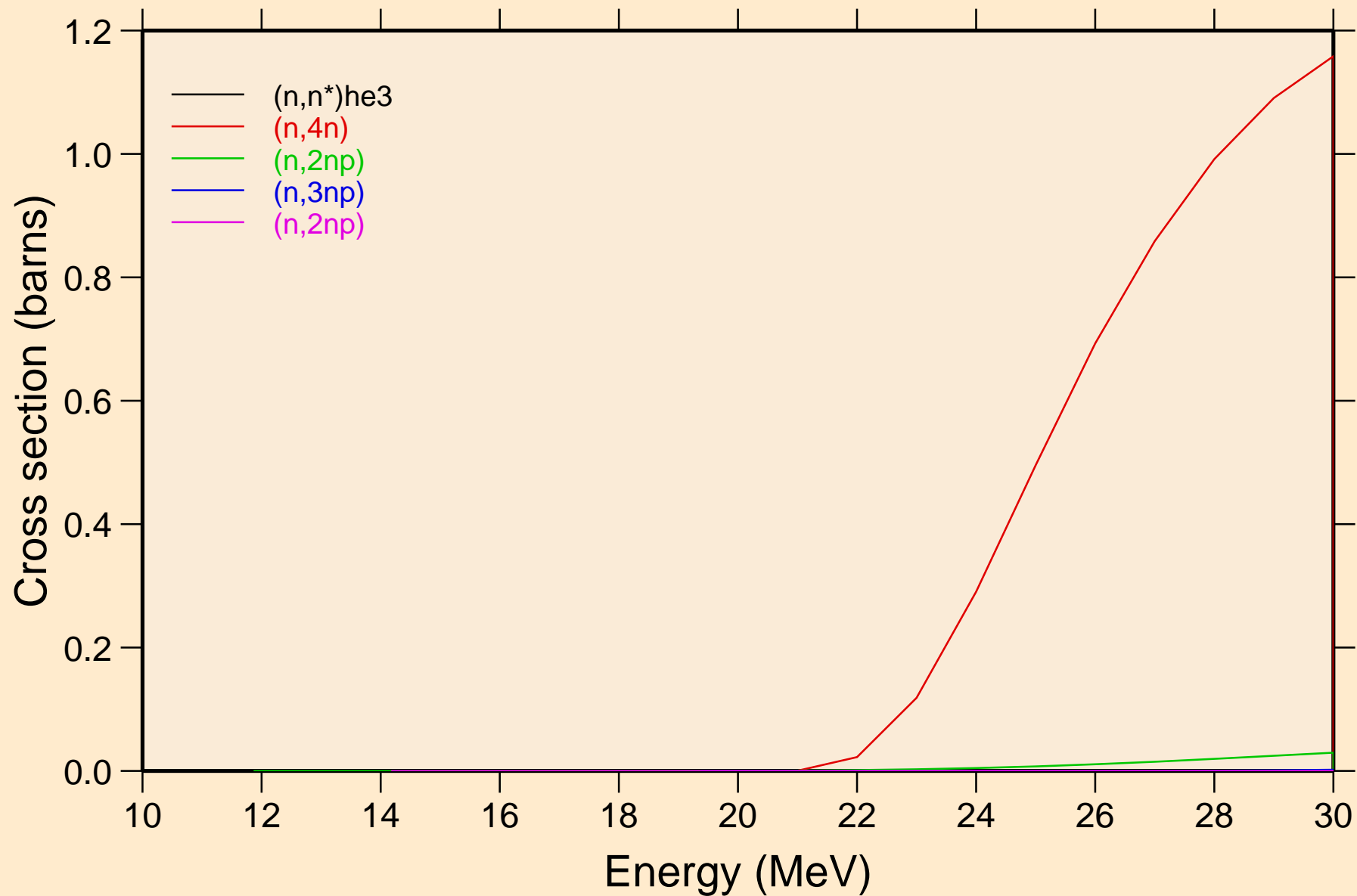

LU176 NEUTRON ACER TENDL-2019 LIBRARY; T=293.16K  
Threshold reactions

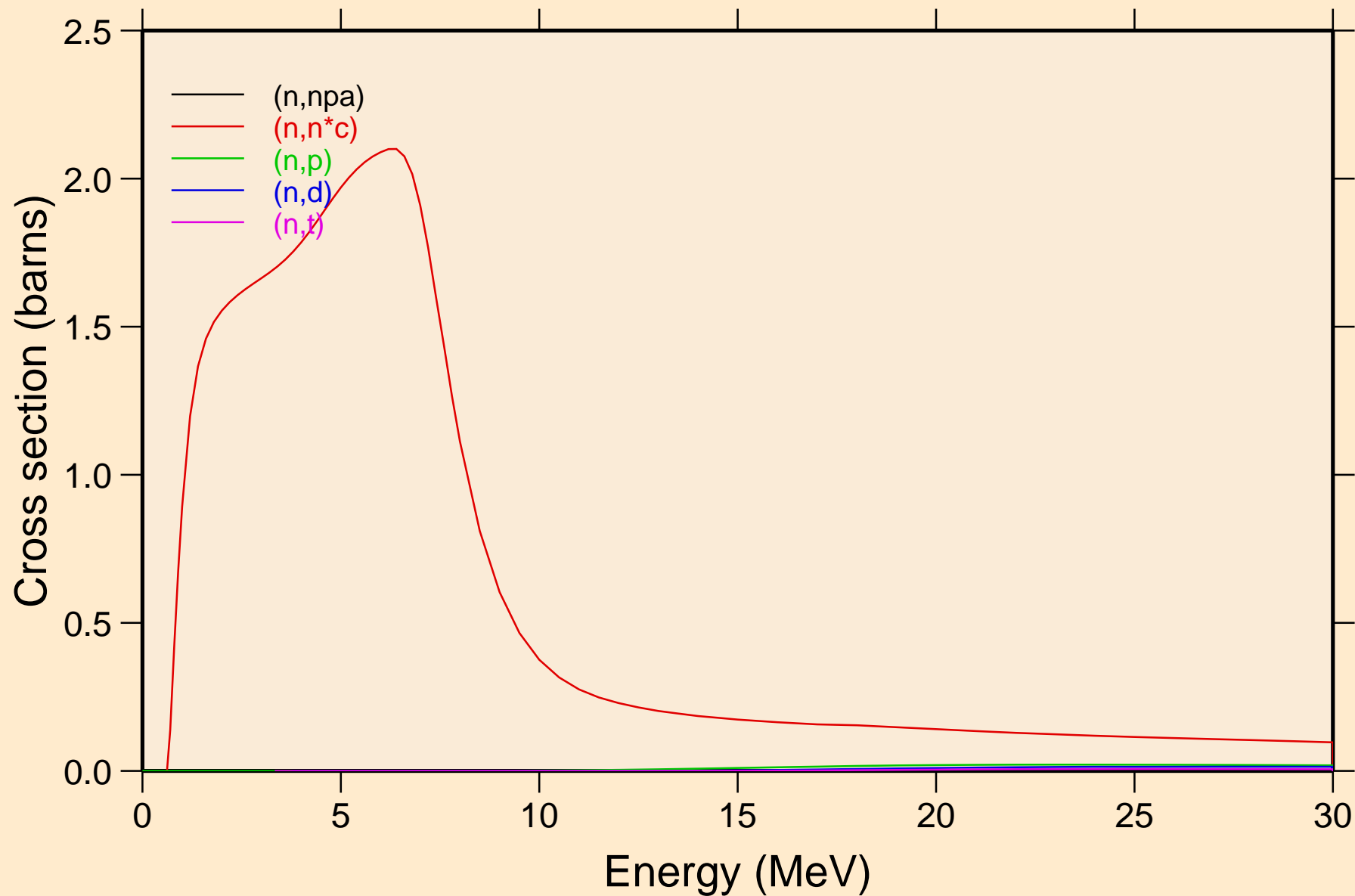

LU176 NEUTRON ACER TENDL-2019 LIBRARY; T=293.16K  
Threshold reactions

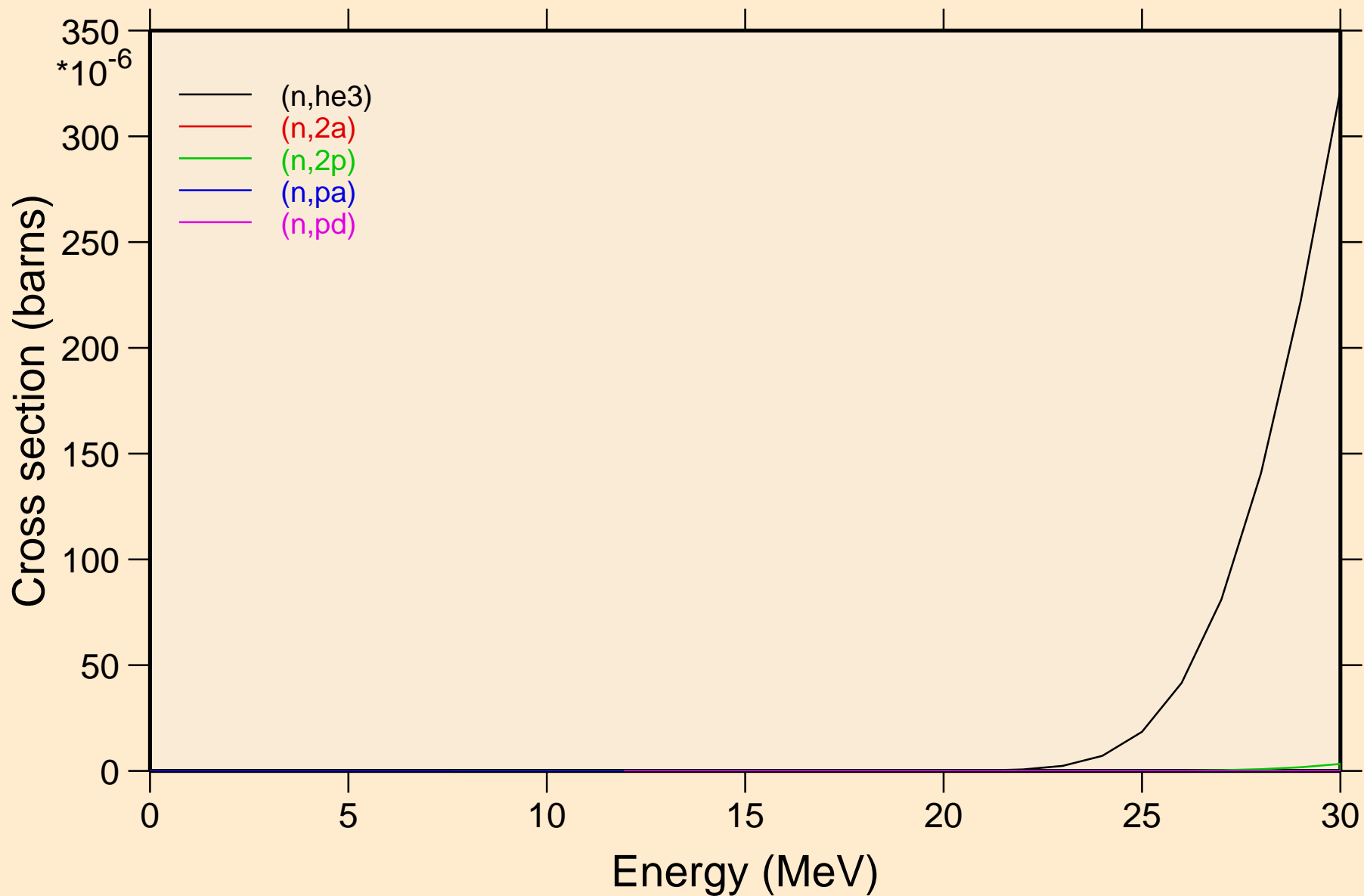

LU176 NEUTRON ACER TENDL-2019 LIBRARY; T=293.16K  
Threshold reactions

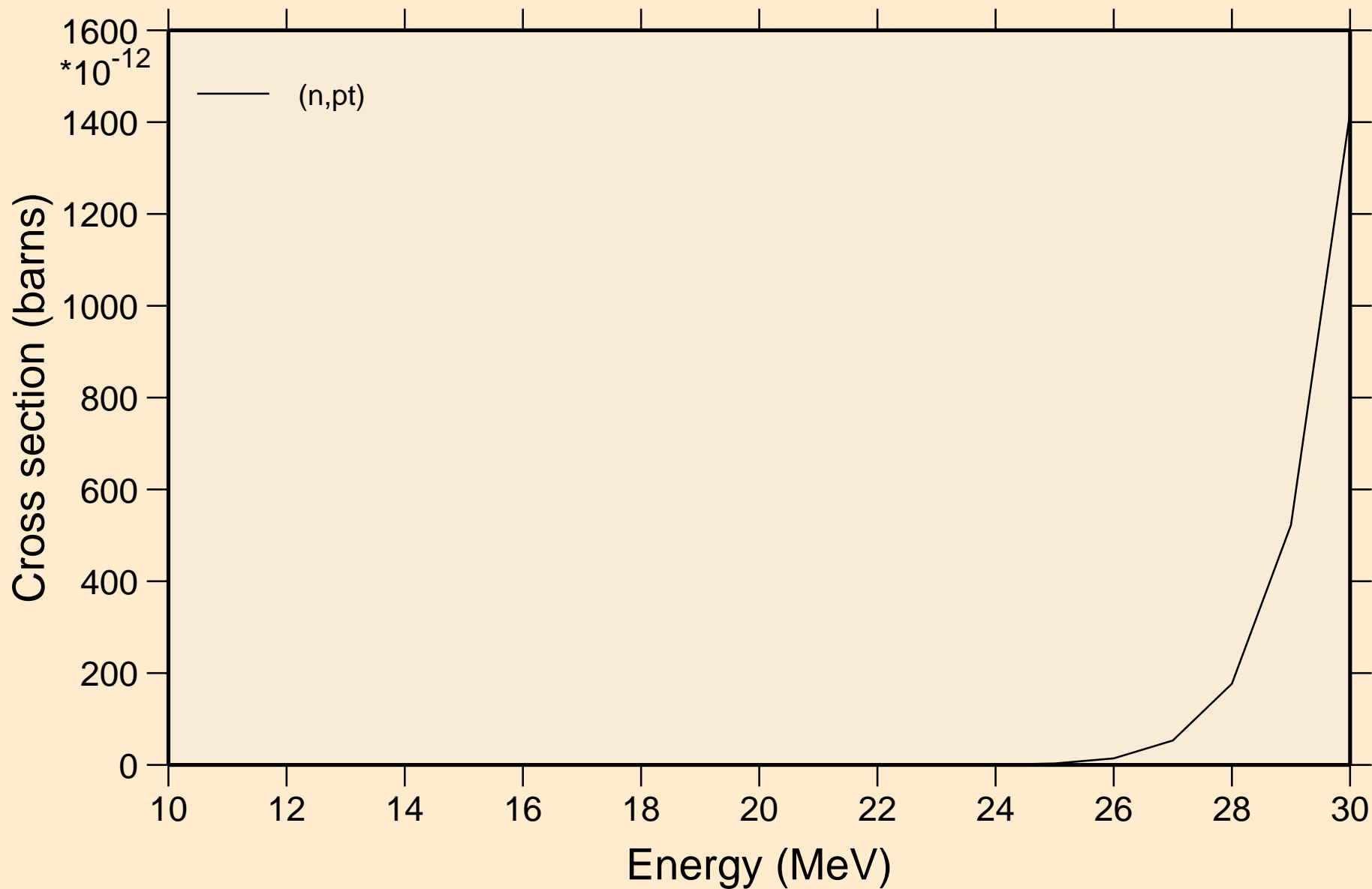

LU176 NEUTRON ACER TENDL-2019 LIBRARY; T=293.16K  
Threshold reactions

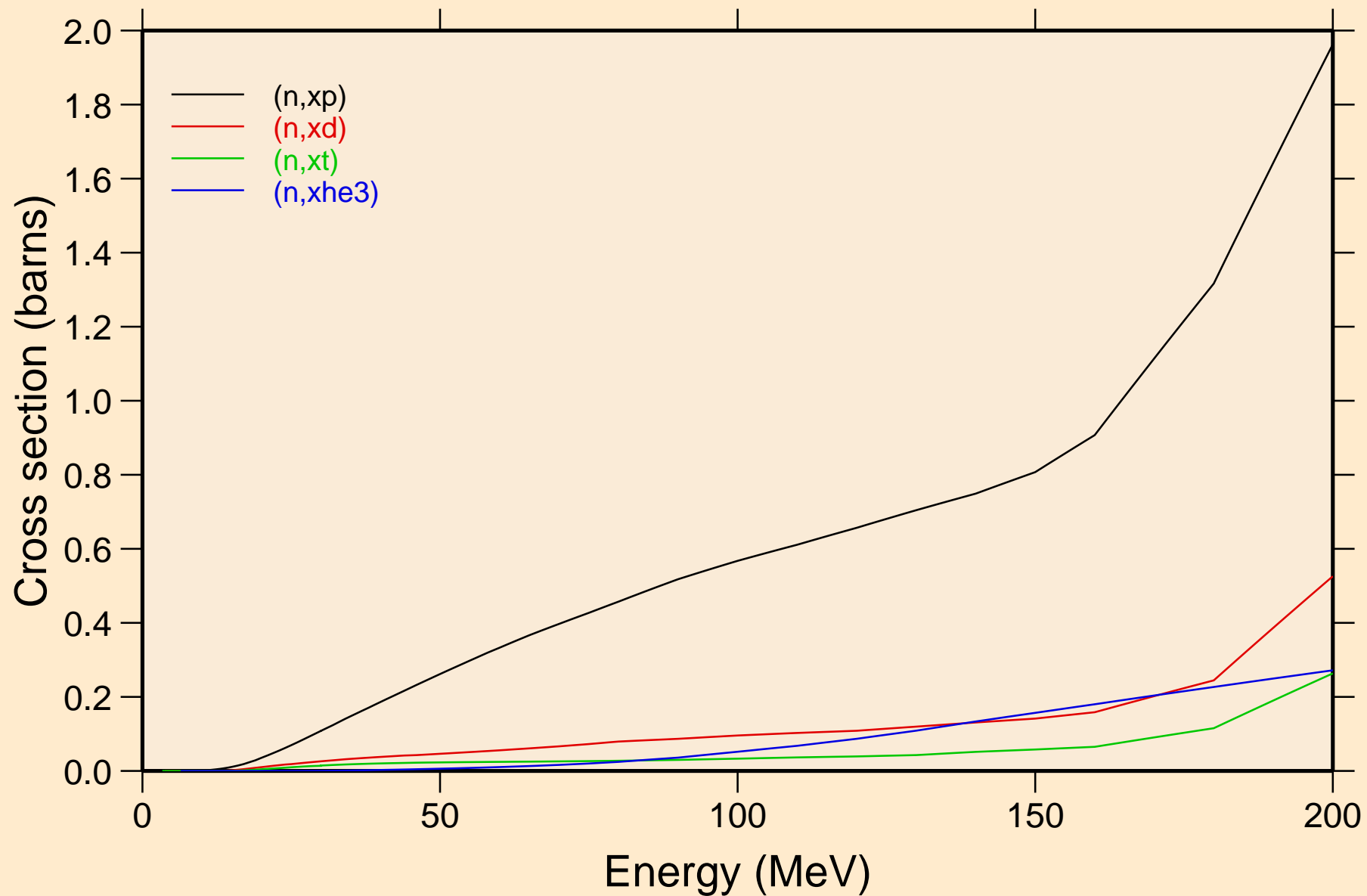



LU176 NEUTRON ACER TENDL-2019 LIBRARY; T=293.16K  
angular distribution for elastic

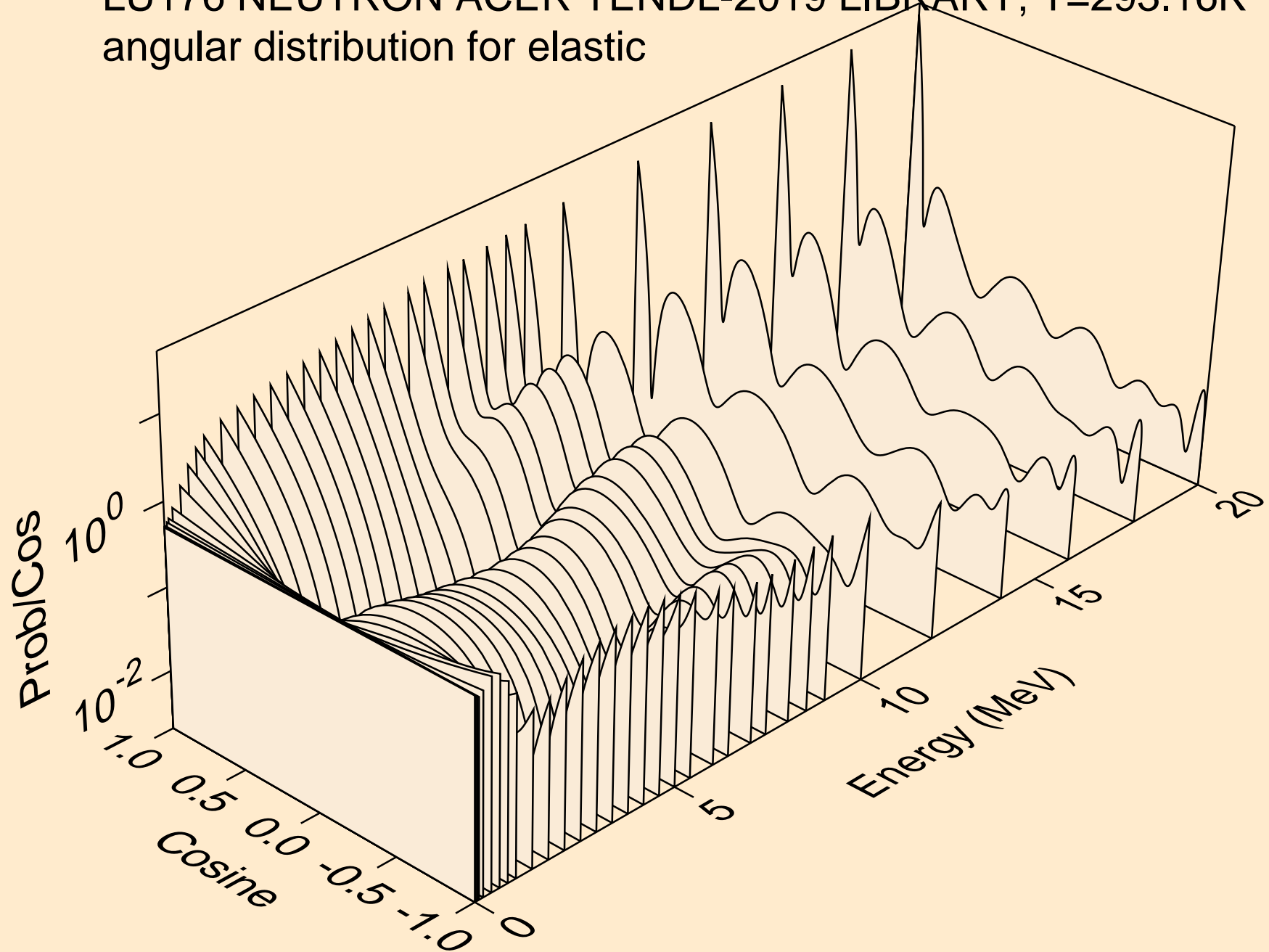

LU176 NEUTRON ACER TENDL-2019 LIBRARY; T=293.16K  
angular distribution for elastic

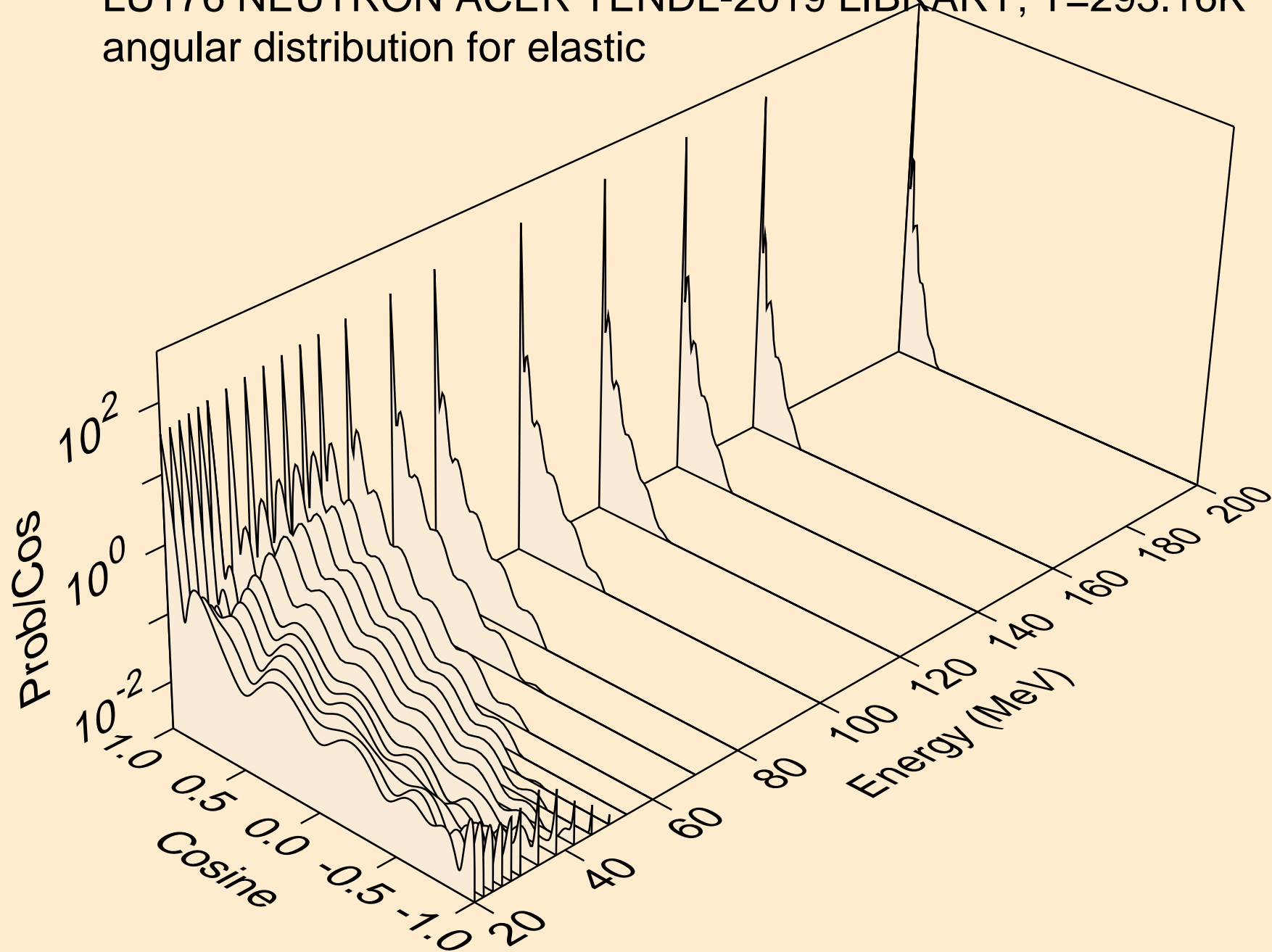

LU176 NEUTRON ACER TENDL-2019 LIBRARY; T=293.16K  
angular distribution for (n,n\*1)

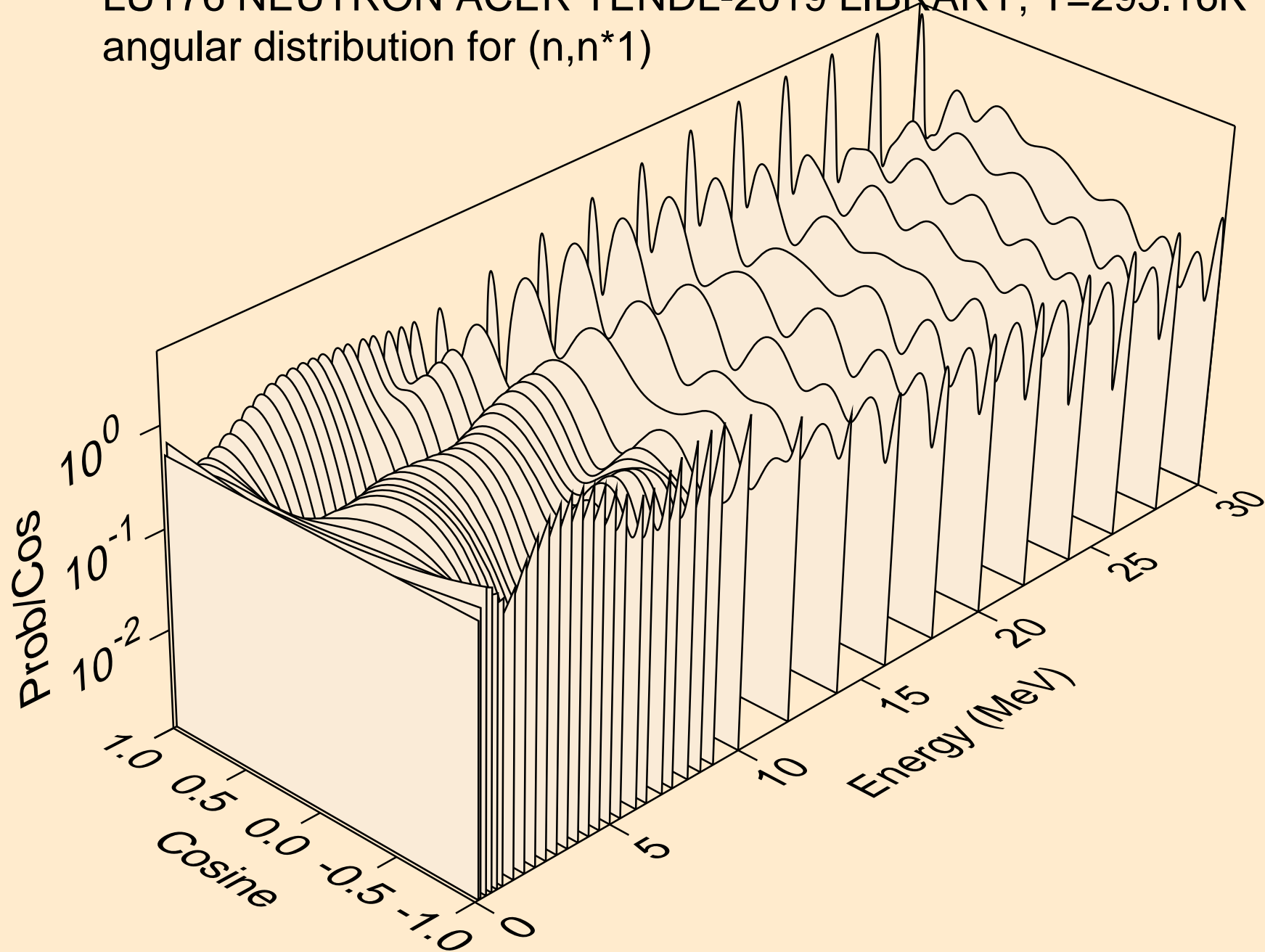

LU176 NEUTRON ACER TENDL-2019 LIBRARY; T=293.16K  
angular distribution for (n,n\*2)

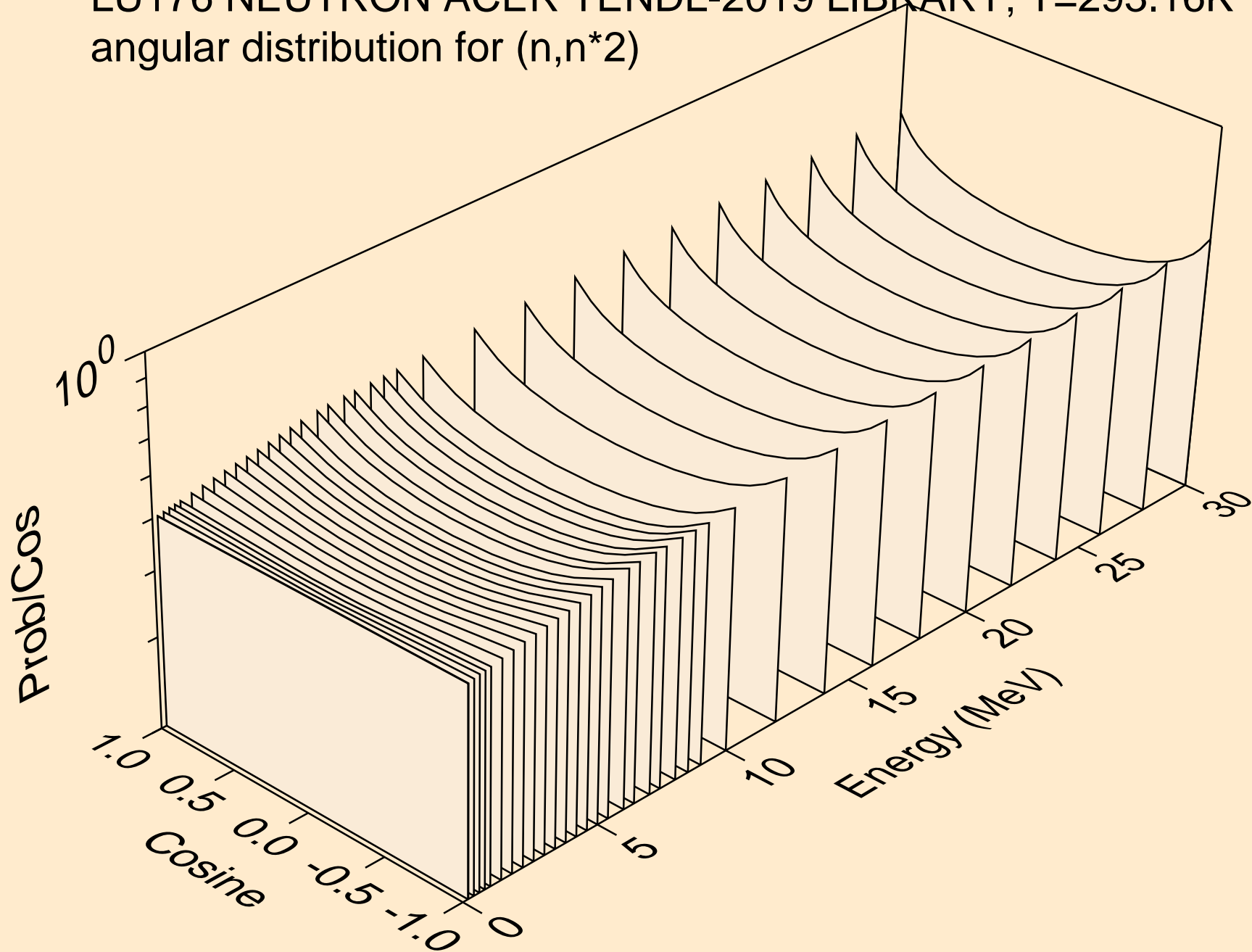

LU176 NEUTRON ACER TENDL-2019 LIBRARY; T=293.16K  
angular distribution for (n,n\*3)

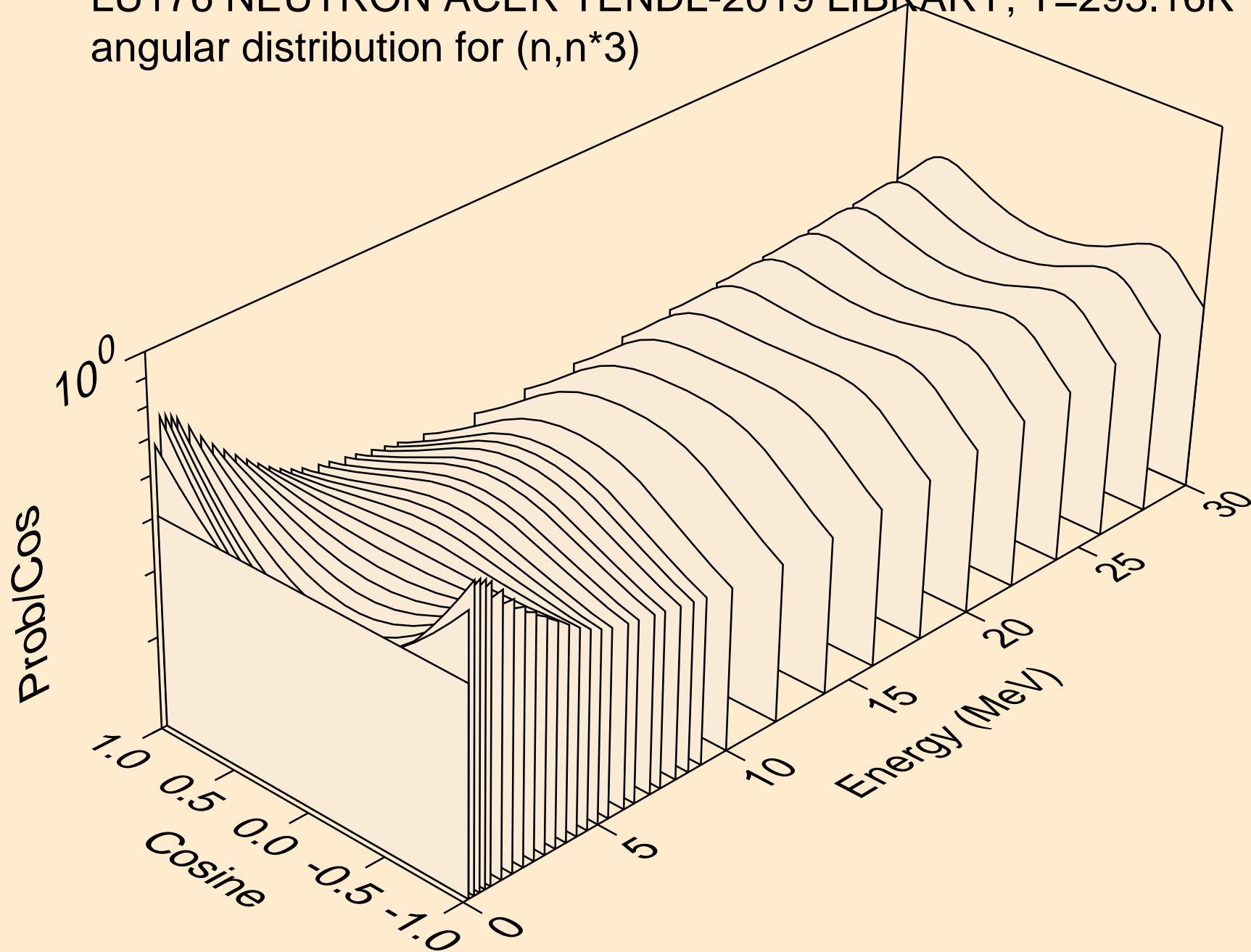

LU176 NEUTRON ACER TENDL-2019 LIBRARY; T=293.16K  
angular distribution for (n,n\*4)

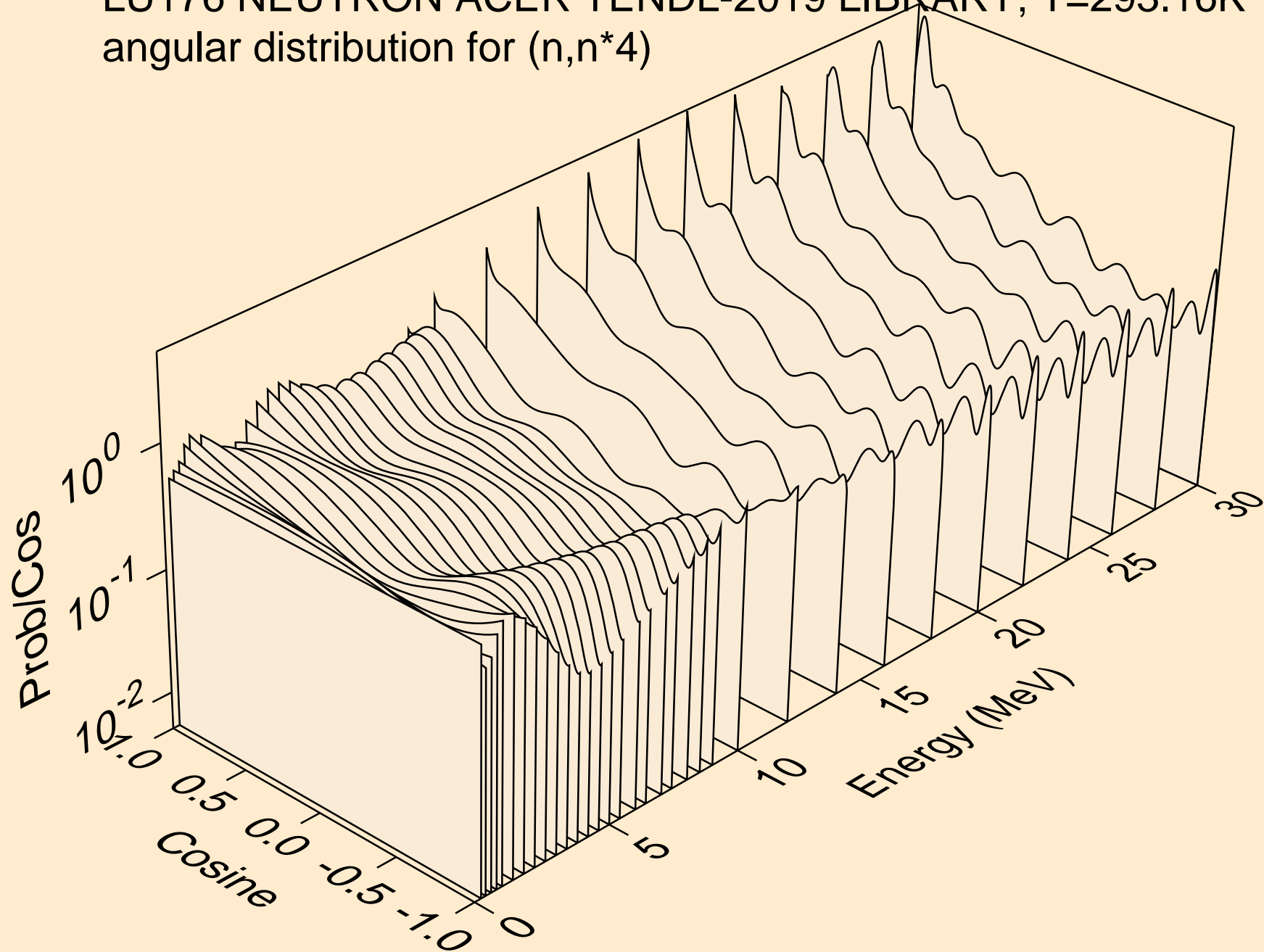

LU176 NEUTRON ACER TENDL-2019 LIBRARY; T=293.16K  
angular distribution for (n,n\*5)

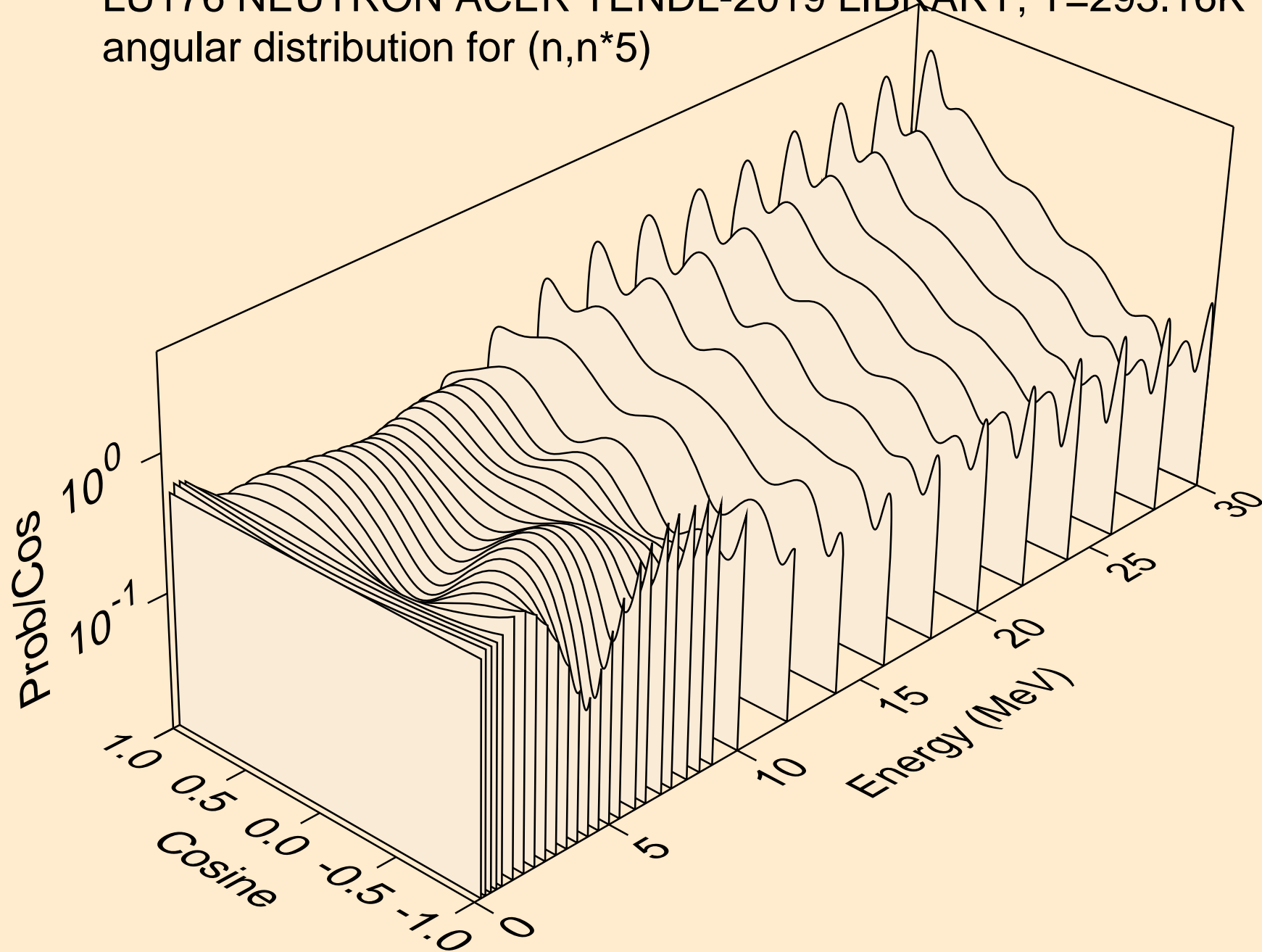

LU176 NEUTRON ACER TENDL-2019 LIBRARY; T=293.16K  
angular distribution for (n,n\*6)

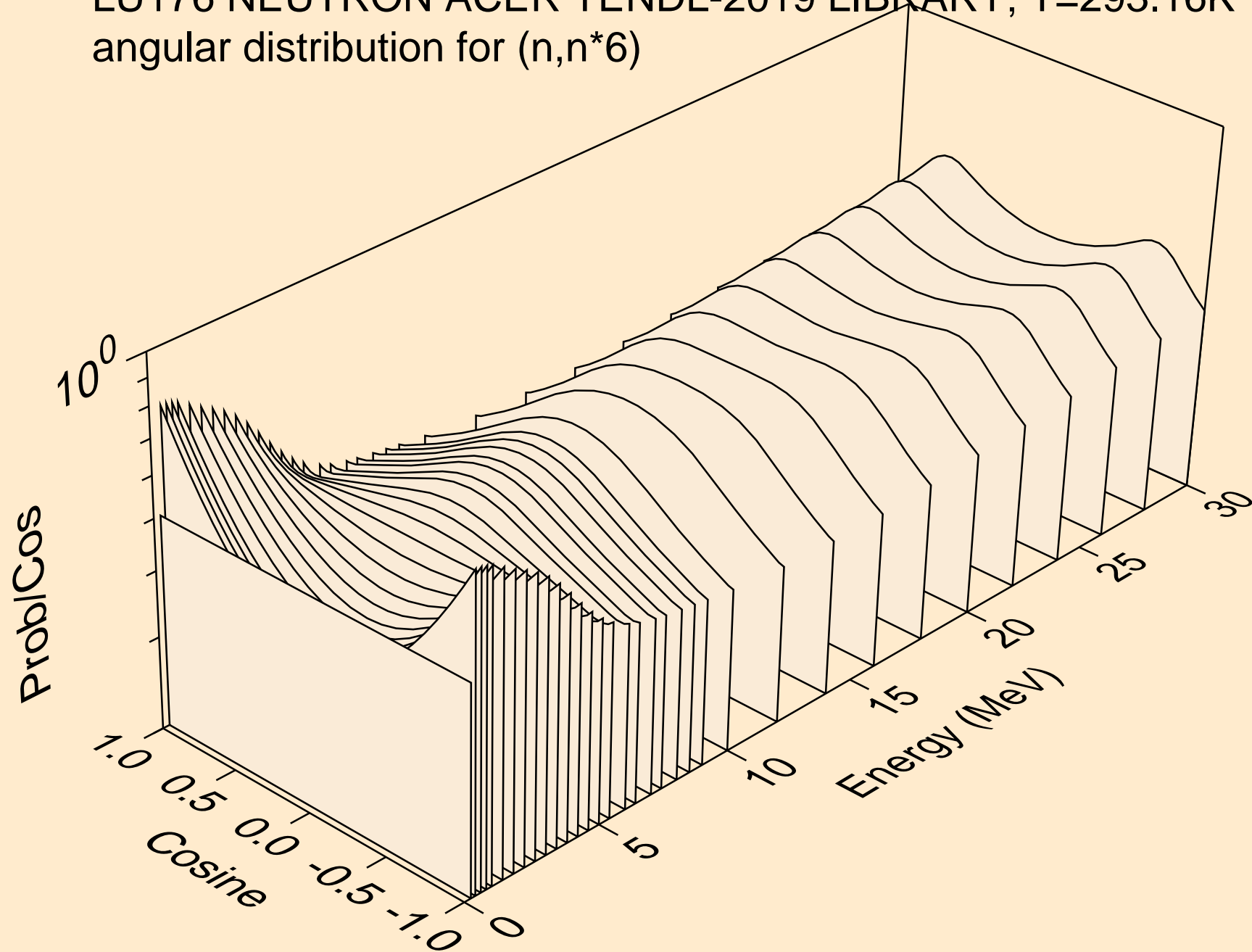



LU176 NEUTRON ACER TENDL-2019 LIBRARY; T=293.16K  
angular distribution for (n,n\*7)

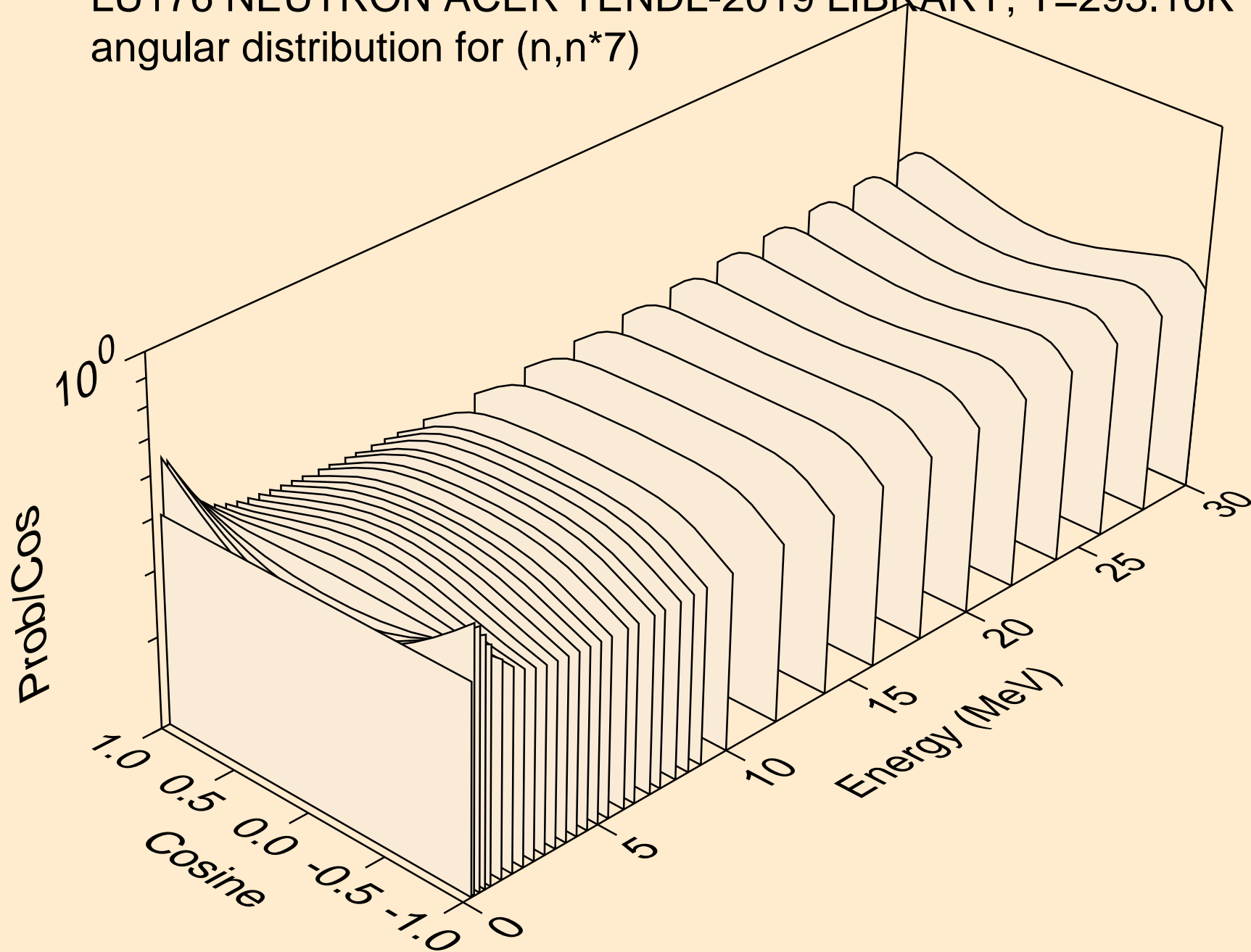

LU176 NEUTRON ACER TENDL-2019 LIBRARY; T=293.16K  
angular distribution for (n,n\*8)

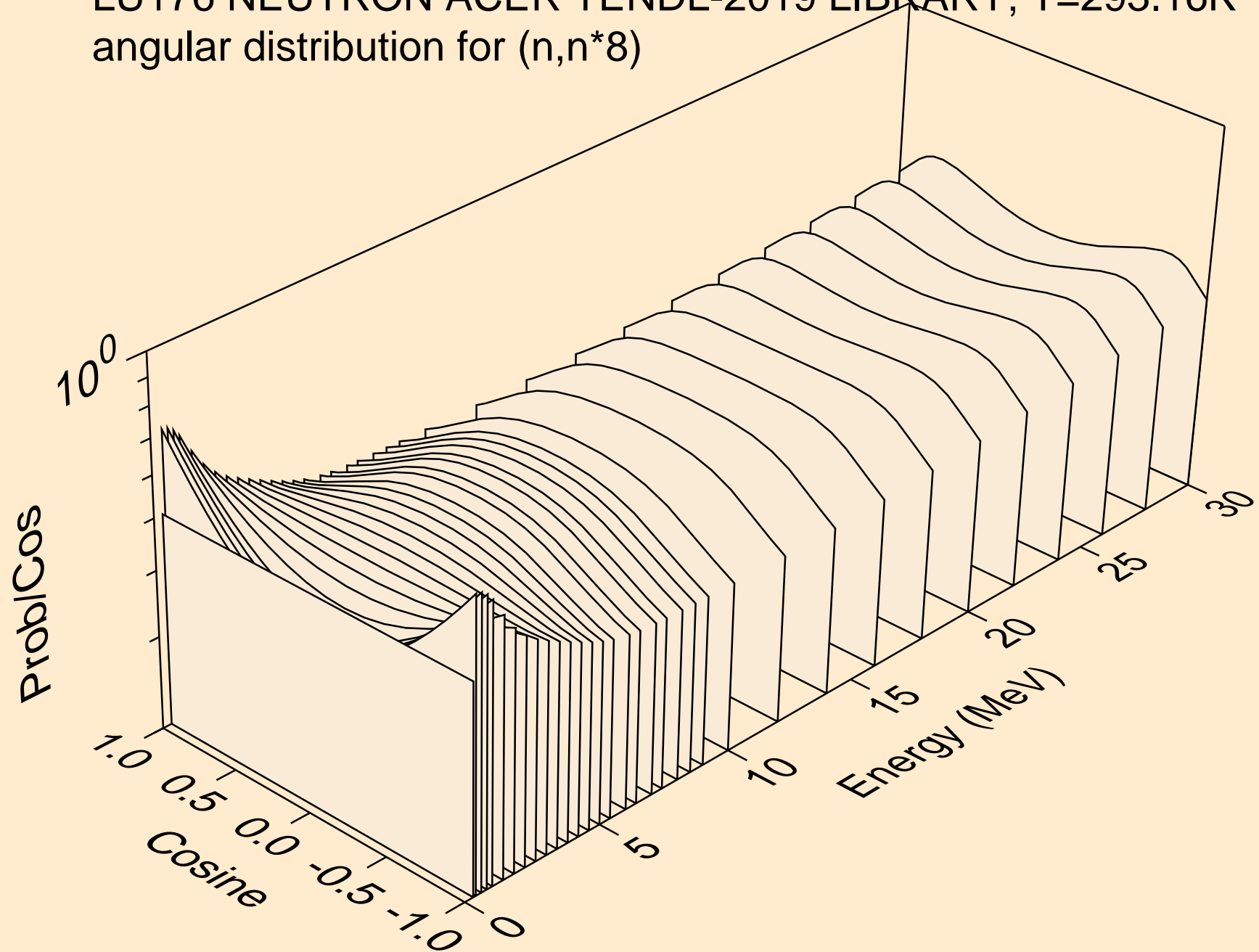

LU176 NEUTRON ACER TENDL-2019 LIBRARY; T=293.16K  
angular distribution for (n,n\*9)

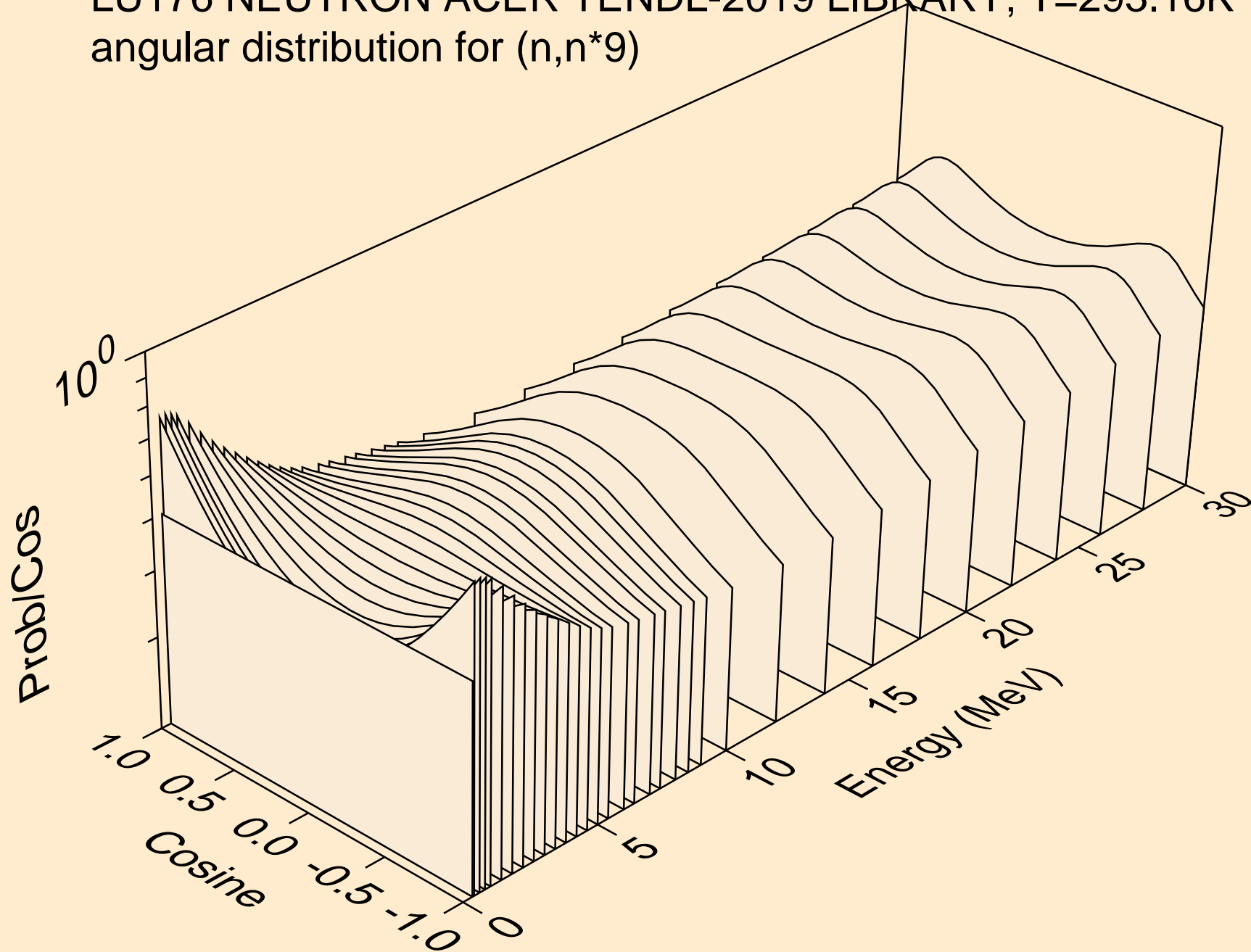

LU176 NEUTRON ACER TENDL-2019 LIBRARY; T=293.16K  
angular distribution for (n,n\*10)

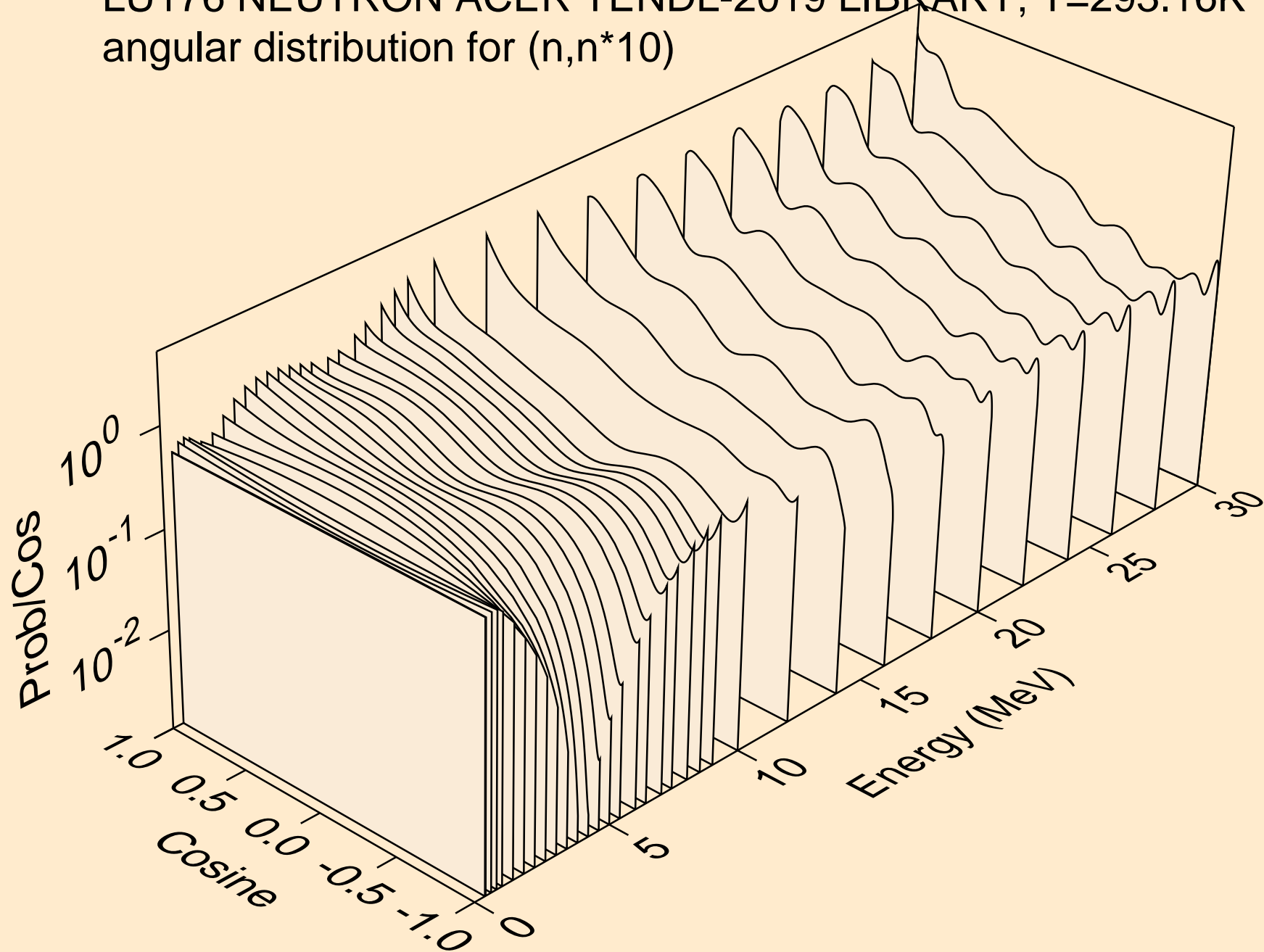

LU176 NEUTRON ACER TENDL-2019 LIBRARY; T=293.16K  
angular distribution for (n,n\*11)

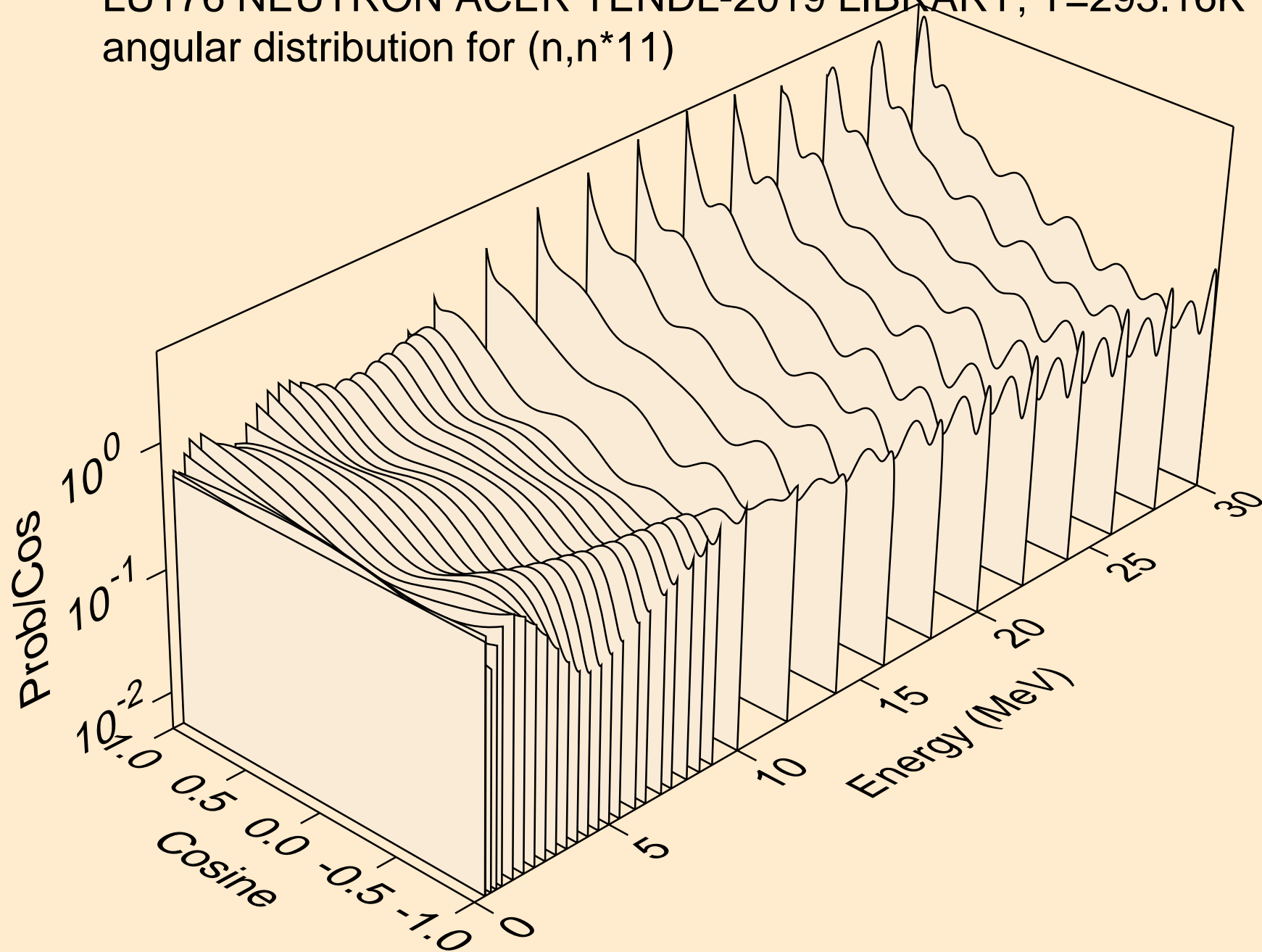

LU176 NEUTRON ACER TENDL-2019 LIBRARY; T=293.16K  
angular distribution for (n,n\*12)

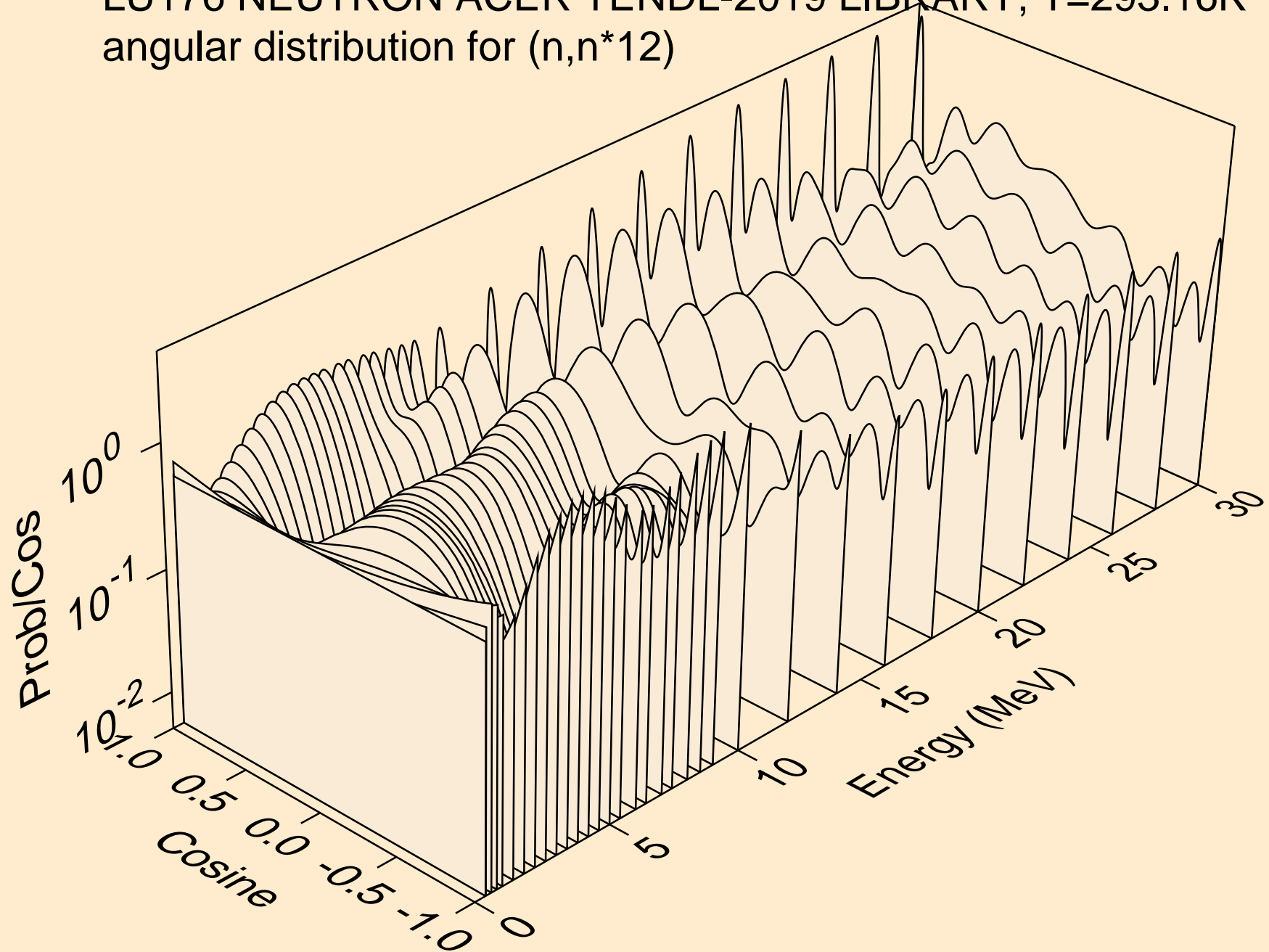

LU176 NEUTRON ACER TENDL-2019 LIBRARY; T=293.16K  
angular distribution for (n,n\*13)

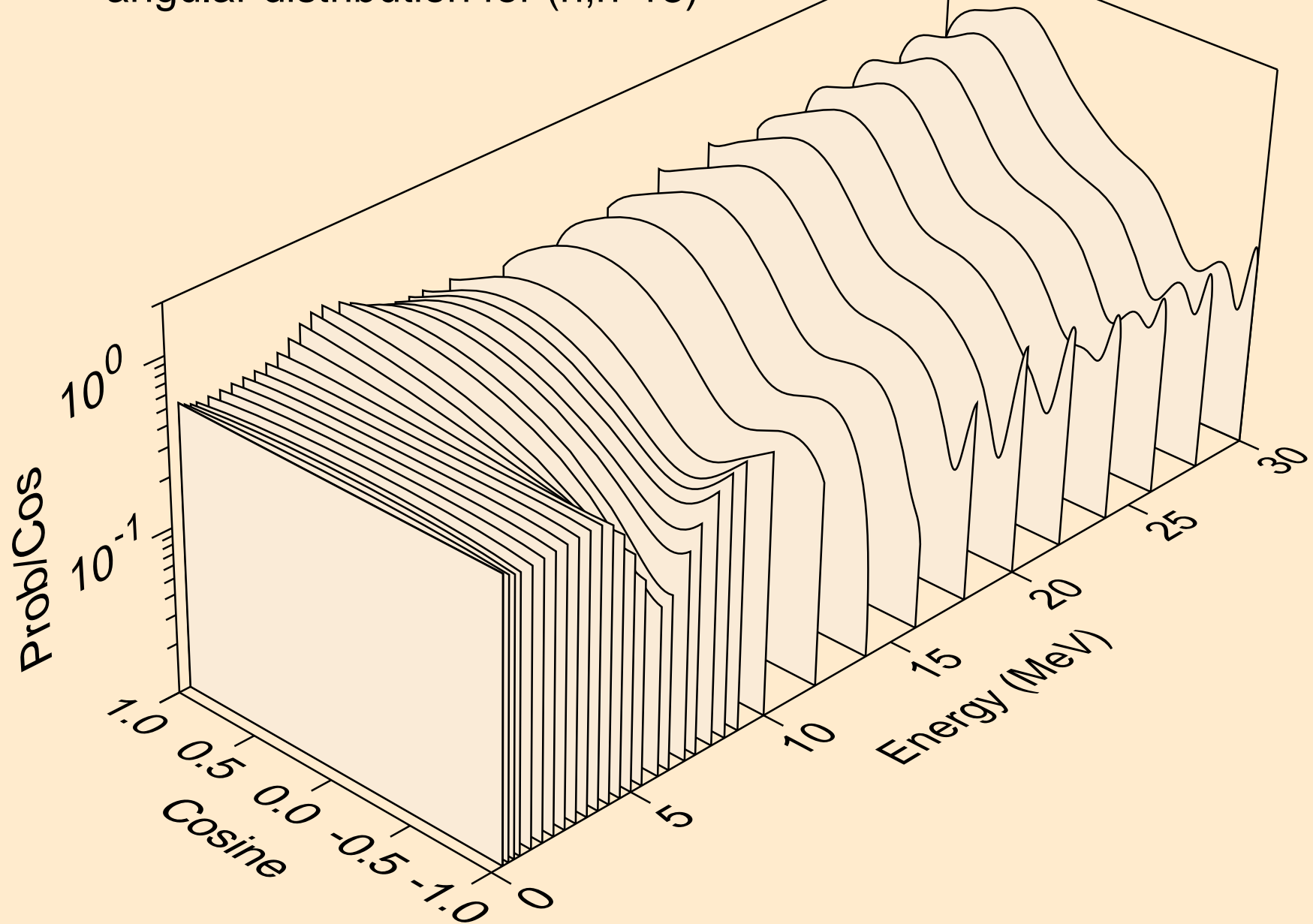

LU176 NEUTRON ACER TENDL-2019 LIBRARY; T=293.16K  
angular distribution for (n,n\*14)

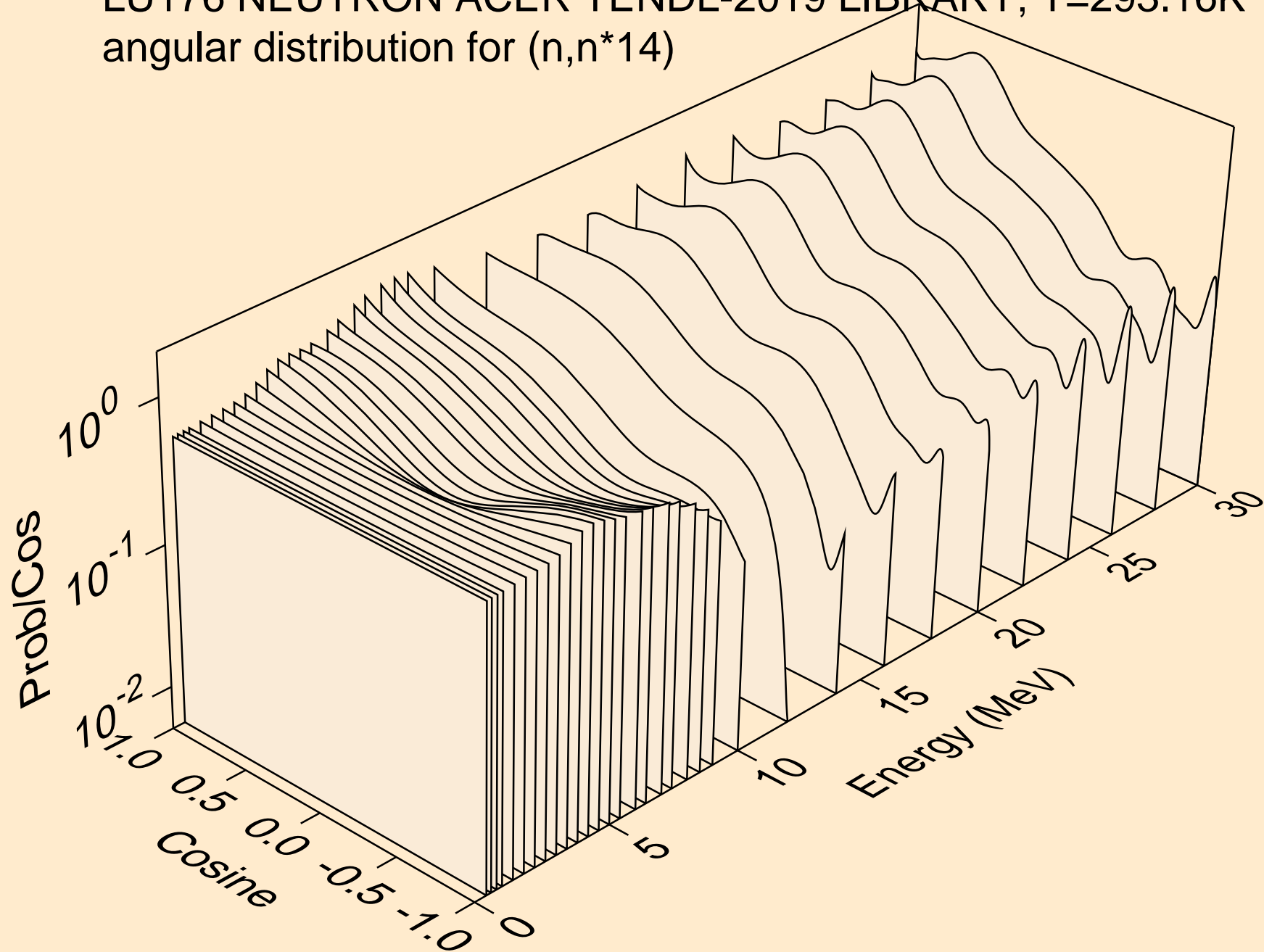



LU176 NEUTRON ACER TENDL-2019 LIBRARY; T=293.16K  
angular distribution for (n,n\*15)

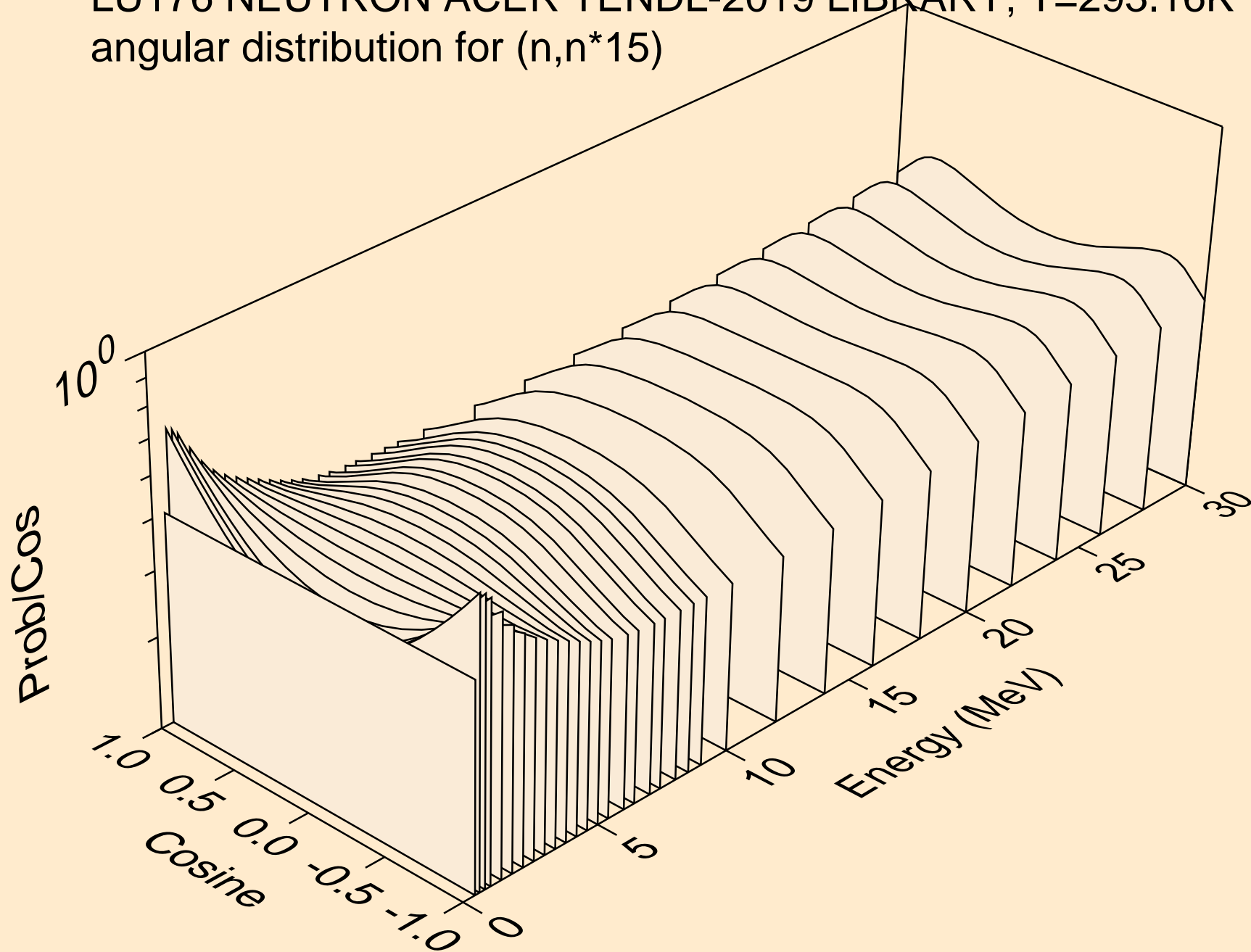

LU176 NEUTRON ACER TENDL-2019 LIBRARY; T=293.16K  
angular distribution for (n,n\*16)

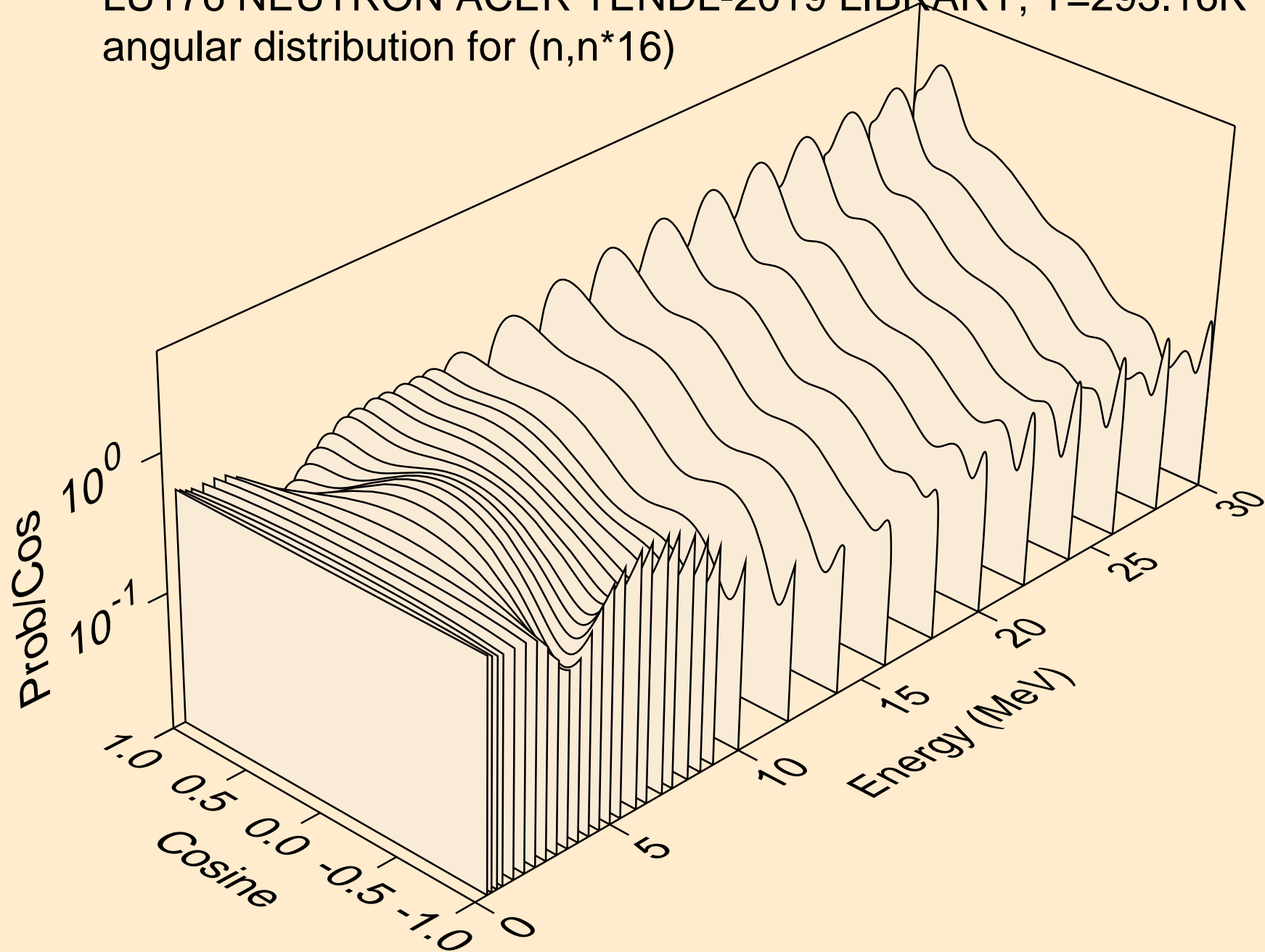

LU176 NEUTRON ACER TENDL-2019 LIBRARY; T=293.16K  
angular distribution for (n,n\*17)

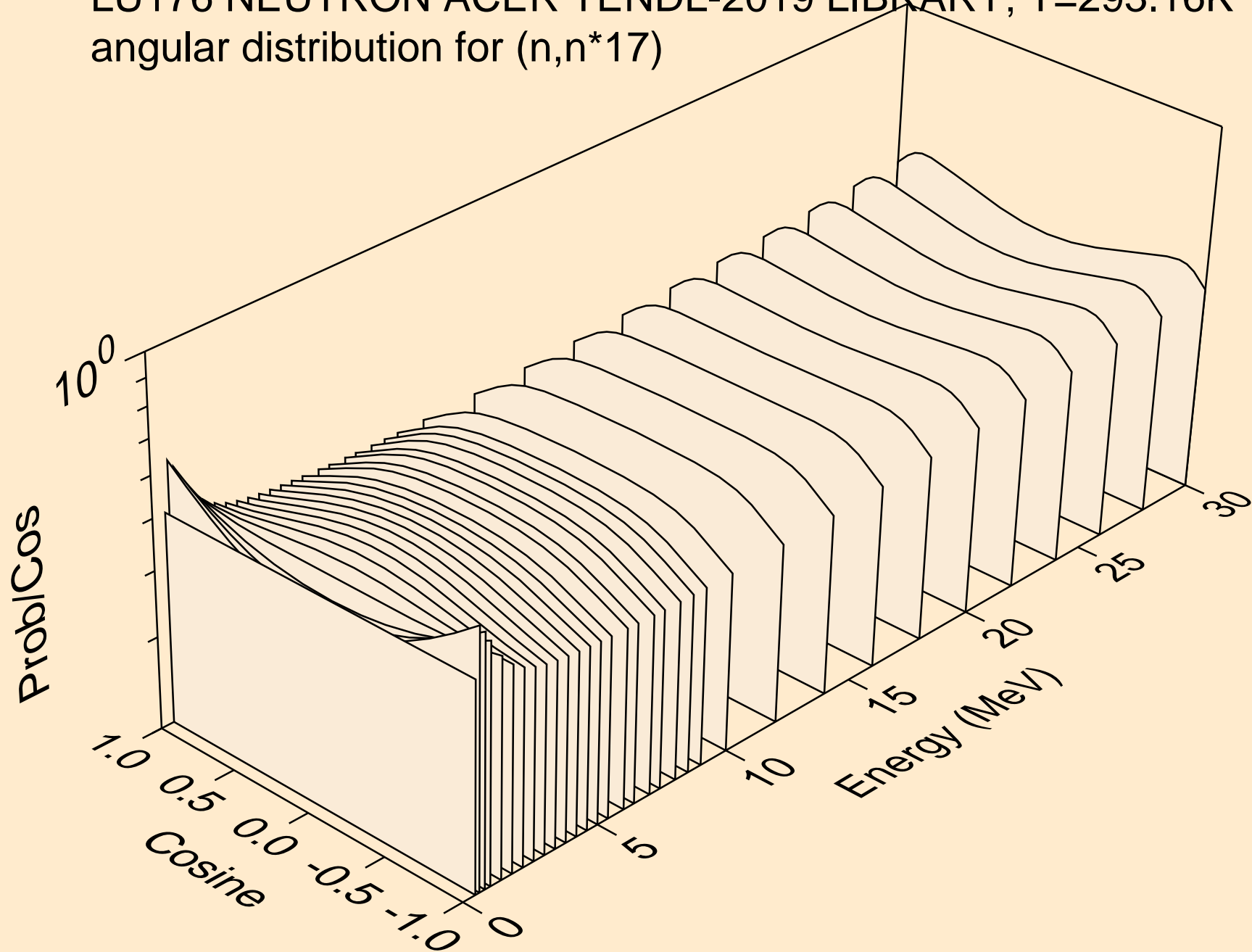

LU176 NEUTRON ACER TENDL-2019 LIBRARY; T=293.16K  
angular distribution for (n,n\*18)

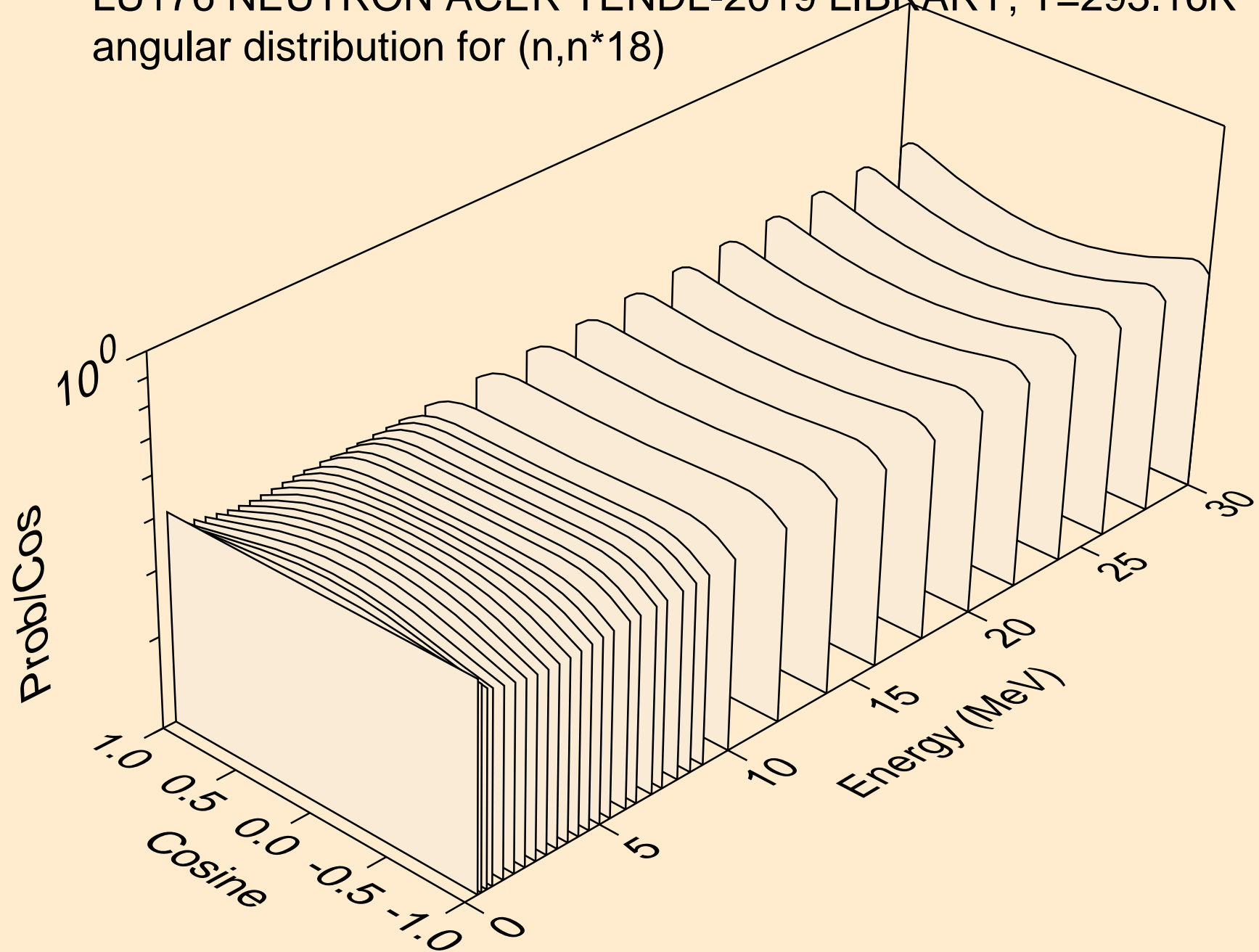

LU176 NEUTRON ACER TENDL-2019 LIBRARY; T=293.16K  
angular distribution for (n,n\*19)

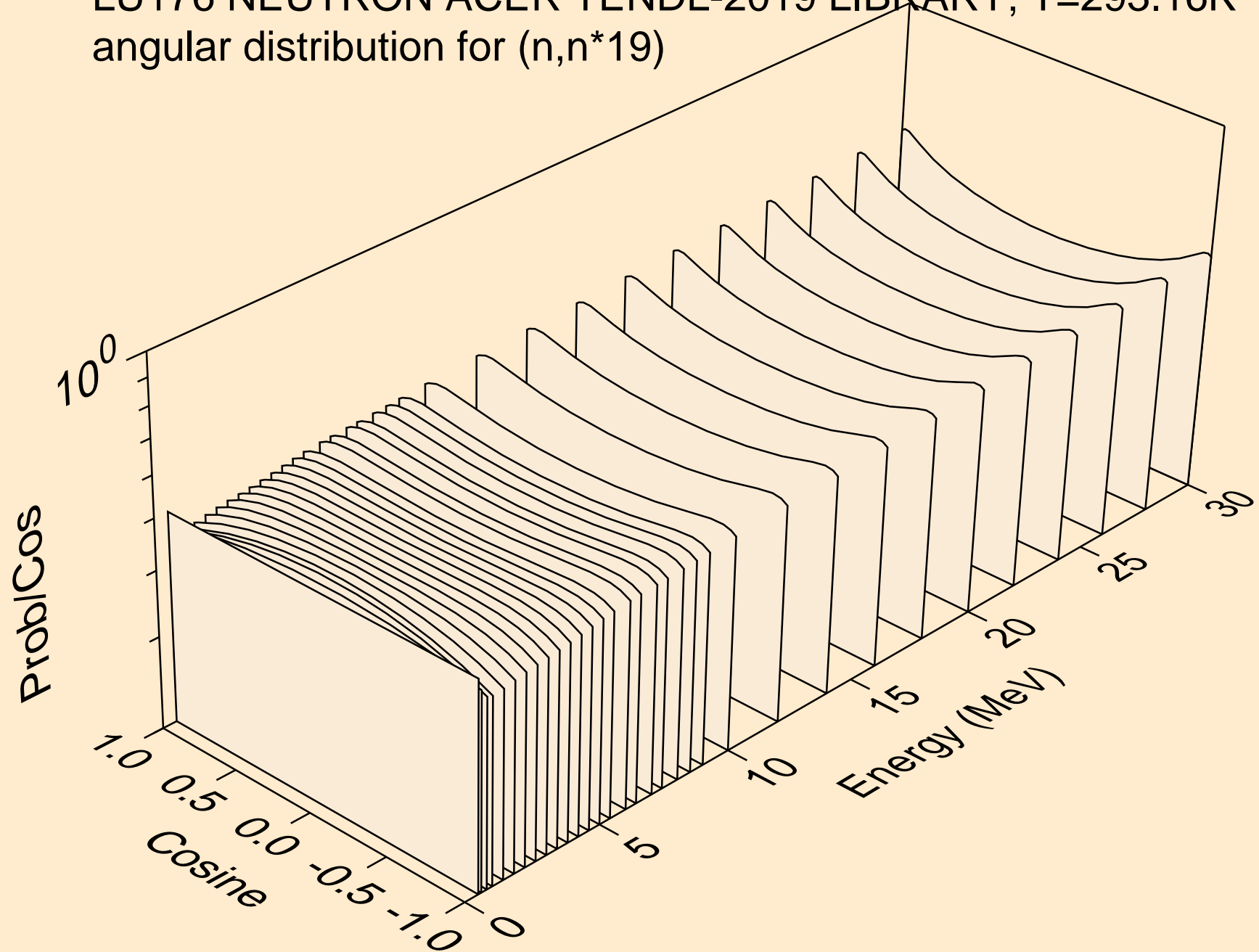

LU176 NEUTRON ACER TENDL-2019 LIBRARY; T=293.16K  
angular distribution for (n,n\*20)

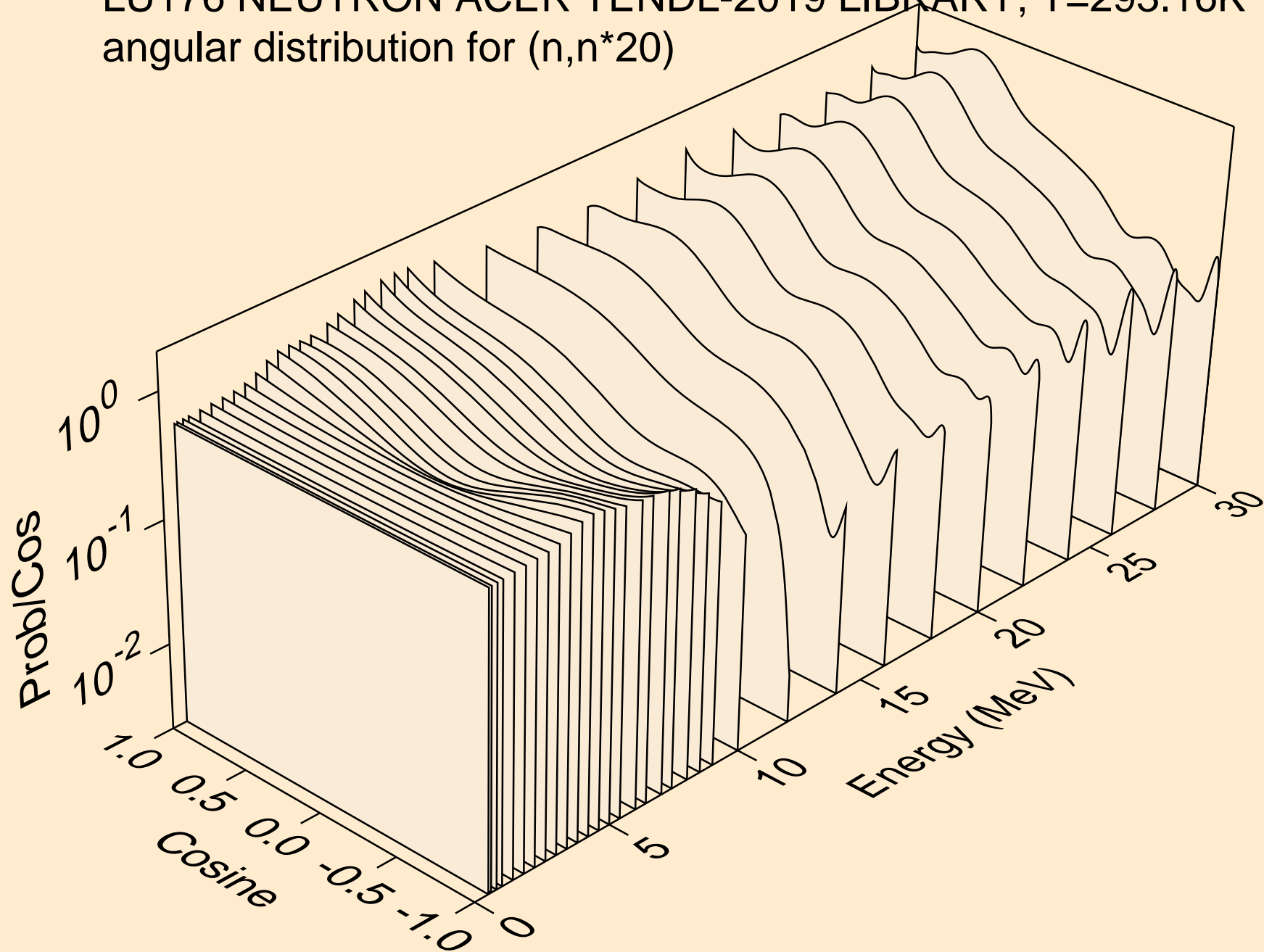

LU176 NEUTRON ACER TENDL-2019 LIBRARY; T=293.16K  
angular distribution for (n,n\*21)

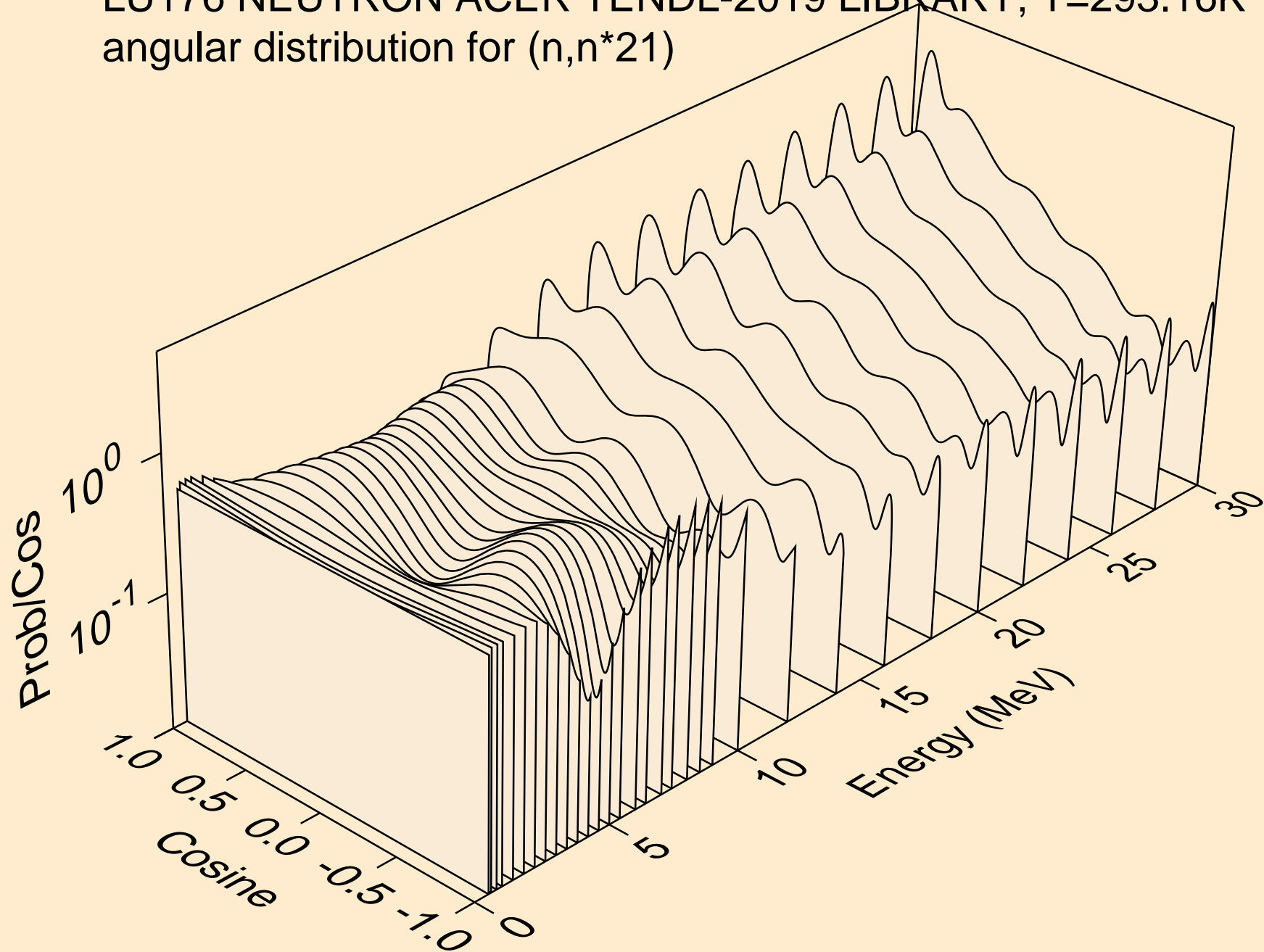

LU176 NEUTRON ACER TENDL-2019 LIBRARY; T=293.16K  
angular distribution for (n,n\*22)

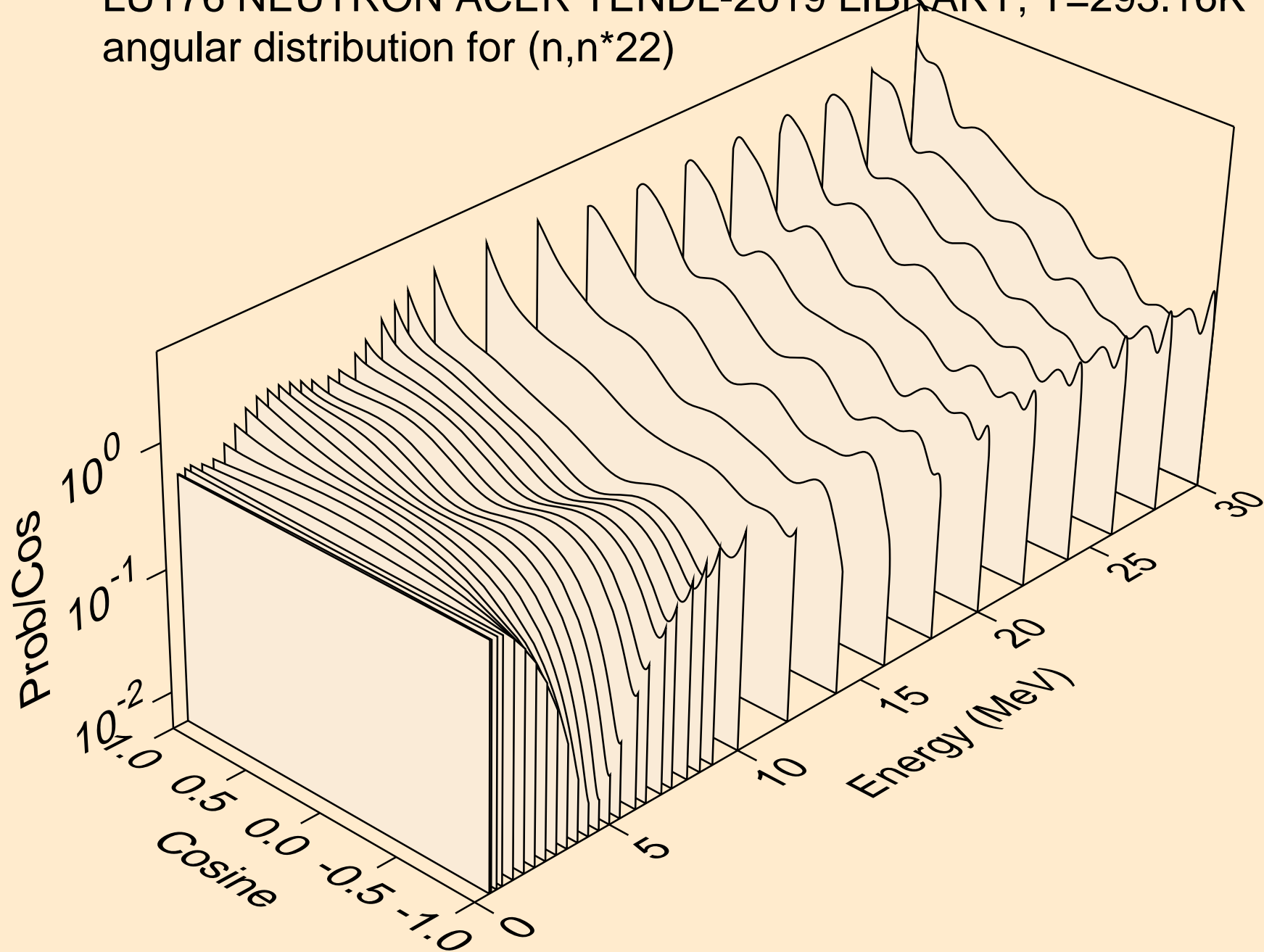



LU176 NEUTRON ACER TENDL-2019 LIBRARY; T=293.16K  
angular distribution for (n,n\*23)

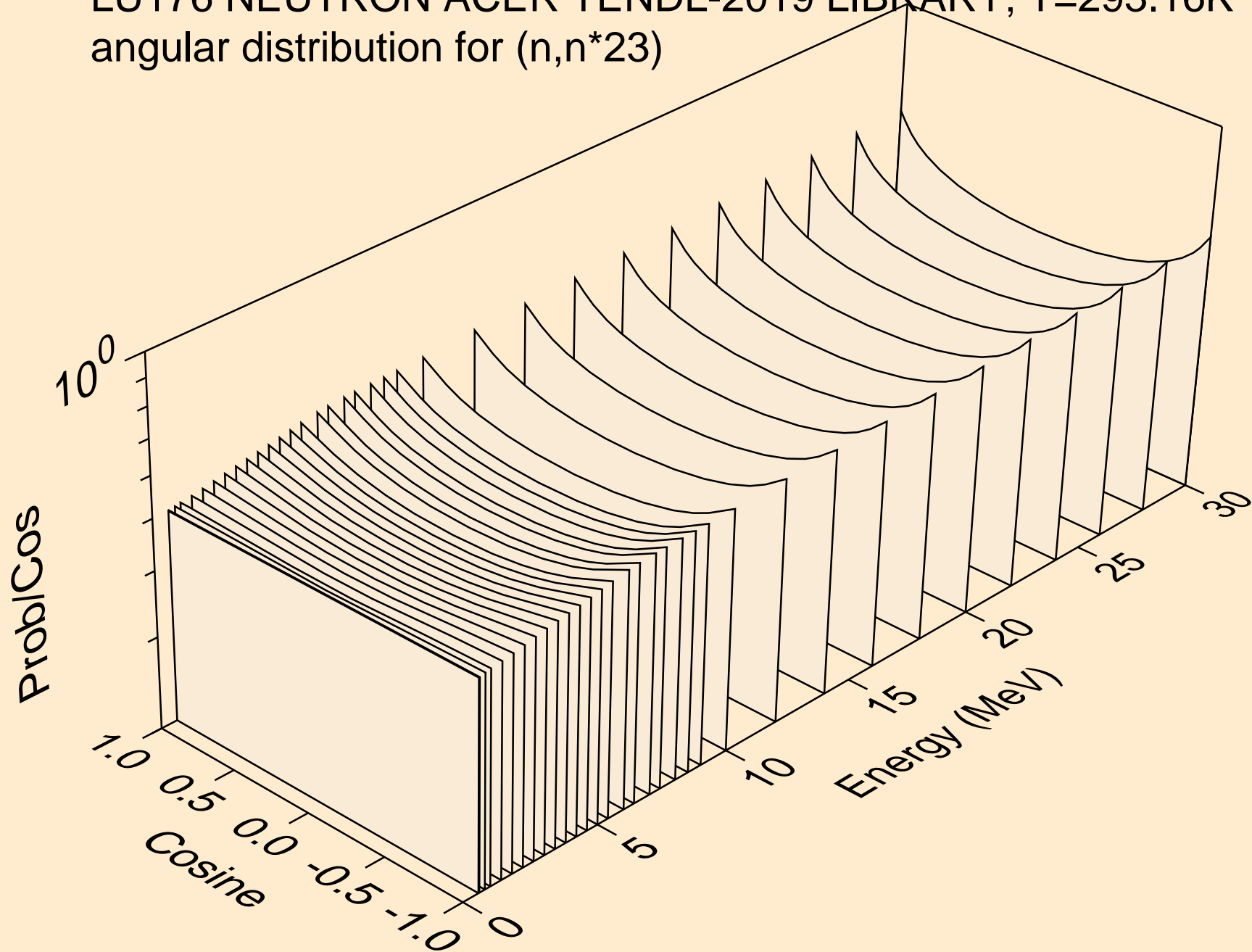

LU176 NEUTRON ACER TENDL-2019 LIBRARY; T=293.16K  
angular distribution for (n,n\*24)

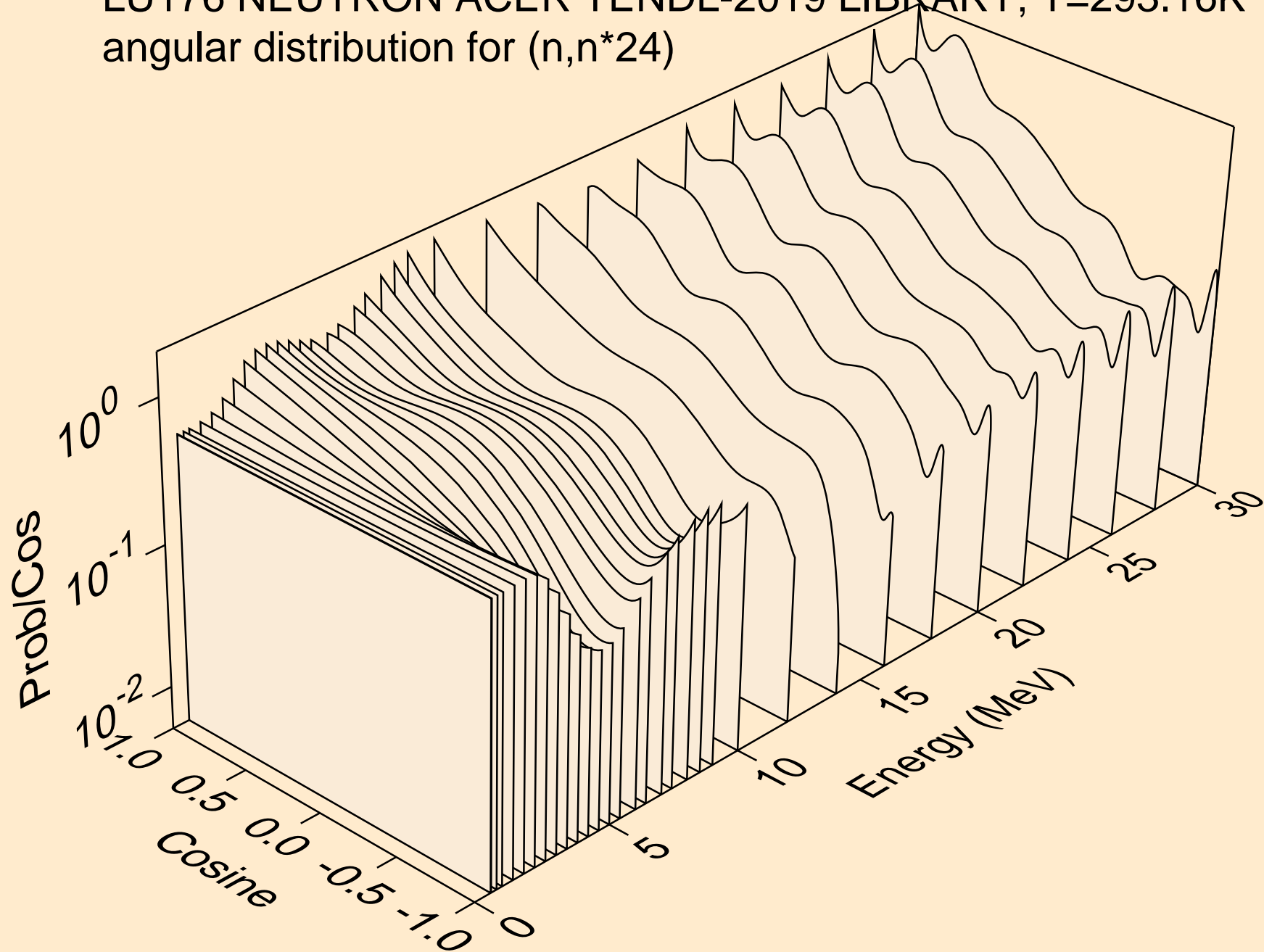

LU176 NEUTRON ACER TENDL-2019 LIBRARY; T=293.16K  
angular distribution for (n,n\*25)

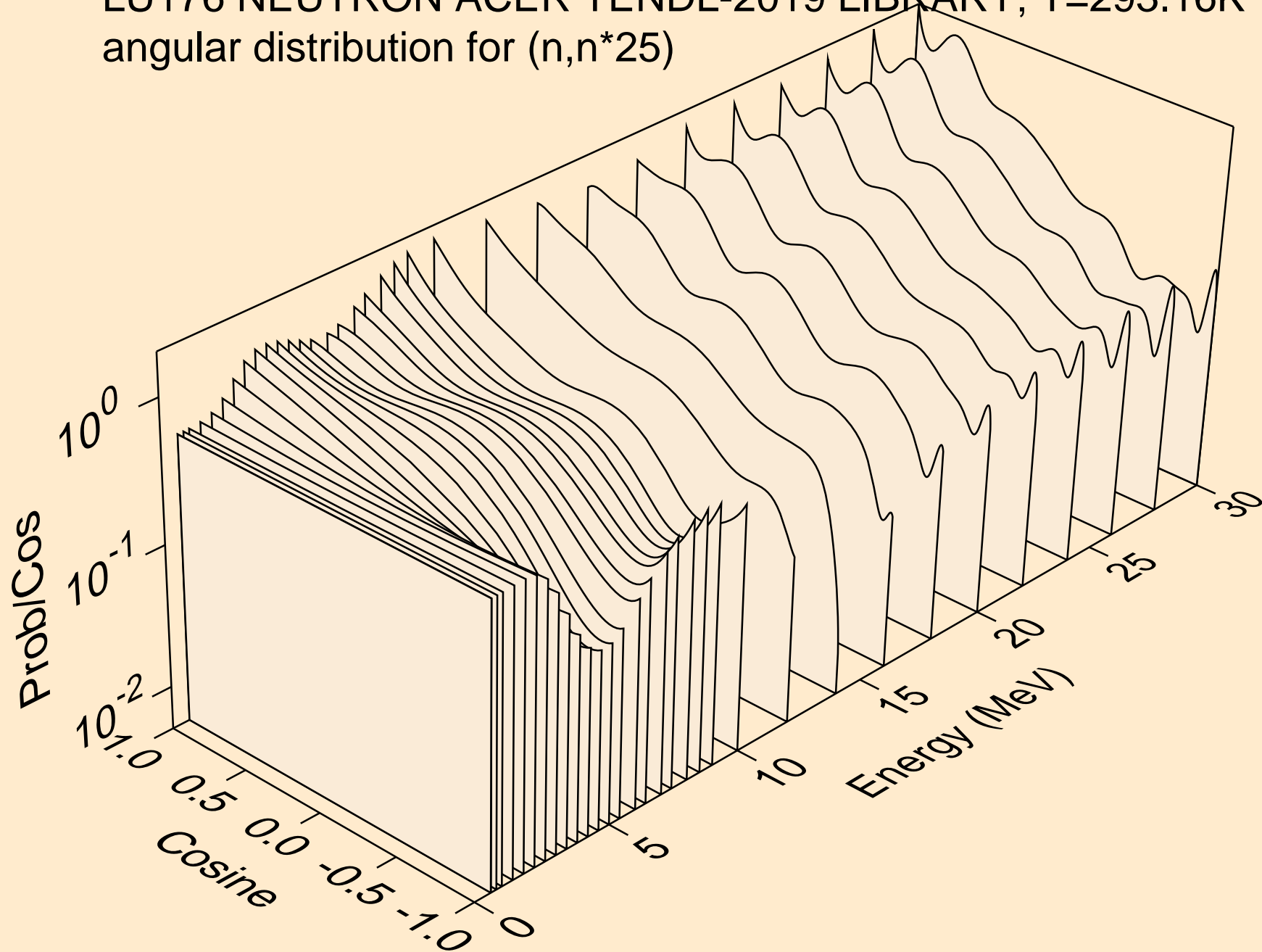

LU176 NEUTRON ACER TENDL-2019 LIBRARY; T=293.16K  
angular distribution for (n,n\*26)

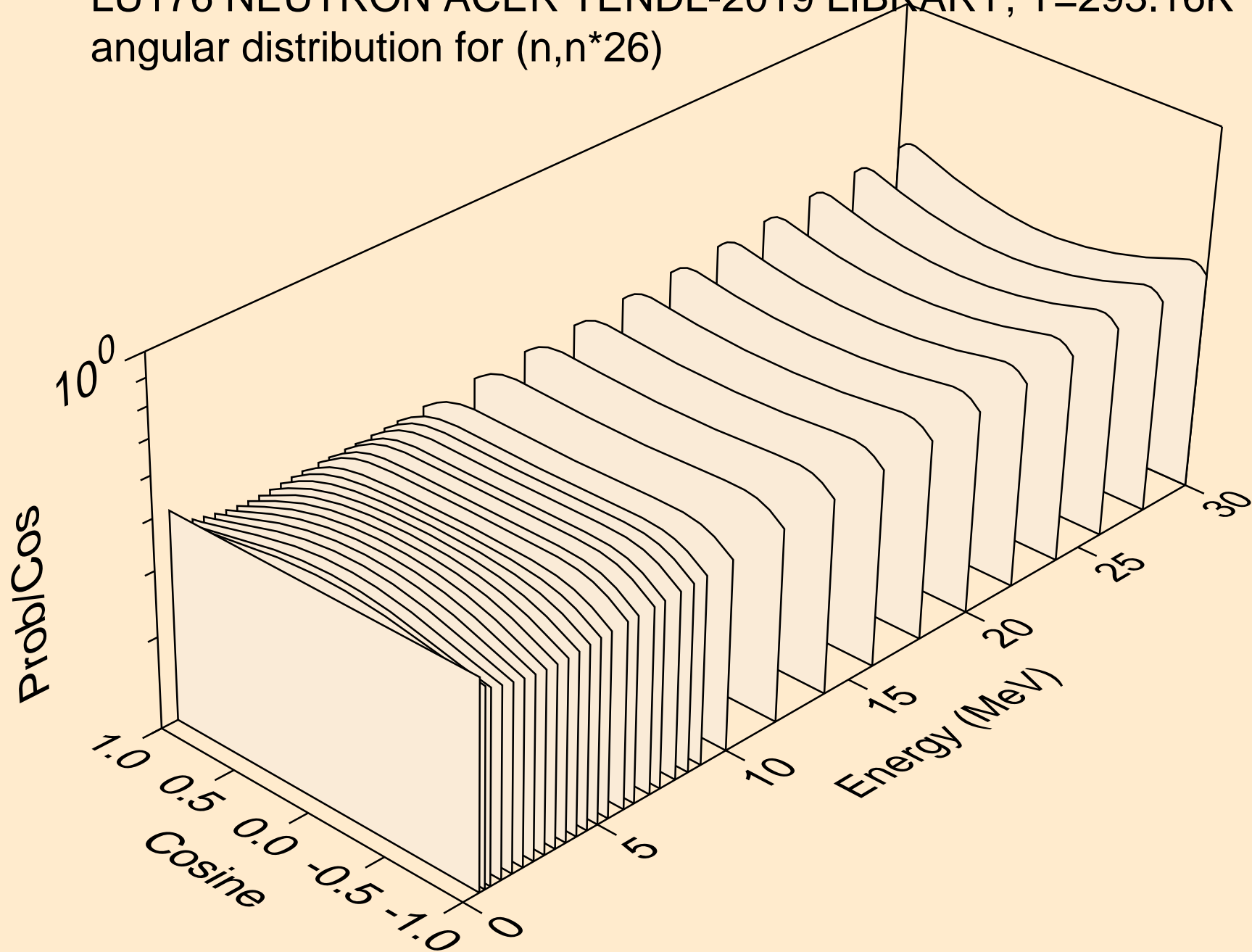

LU176 NEUTRON ACER TENDL-2019 LIBRARY; T=293.16K  
angular distribution for (n,n\*27)

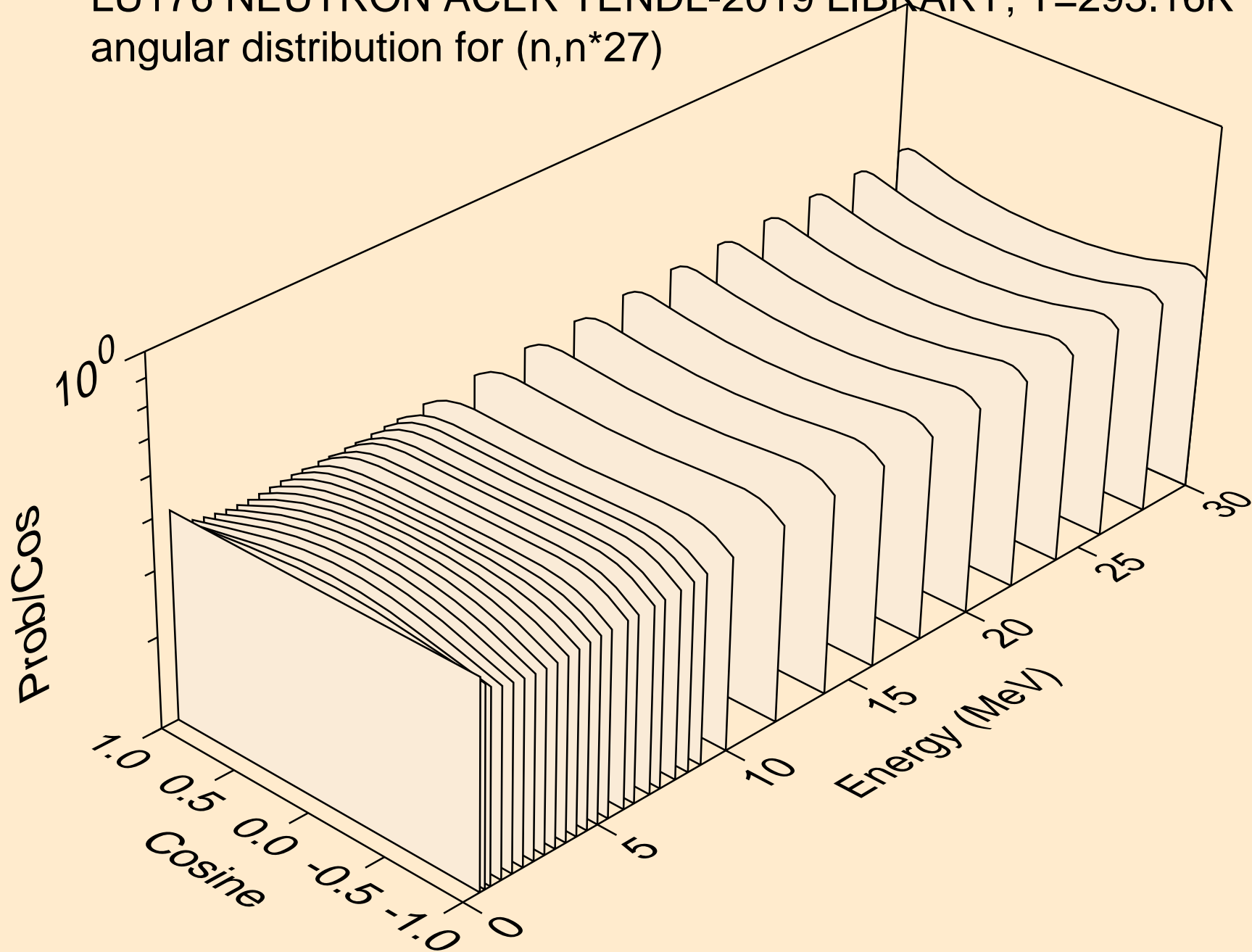

LU176 NEUTRON ACER TENDL-2019 LIBRARY; T=293.16K  
angular distribution for (n,n\*28)

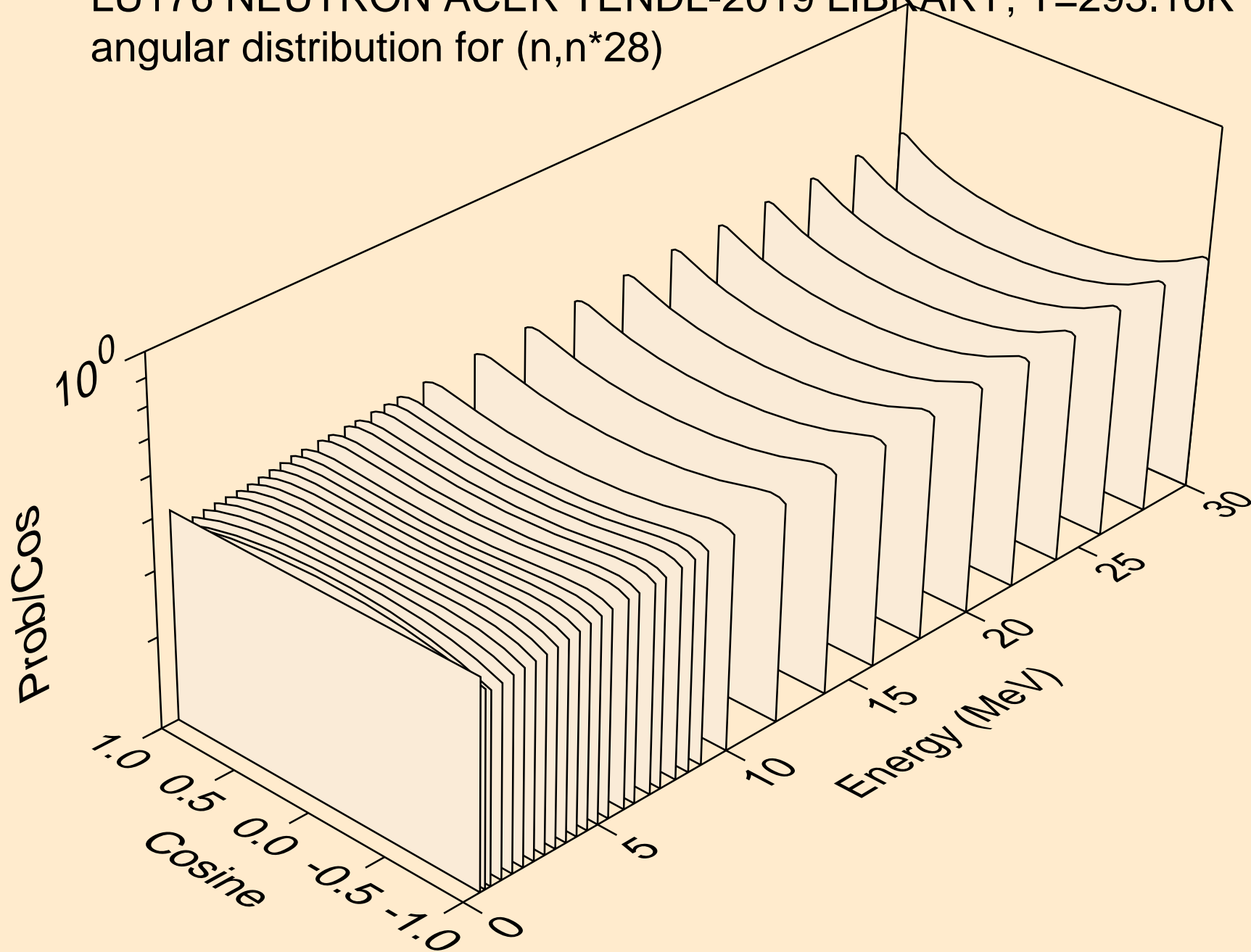

LU176 NEUTRON ACER TENDL-2019 LIBRARY; T=293.16K  
Neutron emission for (n,x)

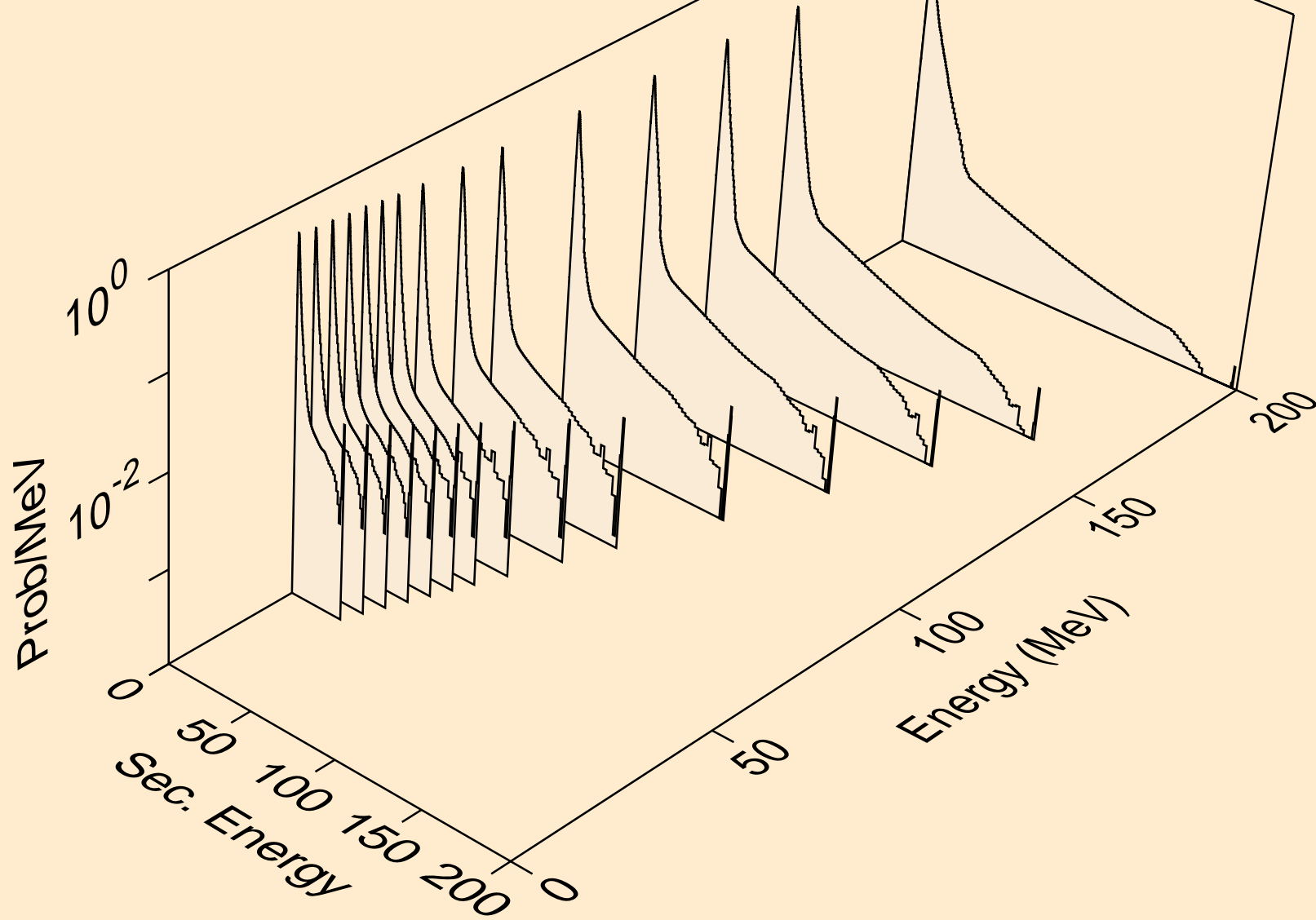

LU176 NEUTRON ACER TENDL-2019 LIBRARY; T=293.16K  
Neutron emission for (n,2nd)

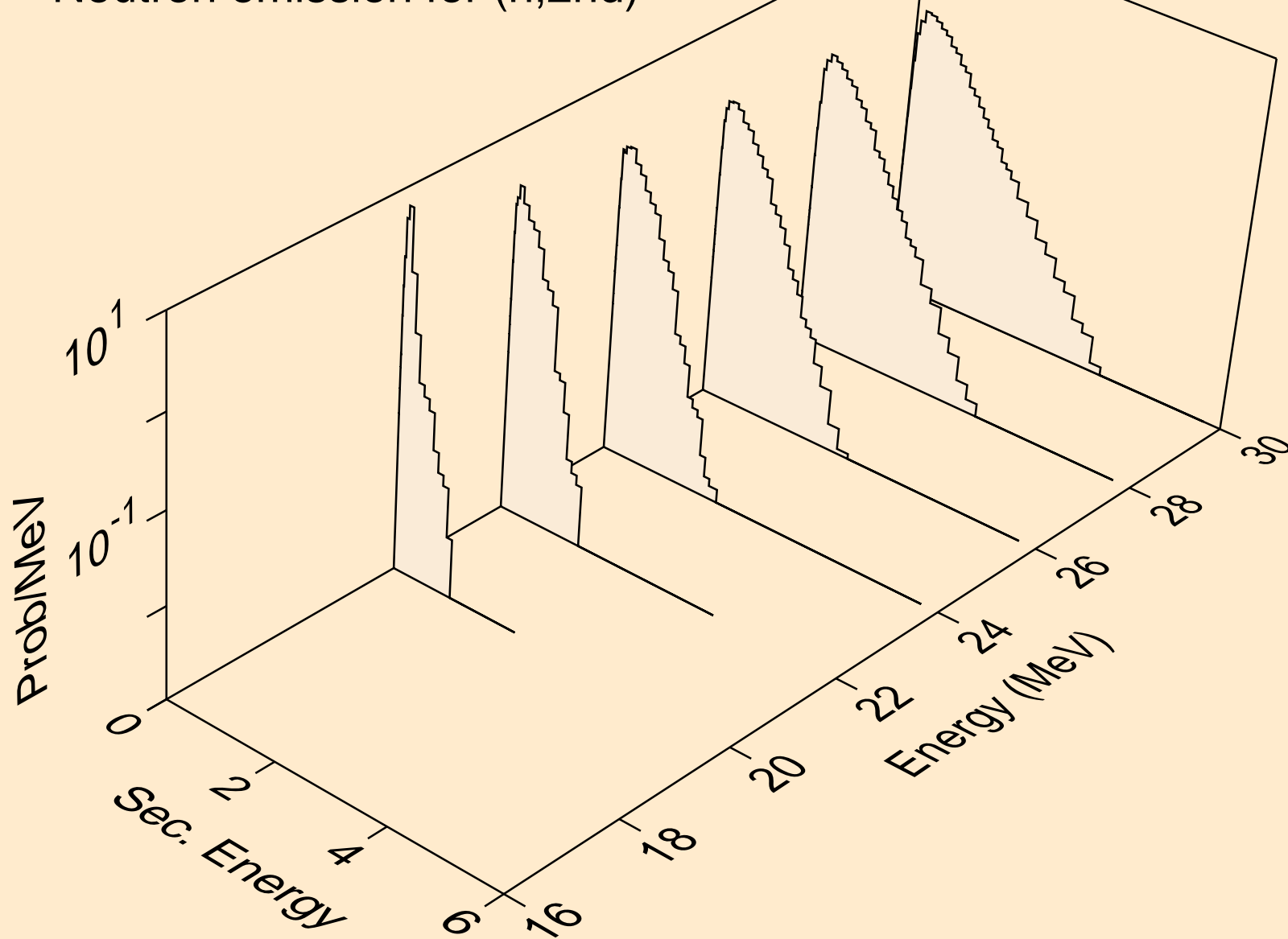



LU176 NEUTRON ACER TENDL-2019 LIBRARY; T=293.16K  
Neutron emission for (n,2n)

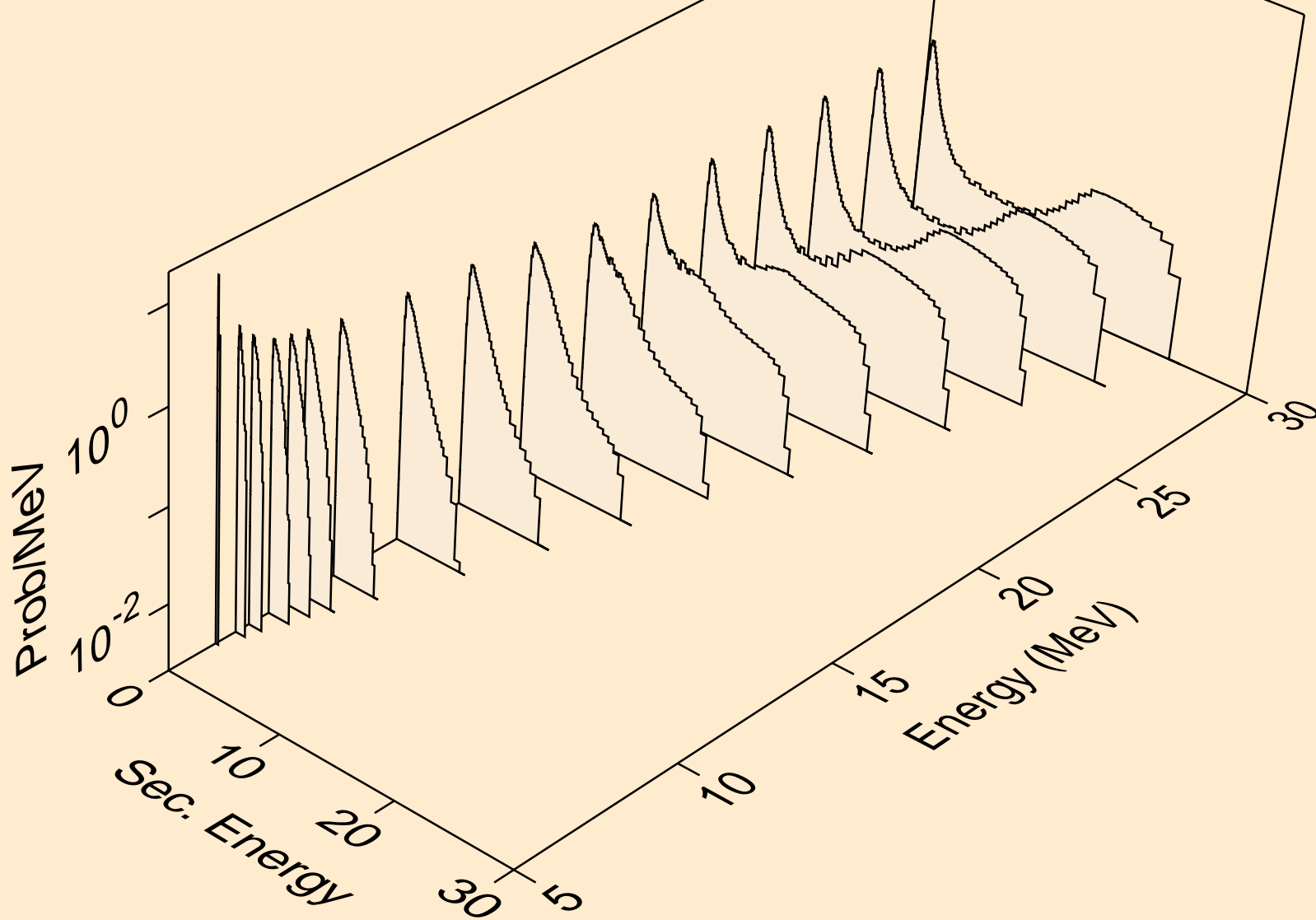

LU176 NEUTRON ACER TENDL-2019 LIBRARY; T=293.16K  
Neutron emission for (n,3n)

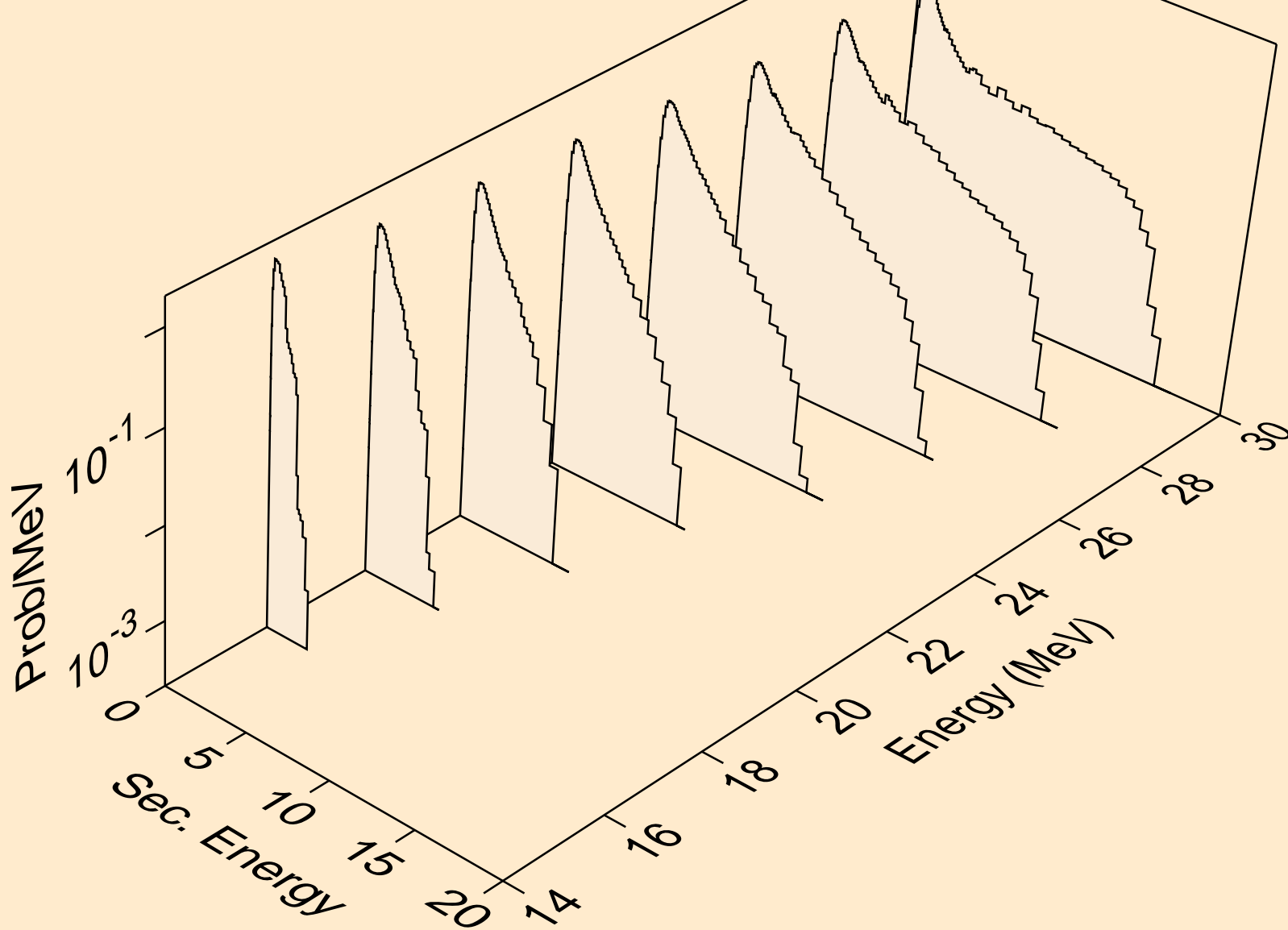

LU176 NEUTRON ACER TENDL-2019 LIBRARY; T=293.16K  
Neutron emission for (n,n\*)a

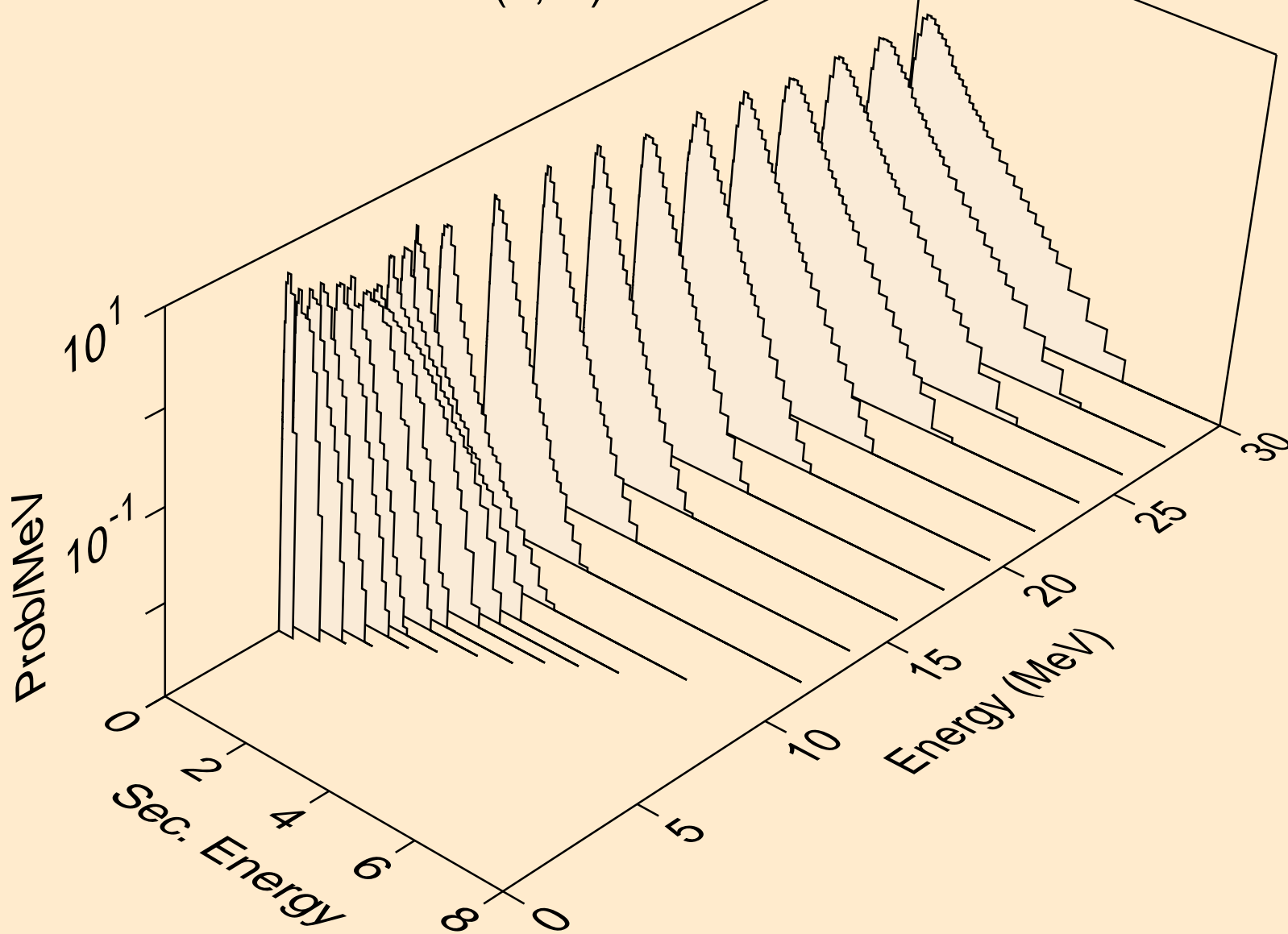

LU176 NEUTRON ACER TENDL-2019 LIBRARY; T=293.16K  
Neutron emission for (n,2n)a

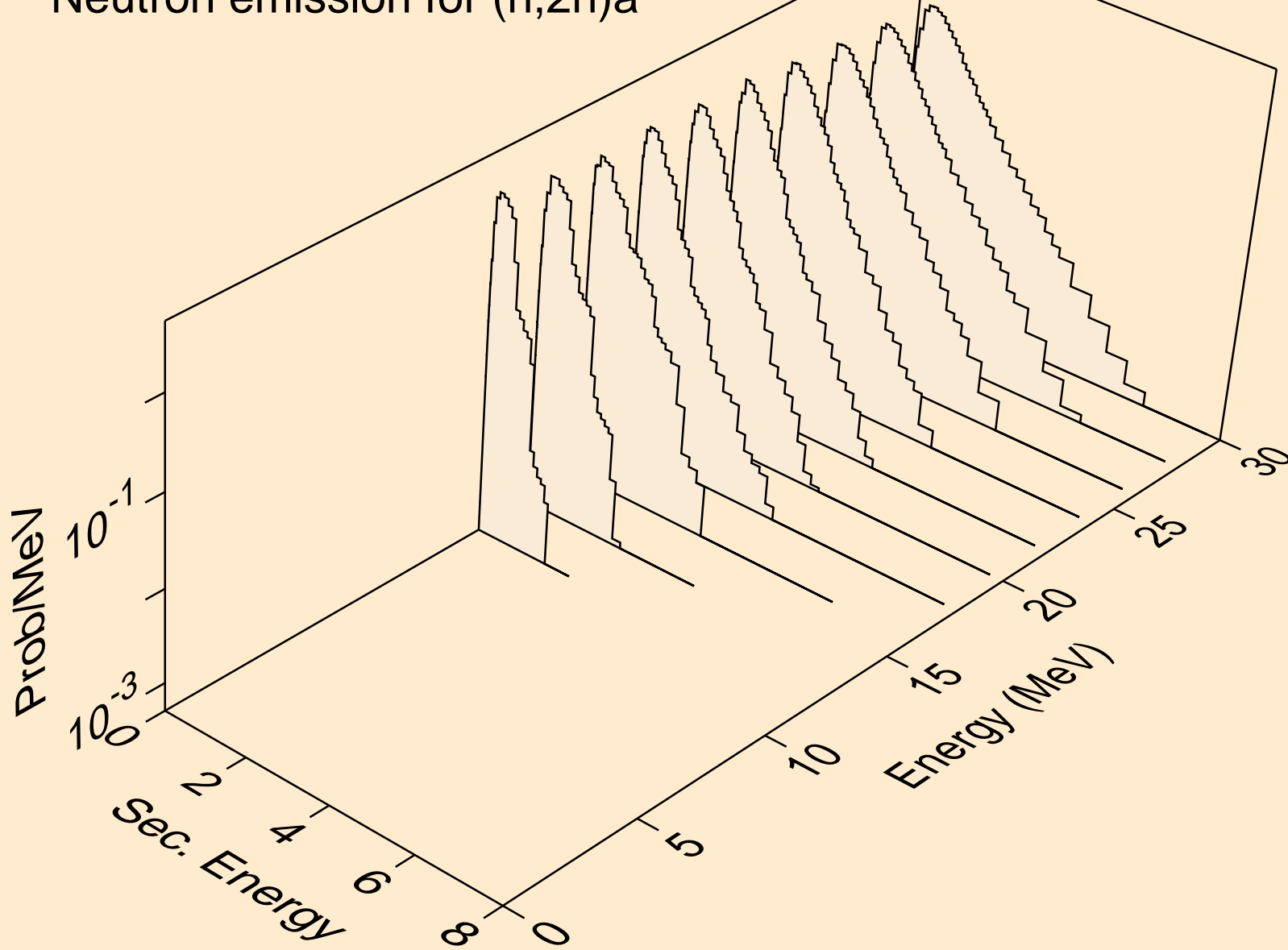

LU176 NEUTRON ACER TENDL-2019 LIBRARY; T=293.16K  
Neutron emission for (n,3n)a

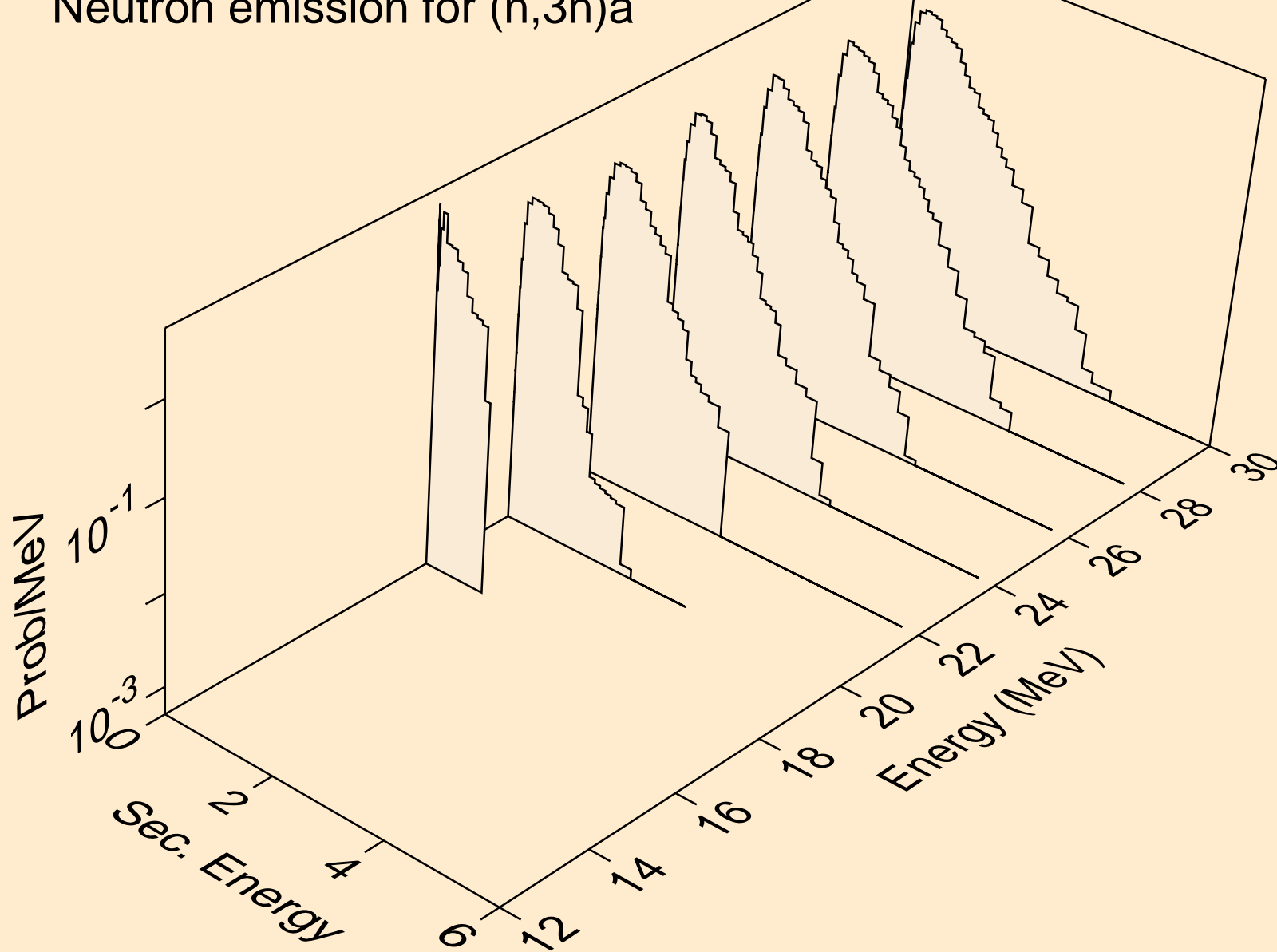

LU176 NEUTRON ACER TENDL-2019 LIBRARY; T=293.16K  
Neutron emission for (n,n\*)p

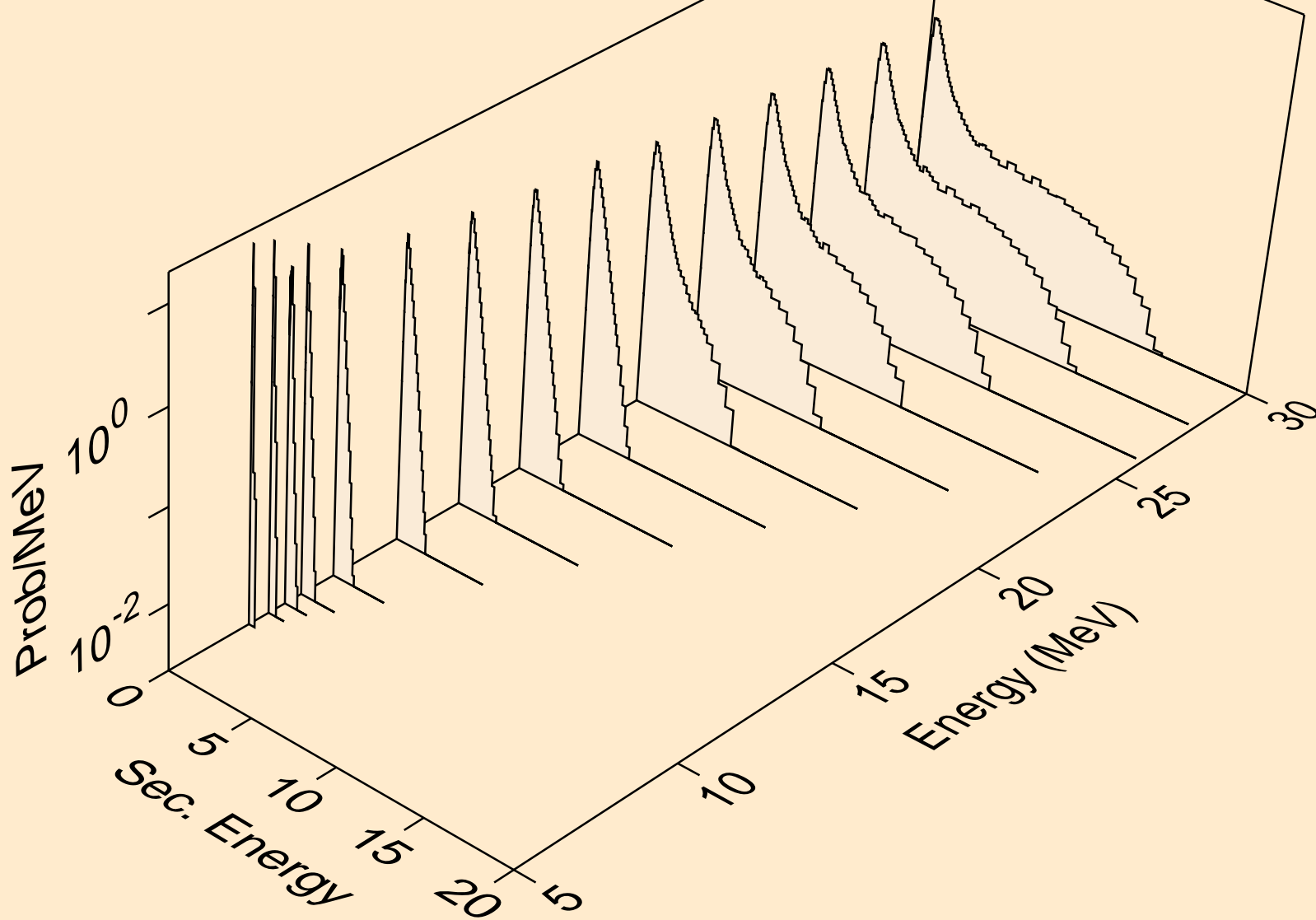

LU176 NEUTRON ACER TENDL-2019 LIBRARY; T=293.16K  
Neutron emission for (n,n\*)d

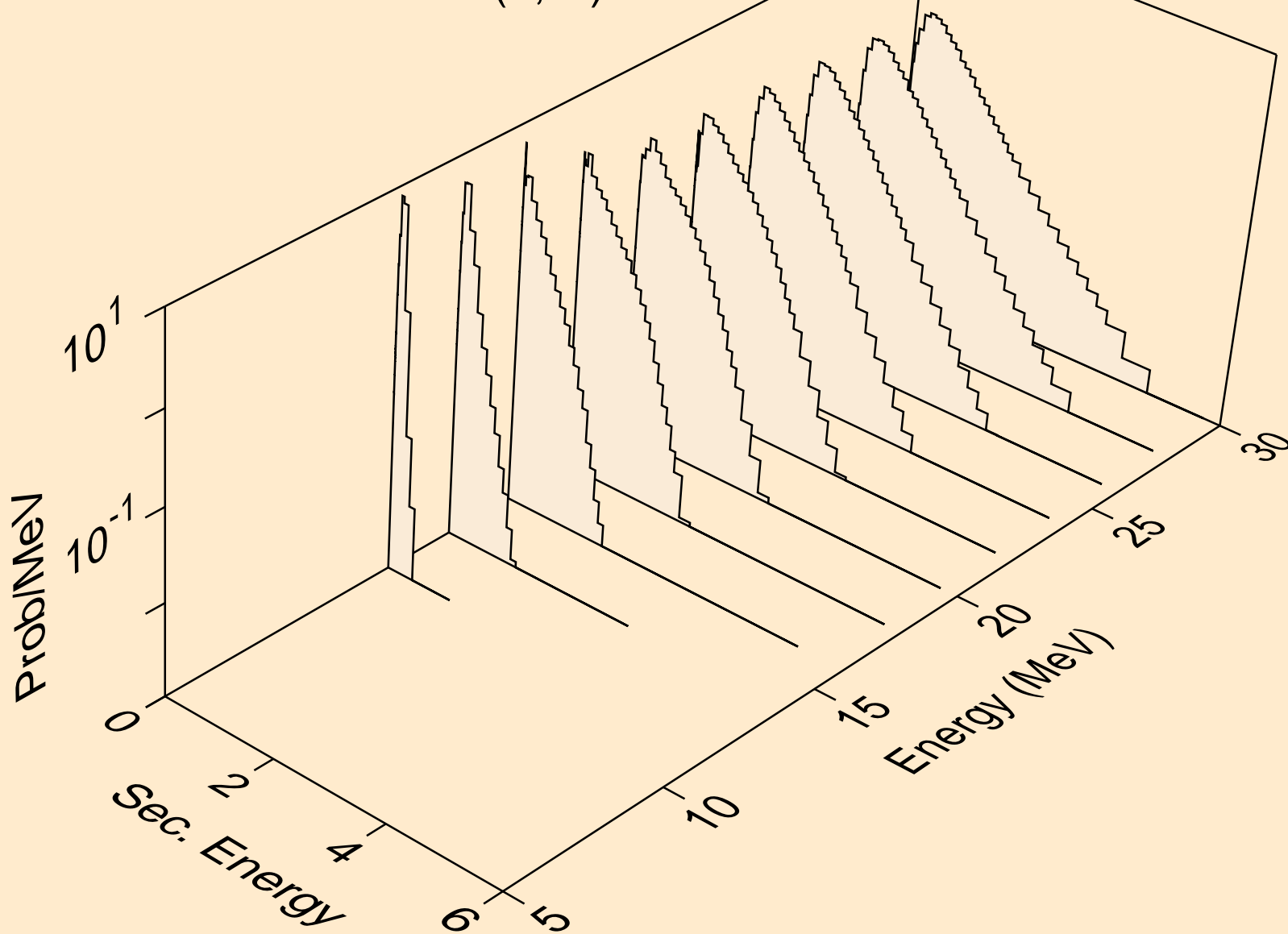

LU176 NEUTRON ACER TENDL-2019 LIBRARY; T=293.16K  
Neutron emission for (n,n\*)t

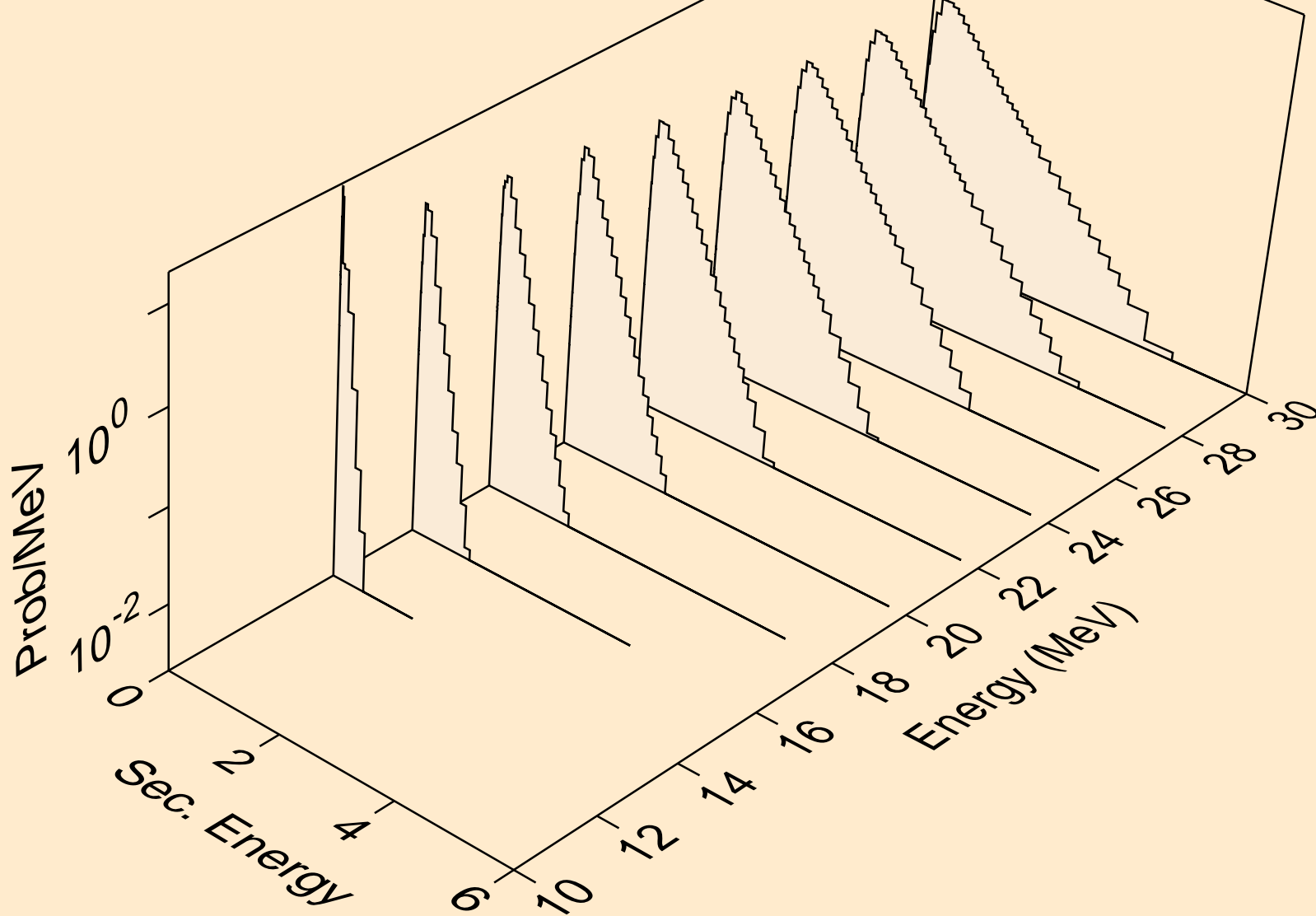



LU176 NEUTRON ACER TENDL-2019 LIBRARY; T=293.16K  
Neutron emission for (n,n\*)he3

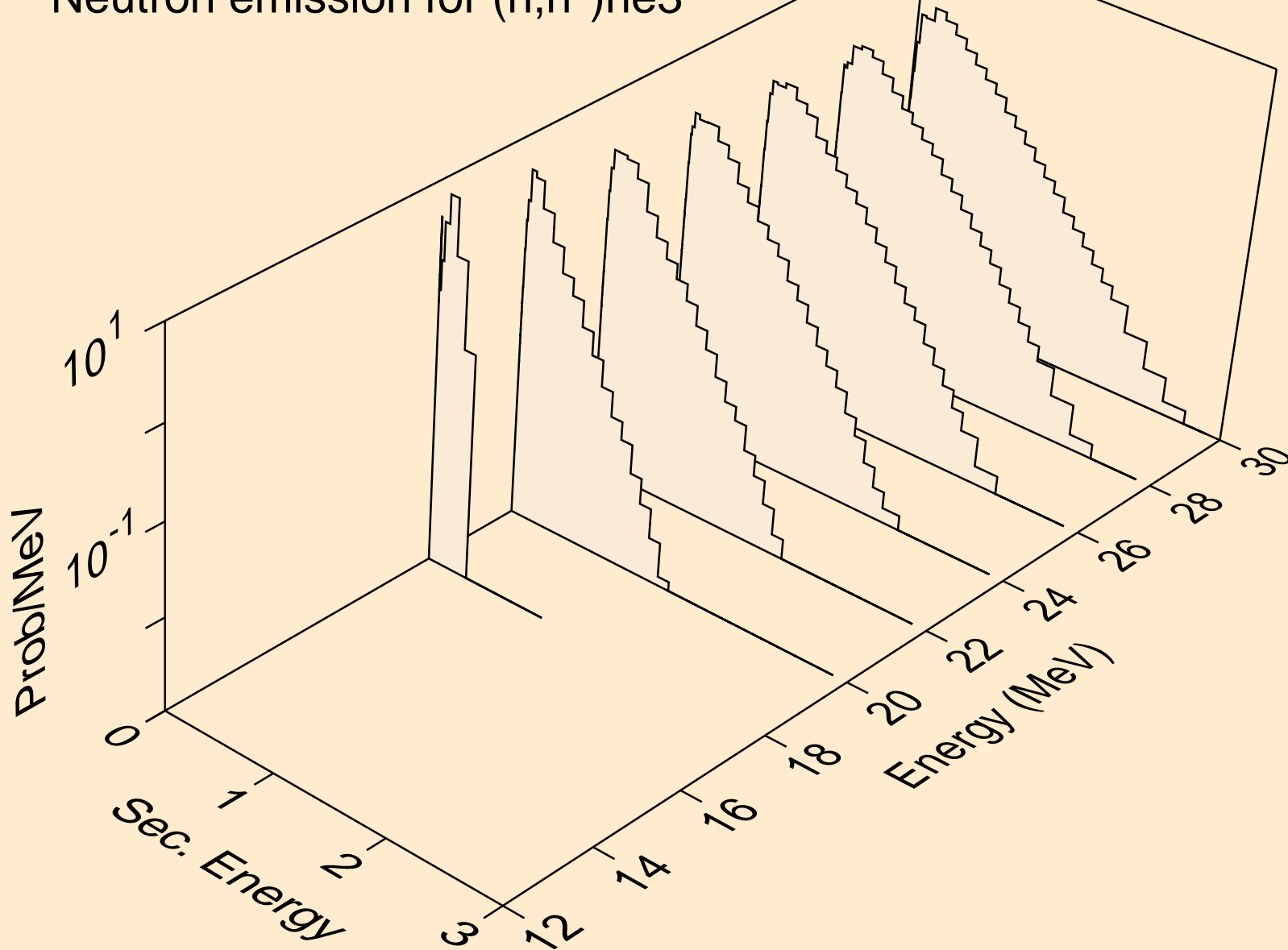

LU176 NEUTRON ACER TENDL-2019 LIBRARY; T=293.16K  
Neutron emission for (n,4n)

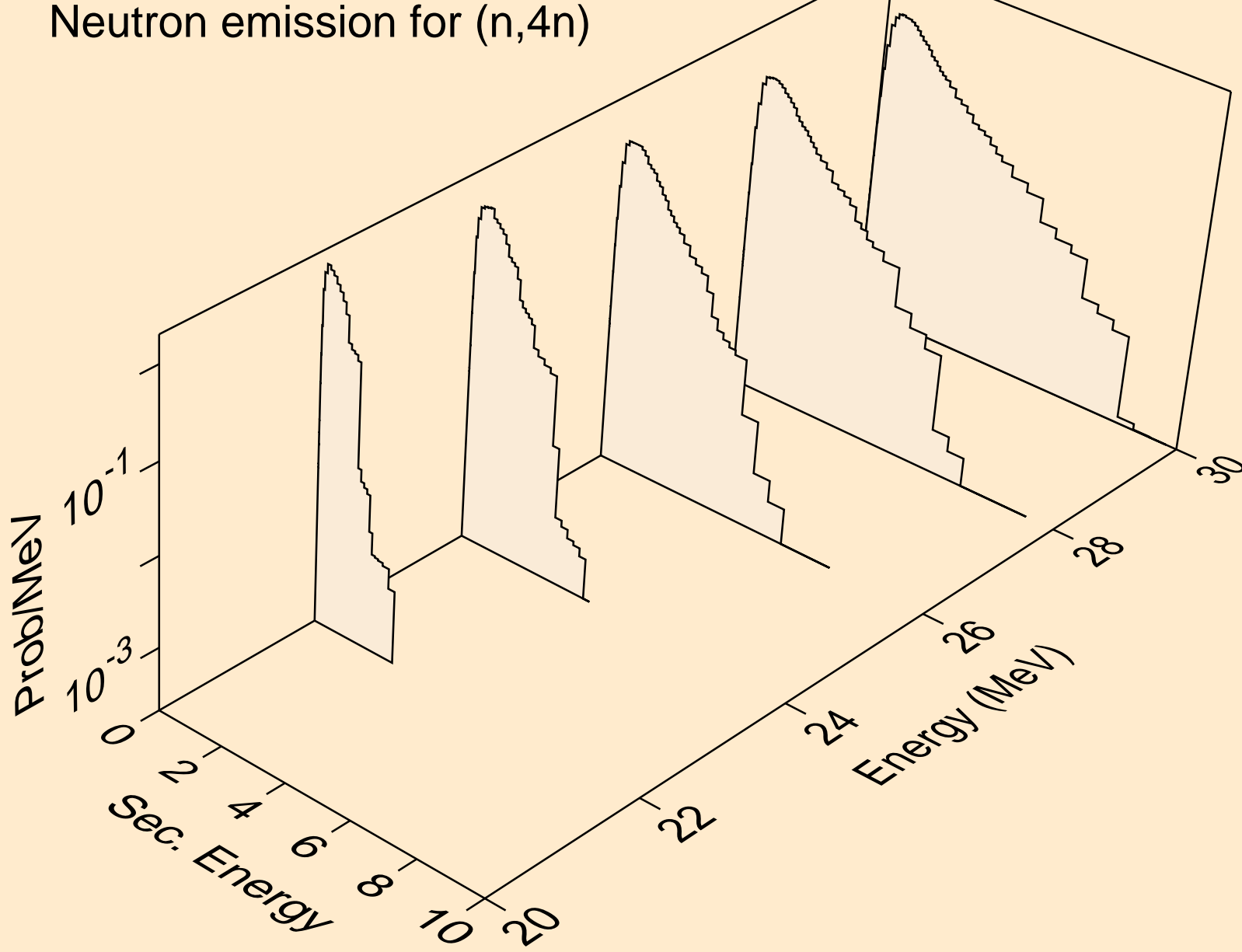

LU176 NEUTRON ACER TENDL-2019 LIBRARY; T=293.16K  
Neutron emission for (n,2np)

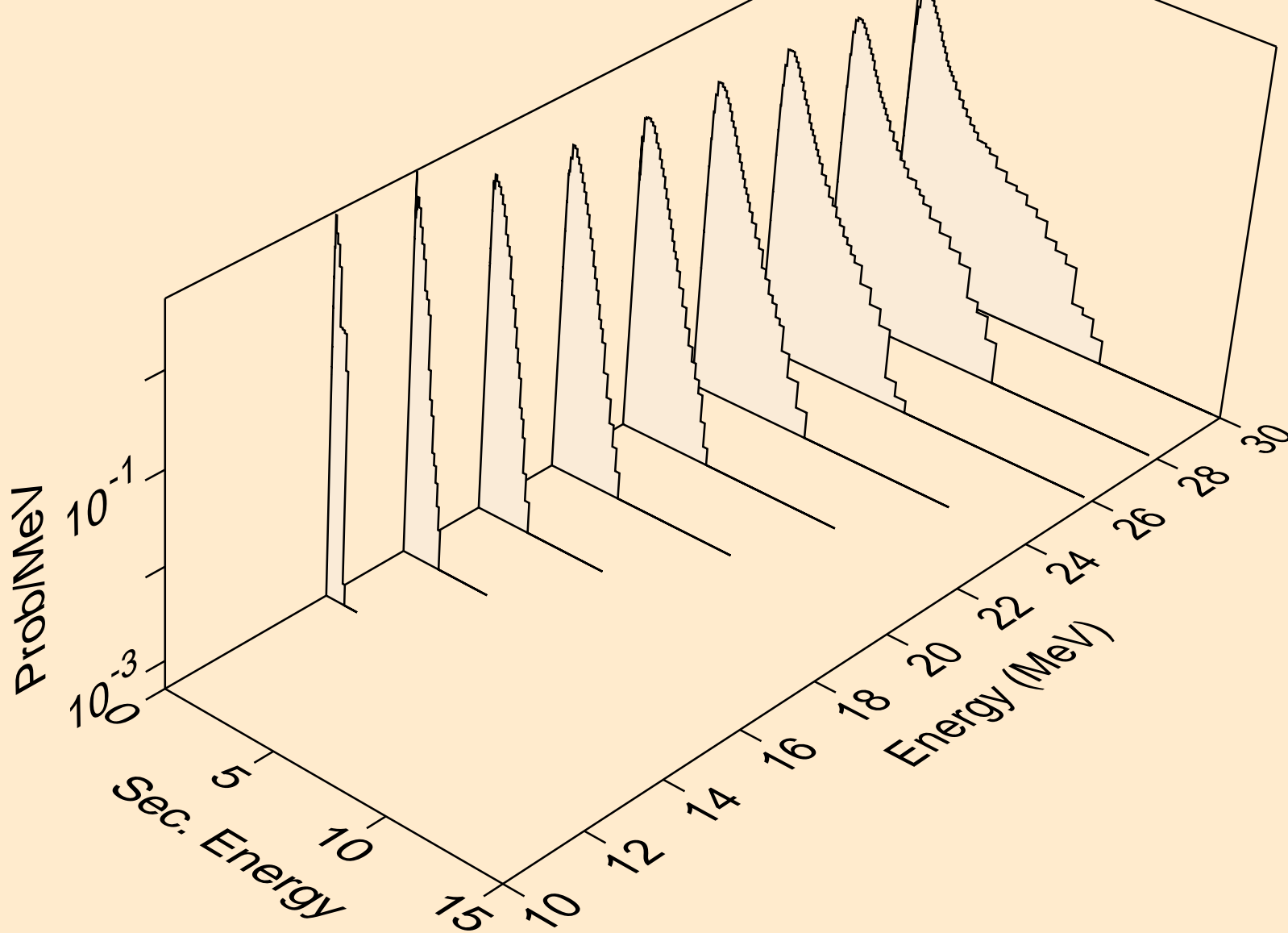

LU176 NEUTRON ACER TENDL-2019 LIBRARY; T=293.16K  
Neutron emission for (n,3np)

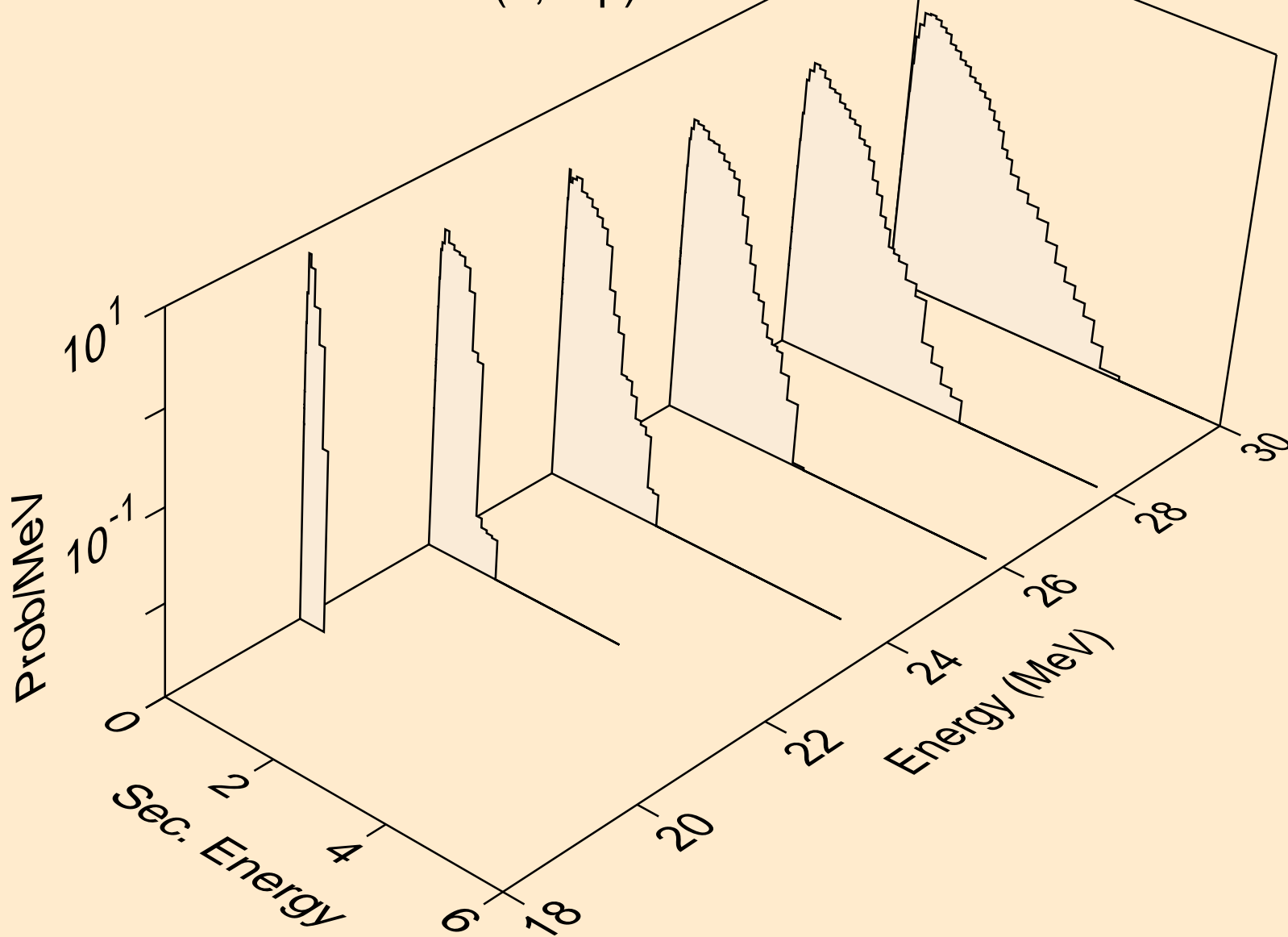

LU176 NEUTRON ACER TENDL-2019 LIBRARY; T=293.16K  
Neutron emission for (n,2np)

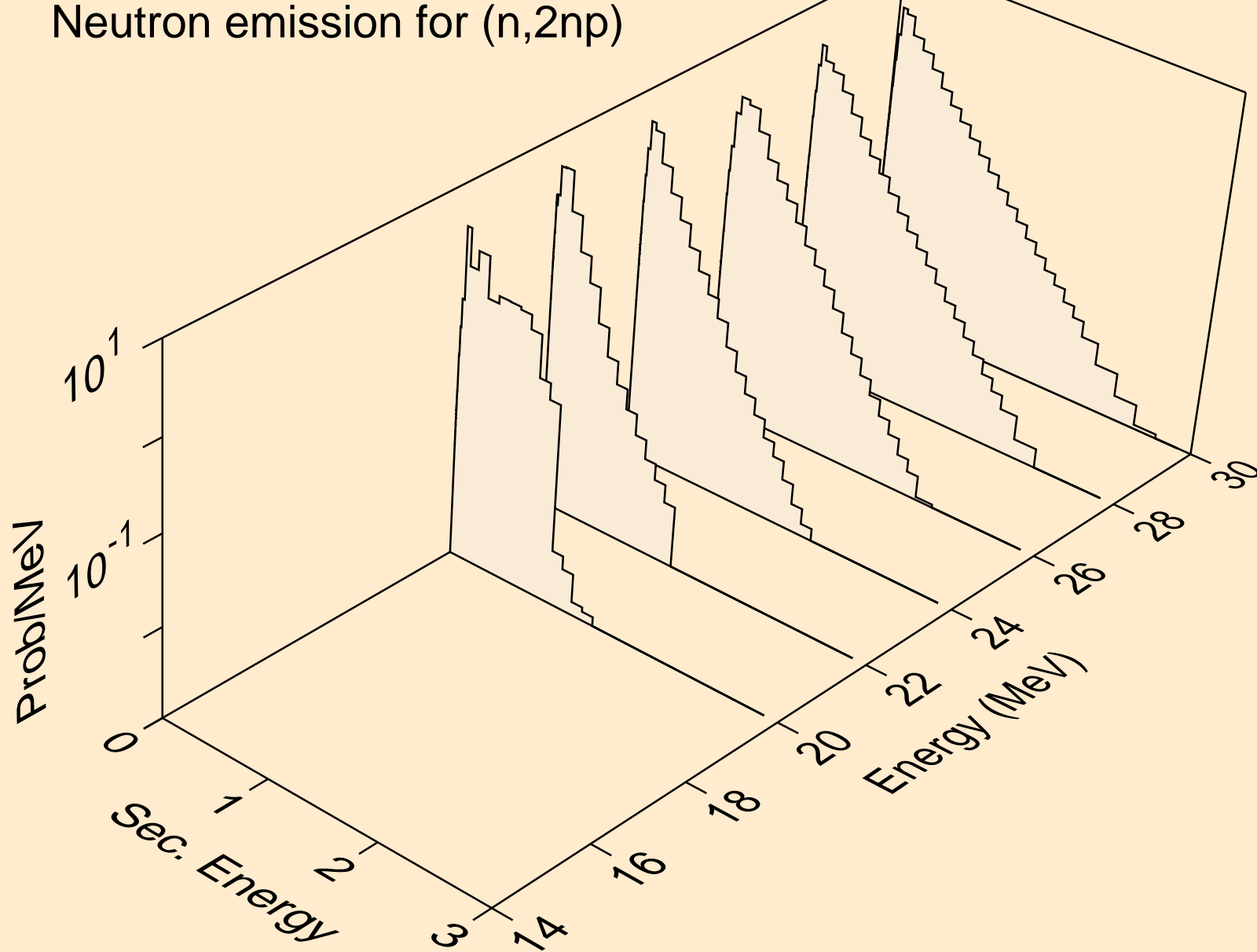

LU176 NEUTRON ACER TENDL-2019 LIBRARY; T=293.16K  
Neutron emission for (n,npa)

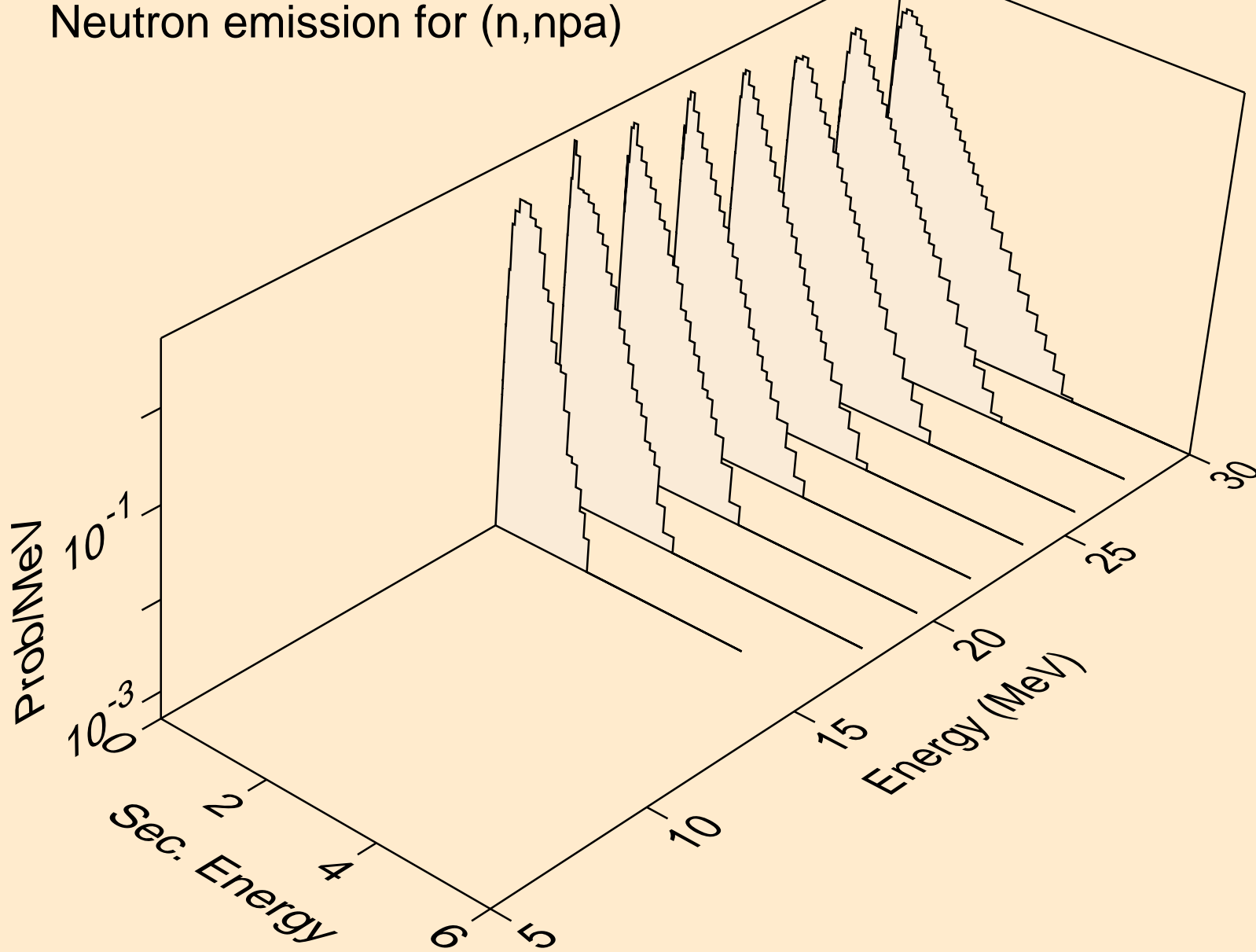

LU176 NEUTRON ACER TENDL-2019 LIBRARY; T=293.16K  
Neutron emission for (n,n\*c)

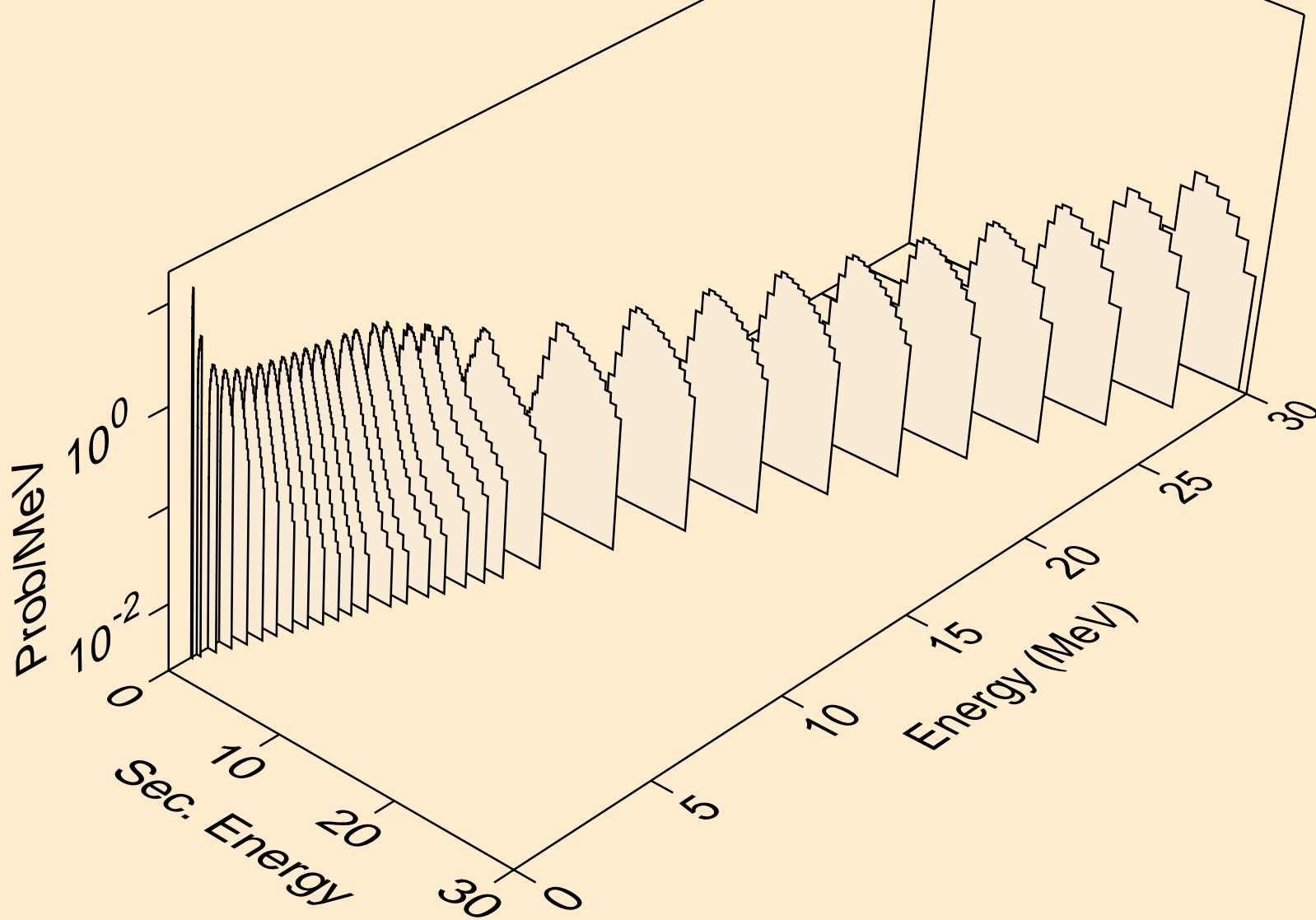

LU176 NEUTRON ACER TENDL-2019 LIBRARY; T=293.16K  
Photon emission for (n,x)

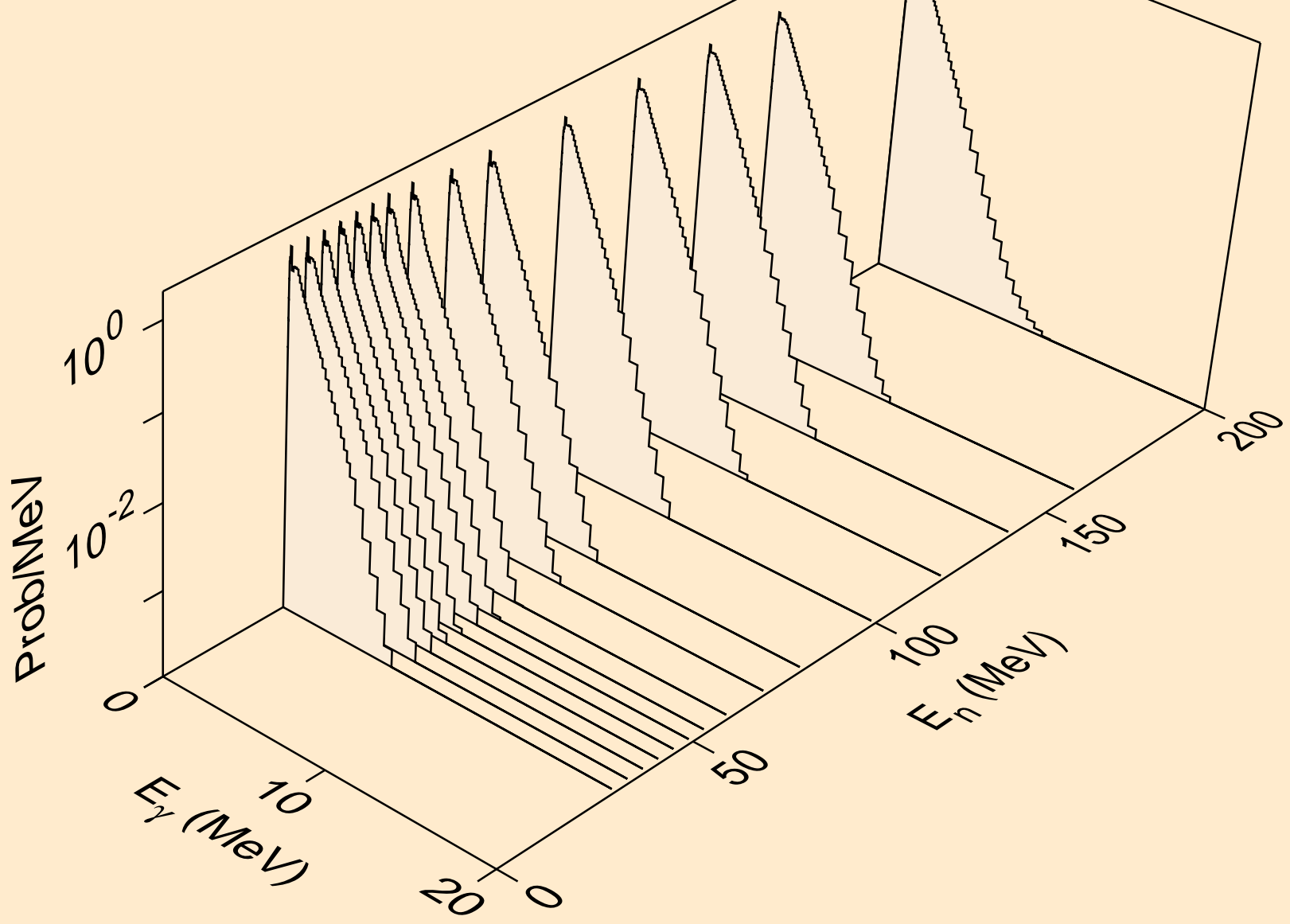



LU176 NEUTRON ACER TENDL-2019 LIBRARY; T=293.16K  
Photon emission for (n,2nd)

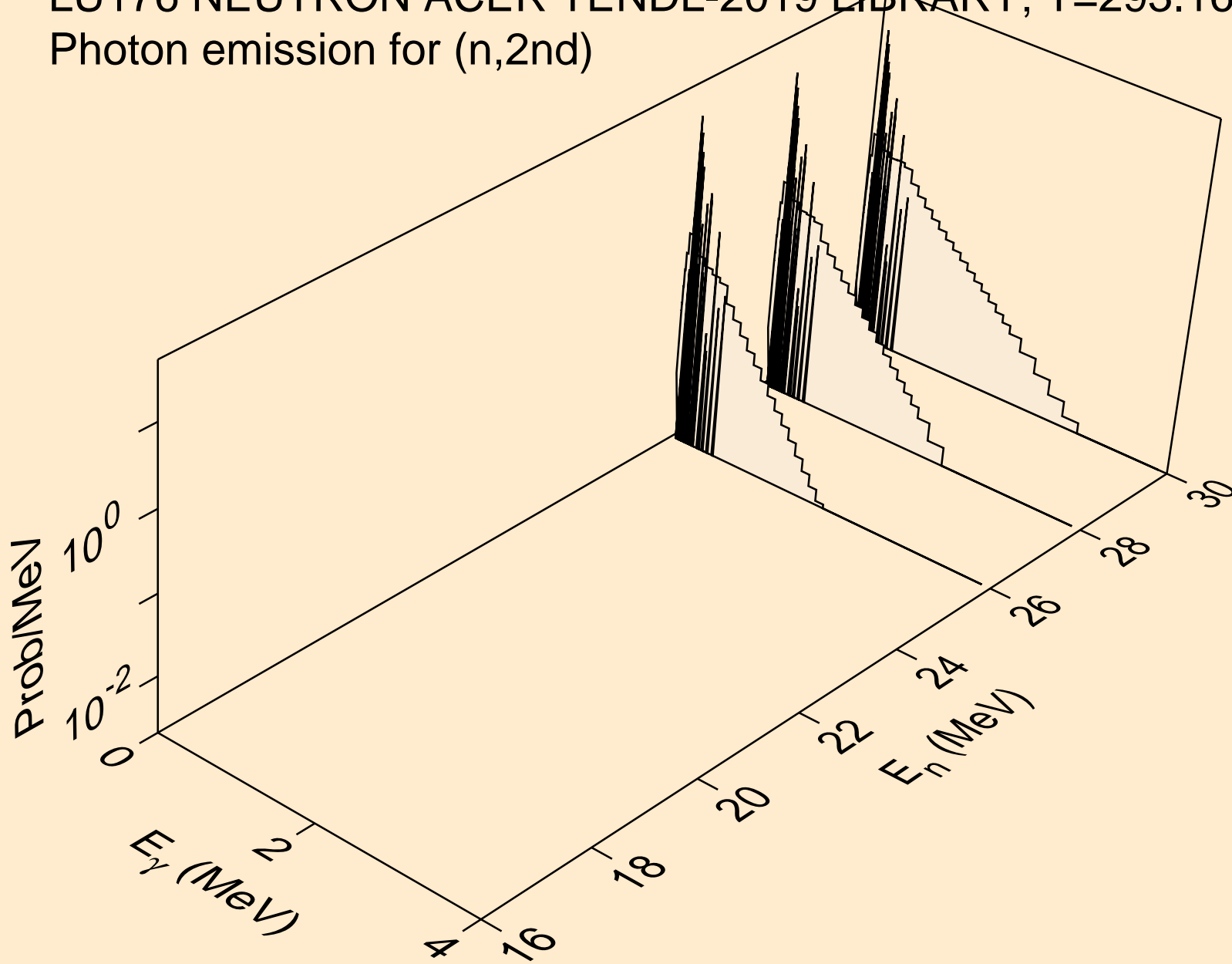

LU176 NEUTRON ACER TENDL-2019 LIBRARY; T=293.16K  
Photon emission for (n,2n)

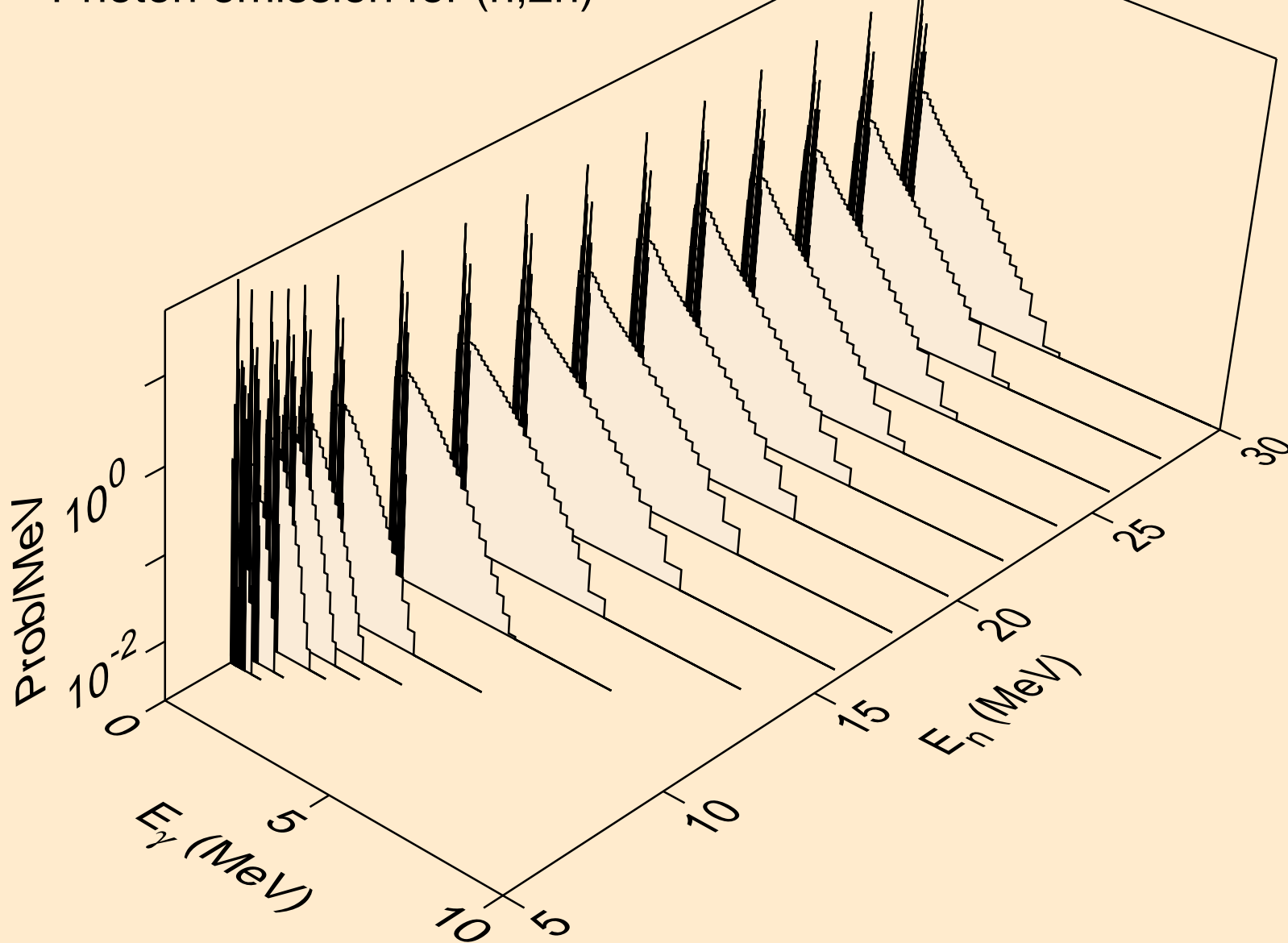

LU176 NEUTRON ACER TENDL-2019 LIBRARY; T=293.16K  
Photon emission for (n,3n)

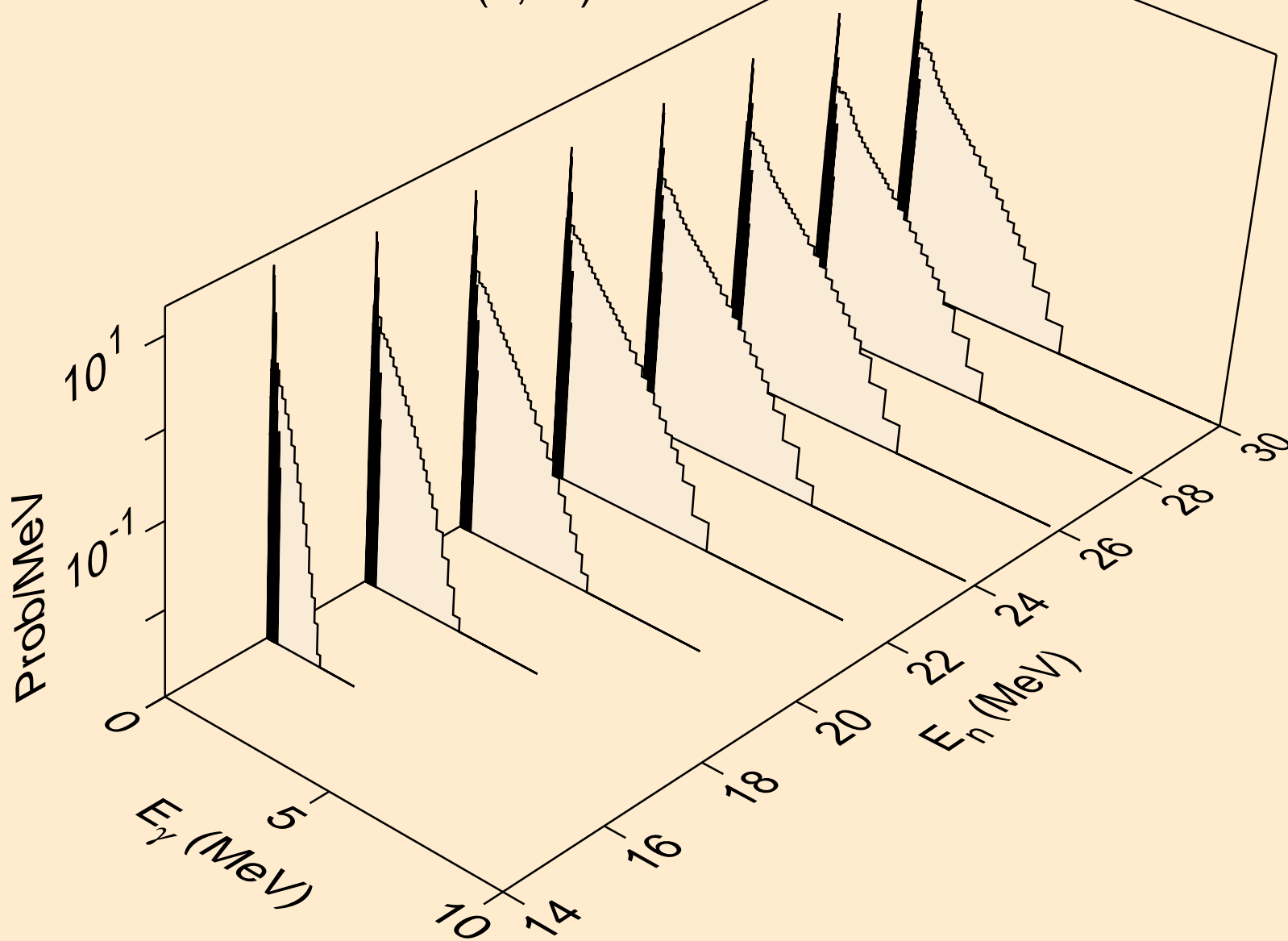

LU176 NEUTRON ACER TENDL-2019 LIBRARY; T=293.16K  
Photon emission for (n,n\*)a

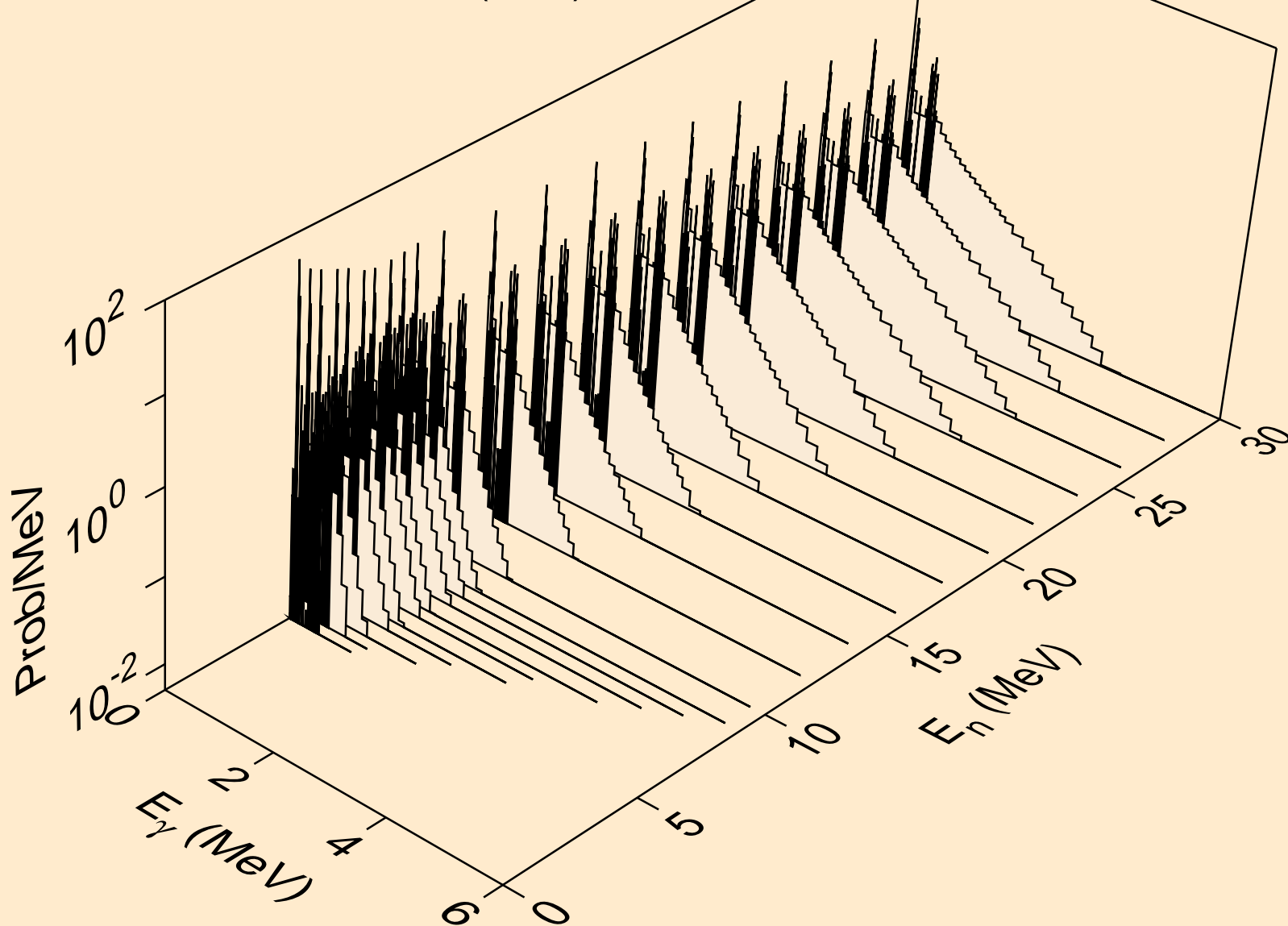

LU176 NEUTRON ACER TENDL-2019 LIBRARY; T=293.16K  
Photon emission for (n,2n)a

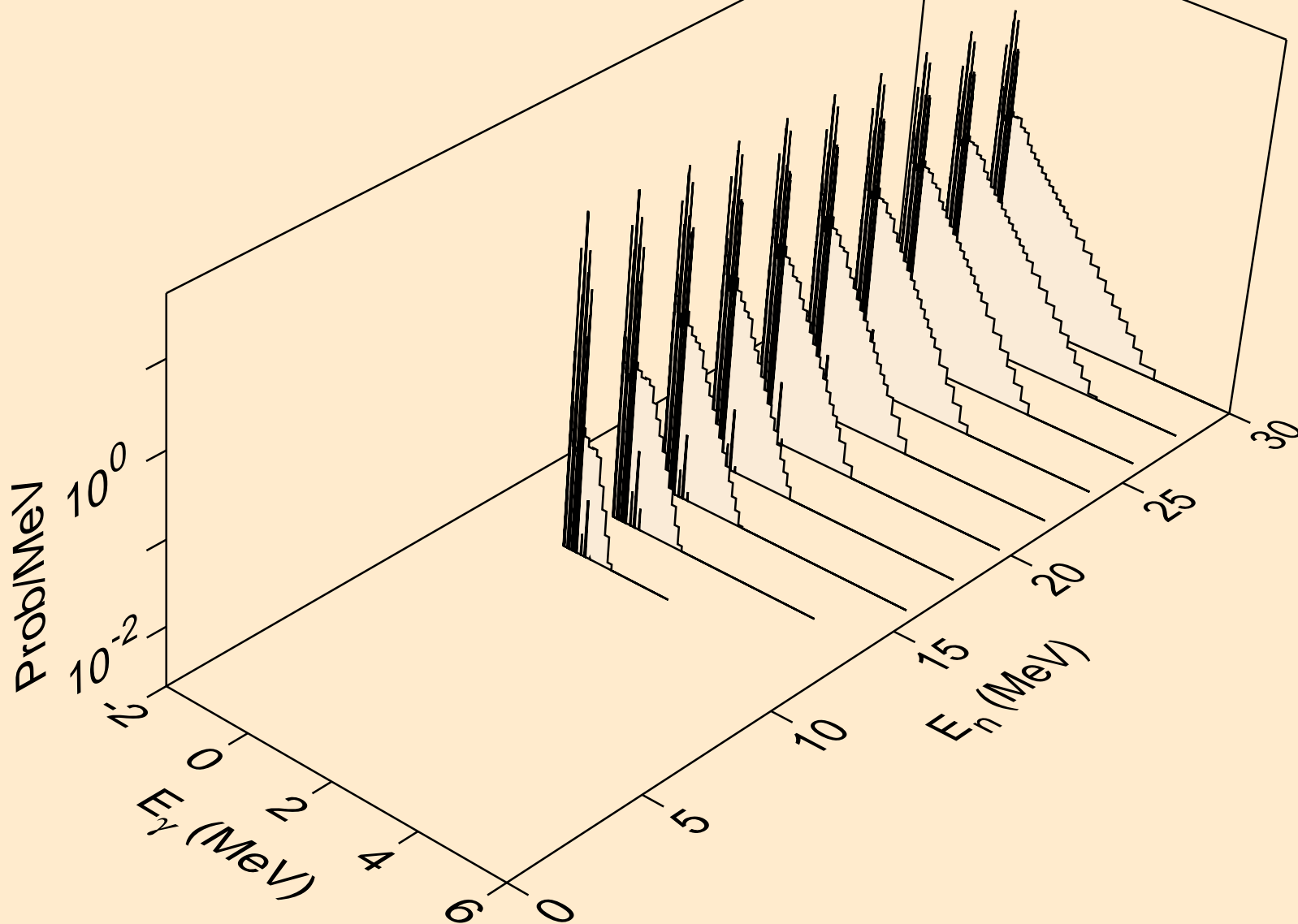

LU176 NEUTRON ACER TENDL-2019 LIBRARY; T=293.16K  
Photon emission for (n,3n)a

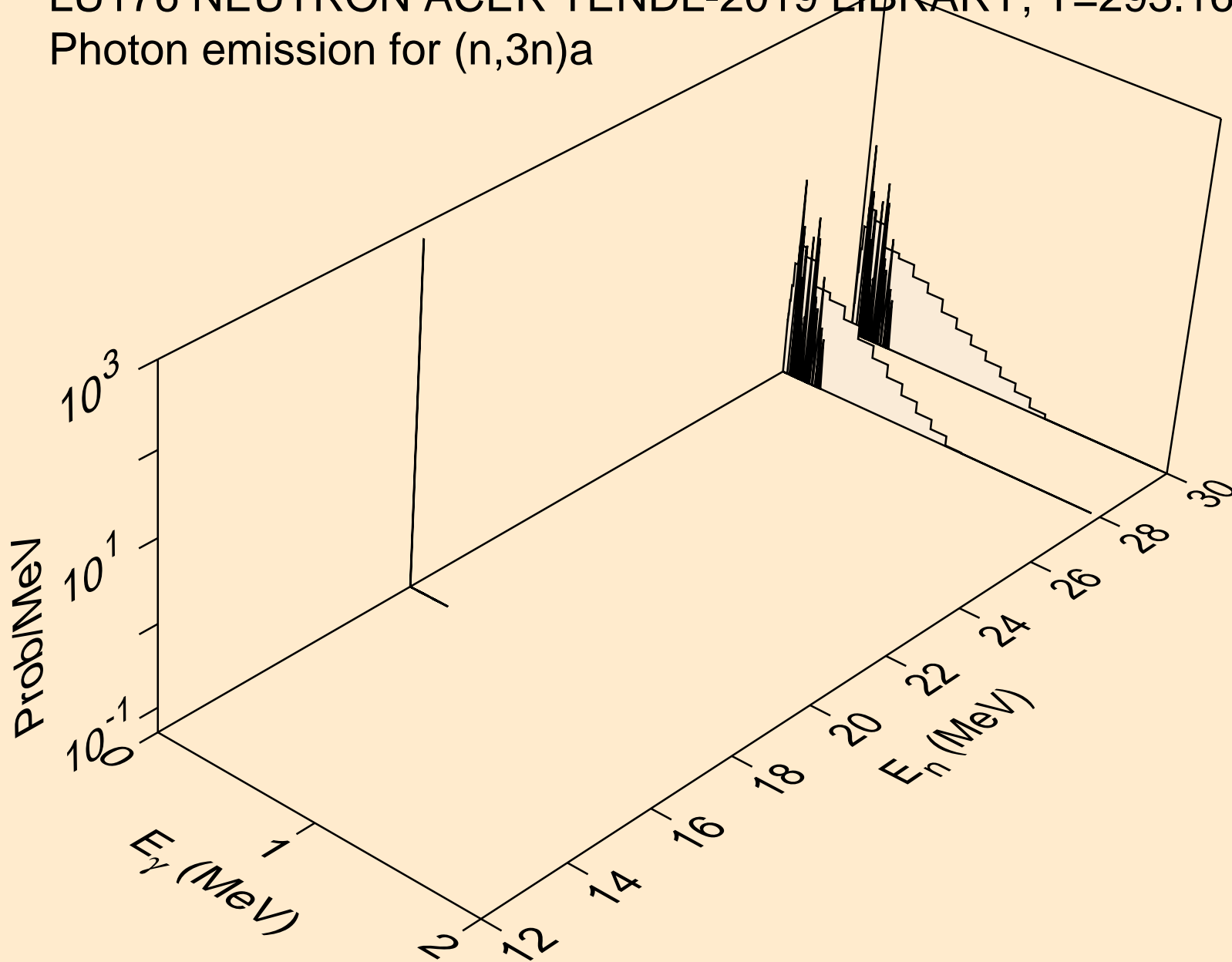

LU176 NEUTRON ACER TENDL-2019 LIBRARY; T=293.16K  
Photon emission for (n,n\*)p

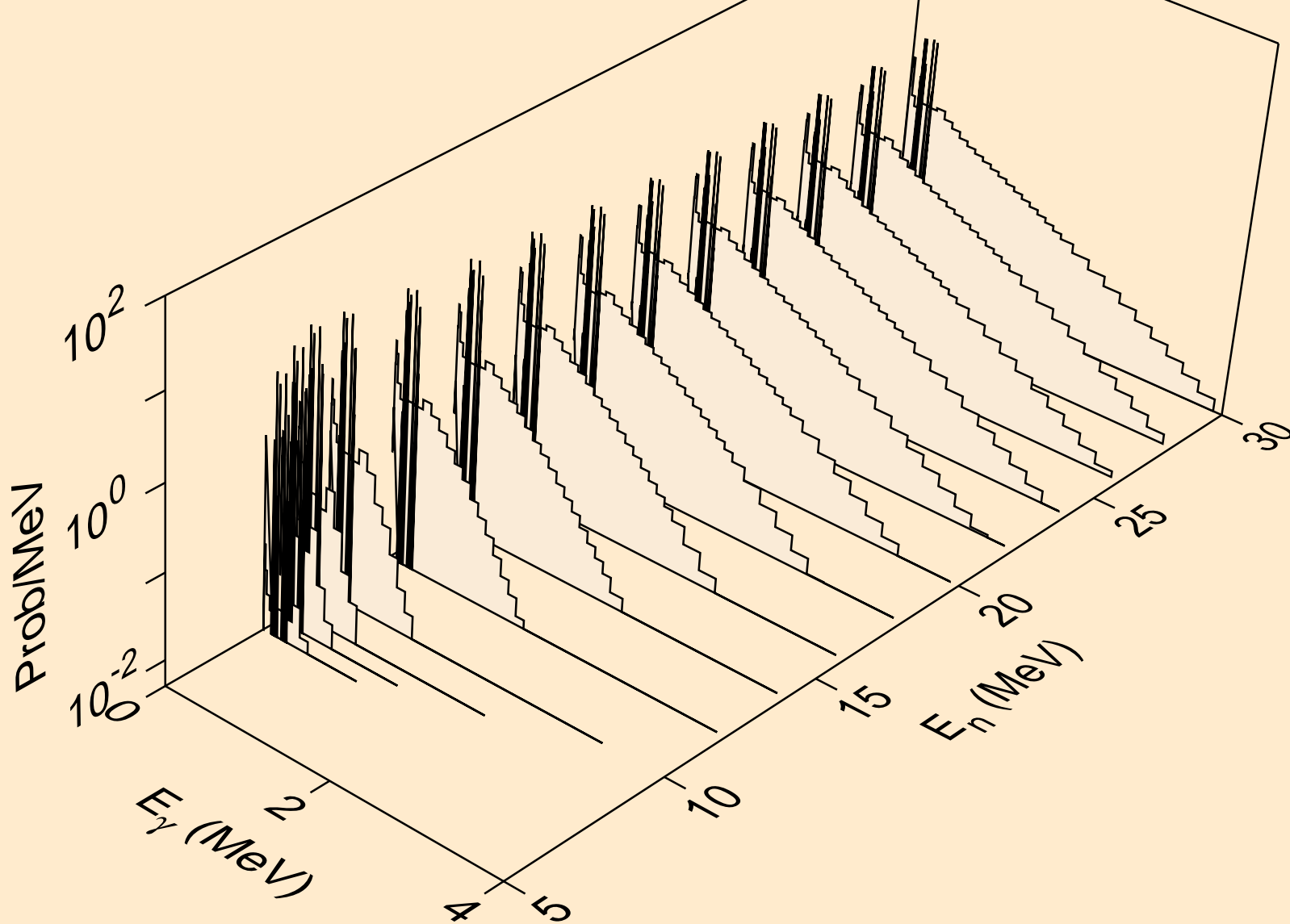

LU176 NEUTRON ACER TENDL-2019 LIBRARY; T=293.16K  
Photon emission for (n,n\*)d

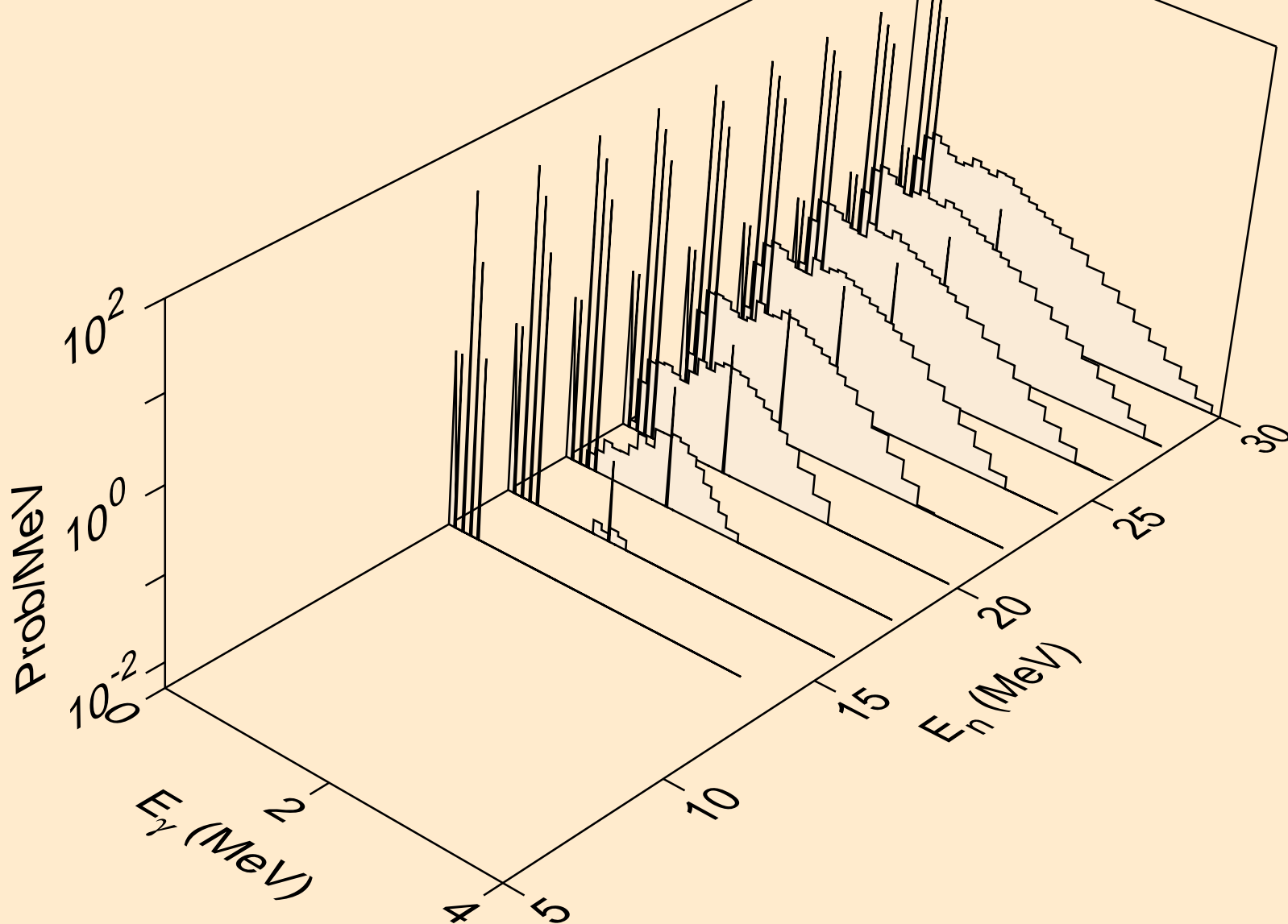



LU176 NEUTRON ACER TENDL-2019 LIBRARY; T=293.16K  
Photon emission for (n,n\*)t

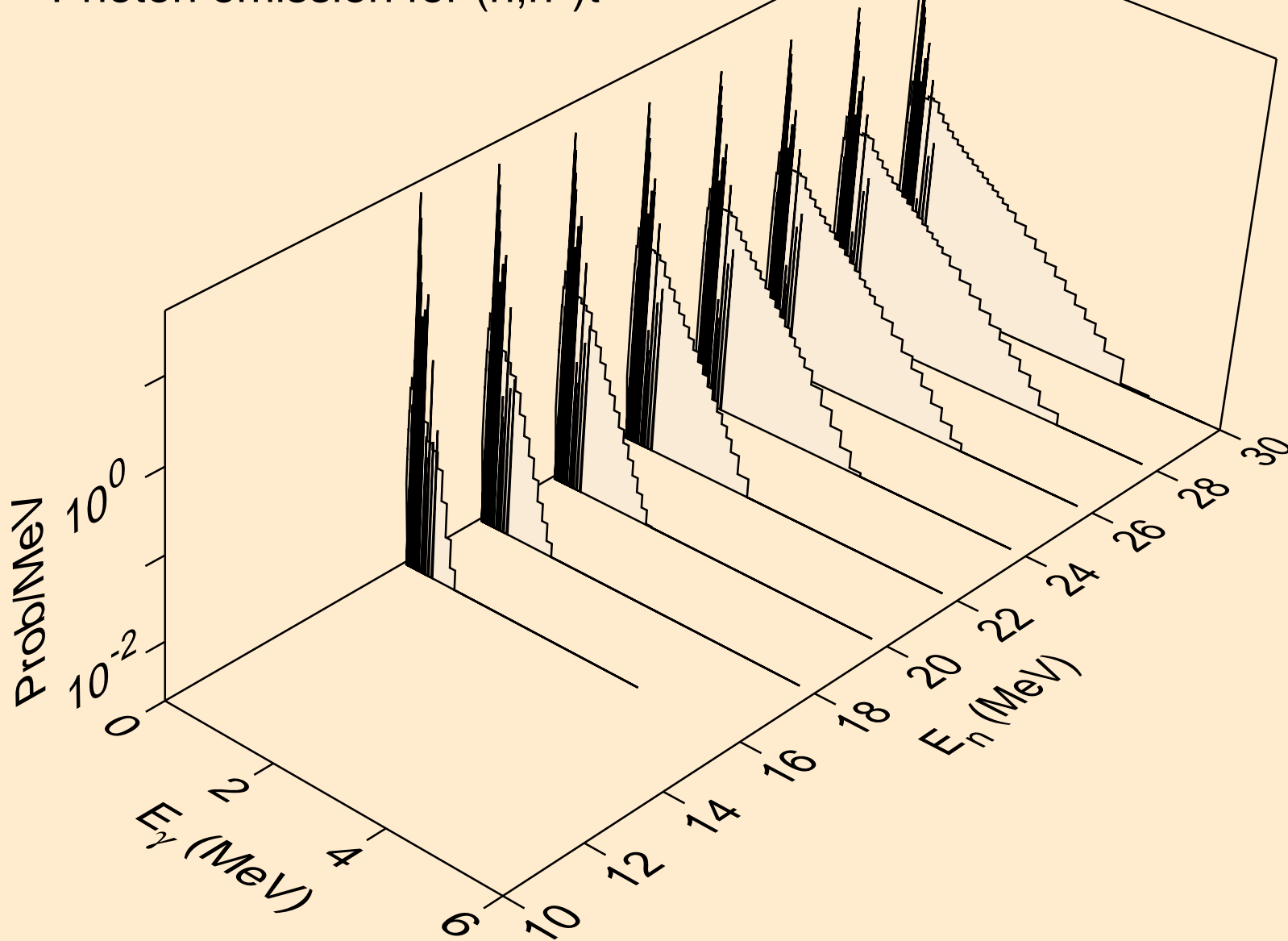

LU176 NEUTRON ACER TENDL-2019 LIBRARY; T=293.16K  
Photon emission for (n,n\*)he3

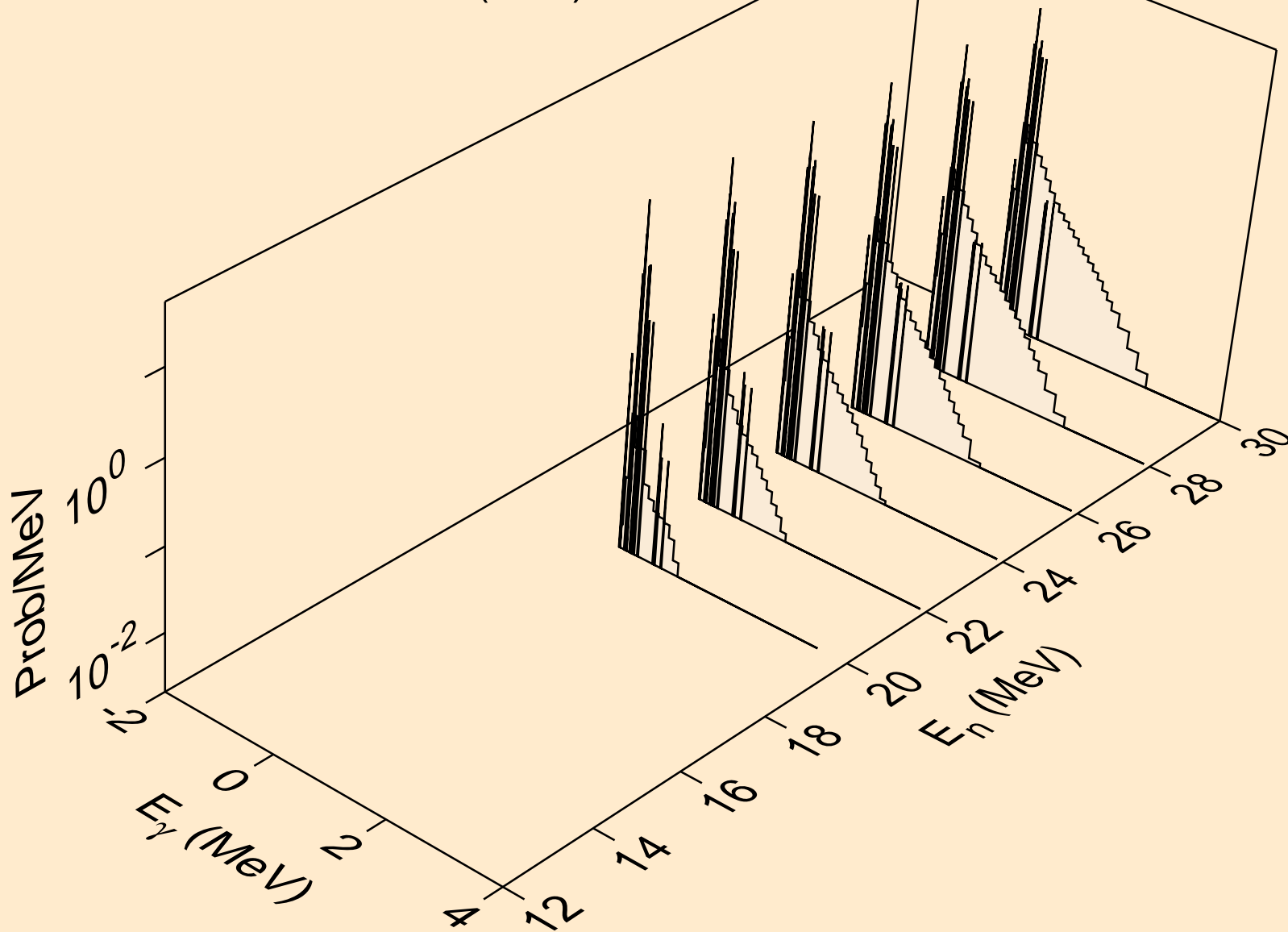

LU176 NEUTRON ACER TENDL-2019 LIBRARY; T=293.16K  
Photon emission for (n,4n)

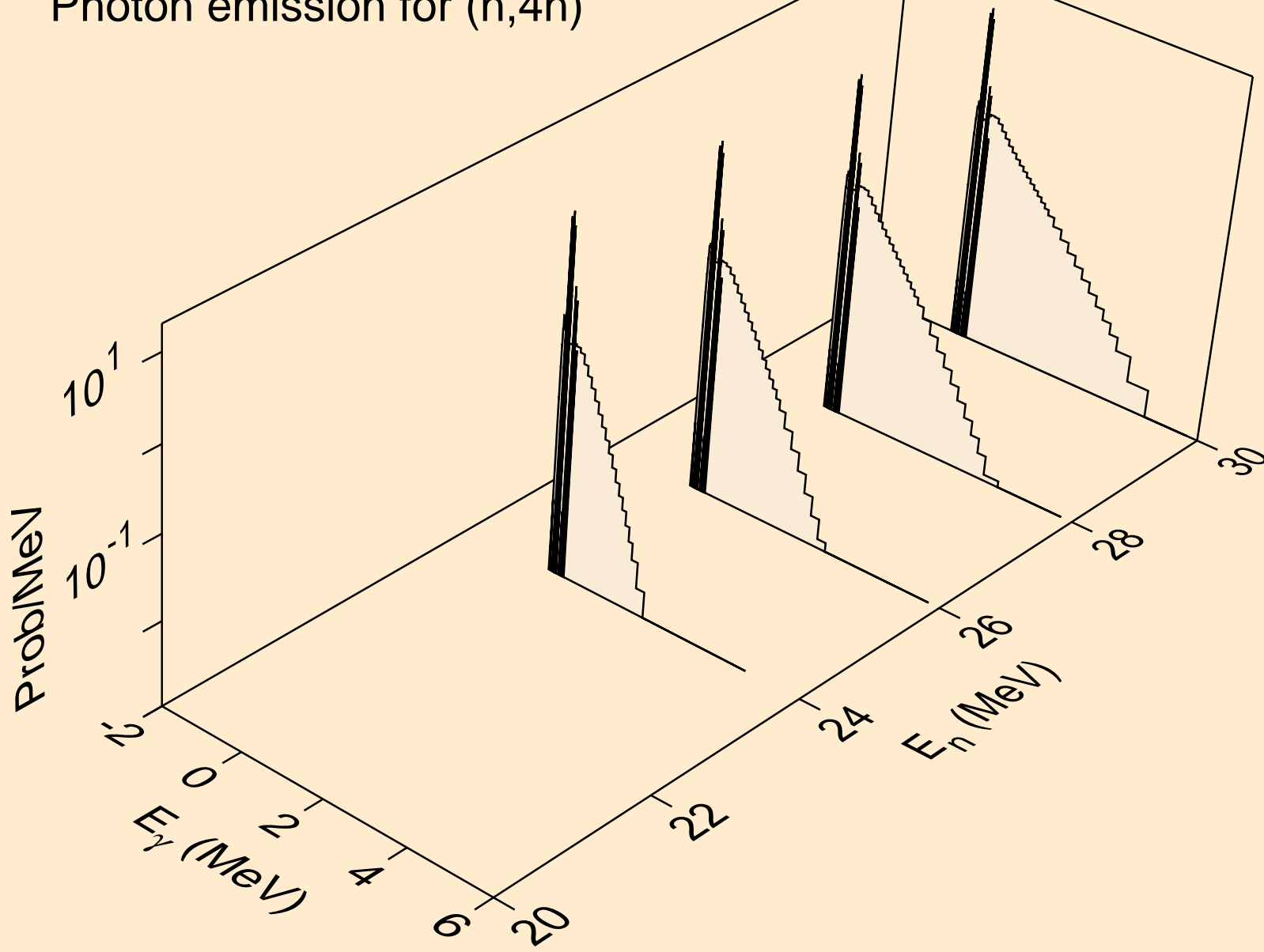

LU176 NEUTRON ACER TENDL-2019 LIBRARY; T=293.16K  
Photon emission for (n,2np)

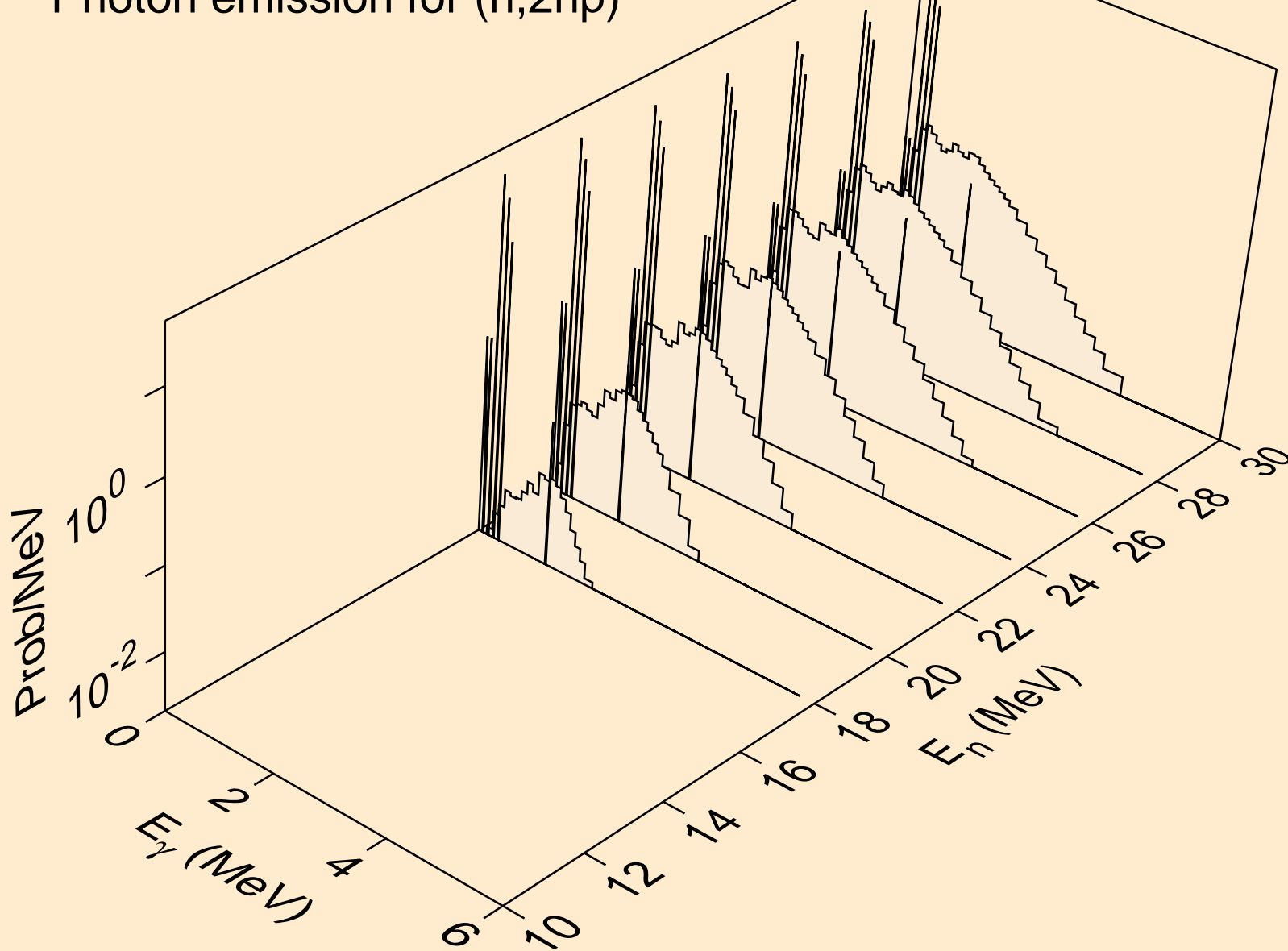

LU176 NEUTRON ACER TENDL-2019 LIBRARY; T=293.16K  
Photon emission for (n,3np)

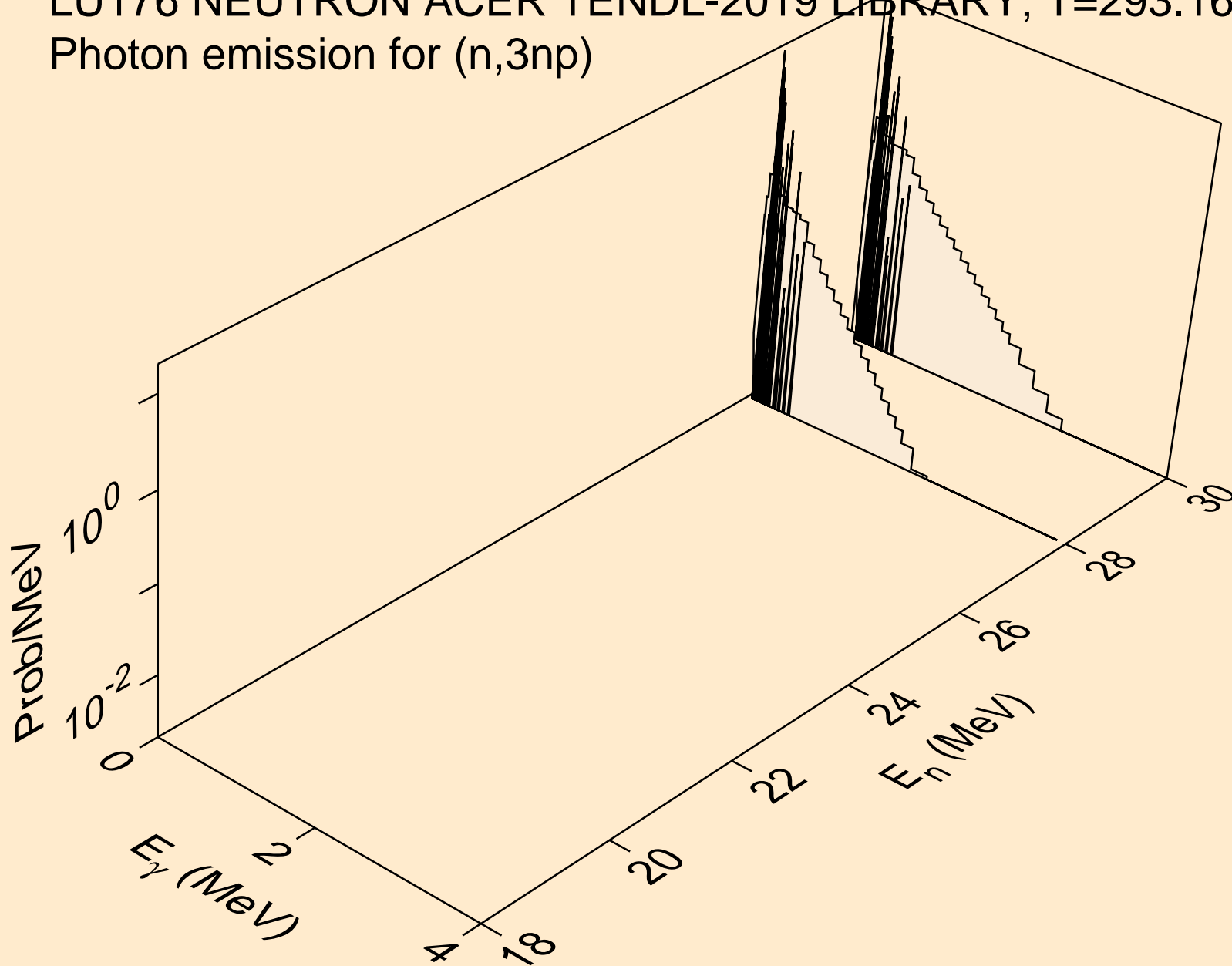

LU176 NEUTRON ACER TENDL-2019 LIBRARY; T=293.16K  
Photon emission for (n,2np)

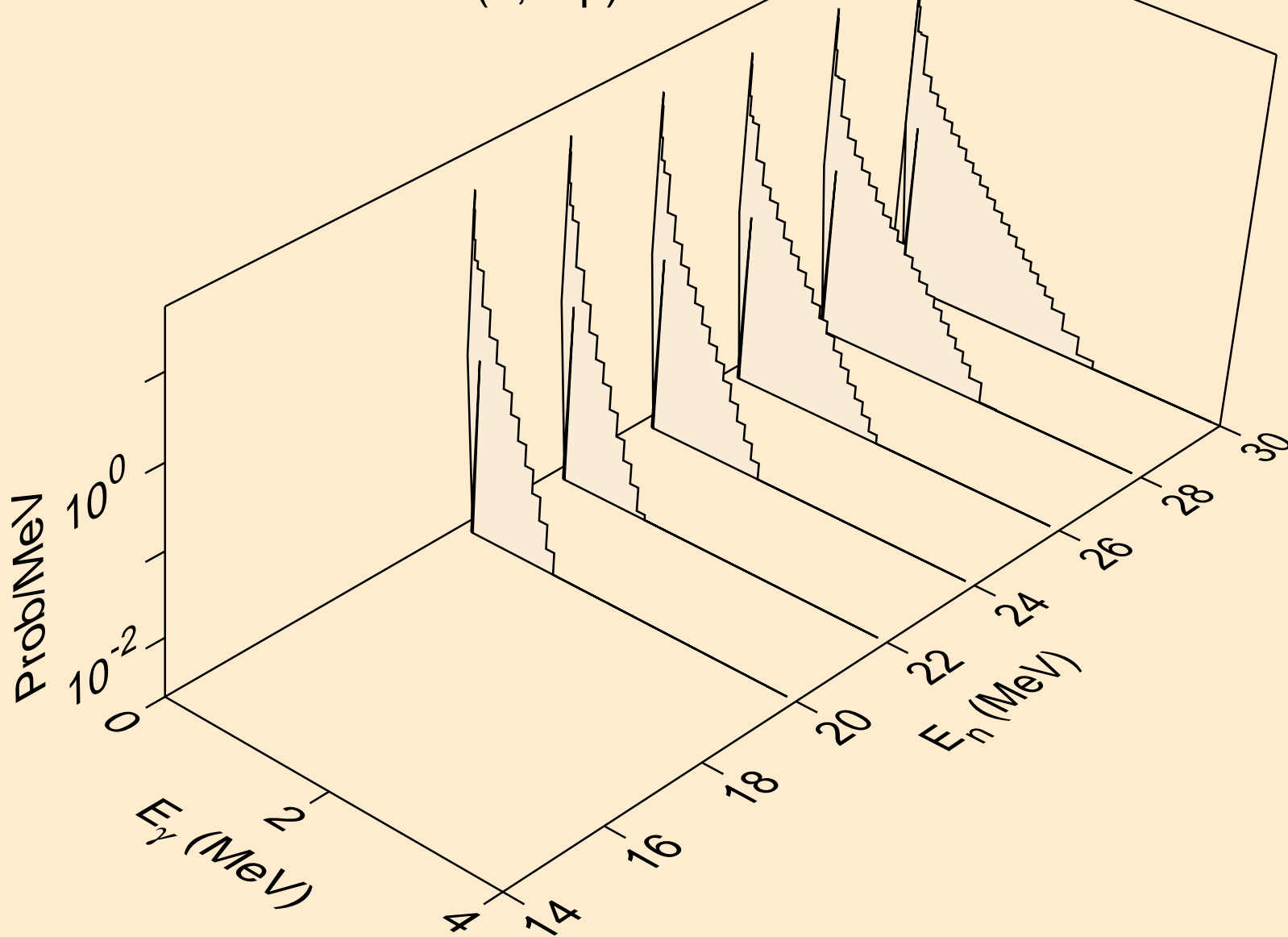

LU176 NEUTRON ACER TENDL-2019 LIBRARY; T=293.16K  
Photon emission for (n,npa)

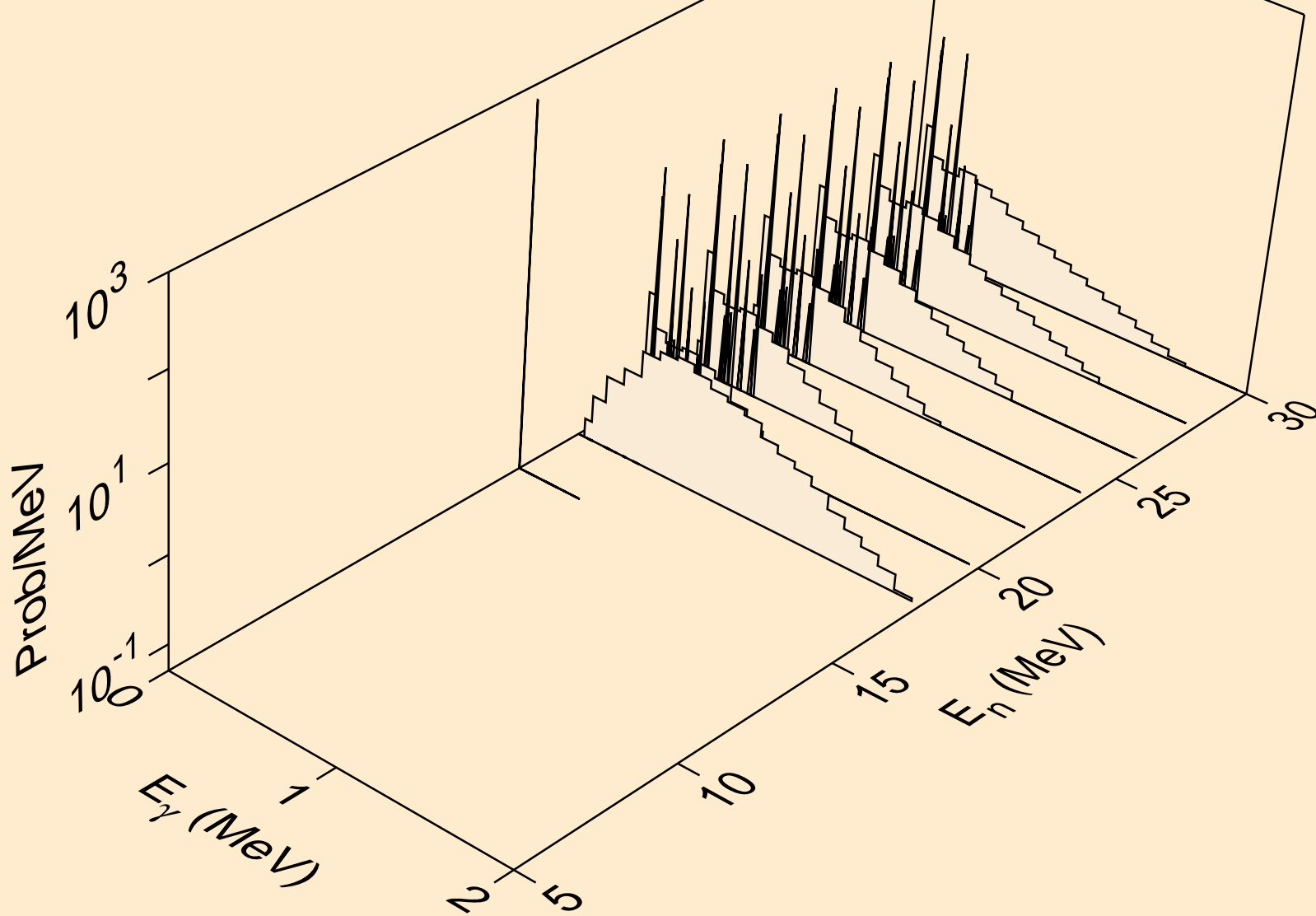

LU176 NEUTRON ACER TENDL-2019 LIBRARY; T=293.16K  
Photon emission for (n,n\*c)

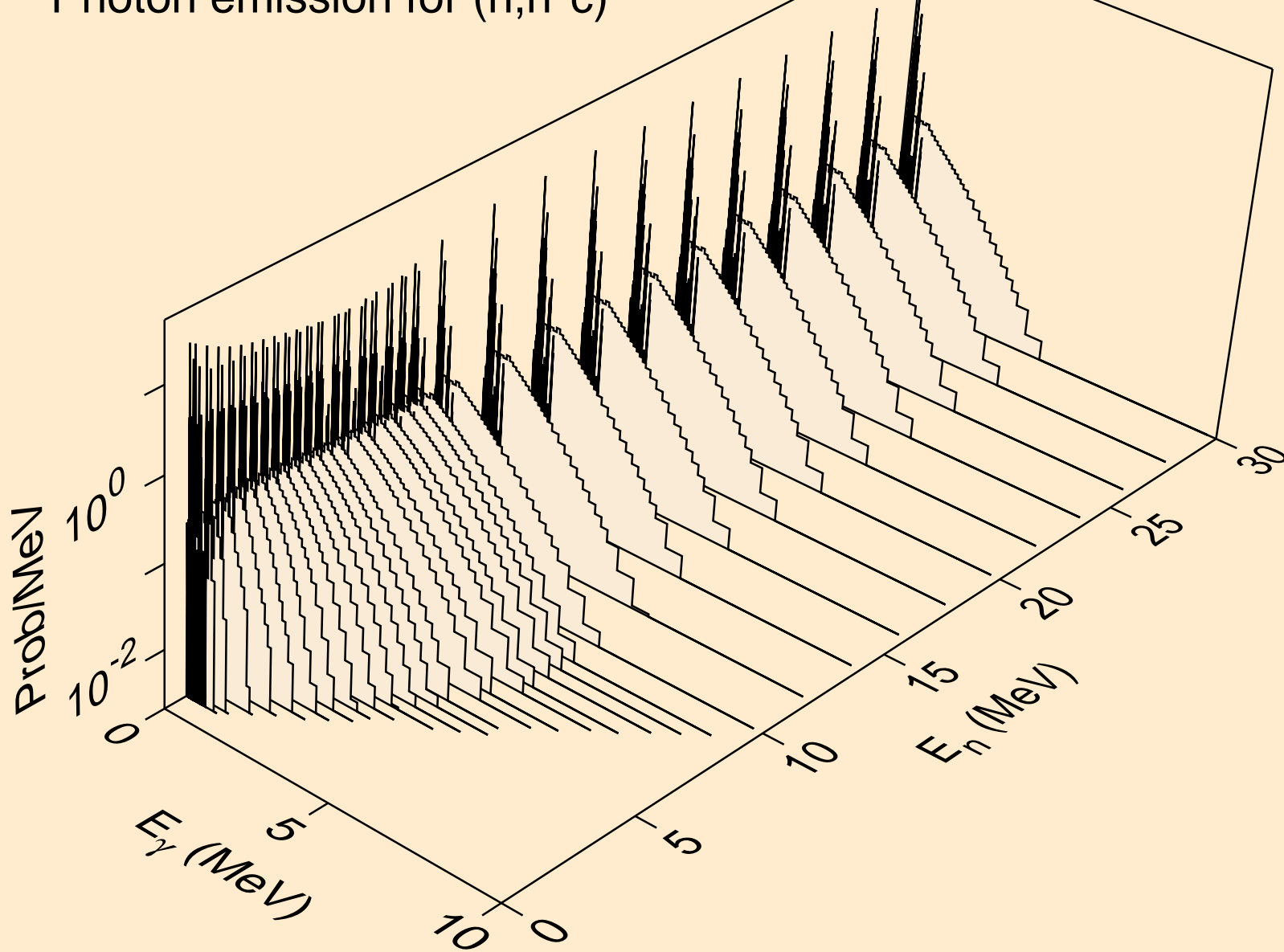



LU176 NEUTRON ACER TENDL-2019 LIBRARY; T=293.16K  
Photon emission for (n,gma)

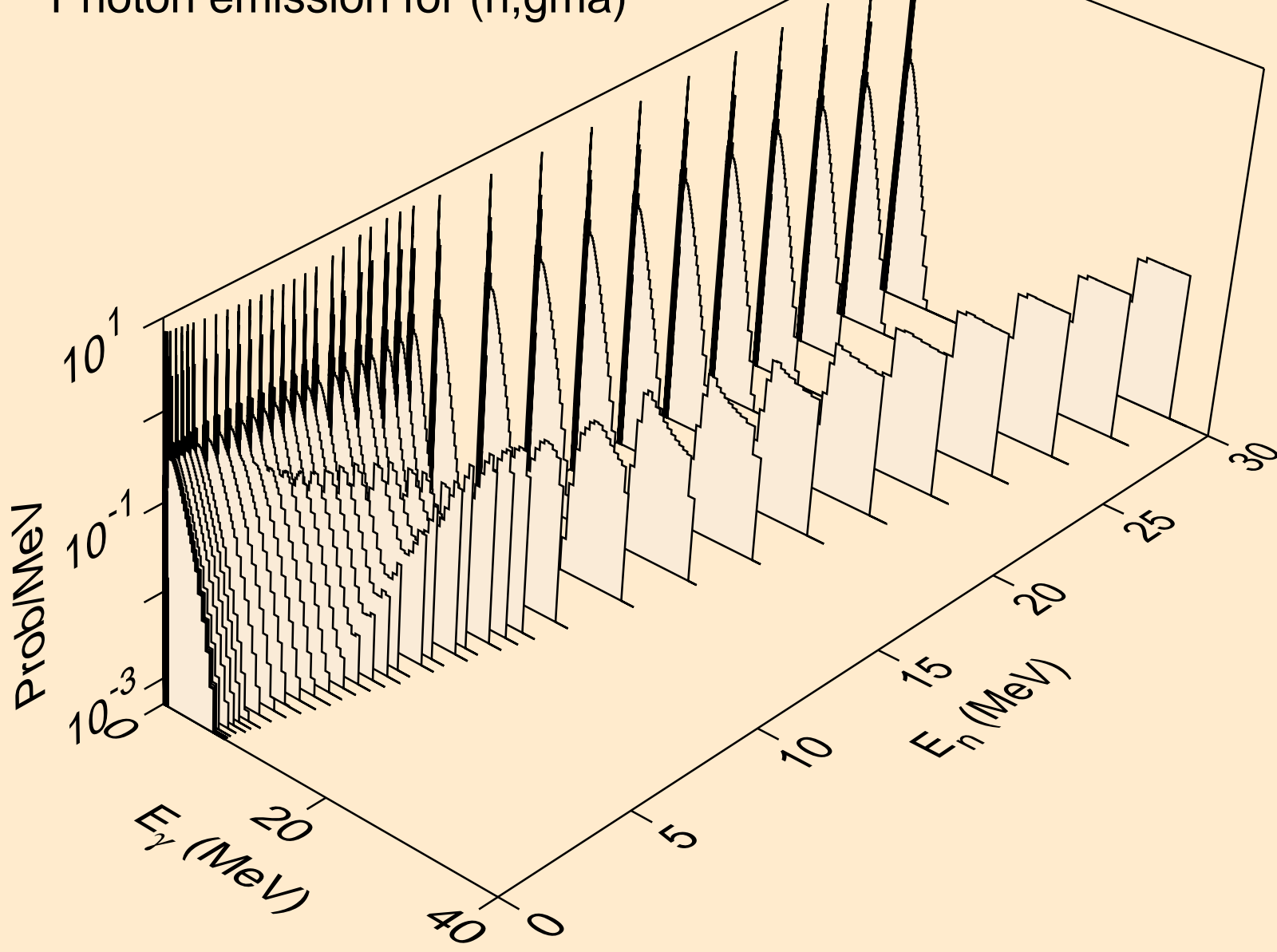

LU176 NEUTRON ACER TENDL-2019 LIBRARY; T=293.16K  
Photon emission for (n,p)

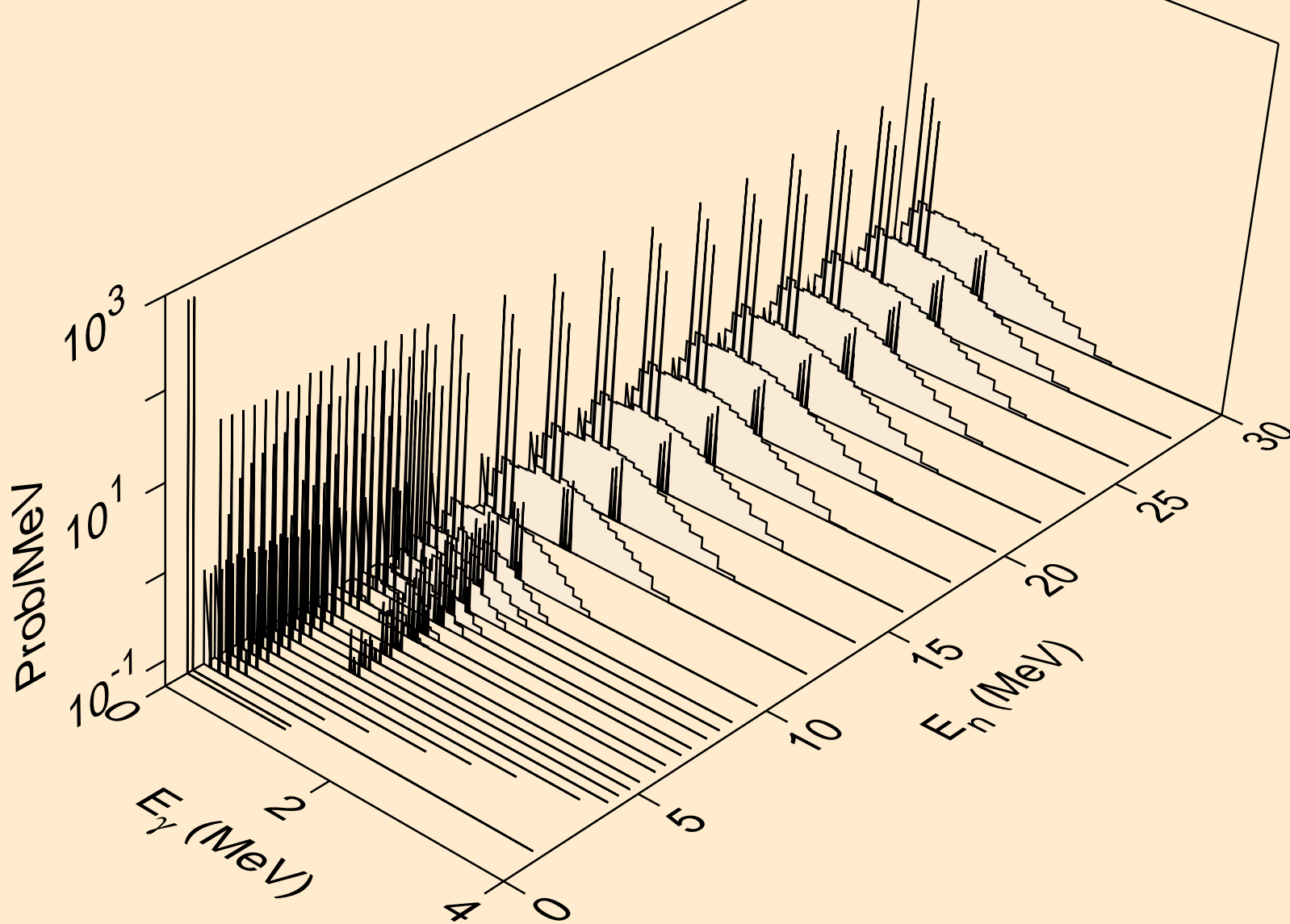

LU176 NEUTRON ACER TENDL-2019 LIBRARY; T=293.16K  
Photon emission for (n,d)

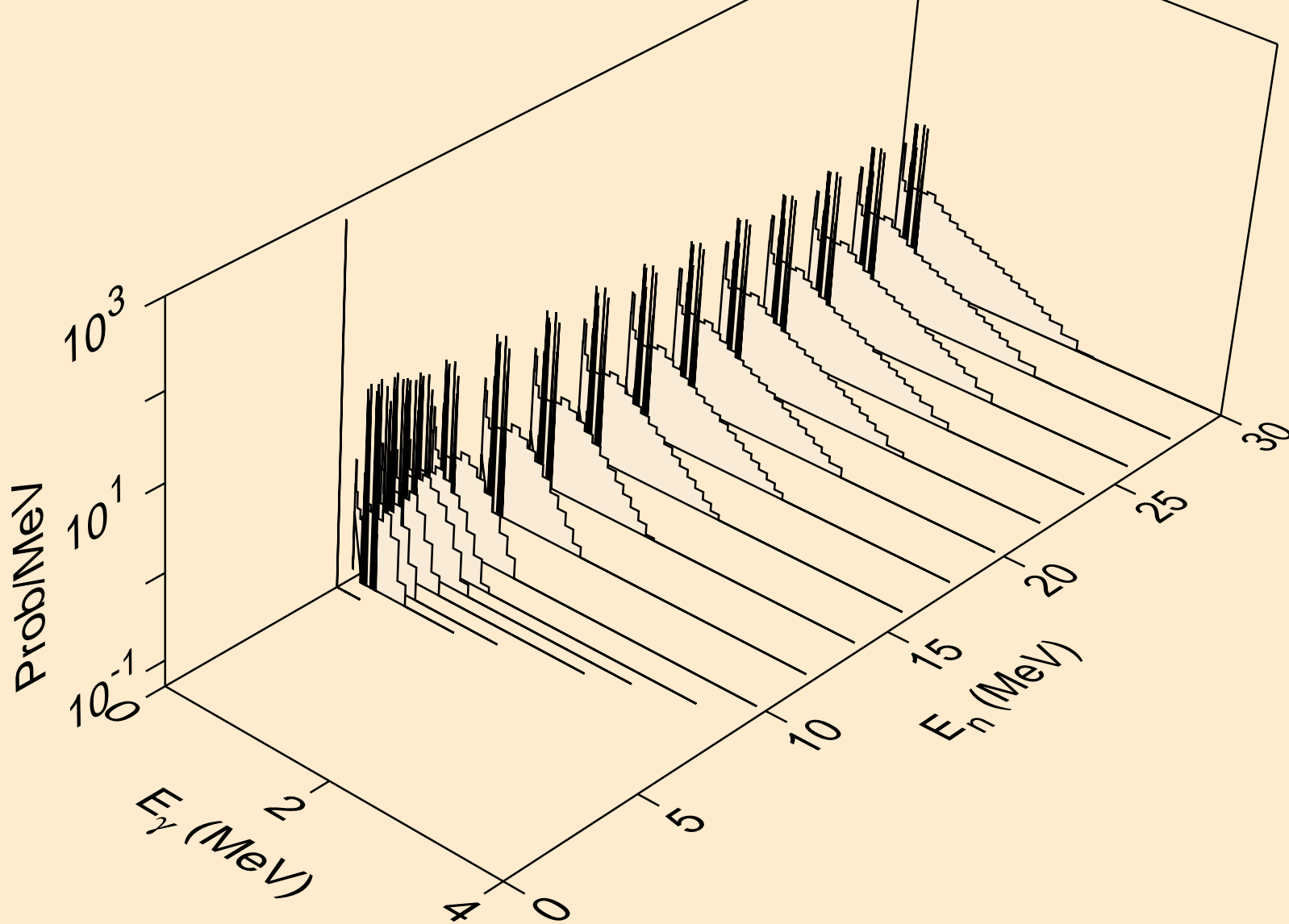

LU176 NEUTRON ACER TENDL-2019 LIBRARY; T=293.16K  
Photon emission for (n,t)

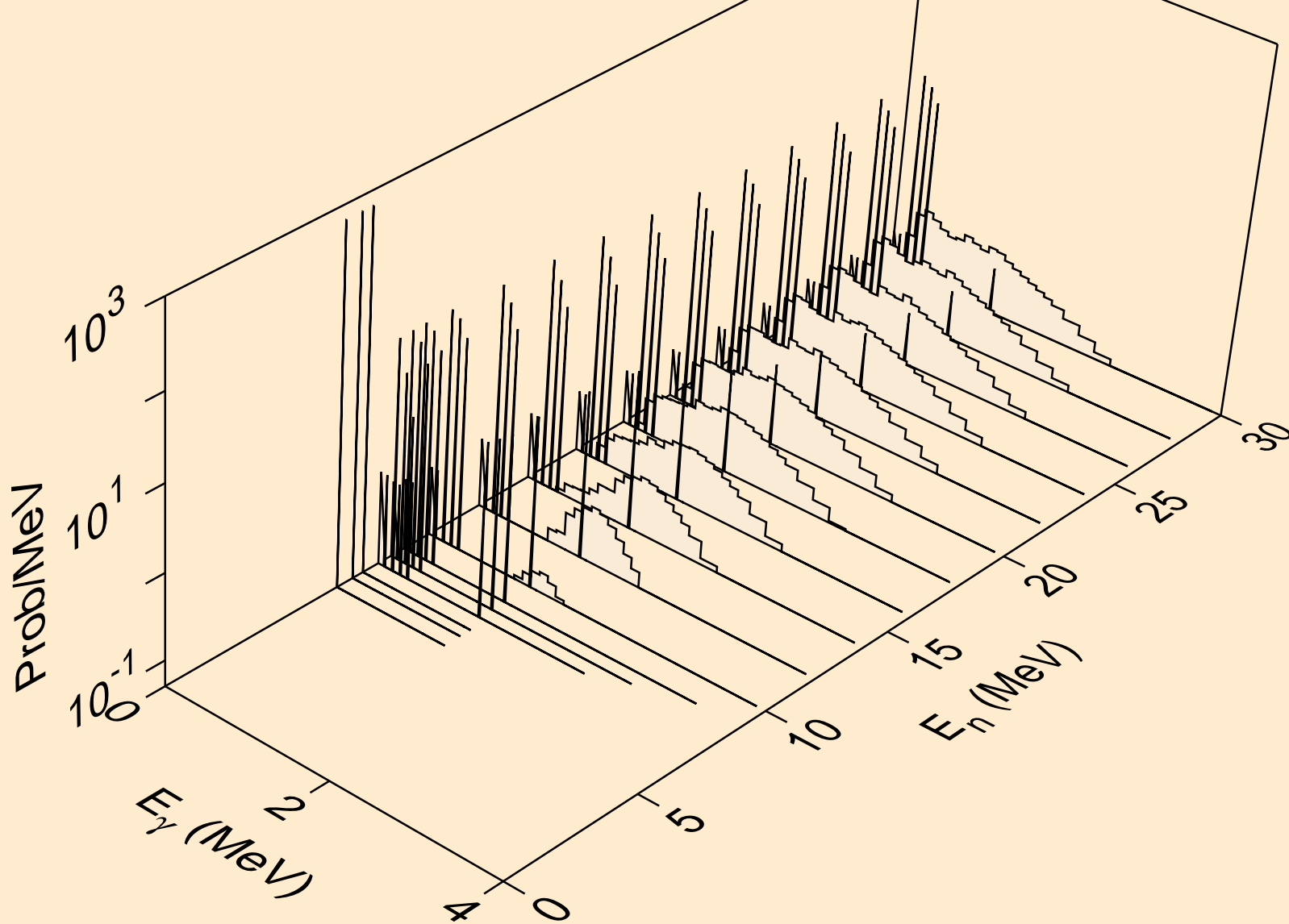

LU176 NEUTRON ACER TENDL-2019 LIBRARY; T=293.16K  
Photon emission for (n,he3)

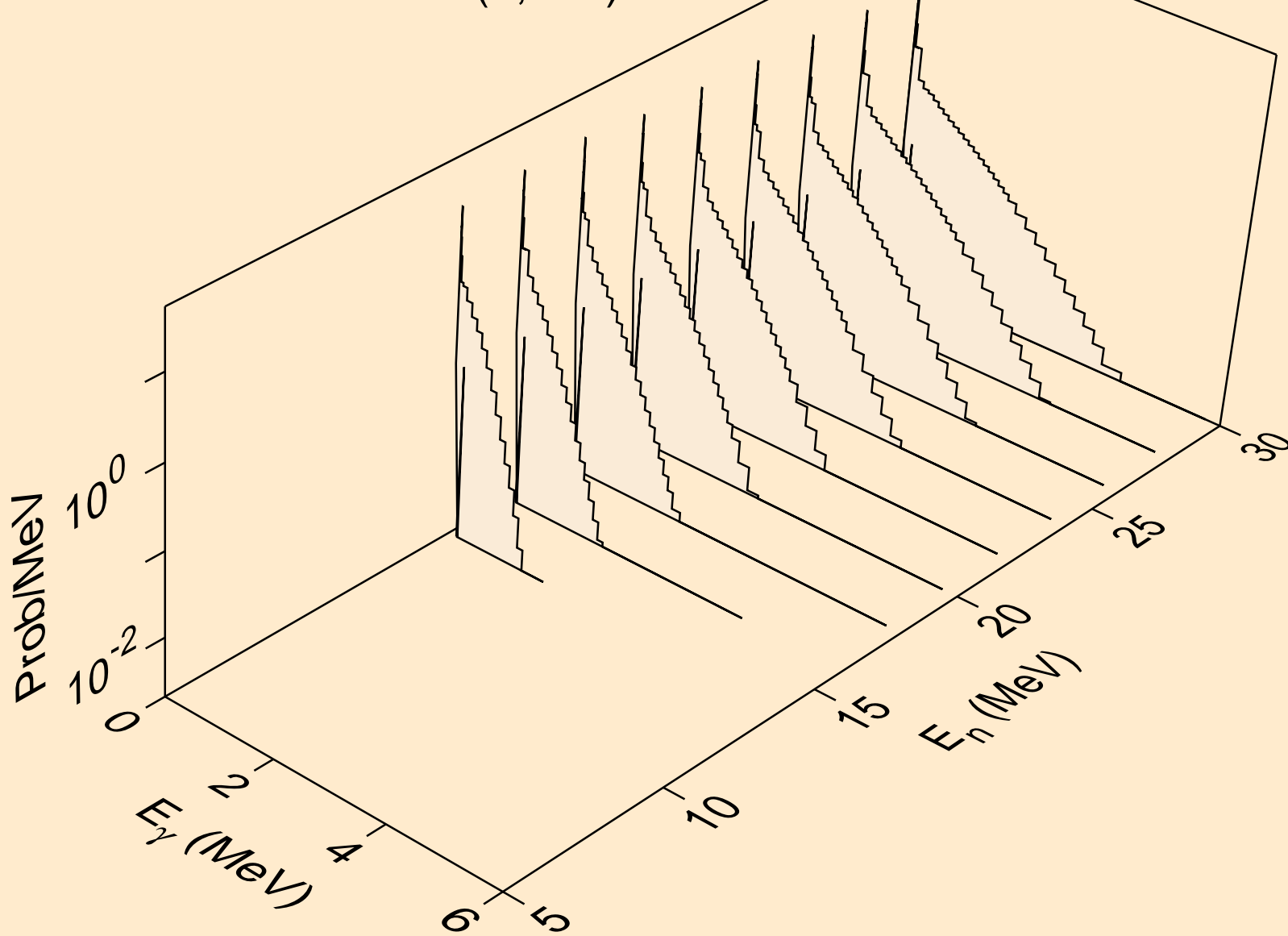

LU176 NEUTRON ACER TENDL-2019 LIBRARY; T=293.16K  
Photon emission for (n,a)

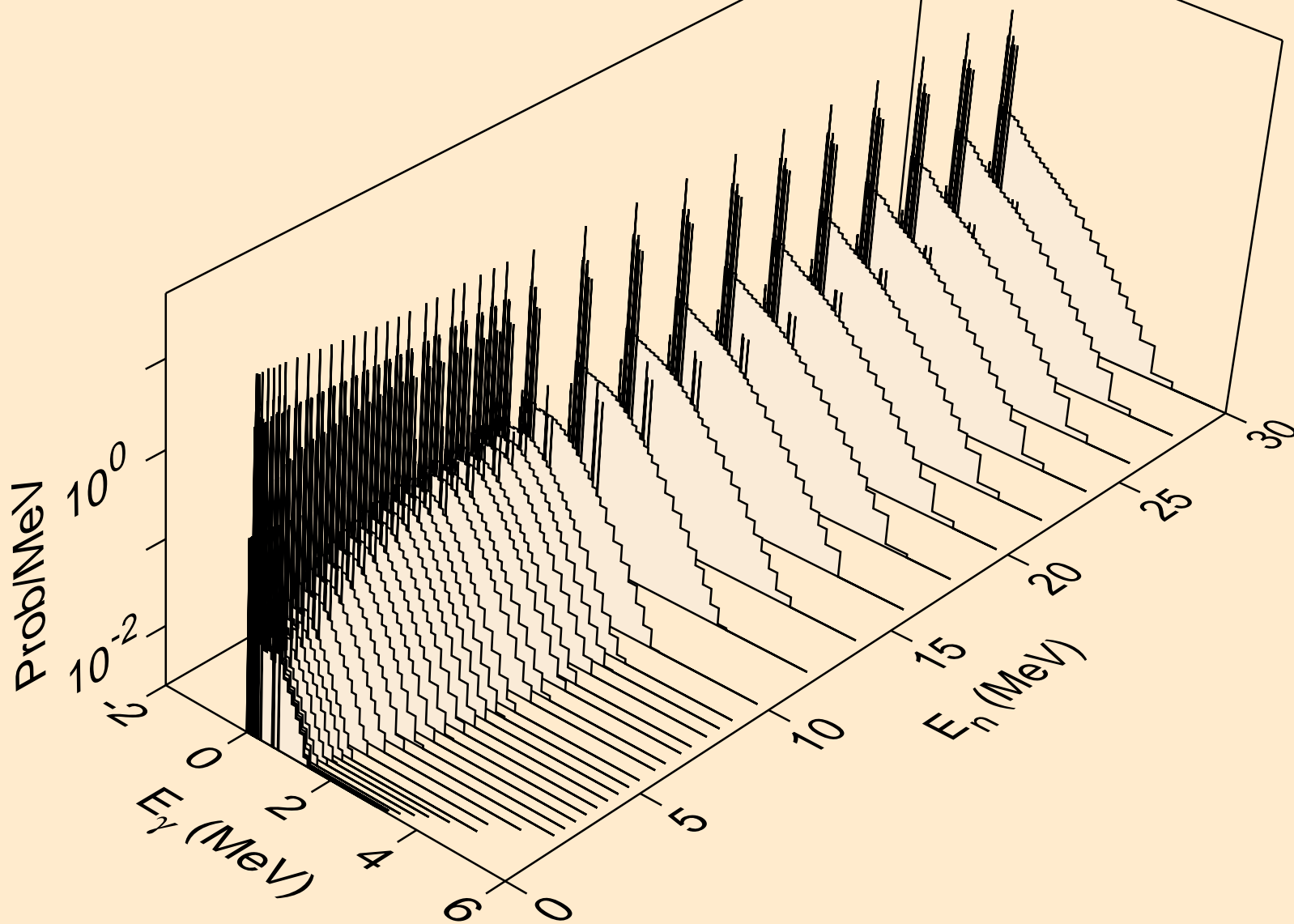

LU176 NEUTRON ACER TENDL-2019 LIBRARY; T=293.16K  
Photon emission for (n,2a)

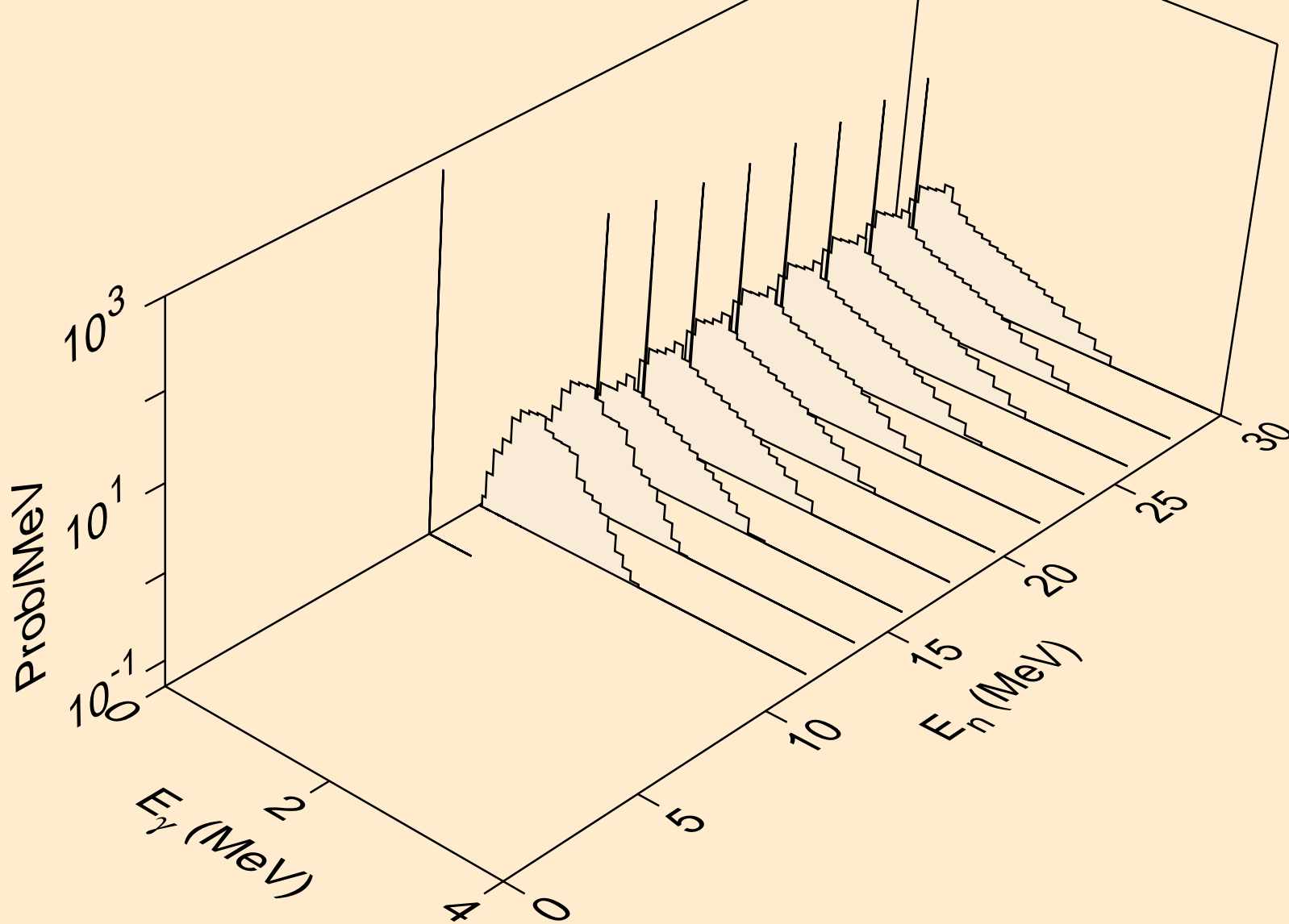

LU176 NEUTRON ACER TENDL-2019 LIBRARY; T=293.16K  
Photon emission for (n,2p)

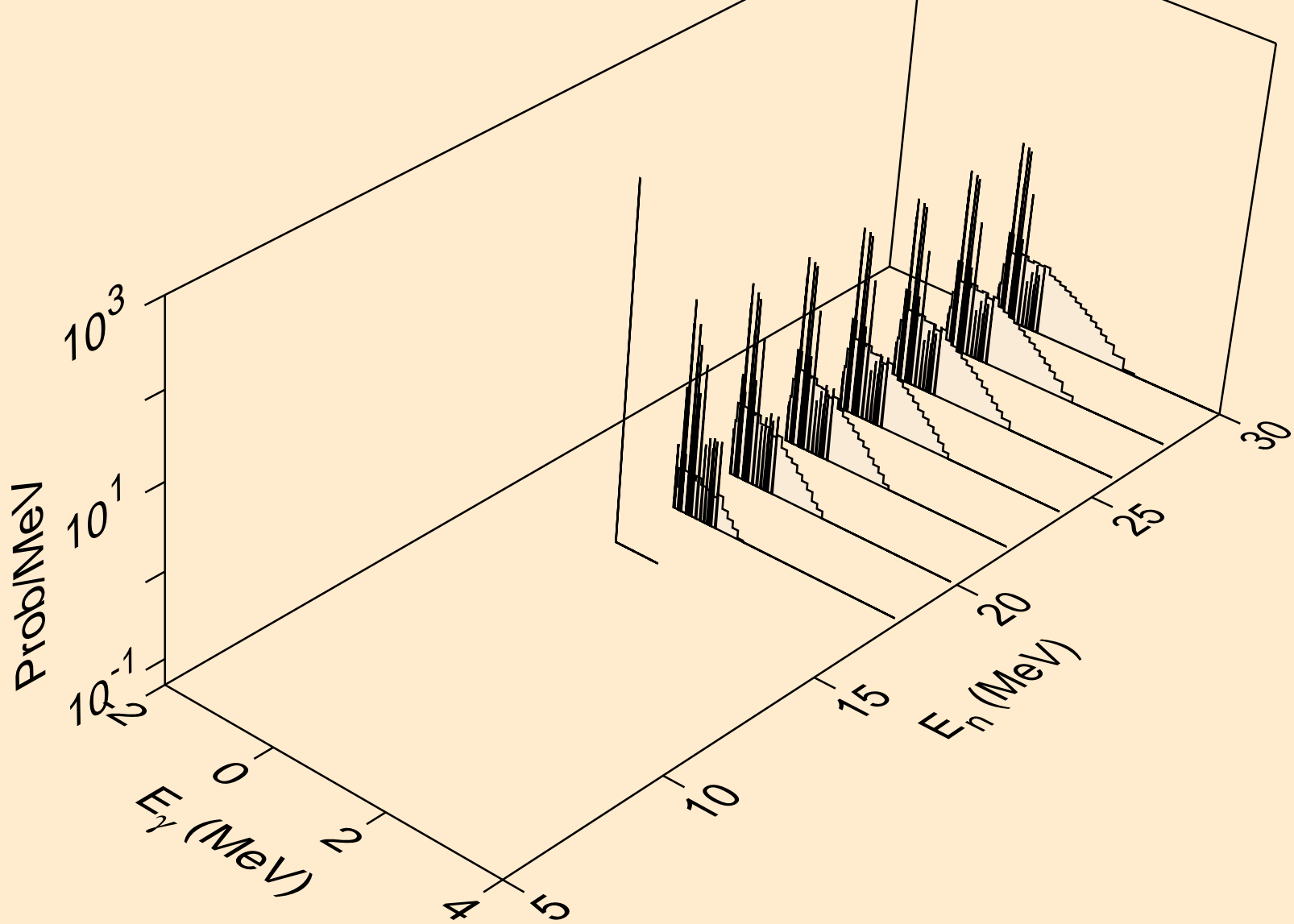



LU176 NEUTRON ACER TENDL-2019 LIBRARY; T=293.16K  
Photon emission for (n,p $\alpha$ )

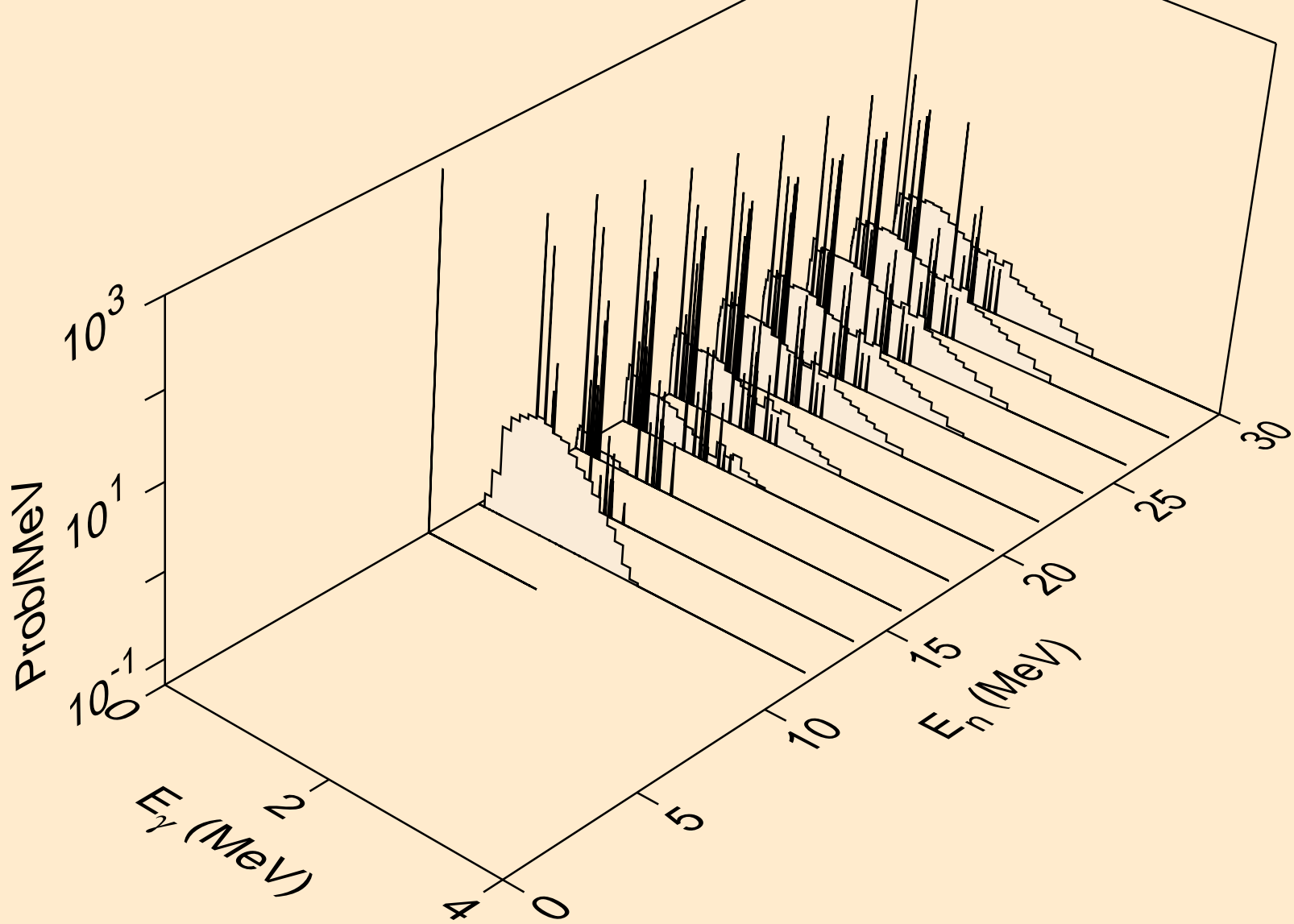

LU176 NEUTRON ACER TENDL-2019 LIBRARY; T=293.16K  
Photon emission for (n,pd)

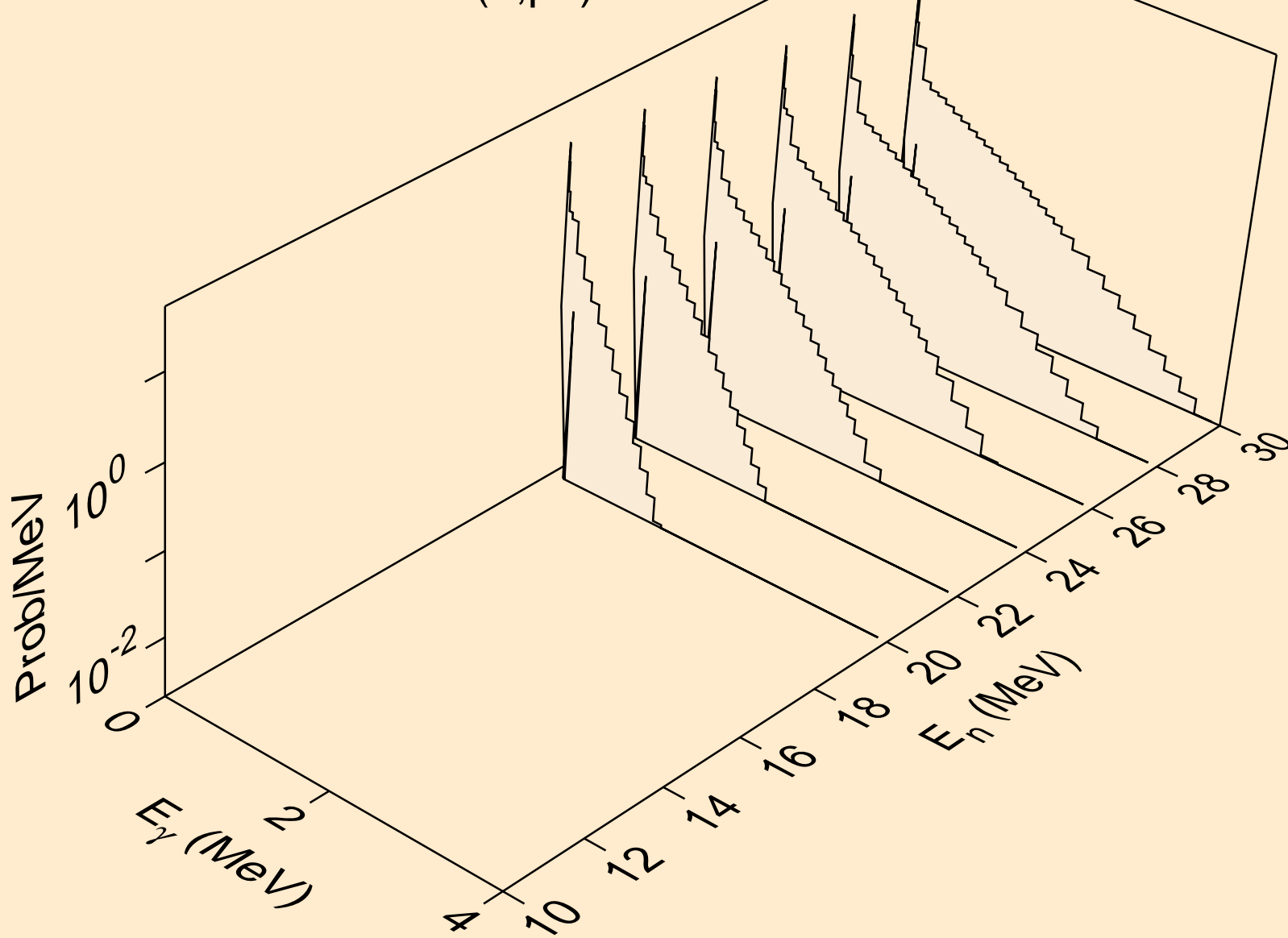

LU176 NEUTRON ACER TENDL-2019 LIBRARY; T=293.16K  
Photon emission for (n,pt)

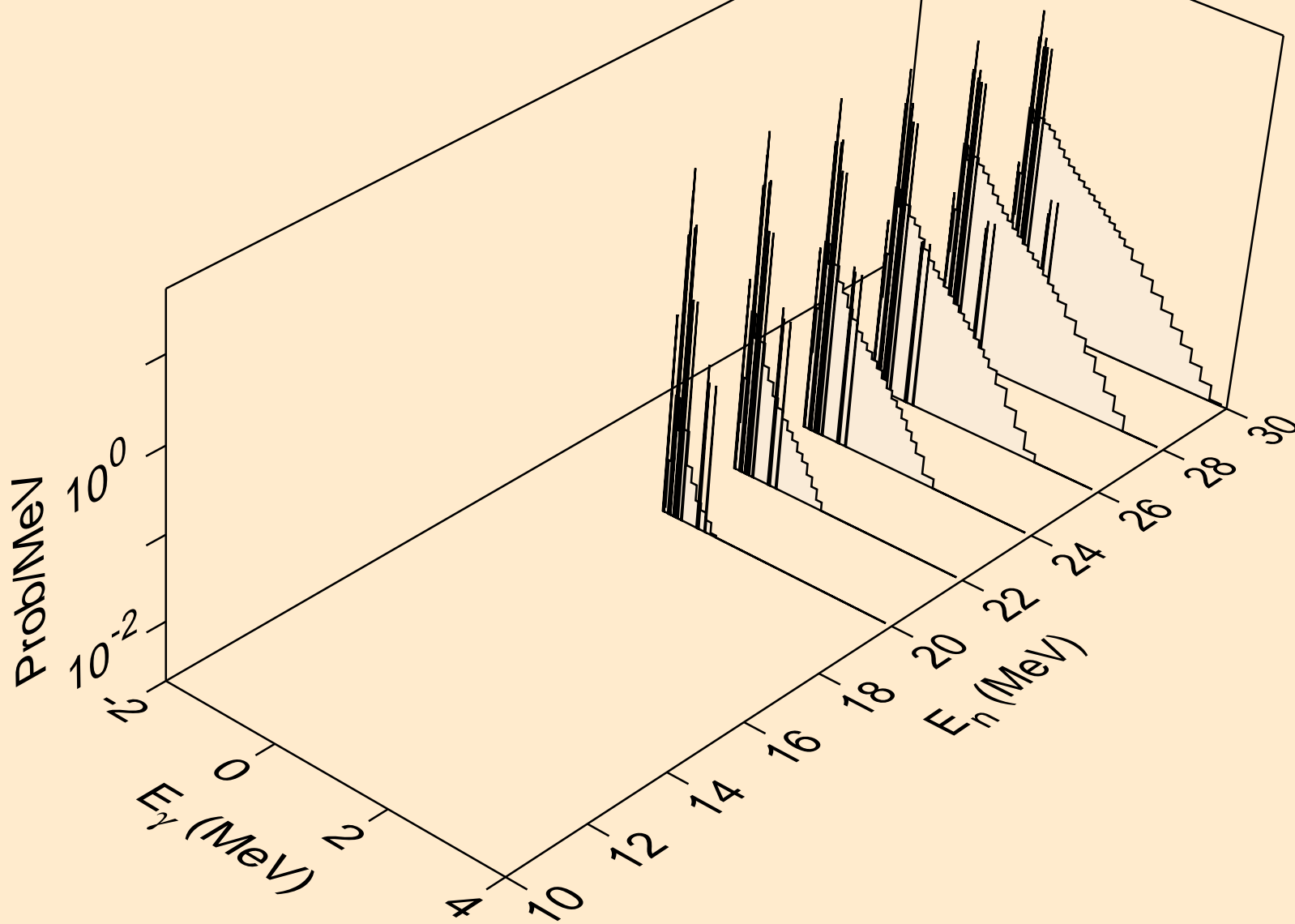

LU176 NEUTRON ACER TENDL-2019 LIBRARY; T=293.16K  
thermal capture photon spectrum

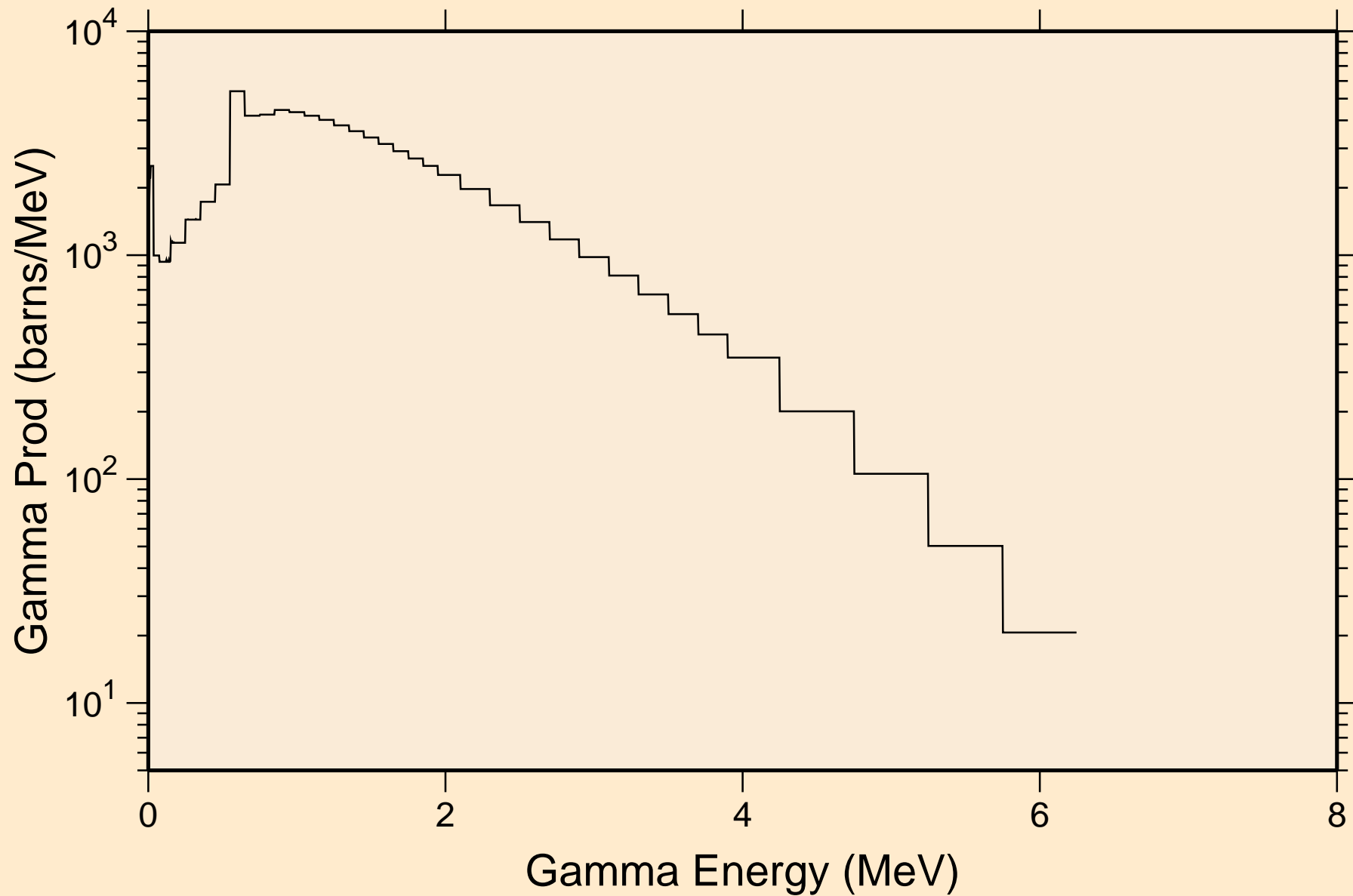

LU176 NEUTRON ACER TENDL-2019 LIBRARY; T=293.16K  
14 MeV photon spectrum

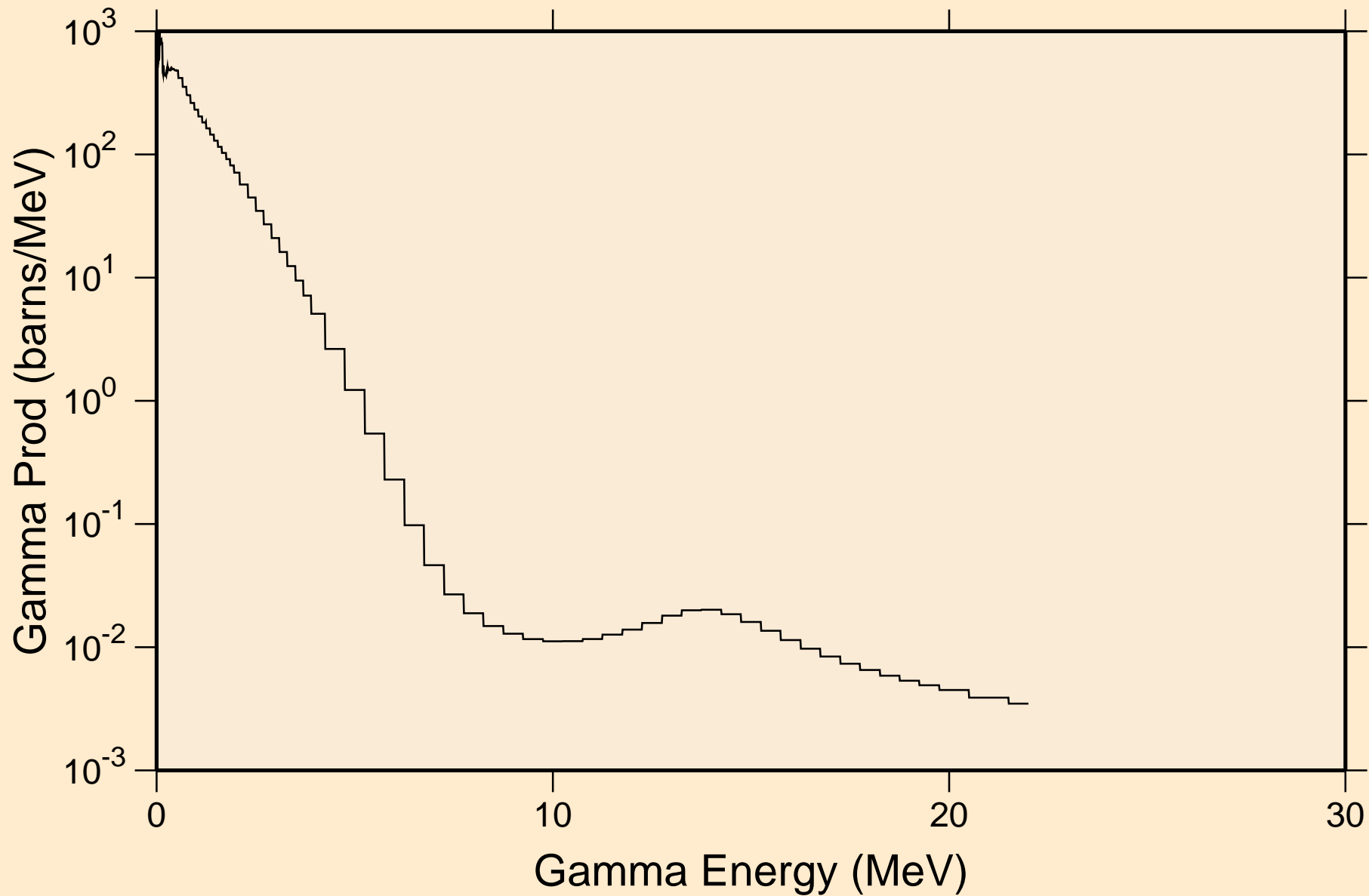

LU176 NEUTRON ACER TENDL-2019 LIBRARY; T=293.16K  
Particle heating contributions

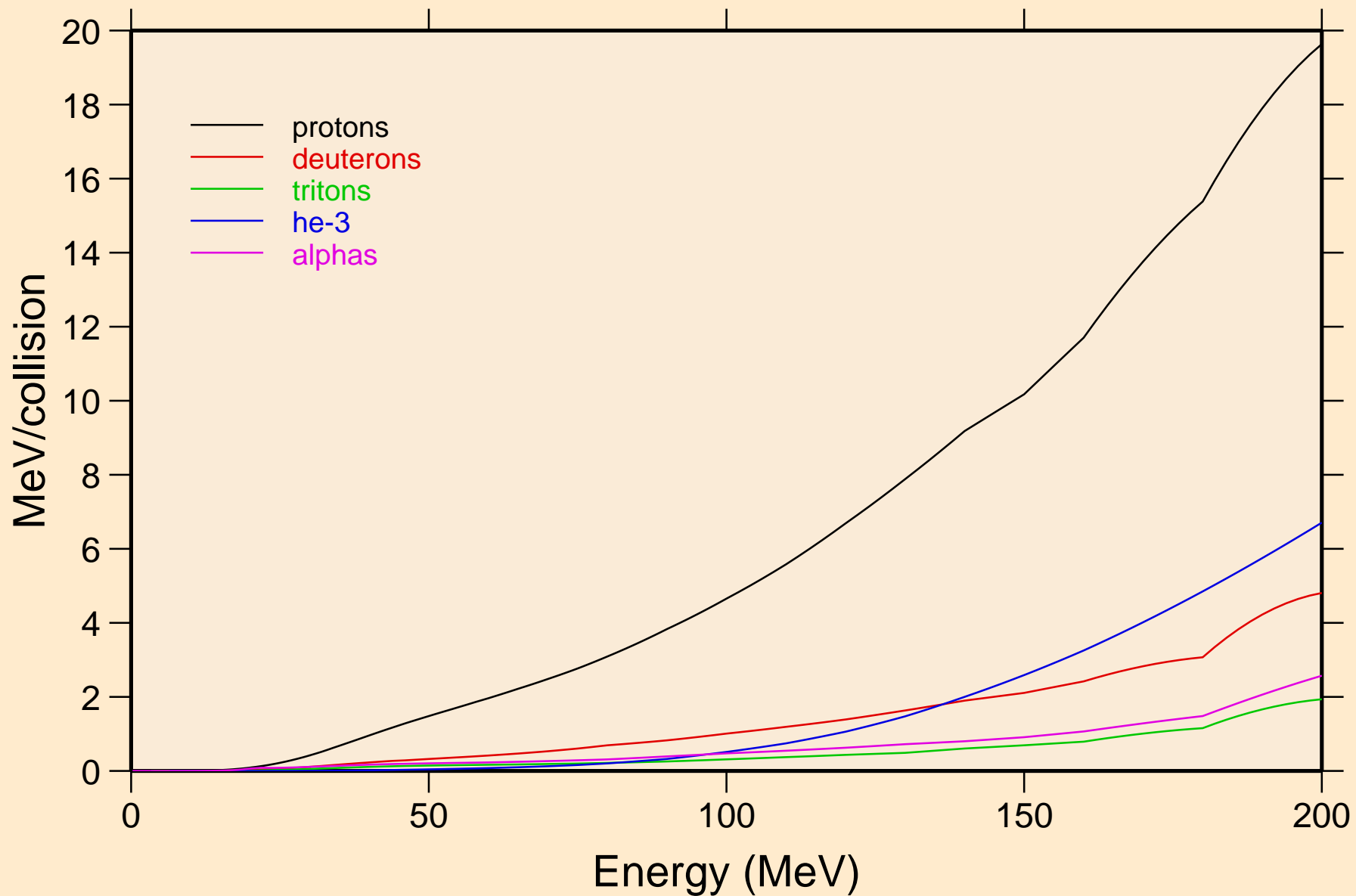

LU176 NEUTRON ACER TENDL-2019 LIBRARY; T=293.16K  
Recoil Heating

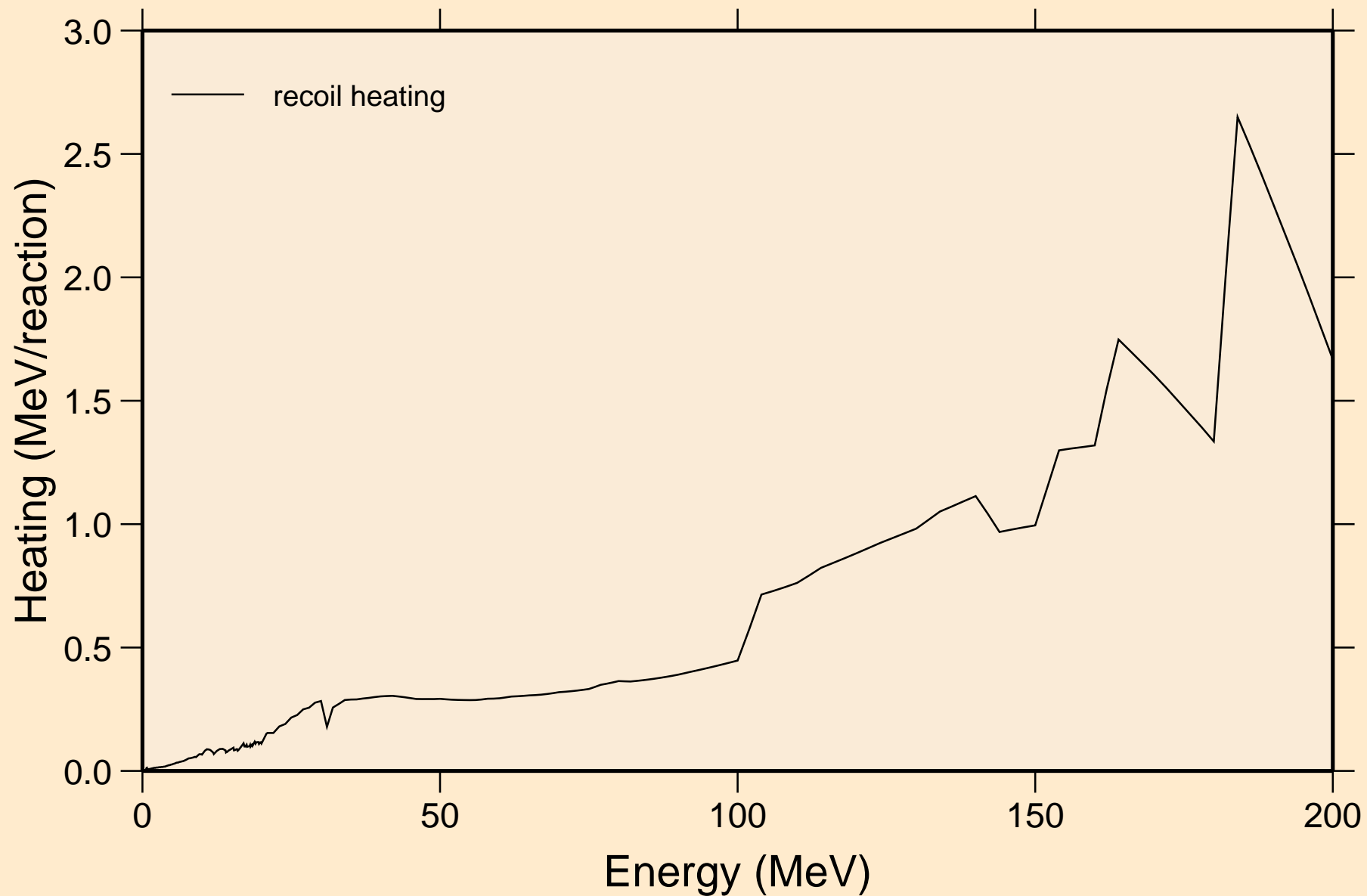

LU176 NEUTRON ACER TENDL-2019 LIBRARY; T=293.16K  
Particle production cross sections

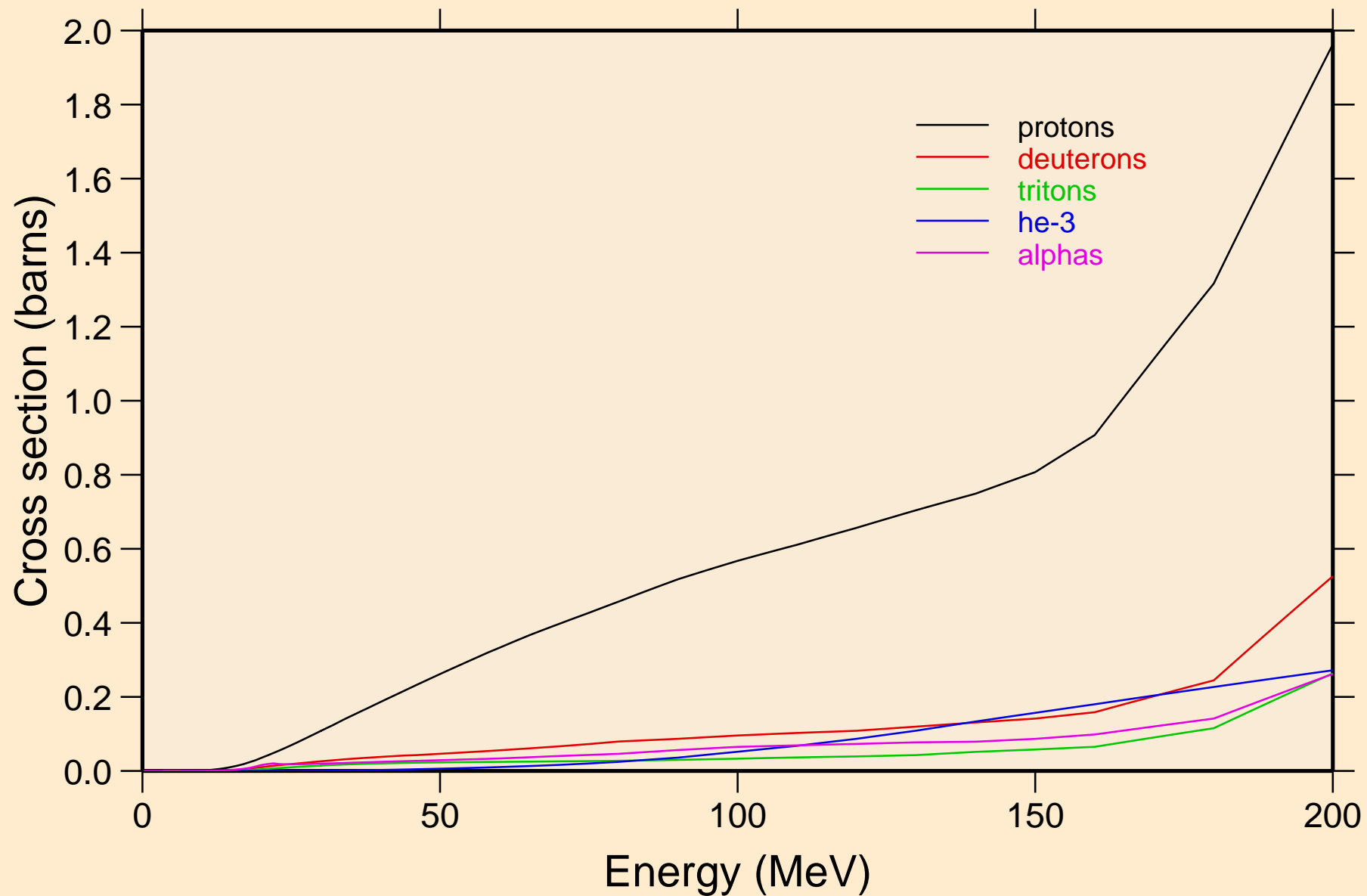



LU176 NEUTRON ACER TENDL-2019 LIBRARY; T=293.16K  
protons from (n,x)

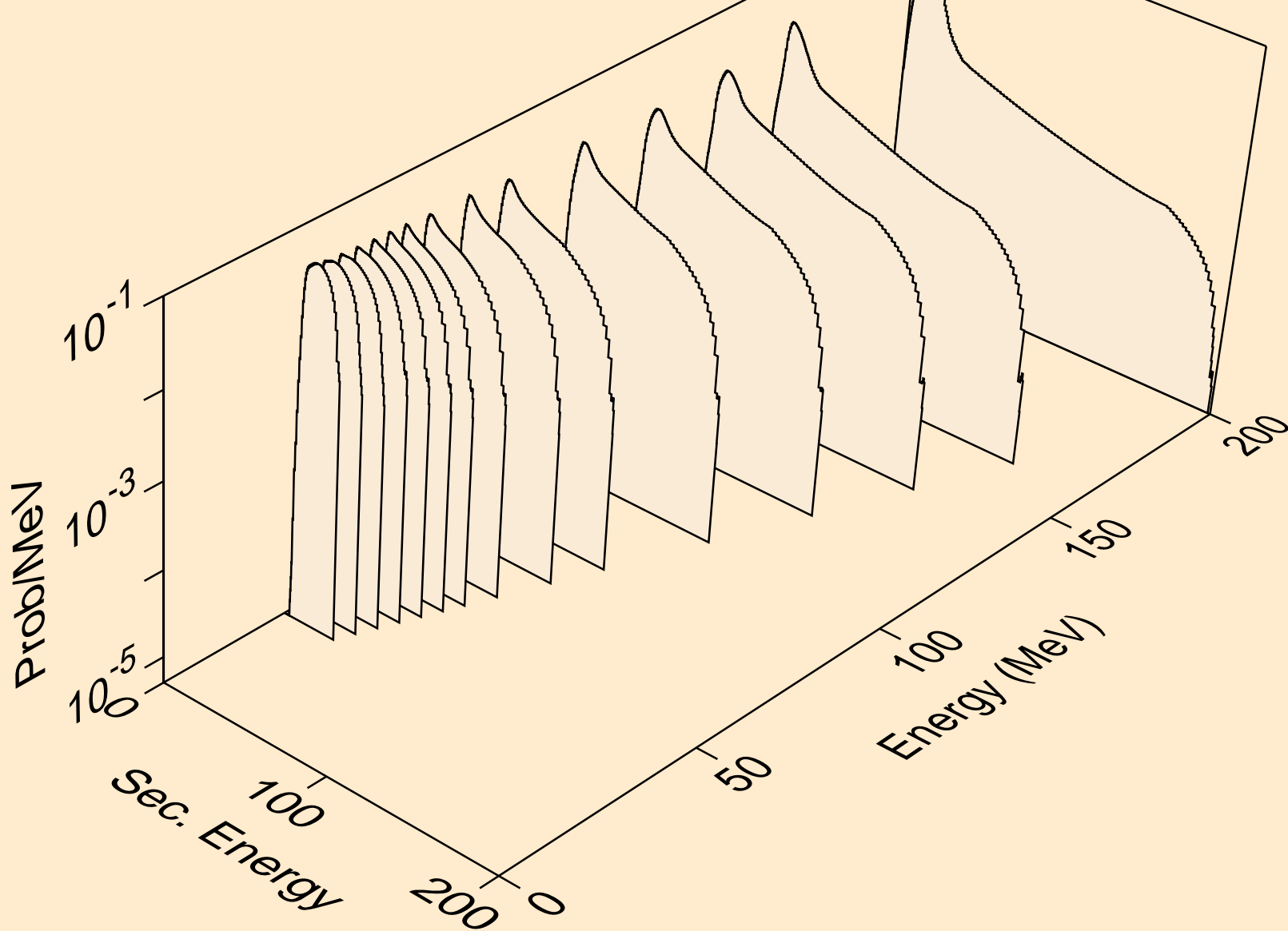

LU176 NEUTRON ACER TENDL-2019 LIBRARY; T=293.16K  
protons from (n,n\*)p

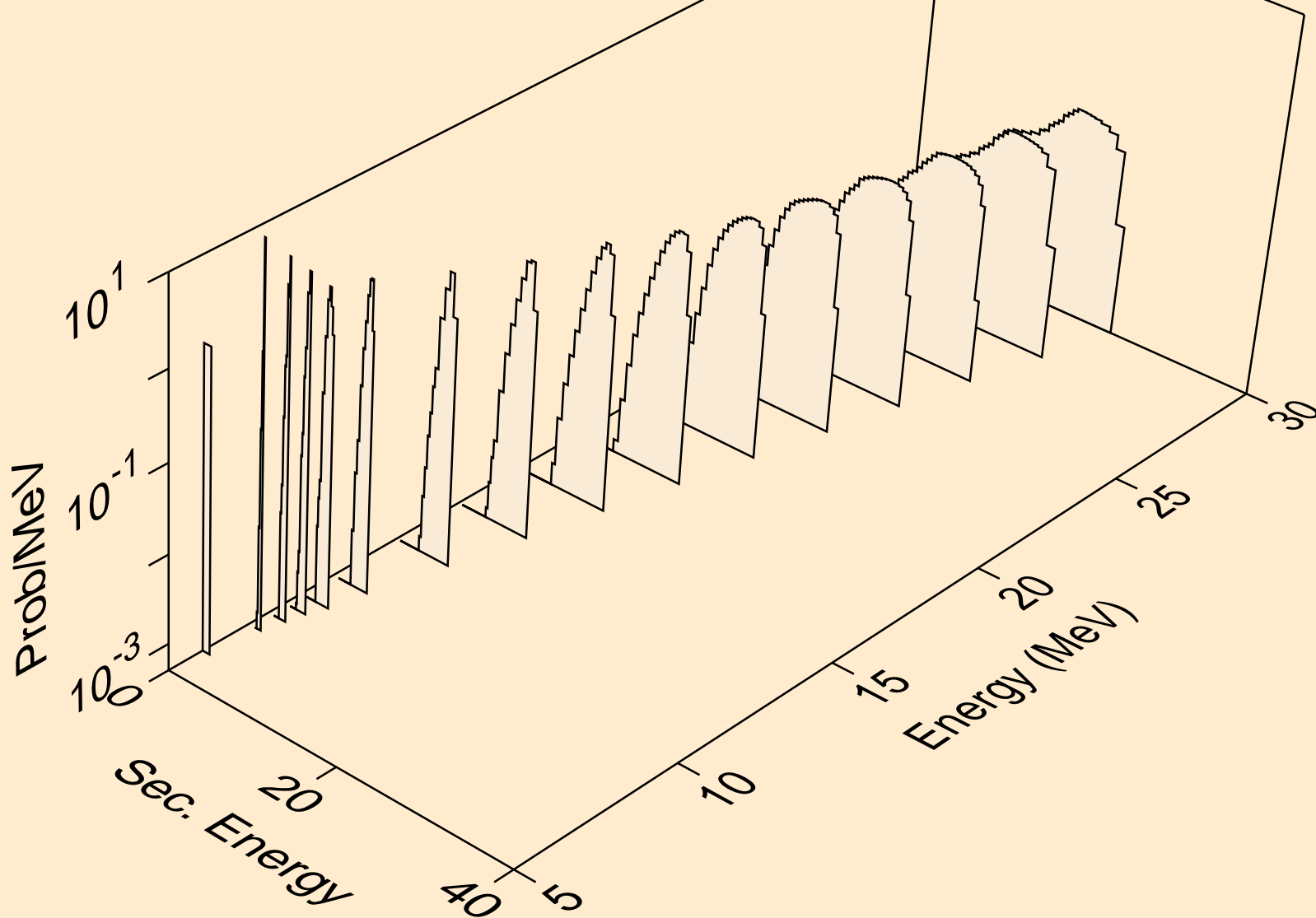

LU176 NEUTRON ACER TENDL-2019 LIBRARY; T=293.16K  
protons from (n,2np)

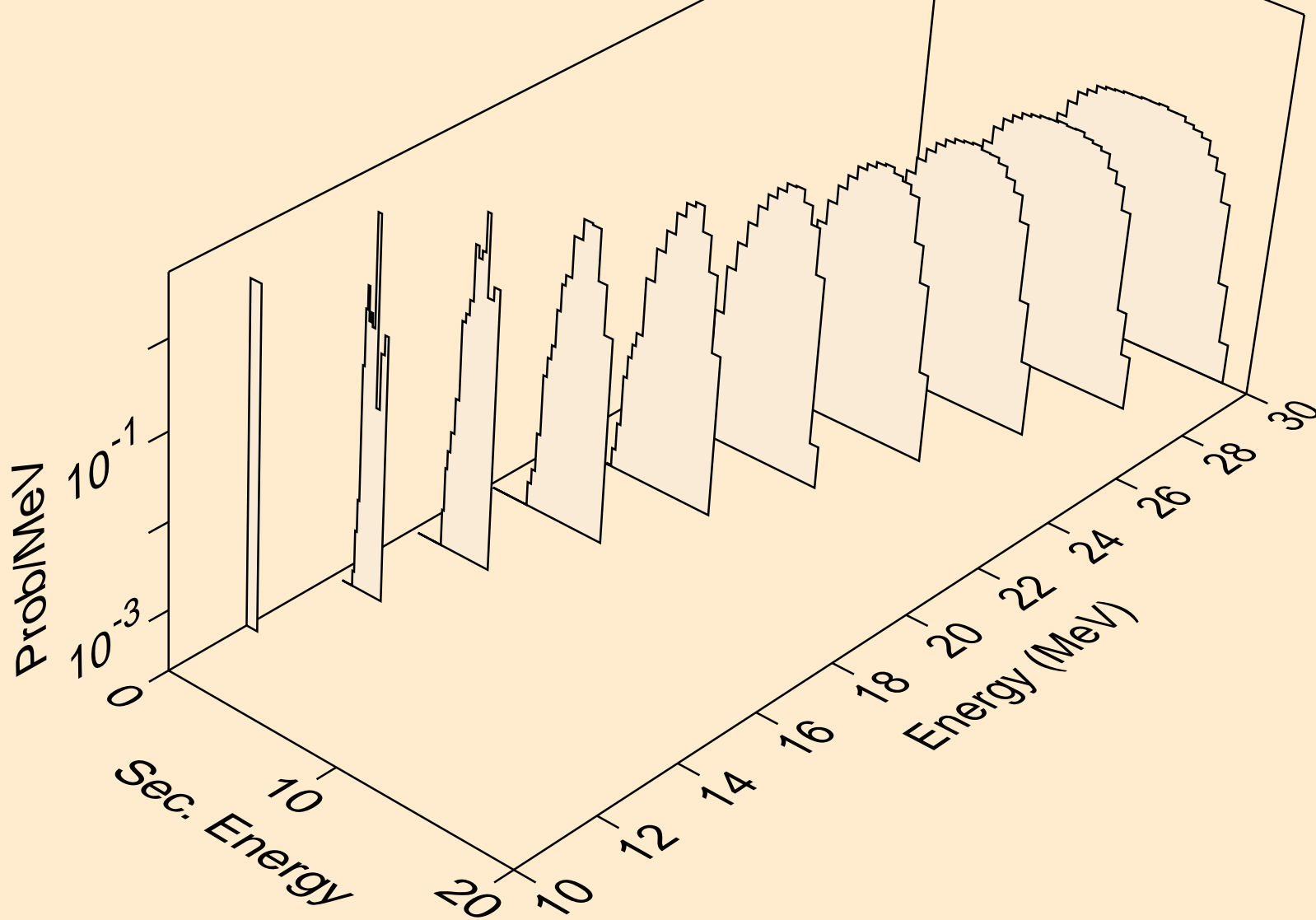

LU176 NEUTRON ACER TENDL-2019 LIBRARY; T=293.16K  
protons from (n,3np)

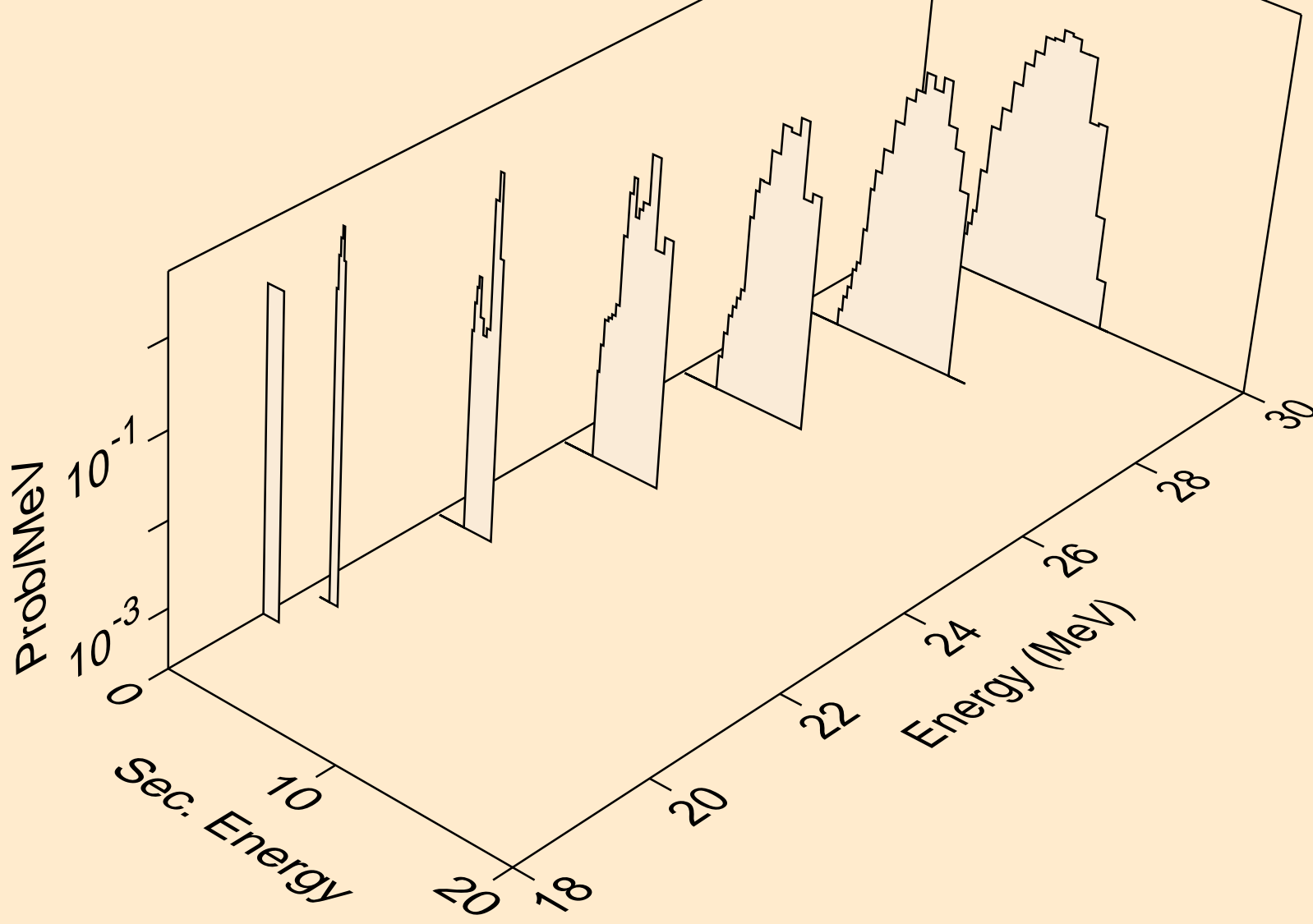

LU176 NEUTRON ACER TENDL-2019 LIBRARY; T=293.16K  
protons from (n,2np)

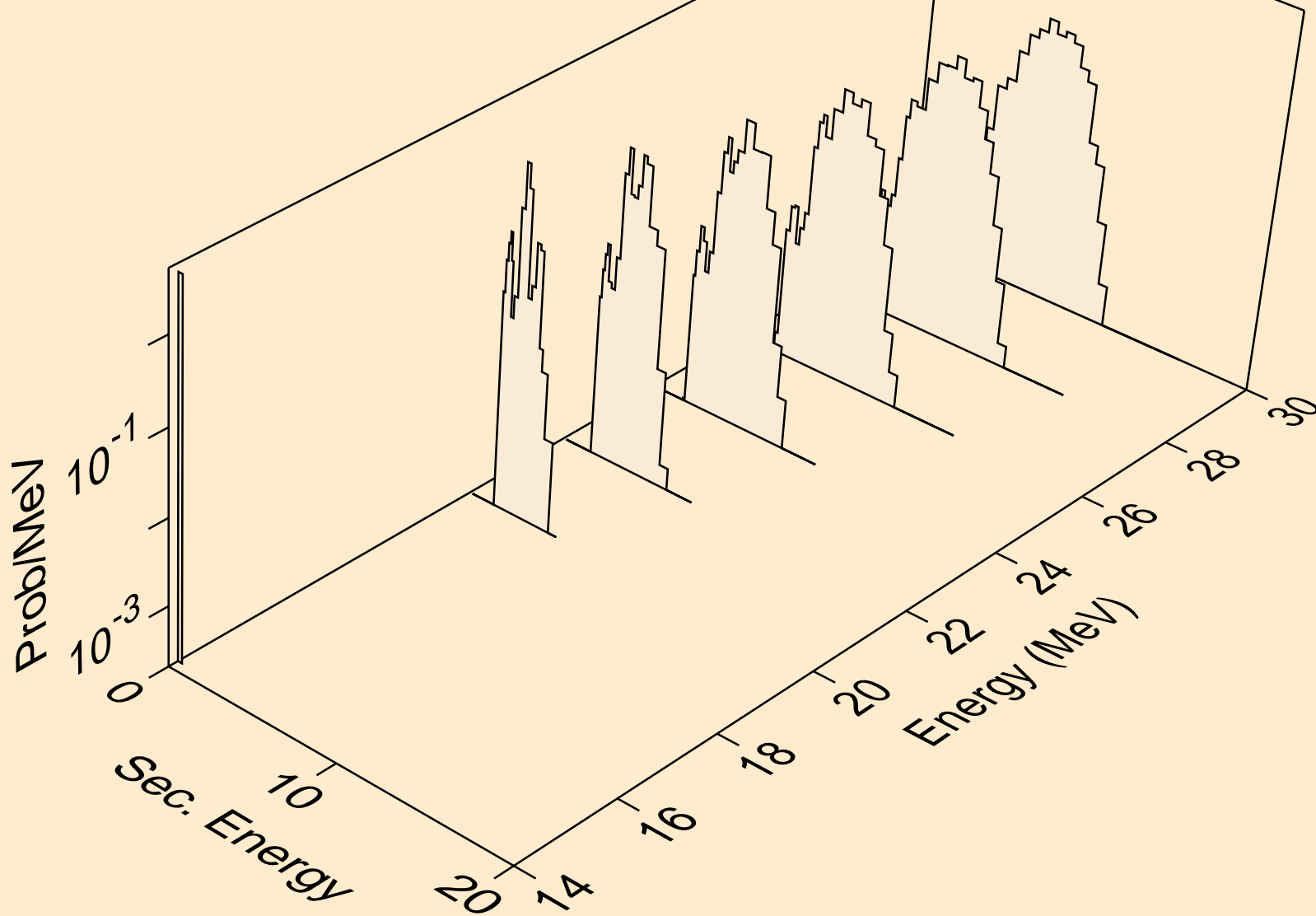

LU176 NEUTRON ACER TENDL-2019 LIBRARY; T=293.16K  
protons from (n,npa)

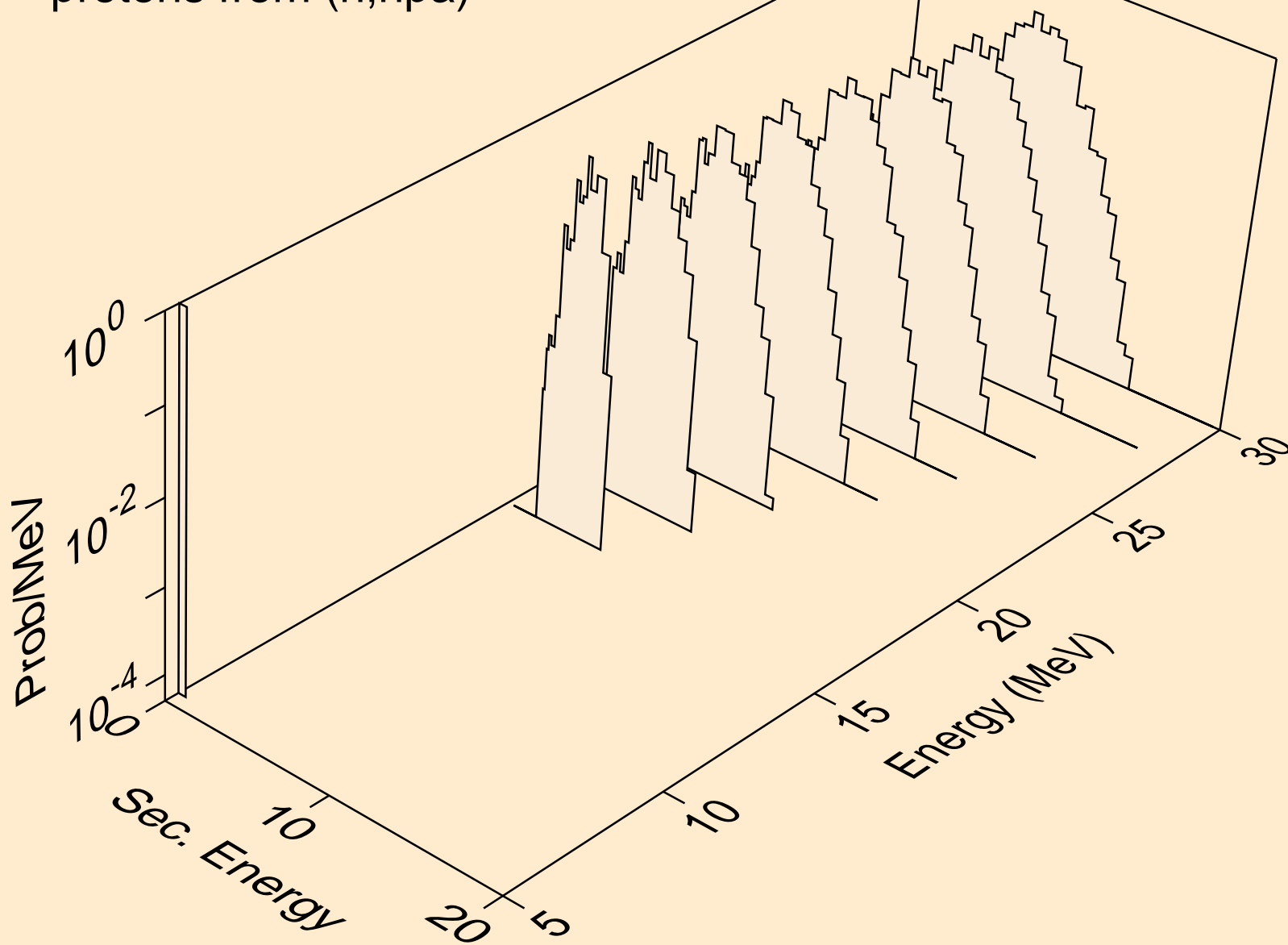

LU176 NEUTRON ACER TENDL-2019 LIBRARY; T=293.16K  
protons from (n,p)

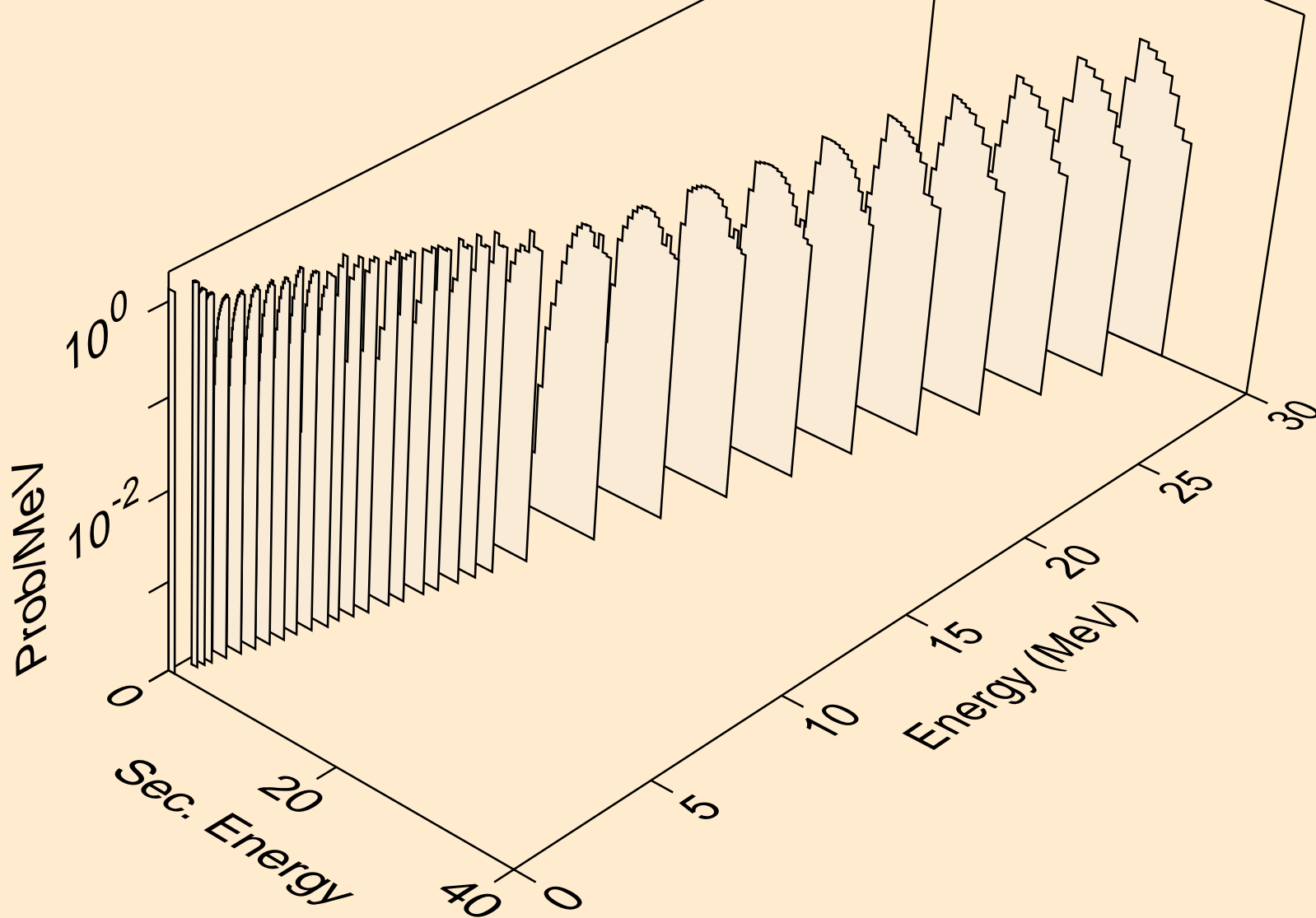

LU176 NEUTRON ACER TENDL-2019 LIBRARY; T=293.16K  
protons from (n,2p)

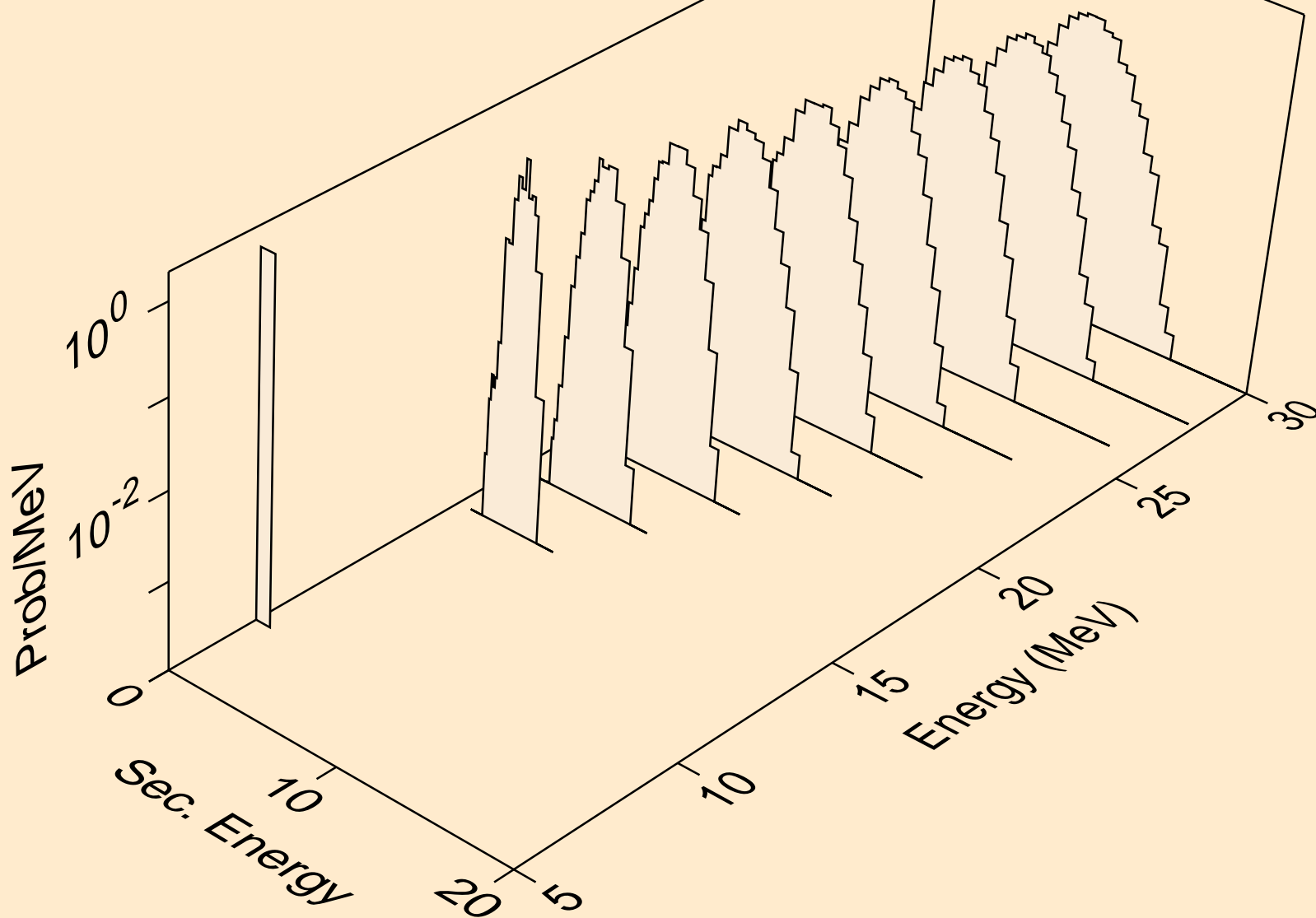



LU176 NEUTRON ACER TENDL-2019 LIBRARY; T=293.16K  
protons from (n,p)

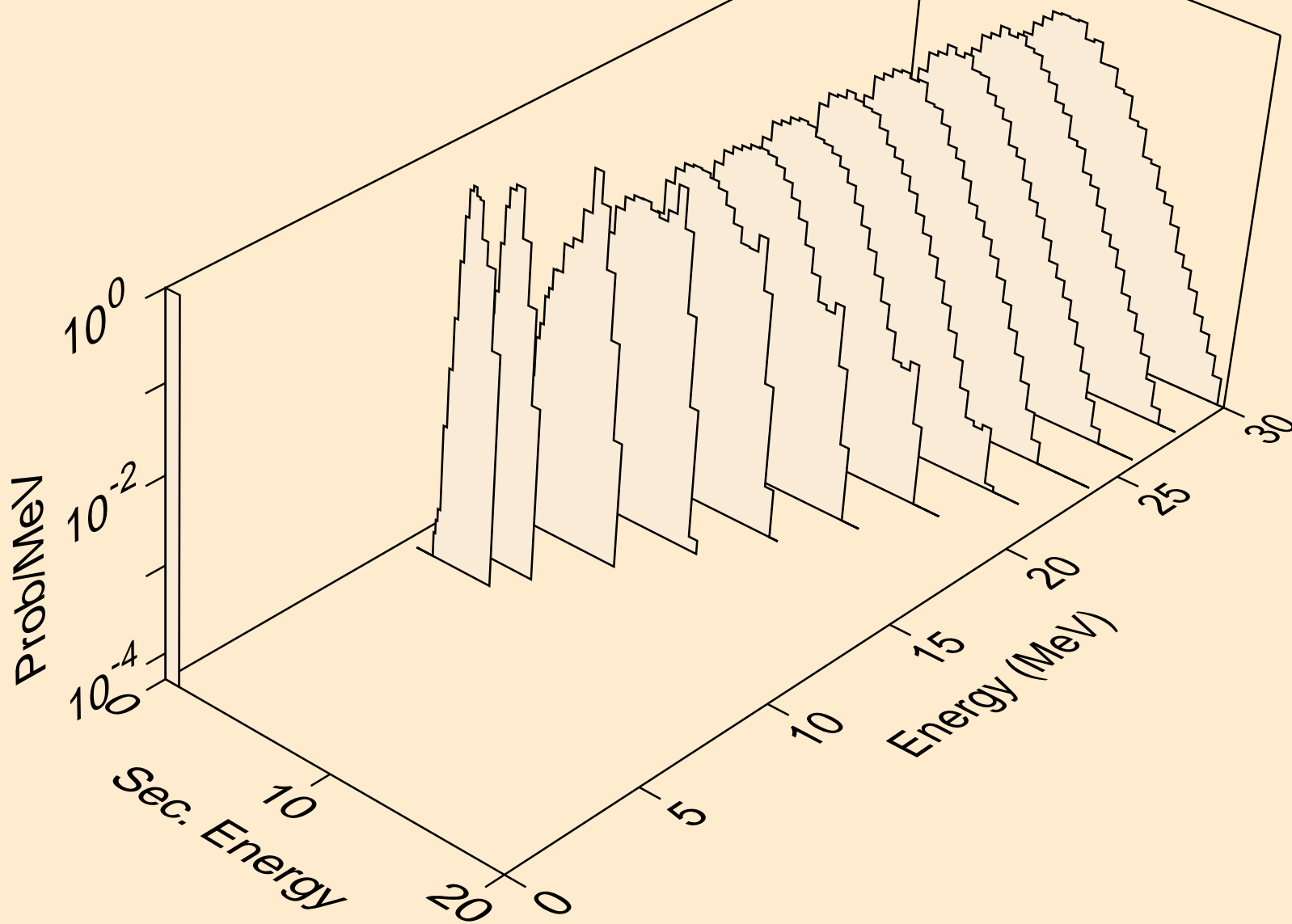

LU176 NEUTRON ACER TENDL-2019 LIBRARY; T=293.16K  
protons from (n,pd)

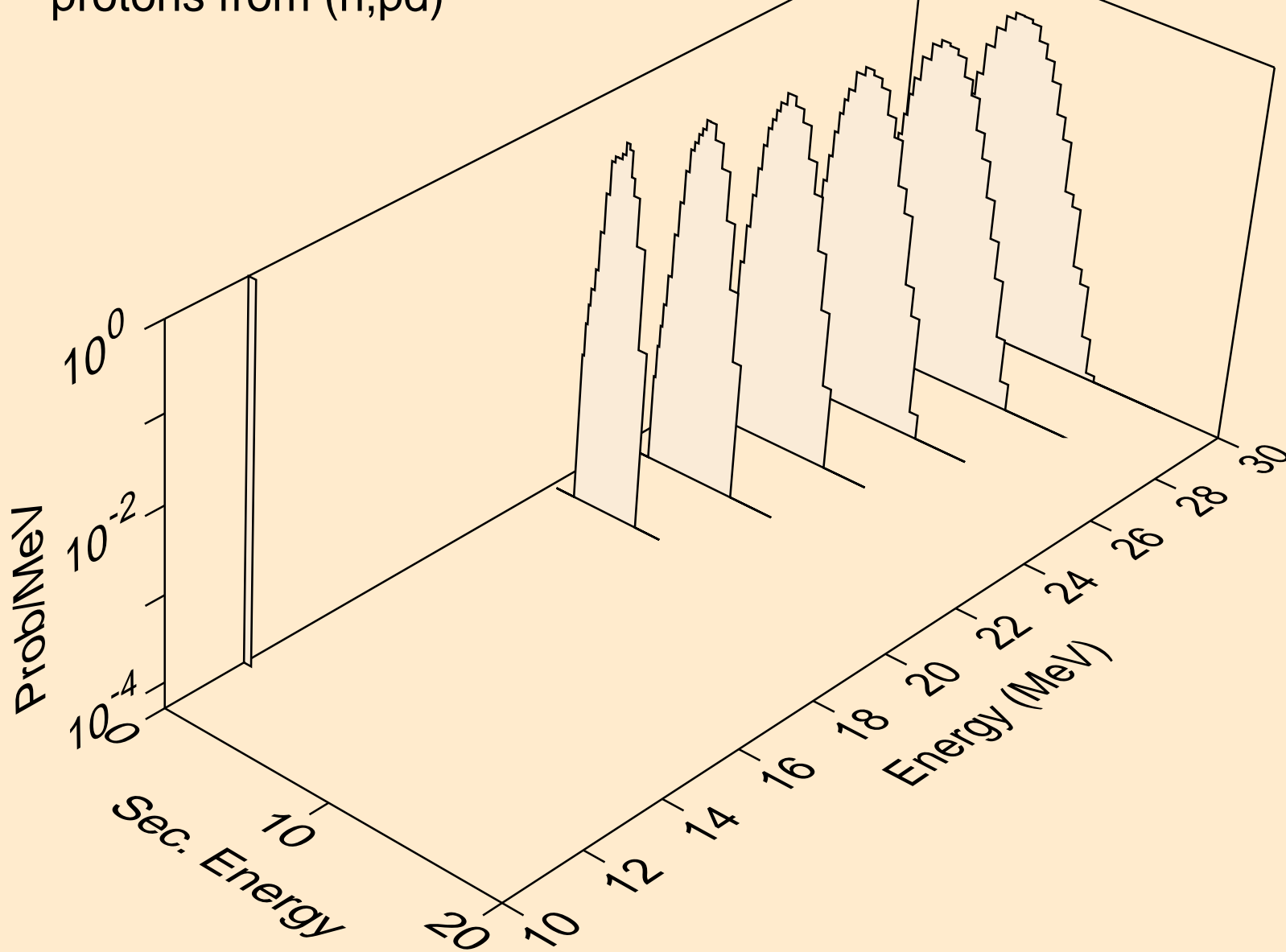

LU176 NEUTRON ACER TENDL-2019 LIBRARY; T=293.16K  
protons from (n,pt)

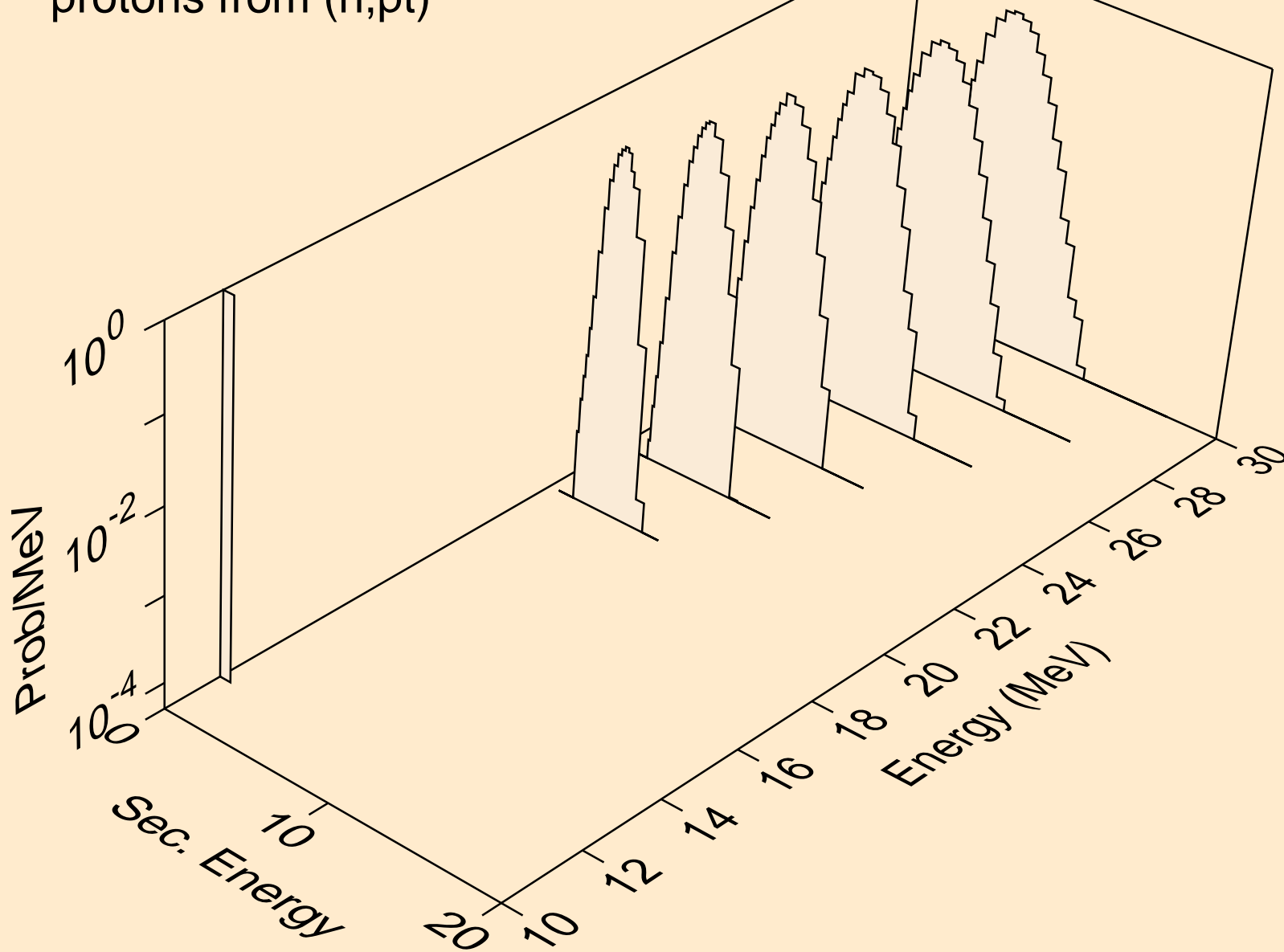

LU176 NEUTRON ACER TENDL-2019 LIBRARY; T=293.16K  
deuterons from (n,x)

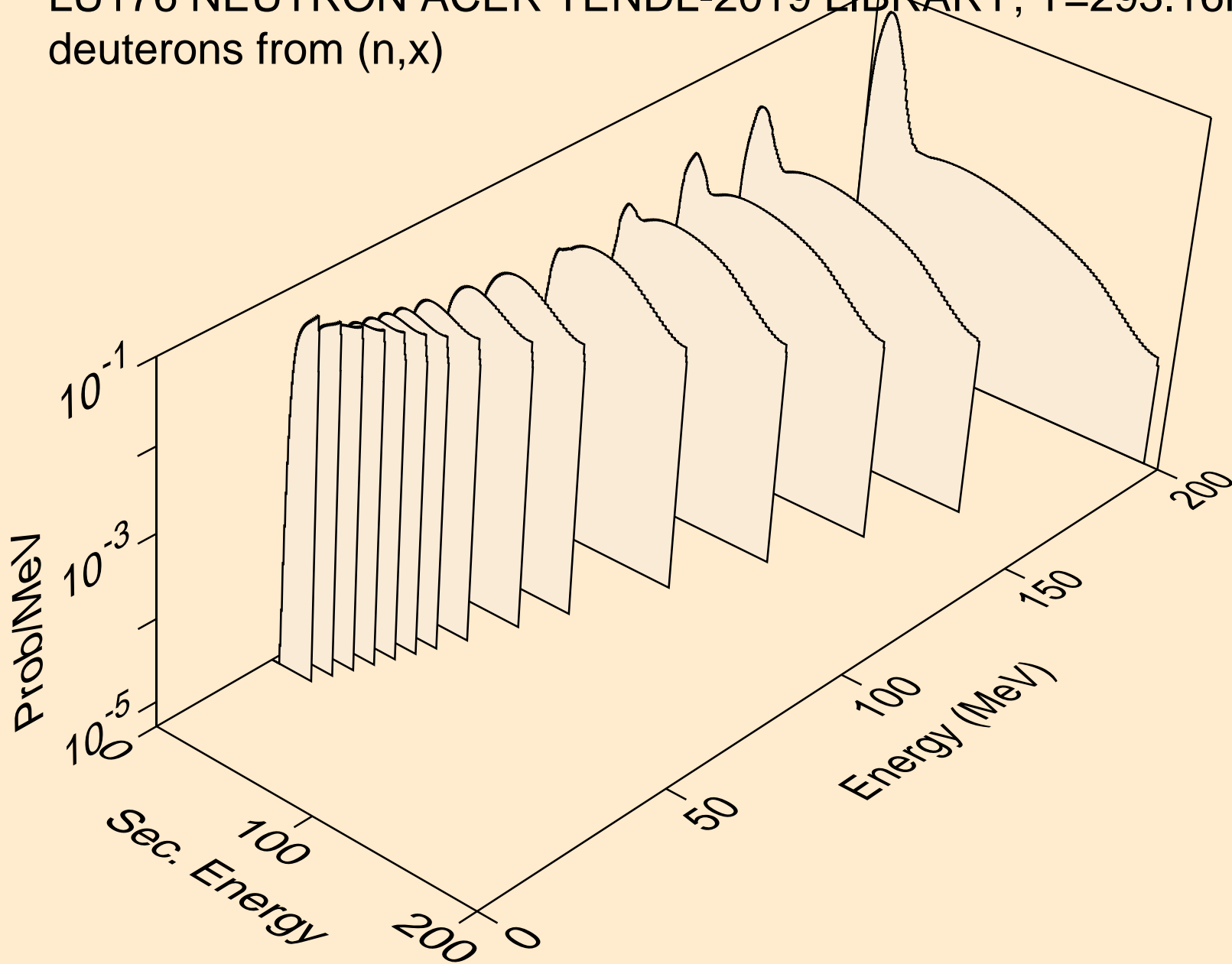

LU176 NEUTRON ACER TENDL-2019 LIBRARY; T=293.16K  
deuterons from (n,2nd)

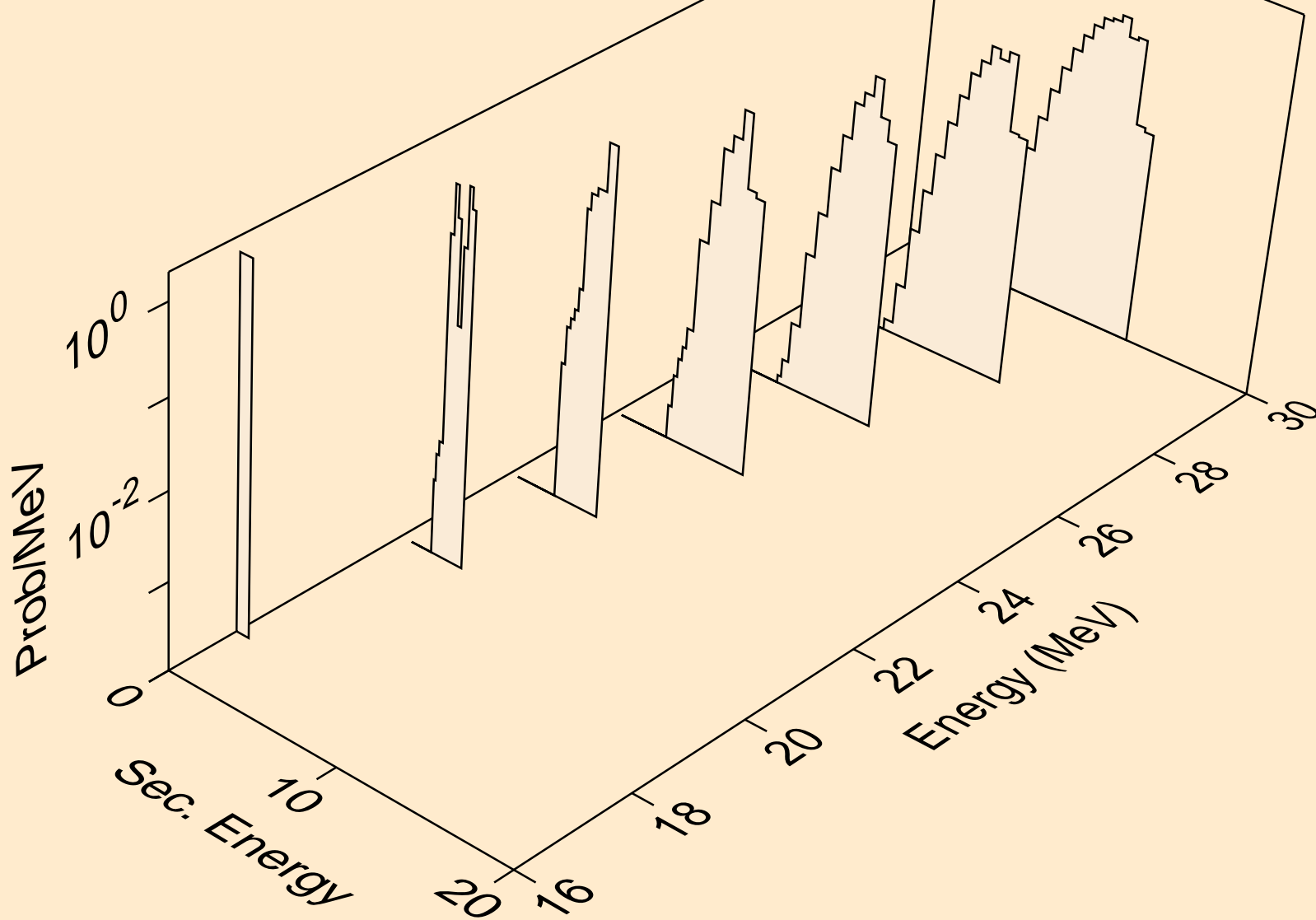

LU176 NEUTRON ACER TENDL-2019 LIBRARY; T=293.16K  
deuterons from (n,n\*)d

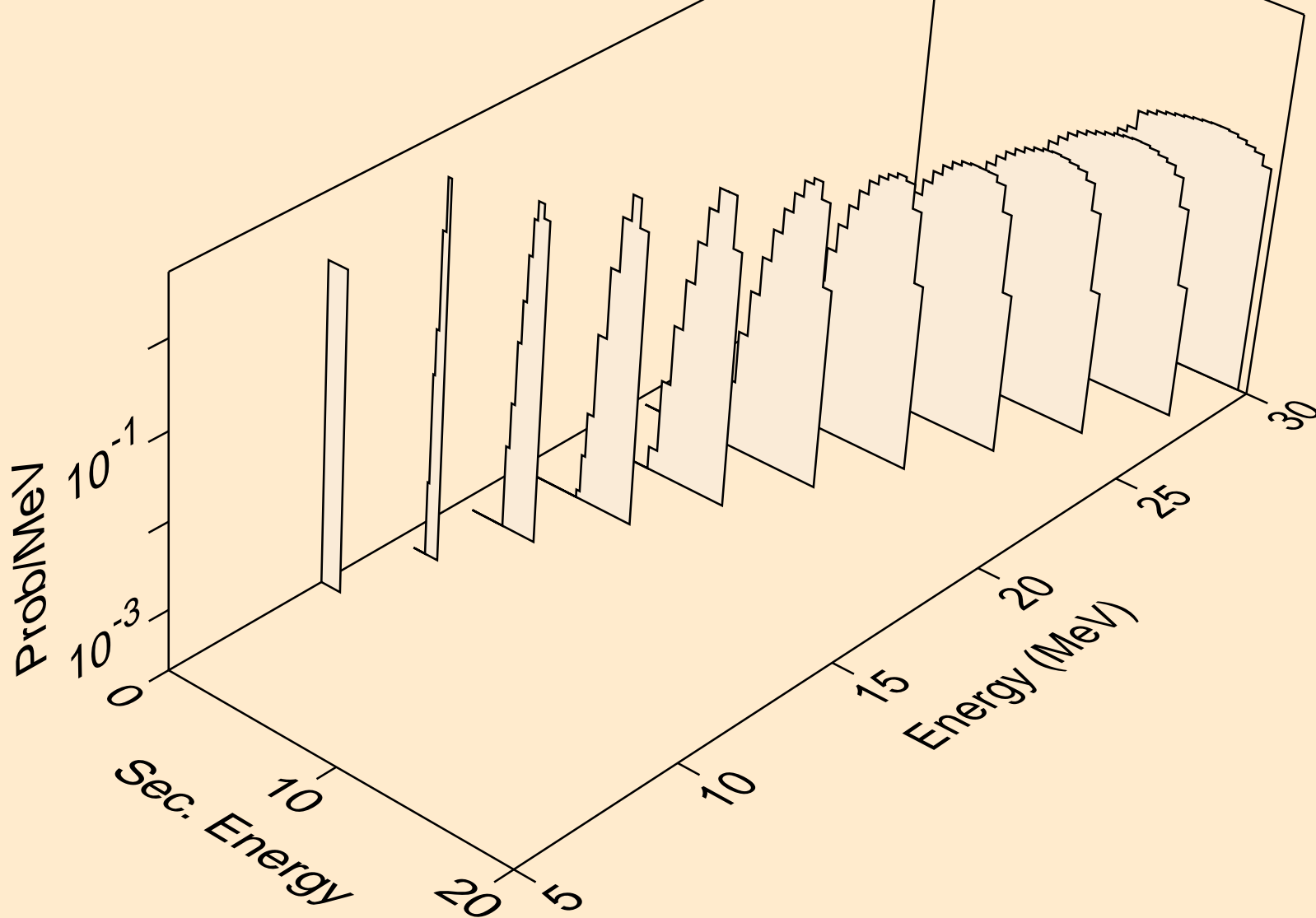

LU176 NEUTRON ACER TENDL-2019 LIBRARY; T=293.16K  
deuterons from (n,d)

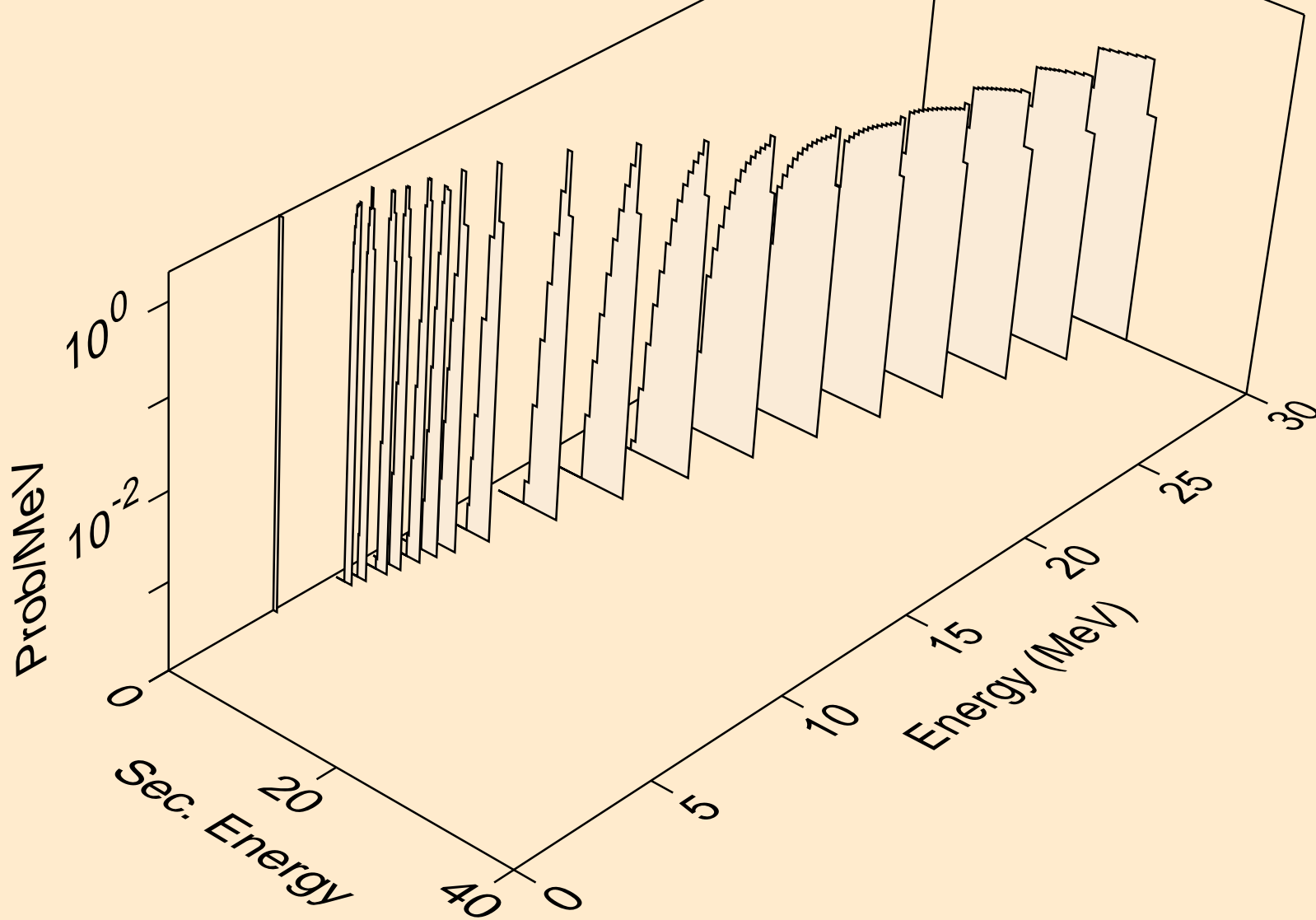

LU176 NEUTRON ACER TENDL-2019 LIBRARY; T=293.16K  
deuterons from (n,pd)

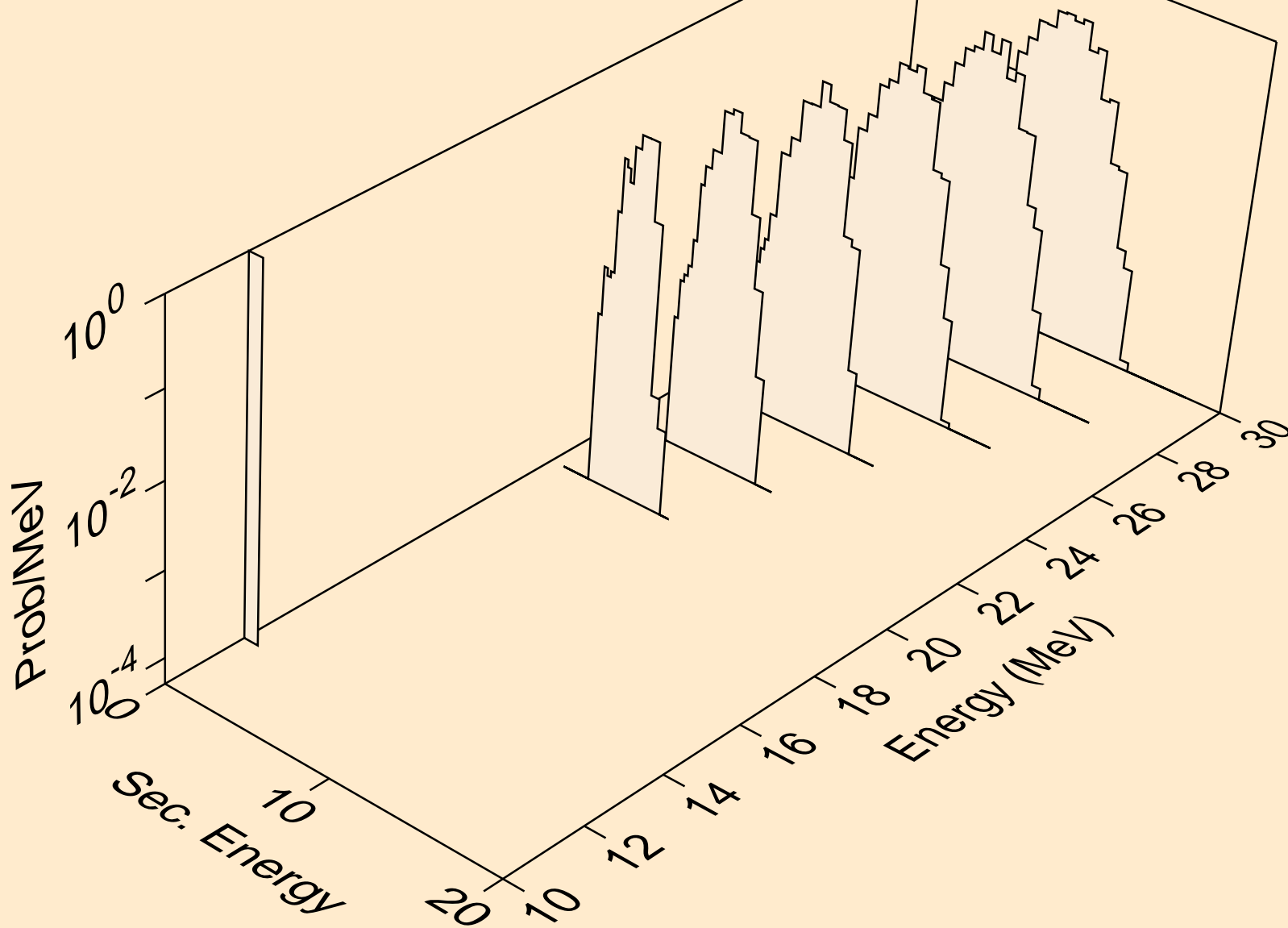



LU176 NEUTRON ACER TENDL-2019 LIBRARY; T=293.16K  
tritons from (n,x)

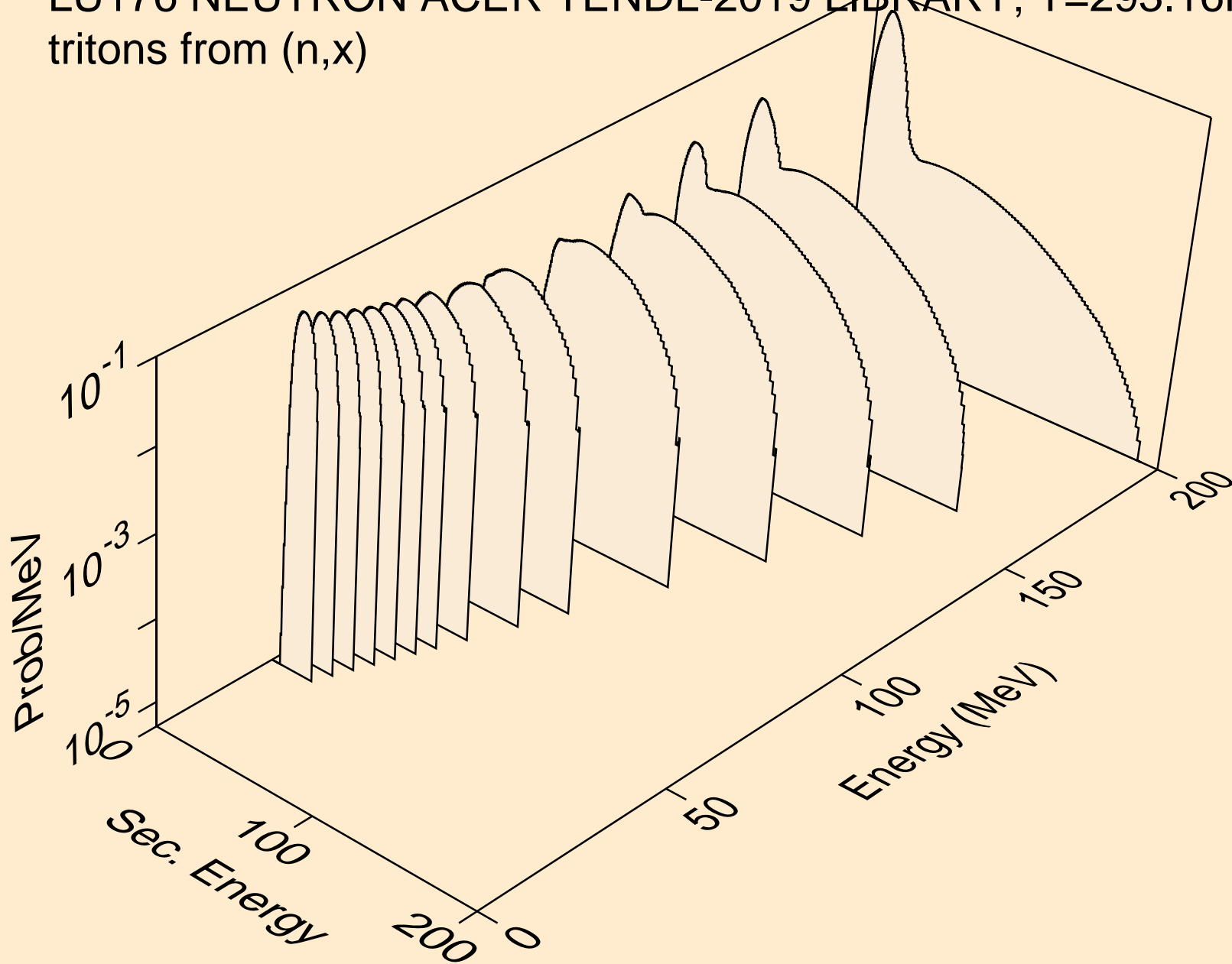

LU176 NEUTRON ACER TENDL-2019 LIBRARY; T=293.16K  
tritons from (n,n\*)t

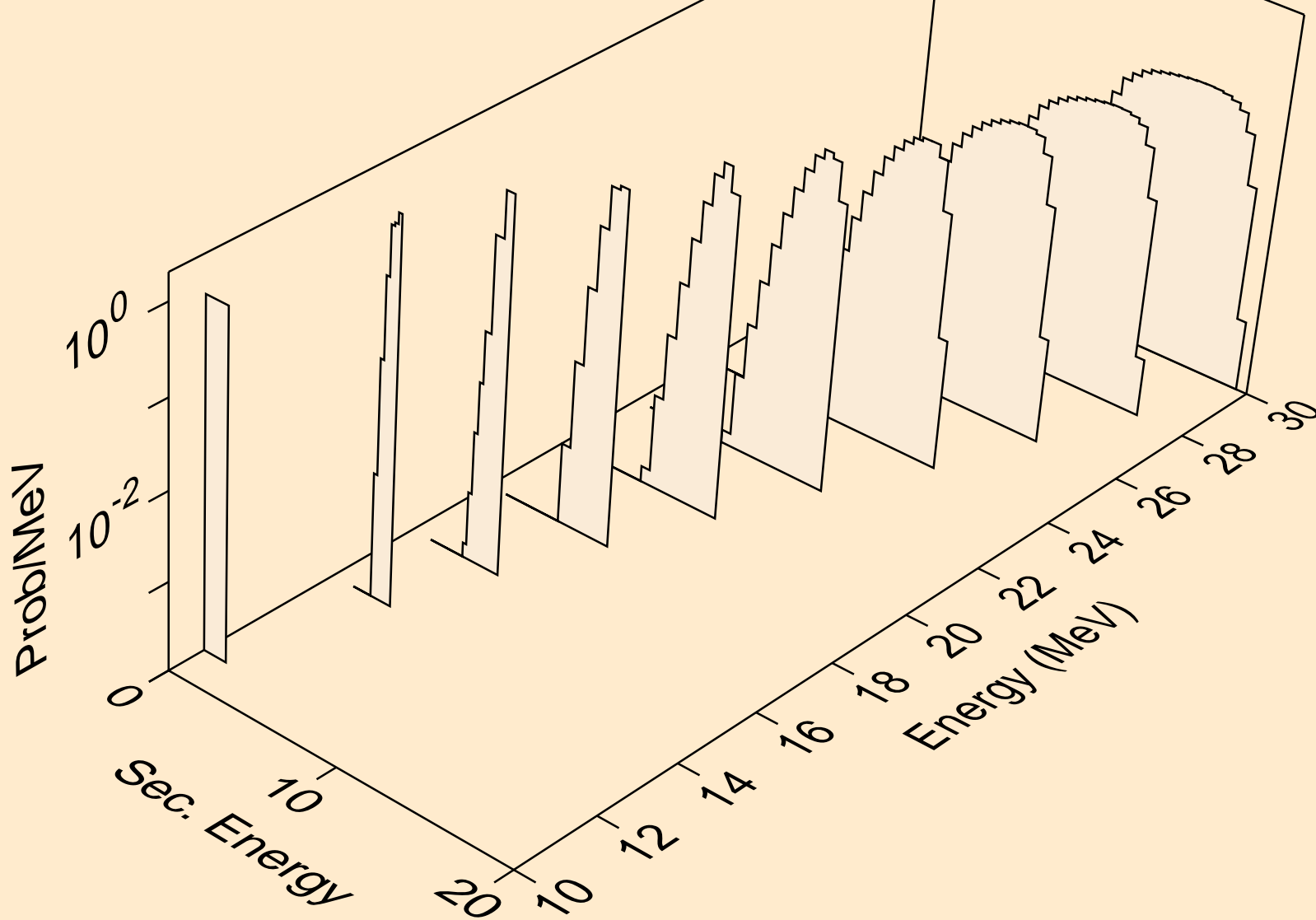

LU176 NEUTRON ACER TENDL-2019 LIBRARY; T=293.16K  
tritons from (n,t)

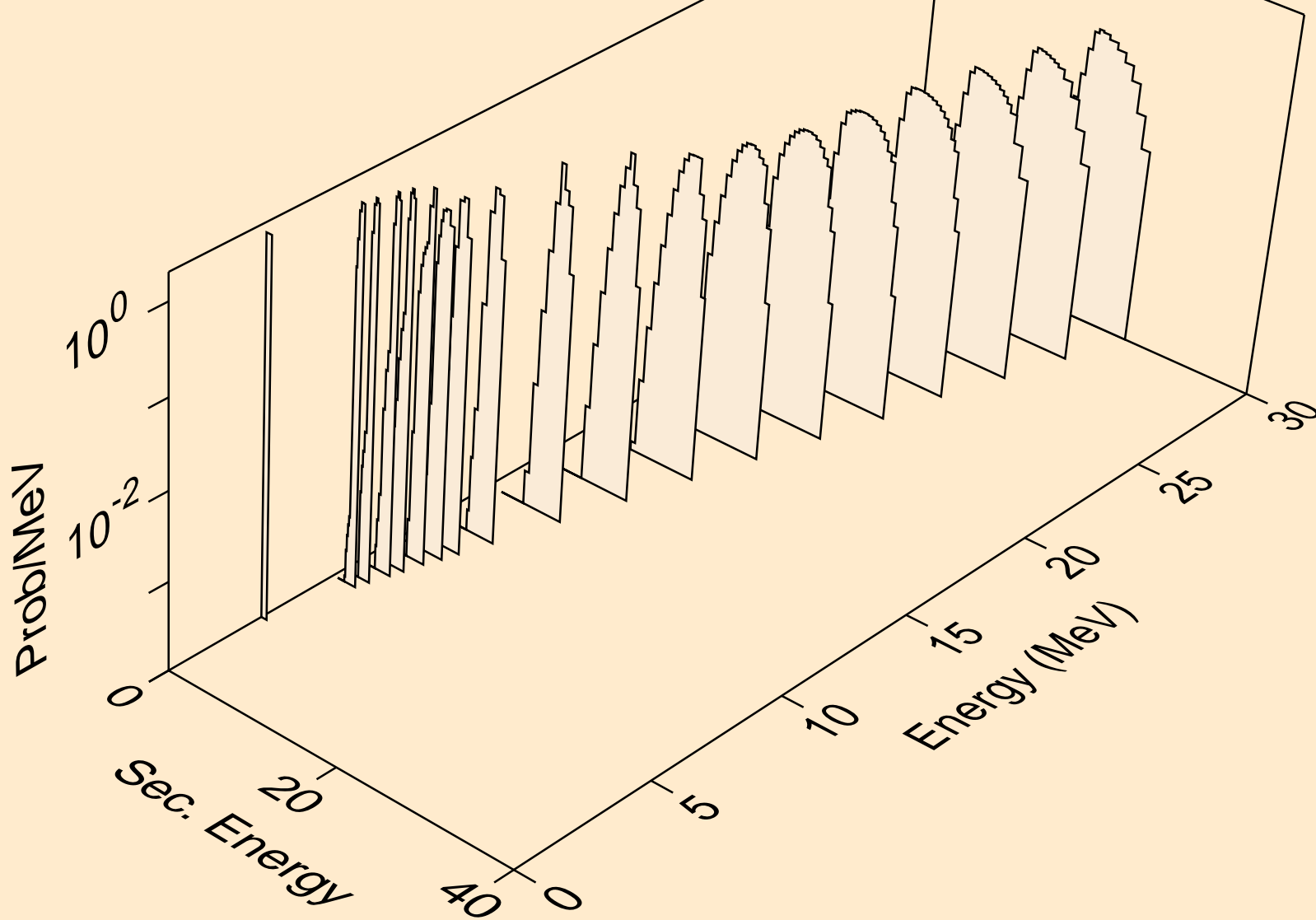

LU176 NEUTRON ACER TENDL-2019 LIBRARY; T=293.16K  
tritons from (n,pt)

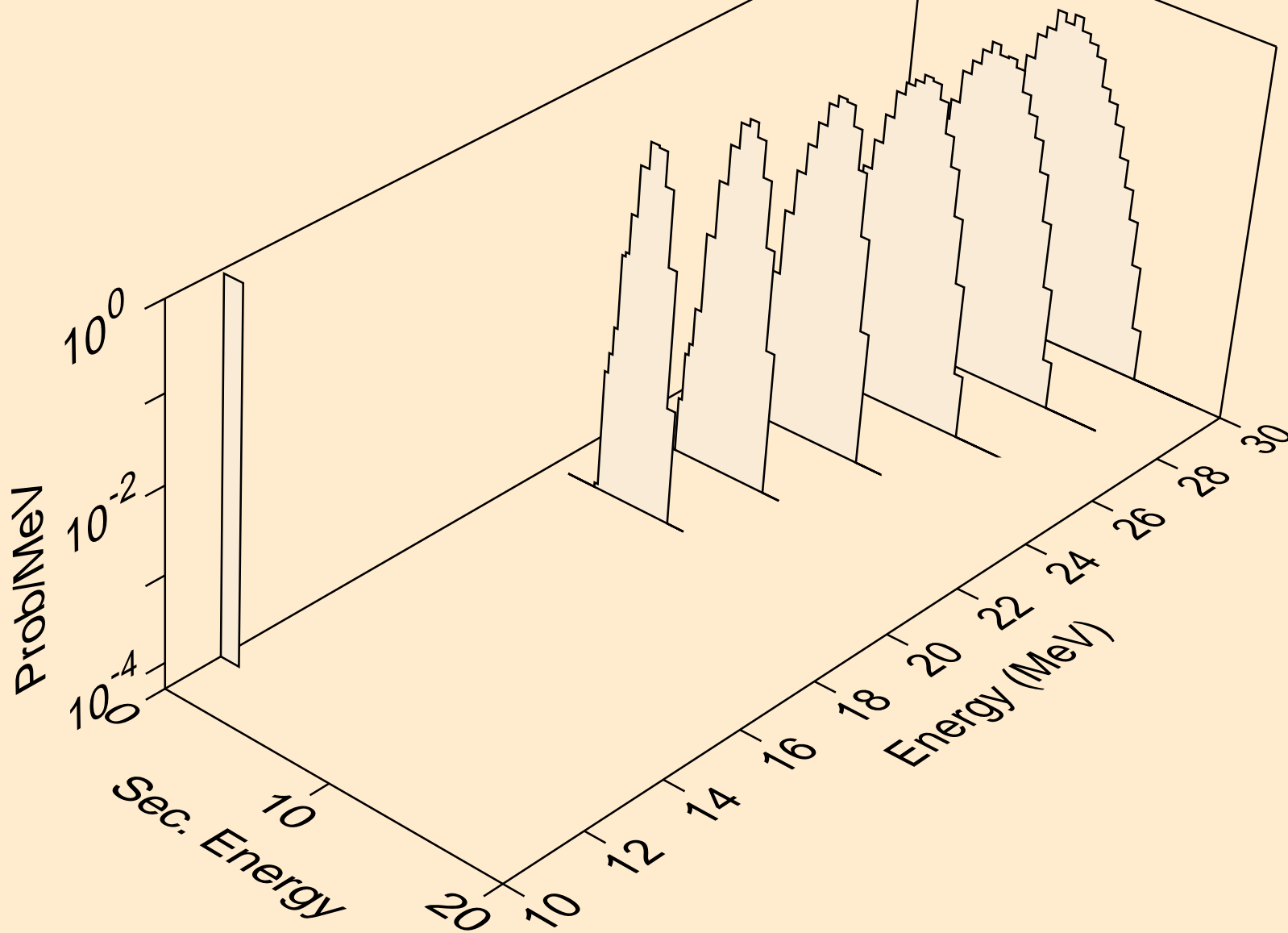

LU176 NEUTRON ACER TENDL-2019 LIBRARY; T=293.16K  
he3s from (n,x)

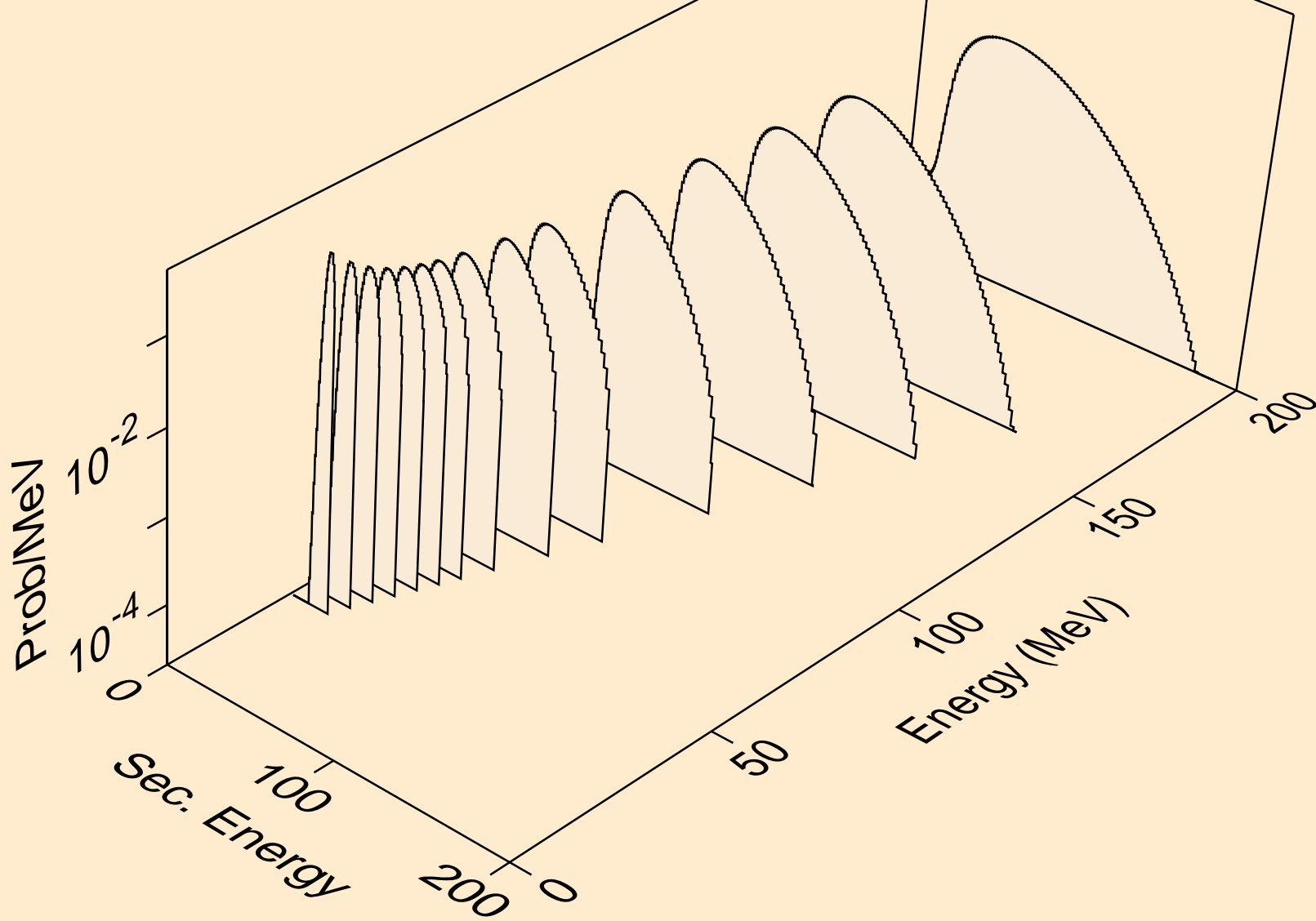

LU176 NEUTRON ACER TENDL-2019 LIBRARY; T=293.16K  
he3s from (n,n\*)he3

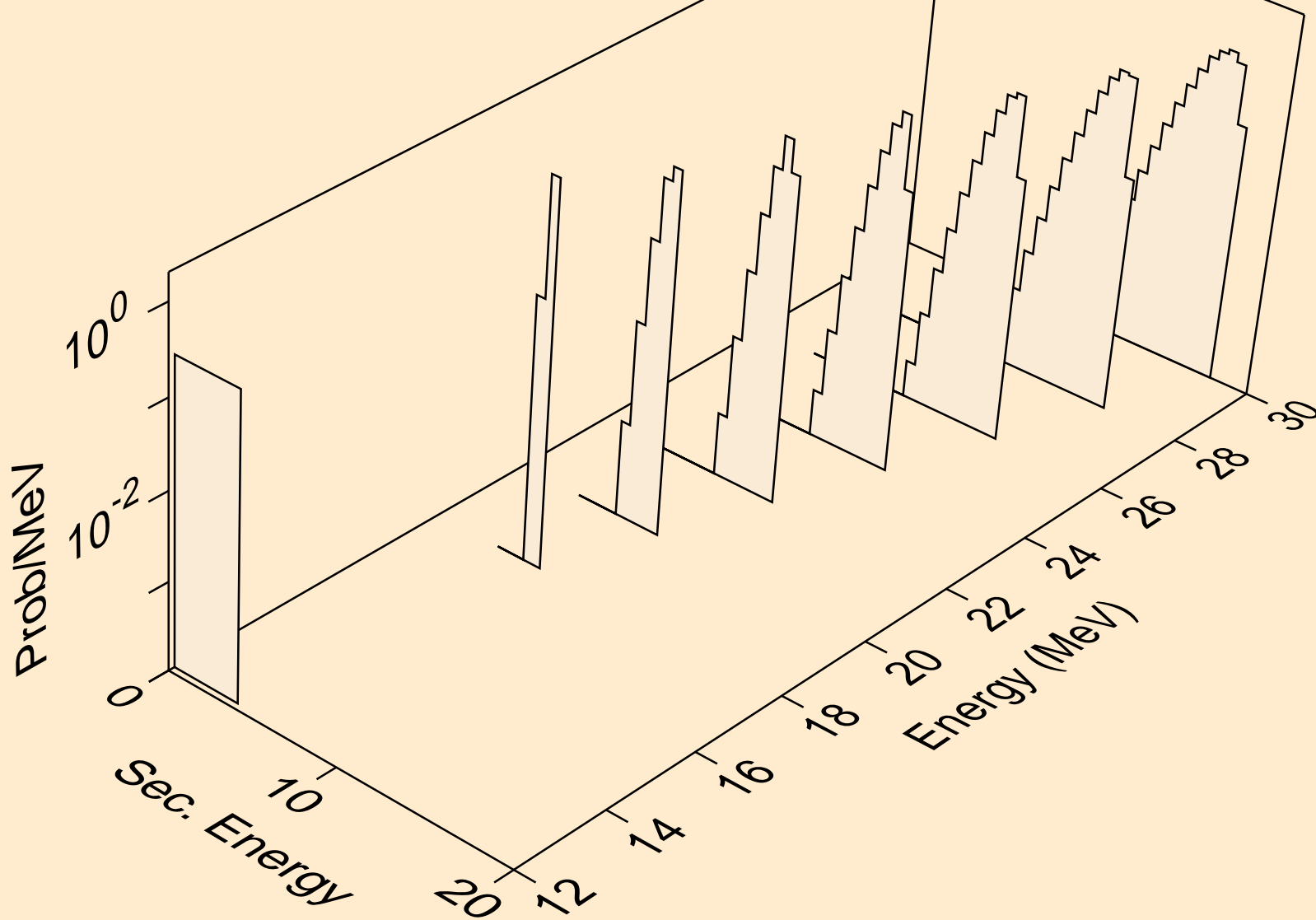

LU176 NEUTRON ACER TENDL-2019 LIBRARY; T=293.16K  
he3s from (n,he3)

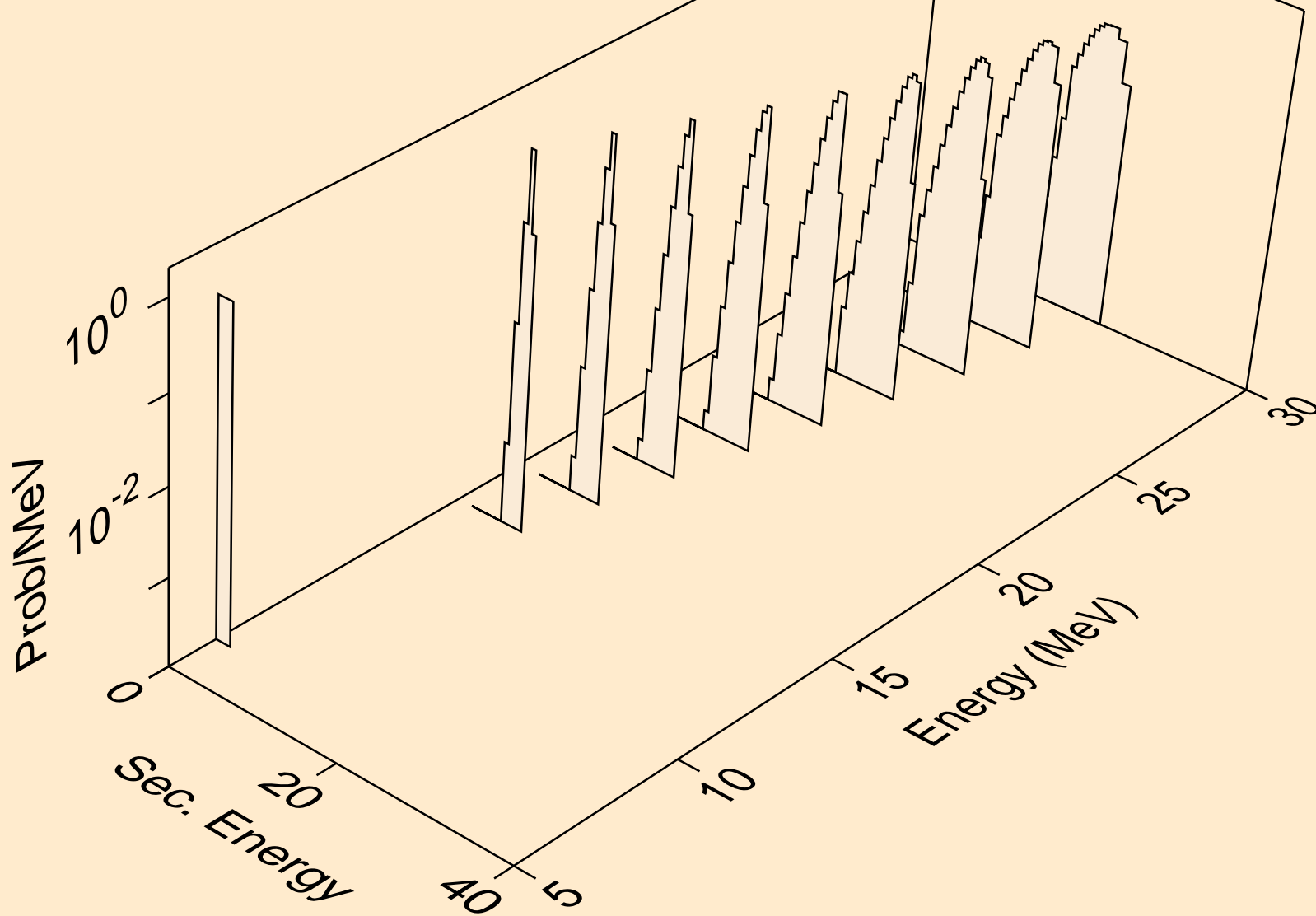

LU176 NEUTRON ACER TENDL-2019 LIBRARY; T=293.16K  
alphas from (n,x)

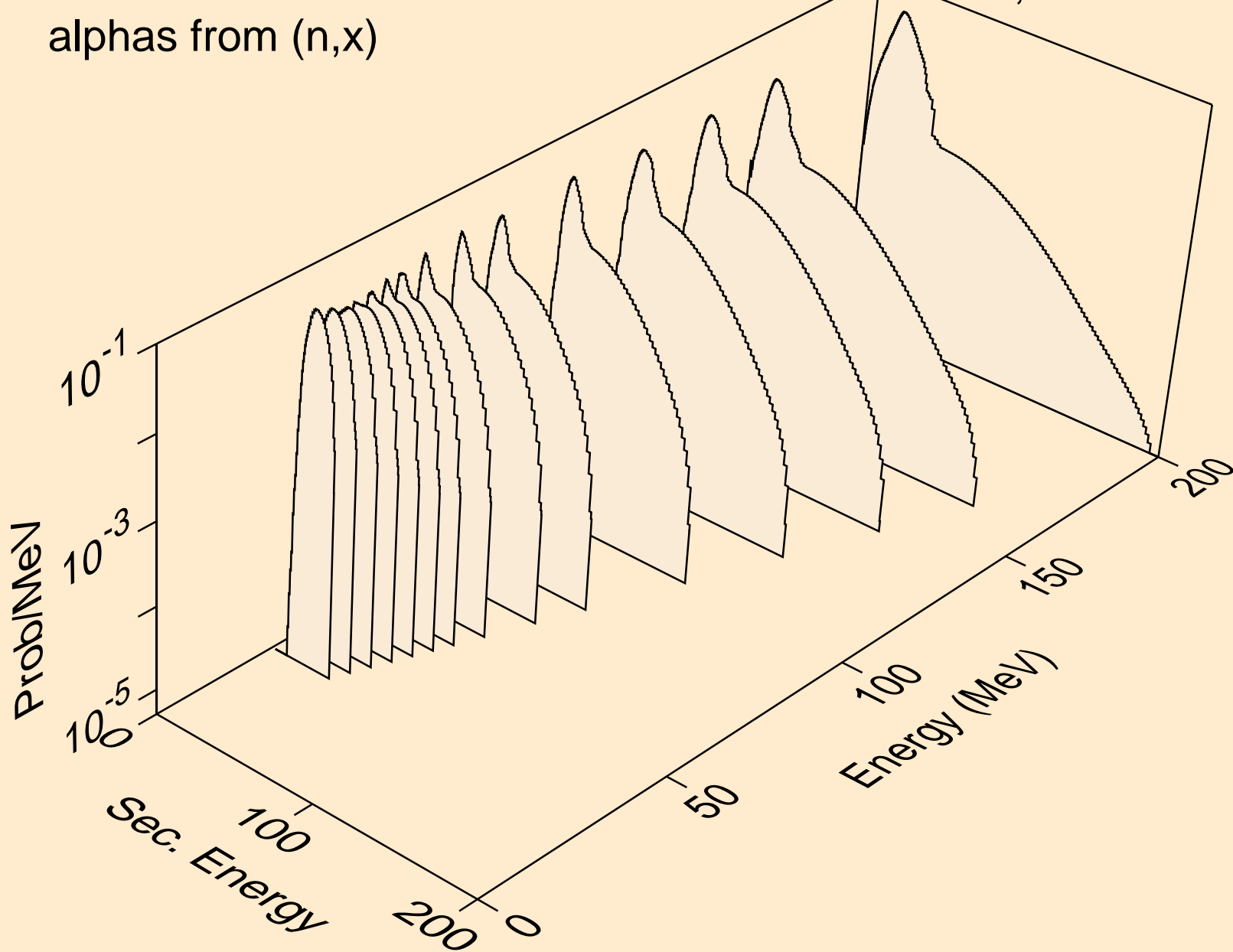



LU176 NEUTRON ACER TENDL-2019 LIBRARY; T=293.16K  
alphas from (n,n\*)a

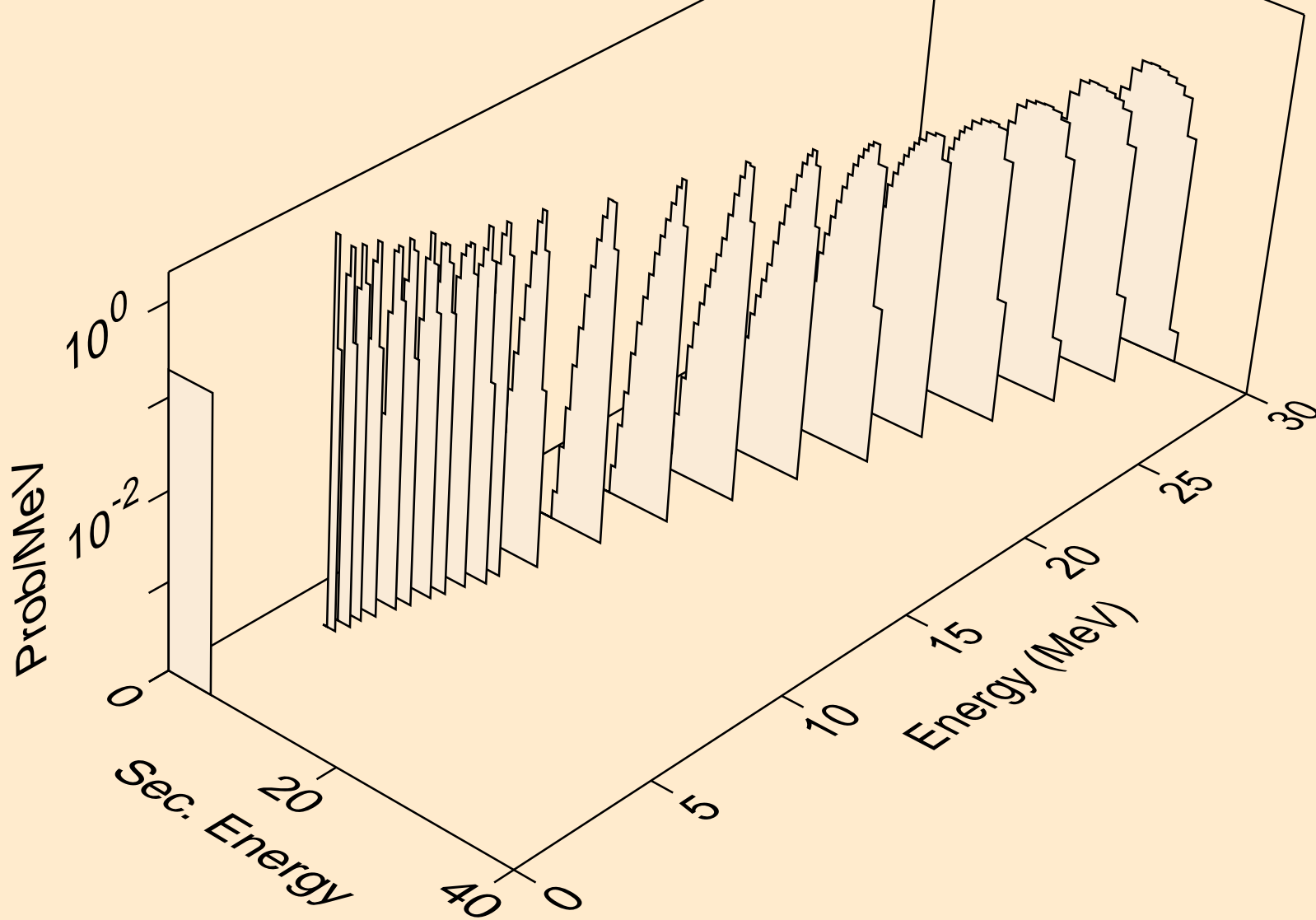

LU176 NEUTRON ACER TENDL-2019 LIBRARY; T=293.16K  
alphas from (n,2n)a

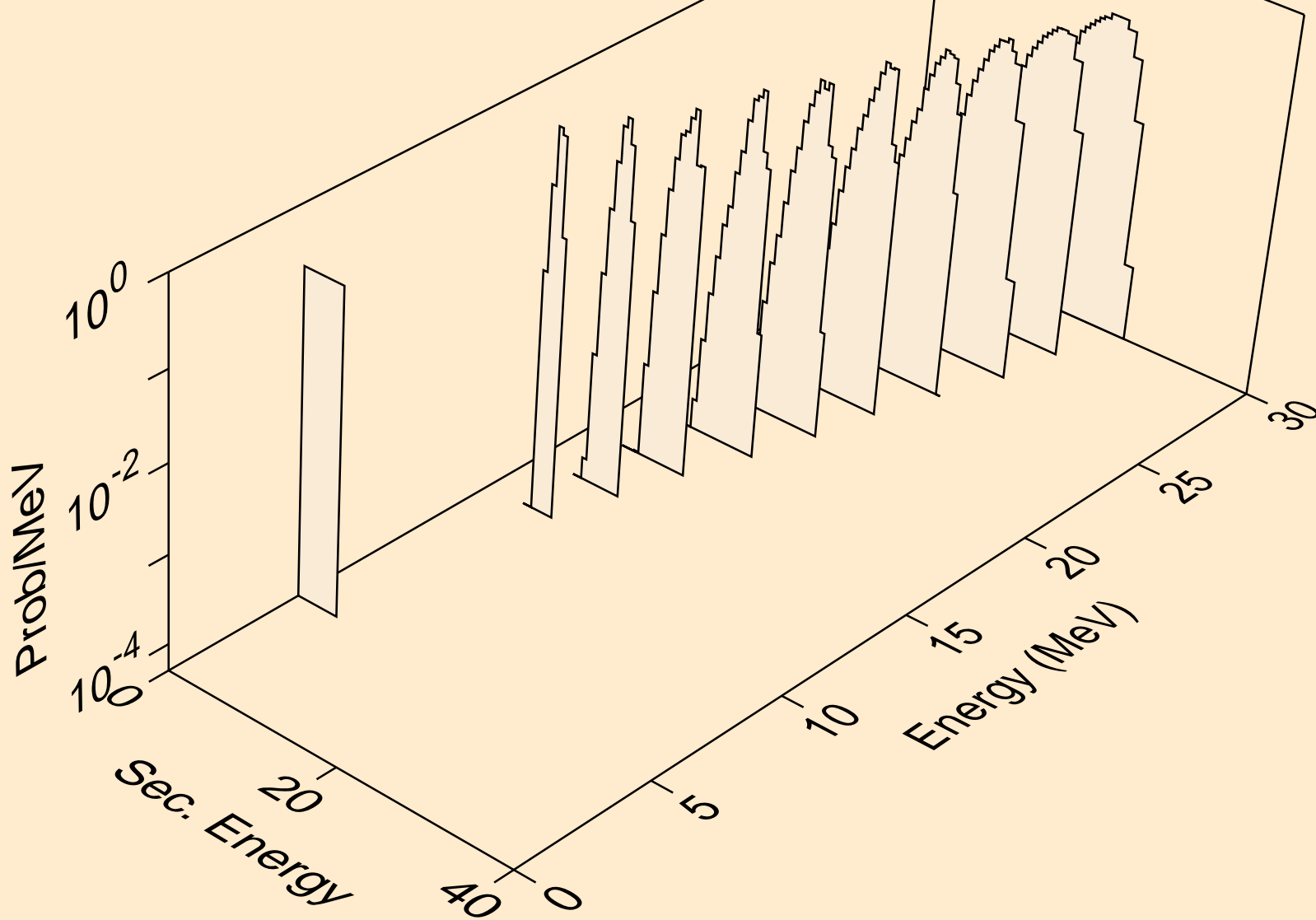

LU176 NEUTRON ACER TENDL-2019 LIBRARY; T=293.16K  
alphas from (n,3n)a

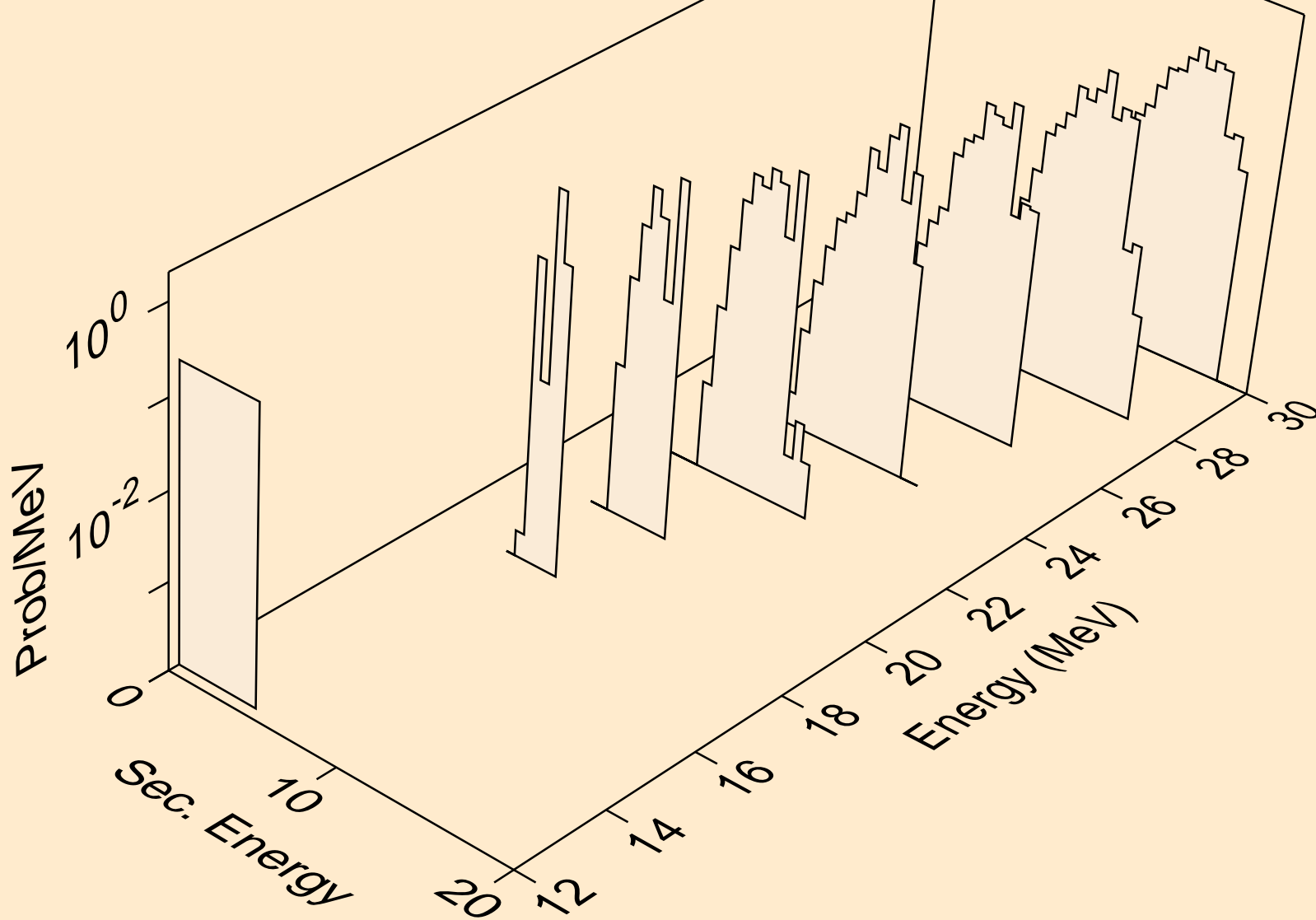

LU176 NEUTRON ACER TENDL-2019 LIBRARY; T=293.16K  
alphas from (n,npa)

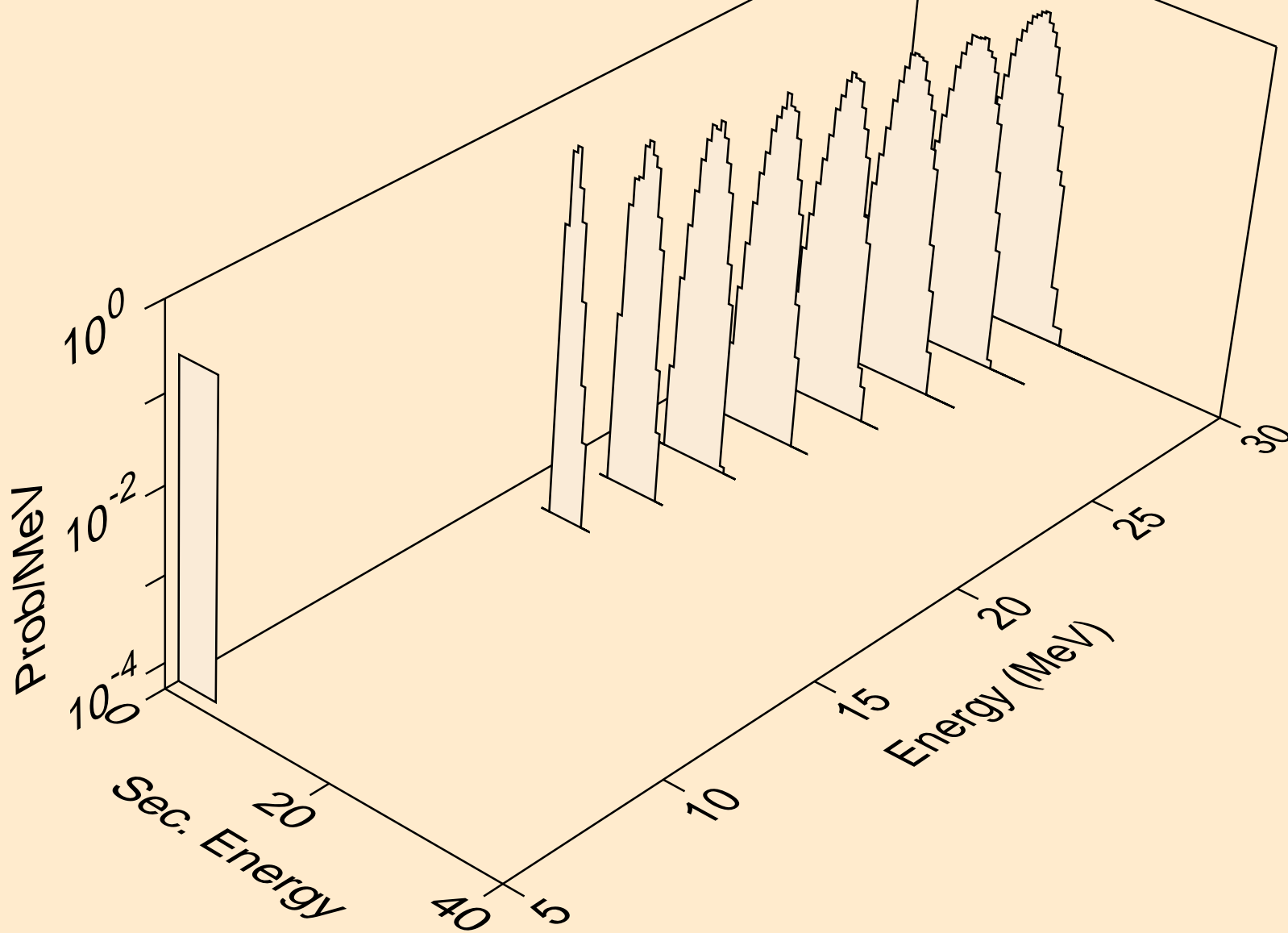

LU176 NEUTRON ACER TENDL-2019 LIBRARY; T=293.16K  
alphas from (n,a)

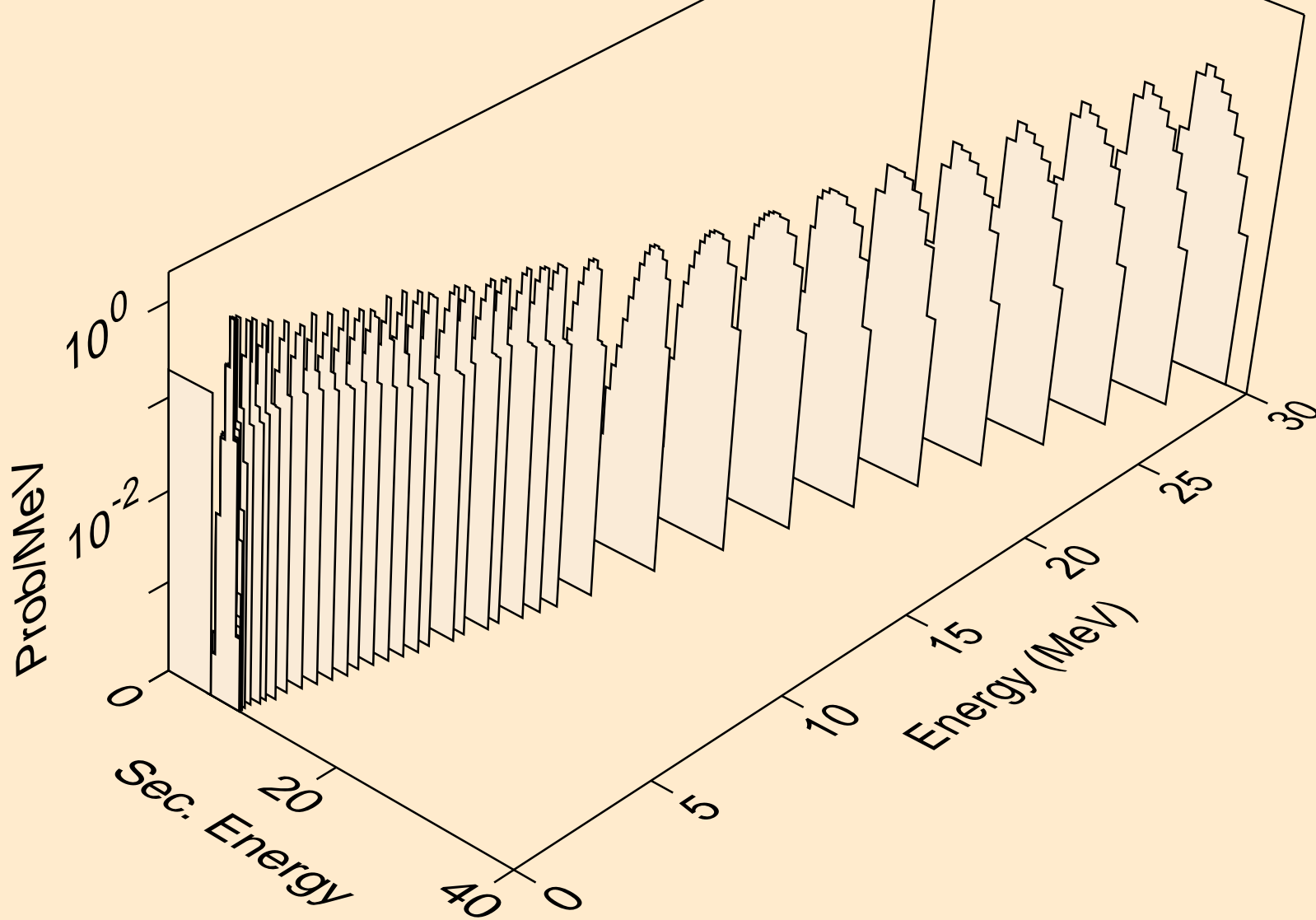

LU176 NEUTRON ACER TENDL-2019 LIBRARY; T=293.16K  
alphas from (n,2a)

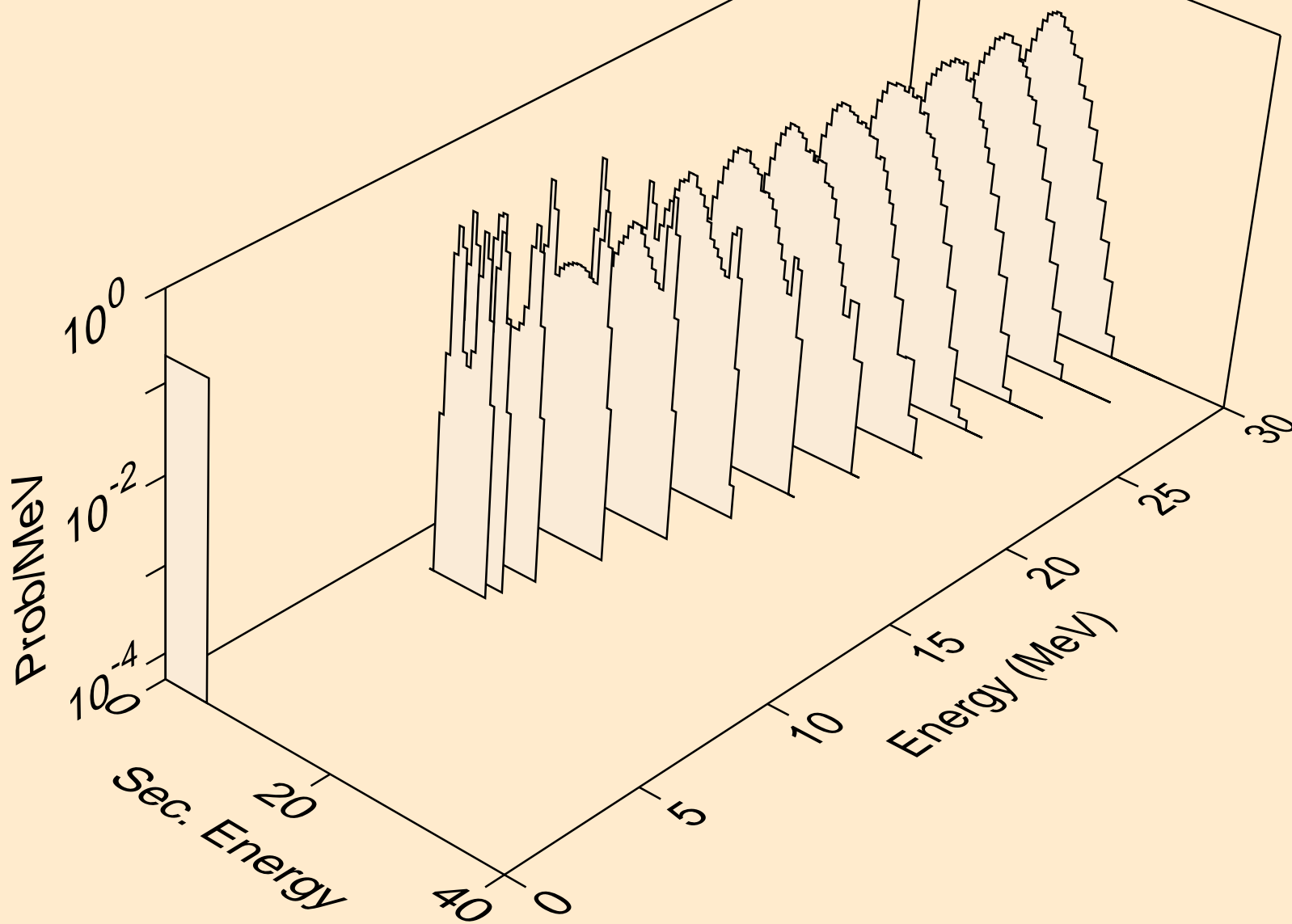

LU176 NEUTRON ACER TENDL-2019 LIBRARY; T=293.16K  
alphas from (n,pa)

