

Program EVALPLOT
(Version 2018-1)

by

Dermott E. Cullen
(Present Contact Information)

Dermott E. Cullen
1466 Hudson Way
Livermore, CA 94550
U.S.A.

Tele: 925-443-1911

E.Mail:redcullen1@comcast.net
Web:redcullen1.net/HOMEPAGE.NEW

Press Mouse Button to Start

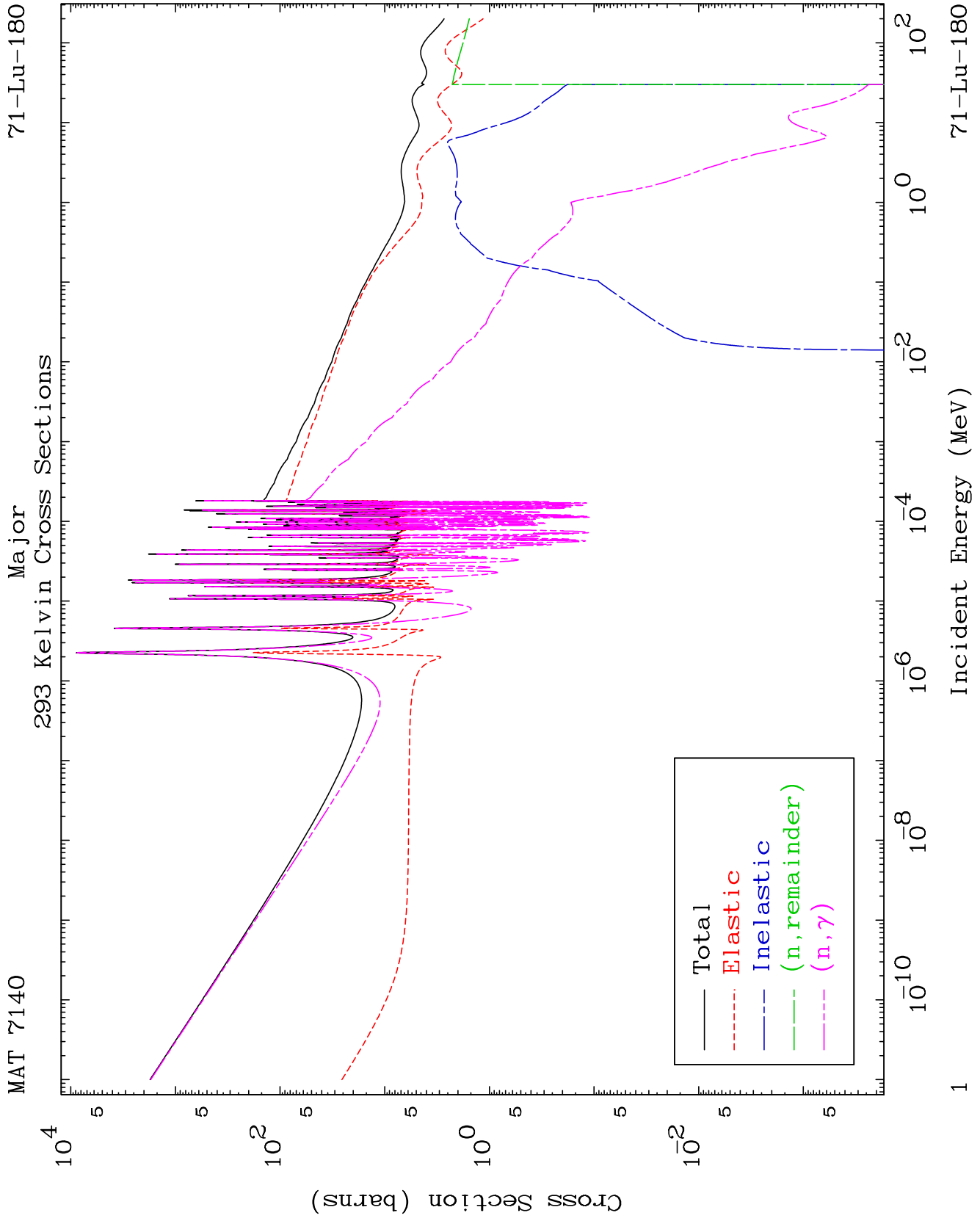

MAT 7140

Neutron Production 293 Kelvin Cross Sections

71-Lu-180

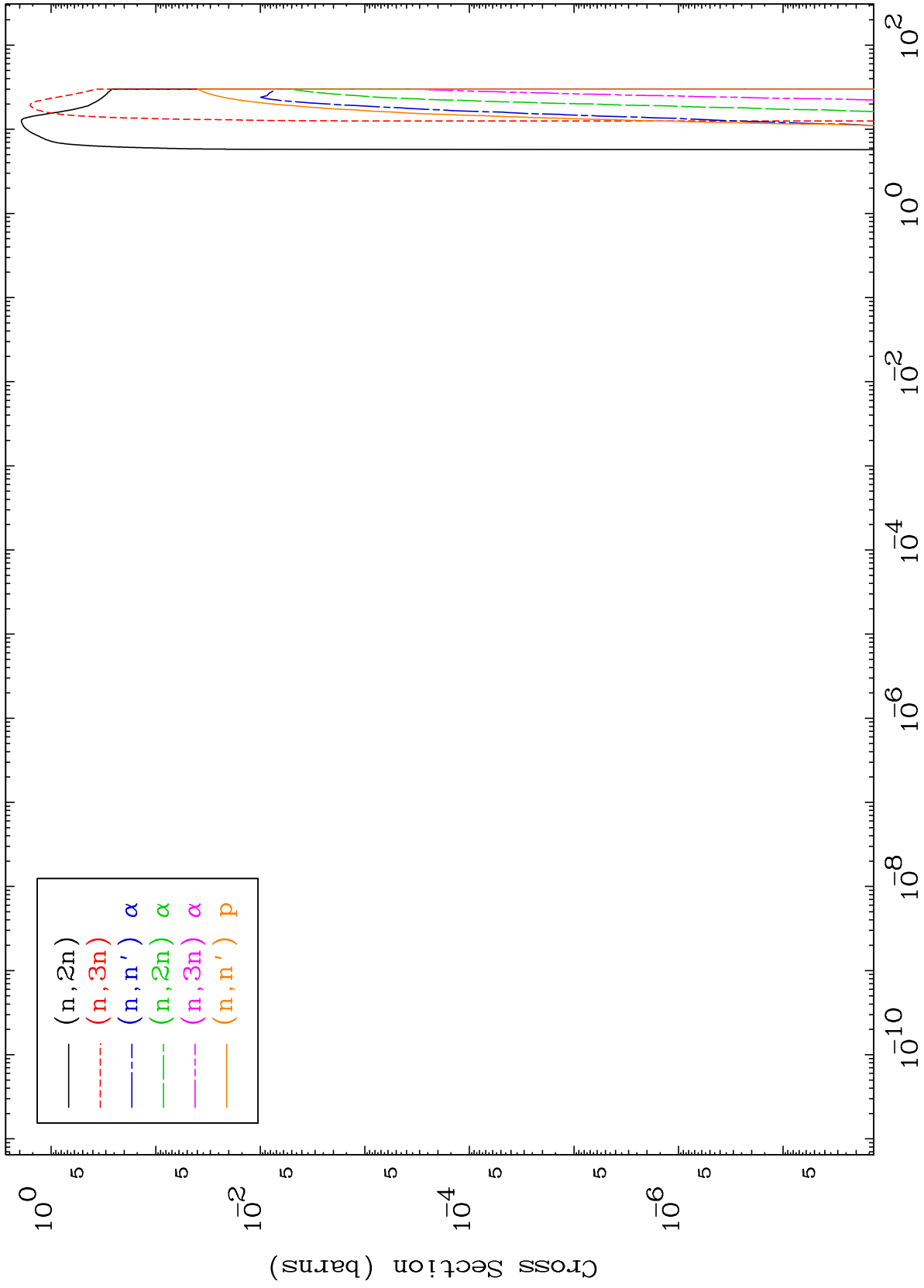

71-Lu-180

MAT 7140

Neutron Production
293 Kelvin Cross Sections

71-Lu-180

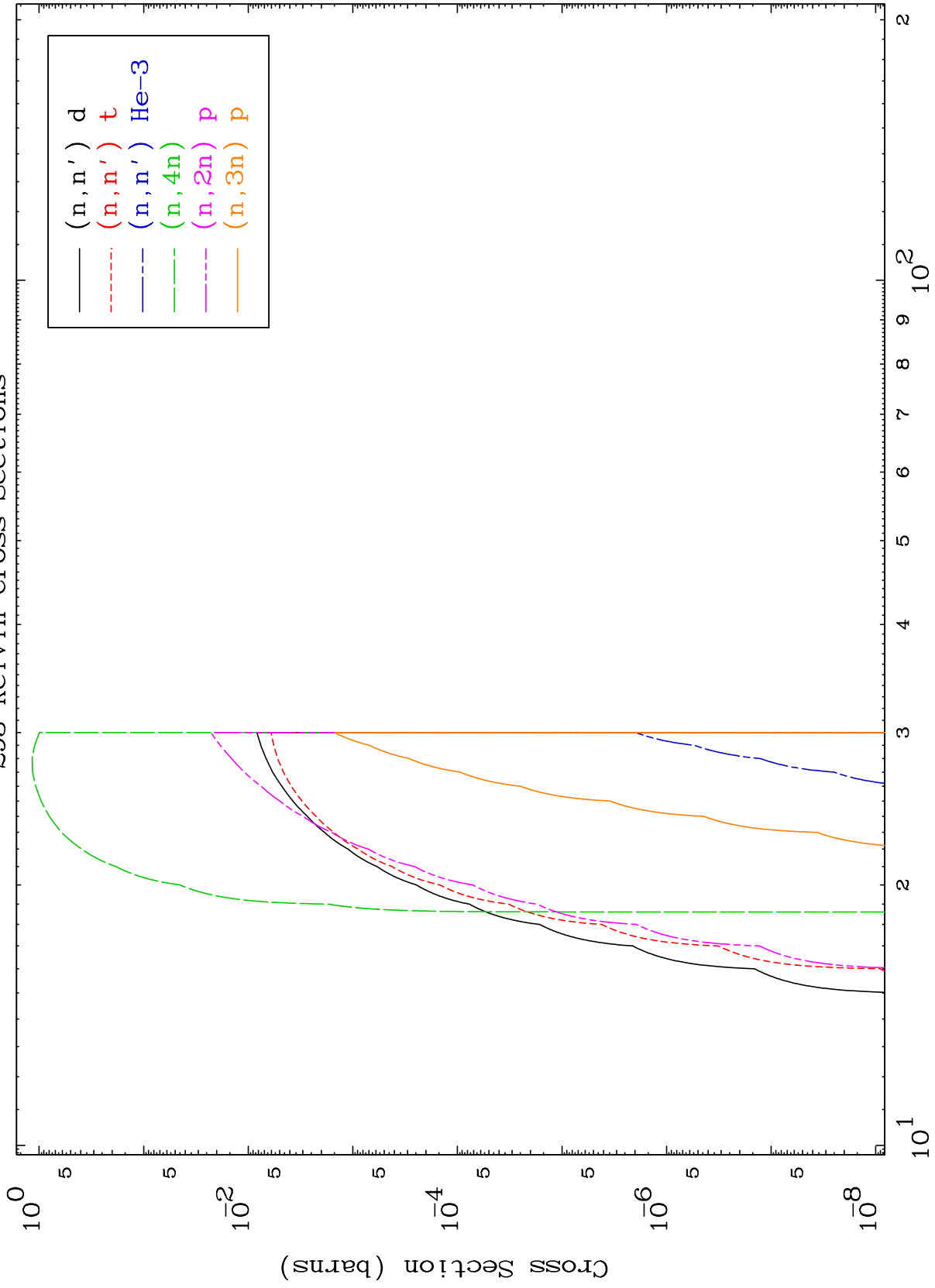

71-Lu-180

Incident Energy (MeV)

3

MAT 7140

293 Kelvin Cross Sections

71-Lu-180

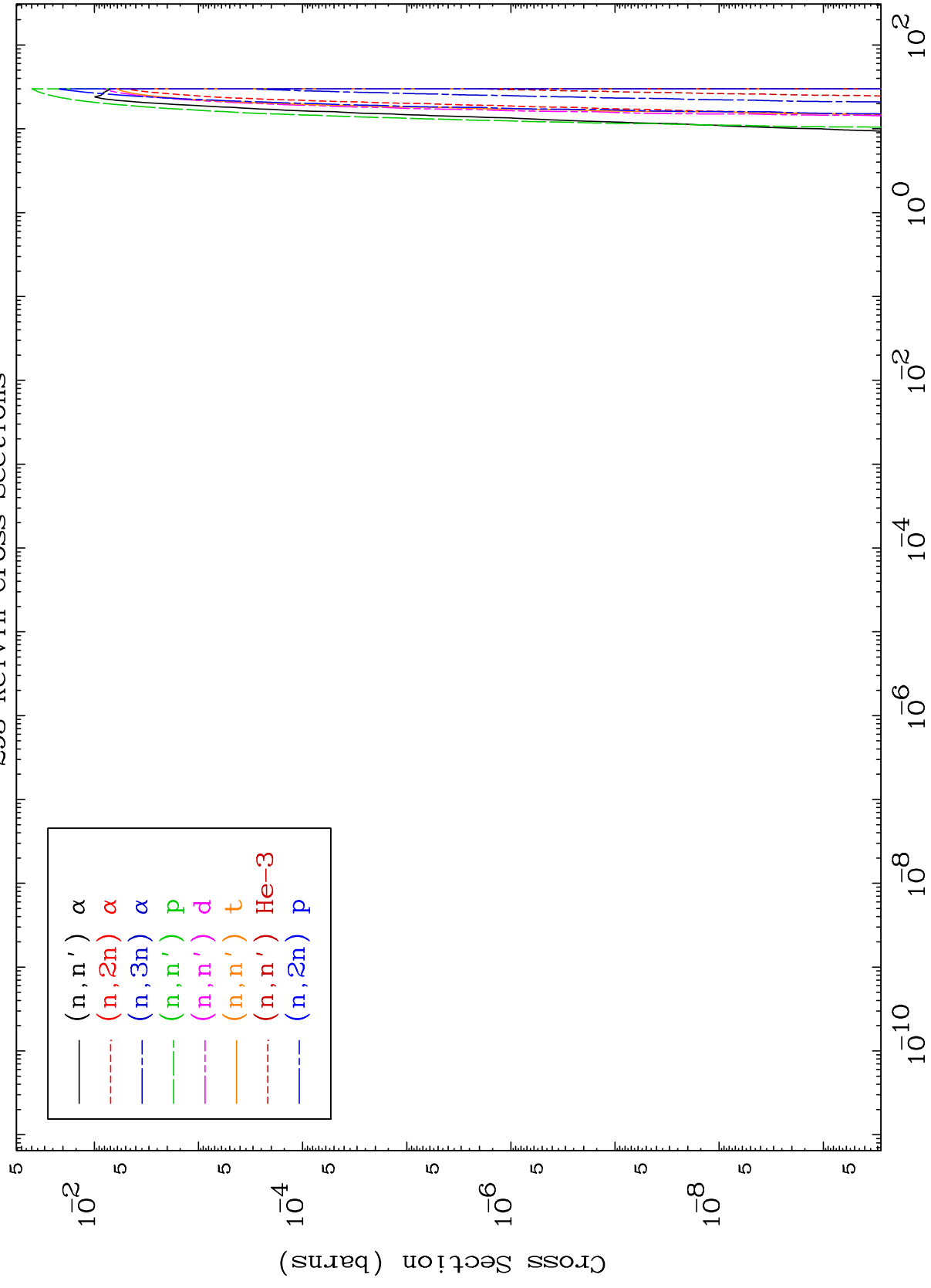

MAT 7140

Charged Particle
293 Kelvin Cross Sections

71-Lu-180

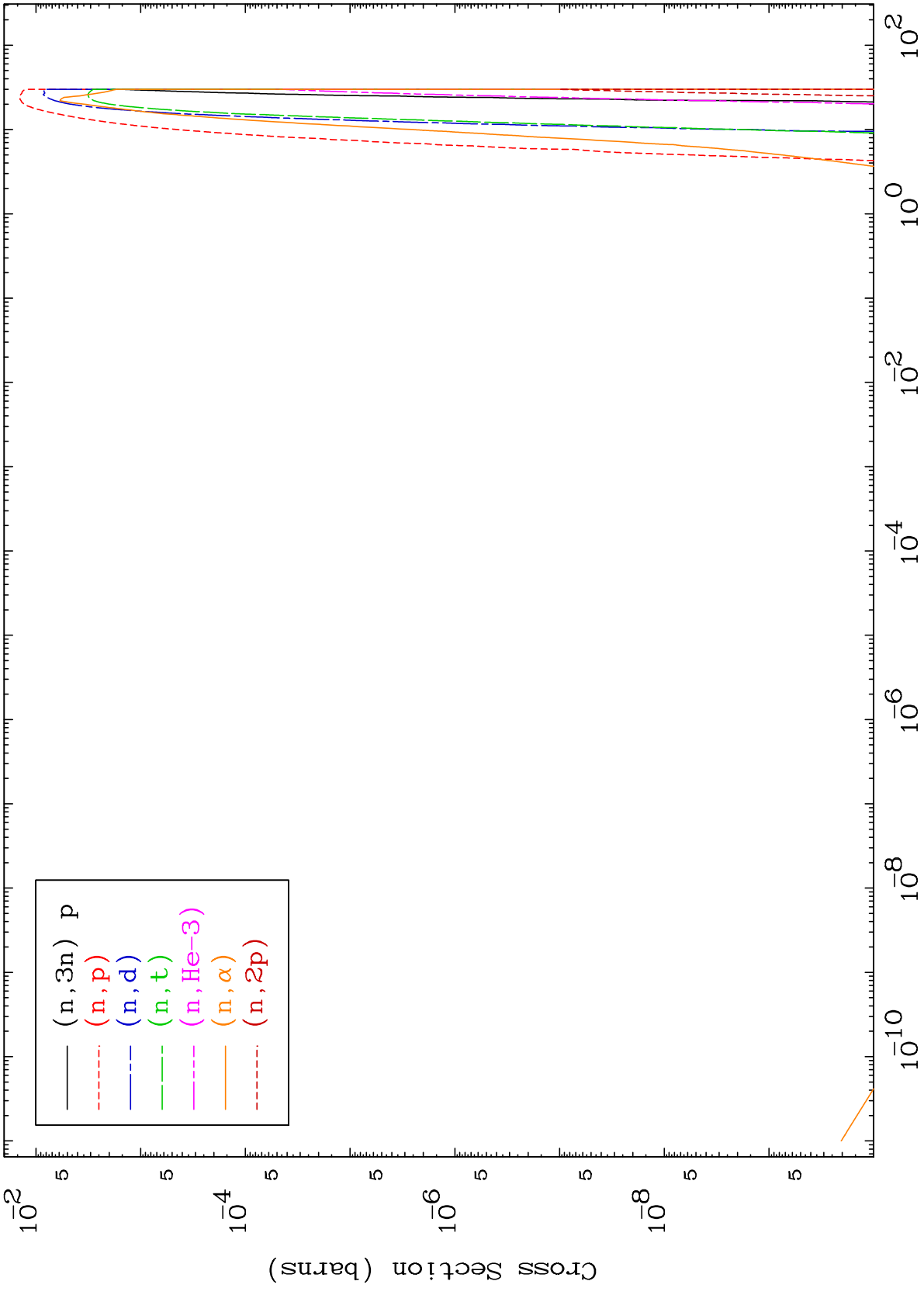

71-Lu-180

Incident Energy (MeV)

5

MAT 7140

Particle Production
293 Kelvin Cross Sections

71-Lu-180

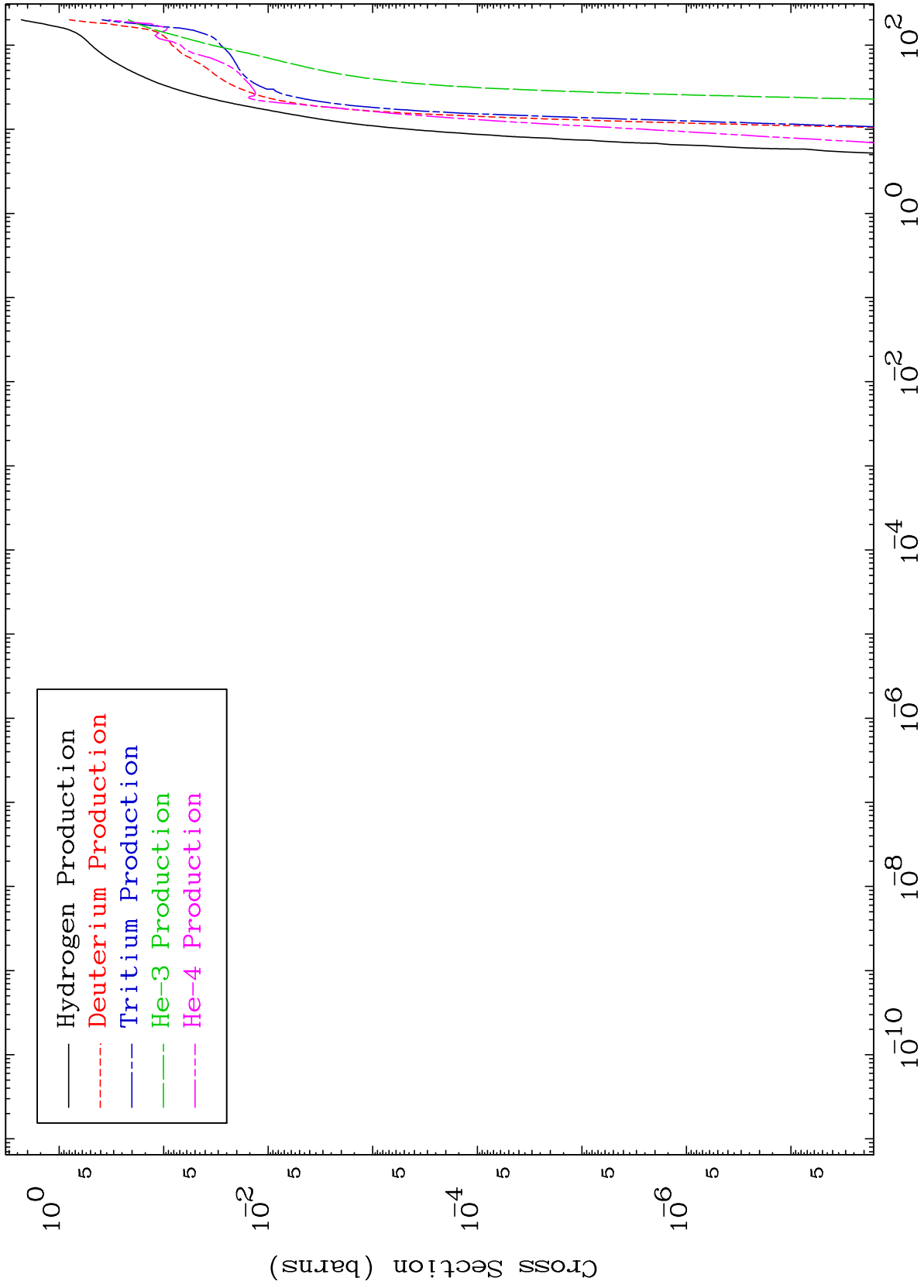

6

Incident Energy (MeV)

71-Lu-180

MAT 7140

(n,n') Level
293 Kelvin Cross Sections

71-Lu-180

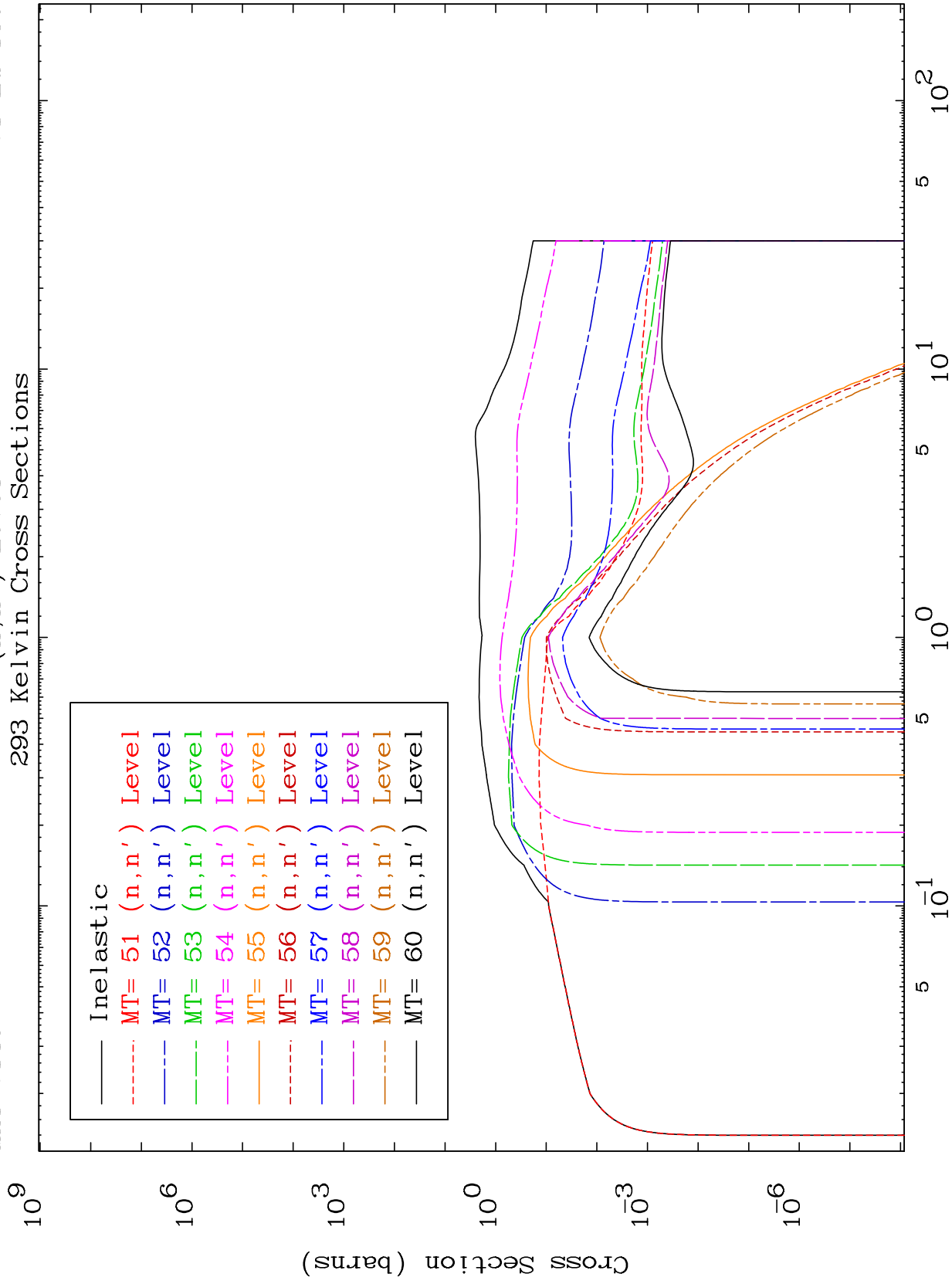

7

Incident Energy (MeV)

71-Lu-180

MAT 7140

(n,n') Level

71-Lu-180

293 Kelvin Cross Sections

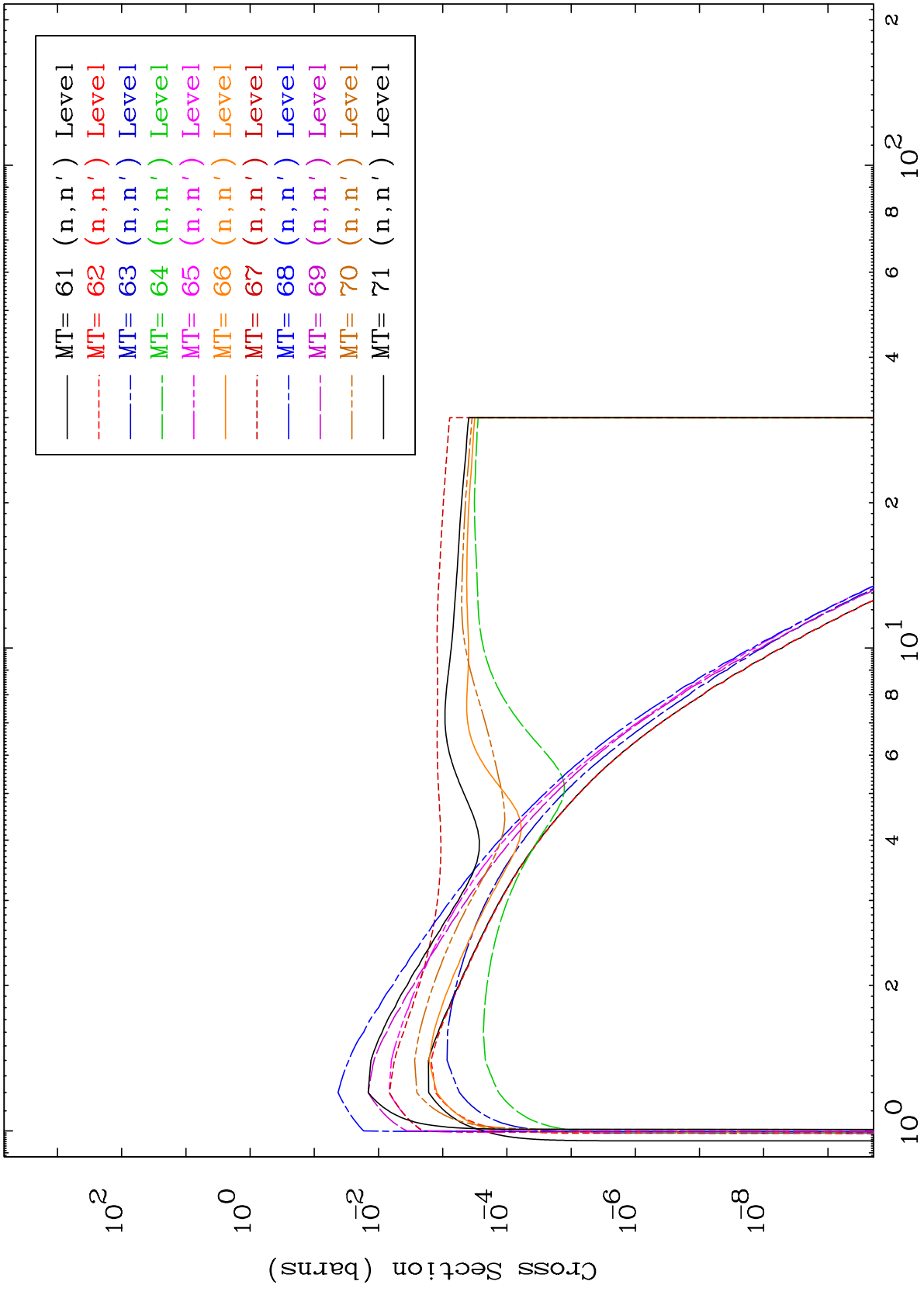

Incident Energy (MeV)

71-Lu-180

MAT 7140

(n,n') Level

71-Lu-180

293 Kelvin Cross Sections

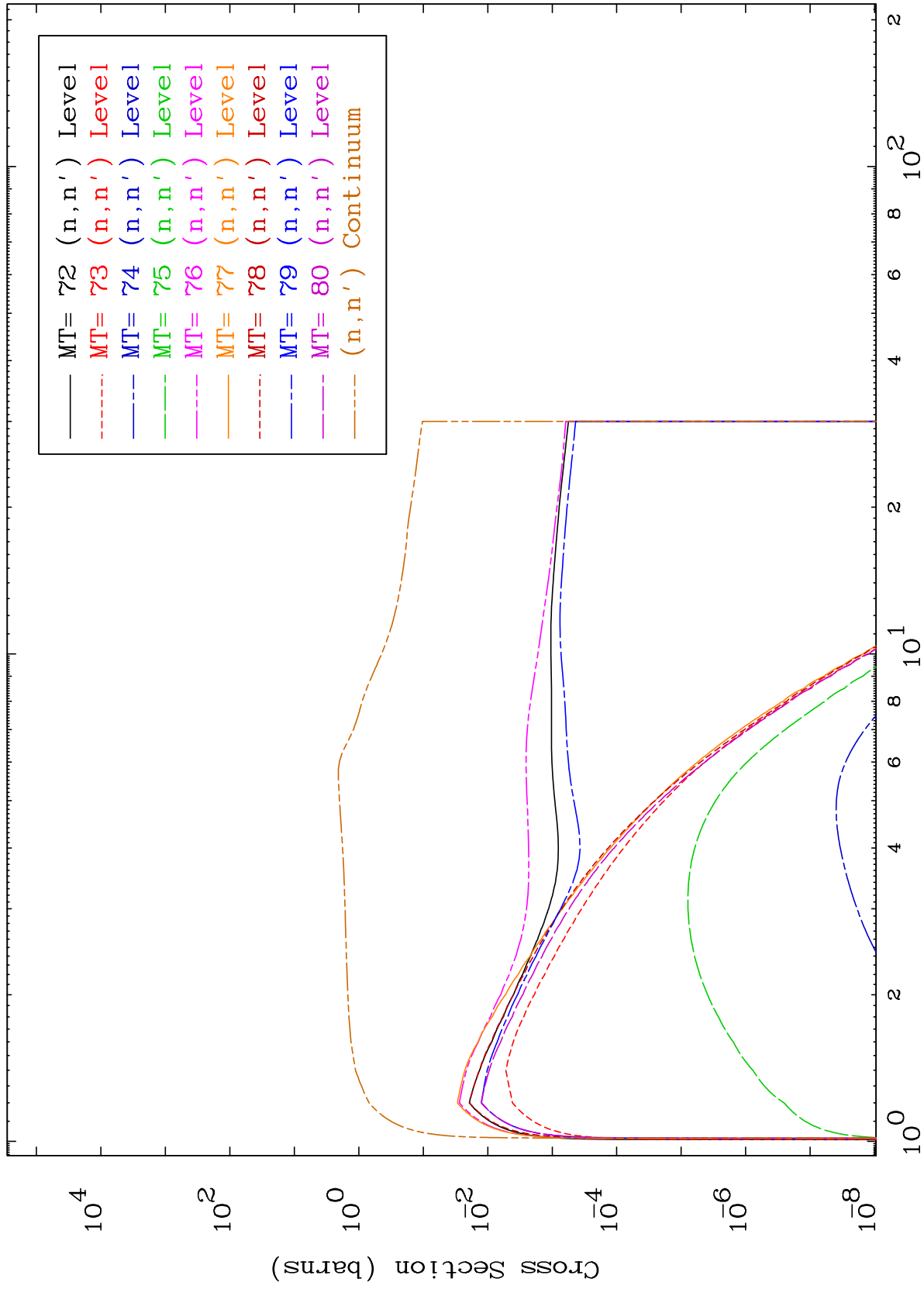

Incident Energy (MeV)

71-Lu-180

MAT 7140

(n,p) Levels
293 Kelvin Cross Sections

71-Lu-180

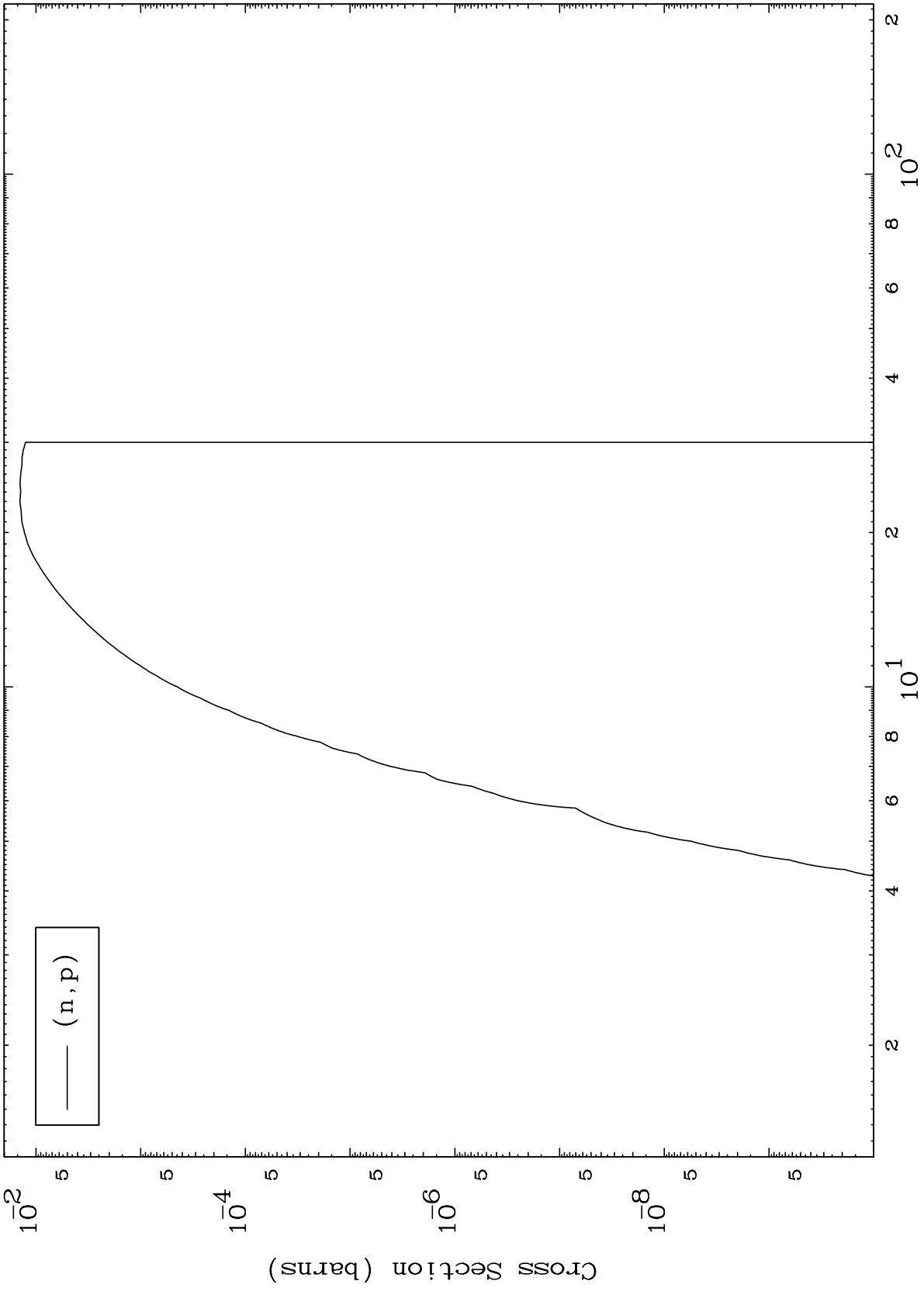

10

Incident Energy (MeV)

71-Lu-180

MAT 7140

(n,d) Levels
293 Kelvin Cross Sections

71-Lu-180

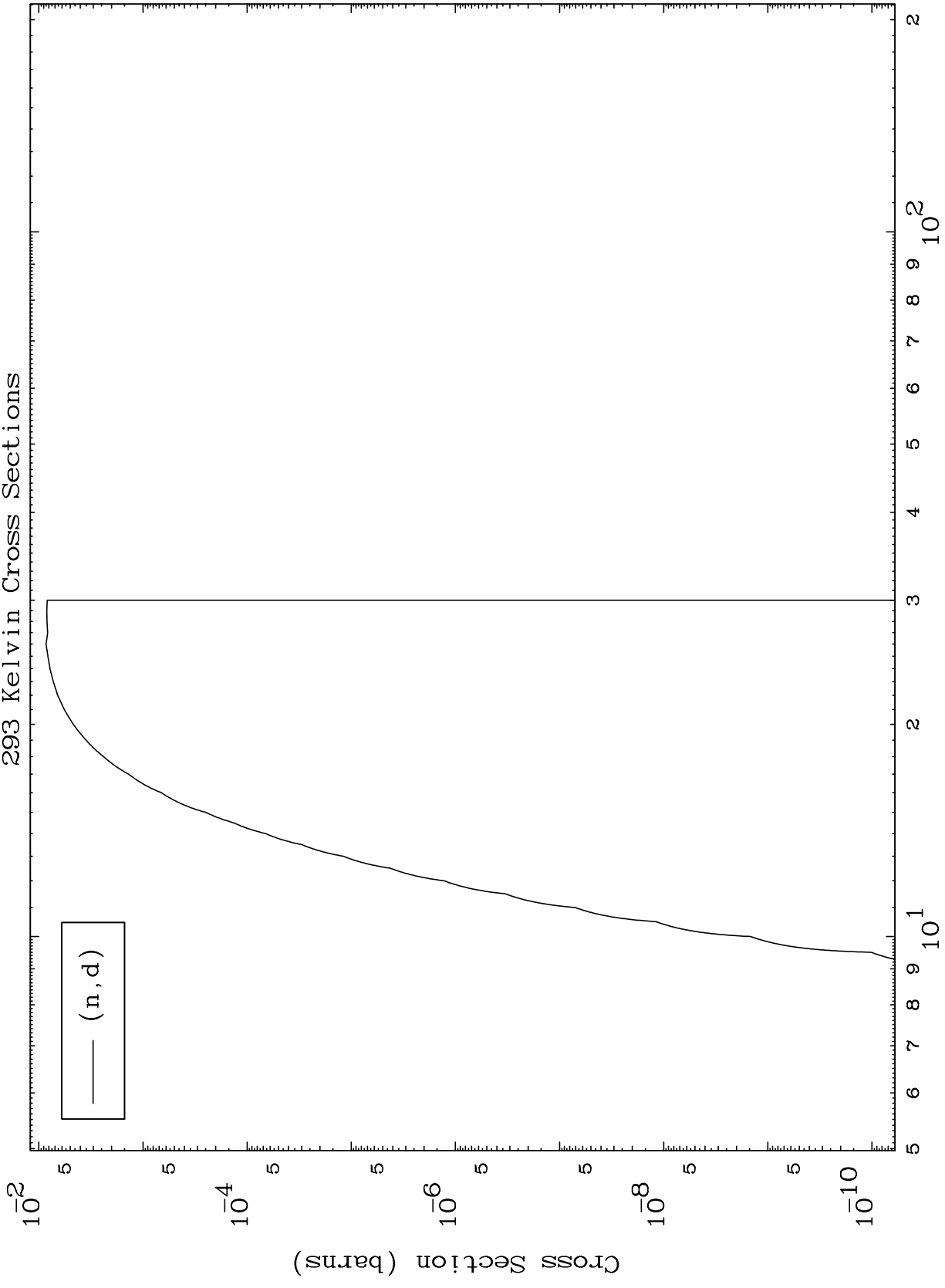

(n,d)

MAT 7140

(n,t) Levels
293 Kelvin Cross Sections

71-Lu-180

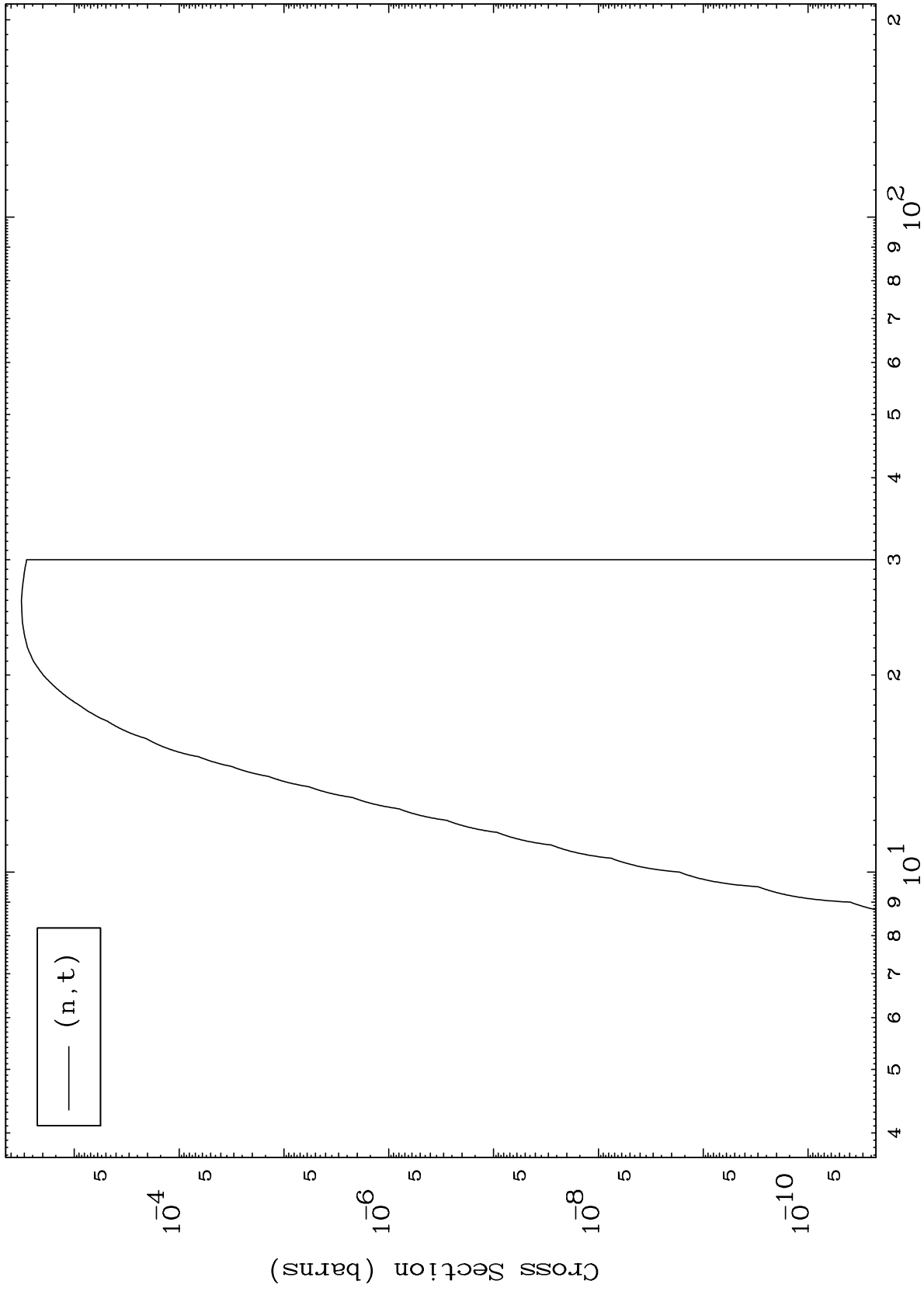

12

Incident Energy (MeV)

71-Lu-180

MAT 7140

(n,He3) Levels
293 Kelvin Cross Sections

71-Lu-180

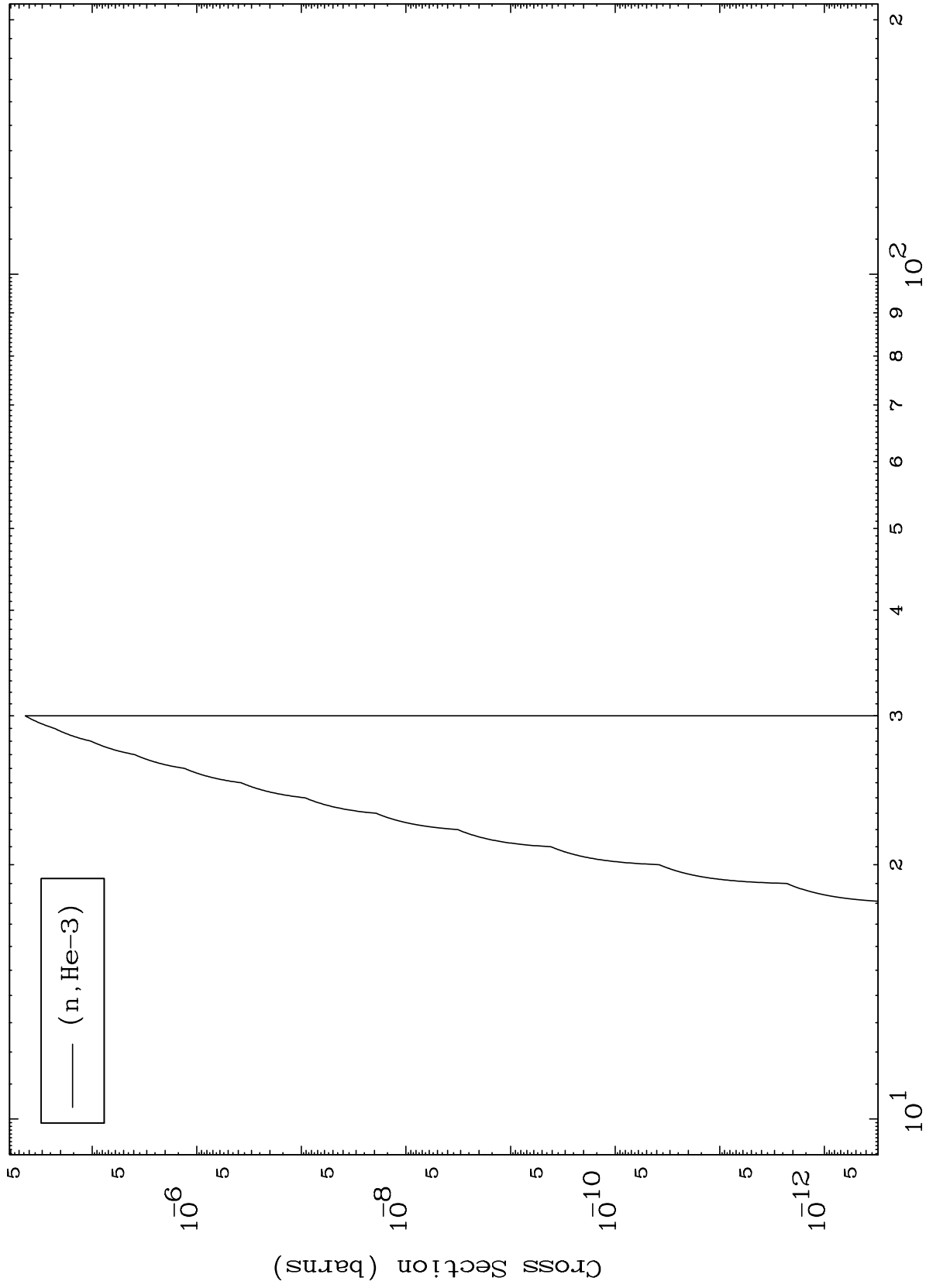

MAT 7140

(n,α) Levels
293 Kelvin Cross Sections

71-Lu-180

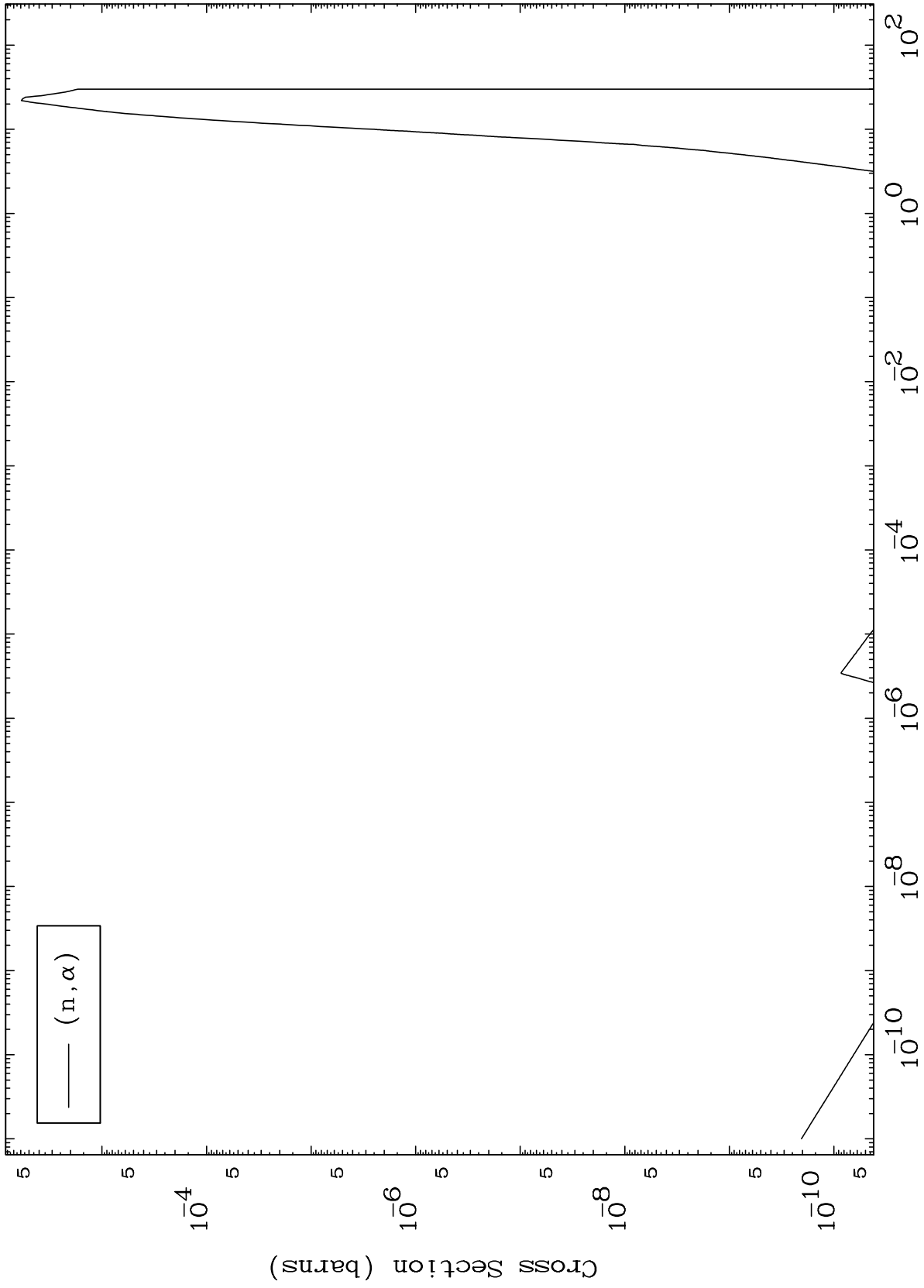

14

Incident Energy (MeV)

71-Lu-180

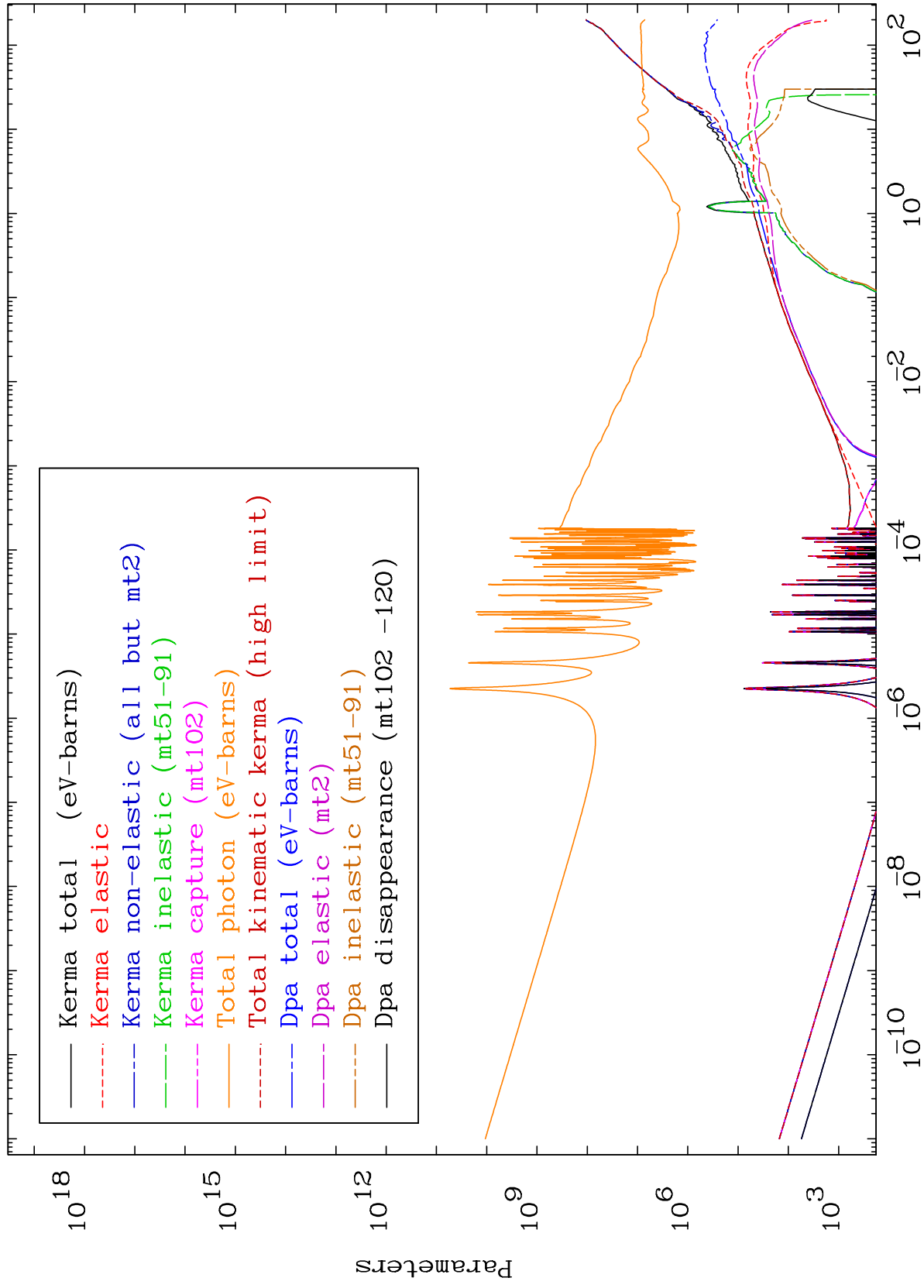

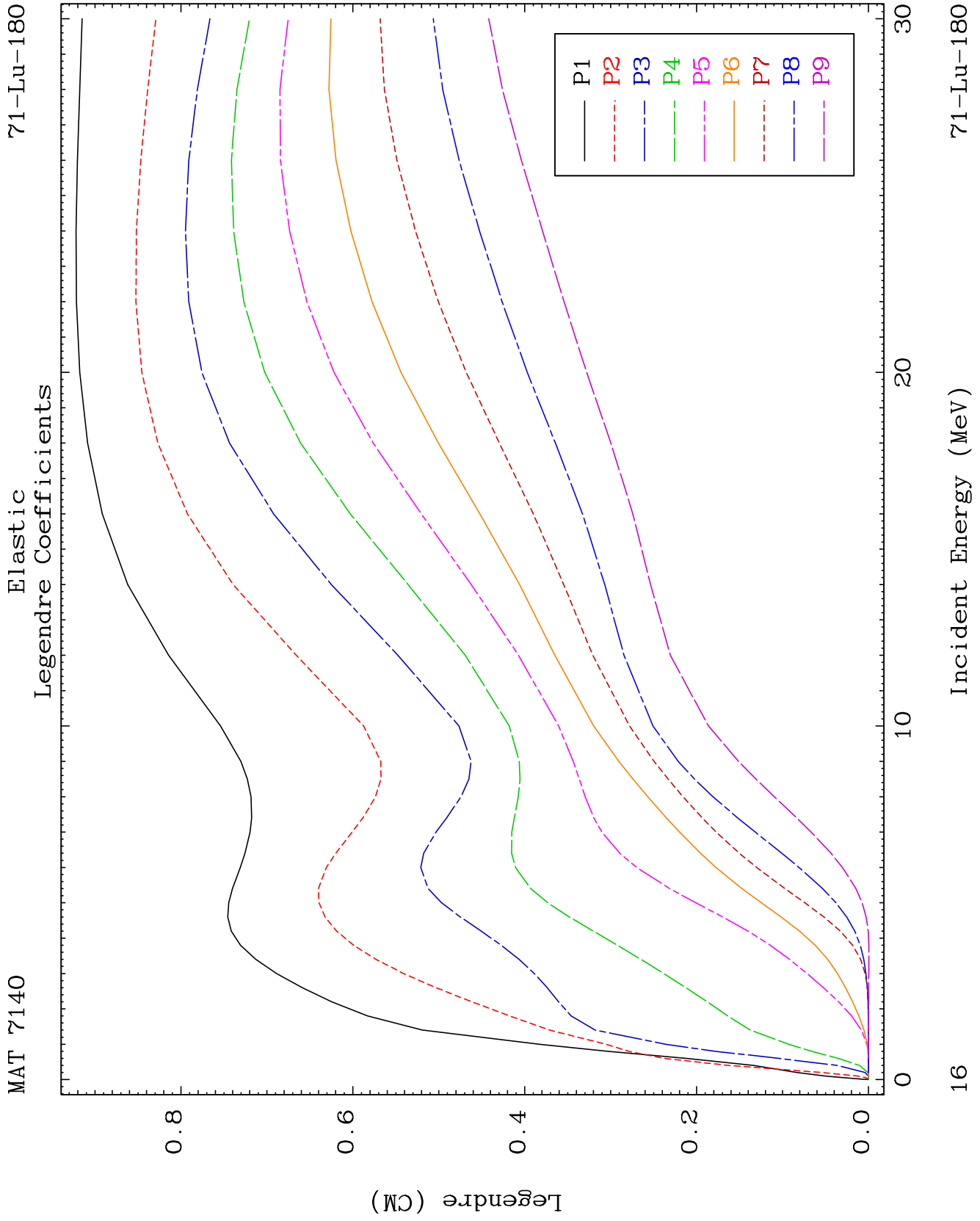

71-Lu-180

Elastic Legendre Coefficients

MAT 7140

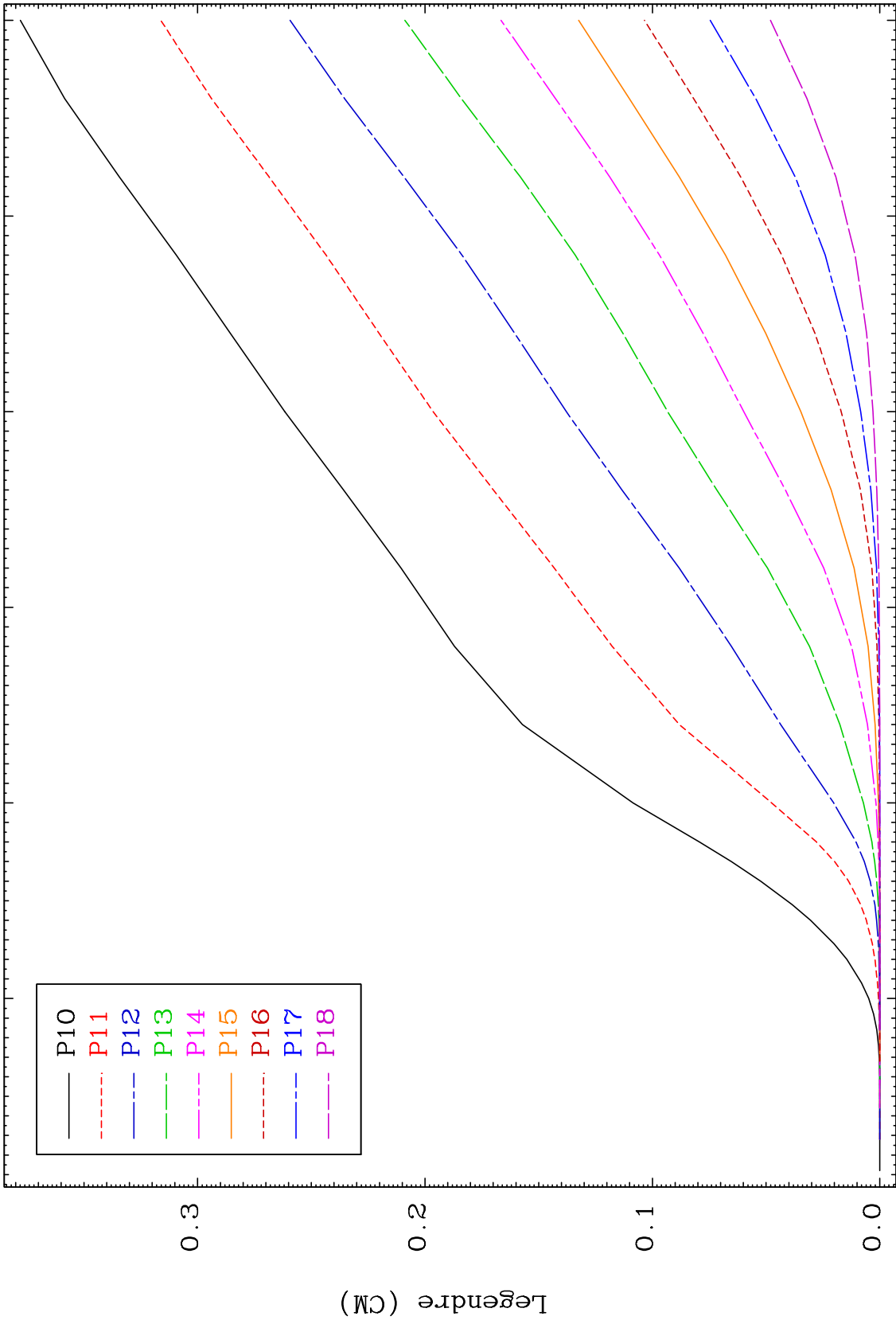

71-Lu-180

Incident Energy (MeV)

17

MAT 7140

Elastic Legendre Coefficients

71-Lu-180

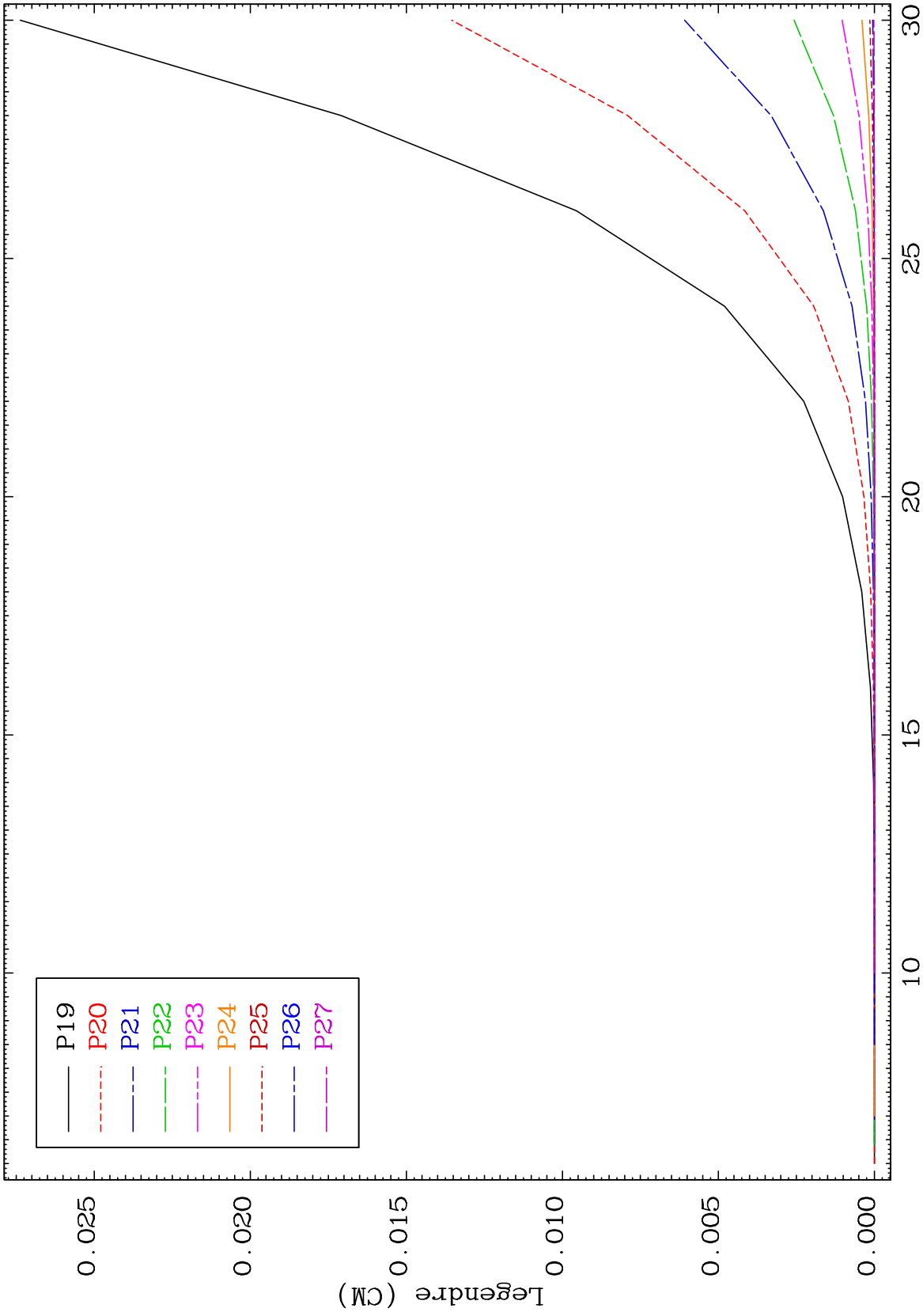

18

Incident Energy (MeV)

71-Lu-180

MAT 7140

Elastic Legendre Coefficients

71-Lu-180

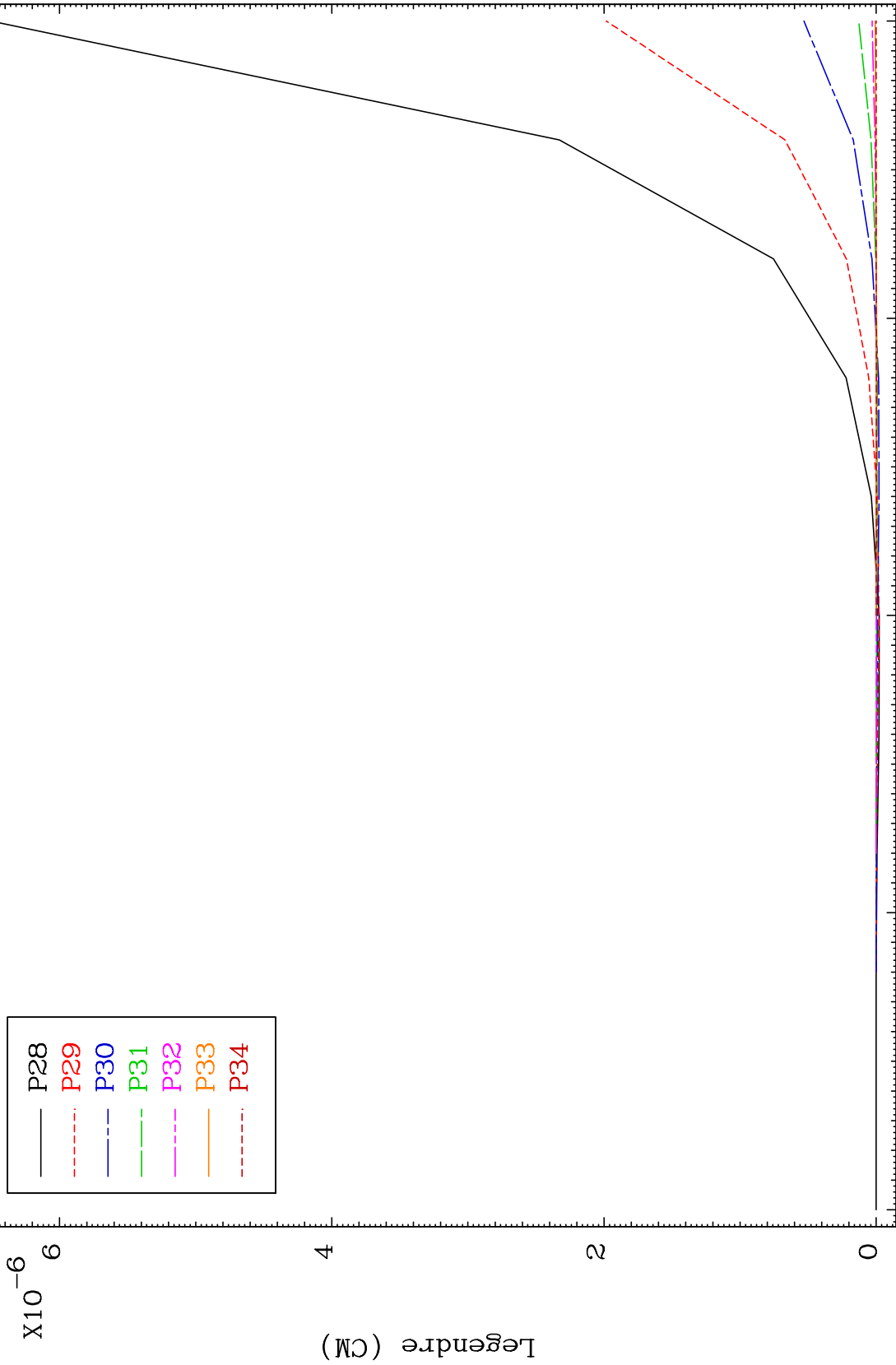
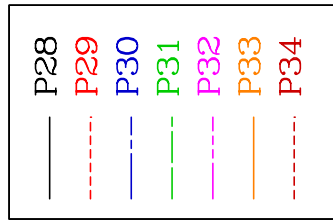

19

Incident Energy (MeV)

71-Lu-180

MAT 7140 MT= 51 (n,n') Level Legendre Coefficients 71-Lu-180

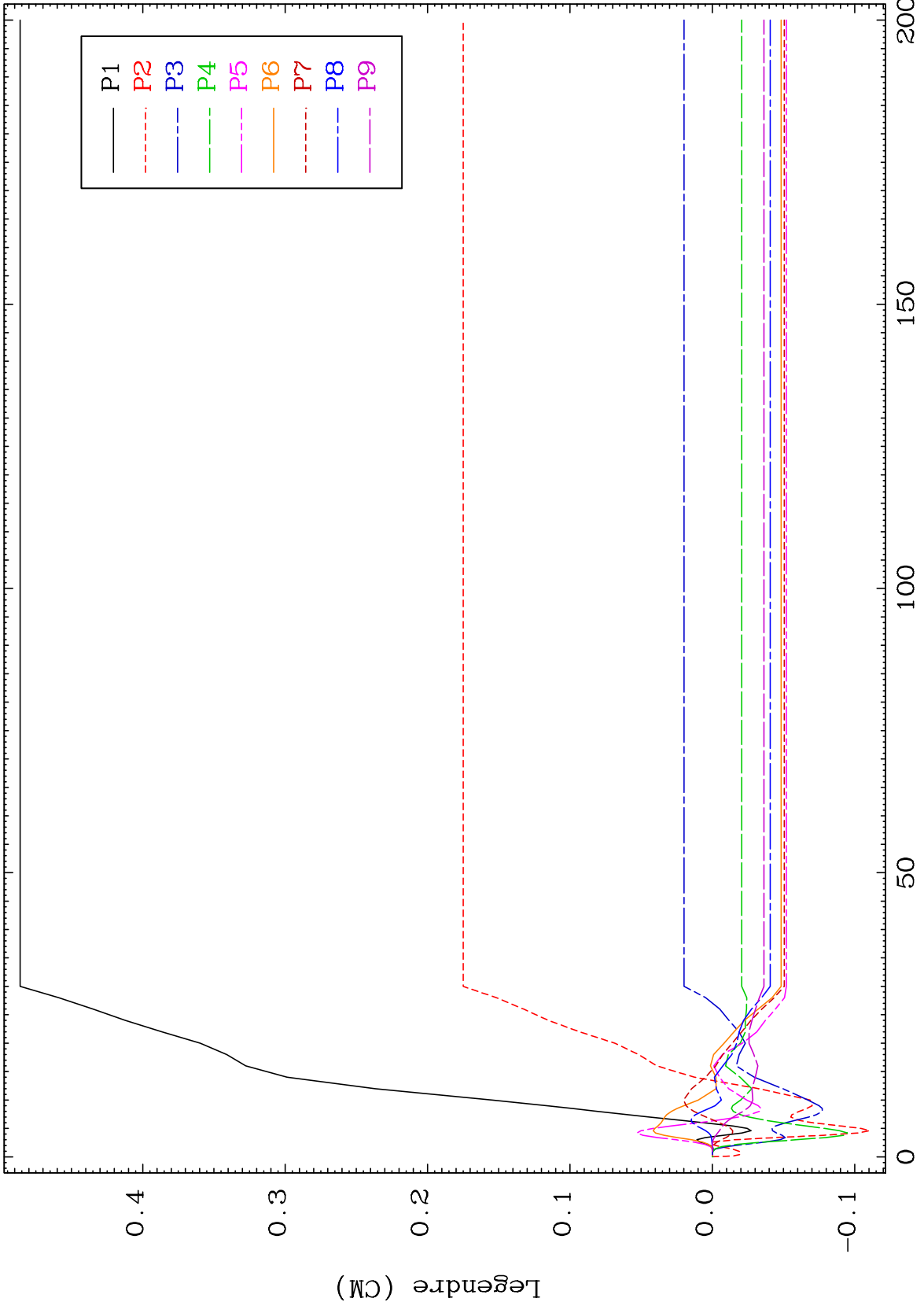

71-Lu-180

MAT 7140

MT= 51 (n,n') Level
Legendre Coefficients

71-Lu-180

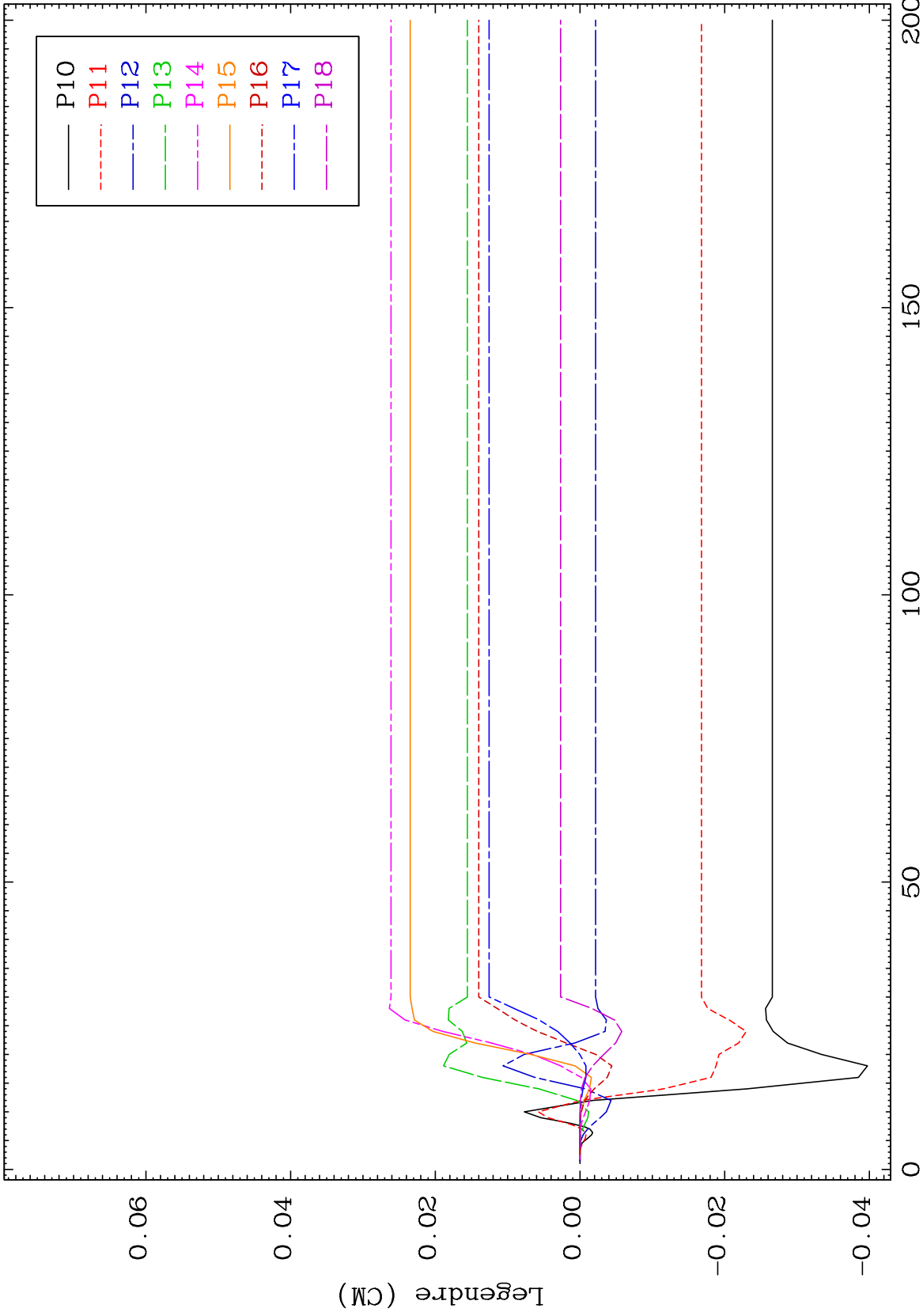

21

Incident Energy (MeV)

71-Lu-180

MAT 7140

MT= 51 (n,n') Level
Legendre Coefficients

71-Lu-180

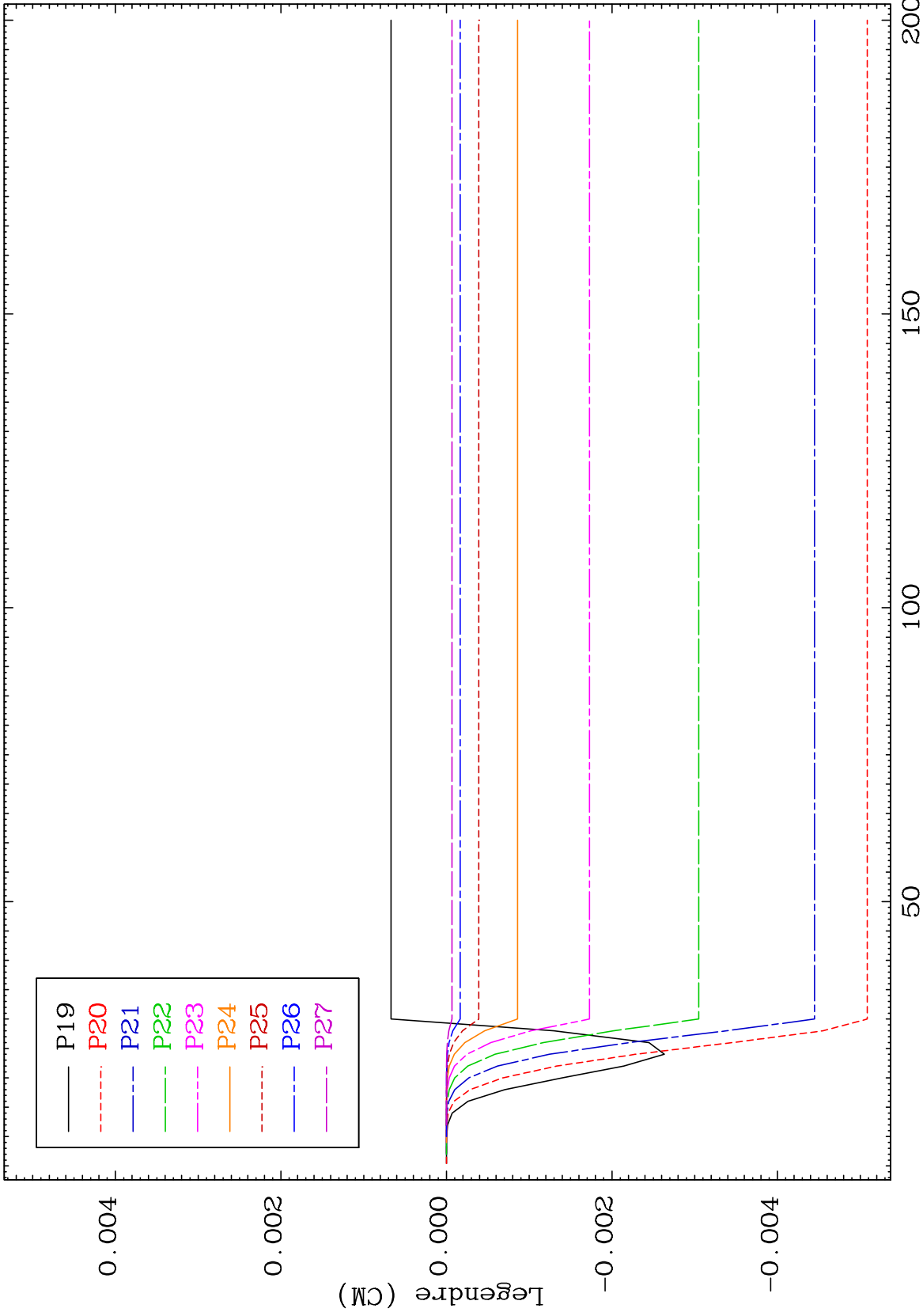

22

71-Lu-180

71-Lu-180

MAT 7140

MT= 51 (n,n') Level
Legendre Coefficients

71-Lu-180

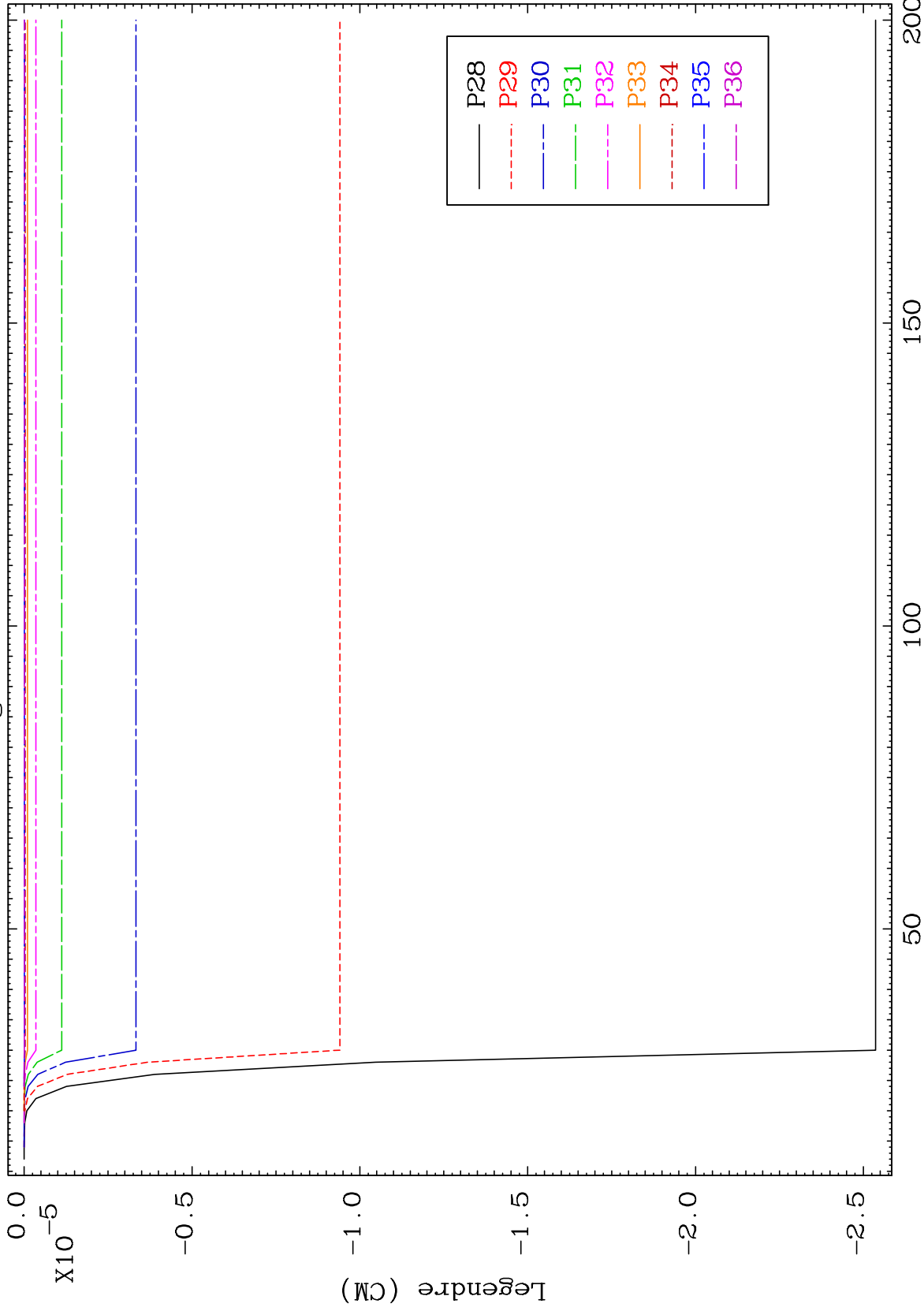

23

Incident Energy (MeV)

71-Lu-180

MAT 7140 MT= 52 (n,n') Level Legendre Coefficients 71-Lu-180

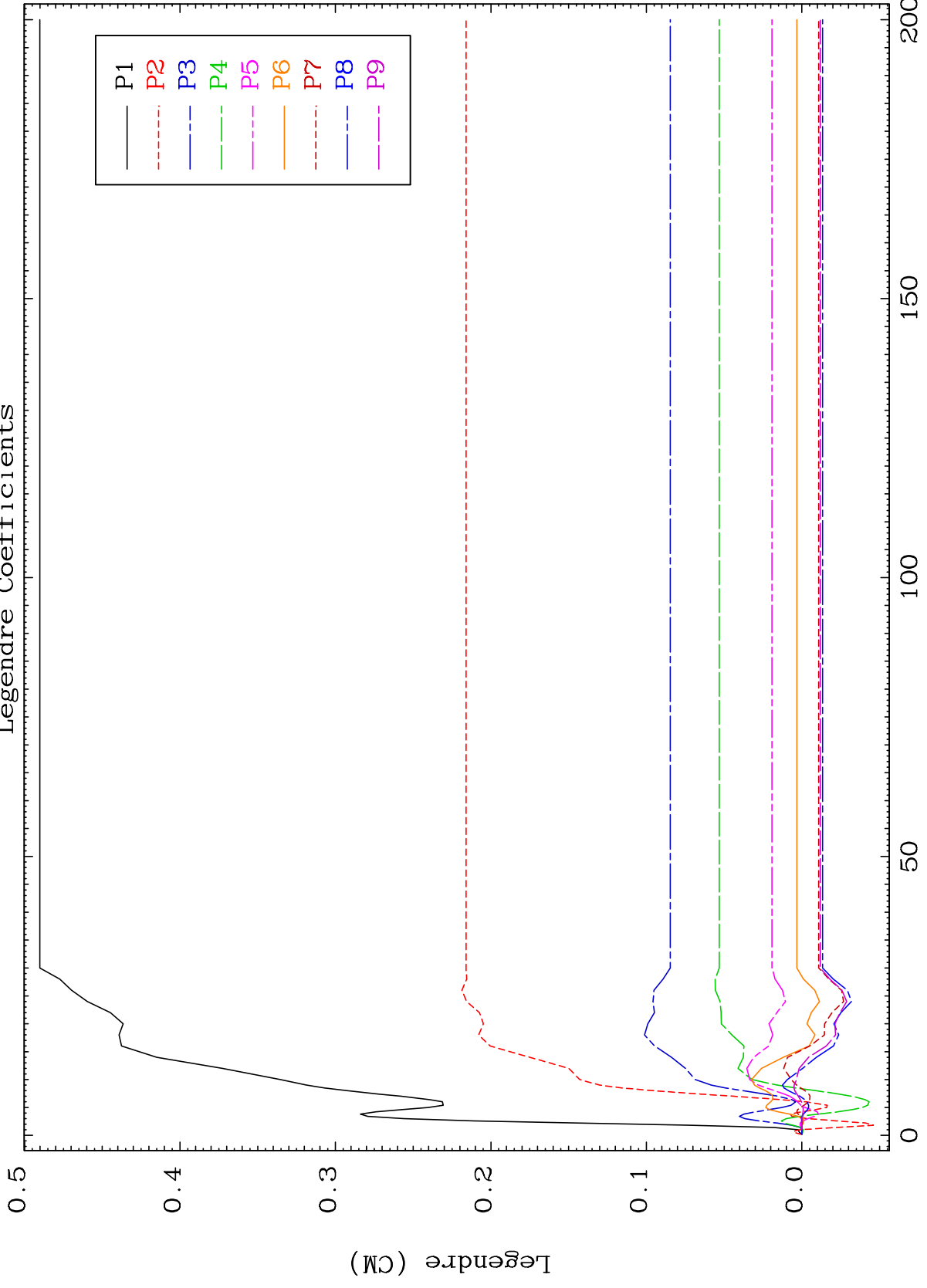

24 Incident Energy (MeV) 71-Lu-180

MAT 7140

MT= 52 (n,n') Level
Legendre Coefficients

71-Lu-180

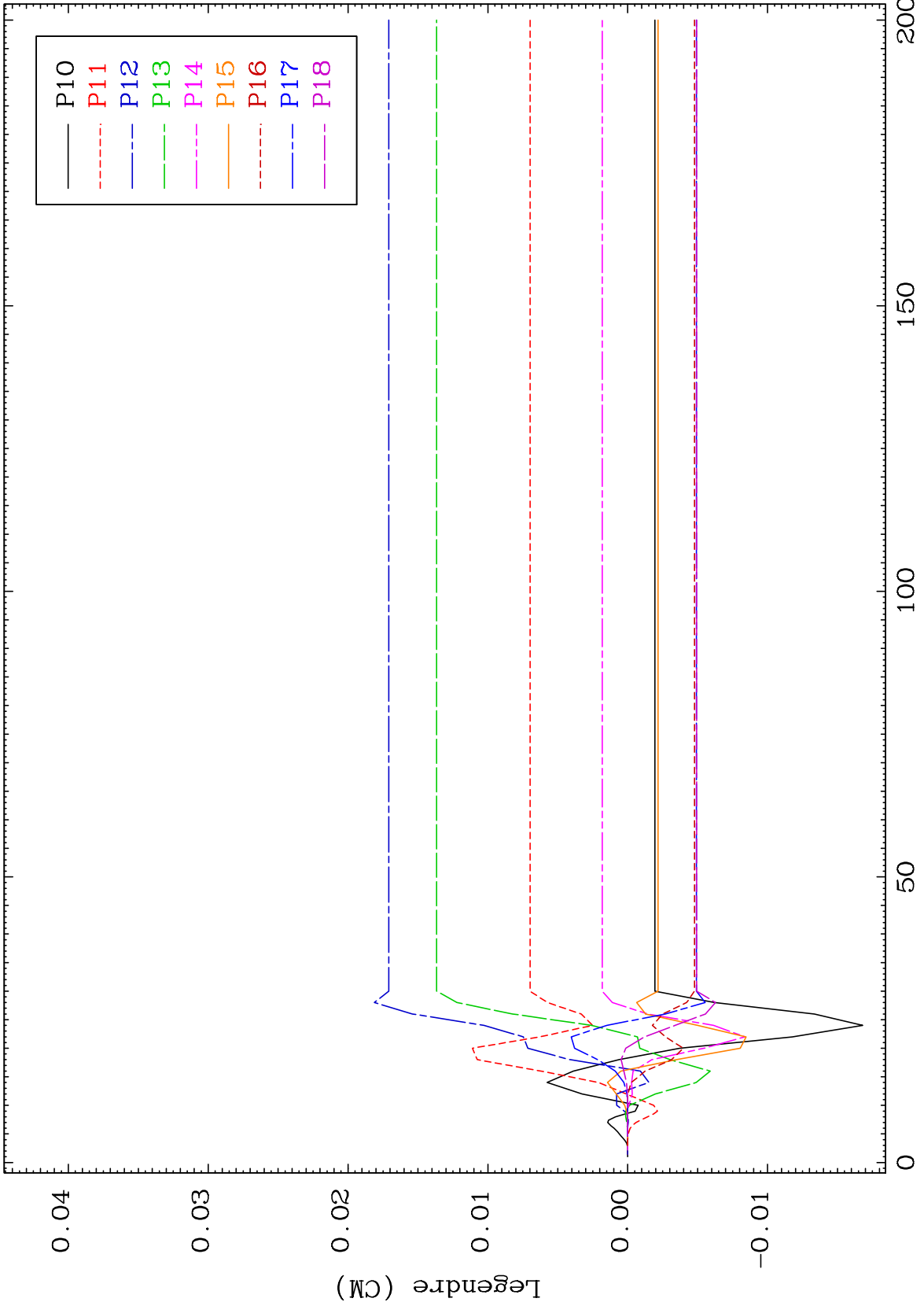

25

Incident Energy (MeV)

71-Lu-180

MAT 7140

MT= 52 (n,n') Level
Legendre Coefficients

71-Lu-180

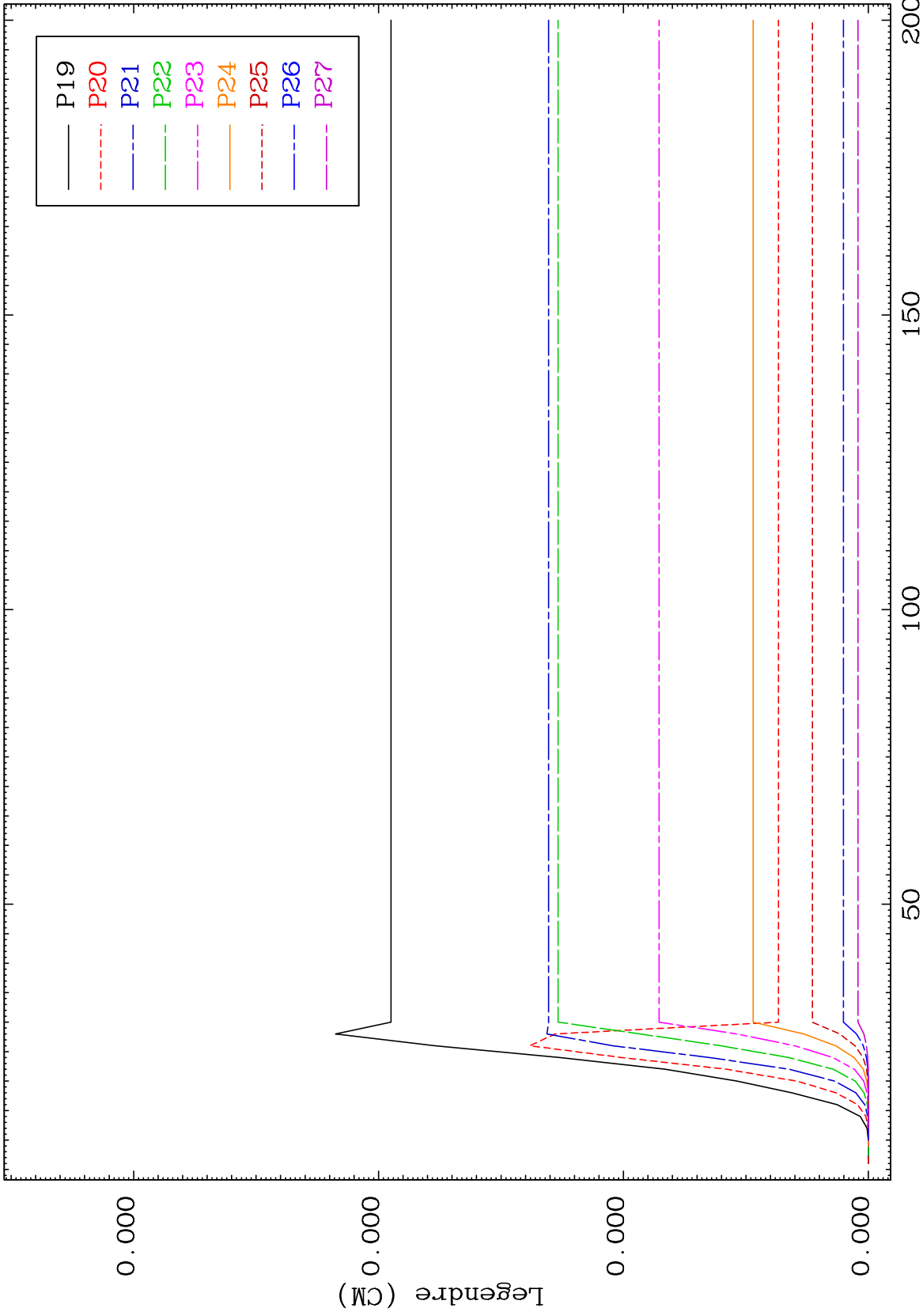

26

71-Lu-180

MAT 7140 MT= 52 (n,n') Level Legendre Coefficients 71-Lu-180

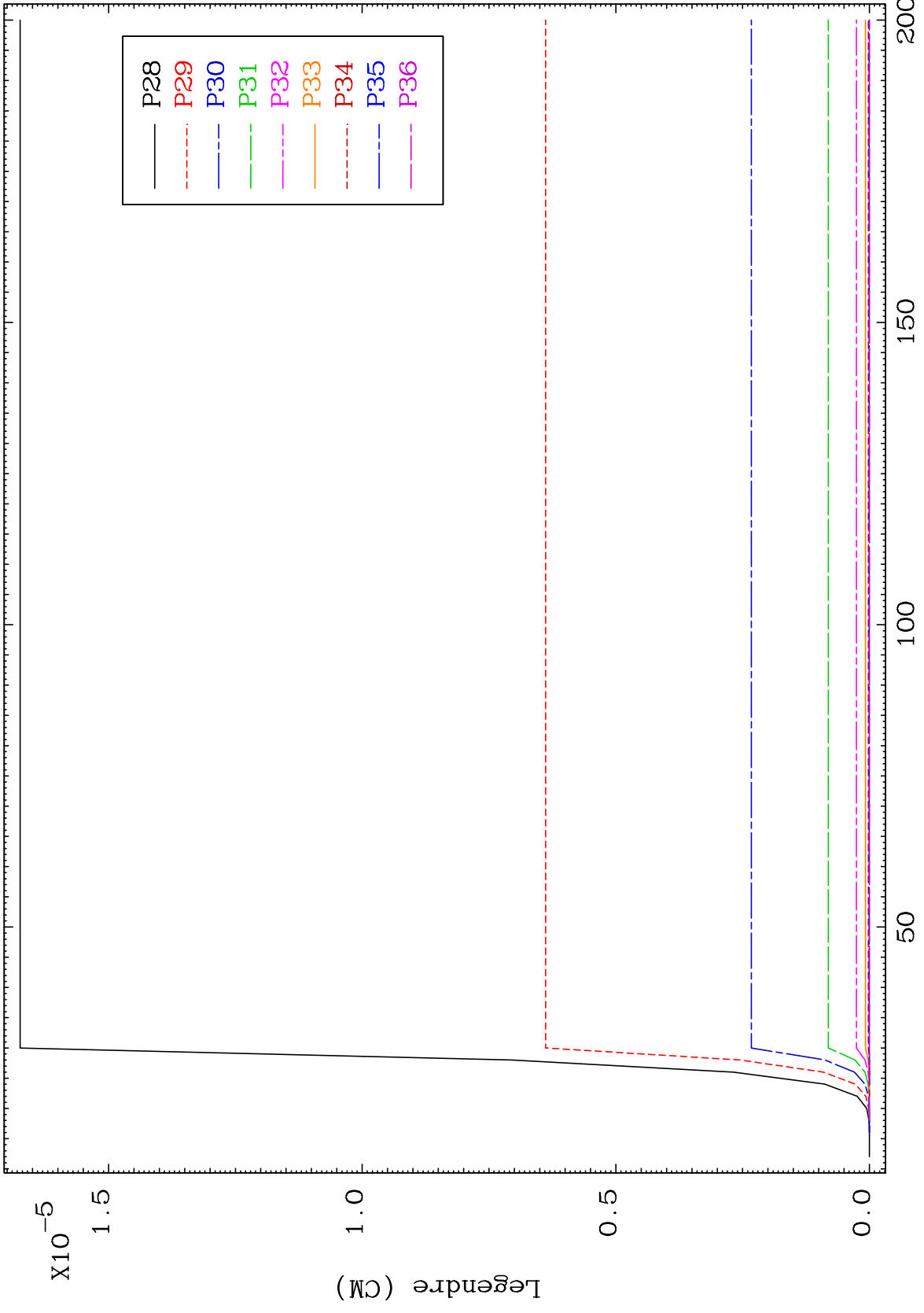

27 Incident Energy (MeV) 71-Lu-180

MAT 7140

MT= 53 (n,n') Level
Legendre Coefficients

71-Lu-180

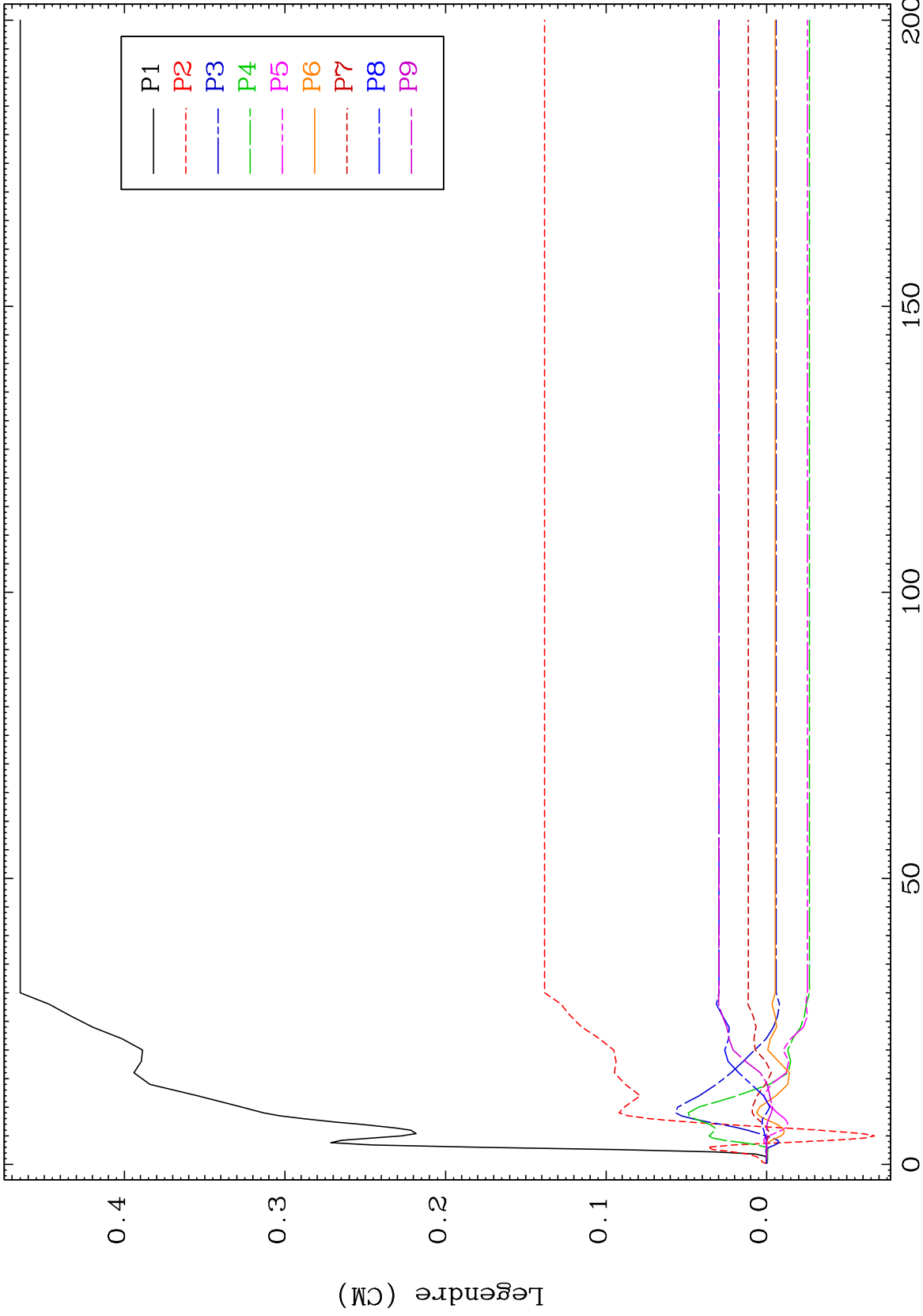

28

Incident Energy (MeV)

71-Lu-180

MAT 7140

MT= 53 (n,n') Level
Legendre Coefficients

71-Lu-180

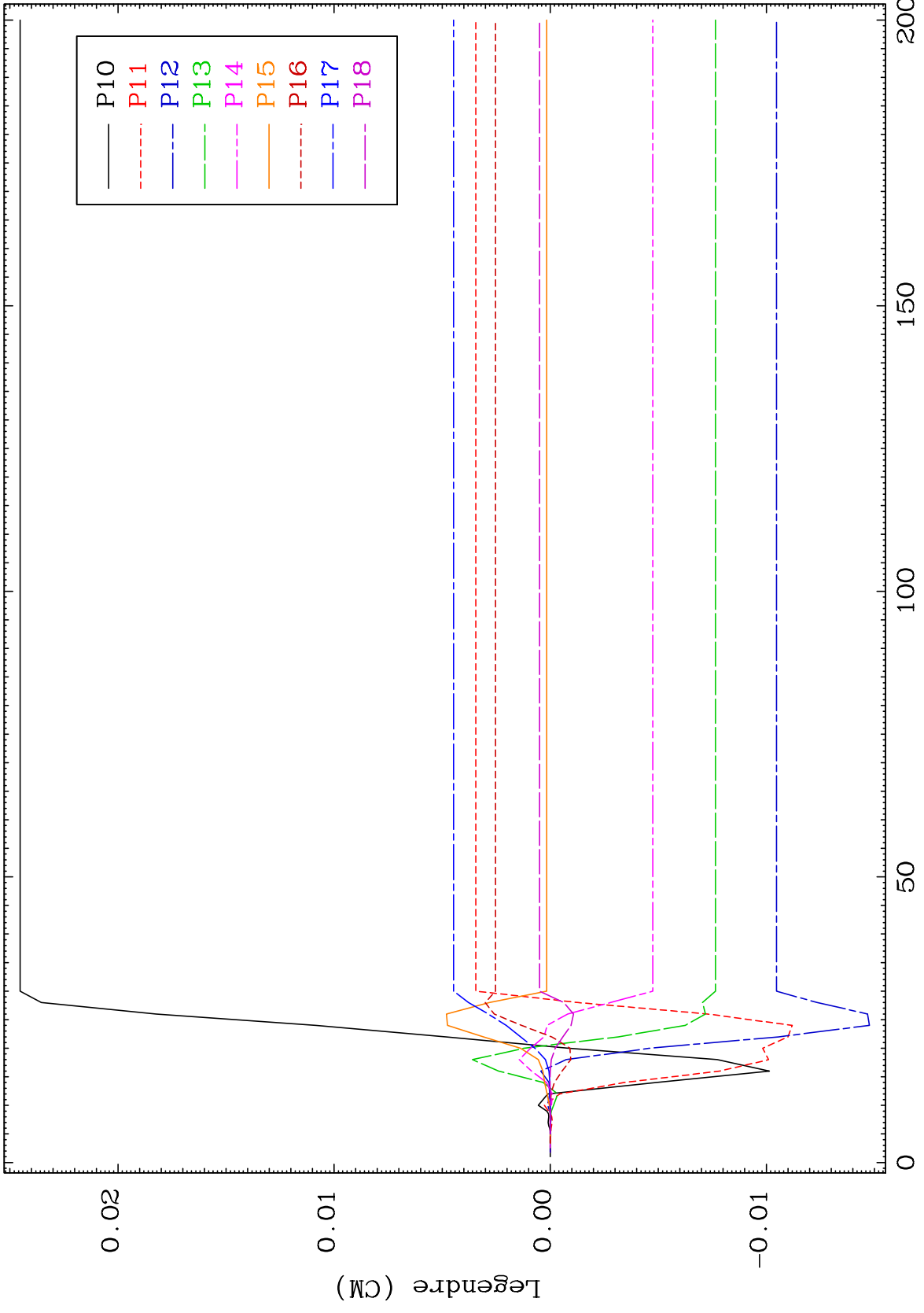

29

Incident Energy (MeV)

71-Lu-180

MAT 7140

MT= 53 (n,n') Level
Legendre Coefficients

71-Lu-180

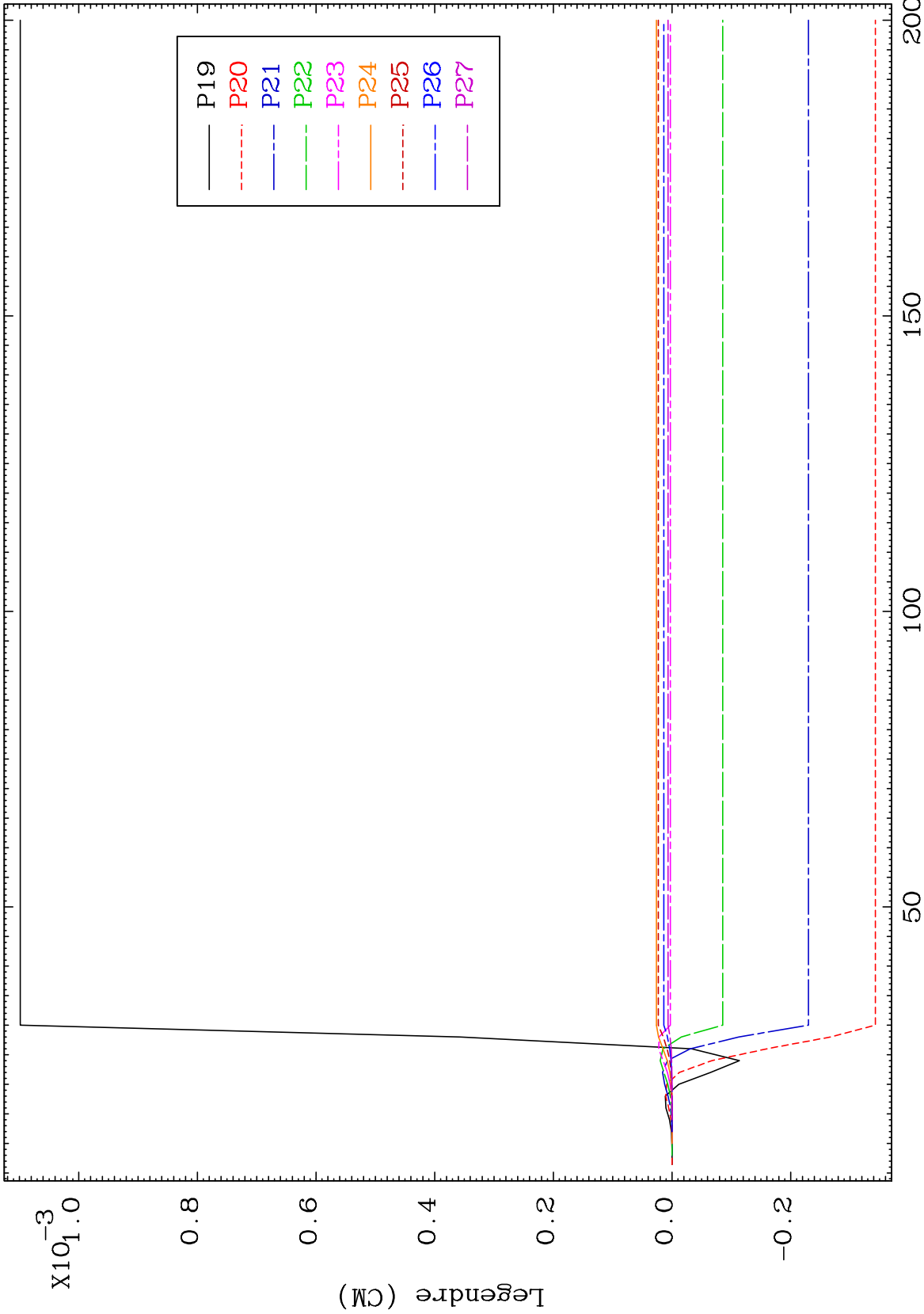

30

Incident Energy (MeV)

71-Lu-180

MAT 7140

MT= 53 (n,n') Level
Legendre Coefficients

71-Lu-180

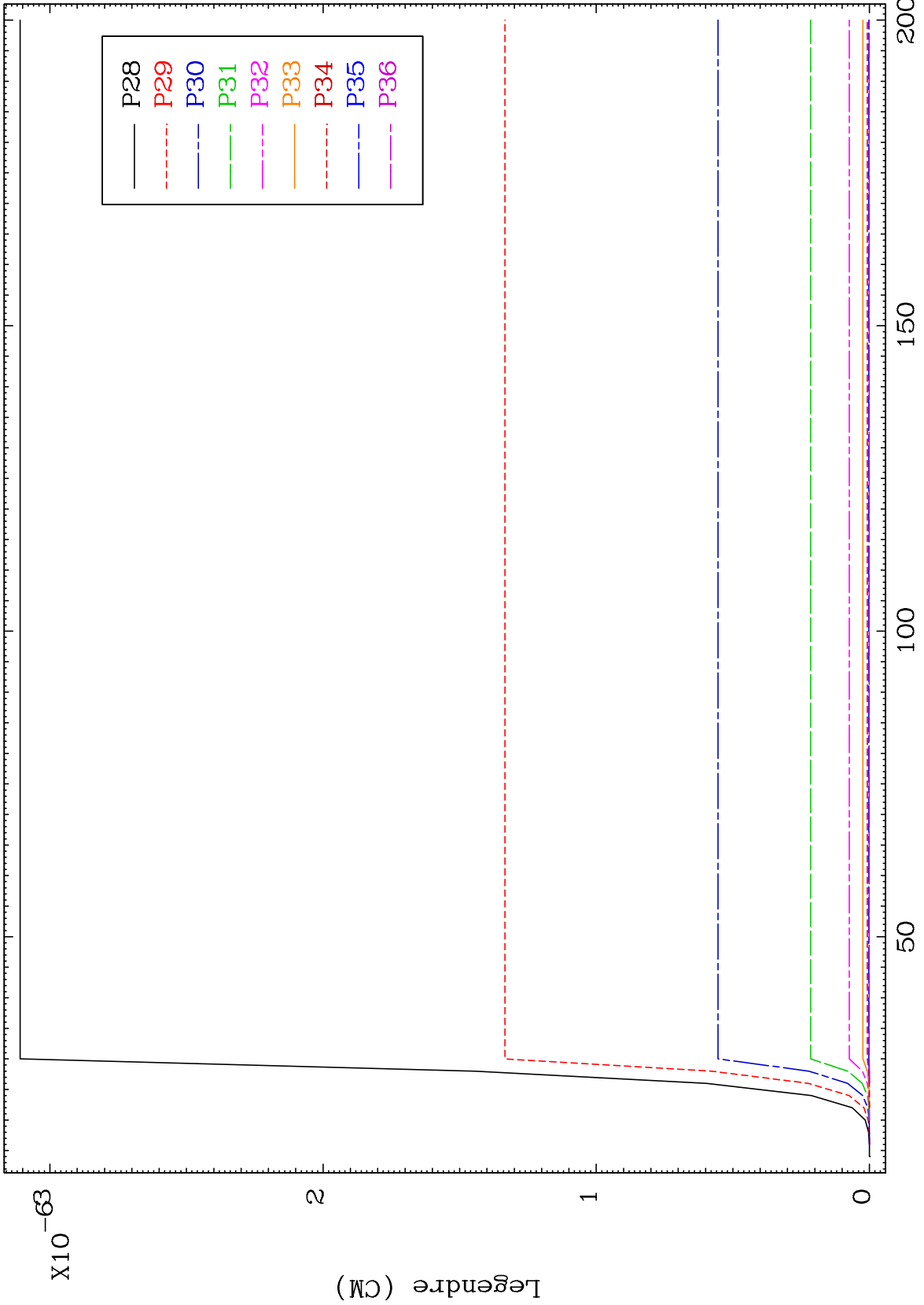

31

Incident Energy (MeV)

71-Lu-180

MAT 7140

MT= 54 (n,n') Level
Legendre Coefficients

71-Lu-180

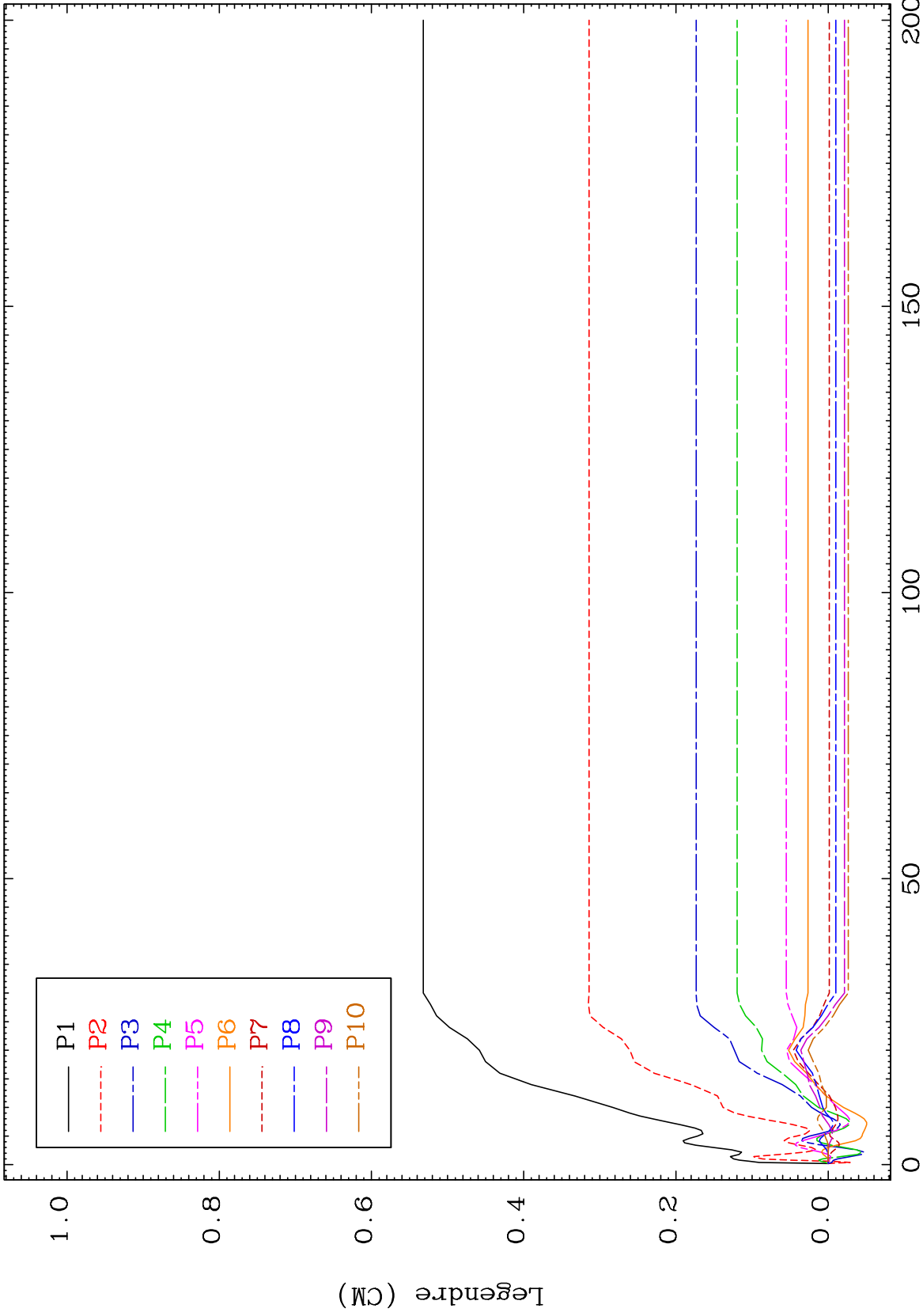

32

Incident Energy (MeV)

71-Lu-180

MAT 7140

MT= 54 (n,n') Level
Legendre Coefficients

71-Lu-180

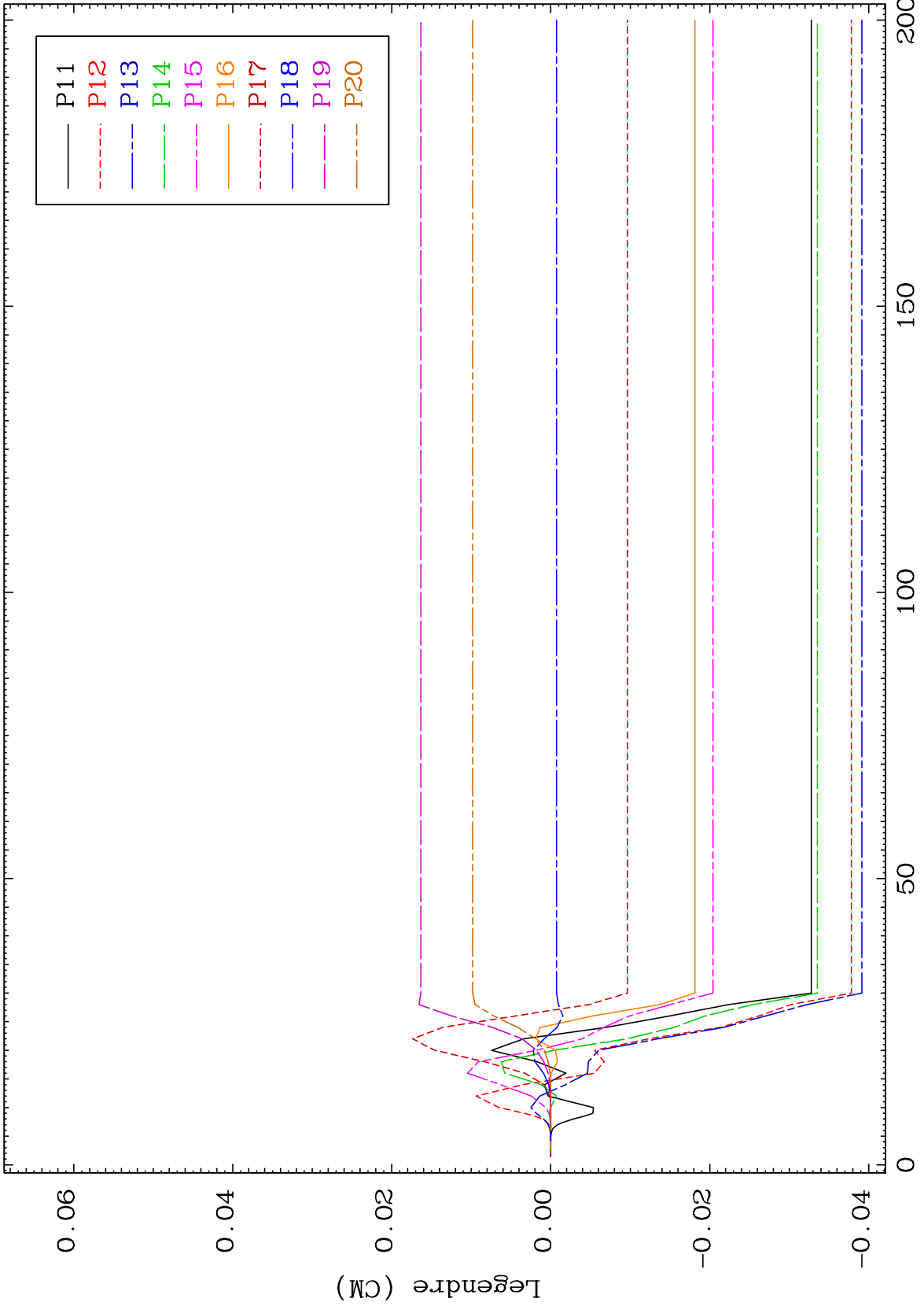

33

Incident Energy (MeV)

71-Lu-180

MAT 7140

MT= 54 (n,n') Level
Legendre Coefficients

71-Lu-180

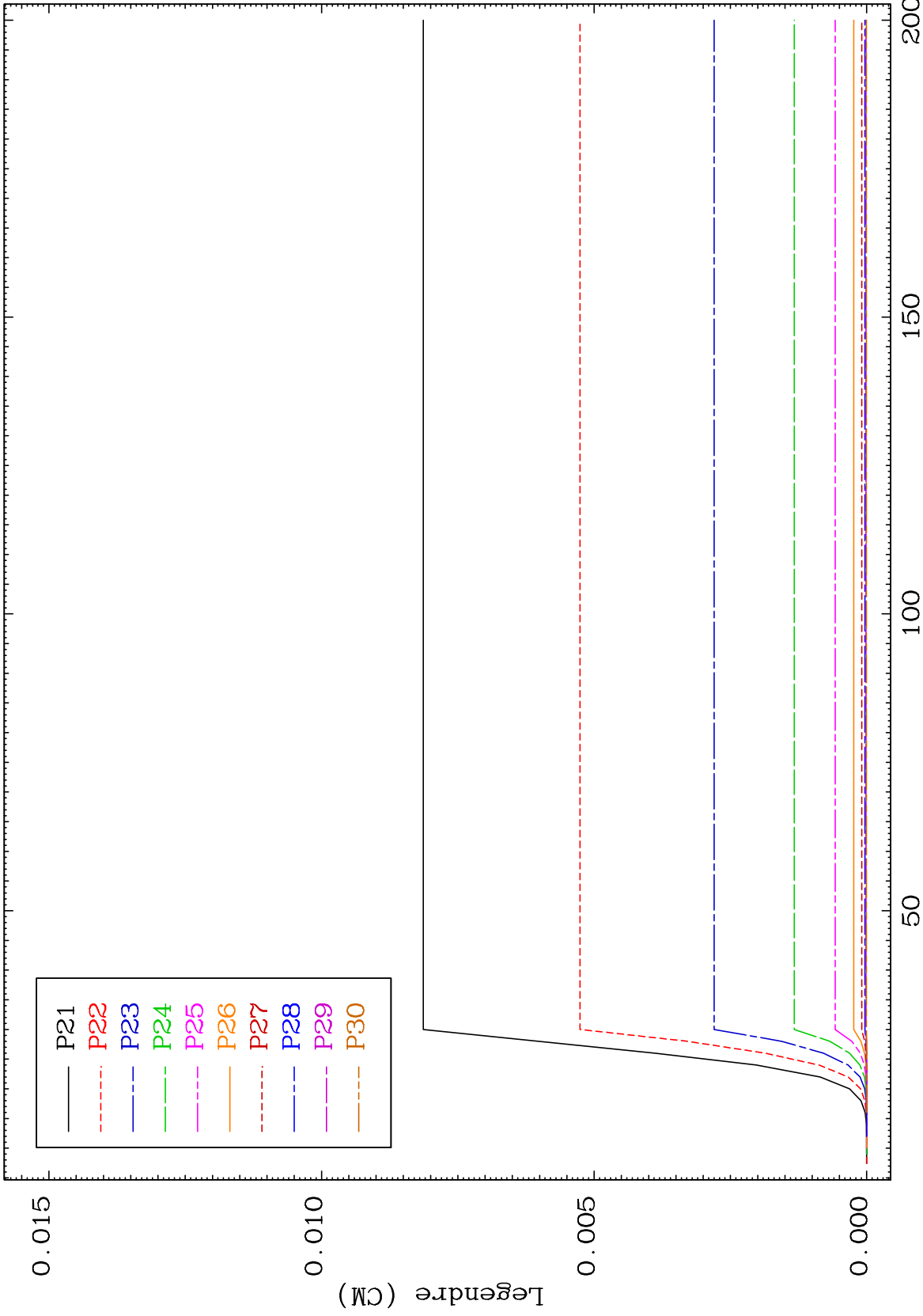

34

Incident Energy (MeV)

71-Lu-180

MAT 7140

MT= 54 (n,n') Level
Legendre Coefficients

71-Lu-180

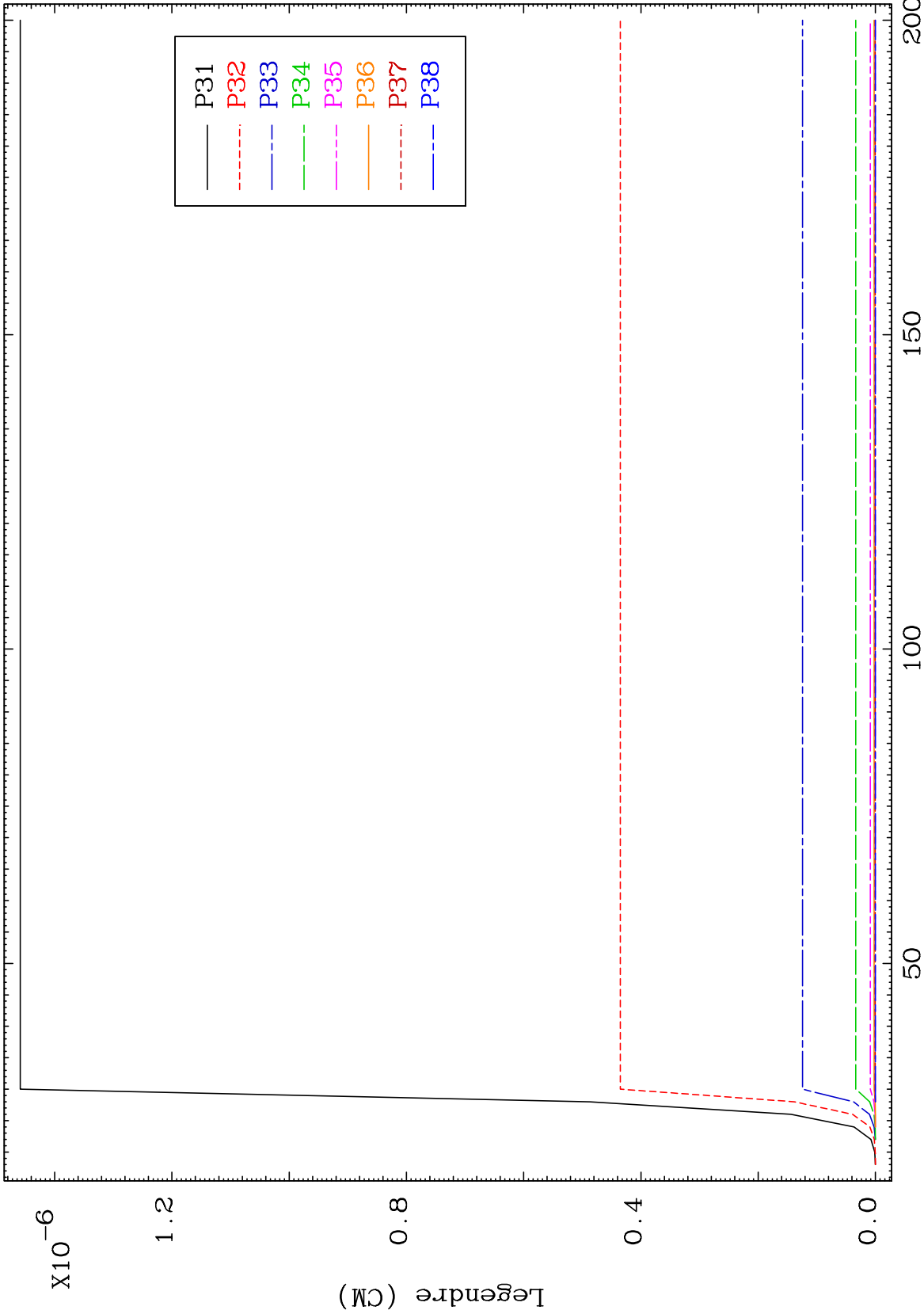

35

71-Lu-180

MAT 7140

MT= 55 (n,n') Level
Legendre Coefficients

71-Lu-180

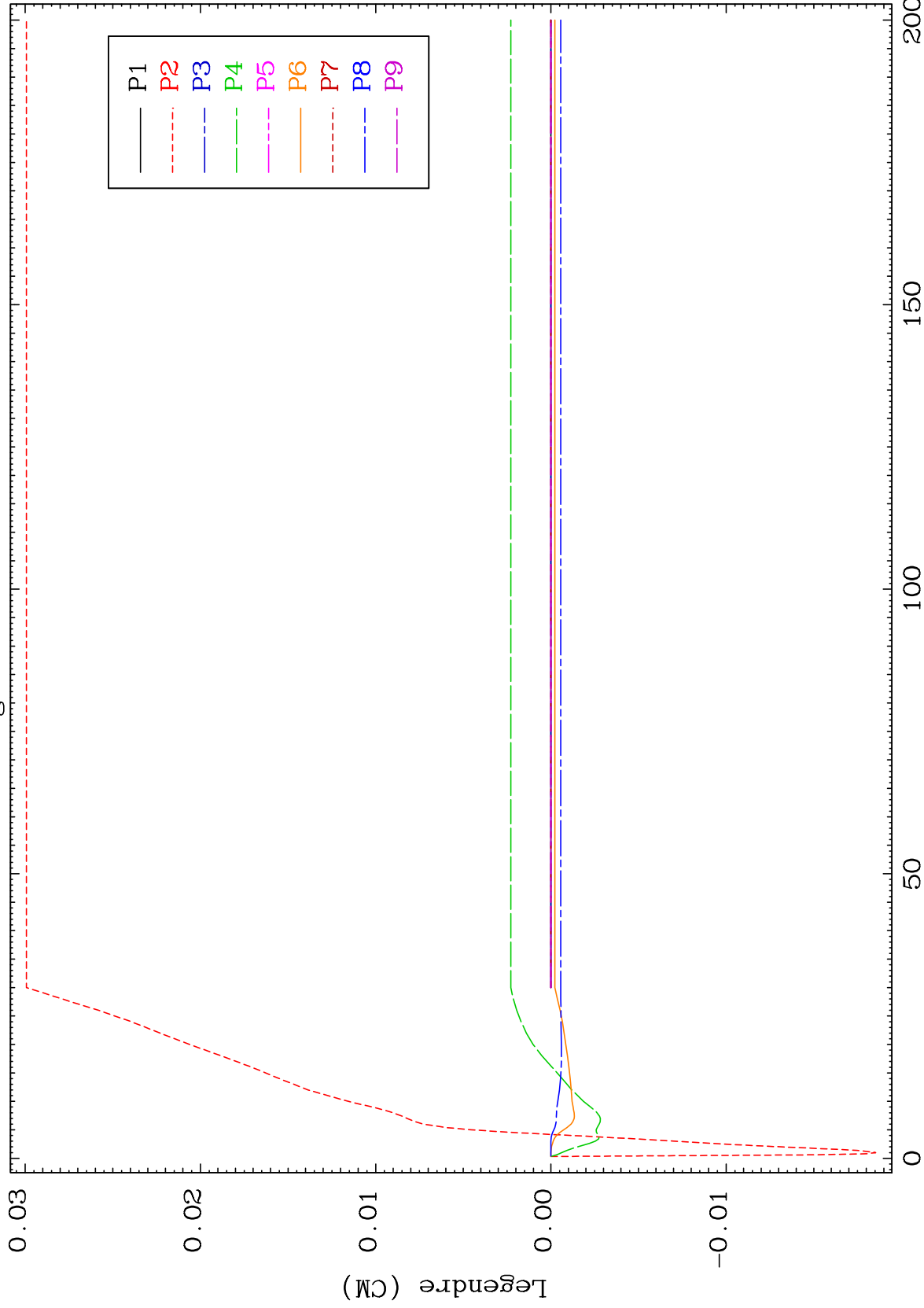

36

Incident Energy (MeV)

71-Lu-180

MAT 7140

MT= 55 (n,n') Level
Legendre Coefficients

71-Lu-180

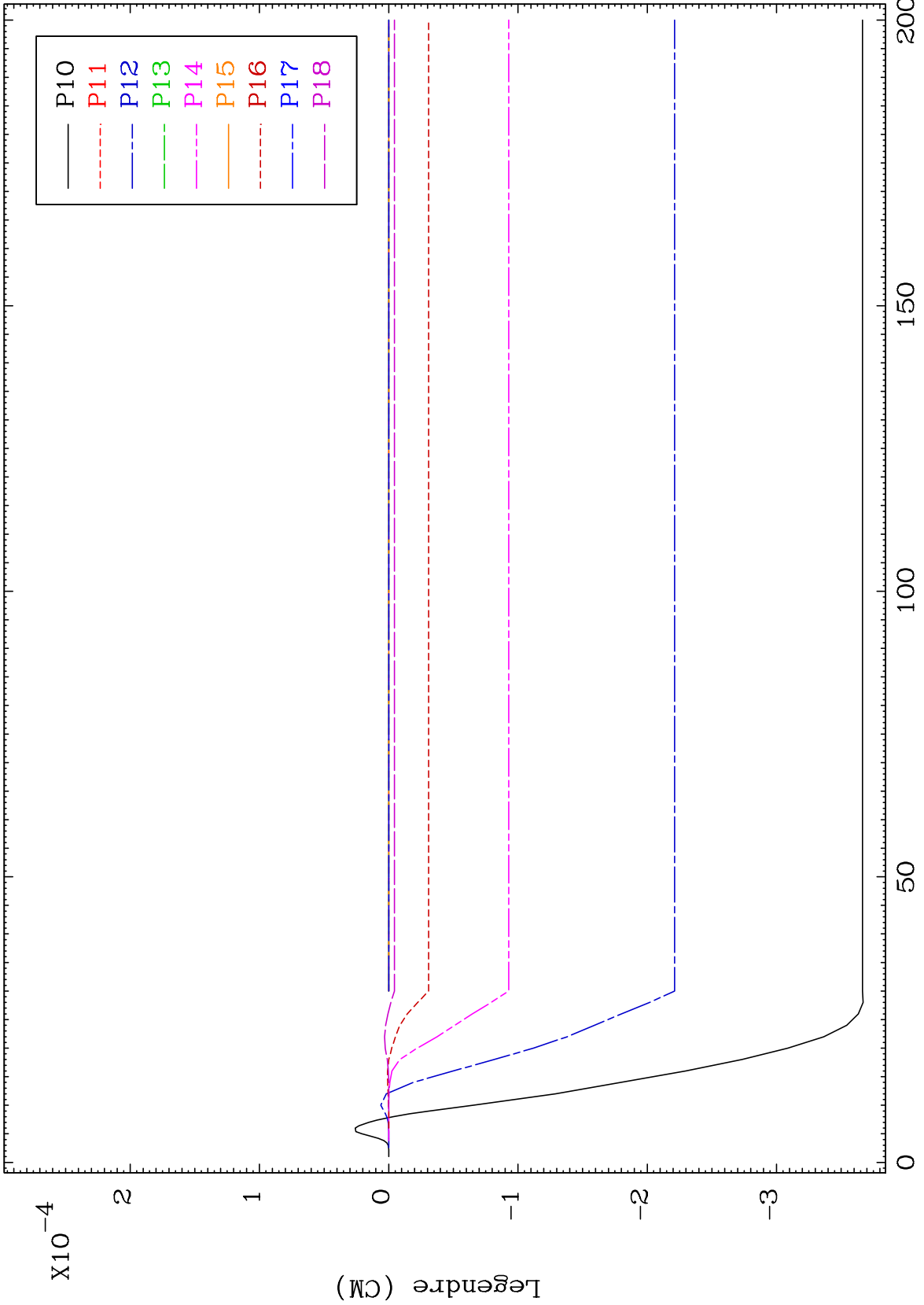

37

Incident Energy (MeV)

71-Lu-180

MAT 7140 MT= 55 (n,n') Level Legendre Coefficients 71-Lu-180

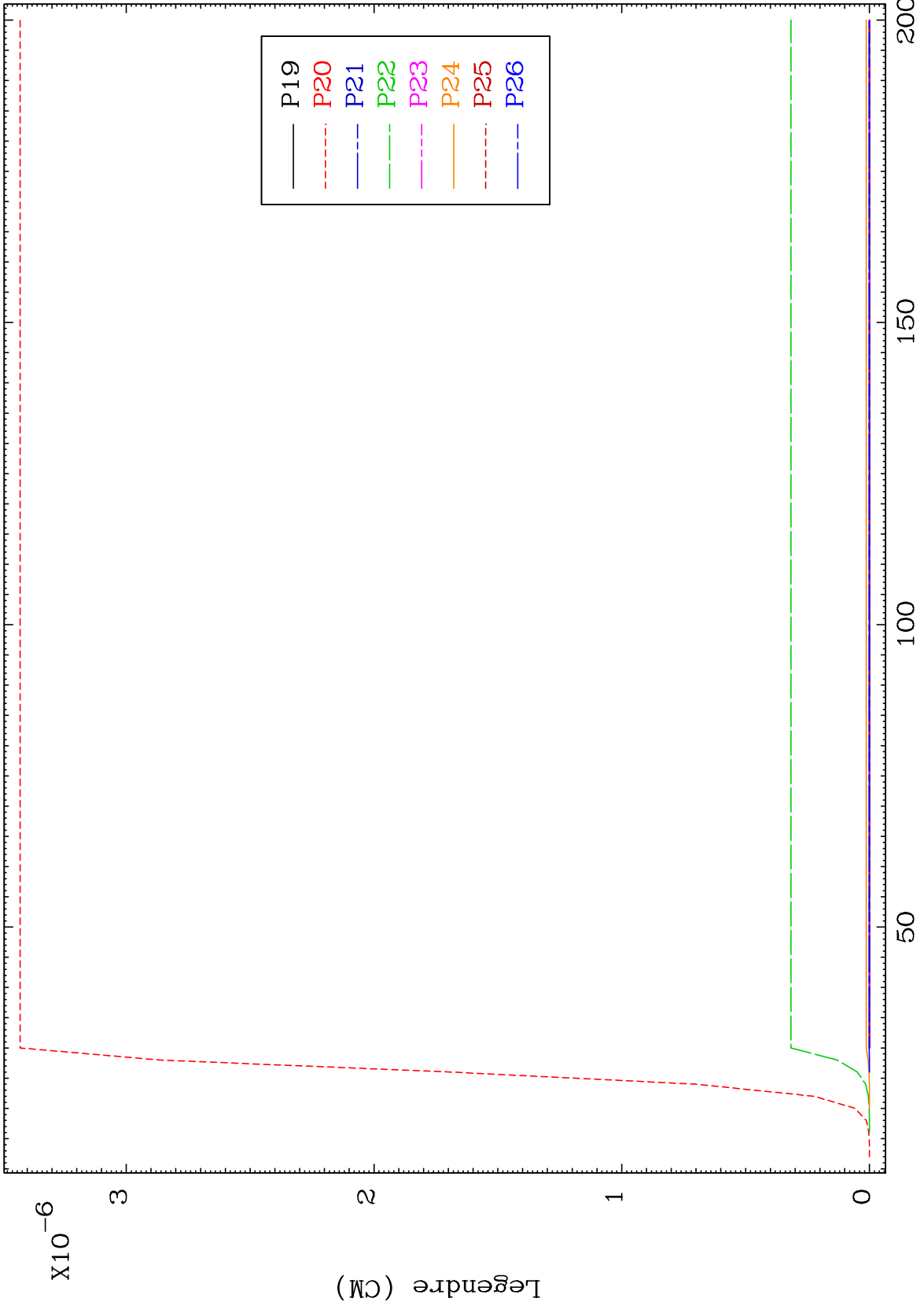

38 Incident Energy (MeV) 71-Lu-180

MAT 7140 MT= 56 (n,n') Level Legendre Coefficients 71-Lu-180

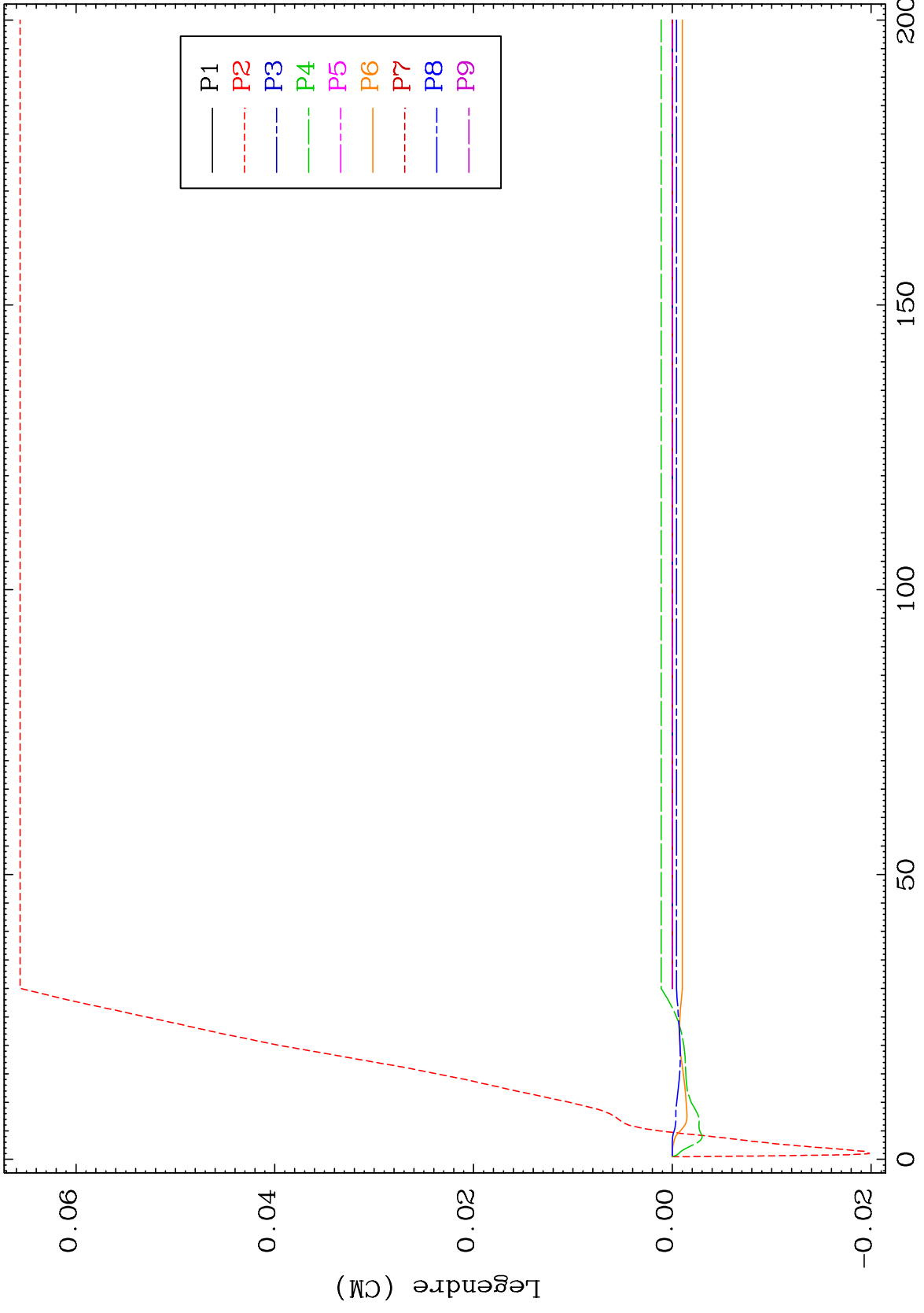

39 71-Lu-180

MAT 7140 MT= 56 (n,n') Level Legendre Coefficients 71-Lu-180

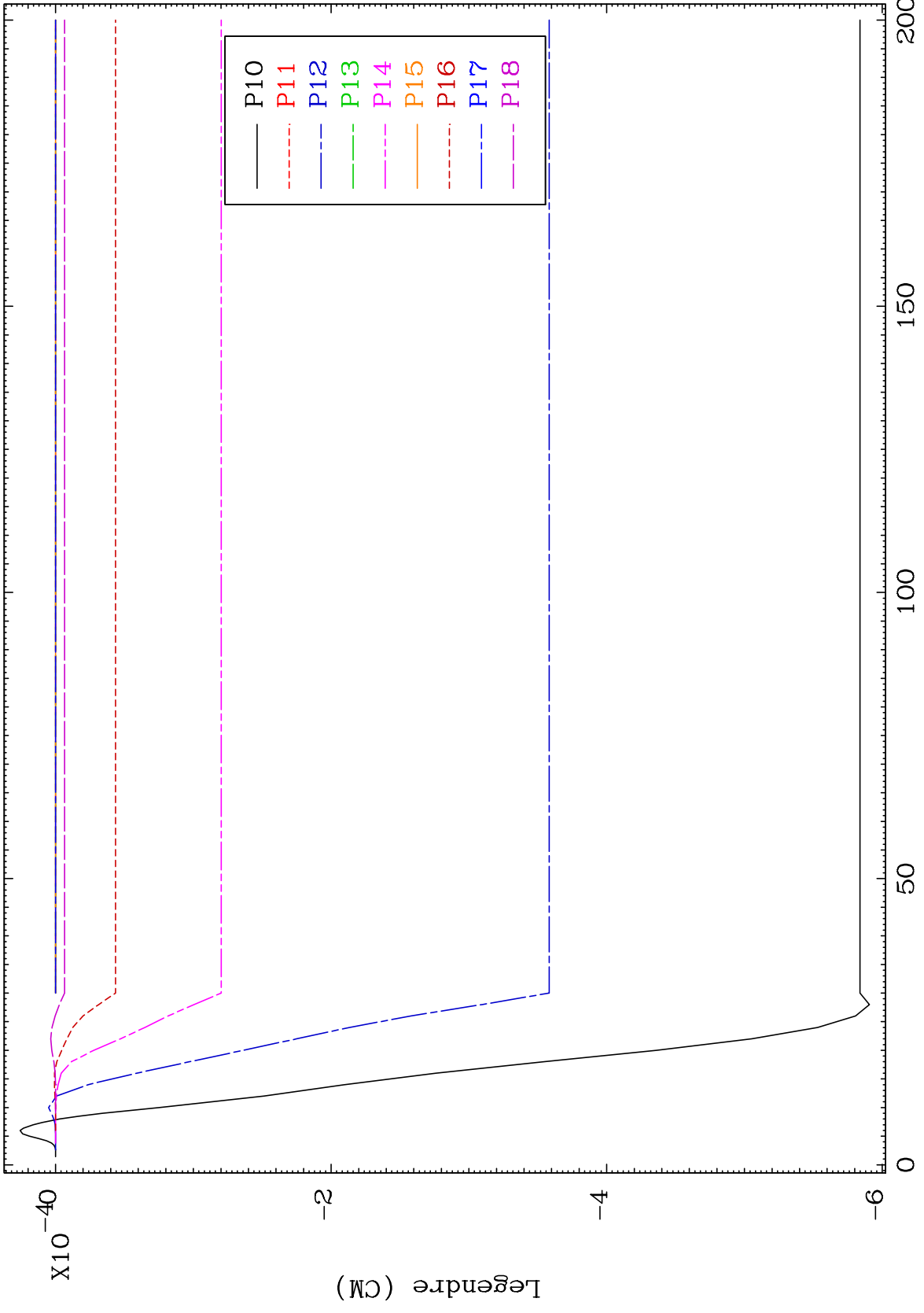

71-Lu-180

MAT 7140 MT= 56 (n,n') Level Legendre Coefficients 71-Lu-180

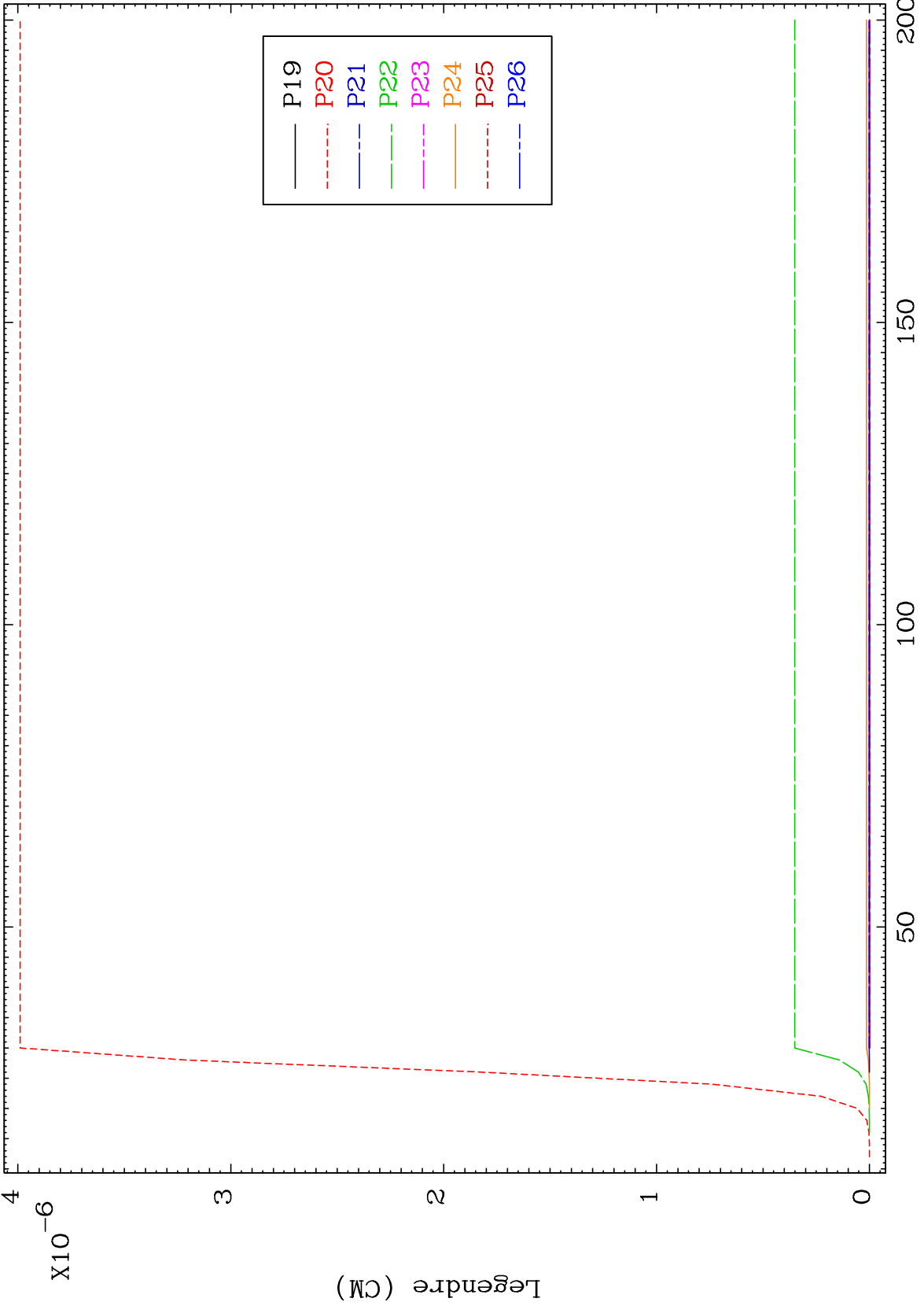

41 Incident Energy (MeV) 71-Lu-180

MAT 7140

MT= 57 (n,n') Level
Legendre Coefficients

71-Lu-180

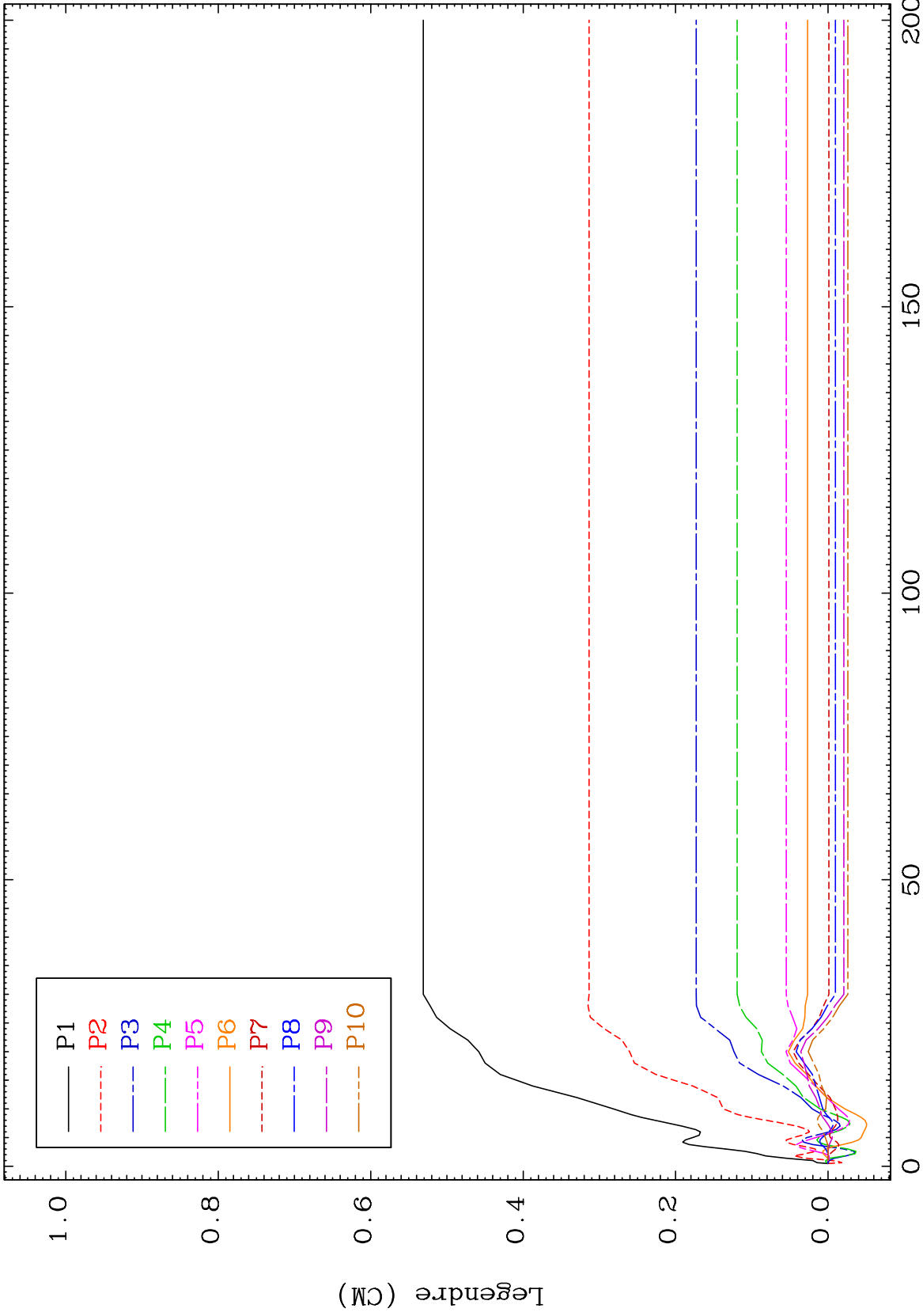

MAT 7140

MT= 57 (n,n') Level
Legendre Coefficients

71-Lu-180

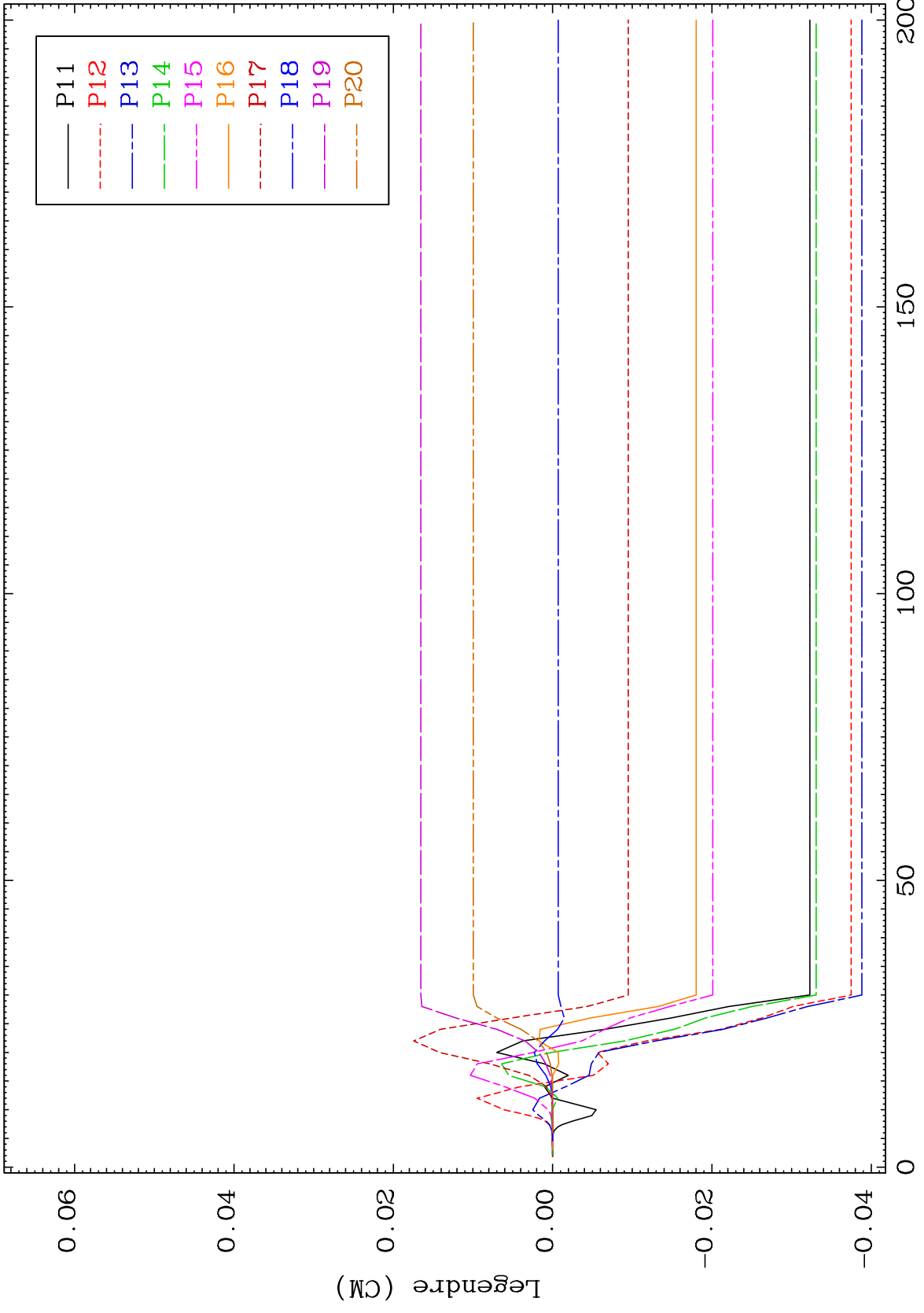

43

Incident Energy (MeV)

71-Lu-180

MAT 7140

MT= 57 (n,n') Level
Legendre Coefficients

71-Lu-180

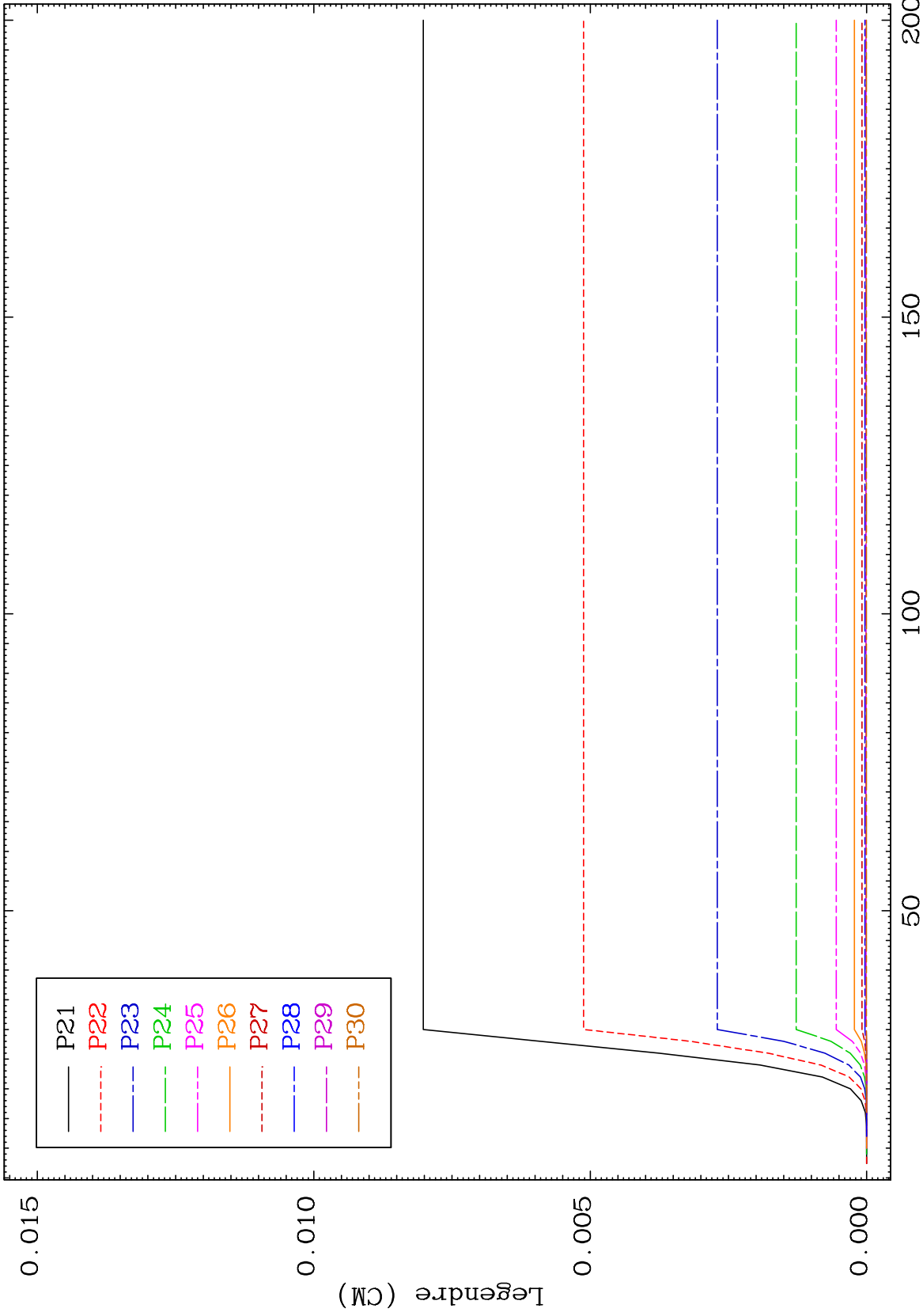

MAT 7140

MT= 57 (n,n') Level
Legendre Coefficients

71-Lu-180

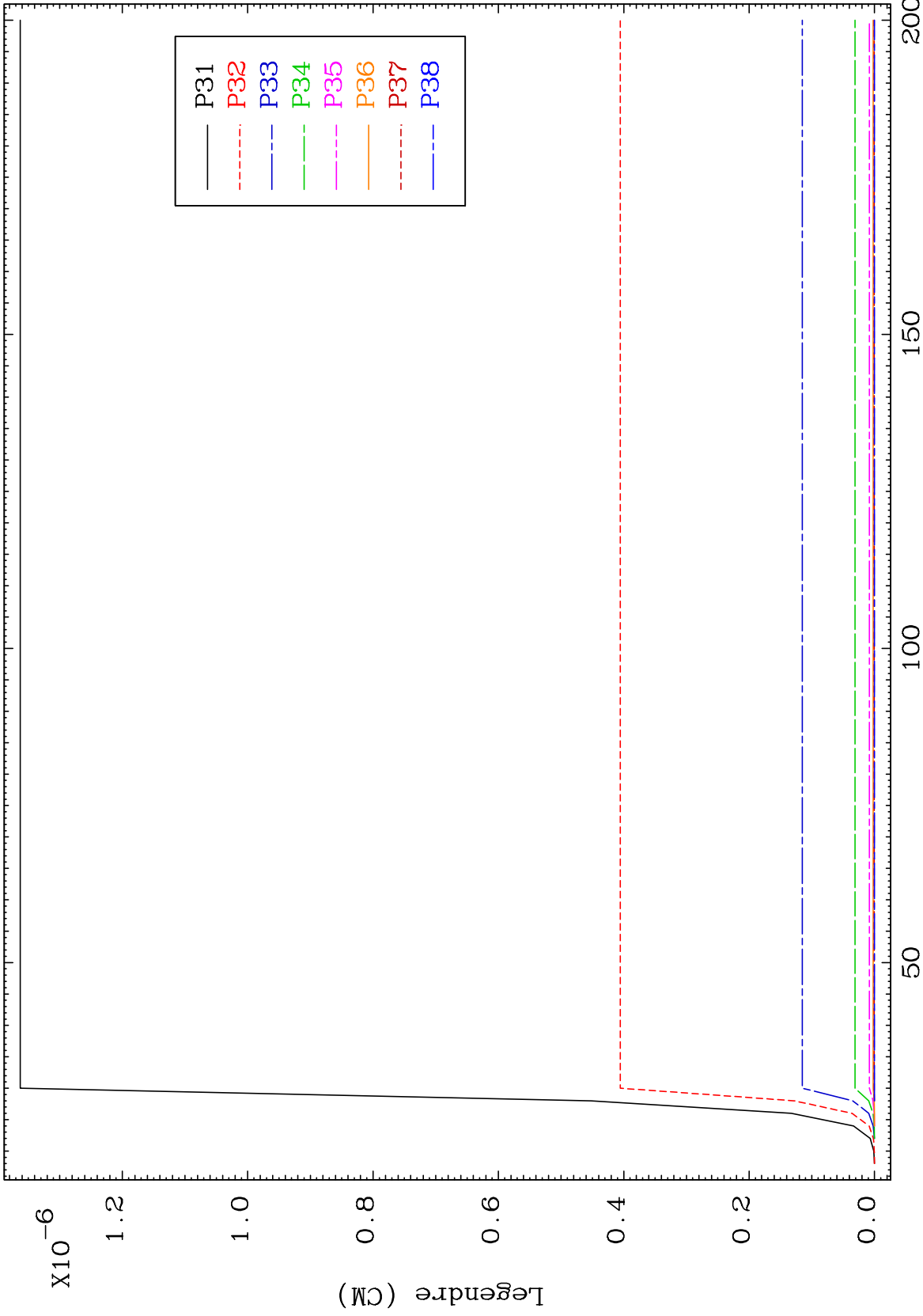

45

Incident Energy (MeV)

71-Lu-180

MAT 7140

MT= 58 (n,n') Level
Legendre Coefficients

71-Lu-180

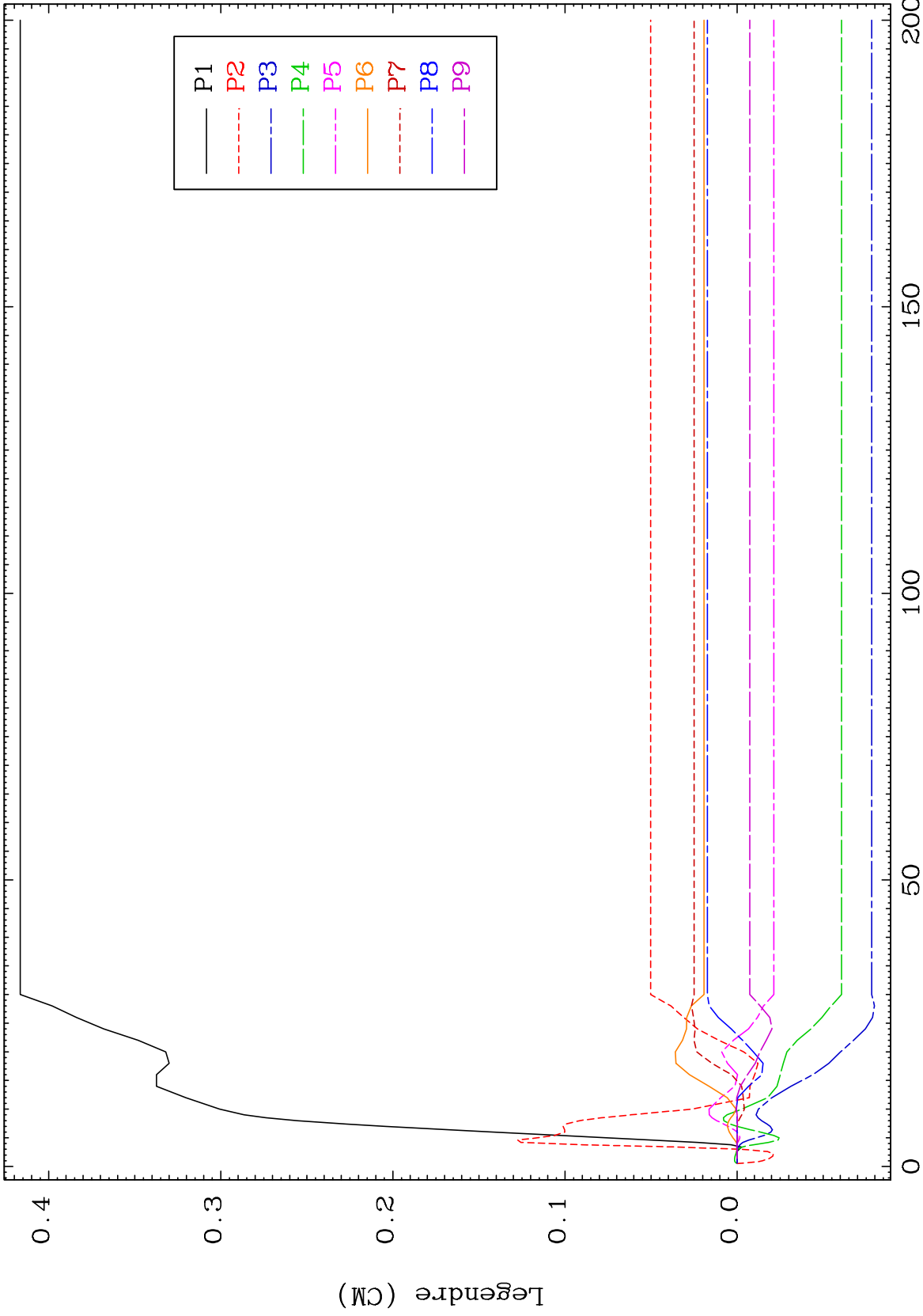

46

Incident Energy (MeV)

71-Lu-180

MAT 7140 MT= 58 (n,n') Level Legendre Coefficients 71-Lu-180

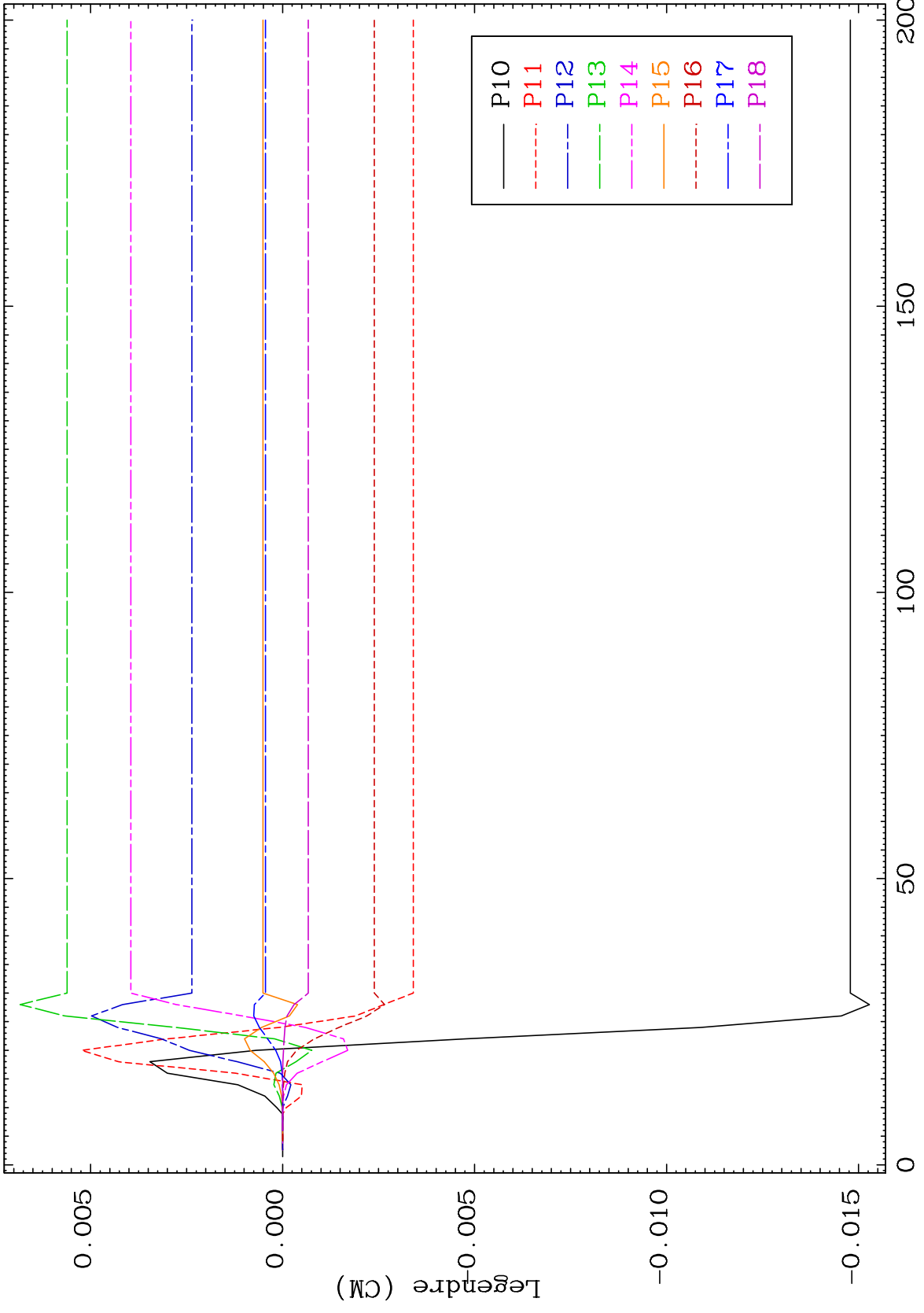

47 71-Lu-180

MAT 7140

MT= 58 (n,n') Level
Legendre Coefficients

71-Lu-180

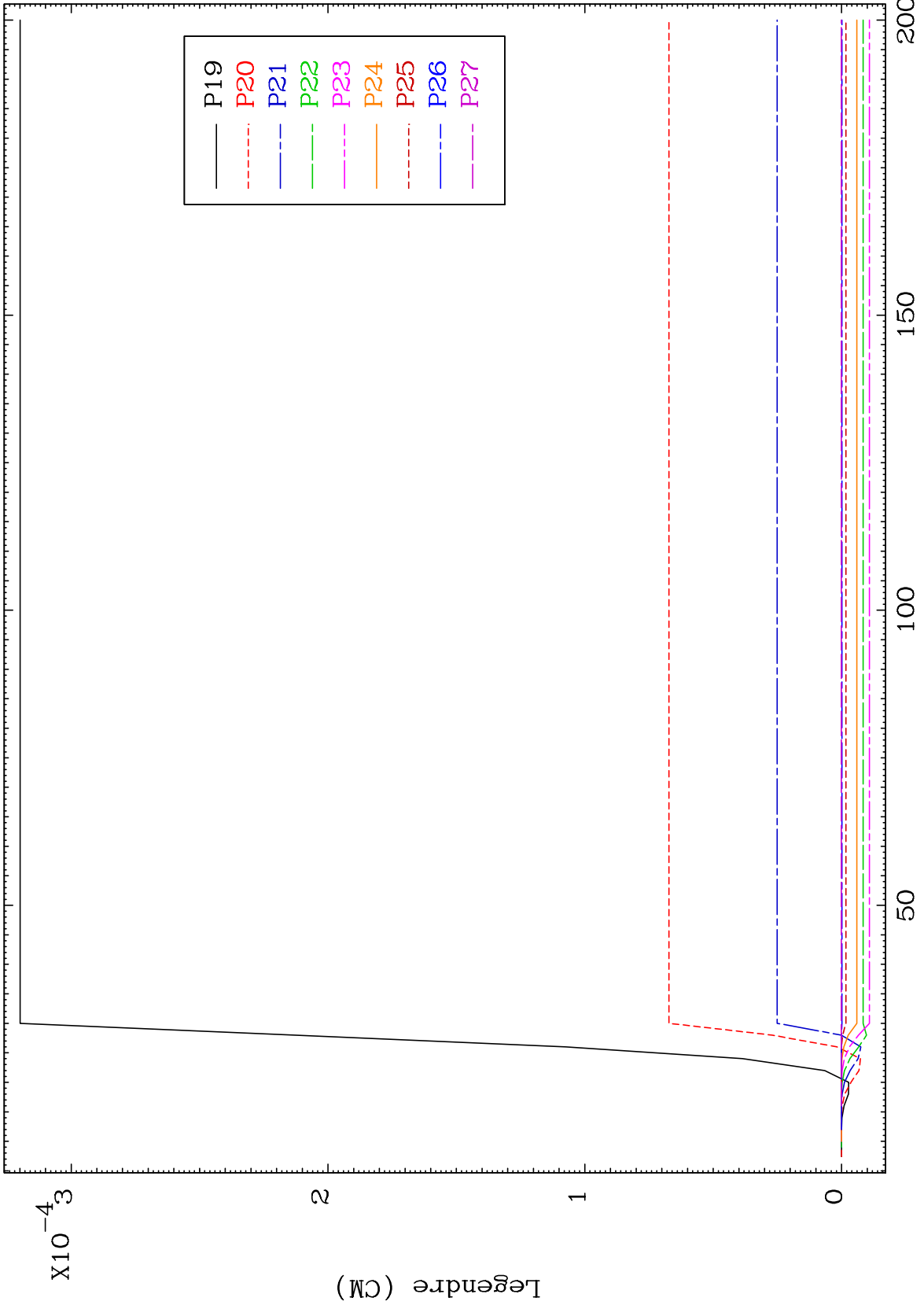

48

Incident Energy (MeV)

71-Lu-180

MAT 7140

MT= 58 (n,n') Level
Legendre Coefficients

71-Lu-180

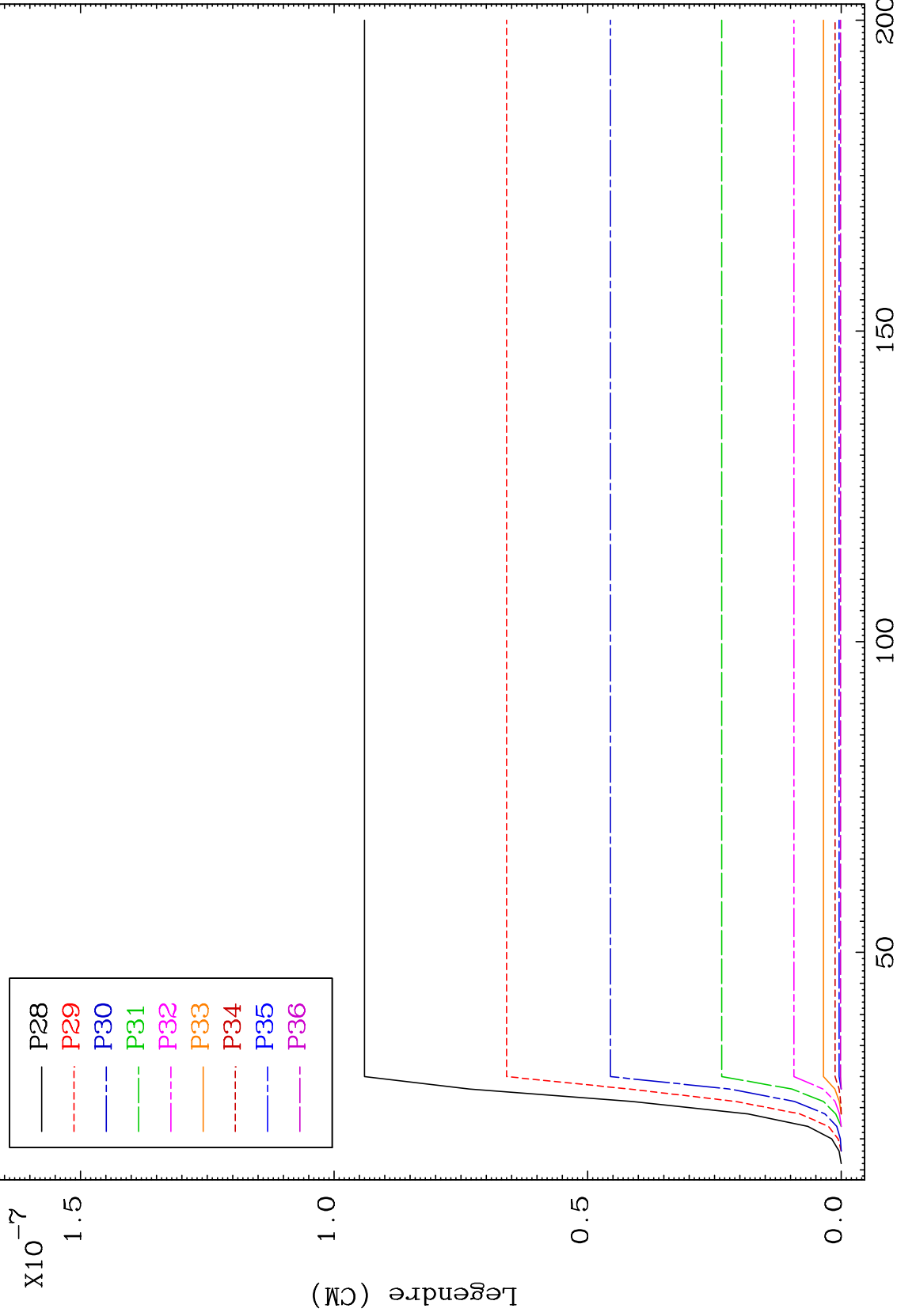

49

Incident Energy (MeV)

71-Lu-180

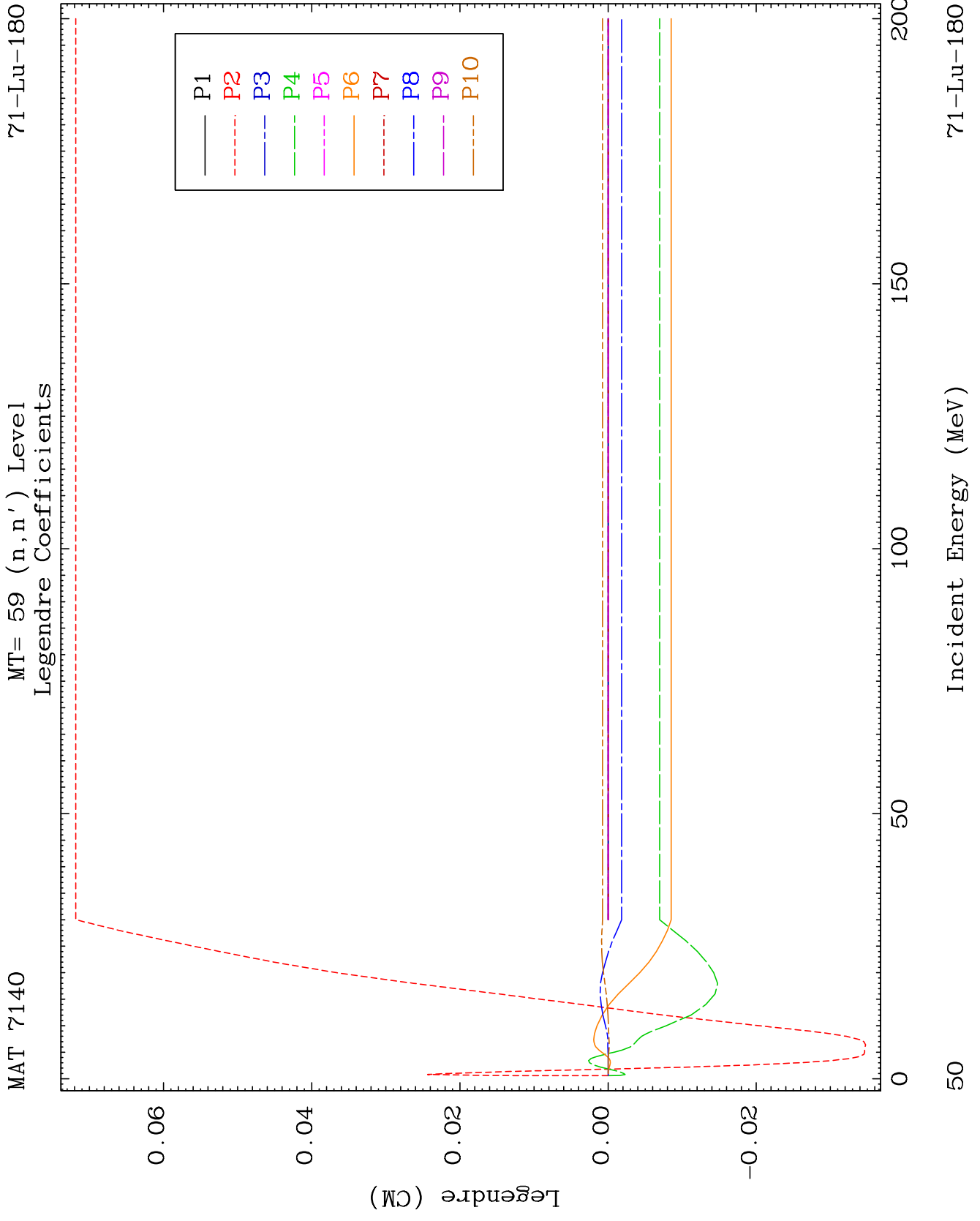

MAT 7140 MT= 59 (n,n') Level Legendre Coefficients 71-Lu-180

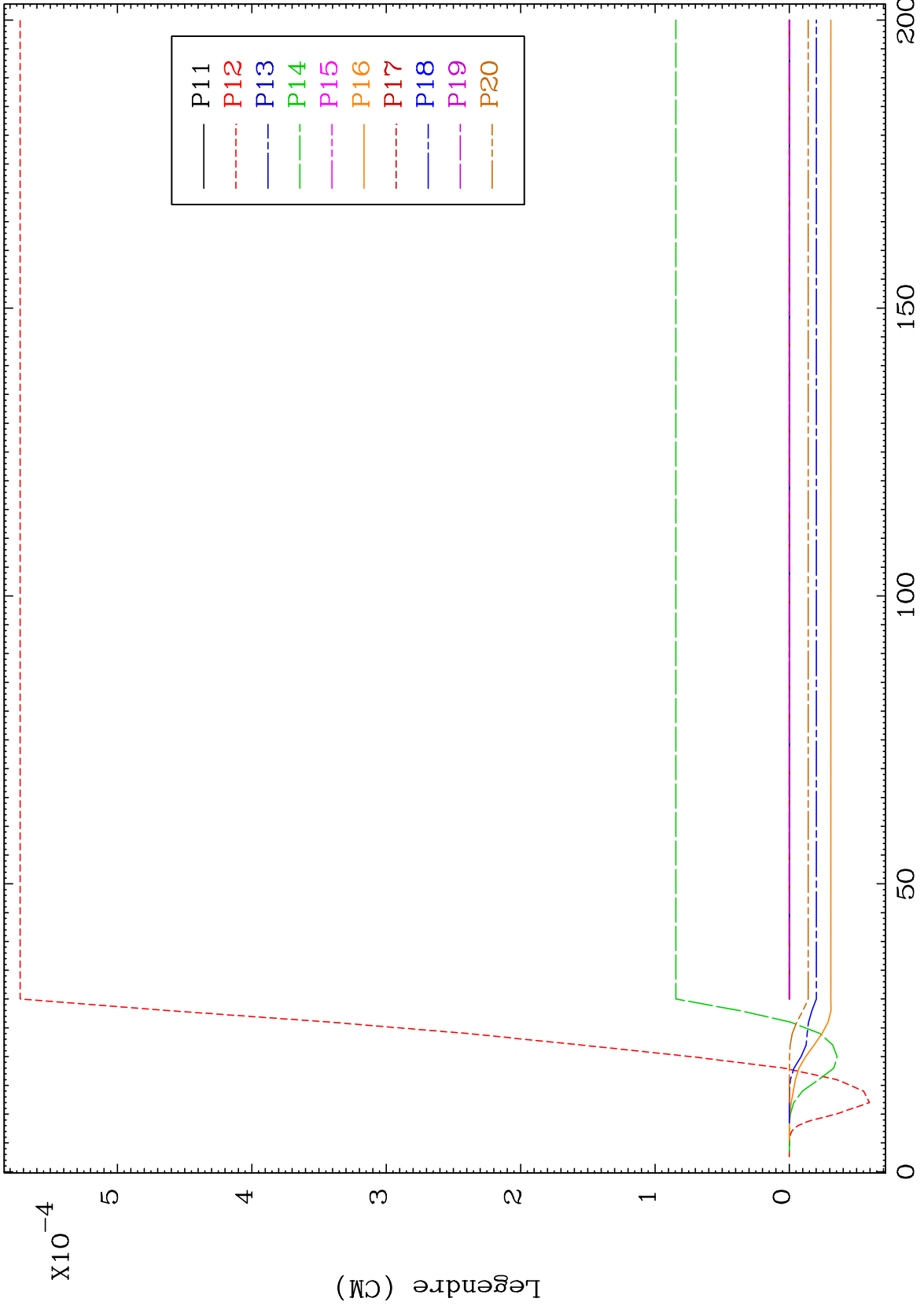

51 71-Lu-180

MAT 7140 MT= 59 (n,n') Level Legendre Coefficients 71-Lu-180

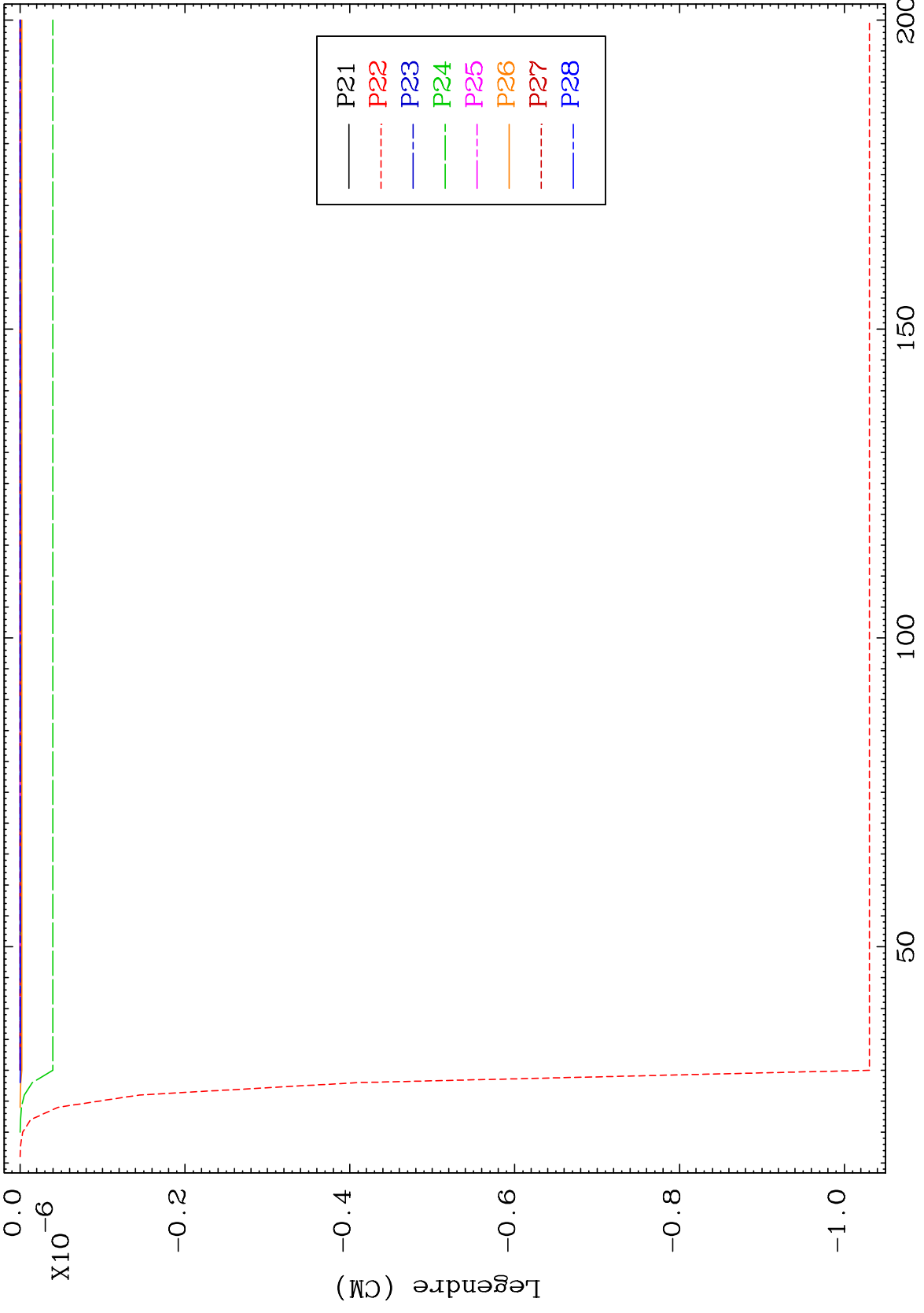

52 Incident Energy (MeV) 71-Lu-180

MAT 7140

MT= 60 (n,n') Level
Legendre Coefficients

71-Lu-180

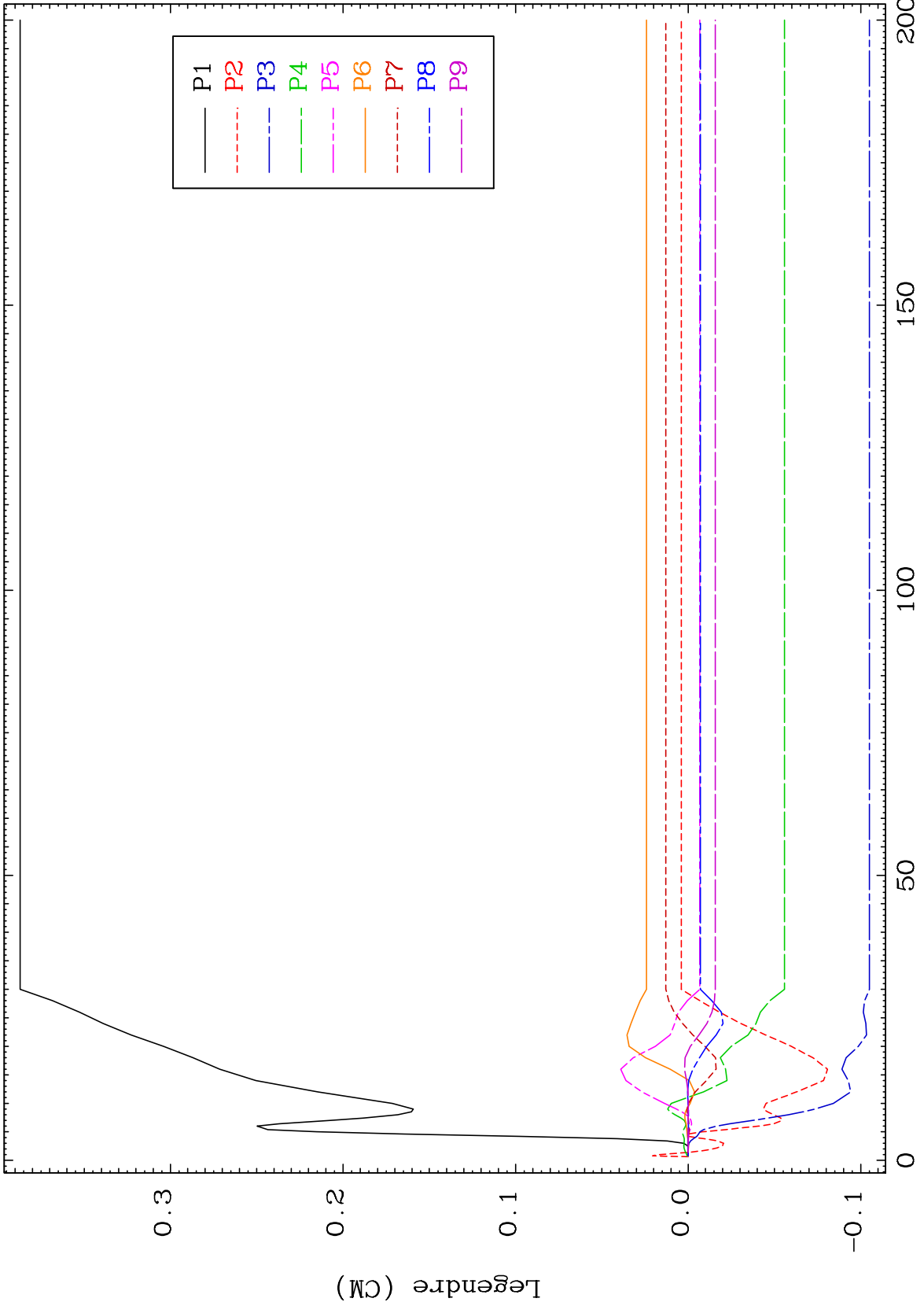

53

Incident Energy (MeV)

71-Lu-180

MAT 7140 MT= 60 (n,n') Level Legendre Coefficients 71-Lu-180

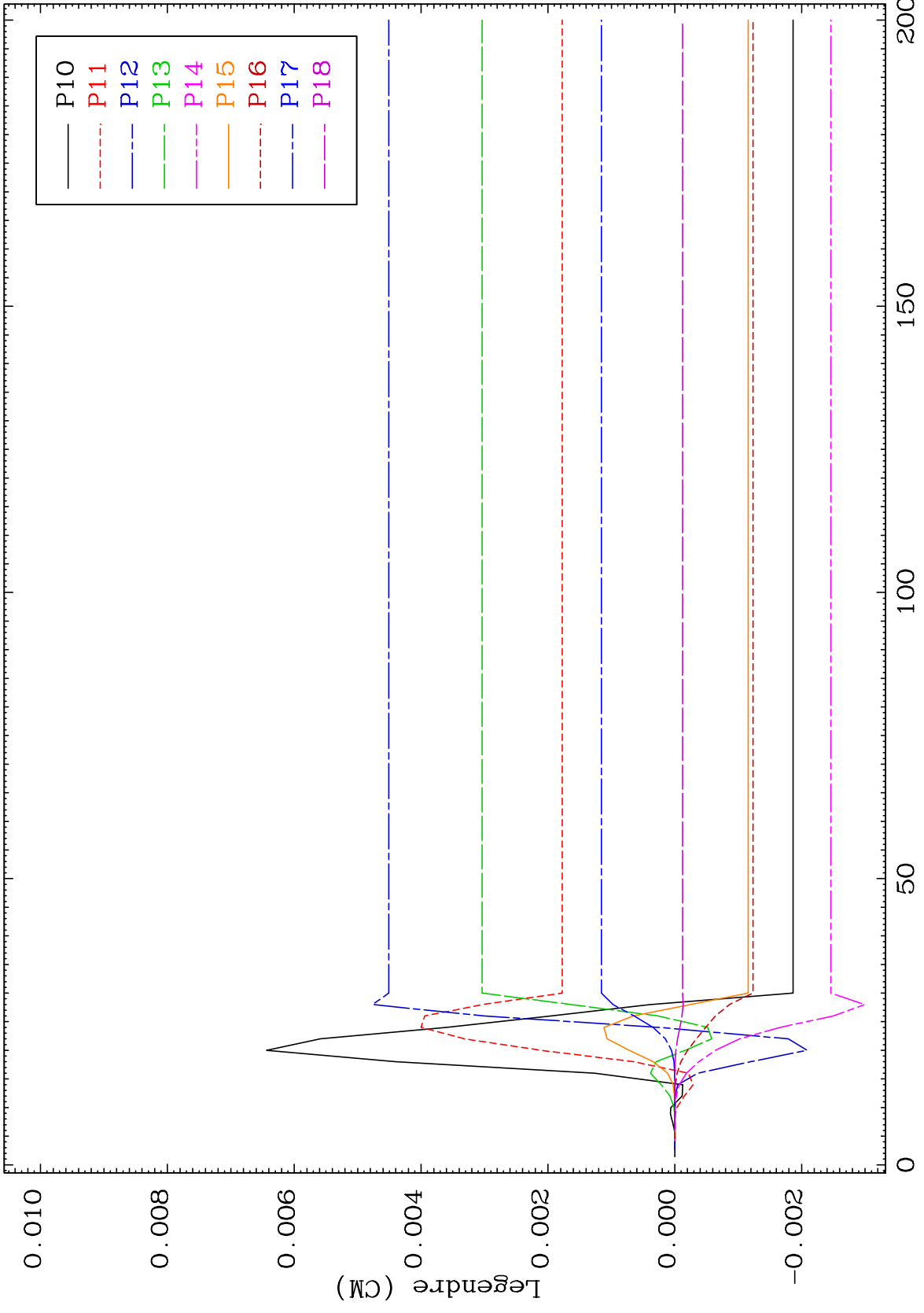

54 71-Lu-180

MAT 7140

MT= 60 (n,n') Level
Legendre Coefficients

71-Lu-180

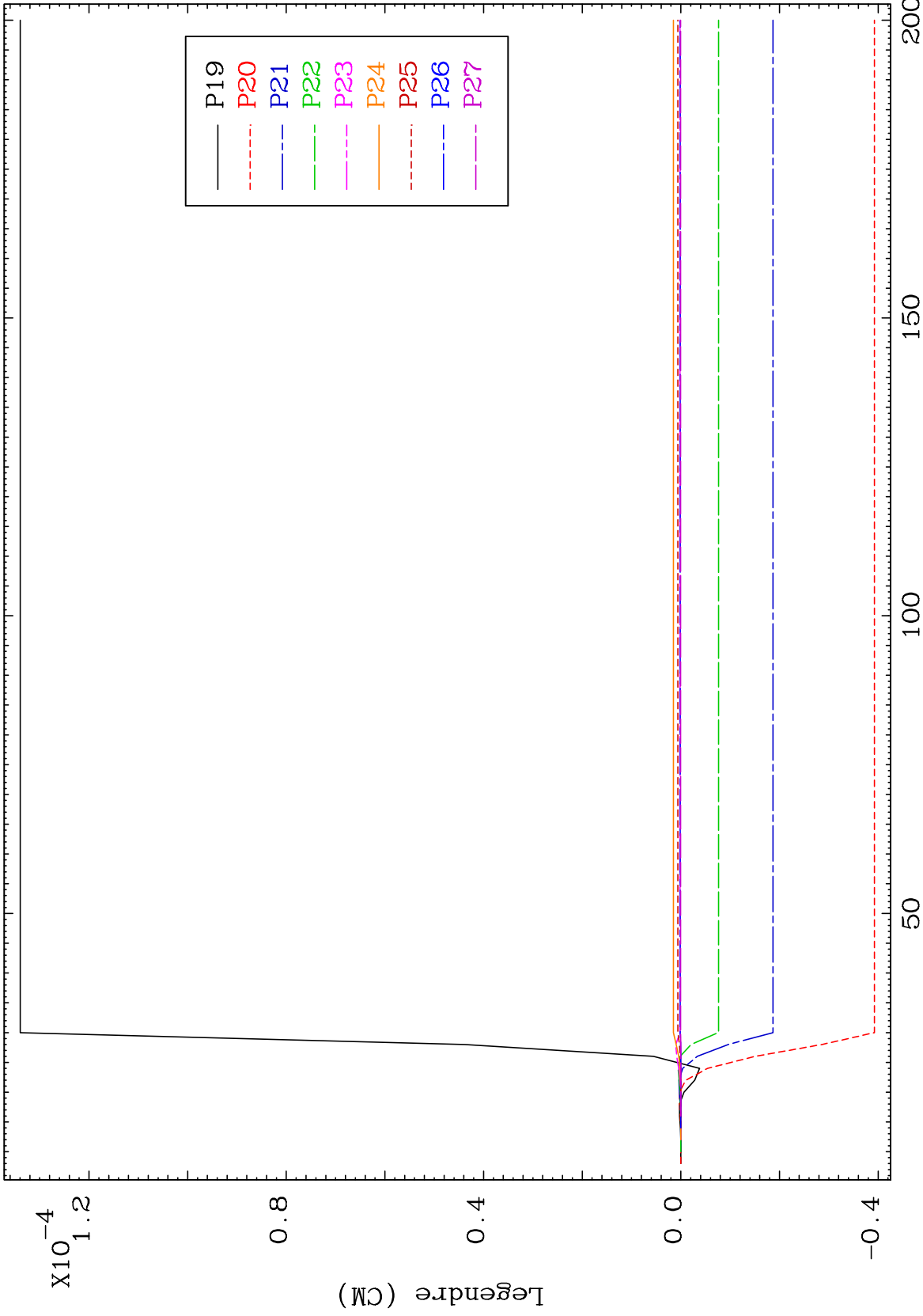

55

Incident Energy (MeV)

71-Lu-180

MAT 7140

MT= 60 (n,n') Level
Legendre Coefficients

71-Lu-180

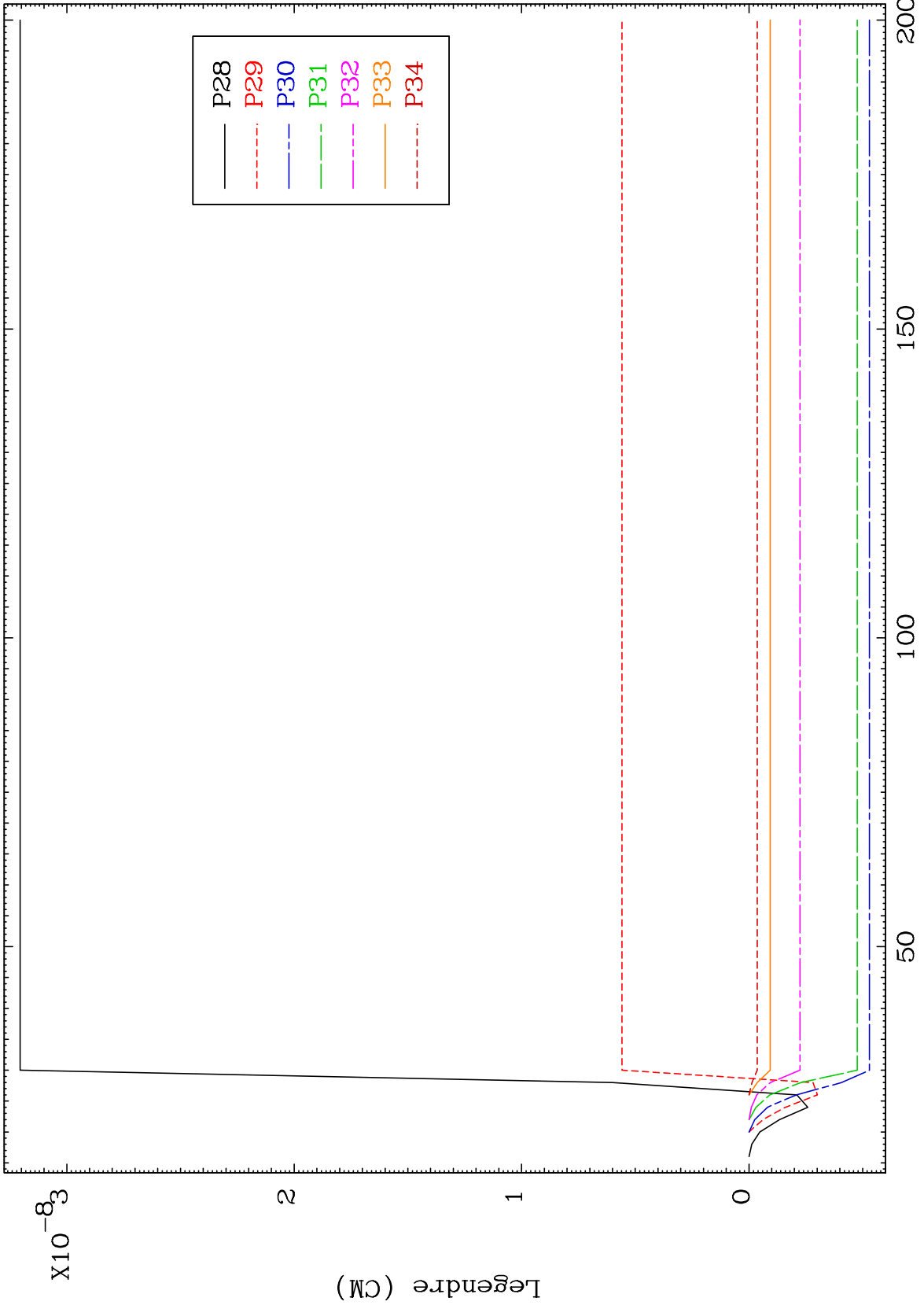

56

Incident Energy (MeV)

71-Lu-180

MAT 7140 MT= 61 (n,n') Level Legendre Coefficients 71-Lu-180

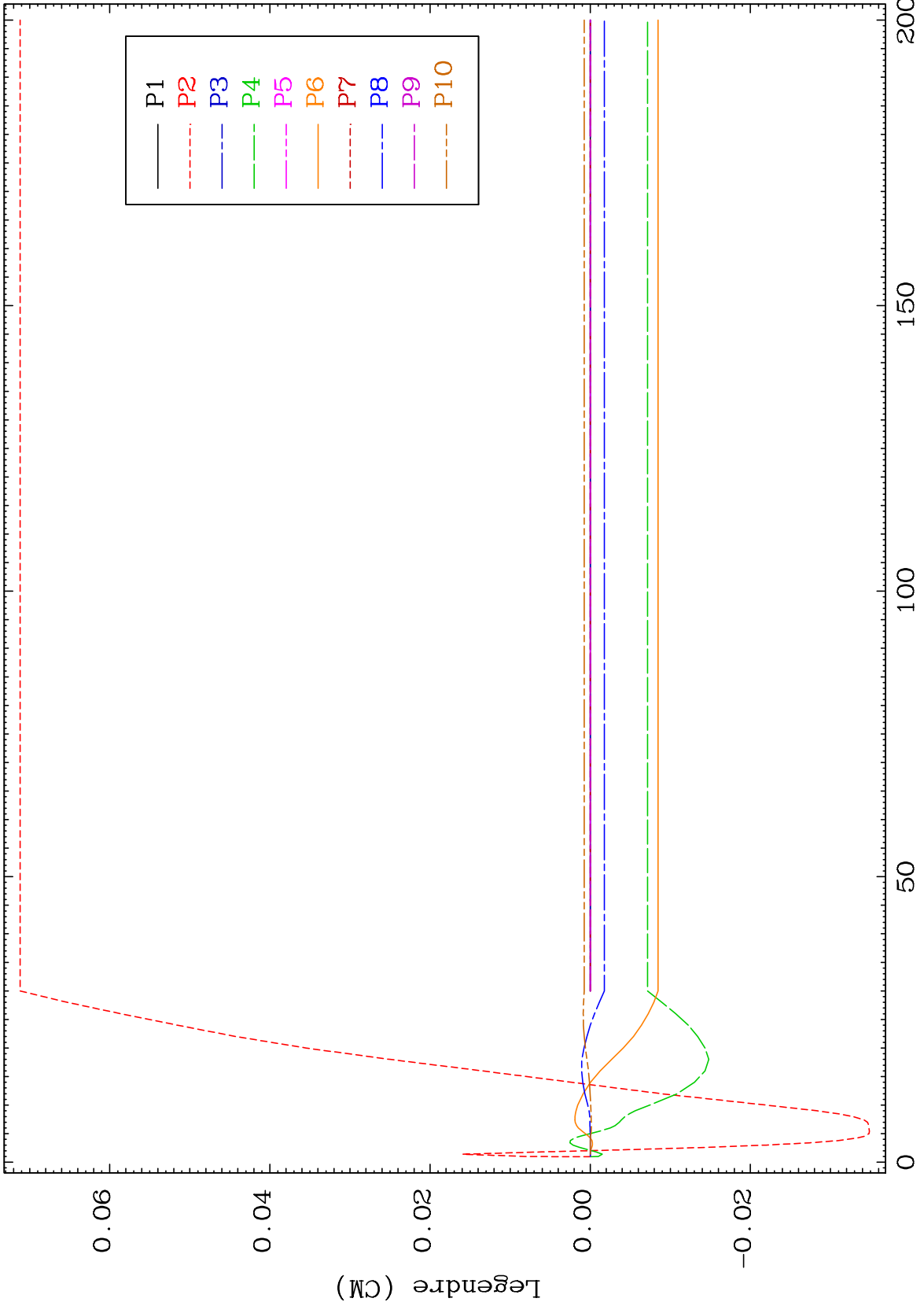

57 71-Lu-180

MAT 7140 MT= 61 (n,n') Level Legendre Coefficients 71-Lu-180

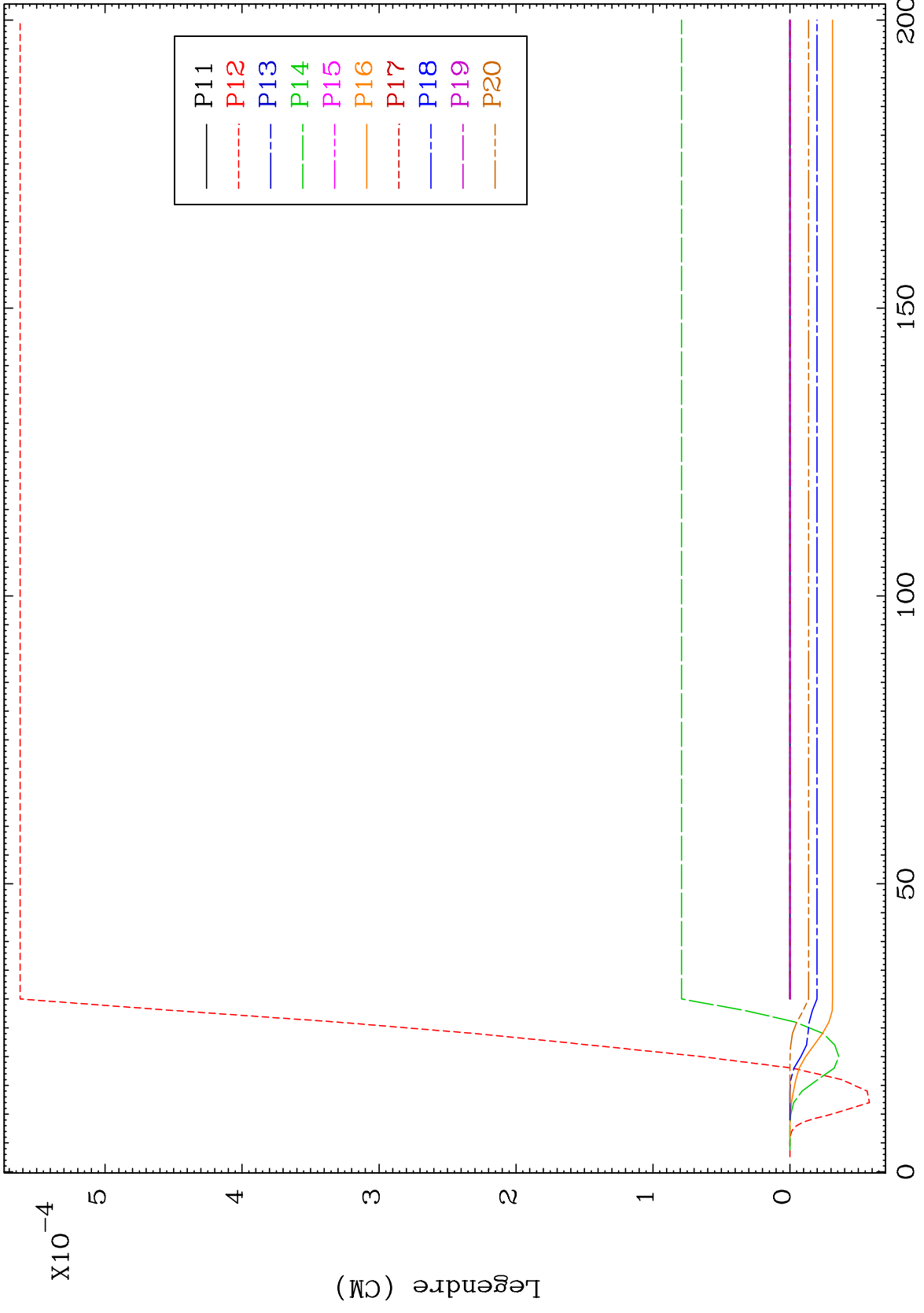

58 71-Lu-180

MAT 7140 MT= 61 (n,n') Level Legendre Coefficients 71-Lu-180

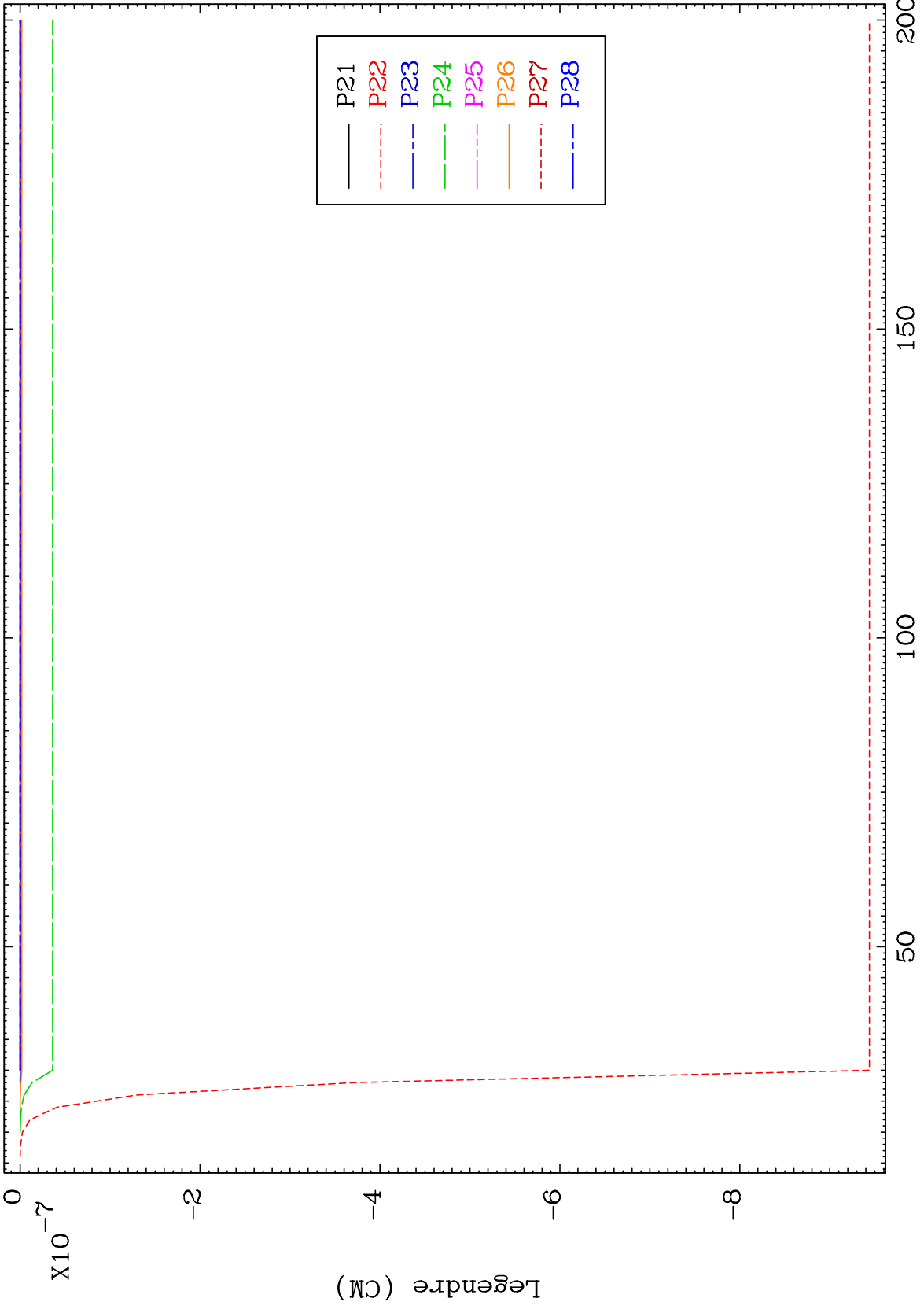

59 71-Lu-180

MAT 7140 MT= 62 (n,n') Level Legendre Coefficients 71-Lu-180

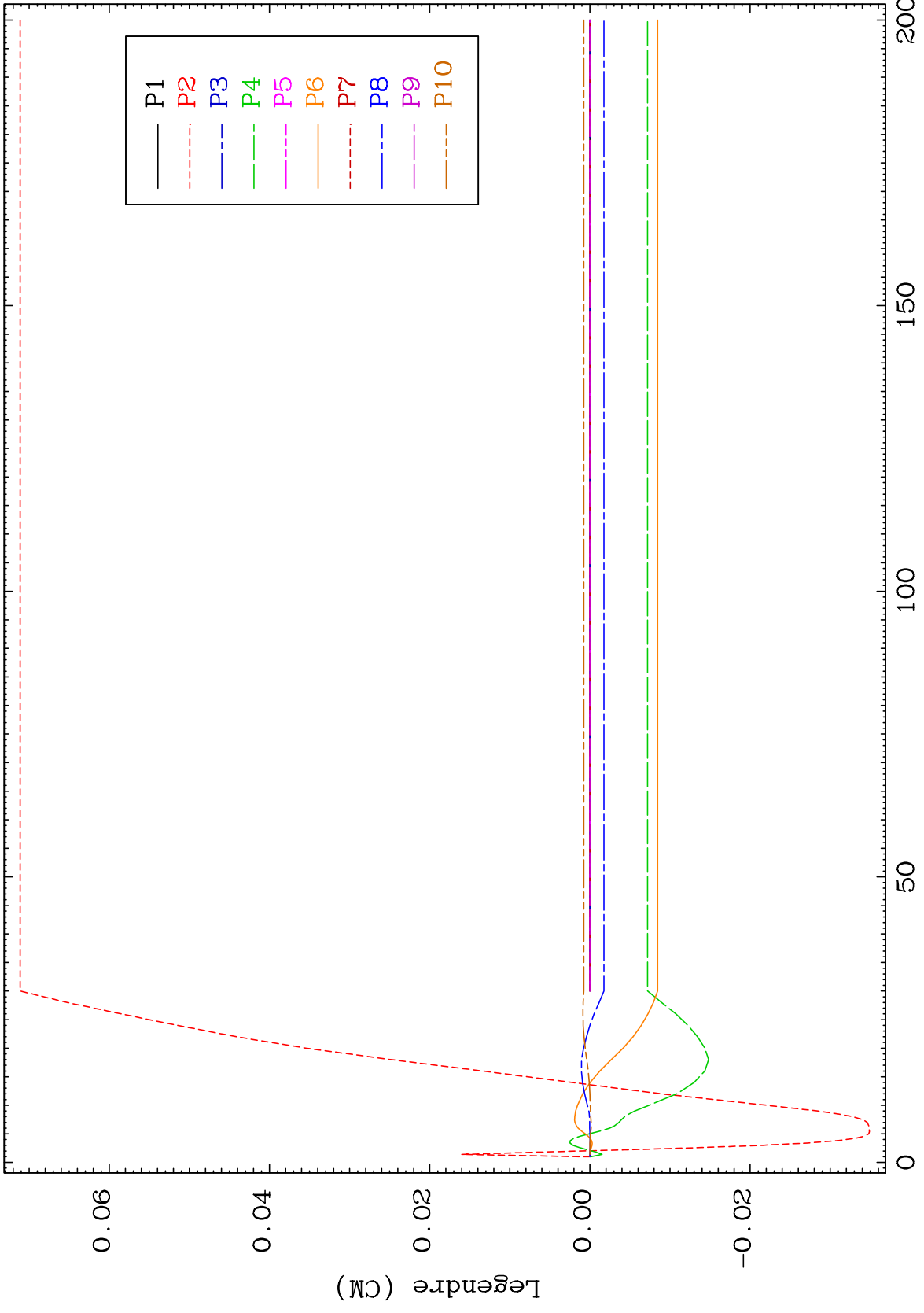

71-Lu-180

MAT 7140

MT= 62 (n,n') Level
Legendre Coefficients

71-Lu-180

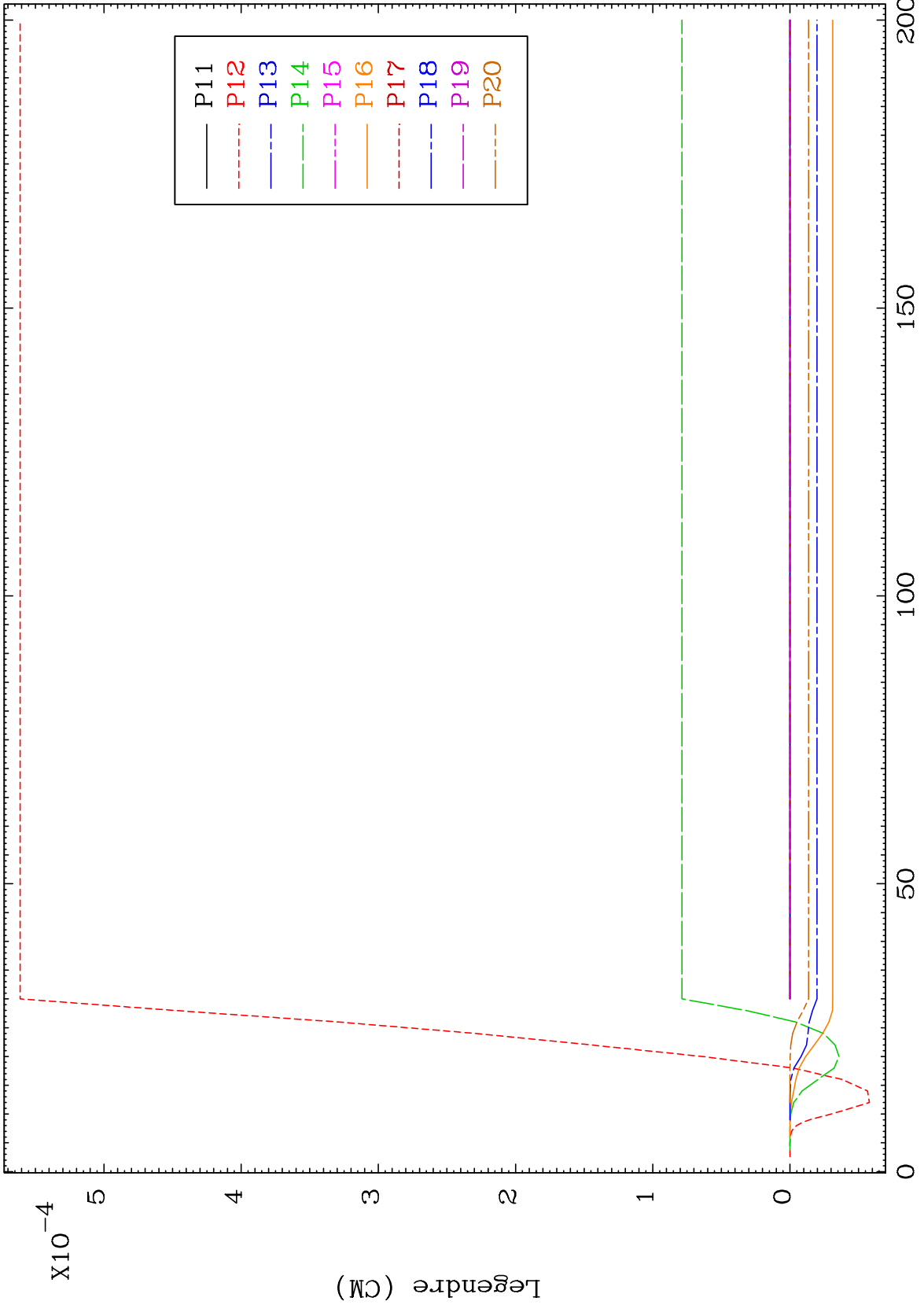

61

Incident Energy (MeV)

71-Lu-180

MAT 7140 MT= 62 (n,n') Level Legendre Coefficients 71-Lu-180

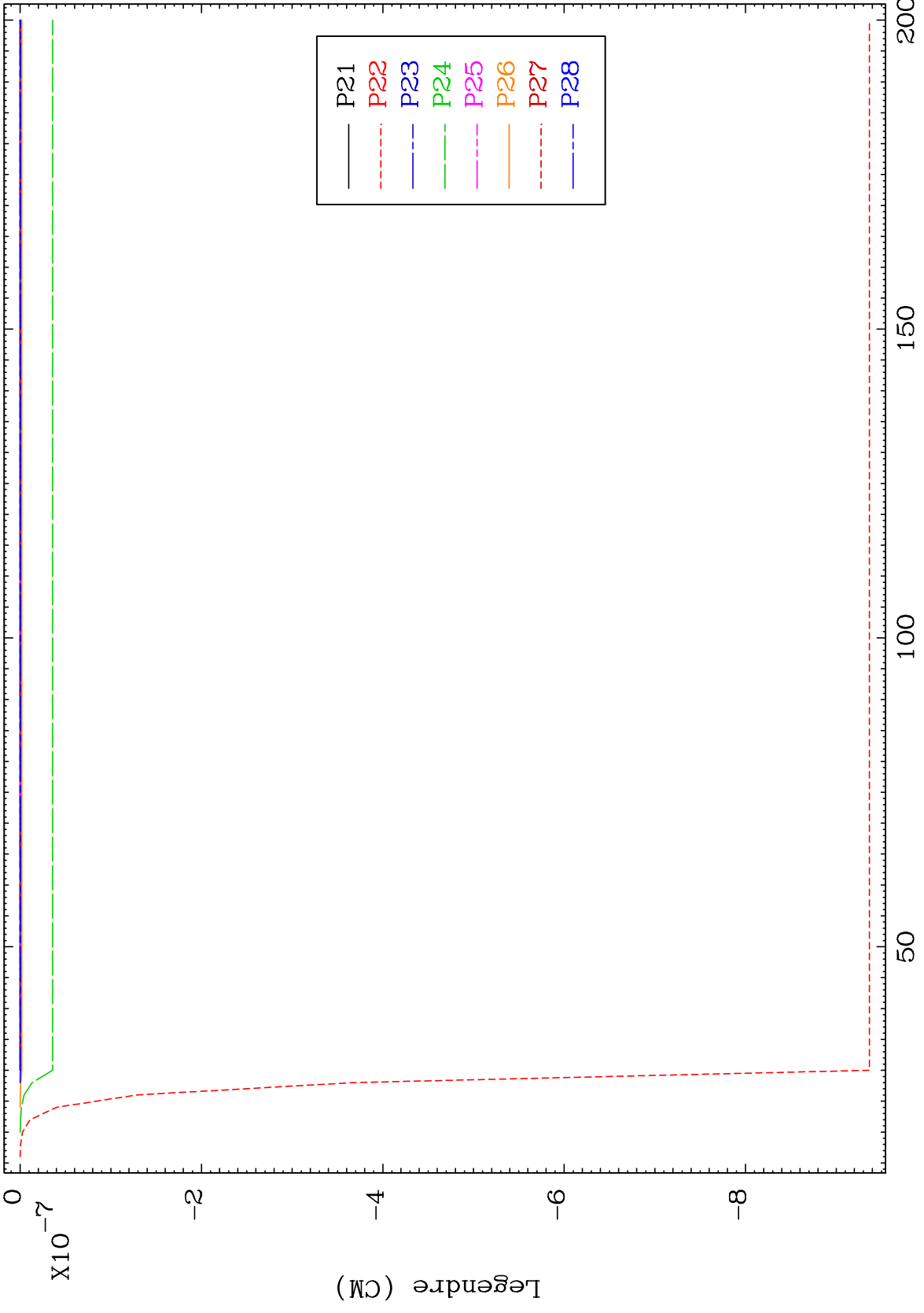

62 71-Lu-180

MAT 7140

MT= 63 (n,n') Level
Legendre Coefficients

71-Lu-180

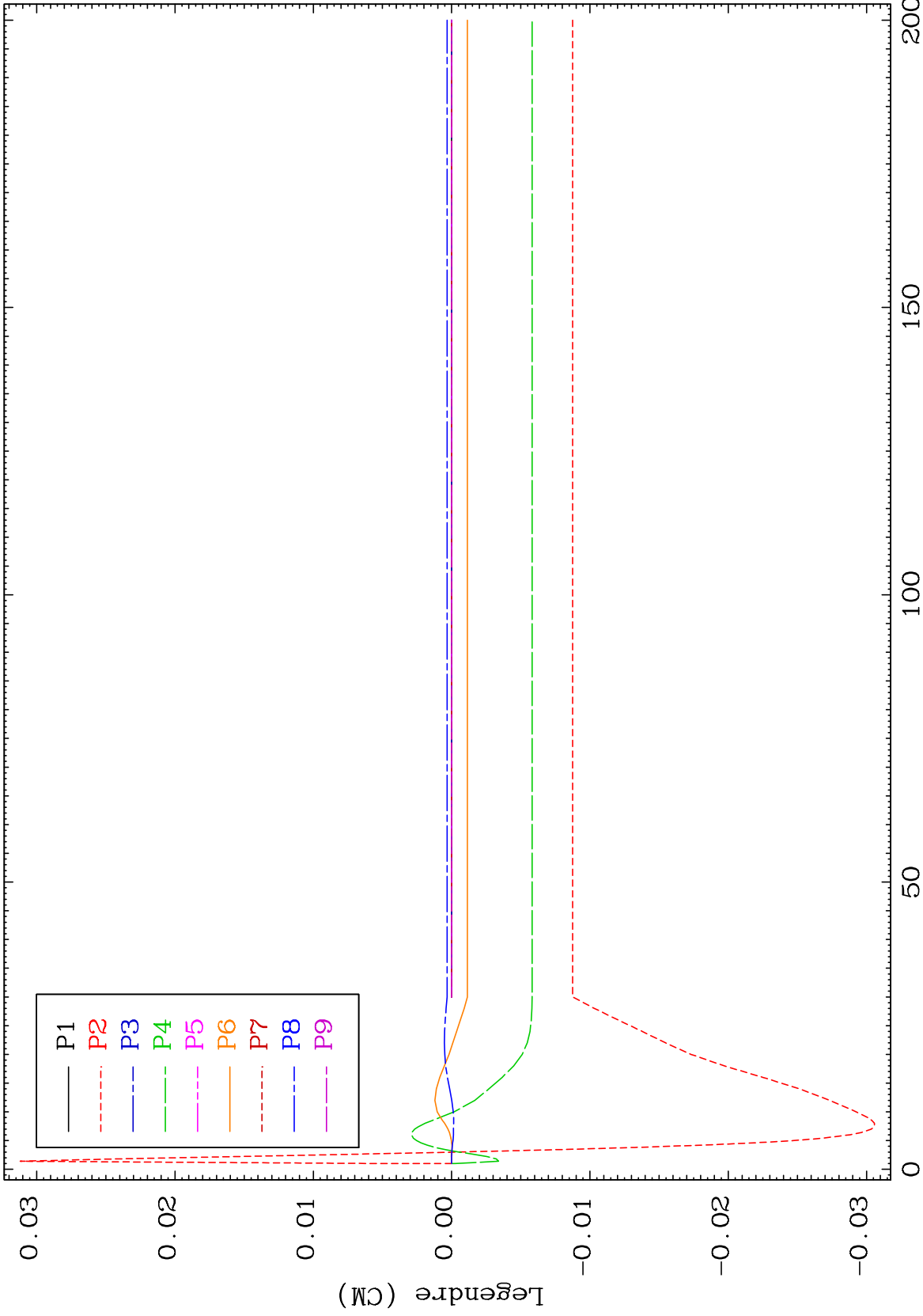

63

Incident Energy (MeV)

71-Lu-180

MAT 7140

MT= 63 (n,n') Level
Legendre Coefficients

71-Lu-180

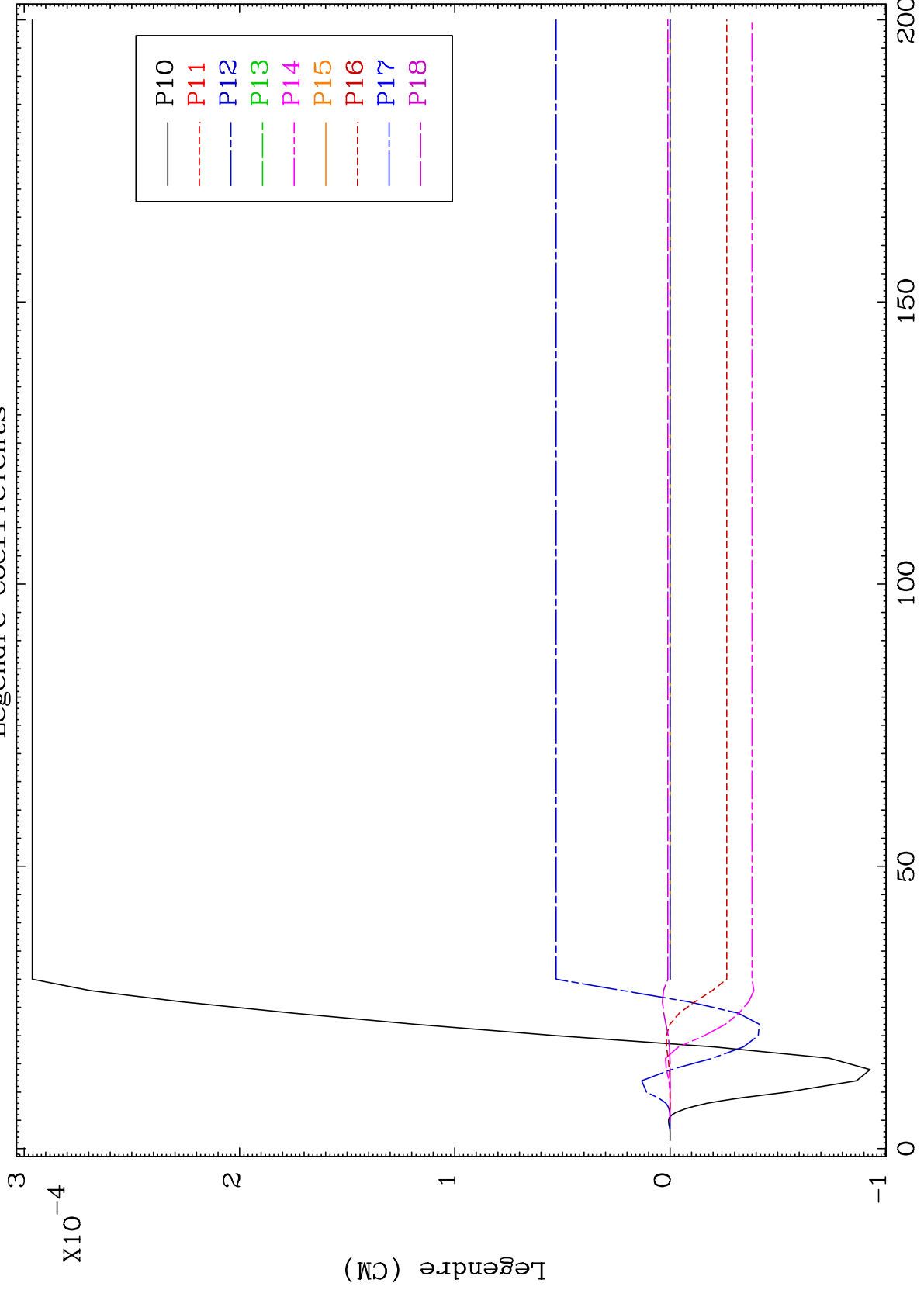

64

Incident Energy (MeV)

71-Lu-180

MAT 7140 MT= 63 (n,n') Level Legendre Coefficients 71-Lu-180

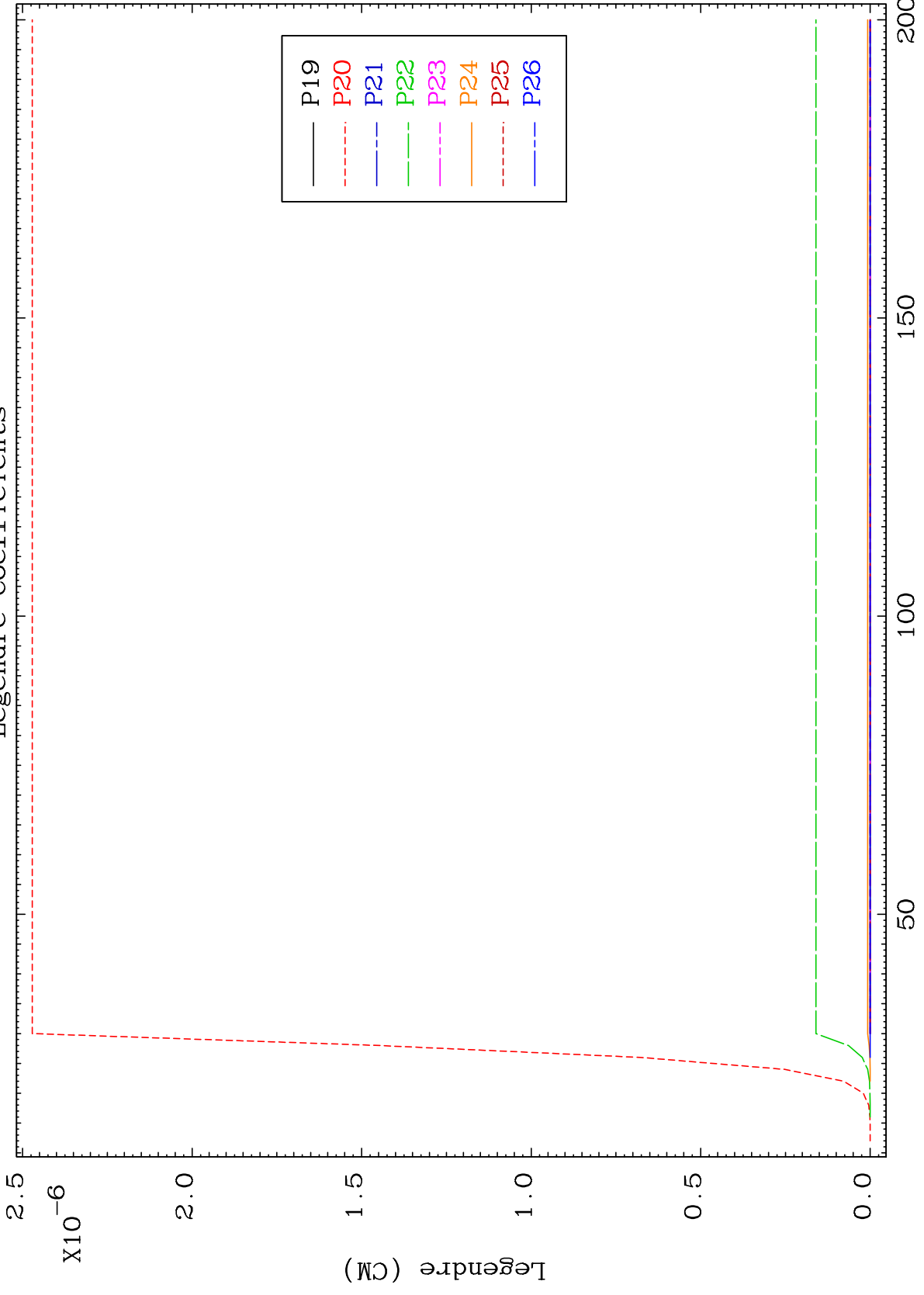

65 Incident Energy (MeV) 71-Lu-180

MAT 7140

MT= 64 (n,n') Level
Legendre Coefficients

71-Lu-180

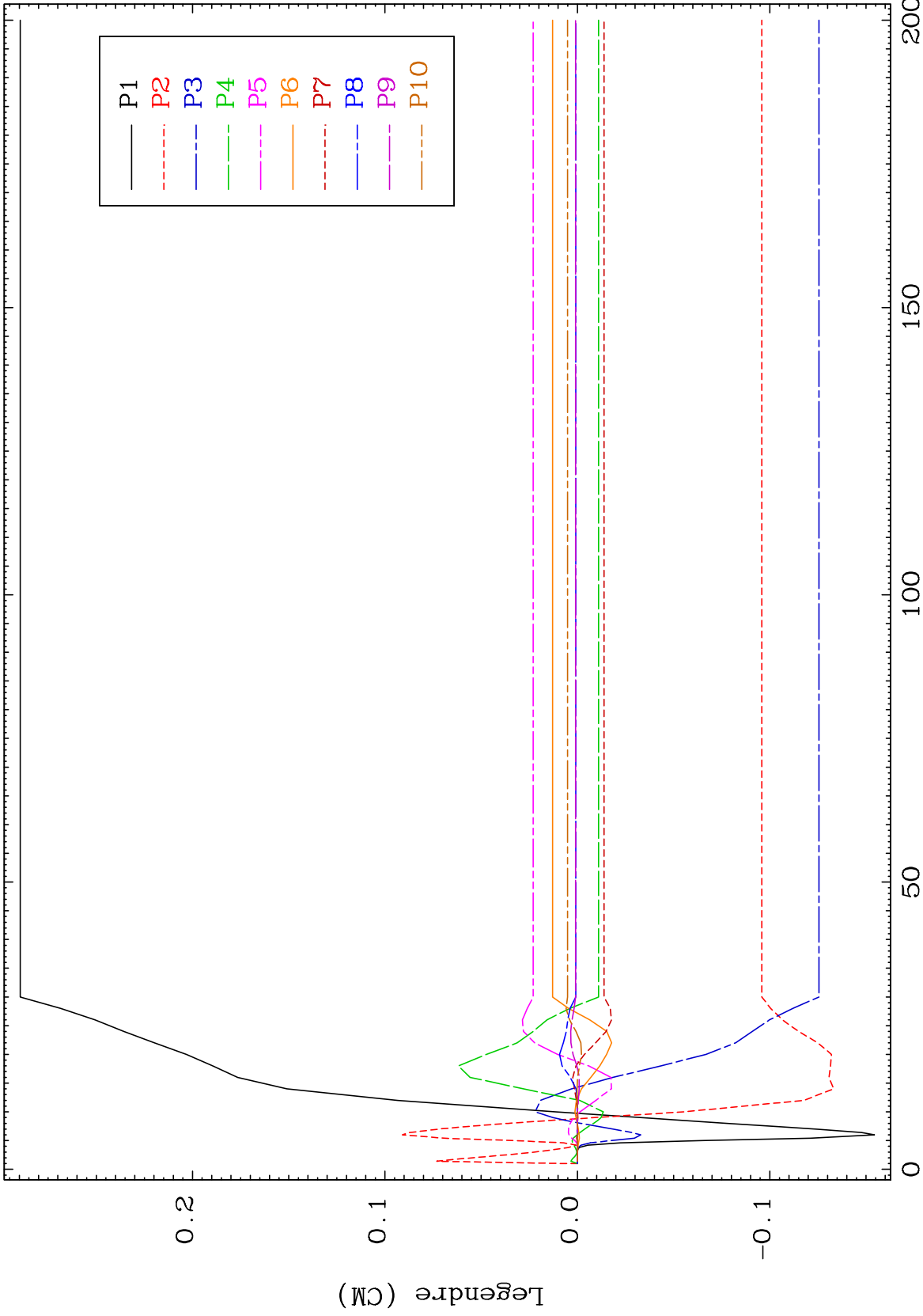

66

Incident Energy (MeV)

71-Lu-180

MAT 7140

MT= 64 (n,n') Level
Legendre Coefficients

71-Lu-180

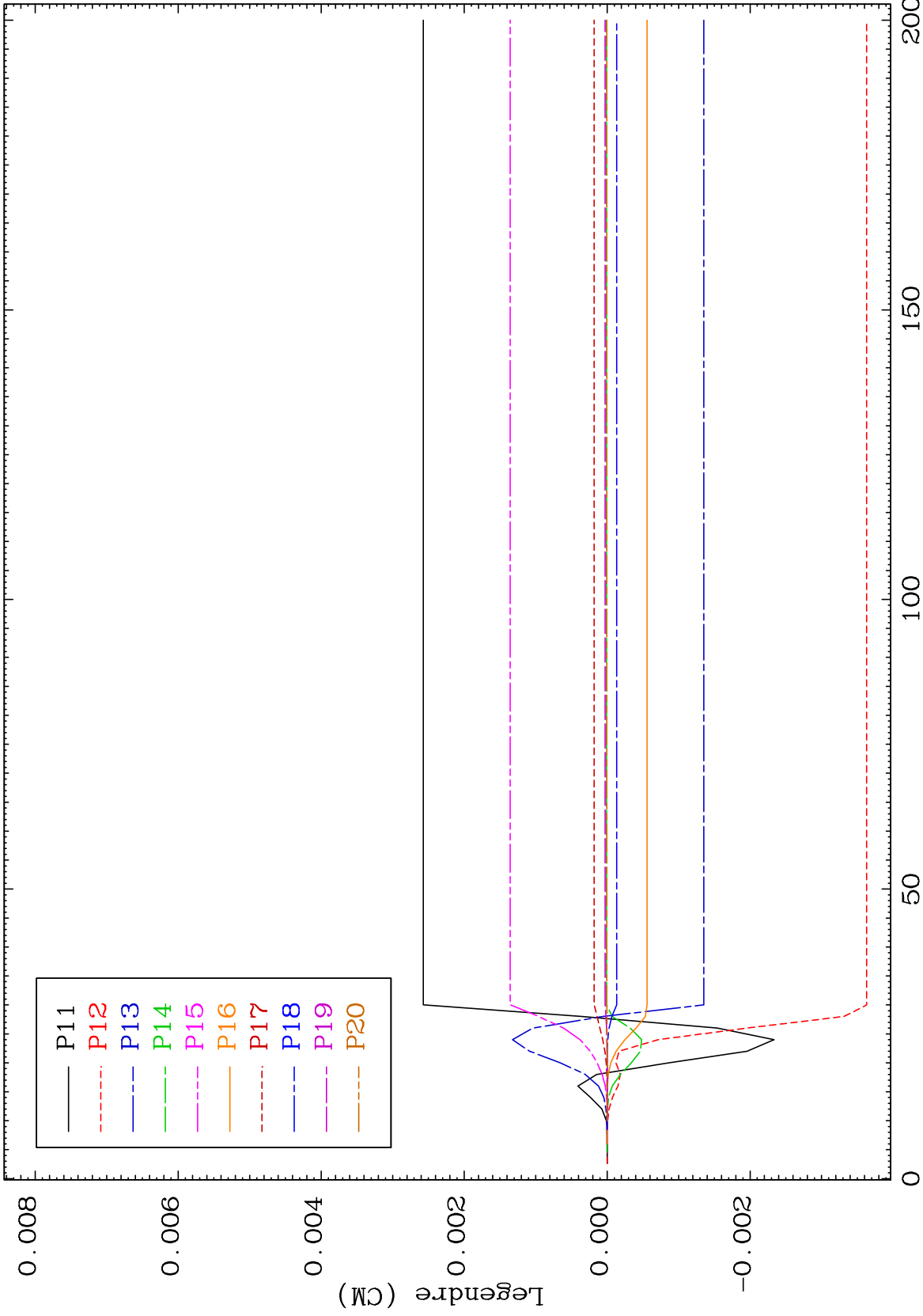

67

Incident Energy (MeV)

71-Lu-180

MAT 7140

MT= 64 (n,n') Level
Legendre Coefficients

71-Lu-180

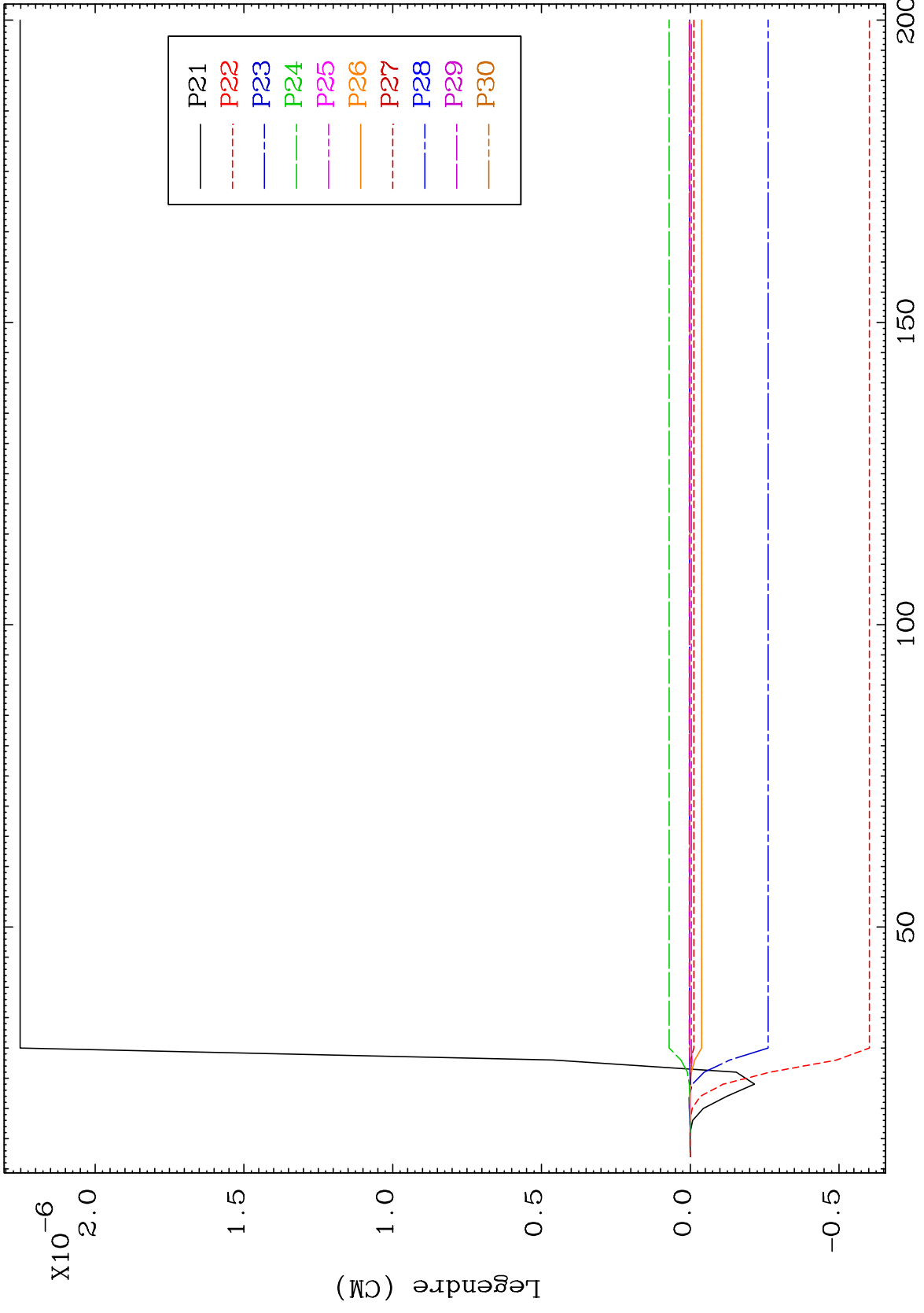

68

Incident Energy (MeV)

71-Lu-180

MAT 7140 MT= 65 (n,n') Level Legendre Coefficients 71-Lu-180

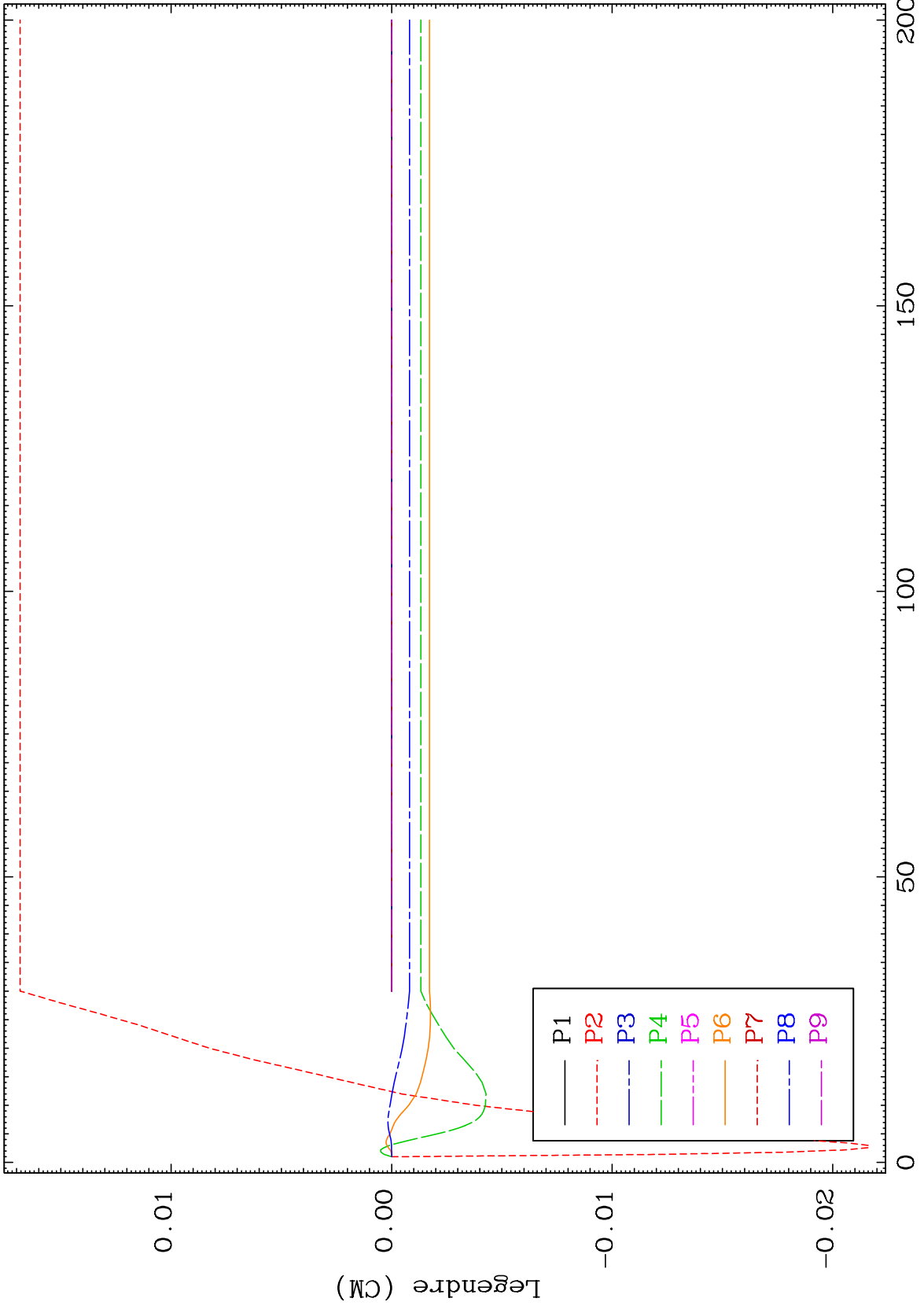

MAT 7140

MT= 65 (n,n') Level
Legendre Coefficients

71-Lu-180

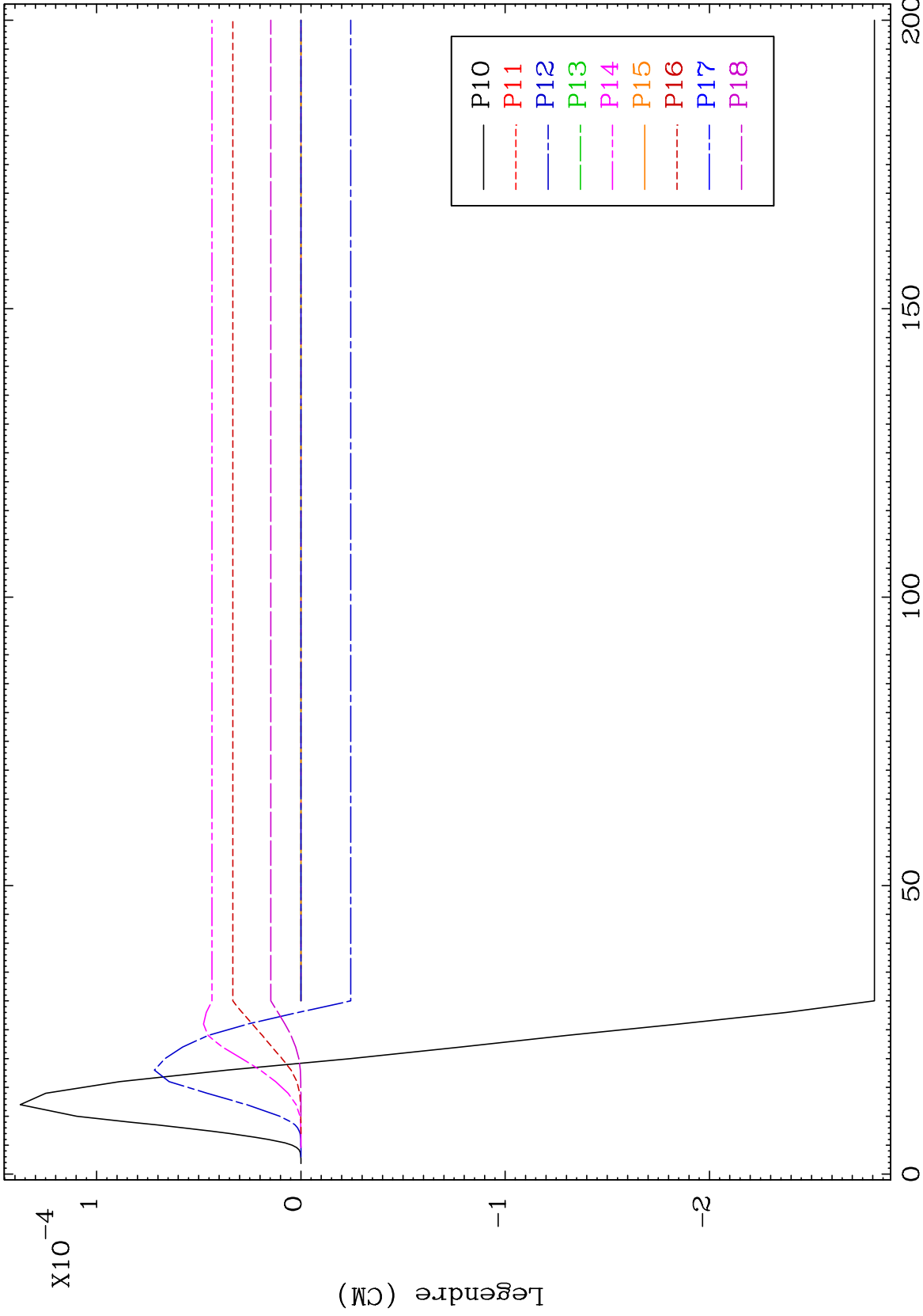

0

50

100

150

200

Incident Energy (MeV)

71-Lu-180

MAT 7140 MT= 65 (n,n') Level Legendre Coefficients 71-Lu-180

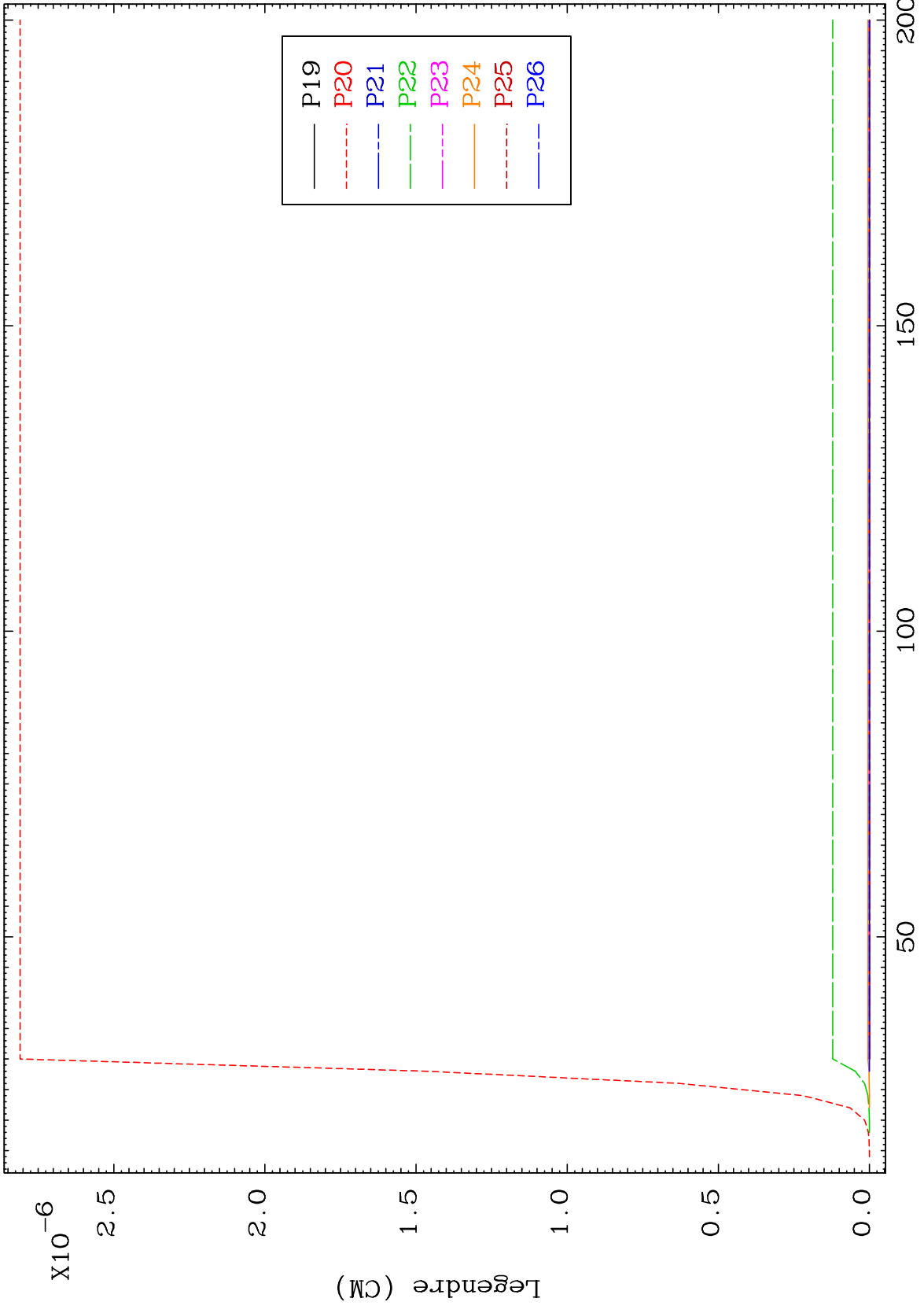

71 71-Lu-180

MAT 7140

MT= 66 (n,n') Level
Legendre Coefficients

71-Lu-180

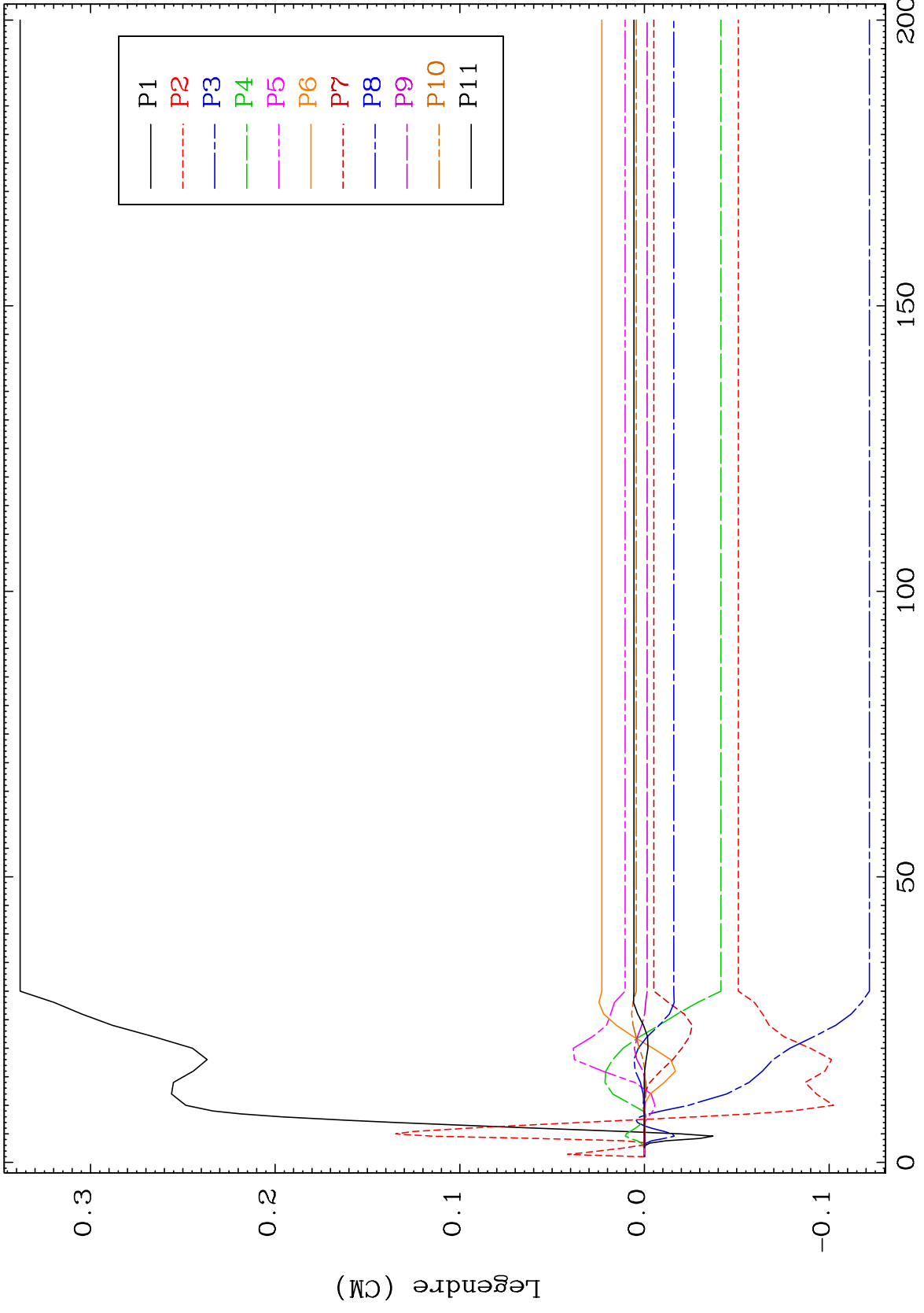

72

Incident Energy (MeV)

71-Lu-180

MAT 7140

MT= 66 (n,n') Level
Legendre Coefficients

71-Lu-180

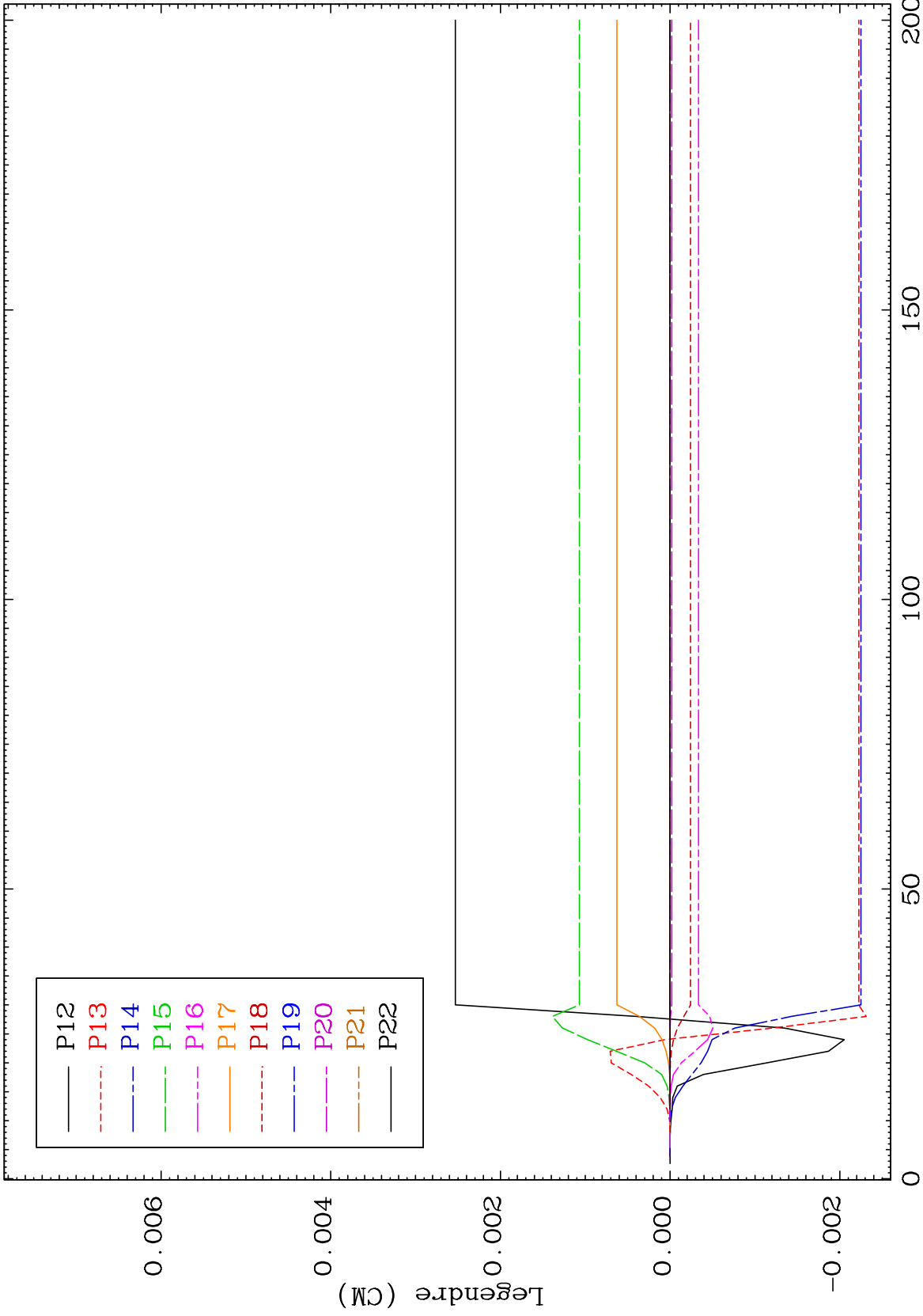

73

Incident Energy (MeV)

71-Lu-180

MAT 7140

MT= 67 (n,n') Level
Legendre Coefficients

71-Lu-180

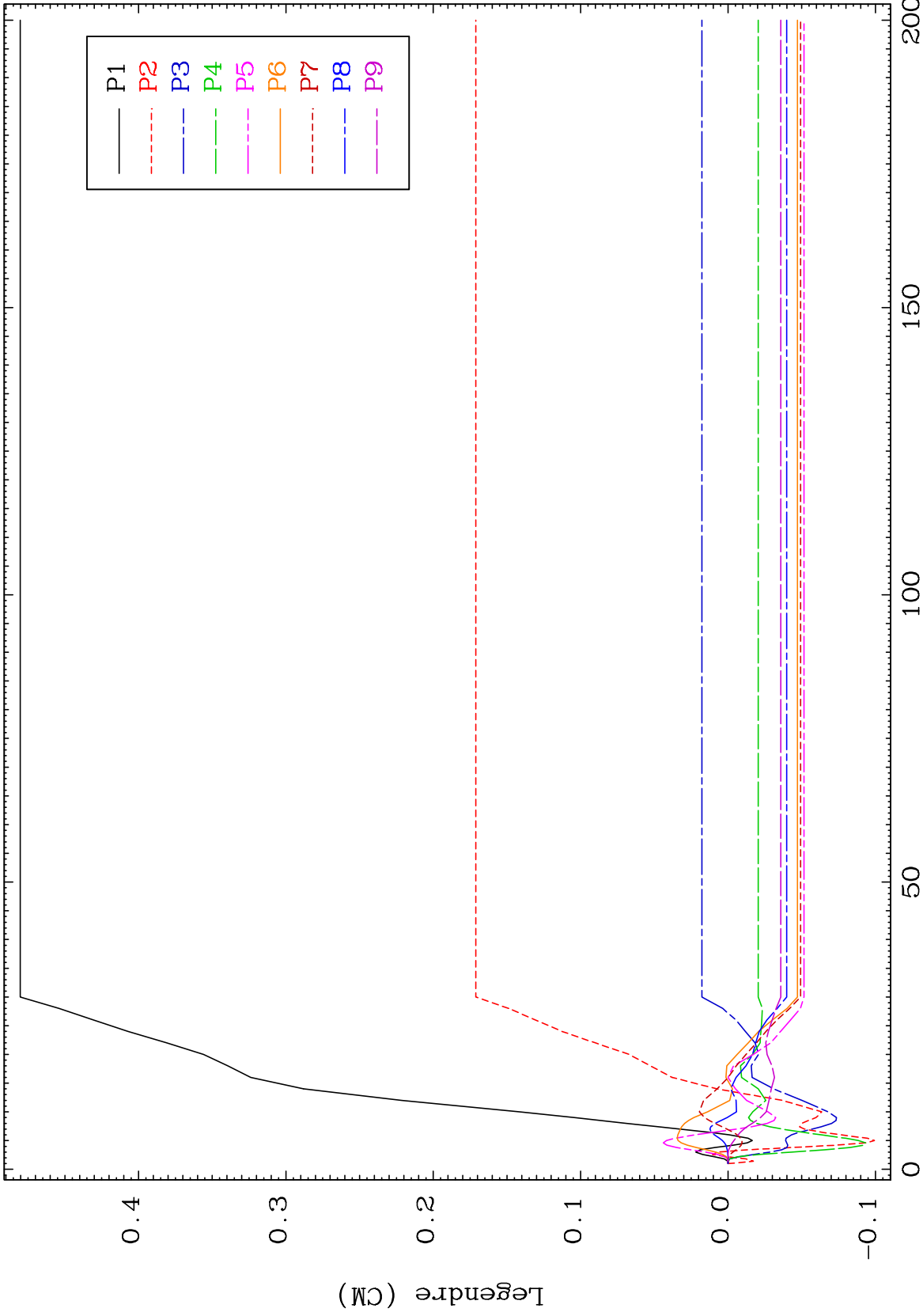

75

Incident Energy (MeV)

71-Lu-180

MAT 7140 MT= 67 (n,n') Level Legendre Coefficients 71-Lu-180

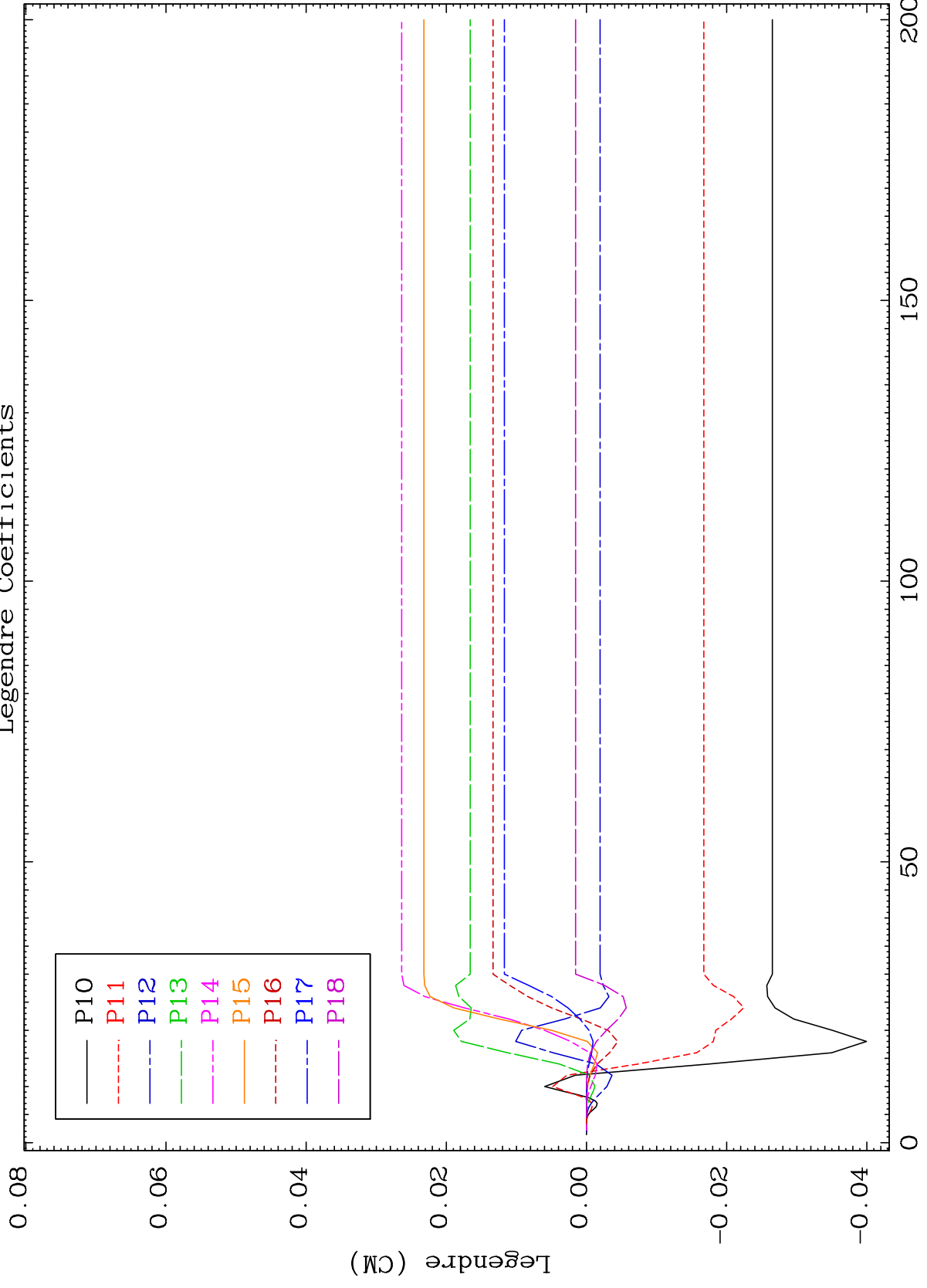

71-Lu-180

Incident Energy (MeV)

76

MAT 7140

MT= 67 (n,n') Level
Legendre Coefficients

71-Lu-180

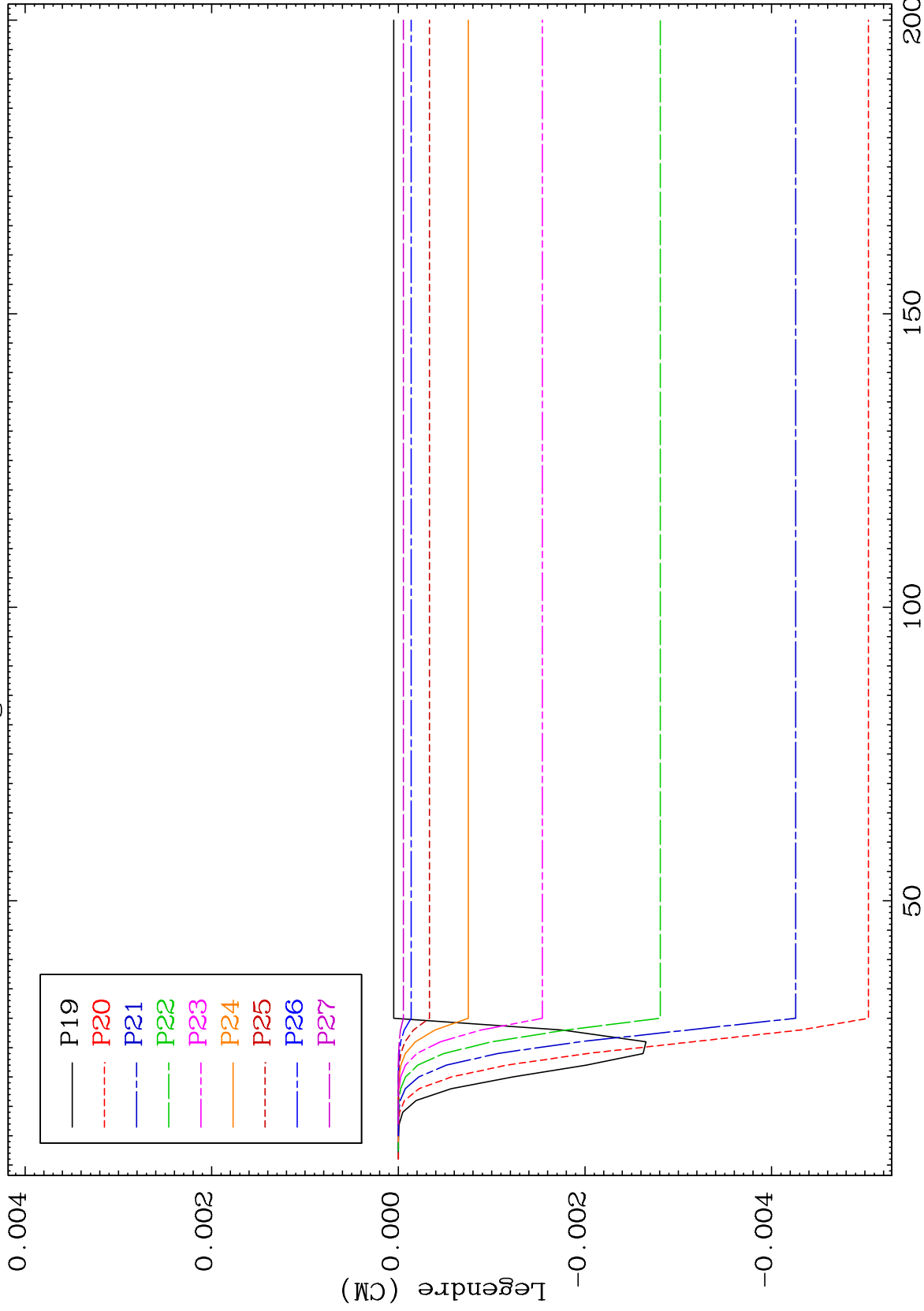

77

Incident Energy (MeV)

71-Lu-180

MAT 7140 MT= 67 (n,n') Level 71-Lu-180

Legendre Coefficients

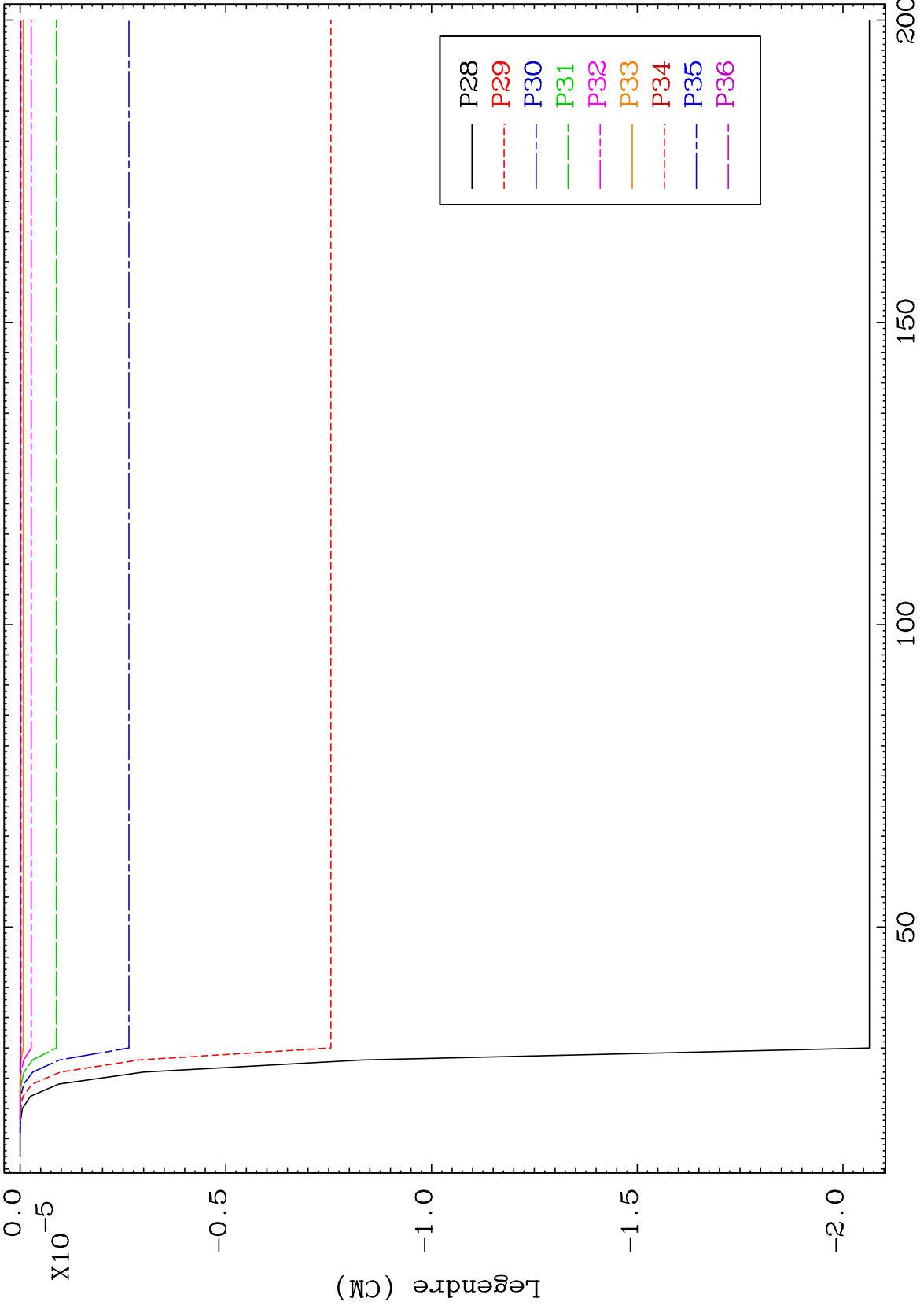

78 Incident Energy (MeV) 71-Lu-180

MAT 7140 MT= 68 (n,n') Level Legendre Coefficients 71-Lu-180

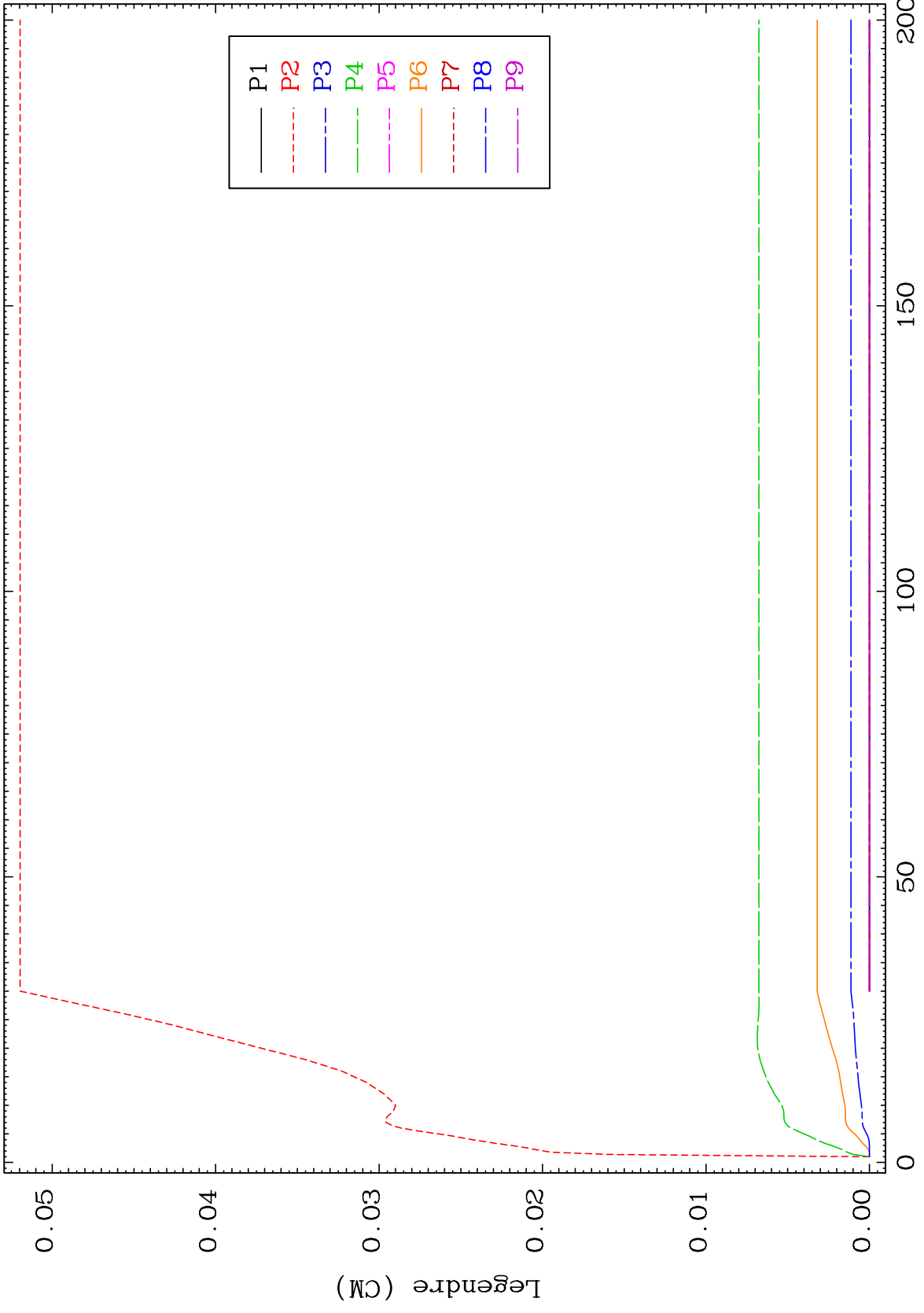

79 71-Lu-180

MAT 7140

MT= 68 (n,n') Level
Legendre Coefficients

71-Lu-180

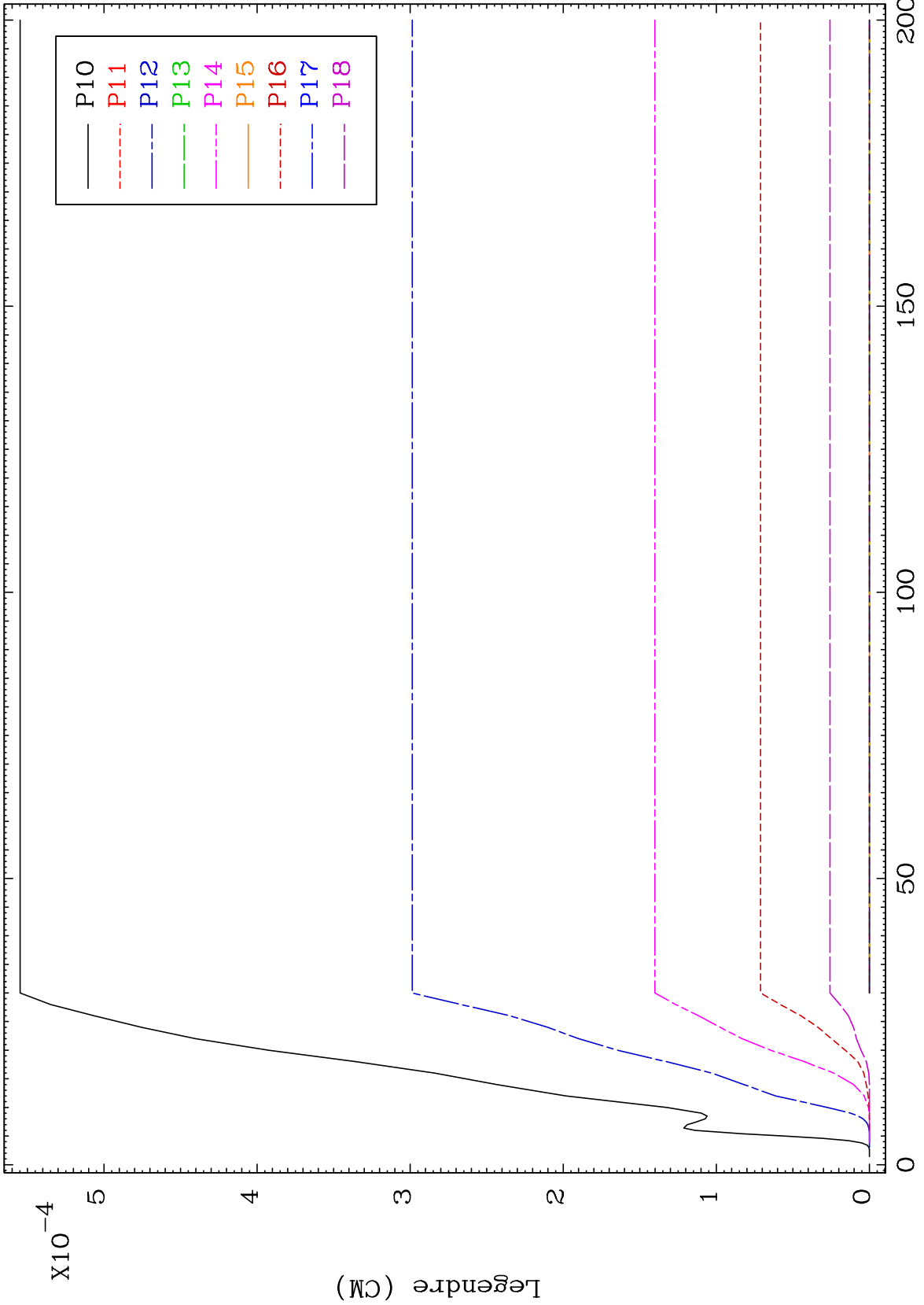

80

Incident Energy (MeV)

71-Lu-180

MAT 7140 MT= 68 (n,n') Level Legendre Coefficients 71-Lu-180

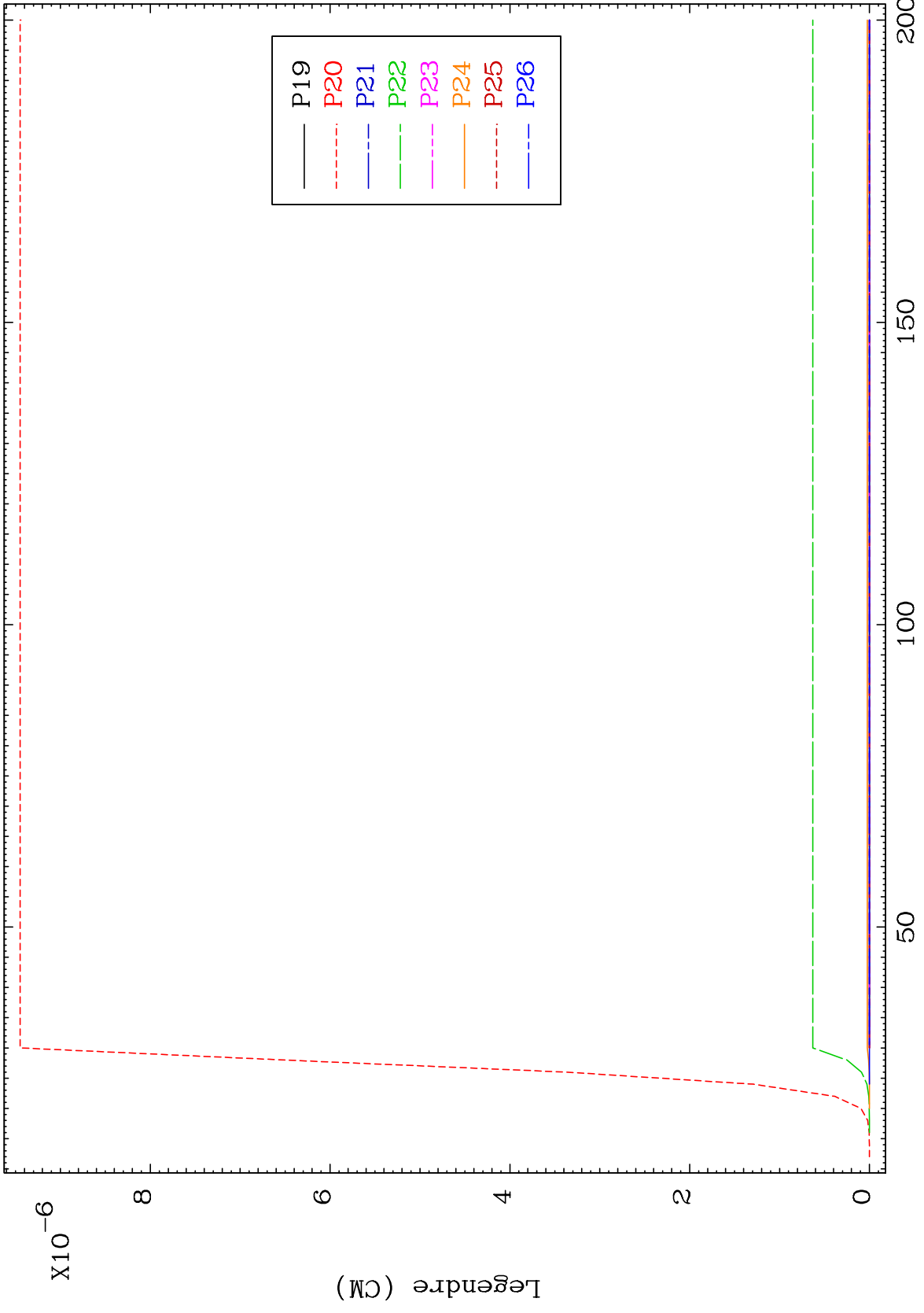

81 71-Lu-180

MAT 7140 MT= 69 (n,n') Level Legendre Coefficients 71-Lu-180

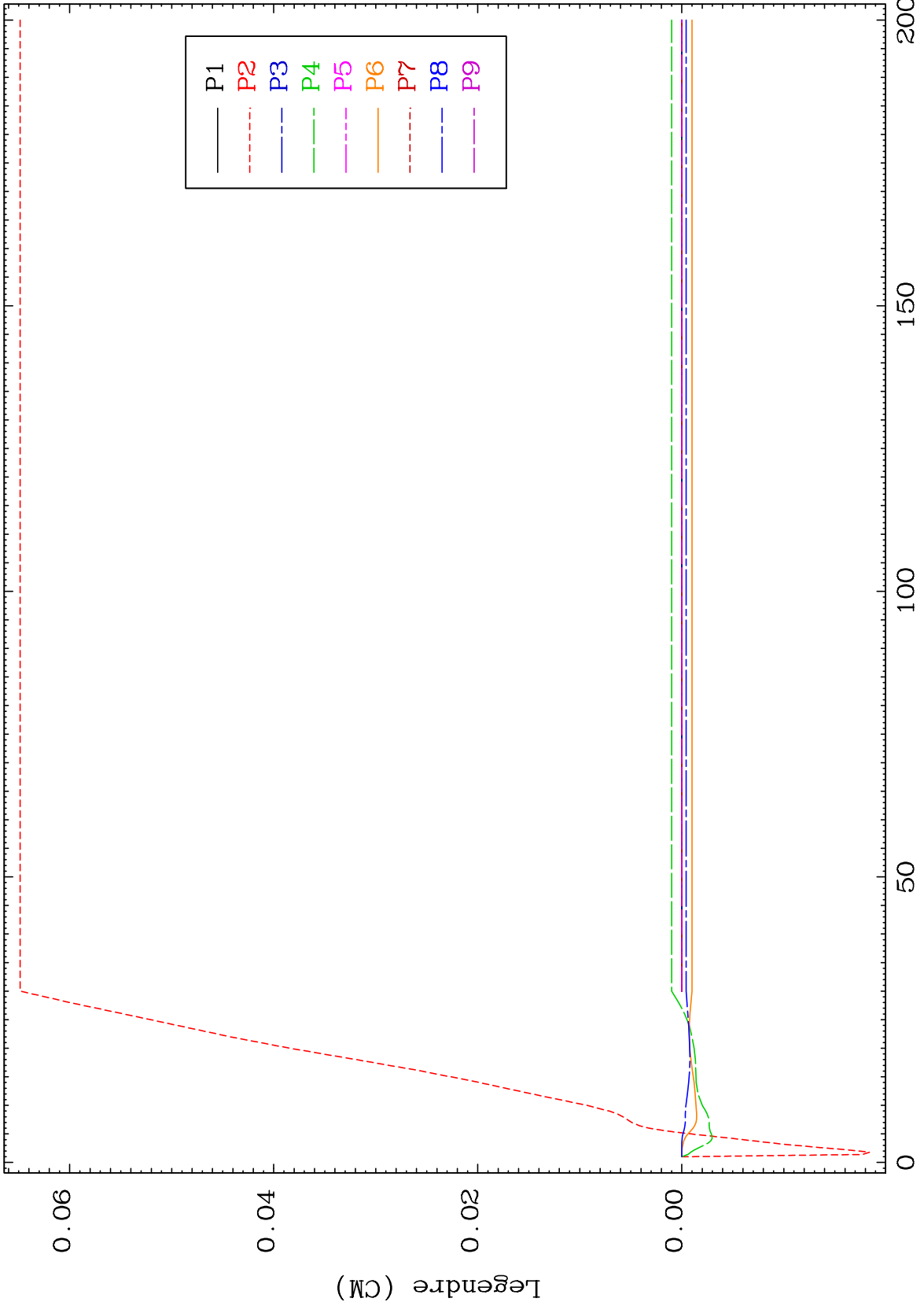

82 71-Lu-180

MAT 7140 MT= 69 (n,n') Level Legendre Coefficients 71-Lu-180

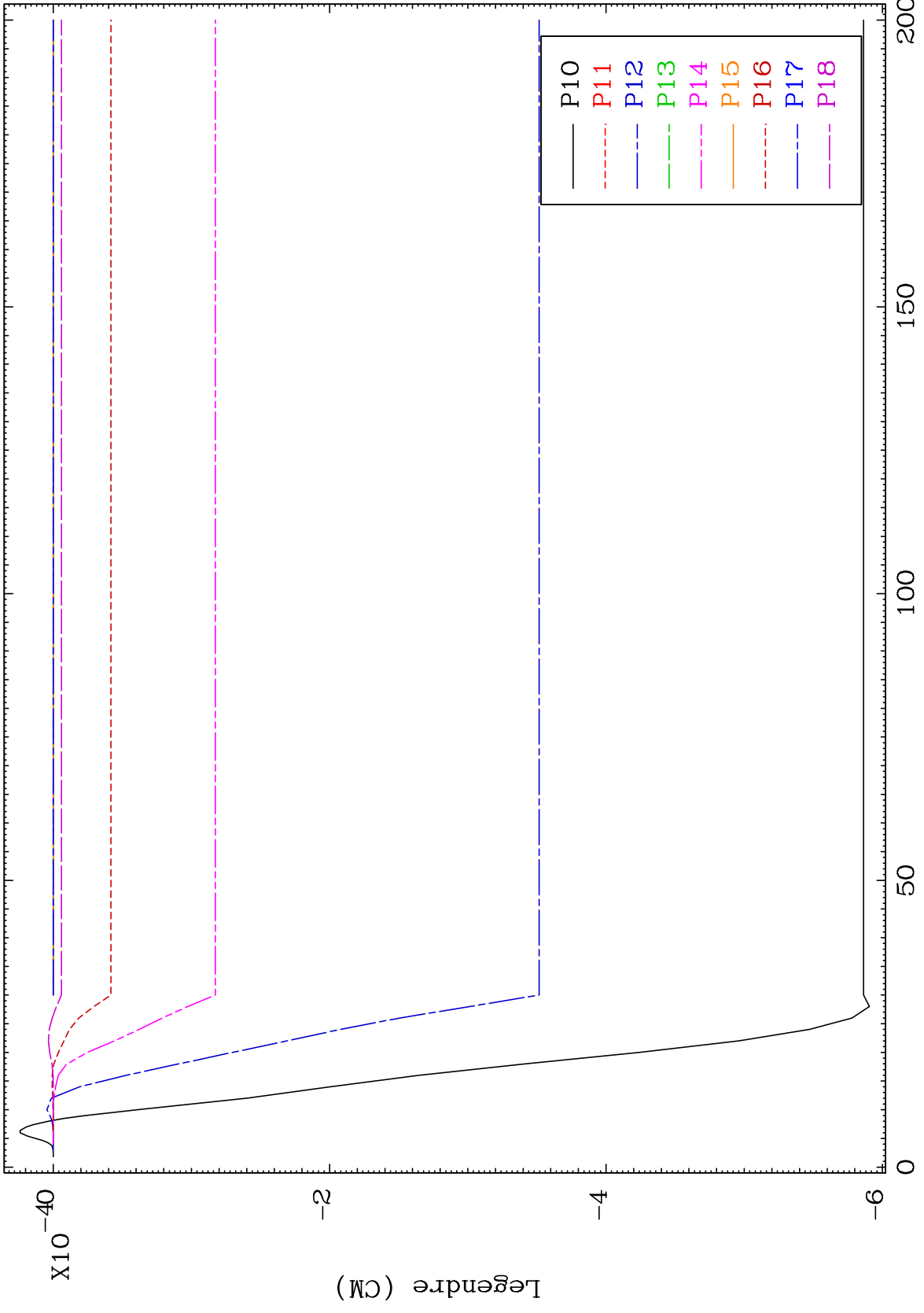

83 71-Lu-180

MAT 7140 MT= 69 (n,n') Level Legendre Coefficients 71-Lu-180

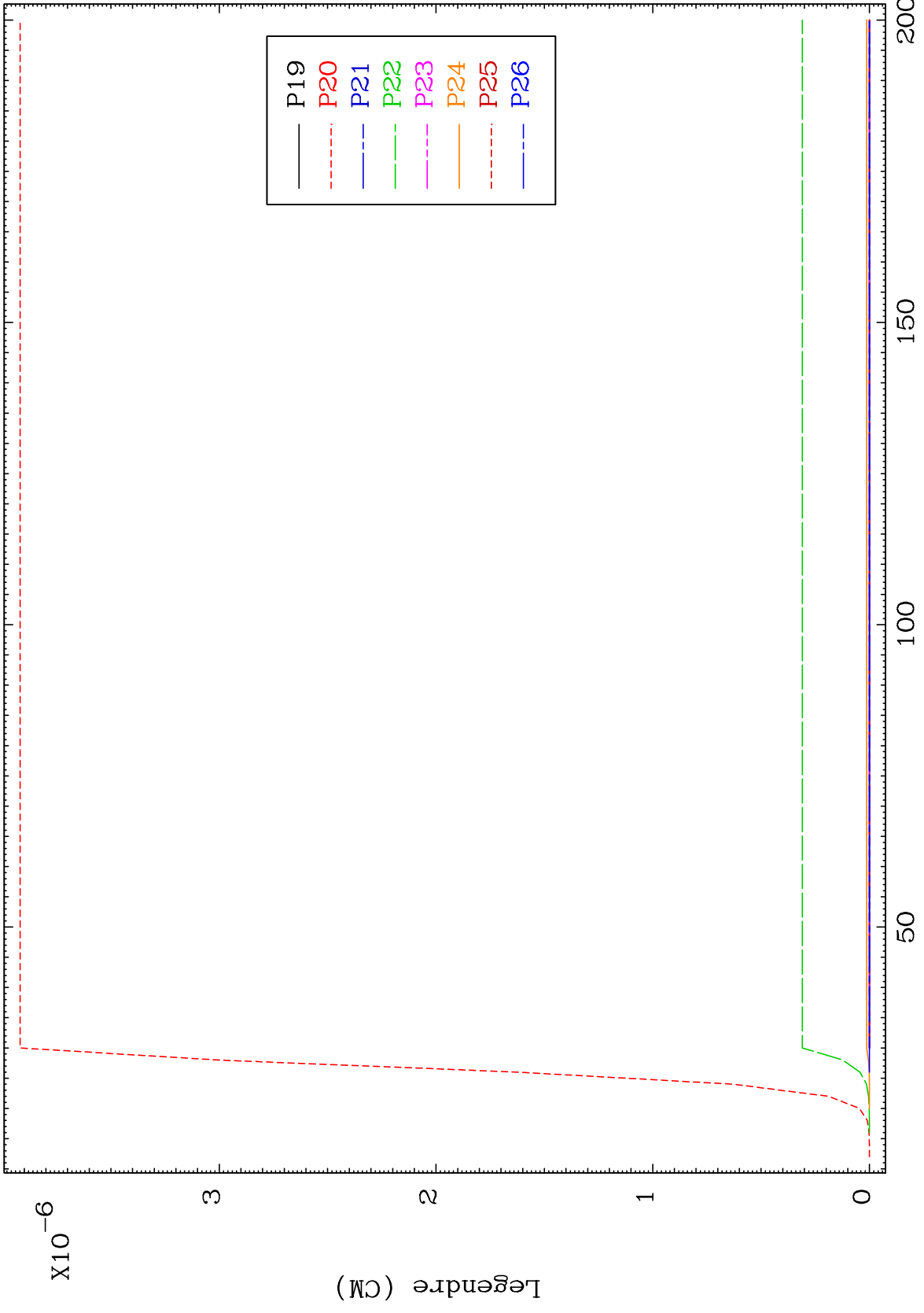

84 71-Lu-180

MAT 7140

MT= 70 (n,n') Level
Legendre Coefficients

71-Lu-180

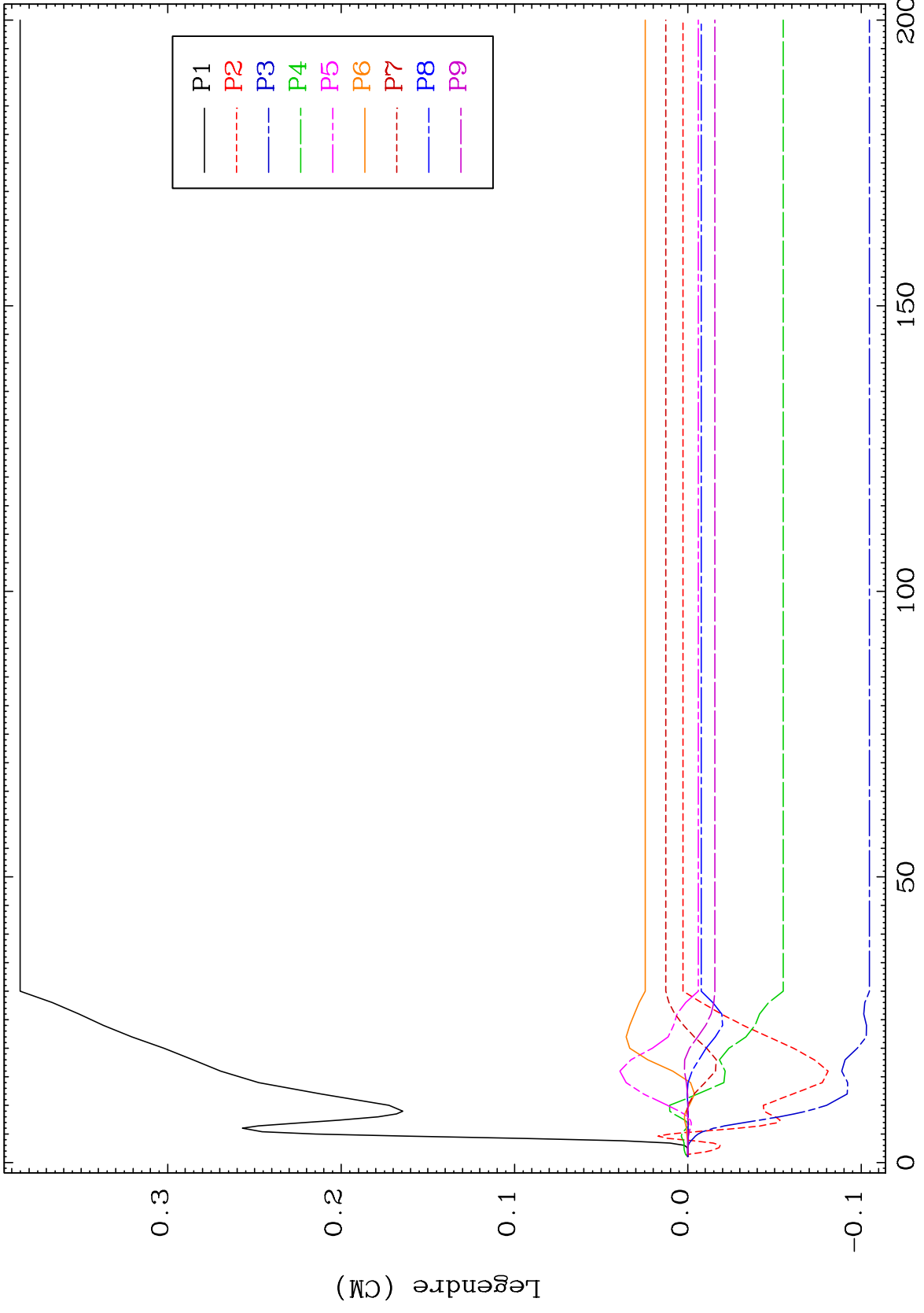

85

Incident Energy (MeV)

71-Lu-180

MAT 7140 MT= 70 (n,n') Level Legendre Coefficients 71-Lu-180

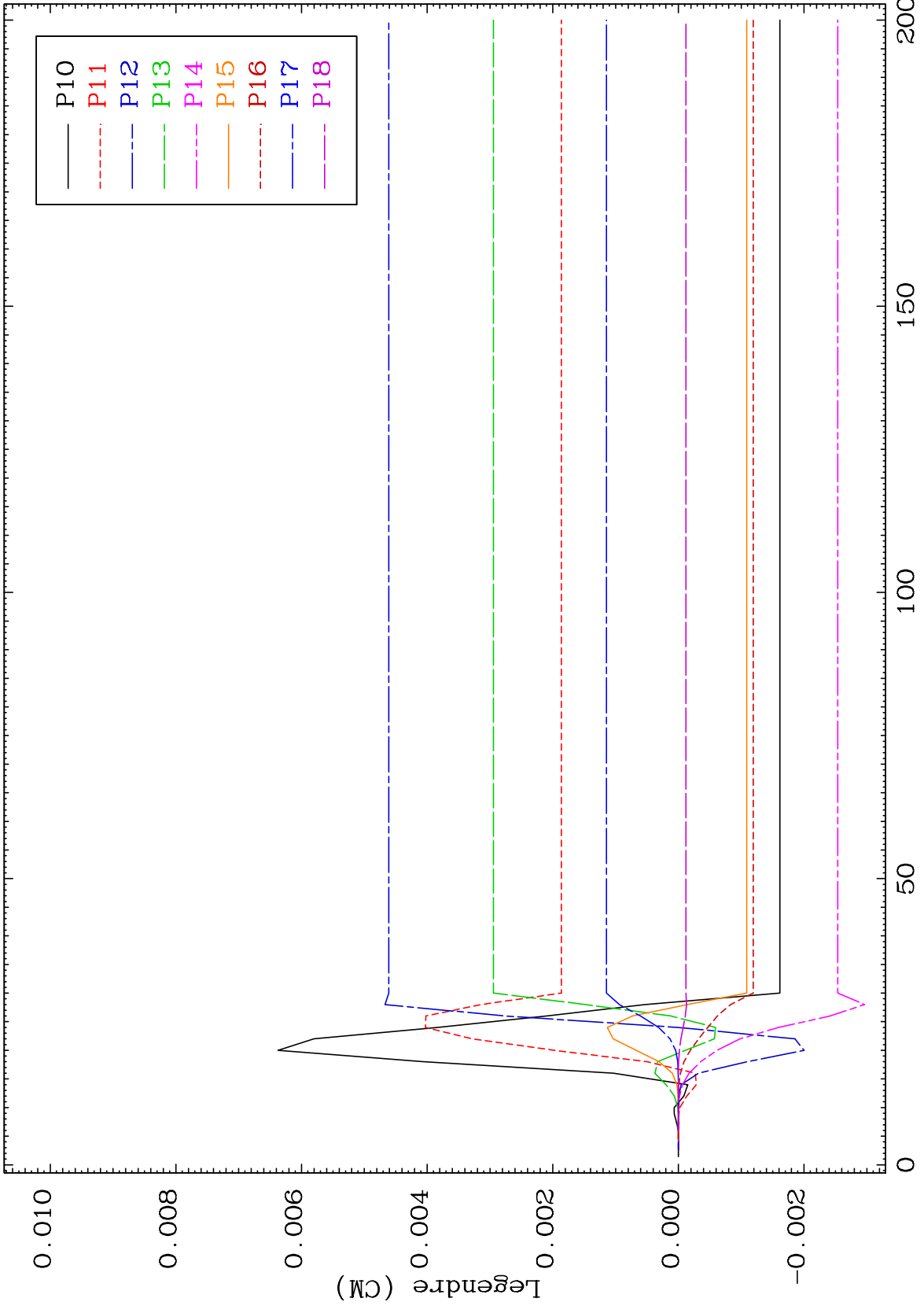

86 71-Lu-180

MAT 7140

MT= 70 (n,n') Level
Legendre Coefficients

71-Lu-180

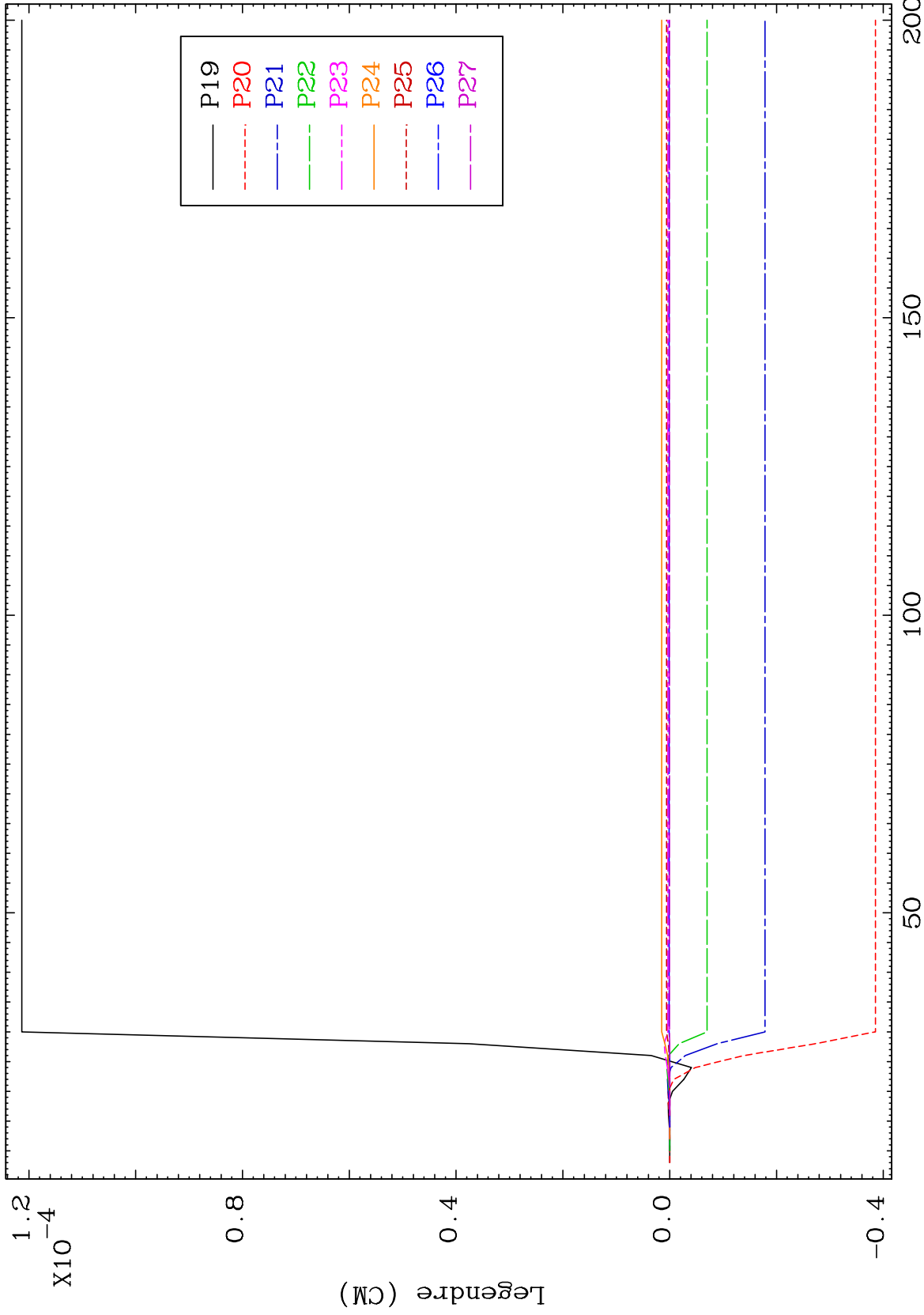

87

Incident Energy (MeV)

71-Lu-180

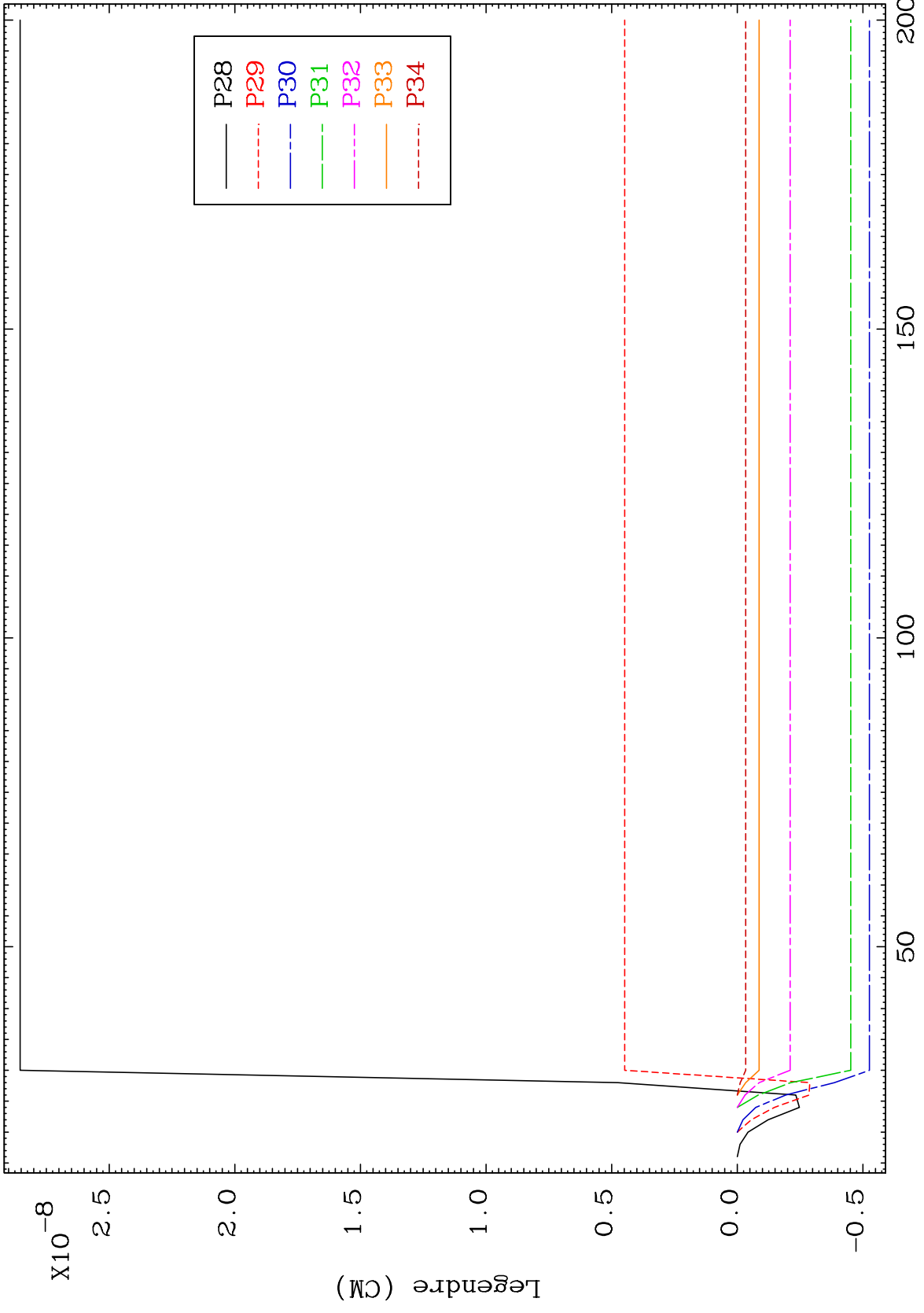

MAT 7140

MT= 71 (n,n') Level
Legendre Coefficients

71-Lu-180

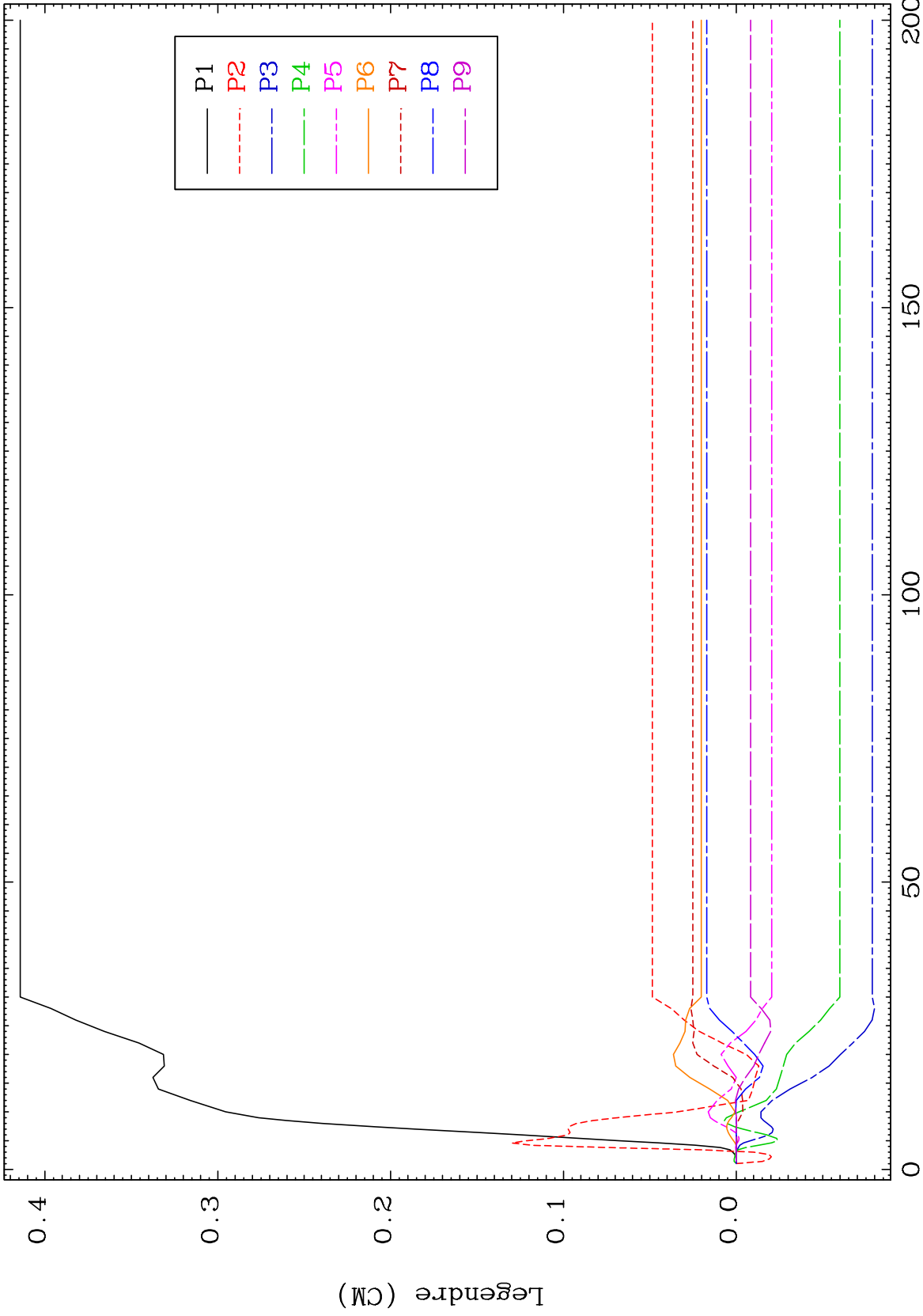

89

Incident Energy (MeV)

71-Lu-180

MAT 7140 MT= 71 (n,n') Level Legendre Coefficients 71-Lu-180

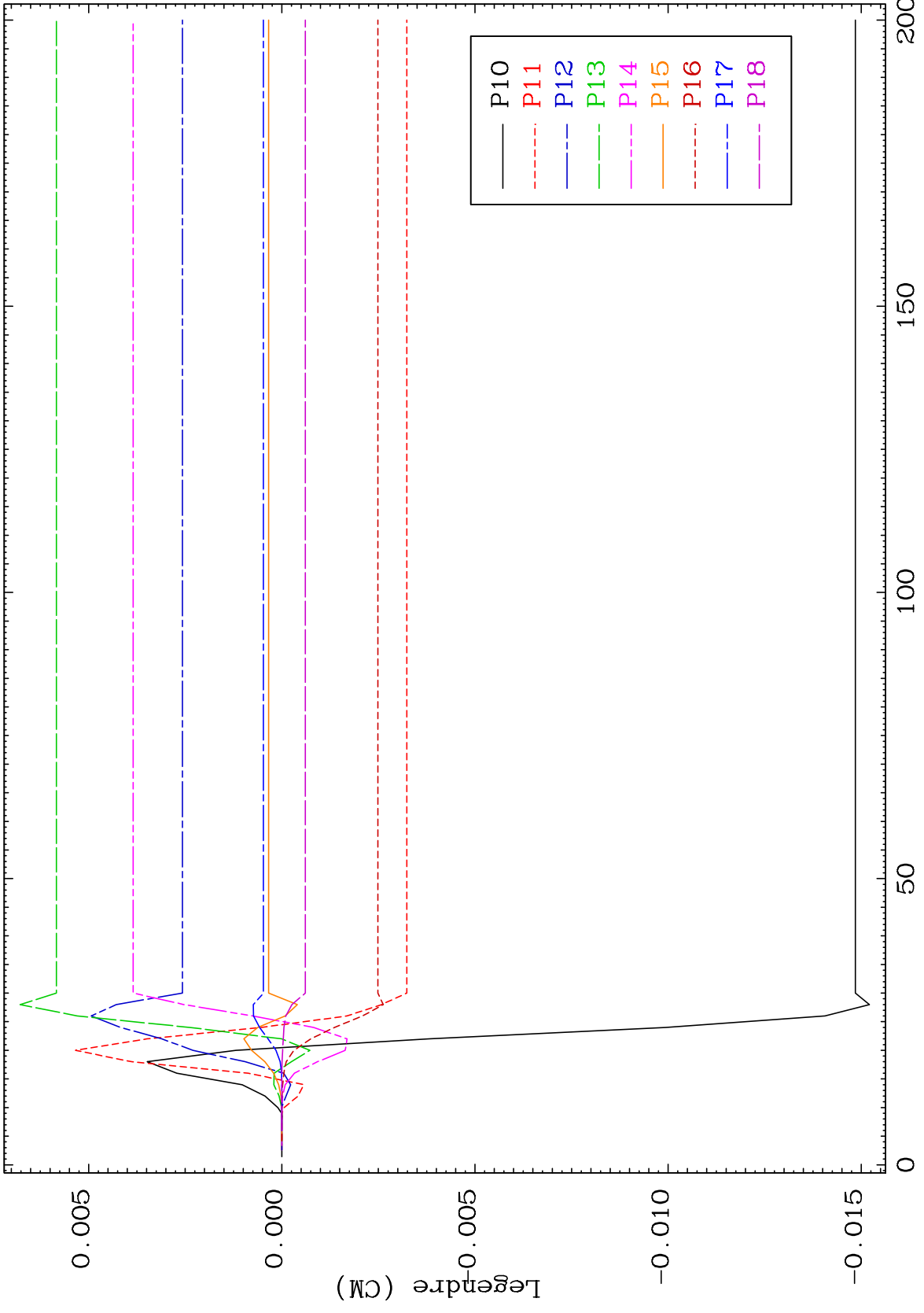

90 Incident Energy (MeV) 71-Lu-180

MAT 7140

MT= 71 (n,n') Level
Legendre Coefficients

71-Lu-180

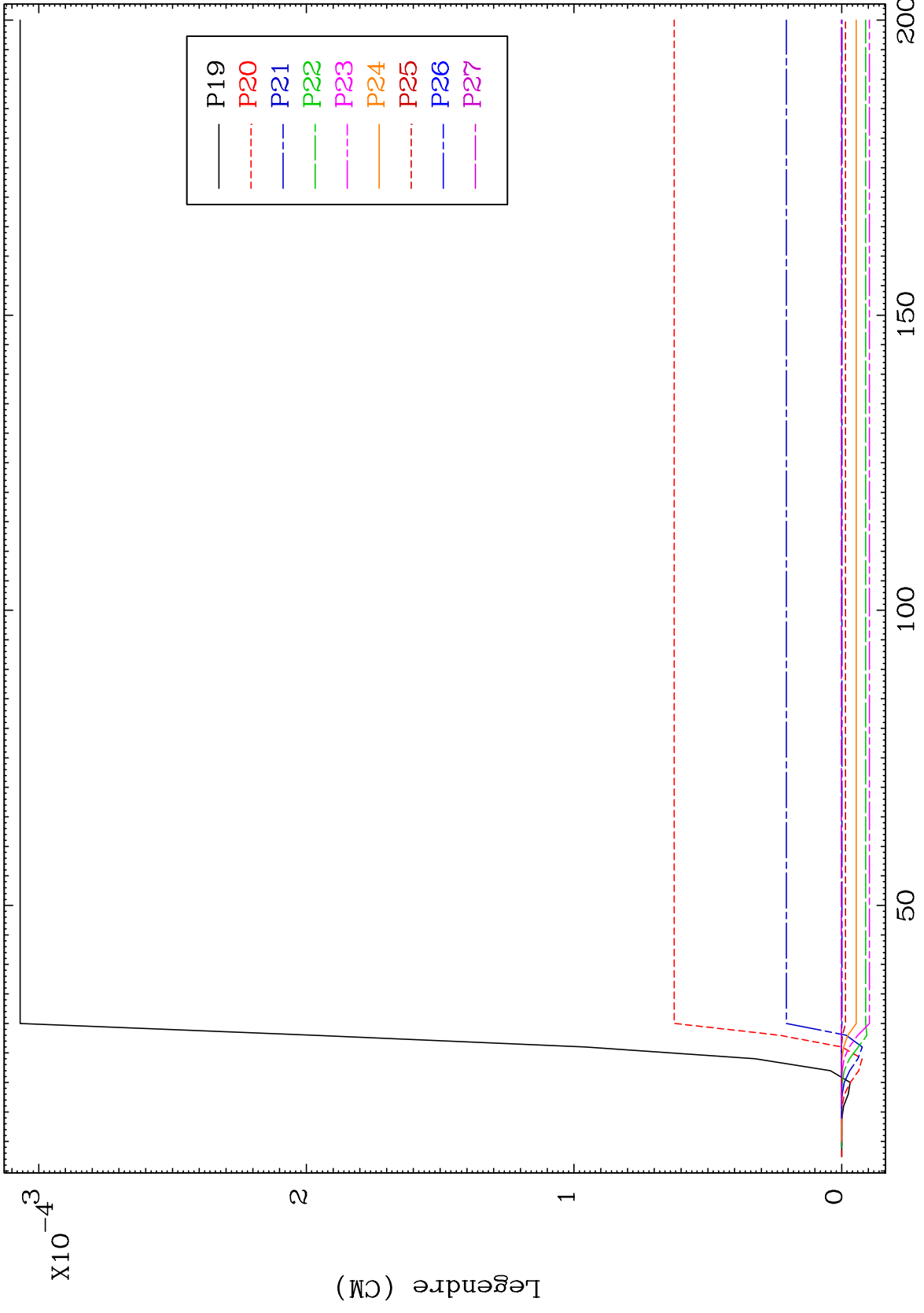

91

Incident Energy (MeV)

71-Lu-180

MAT 7140

MT= 71 (n,n') Level
Legendre Coefficients

71-Lu-180

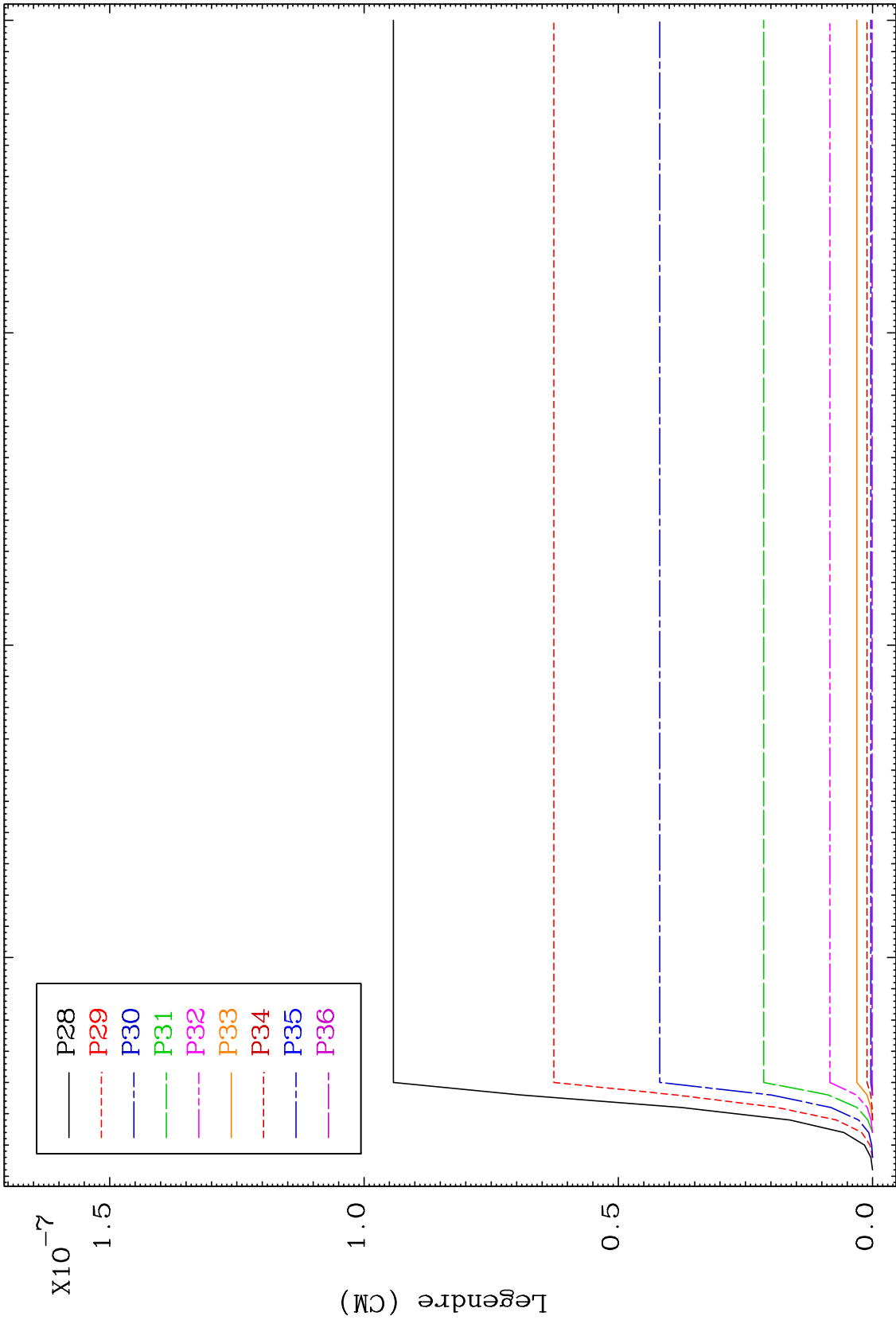
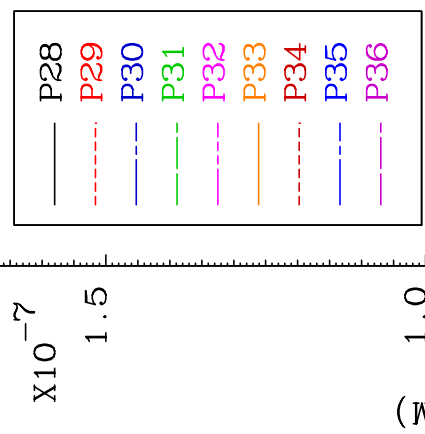

92

Incident Energy (MeV)

71-Lu-180

MAT 7140

MT= 72 (n,n') Level
Legendre Coefficients

71-Lu-180

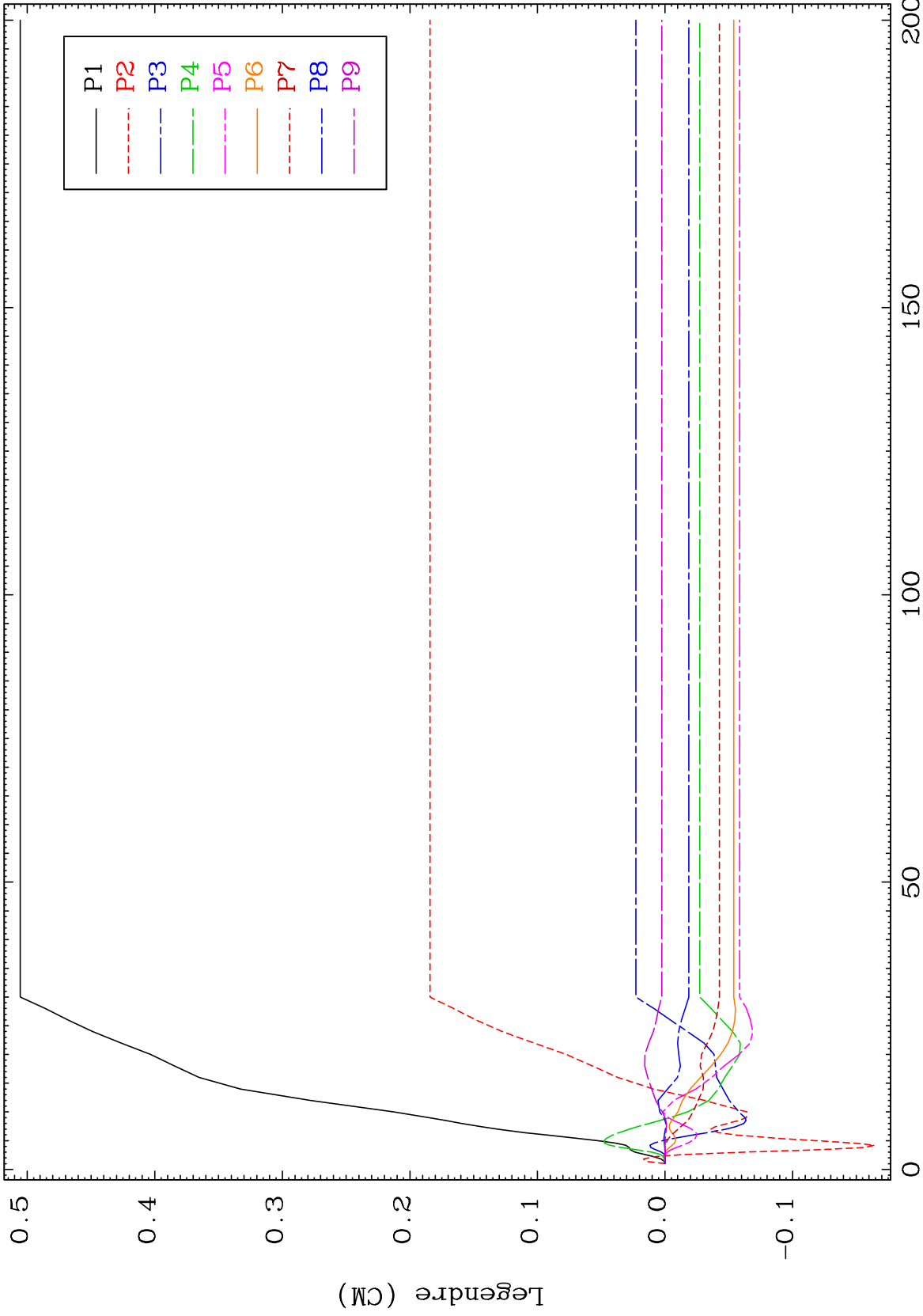

93

Incident Energy (MeV)

71-Lu-180

MAT 7140 MT= 72 (n,n') Level Legendre Coefficients 71-Lu-180

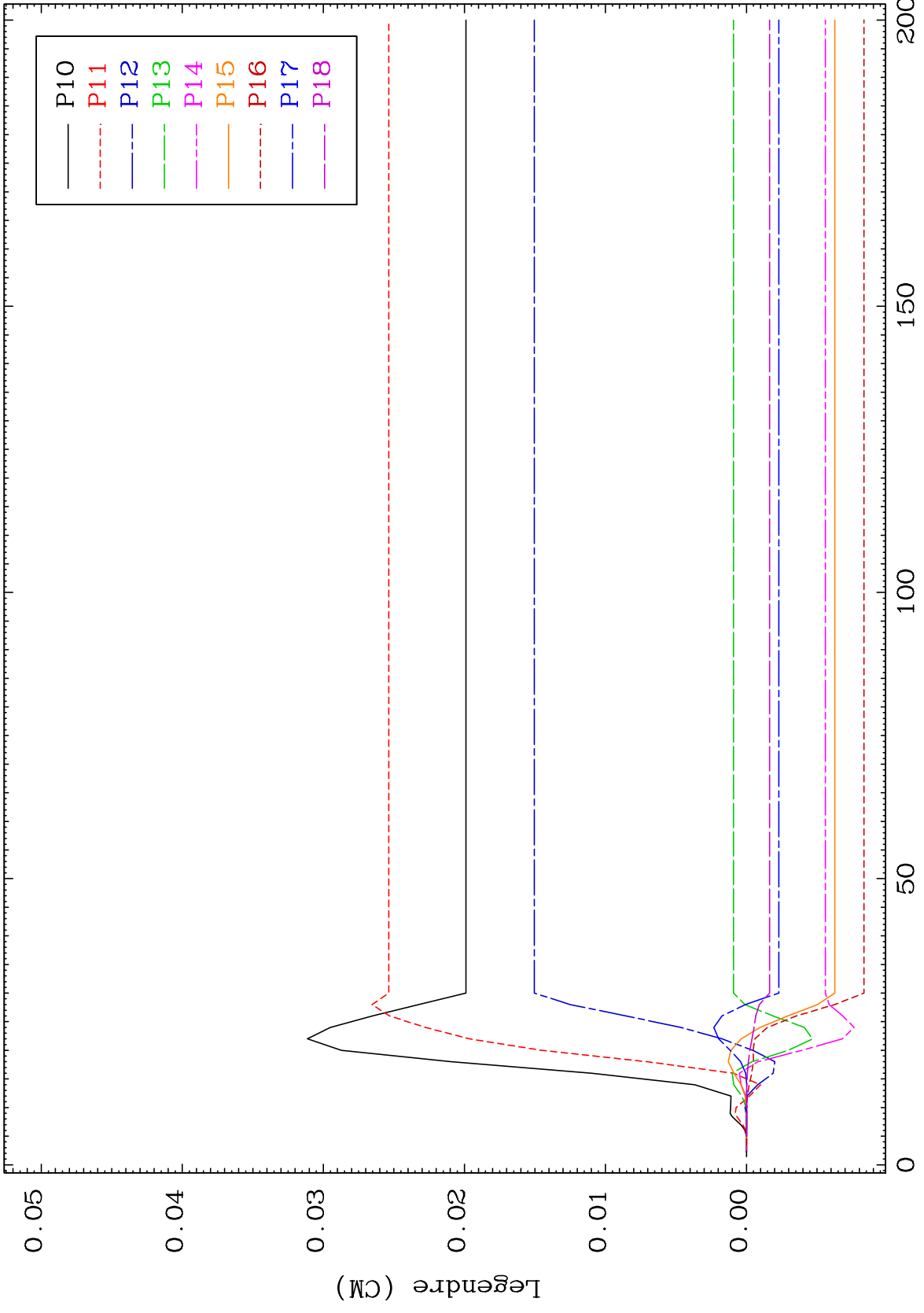

94 71-Lu-180

MAT 7140

MT= 72 (n,n') Level
Legendre Coefficients

71-Lu-180

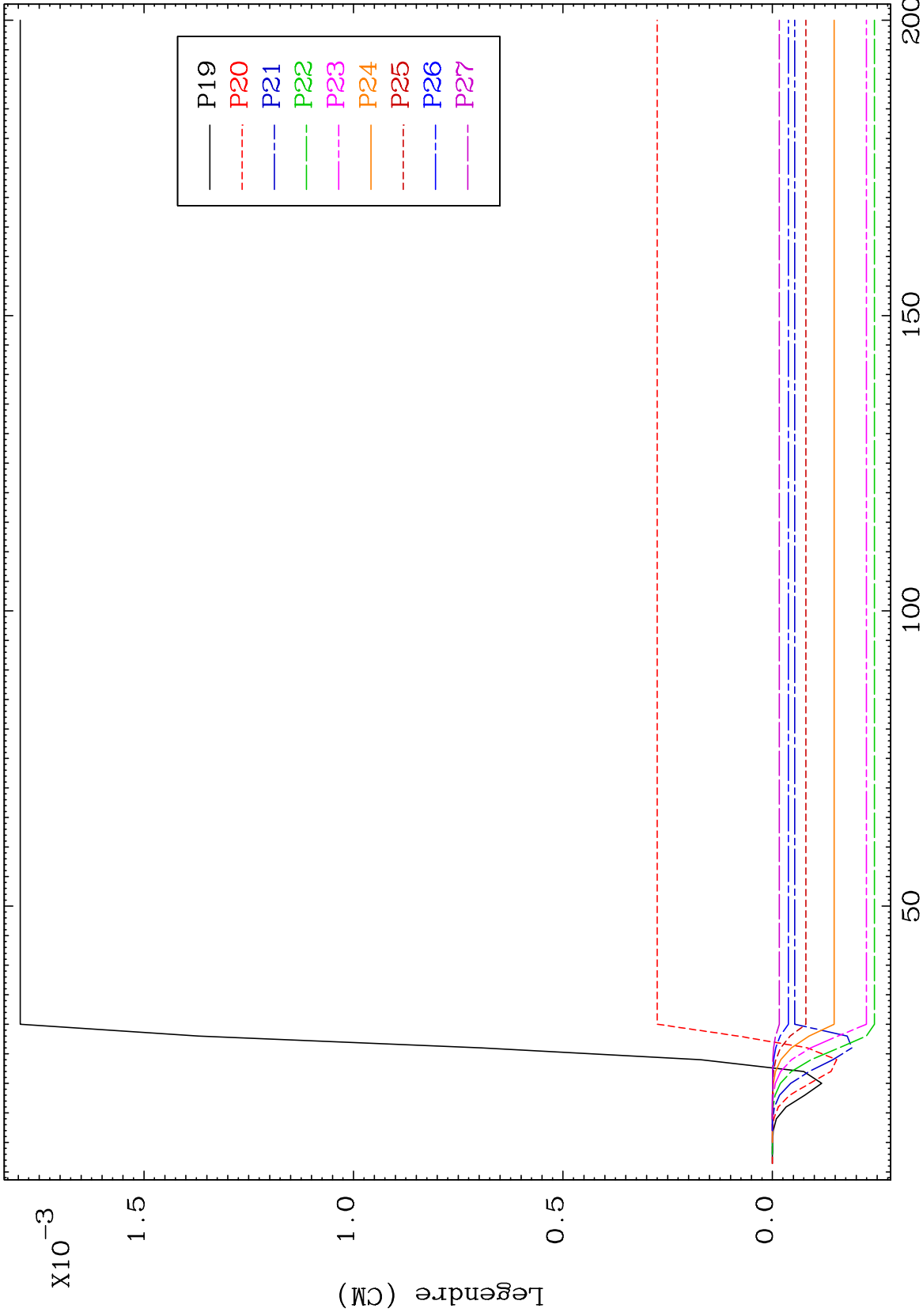

95

Incident Energy (MeV)

71-Lu-180

MAT 7140 MT= 72 (n,n') Level Legendre Coefficients 71-Lu-180

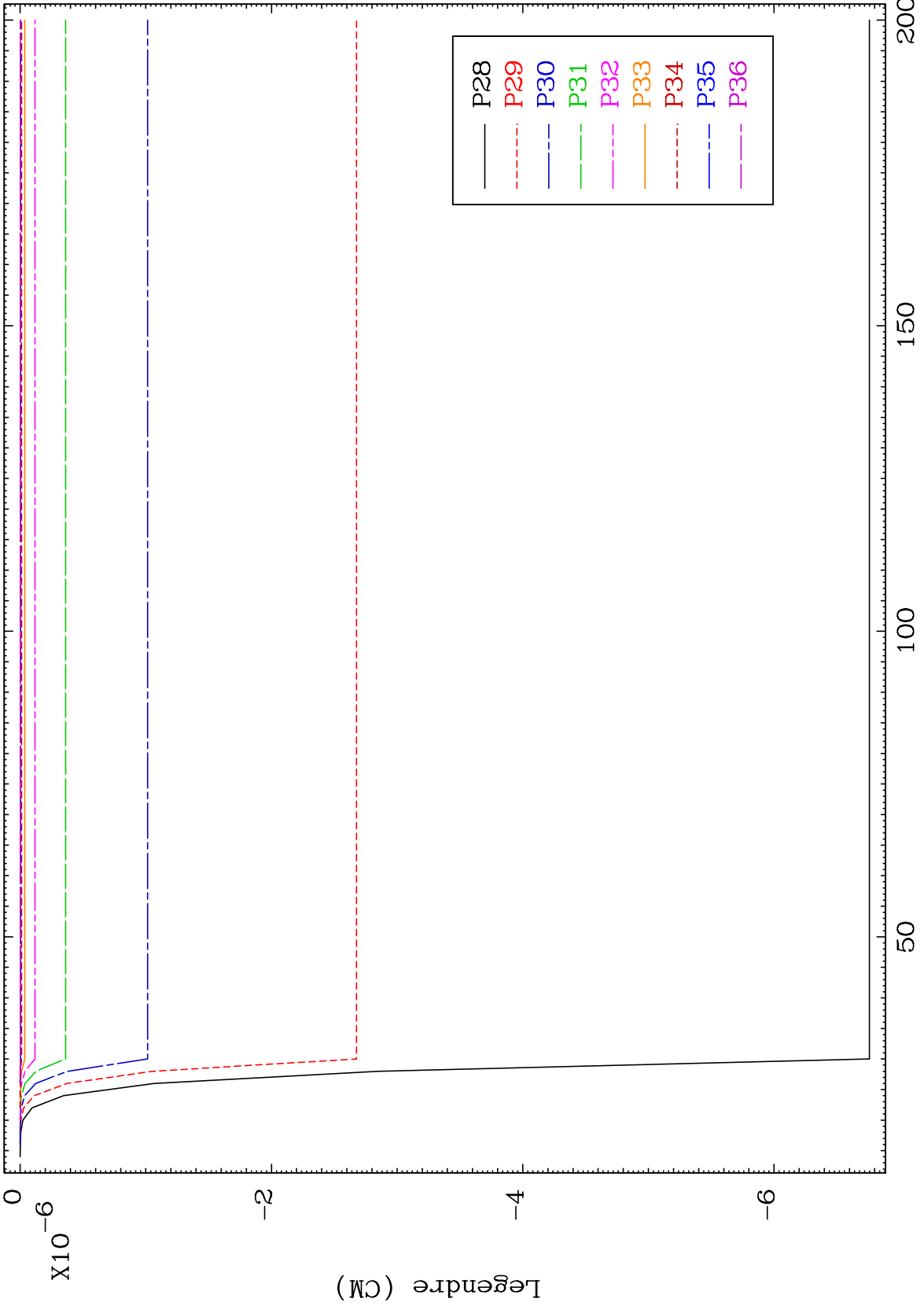

96 71-Lu-180

MAT 7140 MT= 73 (n,n') Level Legendre Coefficients 71-Lu-180

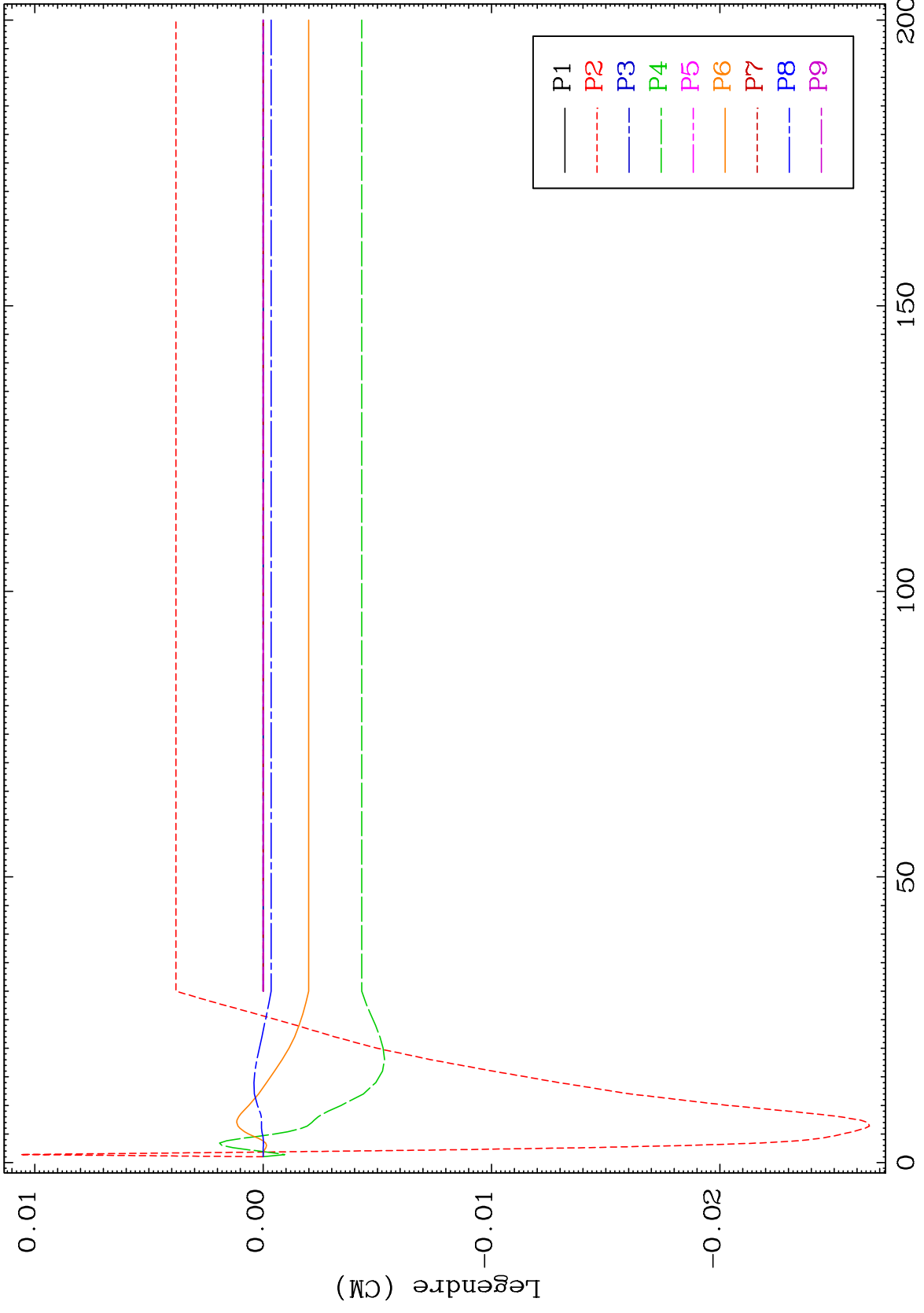

97 Incident Energy (MeV) 71-Lu-180

MAT 7140

MT= 73 (n,n') Level
Legendre Coefficients

71-Lu-180

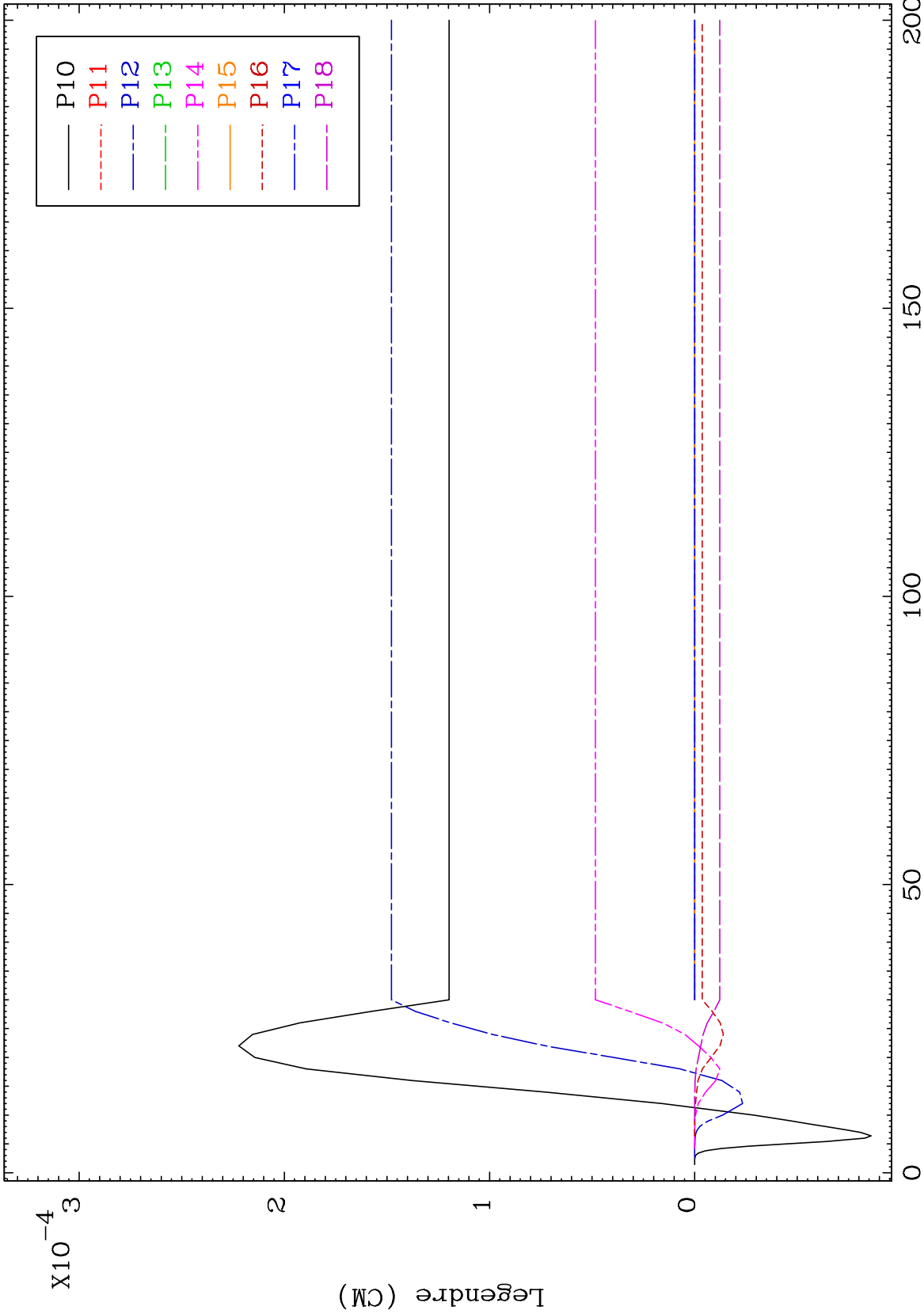

MAT 7140 MT= 73 (n,n') Level Legendre Coefficients 71-Lu-180

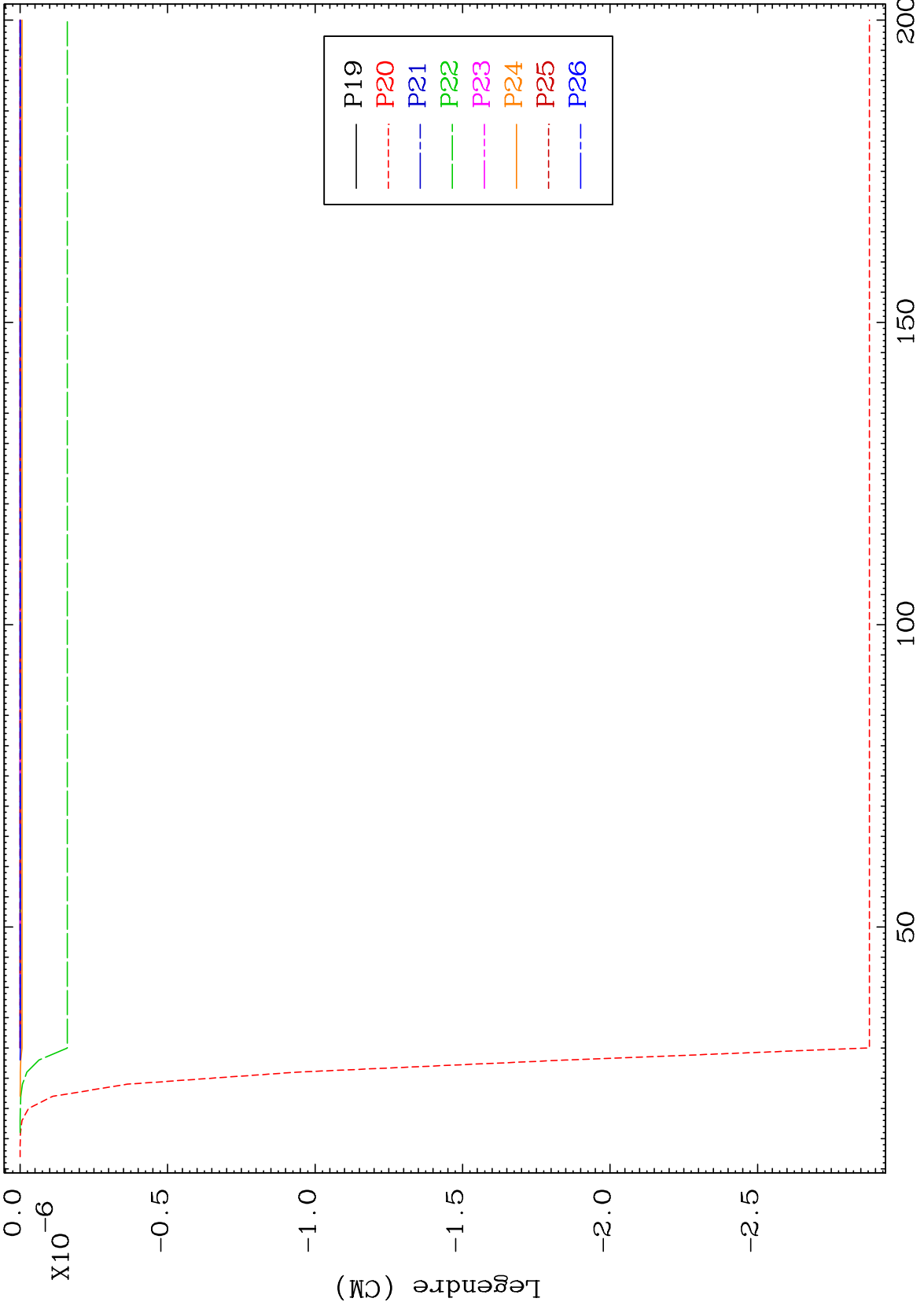

99 71-Lu-180

MAT 7140

MT= 74 (n,n') Level
Legendre Coefficients

71-Lu-180

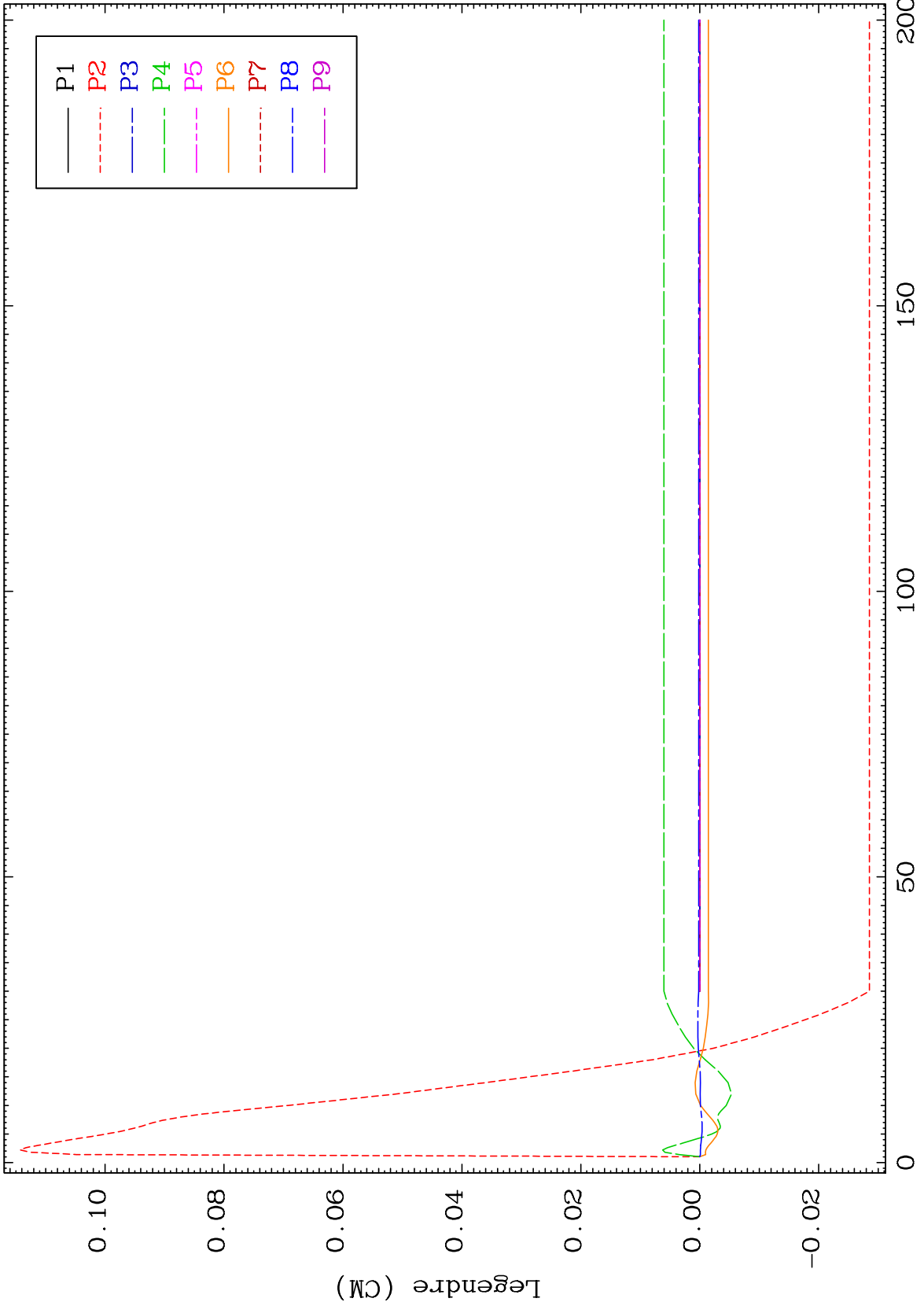

71-Lu-180

Incident Energy (MeV)

Legendre (CM)

MAT 7140

MT= 74 (n,n') Level
Legendre Coefficients

71-Lu-180

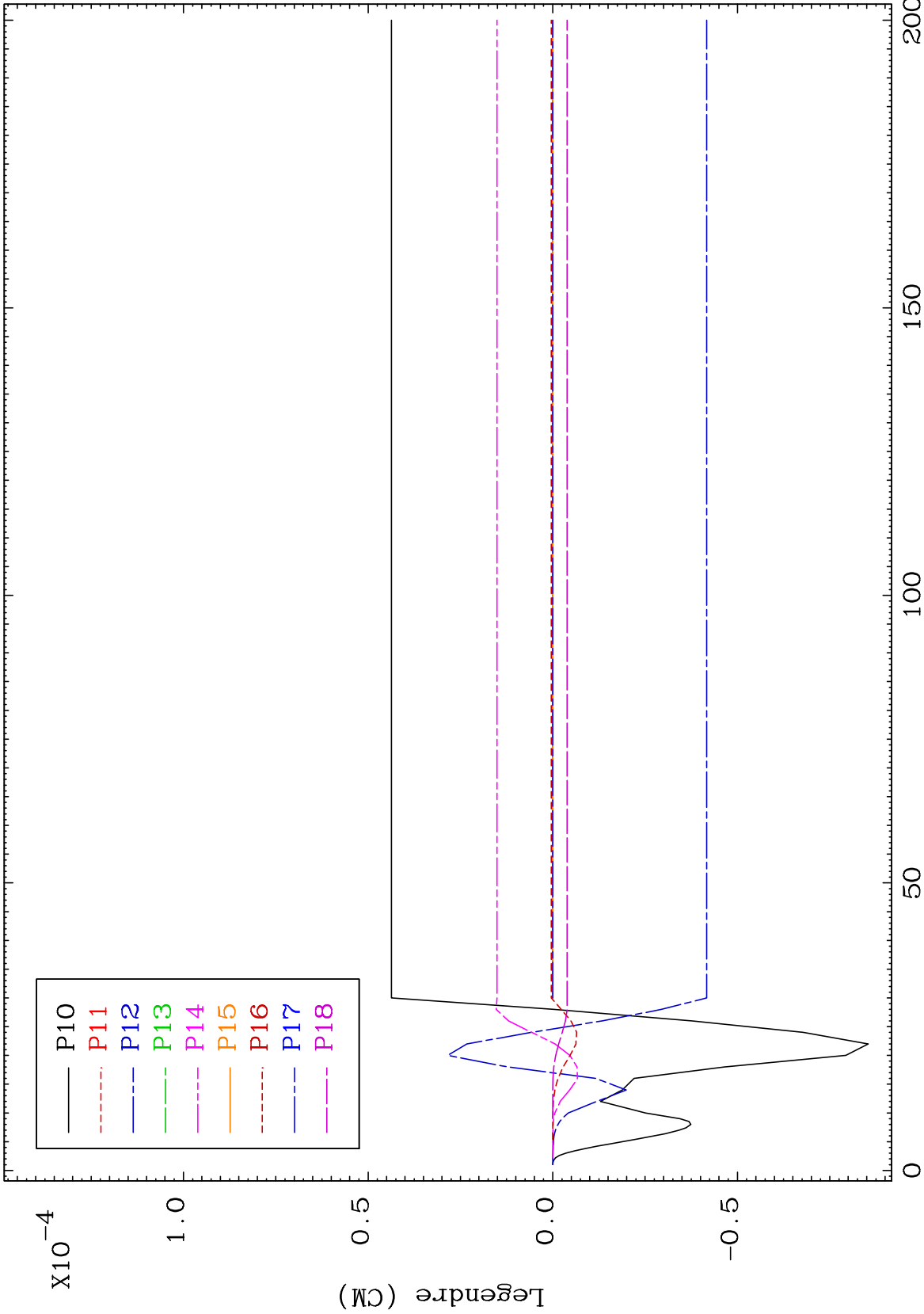

101

MAT 7140 MT= 74 (n,n') Level Legendre Coefficients 71-Lu-180

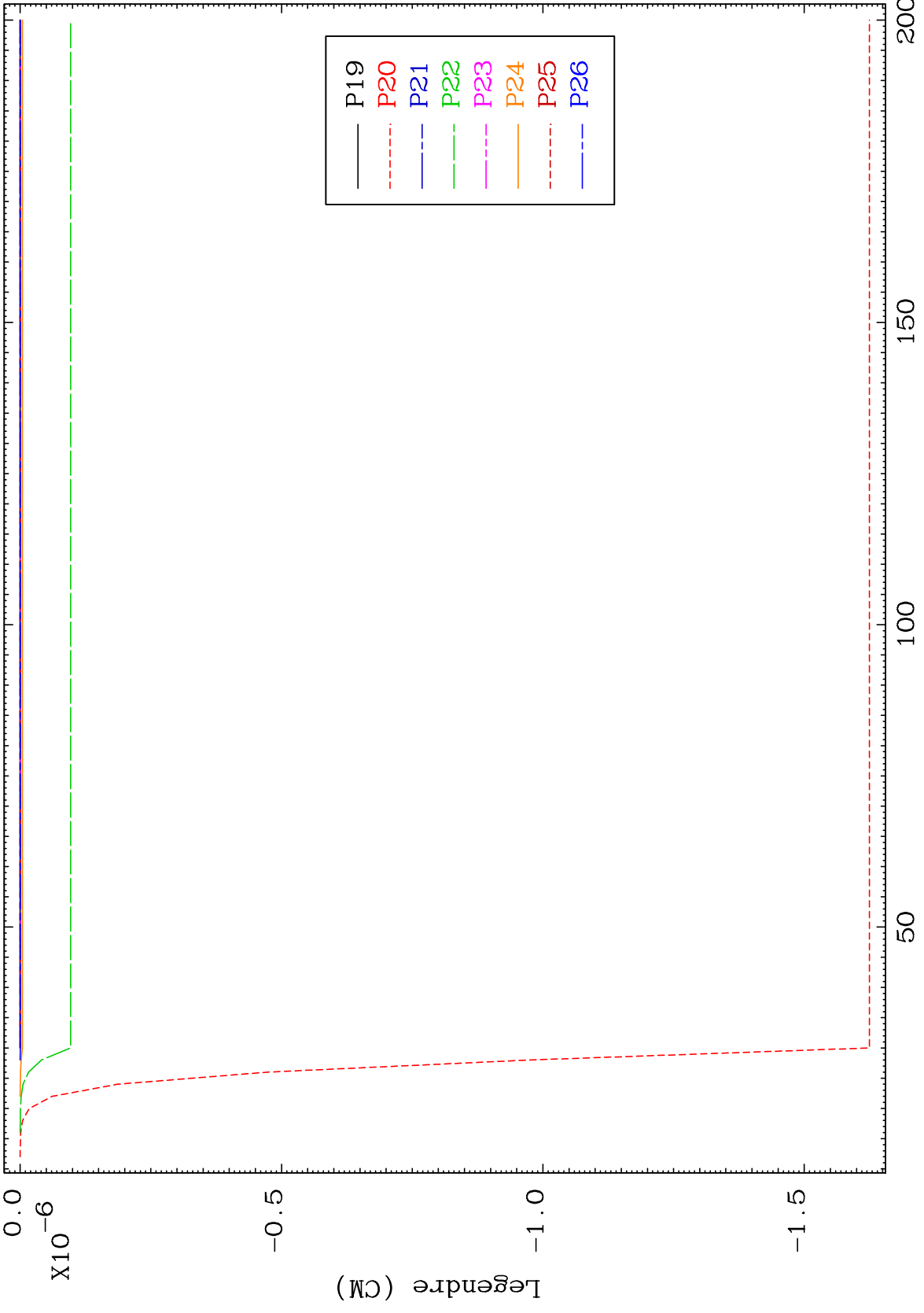

102 Incident Energy (MeV) 71-Lu-180

MAT 7140 MT= 75 (n,n') Level Legendre Coefficients 71-Lu-180

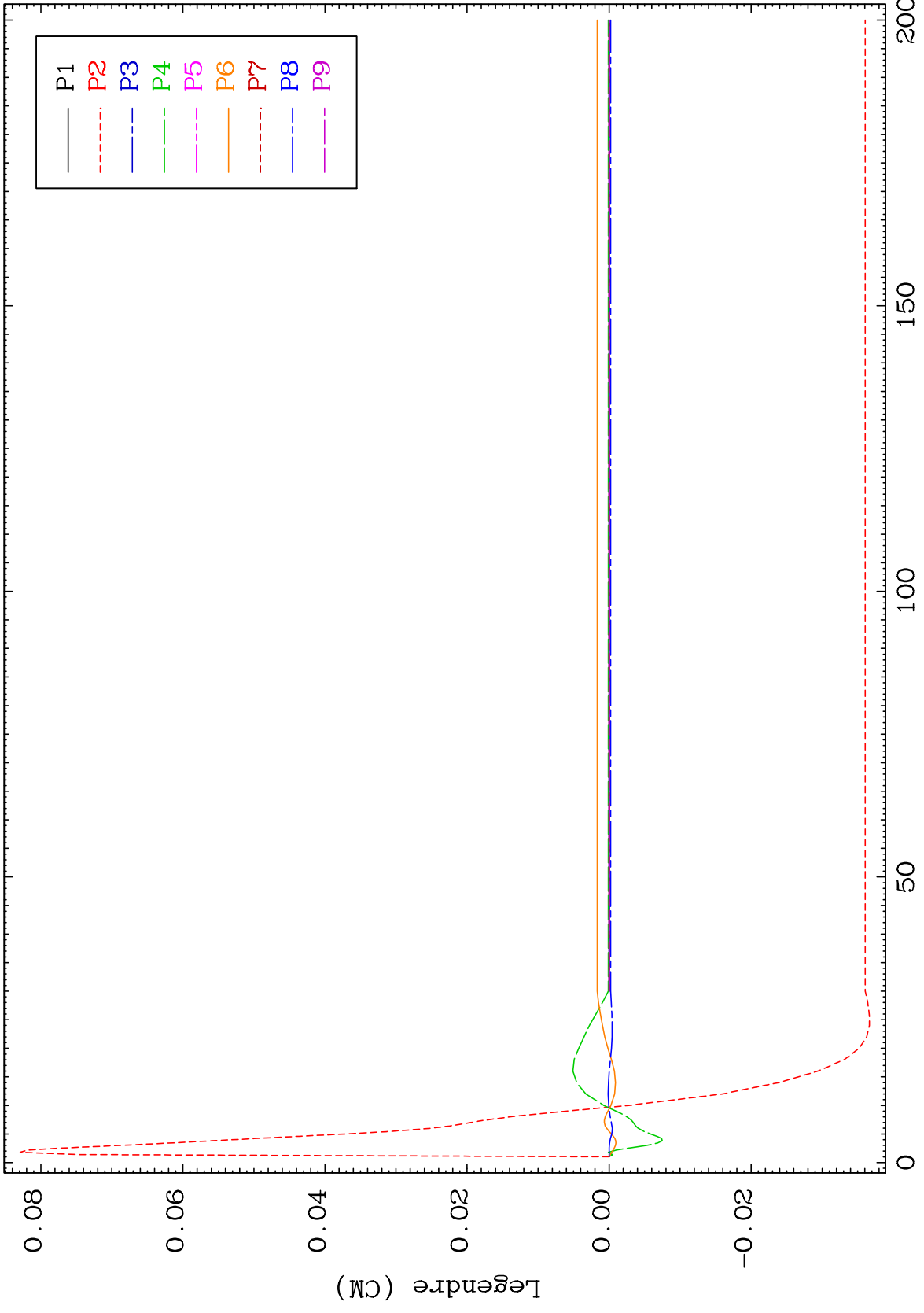

103 71-Lu-180

MAT 7140

MT= 75 (n,n') Level
Legendre Coefficients

71-Lu-180

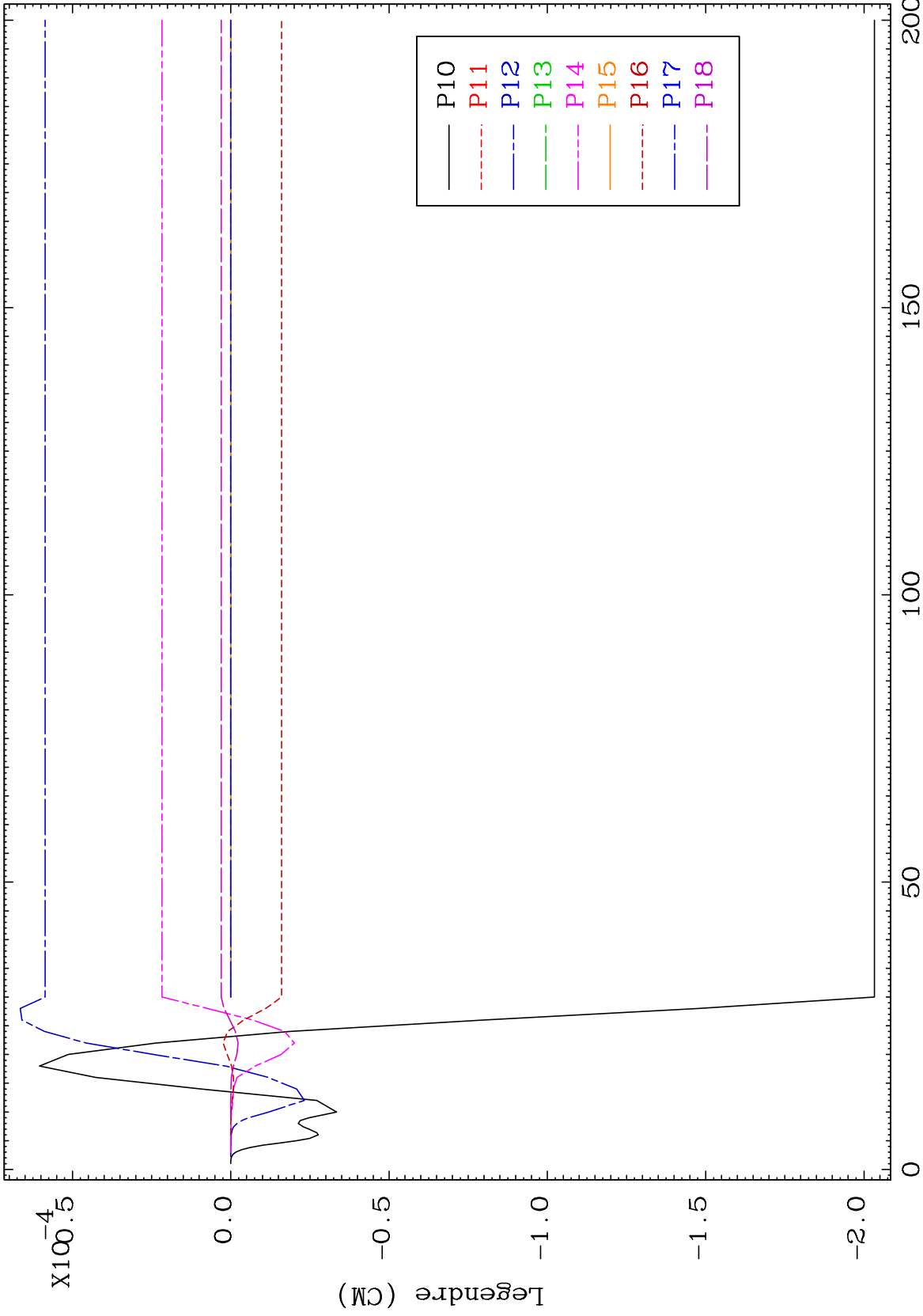

104

71-Lu-180

MAT 7140 MT= 75 (n,n') Level Legendre Coefficients 71-Lu-180

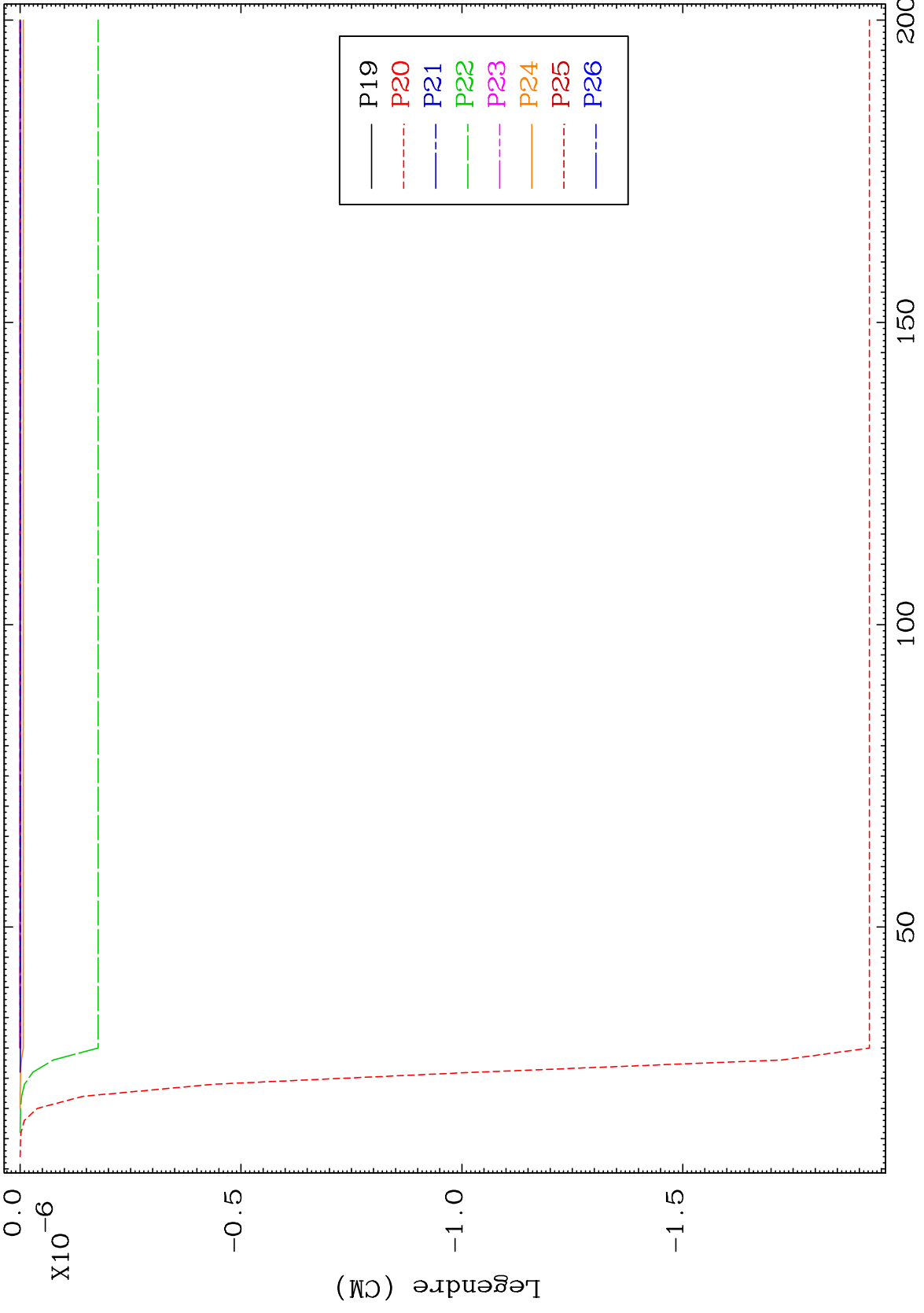

105 Incident Energy (MeV) 71-Lu-180

MAT 7140

MT= 76 (n,n') Level
Legendre Coefficients

71-Lu-180

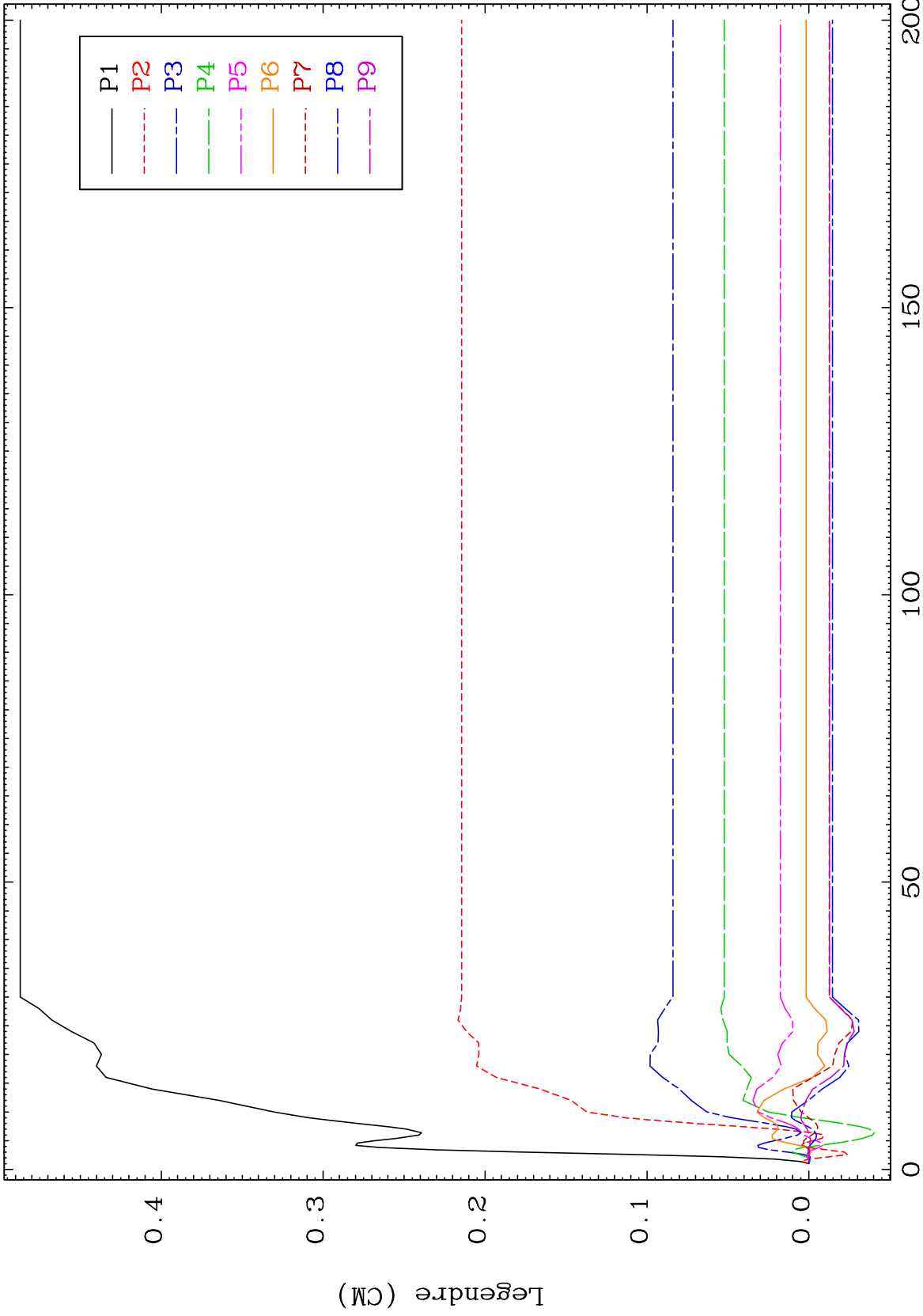

106

Incident Energy (MeV)

71-Lu-180

MAT 7140

MT= 76 (n,n') Level
Legendre Coefficients

71-Lu-180

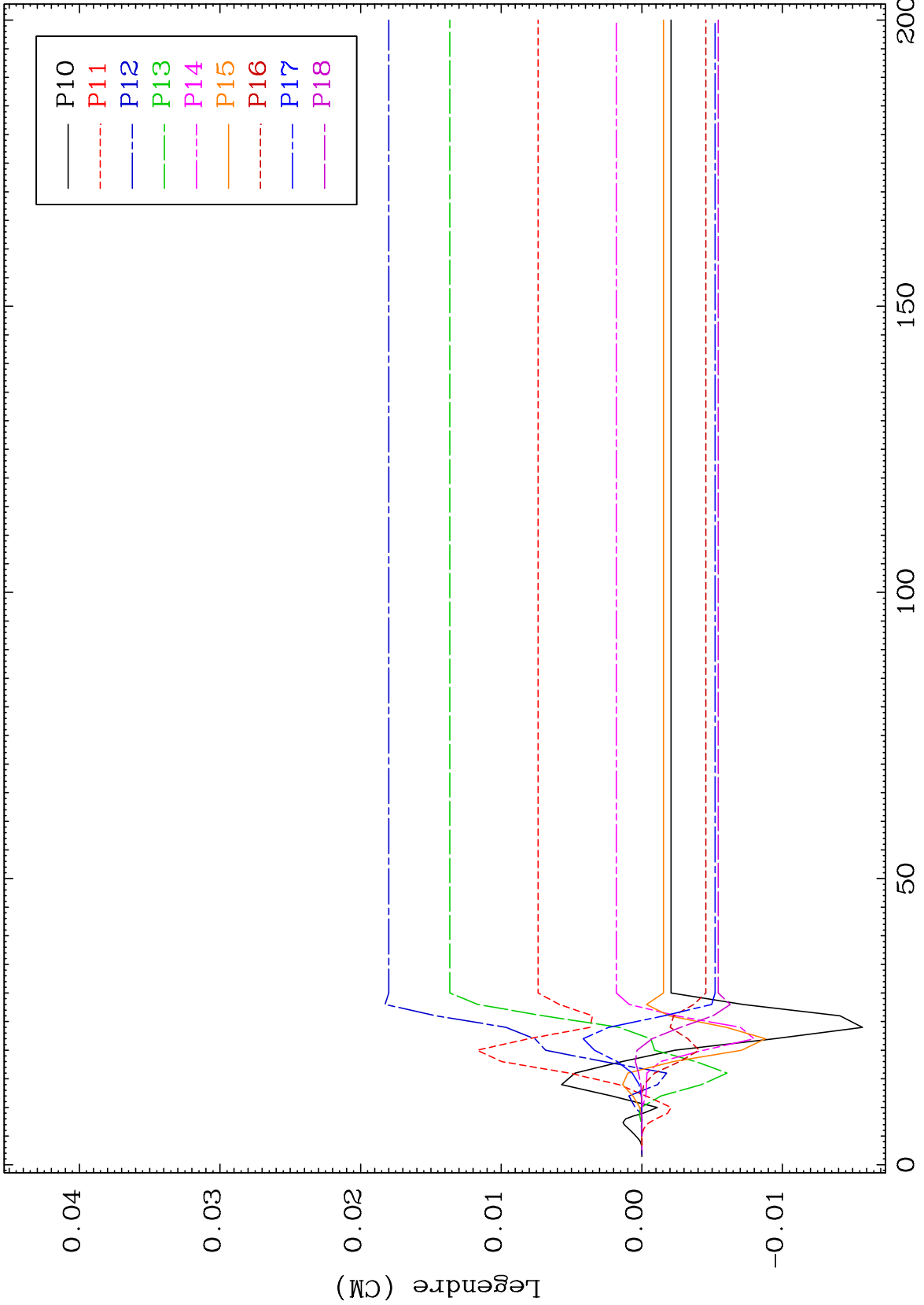

107

Incident Energy (MeV)

71-Lu-180

MAT 7140

MT= 76 (n,n') Level
Legendre Coefficients

71-Lu-180

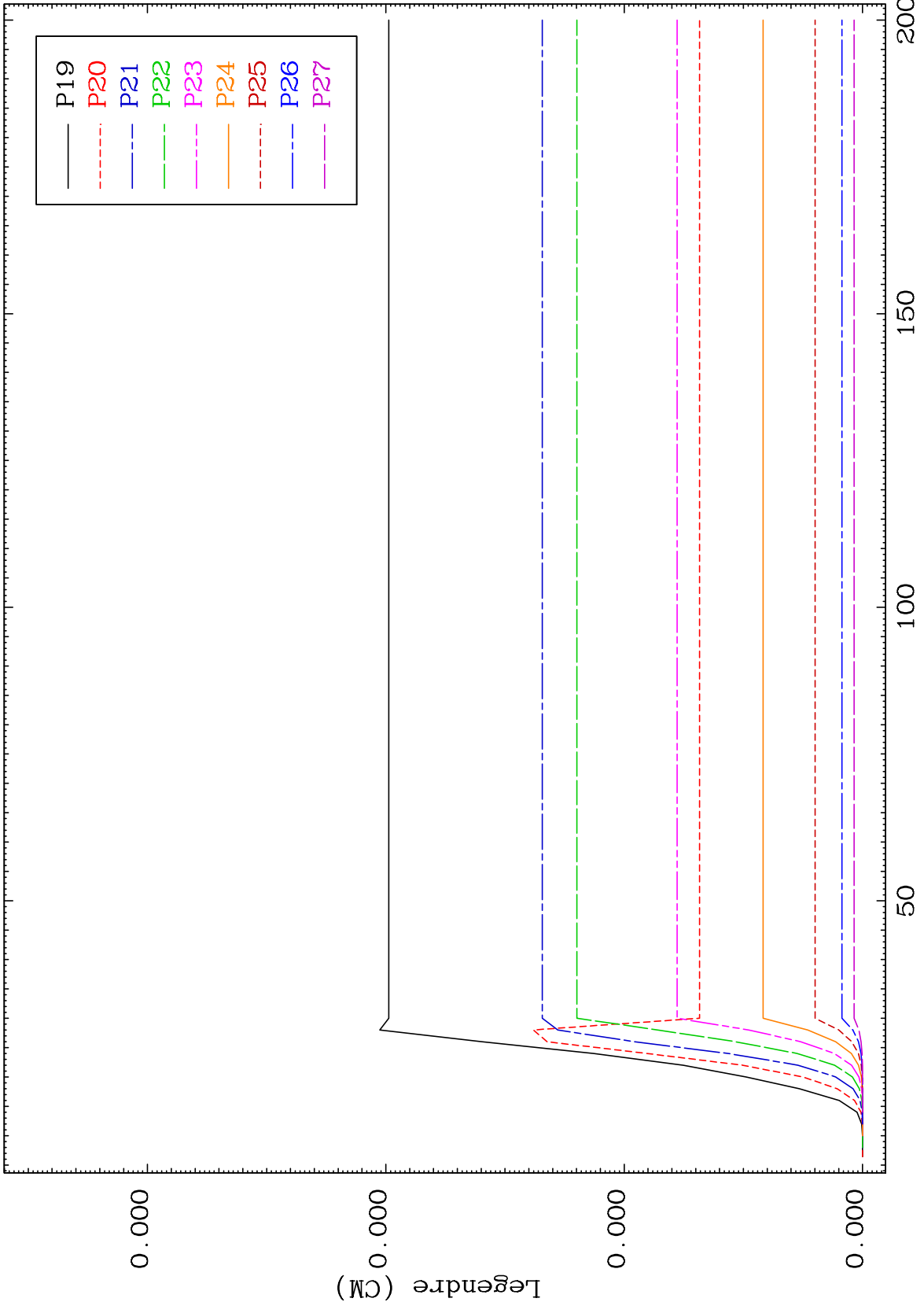

108

Incident Energy (MeV)

71-Lu-180

MAT 7140

MT= 76 (n,n') Level
Legendre Coefficients

71-Lu-180

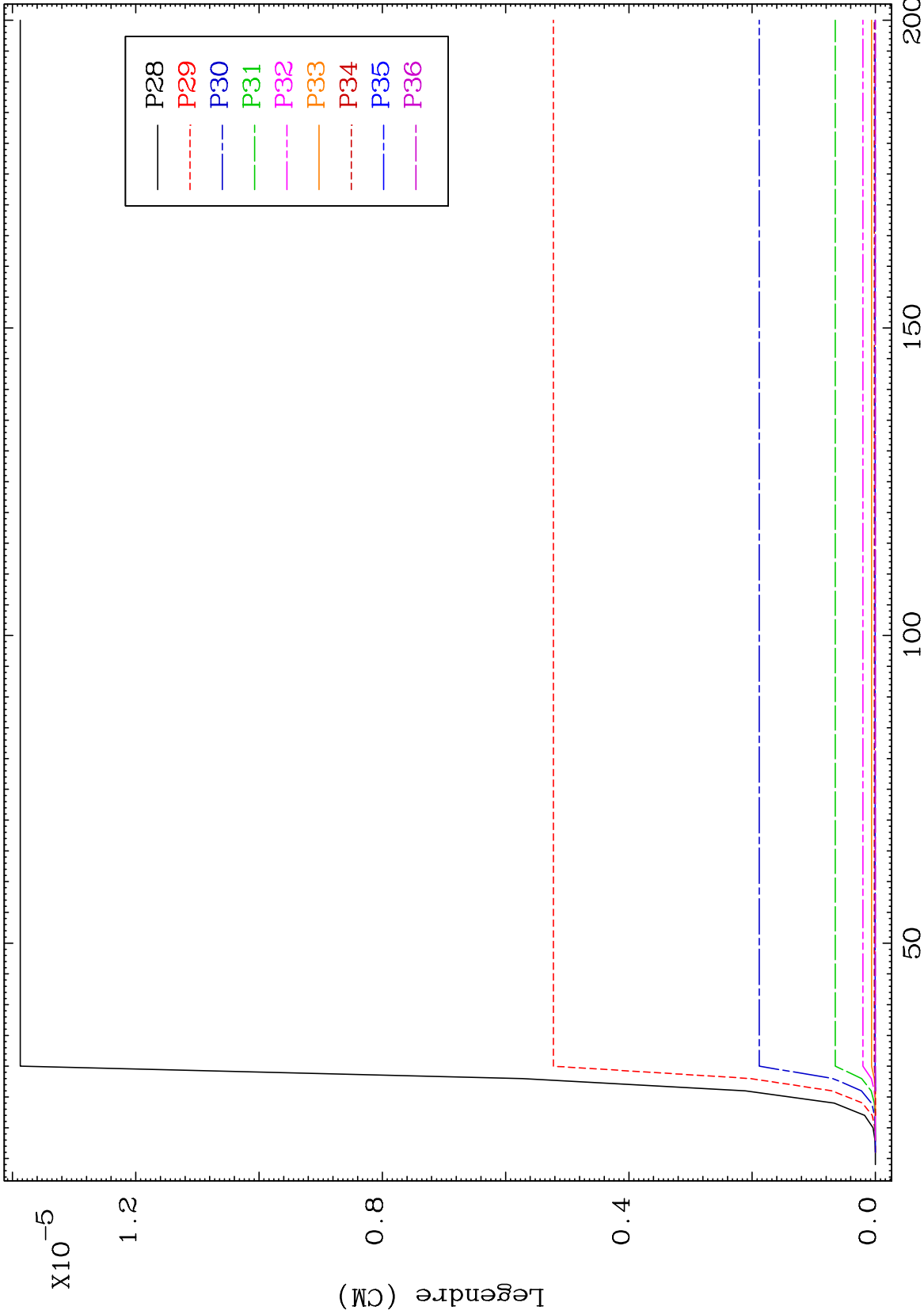

109

Incident Energy (MeV)

71-Lu-180

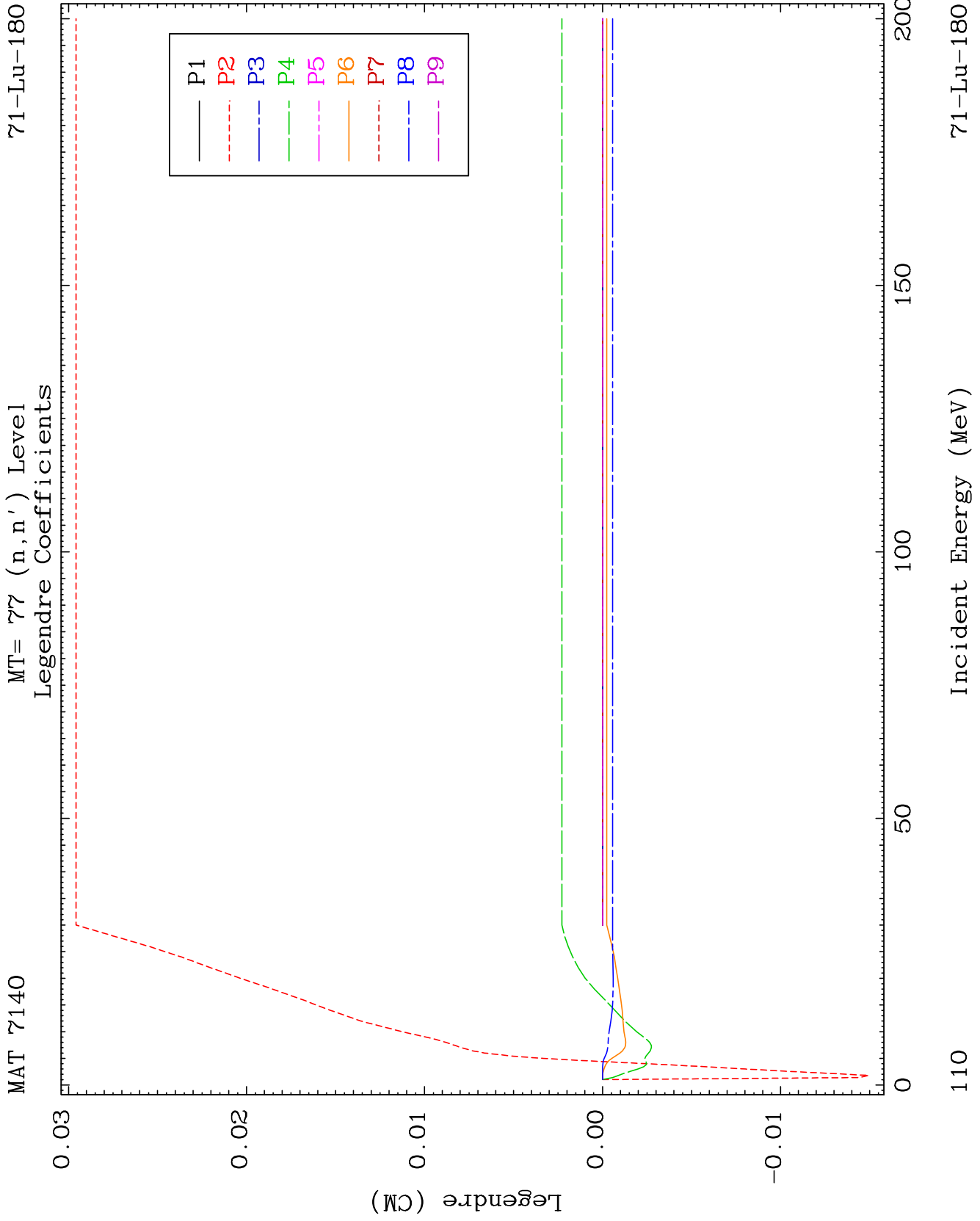

MAT 7140 MT= 77 (n,n') Level Legendre Coefficients 71-Lu-180

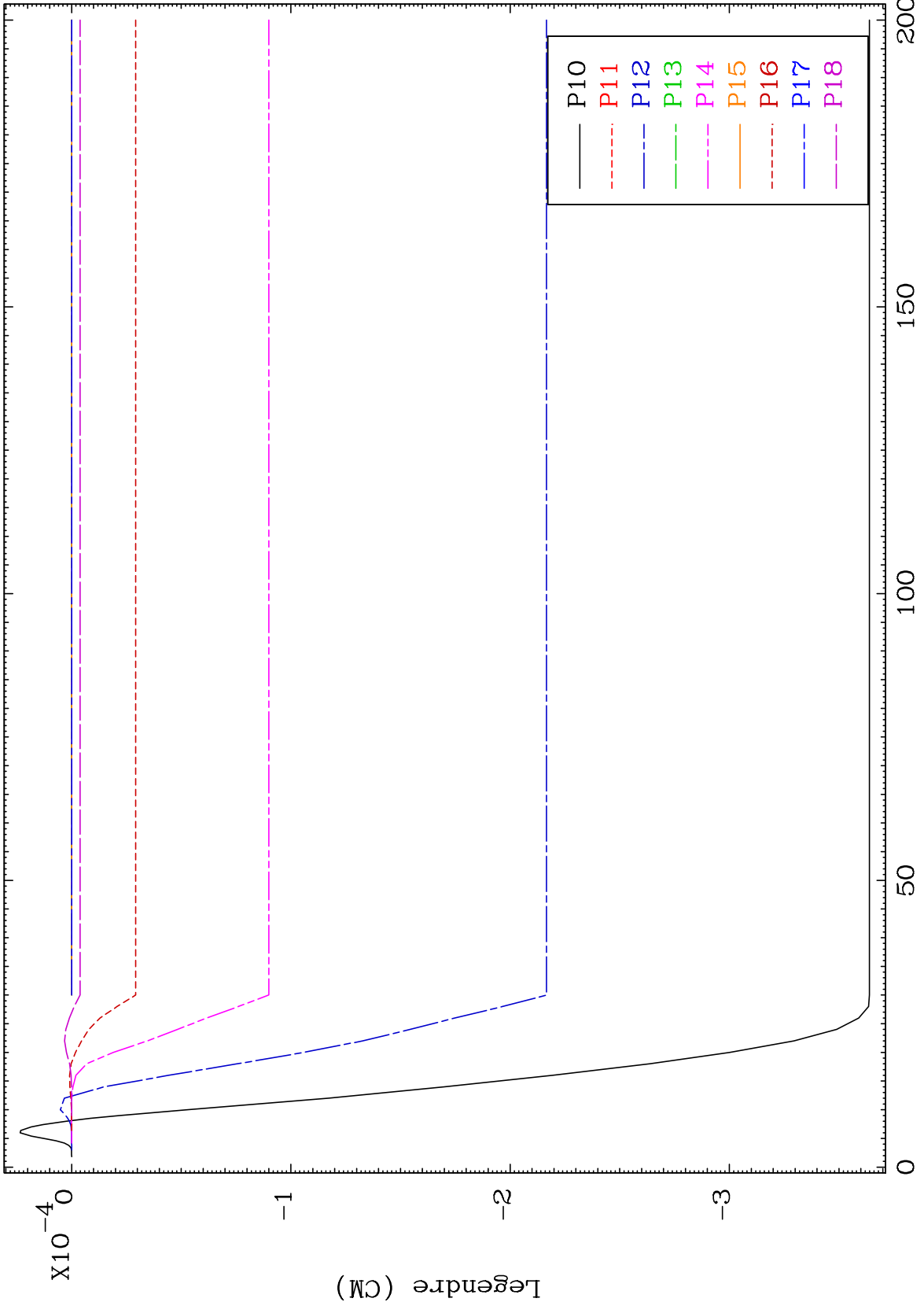

111 71-Lu-180

MAT 7140 MT= 77 (n,n') Level Legendre Coefficients 71-Lu-180

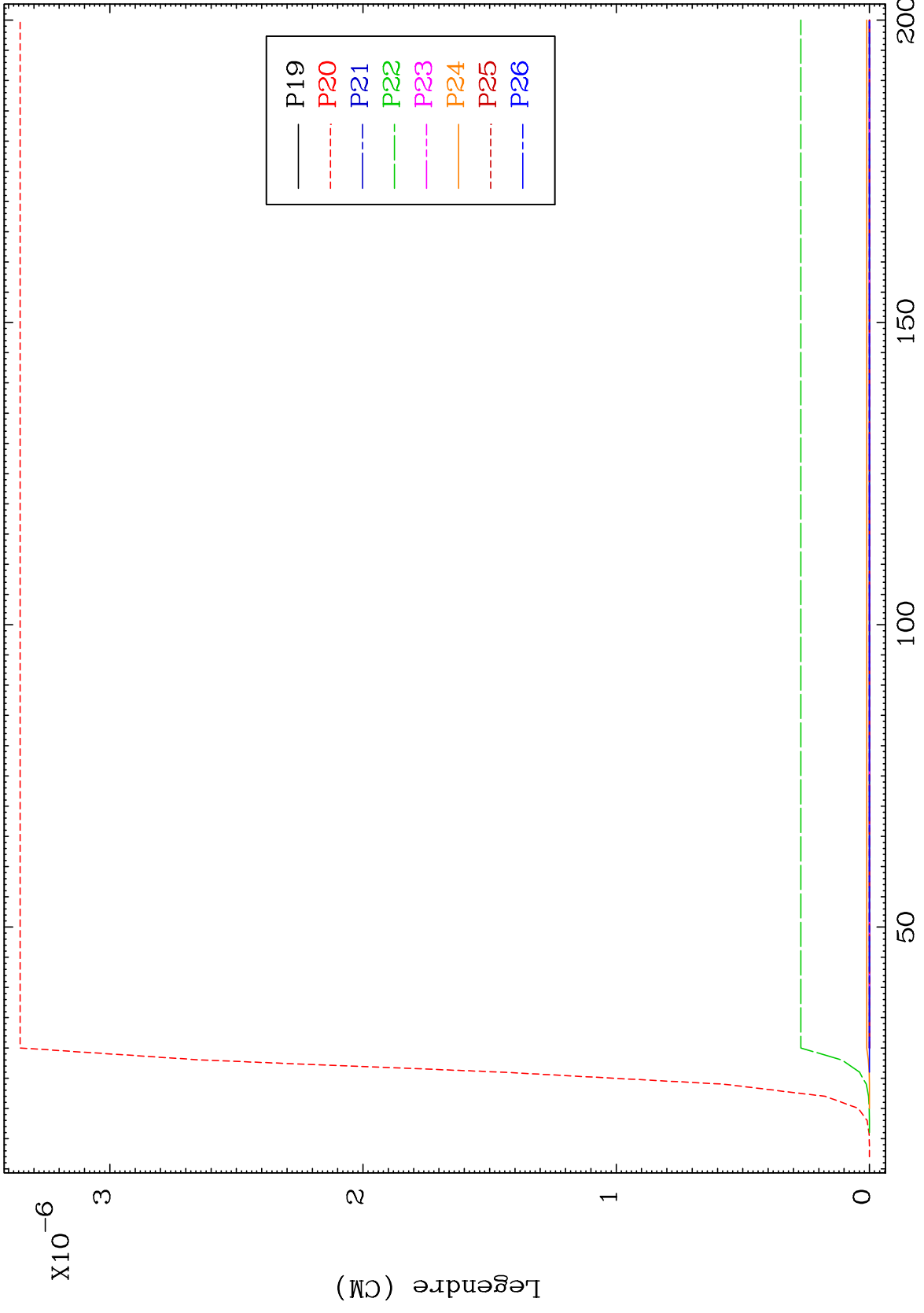

112 50 100 150 200 71-Lu-180

MAT 7140 MT= 78 (n,n') Level Legendre Coefficients 71-Lu-180

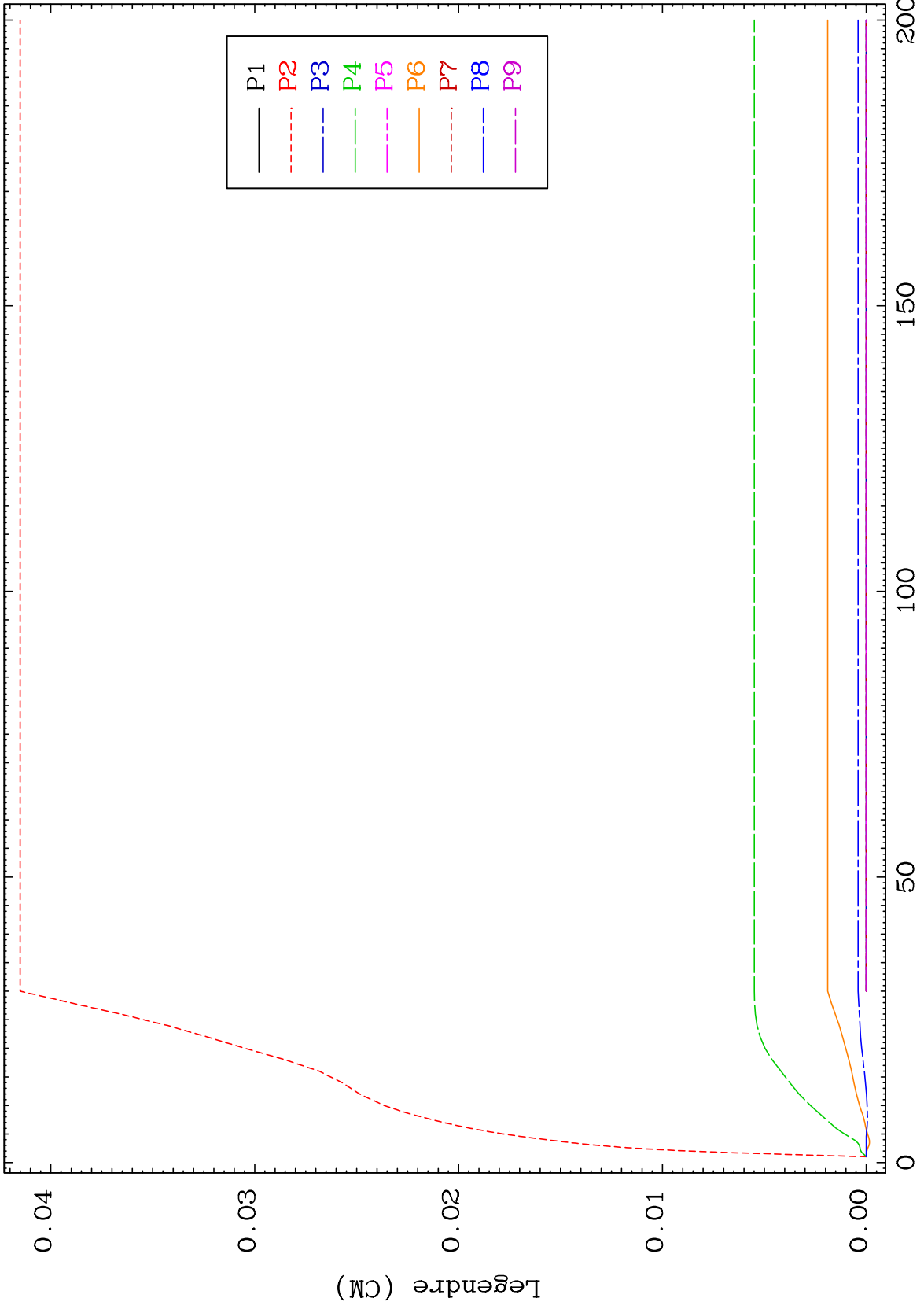

113 71-Lu-180

MAT 7140 MT= 78 (n,n') Level Legendre Coefficients

71-Lu-180

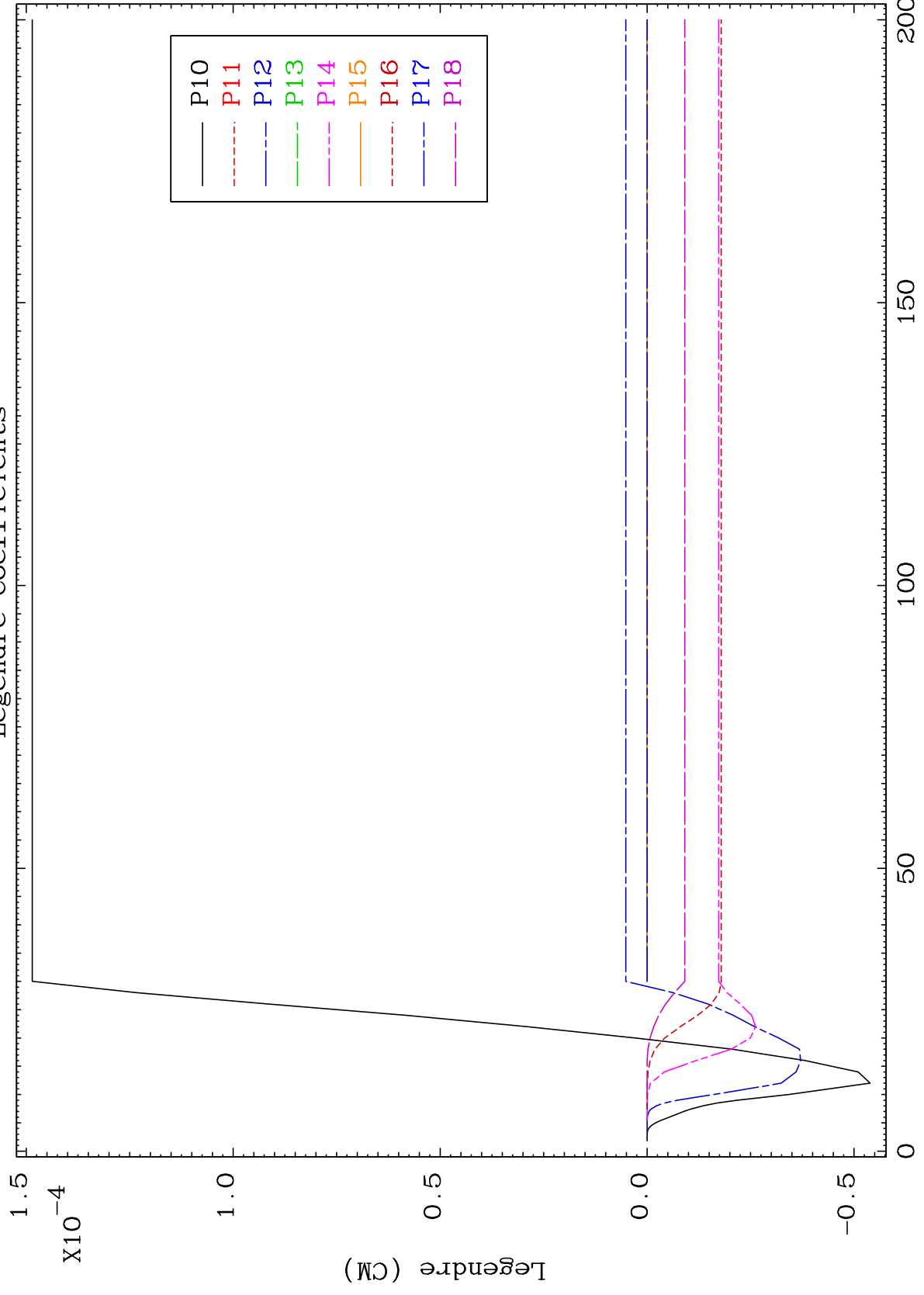

114

Incident Energy (MeV)

71-Lu-180

MAT 7140 MT= 78 (n,n') Level Legendre Coefficients 71-Lu-180

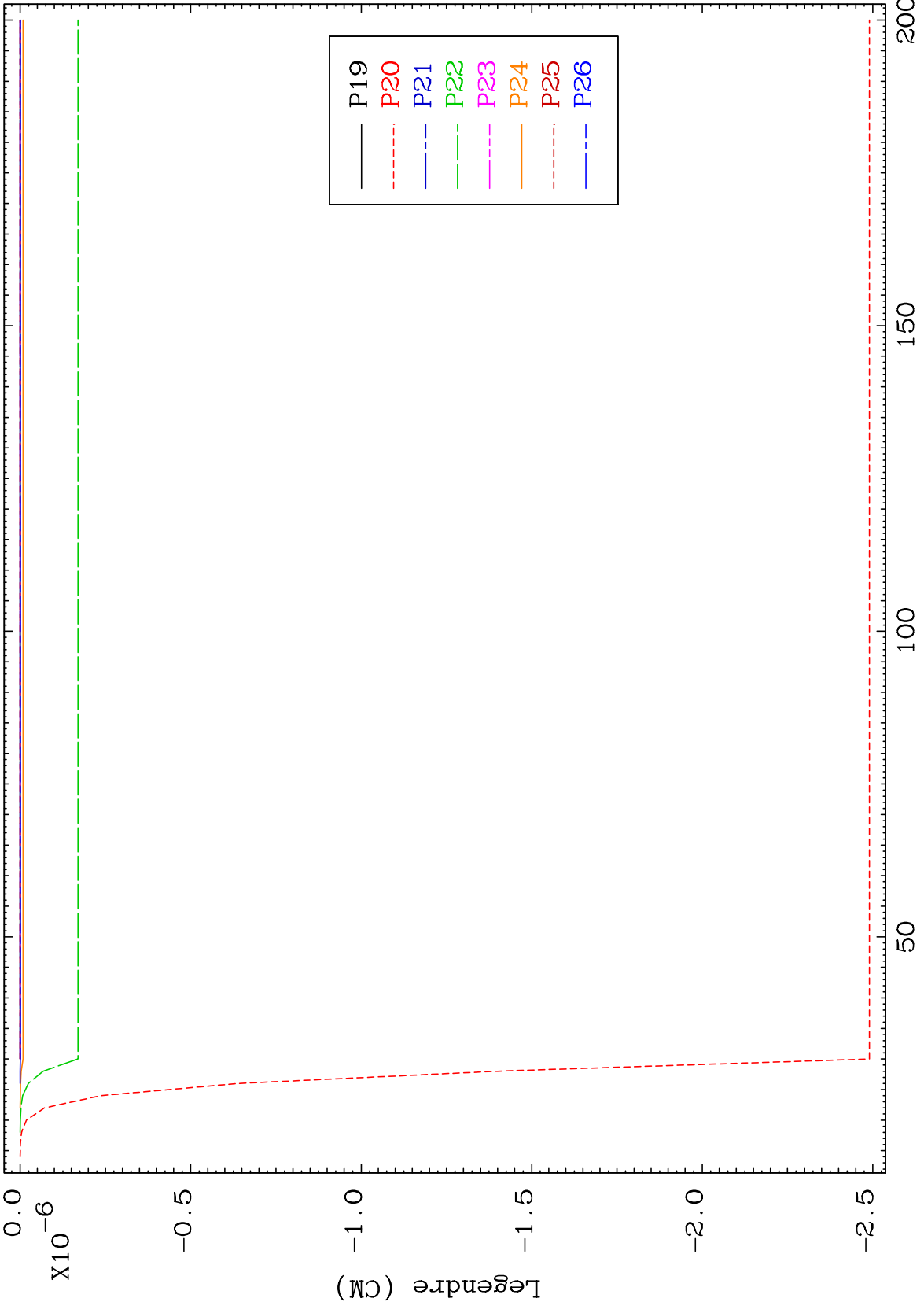

115 71-Lu-180

MAT 7140 MT= 79 (n,n') Level Legendre Coefficients 71-Lu-180

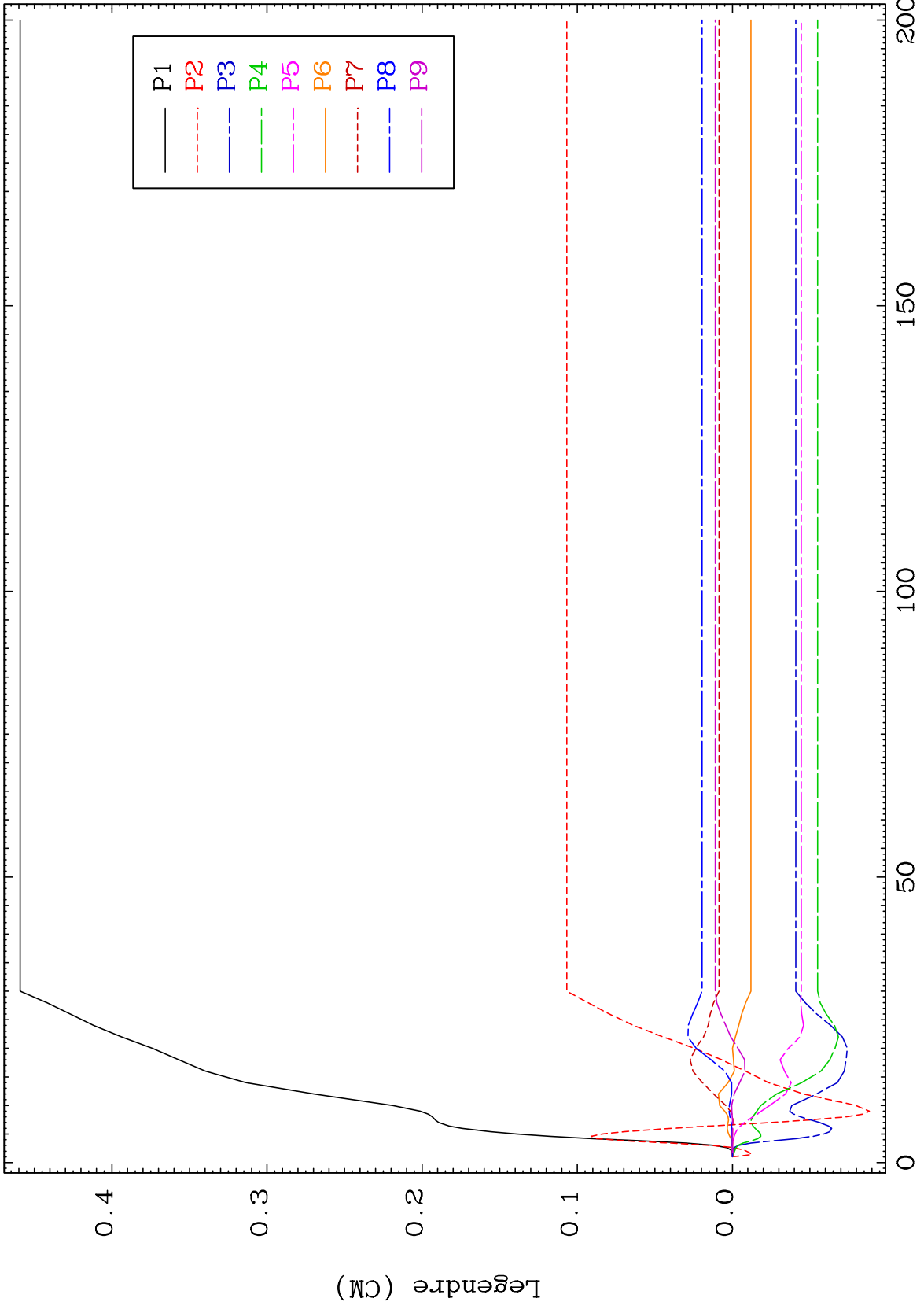

116 71-Lu-180

MAT 7140 MT= 79 (n,n') Level Legendre Coefficients 71-Lu-180

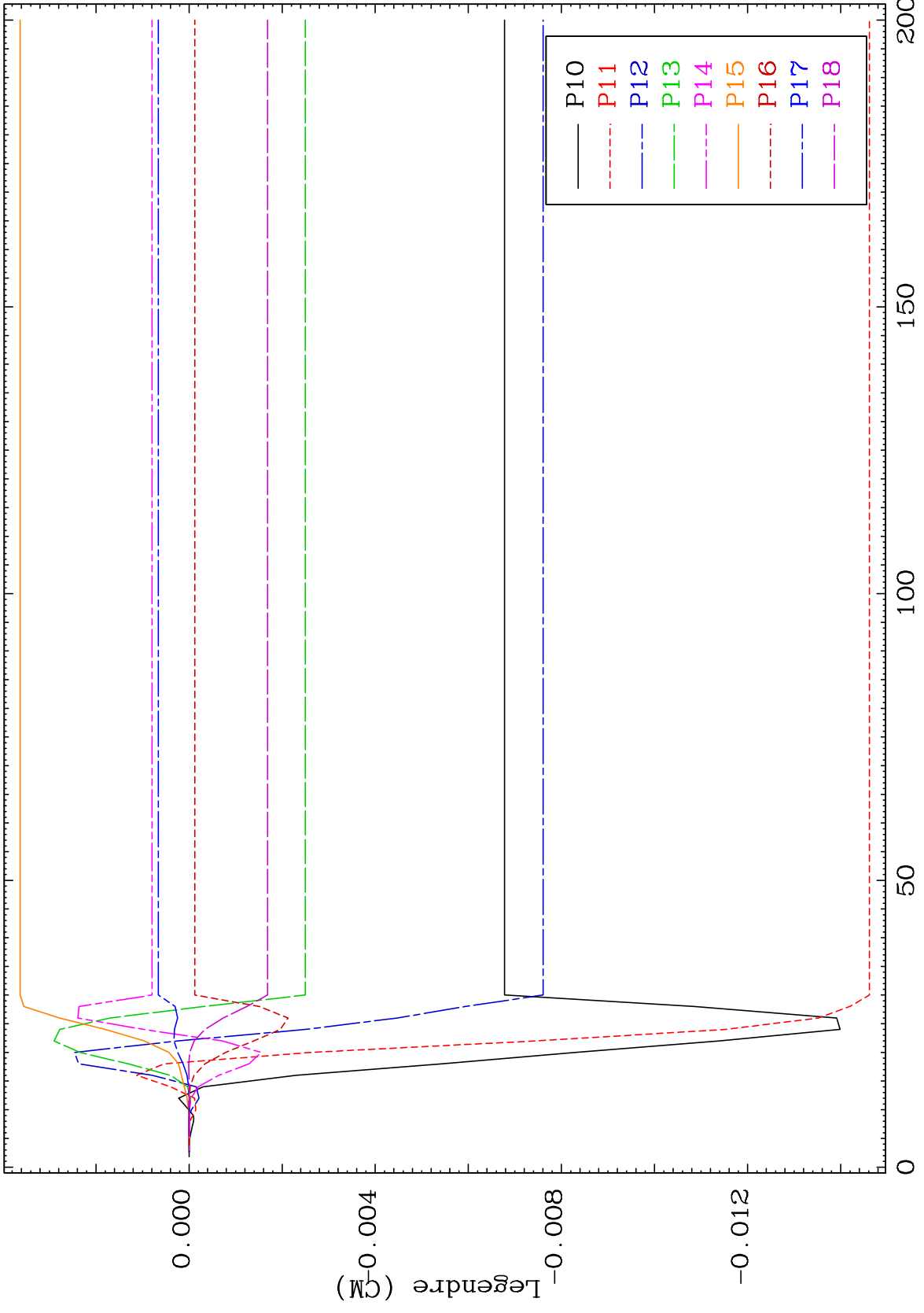

117 71-Lu-180

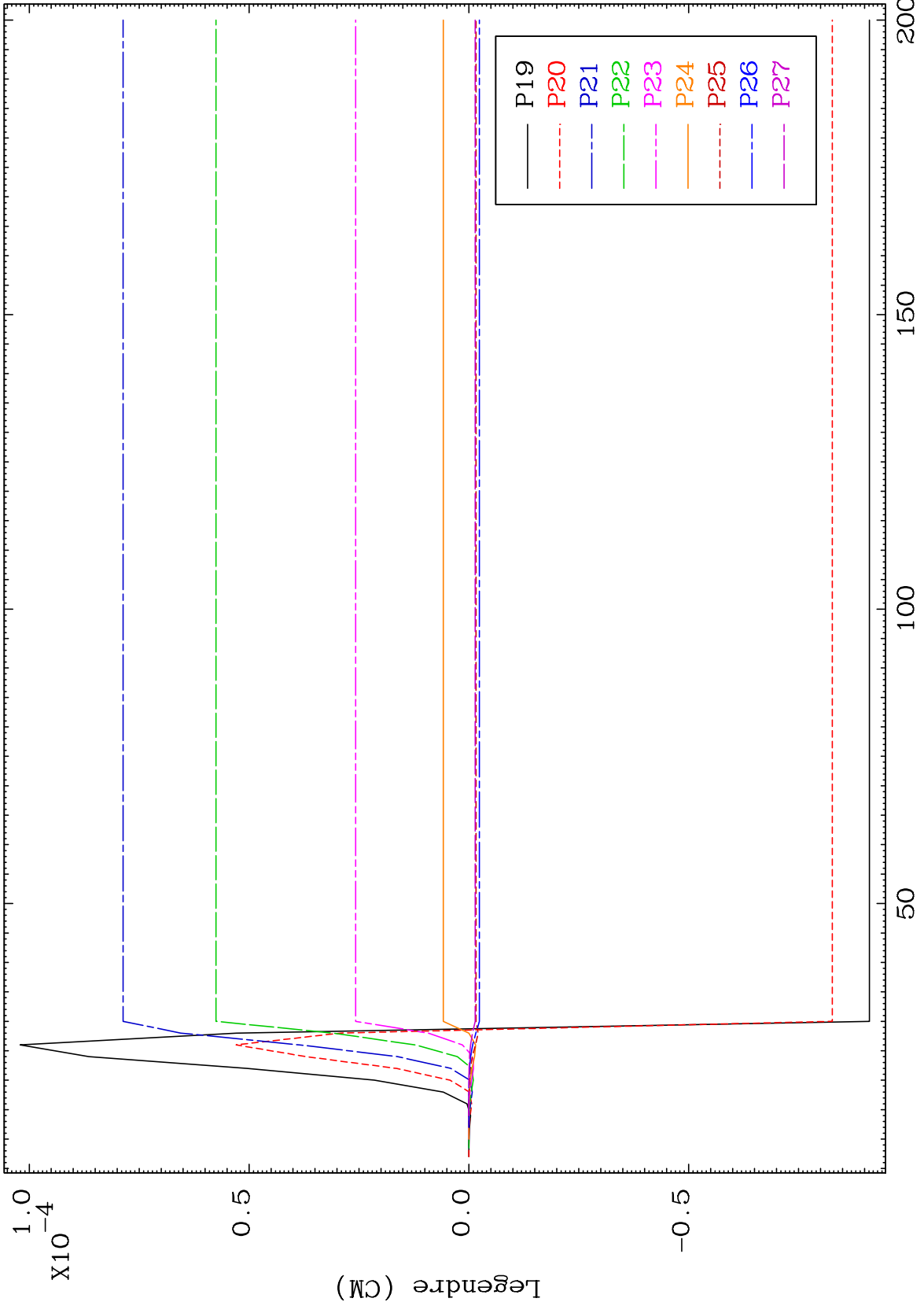

MAT 7140 MT= 79 (n,n') Level Legendre Coefficients 71-Lu-180

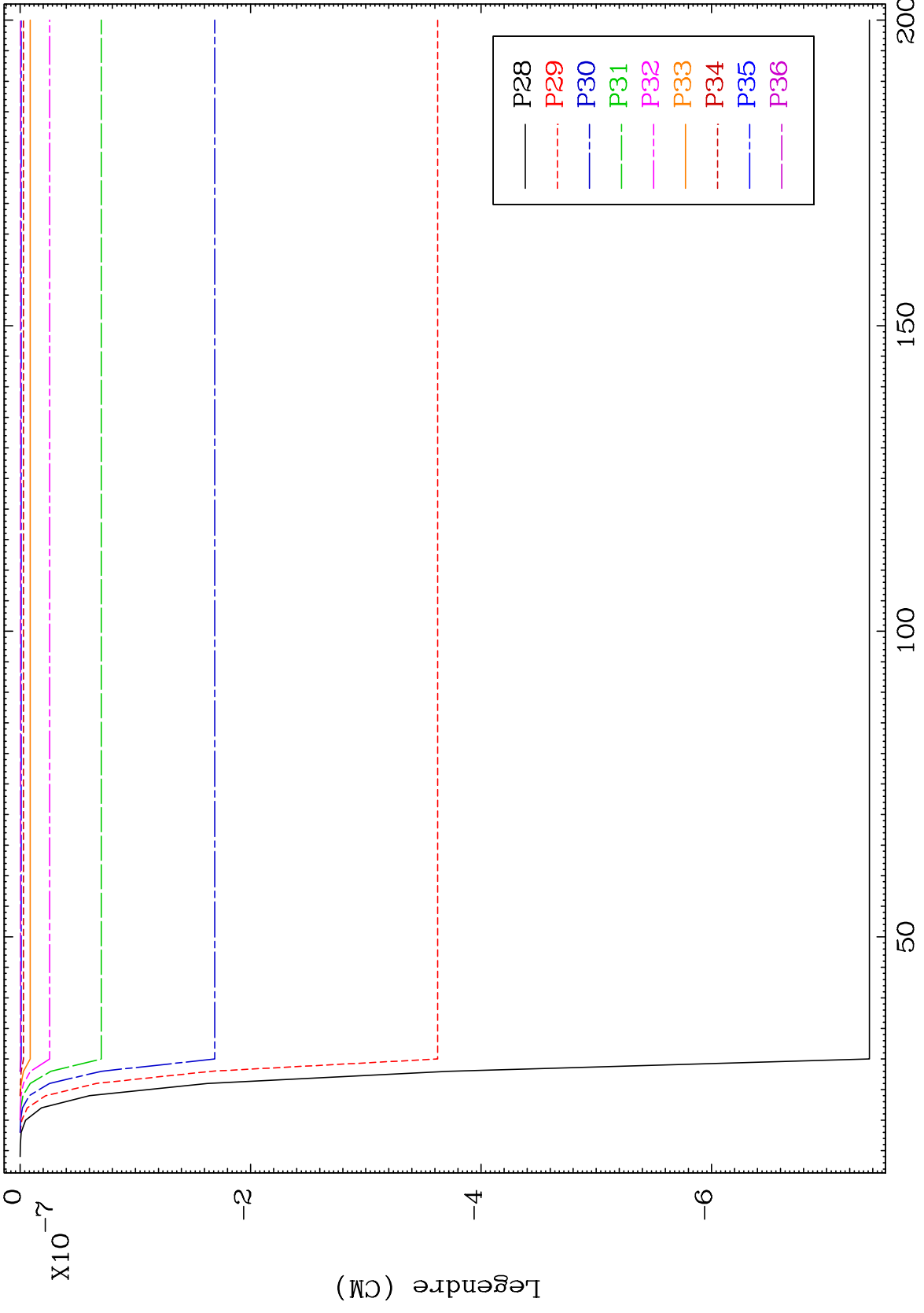

119 71-Lu-180

MAT 7140 MT= 80 (n,n') Level Legendre Coefficients

71-Lu-180

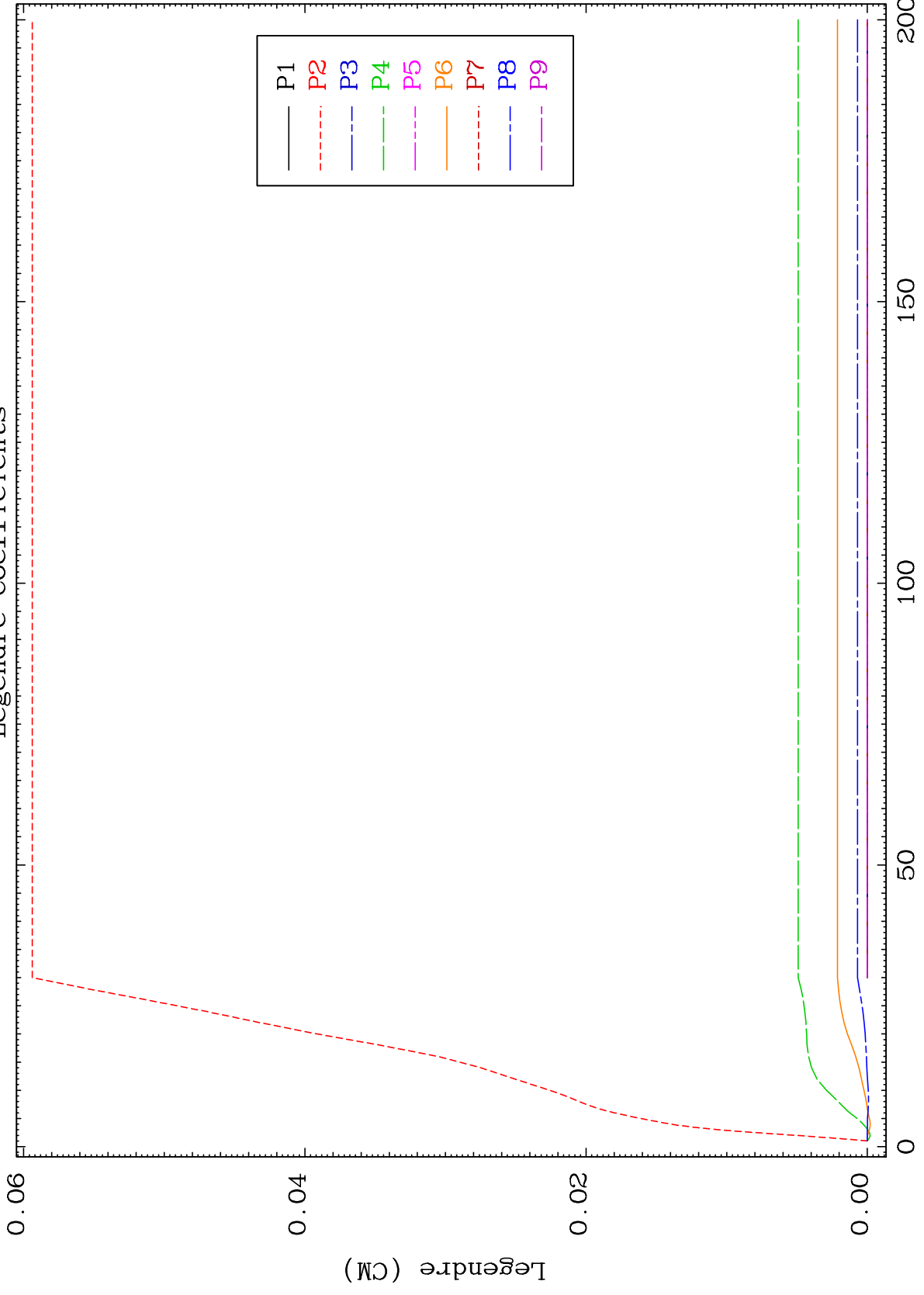

71-Lu-180

Incident Energy (MeV)

120

MAT 7140

MT= 80 (n,n') Level
Legendre Coefficients

71-Lu-180

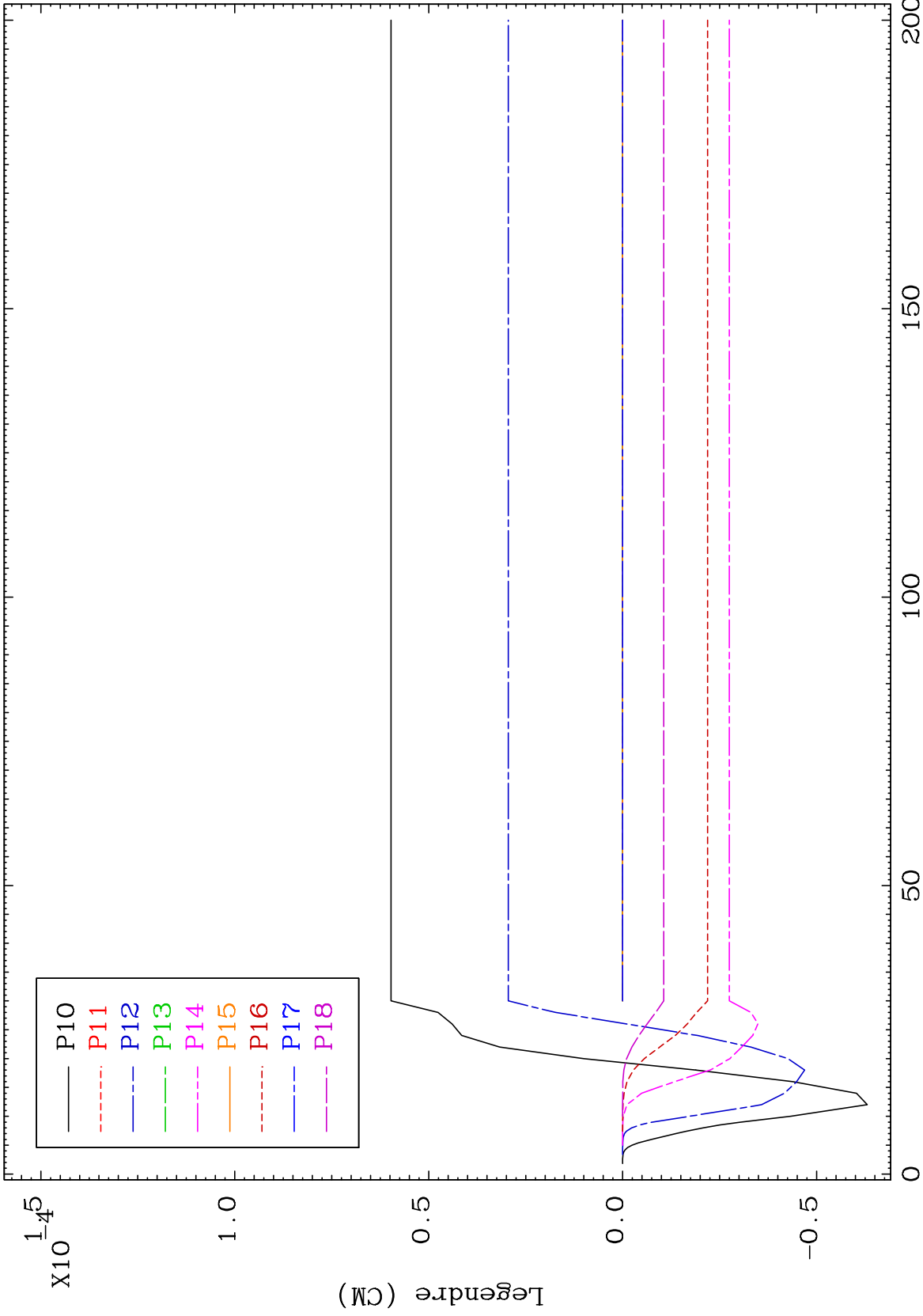

121

Incident Energy (MeV)

71-Lu-180

MAT 7140 MT= 80 (n,n') Level Legendre Coefficients 71-Lu-180

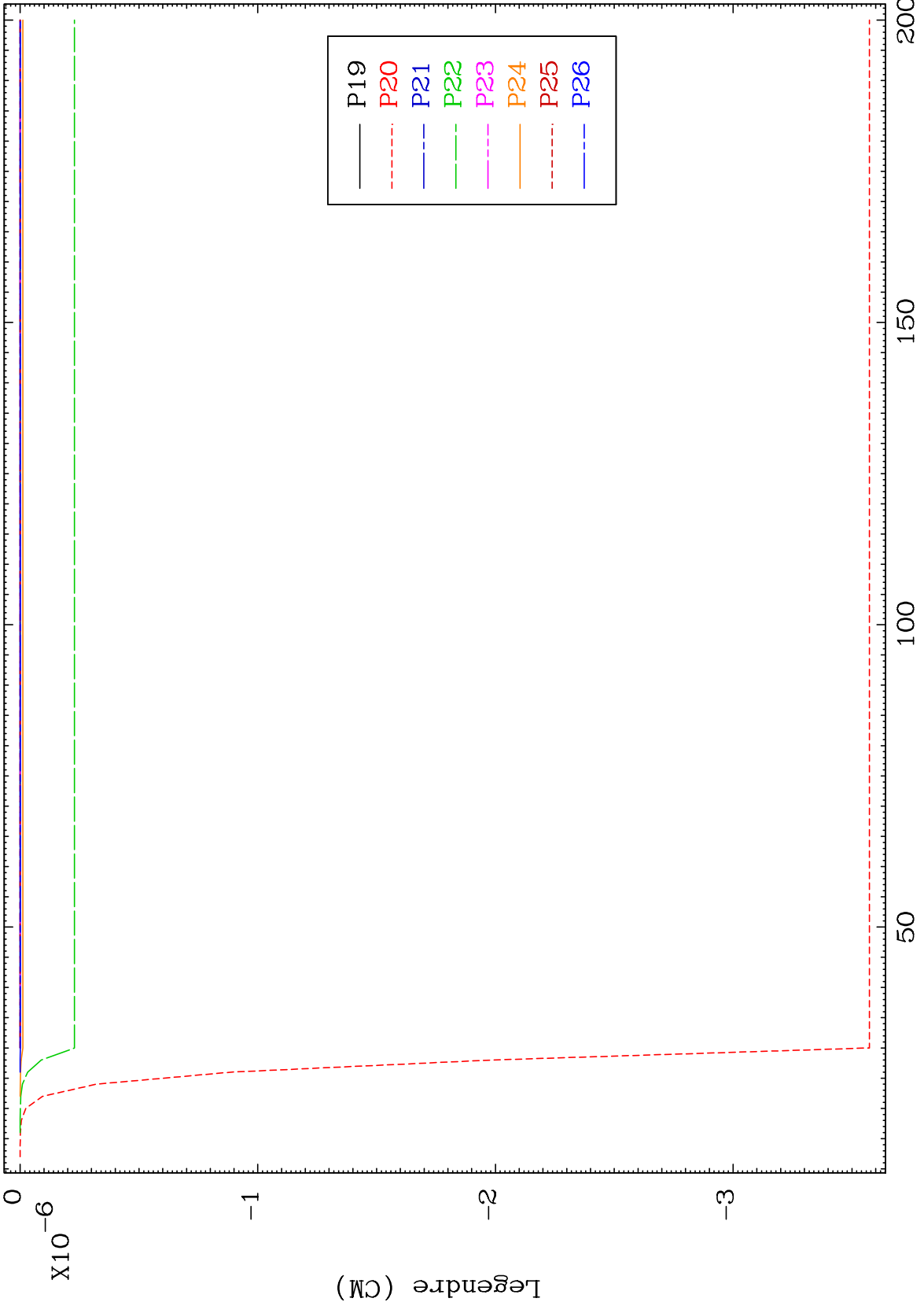

122 Incident Energy (MeV) 71-Lu-180

MAT 7140

(n,2n) d

71-Lu-180

Radionuclide Production Cross Section

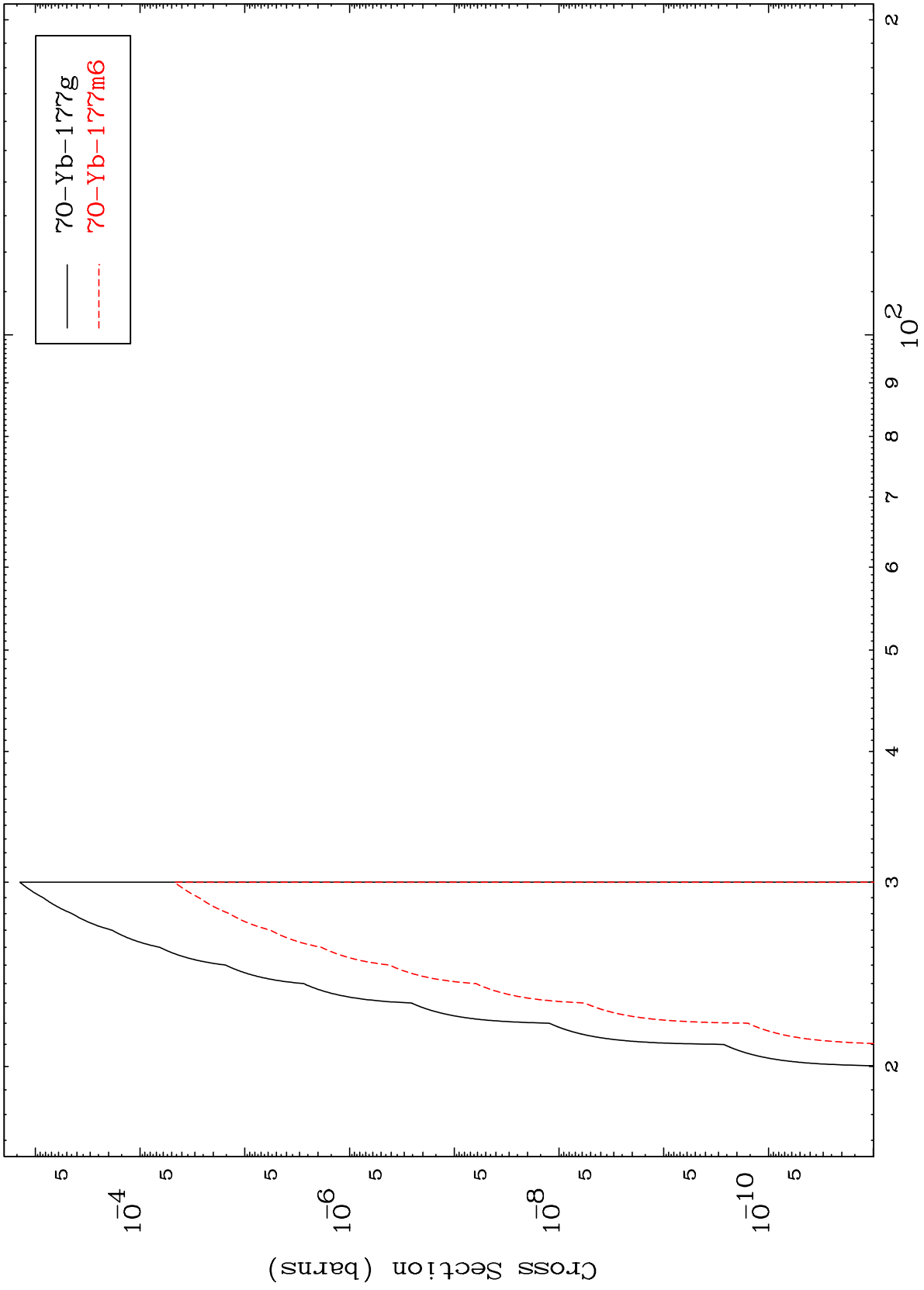

123

Incident Energy (MeV)

71-Lu-180

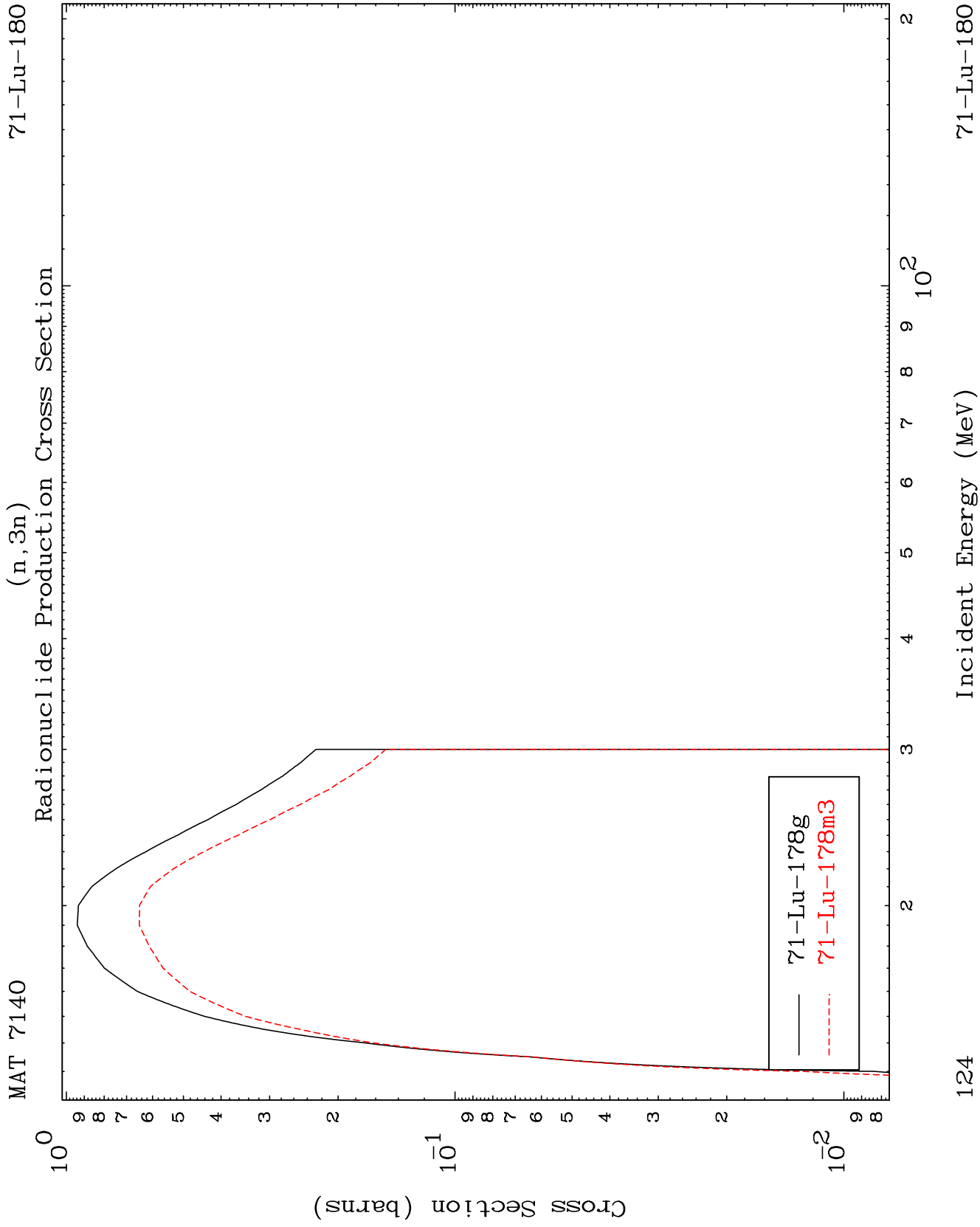

MAT 7140

Fission

⁷¹Lu-180

Radionuclide Production Cross Section

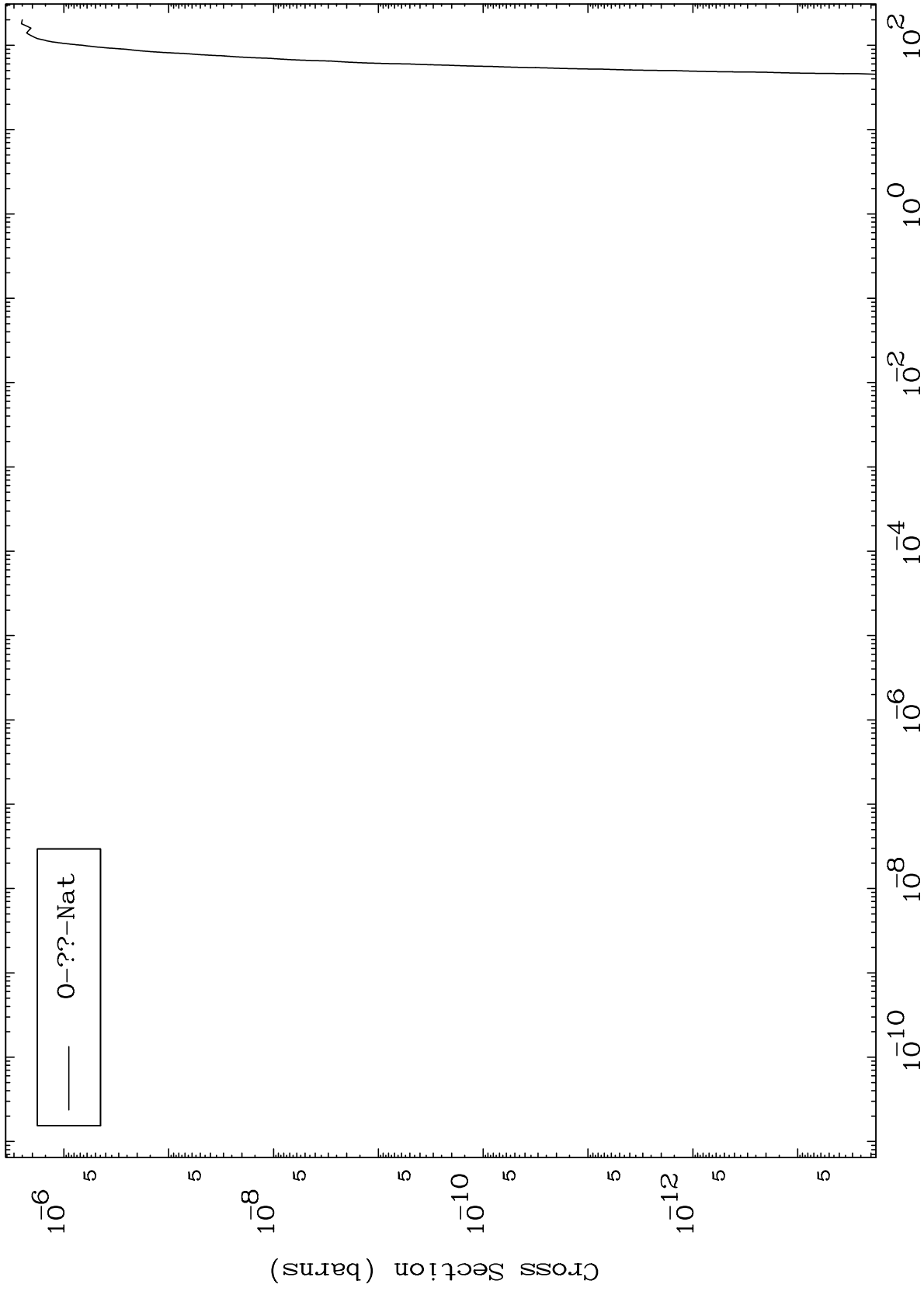

125

Incident Energy (MeV)

⁷¹Lu-180

MAT 7140

(n,n') t

71-Lu-180

Radionuclide Production Cross Section

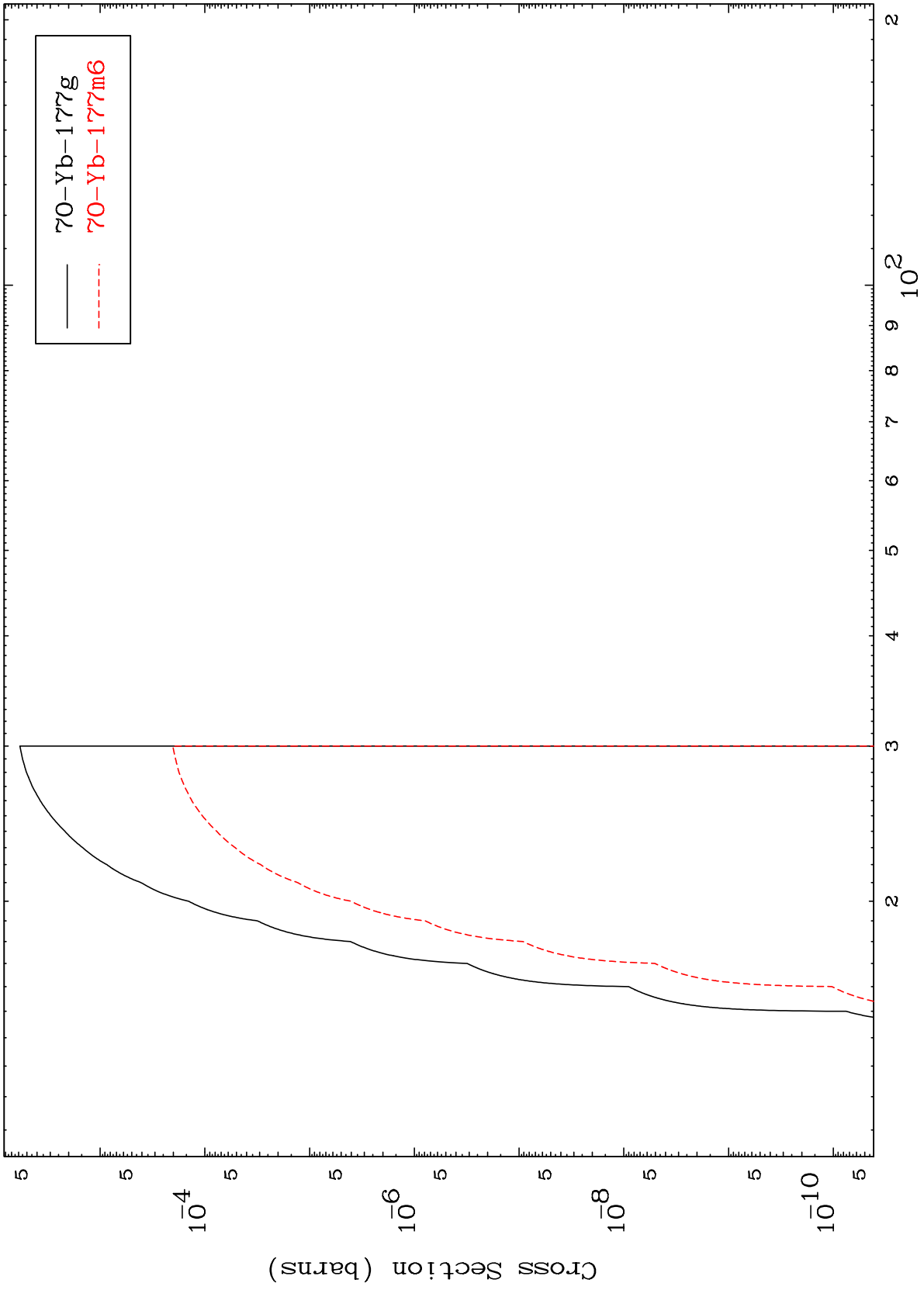

126

Incident Energy (MeV)

71-Lu-180

MAT 7140

(n,4n)

⁷¹Lu-180

Radionuclide Production Cross Section

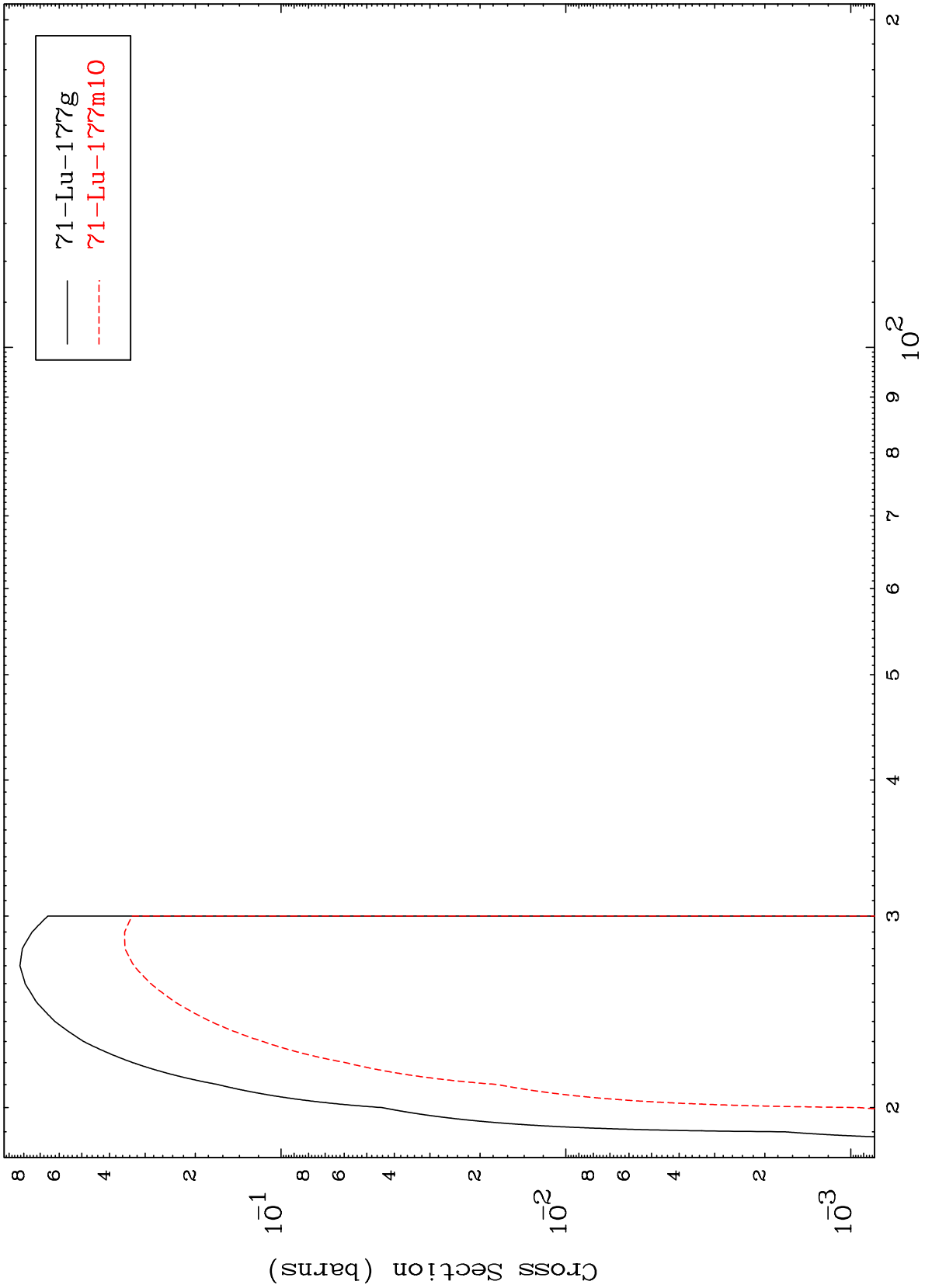

127

Incident Energy (MeV)

⁷¹Lu-180

MAT 7140

(n,3n) p

71-Lu-180

Radionuclide Production Cross Section

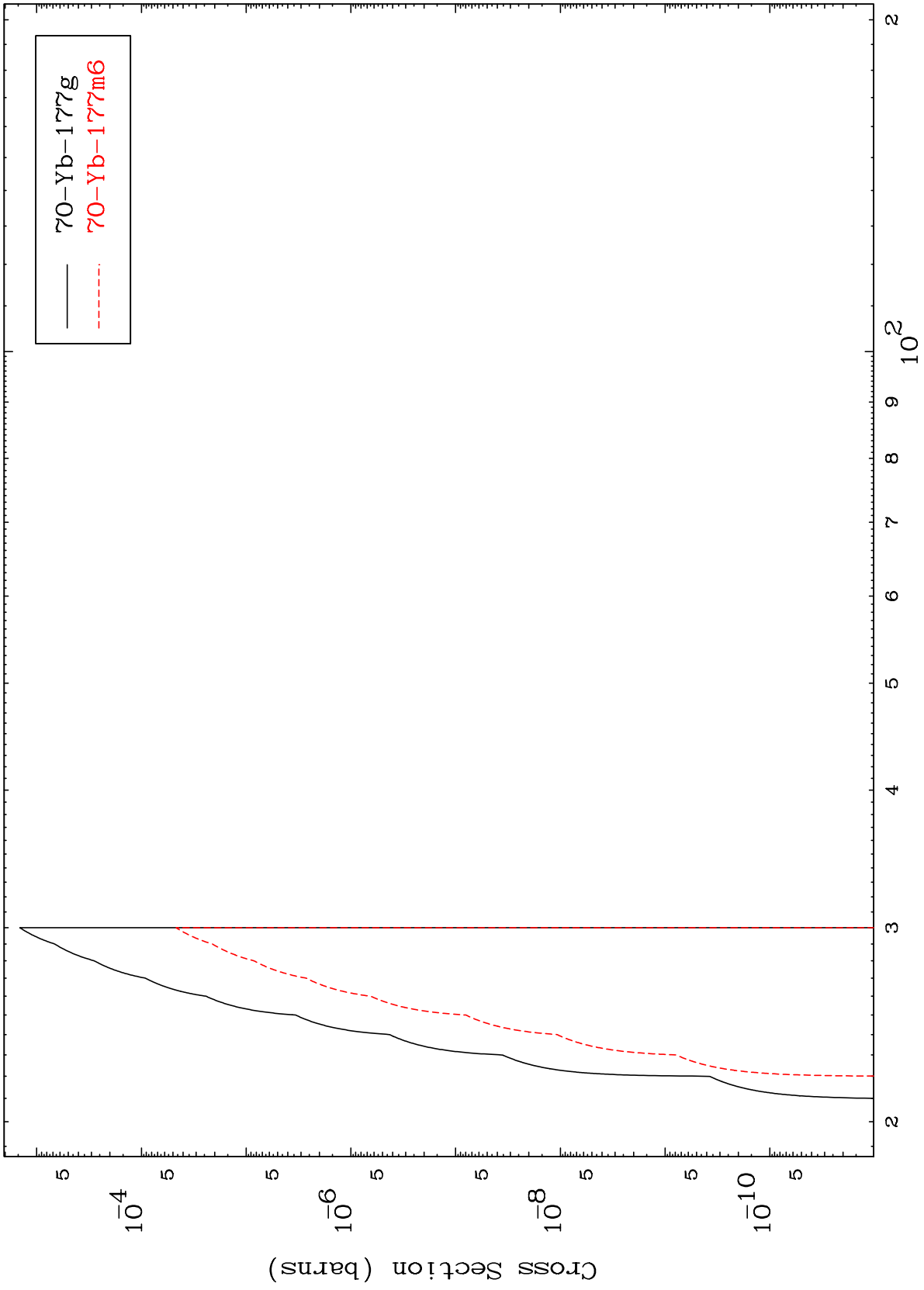

128

Incident Energy (MeV)

71-Lu-180