

# MD253 NEUTRON ACER TENDL-2019 LIBRARY; T=293.16K

## Principal cross sections

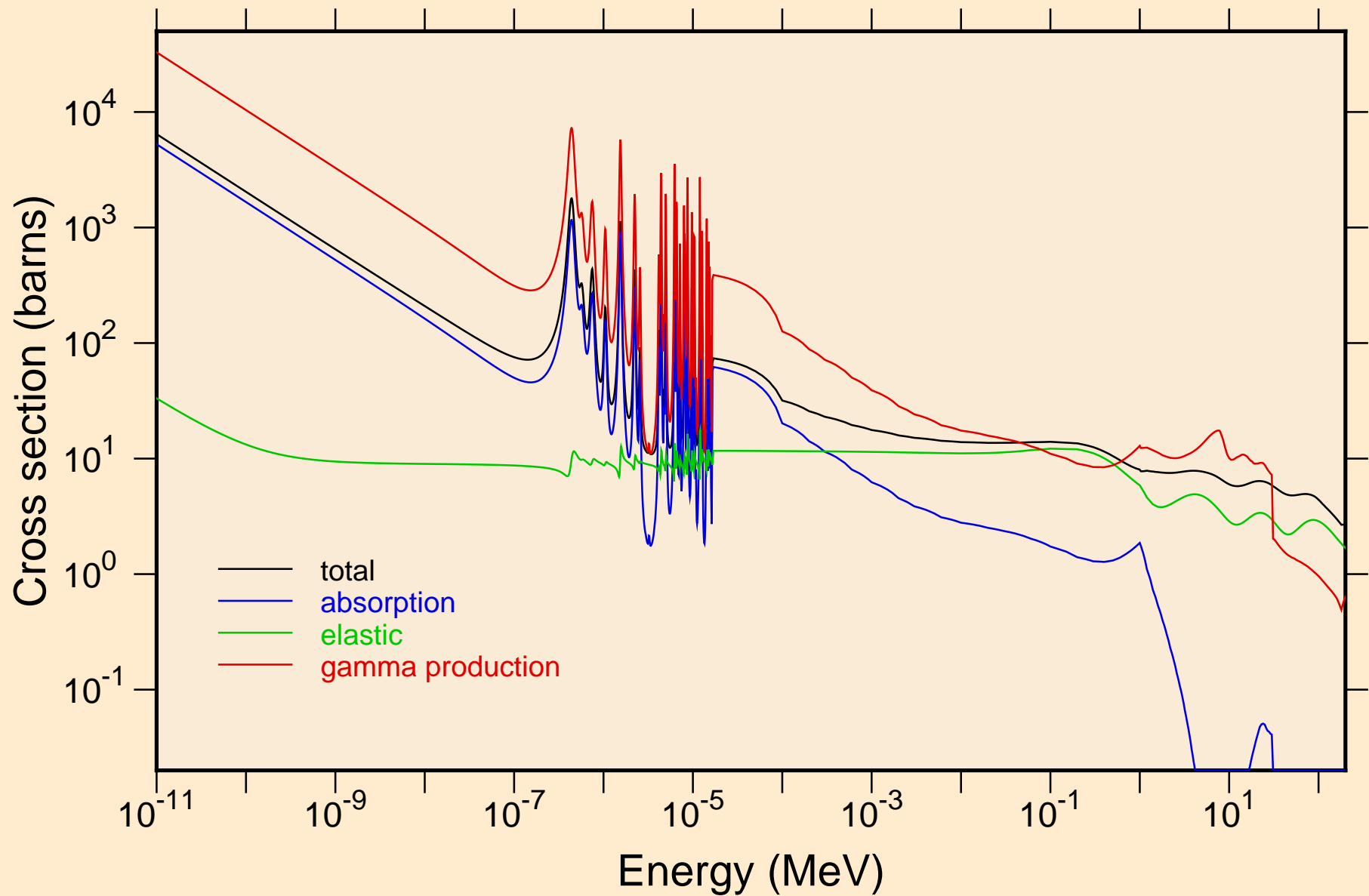

MD253 NEUTRON ACER TENDL-2019 LIBRARY; T=293.16K  
resonance total cross section

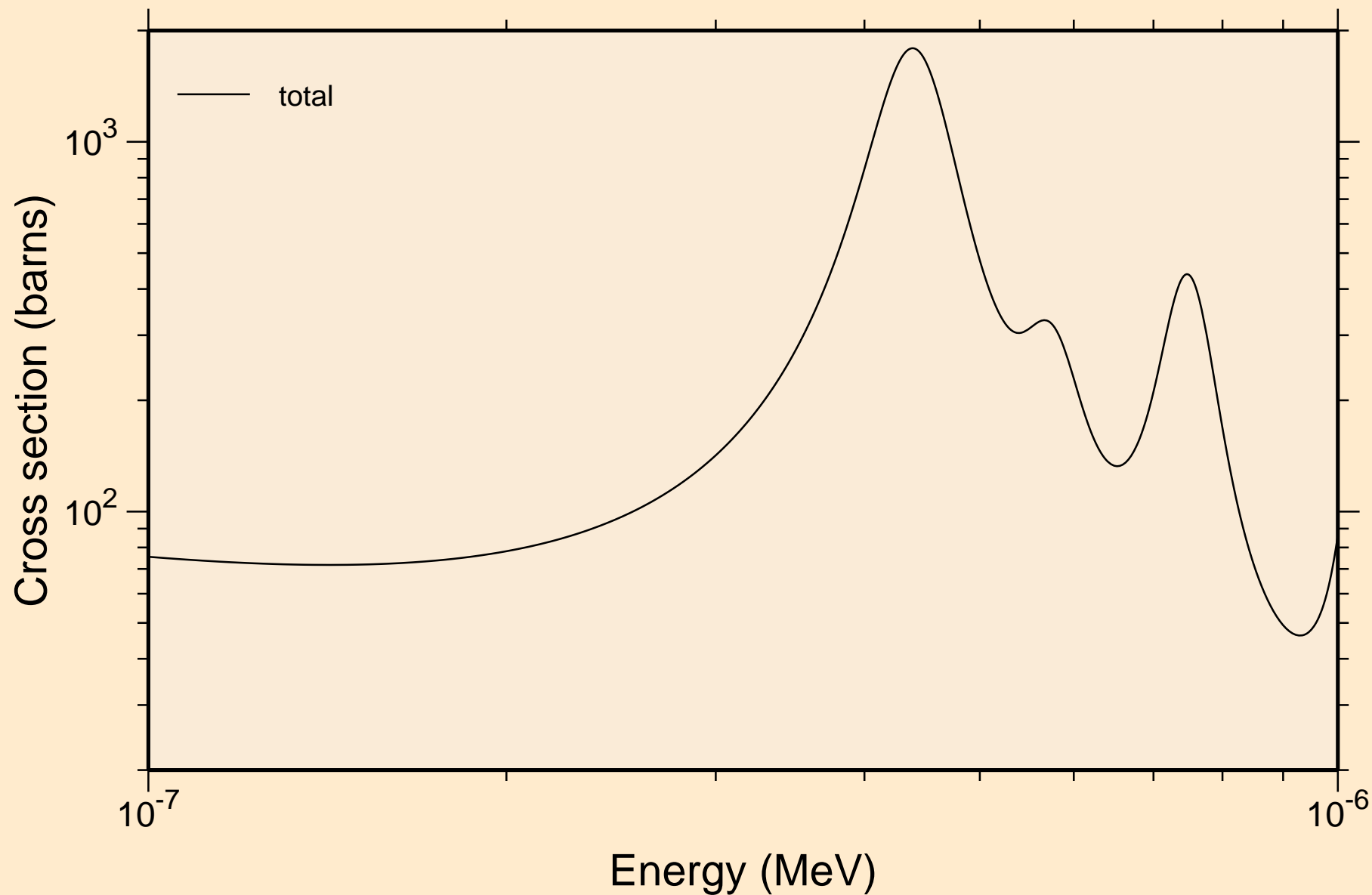

MD253 NEUTRON ACER TENDL-2019 LIBRARY; T=293.16K  
resonance total cross section

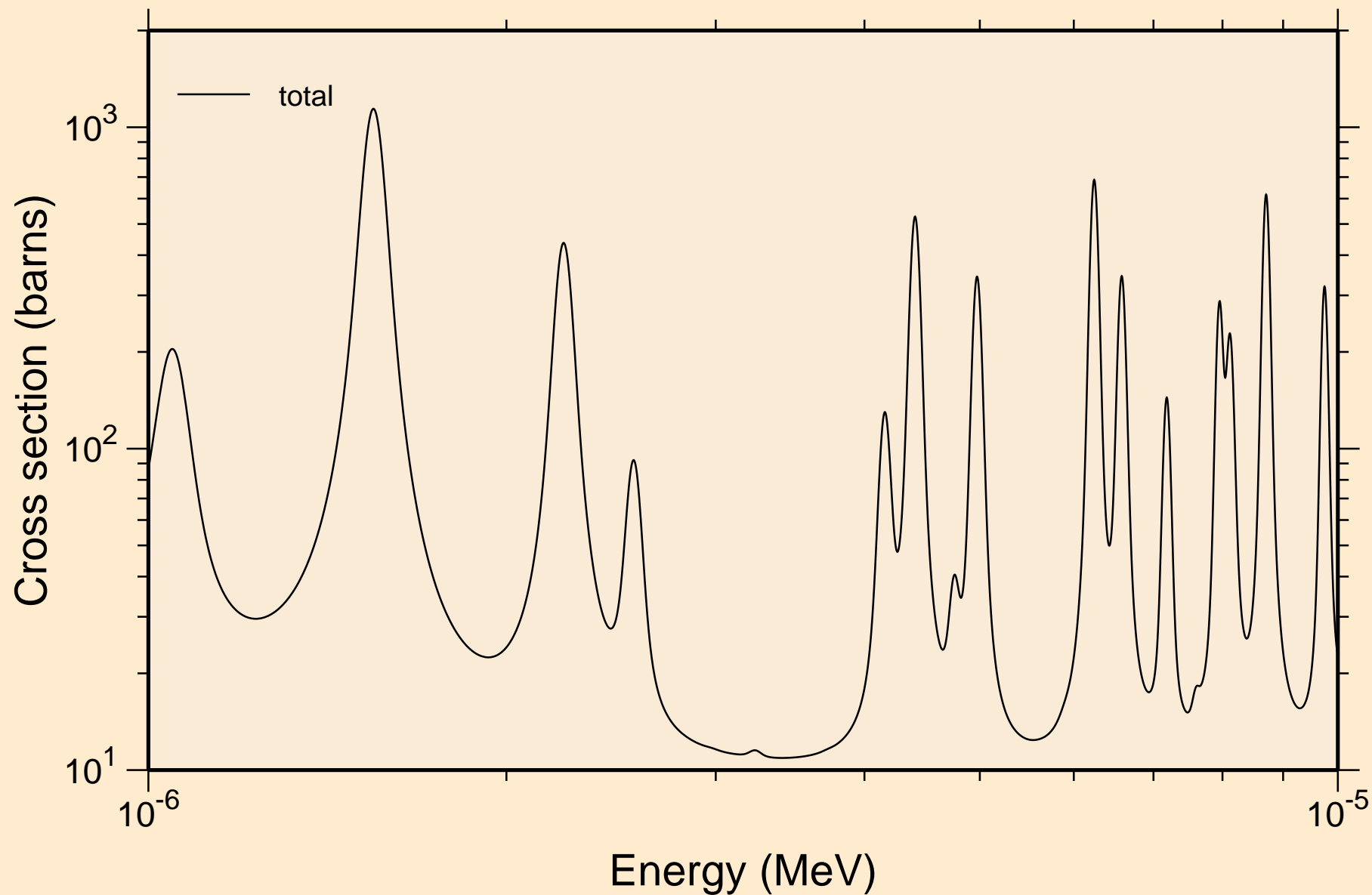

MD253 NEUTRON ACER TENDL-2019 LIBRARY; T=293.16K  
resonance total cross section

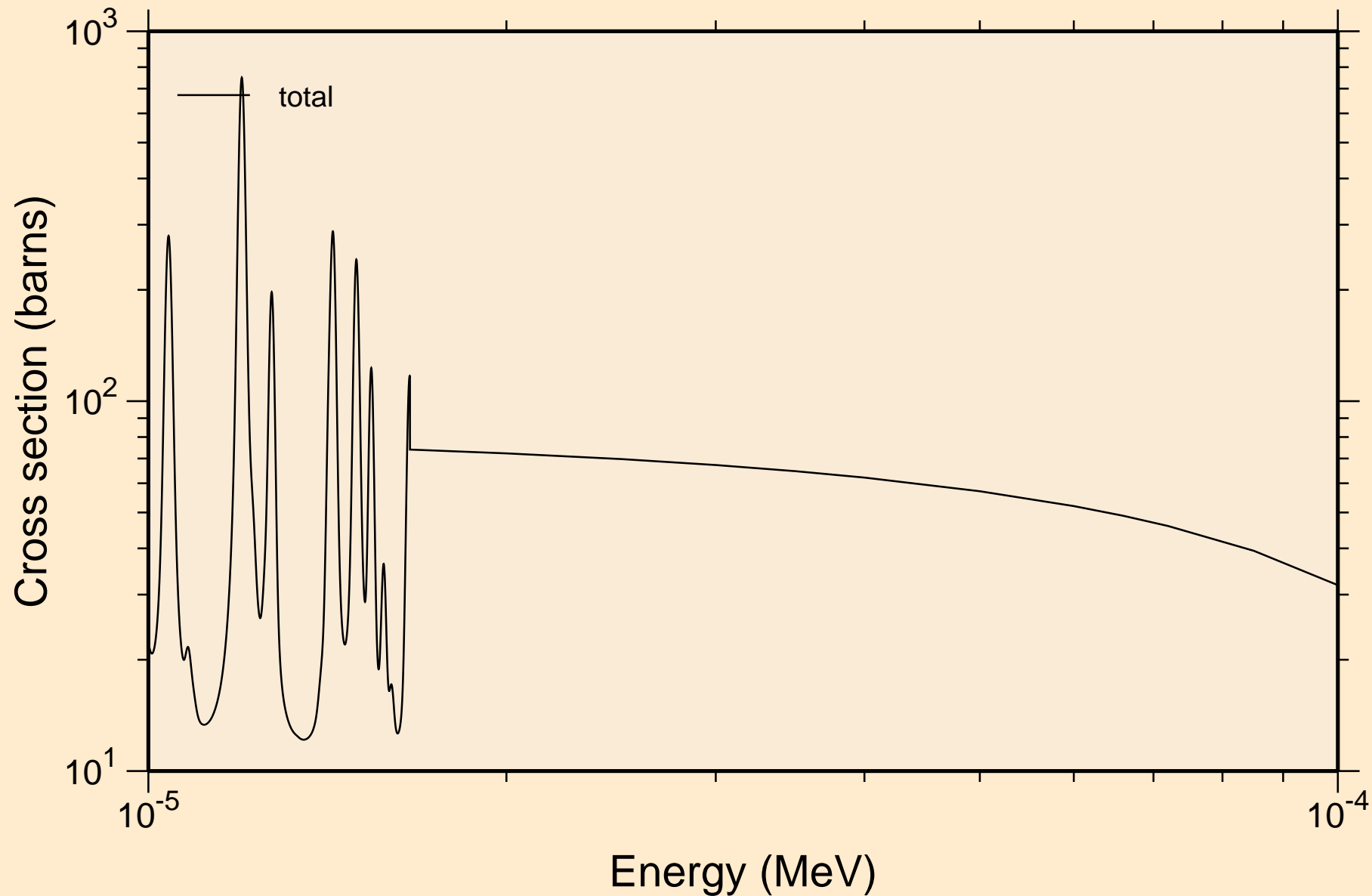

MD253 NEUTRON ACER TENDL-2019 LIBRARY; T=293.16K  
resonance total cross section

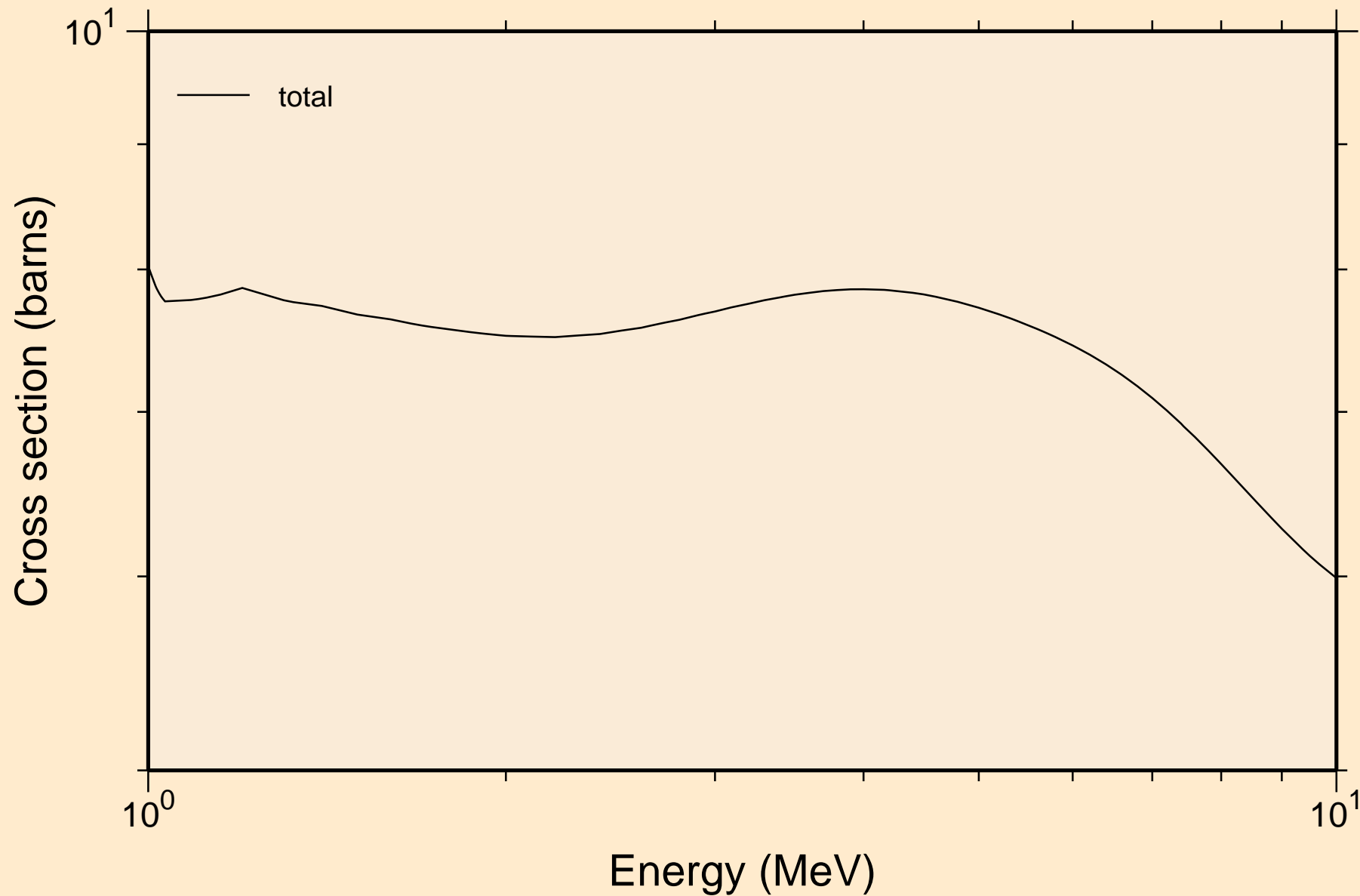

MD253 NEUTRON ACER TENDL-2019 LIBRARY; T=293.16K  
resonance absorption cross sections

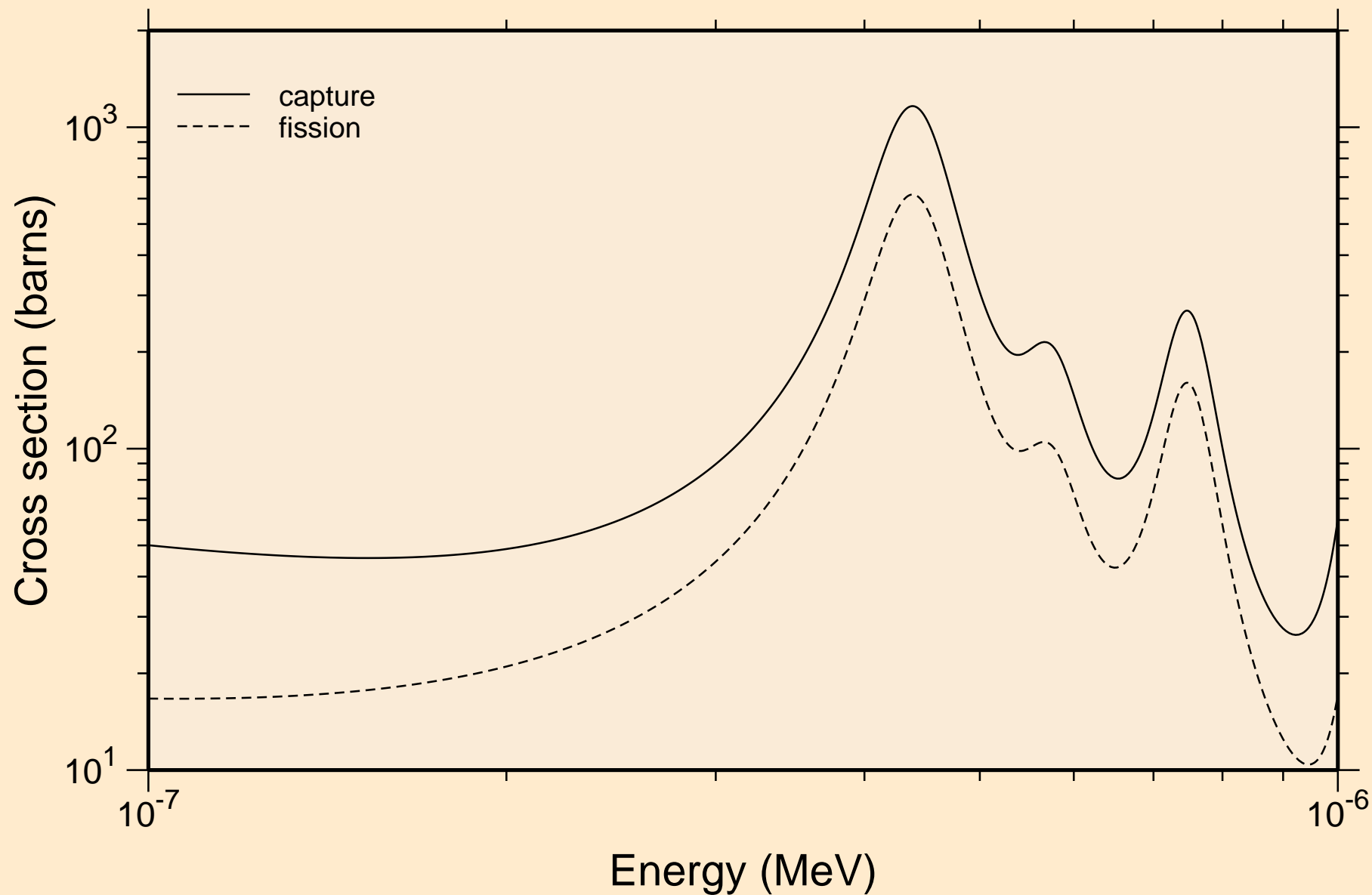

MD253 NEUTRON ACER TENDL-2019 LIBRARY; T=293.16K  
resonance absorption cross sections

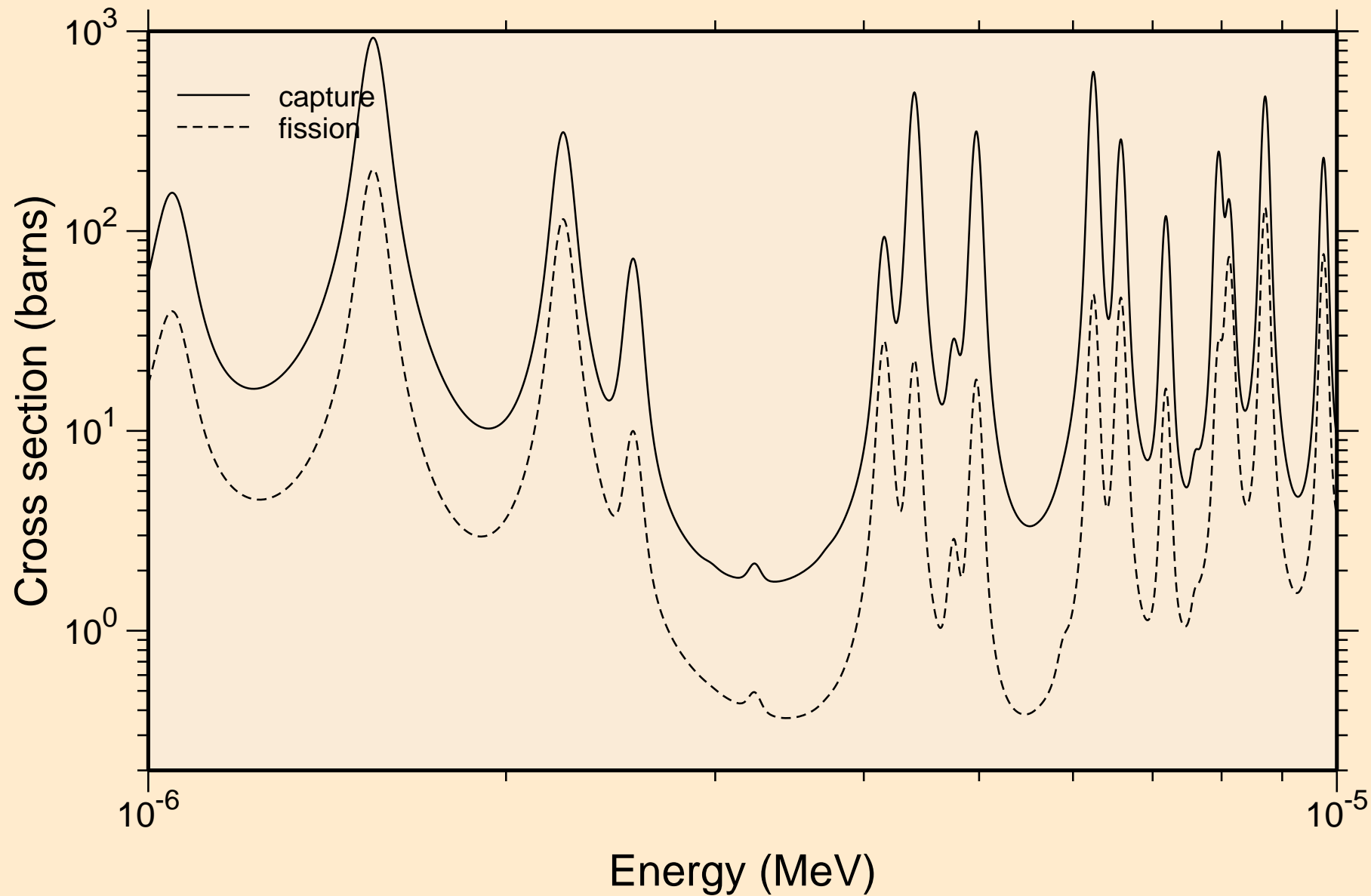

MD253 NEUTRON ACER TENDL-2019 LIBRARY; T=293.16K  
resonance absorption cross sections

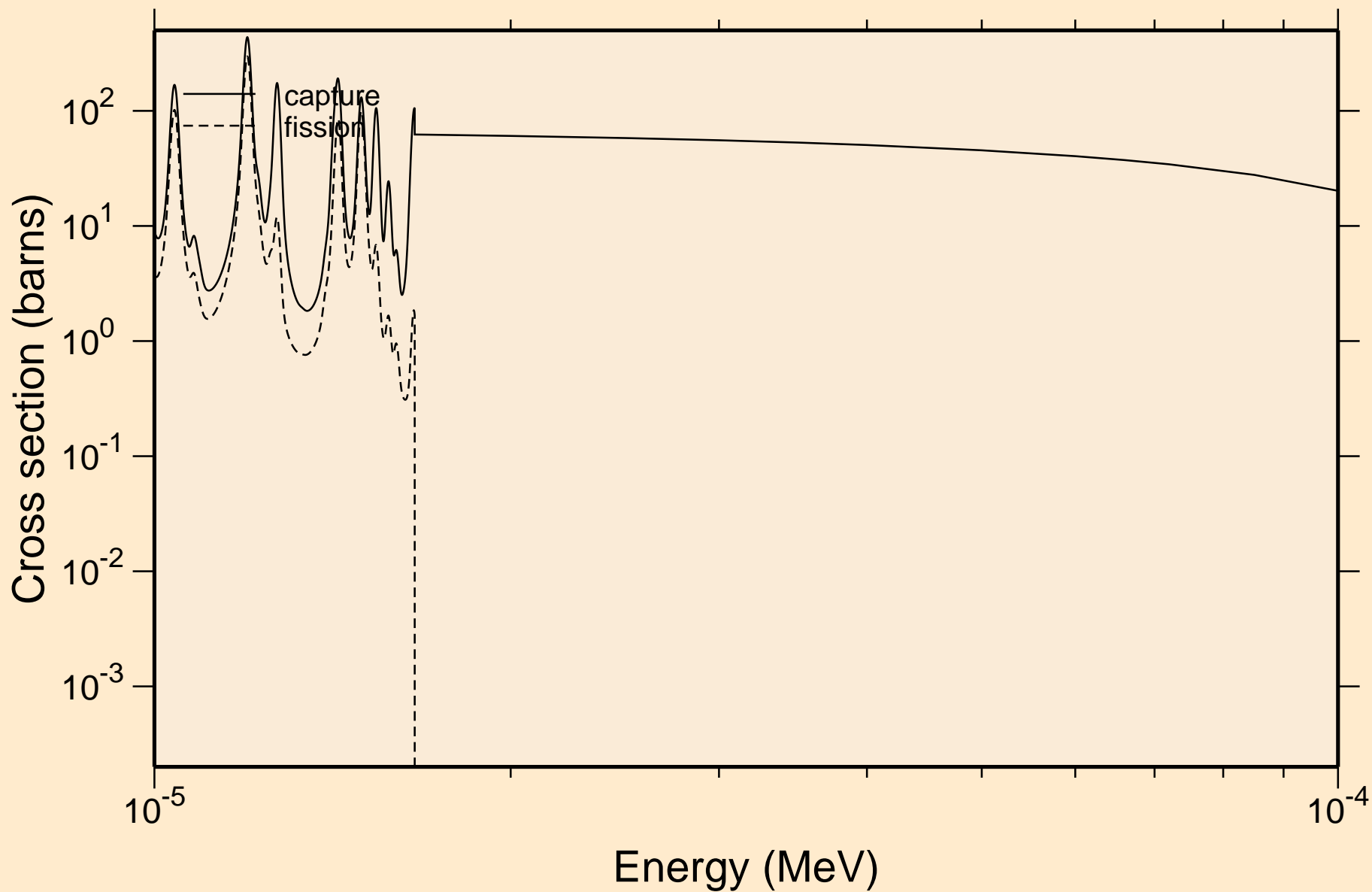



MD253 NEUTRON ACER TENDL-2019 LIBRARY; T=293.16K  
resonance absorption cross sections

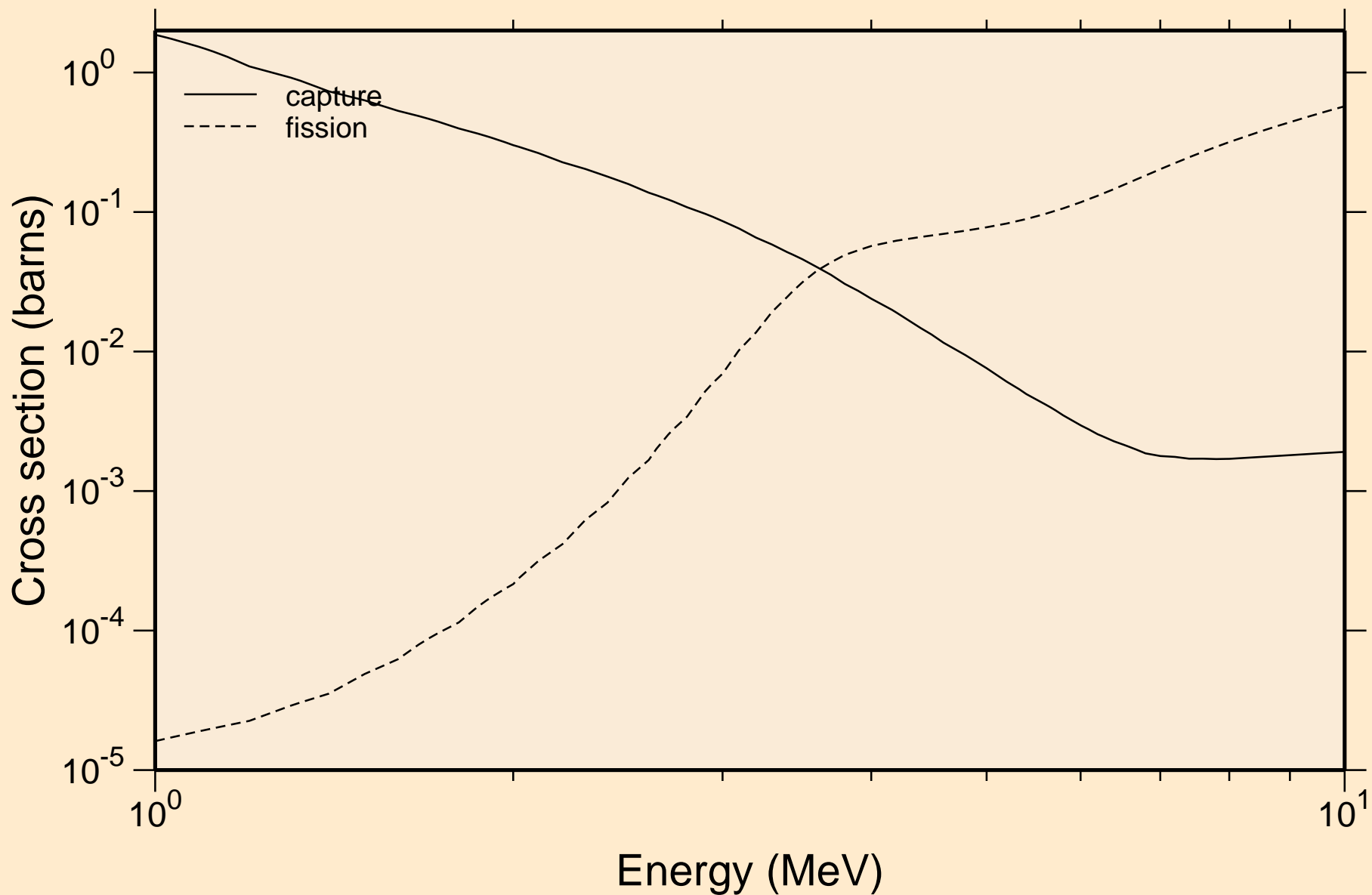

MD253 NEUTRON ACER TENDL-2019 LIBRARY; T=293.16K  
Heating

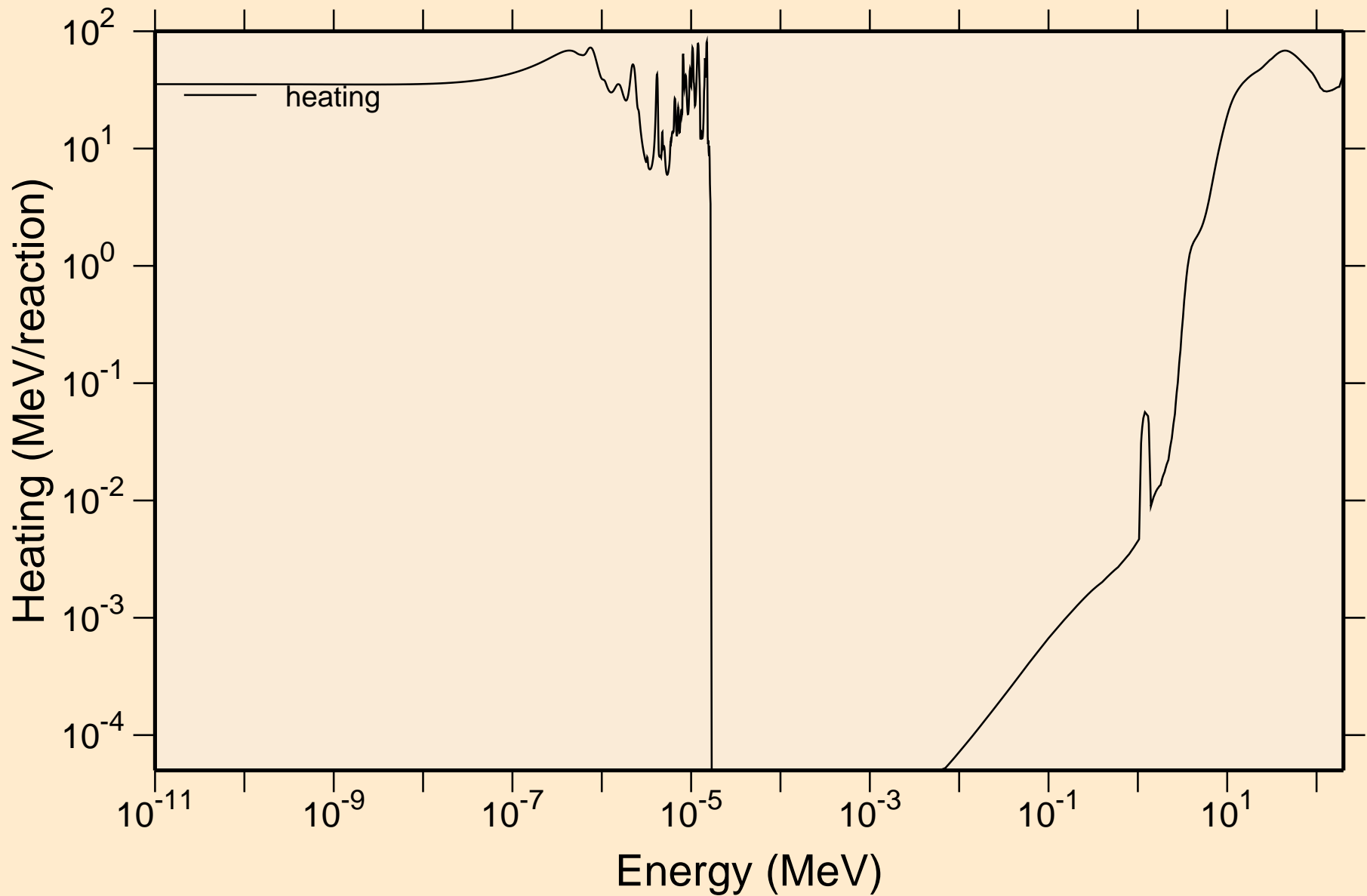

MD253 NEUTRON ACER TENDL-2019 LIBRARY; T=293.16K  
Damage

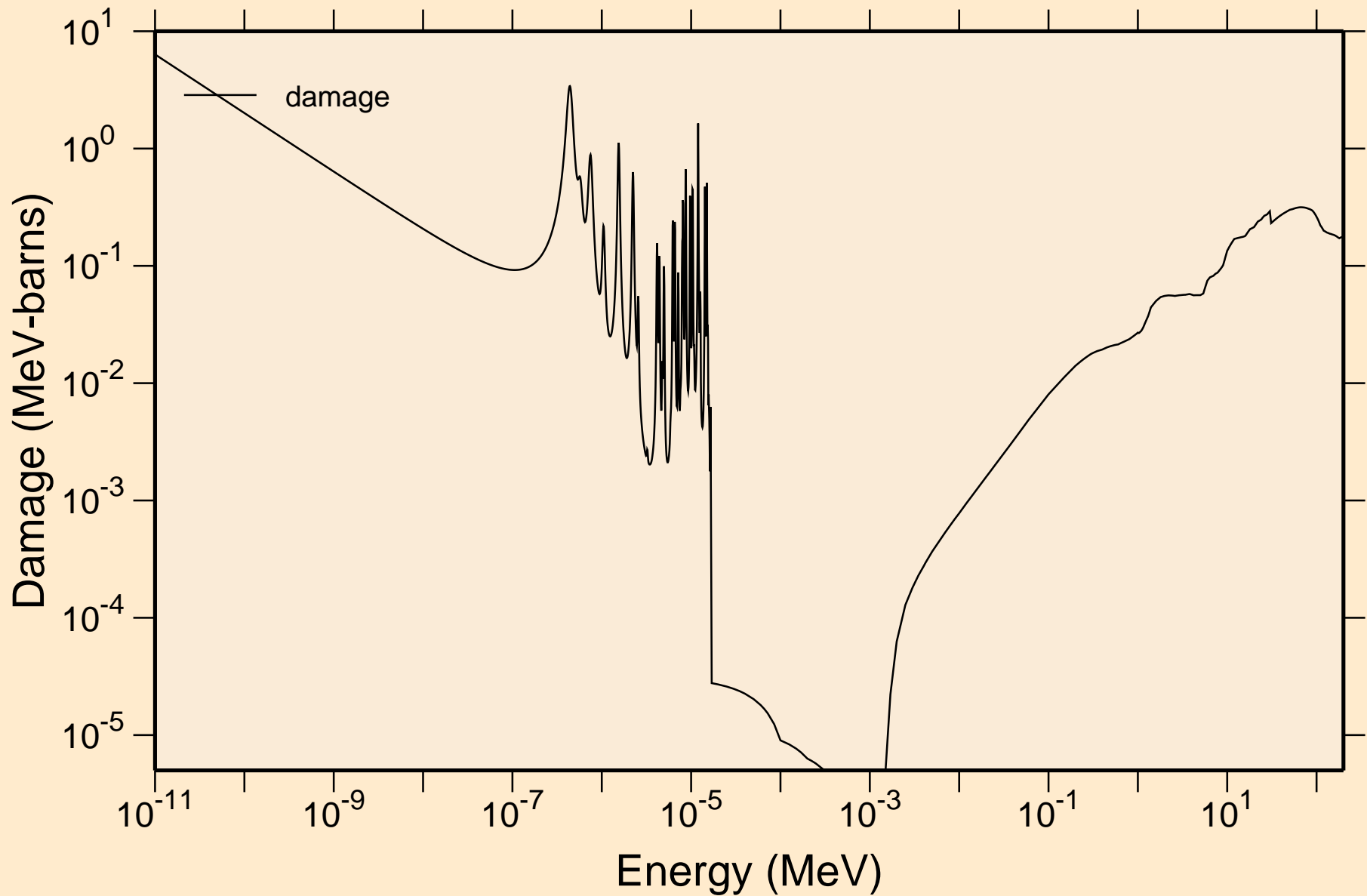

MD253 NEUTRON ACER TENDL-2019 LIBRARY; T=293.16K  
Non-threshold reactions

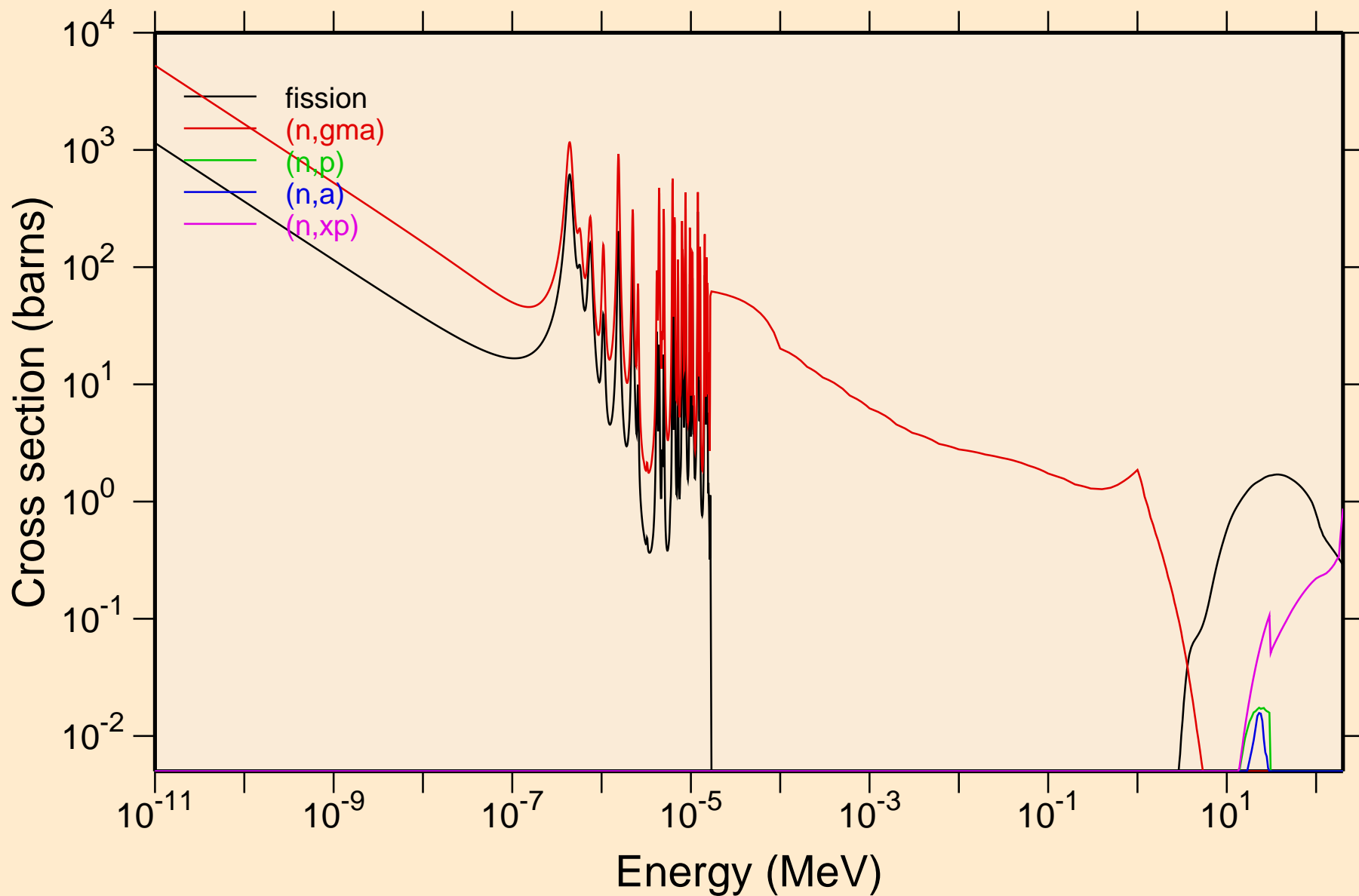

MD253 NEUTRON ACER TENDL-2019 LIBRARY; T=293.16K  
Non-threshold reactions

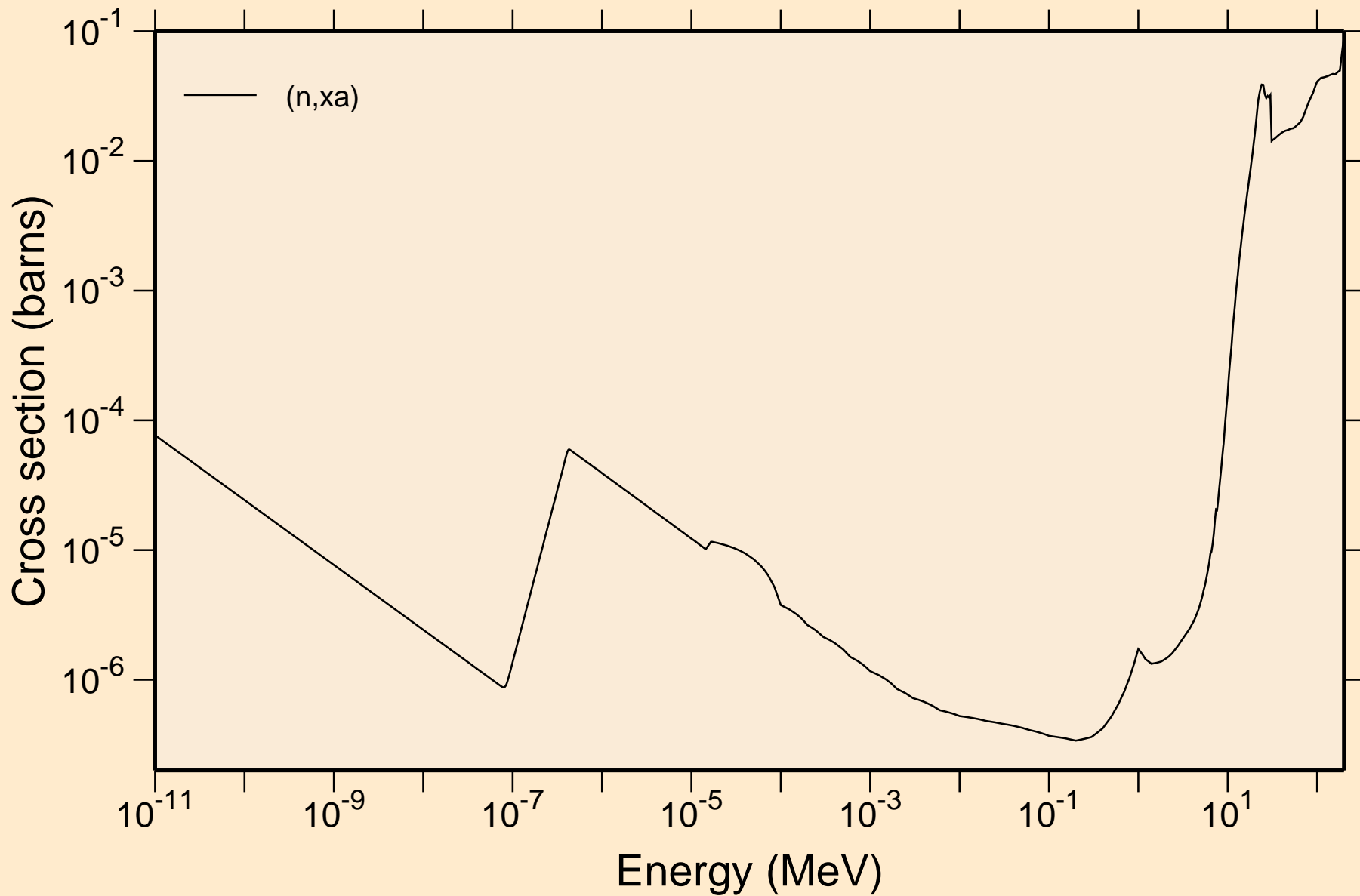

MD253 NEUTRON ACER TENDL-2019 LIBRARY; T=293.16K  
Principal cross sections

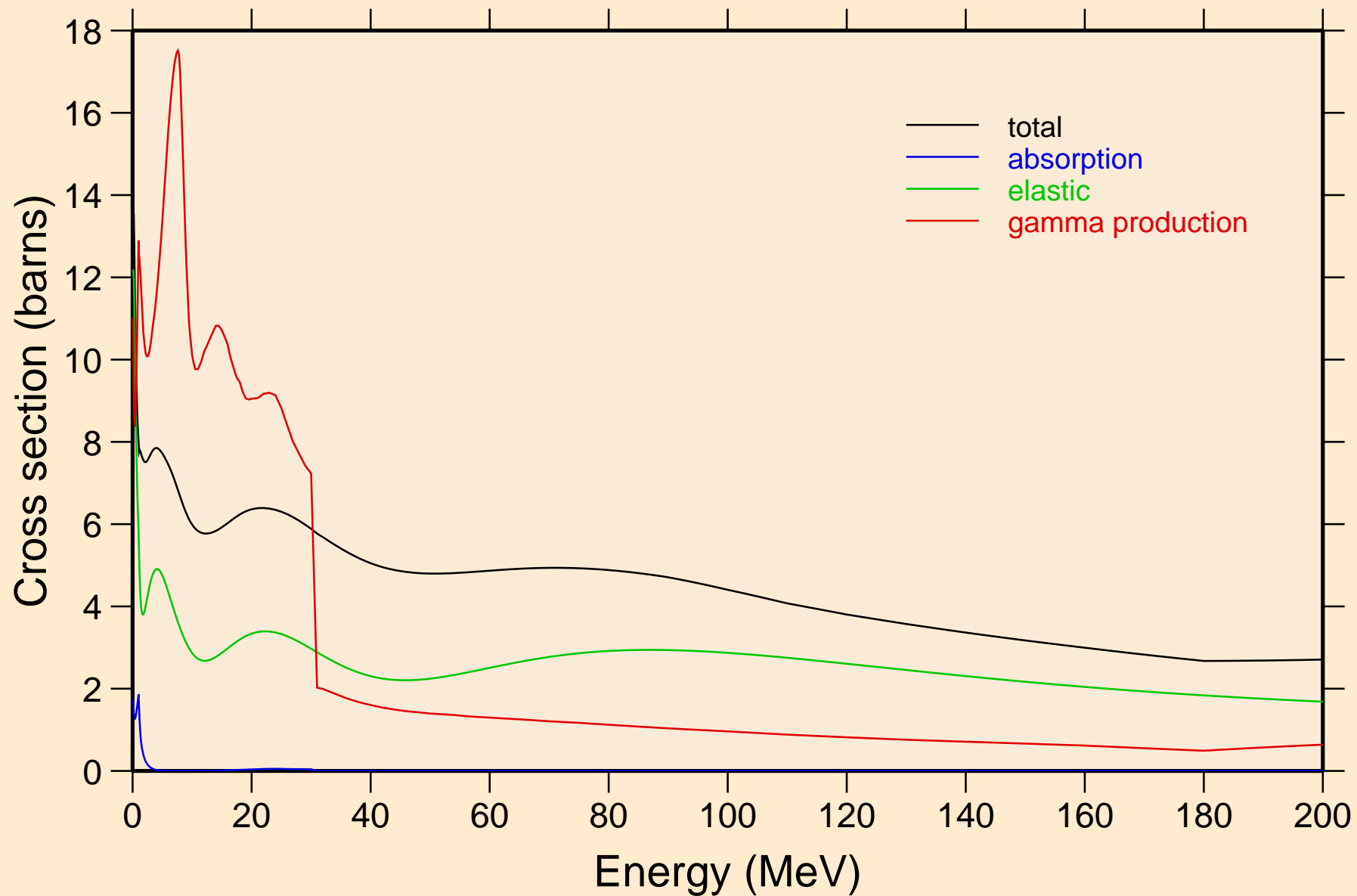

MD253 NEUTRON ACER TENDL-2019 LIBRARY; T=293.16K  
Heating

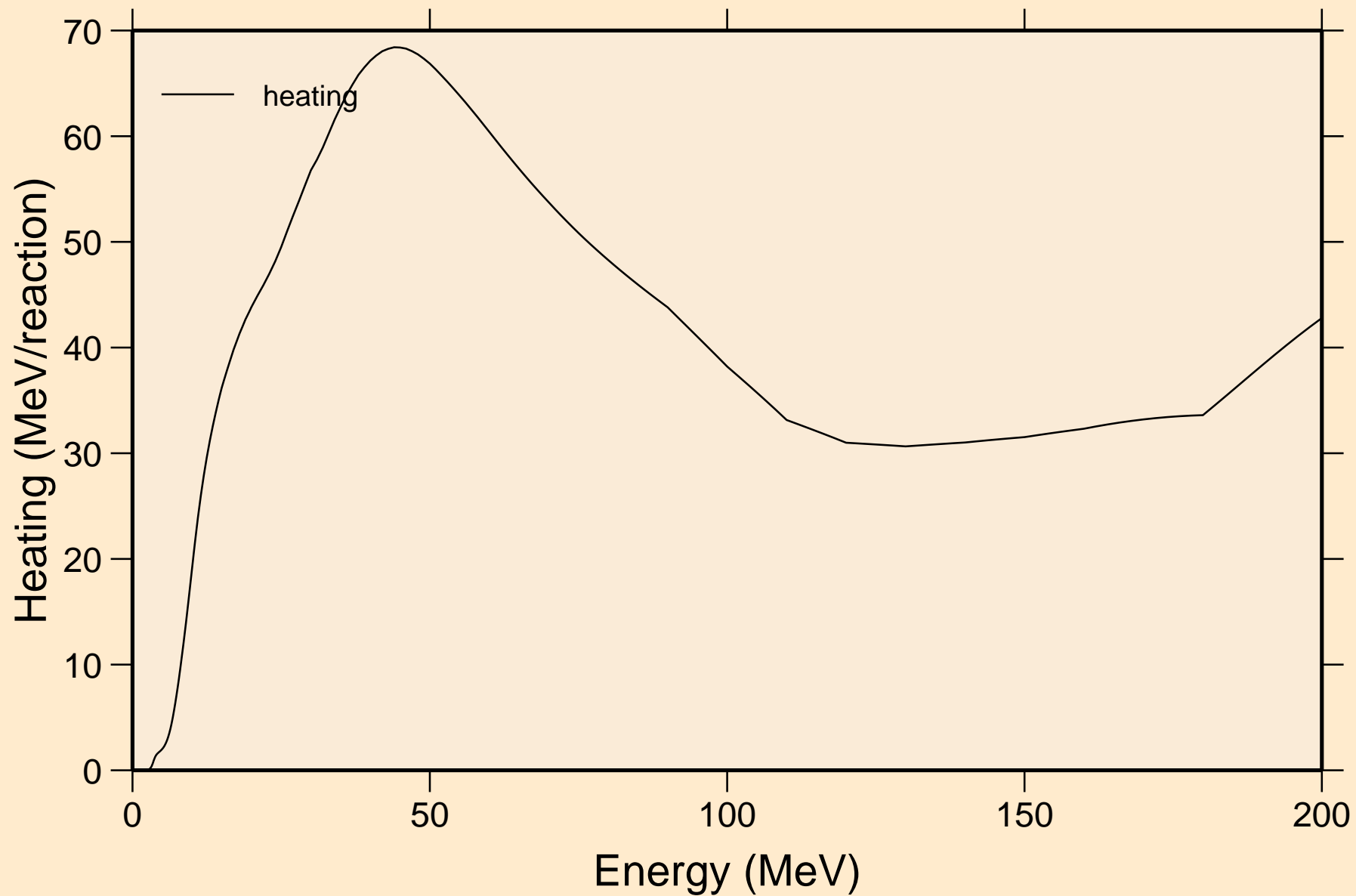

MD253 NEUTRON ACER TENDL-2019 LIBRARY; T=293.16K  
Damage

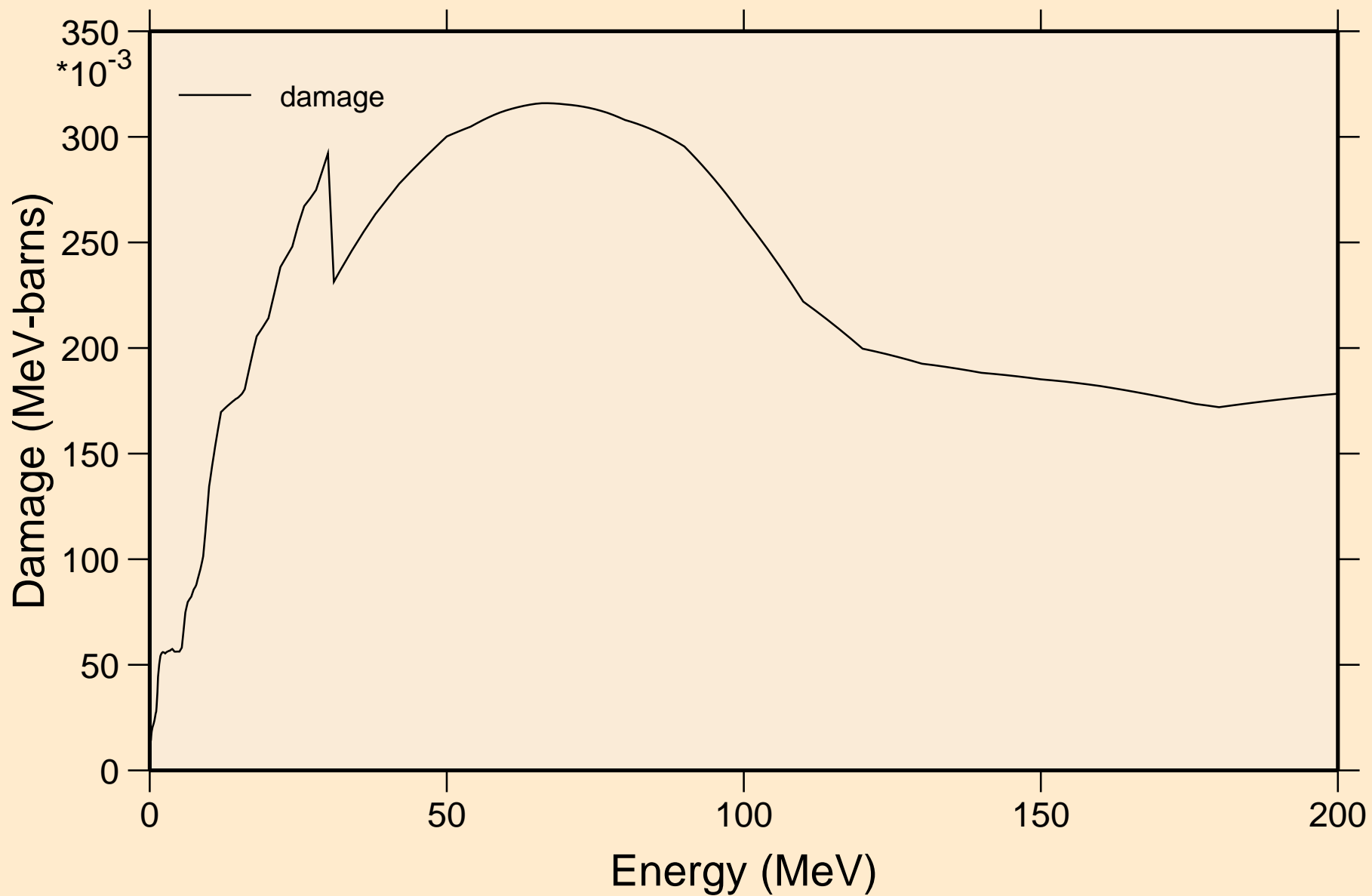



MD253 NEUTRON ACER TENDL-2019 LIBRARY; T=293.16K  
Non-threshold reactions

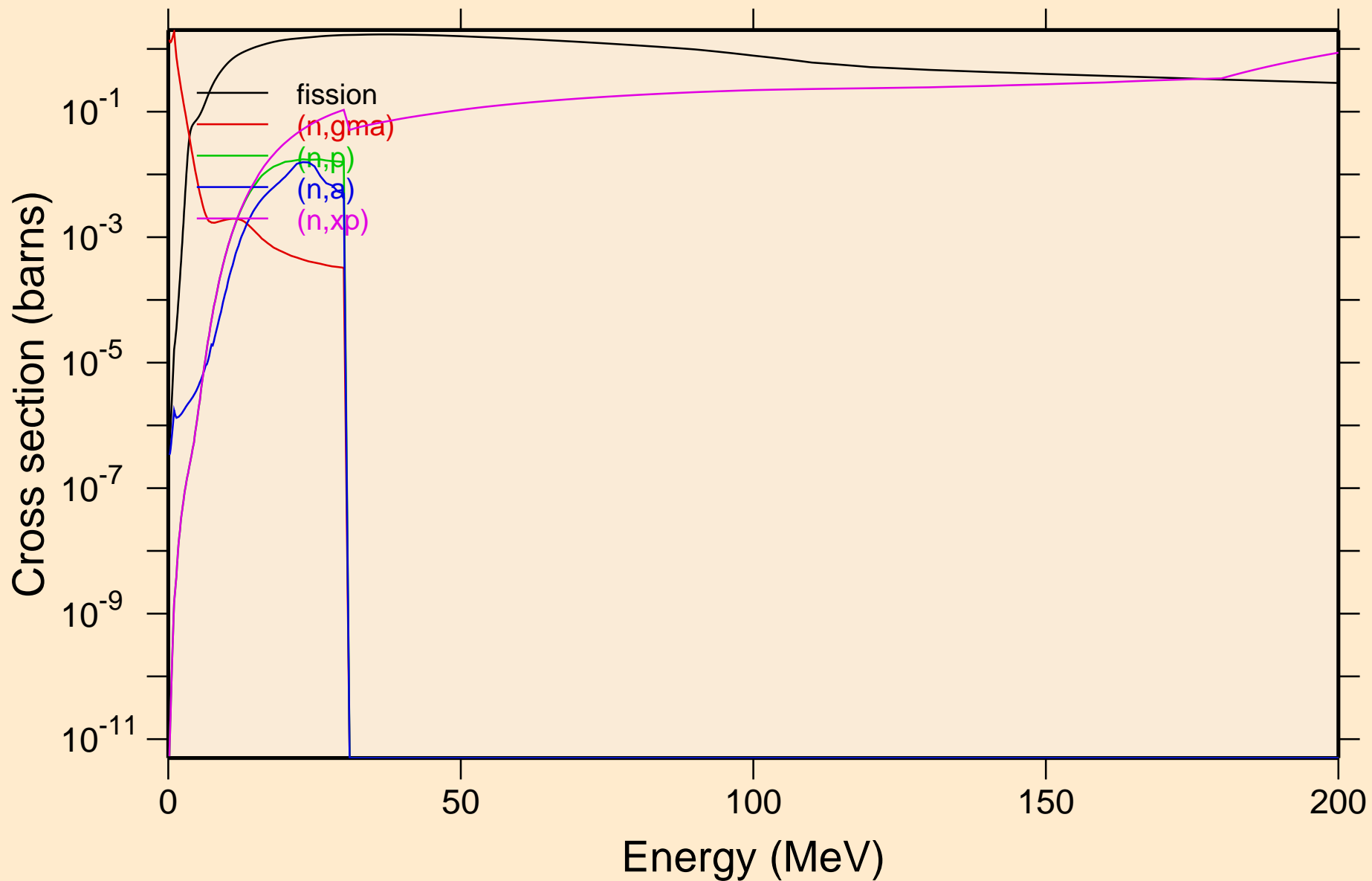

MD253 NEUTRON ACER TENDL-2019 LIBRARY; T=293.16K  
Non-threshold reactions

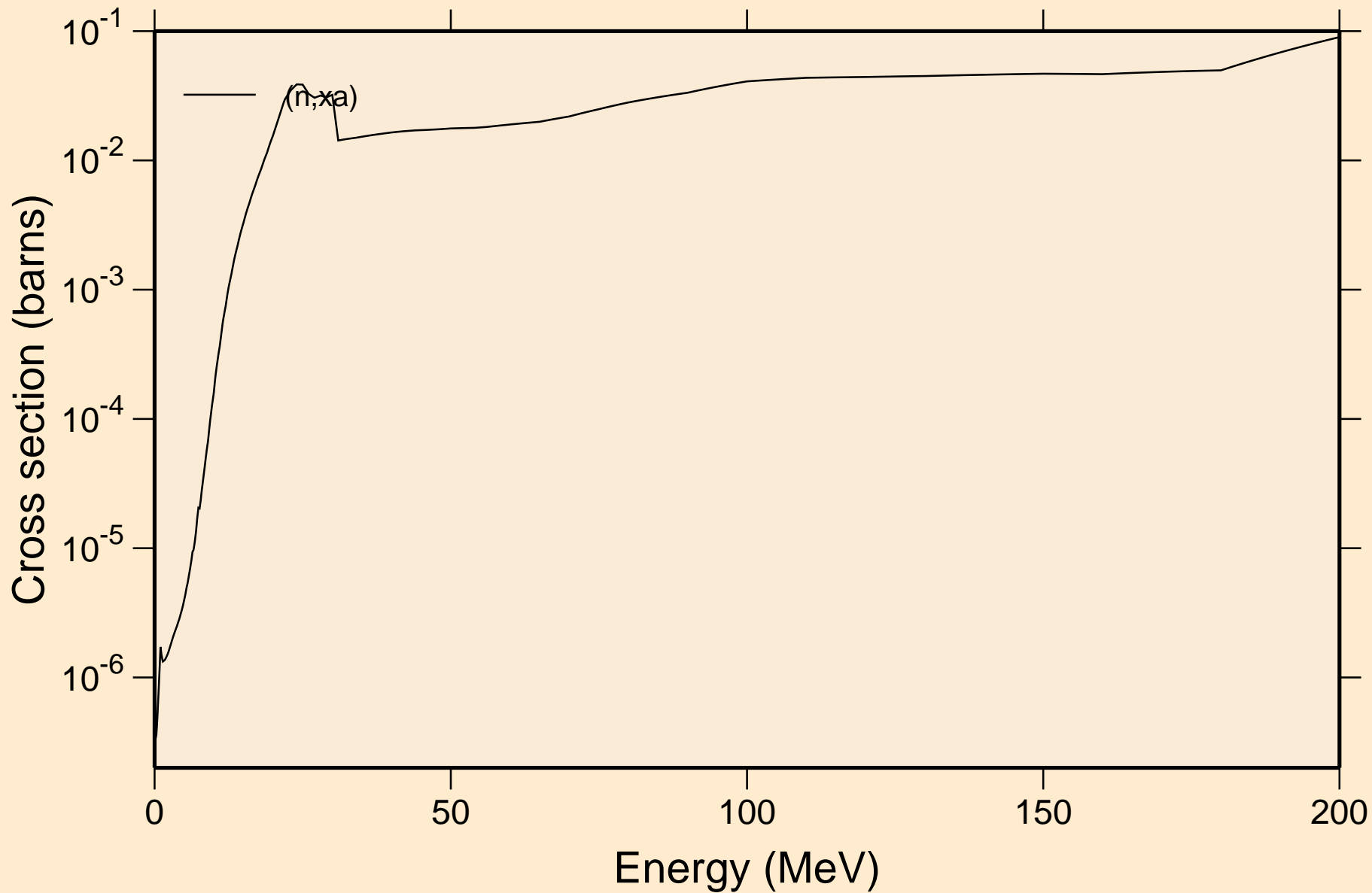

MD253 NEUTRON ACER TENDL-2019 LIBRARY; T=293.16K  
Inelastic levels

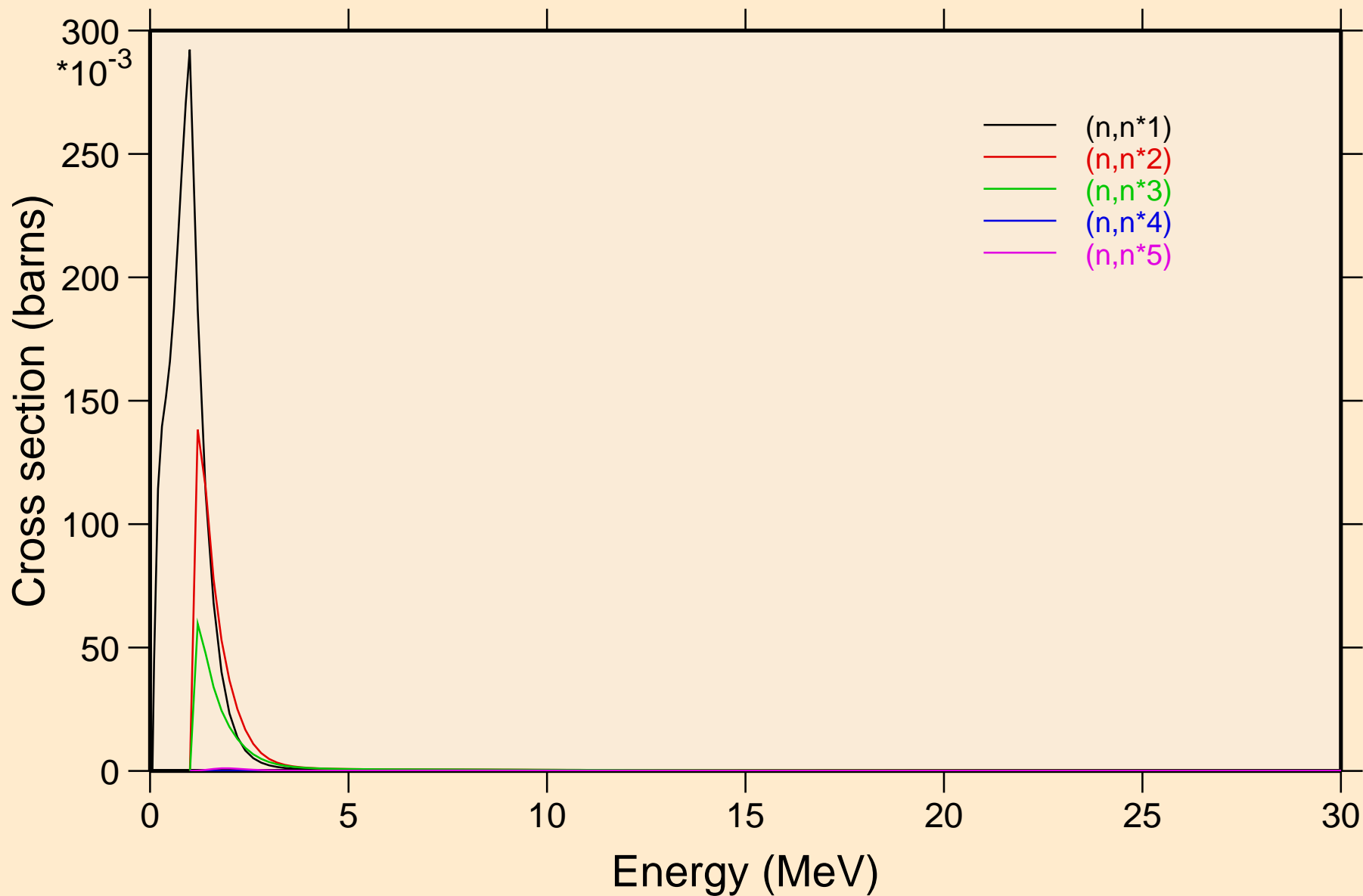

MD253 NEUTRON ACER TENDL-2019 LIBRARY; T=293.16K  
Inelastic levels

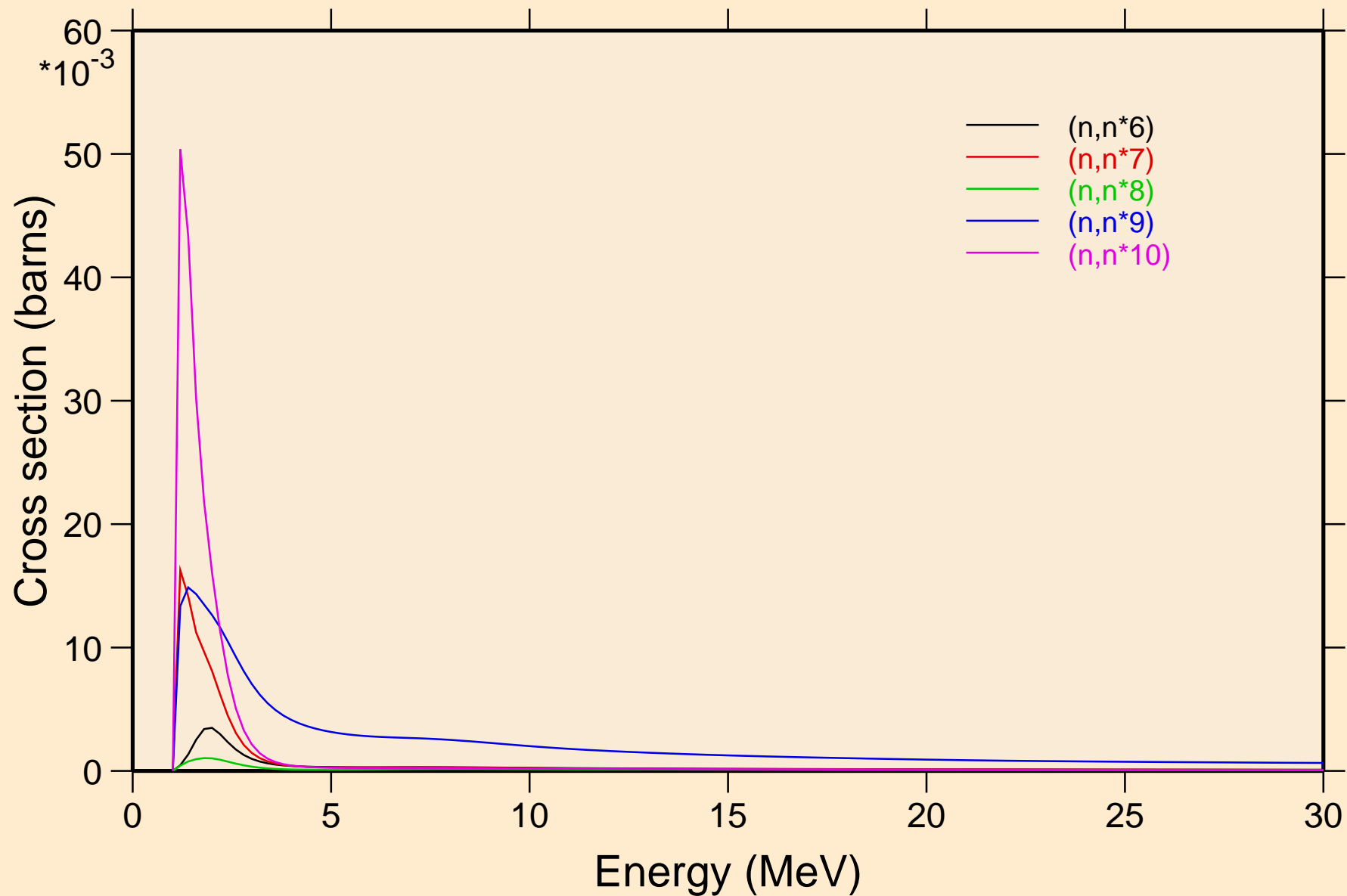

MD253 NEUTRON ACER TENDL-2019 LIBRARY; T=293.16K  
Inelastic levels

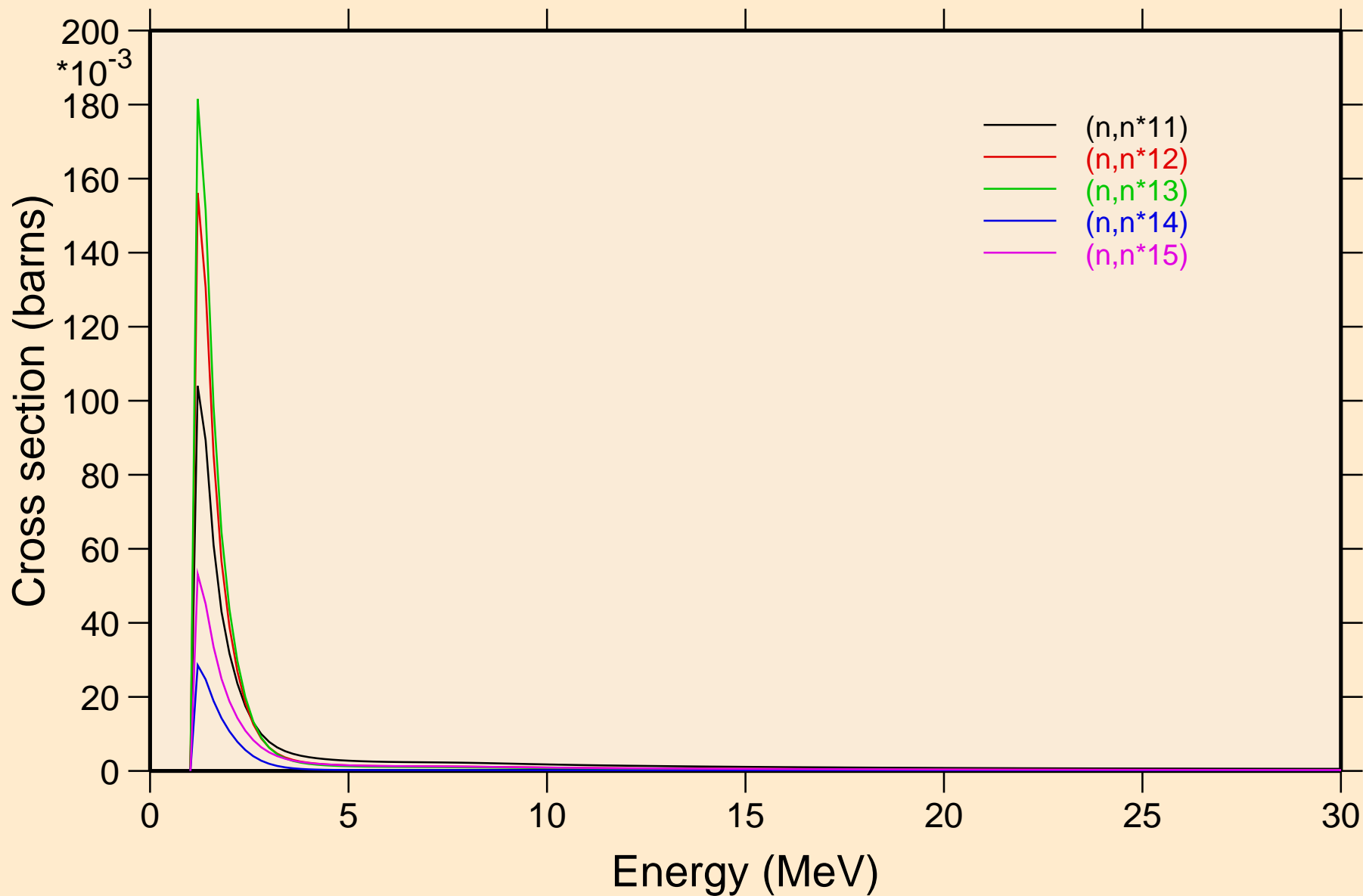

MD253 NEUTRON ACER TENDL-2019 LIBRARY; T=293.16K  
Inelastic levels

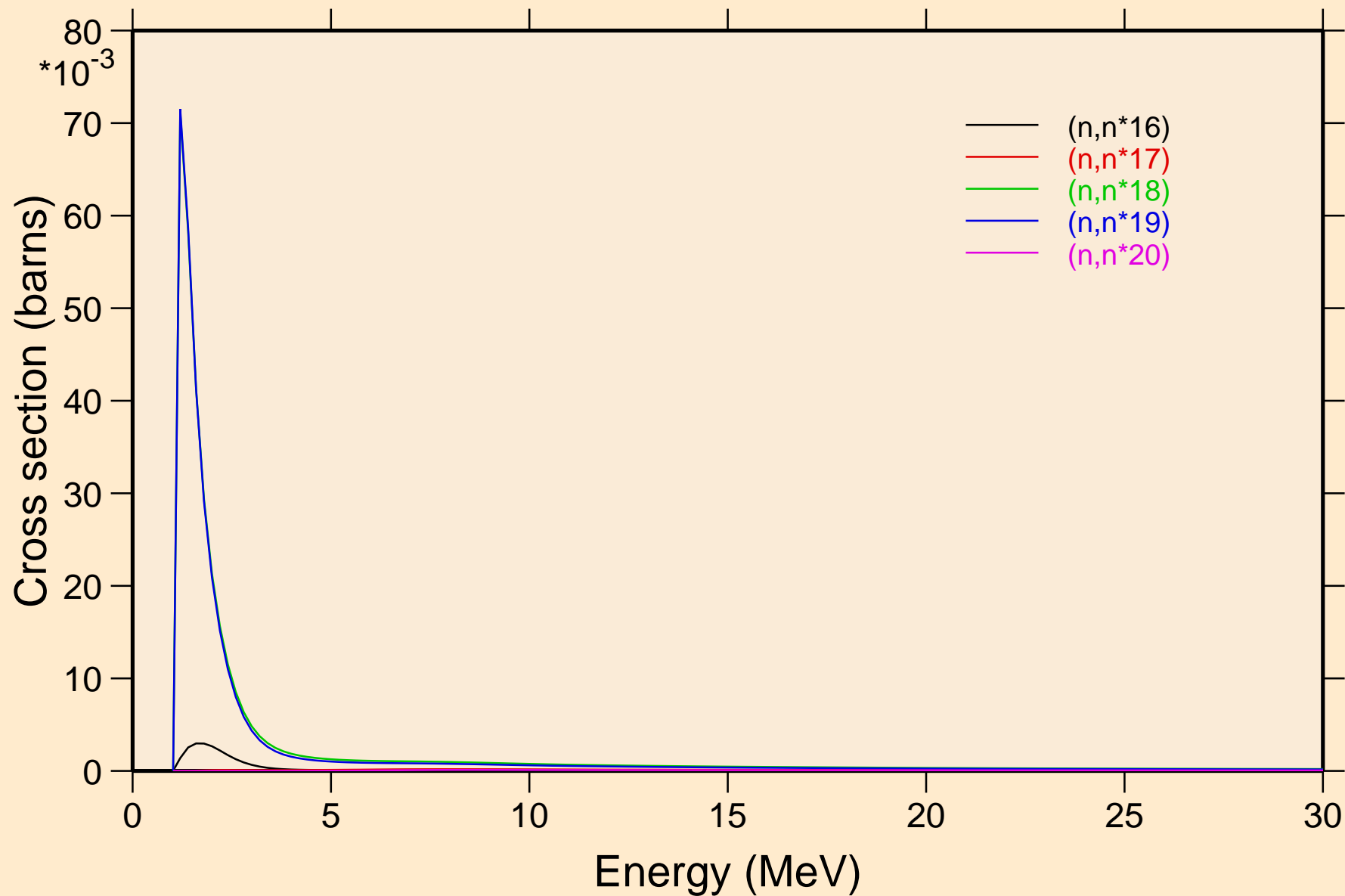

MD253 NEUTRON ACER TENDL-2019 LIBRARY; T=293.16K  
Inelastic levels

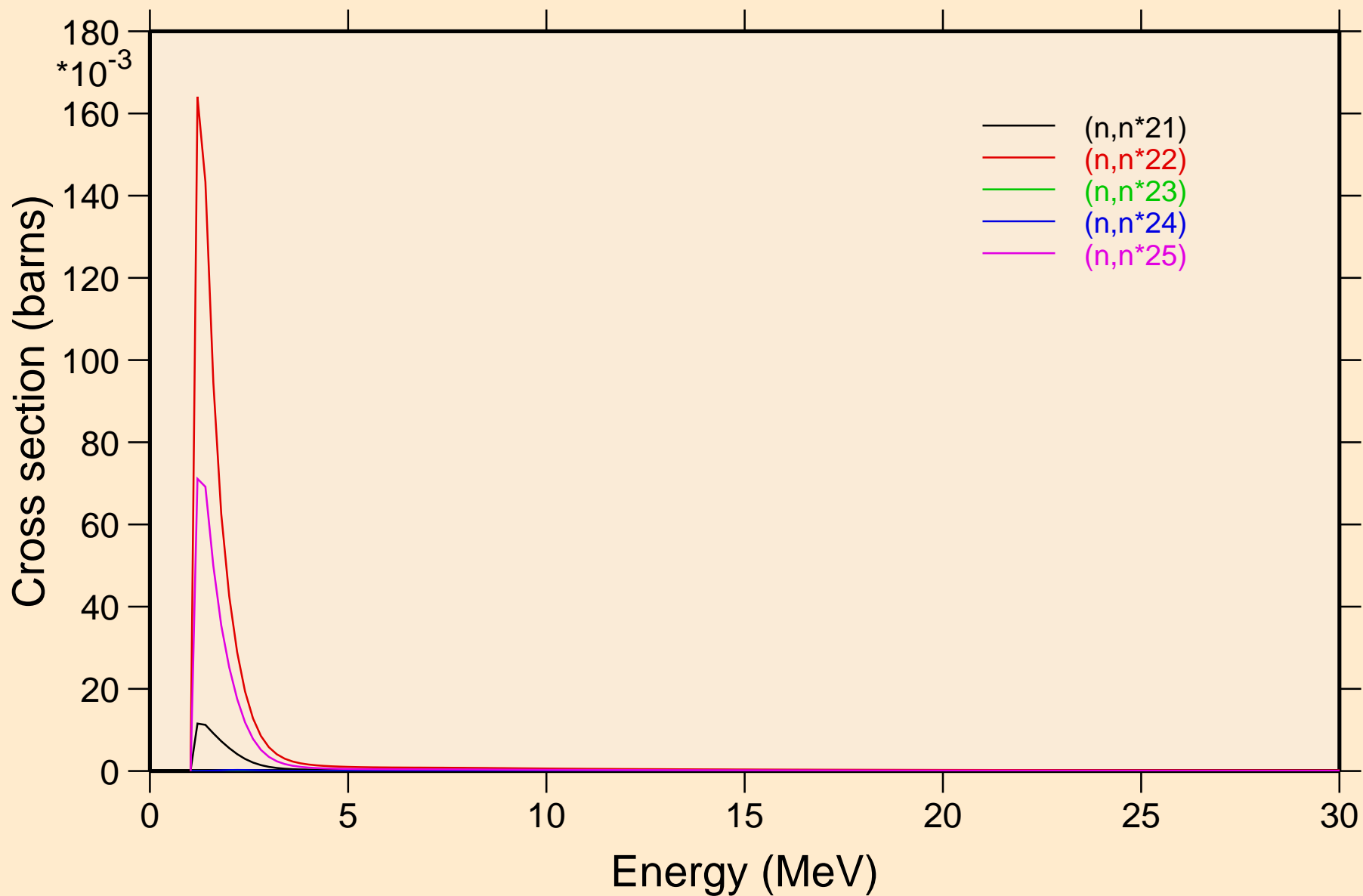

MD253 NEUTRON ACER TENDL-2019 LIBRARY; T=293.16K  
Inelastic levels

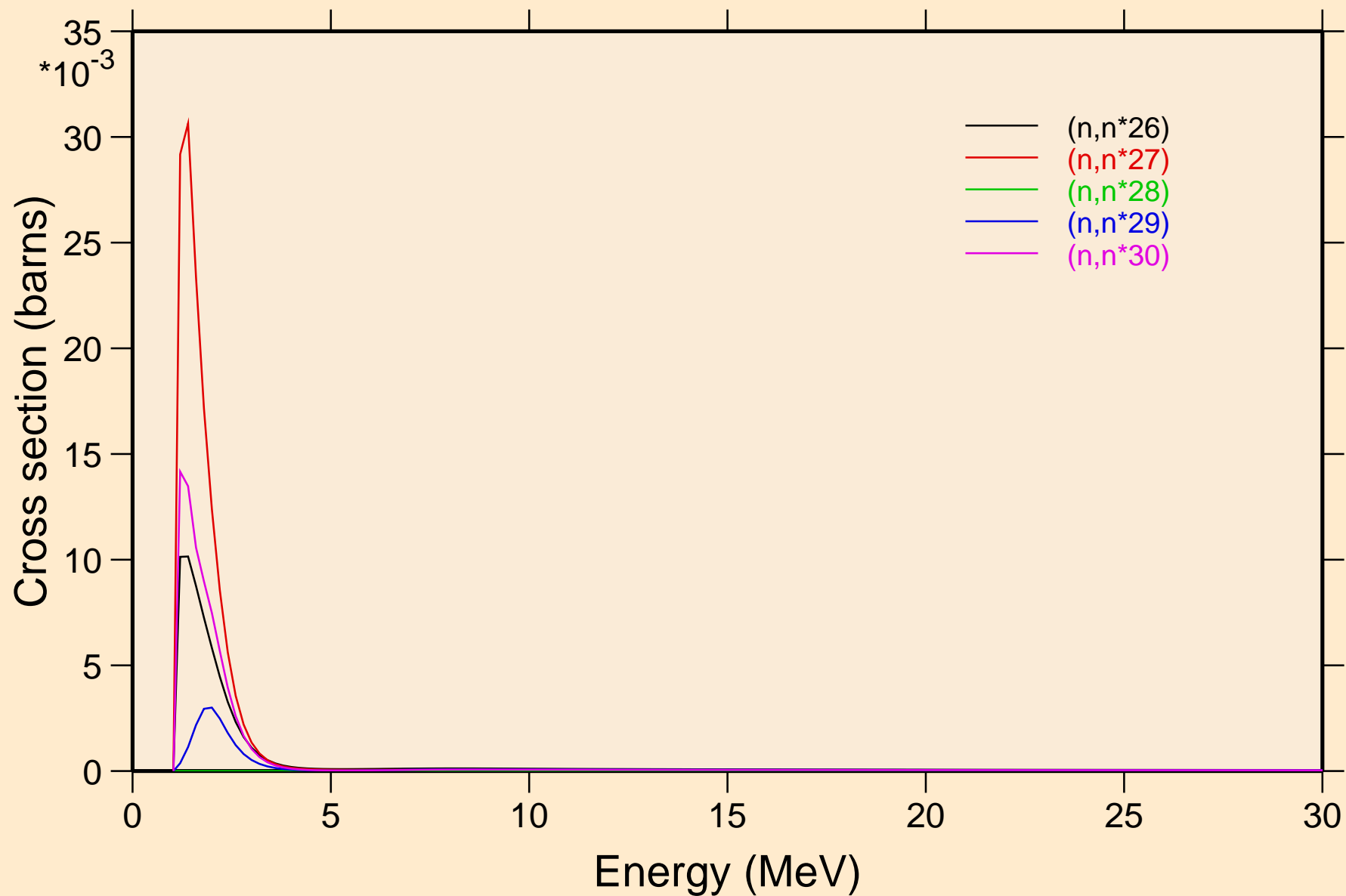



MD253 NEUTRON ACER TENDL-2019 LIBRARY; T=293.16K  
Threshold reactions

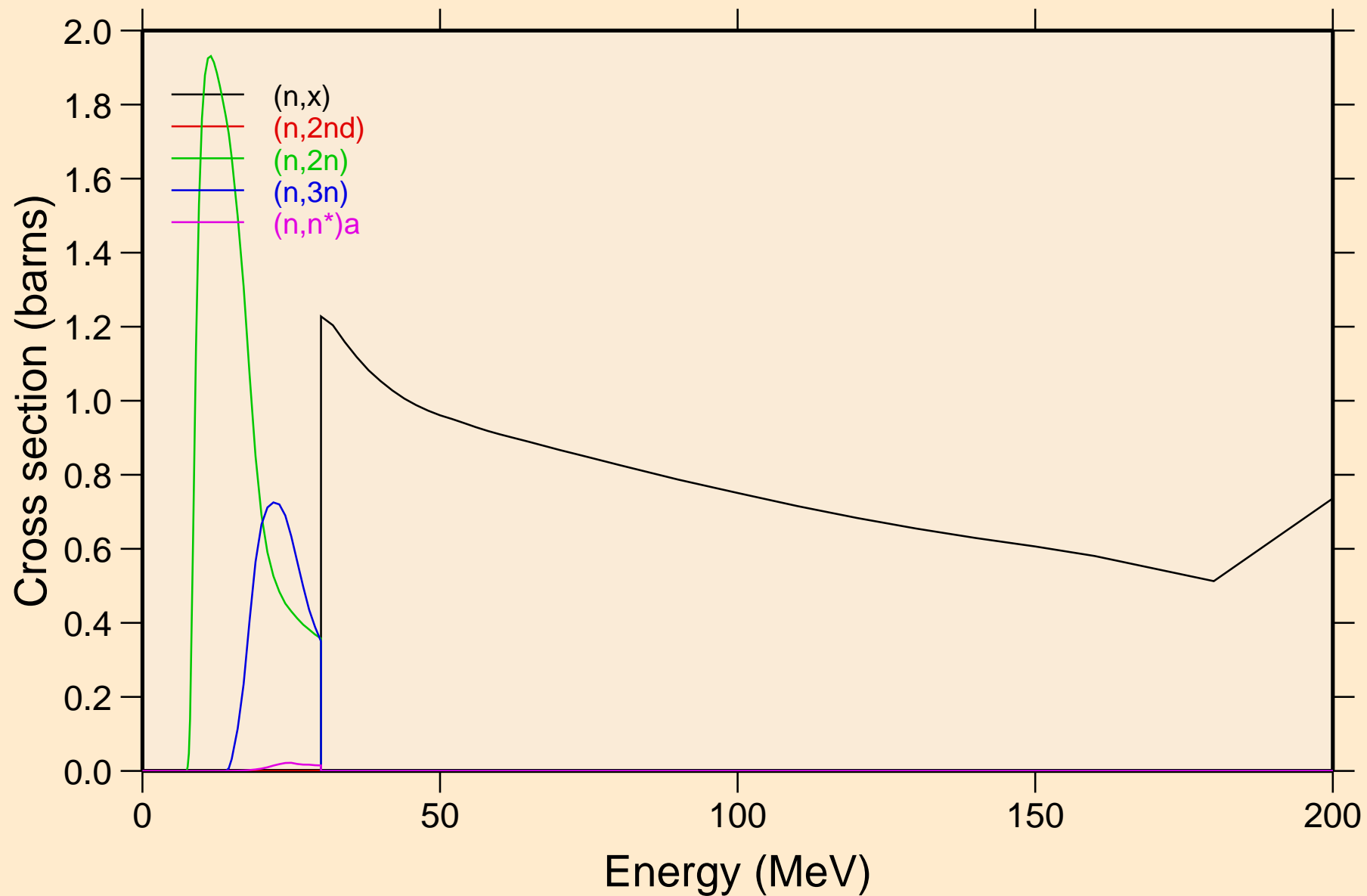

MD253 NEUTRON ACER TENDL-2019 LIBRARY; T=293.16K  
Threshold reactions

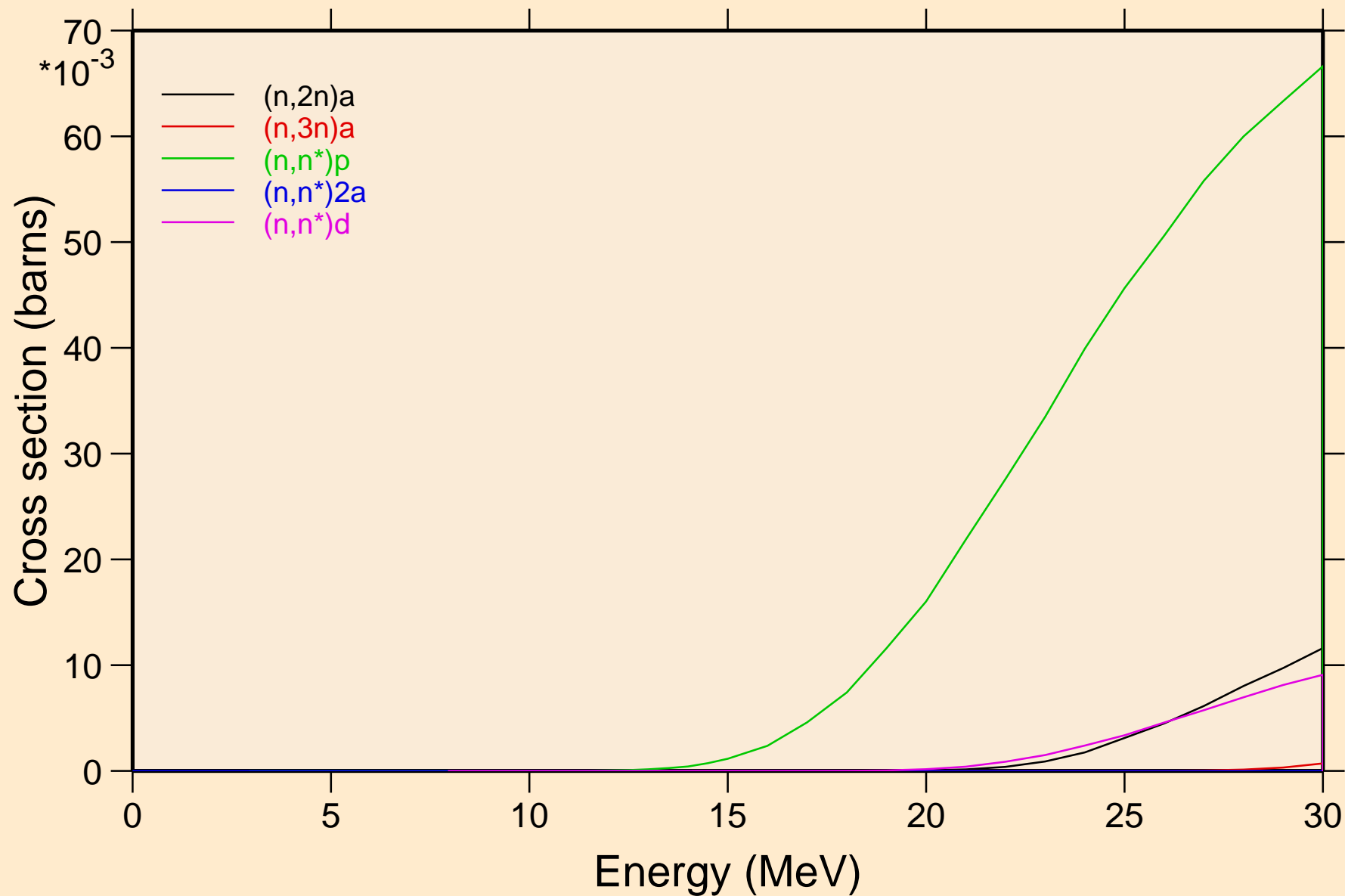

MD253 NEUTRON ACER TENDL-2019 LIBRARY; T=293.16K  
Threshold reactions

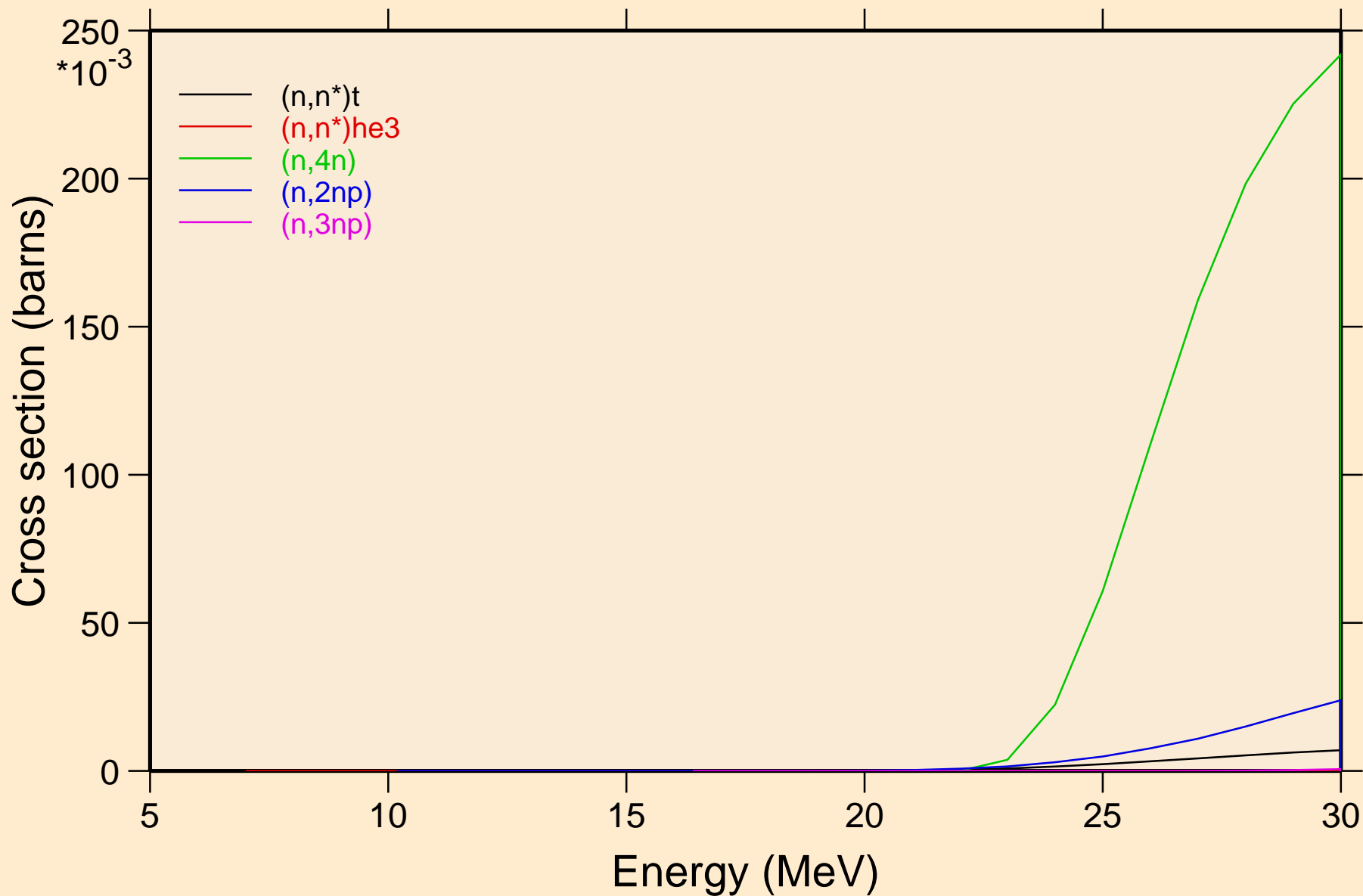

MD253 NEUTRON ACER TENDL-2019 LIBRARY; T=293.16K  
Threshold reactions

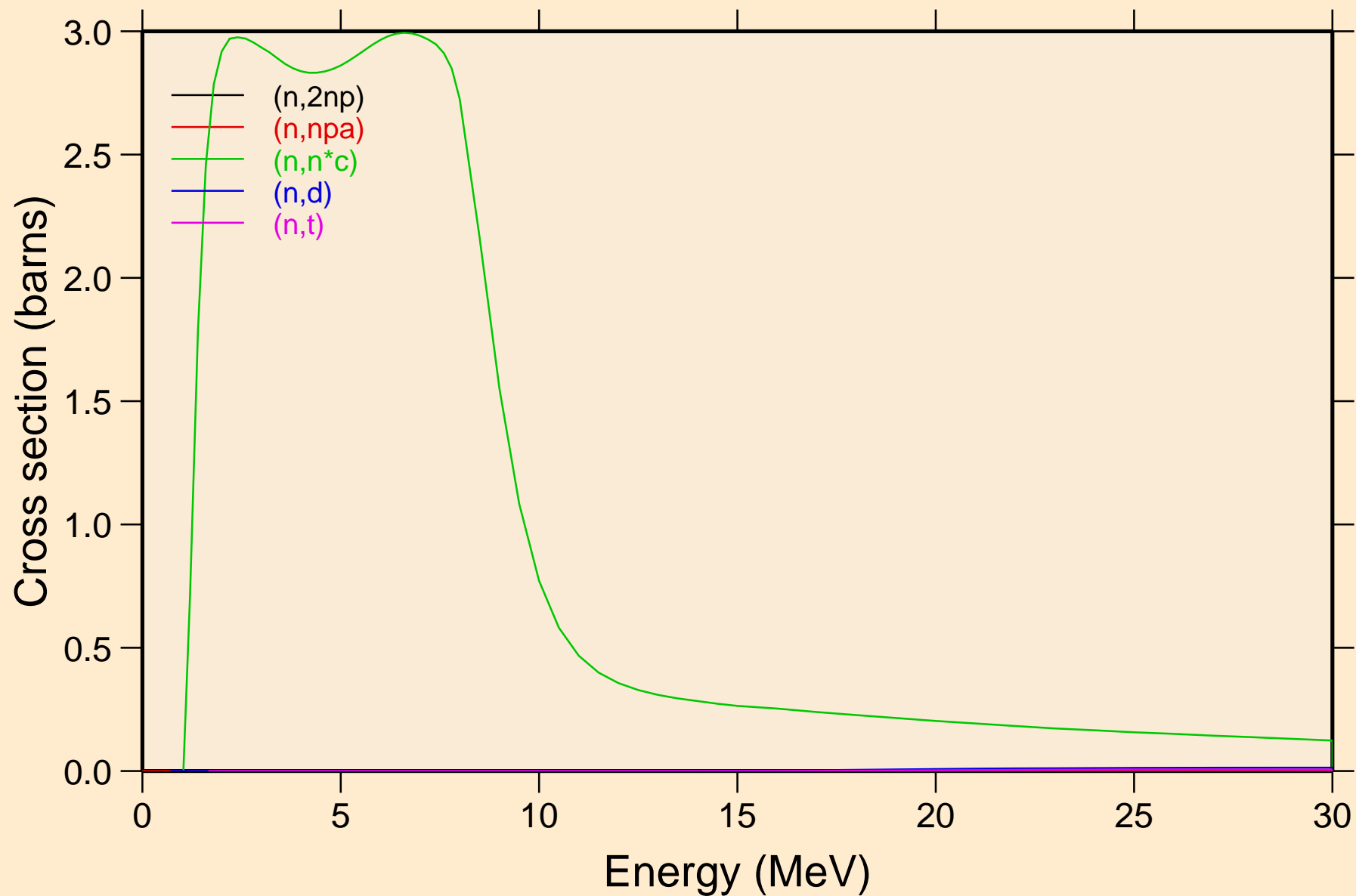

MD253 NEUTRON ACER TENDL-2019 LIBRARY; T=293.16K  
Threshold reactions

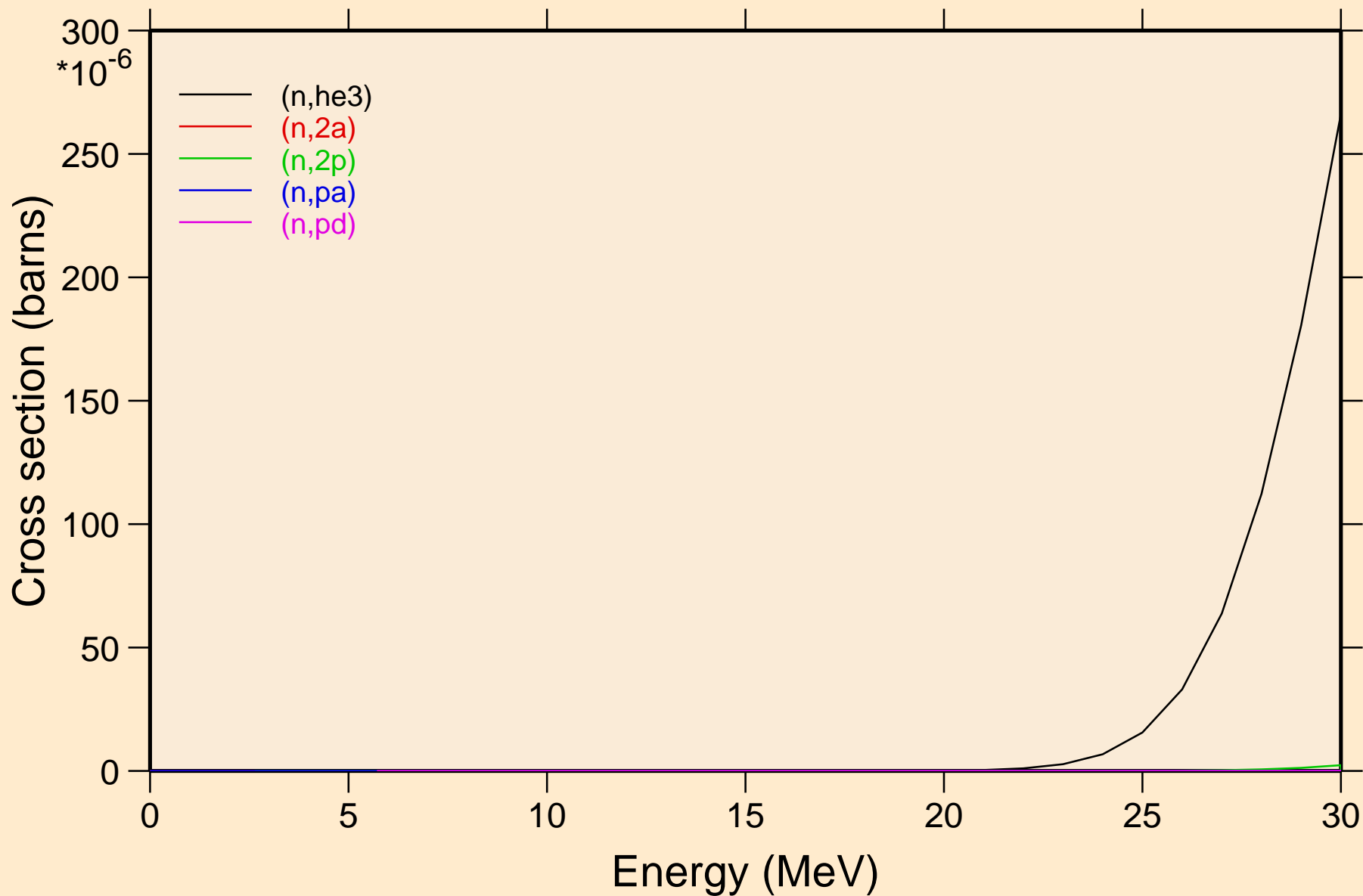

MD253 NEUTRON ACER TENDL-2019 LIBRARY; T=293.16K  
Threshold reactions

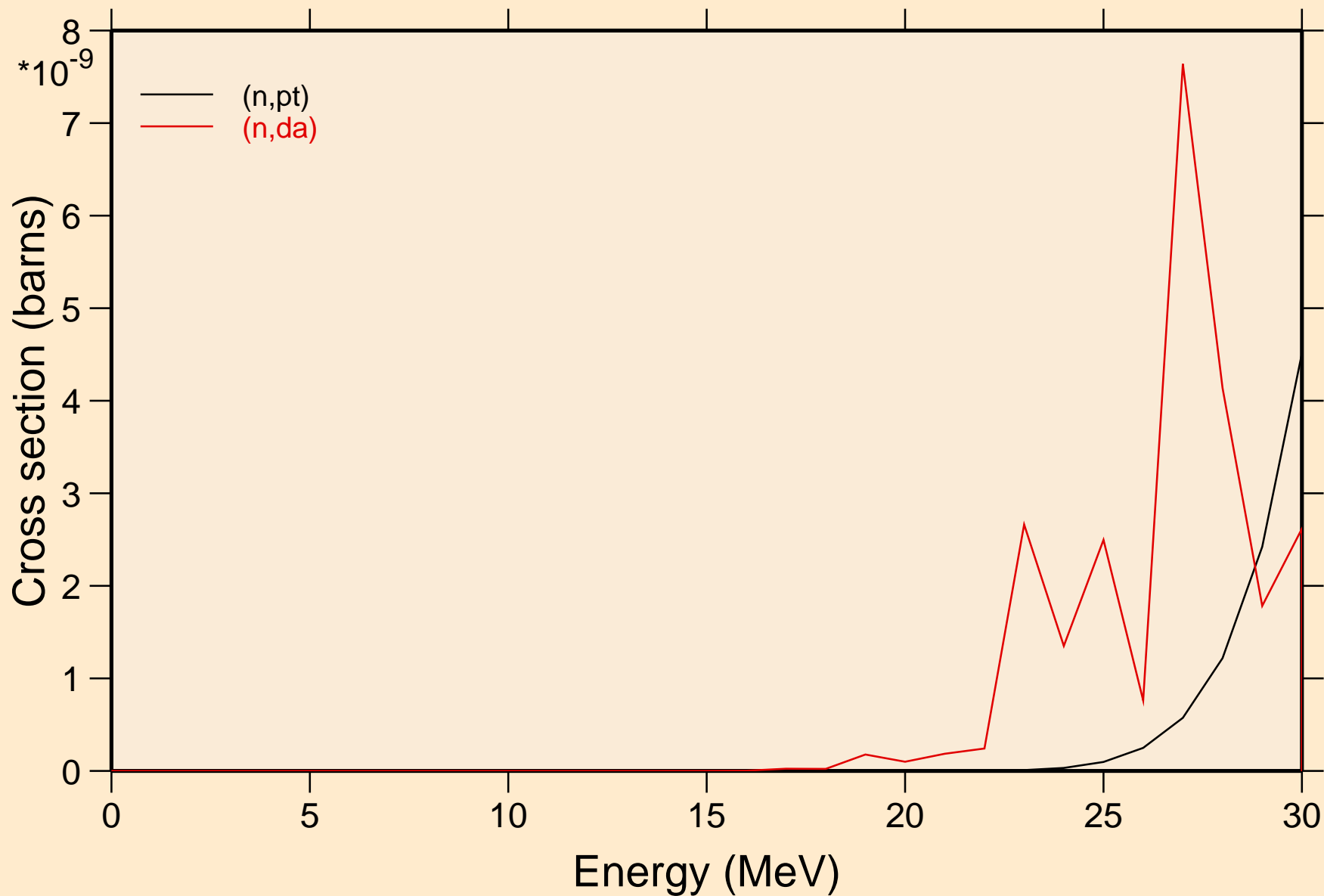

MD253 NEUTRON ACER TENDL-2019 LIBRARY; T=293.16K  
Threshold reactions

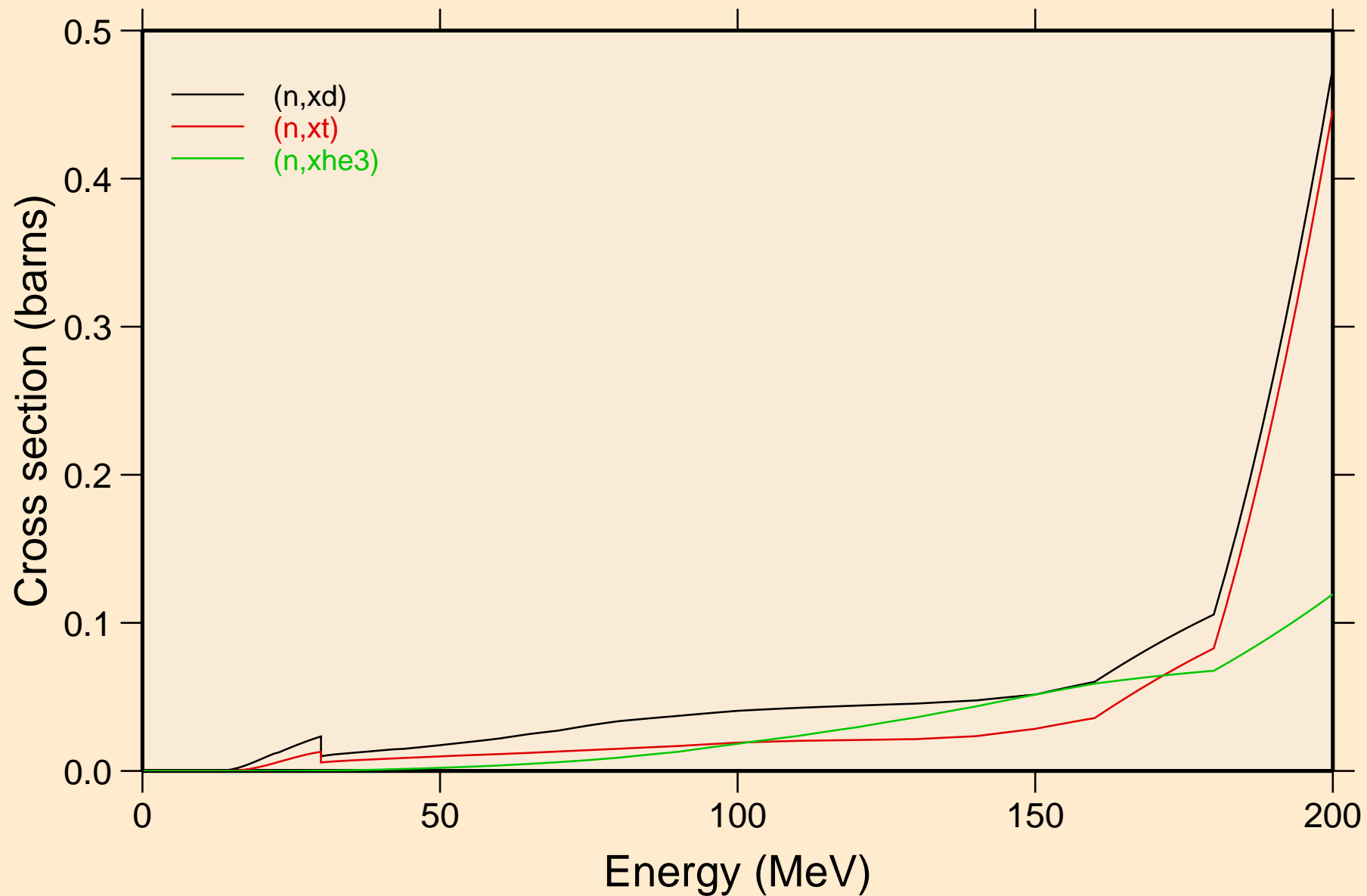

MD253 NEUTRON ACER TENDL-2019 LIBRARY; T=293.16K  
angular distribution for elastic

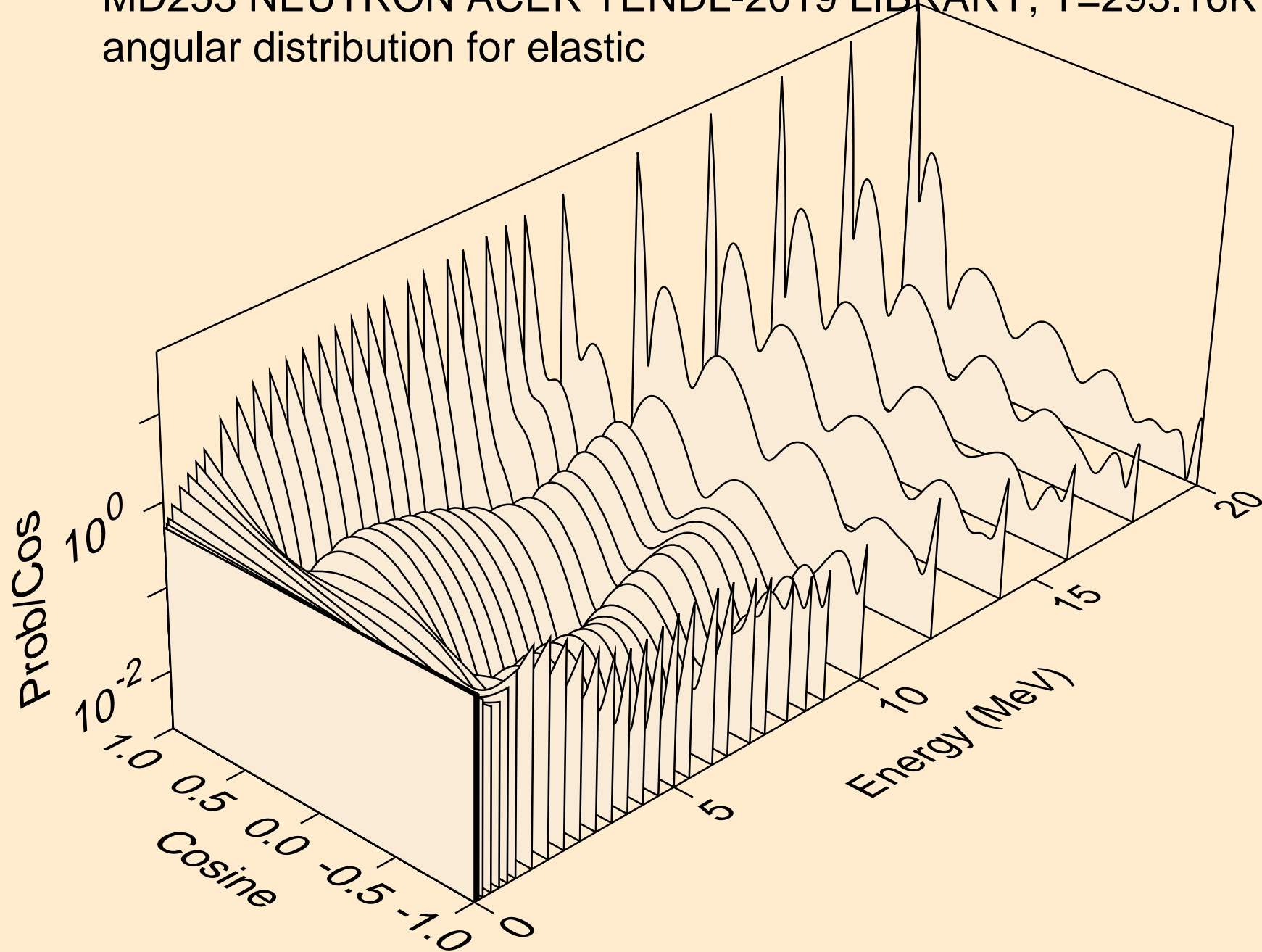



MD253 NEUTRON ACER TENDL-2019 LIBRARY; T=293.16K  
angular distribution for elastic

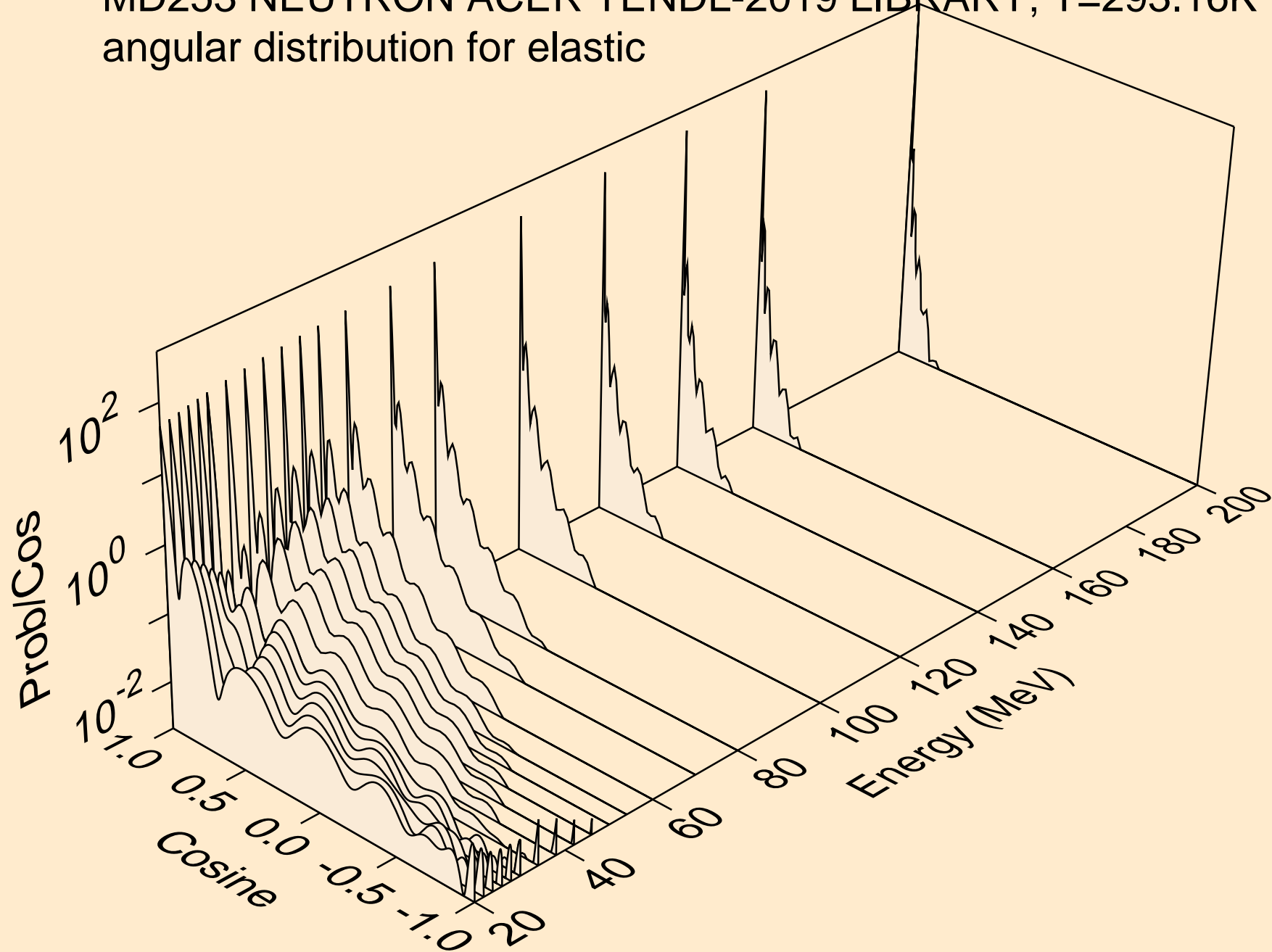

MD253 NEUTRON ACER TENDL-2019 LIBRARY; T=293.16K  
angular distribution for (n,n\*1)

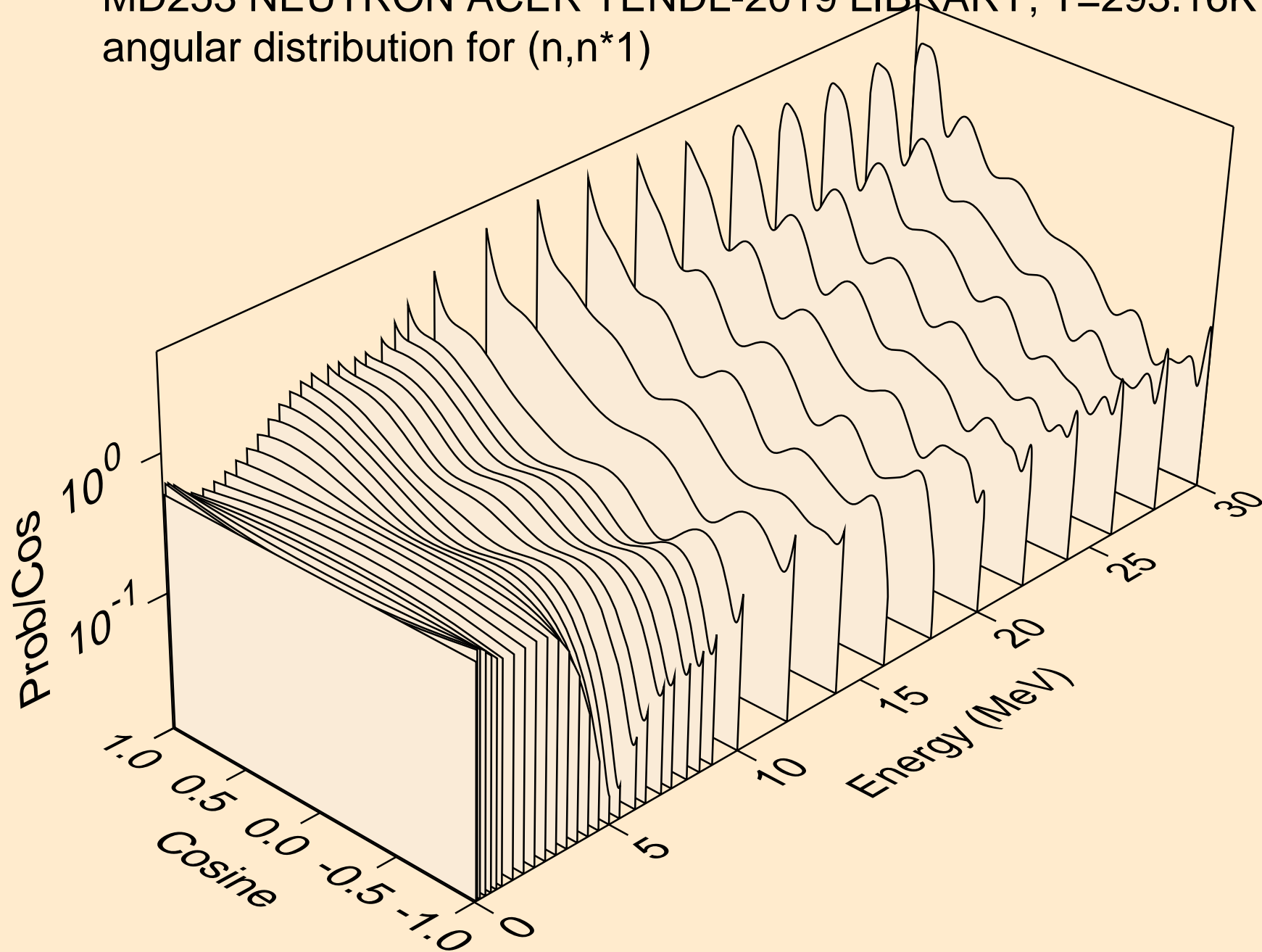

MD253 NEUTRON ACER TENDL-2019 LIBRARY; T=293.16K  
angular distribution for (n,n\*2)

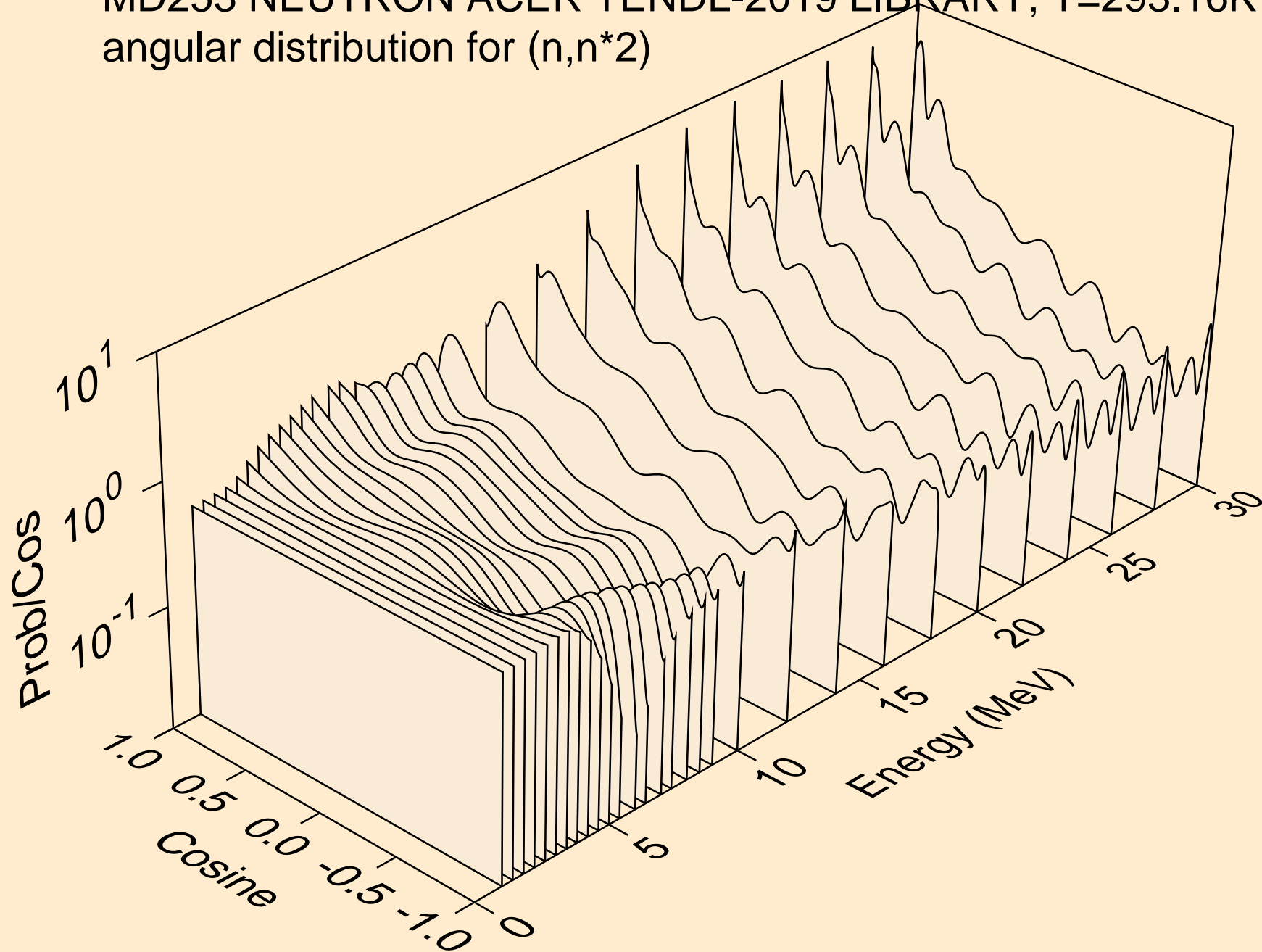

MD253 NEUTRON ACER TENDL-2019 LIBRARY; T=293.16K  
angular distribution for (n,n\*3)

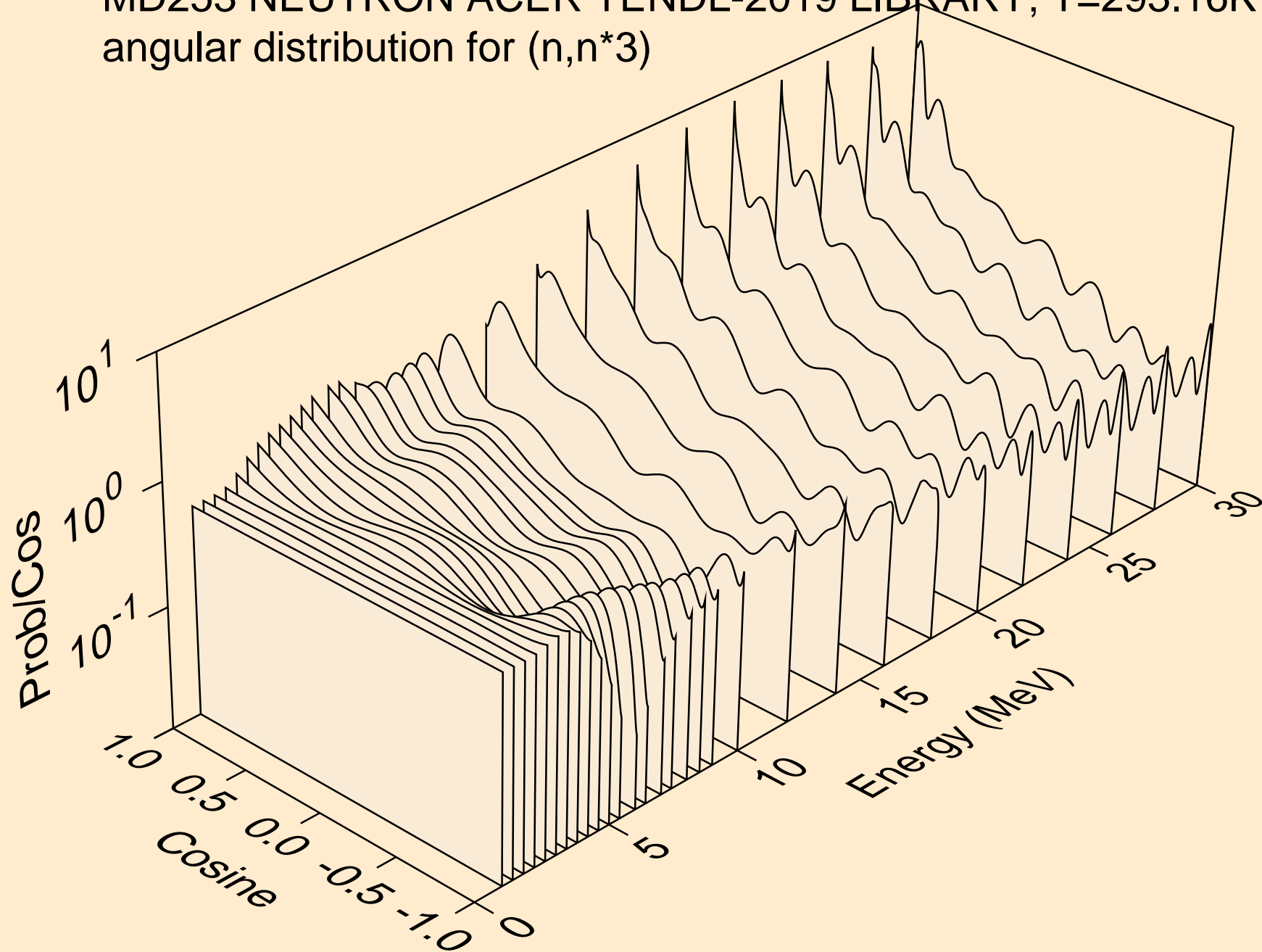

MD253 NEUTRON ACER TENDL-2019 LIBRARY; T=293.16K  
angular distribution for (n,n\*4)

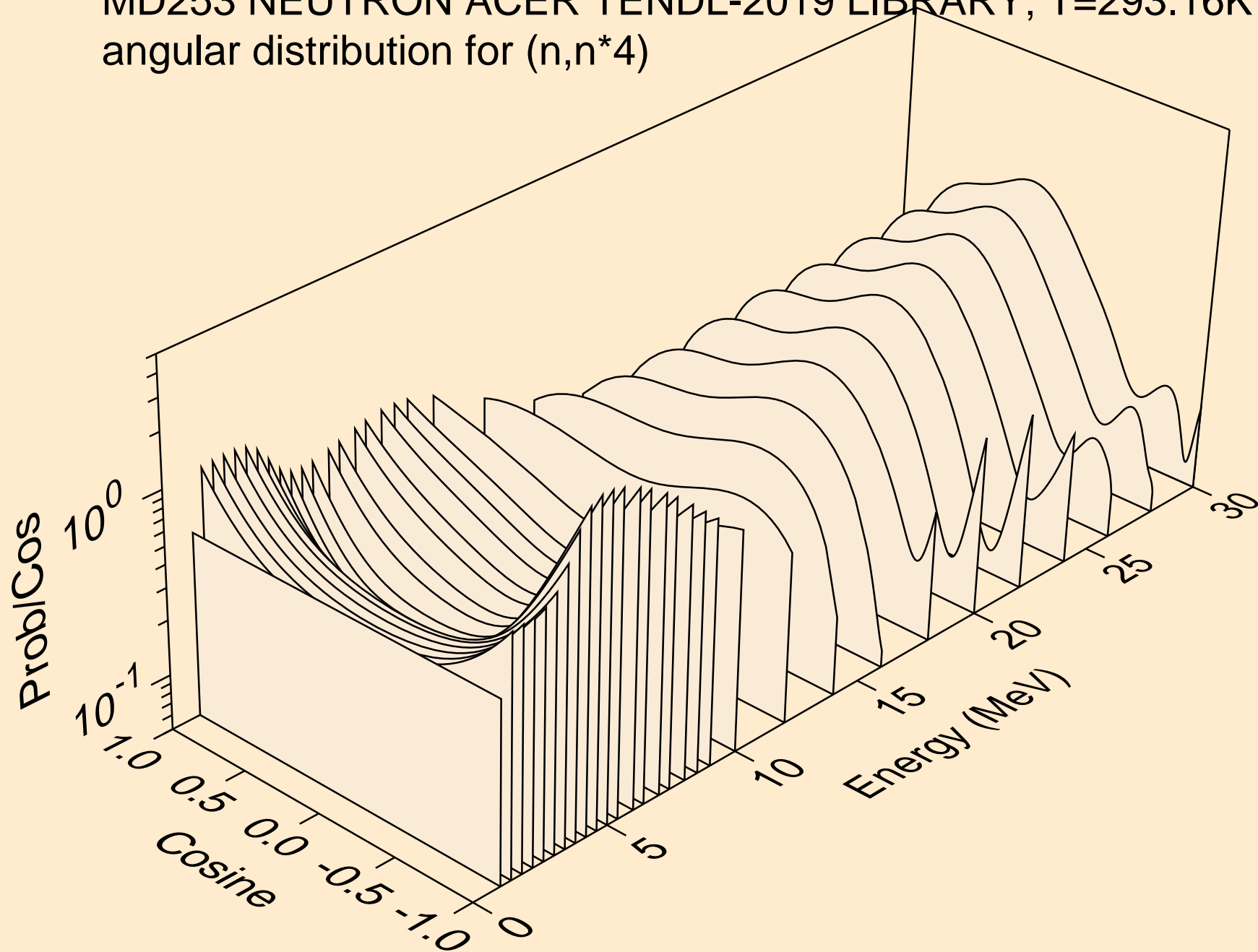

MD253 NEUTRON ACER TENDL-2019 LIBRARY; T=293.16K  
angular distribution for (n,n\*5)

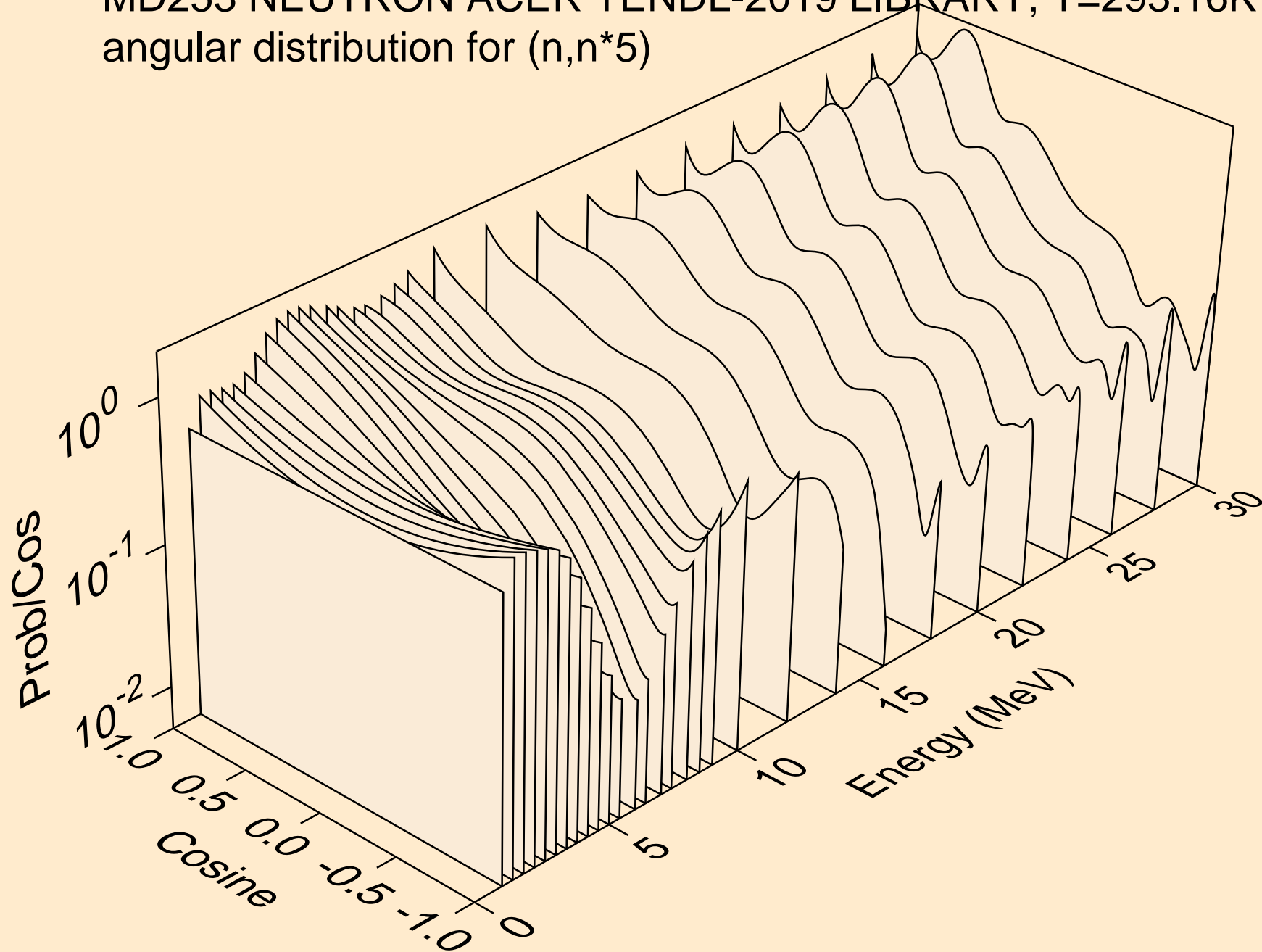

MD253 NEUTRON ACER TENDL-2019 LIBRARY; T=293.16K  
angular distribution for (n,n\*6)

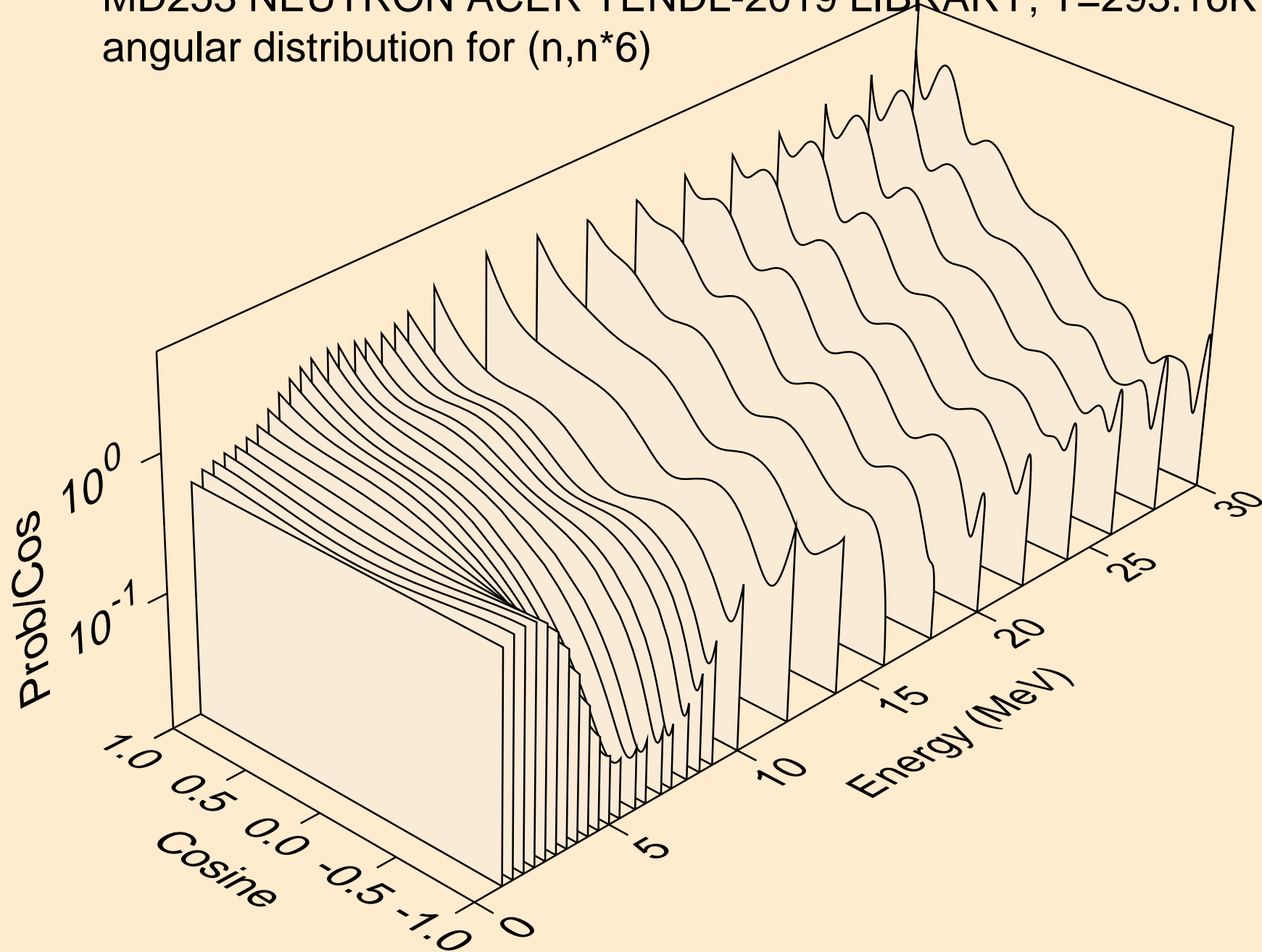

MD253 NEUTRON ACER TENDL-2019 LIBRARY; T=293.16K  
angular distribution for (n,n\*7)

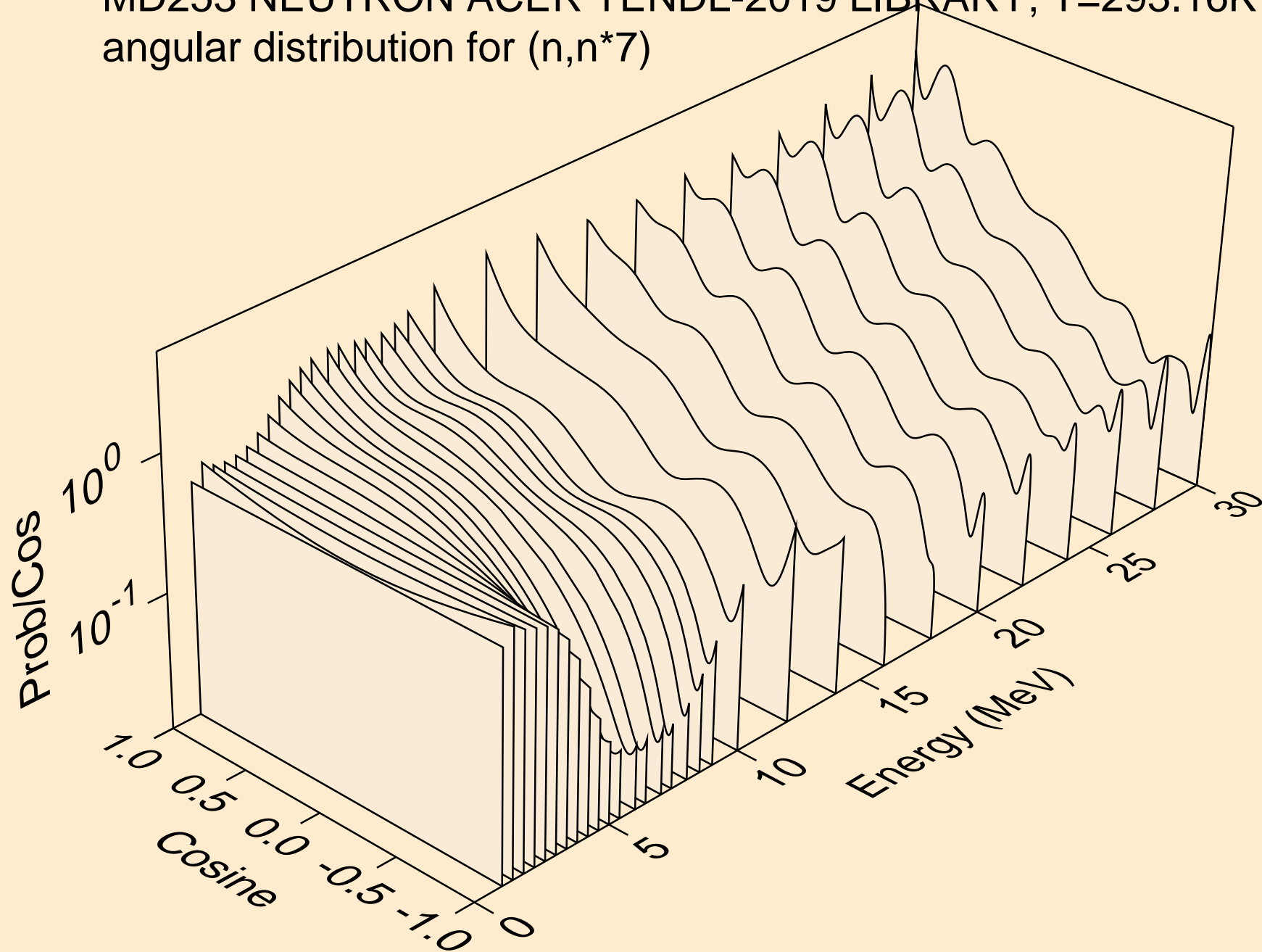



MD253 NEUTRON ACER TENDL-2019 LIBRARY; T=293.16K  
angular distribution for (n,n\*8)

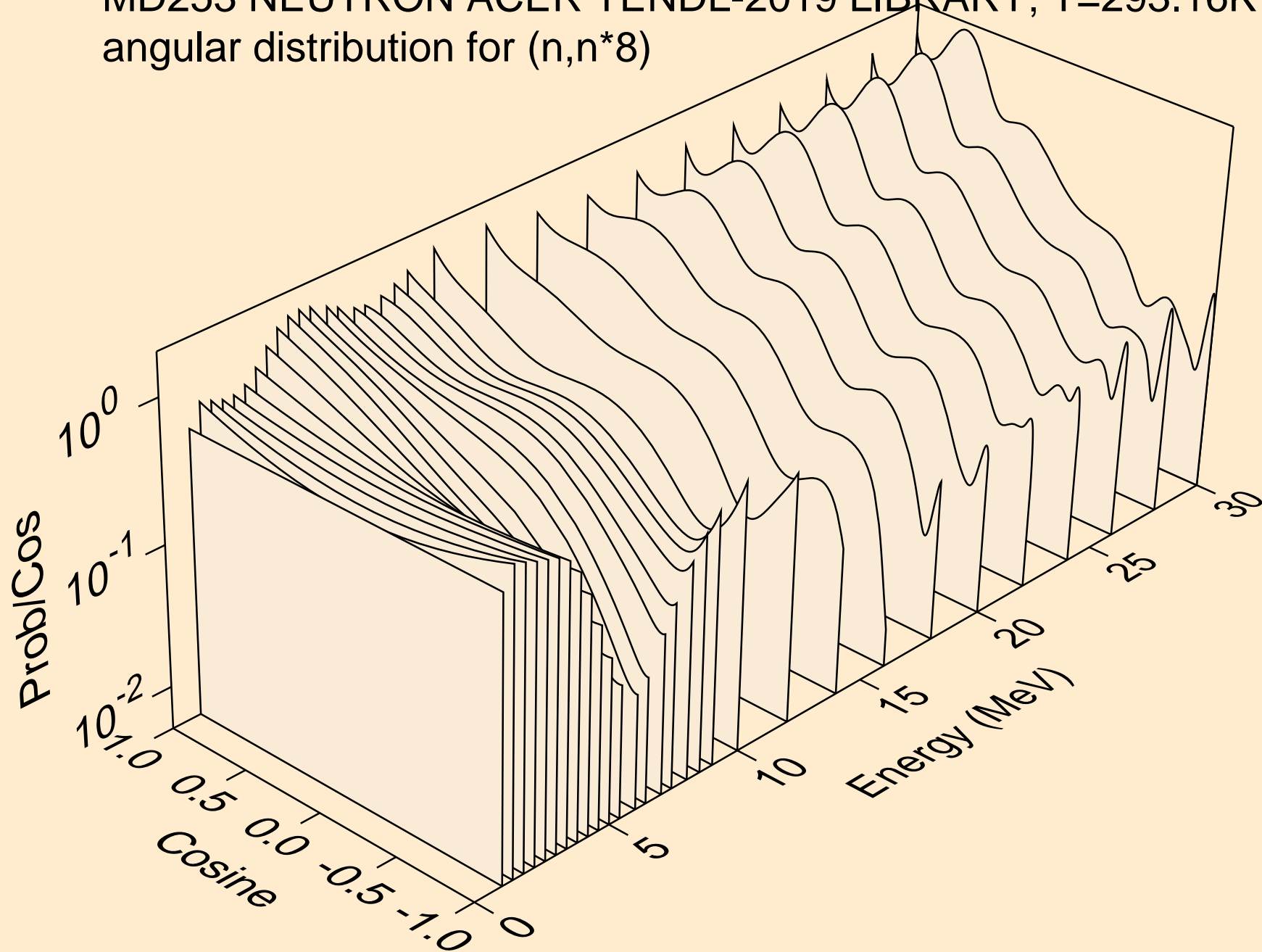

MD253 NEUTRON ACER TENDL-2019 LIBRARY; T=293.16K  
angular distribution for (n,n\*9)

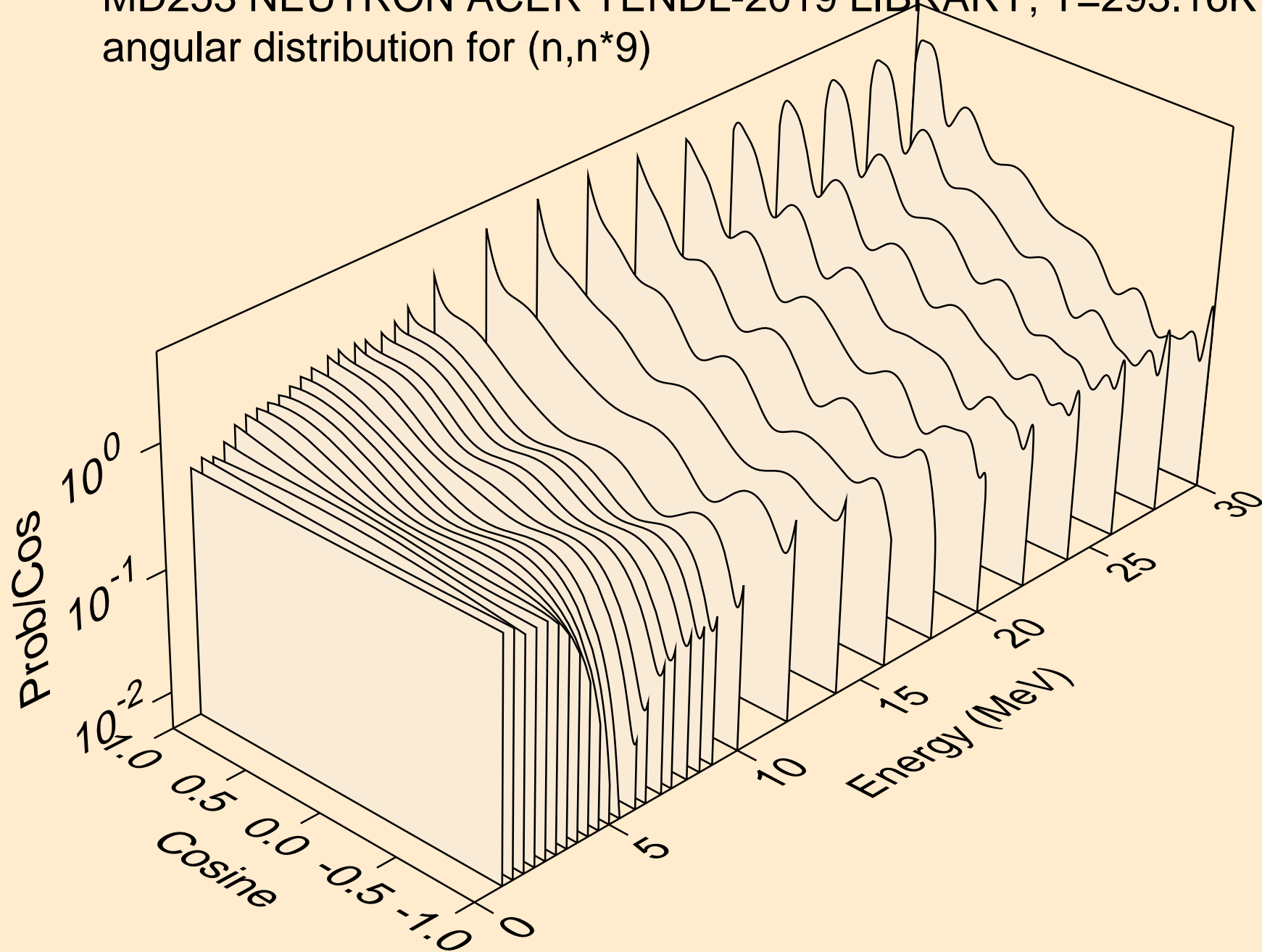

MD253 NEUTRON ACER TENDL-2019 LIBRARY; T=293.16K  
angular distribution for (n,n\*10)

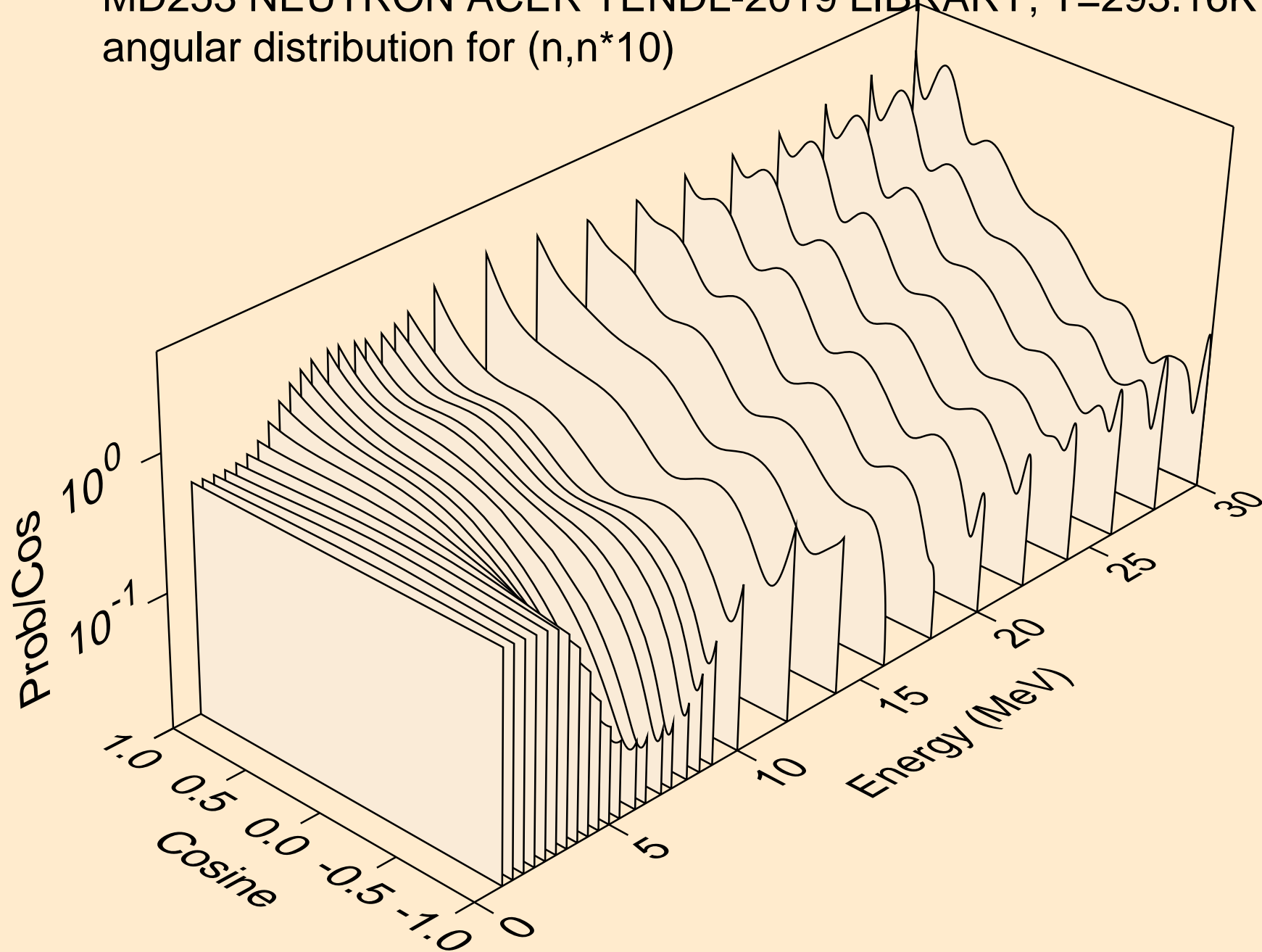

MD253 NEUTRON ACER TENDL-2019 LIBRARY; T=293.16K  
angular distribution for (n,n\*11)

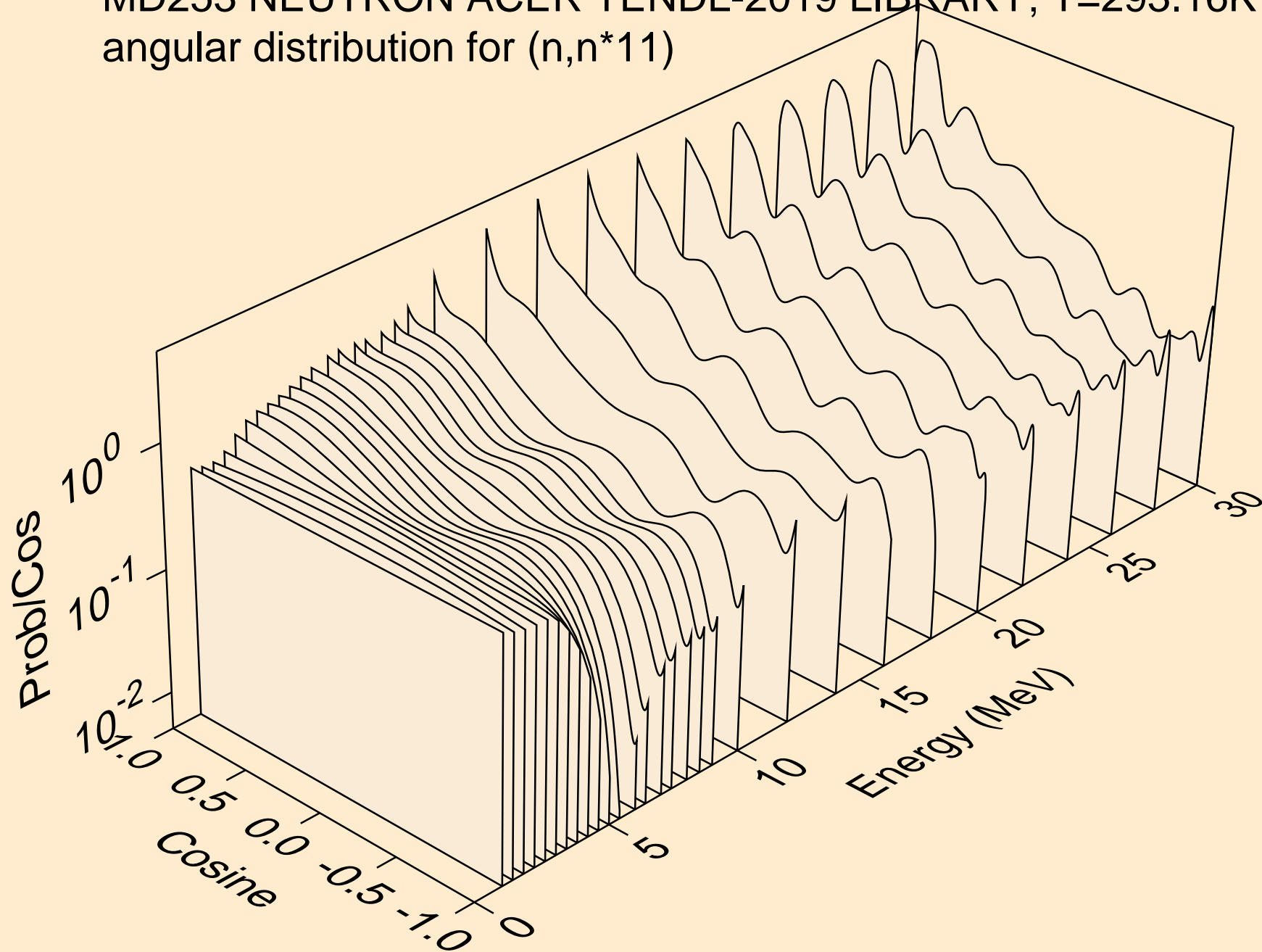

MD253 NEUTRON ACER TENDL-2019 LIBRARY; T=293.16K  
angular distribution for (n,n\*12)

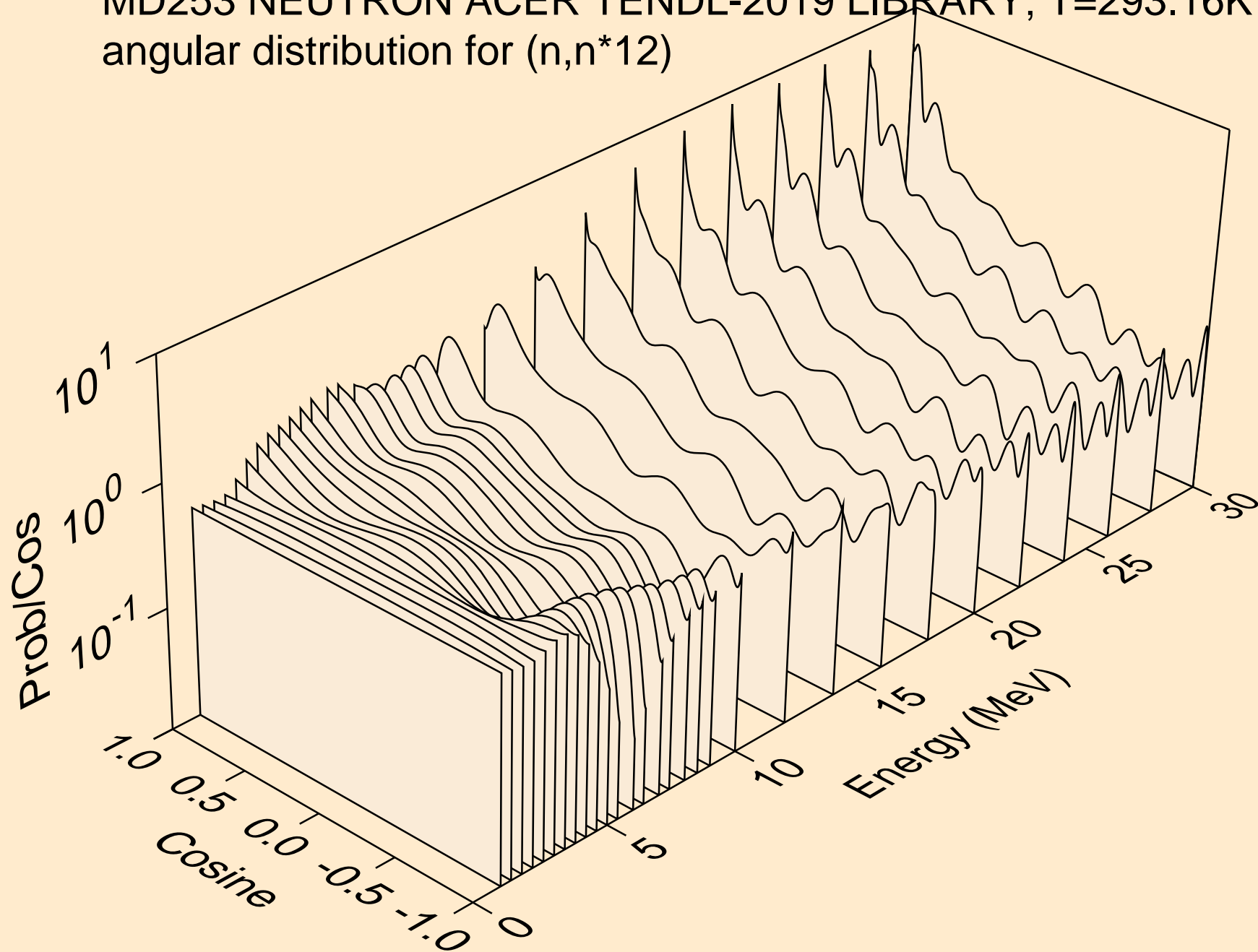

MD253 NEUTRON ACER TENDL-2019 LIBRARY; T=293.16K  
angular distribution for (n,n\*13)

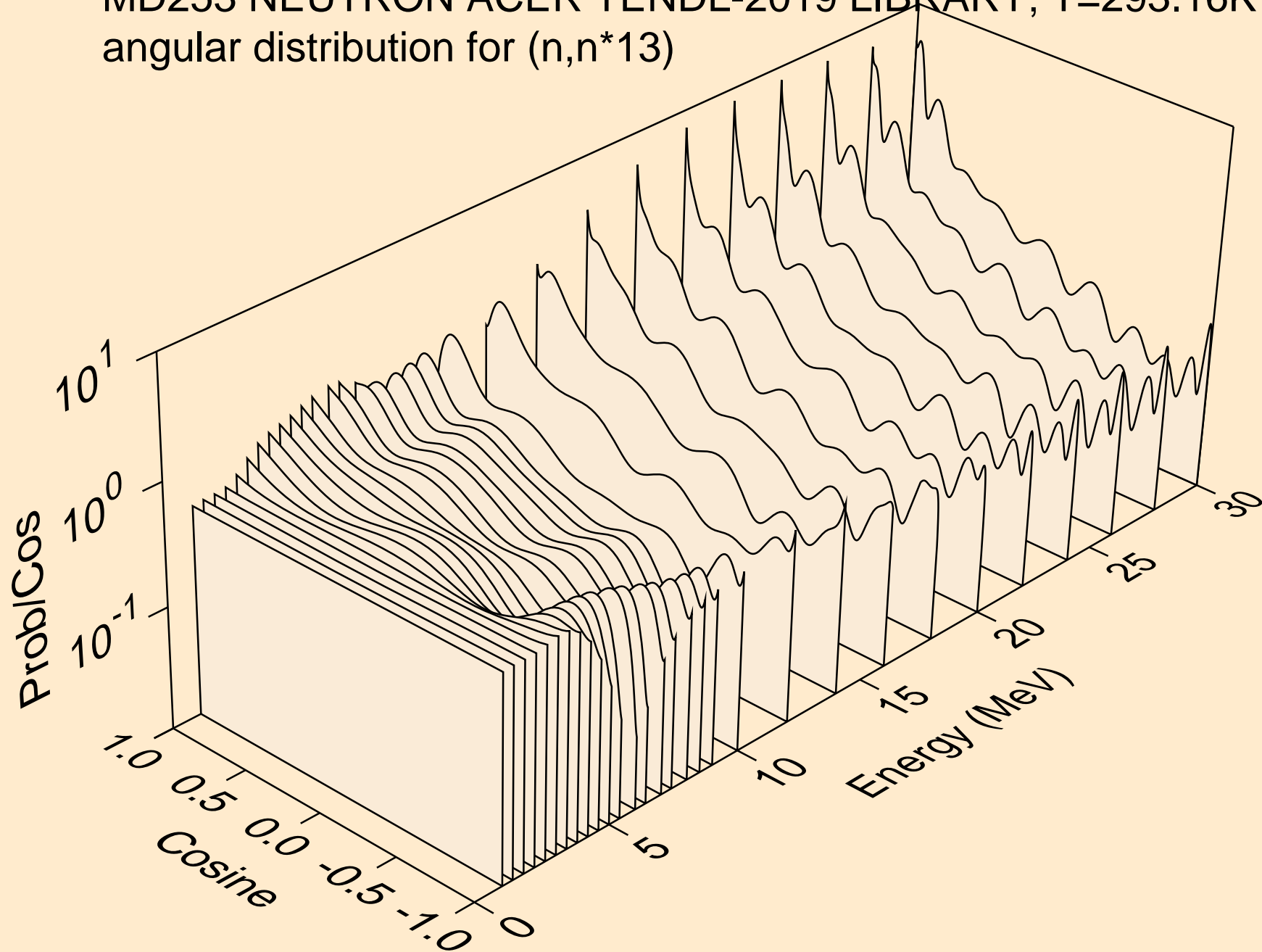

MD253 NEUTRON ACER TENDL-2019 LIBRARY; T=293.16K  
angular distribution for (n,n\*14)

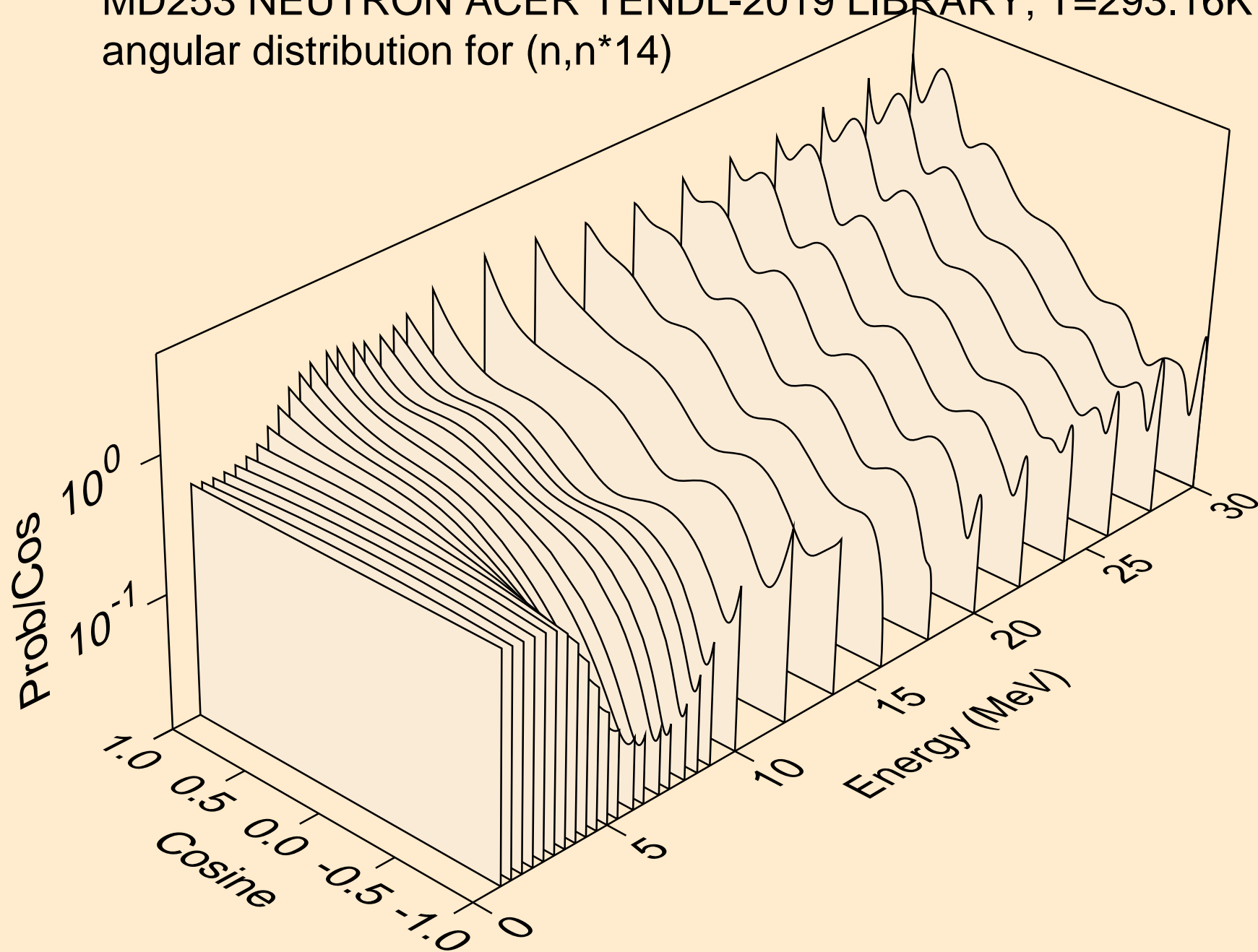

MD253 NEUTRON ACER TENDL-2019 LIBRARY; T=293.16K  
angular distribution for (n,n\*15)

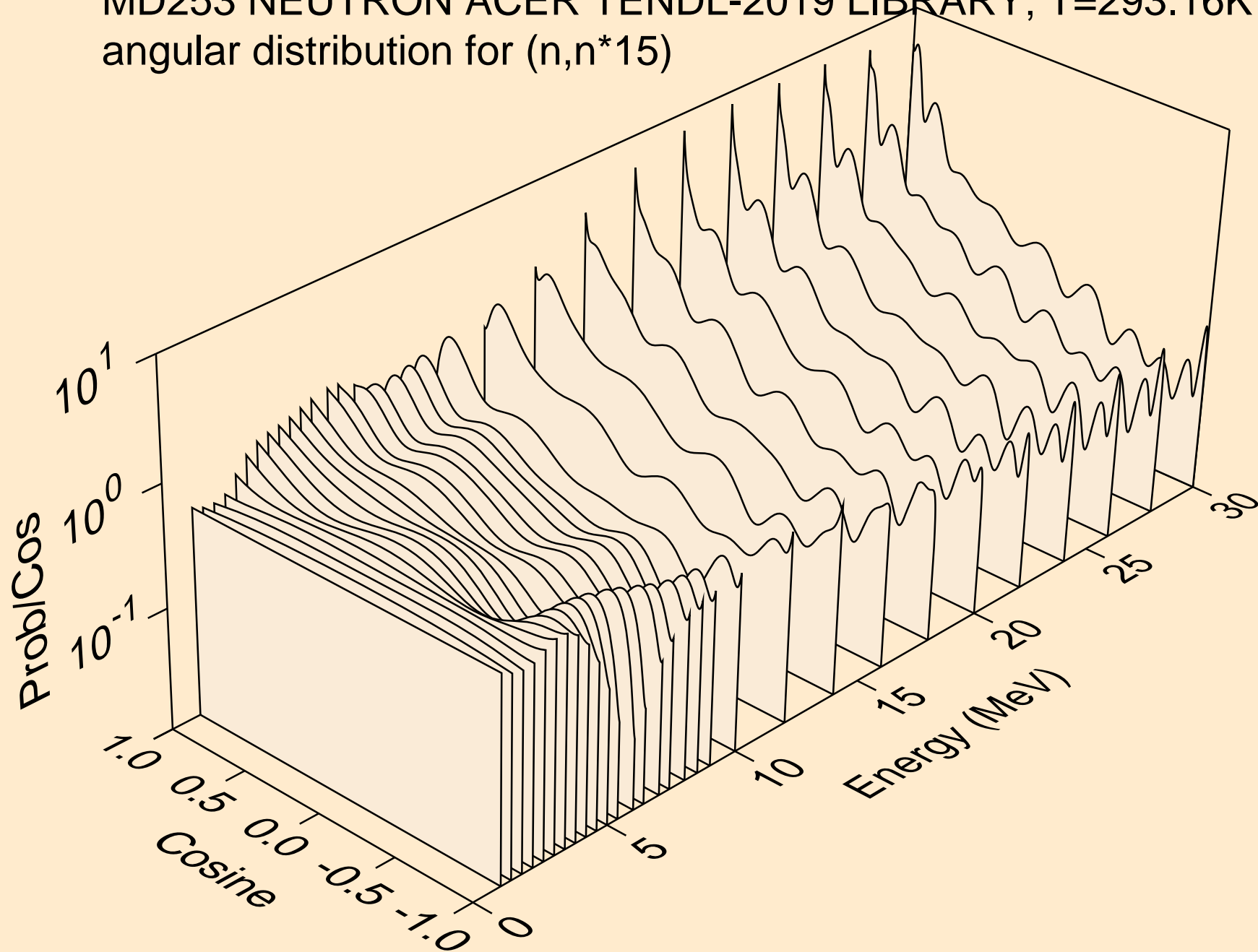



MD253 NEUTRON ACER TENDL-2019 LIBRARY; T=293.16K  
angular distribution for (n,n\*16)

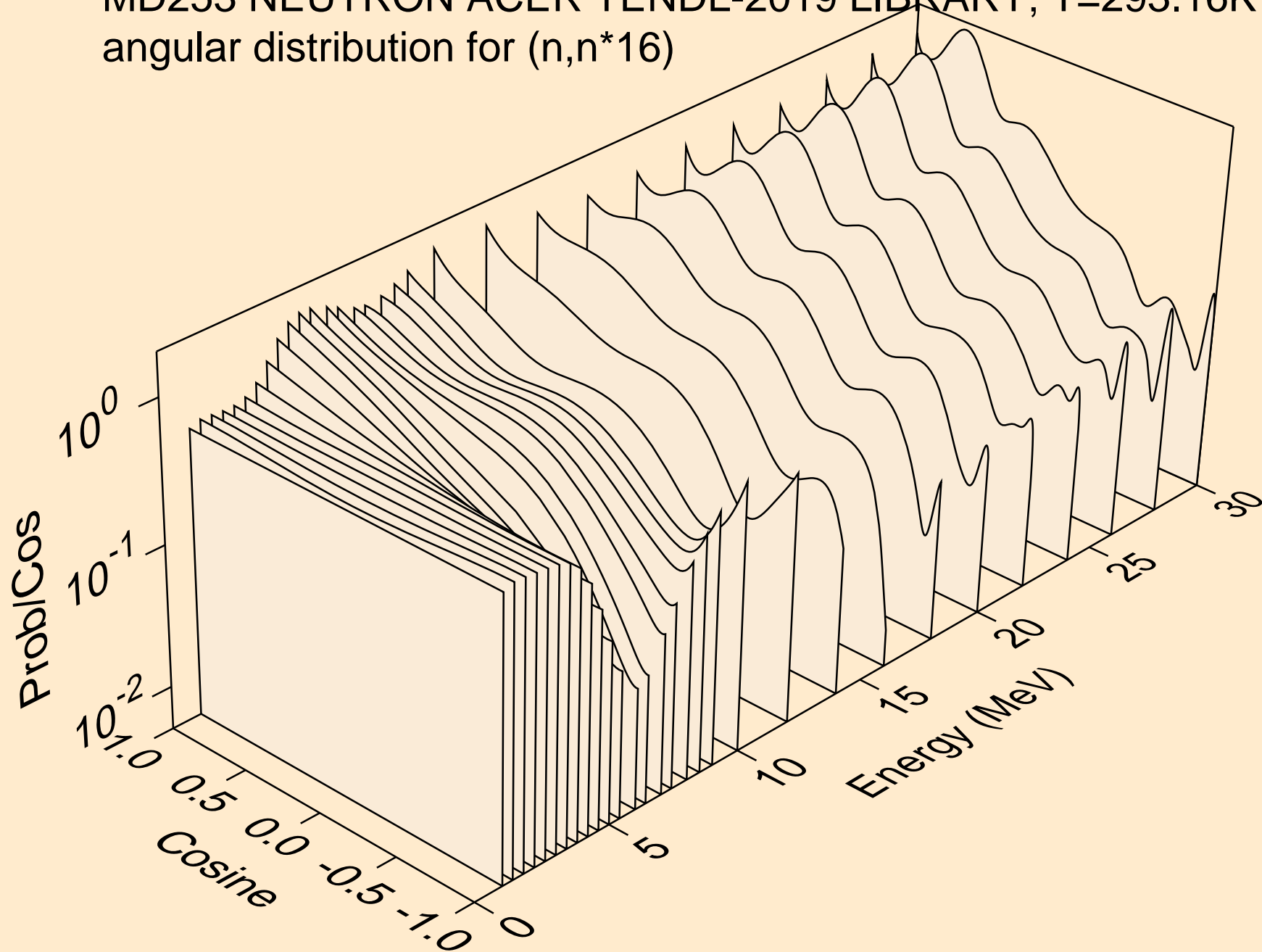

MD253 NEUTRON ACER TENDL-2019 LIBRARY; T=293.16K  
angular distribution for (n,n\*17)

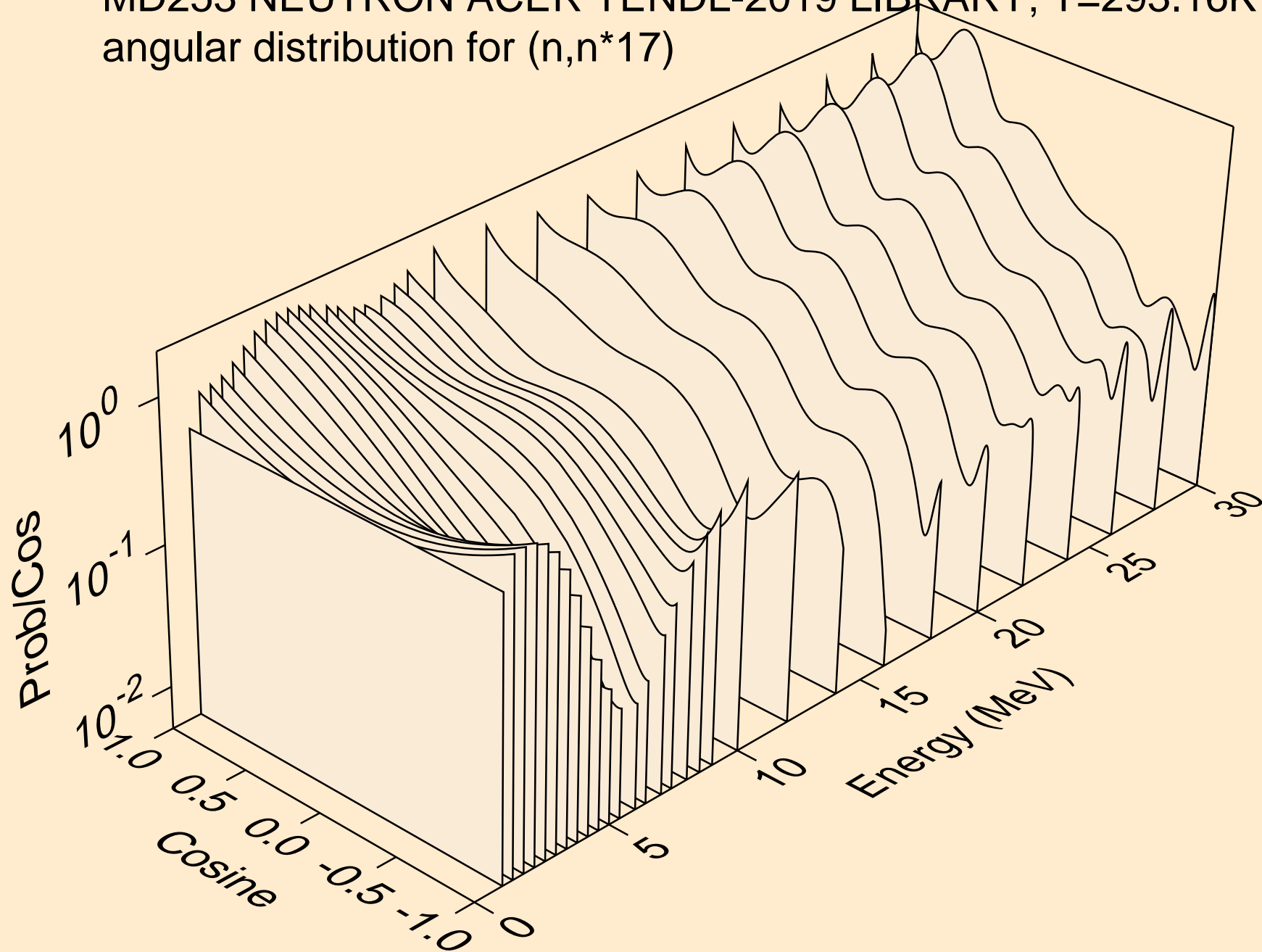

MD253 NEUTRON ACER TENDL-2019 LIBRARY; T=293.16K  
angular distribution for (n,n\*18)

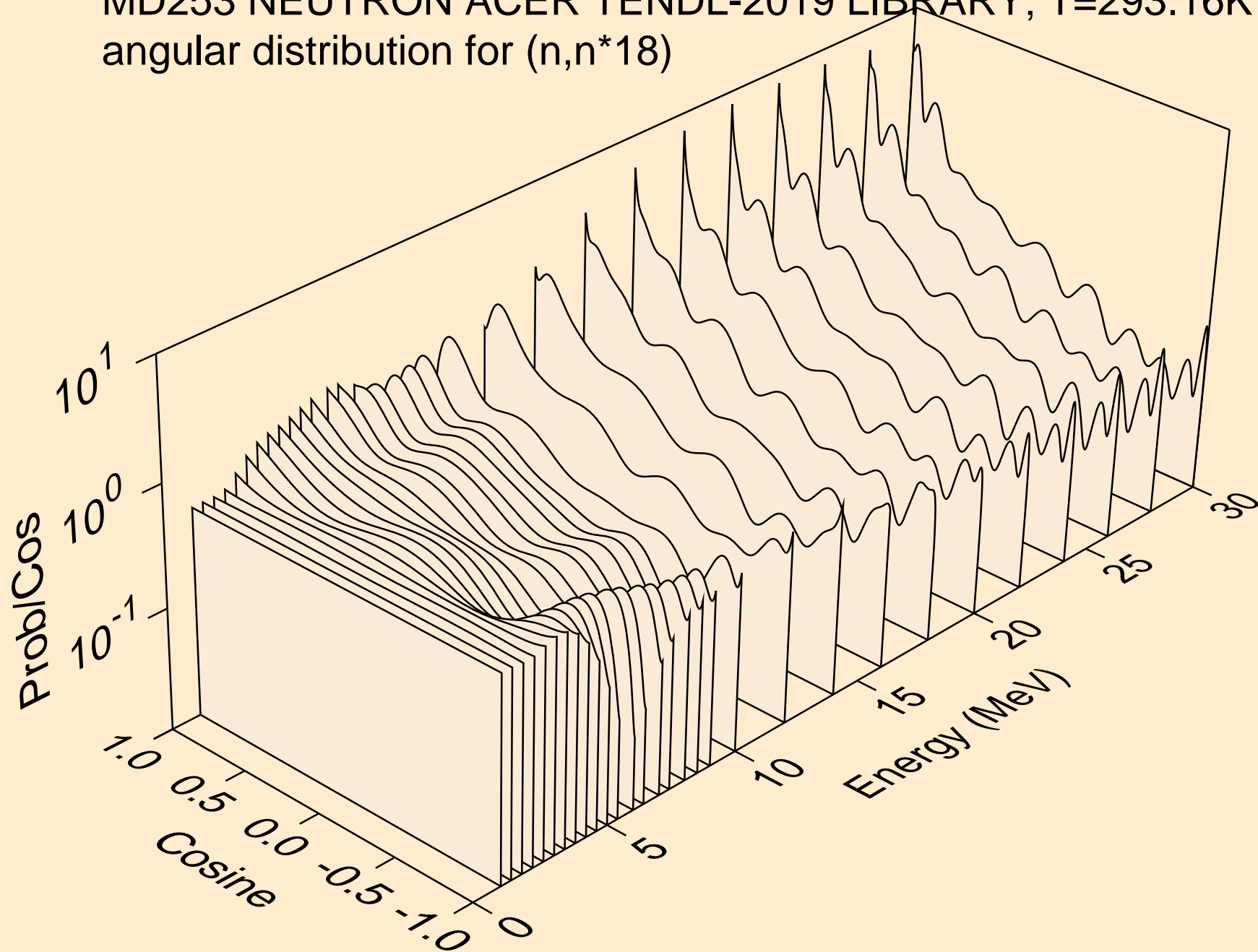

MD253 NEUTRON ACER TENDL-2019 LIBRARY; T=293.16K  
angular distribution for (n,n\*19)

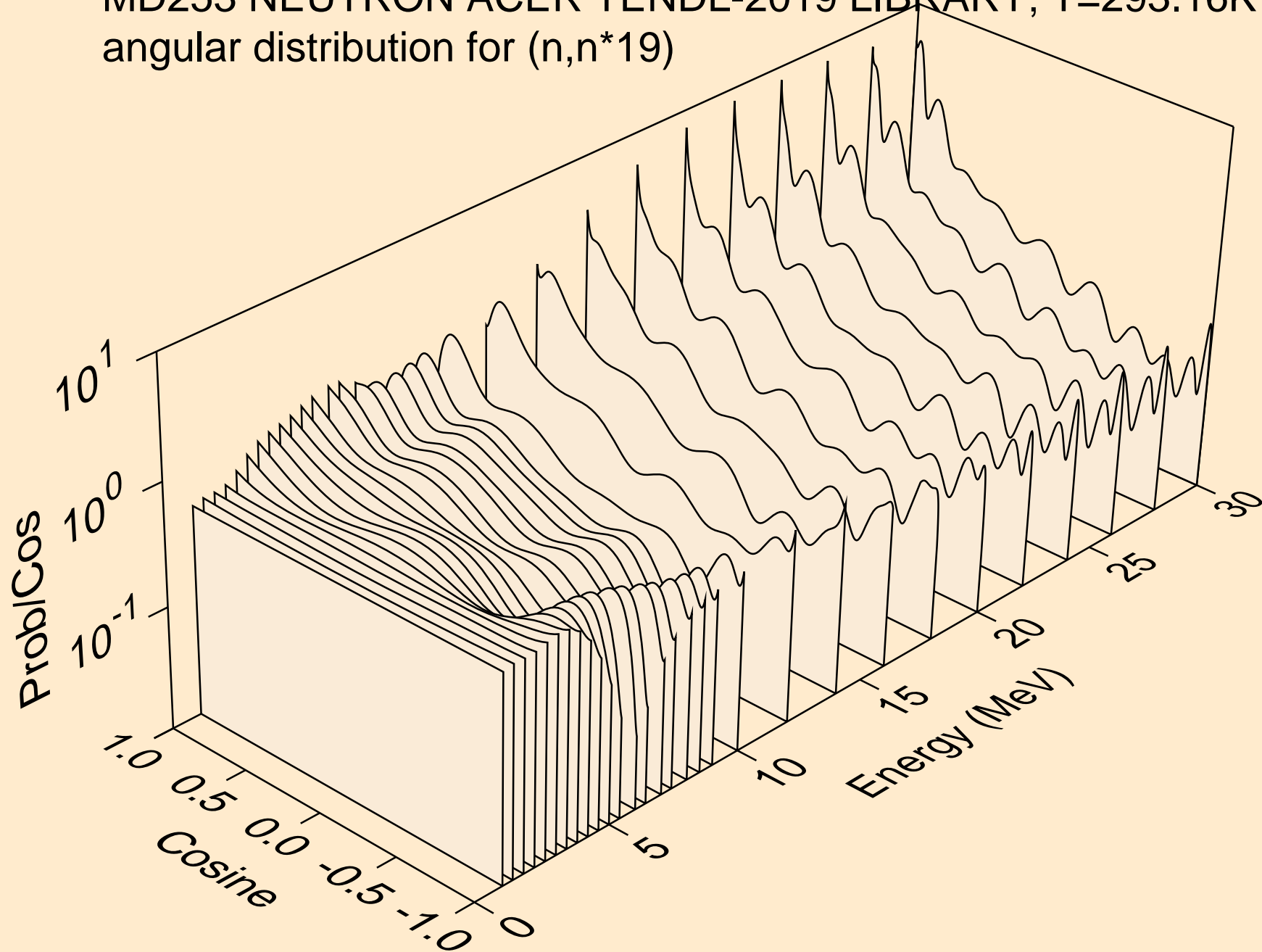

MD253 NEUTRON ACER TENDL-2019 LIBRARY; T=293.16K  
angular distribution for (n,n\*20)

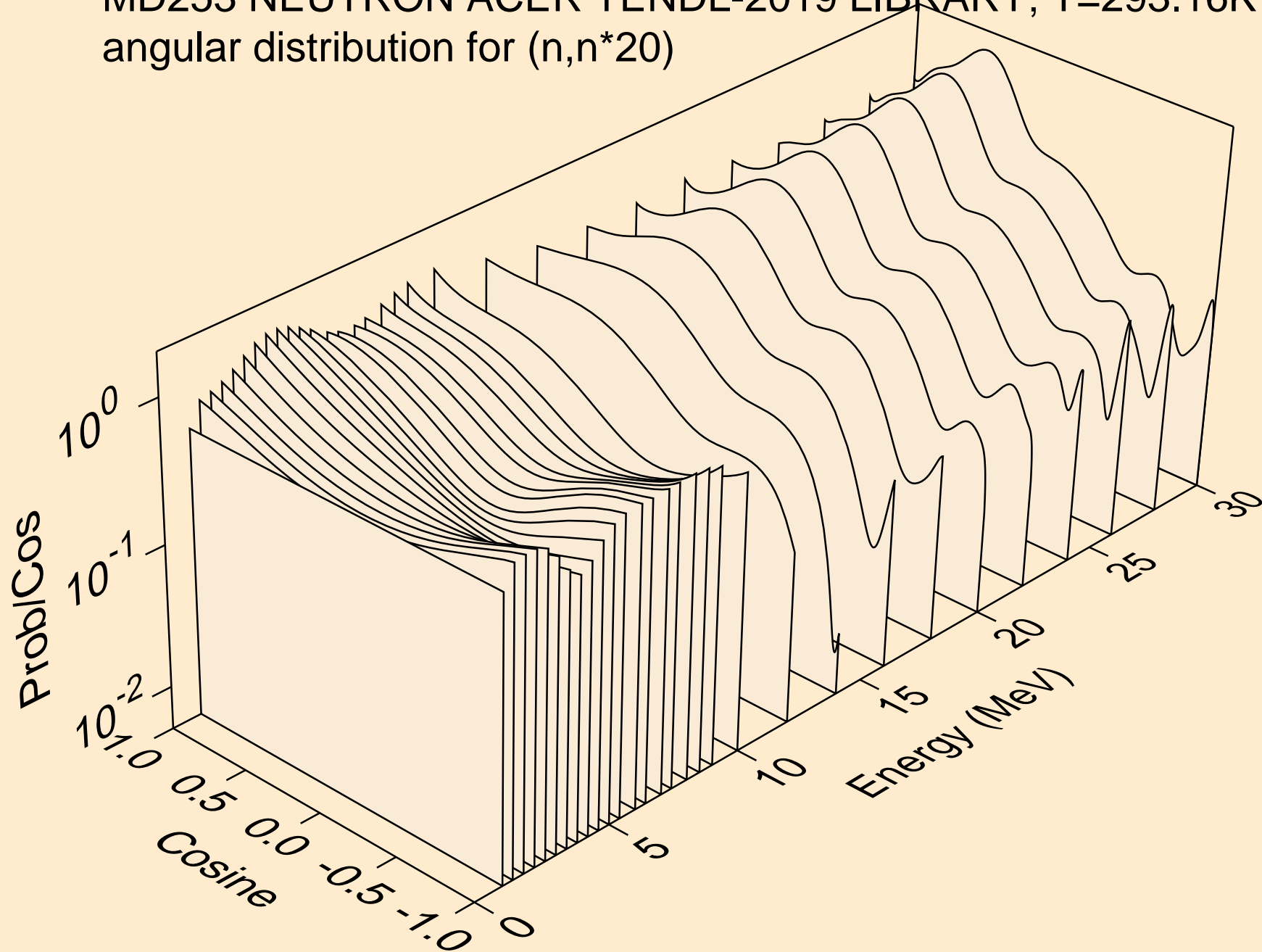

MD253 NEUTRON ACER TENDL-2019 LIBRARY; T=293.16K  
angular distribution for (n,n\*21)

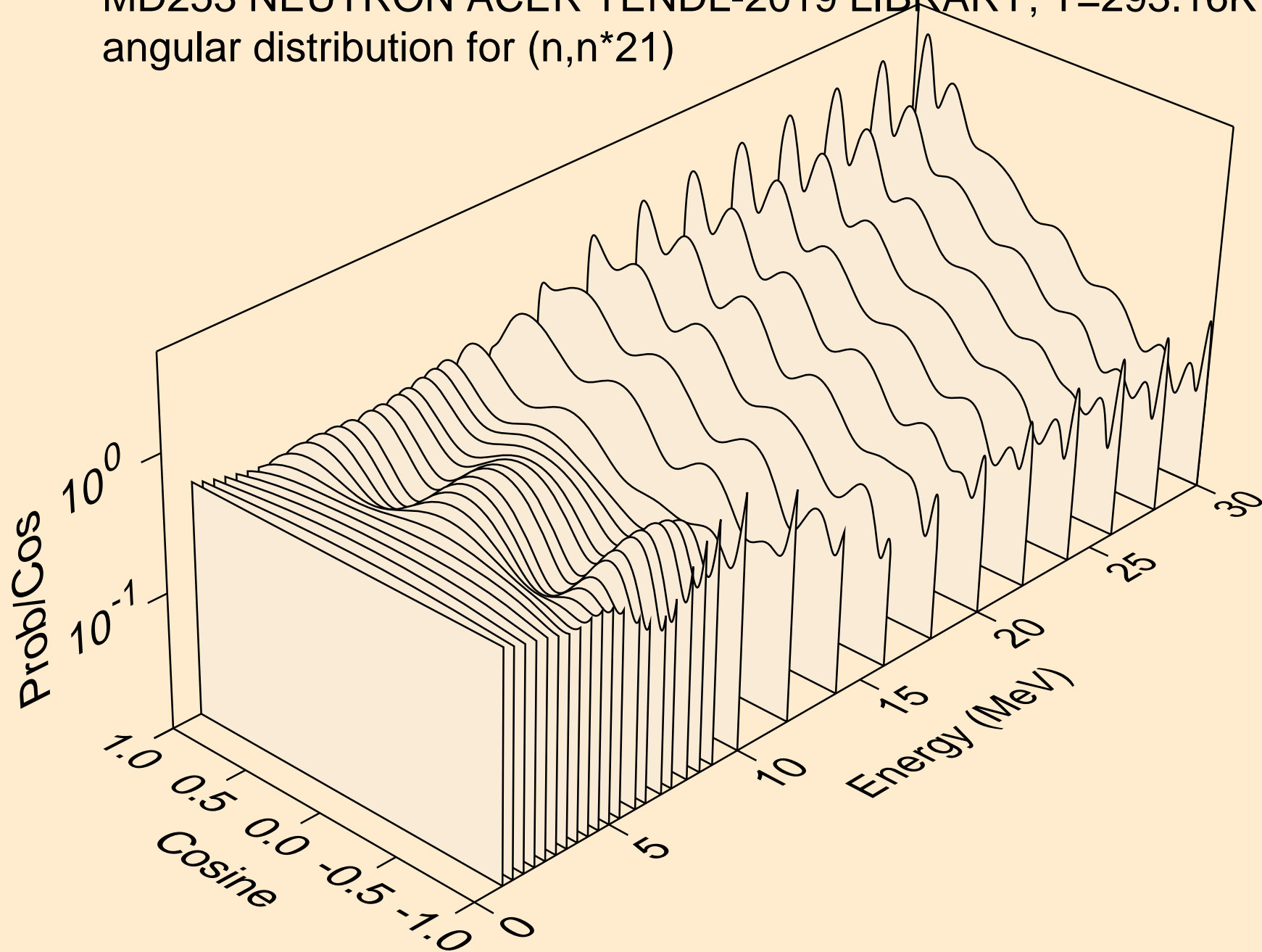

MD253 NEUTRON ACER TENDL-2019 LIBRARY; T=293.16K  
angular distribution for (n,n\*22)

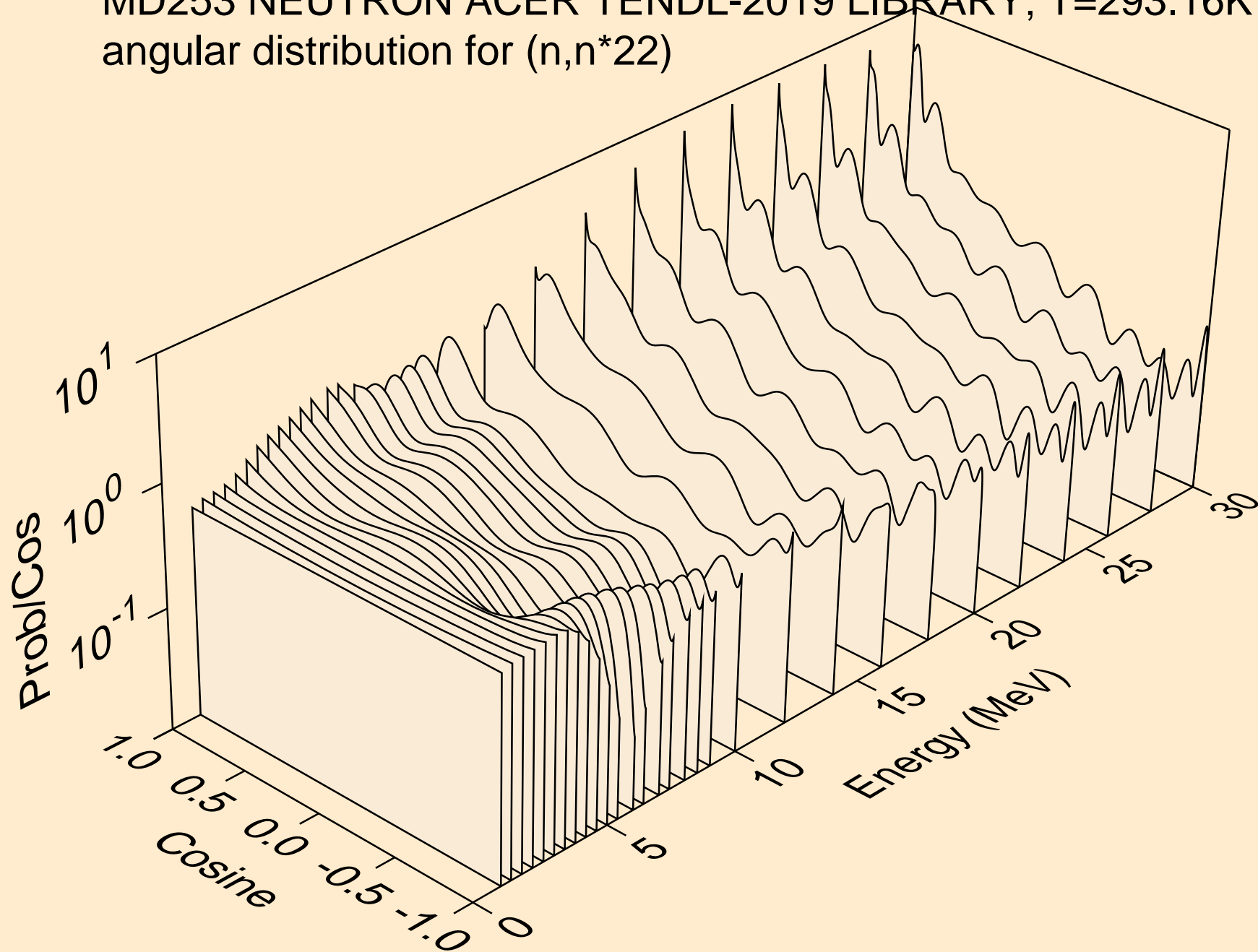

MD253 NEUTRON ACER TENDL-2019 LIBRARY; T=293.16K  
angular distribution for (n,n\*23)

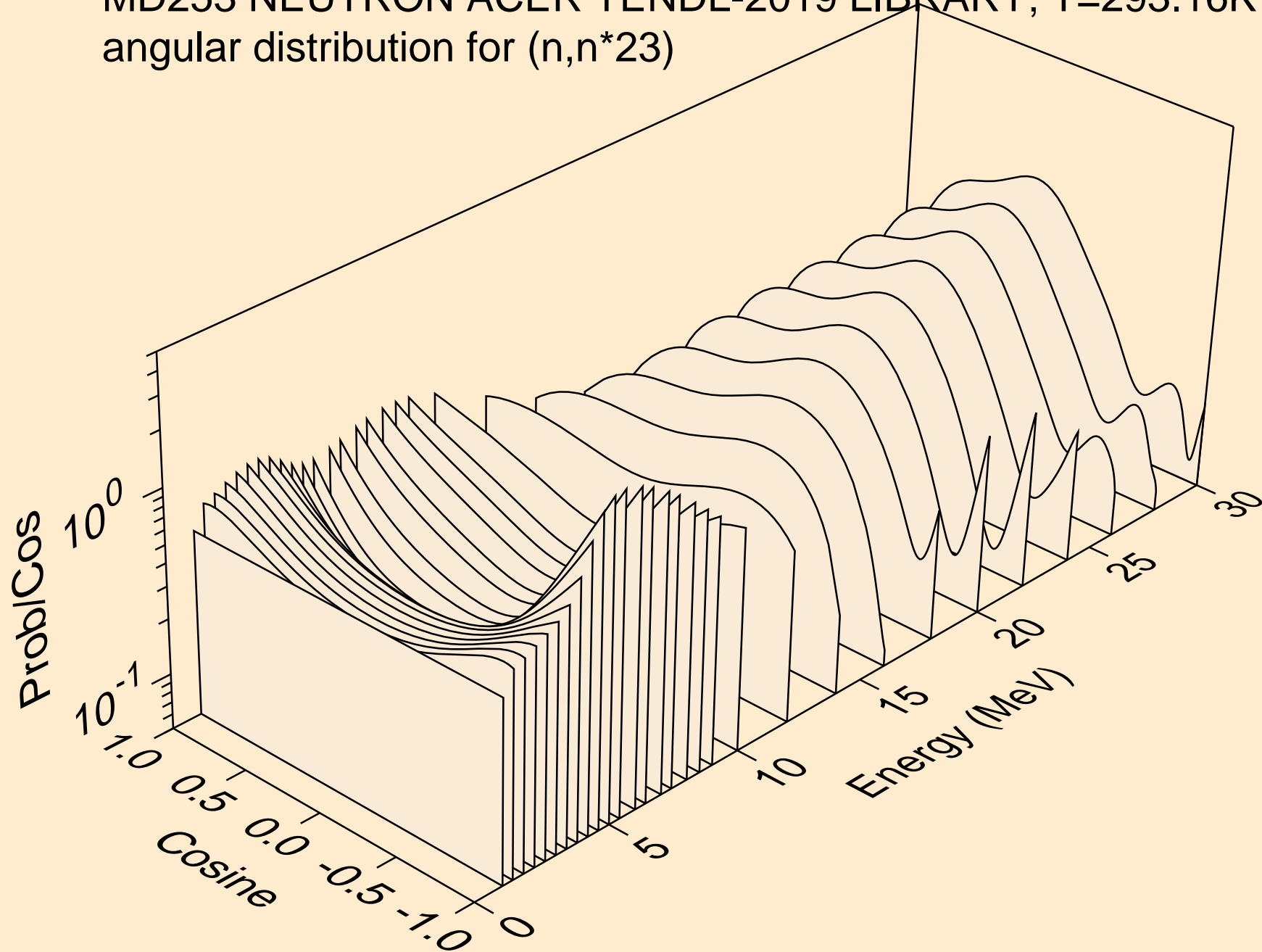



MD253 NEUTRON ACER TENDL-2019 LIBRARY; T=293.16K  
angular distribution for (n,n\*24)

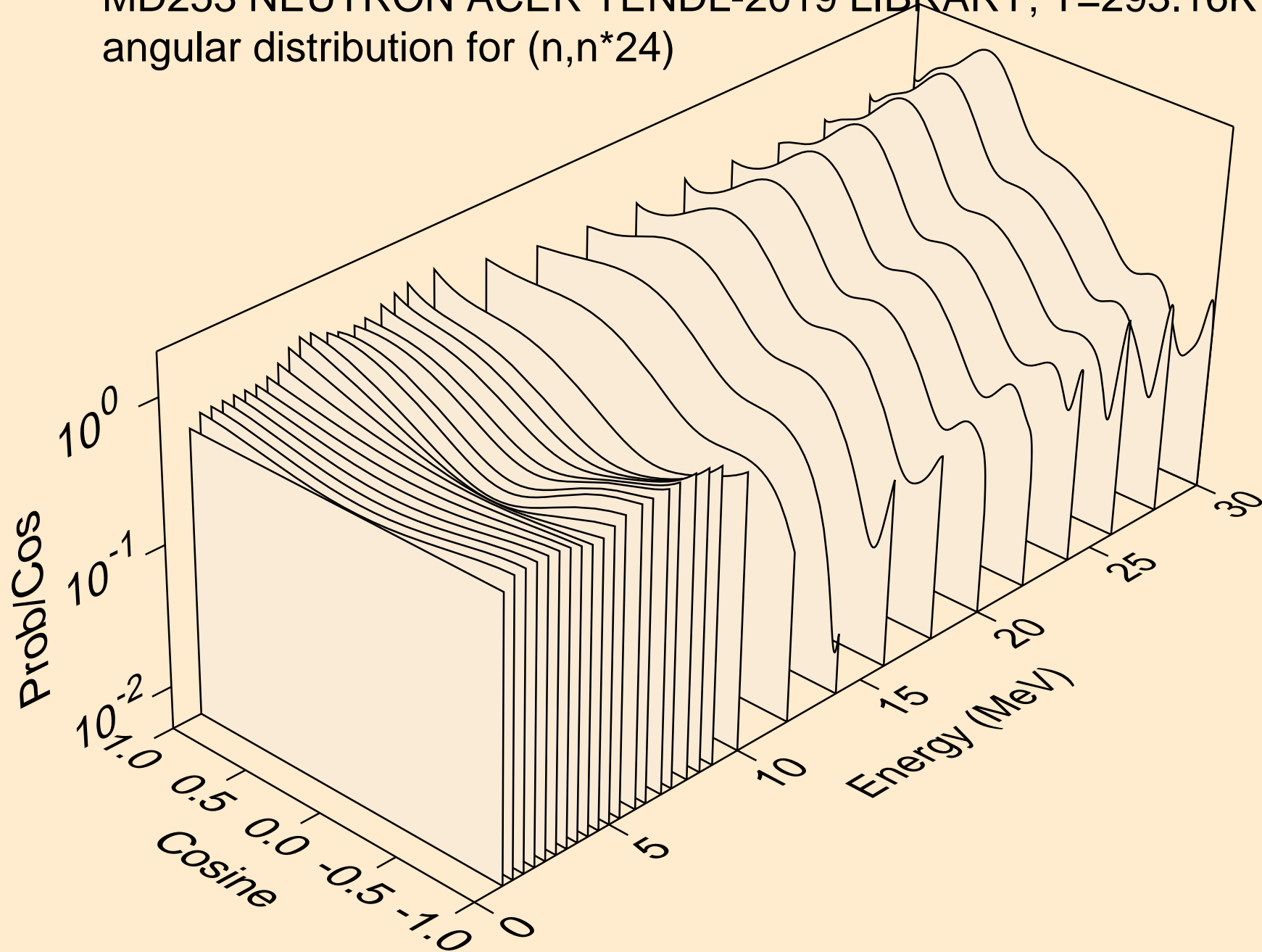

MD253 NEUTRON ACER TENDL-2019 LIBRARY; T=293.16K  
angular distribution for (n,n\*25)

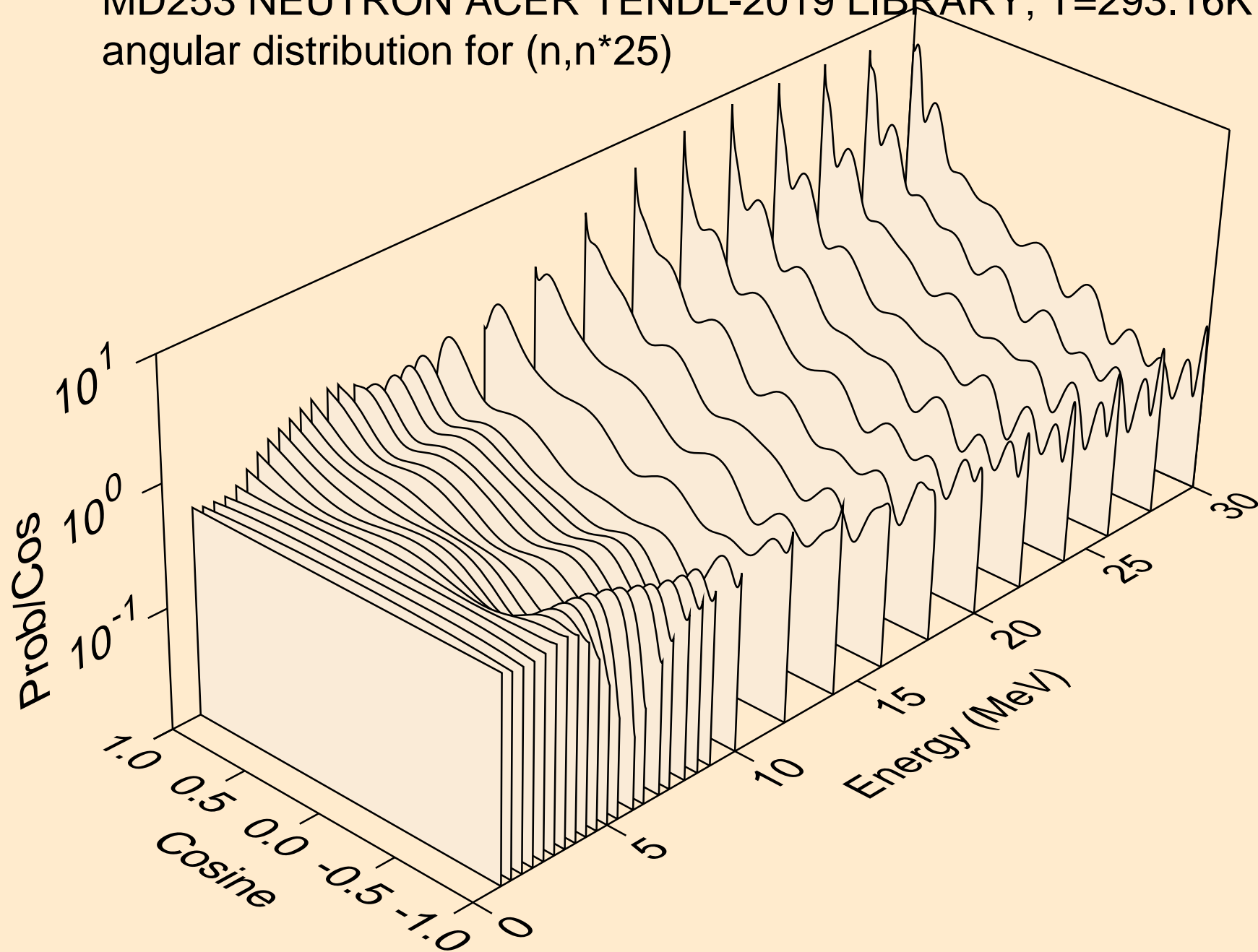

MD253 NEUTRON ACER TENDL-2019 LIBRARY; T=293.16K  
angular distribution for (n,n\*26)

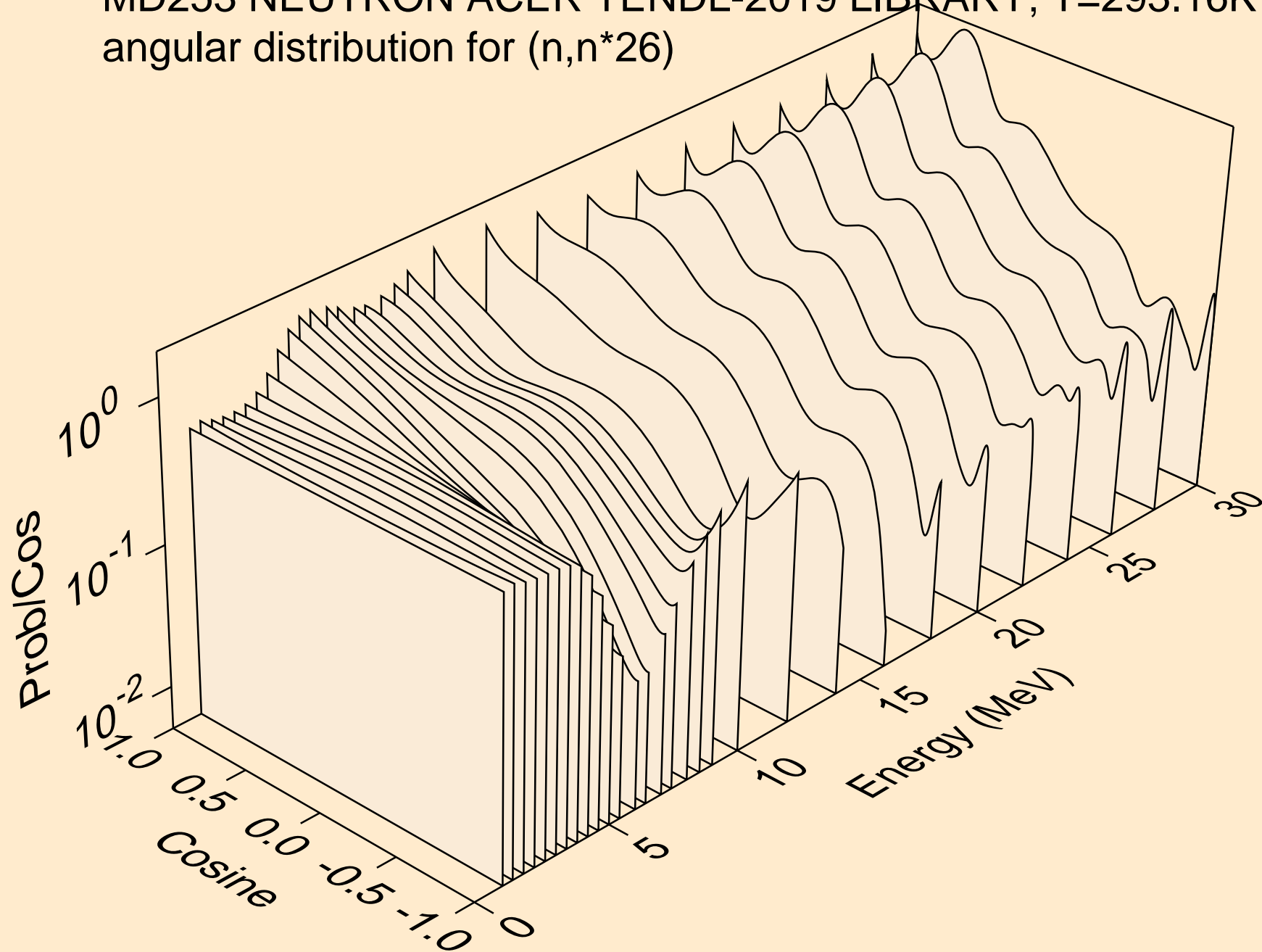

MD253 NEUTRON ACER TENDL-2019 LIBRARY; T=293.16K  
angular distribution for (n,n\*27)

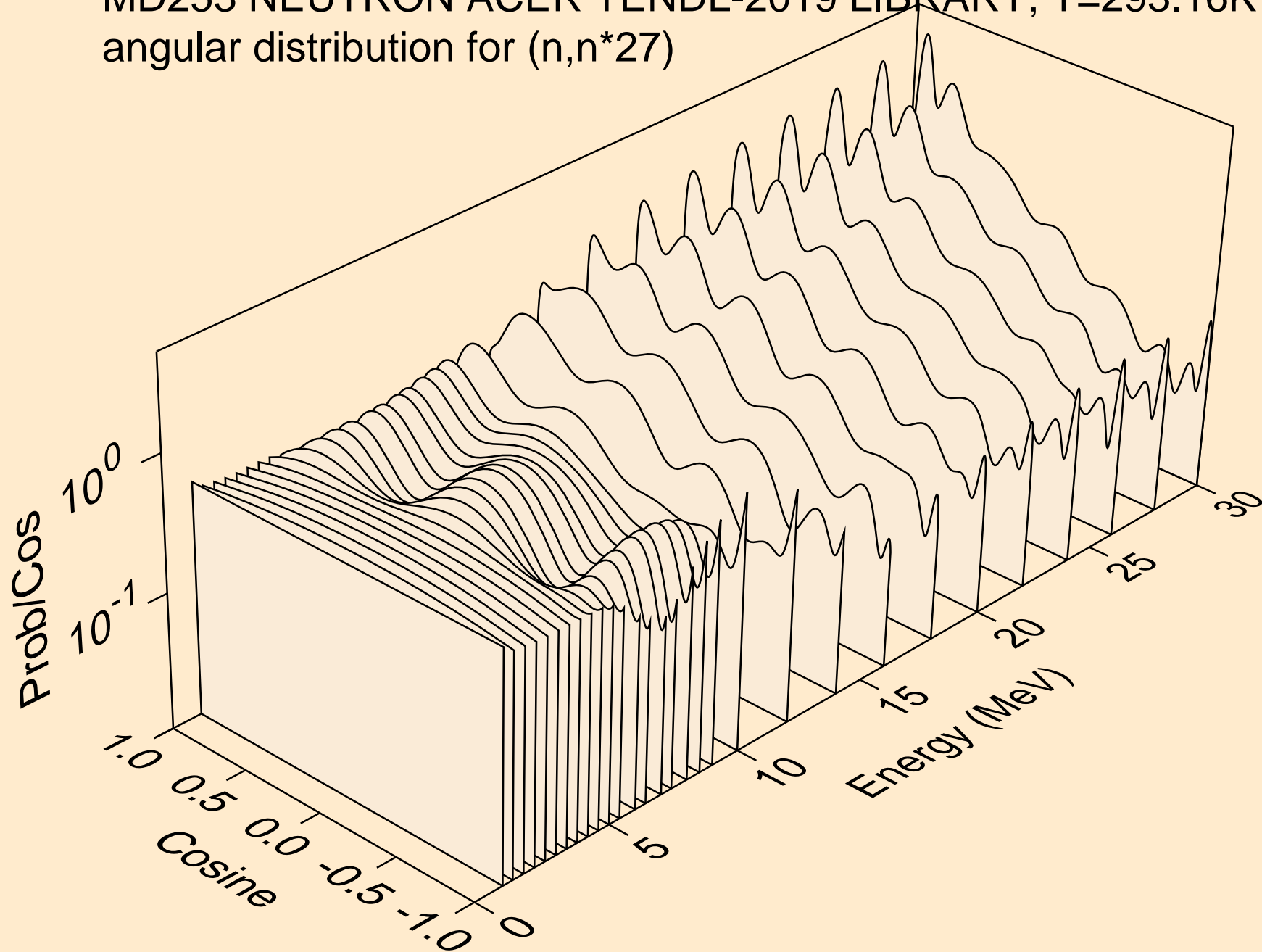

MD253 NEUTRON ACER TENDL-2019 LIBRARY; T=293.16K  
angular distribution for (n,n\*28)

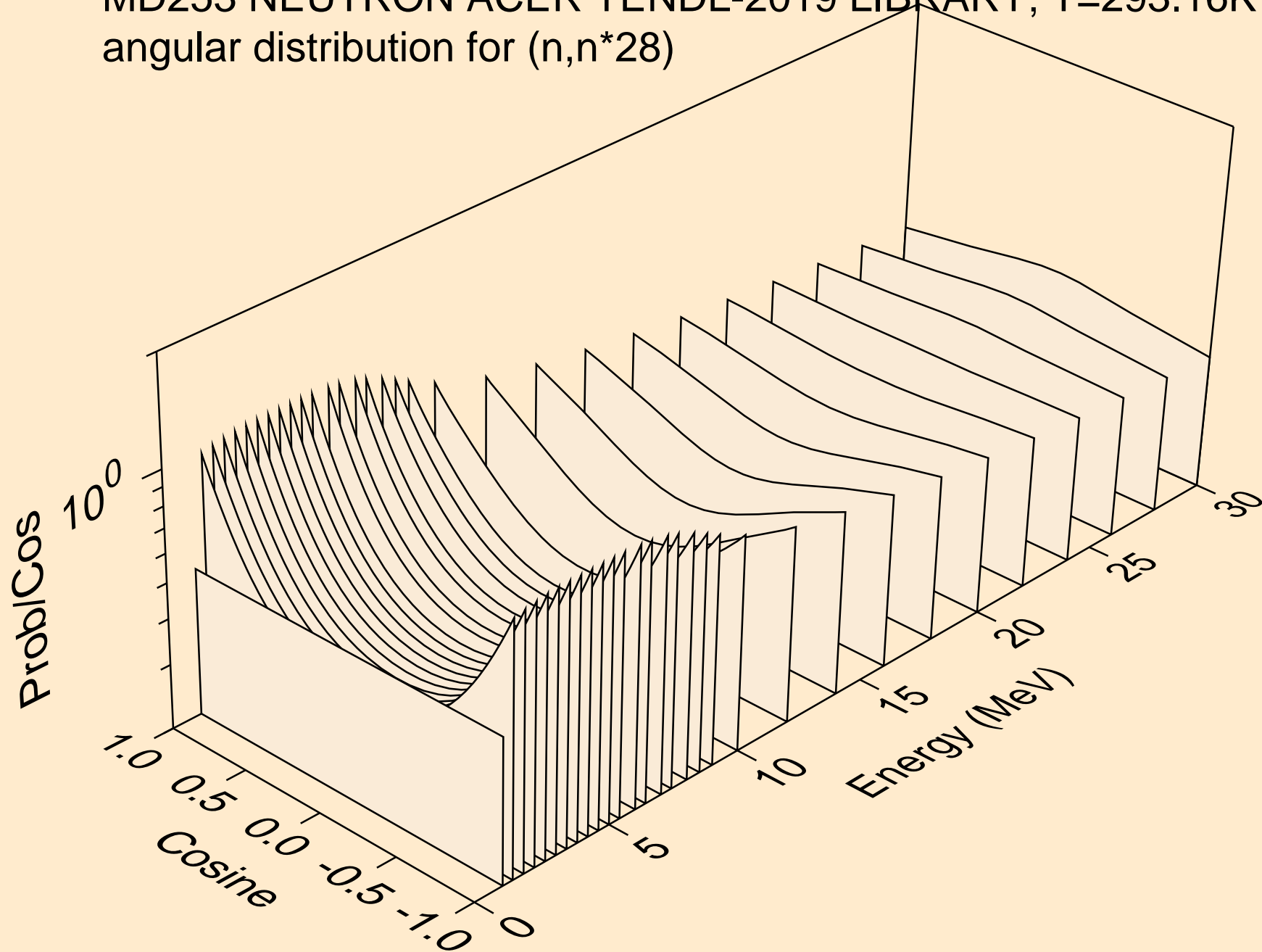

MD253 NEUTRON ACER TENDL-2019 LIBRARY; T=293.16K  
angular distribution for (n,n\*29)

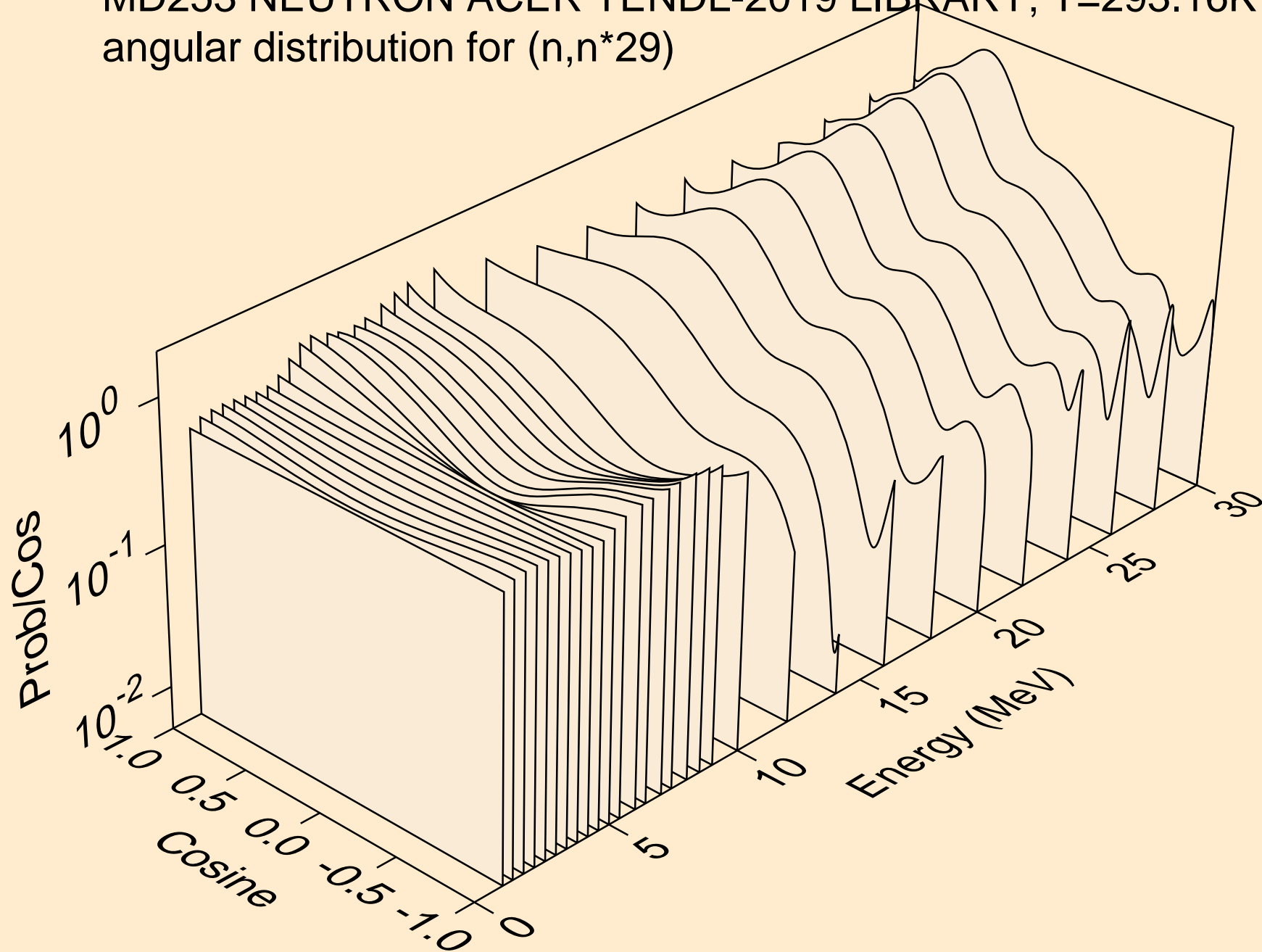

MD253 NEUTRON ACER TENDL-2019 LIBRARY; T=293.16K  
angular distribution for (n,n\*30)

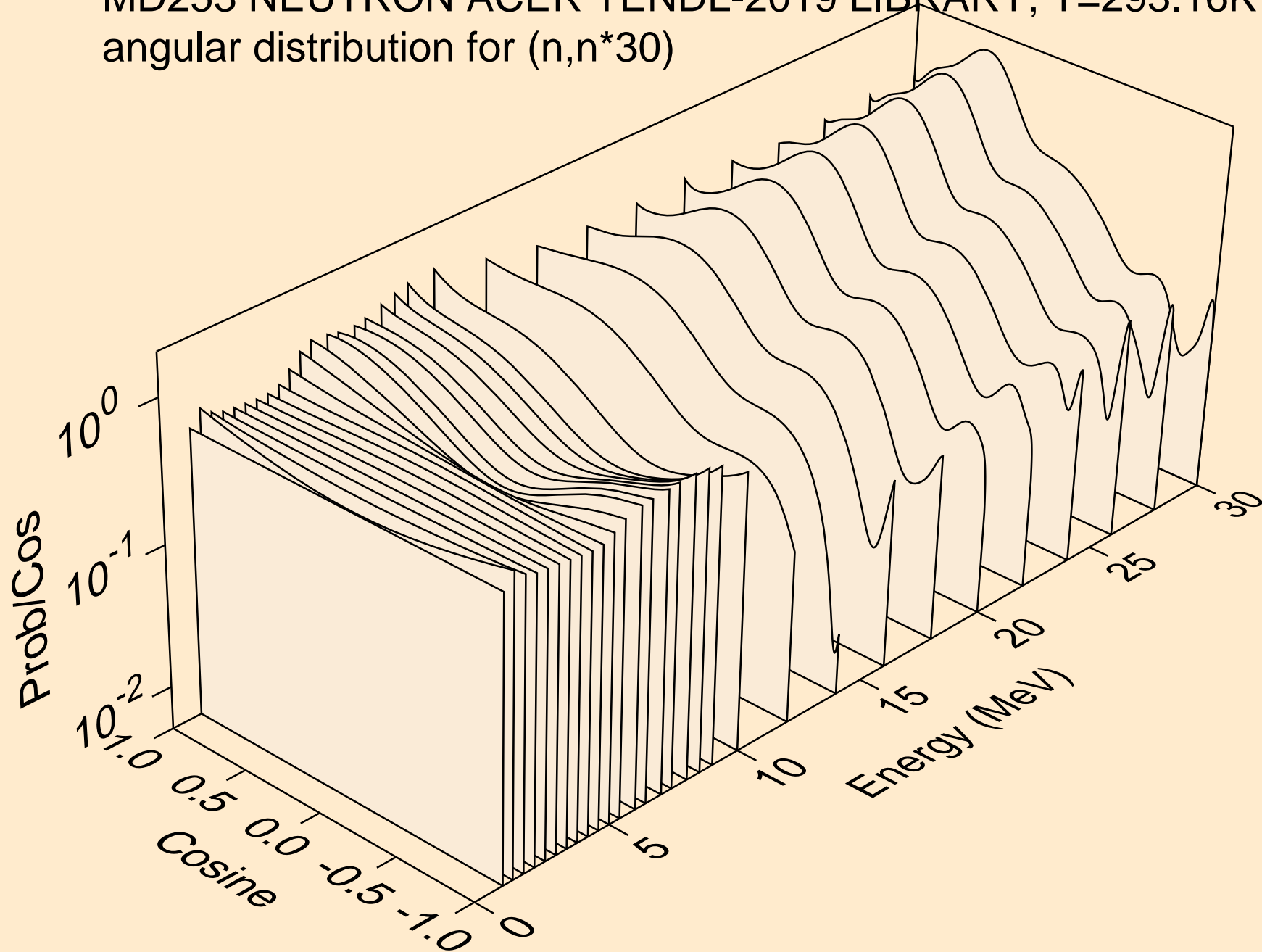

MD253 NEUTRON ACER TENDL-2019 LIBRARY; T=293.16K  
Total fission nubar

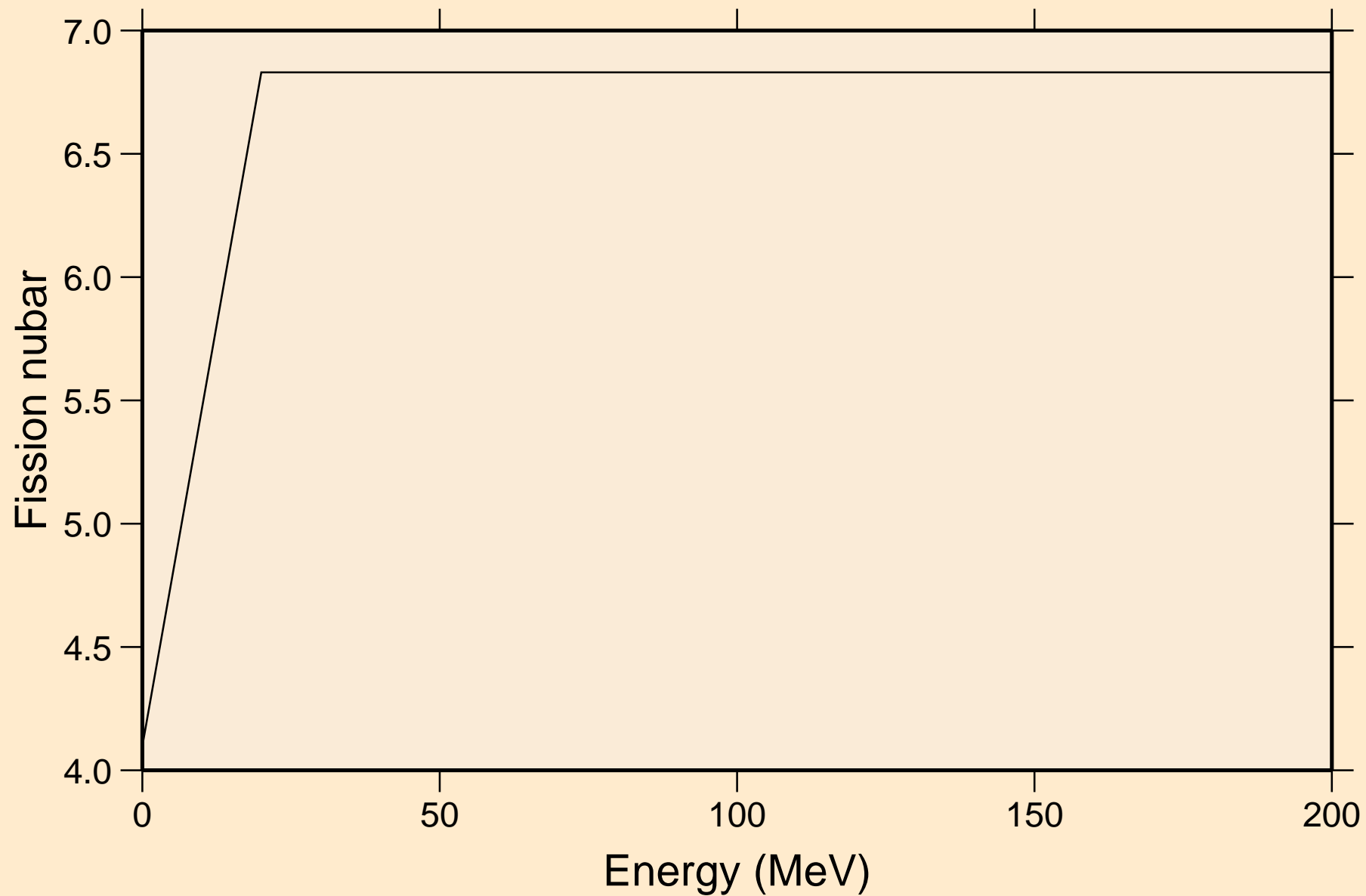



MD253 NEUTRON ACER TENDL-2019 LIBRARY; T=293.16K  
Neutron emission for (n,x)

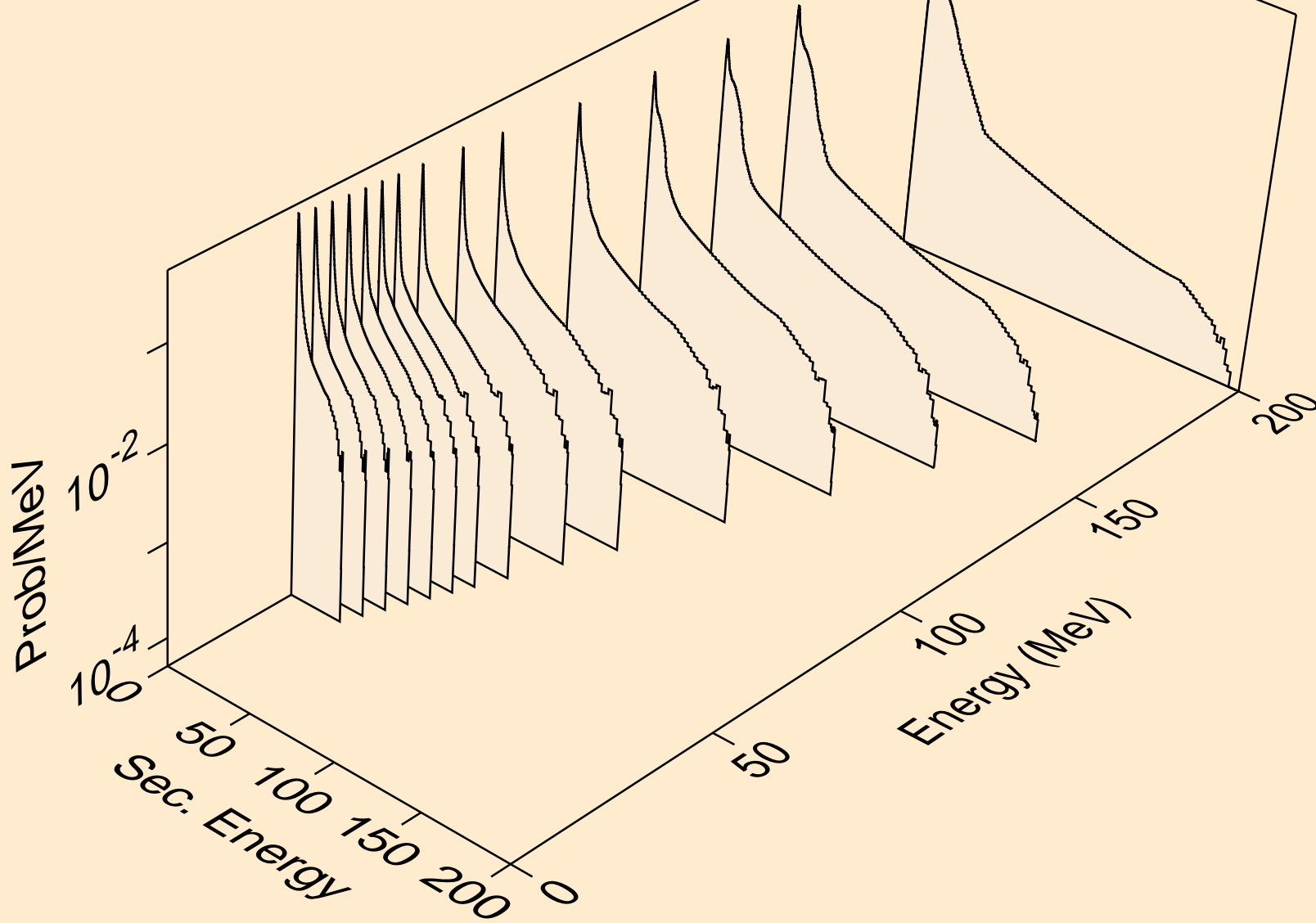

MD253 NEUTRON ACER TENDL-2019 LIBRARY; T=293.16K  
Neutron emission for (n,2nd)

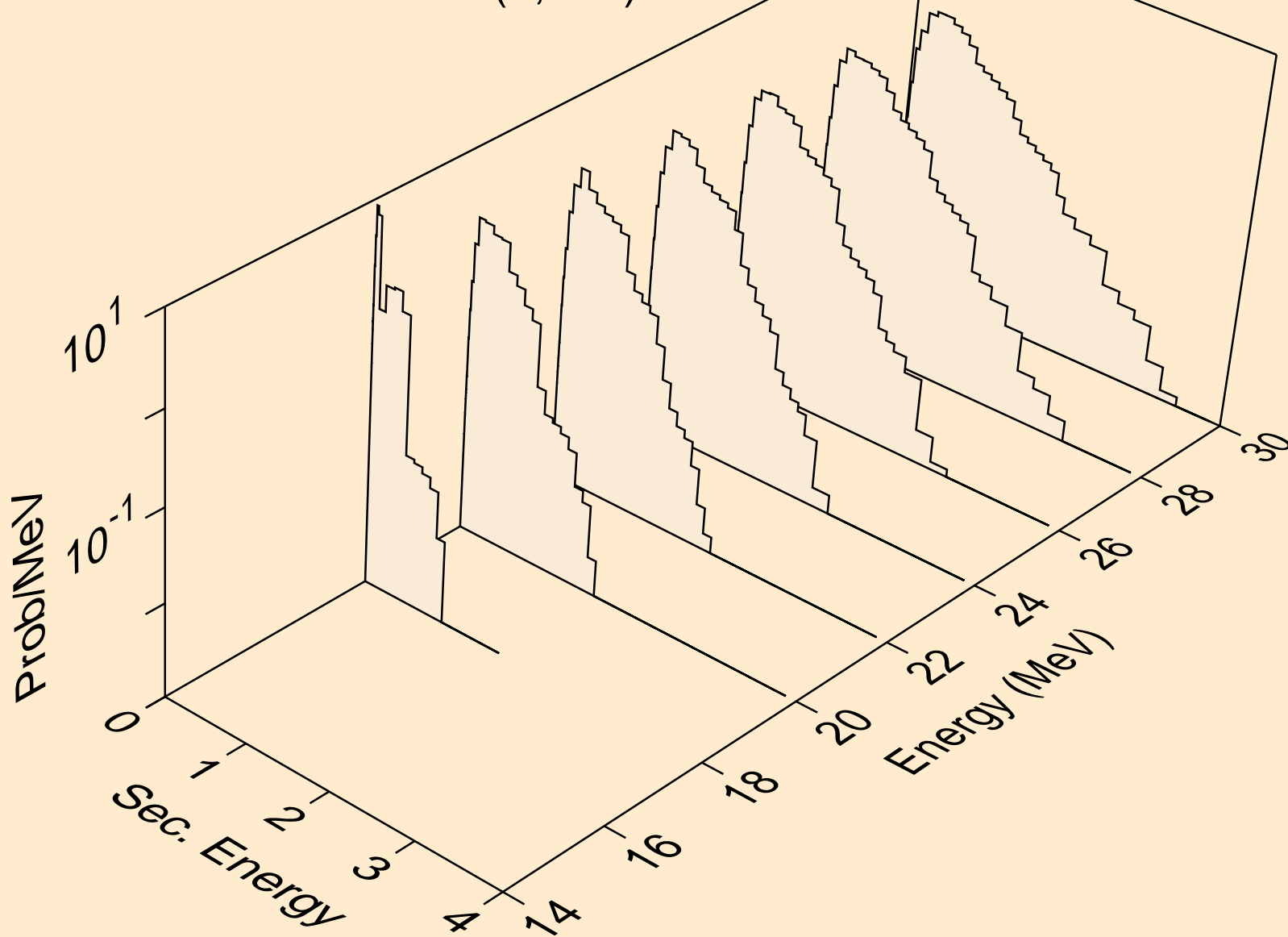

MD253 NEUTRON ACER TENDL-2019 LIBRARY; T=293.16K  
Neutron emission for (n,2n)

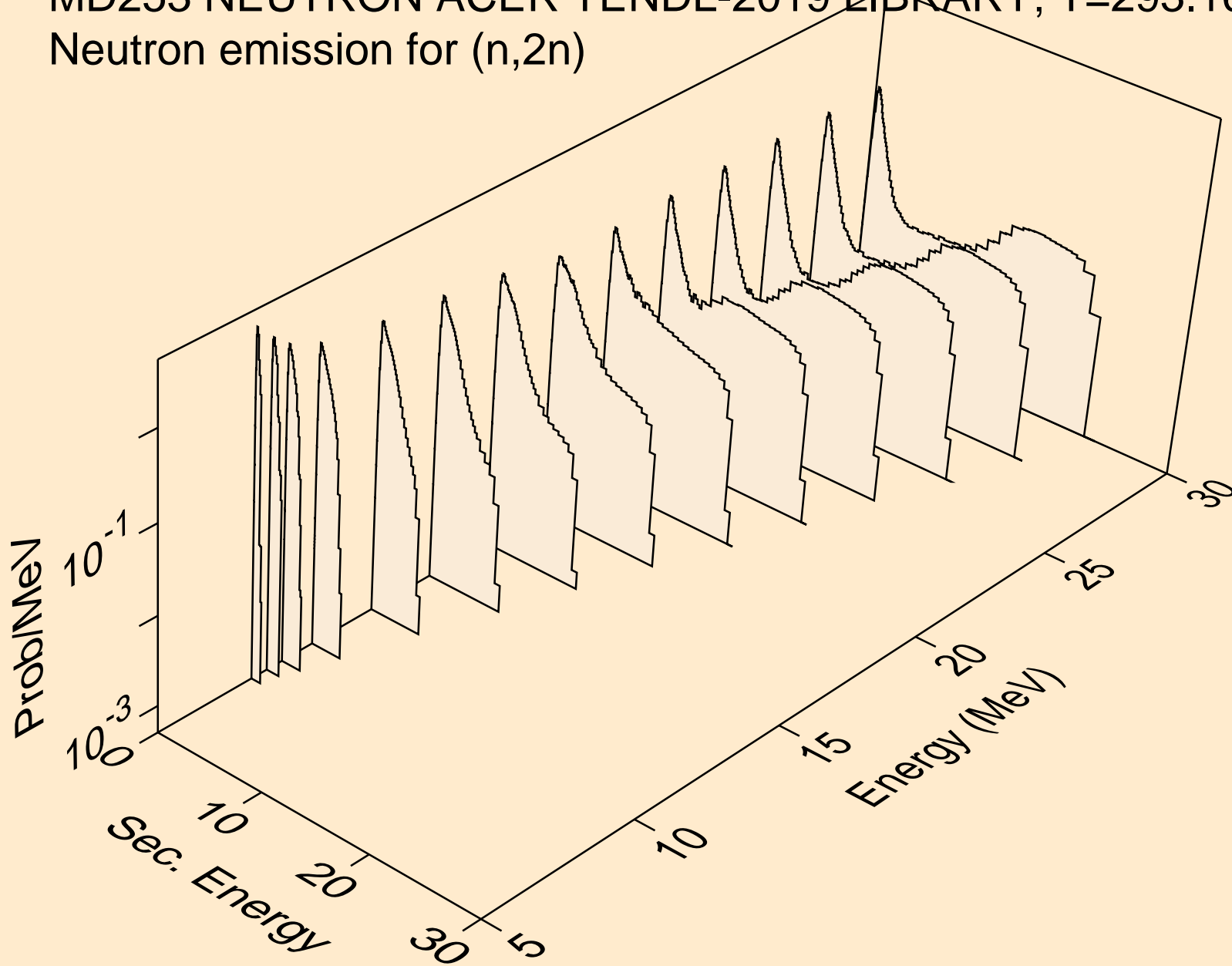

MD253 NEUTRON ACER TENDL-2019 LIBRARY; T=293.16K  
Neutron emission for (n,3n)

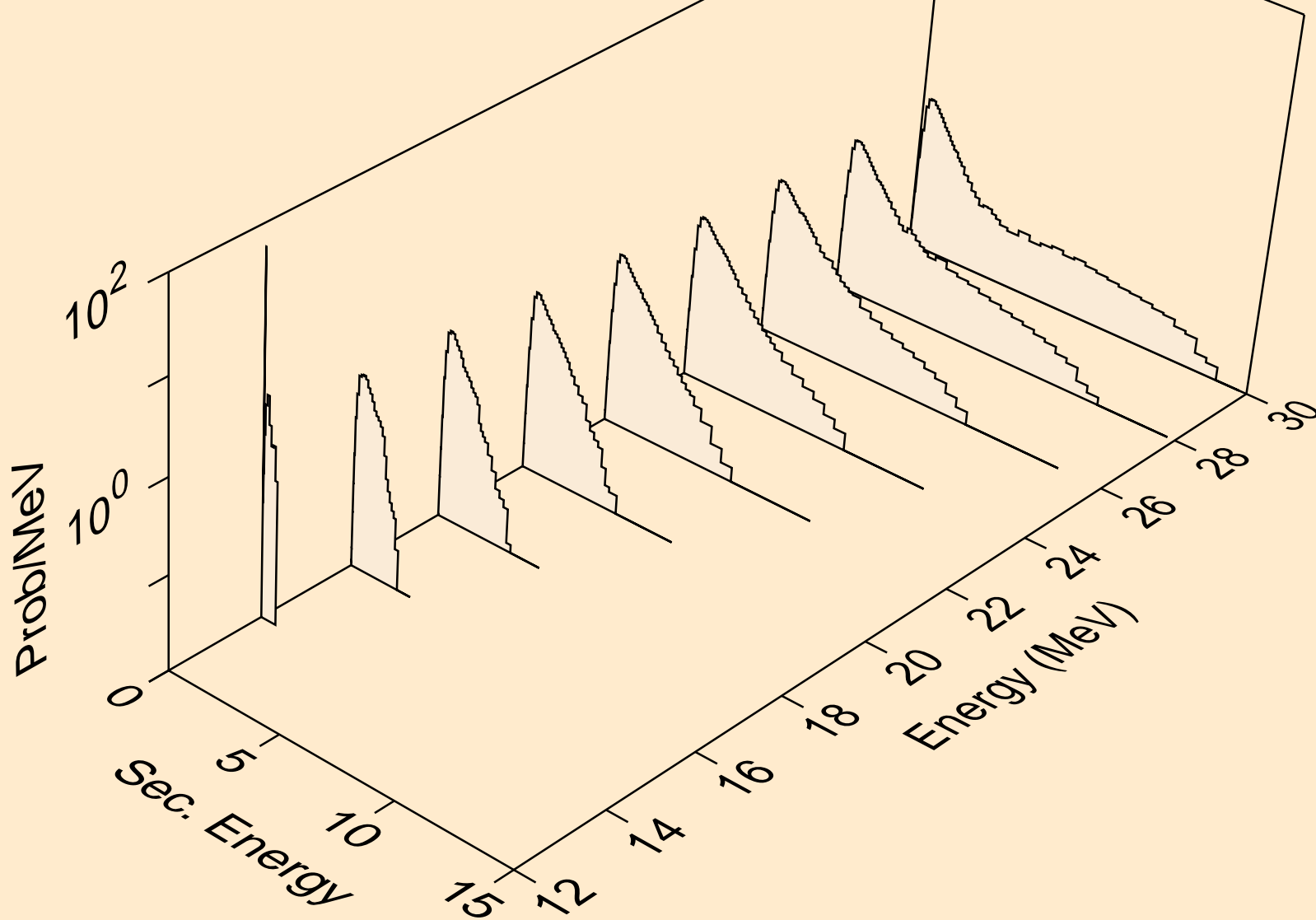

MD253 NEUTRON ACER TENDL-2019 LIBRARY; T=293.16K  
Neutron emission for fission

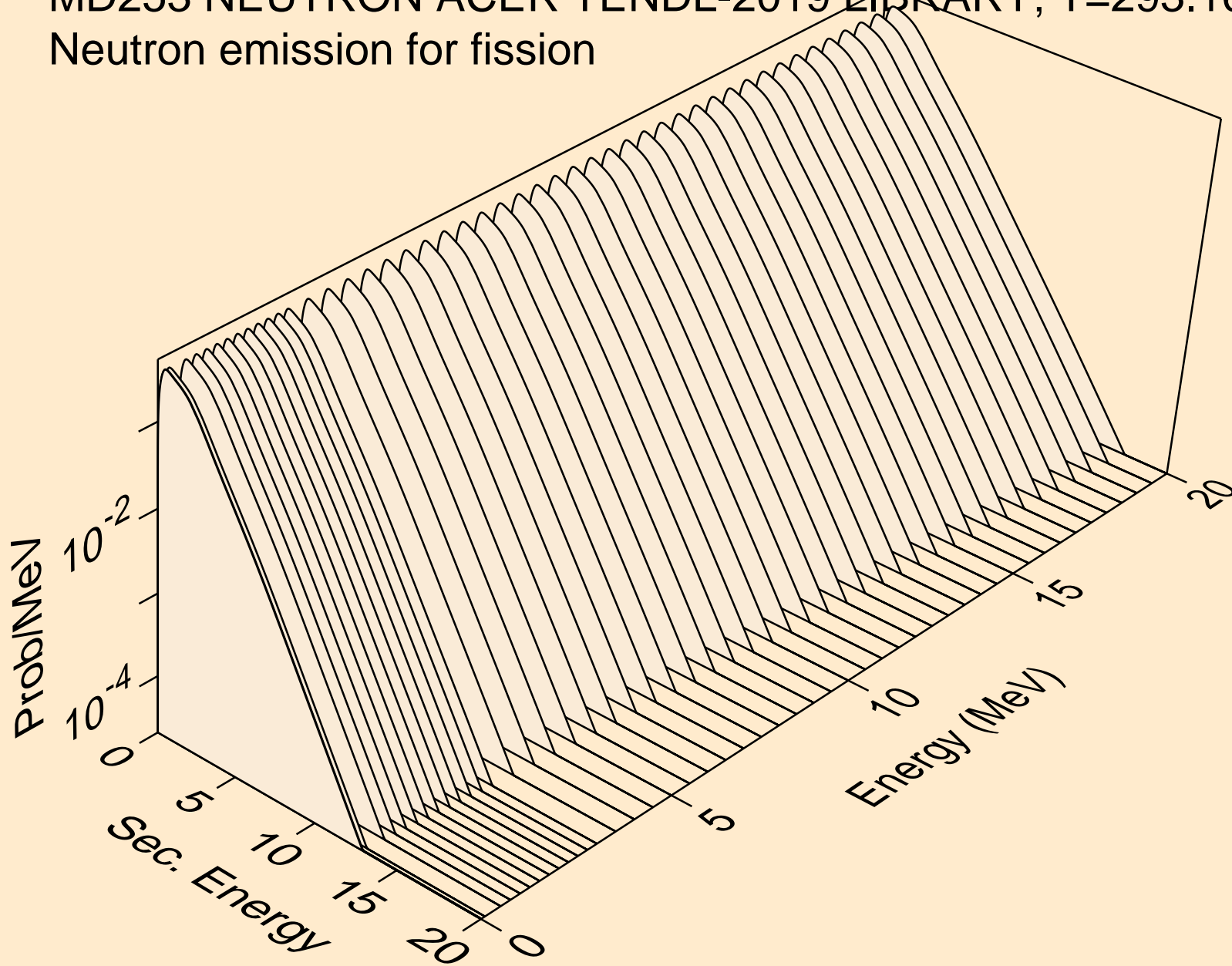

MD253 NEUTRON ACER TENDL-2019 LIBRARY; T=293.16K  
Neutron emission for (n,n\*)a

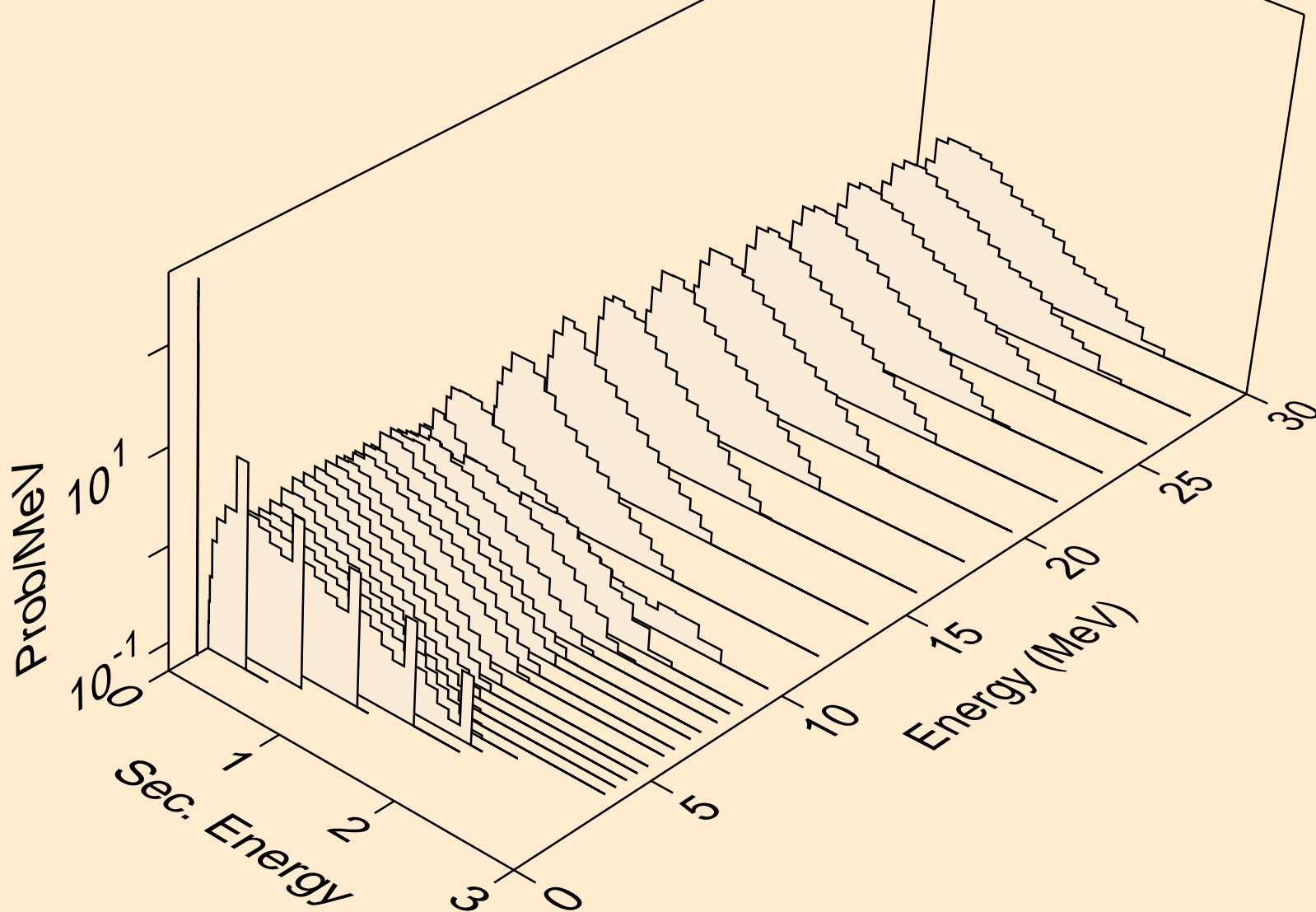

MD253 NEUTRON ACER TENDL-2019 LIBRARY; T=293.16K  
Neutron emission for (n,2n)a

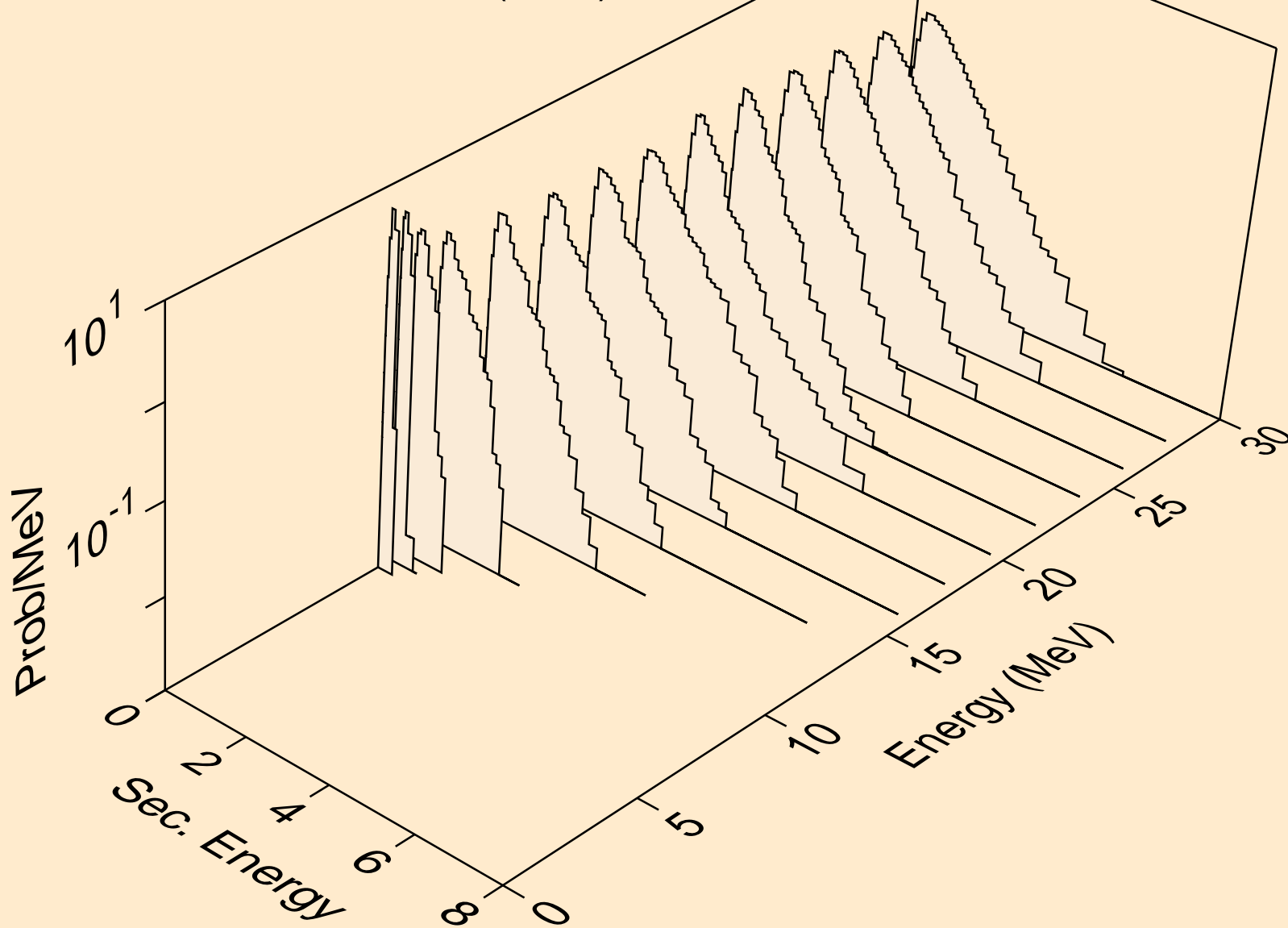

MD253 NEUTRON ACER TENDL-2019 LIBRARY; T=293.16K  
Neutron emission for (n,3n)a

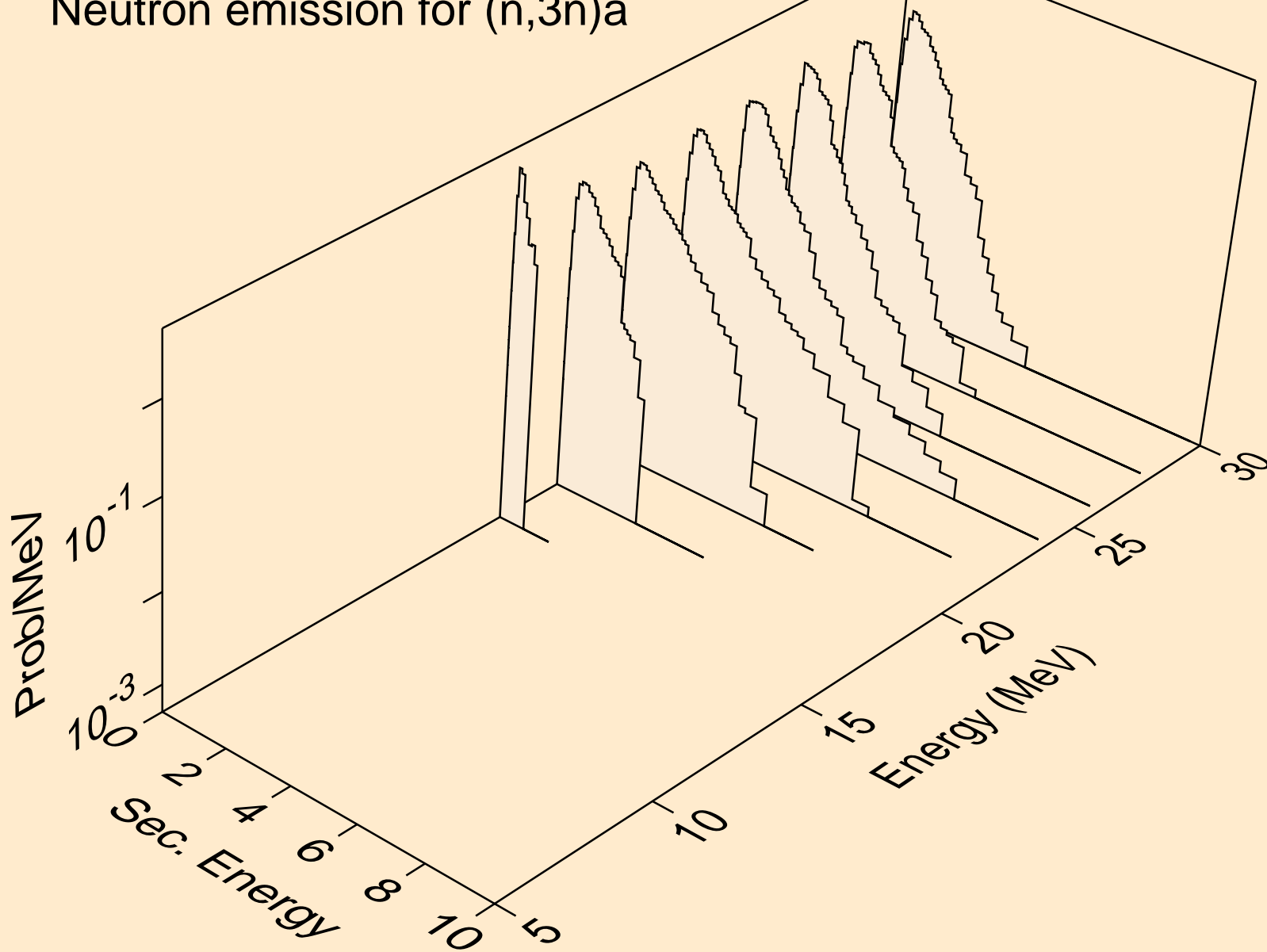



MD253 NEUTRON ACER TENDL-2019 LIBRARY; T=293.16K  
Neutron emission for (n,n\*)p

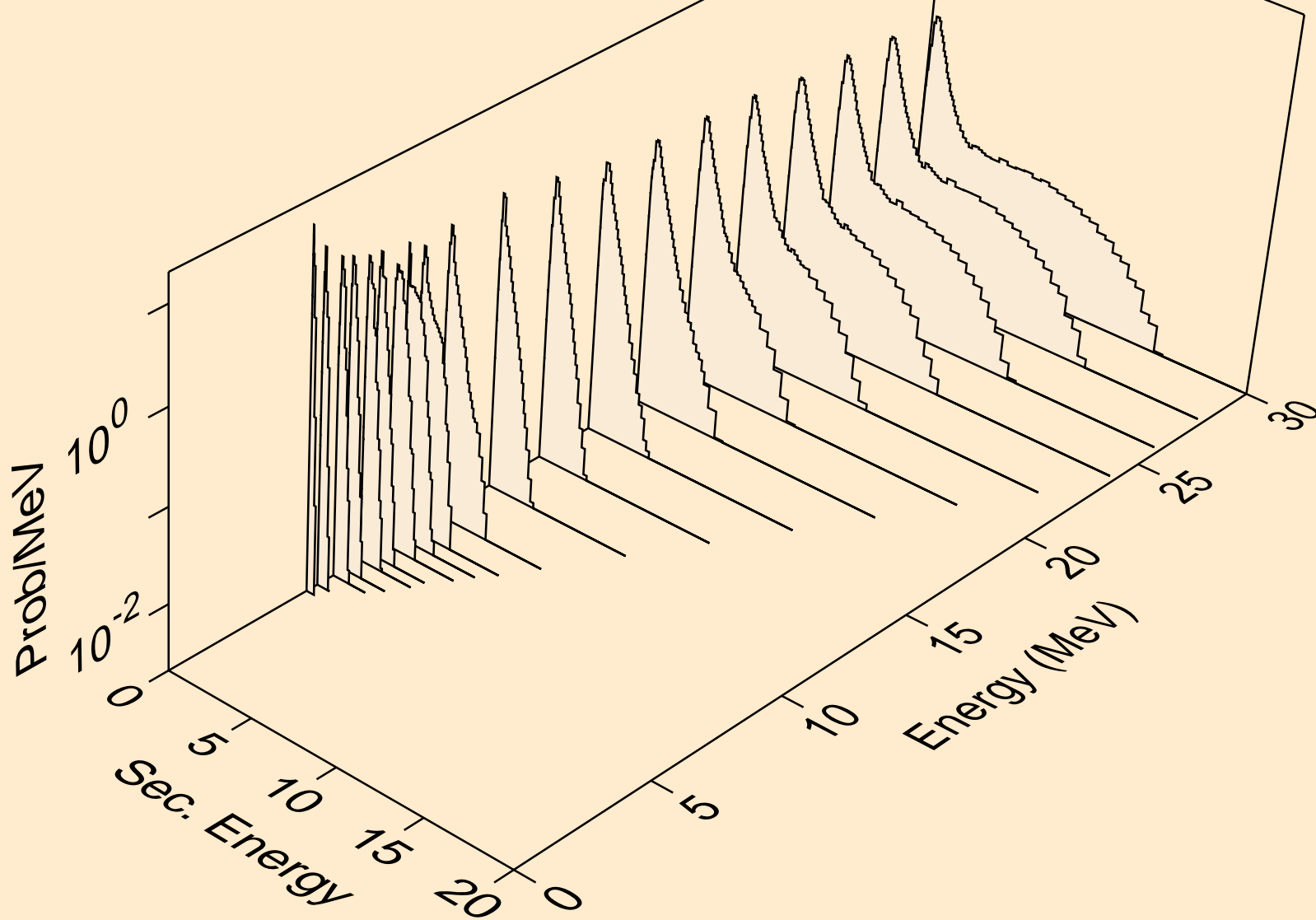

MD253 NEUTRON ACER TENDL-2019 LIBRARY; T=293.16K  
Neutron emission for (n,n\*)2a

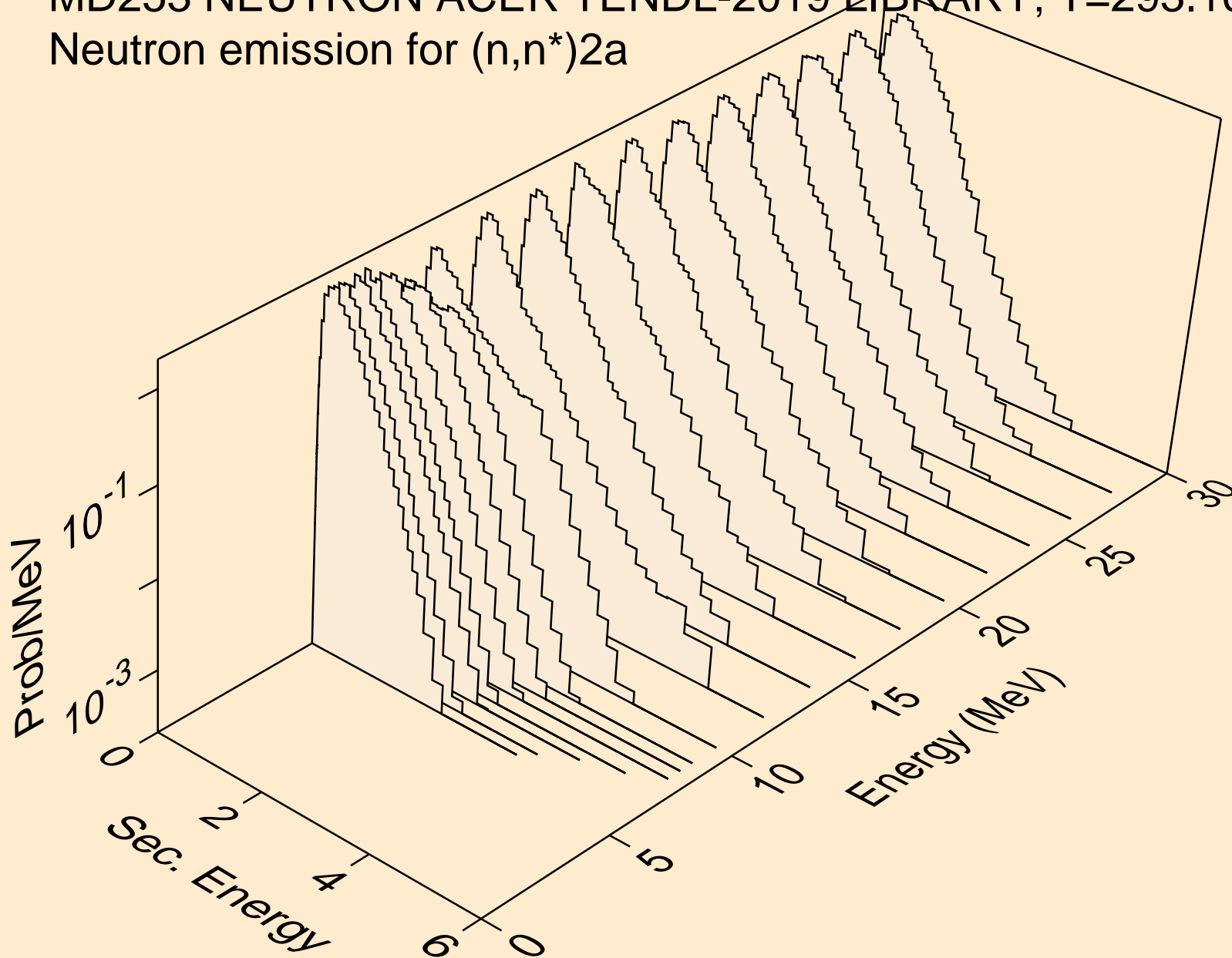

MD253 NEUTRON ACER TENDL-2019 LIBRARY; T=293.16K  
Neutron emission for (n,n\*)d

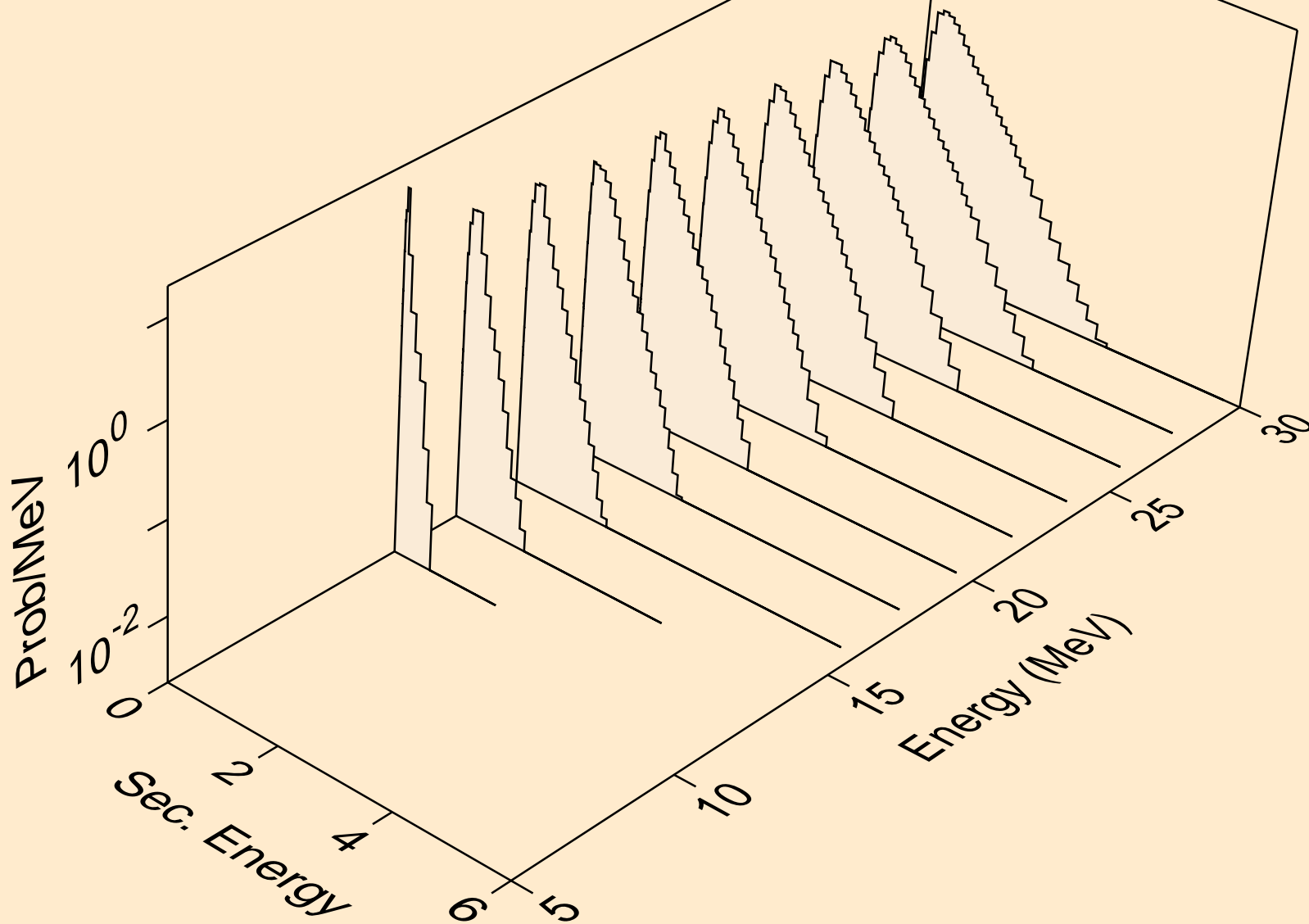

MD253 NEUTRON ACER TENDL-2019 LIBRARY; T=293.16K  
Neutron emission for (n,n\*)t

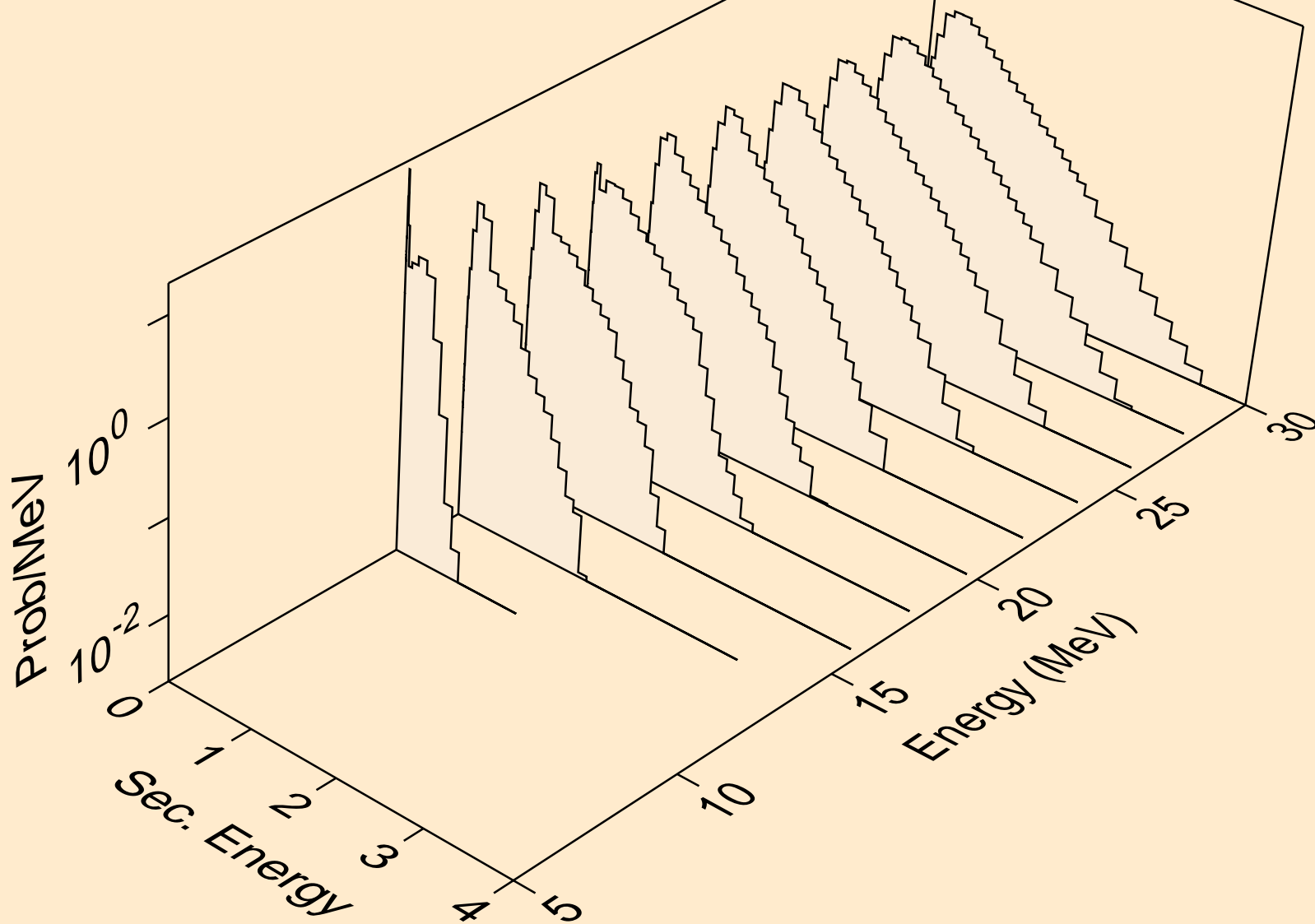

MD253 NEUTRON ACER TENDL-2019 LIBRARY; T=293.16K  
Neutron emission for (n,n\*)he3

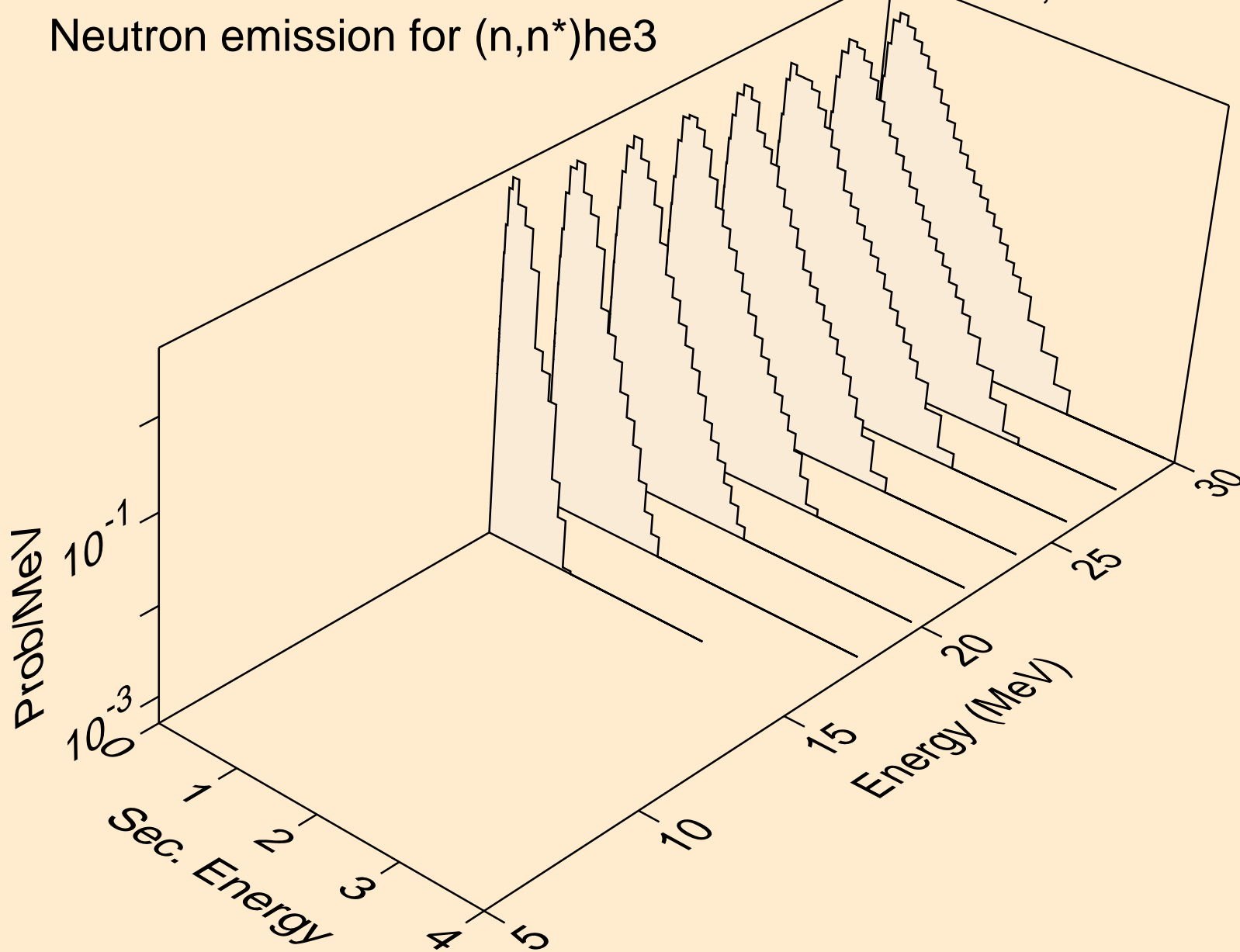

MD253 NEUTRON ACER TENDL-2019 LIBRARY; T=293.16K  
Neutron emission for (n,4n)

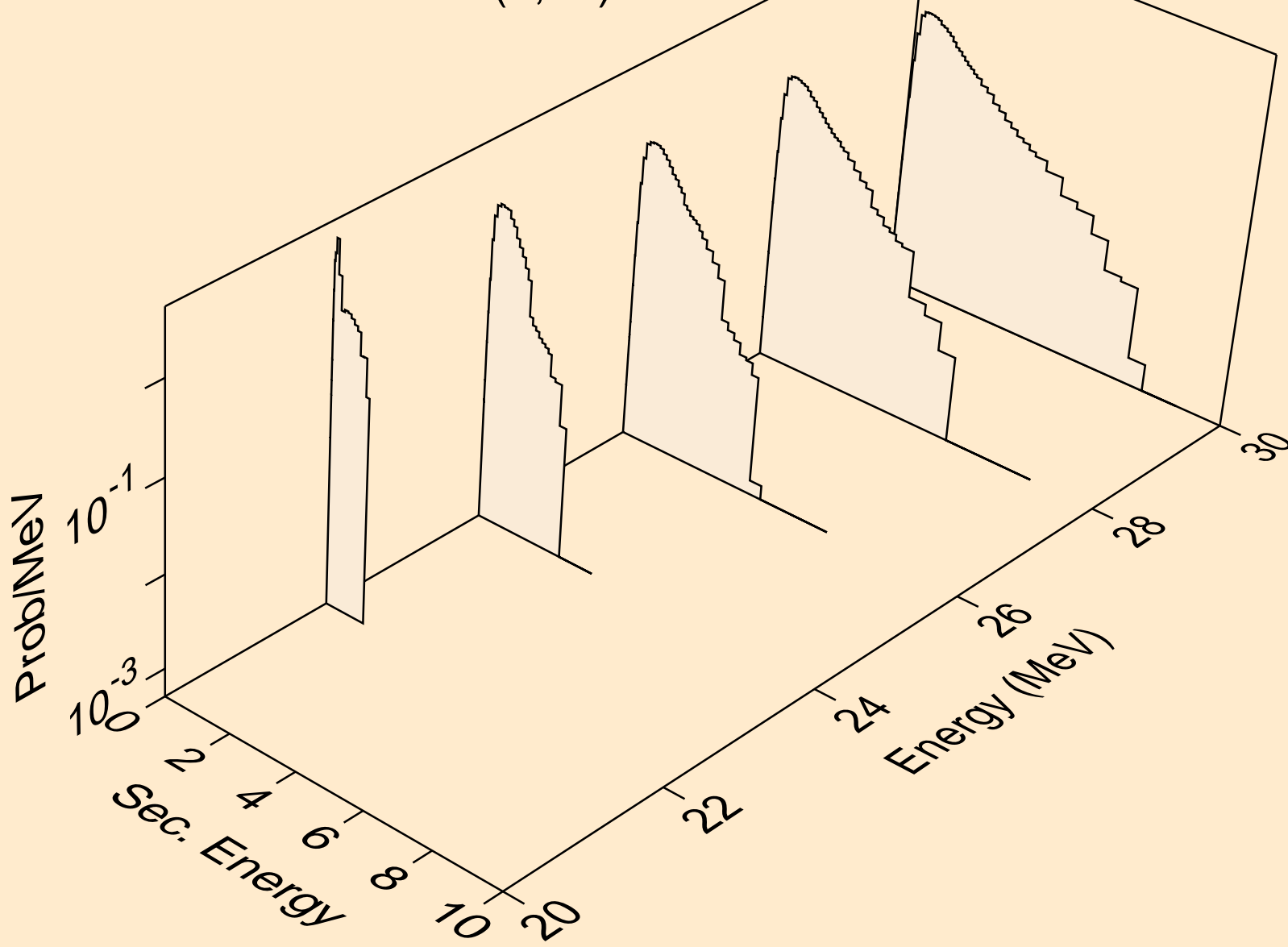

MD253 NEUTRON ACER TENDL-2019 LIBRARY; T=293.16K  
Neutron emission for (n,2np)

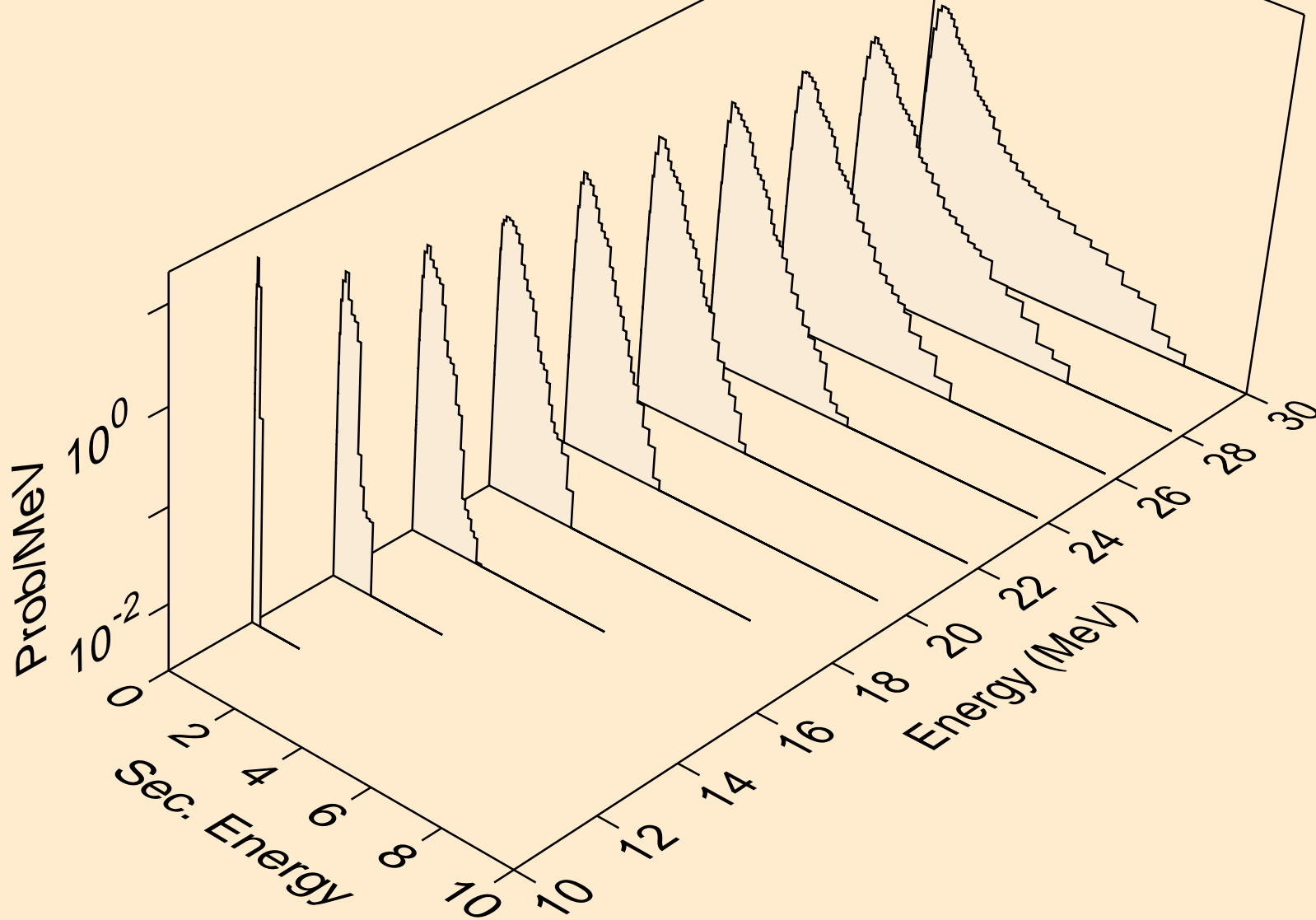

MD253 NEUTRON ACER TENDL-2019 LIBRARY; T=293.16K  
Neutron emission for (n,3np)

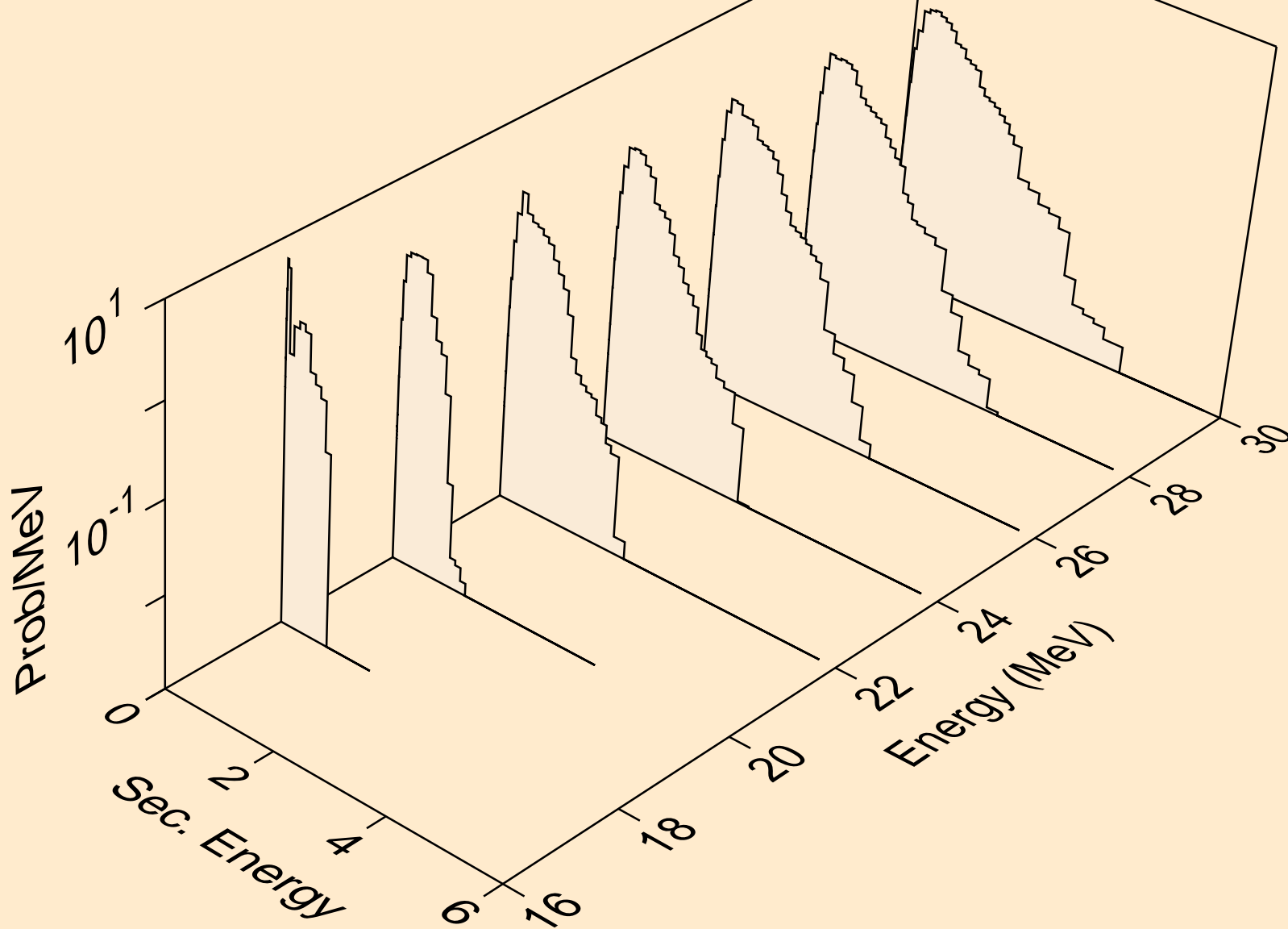



MD253 NEUTRON ACER TENDL-2019 LIBRARY; T=293.16K  
Neutron emission for (n,2np)

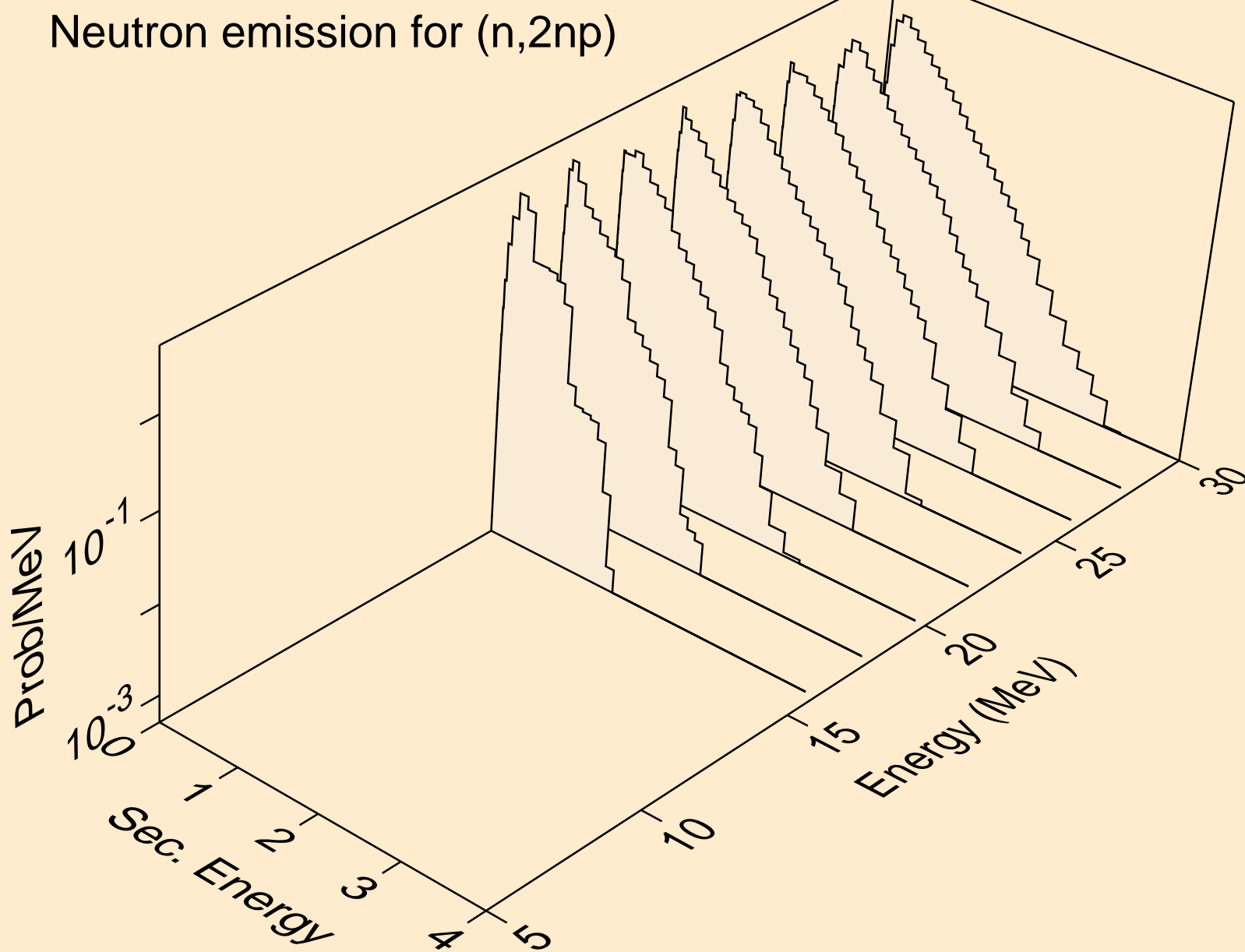

MD253 NEUTRON ACER TENDL-2019 LIBRARY; T=293.16K  
Neutron emission for (n,npa)

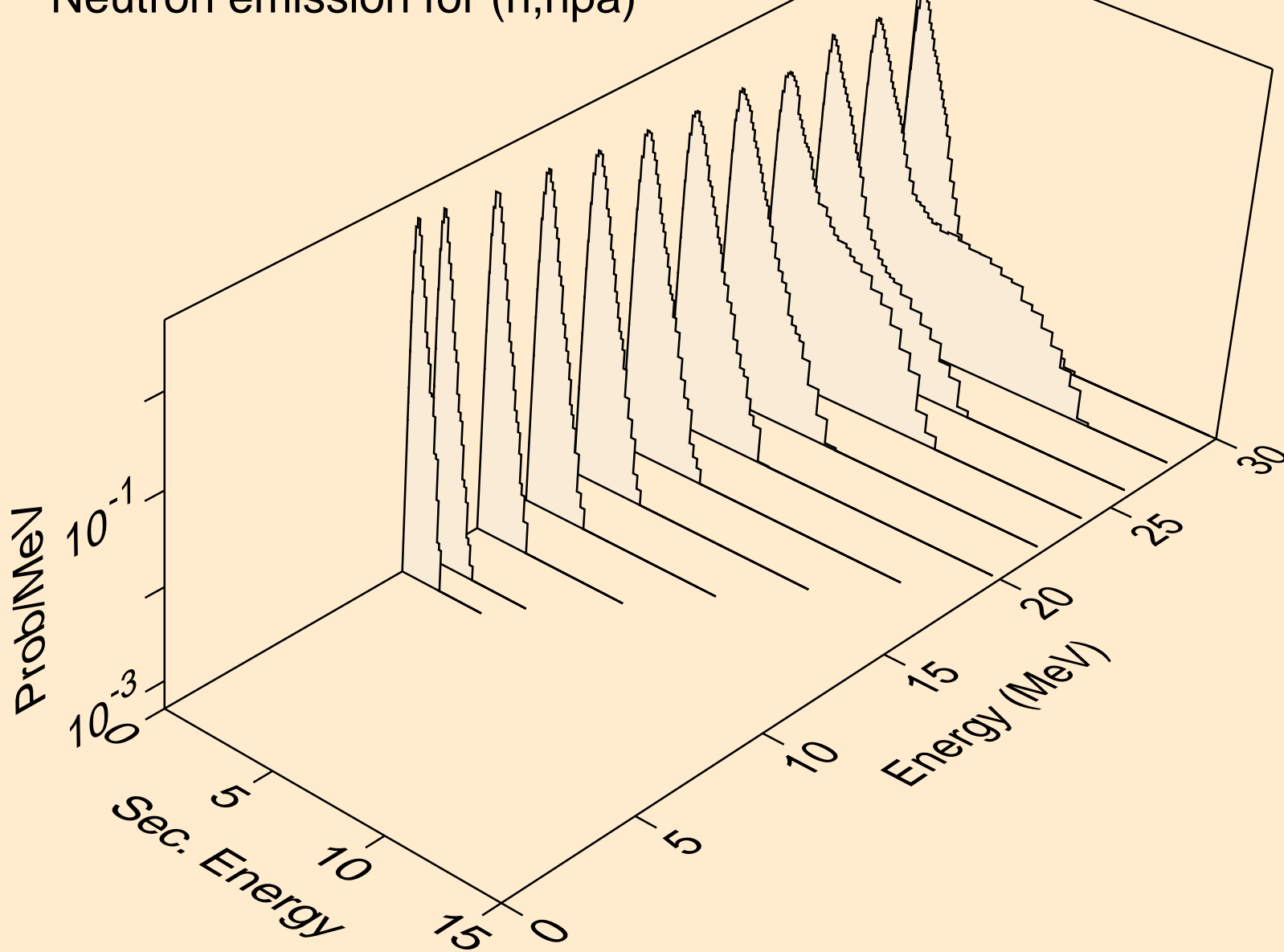

MD253 NEUTRON ACER TENDL-2019 LIBRARY; T=293.16K  
Neutron emission for (n,n\*c)

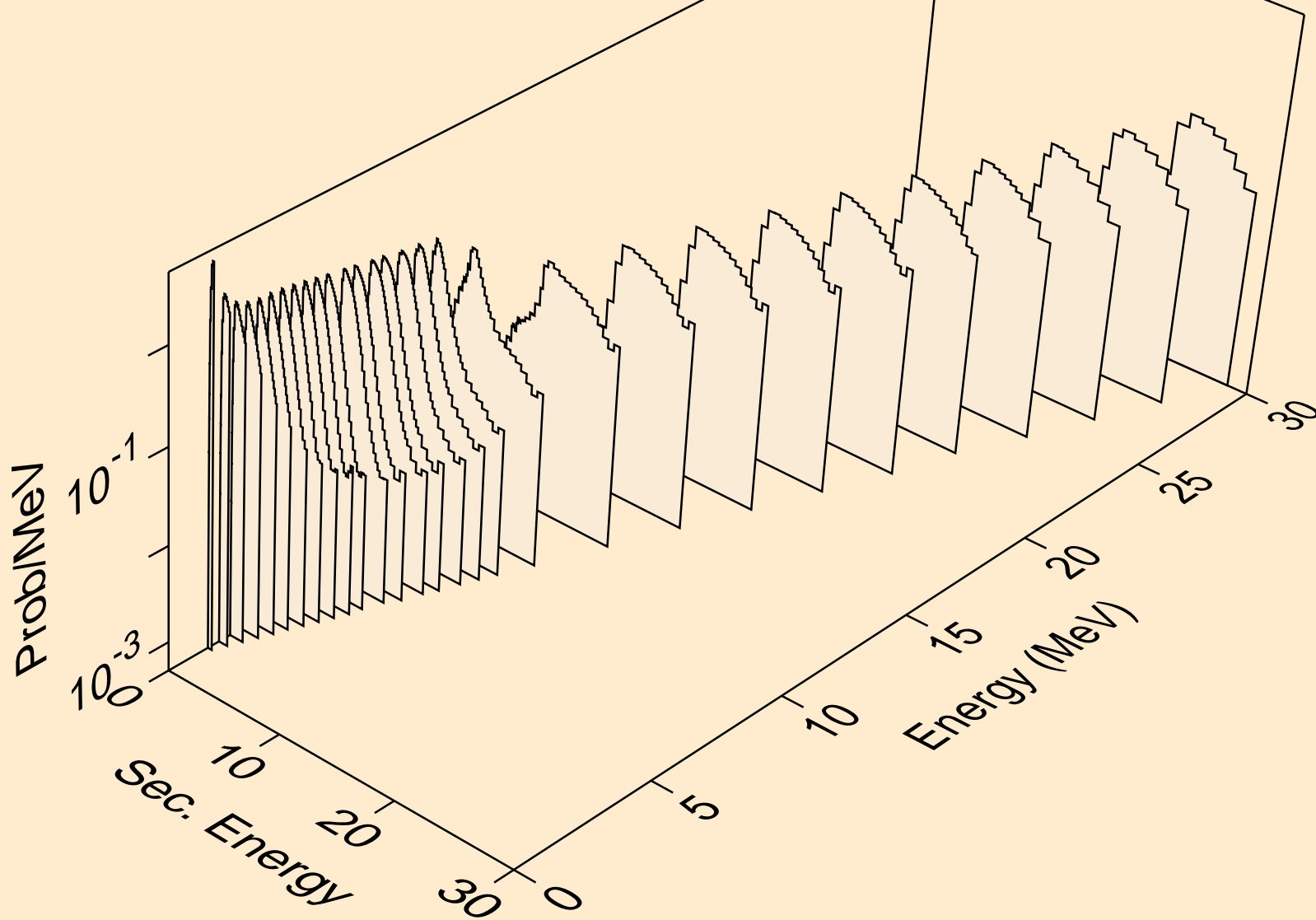

# MD253 NEUTRON ACER TENDL-2019 LIBRARY; T=293.16K

## Delayed nubar

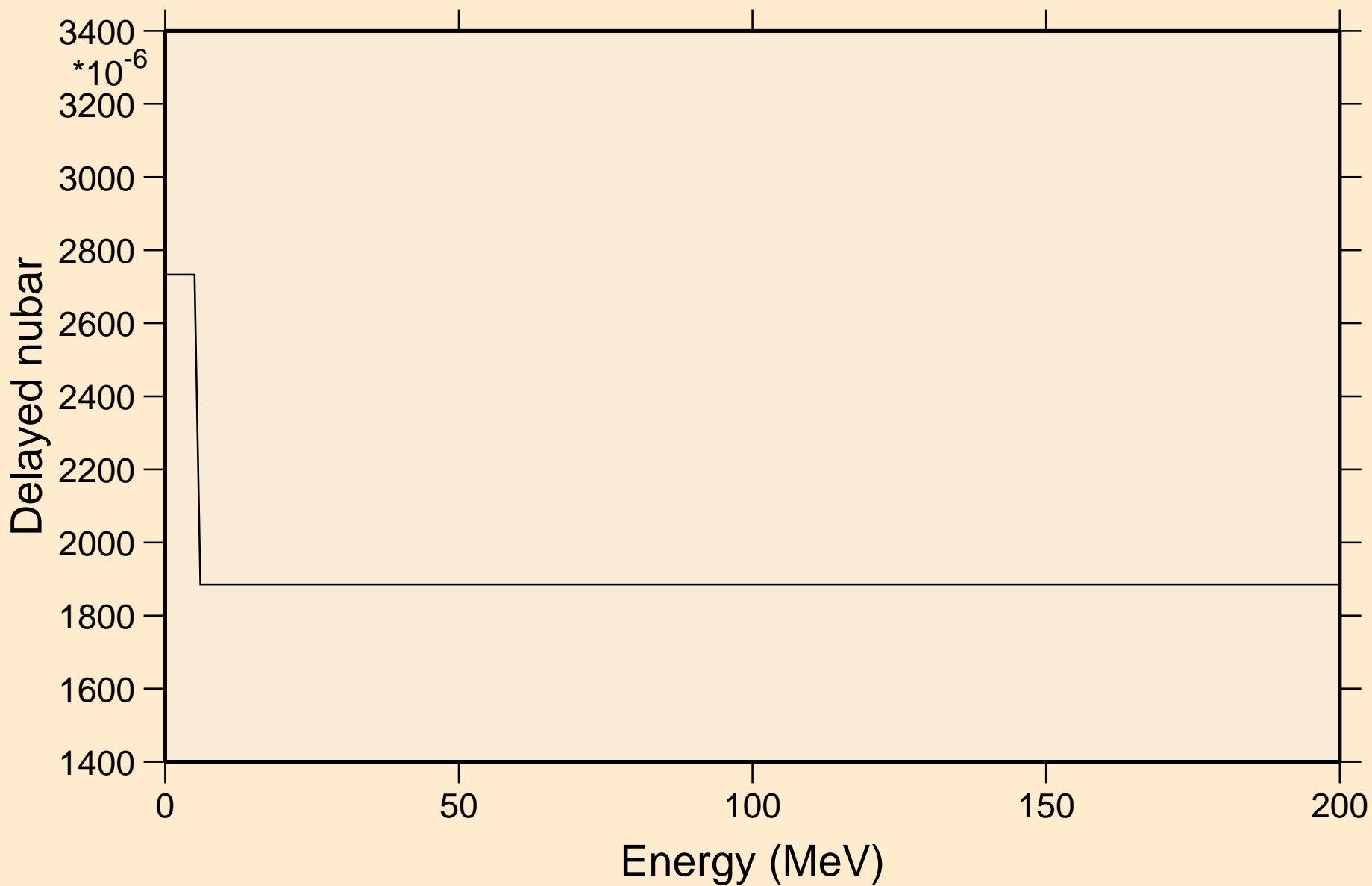

# MD253 NEUTRON ACER TENDL-2019 LIBRARY; T=293.16K

## Delayed neutron spectra

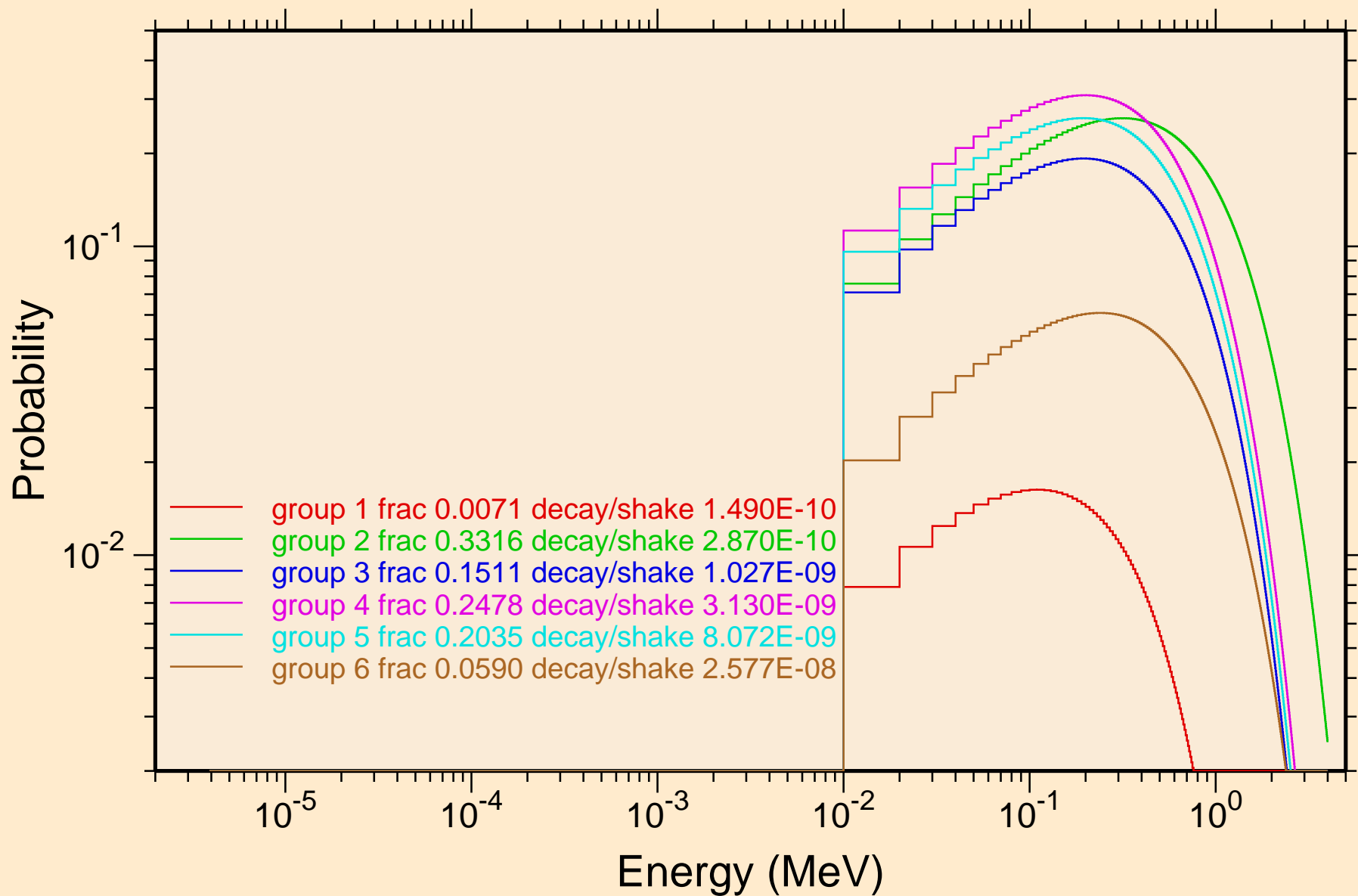

MD253 NEUTRON ACER TENDL-2019 LIBRARY; T=293.16K  
Photon emission for (n,x)

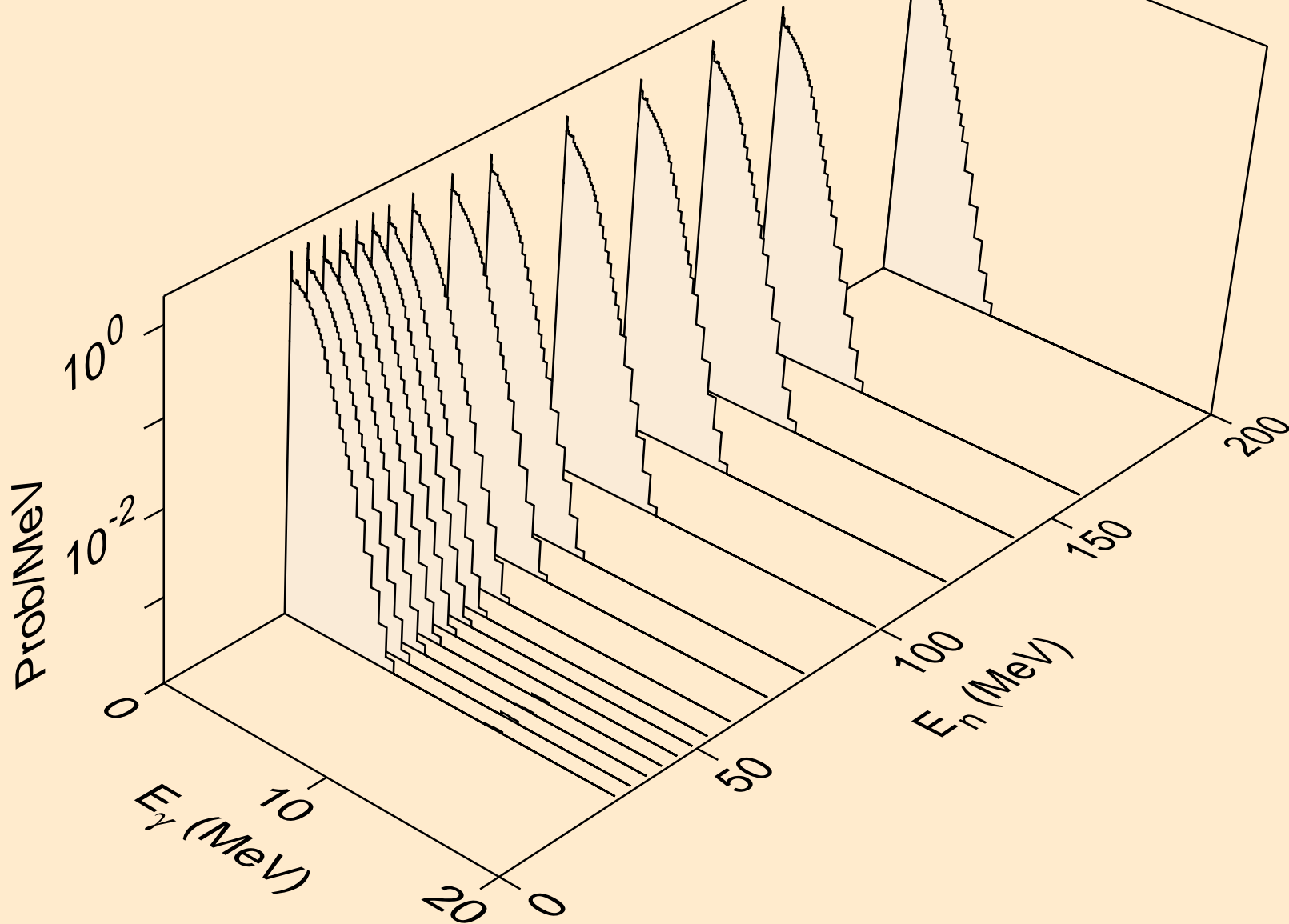

MD253 NEUTRON ACER TENDL-2019 LIBRARY; T=293.16K  
Photon emission for (n,2nd)

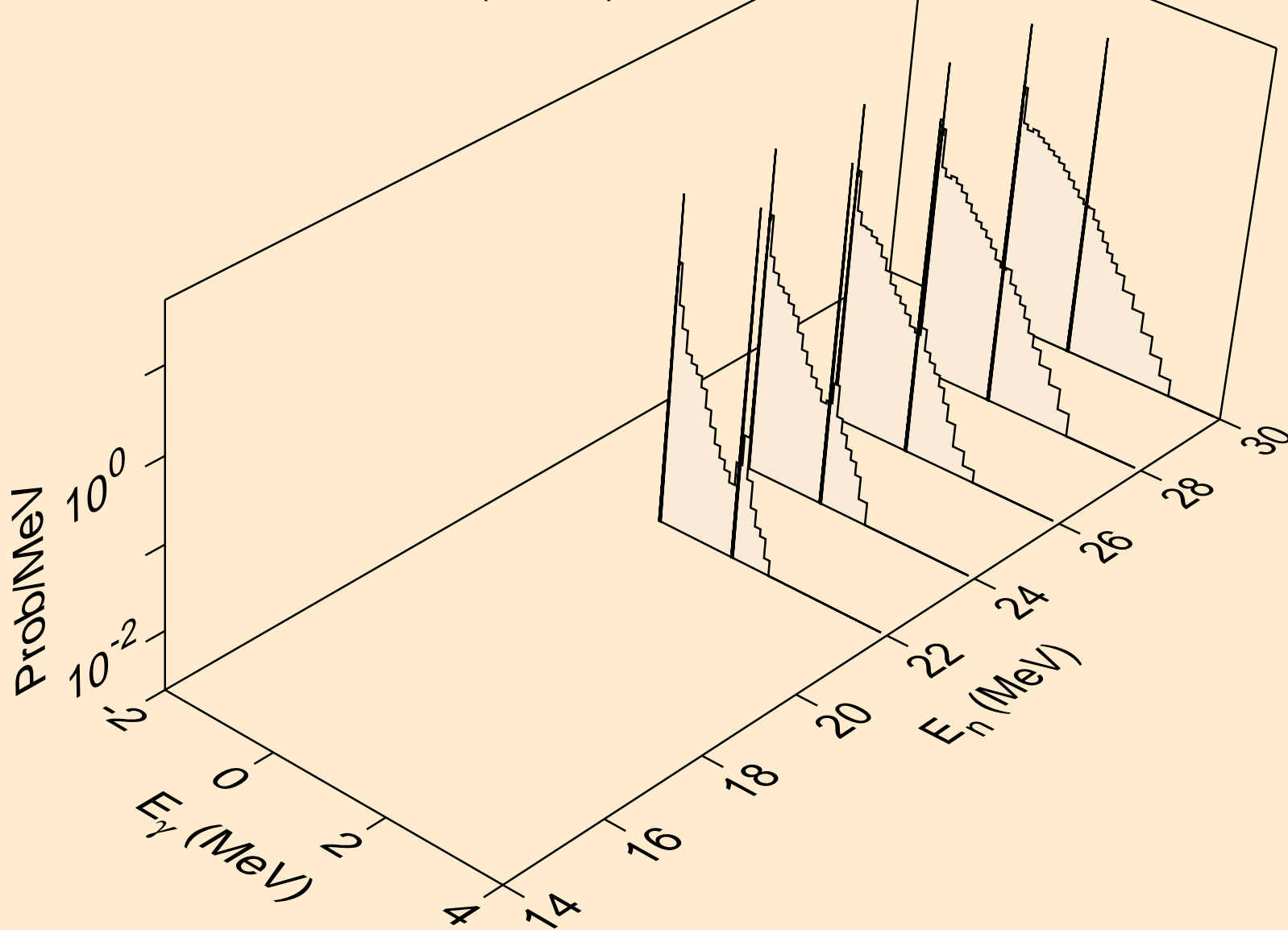

MD253 NEUTRON ACER TENDL-2019 LIBRARY; T=293.16K  
Photon emission for (n,2n)

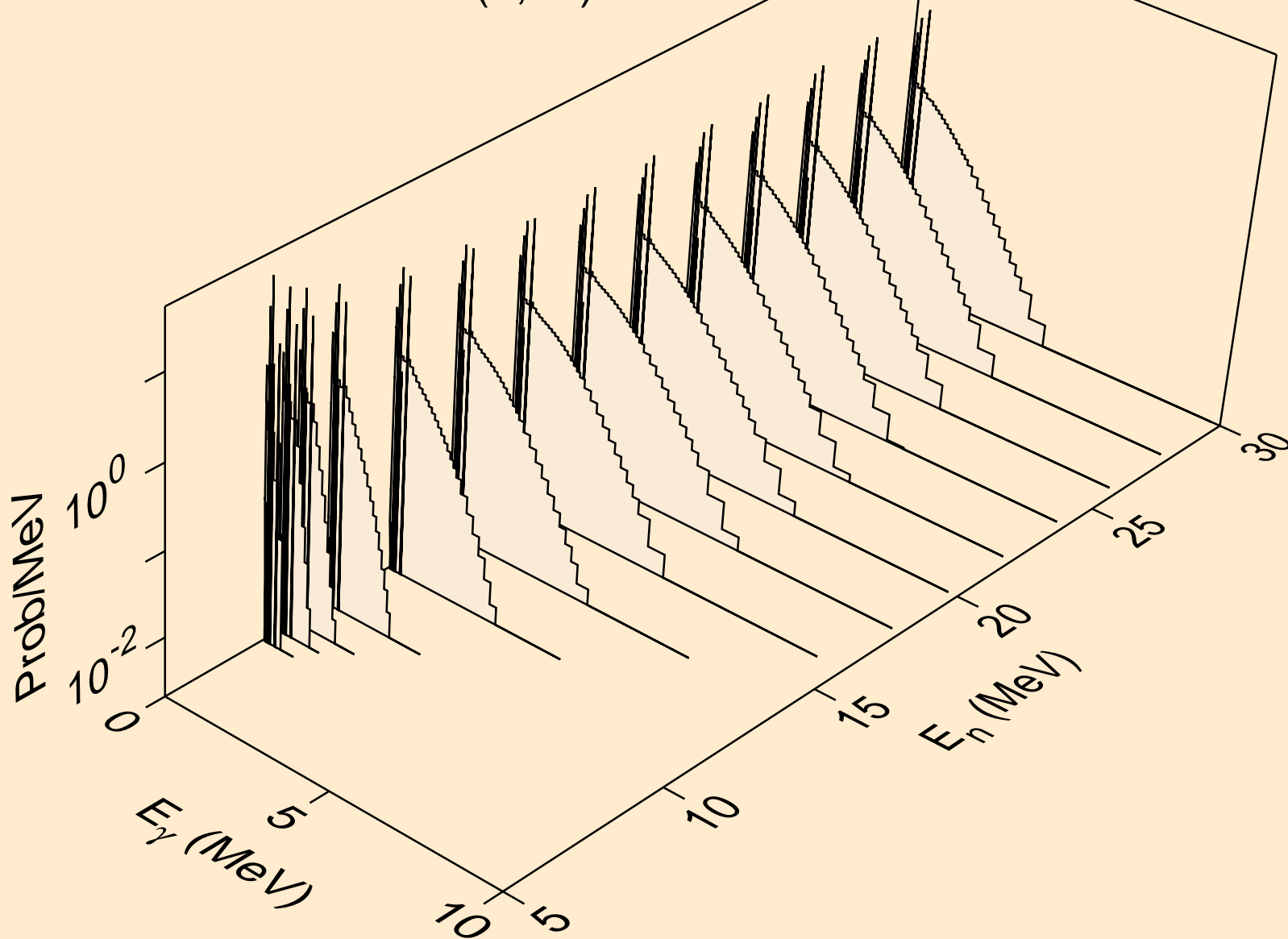



MD253 NEUTRON ACER TENDL-2019 LIBRARY; T=293.16K  
Photon emission for (n,3n)

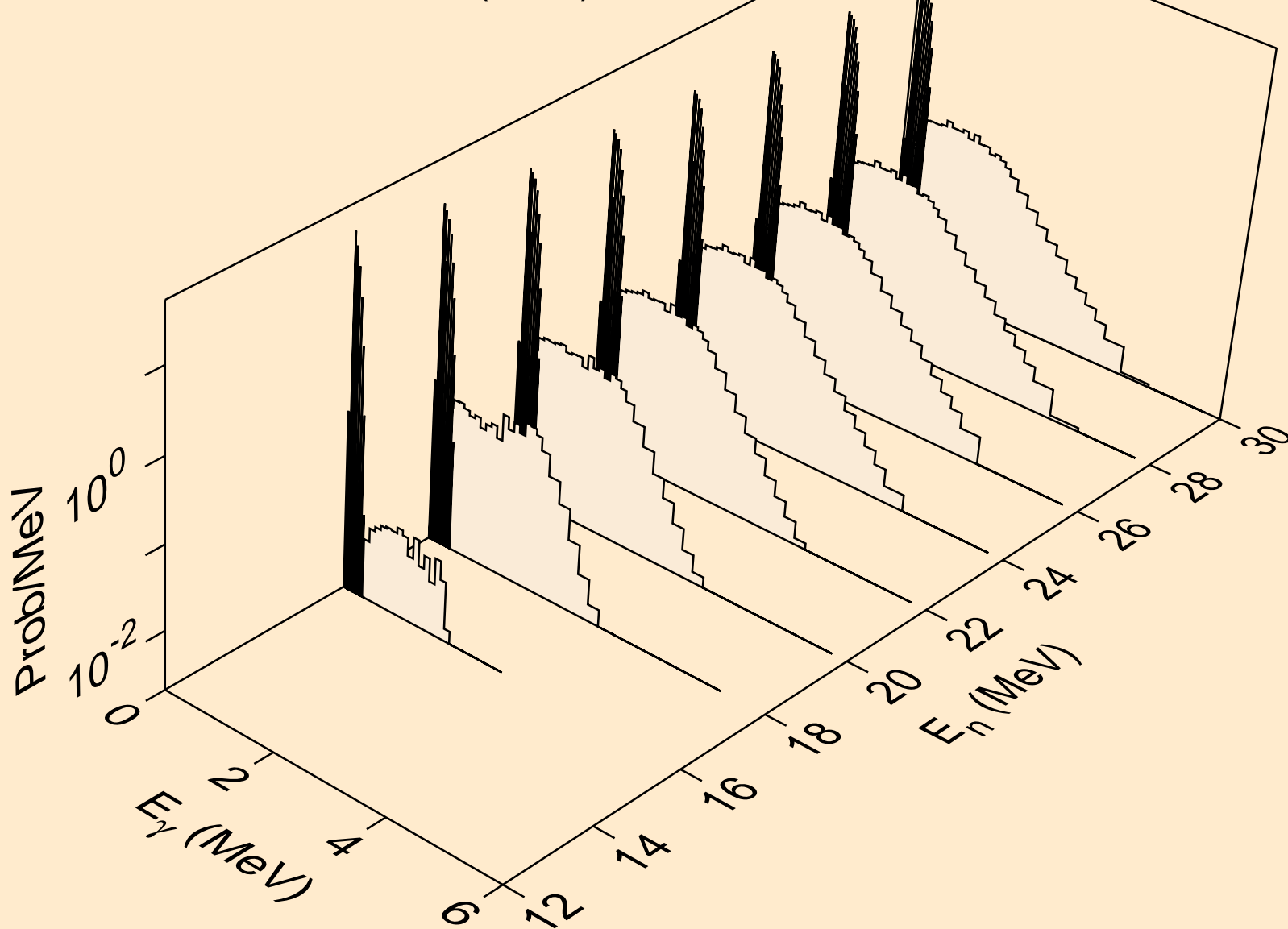

MD253 NEUTRON ACER TENDL-2019 LIBRARY; T=293.16K  
Photon emission for (n,n\*)a

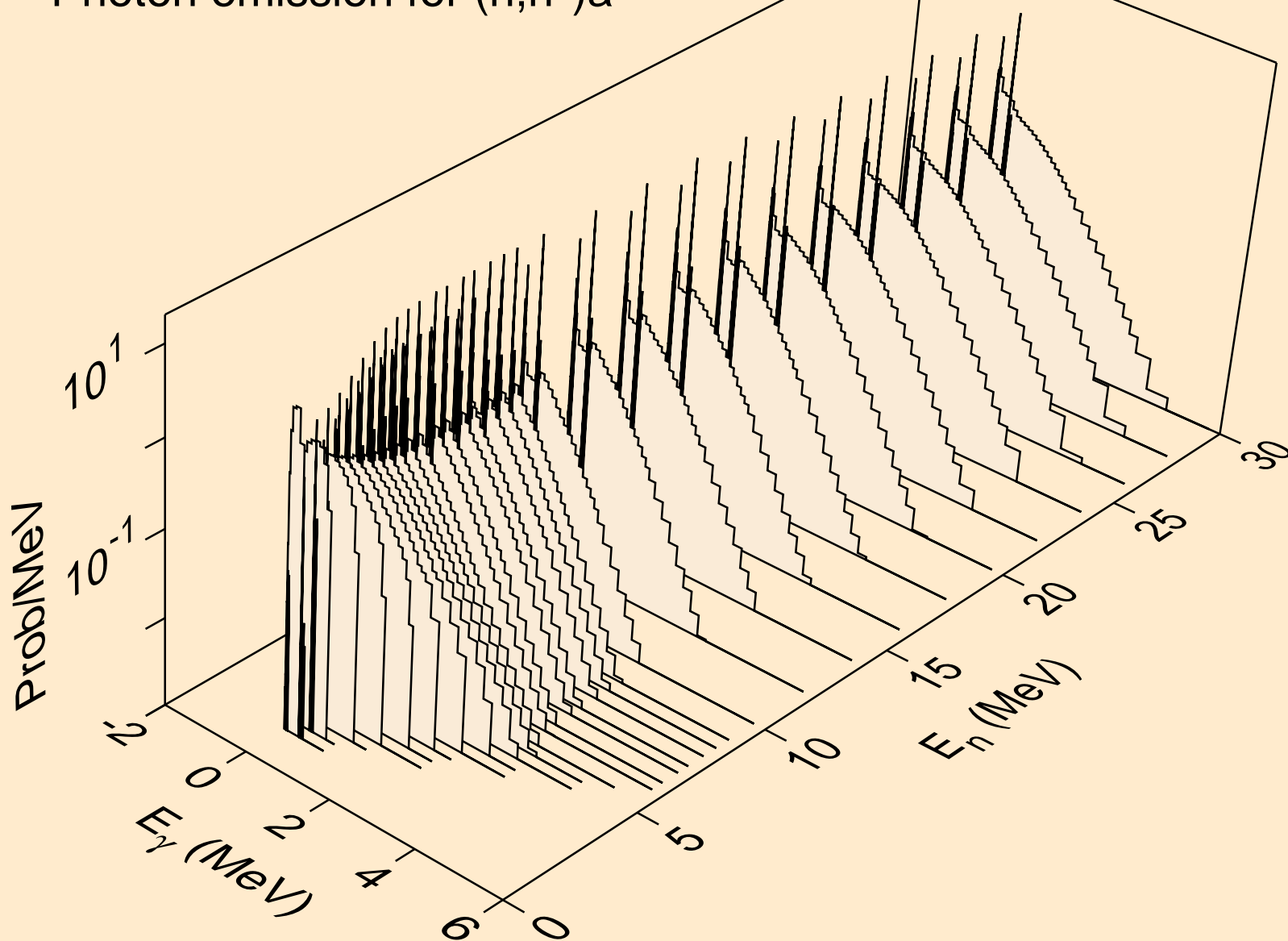

MD253 NEUTRON ACER TENDL-2019 LIBRARY; T=293.16K  
Photon emission for (n,2n)a

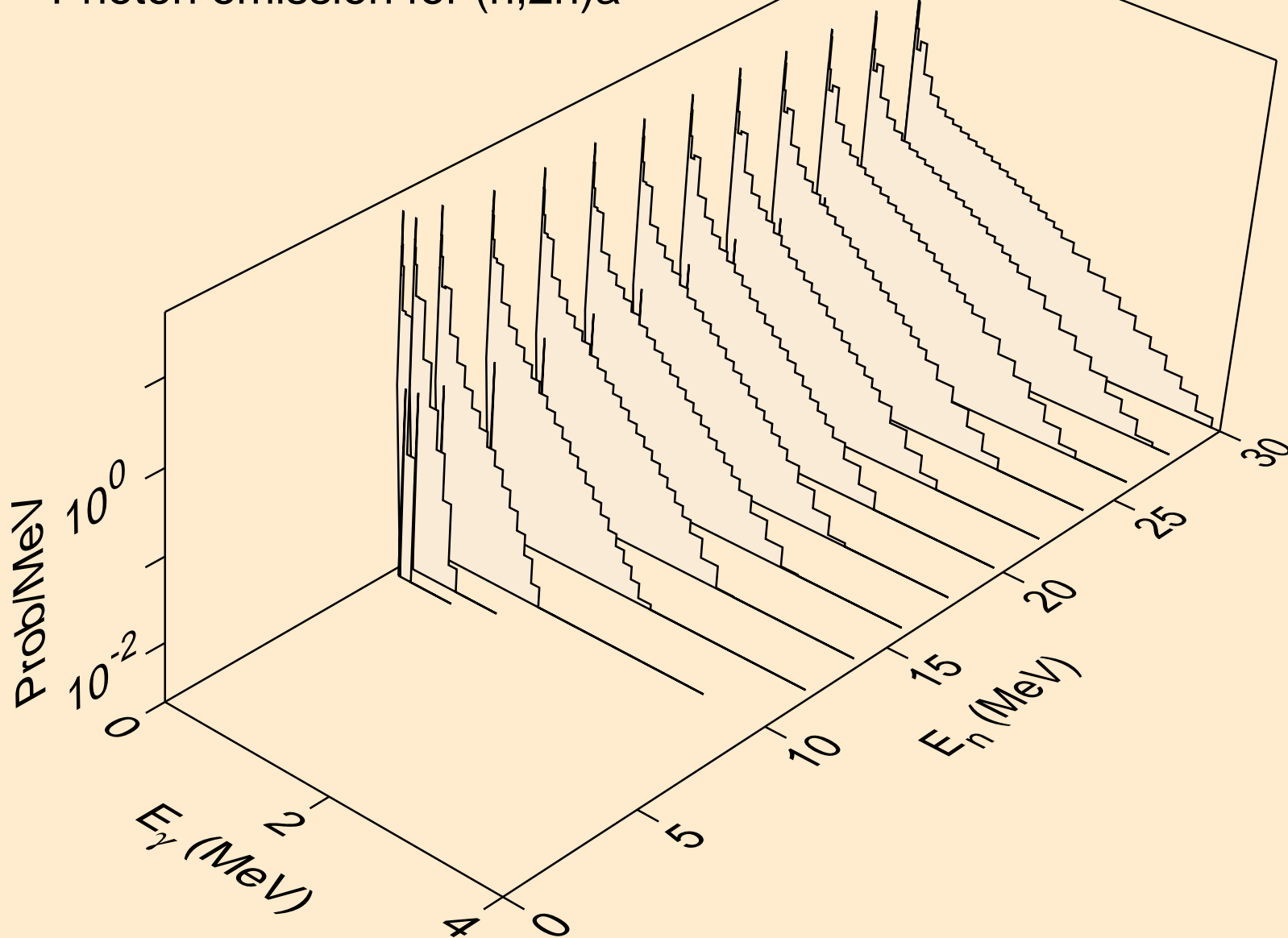

MD253 NEUTRON ACER TENDL-2019 LIBRARY; T=293.16K  
Photon emission for (n,3n) $\alpha$

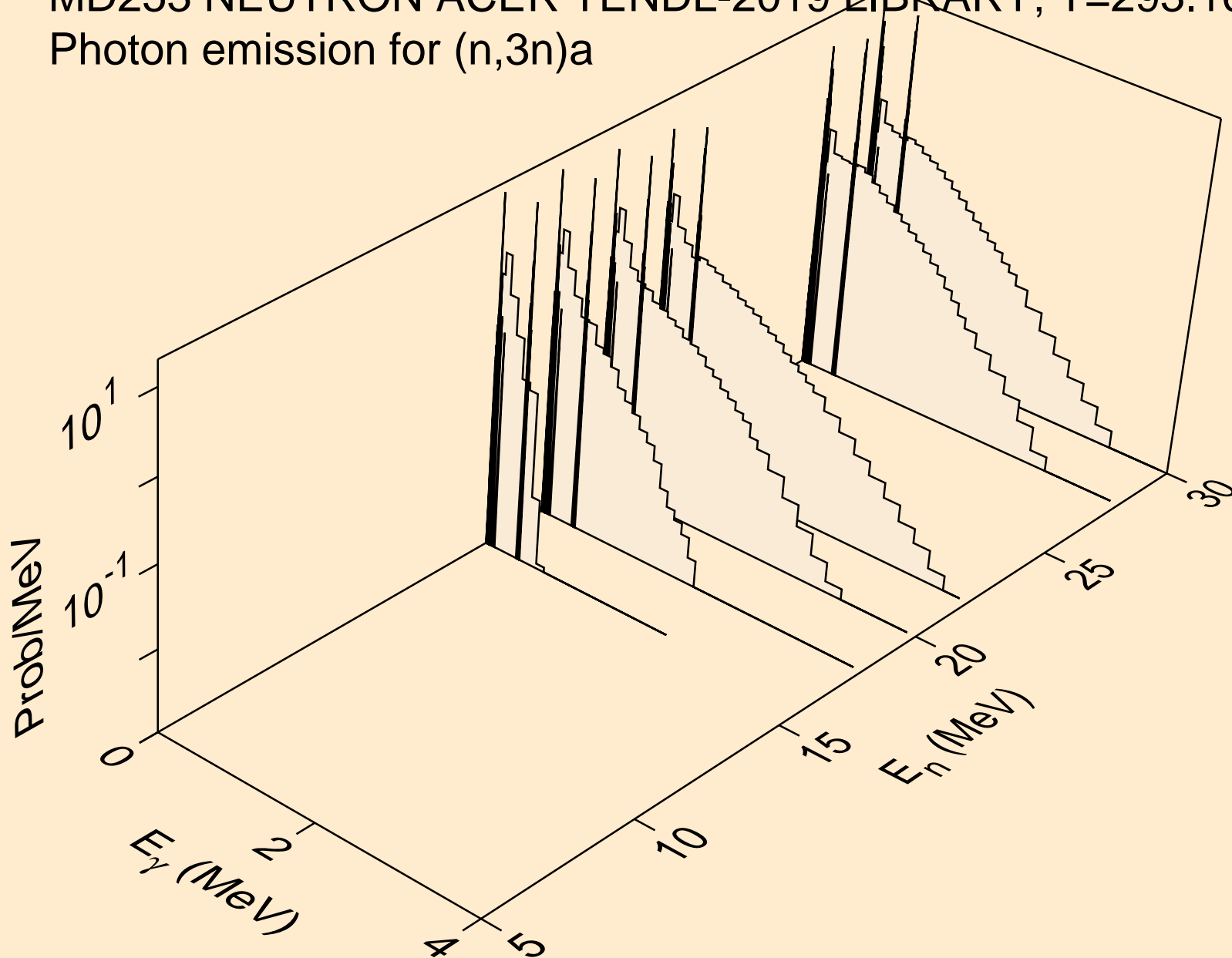

MD253 NEUTRON ACER TENDL-2019 LIBRARY; T=293.16K  
Photon emission for (n,n\*)p

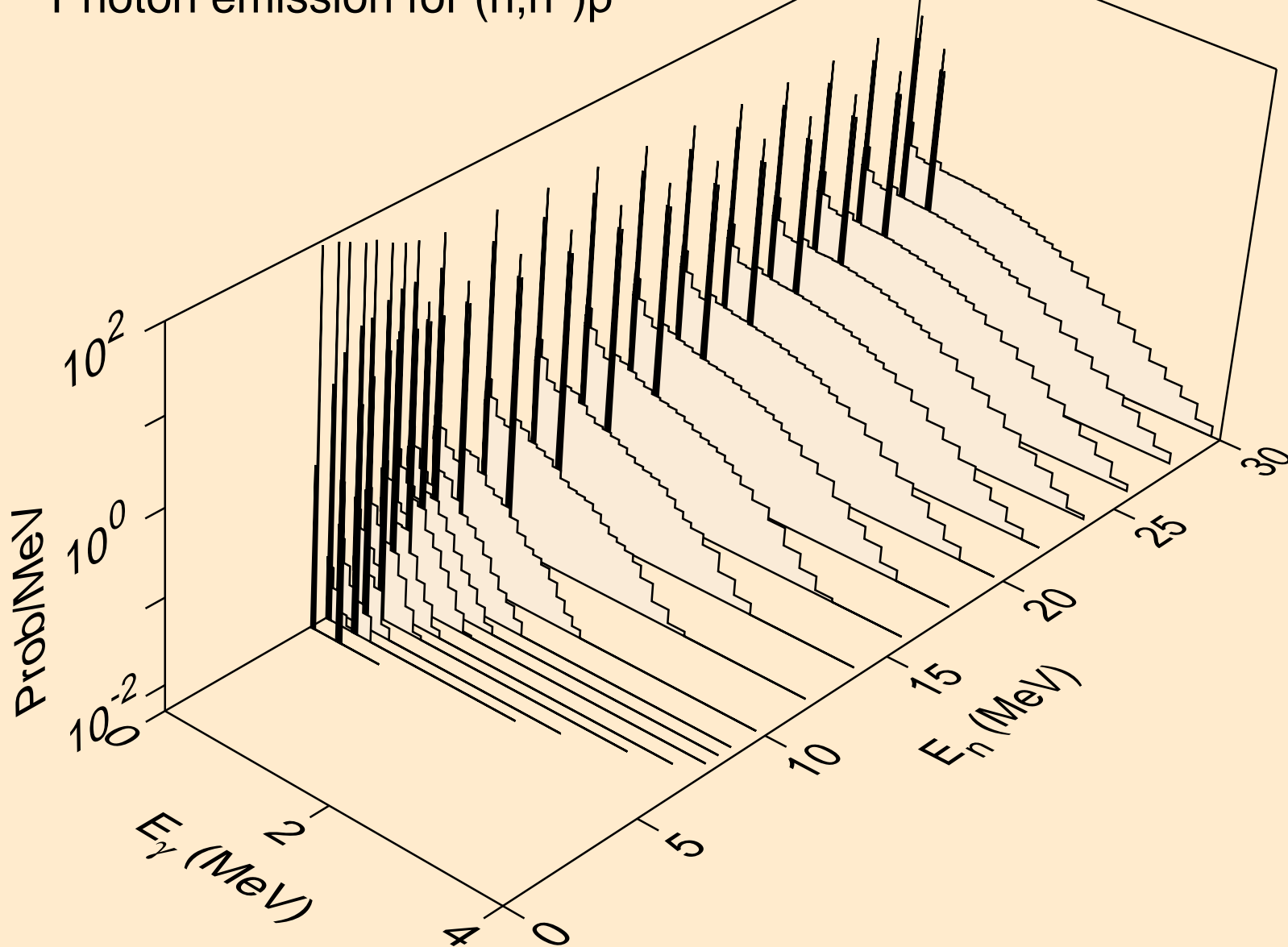

MD253 NEUTRON ACER TENDL-2019 LIBRARY; T=293.16K  
Photon emission for (n,n\*)2a

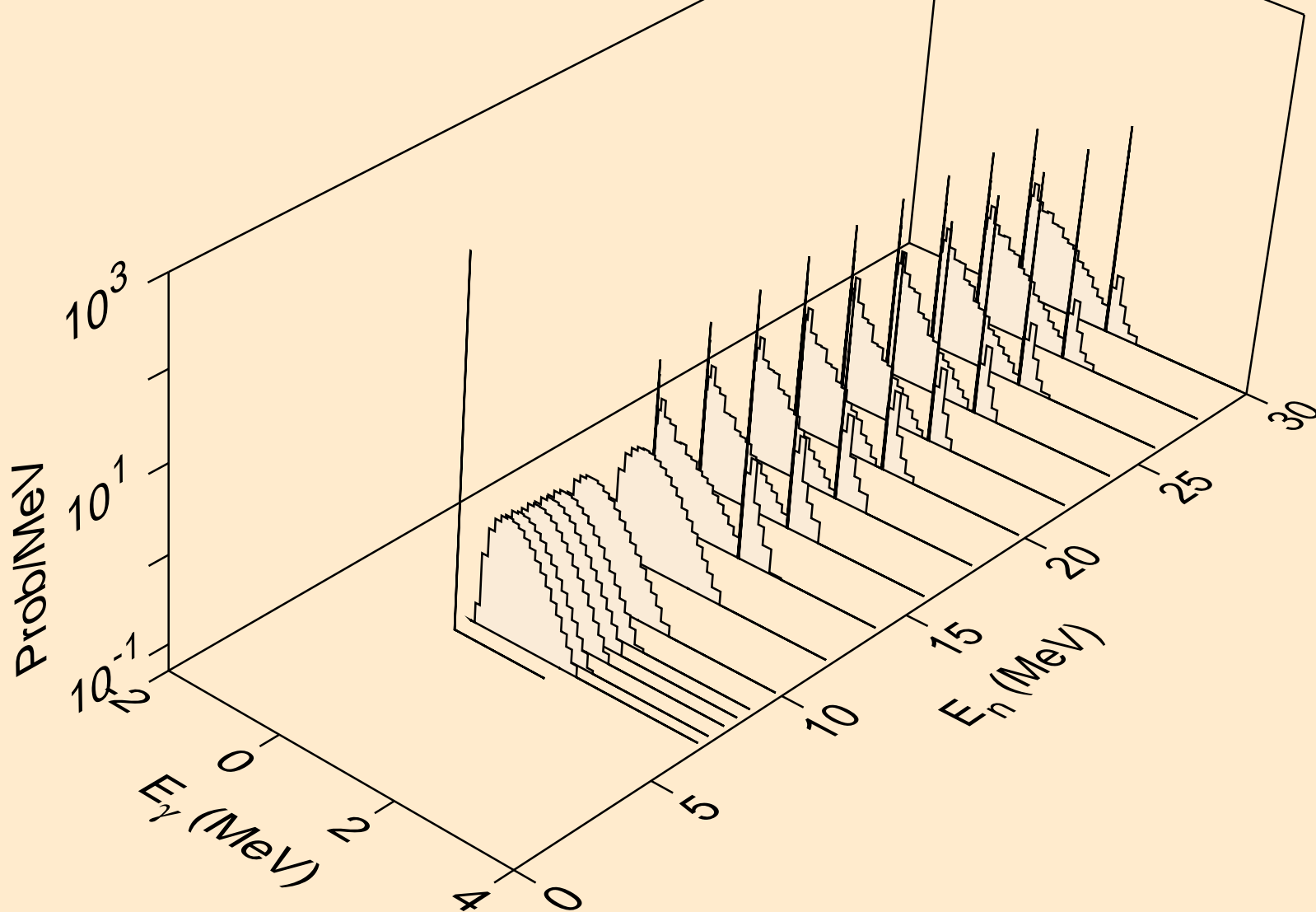

MD253 NEUTRON ACER TENDL-2019 LIBRARY; T=293.16K  
Photon emission for (n,n\*)d

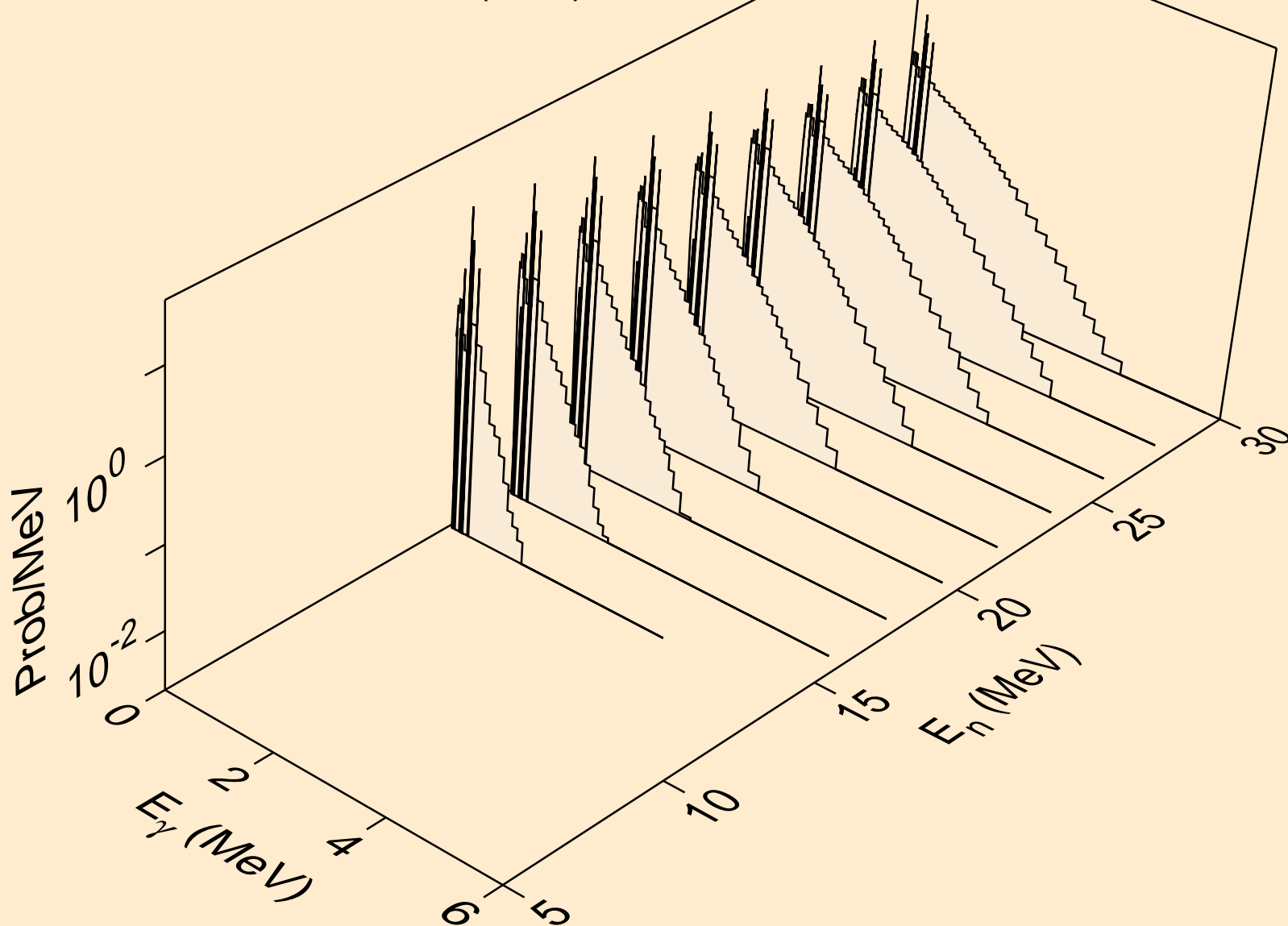

MD253 NEUTRON ACER TENDL-2019 LIBRARY; T=293.16K  
Photon emission for (n,n\*)t

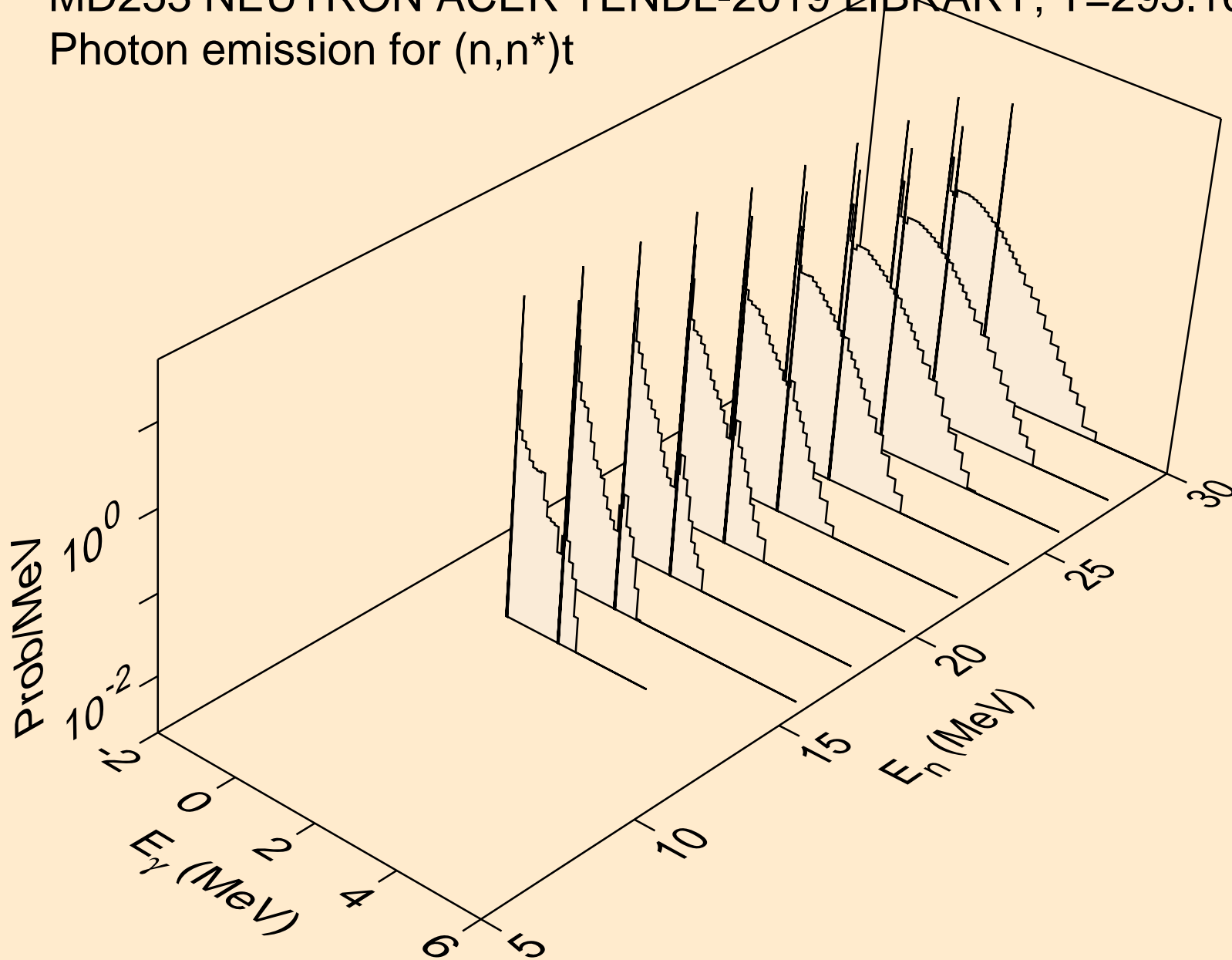



MD253 NEUTRON ACER TENDL-2019 LIBRARY; T=293.16K  
Photon emission for (n,n\*)he3

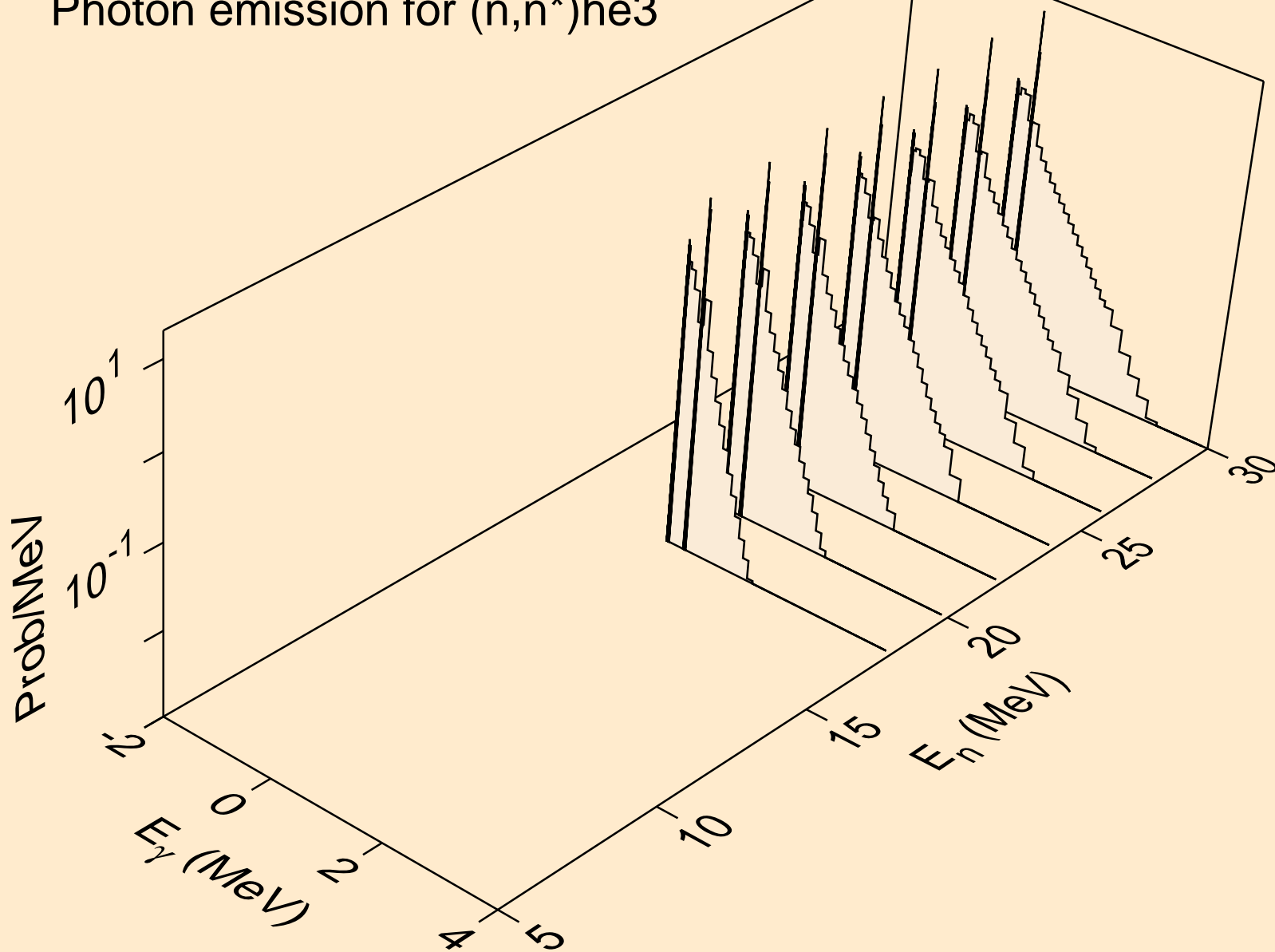

MD253 NEUTRON ACER TENDL-2019 LIBRARY; T=293.16K  
Photon emission for (n,4n)

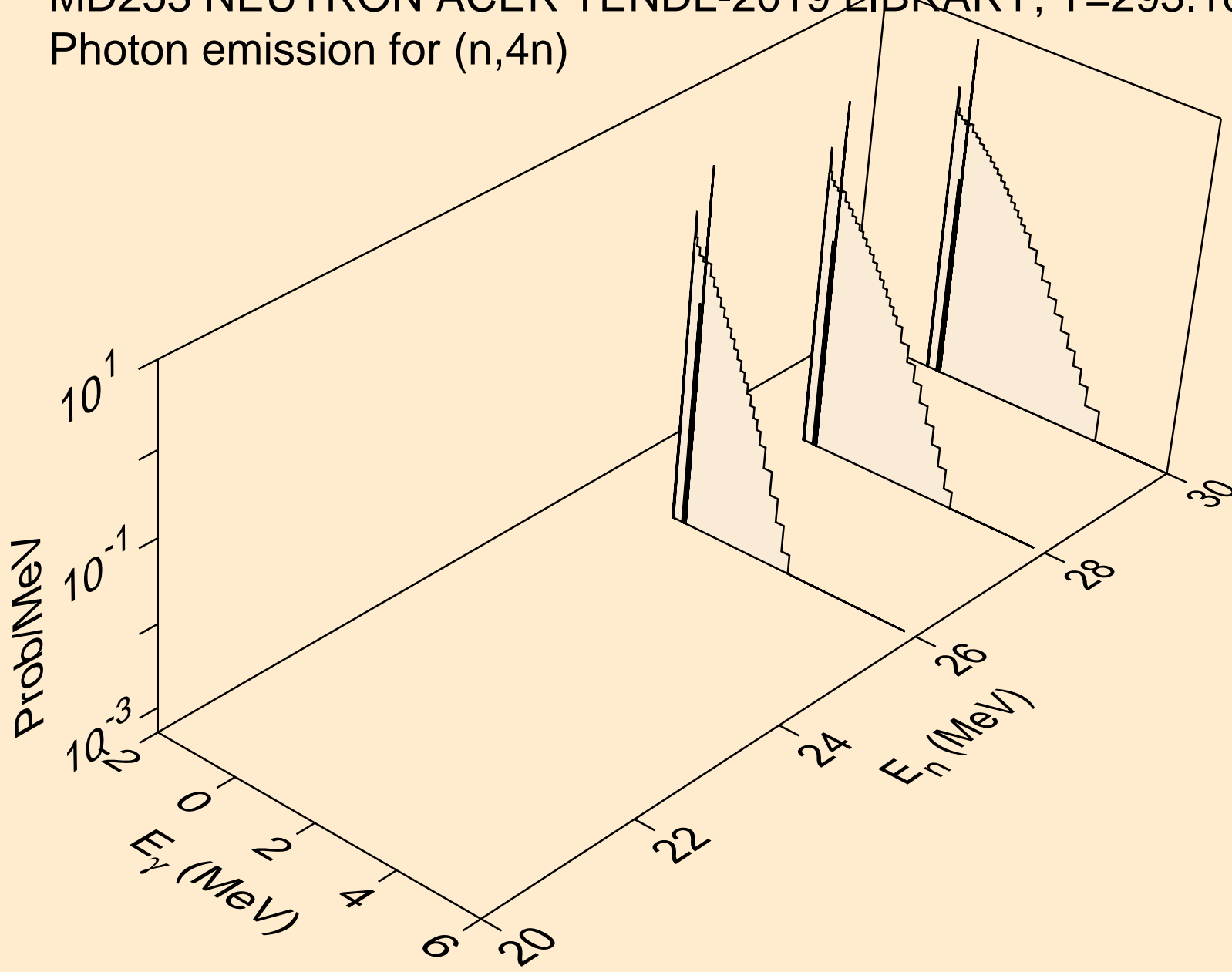

MD253 NEUTRON ACER TENDL-2019 LIBRARY; T=293.16K  
Photon emission for (n,2np)

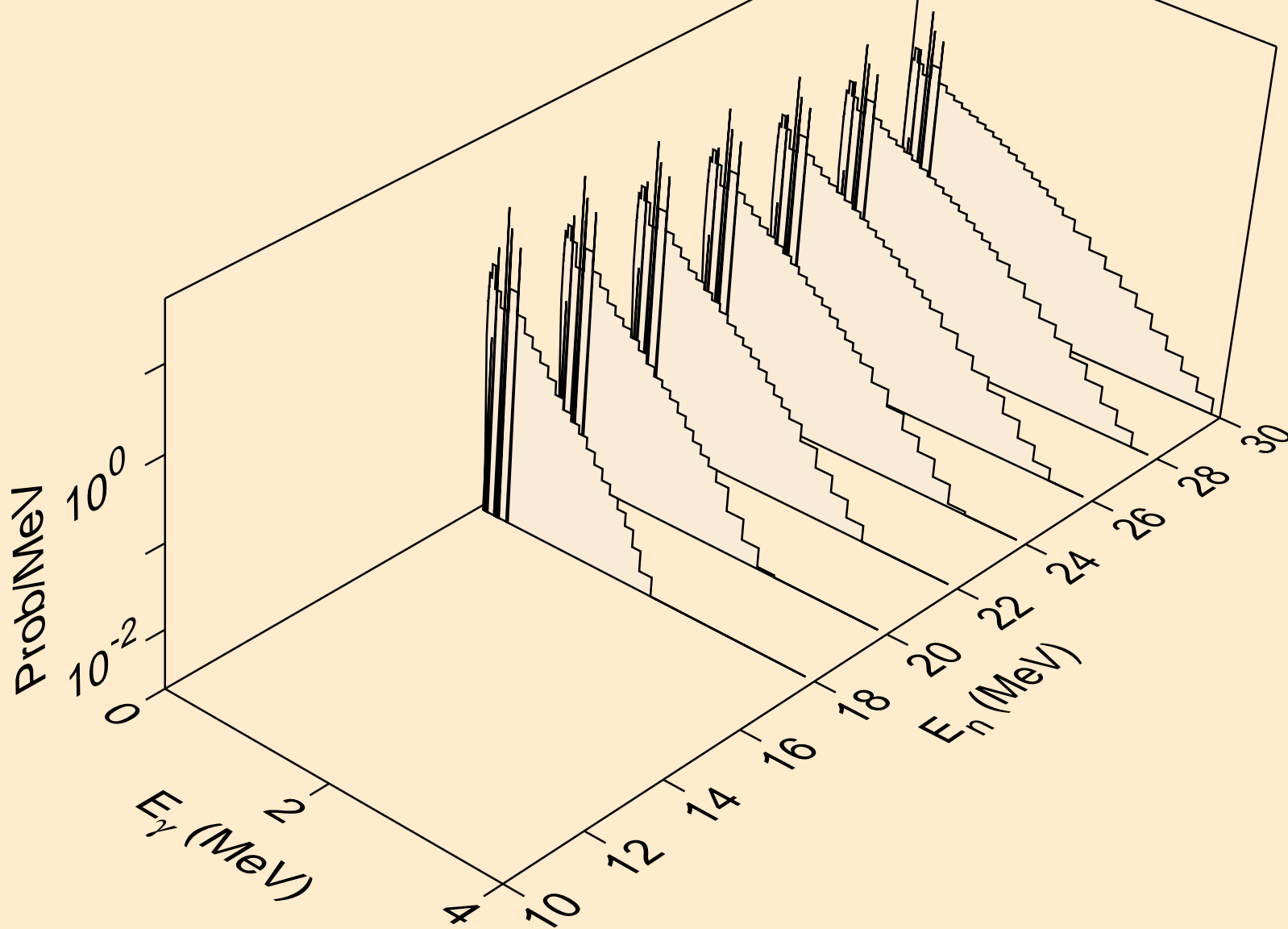

MD253 NEUTRON ACER TENDL-2019 LIBRARY; T=293.16K  
Photon emission for (n,3np)

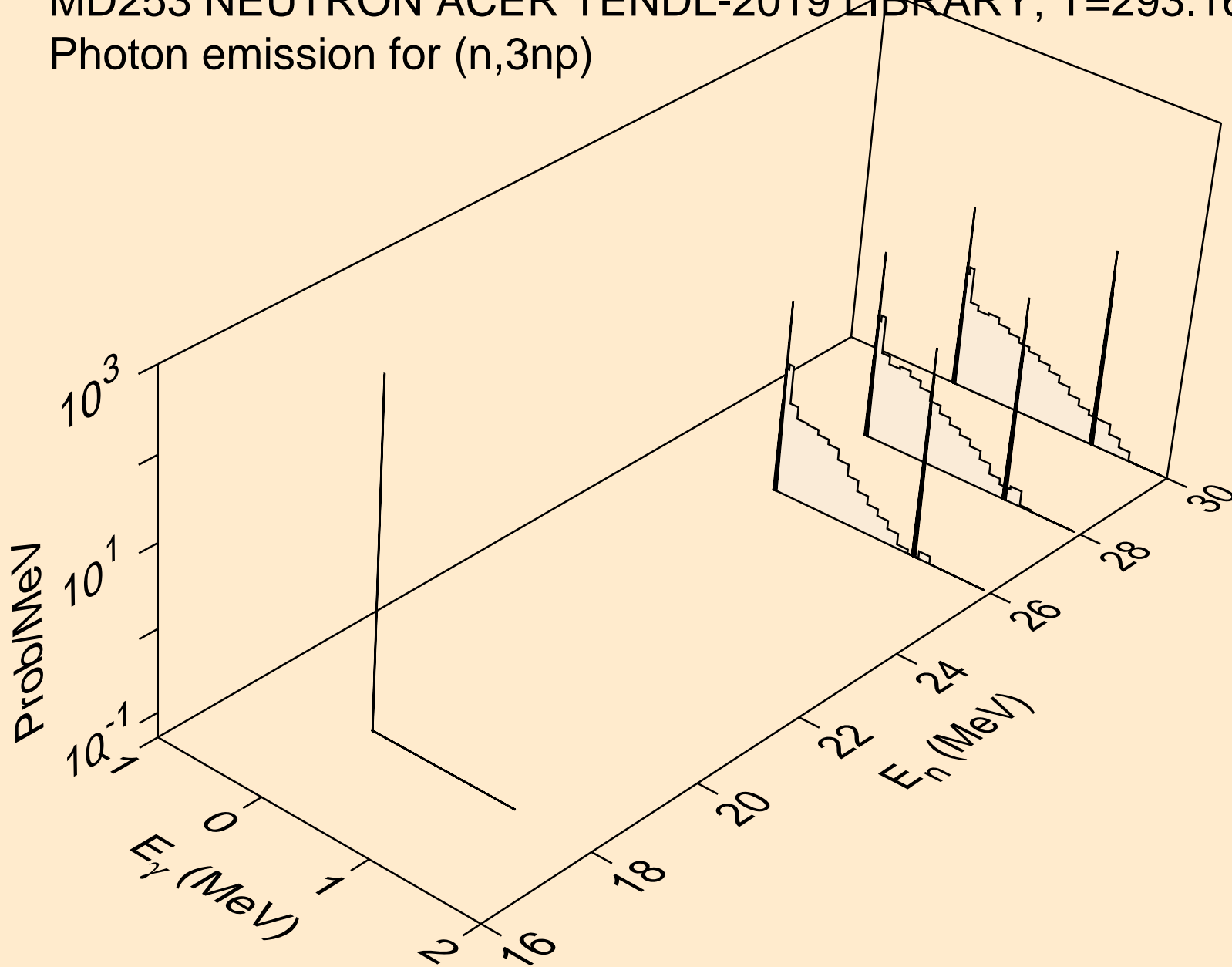

MD253 NEUTRON ACER TENDL-2019 LIBRARY; T=293.16K  
Photon emission for (n,2np)

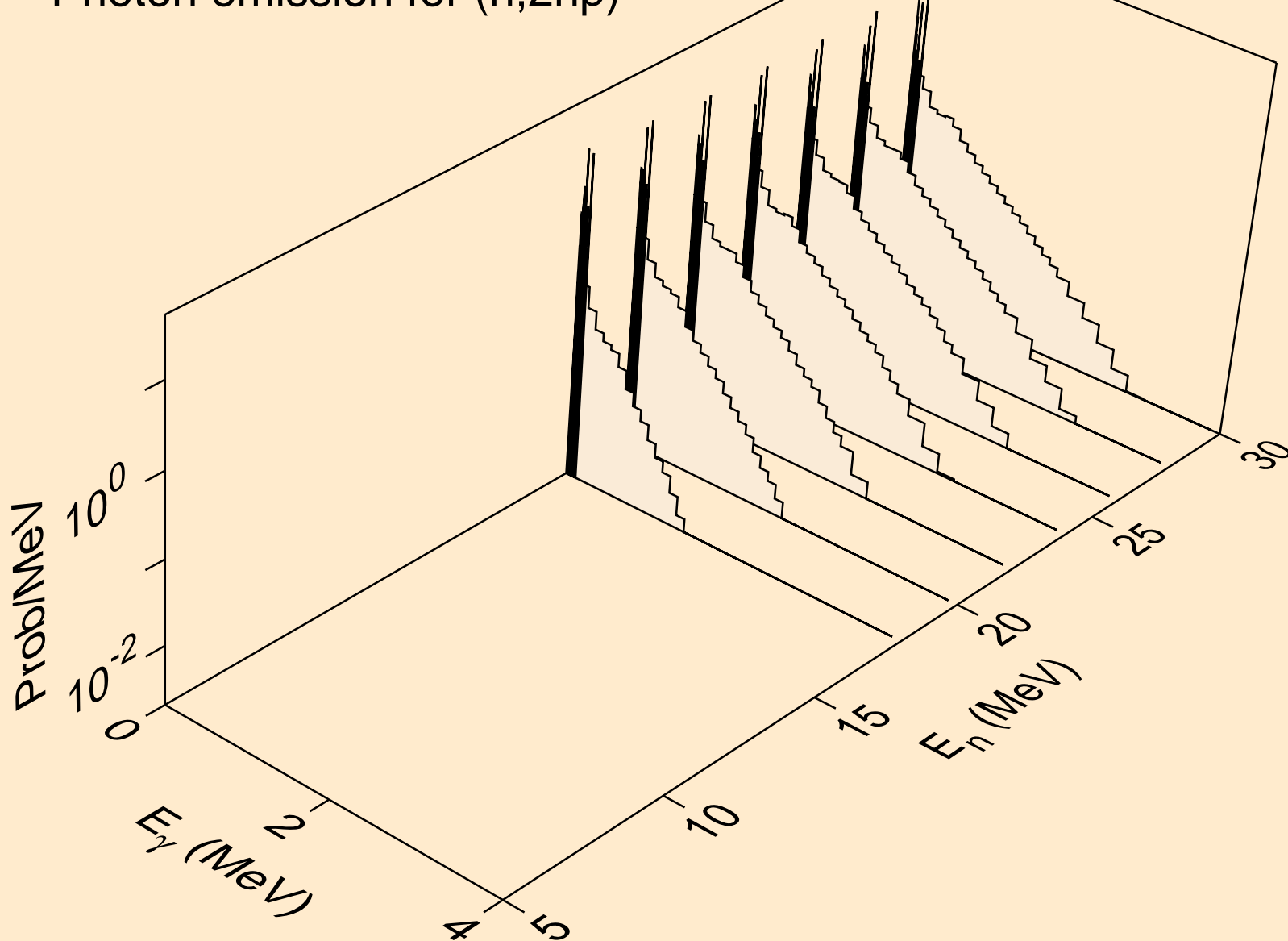

MD253 NEUTRON ACER TENDL-2019 LIBRARY; T=293.16K  
Photon emission for (n,npa)

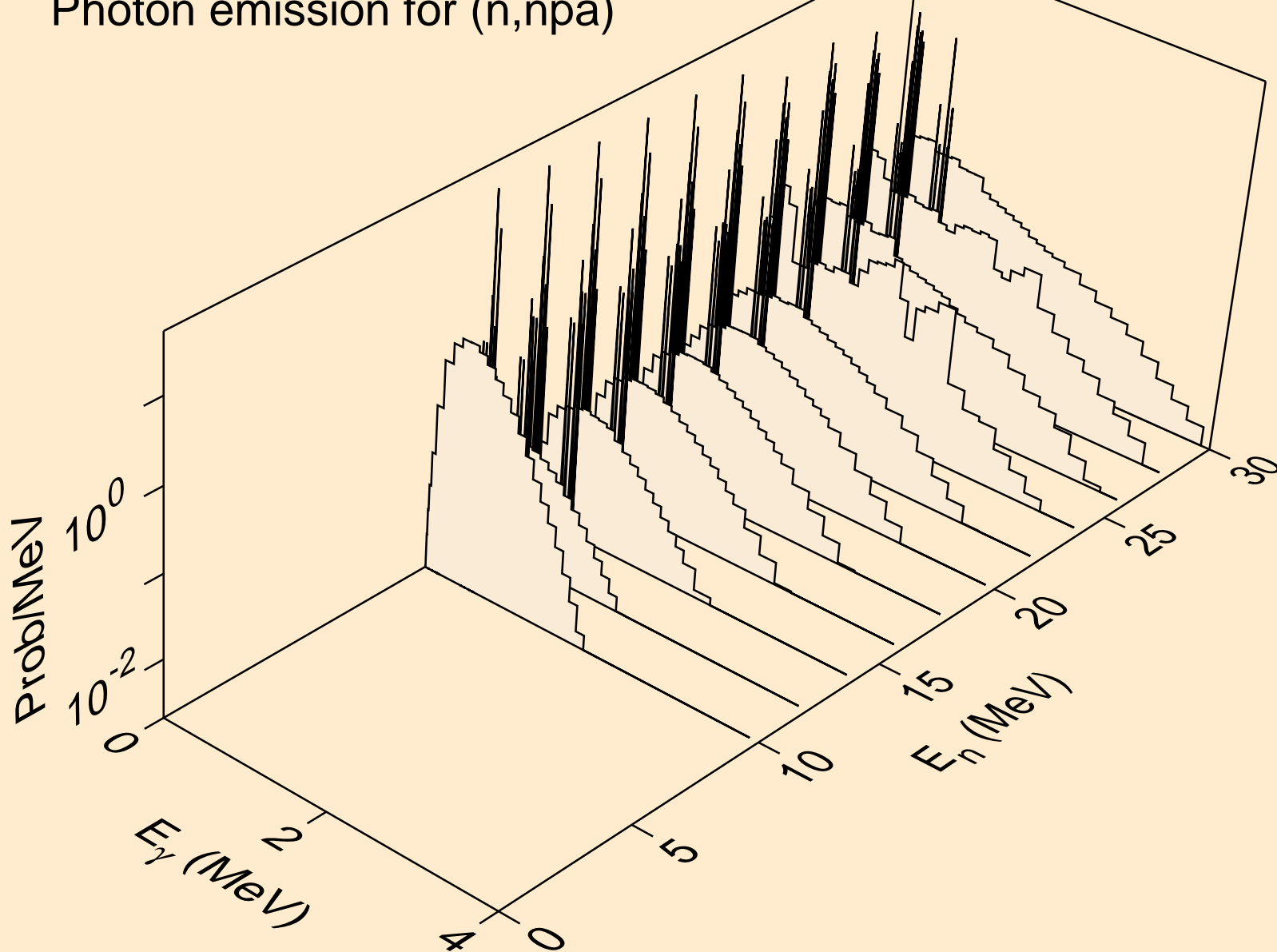

MD253 NEUTRON ACER TENDL-2019 LIBRARY; T=293.16K  
Photon emission for (n,n\*c)

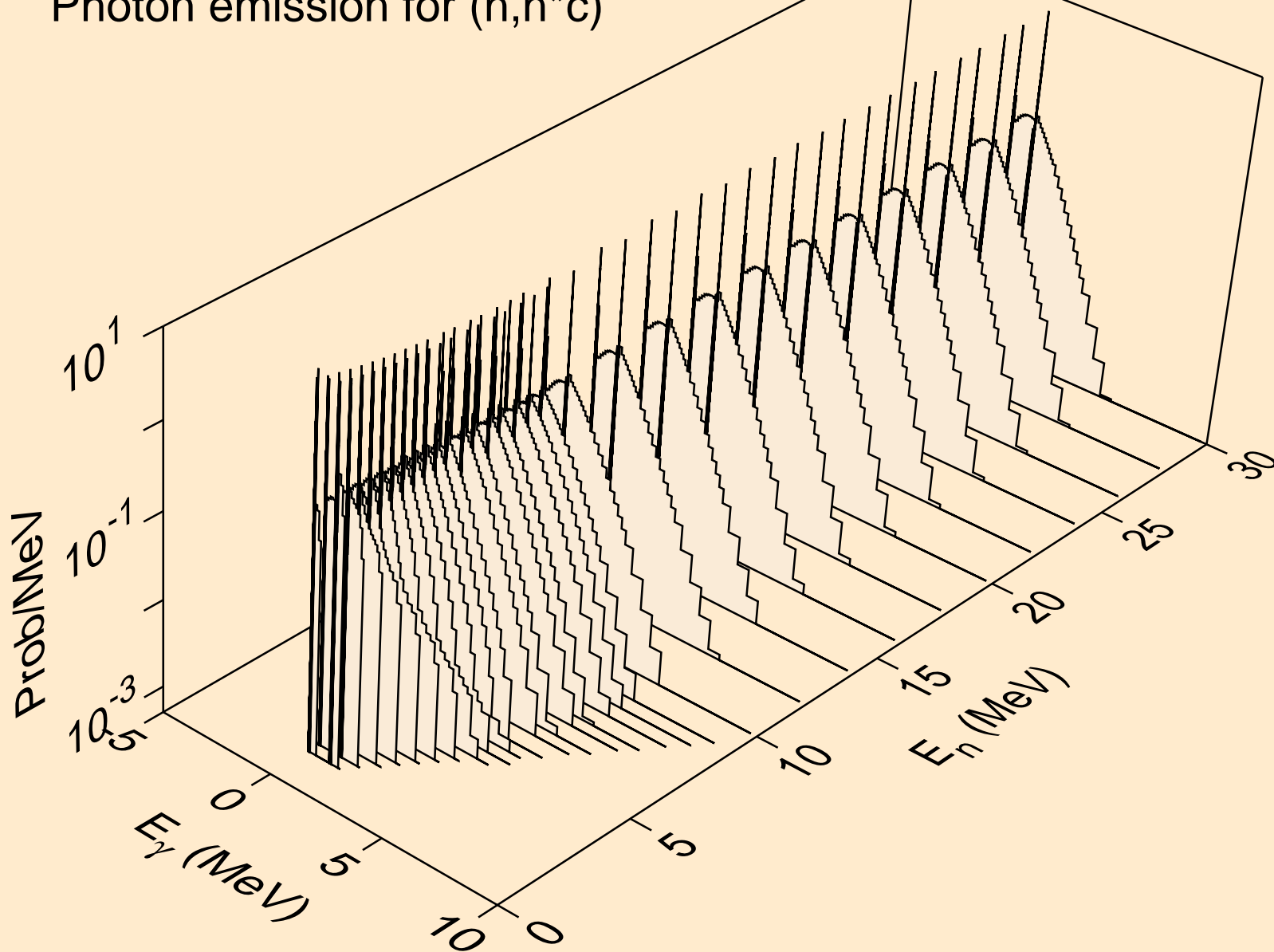

MD253 NEUTRON ACER TENDL-2019 LIBRARY; T=293.16K  
Photon emission for (n,gma)

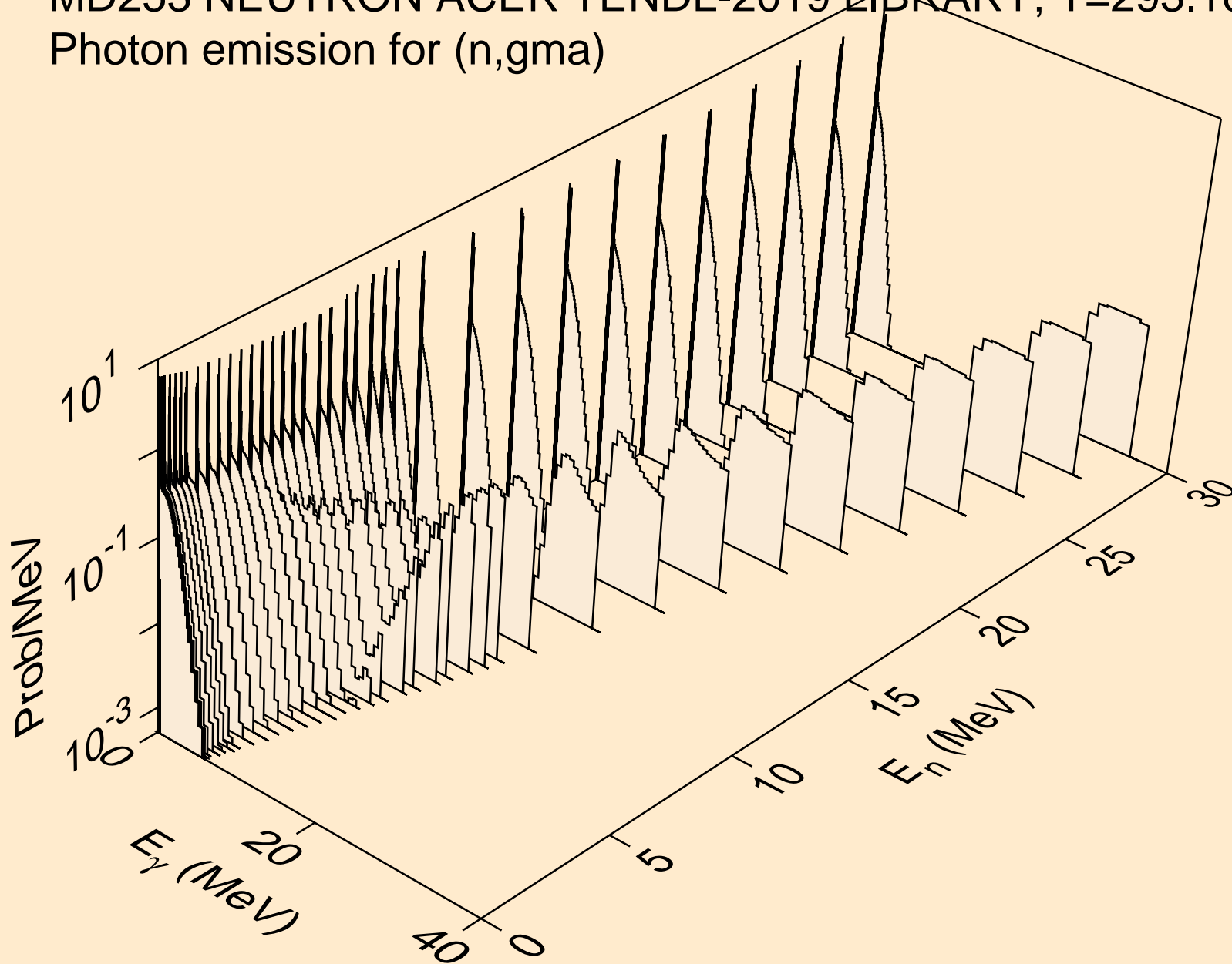



MD253 NEUTRON ACER TENDL-2019 LIBRARY; T=293.16K  
Photon emission for (n,p)

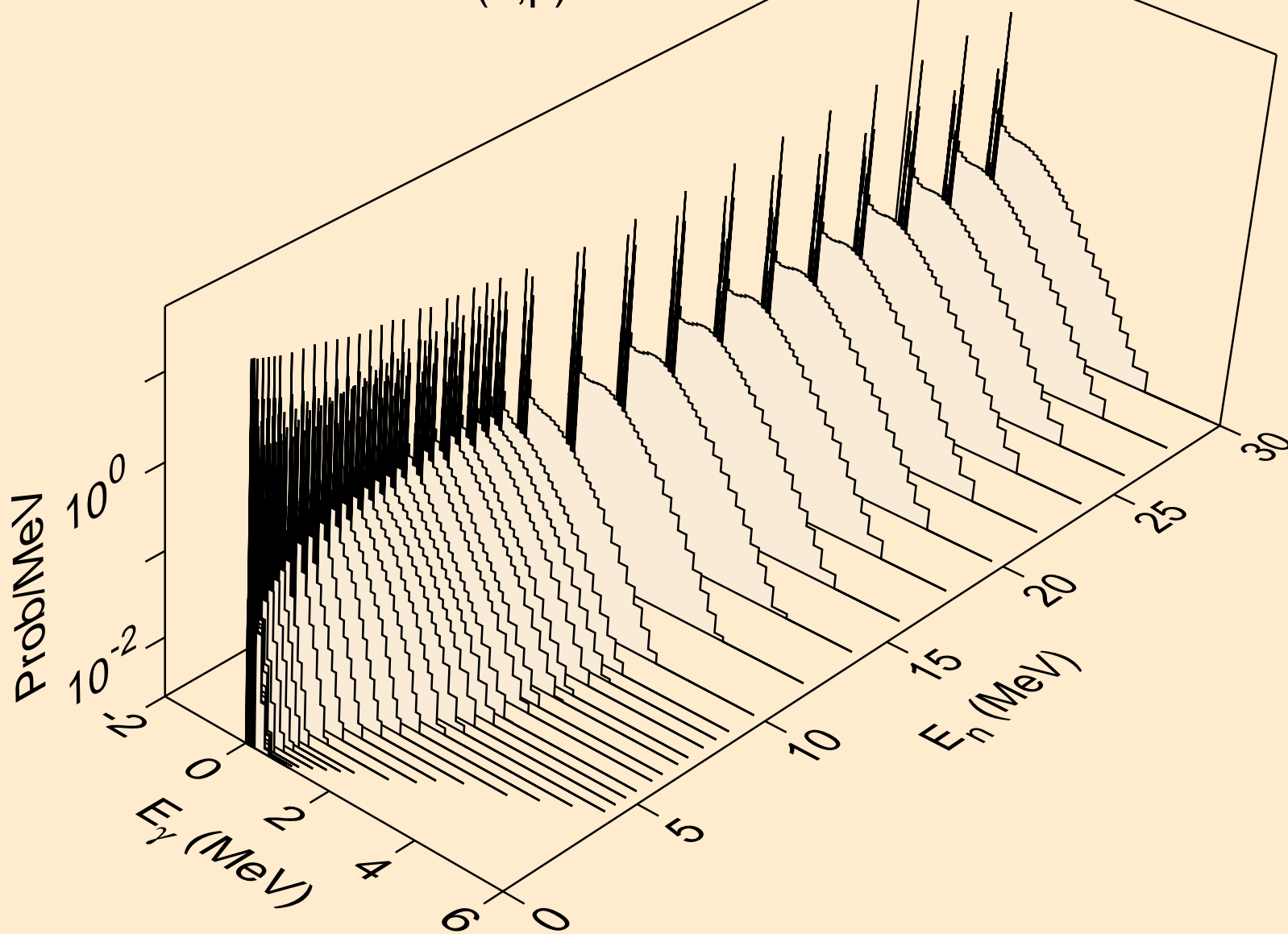

MD253 NEUTRON ACER TENDL-2019 LIBRARY; T=293.16K  
Photon emission for (n,d)

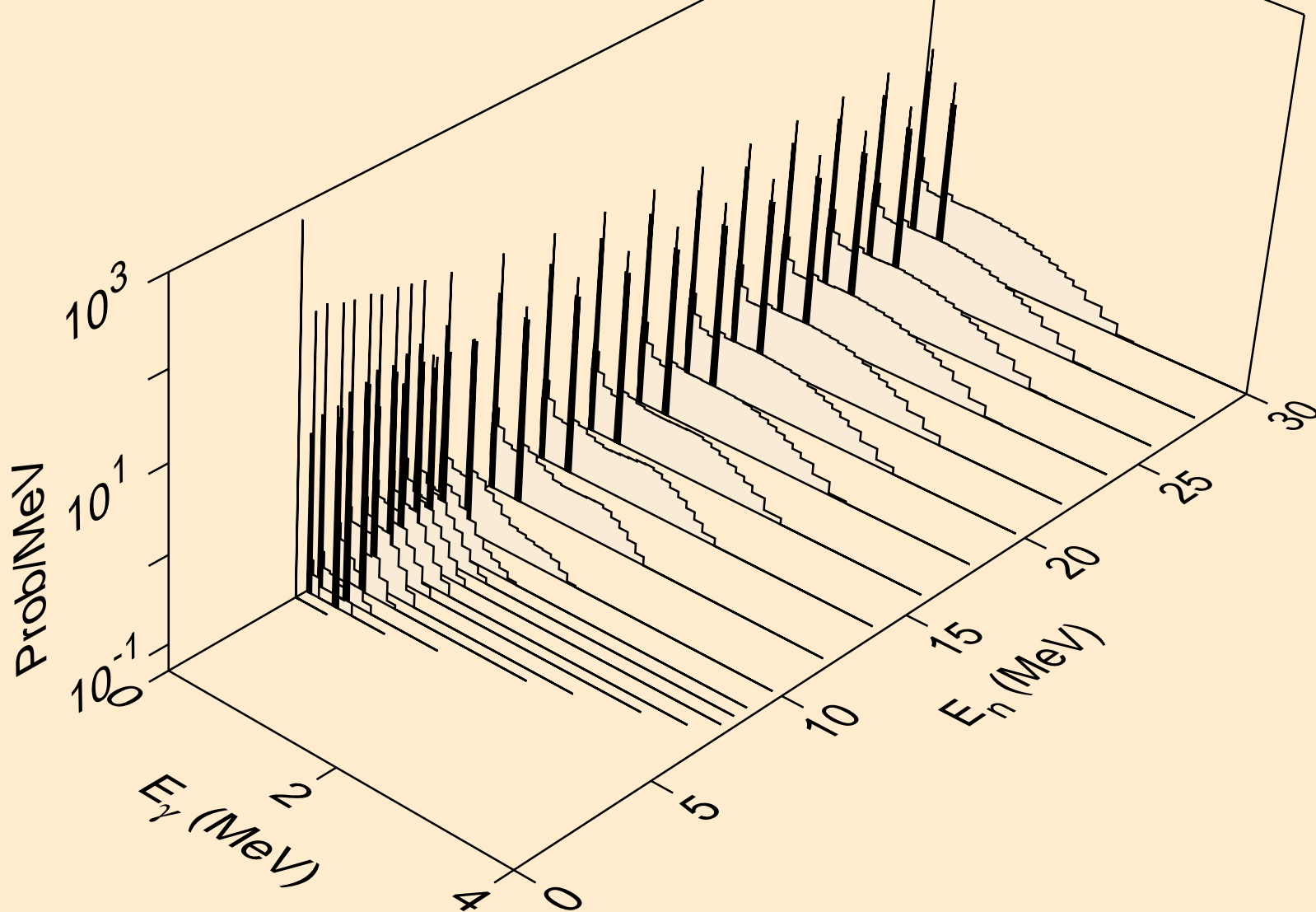

MD253 NEUTRON ACER TENDL-2019 LIBRARY; T=293.16K  
Photon emission for (n,t)

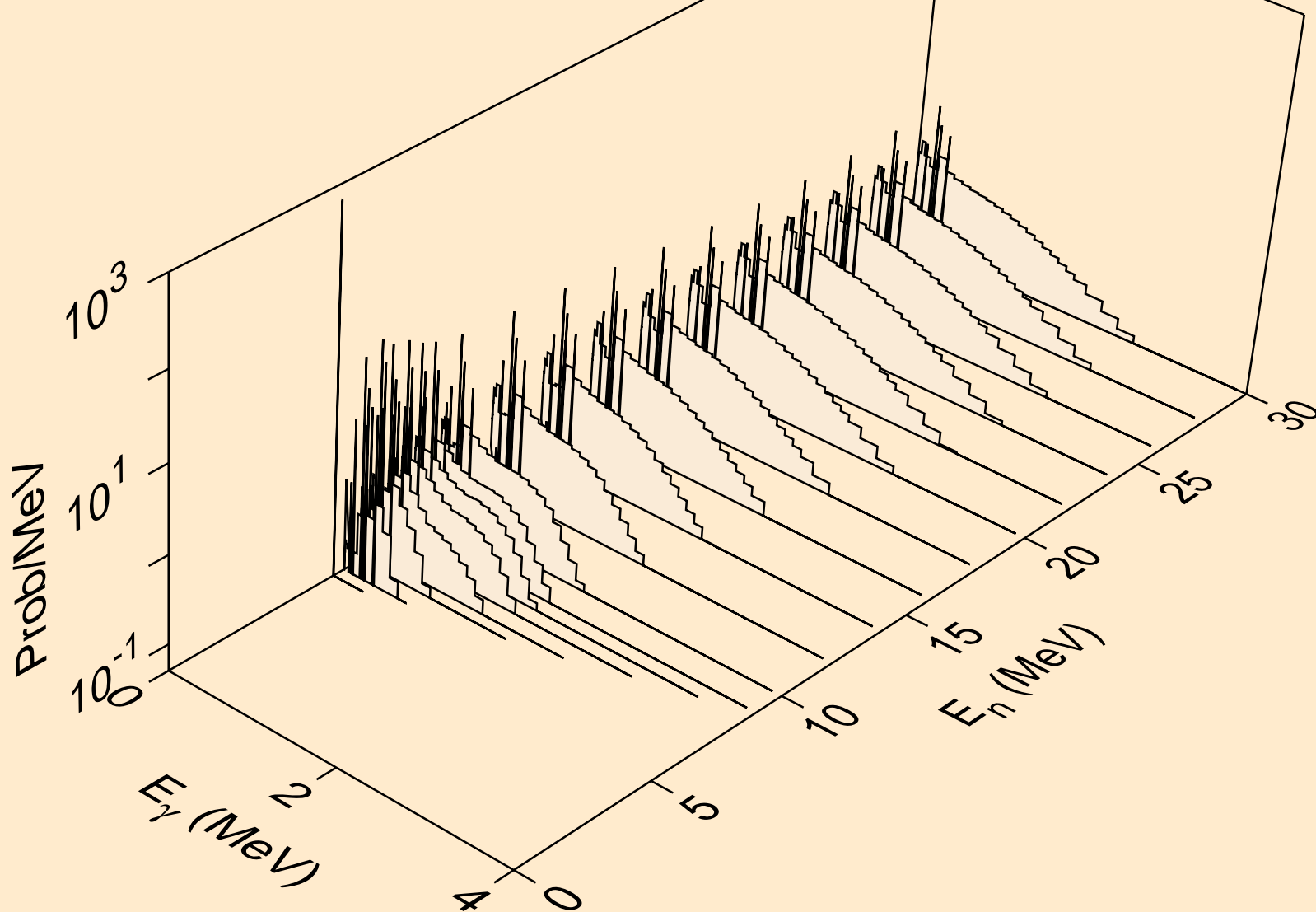

MD253 NEUTRON ACER TENDL-2019 LIBRARY; T=293.16K  
Photon emission for (n,he3)

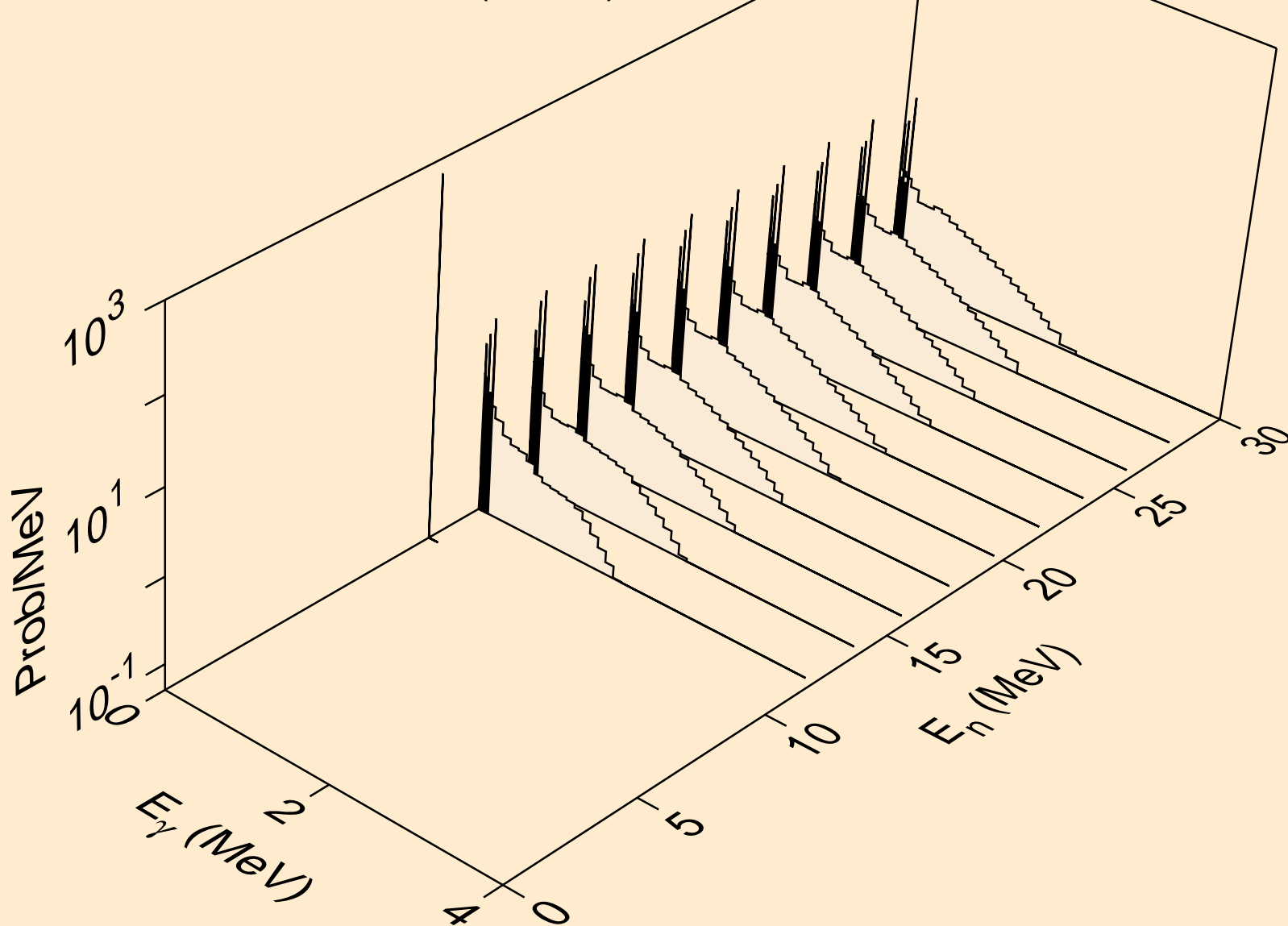

MD253 NEUTRON ACER TENDL-2019 LIBRARY; T=293.16K  
Photon emission for (n,a)

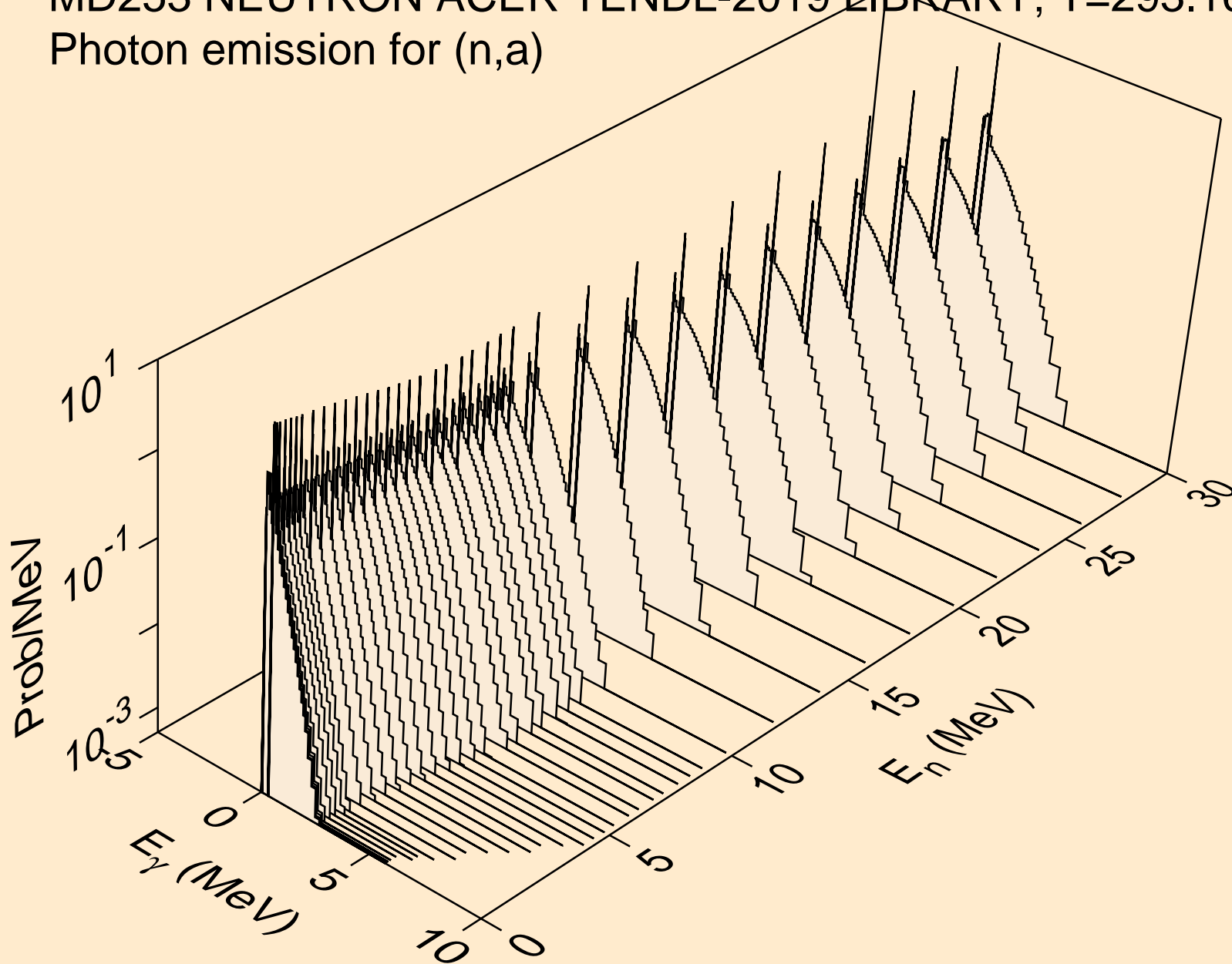

MD253 NEUTRON ACER TENDL-2019 LIBRARY; T=293.16K  
Photon emission for (n,2a)

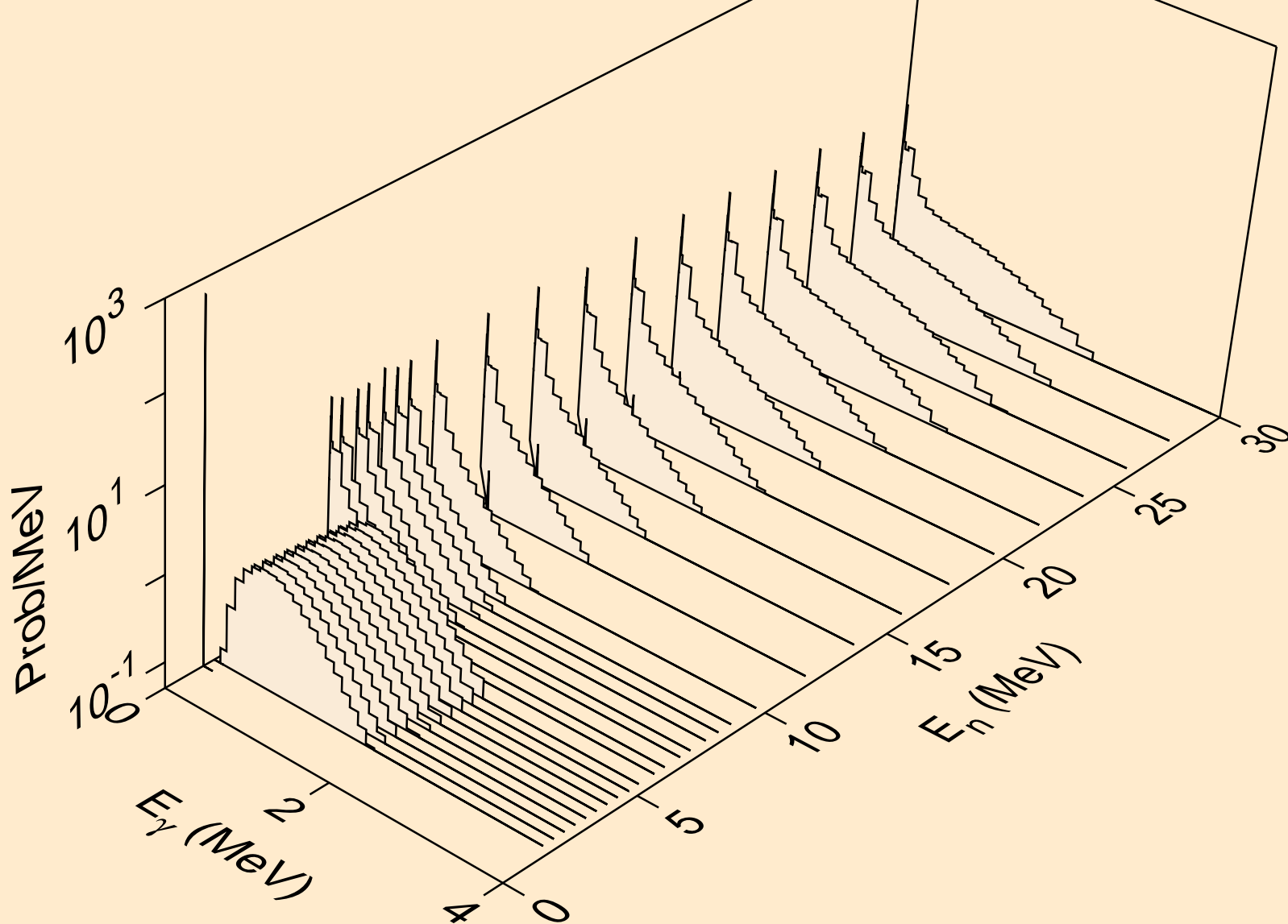

MD253 NEUTRON ACER TENDL-2019 LIBRARY; T=293.16K  
Photon emission for (n,2p)

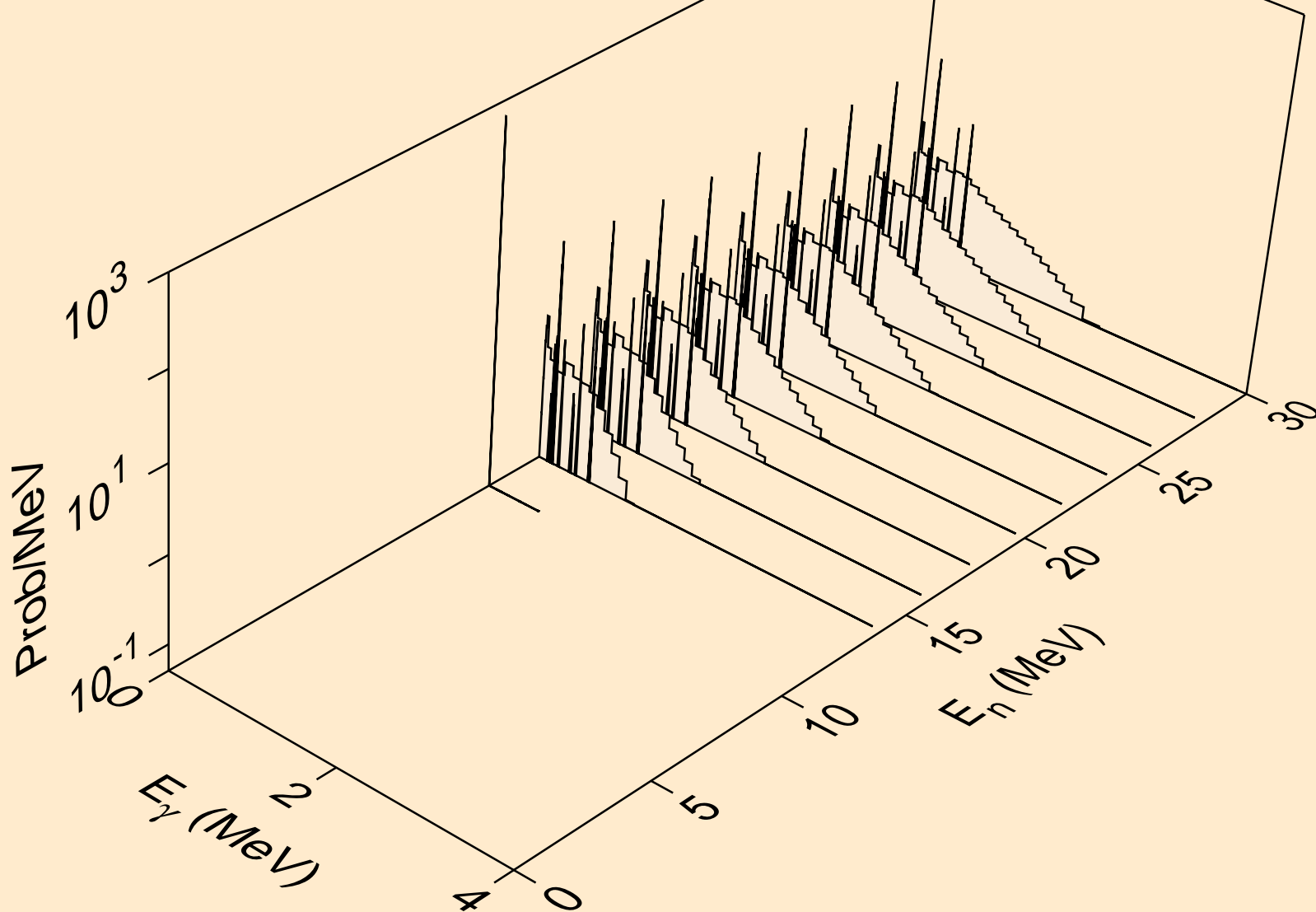

MD253 NEUTRON ACER TENDL-2019 LIBRARY; T=293.16K  
Photon emission for (n,p $\alpha$ )

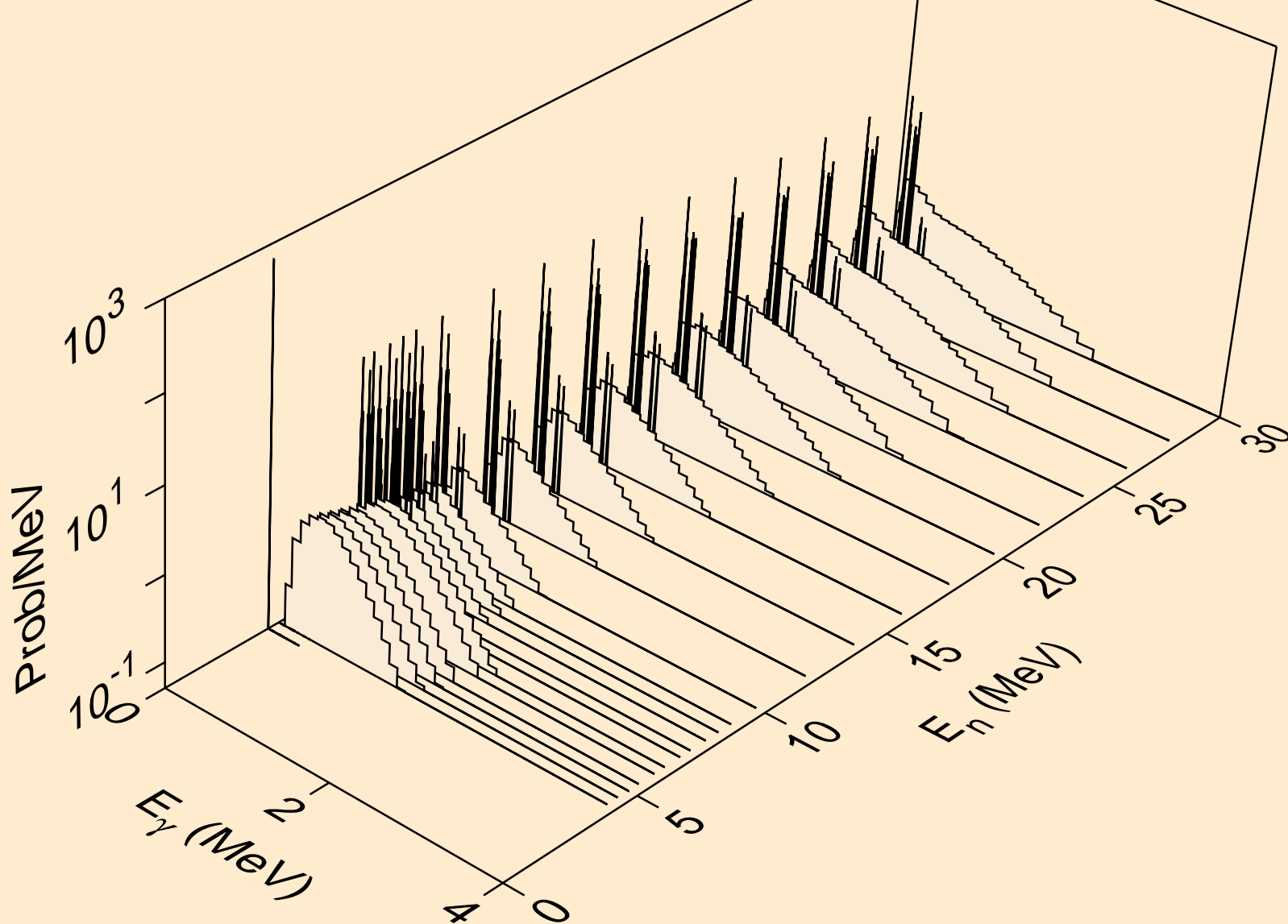



MD253 NEUTRON ACER TENDL-2019 LIBRARY; T=293.16K  
Photon emission for (n,pd)

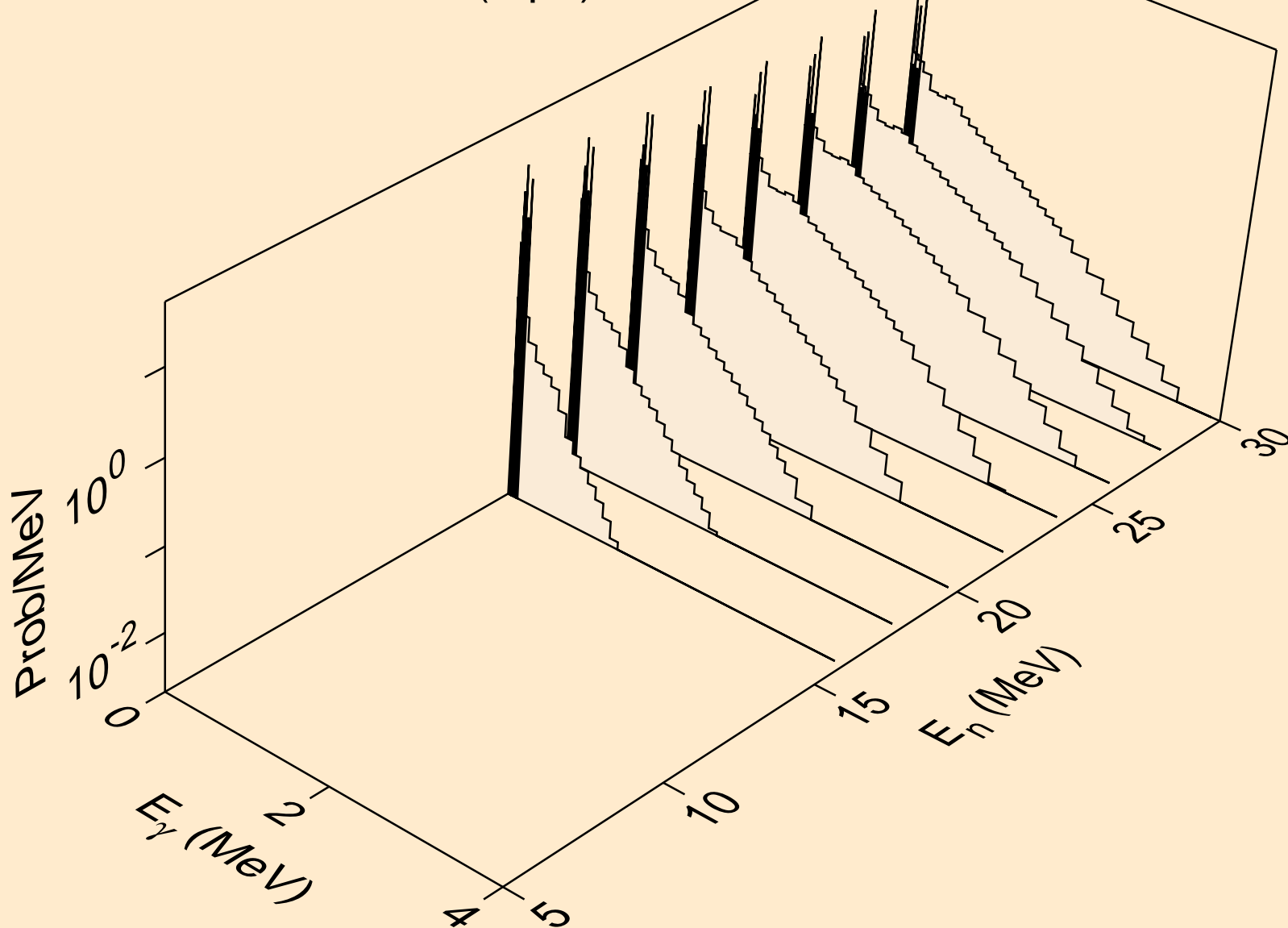

MD253 NEUTRON ACER TENDL-2019 LIBRARY; T=293.16K  
Photon emission for (n,pt)

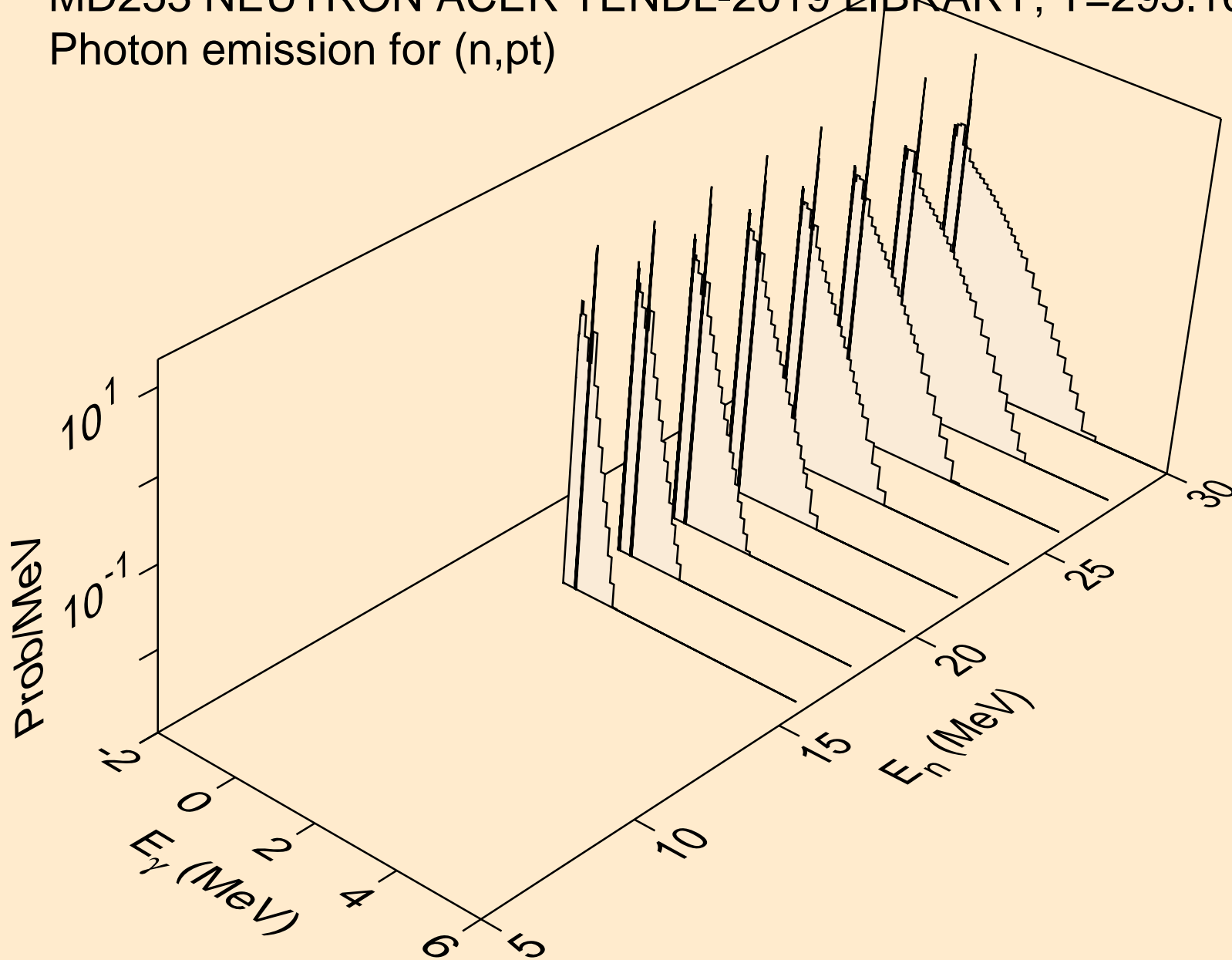

MD253 NEUTRON ACER TENDL-2019 LIBRARY; T=293.16K  
Photon emission for (n,da)

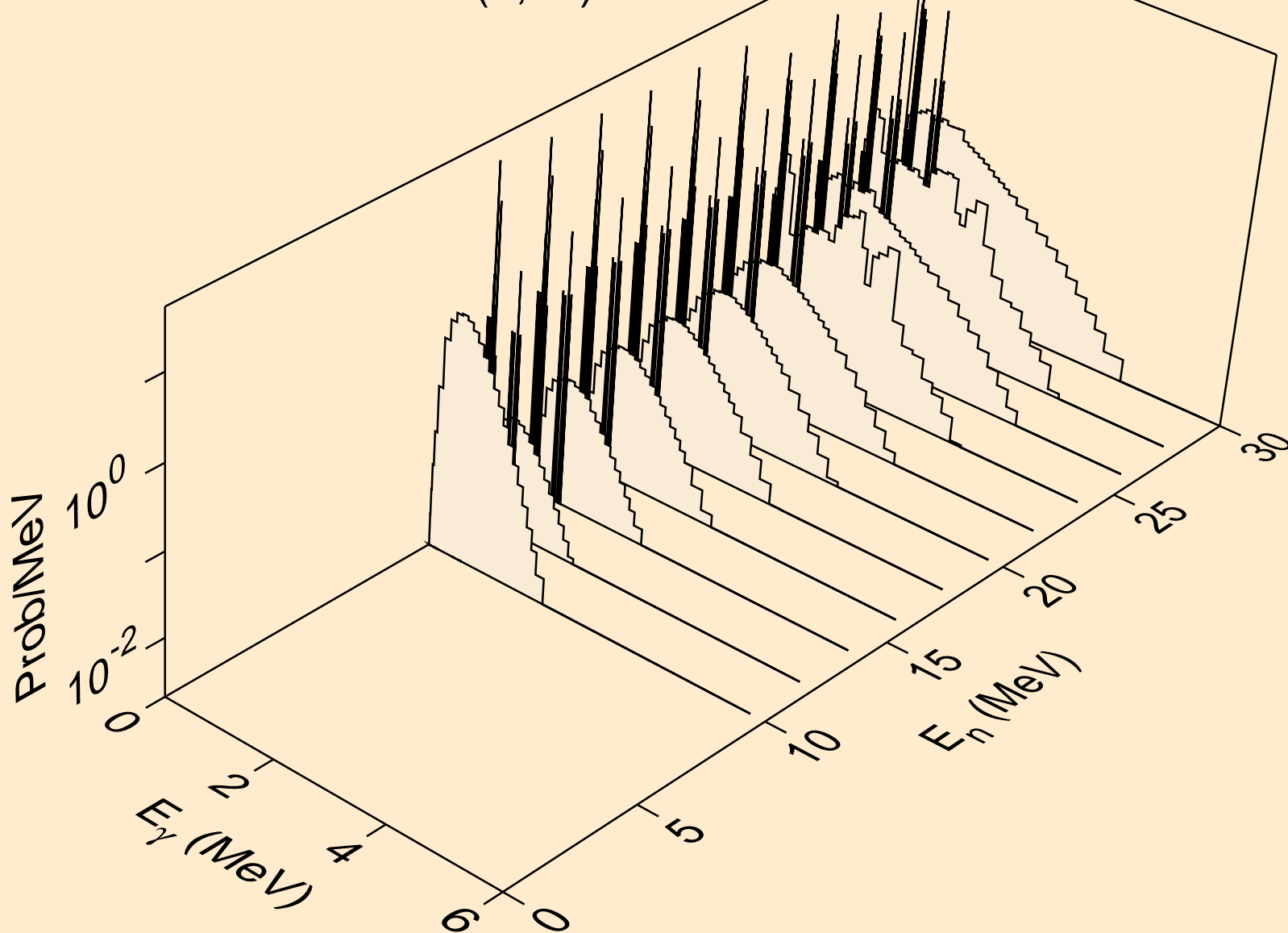

MD253 NEUTRON ACER TENDL-2019 LIBRARY; T=293.16K  
thermal capture photon spectrum

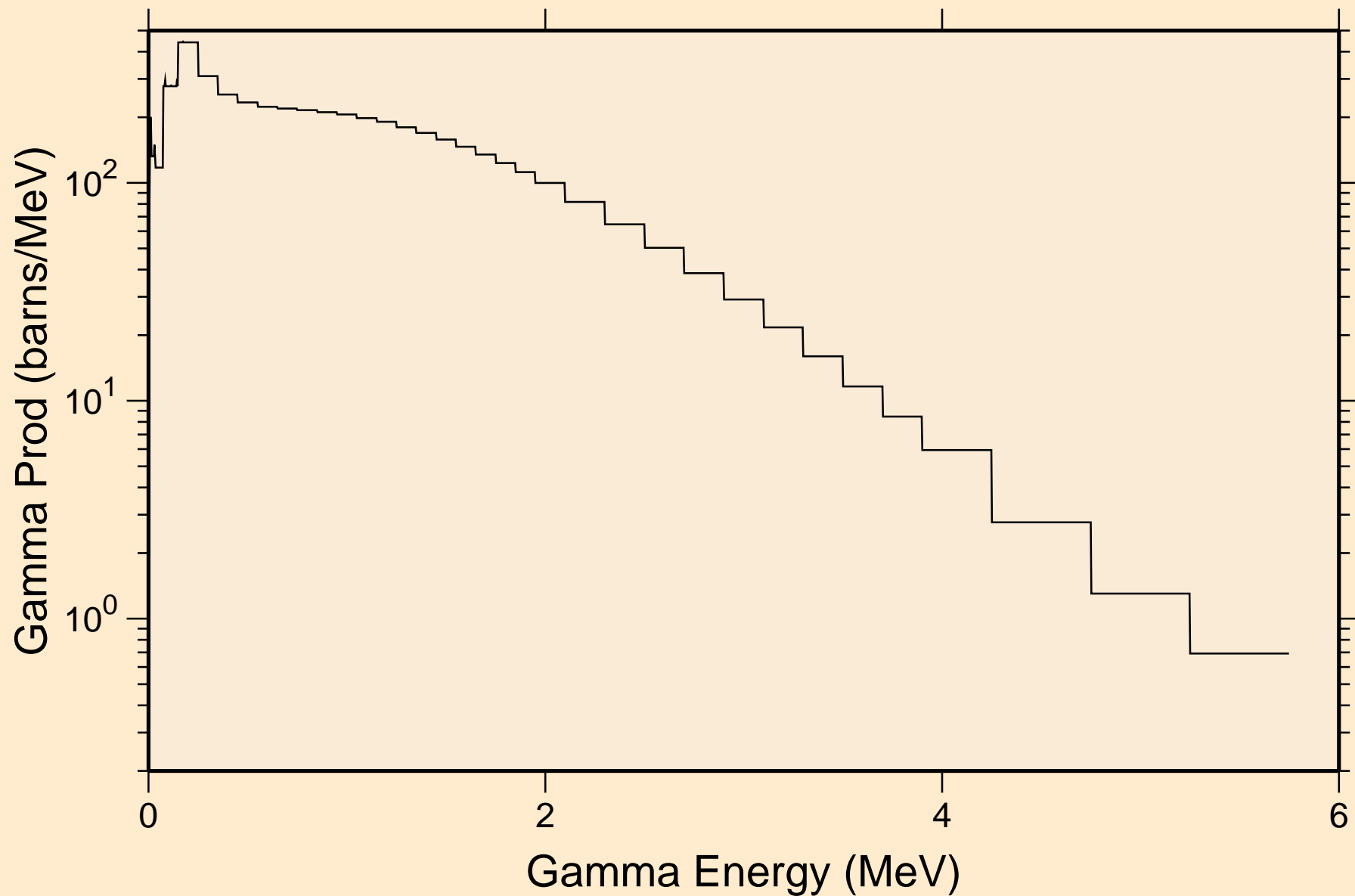

MD253 NEUTRON ACER TENDL-2019 LIBRARY; T=293.16K  
14 MeV photon spectrum

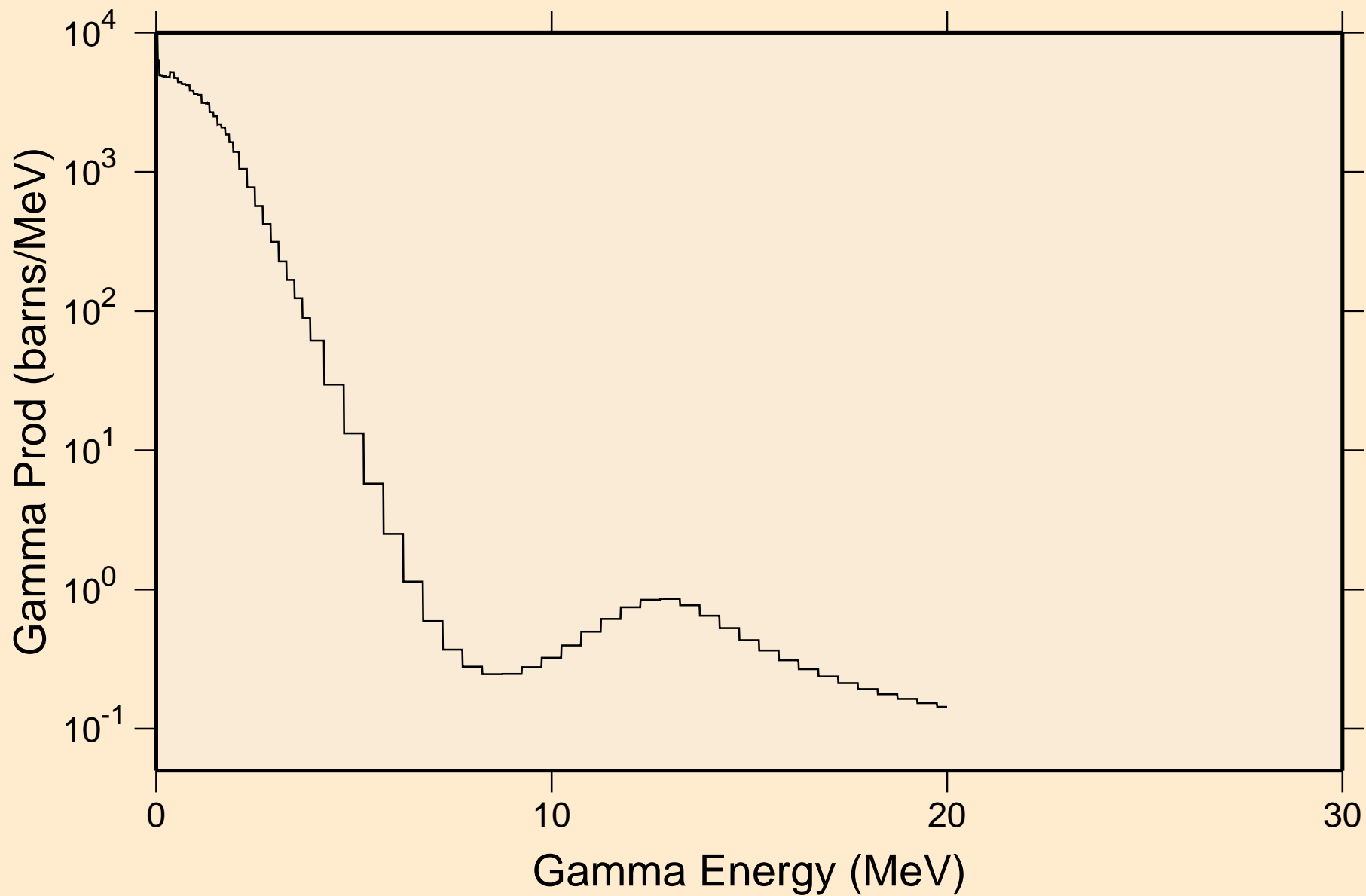

MD253 NEUTRON ACER TENDL-2019 LIBRARY; T=293.16K  
Particle heating contributions

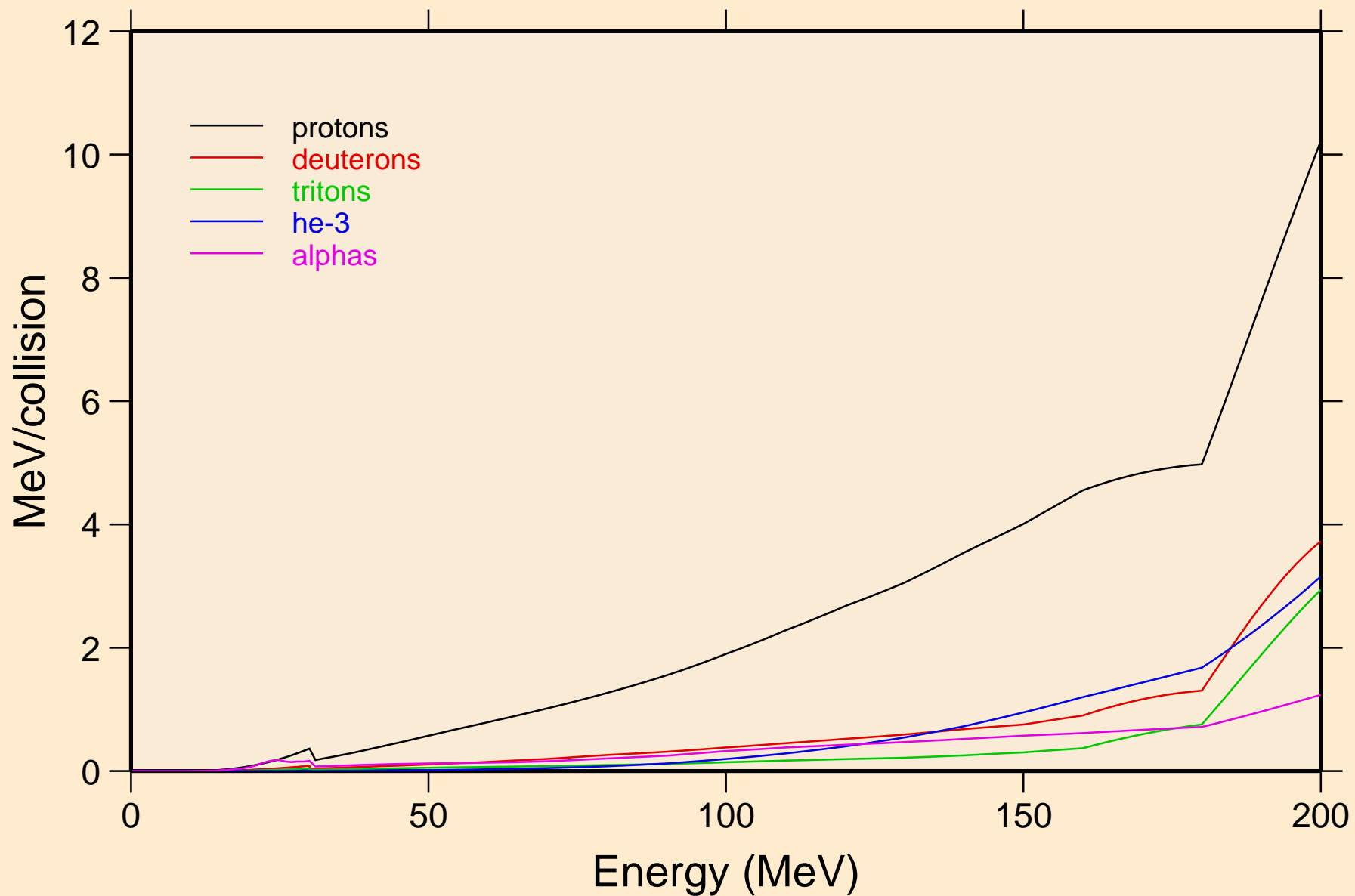

MD253 NEUTRON ACER TENDL-2019 LIBRARY; T=293.16K  
Recoil Heating

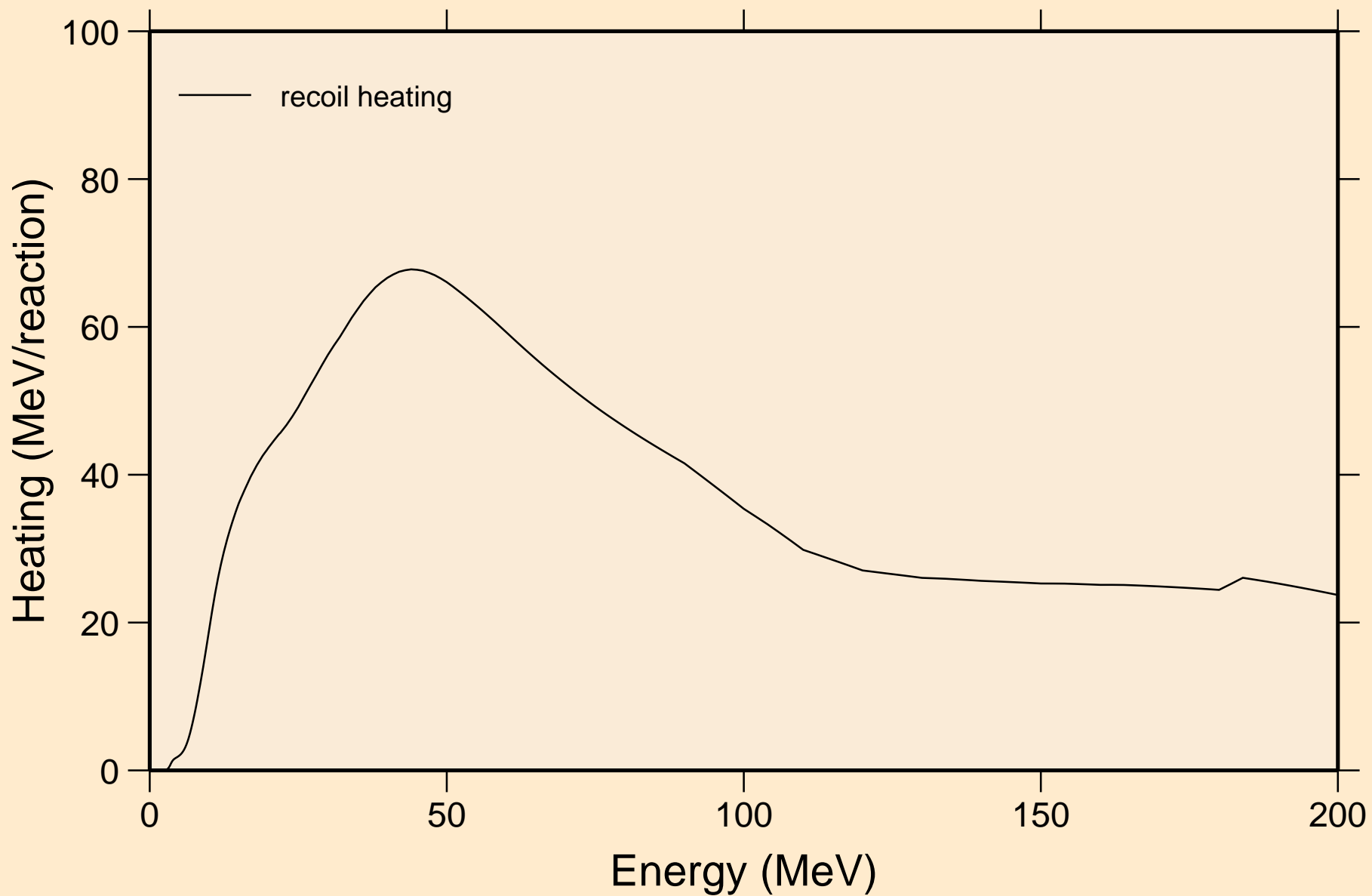

MD253 NEUTRON ACER TENDL-2019 LIBRARY; T=293.16K  
Particle production cross sections

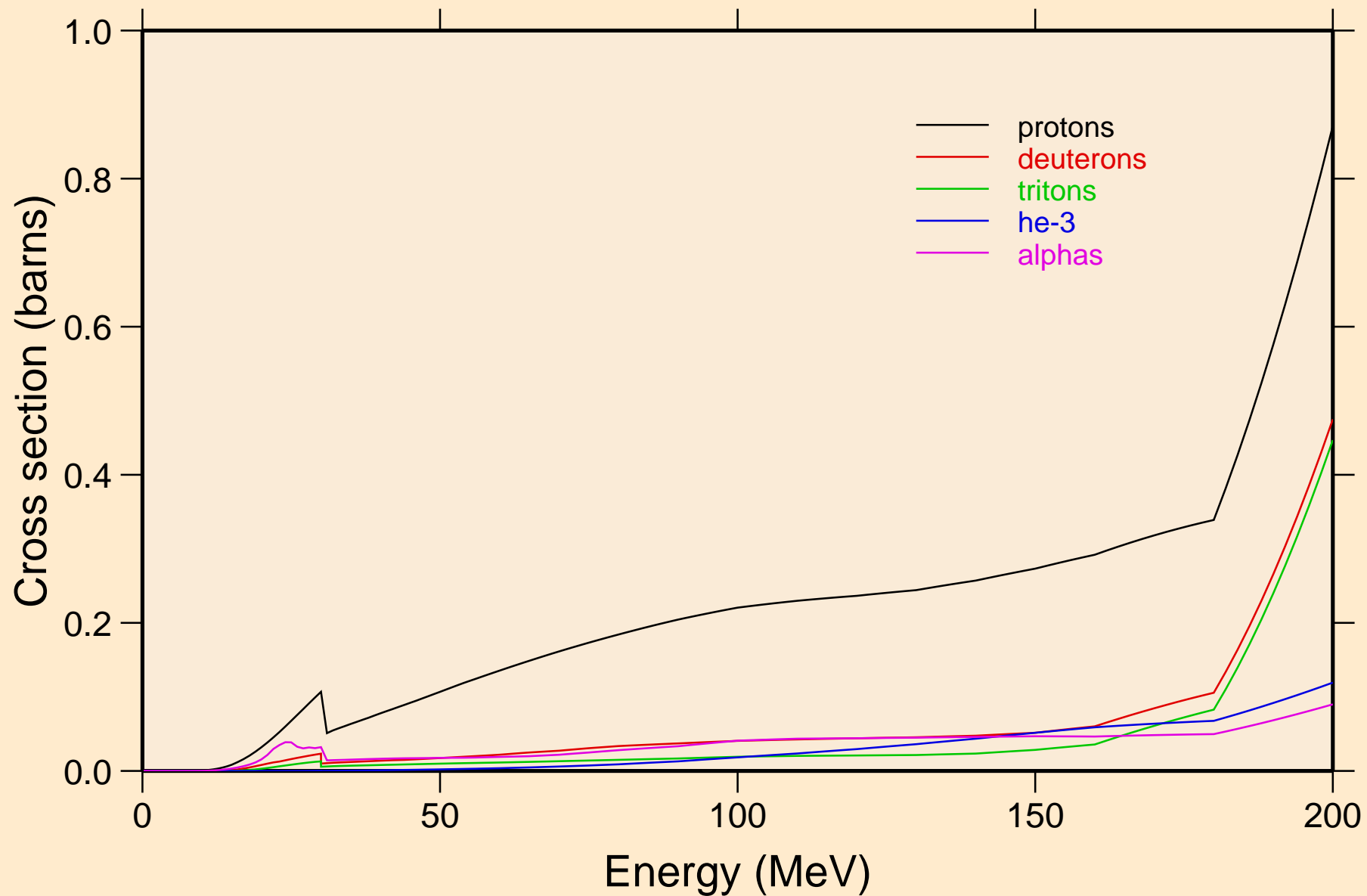



MD253 NEUTRON ACER TENDL-2019 LIBRARY; T=293.16K  
protons from (n,x)

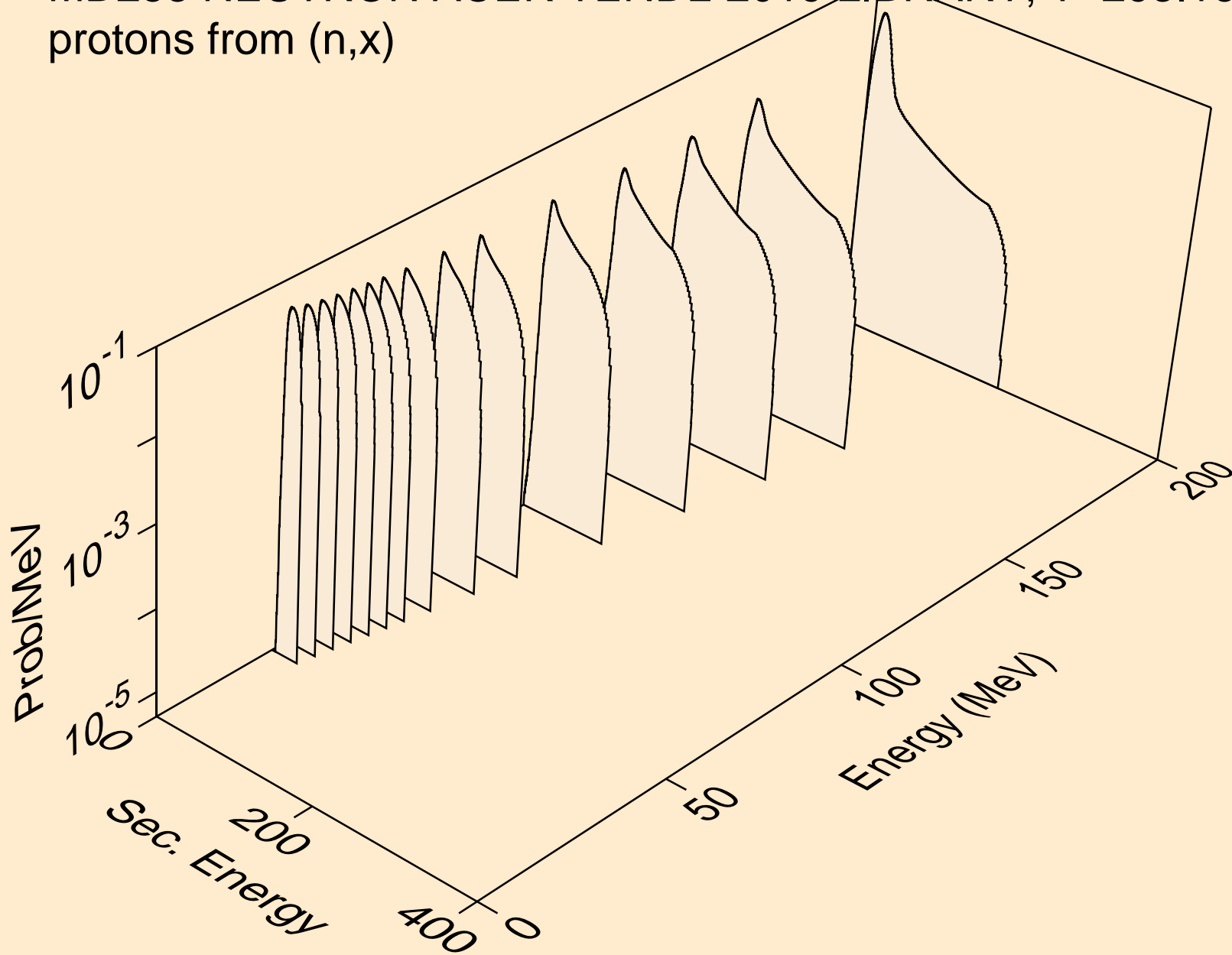

MD253 NEUTRON ACER TENDL-2019 LIBRARY; T=293.16K  
protons from (n,n\*)p

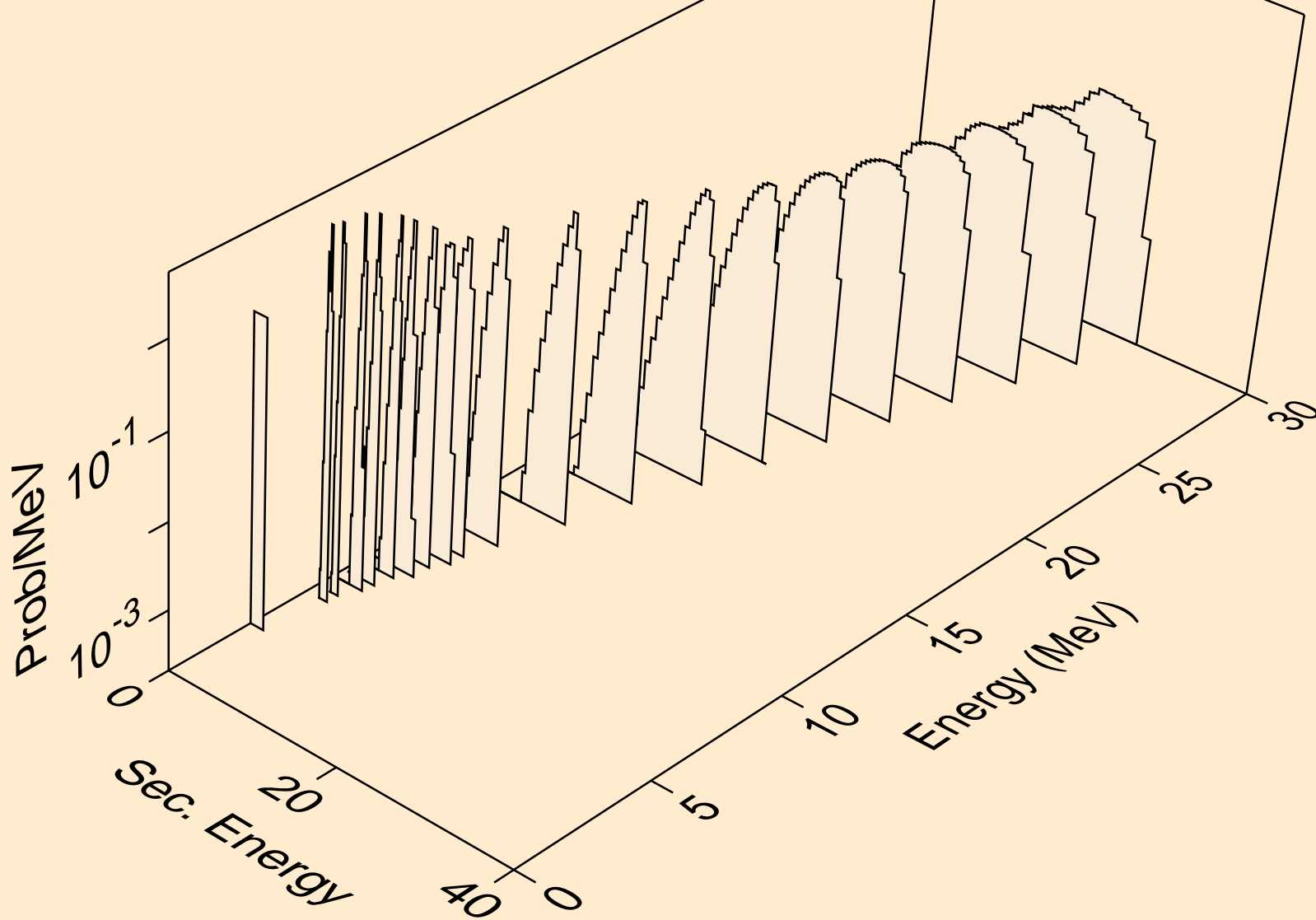

MD253 NEUTRON ACER TENDL-2019 LIBRARY; T=293.16K  
protons from (n,2np)

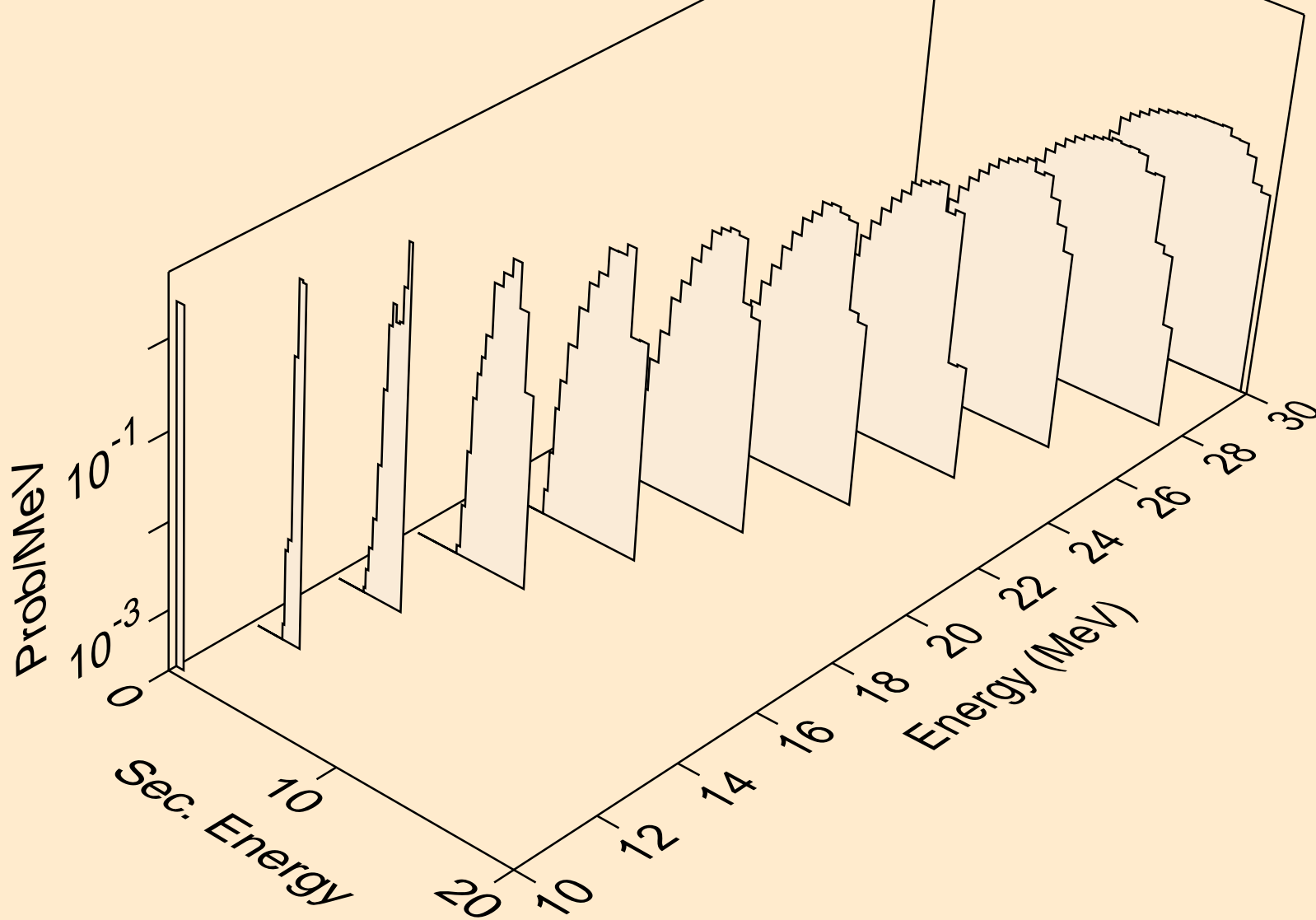

MD253 NEUTRON ACER TENDL-2019 LIBRARY; T=293.16K  
protons from (n,3np)

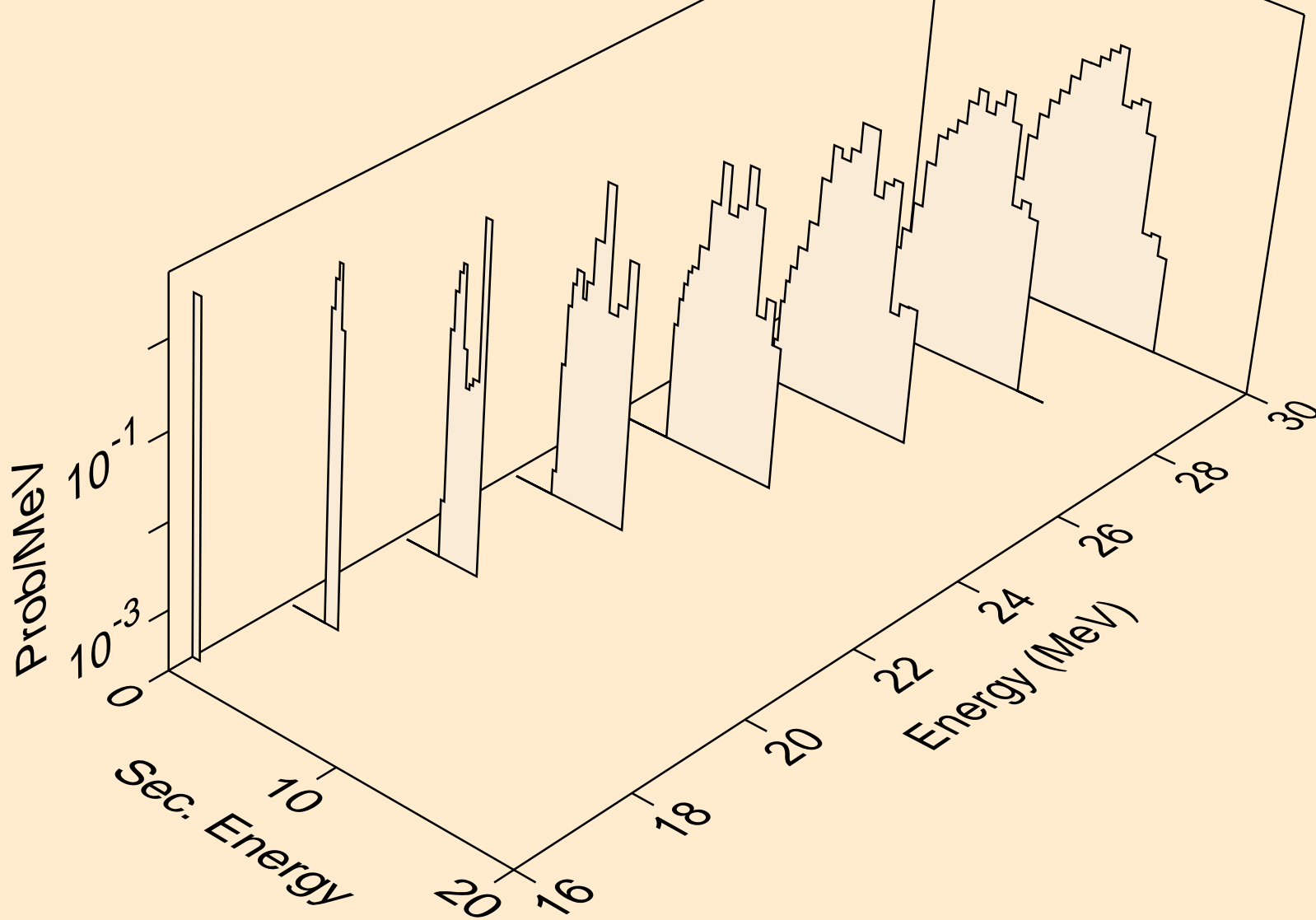

MD253 NEUTRON ACER TENDL-2019 LIBRARY; T=293.16K  
protons from (n,2np)

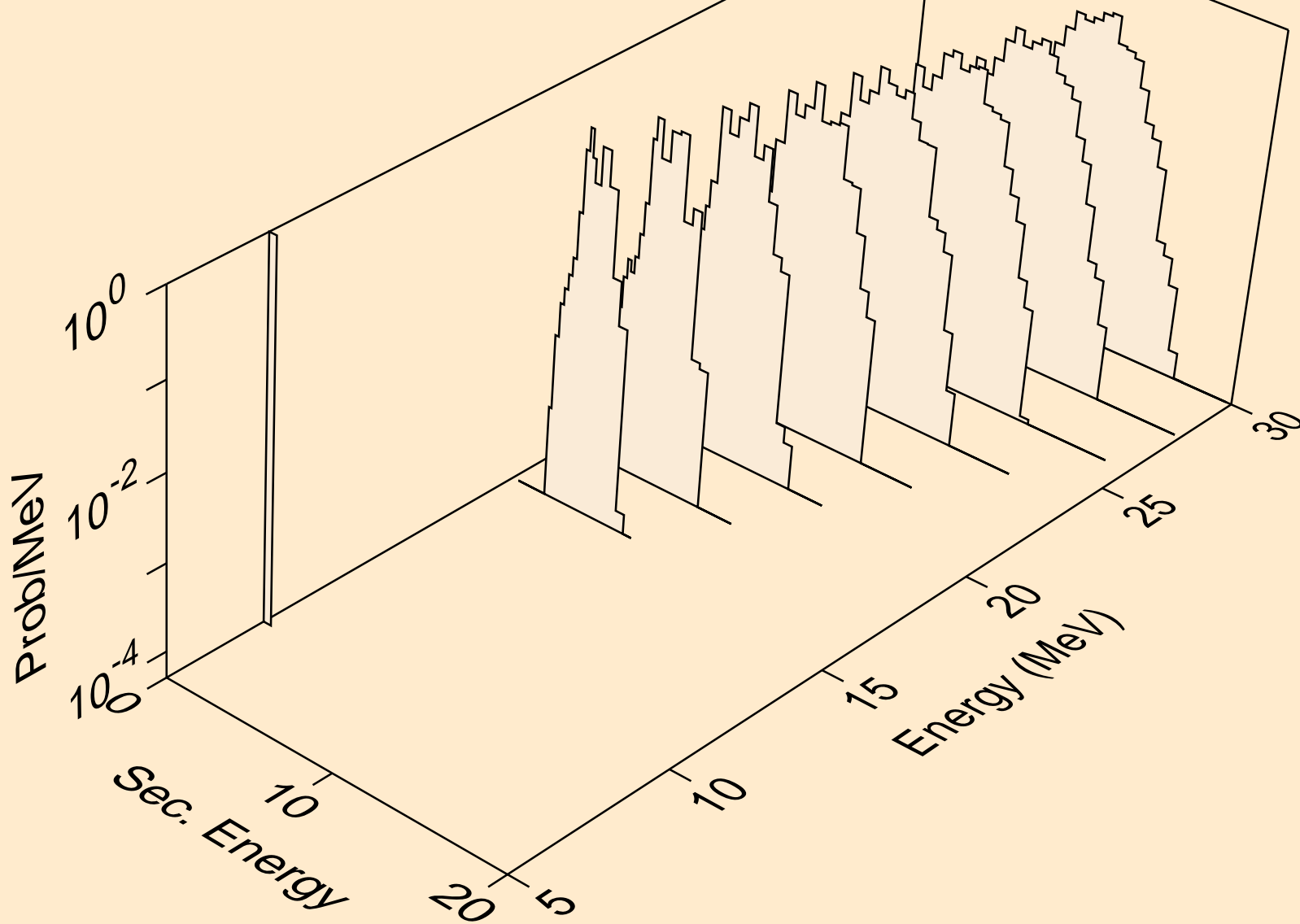

MD253 NEUTRON ACER TENDL-2019 LIBRARY; T=293.16K  
protons from (n,npa)

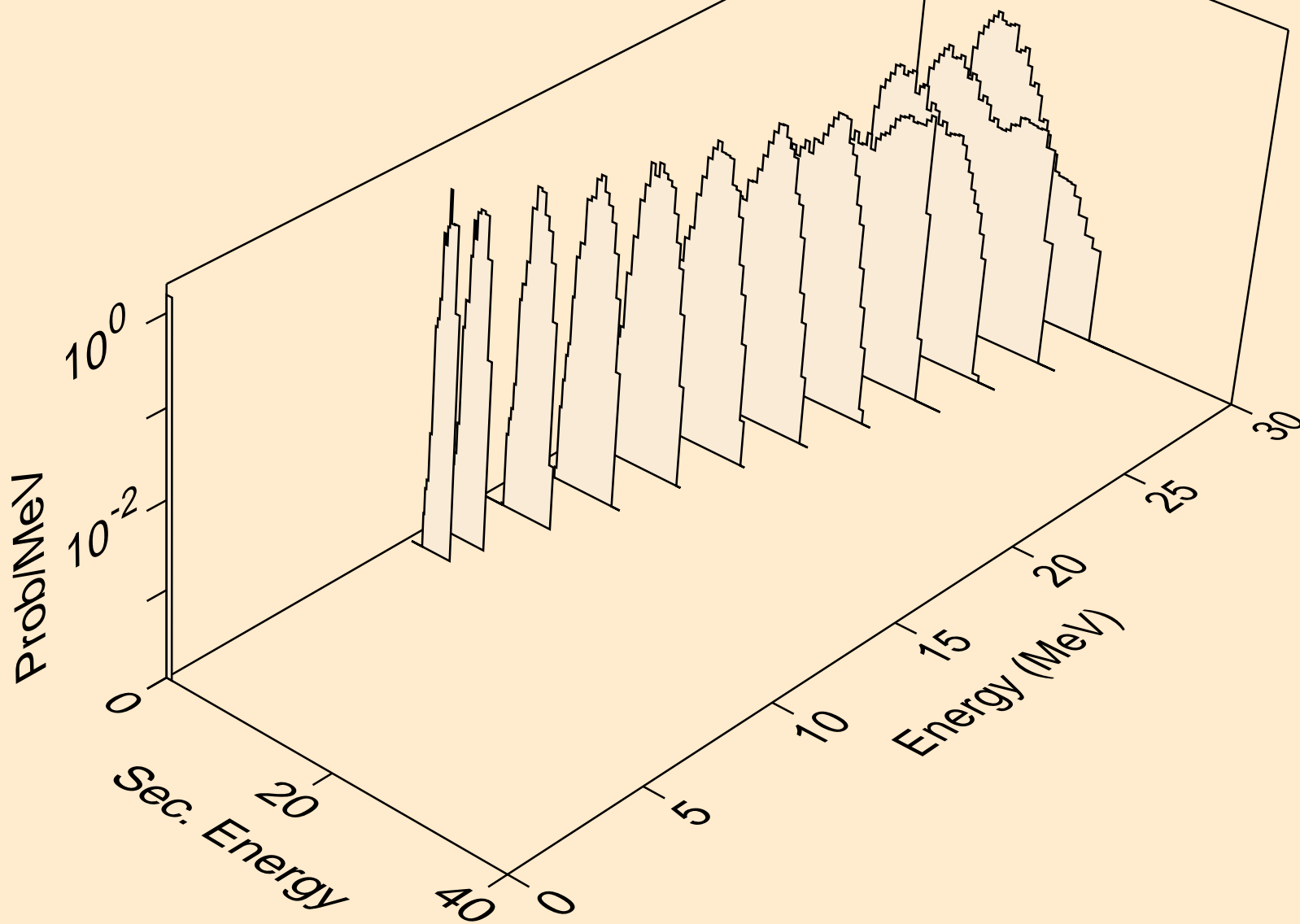

MD253 NEUTRON ACER TENDL-2019 LIBRARY; T=293.16K  
protons from (n,p)

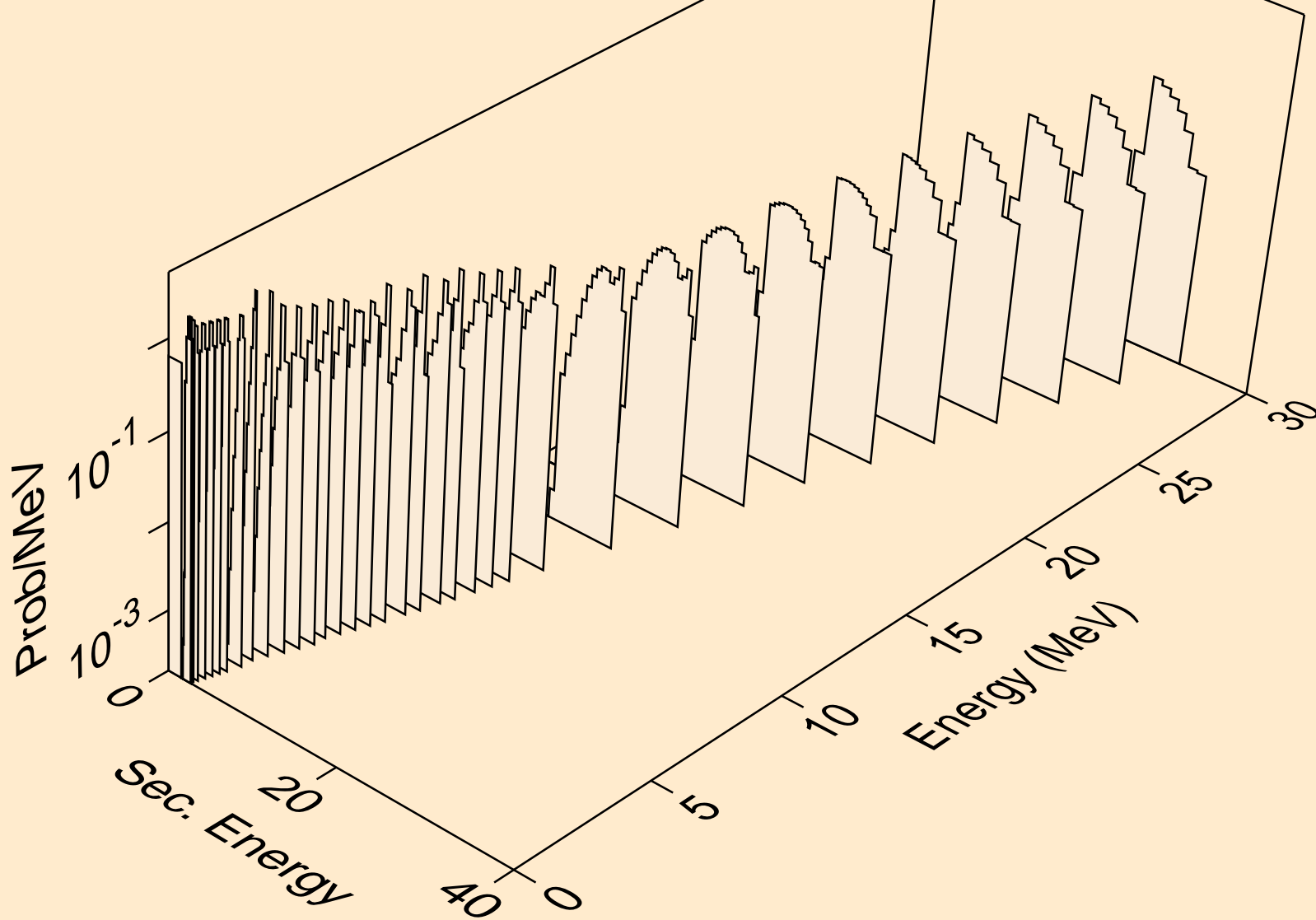

MD253 NEUTRON ACER TENDL-2019 LIBRARY; T=293.16K  
protons from (n,2p)

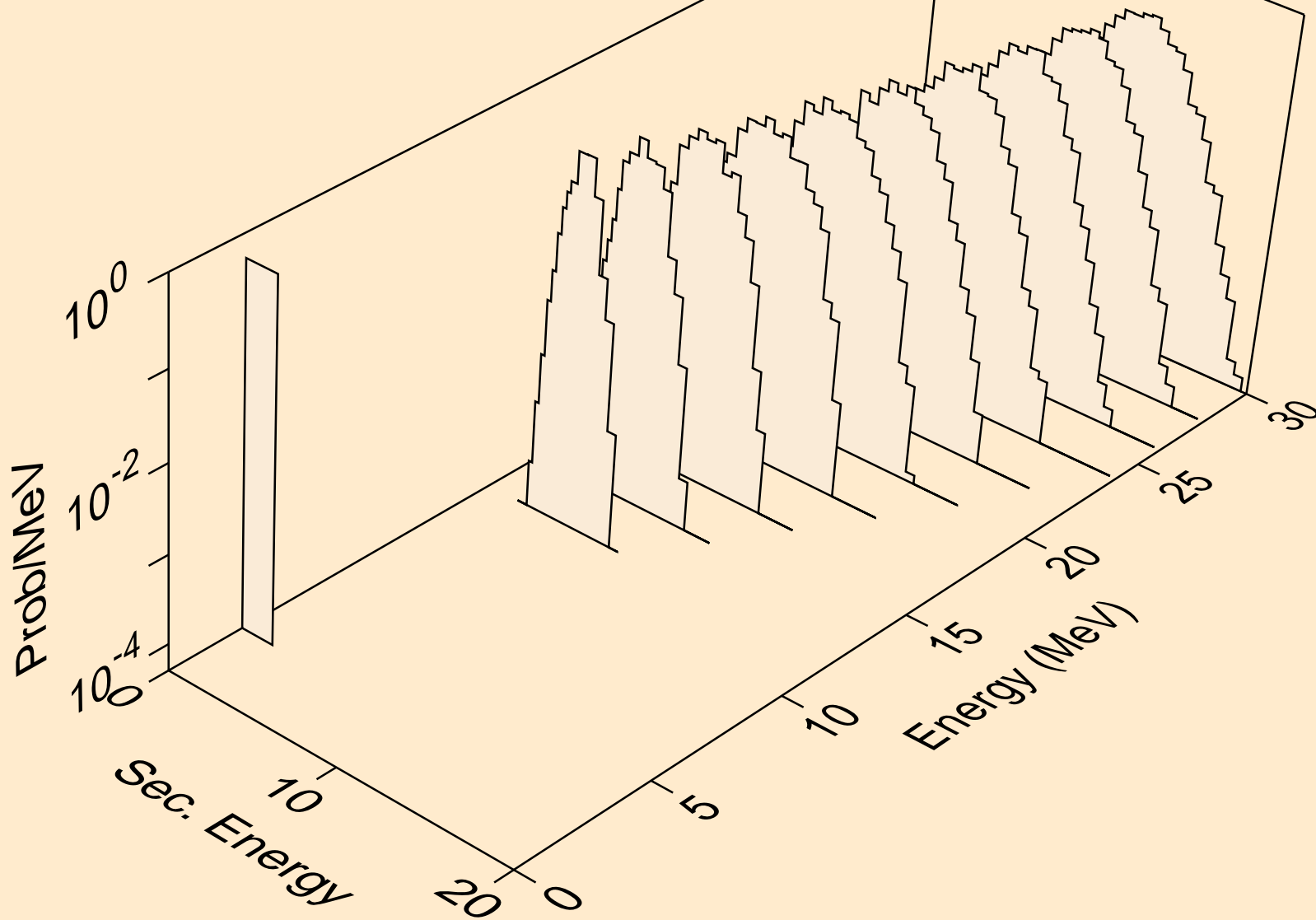



MD253 NEUTRON ACER TENDL-2019 LIBRARY; T=293.16K  
protons from (n,p)

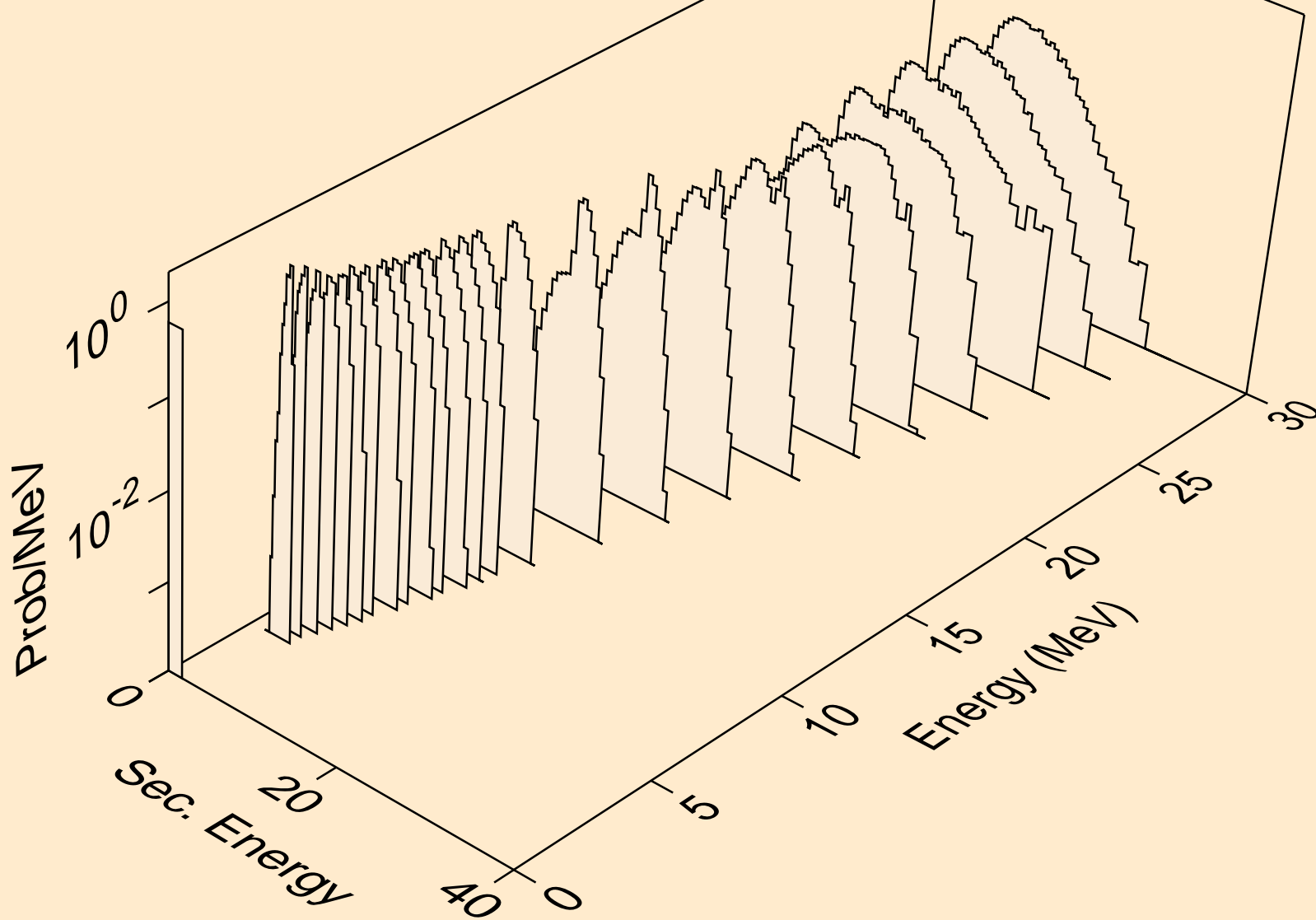

MD253 NEUTRON ACER TENDL-2019 LIBRARY; T=293.16K  
protons from (n,pd)

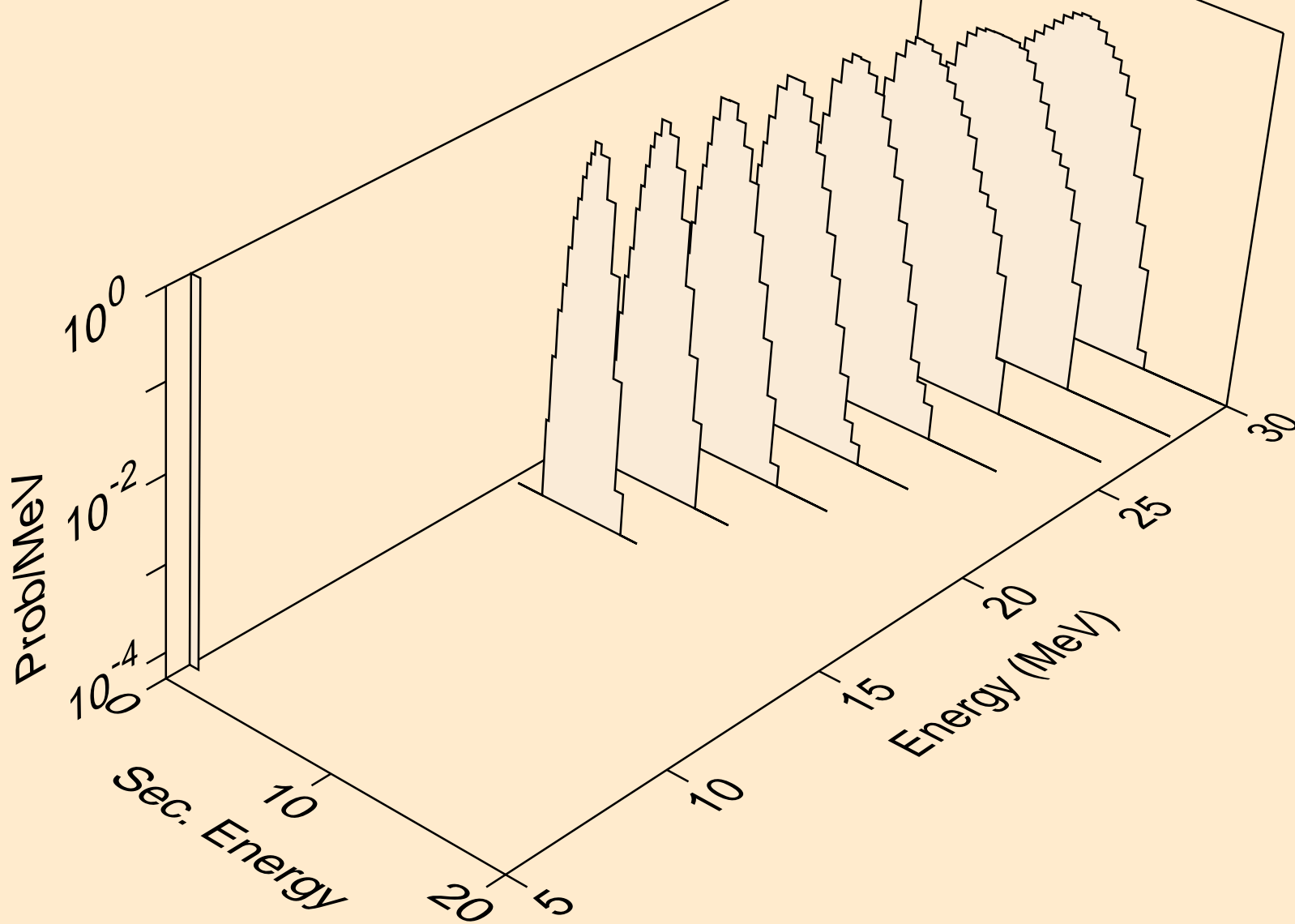

MD253 NEUTRON ACER TENDL-2019 LIBRARY; T=293.16K  
protons from (n,pt)

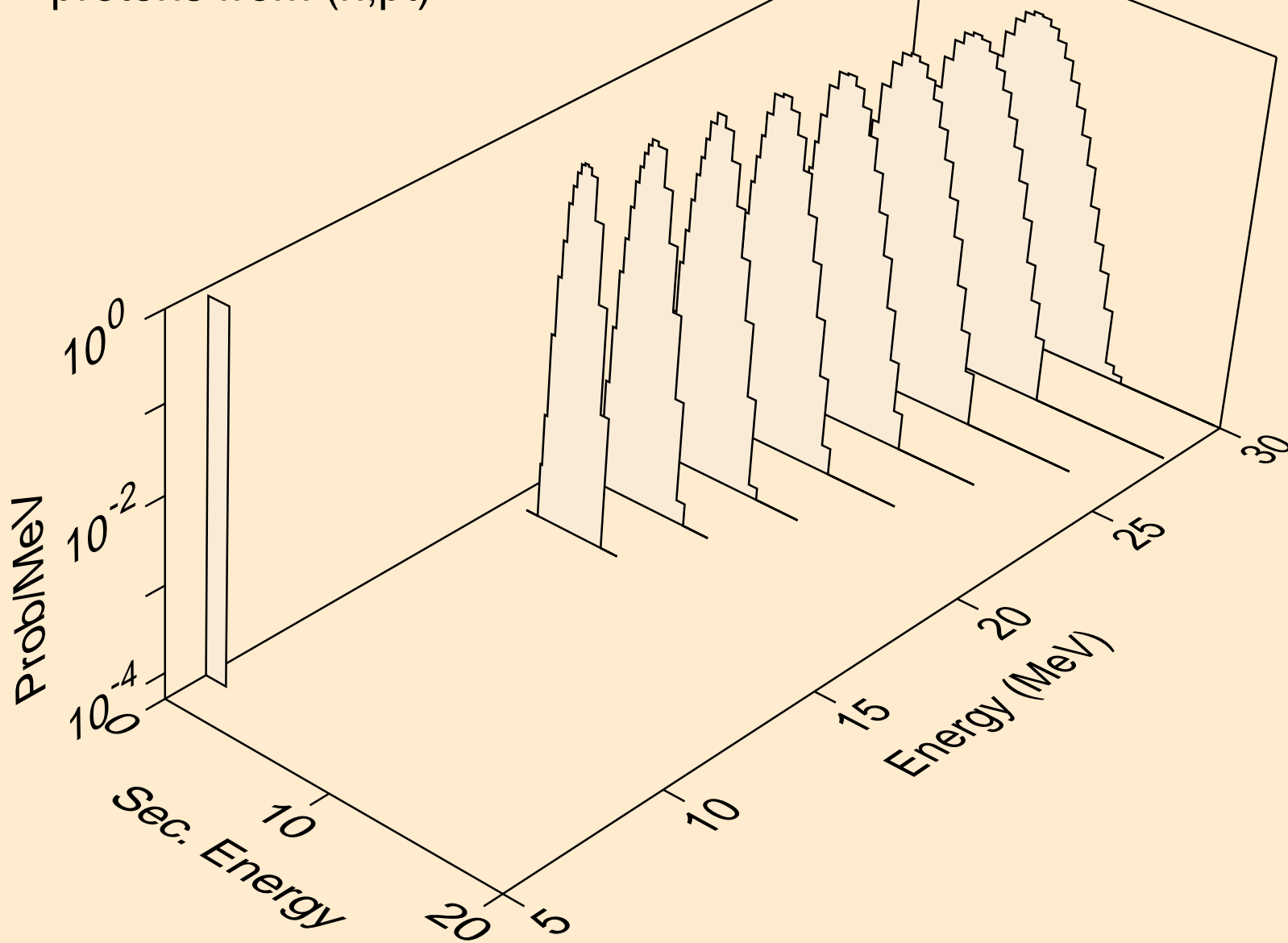

MD253 NEUTRON ACER TENDL-2019 LIBRARY; T=293.16K  
deuterons from (n,x)

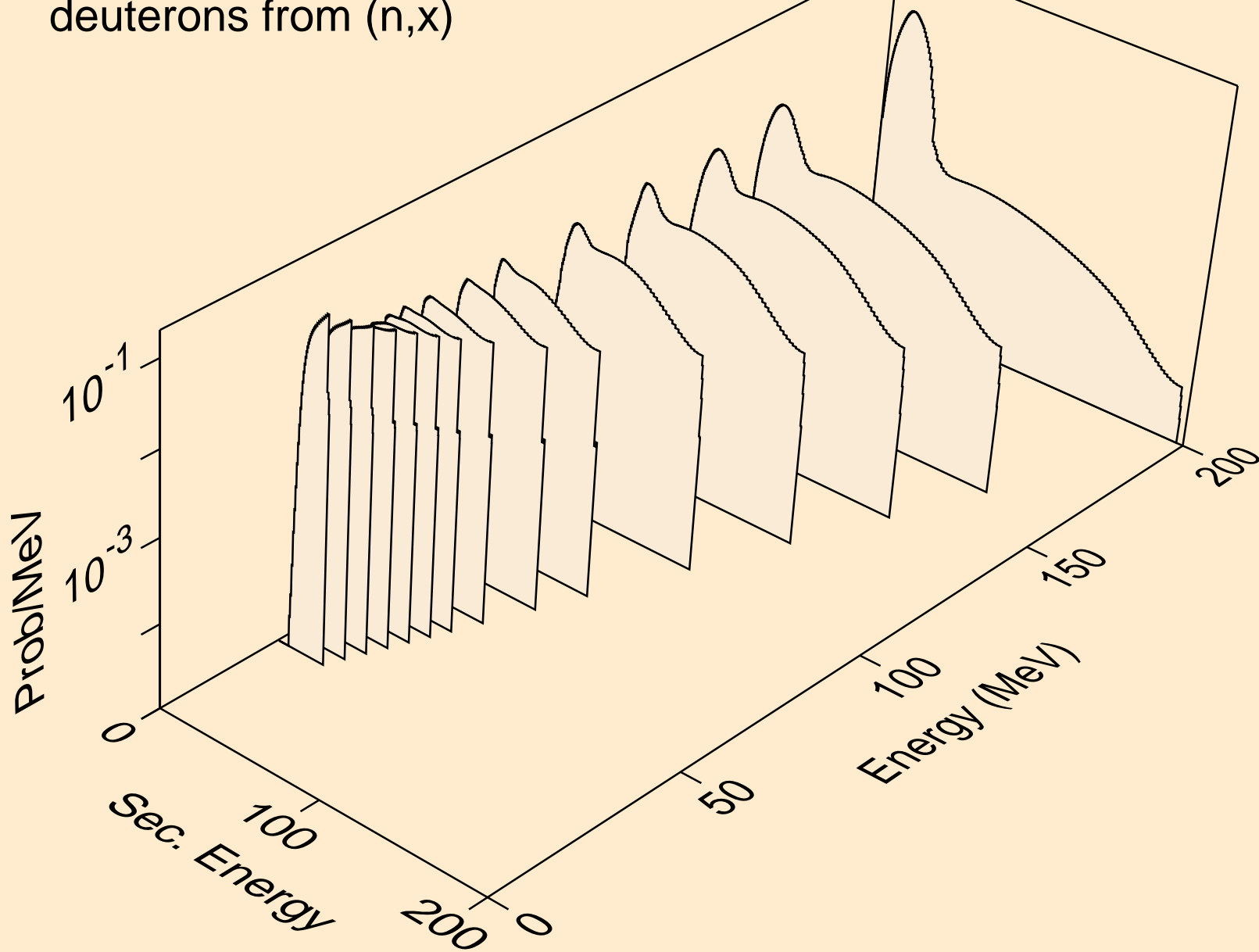

MD253 NEUTRON ACER TENDL-2019 LIBRARY; T=293.16K  
deuterons from (n,2nd)

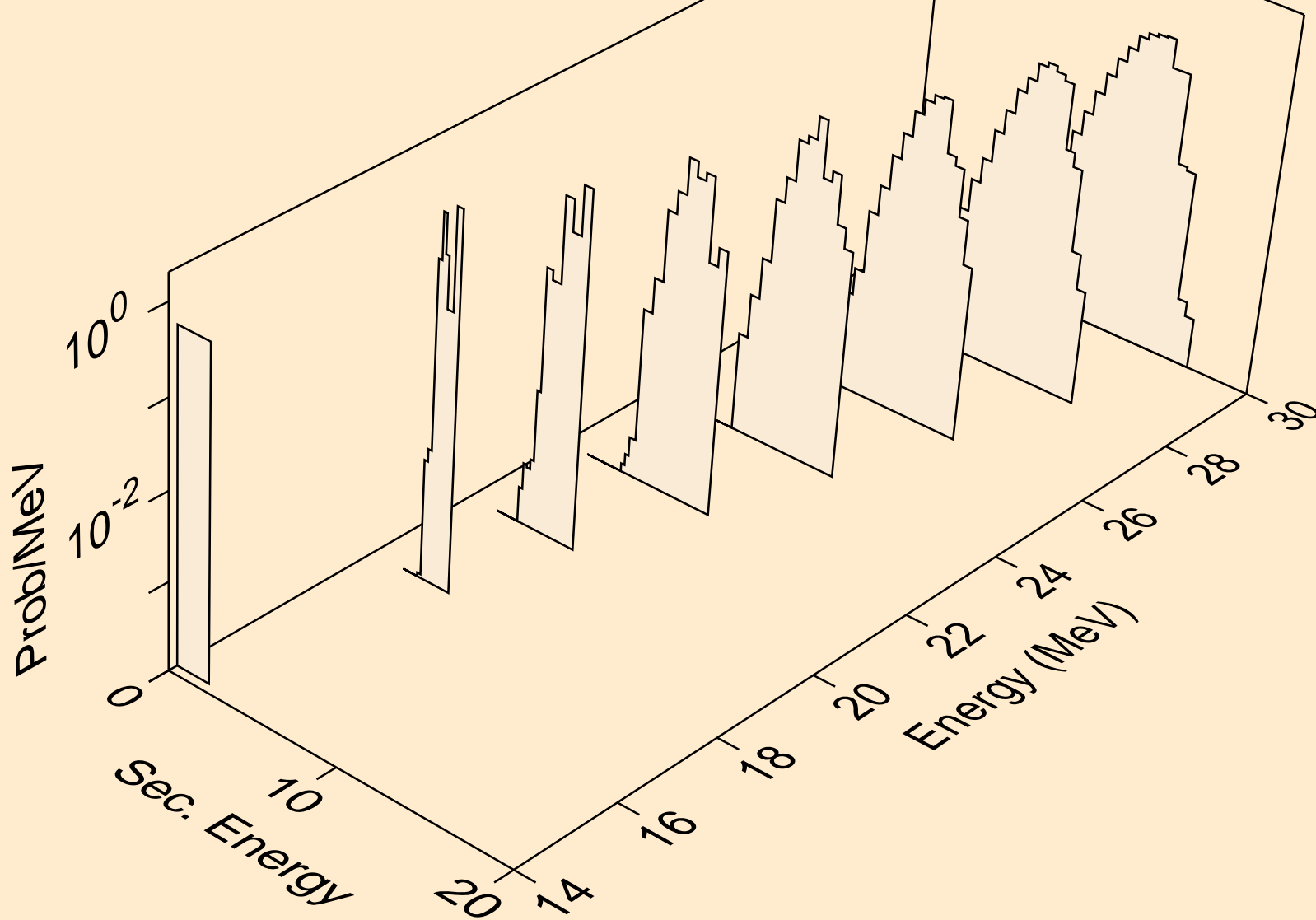

MD253 NEUTRON ACER TENDL-2019 LIBRARY; T=293.16K  
deuterons from (n,n\*)d

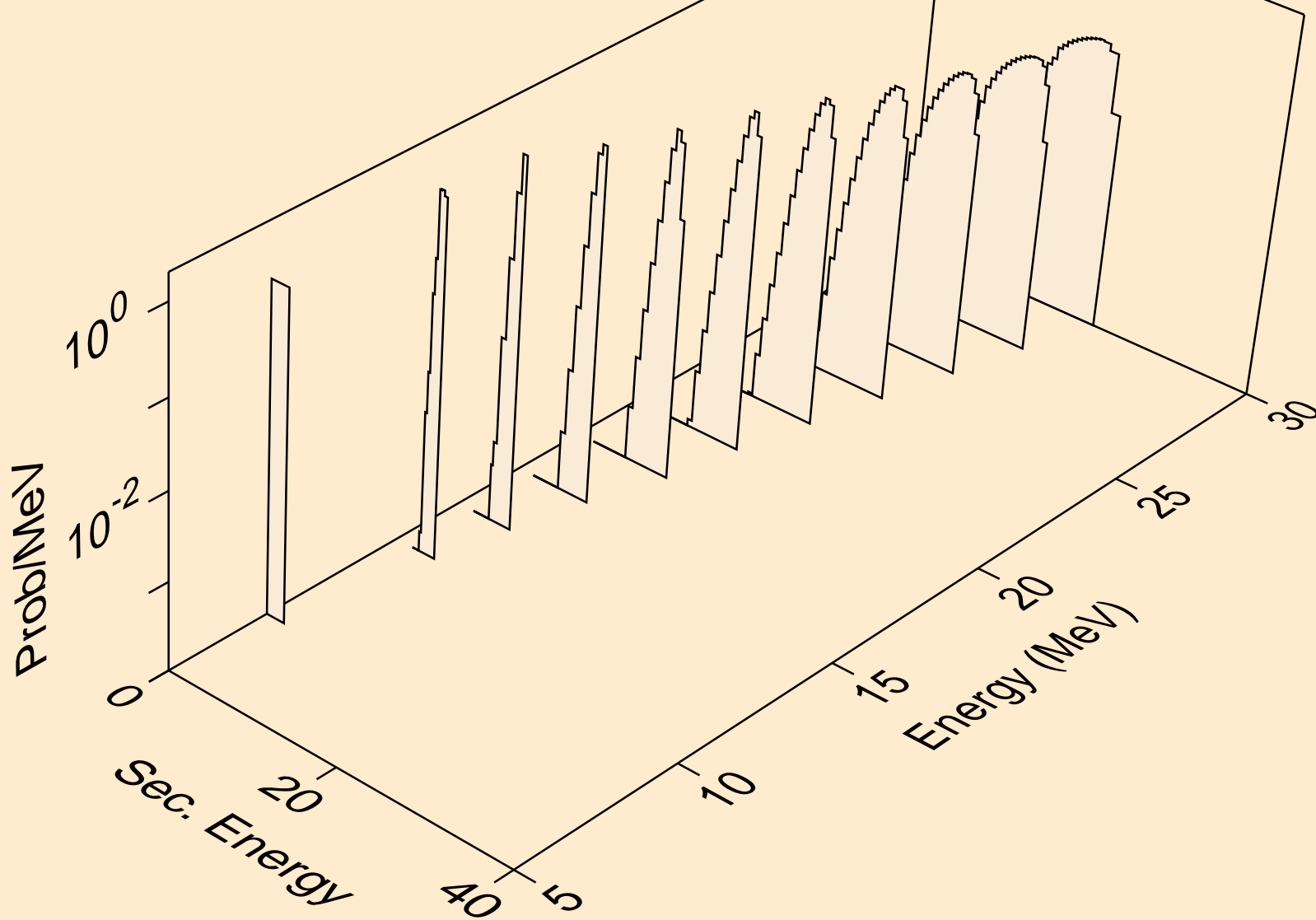

MD253 NEUTRON ACER TENDL-2019 LIBRARY; T=293.16K  
deuterons from (n,d)

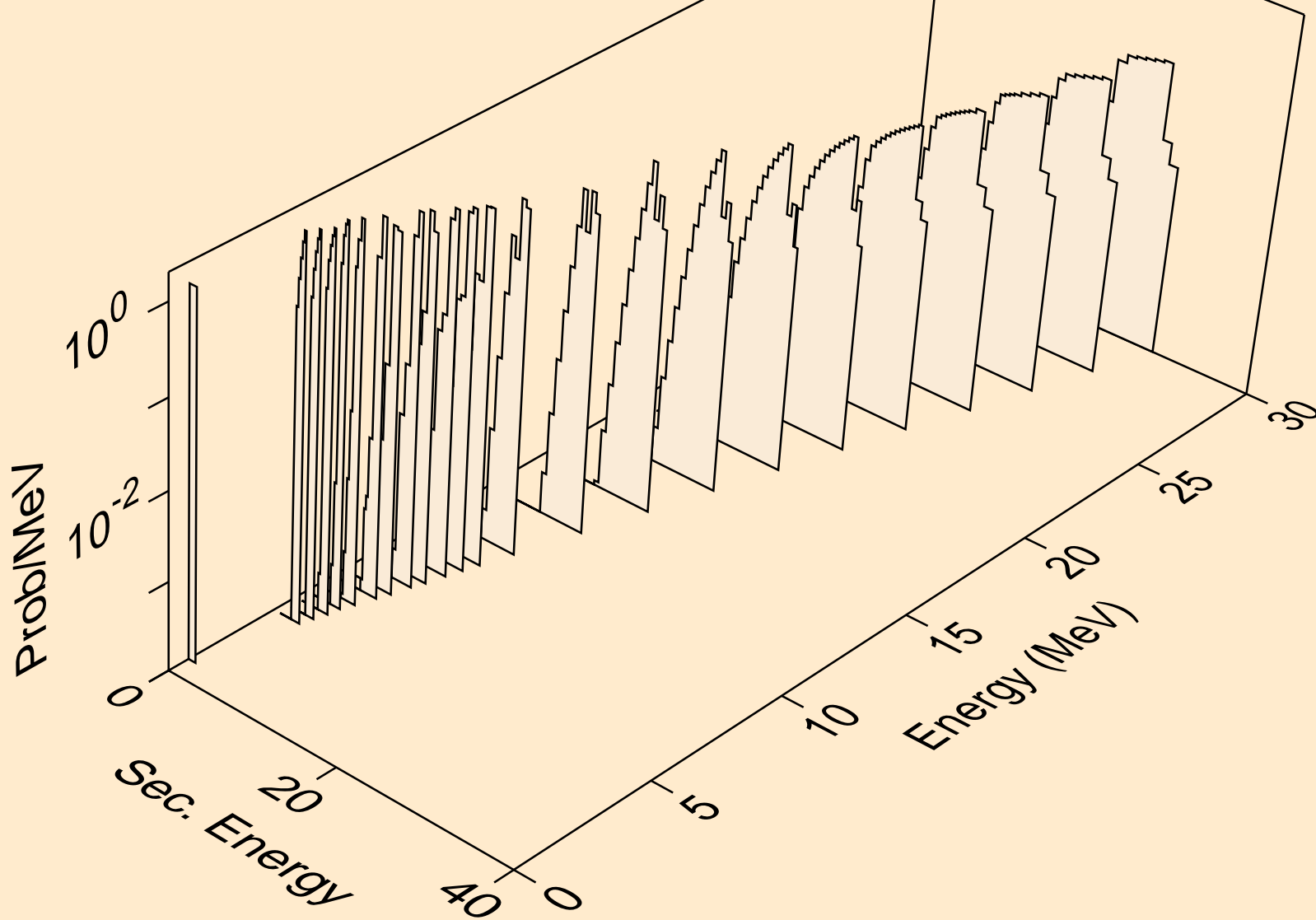

MD253 NEUTRON ACER TENDL-2019 LIBRARY; T=293.16K  
deuterons from (n,pd)

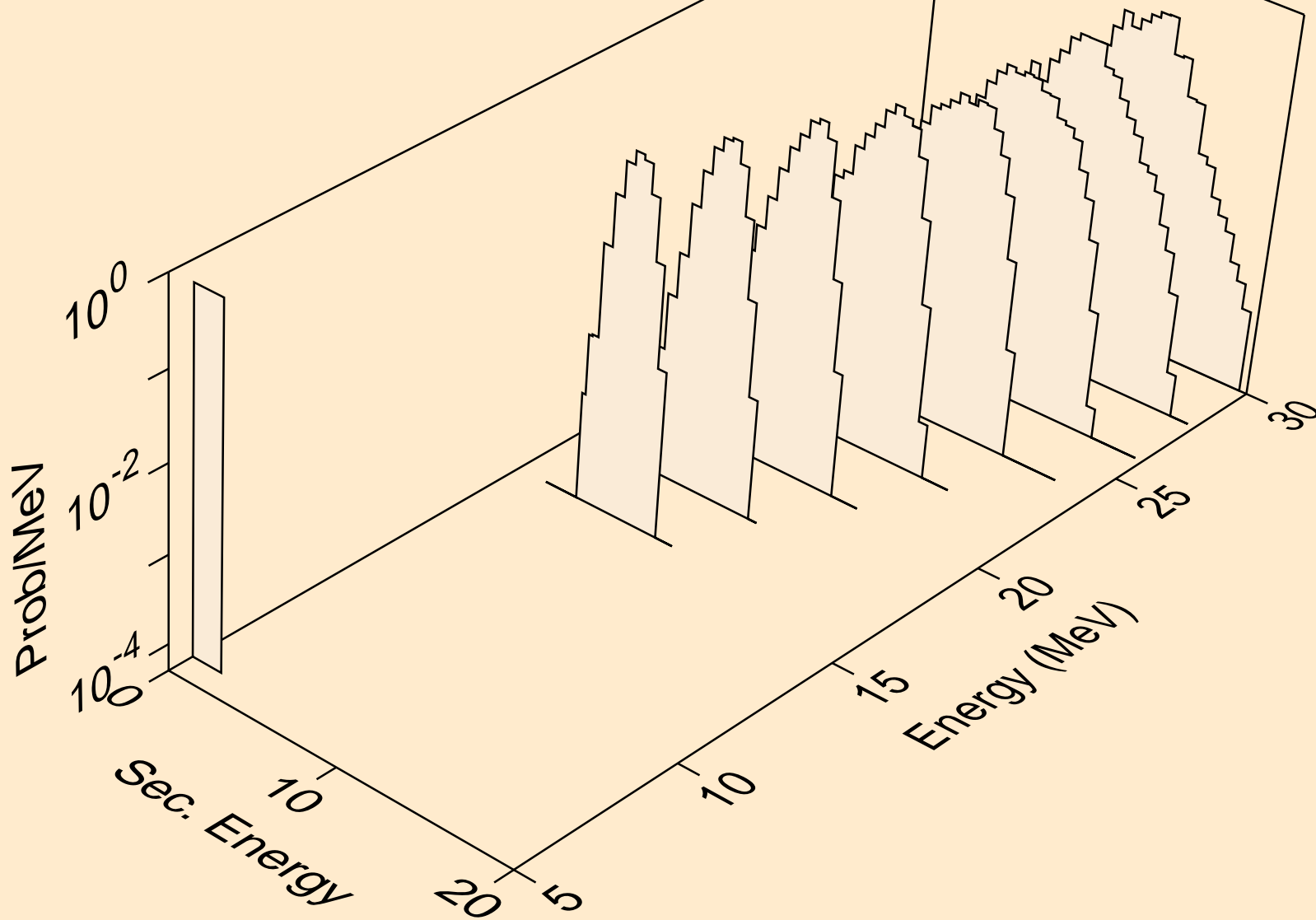



MD253 NEUTRON ACER TENDL-2019 LIBRARY; T=293.16K  
deuterons from (n,da)

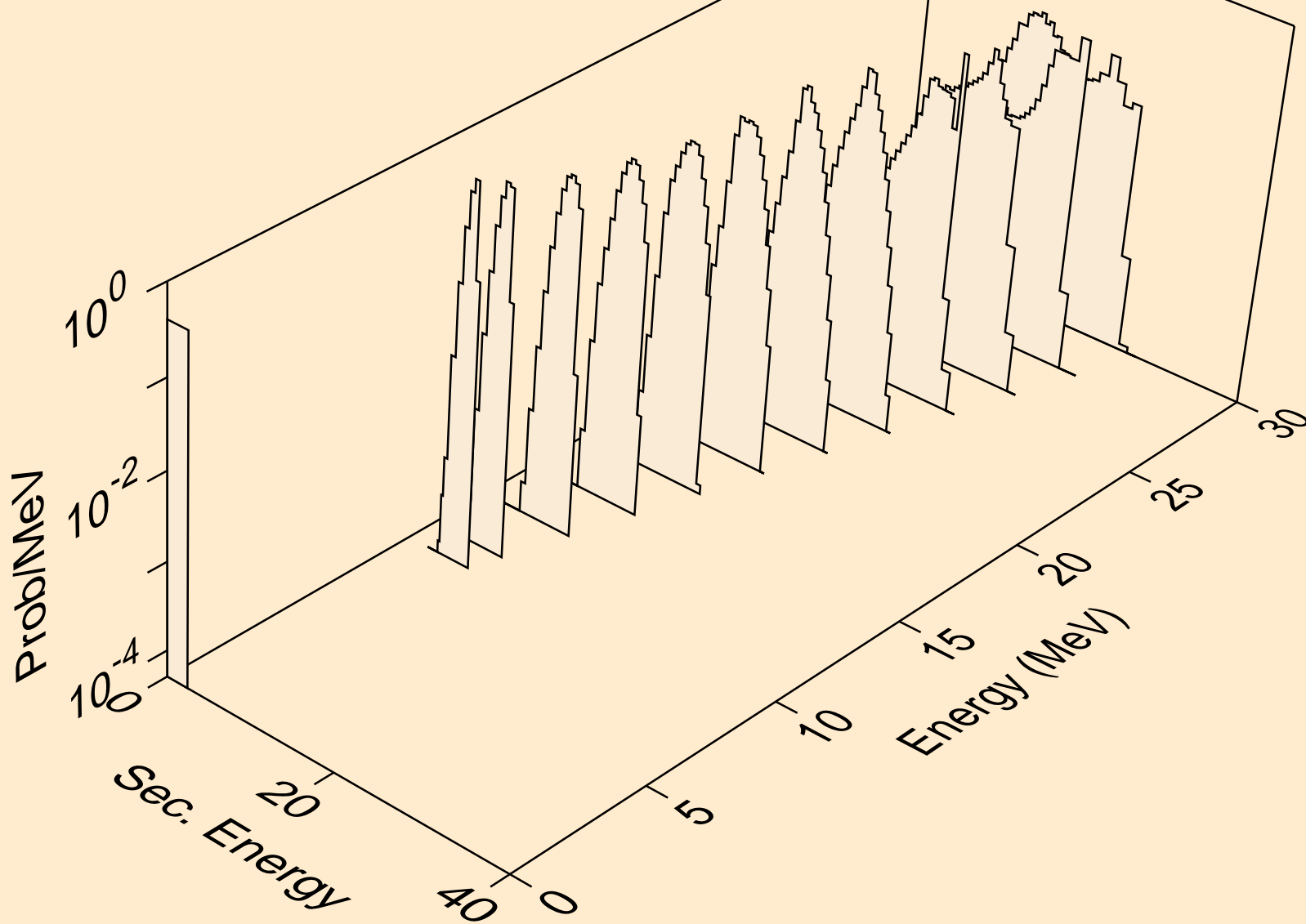

MD253 NEUTRON ACER TENDL-2019 LIBRARY; T=293.16K  
tritons from (n,x)

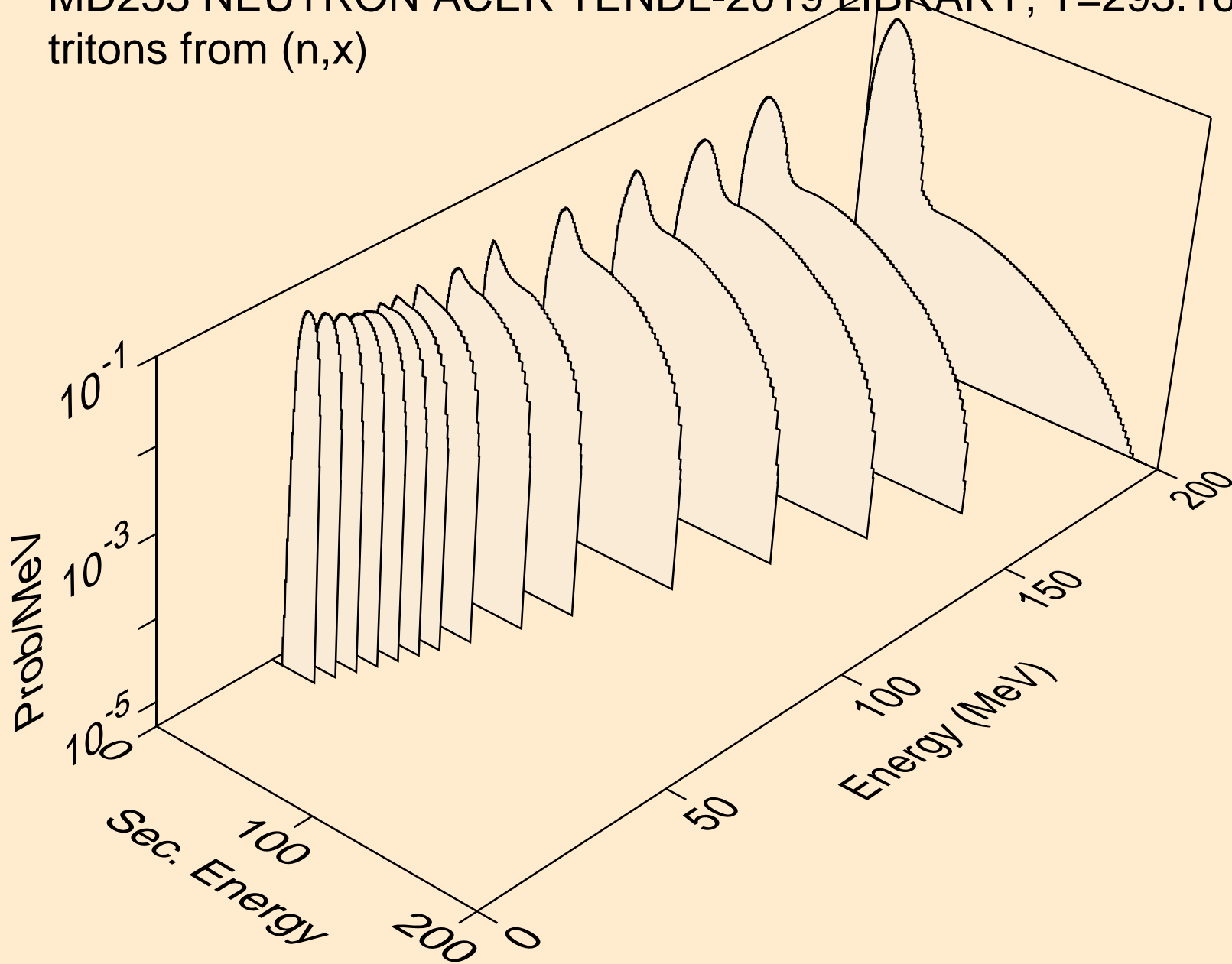

MD253 NEUTRON ACER TENDL-2019 LIBRARY; T=293.16K  
tritons from (n,n\*)t

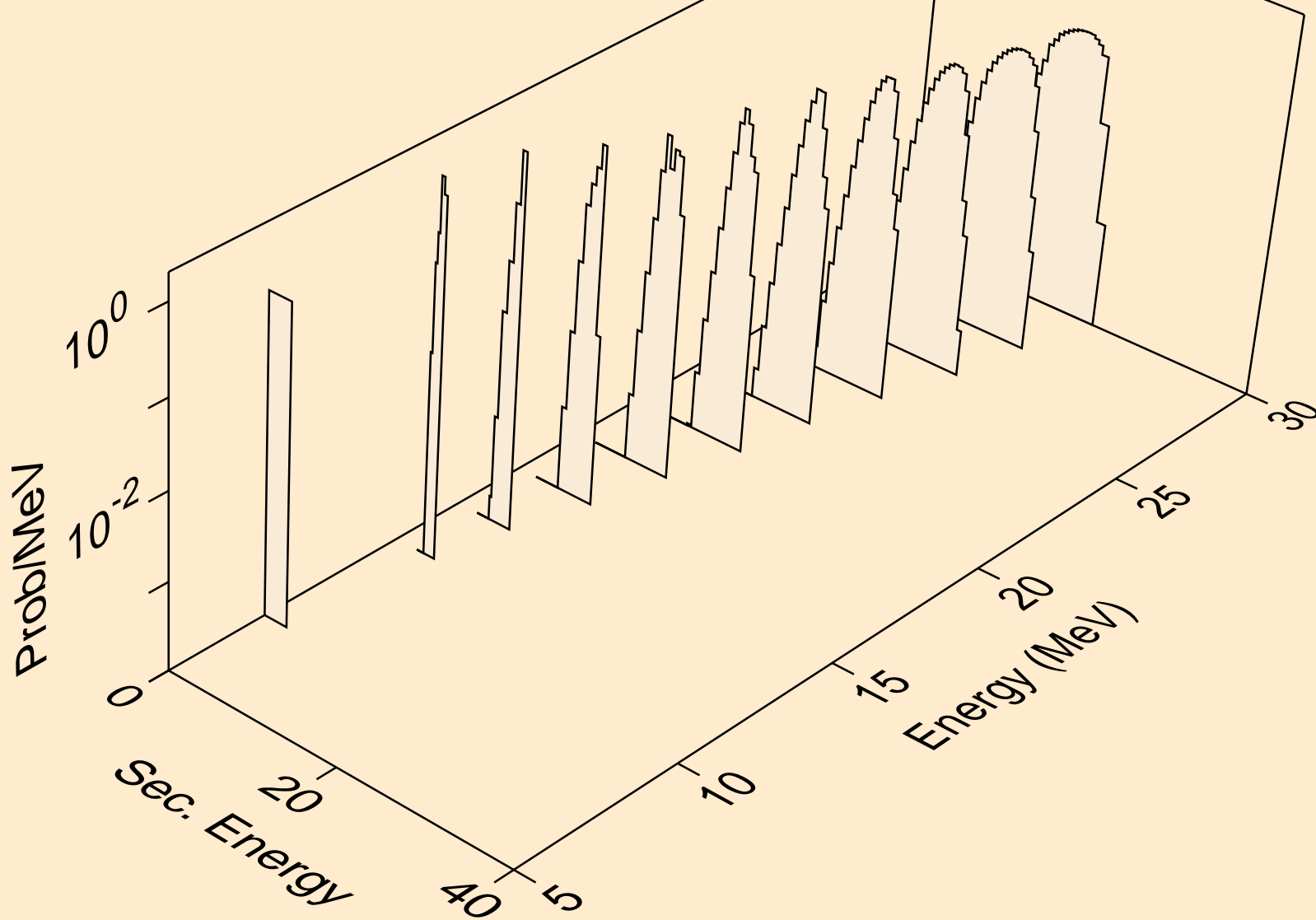

MD253 NEUTRON ACER TENDL-2019 LIBRARY; T=293.16K  
tritons from (n,t)

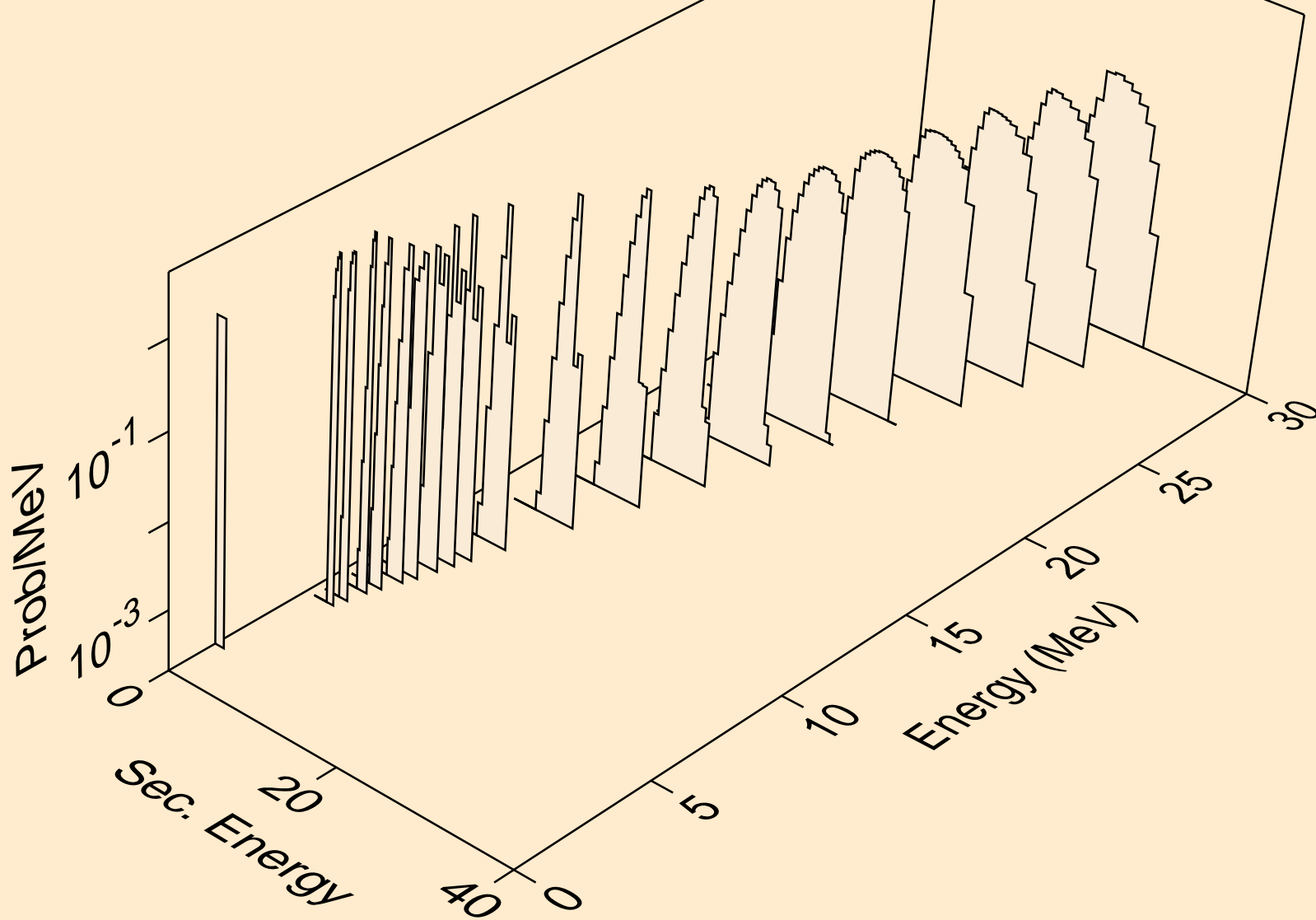

MD253 NEUTRON ACER TENDL-2019 LIBRARY; T=293.16K  
tritons from (n,pt)

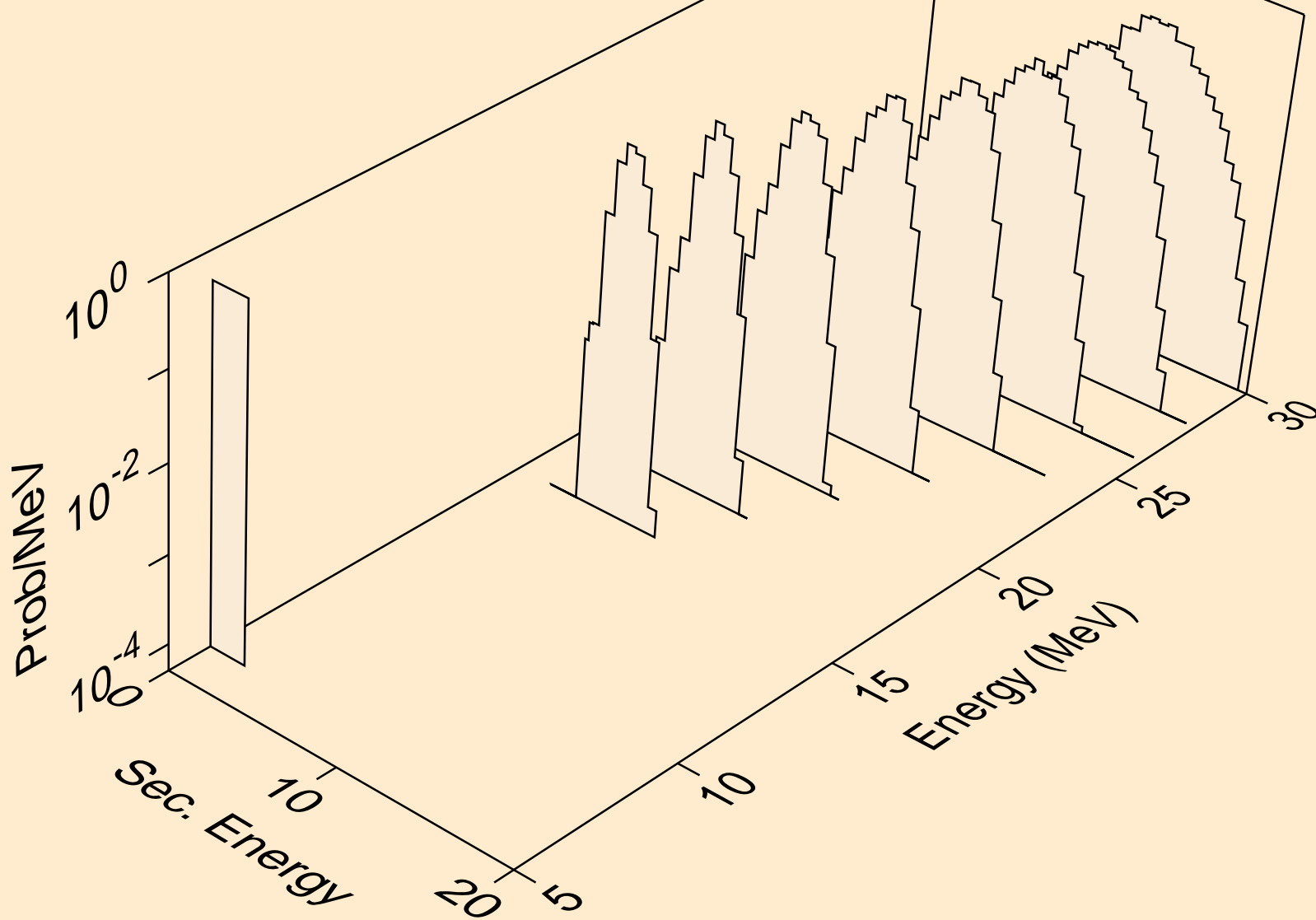

MD253 NEUTRON ACER TENDL-2019 LIBRARY; T=293.16K  
he3s from (n,x)

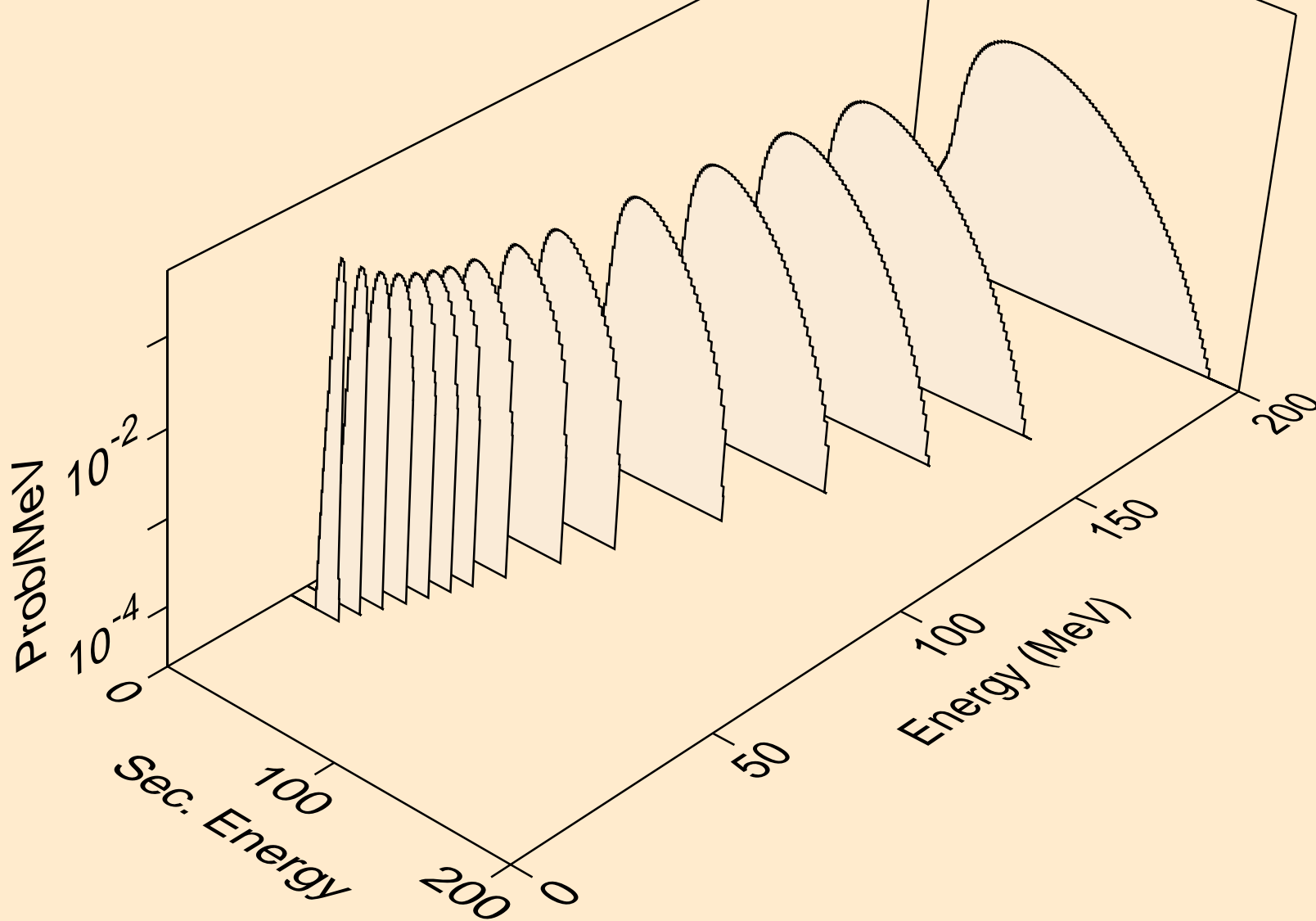

MD253 NEUTRON ACER TENDL-2019 LIBRARY; T=293.16K  
he3s from (n,n\*)he3

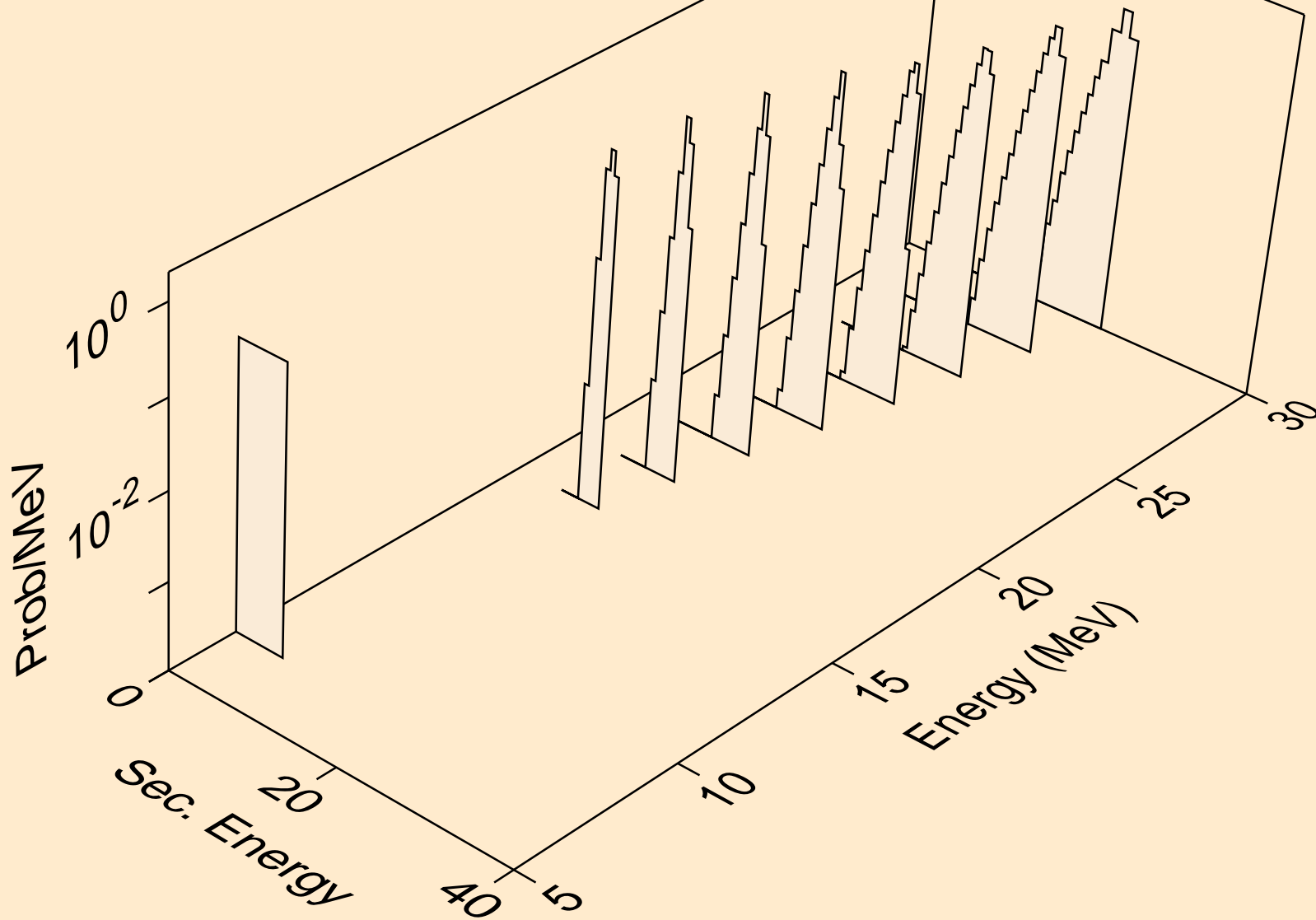

MD253 NEUTRON ACER TENDL-2019 LIBRARY; T=293.16K  
he3s from (n,he3)

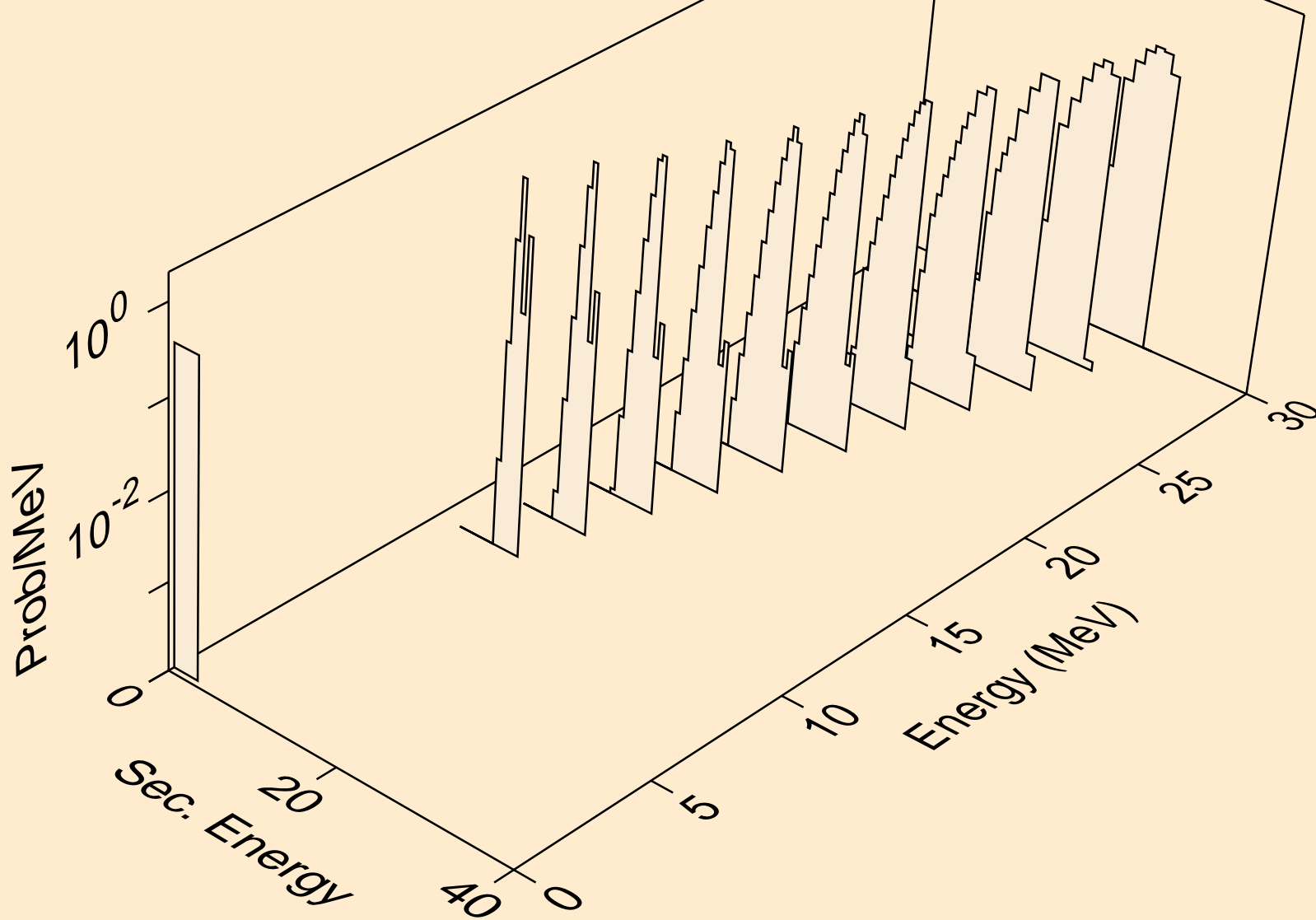



MD253 NEUTRON ACER TENDL-2019 LIBRARY; T=293.16K  
alphas from (n,x)

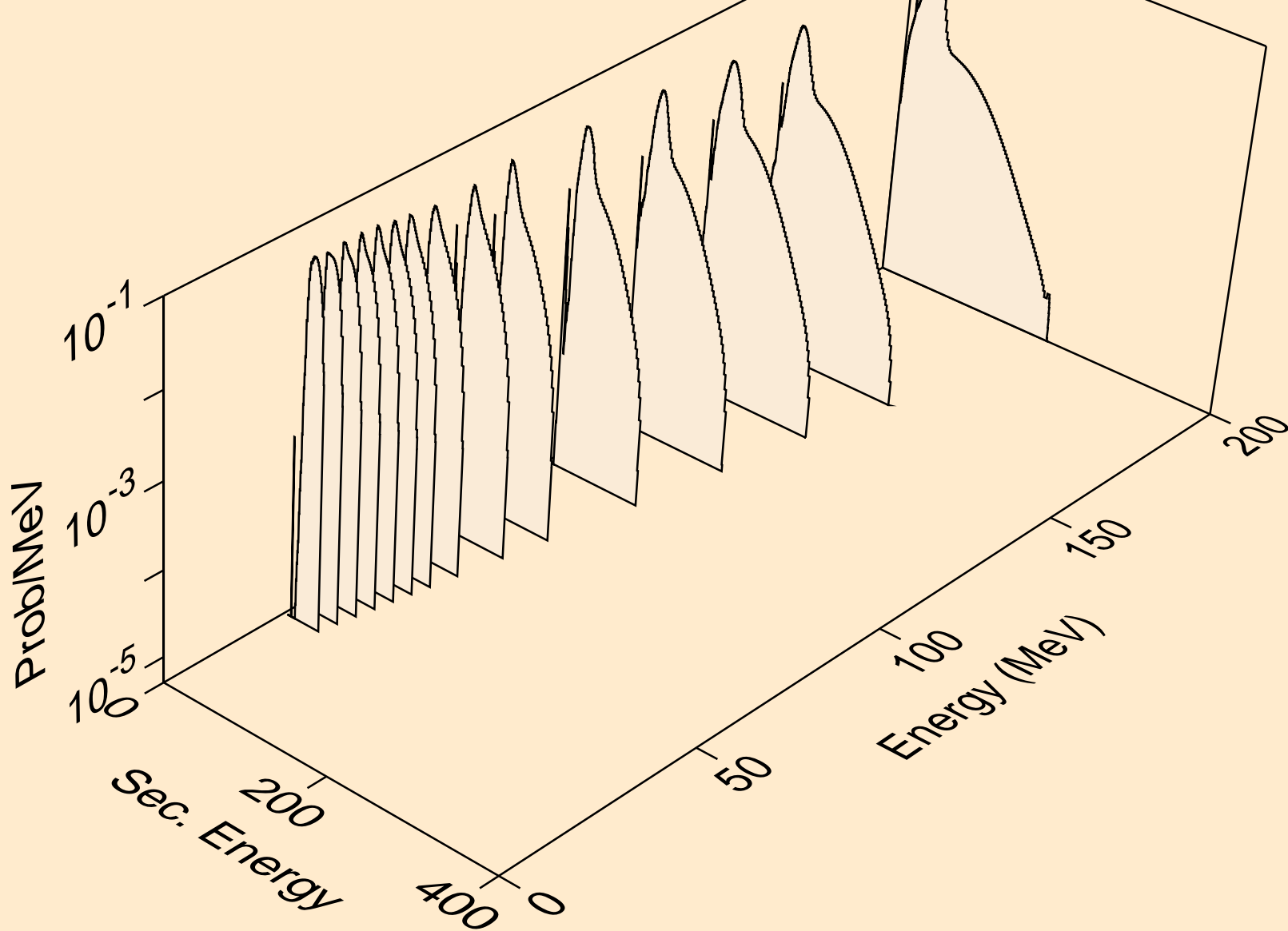

MD253 NEUTRON ACER TENDL-2019 LIBRARY; T=293.16K  
alphas from (n,n\*)a

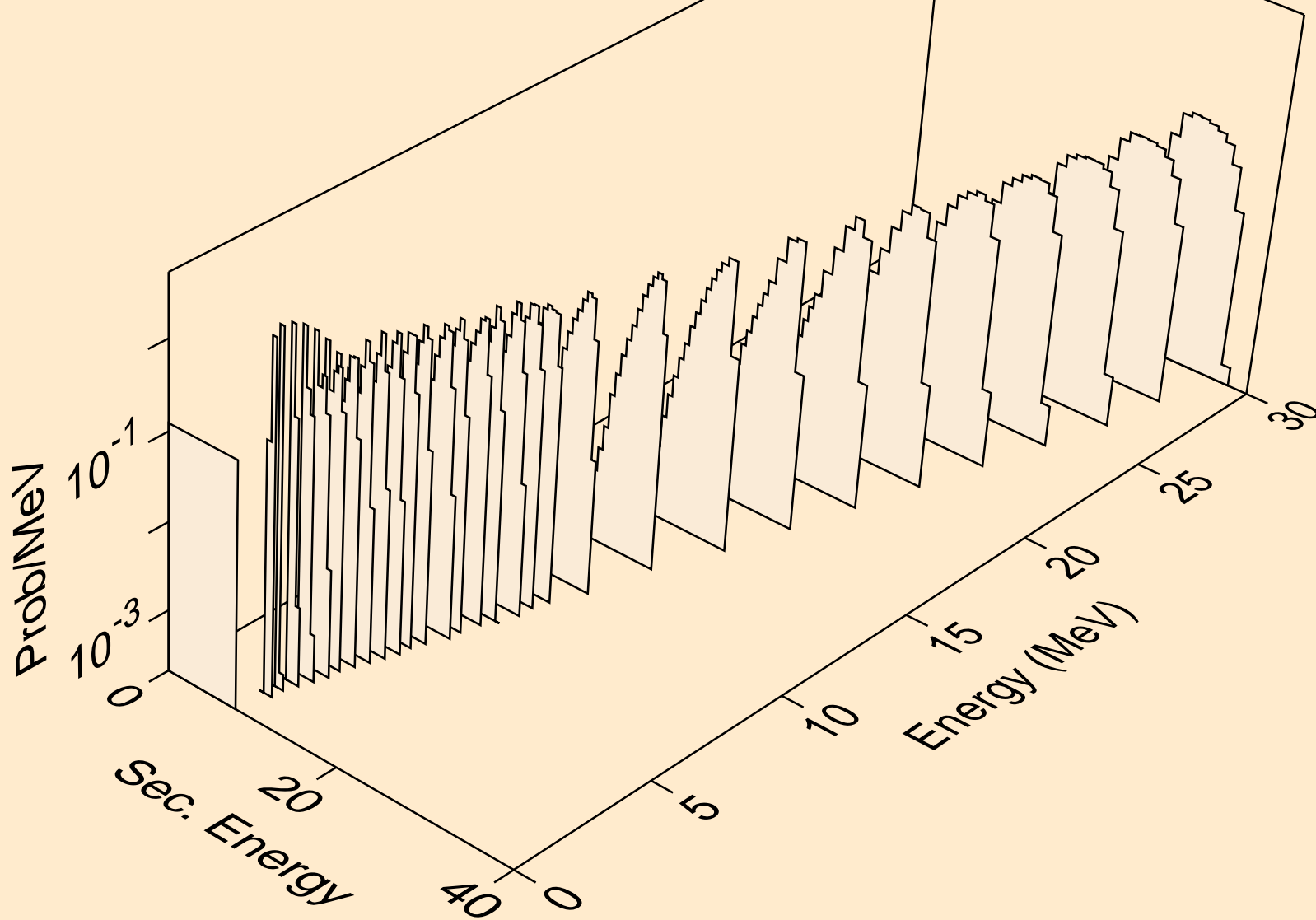

MD253 NEUTRON ACER TENDL-2019 LIBRARY; T=293.16K  
alphas from (n,2n)a

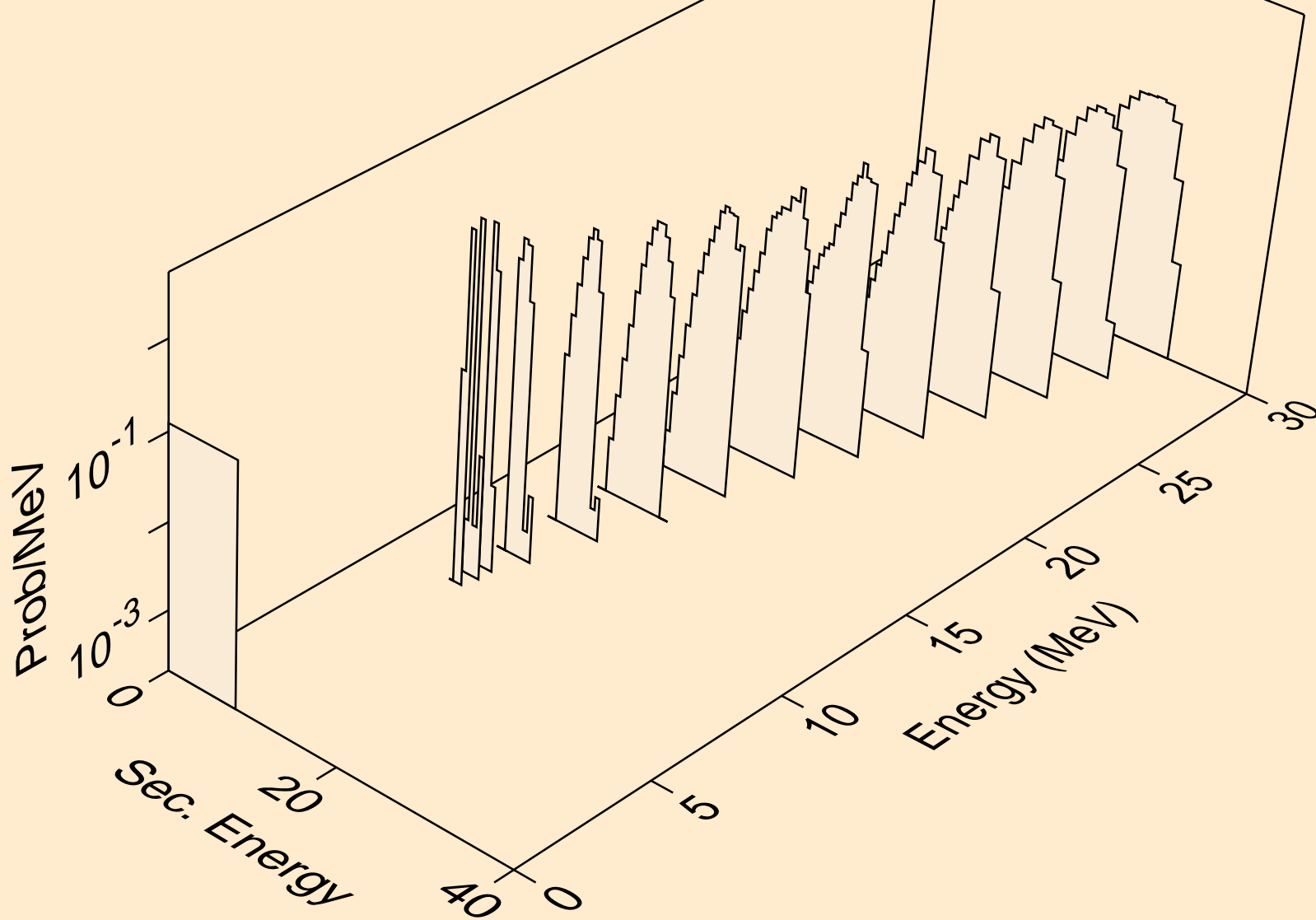

MD253 NEUTRON ACER TENDL-2019 LIBRARY; T=293.16K  
alphas from (n,3n)a

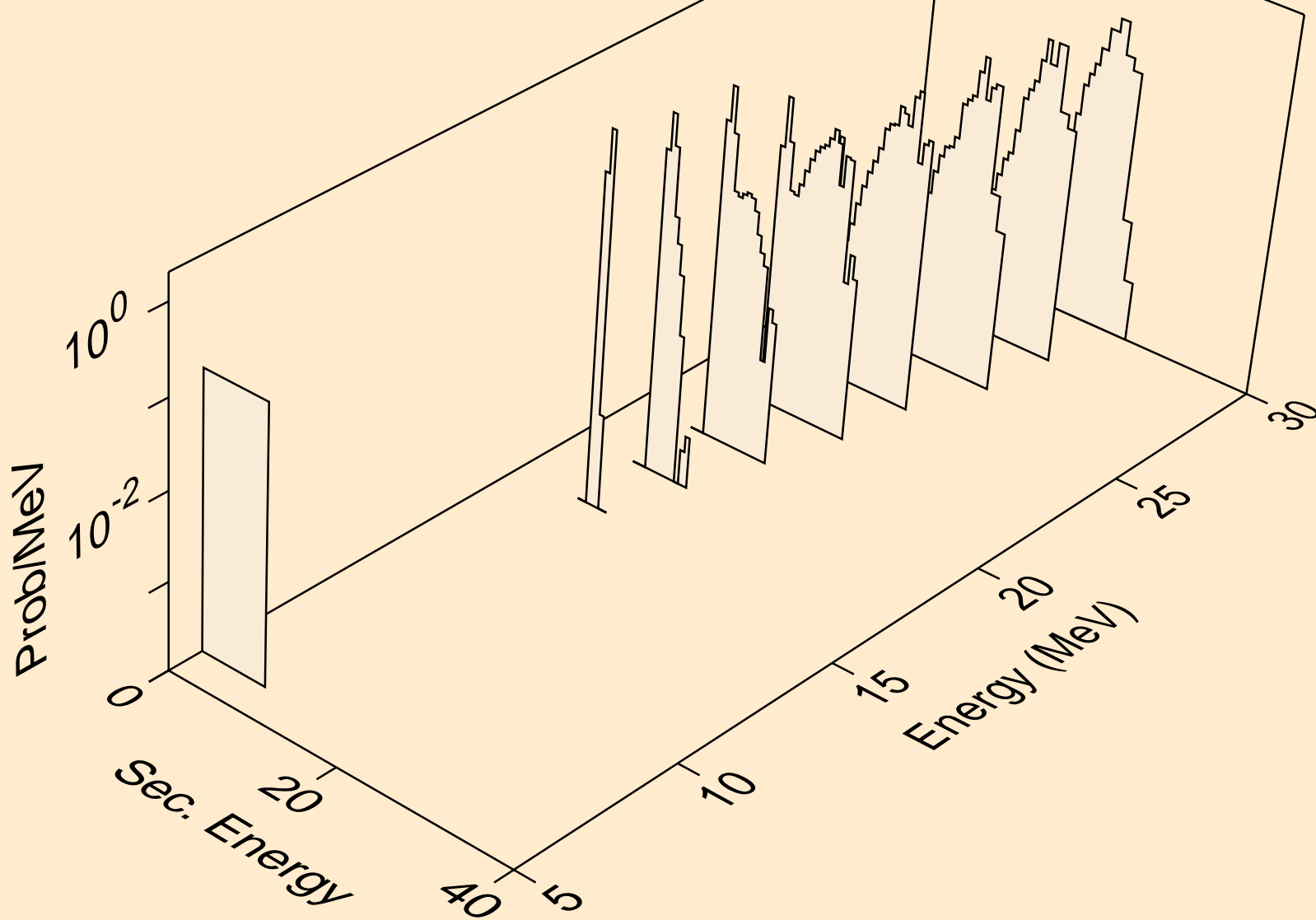

MD253 NEUTRON ACER TENDL-2019 LIBRARY; T=293.16K  
alphas from (n,n\*)2a

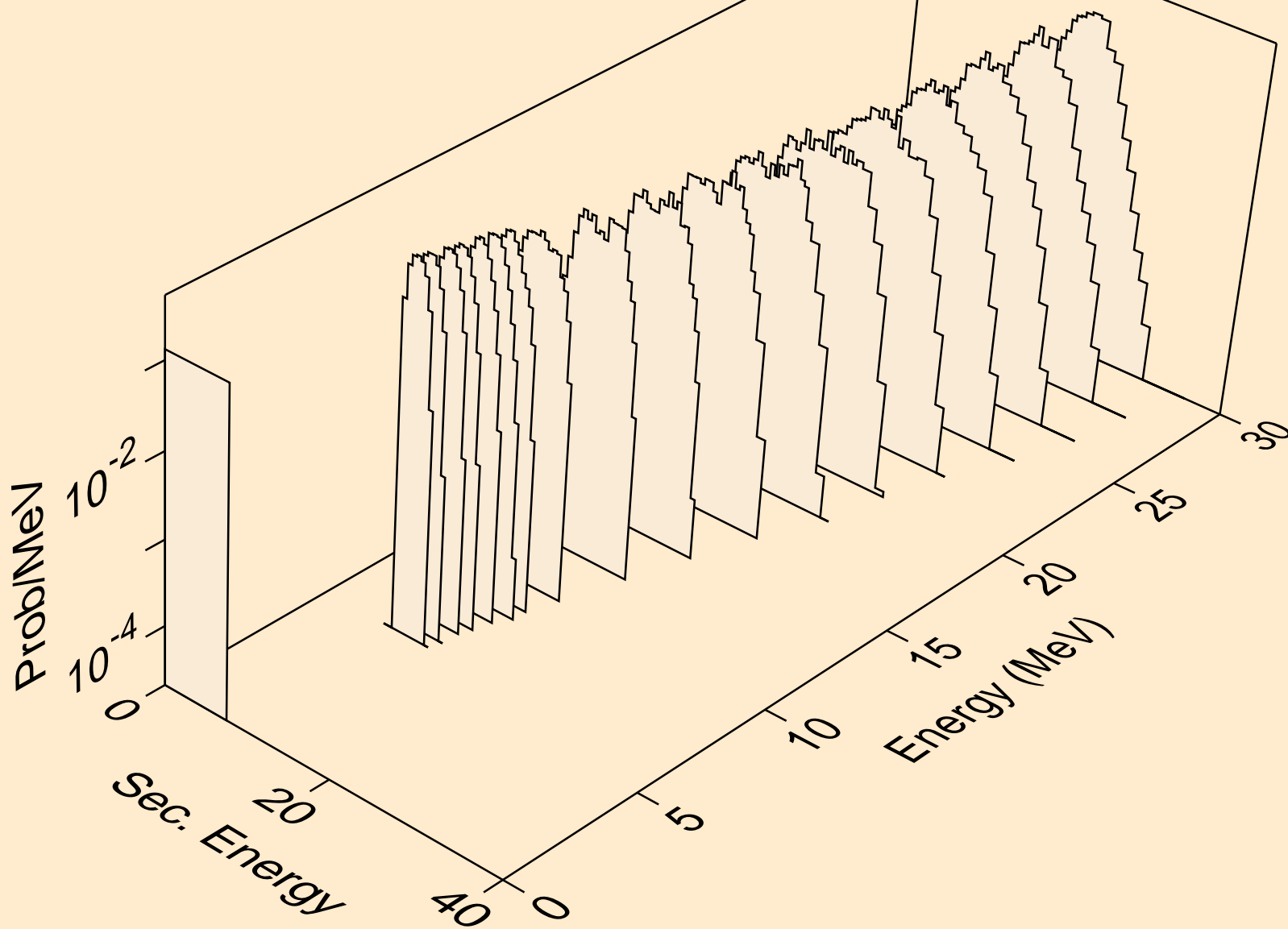

MD253 NEUTRON ACER TENDL-2019 LIBRARY; T=293.16K  
alphas from (n,npa)

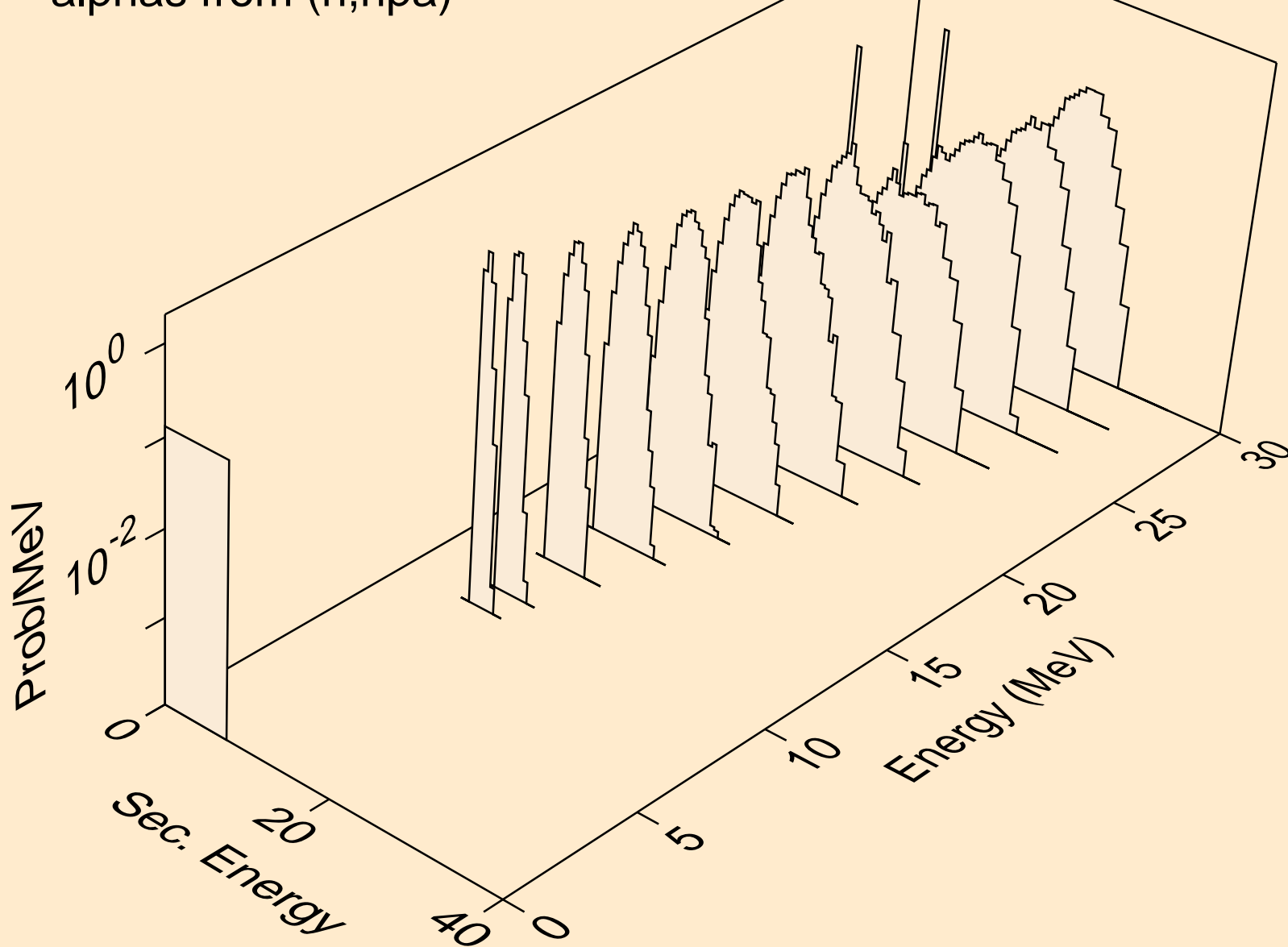

MD253 NEUTRON ACER TENDL-2019 LIBRARY; T=293.16K  
alphas from (n,a)

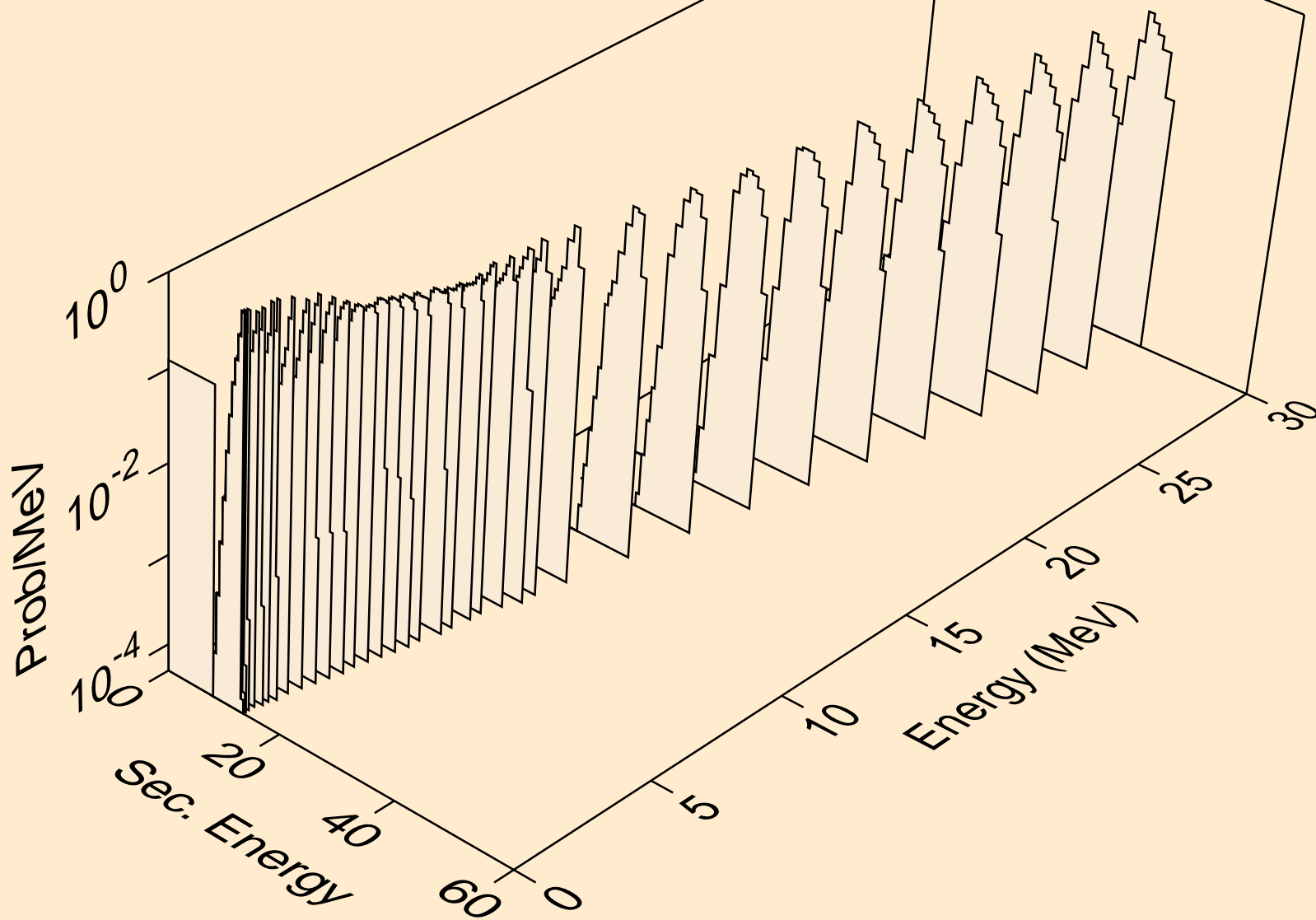

MD253 NEUTRON ACER TENDL-2019 LIBRARY; T=293.16K  
alphas from (n,2a)

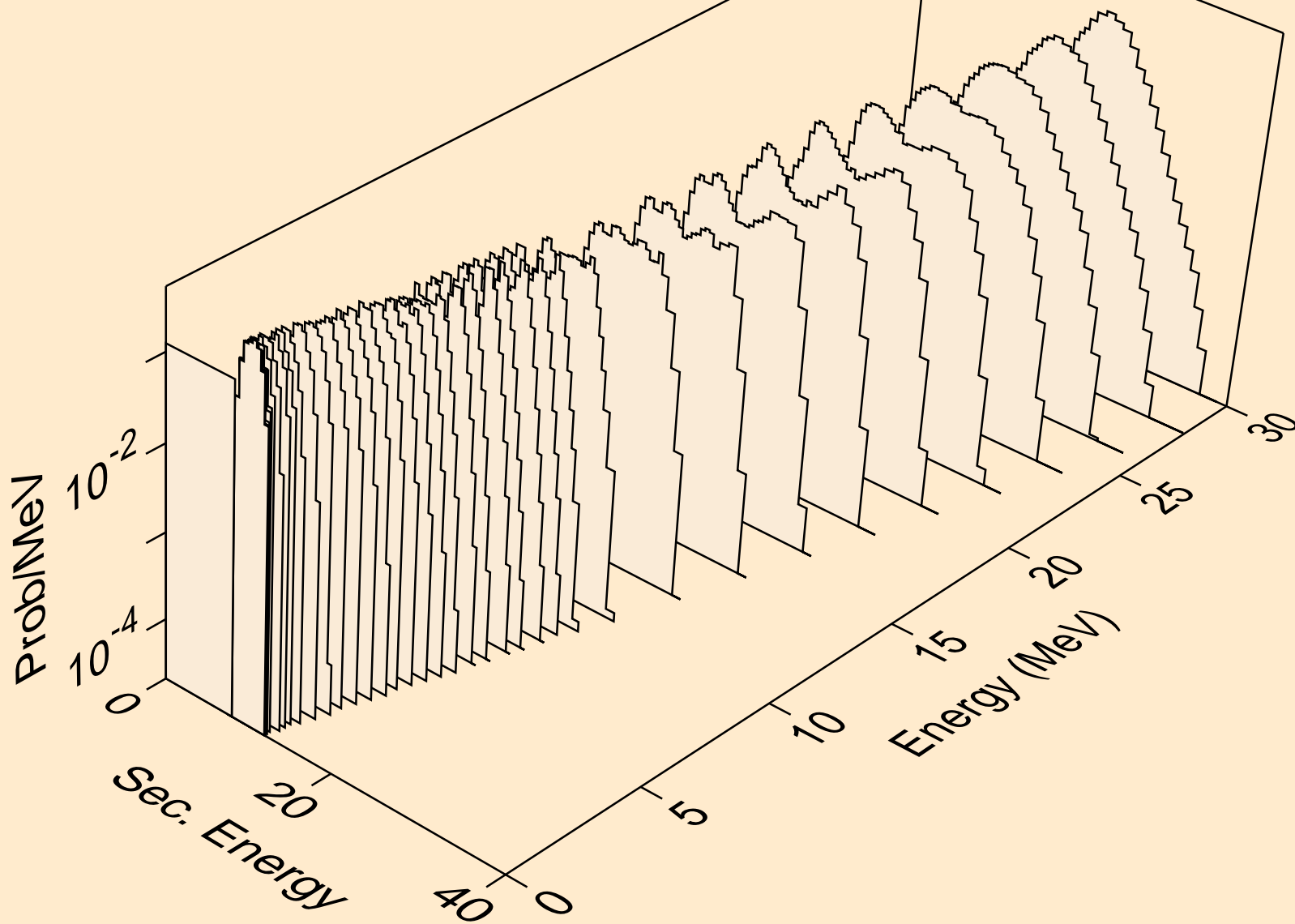



MD253 NEUTRON ACER TENDL-2019 LIBRARY; T=293.16K  
alphas from (n,pa)

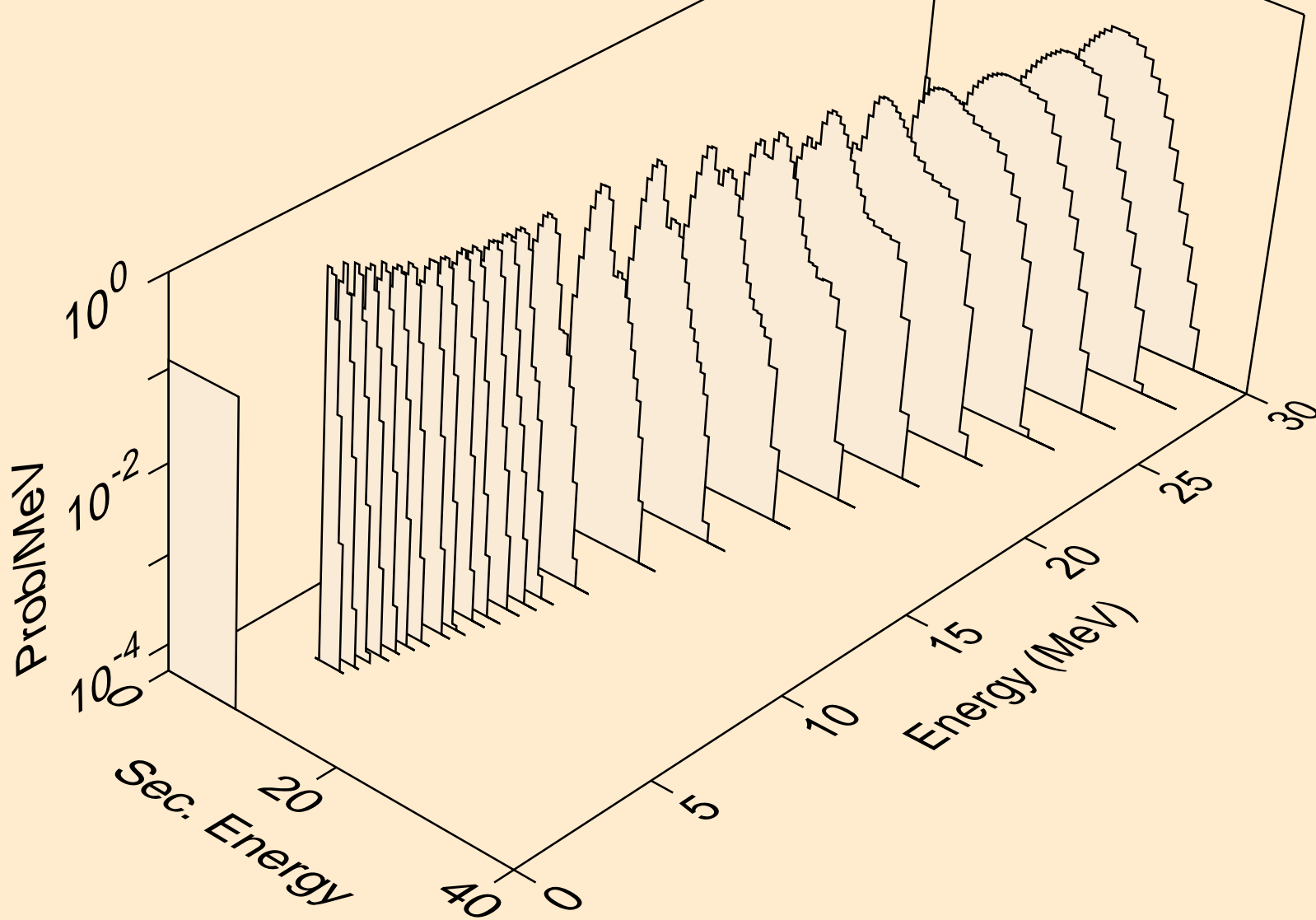

MD253 NEUTRON ACER TENDL-2019 LIBRARY; T=293.16K  
alphas from (n,da)

