

MD255 NEUTRON ACER TENDL-2019 LIBRARY; T=293.16K

Principal cross sections

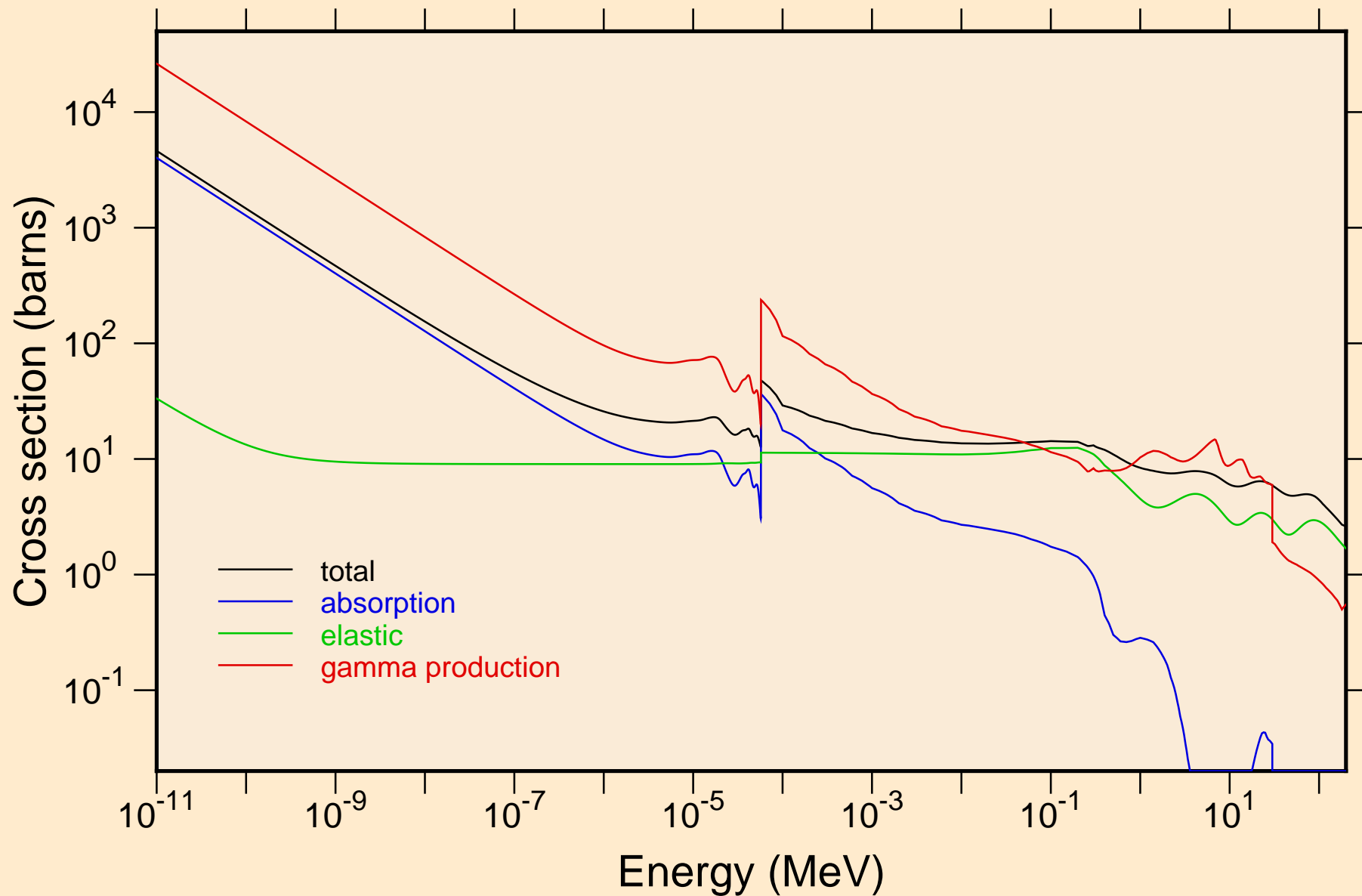

MD255 NEUTRON ACER TENDL-2019 LIBRARY; T=293.16K
Heating

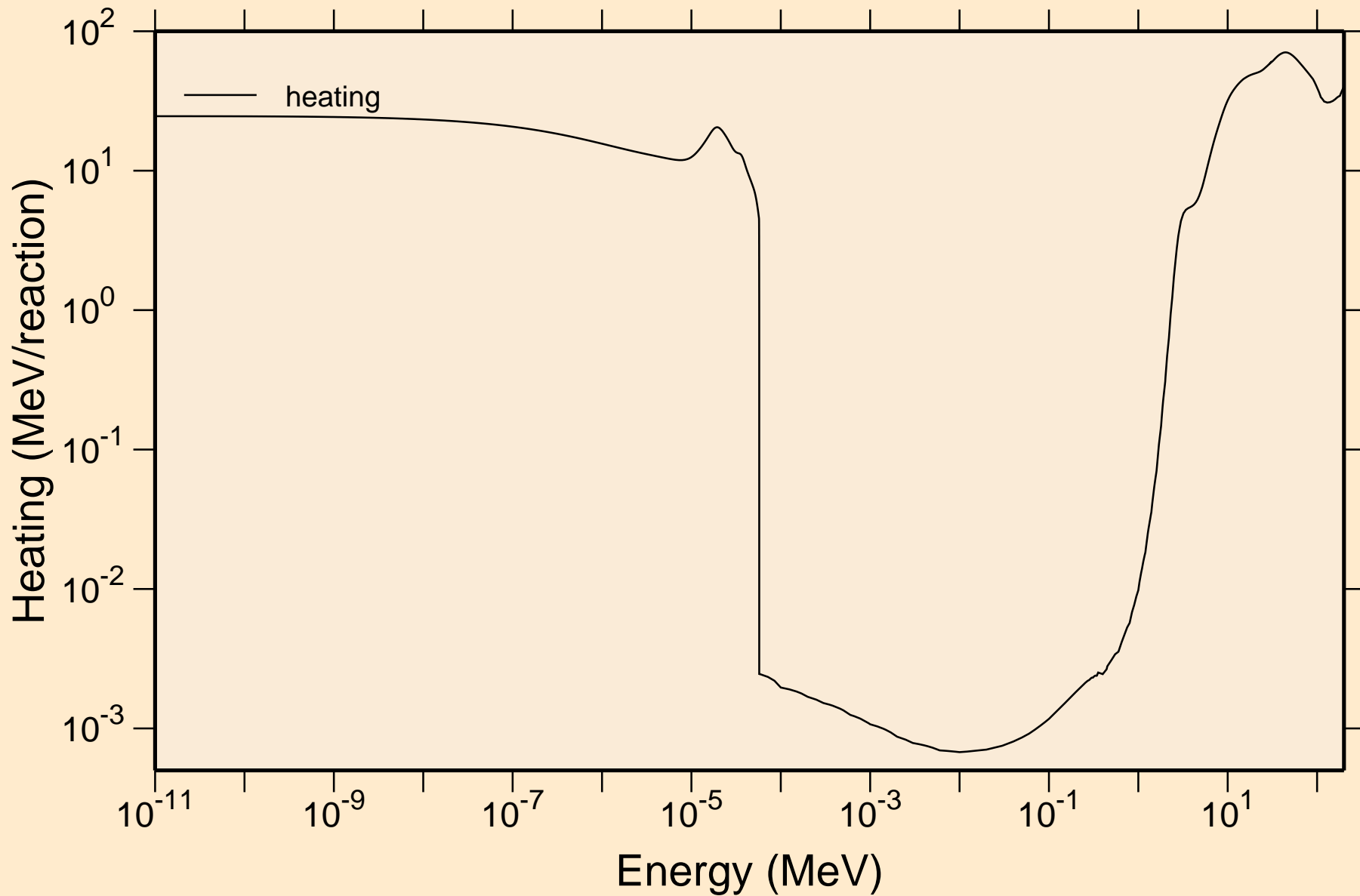

MD255 NEUTRON ACER TENDL-2019 LIBRARY; T=293.16K
Damage

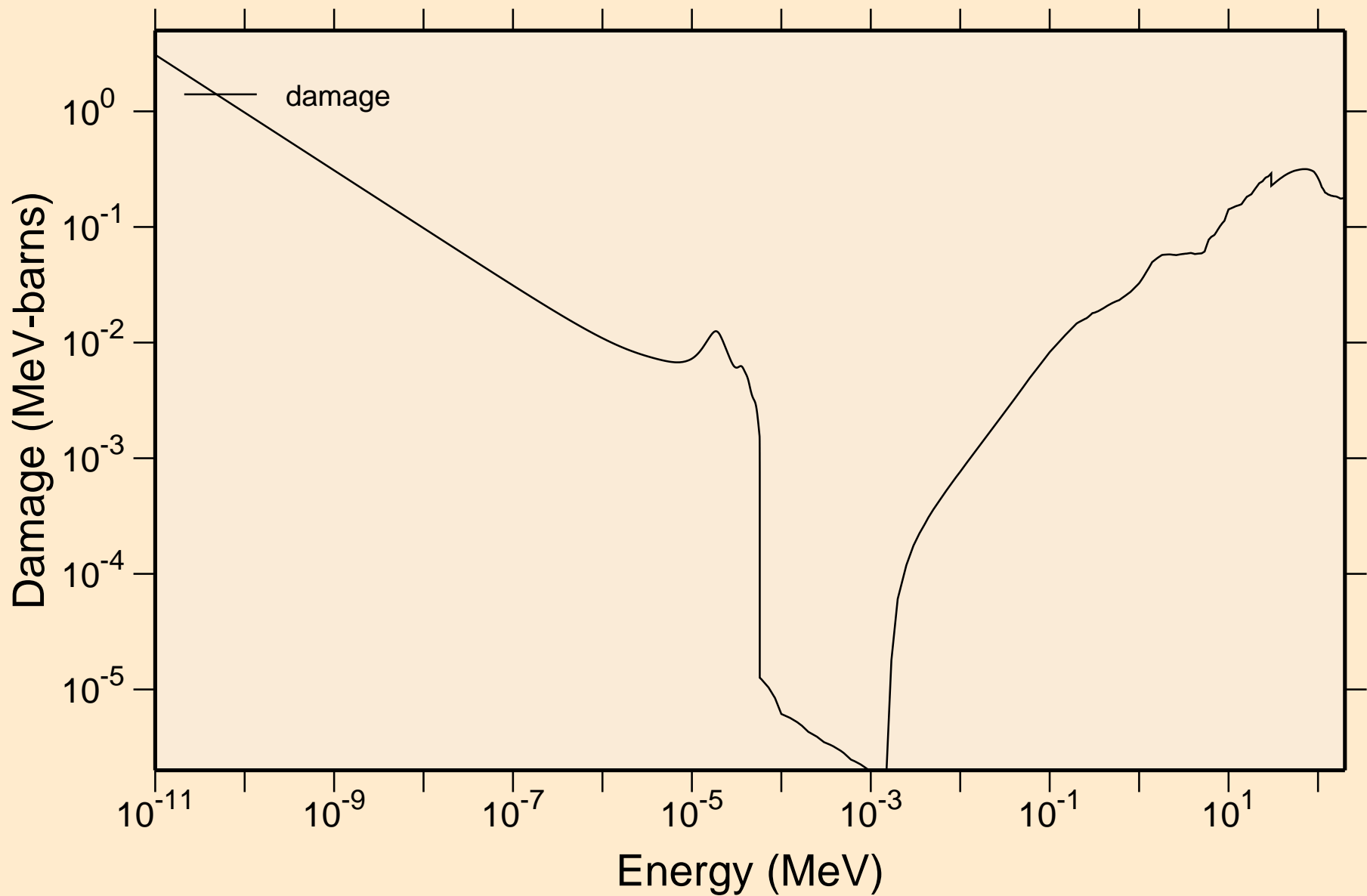

MD255 NEUTRON ACER TENDL-2019 LIBRARY; T=293.16K
Non-threshold reactions

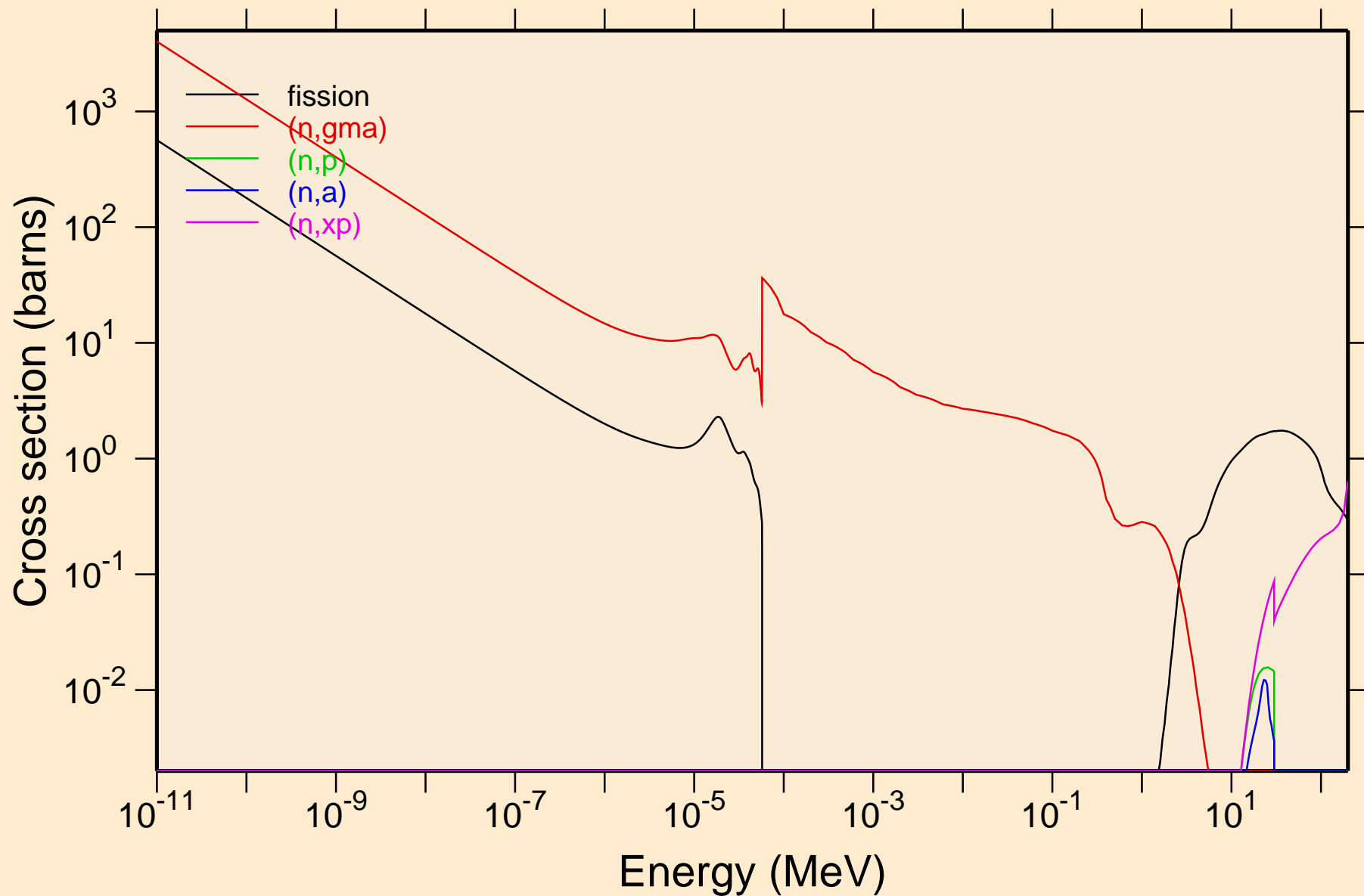

MD255 NEUTRON ACER TENDL-2019 LIBRARY; T=293.16K
Non-threshold reactions

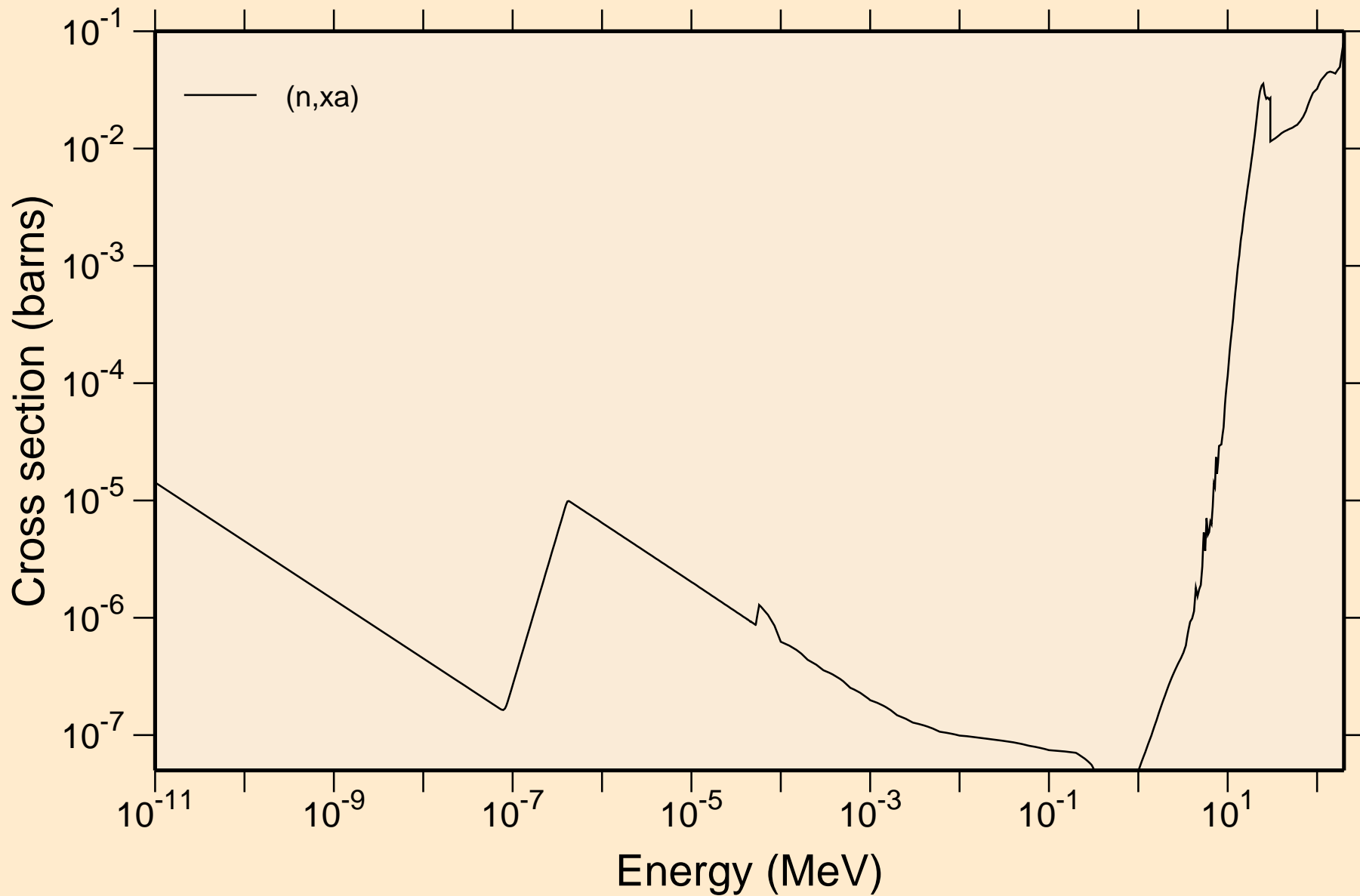

MD255 NEUTRON ACER TENDL-2019 LIBRARY; T=293.16K
Principal cross sections

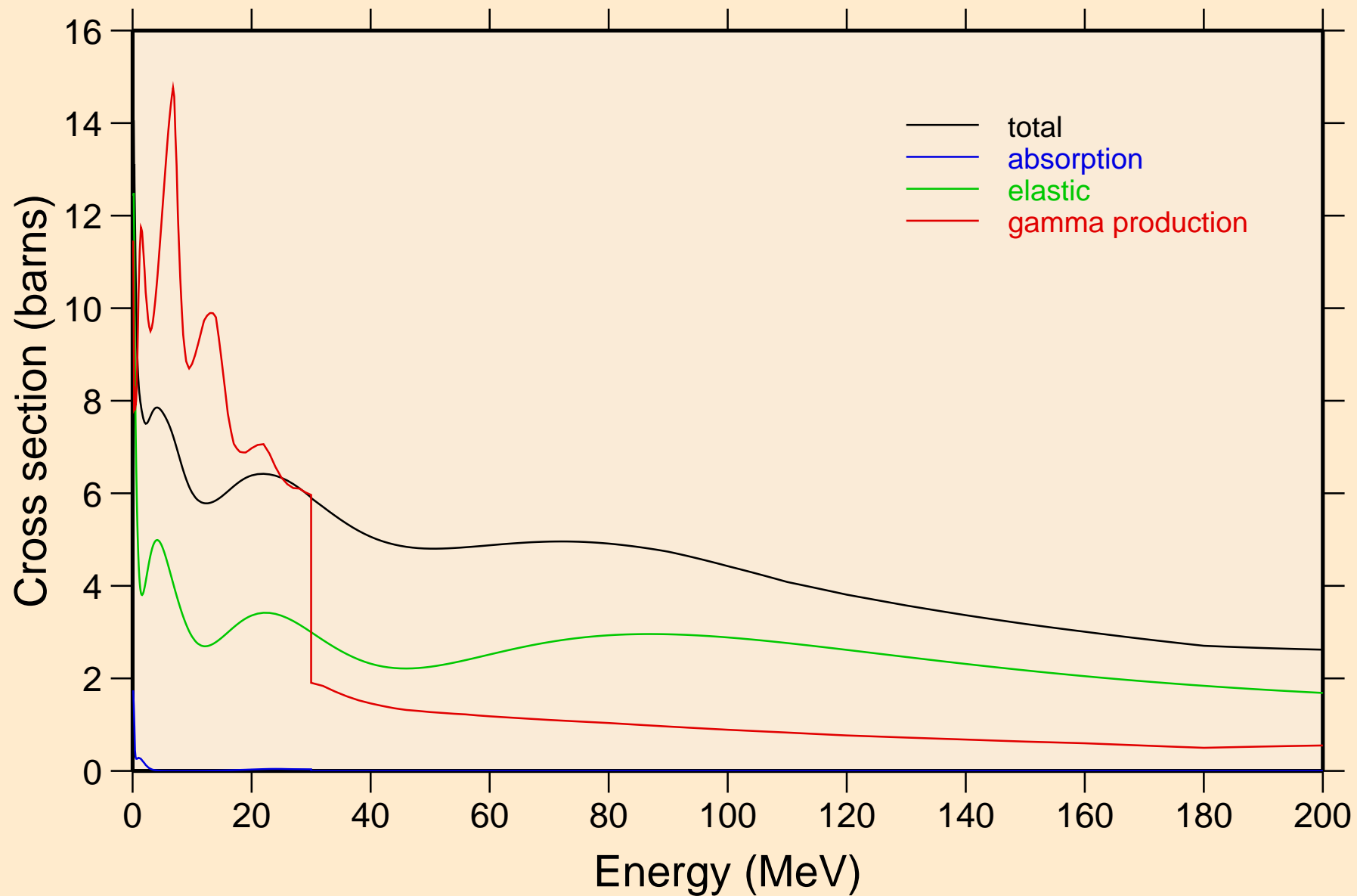

MD255 NEUTRON ACER TENDL-2019 LIBRARY; T=293.16K
Heating

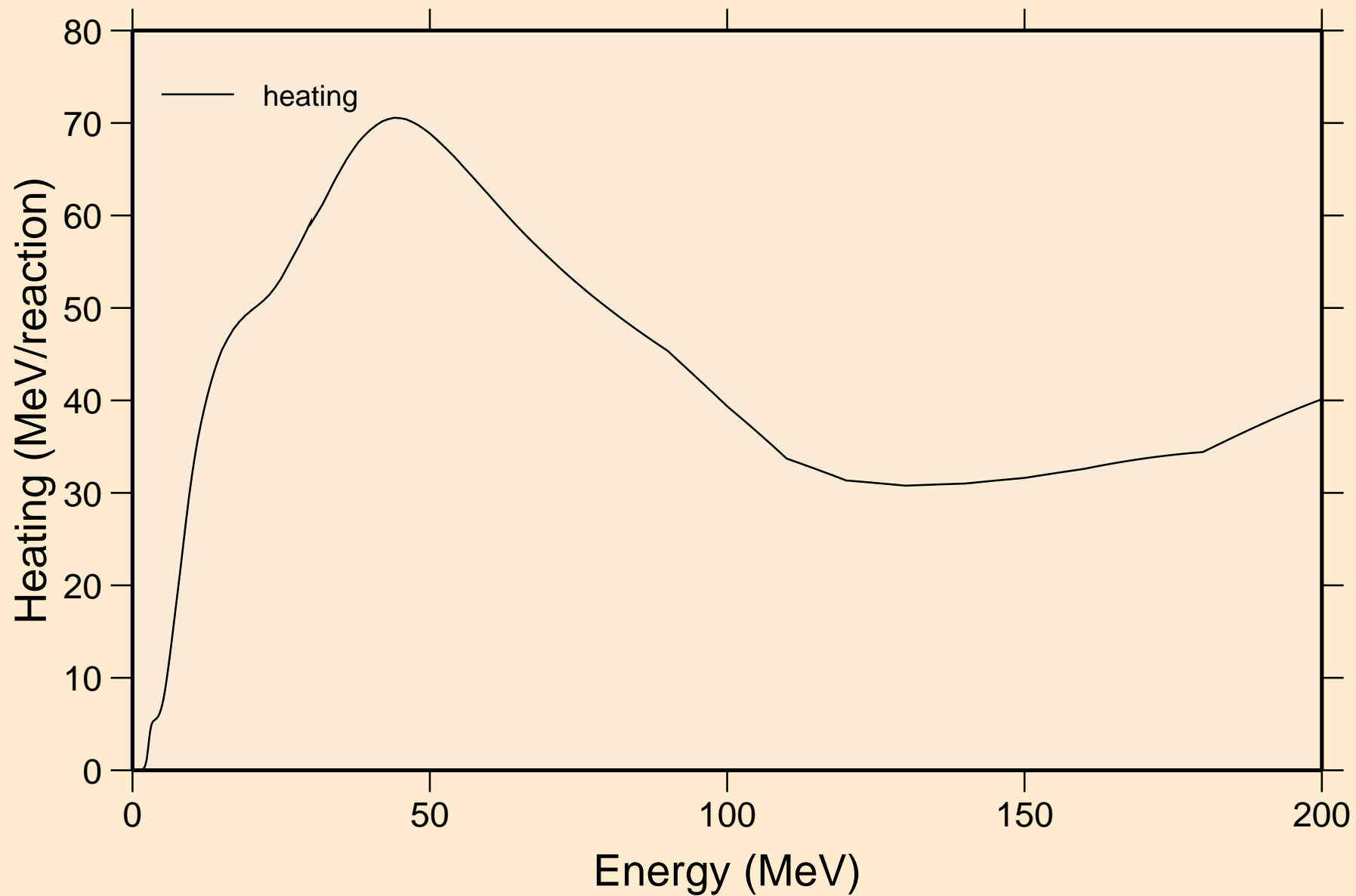

MD255 NEUTRON ACER TENDL-2019 LIBRARY; T=293.16K Damage

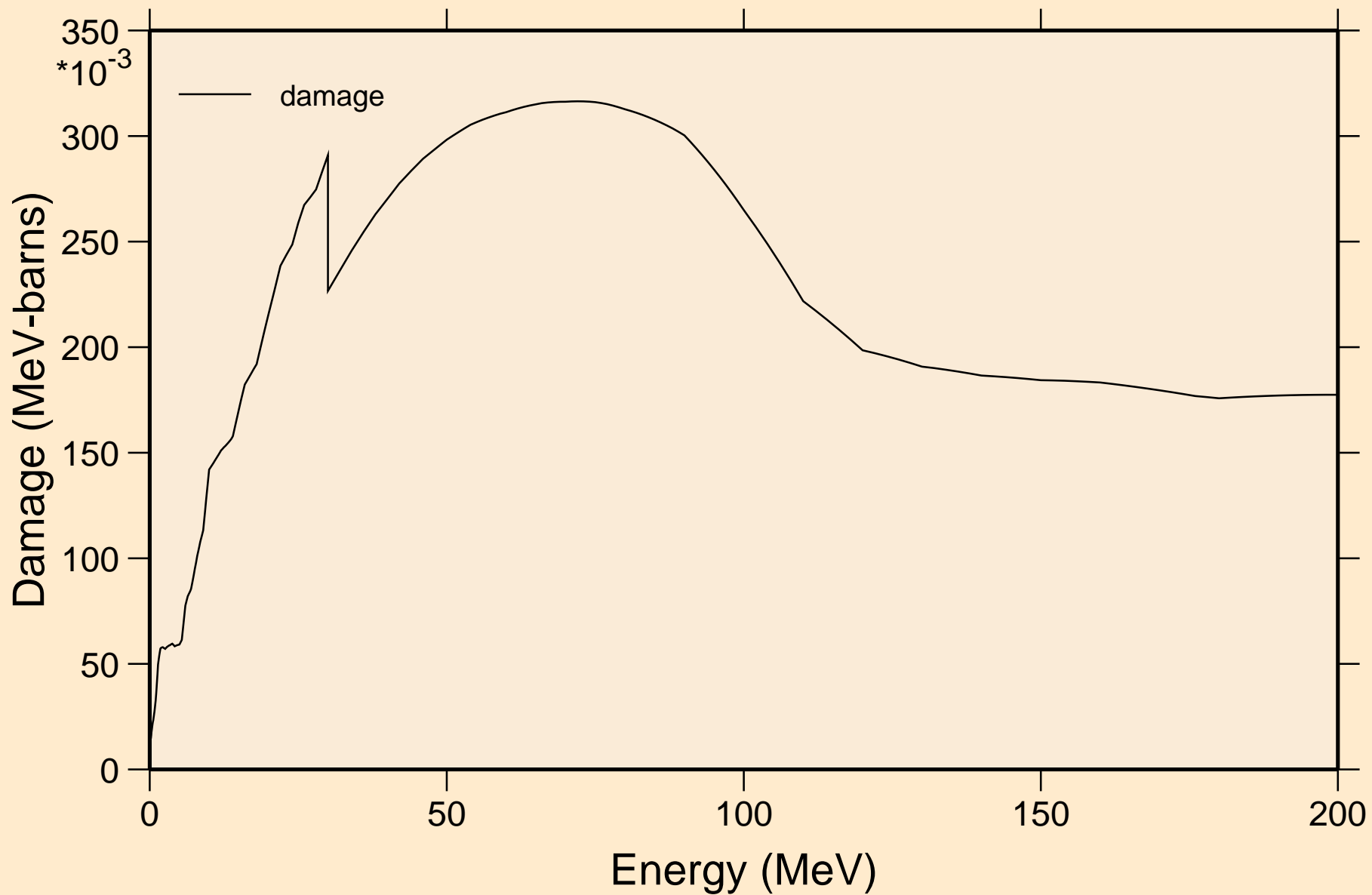

MD255 NEUTRON ACER TENDL-2019 LIBRARY; T=293.16K
Non-threshold reactions

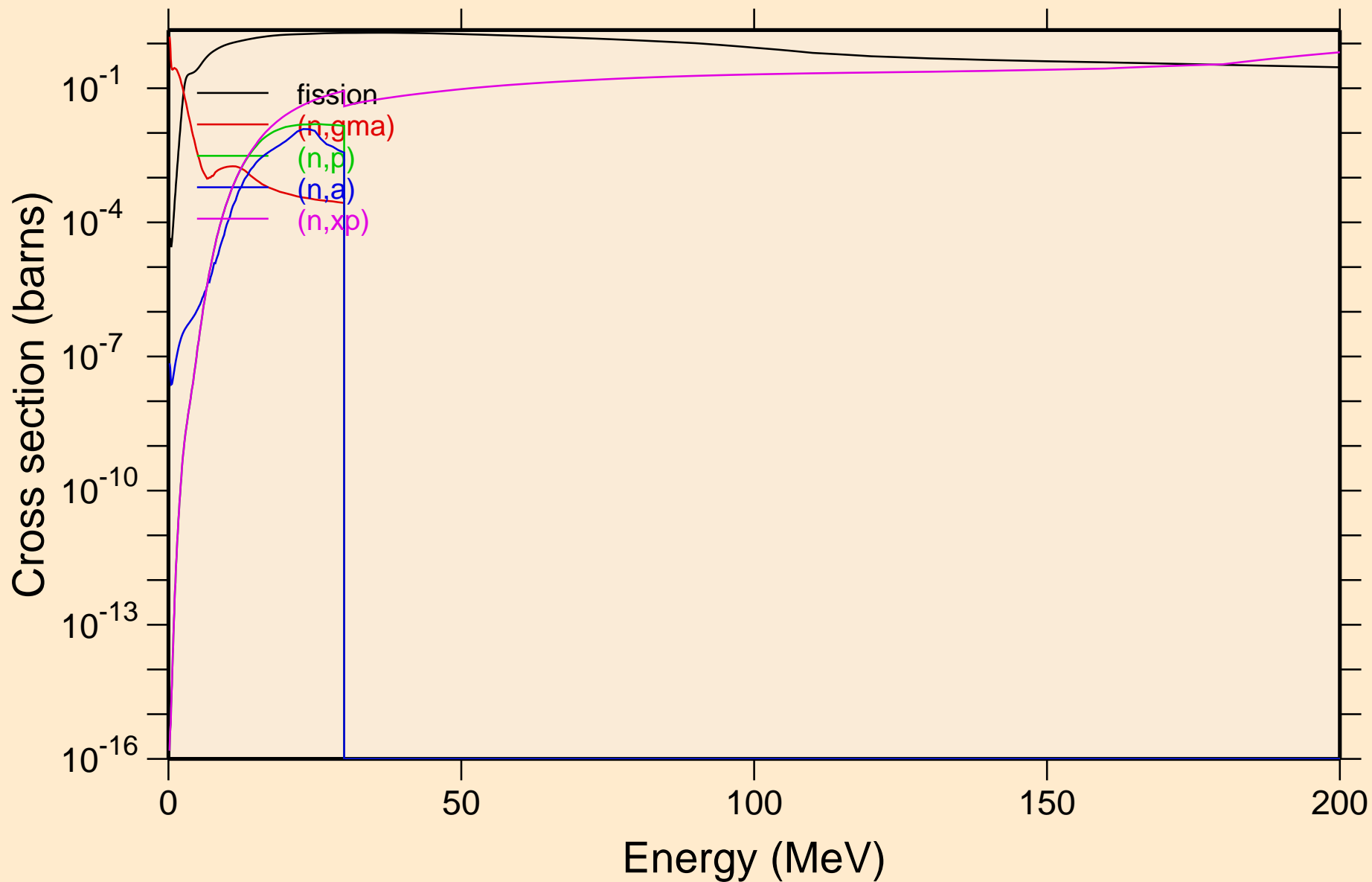

MD255 NEUTRON ACER TENDL-2019 LIBRARY; T=293.16K
Non-threshold reactions

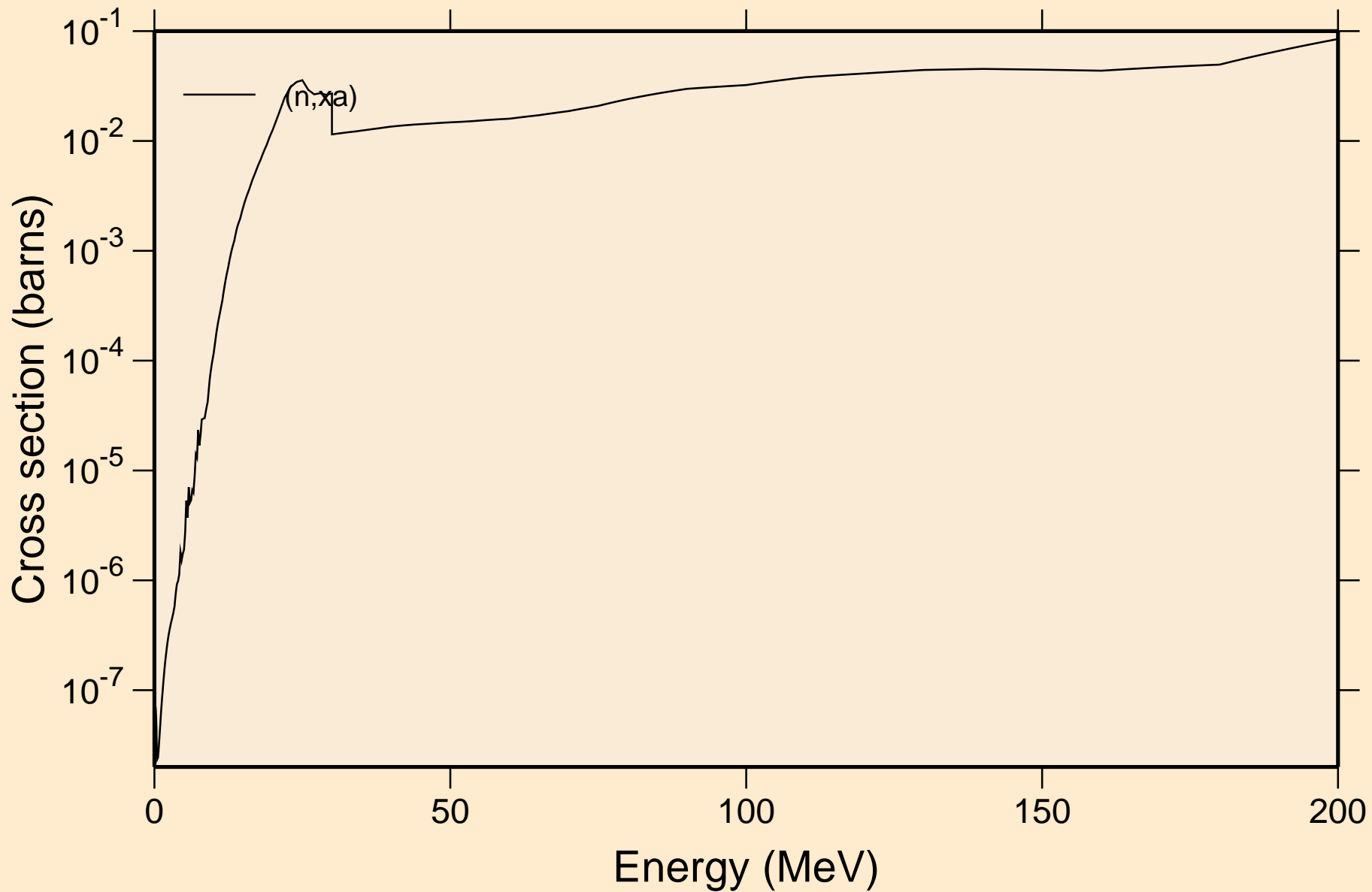

MD255 NEUTRON ACER TENDL-2019 LIBRARY; T=293.16K
Inelastic levels

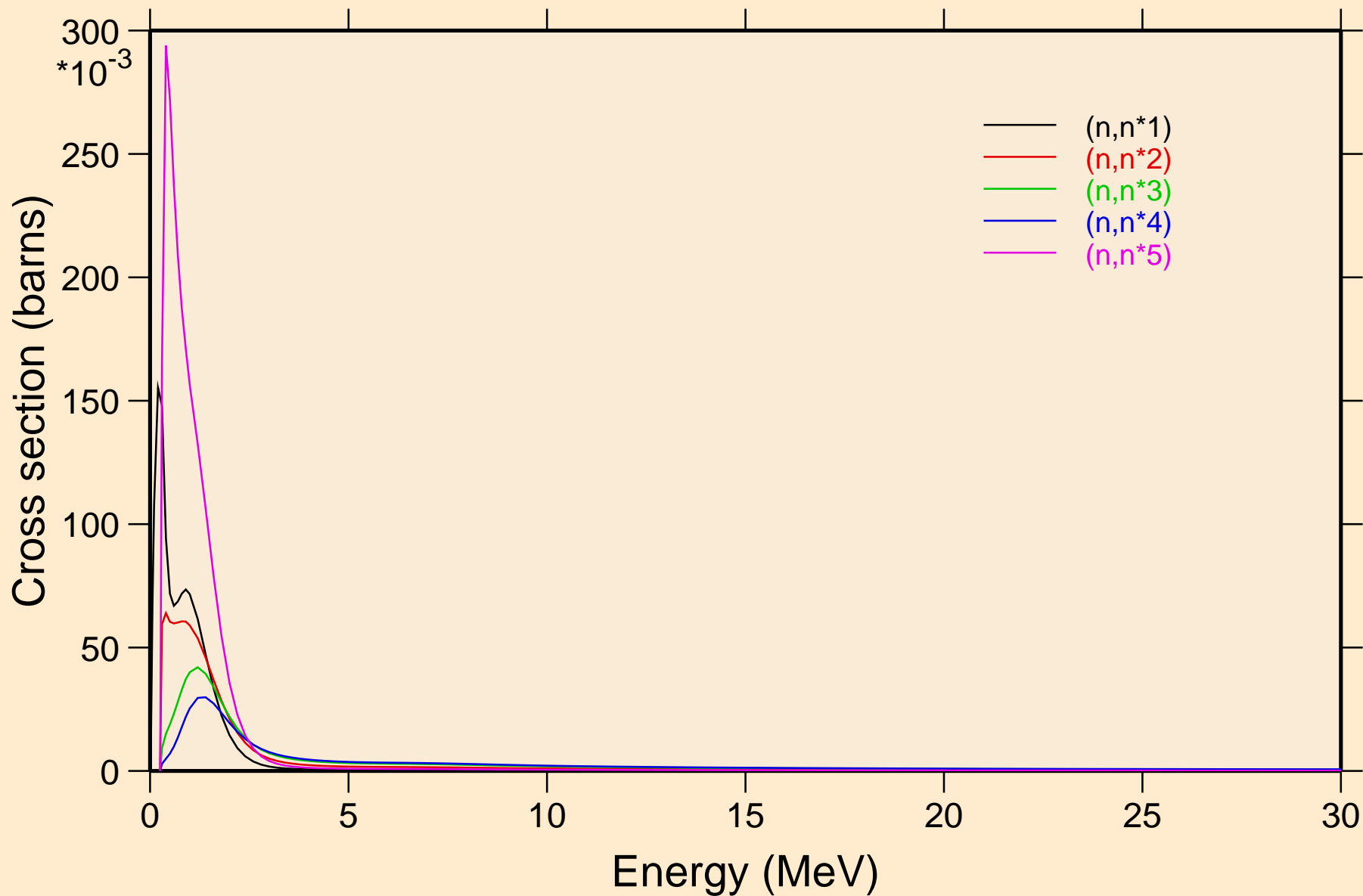

MD255 NEUTRON ACER TENDL-2019 LIBRARY; T=293.16K
Inelastic levels

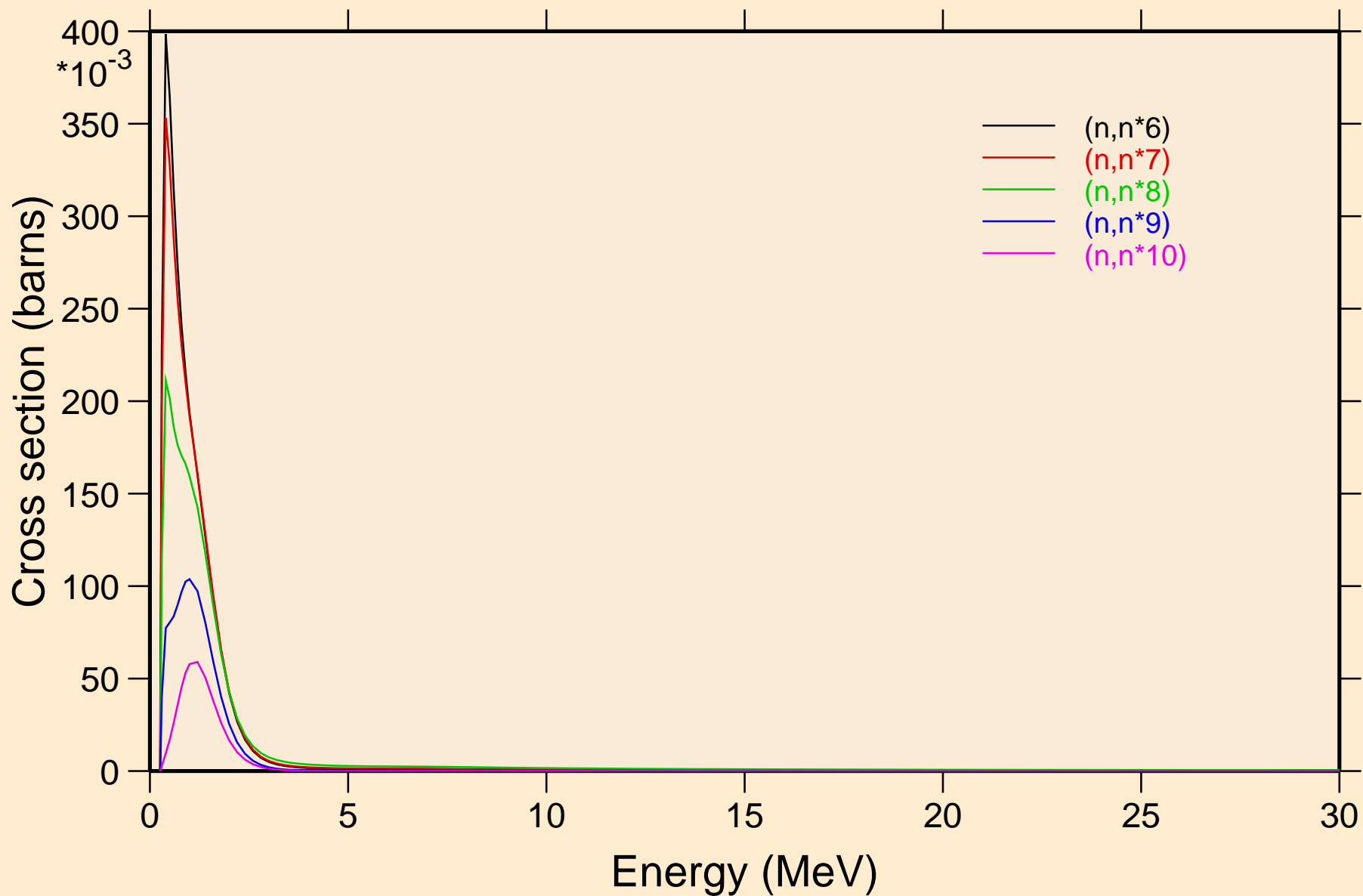

MD255 NEUTRON ACER TENDL-2019 LIBRARY; T=293.16K
Inelastic levels

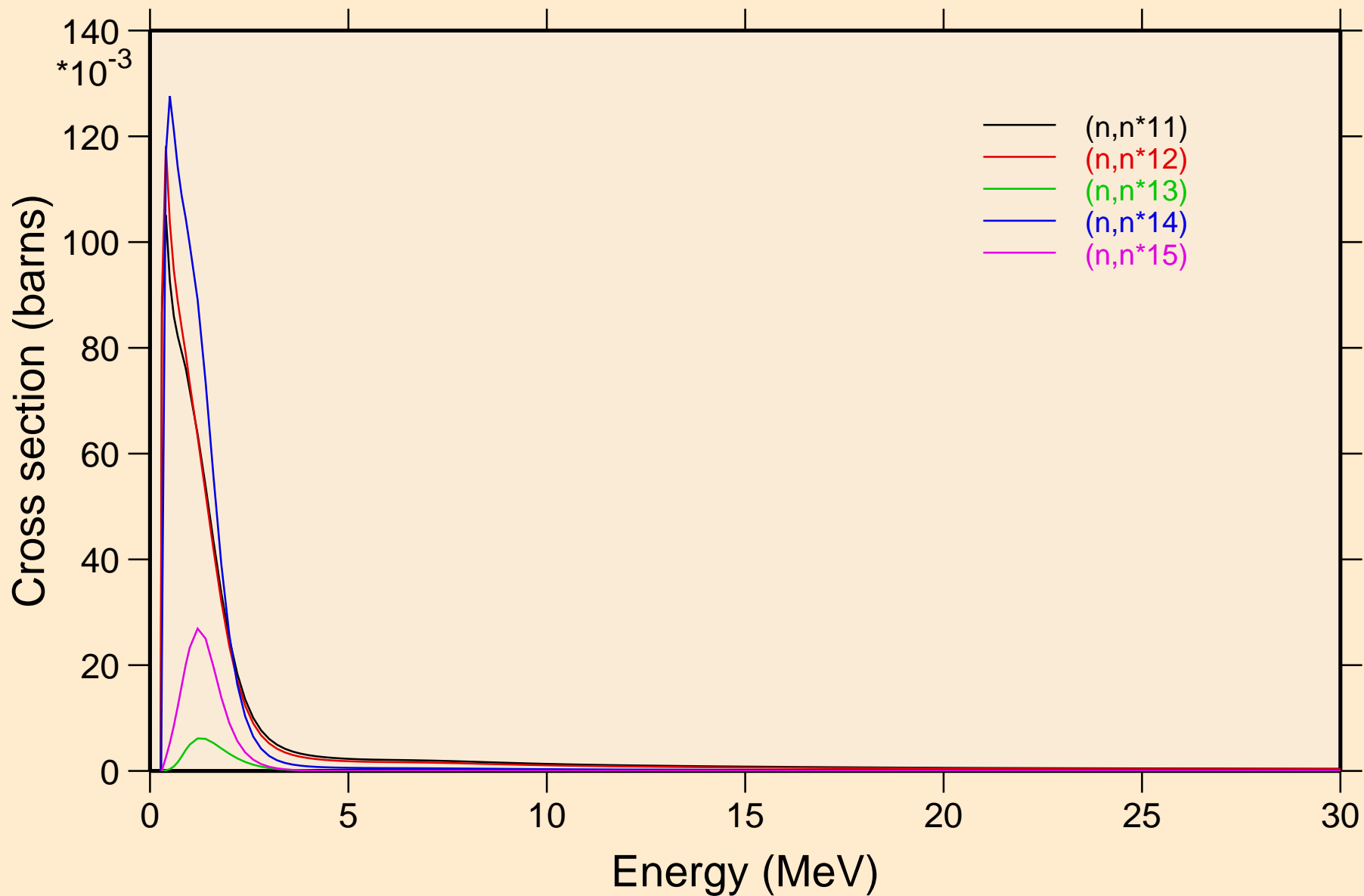

MD255 NEUTRON ACER TENDL-2019 LIBRARY; T=293.16K
Inelastic levels

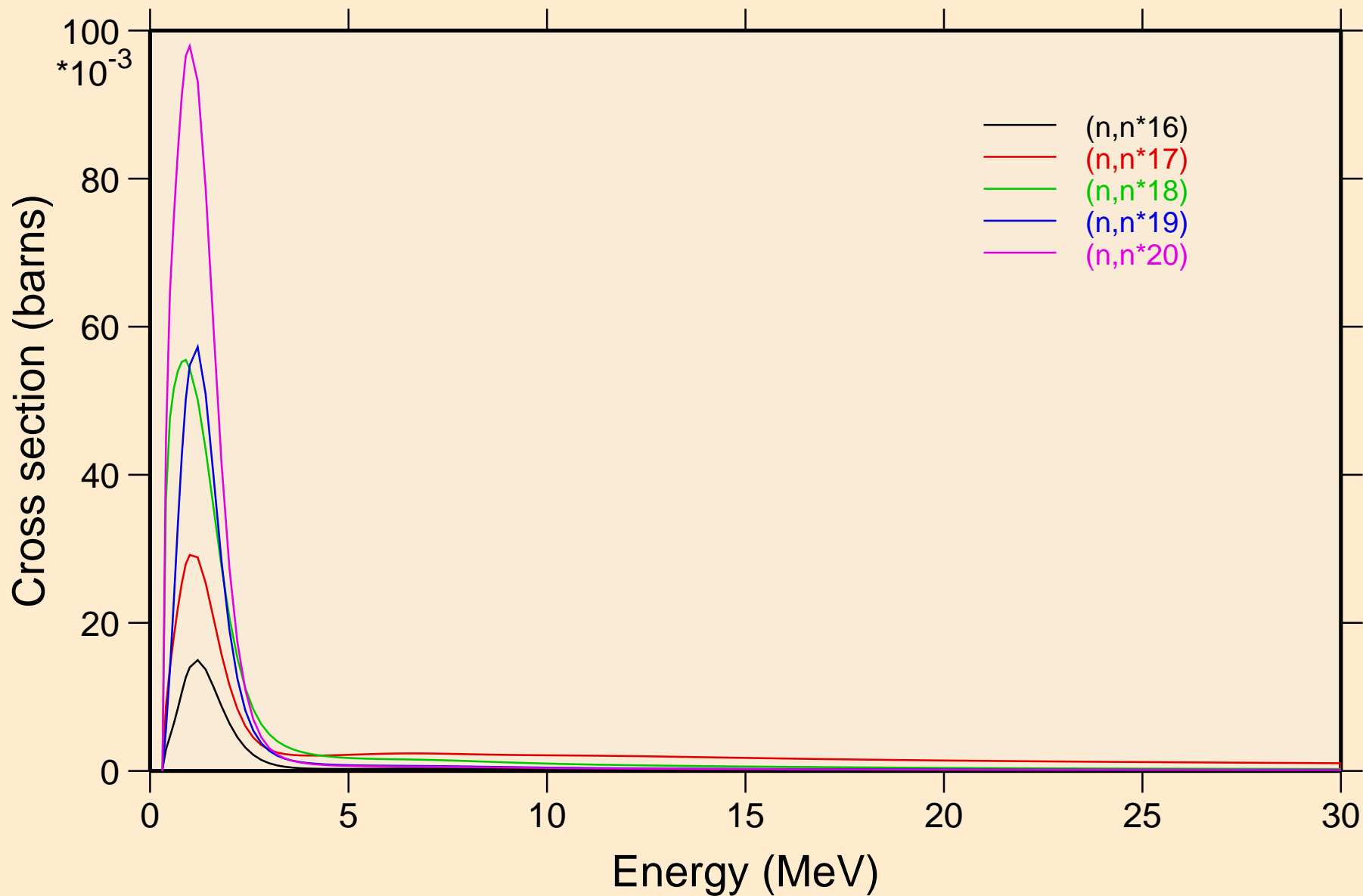

MD255 NEUTRON ACER TENDL-2019 LIBRARY; T=293.16K
Inelastic levels

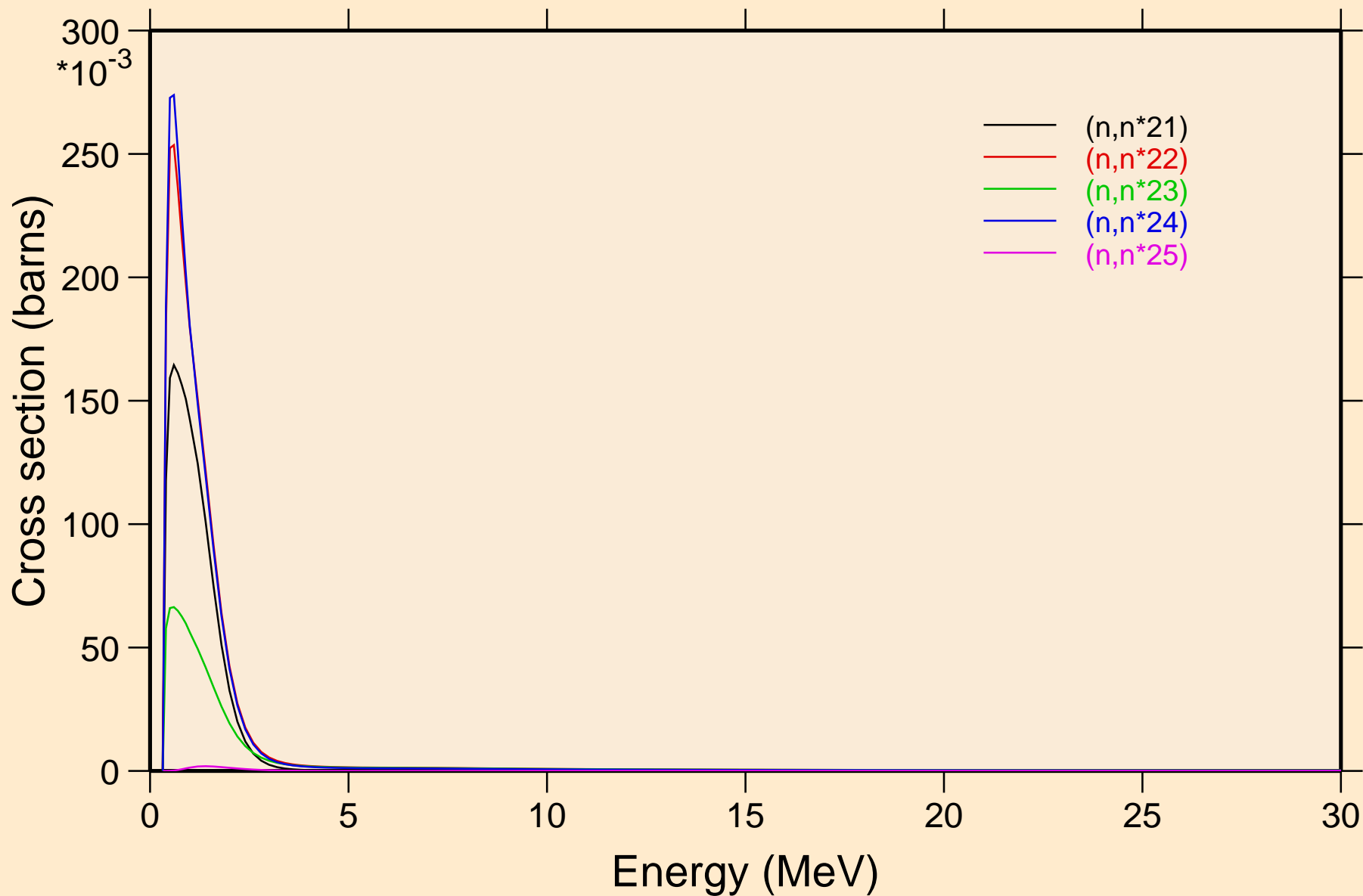

MD255 NEUTRON ACER TENDL-2019 LIBRARY; T=293.16K
Inelastic levels

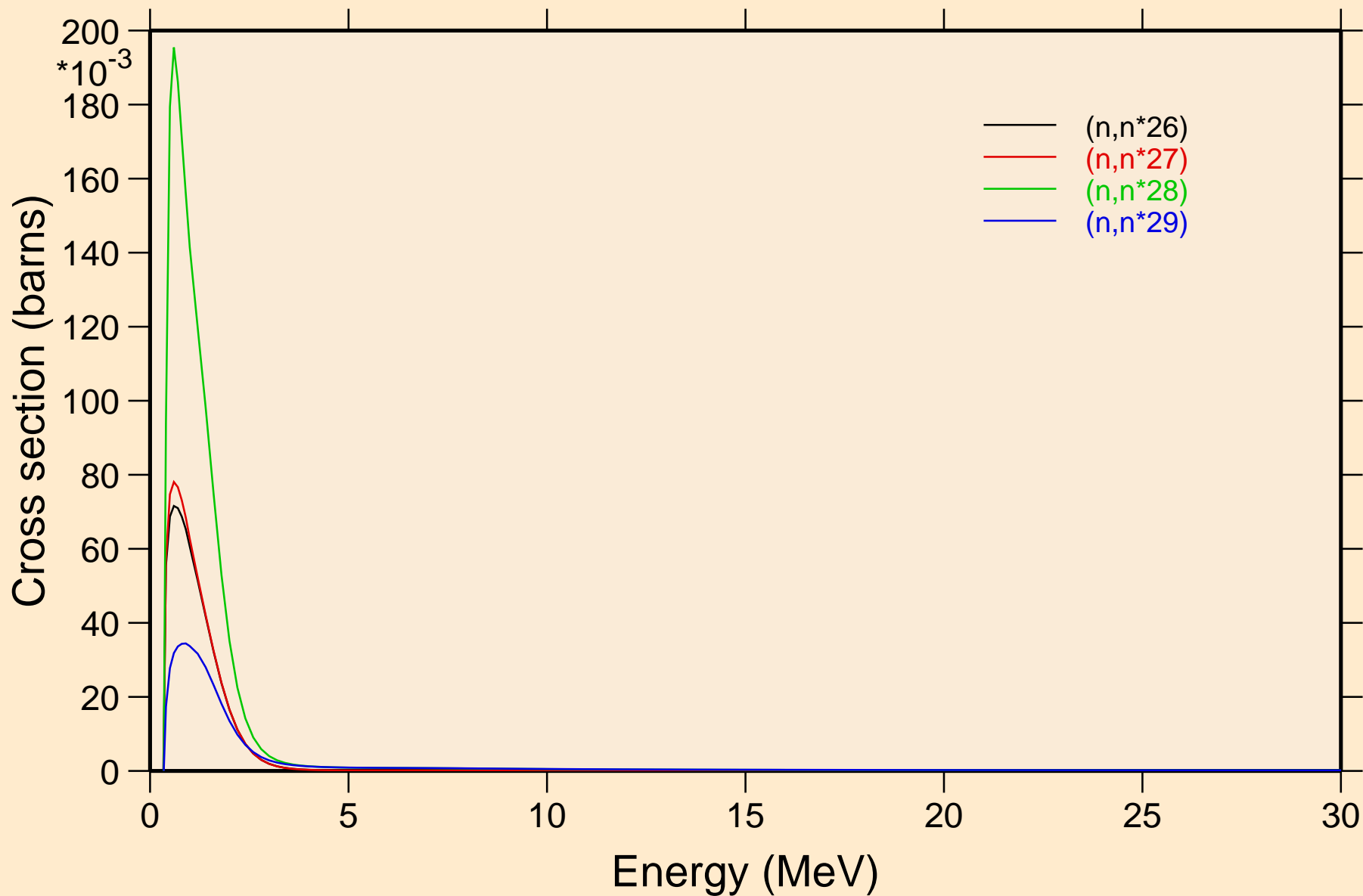

MD255 NEUTRON ACER TENDL-2019 LIBRARY; T=293.16K
Threshold reactions

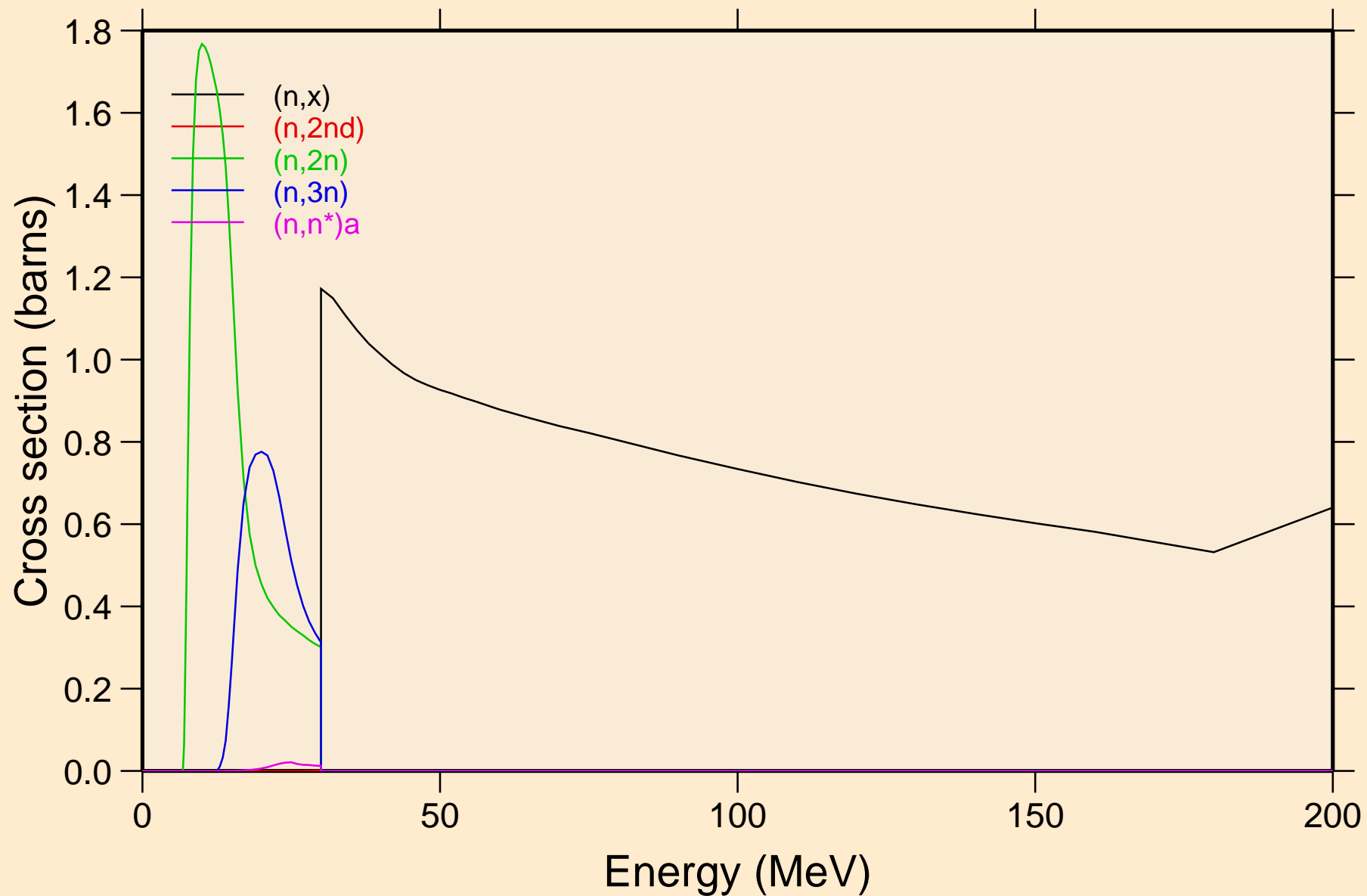

MD255 NEUTRON ACER TENDL-2019 LIBRARY; T=293.16K
Threshold reactions

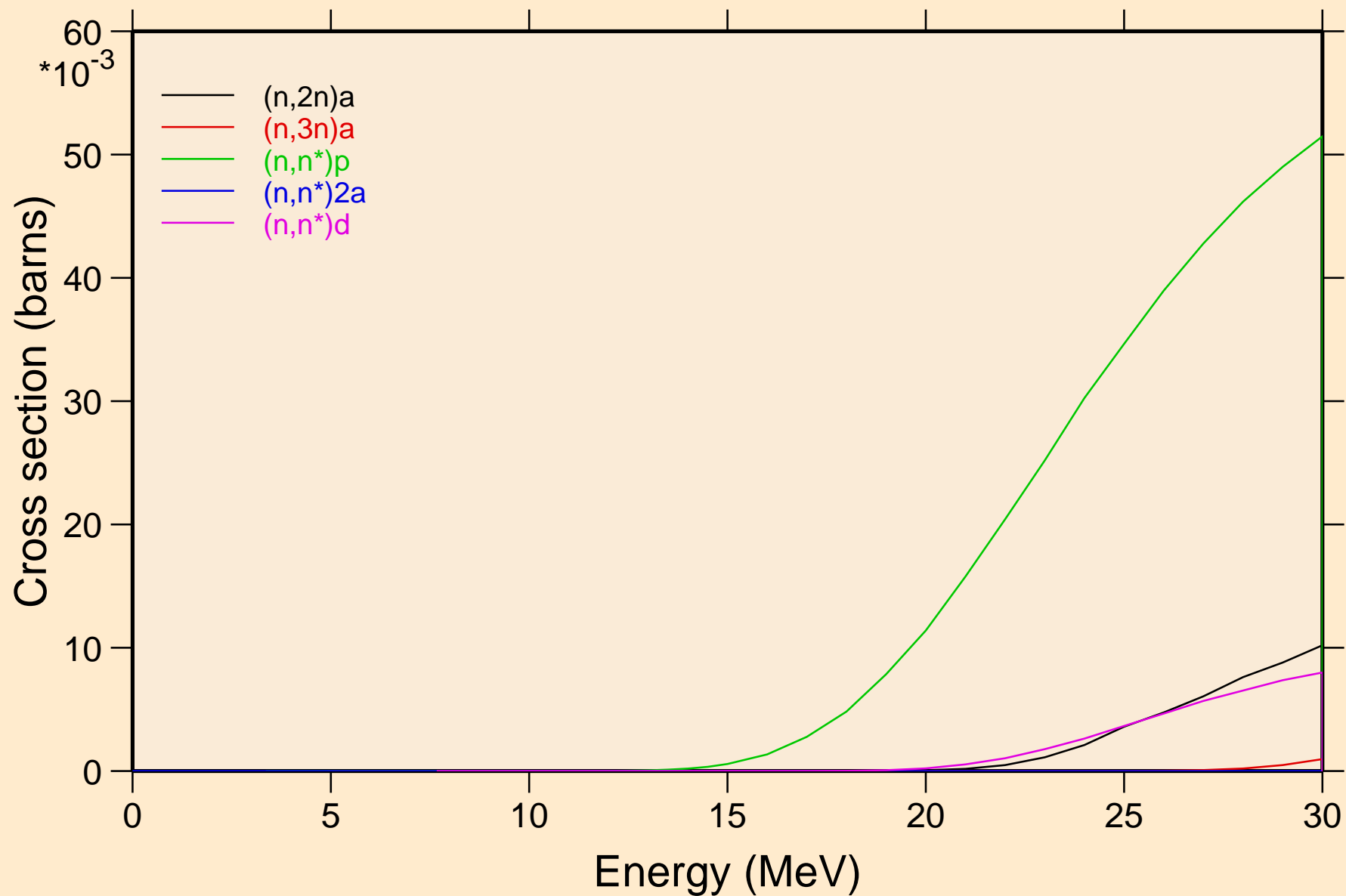

MD255 NEUTRON ACER TENDL-2019 LIBRARY; T=293.16K
Threshold reactions

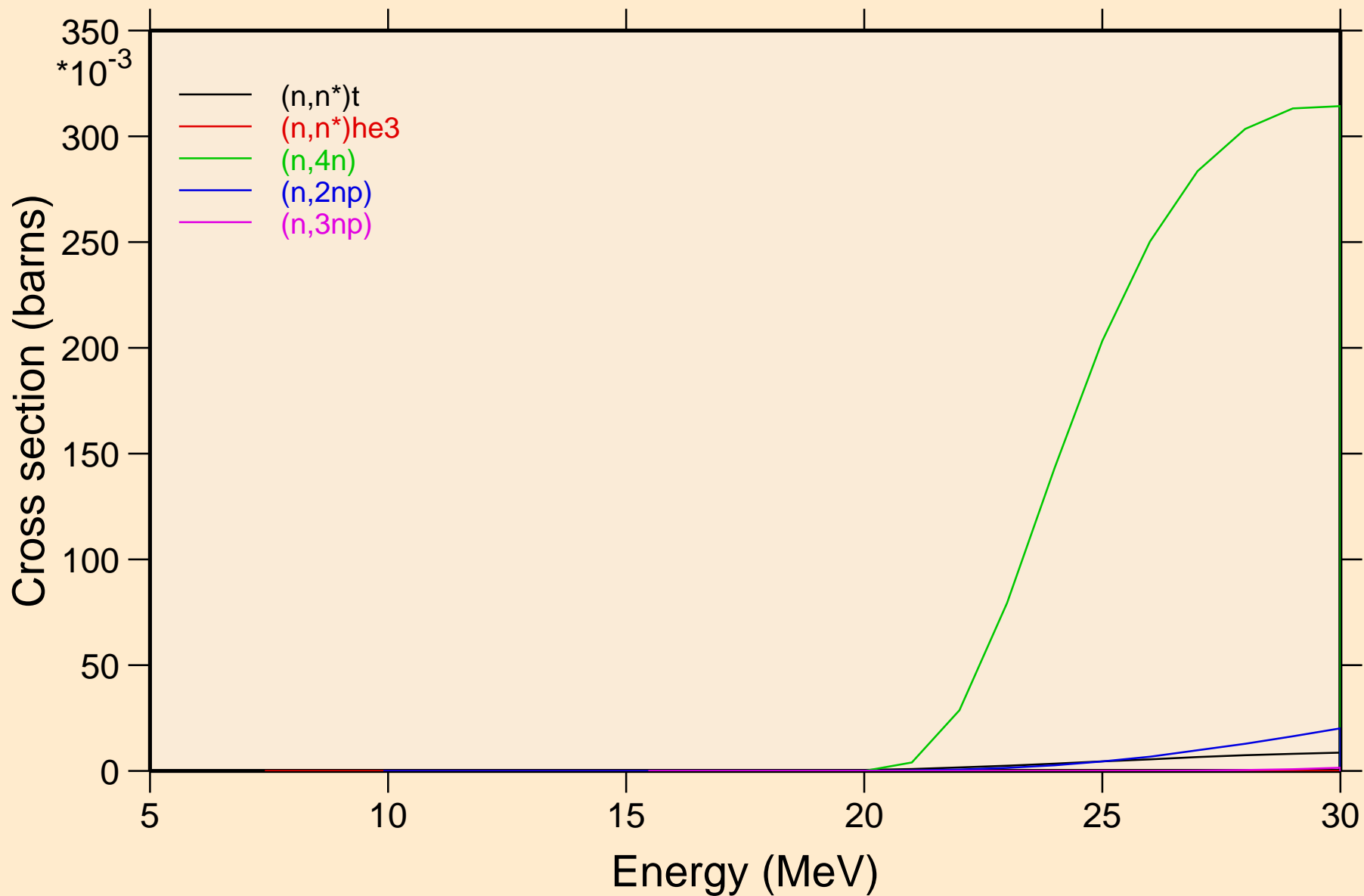

MD255 NEUTRON ACER TENDL-2019 LIBRARY; T=293.16K
Threshold reactions

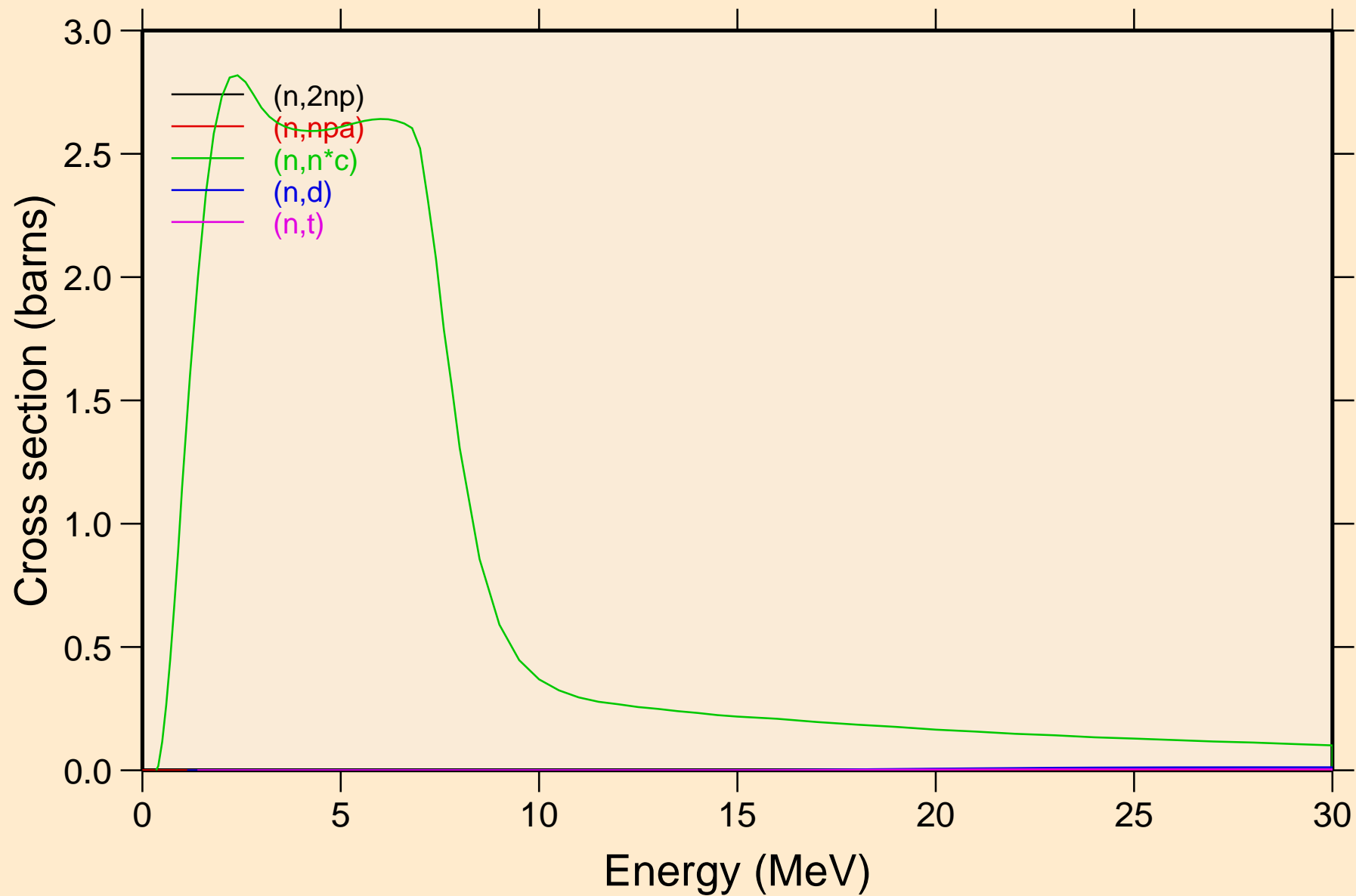

MD255 NEUTRON ACER TENDL-2019 LIBRARY; T=293.16K
Threshold reactions

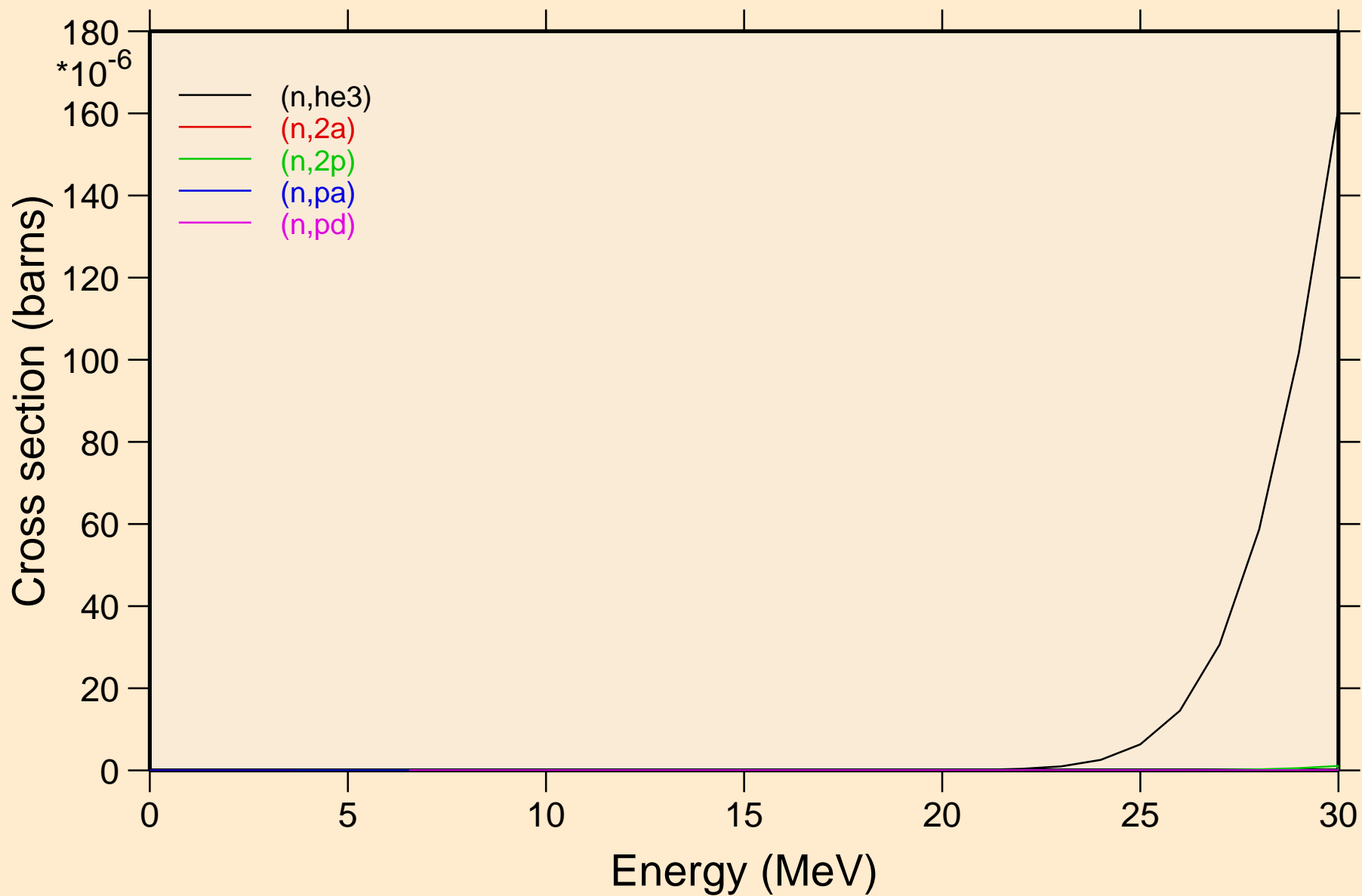

MD255 NEUTRON ACER TENDL-2019 LIBRARY; T=293.16K
Threshold reactions

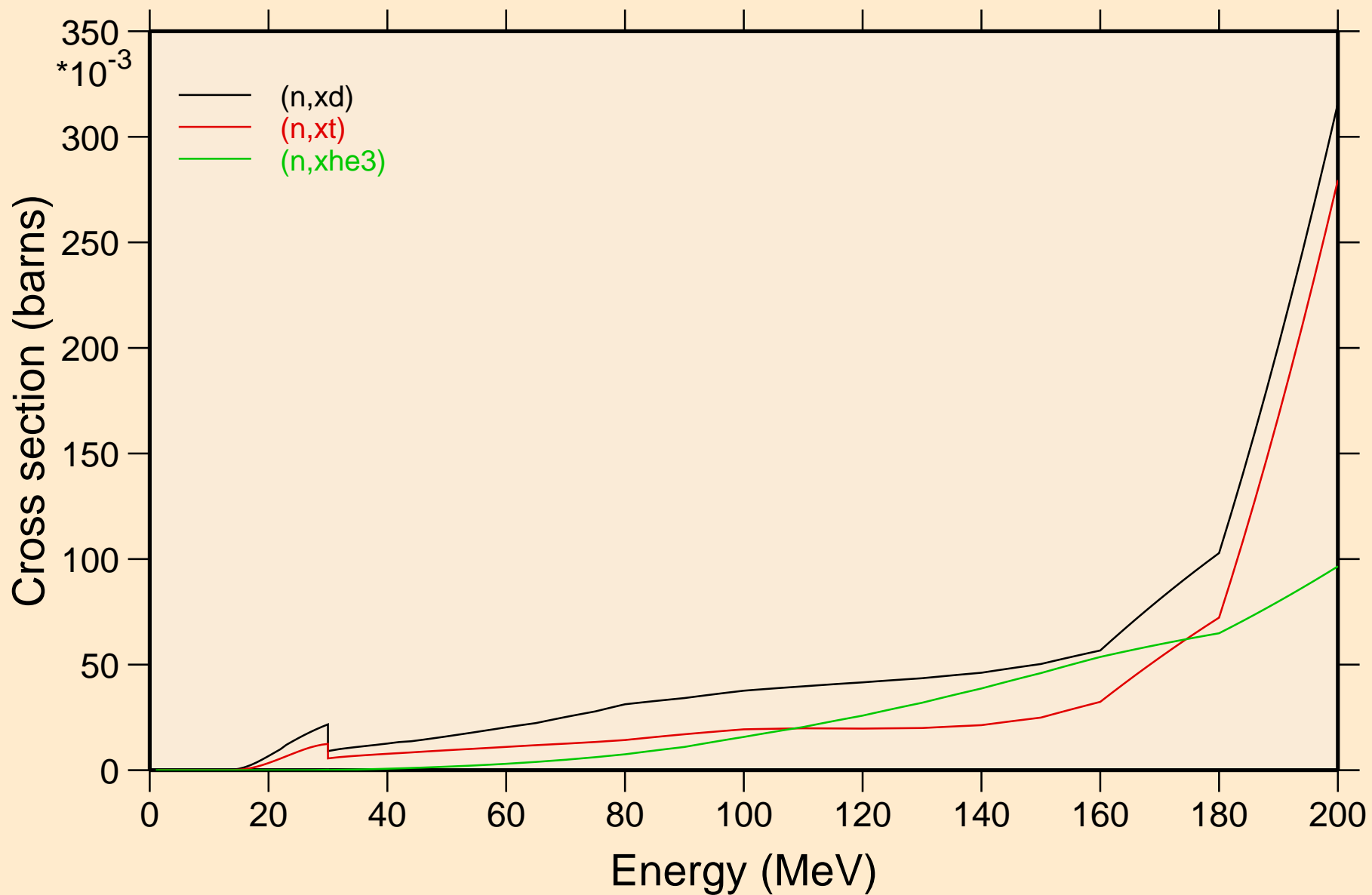

MD255 NEUTRON ACER TENDL-2019 LIBRARY; T=293.16K
angular distribution for elastic

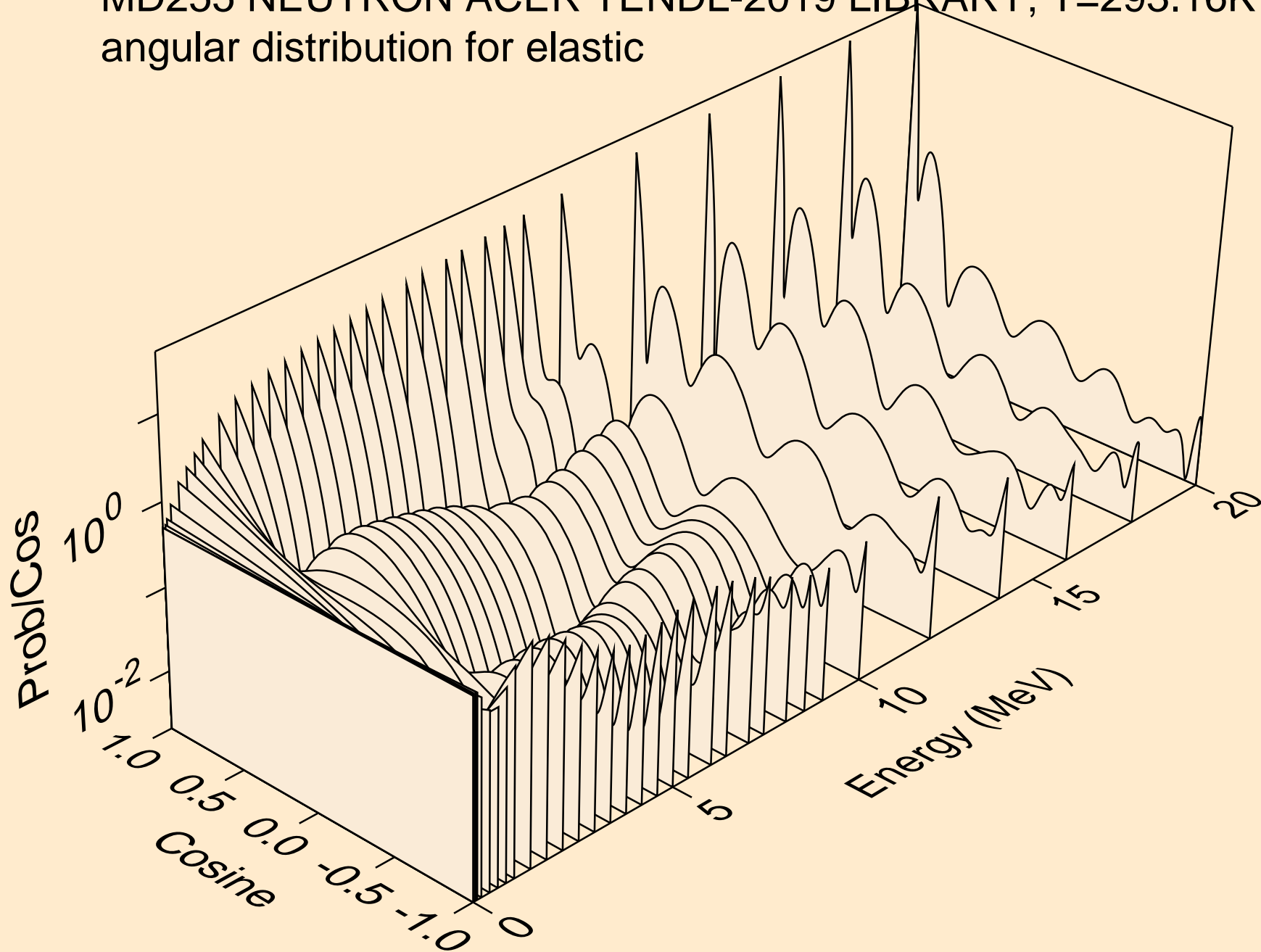

MD255 NEUTRON ACER TENDL-2019 LIBRARY; T=293.16K
angular distribution for elastic

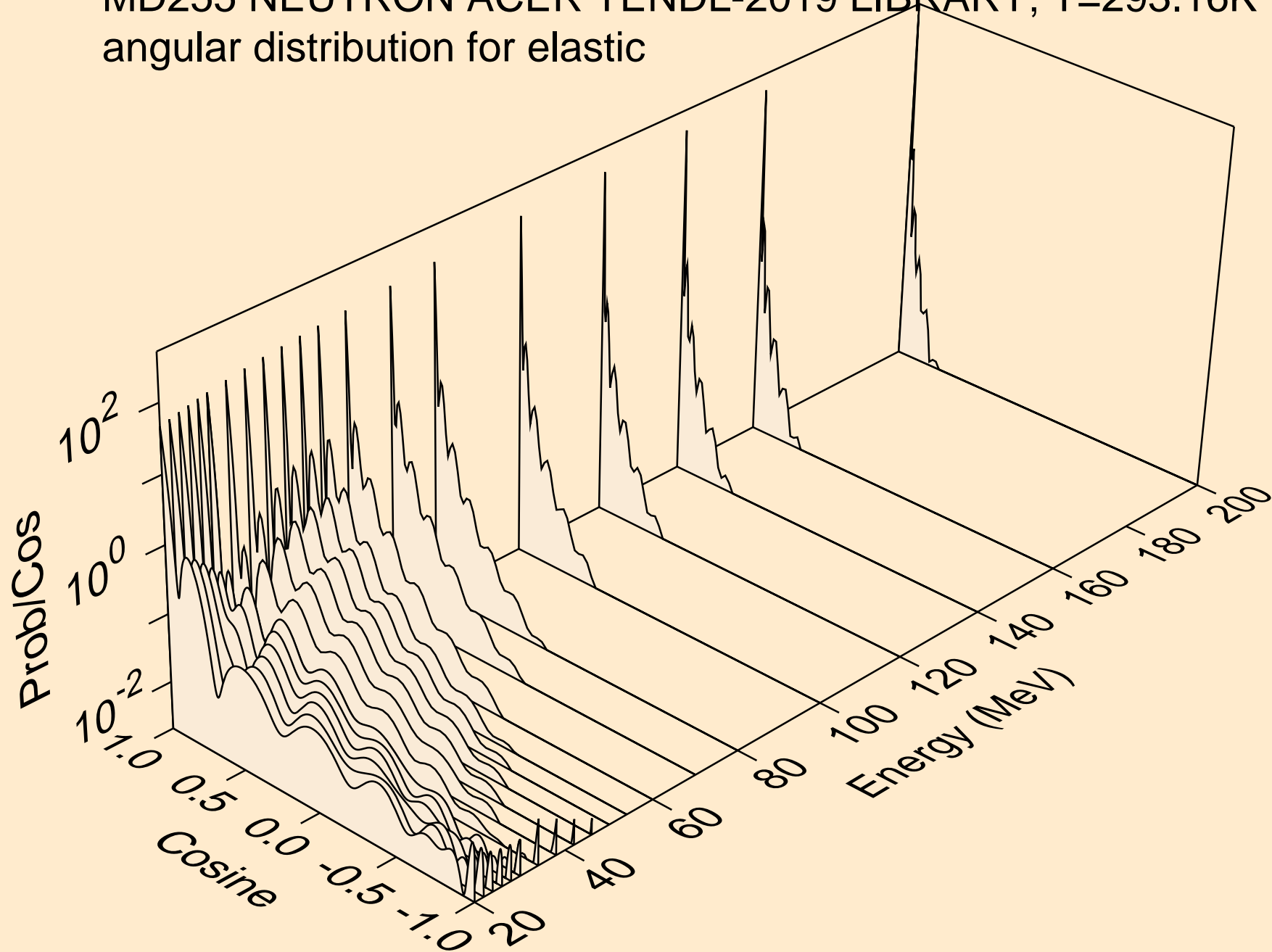

MD255 NEUTRON ACER TENDL-2019 LIBRARY; T=293.16K
angular distribution for (n,n*1)

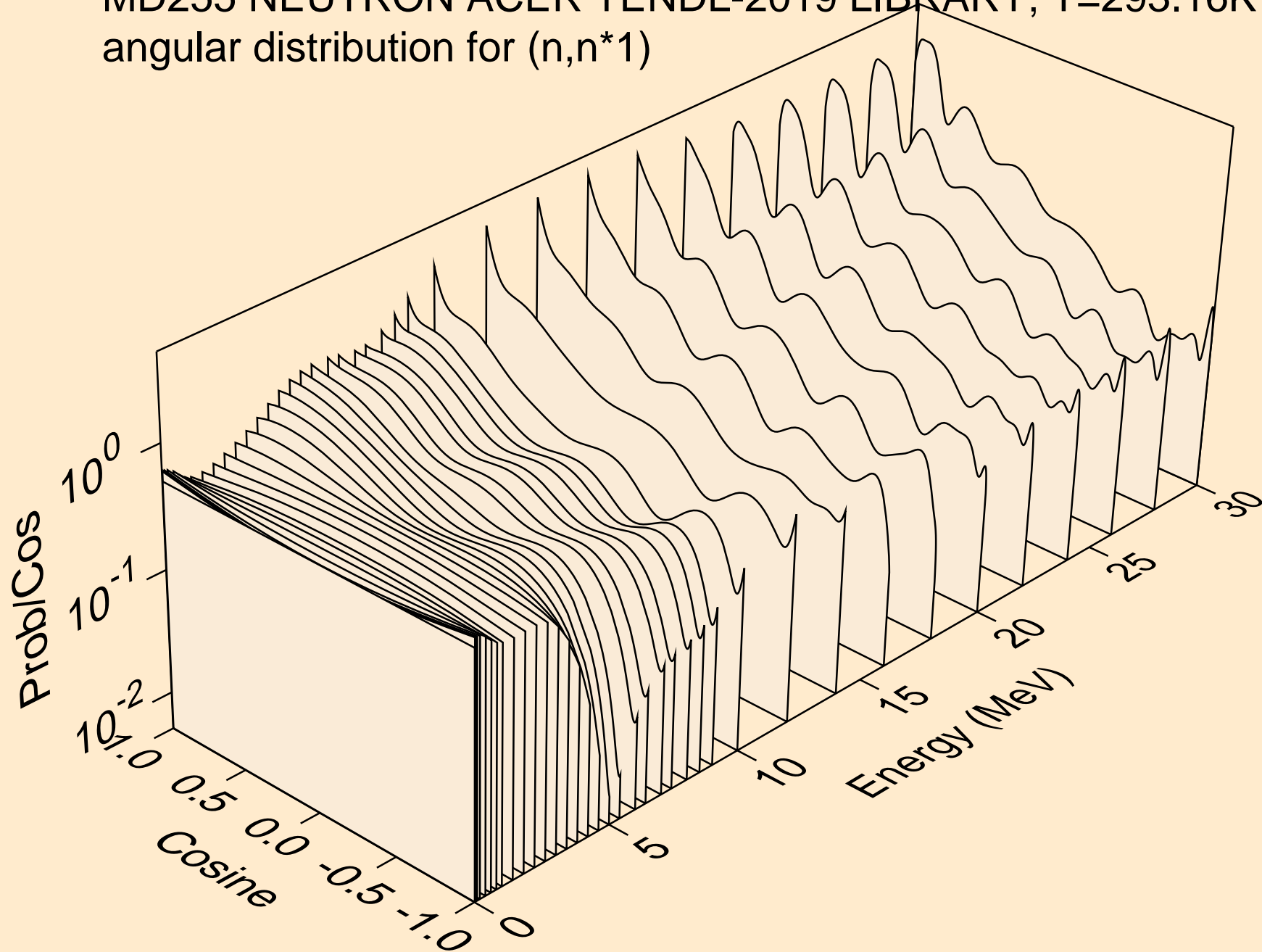

MD255 NEUTRON ACER TENDL-2019 LIBRARY; T=293.16K
angular distribution for (n,n*2)

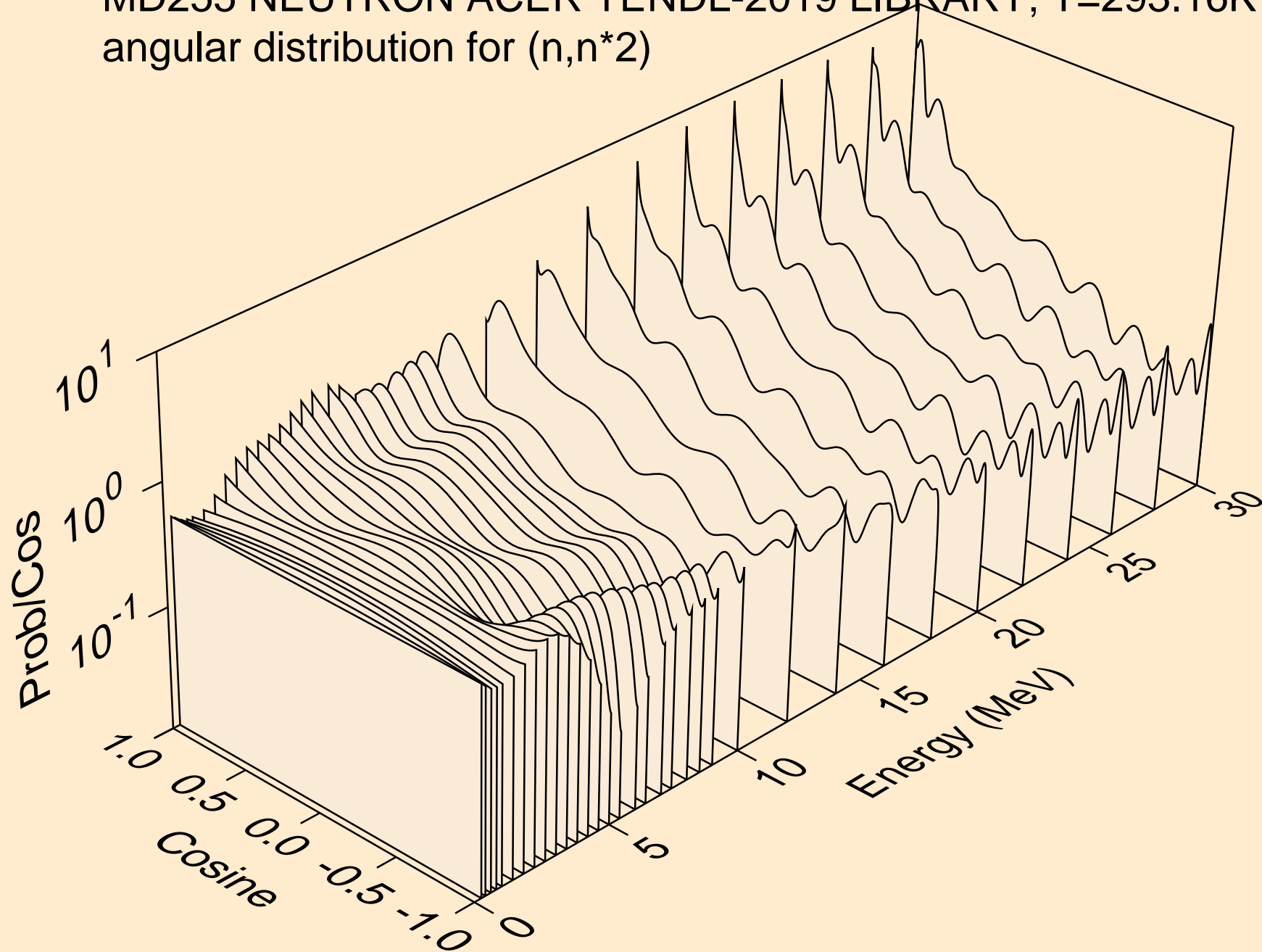

MD255 NEUTRON ACER TENDL-2019 LIBRARY; T=293.16K
angular distribution for (n,n*3)

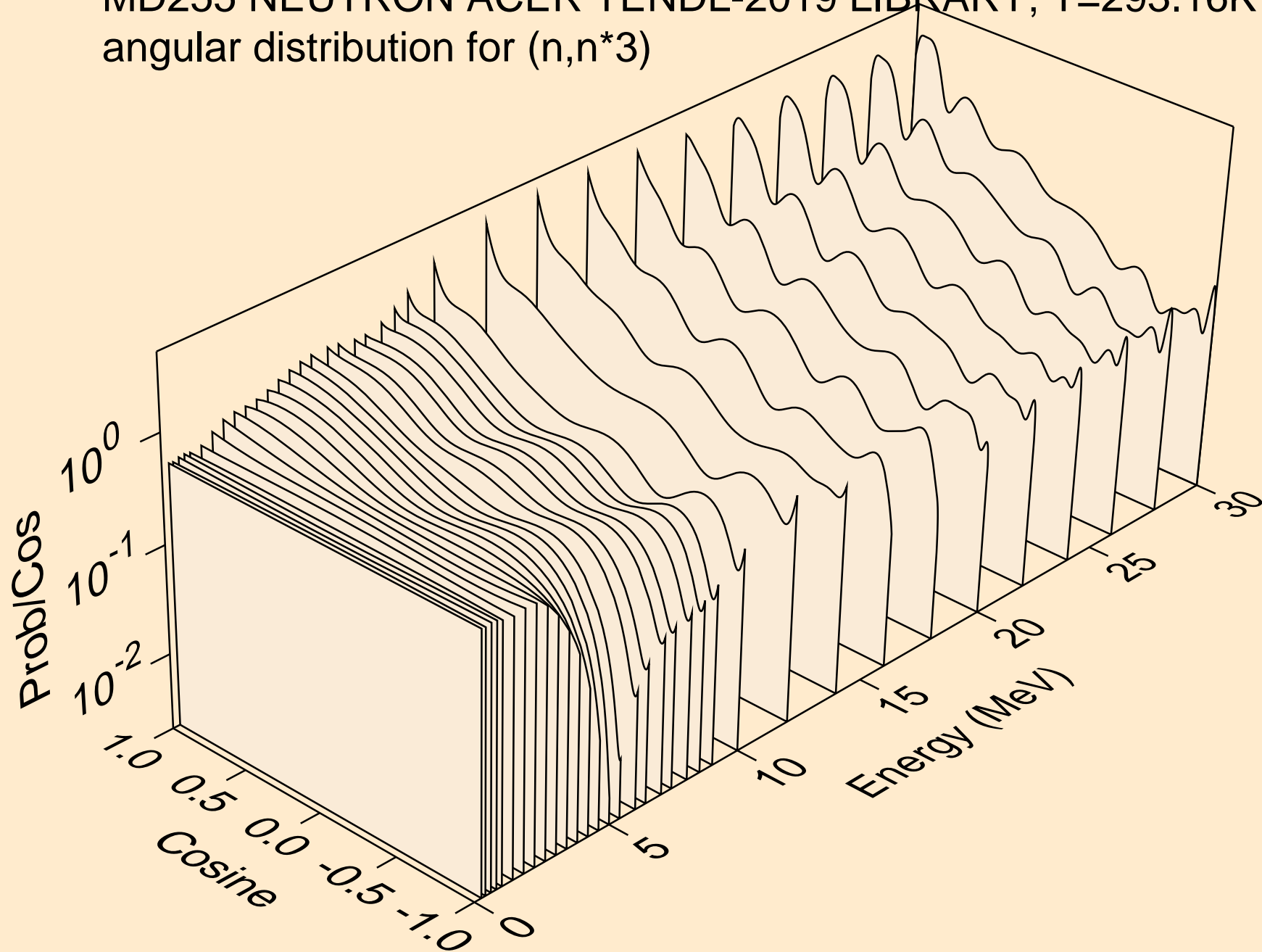

MD255 NEUTRON ACER TENDL-2019 LIBRARY; T=293.16K
angular distribution for (n,n*4)

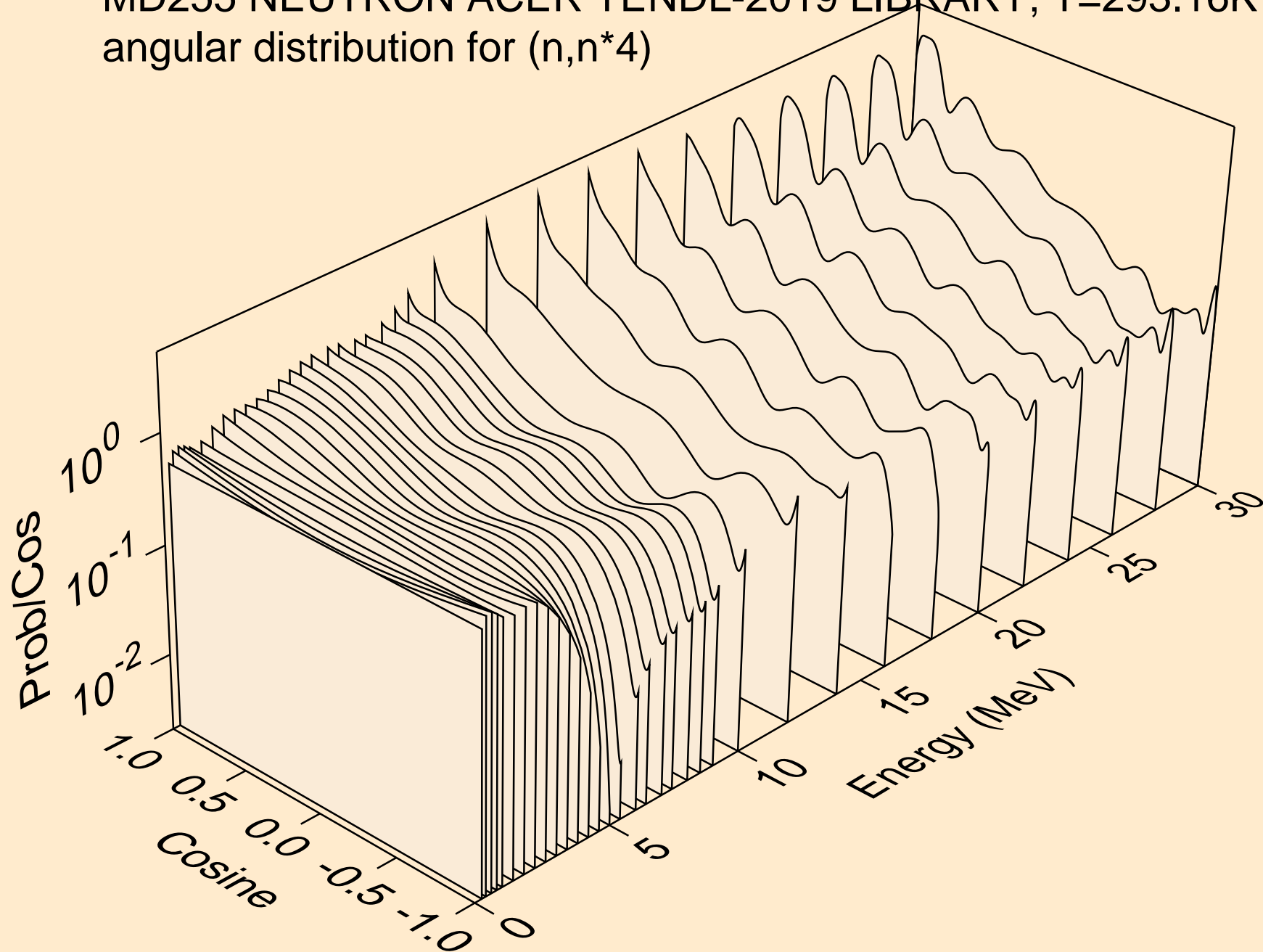

MD255 NEUTRON ACER TENDL-2019 LIBRARY; T=293.16K
angular distribution for (n,n*5)

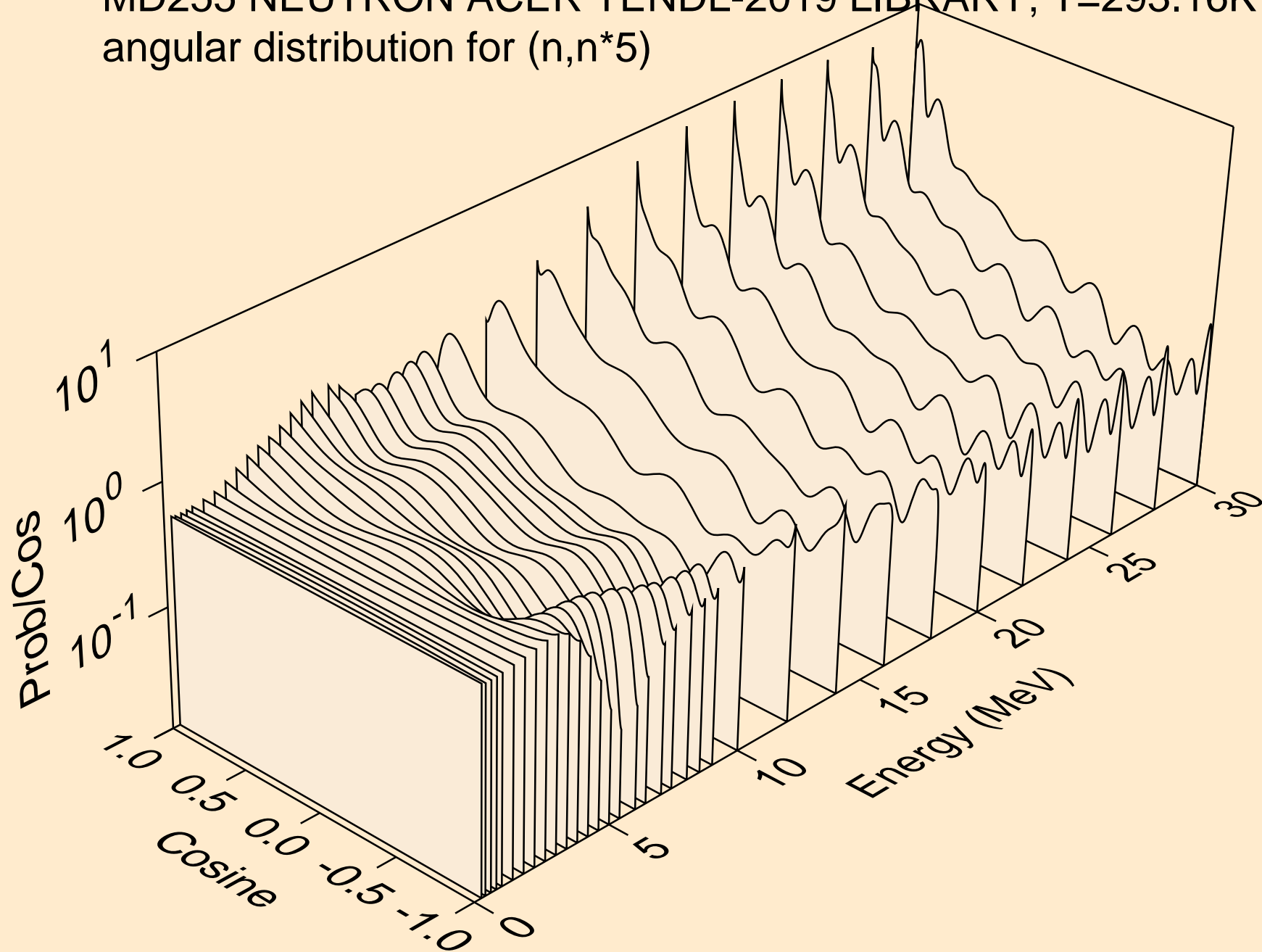

MD255 NEUTRON ACER TENDL-2019 LIBRARY; T=293.16K
angular distribution for (n,n*6)

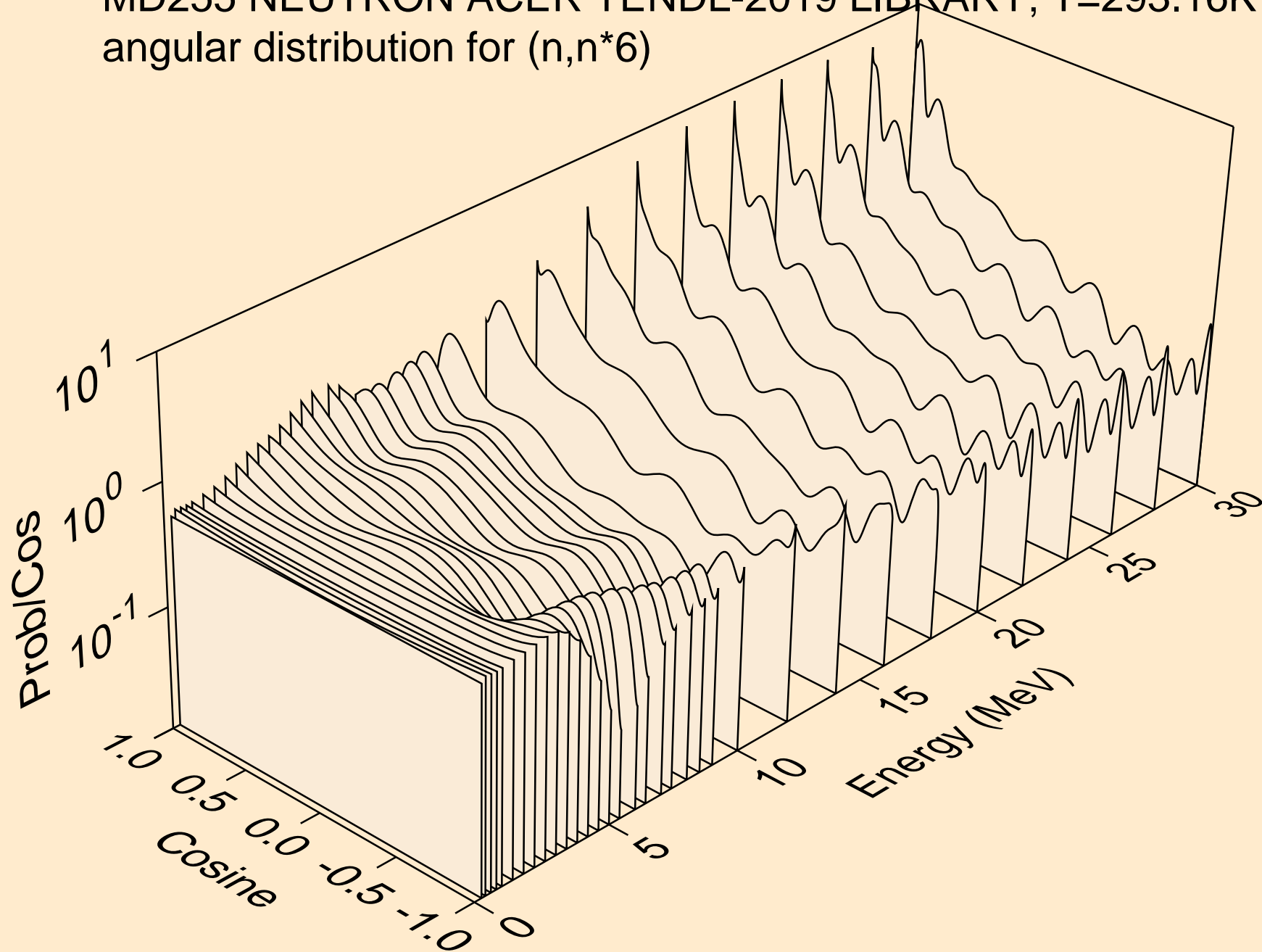

MD255 NEUTRON ACER TENDL-2019 LIBRARY; T=293.16K
angular distribution for (n,n*7)

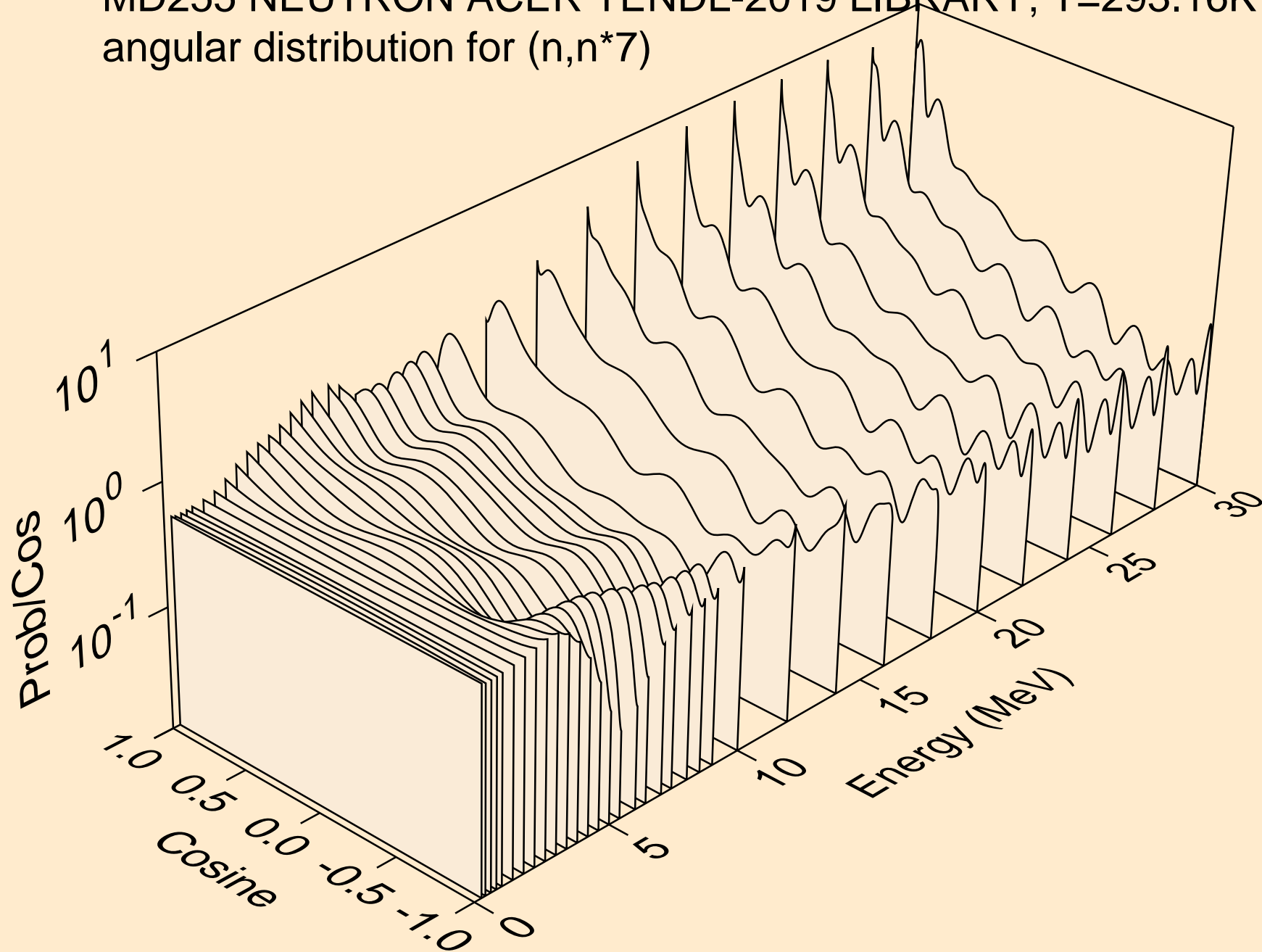

MD255 NEUTRON ACER TENDL-2019 LIBRARY; T=293.16K
angular distribution for (n,n*8)

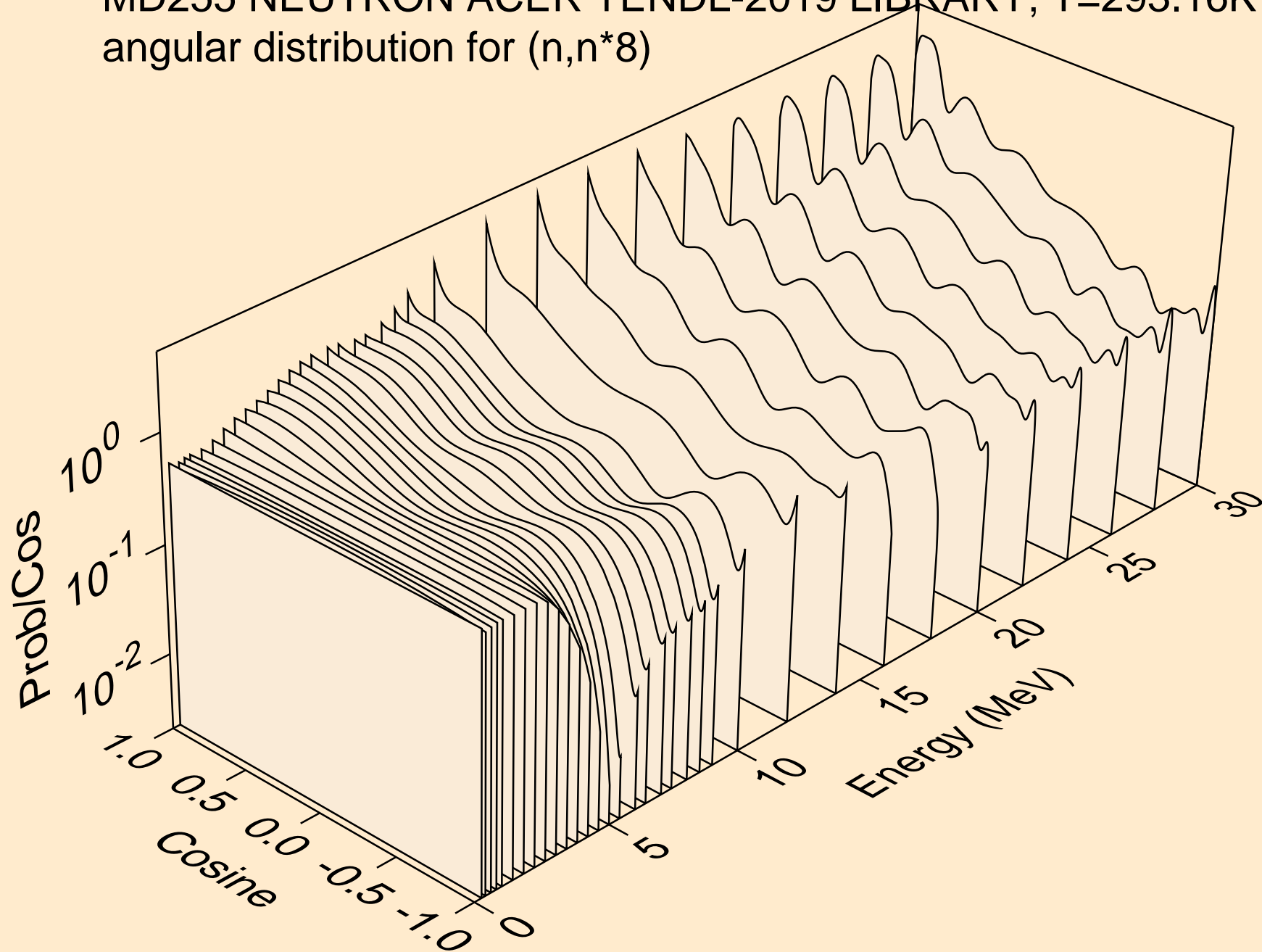

MD255 NEUTRON ACER TENDL-2019 LIBRARY; T=293.16K
angular distribution for (n,n*9)

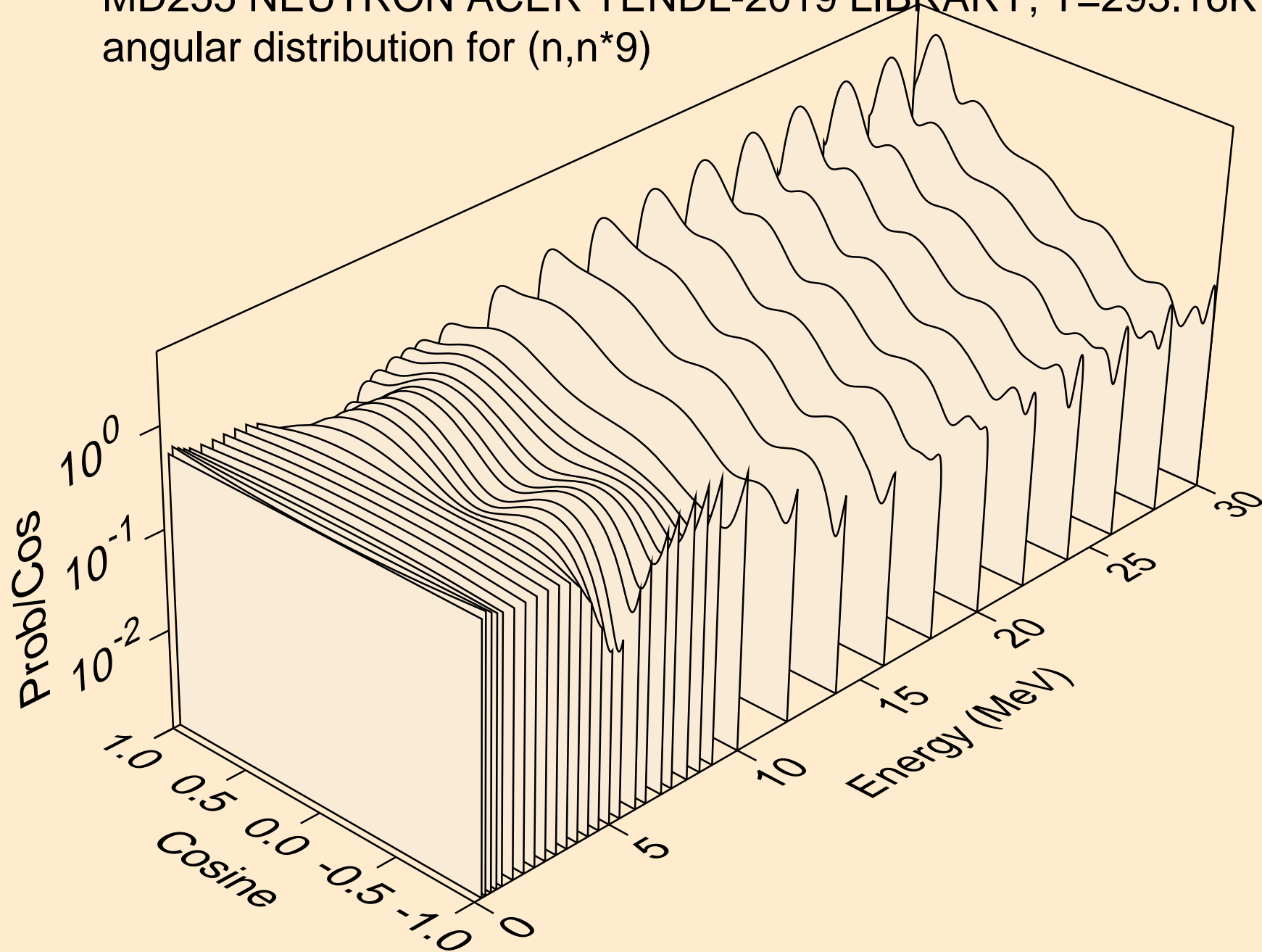

MD255 NEUTRON ACER TENDL-2019 LIBRARY; T=293.16K
angular distribution for (n,n*10)

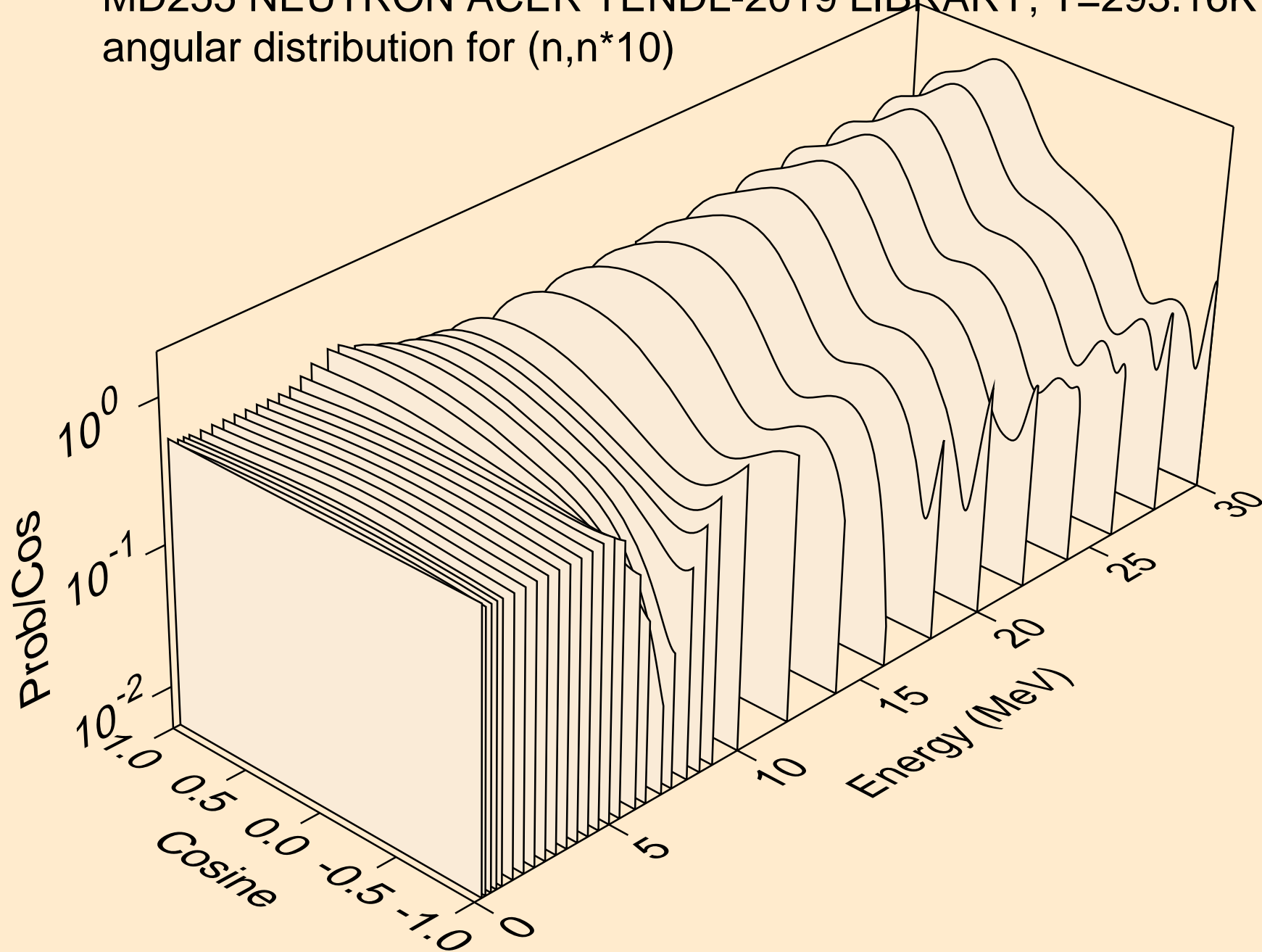

MD255 NEUTRON ACER TENDL-2019 LIBRARY; T=293.16K
angular distribution for (n,n*11)

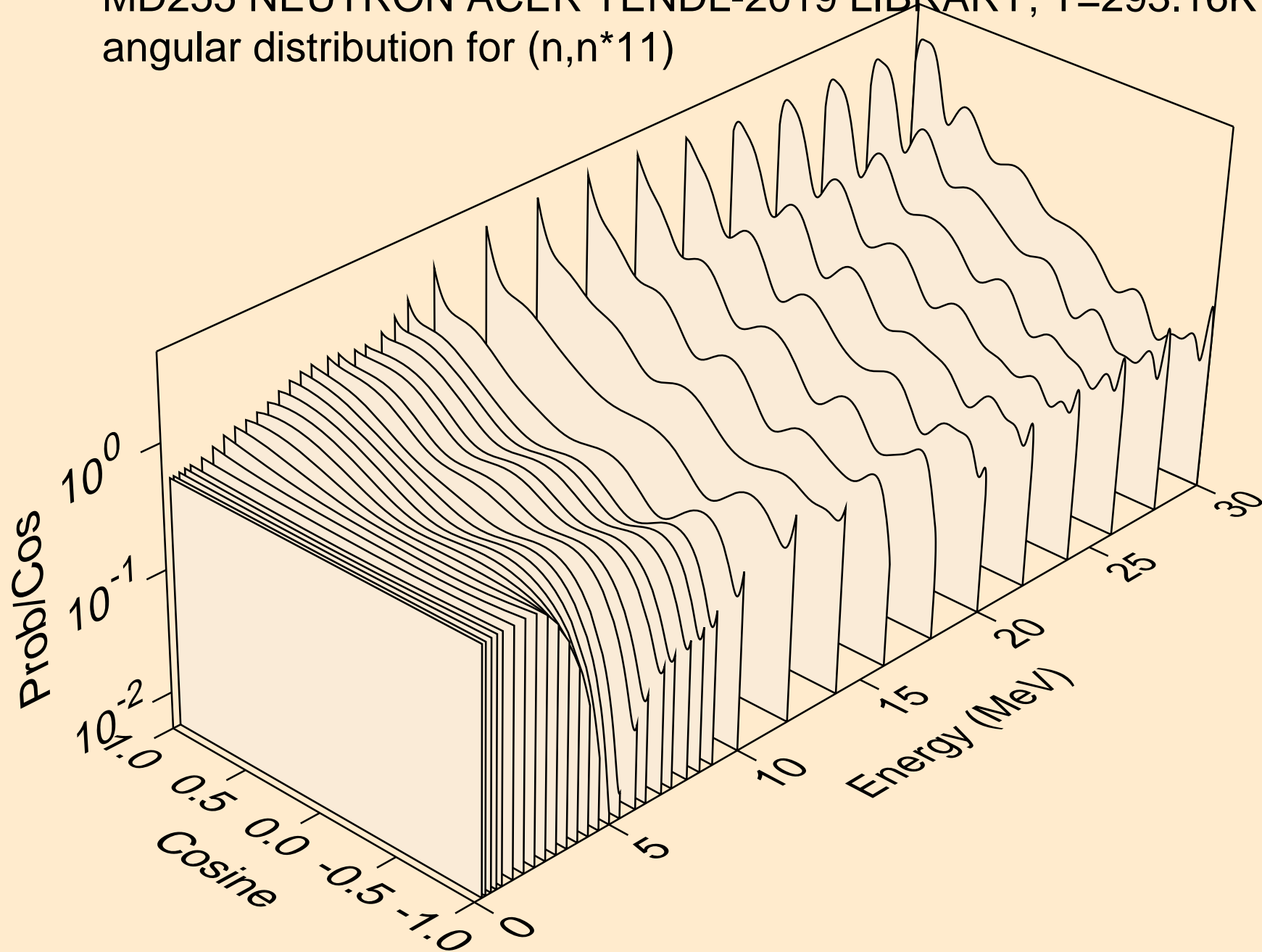

MD255 NEUTRON ACER TENDL-2019 LIBRARY; T=293.16K
angular distribution for (n,n*12)

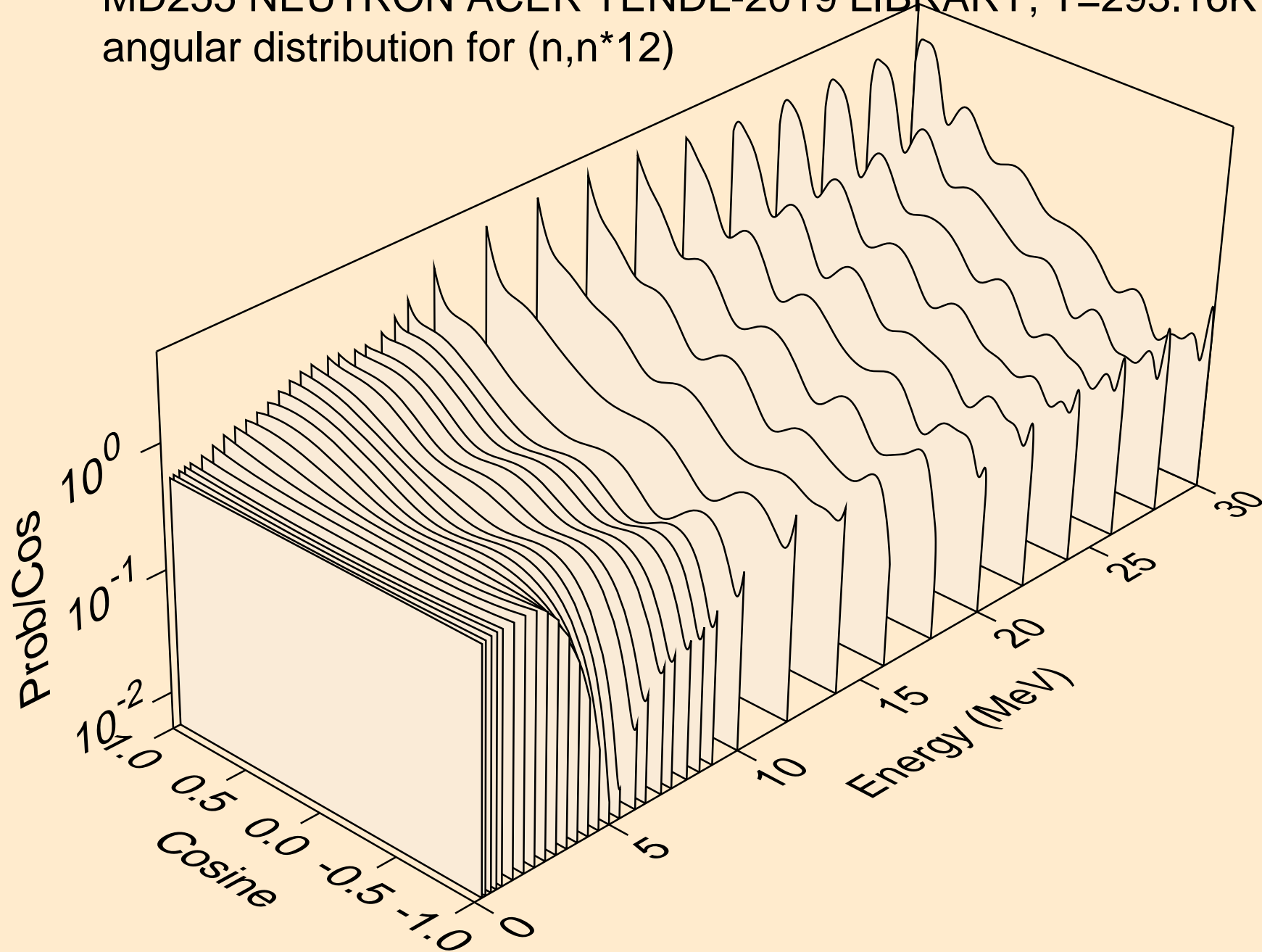

MD255 NEUTRON ACER TENDL-2019 LIBRARY; T=293.16K
angular distribution for (n,n*13)

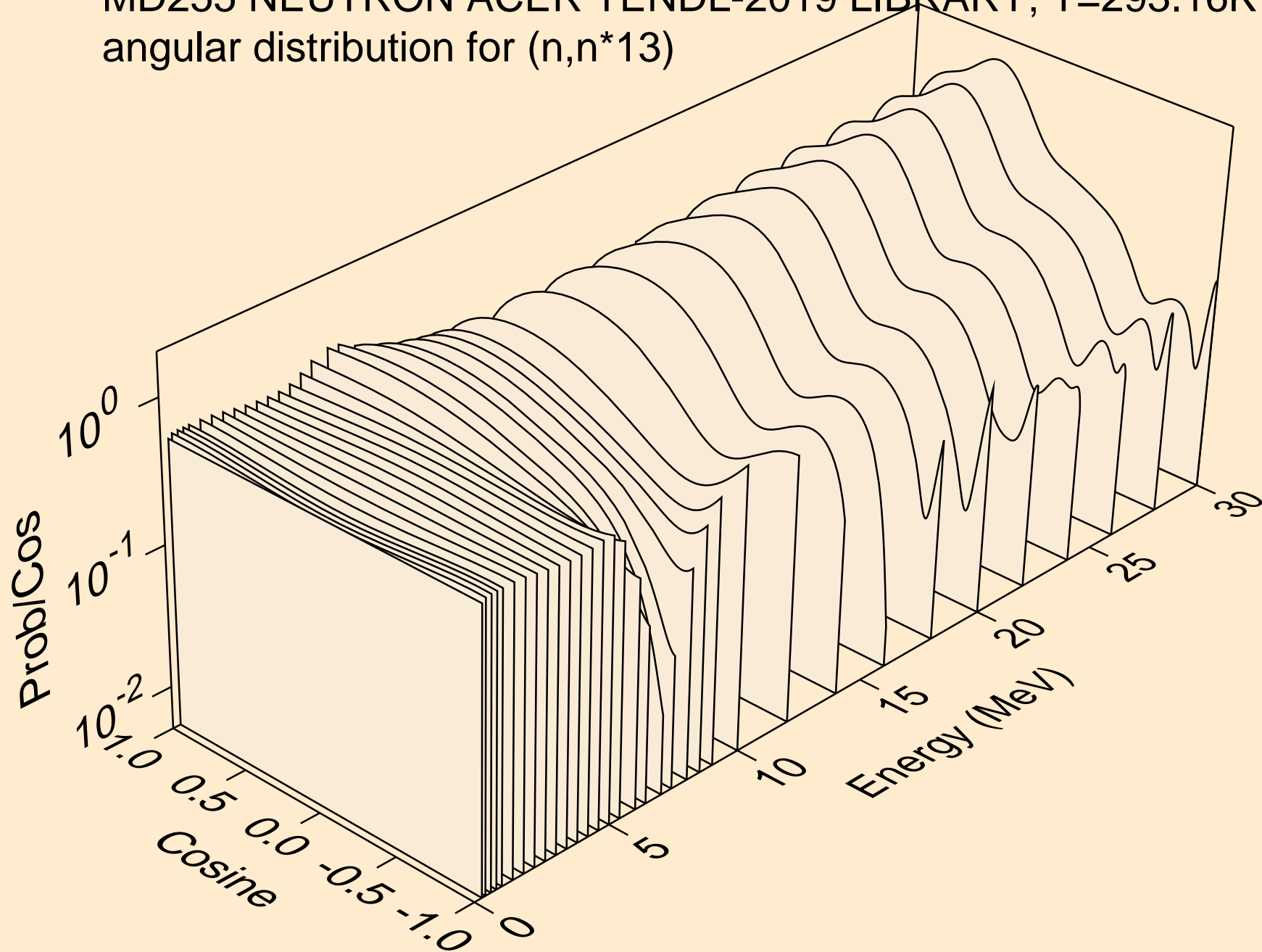

MD255 NEUTRON ACER TENDL-2019 LIBRARY; T=293.16K
angular distribution for (n,n*14)

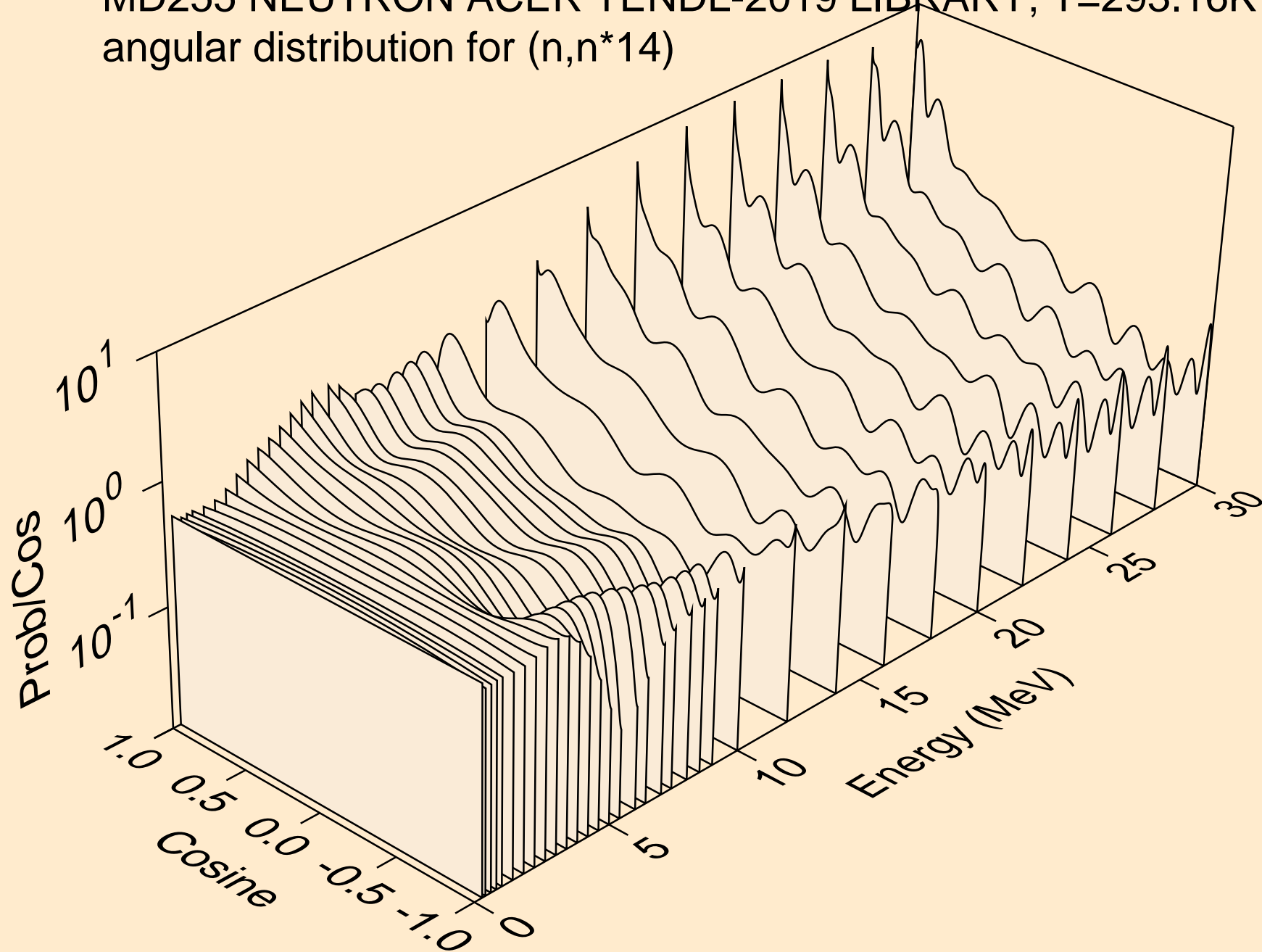

MD255 NEUTRON ACER TENDL-2019 LIBRARY; T=293.16K
angular distribution for (n,n*15)

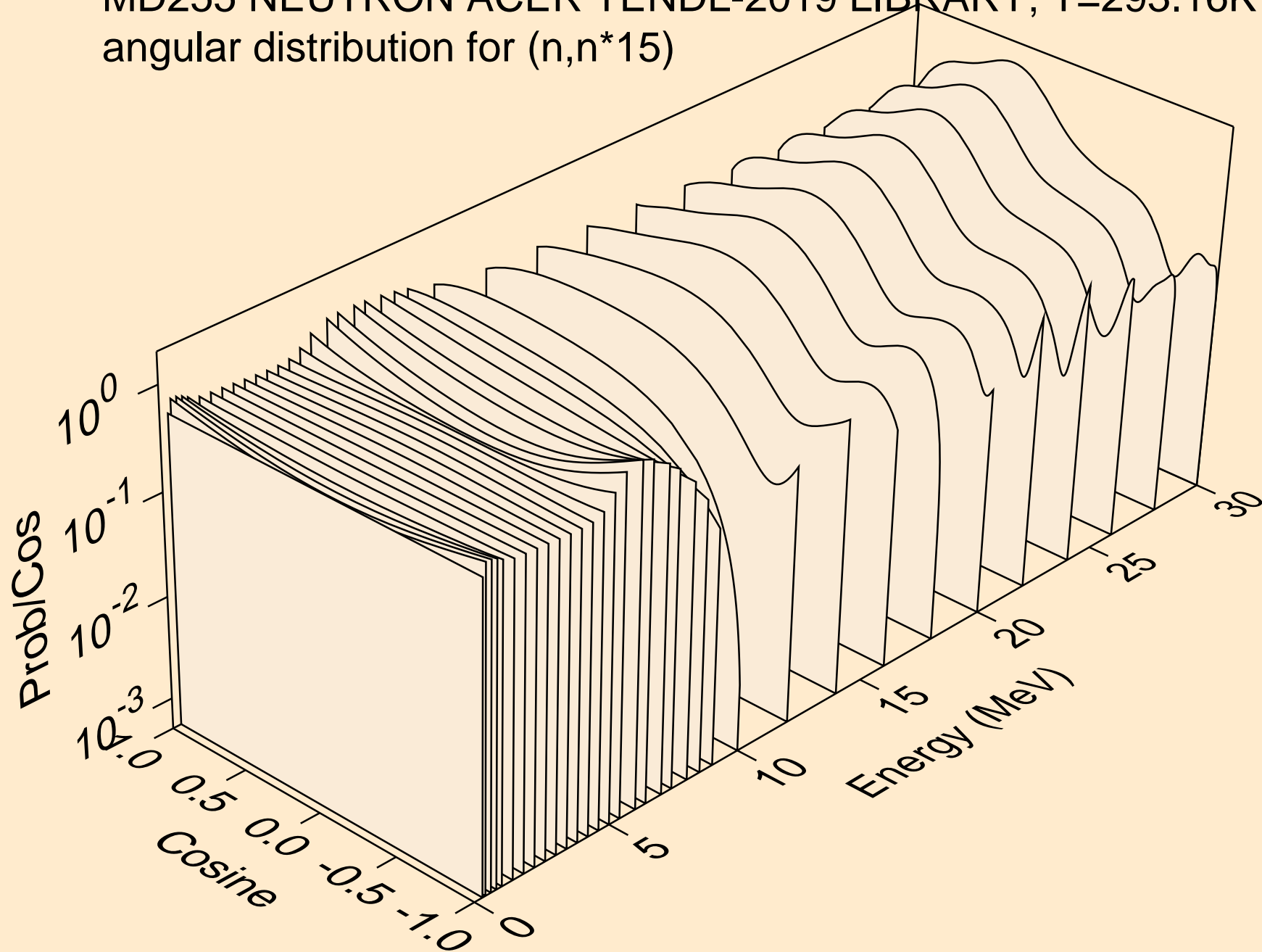

MD255 NEUTRON ACER TENDL-2019 LIBRARY; T=293.16K
angular distribution for (n,n*16)

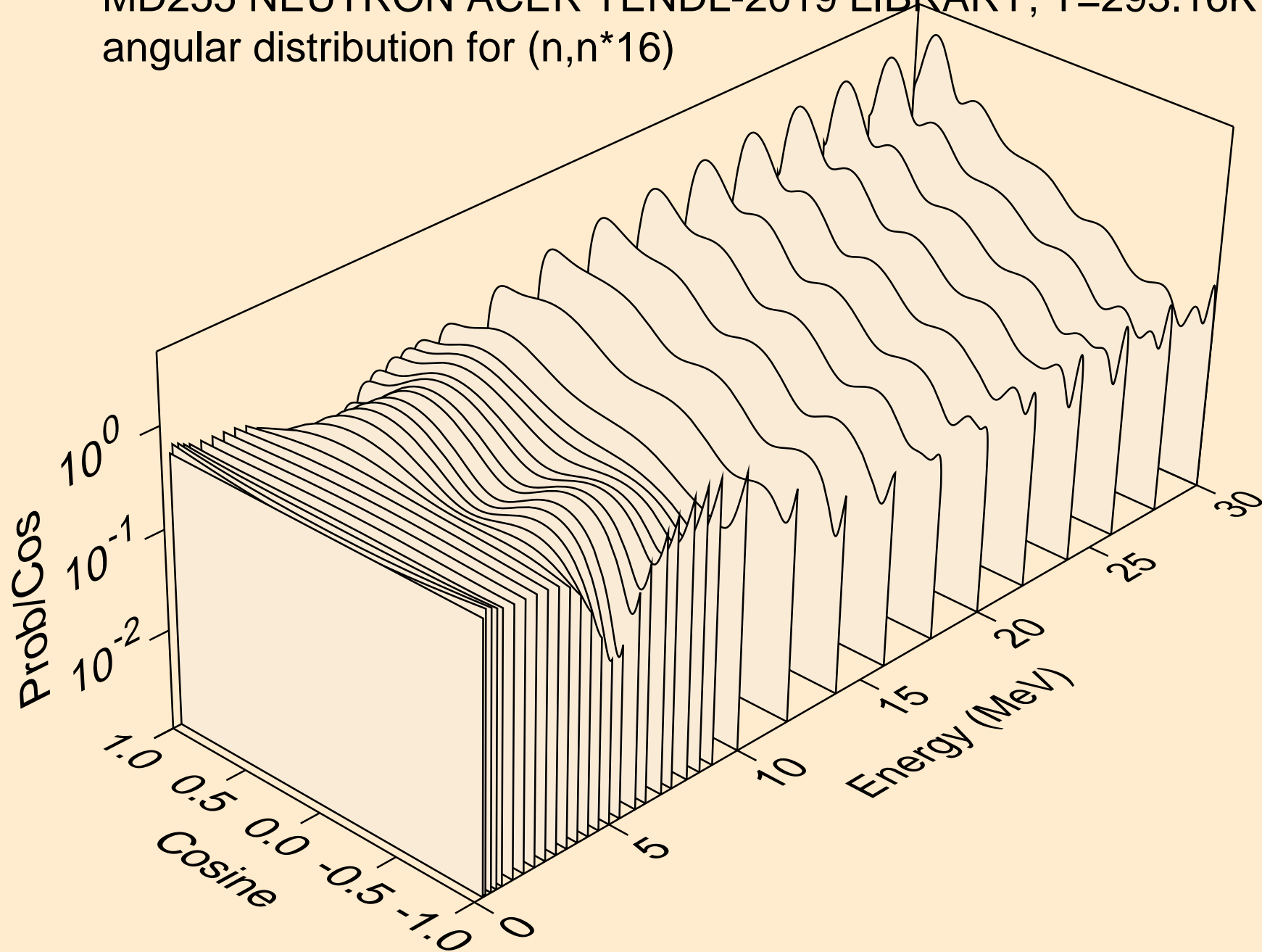

MD255 NEUTRON ACER TENDL-2019 LIBRARY; T=293.16K
angular distribution for (n,n*17)

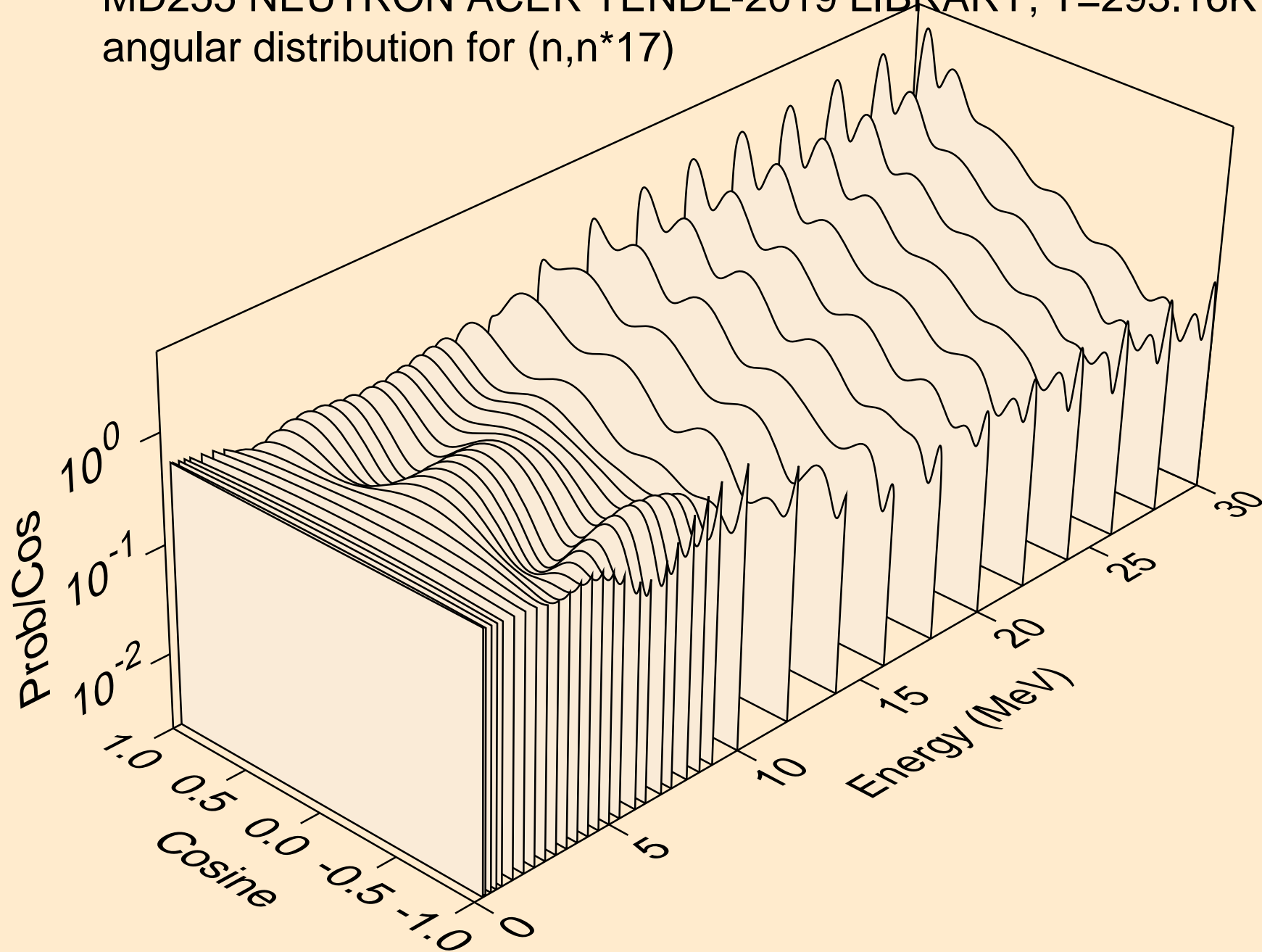

MD255 NEUTRON ACER TENDL-2019 LIBRARY; T=293.16K
angular distribution for (n,n*18)

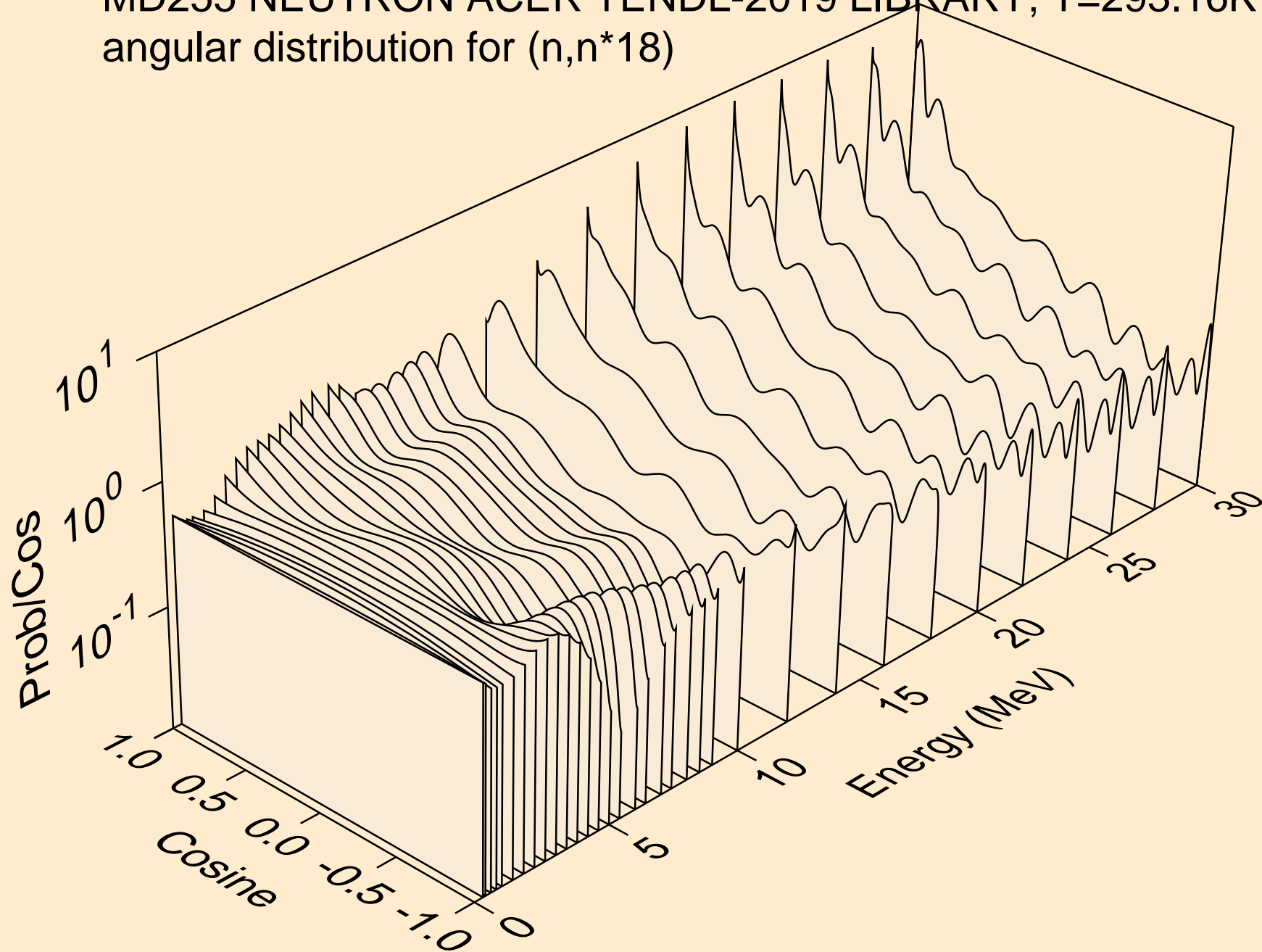

MD255 NEUTRON ACER TENDL-2019 LIBRARY; T=293.16K
angular distribution for (n,n*19)

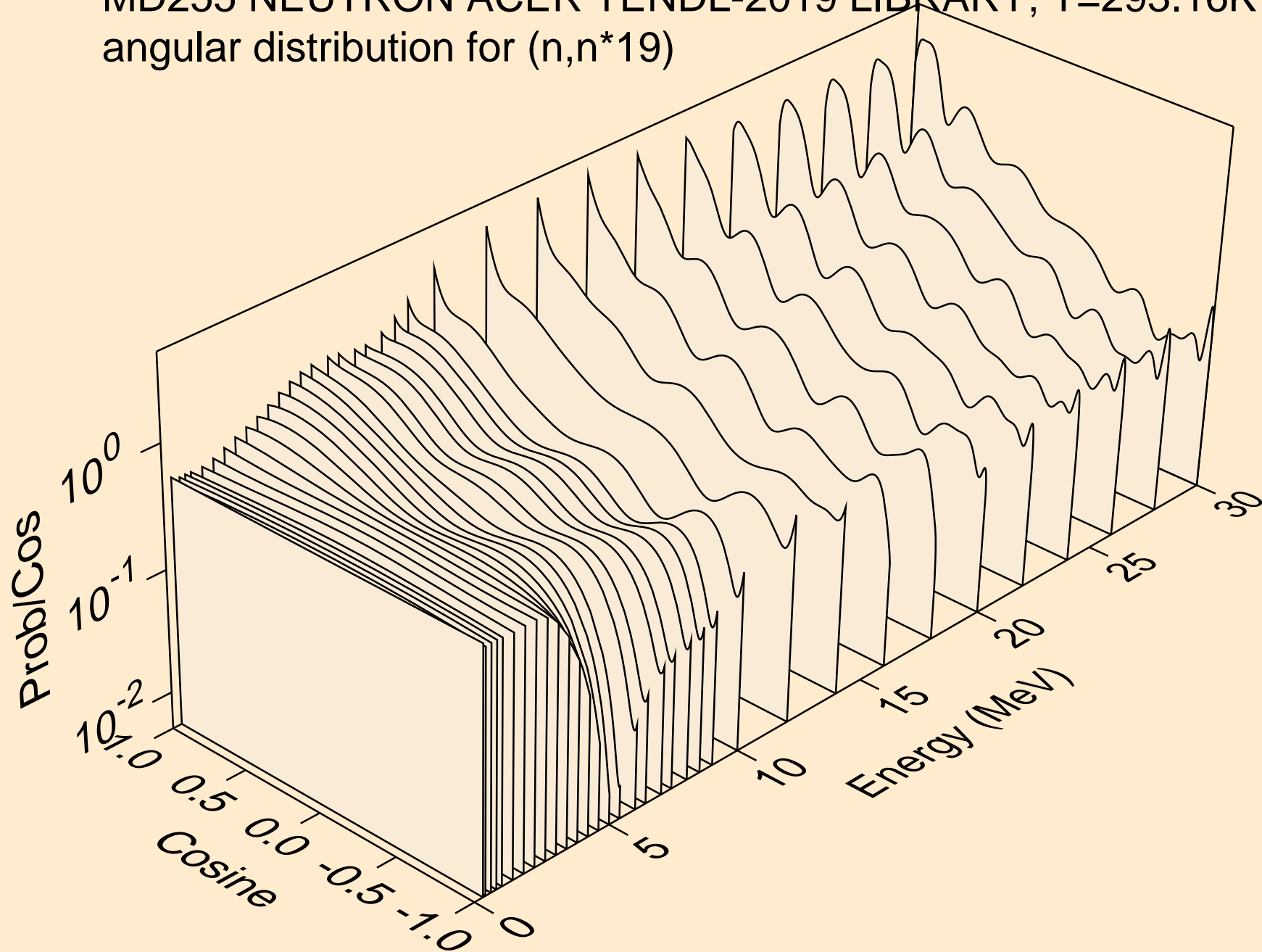

MD255 NEUTRON ACER TENDL-2019 LIBRARY; T=293.16K
angular distribution for (n,n*20)

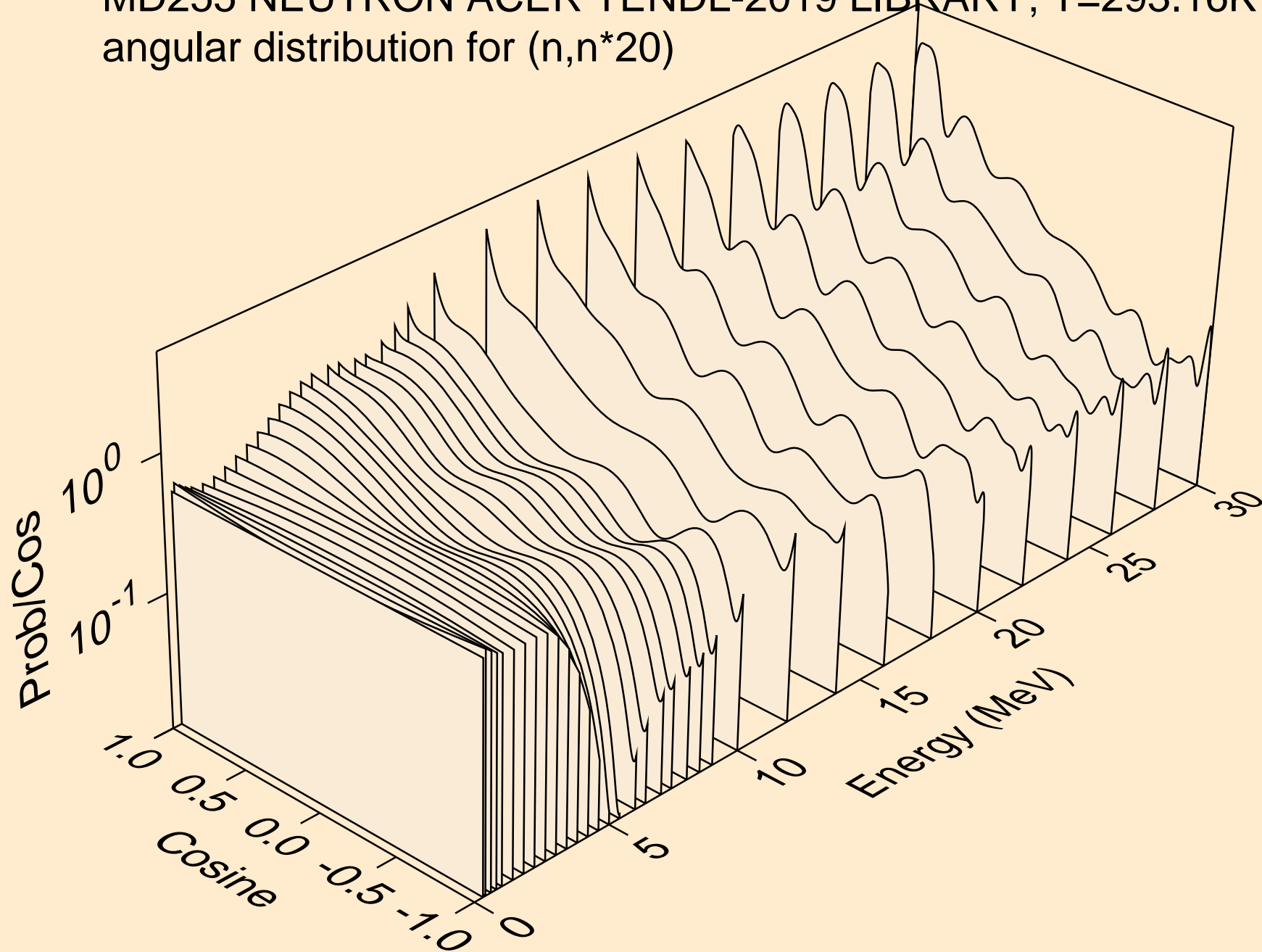

MD255 NEUTRON ACER TENDL-2019 LIBRARY; T=293.16K
angular distribution for (n,n*21)

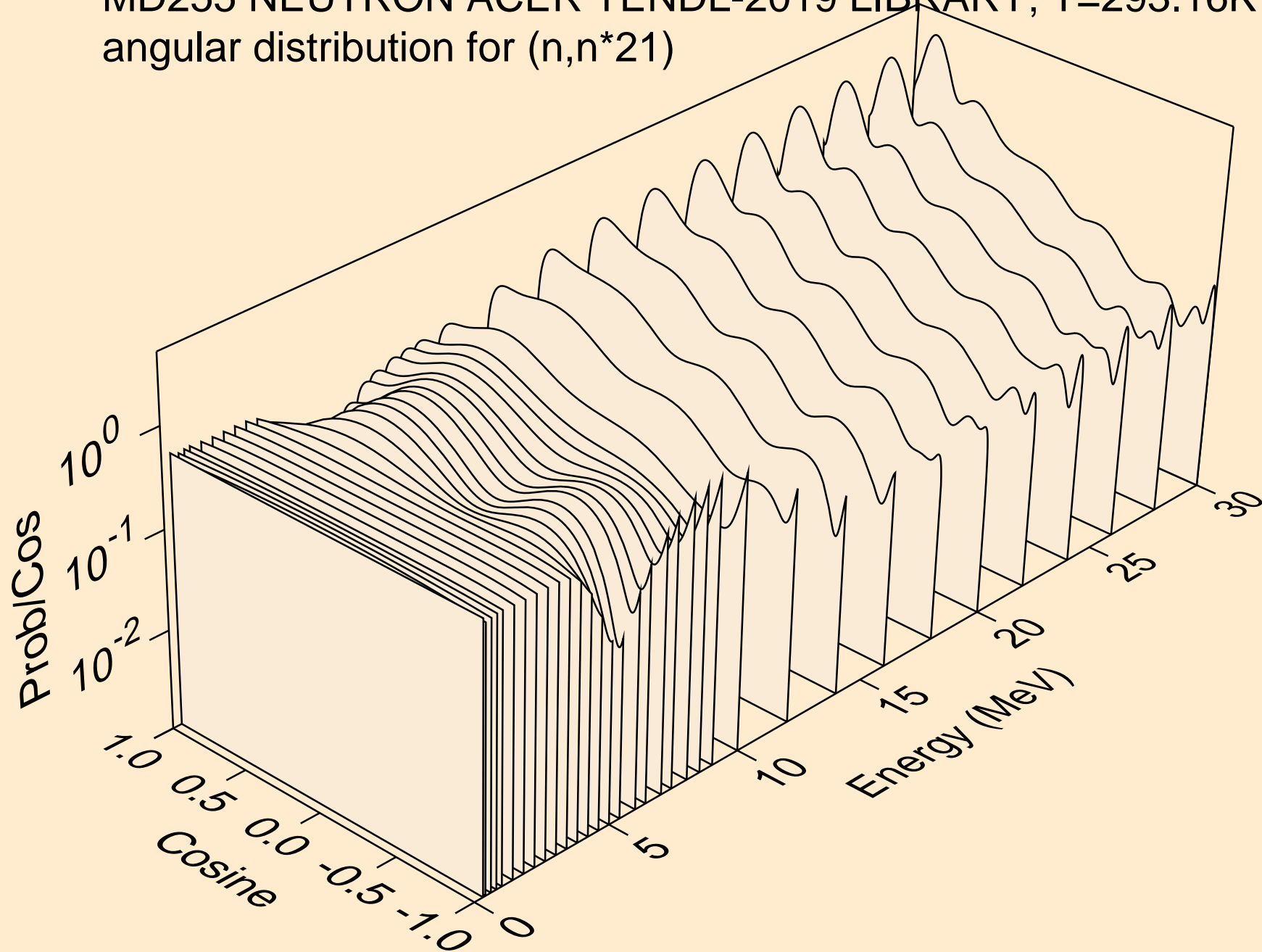

MD255 NEUTRON ACER TENDL-2019 LIBRARY; T=293.16K
angular distribution for (n,n*22)

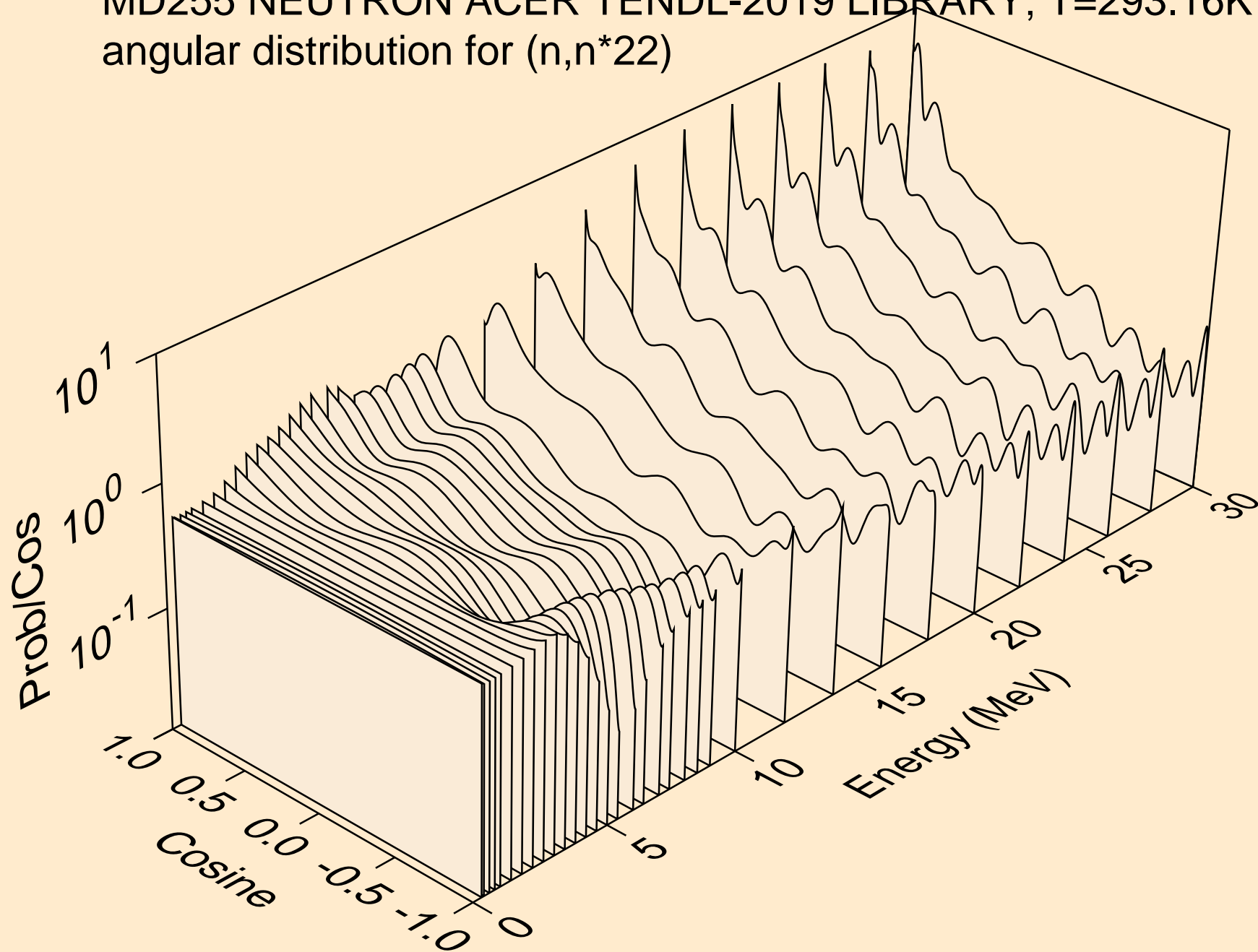

MD255 NEUTRON ACER TENDL-2019 LIBRARY; T=293.16K
angular distribution for (n,n*23)

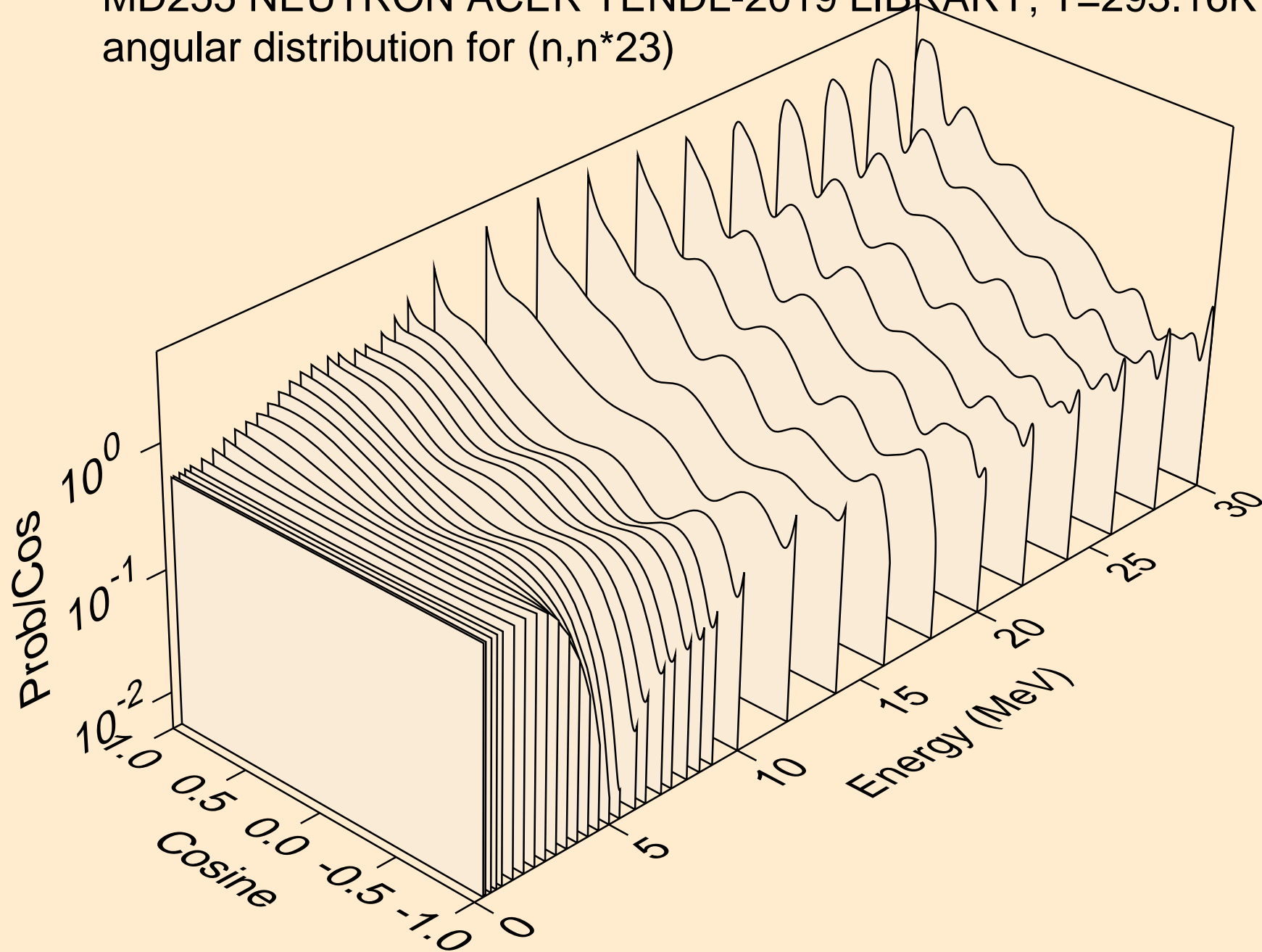

MD255 NEUTRON ACER TENDL-2019 LIBRARY; T=293.16K
angular distribution for (n,n*24)

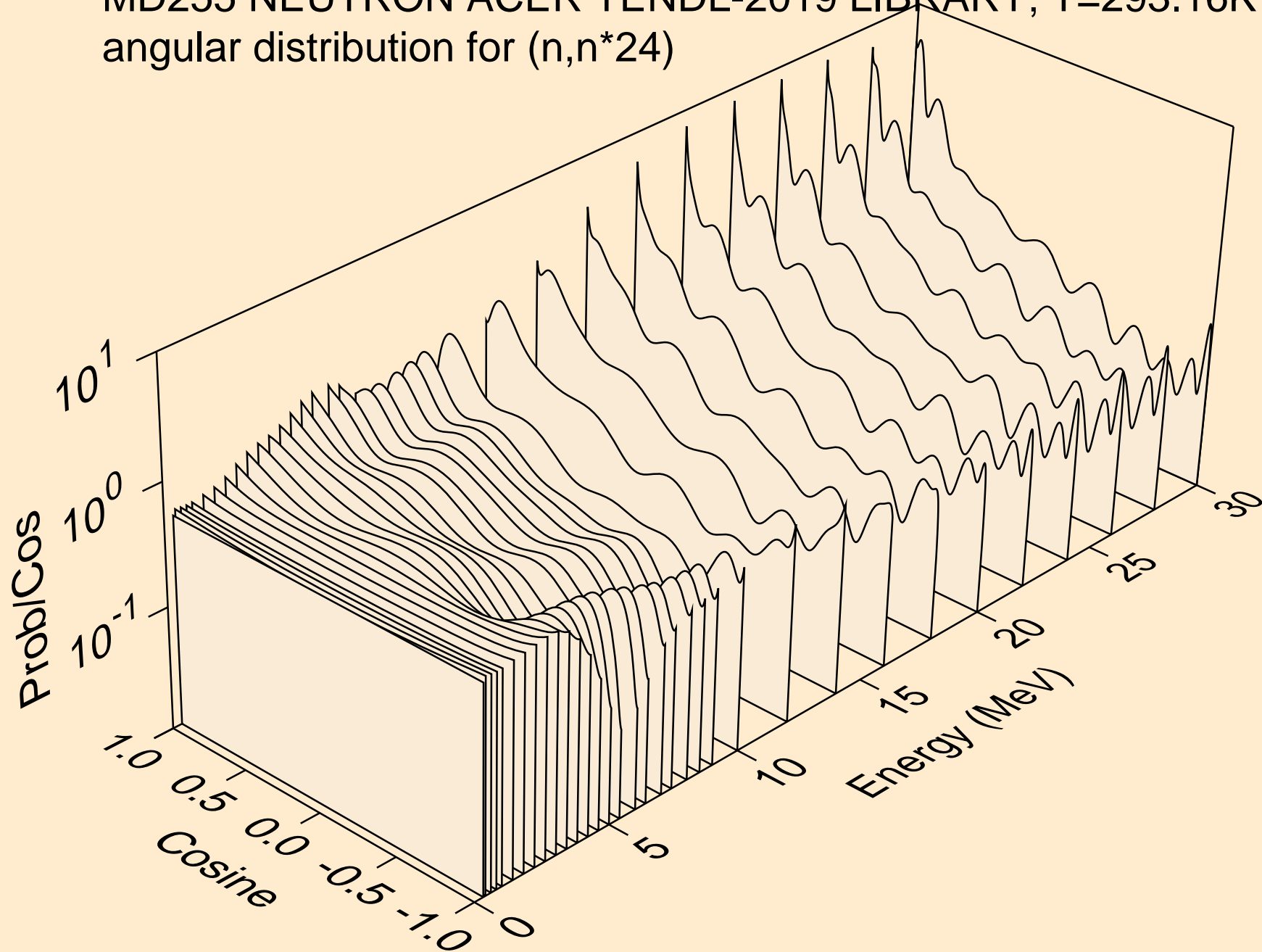

MD255 NEUTRON ACER TENDL-2019 LIBRARY; T=293.16K
angular distribution for (n,n*25)

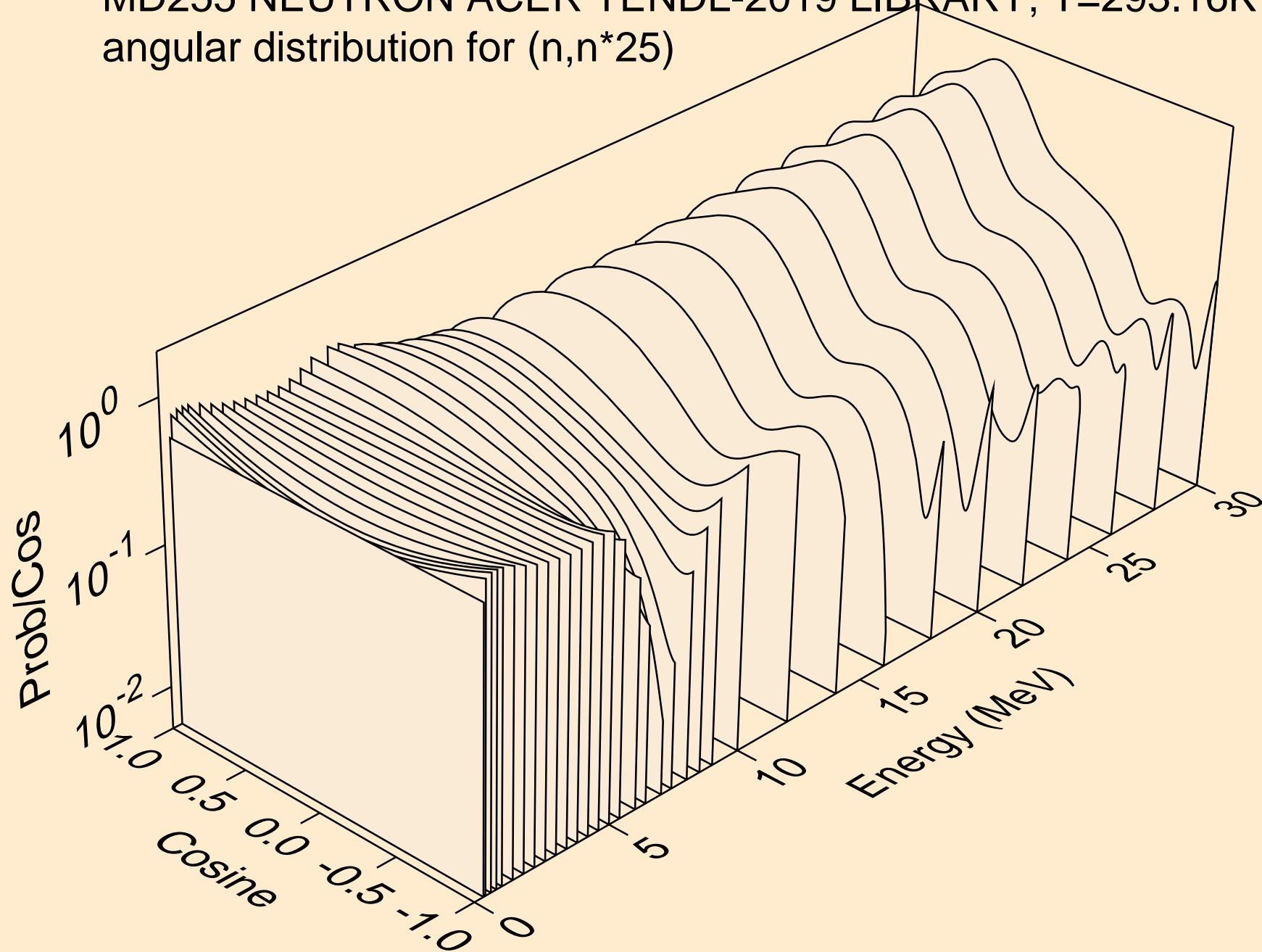

MD255 NEUTRON ACER TENDL-2019 LIBRARY; T=293.16K
angular distribution for (n,n*26)

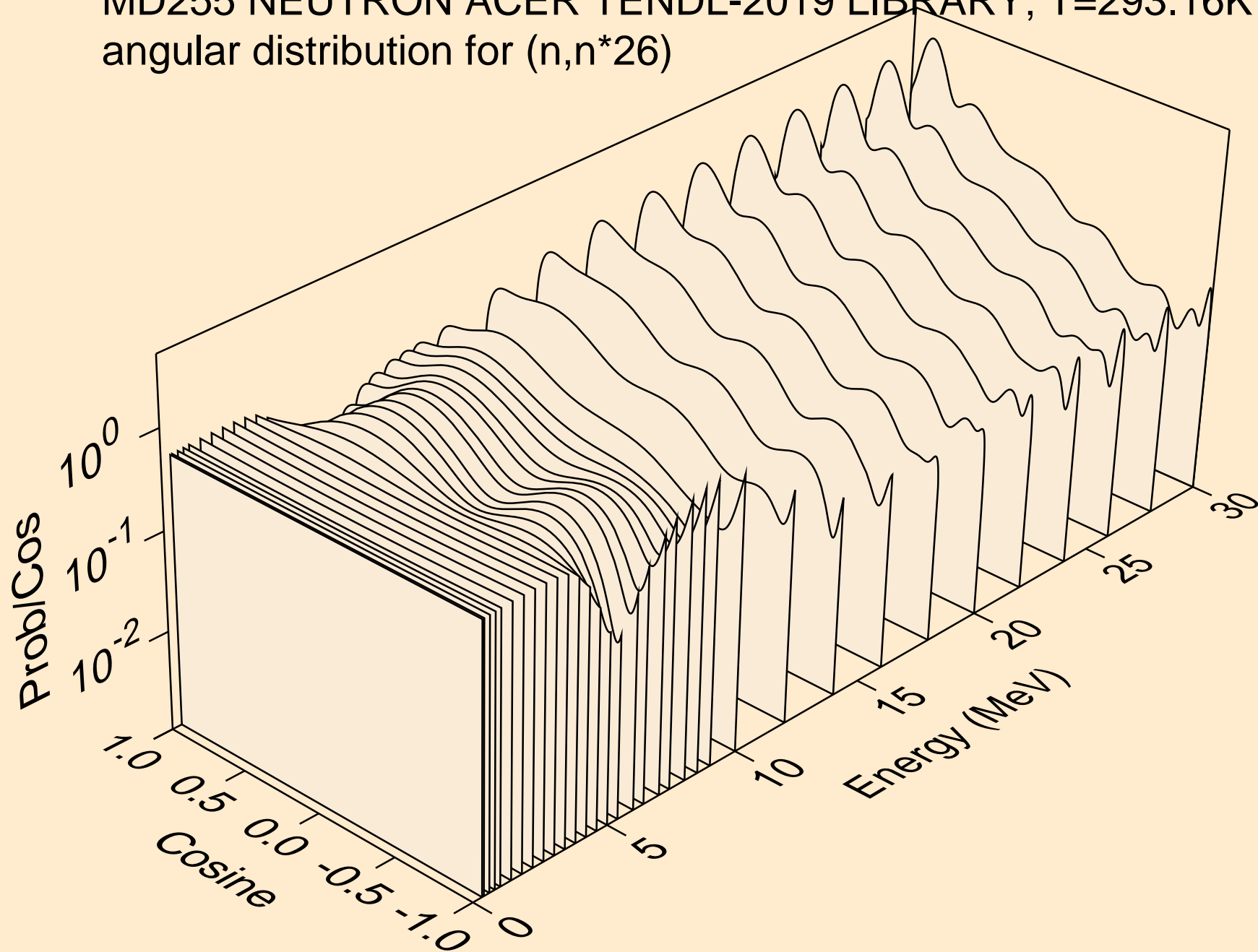

MD255 NEUTRON ACER TENDL-2019 LIBRARY; T=293.16K
angular distribution for (n,n*27)

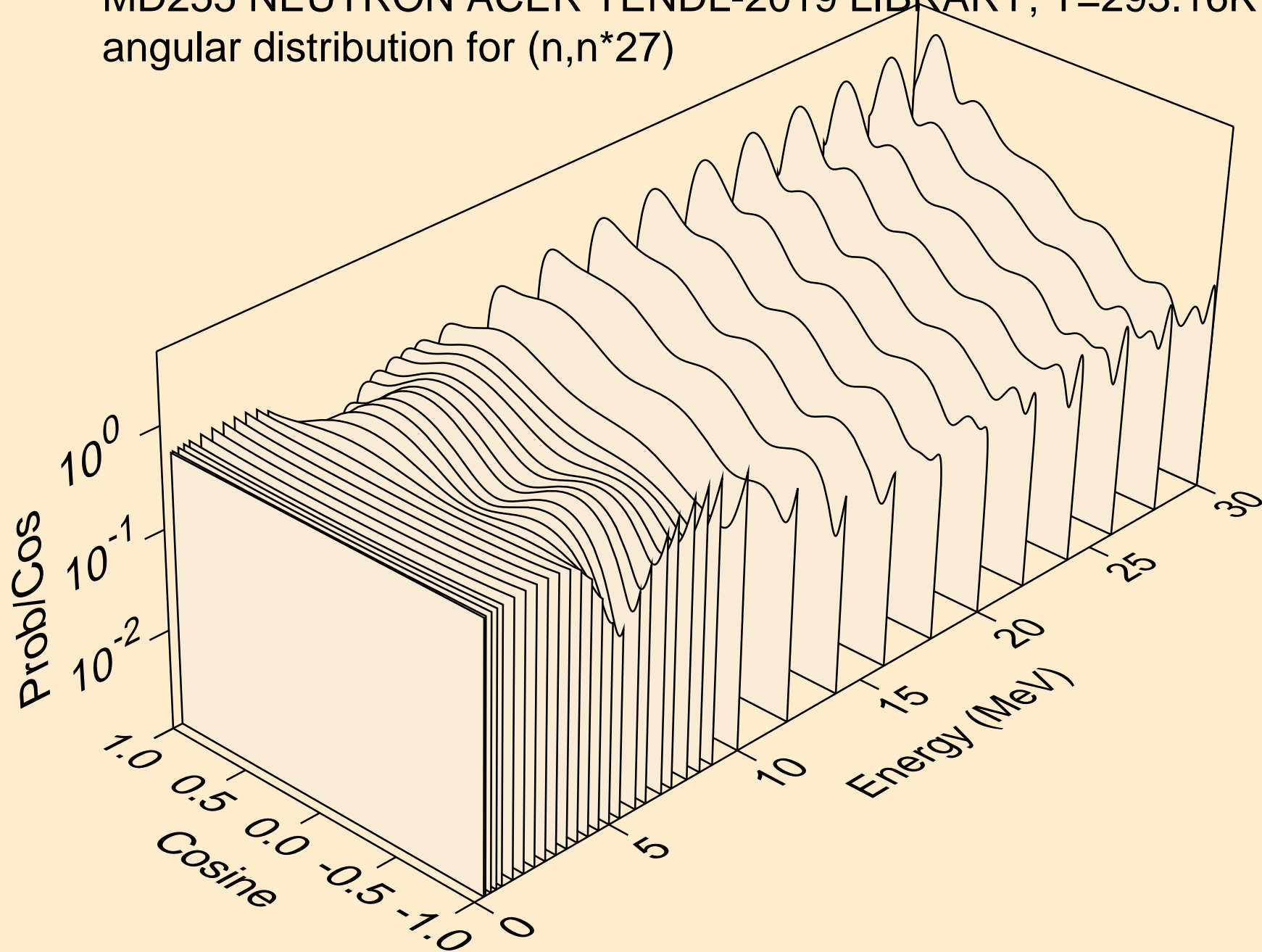

MD255 NEUTRON ACER TENDL-2019 LIBRARY; T=293.16K
angular distribution for (n,n*28)

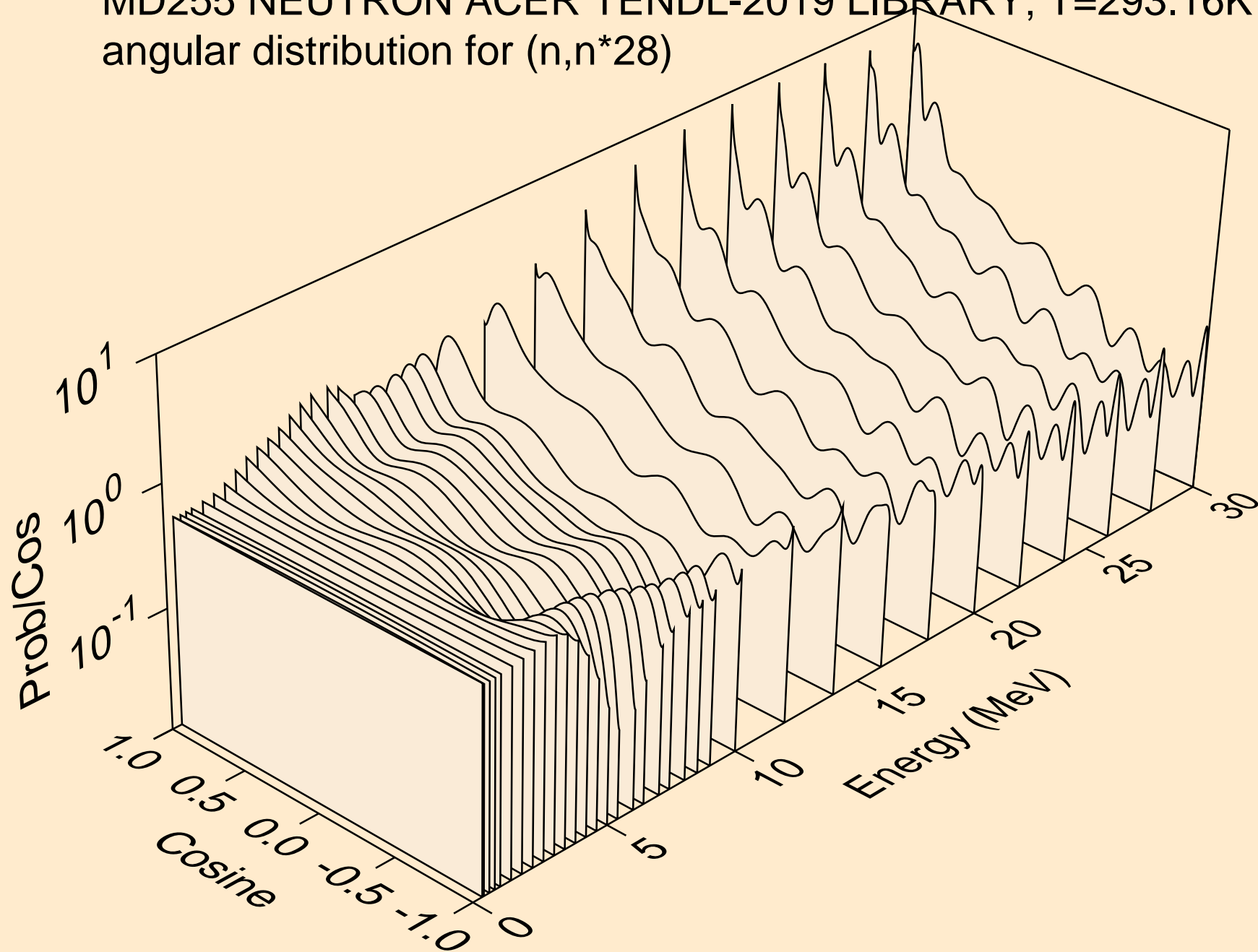

MD255 NEUTRON ACER TENDL-2019 LIBRARY; T=293.16K
angular distribution for (n,n*29)

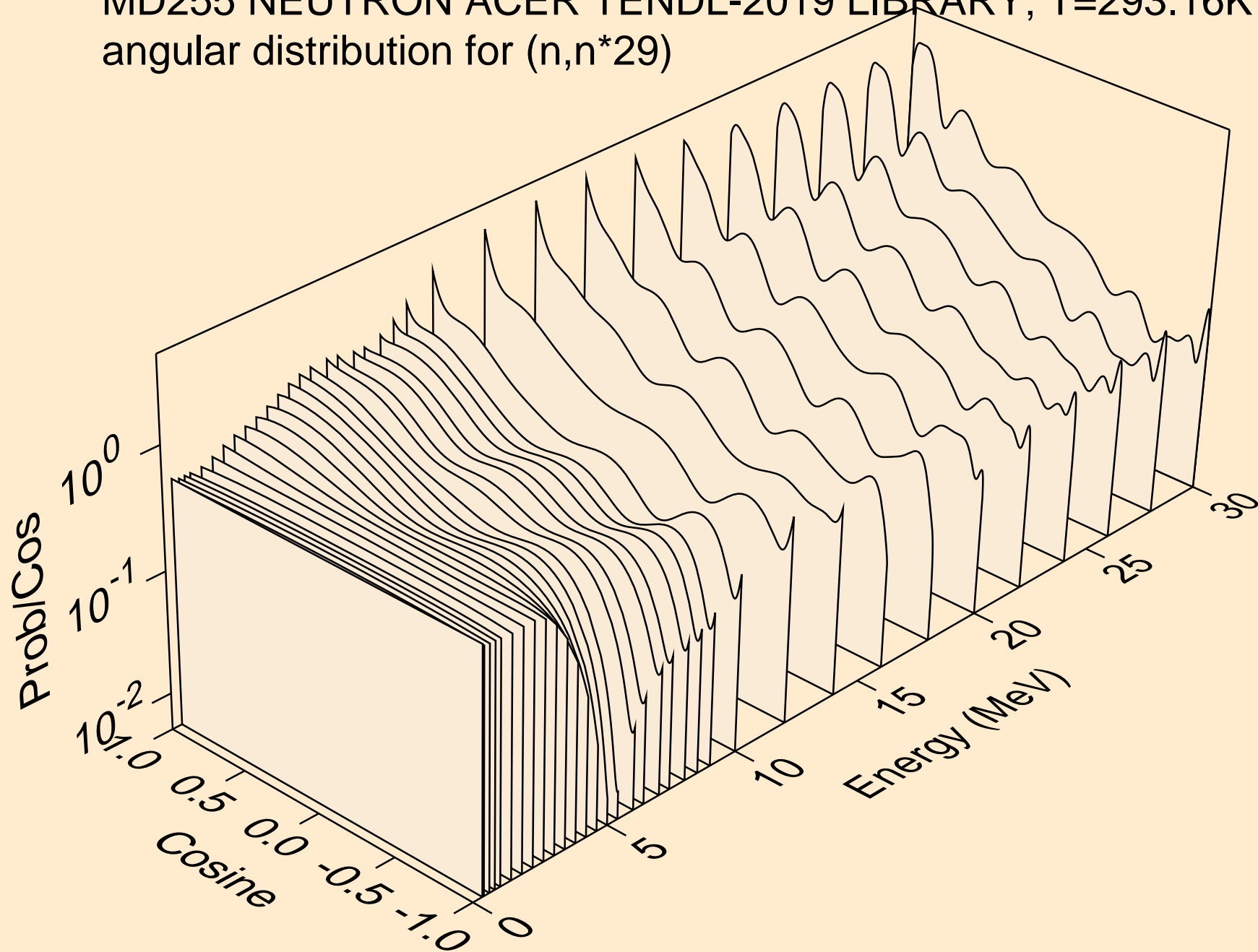

MD255 NEUTRON ACER TENDL-2019 LIBRARY; T=293.16K
Total fission nuabar

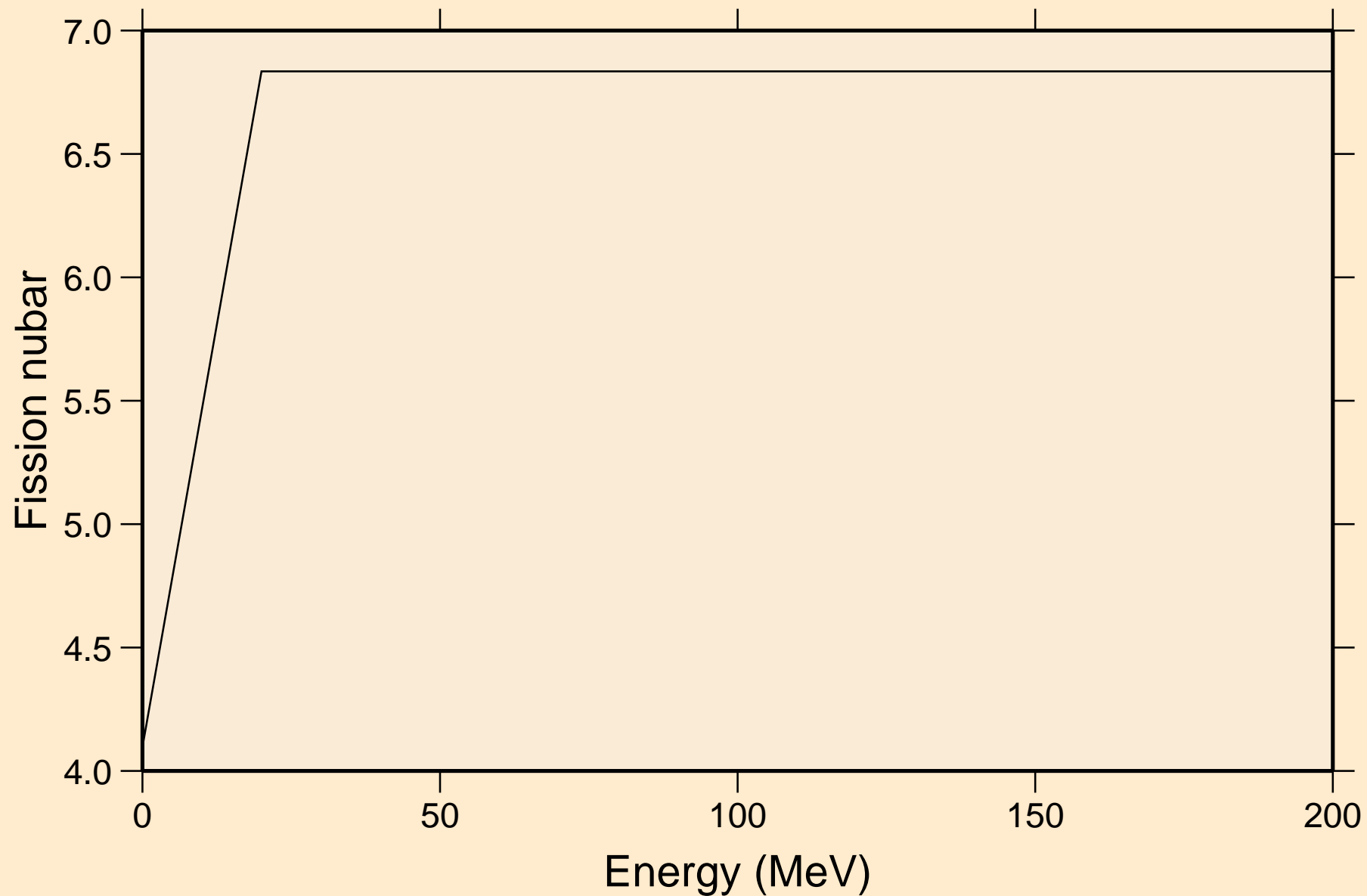

MD255 NEUTRON ACER TENDL-2019 LIBRARY; T=293.16K
Neutron emission for (n,x)

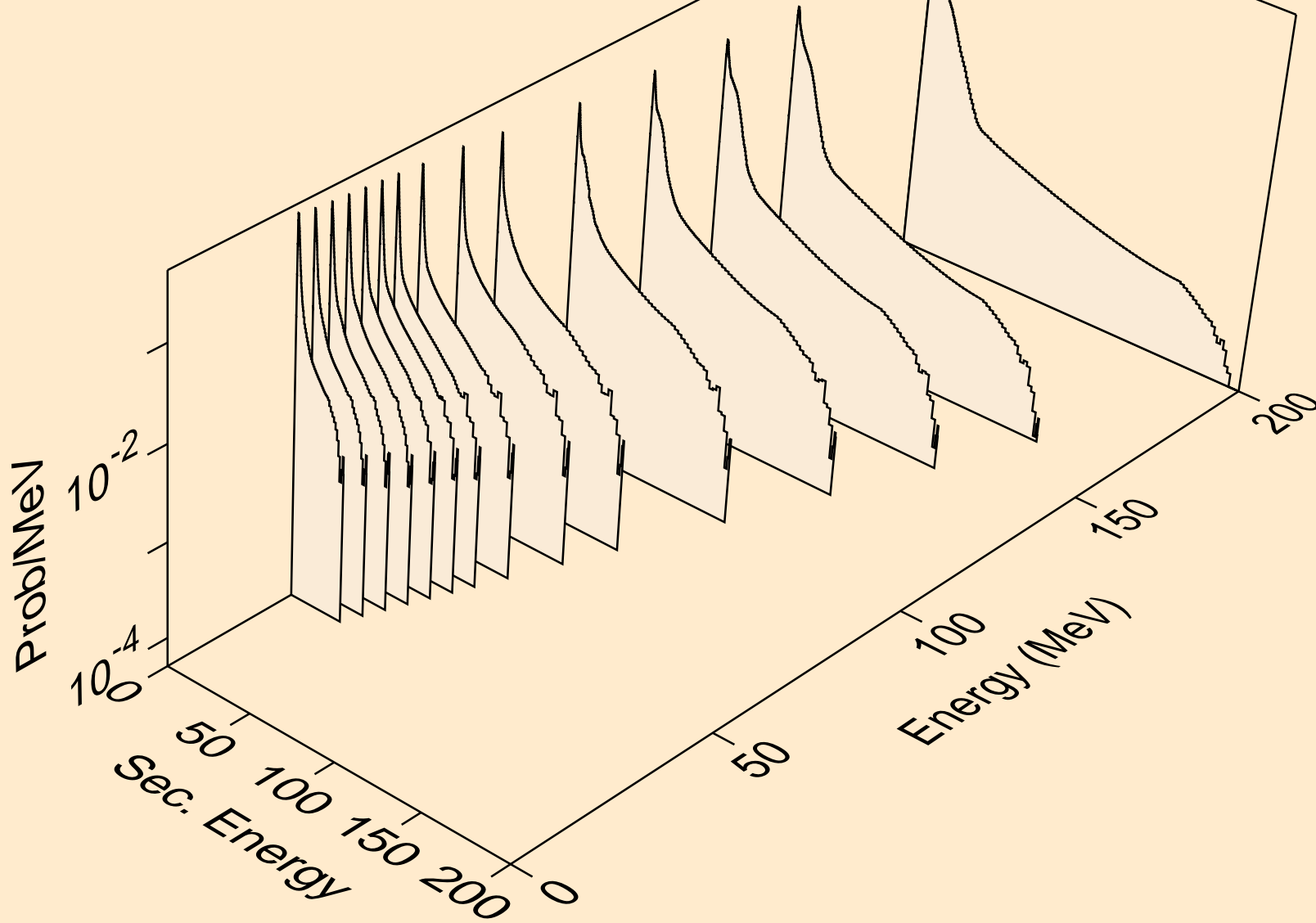

MD255 NEUTRON ACER TENDL-2019 LIBRARY; T=293.16K
Neutron emission for (n,2nd)

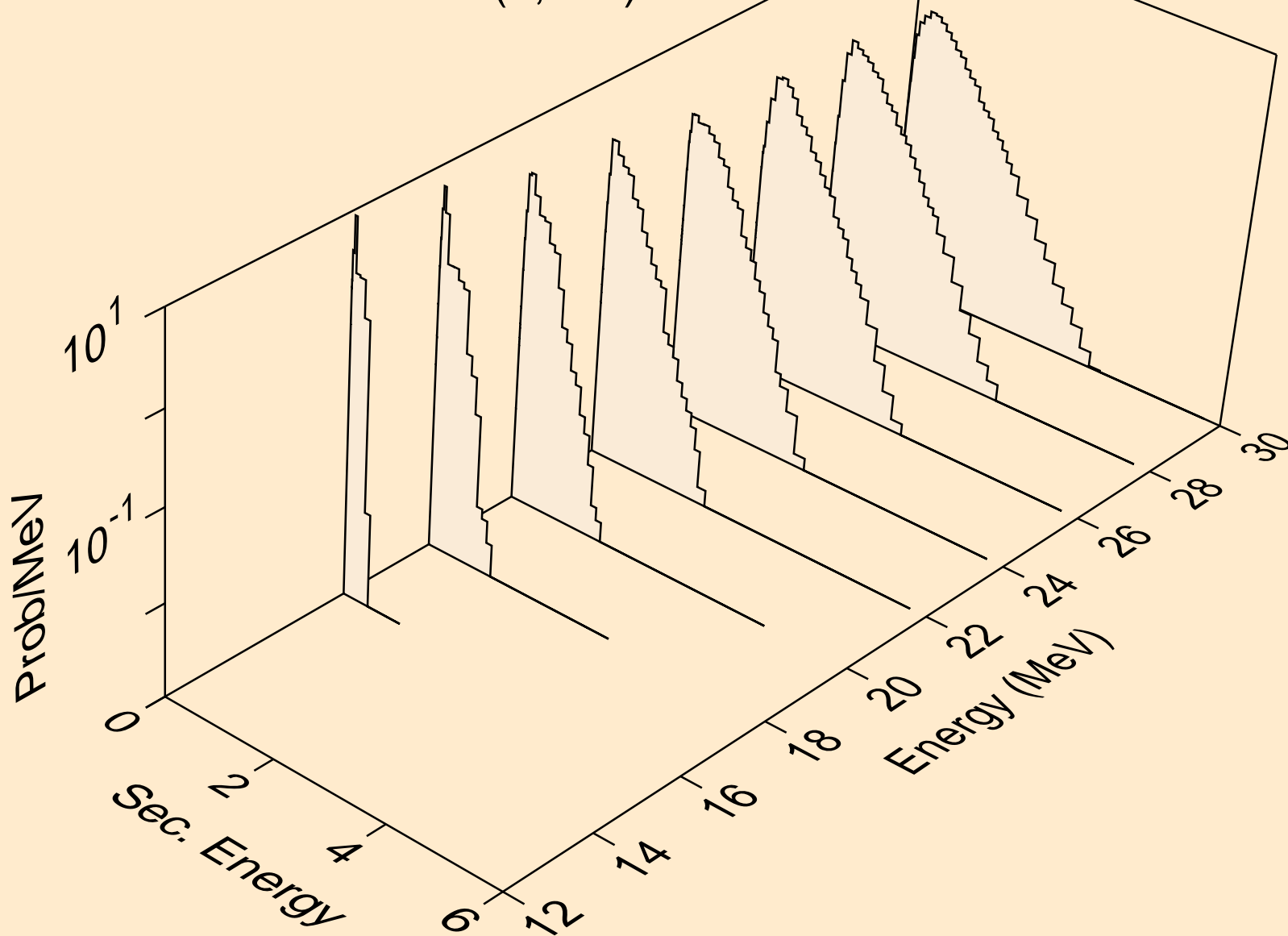

MD255 NEUTRON ACER TENDL-2019 LIBRARY; T=293.16K
Neutron emission for (n,2n)

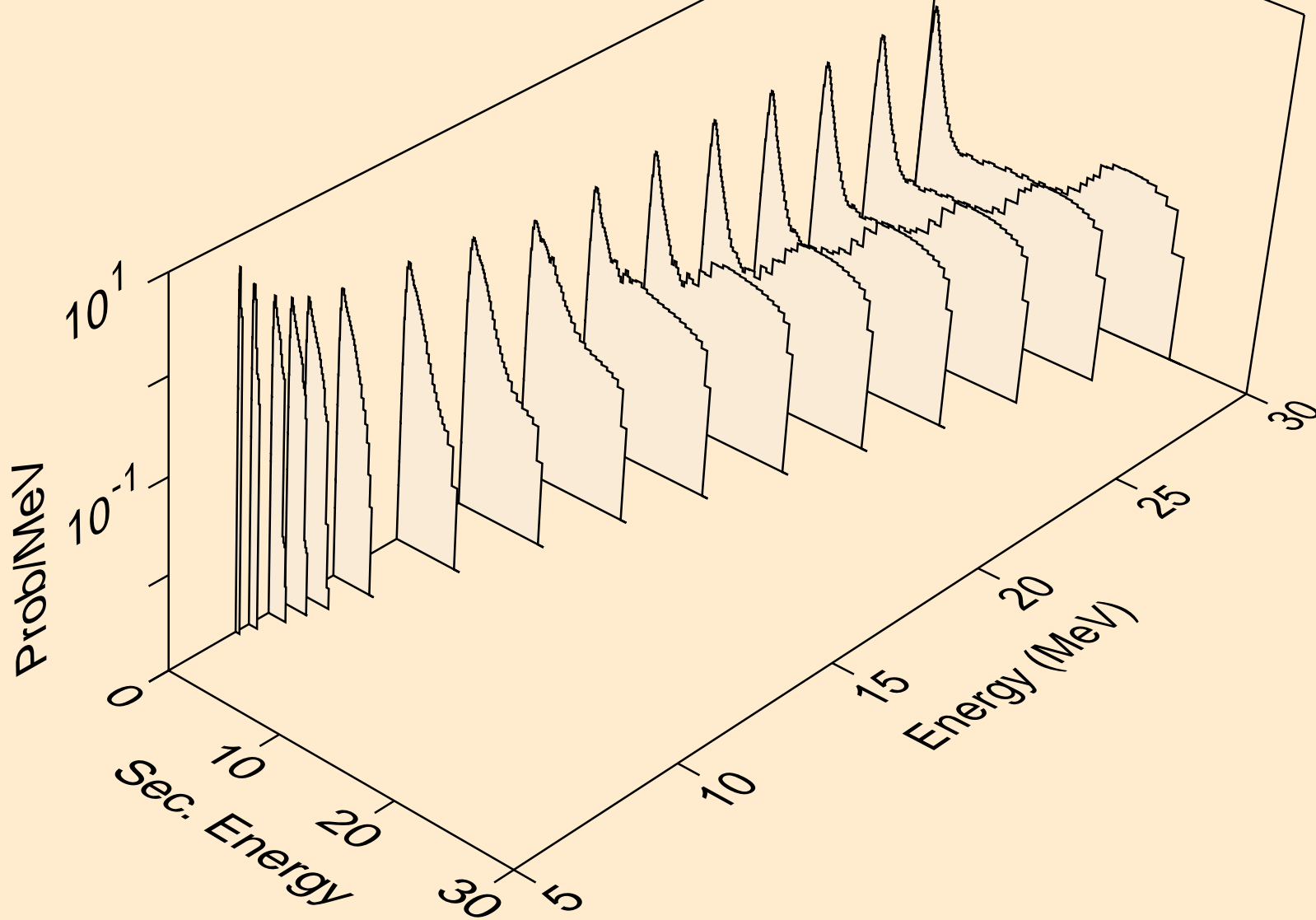

MD255 NEUTRON ACER TENDL-2019 LIBRARY; T=293.16K
Neutron emission for (n,3n)

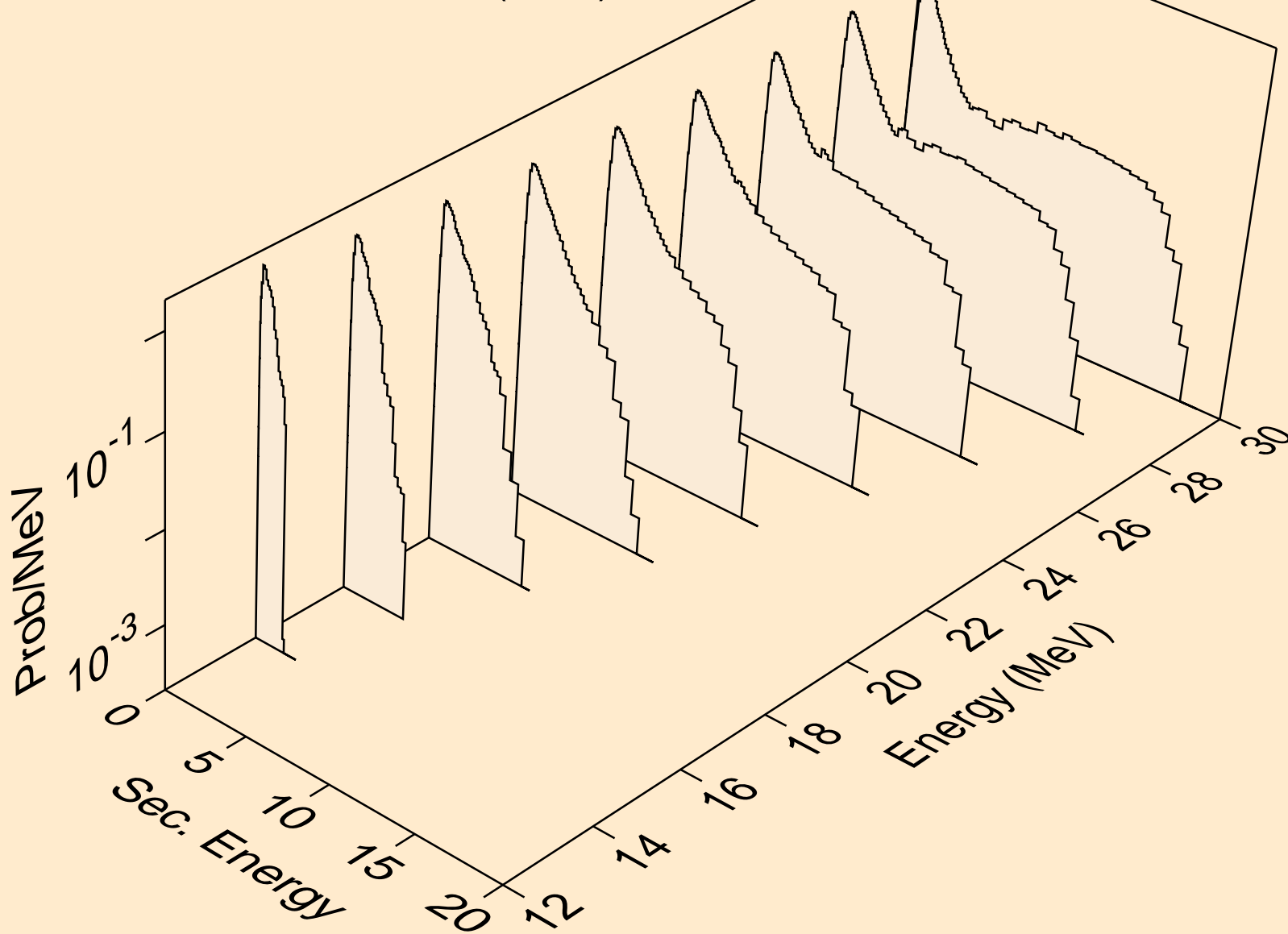

MD255 NEUTRON ACER TENDL-2019 LIBRARY; T=293.16K
Neutron emission for fission

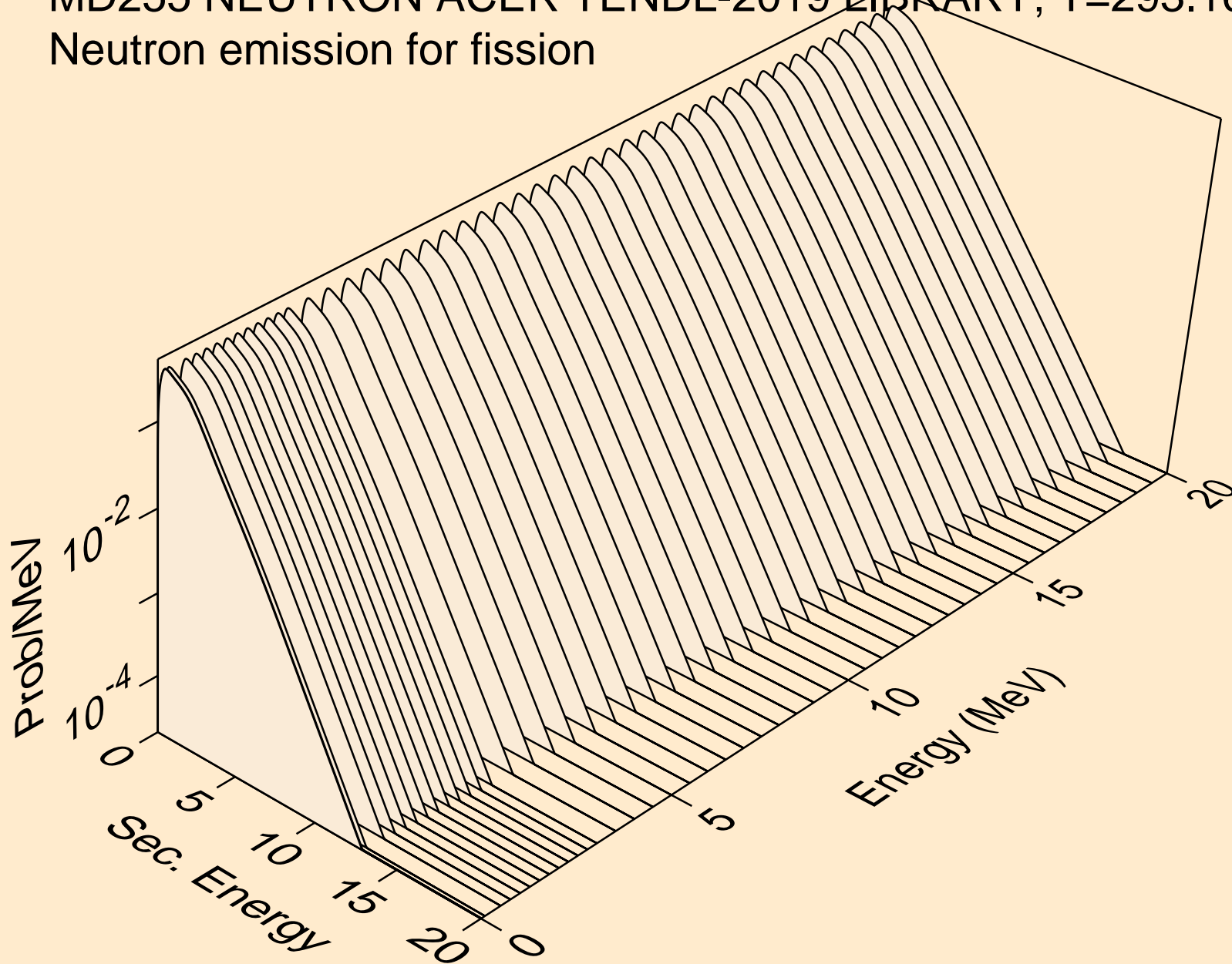

MD255 NEUTRON ACER TENDL-2019 LIBRARY; T=293.16K
Neutron emission for (n,n*)a

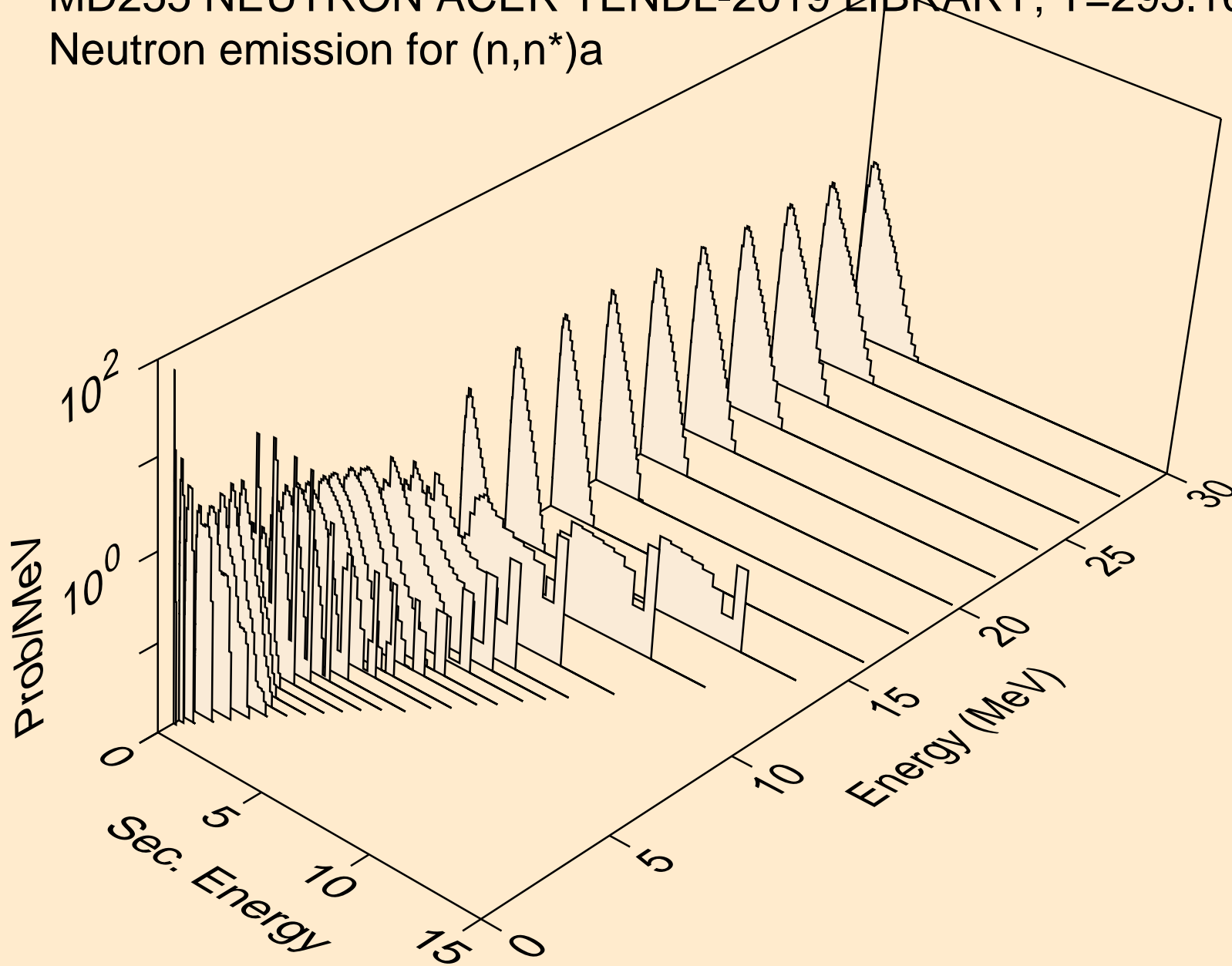

MD255 NEUTRON ACER TENDL-2019 LIBRARY; T=293.16K
Neutron emission for (n,2n)a

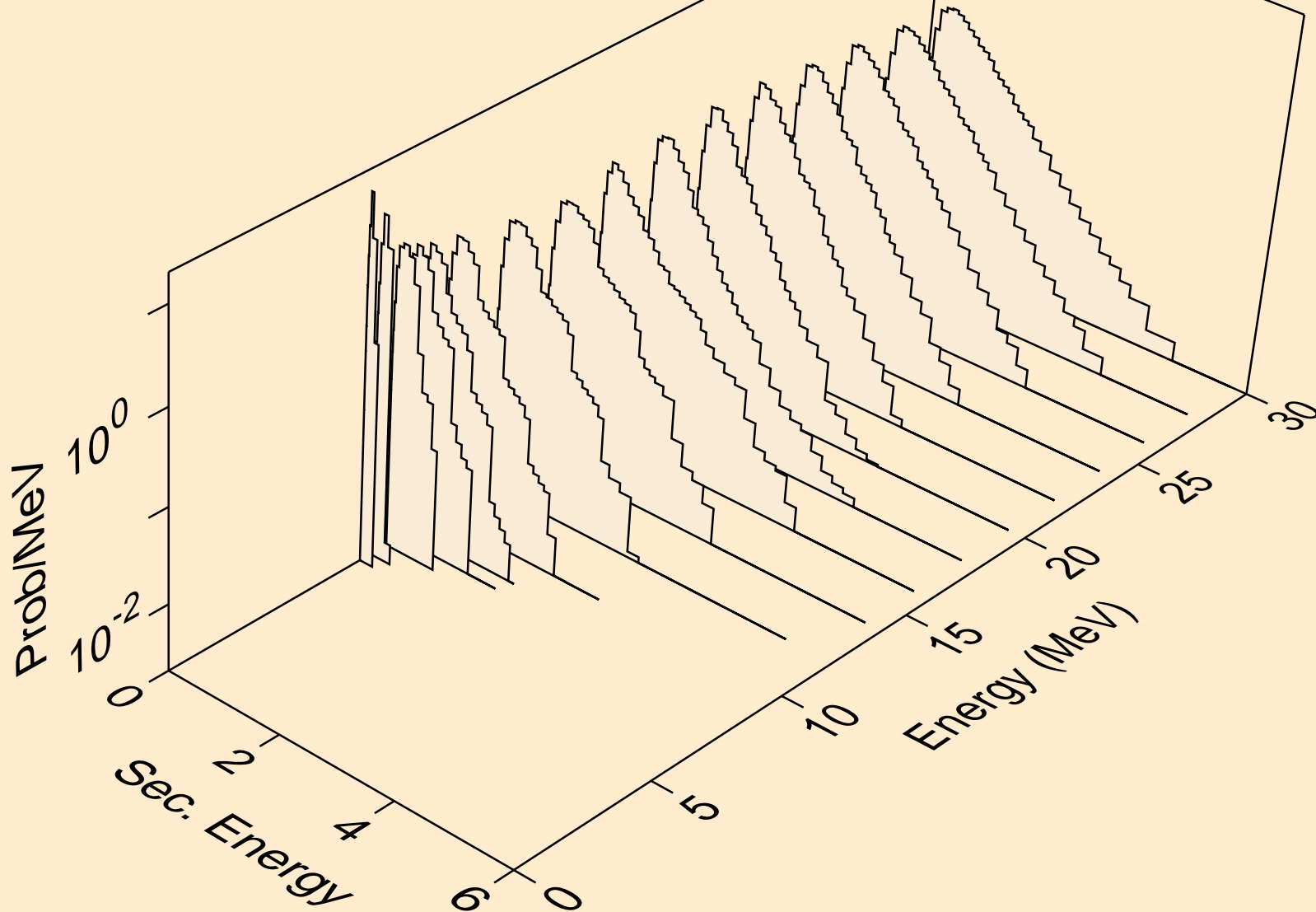

MD255 NEUTRON ACER TENDL-2019 LIBRARY; T=293.16K
Neutron emission for (n,3n)a

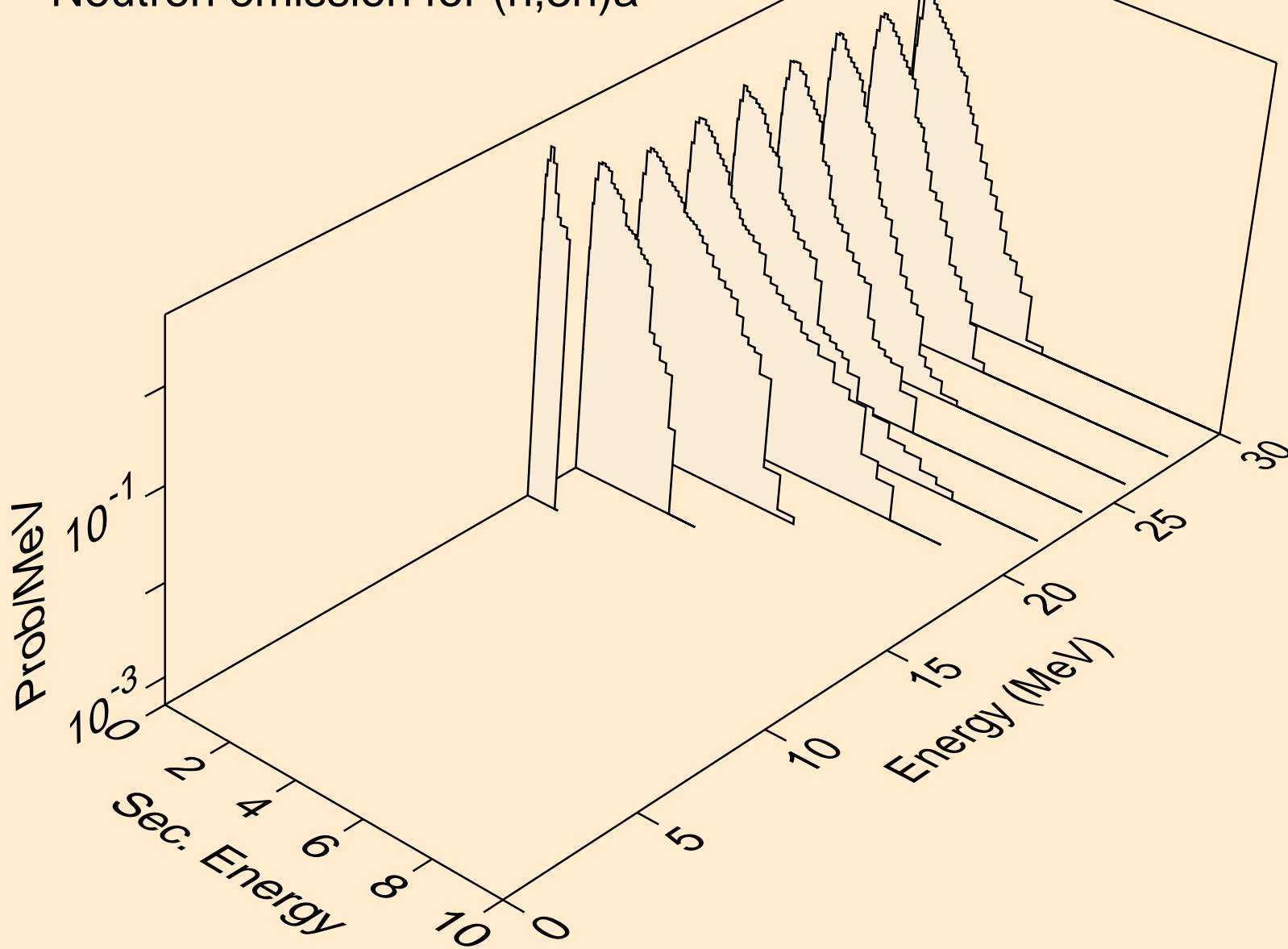

MD255 NEUTRON ACER TENDL-2019 LIBRARY; T=293.16K
Neutron emission for (n,n*)p

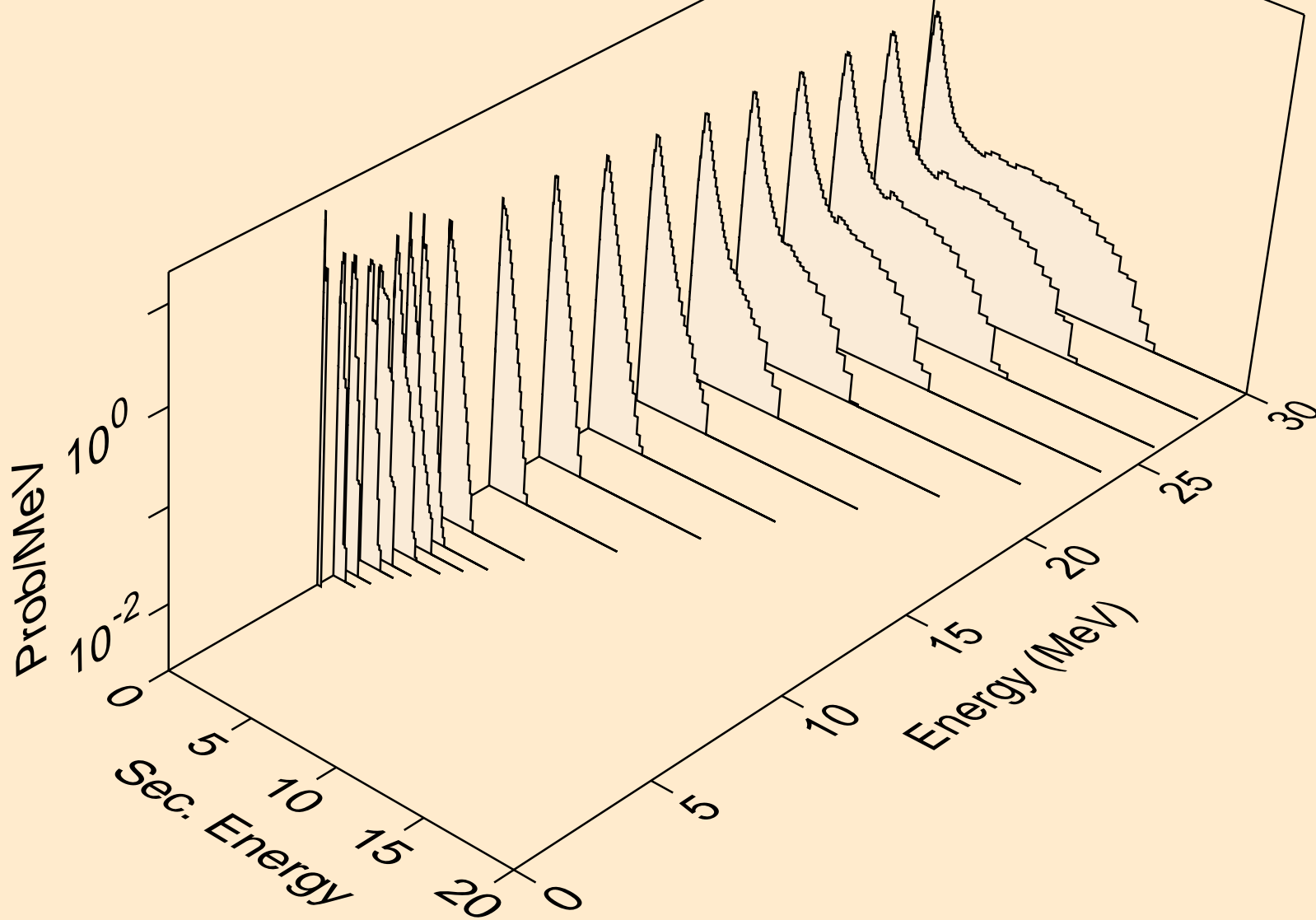

MD255 NEUTRON ACER TENDL-2019 LIBRARY; T=293.16K
Neutron emission for (n,n*)2a

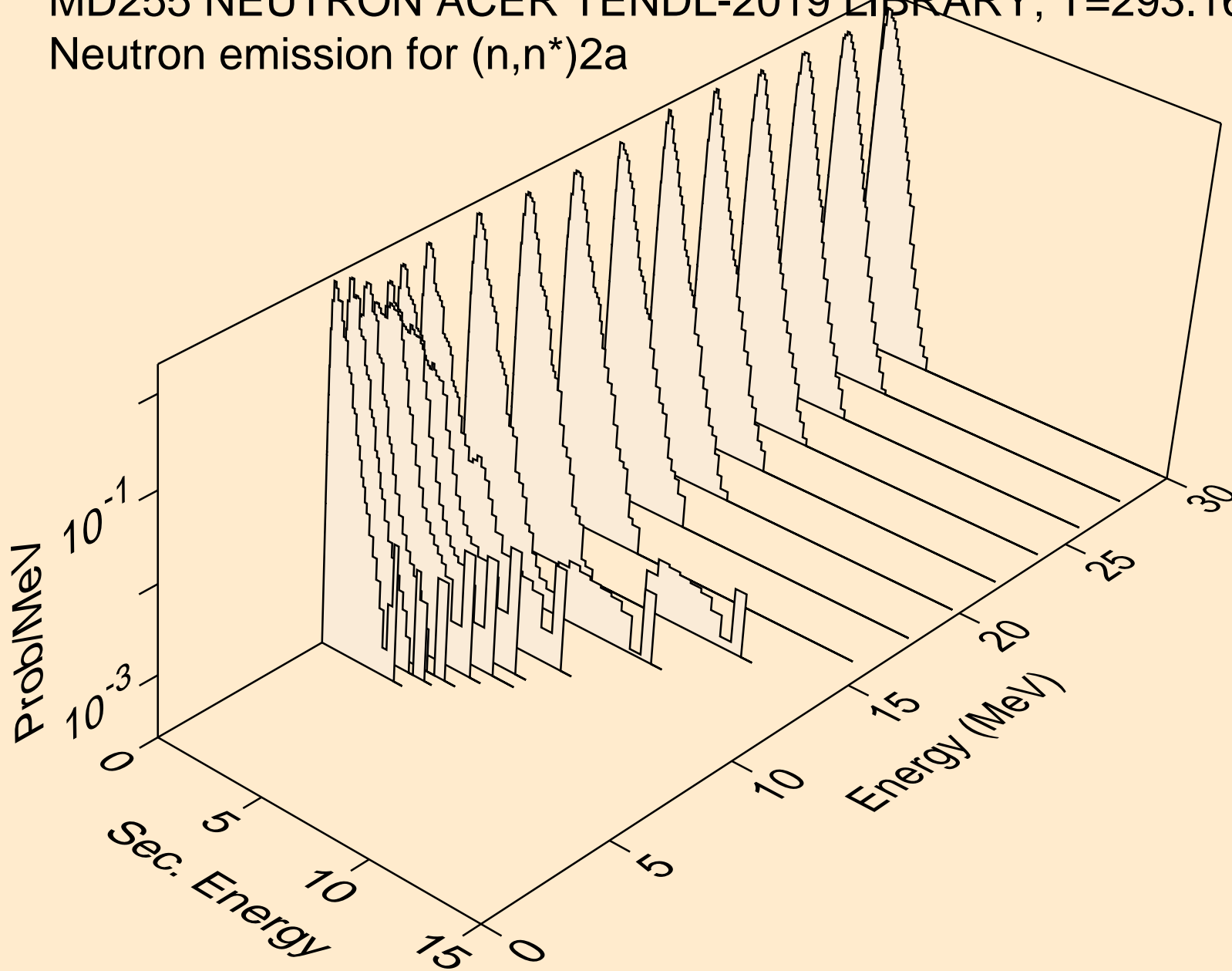

MD255 NEUTRON ACER TENDL-2019 LIBRARY; T=293.16K
Neutron emission for (n,n*)d

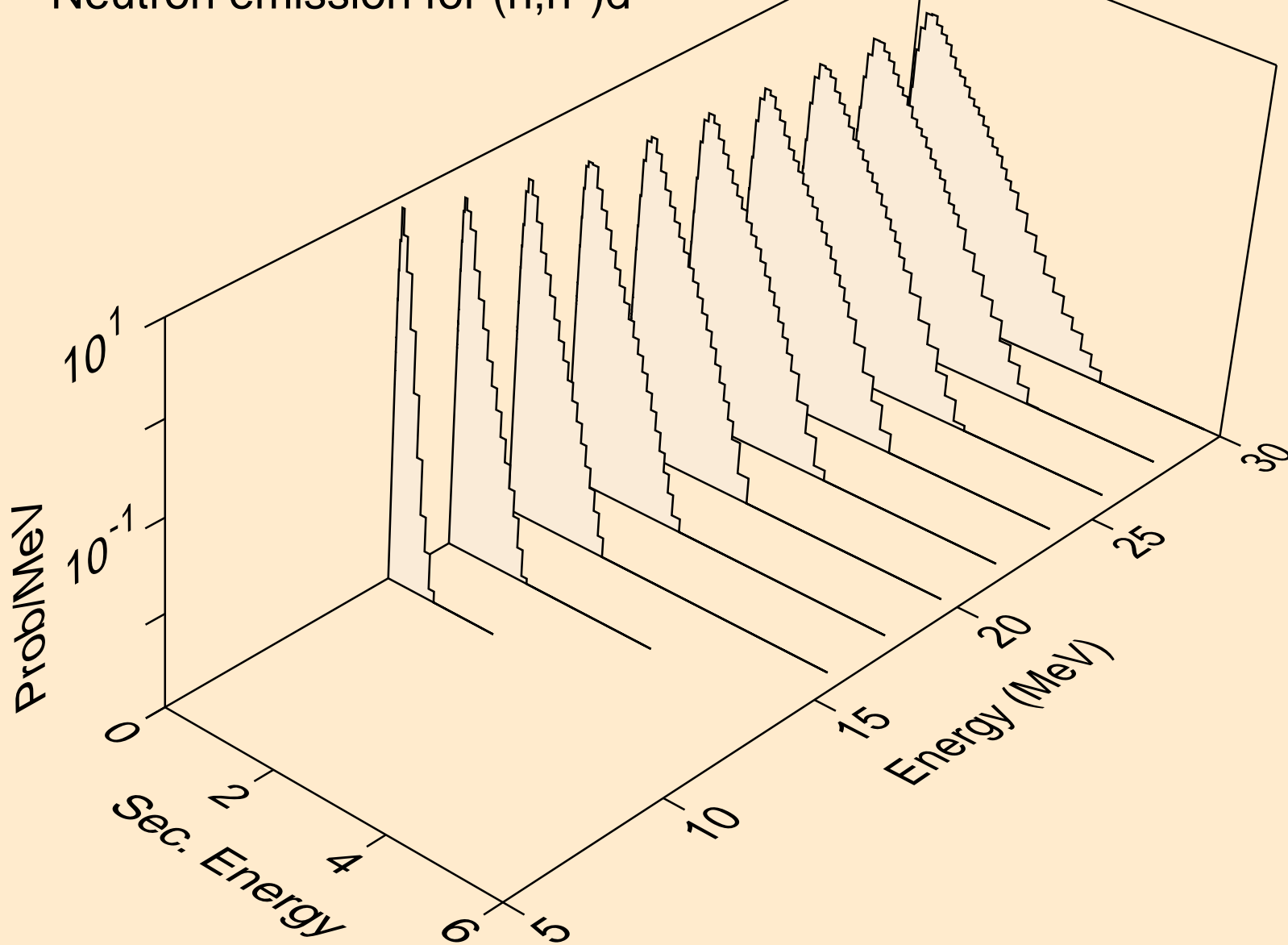

MD255 NEUTRON ACER TENDL-2019 LIBRARY; T=293.16K
Neutron emission for (n,n*)t

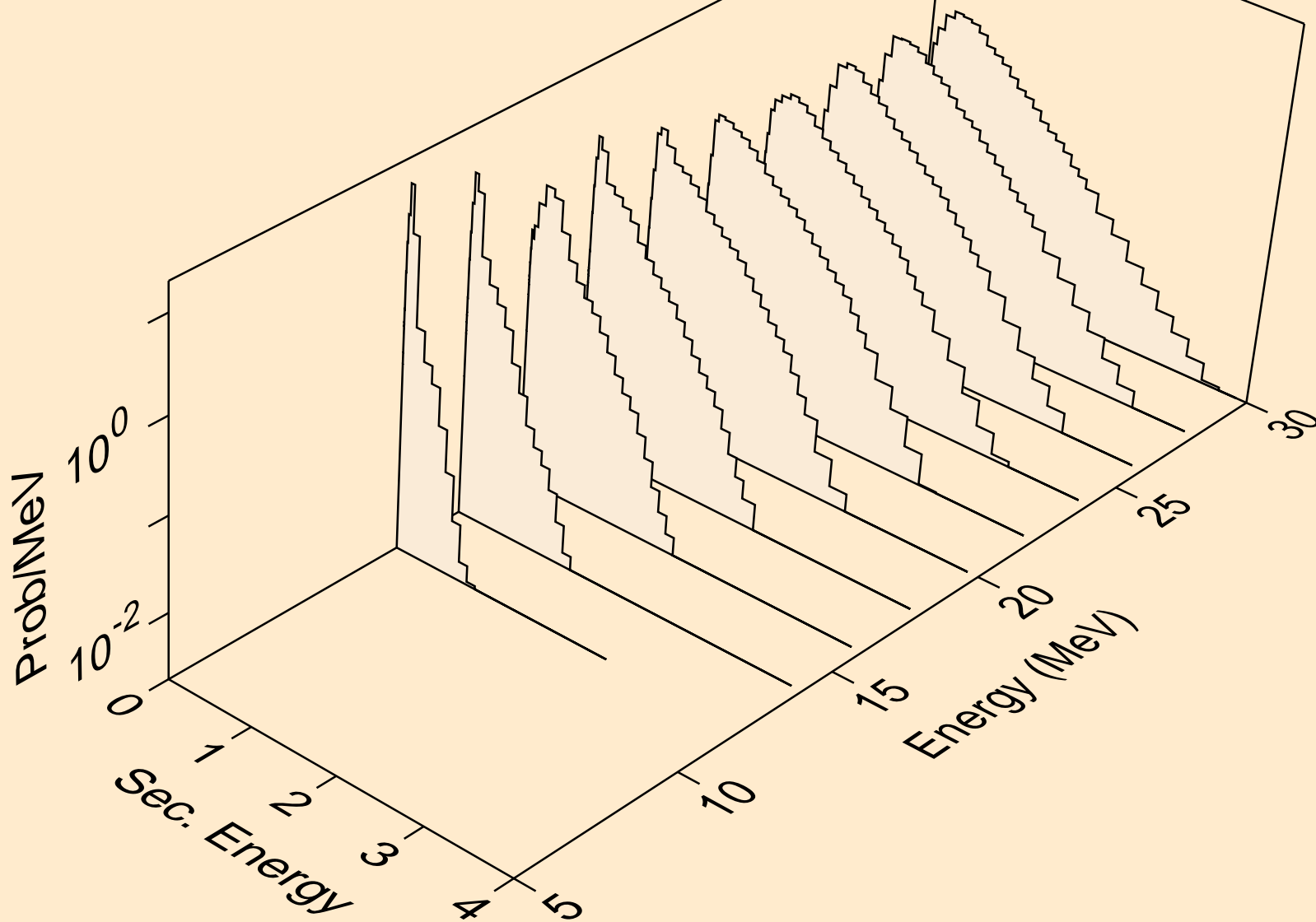

MD255 NEUTRON ACER TENDL-2019 LIBRARY; T=293.16K
Neutron emission for (n,n*)he3

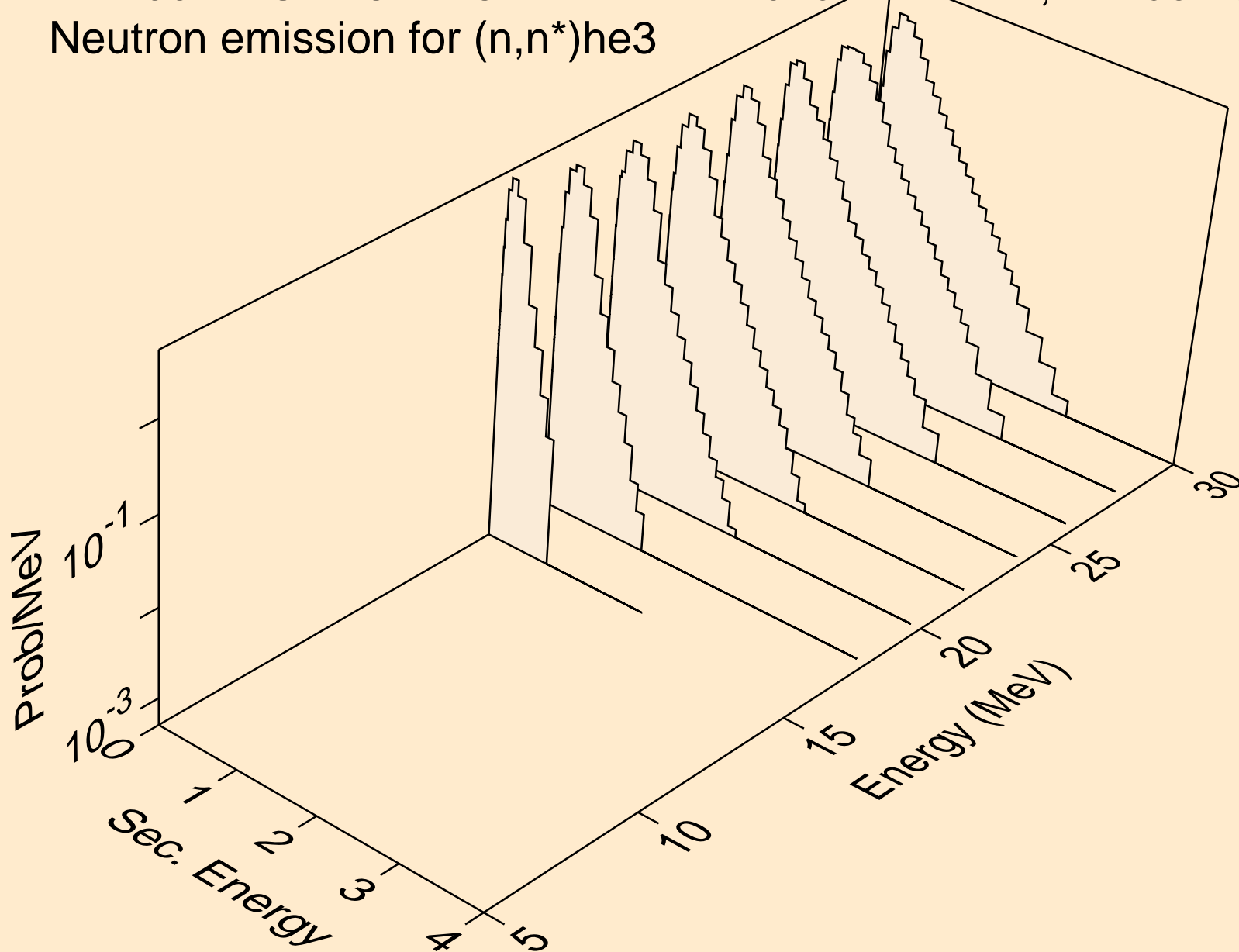

MD255 NEUTRON ACER TENDL-2019 LIBRARY; T=293.16K
Neutron emission for (n,4n)

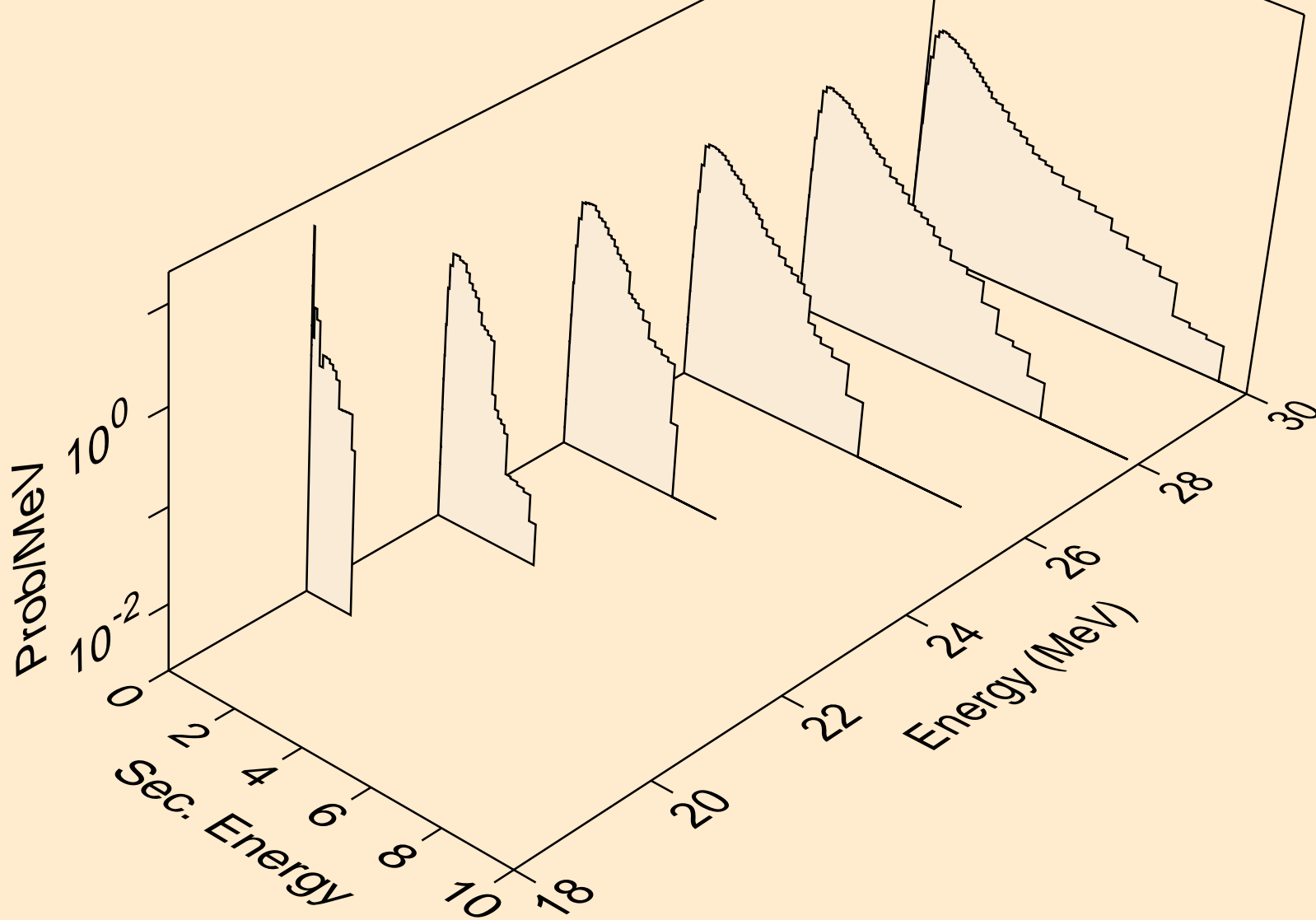

MD255 NEUTRON ACER TENDL-2019 LIBRARY; T=293.16K
Neutron emission for (n,2np)

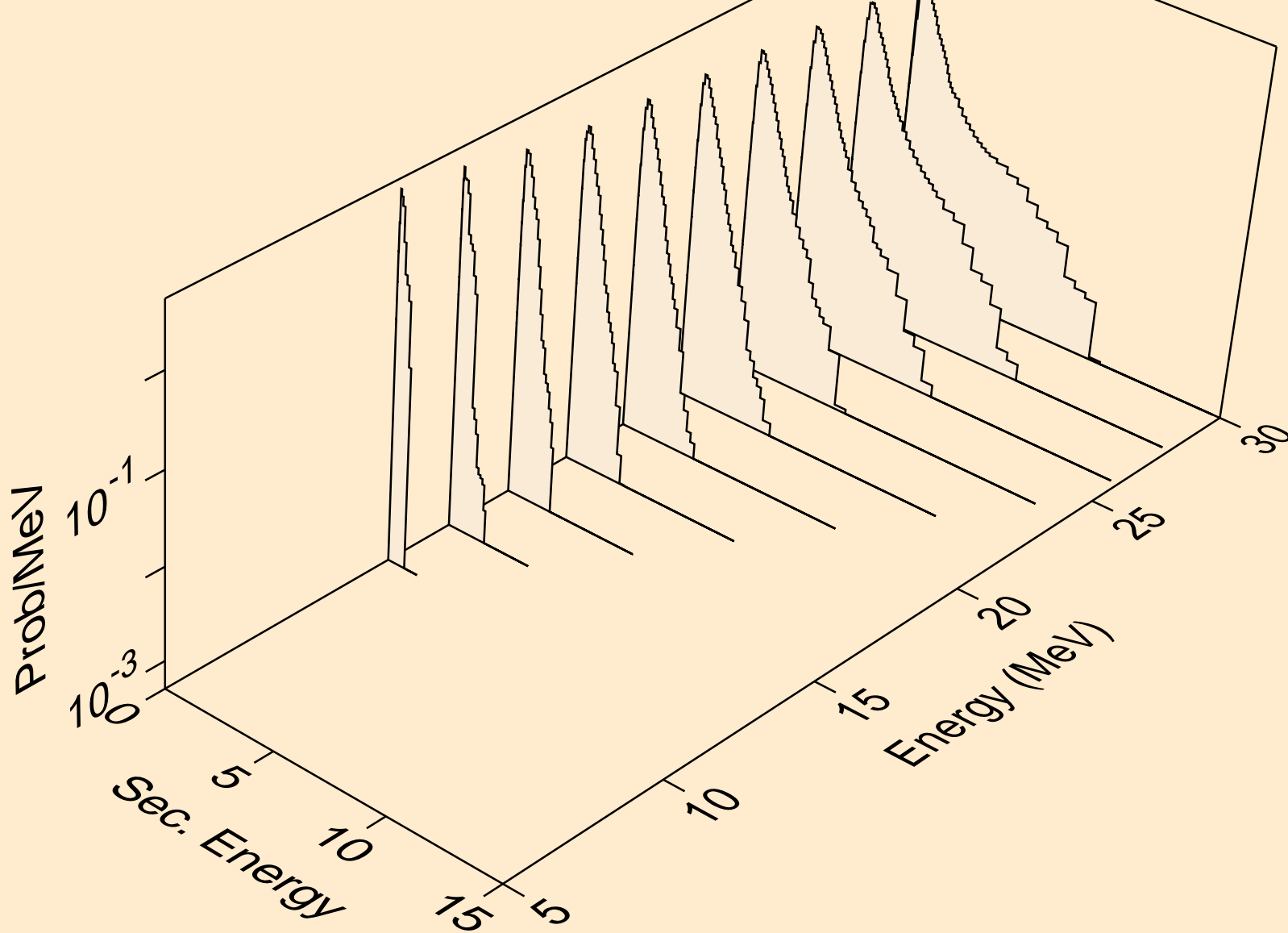

MD255 NEUTRON ACER TENDL-2019 LIBRARY; T=293.16K
Neutron emission for (n,3np)

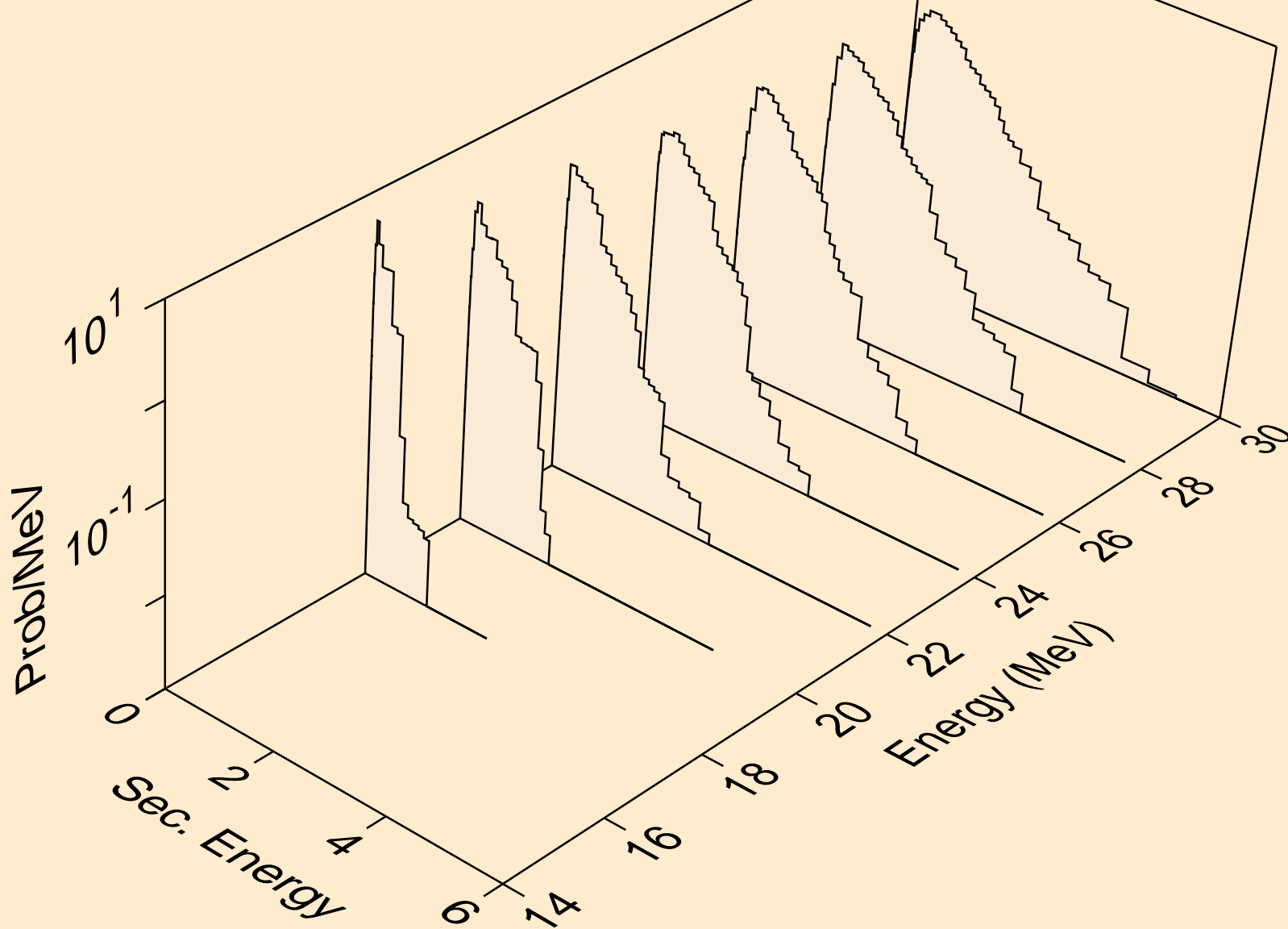

MD255 NEUTRON ACER TENDL-2019 LIBRARY; T=293.16K
Neutron emission for (n,2np)

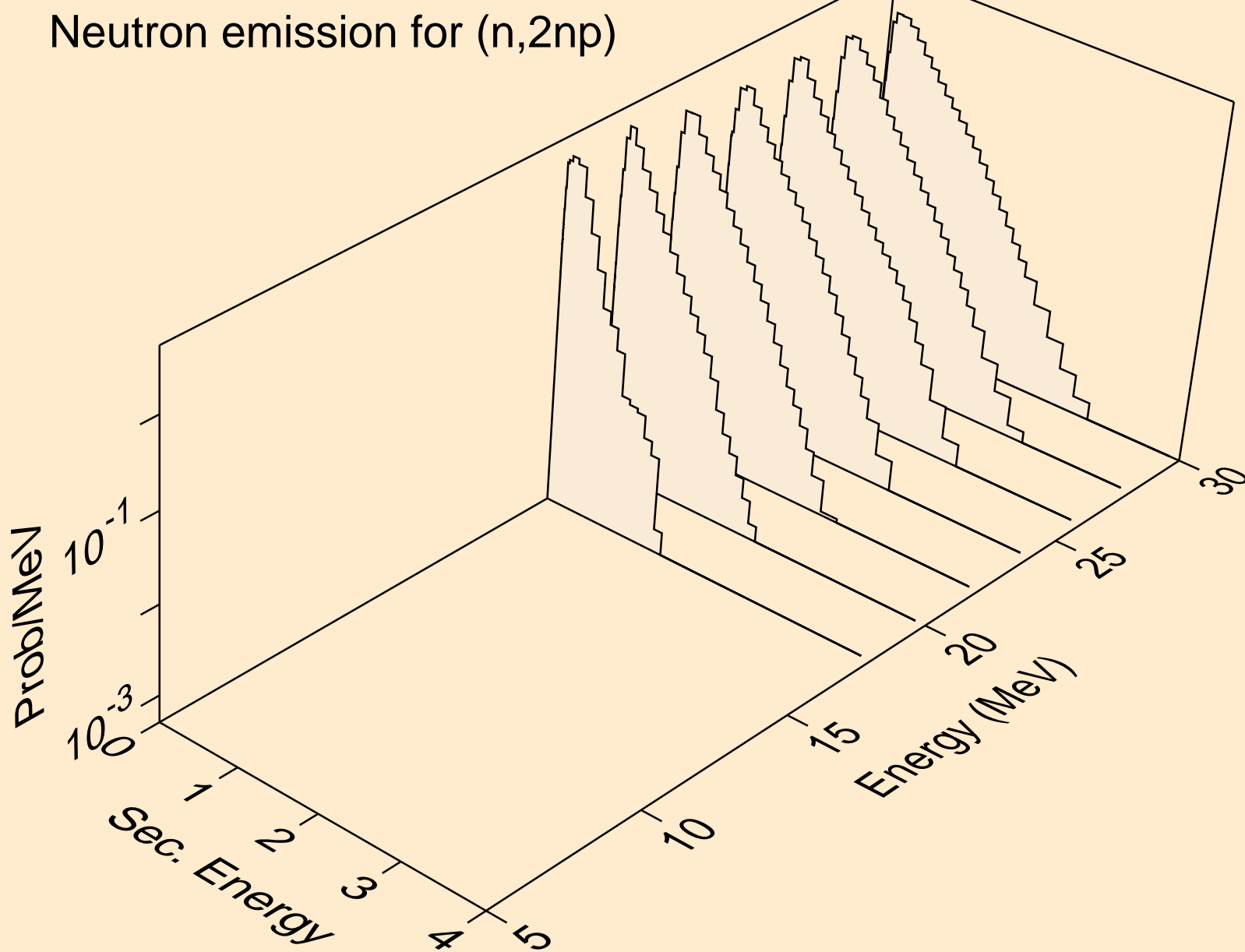

MD255 NEUTRON ACER TENDL-2019 LIBRARY; T=293.16K
Neutron emission for (n,npa)

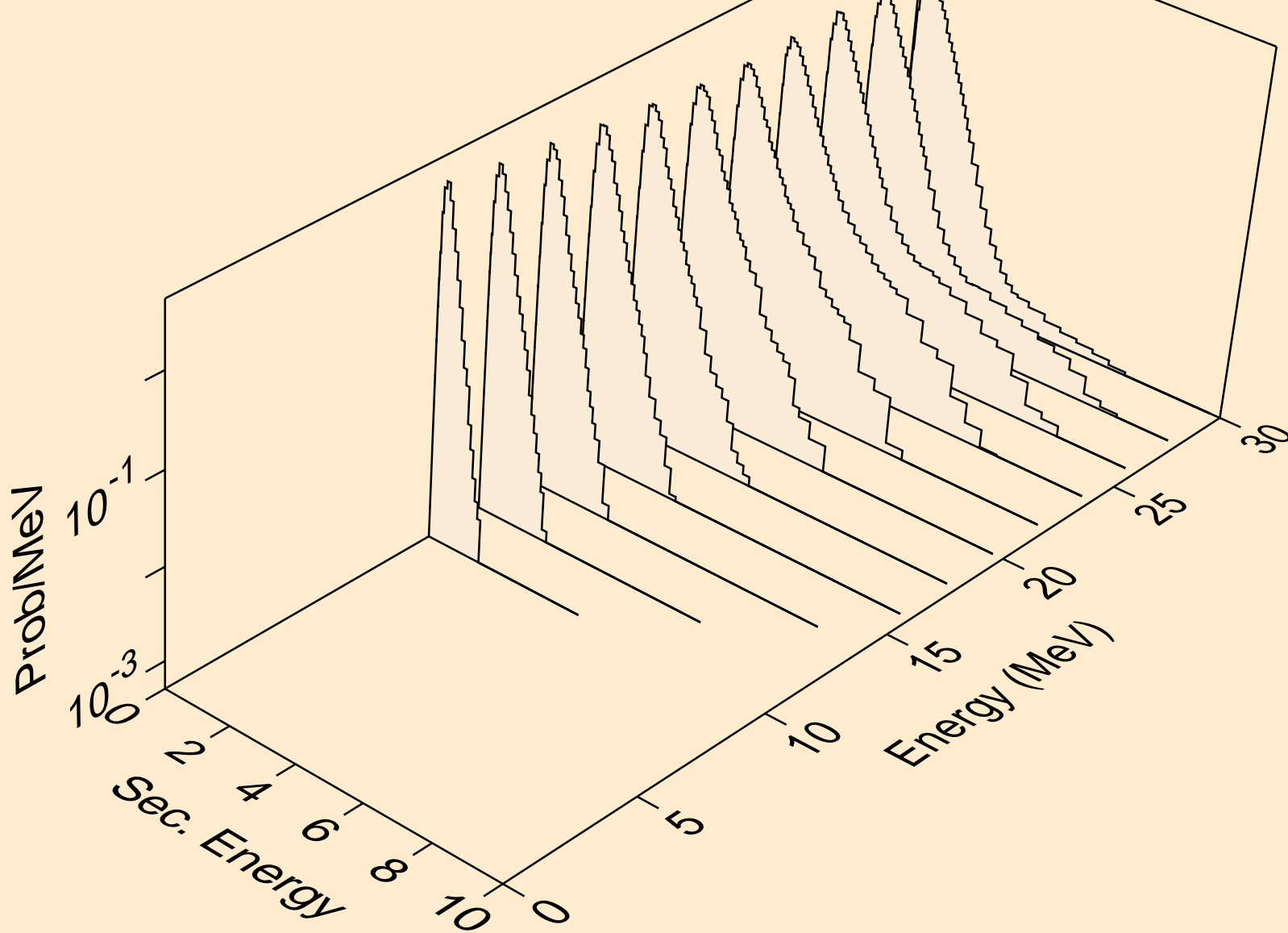

MD255 NEUTRON ACER TENDL-2019 LIBRARY; T=293.16K
Neutron emission for (n,n*c)

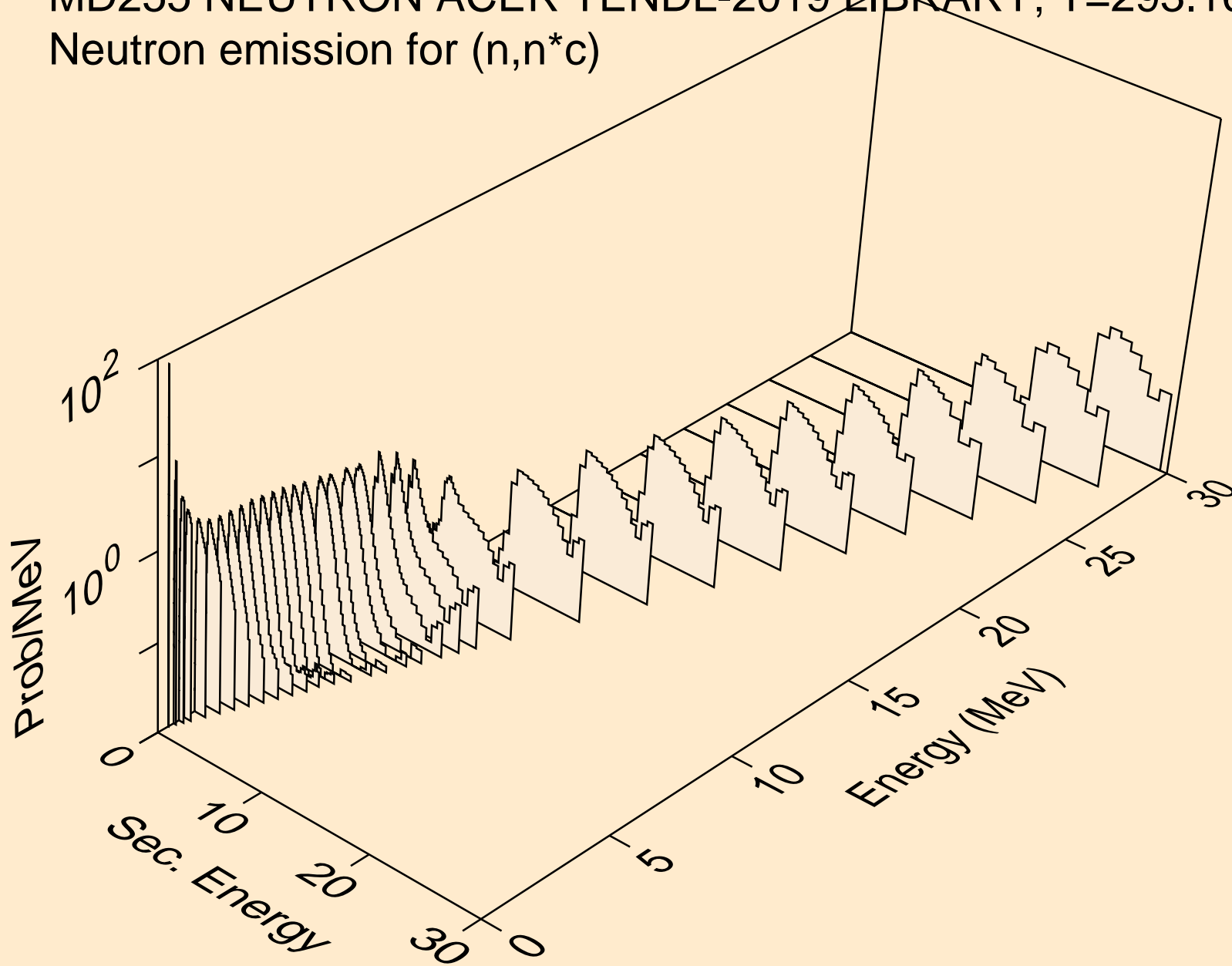

MD255 NEUTRON ACER TENDL-2019 LIBRARY; T=293.16K

Delayed nubar

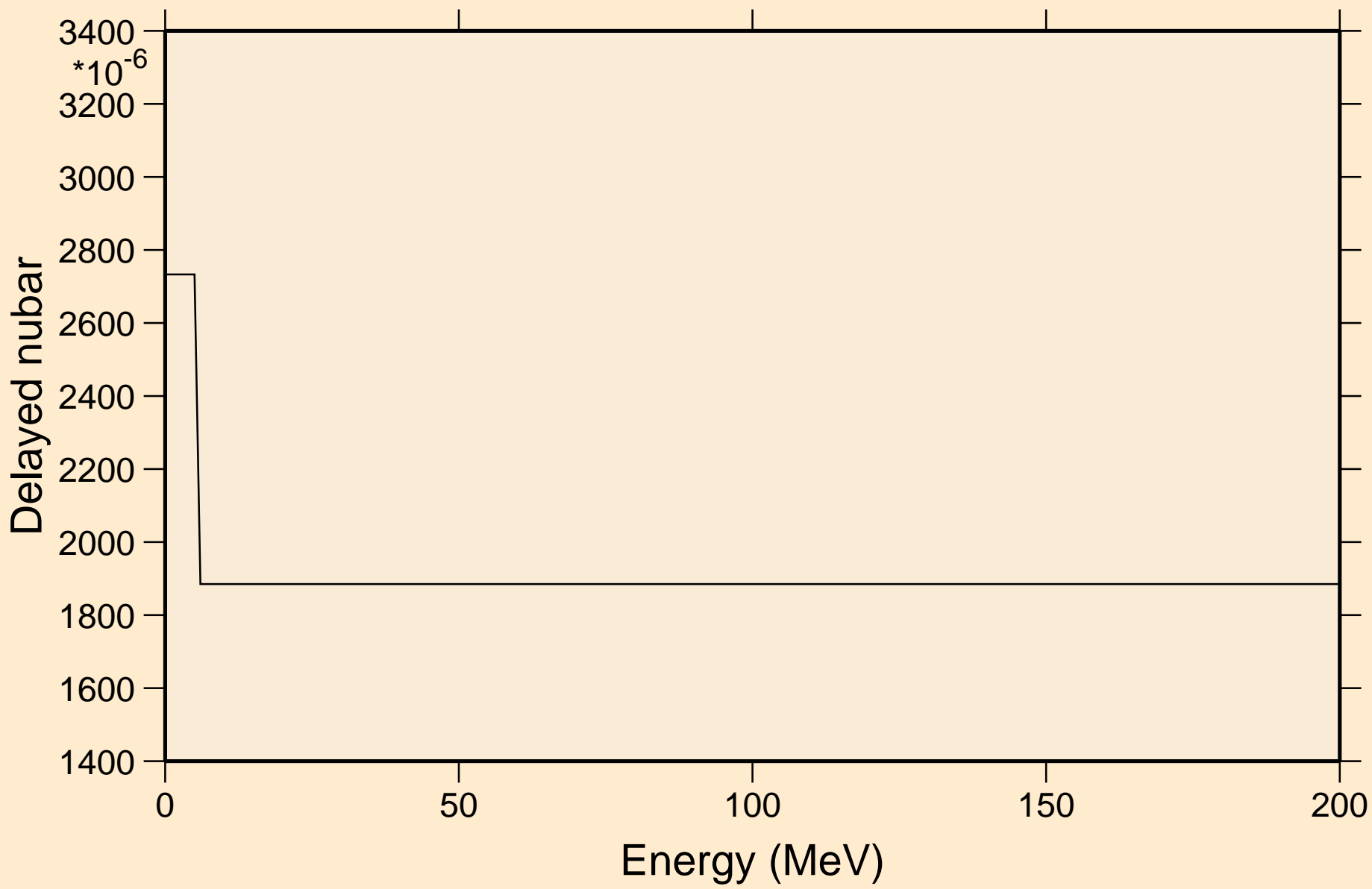

MD255 NEUTRON ACER TENDL-2019 LIBRARY; T=293.16K

Delayed neutron spectra

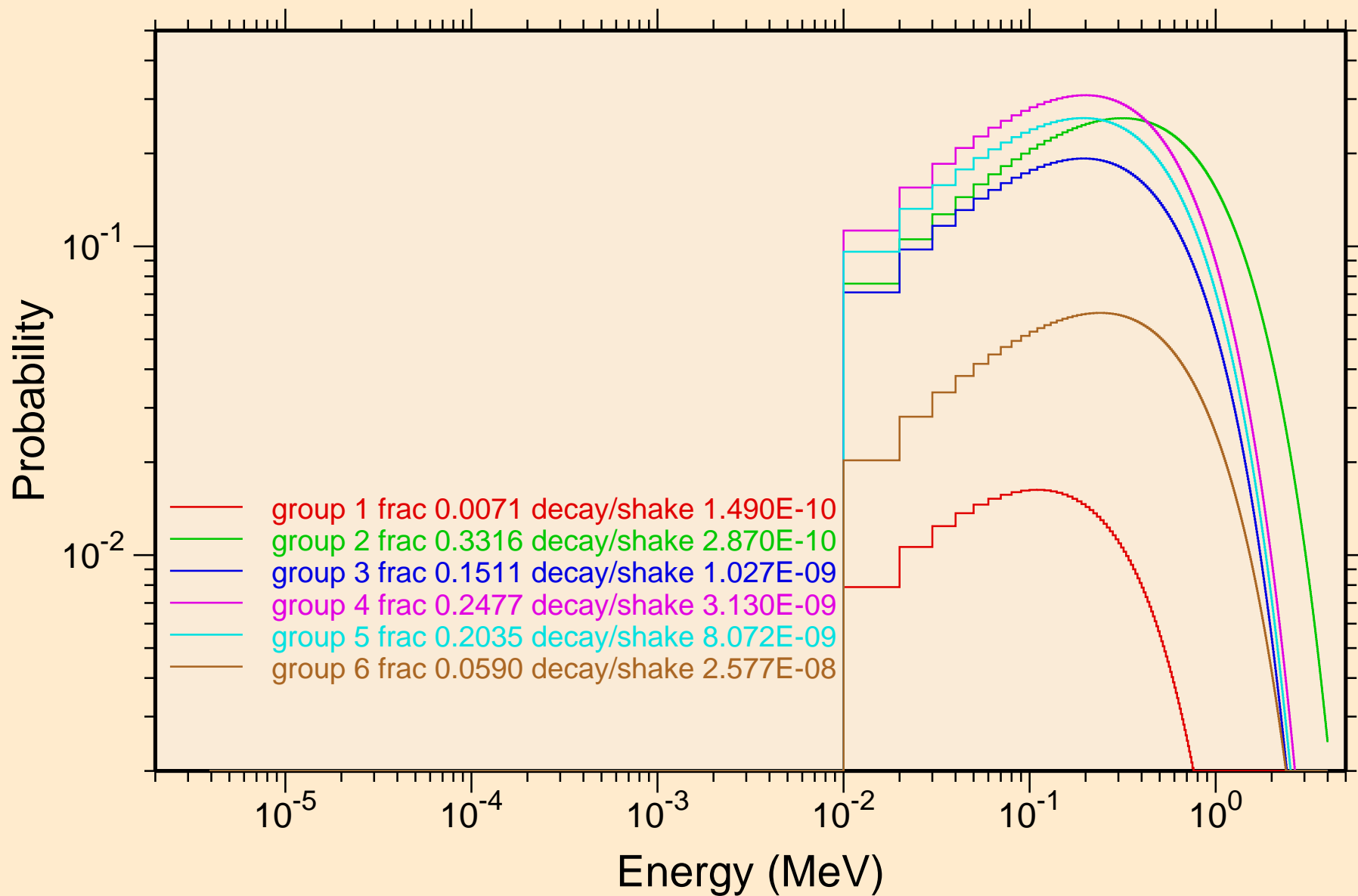

MD255 NEUTRON ACER TENDL-2019 LIBRARY; T=293.16K
Photon emission for (n,x)

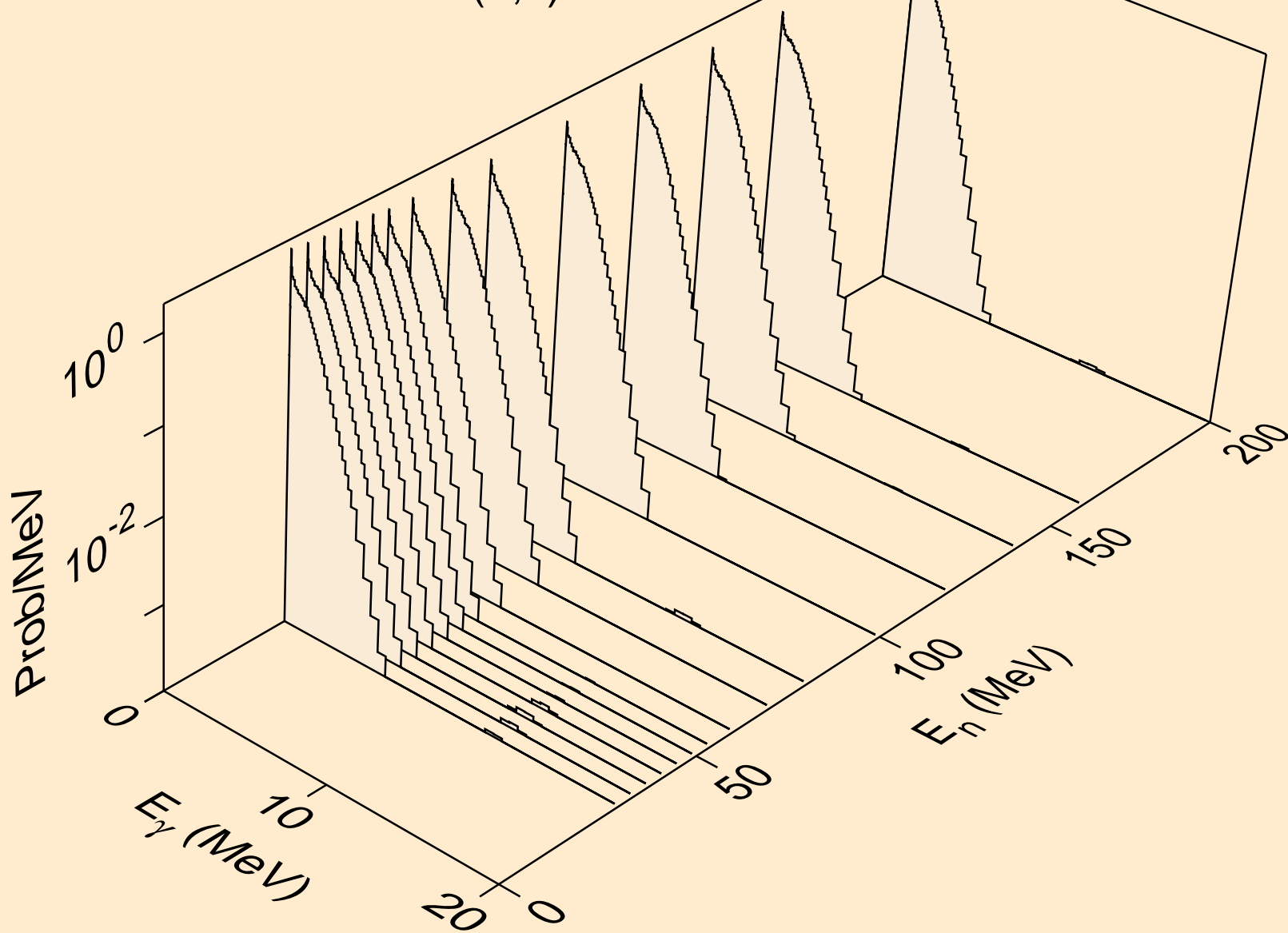

MD255 NEUTRON ACER TENDL-2019 LIBRARY; T=293.16K
Photon emission for (n,2nd)

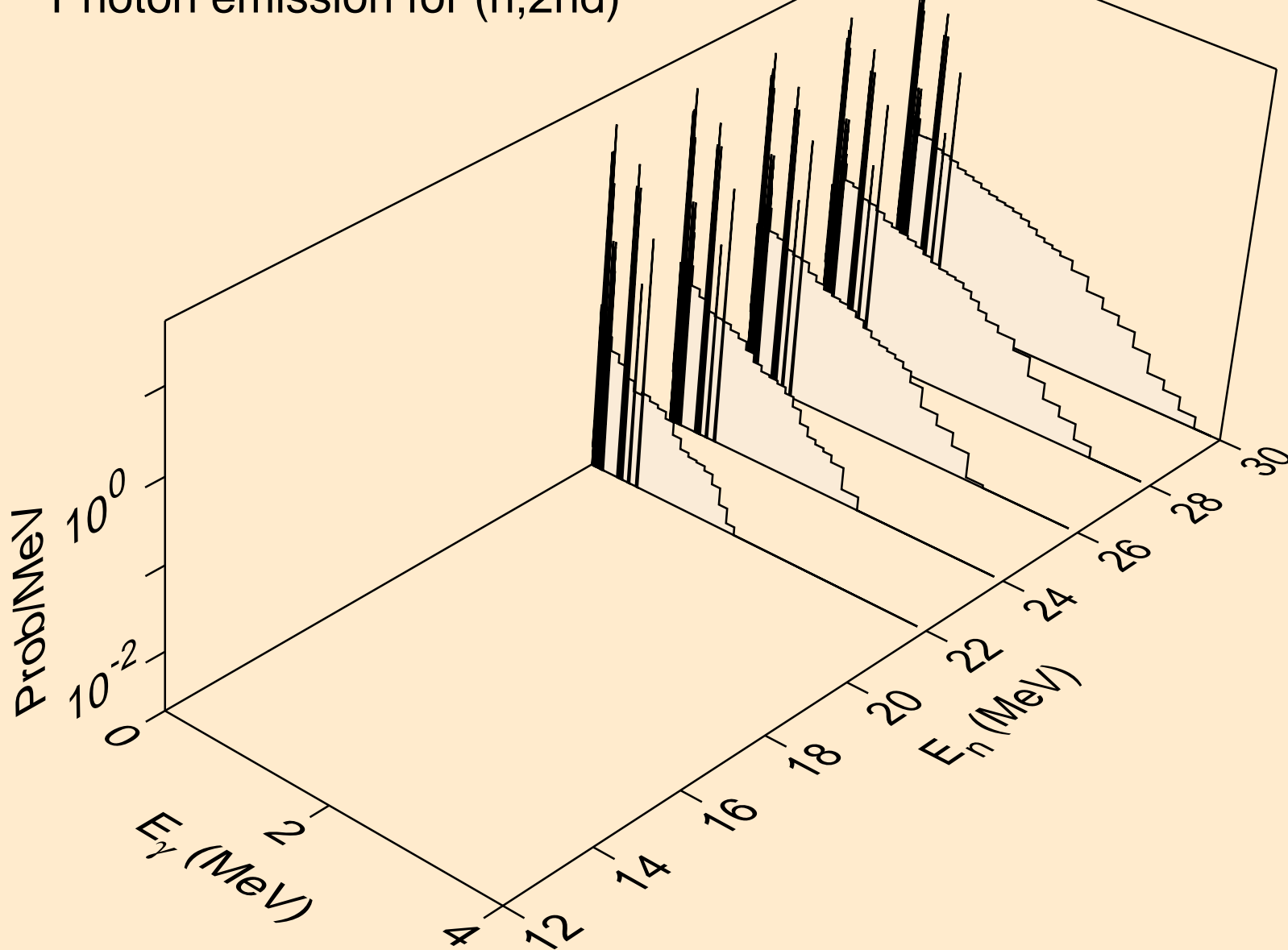

MD255 NEUTRON ACER TENDL-2019 LIBRARY; T=293.16K
Photon emission for (n,2n)

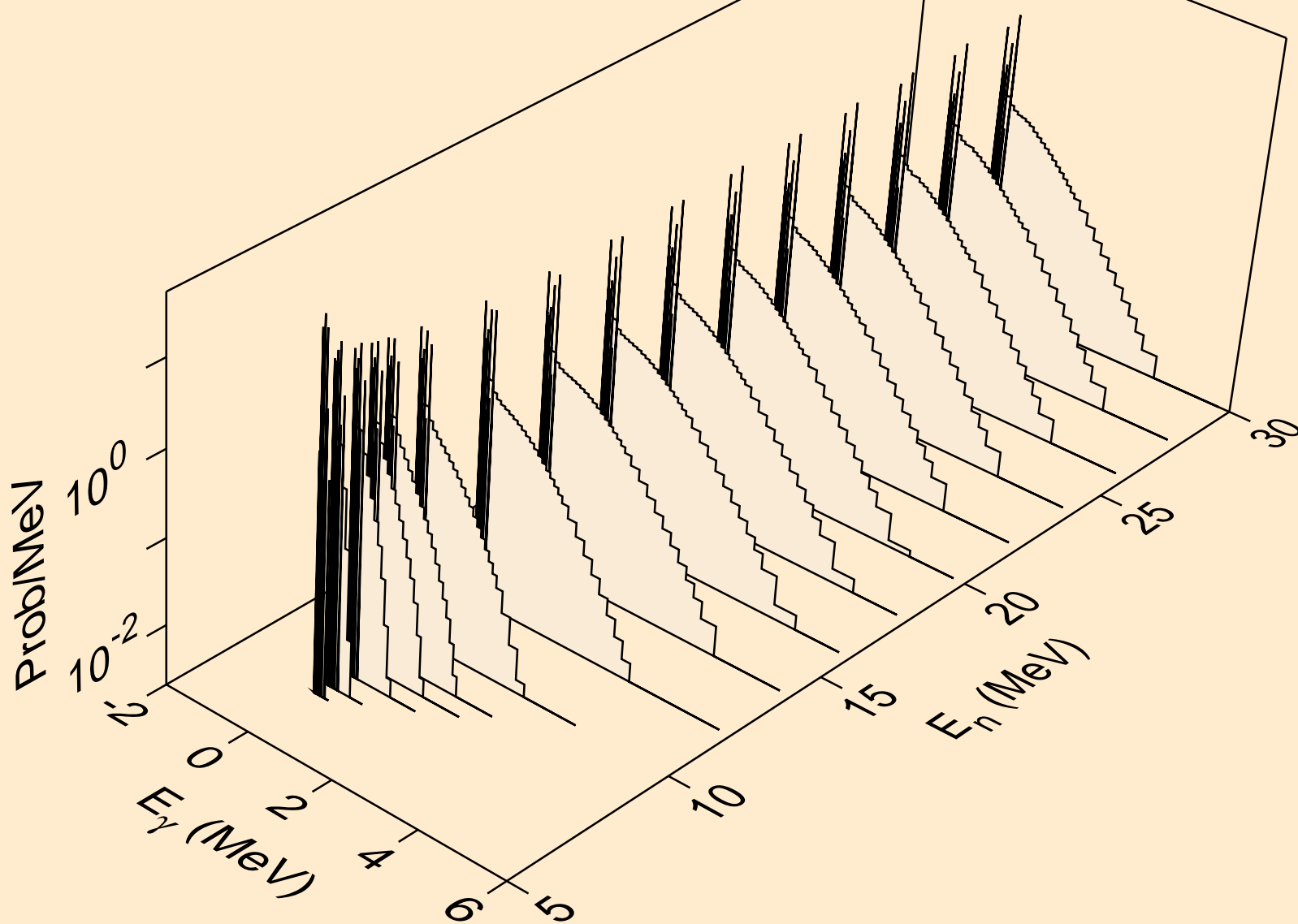

MD255 NEUTRON ACER TENDL-2019 LIBRARY; T=293.16K
Photon emission for (n,3n)

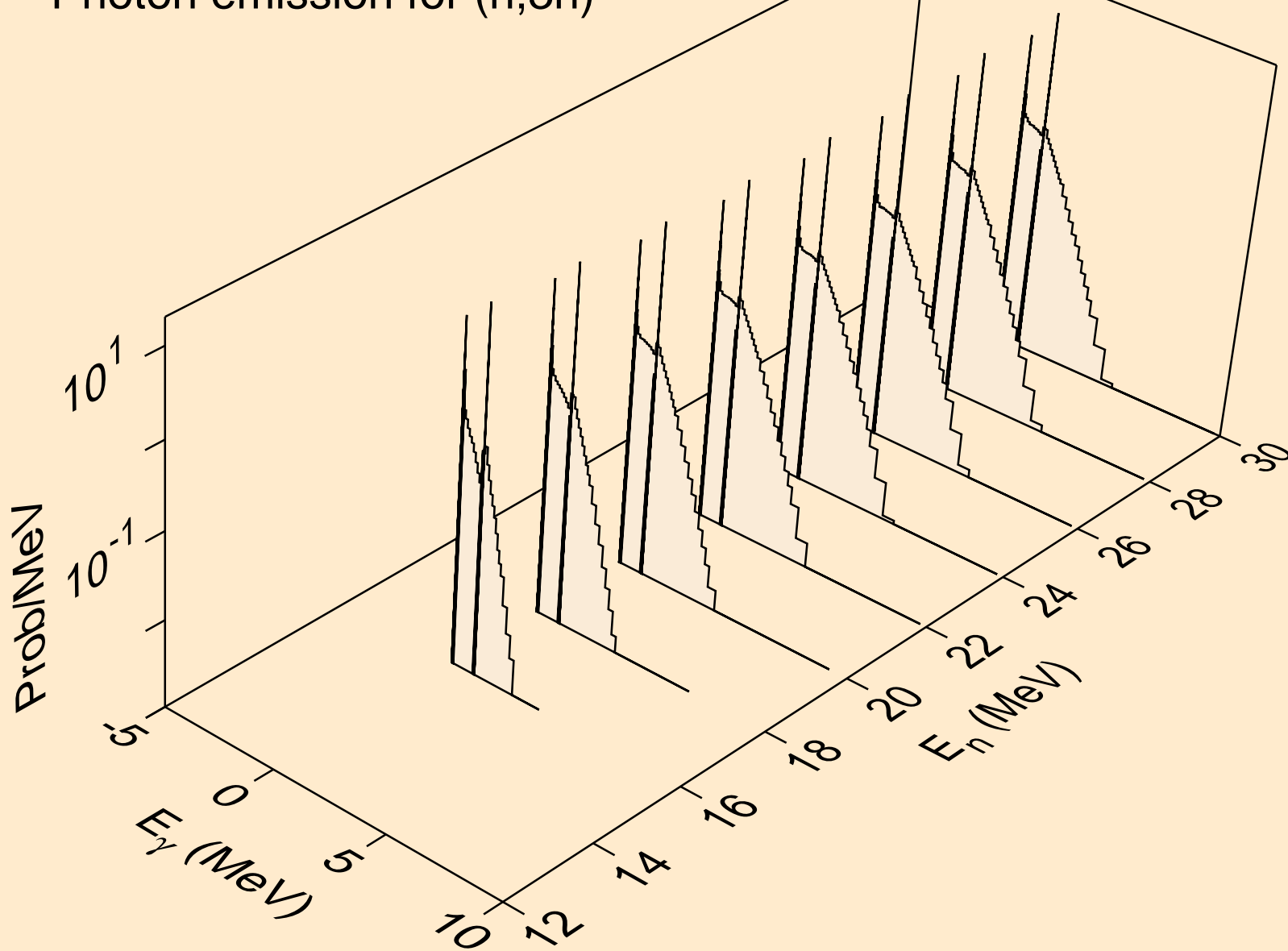

MD255 NEUTRON ACER TENDL-2019 LIBRARY; T=293.16K
Photon emission for (n,n*)a

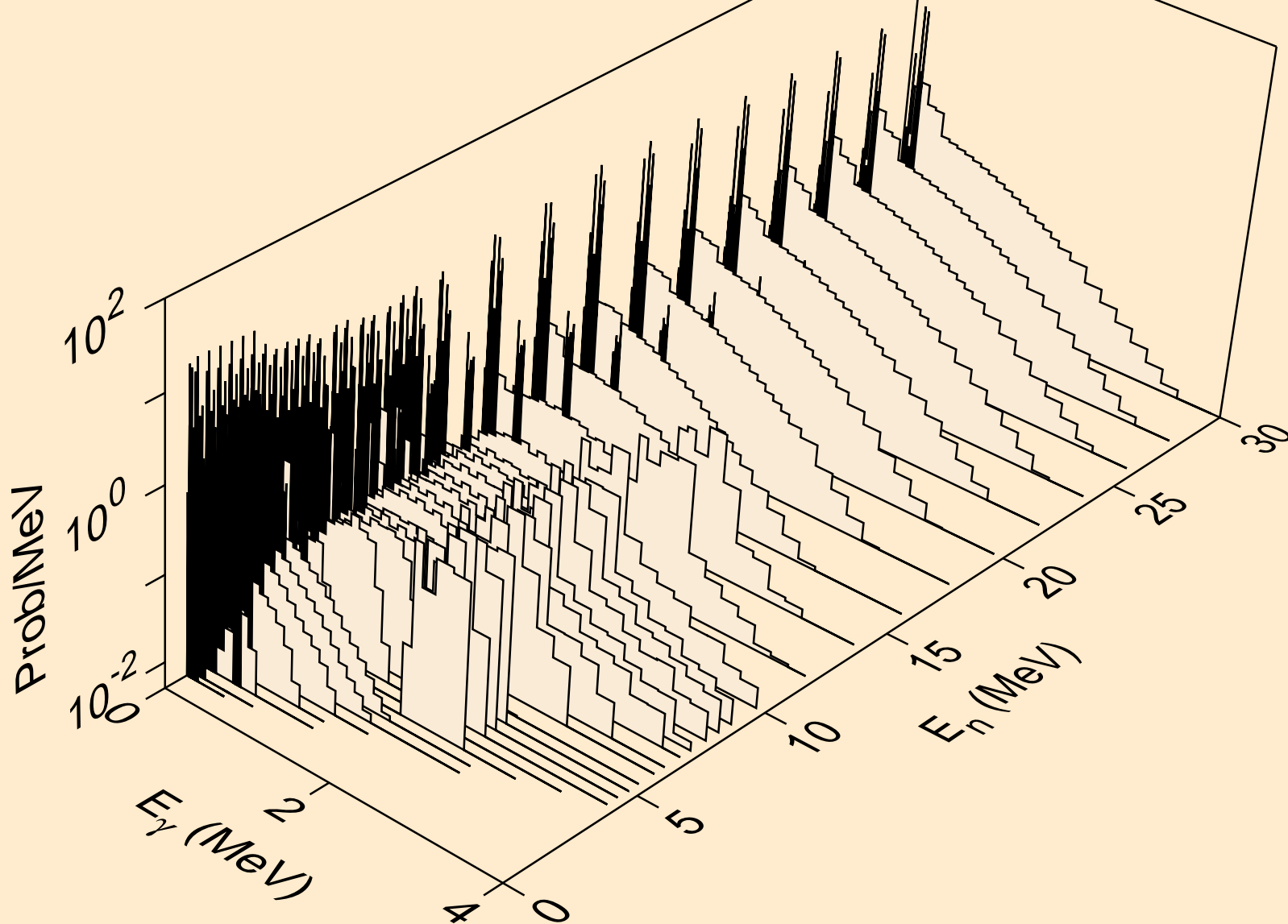

MD255 NEUTRON ACER TENDL-2019 LIBRARY; T=293.16K
Photon emission for (n,2n)a

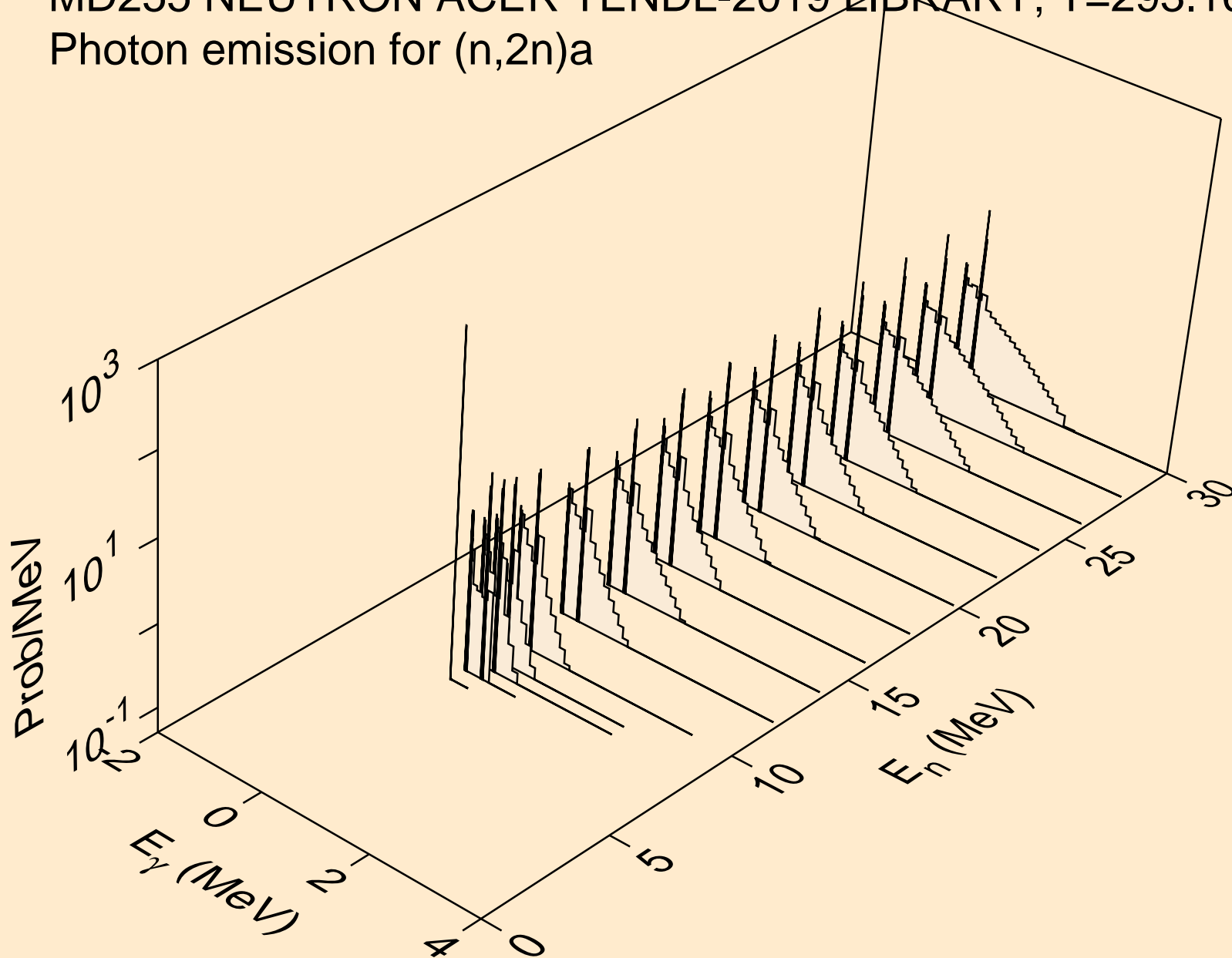

MD255 NEUTRON ACER TENDL-2019 LIBRARY; T=293.16K
Photon emission for (n,3n)a

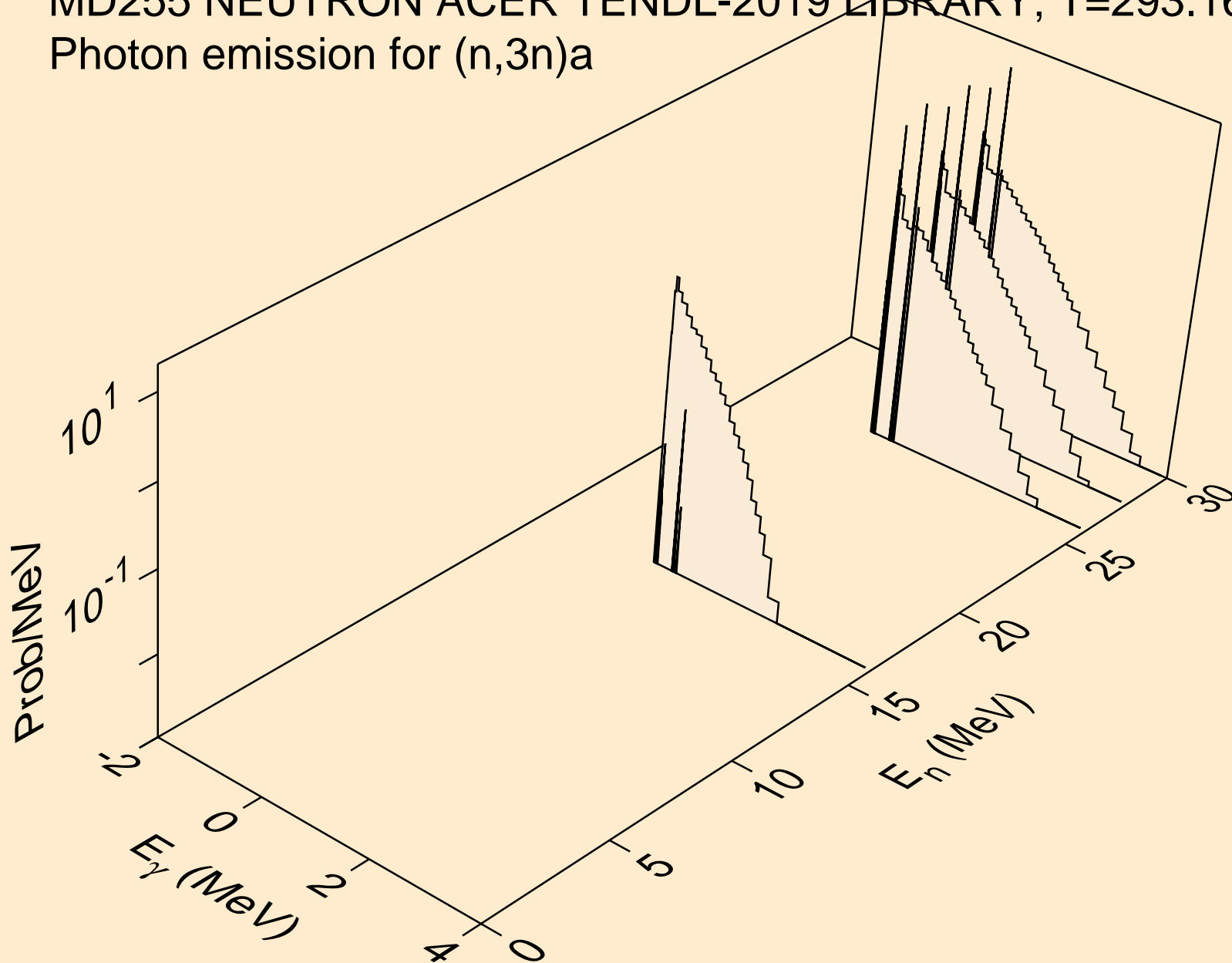

MD255 NEUTRON ACER TENDL-2019 LIBRARY; T=293.16K
Photon emission for (n,n*)p

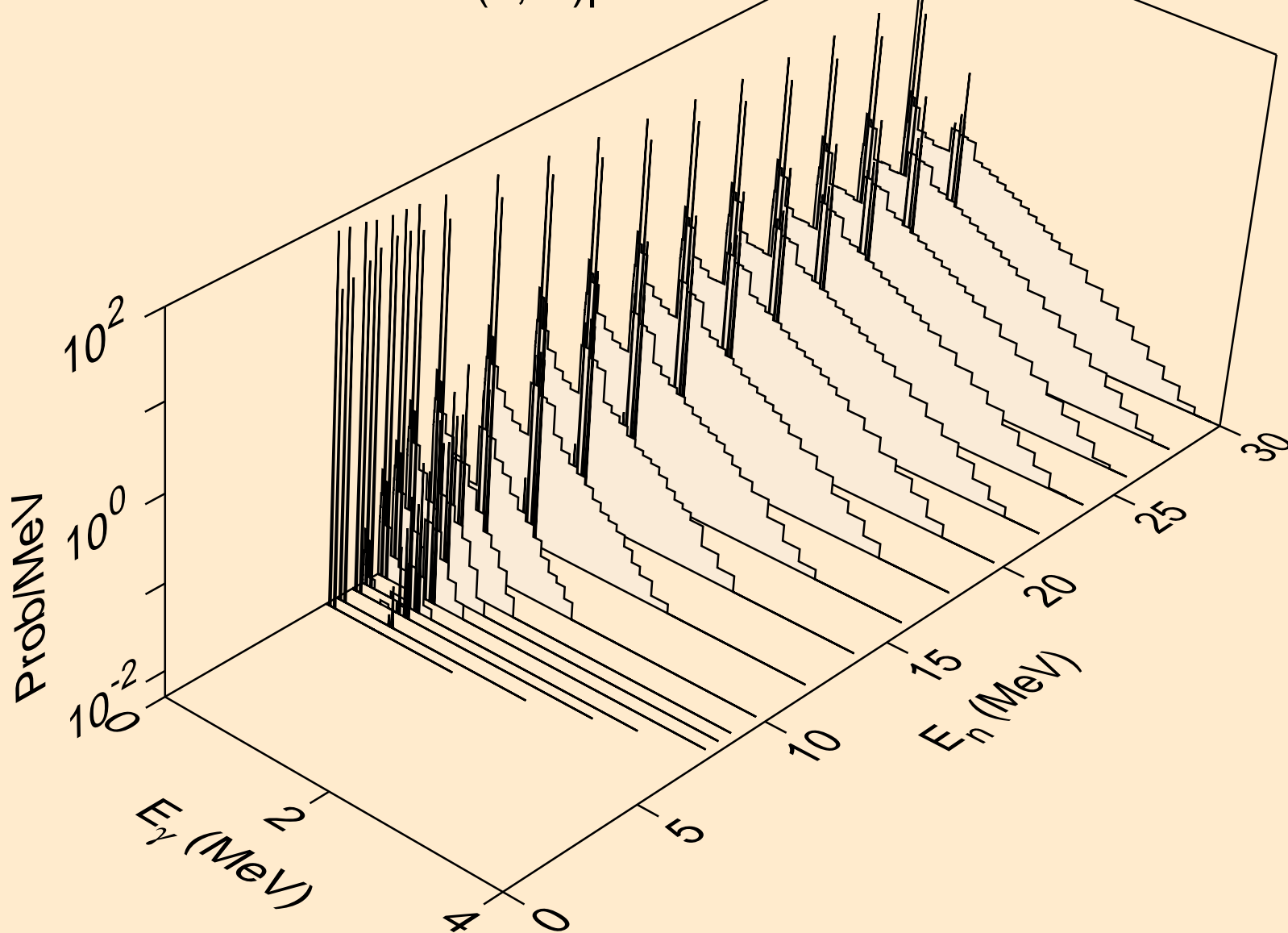

MD255 NEUTRON ACER TENDL-2019 LIBRARY; T=293.16K
Photon emission for (n,n*)2a

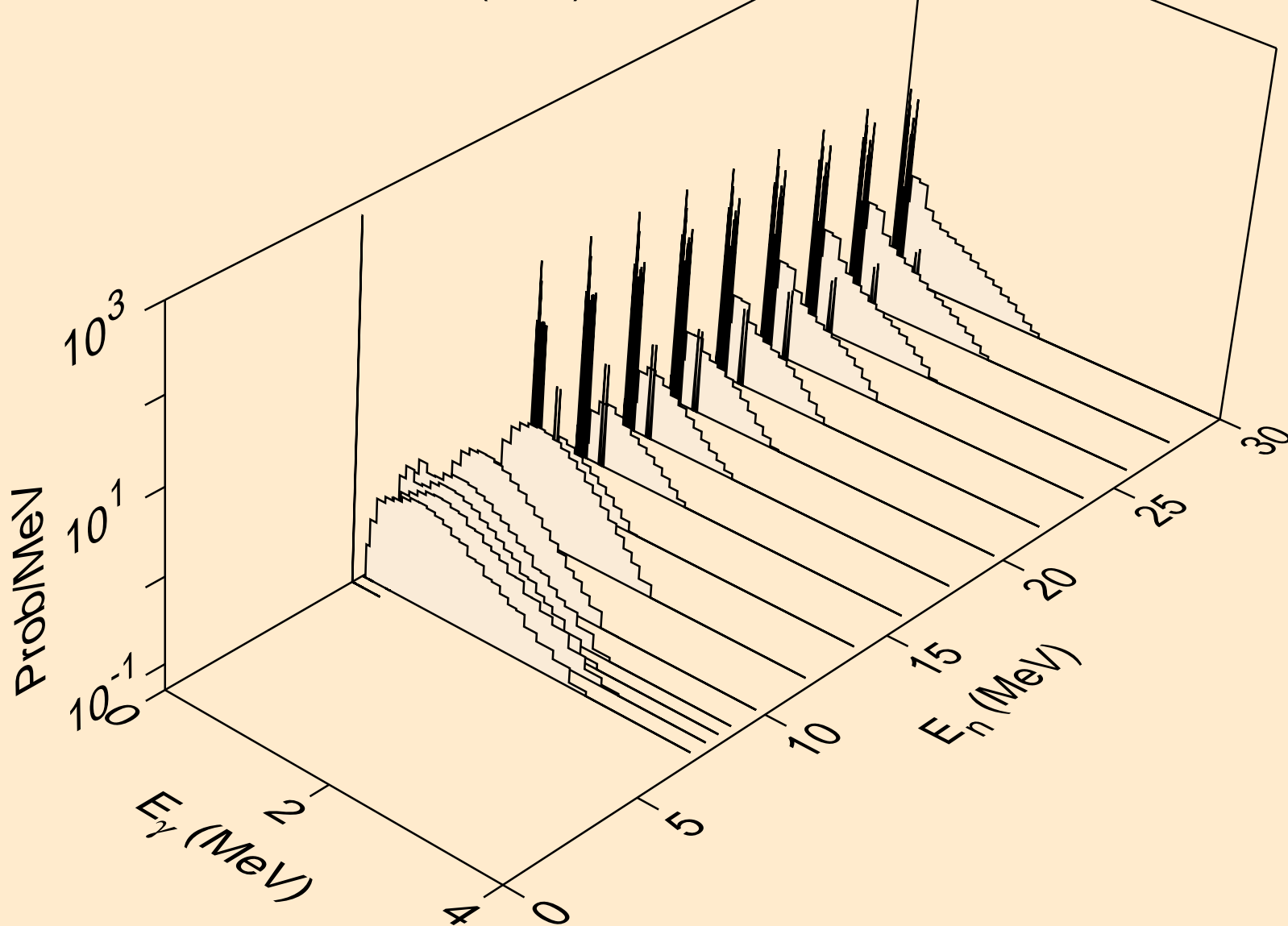

MD255 NEUTRON ACER TENDL-2019 LIBRARY; T=293.16K
Photon emission for (n,n*)d

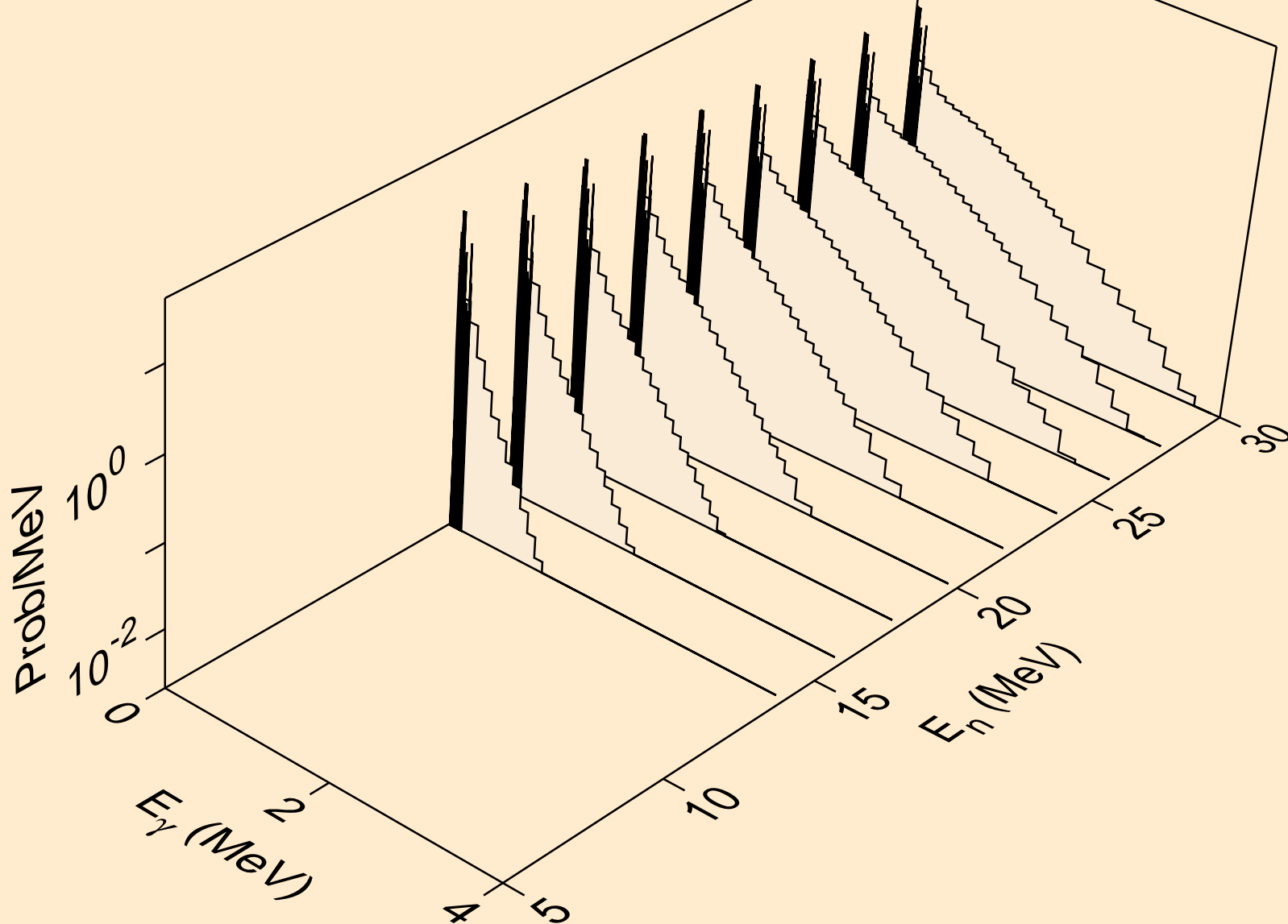

MD255 NEUTRON ACER TENDL-2019 LIBRARY; T=293.16K
Photon emission for (n,n*)t

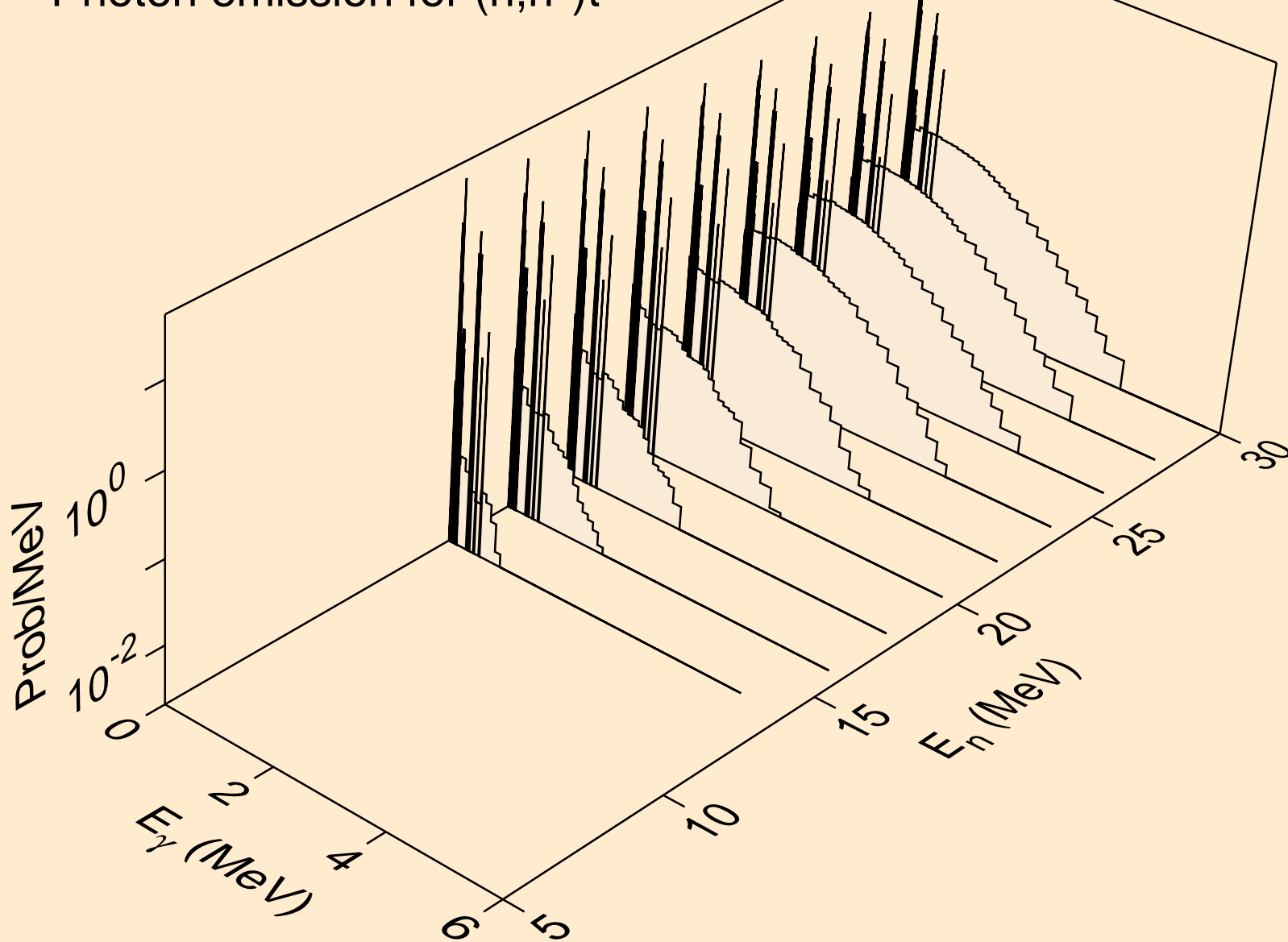

MD255 NEUTRON ACER TENDL-2019 LIBRARY; T=293.16K
Photon emission for (n,n*)he3

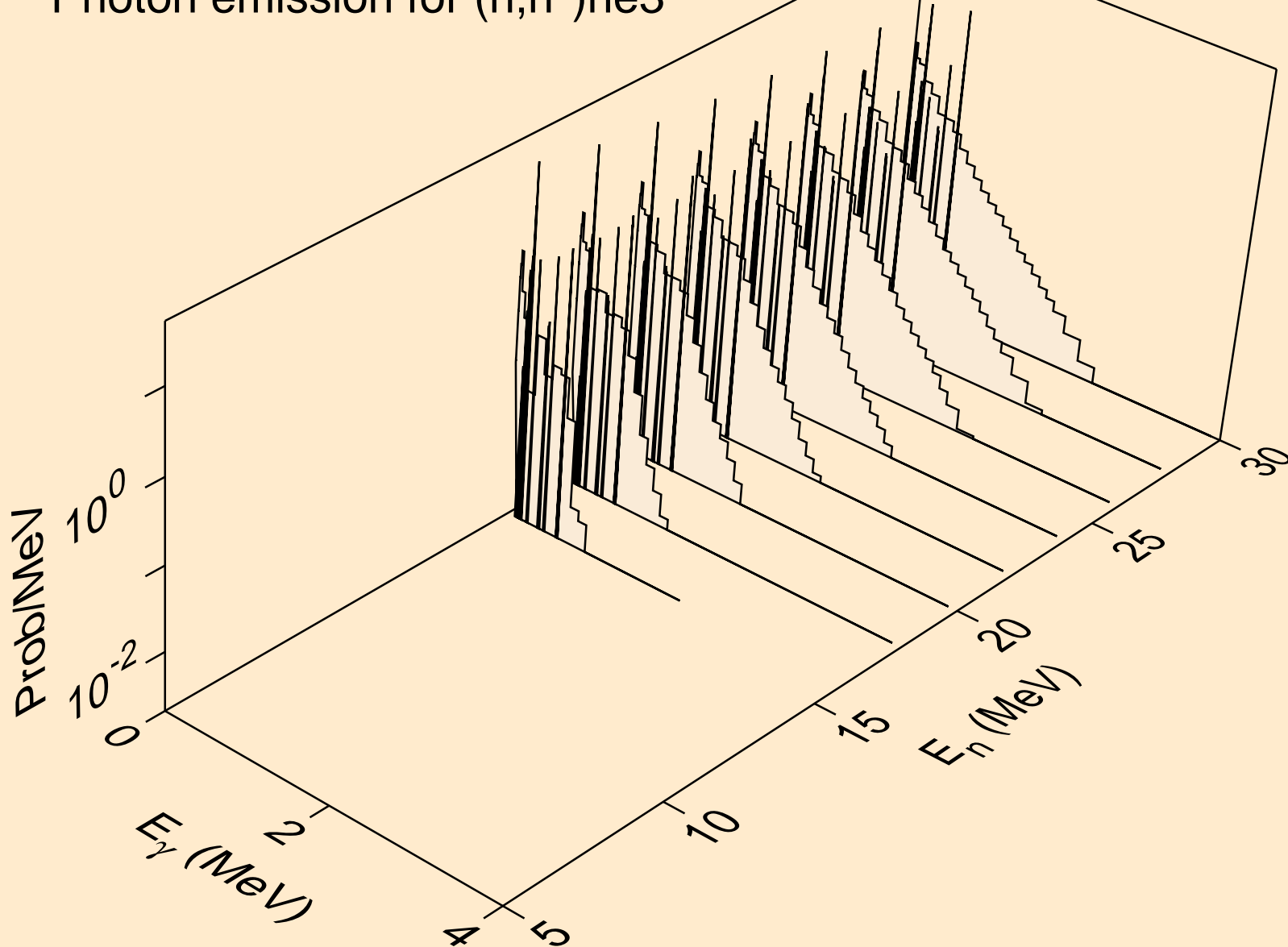

MD255 NEUTRON ACER TENDL-2019 LIBRARY; T=293.16K
Photon emission for (n,4n)

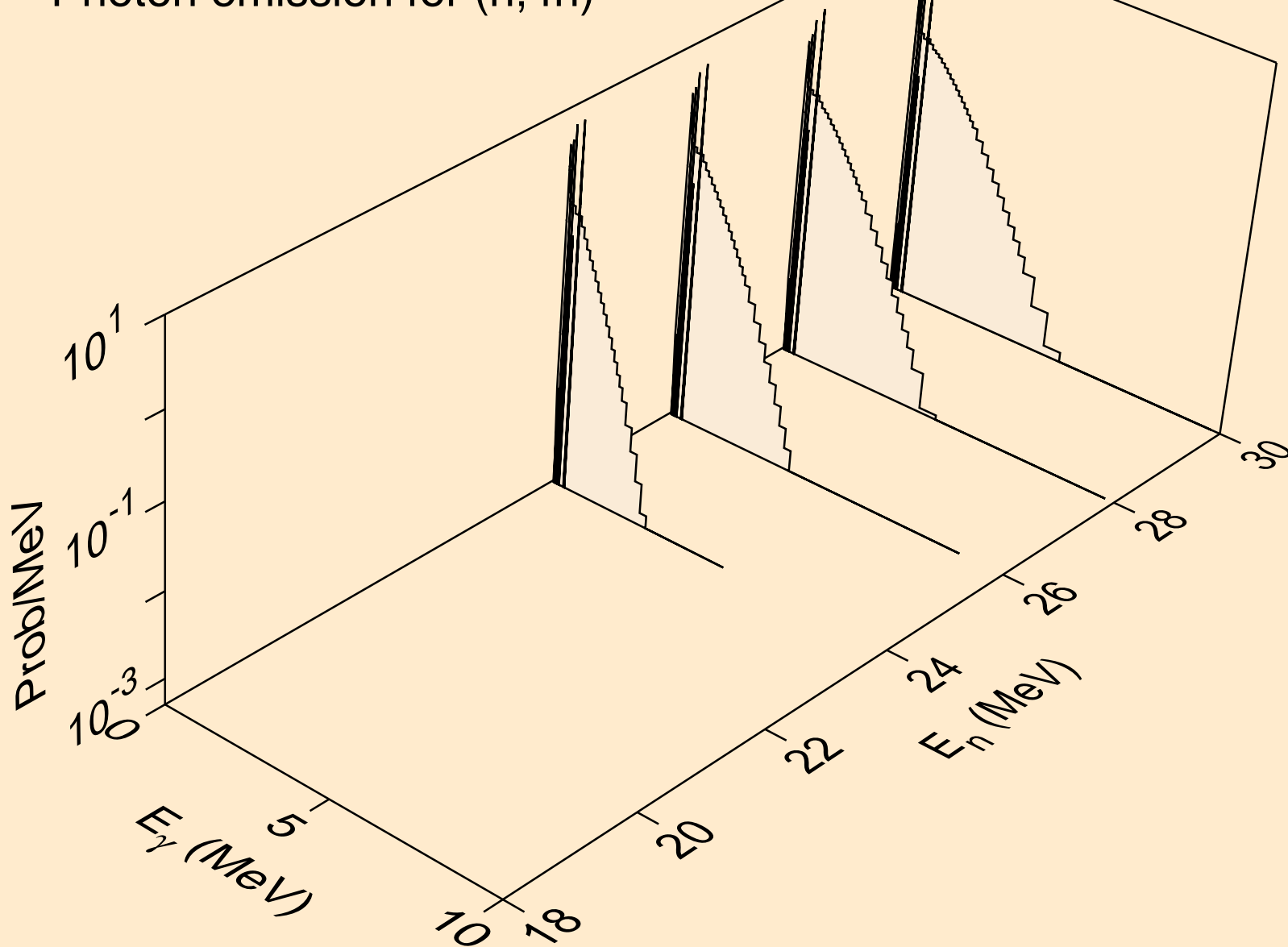

MD255 NEUTRON ACER TENDL-2019 LIBRARY; T=293.16K
Photon emission for (n,2np)

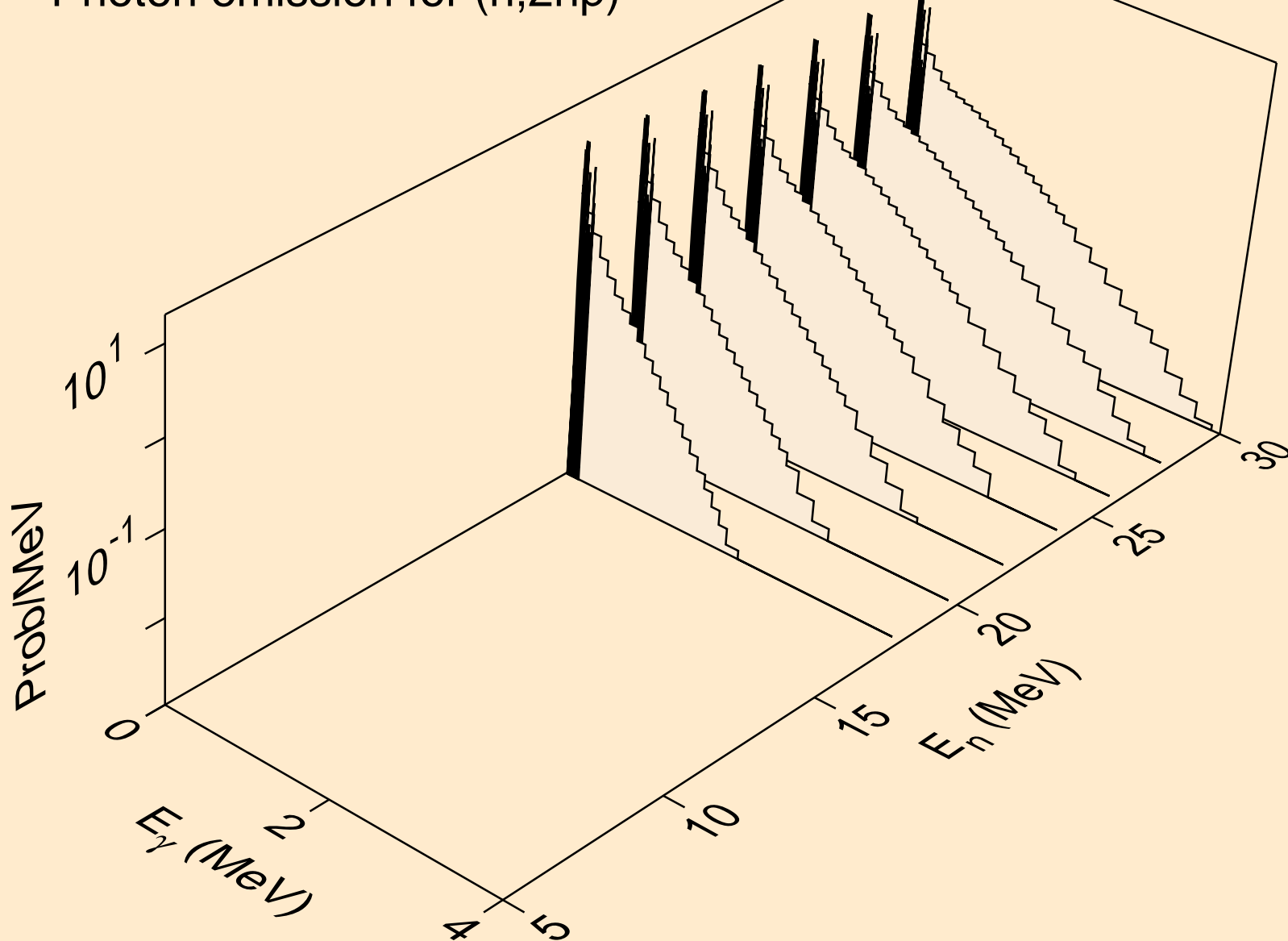

MD255 NEUTRON ACER TENDL-2019 LIBRARY; T=293.16K
Photon emission for (n,3np)

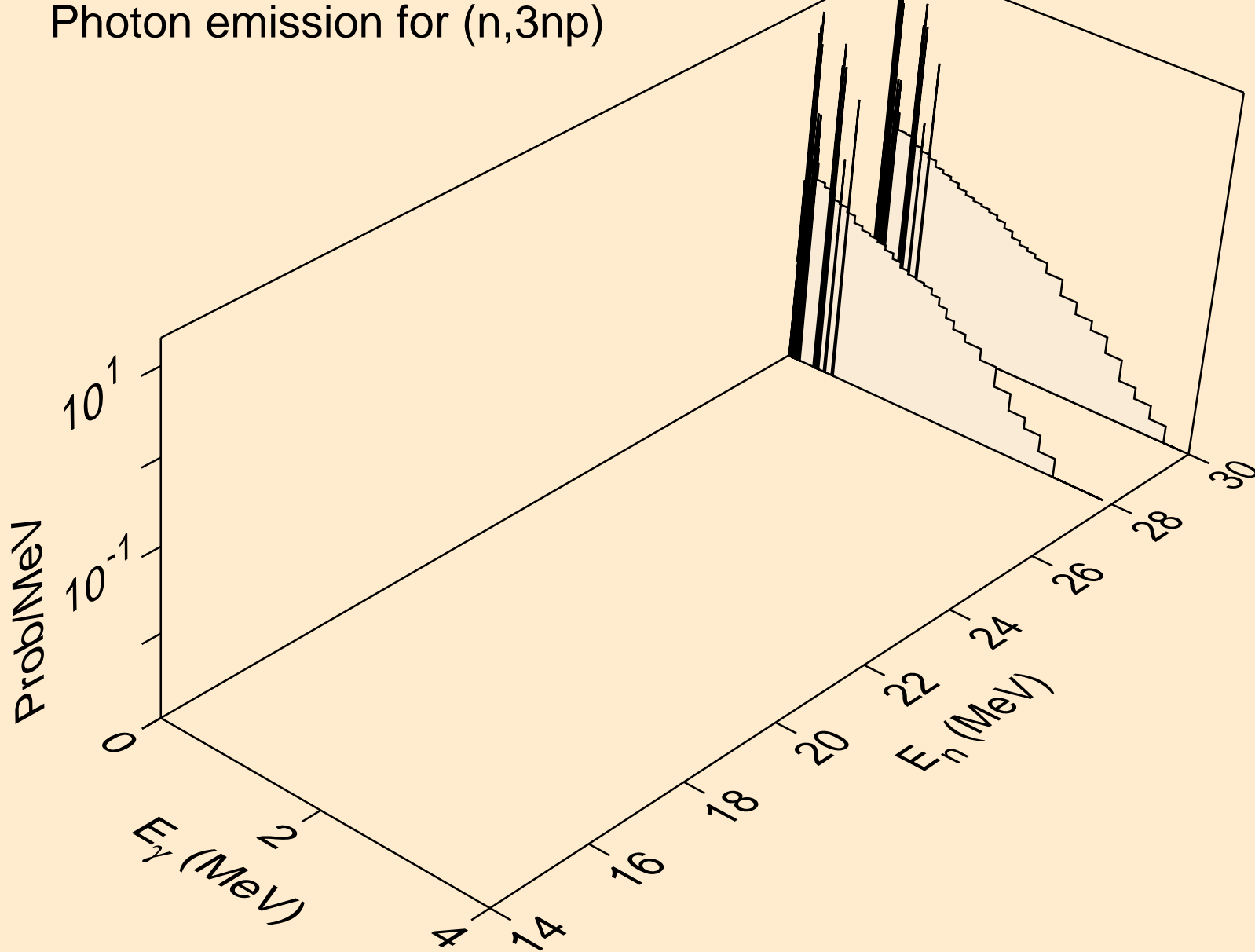

MD255 NEUTRON ACER TENDL-2019 LIBRARY; T=293.16K
Photon emission for (n,2np)

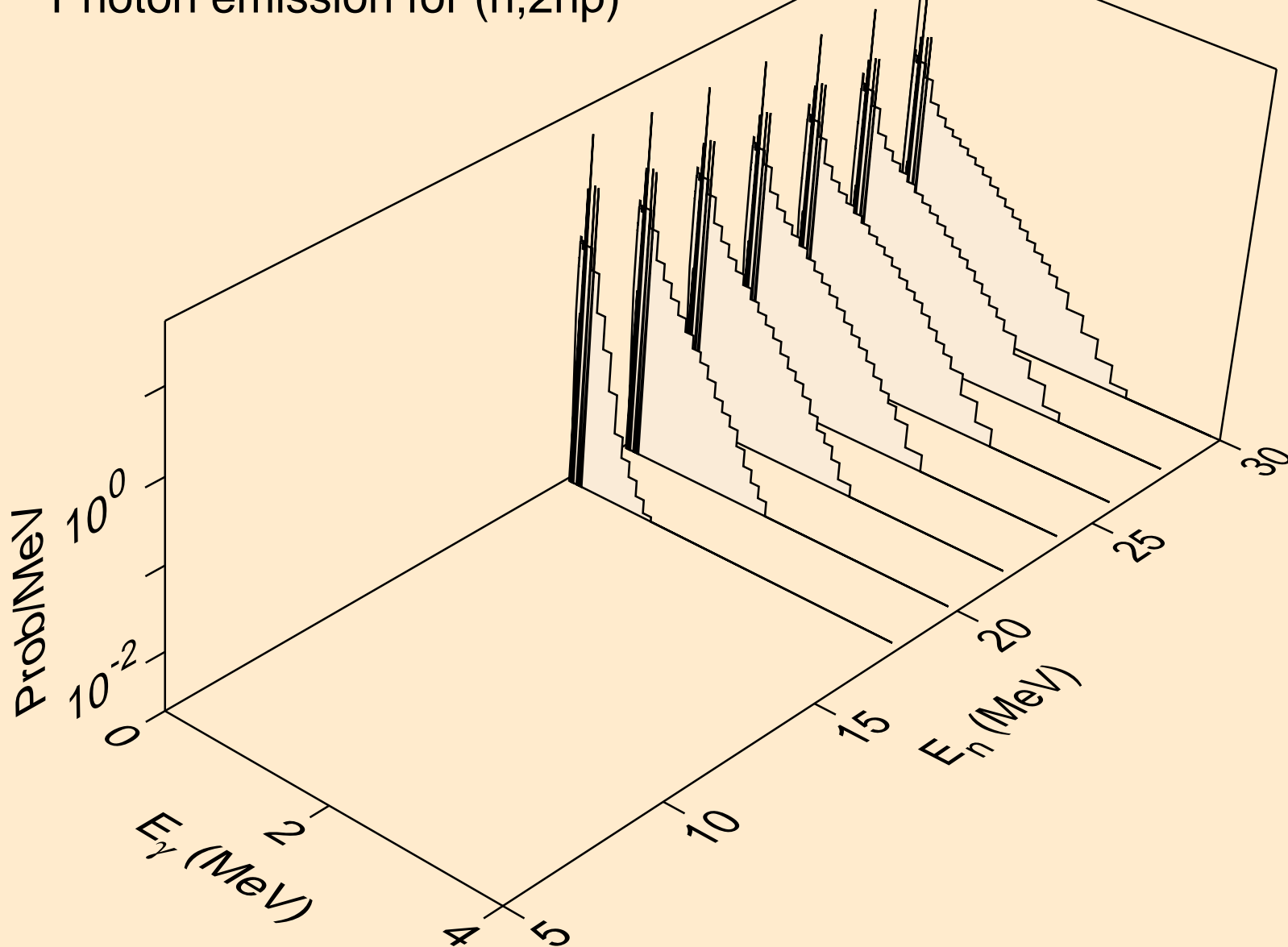

MD255 NEUTRON ACER TENDL-2019 LIBRARY; T=293.16K
Photon emission for (n,npa)

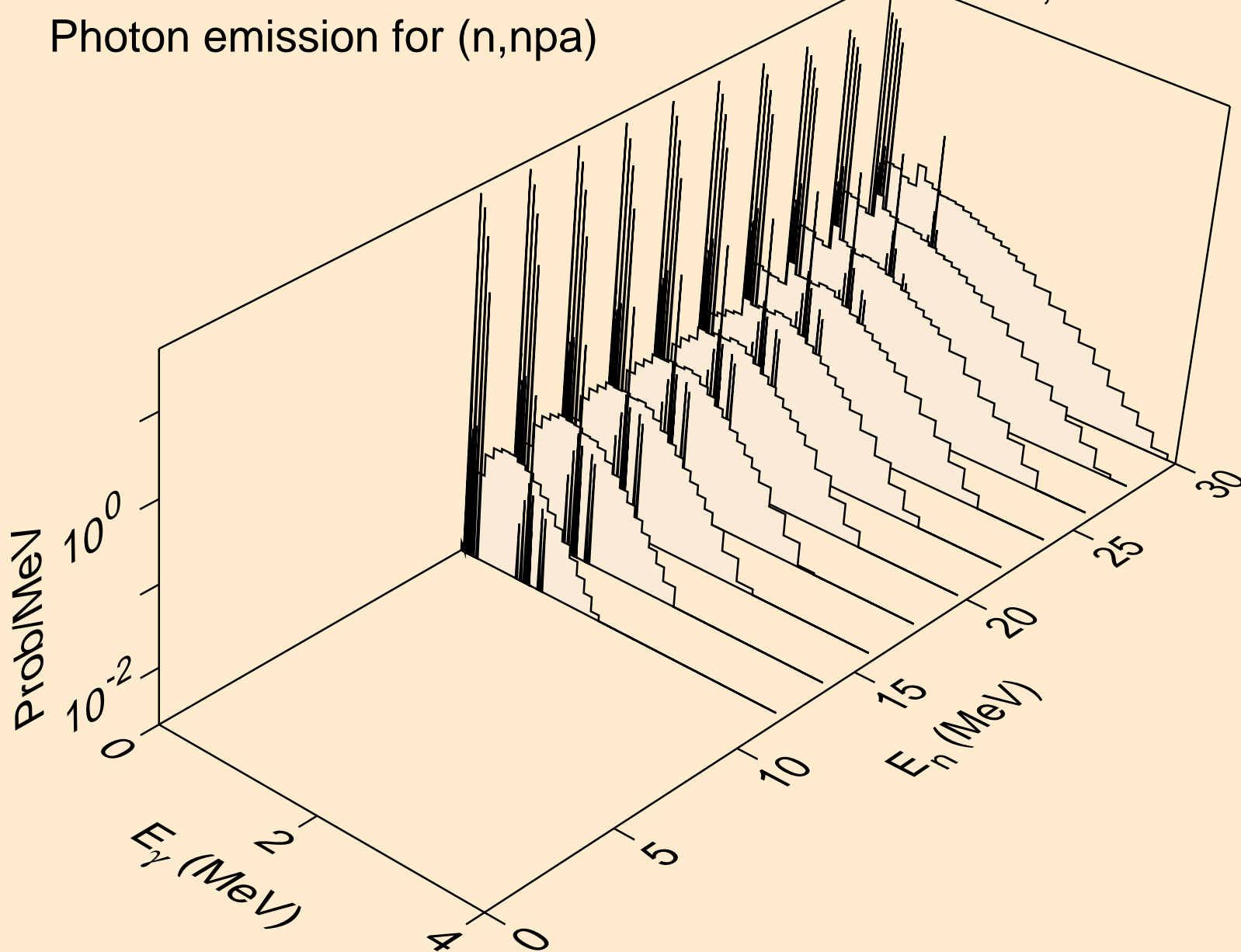

MD255 NEUTRON ACER TENDL-2019 LIBRARY; T=293.16K
Photon emission for (n,n*c)

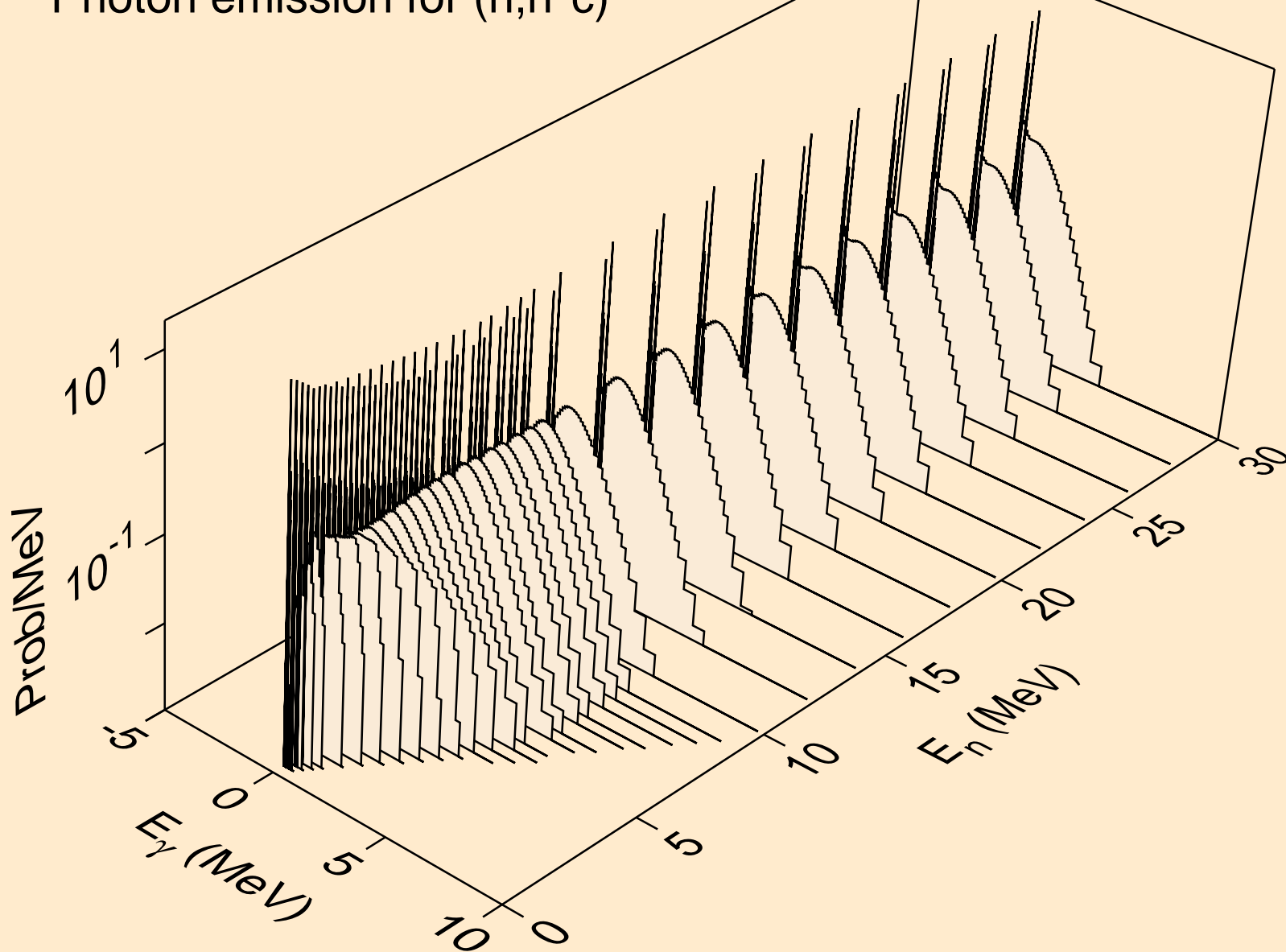

MD255 NEUTRON ACER TENDL-2019 LIBRARY; T=293.16K
Photon emission for (n,gma)

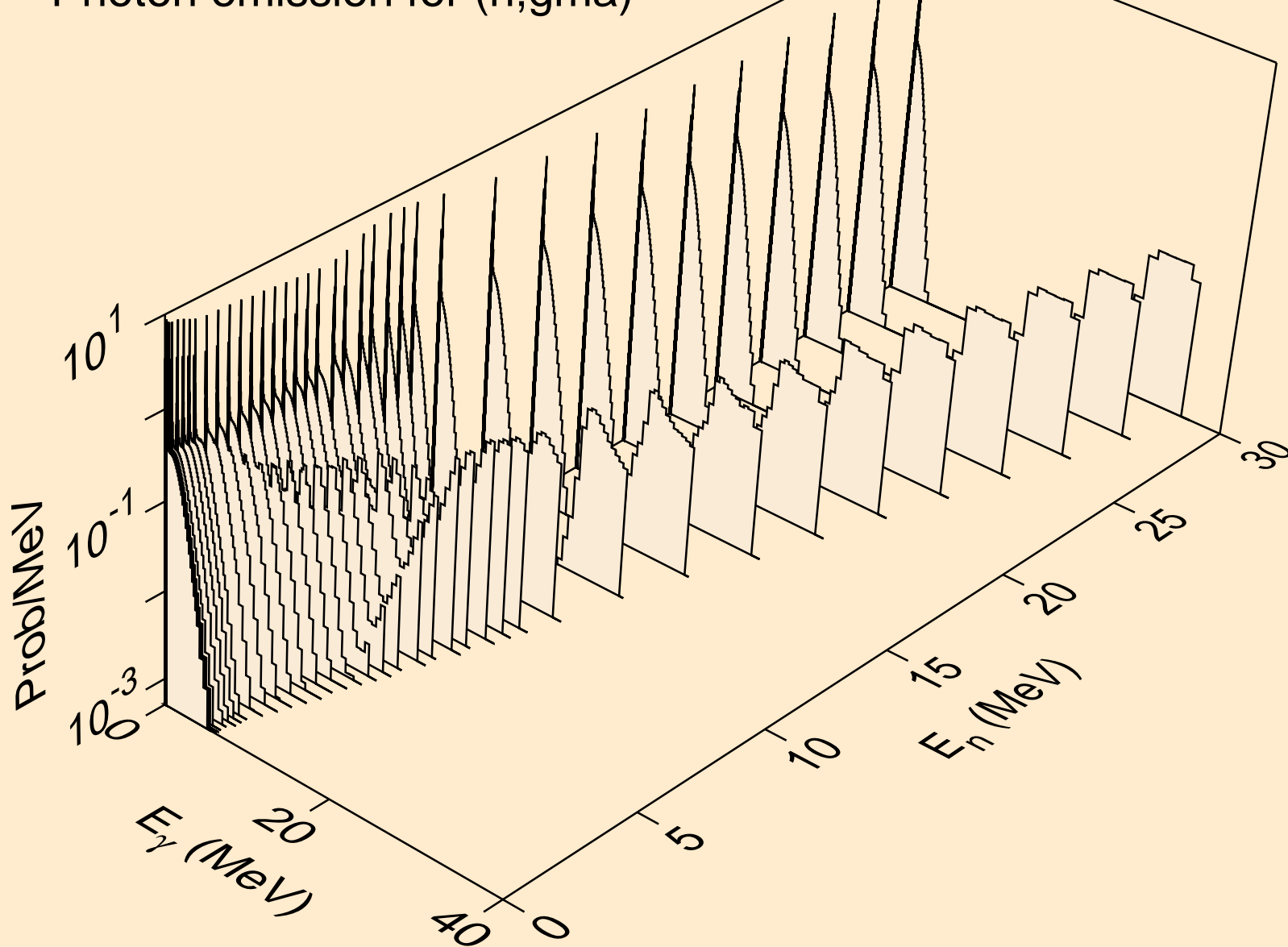

MD255 NEUTRON ACER TENDL-2019 LIBRARY; T=293.16K
Photon emission for (n,p)

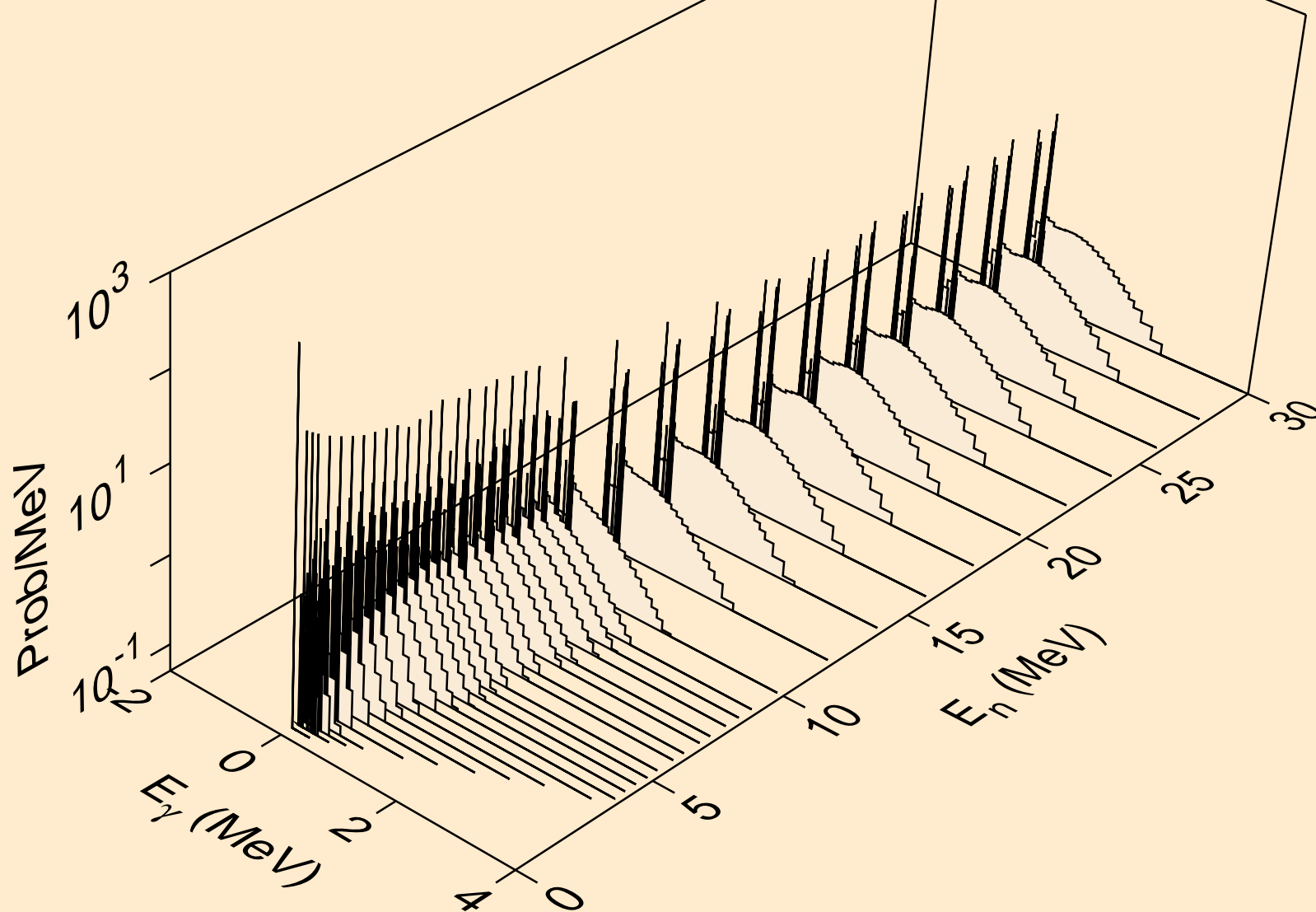

MD255 NEUTRON ACER TENDL-2019 LIBRARY; T=293.16K
Photon emission for (n,d)

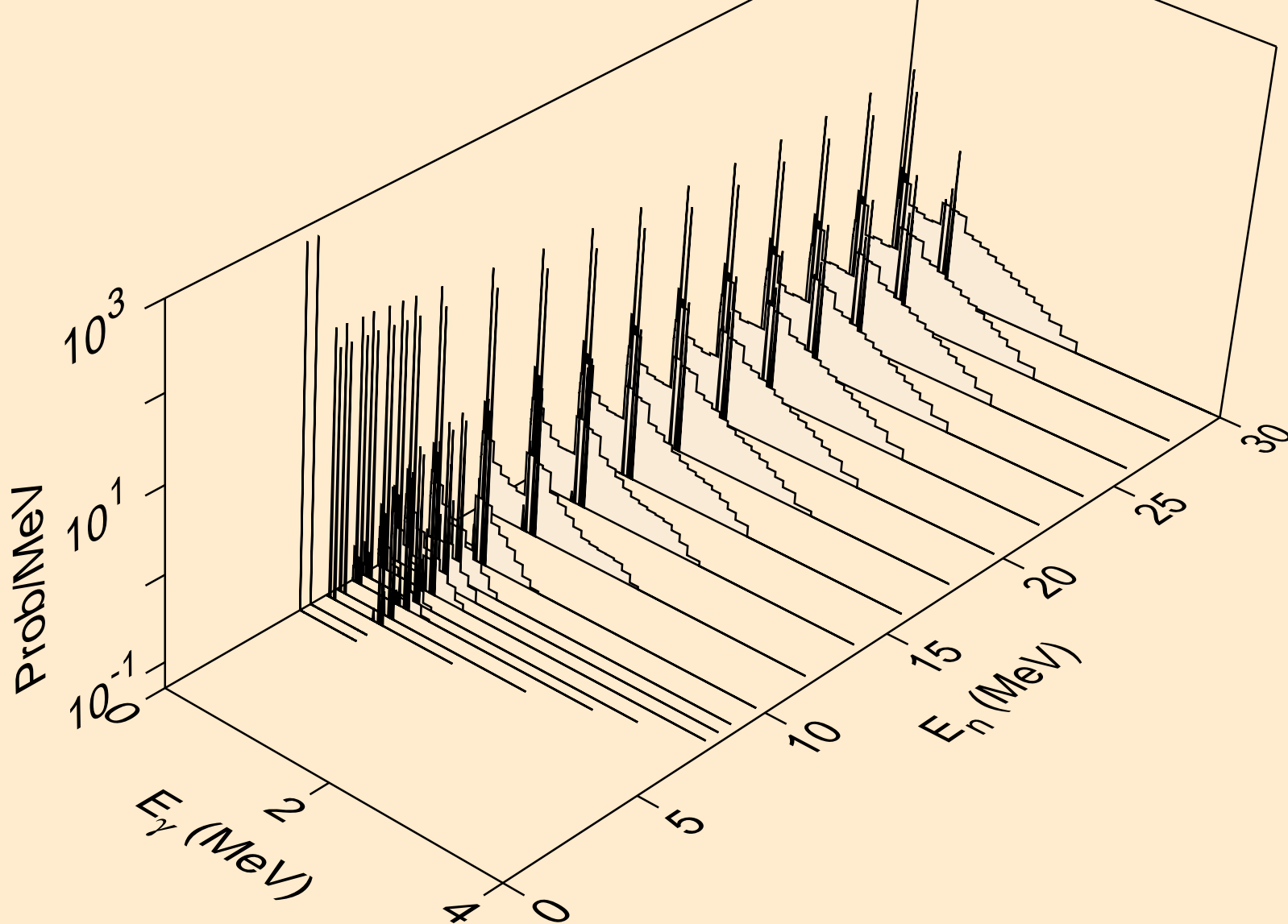

MD255 NEUTRON ACER TENDL-2019 LIBRARY; T=293.16K
Photon emission for (n,t)

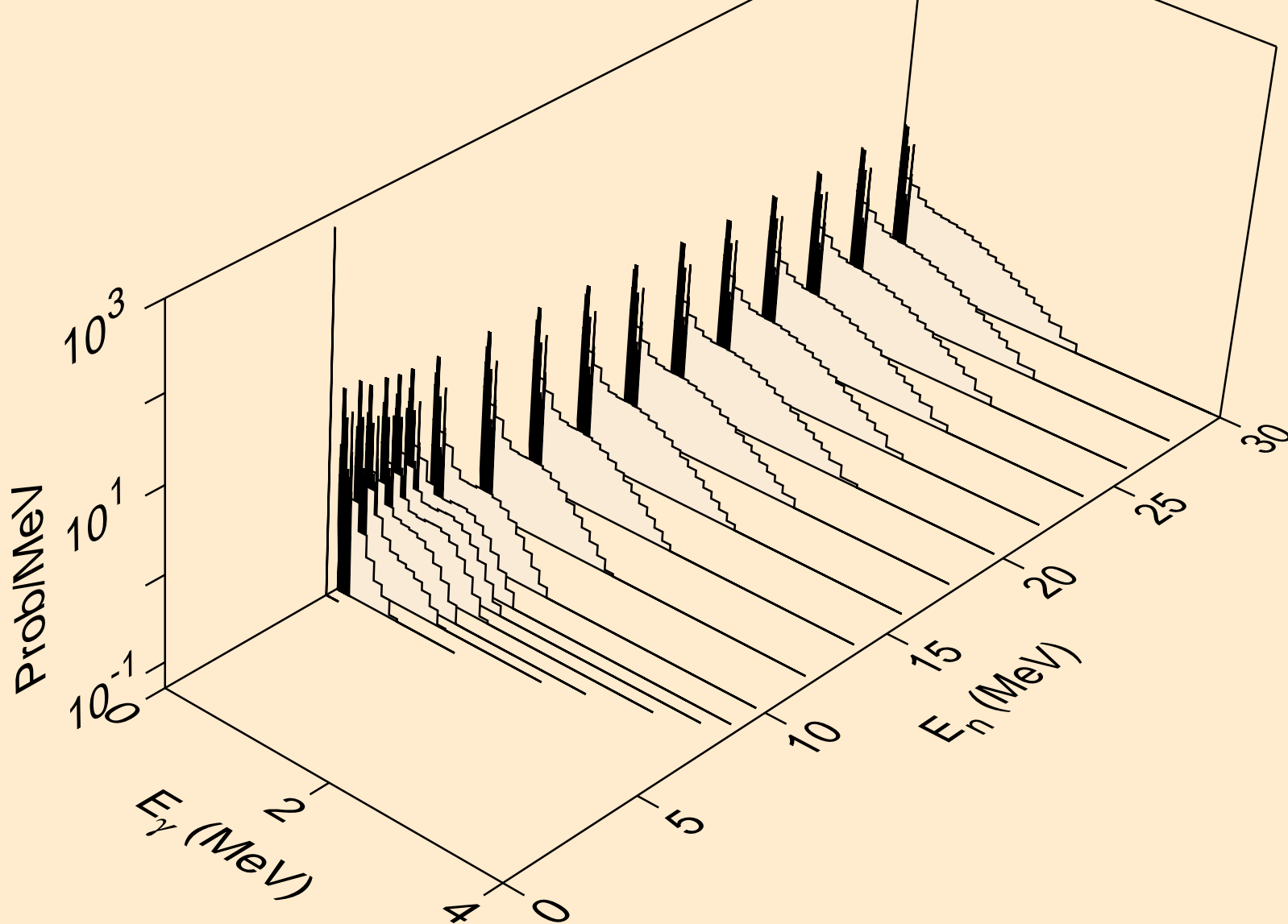

MD255 NEUTRON ACER TENDL-2019 LIBRARY; T=293.16K
Photon emission for (n,he3)

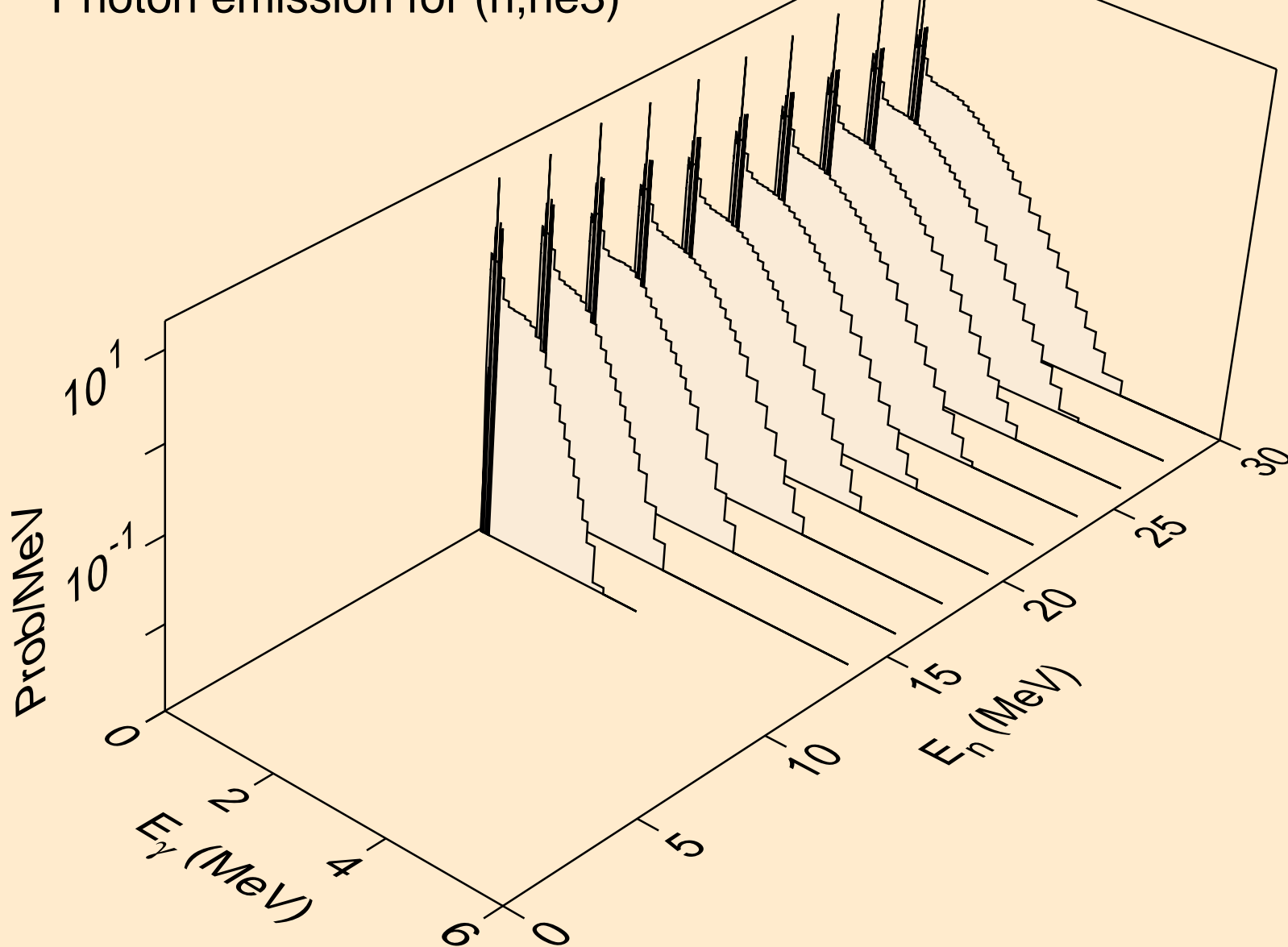

MD255 NEUTRON ACER TENDL-2019 LIBRARY; T=293.16K
Photon emission for (n,a)

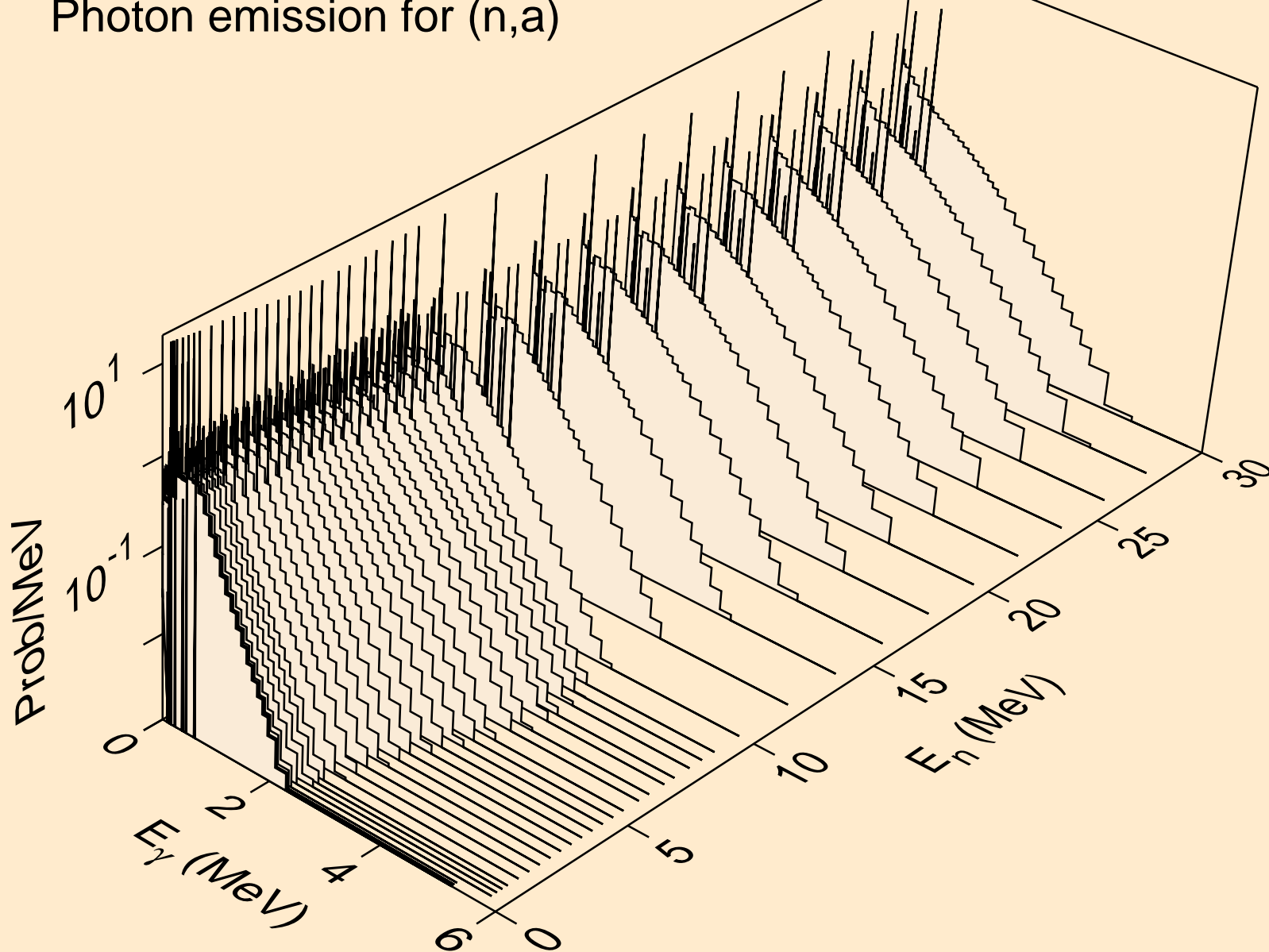

MD255 NEUTRON ACER TENDL-2019 LIBRARY; T=293.16K
Photon emission for (n,2a)

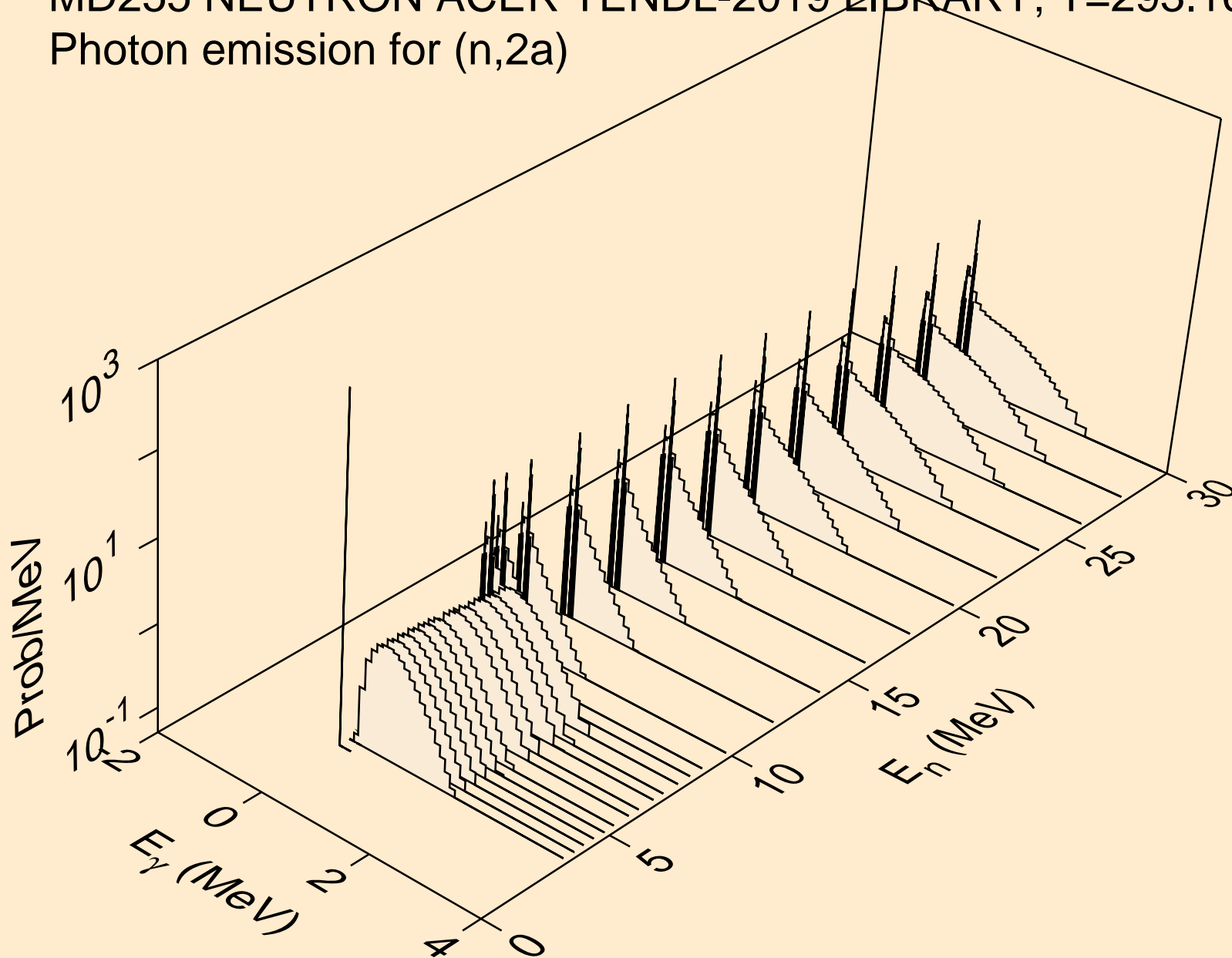

MD255 NEUTRON ACER TENDL-2019 LIBRARY; T=293.16K
Photon emission for (n,2p)

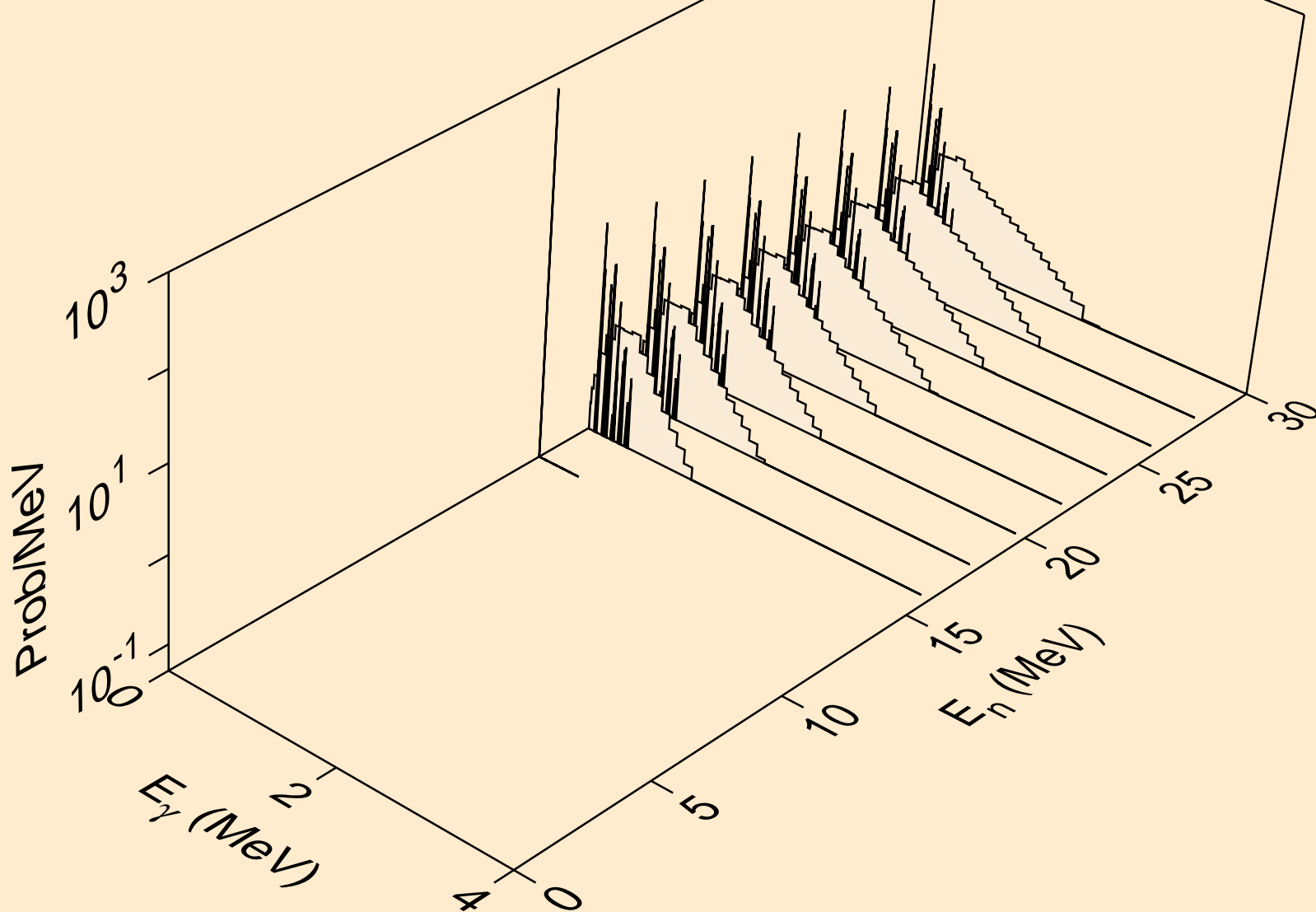

MD255 NEUTRON ACER TENDL-2019 LIBRARY; T=293.16K
Photon emission for (n,p)

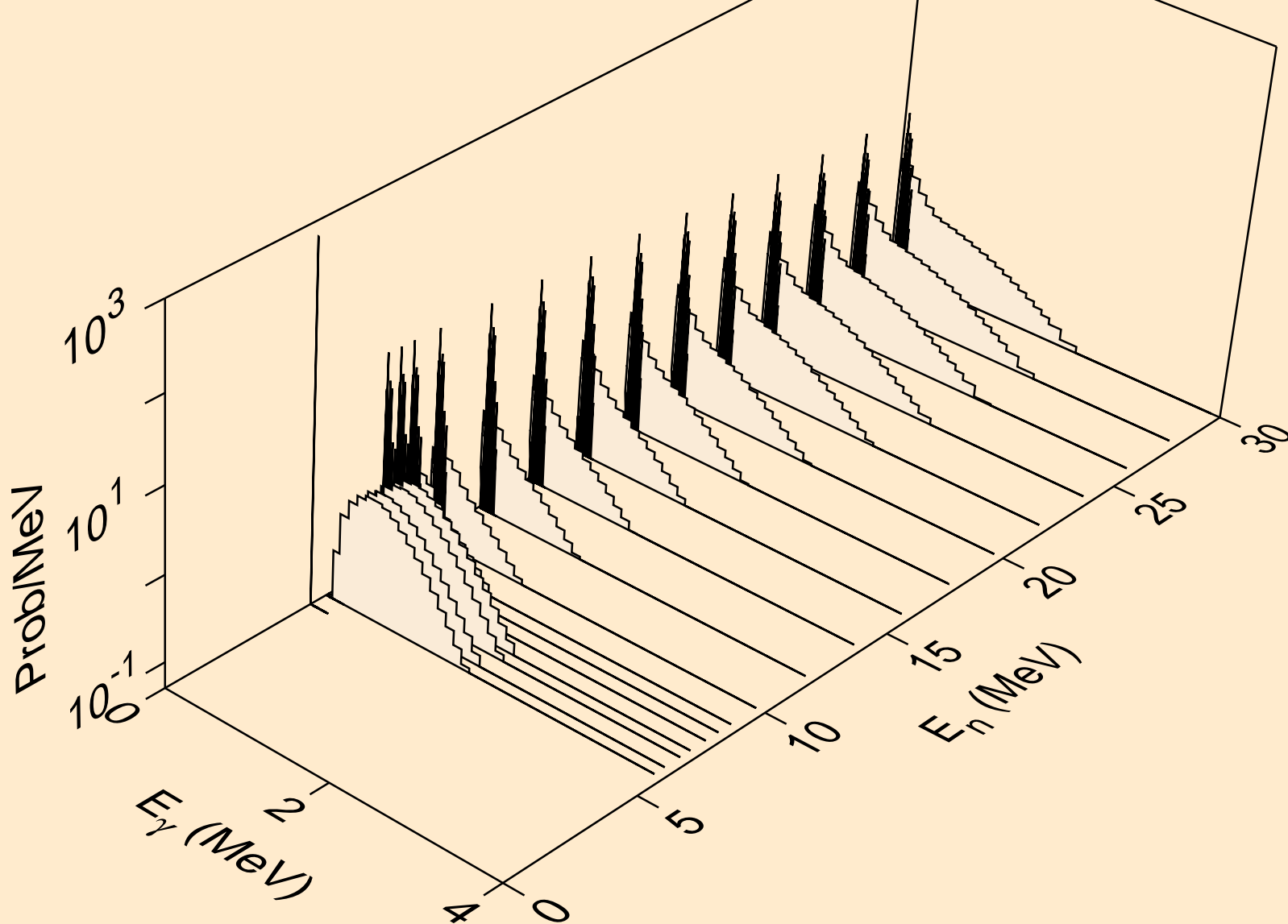

MD255 NEUTRON ACER TENDL-2019 LIBRARY; T=293.16K
Photon emission for (n,pd)

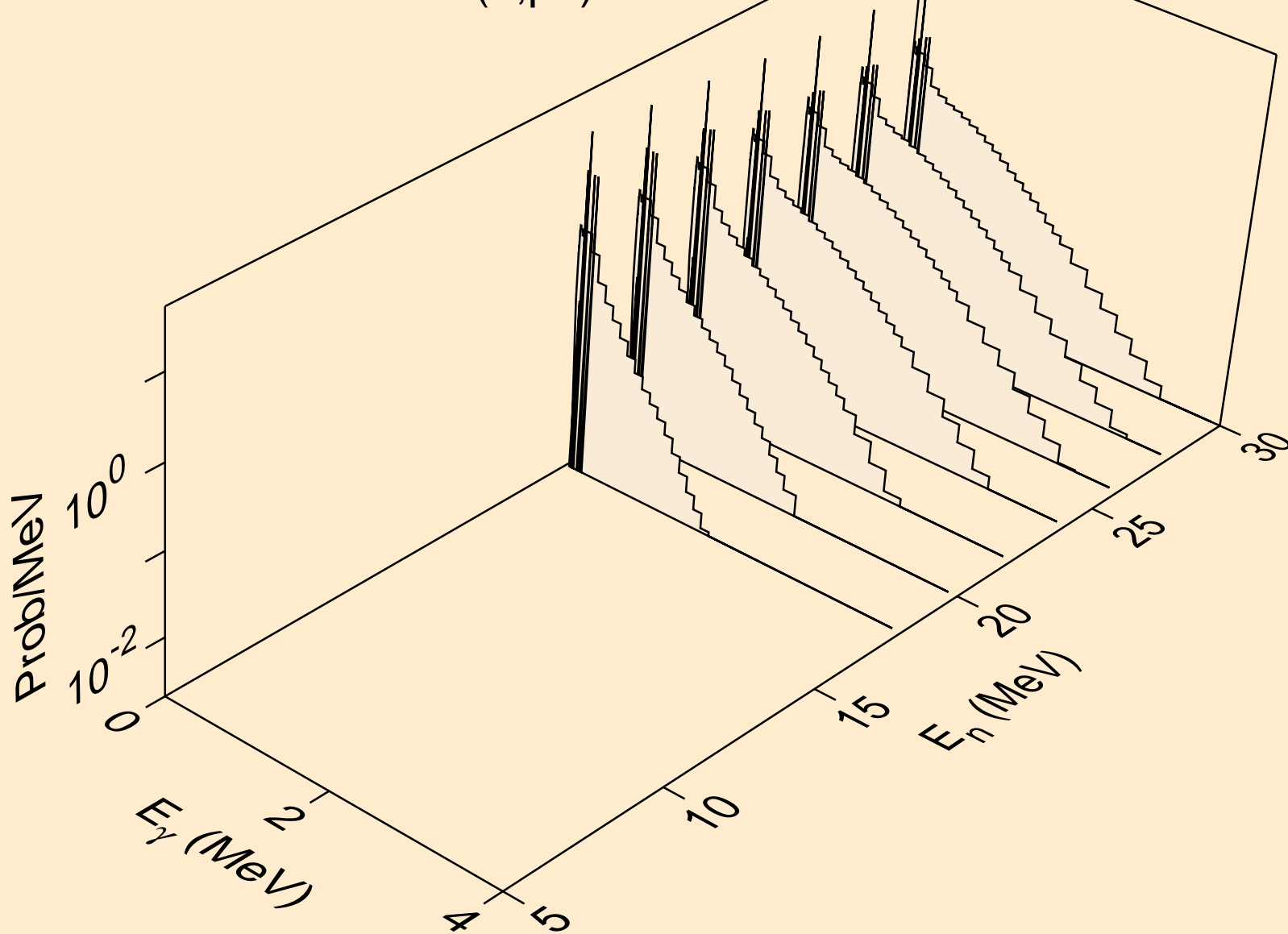

MD255 NEUTRON ACER TENDL-2019 LIBRARY; T=293.16K
thermal capture photon spectrum

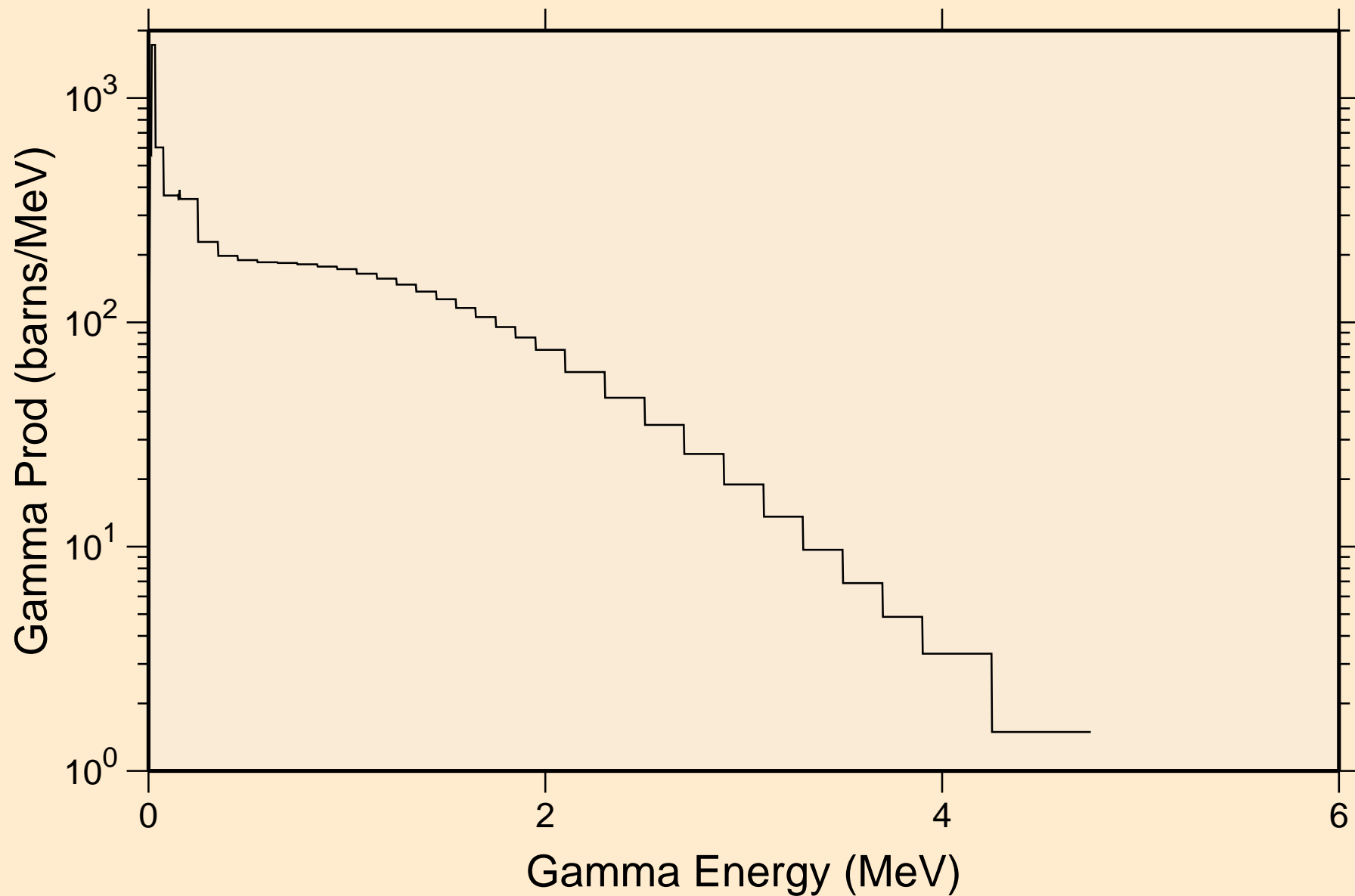

MD255 NEUTRON ACER TENDL-2019 LIBRARY; T=293.16K
14 MeV photon spectrum

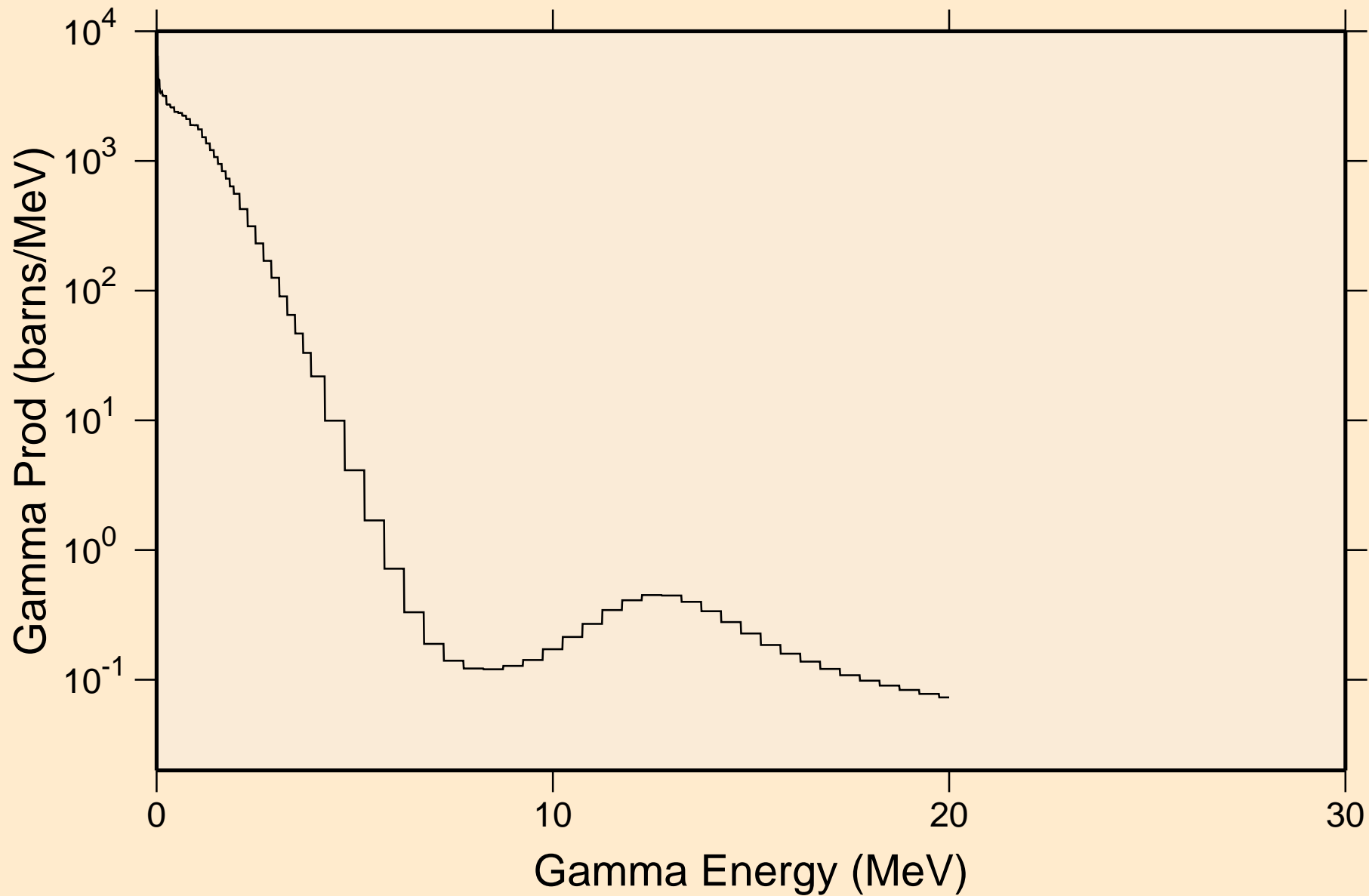

MD255 NEUTRON ACER TENDL-2019 LIBRARY; T=293.16K
Particle heating contributions

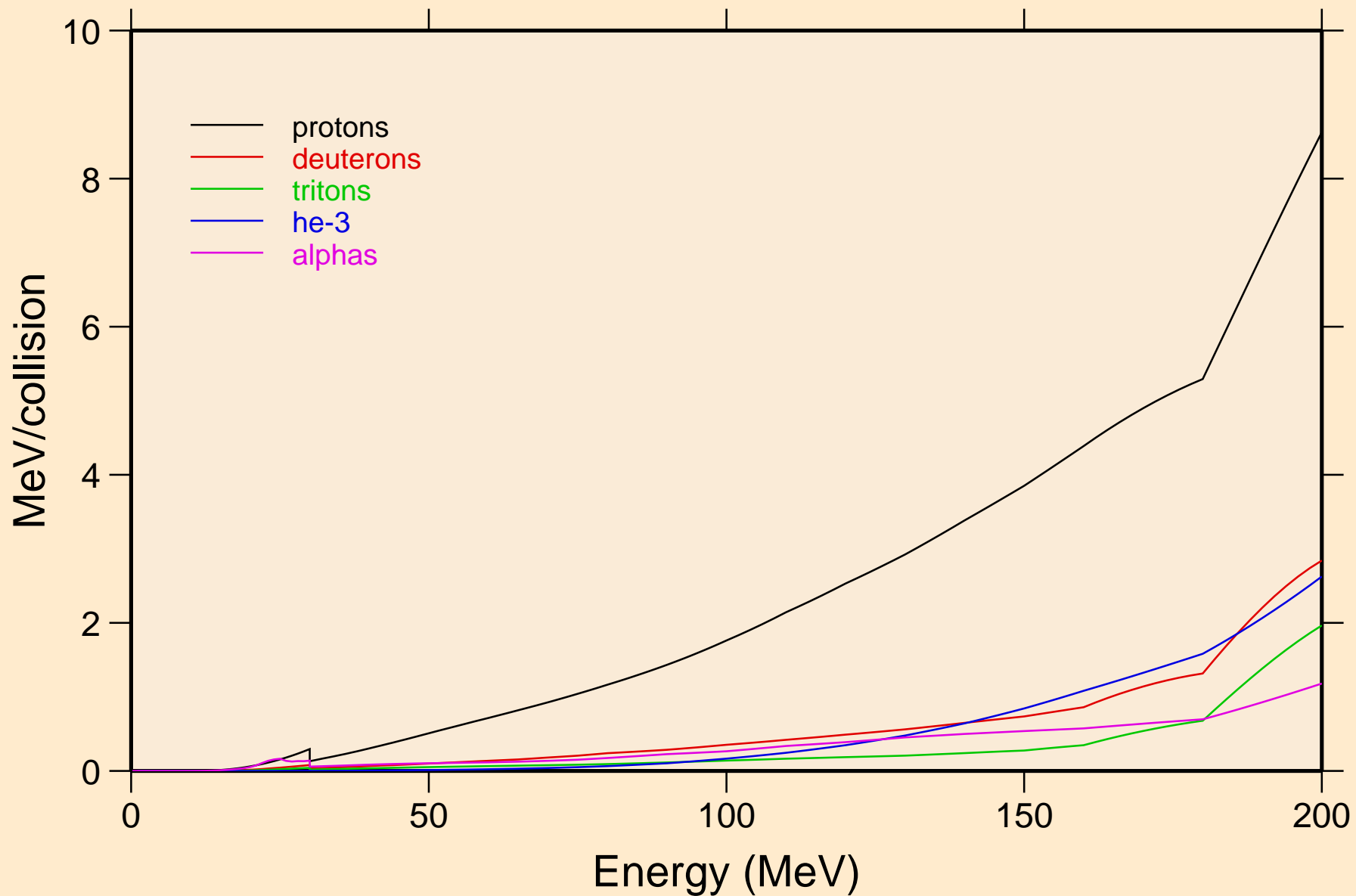

MD255 NEUTRON ACER TENDL-2019 LIBRARY; T=293.16K
Recoil Heating

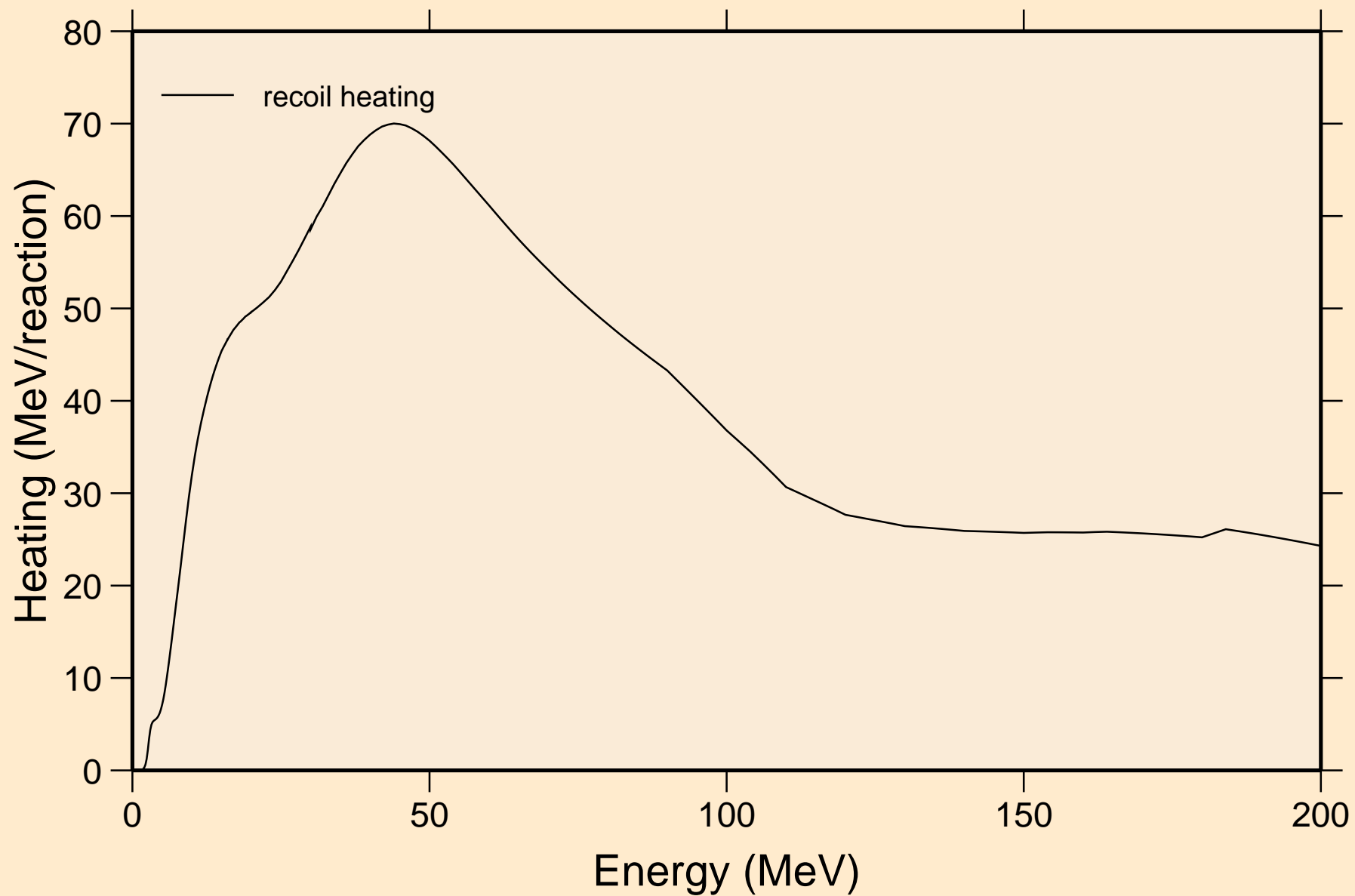

MD255 NEUTRON ACER TENDL-2019 LIBRARY; T=293.16K
Particle production cross sections

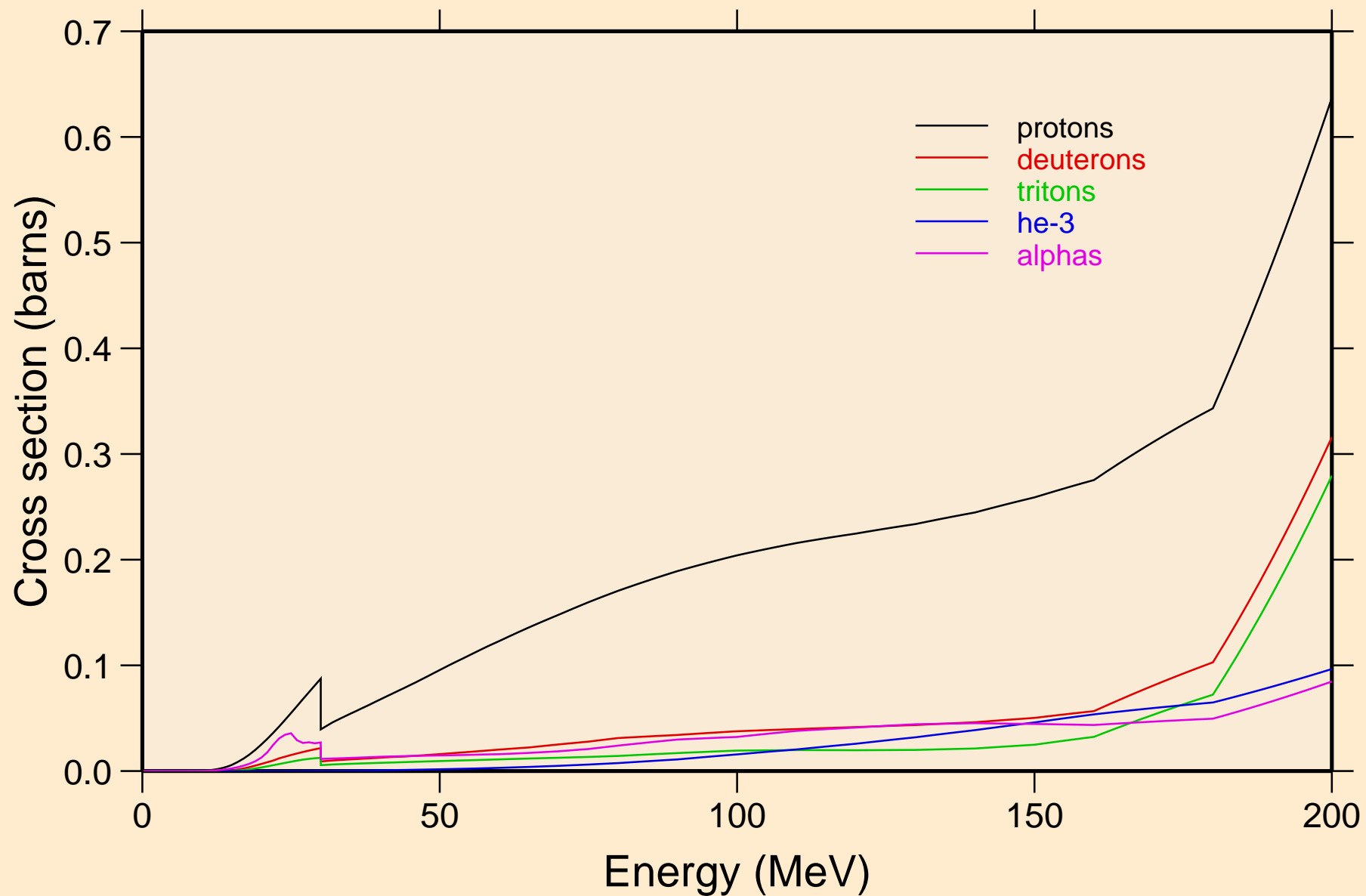

MD255 NEUTRON ACER TENDL-2019 LIBRARY; T=293.16K
protons from (n,x)

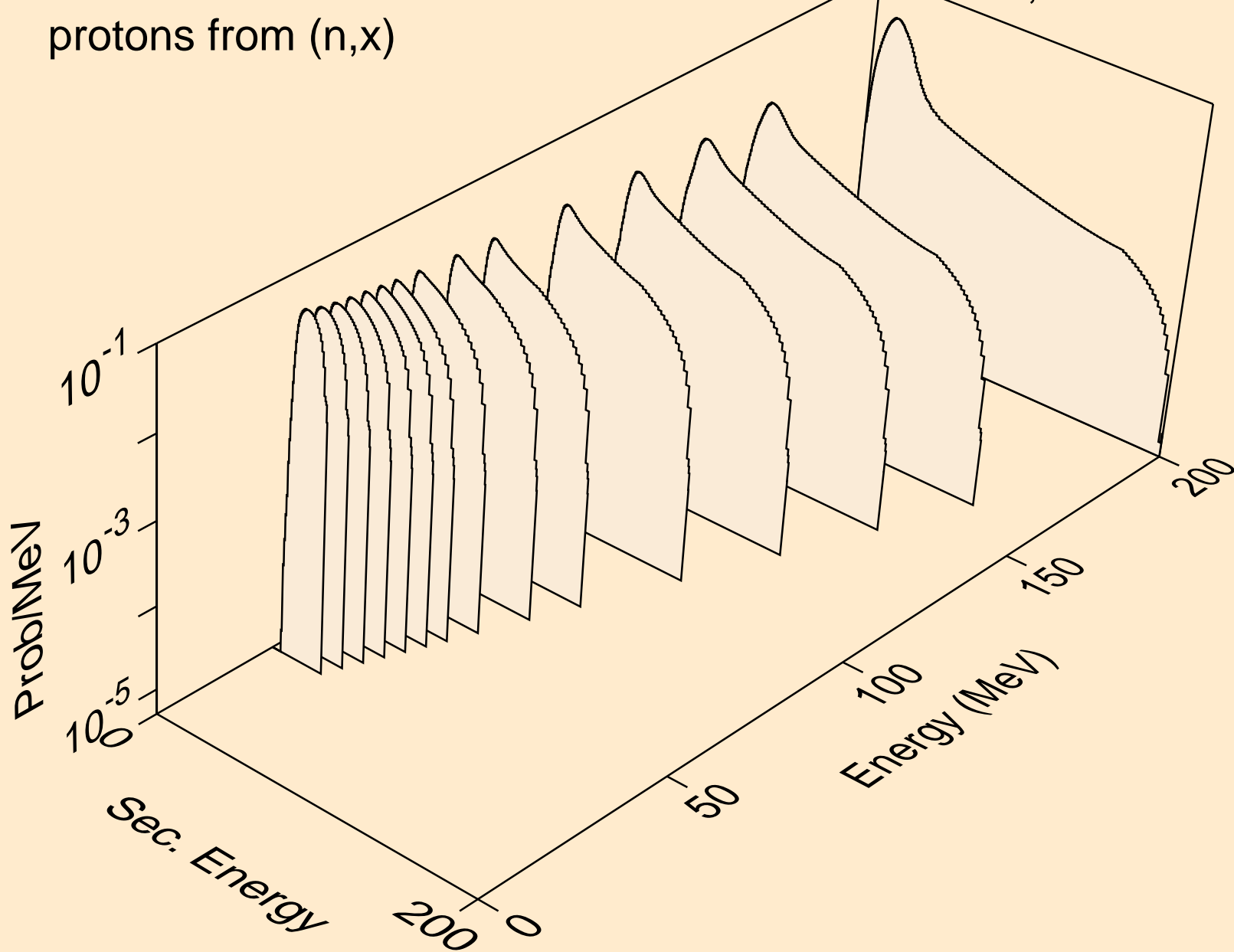

MD255 NEUTRON ACER TENDL-2019 LIBRARY; T=293.16K
protons from (n,n*)p

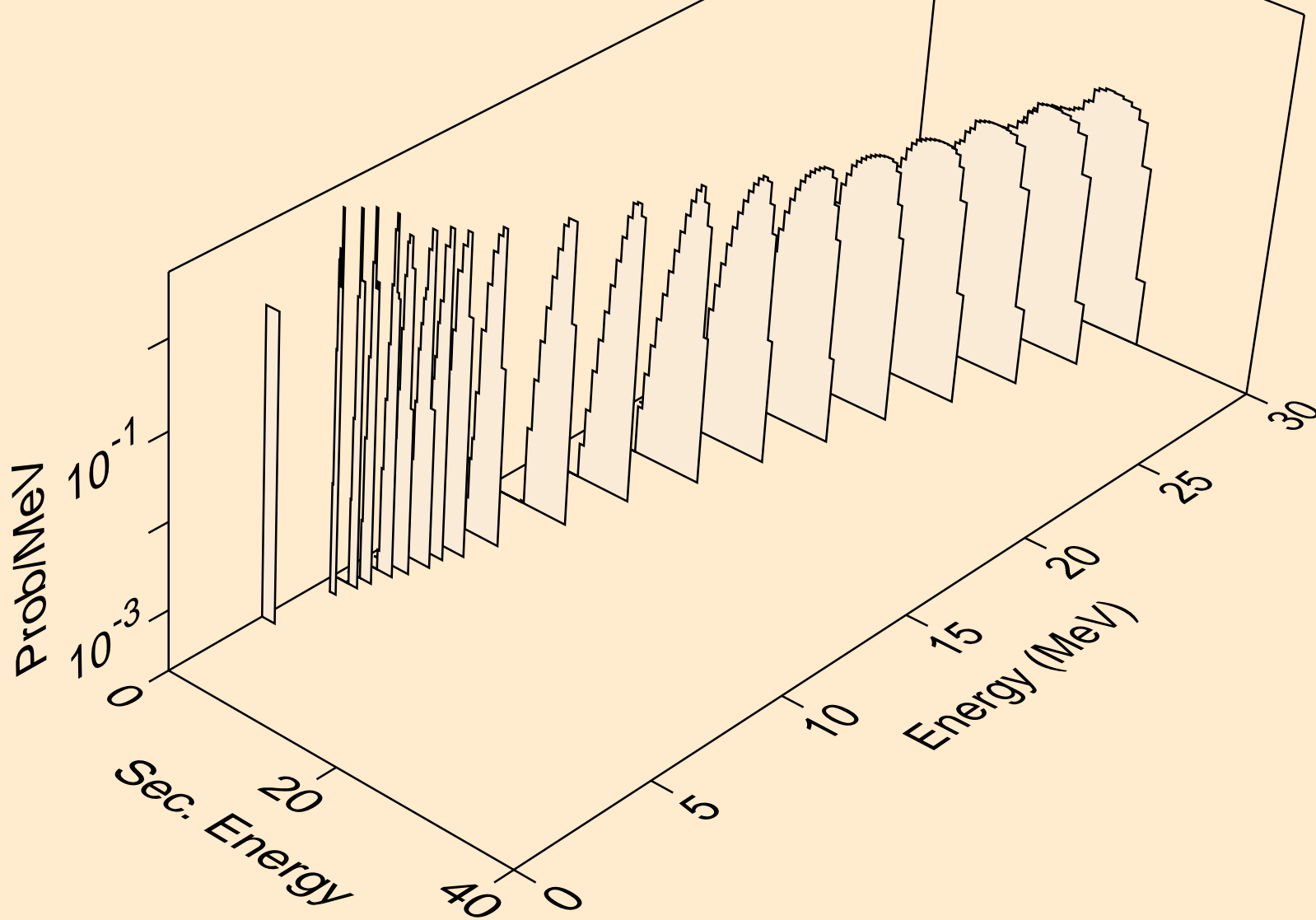

MD255 NEUTRON ACER TENDL-2019 LIBRARY; T=293.16K
protons from (n,2np)

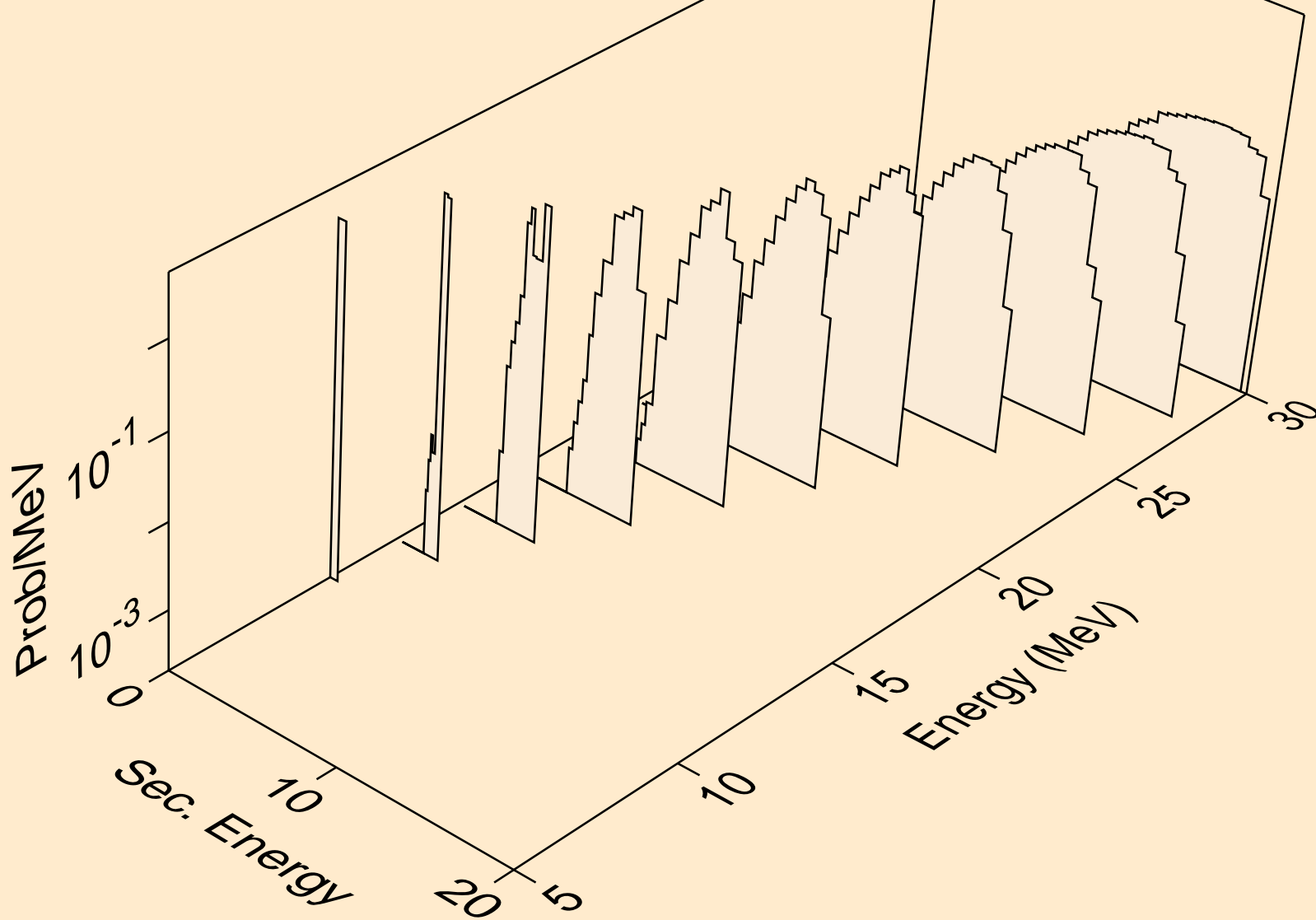

MD255 NEUTRON ACER TENDL-2019 LIBRARY; T=293.16K
protons from (n,3np)

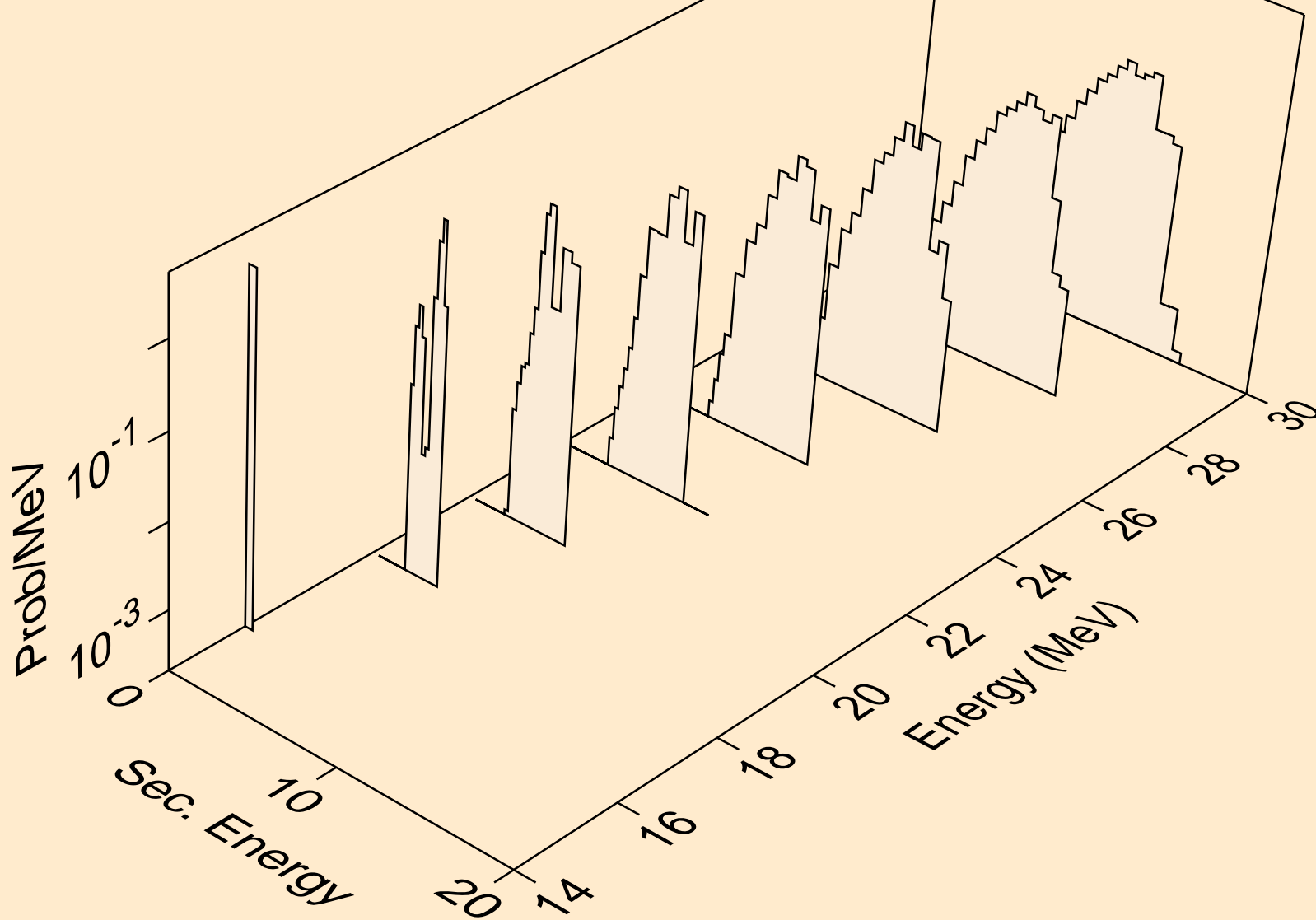

MD255 NEUTRON ACER TENDL-2019 LIBRARY; T=293.16K
protons from (n,2np)

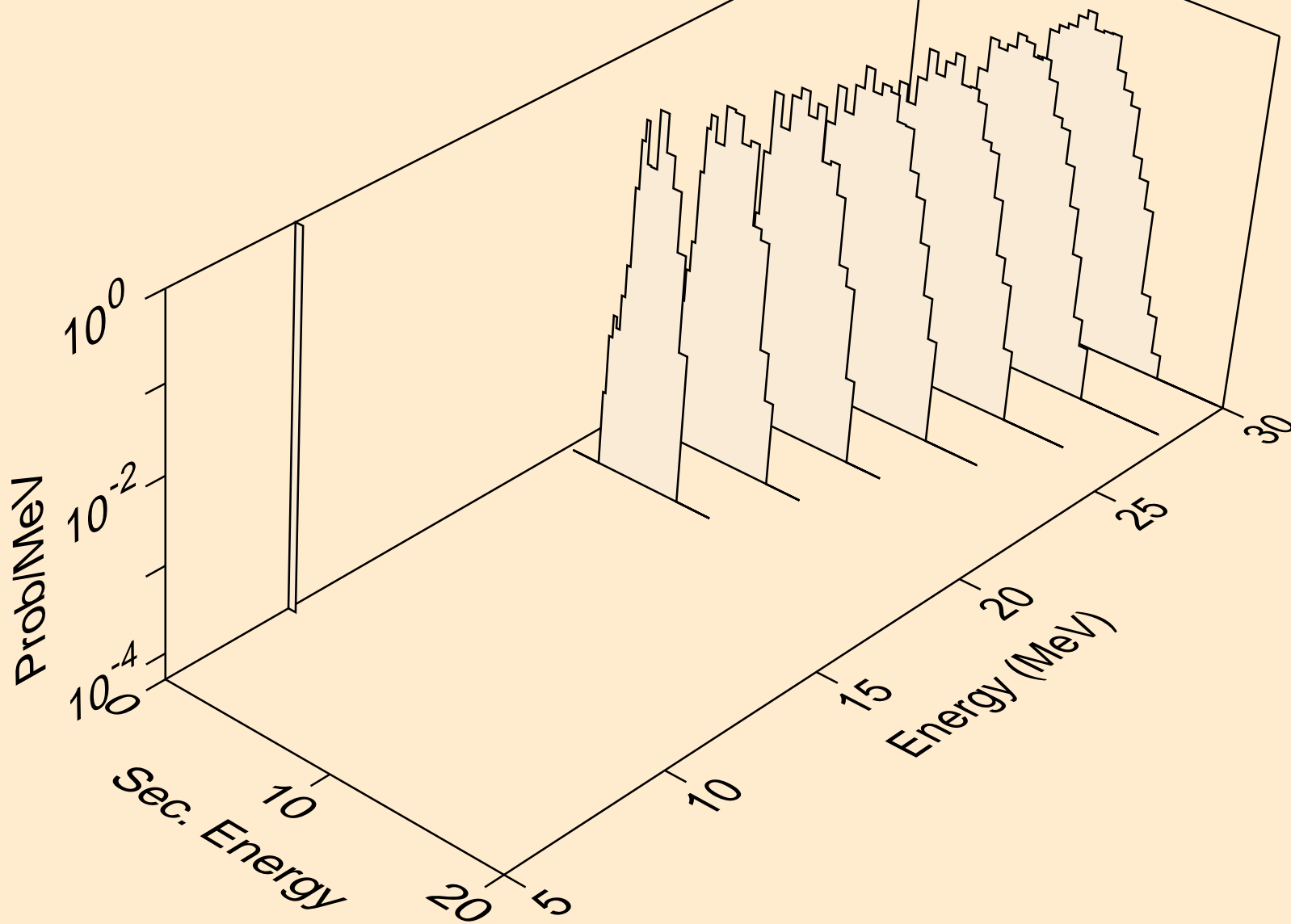

MD255 NEUTRON ACER TENDL-2019 LIBRARY; T=293.16K
protons from (n,npa)

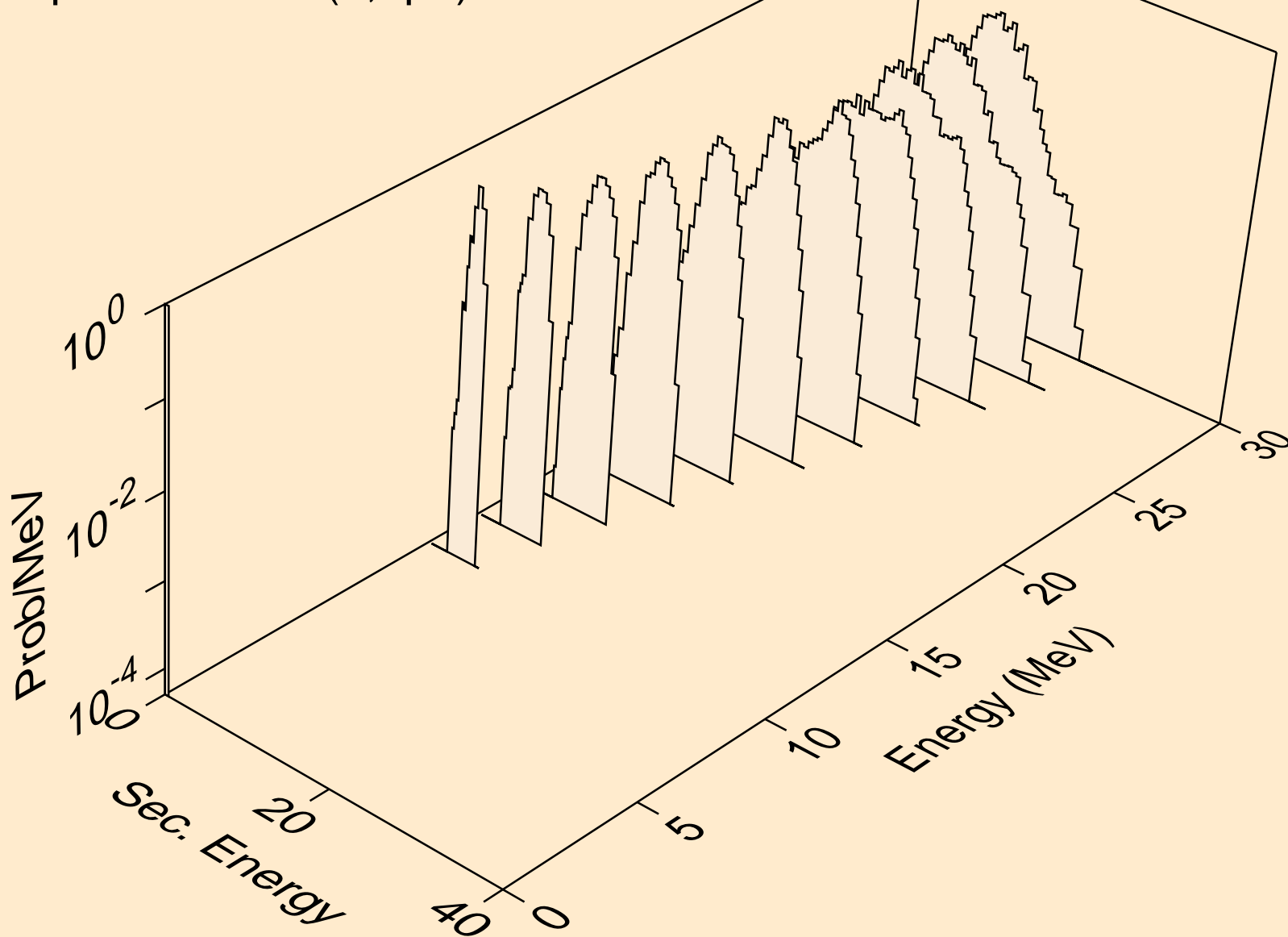

MD255 NEUTRON ACER TENDL-2019 LIBRARY; T=293.16K
protons from (n,p)

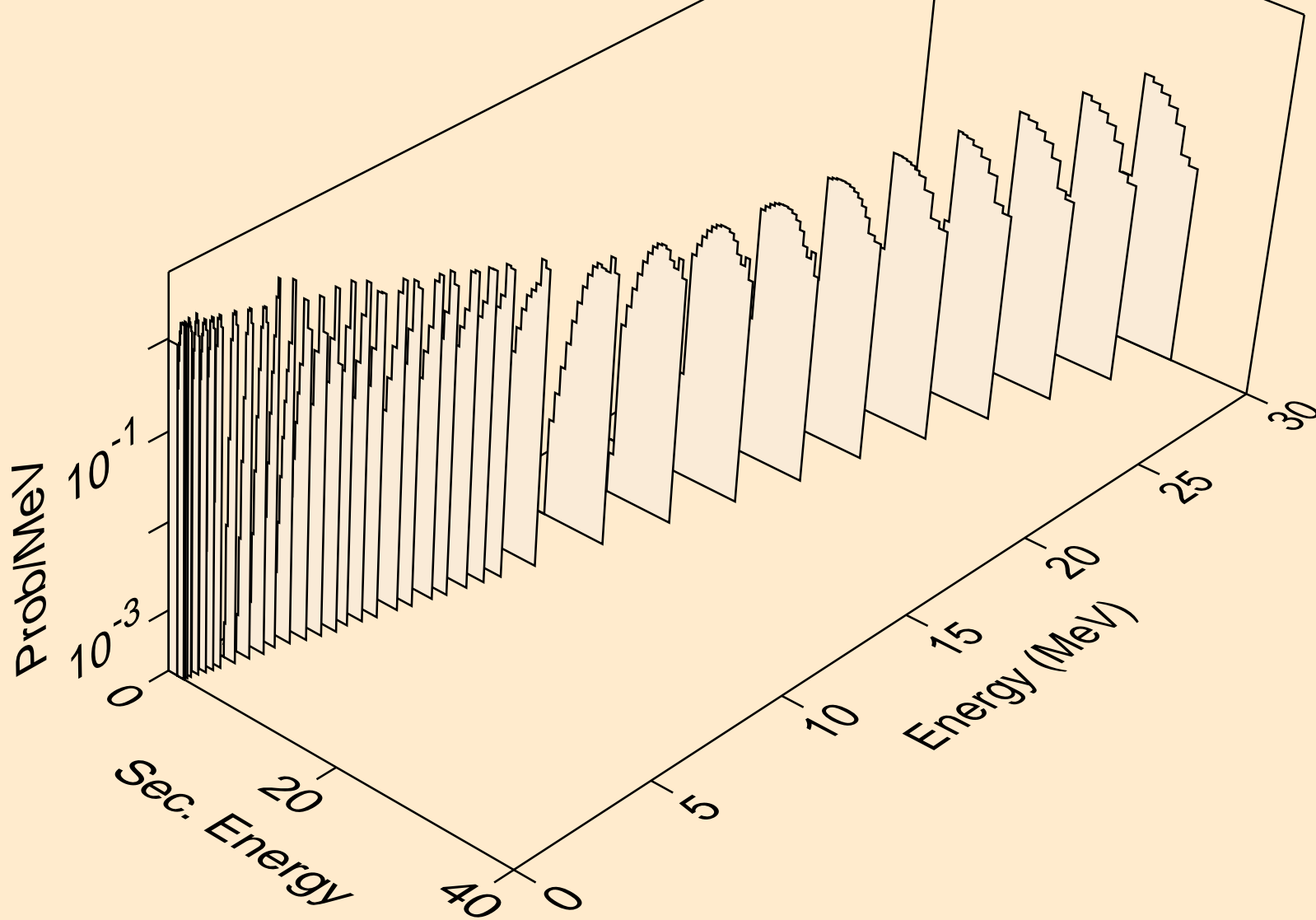

MD255 NEUTRON ACER TENDL-2019 LIBRARY; T=293.16K
protons from (n,2p)

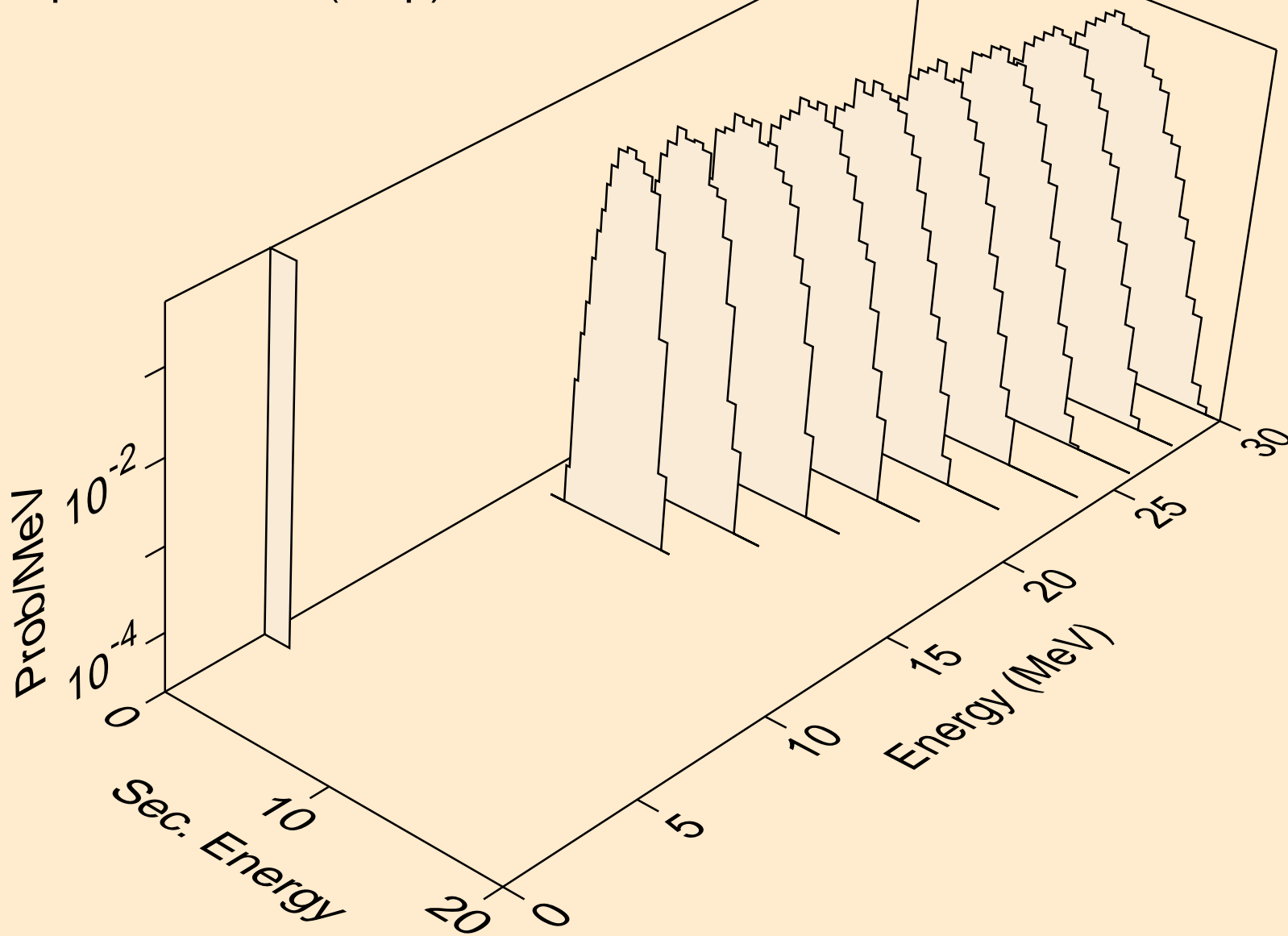

MD255 NEUTRON ACER TENDL-2019 LIBRARY; T=293.16K
protons from (n,p)

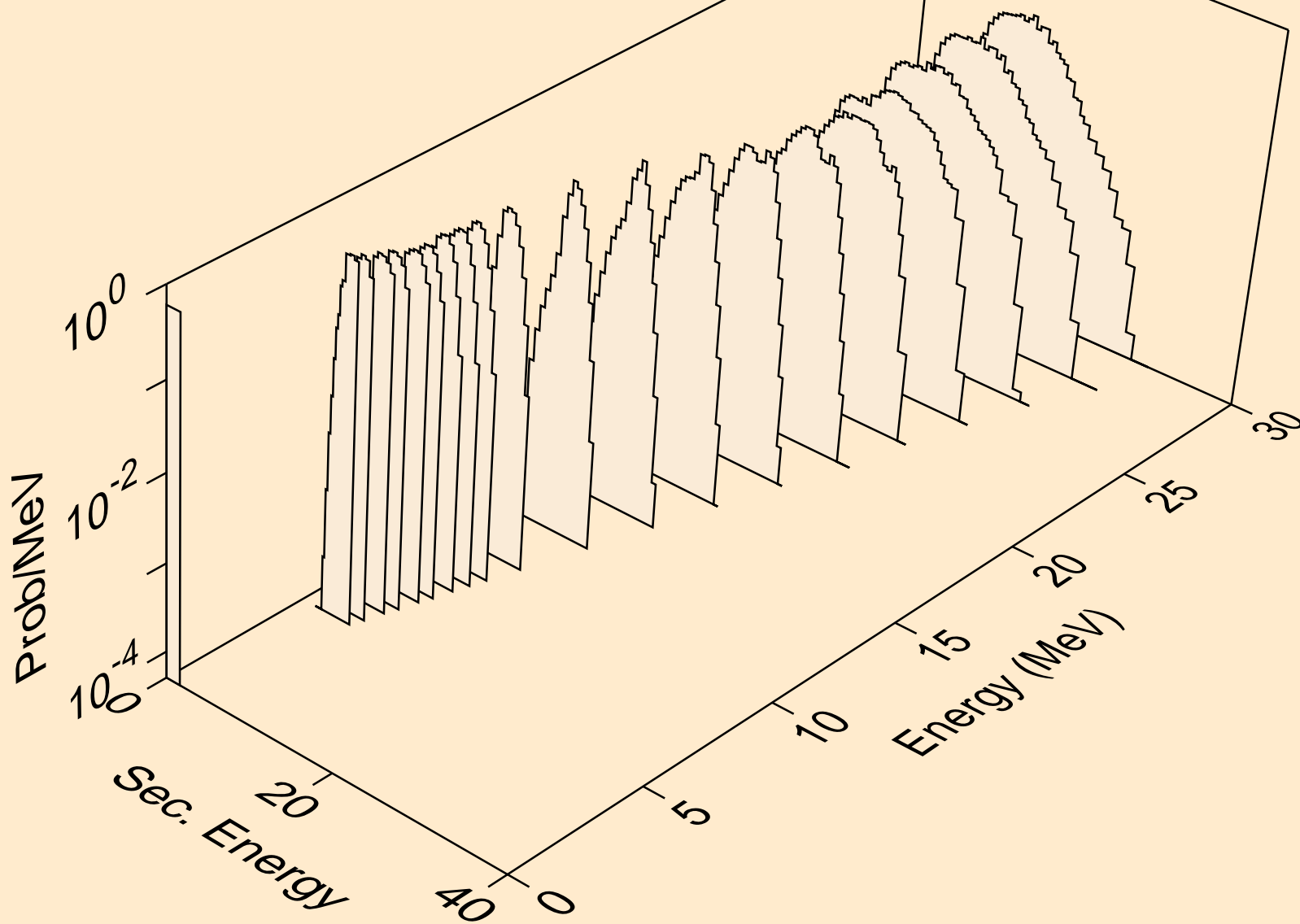

MD255 NEUTRON ACER TENDL-2019 LIBRARY; T=293.16K
protons from (n,pd)

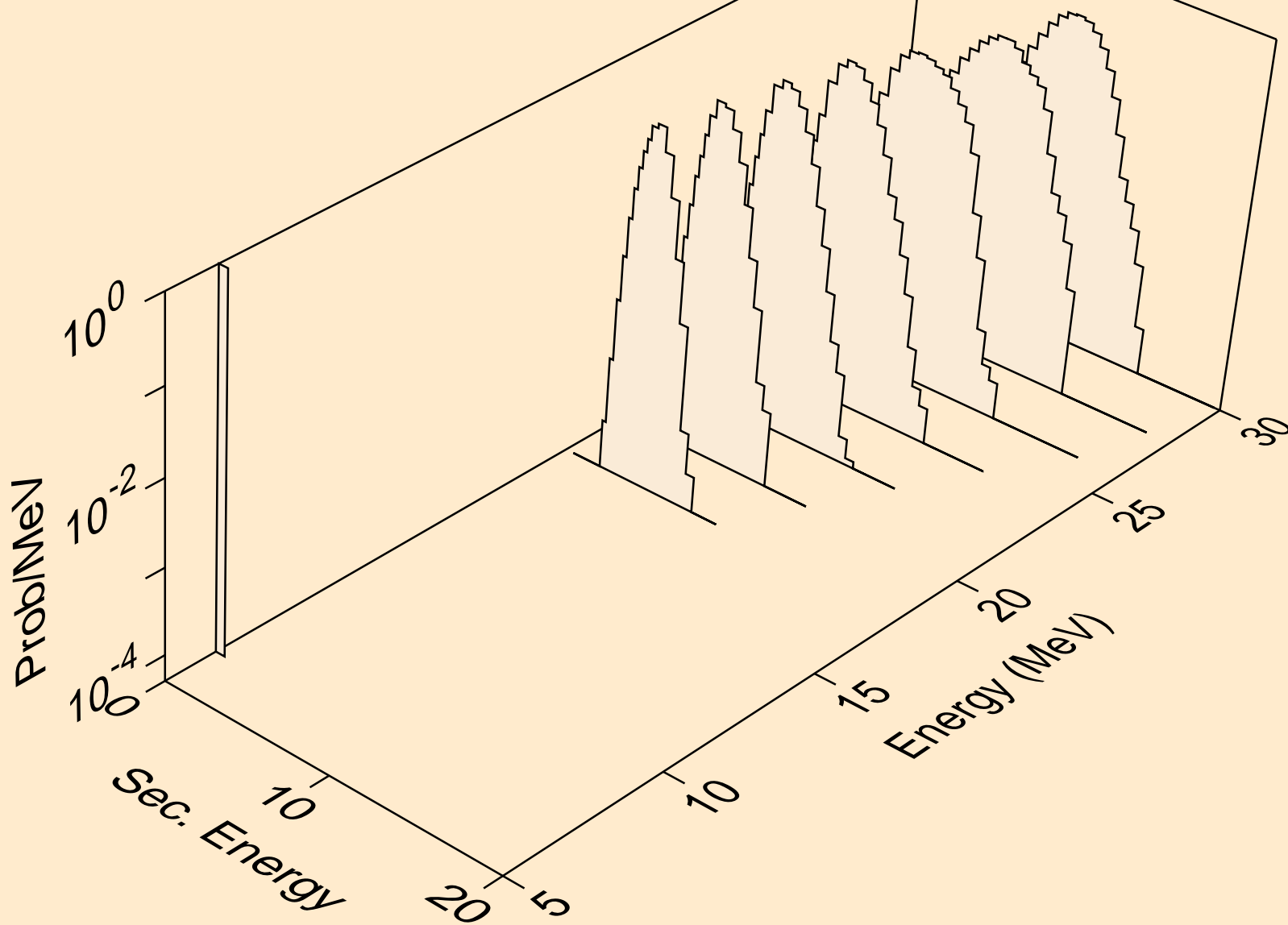

MD255 NEUTRON ACER TENDL-2019 LIBRARY; T=293.16K
deuterons from (n,x)

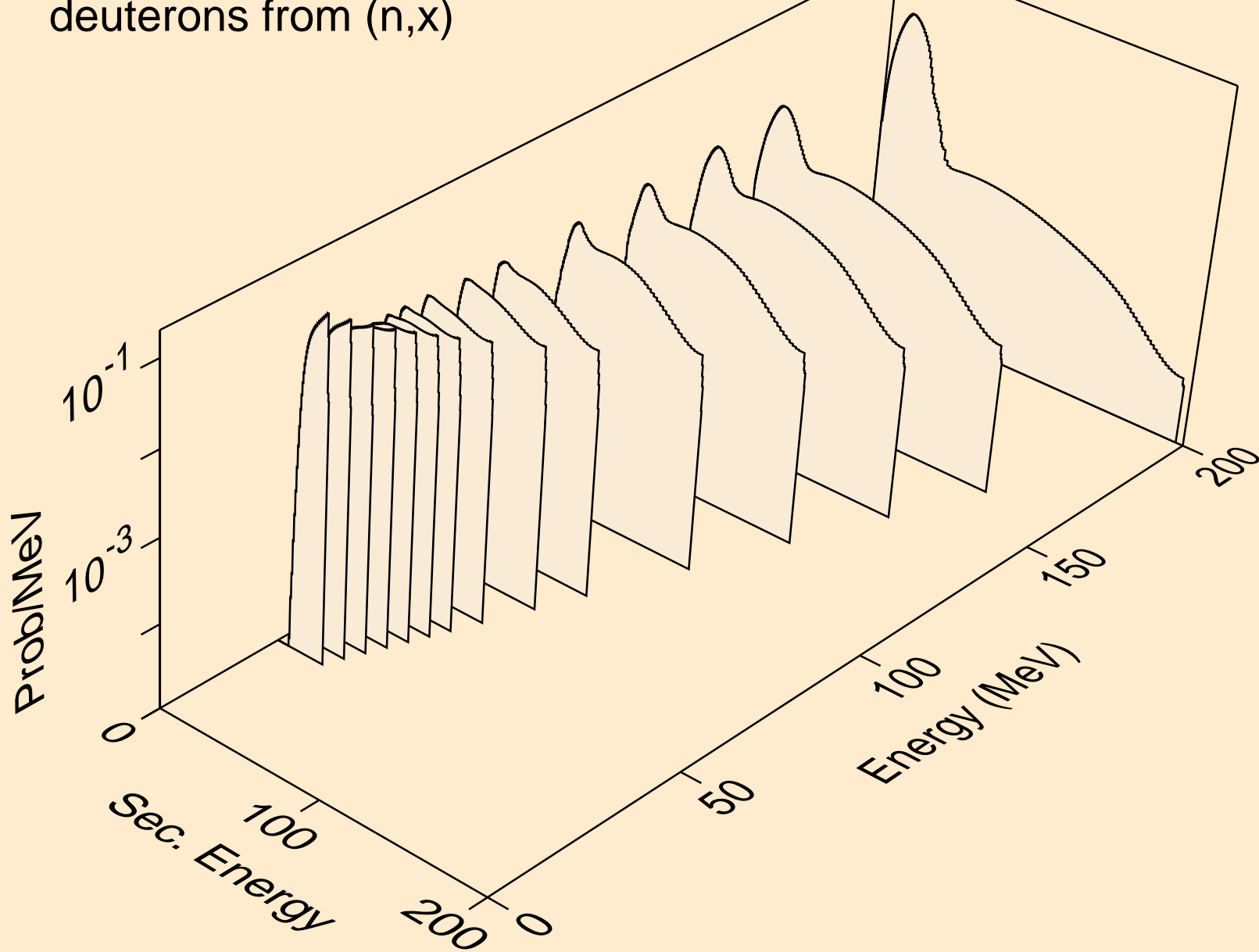

MD255 NEUTRON ACER TENDL-2019 LIBRARY; T=293.16K
deuterons from (n,2nd)

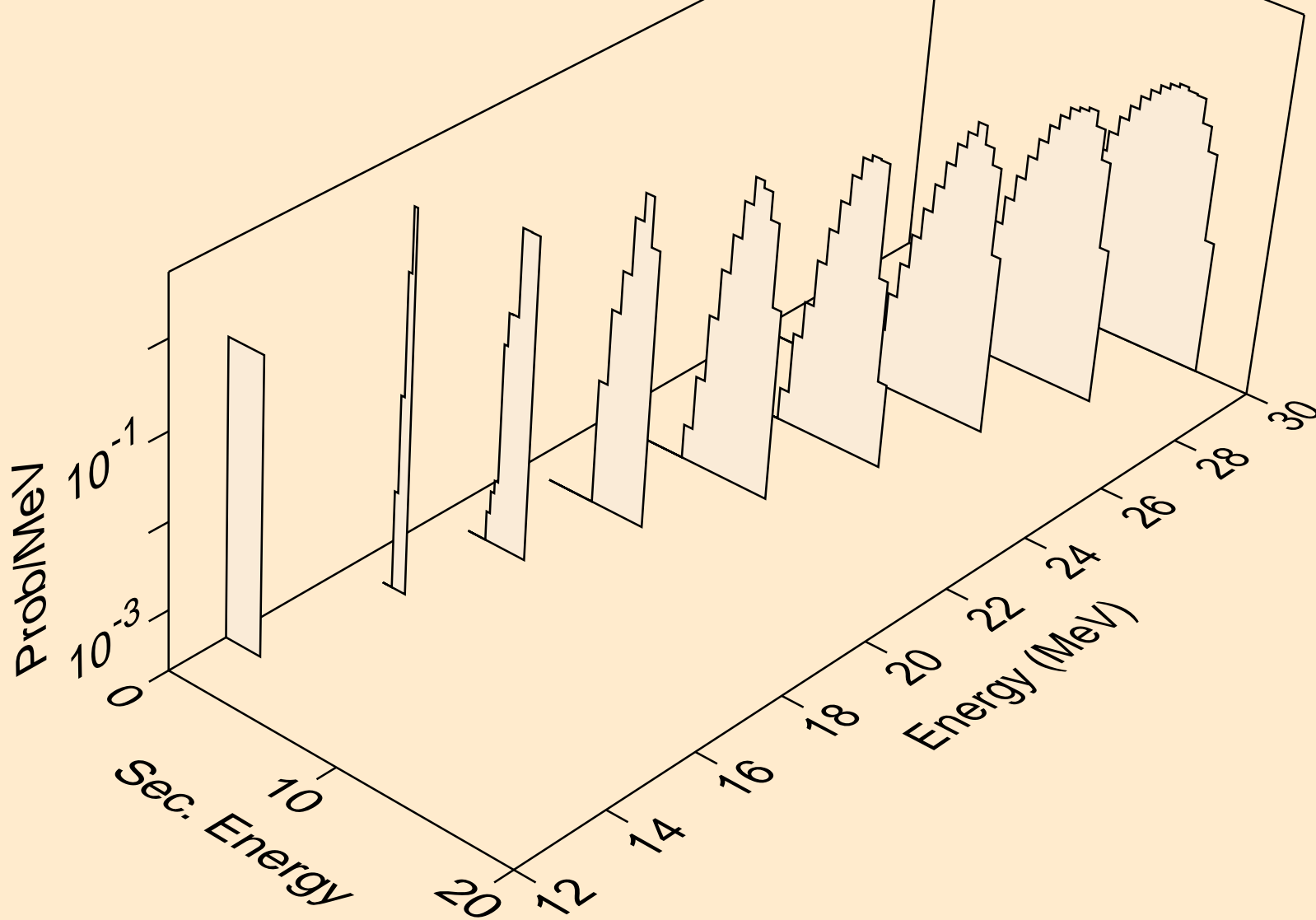

MD255 NEUTRON ACER TENDL-2019 LIBRARY; T=293.16K
deuterons from (n,n*)d

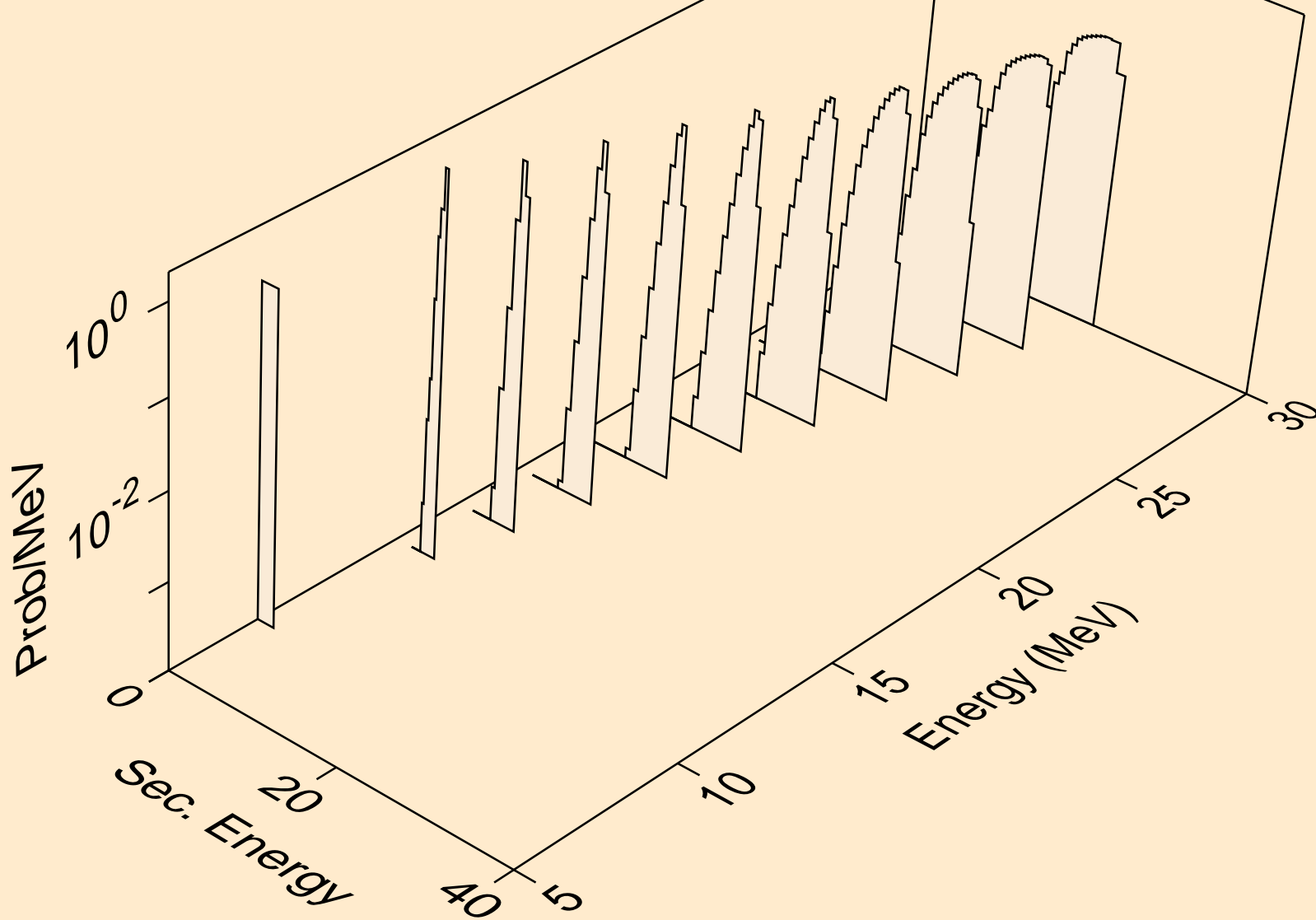

MD255 NEUTRON ACER TENDL-2019 LIBRARY; T=293.16K
deuterons from (n,d)

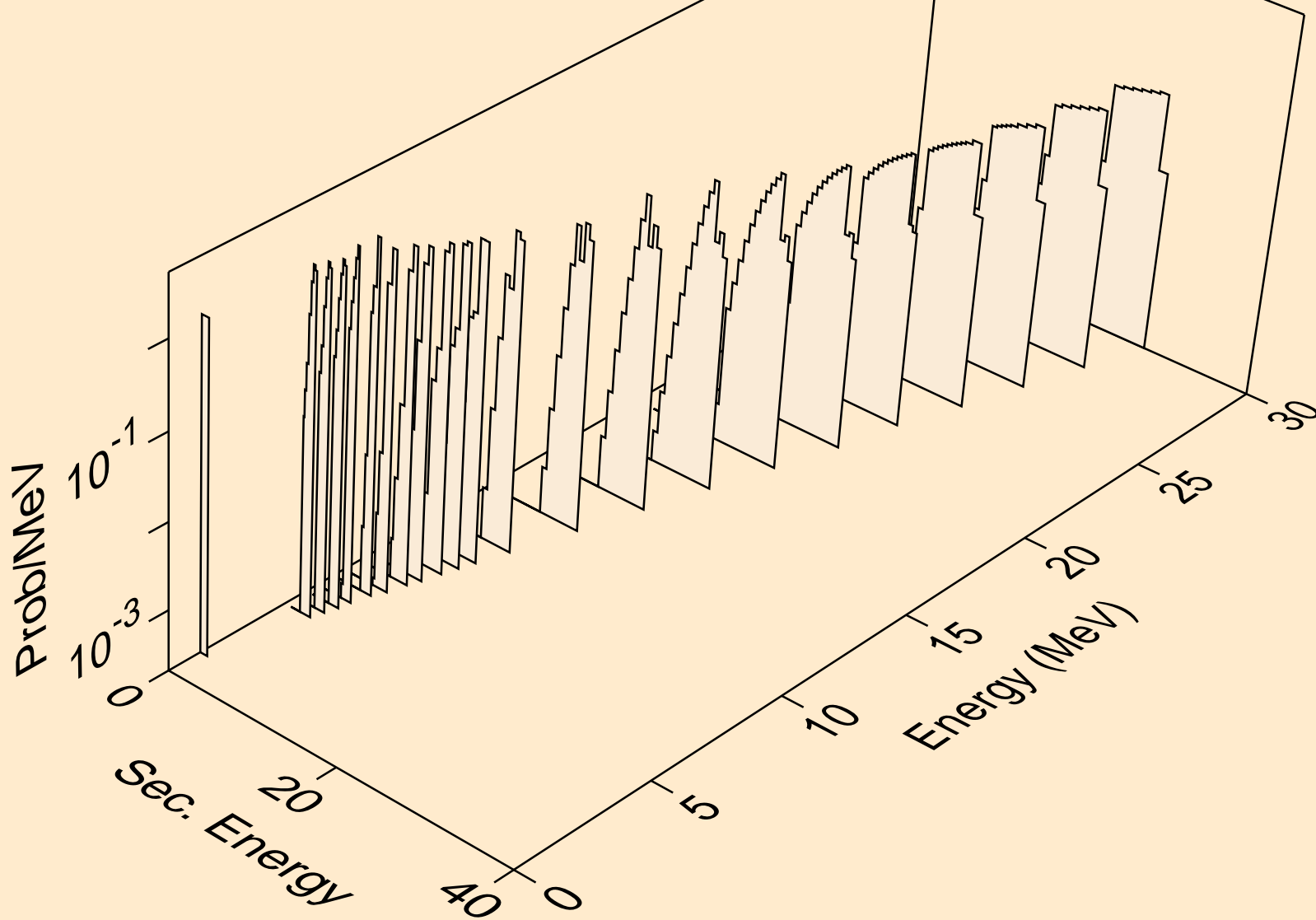

MD255 NEUTRON ACER TENDL-2019 LIBRARY; T=293.16K
deuterons from (n,pd)

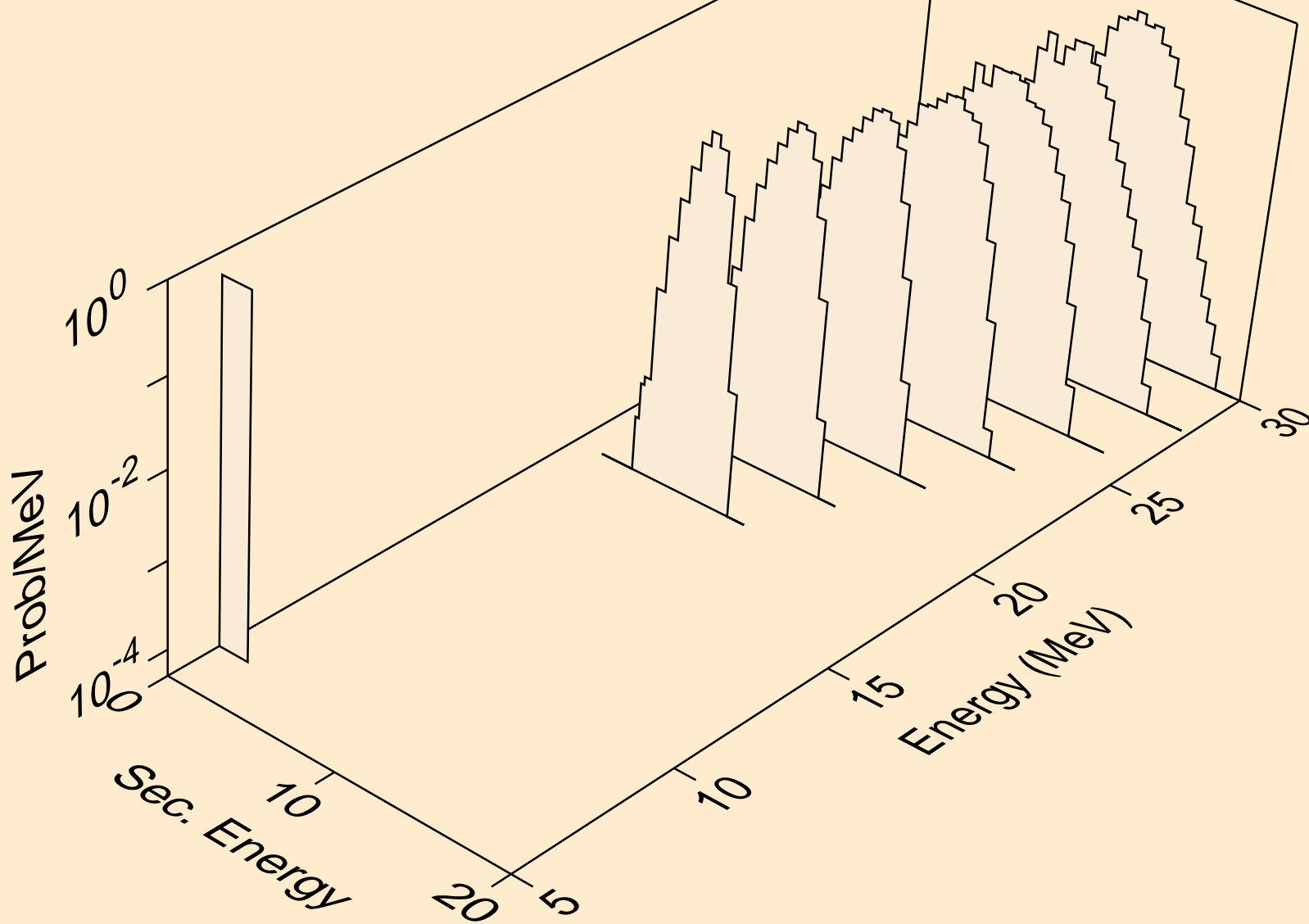

MD255 NEUTRON ACER TENDL-2019 LIBRARY; T=293.16K
tritons from (n,x)

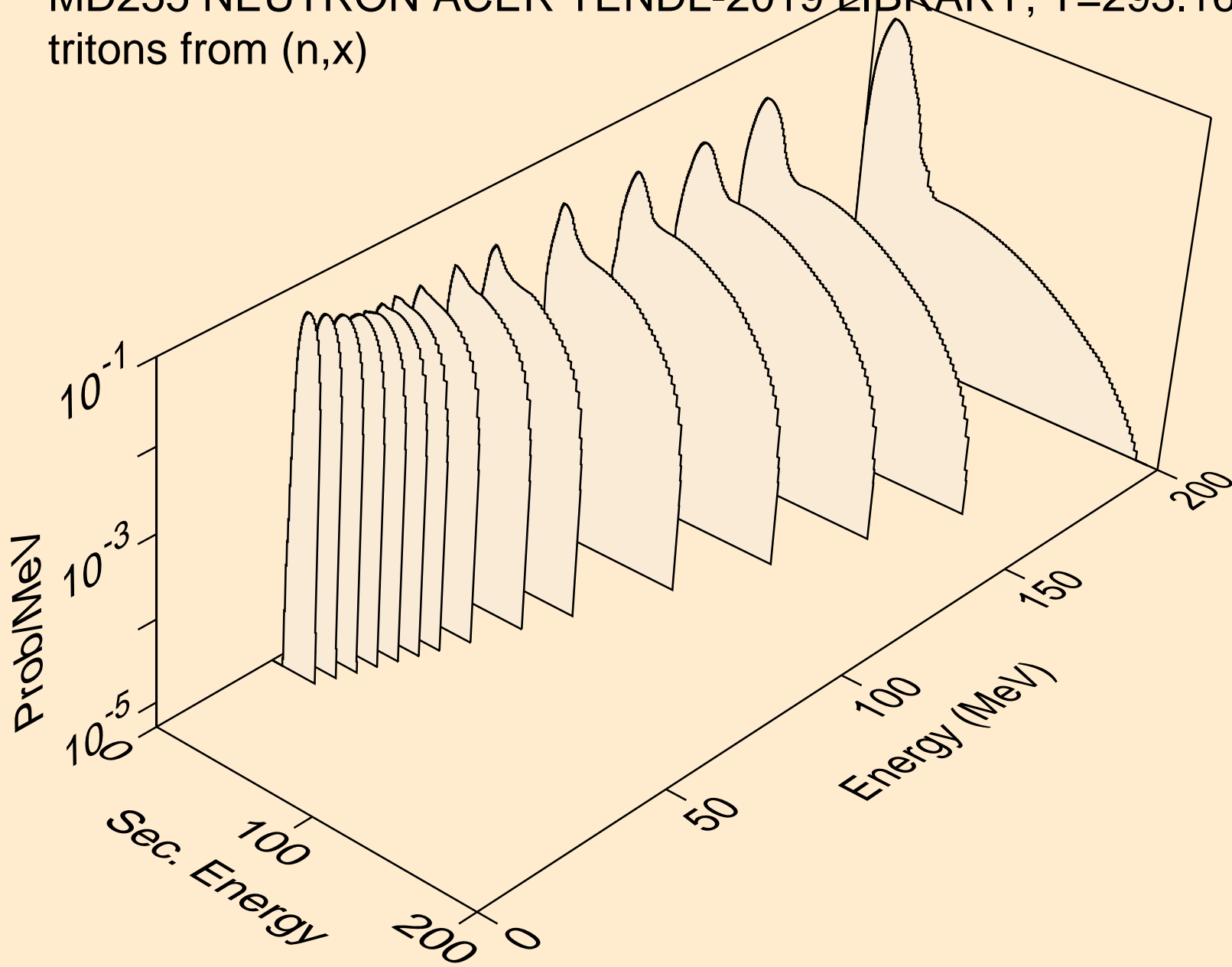

MD255 NEUTRON ACER TENDL-2019 LIBRARY; T=293.16K
tritons from (n,n*)t

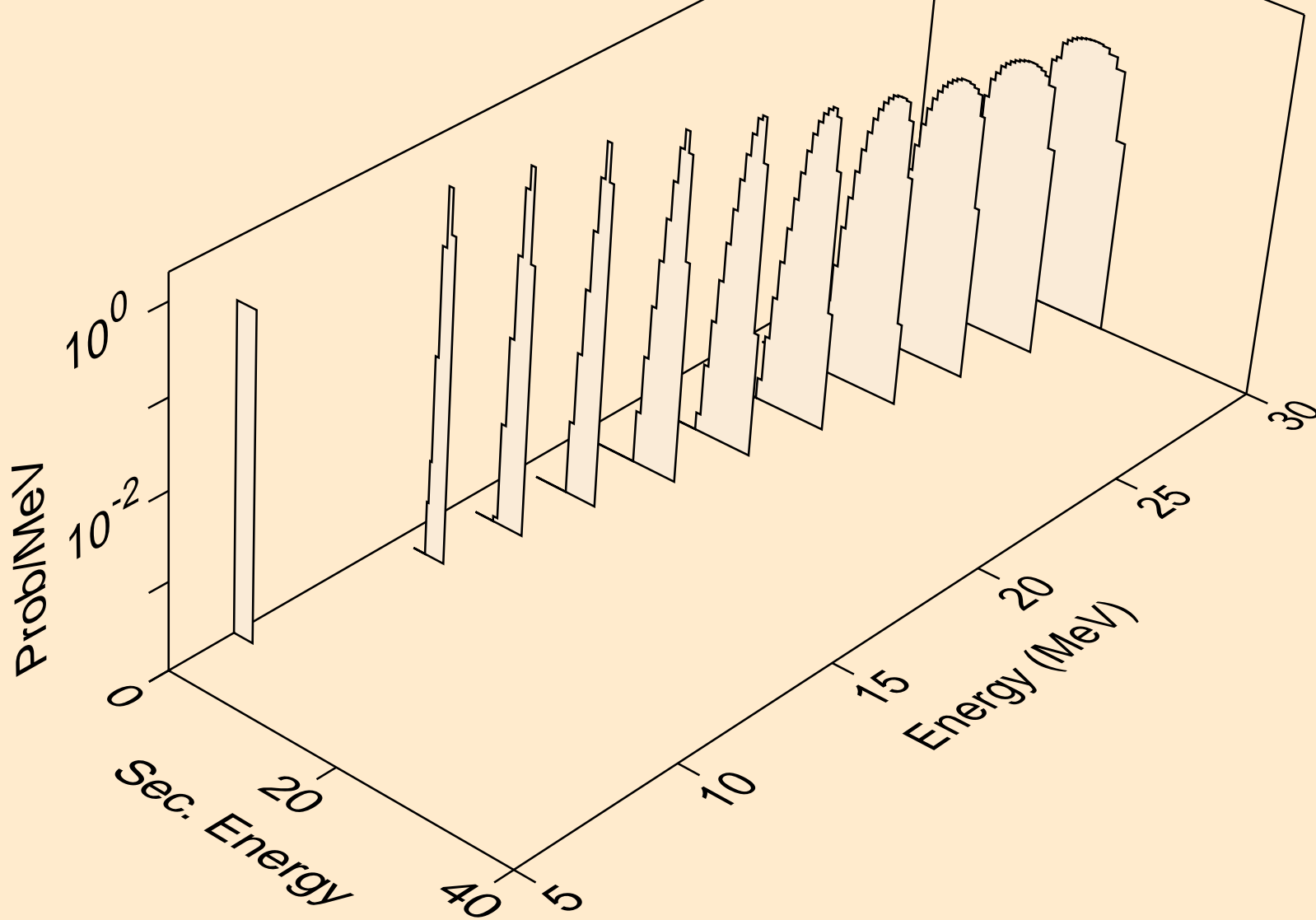

MD255 NEUTRON ACER TENDL-2019 LIBRARY; T=293.16K
tritons from (n,t)

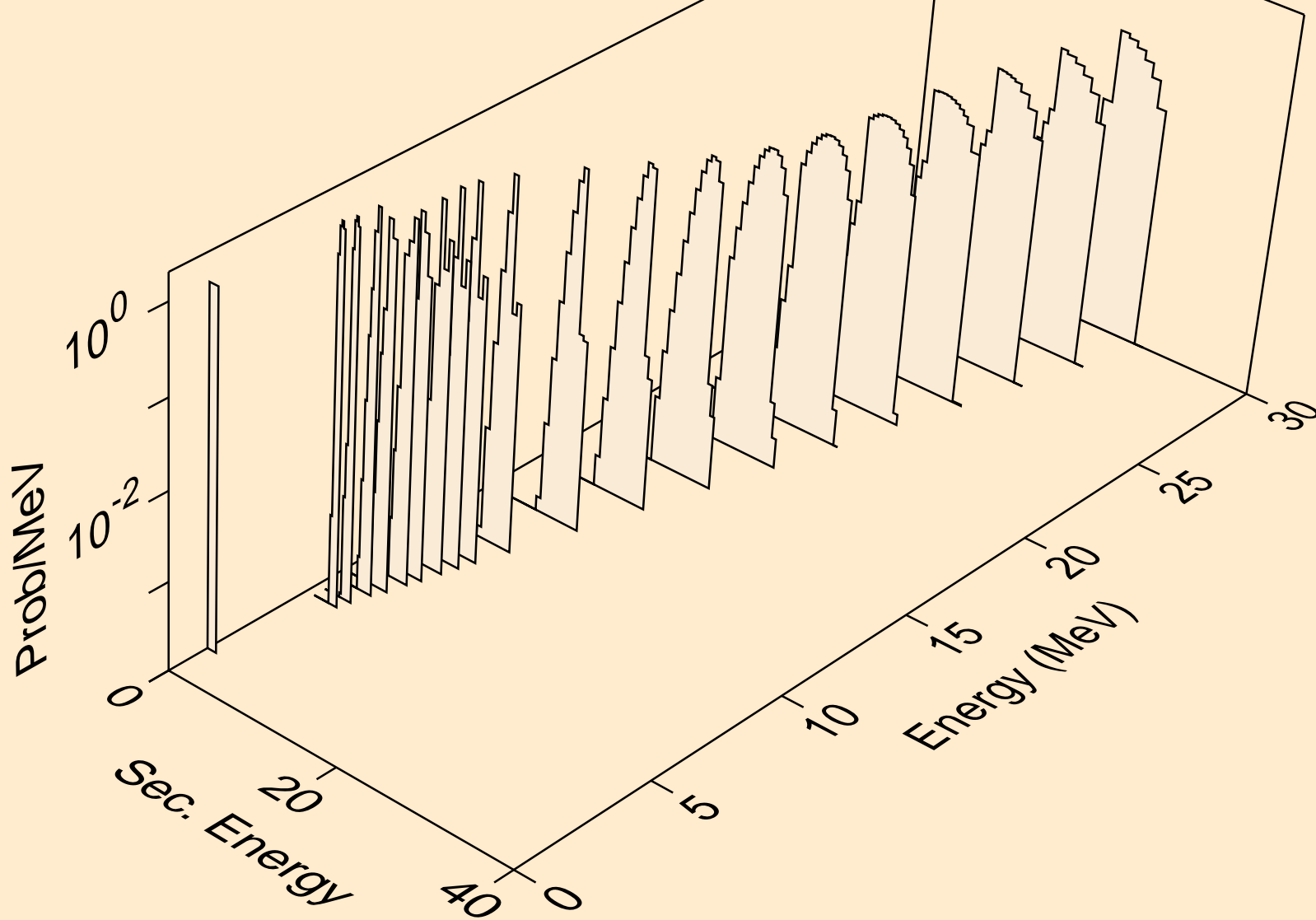

MD255 NEUTRON ACER TENDL-2019 LIBRARY; T=293.16K
he3s from (n,x)

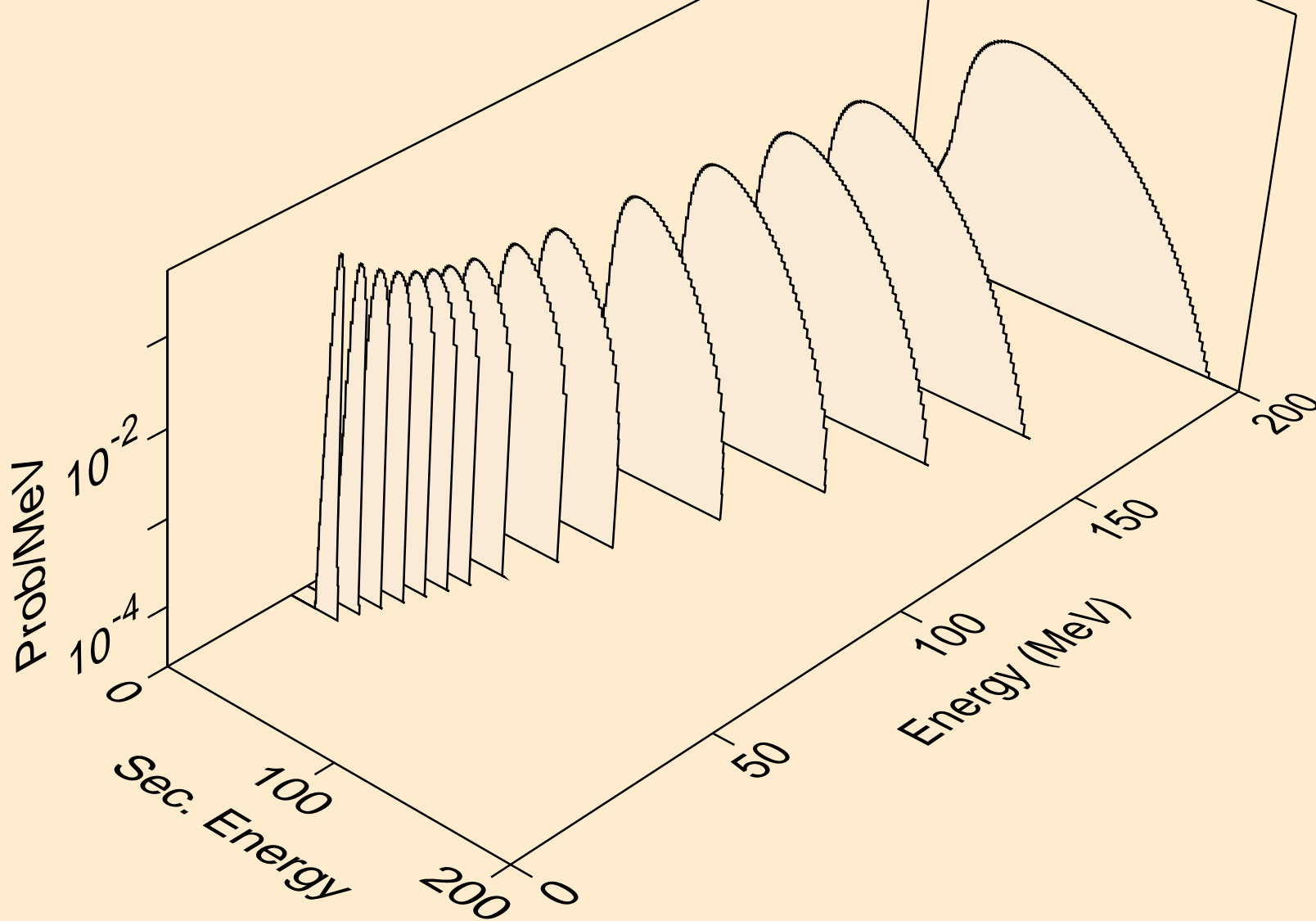

MD255 NEUTRON ACER TENDL-2019 LIBRARY; T=293.16K
he3s from (n,n*)he3

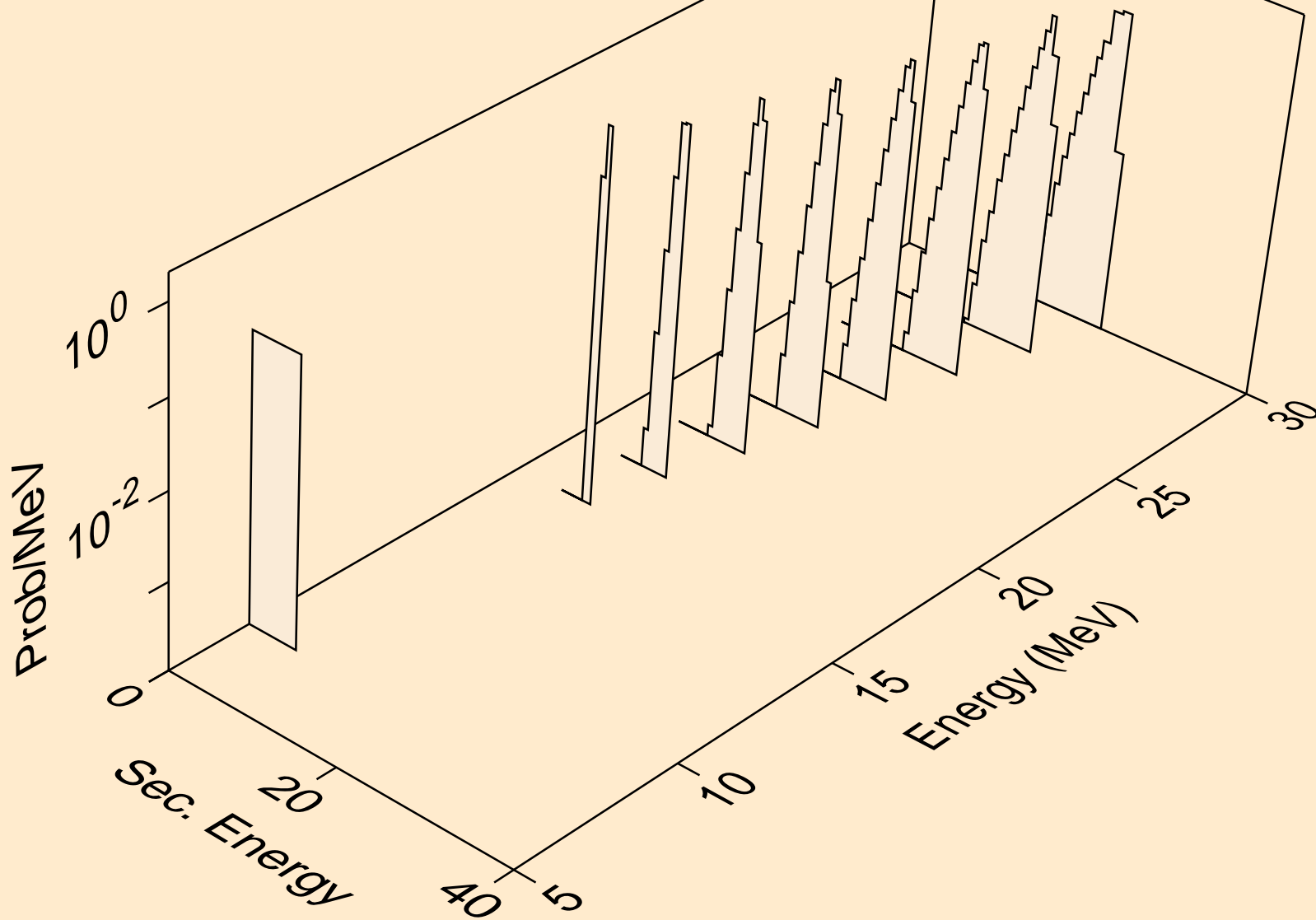

MD255 NEUTRON ACER TENDL-2019 LIBRARY; T=293.16K
he3s from (n,he3)

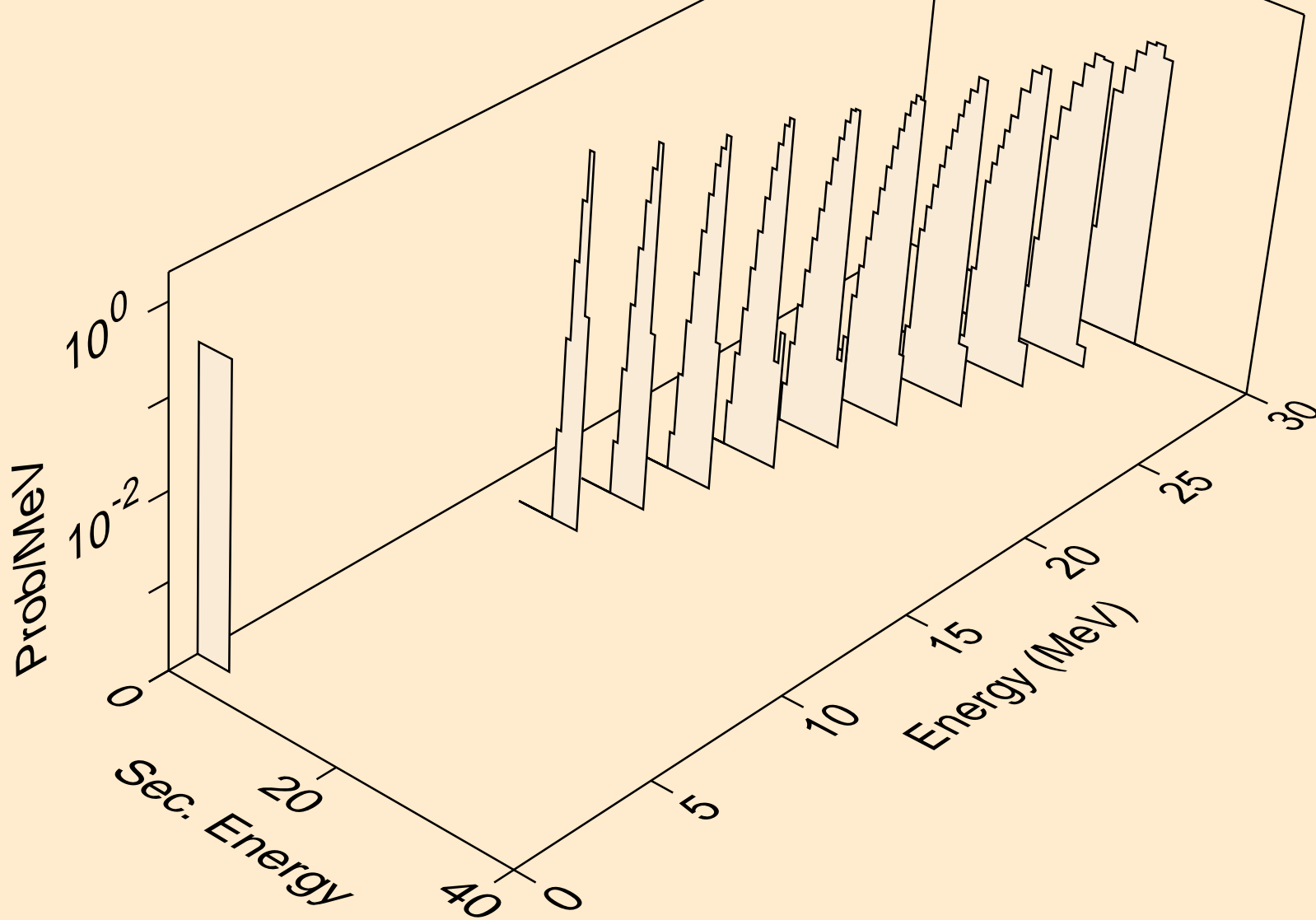

MD255 NEUTRON ACER TENDL-2019 LIBRARY; T=293.16K
alphas from (n,x)

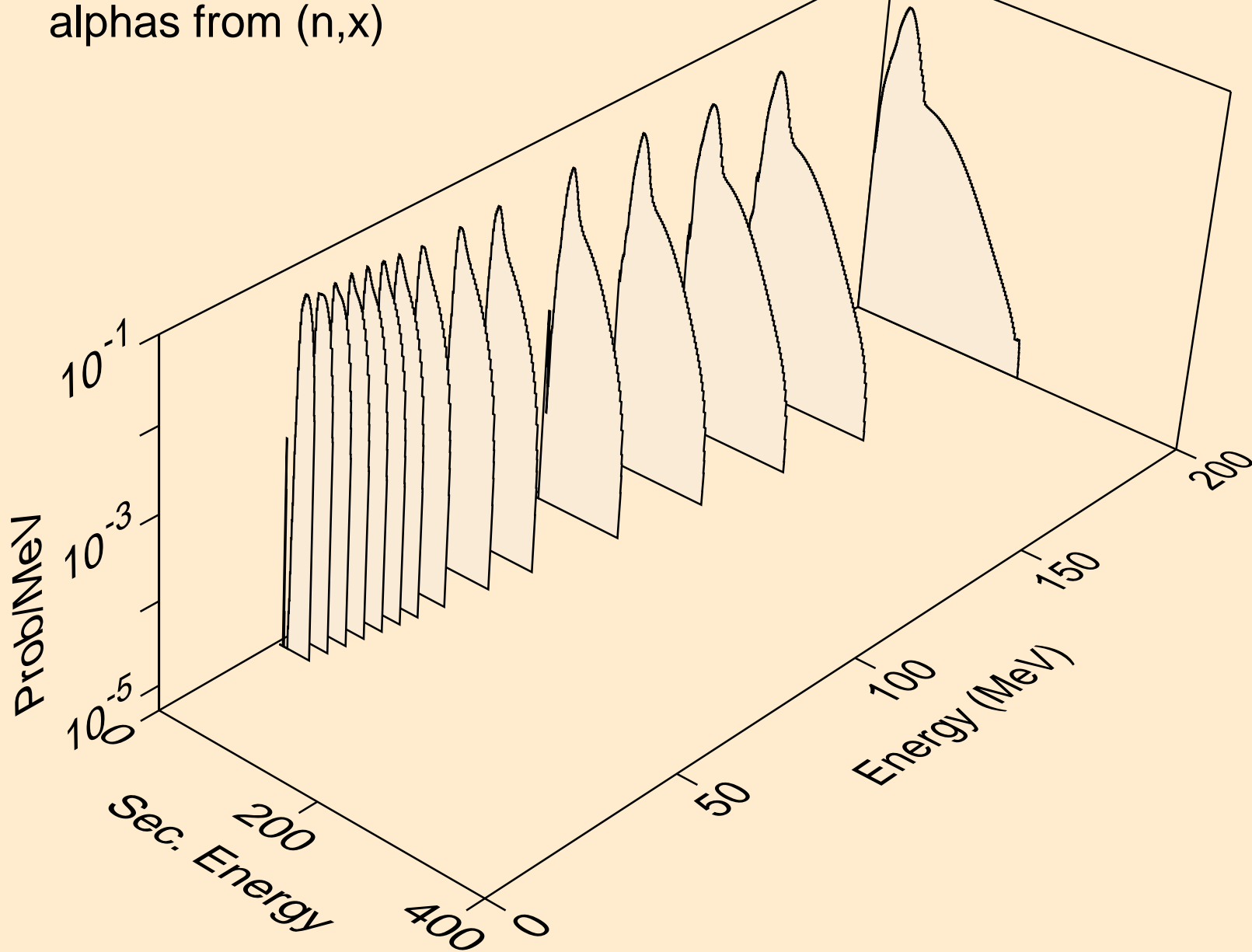

MD255 NEUTRON ACER TENDL-2019 LIBRARY; T=293.16K
alphas from (n,n*)a

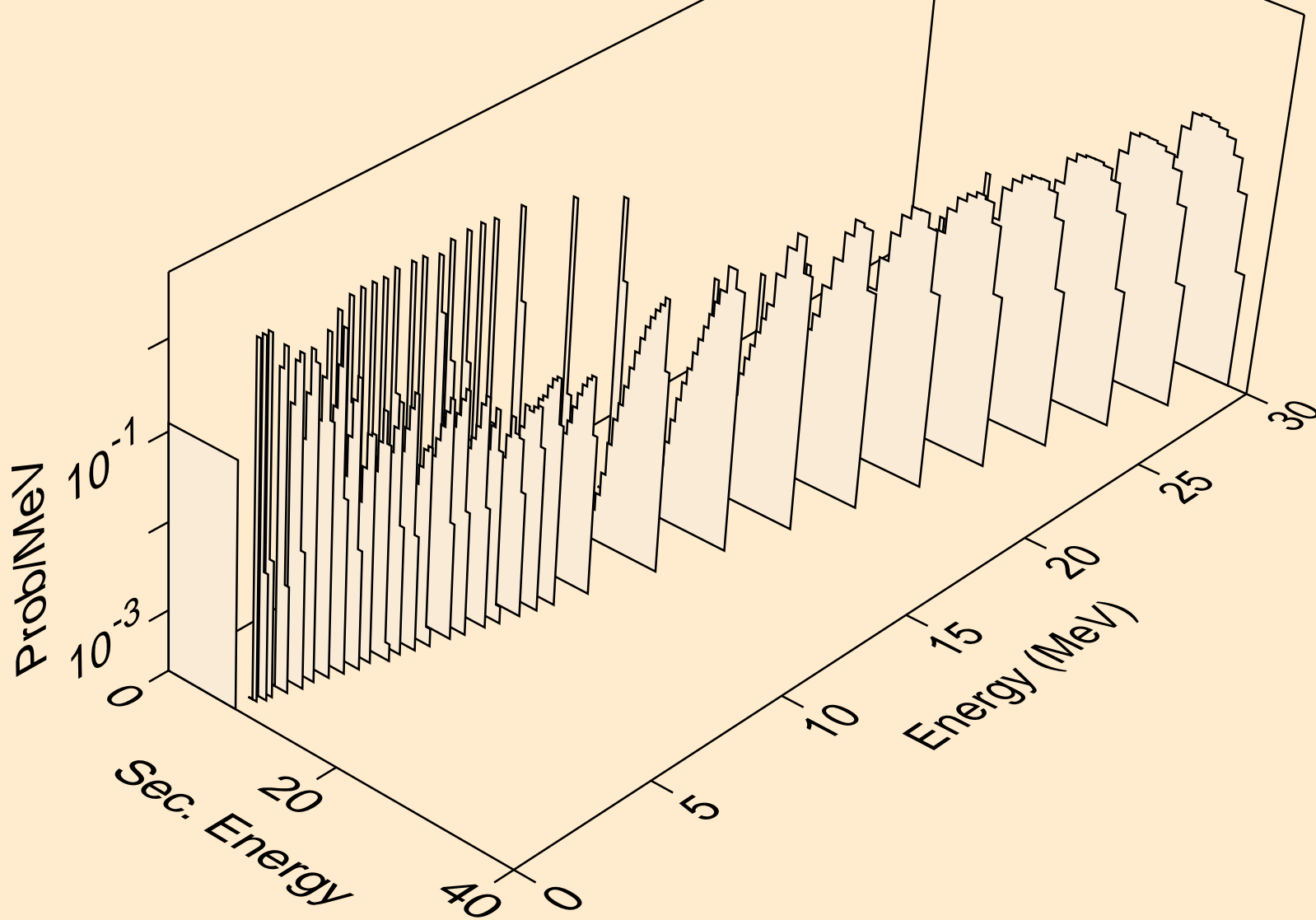

MD255 NEUTRON ACER TENDL-2019 LIBRARY; T=293.16K
alphas from (n,2n)a

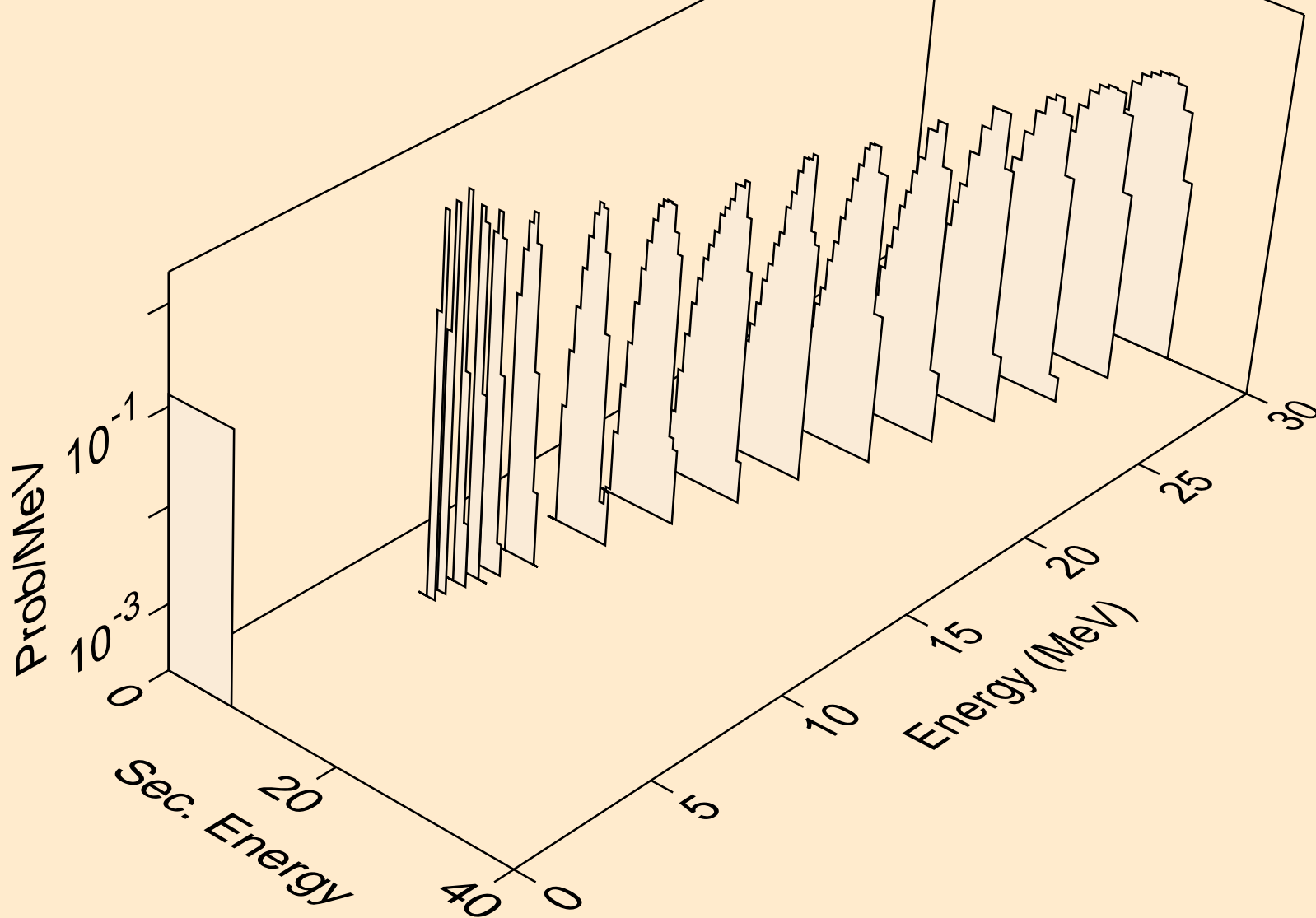

MD255 NEUTRON ACER TENDL-2019 LIBRARY; T=293.16K
alphas from (n,3n)a

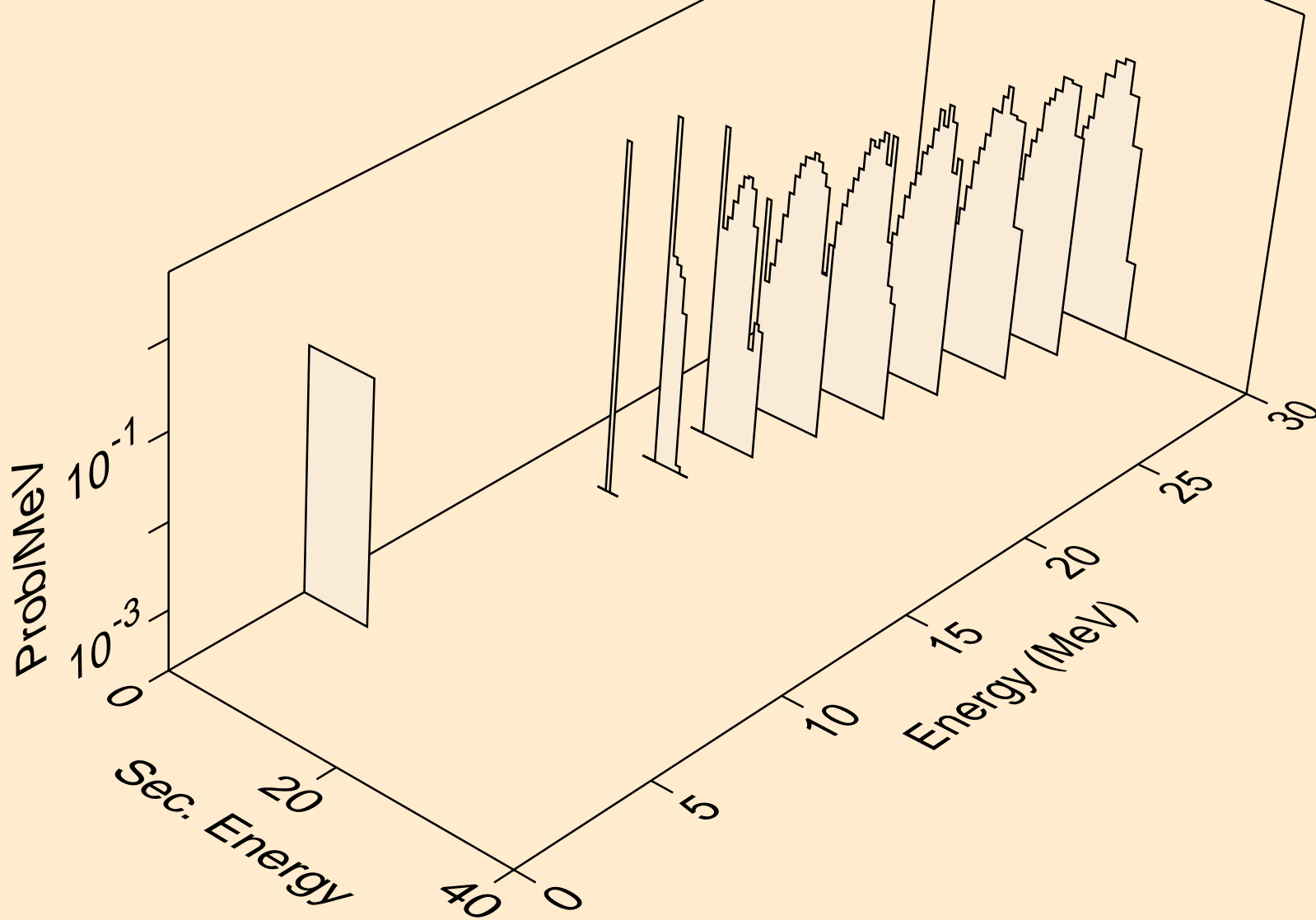

MD255 NEUTRON ACER TENDL-2019 LIBRARY; T=293.16K
alphas from (n,n*)2a

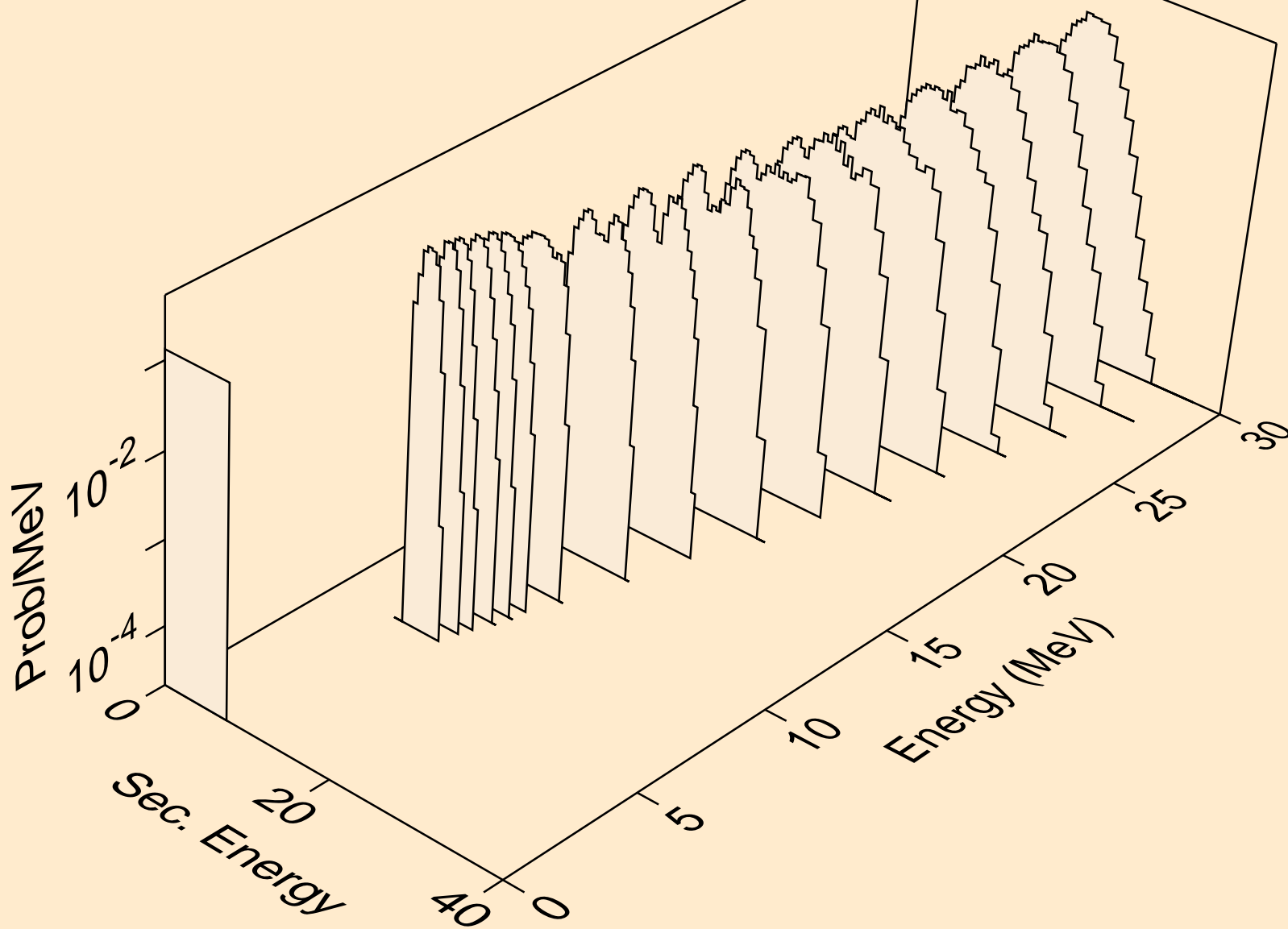

MD255 NEUTRON ACER TENDL-2019 LIBRARY; T=293.16K
alphas from (n,npa)

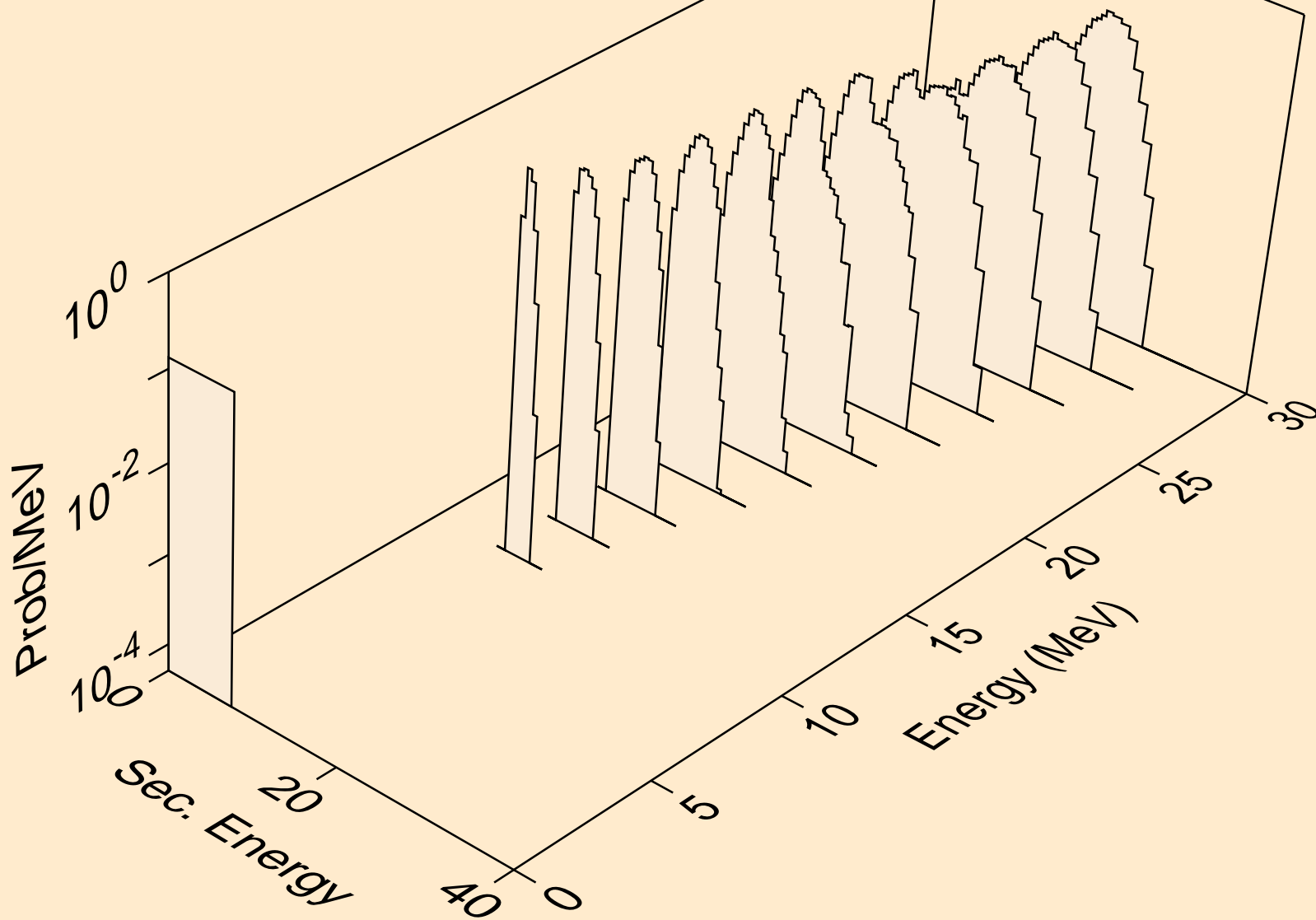

MD255 NEUTRON ACER TENDL-2019 LIBRARY; T=293.16K
alphas from (n,a)

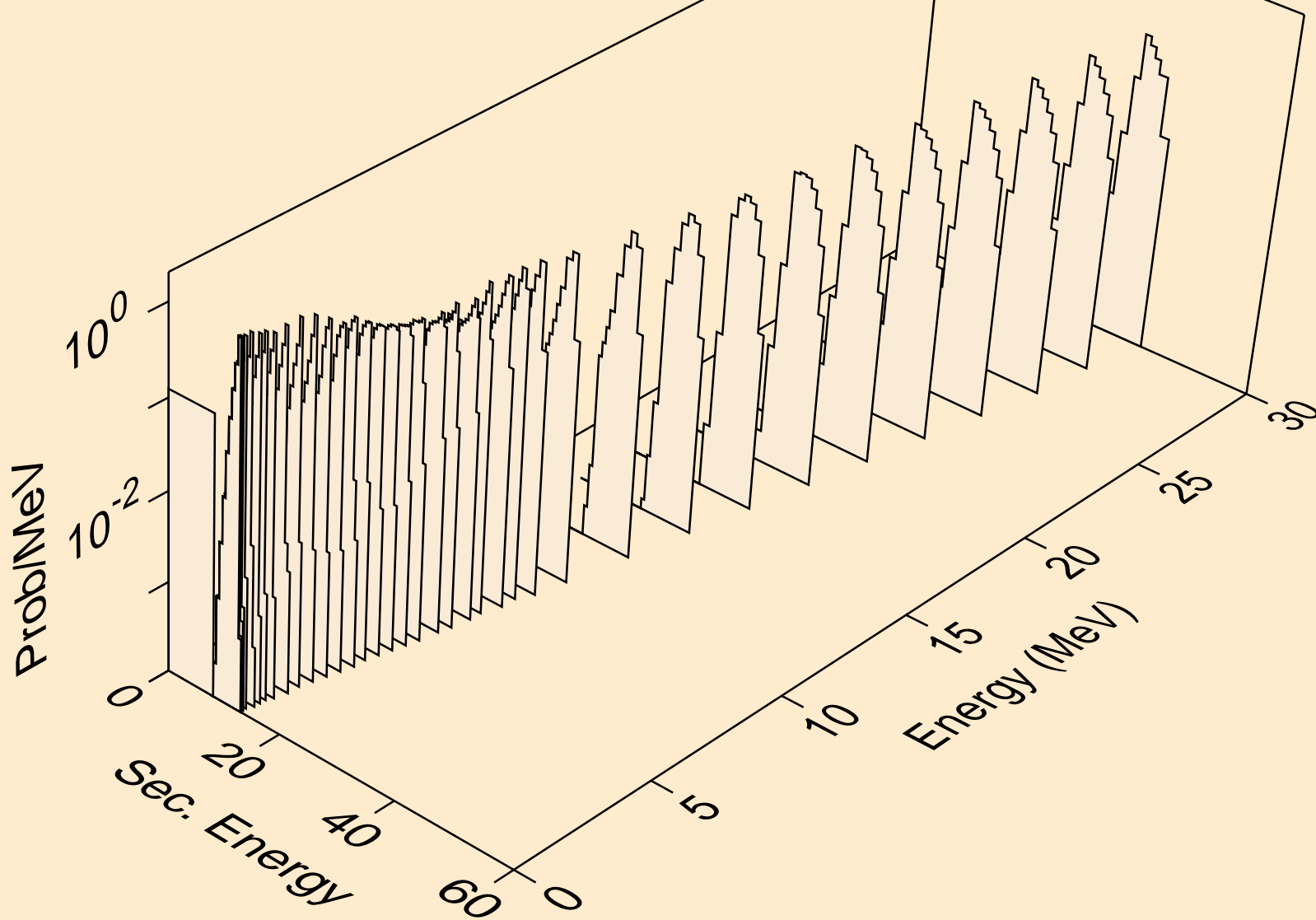

MD255 NEUTRON ACER TENDL-2019 LIBRARY; T=293.16K
alphas from (n,2a)

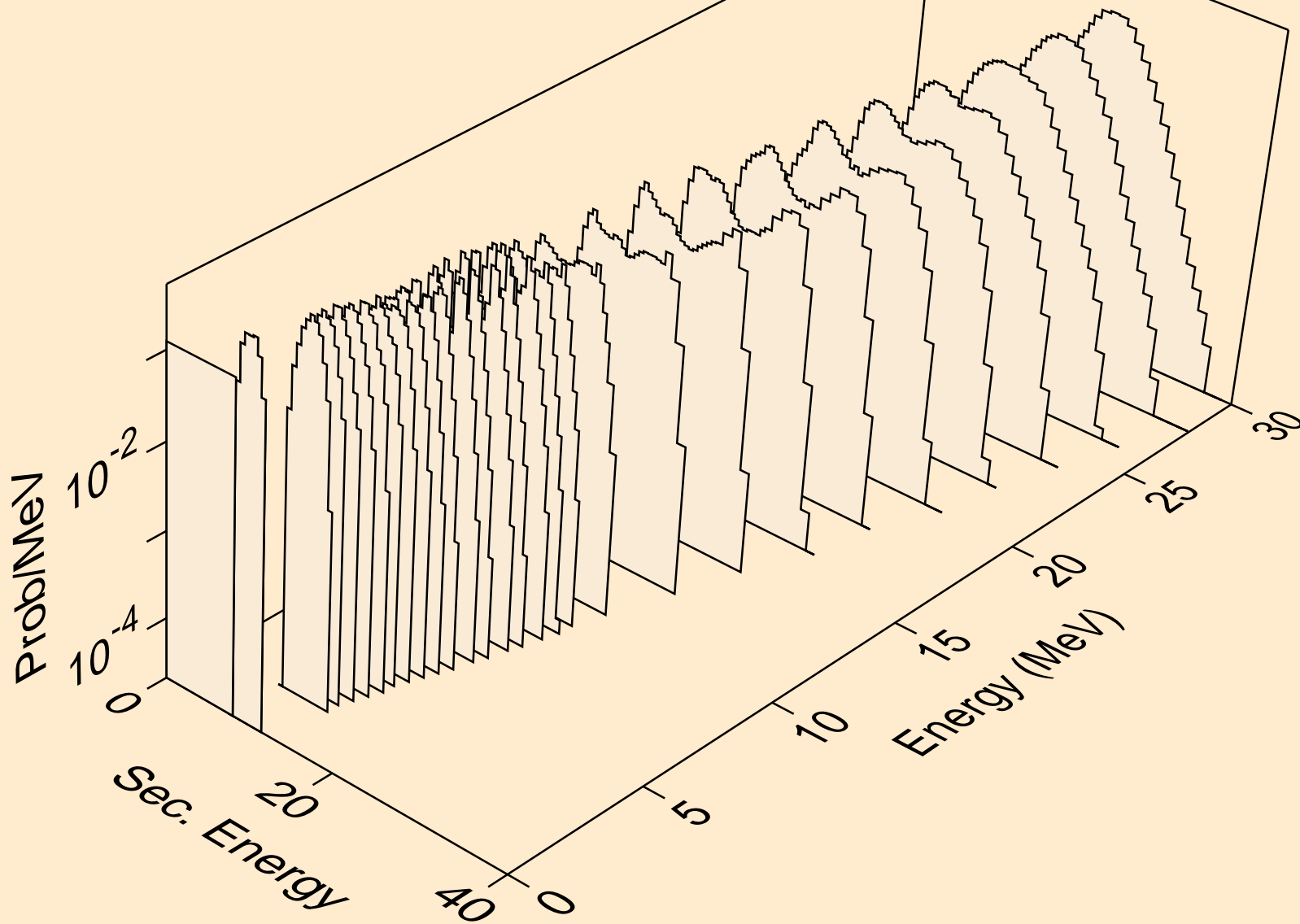

MD255 NEUTRON ACER TENDL-2019 LIBRARY; T=293.16K
alphas from (n,pa)

