

MD256 NEUTRON ACER TENDL-2019 LIBRARY; T=293.16K
Principal cross sections

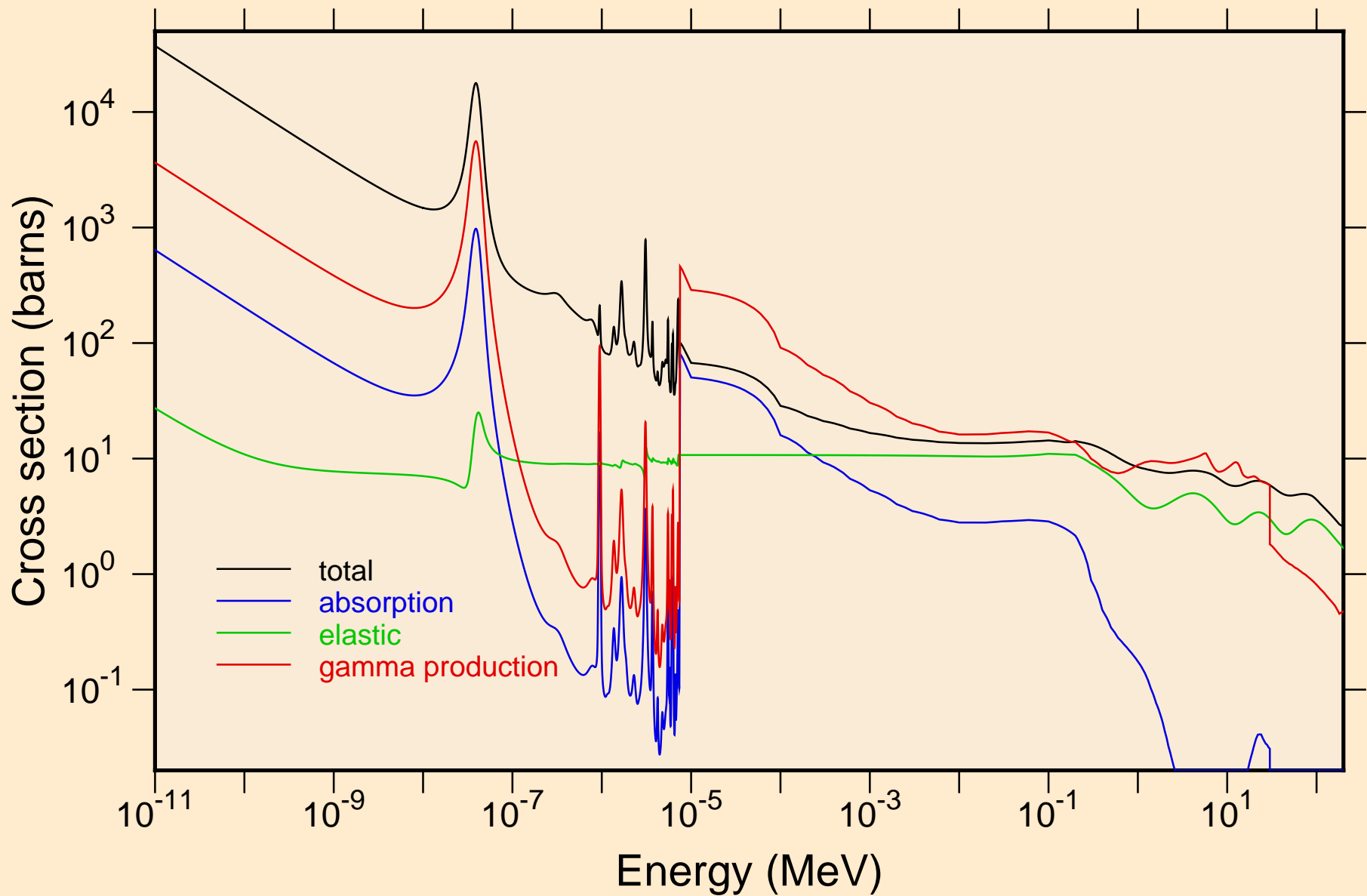

MD256 NEUTRON ACER TENDL-2019 LIBRARY; T=293.16K
resonance total cross section

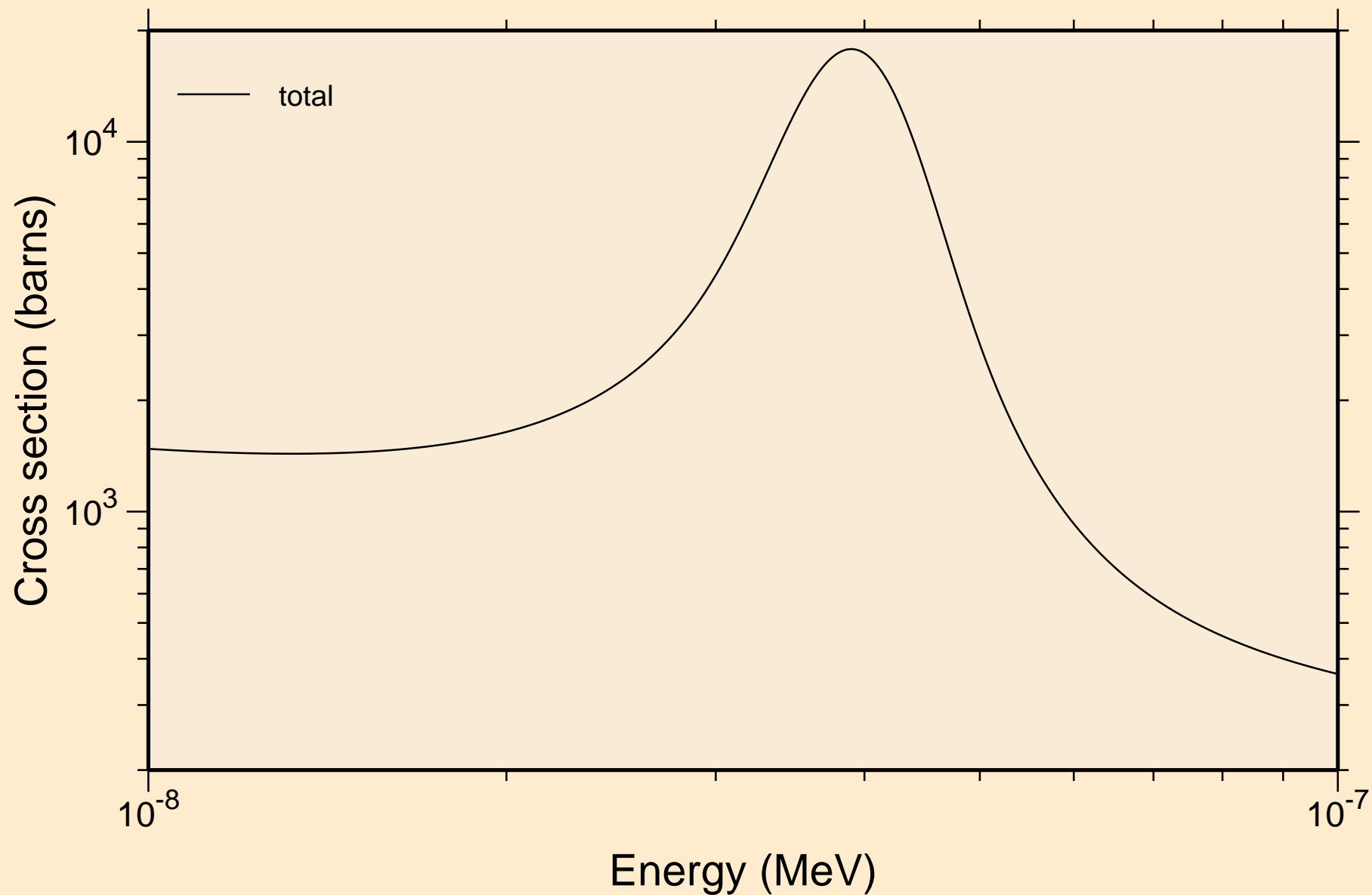

MD256 NEUTRON ACER TENDL-2019 LIBRARY; T=293.16K
resonance total cross section

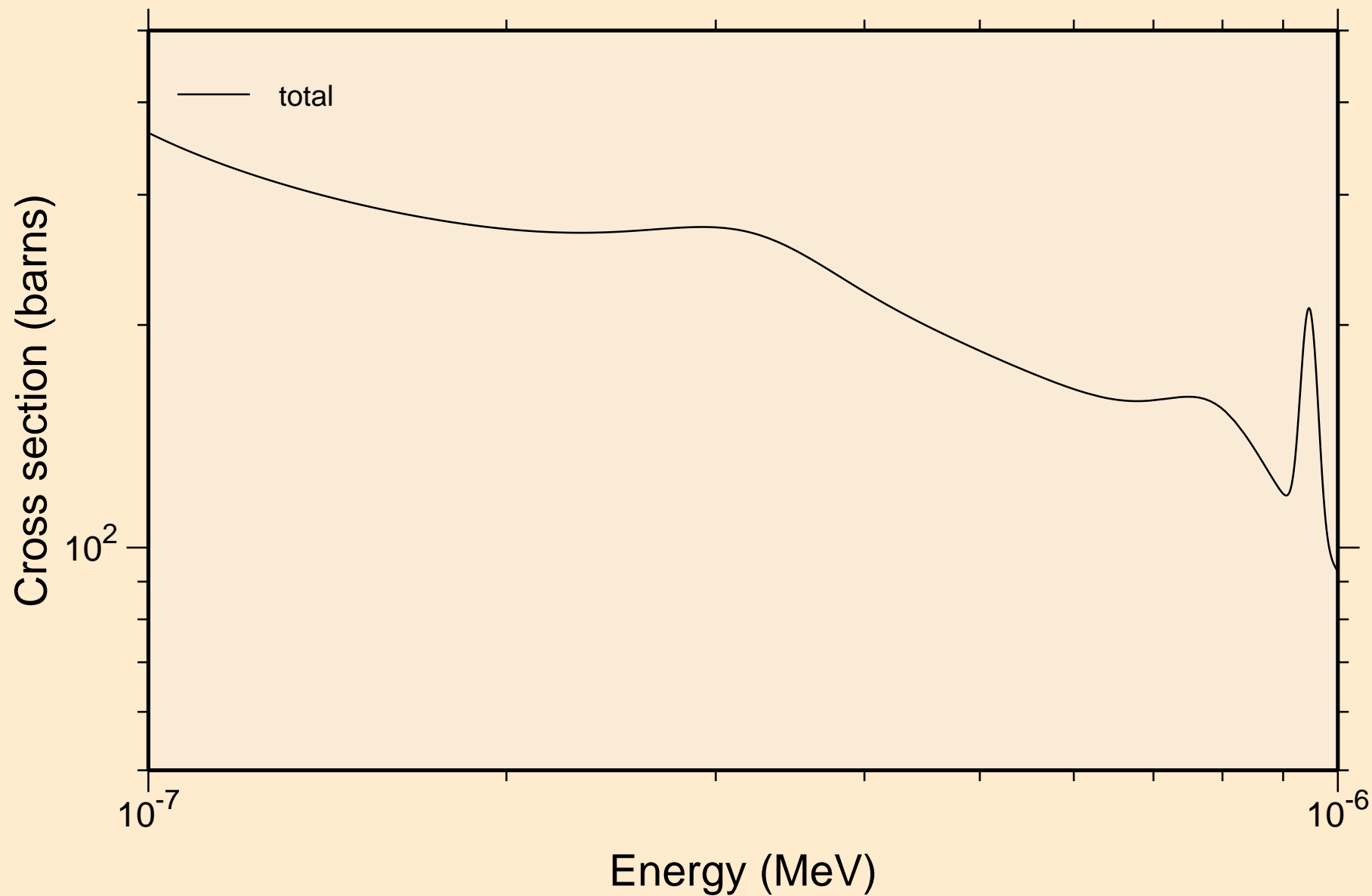

MD256 NEUTRON ACER TENDL-2019 LIBRARY; T=293.16K
resonance total cross section

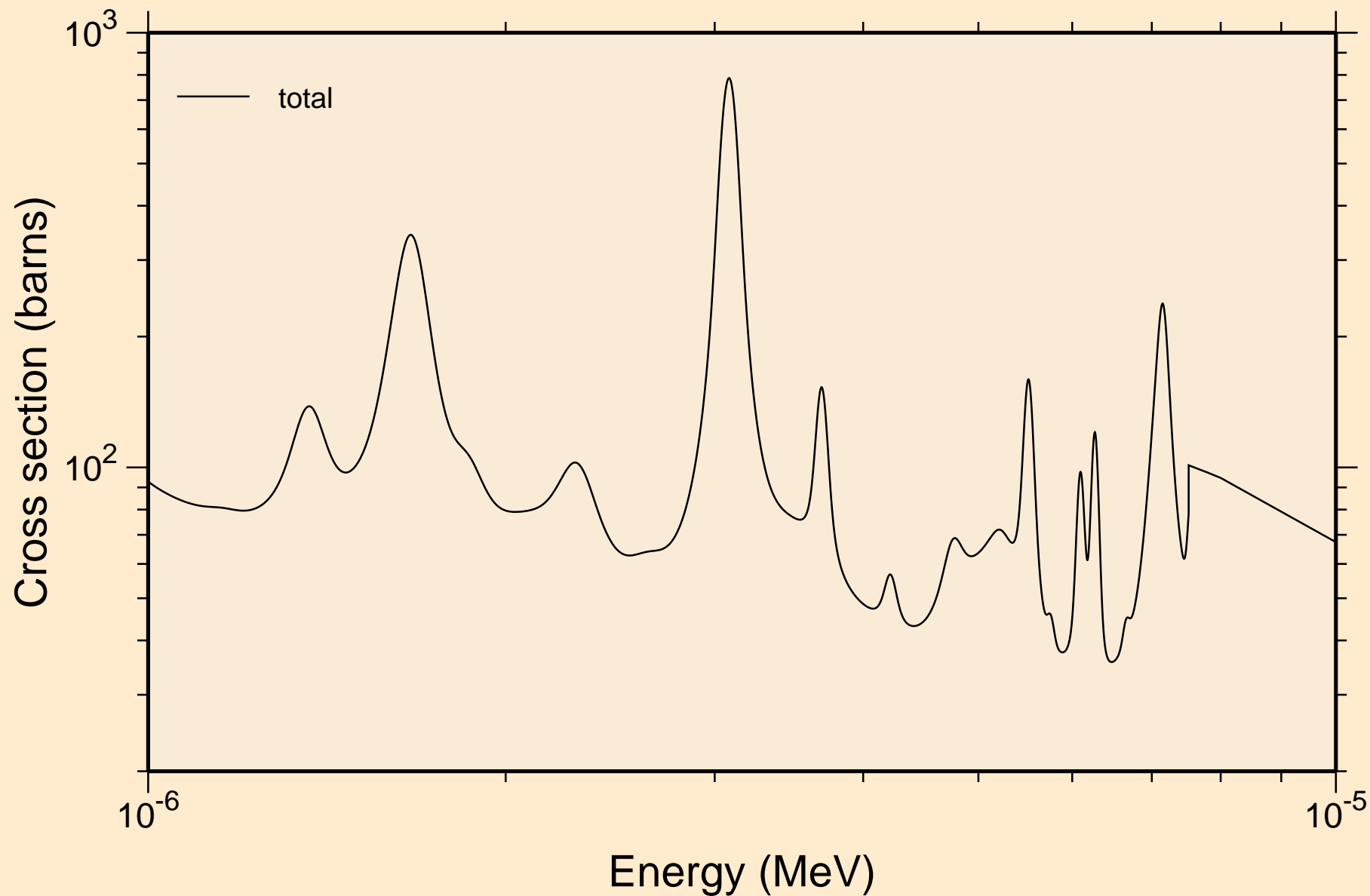

MD256 NEUTRON ACER TENDL-2019 LIBRARY; T=293.16K
resonance total cross section

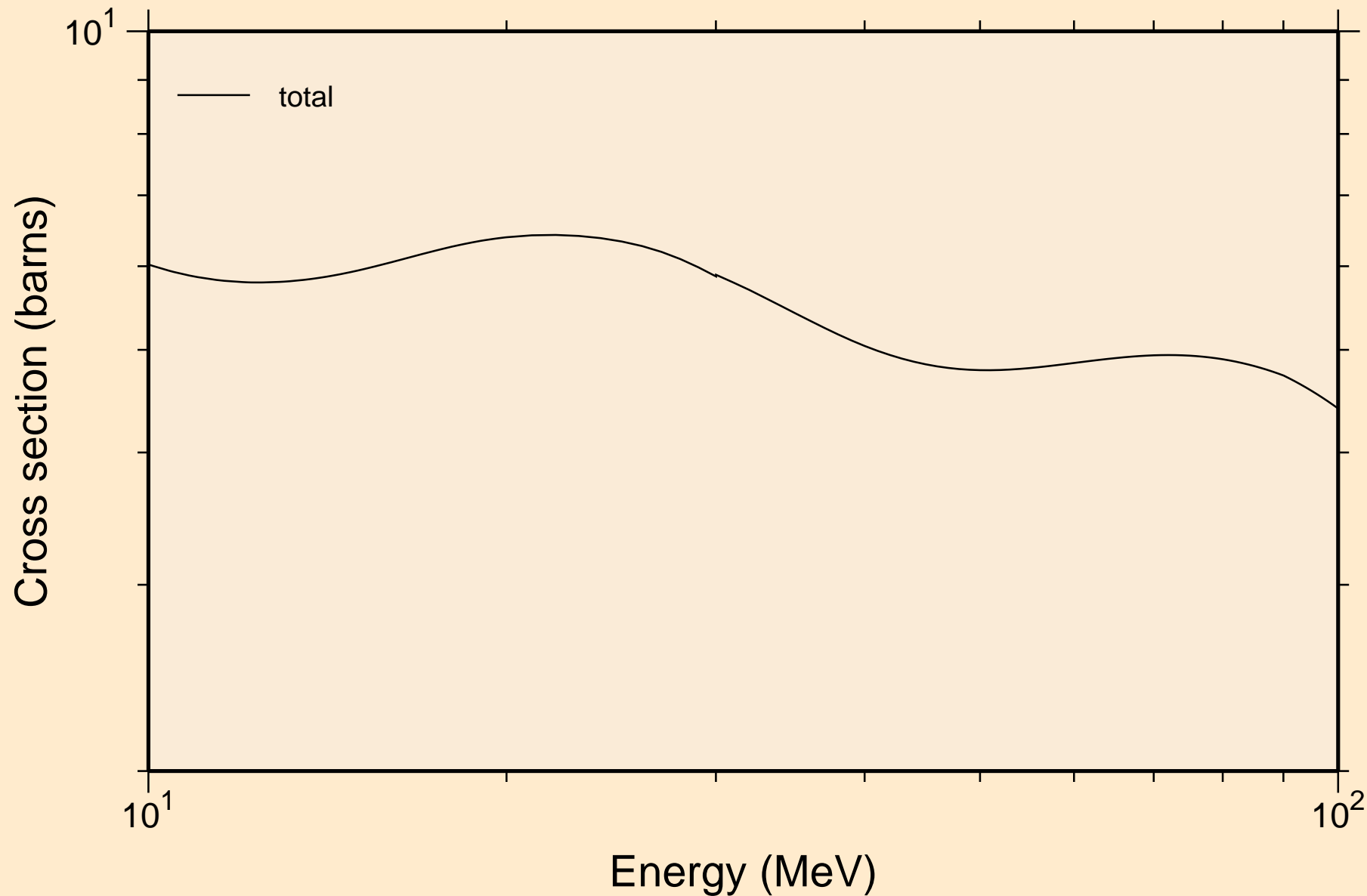

MD256 NEUTRON ACER TENDL-2019 LIBRARY; T=293.16K
resonance absorption cross sections

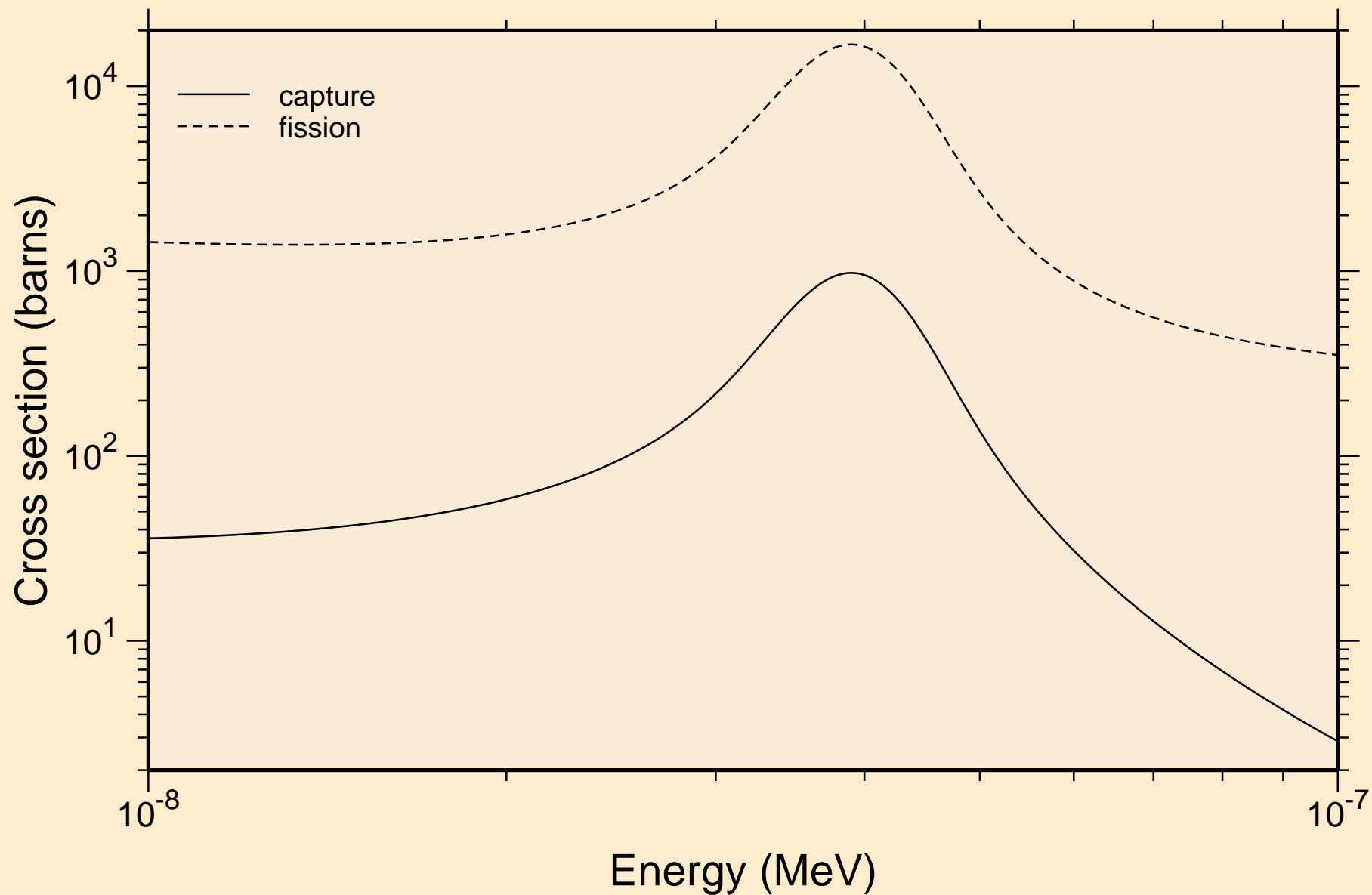

MD256 NEUTRON ACER TENDL-2019 LIBRARY; T=293.16K
resonance absorption cross sections

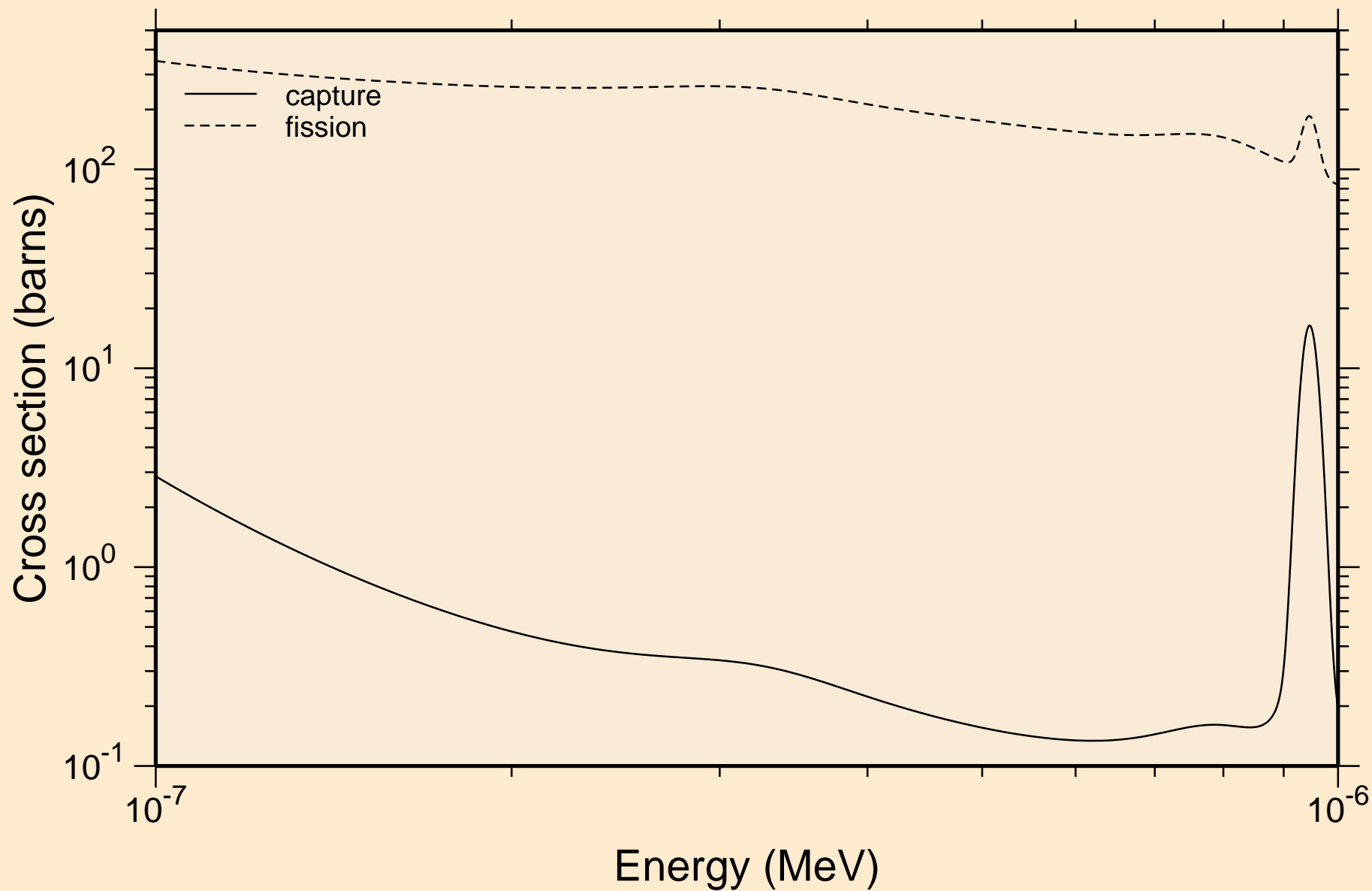

MD256 NEUTRON ACER TENDL-2019 LIBRARY; T=293.16K
resonance absorption cross sections

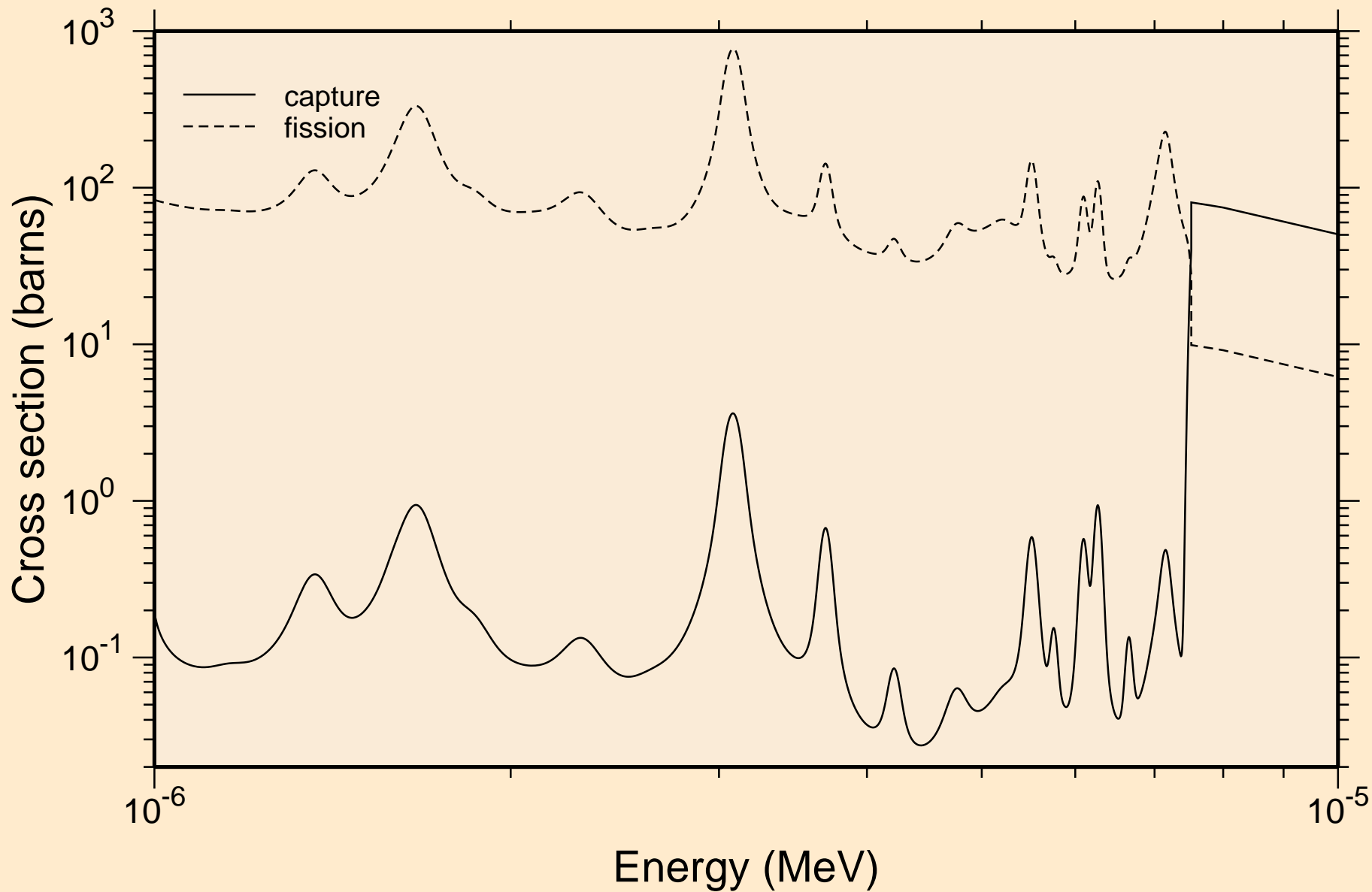

MD256 NEUTRON ACER TENDL-2019 LIBRARY; T=293.16K
resonance absorption cross sections

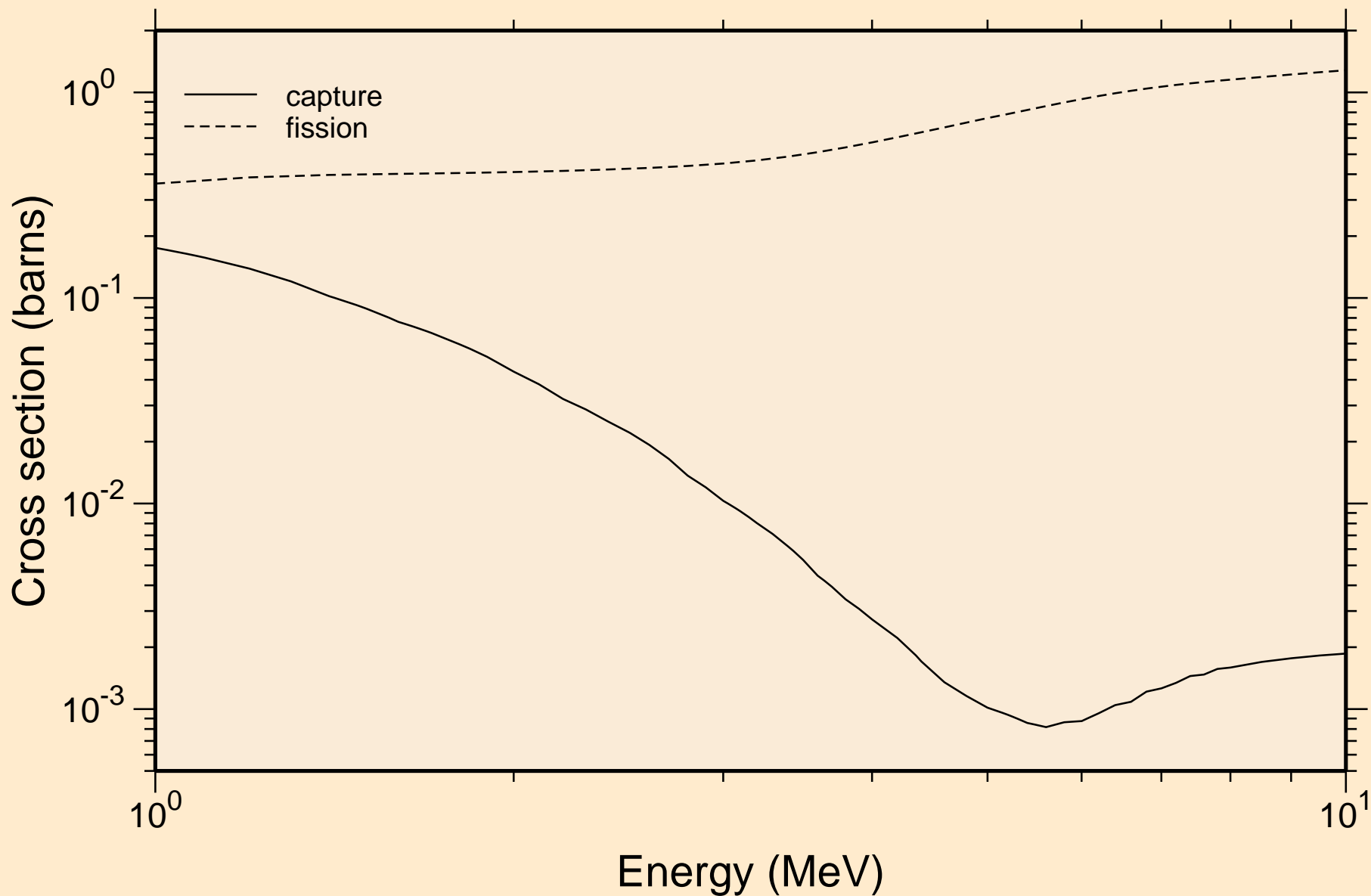

MD256 NEUTRON ACER TENDL-2019 LIBRARY; T=293.16K
Heating

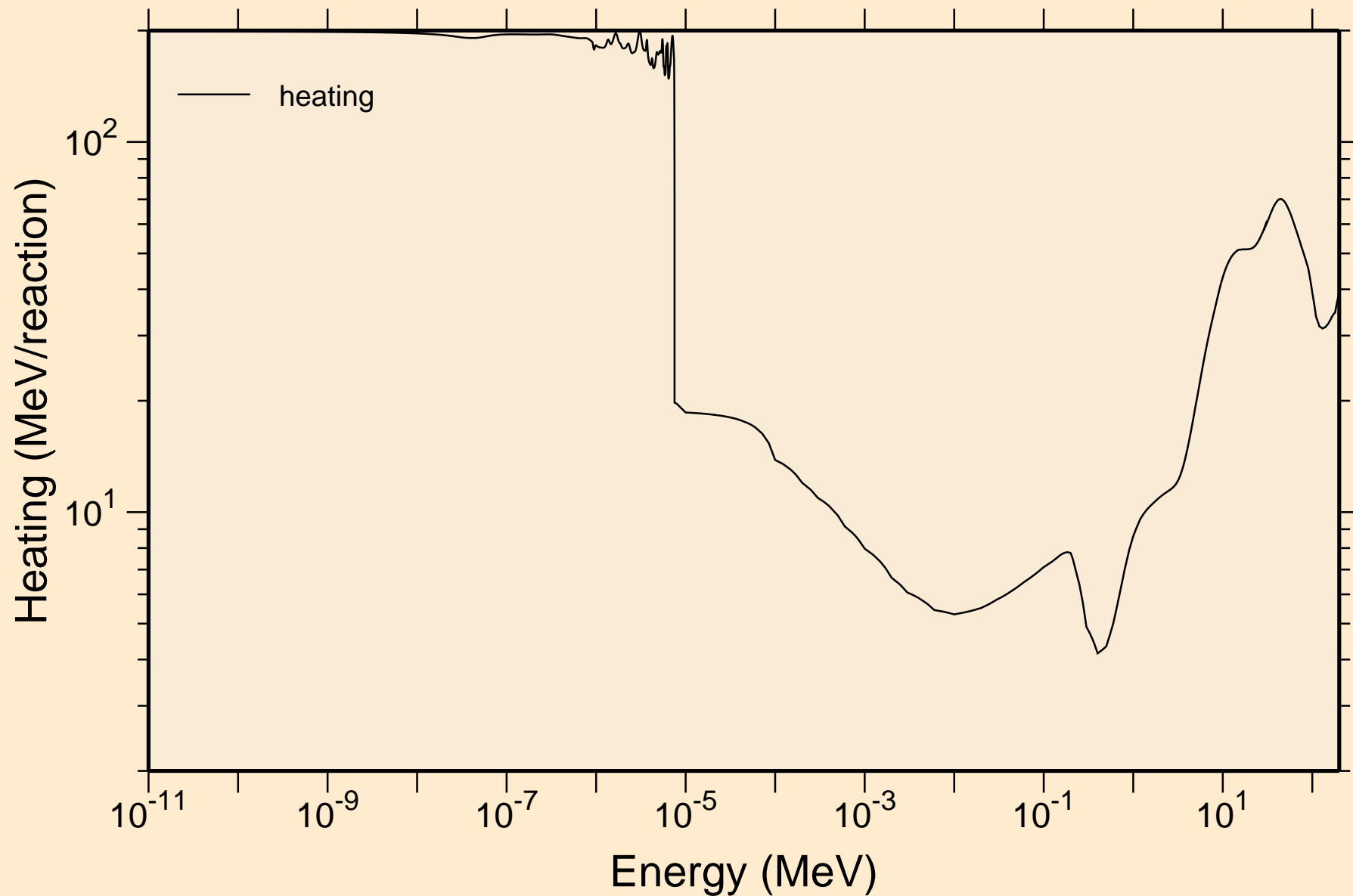

MD256 NEUTRON ACER TENDL-2019 LIBRARY; T=293.16K
Damage

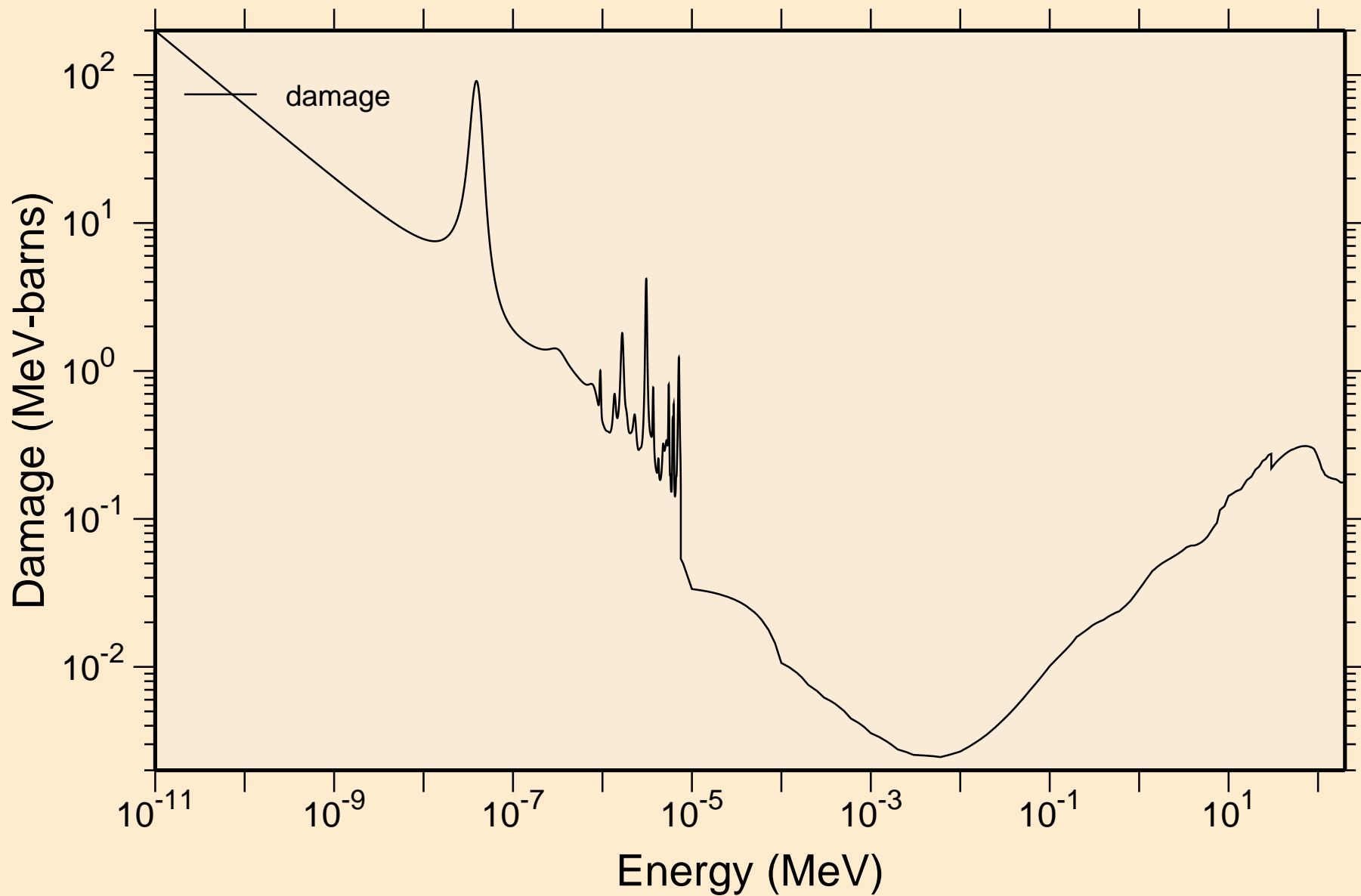

MD256 NEUTRON ACER TENDL-2019 LIBRARY; T=293.16K
Non-threshold reactions

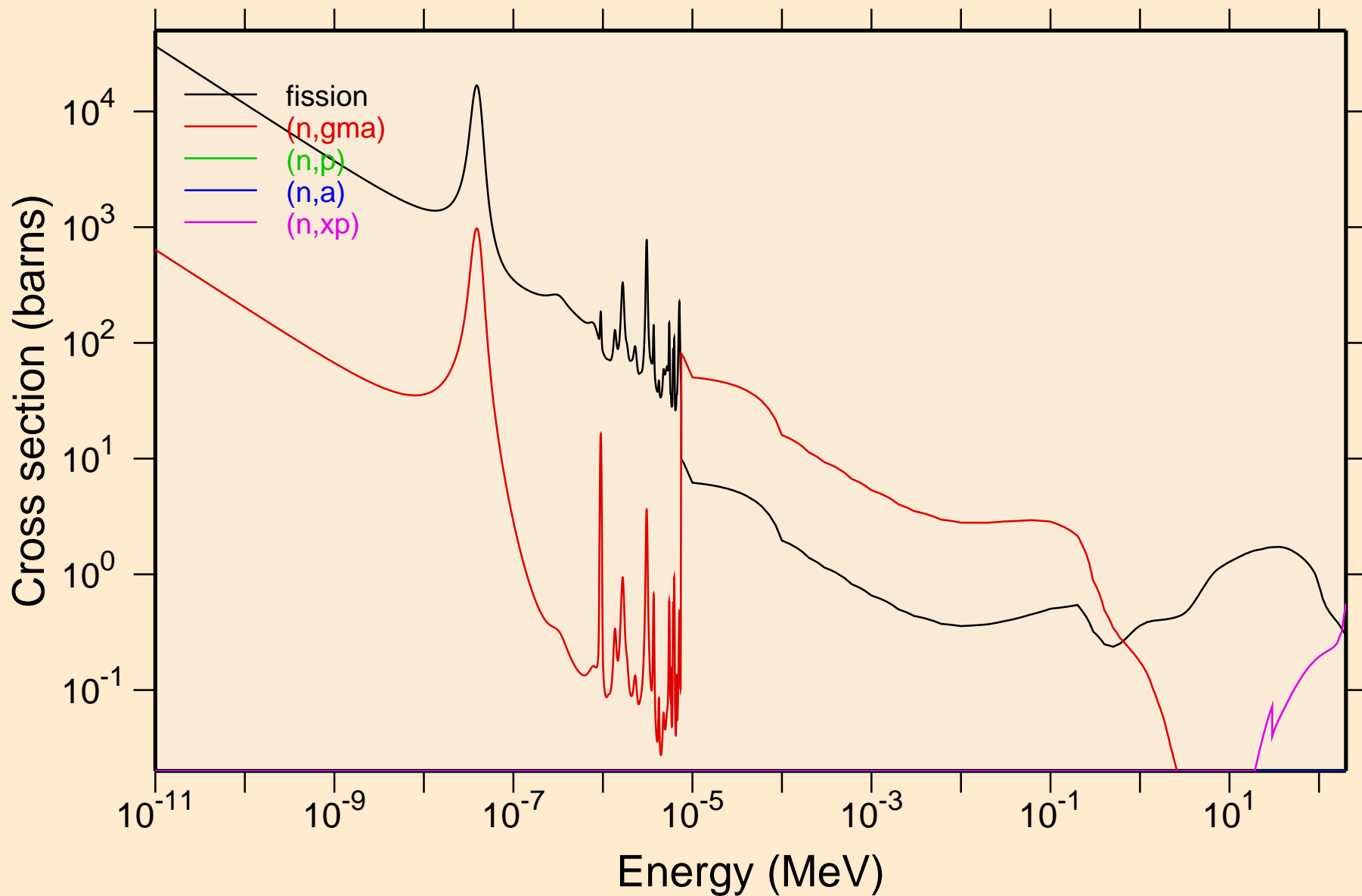

MD256 NEUTRON ACER TENDL-2019 LIBRARY; T=293.16K
Non-threshold reactions

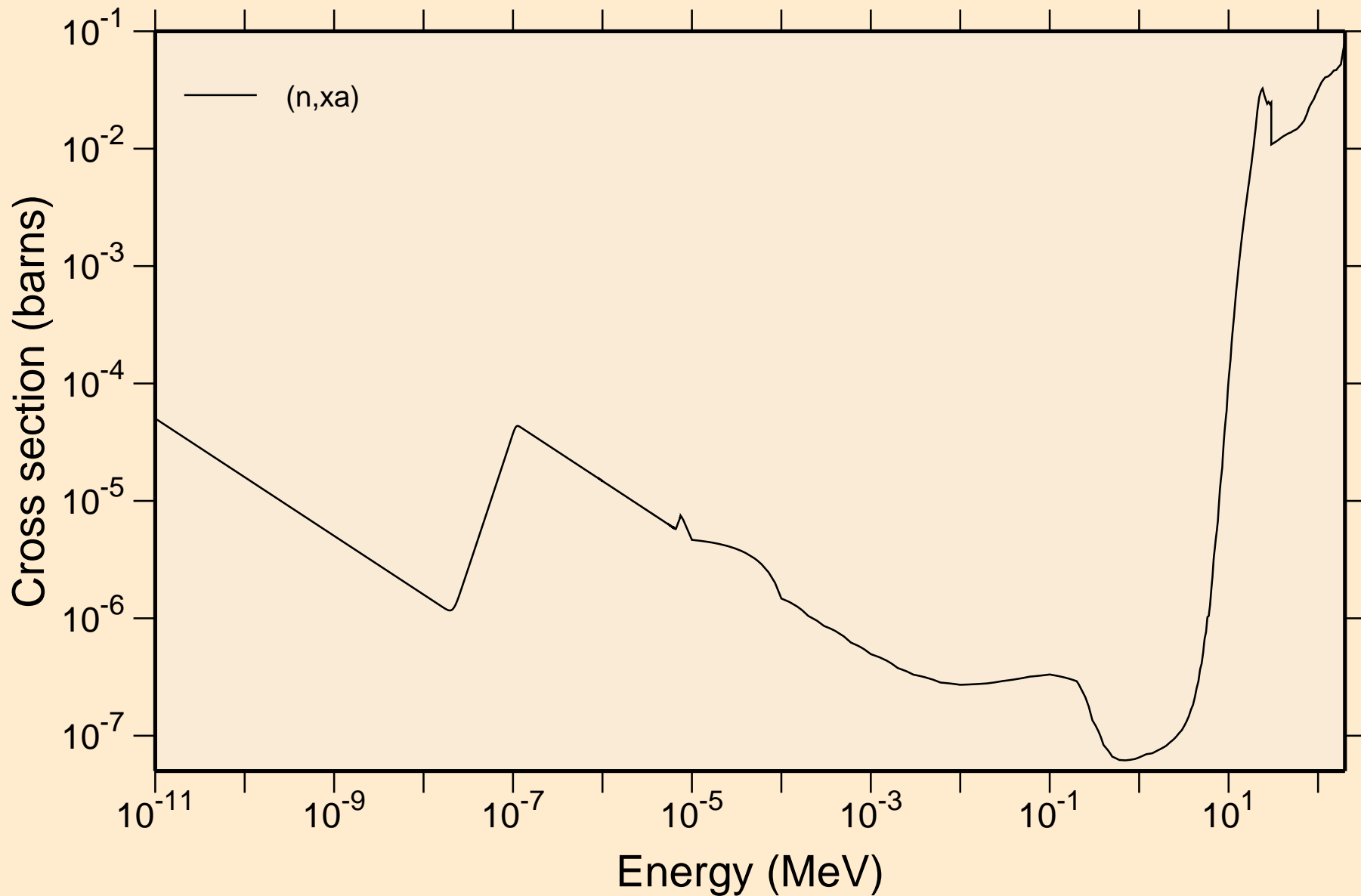

MD256 NEUTRON ACER TENDL-2019 LIBRARY; T=293.16K
Principal cross sections

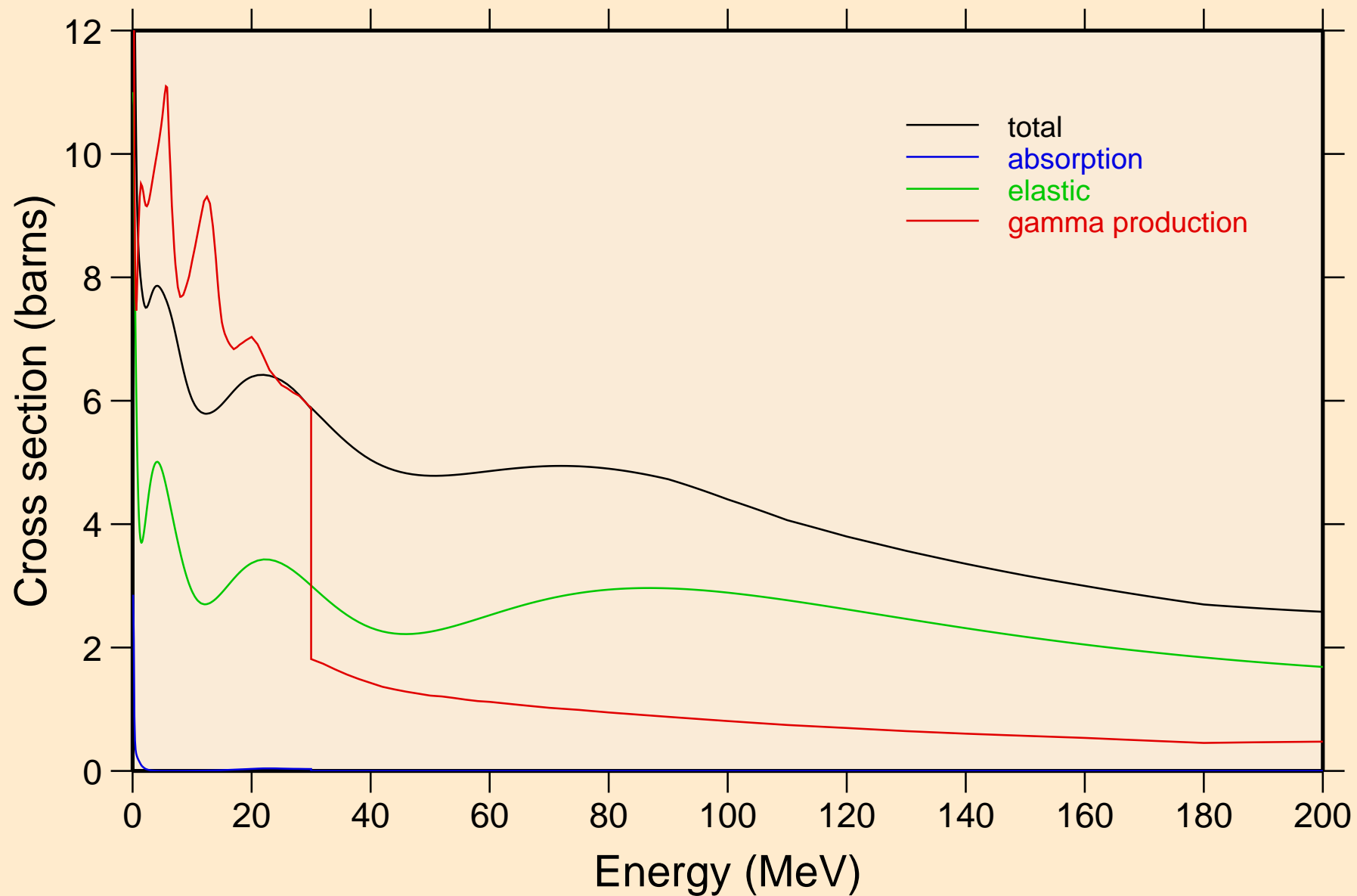

MD256 NEUTRON ACER TENDL-2019 LIBRARY; T=293.16K
Heating

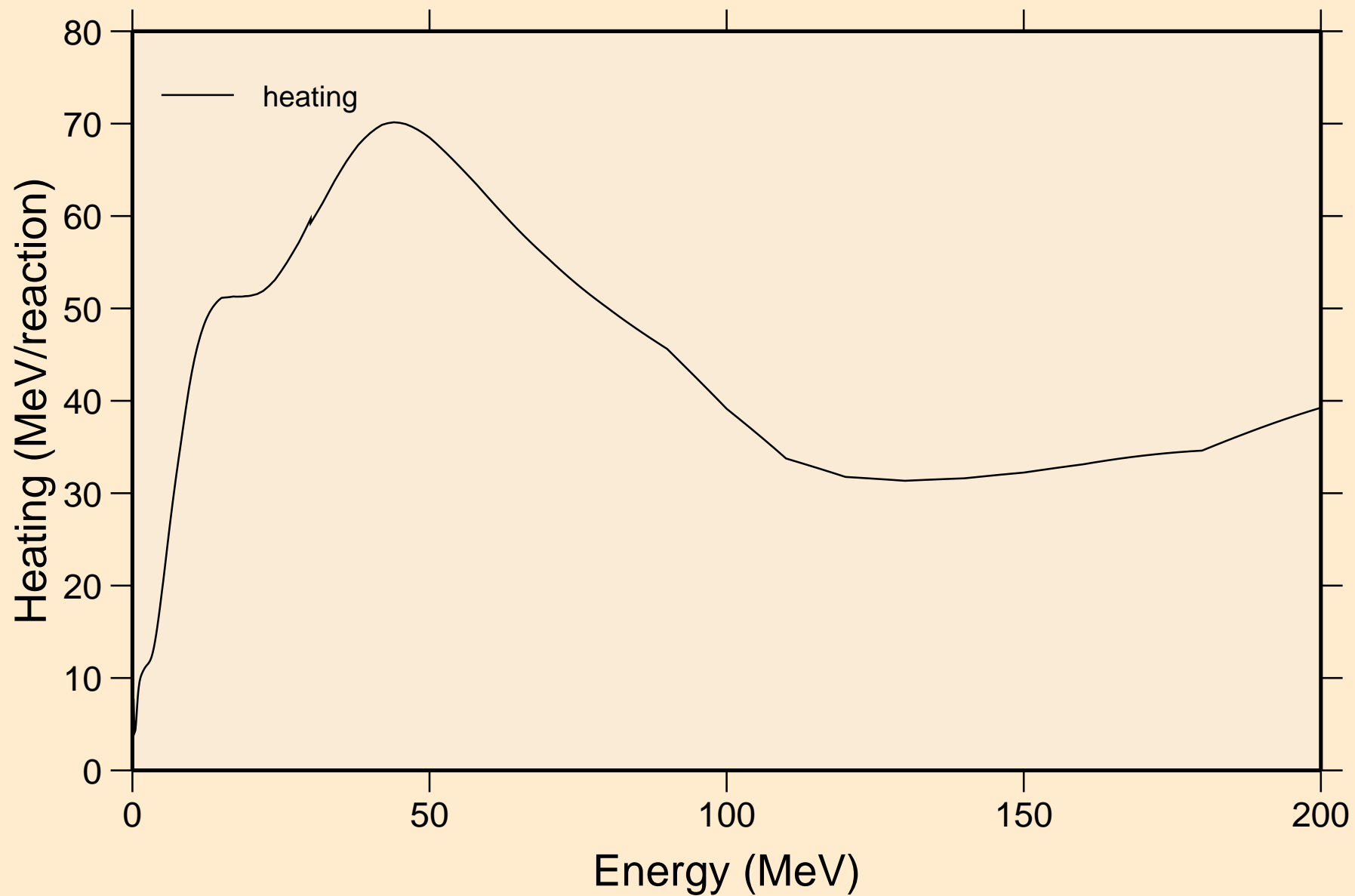

MD256 NEUTRON ACER TENDL-2019 LIBRARY; T=293.16K
Damage

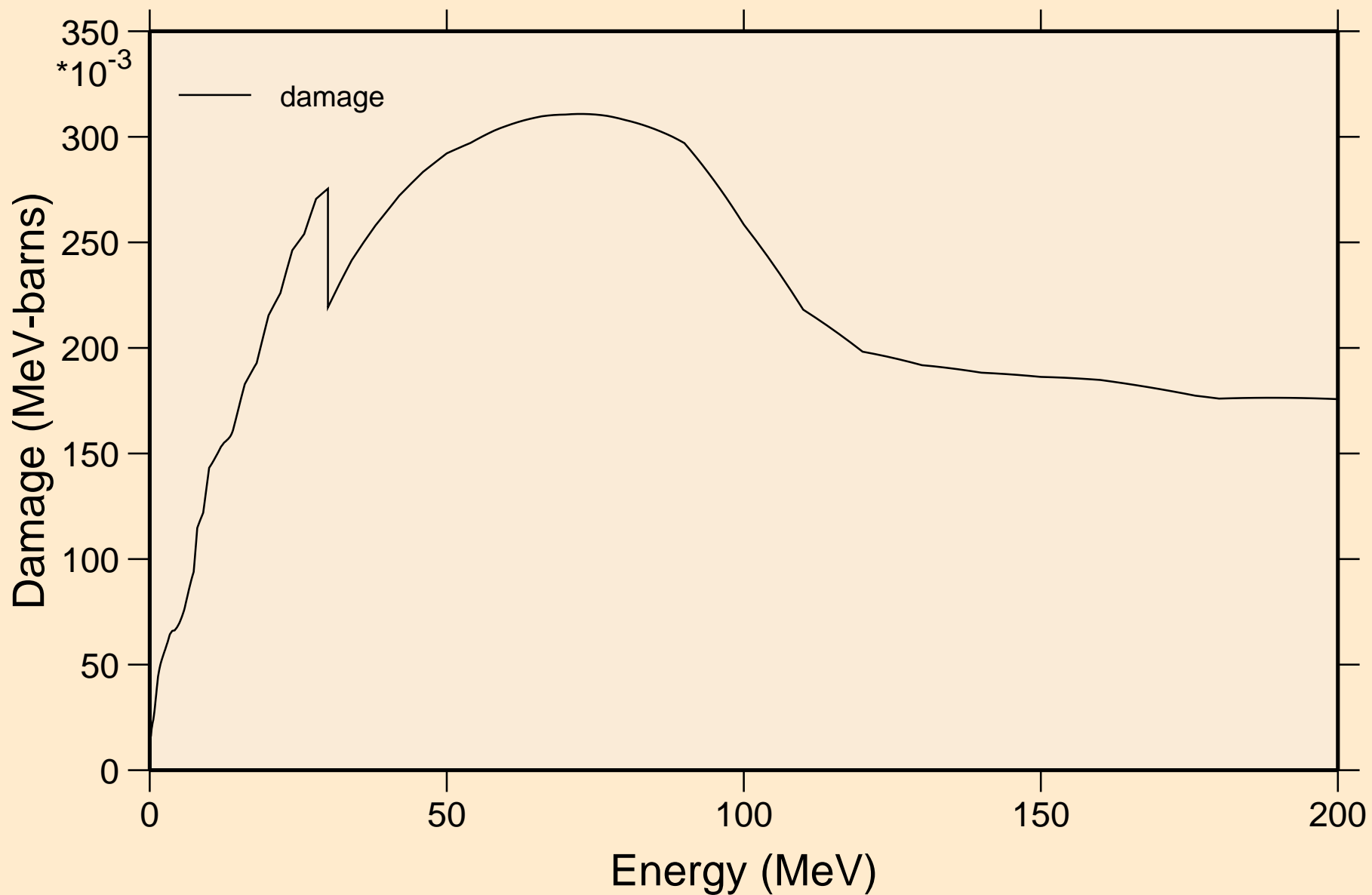

MD256 NEUTRON ACER TENDL-2019 LIBRARY; T=293.16K
Non-threshold reactions

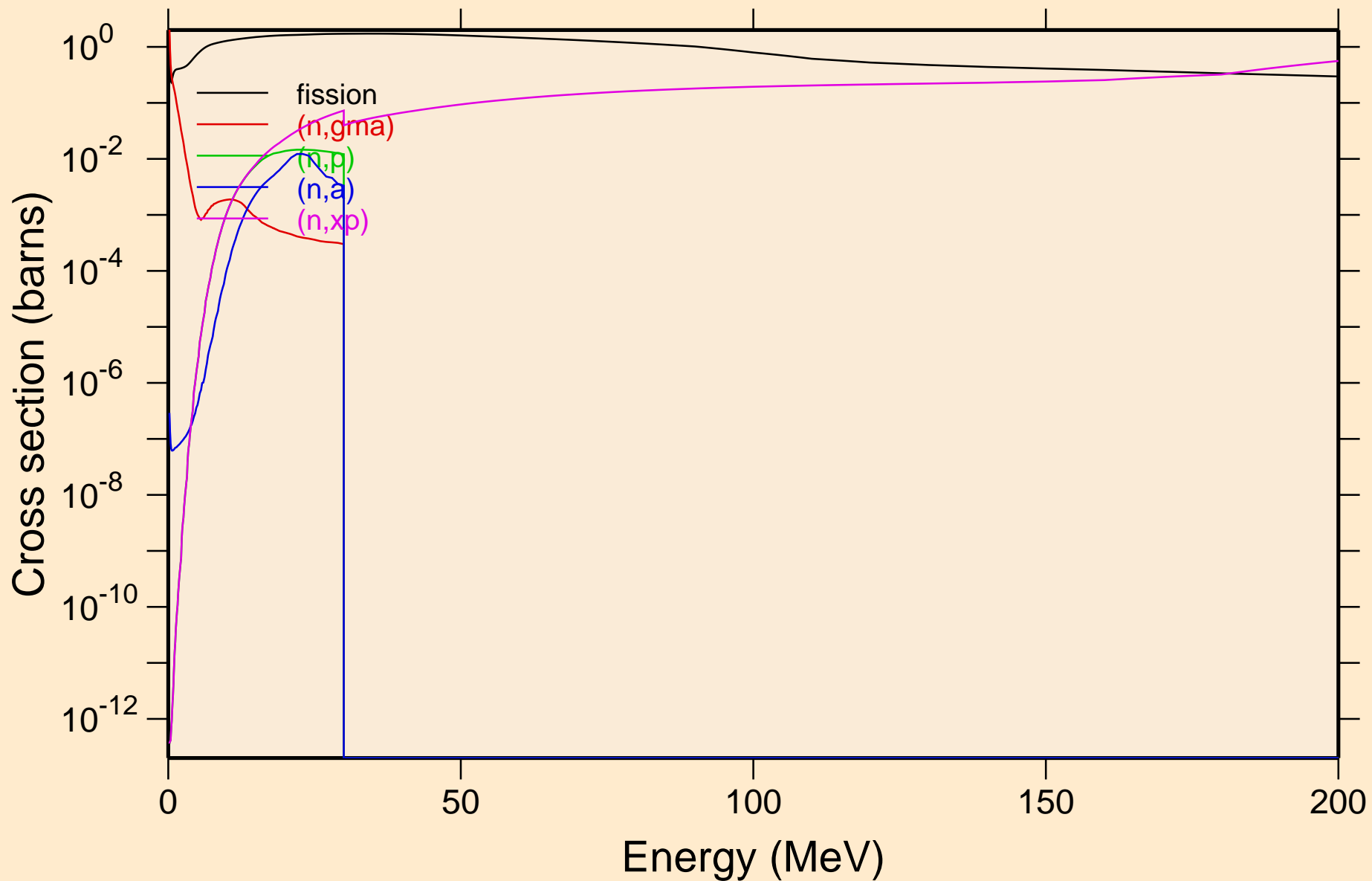

MD256 NEUTRON ACER TENDL-2019 LIBRARY; T=293.16K
Non-threshold reactions

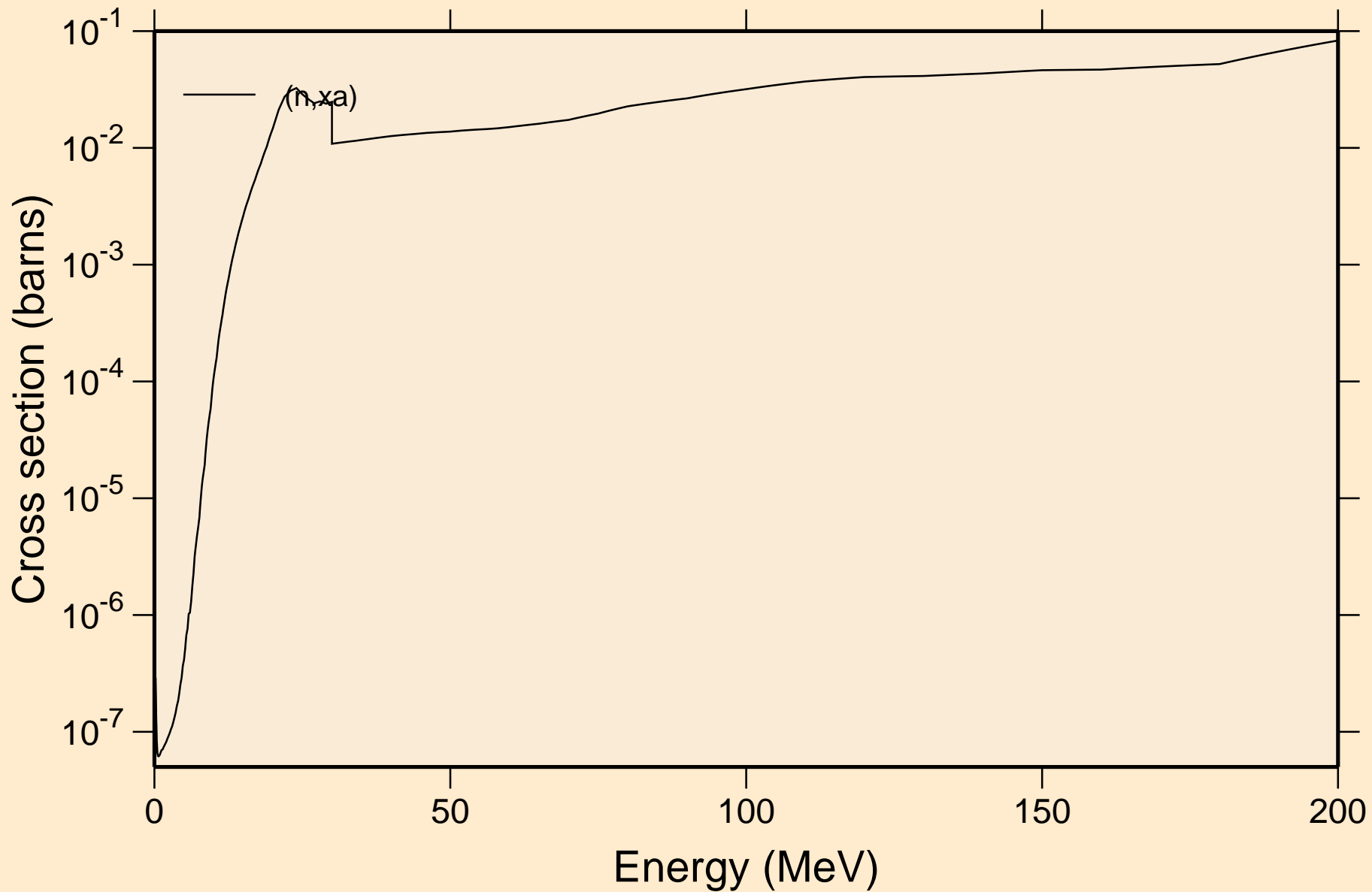

MD256 NEUTRON ACER TENDL-2019 LIBRARY; T=293.16K
Inelastic levels

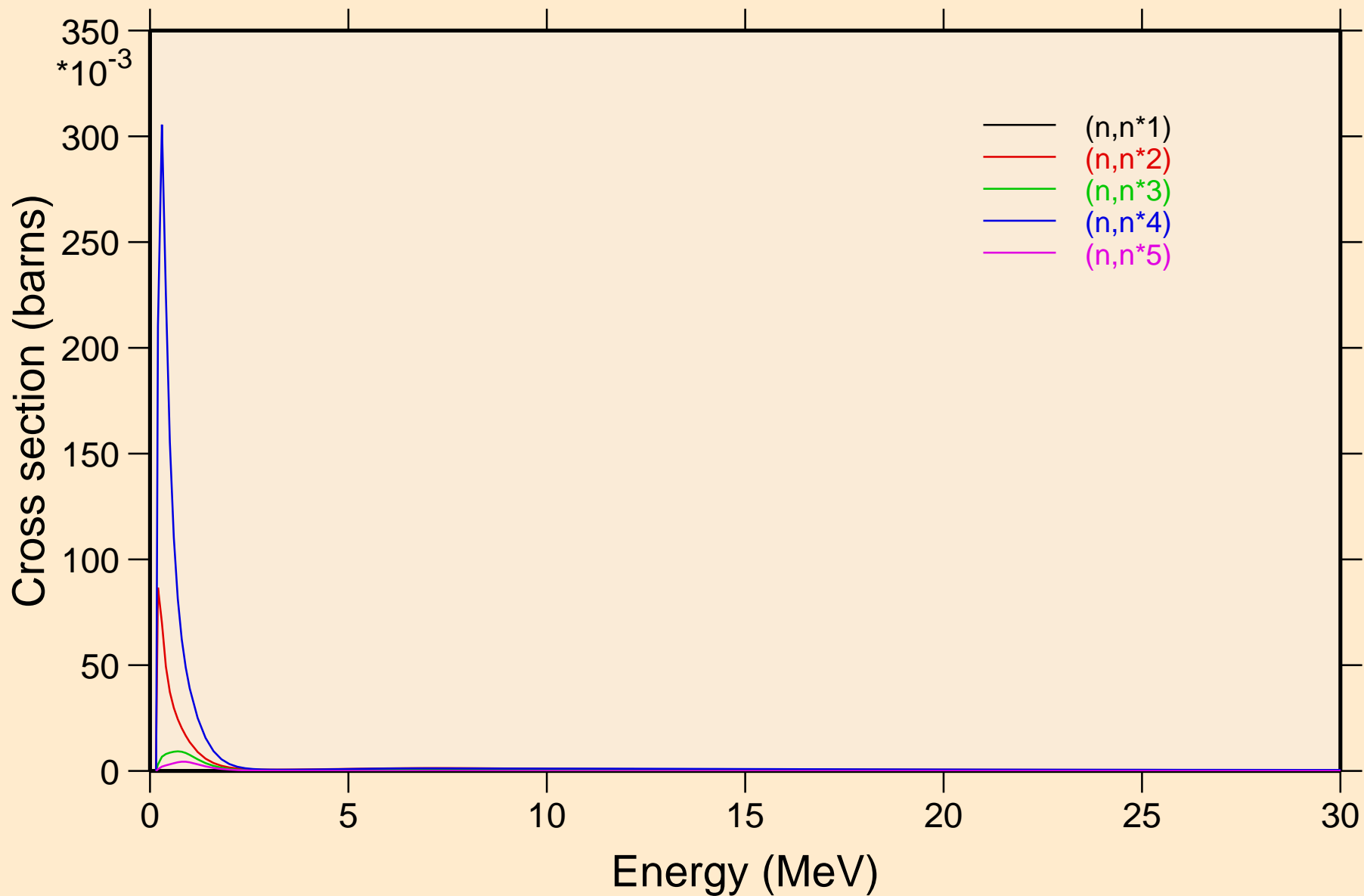

MD256 NEUTRON ACER TENDL-2019 LIBRARY; T=293.16K
Inelastic levels

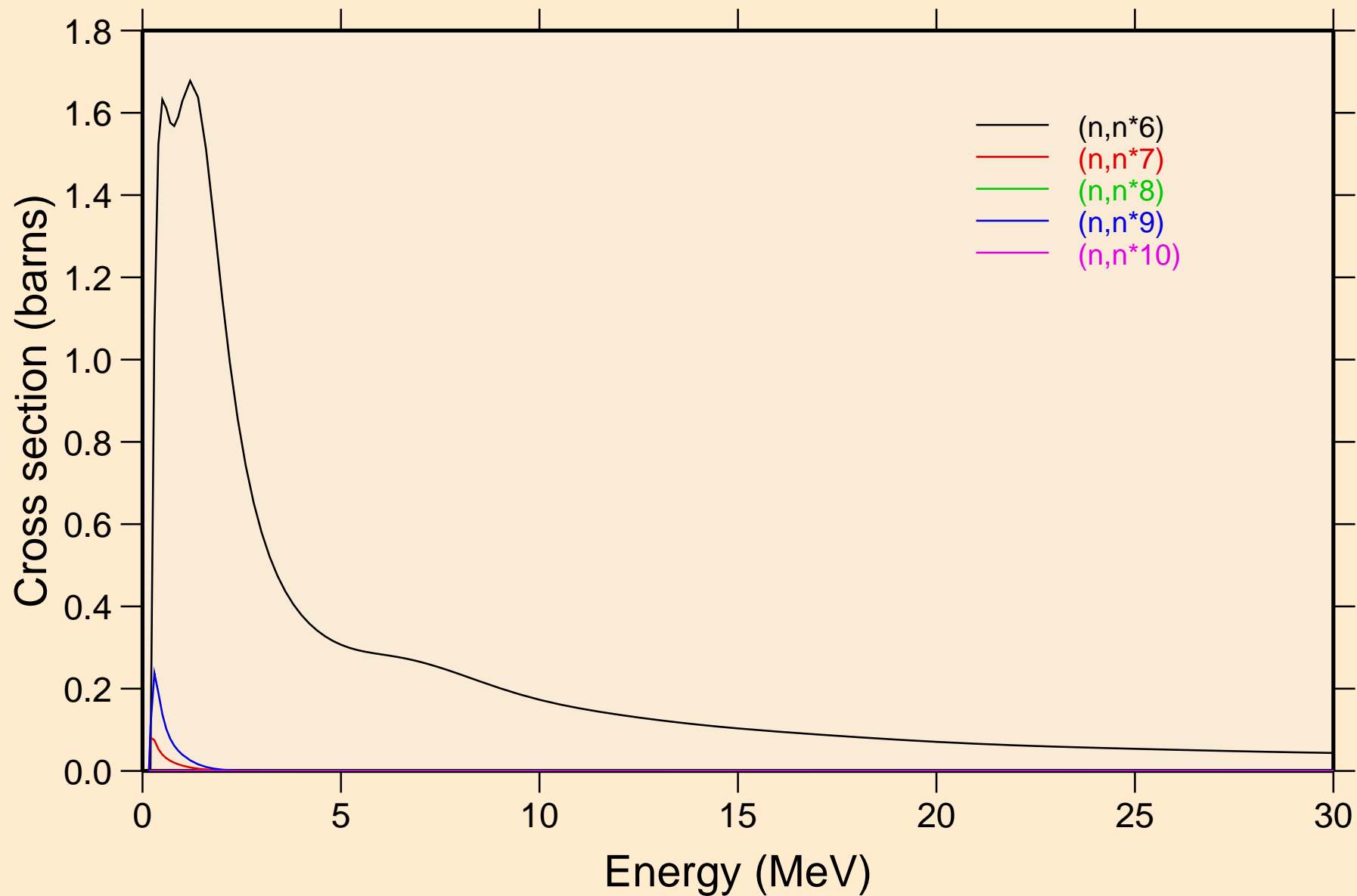

MD256 NEUTRON ACER TENDL-2019 LIBRARY; T=293.16K
Inelastic levels

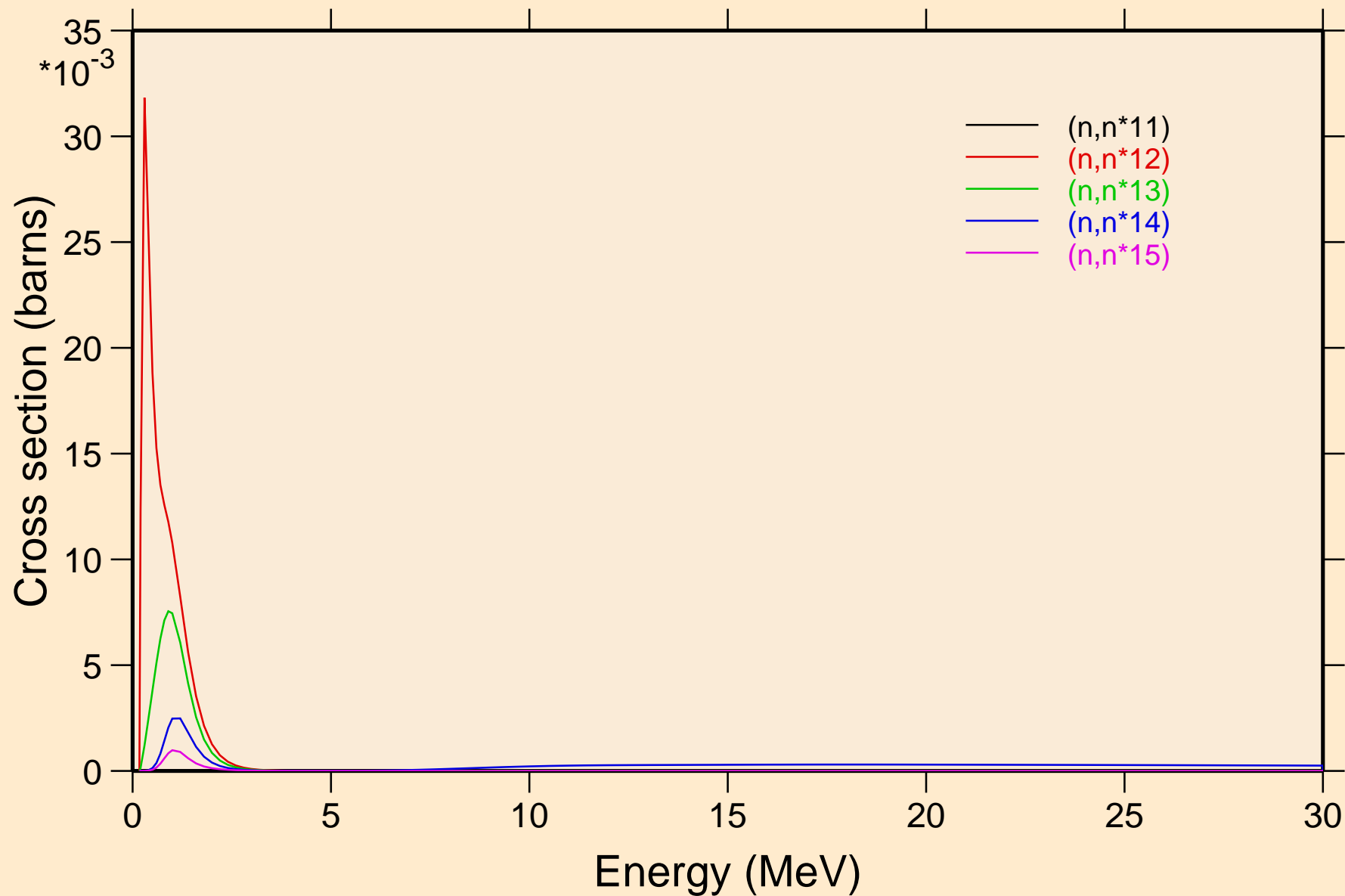

MD256 NEUTRON ACER TENDL-2019 LIBRARY; T=293.16K
Inelastic levels

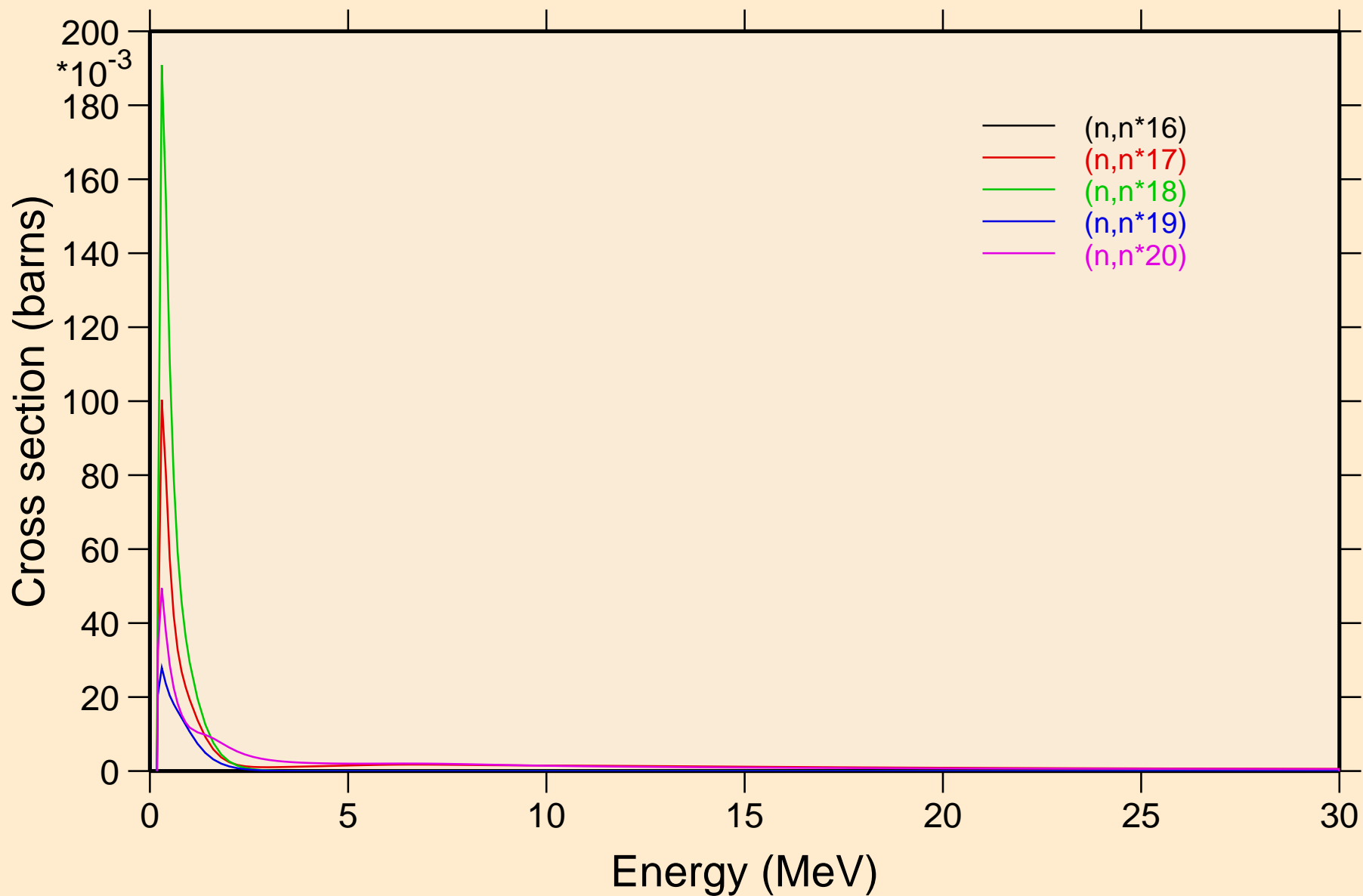

MD256 NEUTRON ACER TENDL-2019 LIBRARY; T=293.16K
Inelastic levels

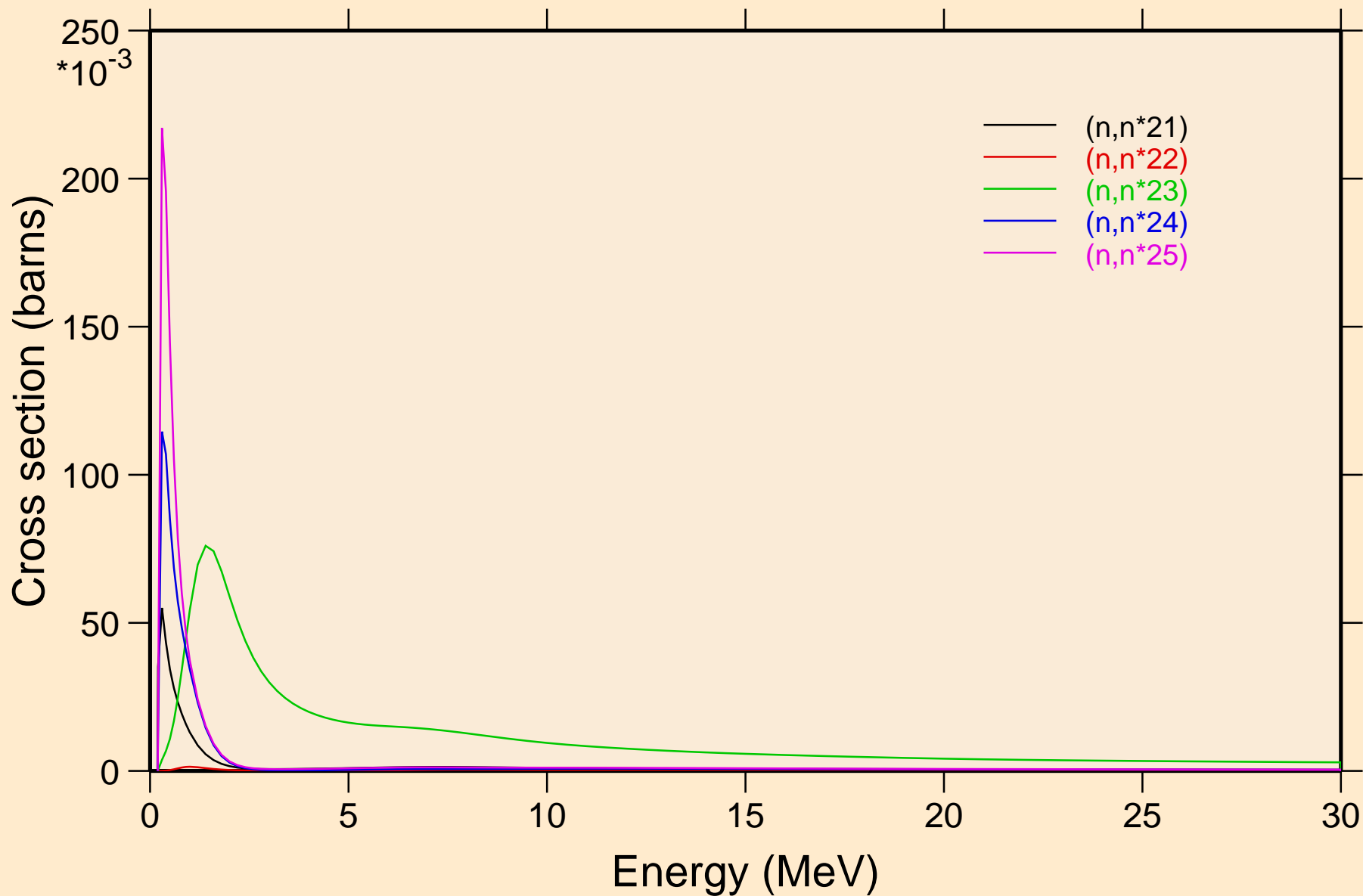

MD256 NEUTRON ACER TENDL-2019 LIBRARY; T=293.16K
Inelastic levels

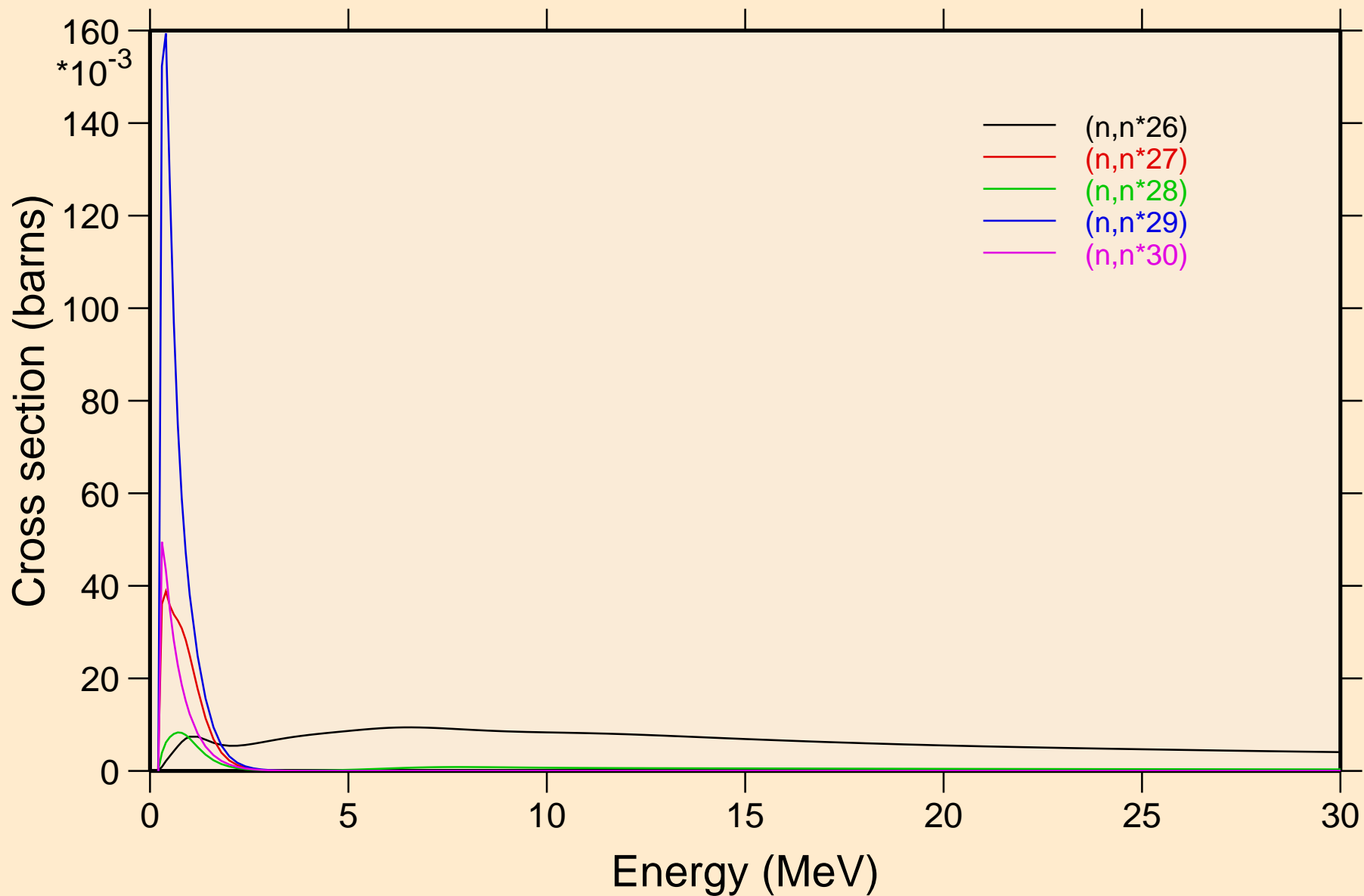

MD256 NEUTRON ACER TENDL-2019 LIBRARY; T=293.16K
Threshold reactions

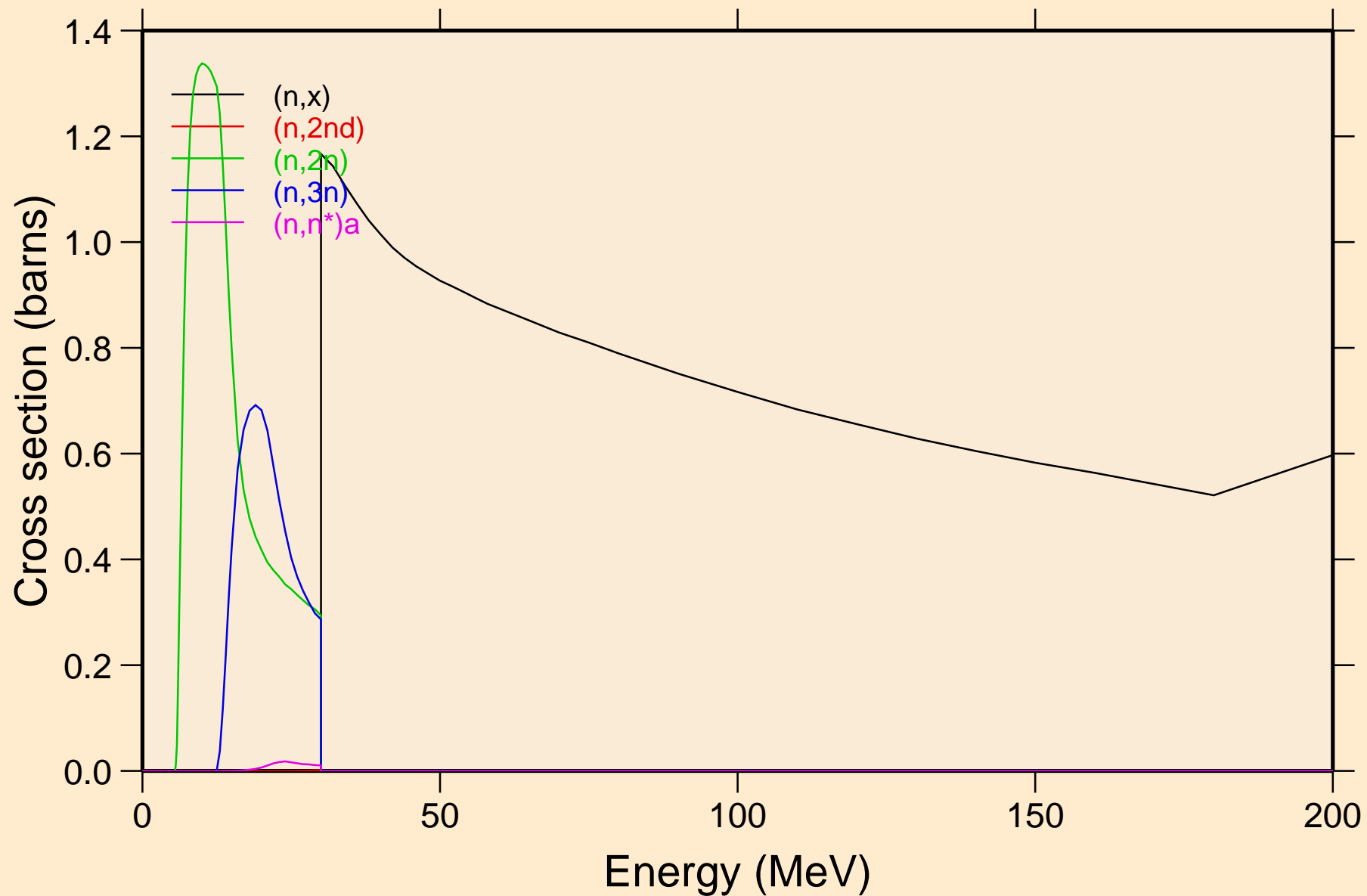

MD256 NEUTRON ACER TENDL-2019 LIBRARY; T=293.16K
Threshold reactions

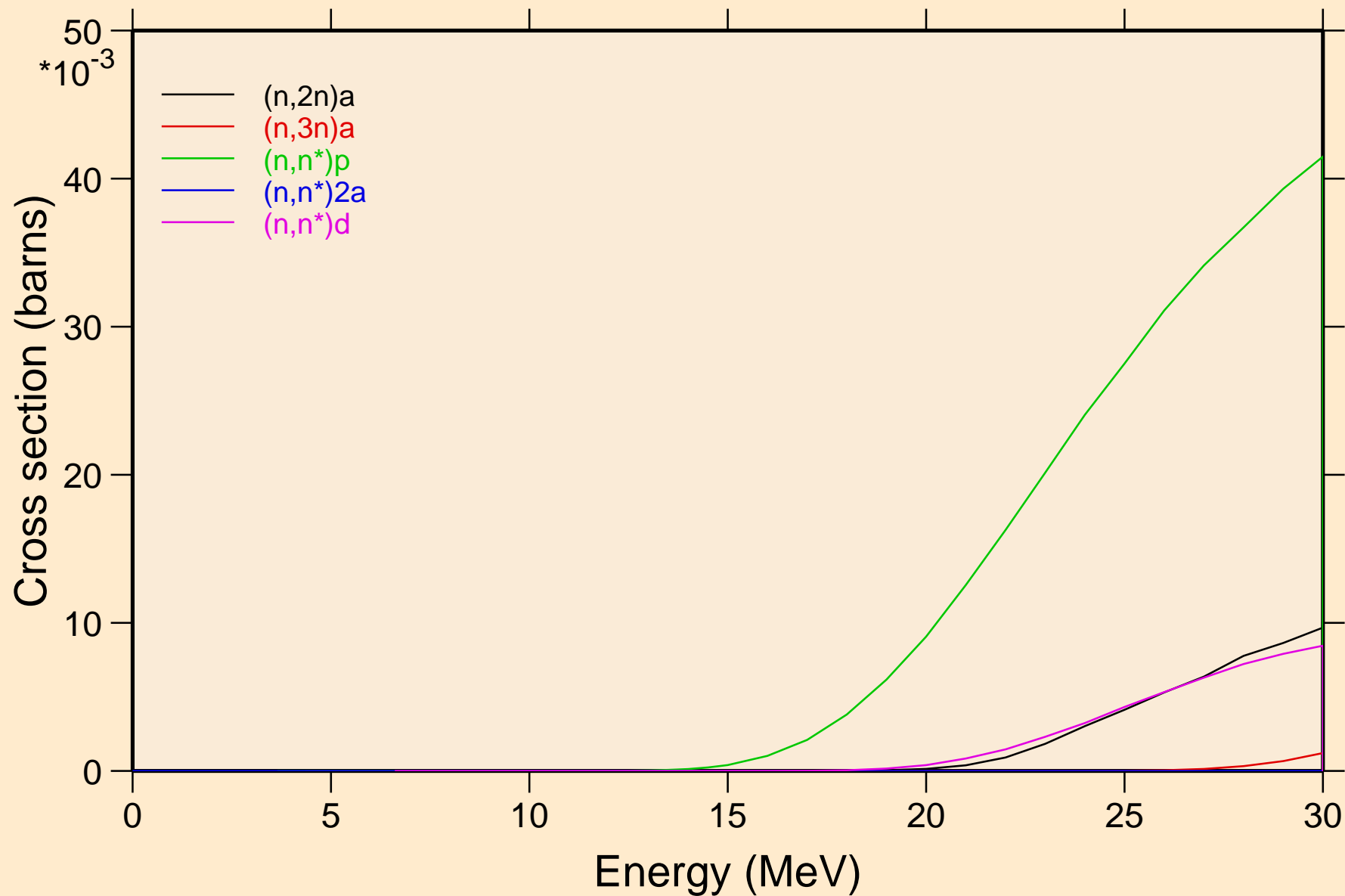

MD256 NEUTRON ACER TENDL-2019 LIBRARY; T=293.16K
Threshold reactions

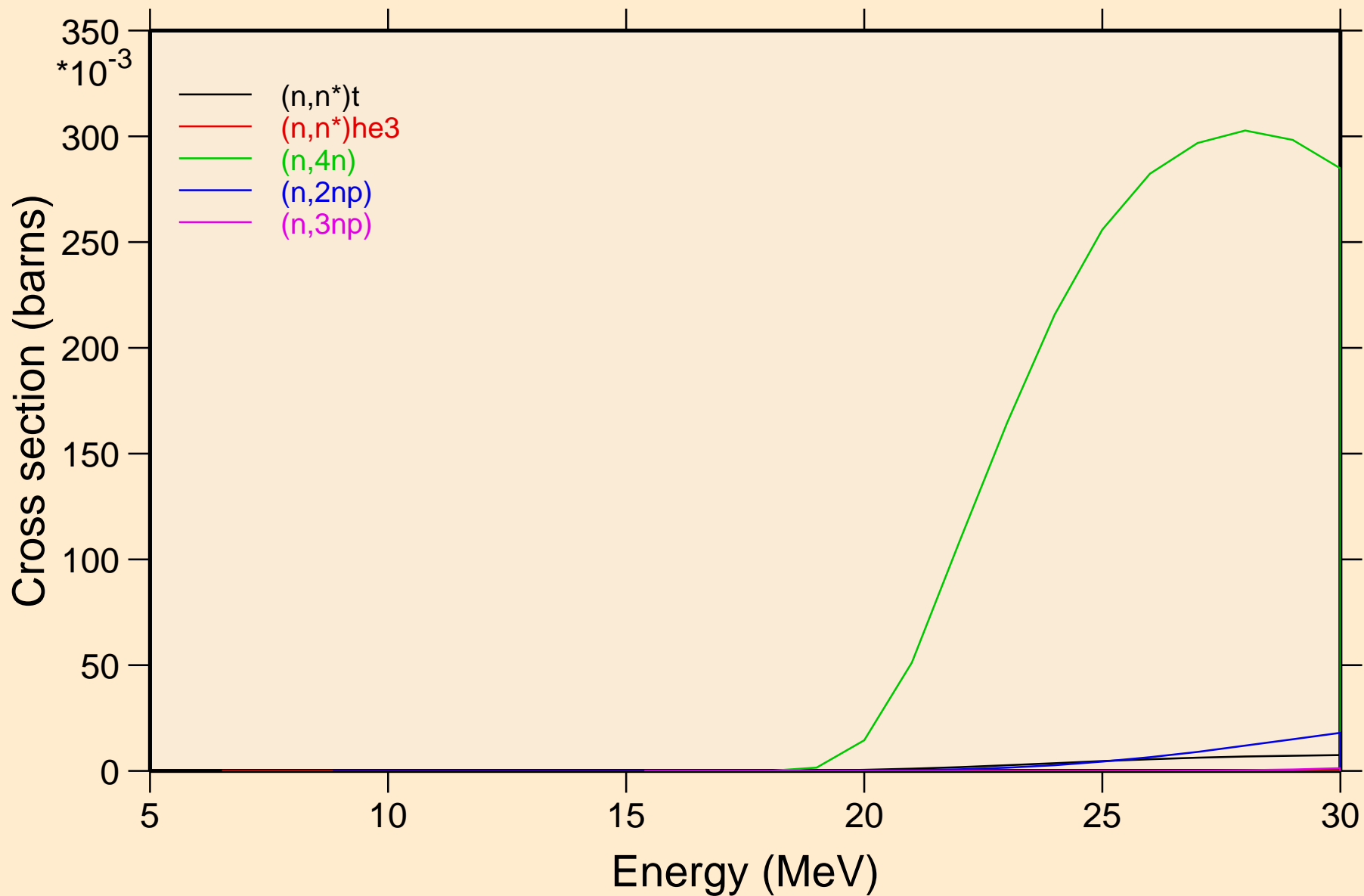

MD256 NEUTRON ACER TENDL-2019 LIBRARY; T=293.16K
Threshold reactions

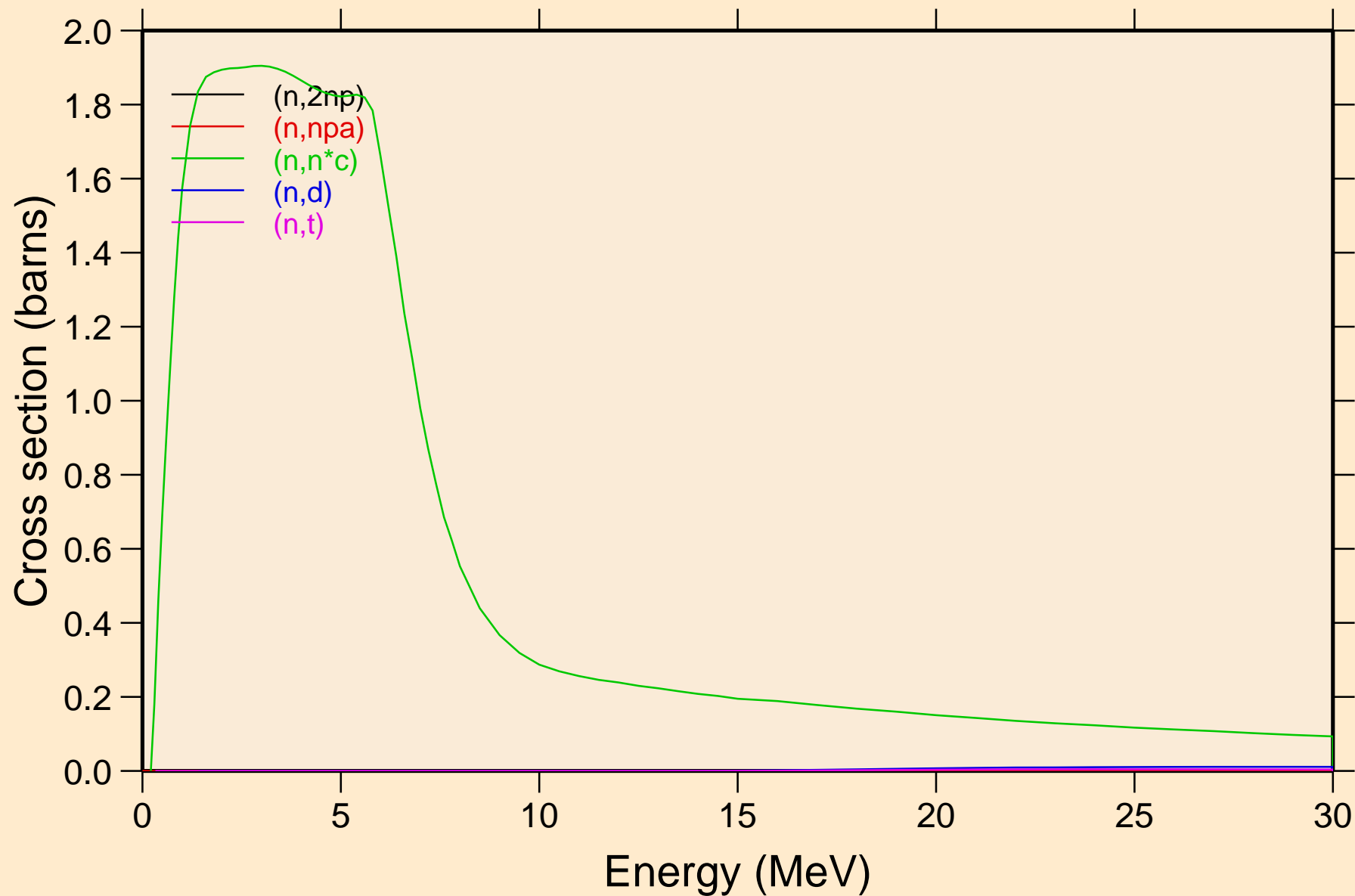

MD256 NEUTRON ACER TENDL-2019 LIBRARY; T=293.16K
Threshold reactions

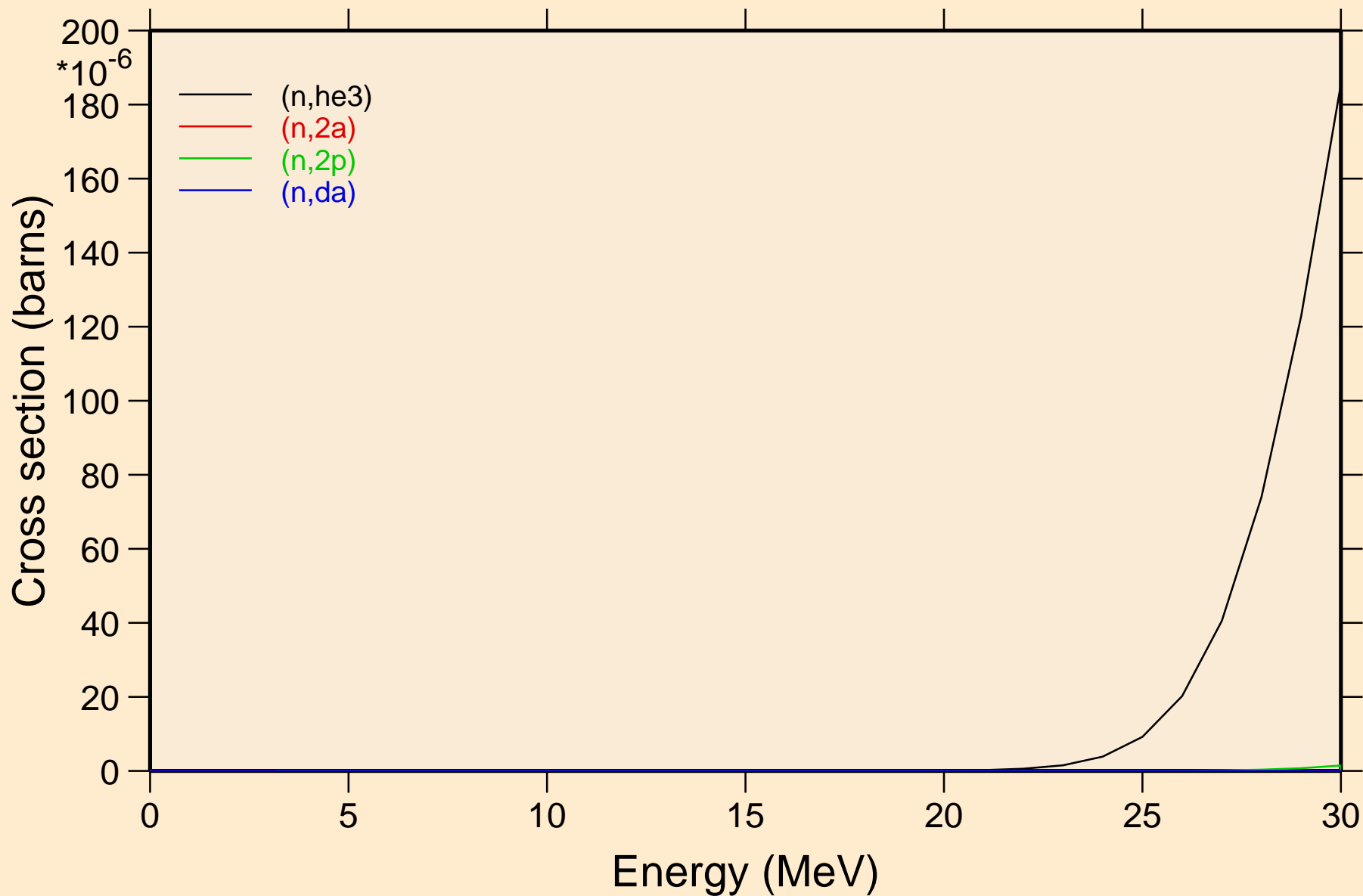

MD256 NEUTRON ACER TENDL-2019 LIBRARY; T=293.16K
Threshold reactions

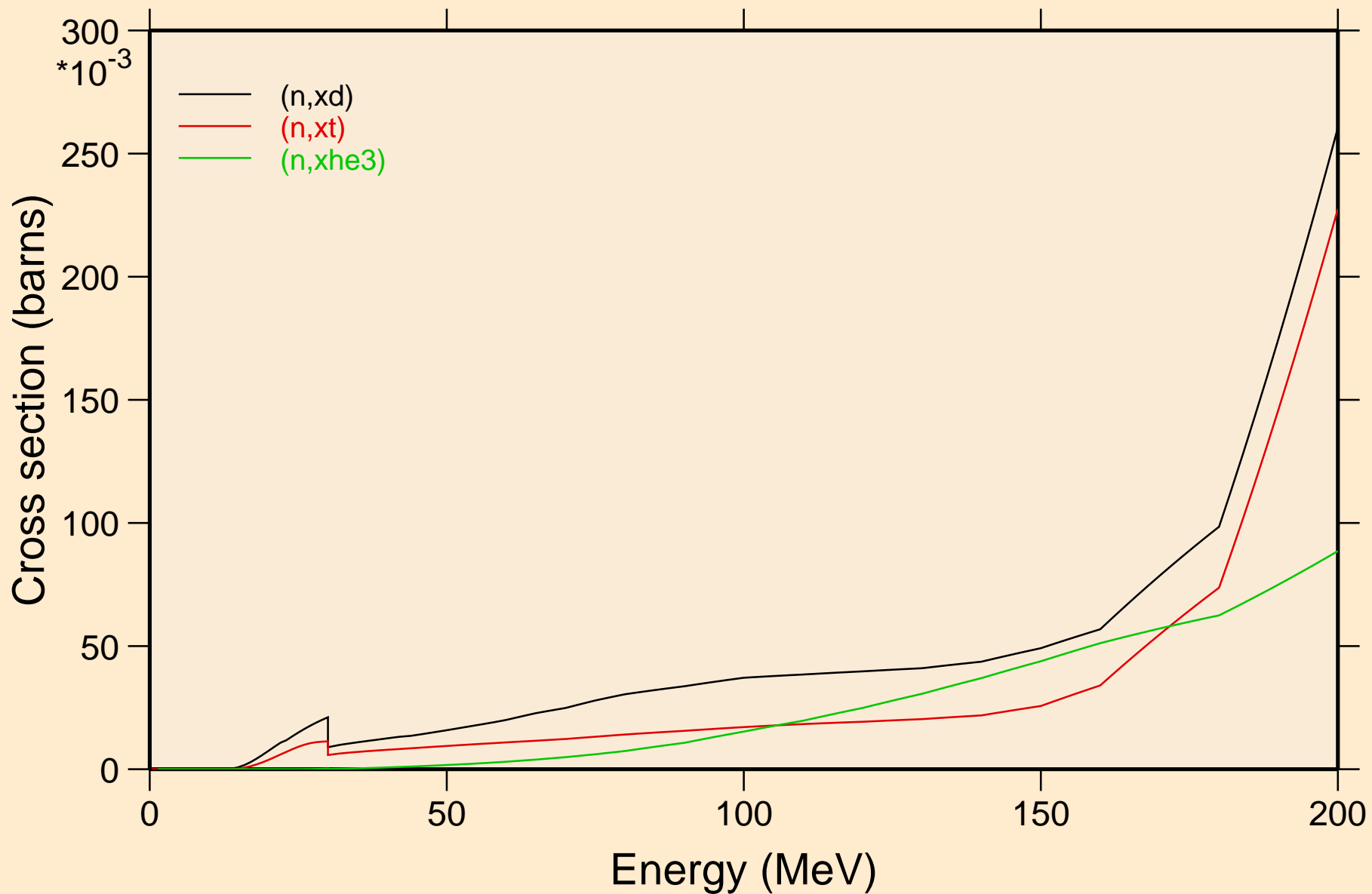

MD256 NEUTRON ACER TENDL-2019 LIBRARY; T=293.16K
angular distribution for elastic

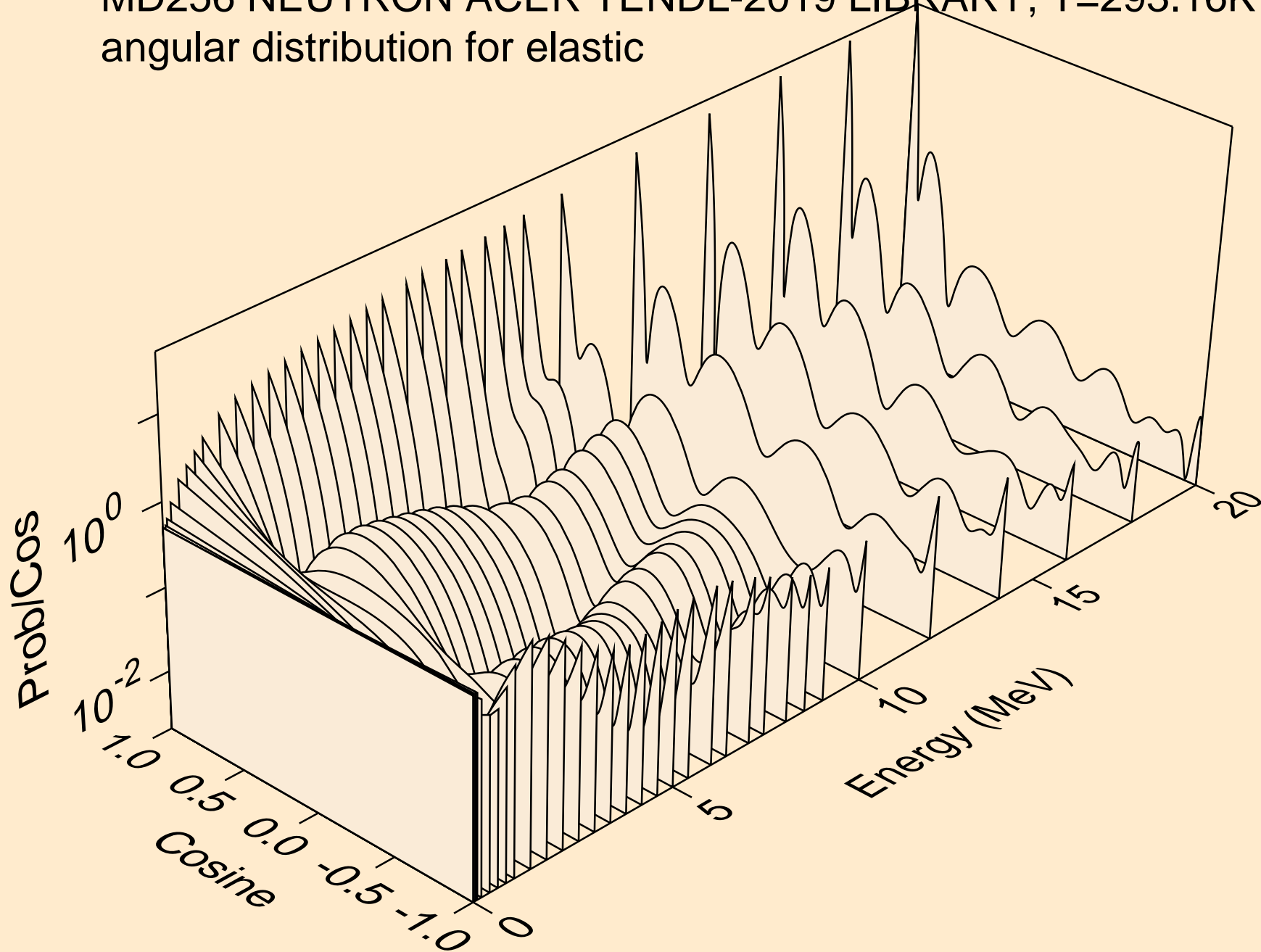

MD256 NEUTRON ACER TENDL-2019 LIBRARY; T=293.16K
angular distribution for elastic

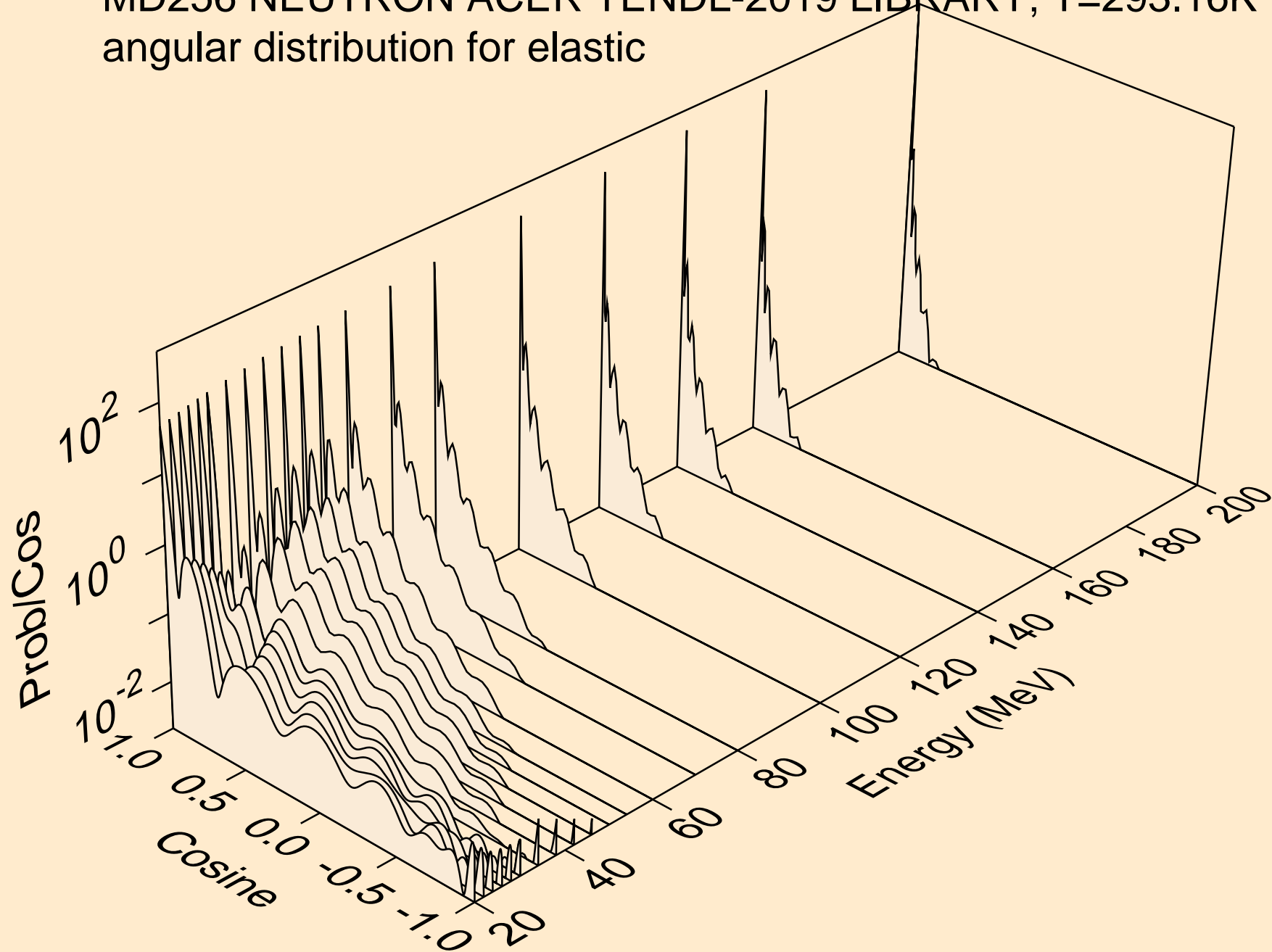

MD256 NEUTRON ACER TENDL-2019 LIBRARY; T=293.16K
angular distribution for (n,n*1)

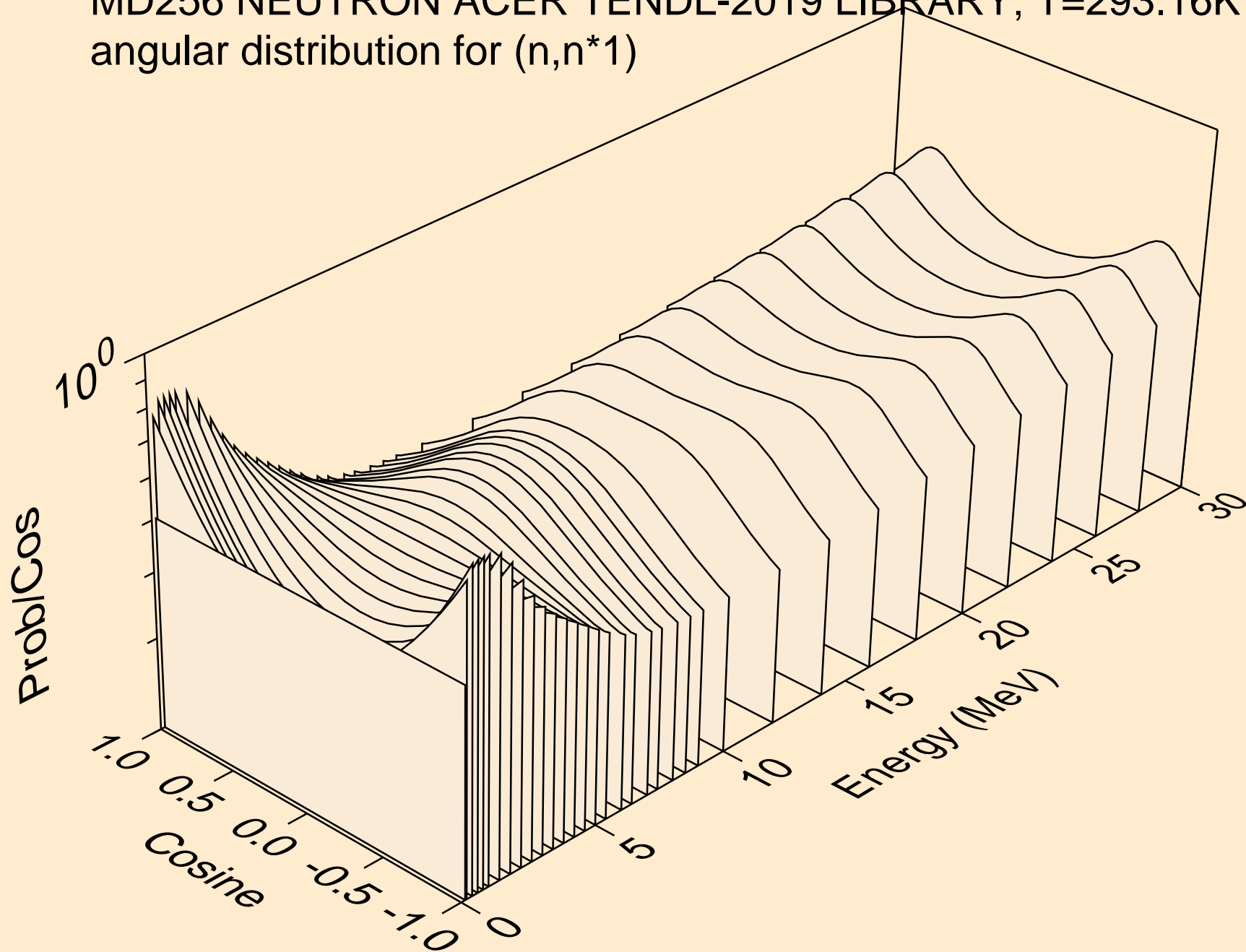

MD256 NEUTRON ACER TENDL-2019 LIBRARY; T=293.16K
angular distribution for (n,n*2)

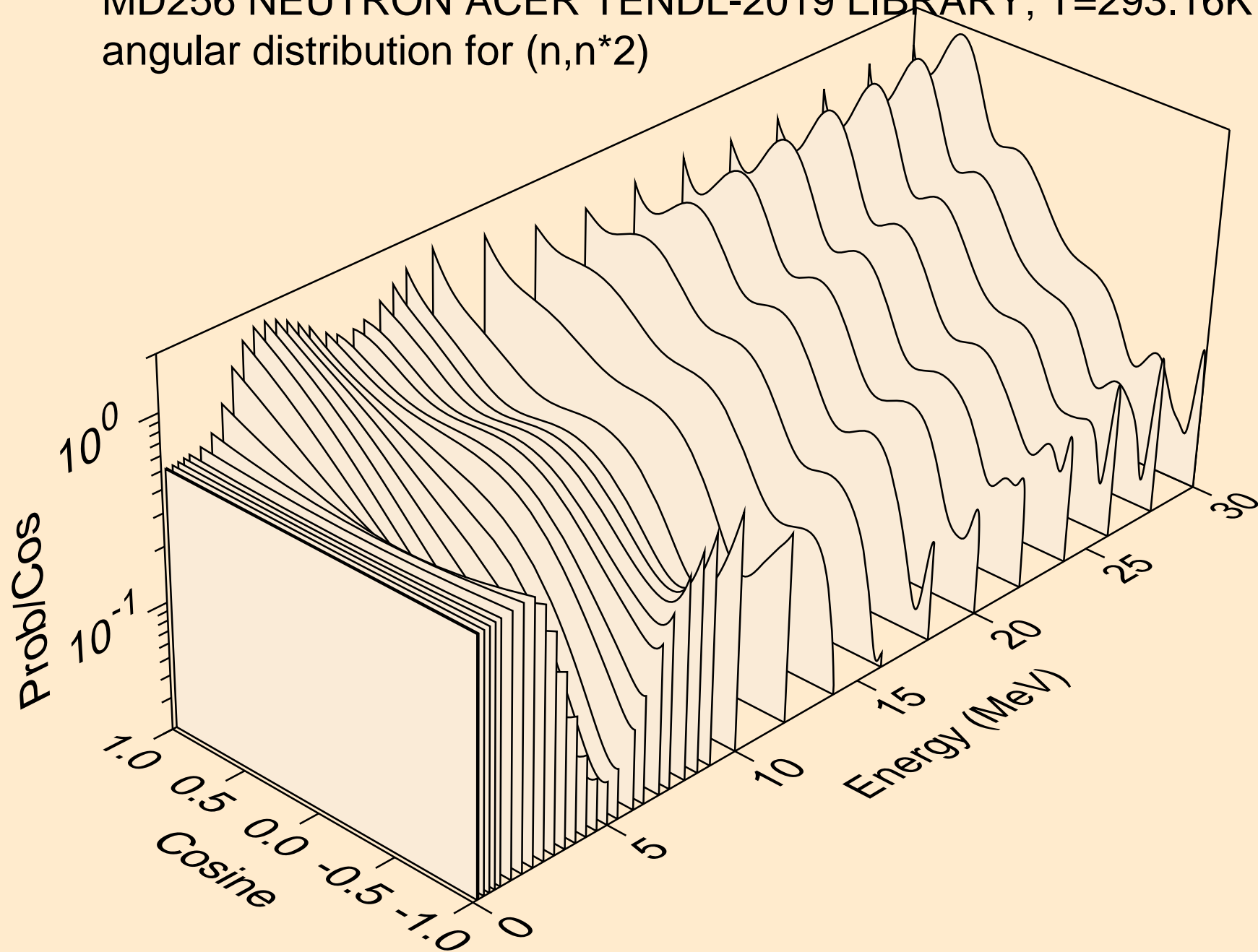

MD256 NEUTRON ACER TENDL-2019 LIBRARY; T=293.16K
angular distribution for (n,n*3)

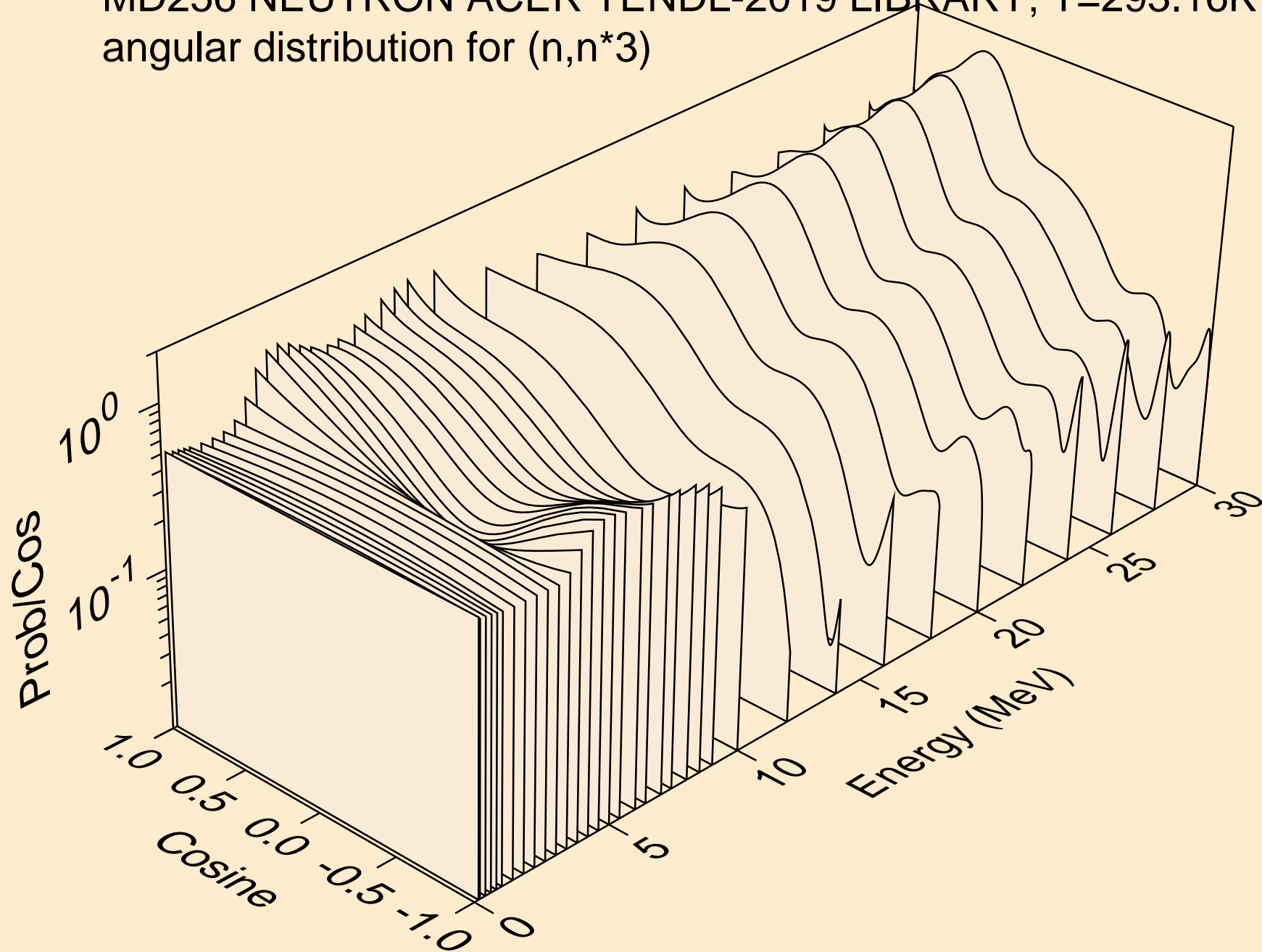

MD256 NEUTRON ACER TENDL-2019 LIBRARY; T=293.16K
angular distribution for (n,n*4)

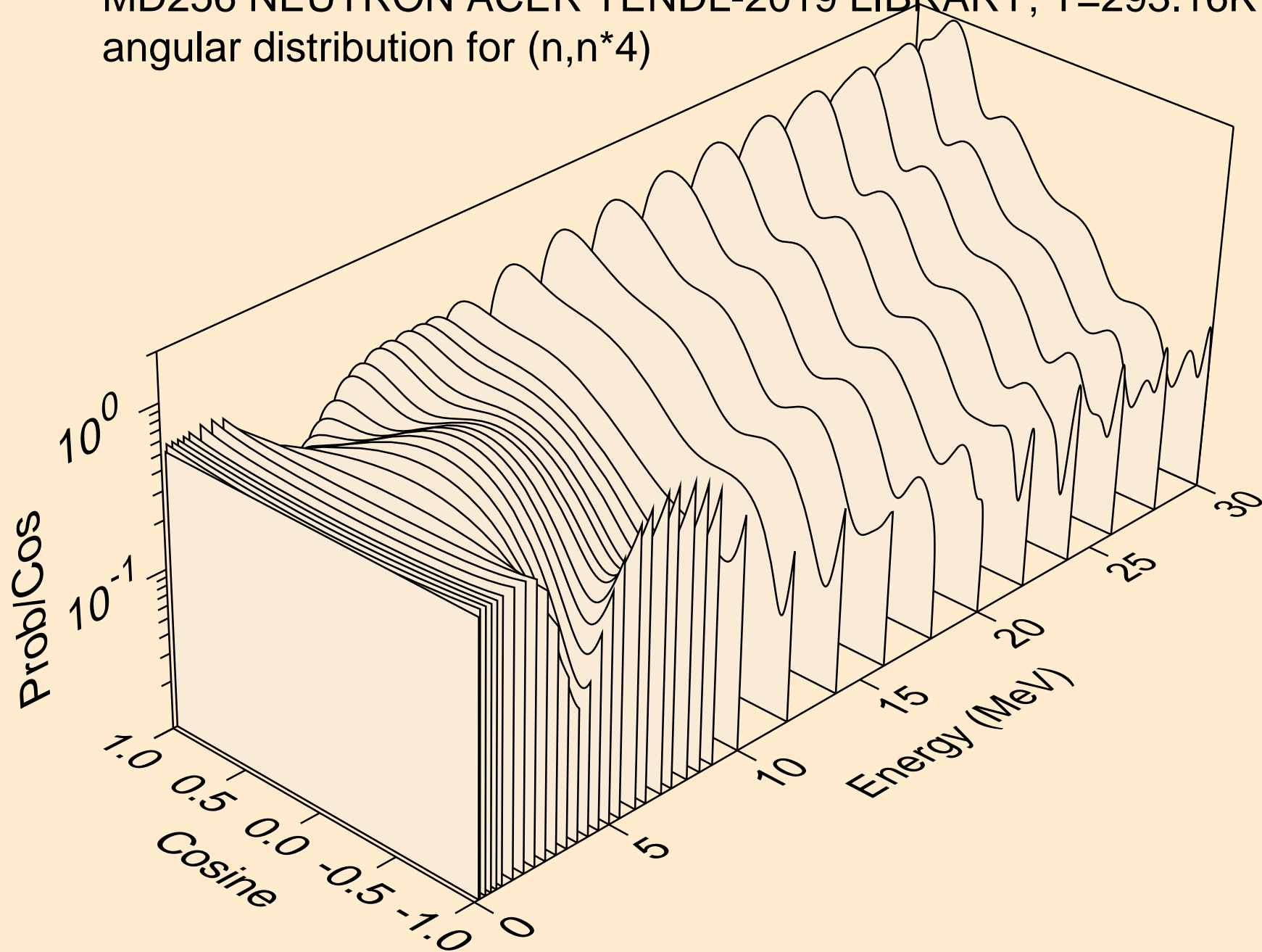

MD256 NEUTRON ACER TENDL-2019 LIBRARY; T=293.16K
angular distribution for (n,n*5)

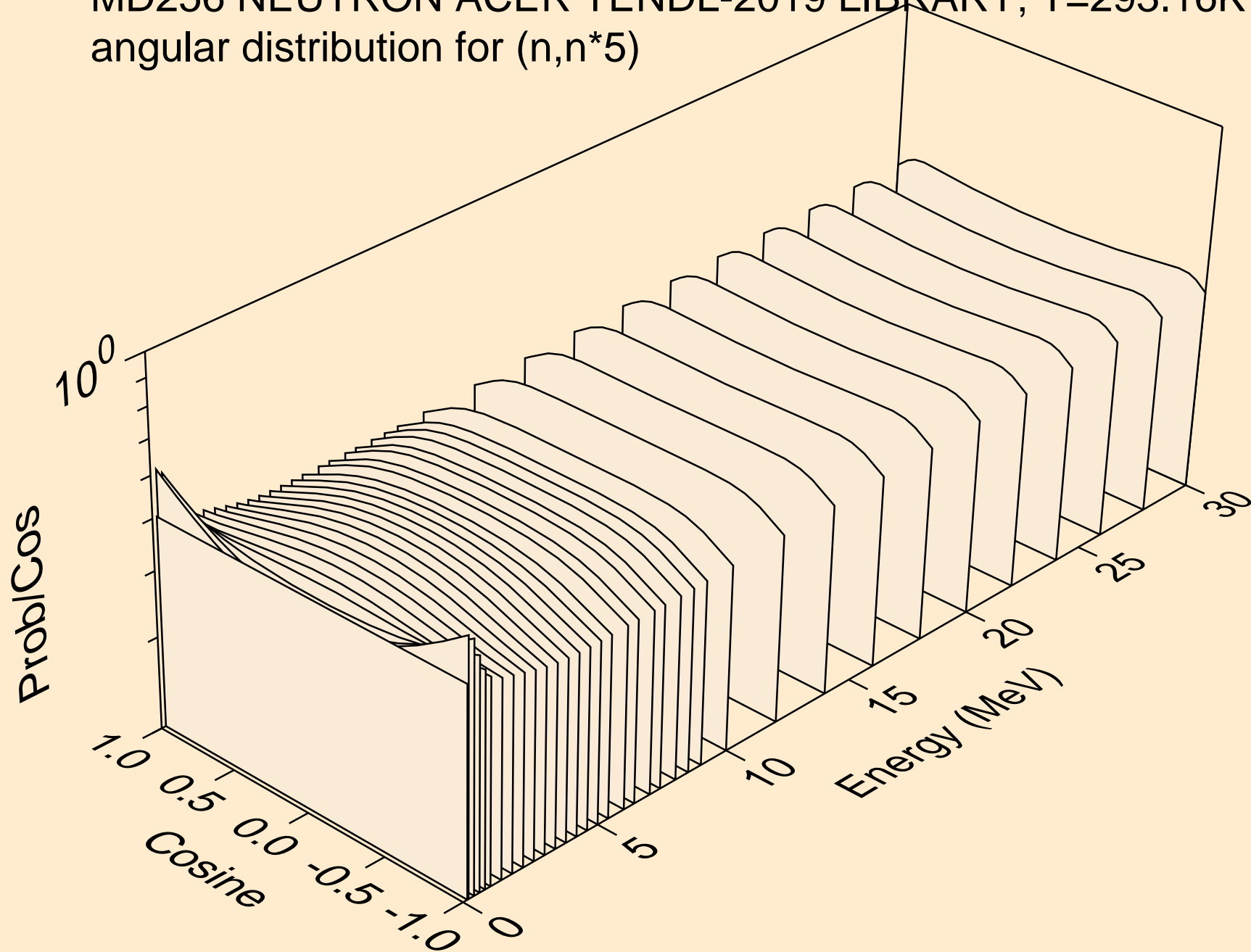

MD256 NEUTRON ACER TENDL-2019 LIBRARY; T=293.16K
angular distribution for (n,n*6)

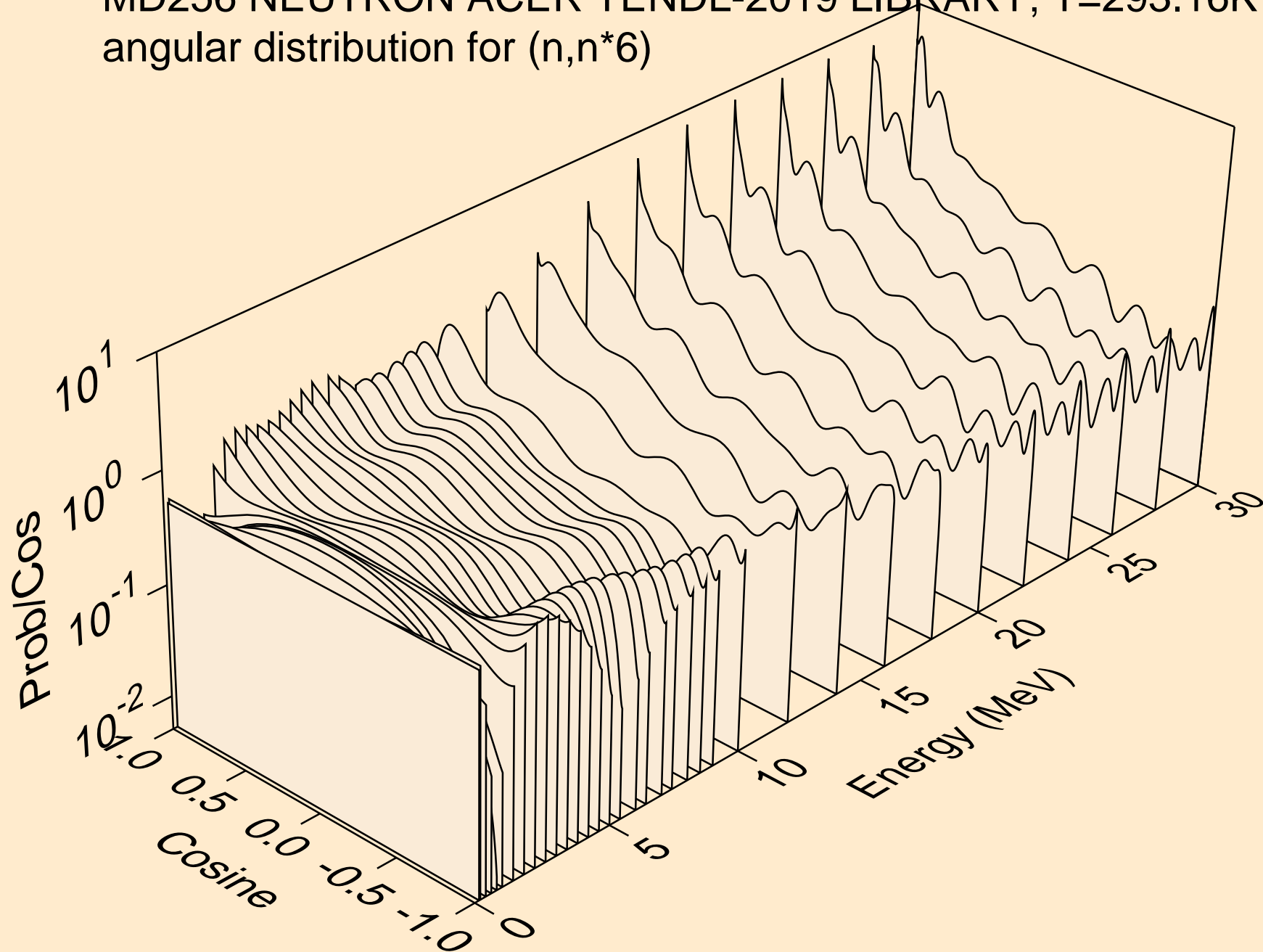

MD256 NEUTRON ACER TENDL-2019 LIBRARY; T=293.16K
angular distribution for (n,n*7)

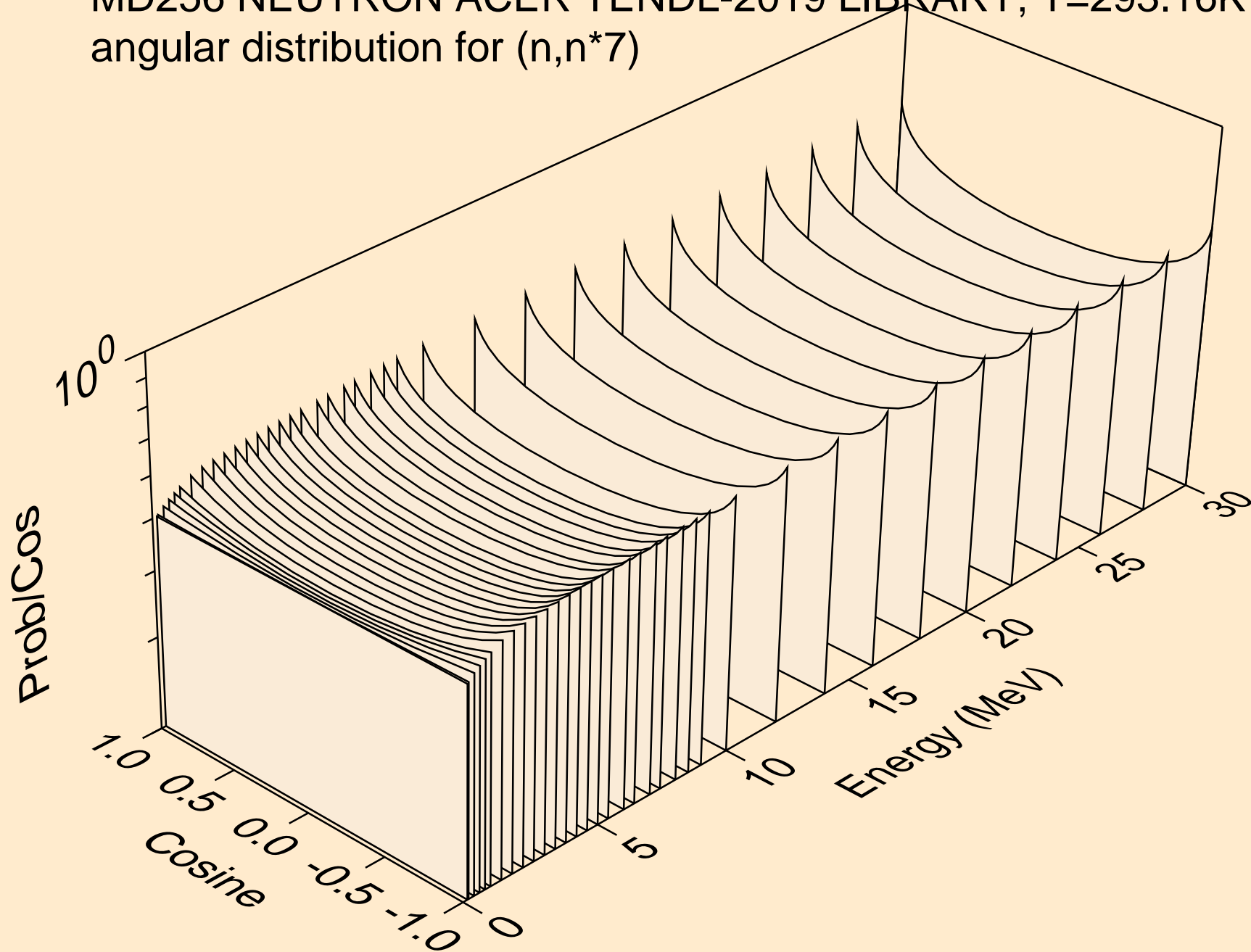

MD256 NEUTRON ACER TENDL-2019 LIBRARY; T=293.16K
angular distribution for (n,n*8)

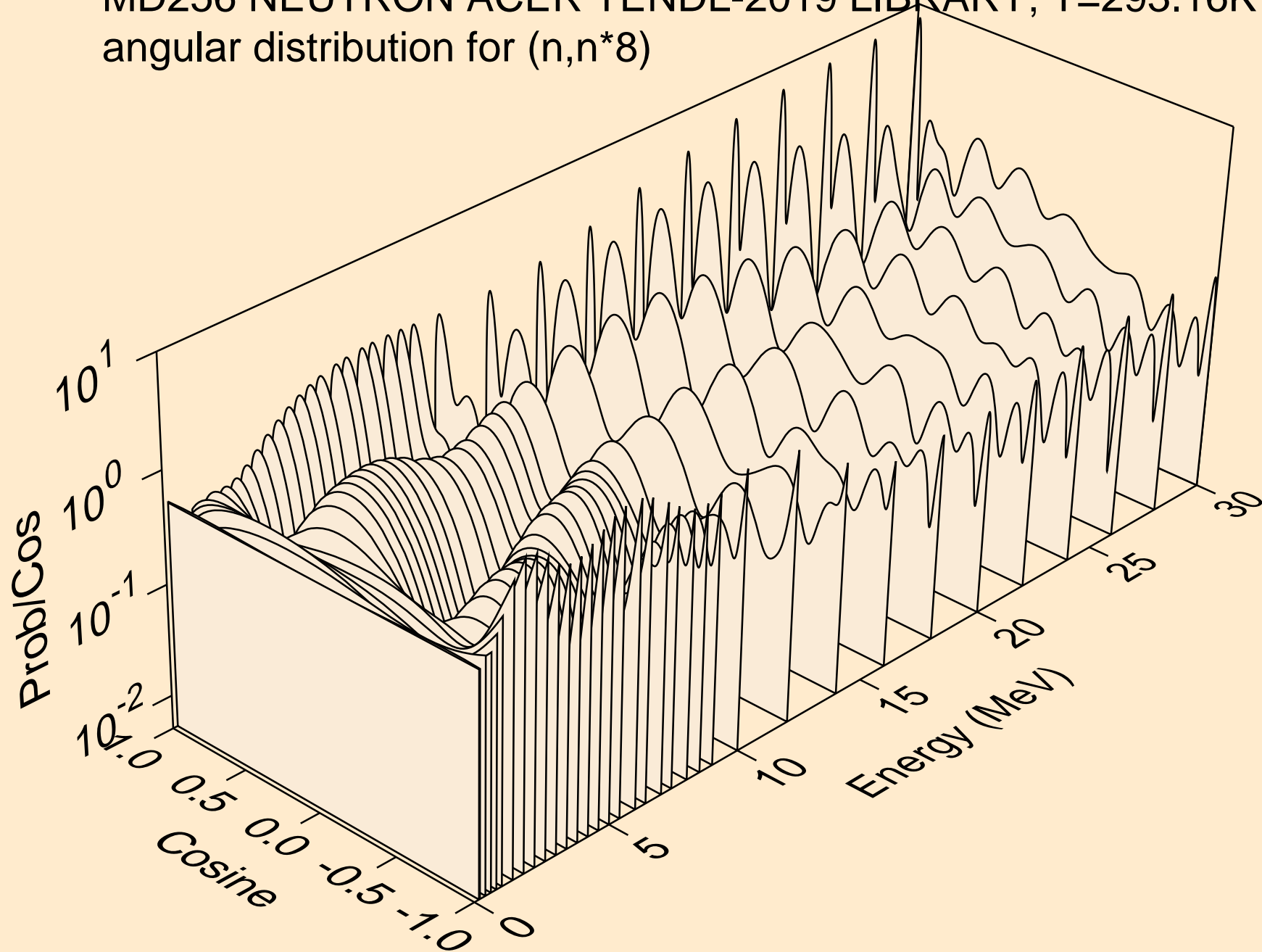

MD256 NEUTRON ACER TENDL-2019 LIBRARY; T=293.16K
angular distribution for (n,n*9)

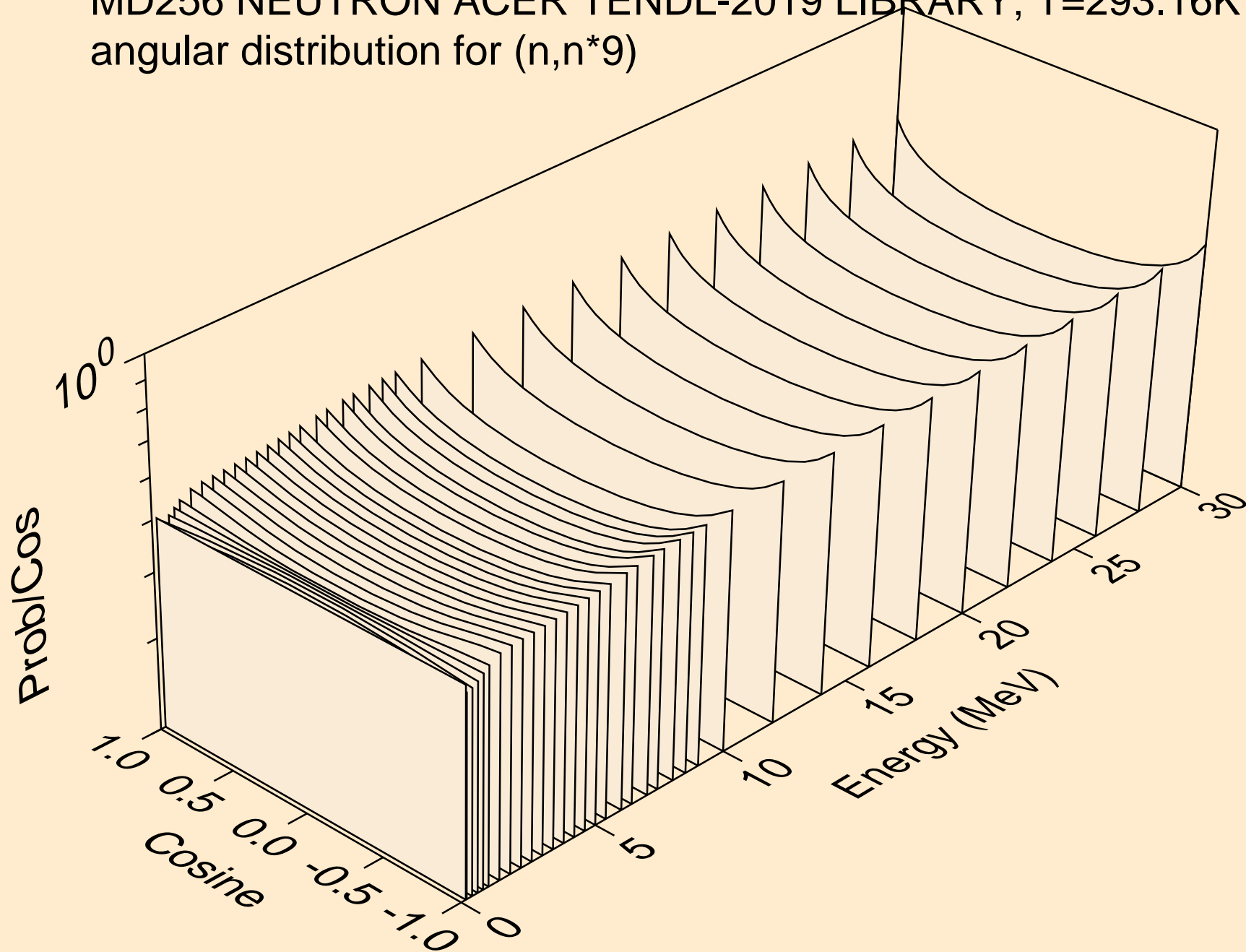

MD256 NEUTRON ACER TENDL-2019 LIBRARY; T=293.16K
angular distribution for (n,n*10)

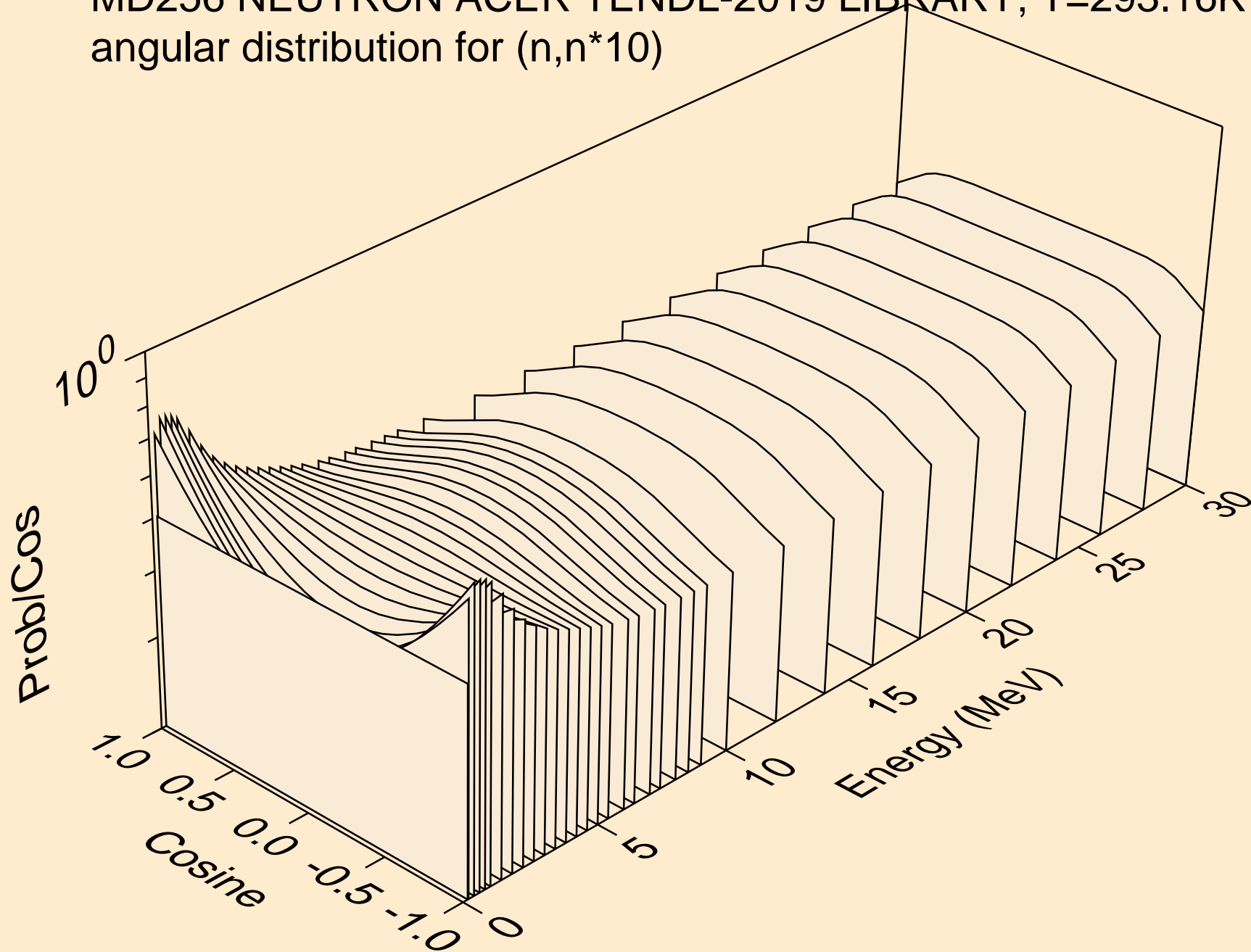

MD256 NEUTRON ACER TENDL-2019 LIBRARY; T=293.16K
angular distribution for (n,n*11)

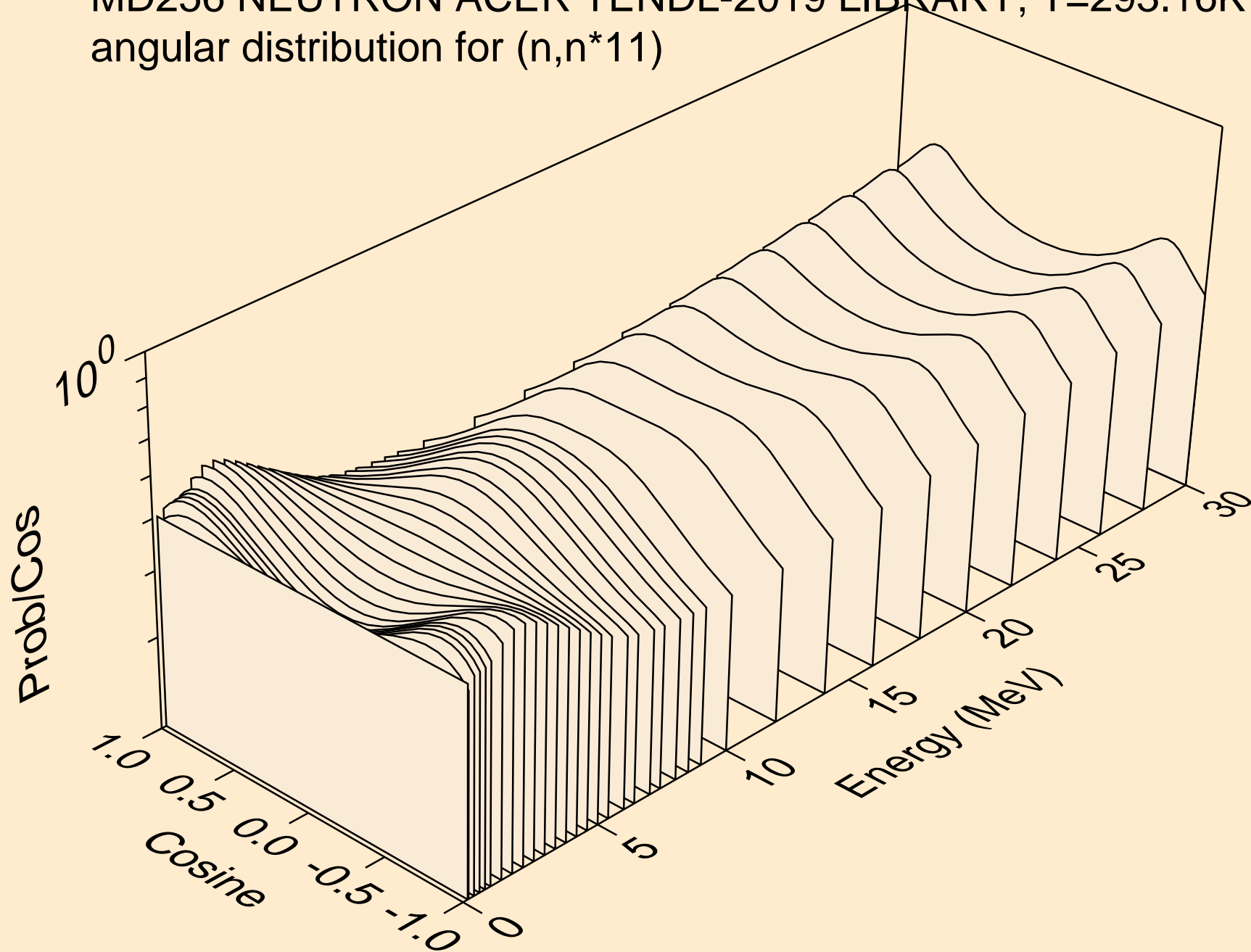

MD256 NEUTRON ACER TENDL-2019 LIBRARY; T=293.16K
angular distribution for (n,n*12)

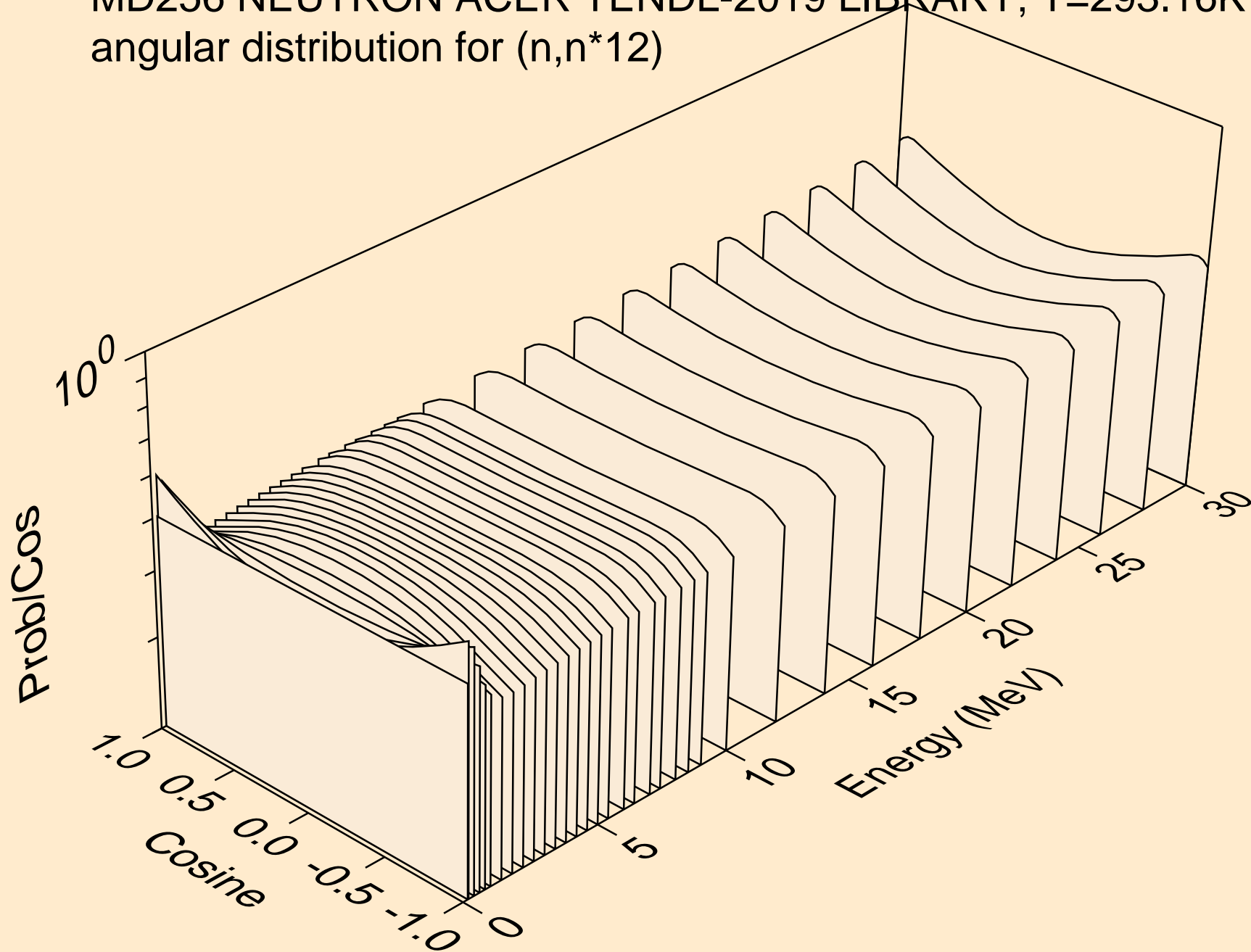

MD256 NEUTRON ACER TENDL-2019 LIBRARY; T=293.16K
angular distribution for (n,n*13)

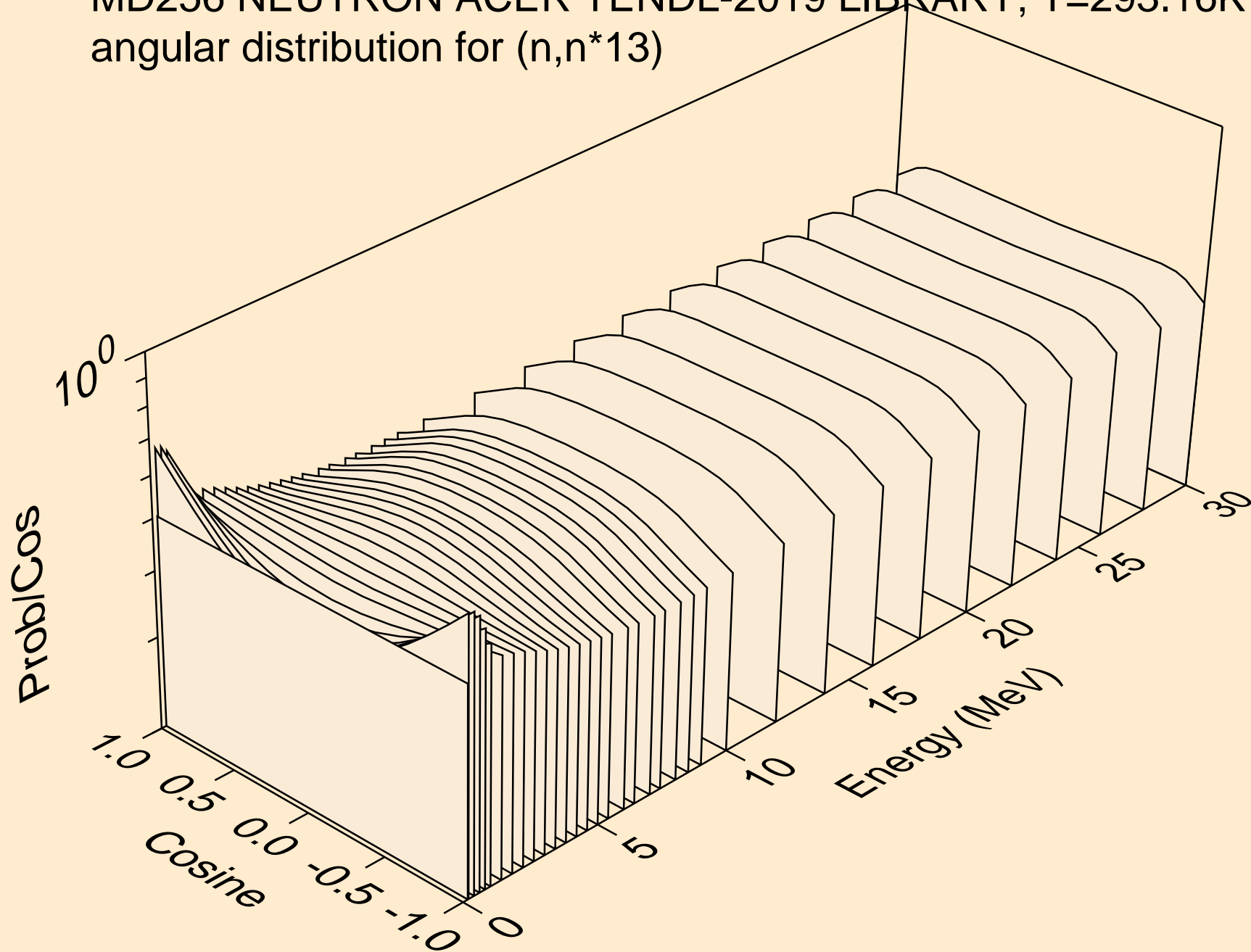

MD256 NEUTRON ACER TENDL-2019 LIBRARY; T=293.16K
angular distribution for (n,n*14)

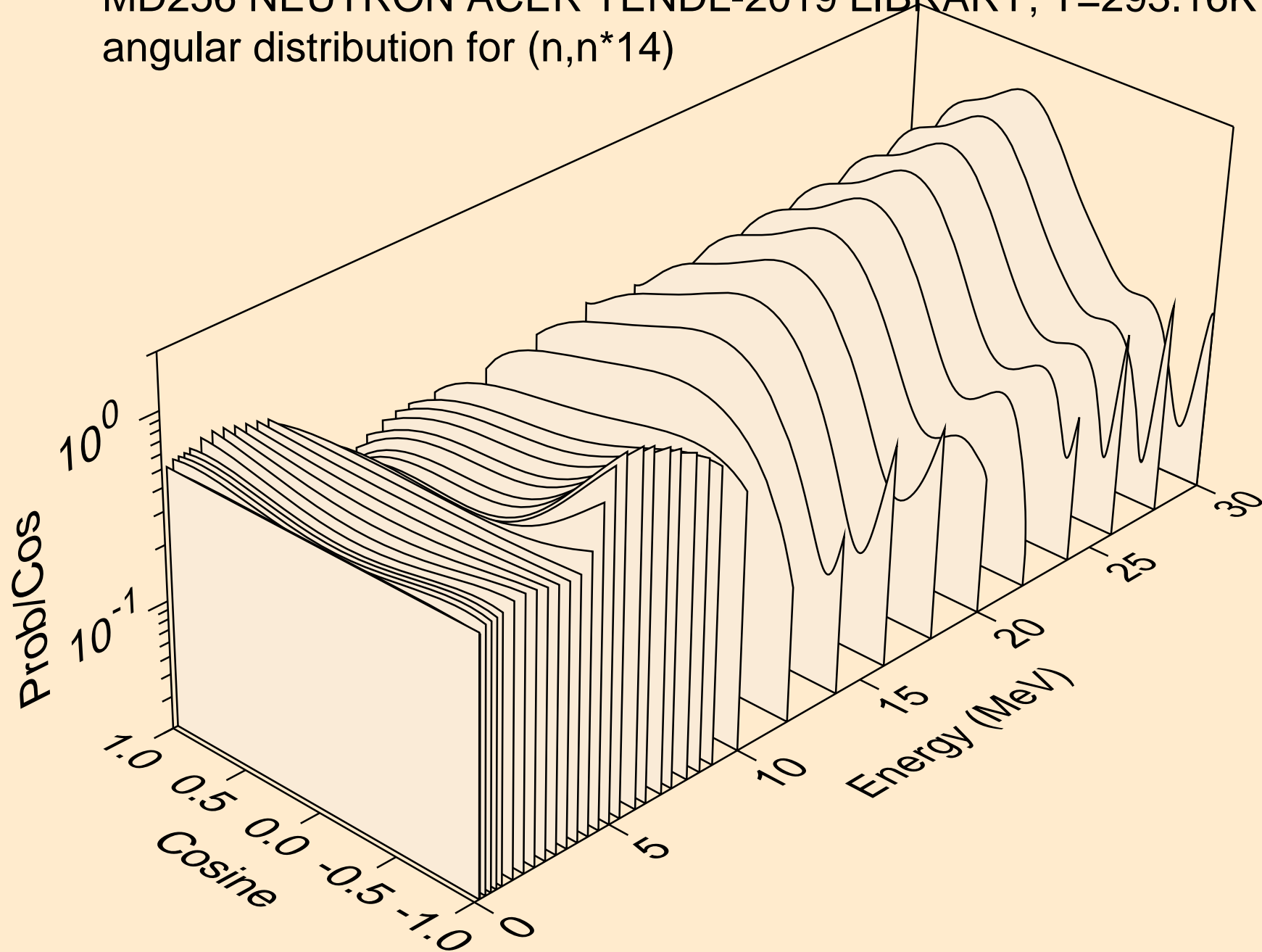

MD256 NEUTRON ACER TENDL-2019 LIBRARY; T=293.16K
angular distribution for (n,n*15)

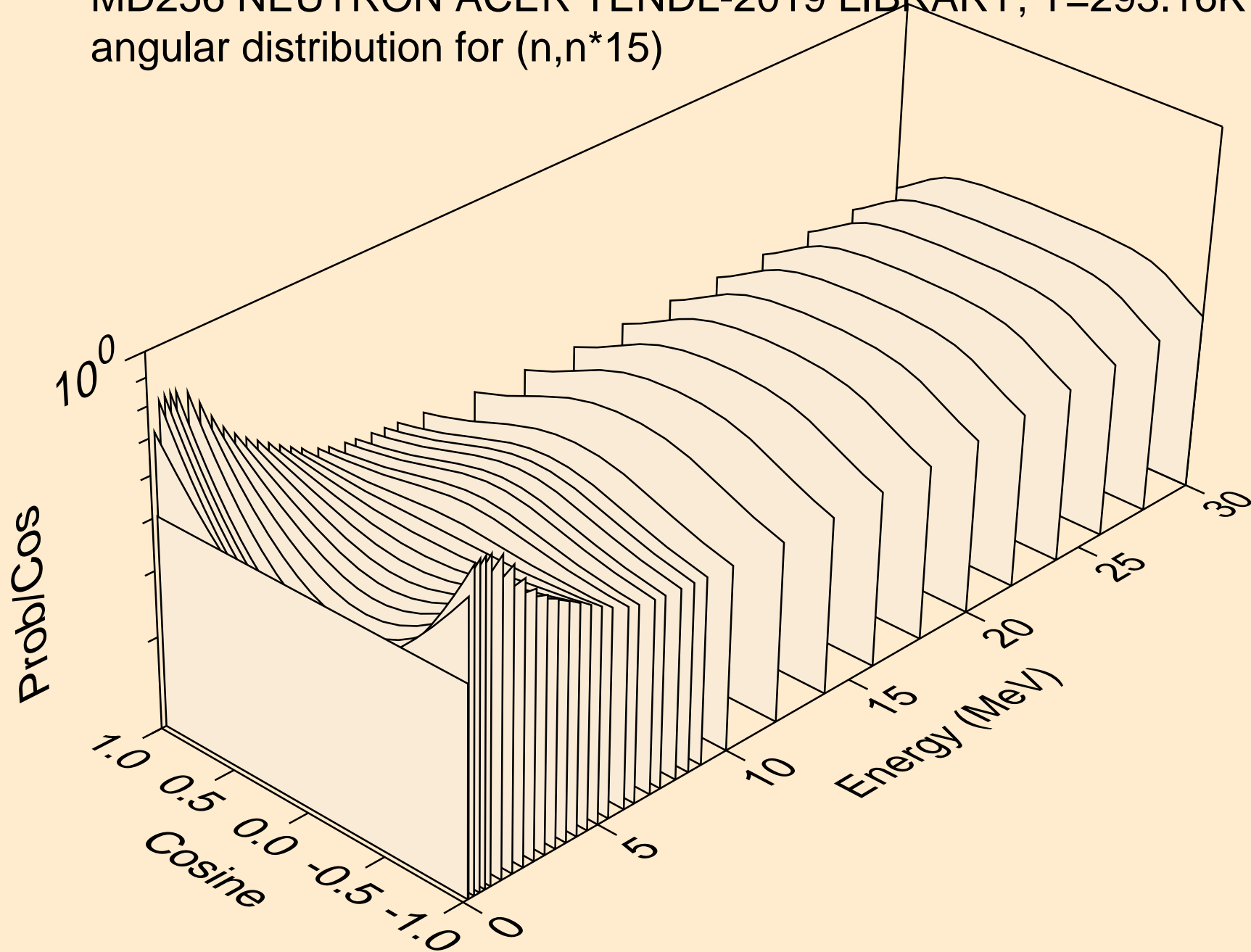

MD256 NEUTRON ACER TENDL-2019 LIBRARY; T=293.16K
angular distribution for (n,n*16)

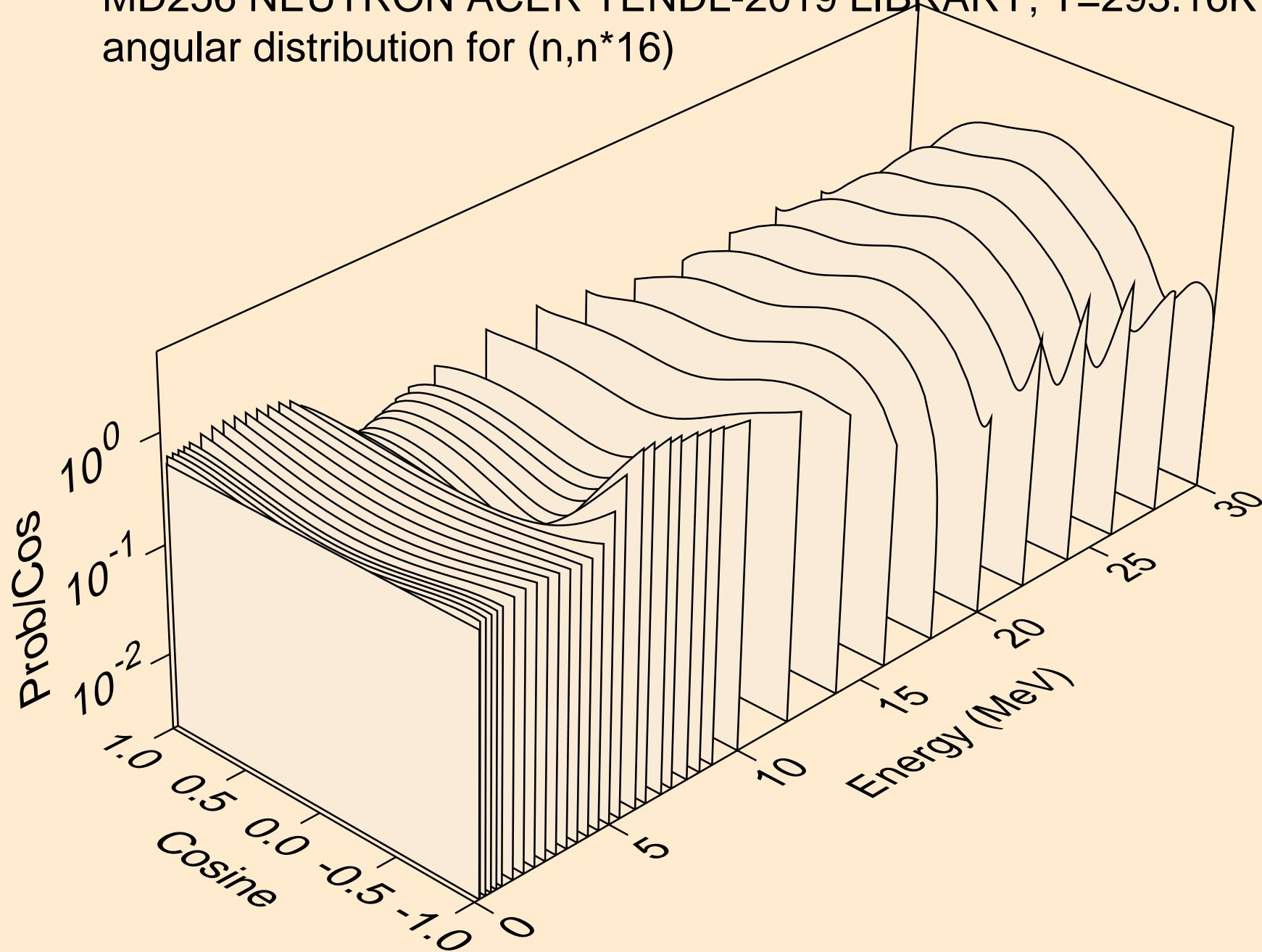

MD256 NEUTRON ACER TENDL-2019 LIBRARY; T=293.16K
angular distribution for (n,n*17)

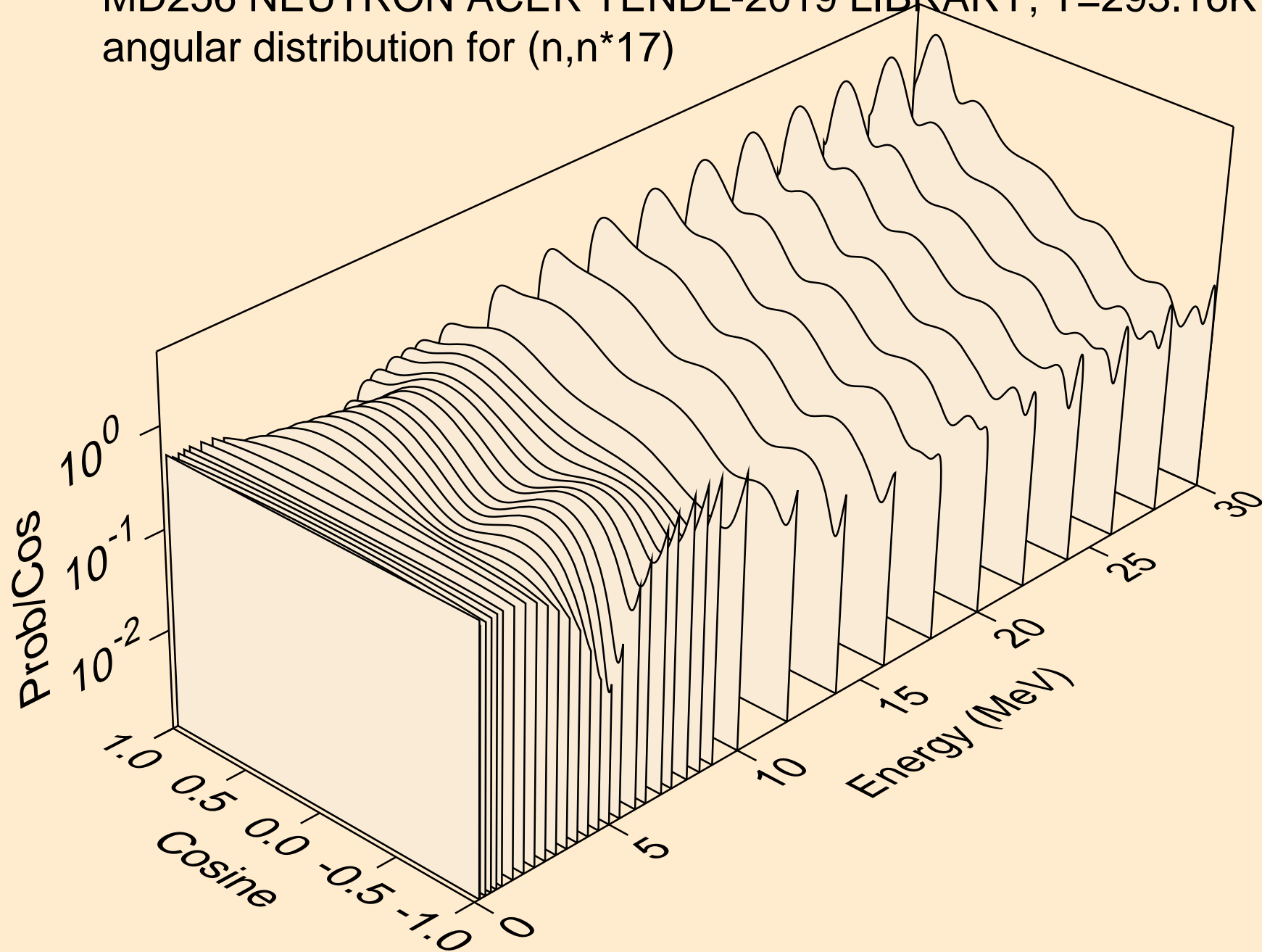

MD256 NEUTRON ACER TENDL-2019 LIBRARY; T=293.16K
angular distribution for (n,n*18)

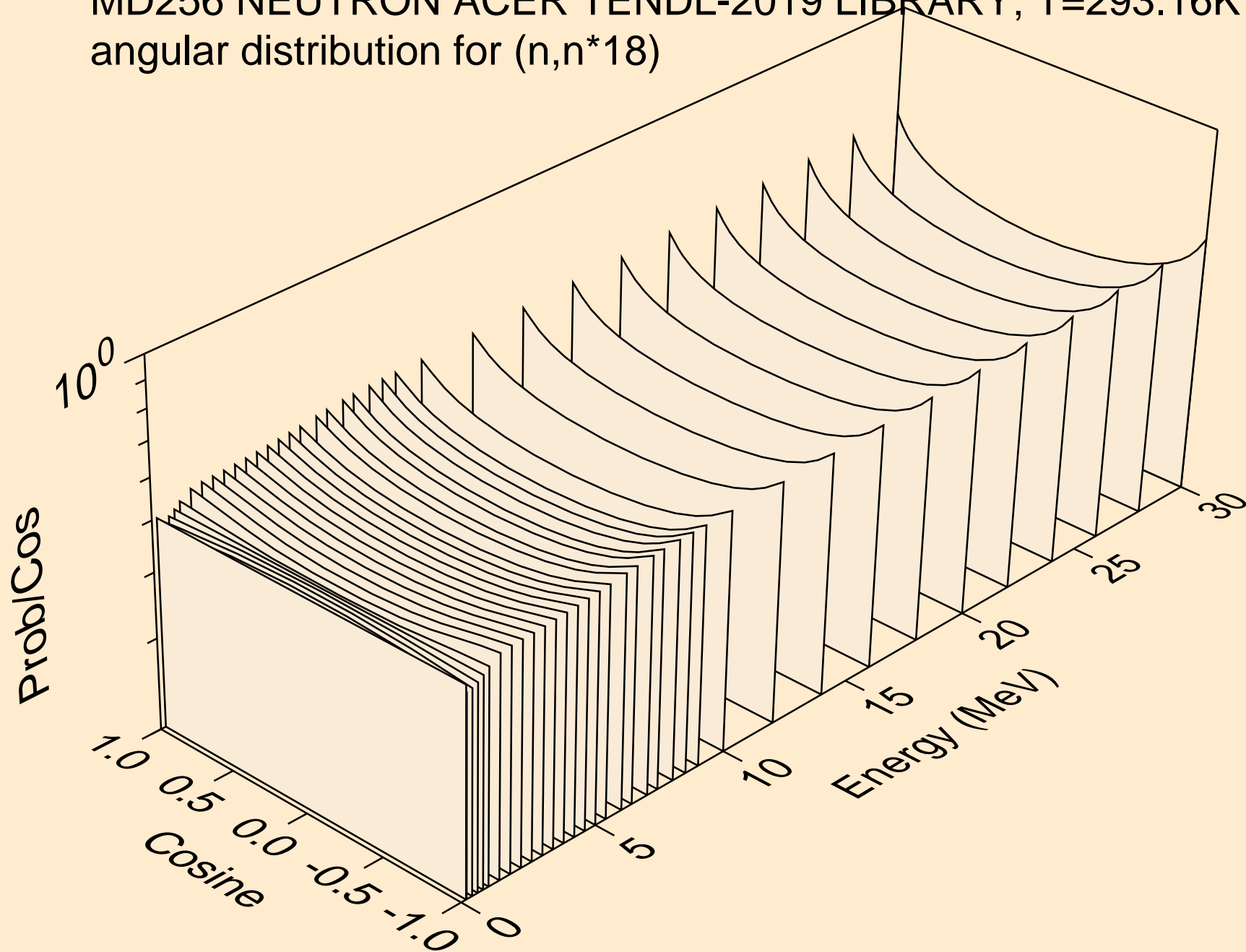

MD256 NEUTRON ACER TENDL-2019 LIBRARY; T=293.16K
angular distribution for (n,n*19)

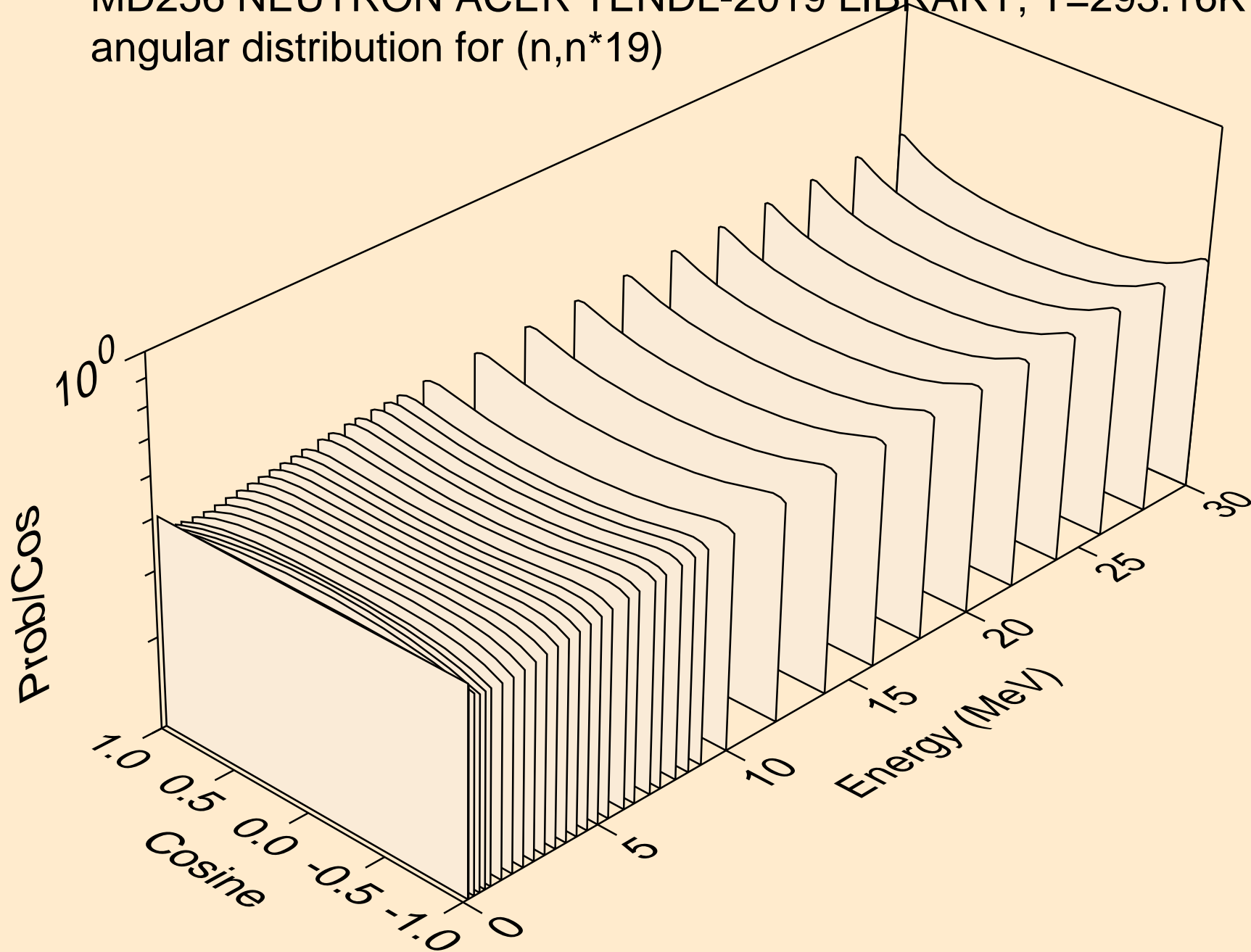

MD256 NEUTRON ACER TENDL-2019 LIBRARY; T=293.16K
angular distribution for (n,n*20)

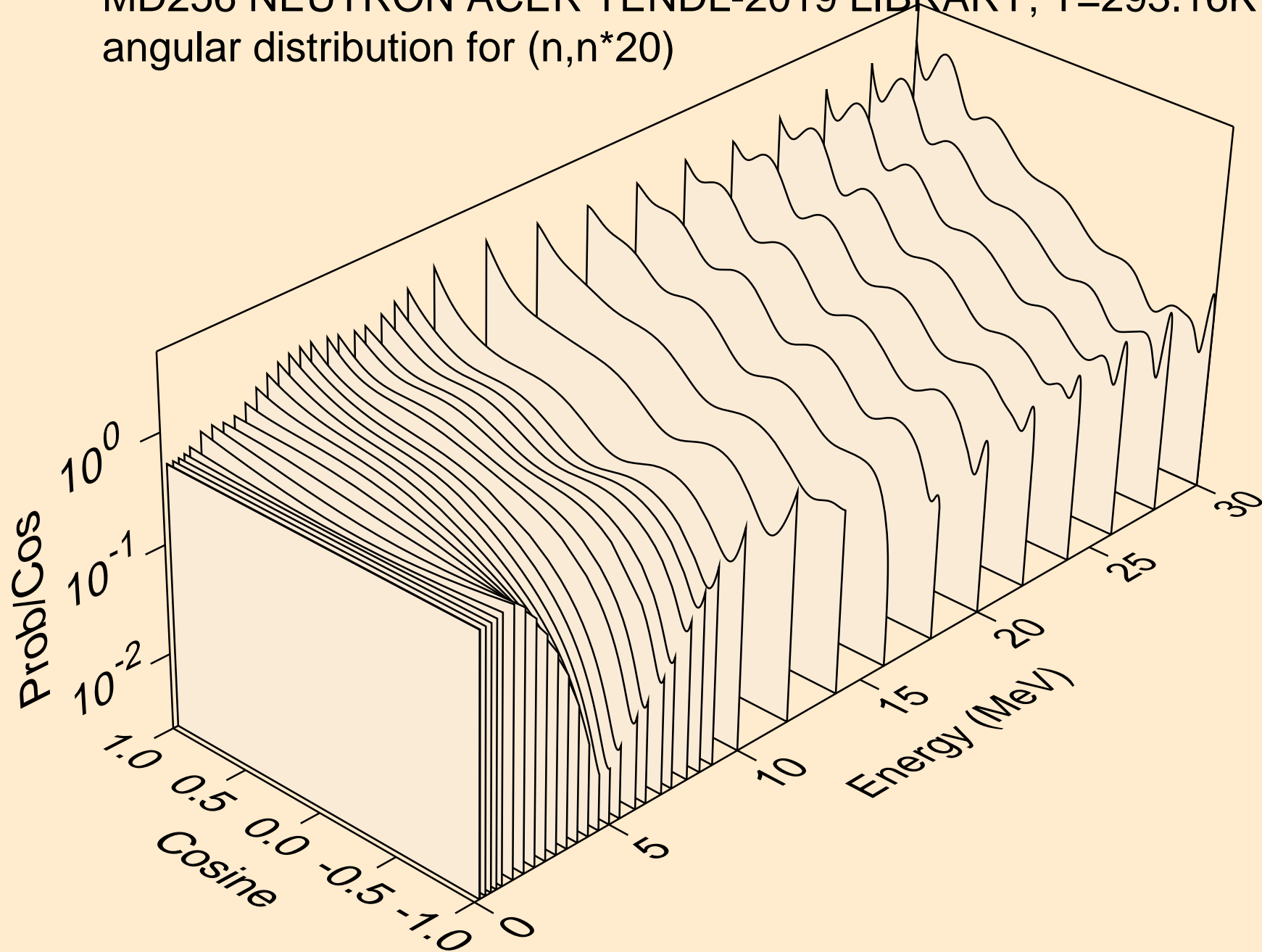

MD256 NEUTRON ACER TENDL-2019 LIBRARY; T=293.16K
angular distribution for (n,n*21)

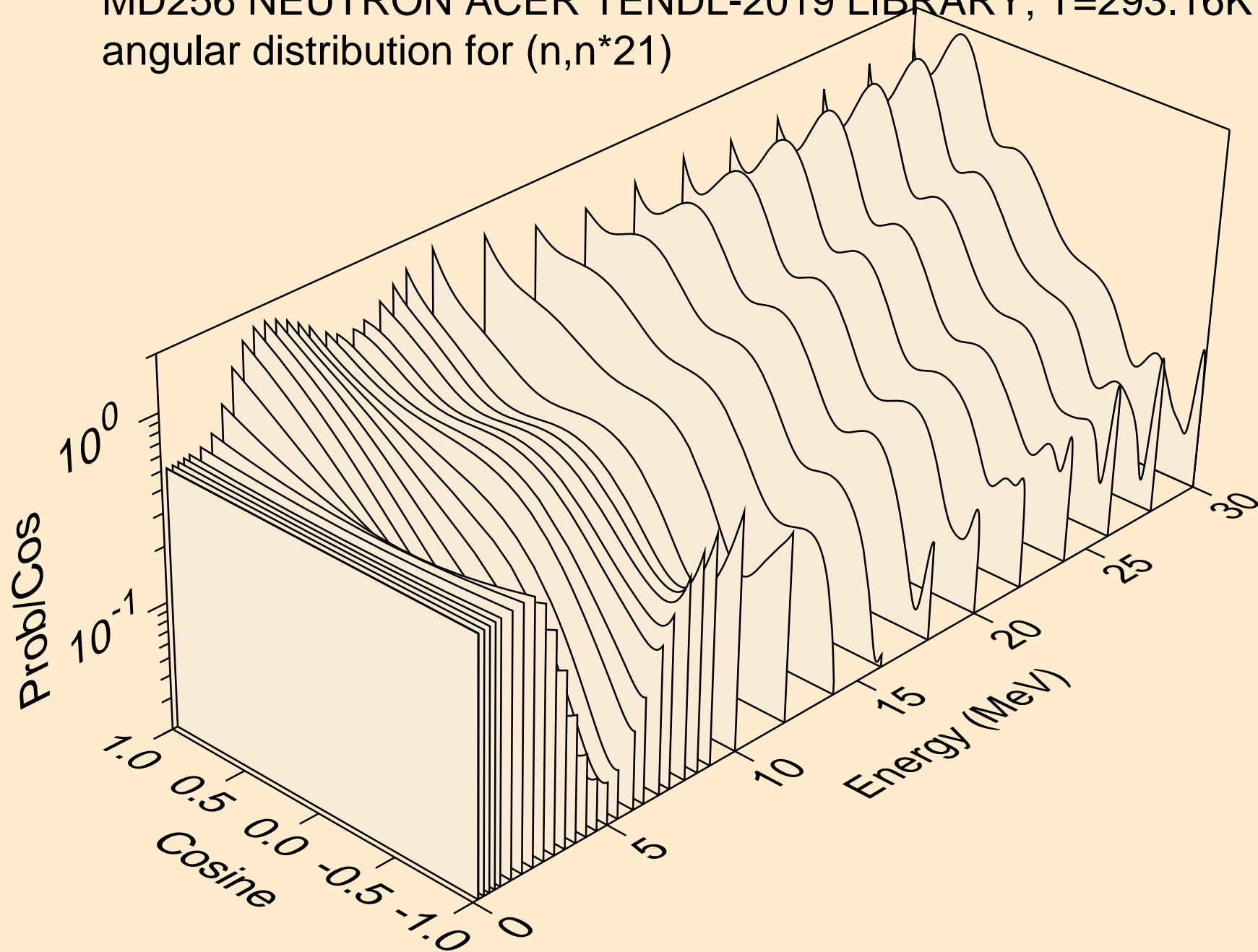

MD256 NEUTRON ACER TENDL-2019 LIBRARY; T=293.16K
angular distribution for (n,n*22)

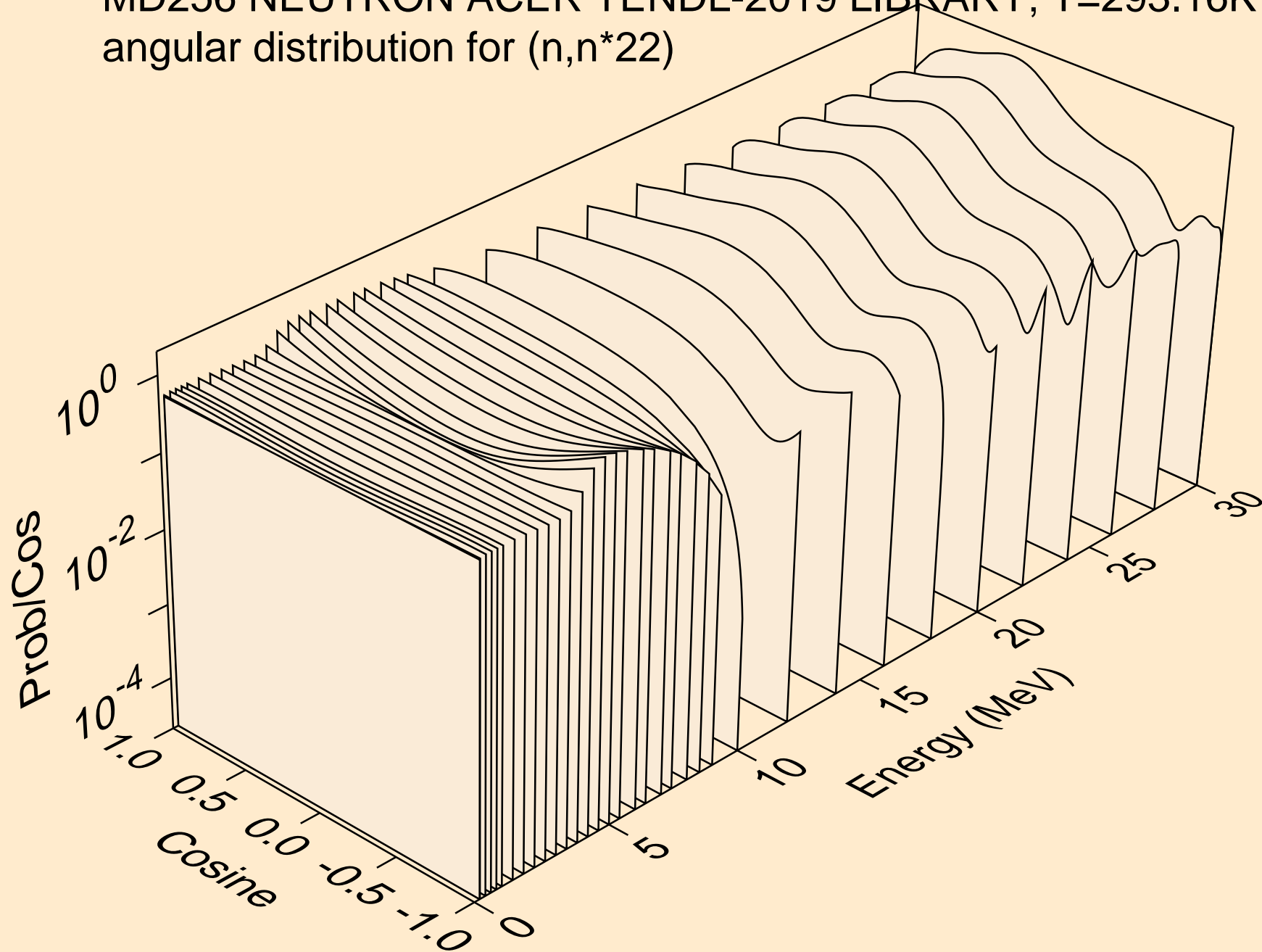

MD256 NEUTRON ACER TENDL-2019 LIBRARY; T=293.16K
angular distribution for (n,n*23)

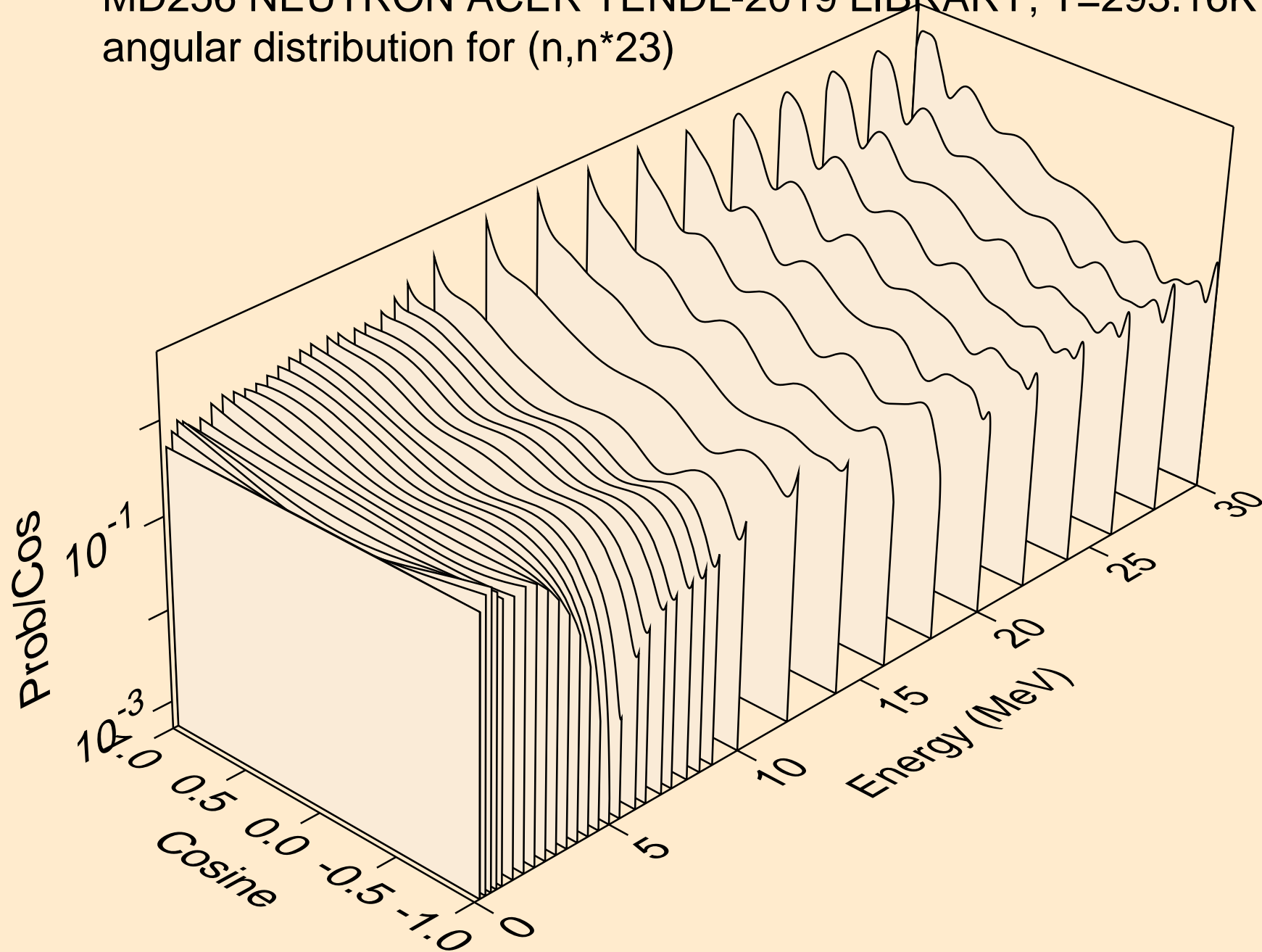

MD256 NEUTRON ACER TENDL-2019 LIBRARY; T=293.16K
angular distribution for (n,n*24)

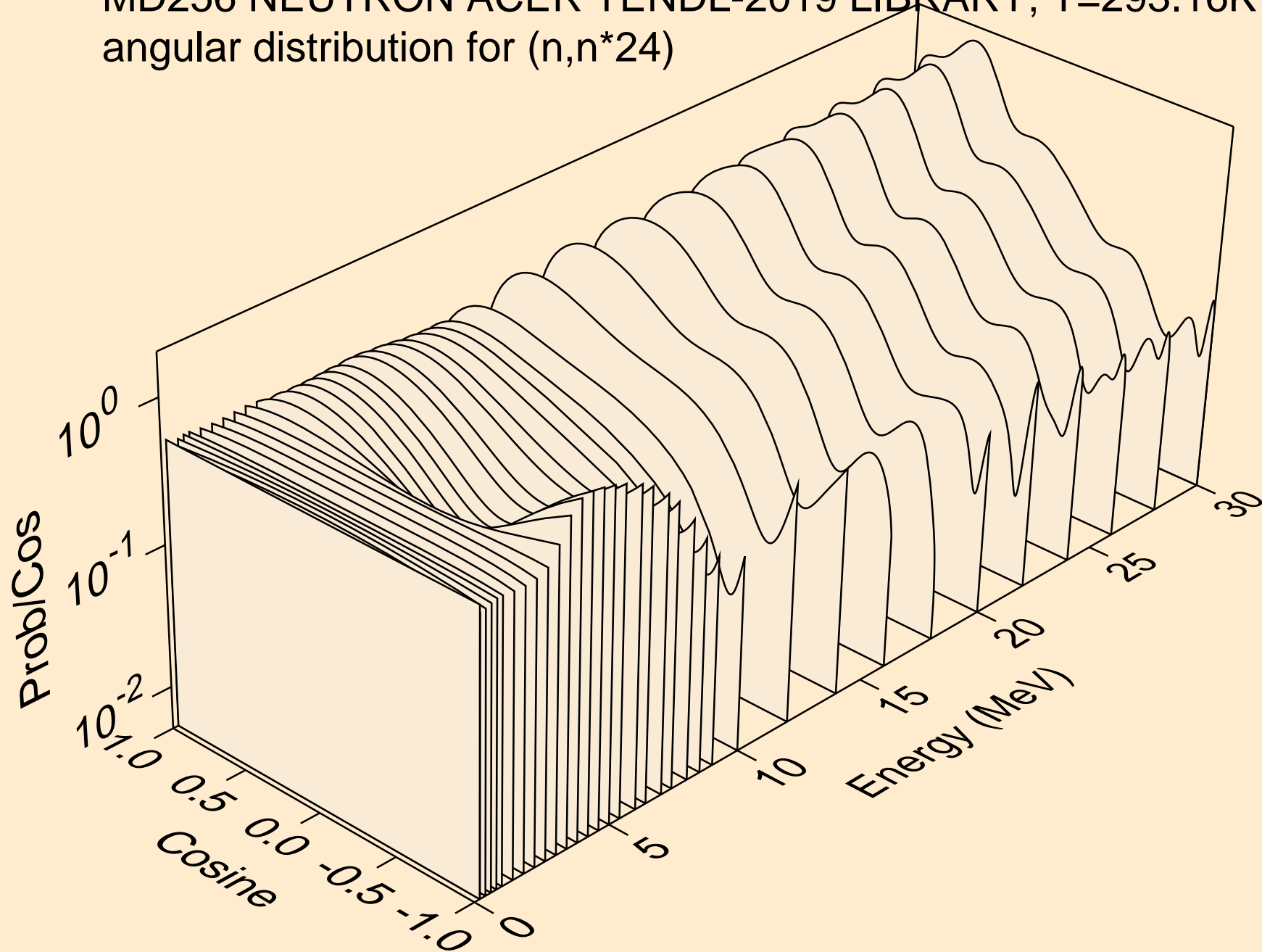

MD256 NEUTRON ACER TENDL-2019 LIBRARY; T=293.16K
angular distribution for (n,n*25)

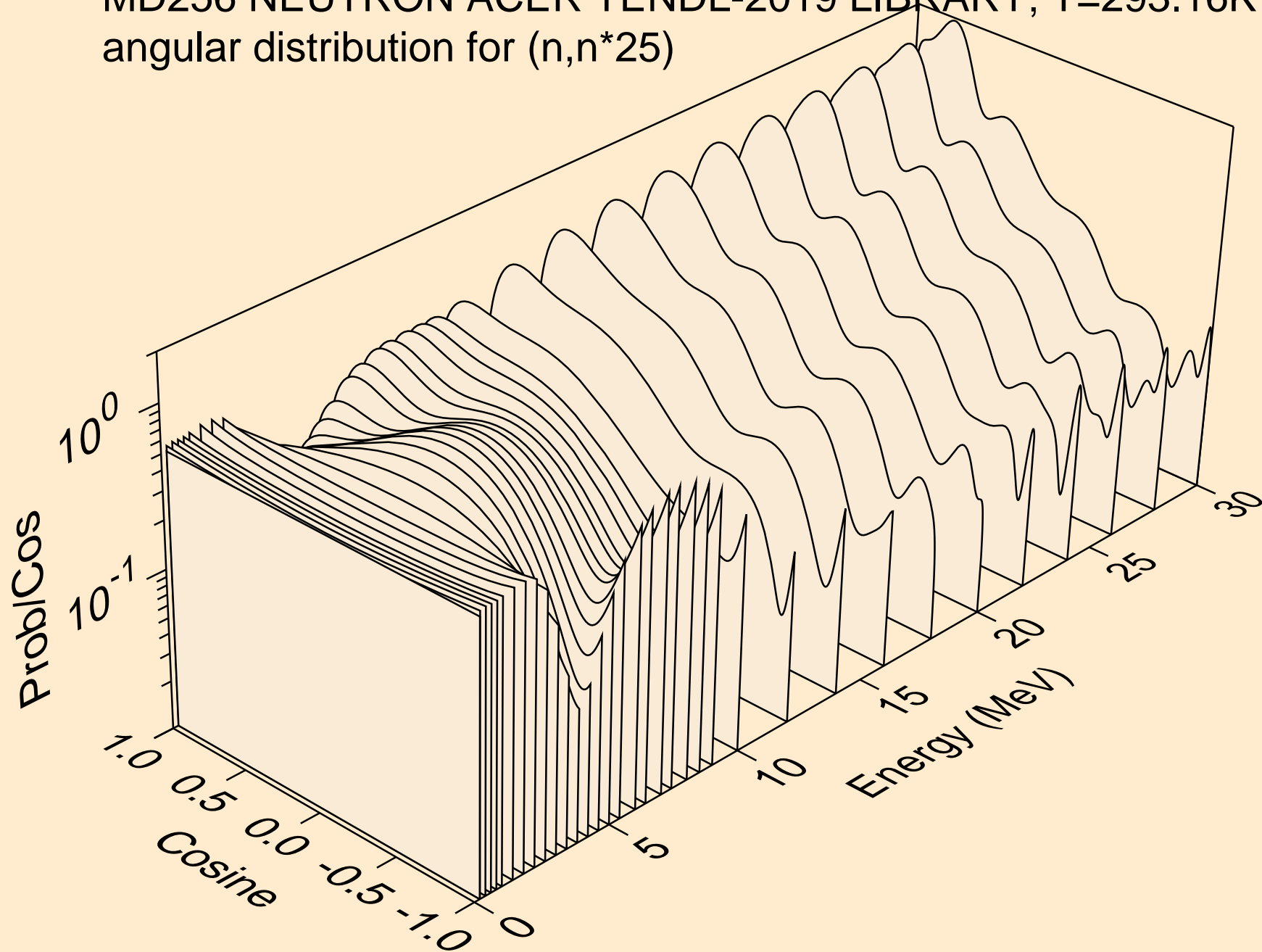

MD256 NEUTRON ACER TENDL-2019 LIBRARY; T=293.16K
angular distribution for (n,n*26)

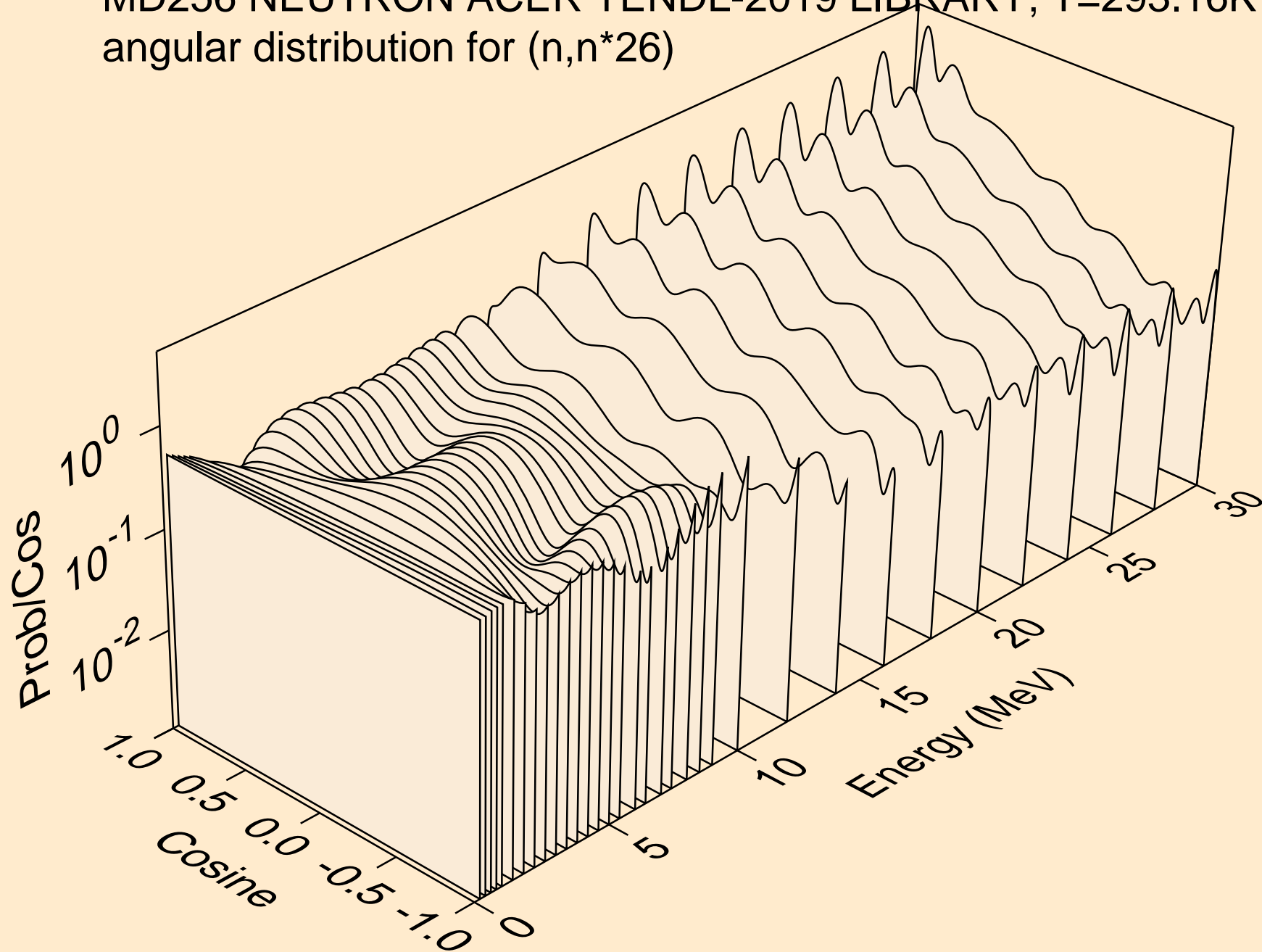

MD256 NEUTRON ACER TENDL-2019 LIBRARY; T=293.16K
angular distribution for (n,n*27)

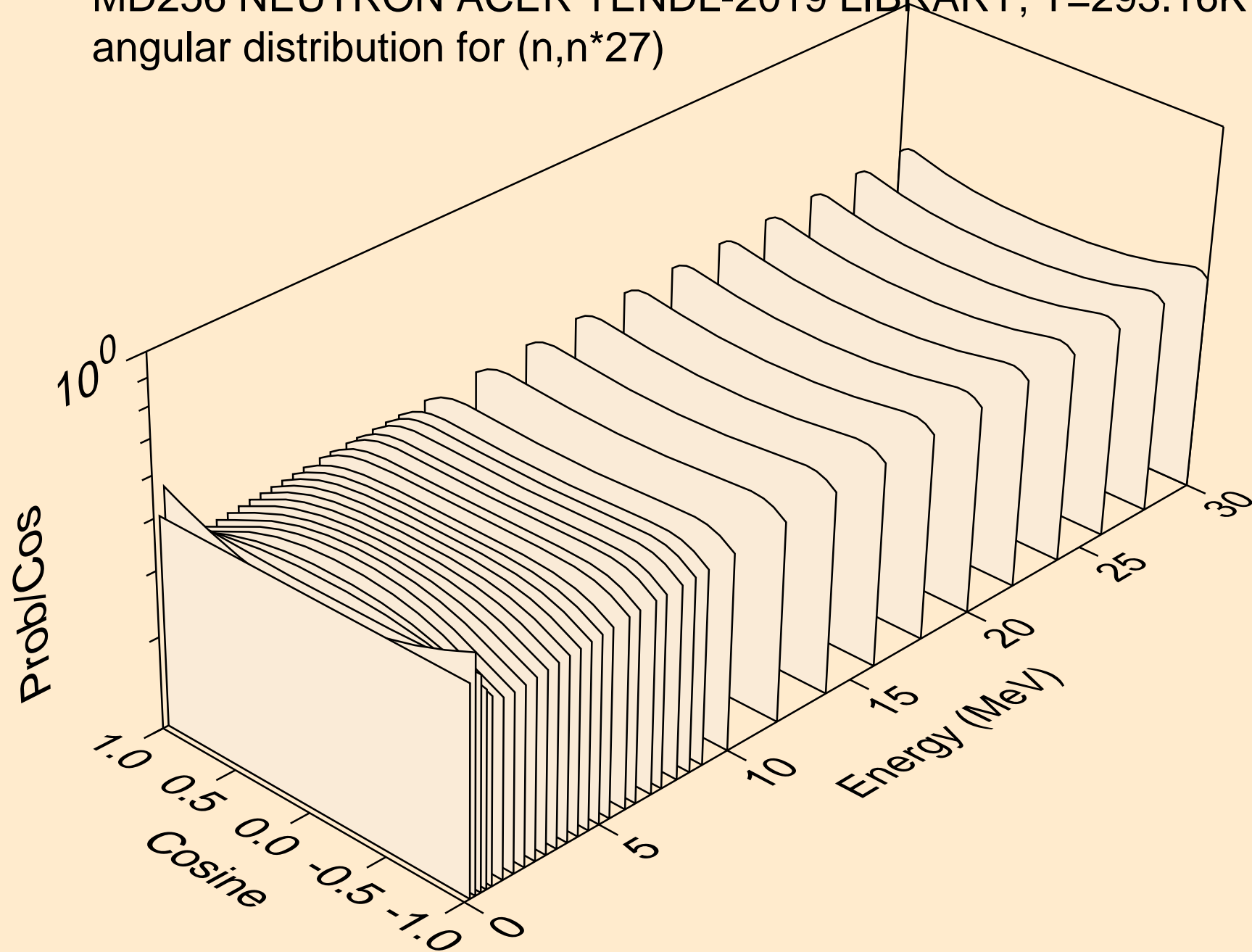

MD256 NEUTRON ACER TENDL-2019 LIBRARY; T=293.16K
angular distribution for (n,n*28)

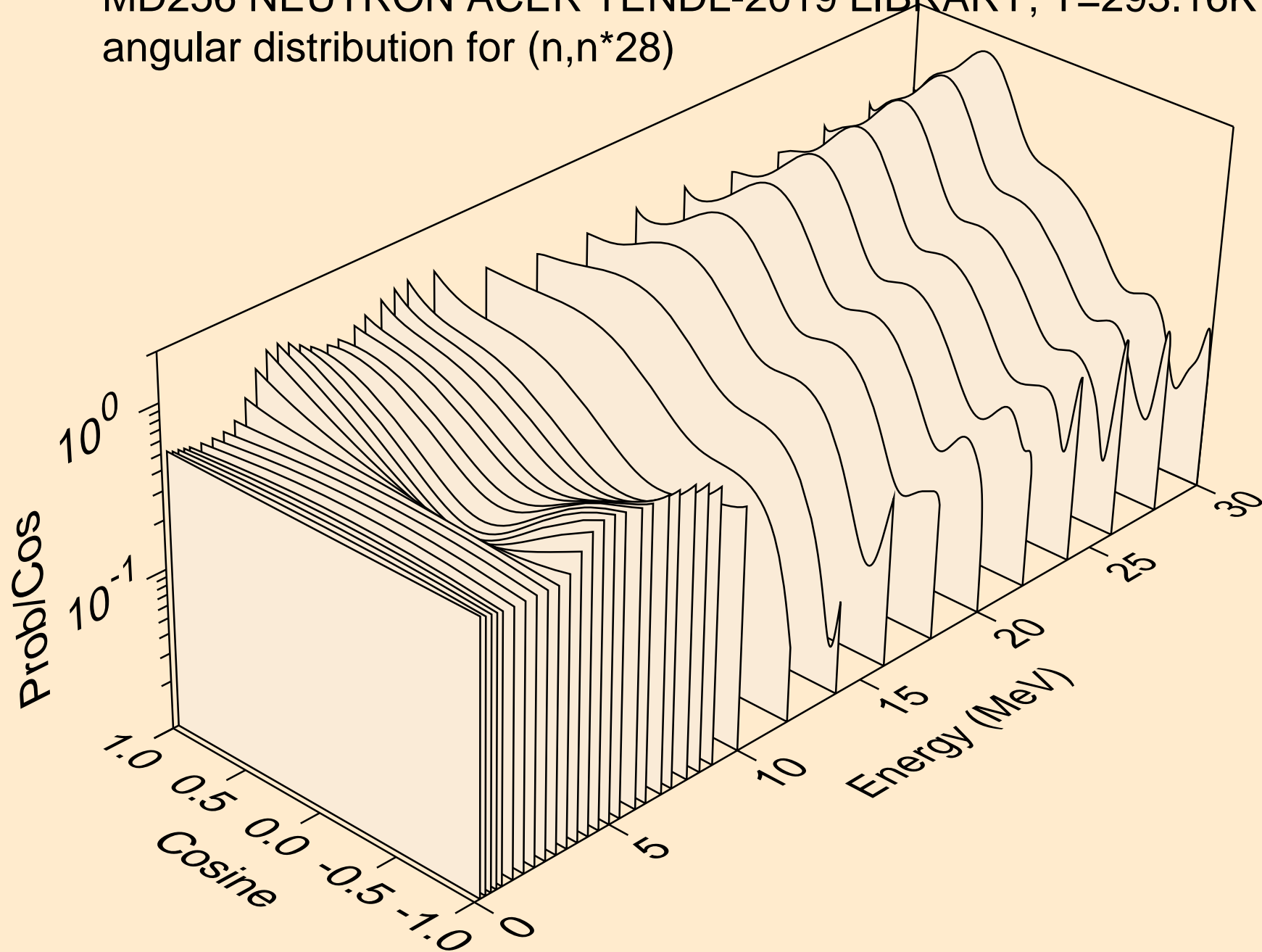

MD256 NEUTRON ACER TENDL-2019 LIBRARY; T=293.16K
angular distribution for (n,n*29)

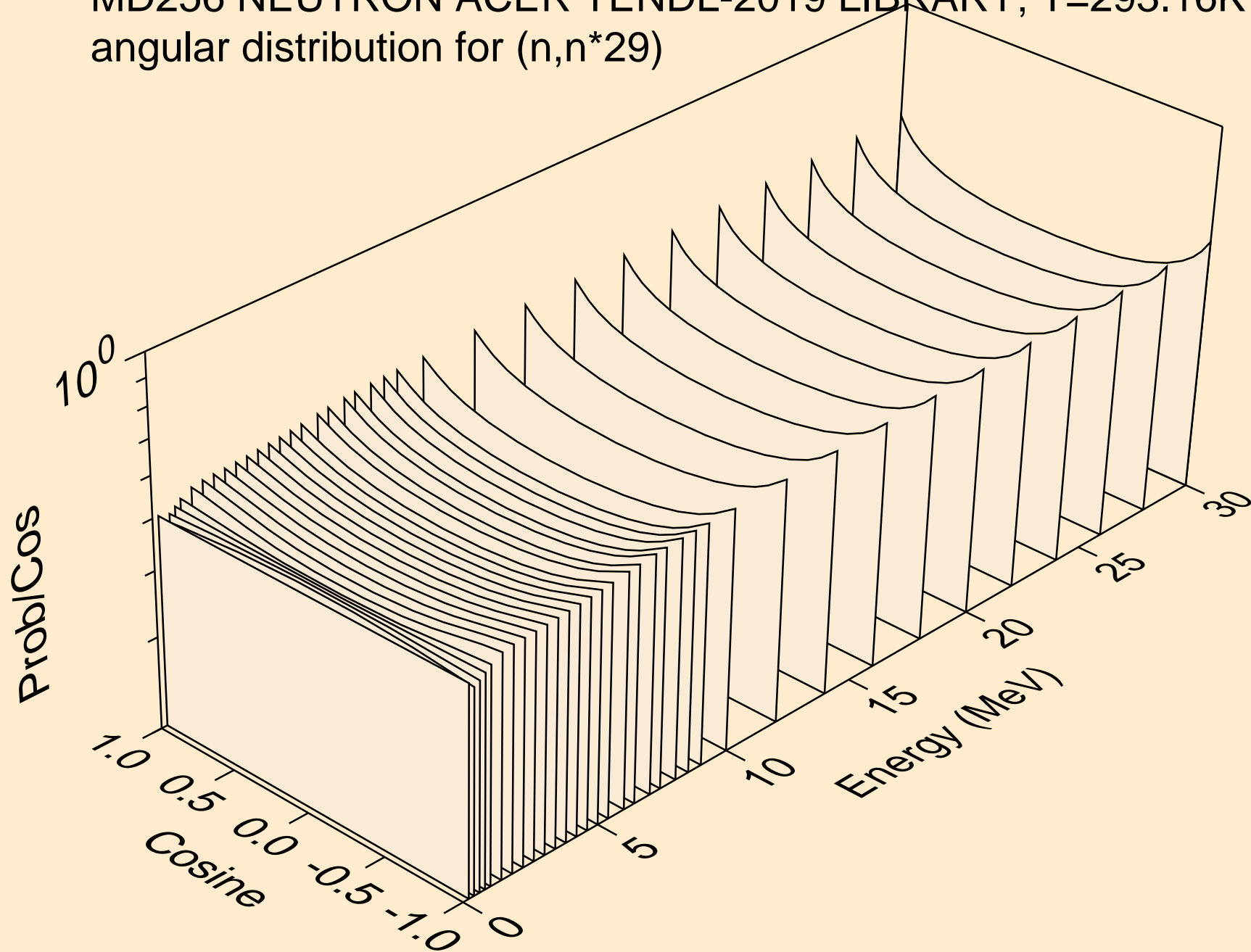

MD256 NEUTRON ACER TENDL-2019 LIBRARY; T=293.16K
angular distribution for (n,n*30)

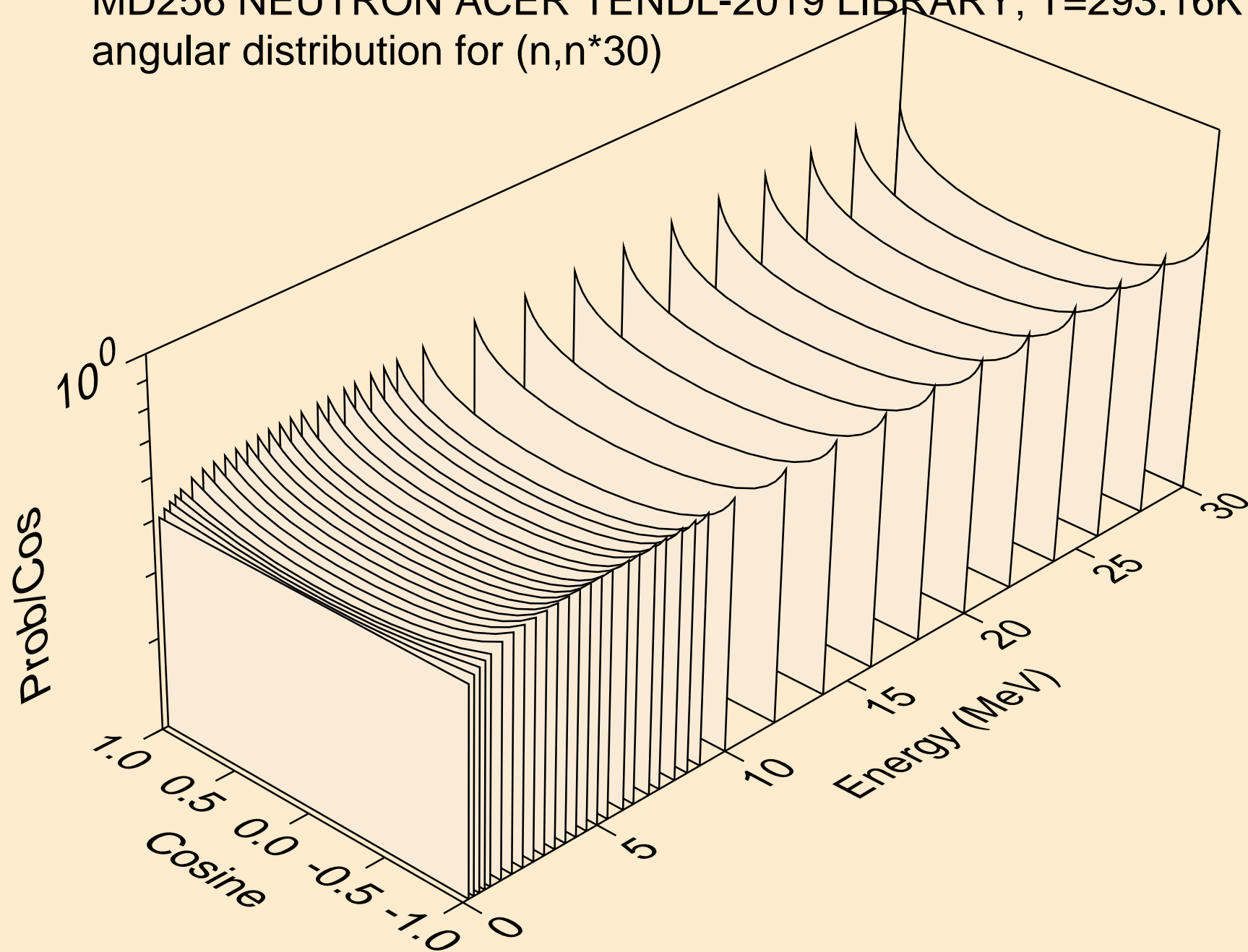

MD256 NEUTRON ACER TENDL-2019 LIBRARY; T=293.16K
Total fission nubar

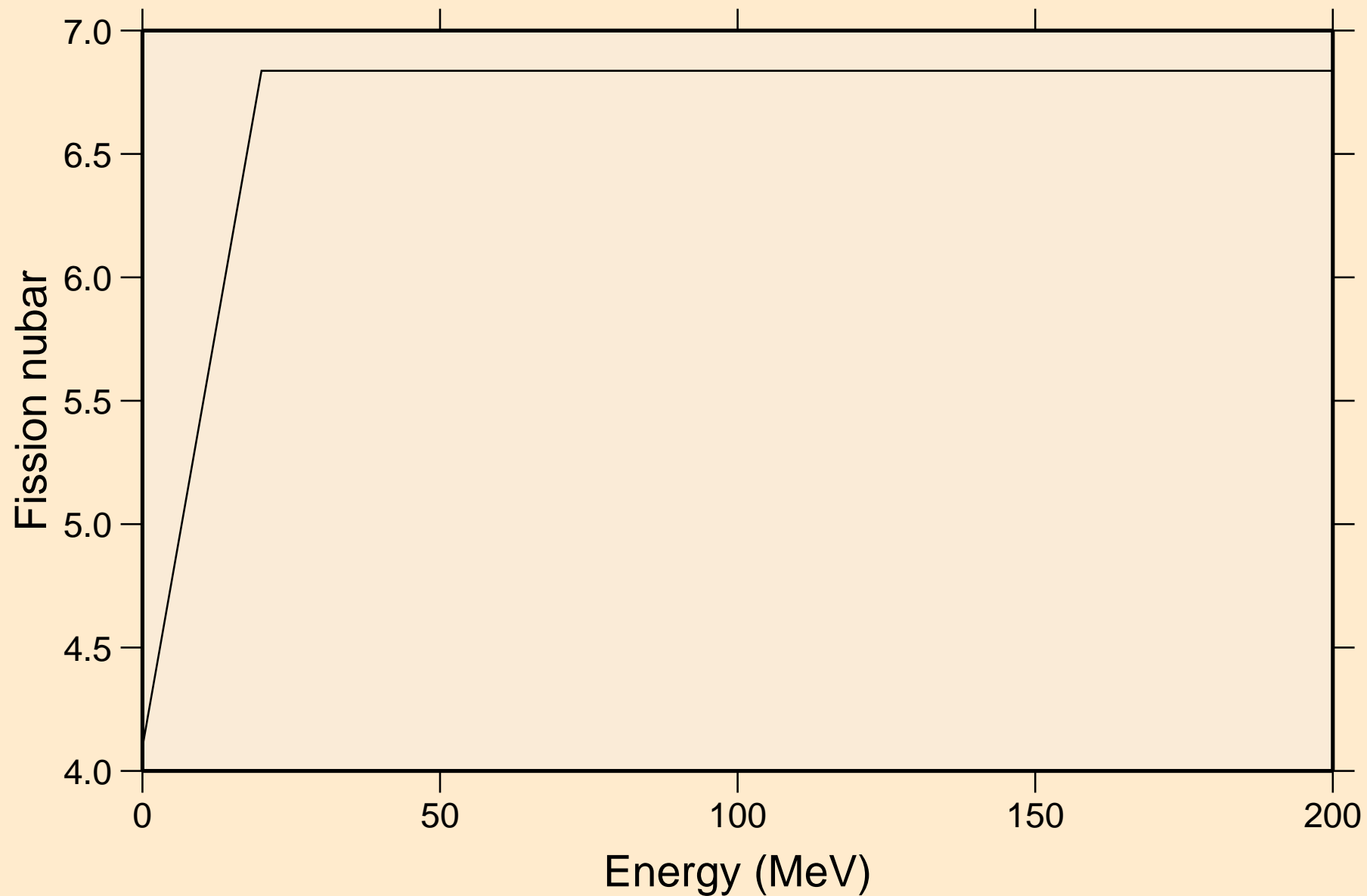

MD256 NEUTRON ACER TENDL-2019 LIBRARY; T=293.16K
Neutron emission for (n,x)

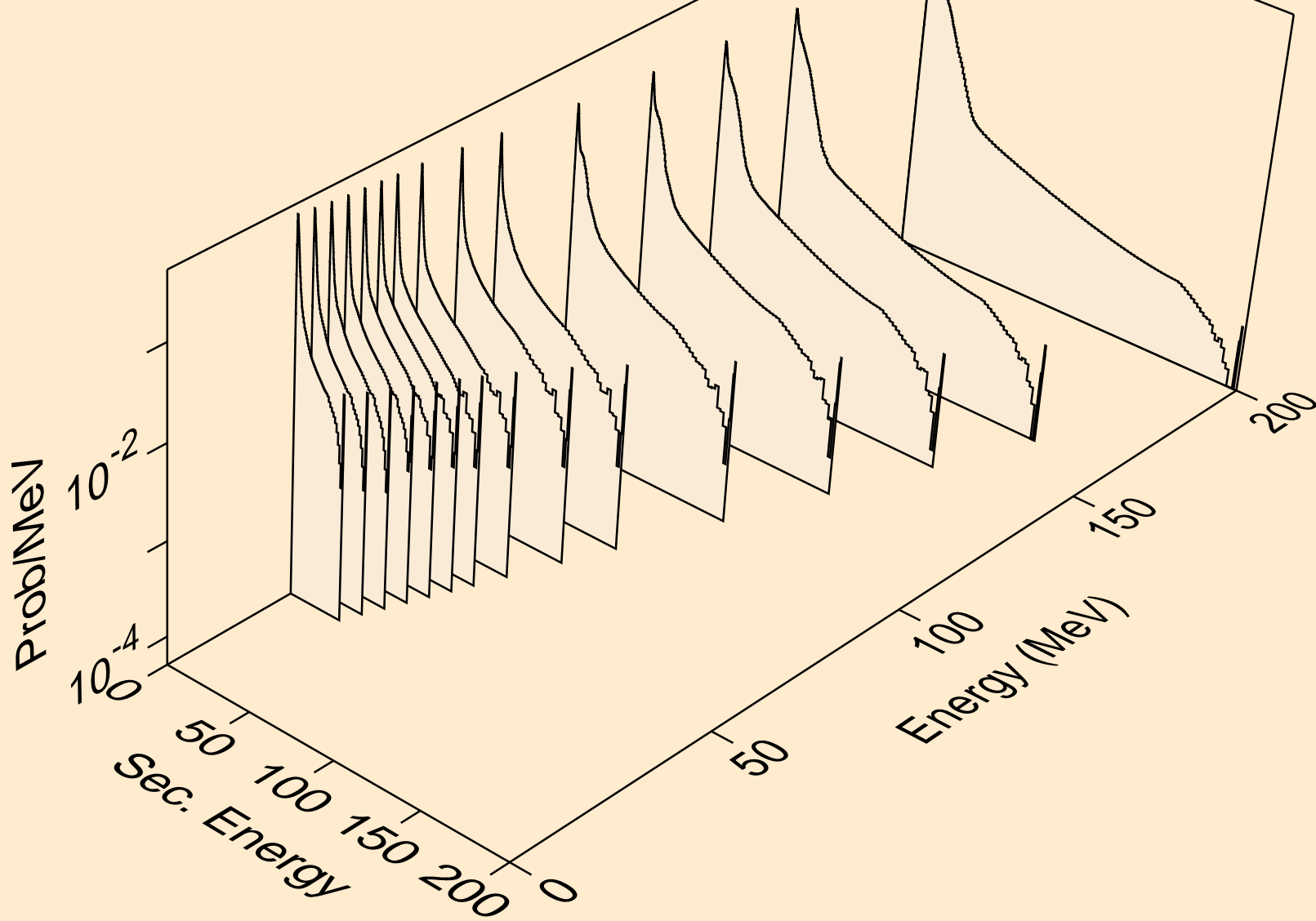

MD256 NEUTRON ACER TENDL-2019 LIBRARY; T=293.16K
Neutron emission for (n,2nd)

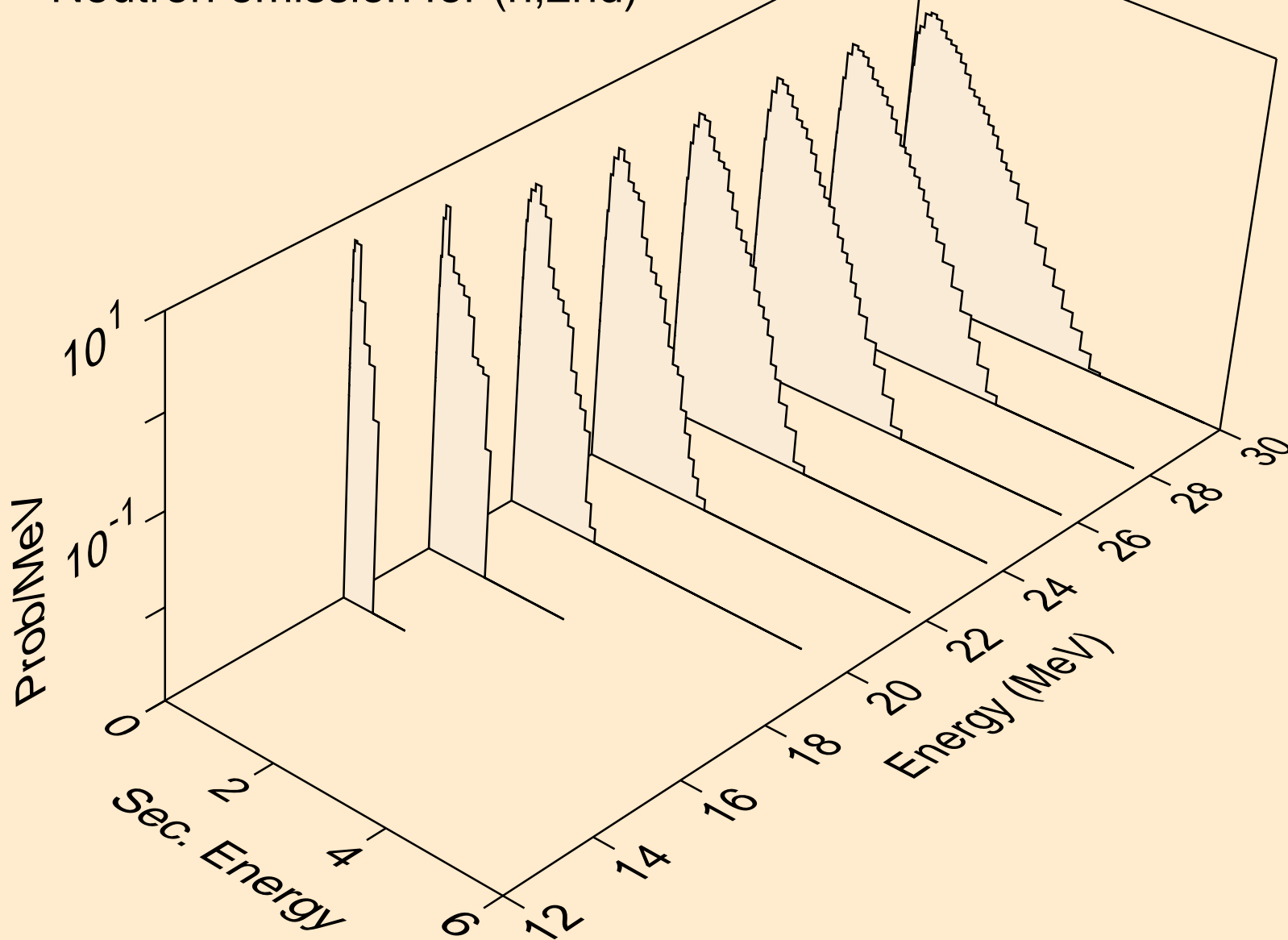

MD256 NEUTRON ACER TENDL-2019 LIBRARY; T=293.16K
Neutron emission for (n,2n)

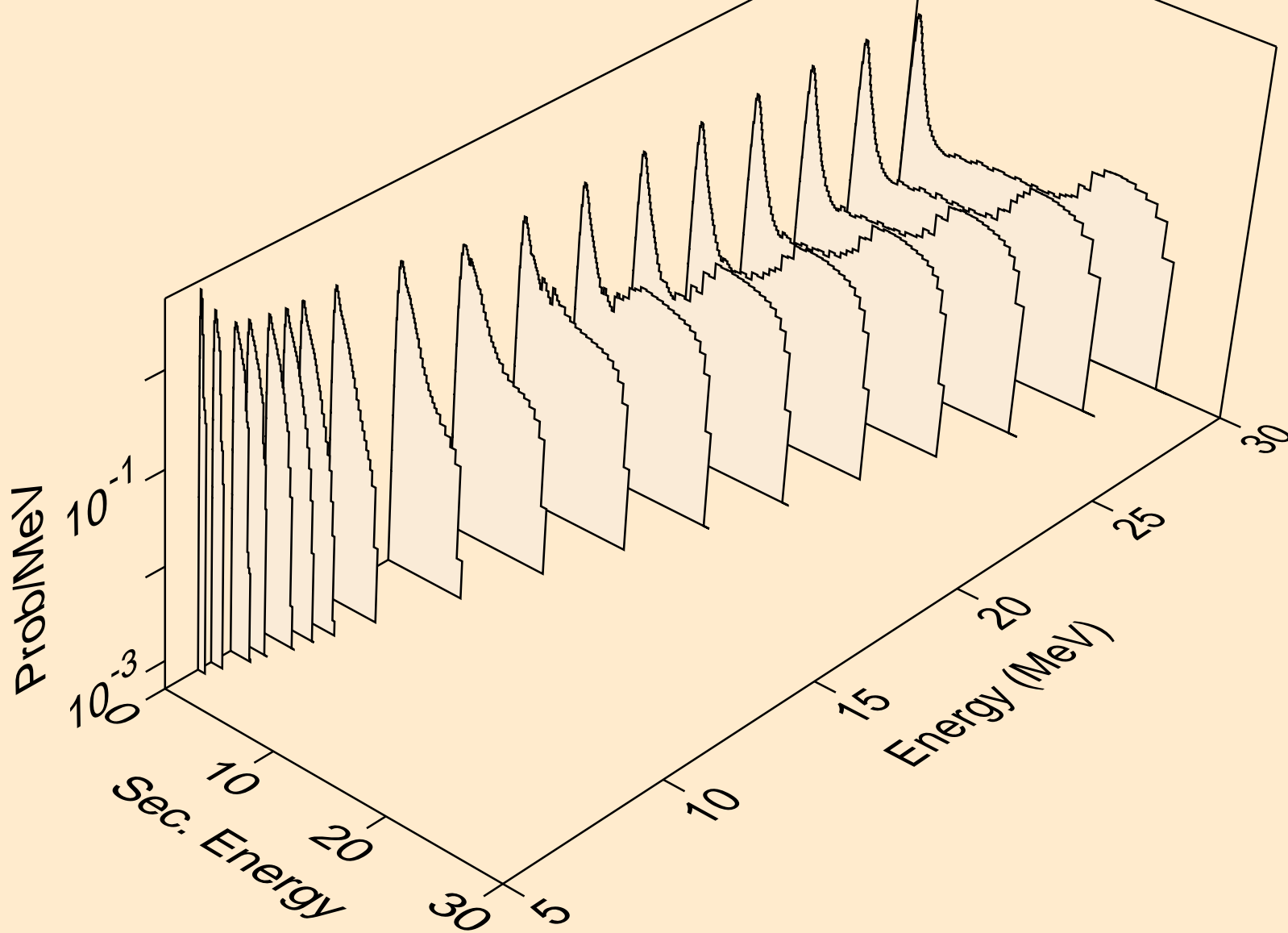

MD256 NEUTRON ACER TENDL-2019 LIBRARY; T=293.16K
Neutron emission for (n,3n)

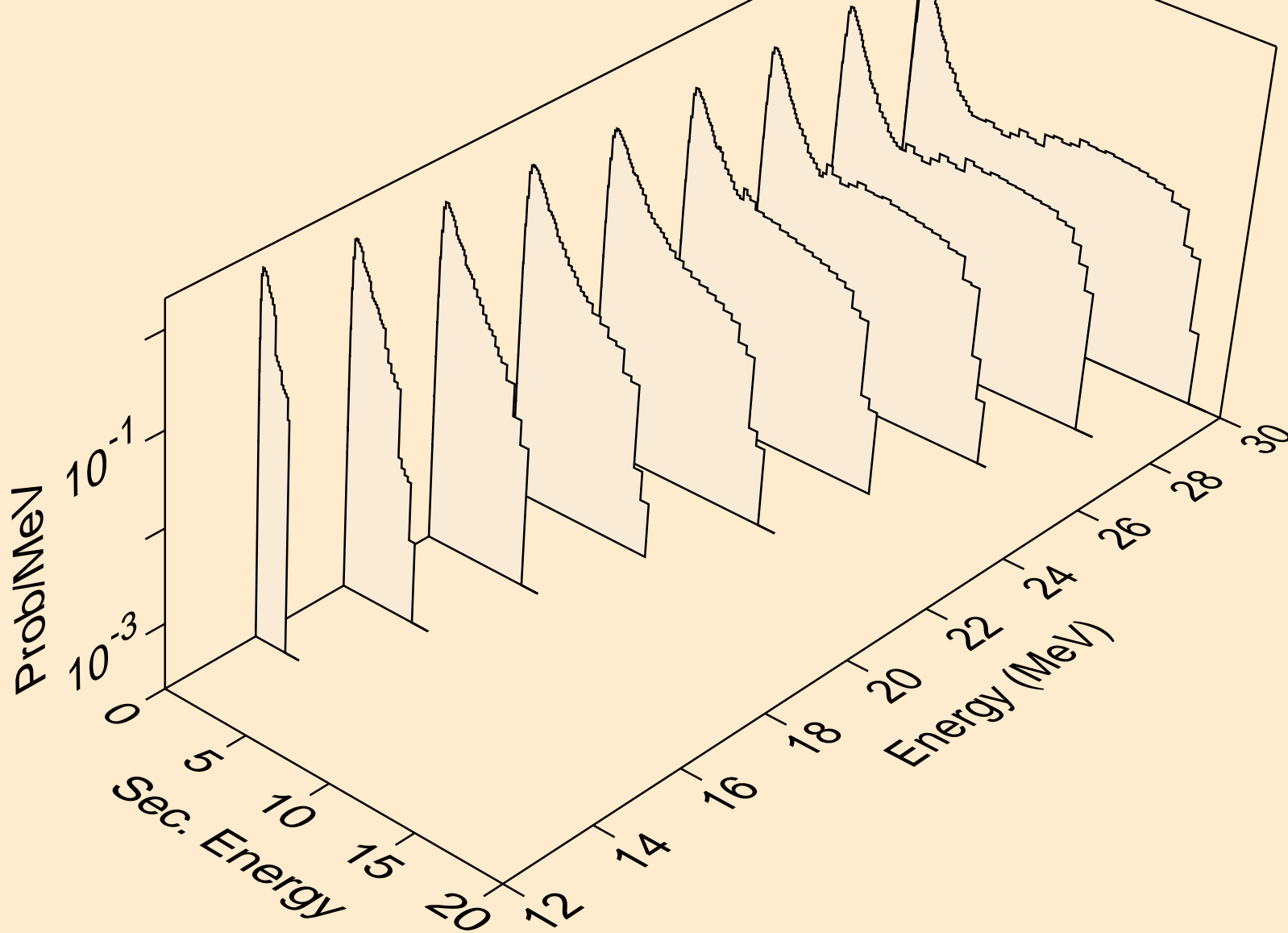

MD256 NEUTRON ACER TENDL-2019 LIBRARY; T=293.16K
Neutron emission for fission

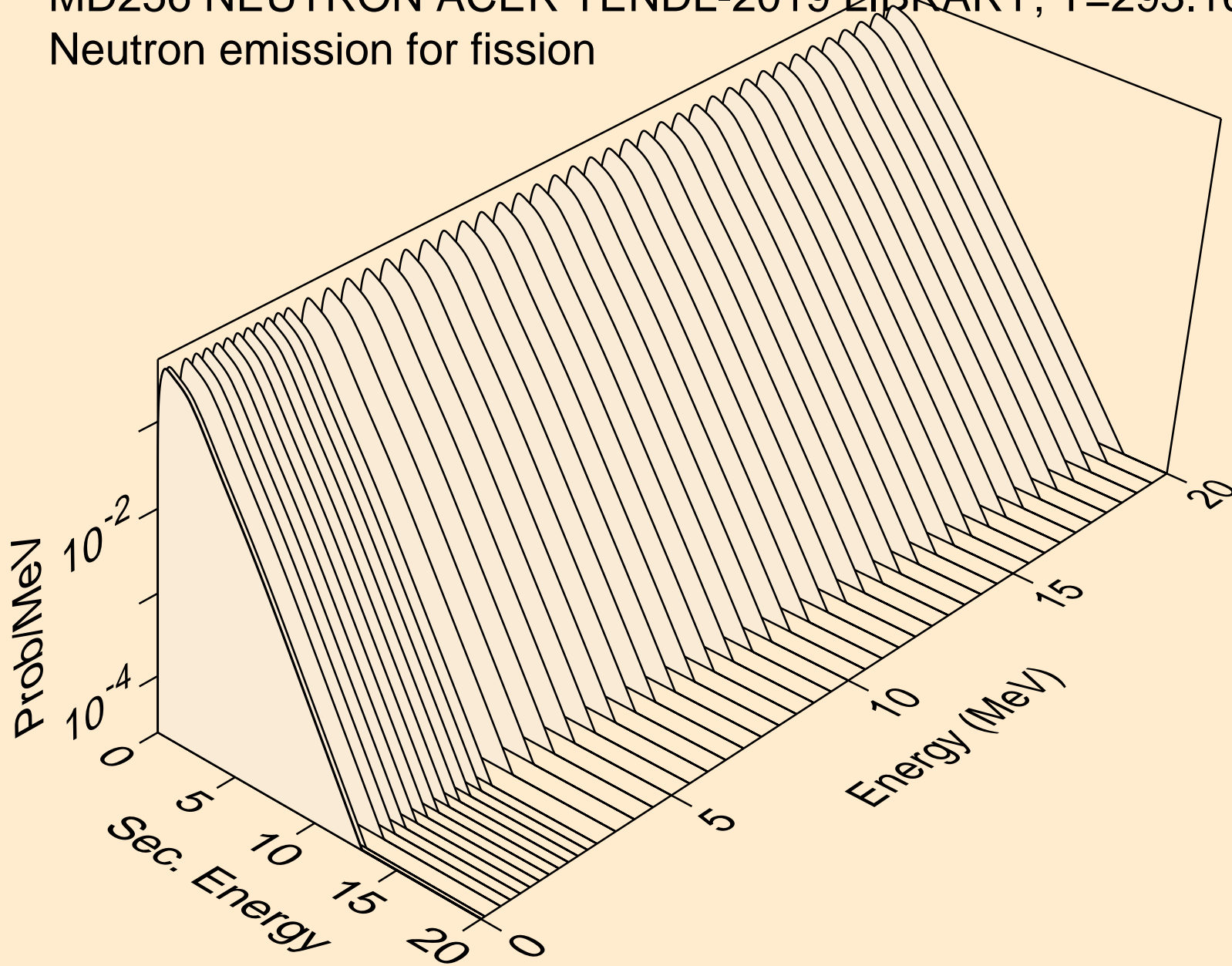

MD256 NEUTRON ACER TENDL-2019 LIBRARY; T=293.16K
Neutron emission for (n,n*)a

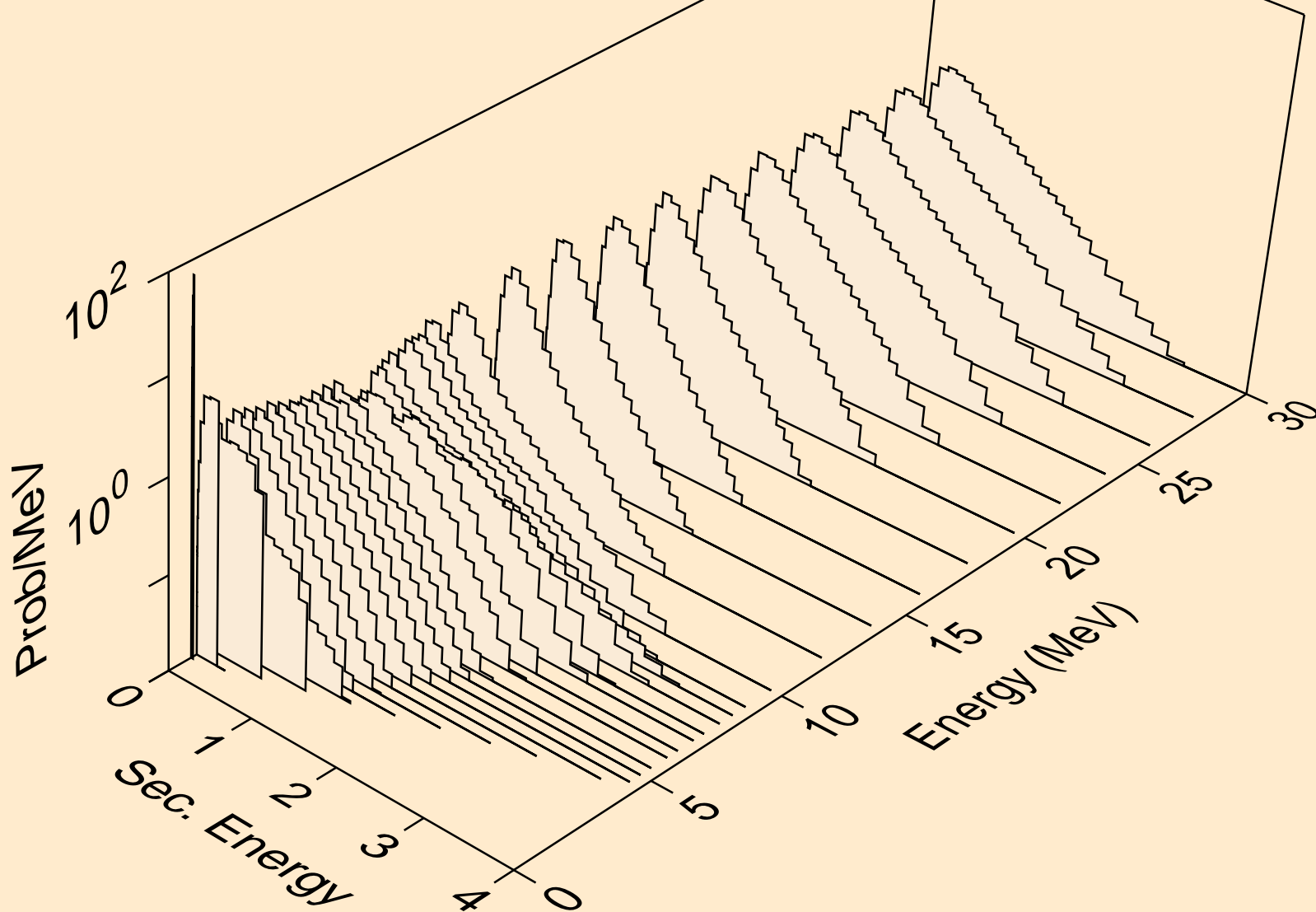

MD256 NEUTRON ACER TENDL-2019 LIBRARY; T=293.16K
Neutron emission for (n,2n)a

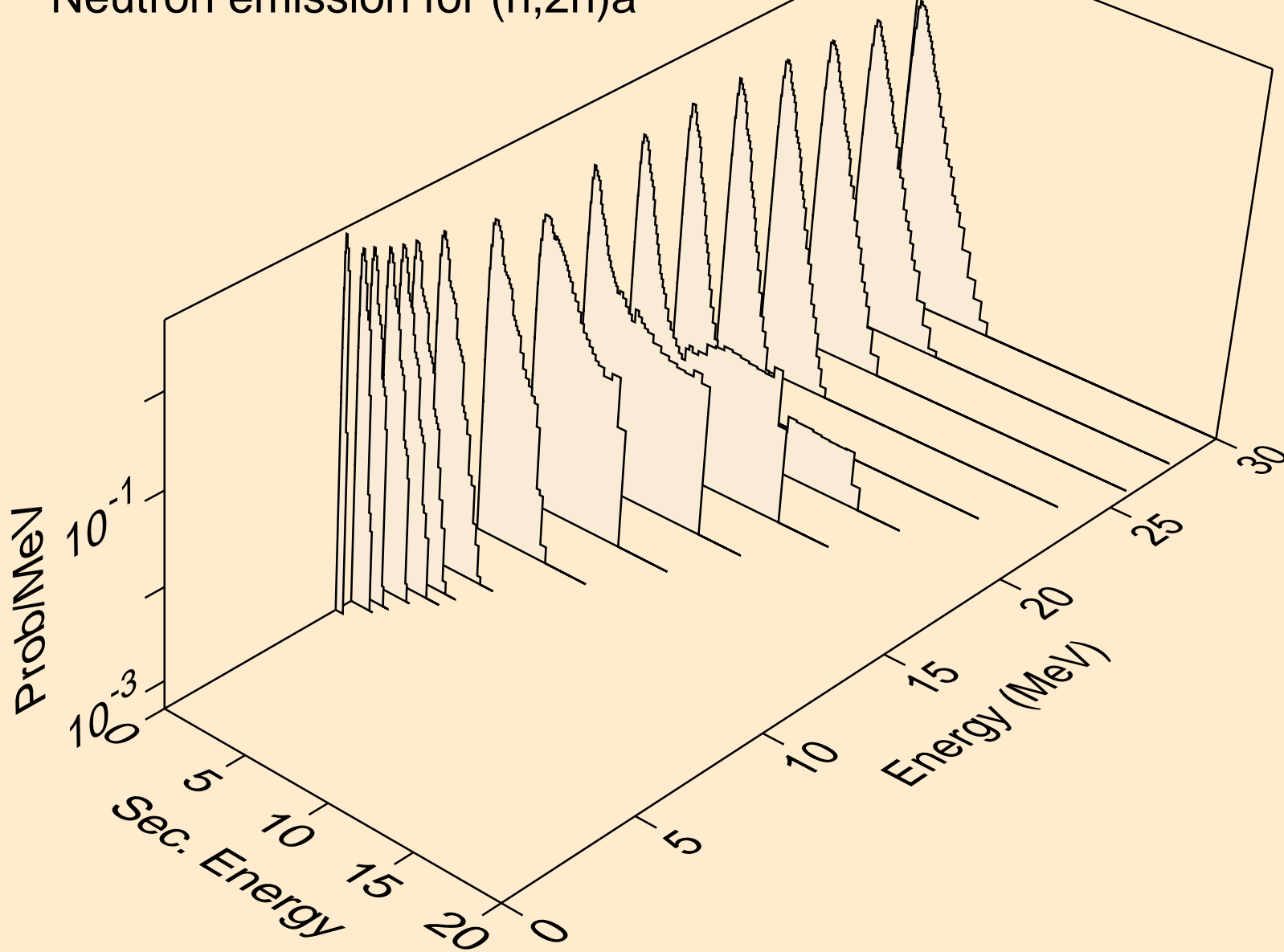

MD256 NEUTRON ACER TENDL-2019 LIBRARY; T=293.16K
Neutron emission for (n,3n)a

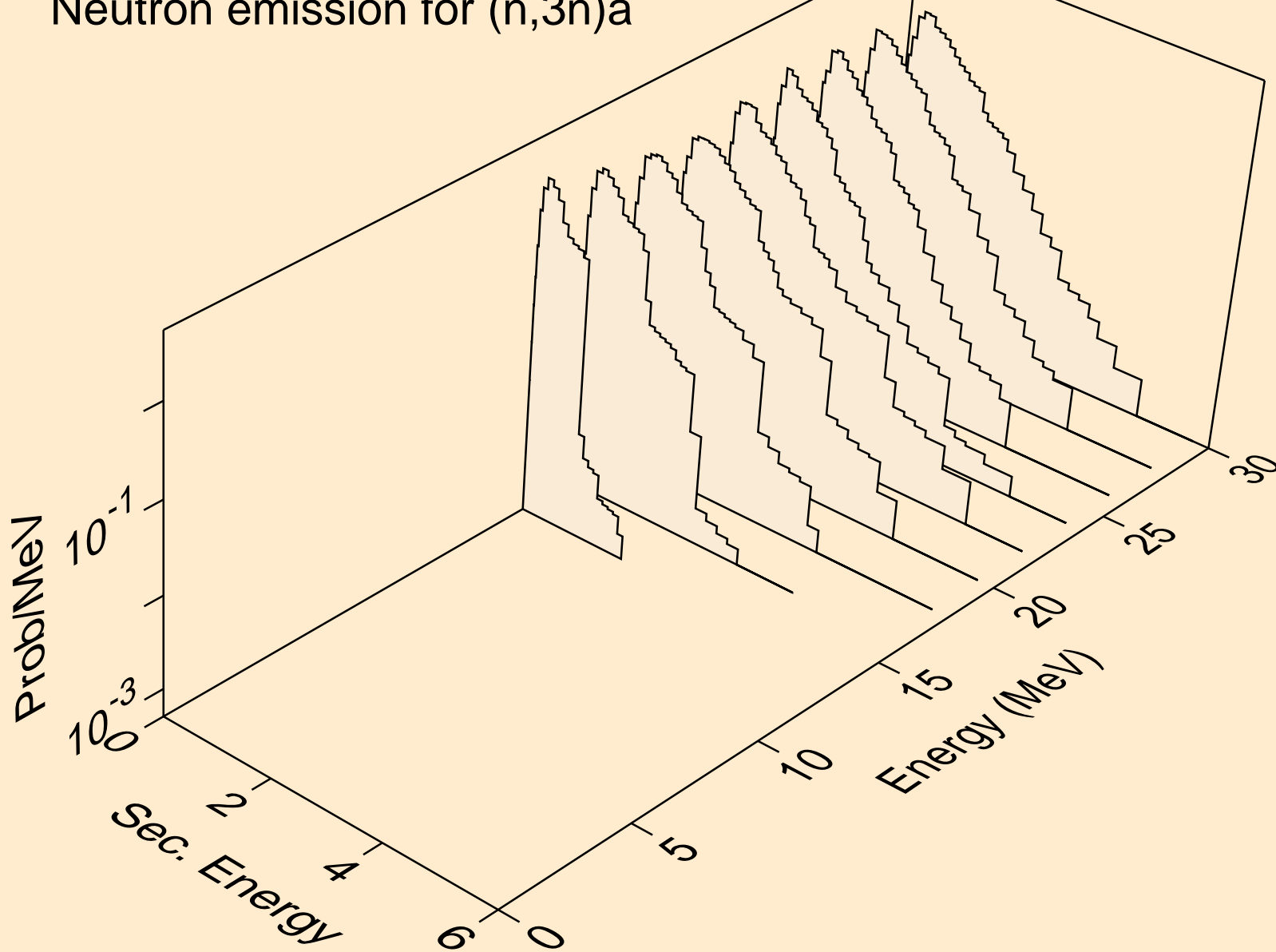

MD256 NEUTRON ACER TENDL-2019 LIBRARY; T=293.16K
Neutron emission for (n,n*)p

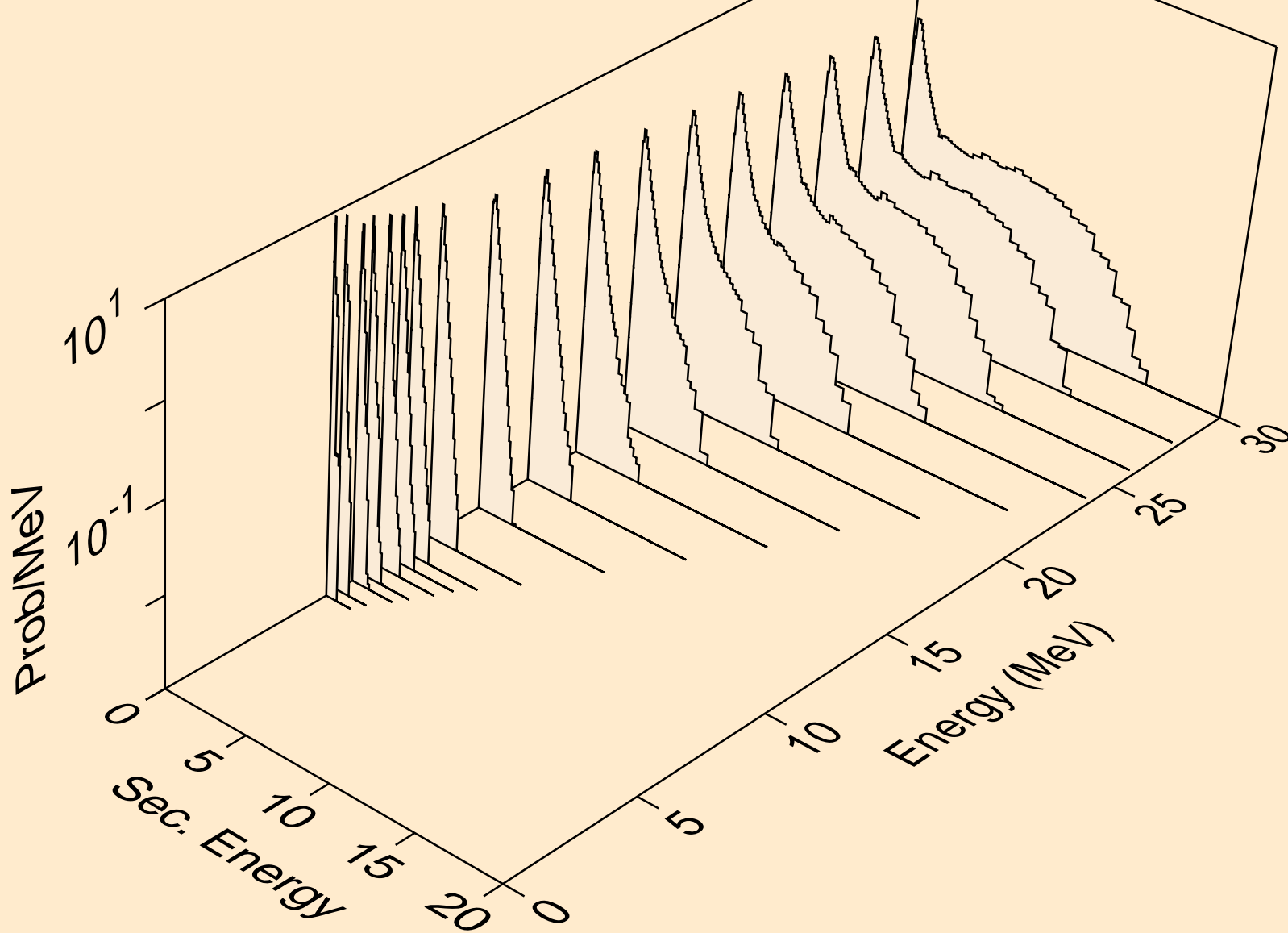

MD256 NEUTRON ACER TENDL-2019 LIBRARY; T=293.16K
Neutron emission for (n,n*)2a

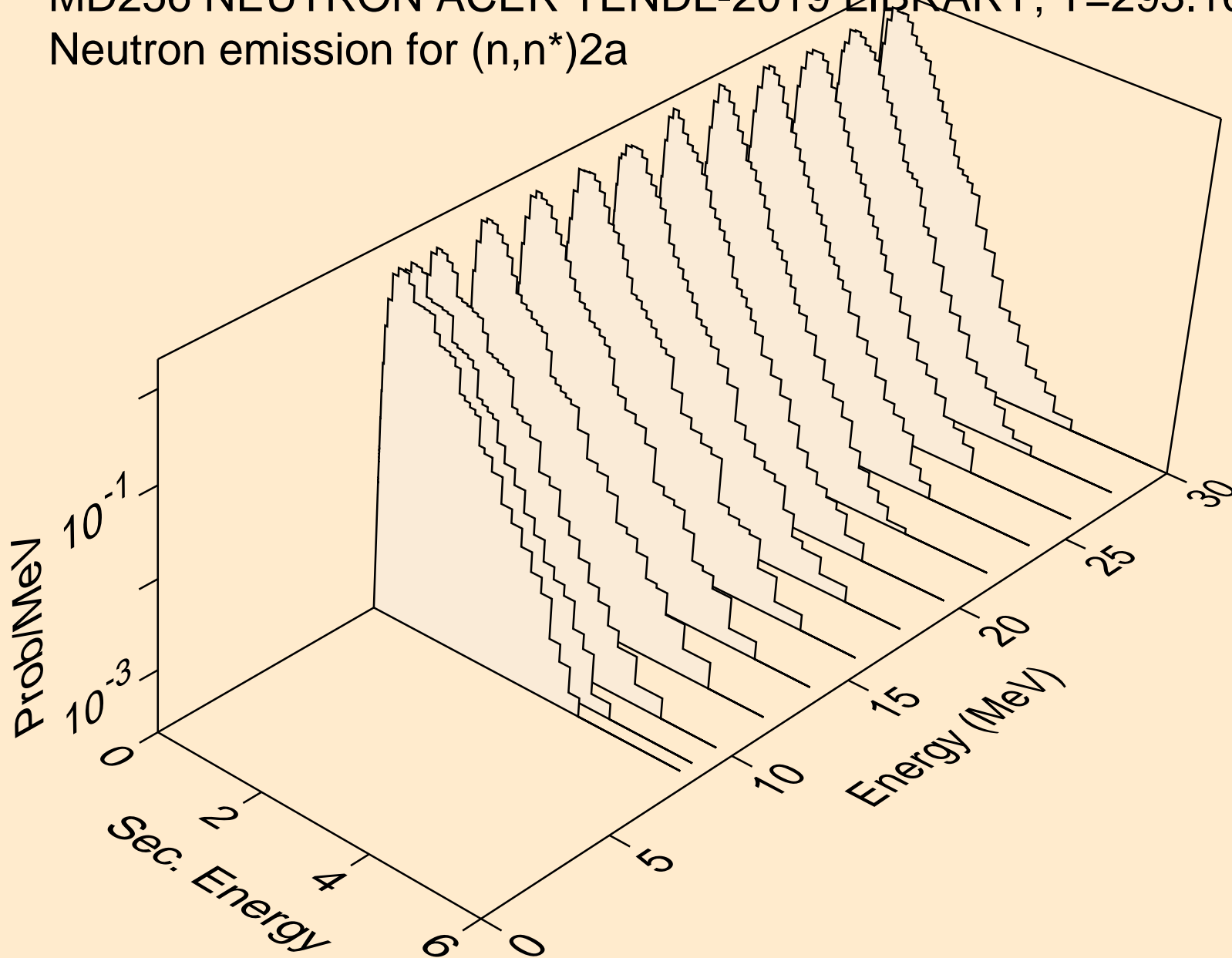

MD256 NEUTRON ACER TENDL-2019 LIBRARY; T=293.16K
Neutron emission for (n,n*)d

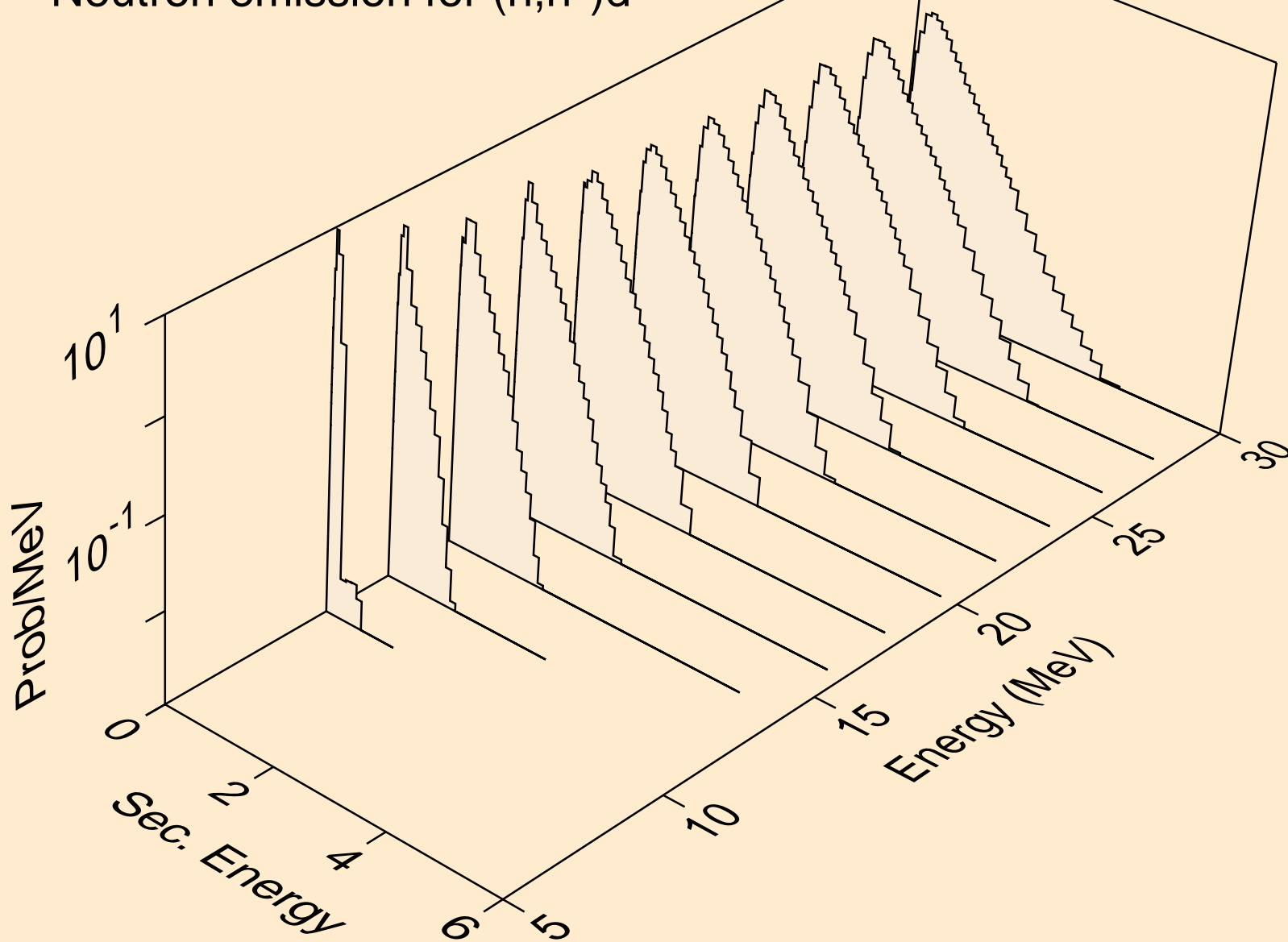

MD256 NEUTRON ACER TENDL-2019 LIBRARY; T=293.16K
Neutron emission for (n,n*)t

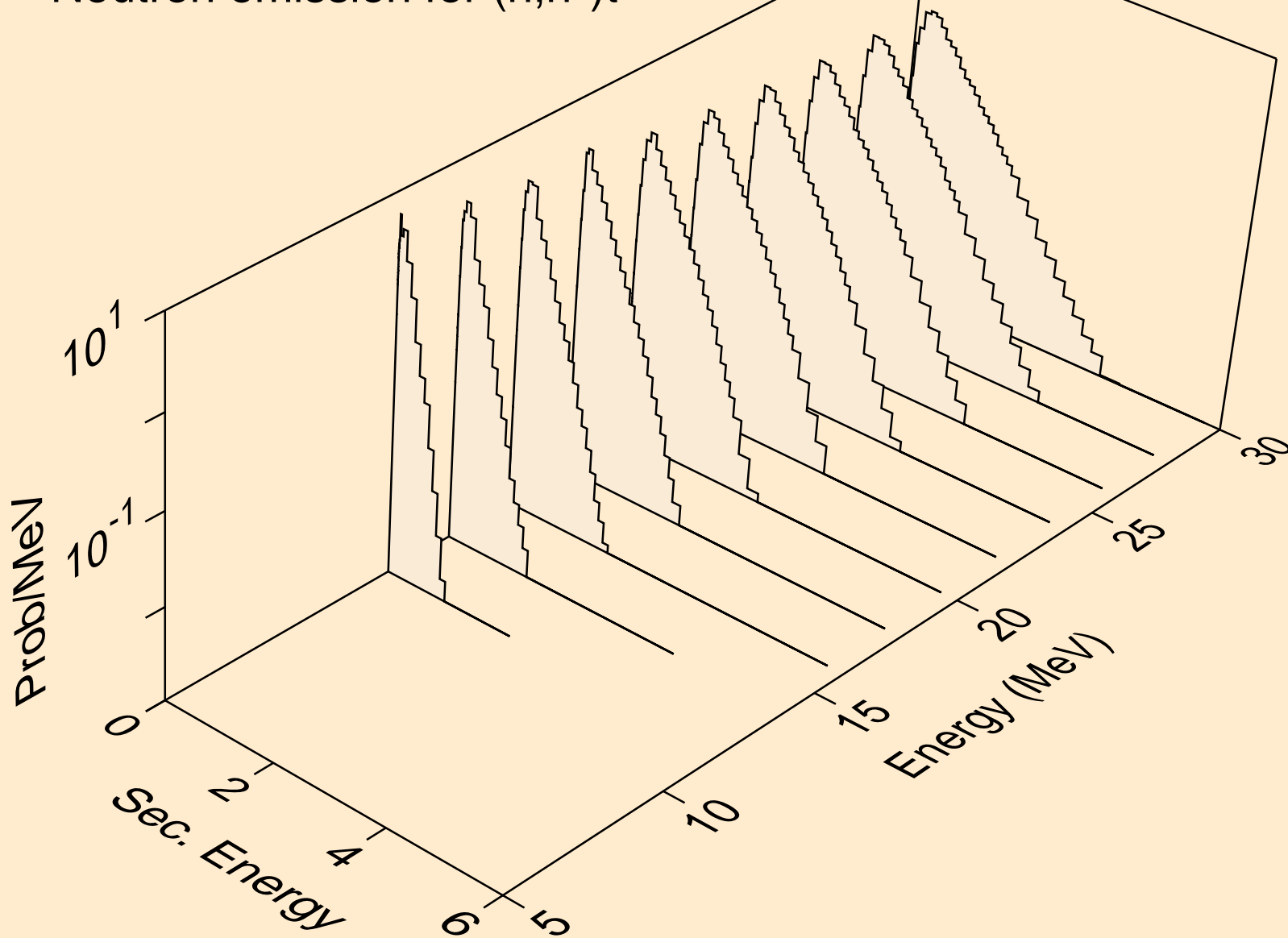

MD256 NEUTRON ACER TENDL-2019 LIBRARY; T=293.16K
Neutron emission for (n,n*)he3

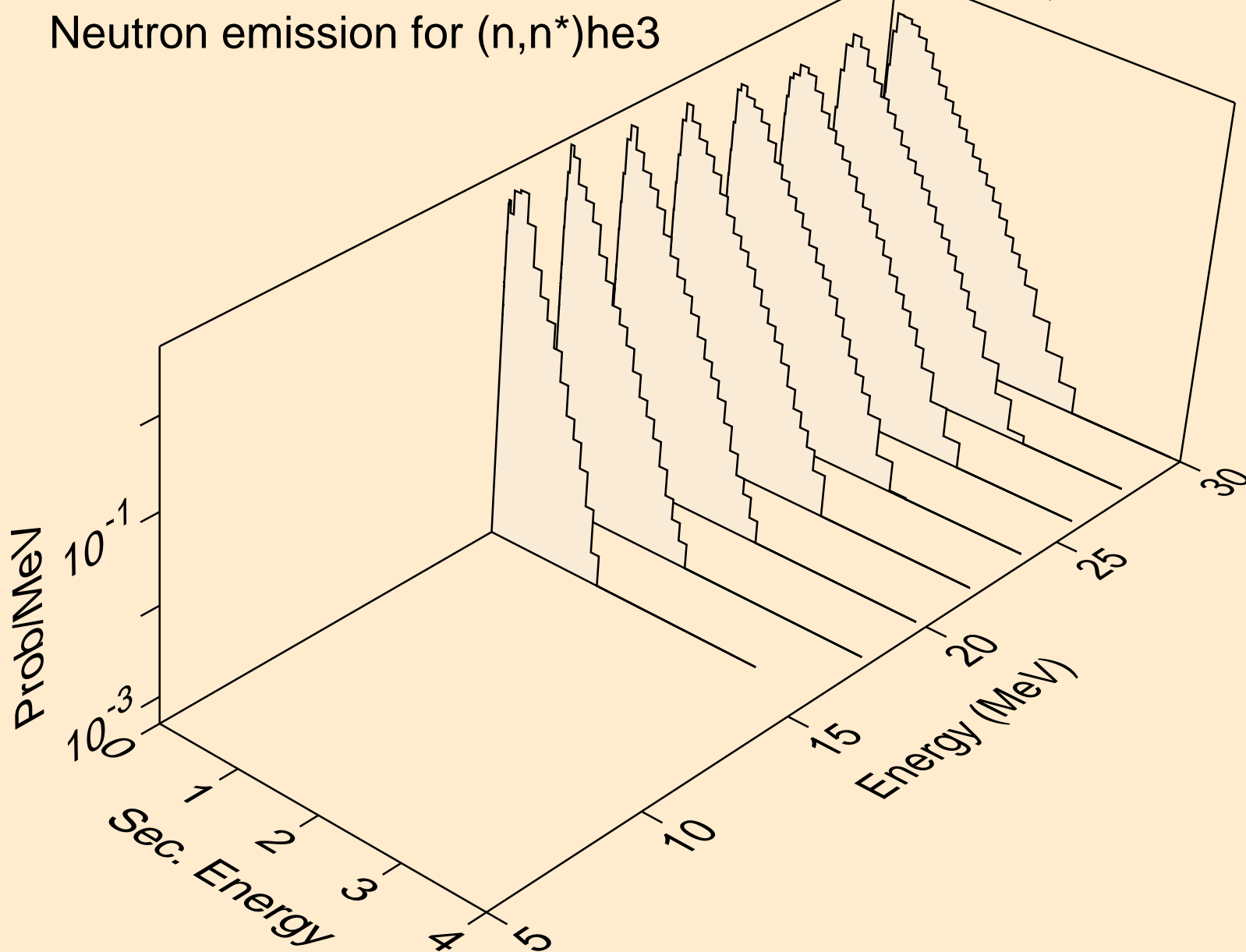

MD256 NEUTRON ACER TENDL-2019 LIBRARY; T=293.16K
Neutron emission for (n,4n)

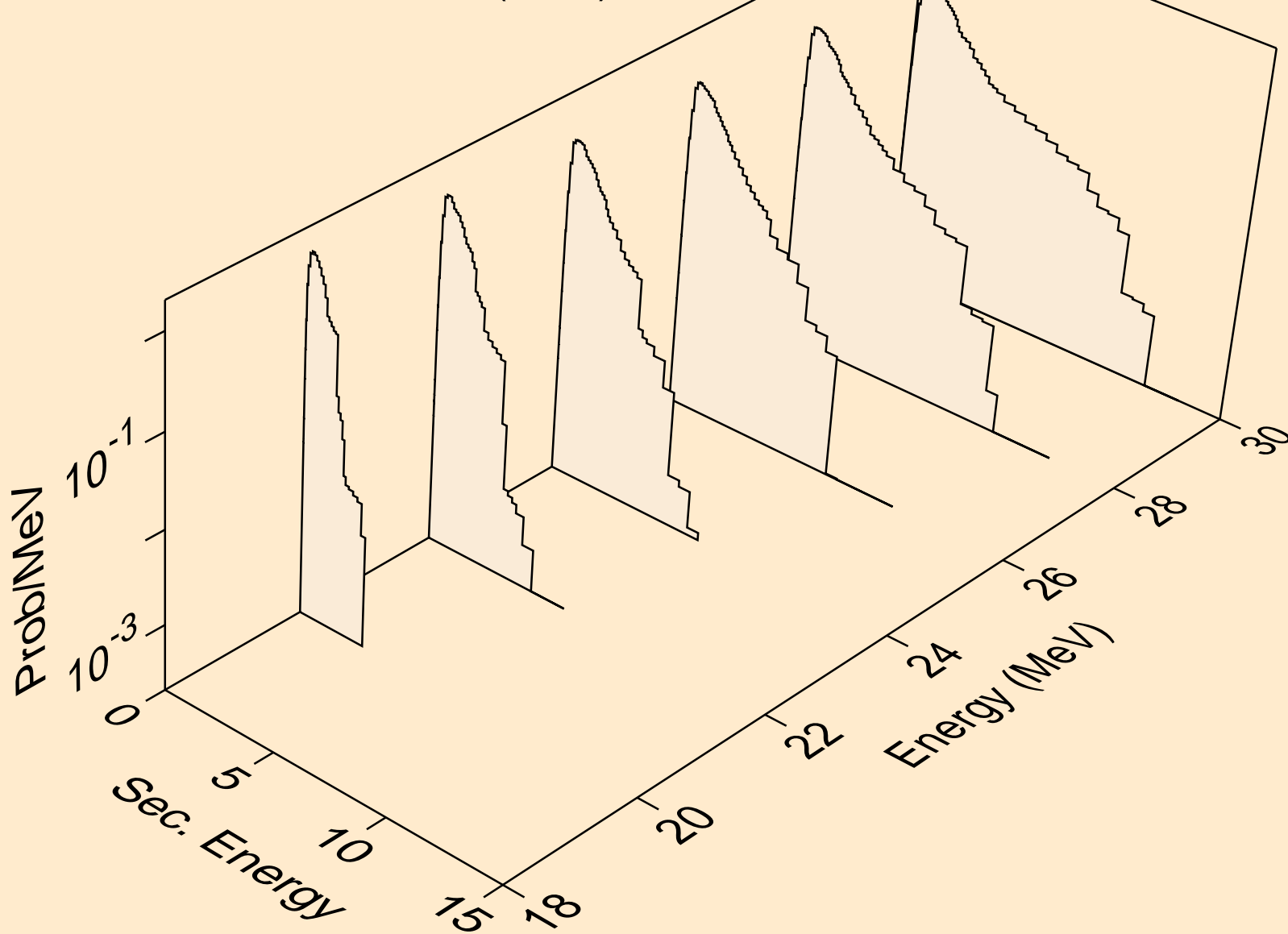

MD256 NEUTRON ACER TENDL-2019 LIBRARY; T=293.16K
Neutron emission for (n,2np)

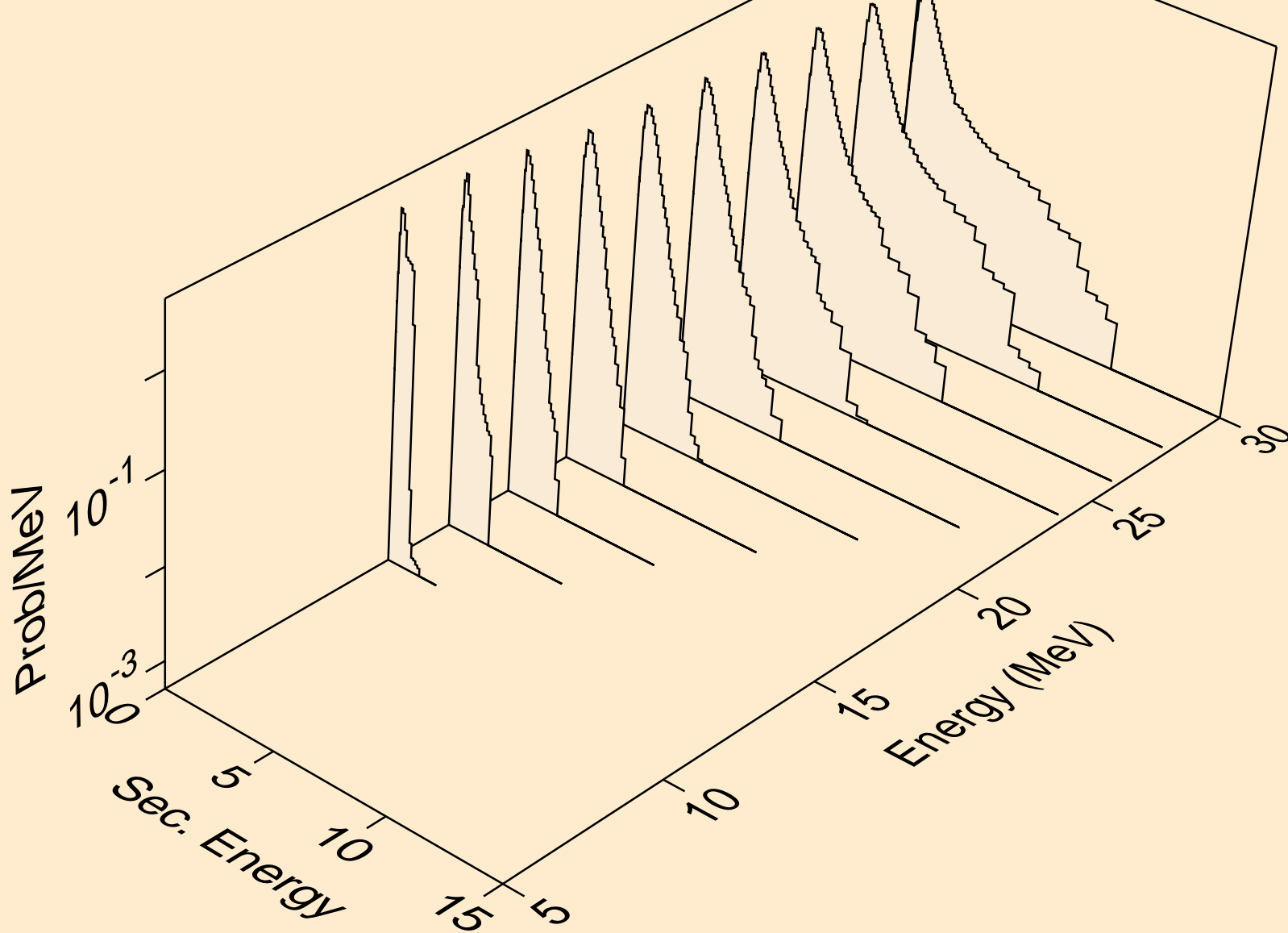

MD256 NEUTRON ACER TENDL-2019 LIBRARY; T=293.16K
Neutron emission for (n,3np)

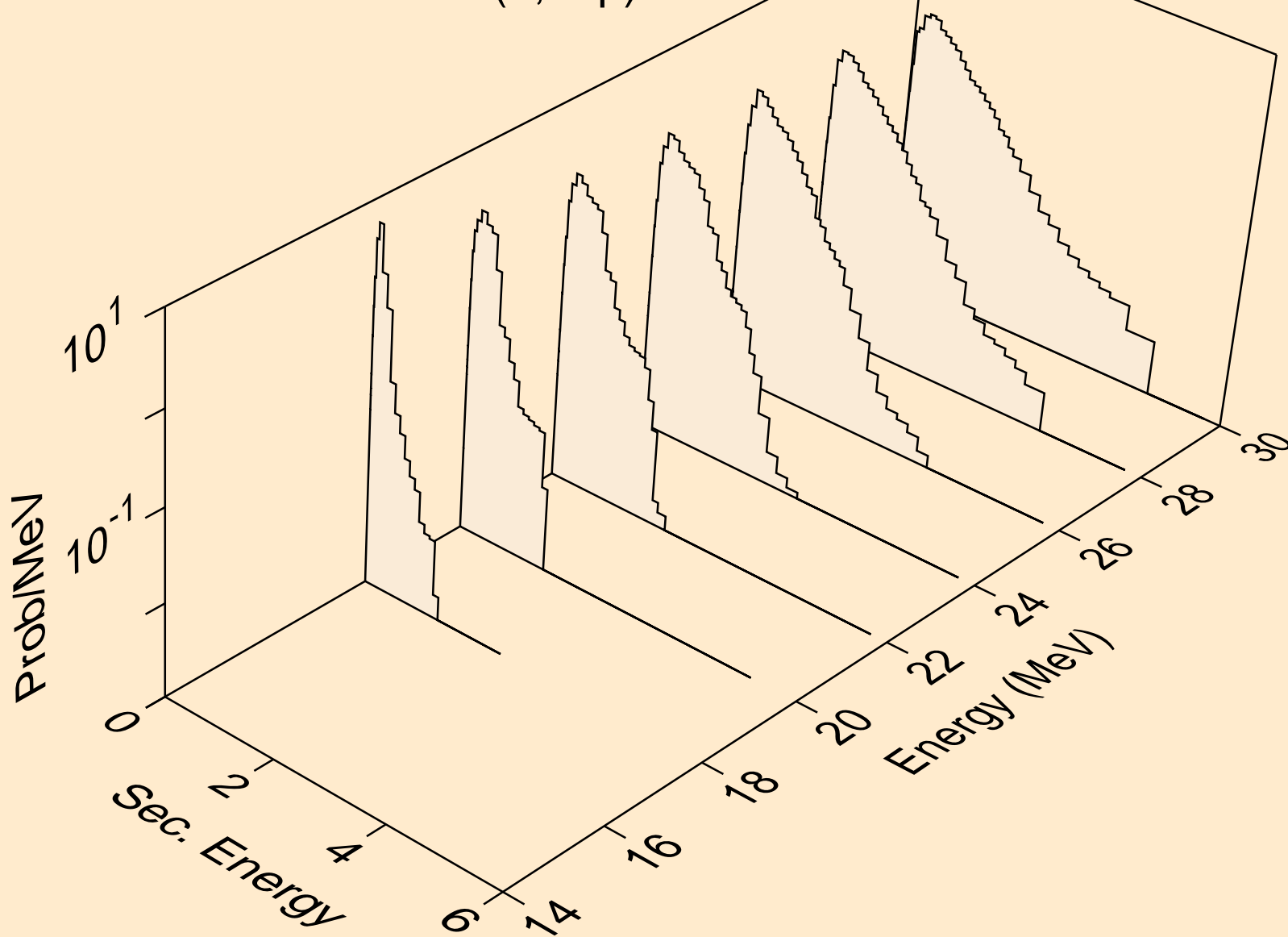

MD256 NEUTRON ACER TENDL-2019 LIBRARY; T=293.16K
Neutron emission for (n,2np)

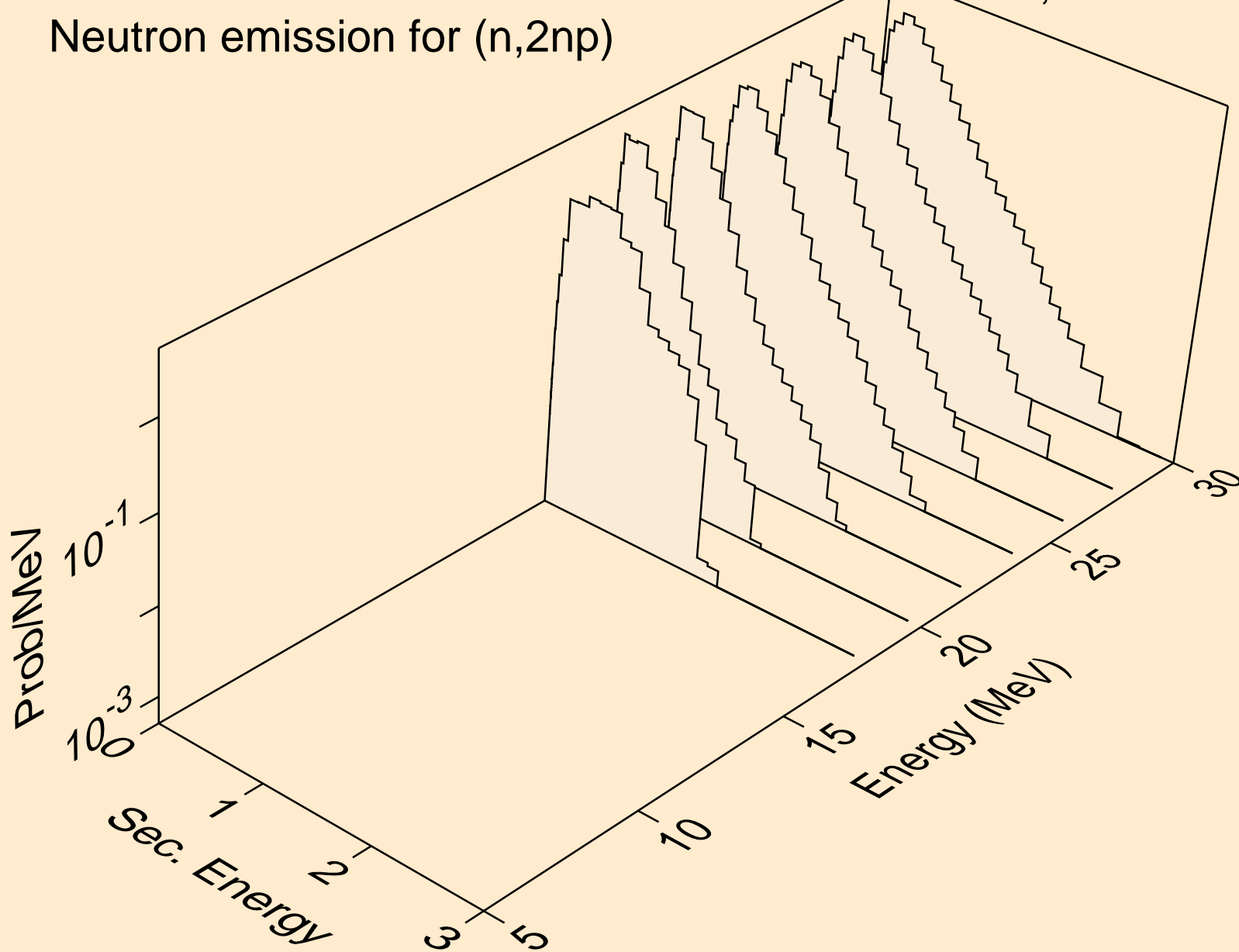

MD256 NEUTRON ACER TENDL-2019 LIBRARY; T=293.16K
Neutron emission for (n,npa)

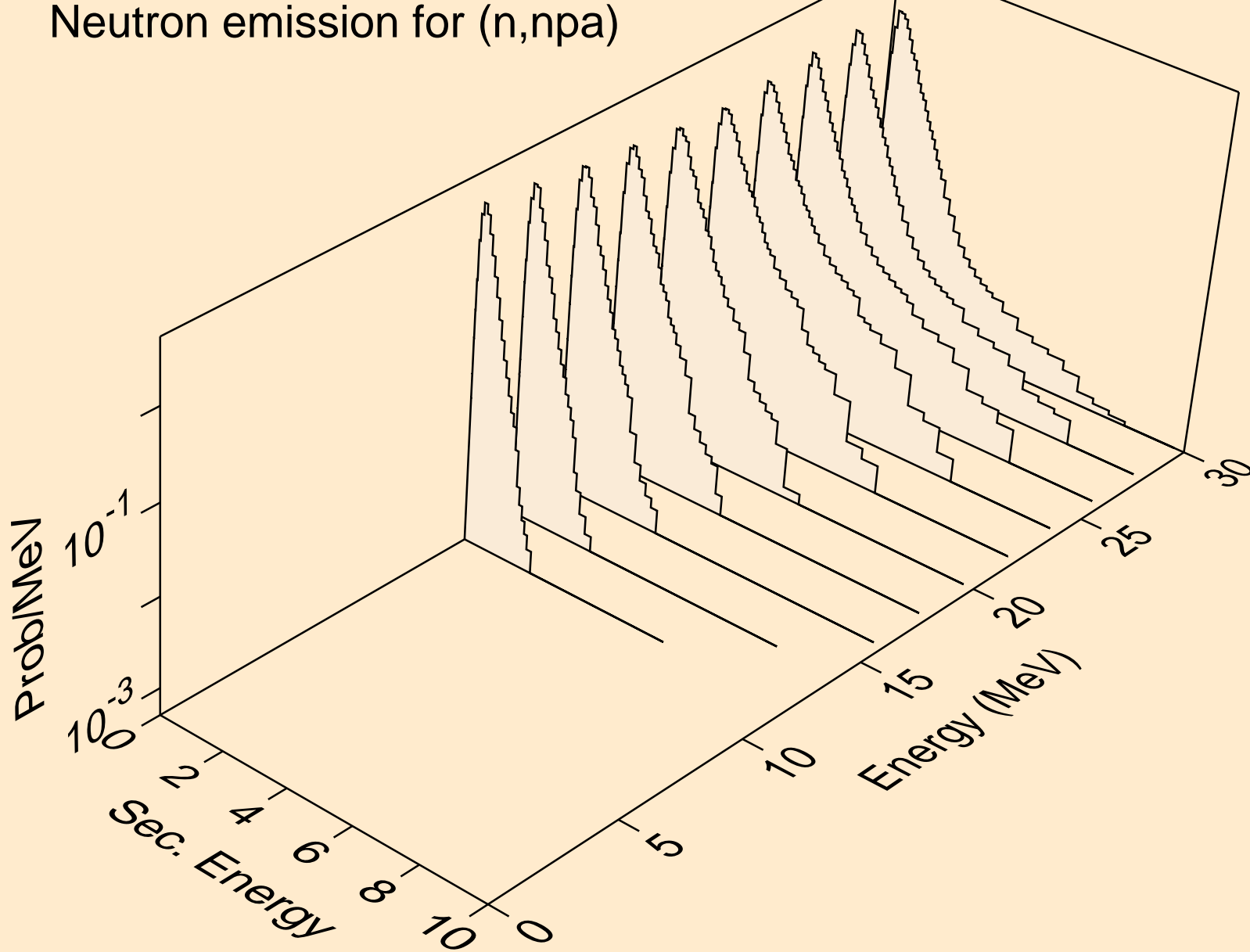

MD256 NEUTRON ACER TENDL-2019 LIBRARY; T=293.16K
Neutron emission for (n,n*c)

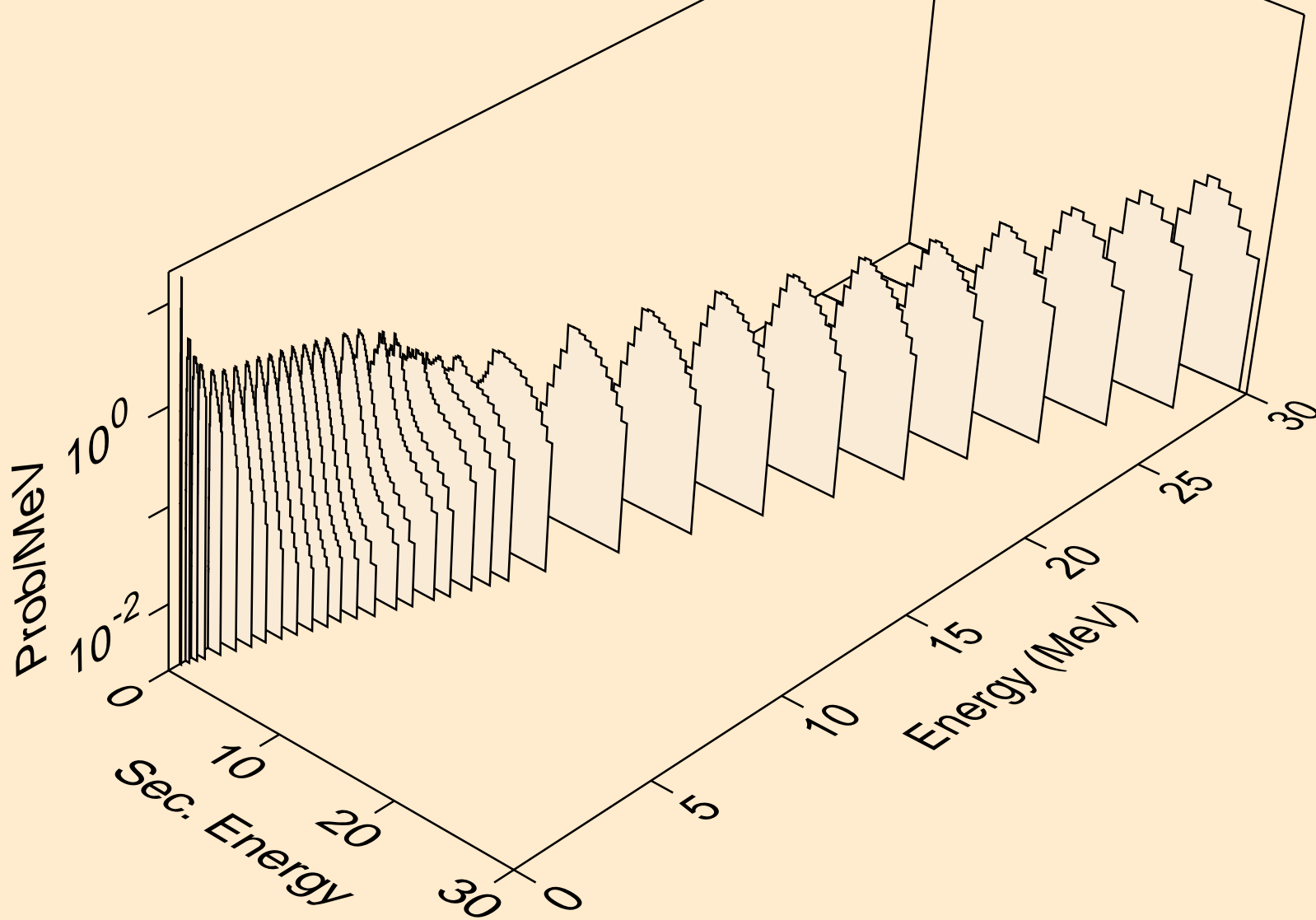

MD256 NEUTRON ACER TENDL-2019 LIBRARY; T=293.16K

Delayed nubar

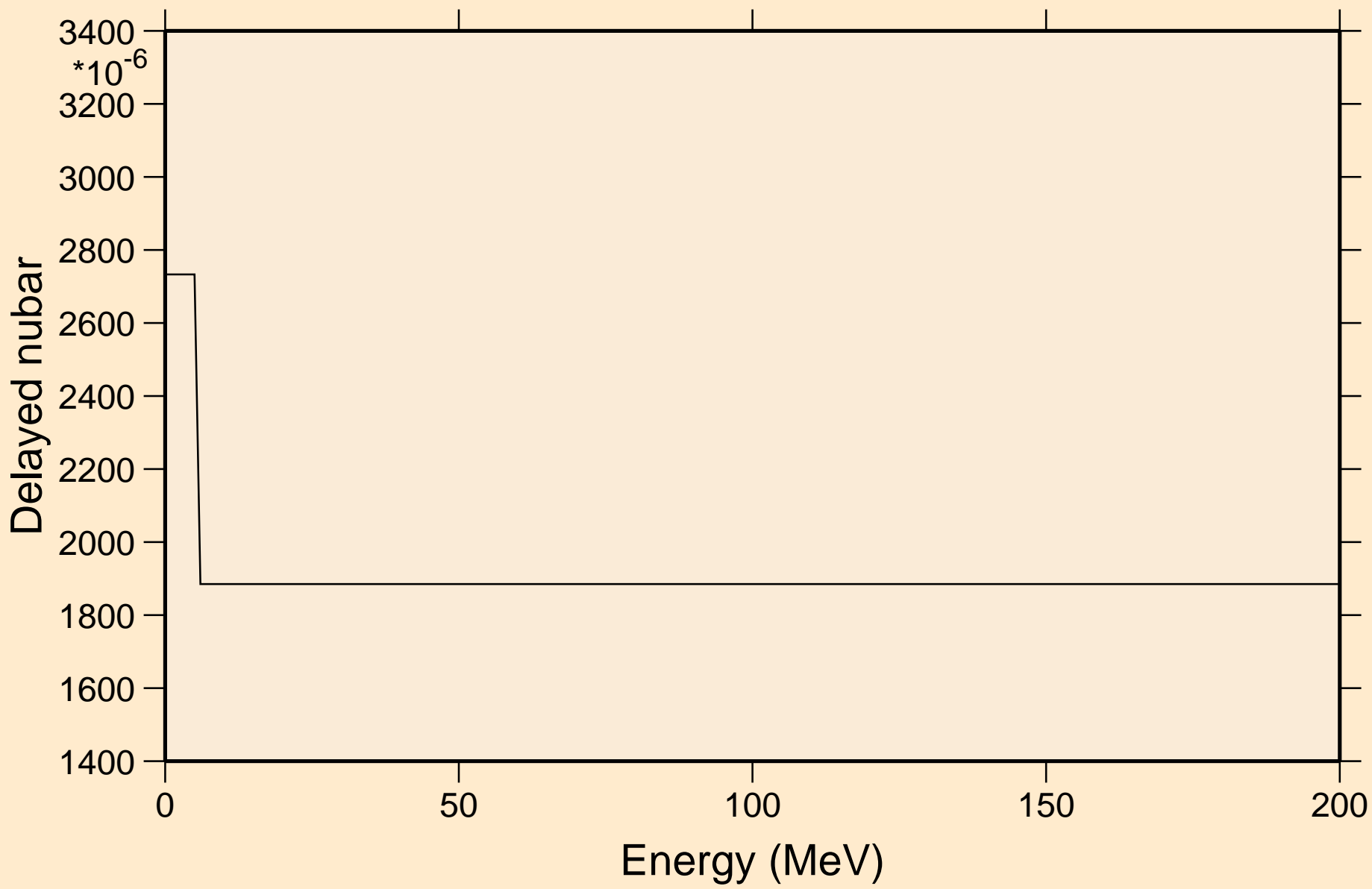

MD256 NEUTRON ACER TENDL-2019 LIBRARY; T=293.16K

Delayed neutron spectra

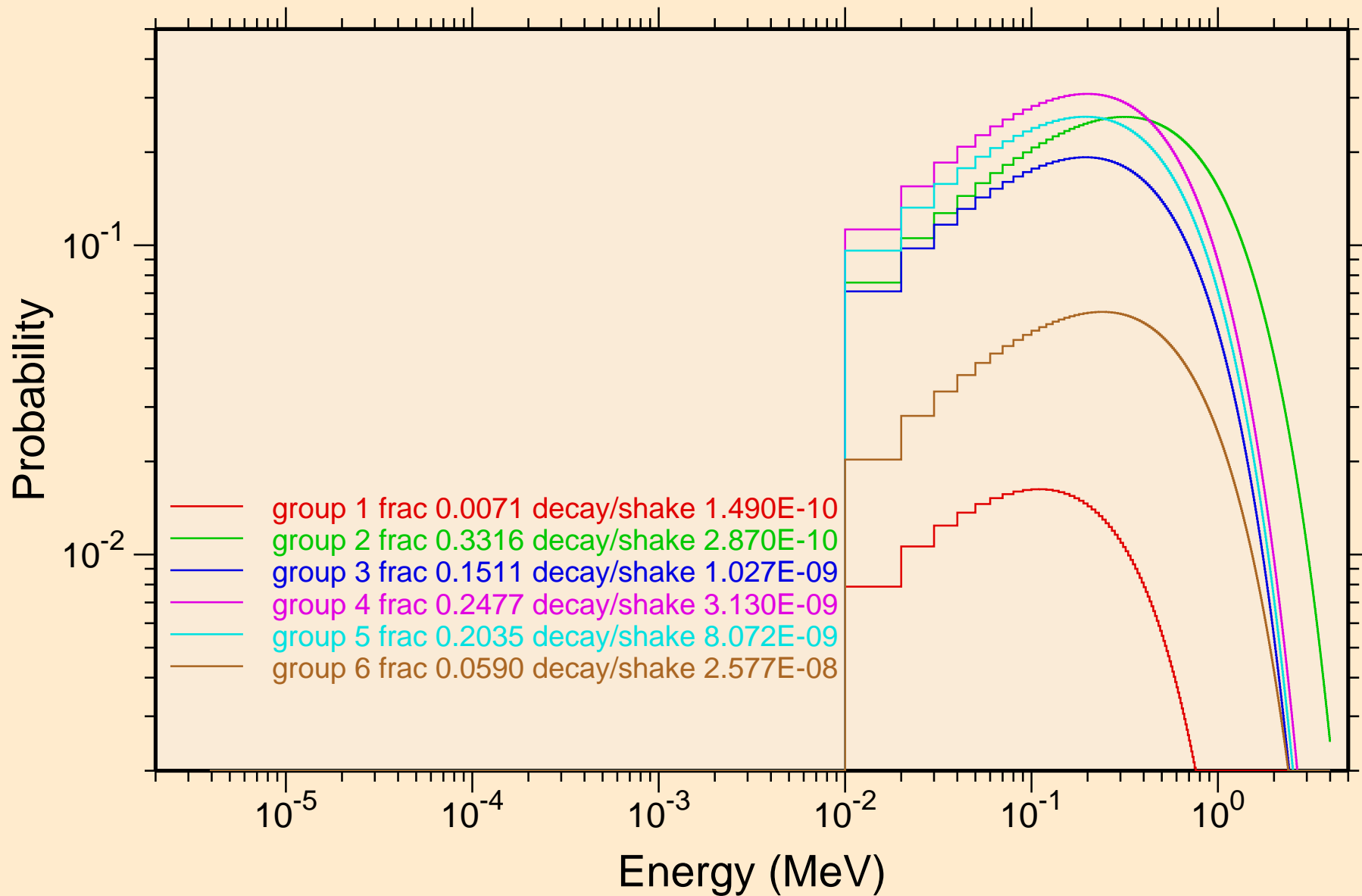

MD256 NEUTRON ACER TENDL-2019 LIBRARY; T=293.16K
Photon emission for (n,x)

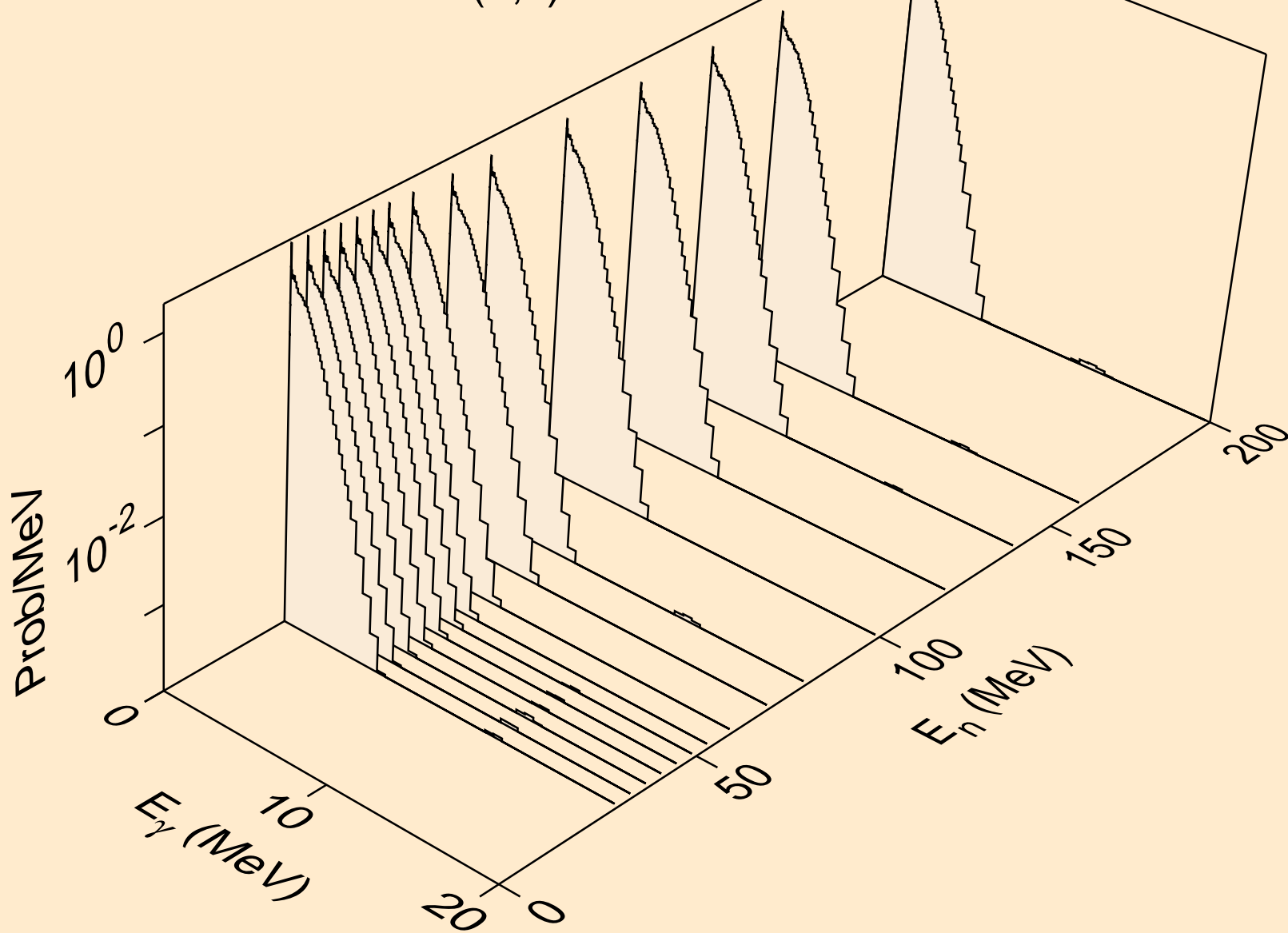

MD256 NEUTRON ACER TENDL-2019 LIBRARY; T=293.16K
Photon emission for (n,2nd)

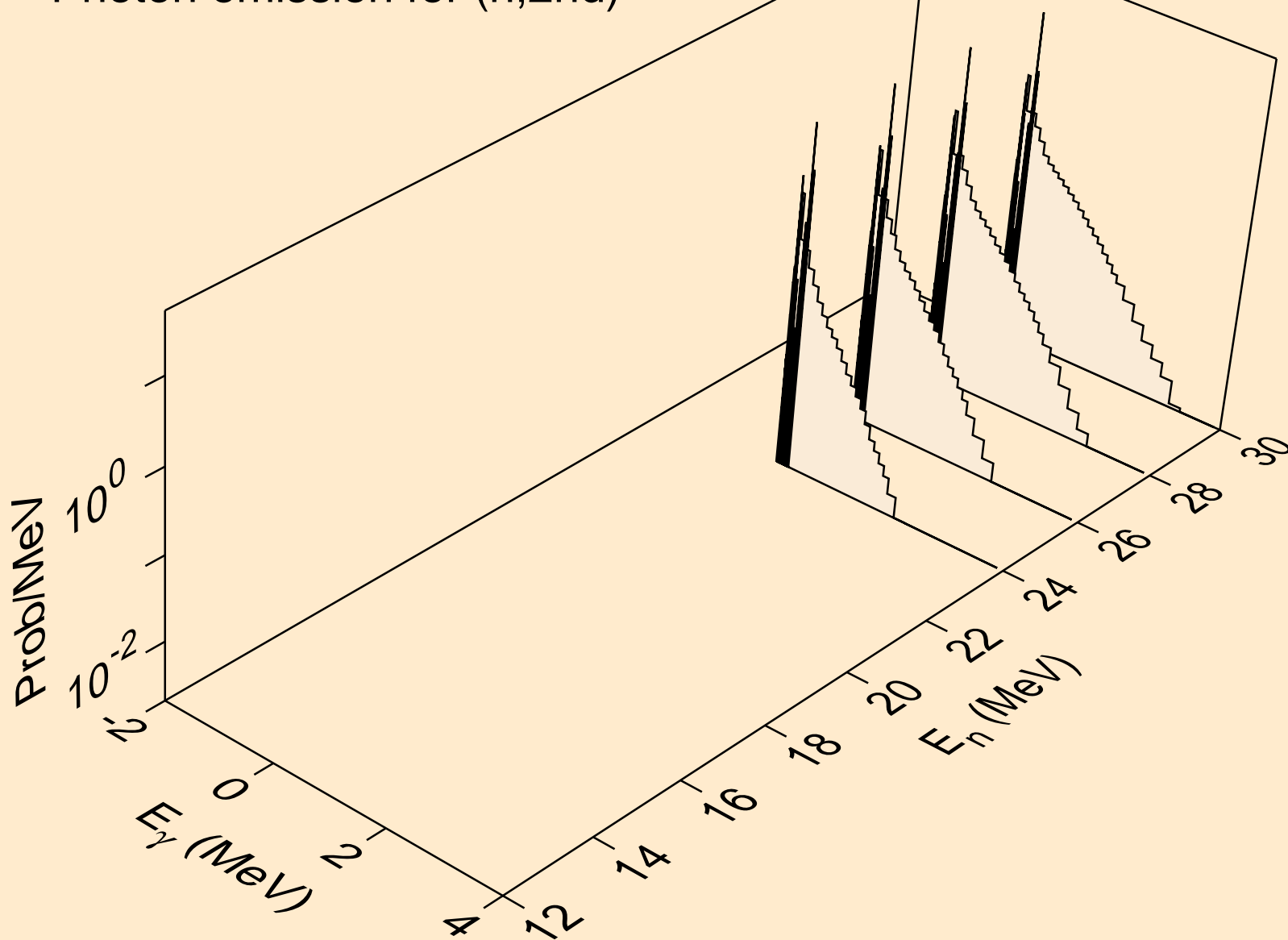

MD256 NEUTRON ACER TENDL-2019 LIBRARY; T=293.16K
Photon emission for (n,2n)

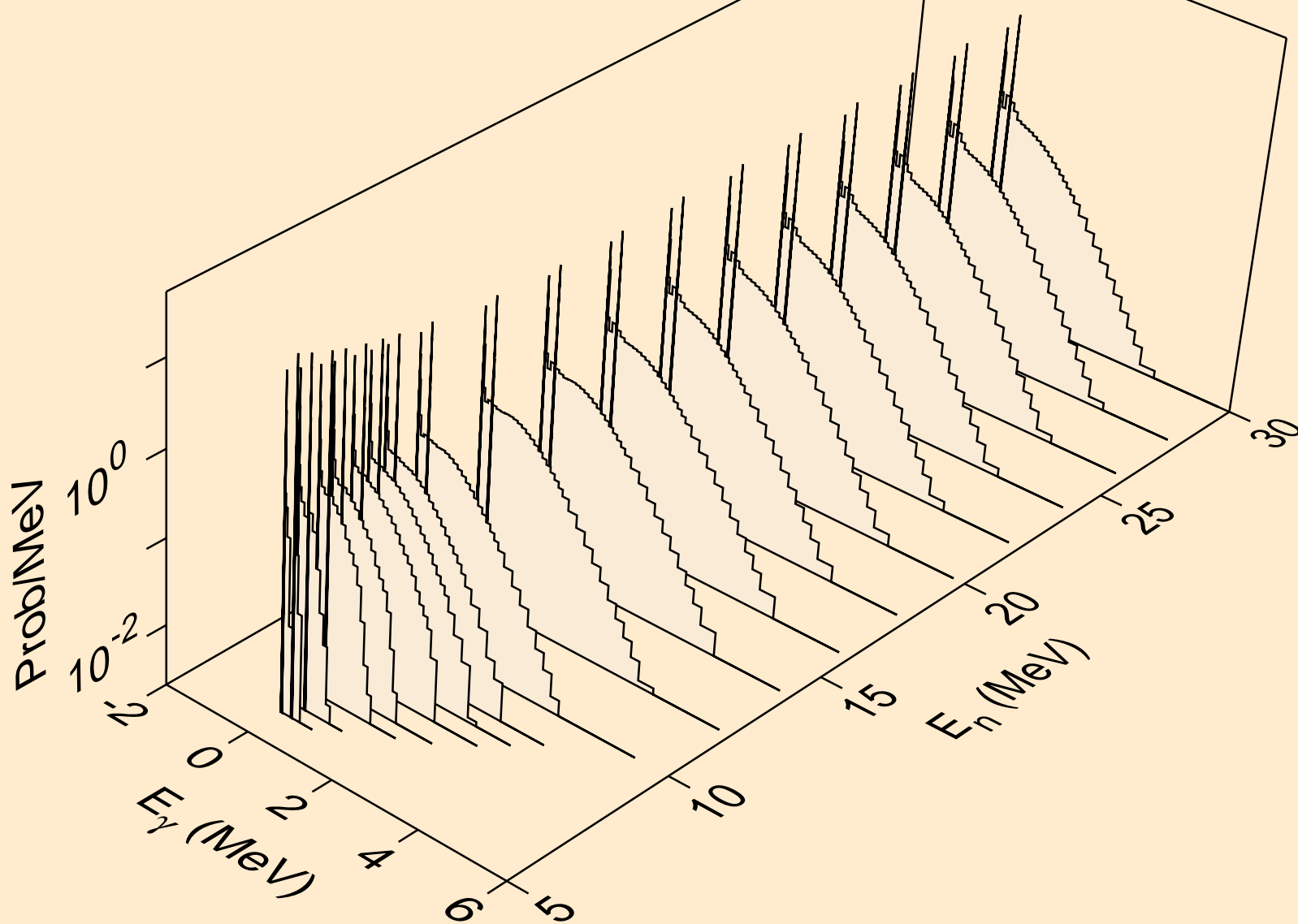

MD256 NEUTRON ACER TENDL-2019 LIBRARY; T=293.16K
Photon emission for (n,3n)

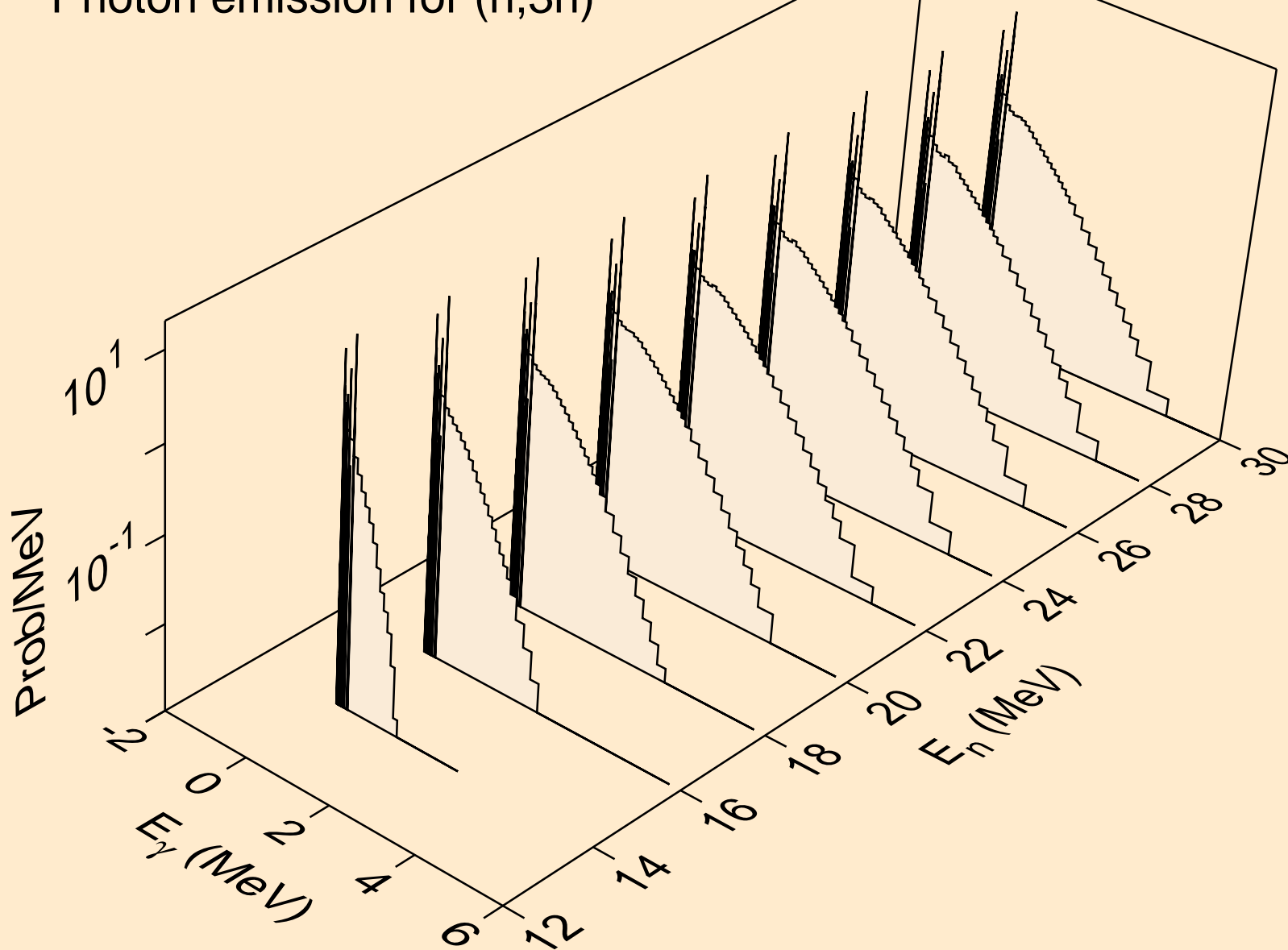

MD256 NEUTRON ACER TENDL-2019 LIBRARY; T=293.16K
Photon emission for (n,n*)a

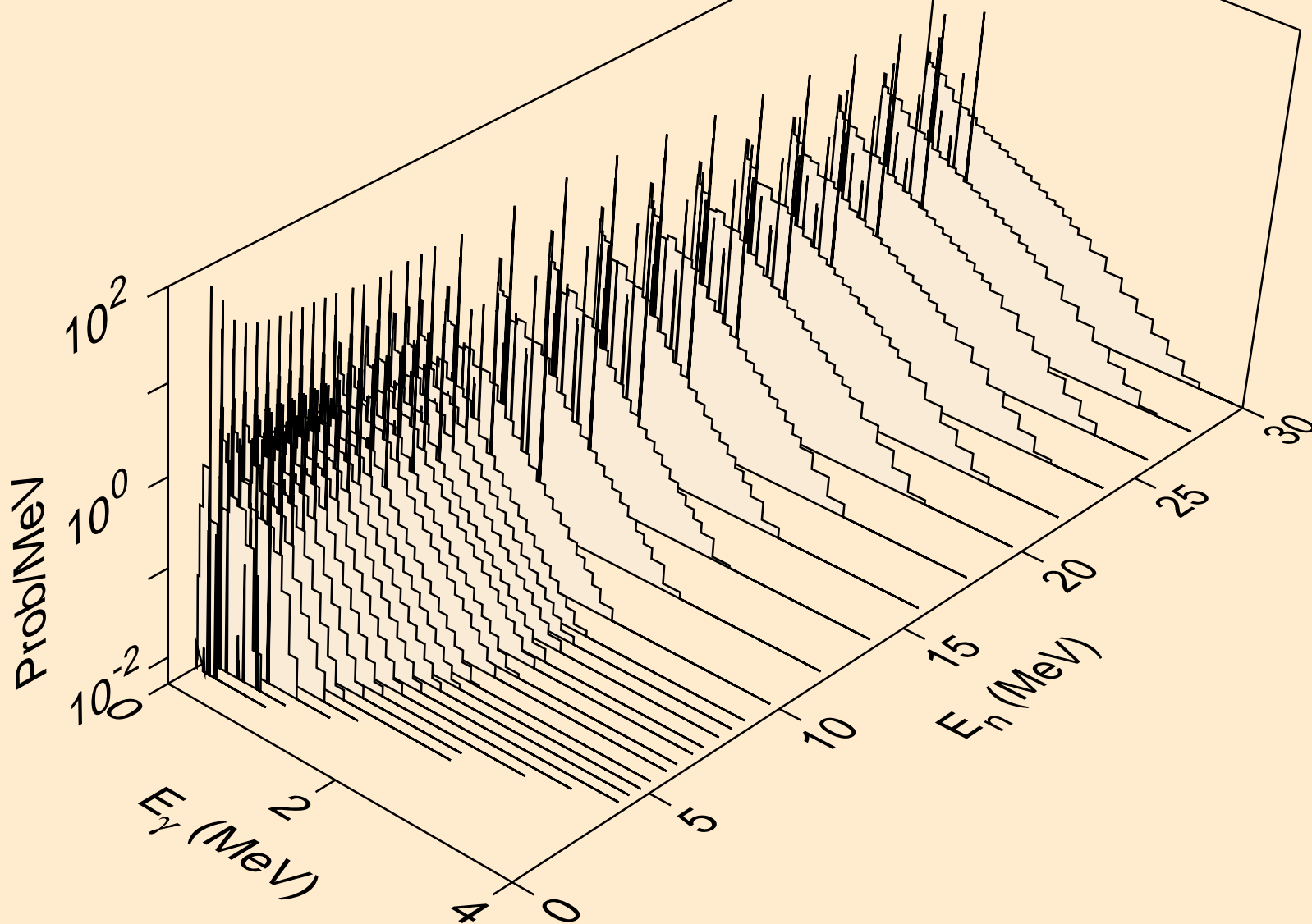

MD256 NEUTRON ACER TENDL-2019 LIBRARY; T=293.16K
Photon emission for (n,2n)a

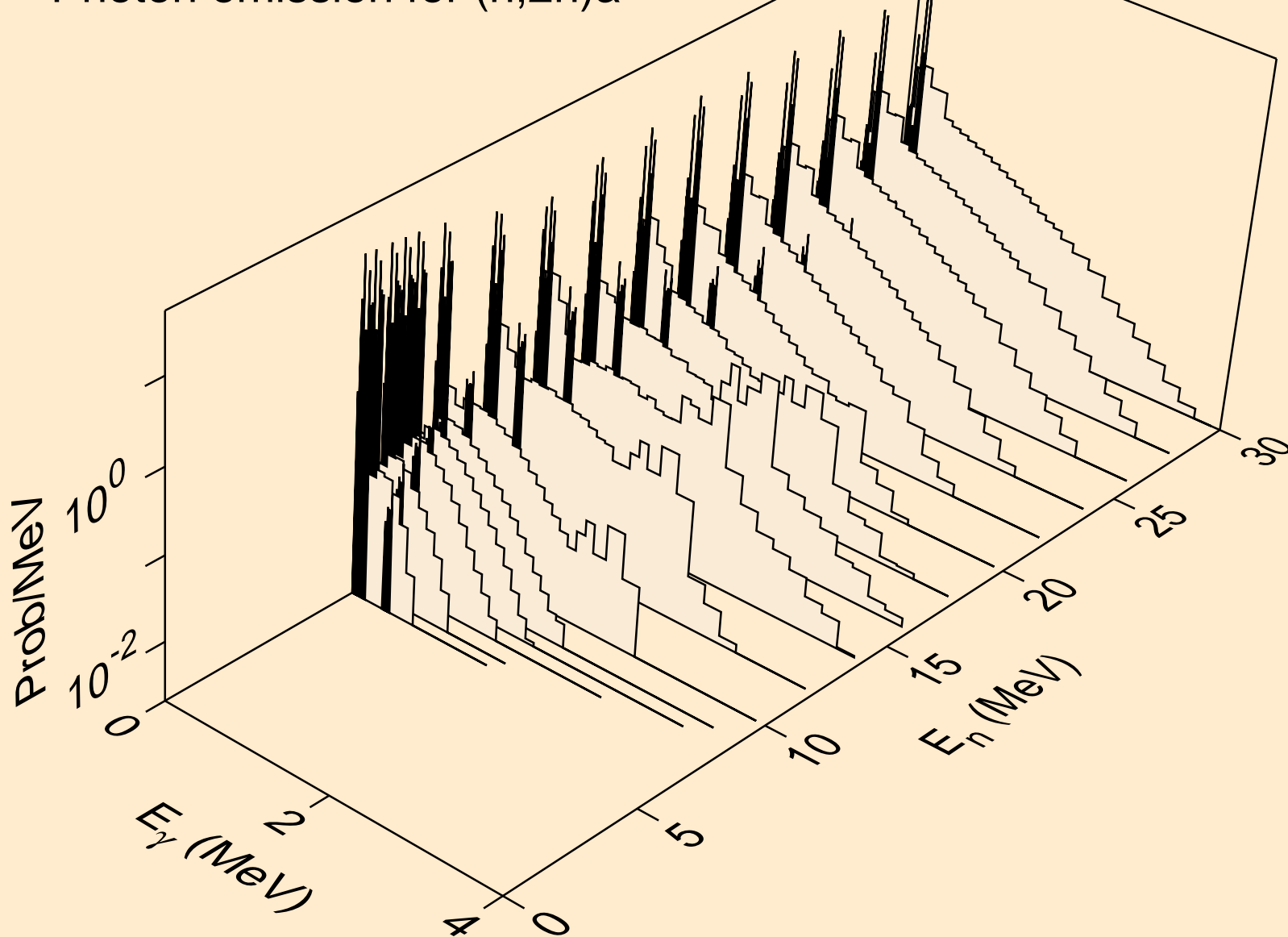

MD256 NEUTRON ACER TENDL-2019 LIBRARY; T=293.16K
Photon emission for (n,3n)a

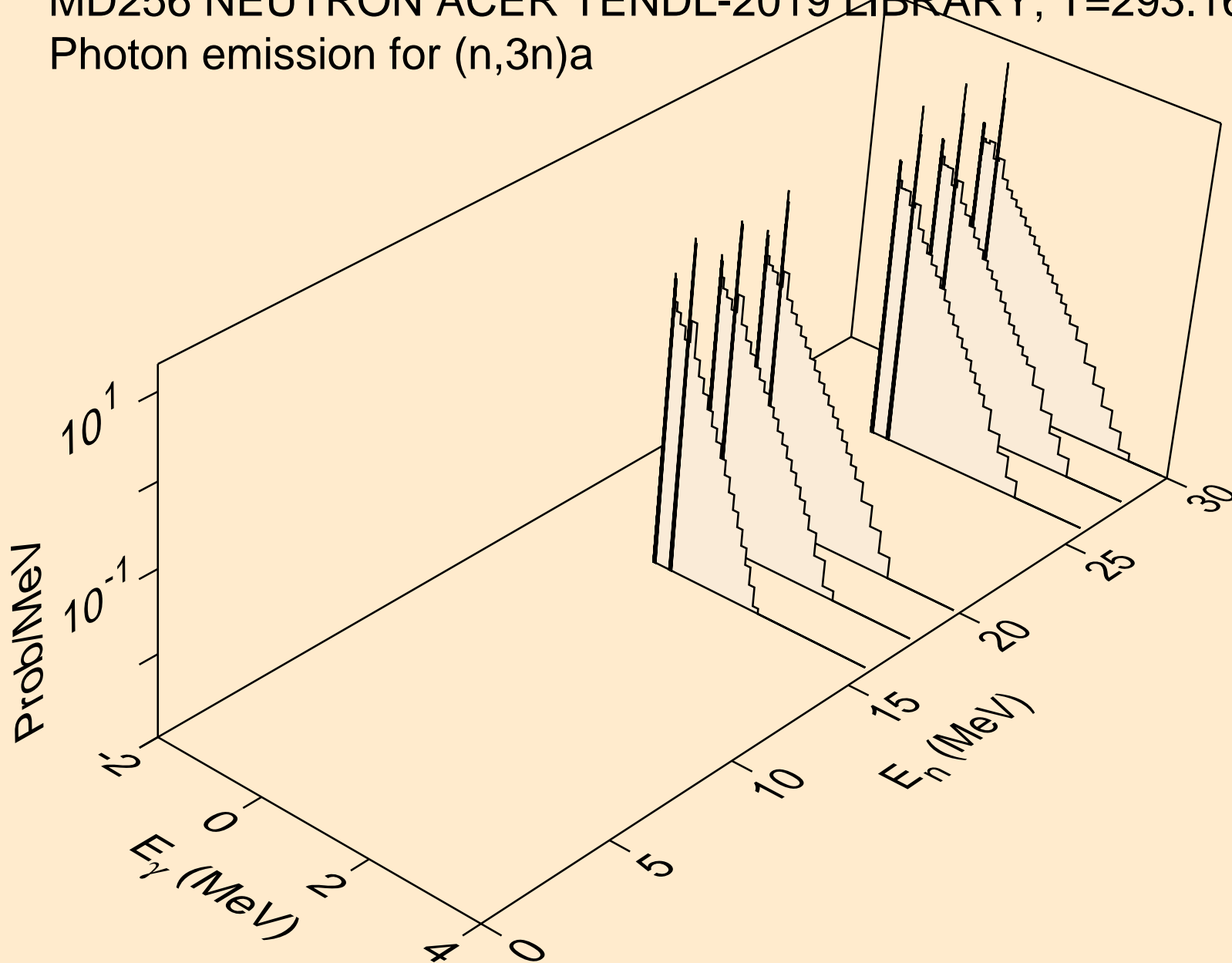

MD256 NEUTRON ACER TENDL-2019 LIBRARY; T=293.16K
Photon emission for (n,n*)p

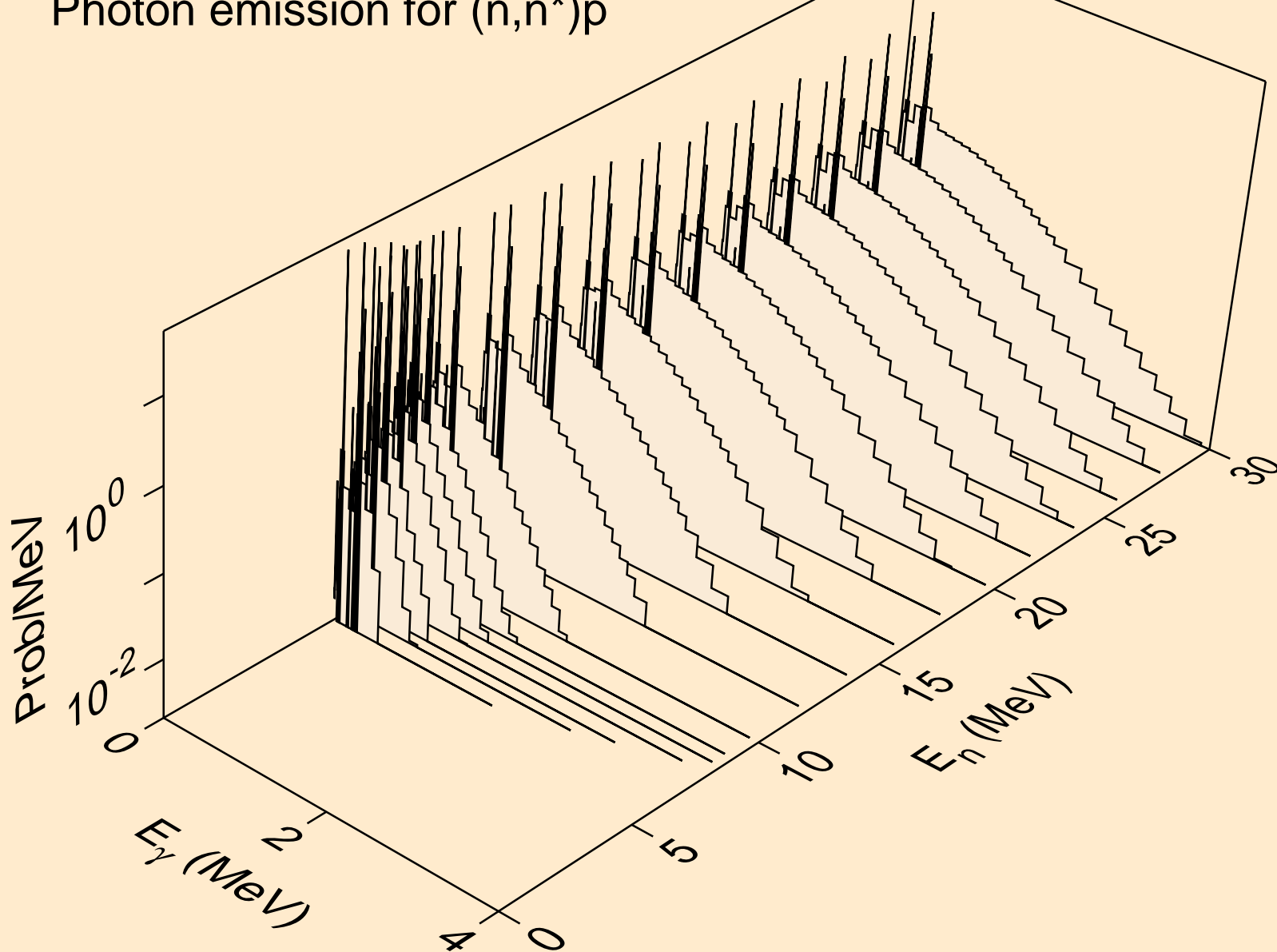

MD256 NEUTRON ACER TENDL-2019 LIBRARY; T=293.16K
Photon emission for (n,n*)2a

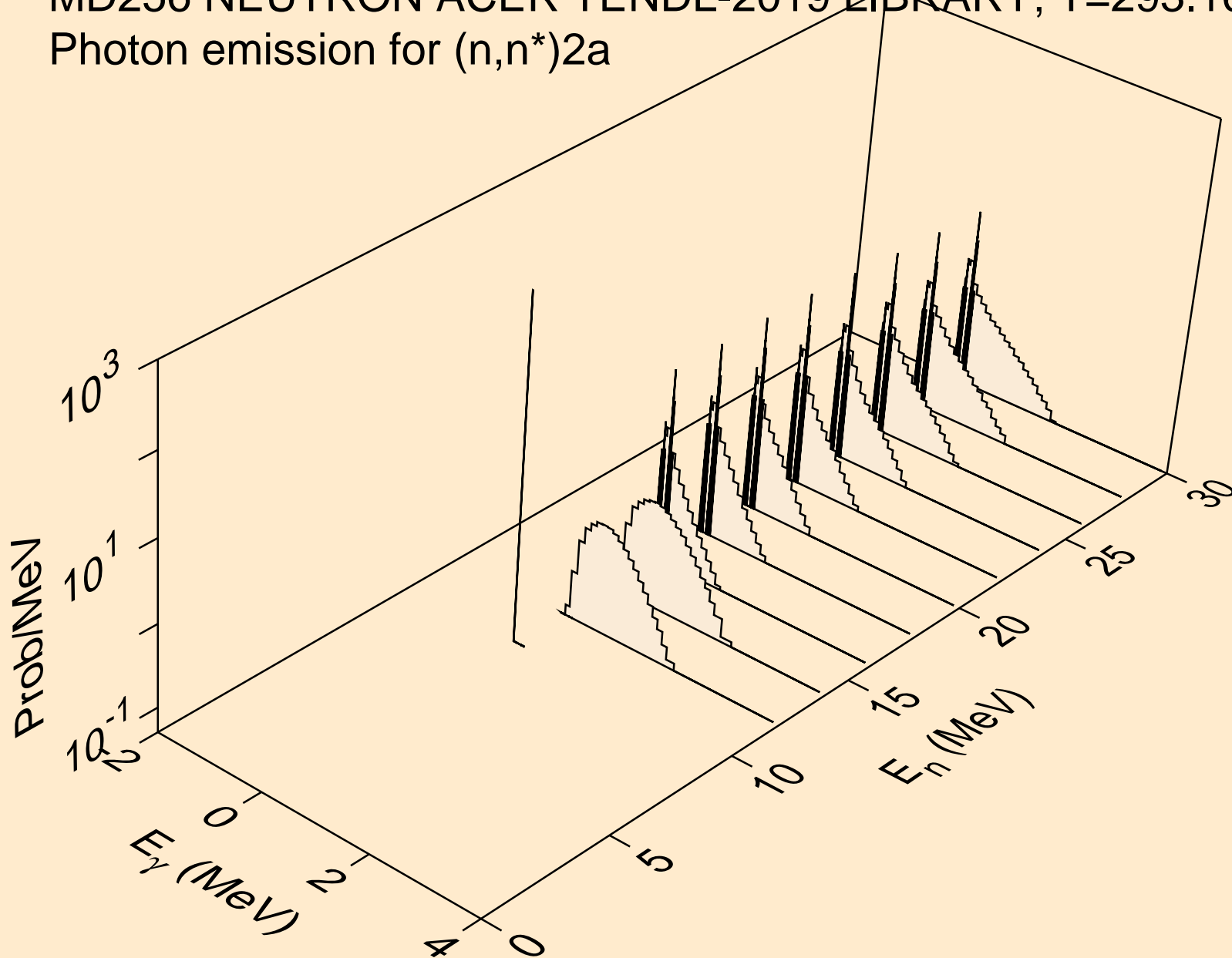

MD256 NEUTRON ACER TENDL-2019 LIBRARY; T=293.16K
Photon emission for (n,n*)d

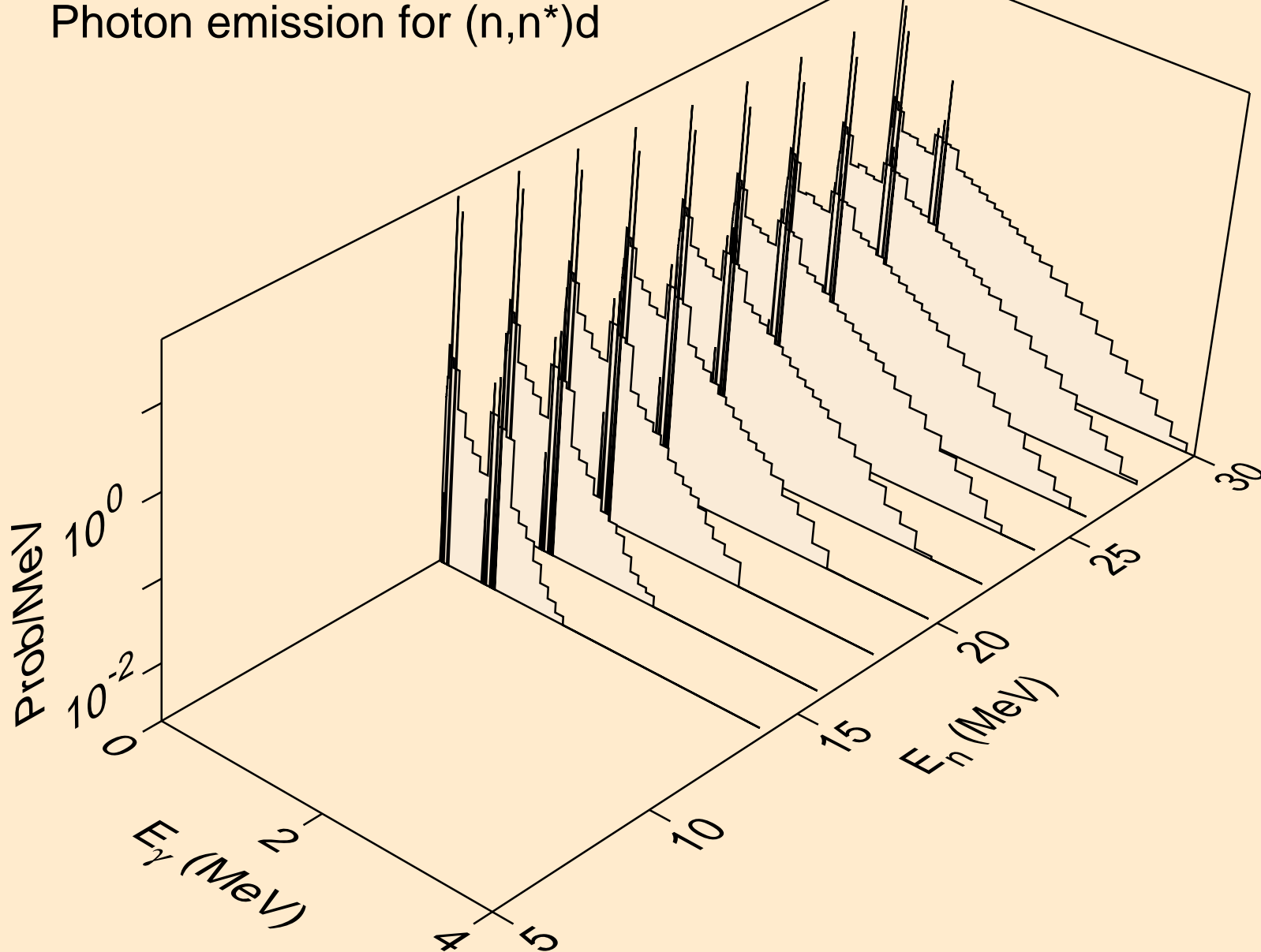

MD256 NEUTRON ACER TENDL-2019 LIBRARY; T=293.16K
Photon emission for (n,n*)t

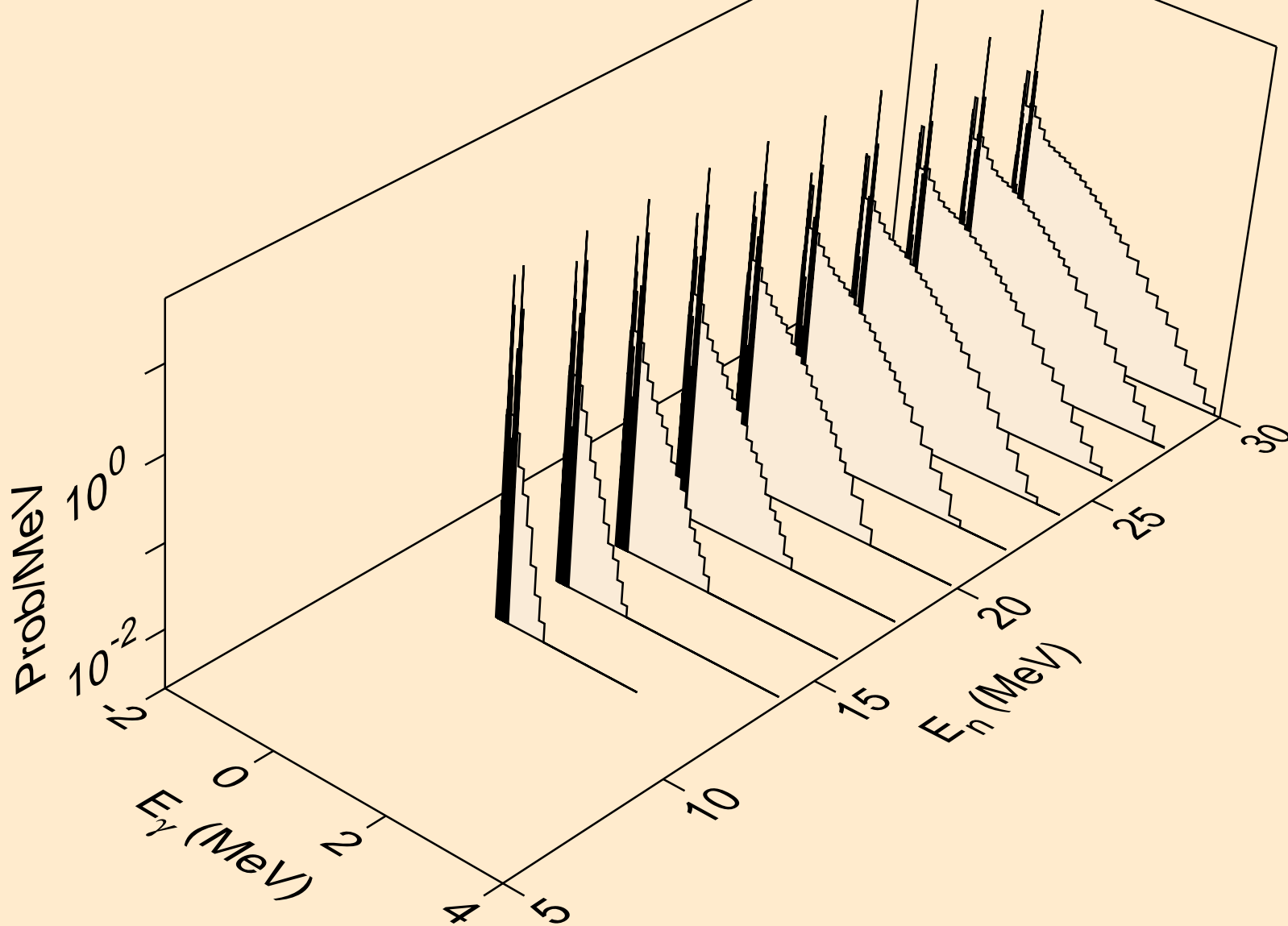

MD256 NEUTRON ACER TENDL-2019 LIBRARY; T=293.16K
Photon emission for (n,n*)he3

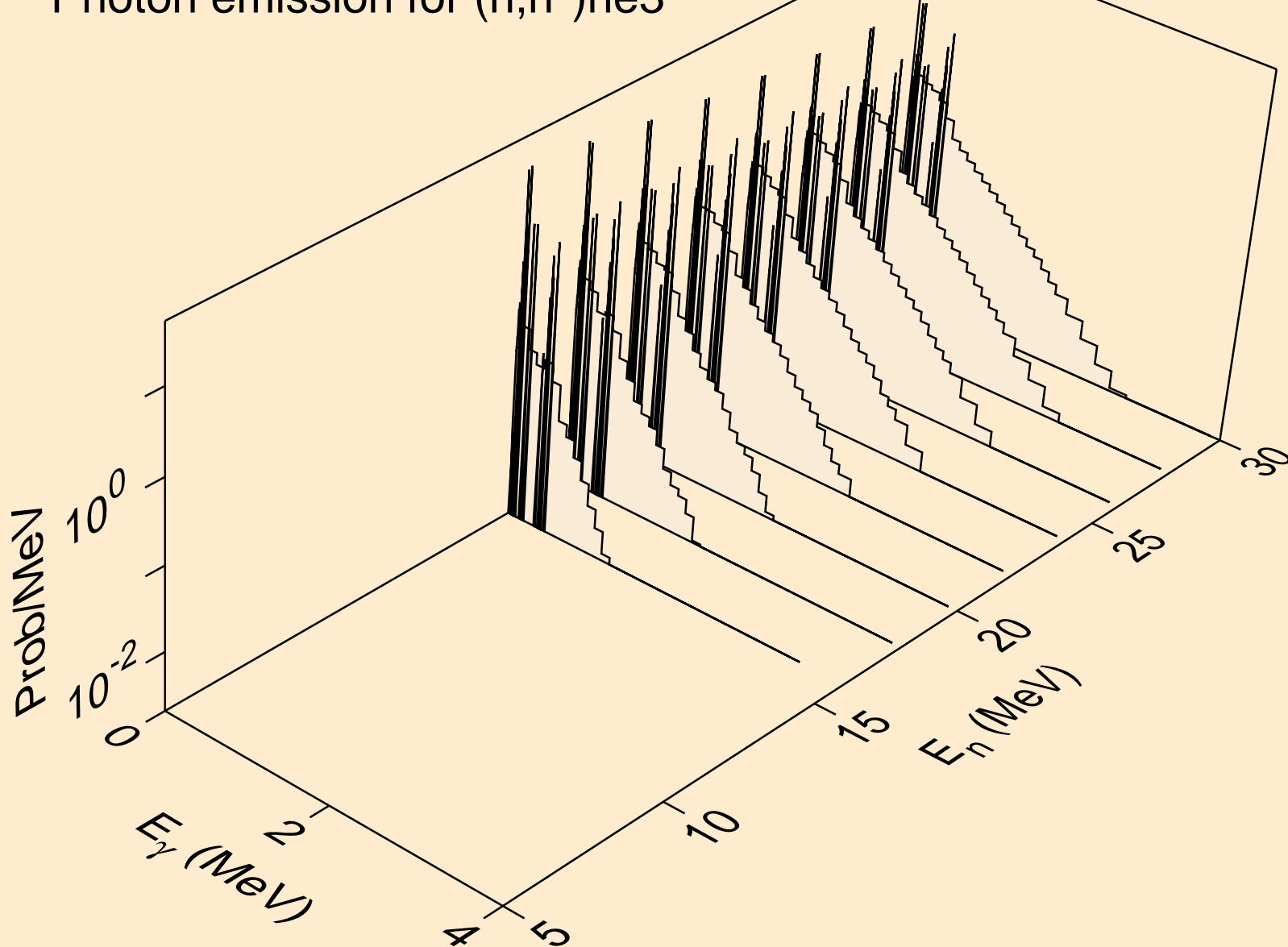

MD256 NEUTRON ACER TENDL-2019 LIBRARY; T=293.16K
Photon emission for (n,4n)

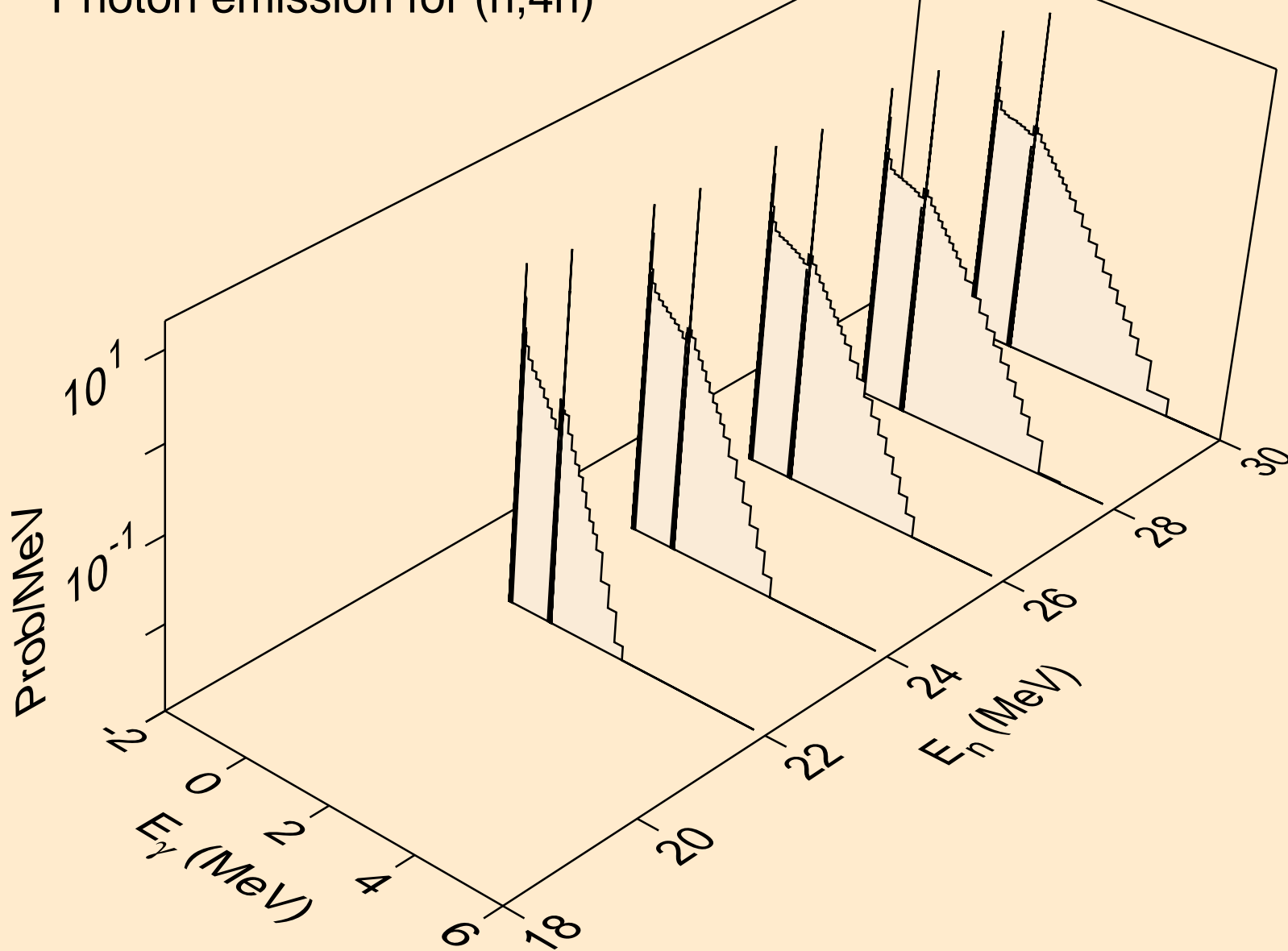

MD256 NEUTRON ACER TENDL-2019 LIBRARY; T=293.16K
Photon emission for (n,2np)

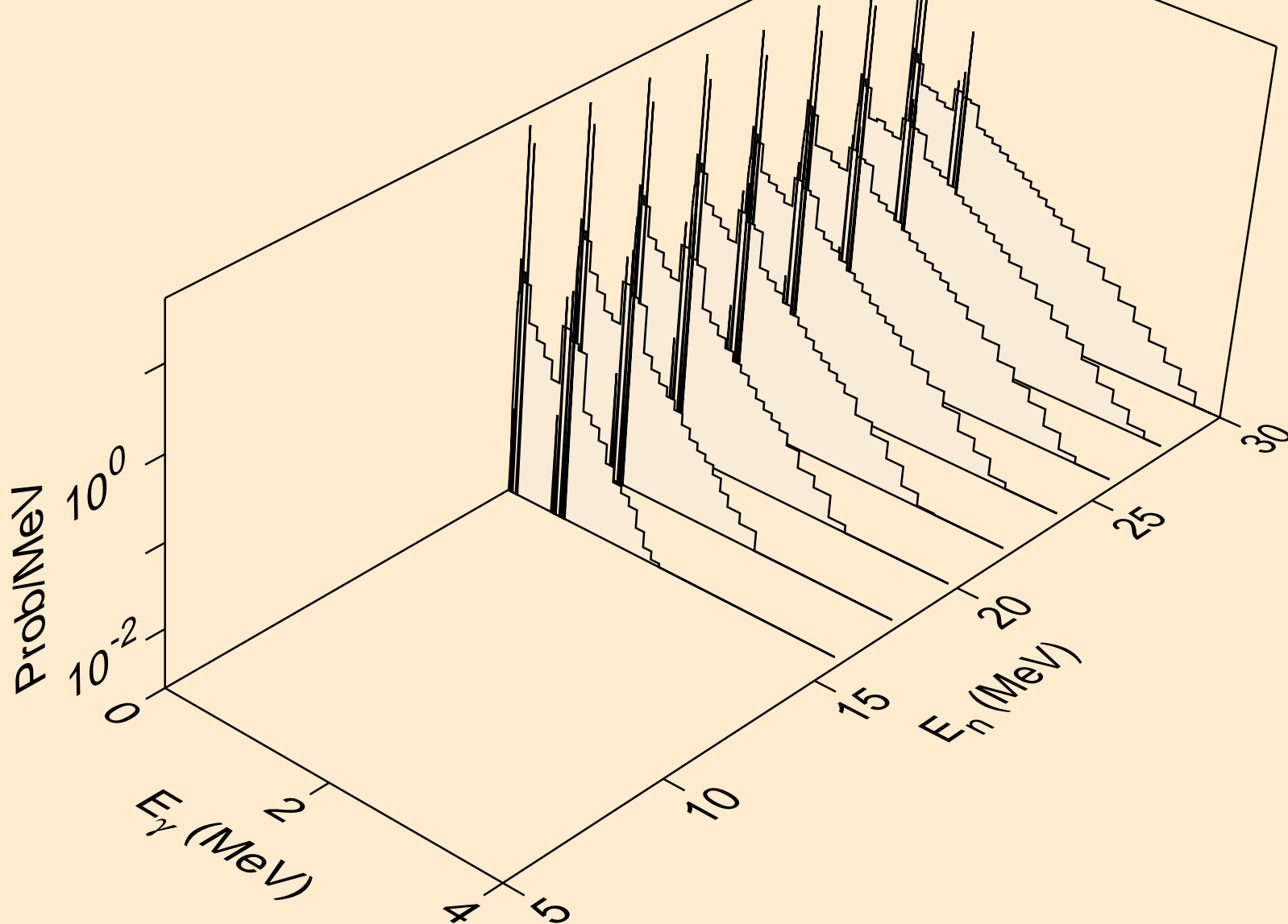

MD256 NEUTRON ACER TENDL-2019 LIBRARY; T=293.16K
Photon emission for (n,3np)

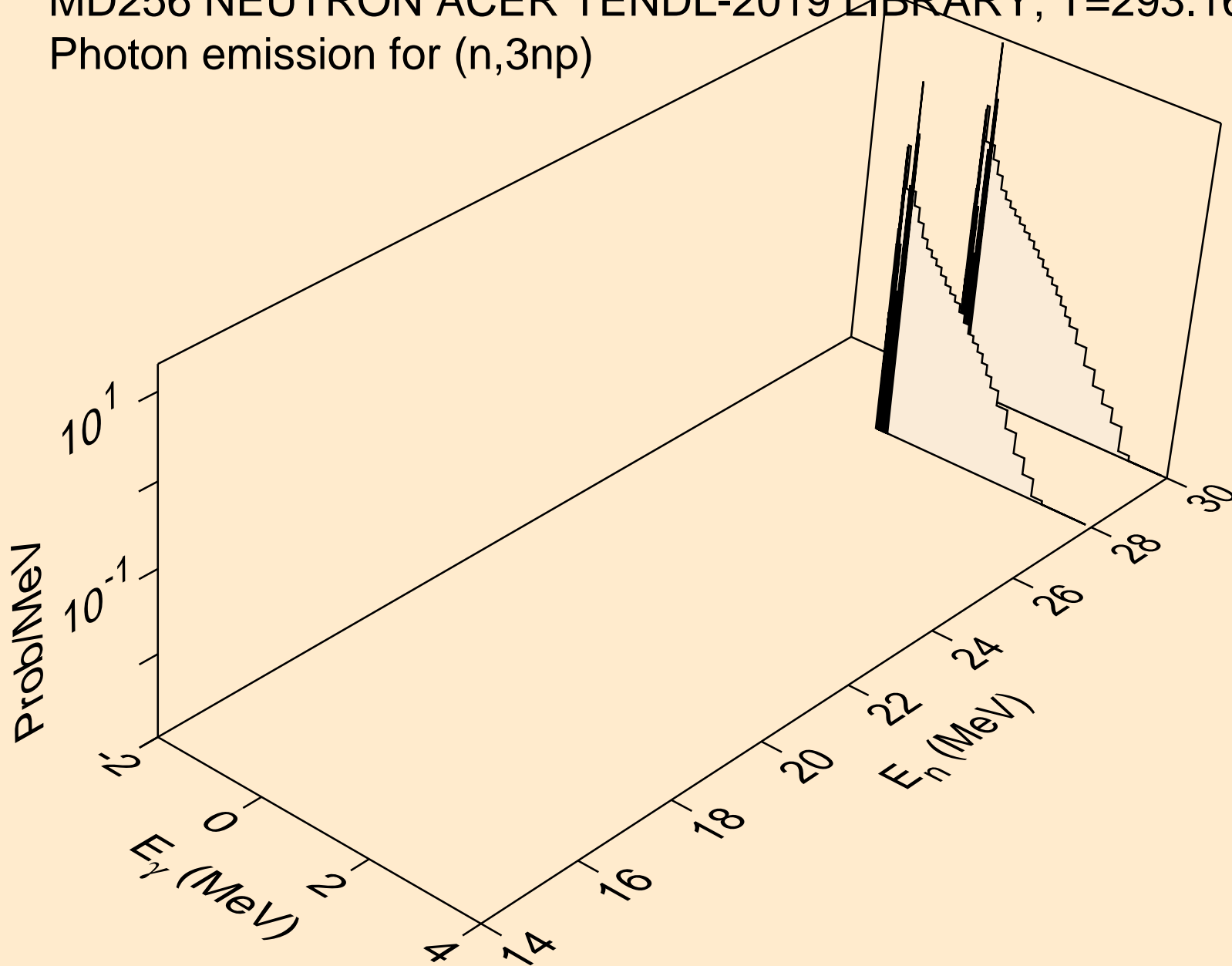

MD256 NEUTRON ACER TENDL-2019 LIBRARY; T=293.16K
Photon emission for (n,2np)

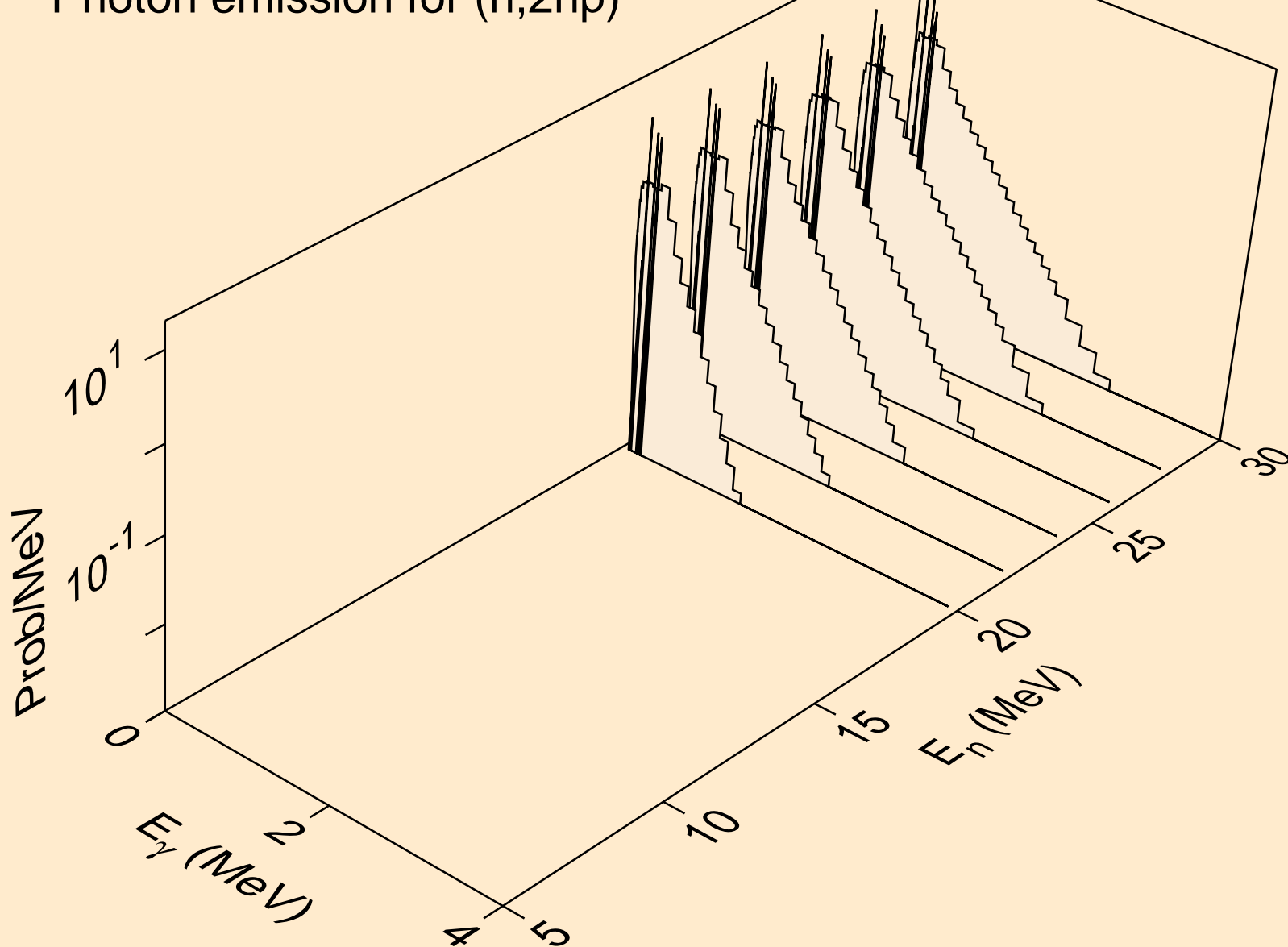

MD256 NEUTRON ACER TENDL-2019 LIBRARY; T=293.16K
Photon emission for (n,npa)

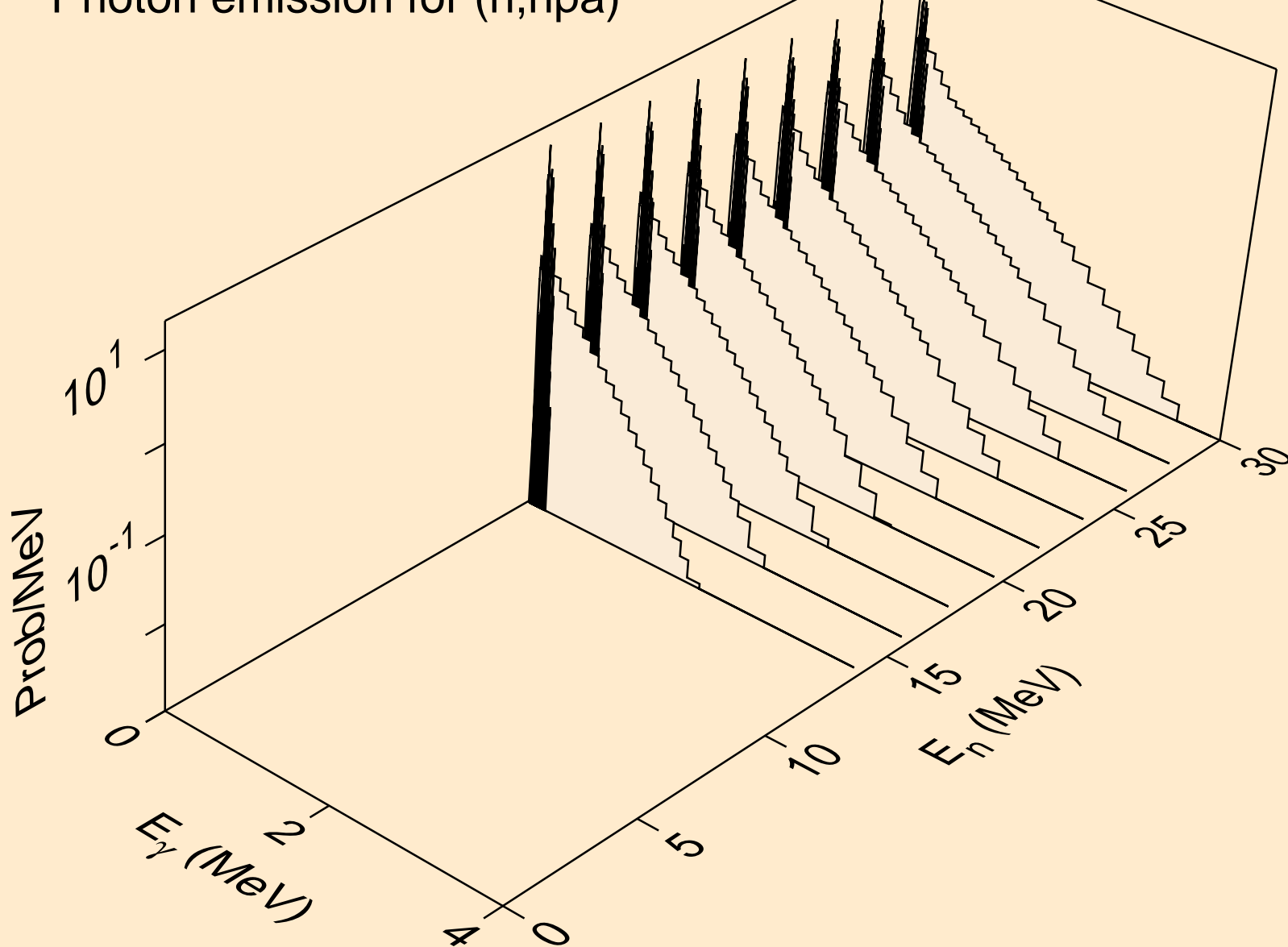

MD256 NEUTRON ACER TENDL-2019 LIBRARY; T=293.16K
Photon emission for (n,n*c)

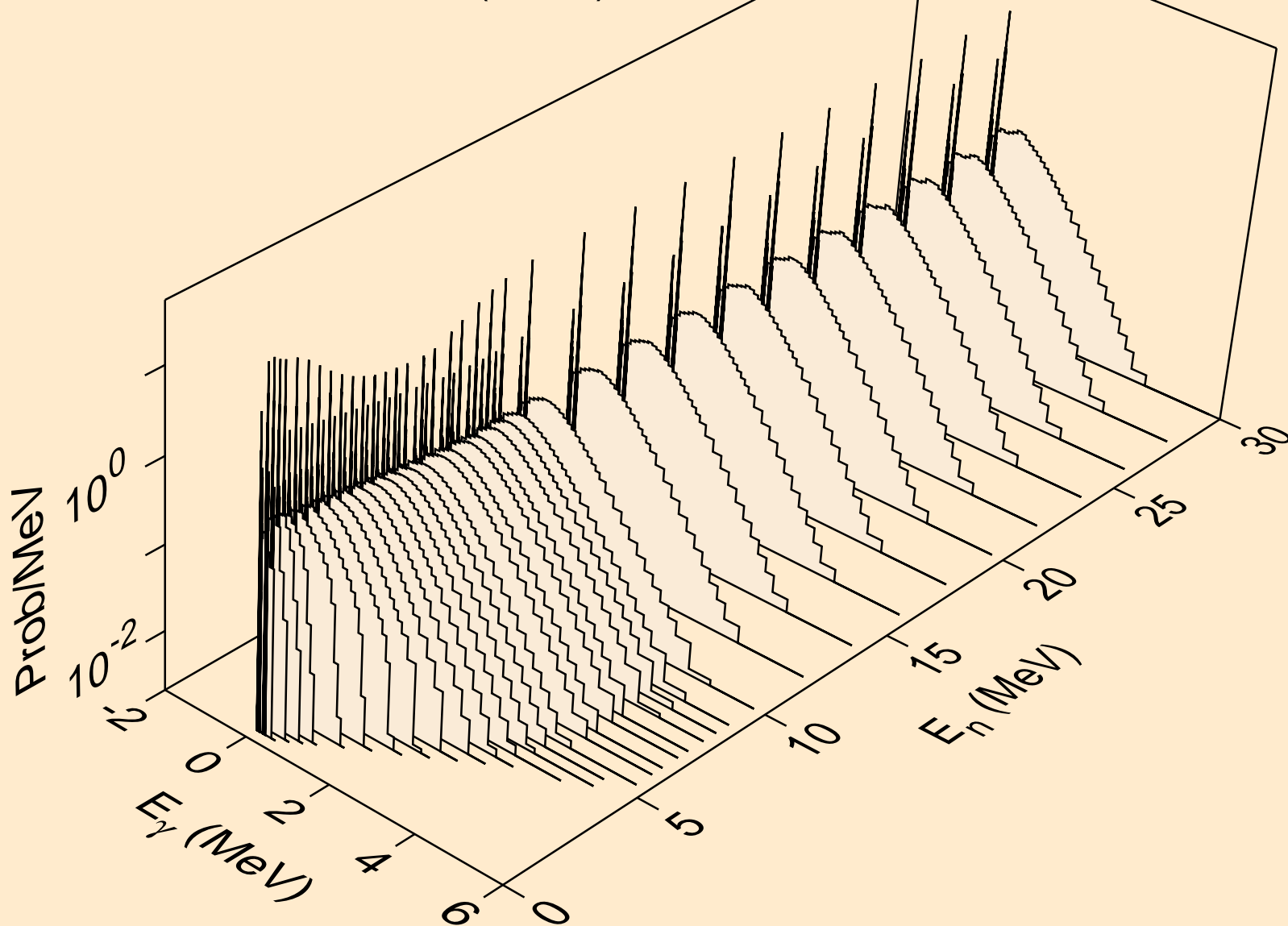

MD256 NEUTRON ACER TENDL-2019 LIBRARY; T=293.16K
Photon emission for (n,gma)

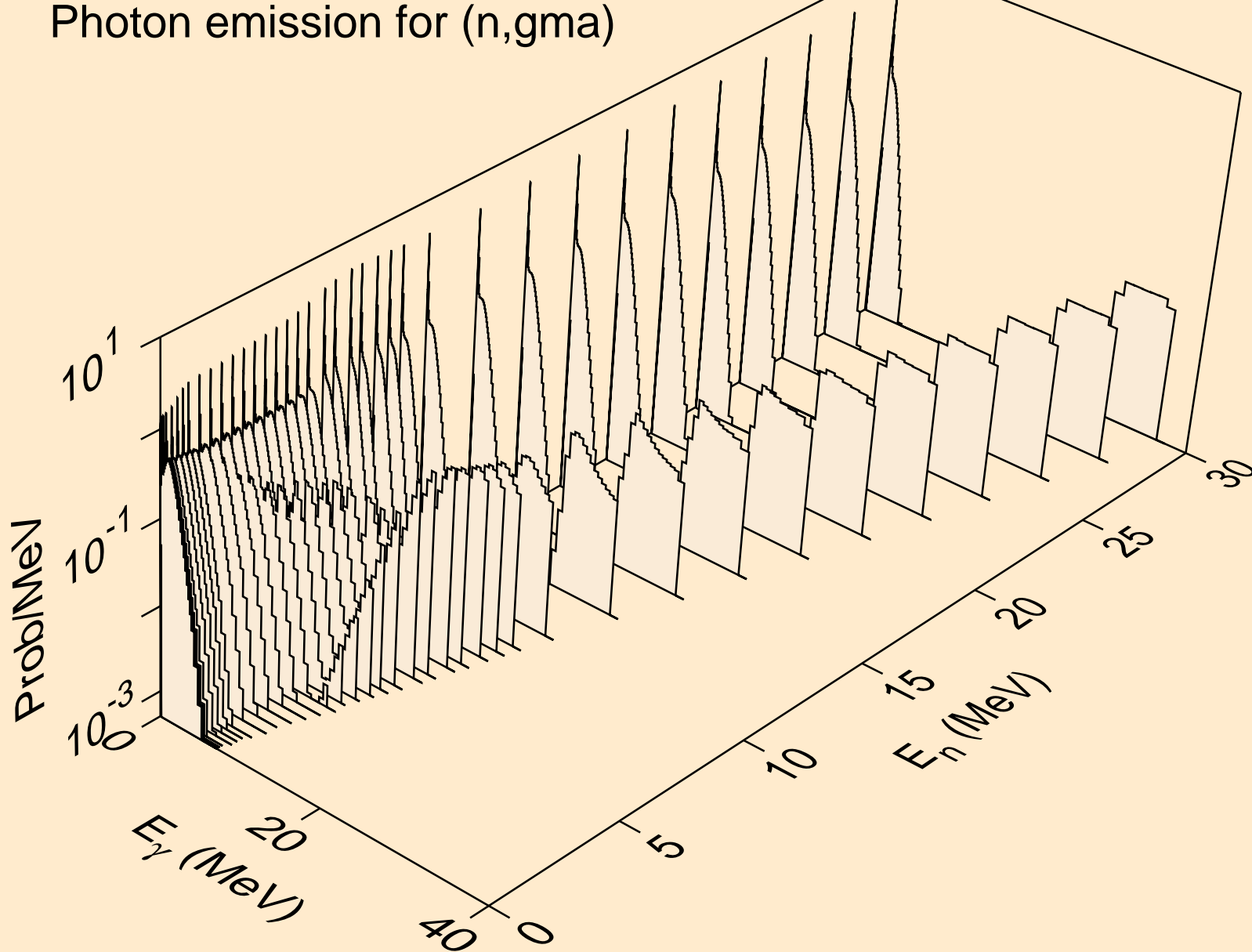

MD256 NEUTRON ACER TENDL-2019 LIBRARY; T=293.16K
Photon emission for (n,p)

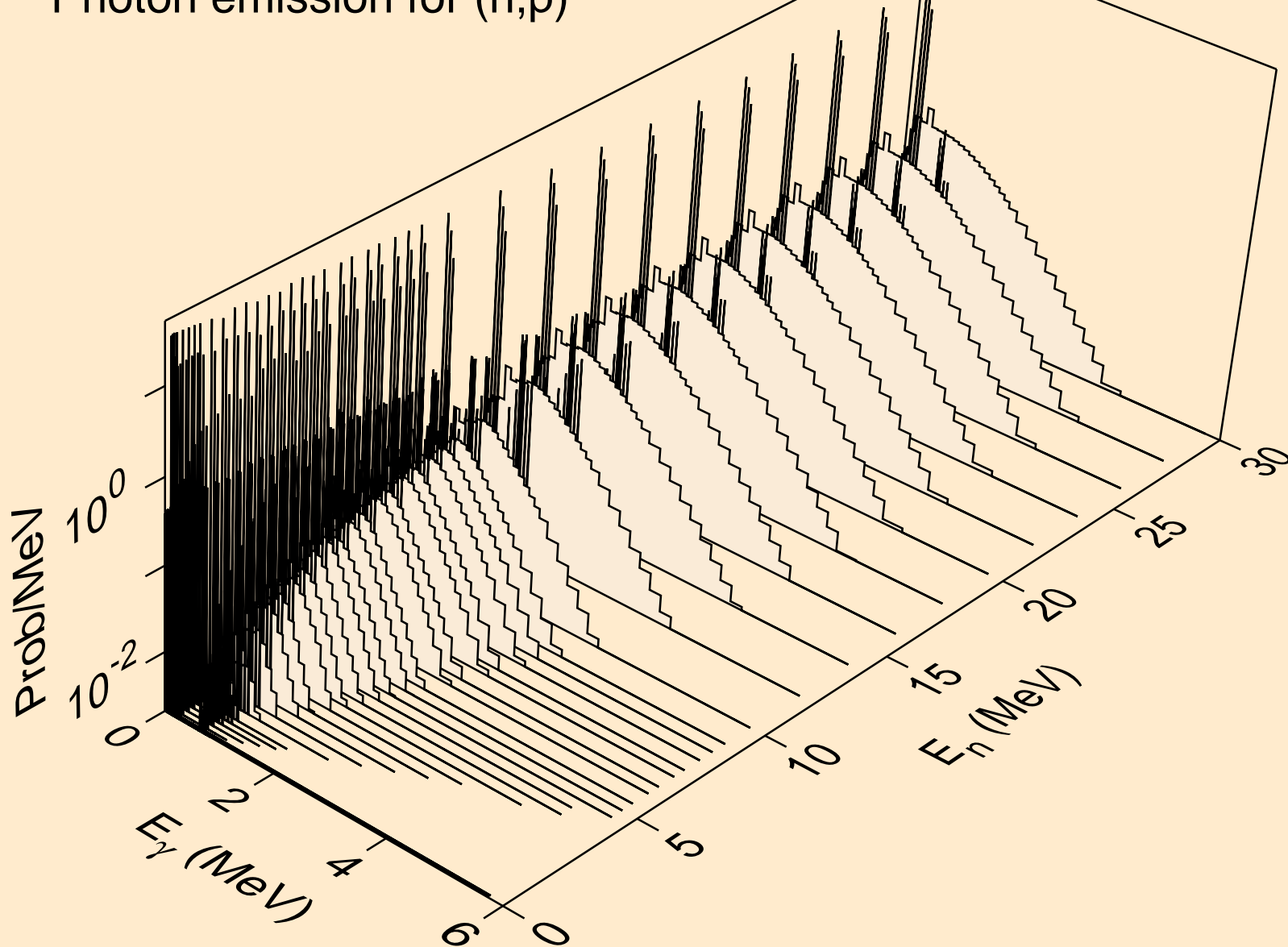

MD256 NEUTRON ACER TENDL-2019 LIBRARY; T=293.16K
Photon emission for (n,d)

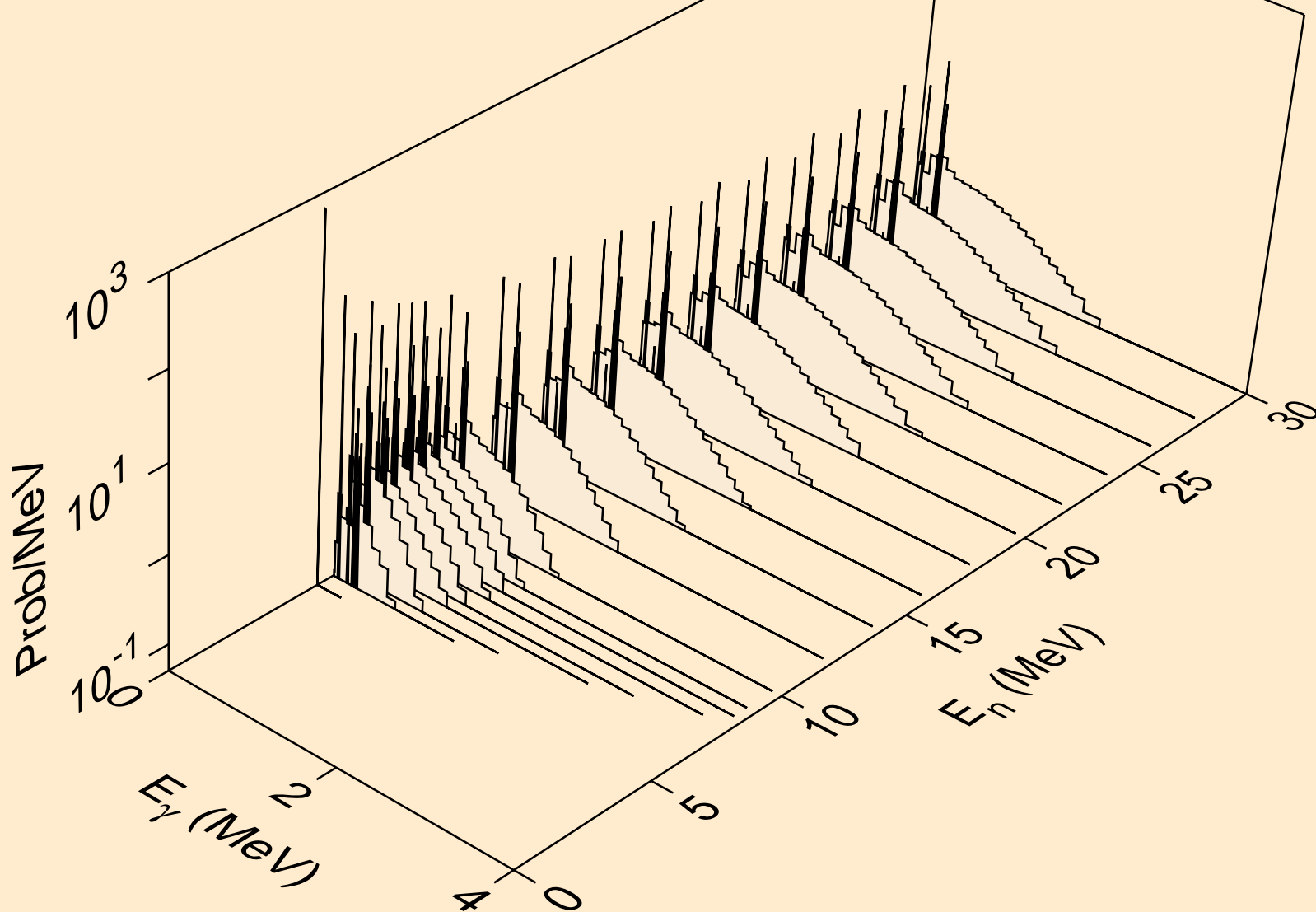

MD256 NEUTRON ACER TENDL-2019 LIBRARY; T=293.16K
Photon emission for (n,t)

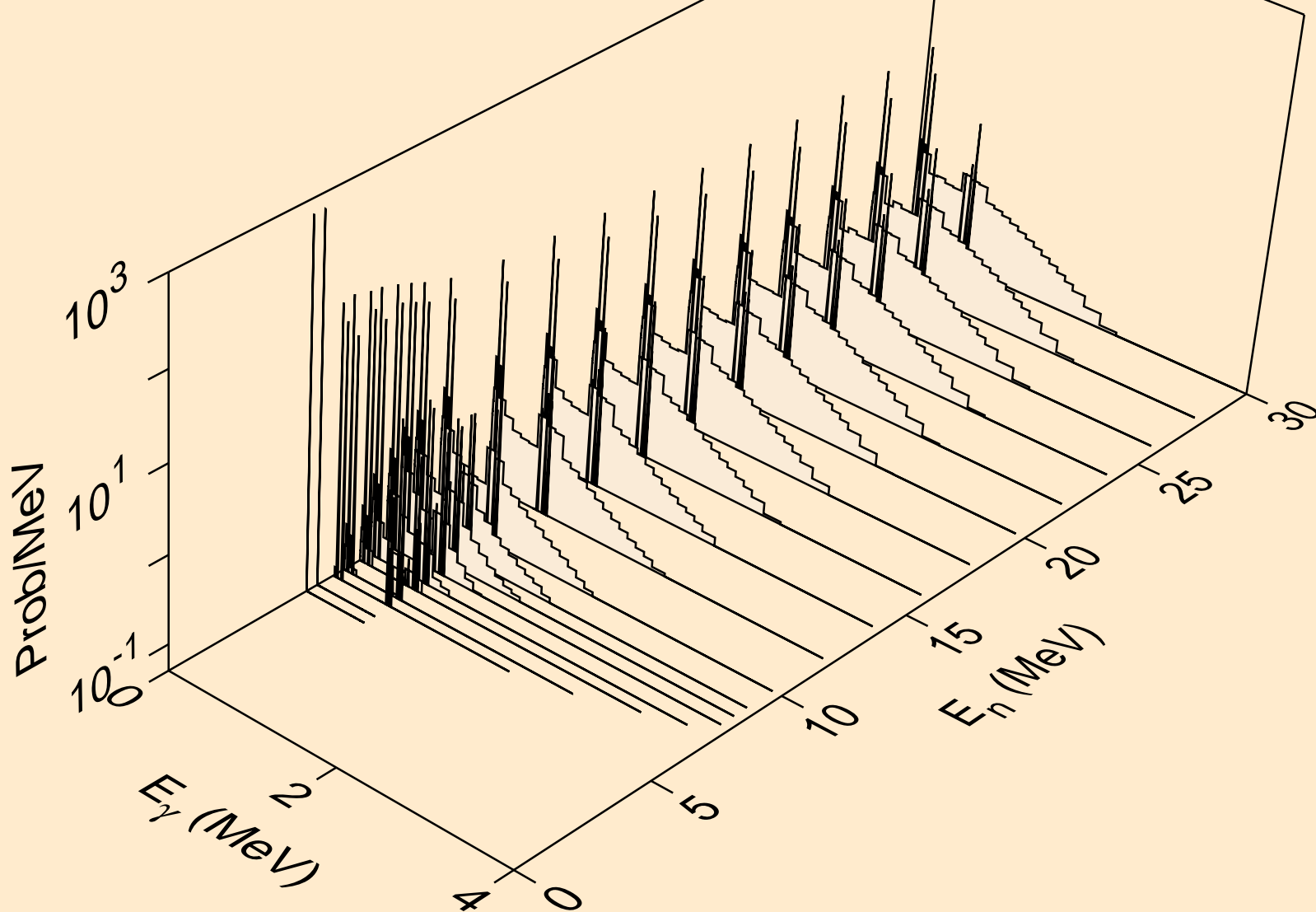

MD256 NEUTRON ACER TENDL-2019 LIBRARY; T=293.16K
Photon emission for (n,he3)

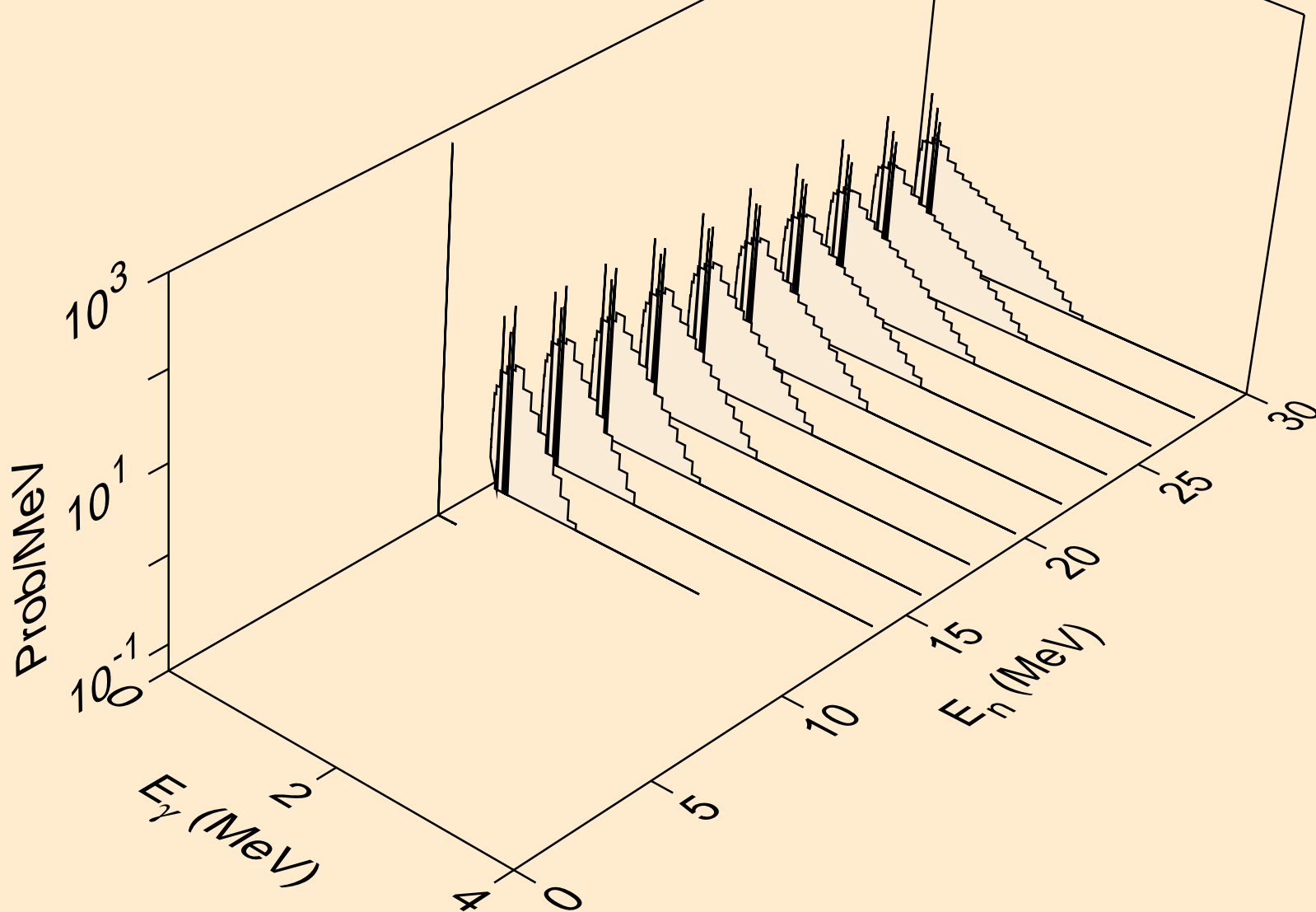

MD256 NEUTRON ACER TENDL-2019 LIBRARY; T=293.16K
Photon emission for (n,a)

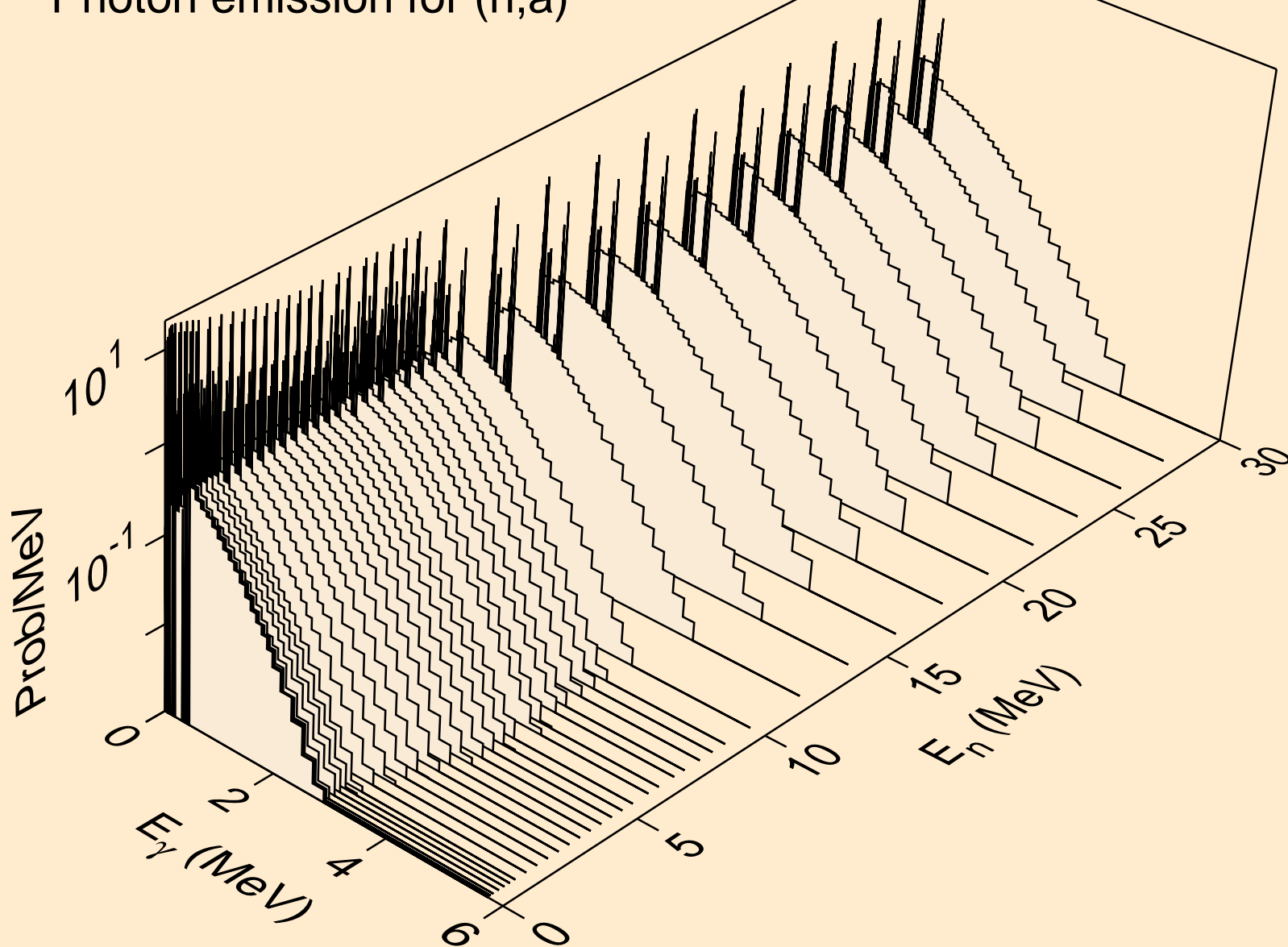

MD256 NEUTRON ACER TENDL-2019 LIBRARY; T=293.16K
Photon emission for (n,2a)

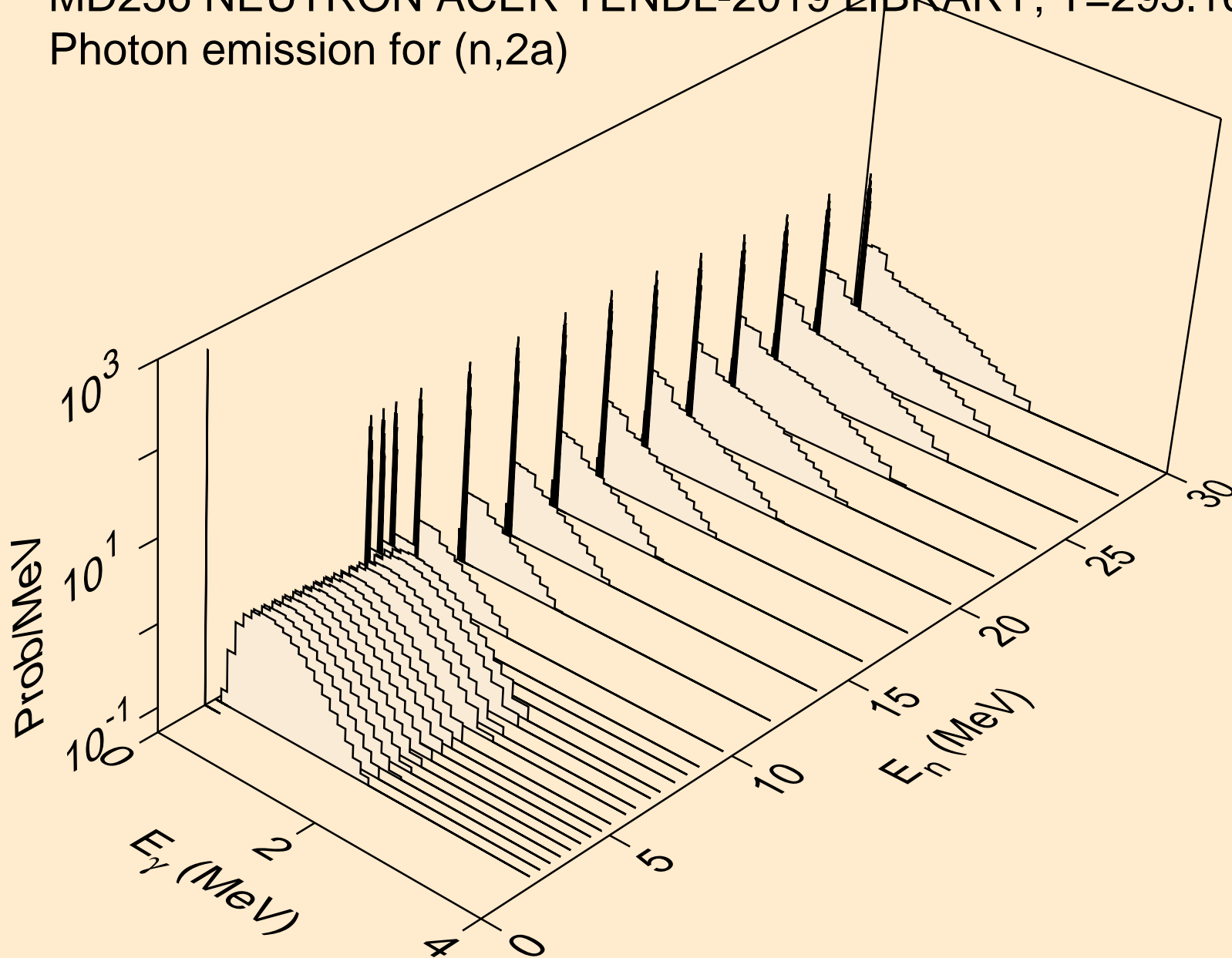

MD256 NEUTRON ACER TENDL-2019 LIBRARY; T=293.16K
Photon emission for (n,2p)

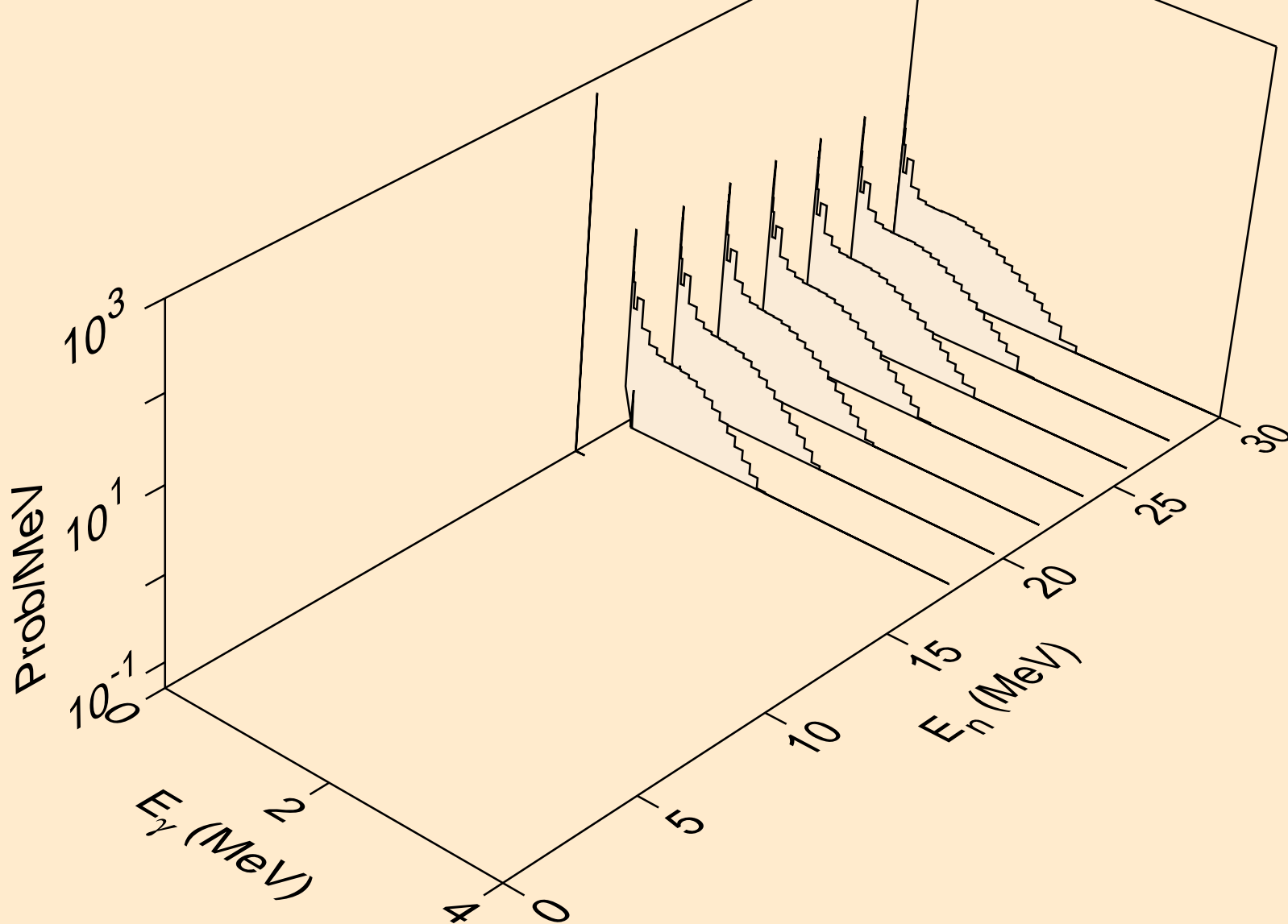

MD256 NEUTRON ACER TENDL-2019 LIBRARY; T=293.16K
Photon emission for (n,da)

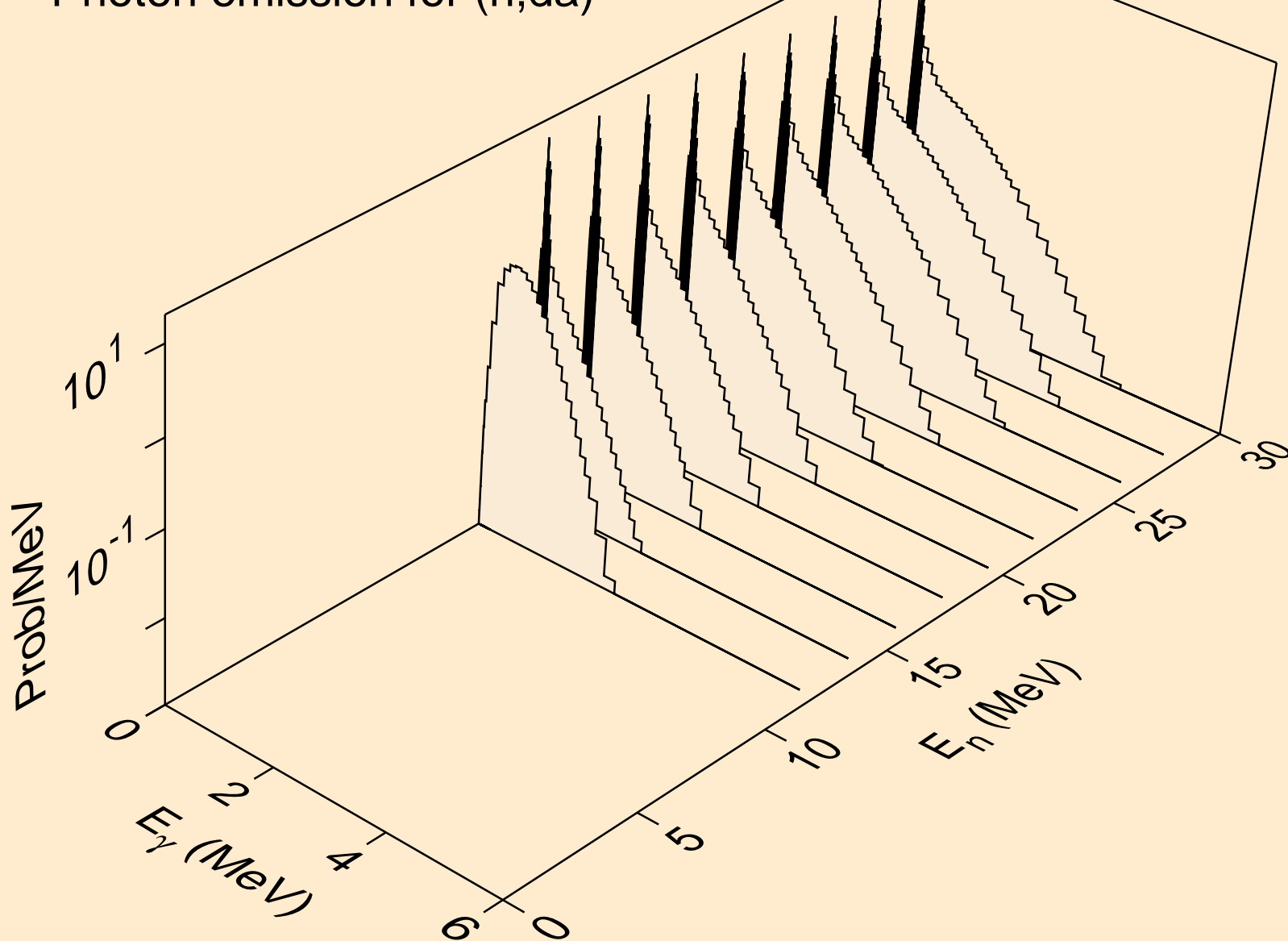

MD256 NEUTRON ACER TENDL-2019 LIBRARY; T=293.16K
thermal capture photon spectrum

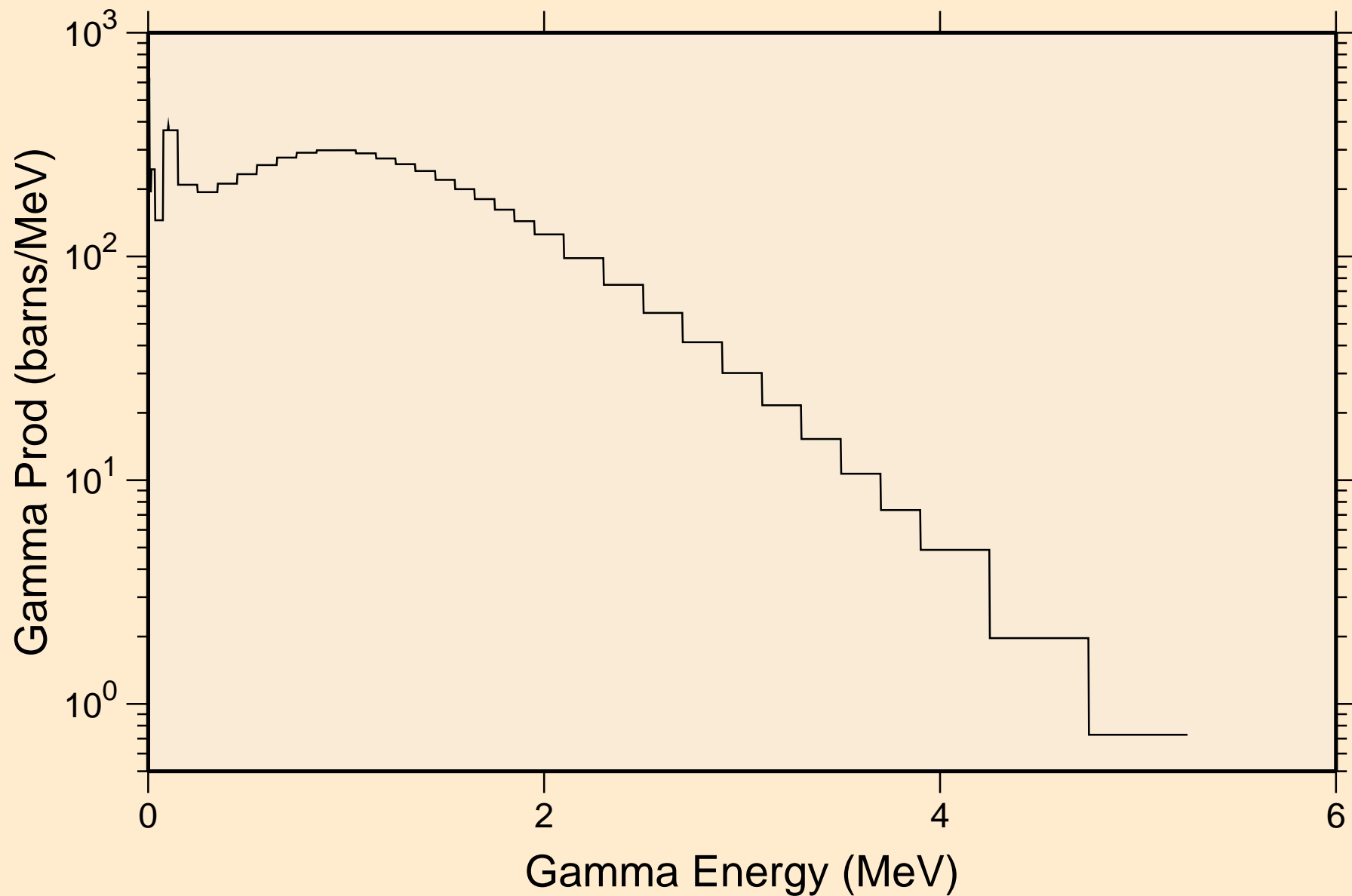

MD256 NEUTRON ACER TENDL-2019 LIBRARY; T=293.16K
14 MeV photon spectrum

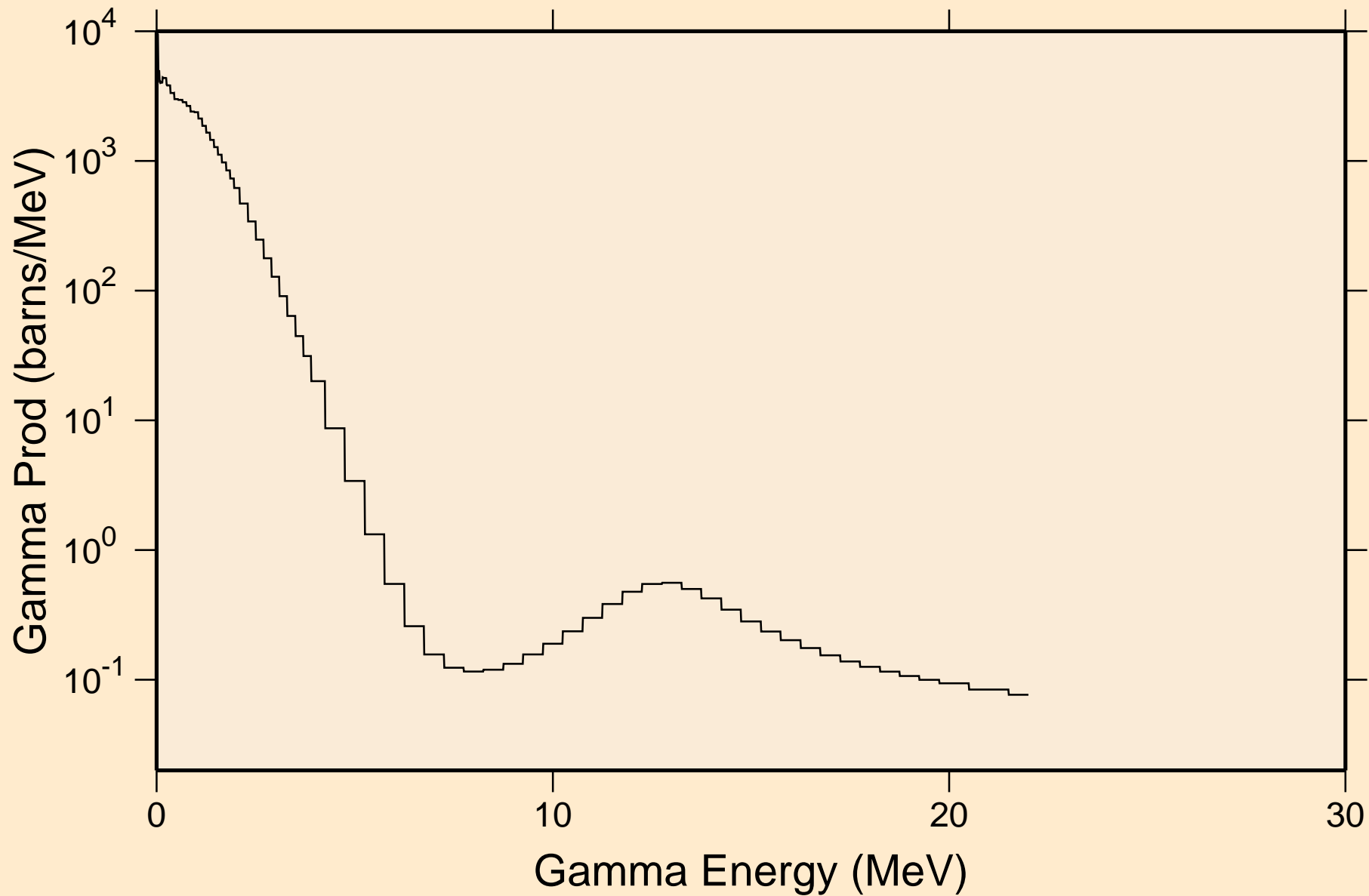

MD256 NEUTRON ACER TENDL-2019 LIBRARY; T=293.16K

Particle heating contributions

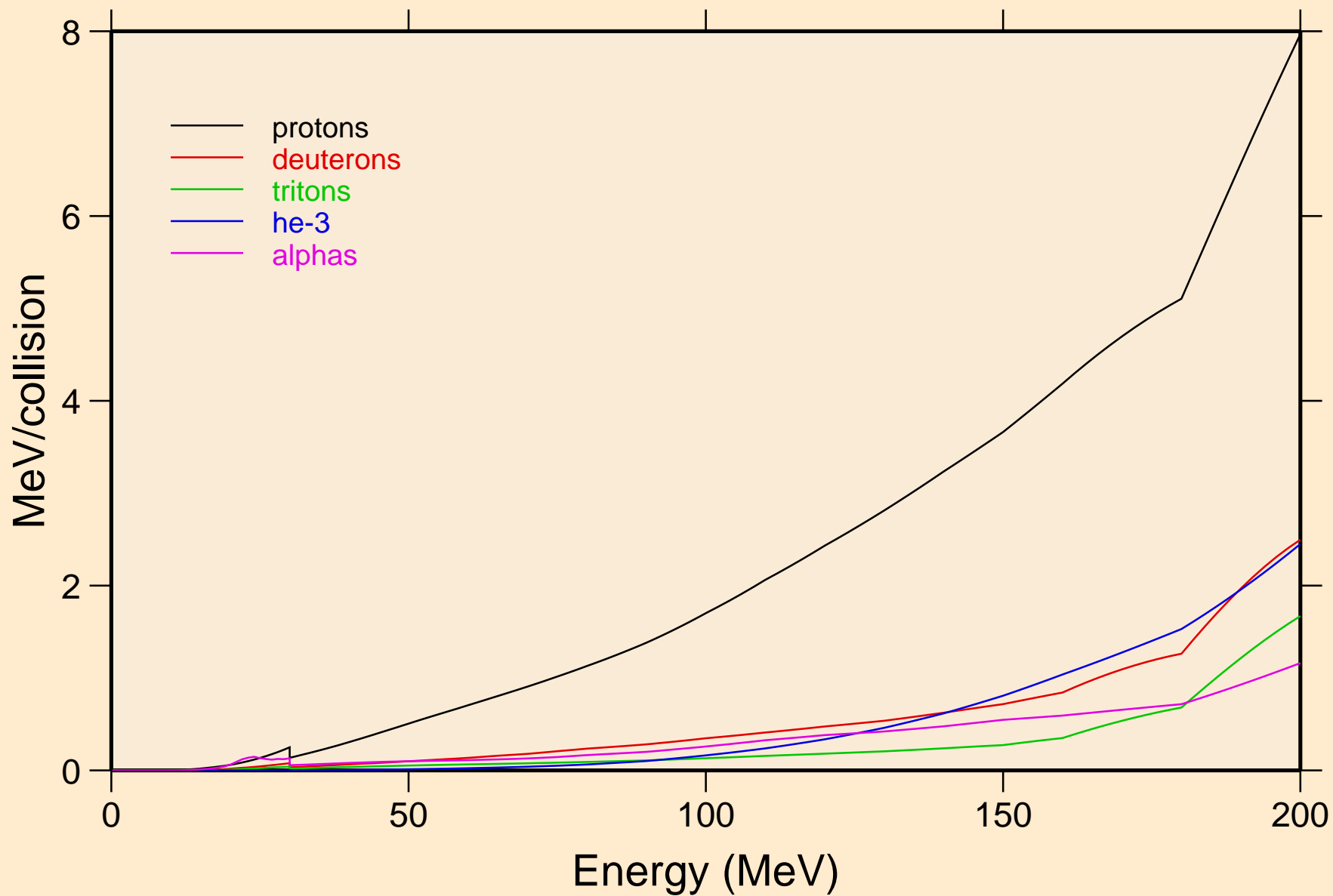

MD256 NEUTRON ACER TENDL-2019 LIBRARY; T=293.16K
Recoil Heating

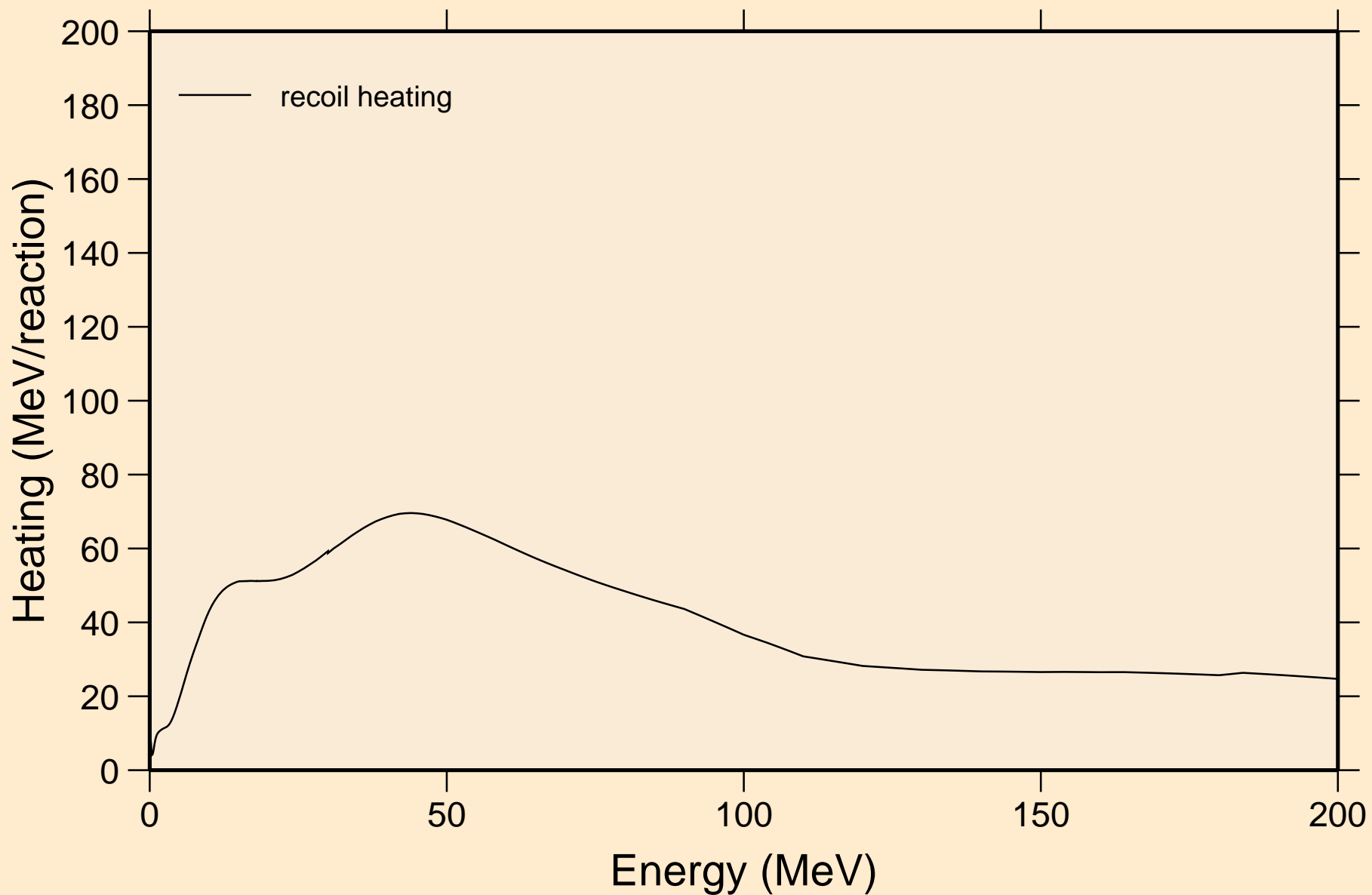

MD256 NEUTRON ACER TENDL-2019 LIBRARY; T=293.16K
Particle production cross sections

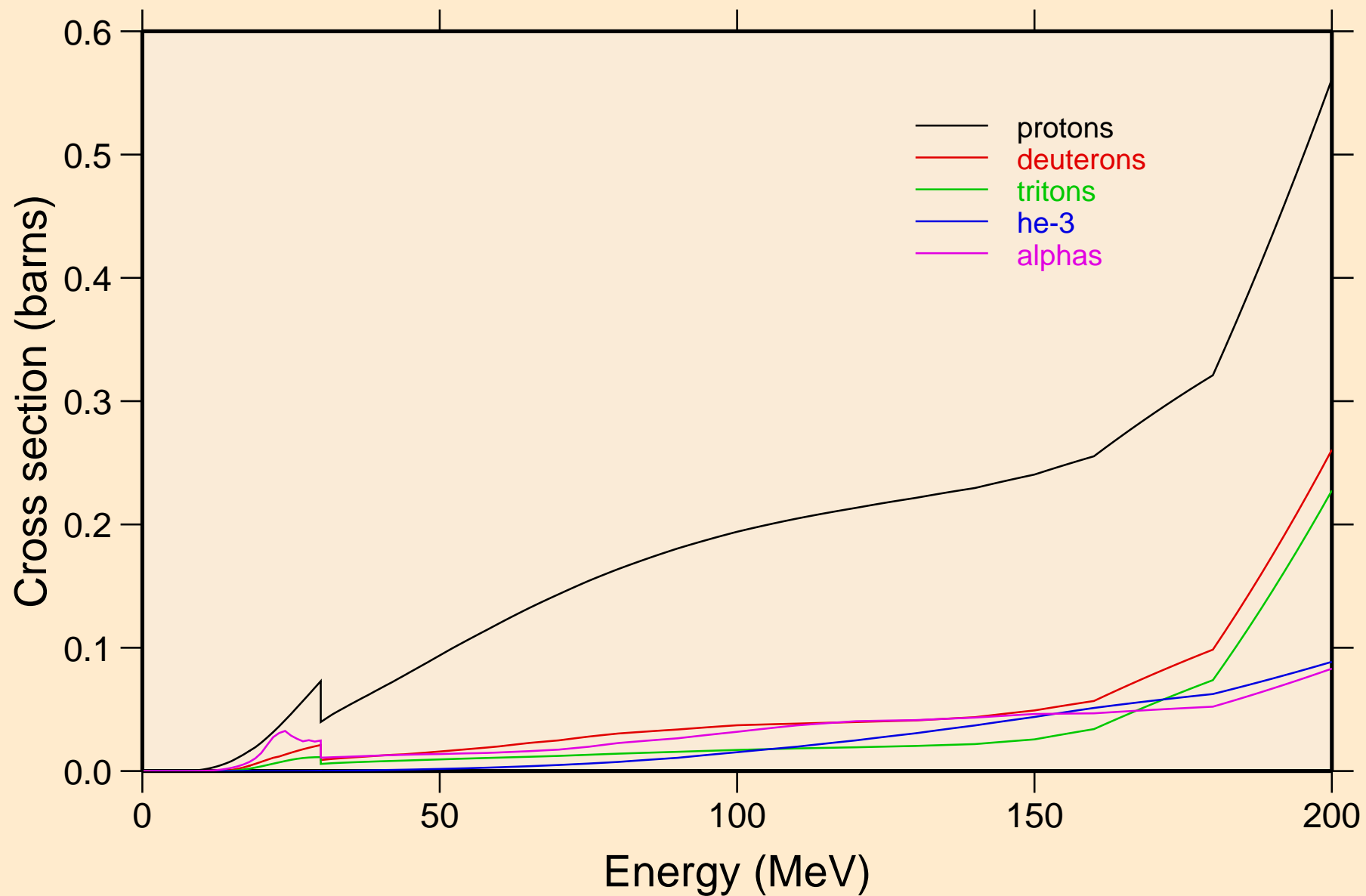

MD256 NEUTRON ACER TENDL-2019 LIBRARY; T=293.16K
protons from (n,x)

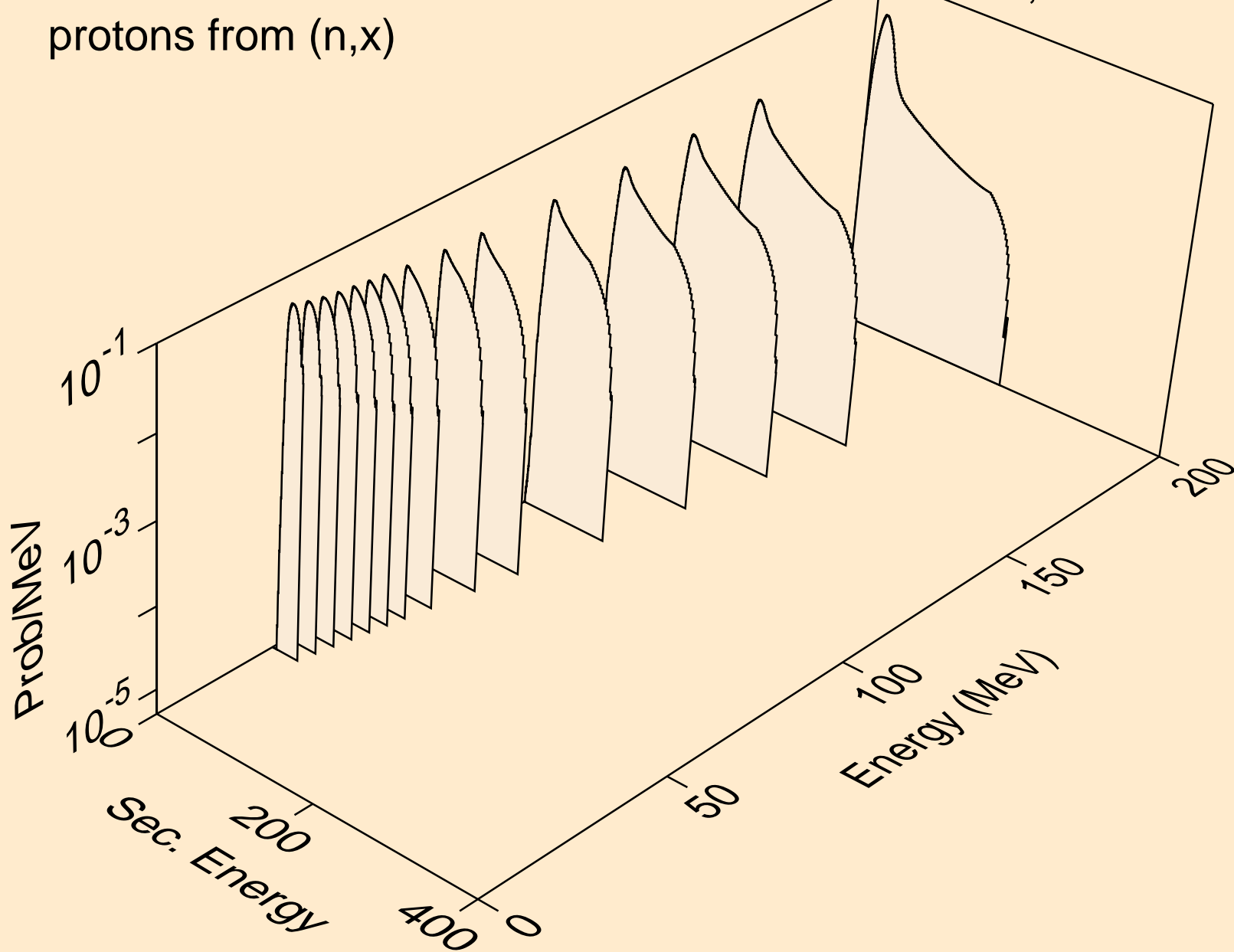

MD256 NEUTRON ACER TENDL-2019 LIBRARY; T=293.16K
protons from (n,n*)p

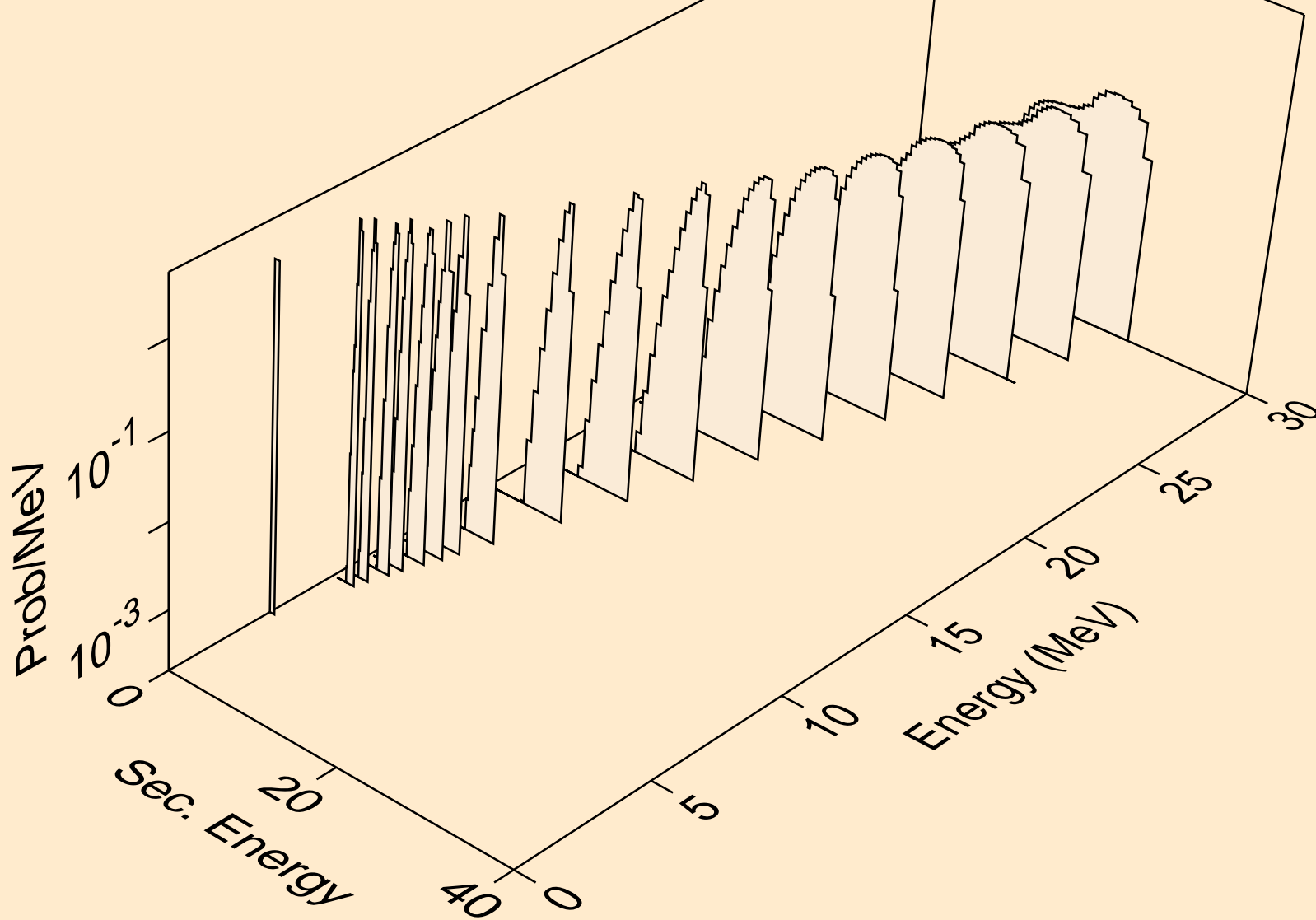

MD256 NEUTRON ACER TENDL-2019 LIBRARY; T=293.16K
protons from (n,2np)

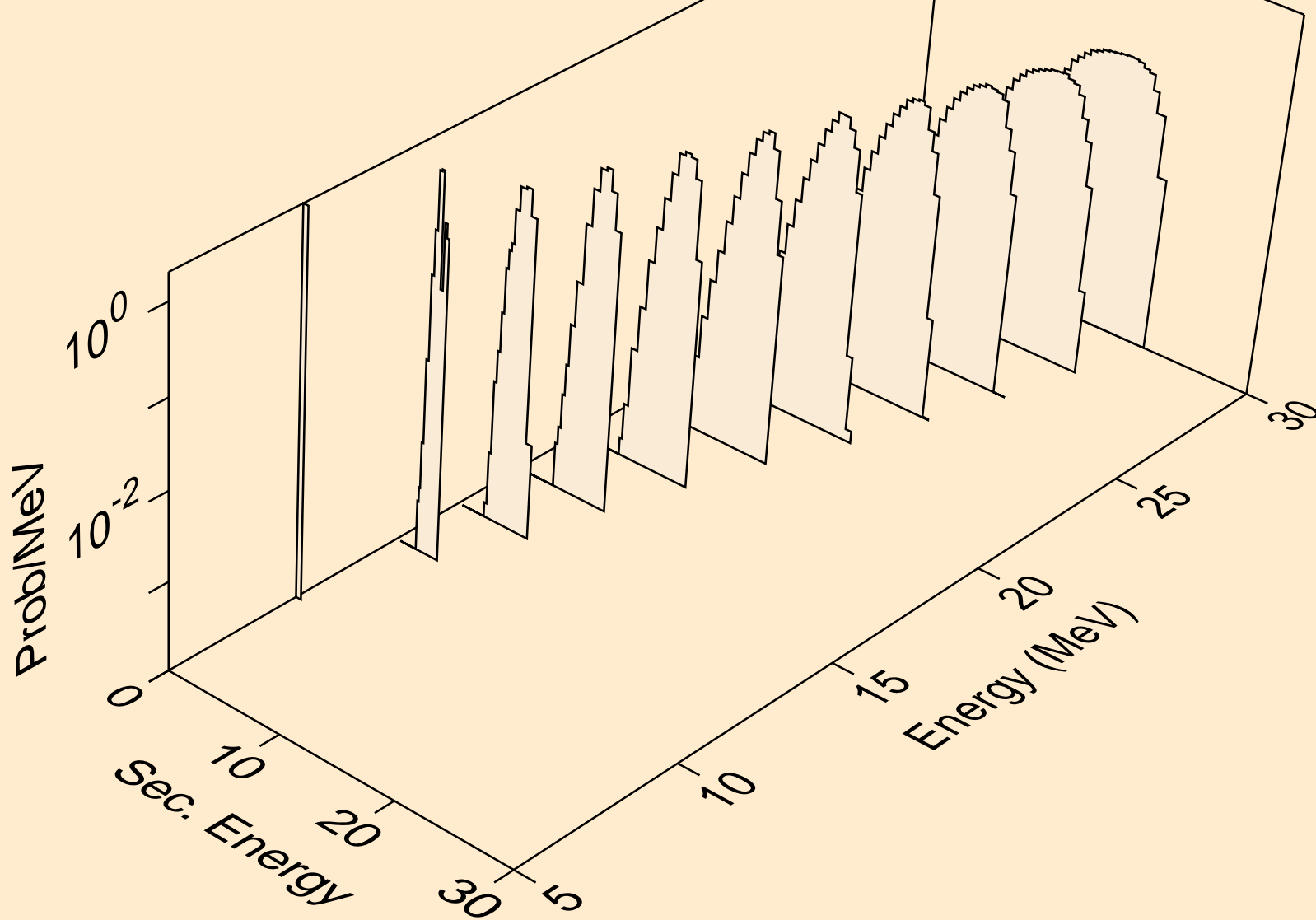

MD256 NEUTRON ACER TENDL-2019 LIBRARY; T=293.16K
protons from (n,3np)

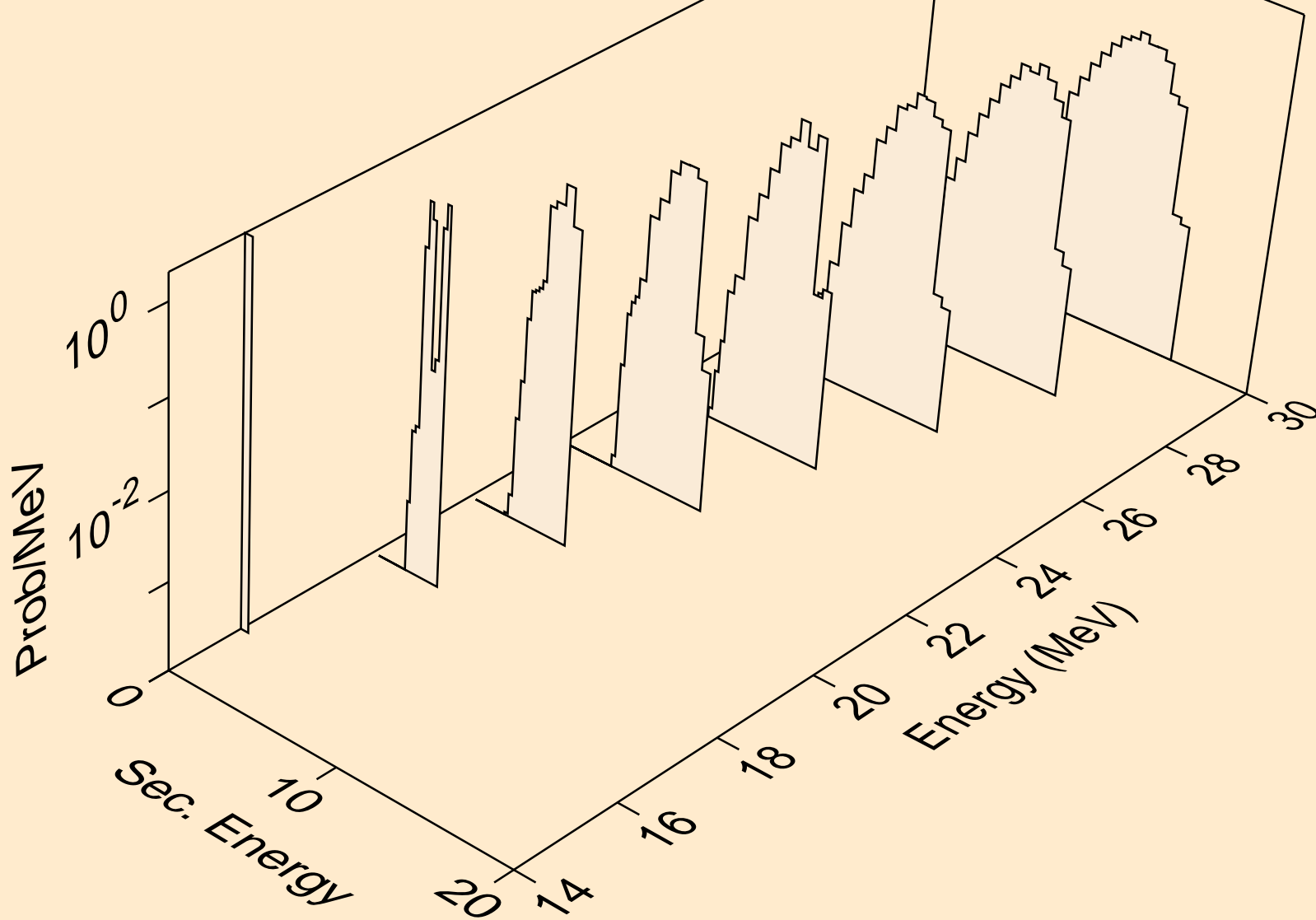

MD256 NEUTRON ACER TENDL-2019 LIBRARY; T=293.16K
protons from (n,2np)

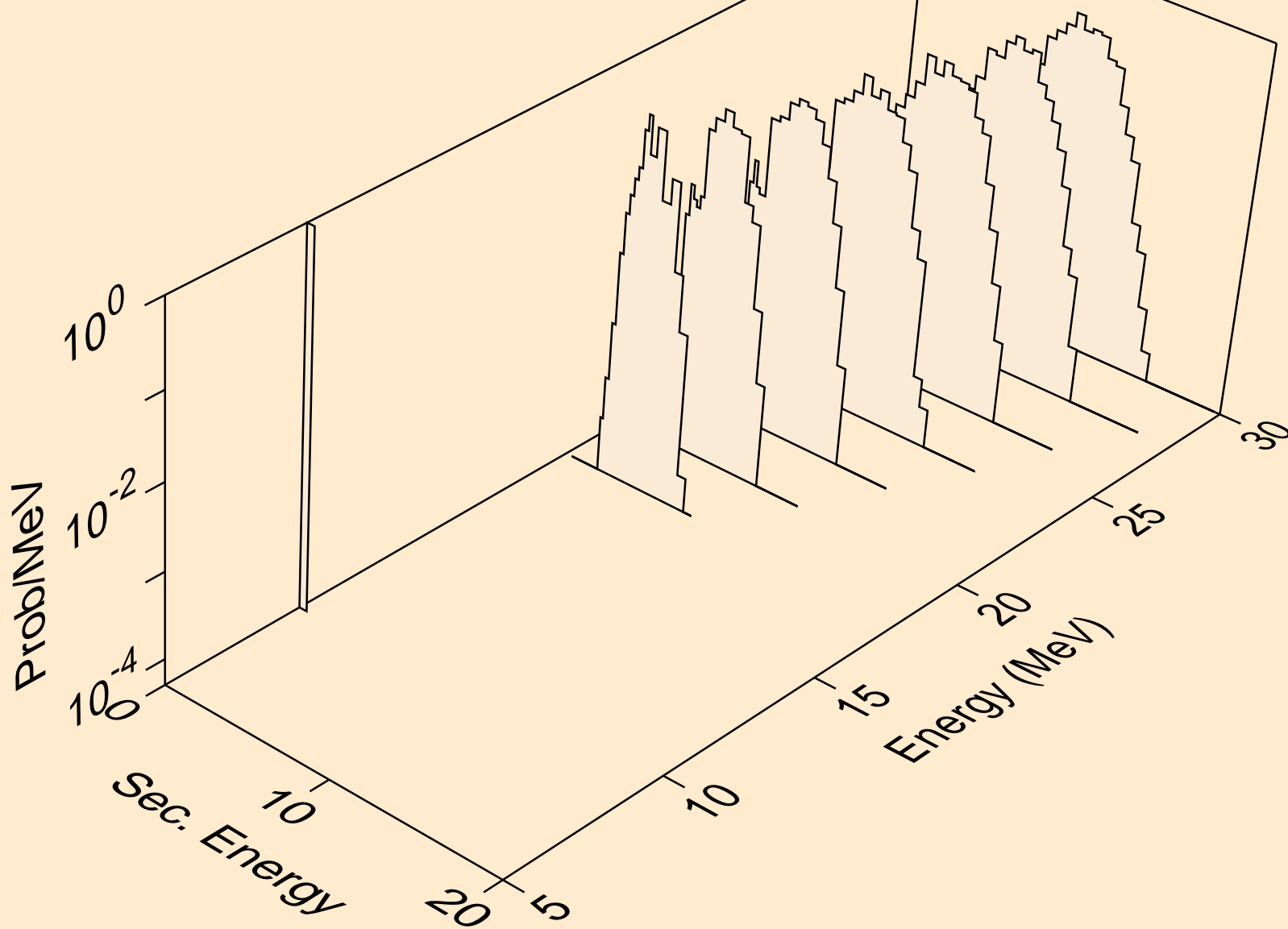

MD256 NEUTRON ACER TENDL-2019 LIBRARY; T=293.16K
protons from (n,npa)

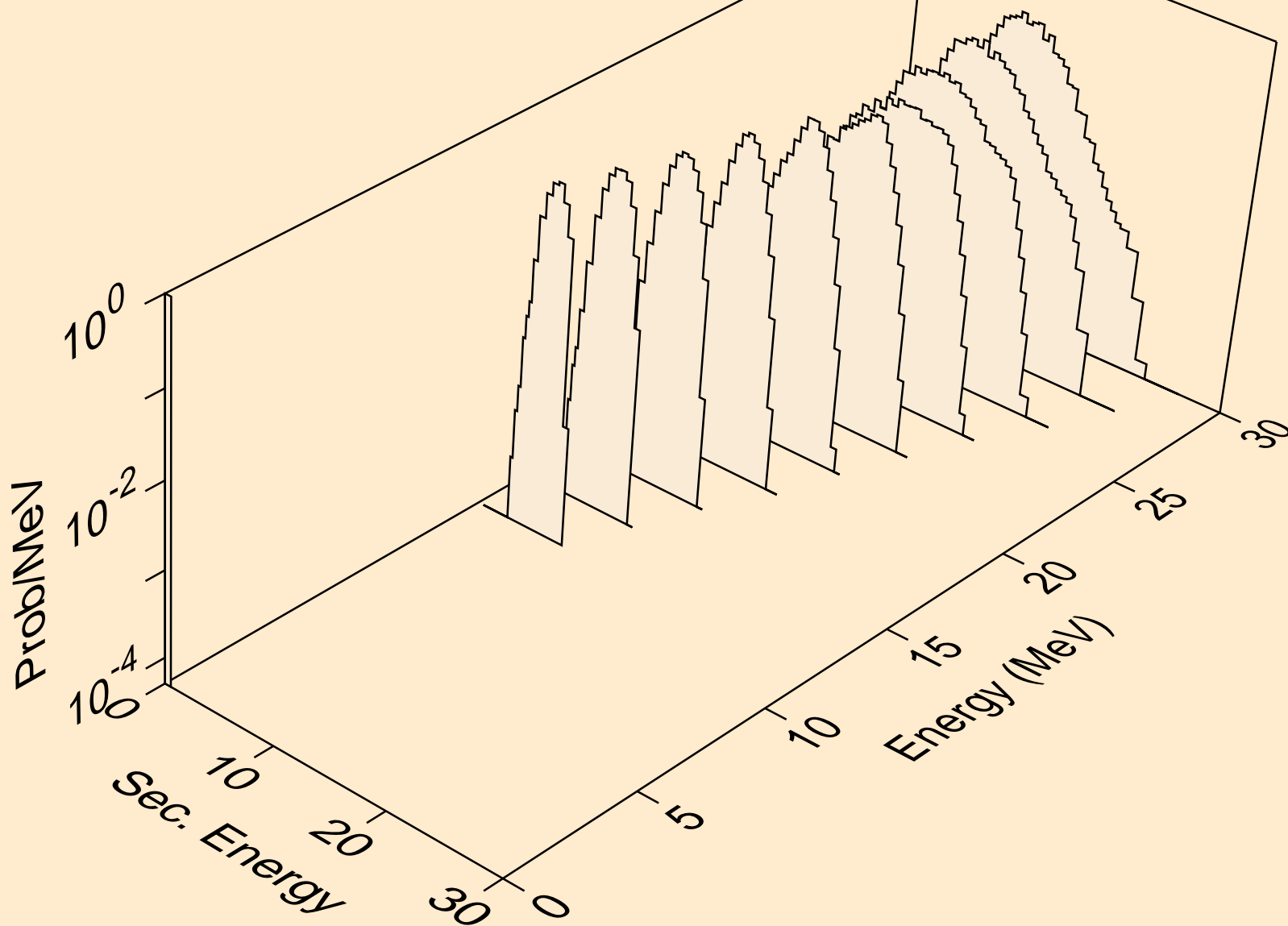

MD256 NEUTRON ACER TENDL-2019 LIBRARY; T=293.16K
protons from (n,p)

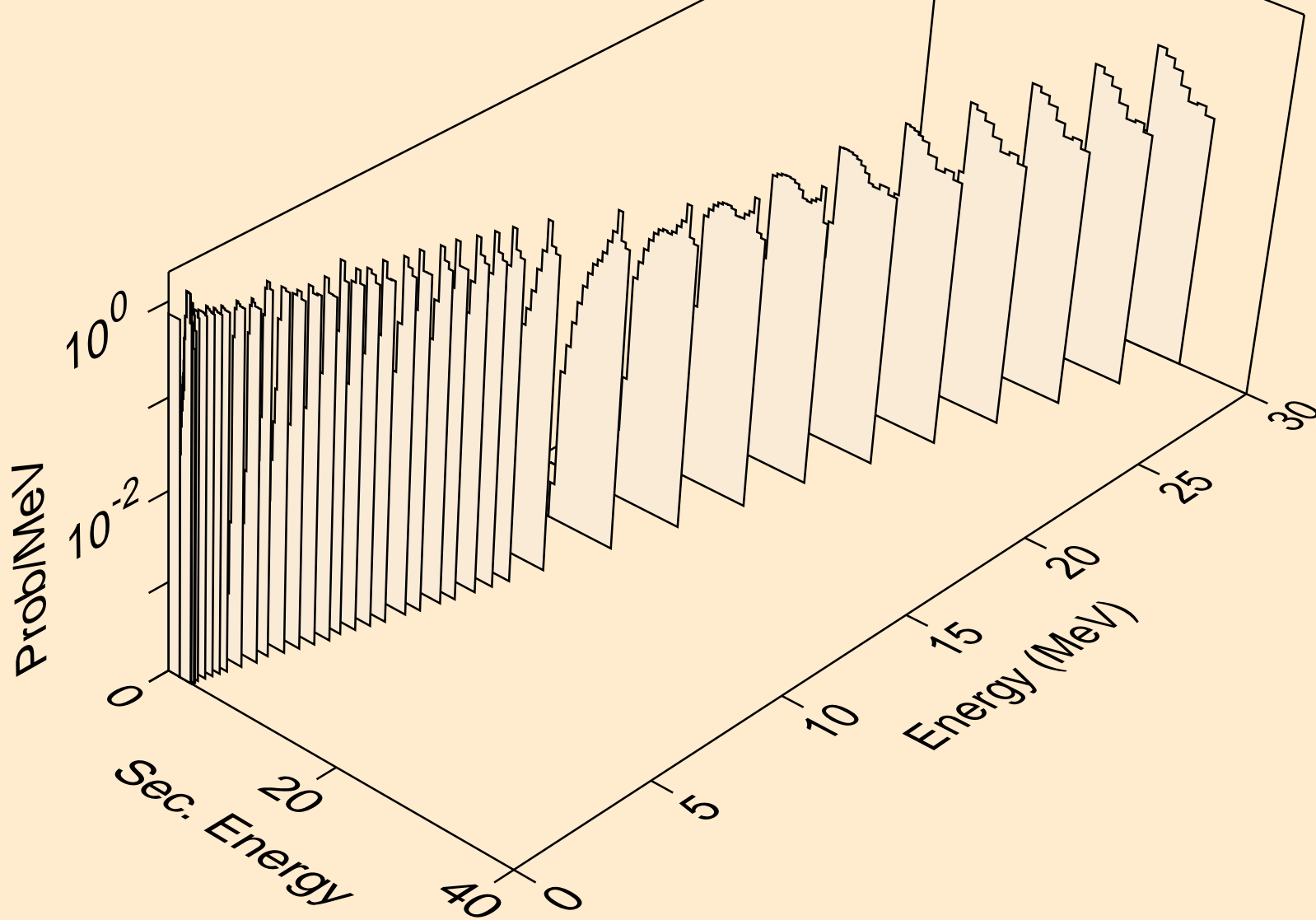

MD256 NEUTRON ACER TENDL-2019 LIBRARY; T=293.16K
protons from (n,2p)

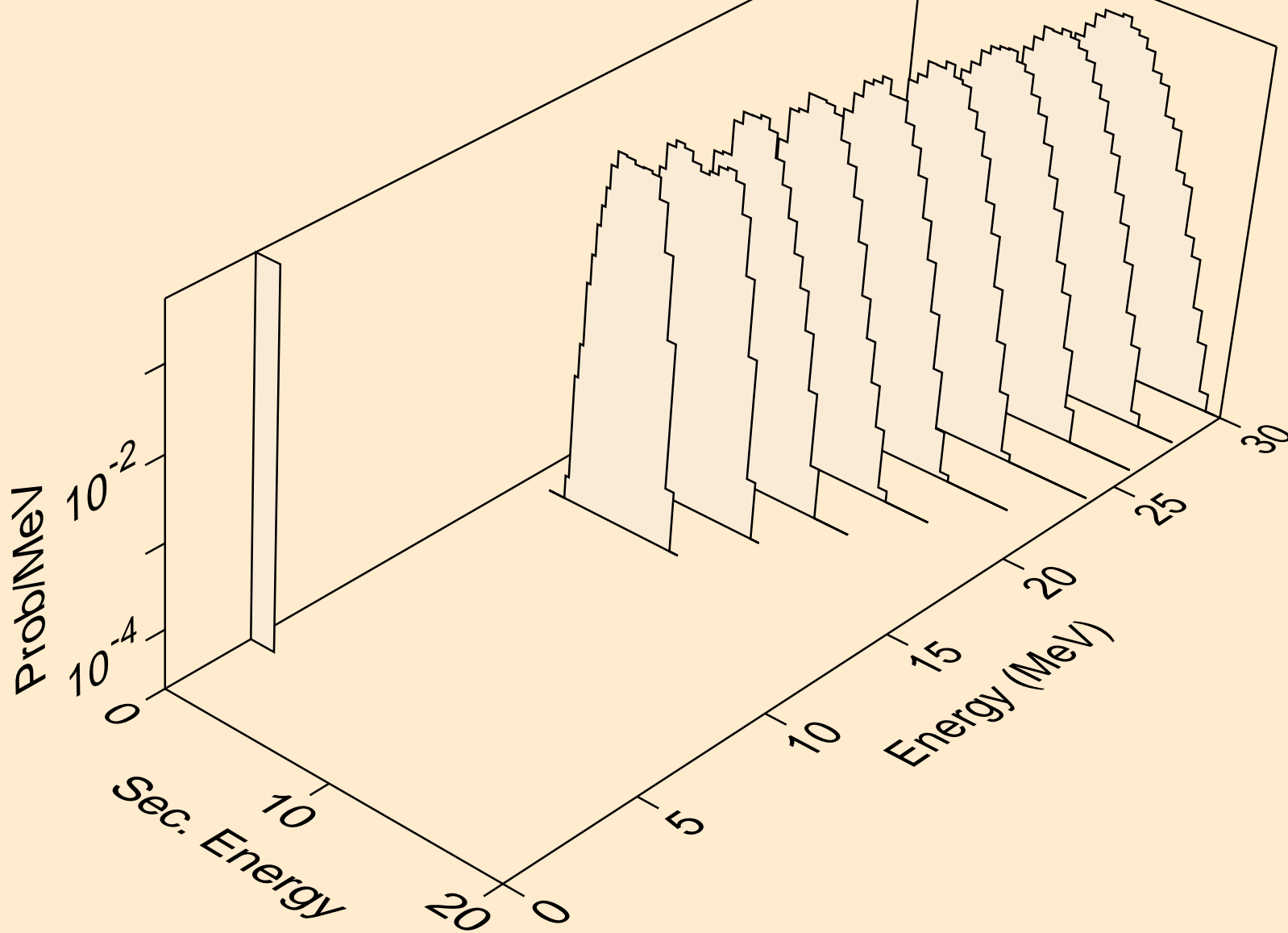

MD256 NEUTRON ACER TENDL-2019 LIBRARY; T=293.16K
deuterons from (n,x)

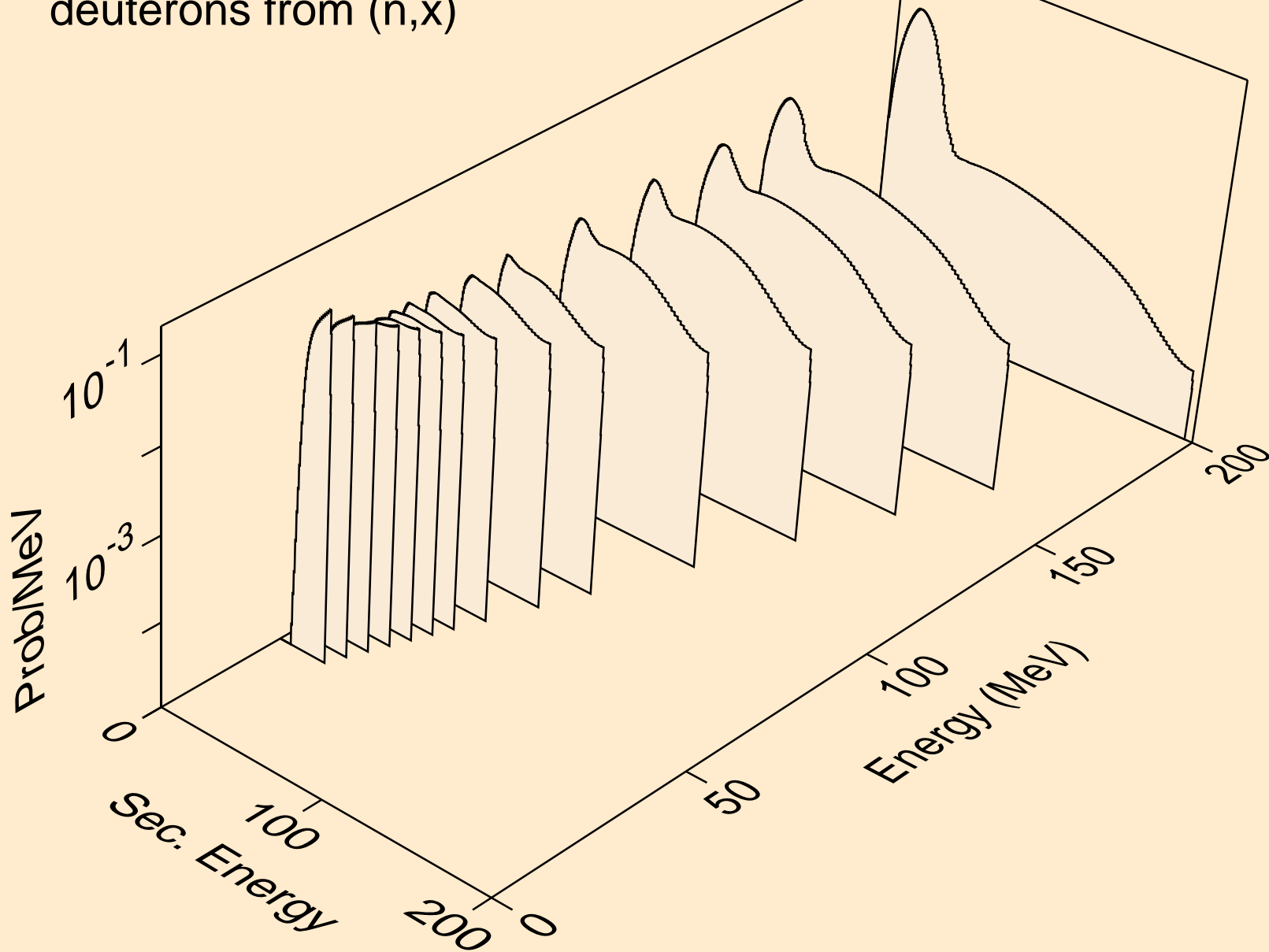

MD256 NEUTRON ACER TENDL-2019 LIBRARY; T=293.16K
deuterons from (n,2nd)

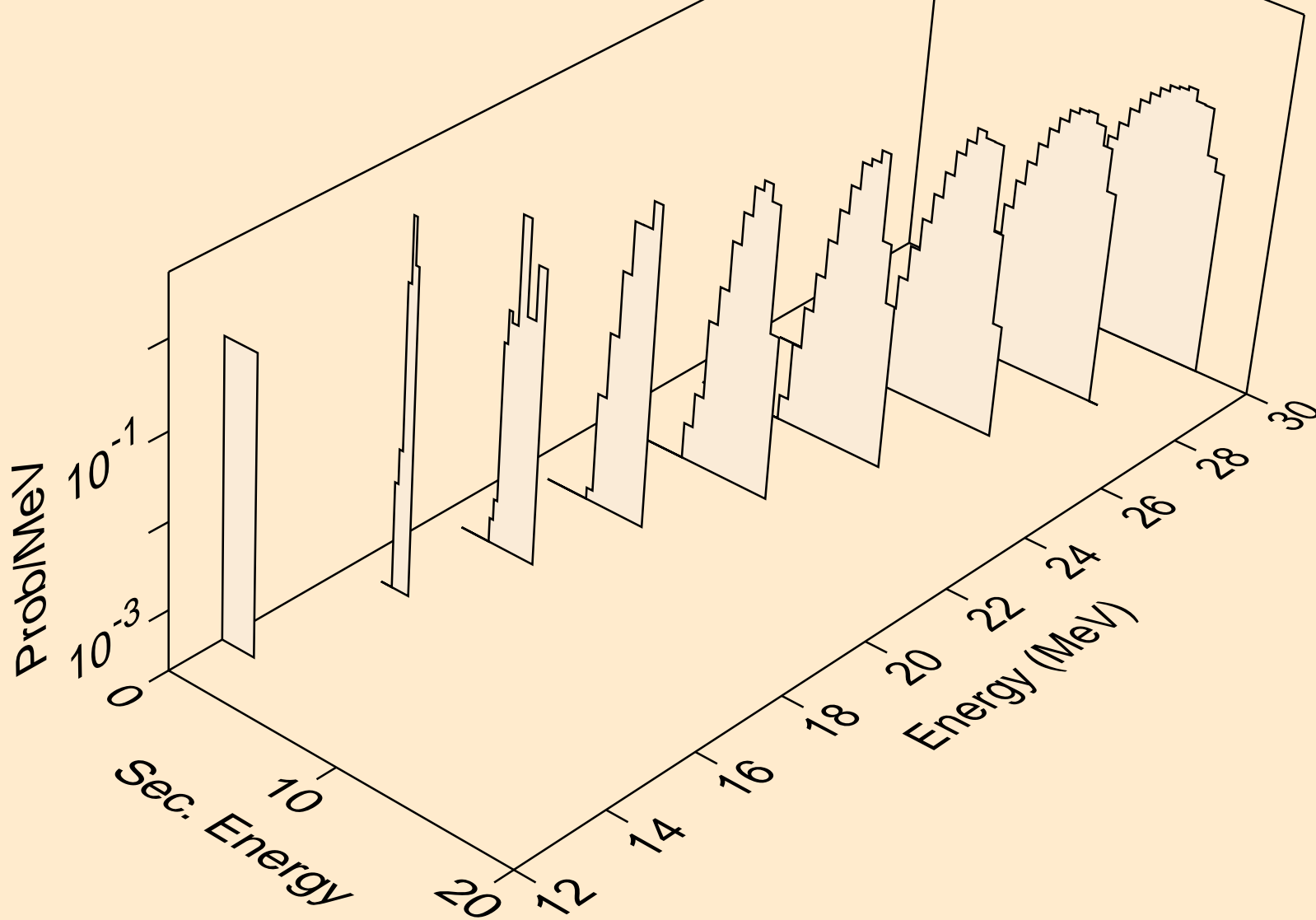

MD256 NEUTRON ACER TENDL-2019 LIBRARY; T=293.16K
deuterons from (n,n*)d

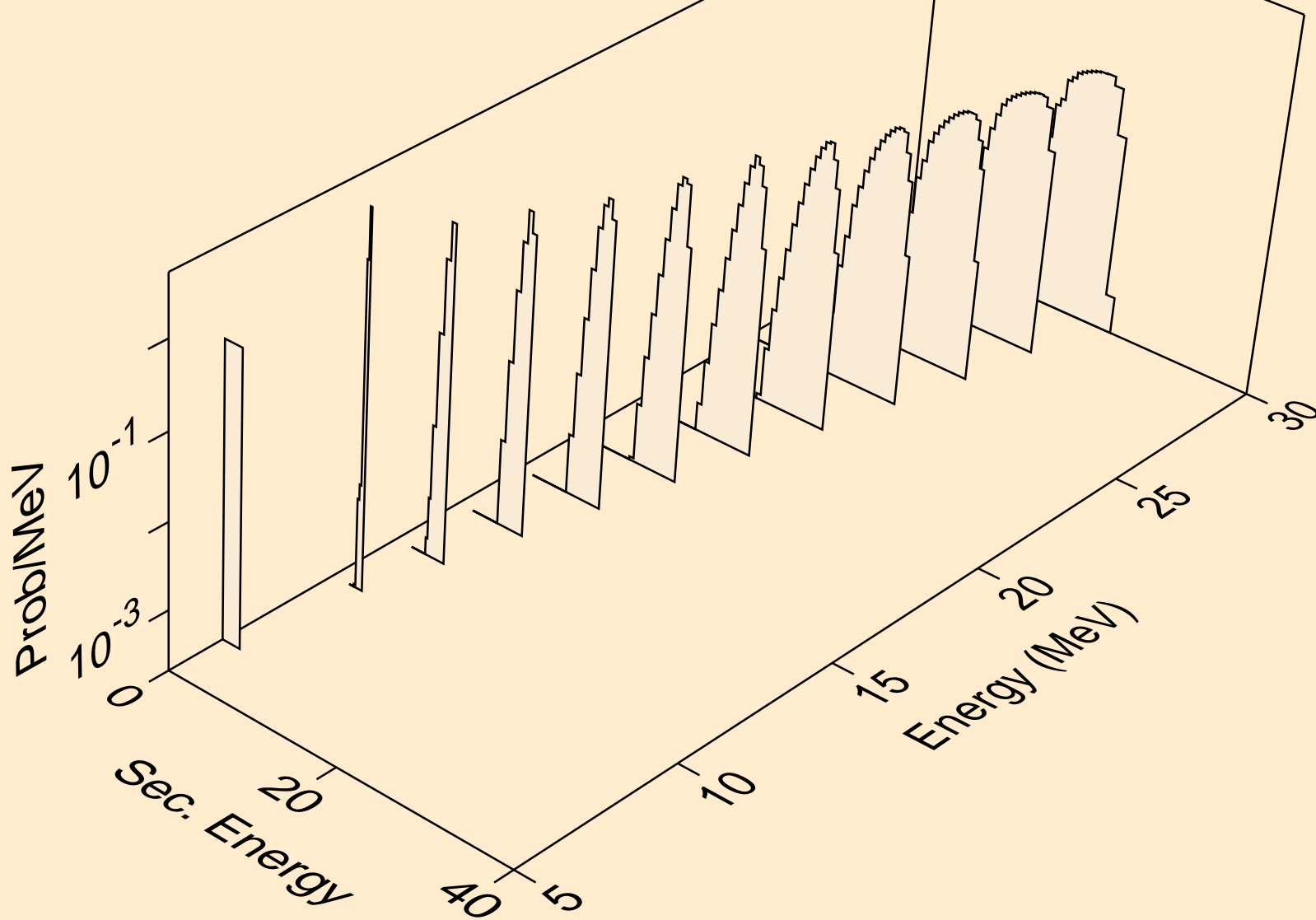

MD256 NEUTRON ACER TENDL-2019 LIBRARY; T=293.16K
deuterons from (n,d)

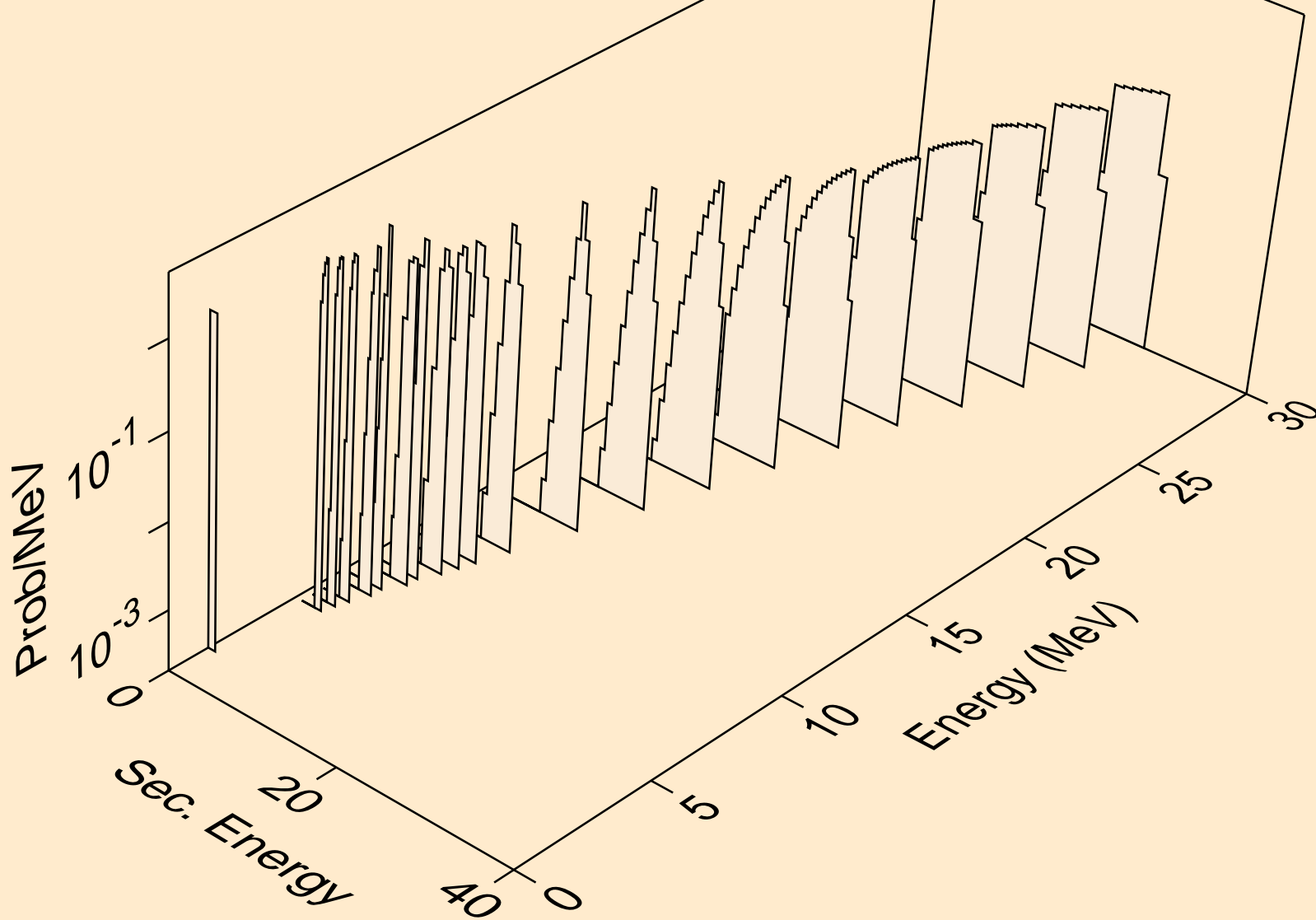

MD256 NEUTRON ACER TENDL-2019 LIBRARY; T=293.16K
deuterons from (n,da)

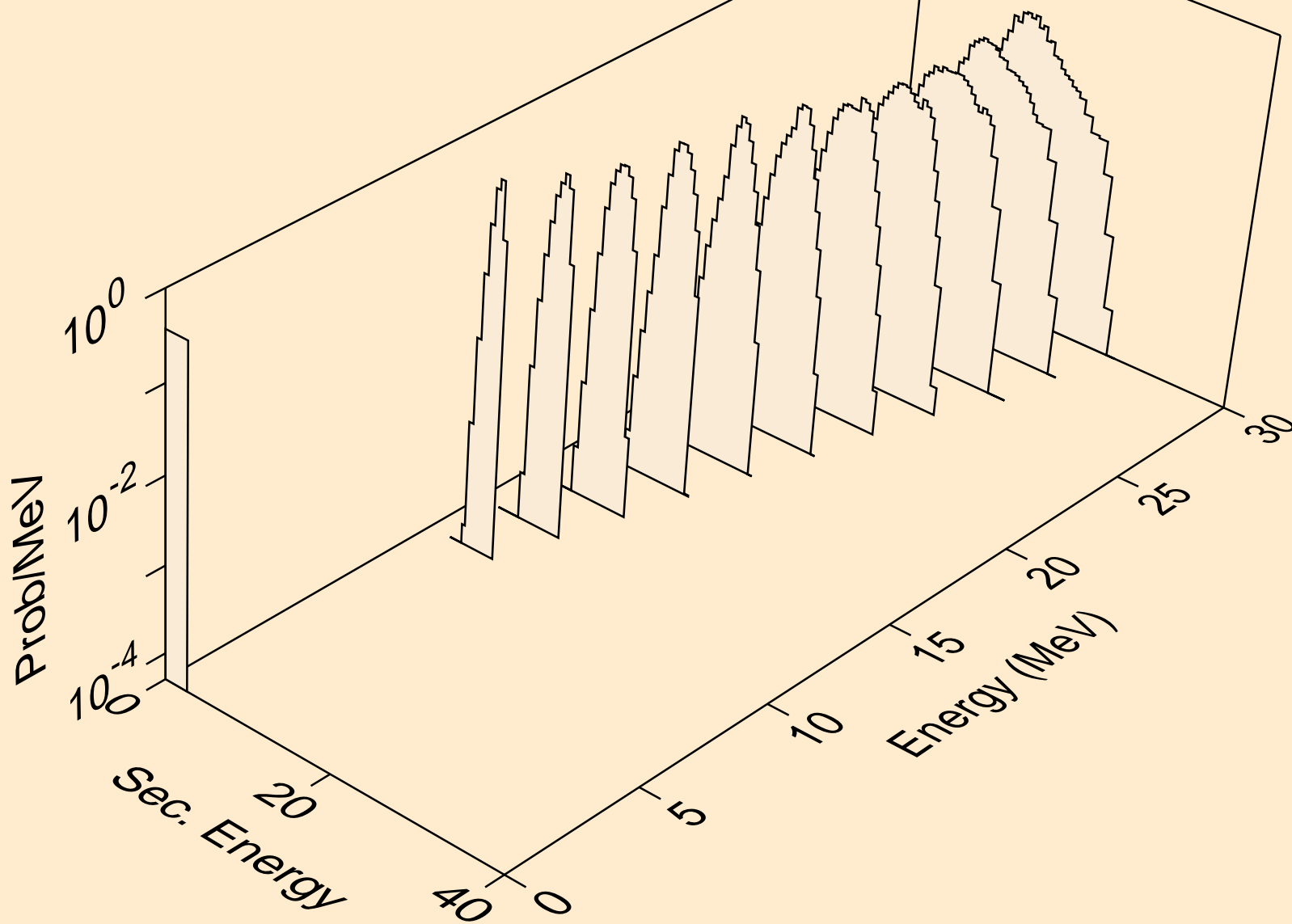

MD256 NEUTRON ACER TENDL-2019 LIBRARY; T=293.16K
tritons from (n,x)

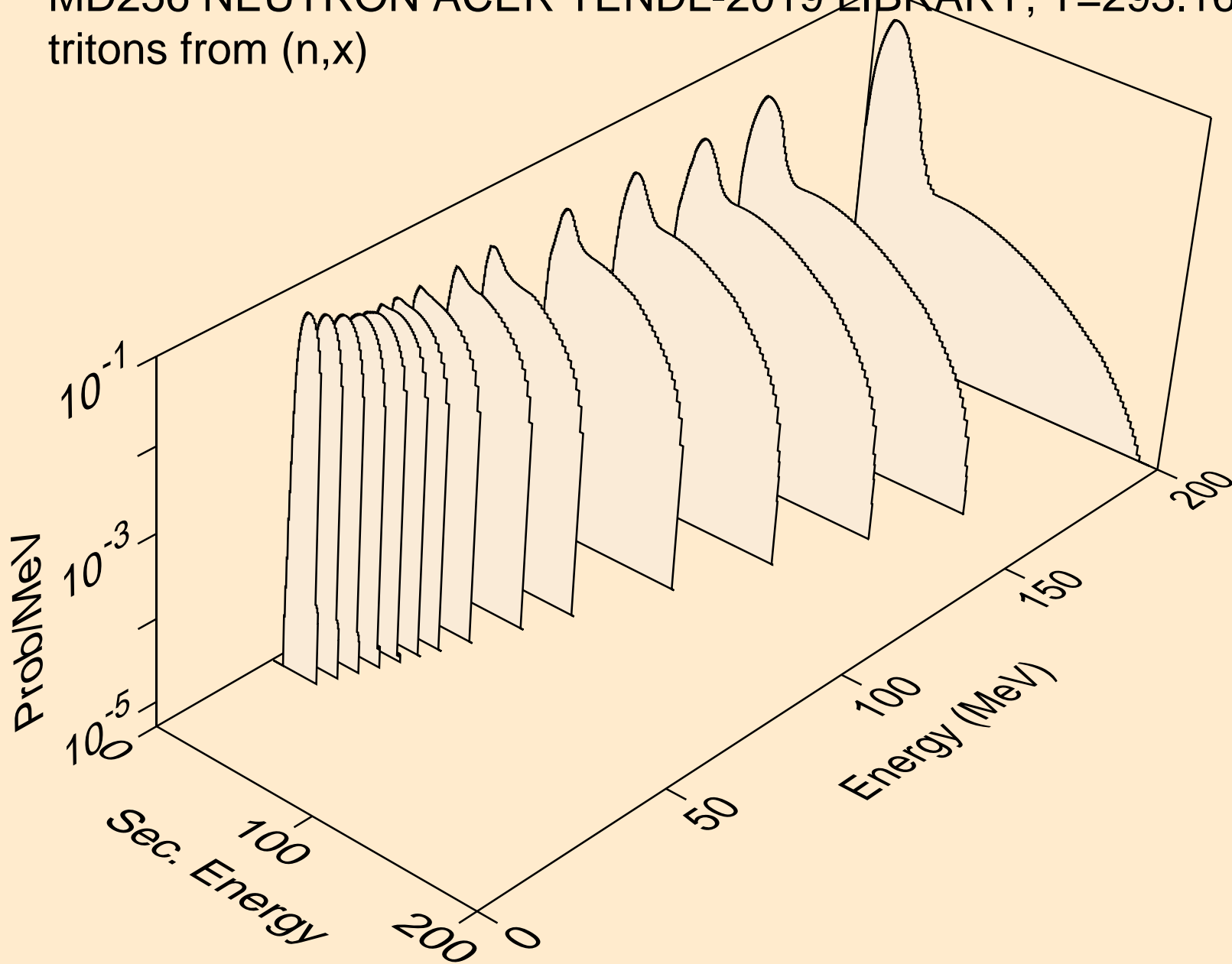

MD256 NEUTRON ACER TENDL-2019 LIBRARY; T=293.16K
tritons from (n,n*)t

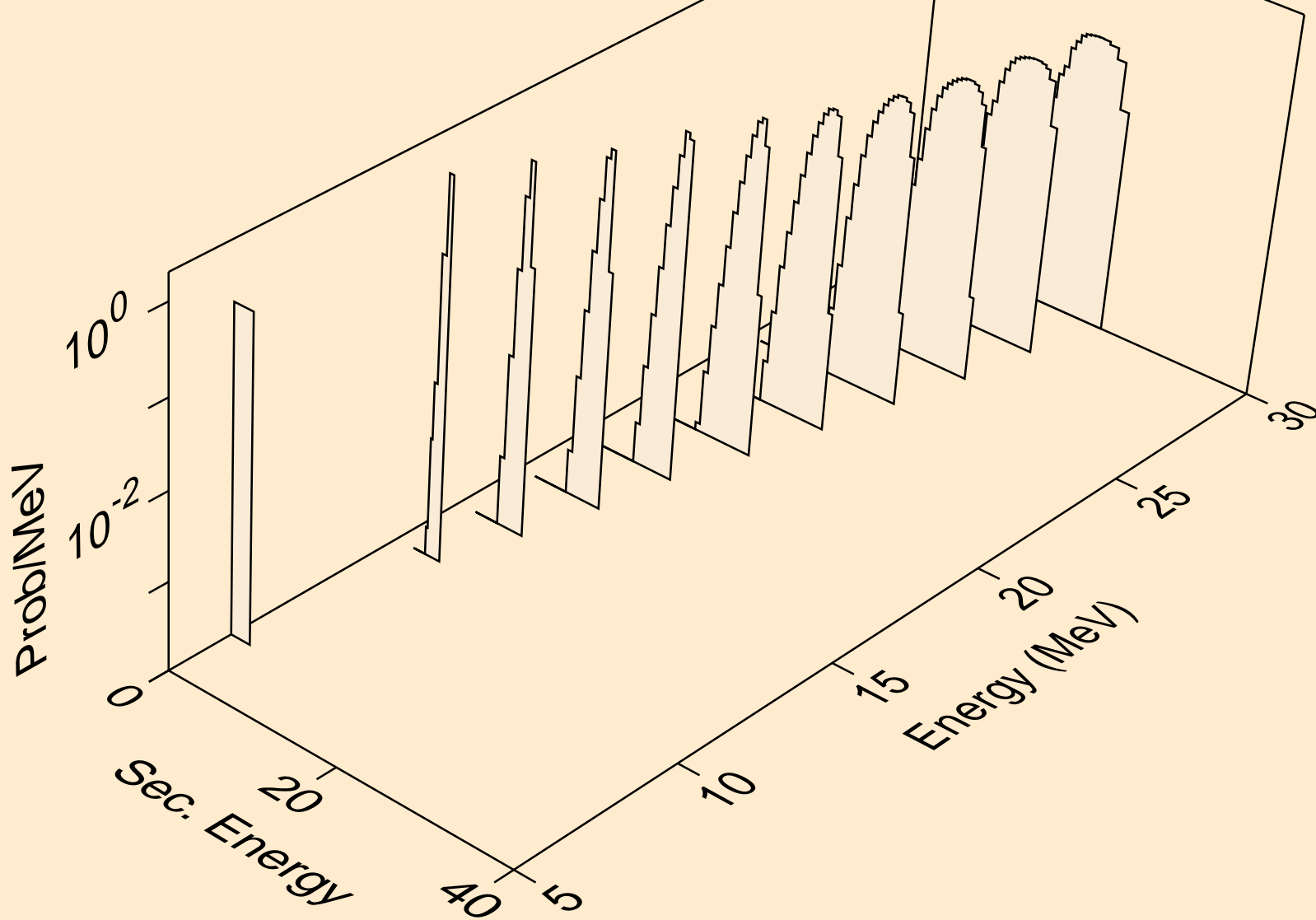

MD256 NEUTRON ACER TENDL-2019 LIBRARY; T=293.16K
tritons from (n,t)

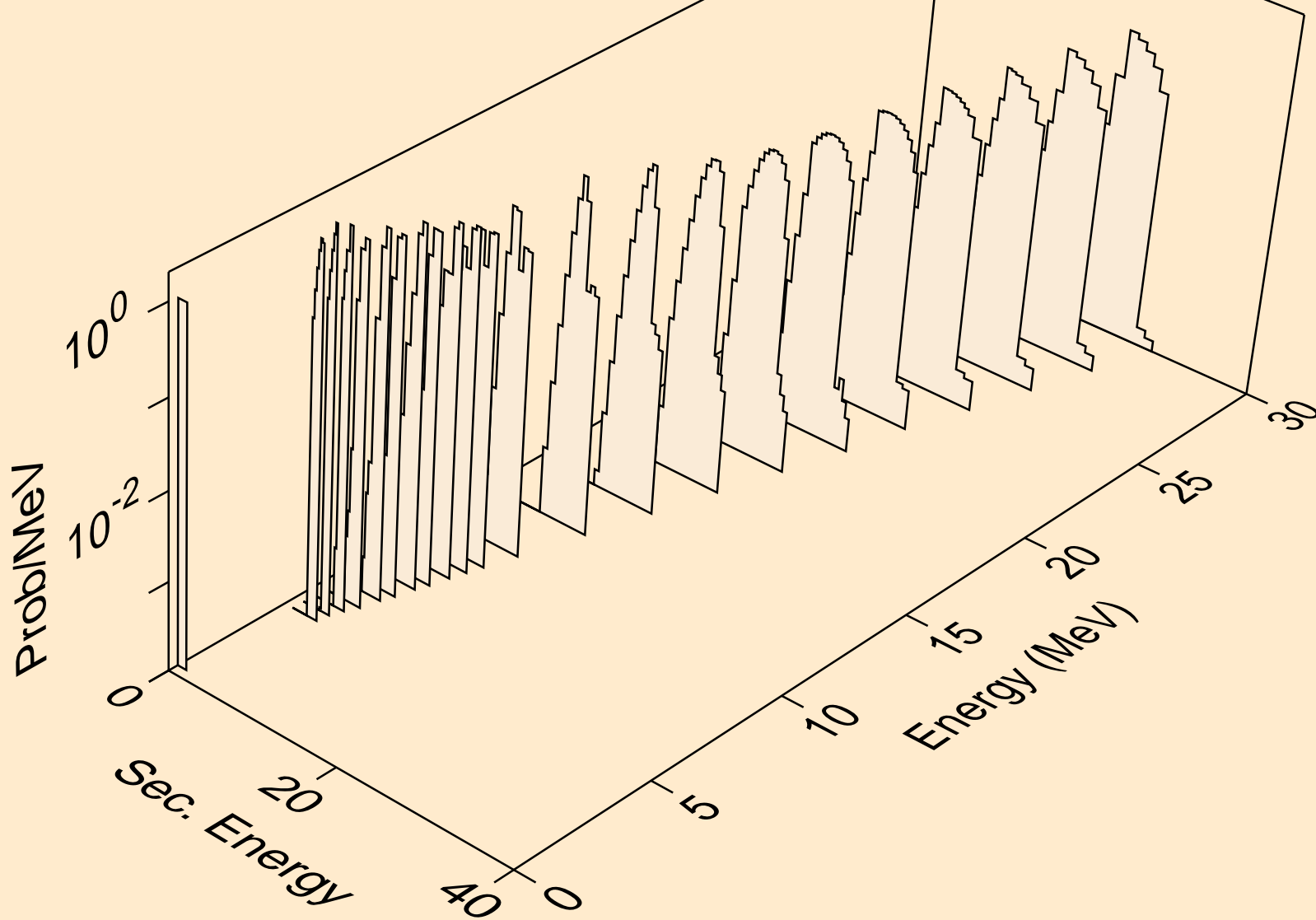

MD256 NEUTRON ACER TENDL-2019 LIBRARY; T=293.16K
he3s from (n,x)

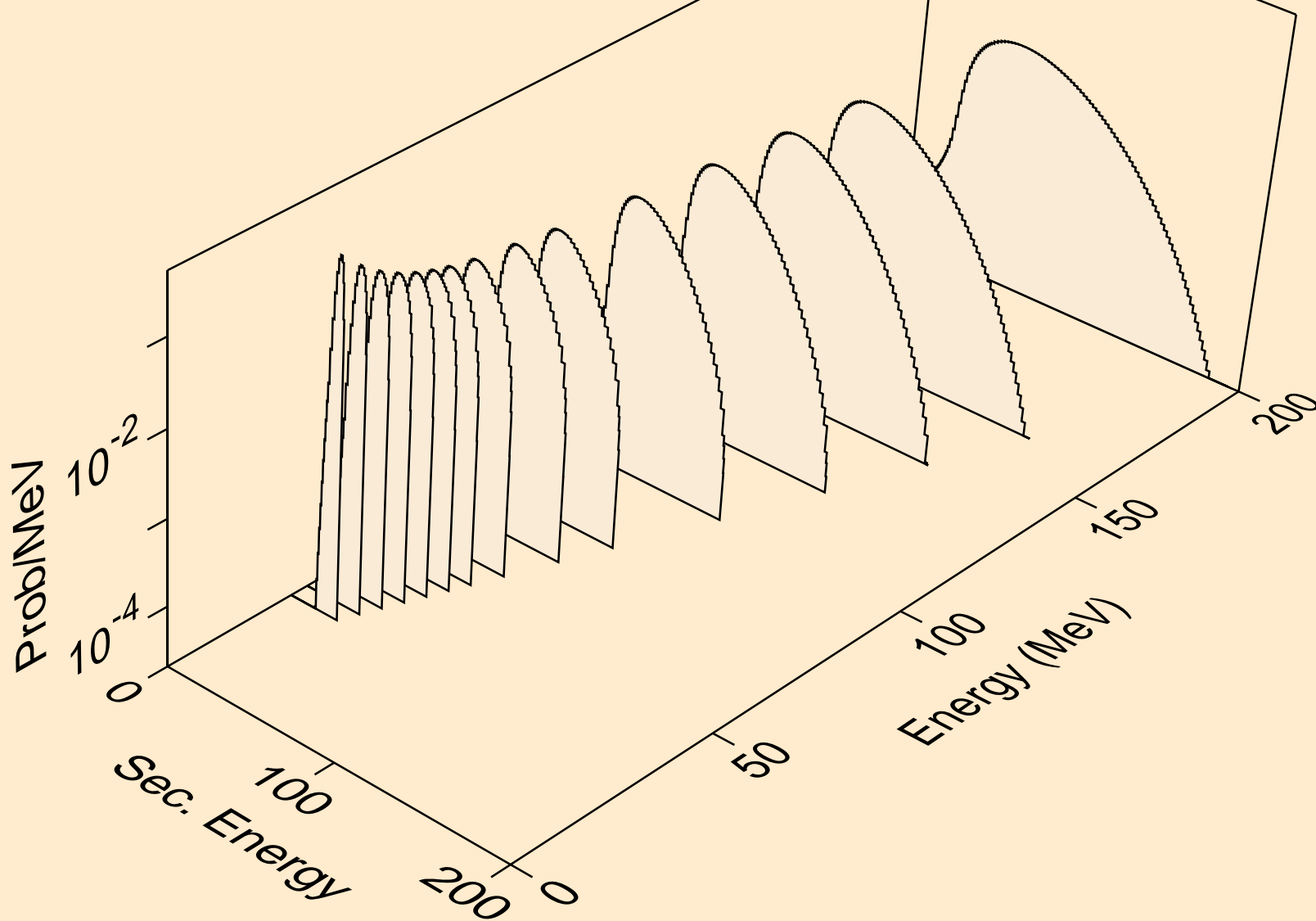

MD256 NEUTRON ACER TENDL-2019 LIBRARY; T=293.16K
he3s from (n,n*)he3

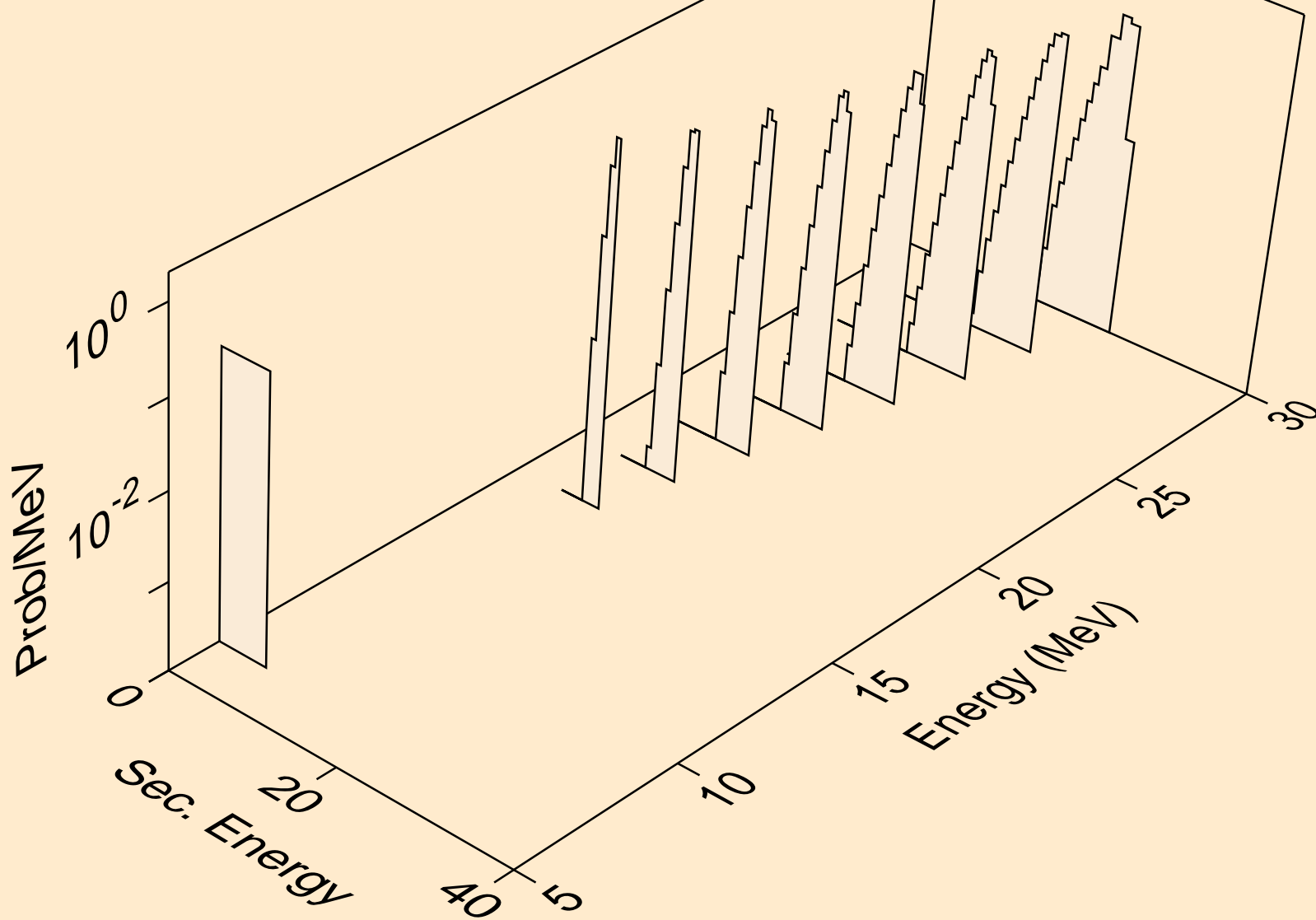

MD256 NEUTRON ACER TENDL-2019 LIBRARY; T=293.16K
he3s from (n,he3)

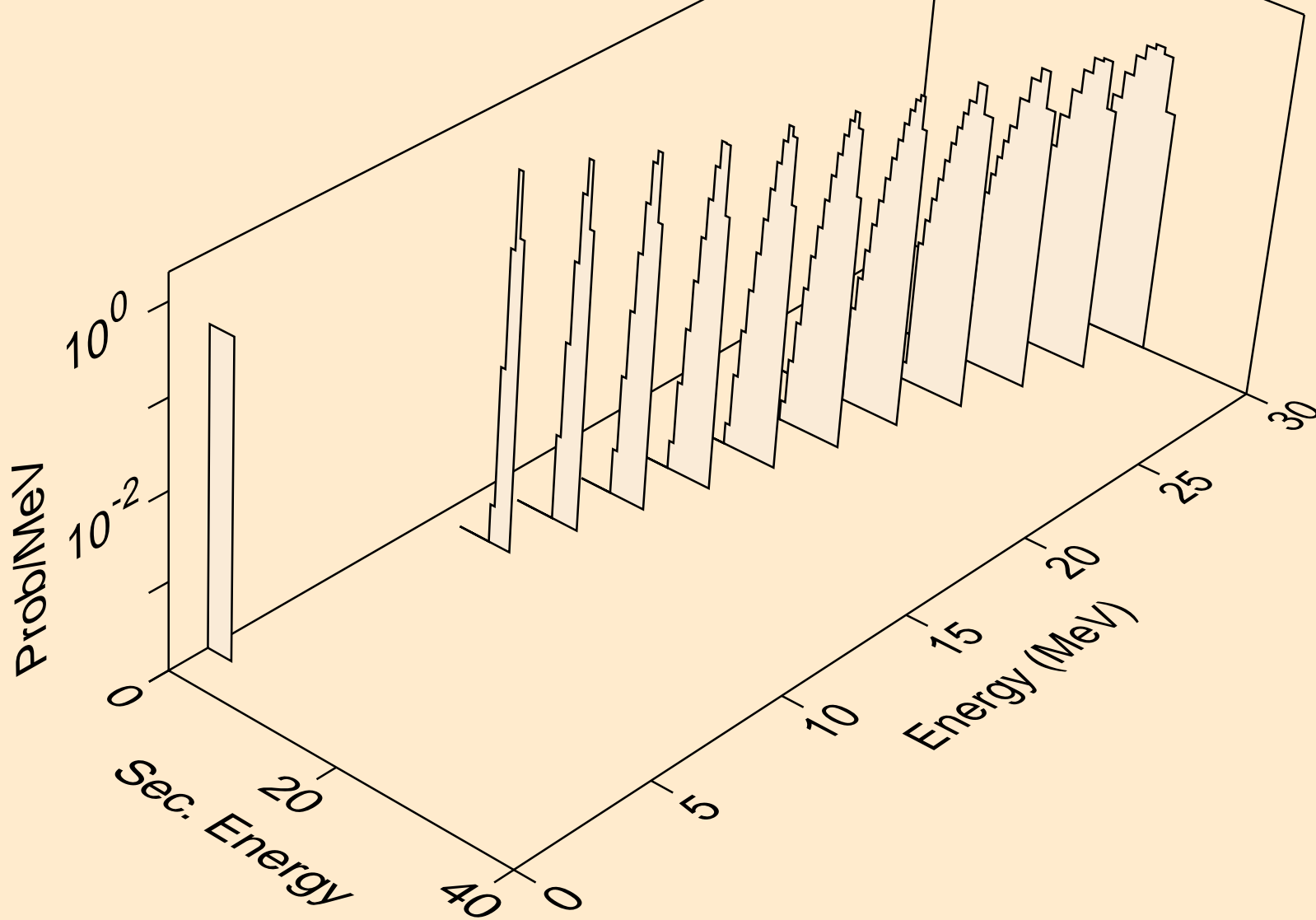

MD256 NEUTRON ACER TENDL-2019 LIBRARY; T=293.16K
alphas from (n,x)

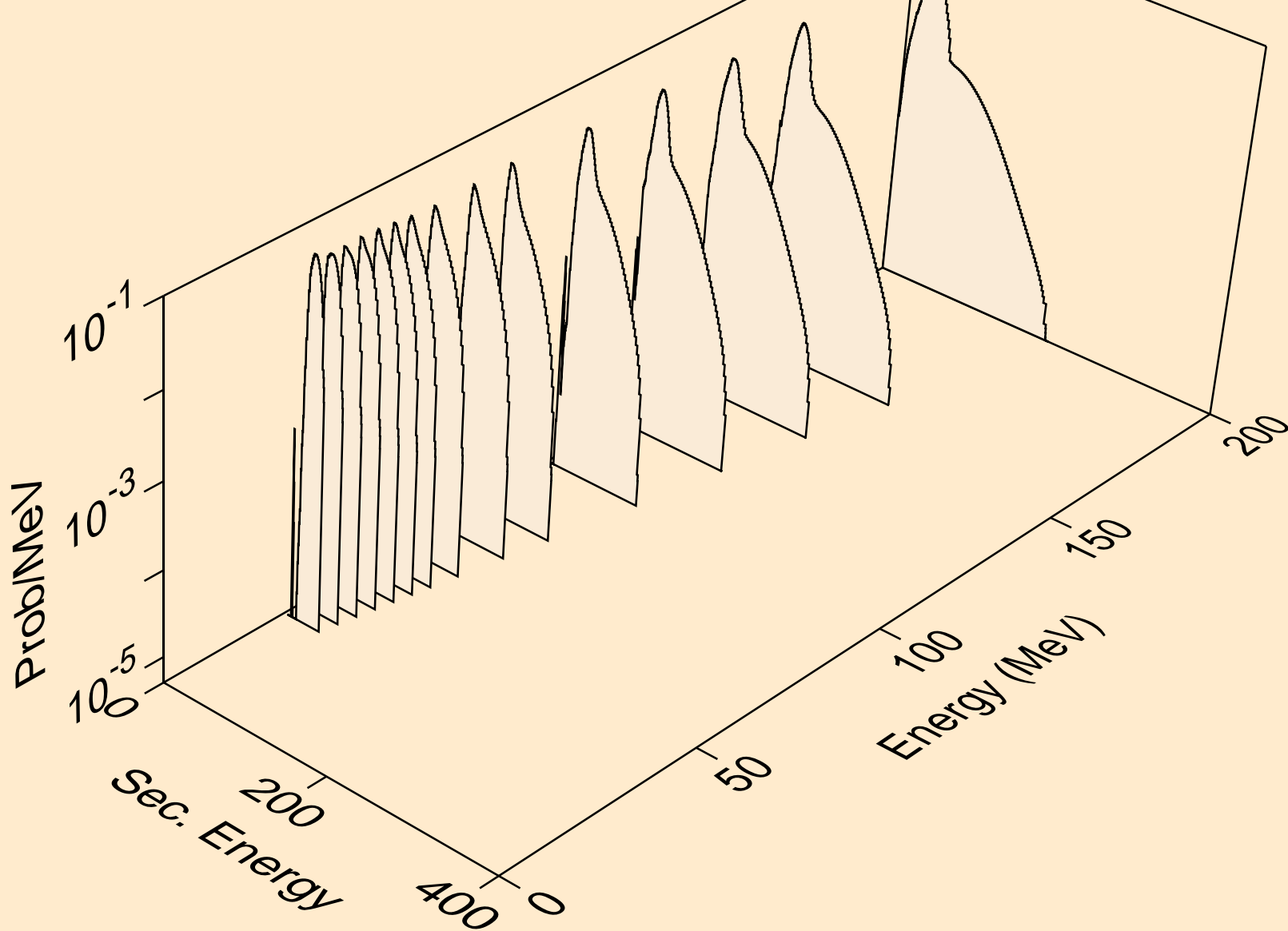

MD256 NEUTRON ACER TENDL-2019 LIBRARY; T=293.16K
alphas from (n,n*)a

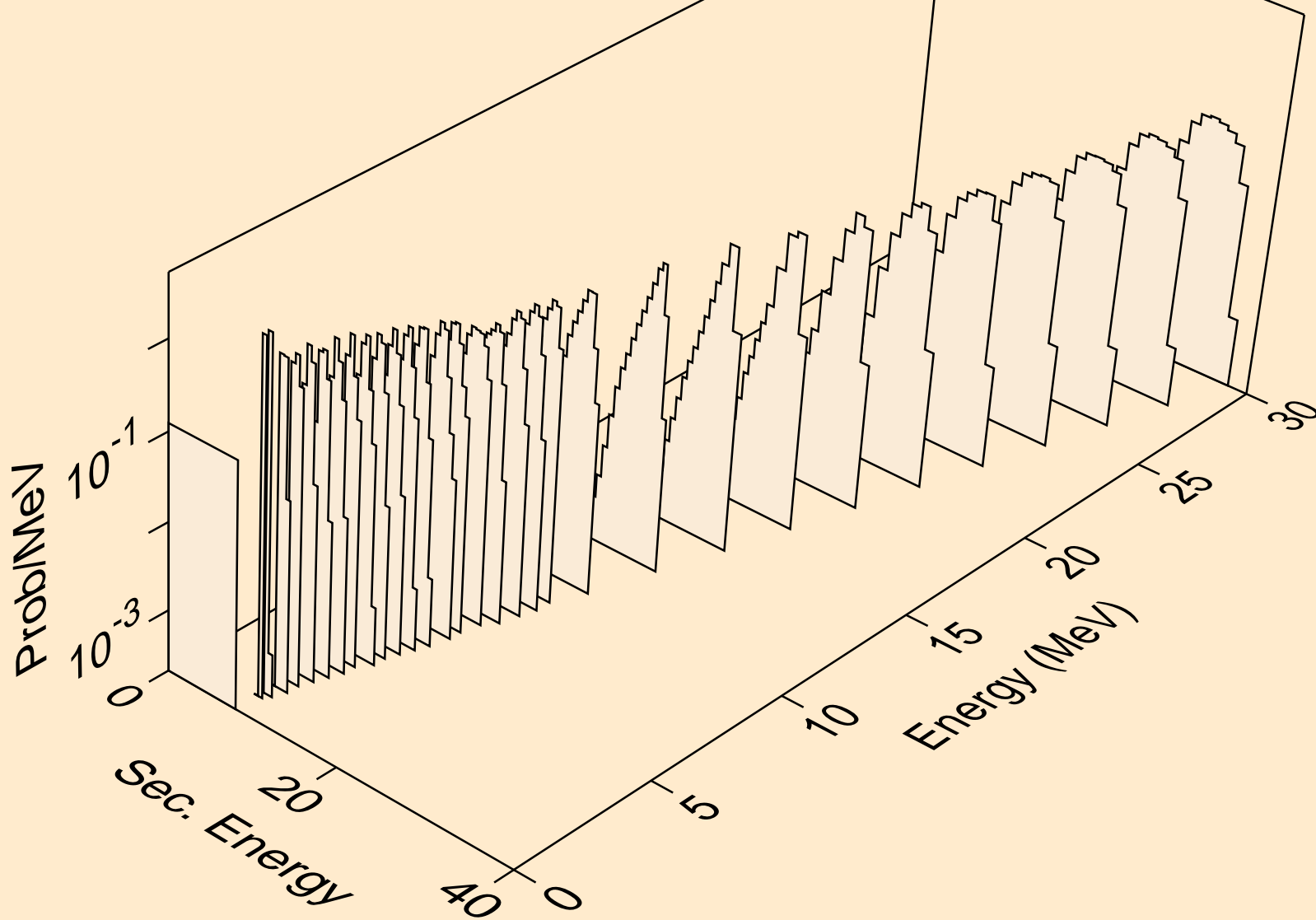

MD256 NEUTRON ACER TENDL-2019 LIBRARY; T=293.16K
alphas from (n,2n)a

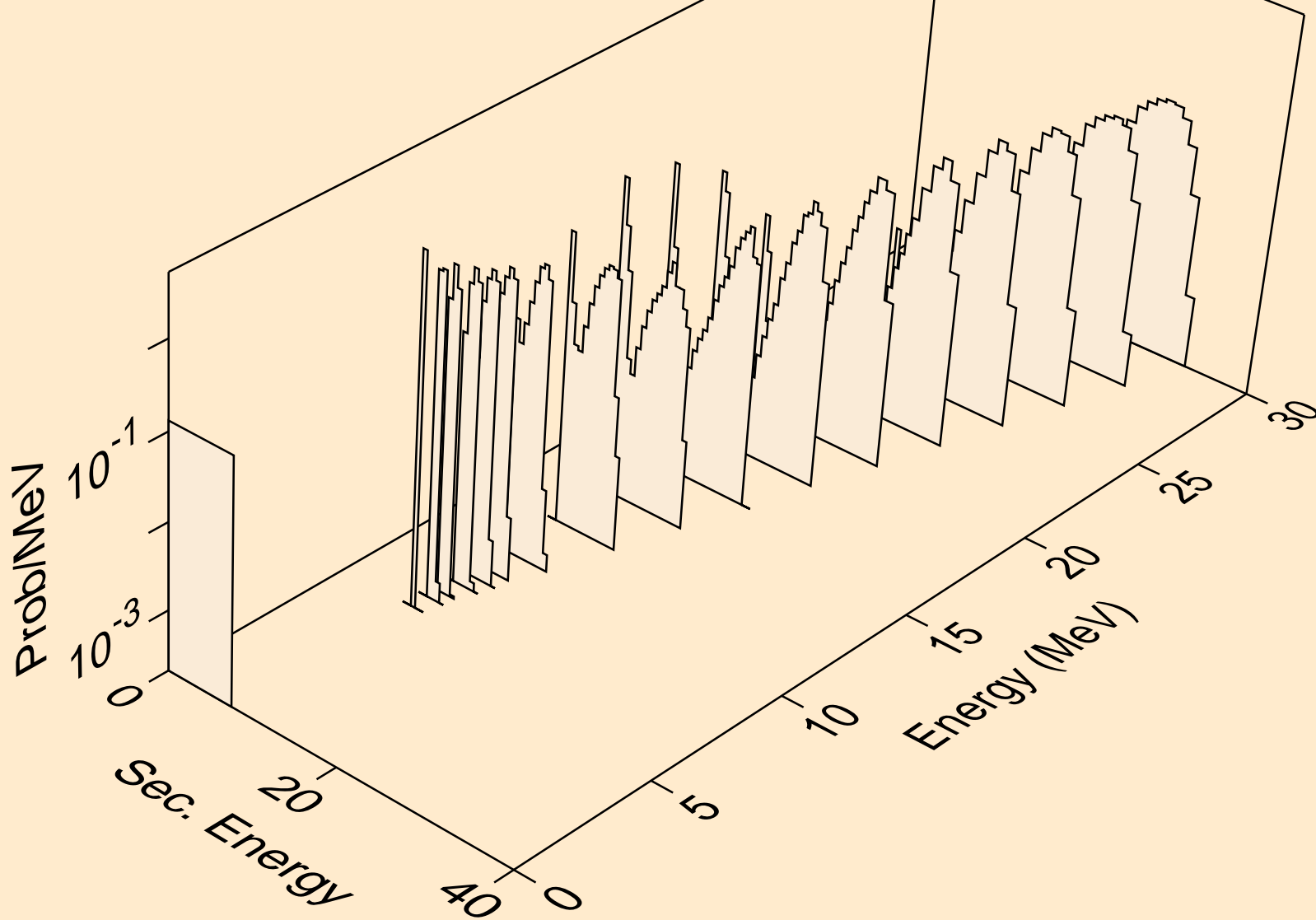

MD256 NEUTRON ACER TENDL-2019 LIBRARY; T=293.16K
alphas from (n,3n)a

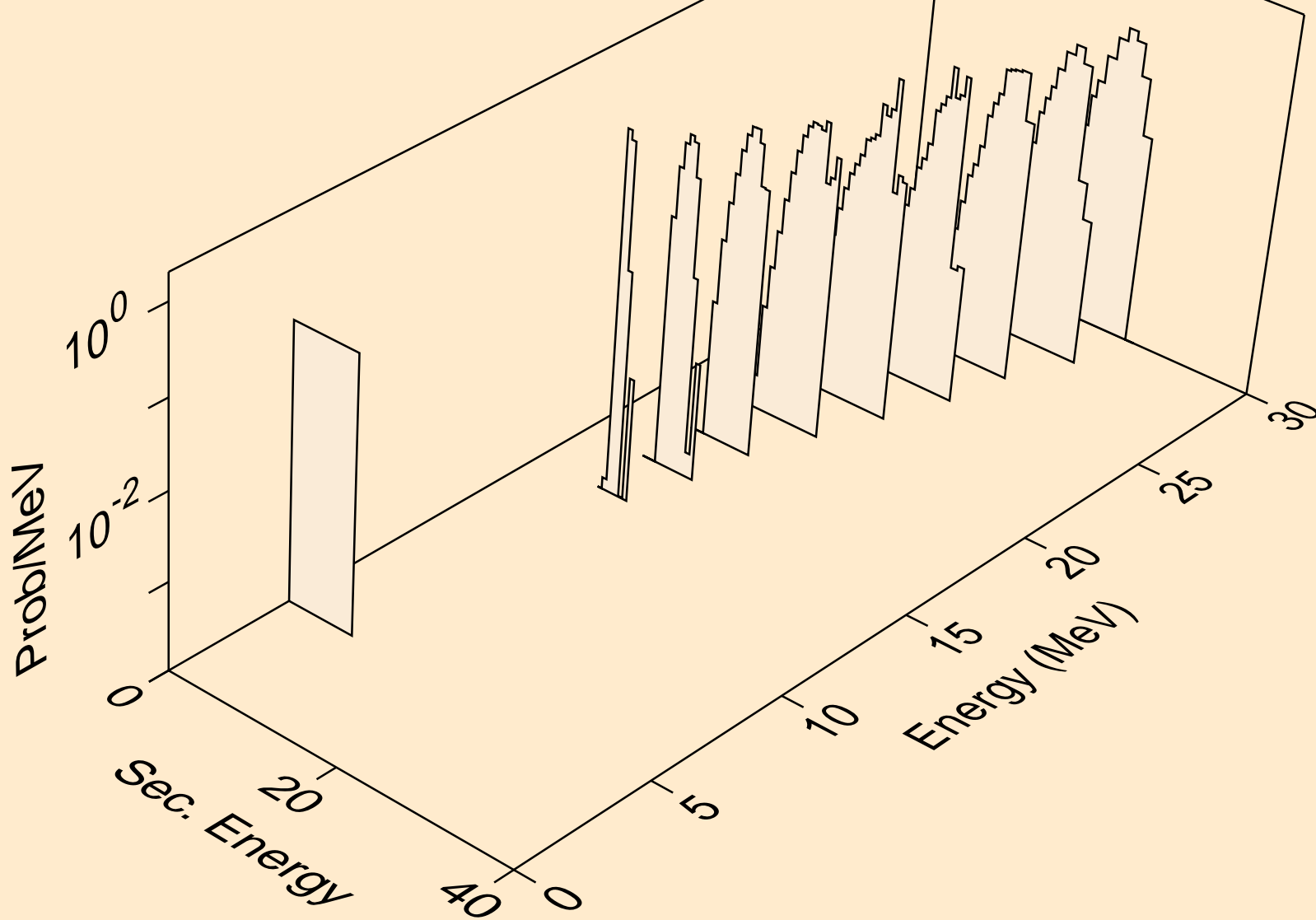

MD256 NEUTRON ACER TENDL-2019 LIBRARY; T=293.16K
alphas from (n,n*)2a

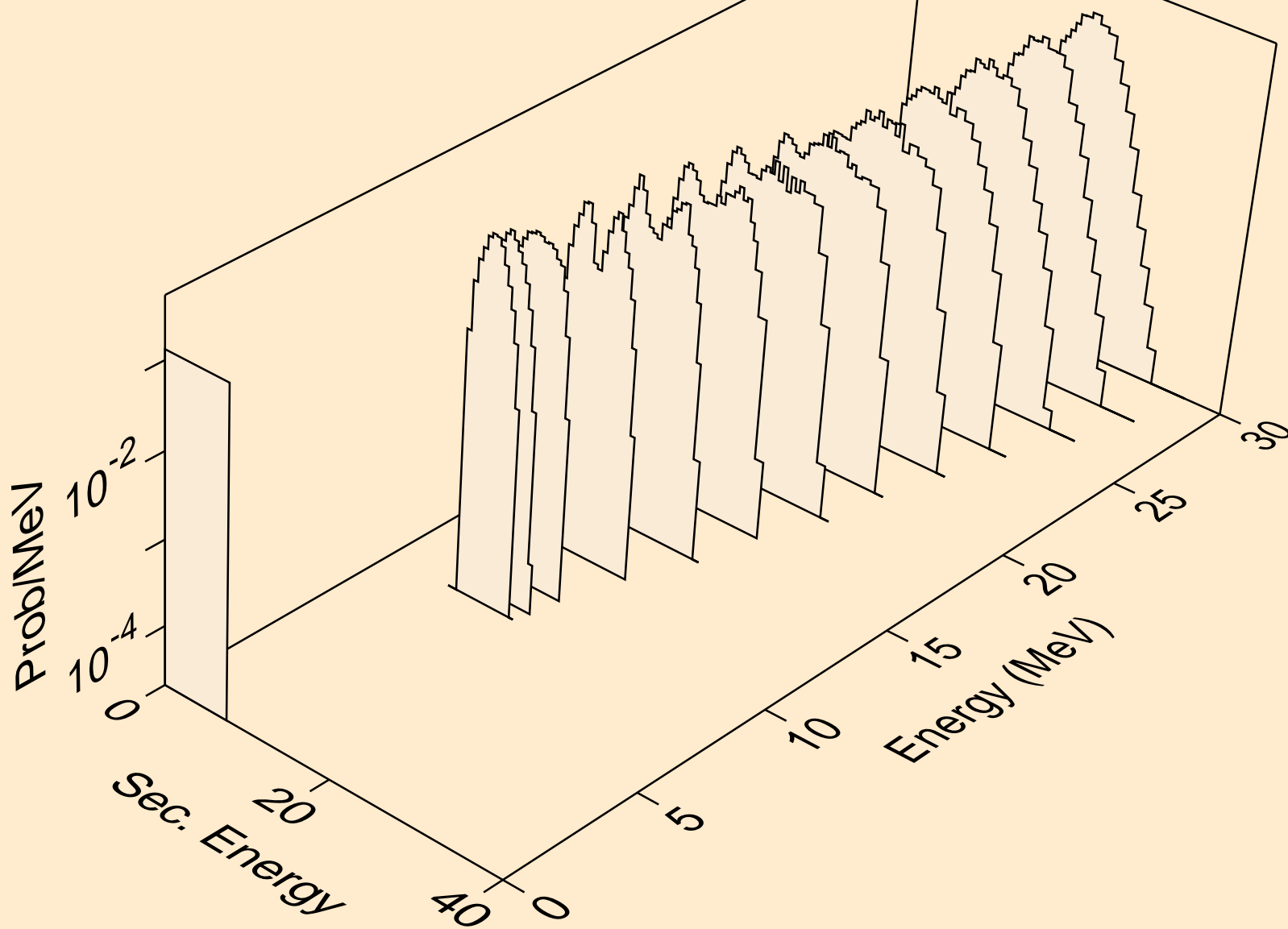

MD256 NEUTRON ACER TENDL-2019 LIBRARY; T=293.16K
alphas from (n,npa)

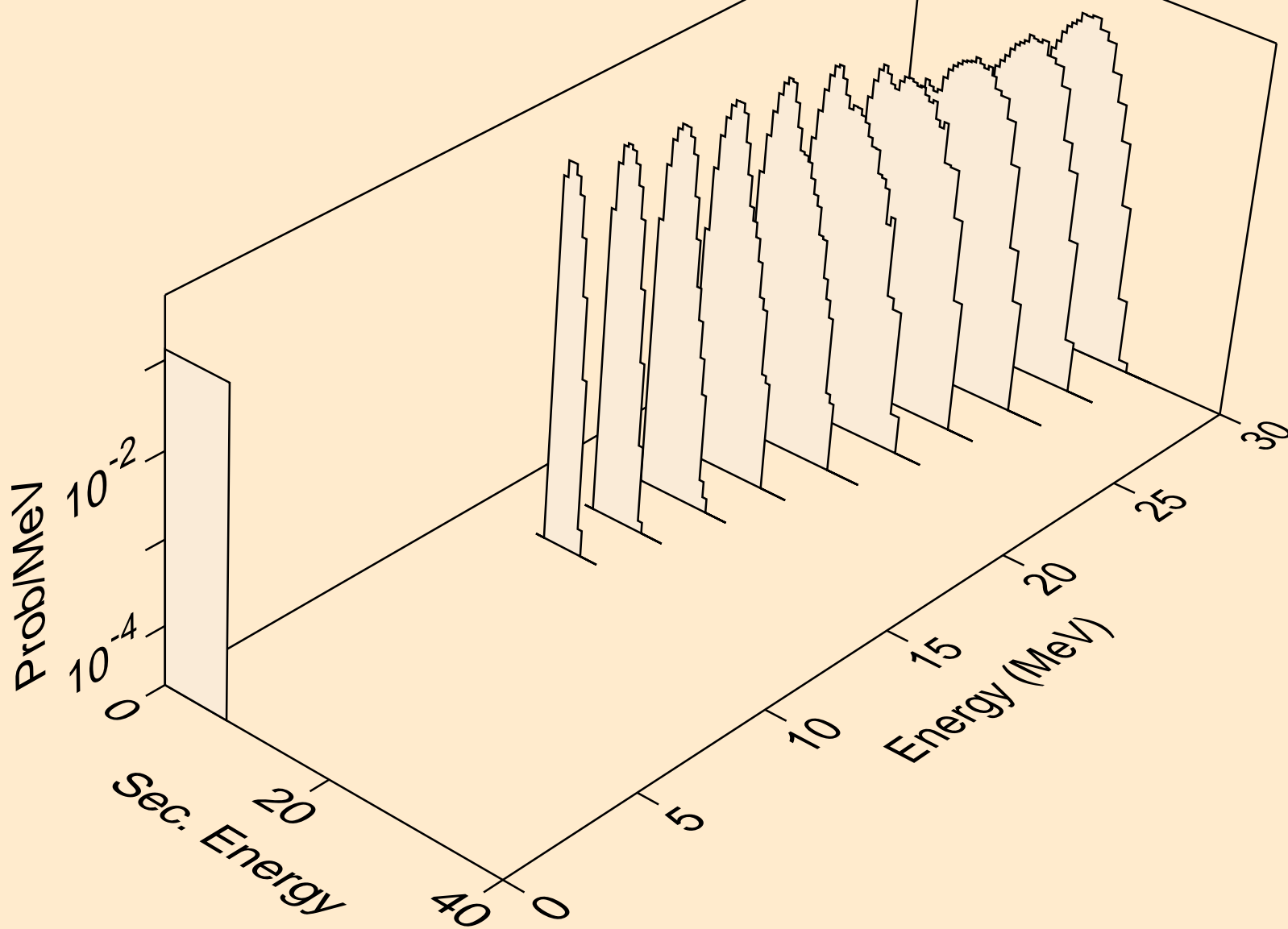

MD256 NEUTRON ACER TENDL-2019 LIBRARY; T=293.16K
alphas from (n,a)

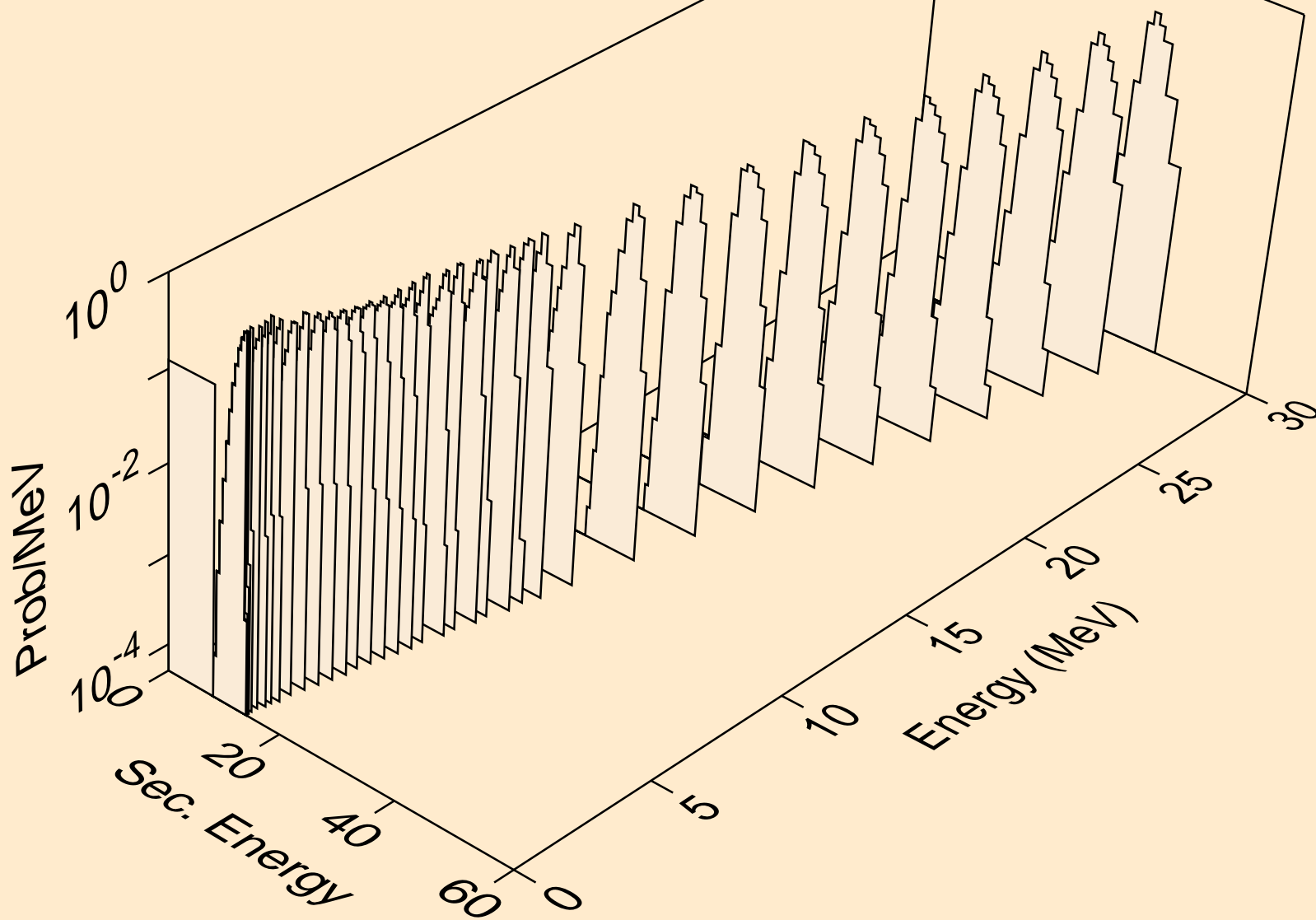

MD256 NEUTRON ACER TENDL-2019 LIBRARY; T=293.16K
alphas from (n,2a)

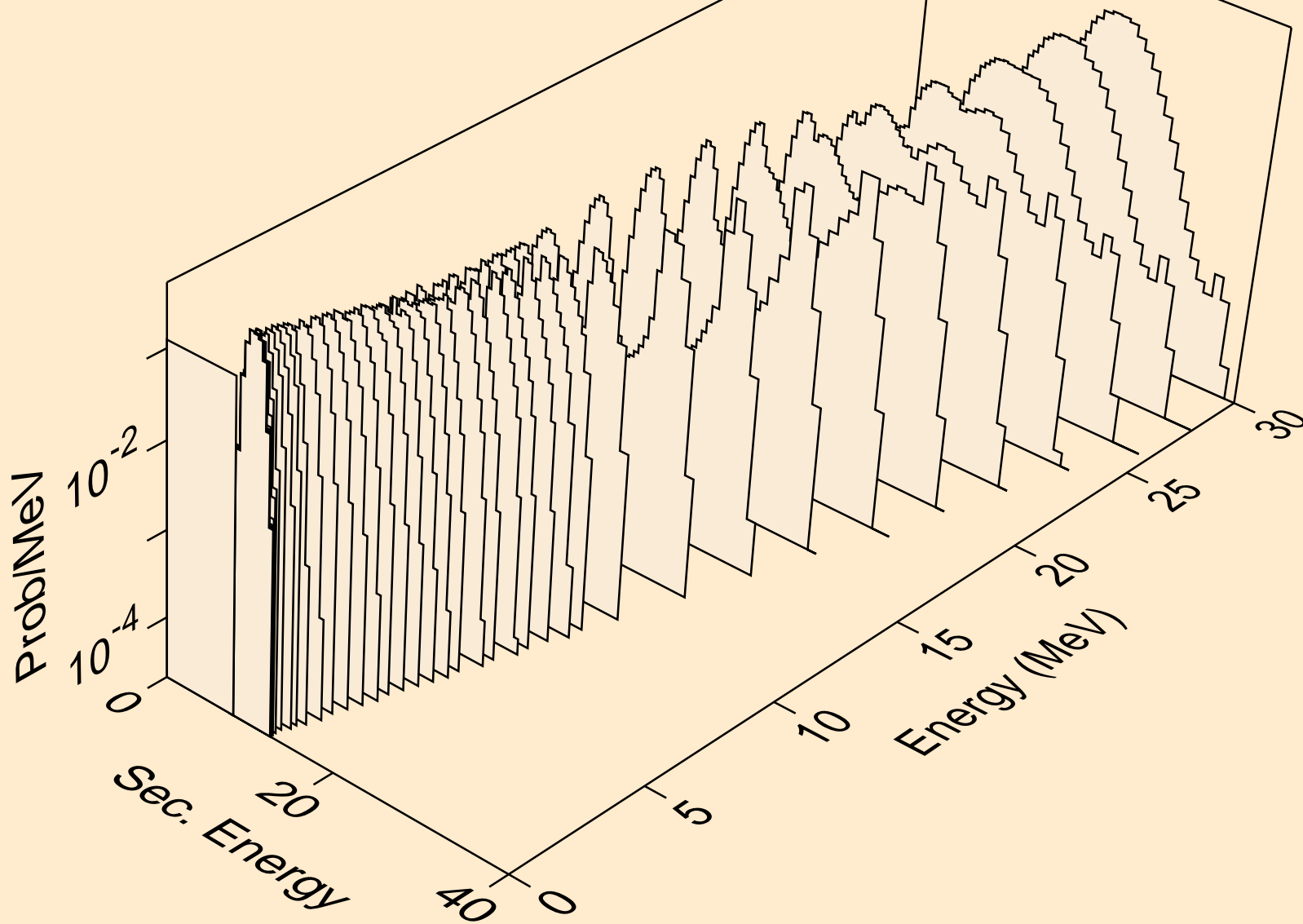

MD256 NEUTRON ACER TENDL-2019 LIBRARY; T=293.16K
alphas from (n,da)

