

MD257 NEUTRON ACER TENDL-2019 LIBRARY; T=293.16K  
Principal cross sections

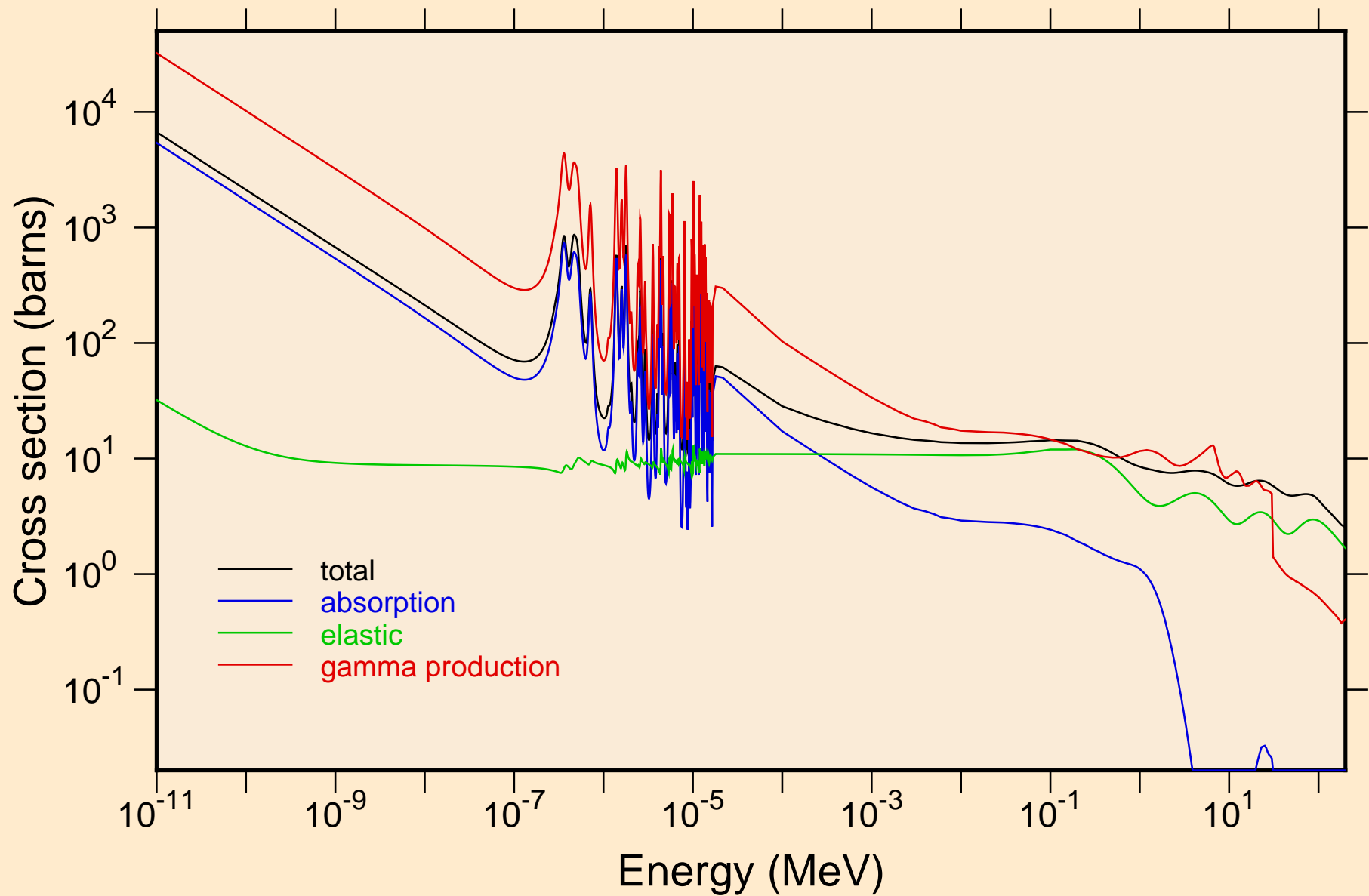

MD257 NEUTRON ACER TENDL-2019 LIBRARY; T=293.16K  
resonance total cross section

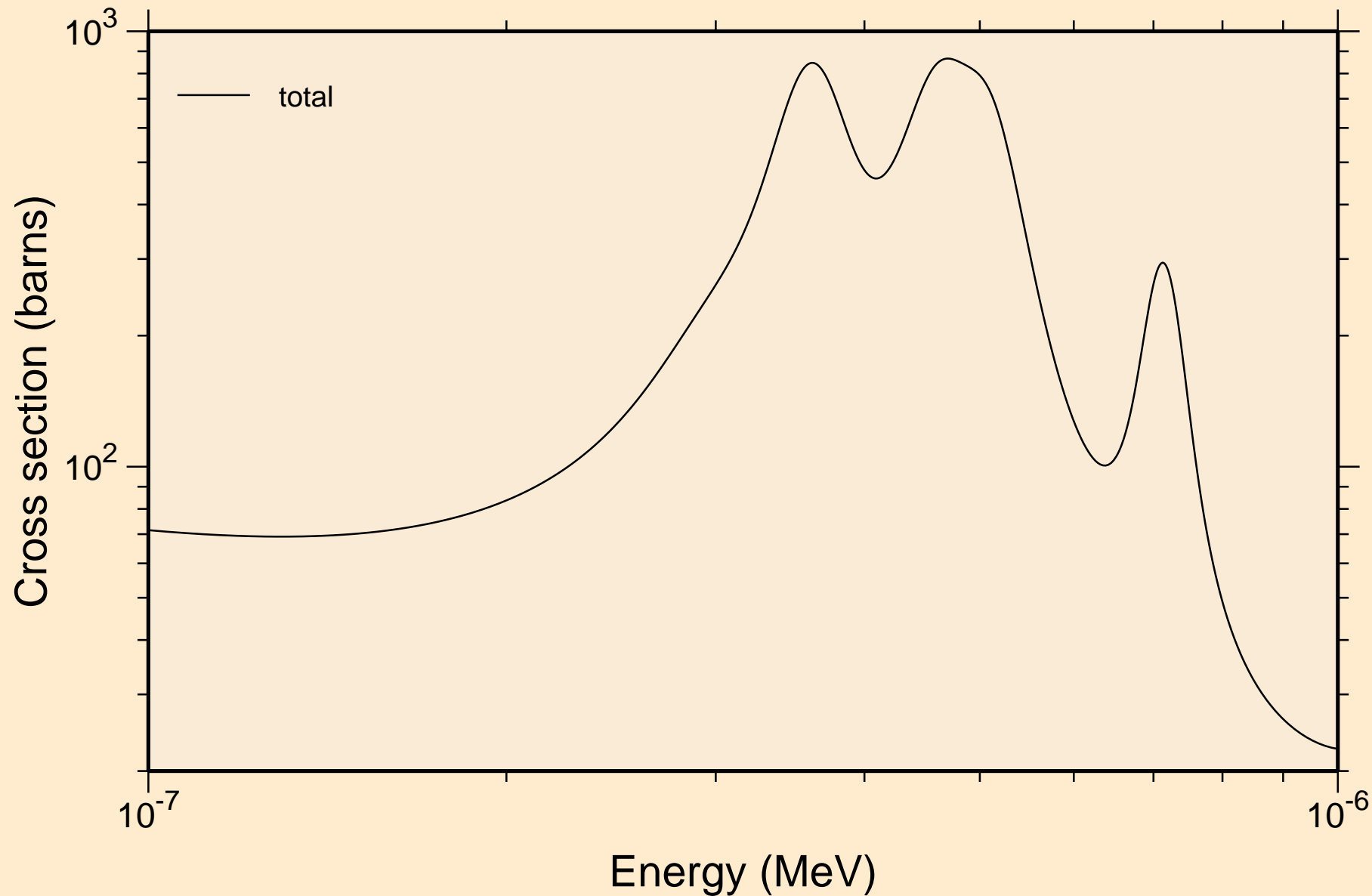

MD257 NEUTRON ACER TENDL-2019 LIBRARY; T=293.16K  
resonance total cross section

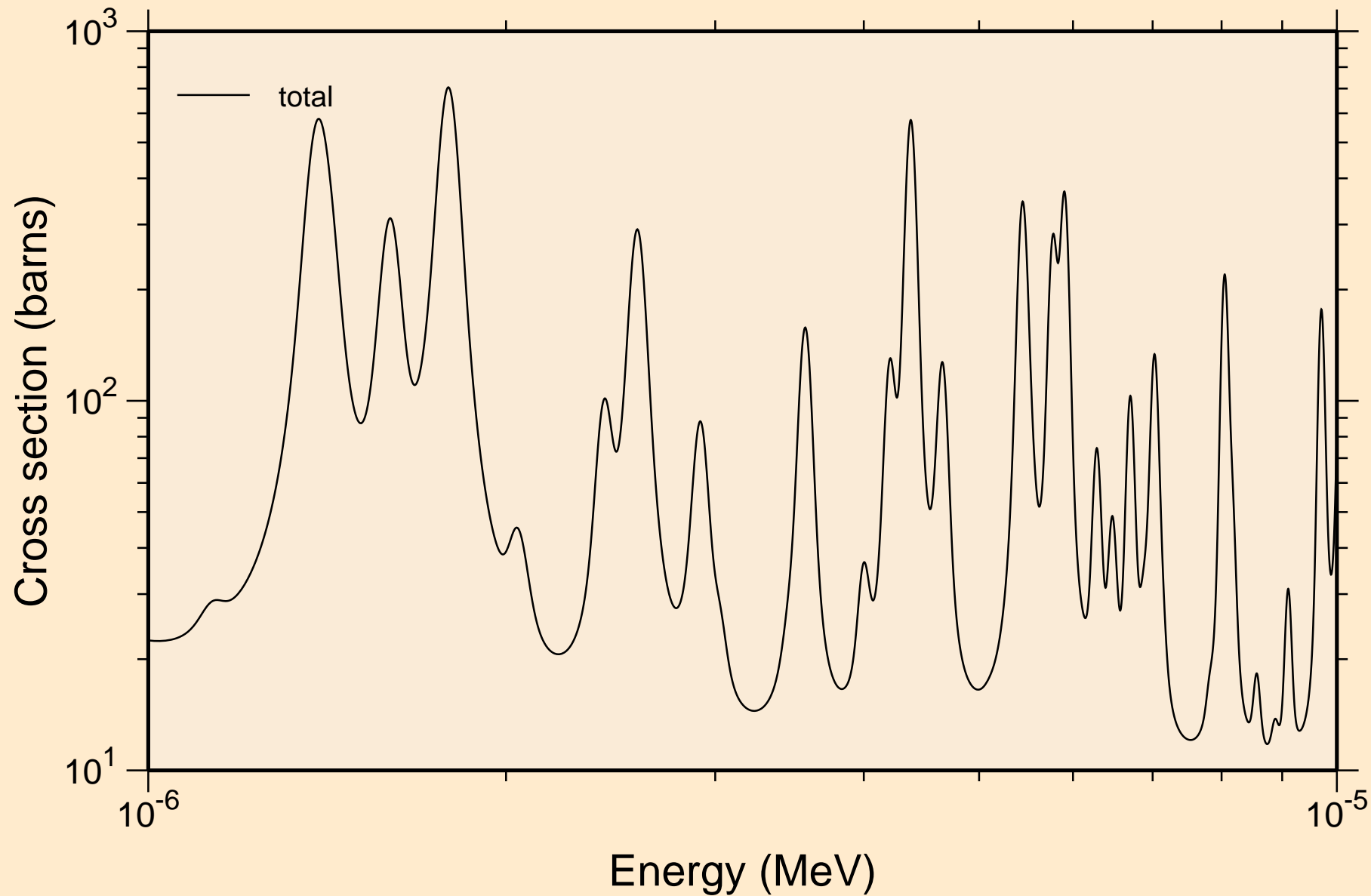

MD257 NEUTRON ACER TENDL-2019 LIBRARY; T=293.16K  
resonance total cross section

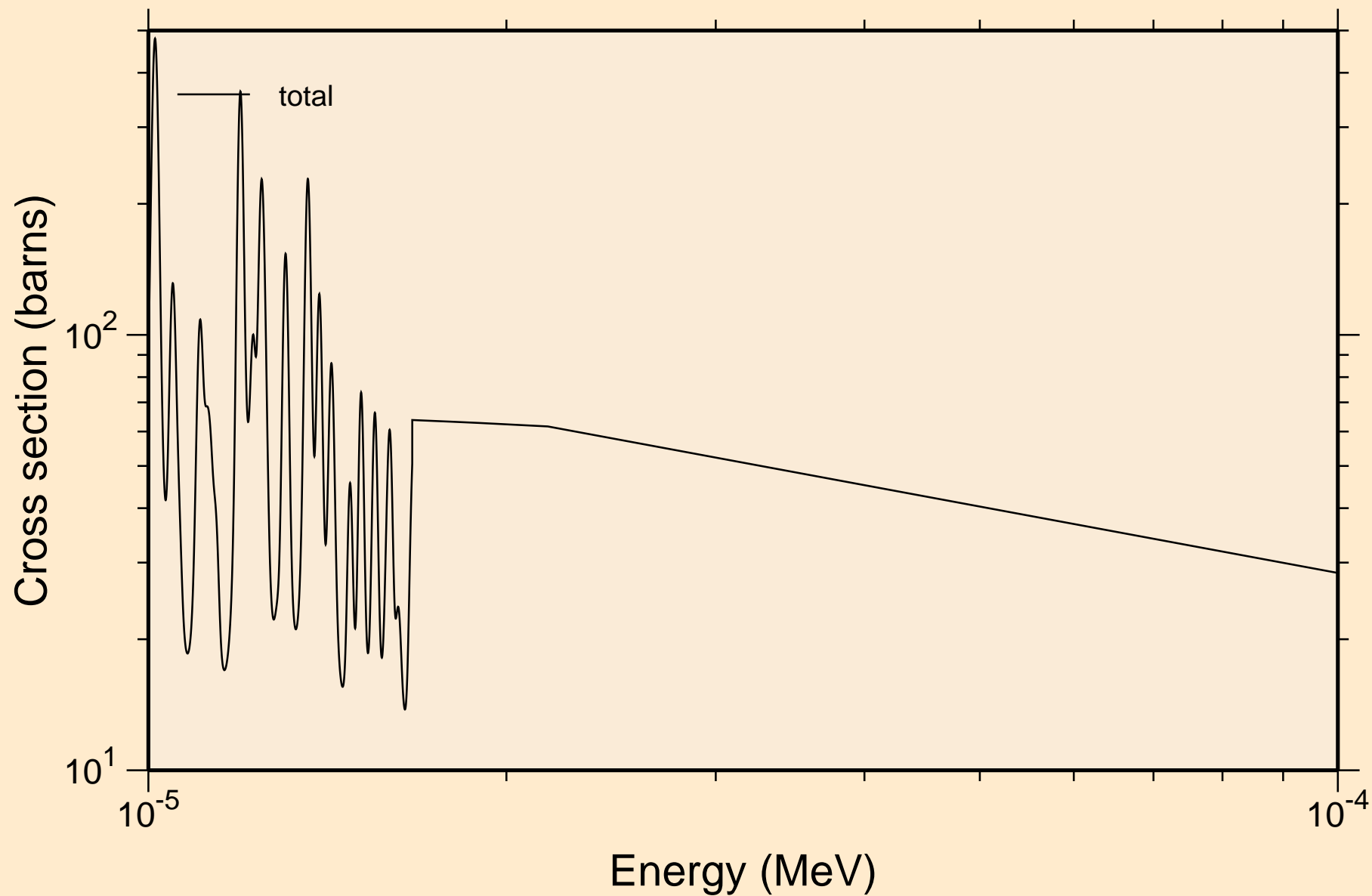

MD257 NEUTRON ACER TENDL-2019 LIBRARY; T=293.16K  
resonance total cross section

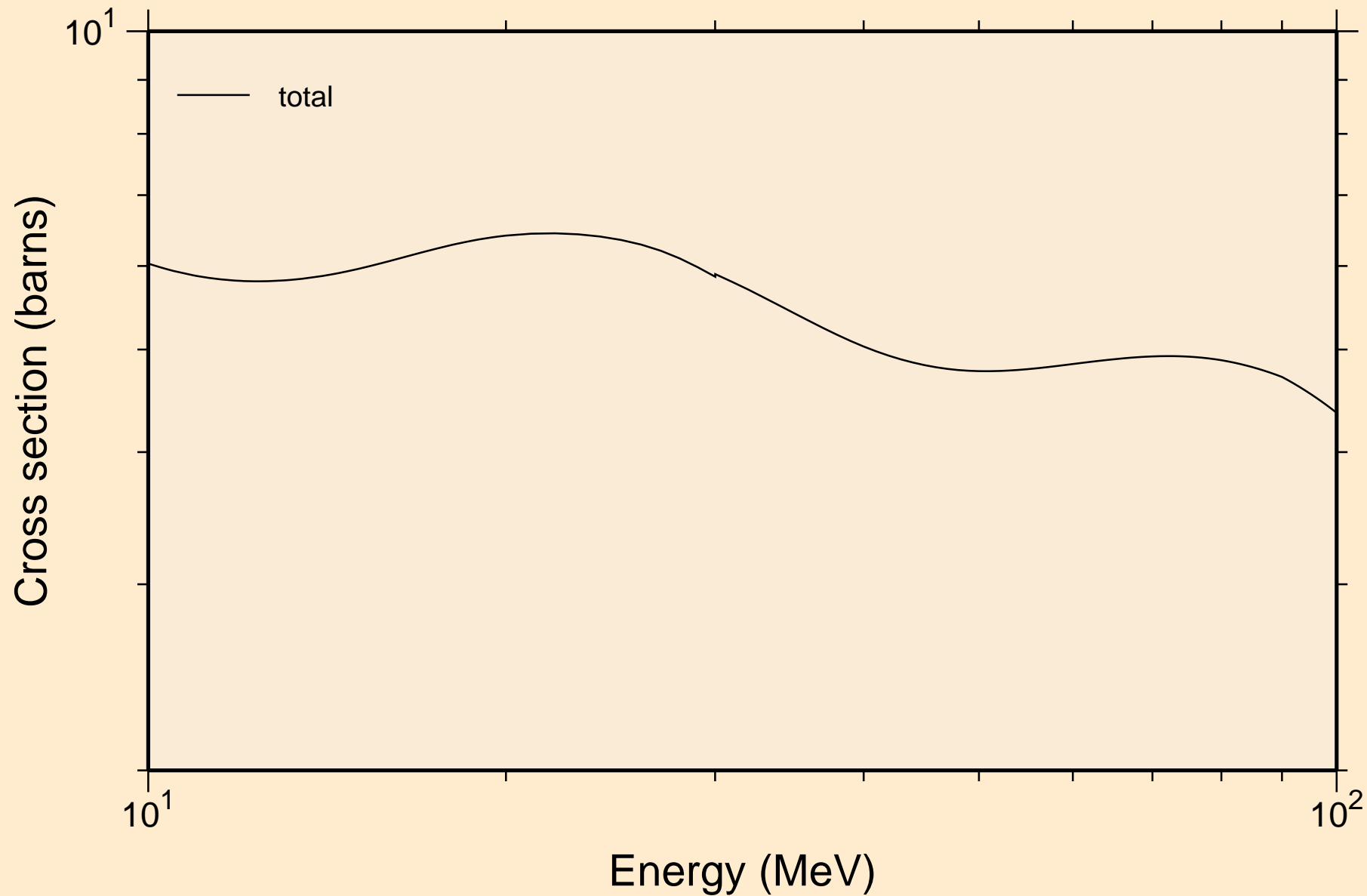

MD257 NEUTRON ACER TENDL-2019 LIBRARY; T=293.16K  
resonance absorption cross sections

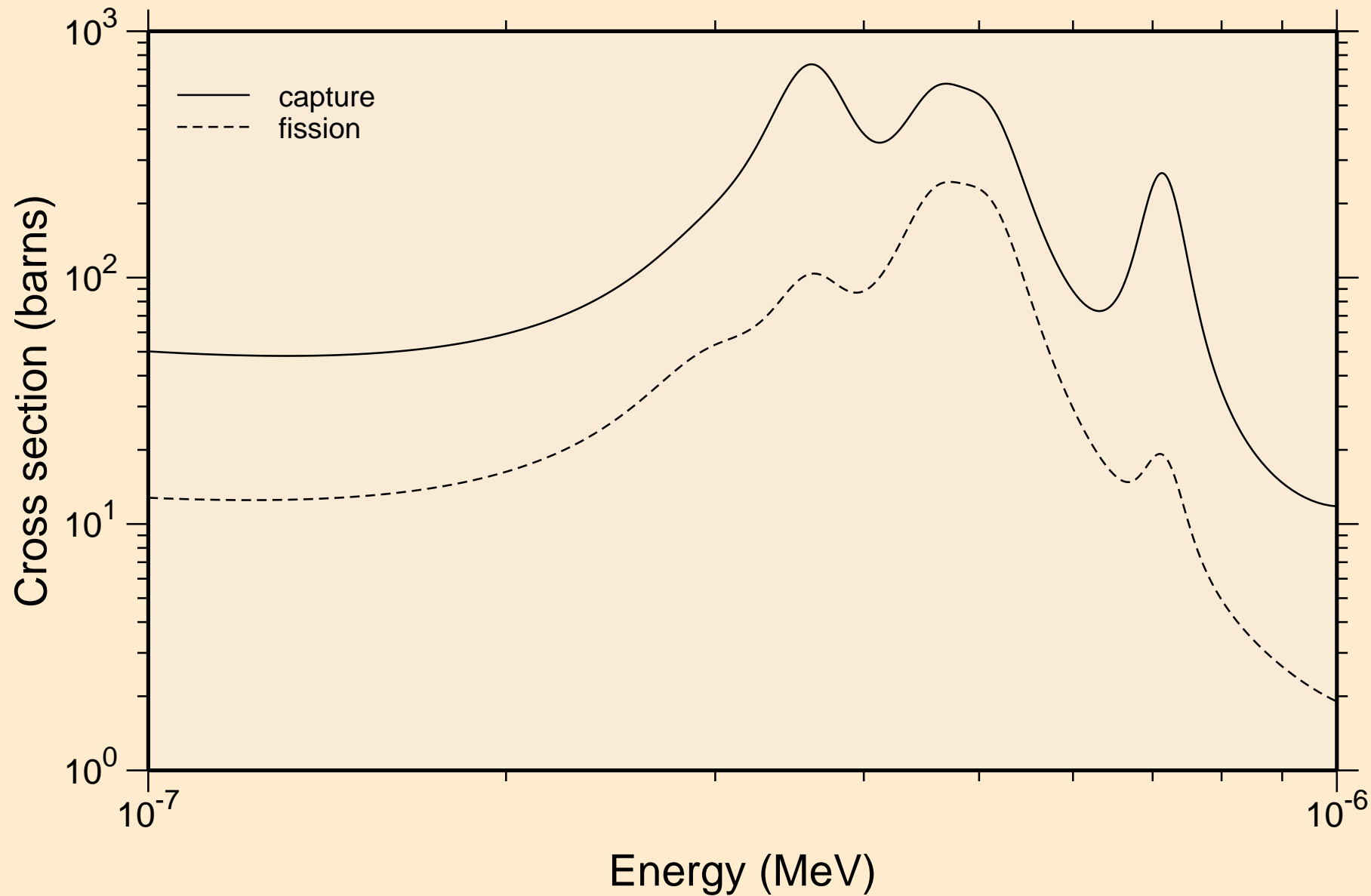

MD257 NEUTRON ACER TENDL-2019 LIBRARY; T=293.16K  
resonance absorption cross sections

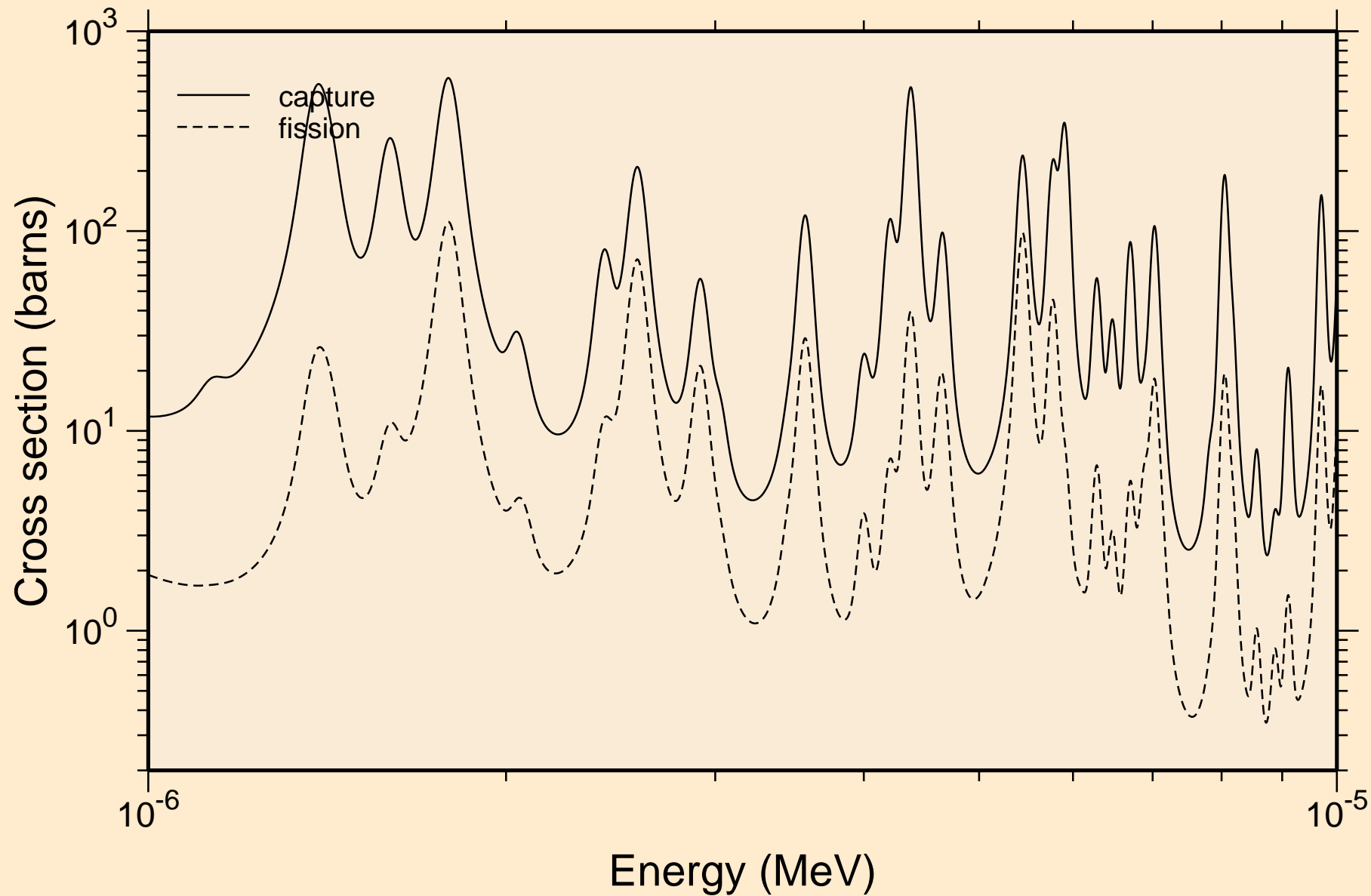

MD257 NEUTRON ACER TENDL-2019 LIBRARY; T=293.16K  
resonance absorption cross sections

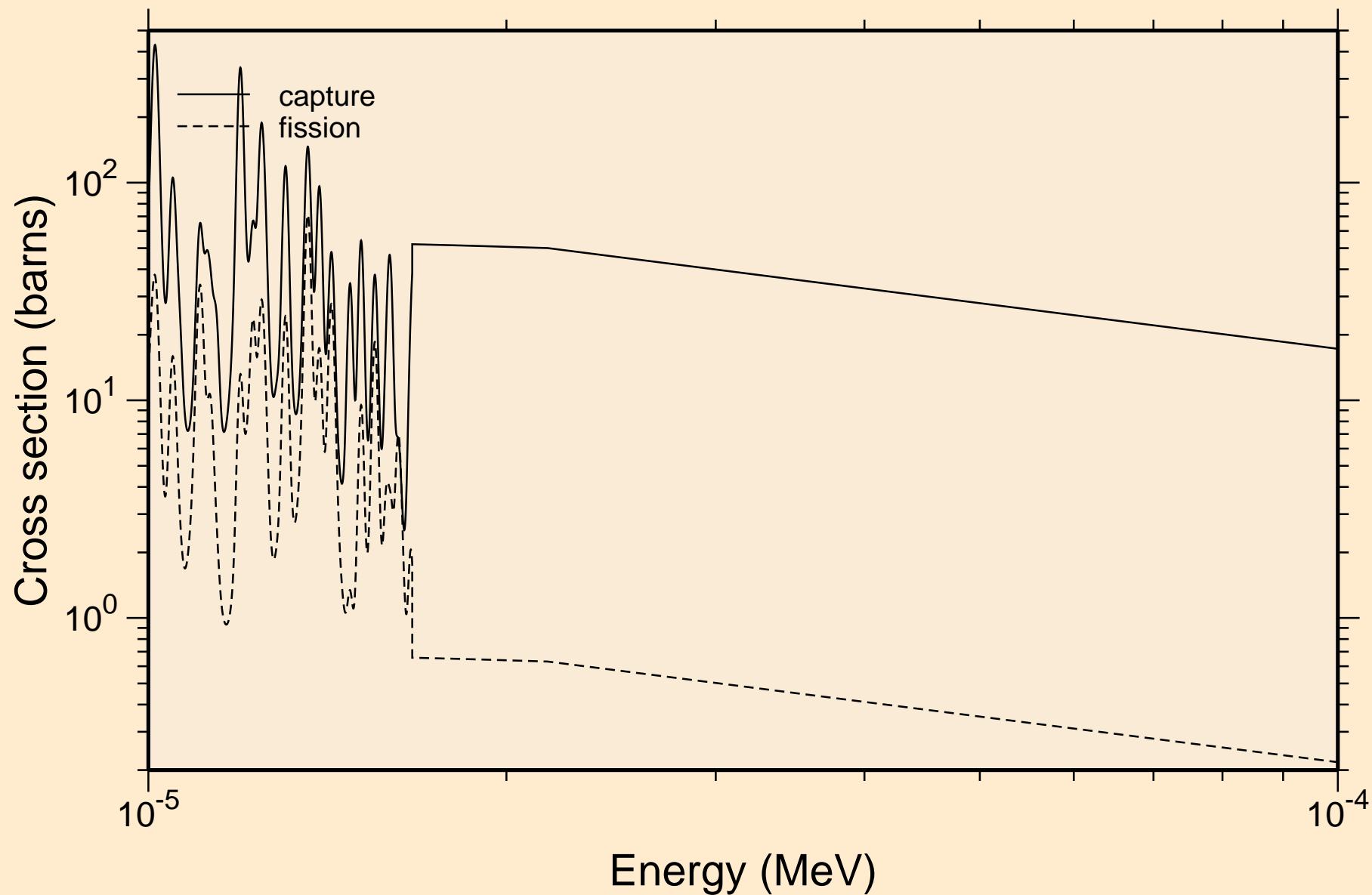



MD257 NEUTRON ACER TENDL-2019 LIBRARY; T=293.16K  
resonance absorption cross sections

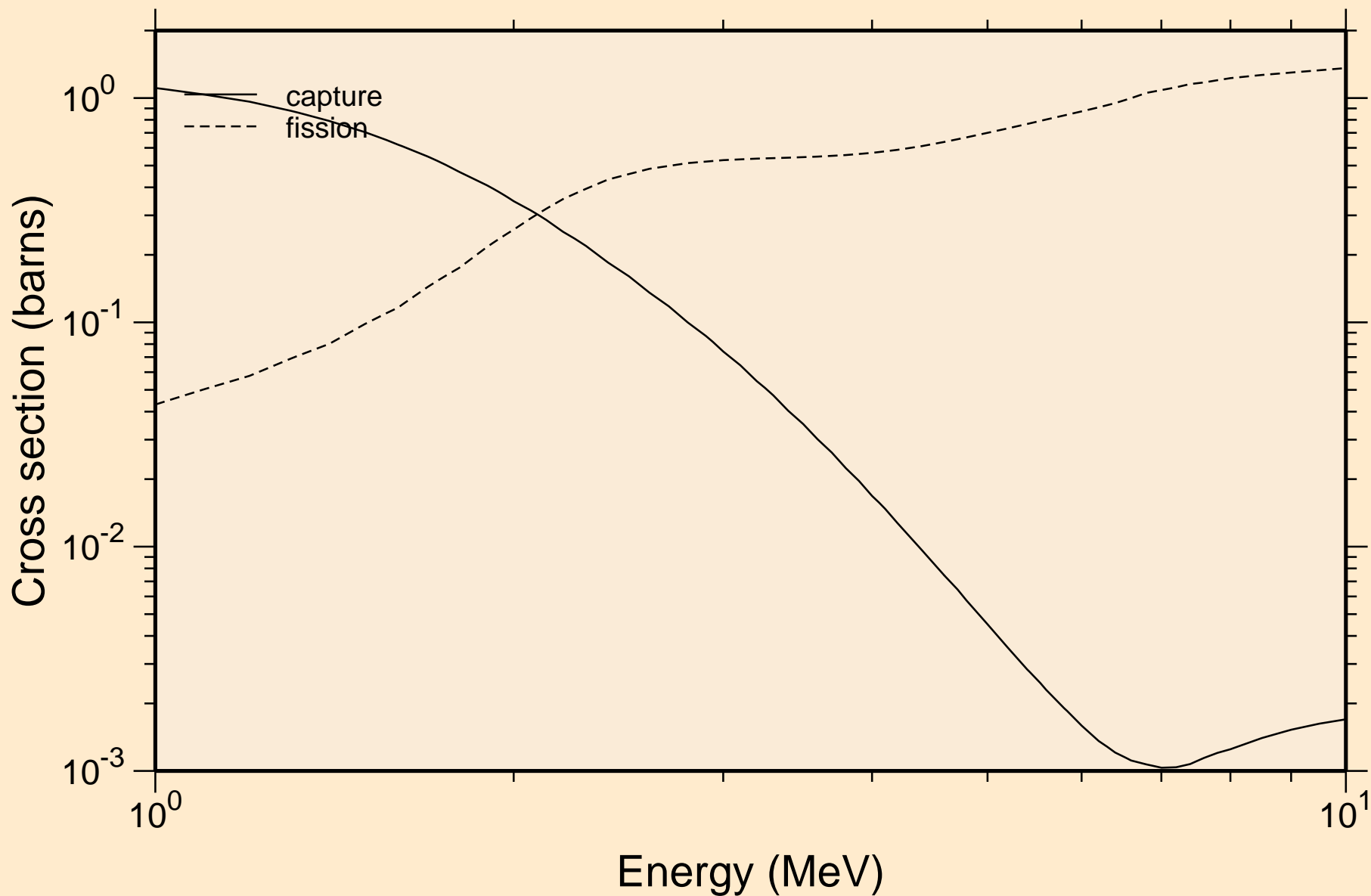

MD257 NEUTRON ACER TENDL-2019 LIBRARY; T=293.16K  
Heating

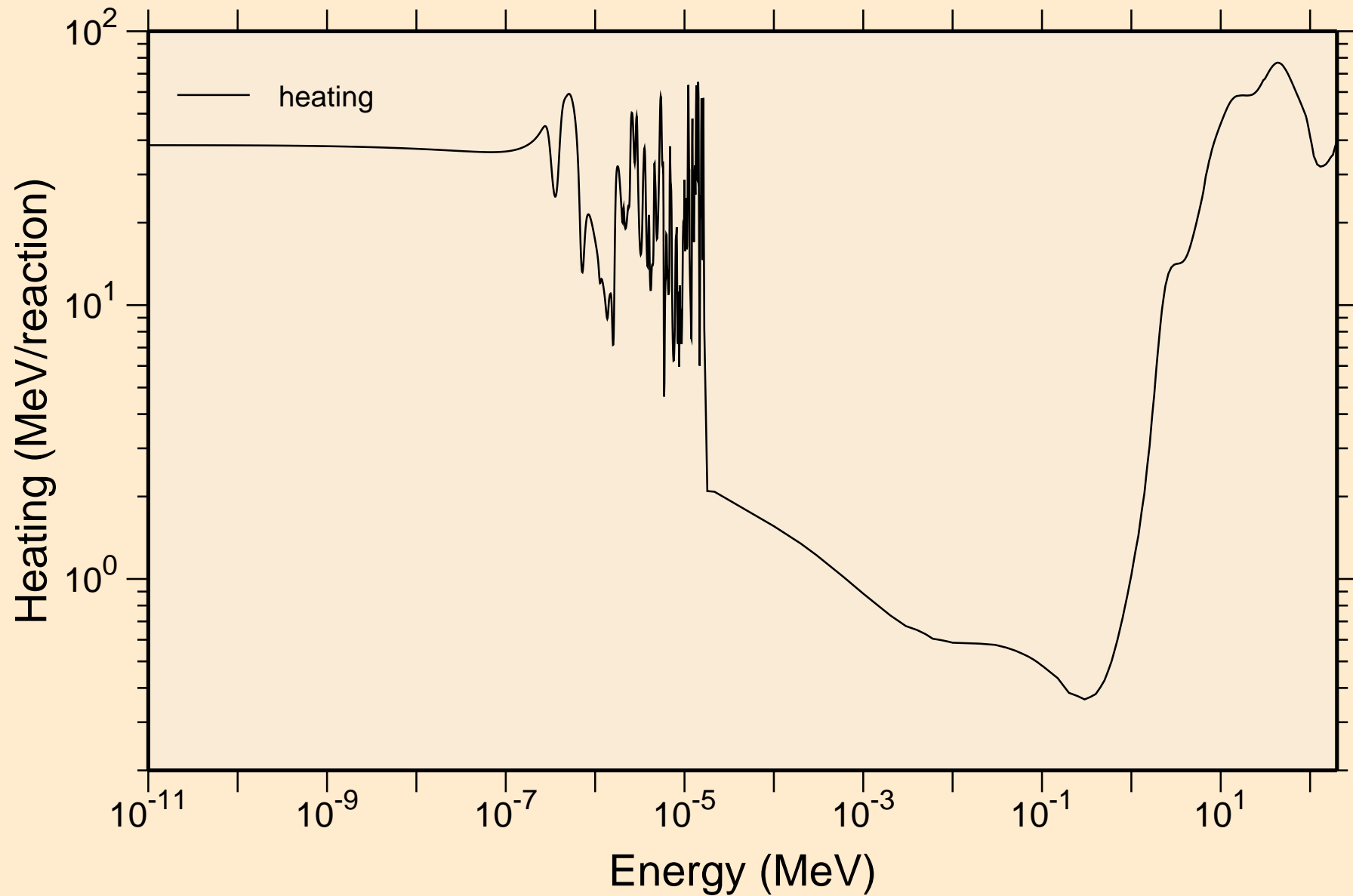

# MD257 NEUTRON ACER TENDL-2019 LIBRARY; T=293.16K Damage

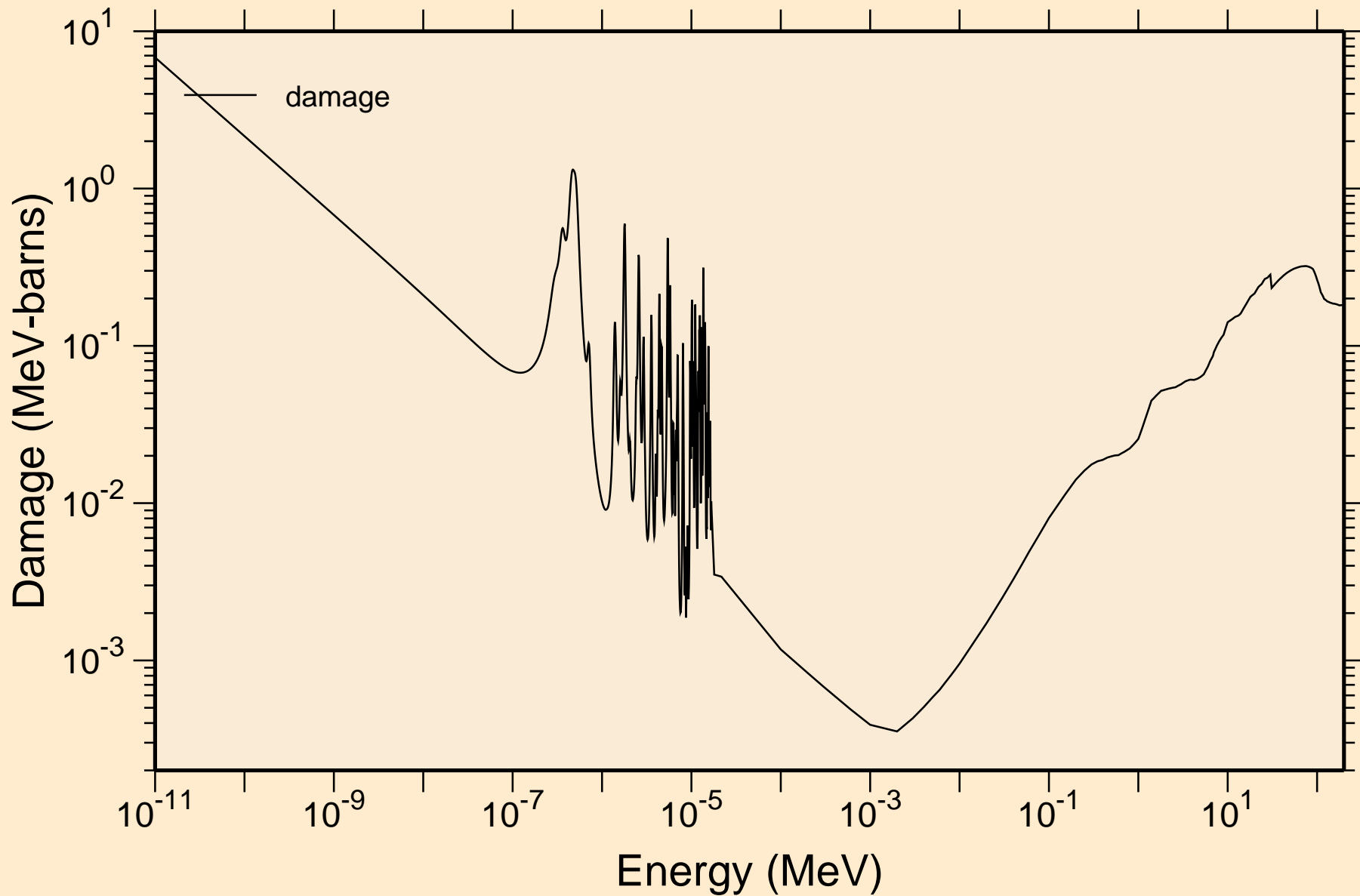

# MD257 NEUTRON ACER TENDL-2019 LIBRARY; T=293.16K

## Non-threshold reactions

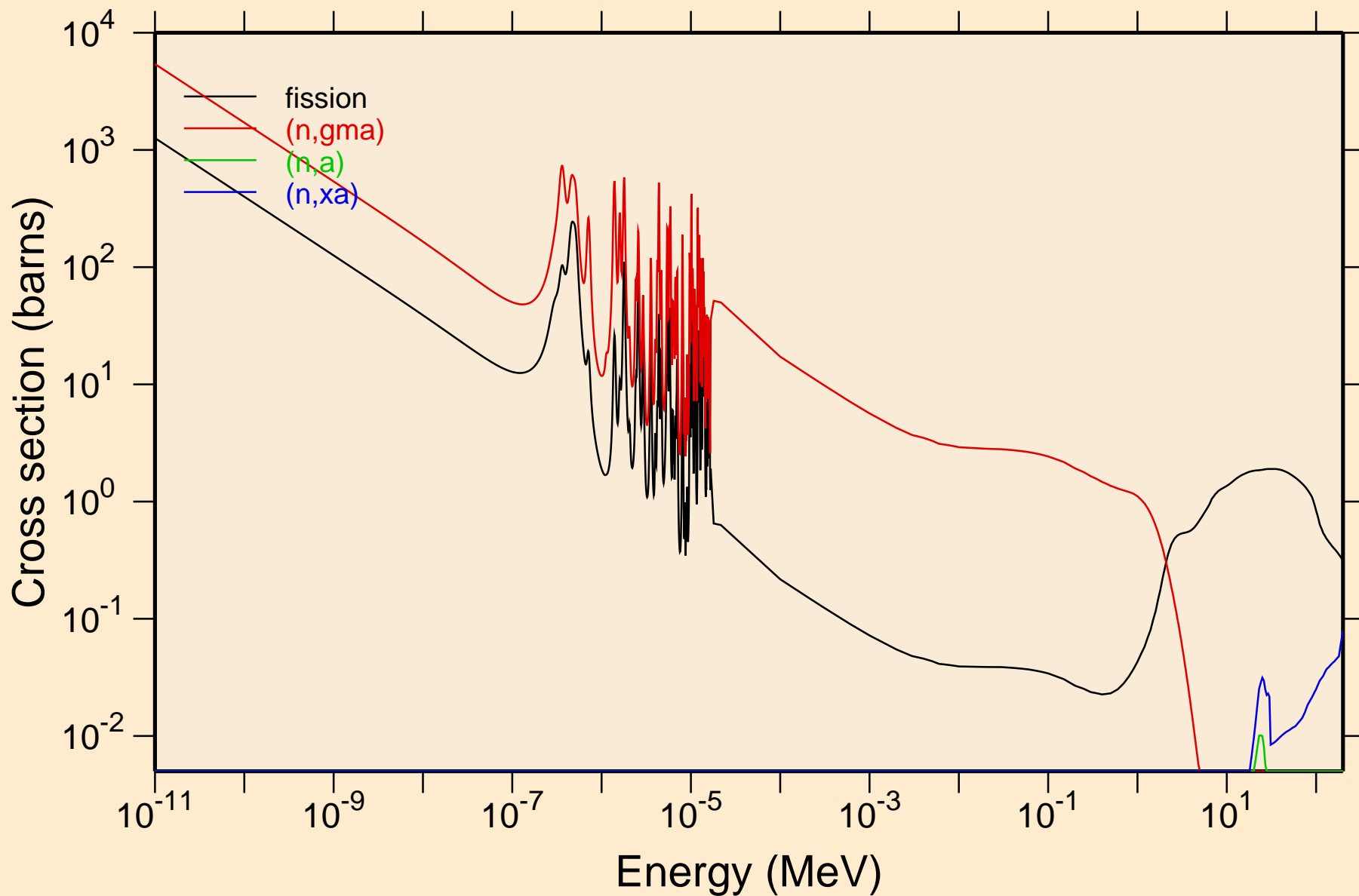

MD257 NEUTRON ACER TENDL-2019 LIBRARY; T=293.16K  
Principal cross sections

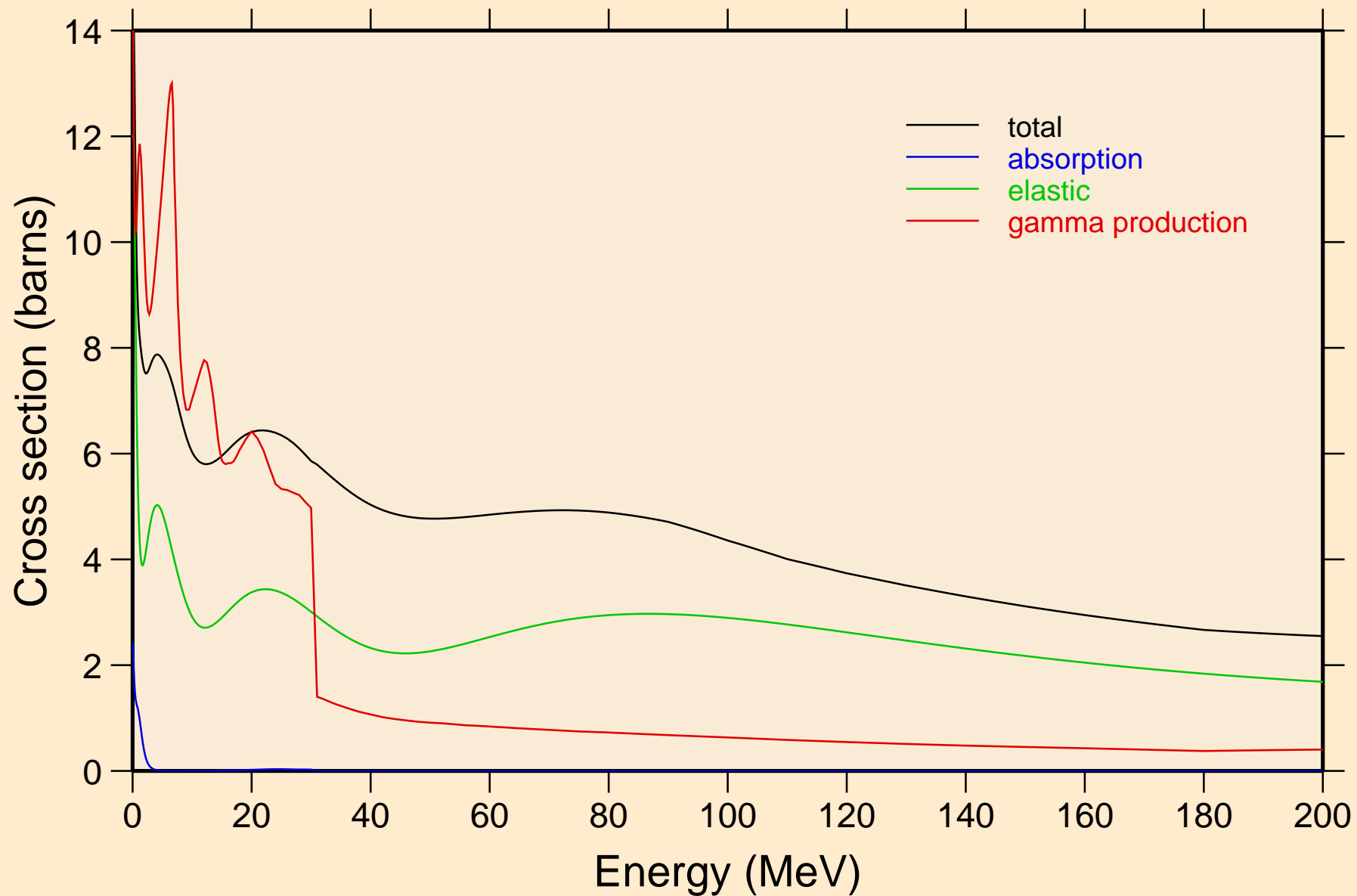

MD257 NEUTRON ACER TENDL-2019 LIBRARY; T=293.16K  
Heating

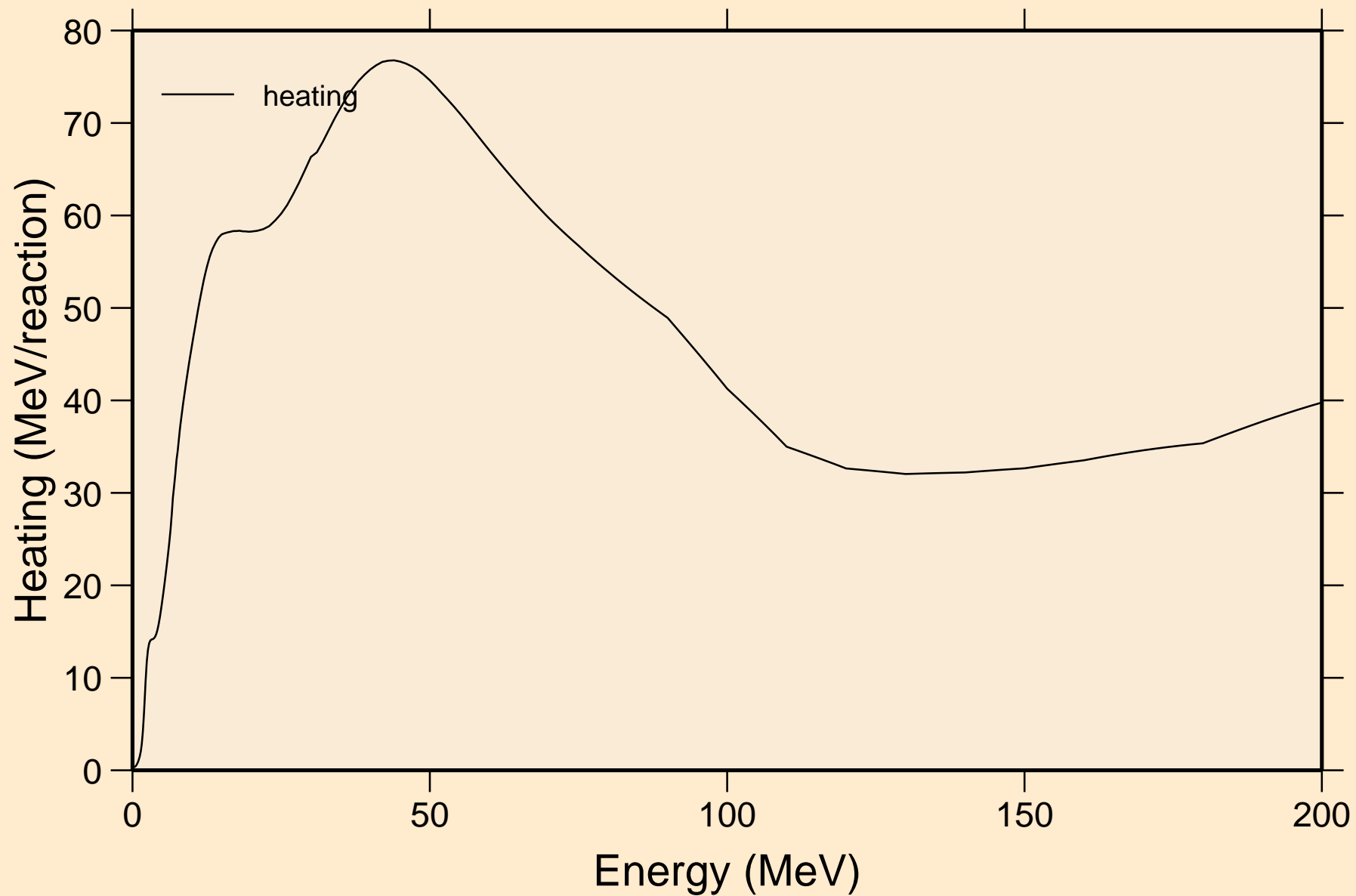

MD257 NEUTRON ACER TENDL-2019 LIBRARY; T=293.16K  
Damage

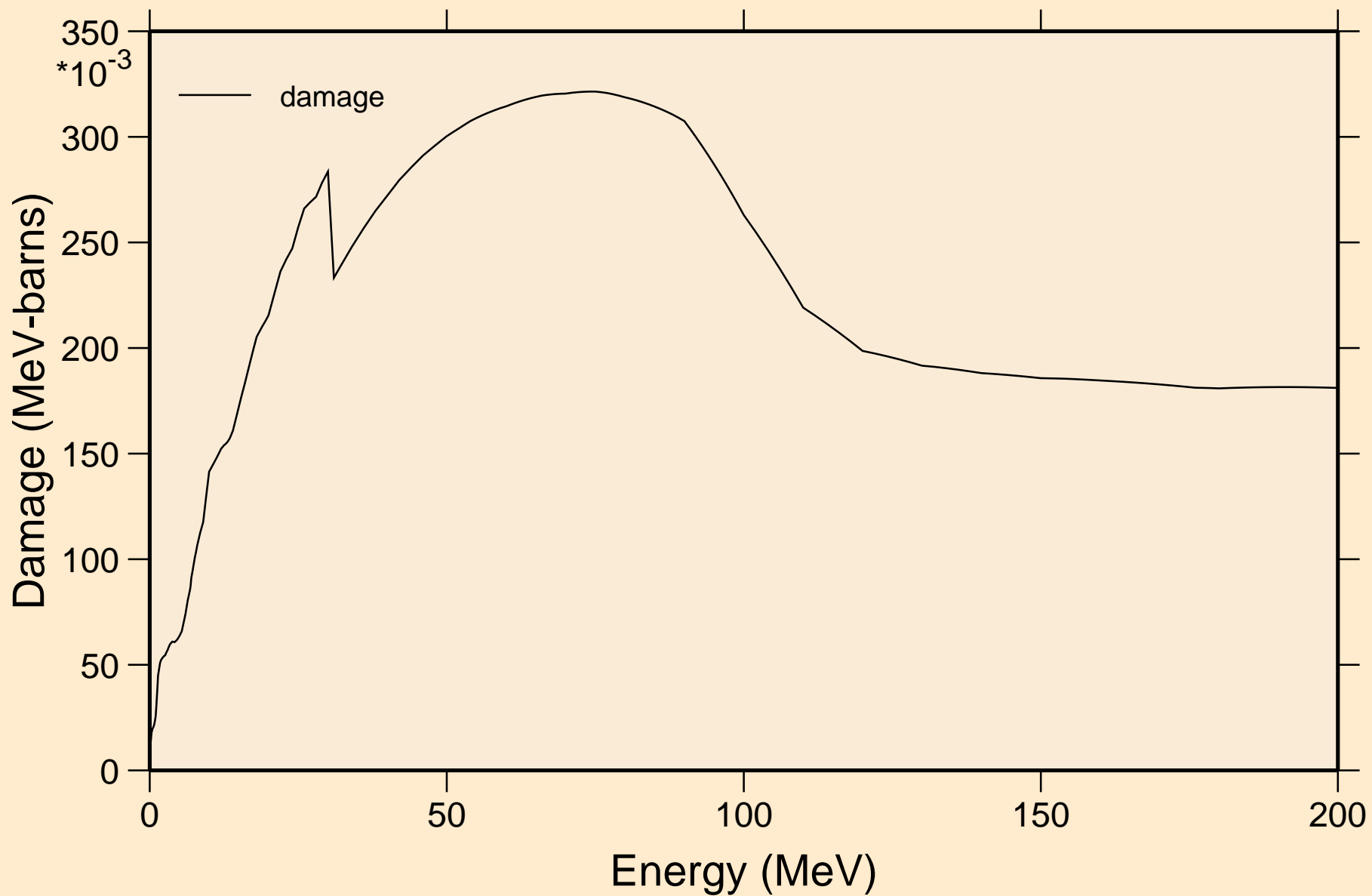

MD257 NEUTRON ACER TENDL-2019 LIBRARY; T=293.16K  
Non-threshold reactions

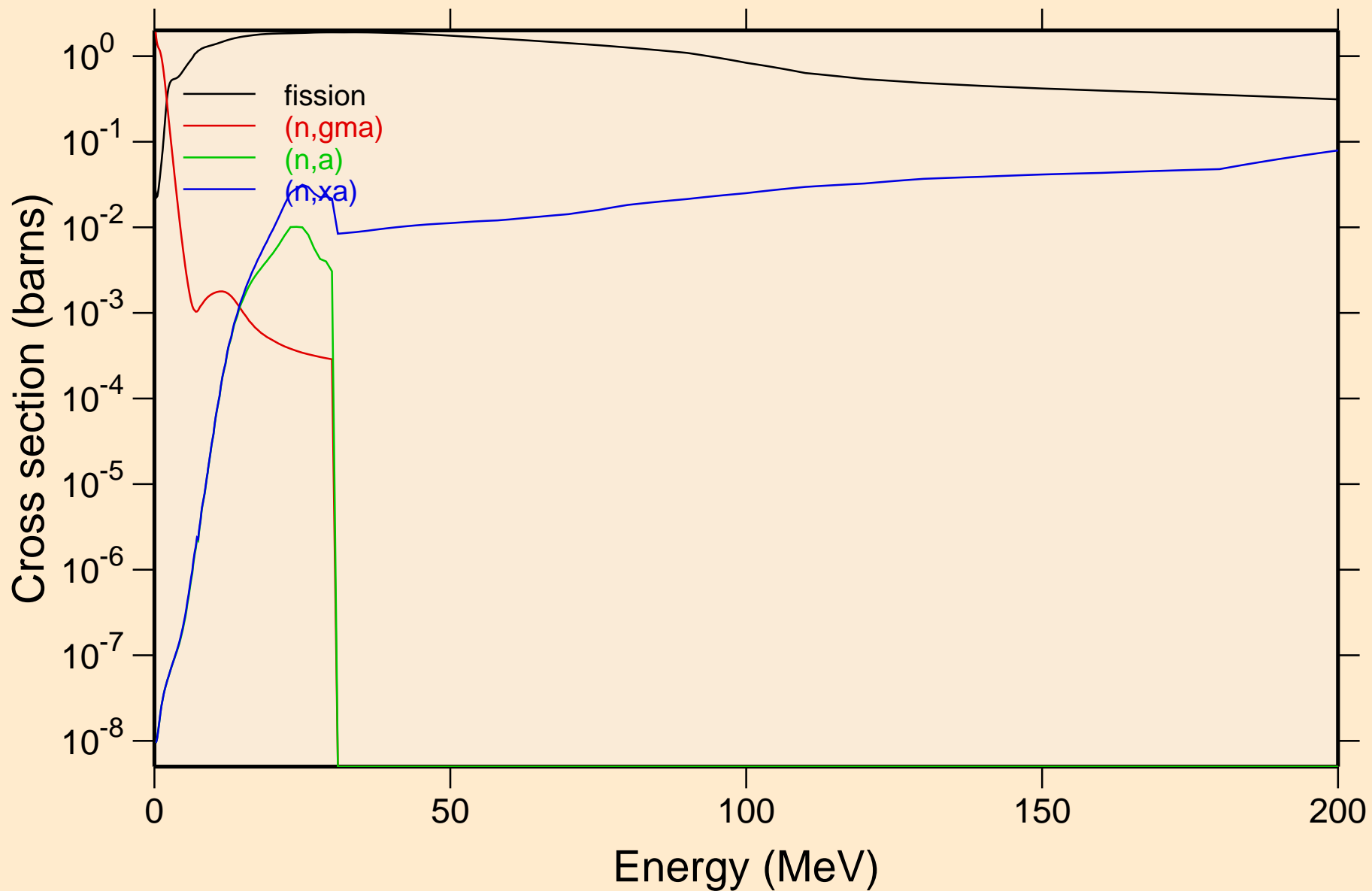



MD257 NEUTRON ACER TENDL-2019 LIBRARY; T=293.16K  
Inelastic levels

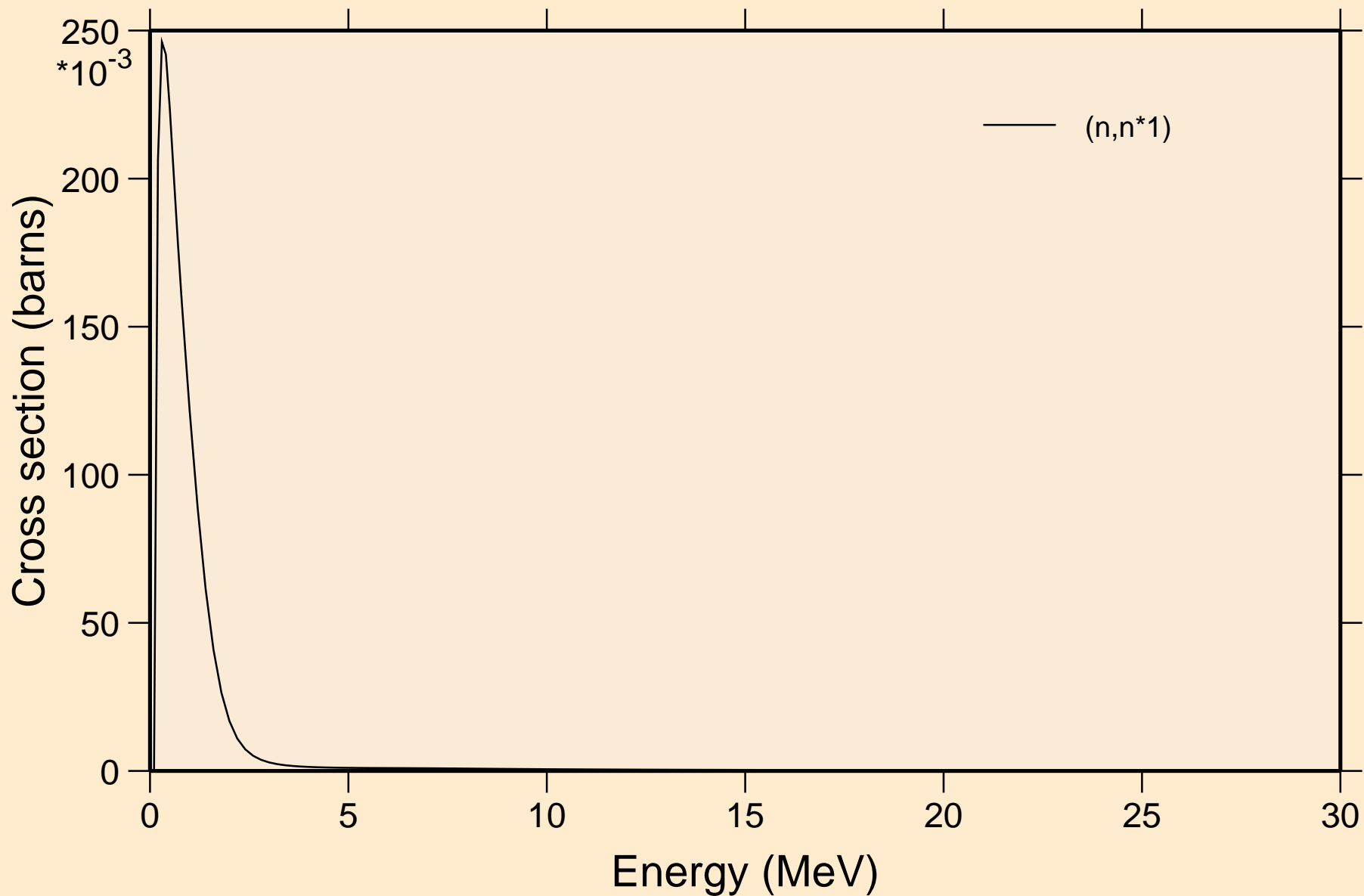

MD257 NEUTRON ACER TENDL-2019 LIBRARY; T=293.16K  
Threshold reactions

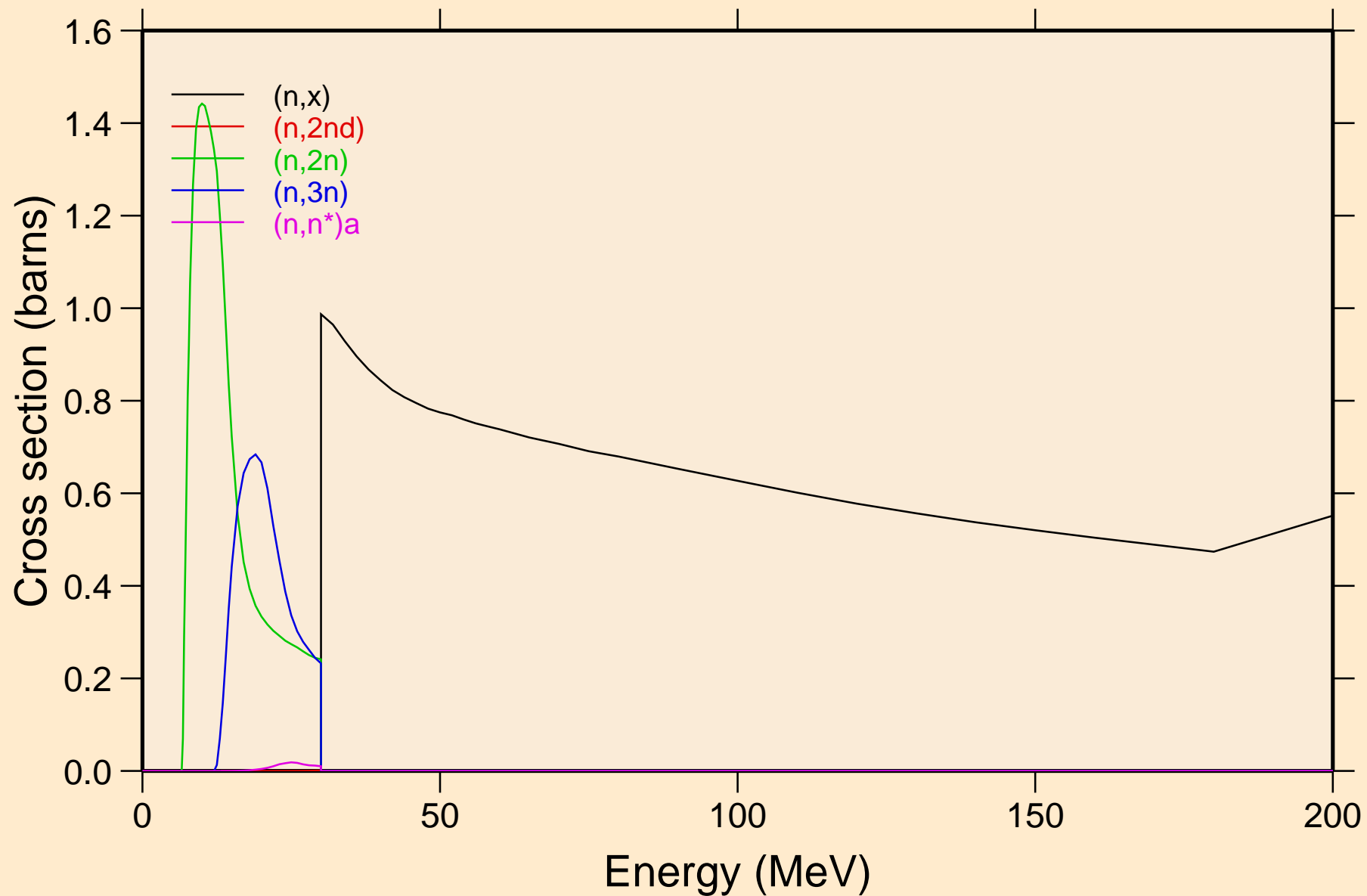

MD257 NEUTRON ACER TENDL-2019 LIBRARY; T=293.16K  
Threshold reactions

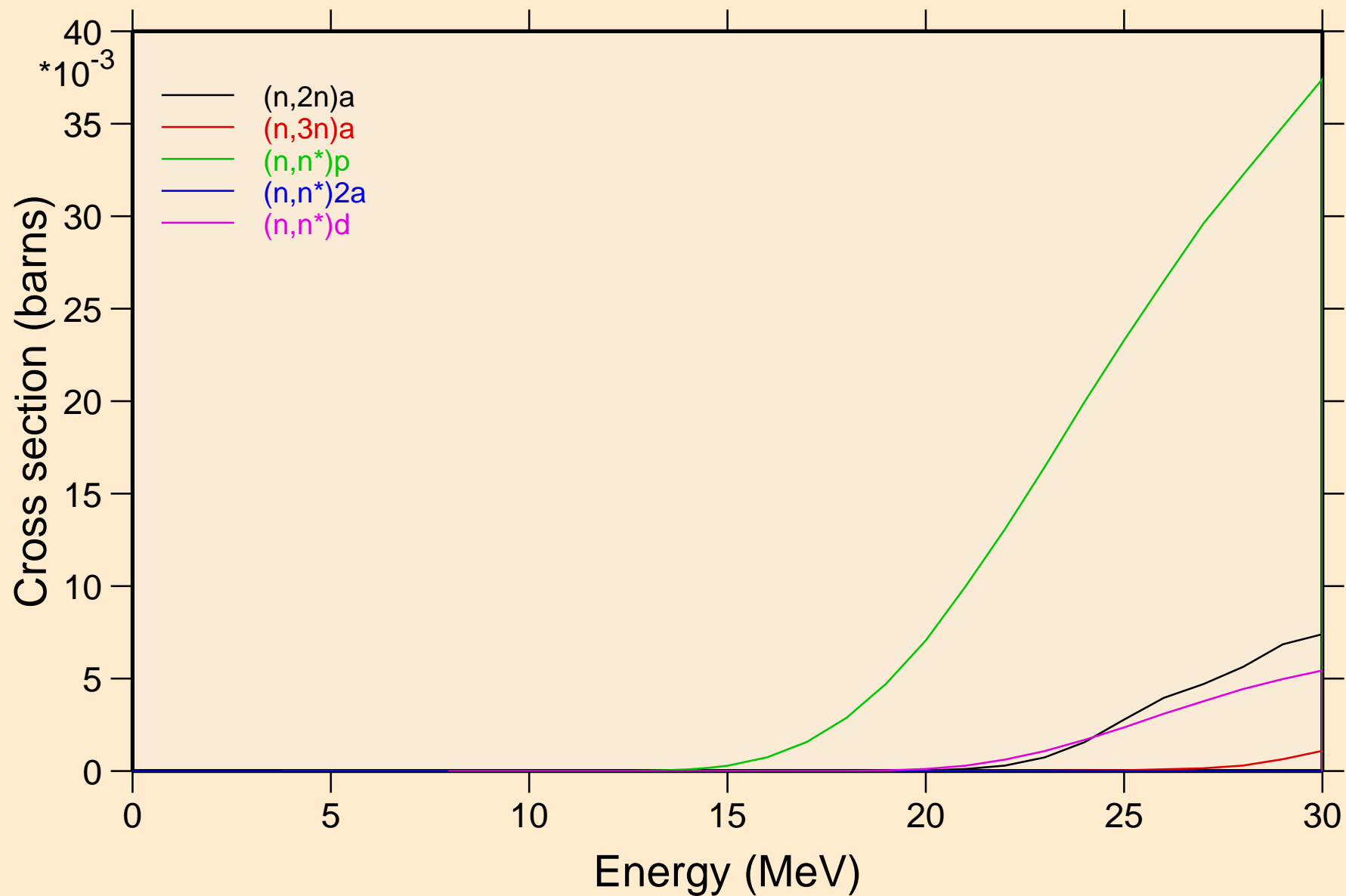

MD257 NEUTRON ACER TENDL-2019 LIBRARY; T=293.16K  
Threshold reactions

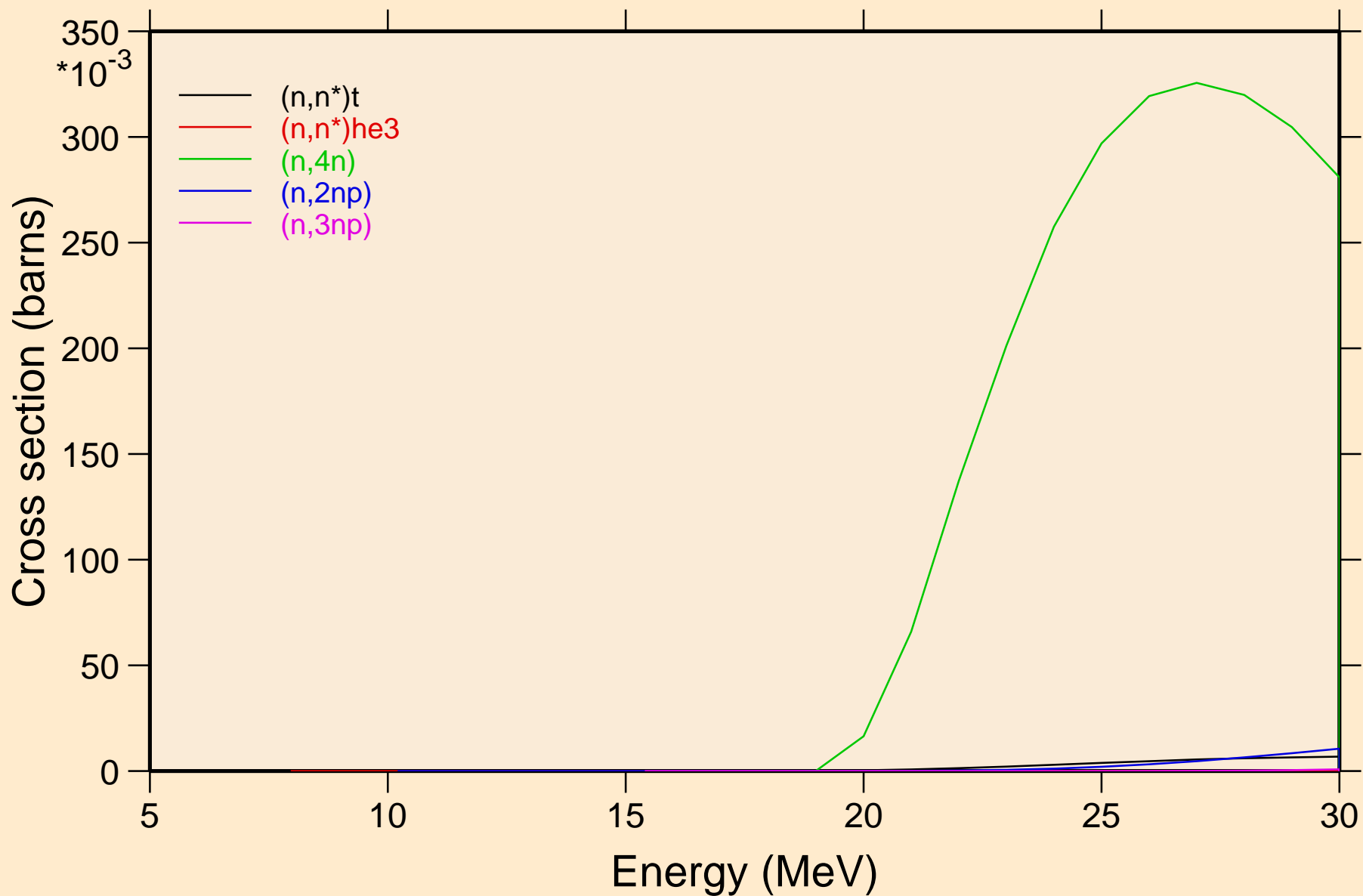

MD257 NEUTRON ACER TENDL-2019 LIBRARY; T=293.16K  
Threshold reactions

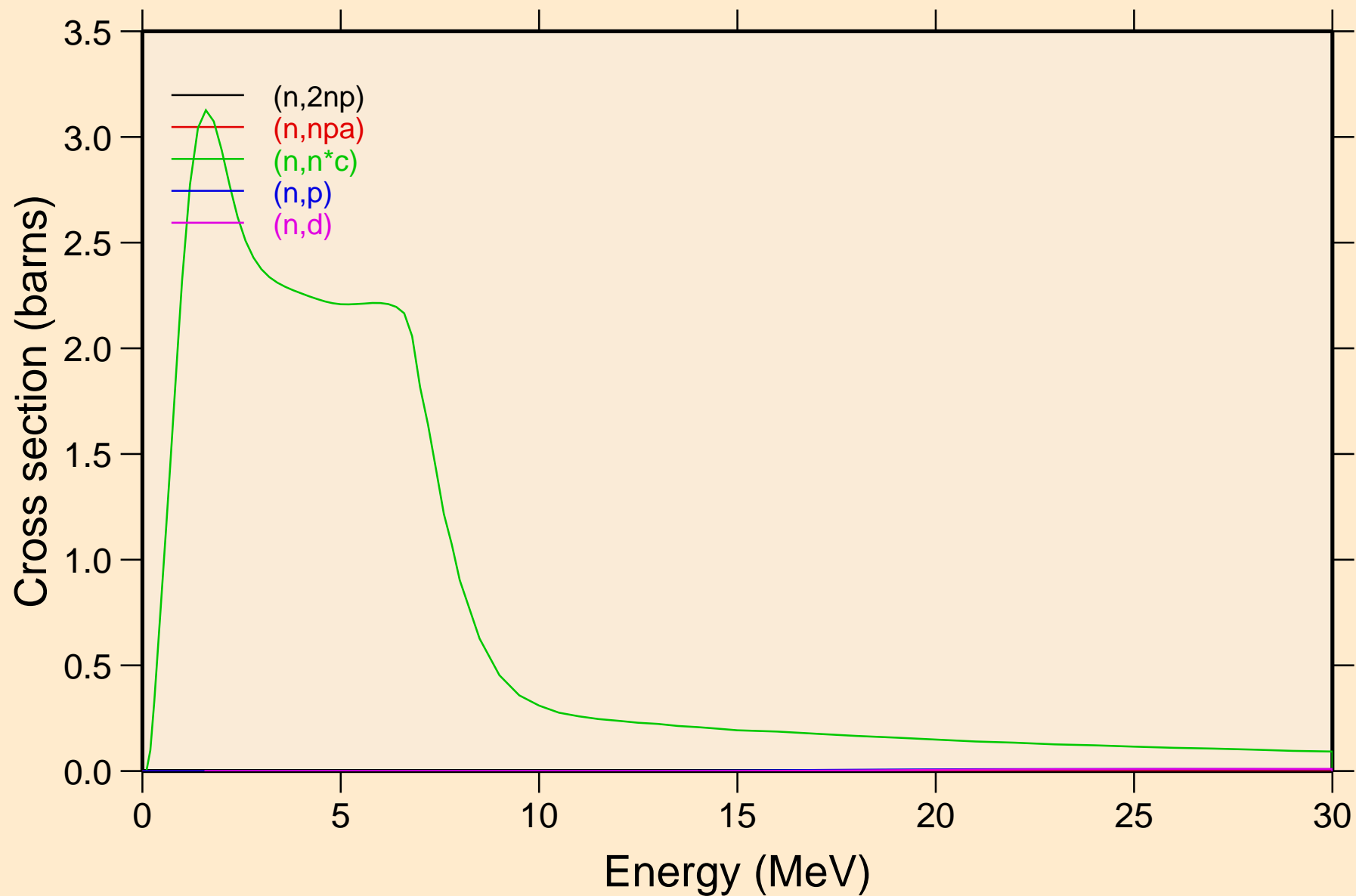

MD257 NEUTRON ACER TENDL-2019 LIBRARY; T=293.16K  
Threshold reactions

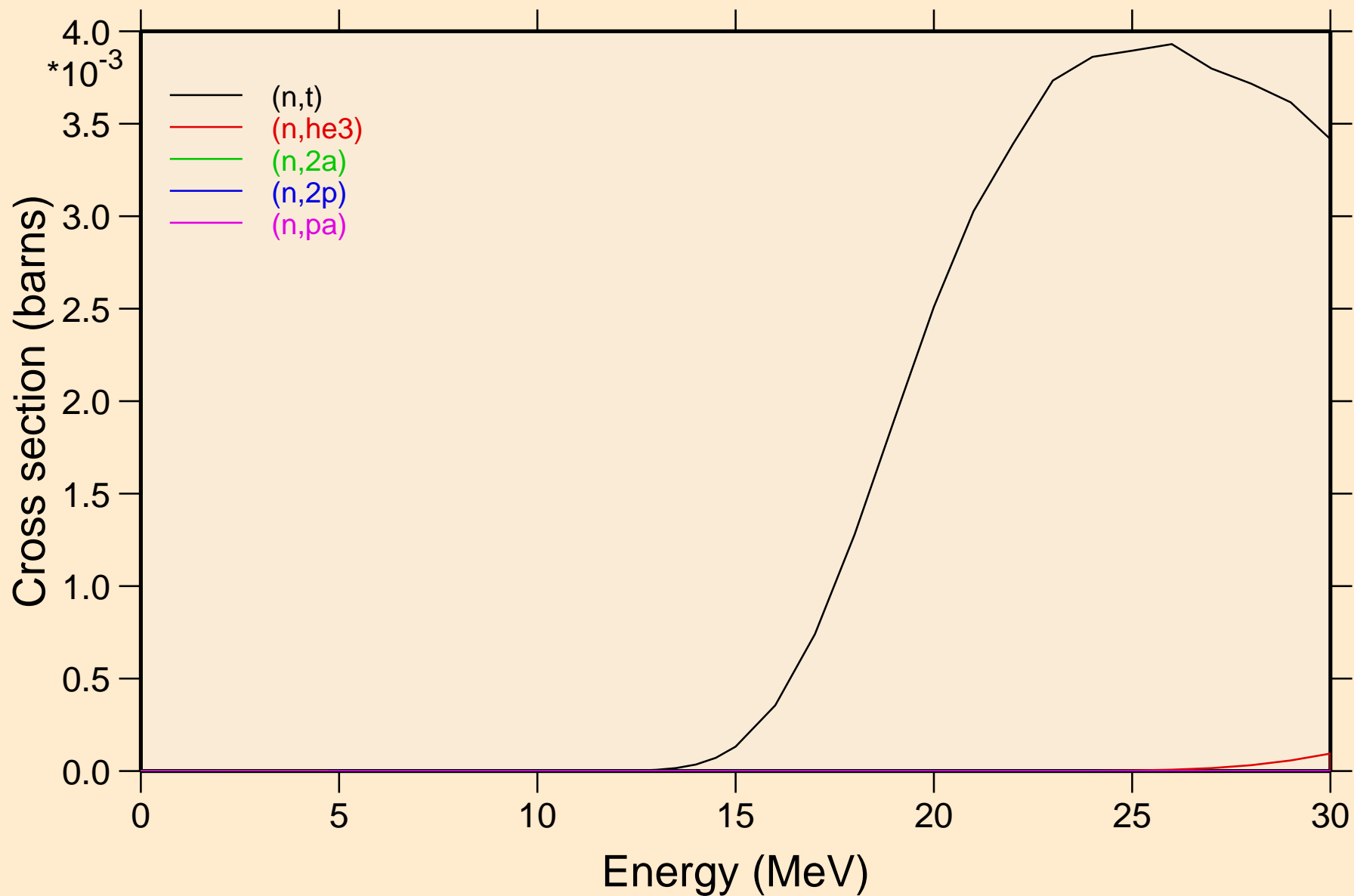

MD257 NEUTRON ACER TENDL-2019 LIBRARY; T=293.16K  
Threshold reactions

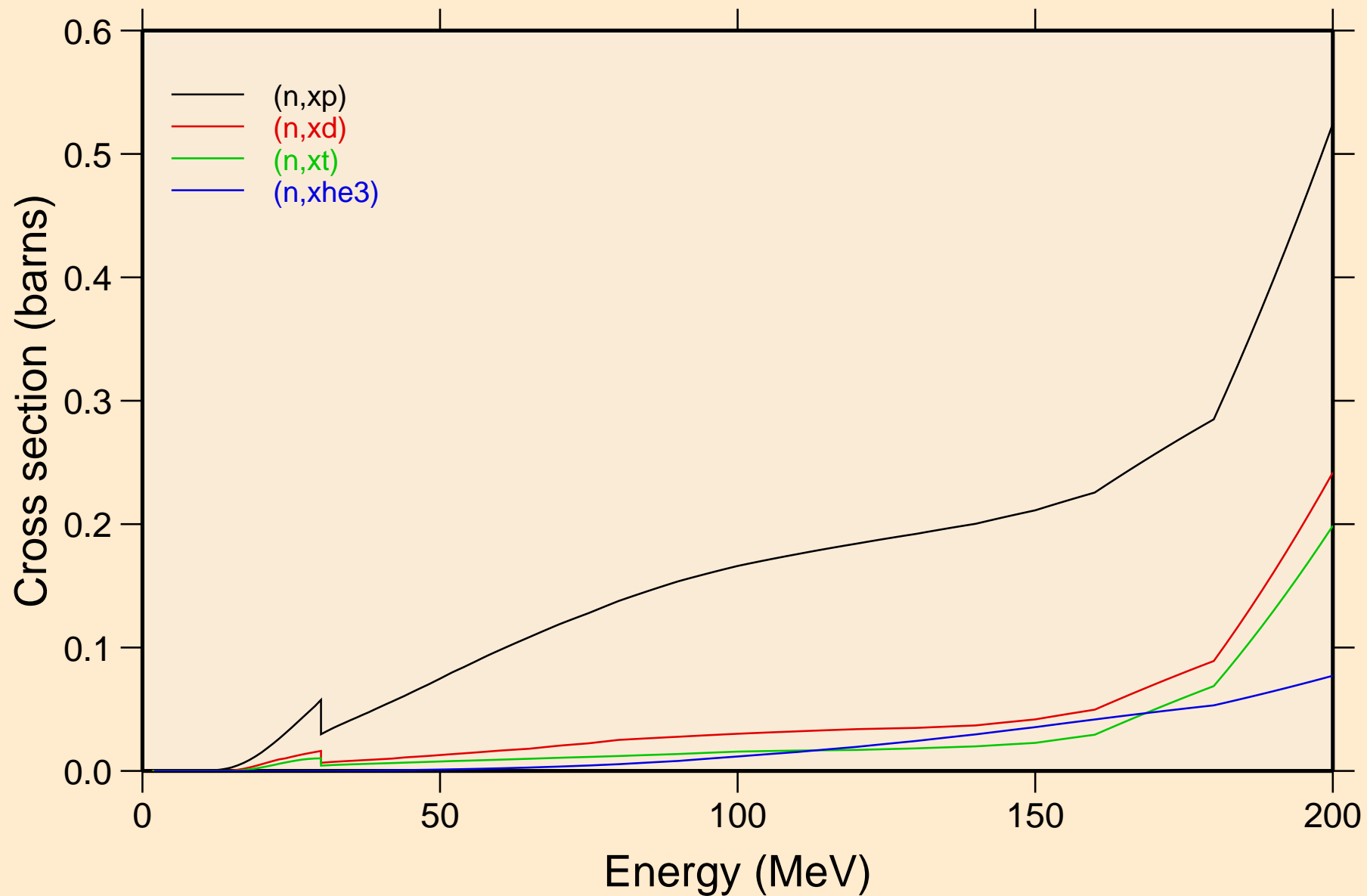

MD257 NEUTRON ACER TENDL-2019 LIBRARY; T=293.16K  
angular distribution for elastic

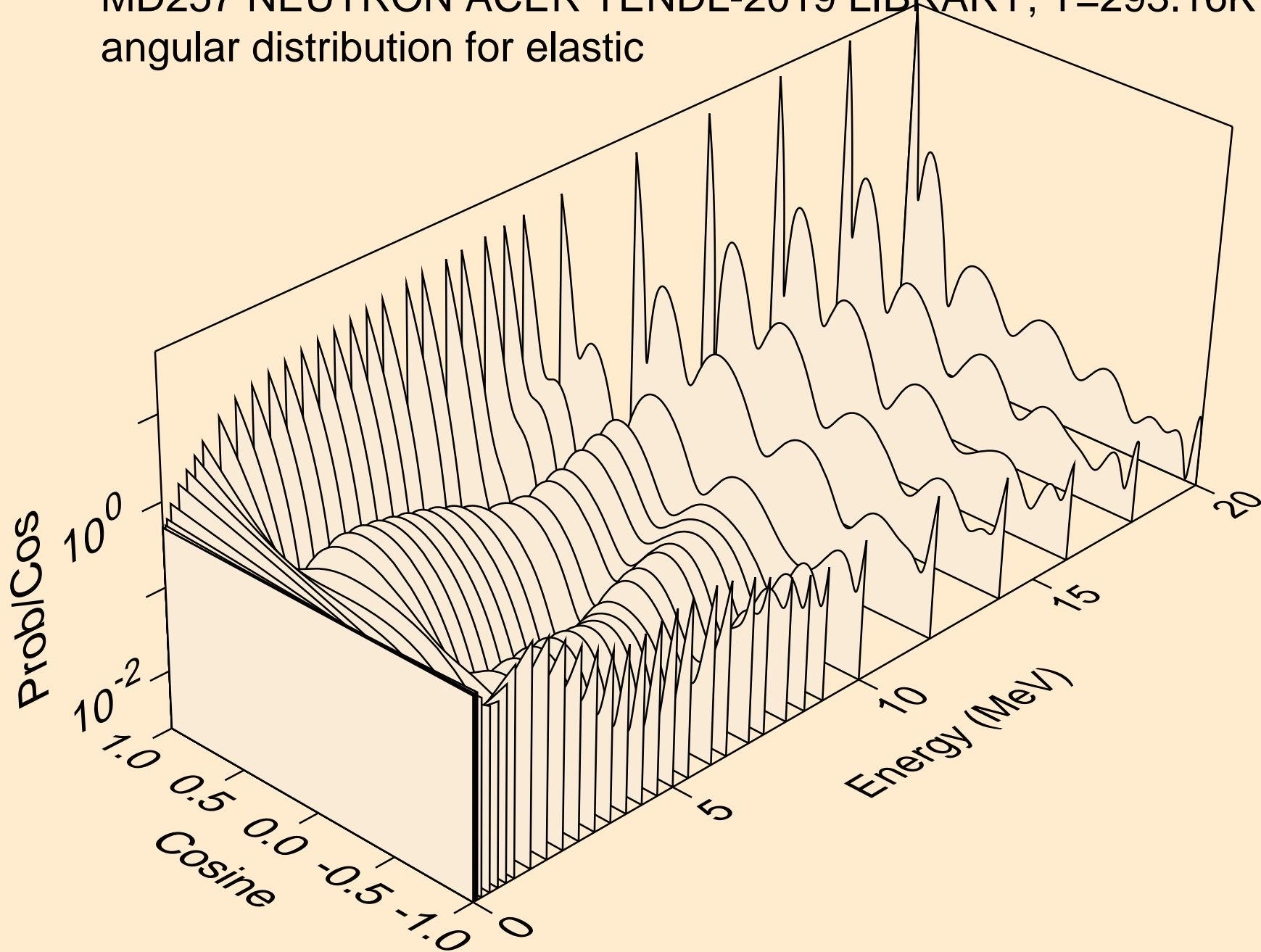



MD257 NEUTRON ACER TENDL-2019 LIBRARY; T=293.16K  
angular distribution for elastic

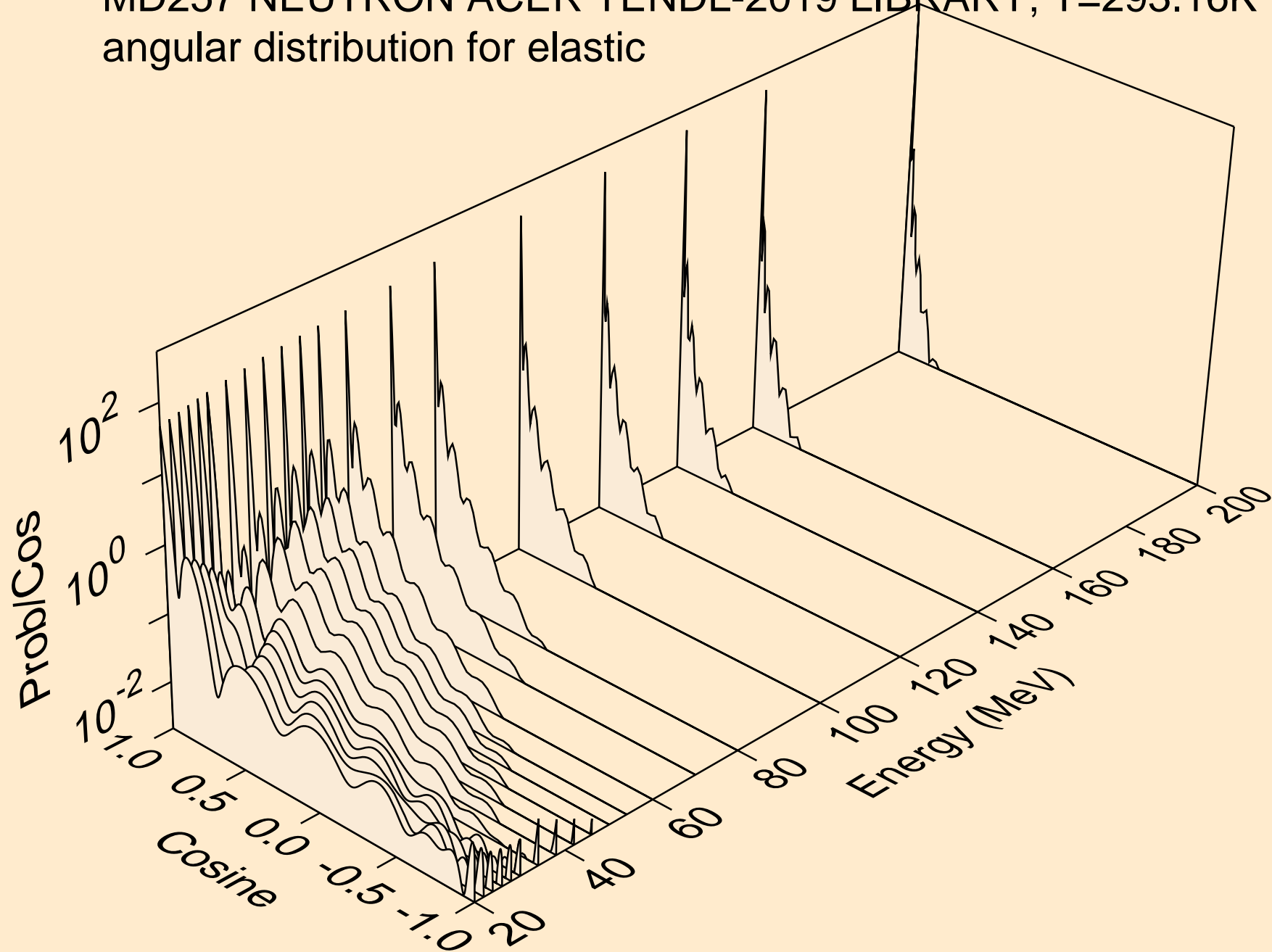

MD257 NEUTRON ACER TENDL-2019 LIBRARY; T=293.16K  
angular distribution for (n,n\*1)

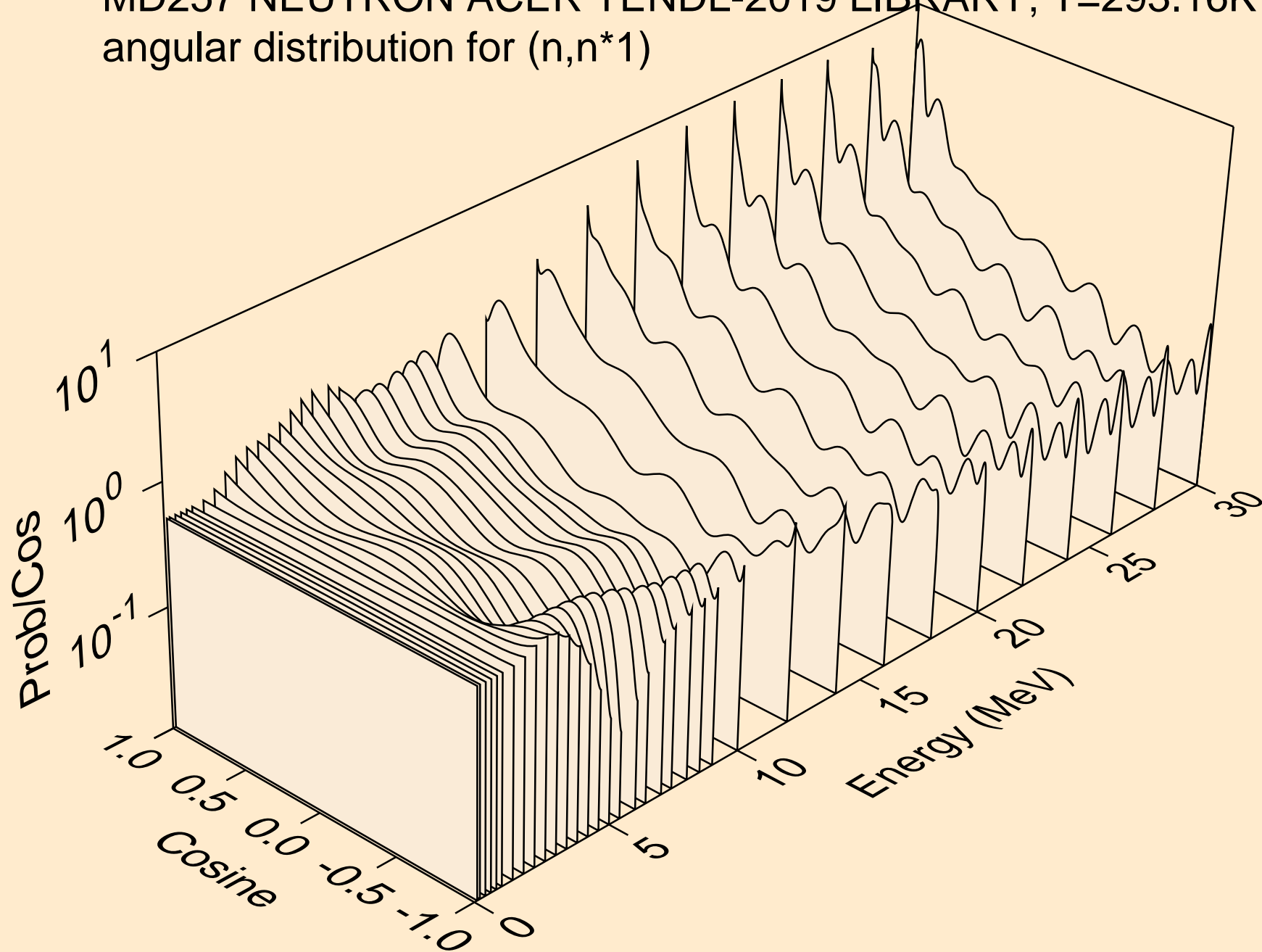

MD257 NEUTRON ACER TENDL-2019 LIBRARY; T=293.16K  
Total fission nubar

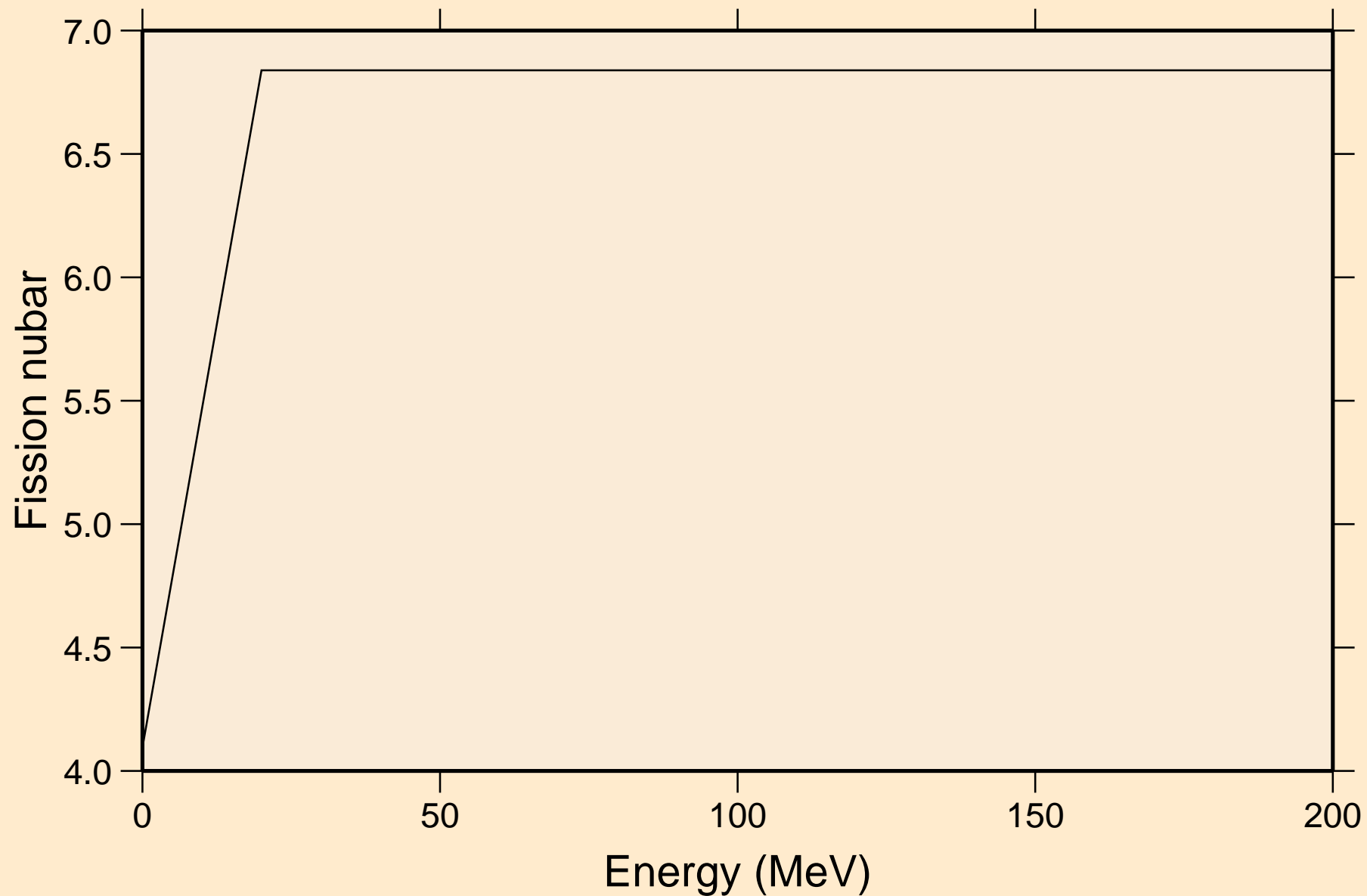

MD257 NEUTRON ACER TENDL-2019 LIBRARY; T=293.16K  
Neutron emission for (n,x)

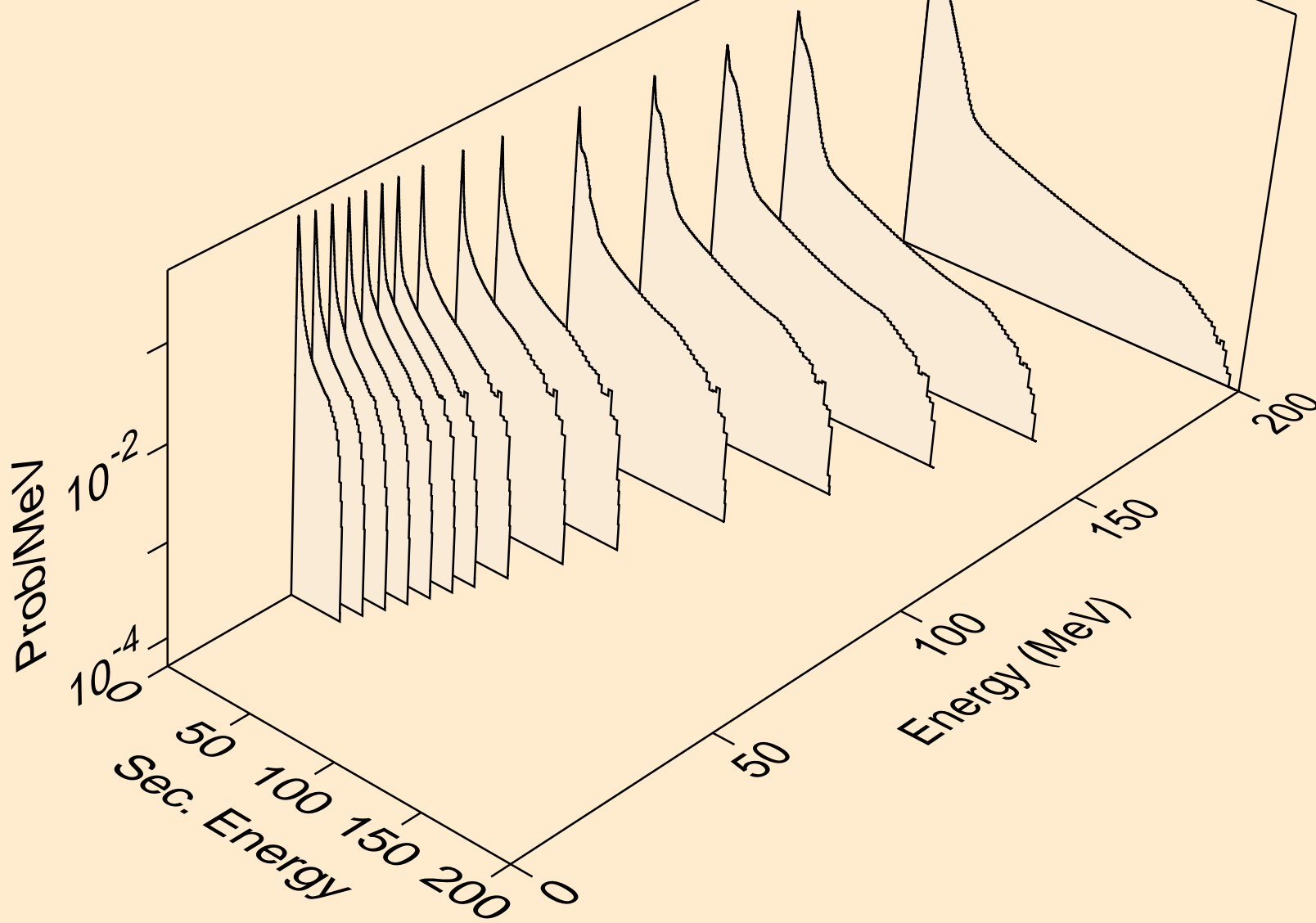

MD257 NEUTRON ACER TENDL-2019 LIBRARY; T=293.16K  
Neutron emission for (n,2nd)

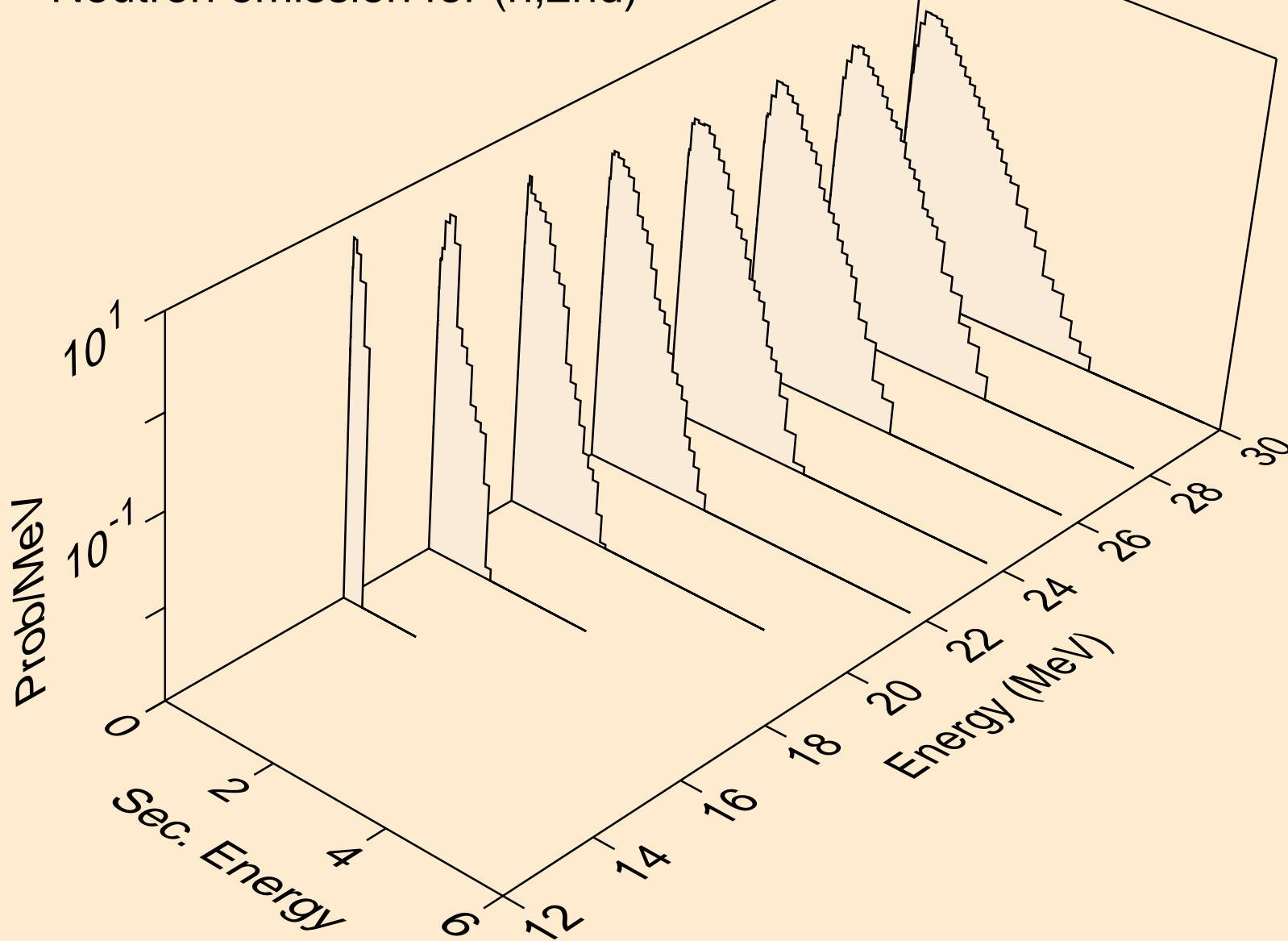

MD257 NEUTRON ACER TENDL-2019 LIBRARY; T=293.16K  
Neutron emission for (n,2n)

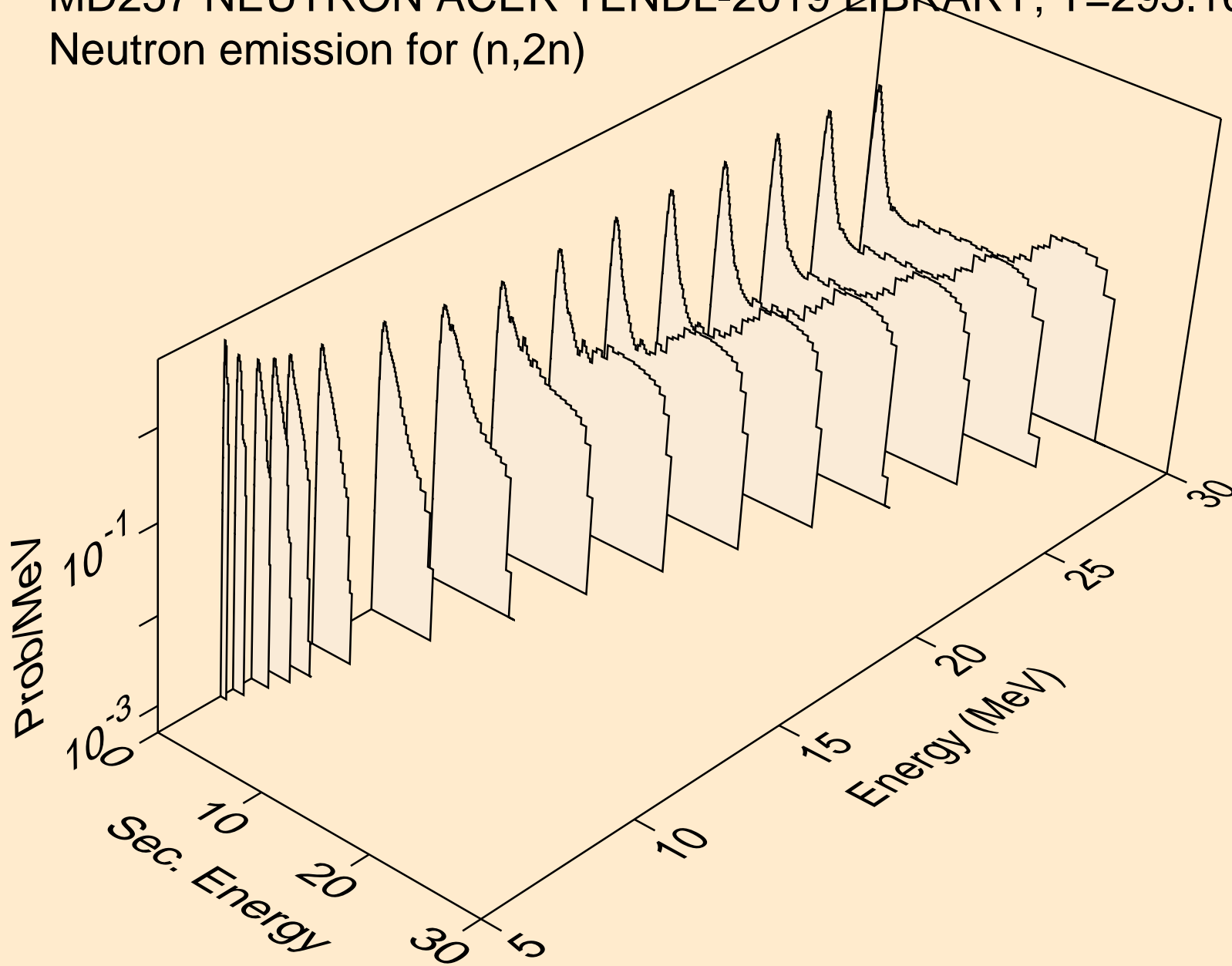

MD257 NEUTRON ACER TENDL-2019 LIBRARY; T=293.16K  
Neutron emission for (n,3n)

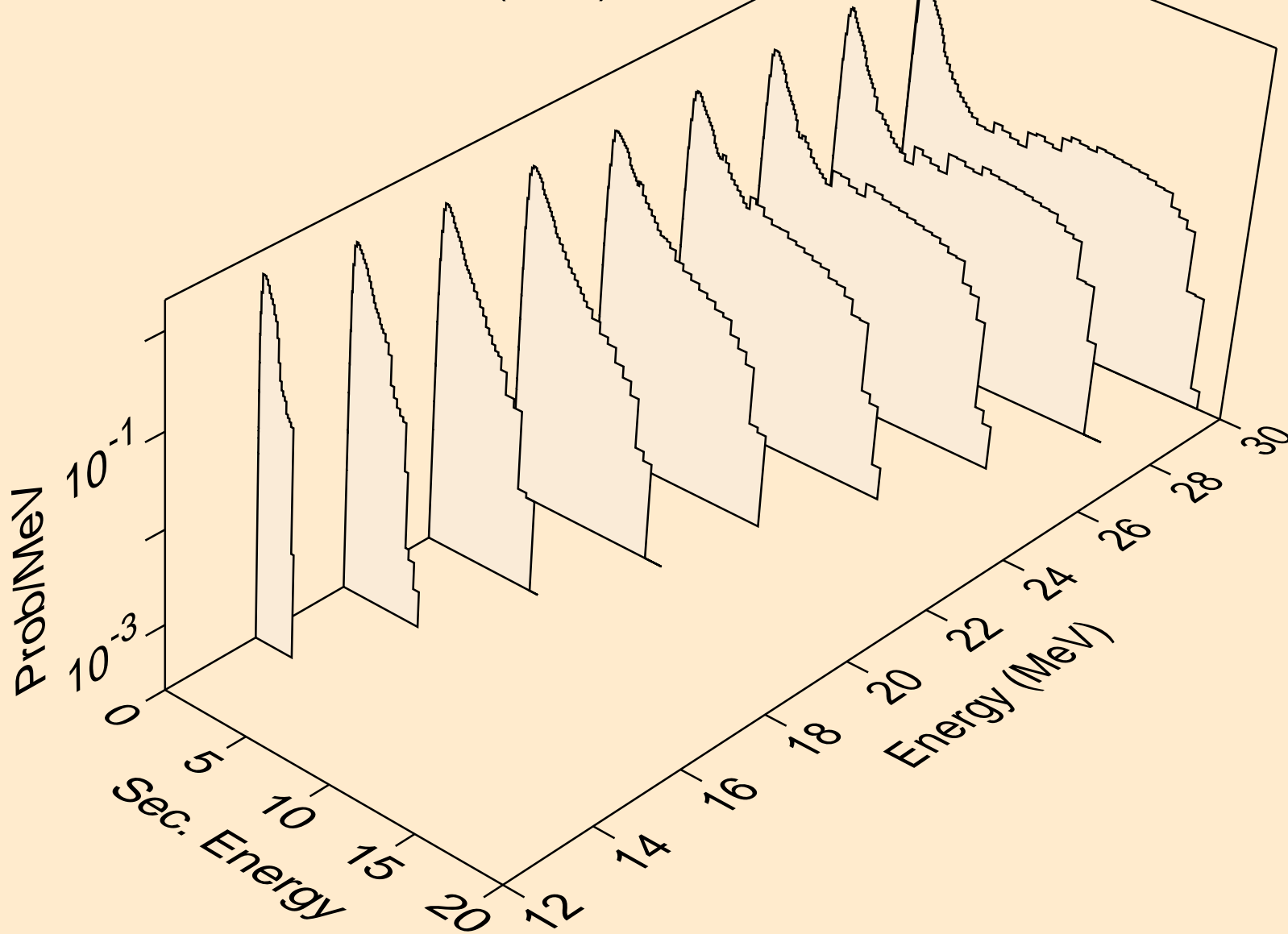

MD257 NEUTRON ACER TENDL-2019 LIBRARY; T=293.16K  
Neutron emission for fission

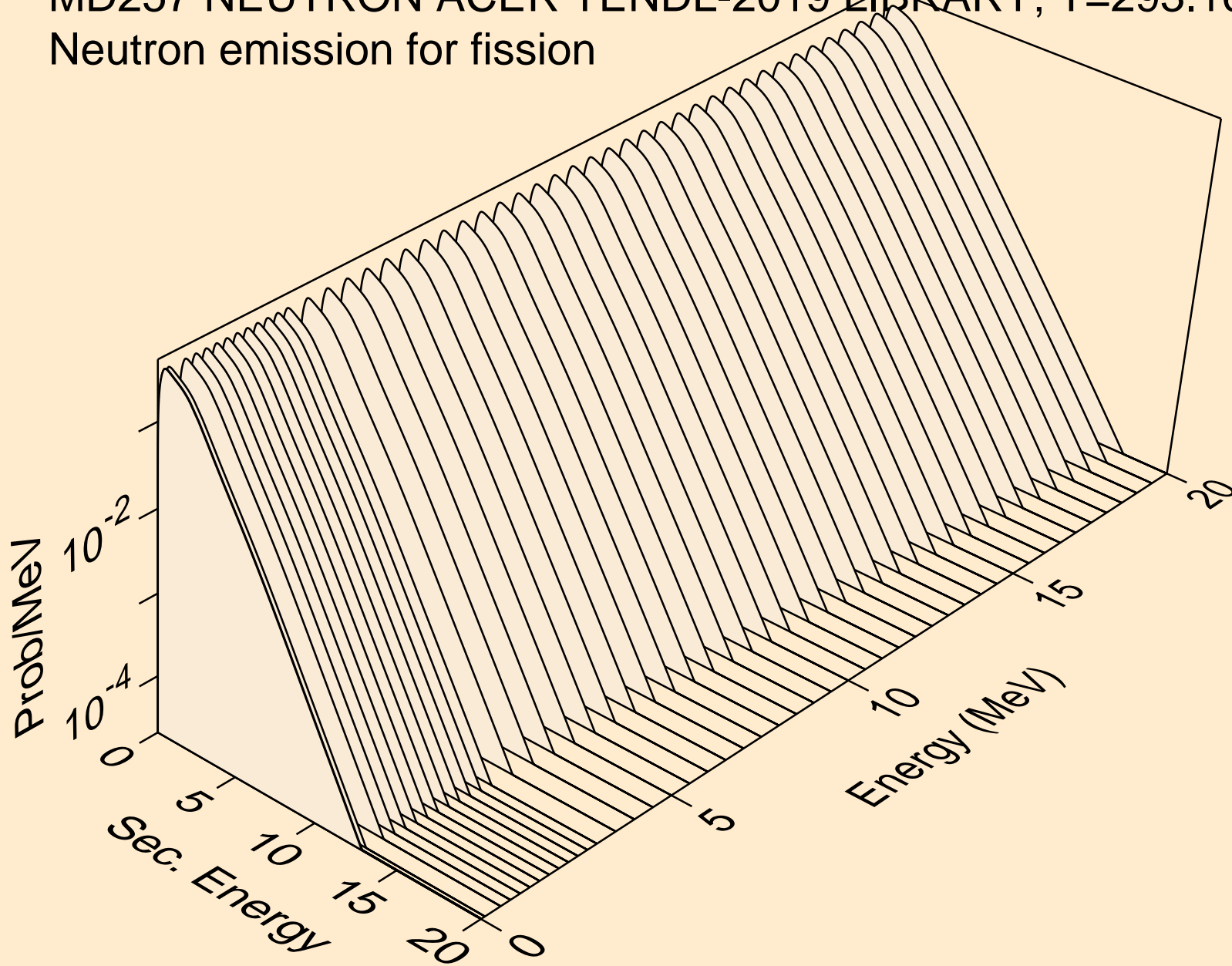



MD257 NEUTRON ACER TENDL-2019 LIBRARY; T=293.16K  
Neutron emission for (n,n\*)a

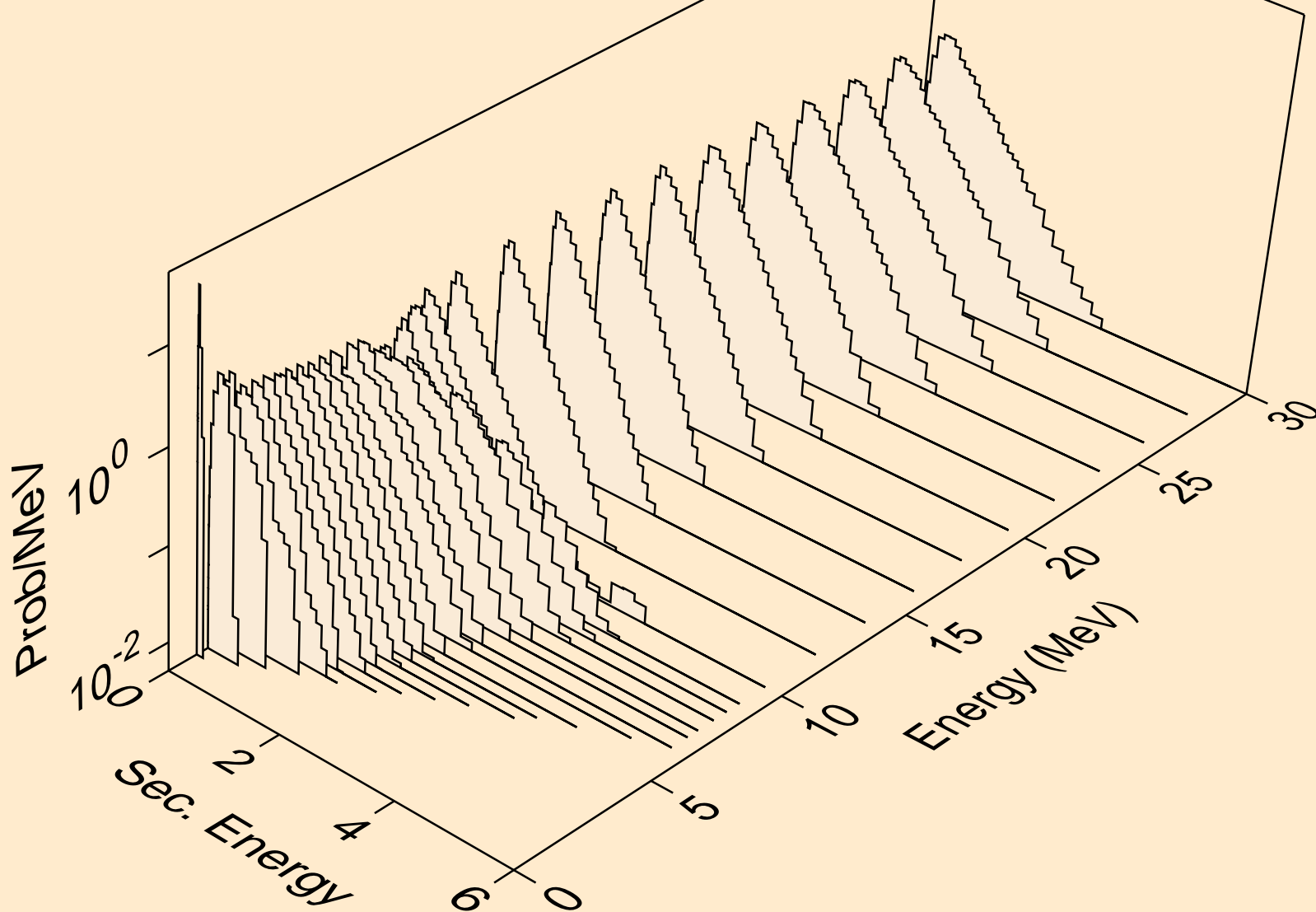

MD257 NEUTRON ACER TENDL-2019 LIBRARY; T=293.16K  
Neutron emission for (n,2n)a

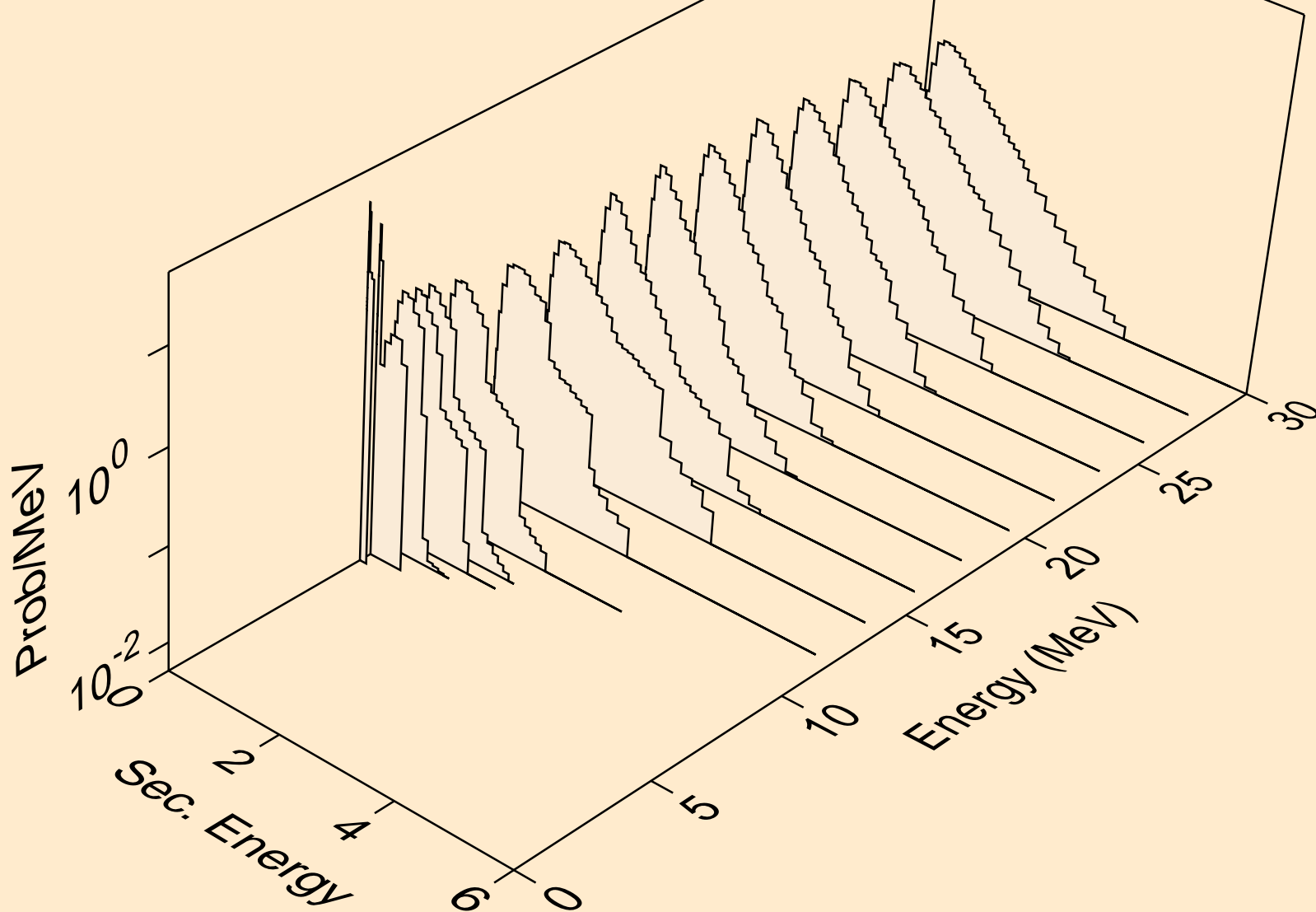

MD257 NEUTRON ACER TENDL-2019 LIBRARY; T=293.16K  
Neutron emission for (n,3n)a

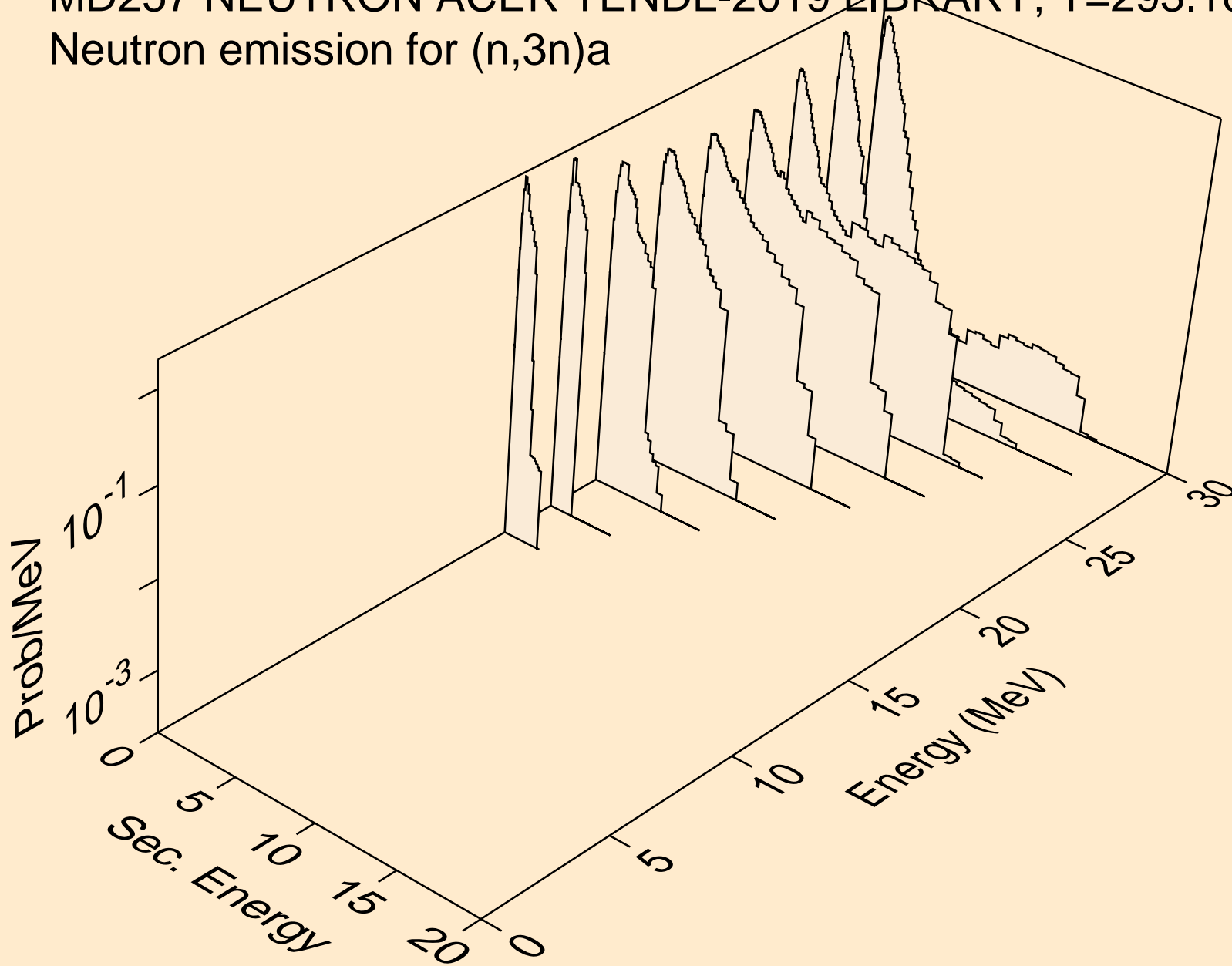

MD257 NEUTRON ACER TENDL-2019 LIBRARY; T=293.16K  
Neutron emission for (n,n\*)p

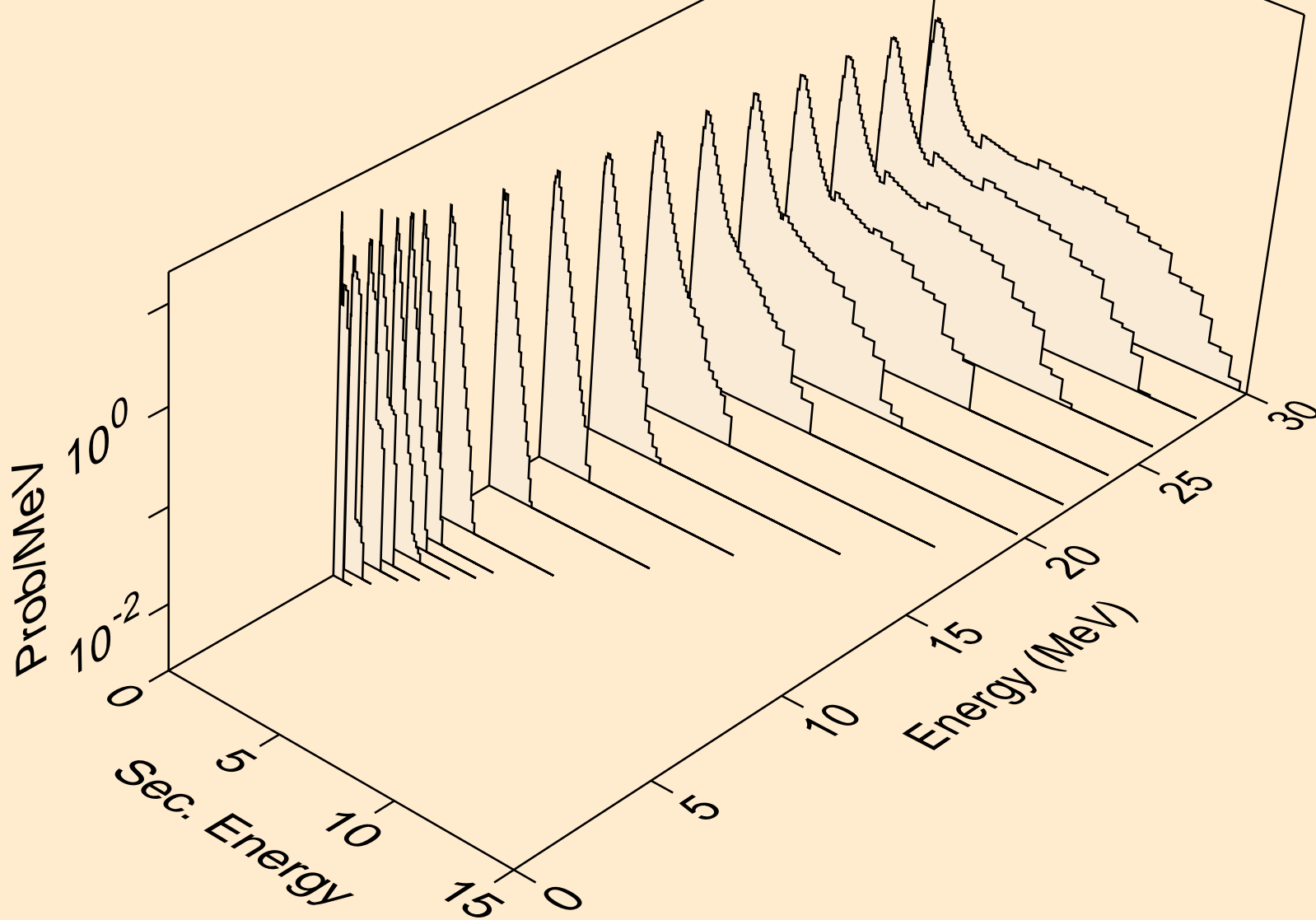

MD257 NEUTRON ACER TENDL-2019 LIBRARY; T=293.16K  
Neutron emission for (n,n\*)2a

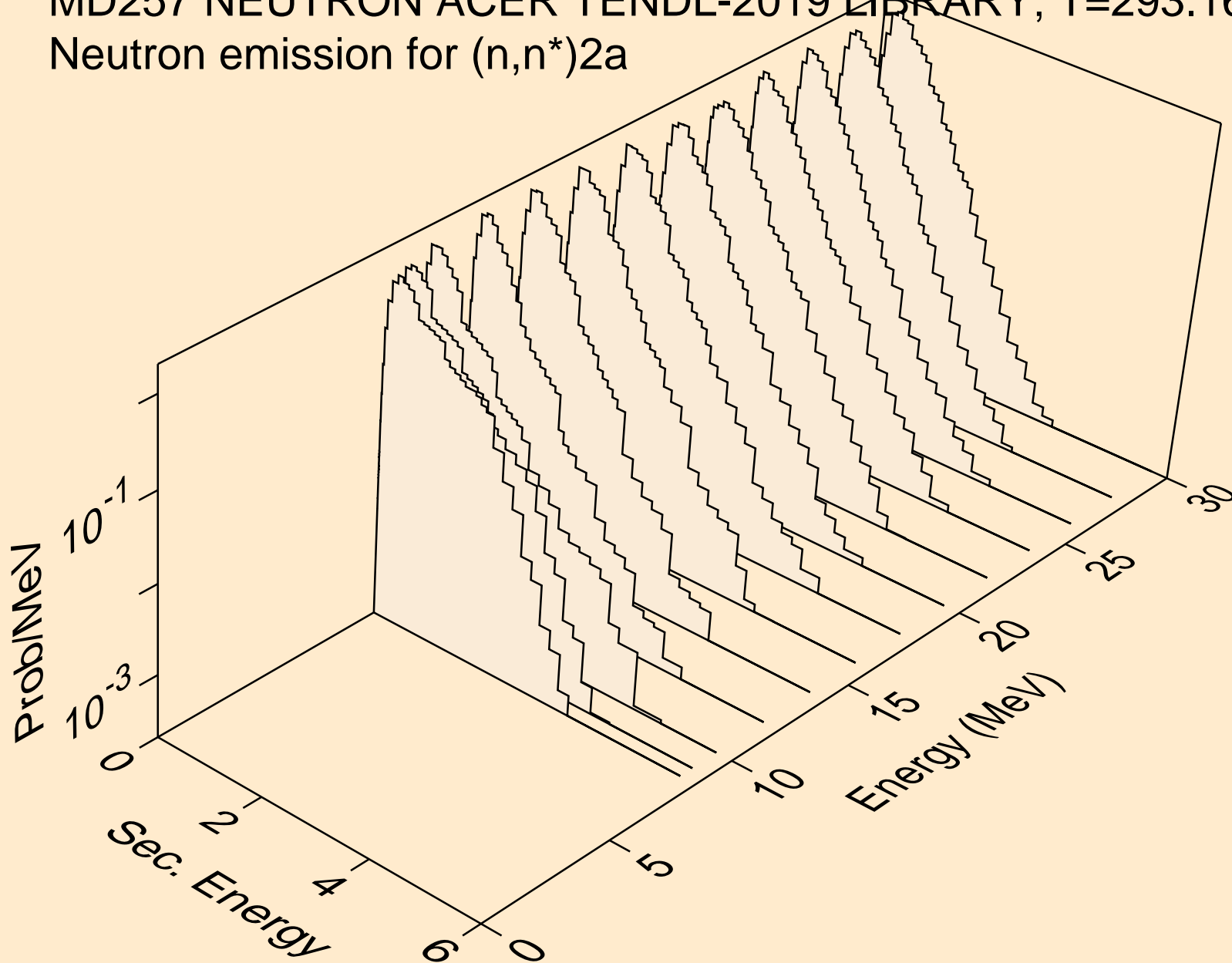

MD257 NEUTRON ACER TENDL-2019 LIBRARY; T=293.16K  
Neutron emission for (n,n\*)d

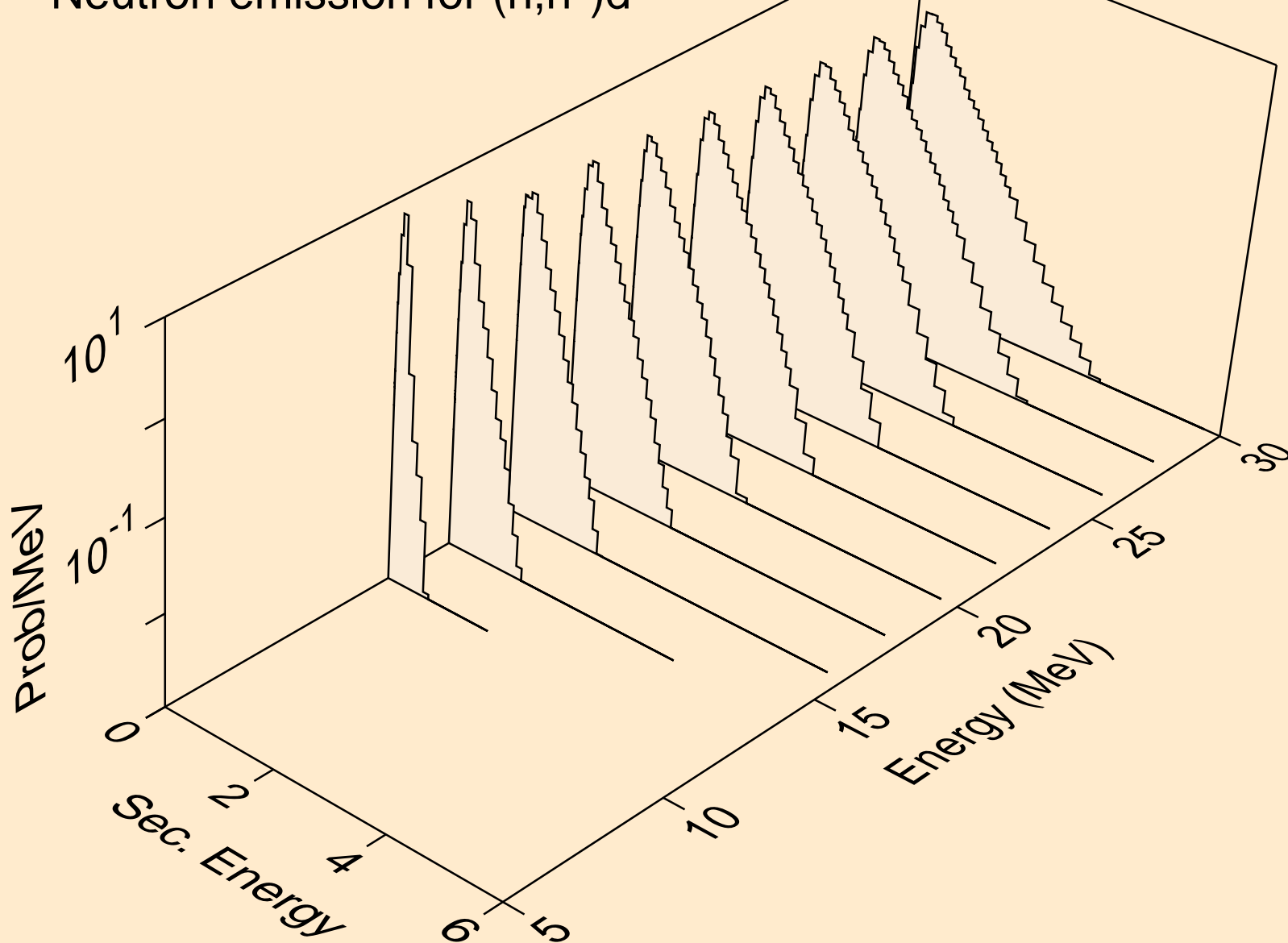

MD257 NEUTRON ACER TENDL-2019 LIBRARY; T=293.16K  
Neutron emission for (n,n\*)t

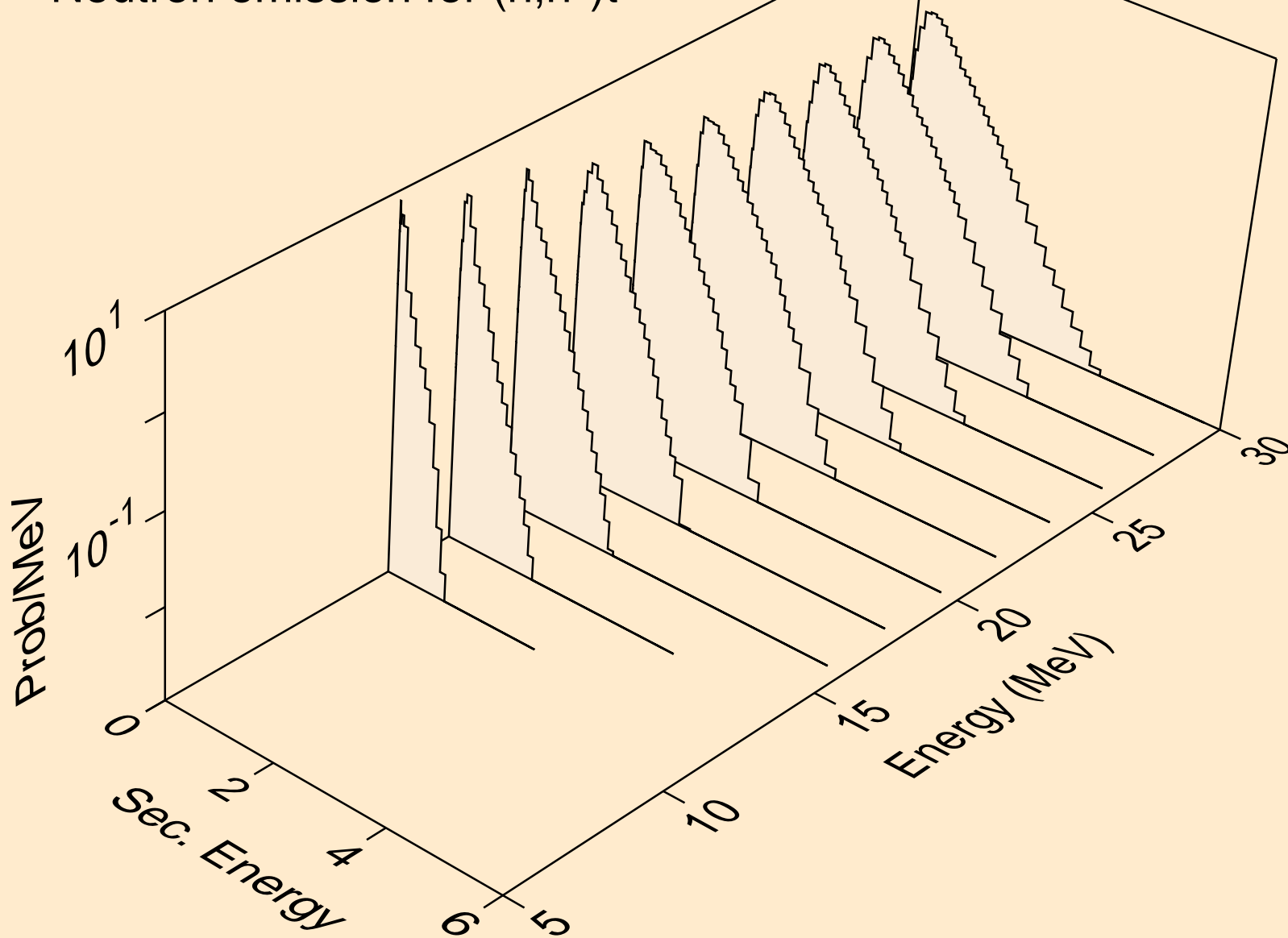

MD257 NEUTRON ACER TENDL-2019 LIBRARY; T=293.16K  
Neutron emission for (n,n\*)he3

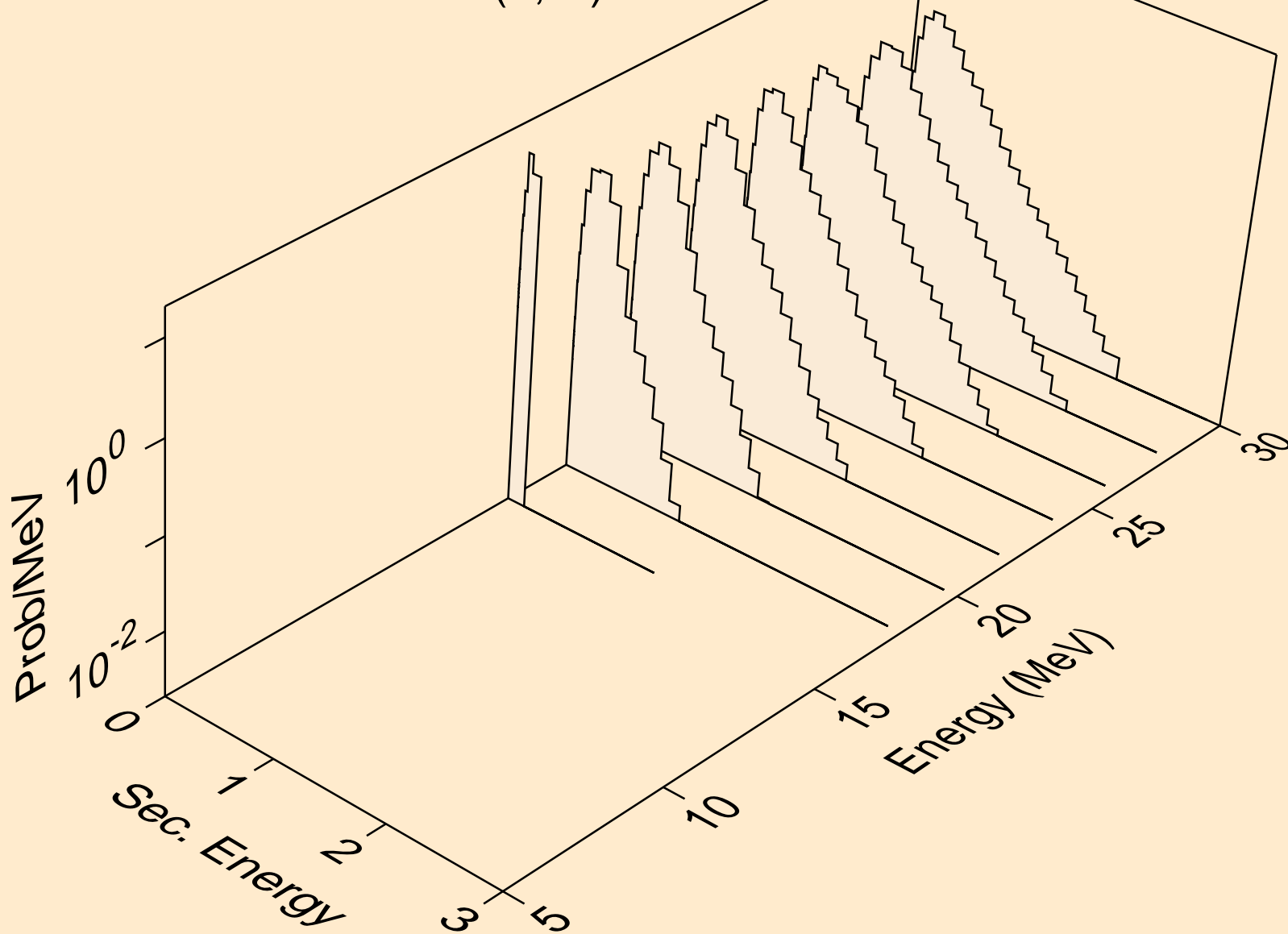



MD257 NEUTRON ACER TENDL-2019 LIBRARY; T=293.16K  
Neutron emission for (n,4n)

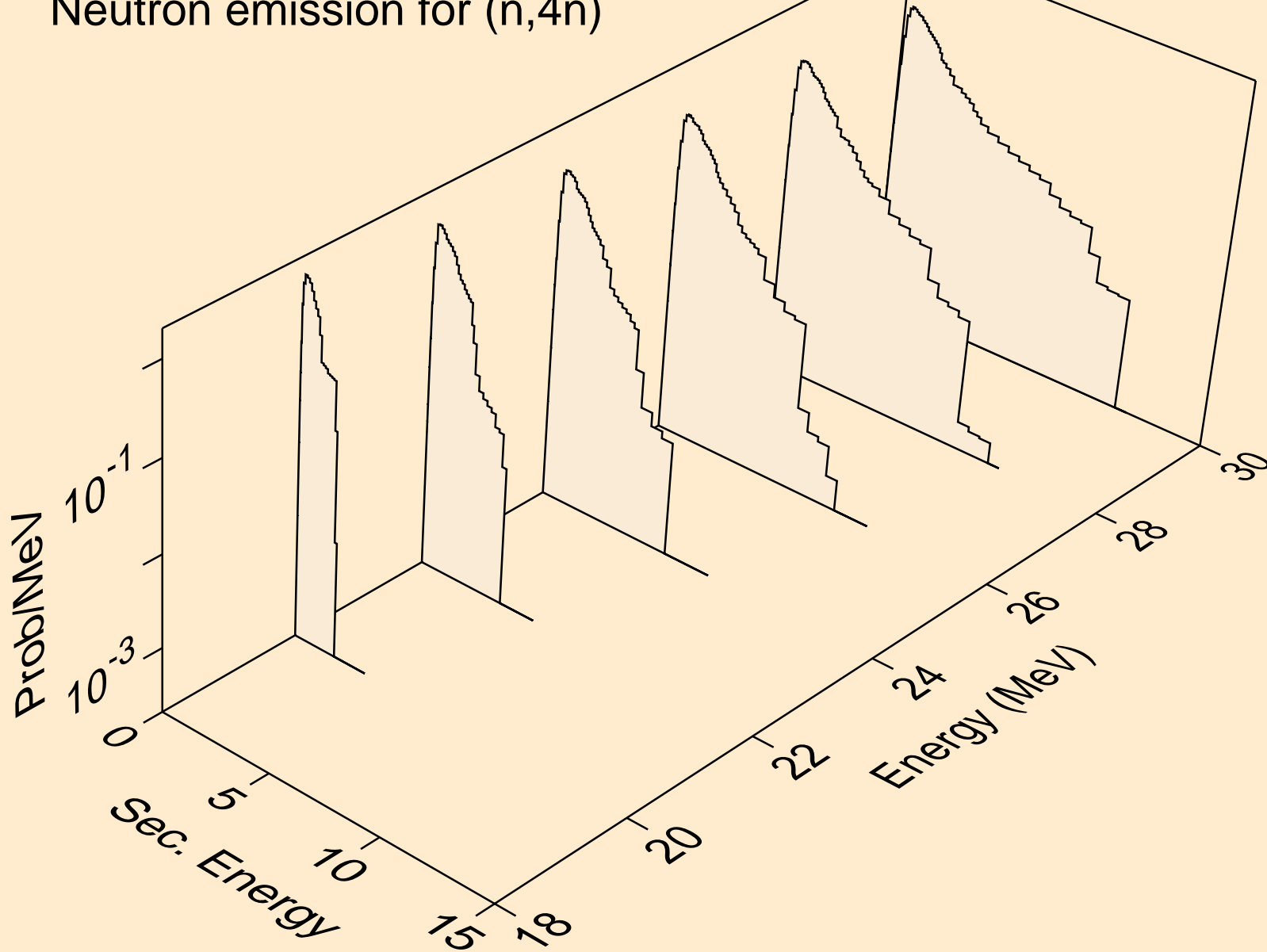

MD257 NEUTRON ACER TENDL-2019 LIBRARY; T=293.16K  
Neutron emission for (n,2np)

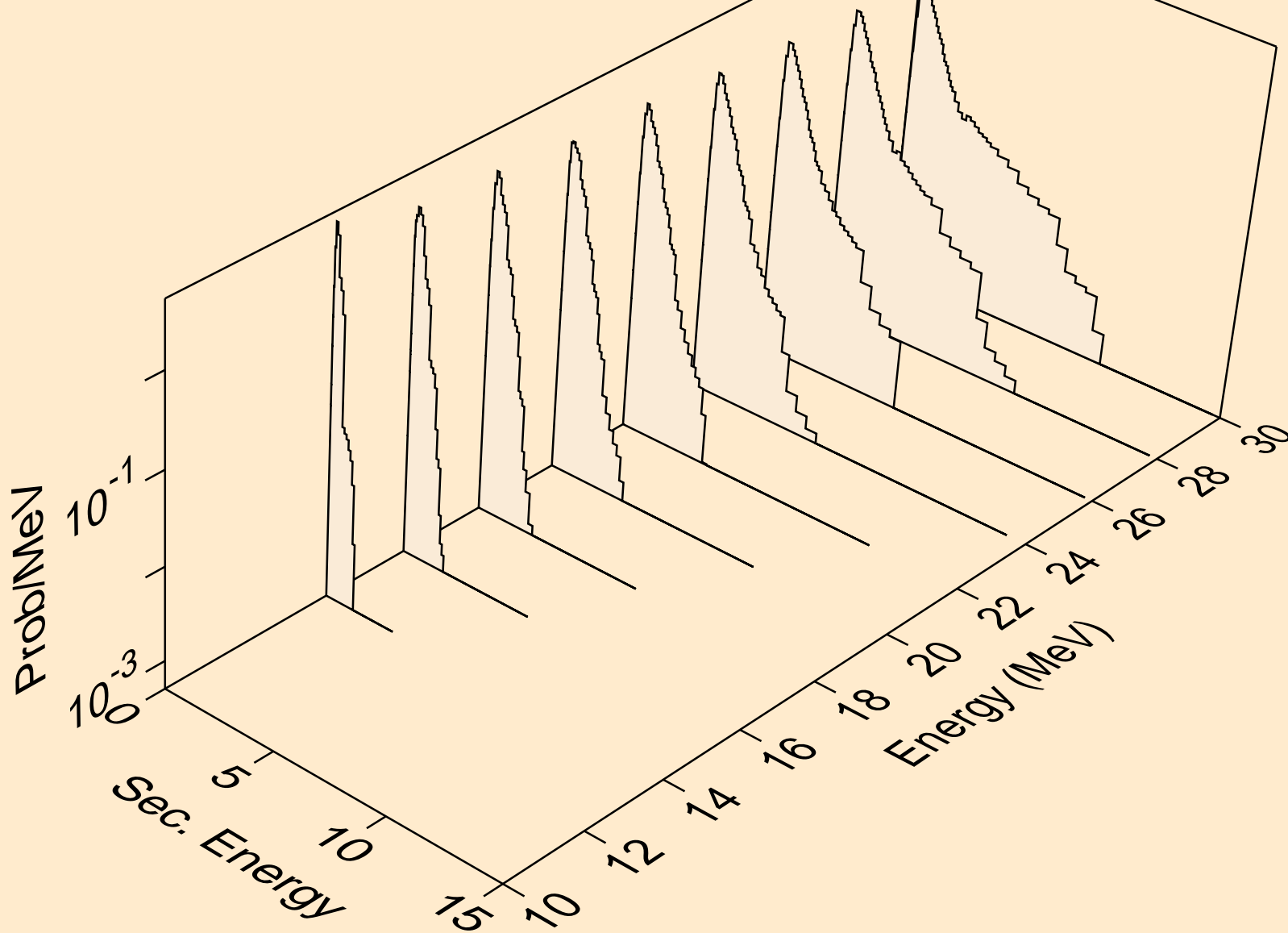

MD257 NEUTRON ACER TENDL-2019 LIBRARY; T=293.16K  
Neutron emission for (n,3np)

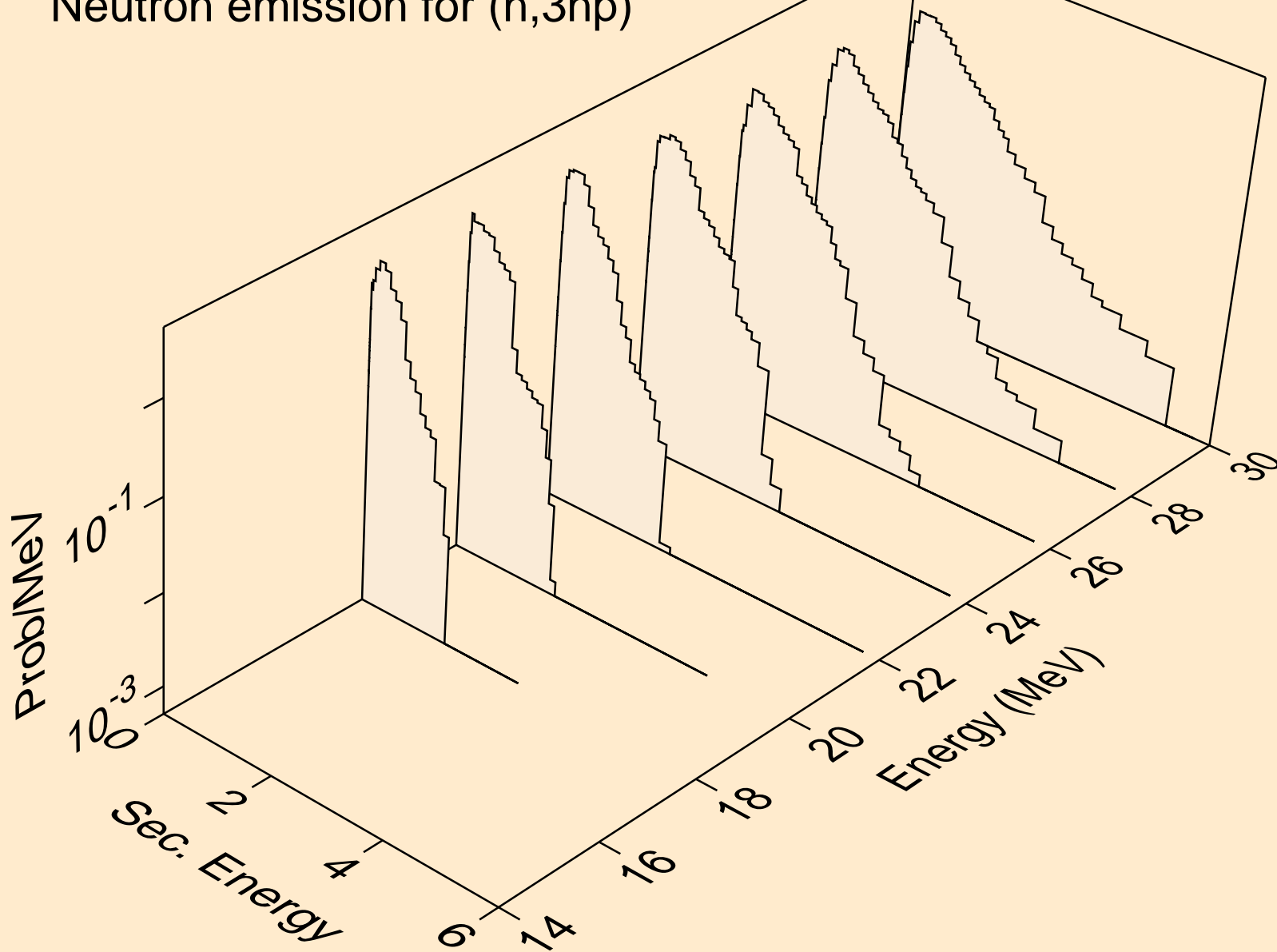

MD257 NEUTRON ACER TENDL-2019 LIBRARY; T=293.16K  
Neutron emission for (n,2np)

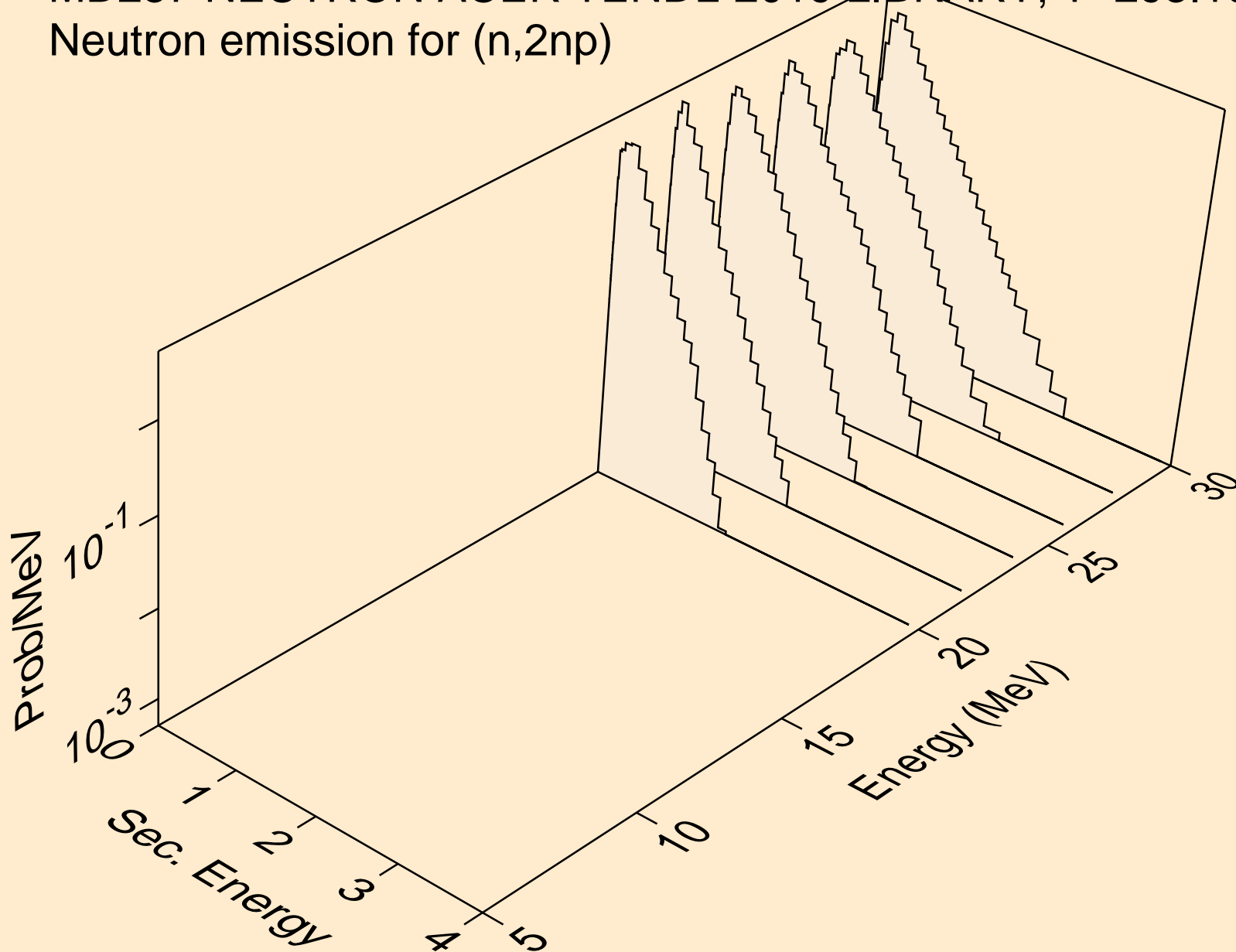

MD257 NEUTRON ACER TENDL-2019 LIBRARY; T=293.16K  
Neutron emission for (n,npa)

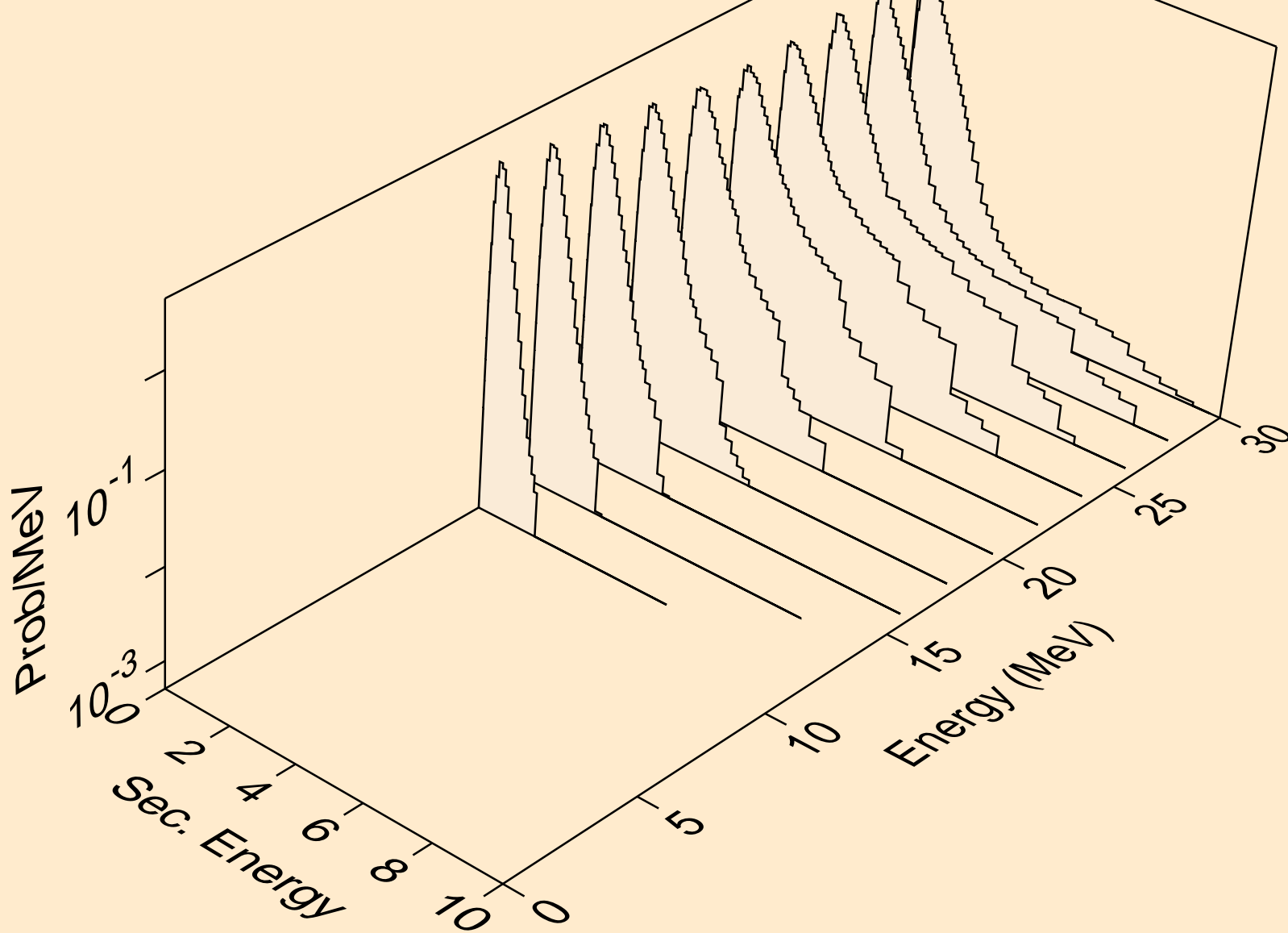

MD257 NEUTRON ACER TENDL-2019 LIBRARY; T=293.16K  
Neutron emission for (n,n\*c)

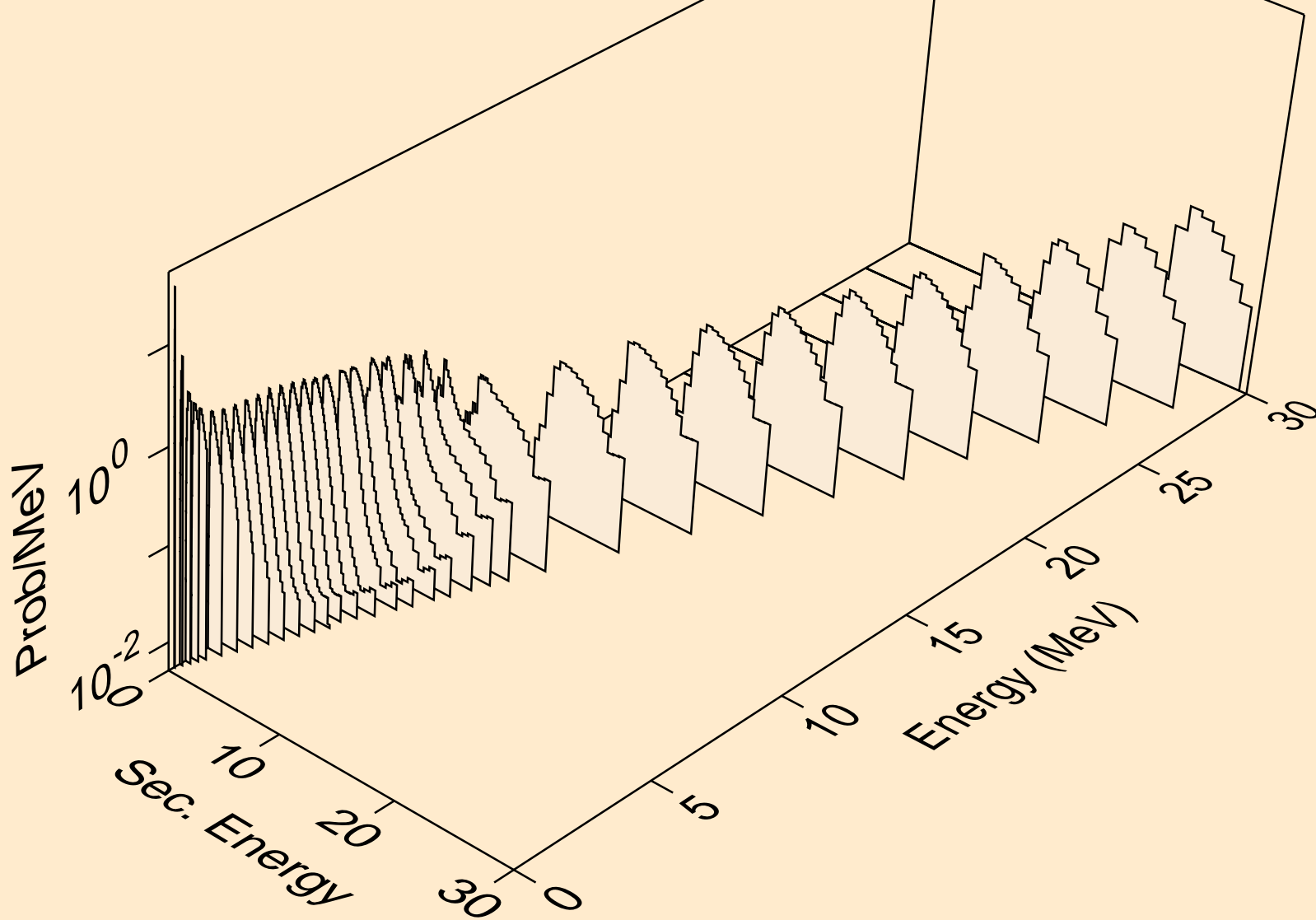

MD257 NEUTRON ACER TENDL-2019 LIBRARY; T=293.16K

Delayed nubar

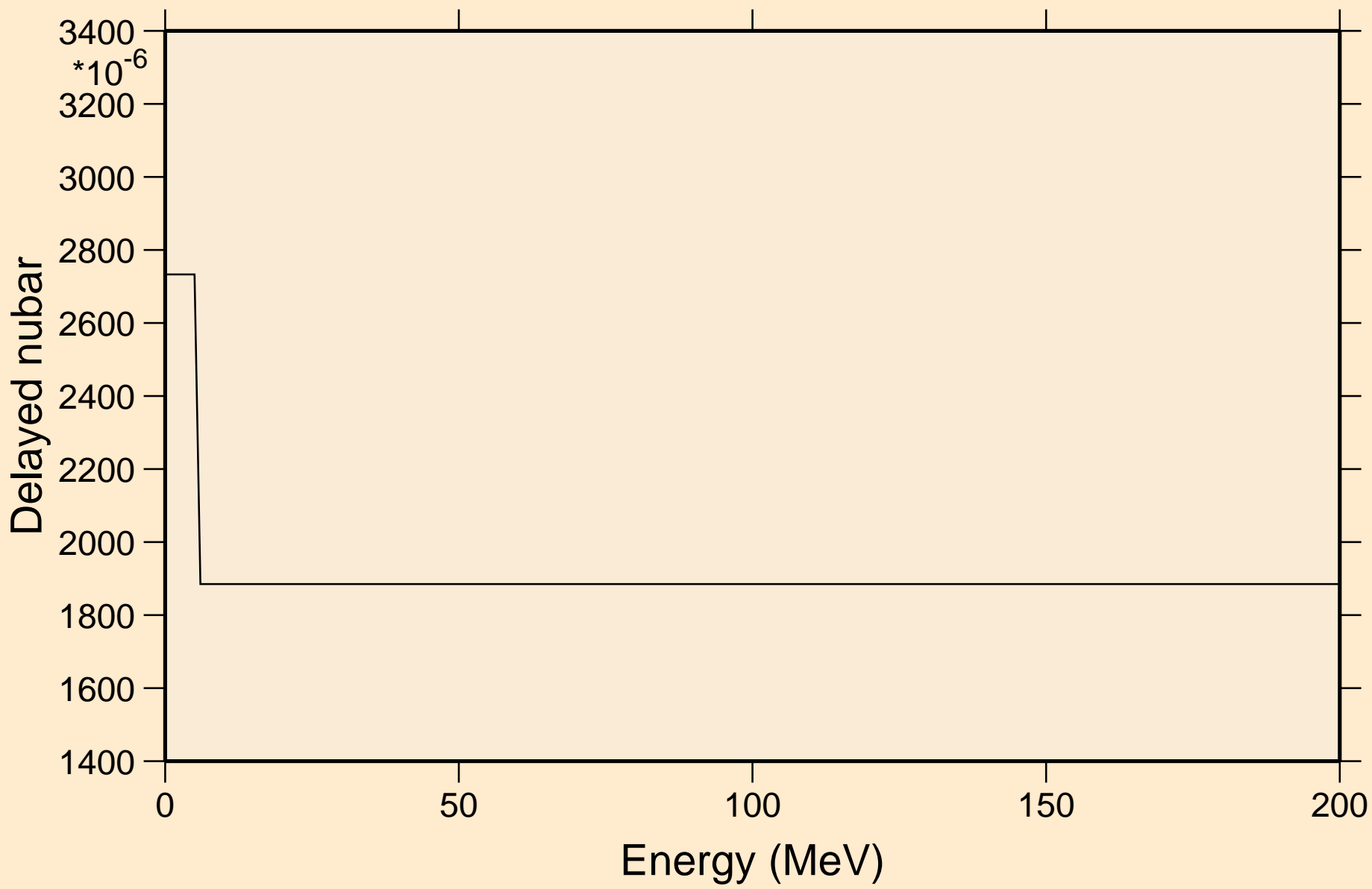

# MD257 NEUTRON ACER TENDL-2019 LIBRARY; T=293.16K

## Delayed neutron spectra

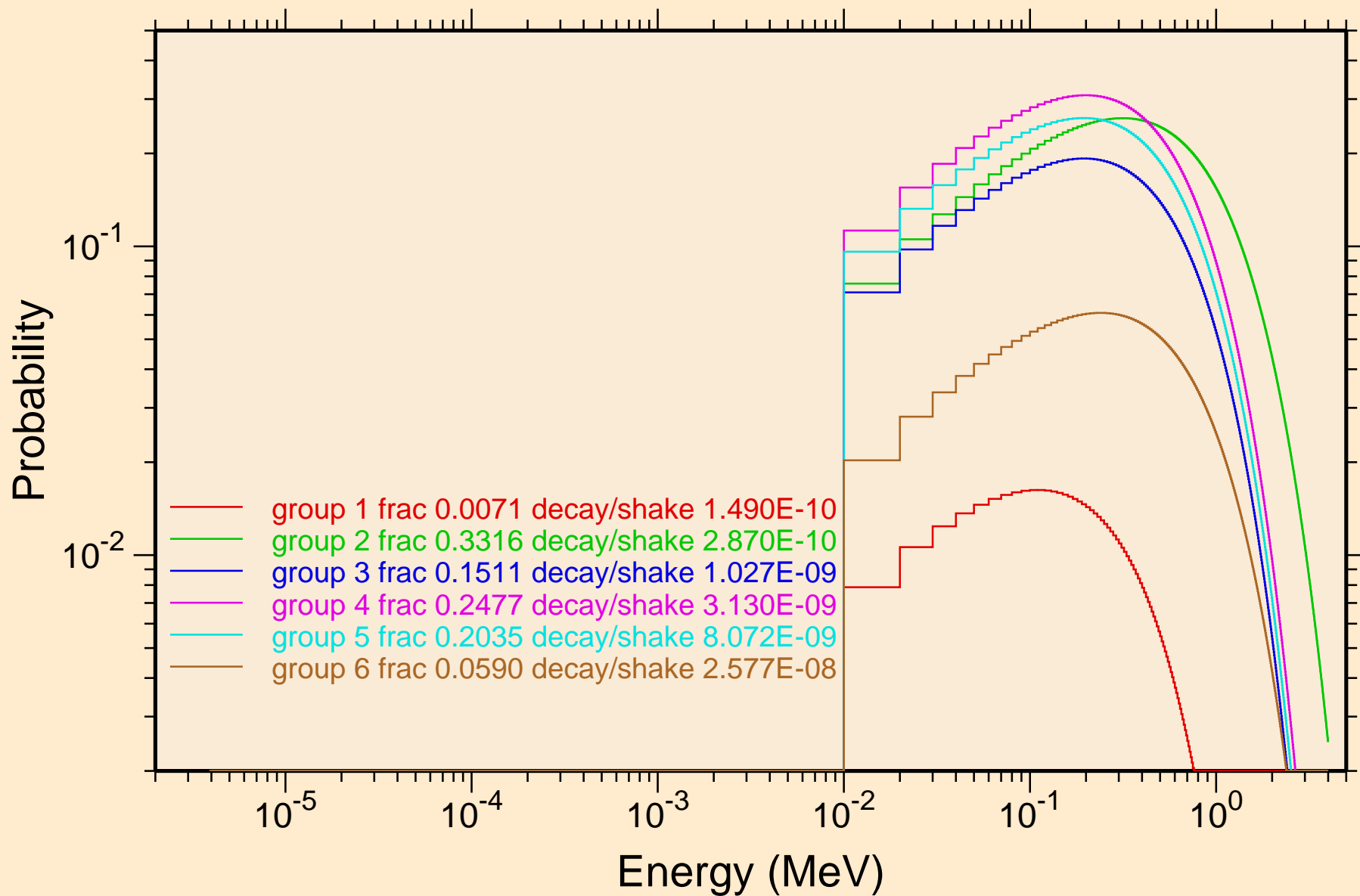



MD257 NEUTRON ACER TENDL-2019 LIBRARY; T=293.16K  
Photon emission for (n,x)

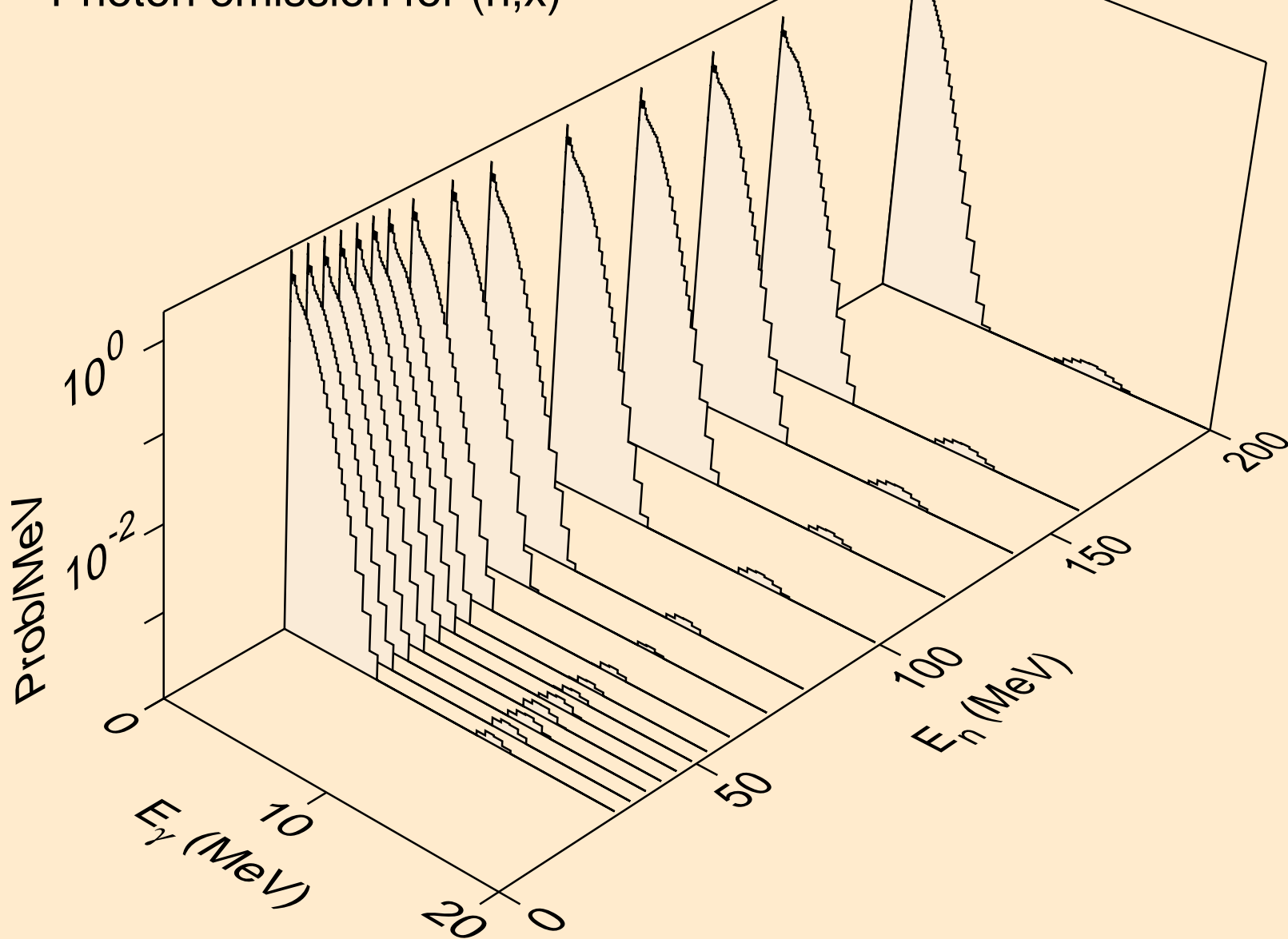

MD257 NEUTRON ACER TENDL-2019 LIBRARY; T=293.16K  
Photon emission for (n,2nd)

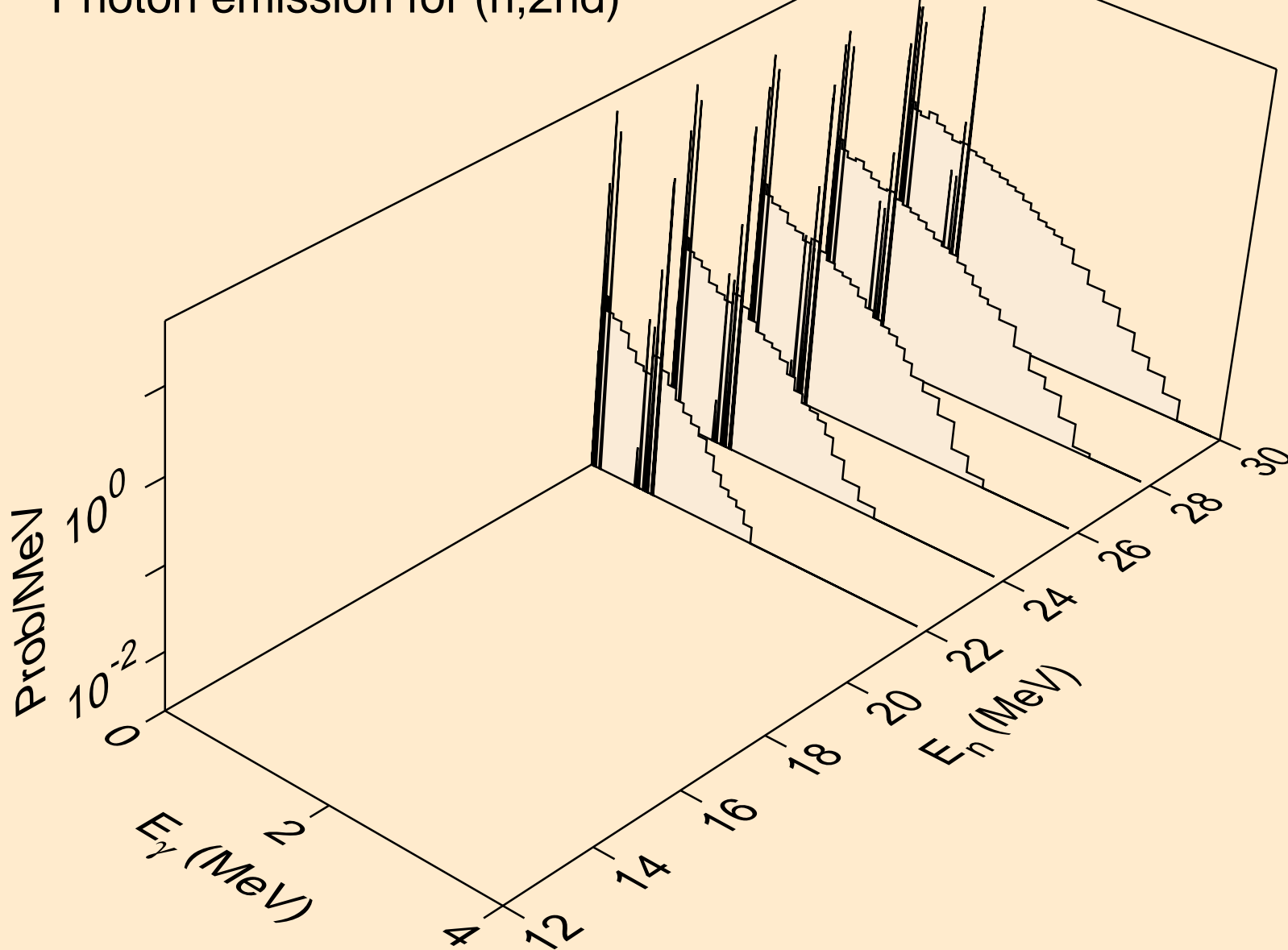

MD257 NEUTRON ACER TENDL-2019 LIBRARY; T=293.16K  
Photon emission for (n,2n)

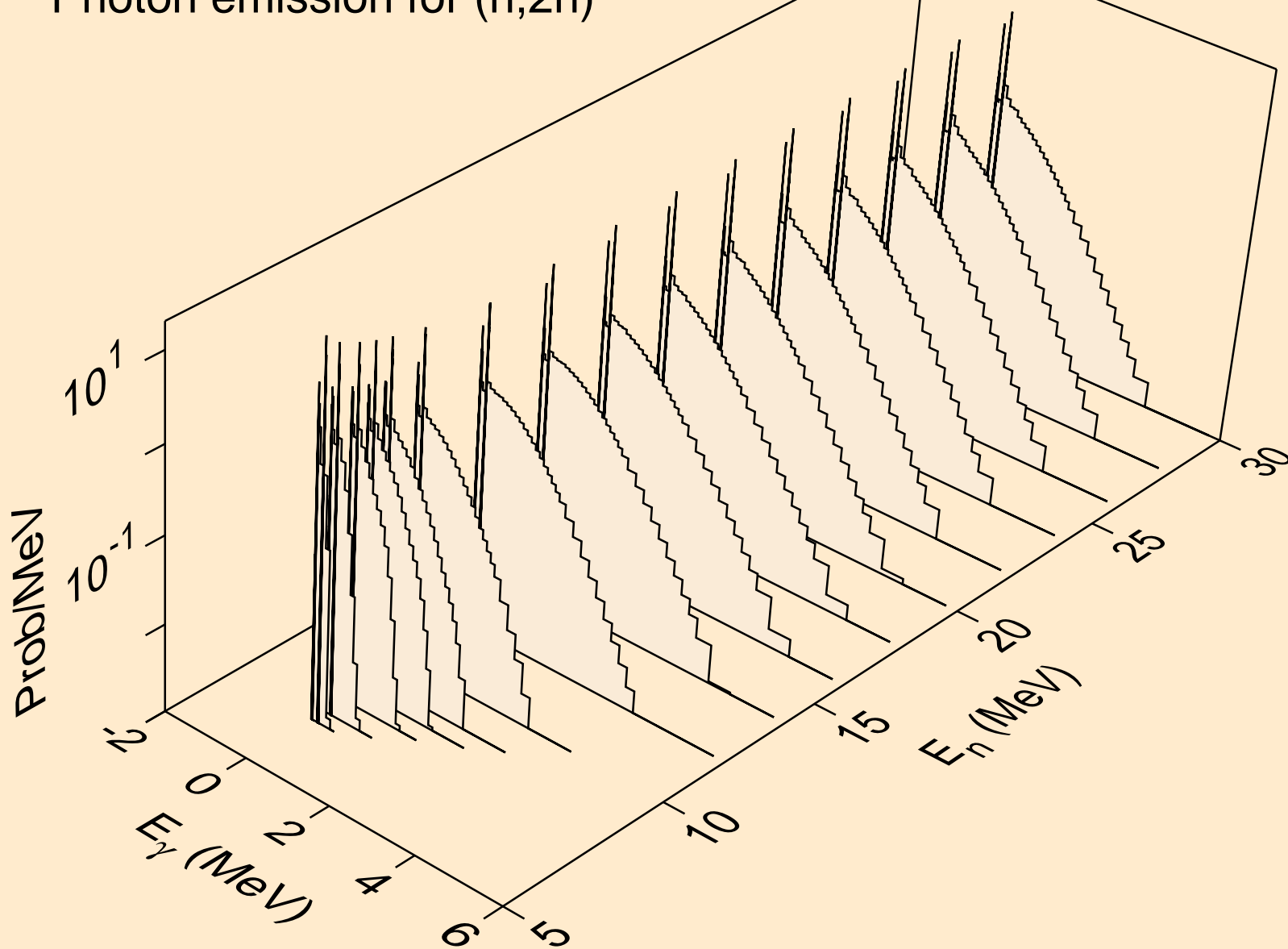

MD257 NEUTRON ACER TENDL-2019 LIBRARY; T=293.16K  
Photon emission for (n,3n)

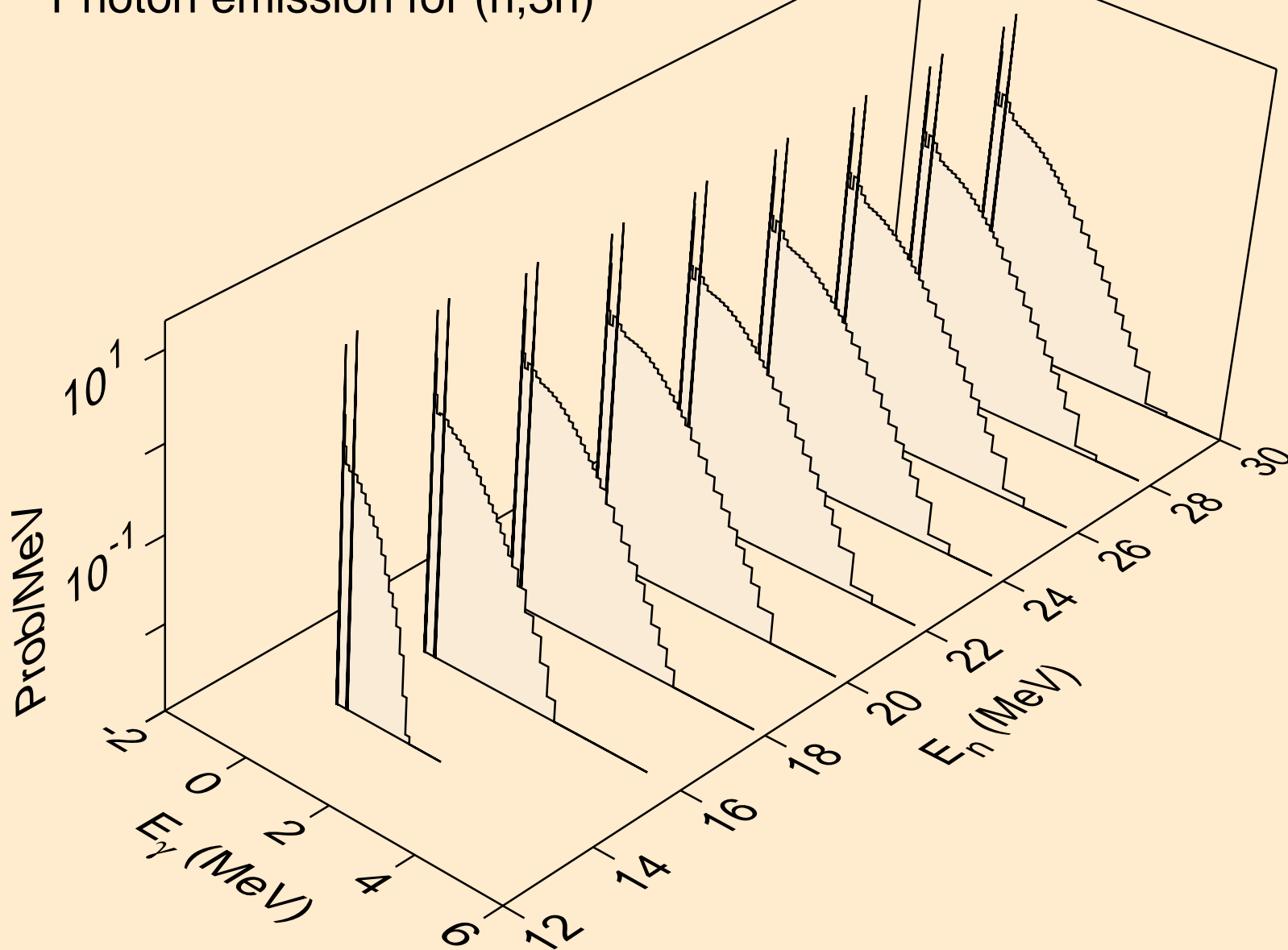

MD257 NEUTRON ACER TENDL-2019 LIBRARY; T=293.16K  
Photon emission for (n,n\*)a

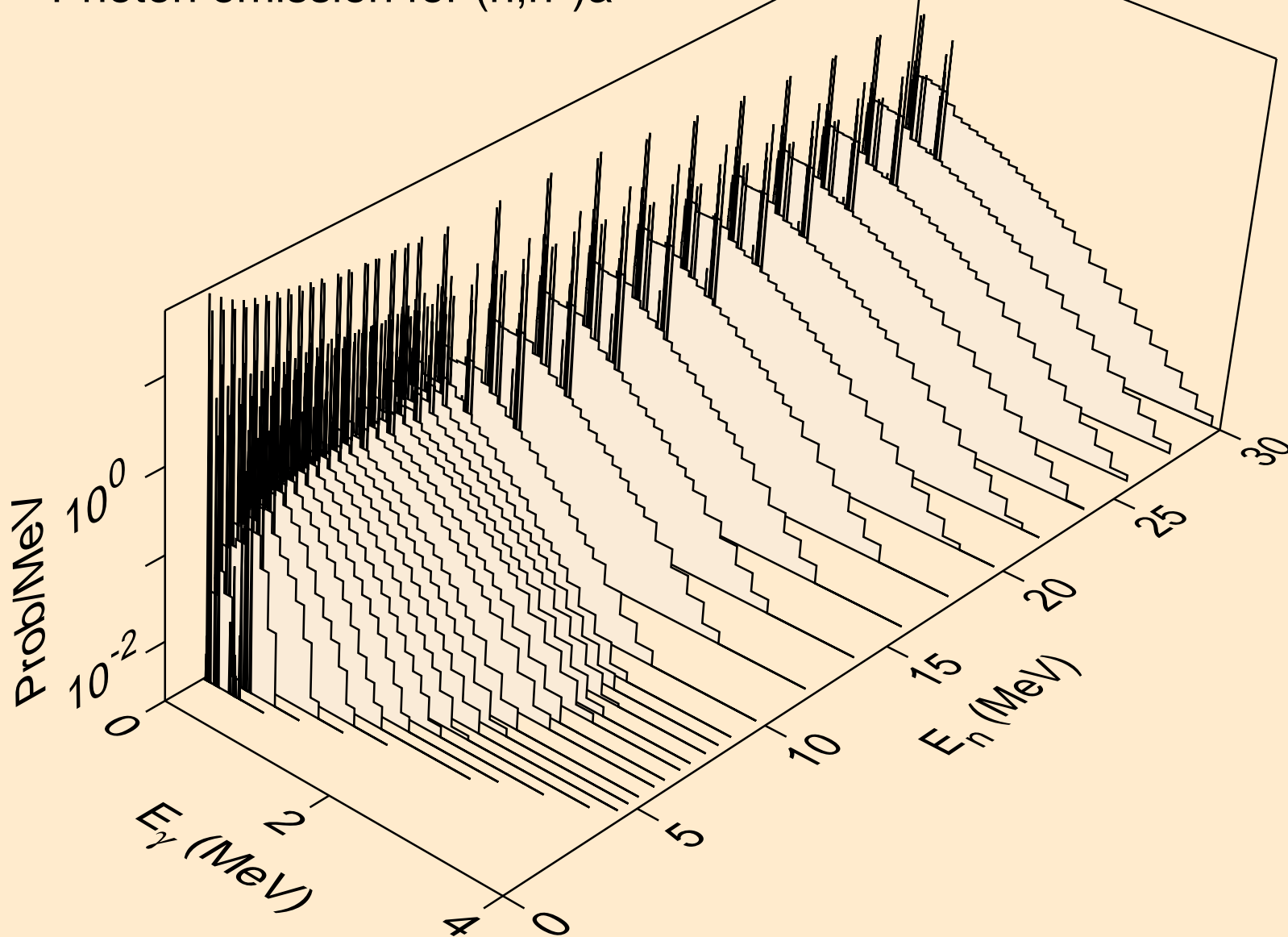

MD257 NEUTRON ACER TENDL-2019 LIBRARY; T=293.16K  
Photon emission for (n,2n)a

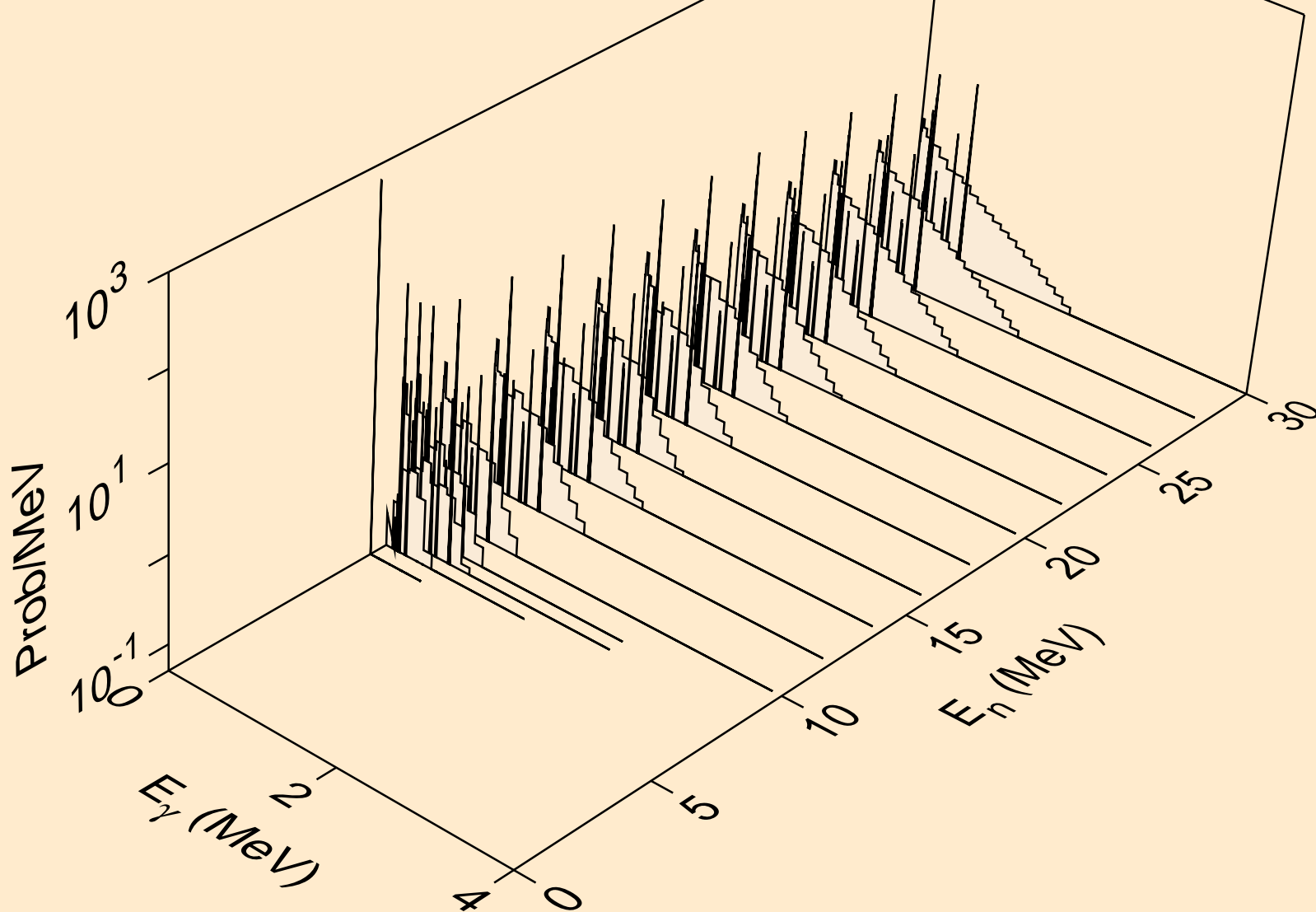

MD257 NEUTRON ACER TENDL-2019 LIBRARY; T=293.16K  
Photon emission for (n,3n)a

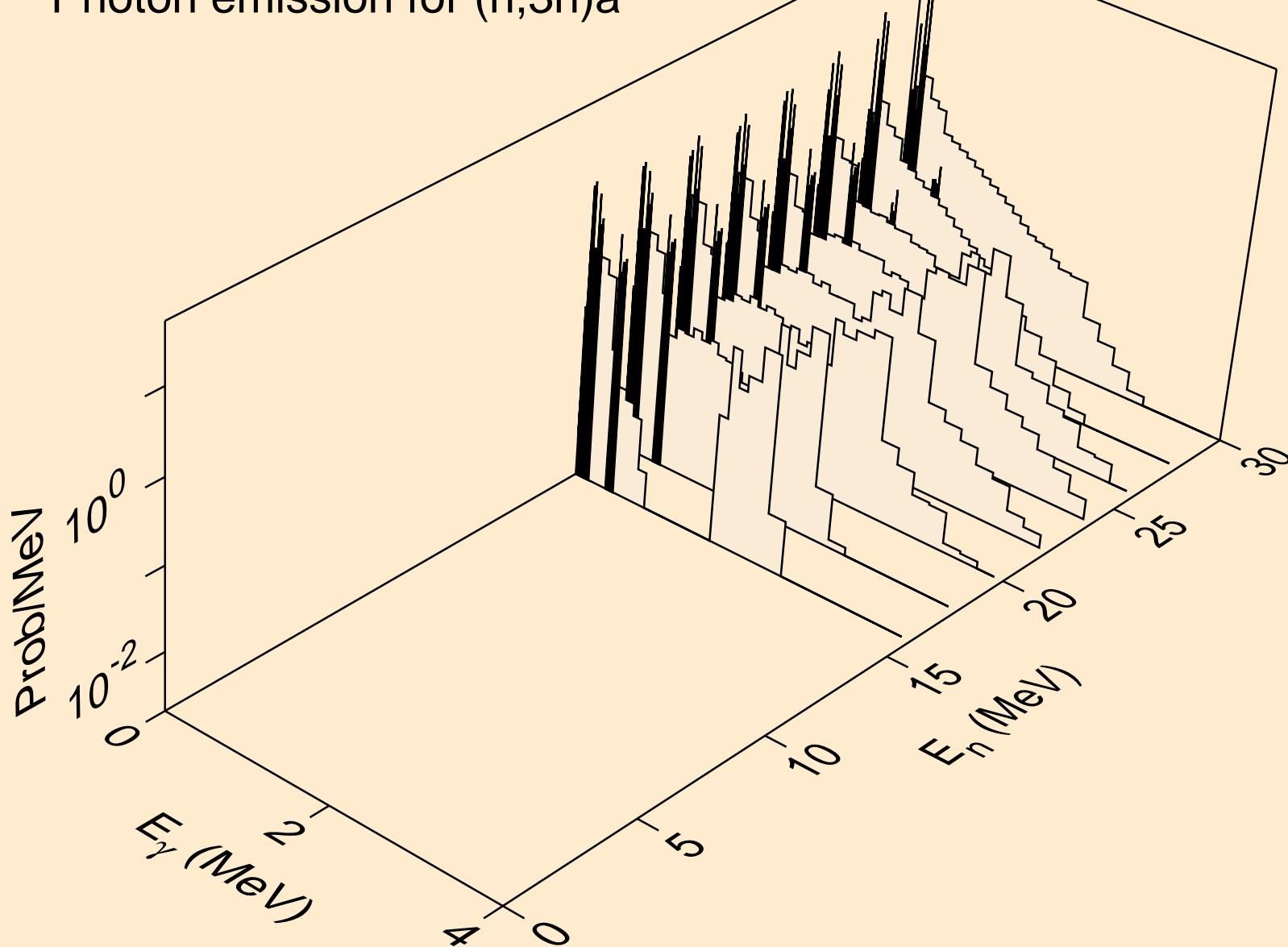

MD257 NEUTRON ACER TENDL-2019 LIBRARY; T=293.16K  
Photon emission for (n,n\*)p

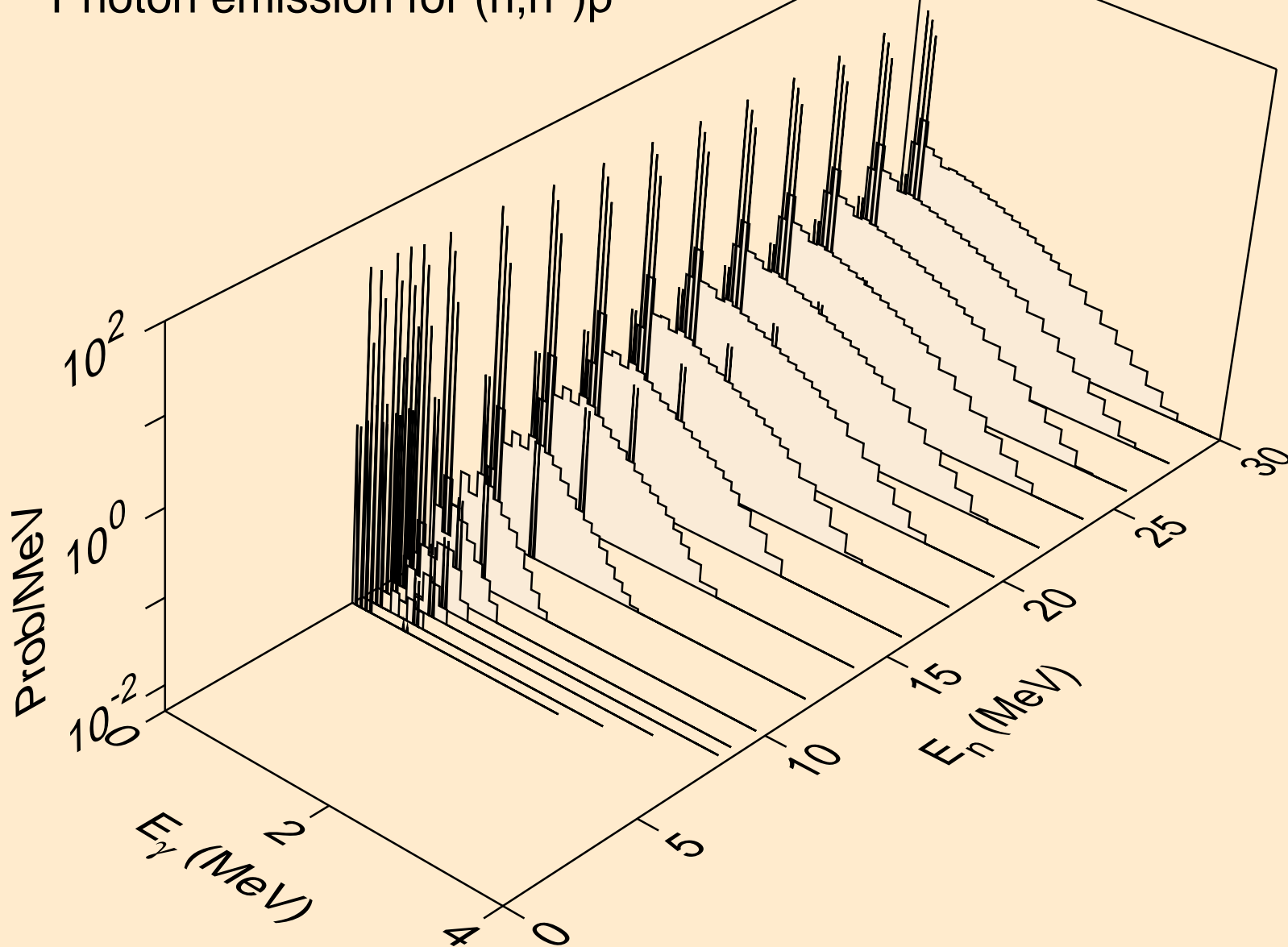



MD257 NEUTRON ACER TENDL-2019 LIBRARY; T=293.16K  
Photon emission for (n,n\*)2a

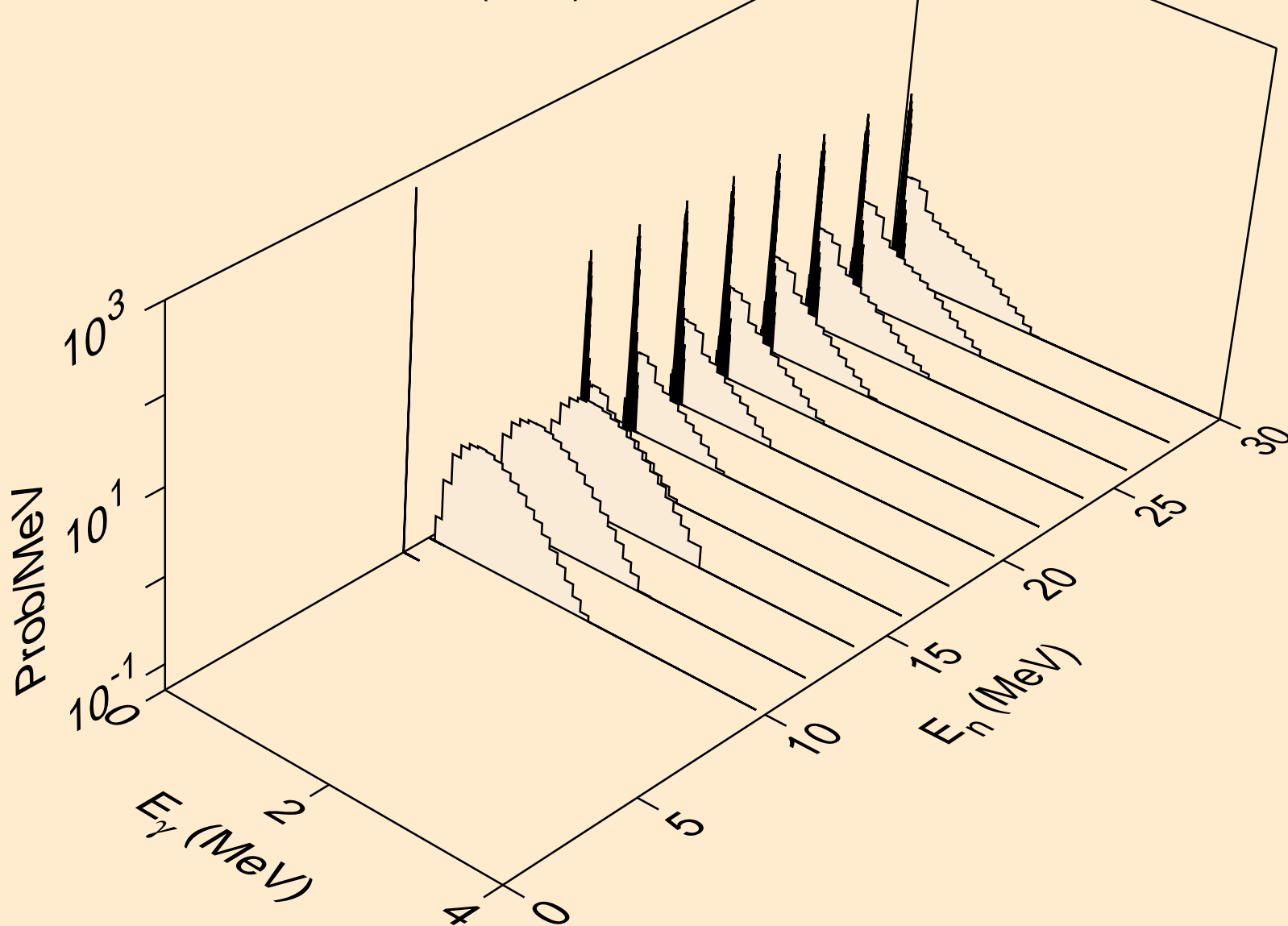

MD257 NEUTRON ACER TENDL-2019 LIBRARY; T=293.16K  
Photon emission for (n,n\*)d

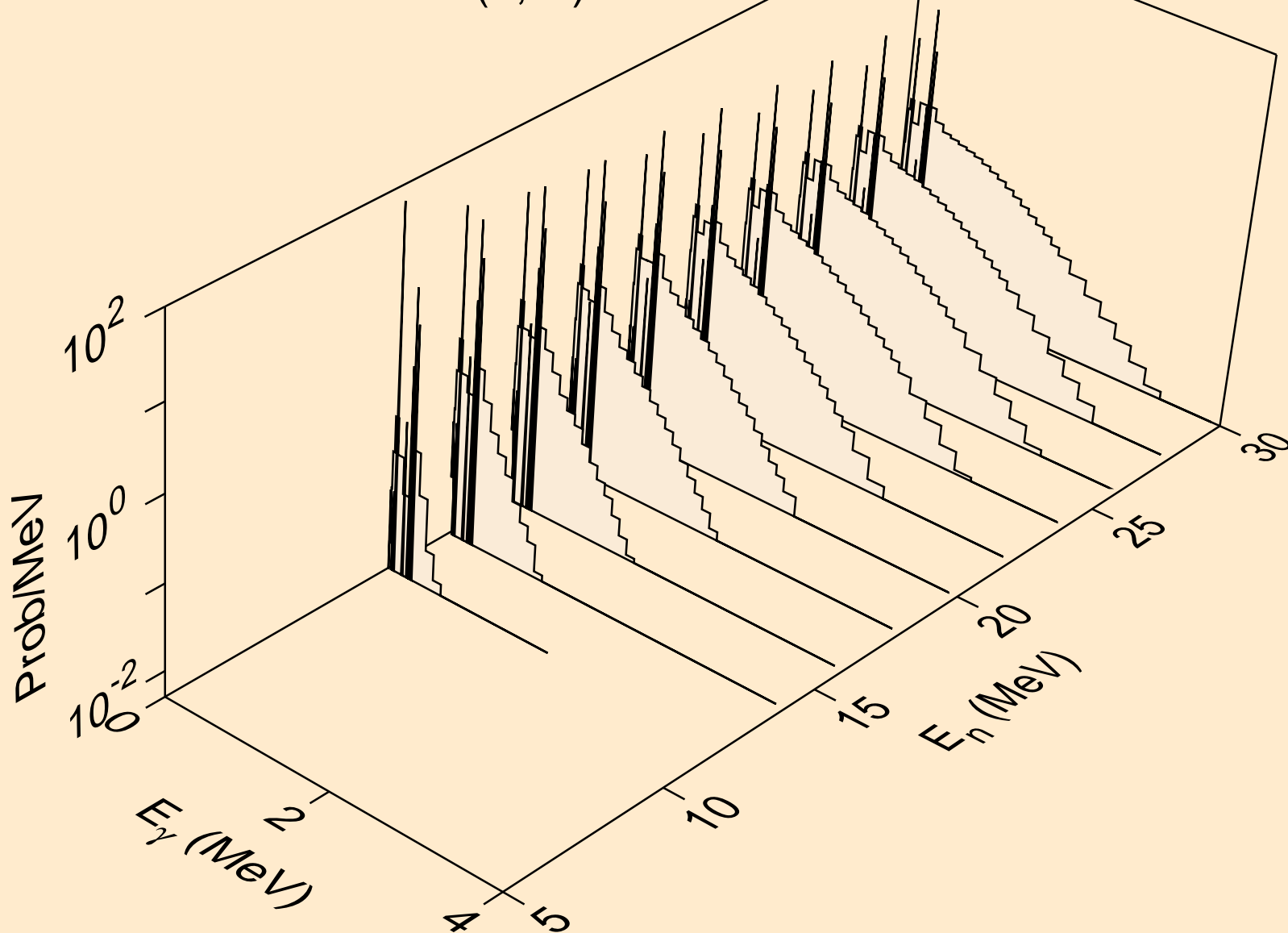

MD257 NEUTRON ACER TENDL-2019 LIBRARY; T=293.16K  
Photon emission for (n,n\*)t

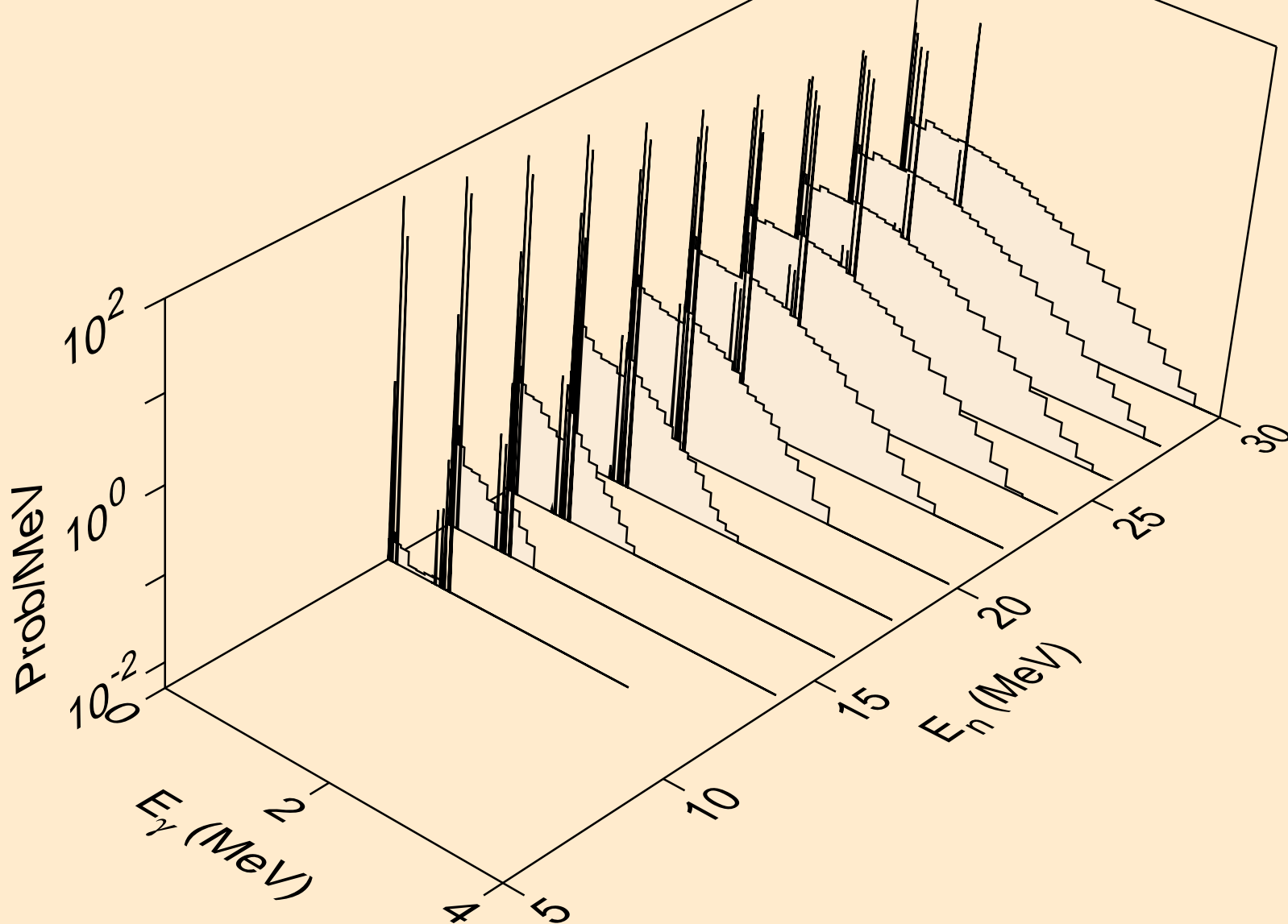

MD257 NEUTRON ACER TENDL-2019 LIBRARY; T=293.16K  
Photon emission for (n,n\*)he3

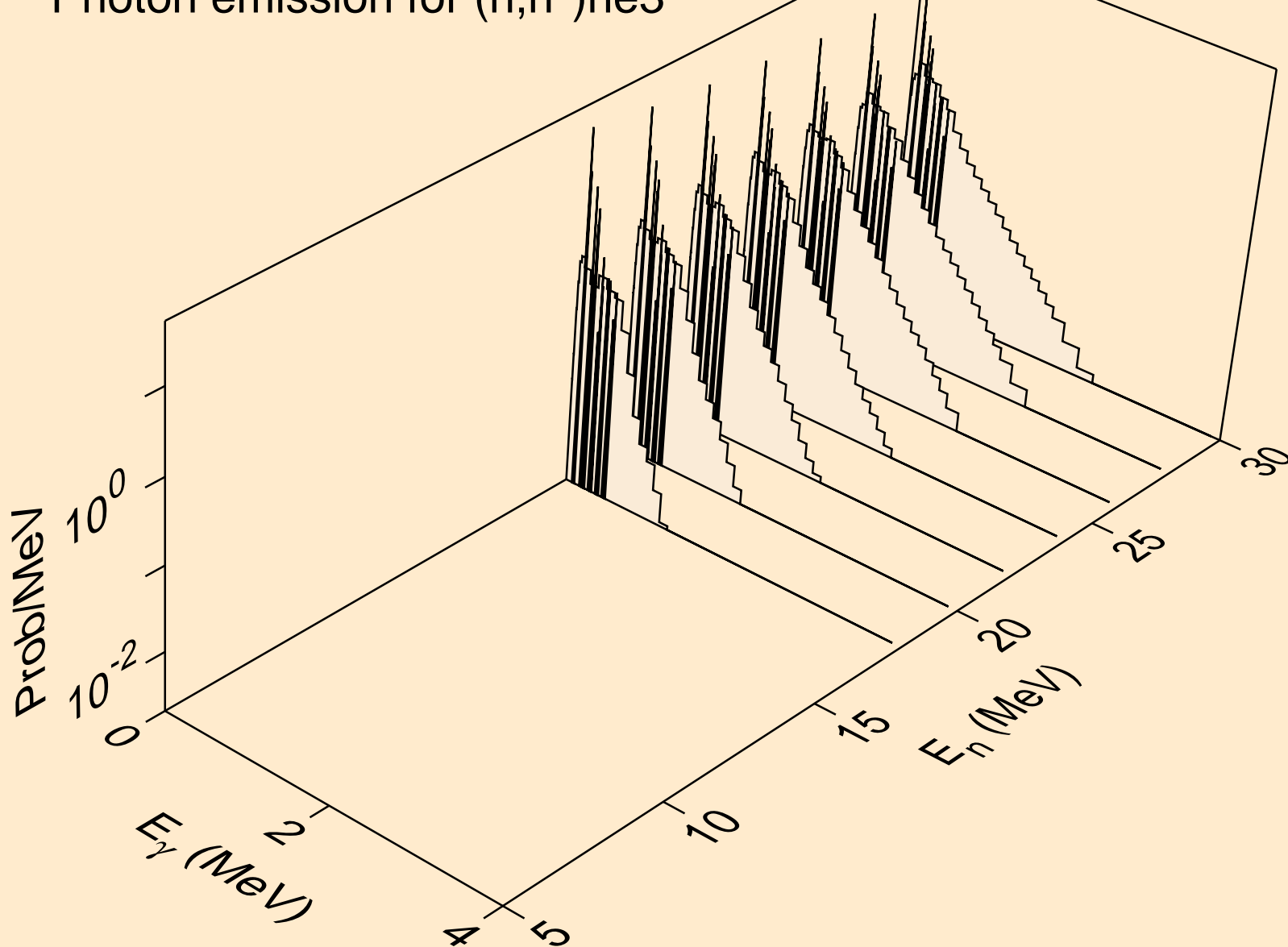

MD257 NEUTRON ACER TENDL-2019 LIBRARY; T=293.16K  
Photon emission for (n,4n)

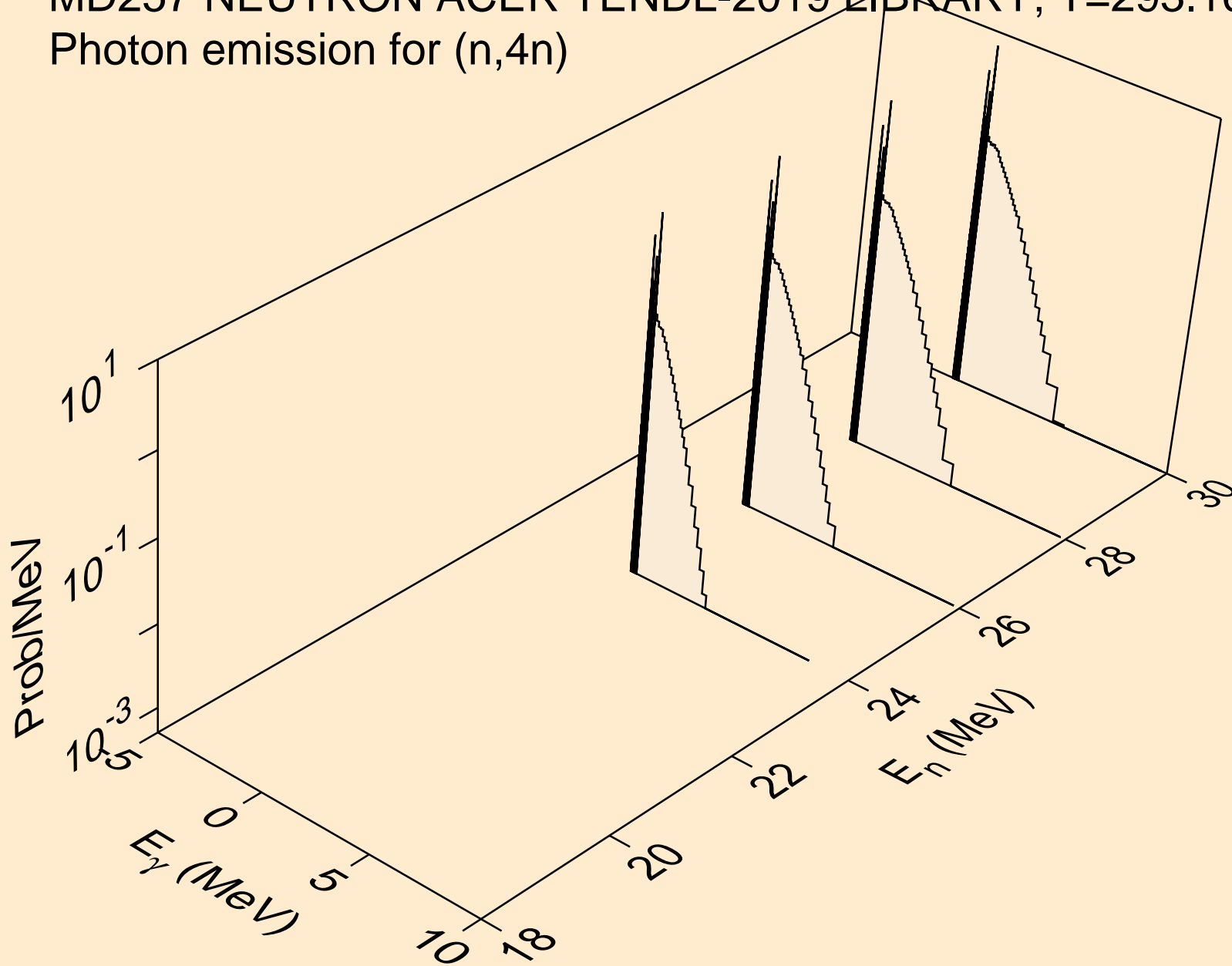

MD257 NEUTRON ACER TENDL-2019 LIBRARY; T=293.16K  
Photon emission for (n,2np)

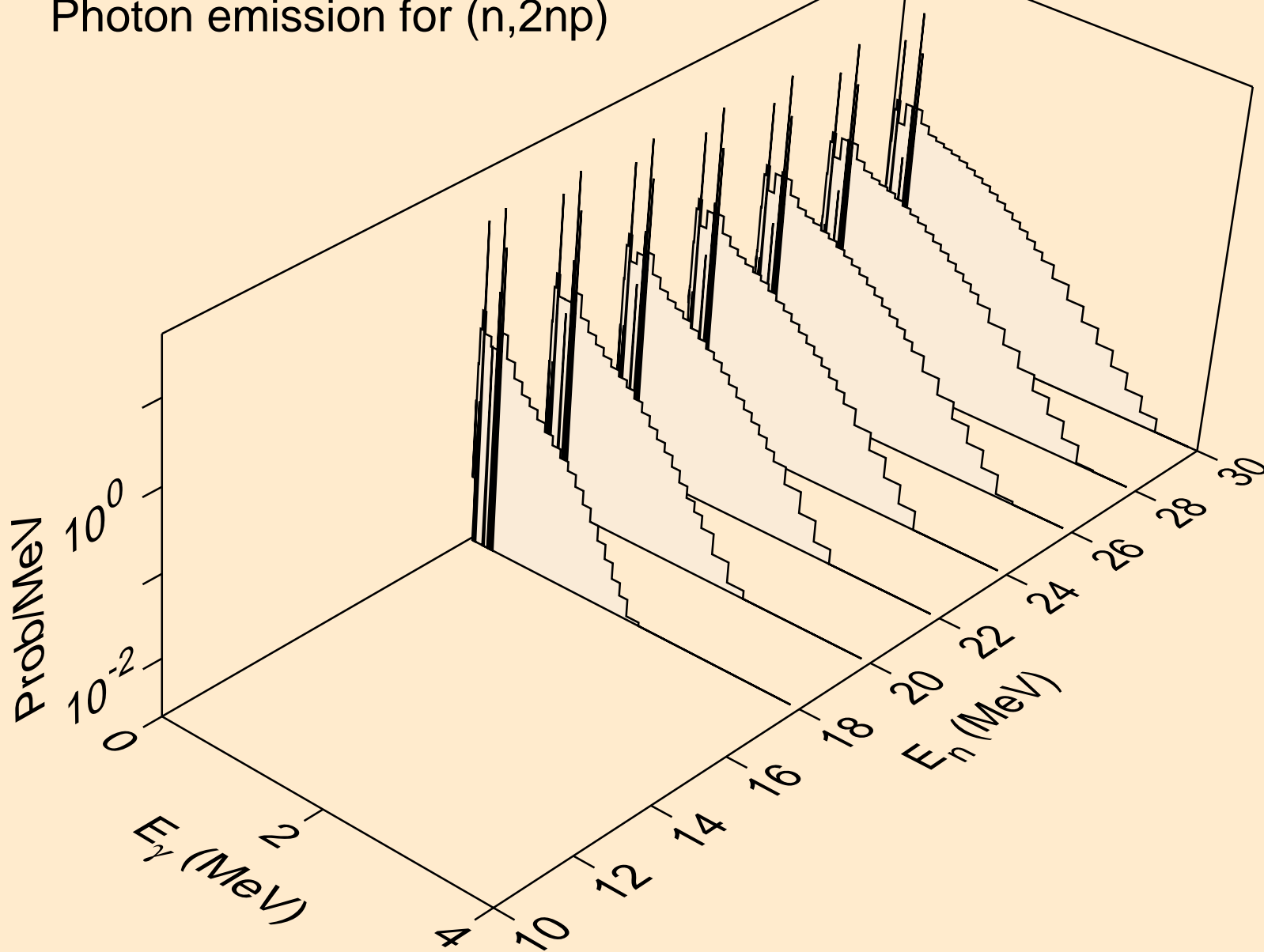

MD257 NEUTRON ACER TENDL-2019 LIBRARY; T=293.16K  
Photon emission for (n,3np)

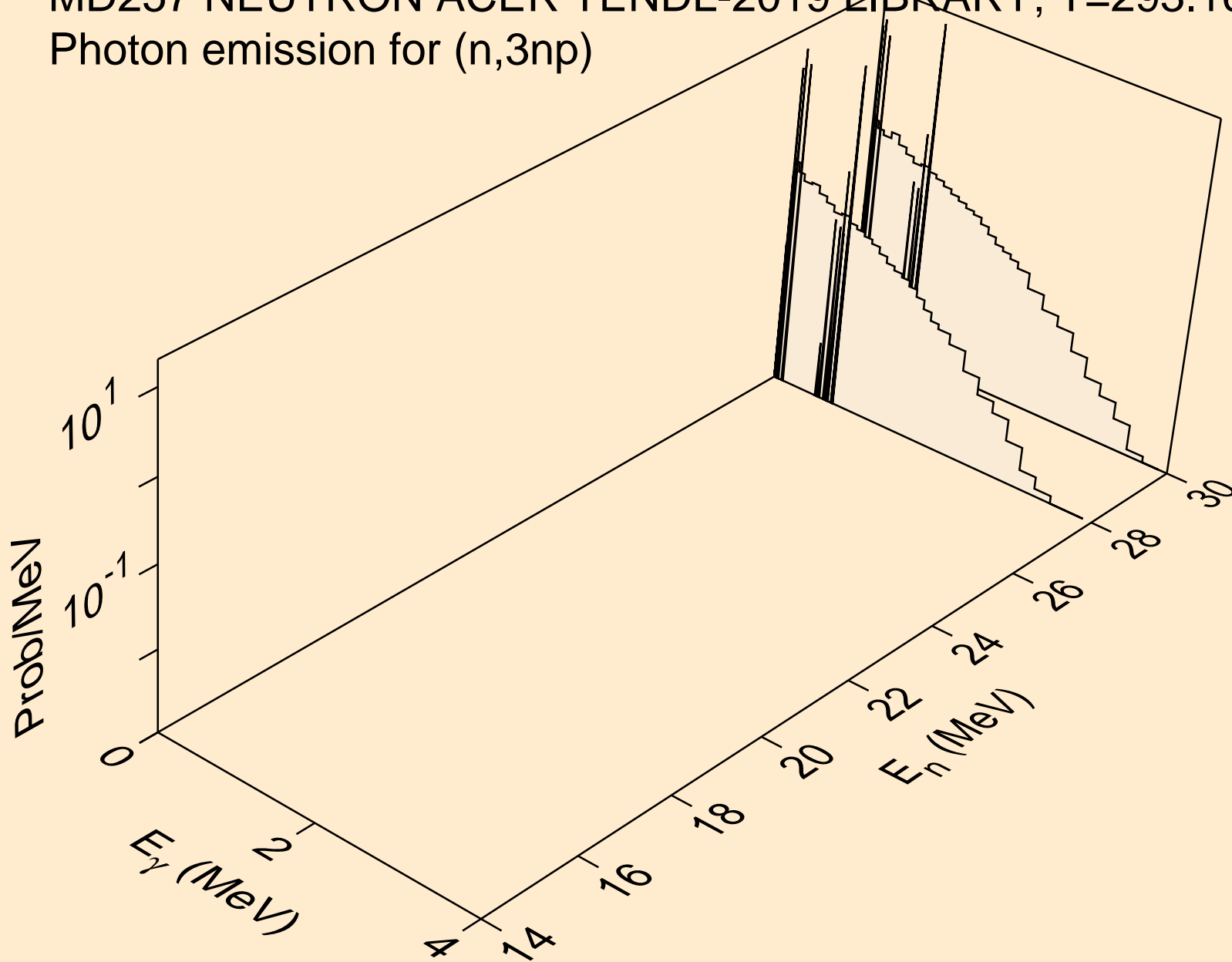

MD257 NEUTRON ACER TENDL-2019 LIBRARY; T=293.16K  
Photon emission for (n,2np)

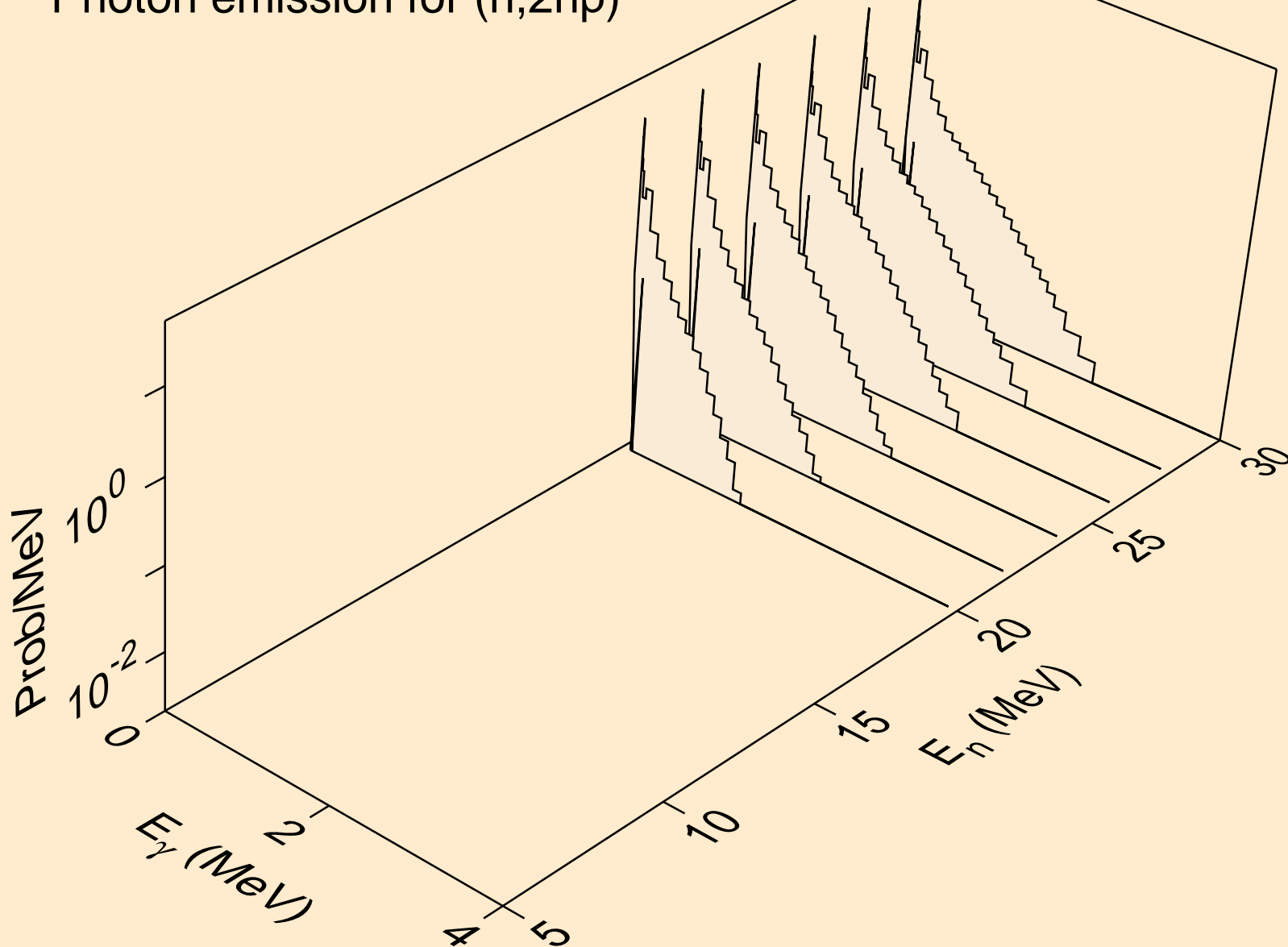



MD257 NEUTRON ACER TENDL-2019 LIBRARY; T=293.16K  
Photon emission for (n,npa)

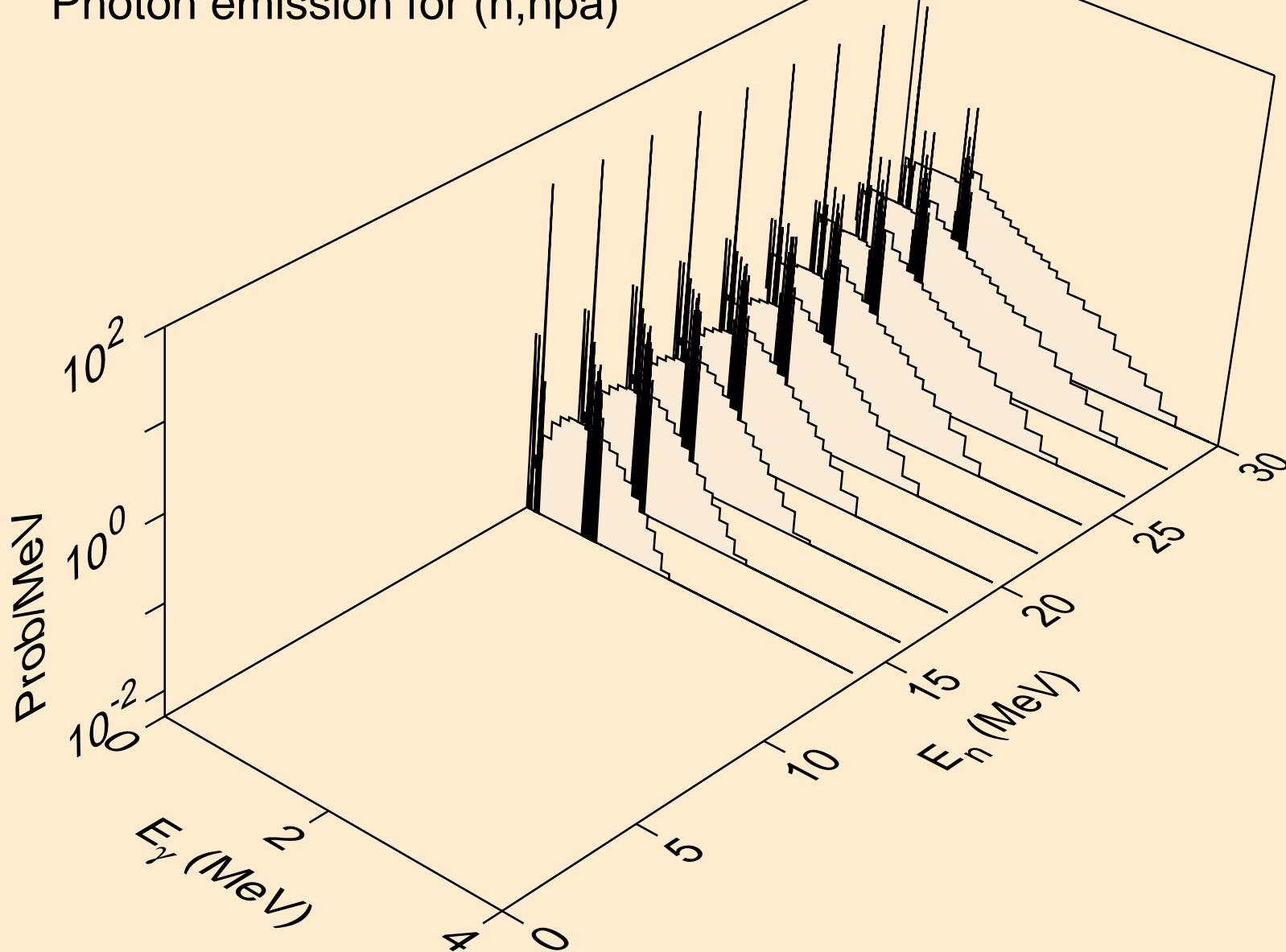

MD257 NEUTRON ACER TENDL-2019 LIBRARY; T=293.16K  
Photon emission for (n,n\*c)

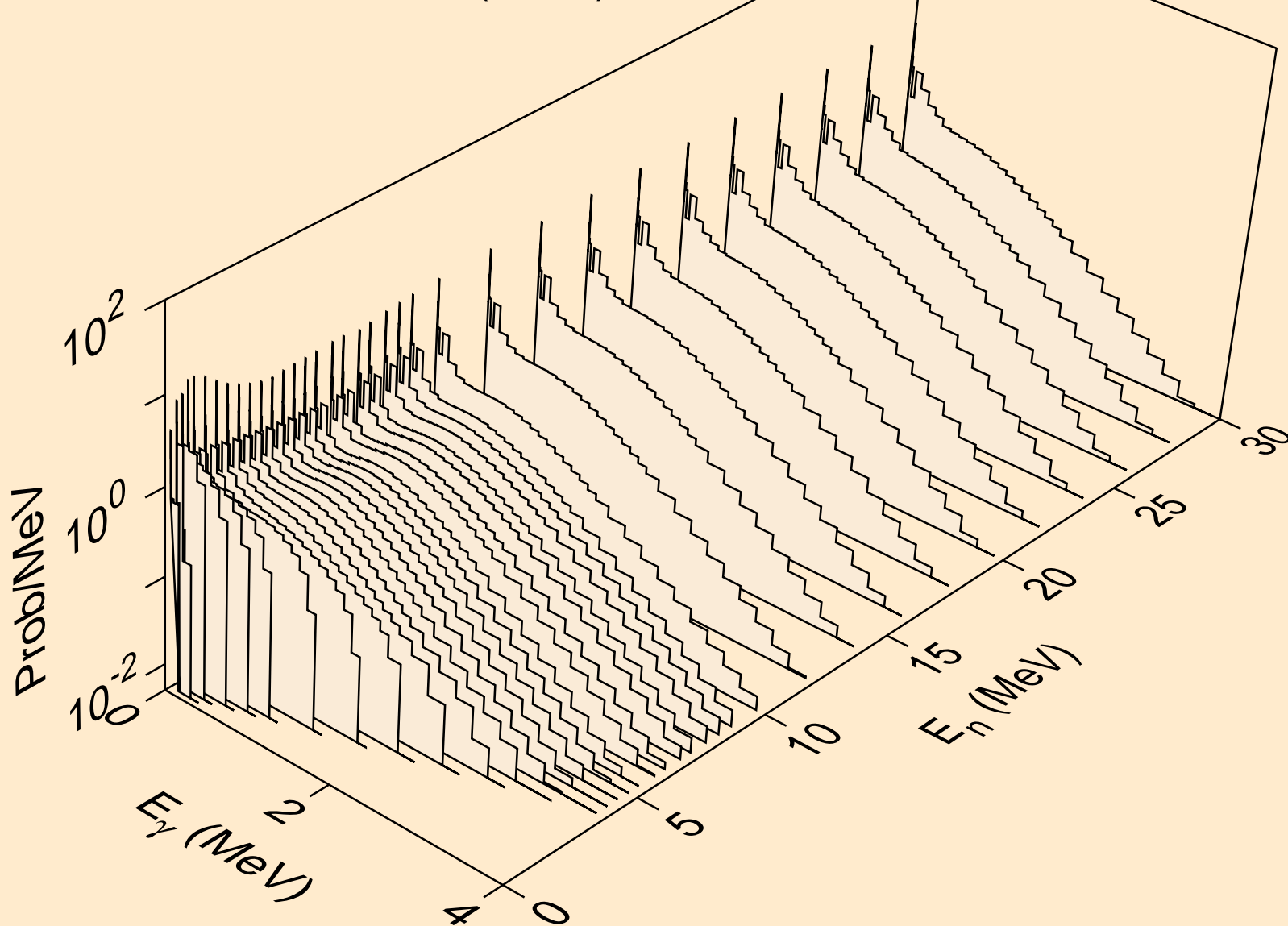

MD257 NEUTRON ACER TENDL-2019 LIBRARY; T=293.16K  
Photon emission for (n,gma)

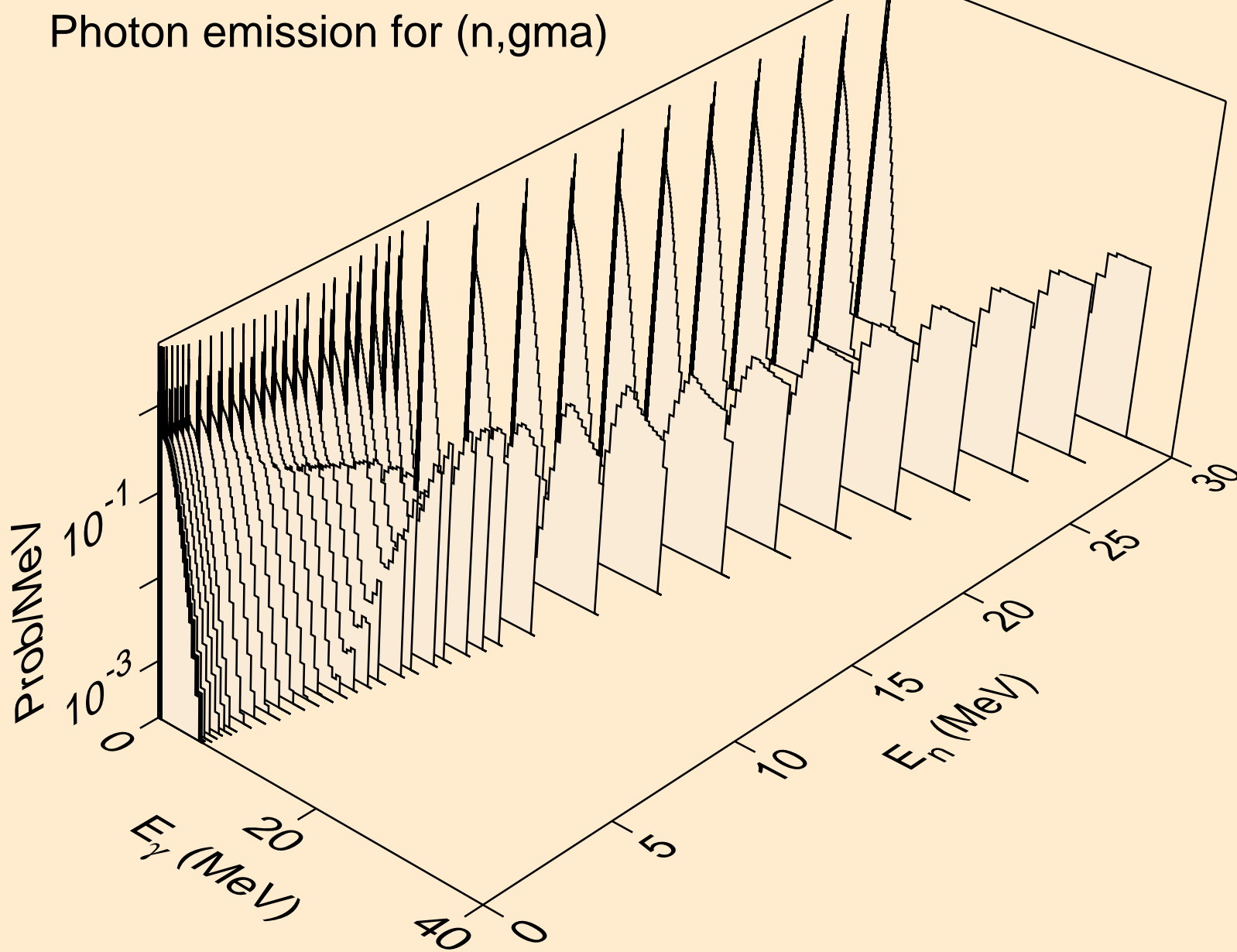

MD257 NEUTRON ACER TENDL-2019 LIBRARY; T=293.16K  
Photon emission for (n,p)

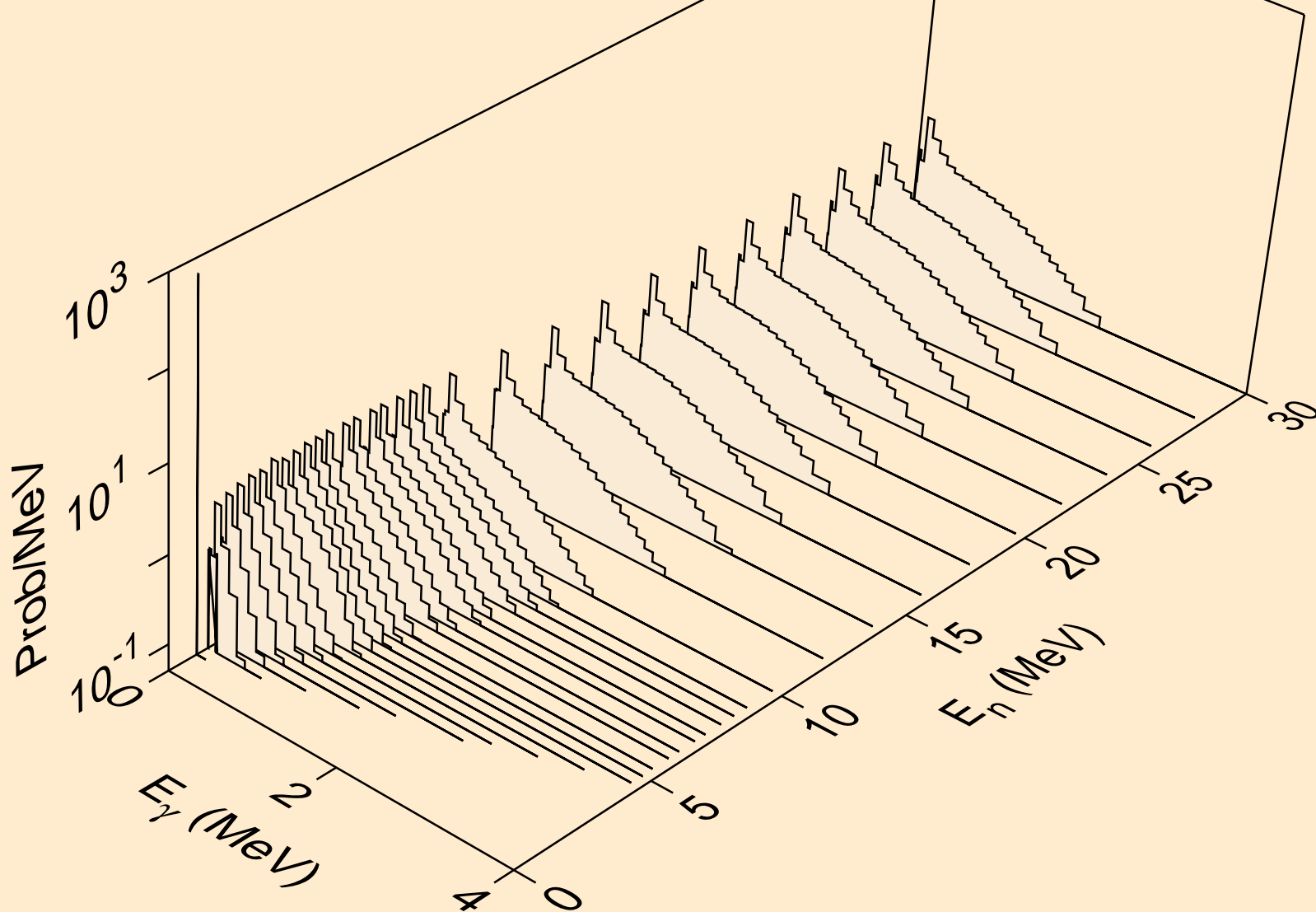

MD257 NEUTRON ACER TENDL-2019 LIBRARY; T=293.16K  
Photon emission for (n,d)

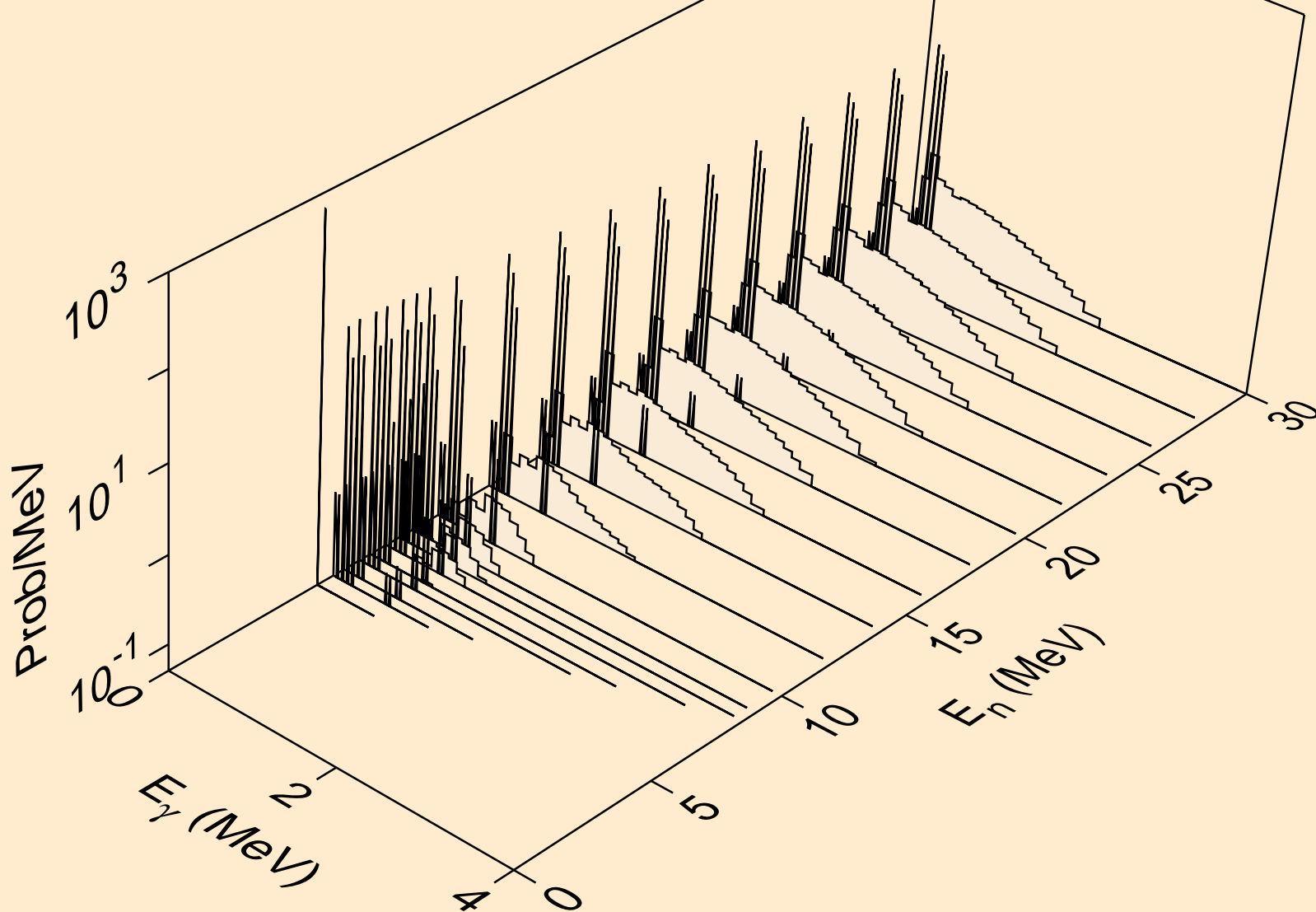

MD257 NEUTRON ACER TENDL-2019 LIBRARY; T=293.16K  
Photon emission for (n,t)

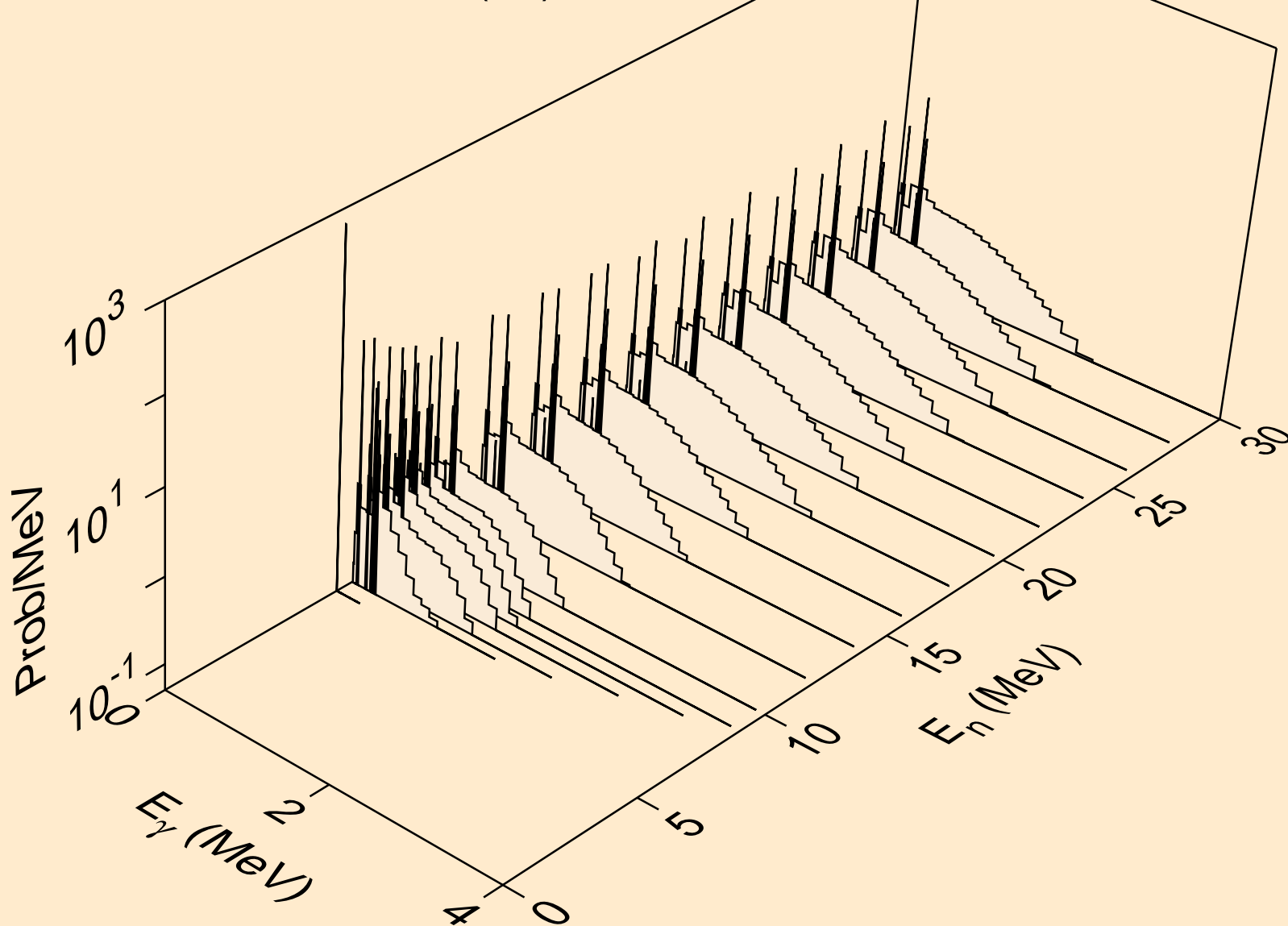

MD257 NEUTRON ACER TENDL-2019 LIBRARY; T=293.16K  
Photon emission for (n,he3)

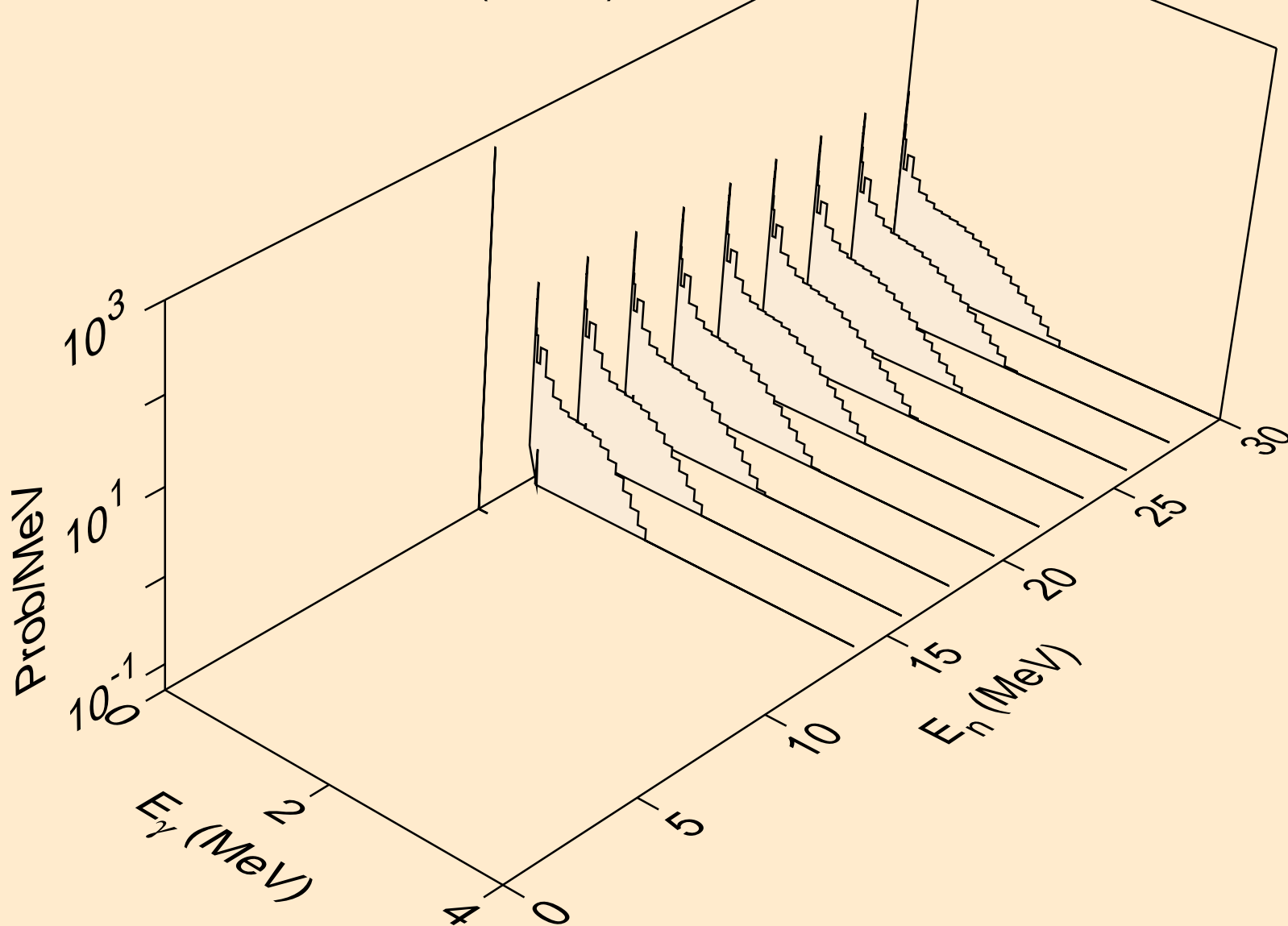

MD257 NEUTRON ACER TENDL-2019 LIBRARY; T=293.16K  
Photon emission for (n,a)

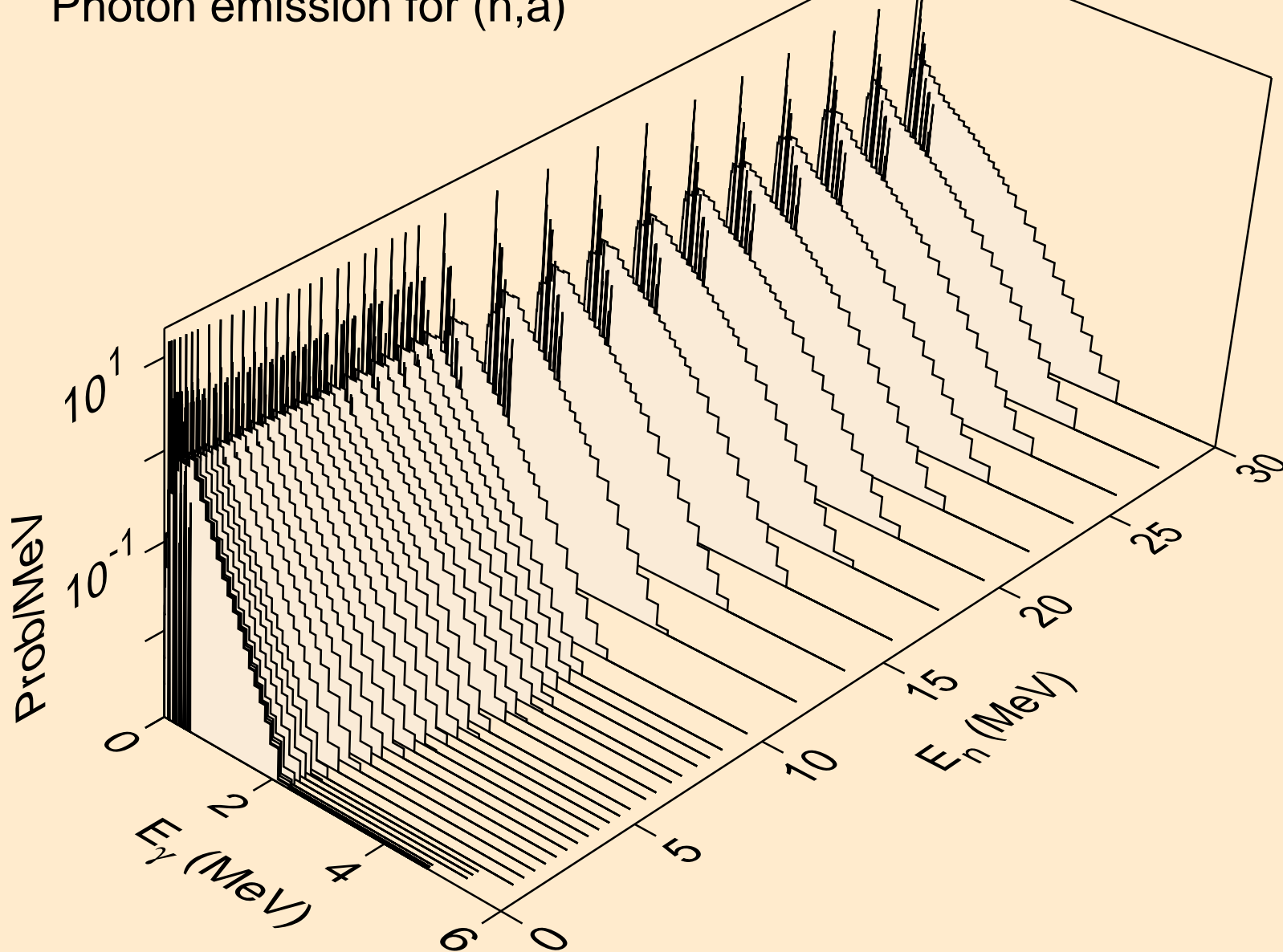



MD257 NEUTRON ACER TENDL-2019 LIBRARY; T=293.16K  
Photon emission for (n,2a)

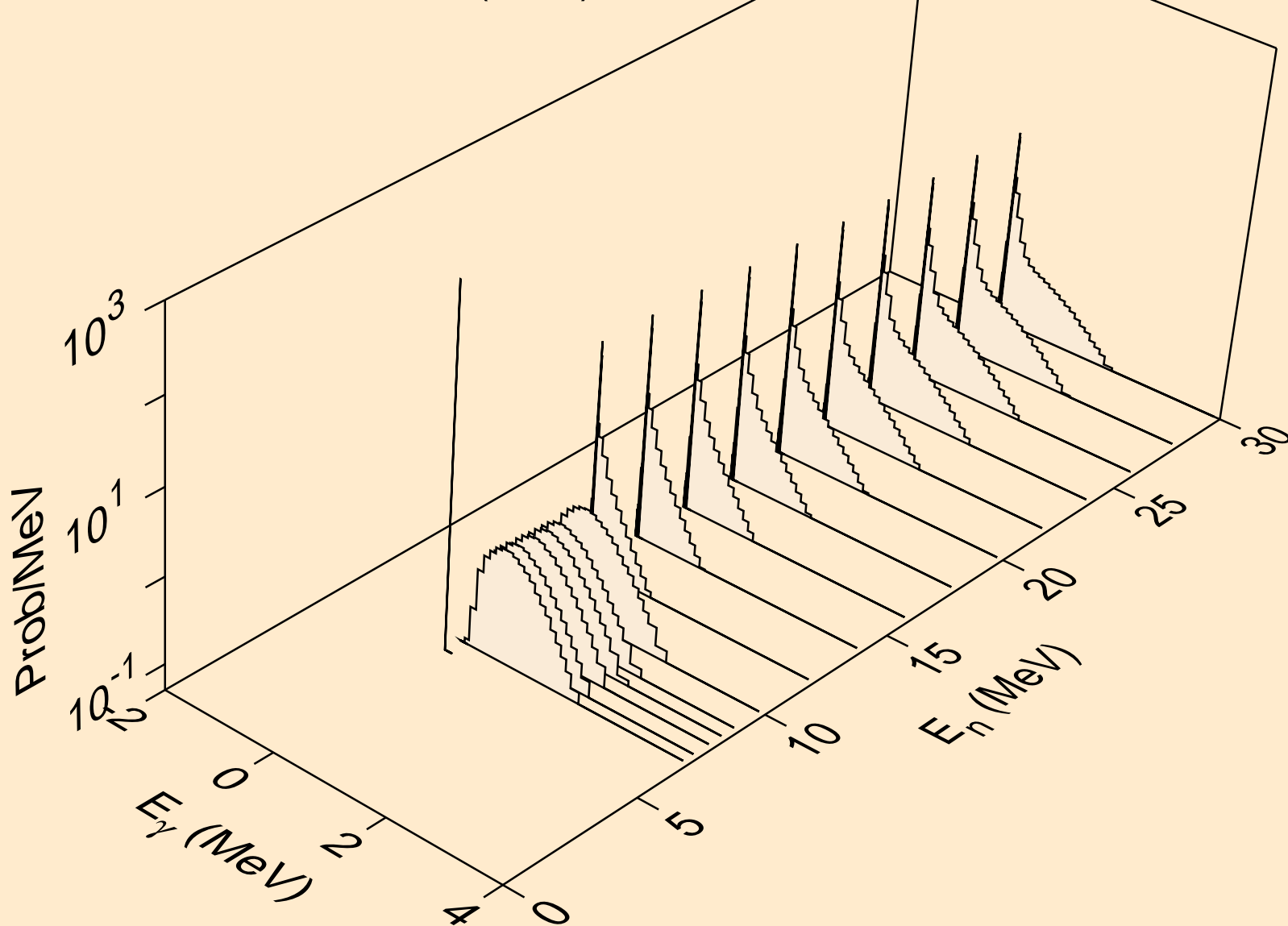

MD257 NEUTRON ACER TENDL-2019 LIBRARY; T=293.16K  
Photon emission for (n,2p)

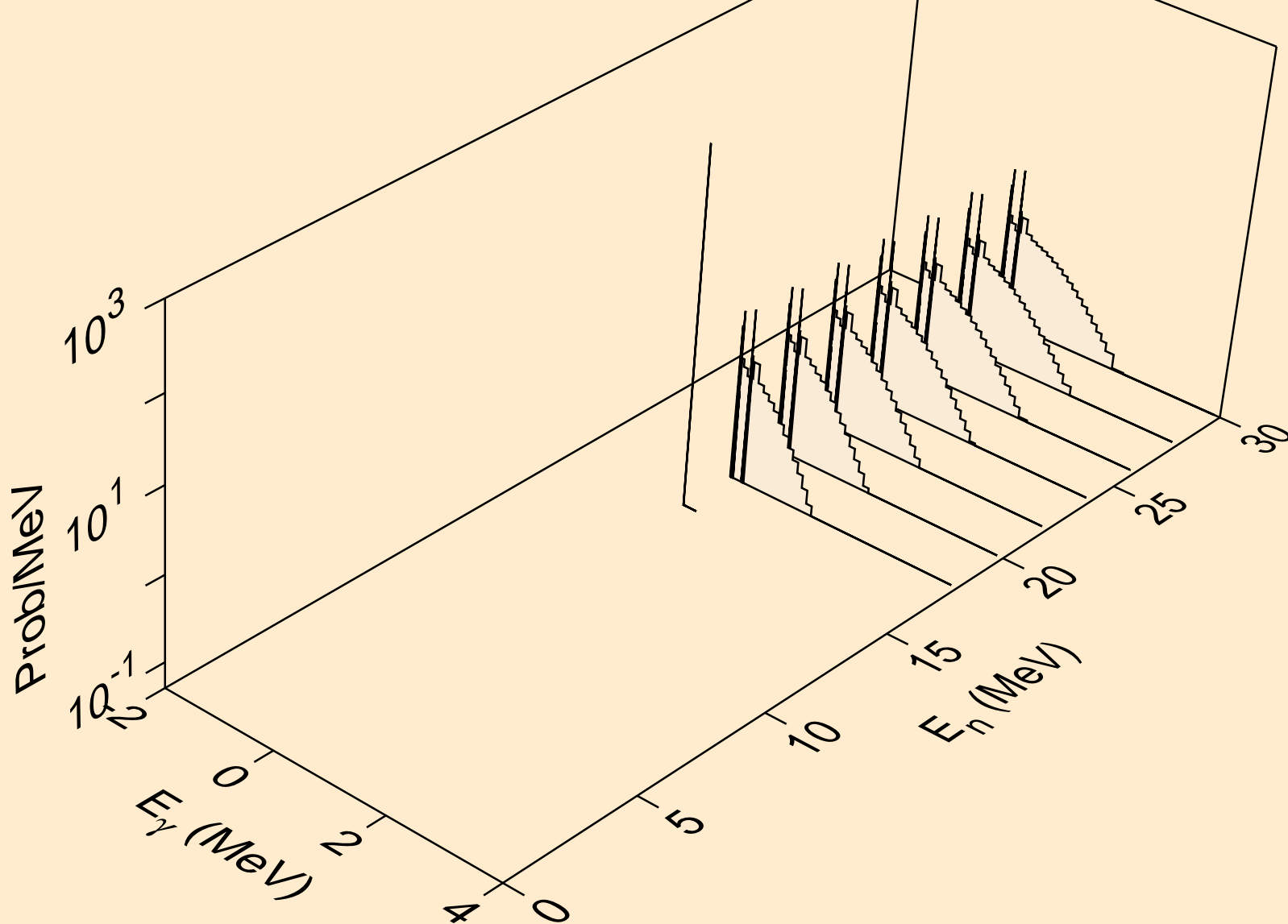

MD257 NEUTRON ACER TENDL-2019 LIBRARY; T=293.16K  
Photon emission for (n,p $\alpha$ )

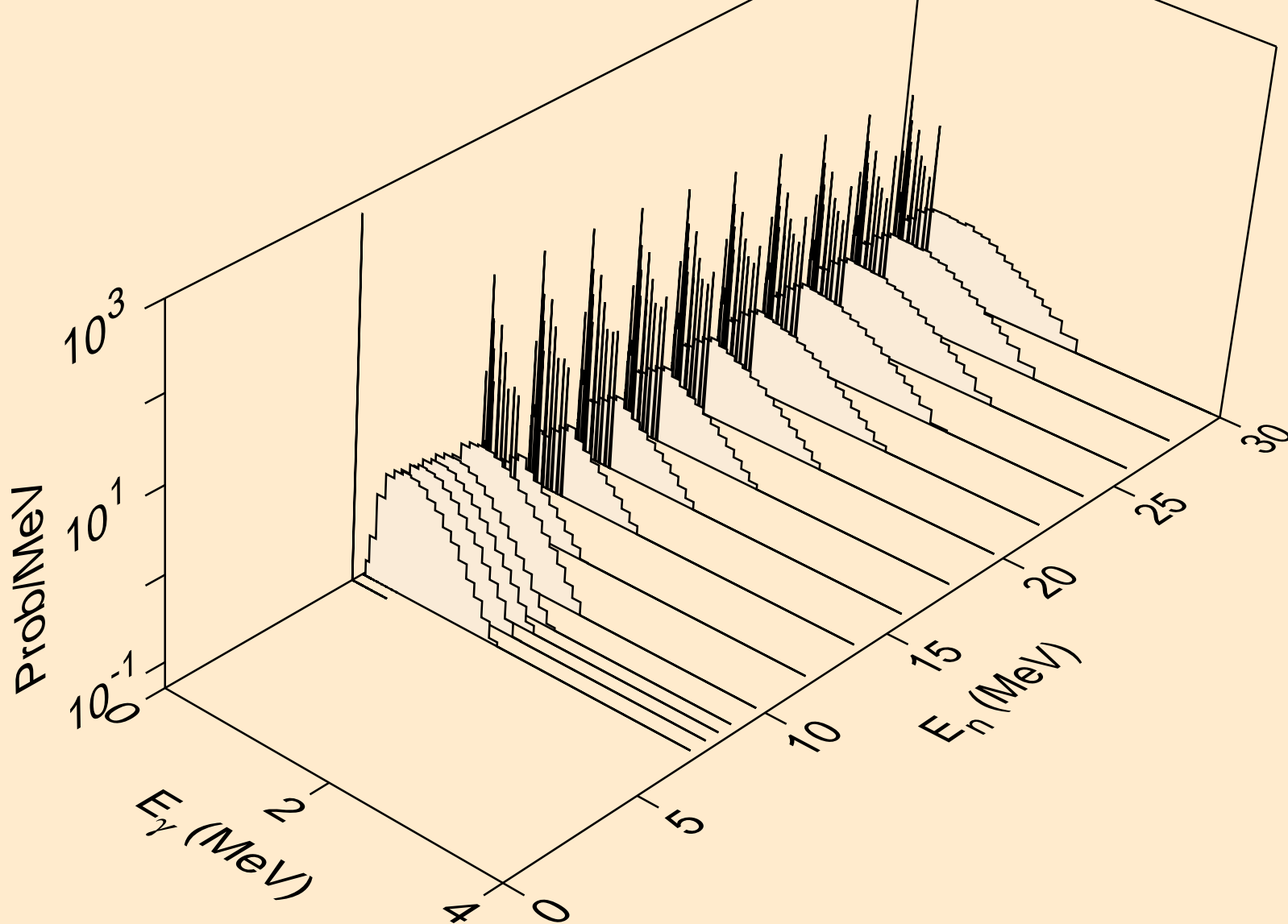

MD257 NEUTRON ACER TENDL-2019 LIBRARY; T=293.16K  
thermal capture photon spectrum

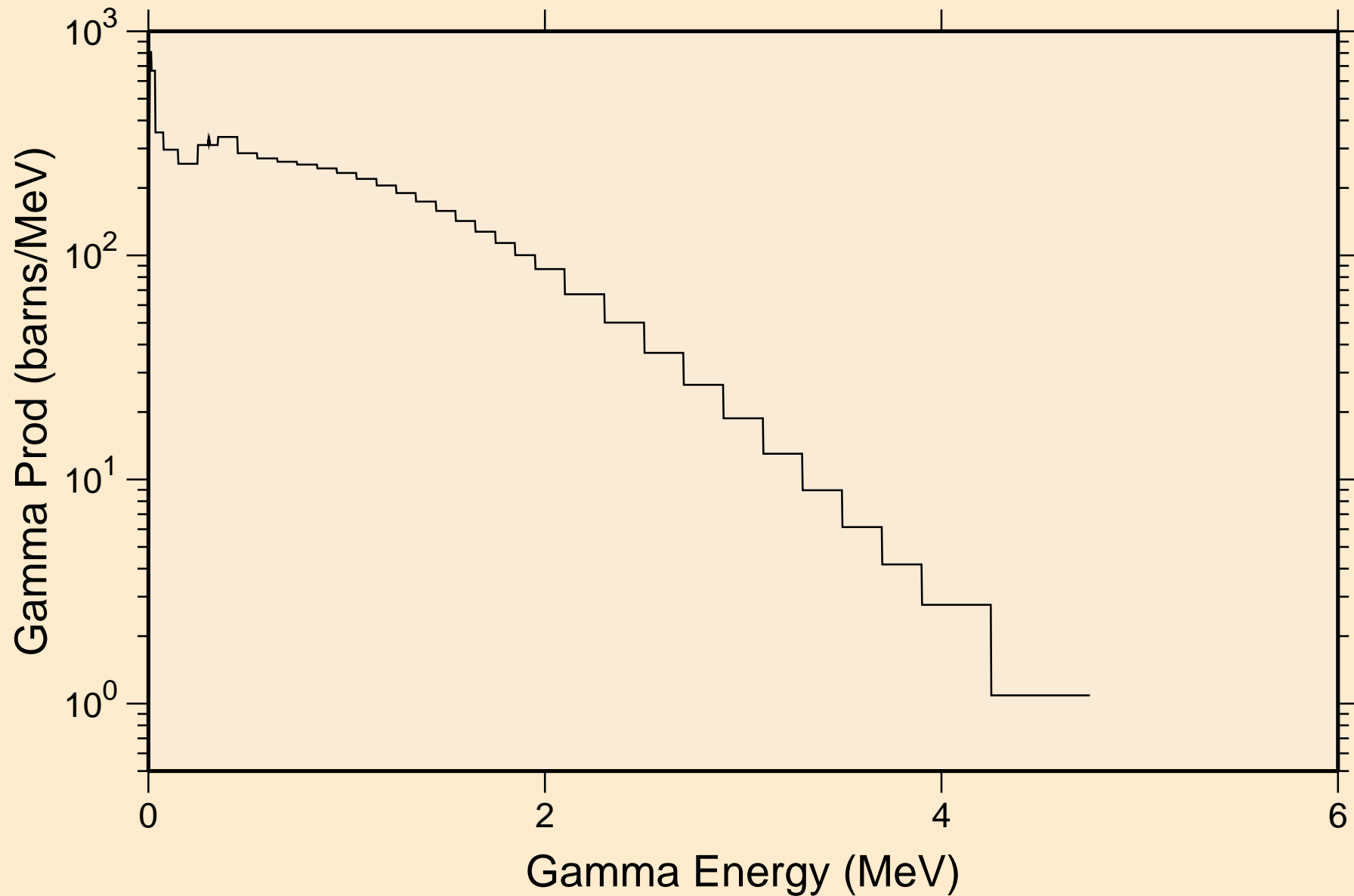

MD257 NEUTRON ACER TENDL-2019 LIBRARY; T=293.16K  
14 MeV photon spectrum

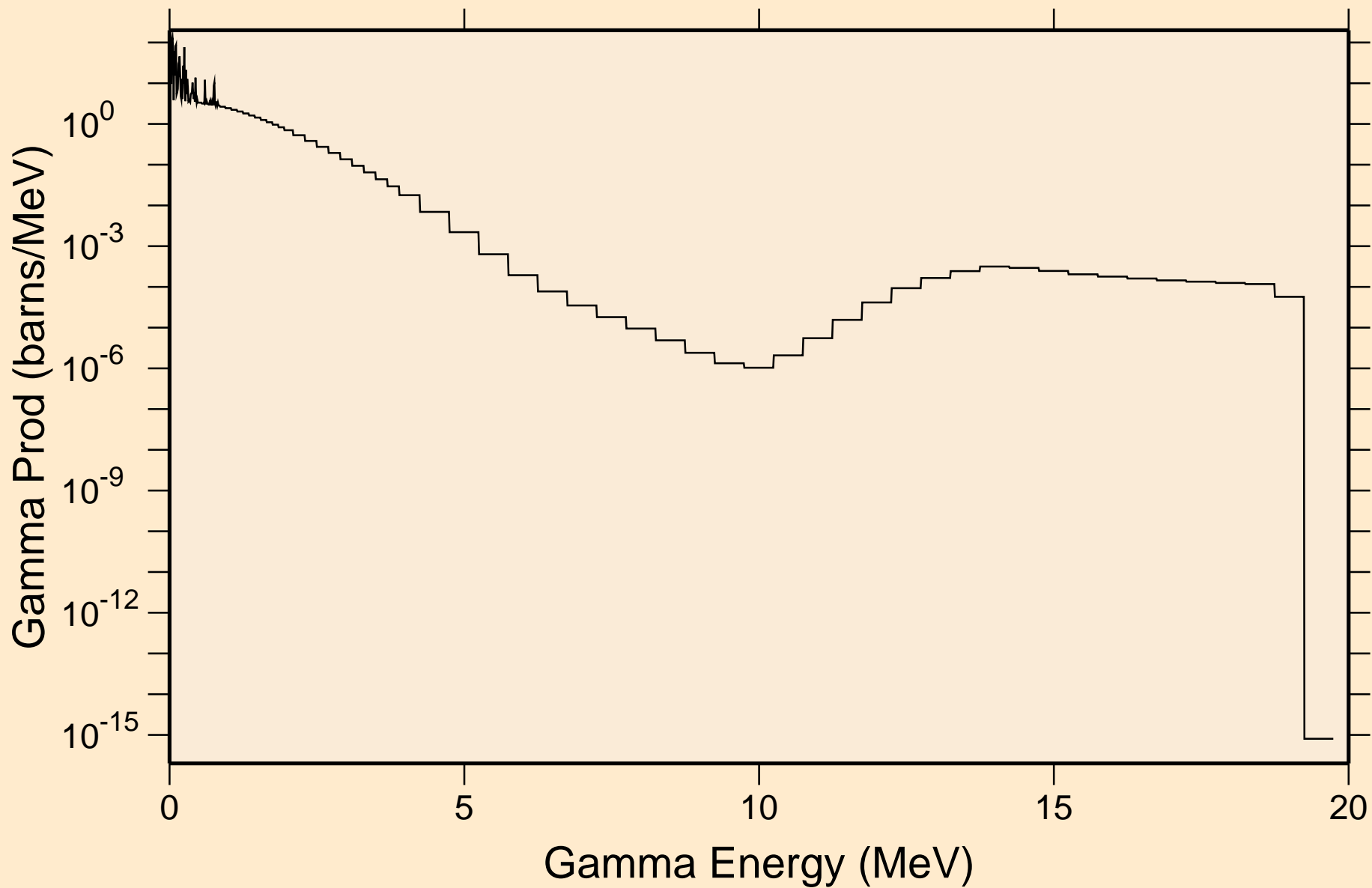

# MD257 NEUTRON ACER TENDL-2019 LIBRARY; T=293.16K

## Particle heating contributions

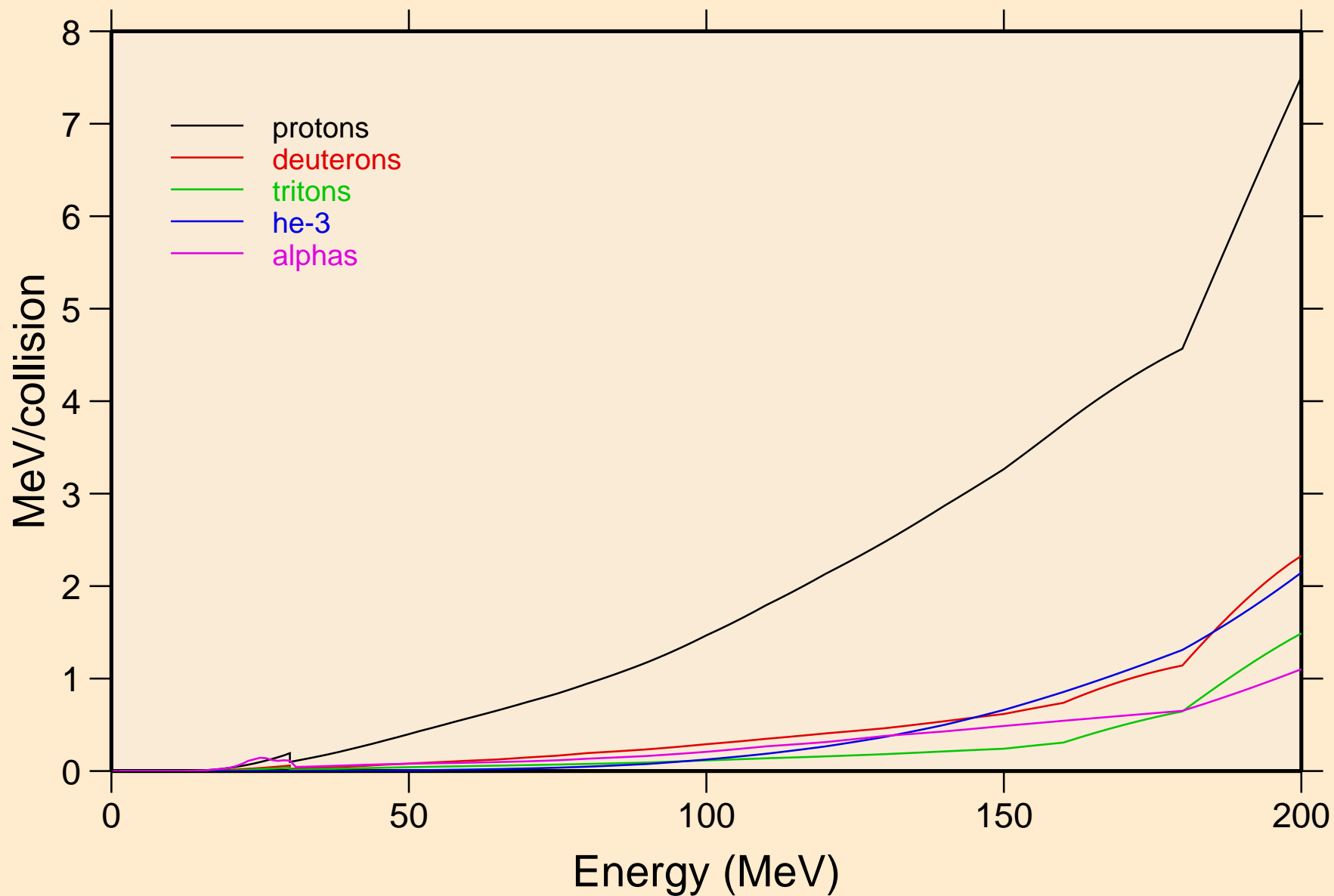

MD257 NEUTRON ACER TENDL-2019 LIBRARY; T=293.16K  
Recoil Heating

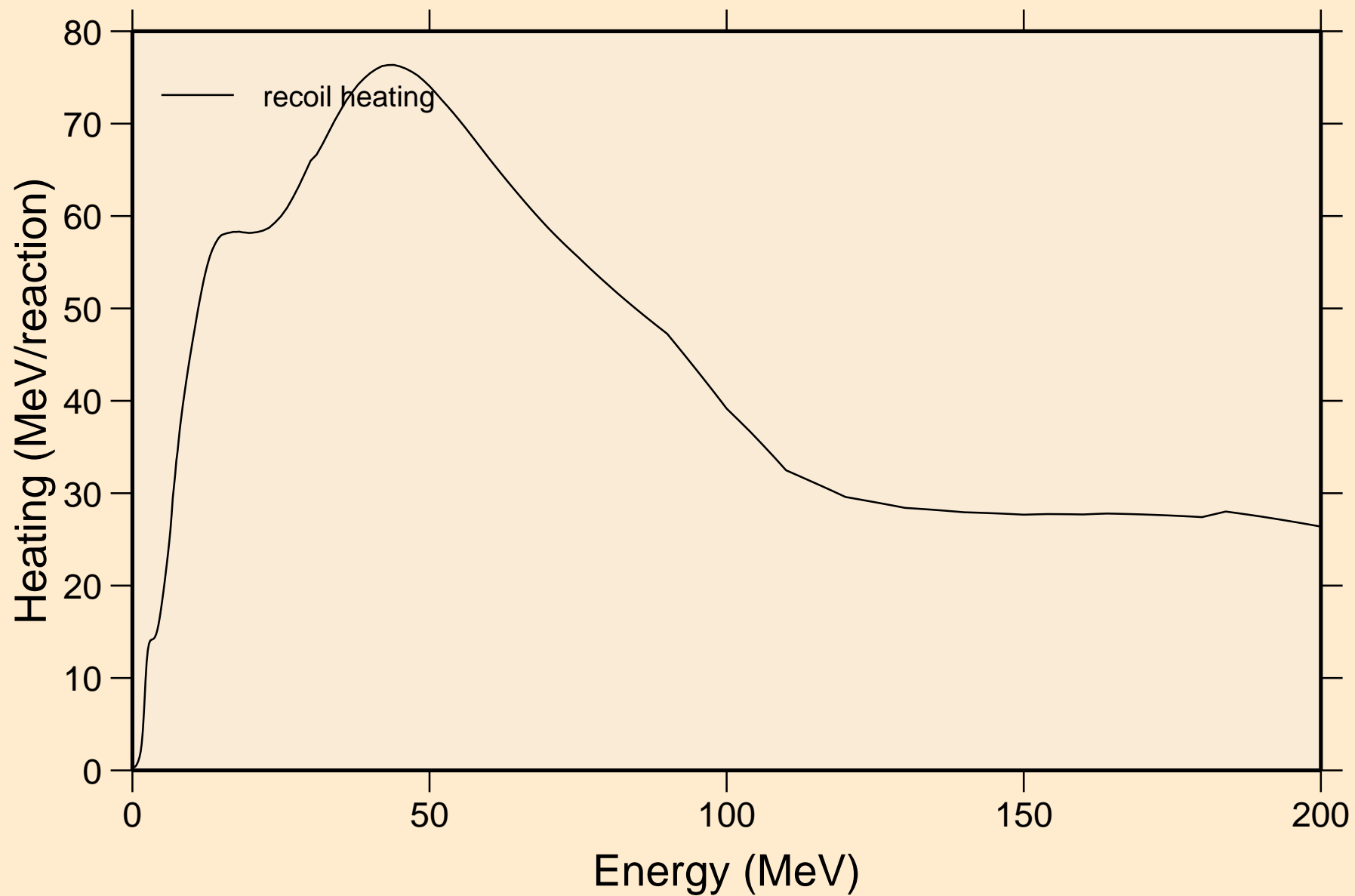

MD257 NEUTRON ACER TENDL-2019 LIBRARY; T=293.16K  
Particle production cross sections

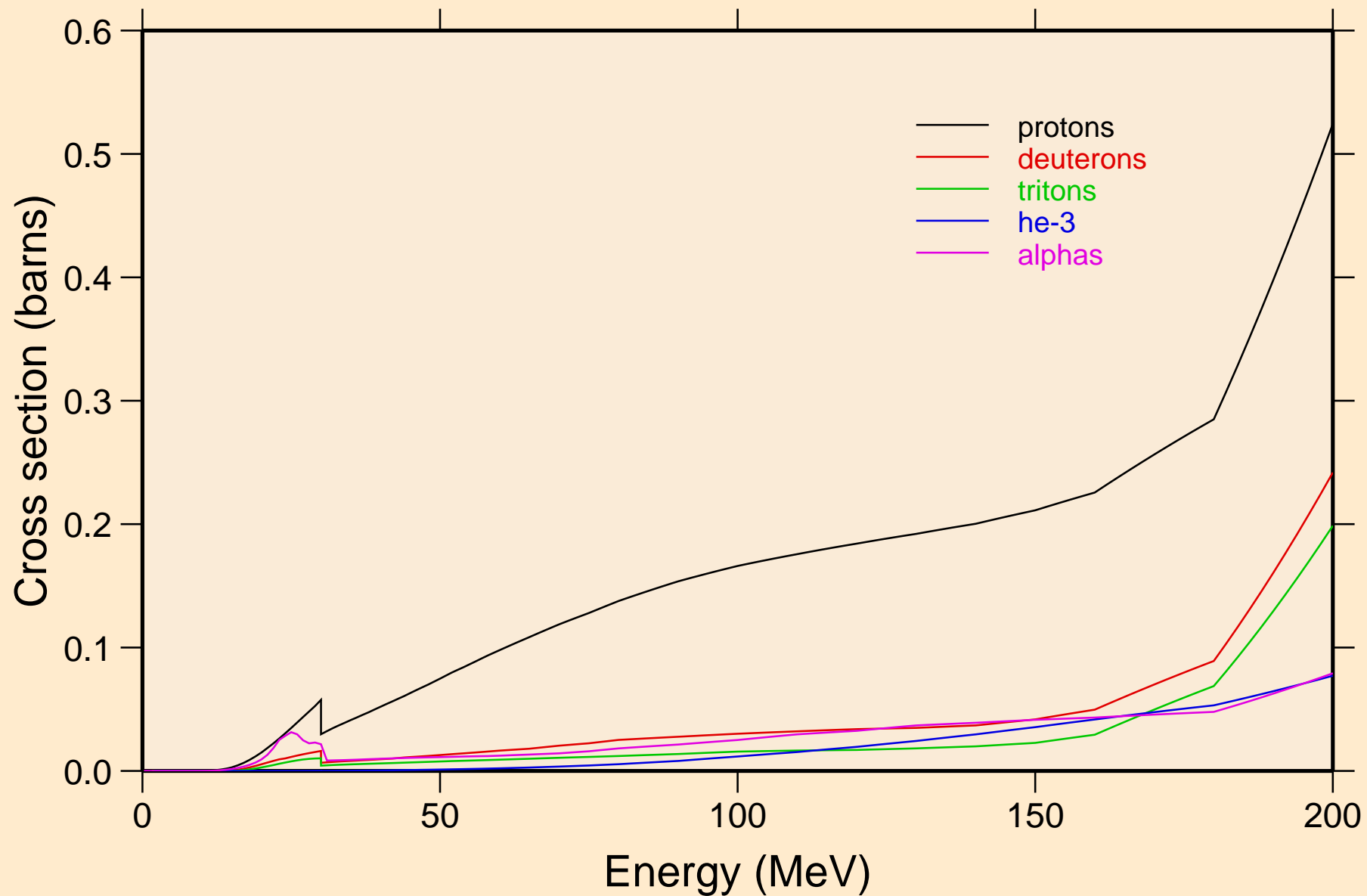



MD257 NEUTRON ACER TENDL-2019 LIBRARY; T=293.16K  
protons from (n,x)

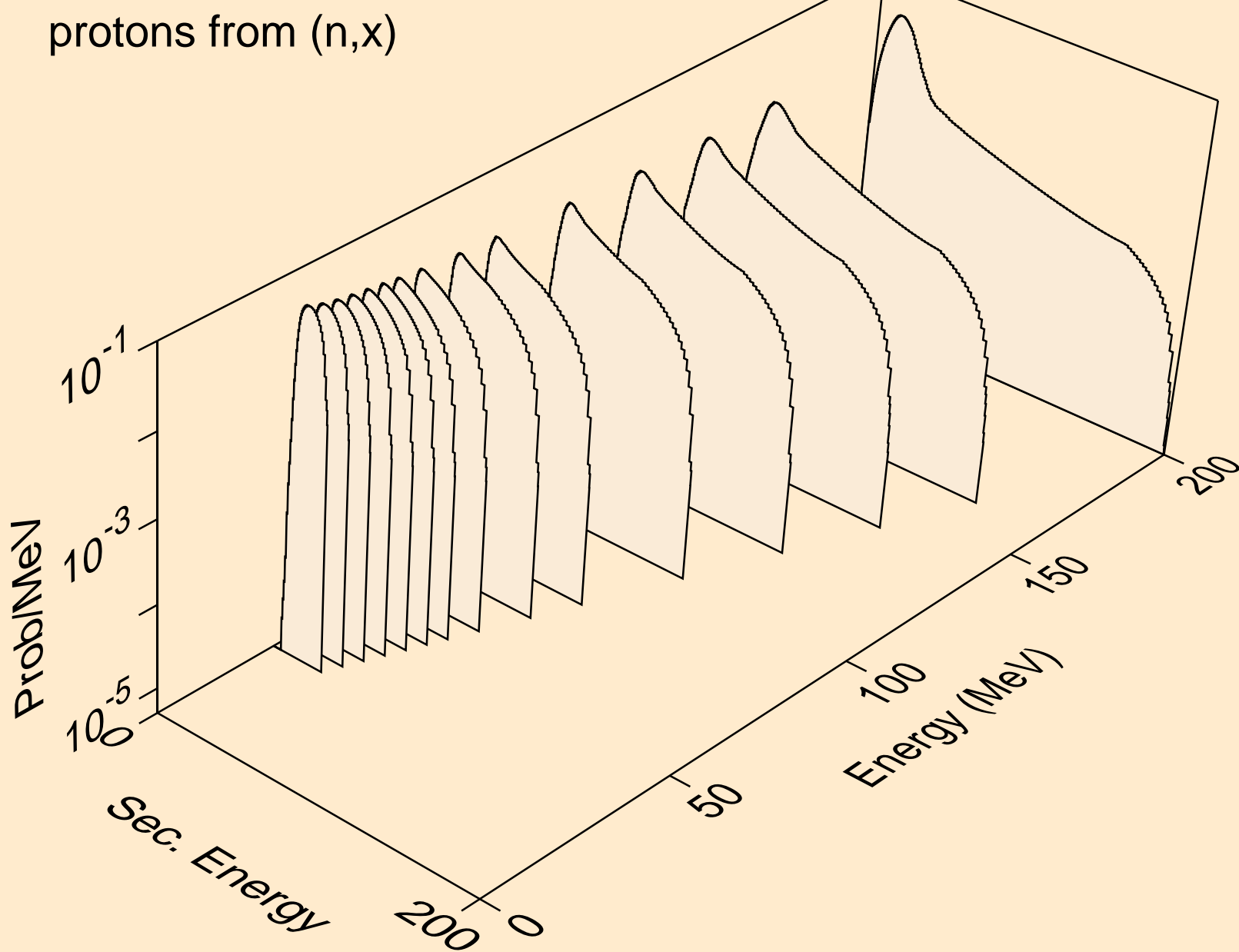

MD257 NEUTRON ACER TENDL-2019 LIBRARY; T=293.16K  
protons from (n,n\*)p

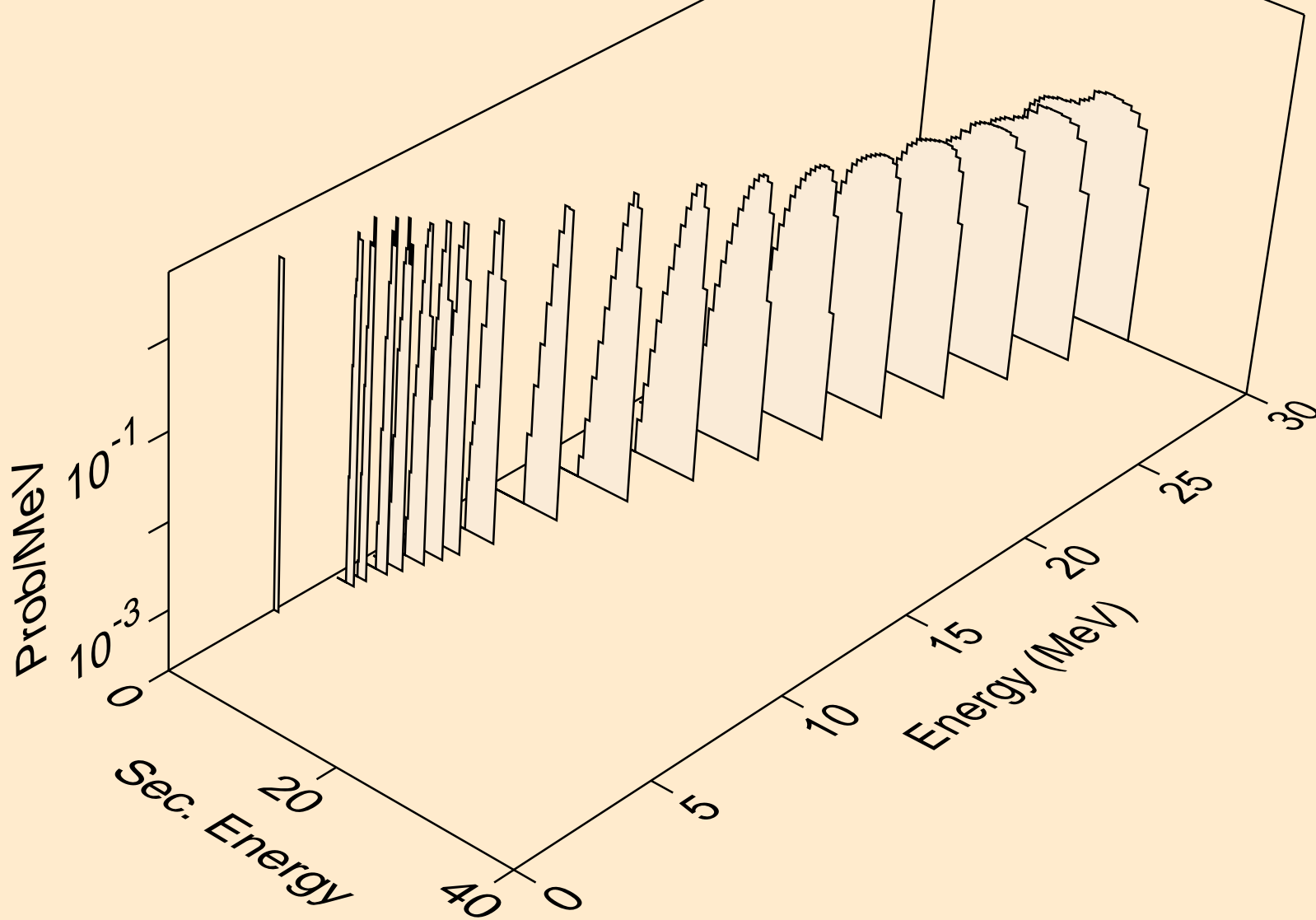

MD257 NEUTRON ACER TENDL-2019 LIBRARY; T=293.16K  
protons from (n,2np)

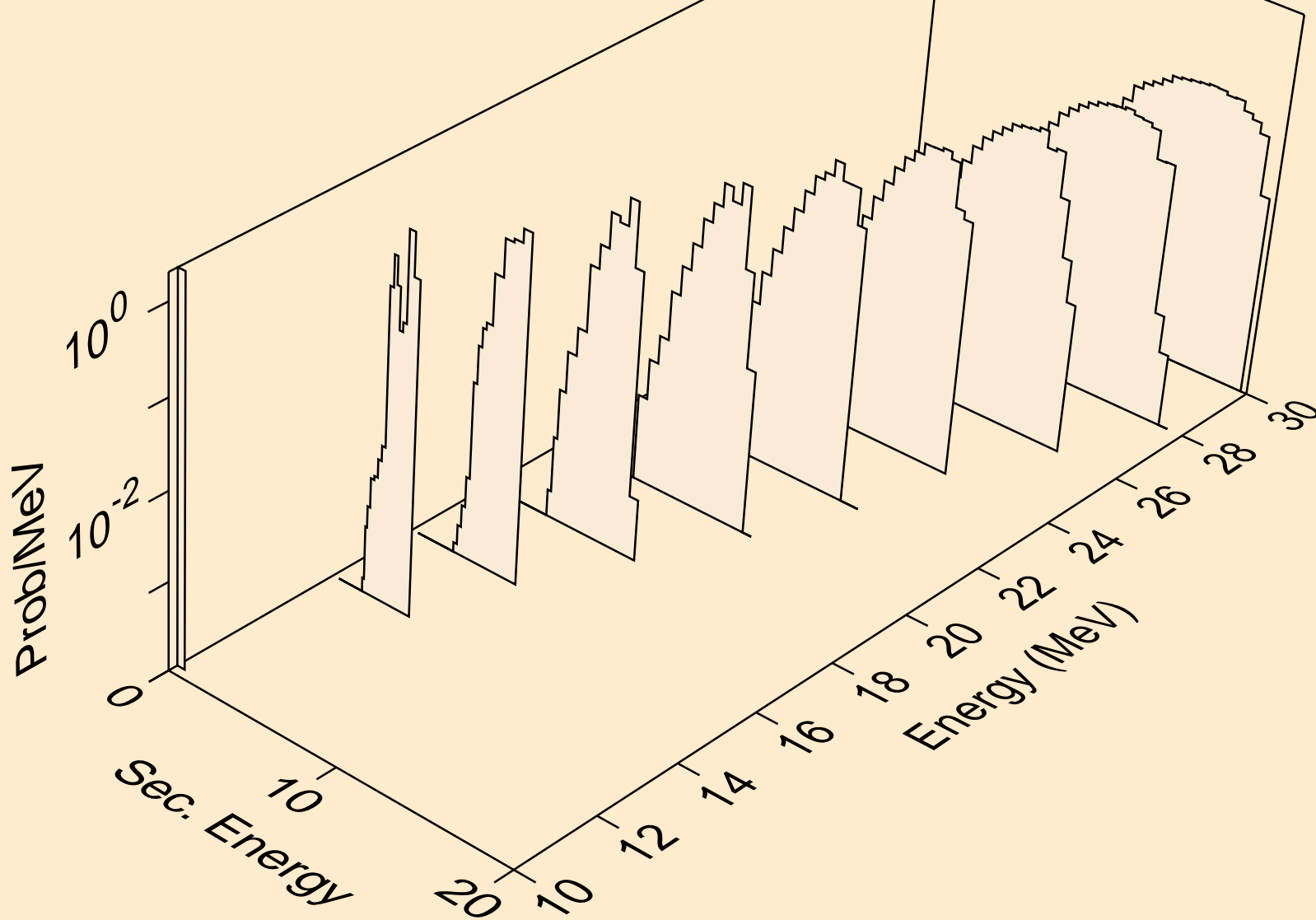

MD257 NEUTRON ACER TENDL-2019 LIBRARY; T=293.16K  
protons from (n,3np)

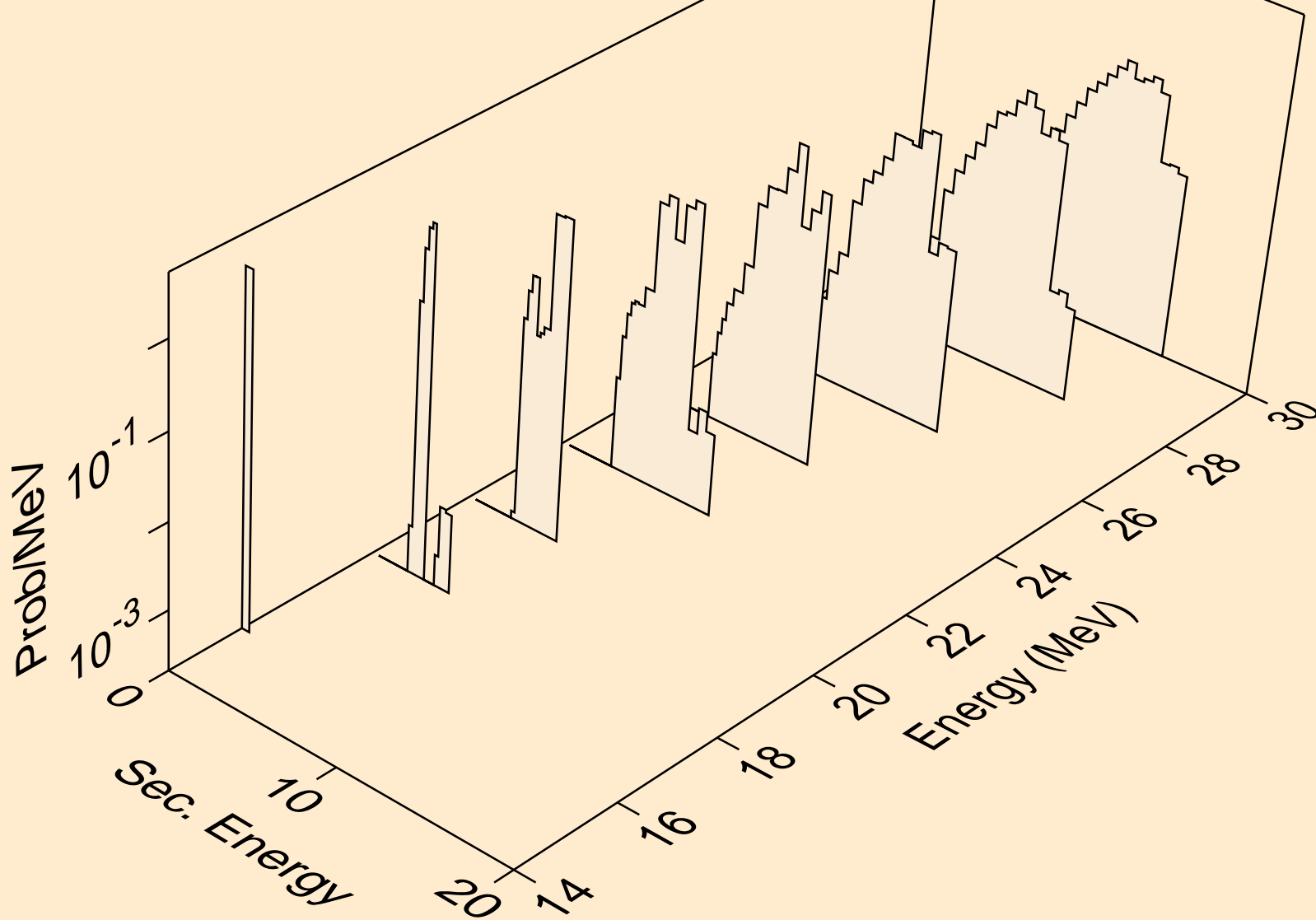

MD257 NEUTRON ACER TENDL-2019 LIBRARY; T=293.16K  
protons from (n,2np)

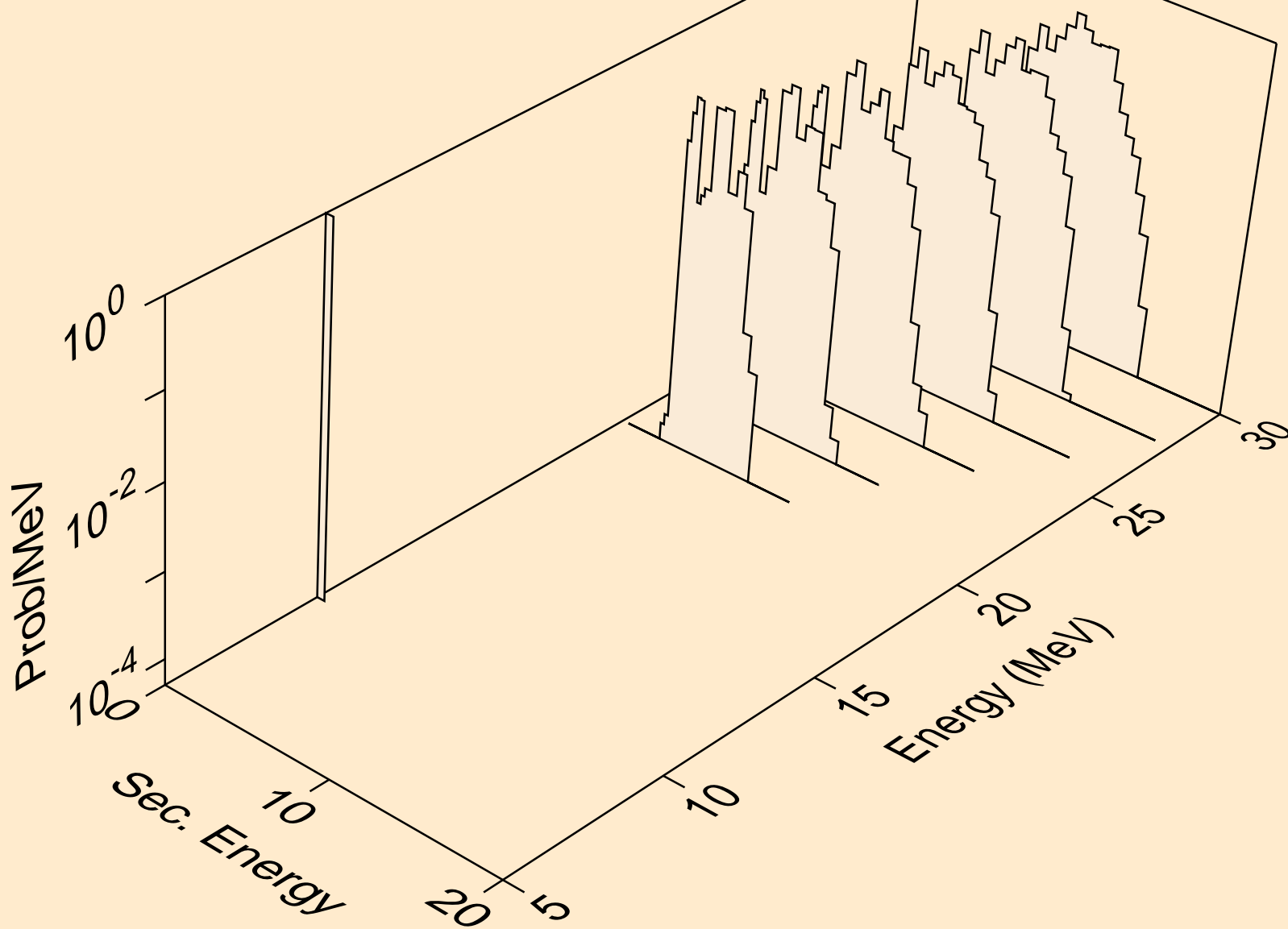

MD257 NEUTRON ACER TENDL-2019 LIBRARY; T=293.16K  
protons from (n,npa)

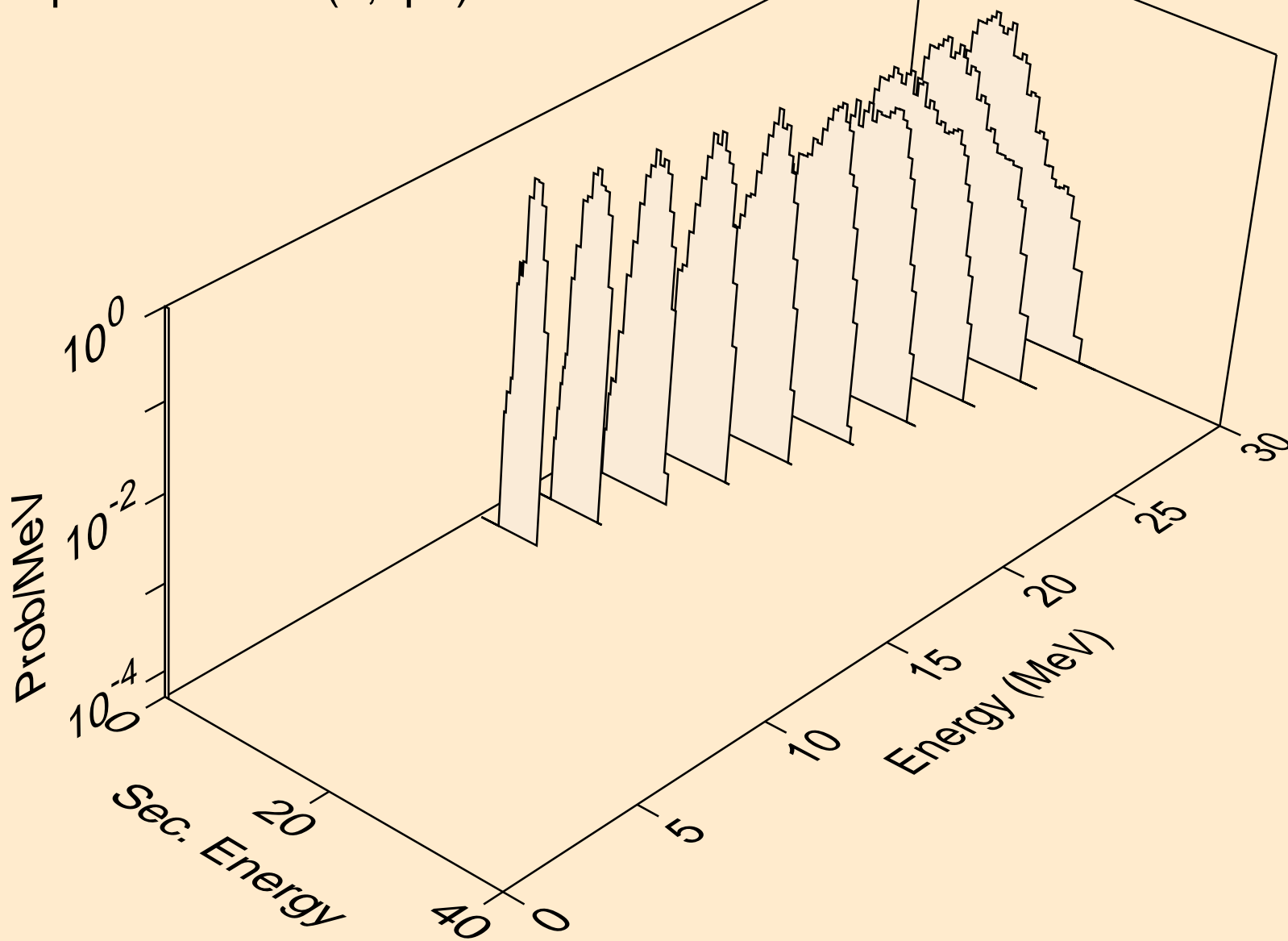

MD257 NEUTRON ACER TENDL-2019 LIBRARY; T=293.16K  
protons from (n,p)

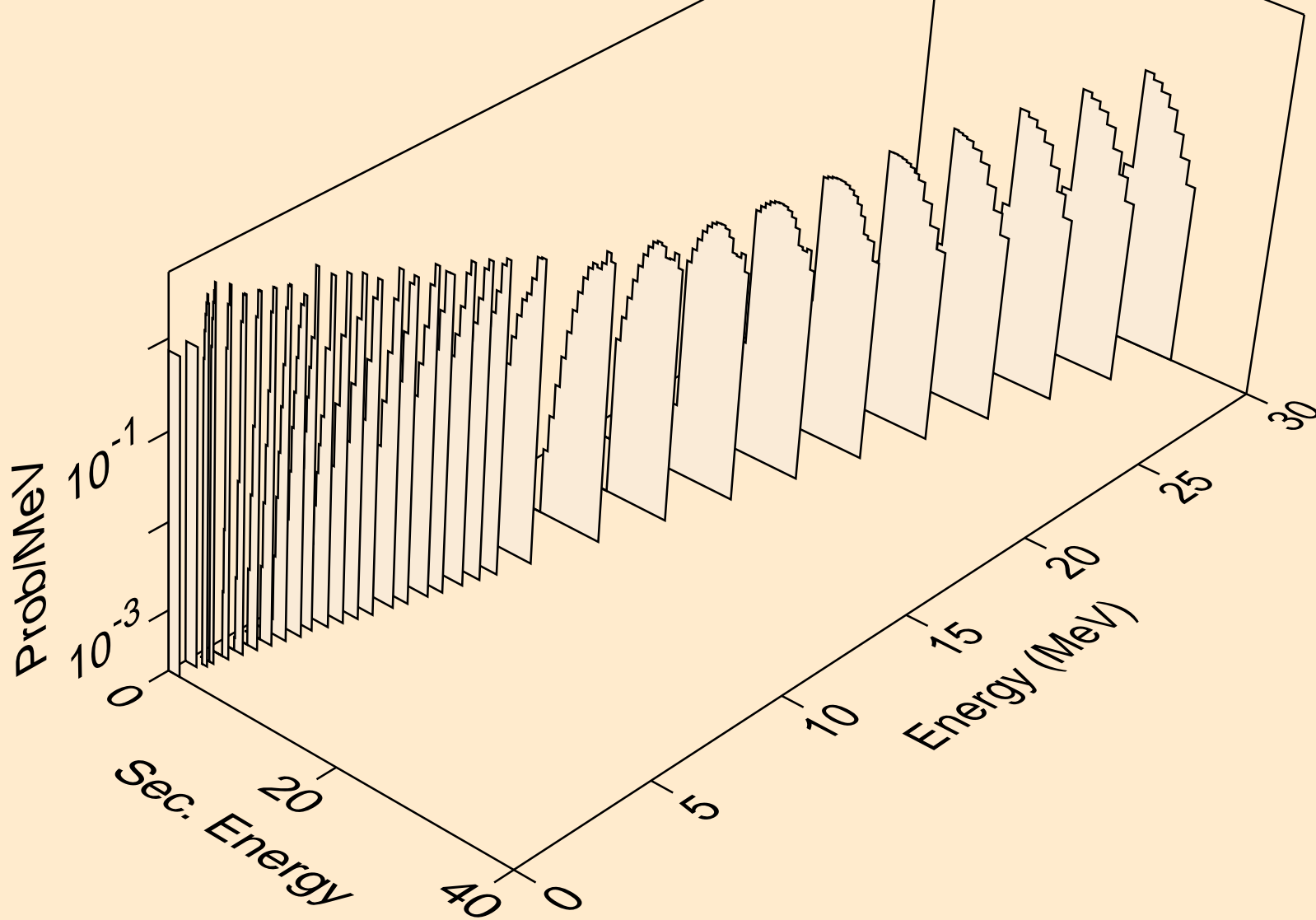

MD257 NEUTRON ACER TENDL-2019 LIBRARY; T=293.16K  
protons from (n,2p)

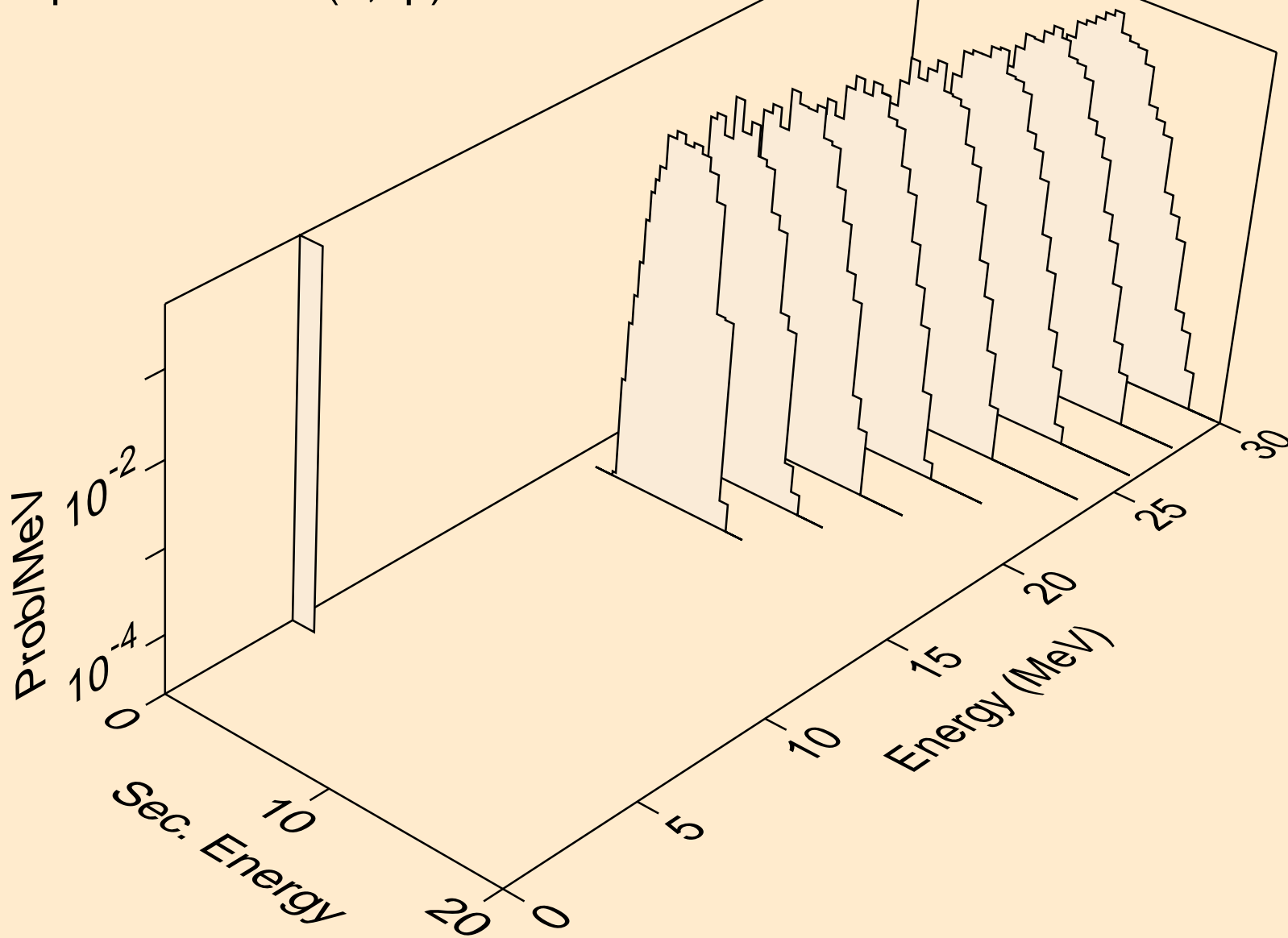



MD257 NEUTRON ACER TENDL-2019 LIBRARY; T=293.16K  
protons from (n,p)

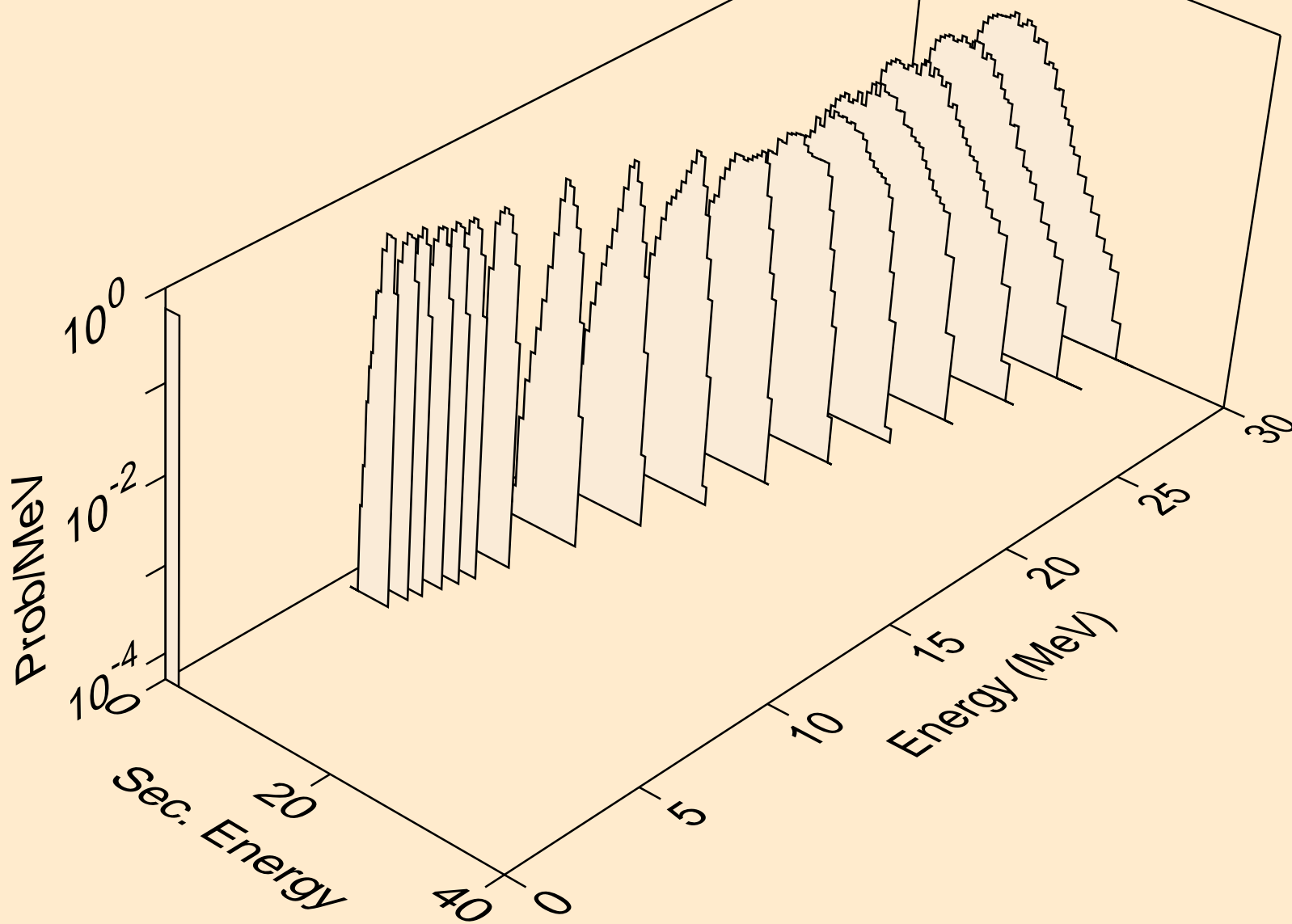

MD257 NEUTRON ACER TENDL-2019 LIBRARY; T=293.16K  
deuterons from (n,x)

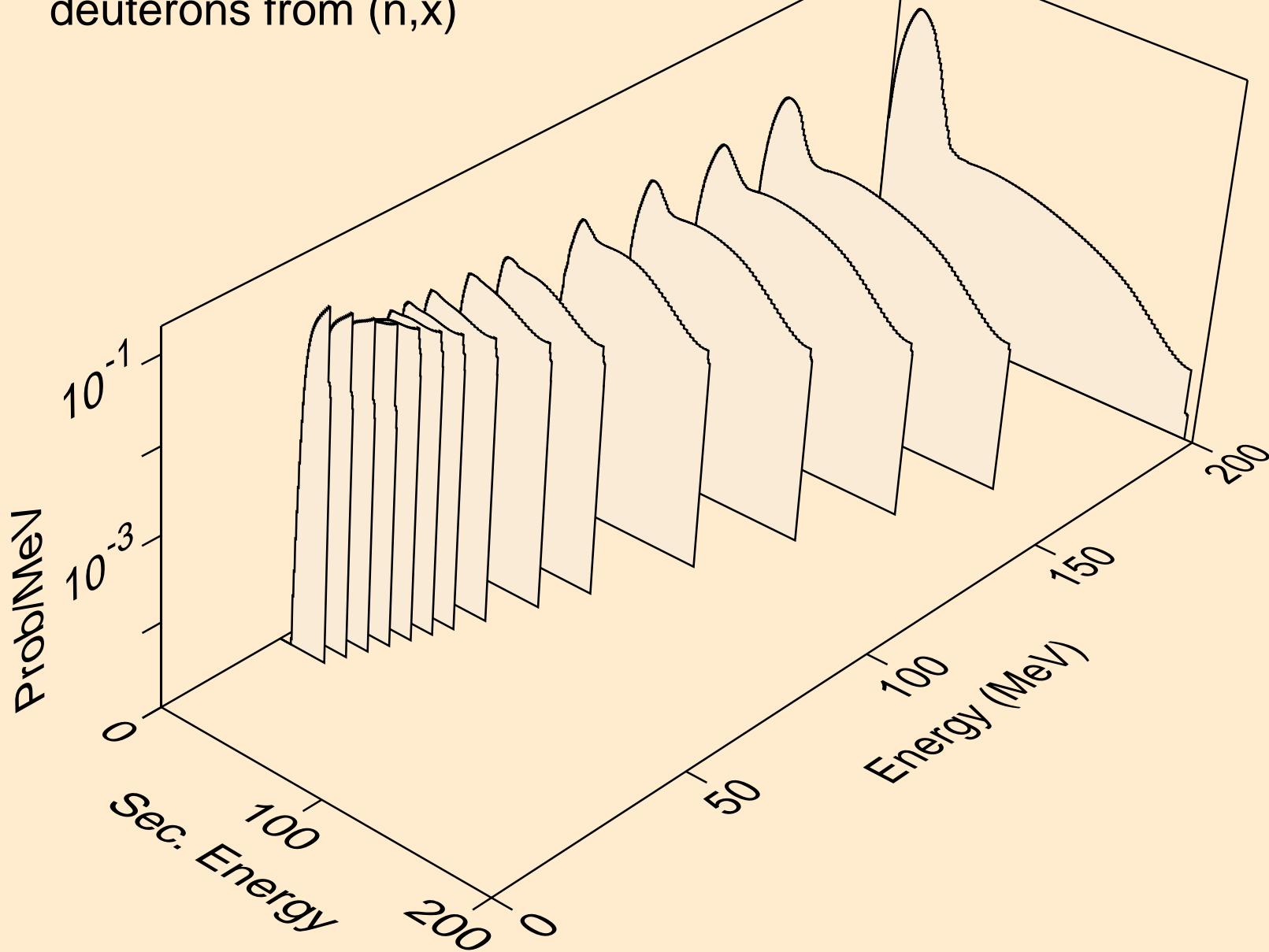

MD257 NEUTRON ACER TENDL-2019 LIBRARY; T=293.16K  
deuterons from (n,2nd)

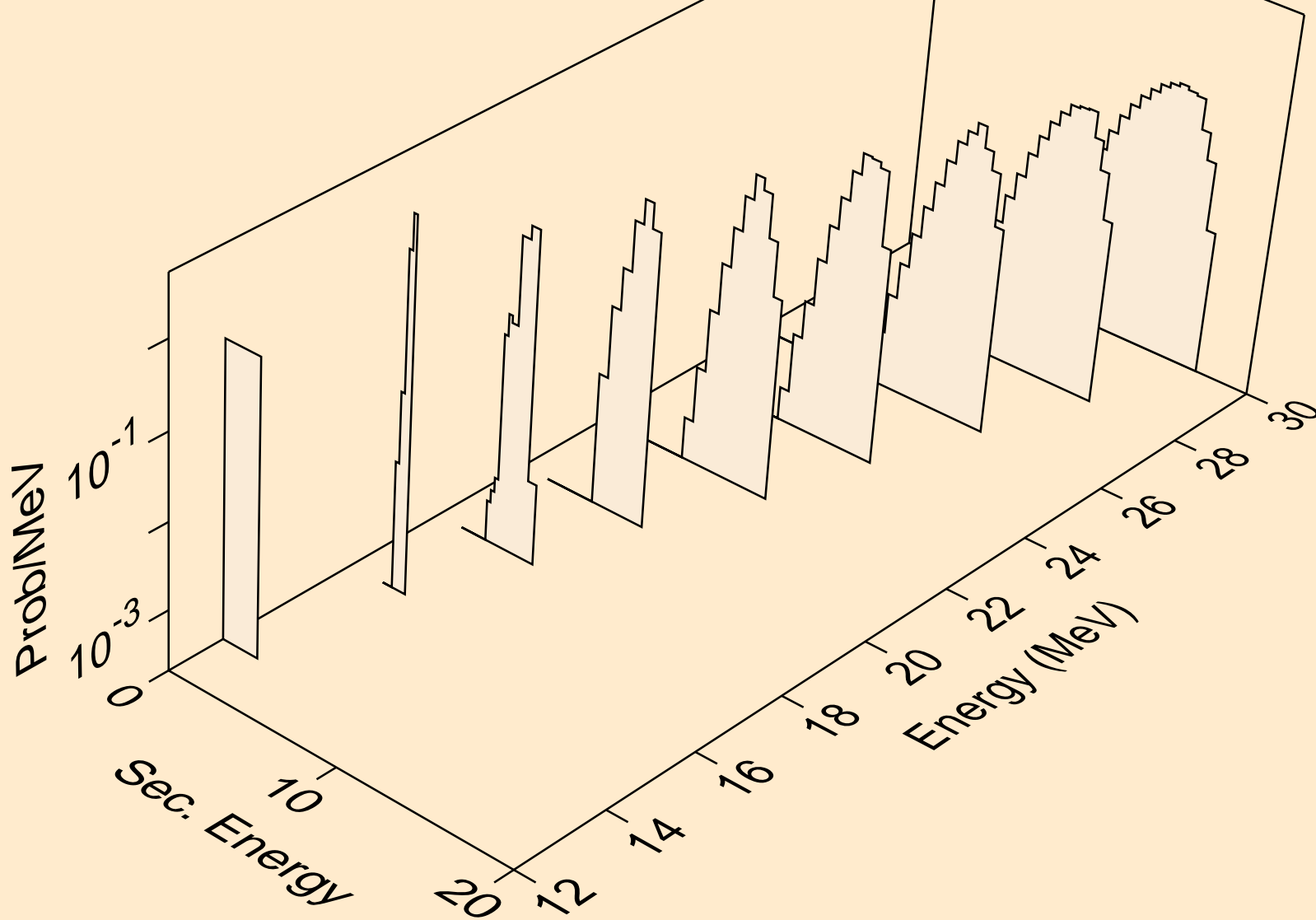

MD257 NEUTRON ACER TENDL-2019 LIBRARY; T=293.16K  
deuterons from (n,n\*)d

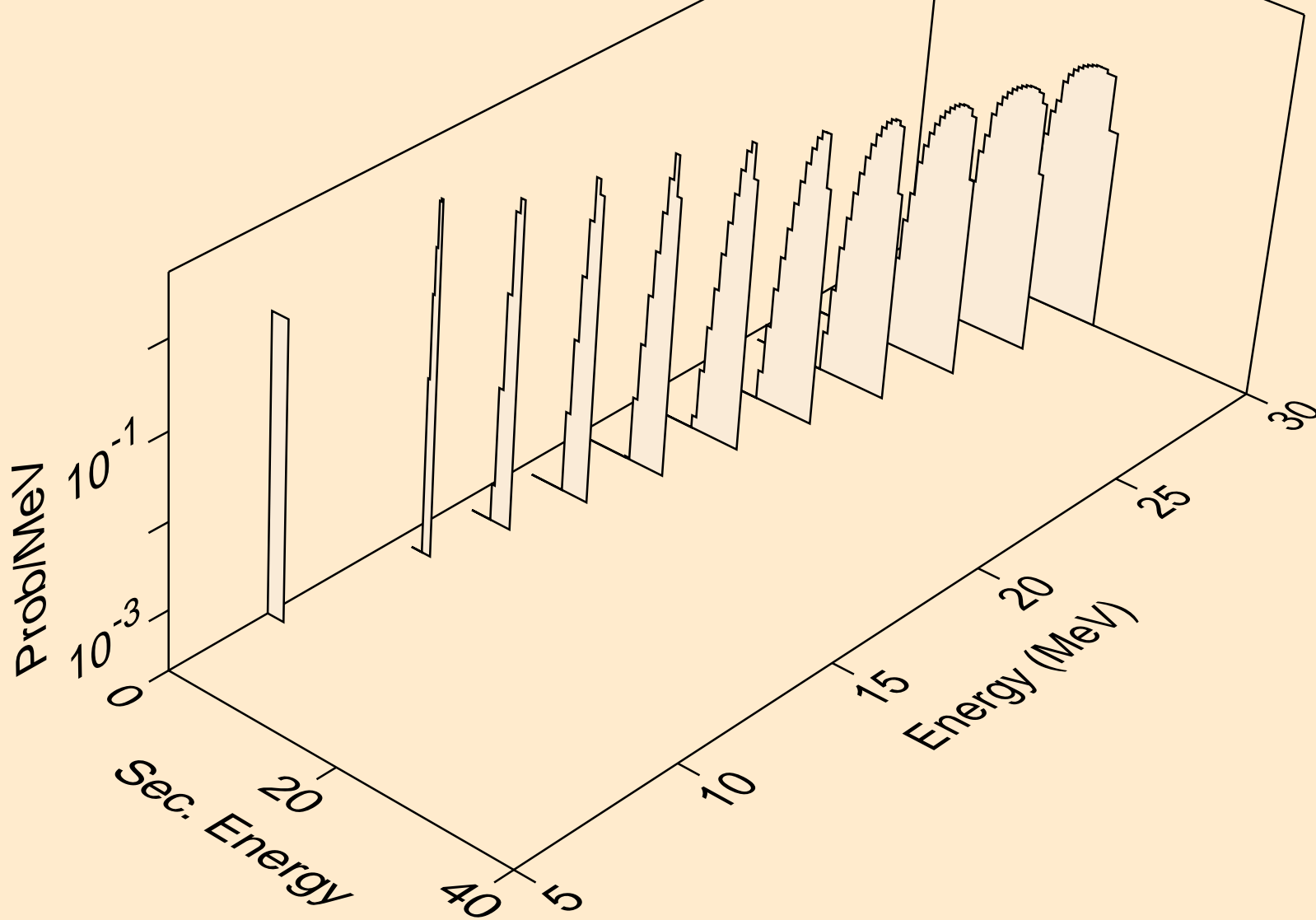

MD257 NEUTRON ACER TENDL-2019 LIBRARY; T=293.16K  
deuterons from (n,d)

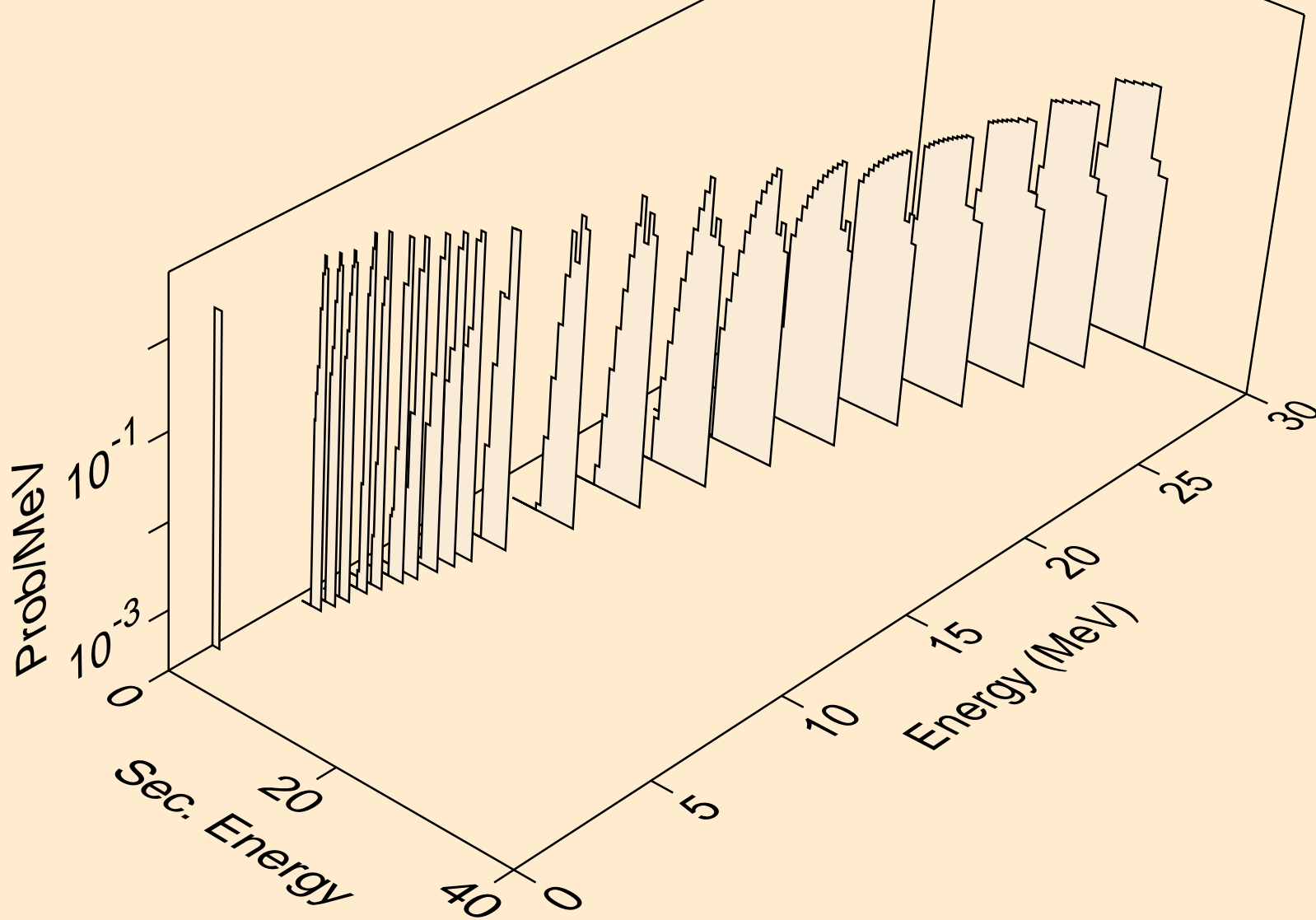

MD257 NEUTRON ACER TENDL-2019 LIBRARY; T=293.16K  
tritons from (n,x)

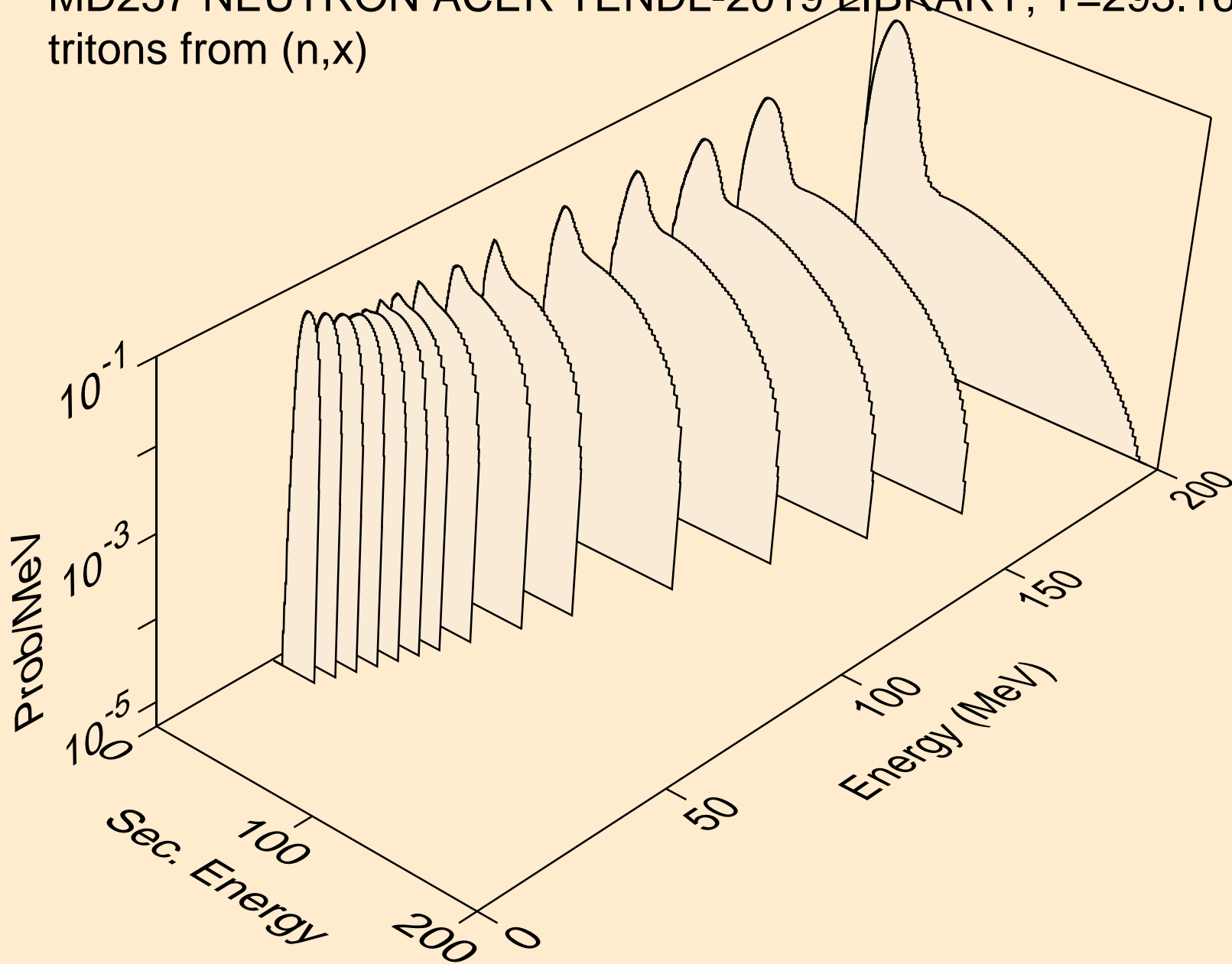

MD257 NEUTRON ACER TENDL-2019 LIBRARY; T=293.16K  
tritons from (n,n\*)t

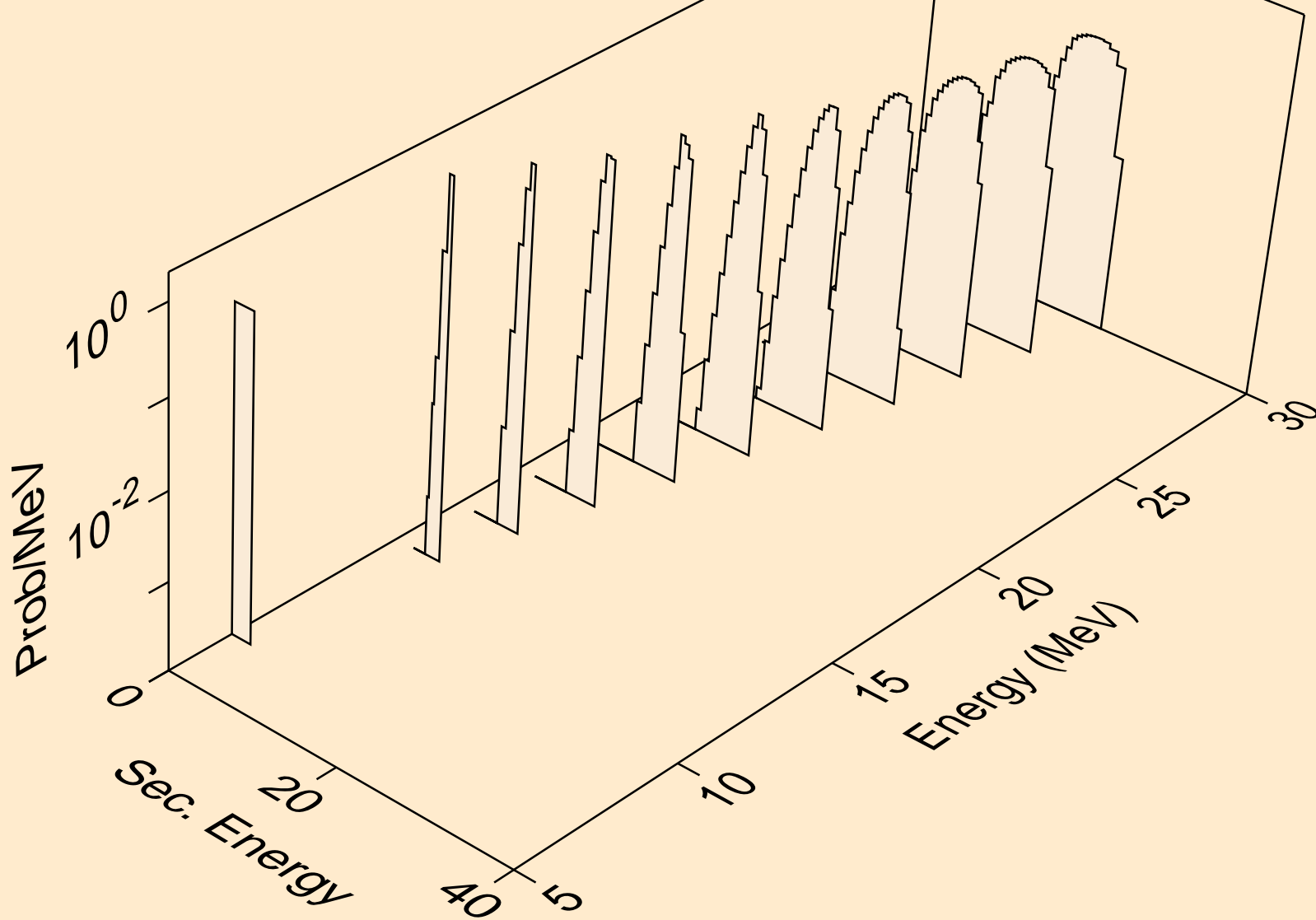

MD257 NEUTRON ACER TENDL-2019 LIBRARY; T=293.16K  
tritons from (n,t)

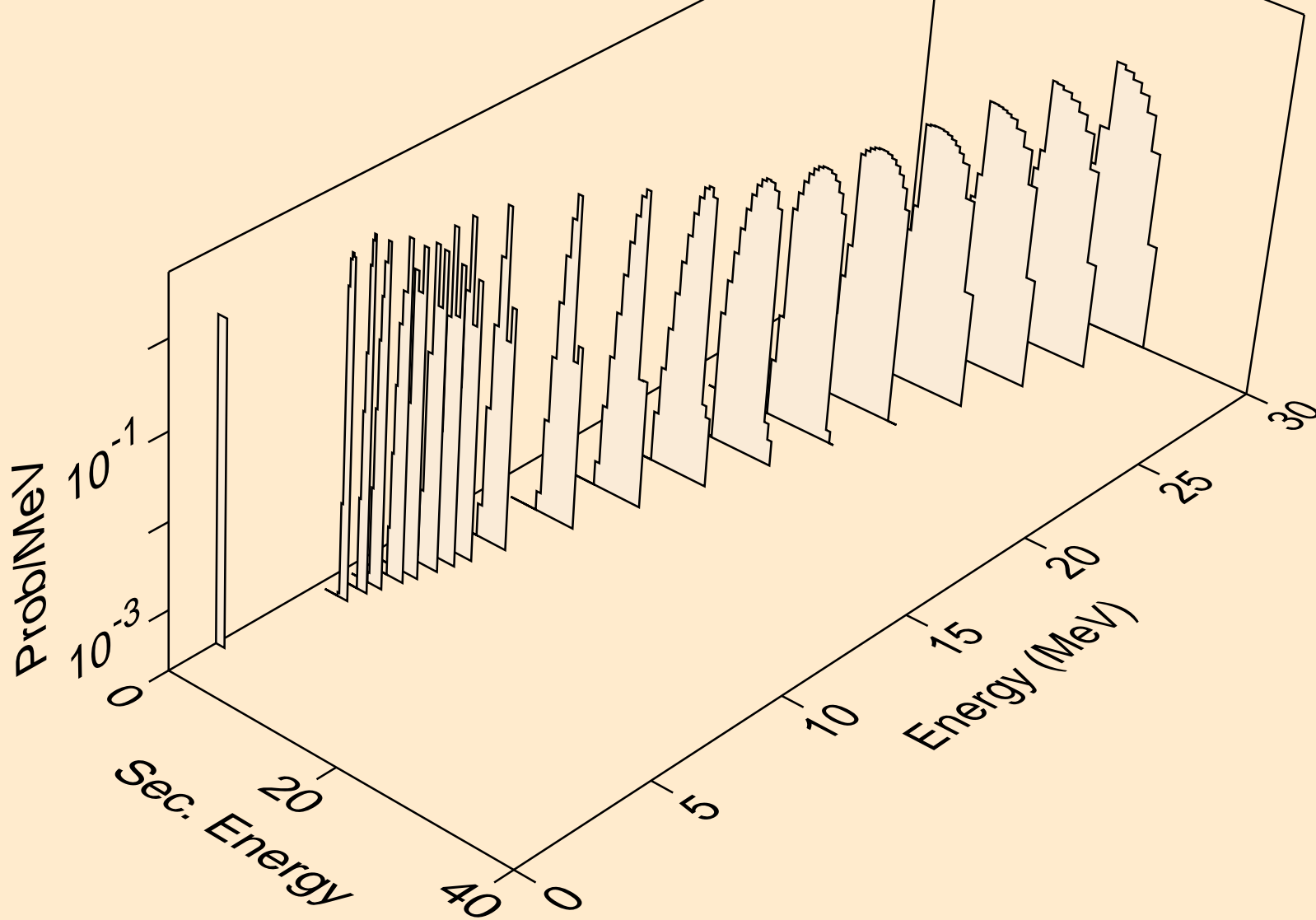



MD257 NEUTRON ACER TENDL-2019 LIBRARY; T=293.16K  
he3s from (n,x)

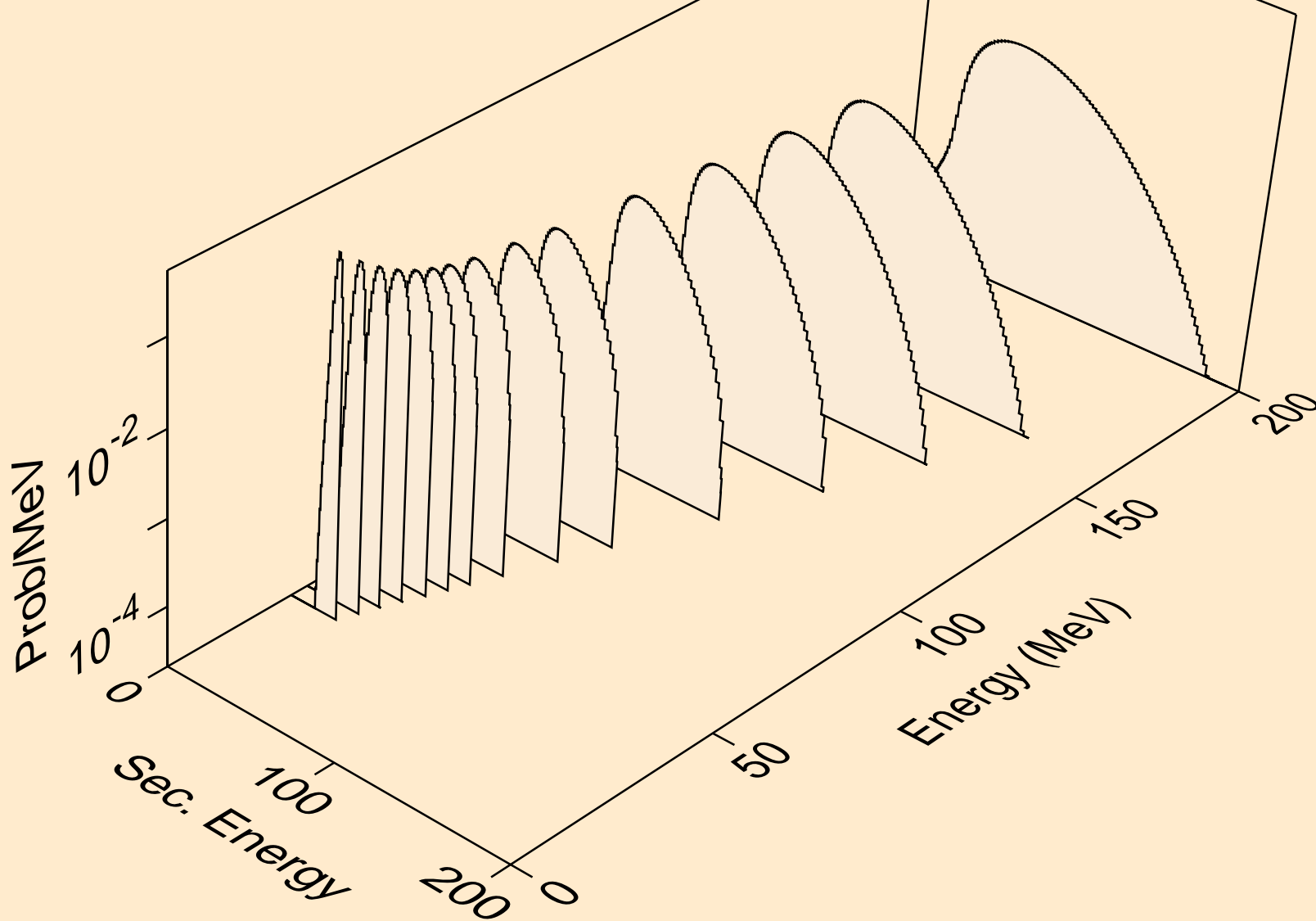

MD257 NEUTRON ACER TENDL-2019 LIBRARY; T=293.16K  
he3s from (n,n\*)he3

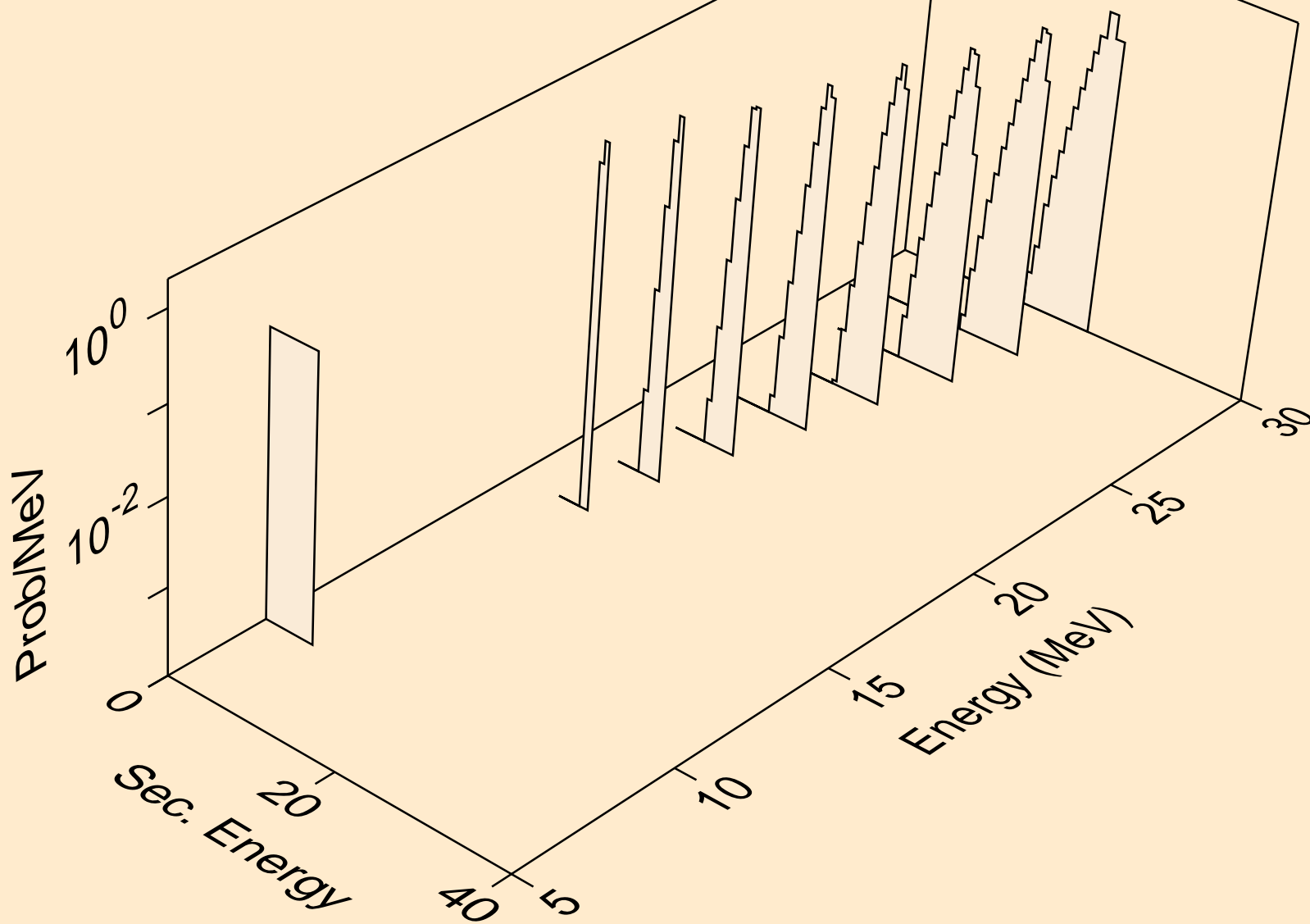

MD257 NEUTRON ACER TENDL-2019 LIBRARY; T=293.16K  
he3s from (n,he3)

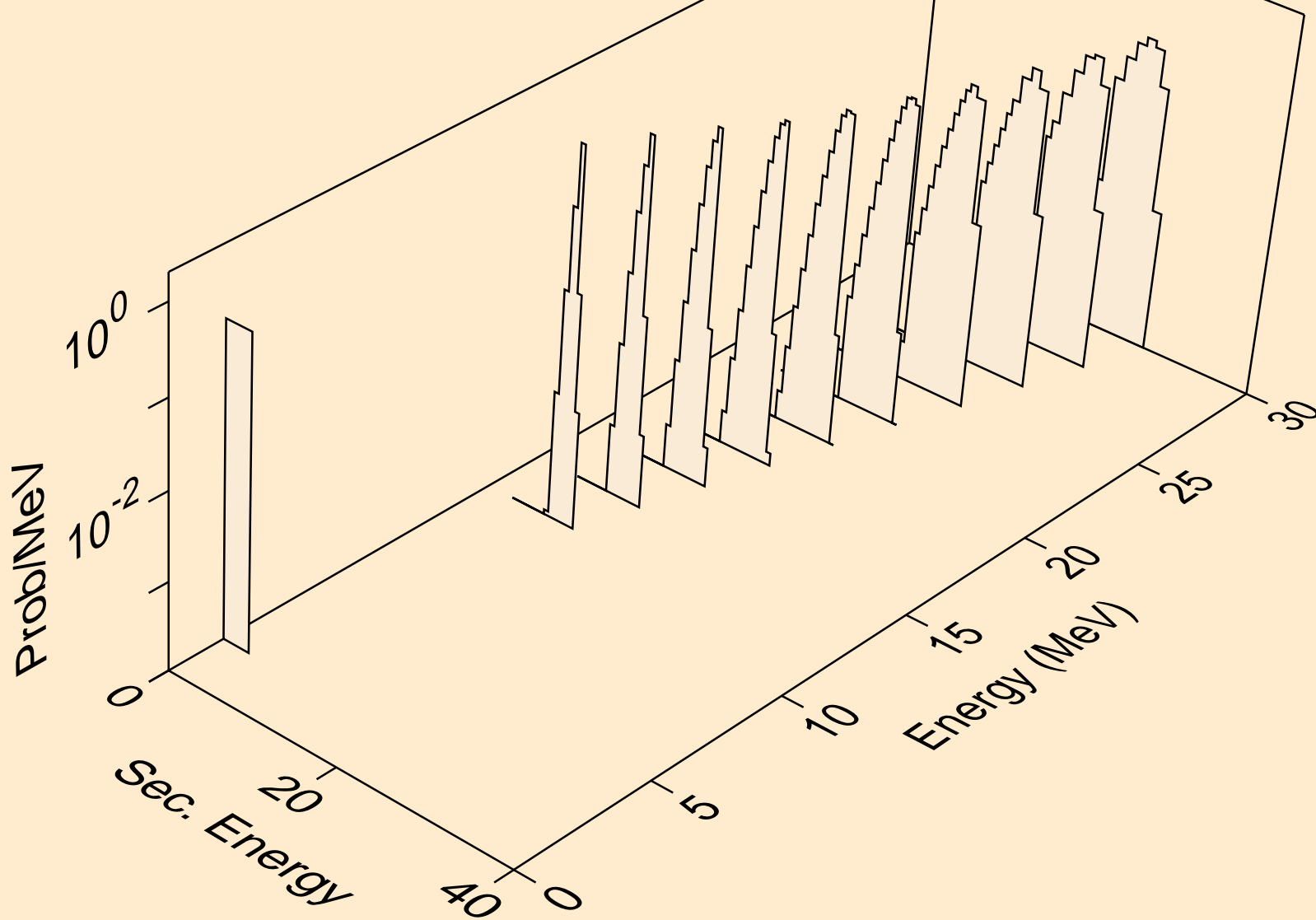

MD257 NEUTRON ACER TENDL-2019 LIBRARY; T=293.16K  
alphas from (n,x)

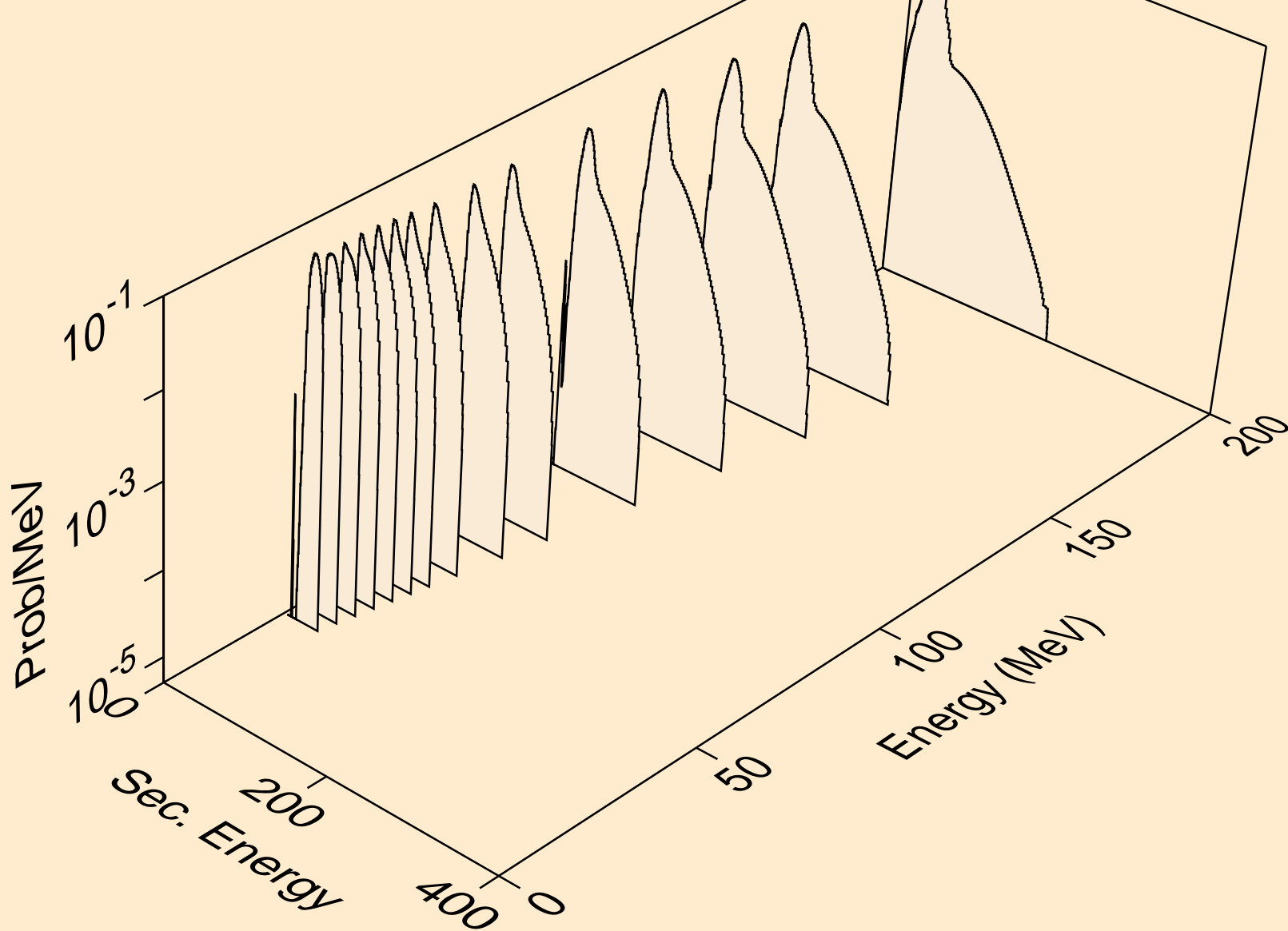

MD257 NEUTRON ACER TENDL-2019 LIBRARY; T=293.16K  
alphas from (n,n\*)a

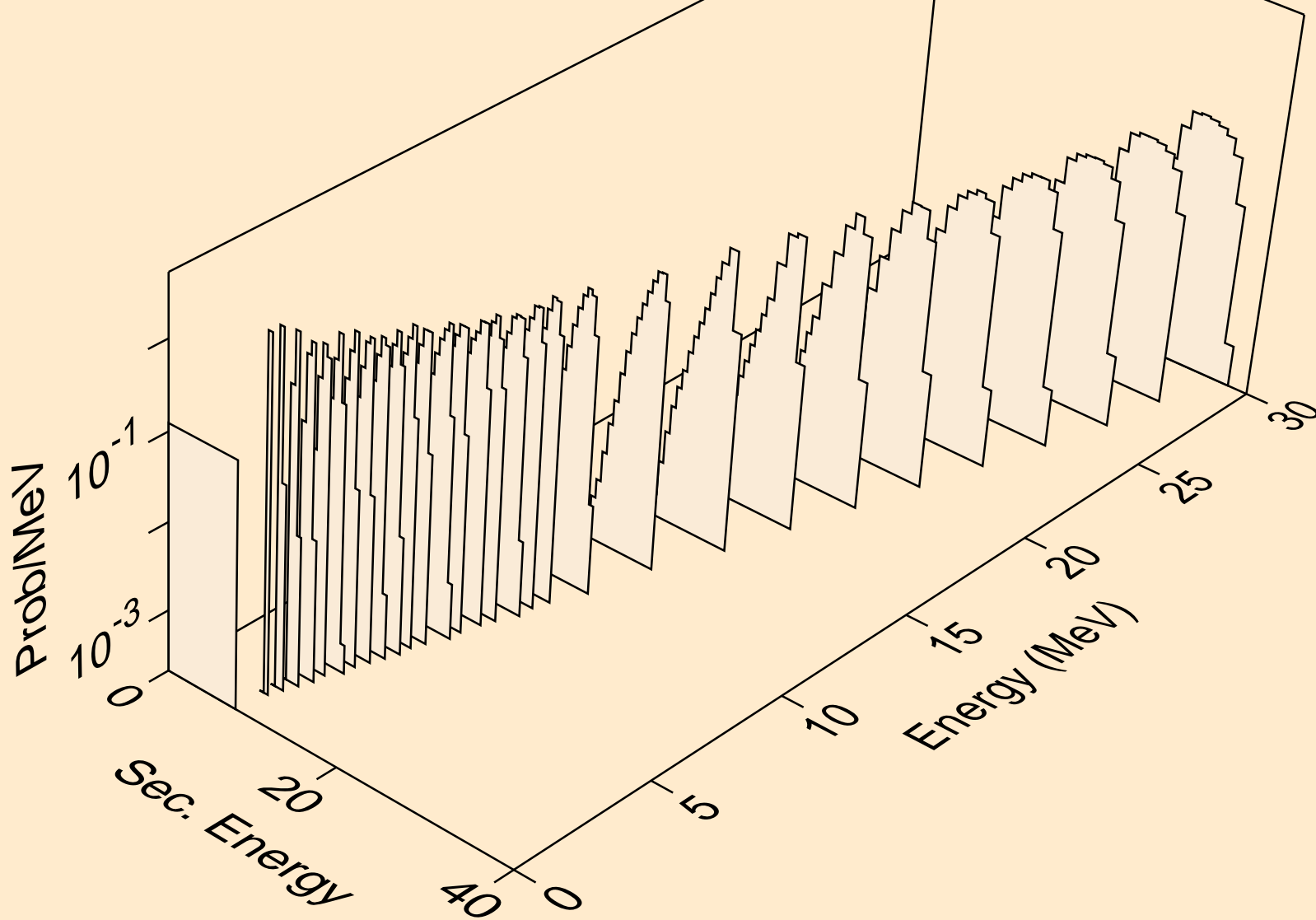

MD257 NEUTRON ACER TENDL-2019 LIBRARY; T=293.16K  
alphas from (n,2n)a

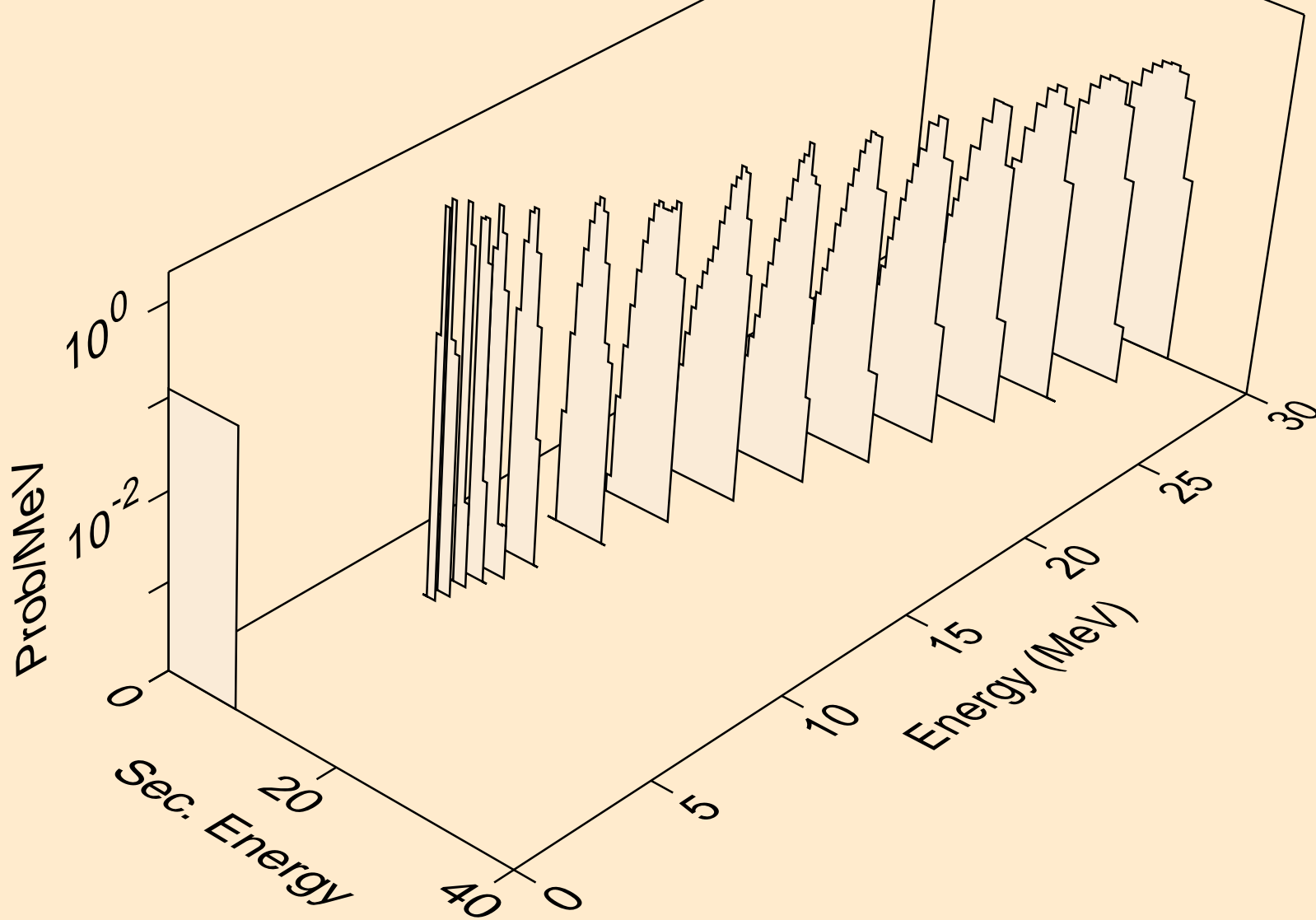

MD257 NEUTRON ACER TENDL-2019 LIBRARY; T=293.16K  
alphas from (n,3n)a

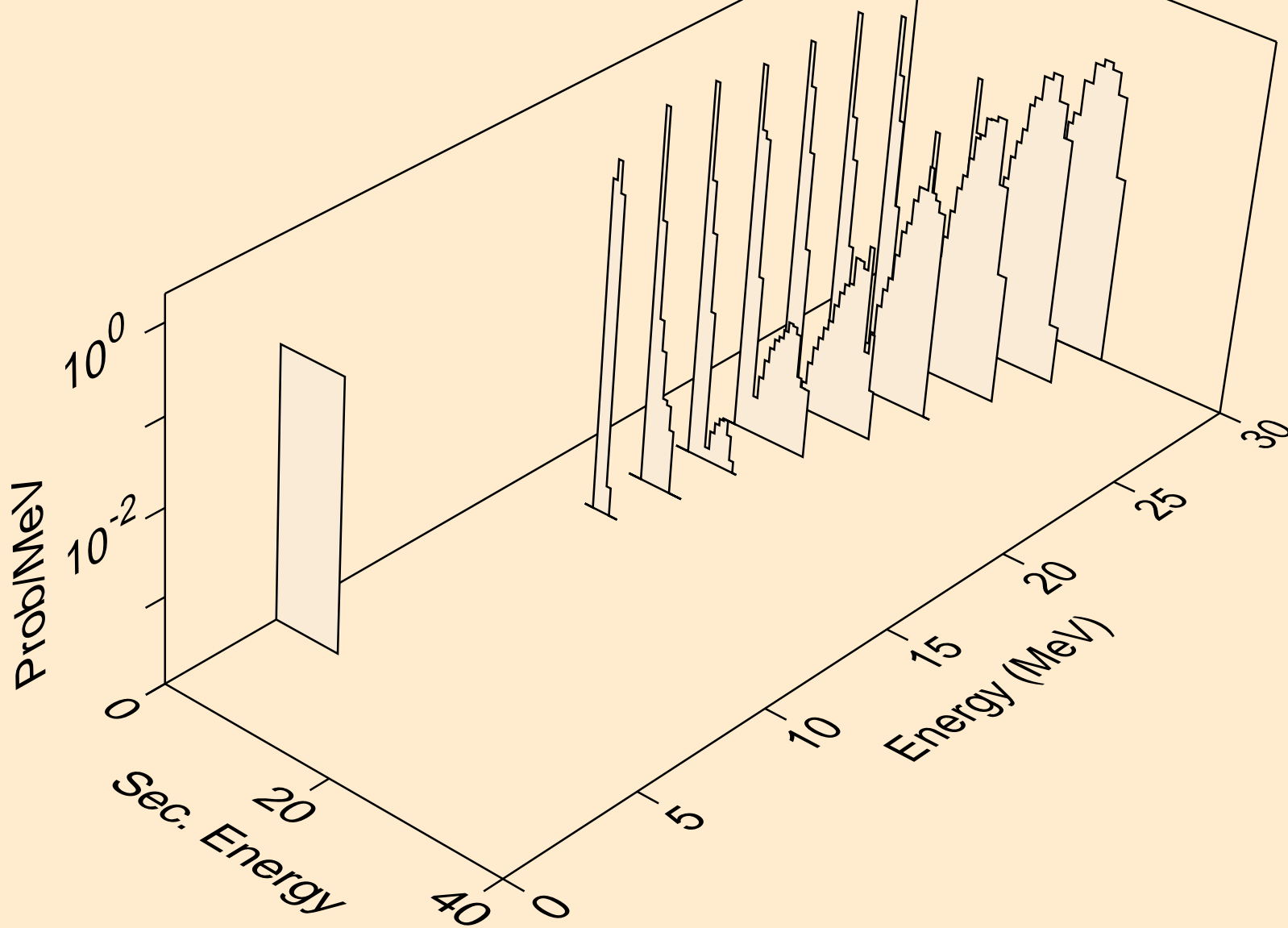

MD257 NEUTRON ACER TENDL-2019 LIBRARY; T=293.16K  
alphas from (n,n\*)2a

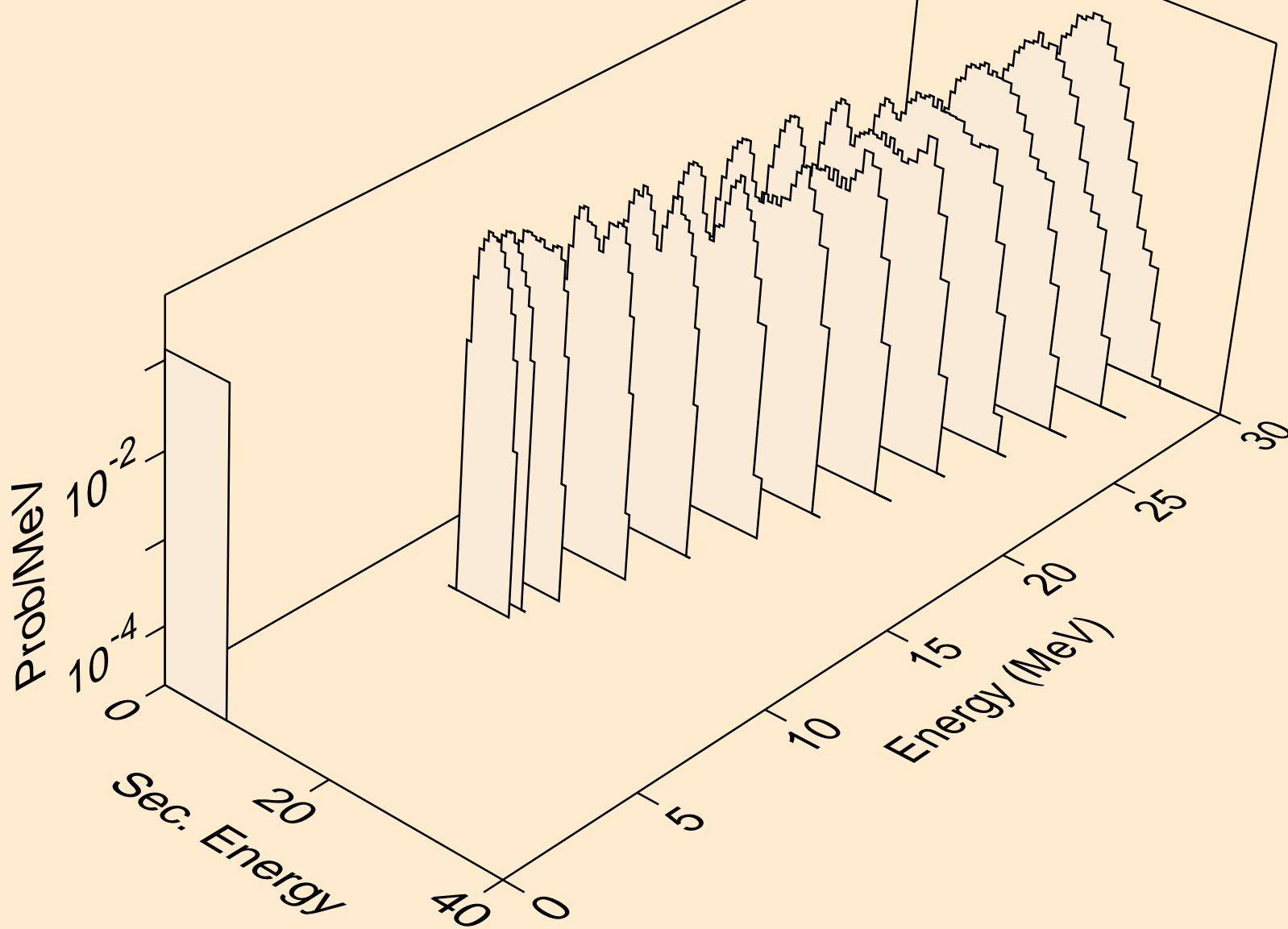



MD257 NEUTRON ACER TENDL-2019 LIBRARY; T=293.16K  
alphas from (n,npa)

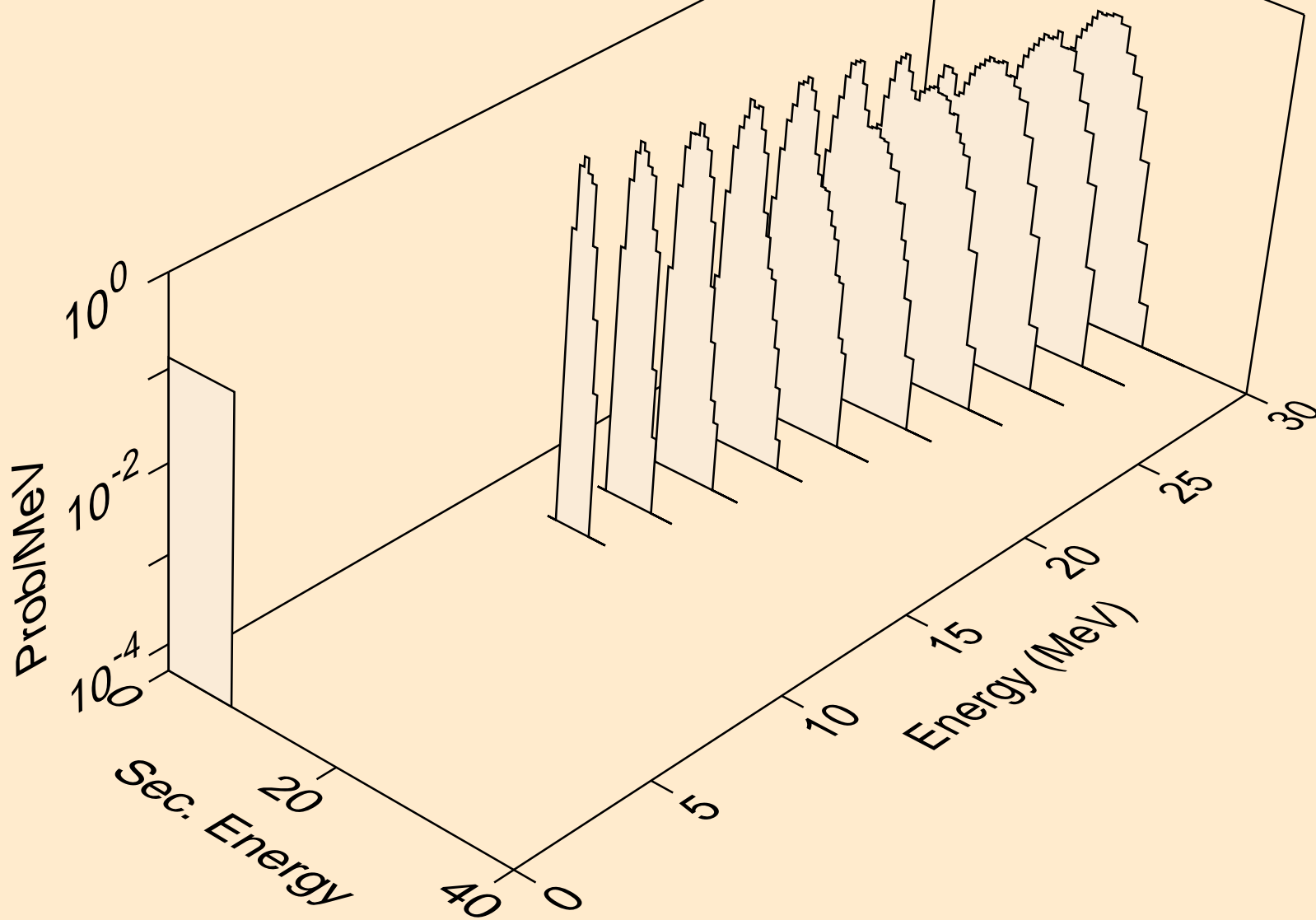

MD257 NEUTRON ACER TENDL-2019 LIBRARY; T=293.16K  
alphas from (n,a)

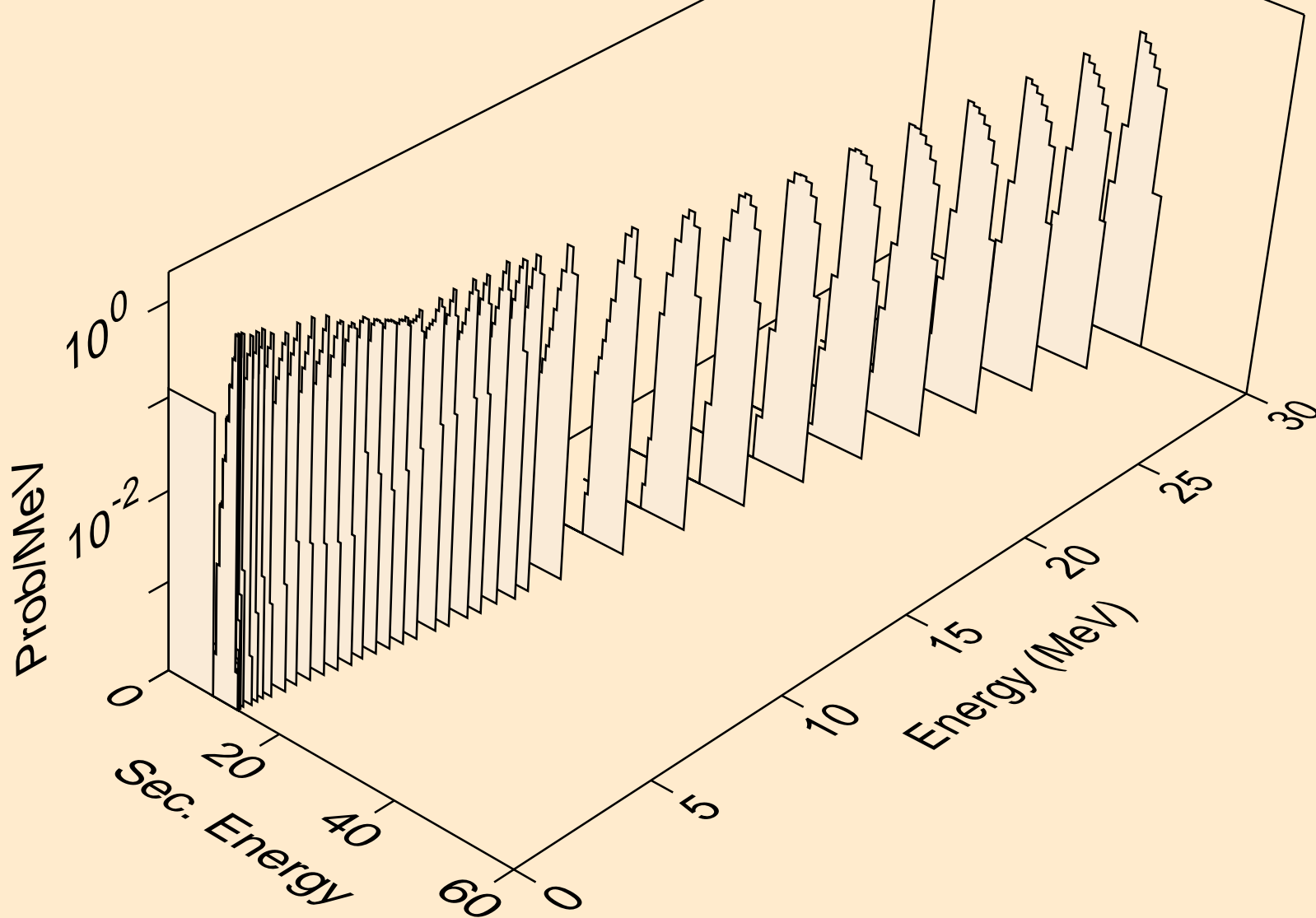

MD257 NEUTRON ACER TENDL-2019 LIBRARY; T=293.16K  
alphas from (n,2a)

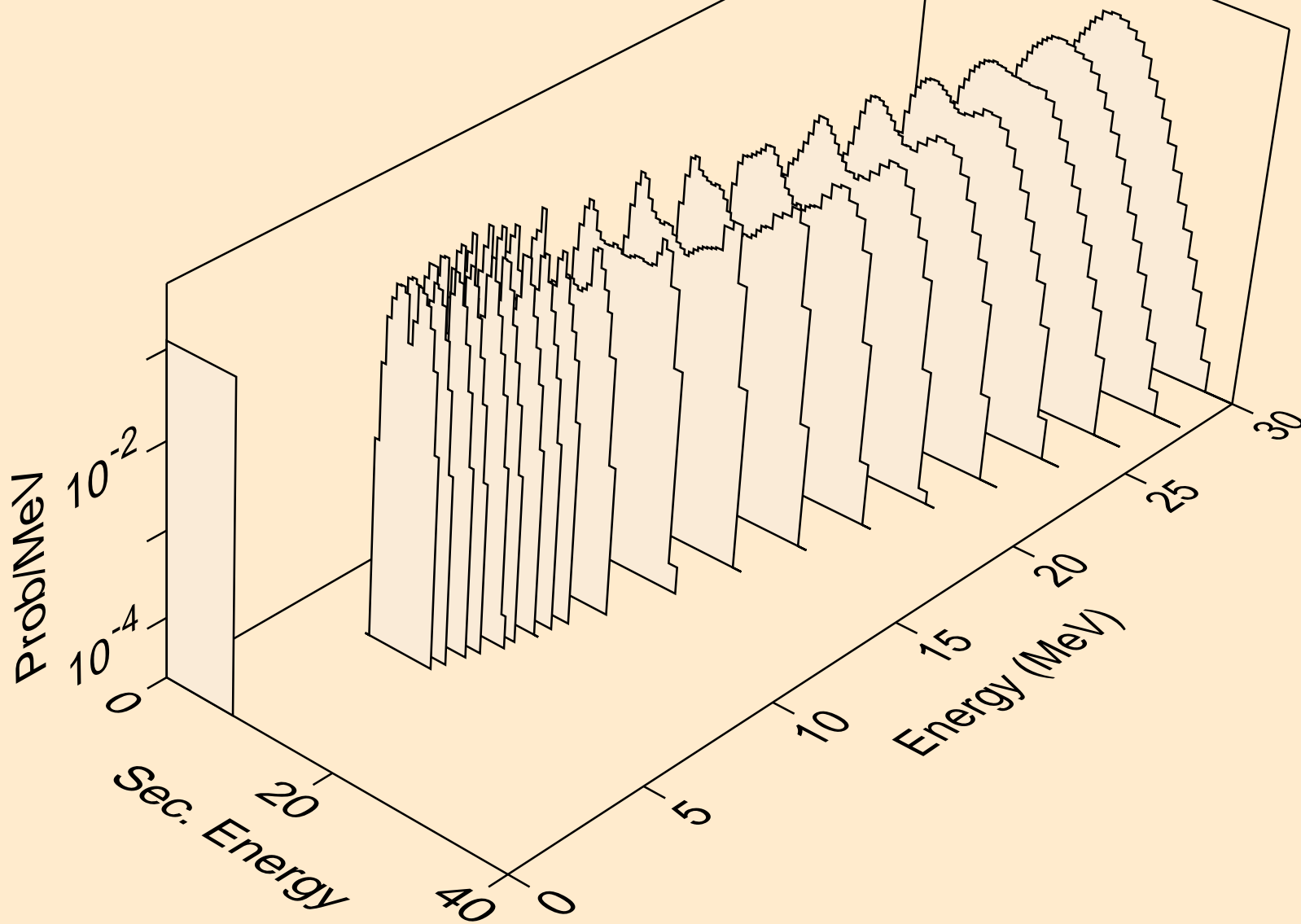

MD257 NEUTRON ACER TENDL-2019 LIBRARY; T=293.16K  
alphas from (n,pa)

