

MD258 NEUTRON ACER TENDL-2019 LIBRARY; T=293.16K  
Principal cross sections

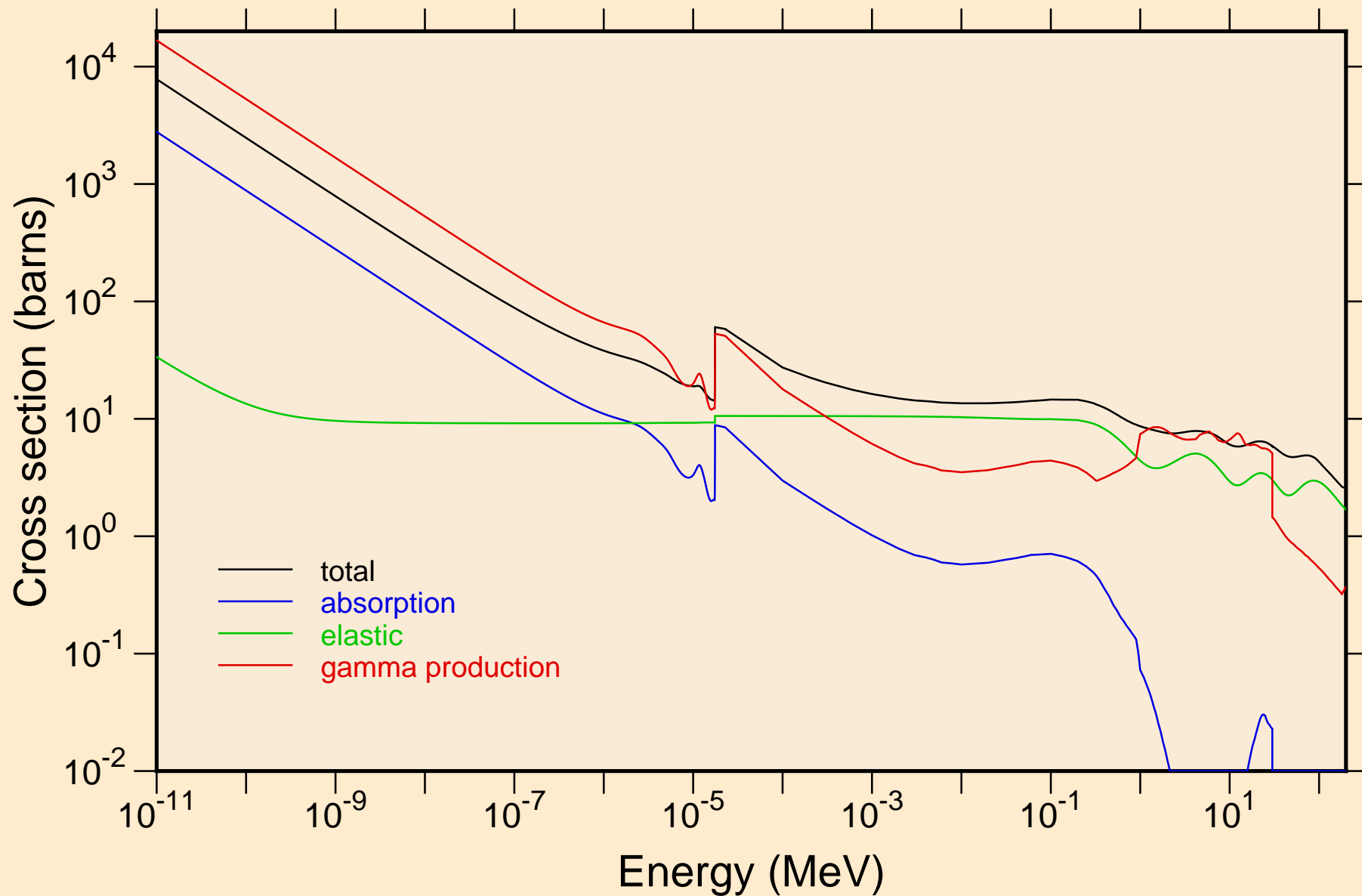

MD258 NEUTRON ACER TENDL-2019 LIBRARY; T=293.16K  
Heating

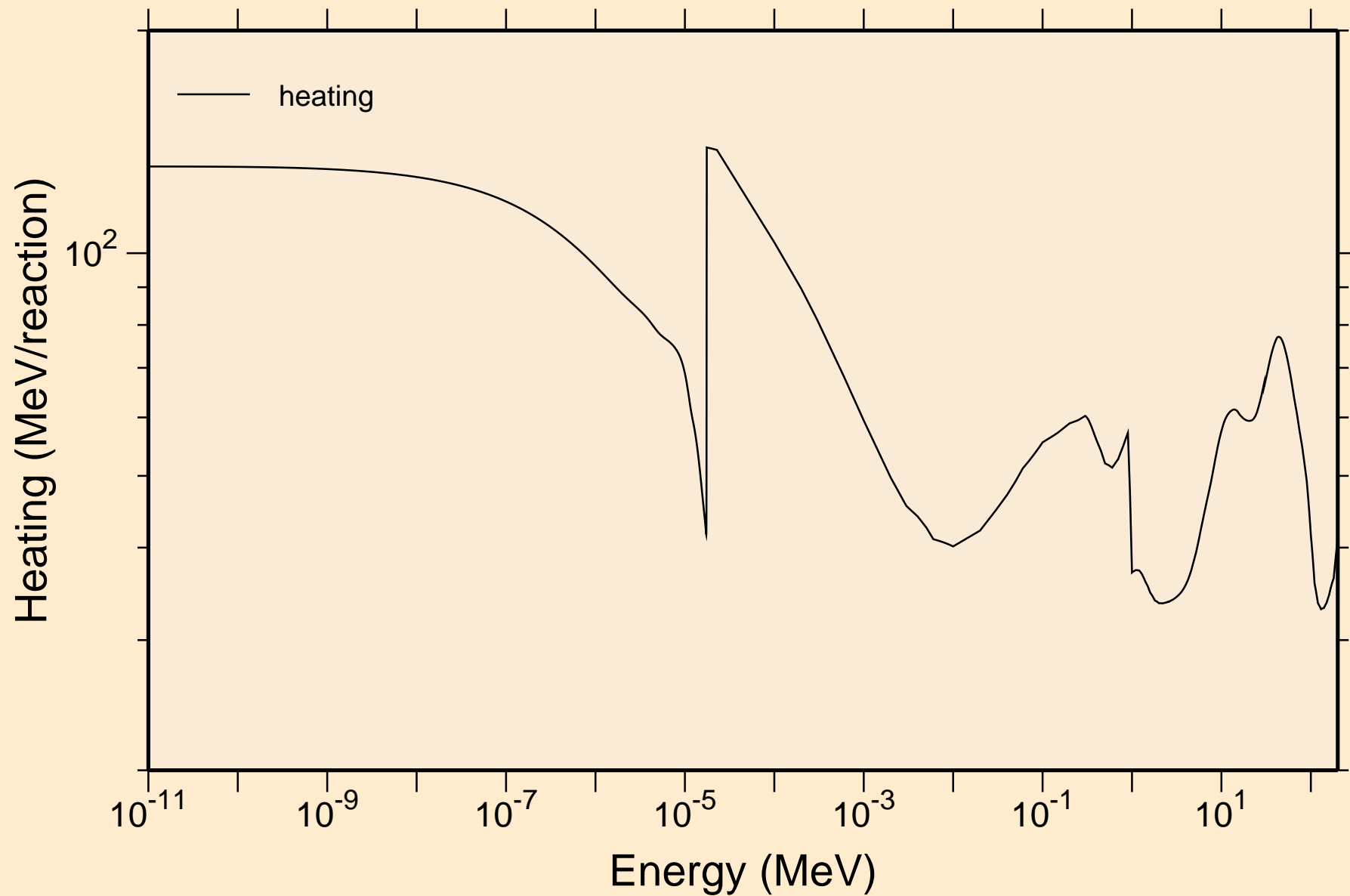

MD258 NEUTRON ACER TENDL-2019 LIBRARY; T=293.16K  
Damage

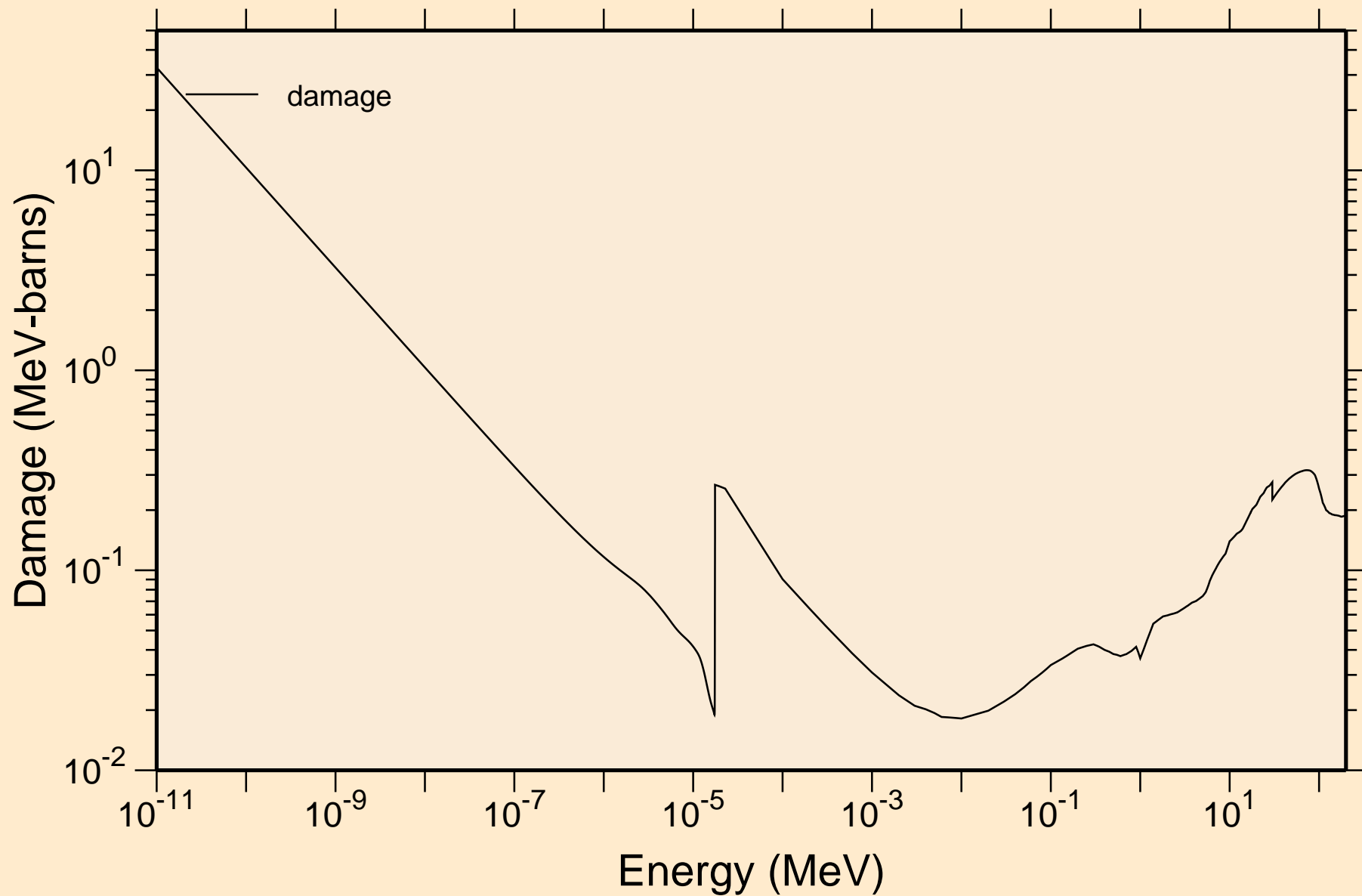

MD258 NEUTRON ACER TENDL-2019 LIBRARY; T=293.16K  
Non-threshold reactions

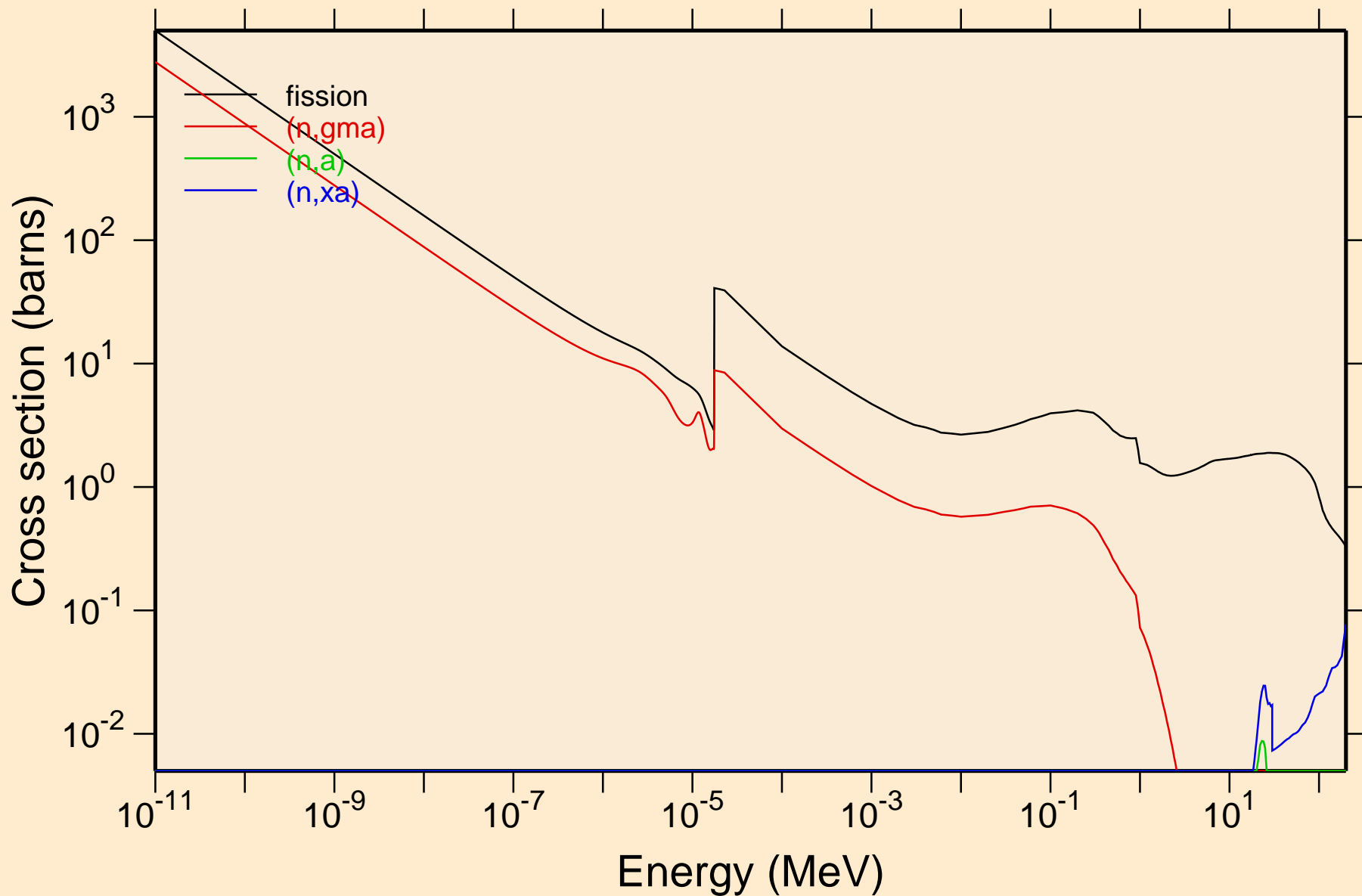

# MD258 NEUTRON ACER TENDL-2019 LIBRARY; T=293.16K

## Principal cross sections

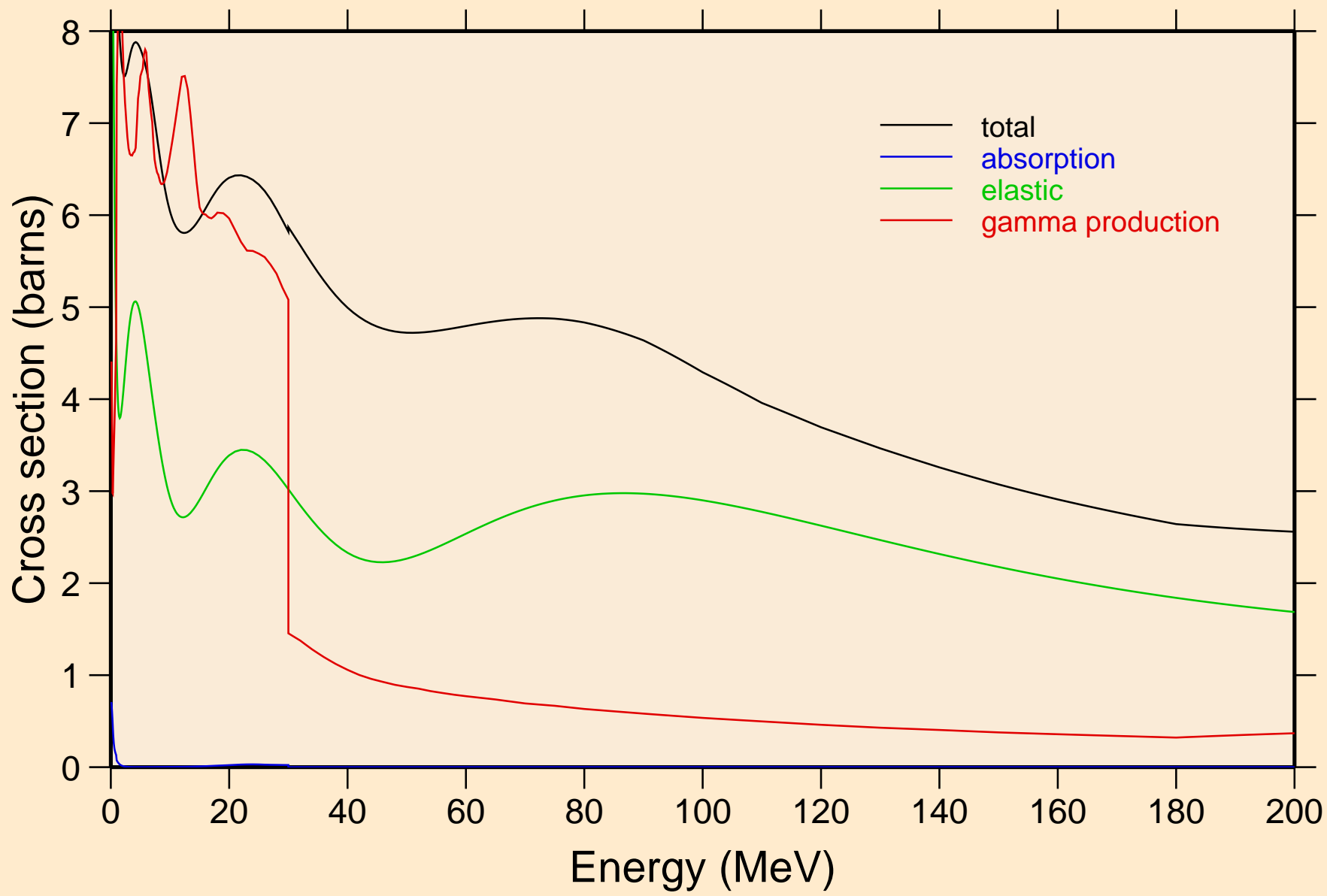

MD258 NEUTRON ACER TENDL-2019 LIBRARY; T=293.16K  
Heating

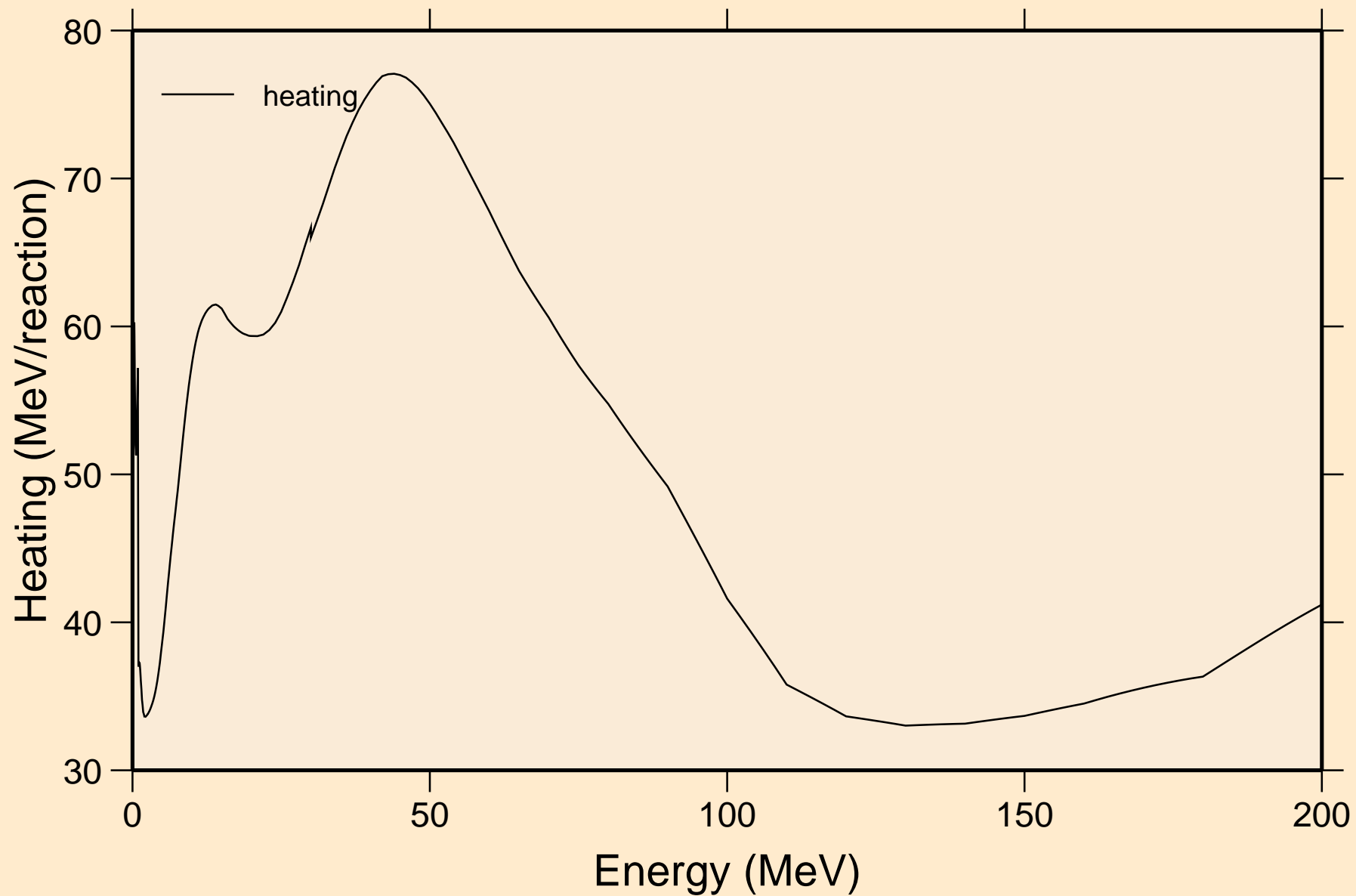

MD258 NEUTRON ACER TENDL-2019 LIBRARY; T=293.16K  
Damage

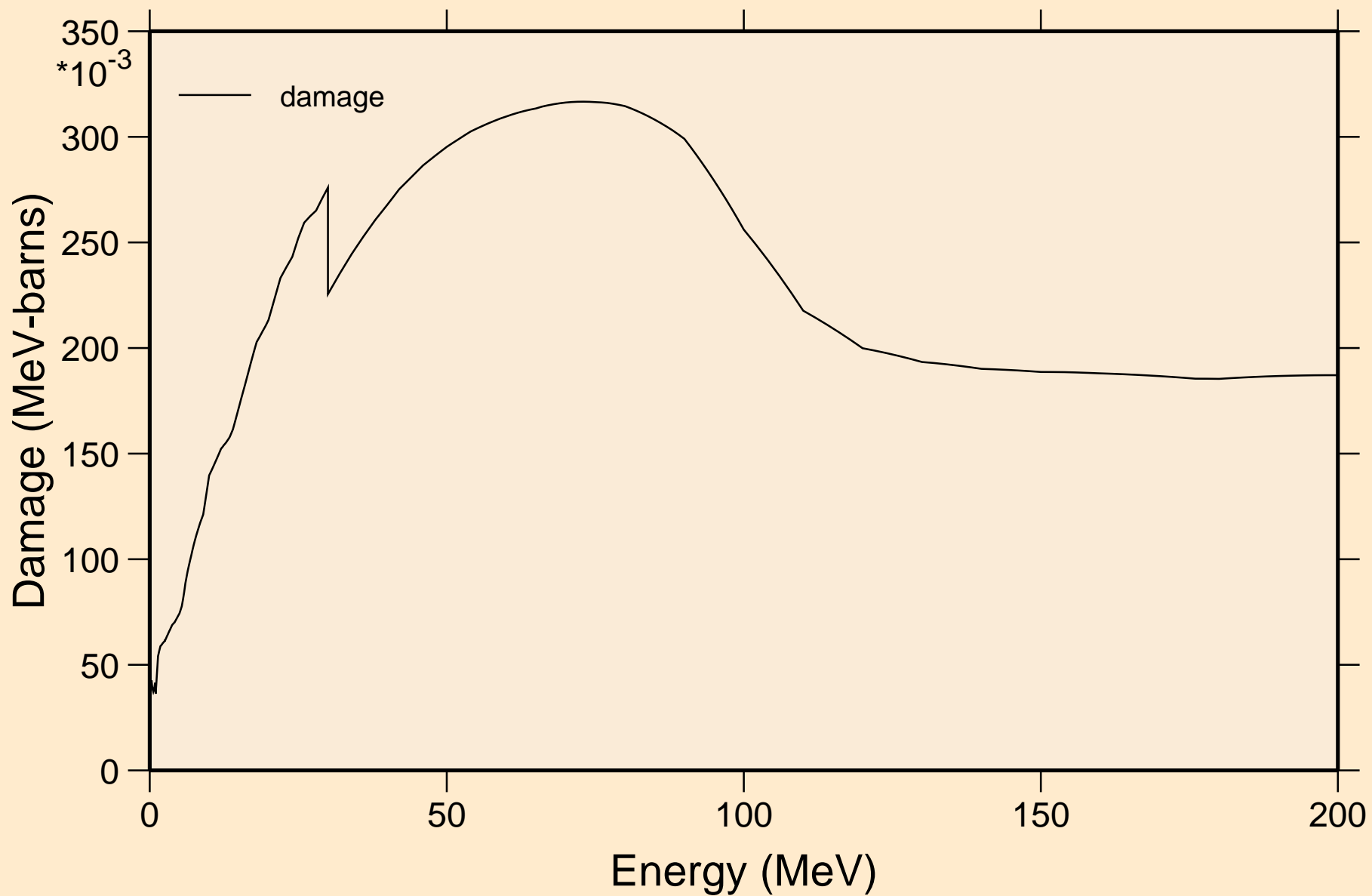

MD258 NEUTRON ACER TENDL-2019 LIBRARY; T=293.16K  
Non-threshold reactions

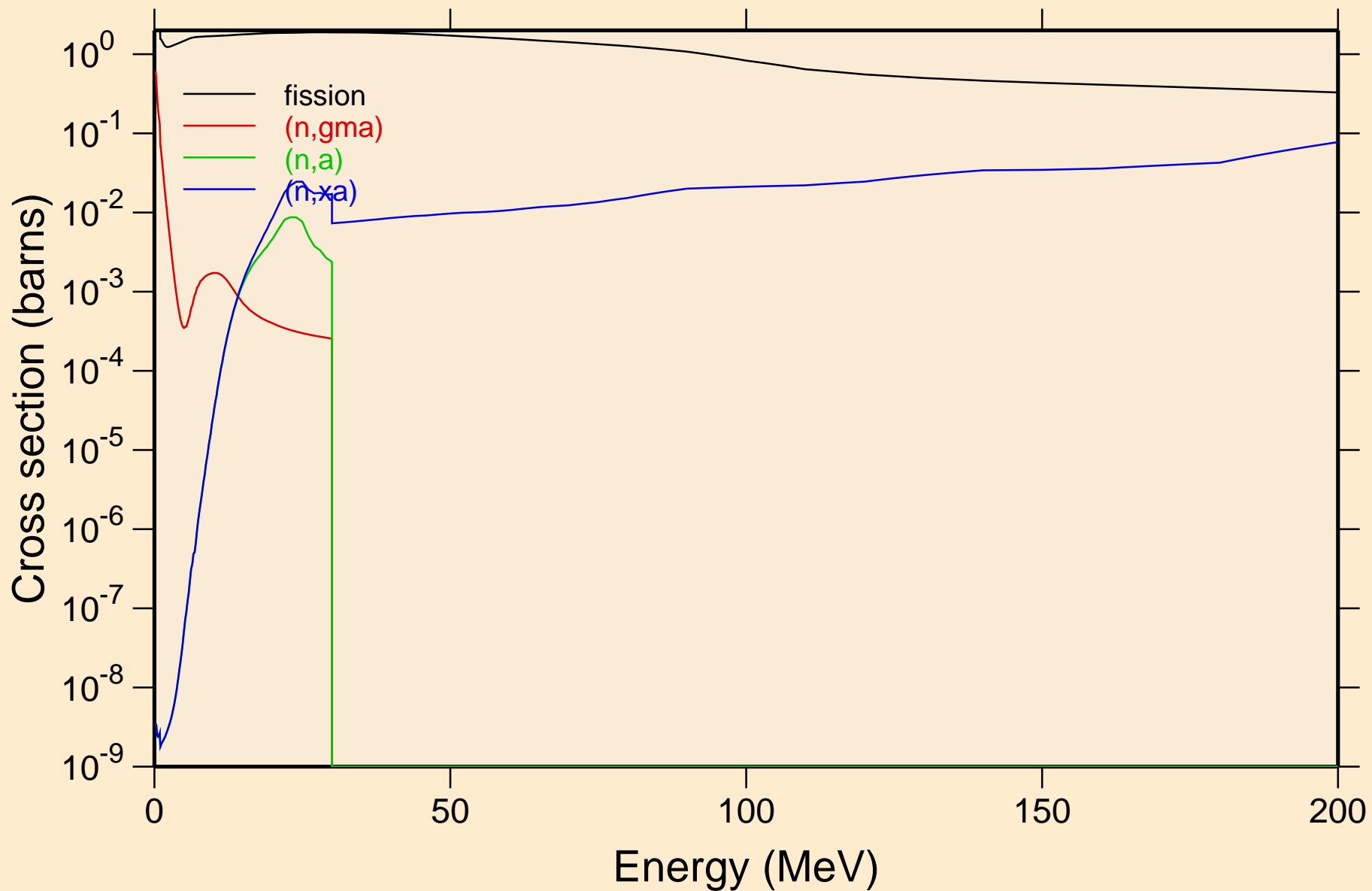



MD258 NEUTRON ACER TENDL-2019 LIBRARY; T=293.16K  
Inelastic levels

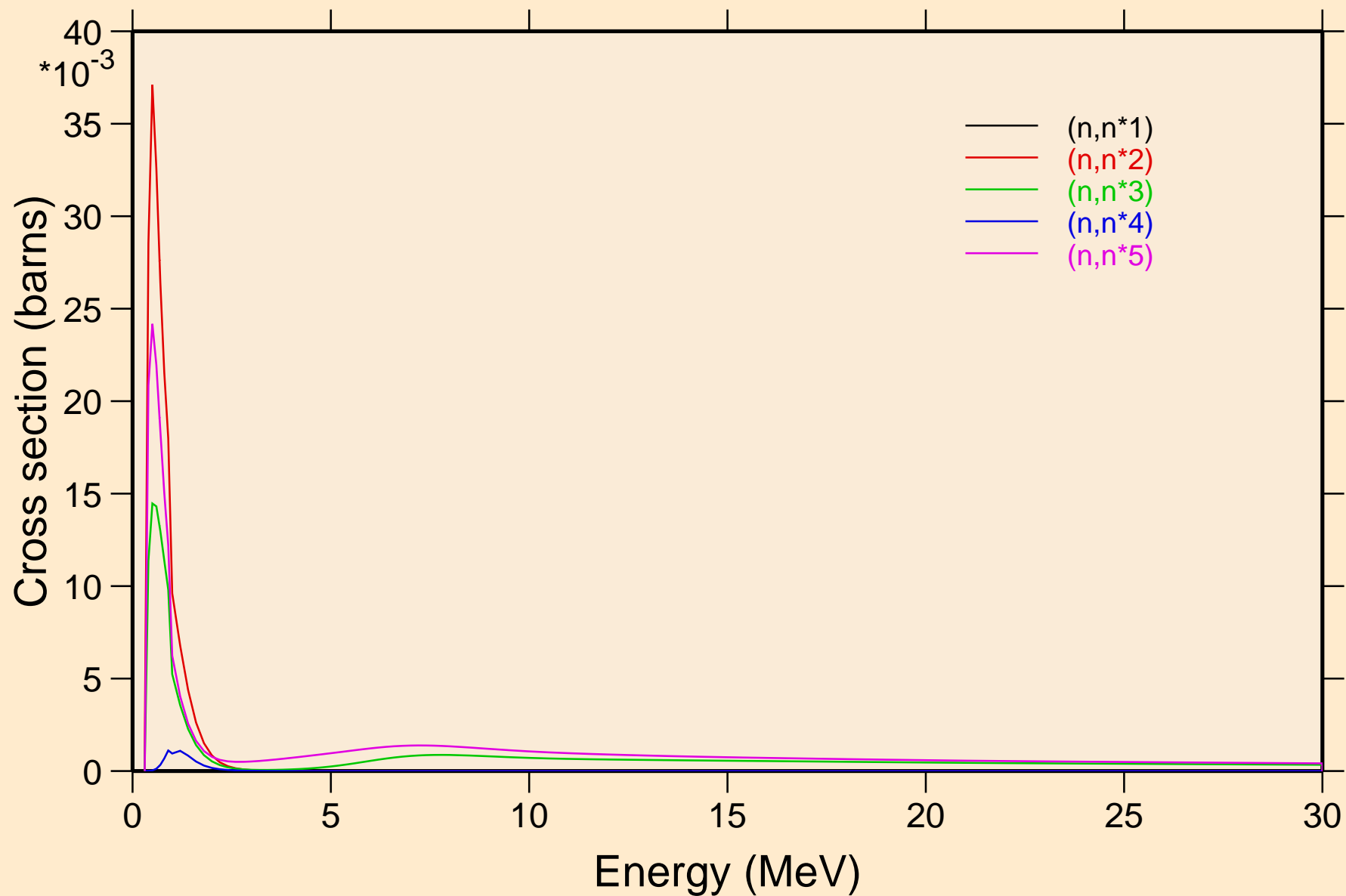

MD258 NEUTRON ACER TENDL-2019 LIBRARY; T=293.16K  
Inelastic levels

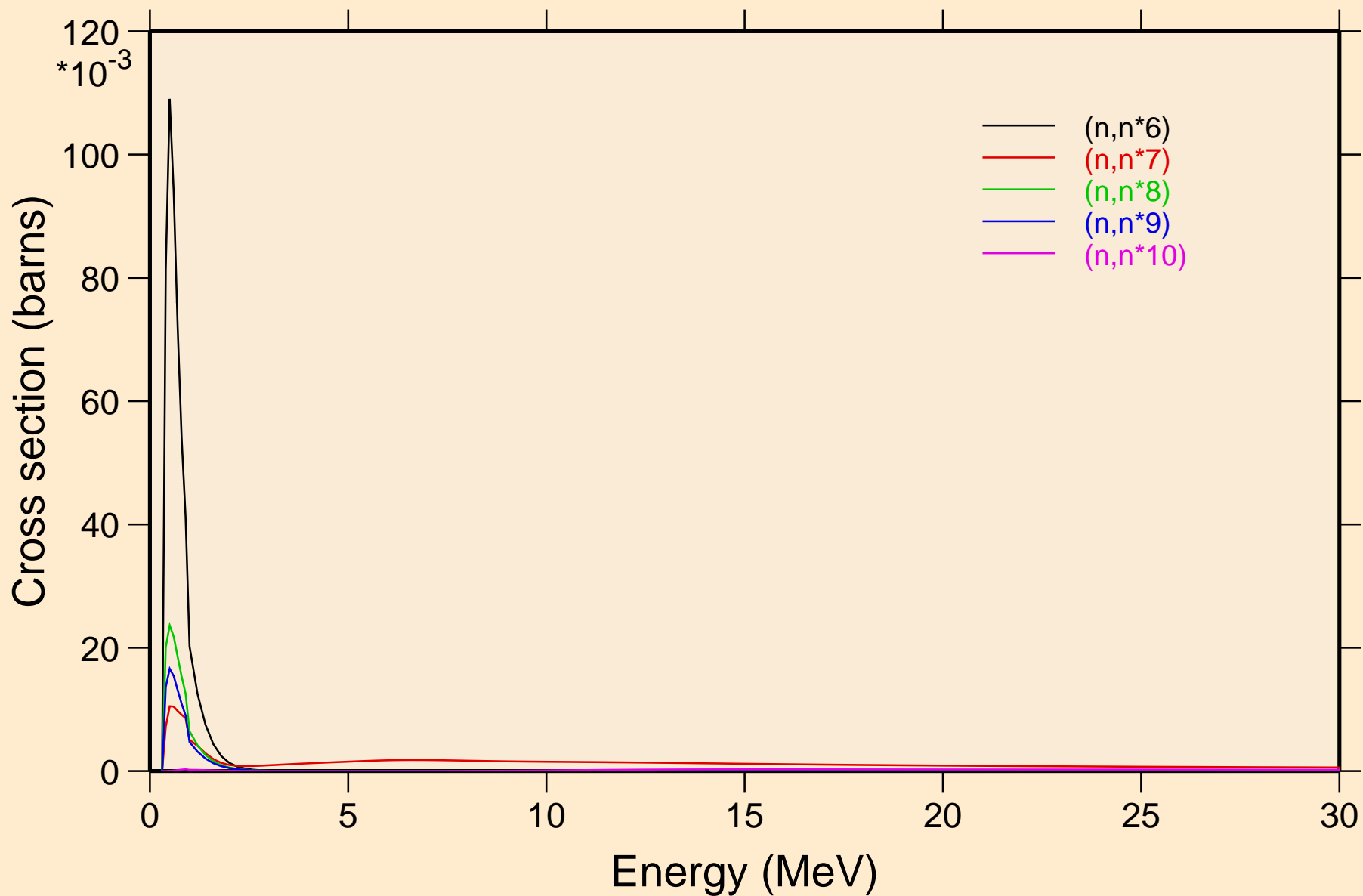

MD258 NEUTRON ACER TENDL-2019 LIBRARY; T=293.16K  
Inelastic levels

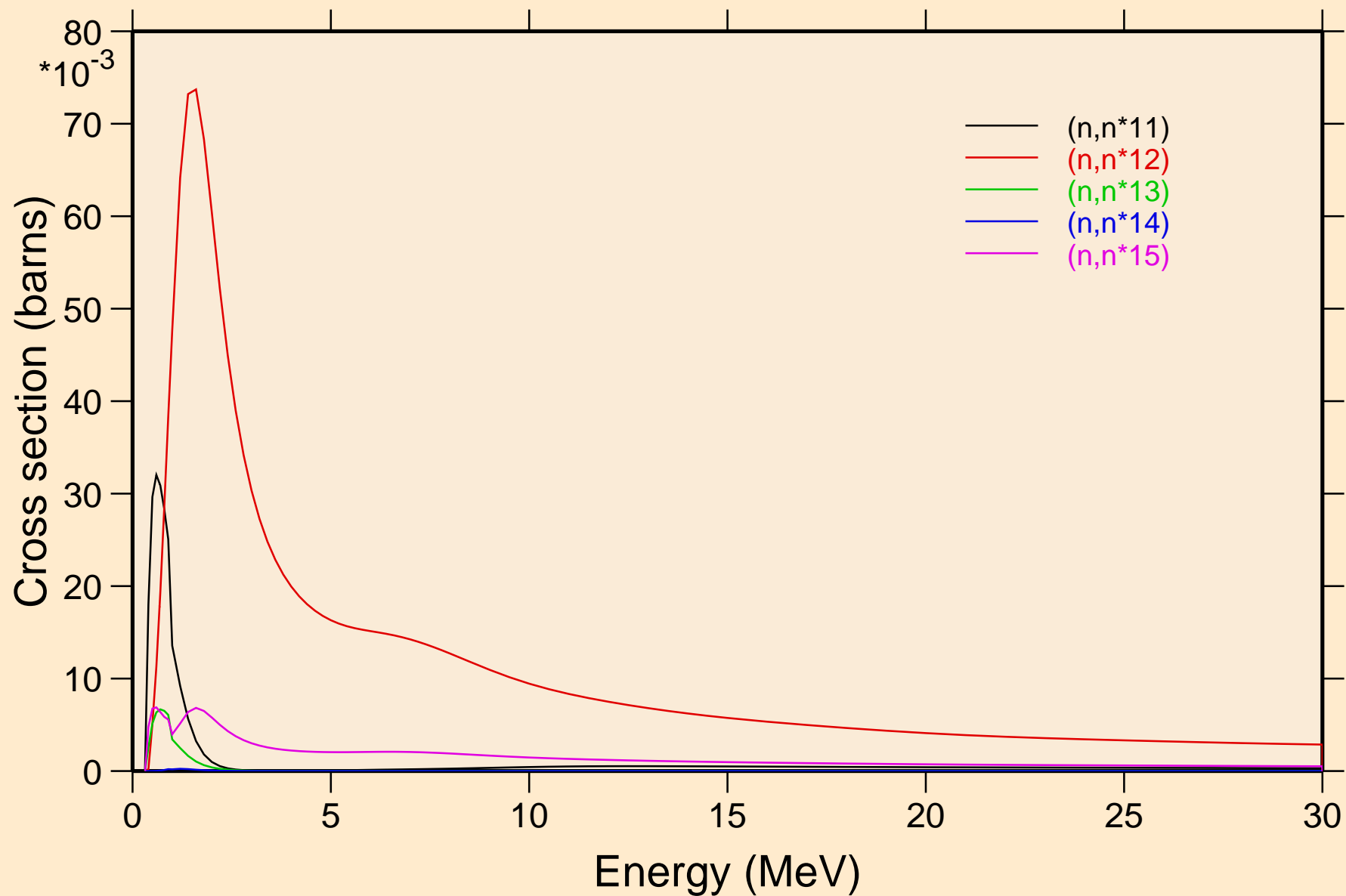

MD258 NEUTRON ACER TENDL-2019 LIBRARY; T=293.16K  
Inelastic levels

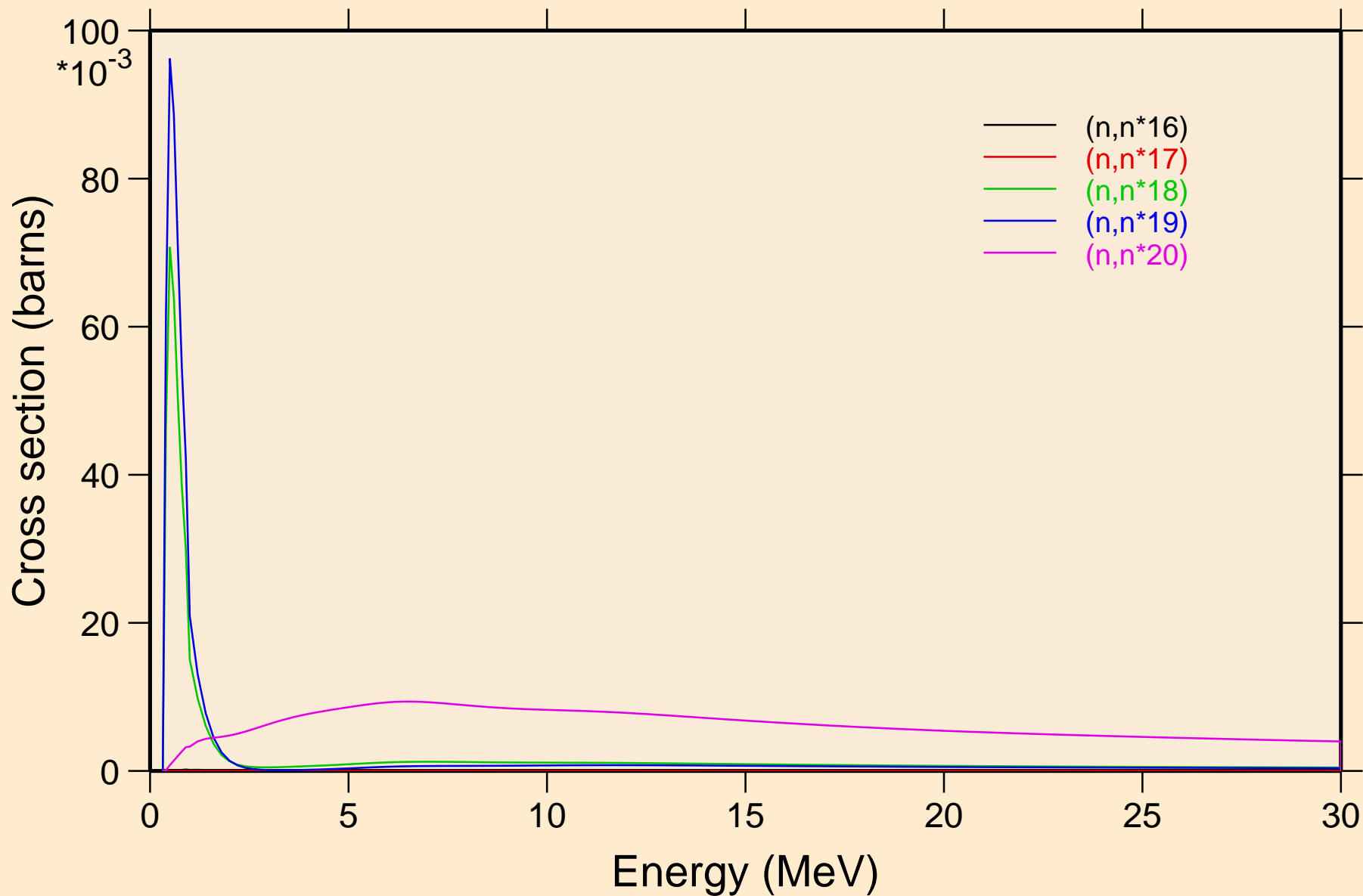

MD258 NEUTRON ACER TENDL-2019 LIBRARY; T=293.16K  
Inelastic levels

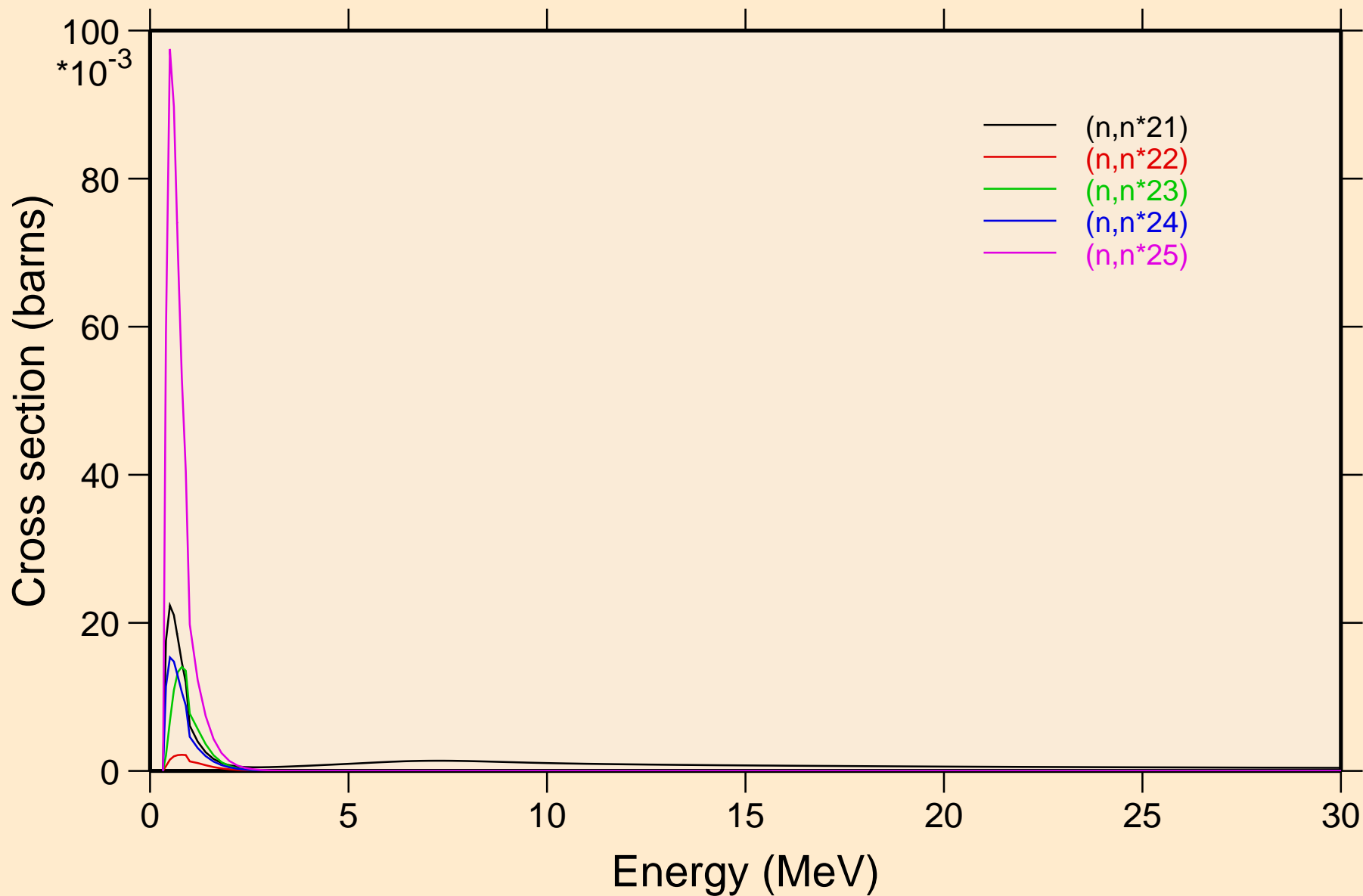

MD258 NEUTRON ACER TENDL-2019 LIBRARY; T=293.16K  
Inelastic levels

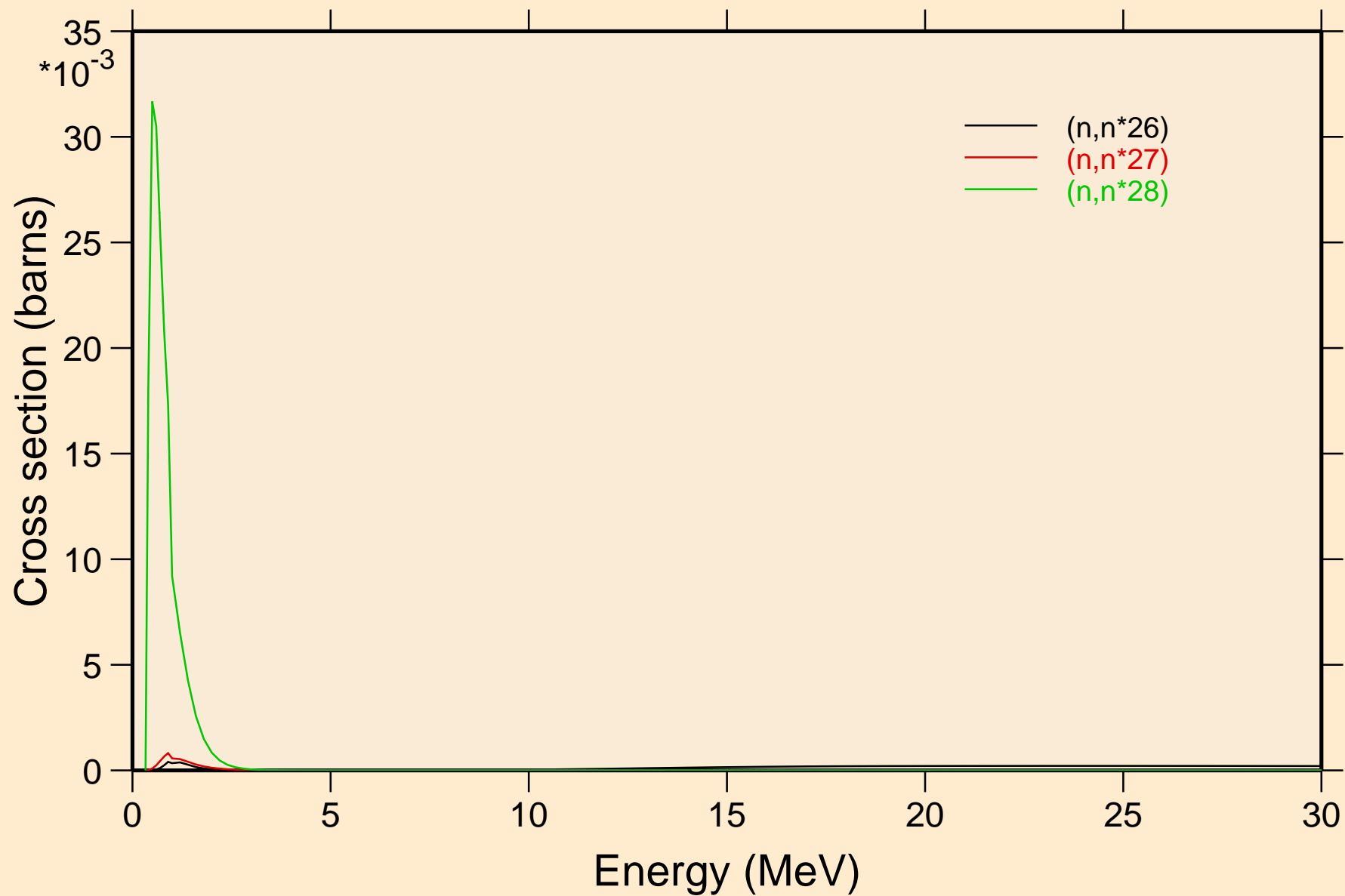

MD258 NEUTRON ACER TENDL-2019 LIBRARY; T=293.16K  
Threshold reactions

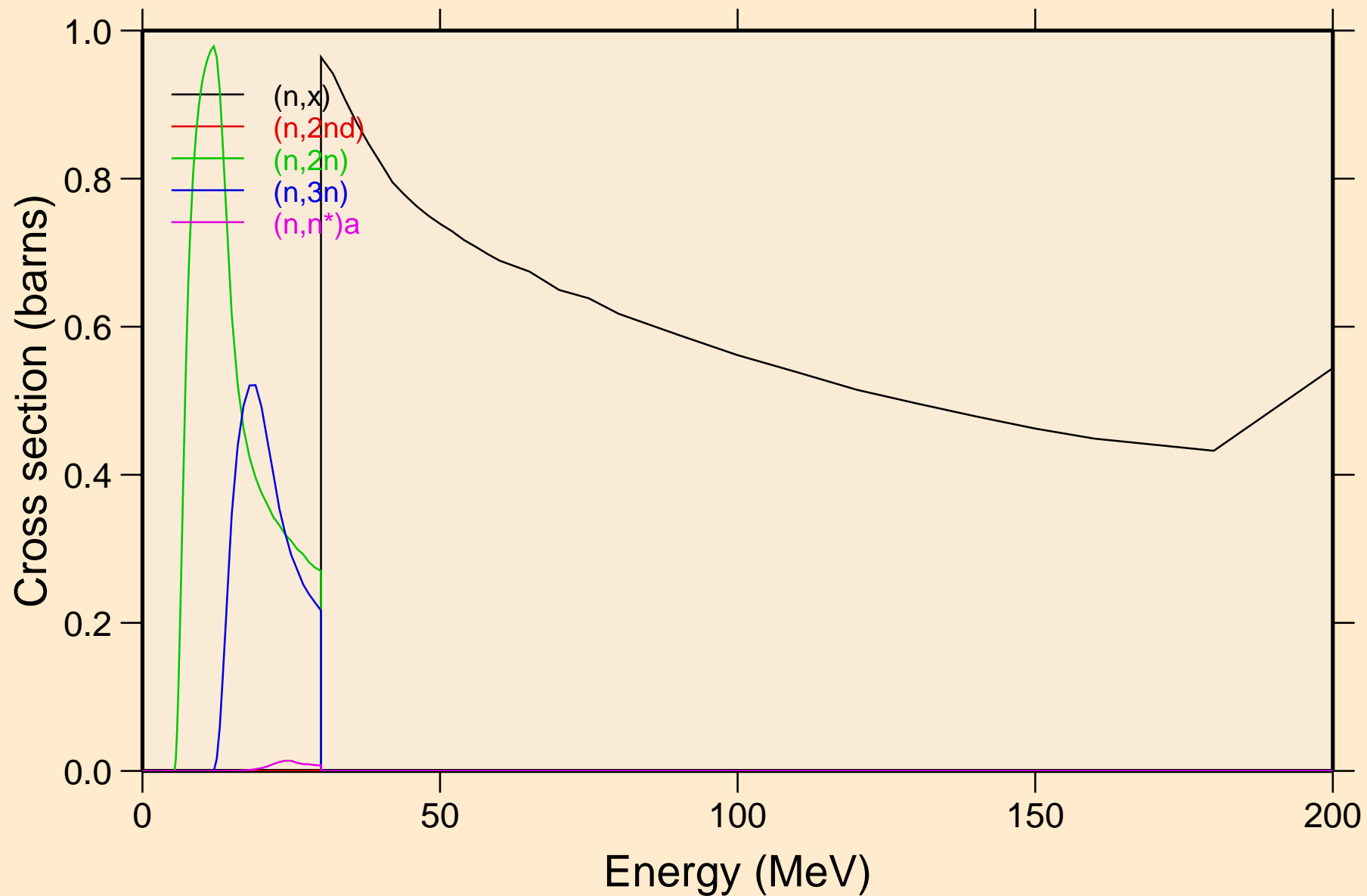

MD258 NEUTRON ACER TENDL-2019 LIBRARY; T=293.16K  
Threshold reactions

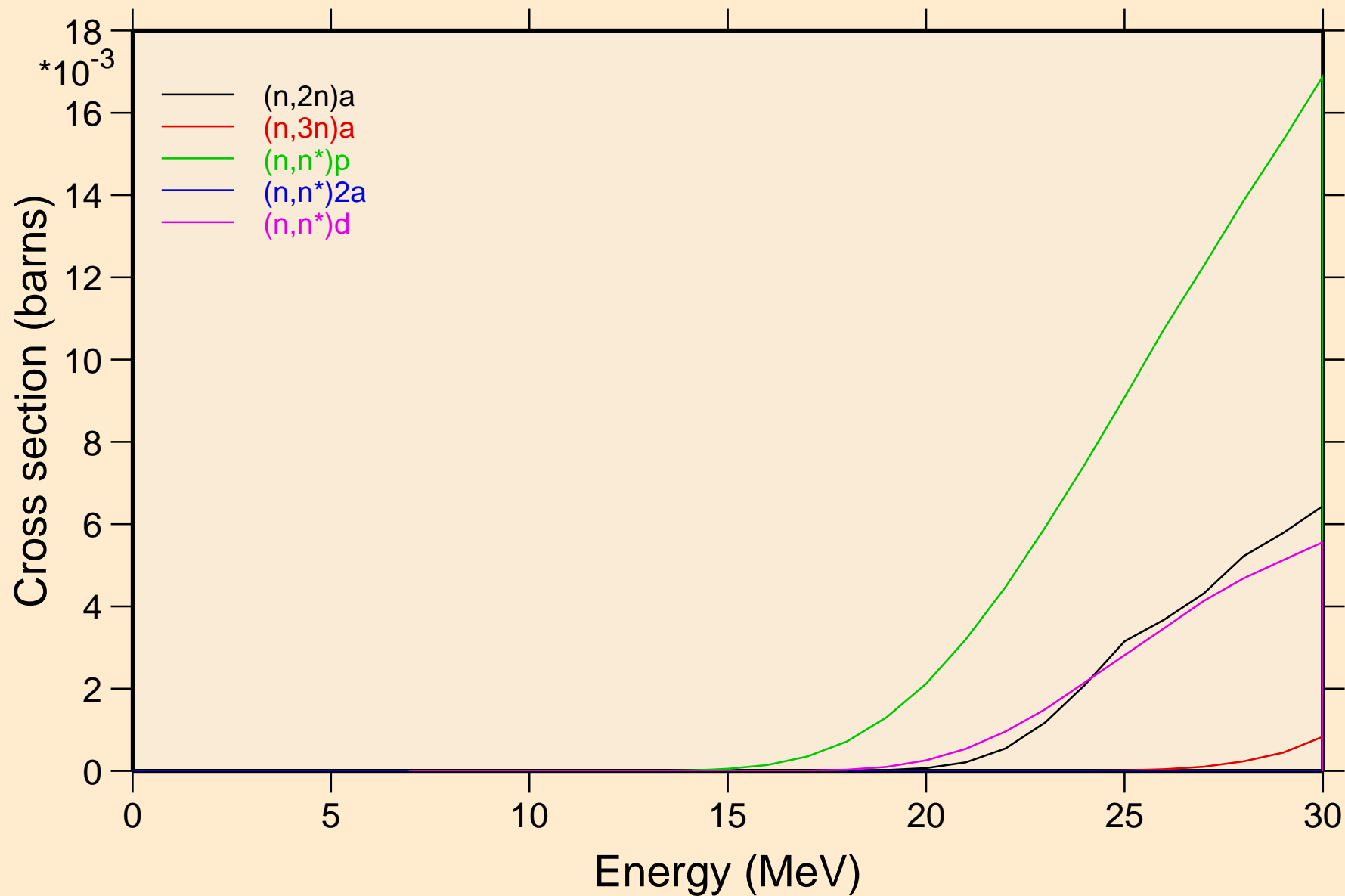



MD258 NEUTRON ACER TENDL-2019 LIBRARY; T=293.16K  
Threshold reactions

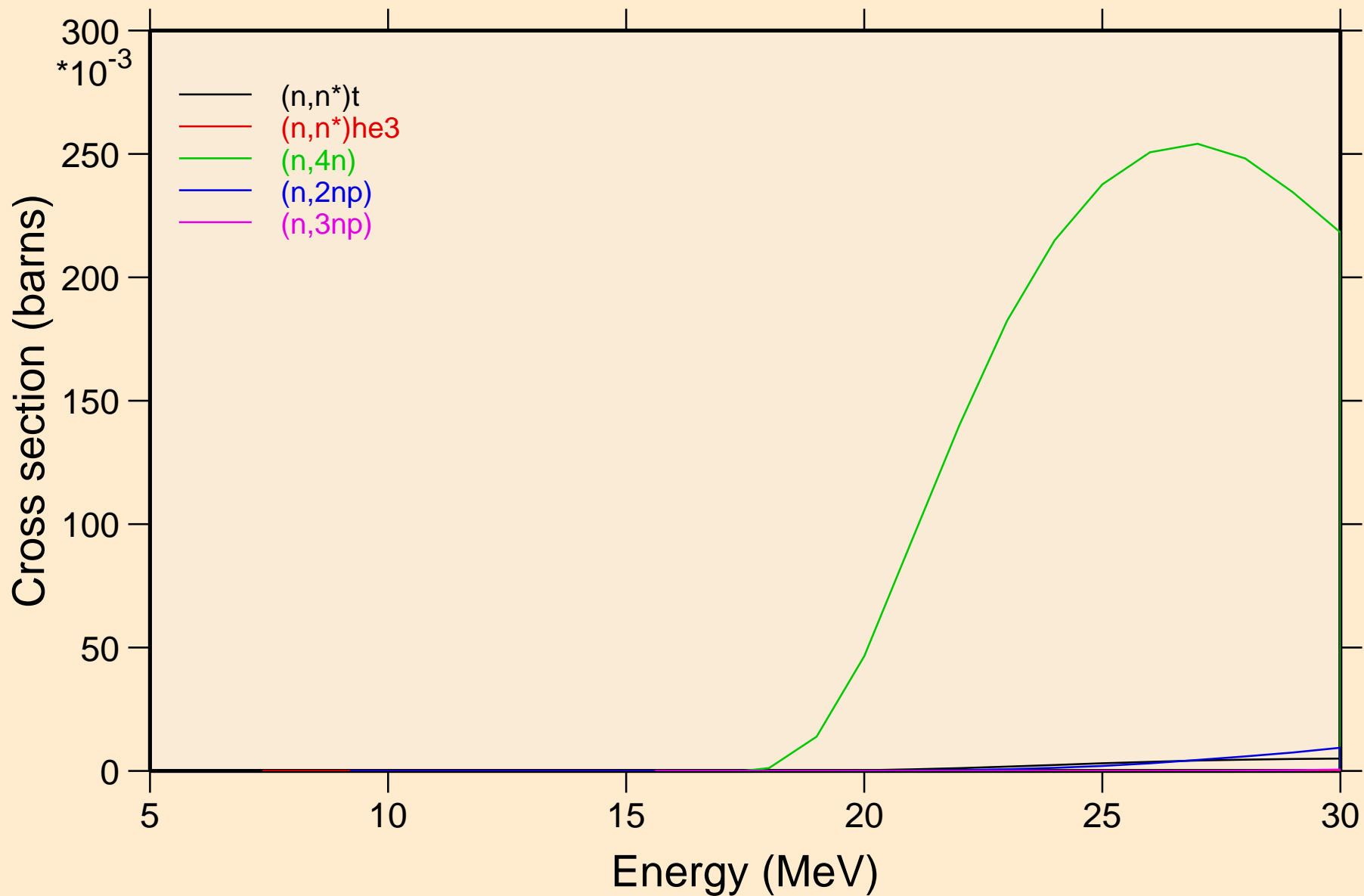

MD258 NEUTRON ACER TENDL-2019 LIBRARY; T=293.16K  
Threshold reactions

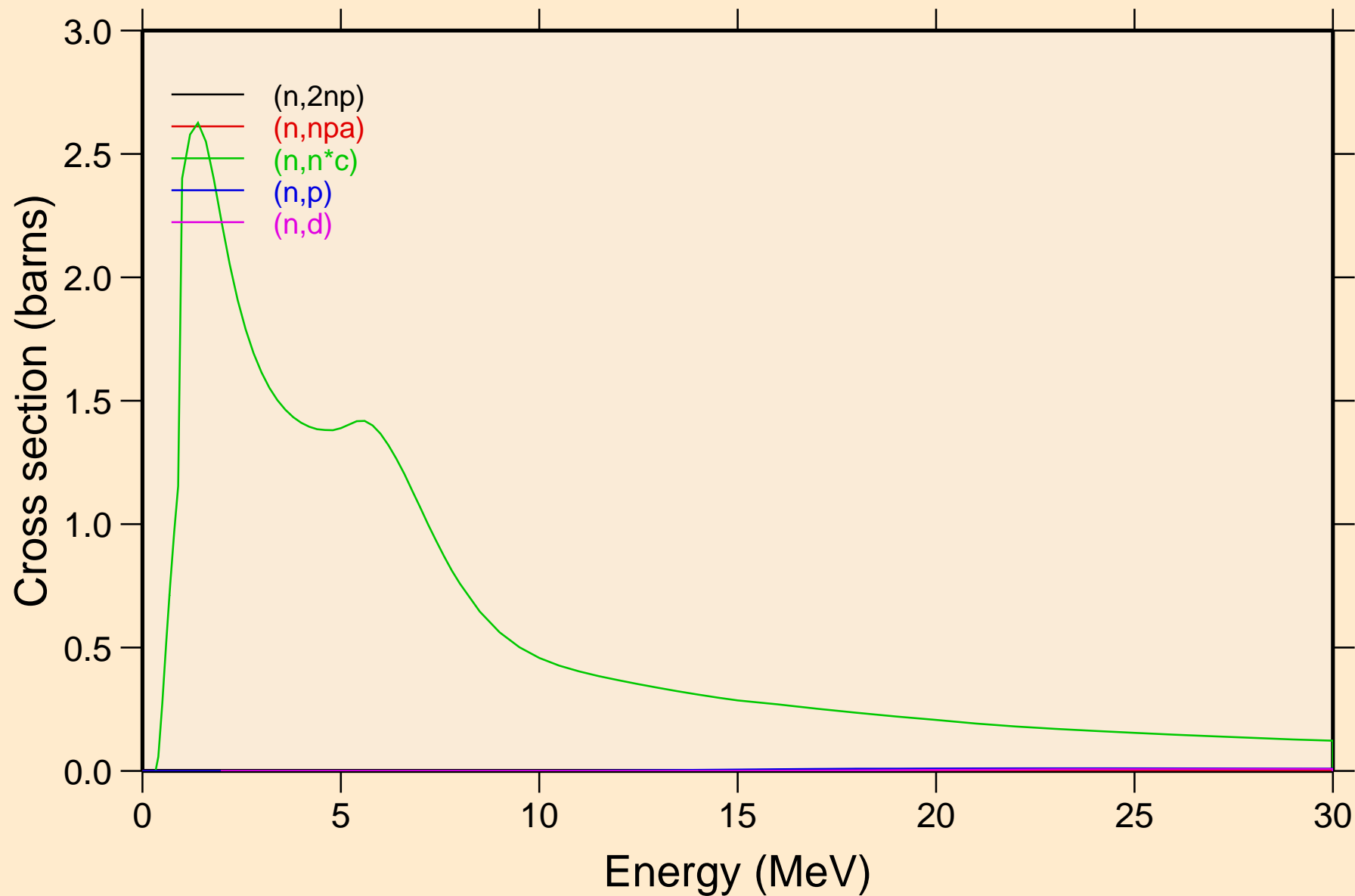

MD258 NEUTRON ACER TENDL-2019 LIBRARY; T=293.16K  
Threshold reactions

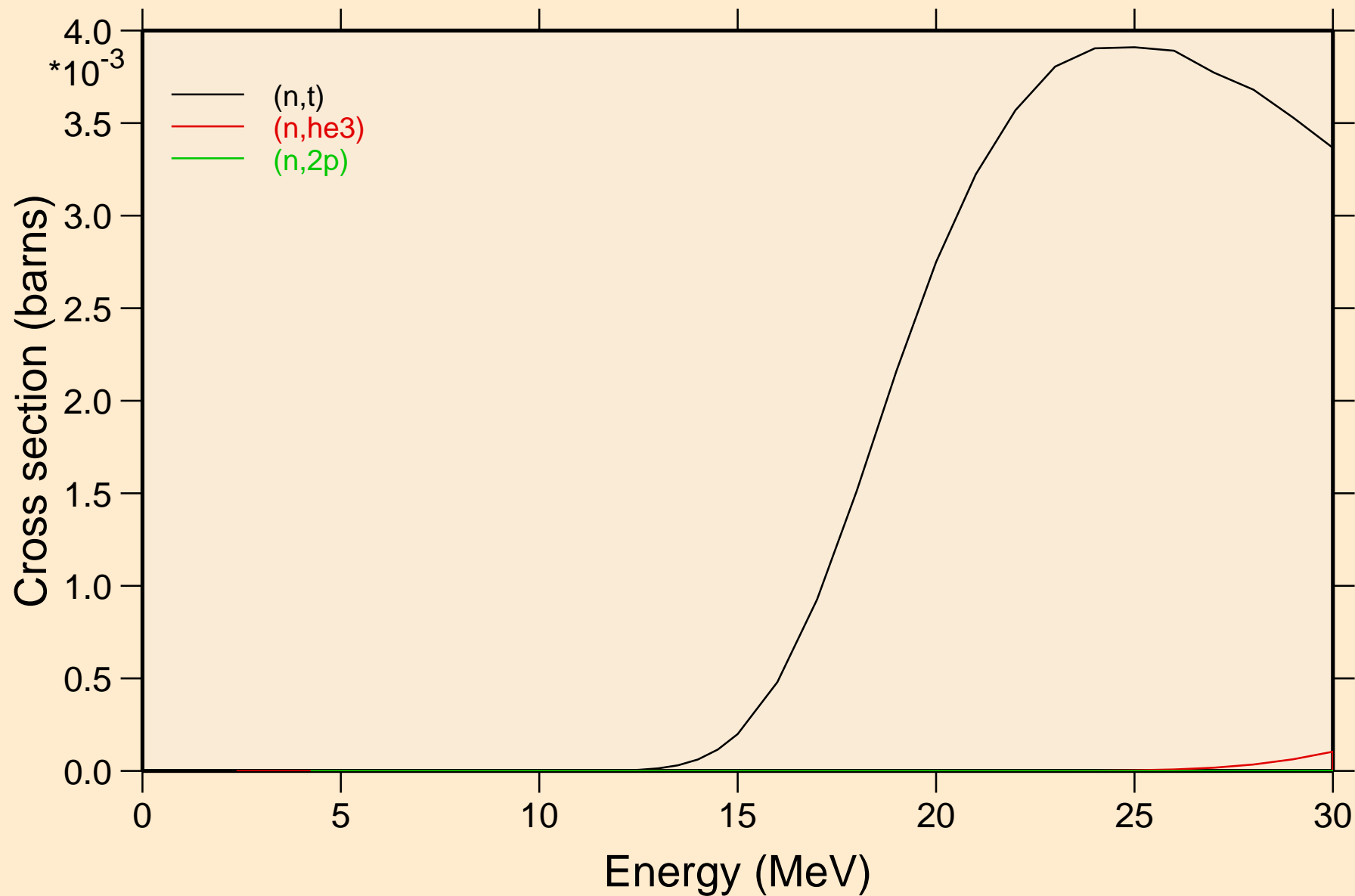

MD258 NEUTRON ACER TENDL-2019 LIBRARY; T=293.16K  
Threshold reactions

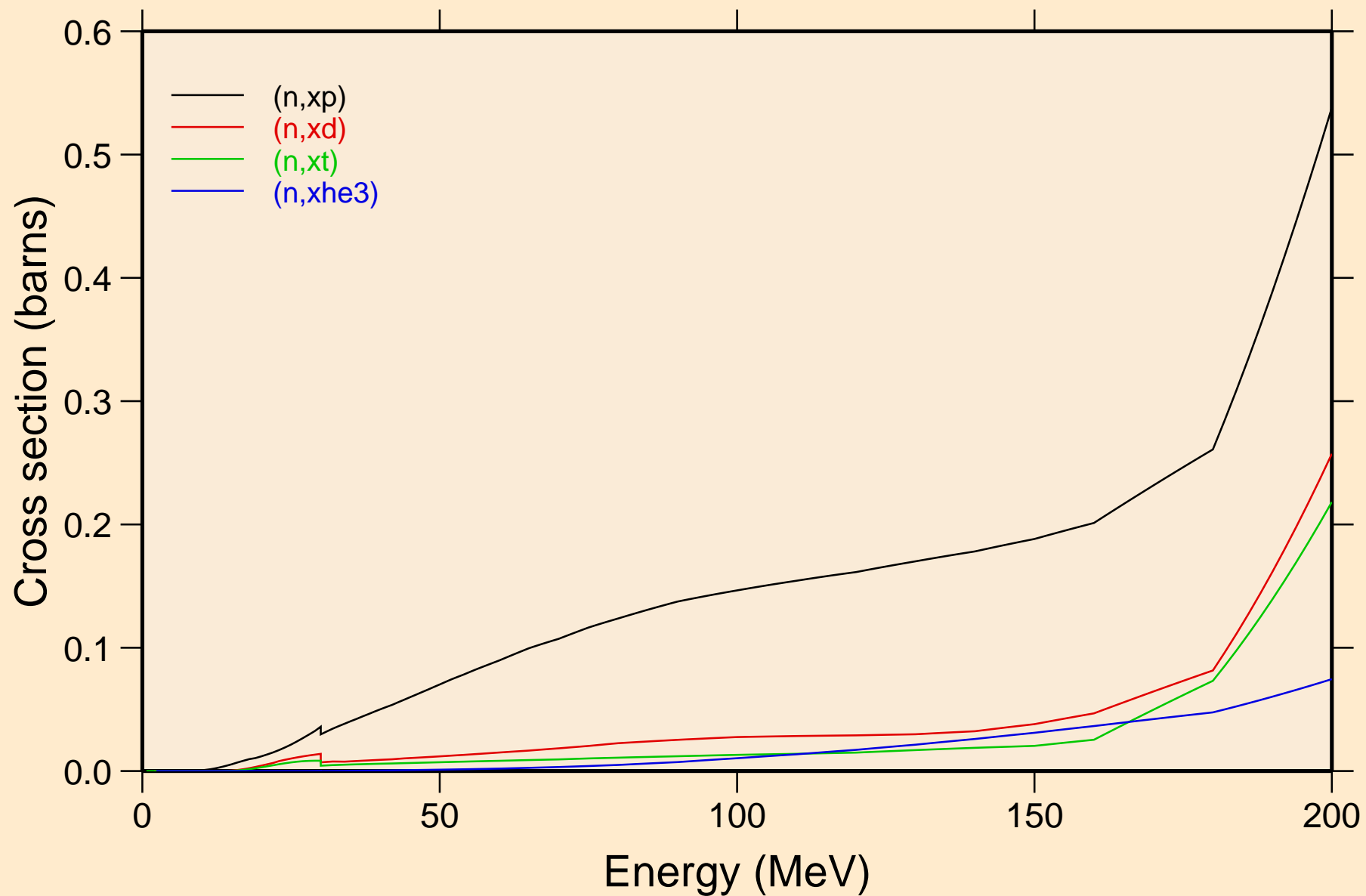

MD258 NEUTRON ACER TENDL-2019 LIBRARY; T=293.16K  
angular distribution for elastic

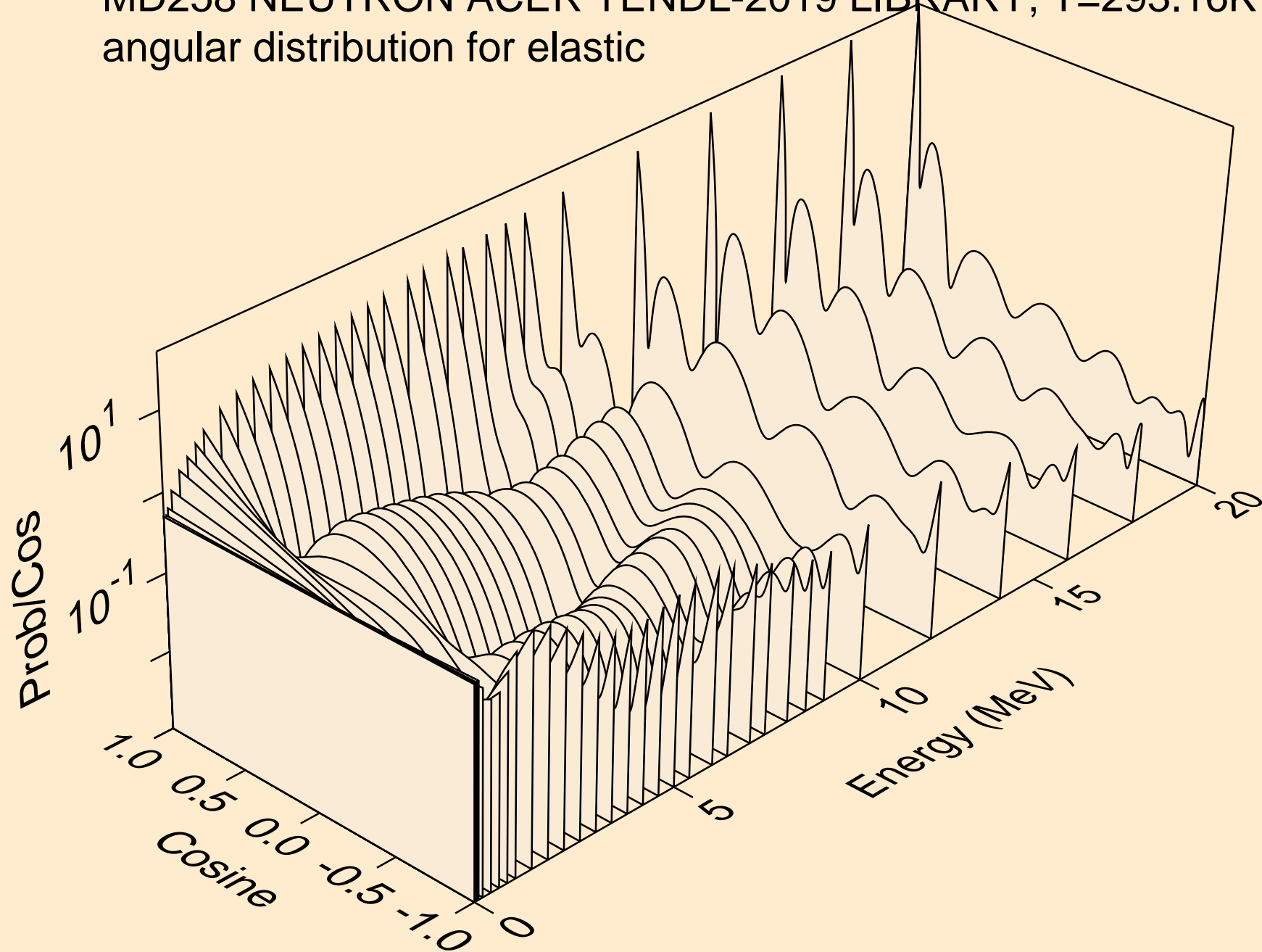

MD258 NEUTRON ACER TENDL-2019 LIBRARY; T=293.16K  
angular distribution for elastic

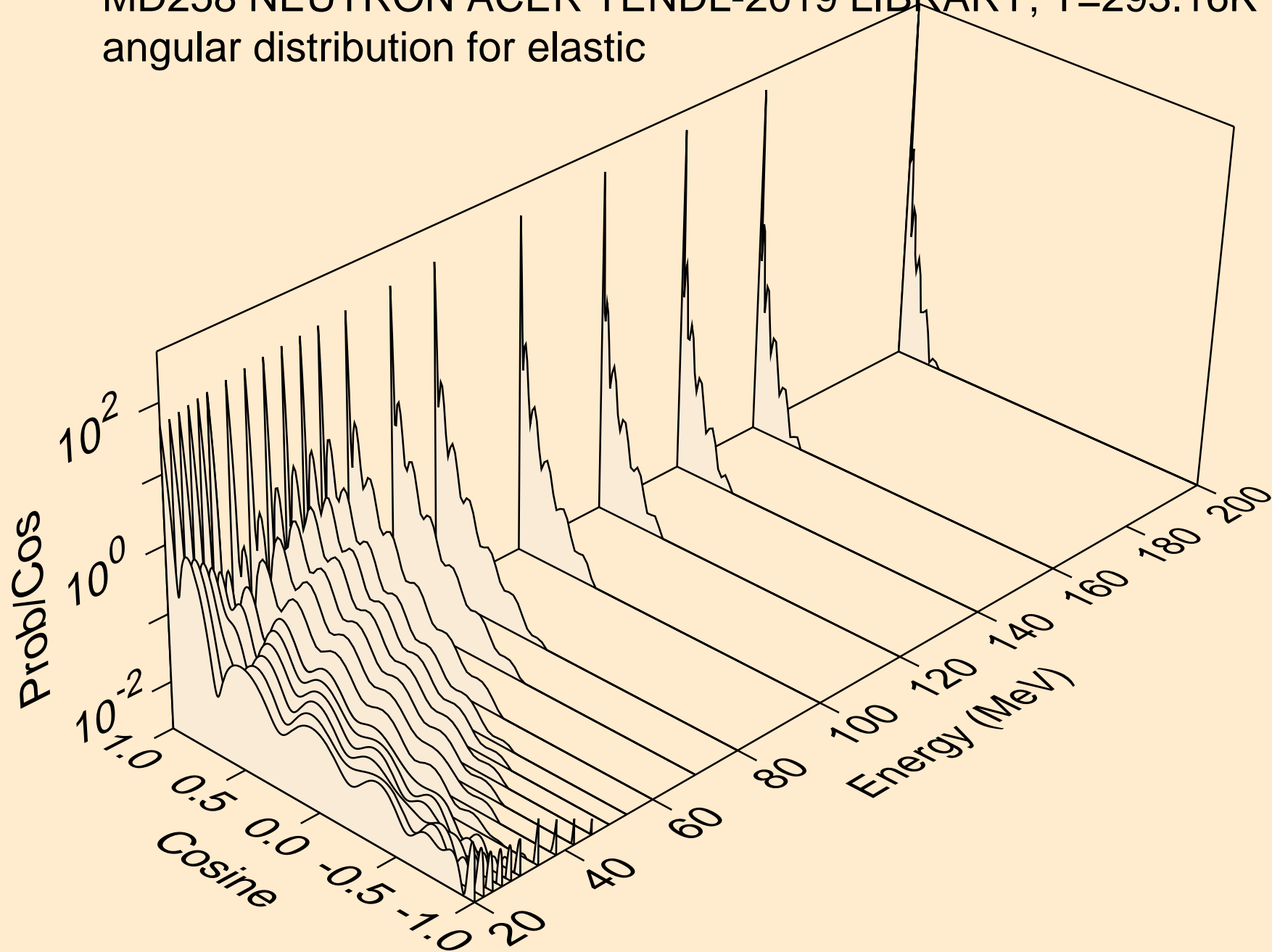

MD258 NEUTRON ACER TENDL-2019 LIBRARY; T=293.16K  
angular distribution for (n,n\*1)

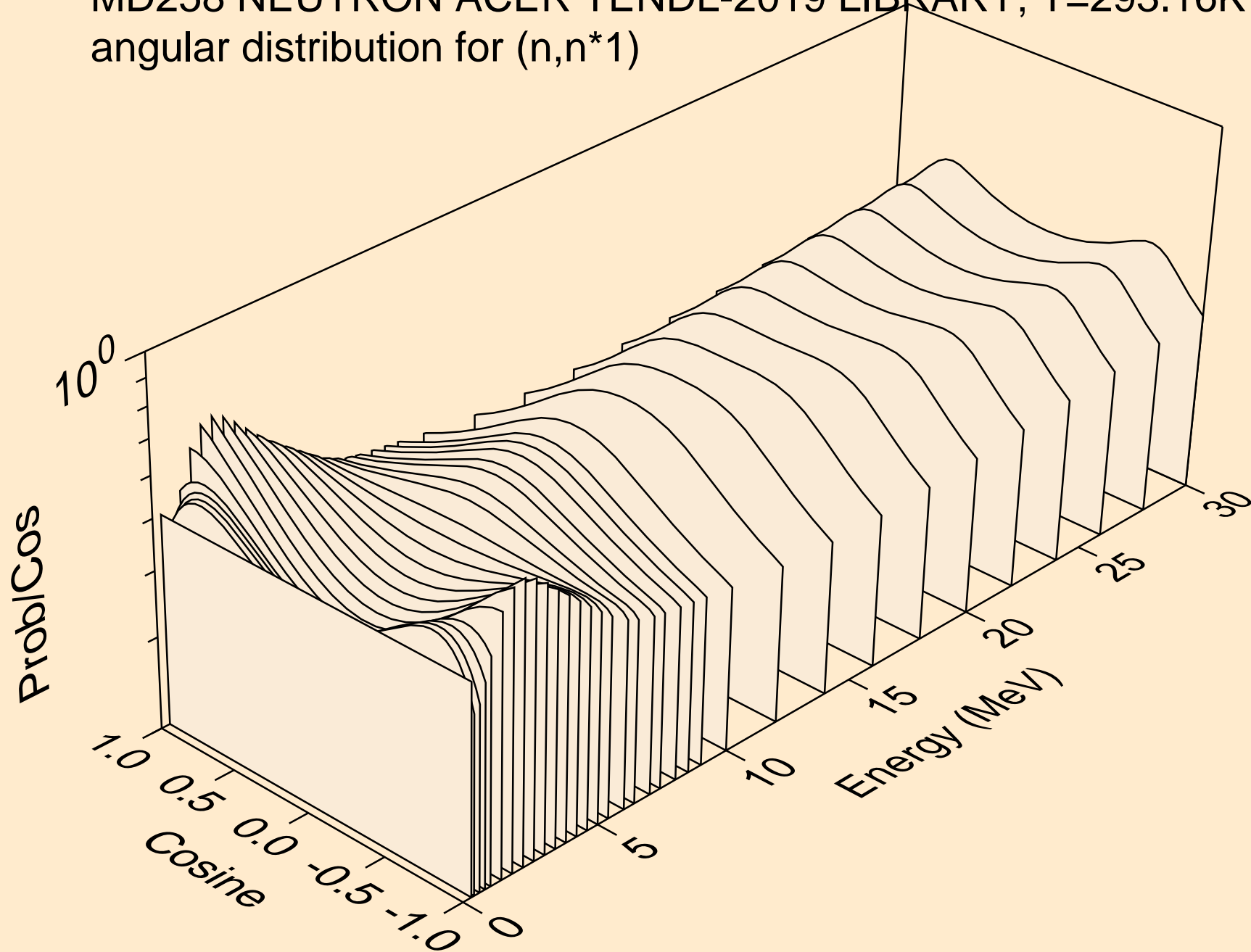

MD258 NEUTRON ACER TENDL-2019 LIBRARY; T=293.16K  
angular distribution for (n,n\*2)

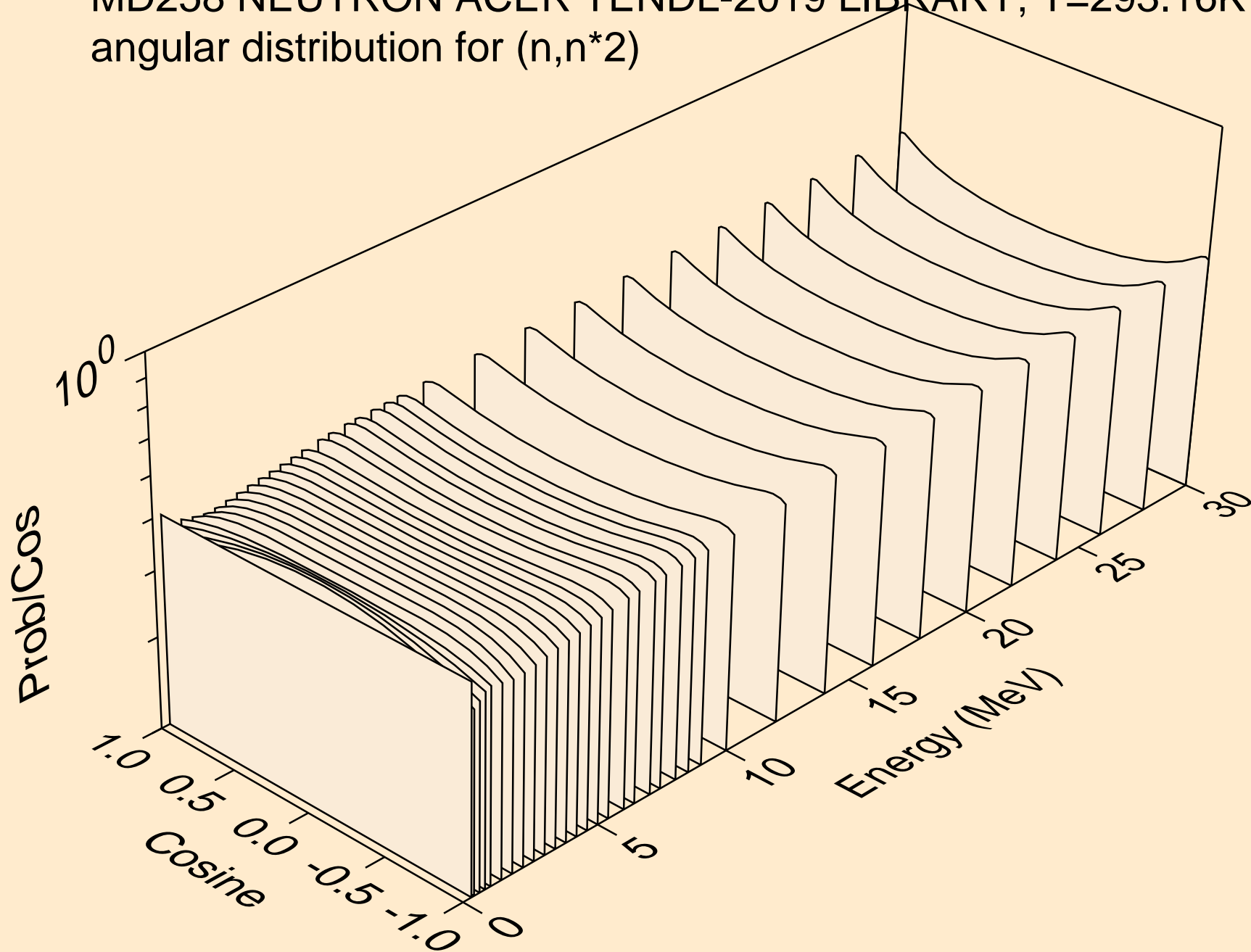



MD258 NEUTRON ACER TENDL-2019 LIBRARY; T=293.16K  
angular distribution for (n,n\*3)

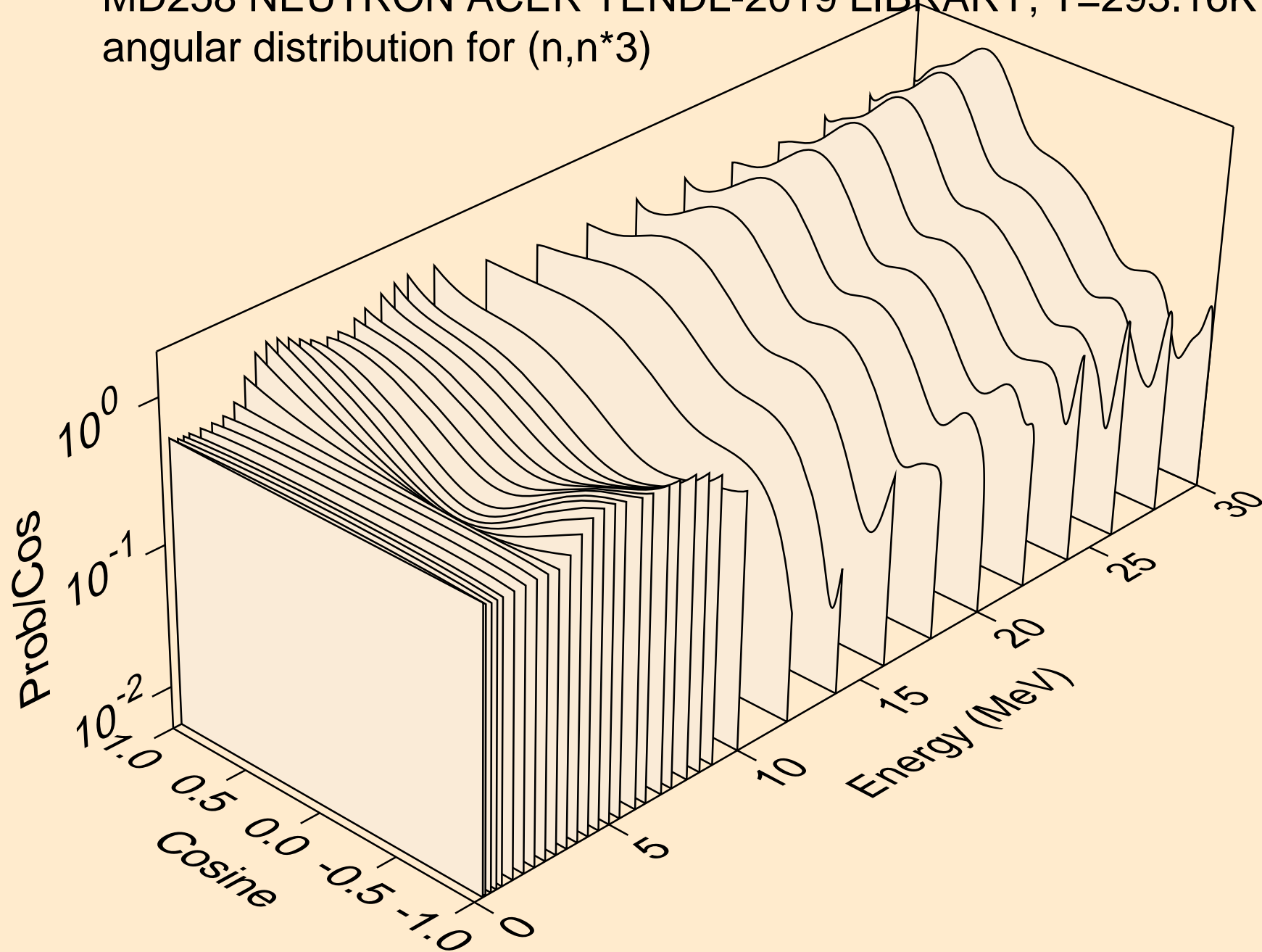

MD258 NEUTRON ACER TENDL-2019 LIBRARY; T=293.16K  
angular distribution for (n,n\*4)

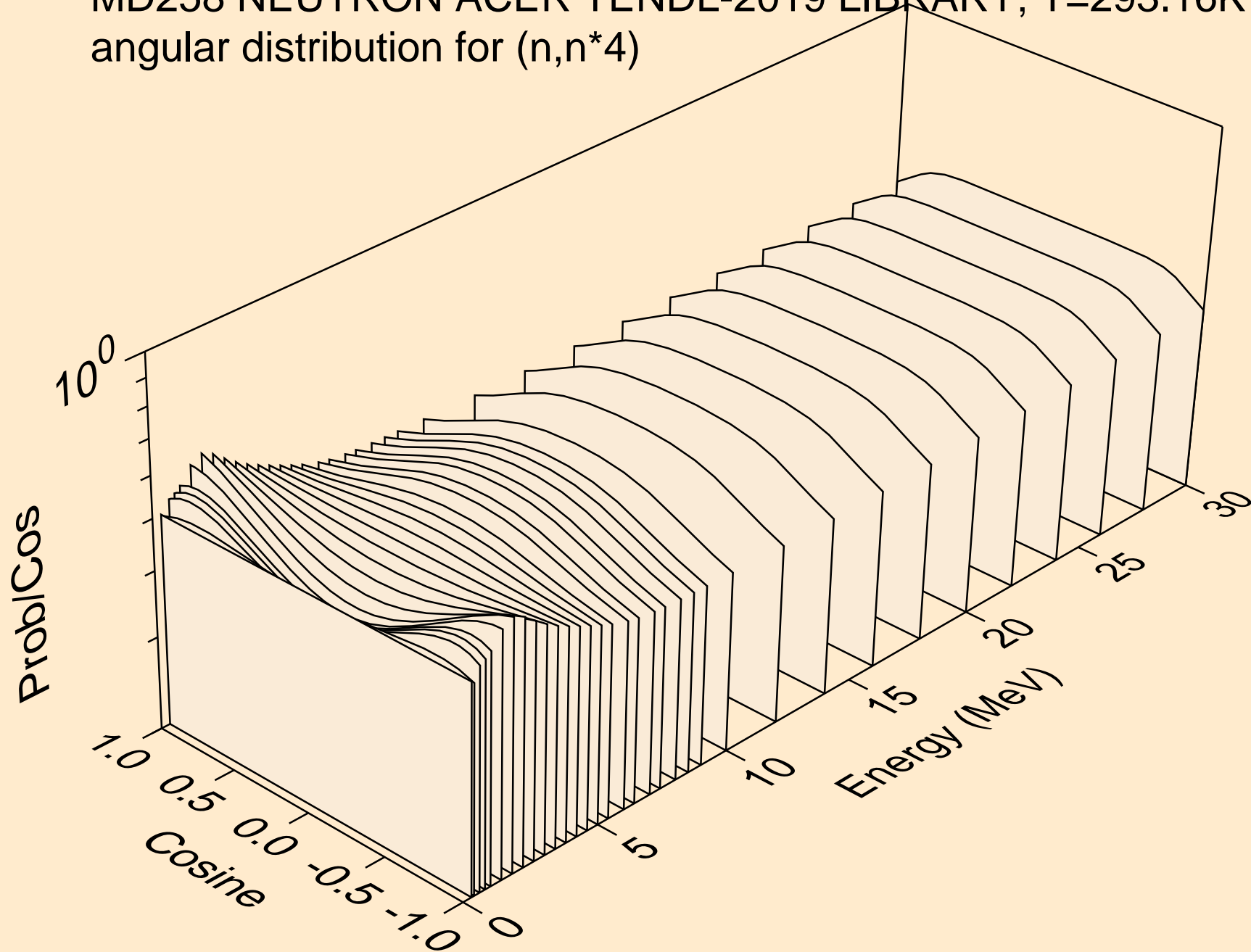

MD258 NEUTRON ACER TENDL-2019 LIBRARY; T=293.16K  
angular distribution for (n,n\*5)

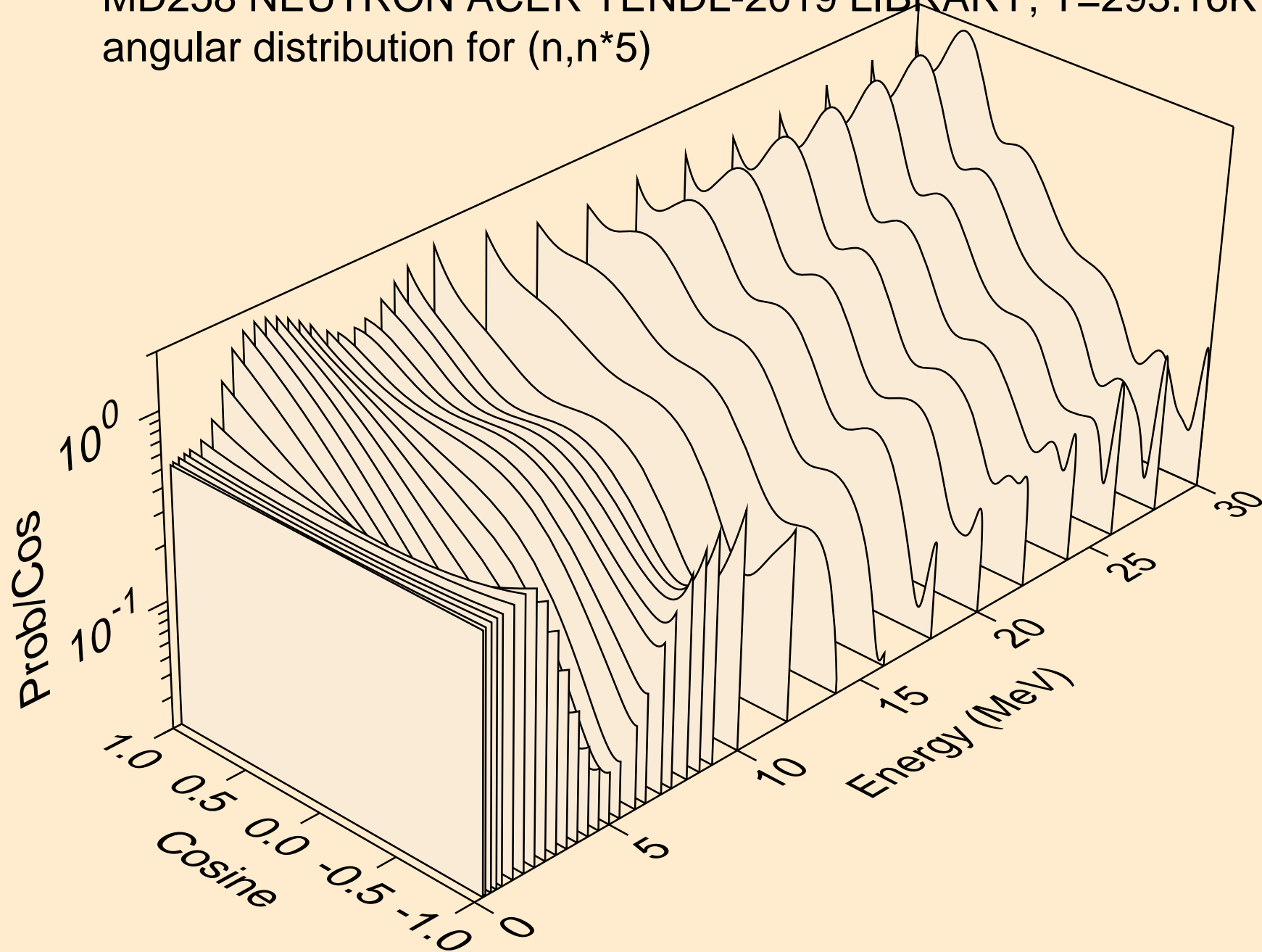

MD258 NEUTRON ACER TENDL-2019 LIBRARY; T=293.16K  
angular distribution for (n,n\*6)

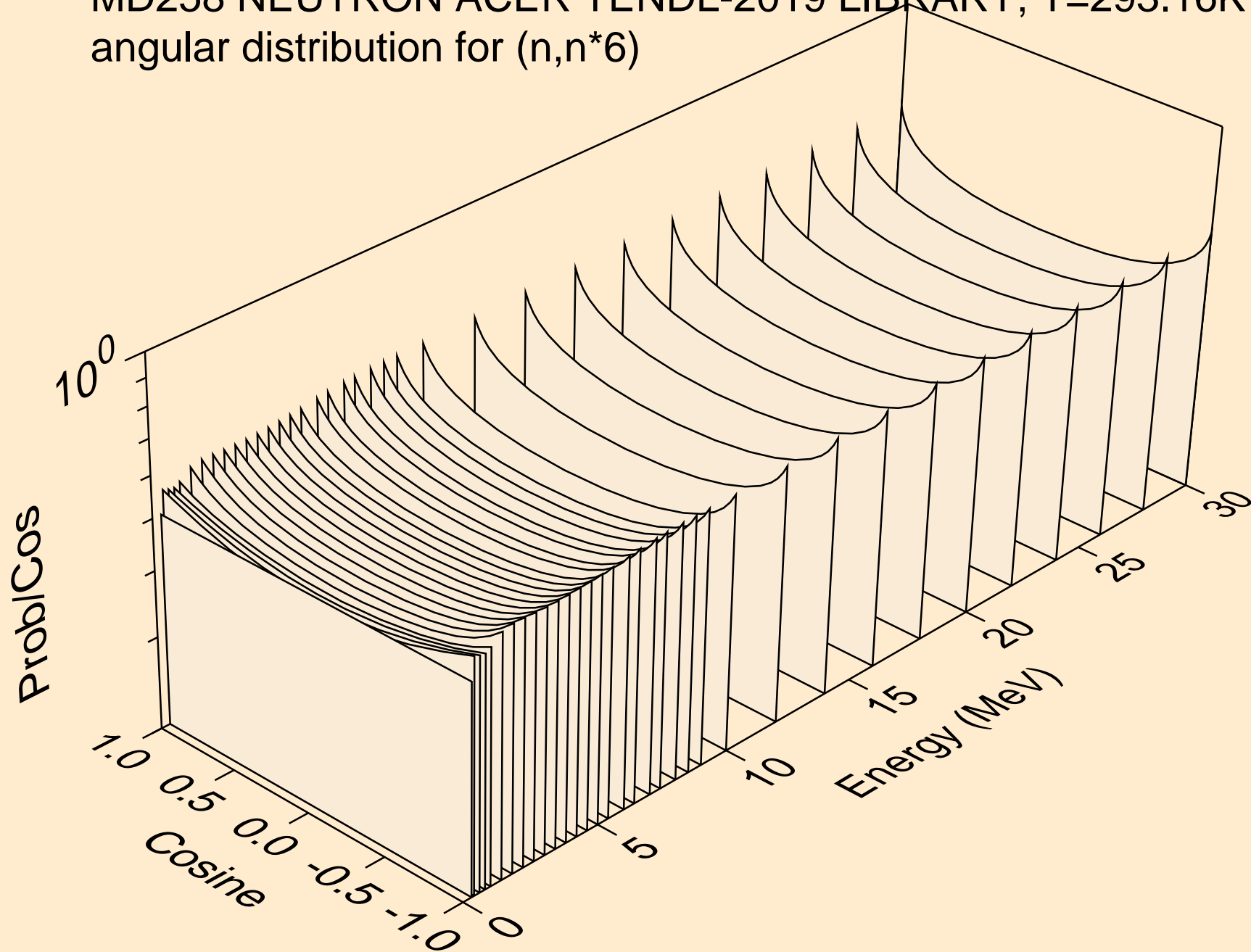

MD258 NEUTRON ACER TENDL-2019 LIBRARY; T=293.16K  
angular distribution for (n,n\*7)

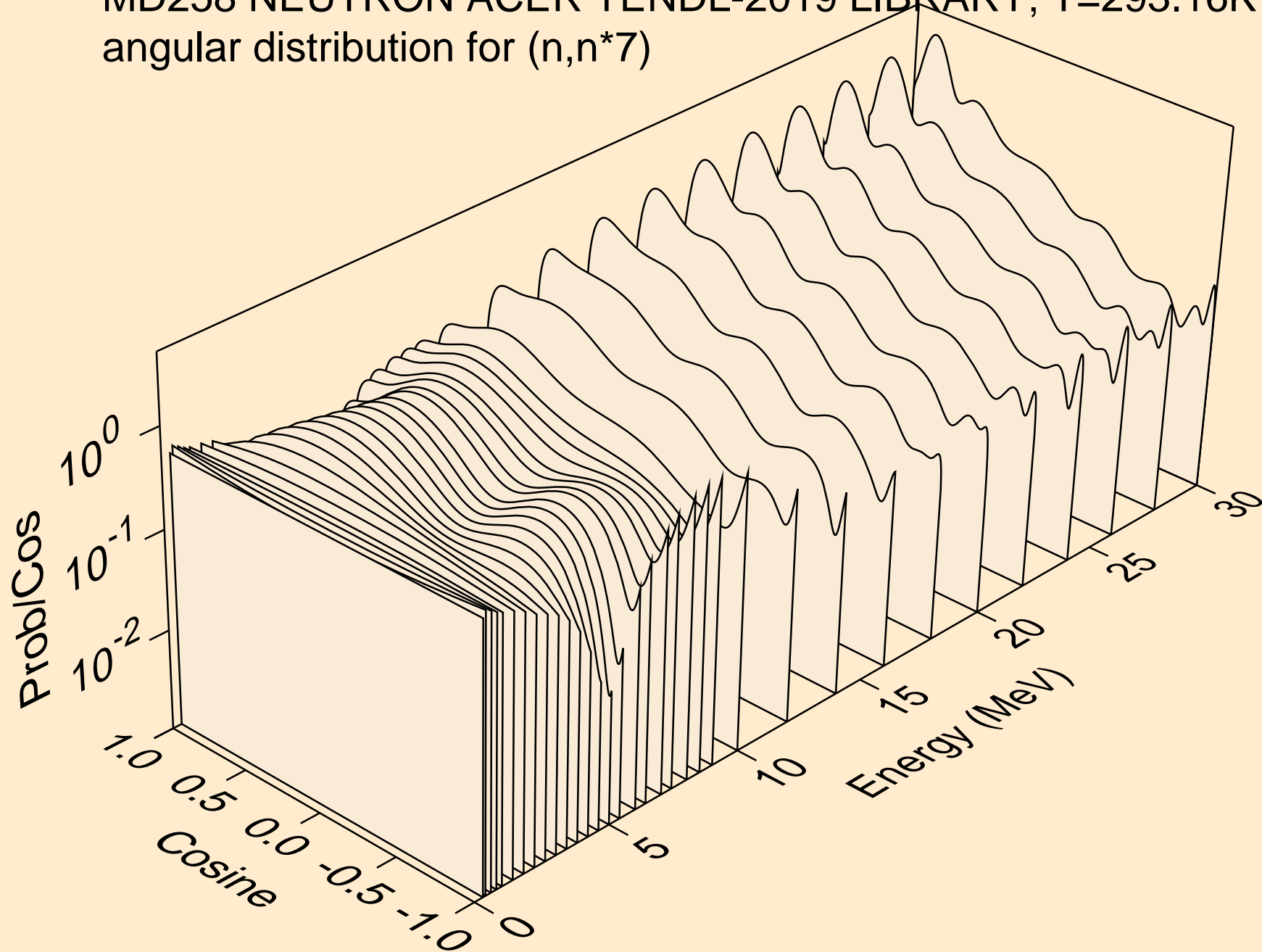

MD258 NEUTRON ACER TENDL-2019 LIBRARY; T=293.16K  
angular distribution for (n,n\*8)

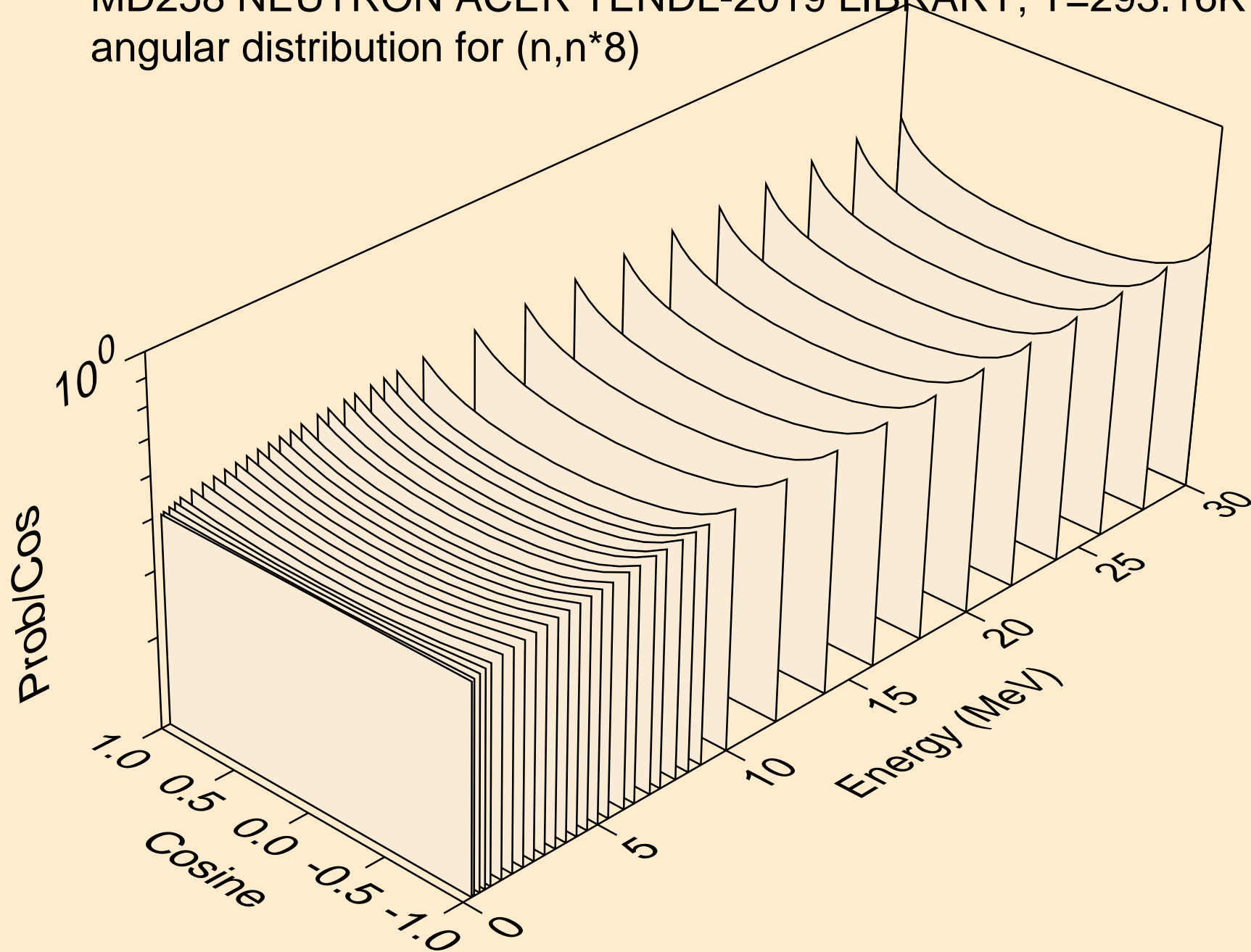

MD258 NEUTRON ACER TENDL-2019 LIBRARY; T=293.16K  
angular distribution for (n,n\*9)

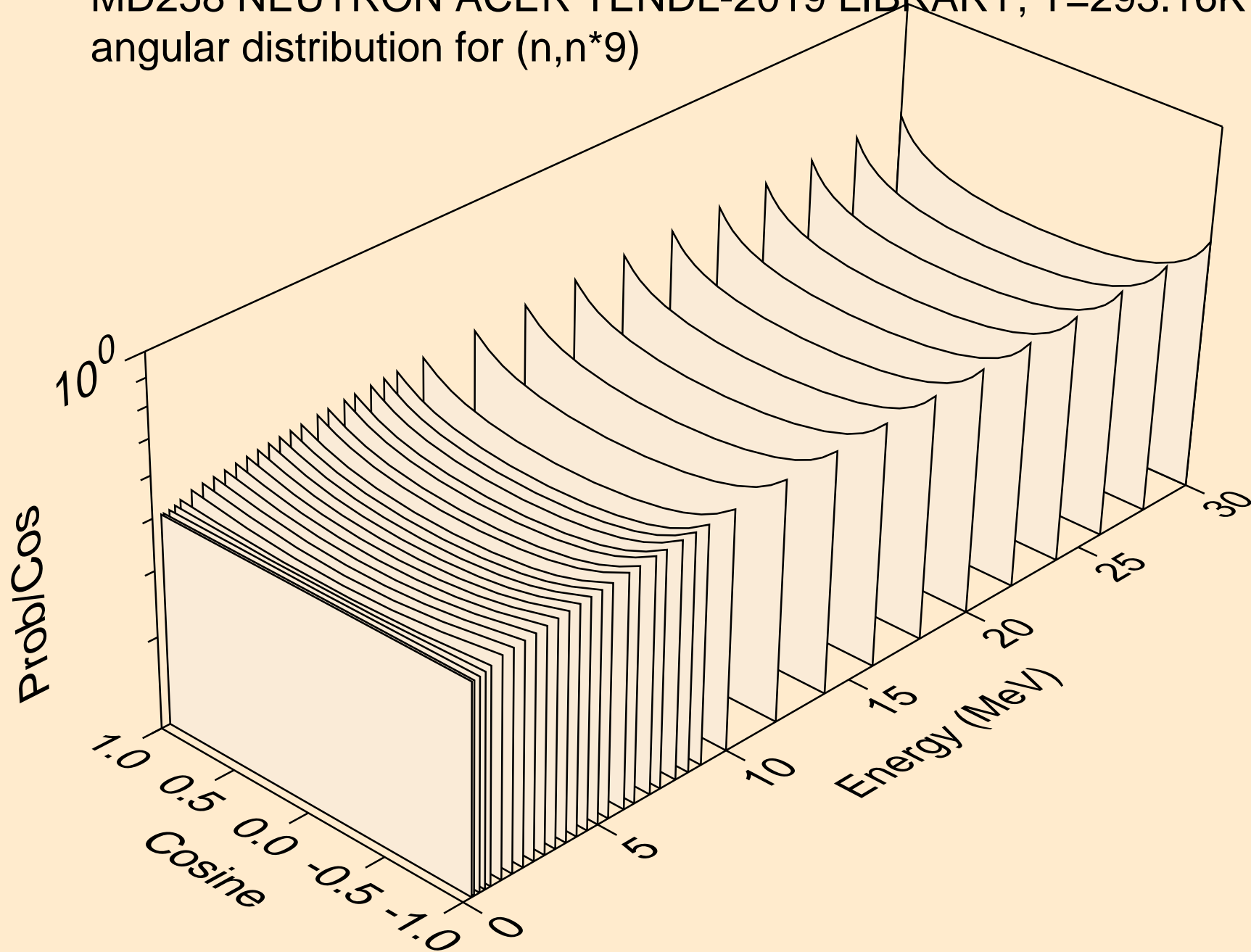

MD258 NEUTRON ACER TENDL-2019 LIBRARY; T=293.16K  
angular distribution for (n,n\*10)

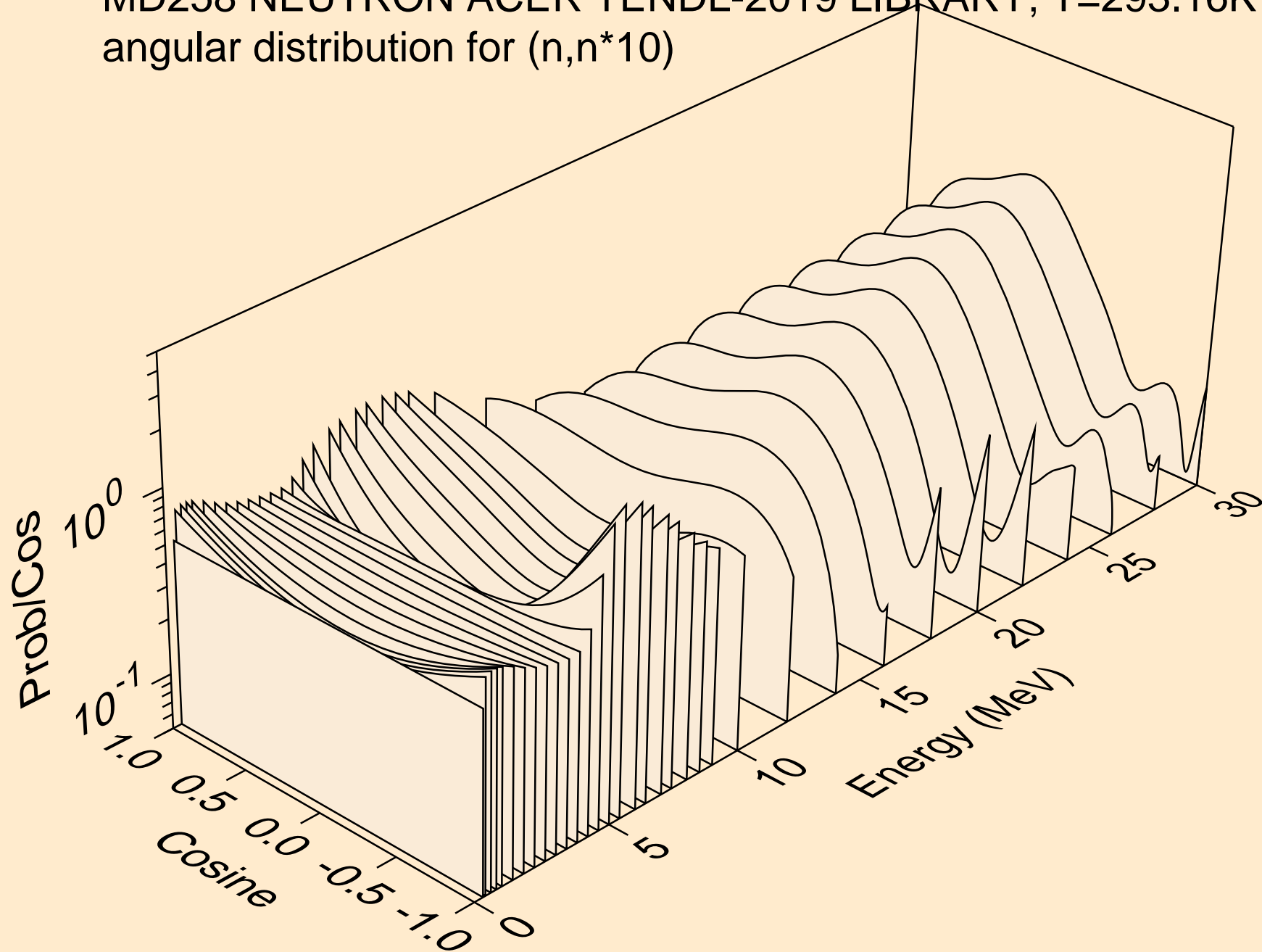



MD258 NEUTRON ACER TENDL-2019 LIBRARY; T=293.16K  
angular distribution for (n,n\*11)

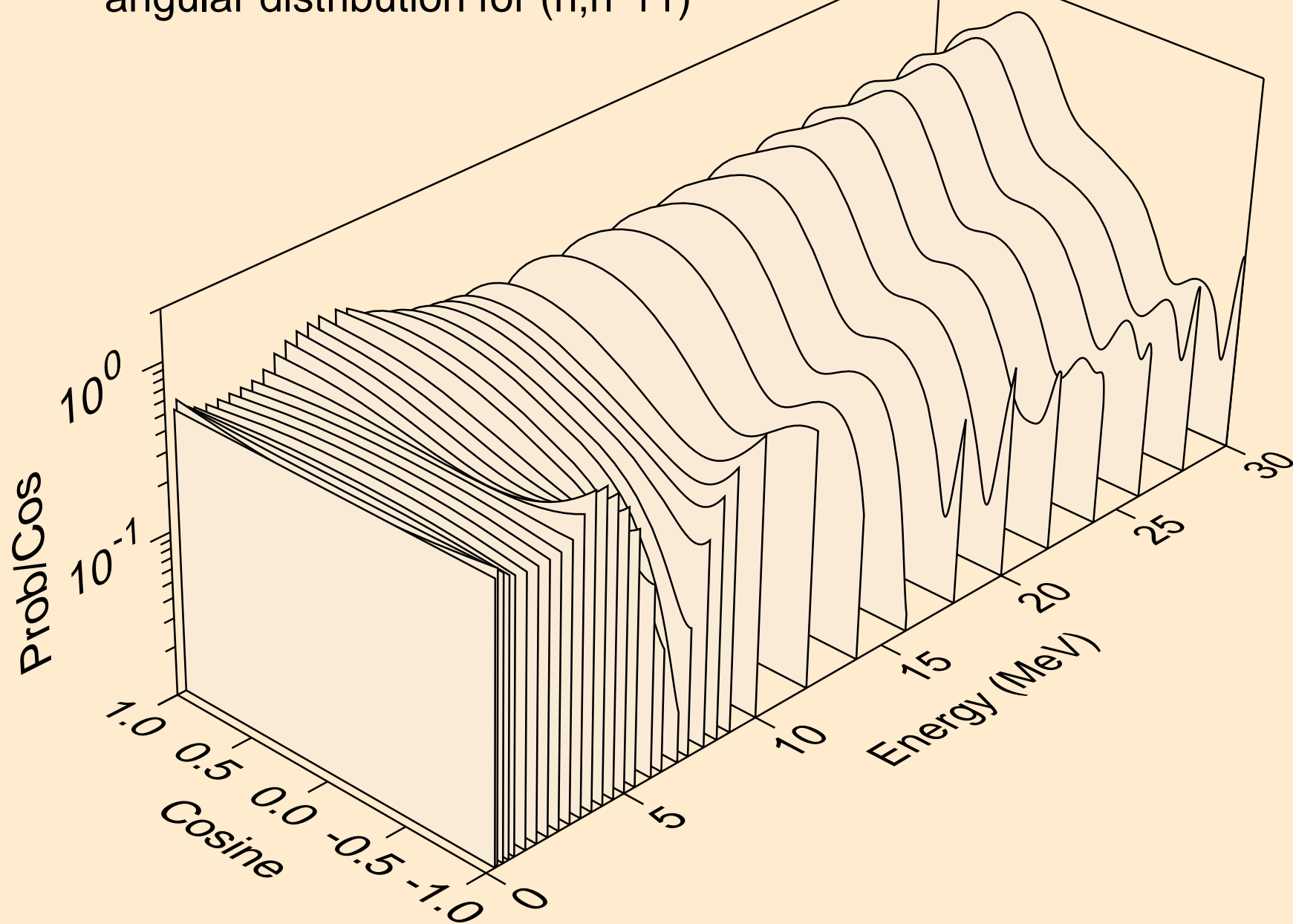

MD258 NEUTRON ACER TENDL-2019 LIBRARY; T=293.16K  
angular distribution for (n,n\*12)

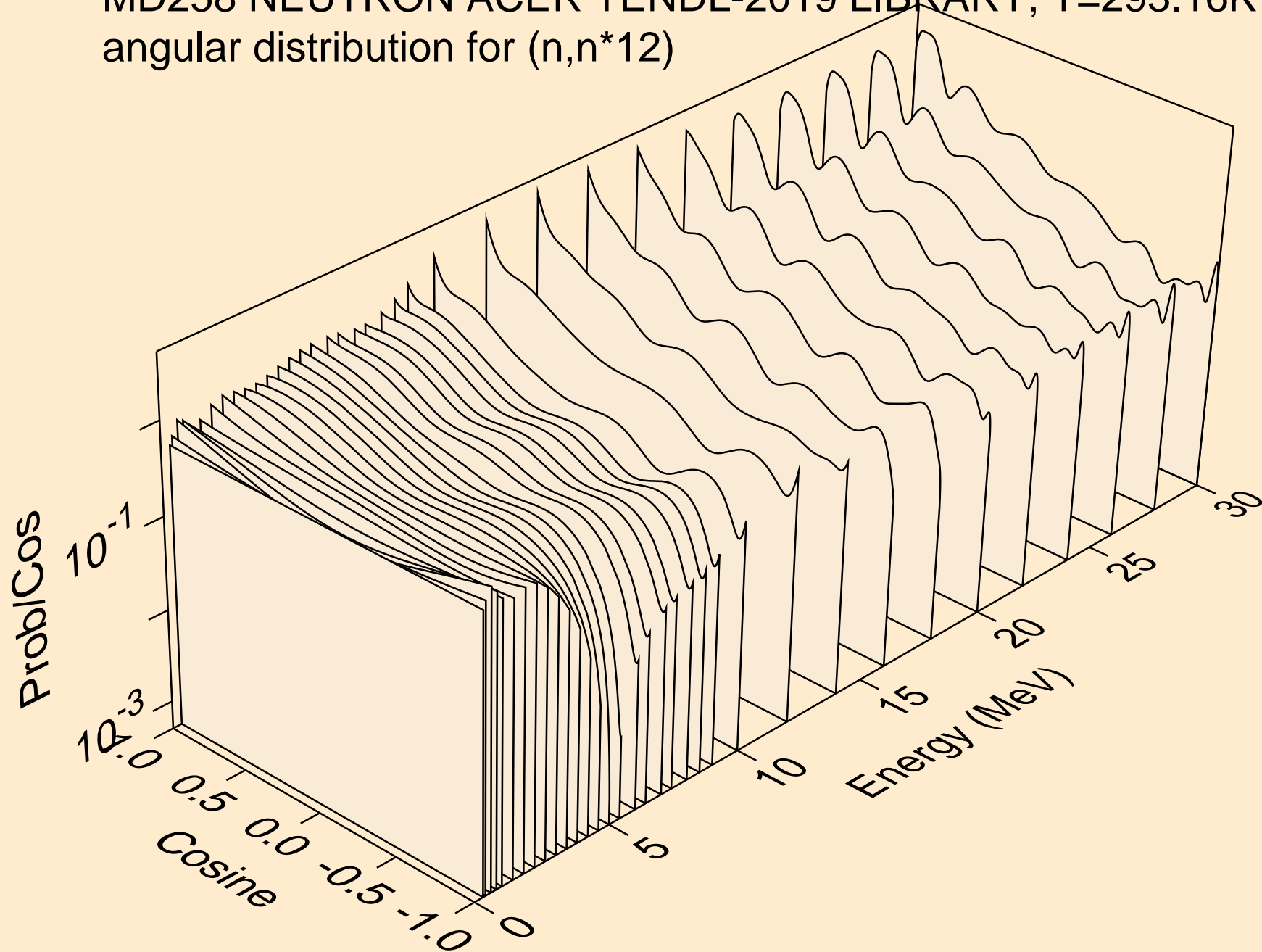

MD258 NEUTRON ACER TENDL-2019 LIBRARY; T=293.16K  
angular distribution for (n,n\*13)

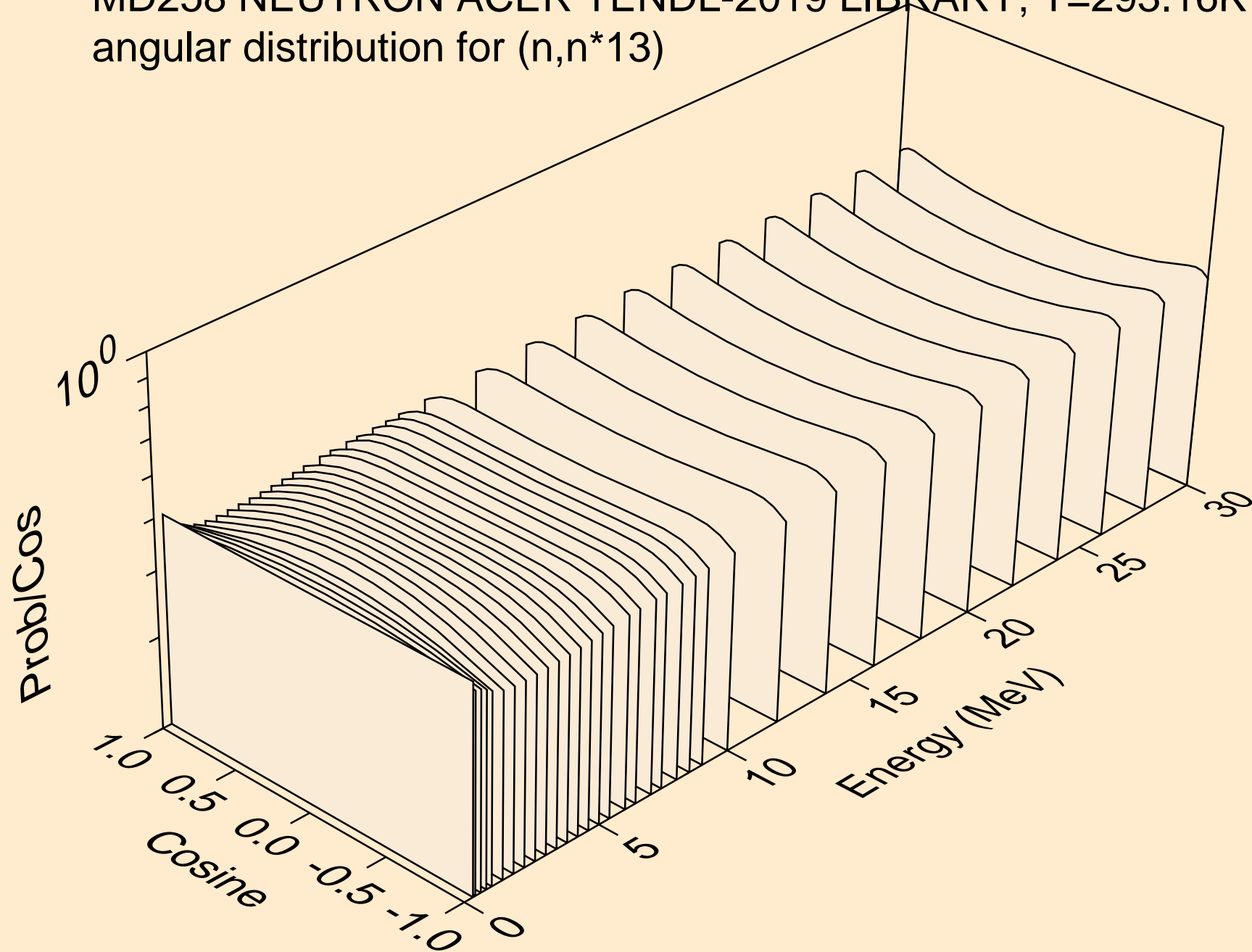

MD258 NEUTRON ACER TENDL-2019 LIBRARY; T=293.16K  
angular distribution for (n,n\*14)

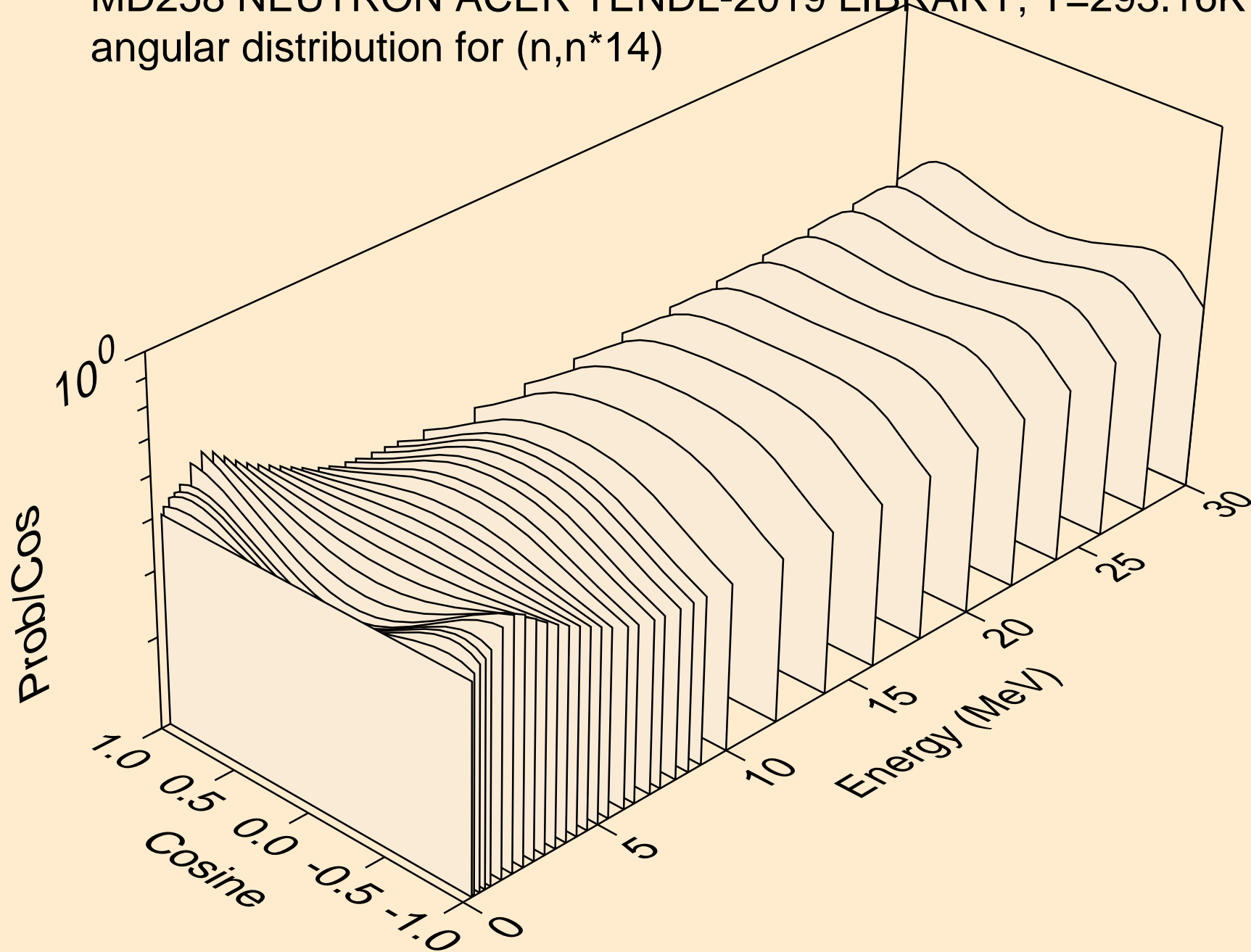

MD258 NEUTRON ACER TENDL-2019 LIBRARY; T=293.16K  
angular distribution for (n,n\*15)

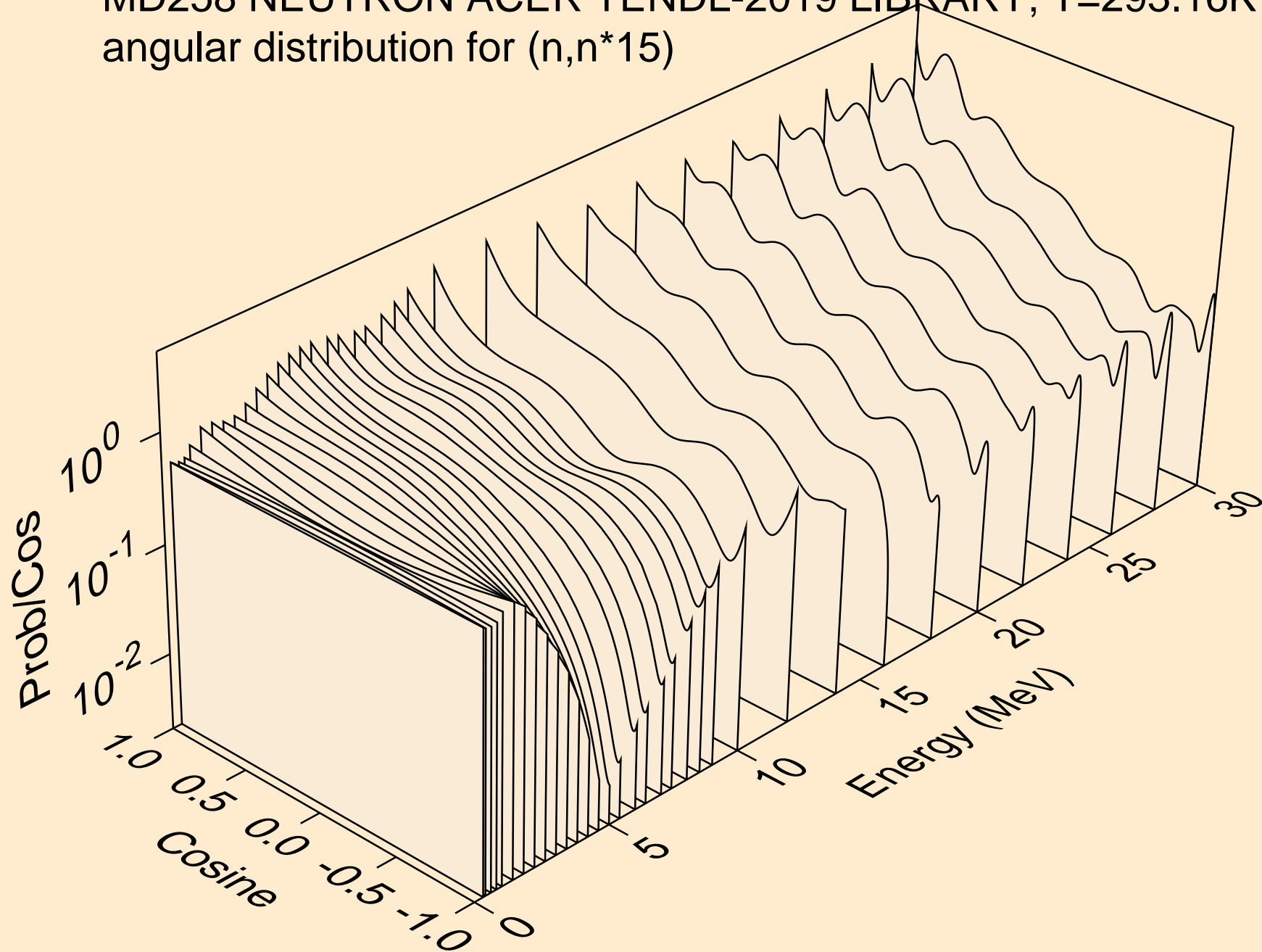

MD258 NEUTRON ACER TENDL-2019 LIBRARY; T=293.16K  
angular distribution for (n,n\*16)

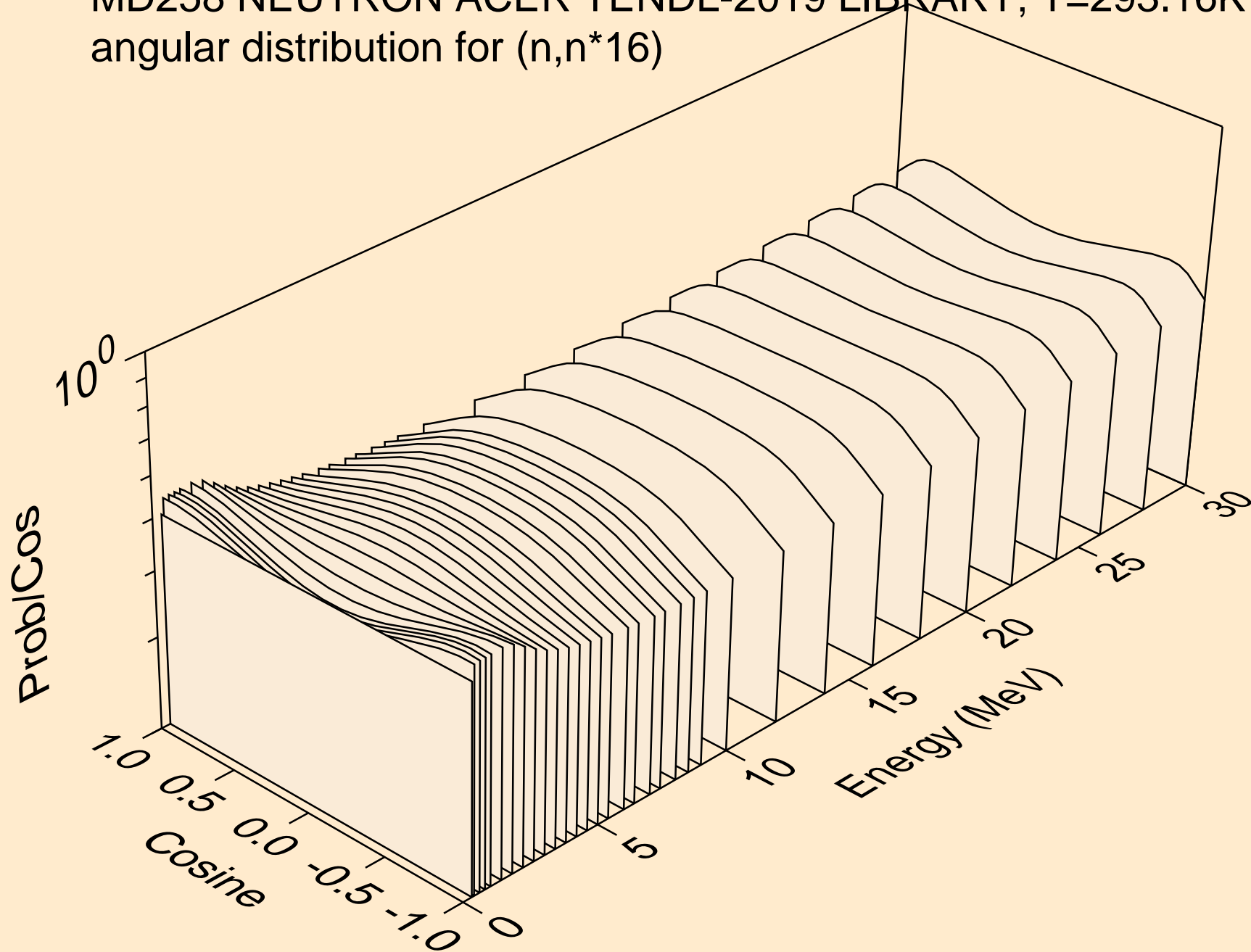

MD258 NEUTRON ACER TENDL-2019 LIBRARY; T=293.16K  
angular distribution for (n,n\*17)

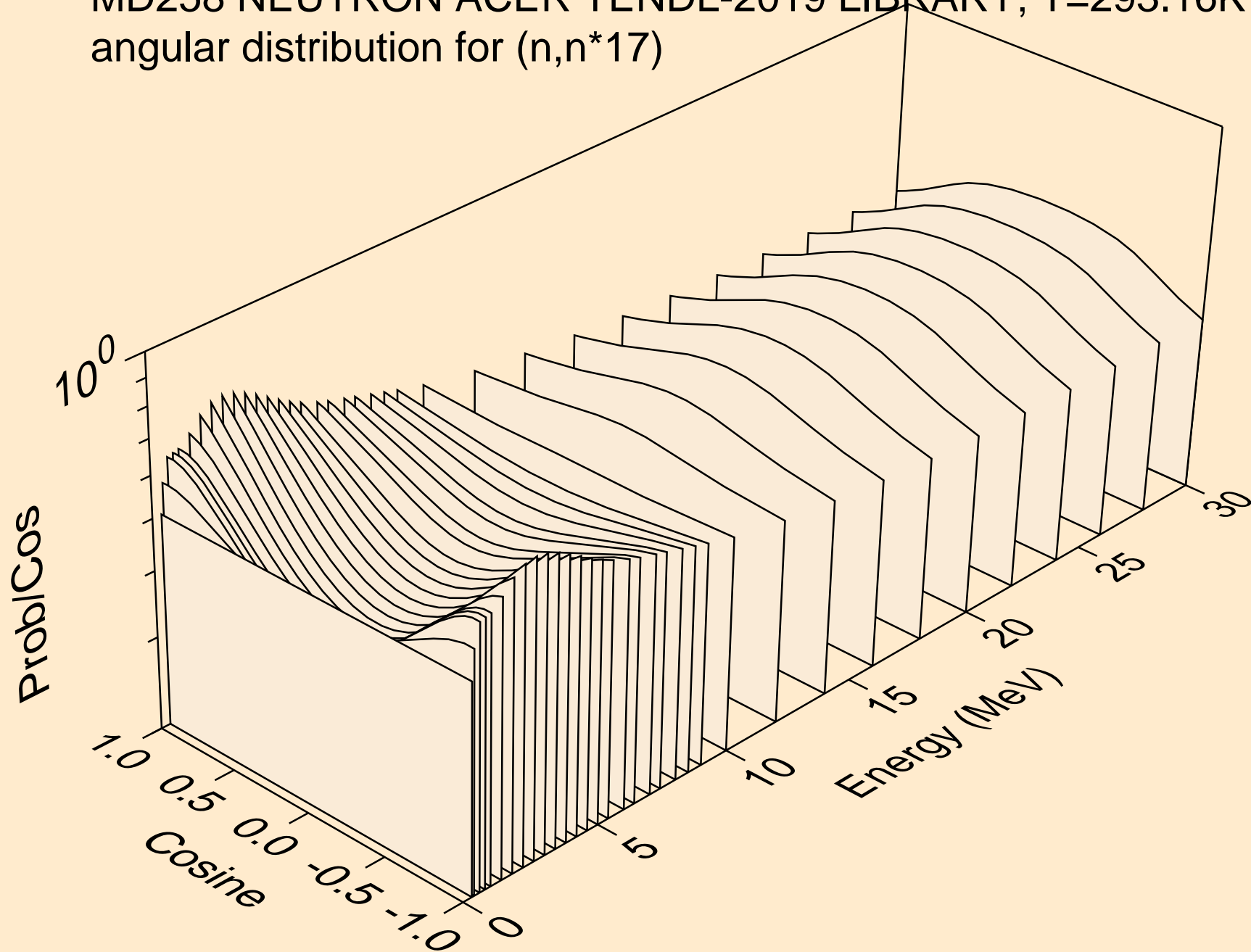

MD258 NEUTRON ACER TENDL-2019 LIBRARY; T=293.16K  
angular distribution for (n,n\*18)

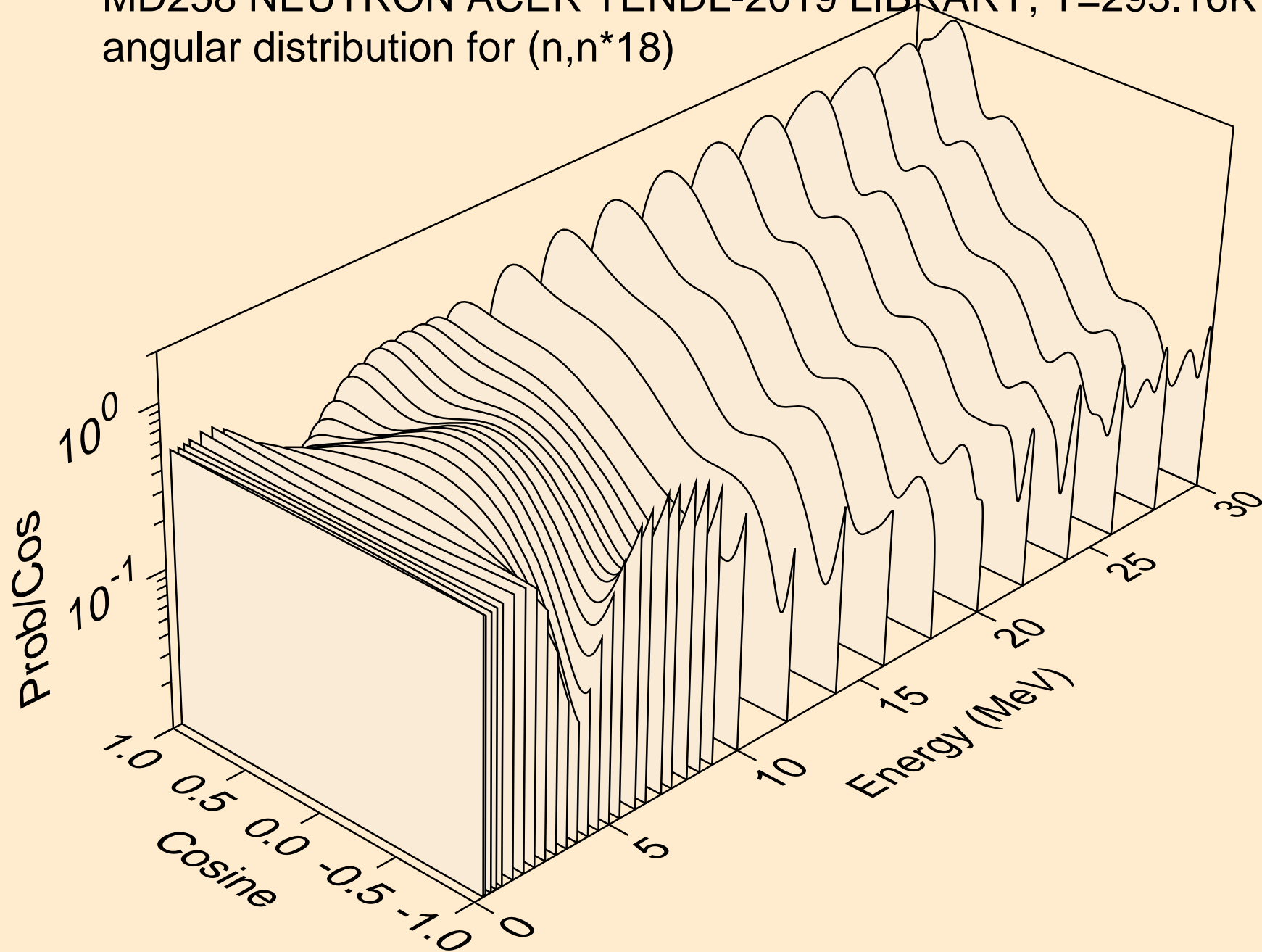



MD258 NEUTRON ACER TENDL-2019 LIBRARY; T=293.16K  
angular distribution for (n,n\*19)

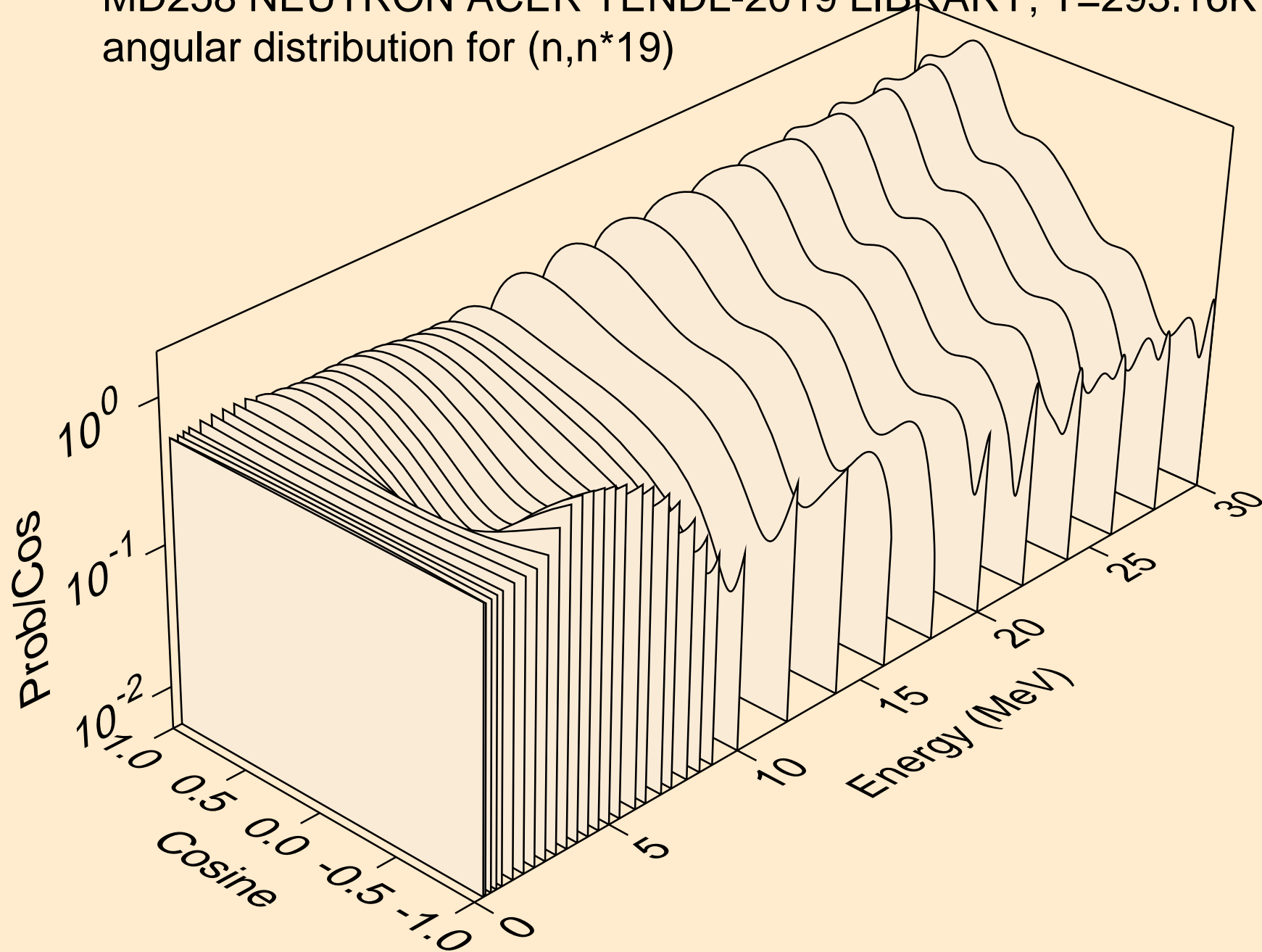

MD258 NEUTRON ACER TENDL-2019 LIBRARY; T=293.16K  
angular distribution for (n,n\*20)

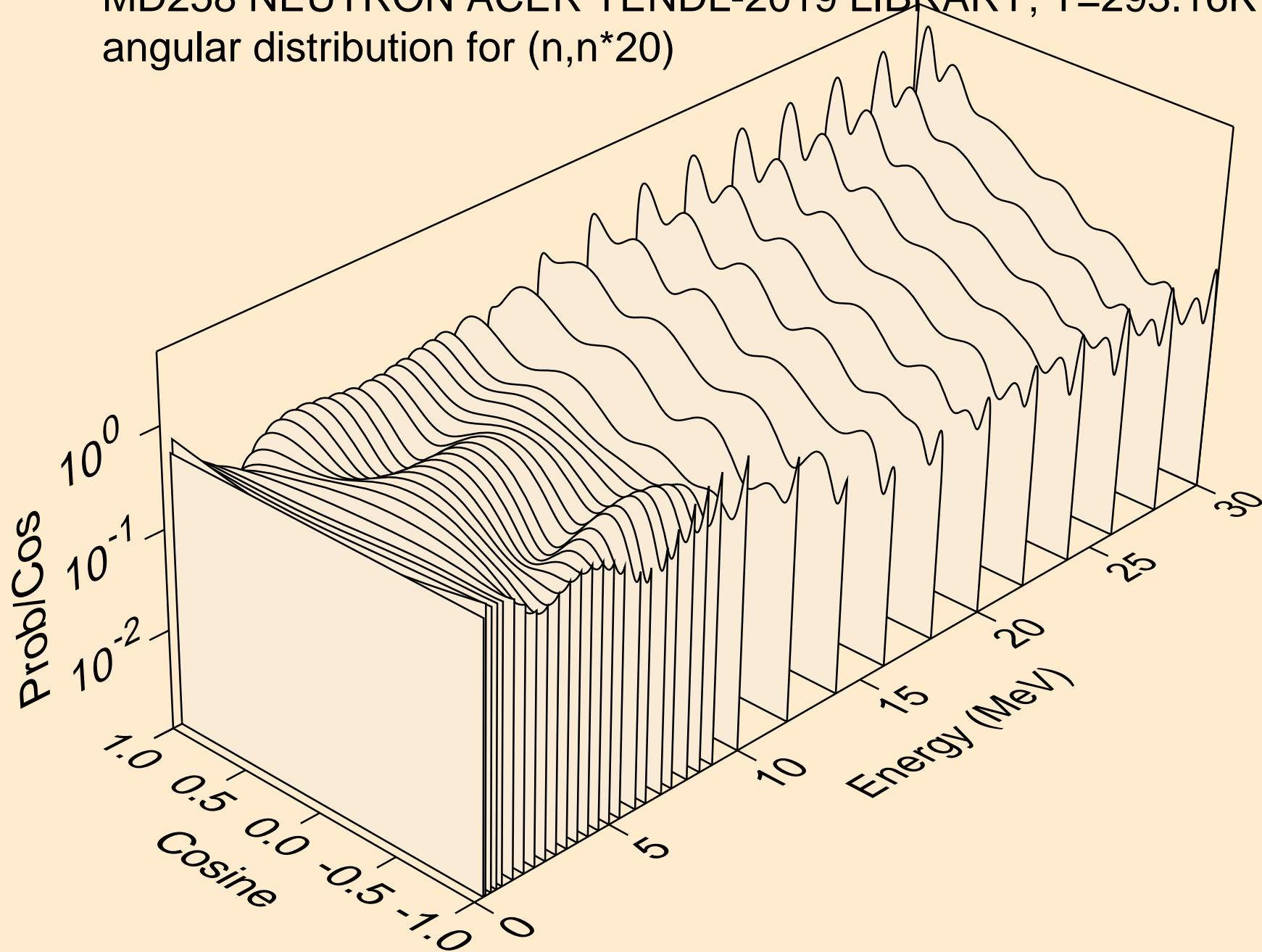

MD258 NEUTRON ACER TENDL-2019 LIBRARY; T=293.16K  
angular distribution for (n,n\*21)

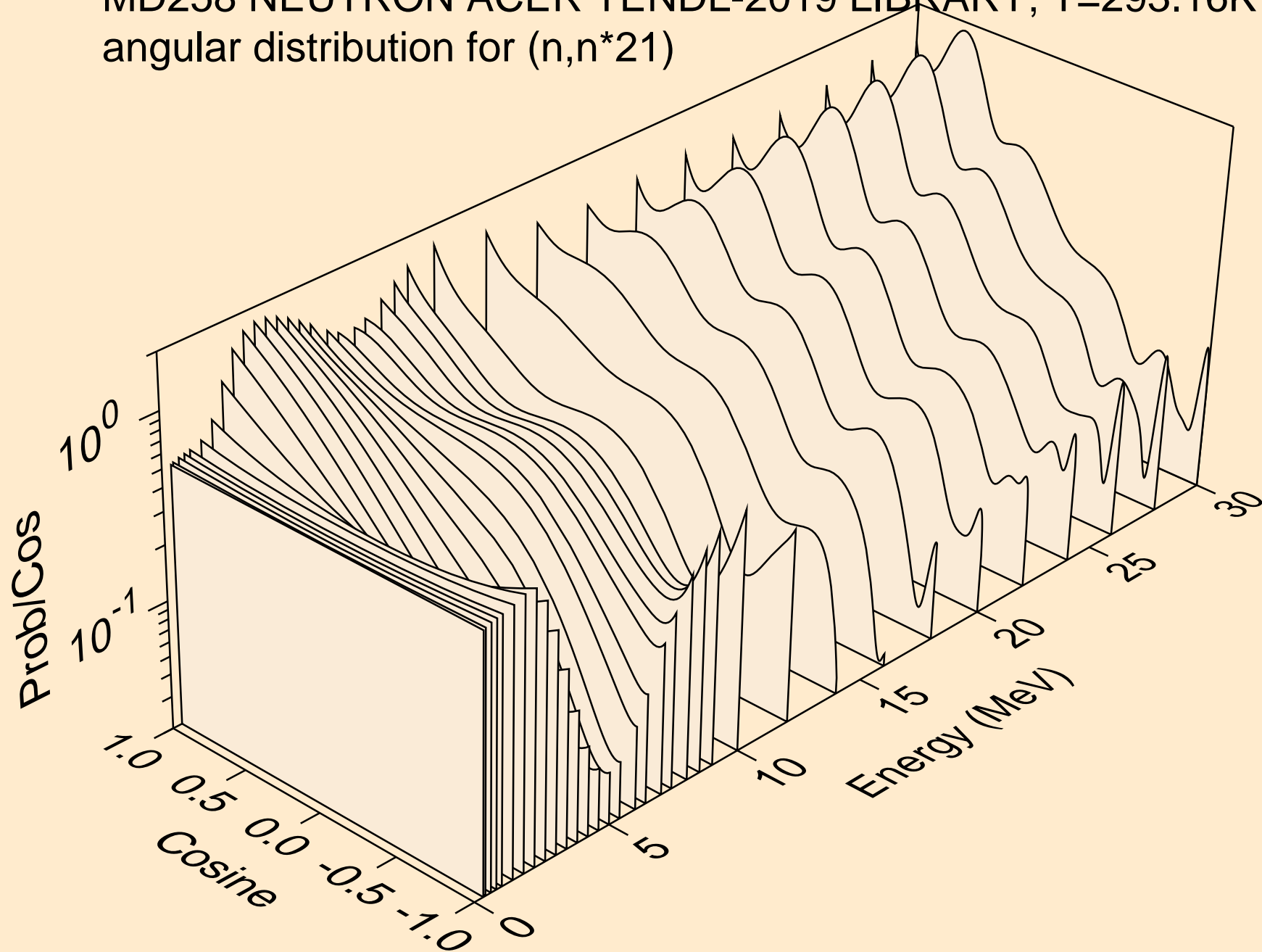

MD258 NEUTRON ACER TENDL-2019 LIBRARY; T=293.16K  
angular distribution for (n,n\*22)

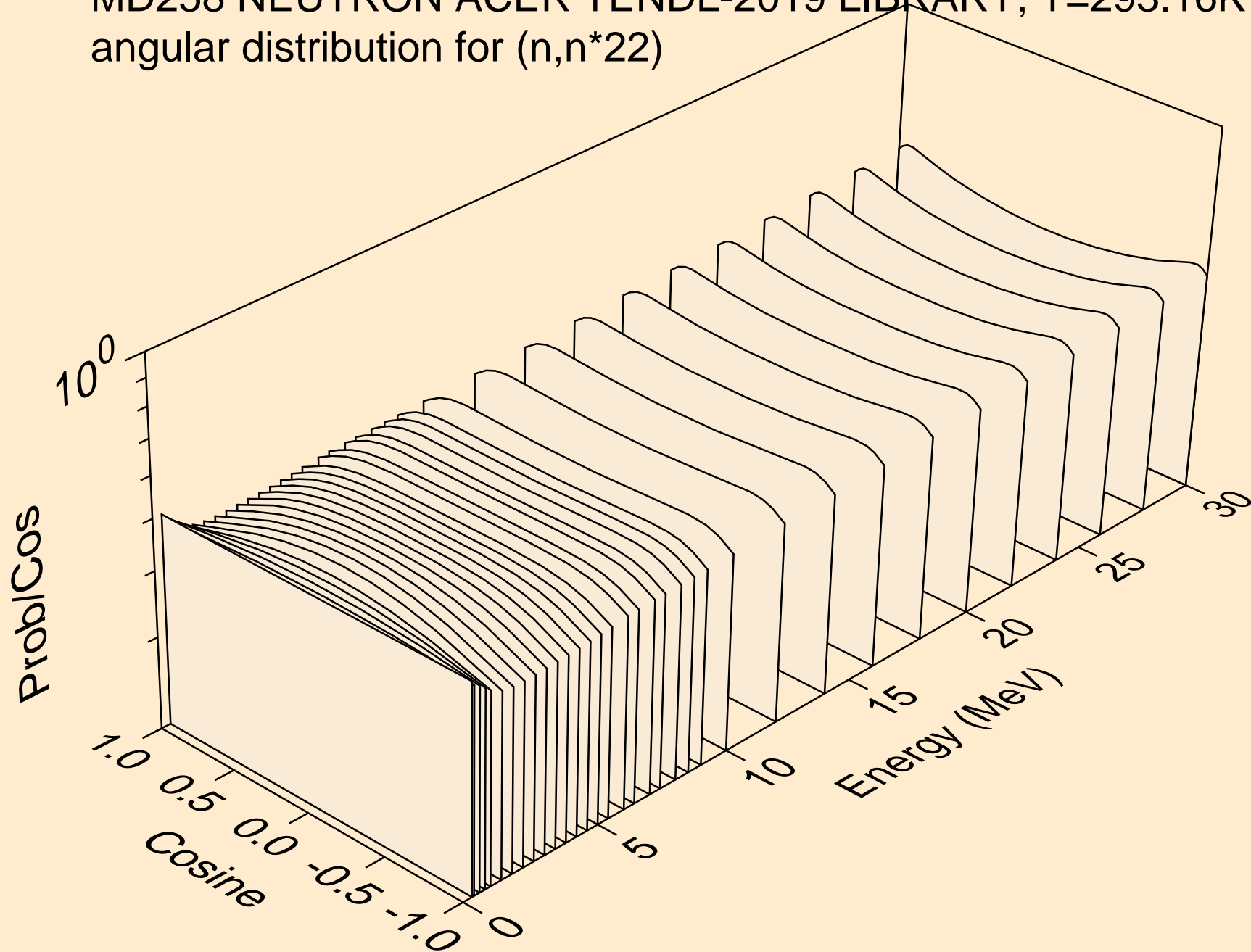

MD258 NEUTRON ACER TENDL-2019 LIBRARY; T=293.16K  
angular distribution for (n,n\*23)

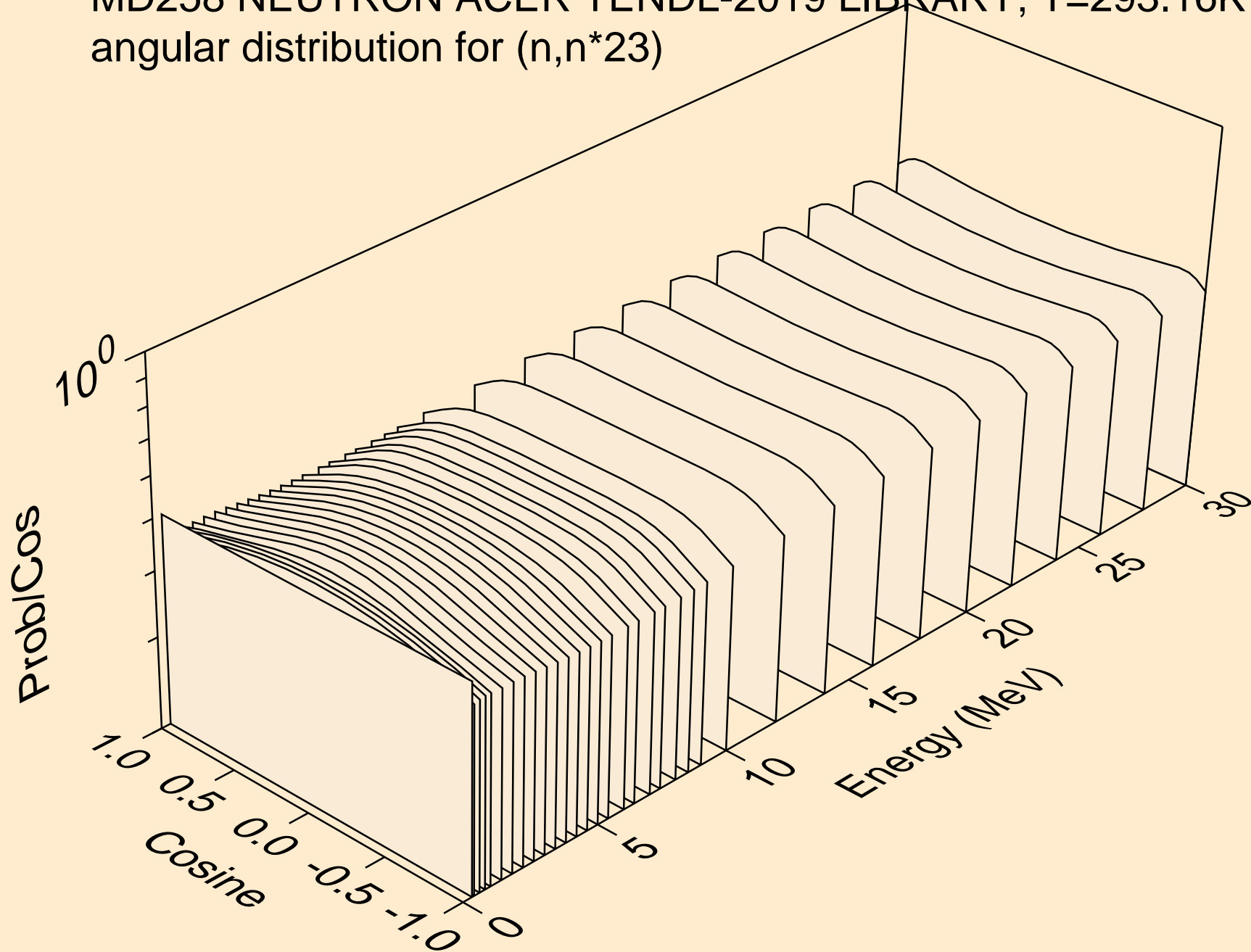

MD258 NEUTRON ACER TENDL-2019 LIBRARY; T=293.16K  
angular distribution for (n,n\*24)

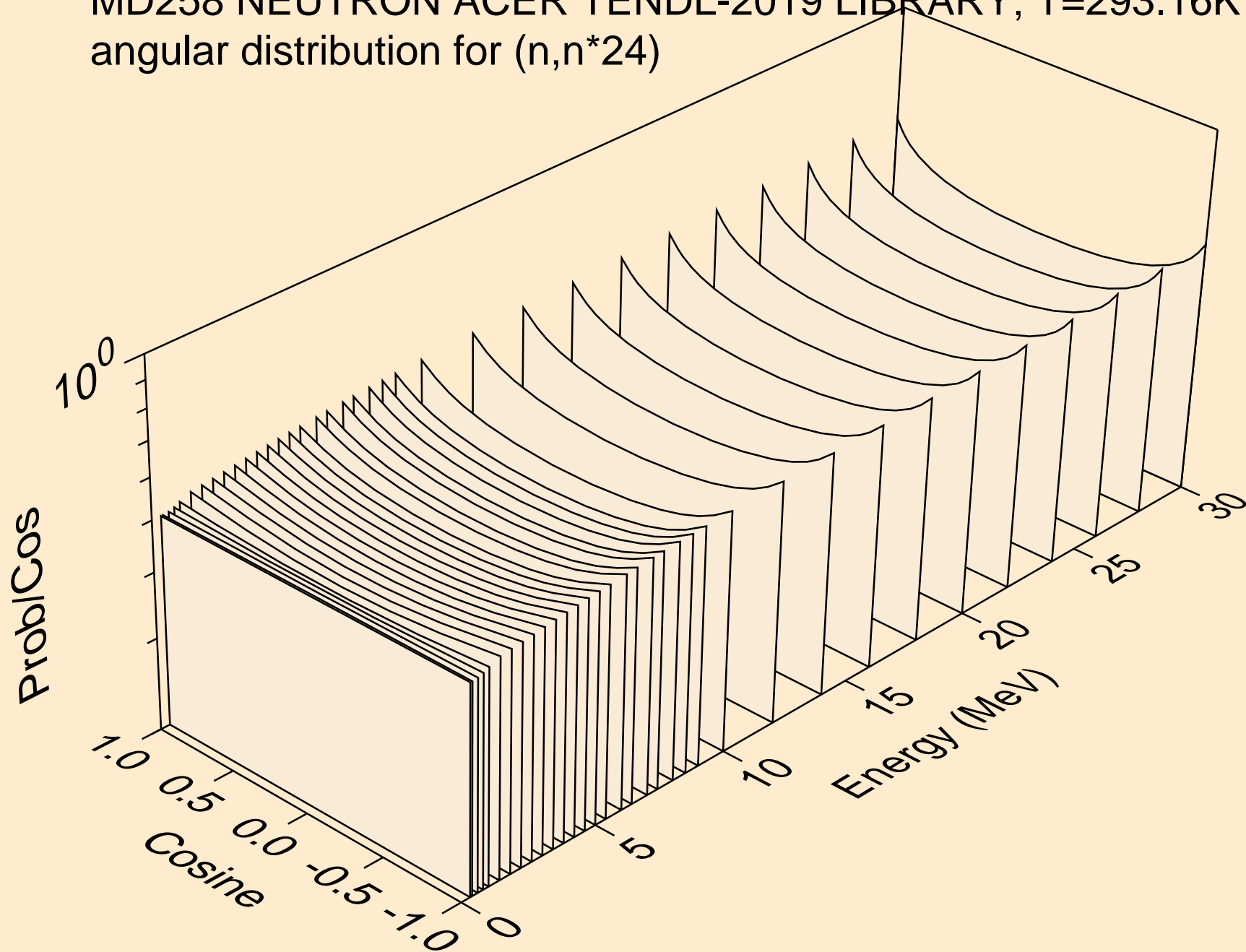

MD258 NEUTRON ACER TENDL-2019 LIBRARY; T=293.16K  
angular distribution for (n,n\*25)

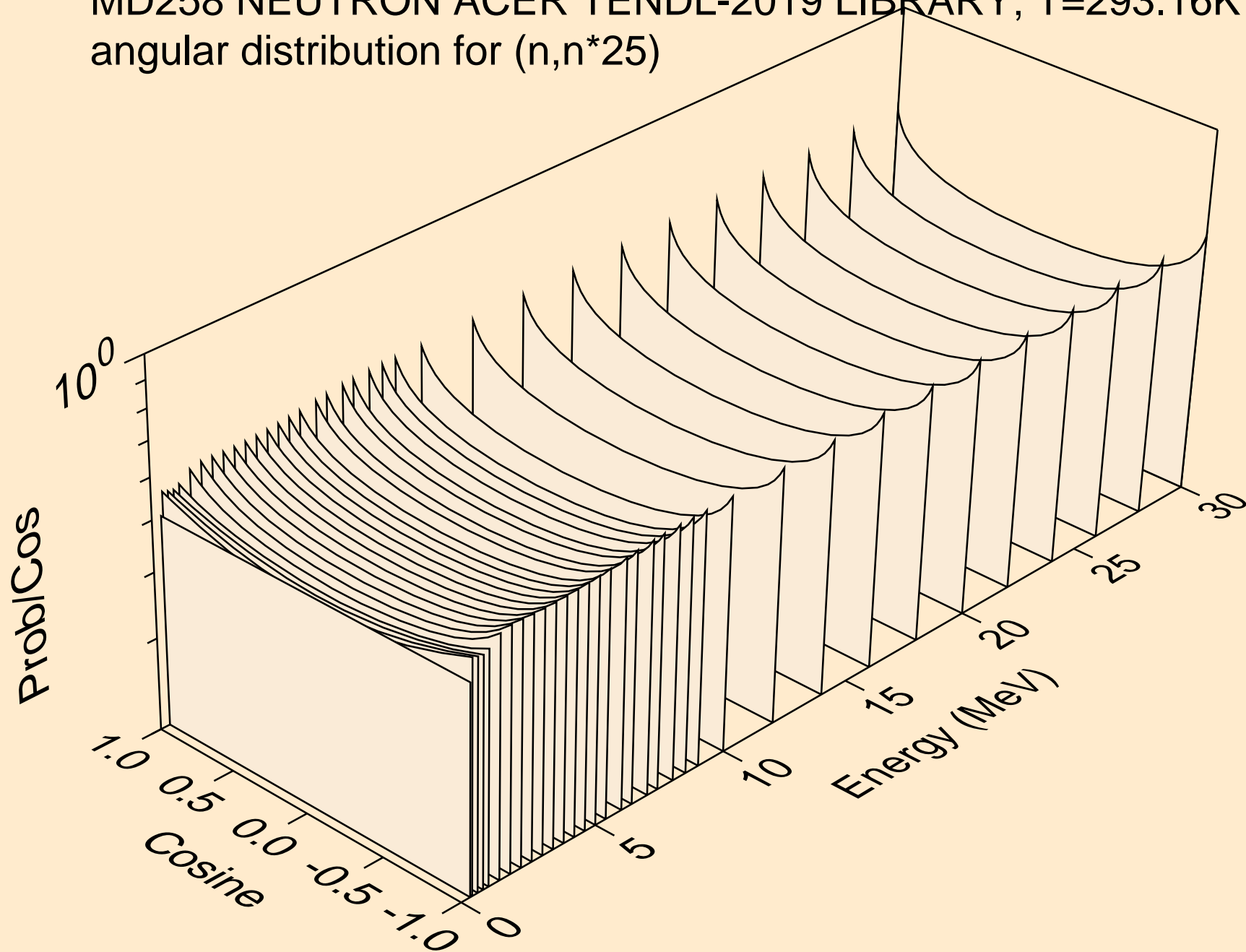

MD258 NEUTRON ACER TENDL-2019 LIBRARY; T=293.16K  
angular distribution for (n,n\*26)

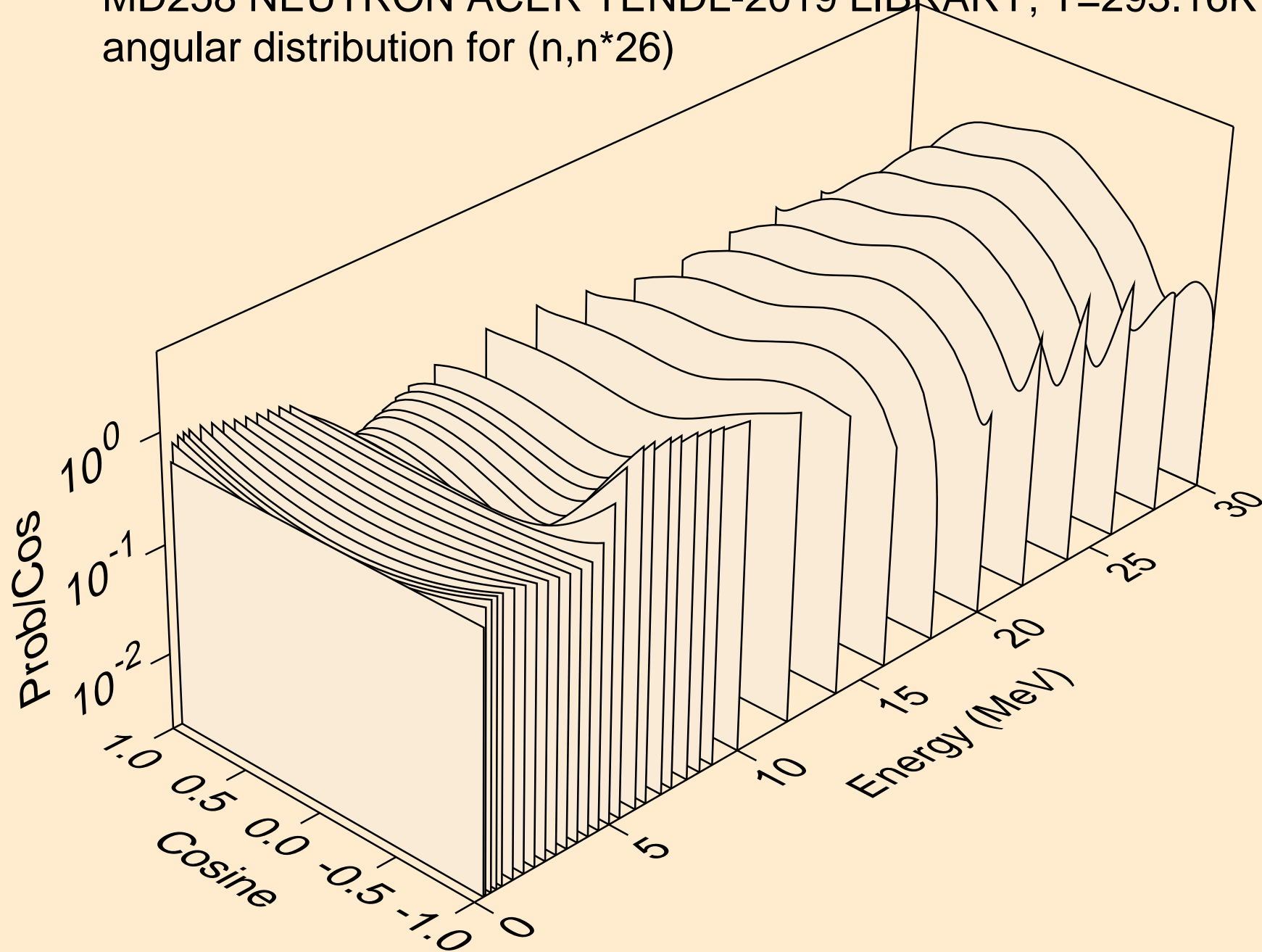



MD258 NEUTRON ACER TENDL-2019 LIBRARY; T=293.16K  
angular distribution for (n,n\*27)

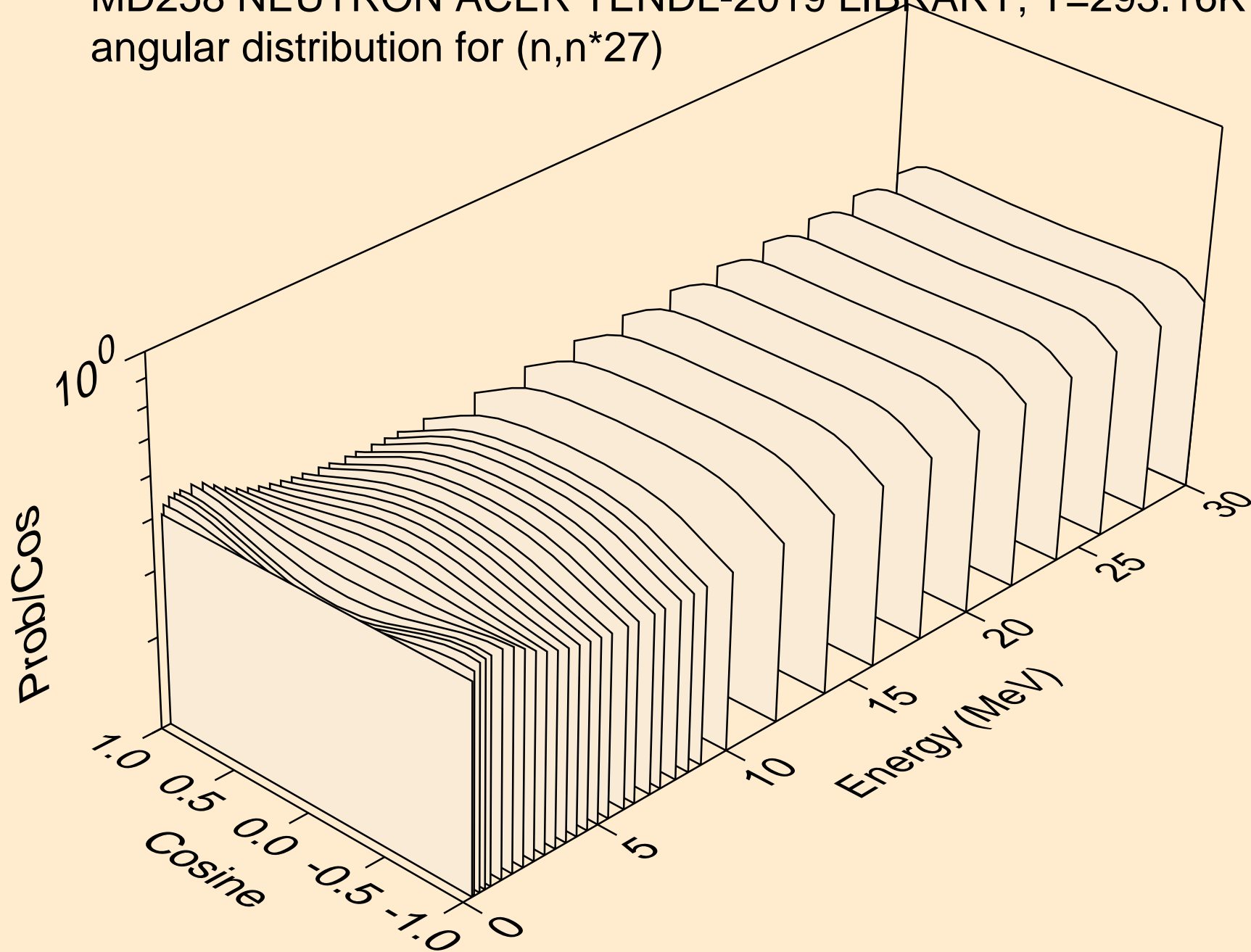

MD258 NEUTRON ACER TENDL-2019 LIBRARY; T=293.16K  
angular distribution for (n,n\*28)

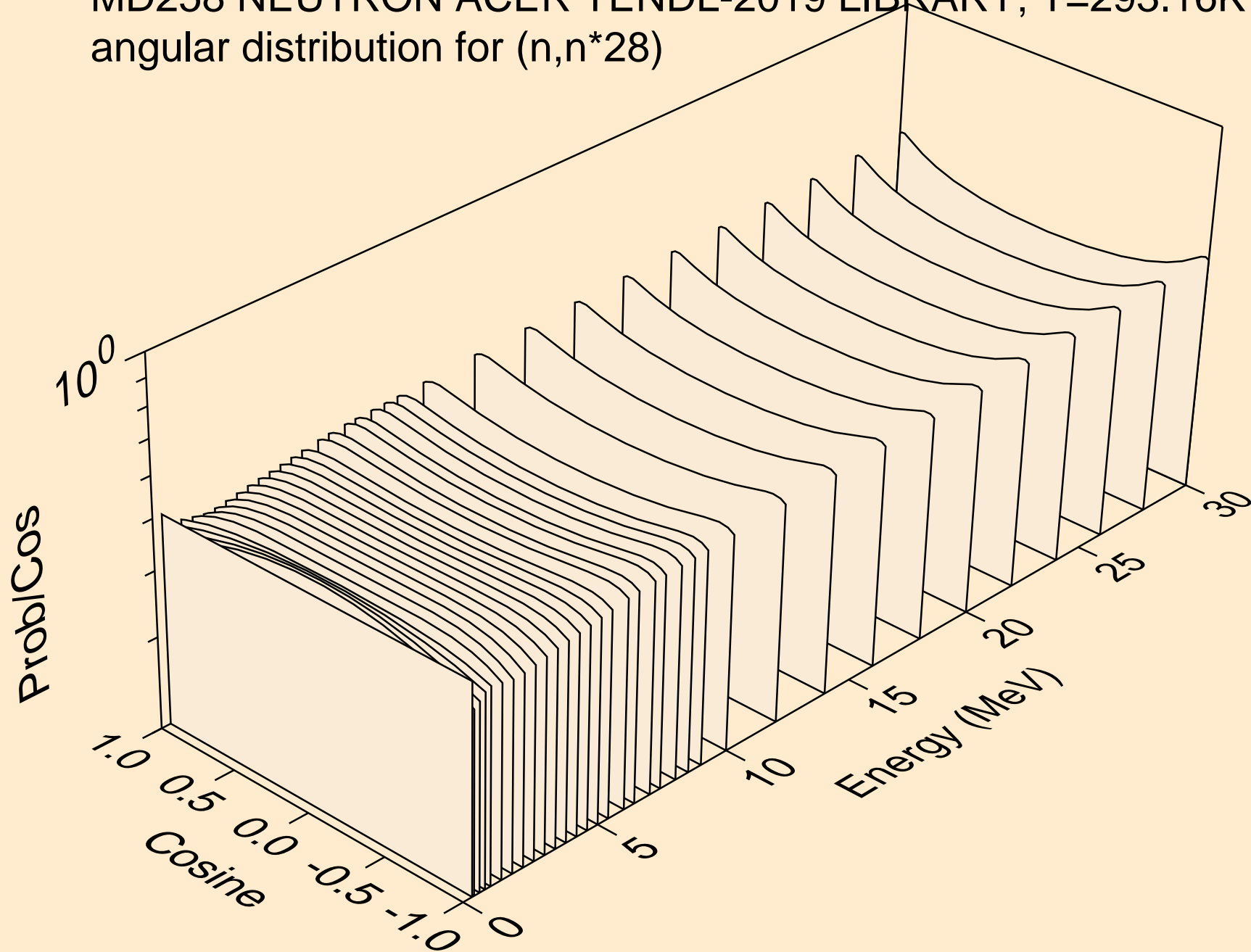

MD258 NEUTRON ACER TENDL-2019 LIBRARY; T=293.16K  
Total fission nuabar

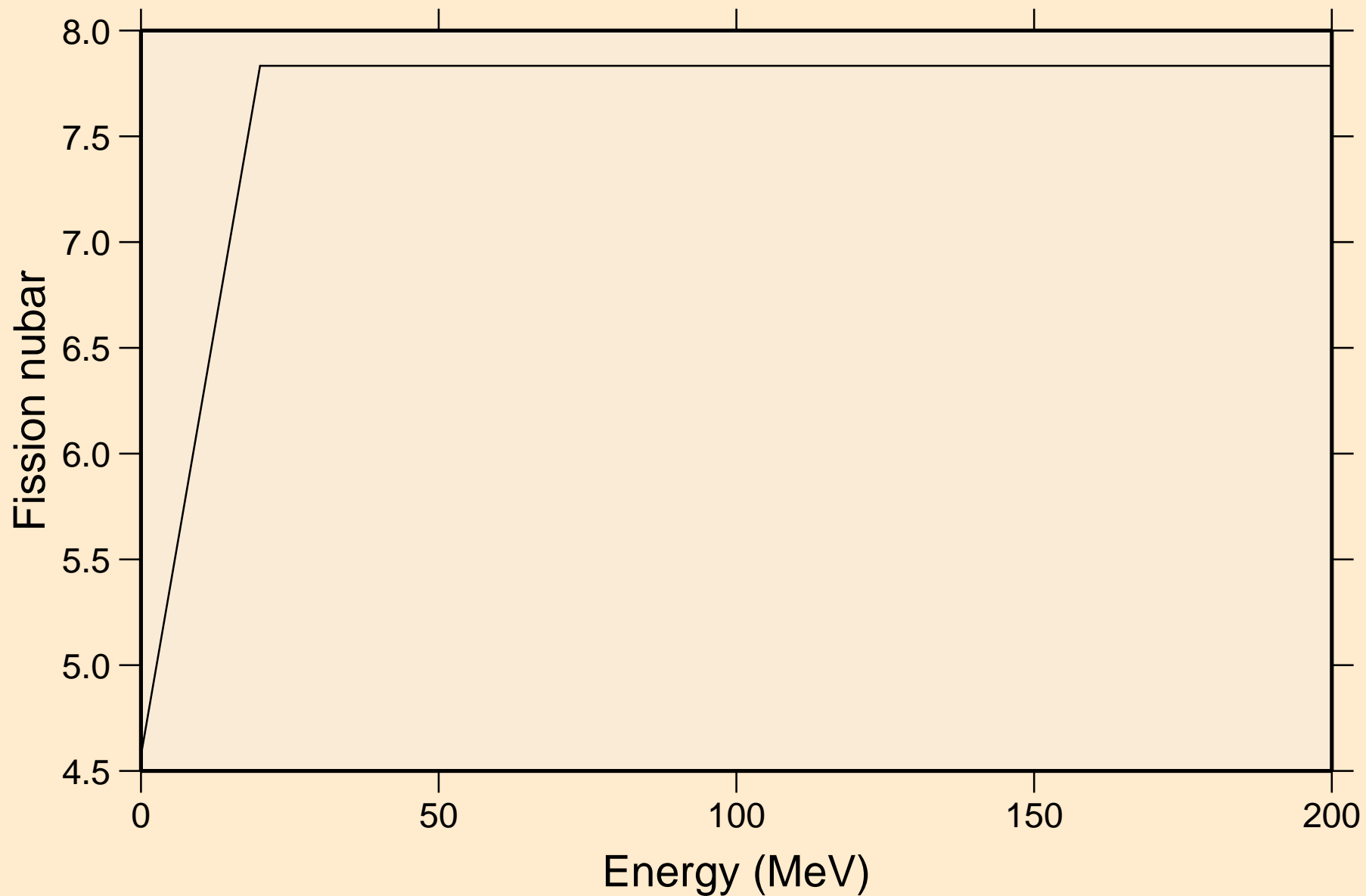

MD258 NEUTRON ACER TENDL-2019 LIBRARY; T=293.16K  
Neutron emission for (n,x)

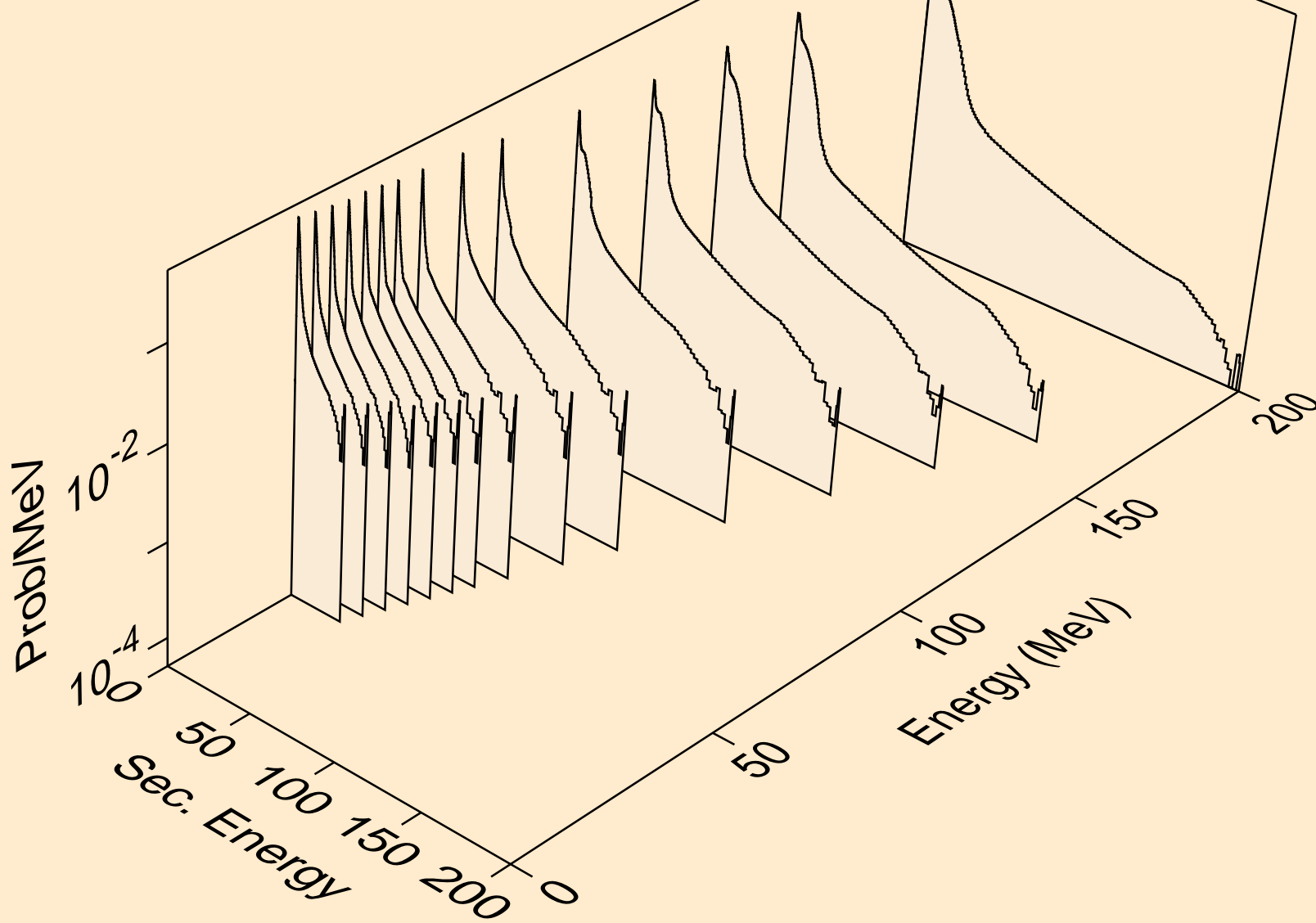

MD258 NEUTRON ACER TENDL-2019 LIBRARY; T=293.16K  
Neutron emission for (n,2nd)

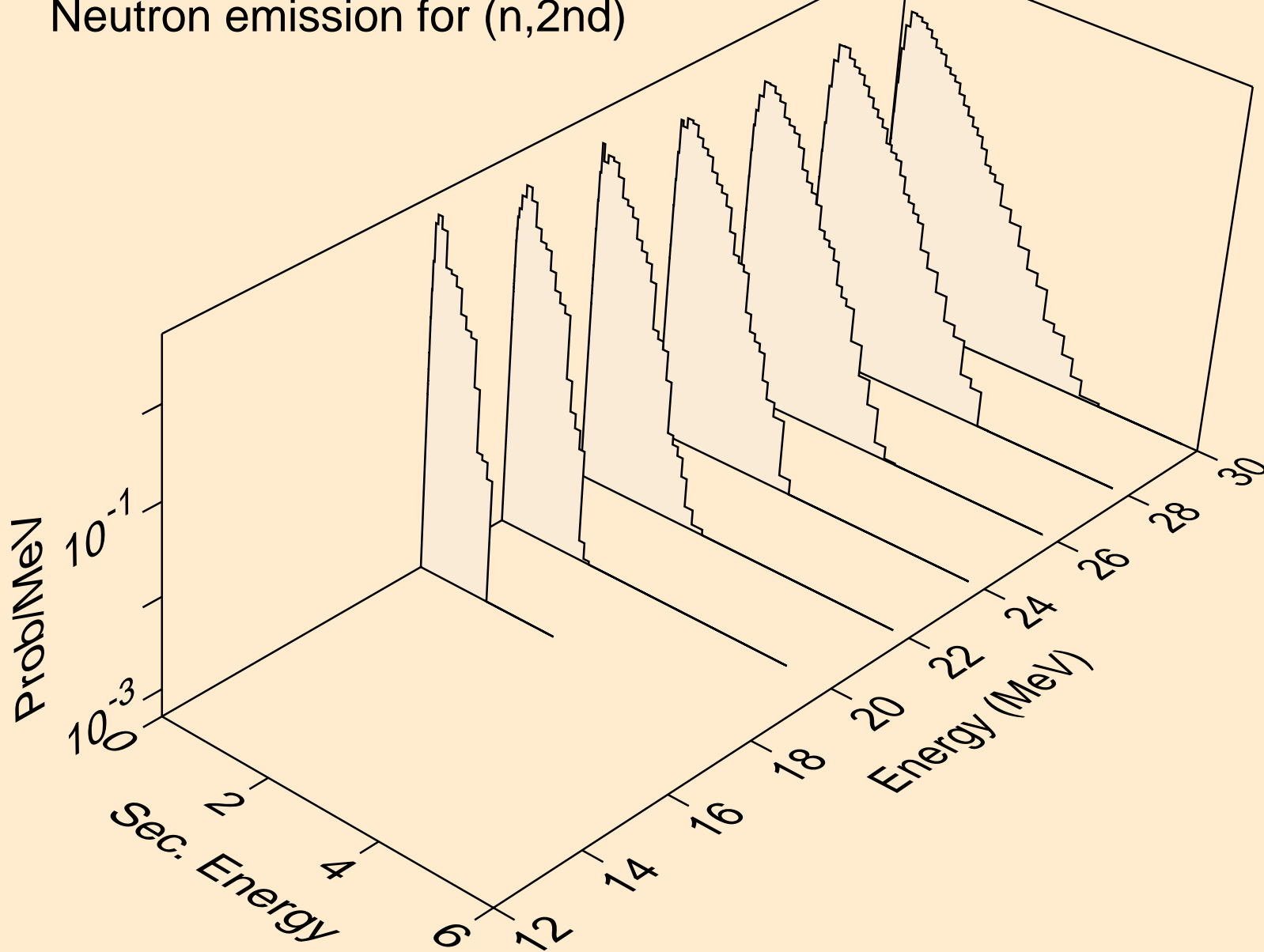

MD258 NEUTRON ACER TENDL-2019 LIBRARY; T=293.16K  
Neutron emission for (n,2n)

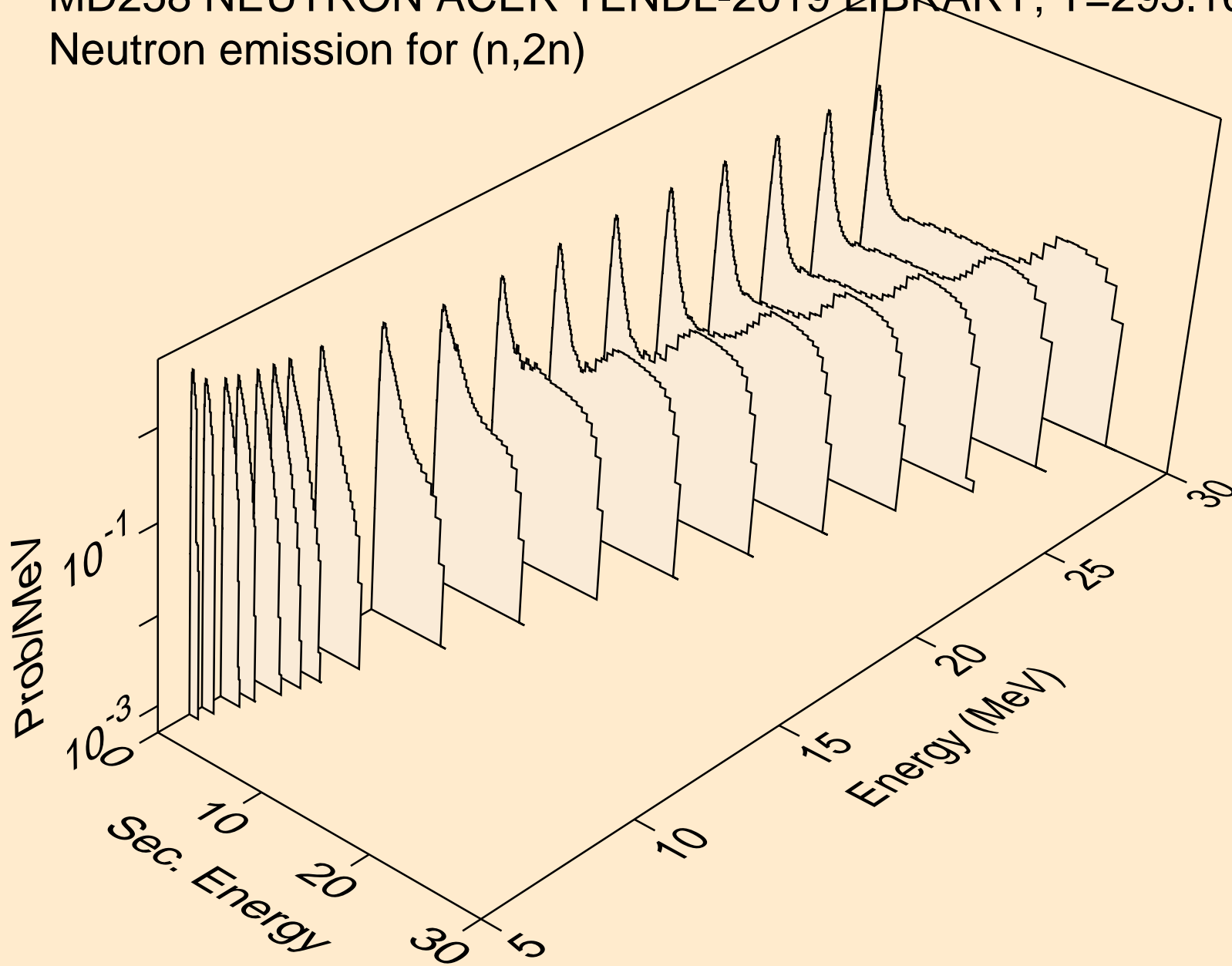

MD258 NEUTRON ACER TENDL-2019 LIBRARY; T=293.16K  
Neutron emission for (n,3n)

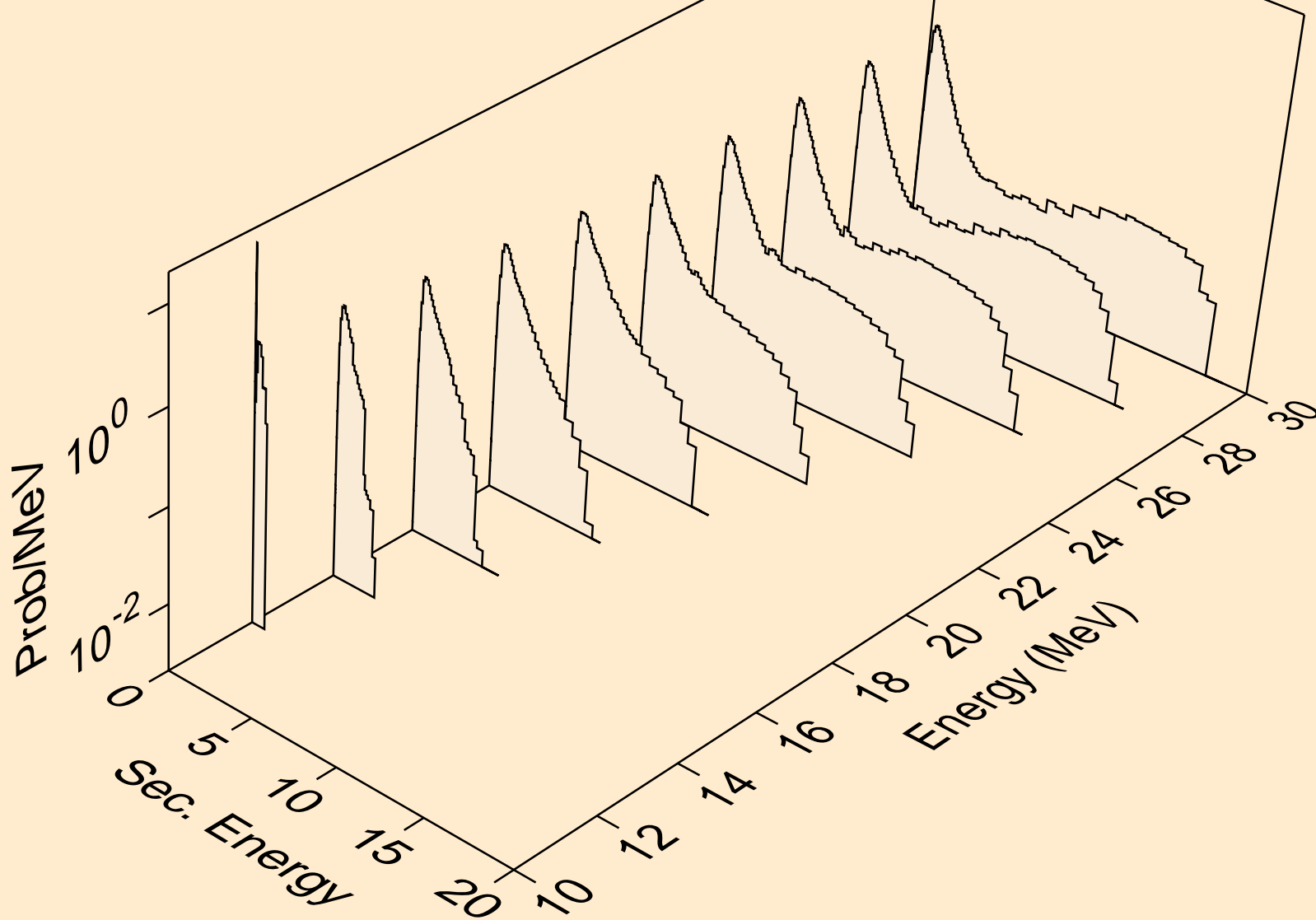

MD258 NEUTRON ACER TENDL-2019 LIBRARY; T=293.16K  
Neutron emission for fission

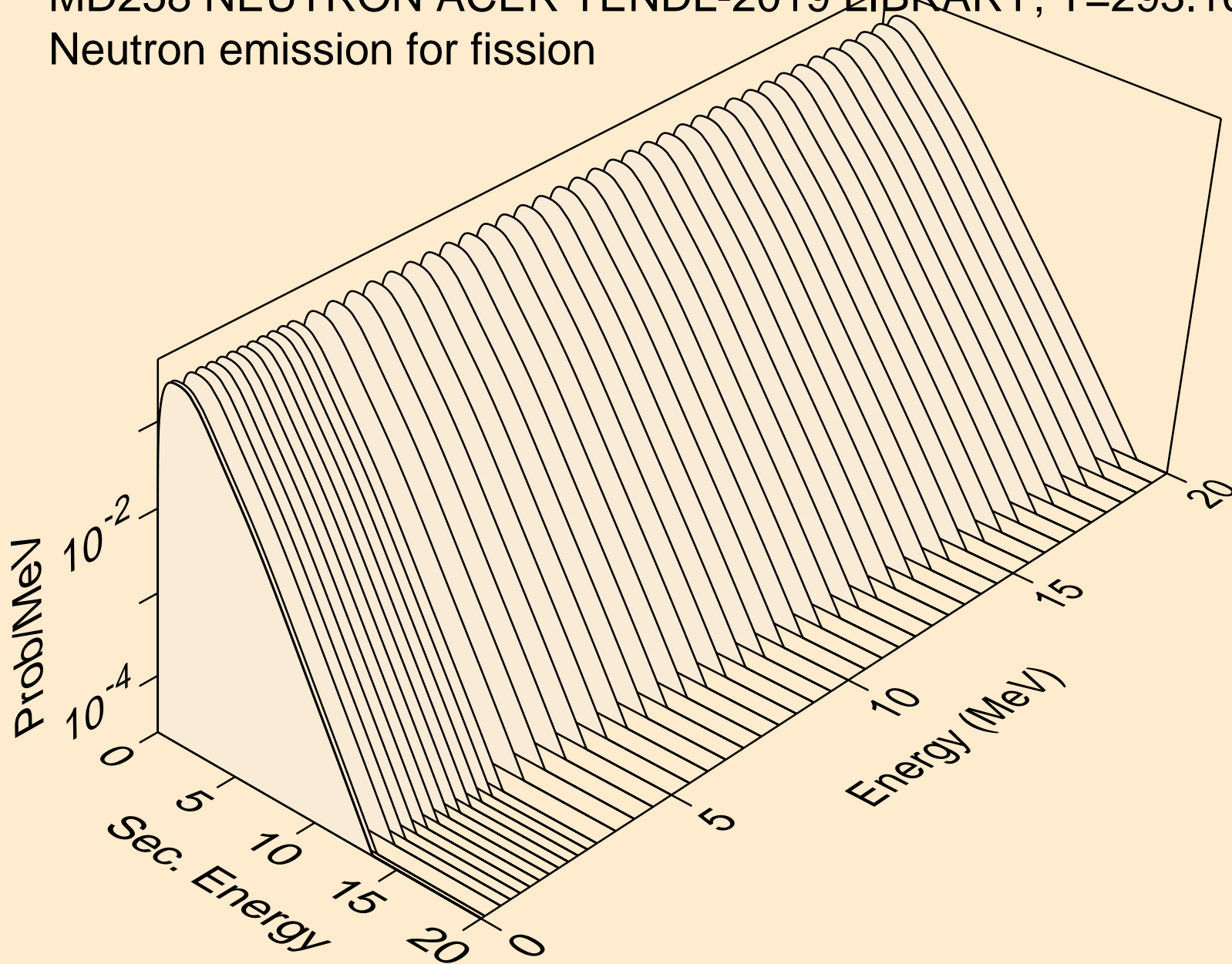



MD258 NEUTRON ACER TENDL-2019 LIBRARY; T=293.16K  
Neutron emission for (n,n\*)a

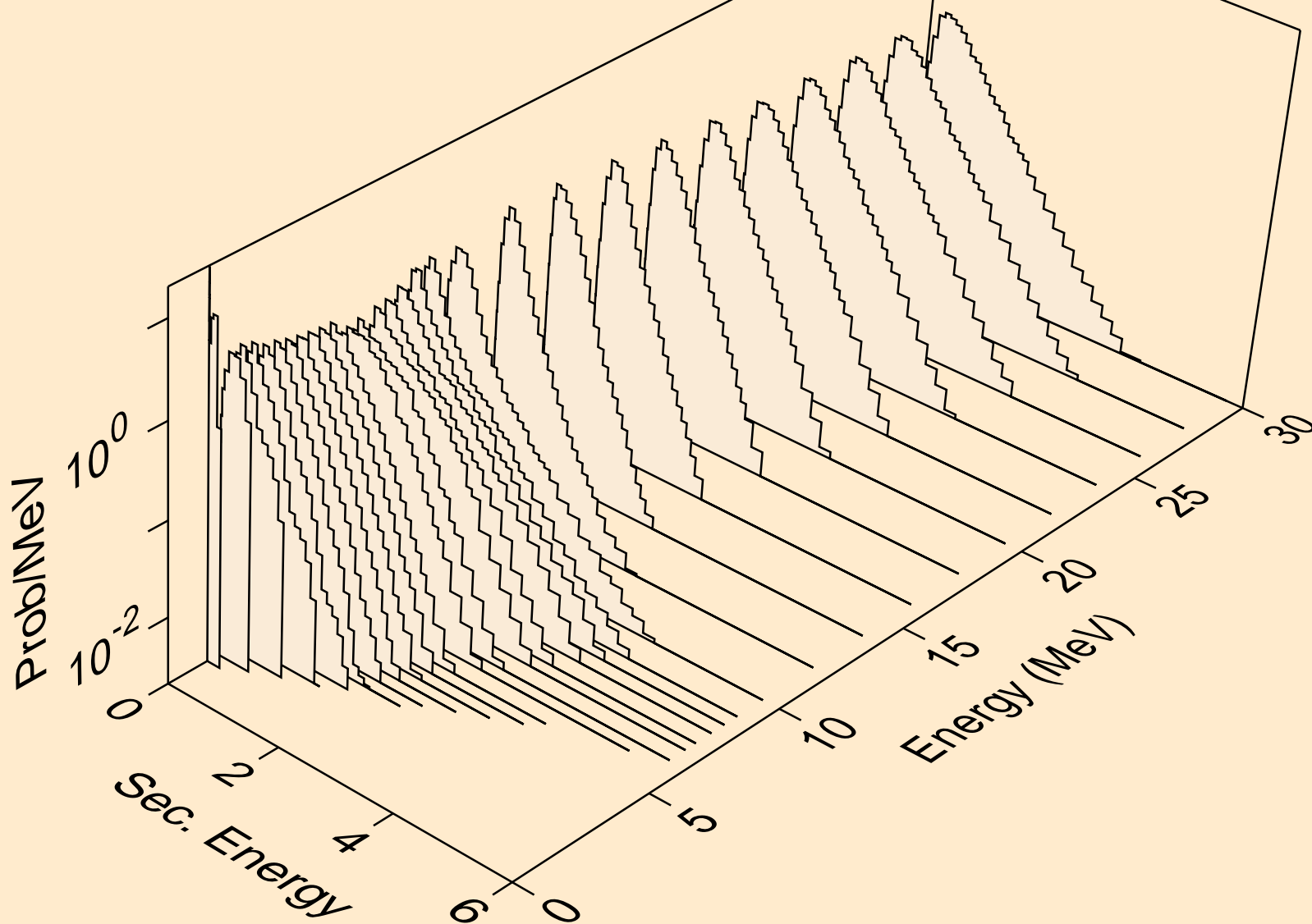

MD258 NEUTRON ACER TENDL-2019 LIBRARY; T=293.16K  
Neutron emission for (n,2n)a

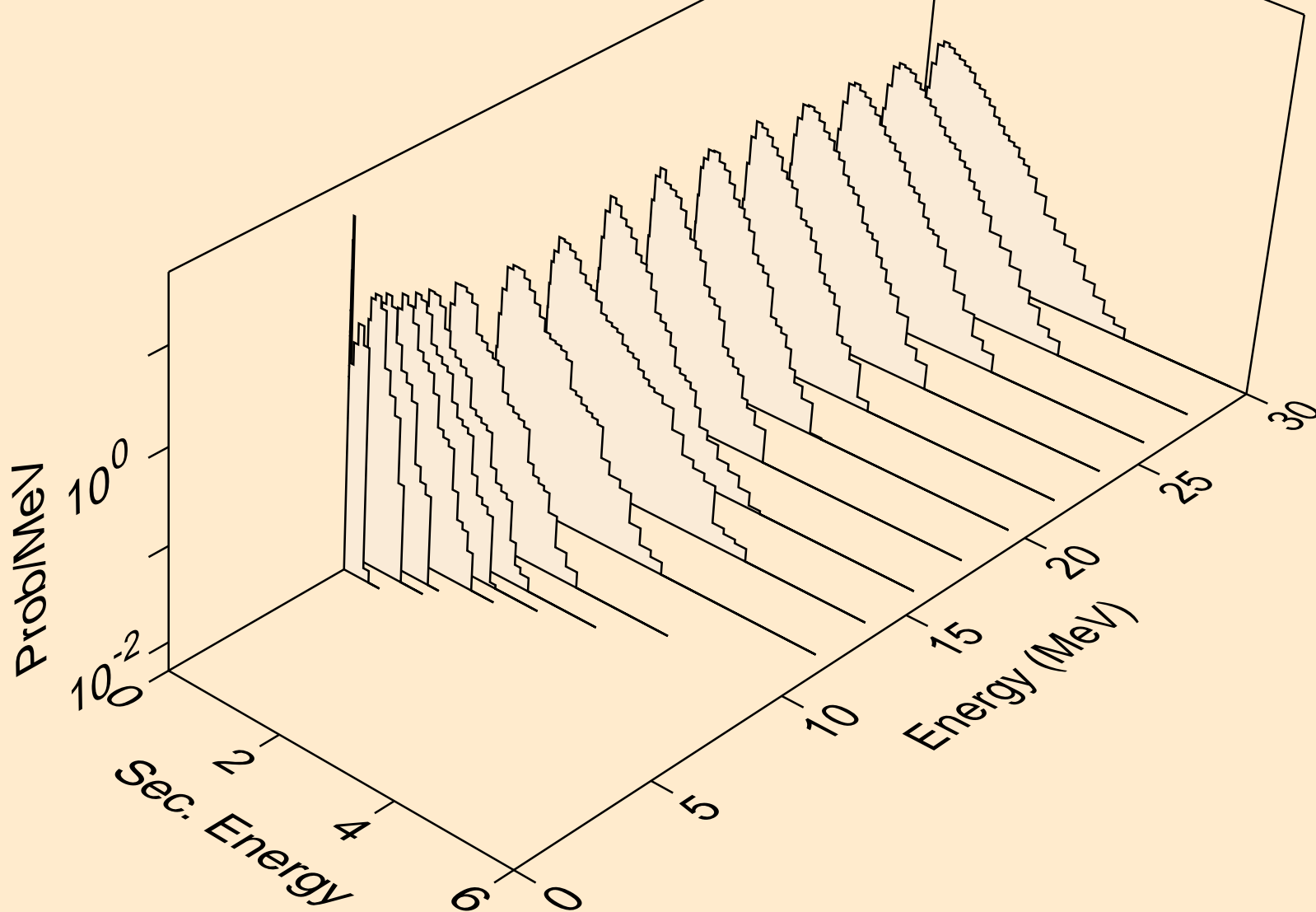

MD258 NEUTRON ACER TENDL-2019 LIBRARY; T=293.16K  
Neutron emission for (n,3n)a

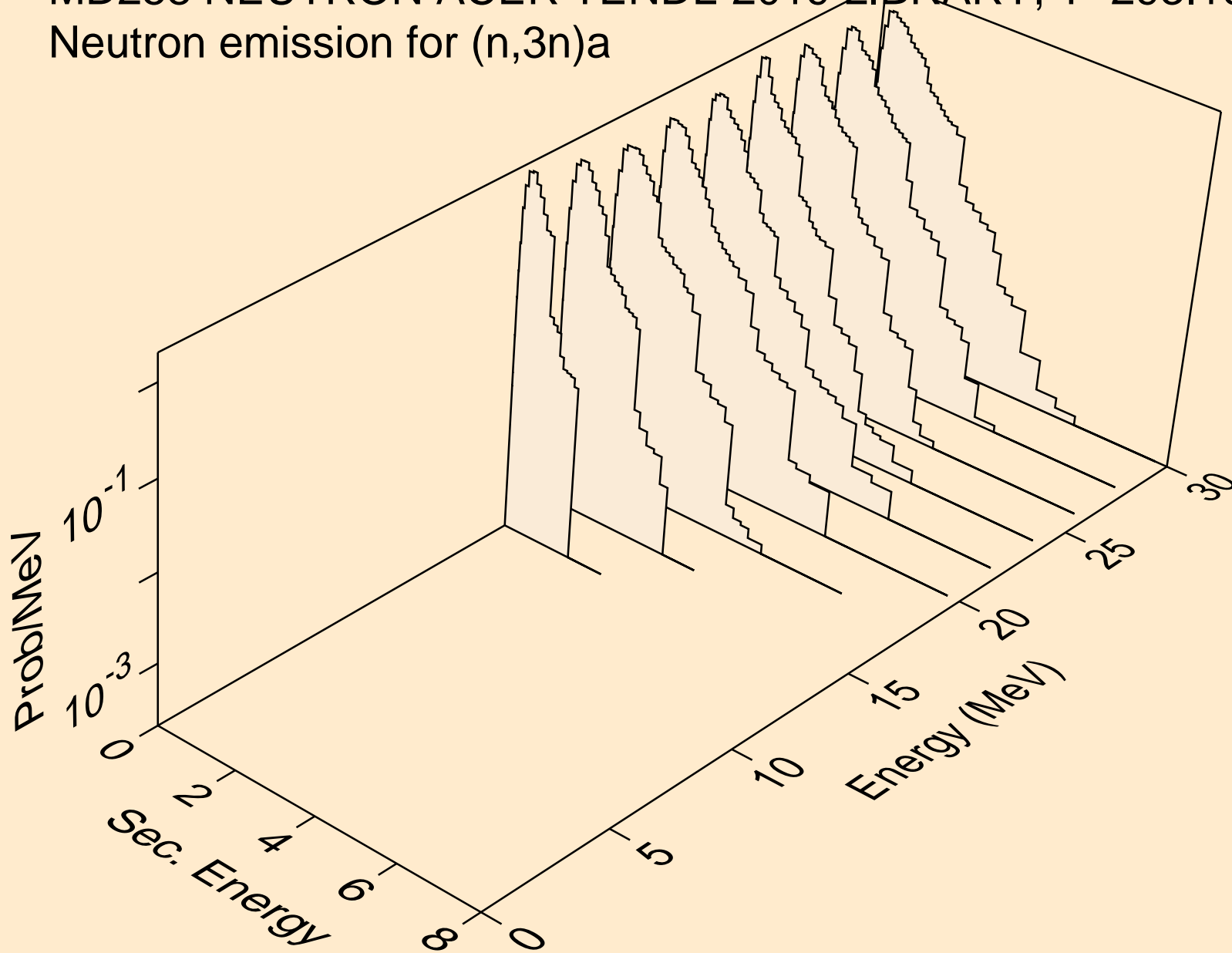

MD258 NEUTRON ACER TENDL-2019 LIBRARY; T=293.16K  
Neutron emission for (n,n\*)p

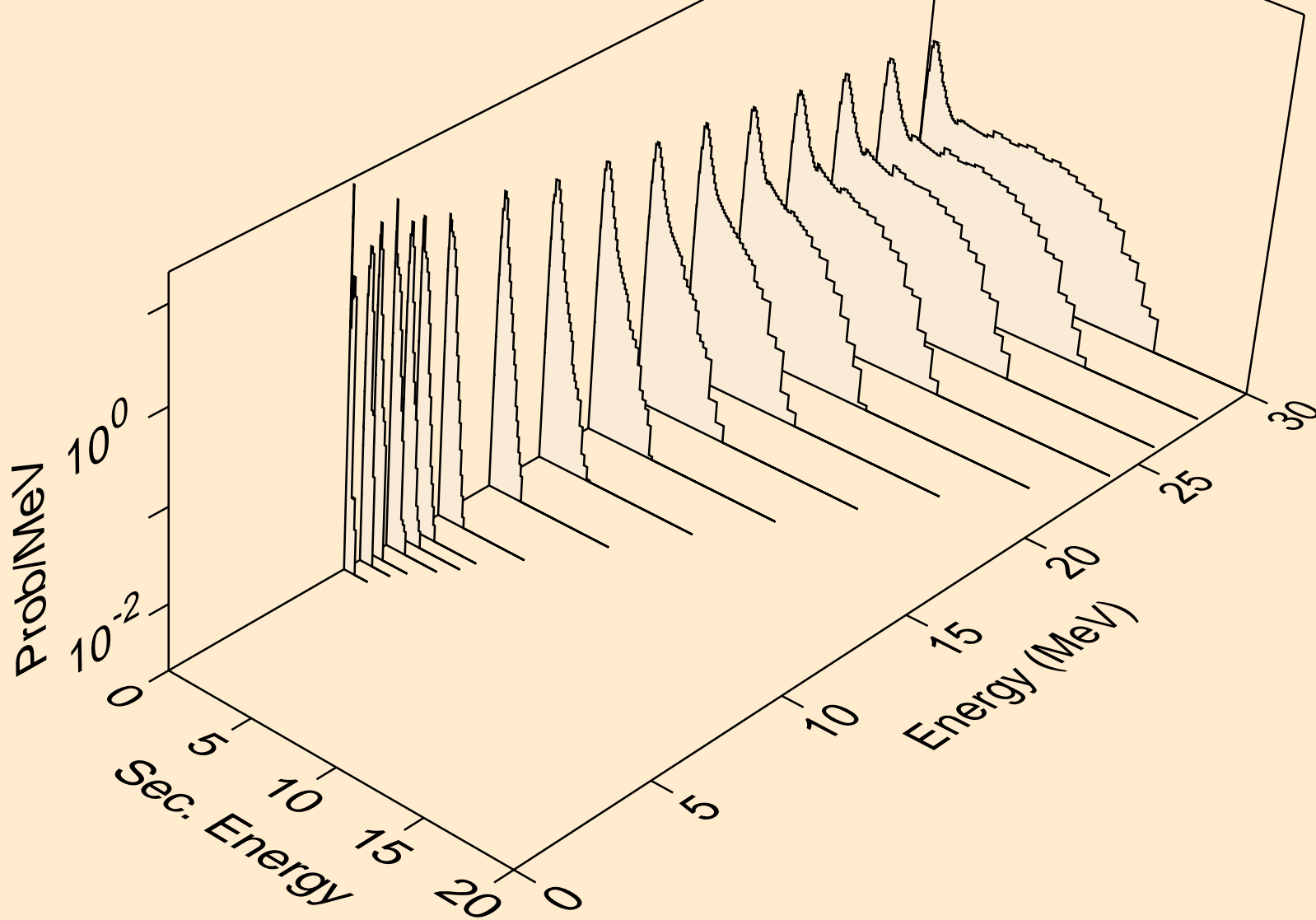

MD258 NEUTRON ACER TENDL-2019 LIBRARY; T=293.16K  
Neutron emission for (n,n\*)2a

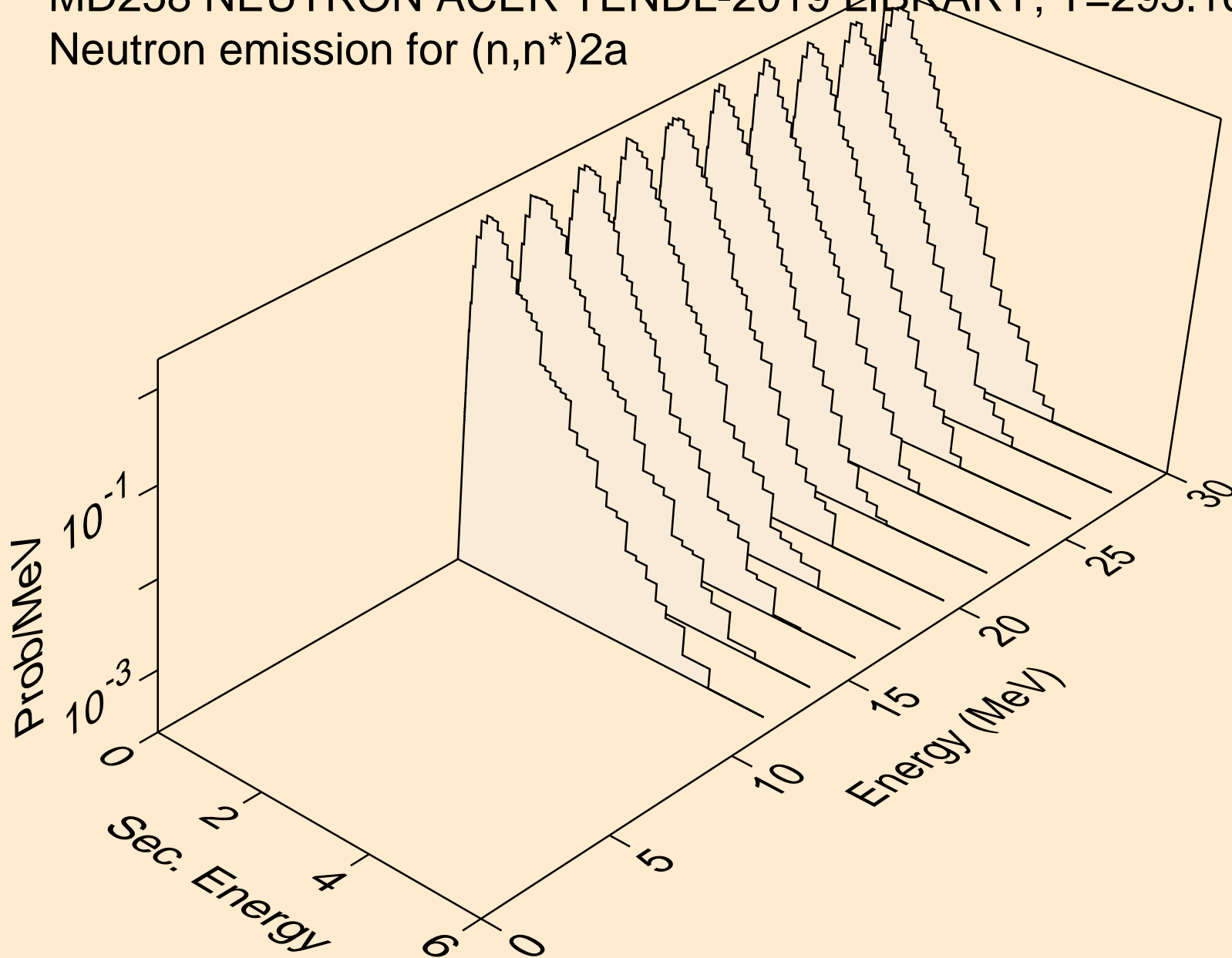

MD258 NEUTRON ACER TENDL-2019 LIBRARY; T=293.16K  
Neutron emission for (n,n\*)d

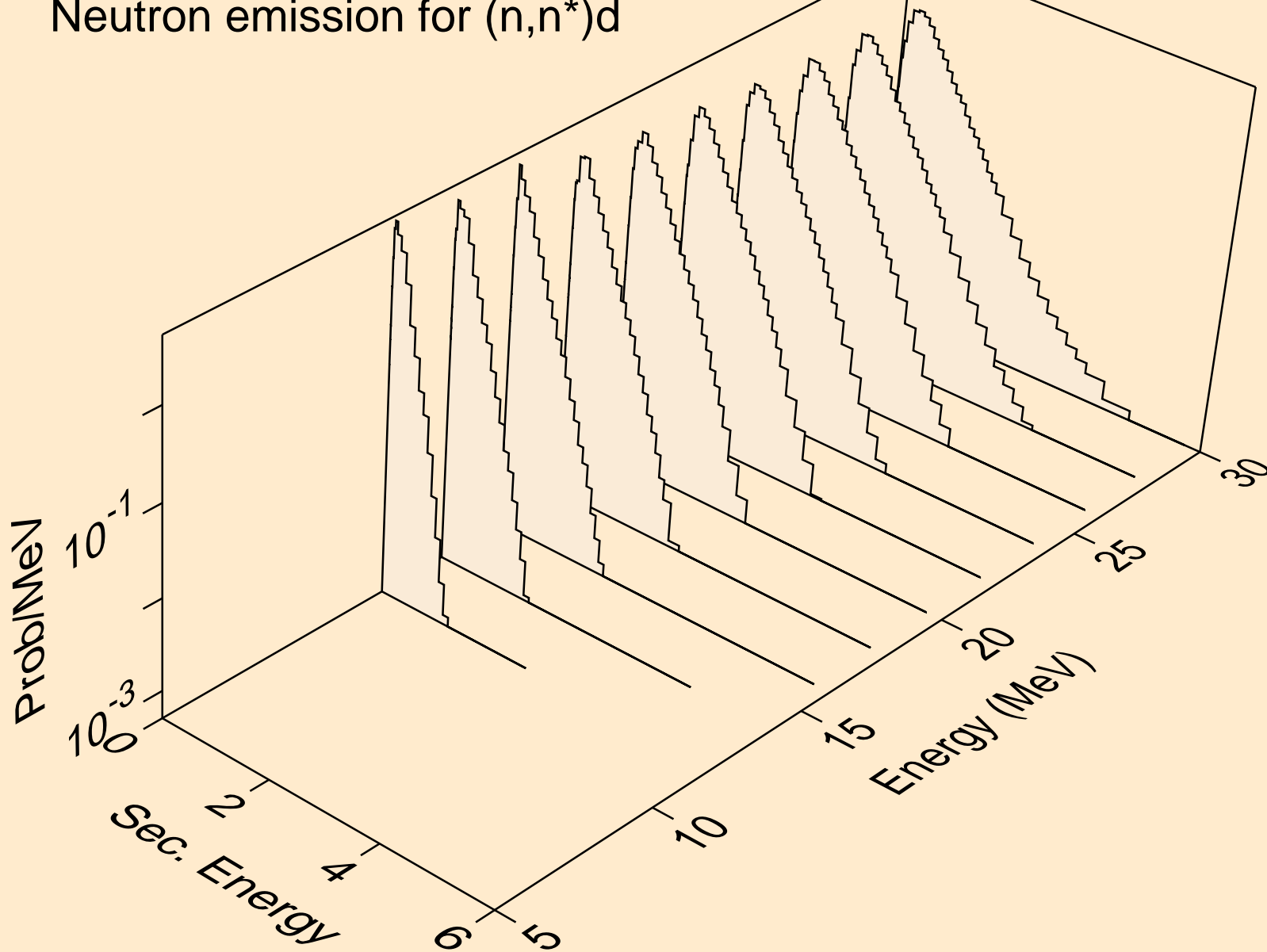

MD258 NEUTRON ACER TENDL-2019 LIBRARY; T=293.16K  
Neutron emission for (n,n\*)t

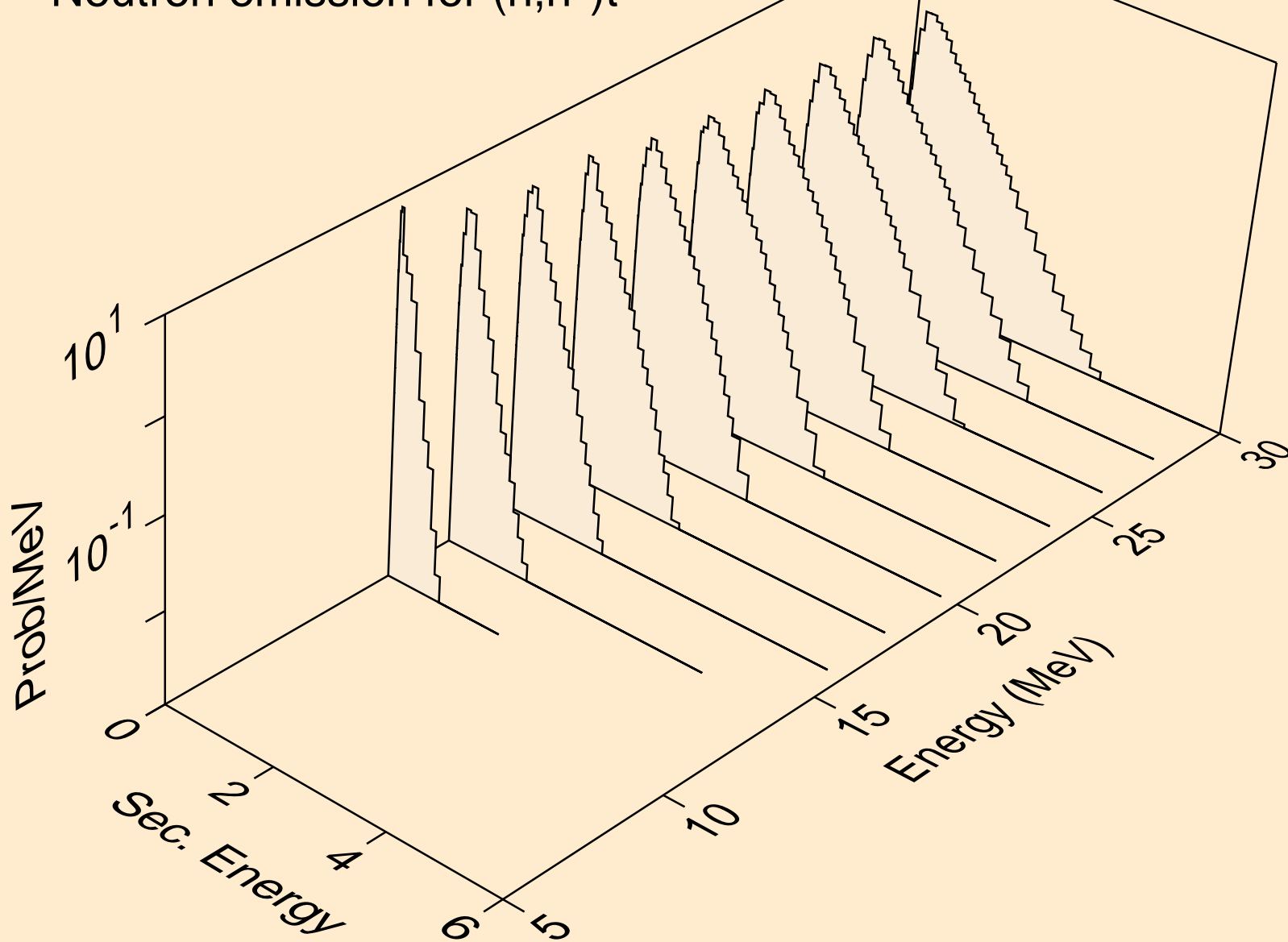

MD258 NEUTRON ACER TENDL-2019 LIBRARY; T=293.16K  
Neutron emission for (n,n\*)he3

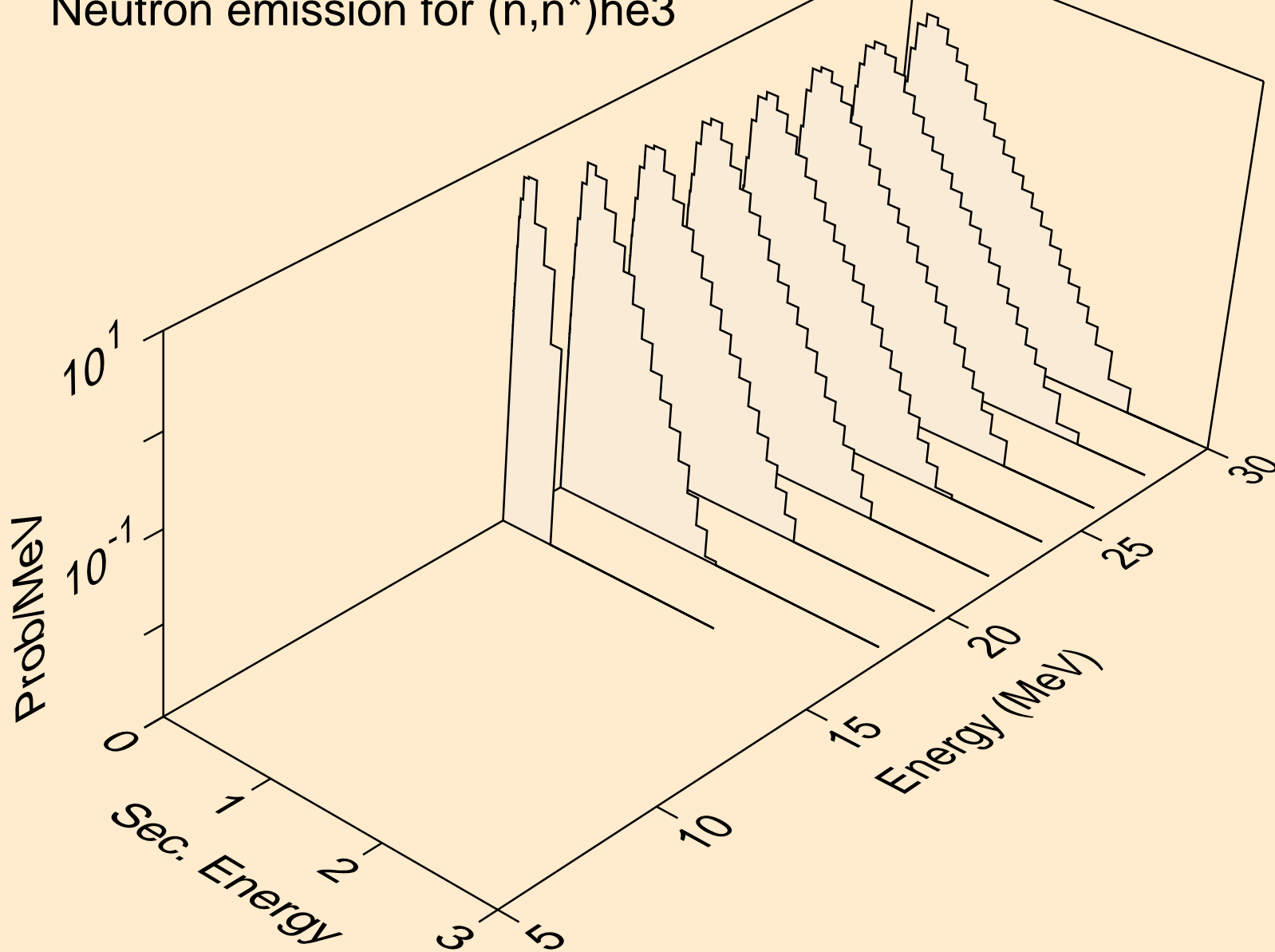



MD258 NEUTRON ACER TENDL-2019 LIBRARY; T=293.16K  
Neutron emission for (n,4n)

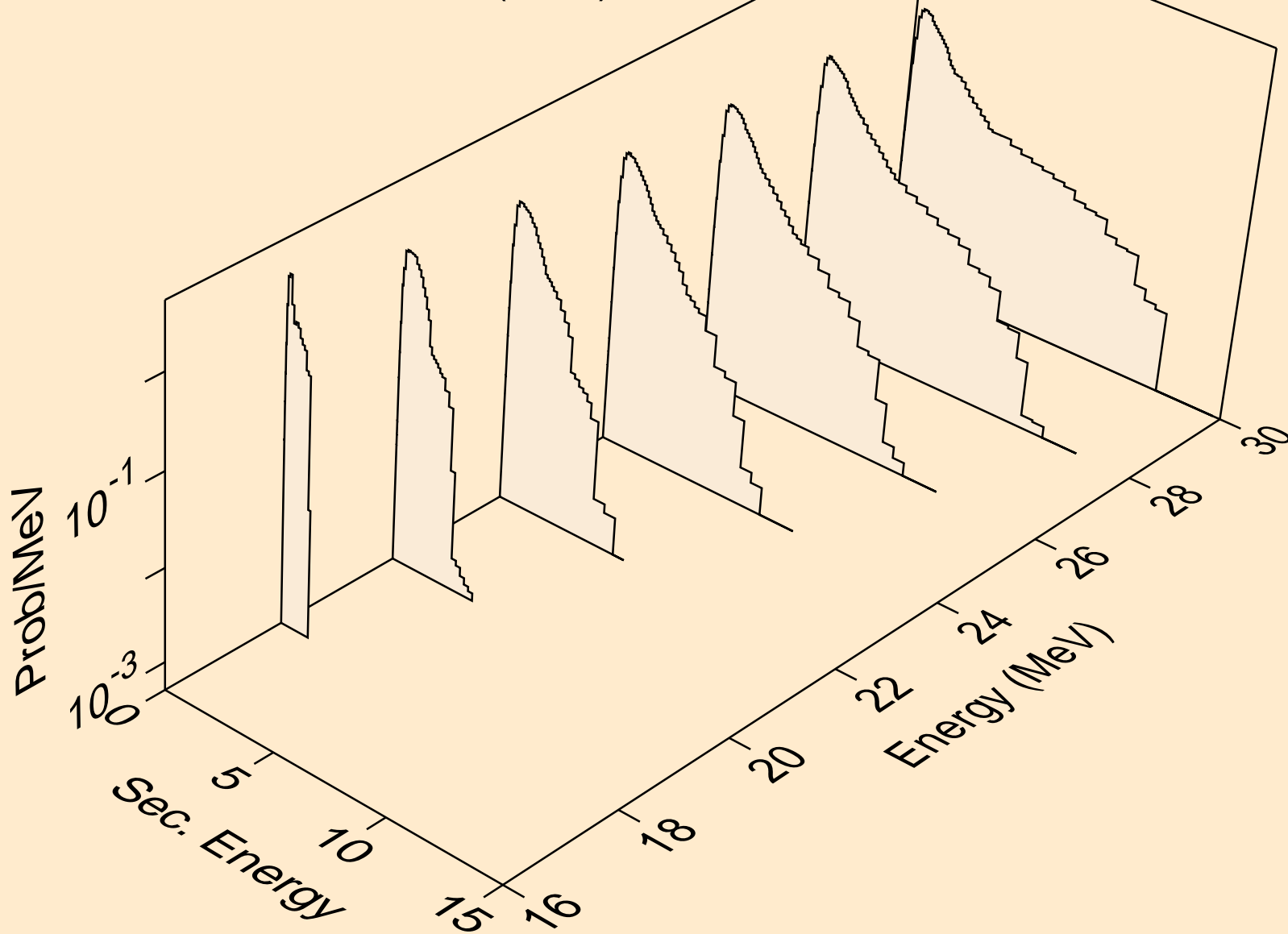

MD258 NEUTRON ACER TENDL-2019 LIBRARY; T=293.16K  
Neutron emission for (n,2np)

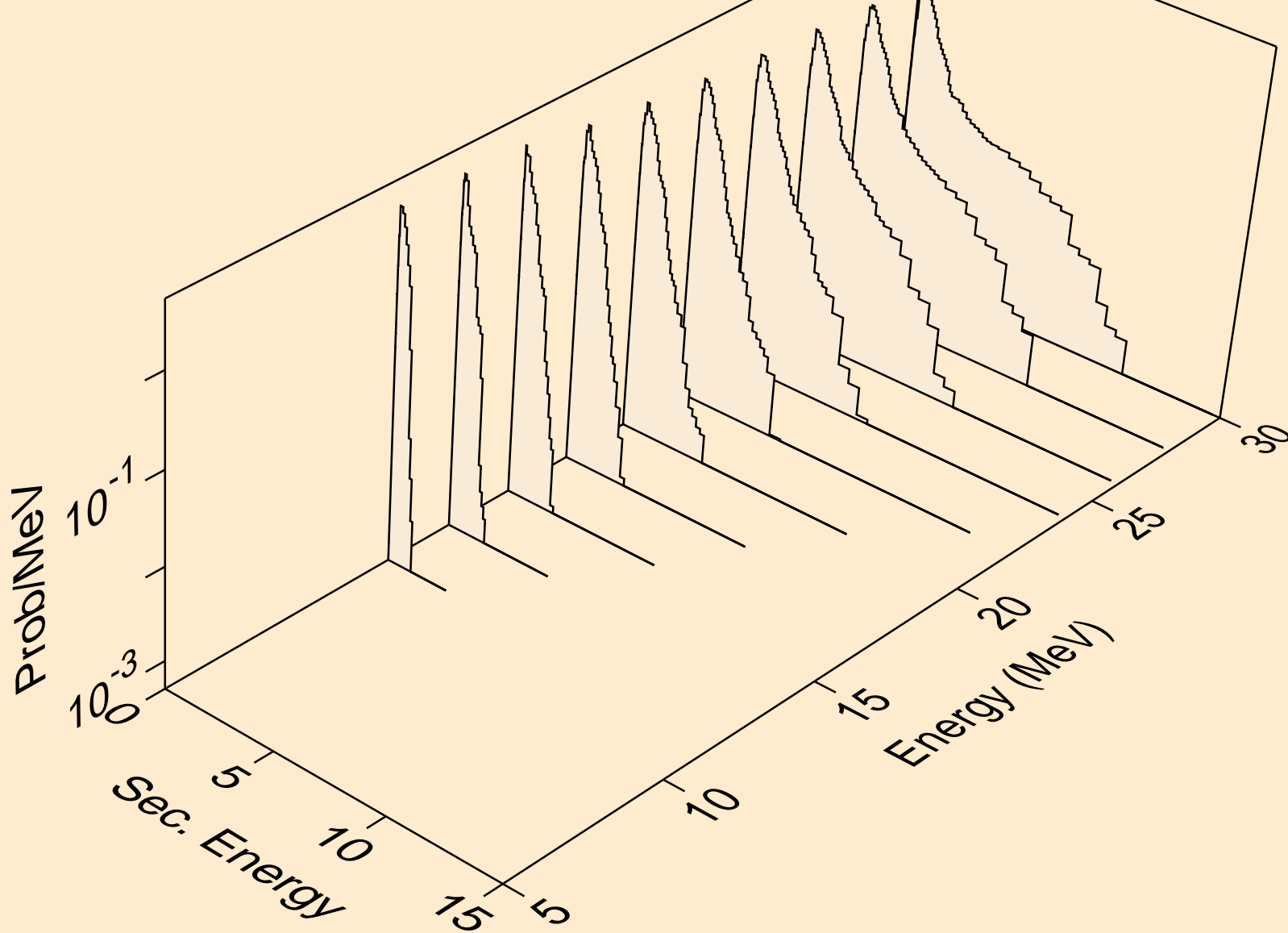

MD258 NEUTRON ACER TENDL-2019 LIBRARY; T=293.16K  
Neutron emission for (n,3np)

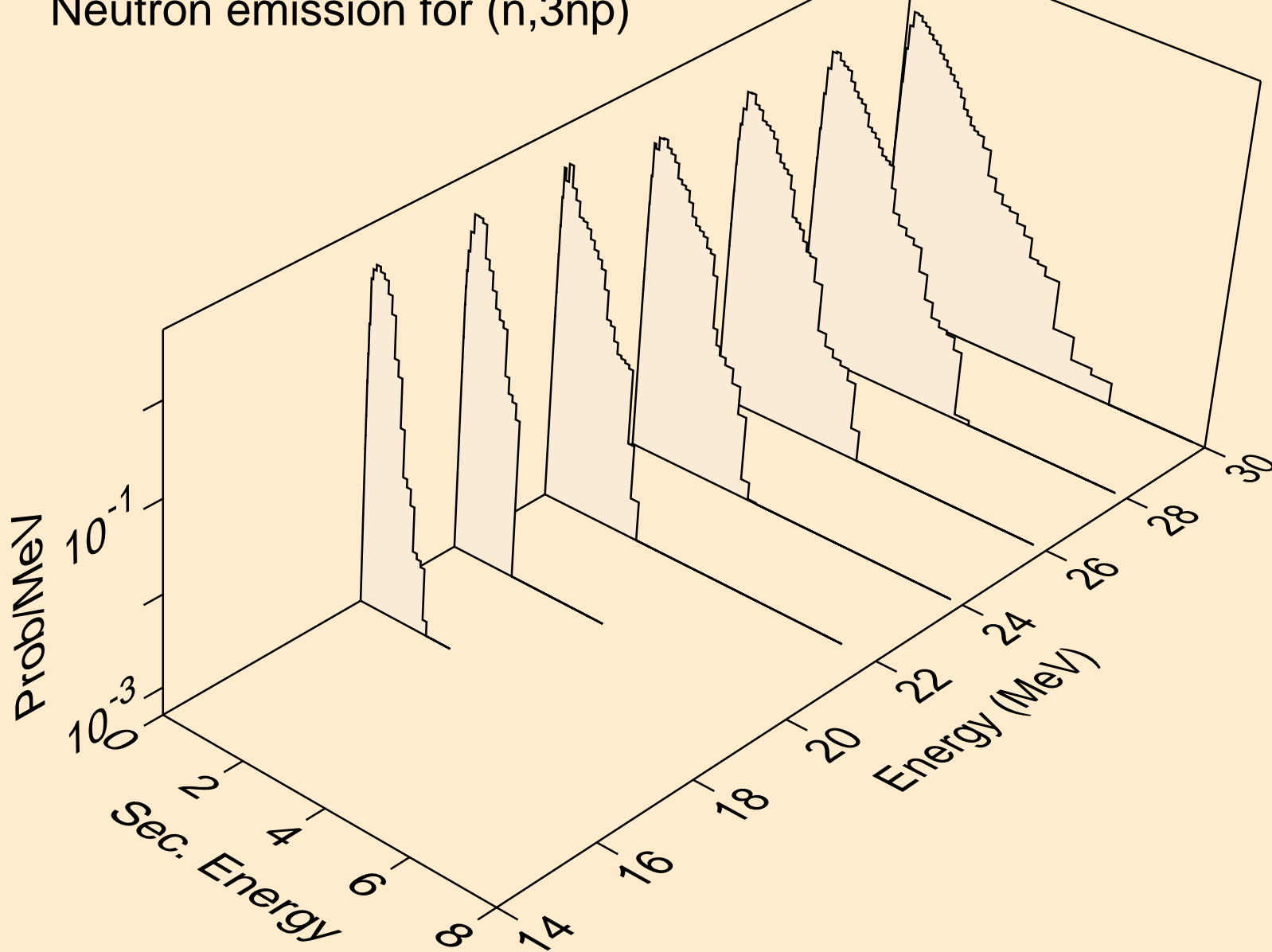

MD258 NEUTRON ACER TENDL-2019 LIBRARY; T=293.16K  
Neutron emission for (n,2np)

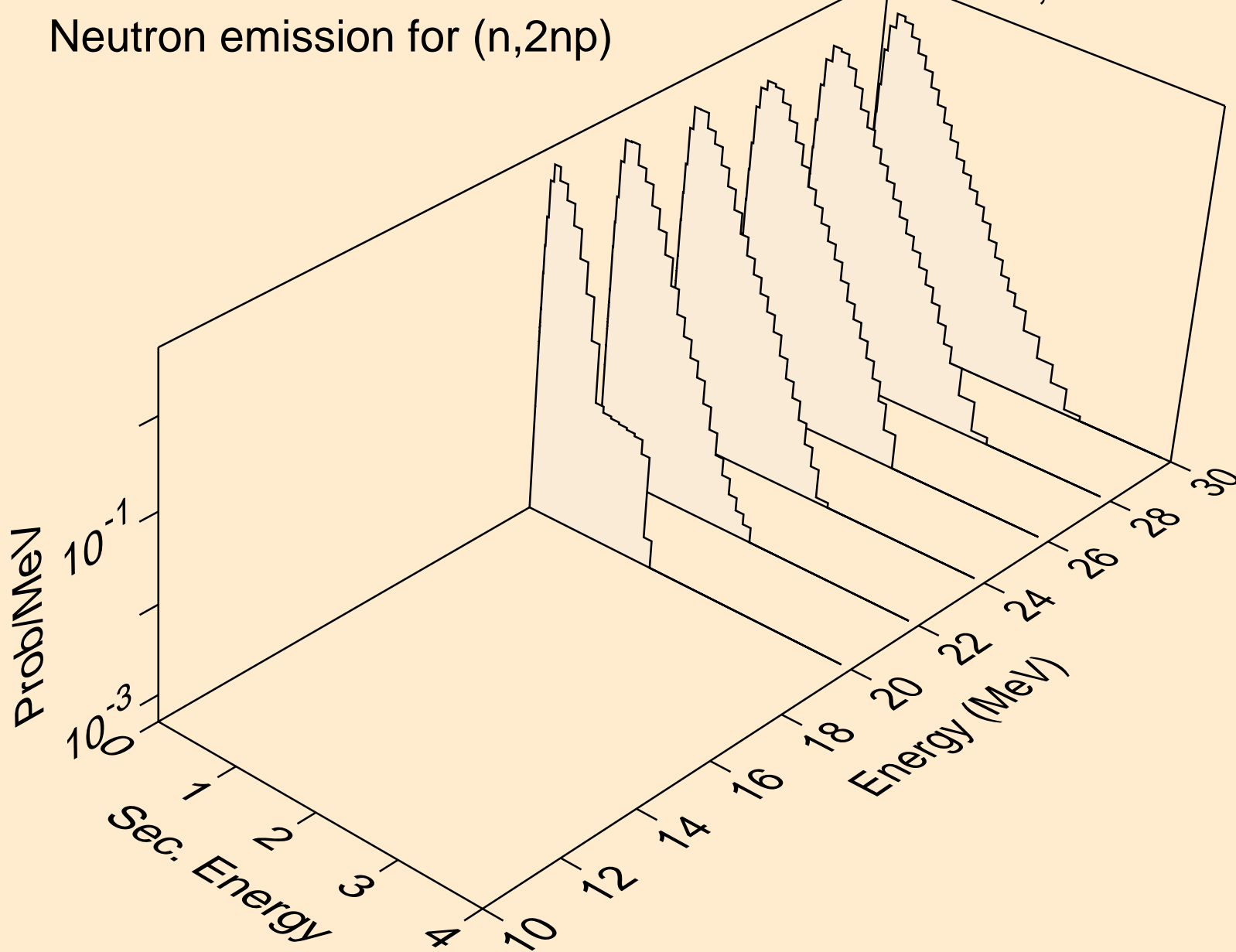

MD258 NEUTRON ACER TENDL-2019 LIBRARY; T=293.16K  
Neutron emission for (n,npa)

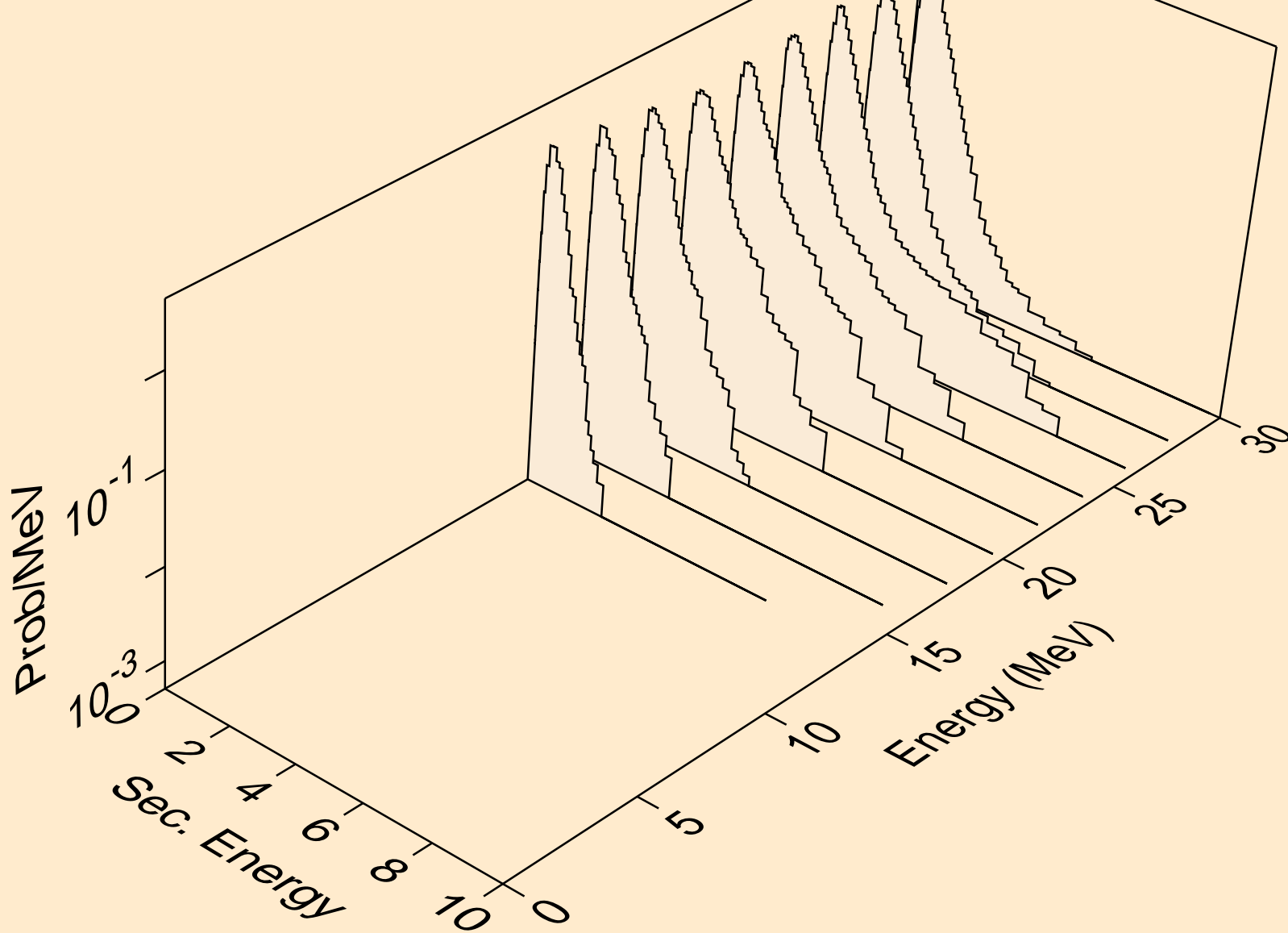

MD258 NEUTRON ACER TENDL-2019 LIBRARY; T=293.16K  
Neutron emission for (n,n\*c)

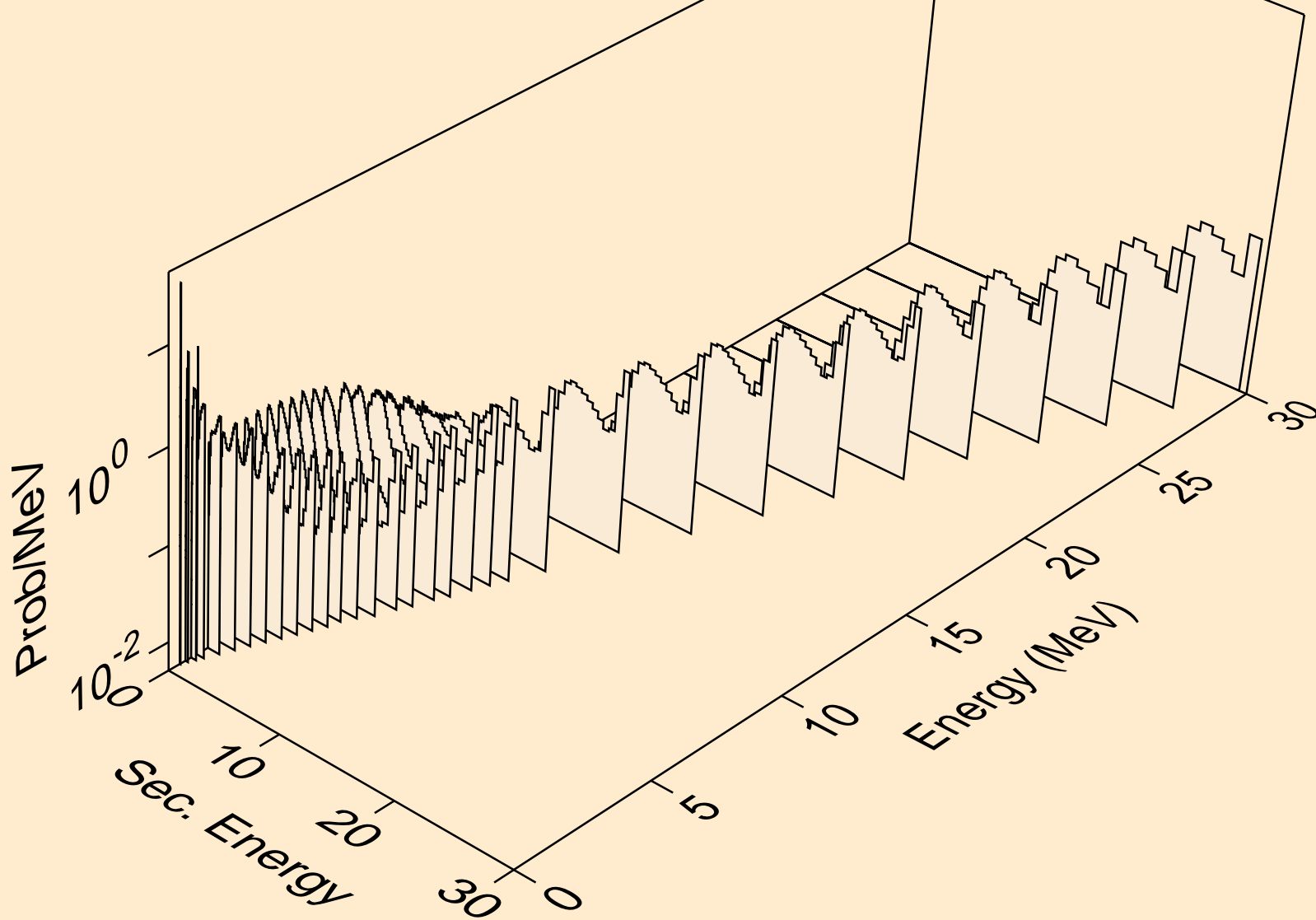

MD258 NEUTRON ACER TENDL-2019 LIBRARY; T=293.16K

Delayed nubar

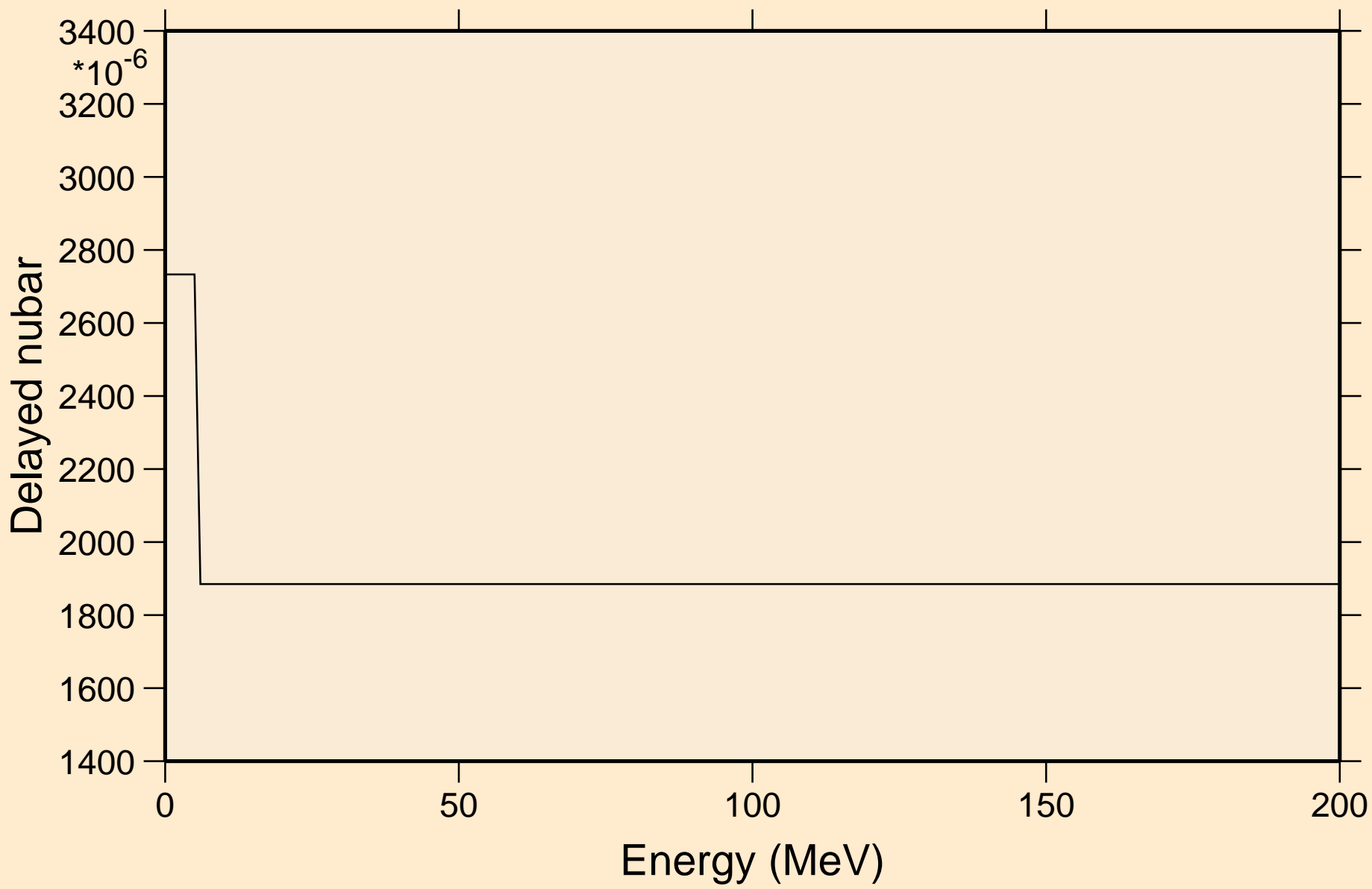

# MD258 NEUTRON ACER TENDL-2019 LIBRARY; T=293.16K

## Delayed neutron spectra

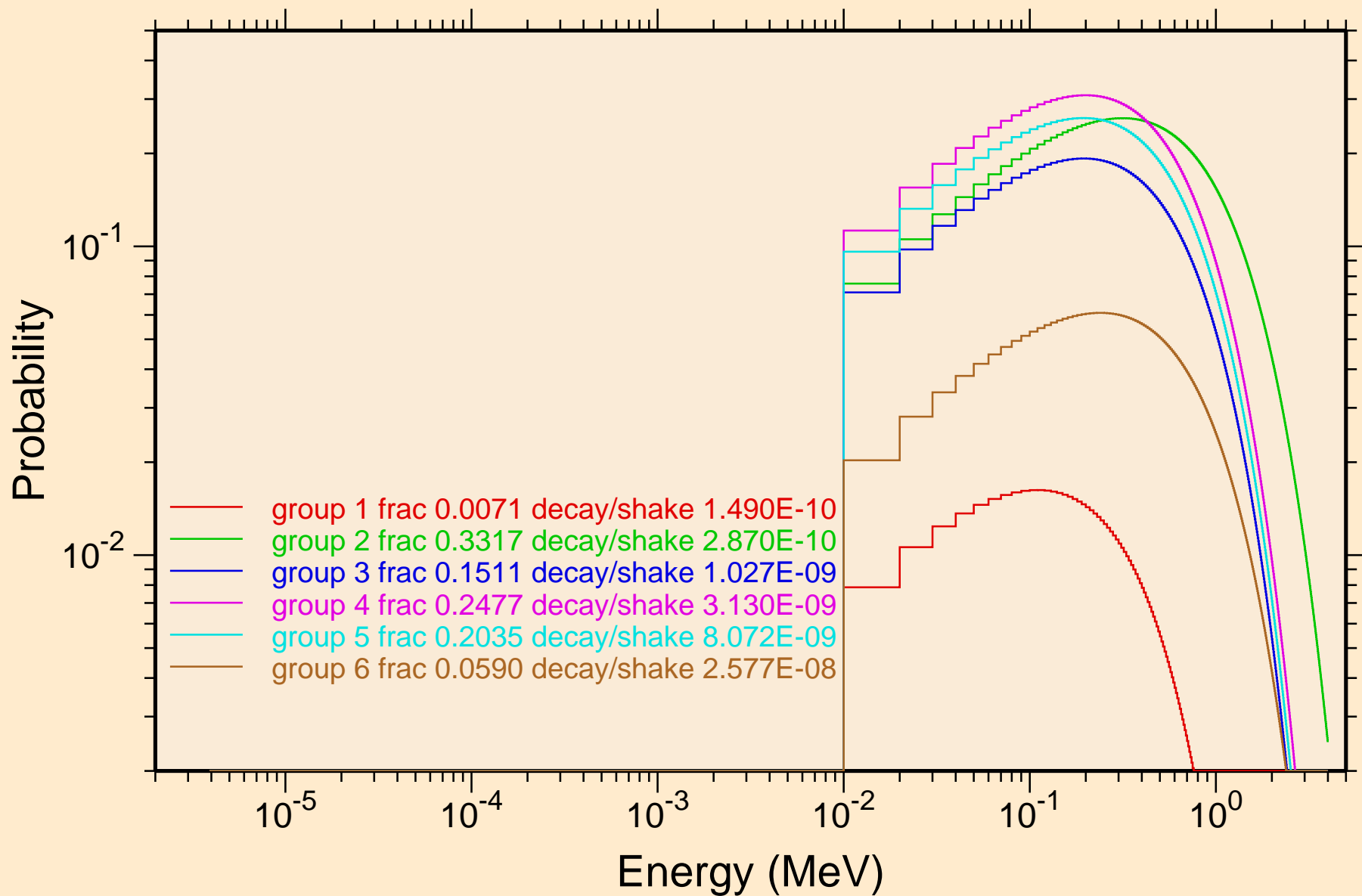



MD258 NEUTRON ACER TENDL-2019 LIBRARY; T=293.16K  
Photon emission for (n,x)

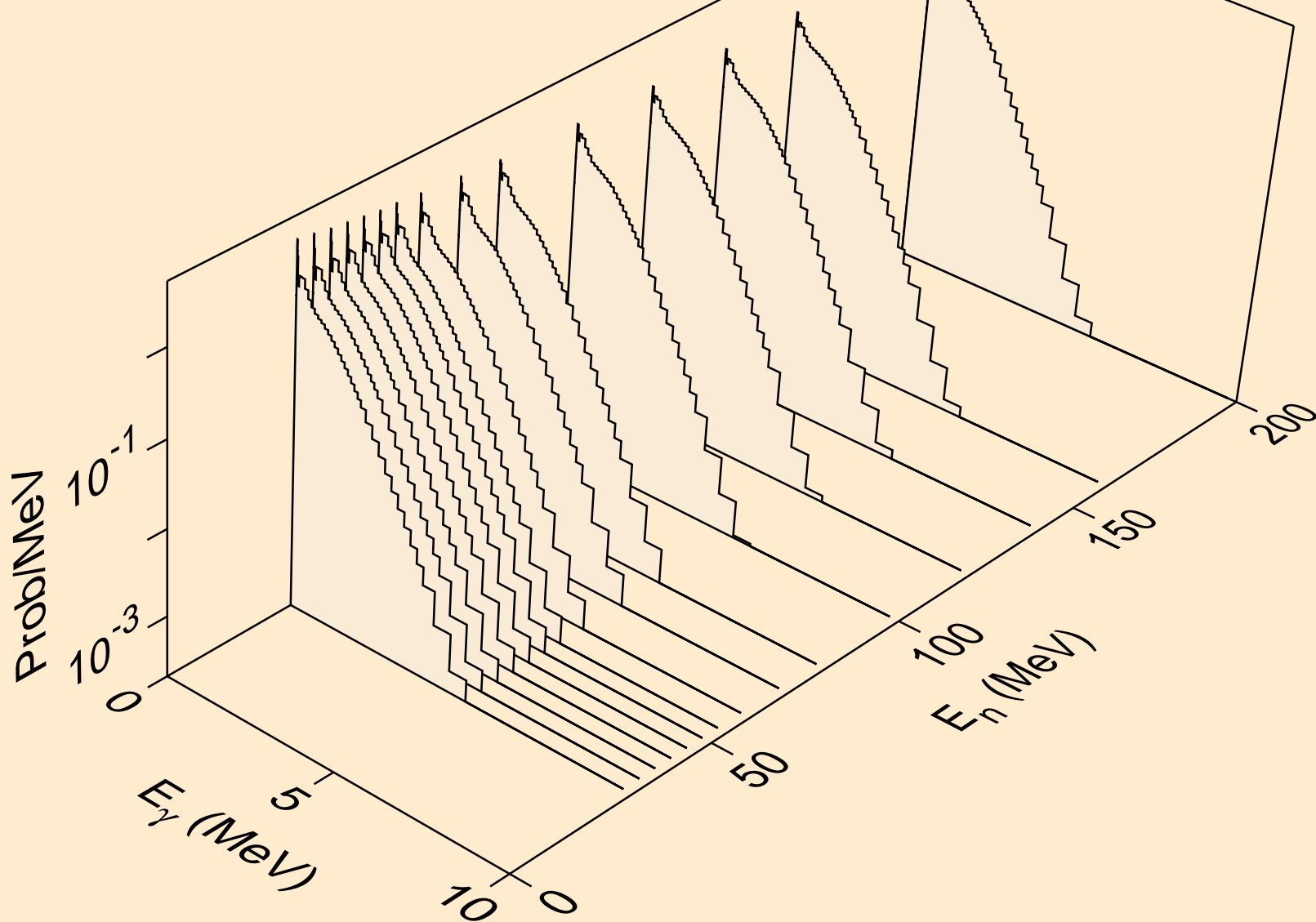

MD258 NEUTRON ACER TENDL-2019 LIBRARY; T=293.16K  
Photon emission for (n,2nd)

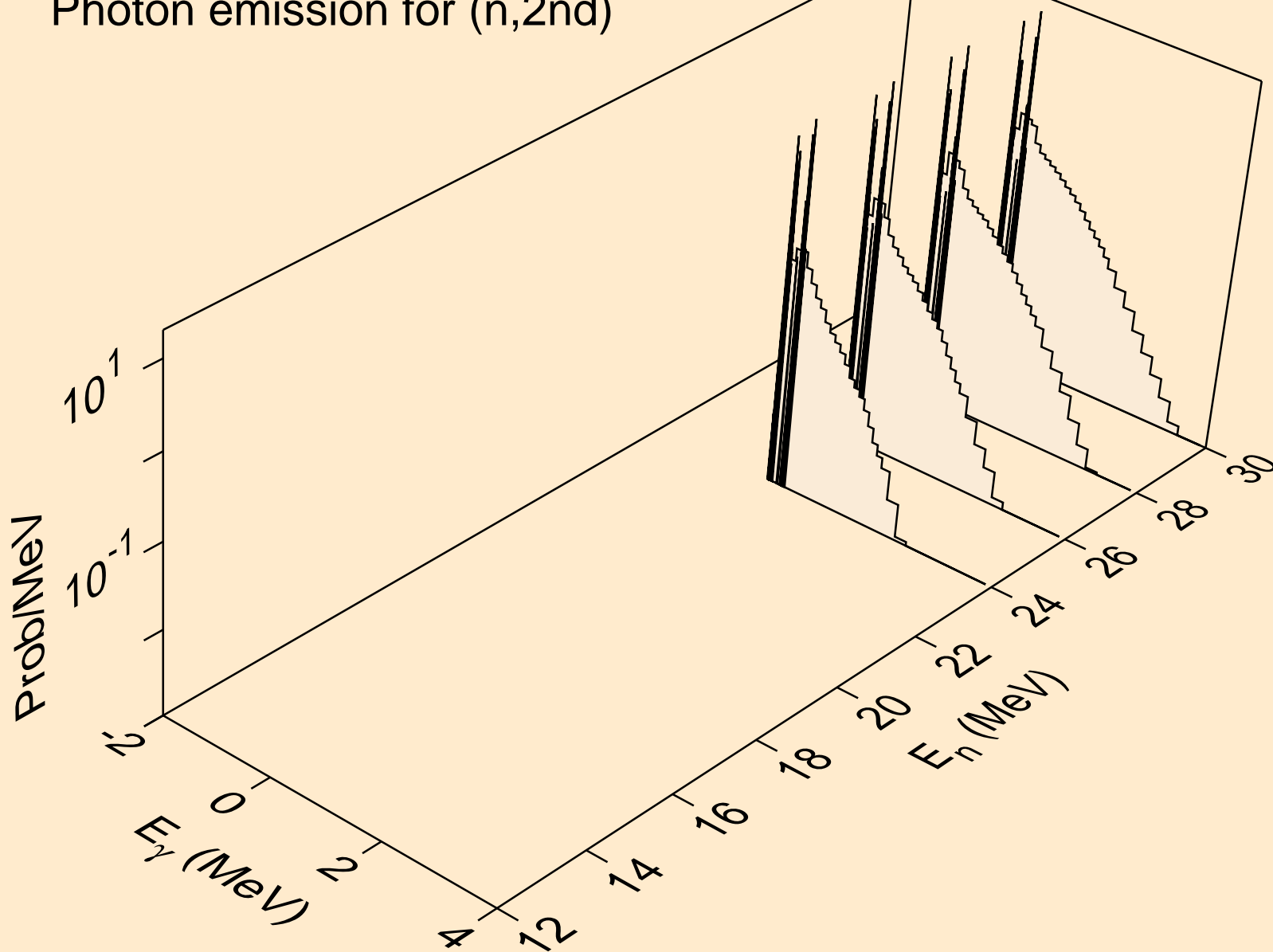

MD258 NEUTRON ACER TENDL-2019 LIBRARY; T=293.16K  
Photon emission for (n,2n)

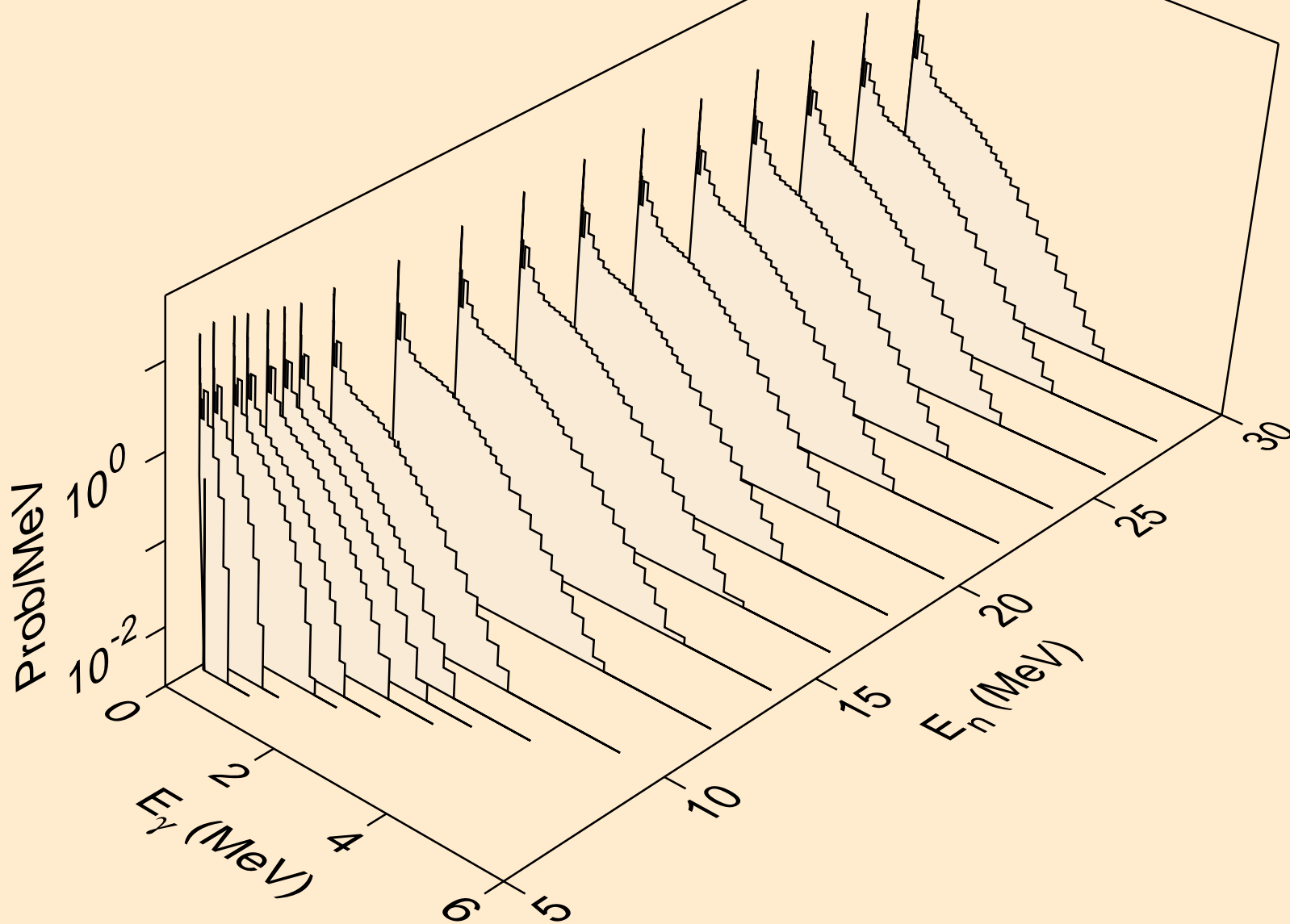

MD258 NEUTRON ACER TENDL-2019 LIBRARY; T=293.16K  
Photon emission for (n,3n)

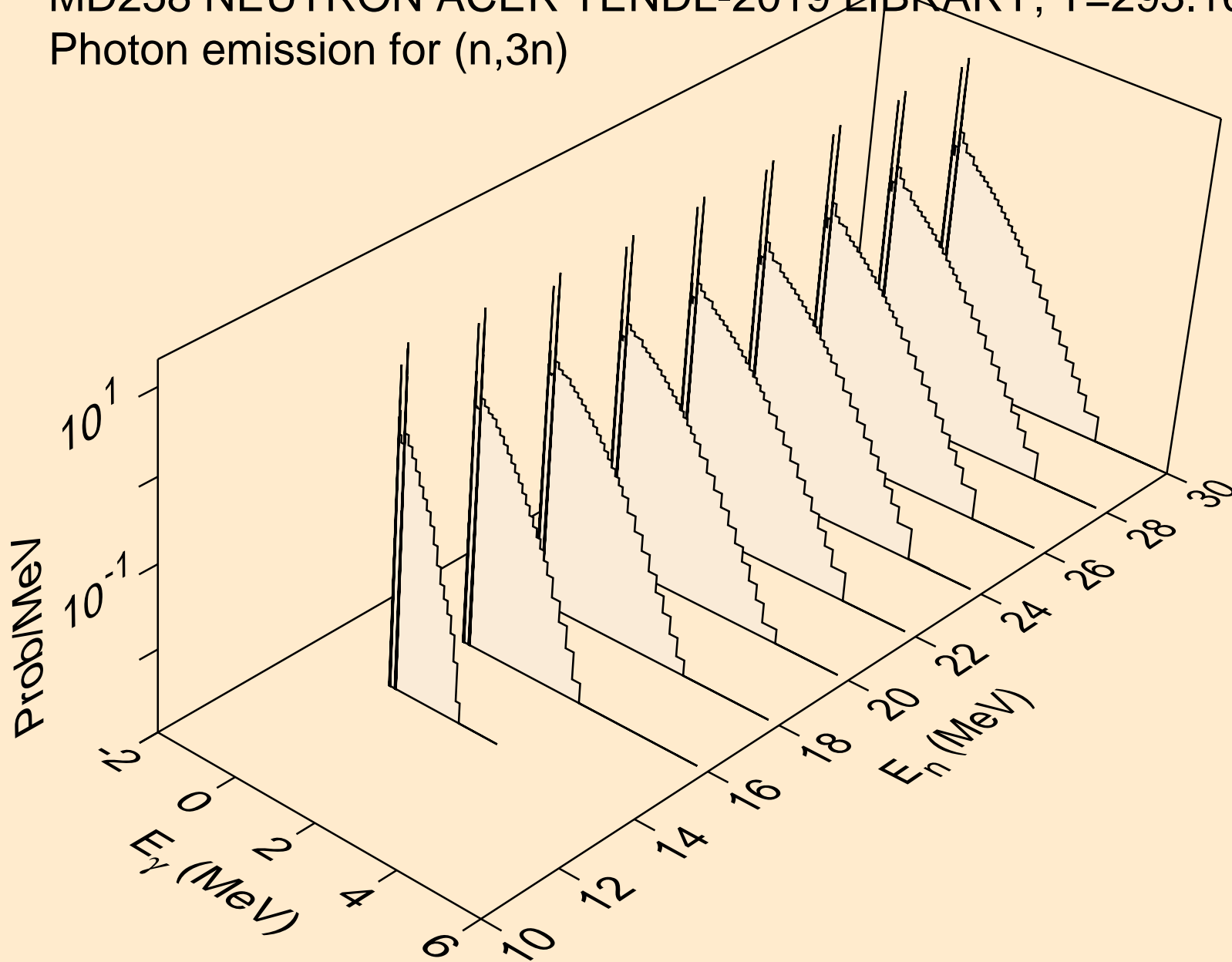

MD258 NEUTRON ACER TENDL-2019 LIBRARY; T=293.16K  
Photon emission for (n,n\*)a

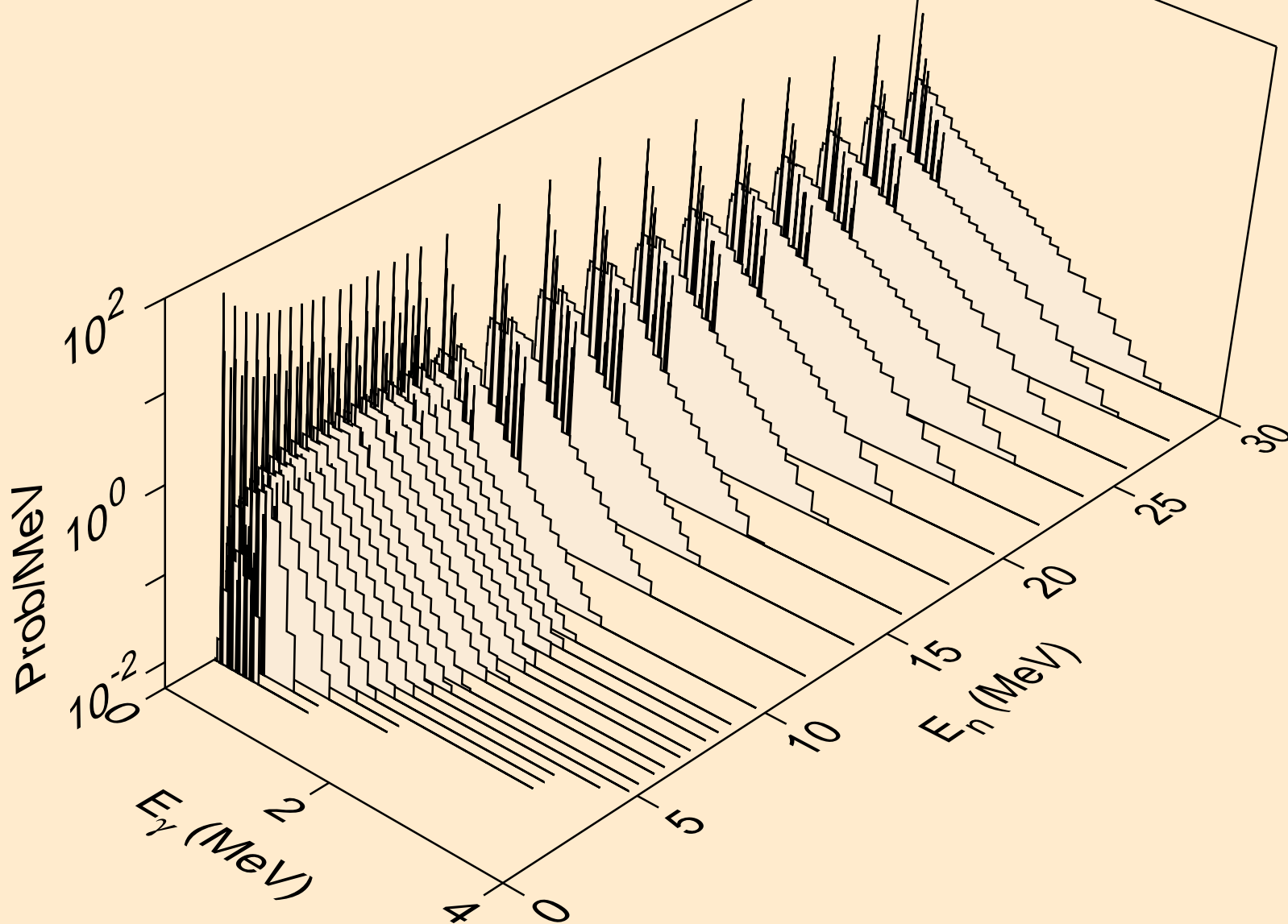

MD258 NEUTRON ACER TENDL-2019 LIBRARY; T=293.16K  
Photon emission for (n,2n)a

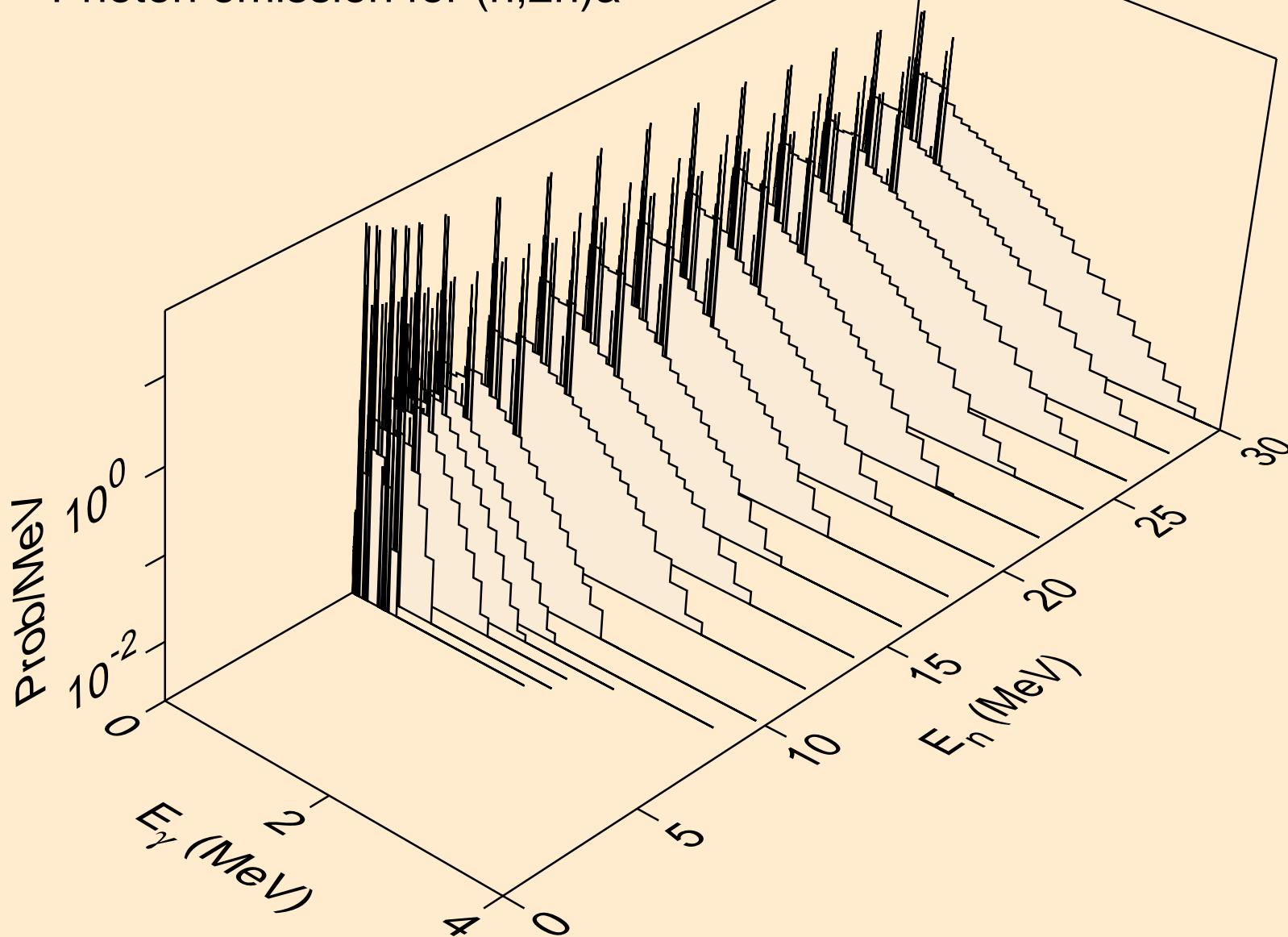

MD258 NEUTRON ACER TENDL-2019 LIBRARY; T=293.16K  
Photon emission for (n,3n)a

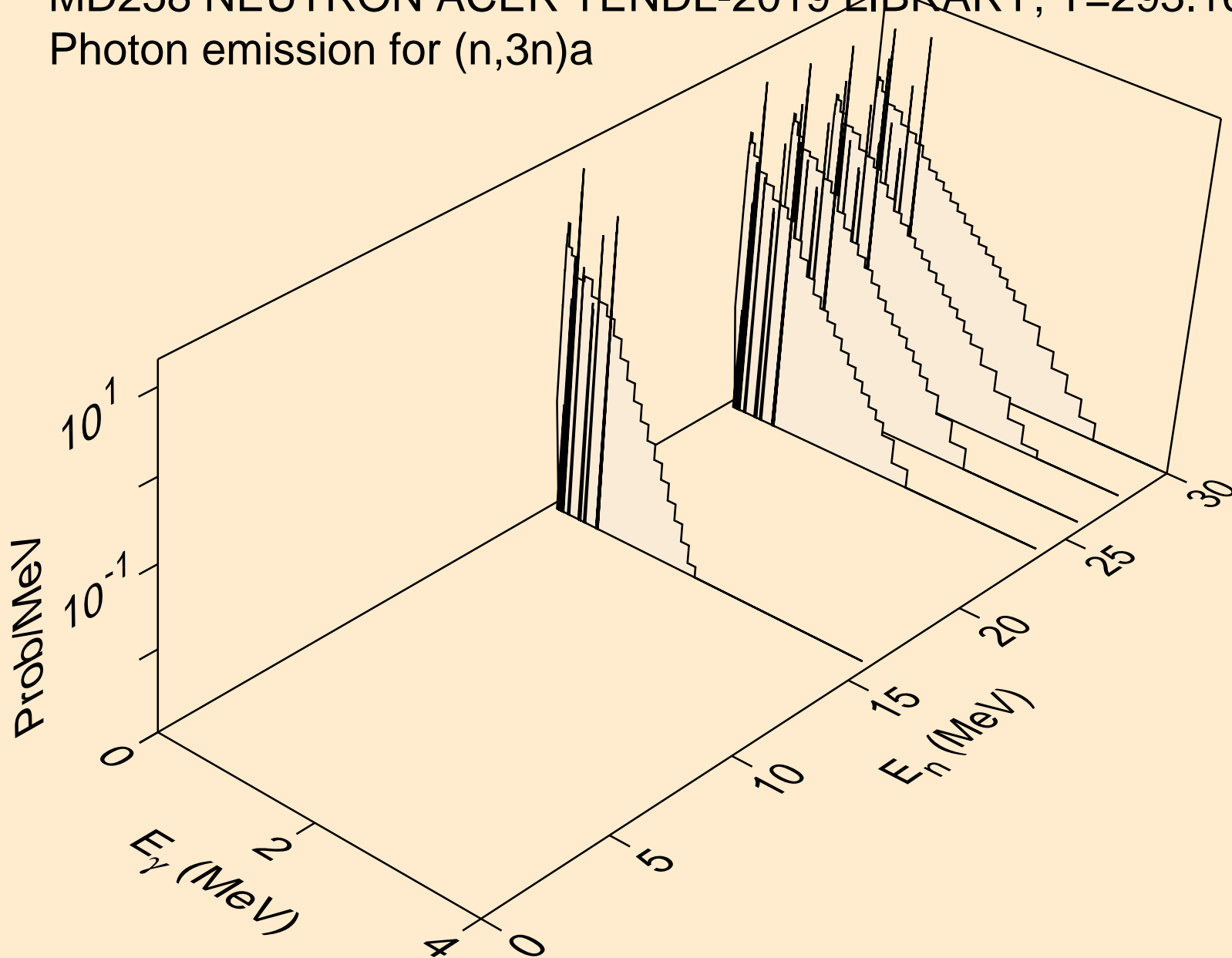

MD258 NEUTRON ACER TENDL-2019 LIBRARY; T=293.16K  
Photon emission for (n,n\*)p

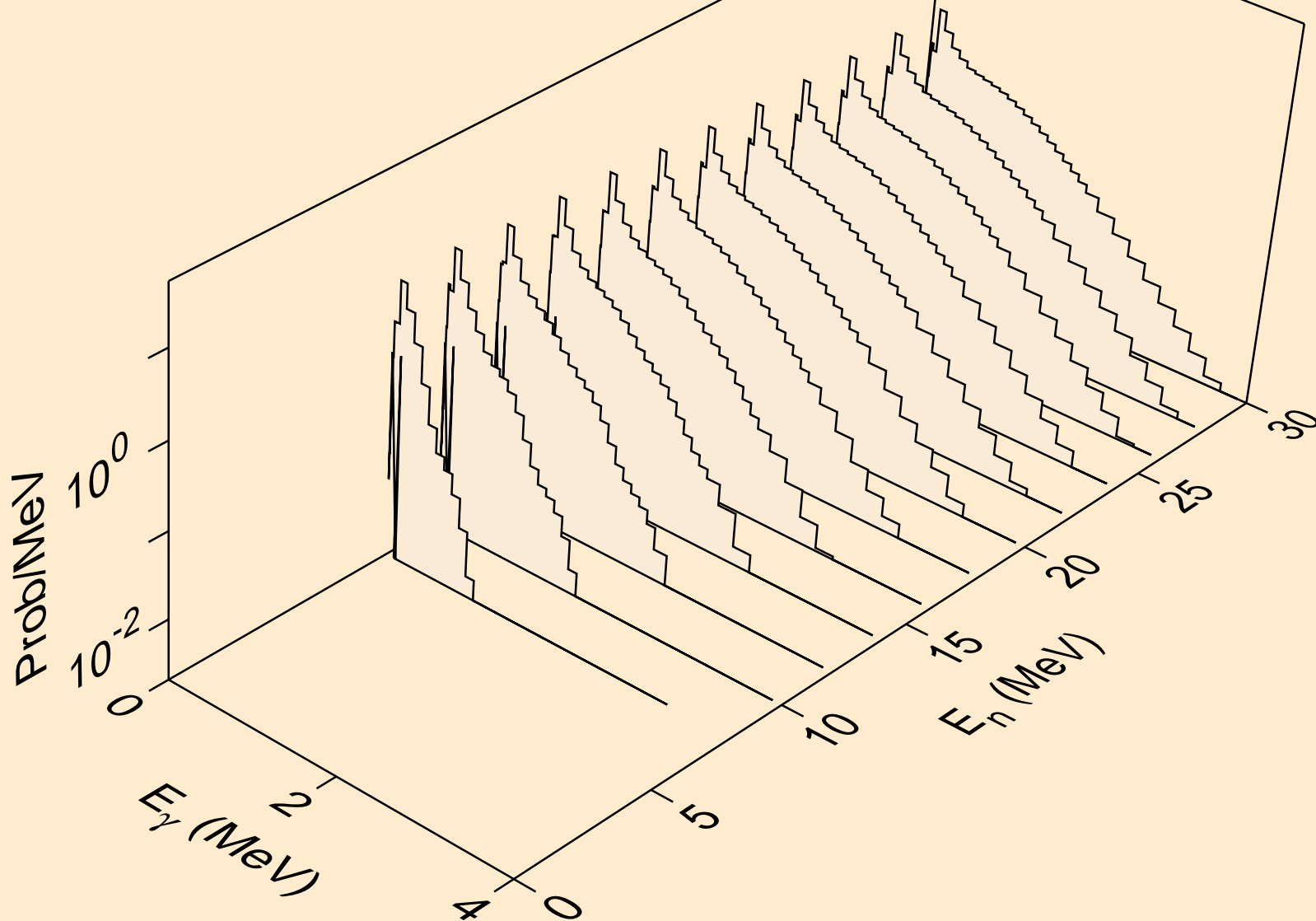



MD258 NEUTRON ACER TENDL-2019 LIBRARY; T=293.16K  
Photon emission for (n,n\*)2a

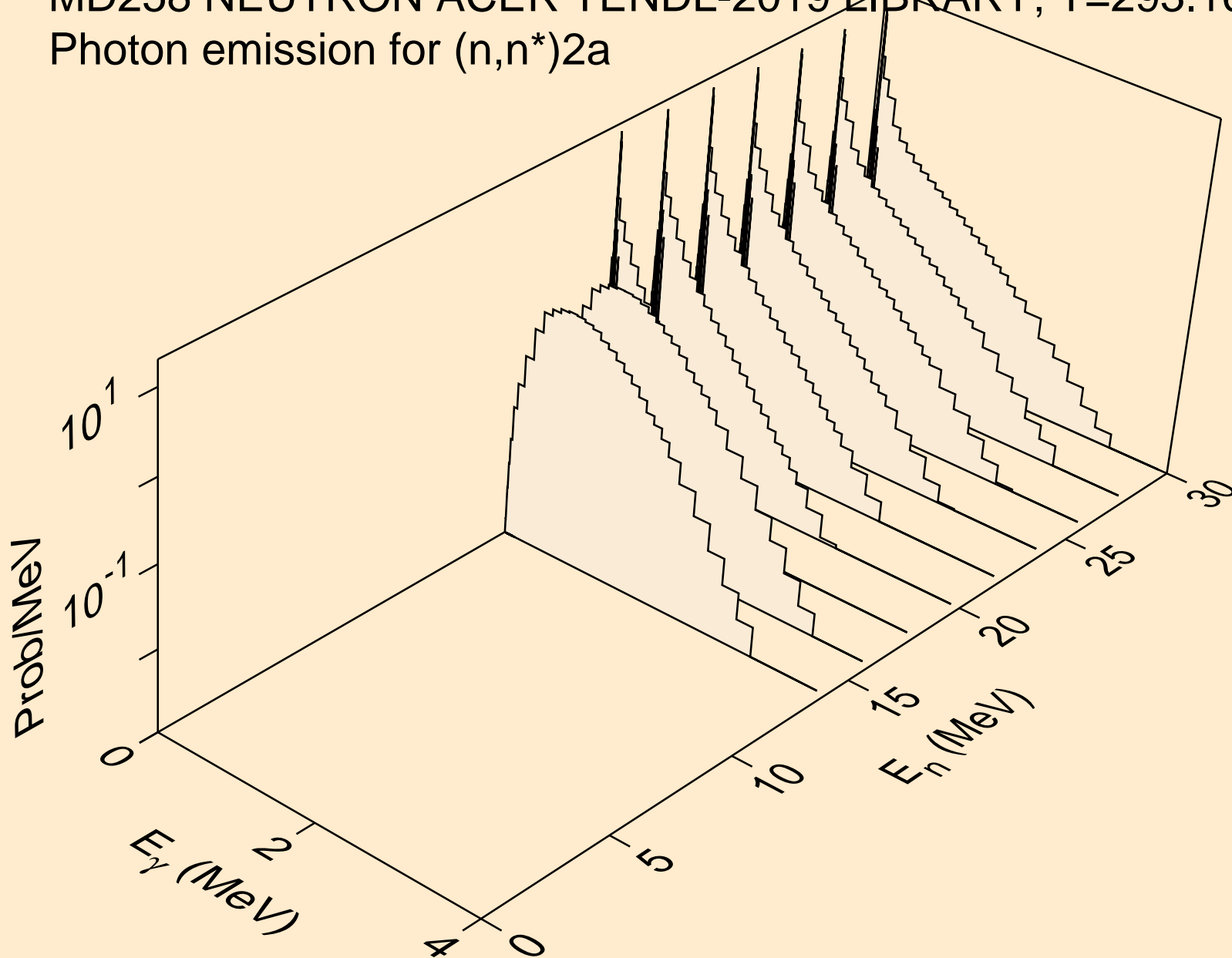

MD258 NEUTRON ACER TENDL-2019 LIBRARY; T=293.16K  
Photon emission for (n,n\*)d

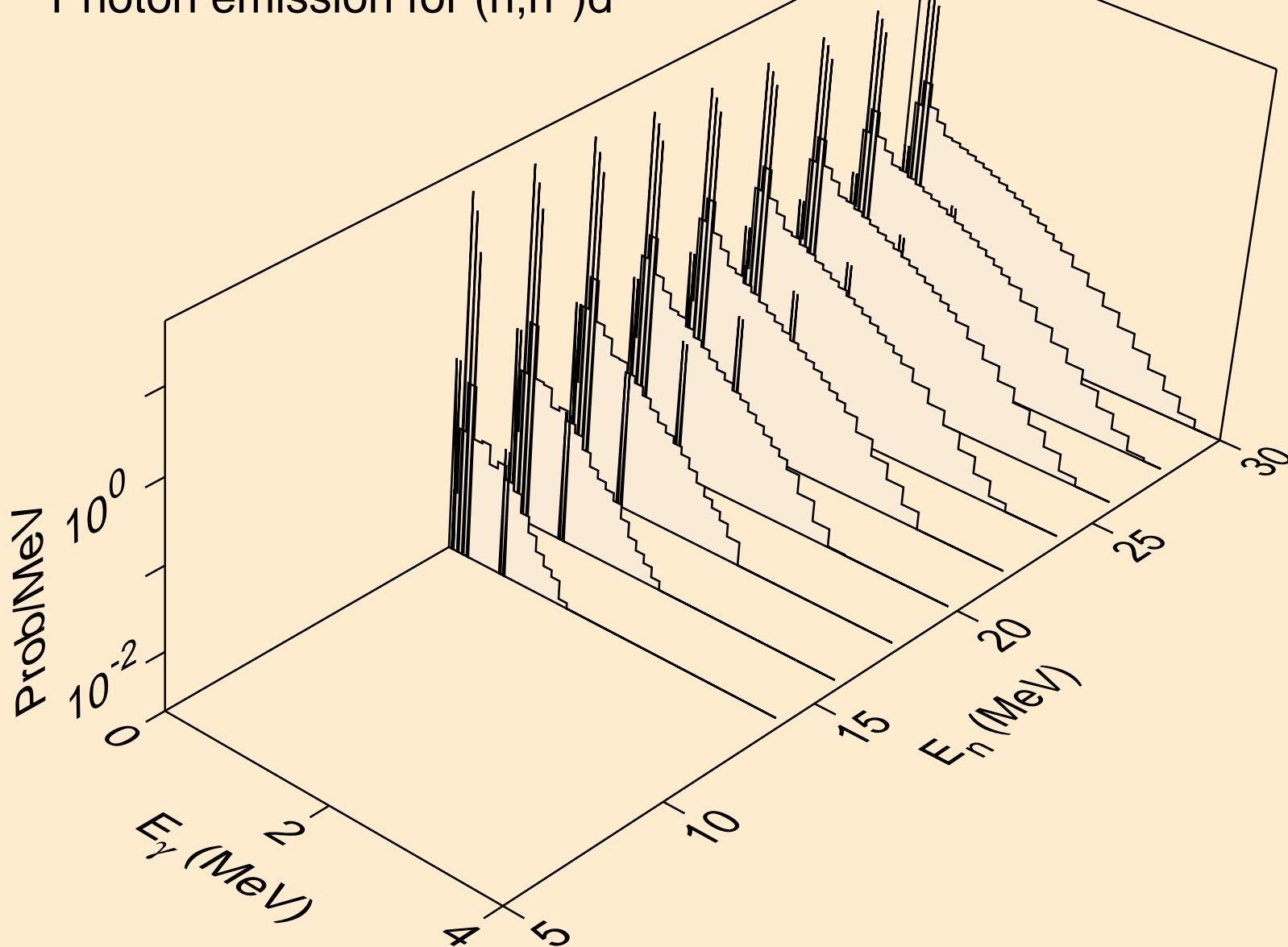

MD258 NEUTRON ACER TENDL-2019 LIBRARY; T=293.16K  
Photon emission for (n,n\*)t

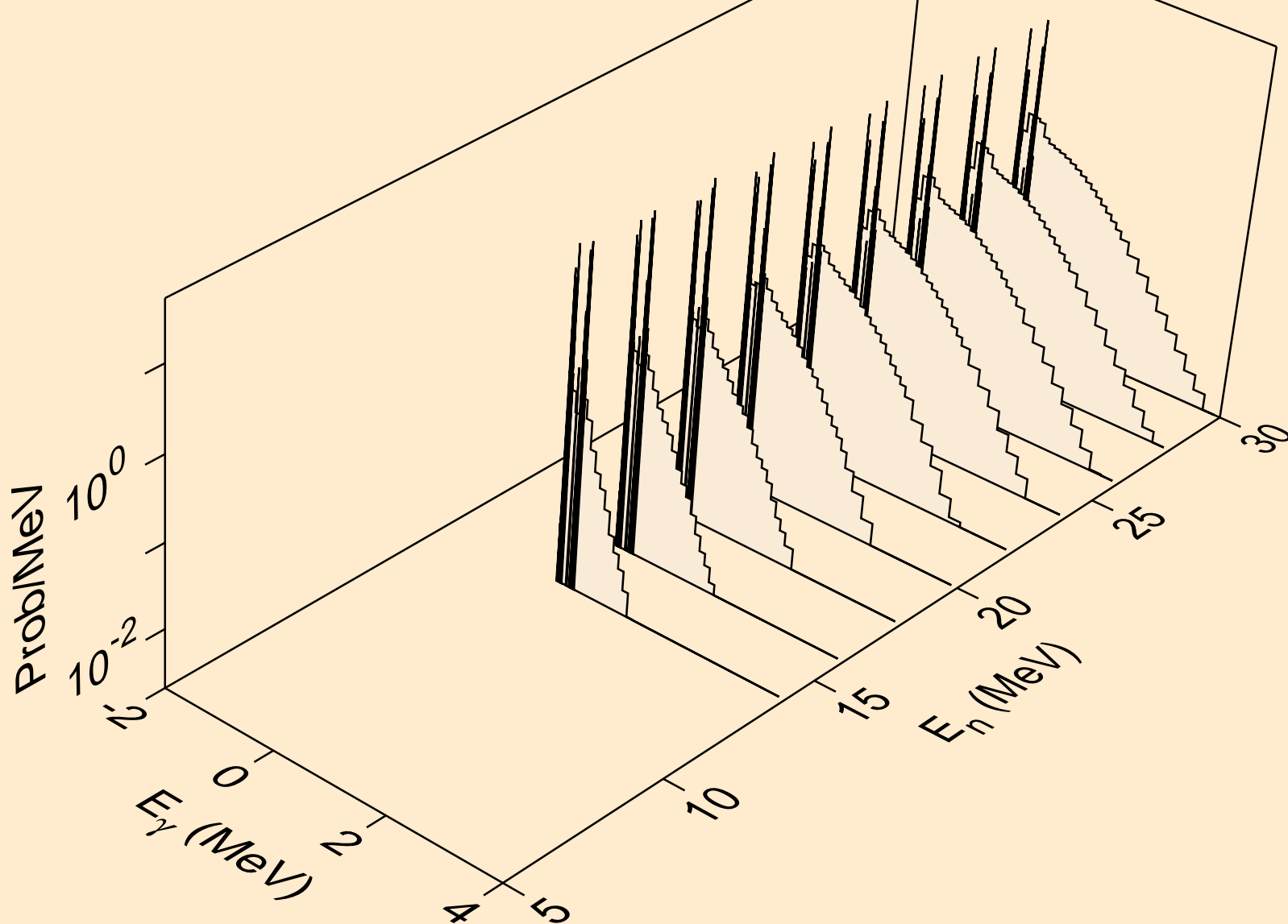

MD258 NEUTRON ACER TENDL-2019 LIBRARY; T=293.16K  
Photon emission for (n,n\*)he3

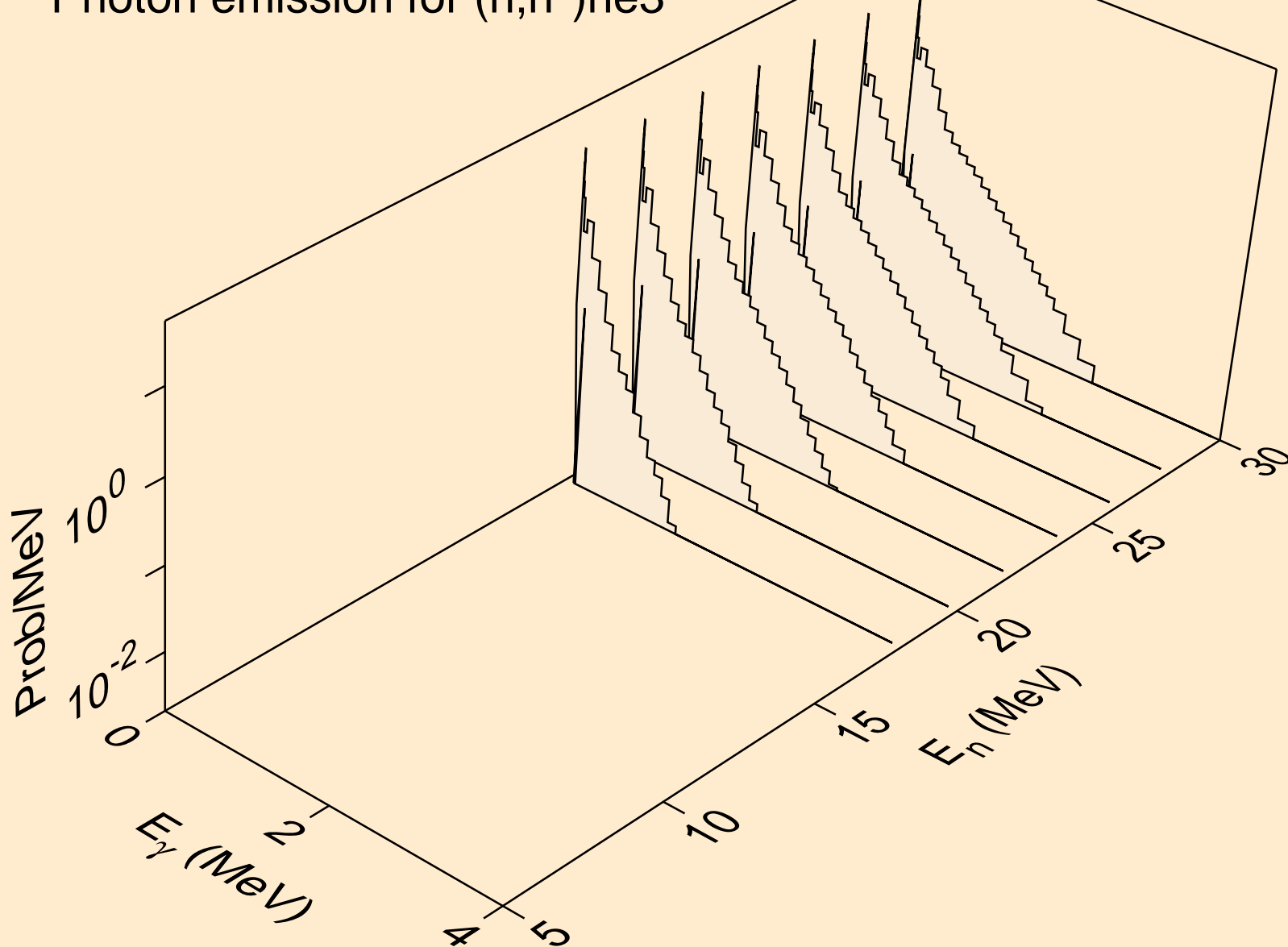

MD258 NEUTRON ACER TENDL-2019 LIBRARY; T=293.16K  
Photon emission for (n,4n)

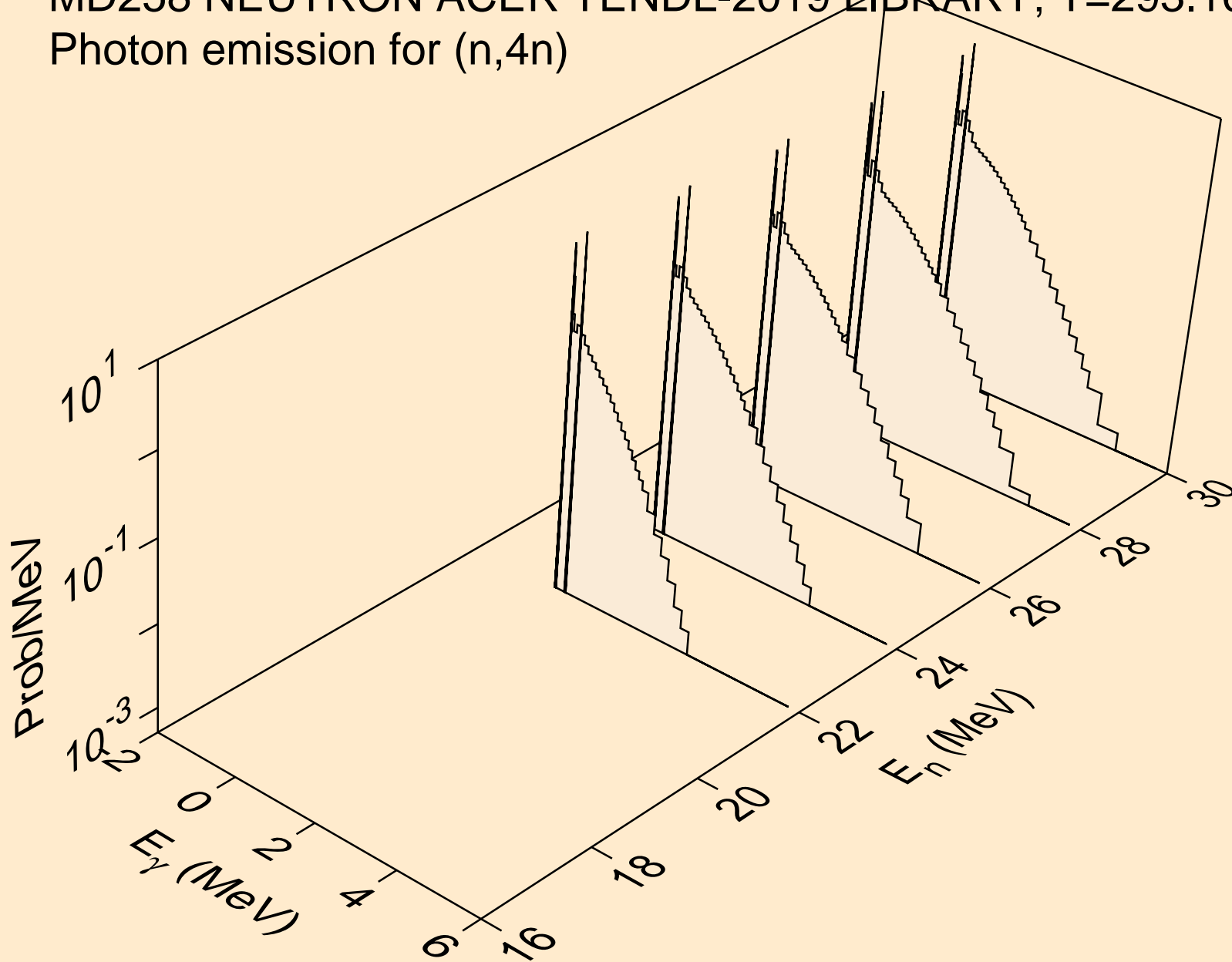

MD258 NEUTRON ACER TENDL-2019 LIBRARY; T=293.16K  
Photon emission for (n,2np)

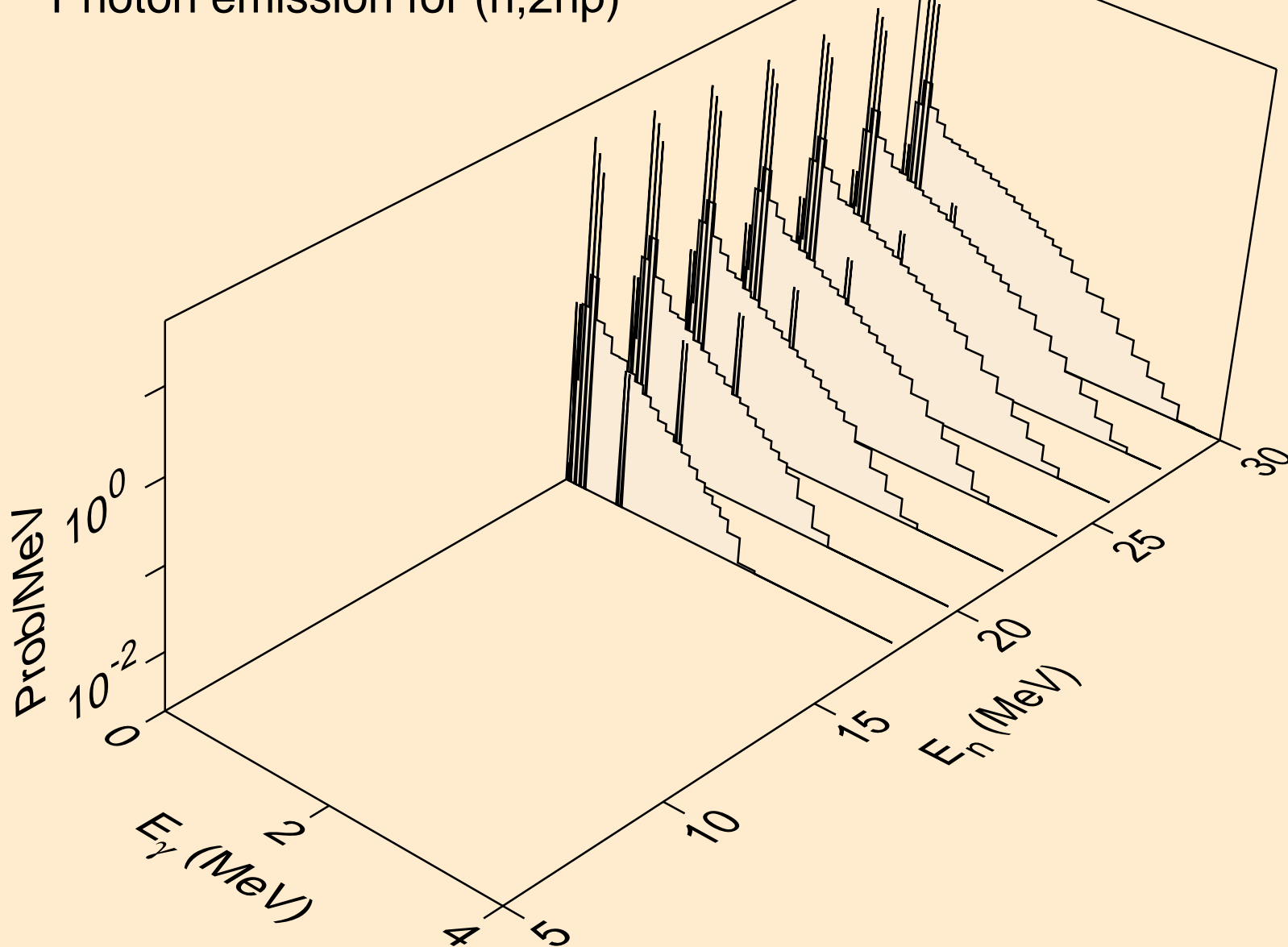

MD258 NEUTRON ACER TENDL-2019 LIBRARY; T=293.16K  
Photon emission for (n,3np)

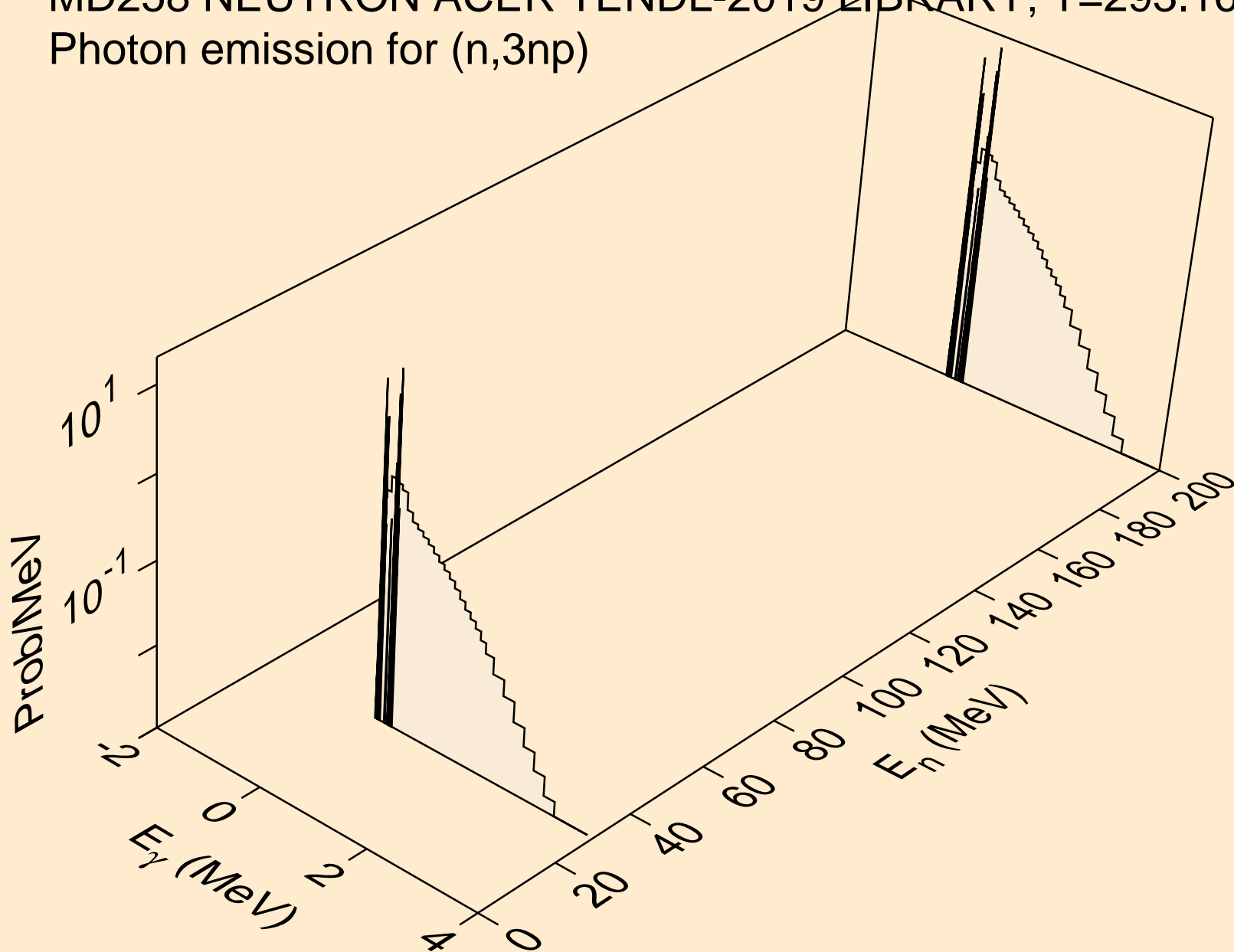

MD258 NEUTRON ACER TENDL-2019 LIBRARY; T=293.16K  
Photon emission for (n,2np)

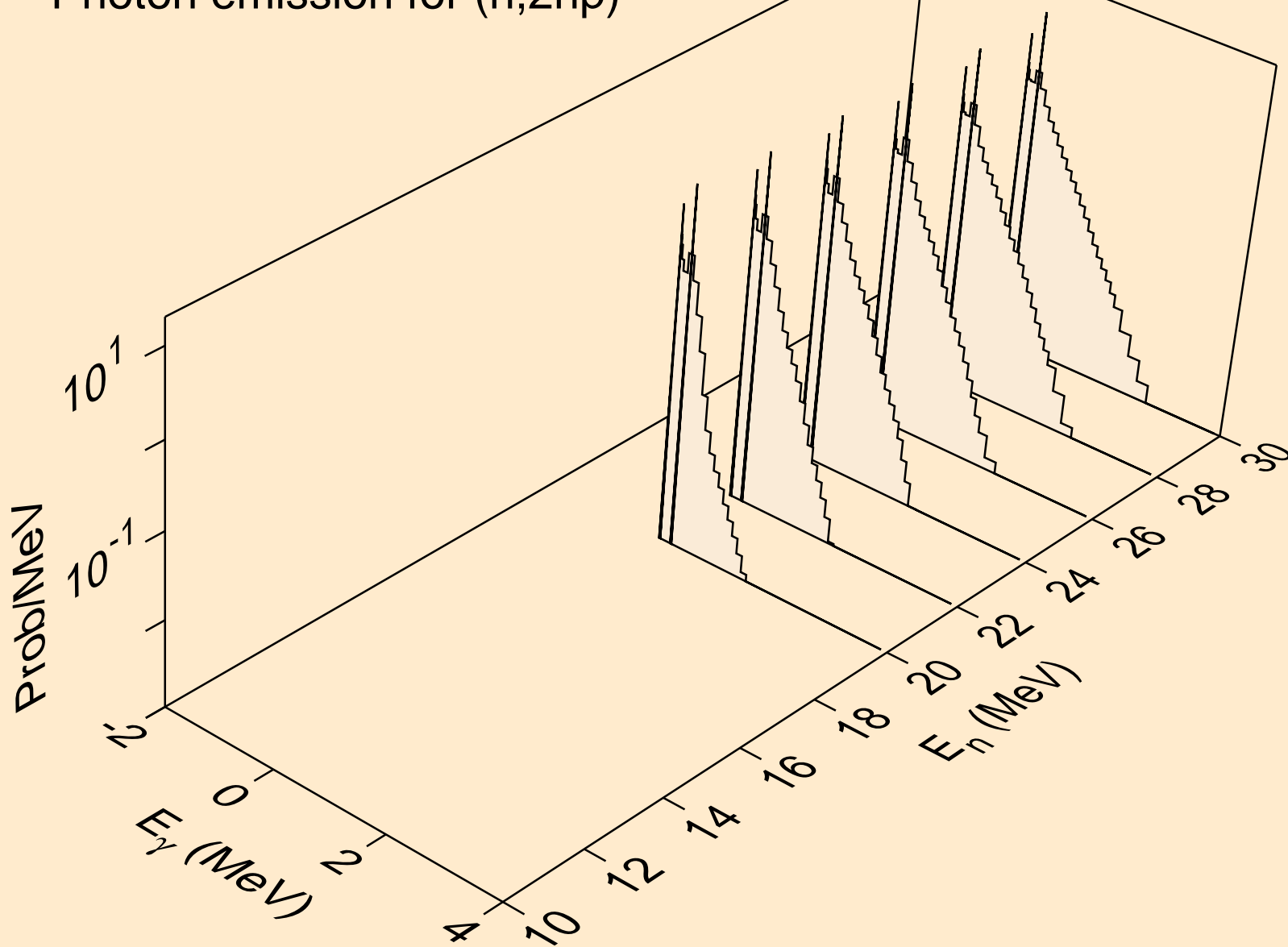



MD258 NEUTRON ACER TENDL-2019 LIBRARY; T=293.16K  
Photon emission for (n,npa)

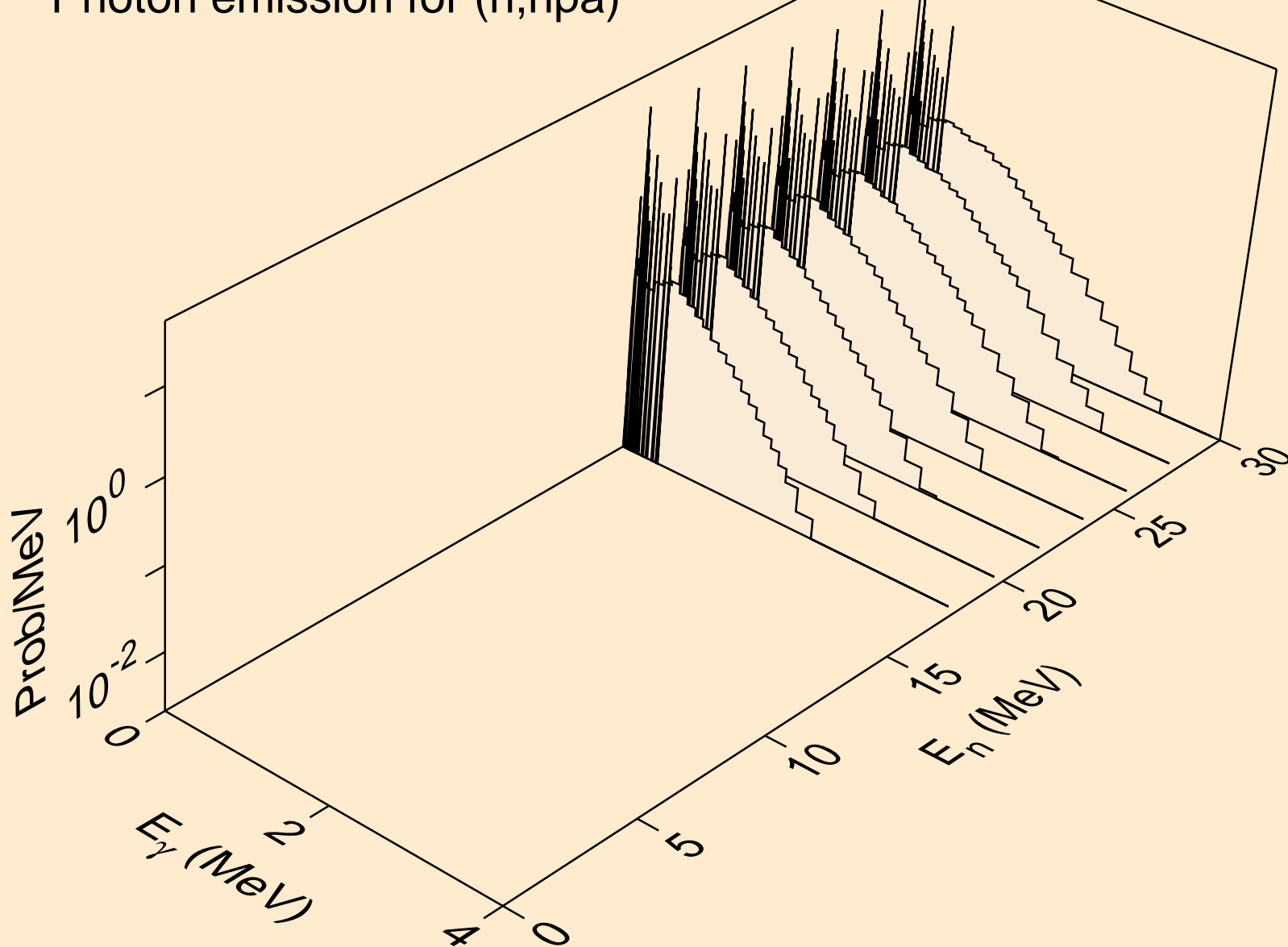

MD258 NEUTRON ACER TENDL-2019 LIBRARY; T=293.16K  
Photon emission for (n,n\*c)

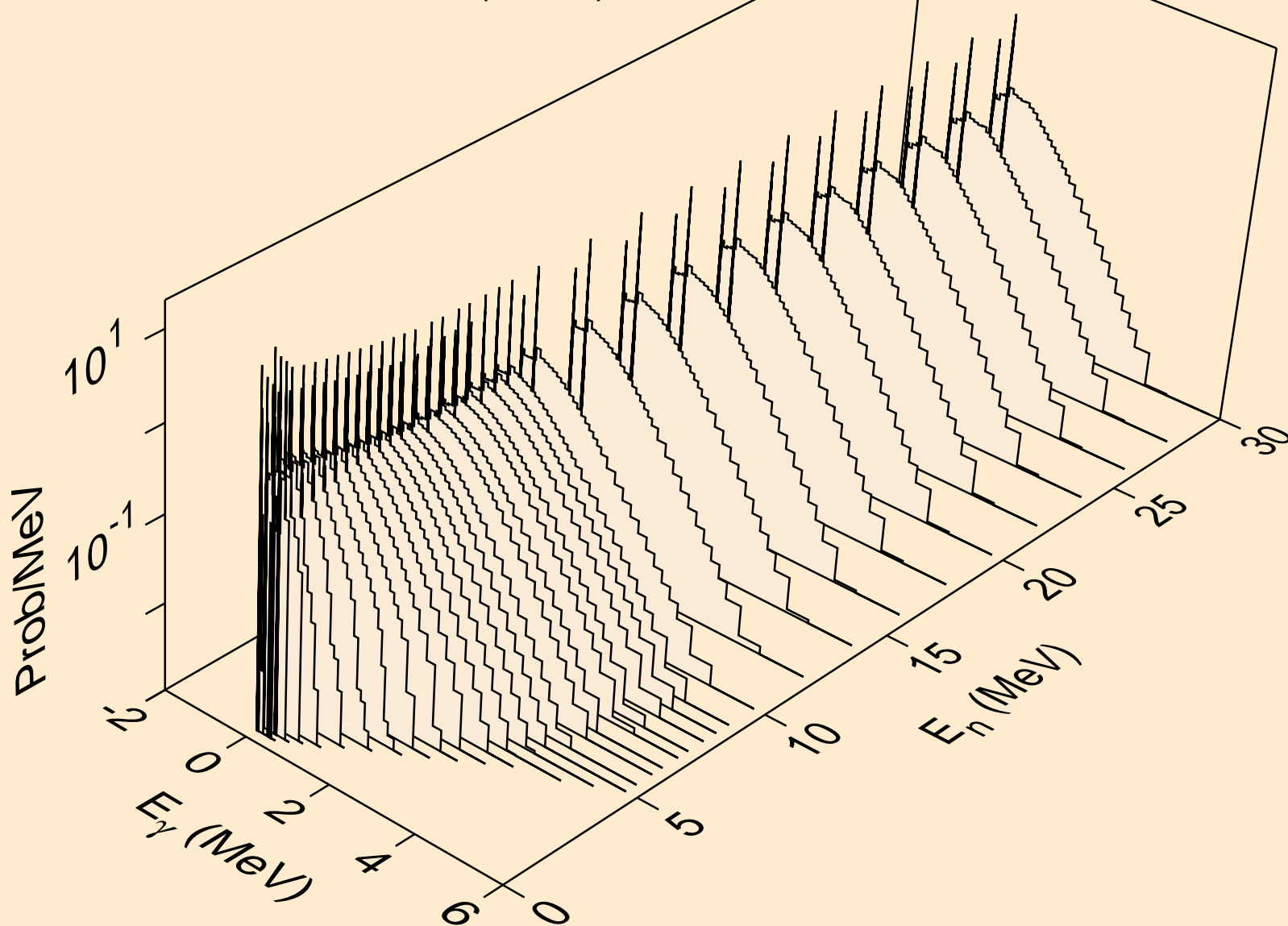

MD258 NEUTRON ACER TENDL-2019 LIBRARY; T=293.16K  
Photon emission for (n,gma)

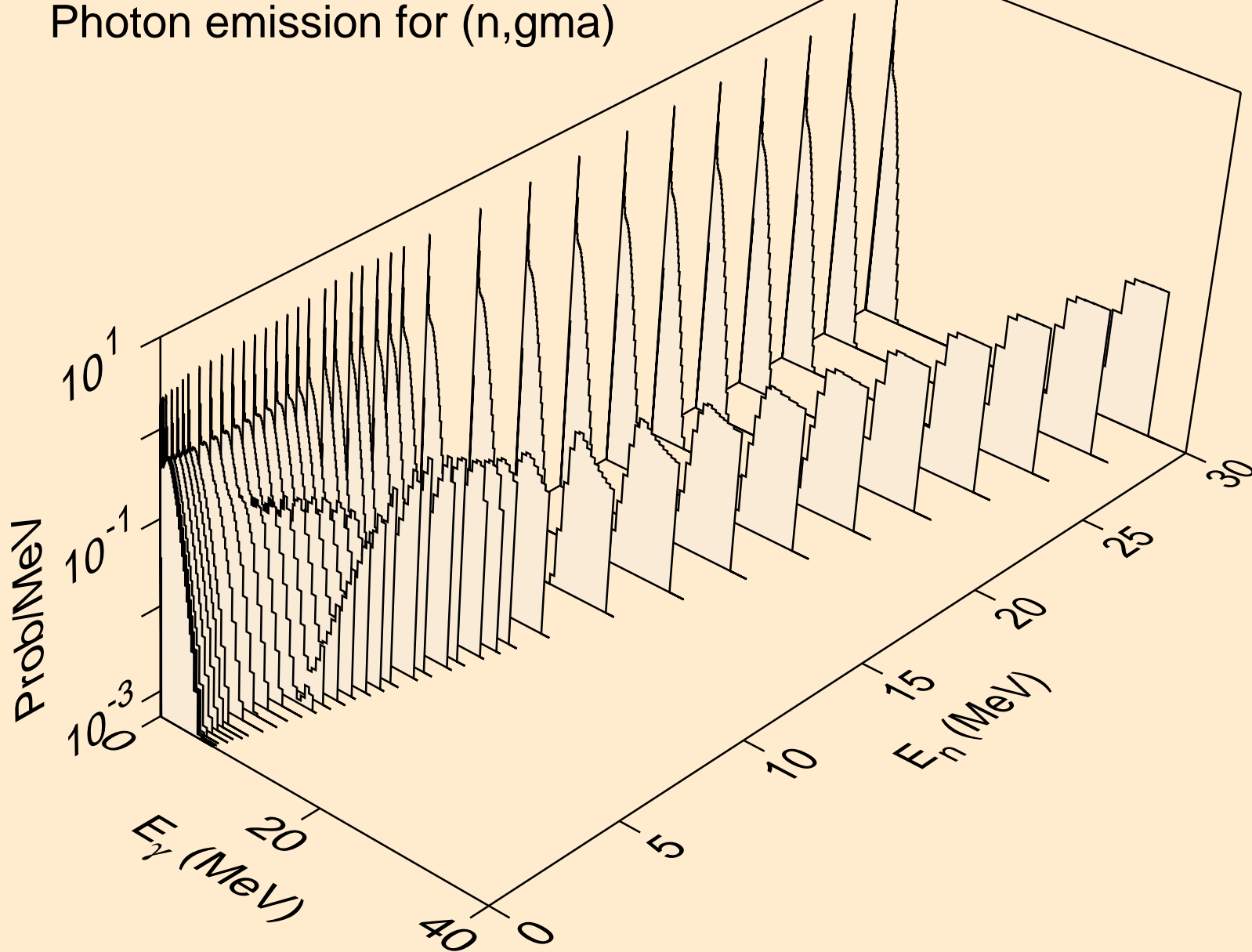

MD258 NEUTRON ACER TENDL-2019 LIBRARY; T=293.16K  
Photon emission for (n,p)

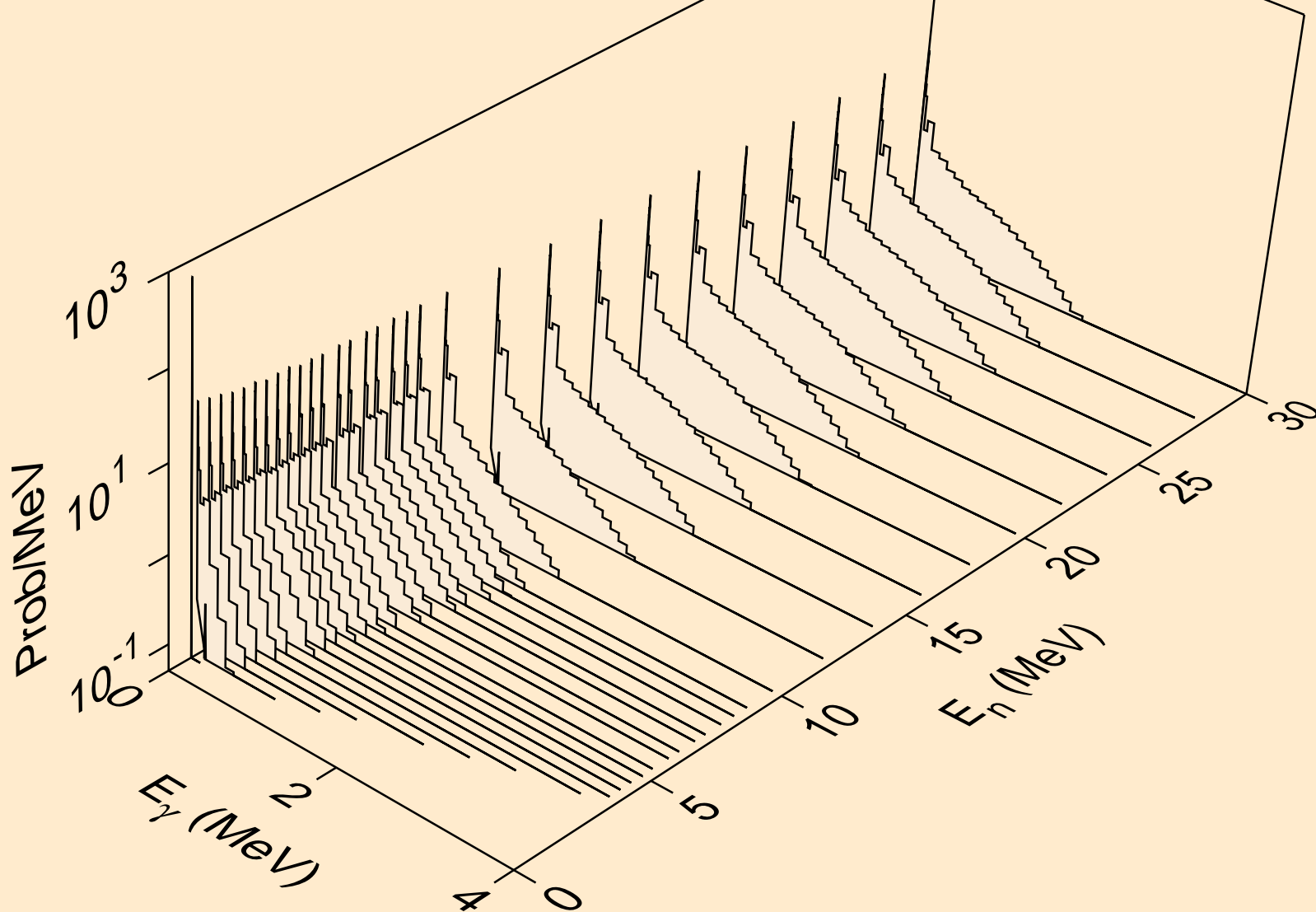

MD258 NEUTRON ACER TENDL-2019 LIBRARY; T=293.16K  
Photon emission for (n,d)

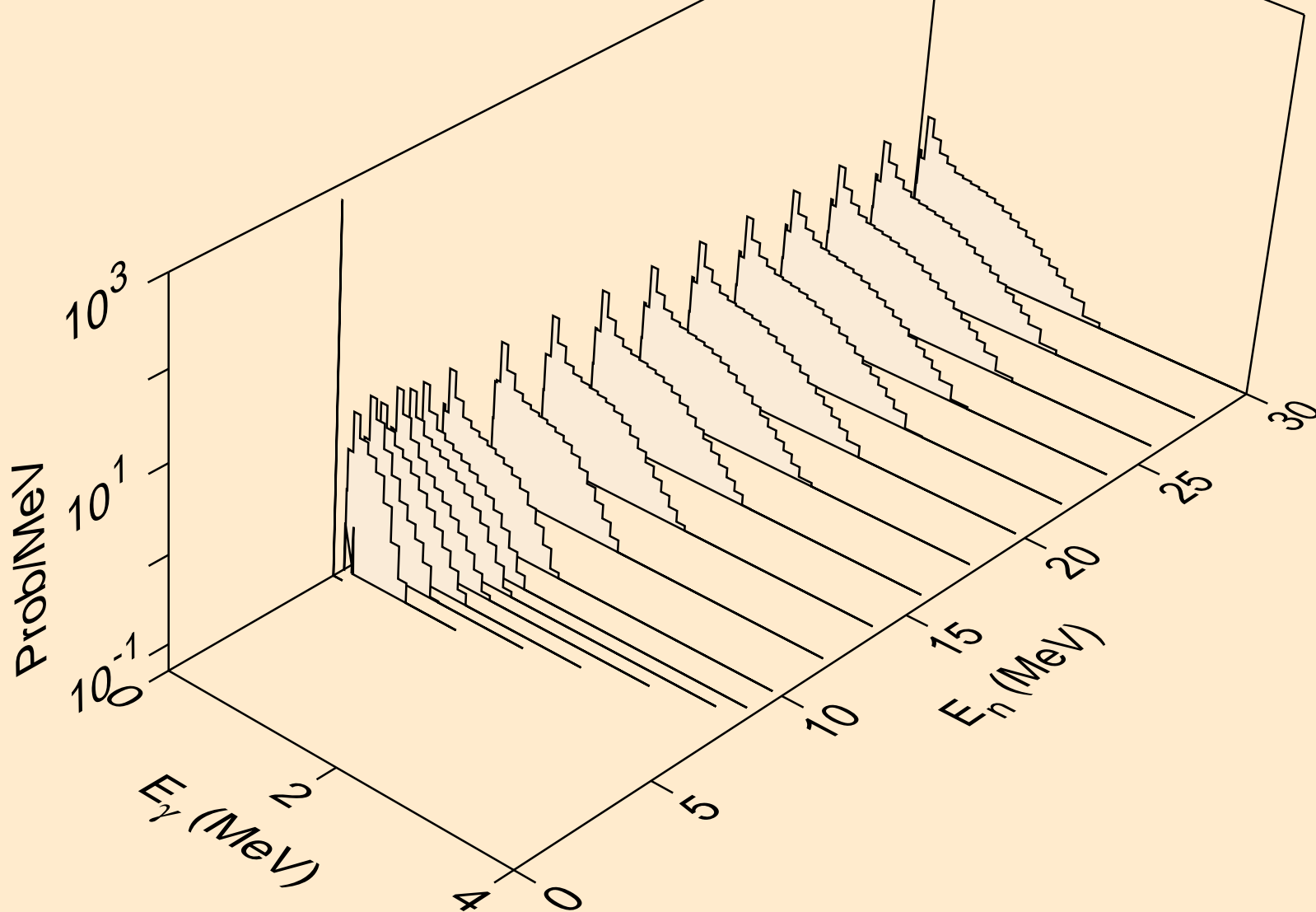

MD258 NEUTRON ACER TENDL-2019 LIBRARY; T=293.16K  
Photon emission for (n,t)

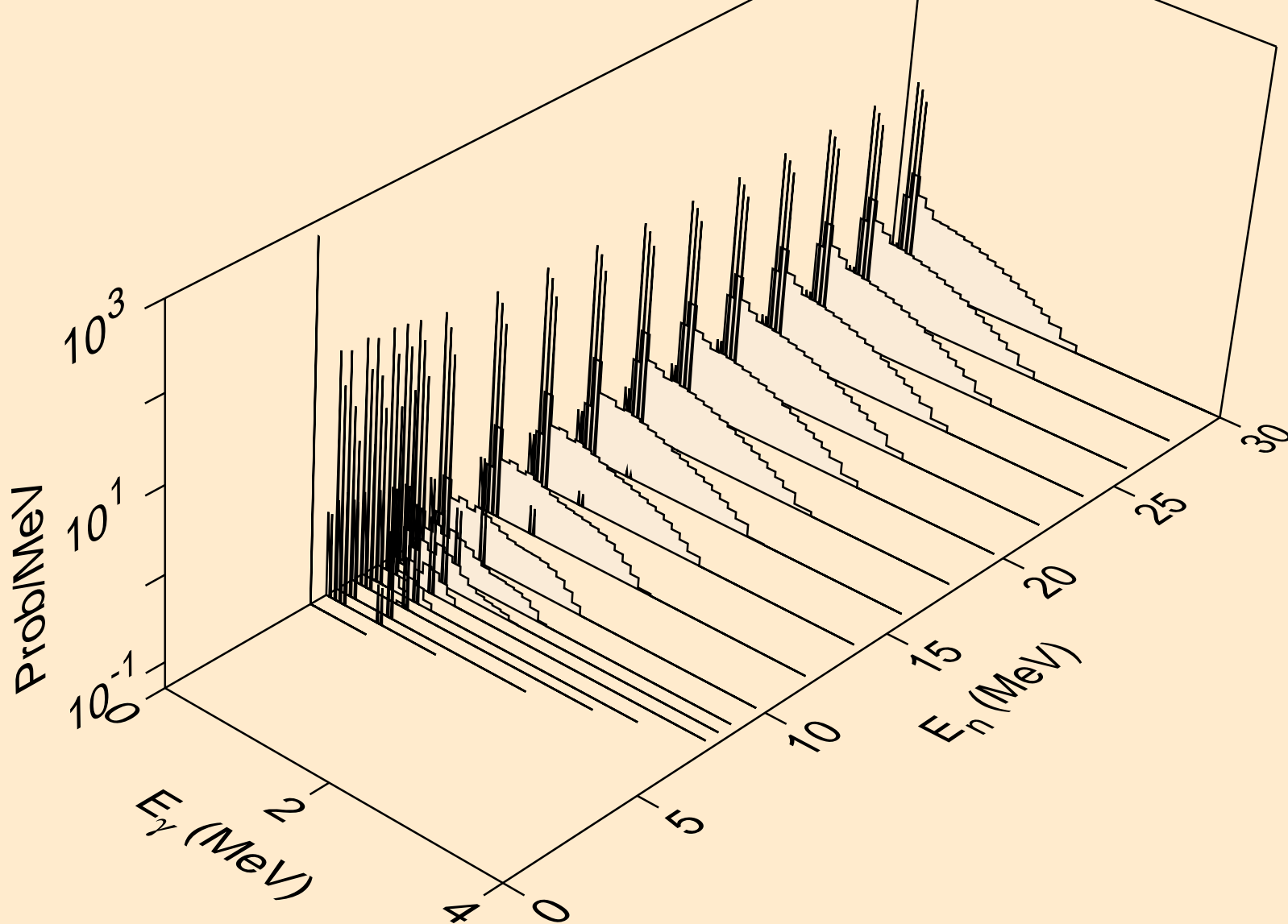

MD258 NEUTRON ACER TENDL-2019 LIBRARY; T=293.16K  
Photon emission for (n,he3)

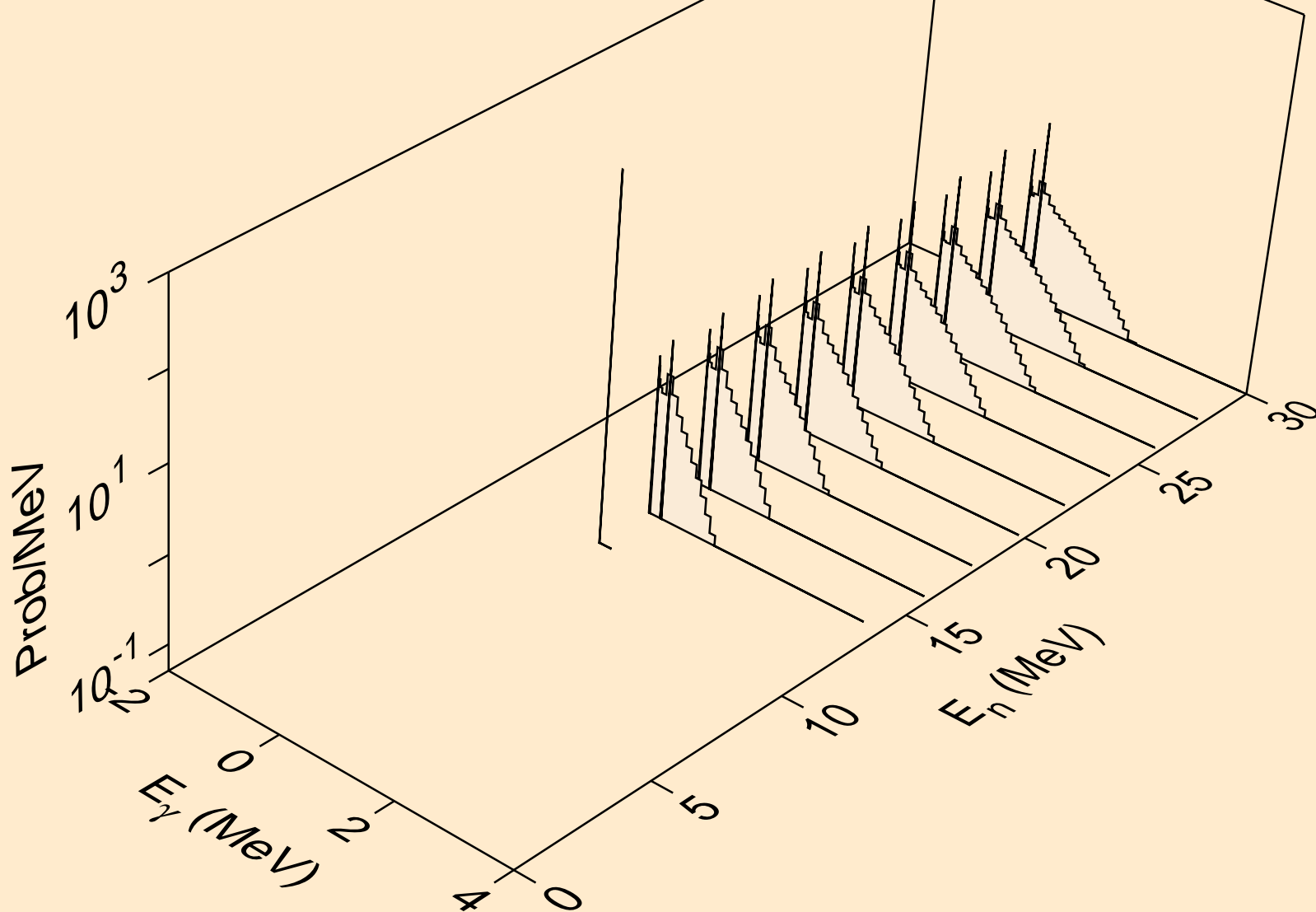

MD258 NEUTRON ACER TENDL-2019 LIBRARY; T=293.16K  
Photon emission for (n,a)

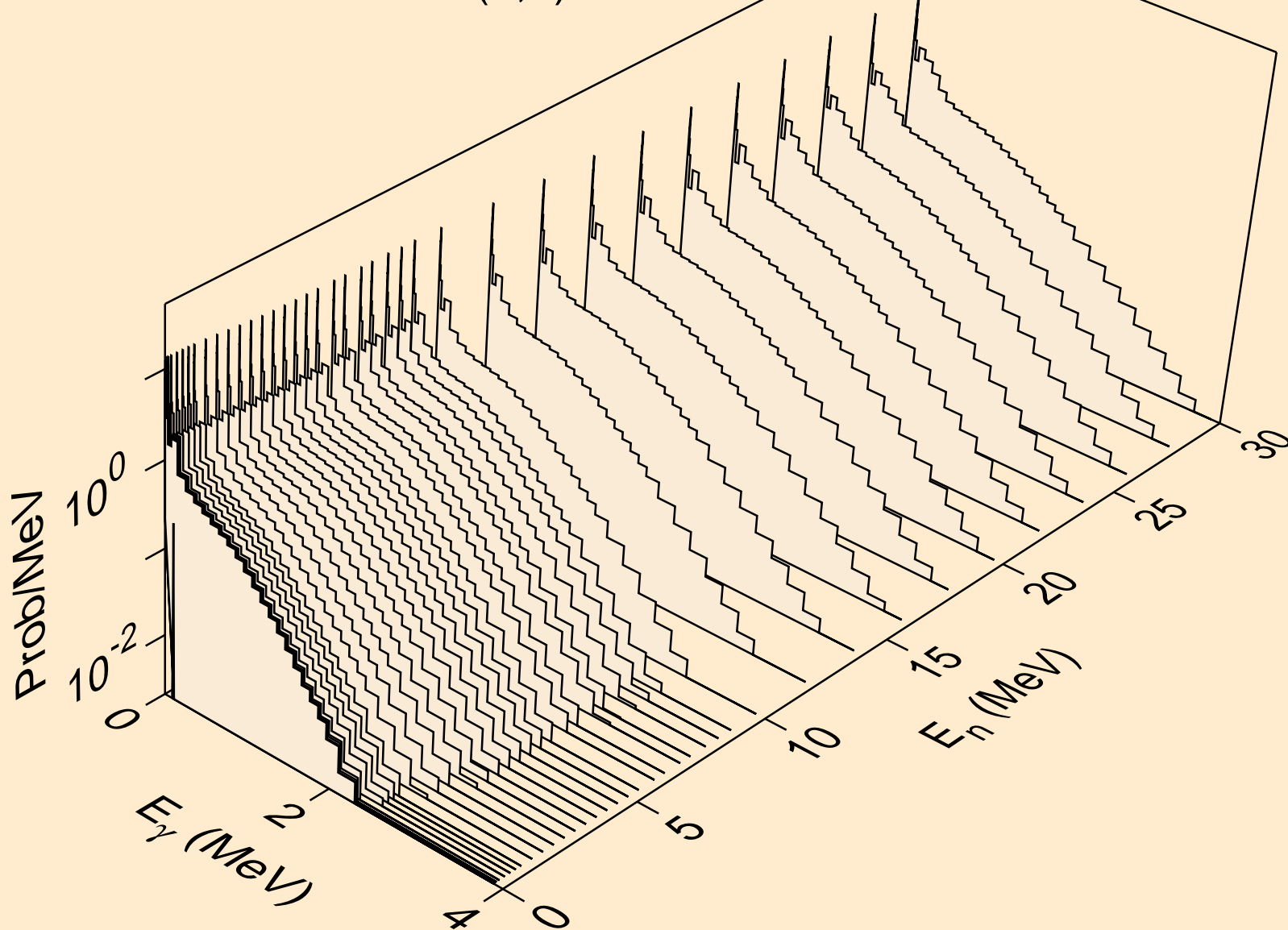



MD258 NEUTRON ACER TENDL-2019 LIBRARY; T=293.16K  
Photon emission for (n,2p)

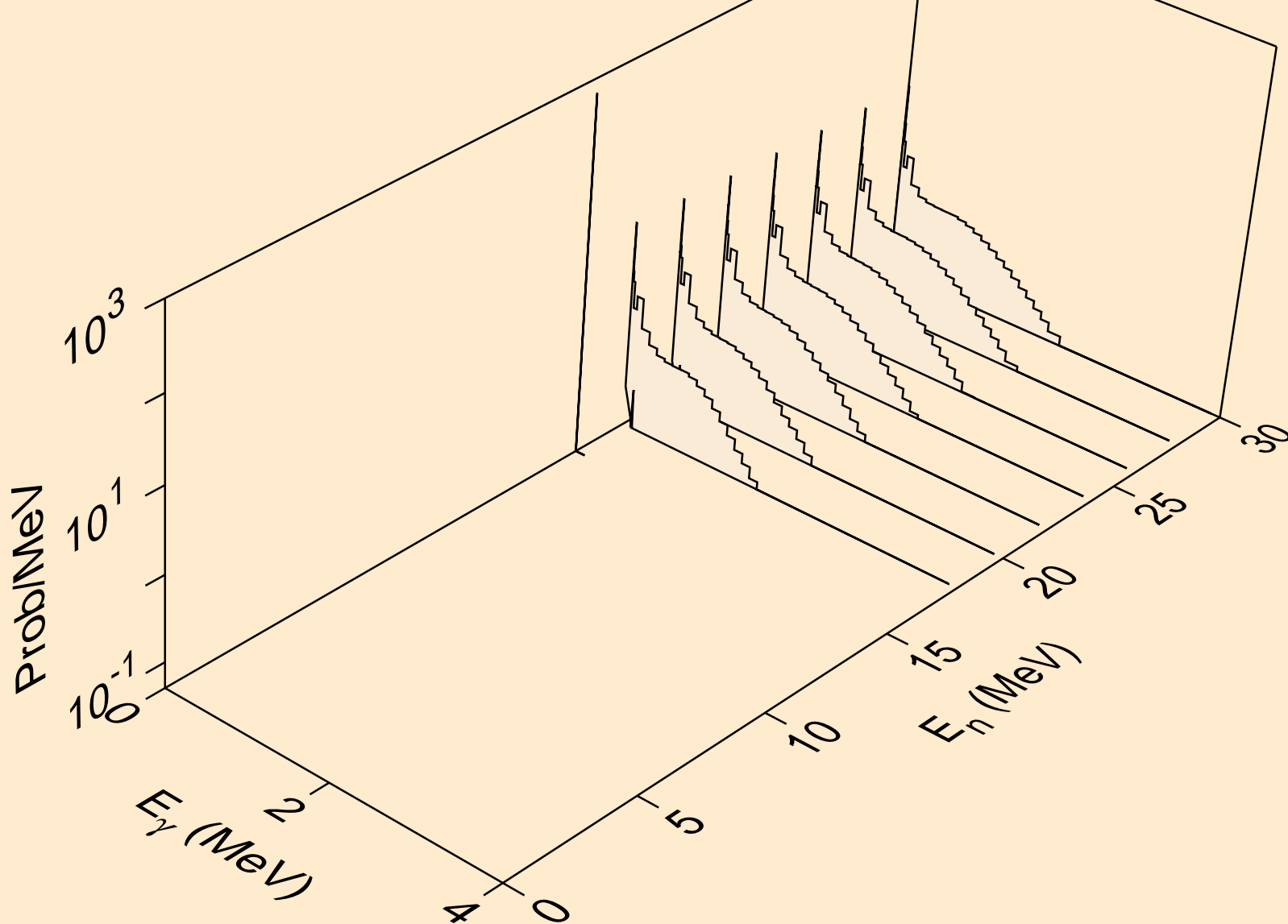

MD258 NEUTRON ACER TENDL-2019 LIBRARY; T=293.16K  
thermal capture photon spectrum

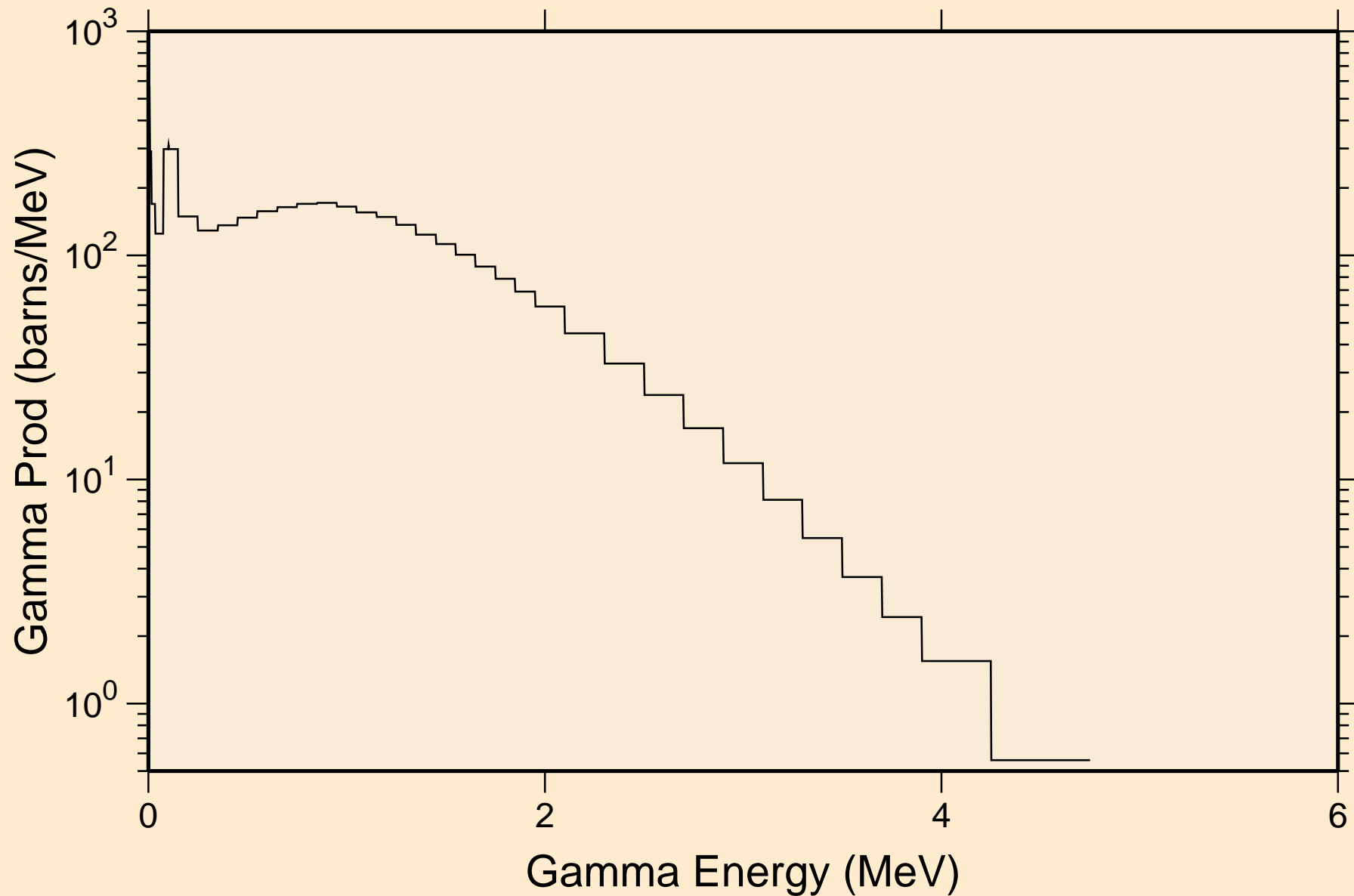

MD258 NEUTRON ACER TENDL-2019 LIBRARY; T=293.16K  
14 MeV photon spectrum

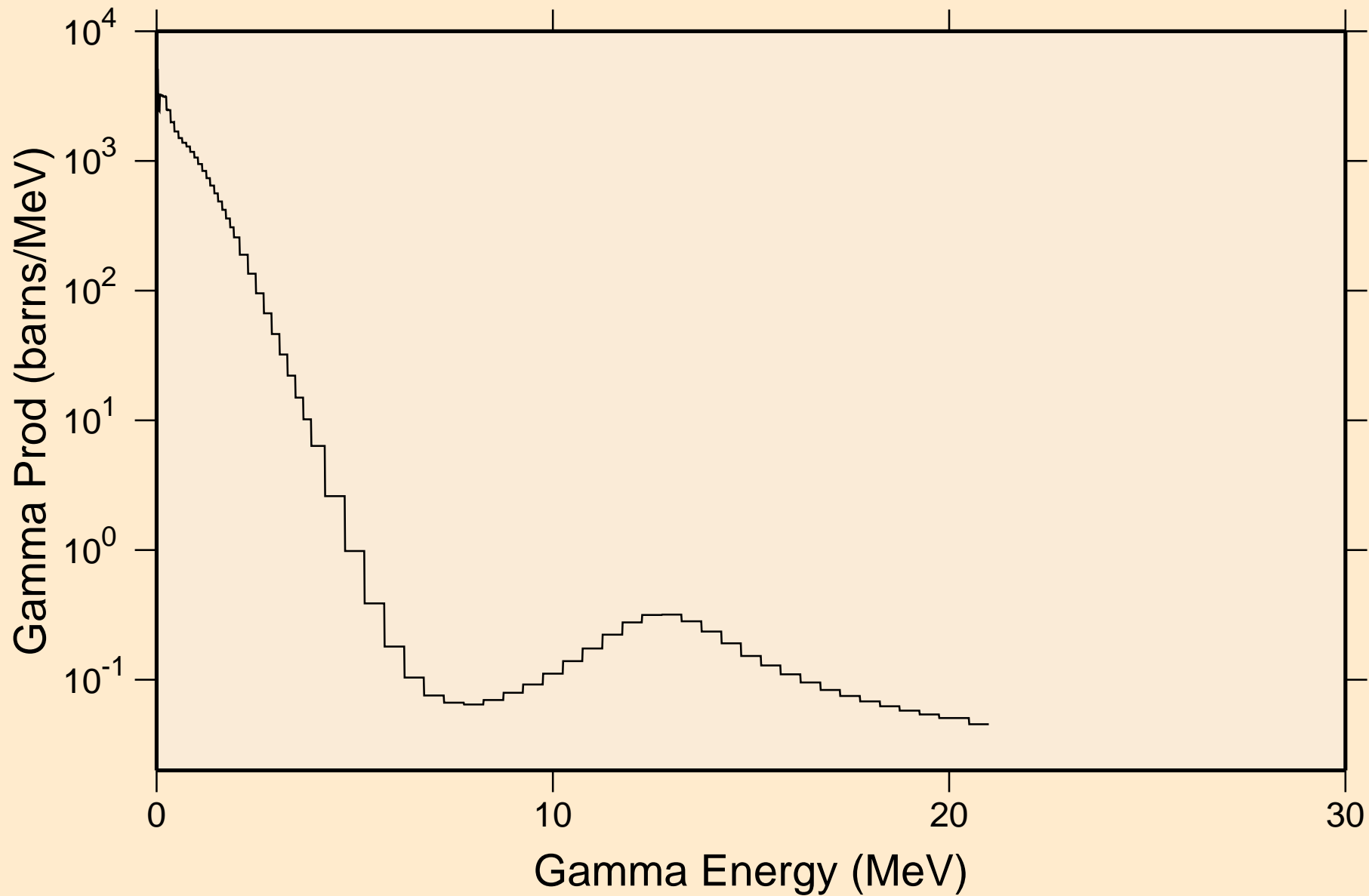

# MD258 NEUTRON ACER TENDL-2019 LIBRARY; T=293.16K

## Particle heating contributions

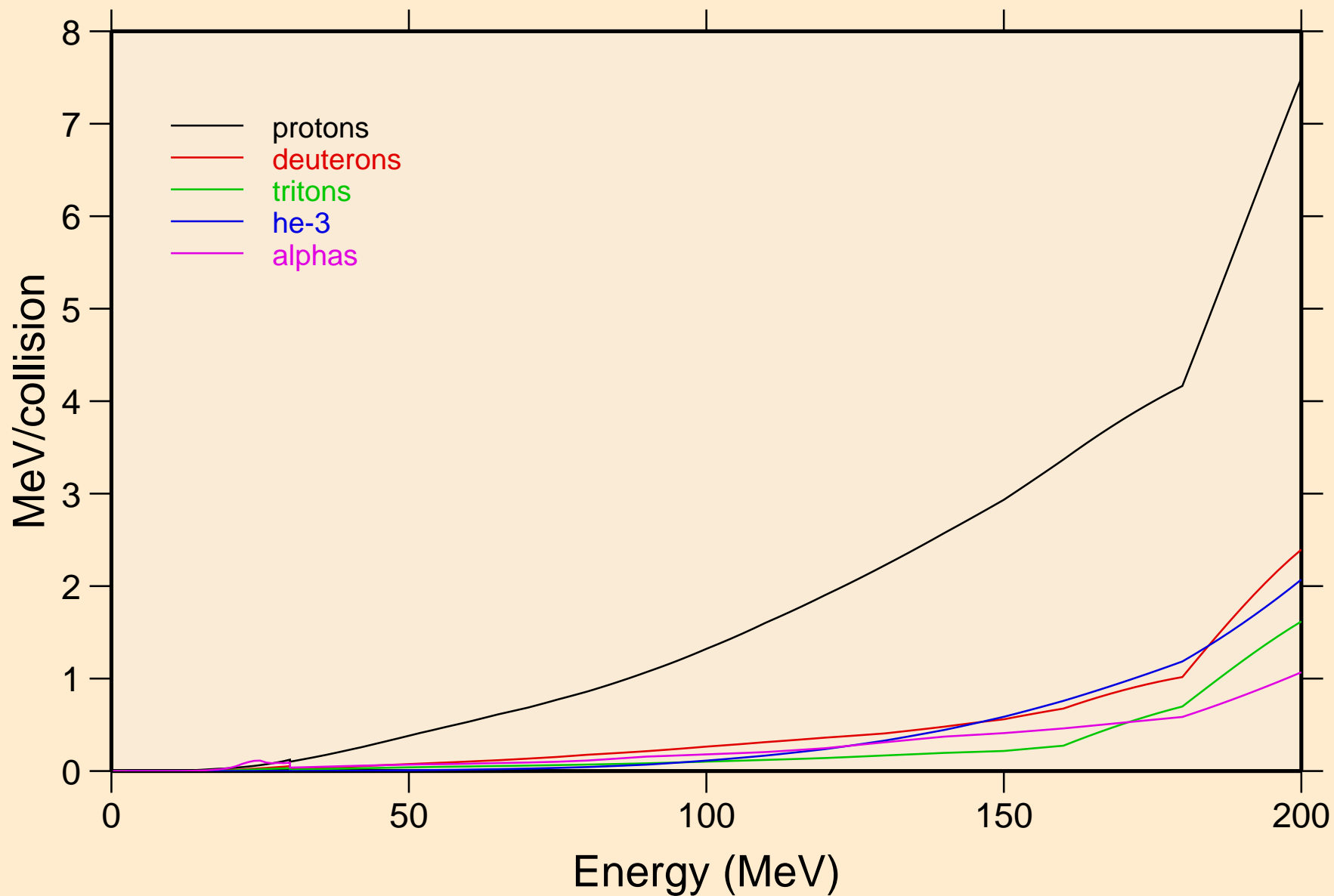

MD258 NEUTRON ACER TENDL-2019 LIBRARY; T=293.16K  
Recoil Heating

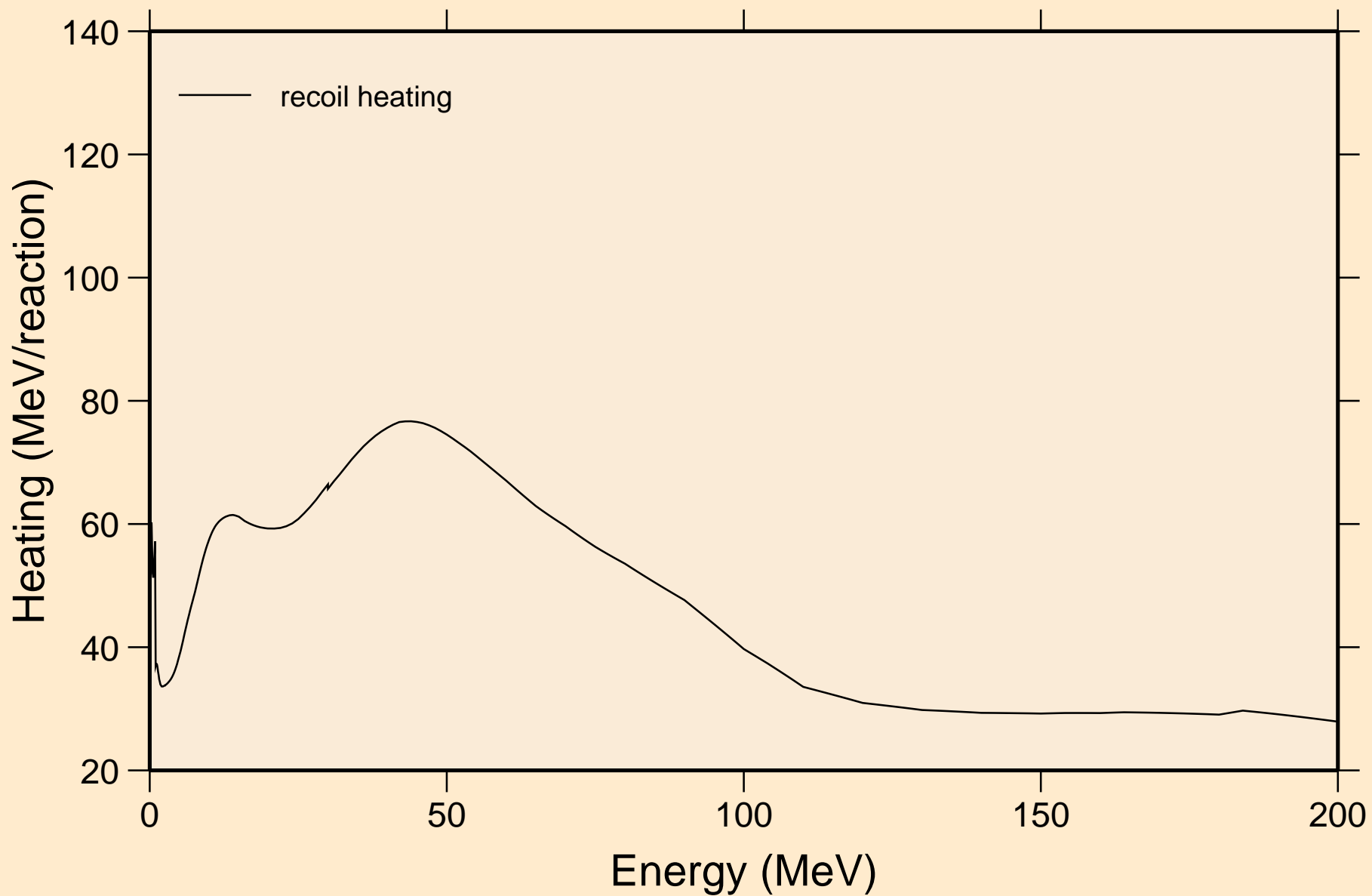

MD258 NEUTRON ACER TENDL-2019 LIBRARY; T=293.16K  
Particle production cross sections

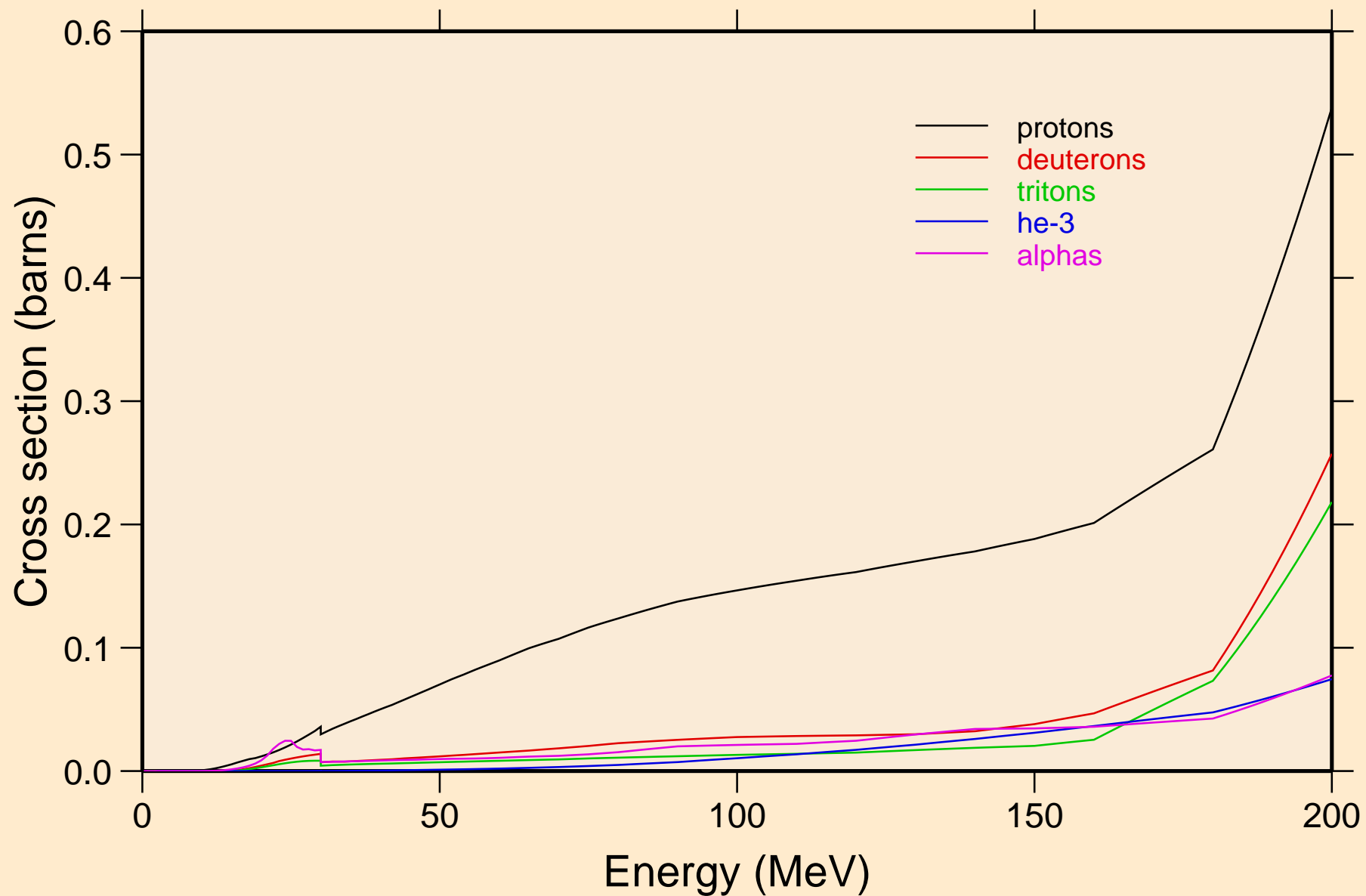

MD258 NEUTRON ACER TENDL-2019 LIBRARY; T=293.16K  
protons from (n,x)

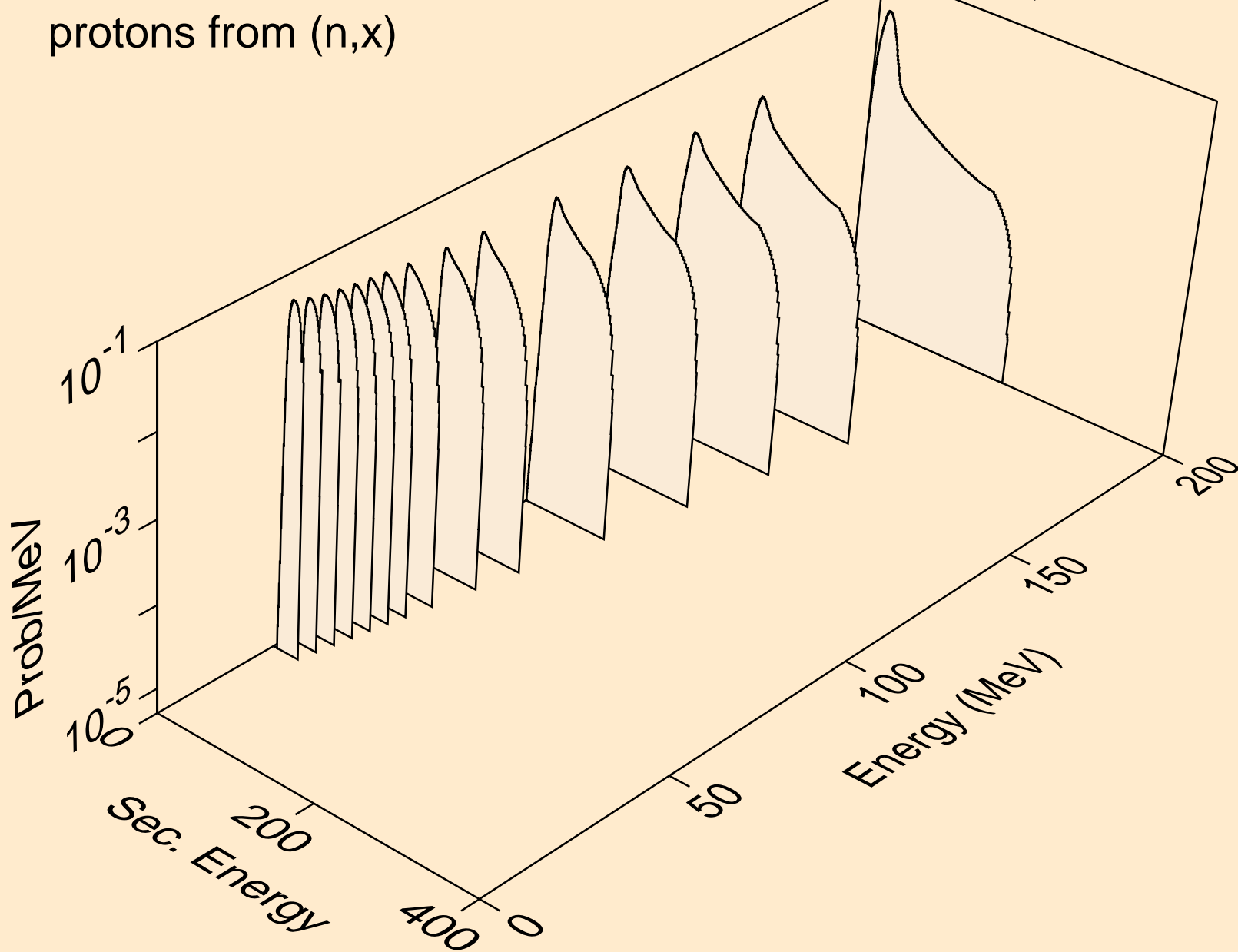

MD258 NEUTRON ACER TENDL-2019 LIBRARY; T=293.16K  
protons from (n,n\*)p

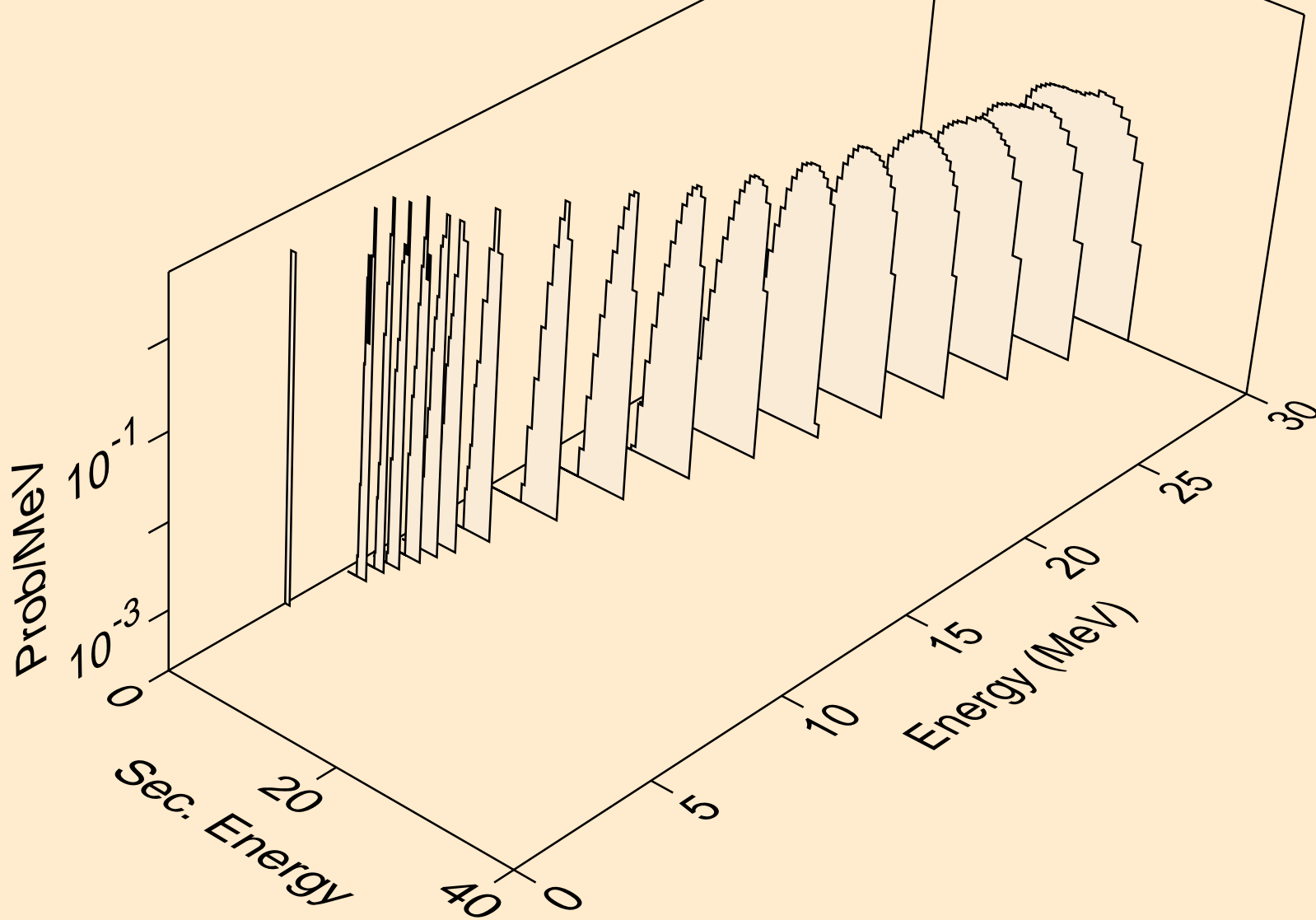



MD258 NEUTRON ACER TENDL-2019 LIBRARY; T=293.16K  
protons from (n,2np)

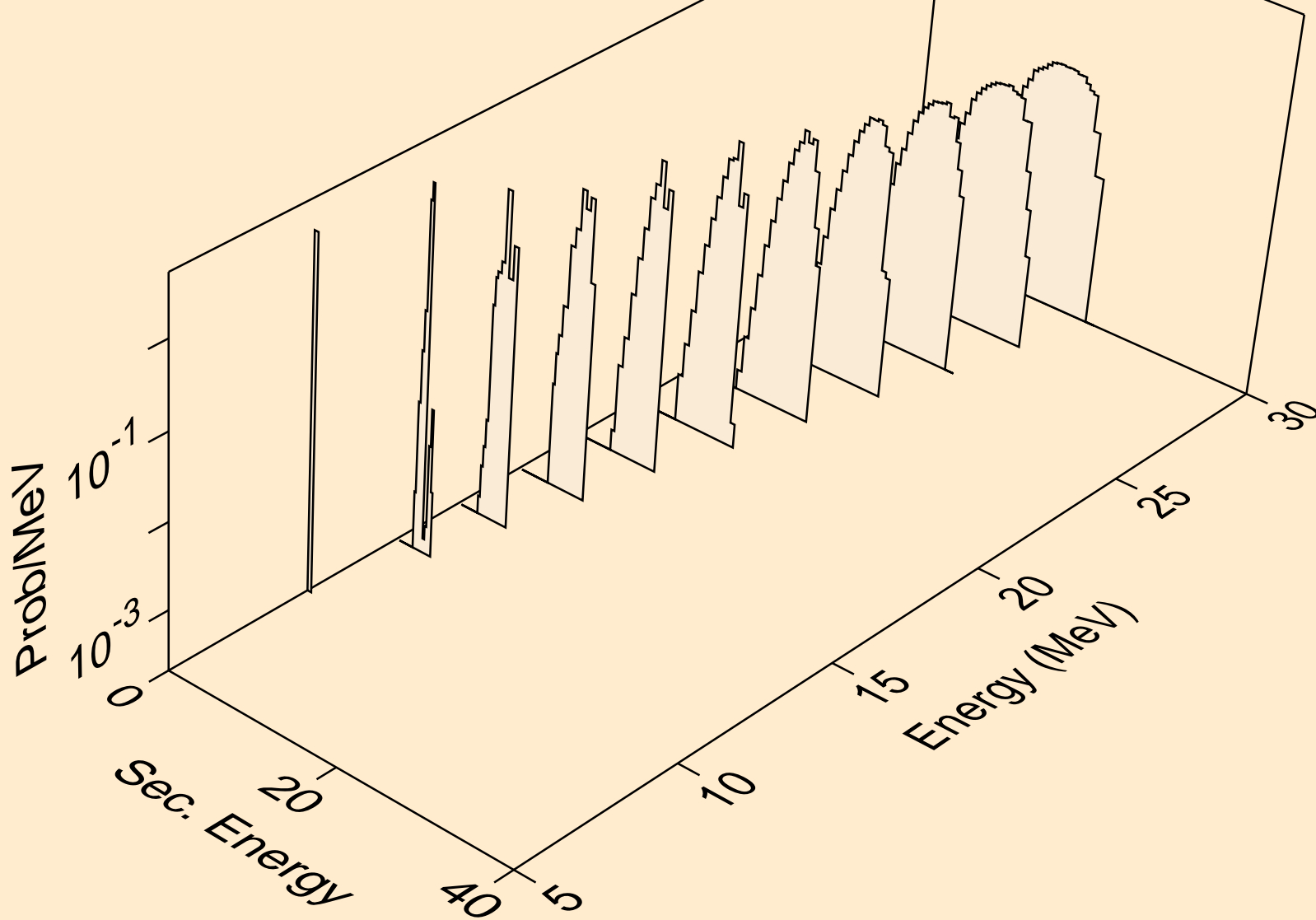

MD258 NEUTRON ACER TENDL-2019 LIBRARY; T=293.16K  
protons from (n,3np)

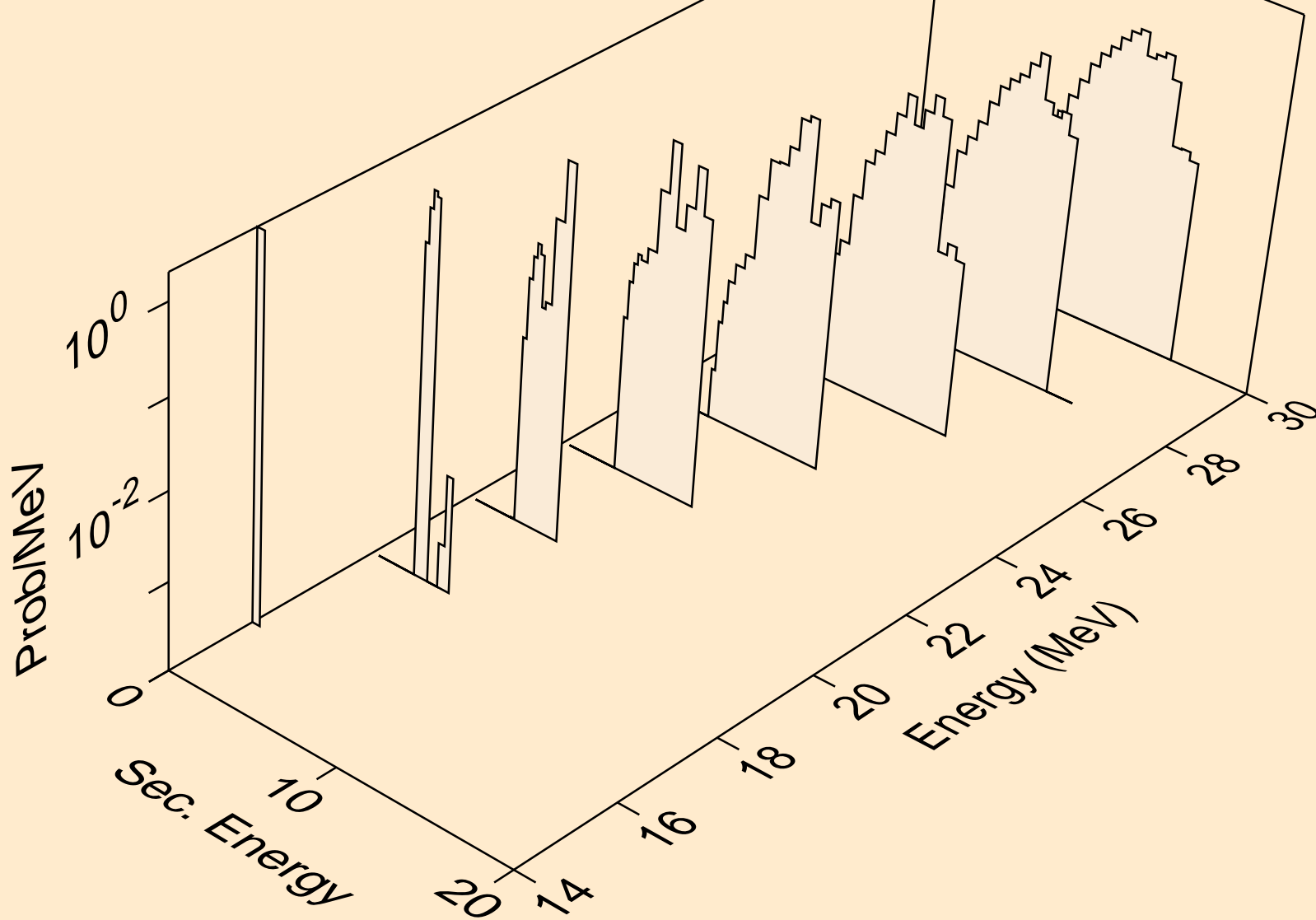

MD258 NEUTRON ACER TENDL-2019 LIBRARY; T=293.16K  
protons from (n,2np)

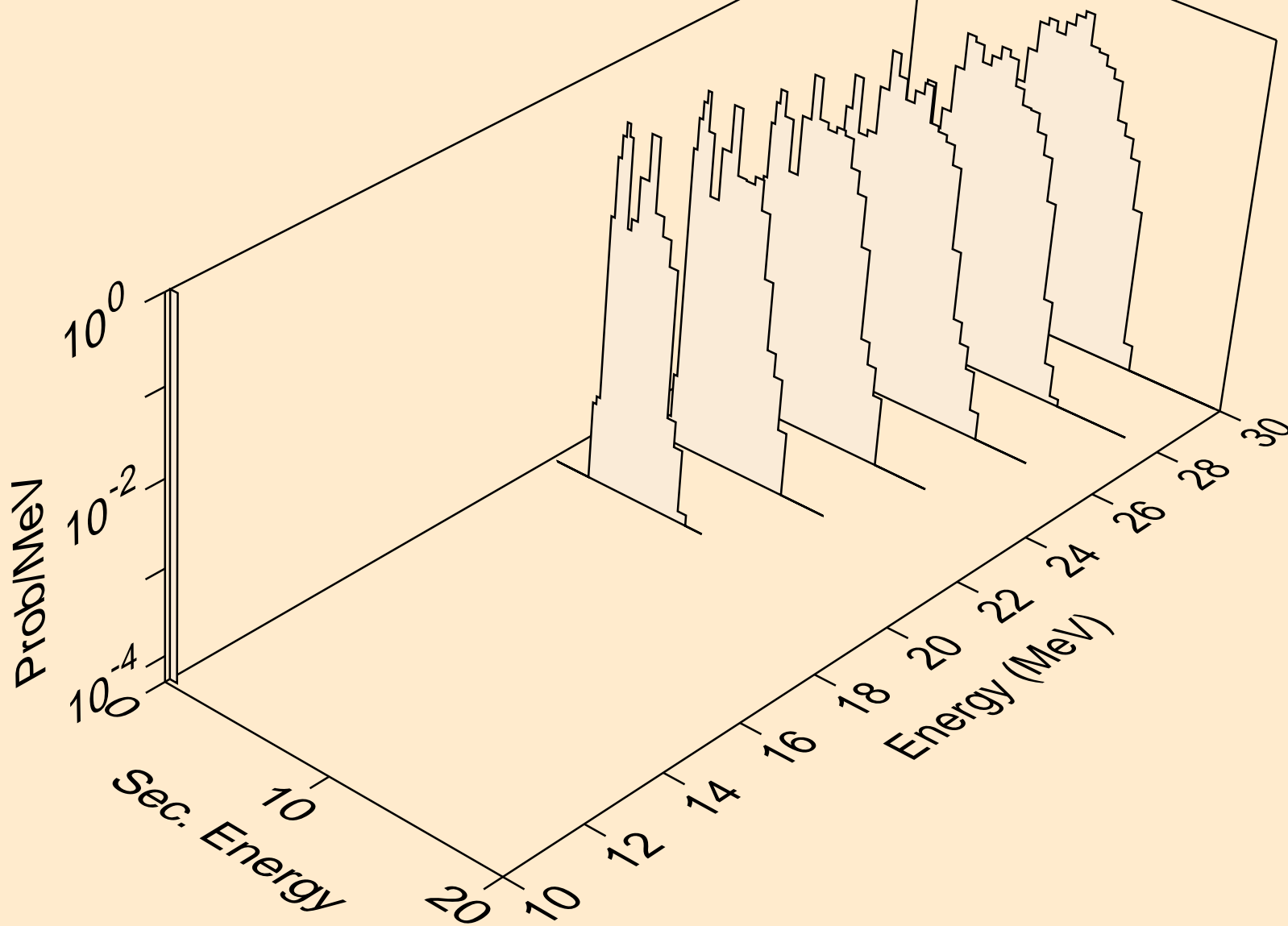

MD258 NEUTRON ACER TENDL-2019 LIBRARY; T=293.16K  
protons from (n,npa)

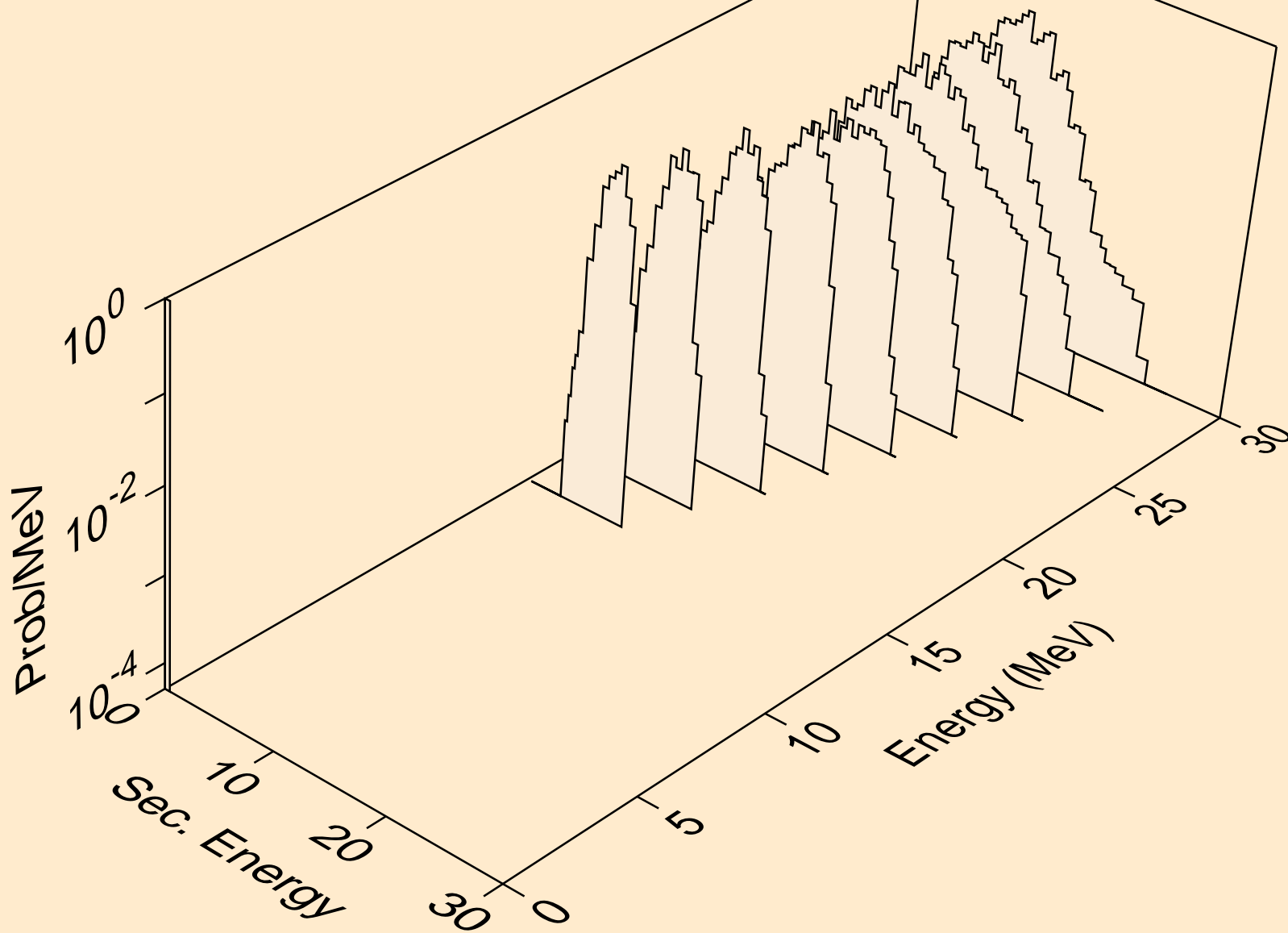

MD258 NEUTRON ACER TENDL-2019 LIBRARY; T=293.16K  
protons from (n,p)

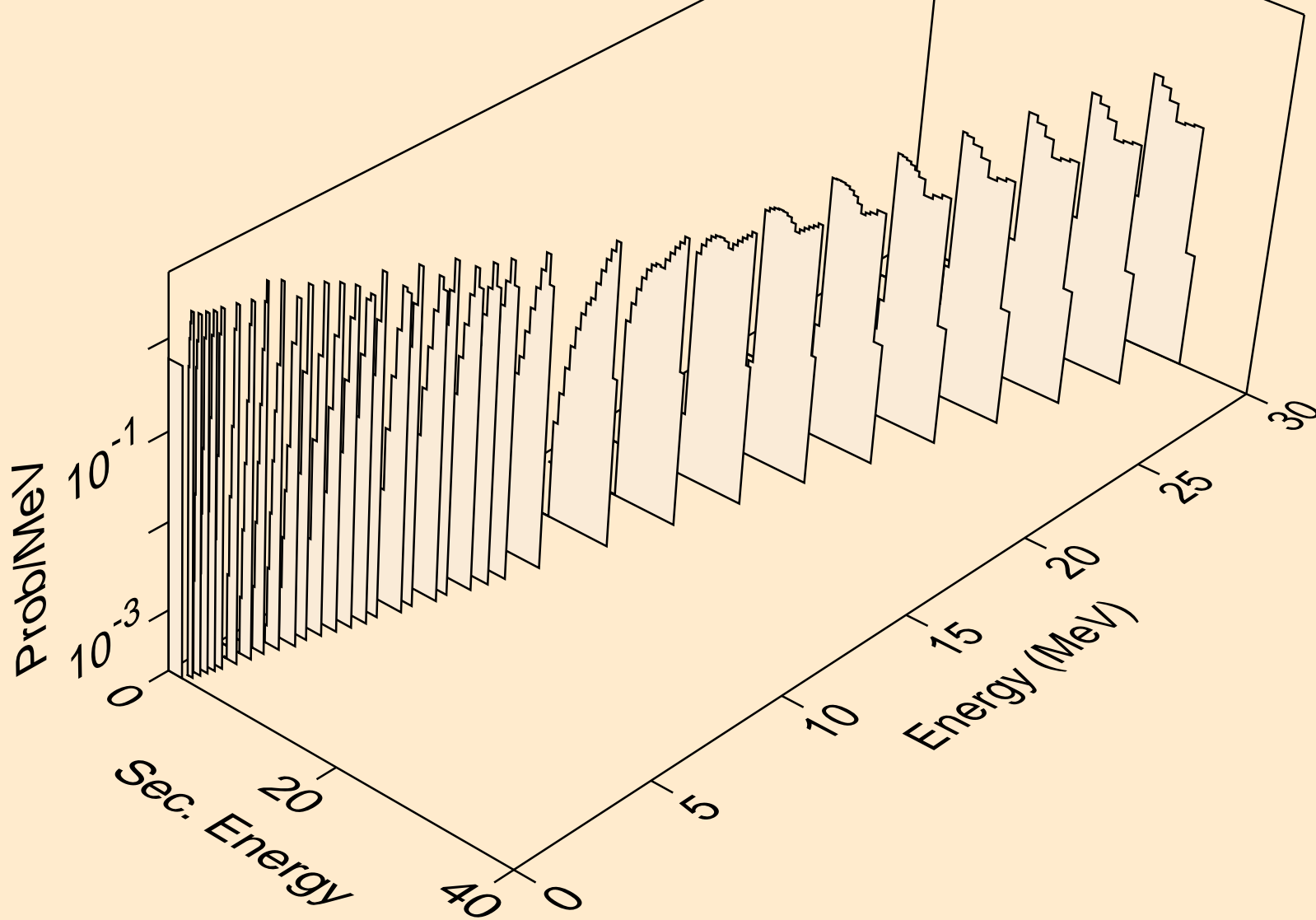

MD258 NEUTRON ACER TENDL-2019 LIBRARY; T=293.16K  
protons from (n,2p)

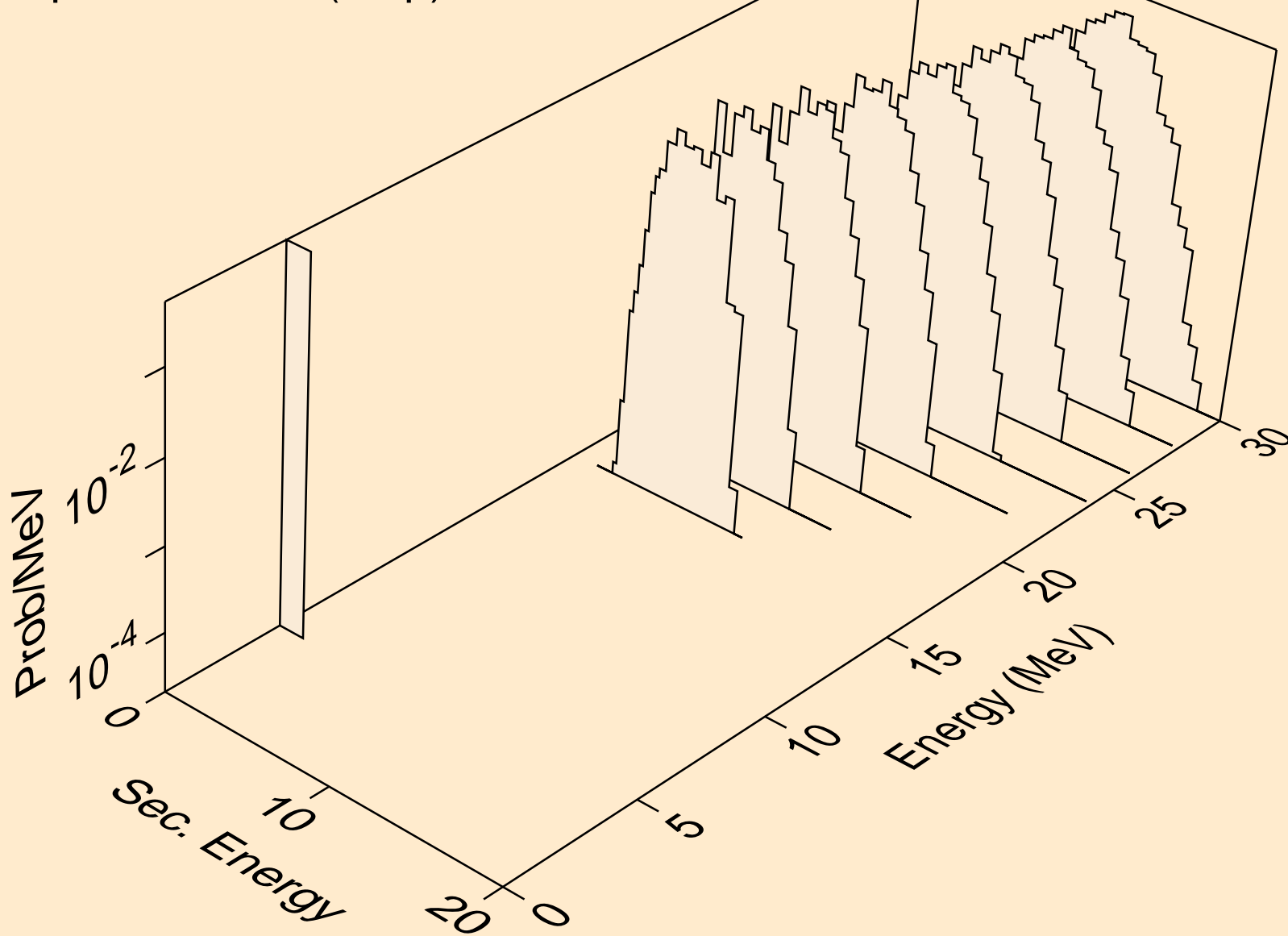

MD258 NEUTRON ACER TENDL-2019 LIBRARY; T=293.16K  
deuterons from (n,x)

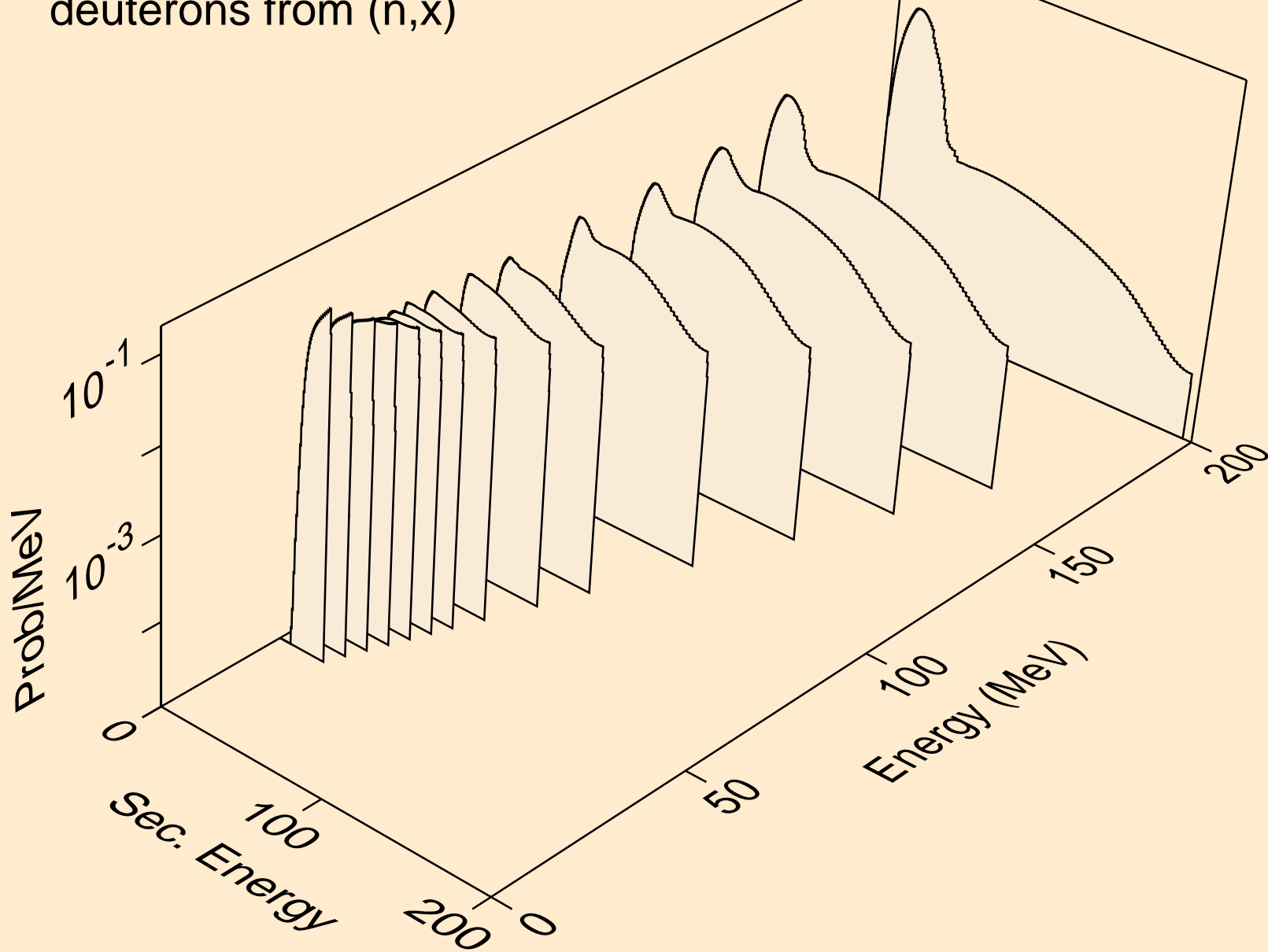

MD258 NEUTRON ACER TENDL-2019 LIBRARY; T=293.16K  
deuterons from (n,2nd)

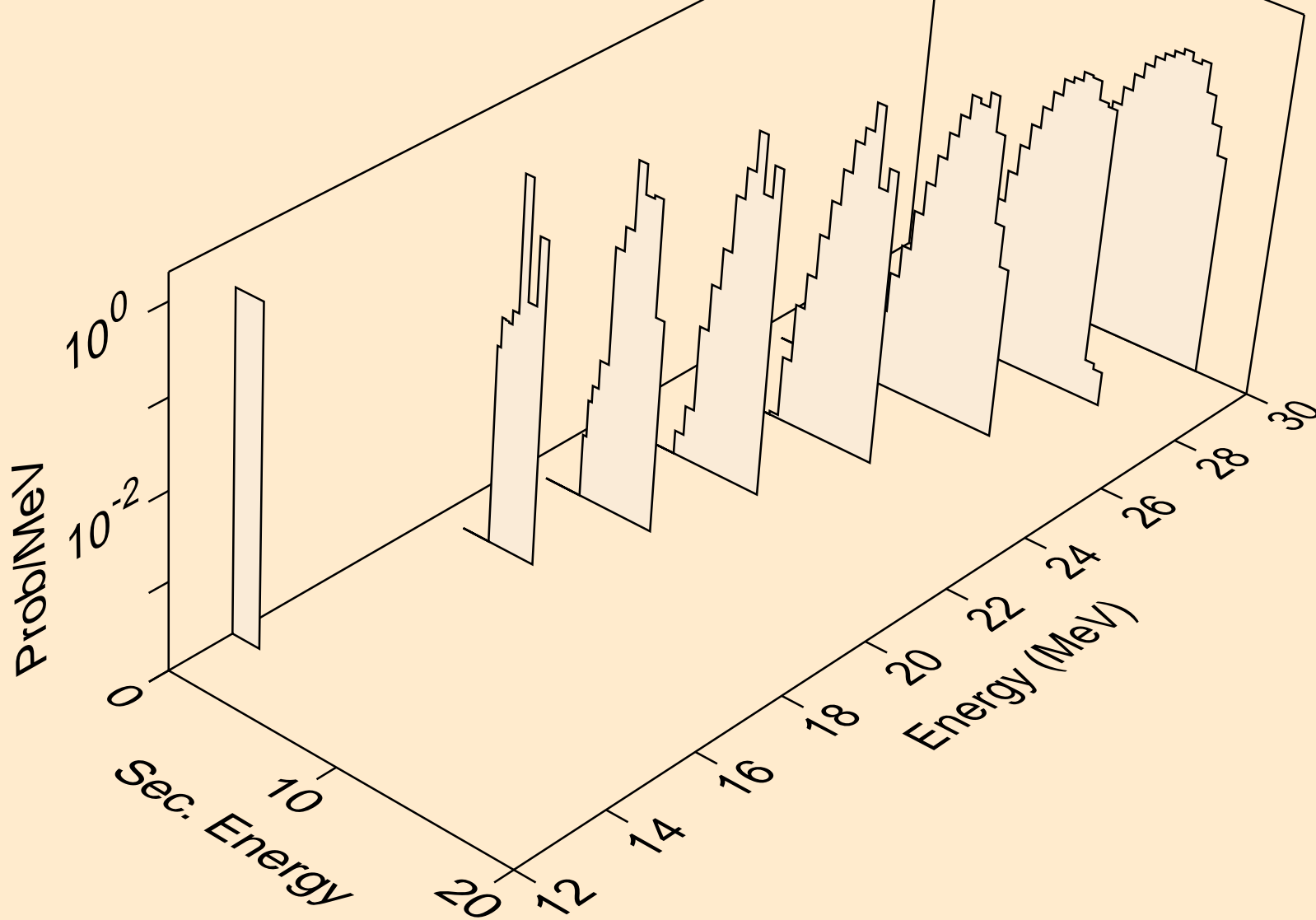



MD258 NEUTRON ACER TENDL-2019 LIBRARY; T=293.16K  
deuterons from (n,n\*)d

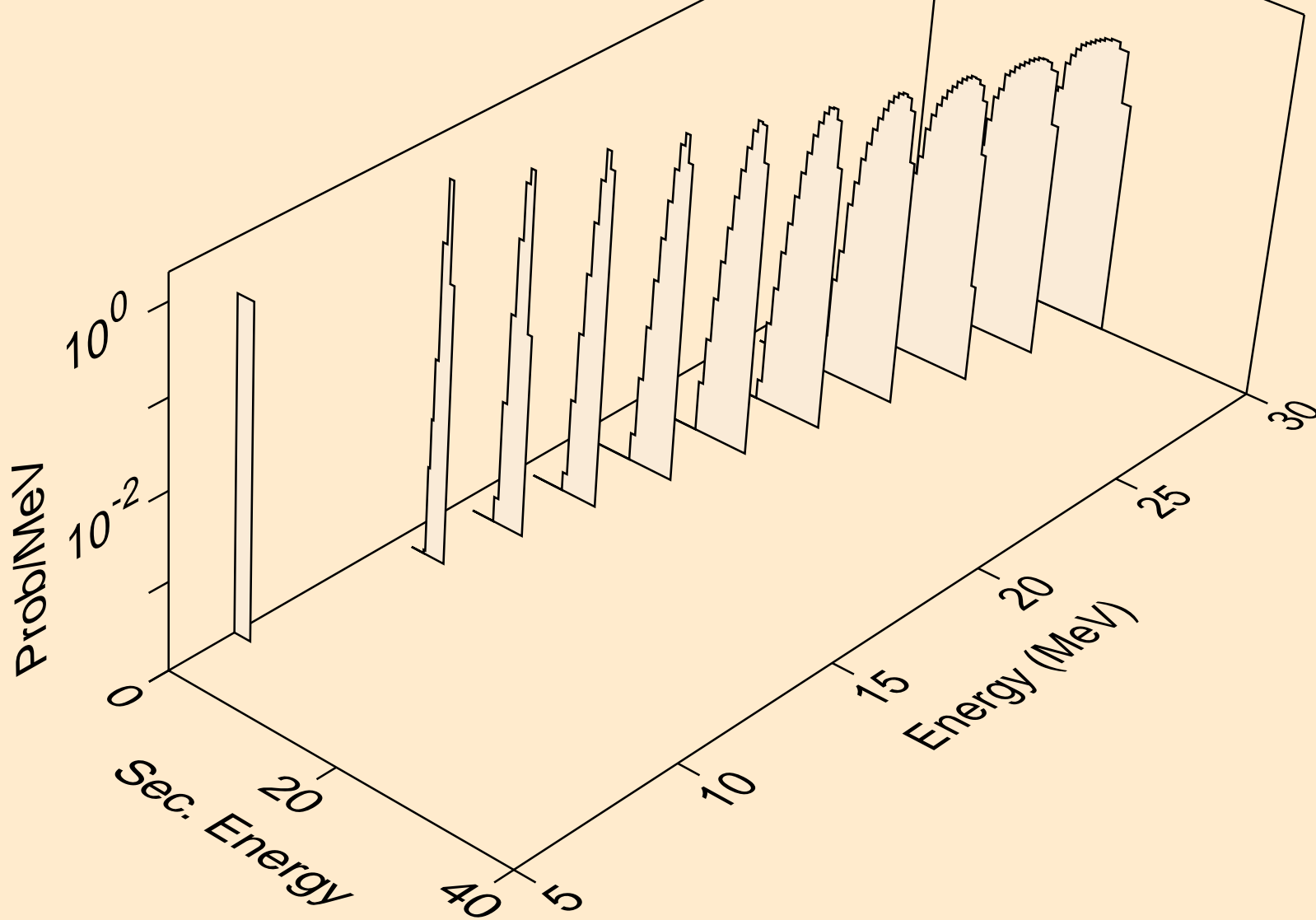

MD258 NEUTRON ACER TENDL-2019 LIBRARY; T=293.16K  
deuterons from (n,d)

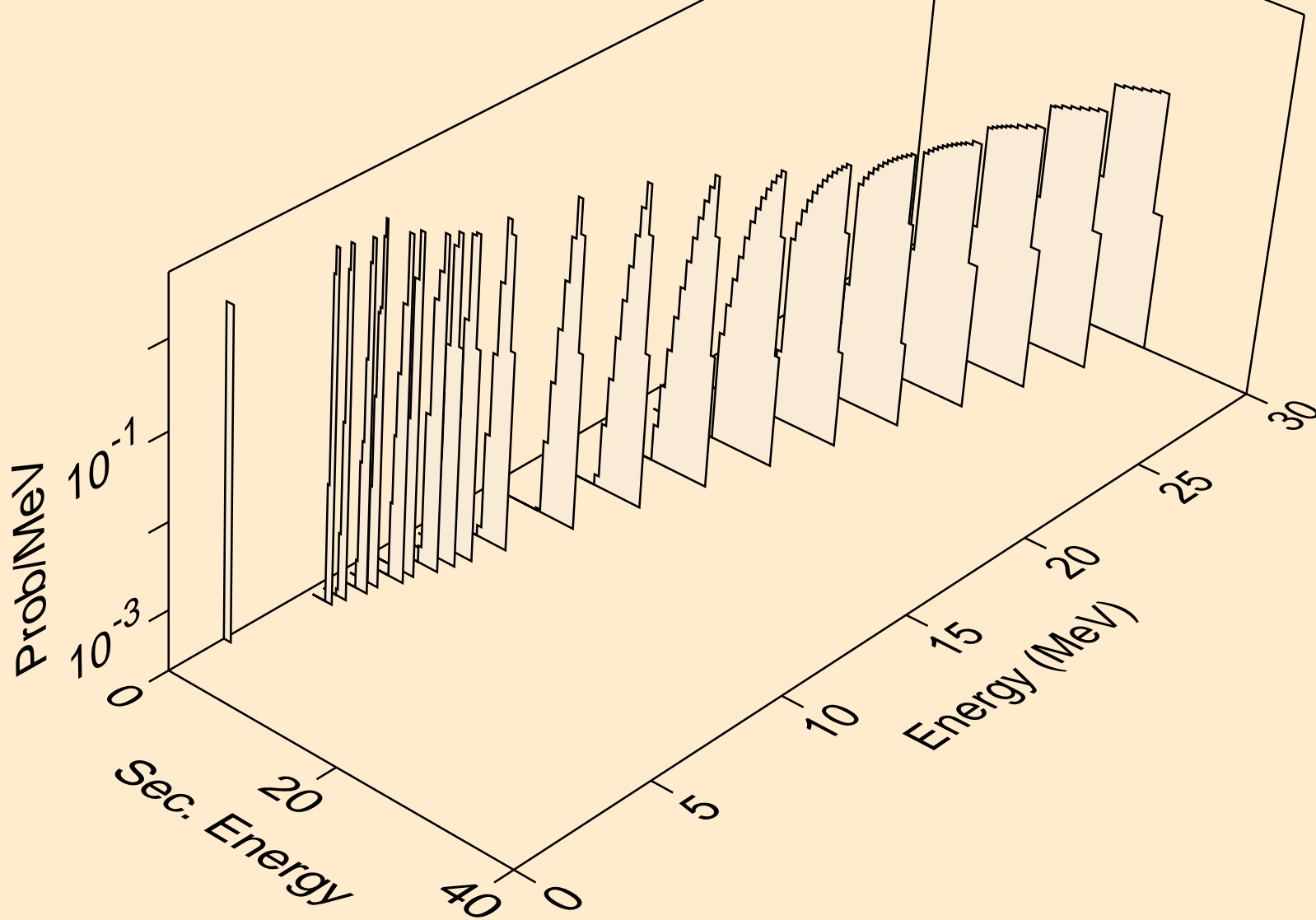

MD258 NEUTRON ACER TENDL-2019 LIBRARY; T=293.16K  
tritons from (n,x)

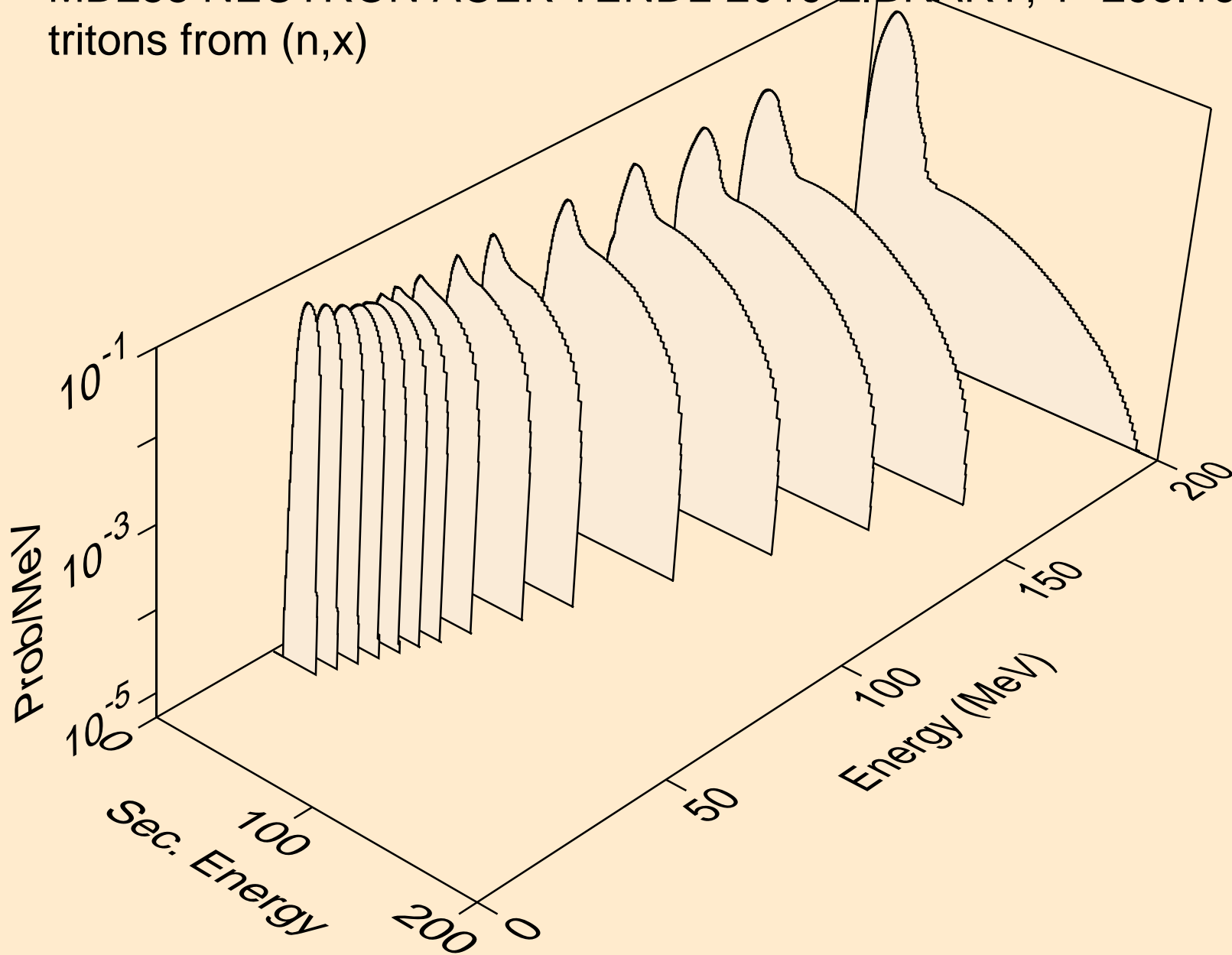

MD258 NEUTRON ACER TENDL-2019 LIBRARY; T=293.16K  
tritons from (n,n\*)t

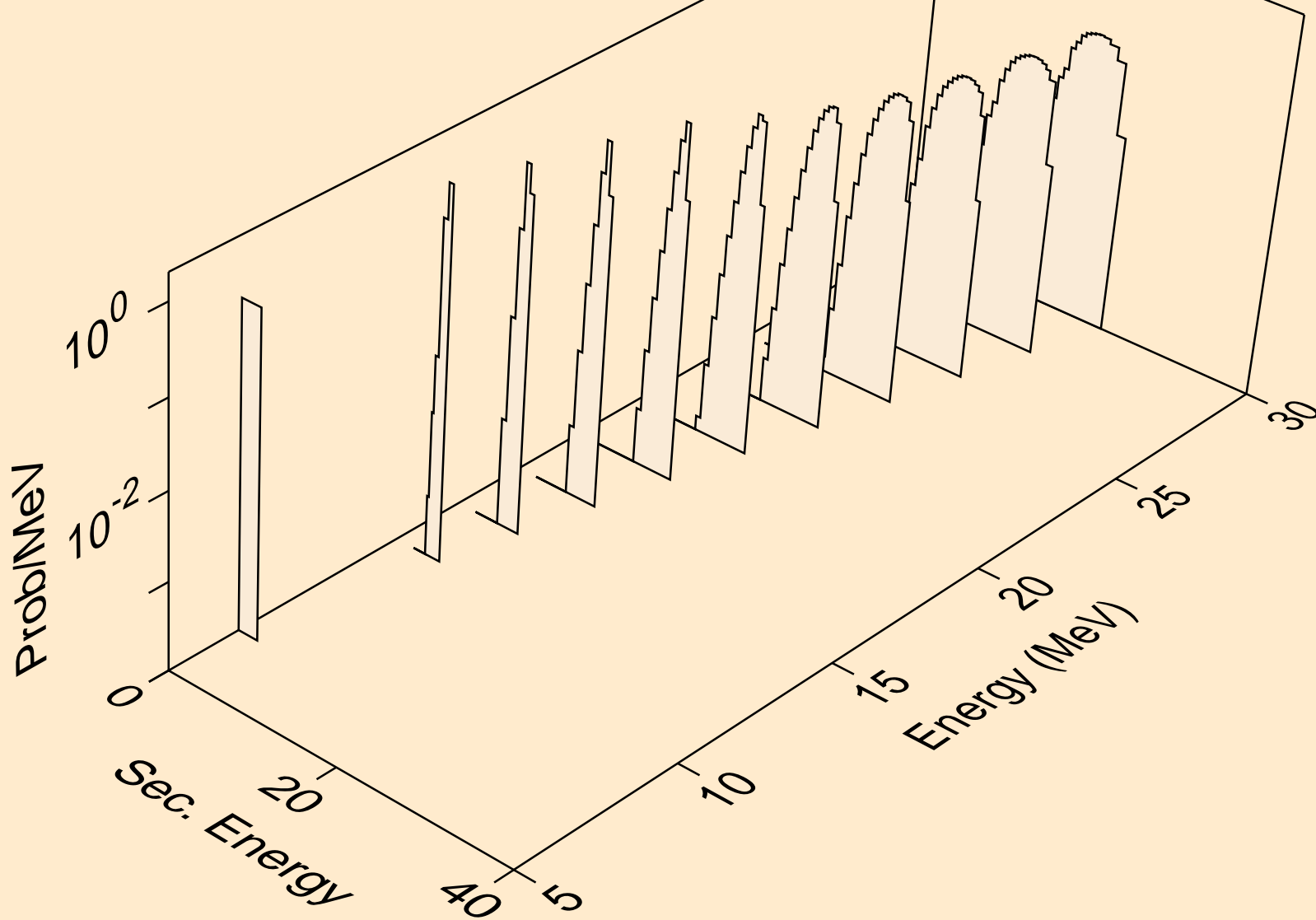

MD258 NEUTRON ACER TENDL-2019 LIBRARY; T=293.16K  
tritons from (n,t)

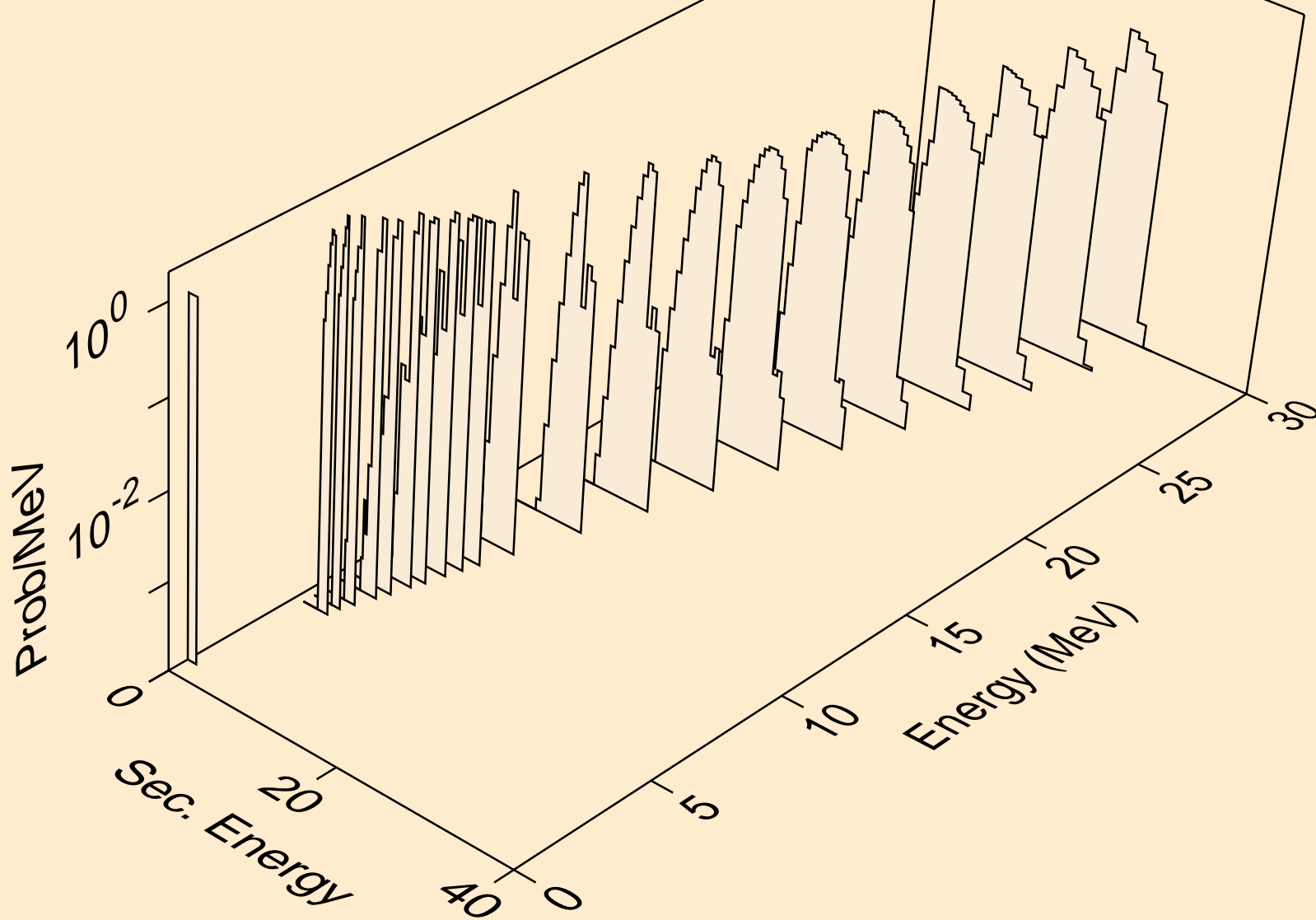

MD258 NEUTRON ACER TENDL-2019 LIBRARY; T=293.16K  
he3s from (n,x)

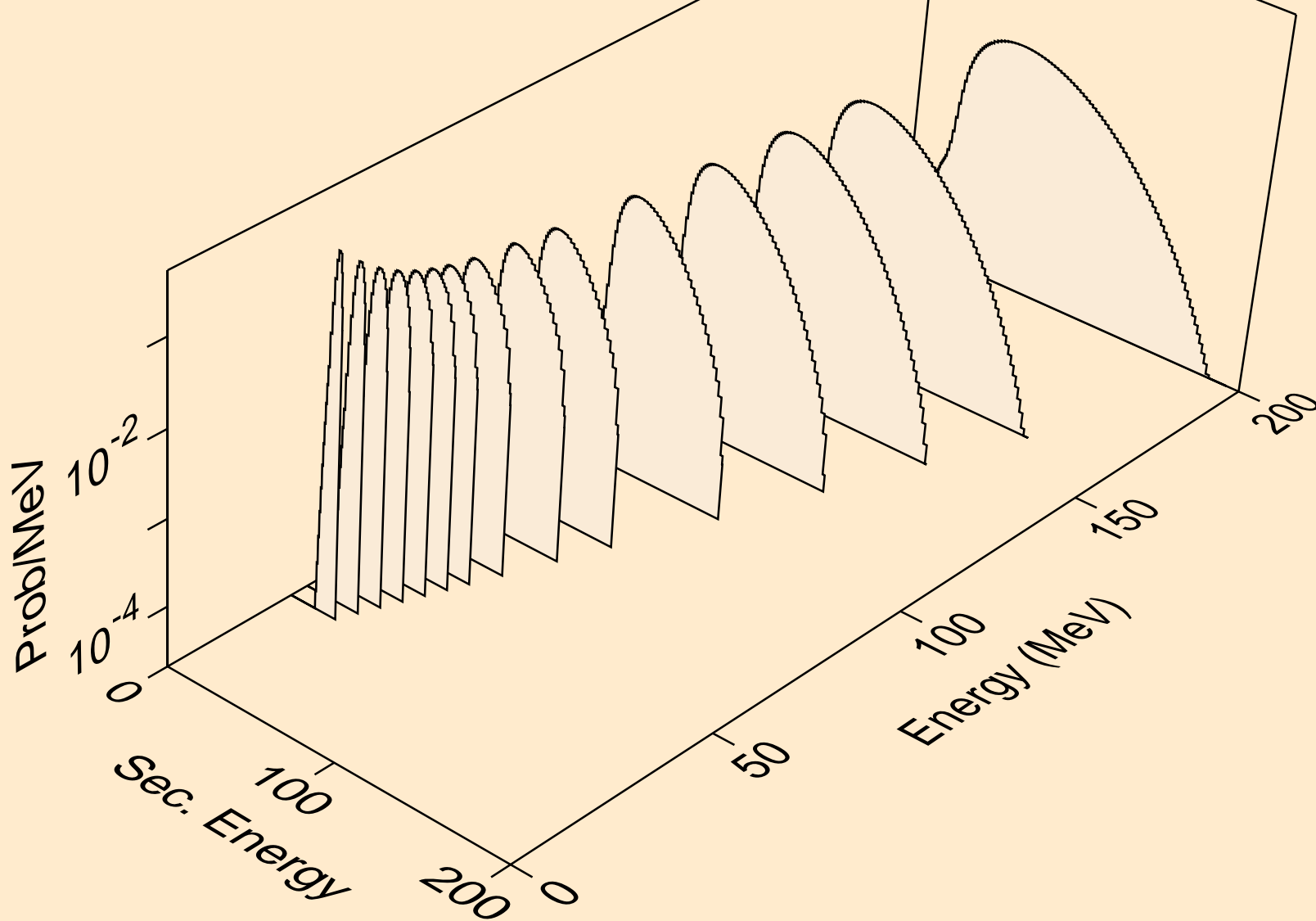

MD258 NEUTRON ACER TENDL-2019 LIBRARY; T=293.16K  
he3s from (n,n\*)he3

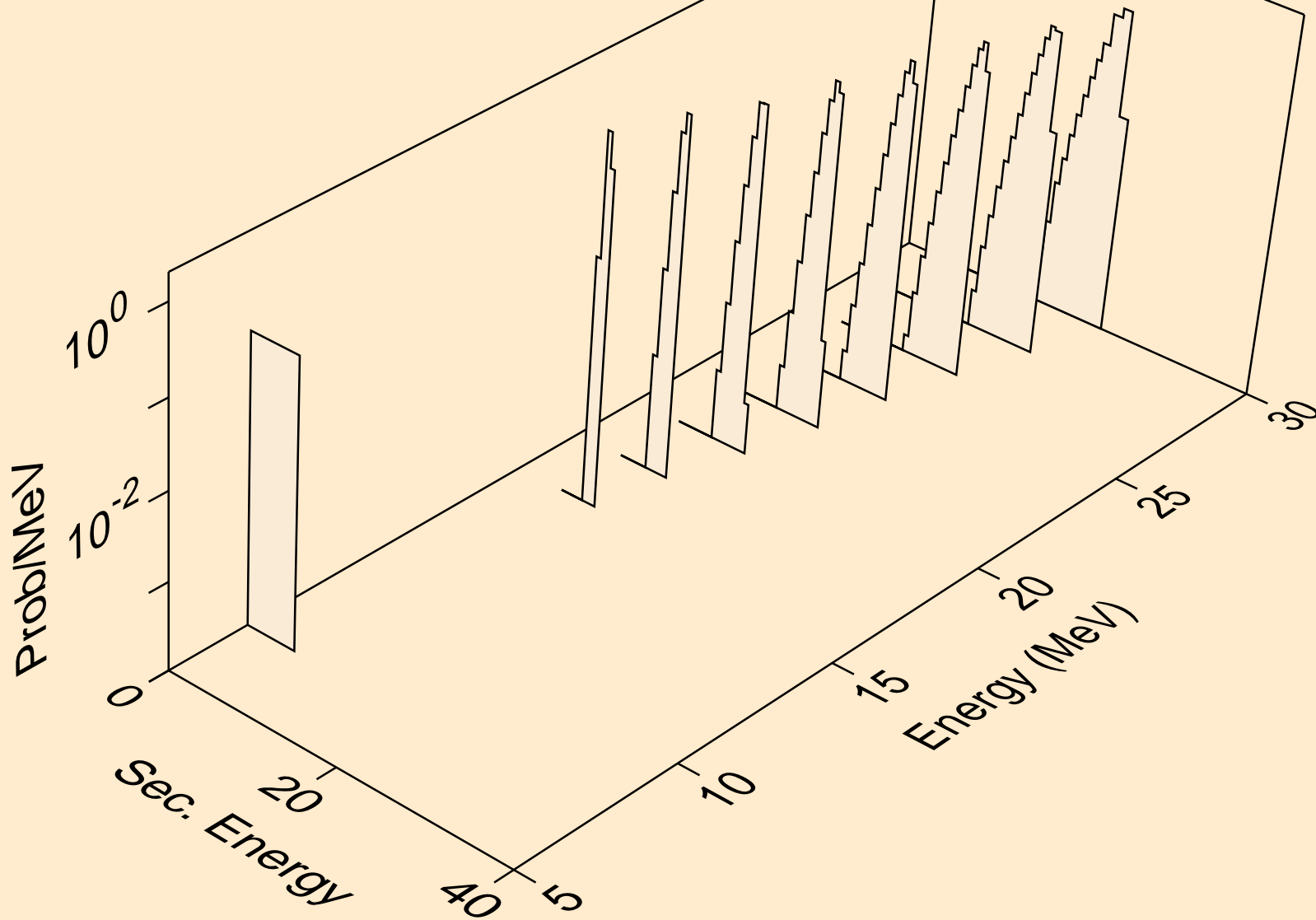

MD258 NEUTRON ACER TENDL-2019 LIBRARY; T=293.16K  
he3s from (n,he3)

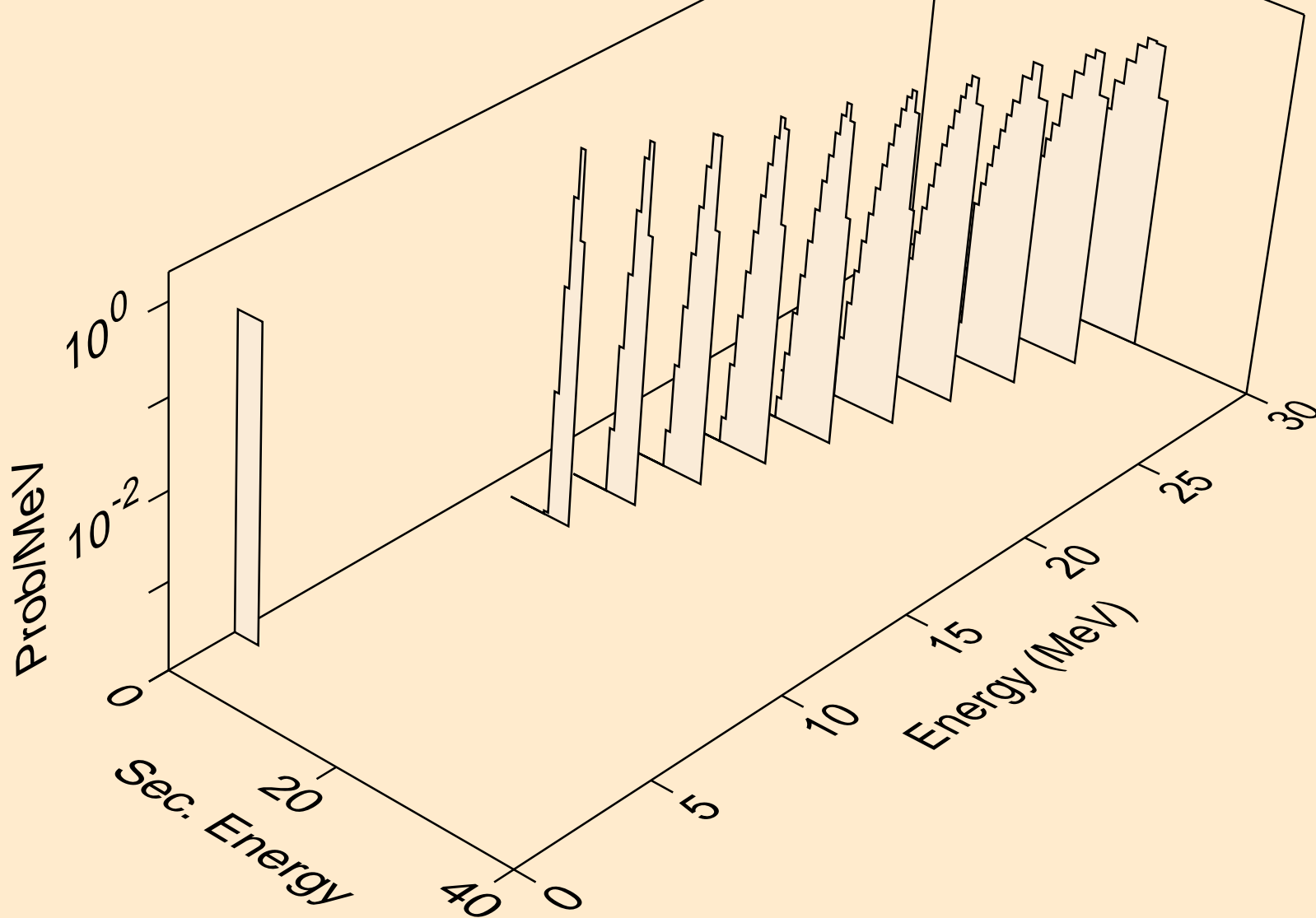



MD258 NEUTRON ACER TENDL-2019 LIBRARY; T=293.16K  
alphas from (n,x)

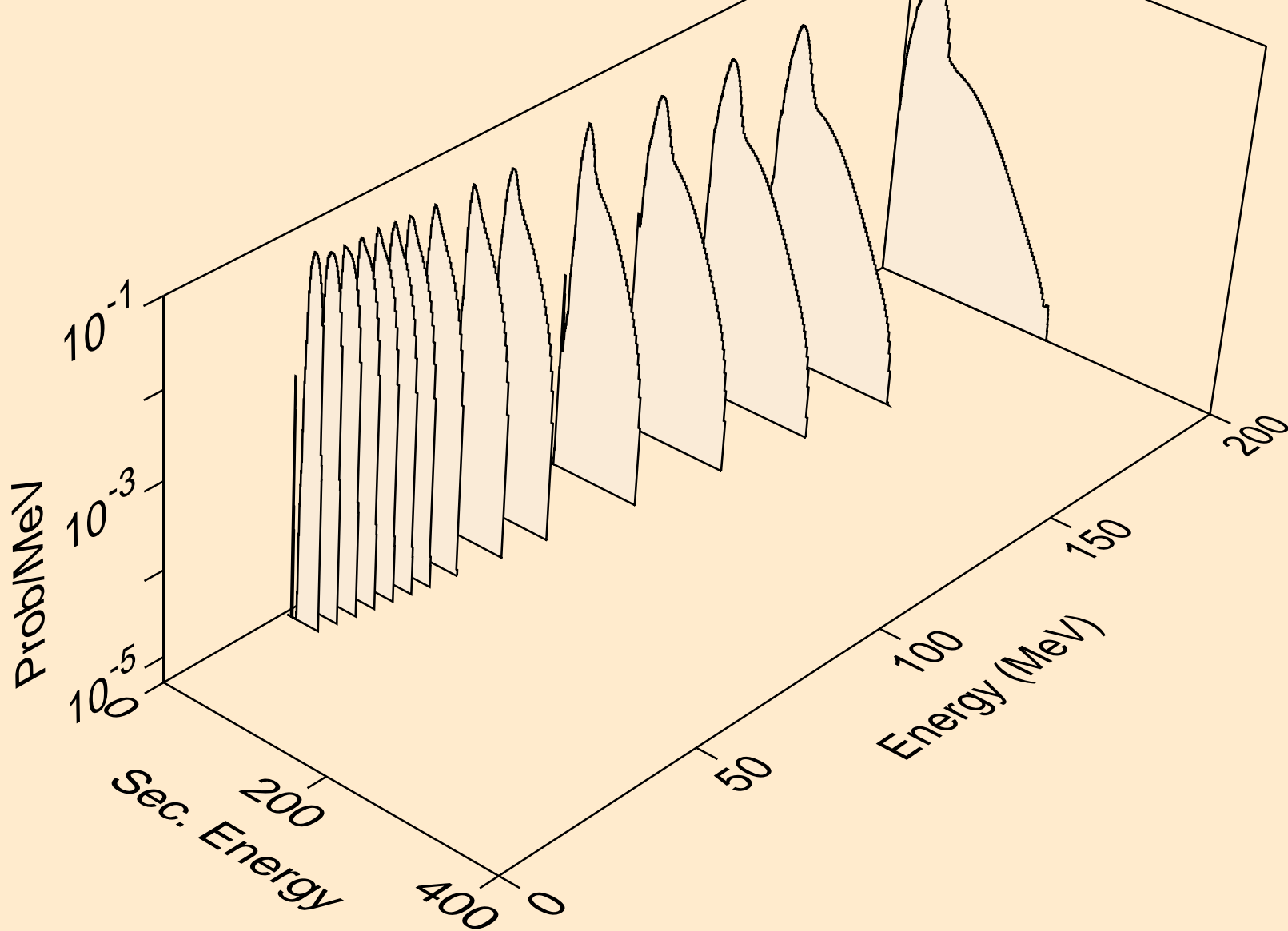

MD258 NEUTRON ACER TENDL-2019 LIBRARY; T=293.16K  
alphas from (n,n\*)a

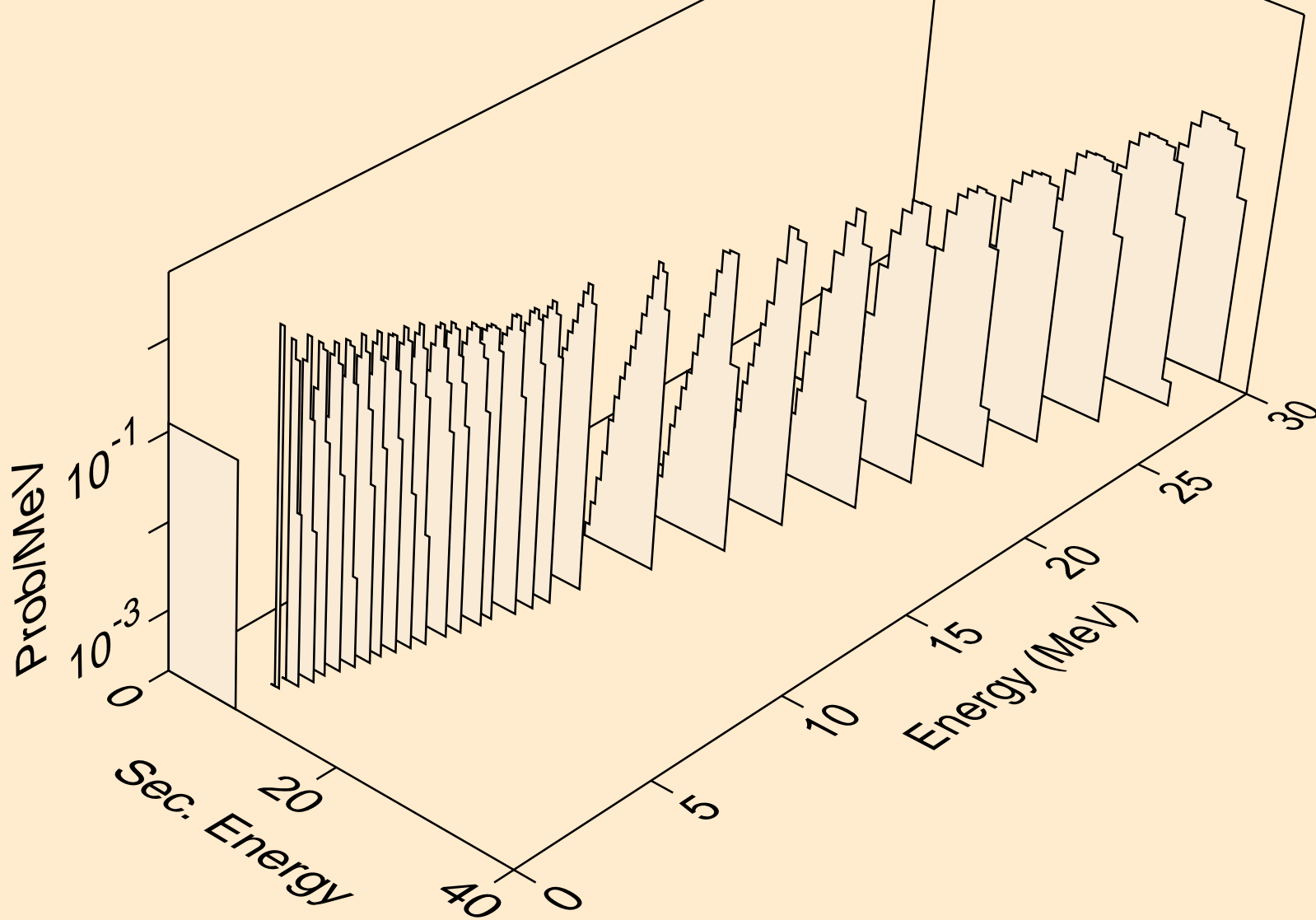

MD258 NEUTRON ACER TENDL-2019 LIBRARY; T=293.16K  
alphas from (n,2n)a

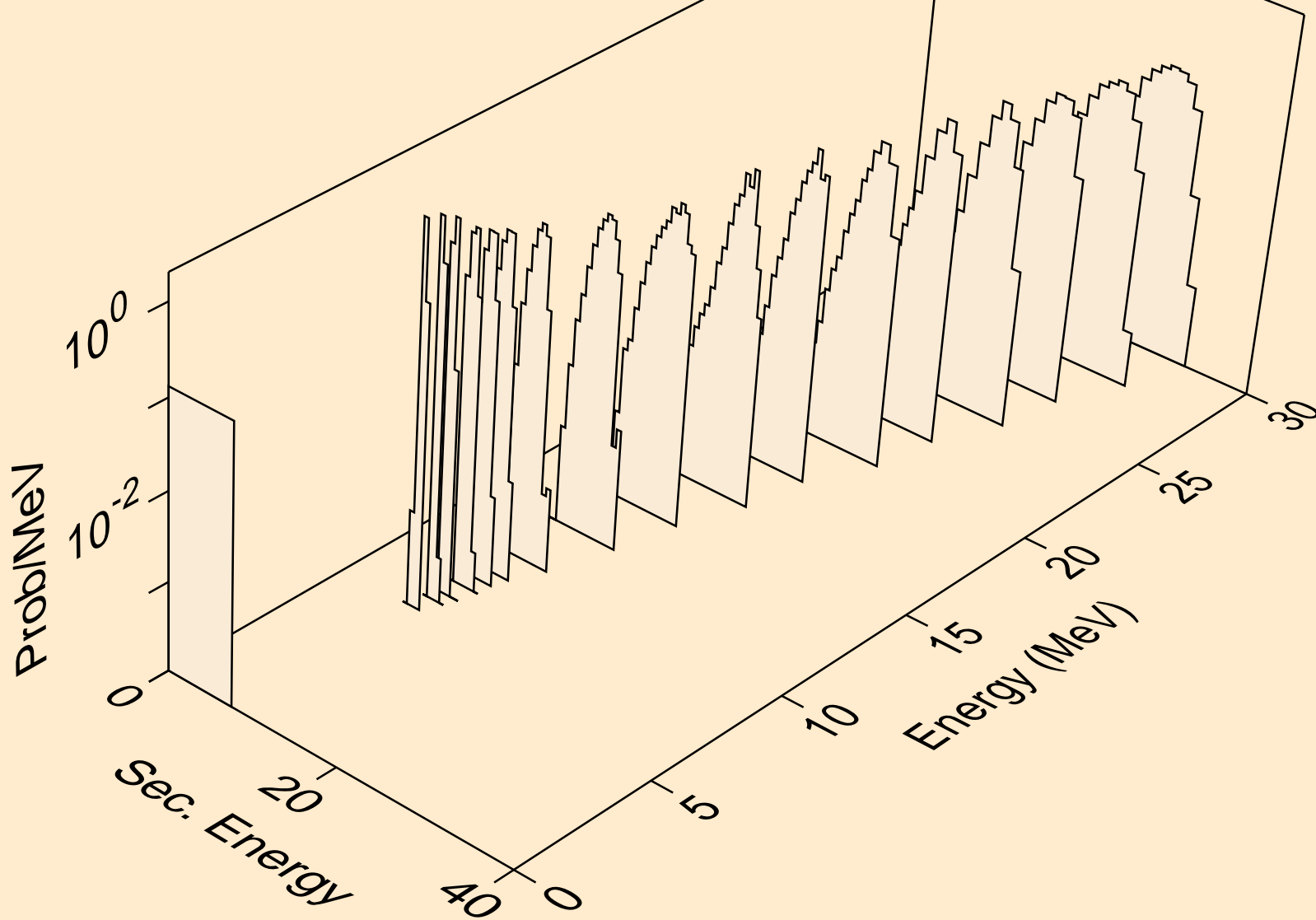

MD258 NEUTRON ACER TENDL-2019 LIBRARY; T=293.16K  
alphas from (n,3n)a

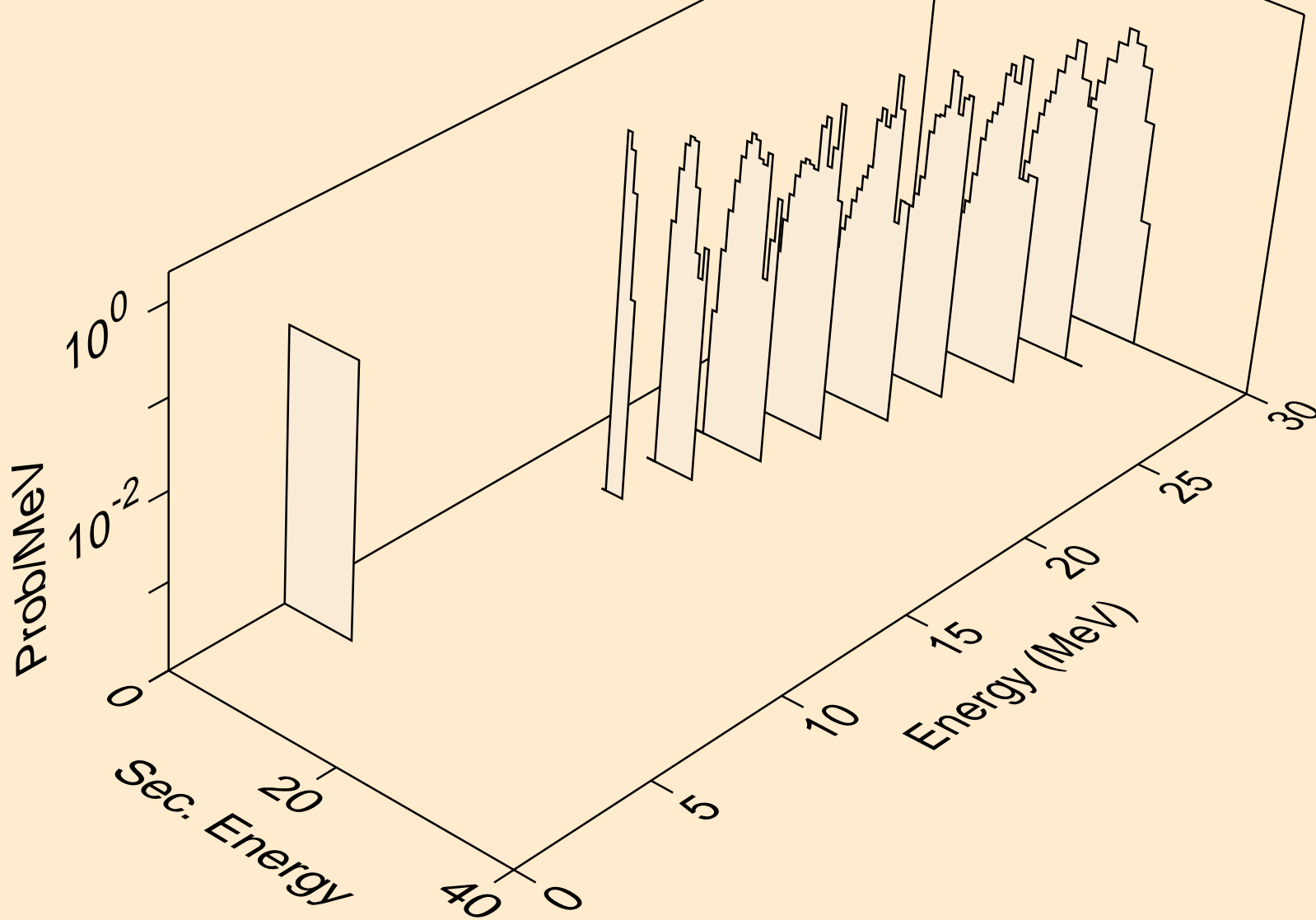

MD258 NEUTRON ACER TENDL-2019 LIBRARY; T=293.16K  
alphas from (n,n\*)2a

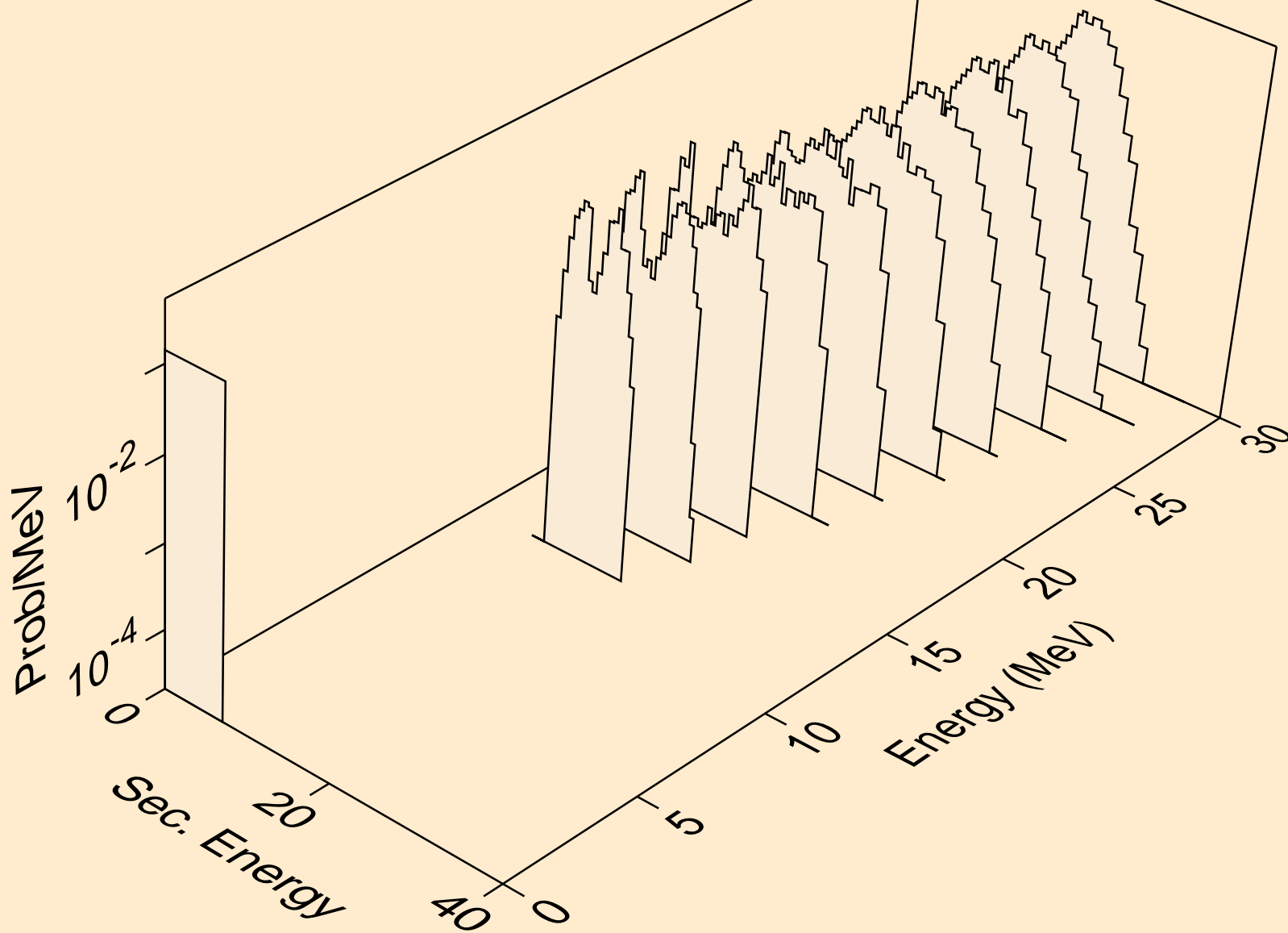

MD258 NEUTRON ACER TENDL-2019 LIBRARY; T=293.16K  
alphas from (n,npa)

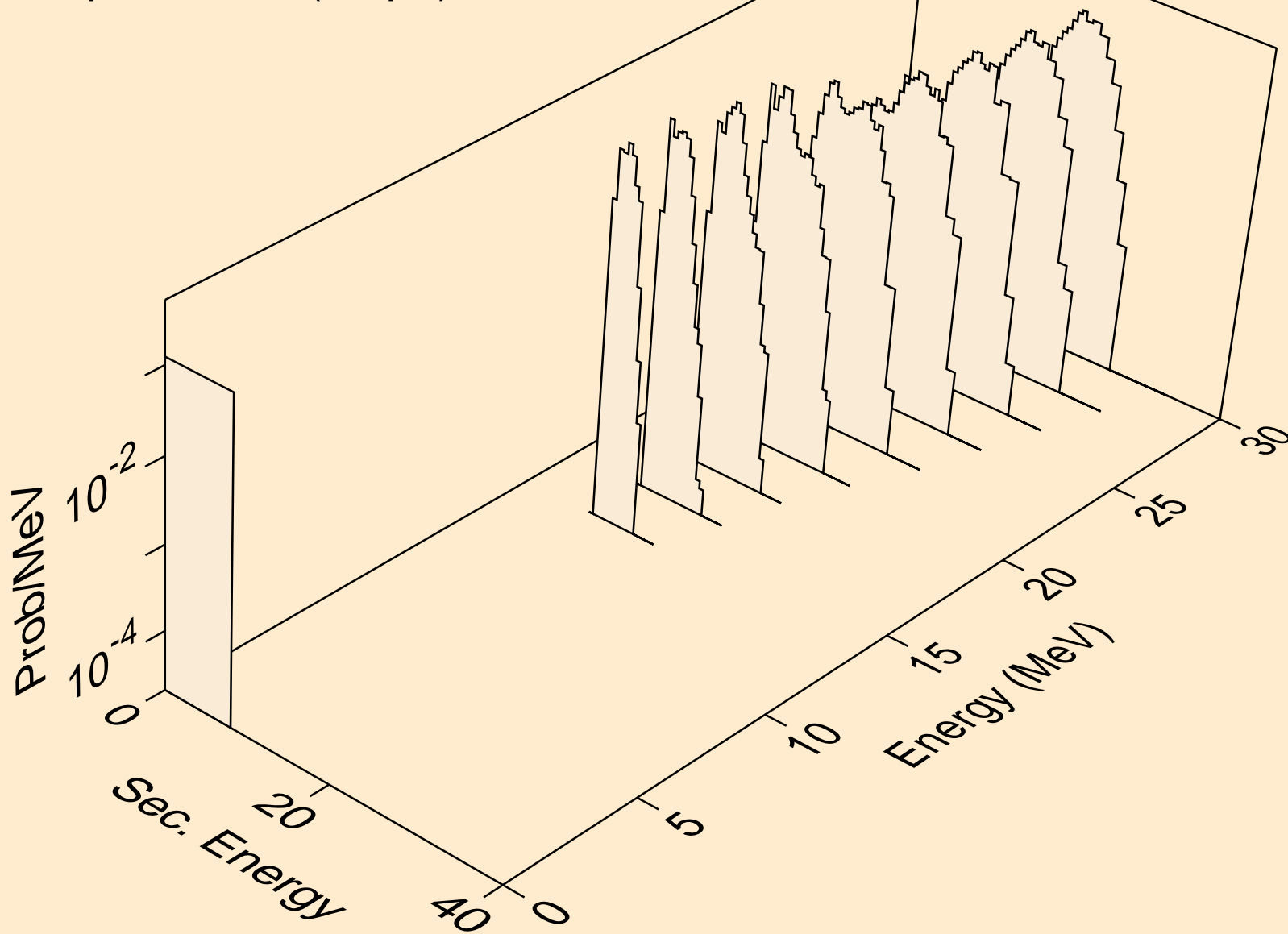

MD258 NEUTRON ACER TENDL-2019 LIBRARY; T=293.16K  
alphas from (n,a)

