

MD260 NEUTRON ACER TENDL-2019 LIBRARY; T=293.16K
Principal cross sections

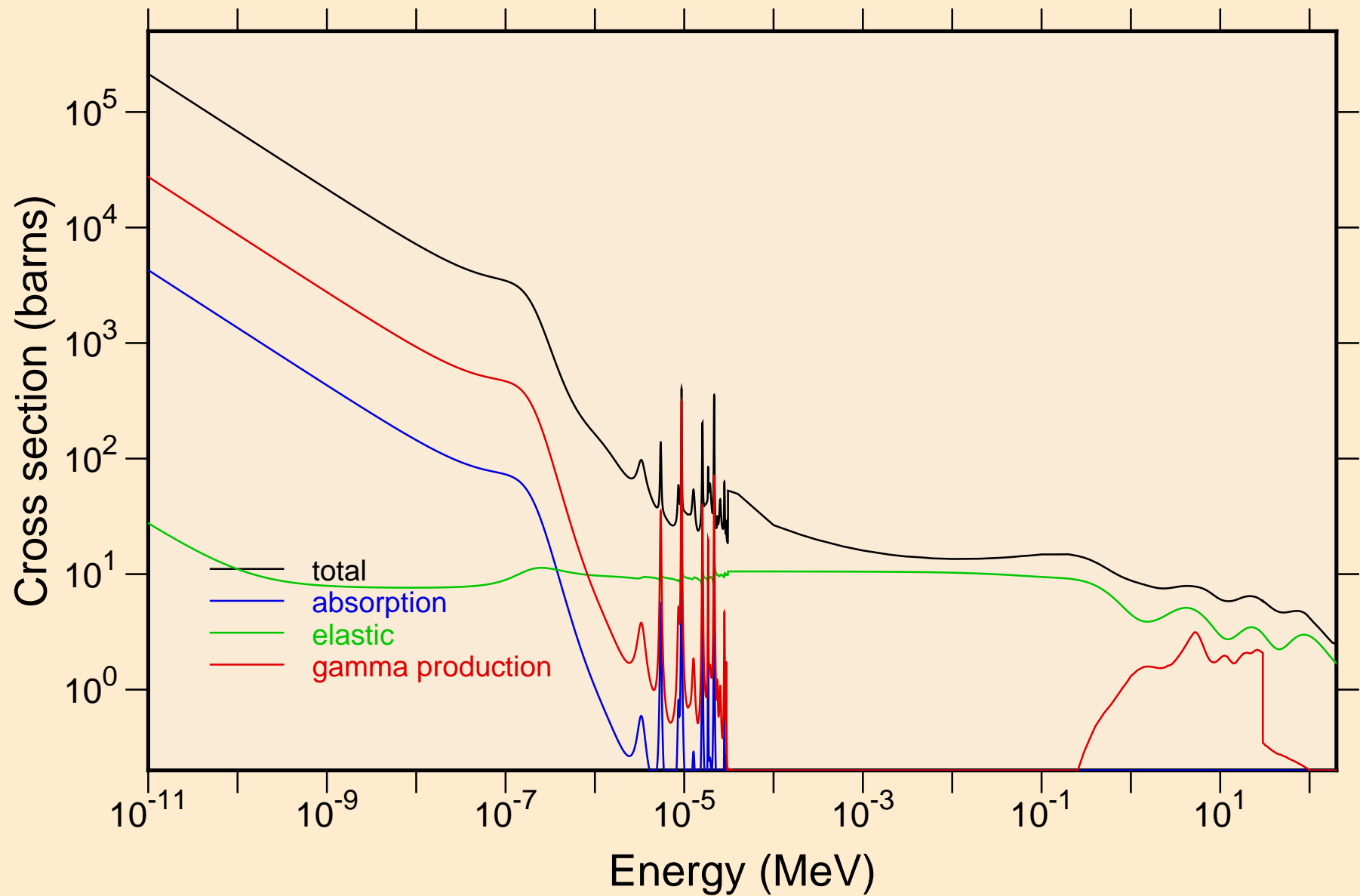

MD260 NEUTRON ACER TENDL-2019 LIBRARY; T=293.16K
resonance total cross section

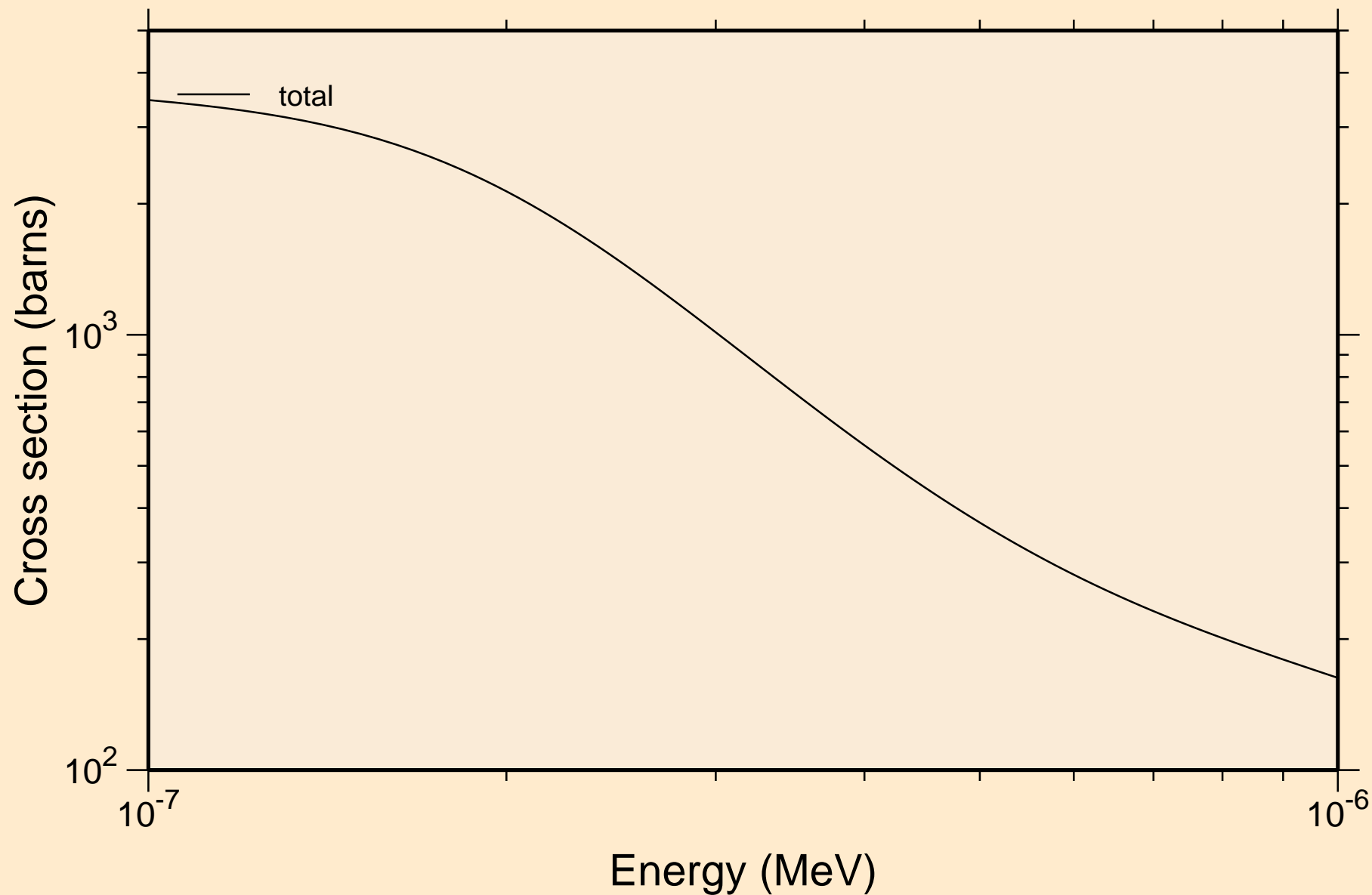

MD260 NEUTRON ACER TENDL-2019 LIBRARY; T=293.16K
resonance total cross section

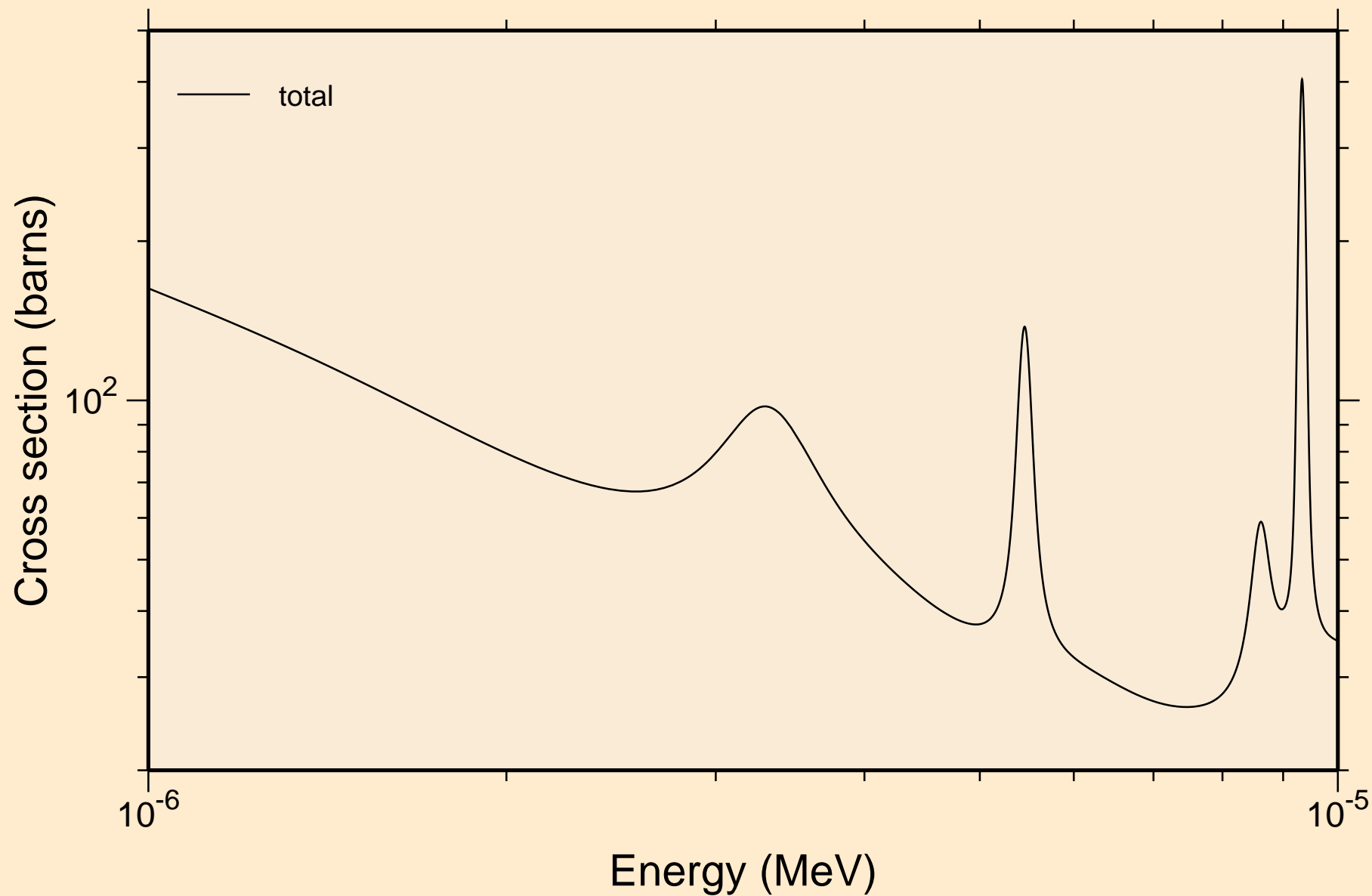

MD260 NEUTRON ACER TENDL-2019 LIBRARY; T=293.16K
resonance total cross section

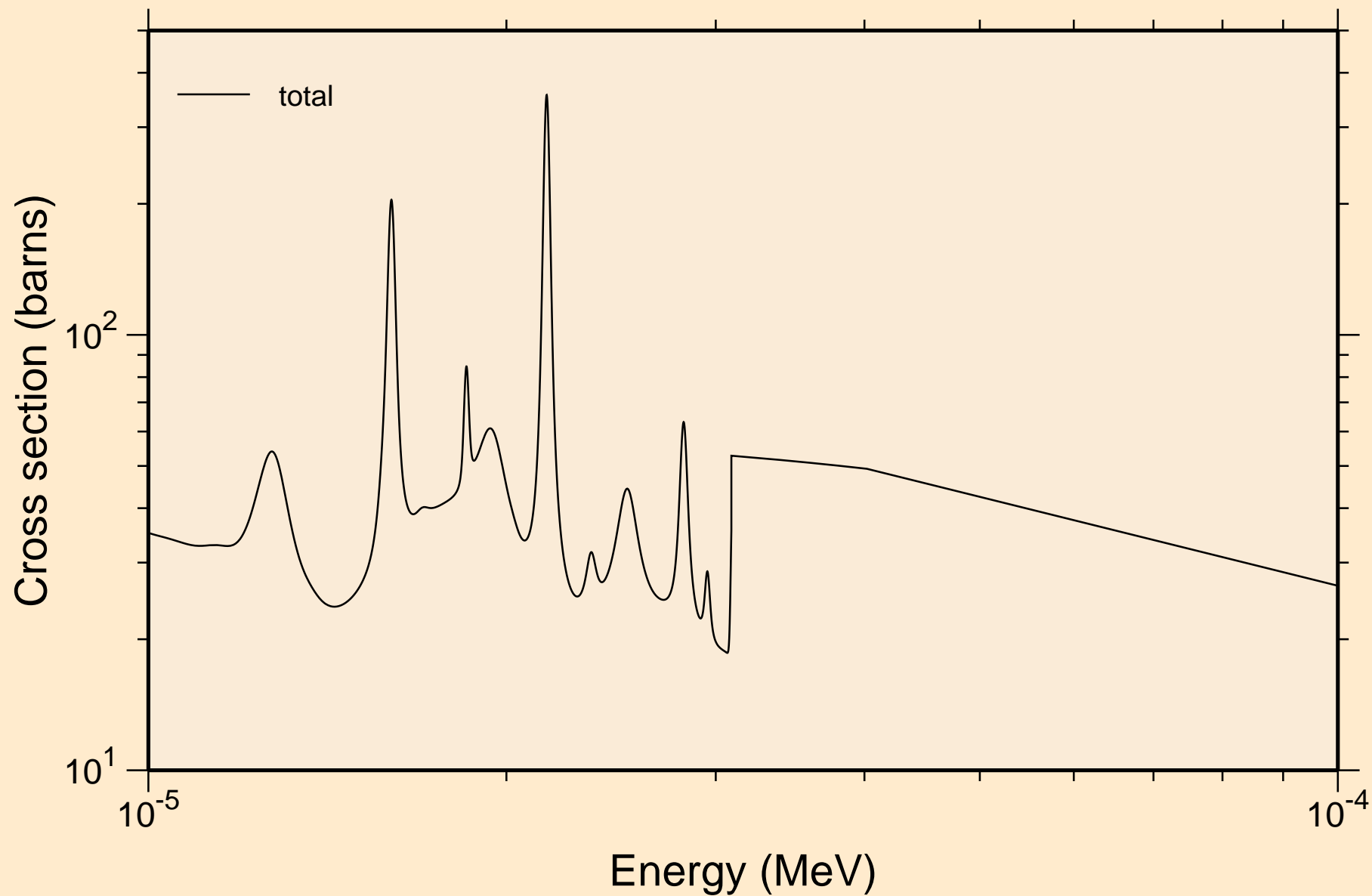

MD260 NEUTRON ACER TENDL-2019 LIBRARY; T=293.16K
resonance total cross section

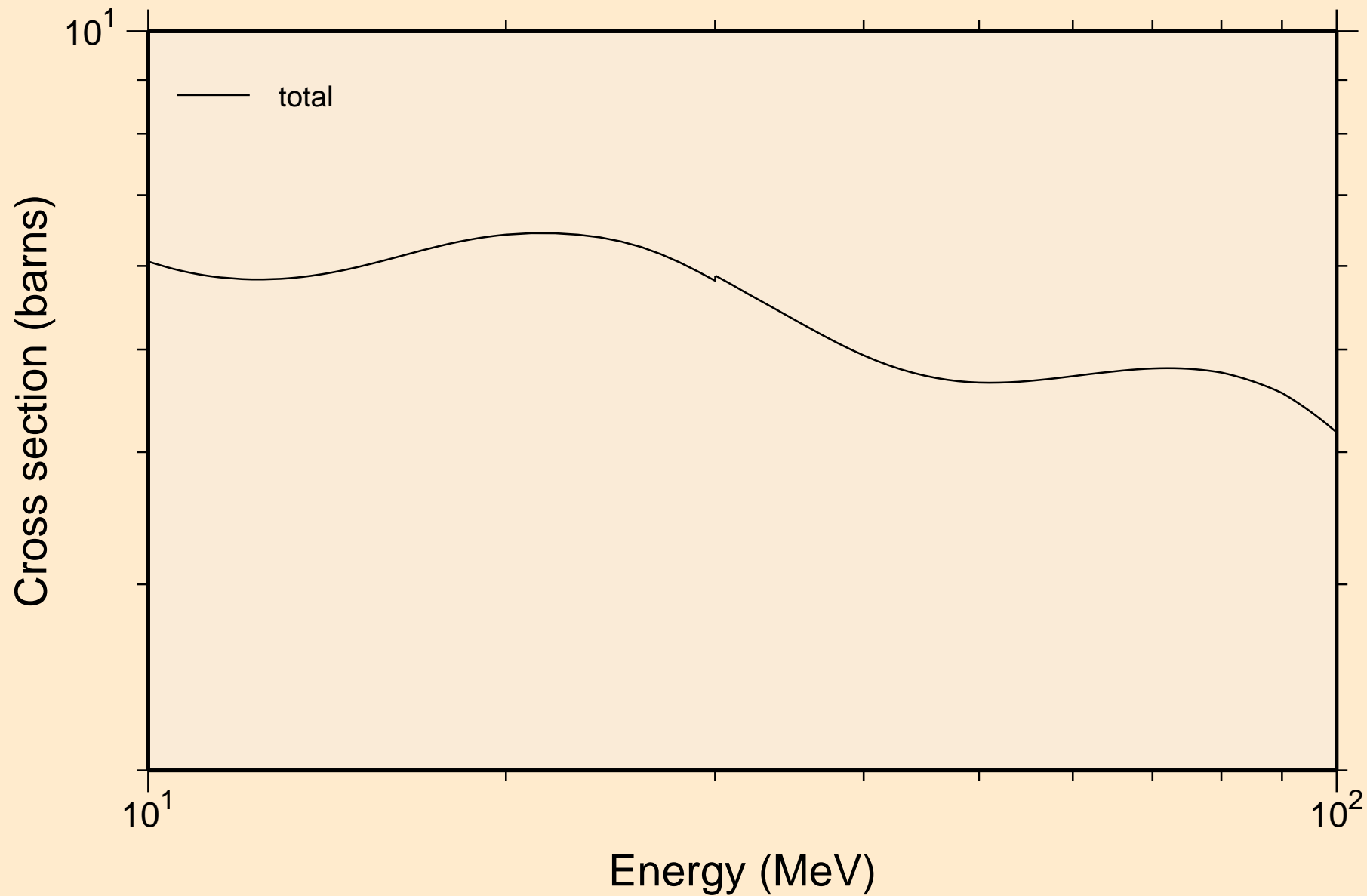

MD260 NEUTRON ACER TENDL-2019 LIBRARY; T=293.16K
resonance absorption cross sections

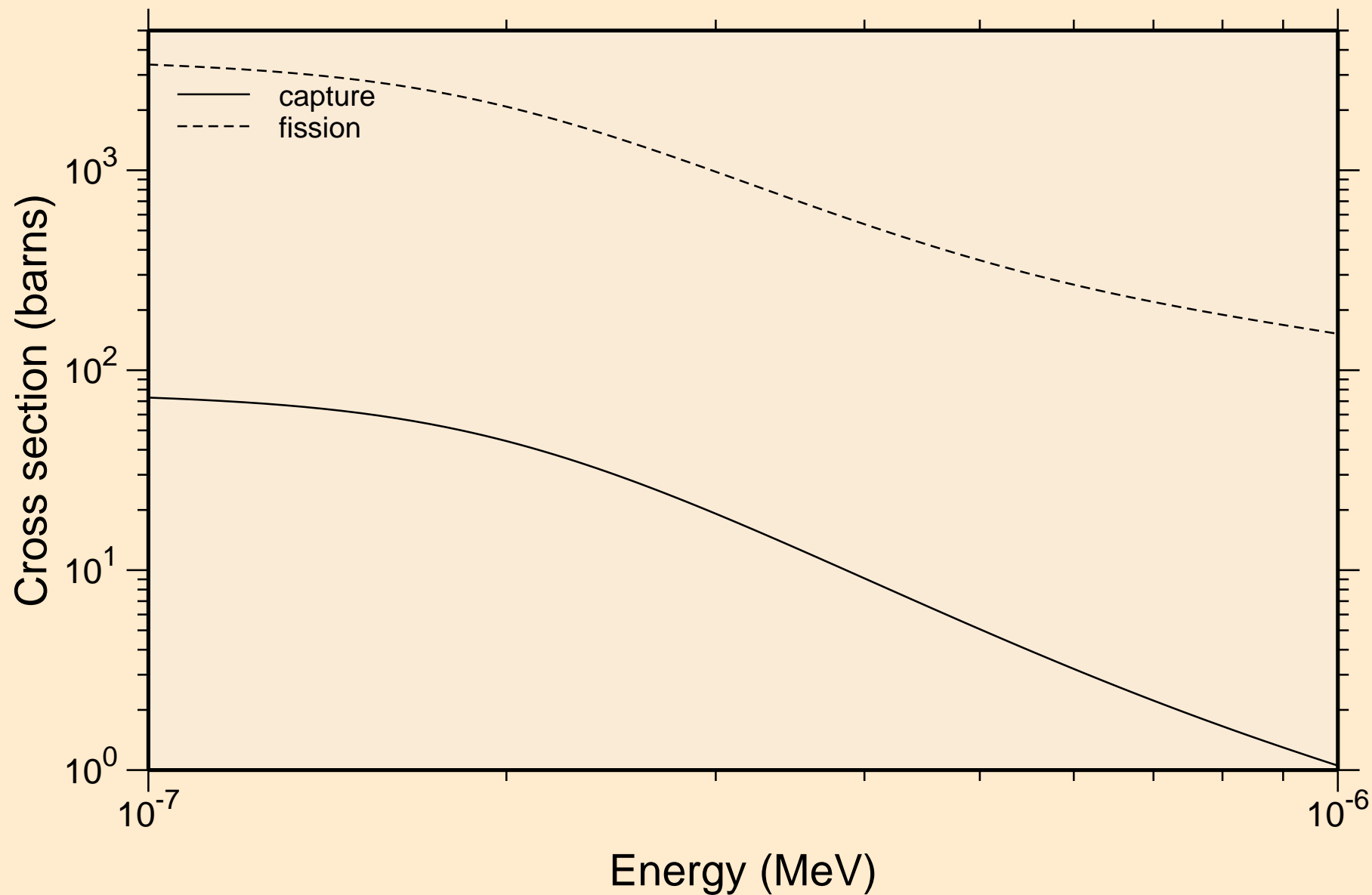

MD260 NEUTRON ACER TENDL-2019 LIBRARY; T=293.16K
resonance absorption cross sections

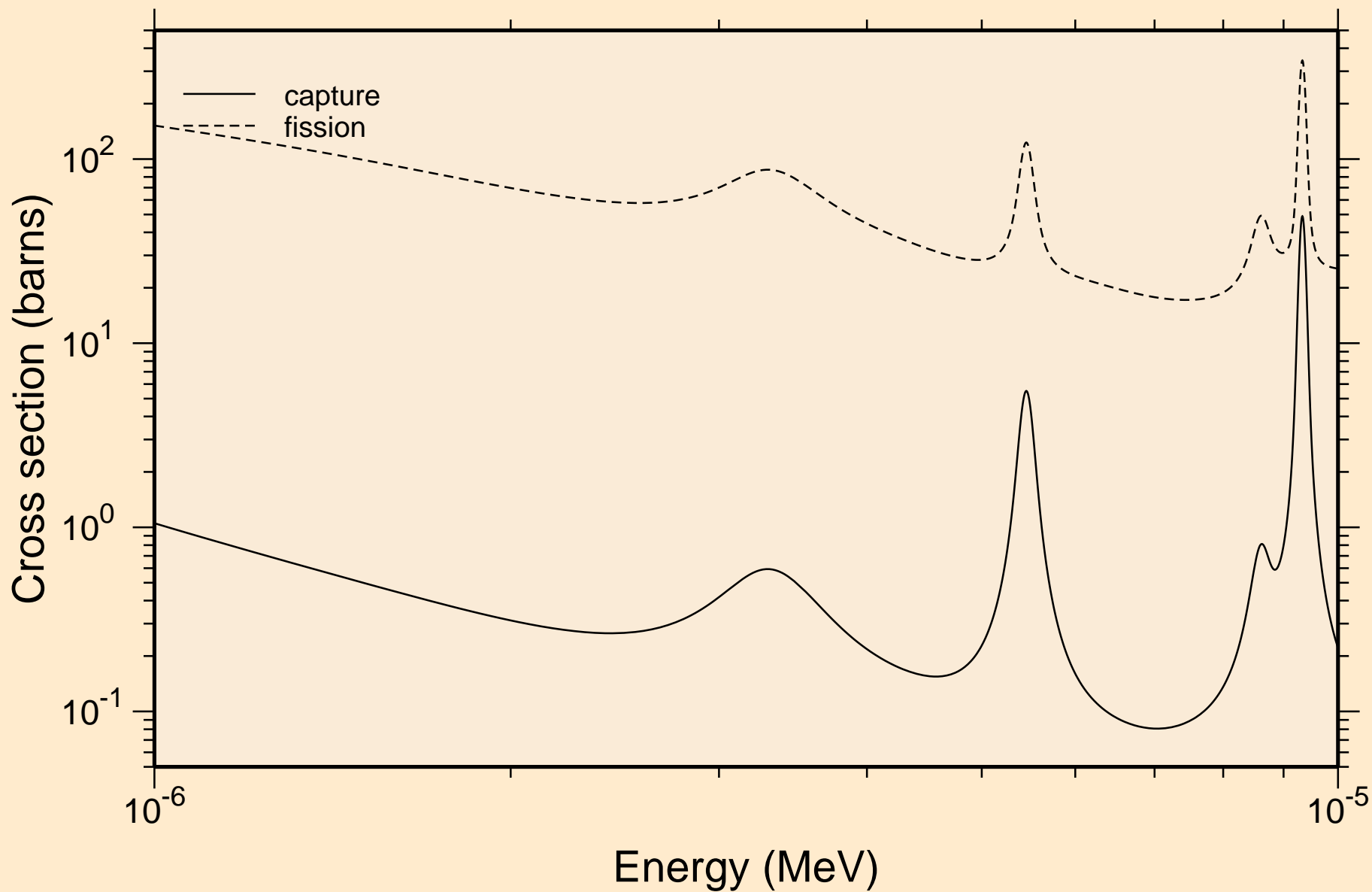

MD260 NEUTRON ACER TENDL-2019 LIBRARY; T=293.16K
resonance absorption cross sections

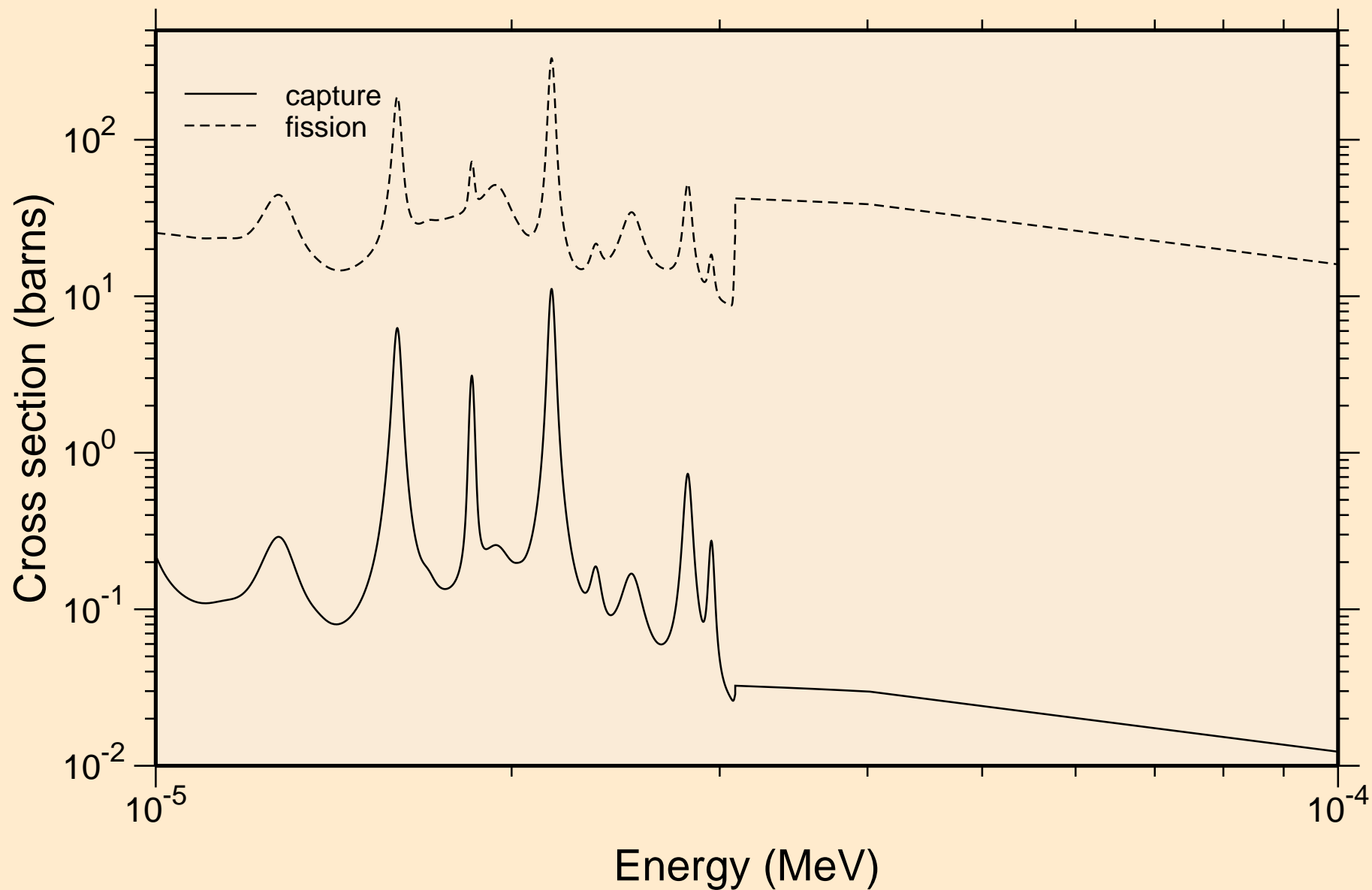

MD260 NEUTRON ACER TENDL-2019 LIBRARY; T=293.16K
resonance absorption cross sections

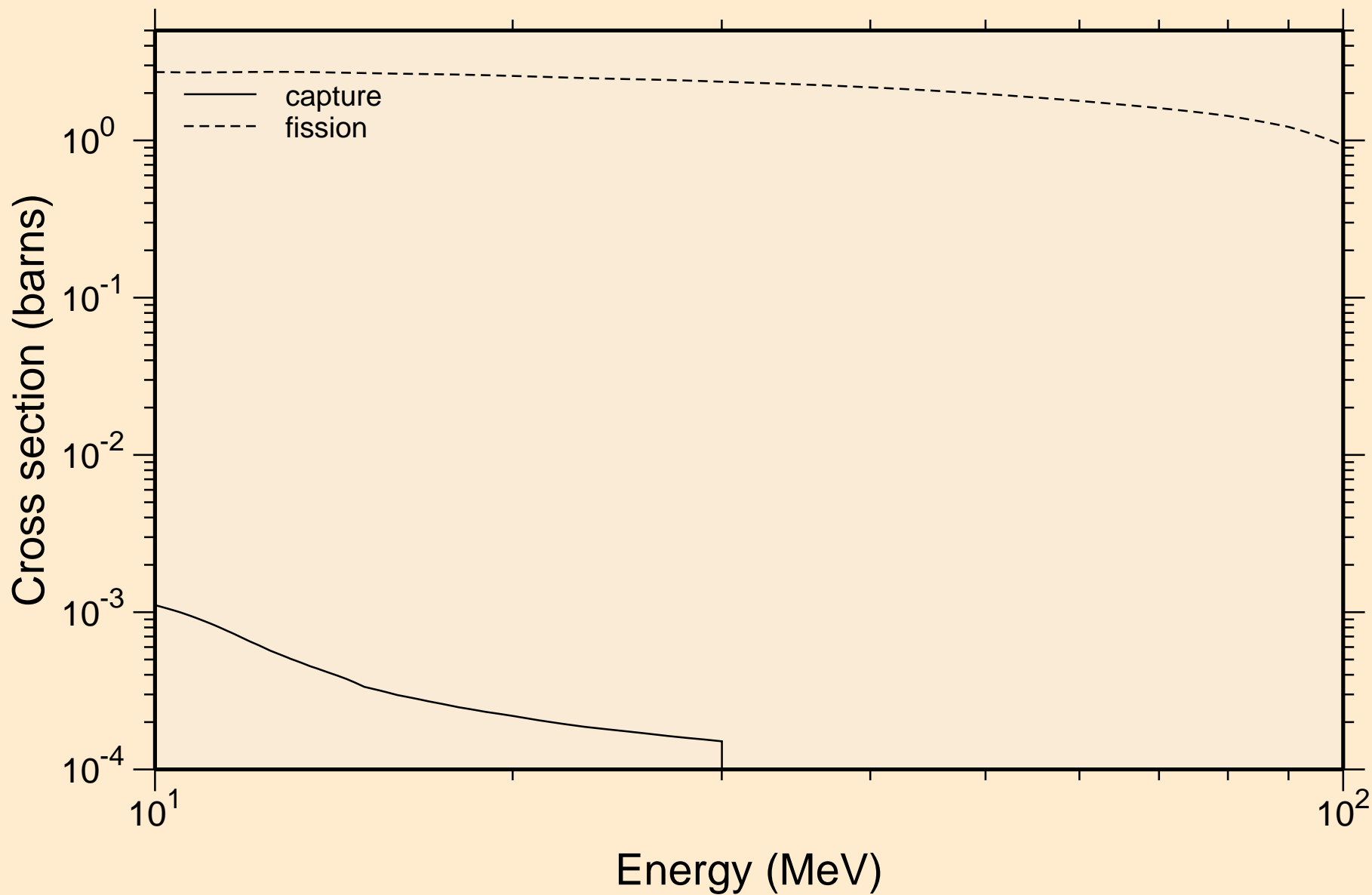

MD260 NEUTRON ACER TENDL-2019 LIBRARY; T=293.16K
Heating

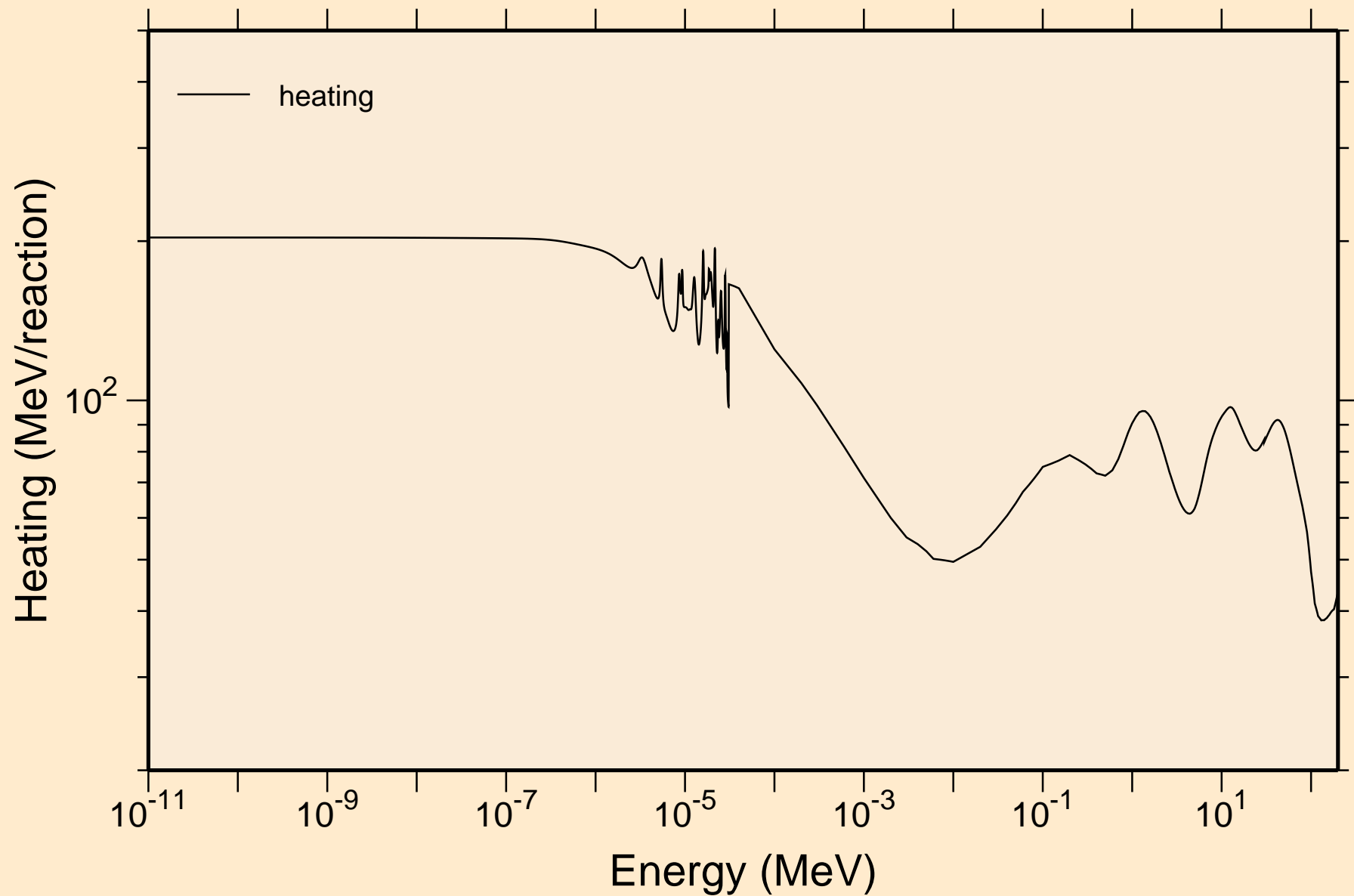

MD260 NEUTRON ACER TENDL-2019 LIBRARY; T=293.16K
Damage

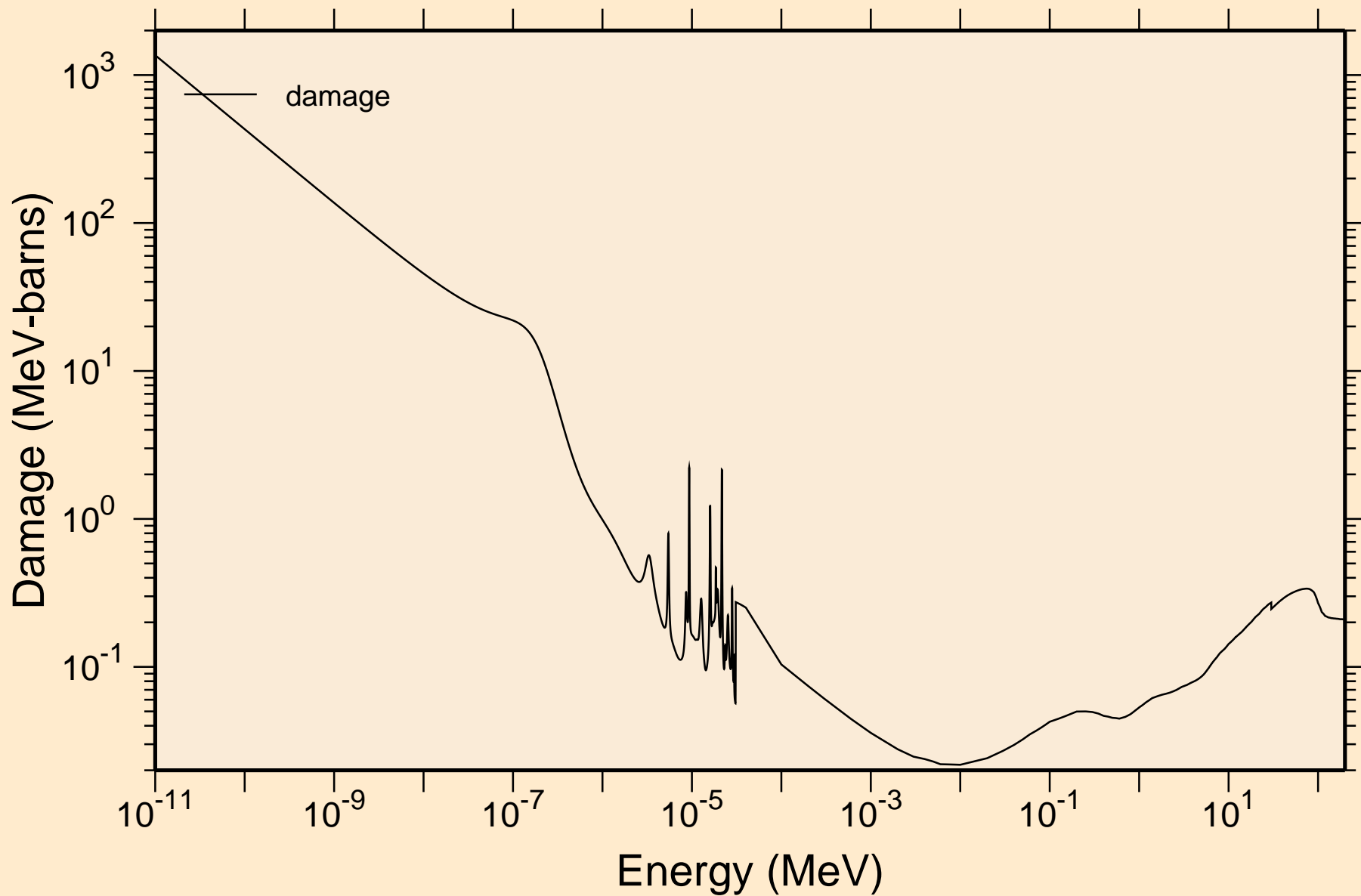

MD260 NEUTRON ACER TENDL-2019 LIBRARY; T=293.16K
Non-threshold reactions

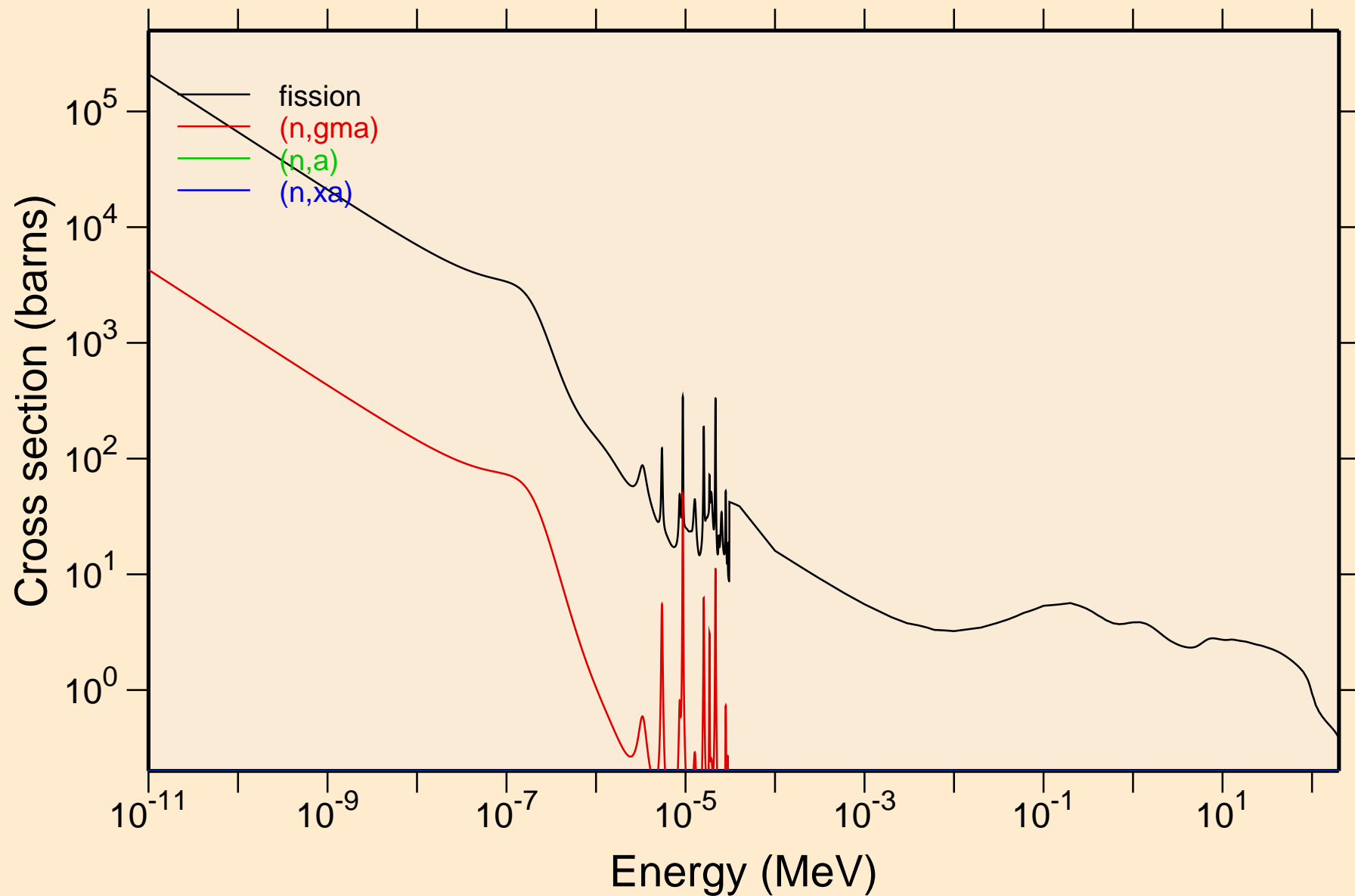

MD260 NEUTRON ACER TENDL-2019 LIBRARY; T=293.16K

Principal cross sections

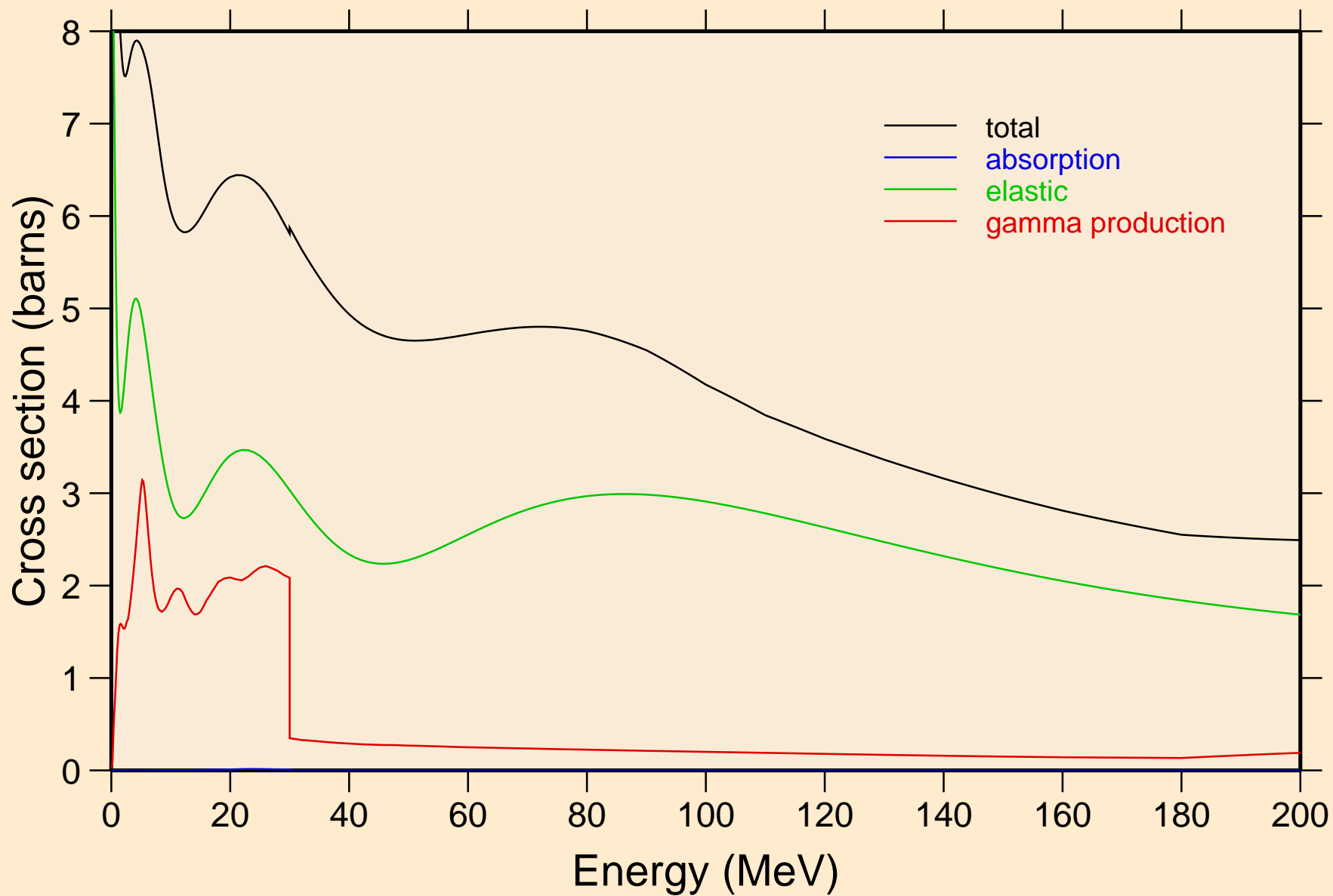

MD260 NEUTRON ACER TENDL-2019 LIBRARY; T=293.16K
Heating

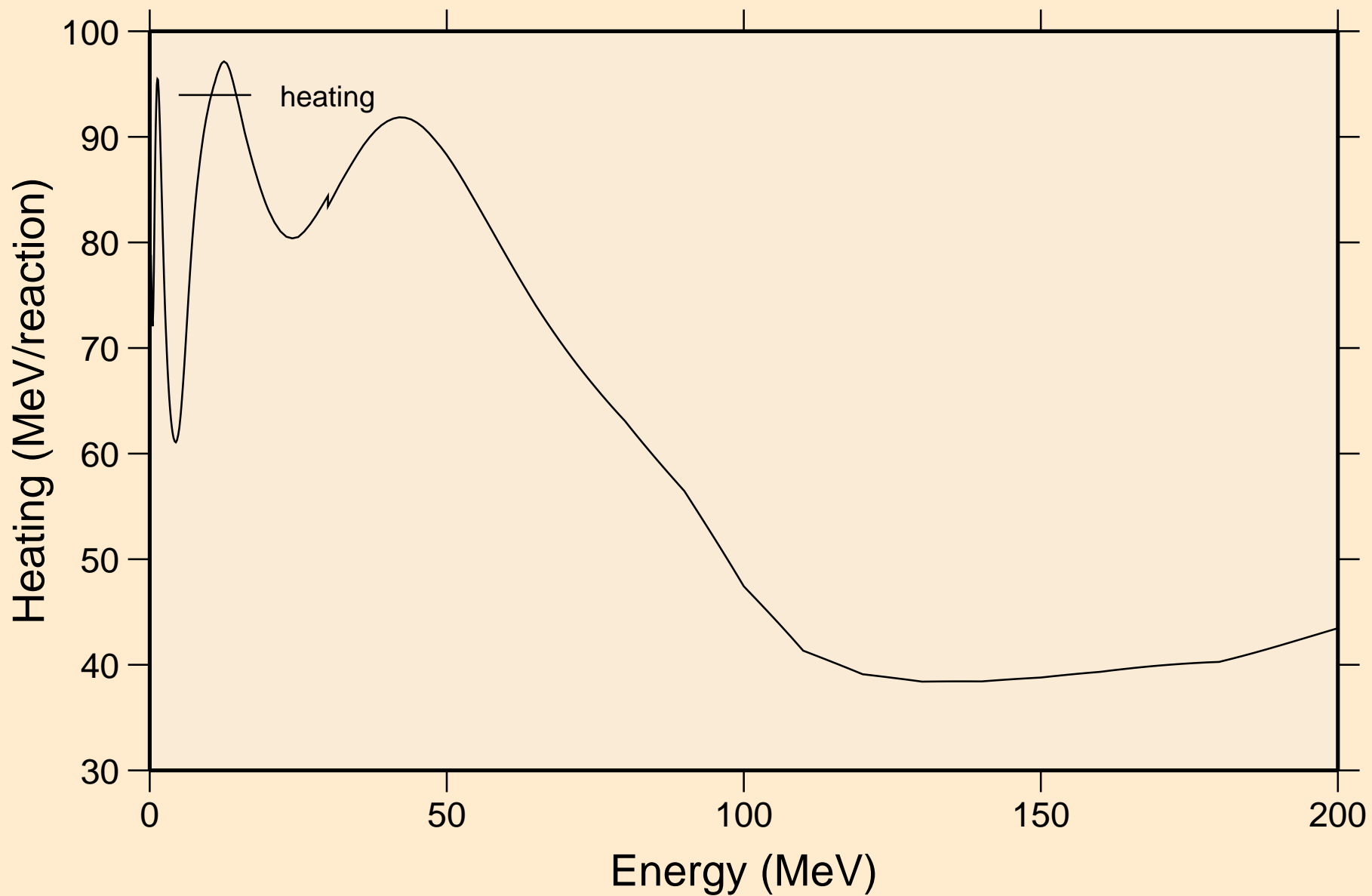

MD260 NEUTRON ACER TENDL-2019 LIBRARY; T=293.16K
Damage

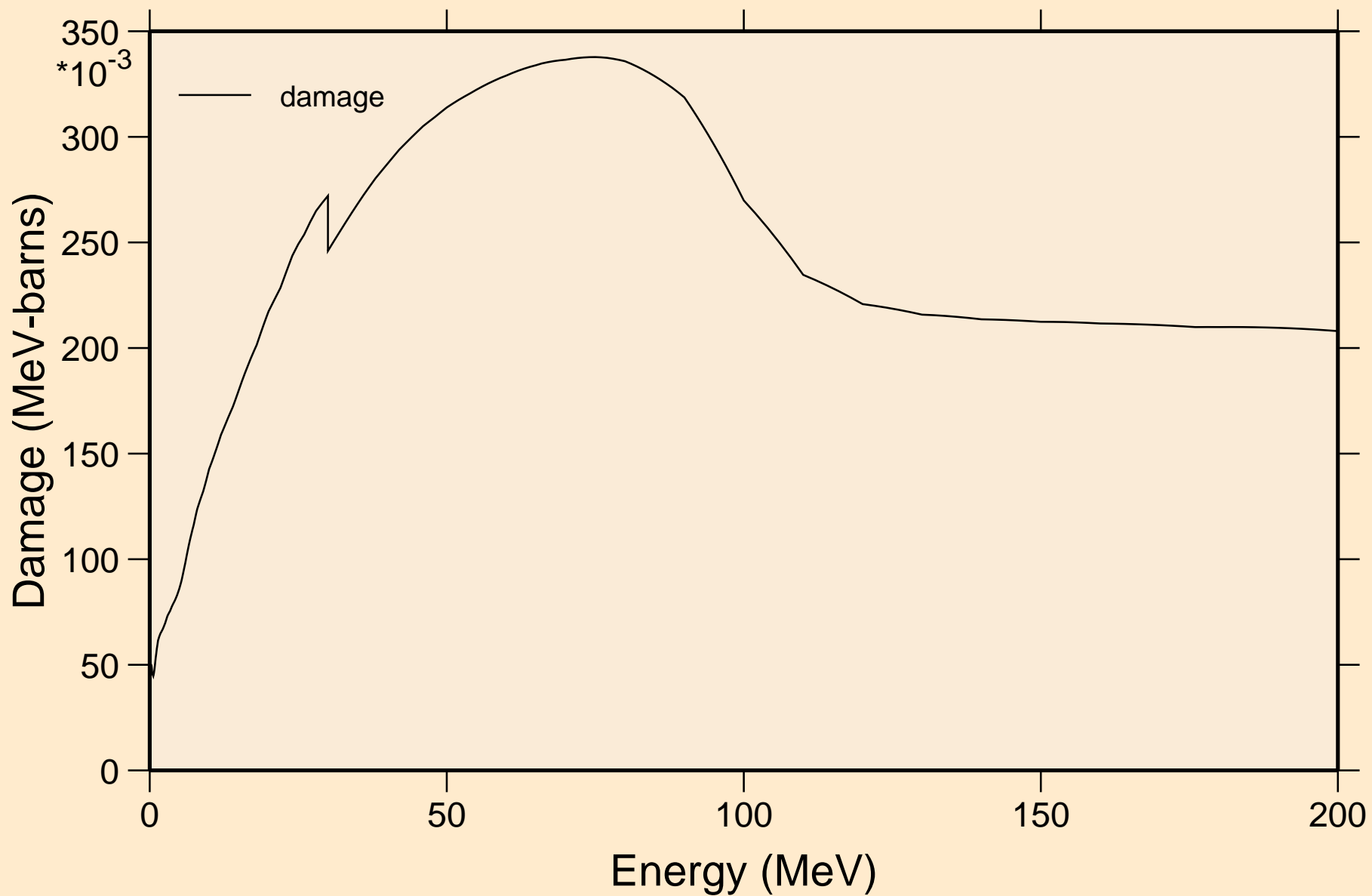

MD260 NEUTRON ACER TENDL-2019 LIBRARY; T=293.16K
Non-threshold reactions

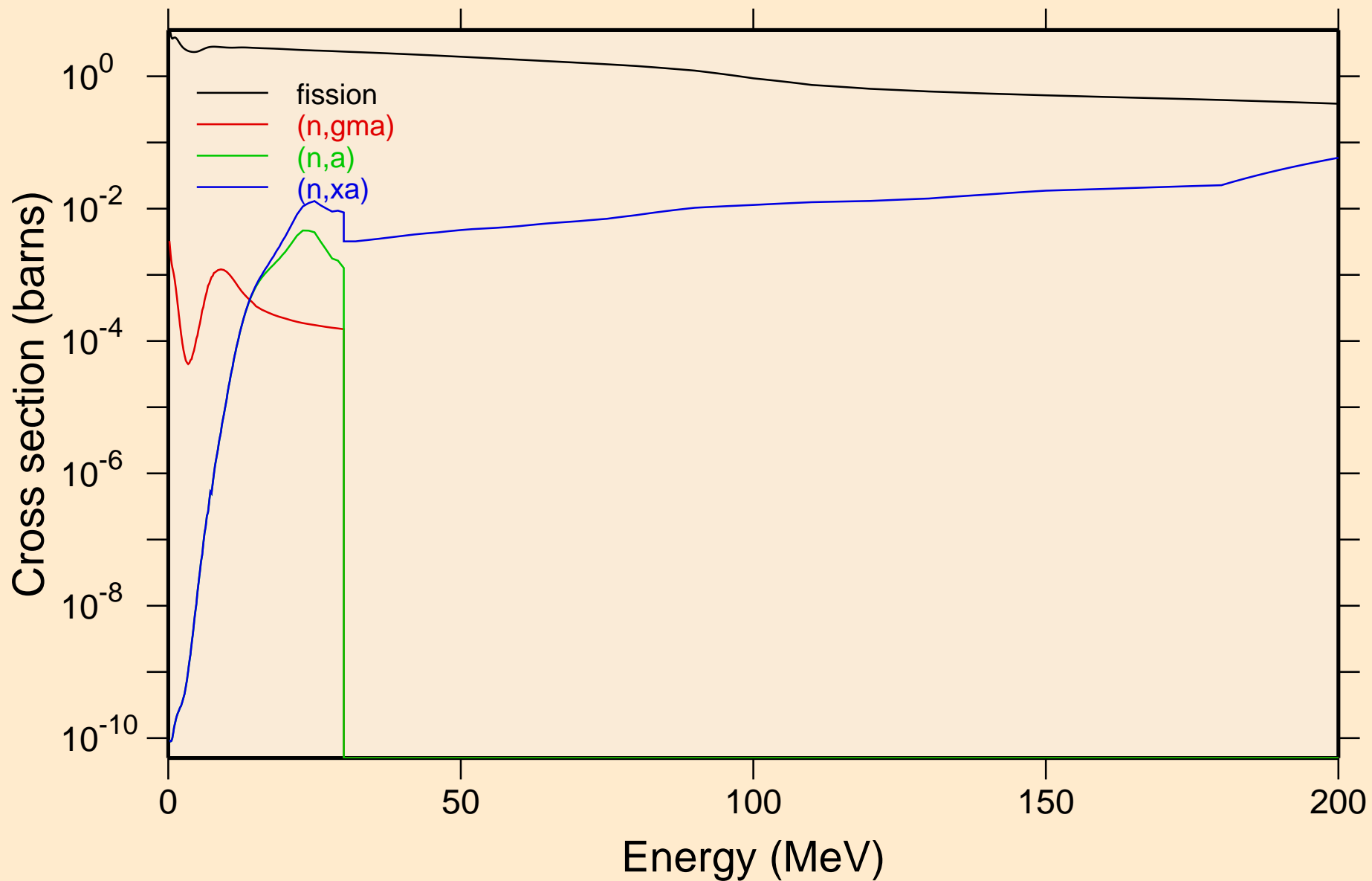

MD260 NEUTRON ACER TENDL-2019 LIBRARY; T=293.16K
Inelastic levels

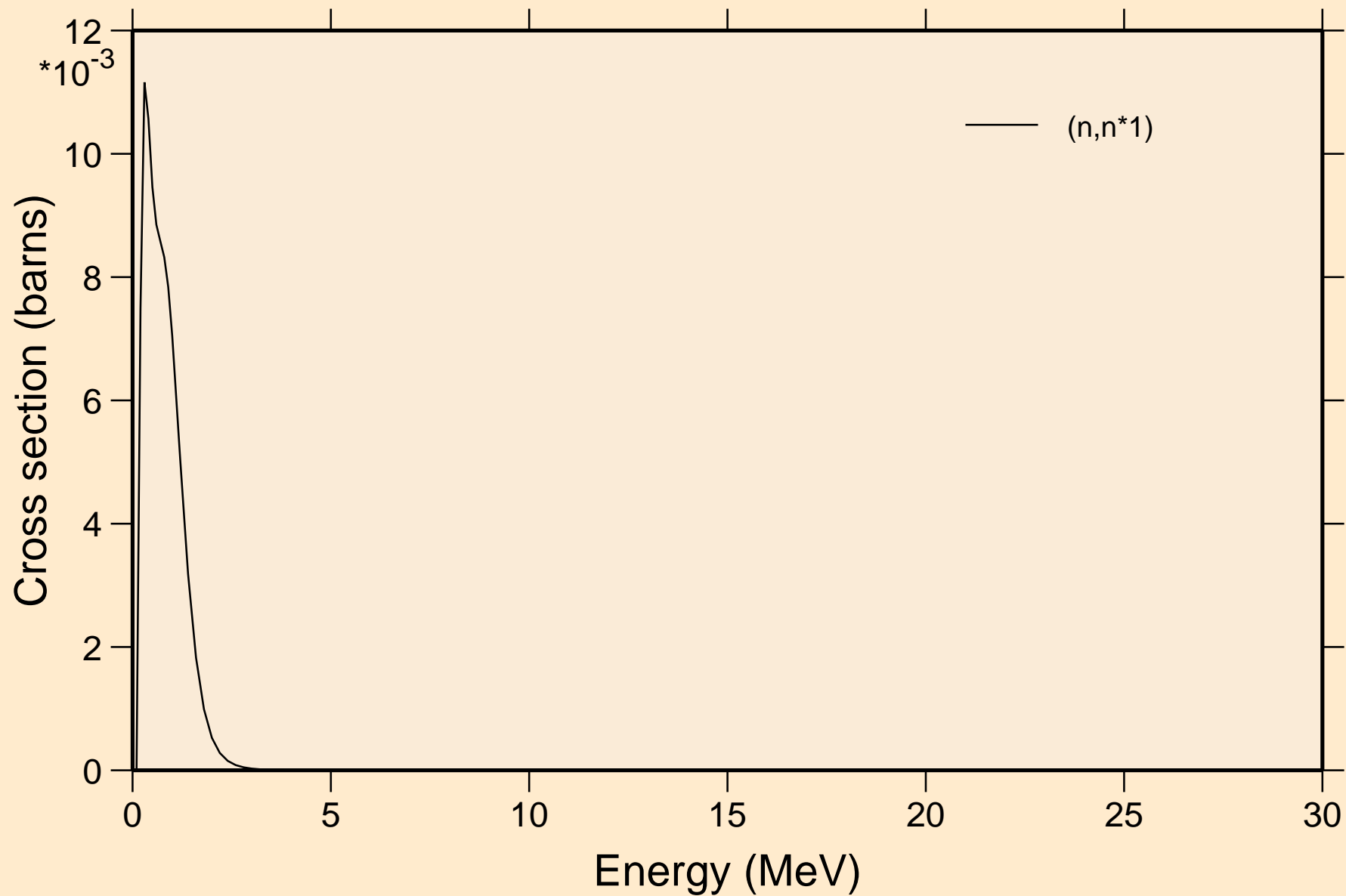

MD260 NEUTRON ACER TENDL-2019 LIBRARY; T=293.16K
Threshold reactions

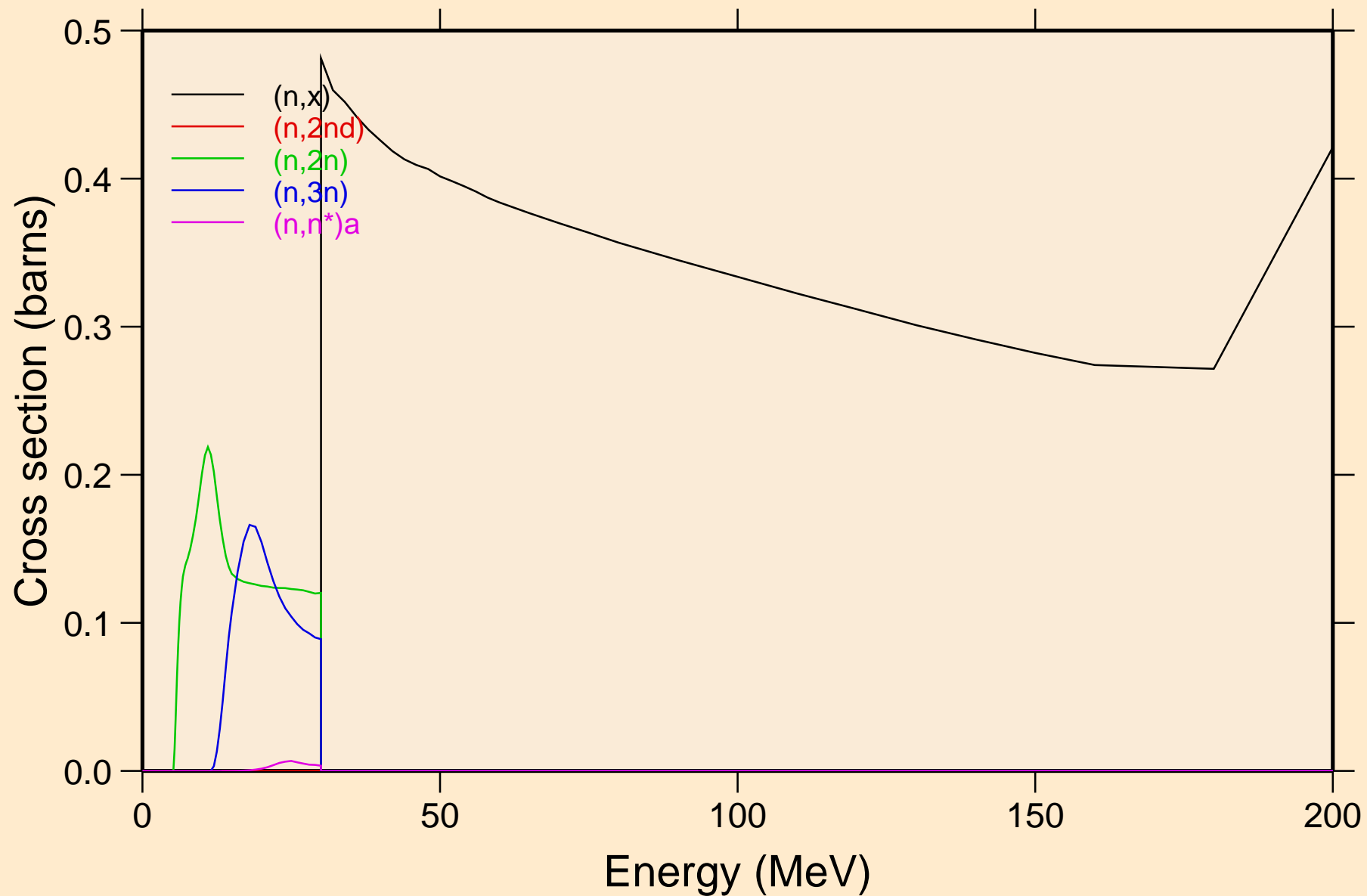

MD260 NEUTRON ACER TENDL-2019 LIBRARY; T=293.16K
Threshold reactions

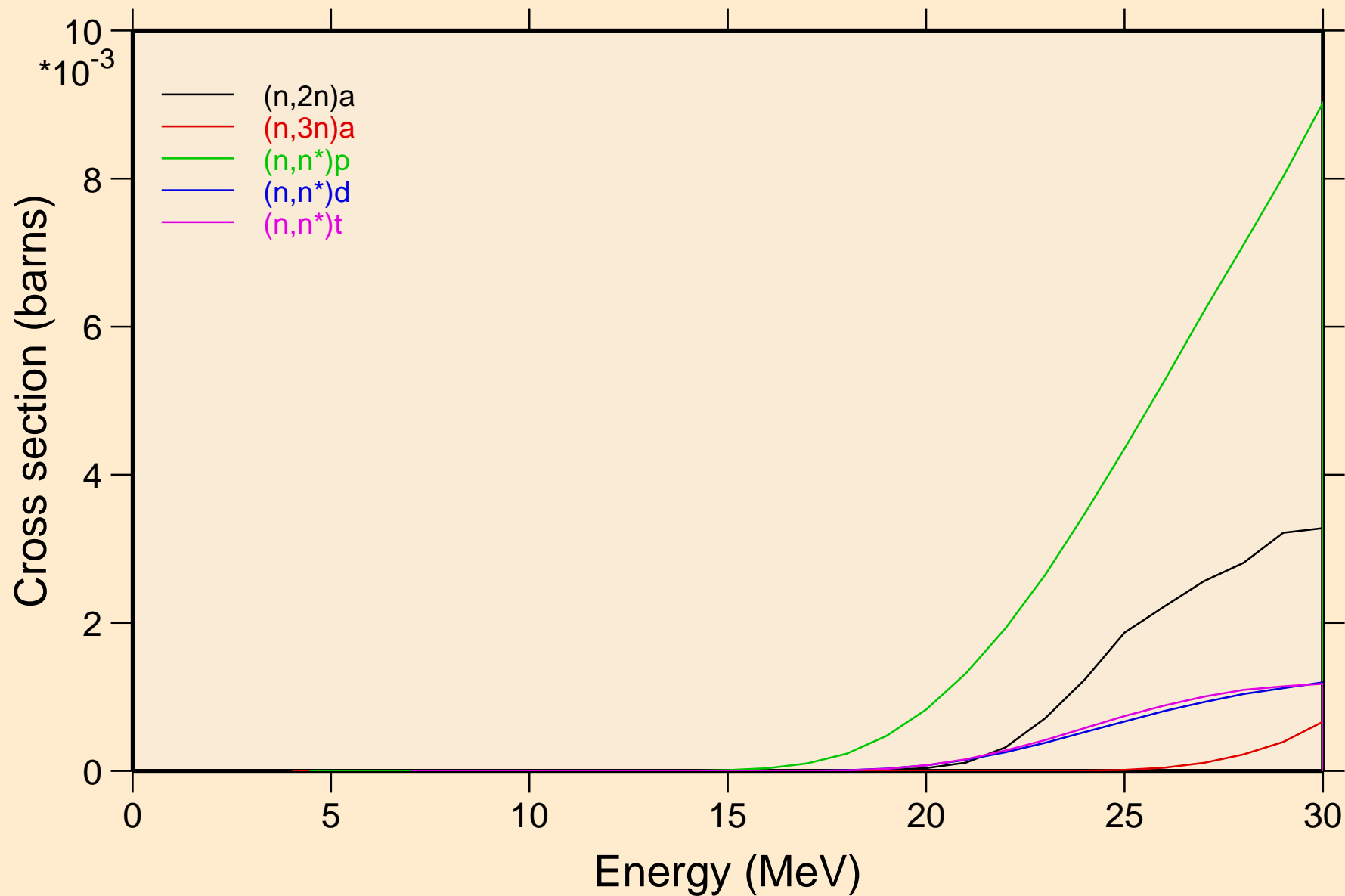

MD260 NEUTRON ACER TENDL-2019 LIBRARY; T=293.16K
Threshold reactions

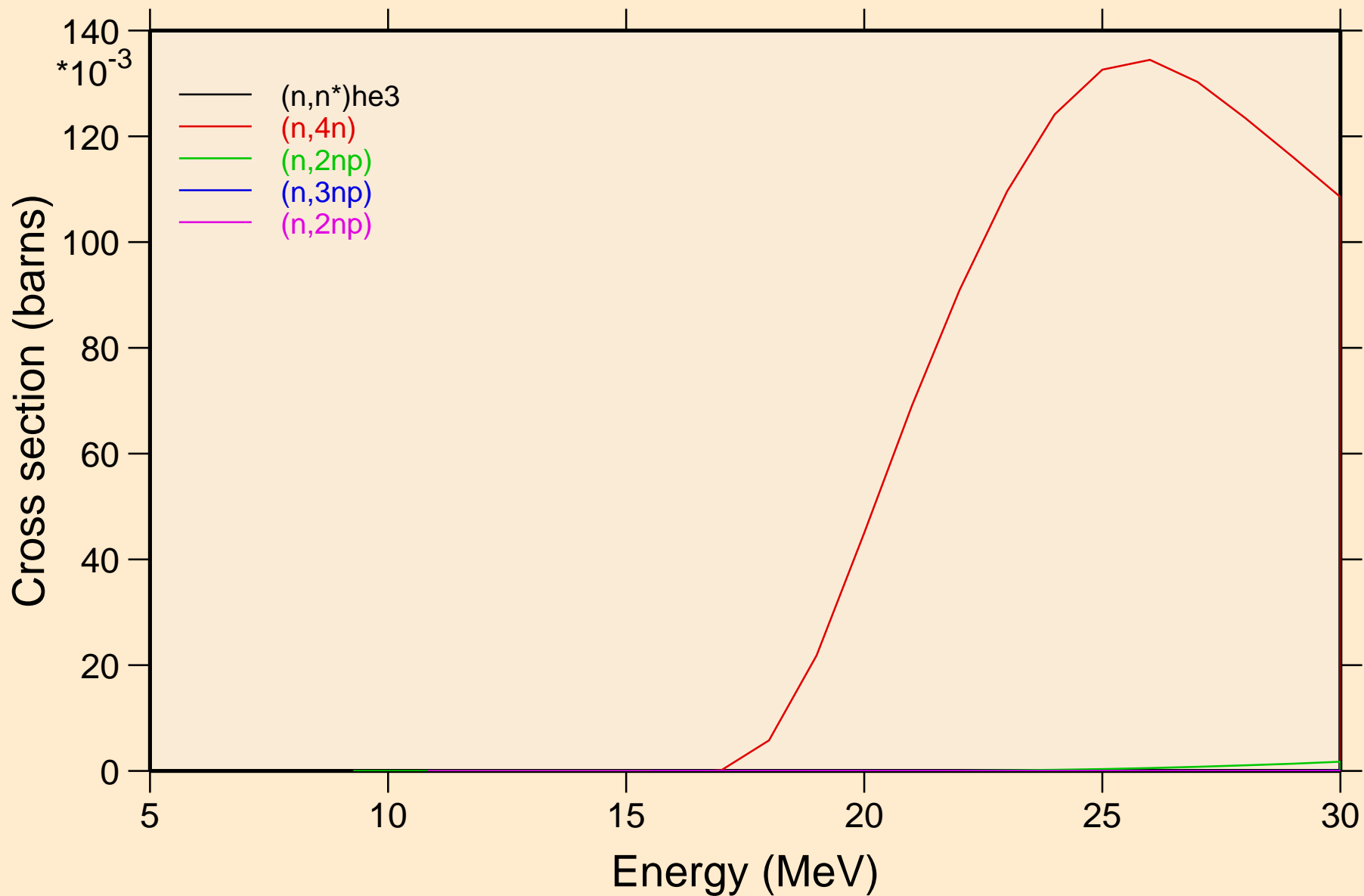

MD260 NEUTRON ACER TENDL-2019 LIBRARY; T=293.16K
Threshold reactions

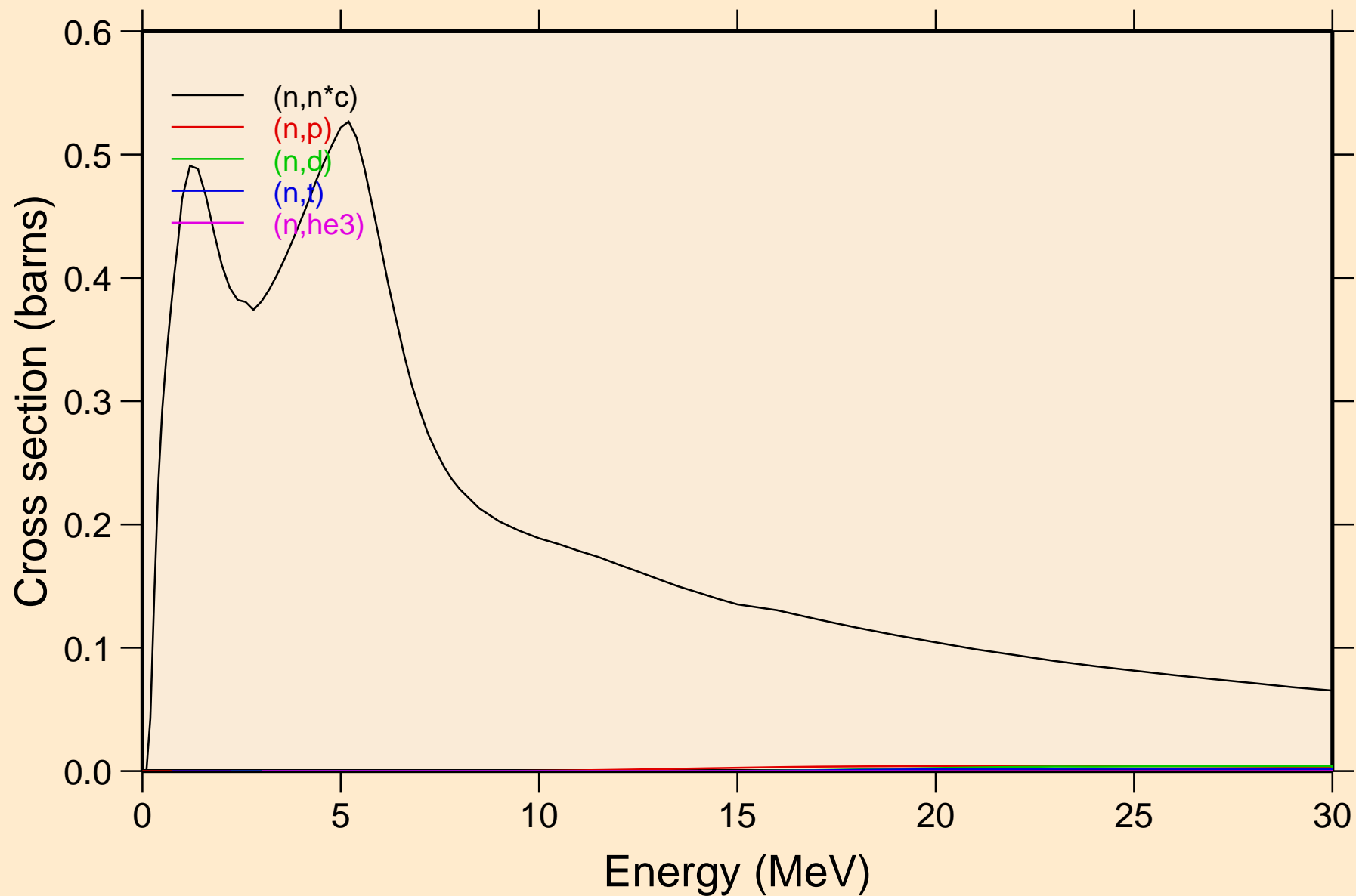

MD260 NEUTRON ACER TENDL-2019 LIBRARY; T=293.16K
Threshold reactions

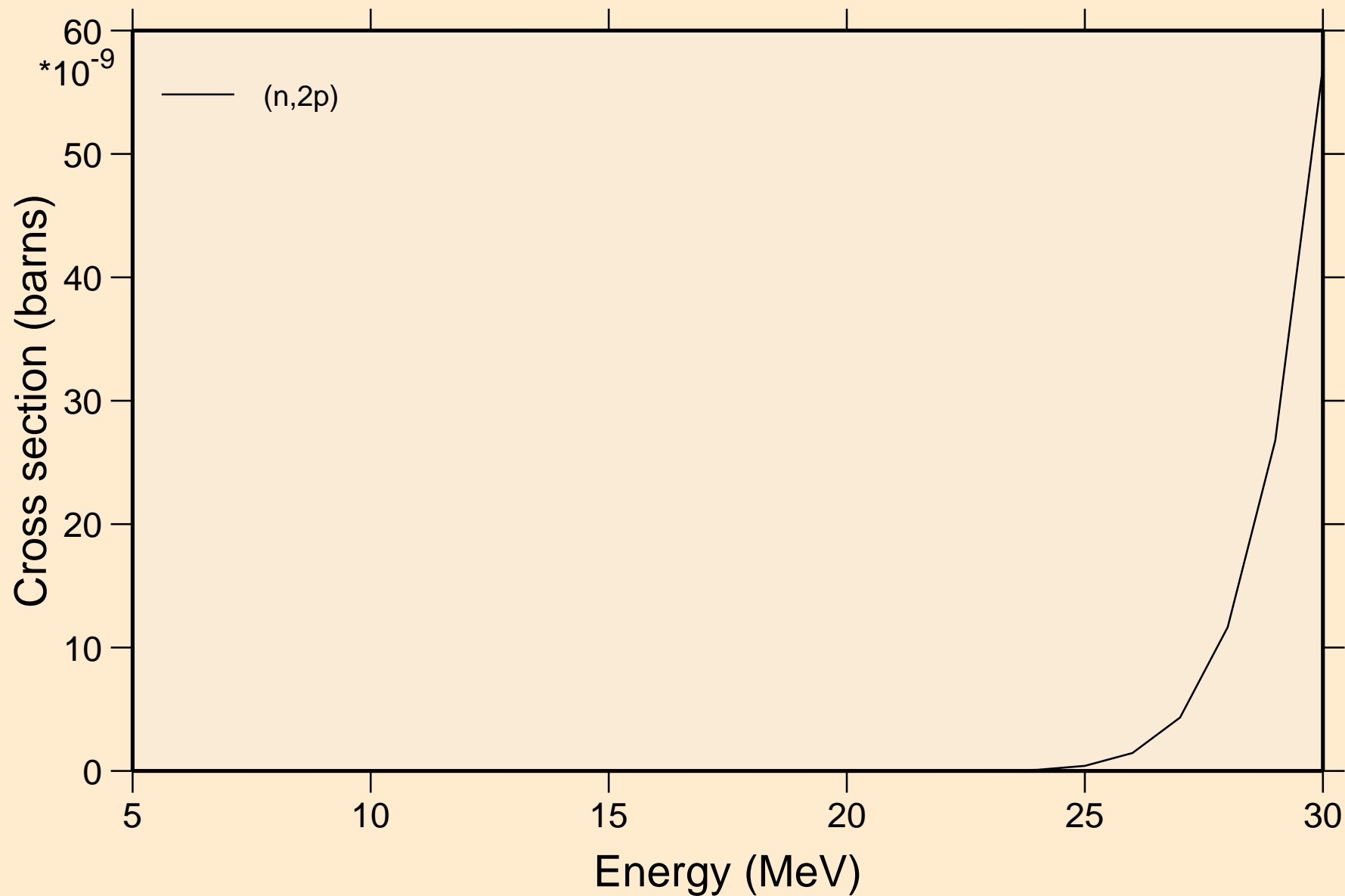

MD260 NEUTRON ACER TENDL-2019 LIBRARY; T=293.16K
Threshold reactions

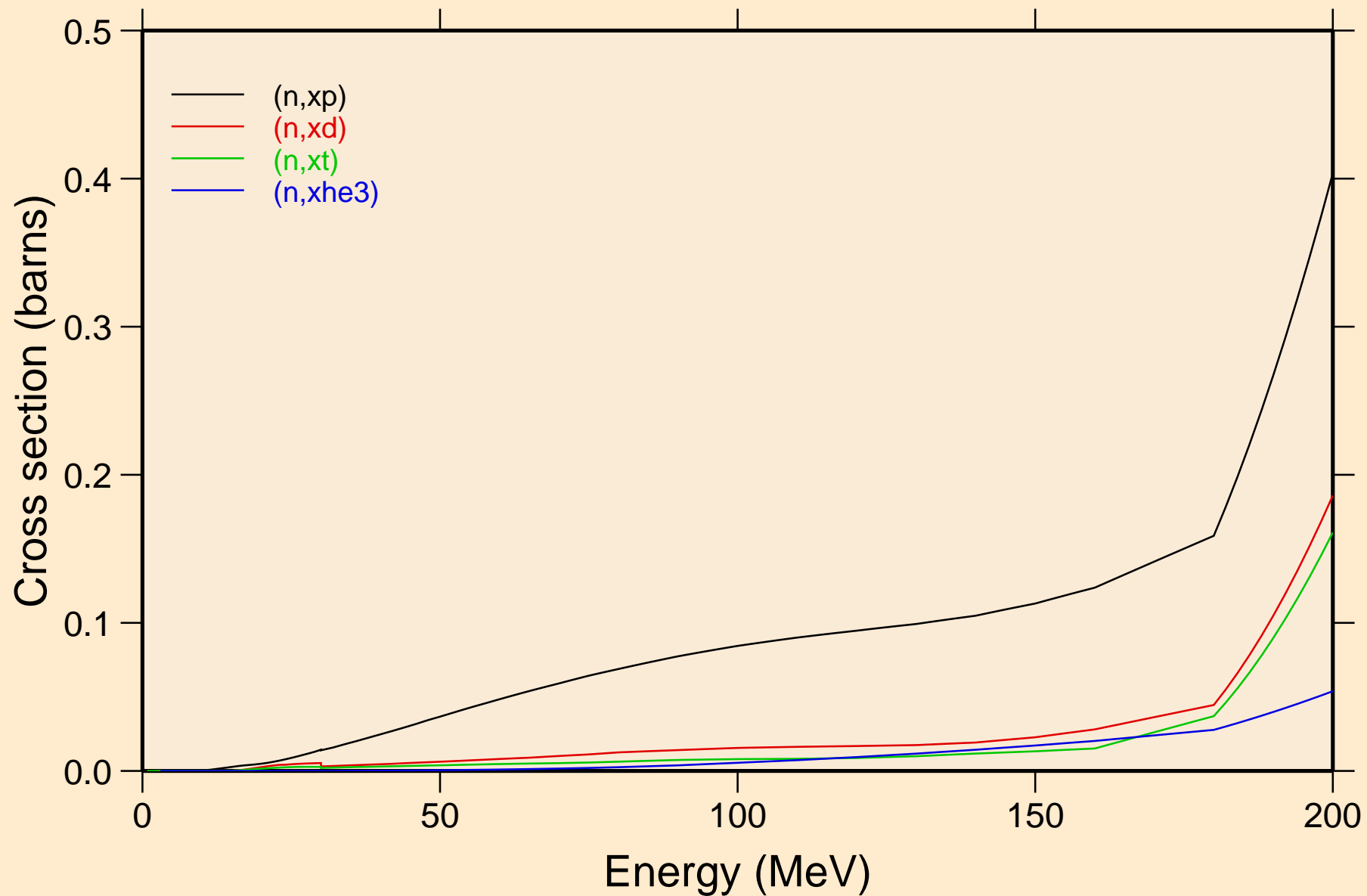

MD260 NEUTRON ACER TENDL-2019 LIBRARY; T=293.16K
angular distribution for elastic

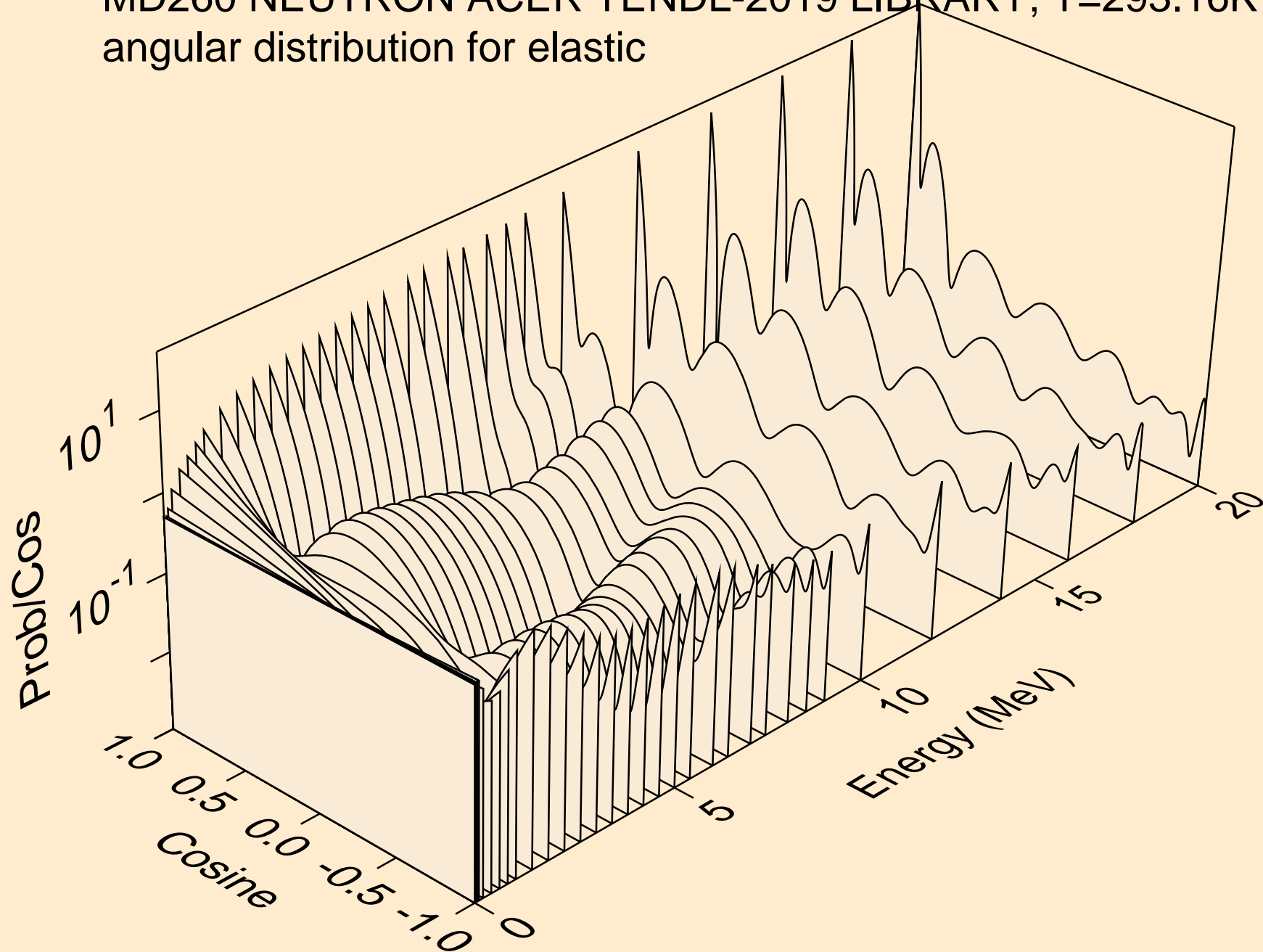

MD260 NEUTRON ACER TENDL-2019 LIBRARY; T=293.16K
angular distribution for elastic

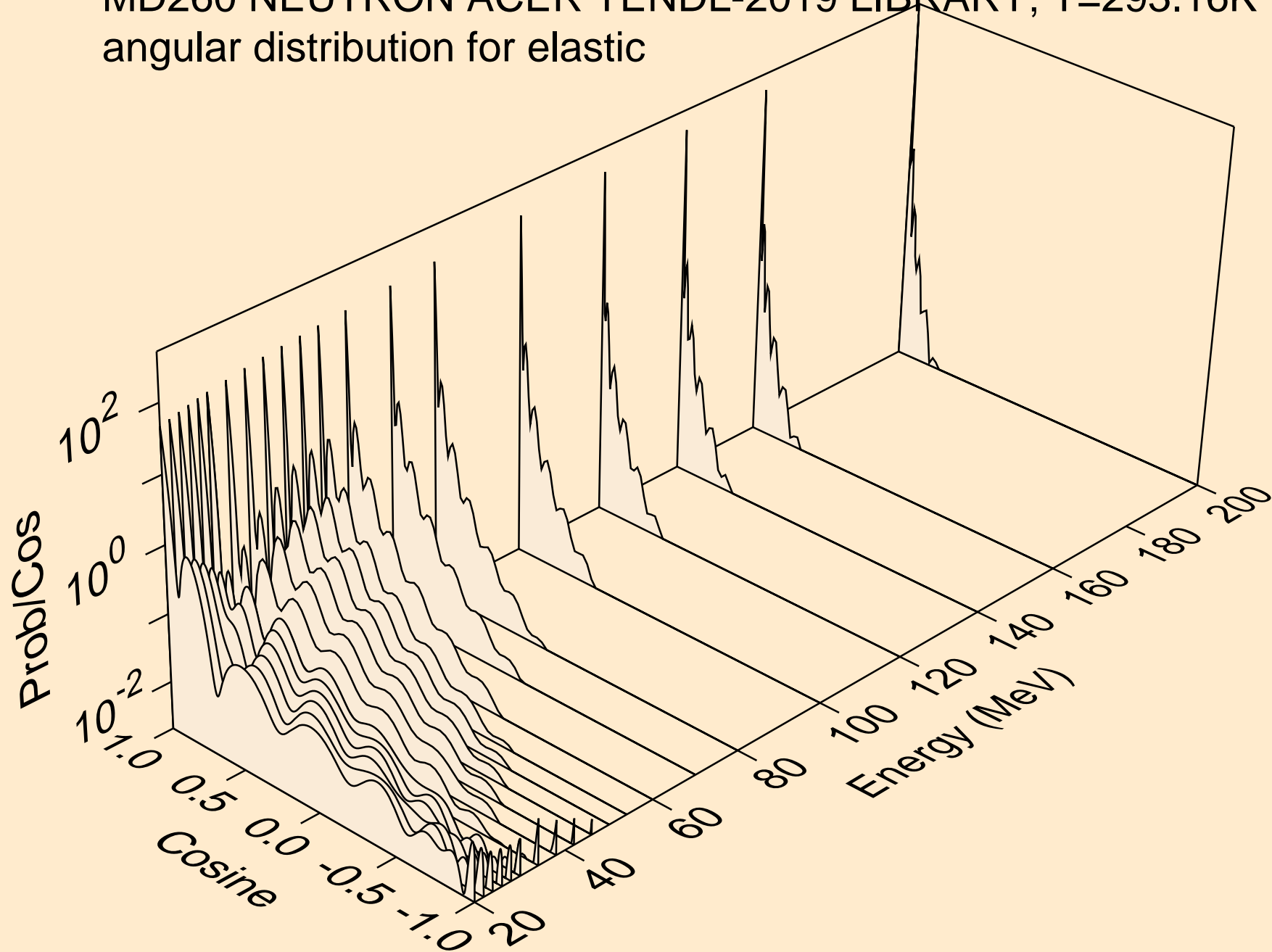

MD260 NEUTRON ACER TENDL-2019 LIBRARY; T=293.16K
angular distribution for (n,n*1)

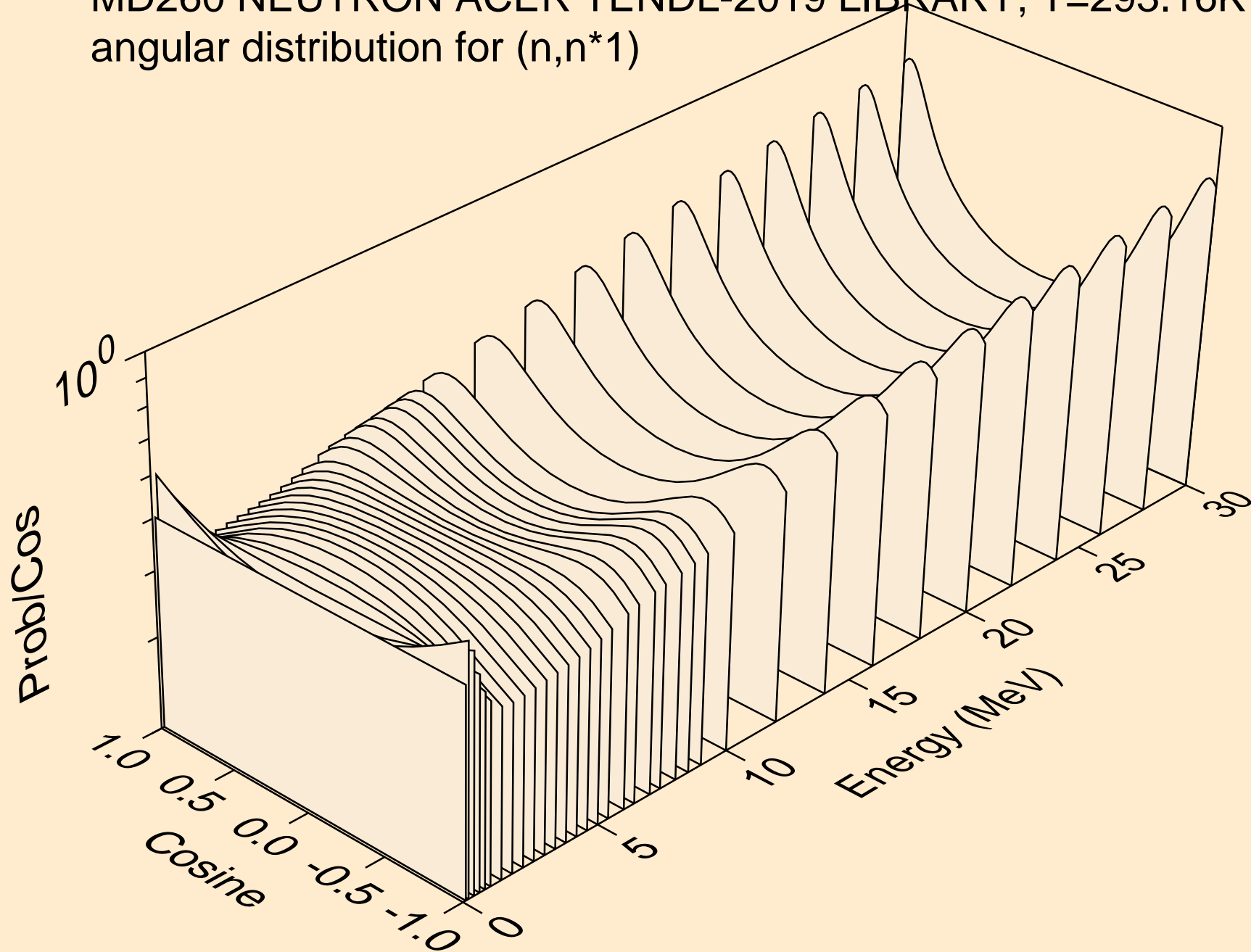

MD260 NEUTRON ACER TENDL-2019 LIBRARY; T=293.16K
Total fission nuubar

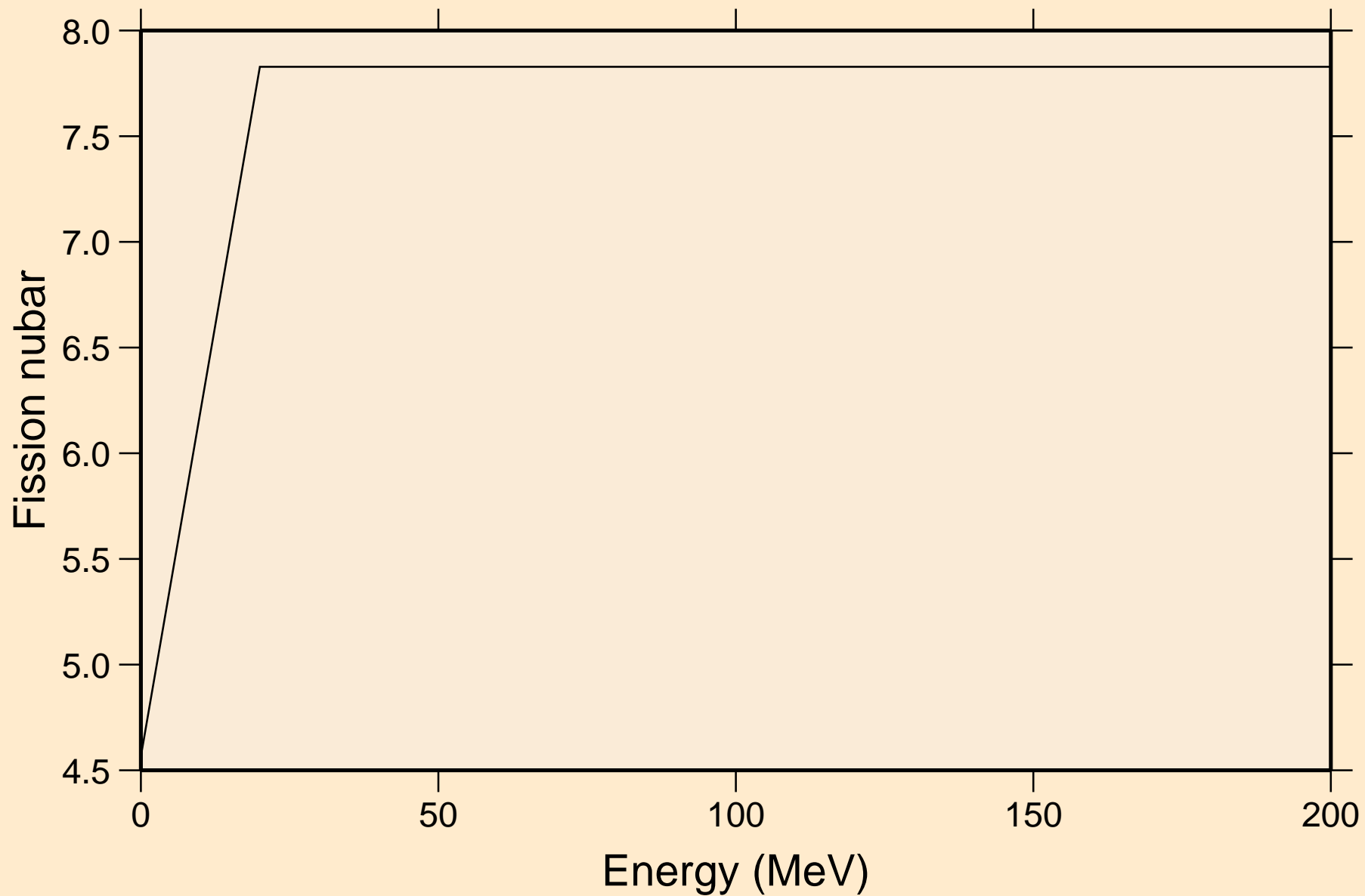

MD260 NEUTRON ACER TENDL-2019 LIBRARY; T=293.16K
Neutron emission for (n,x)

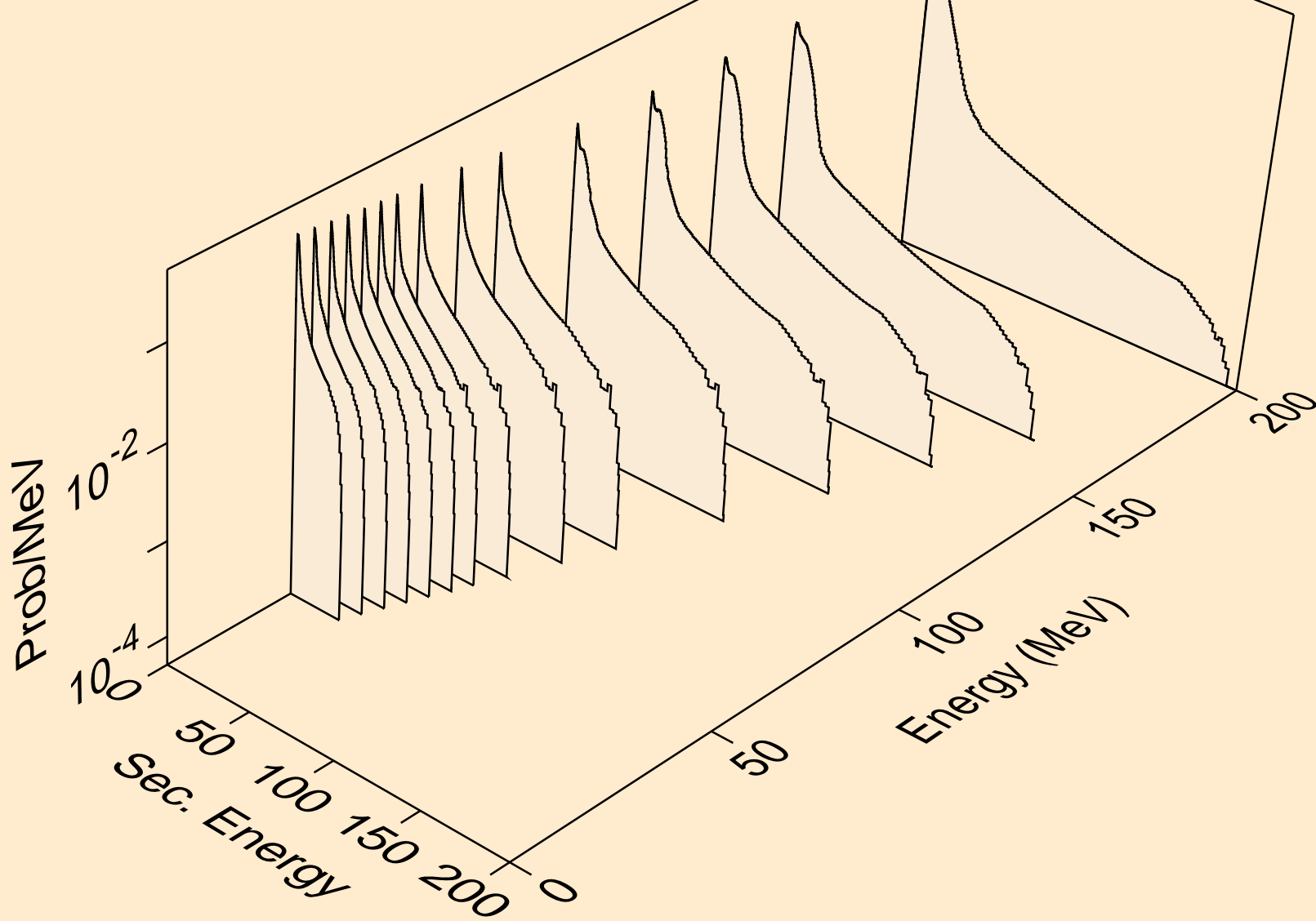

MD260 NEUTRON ACER TENDL-2019 LIBRARY; T=293.16K
Neutron emission for (n,2nd)

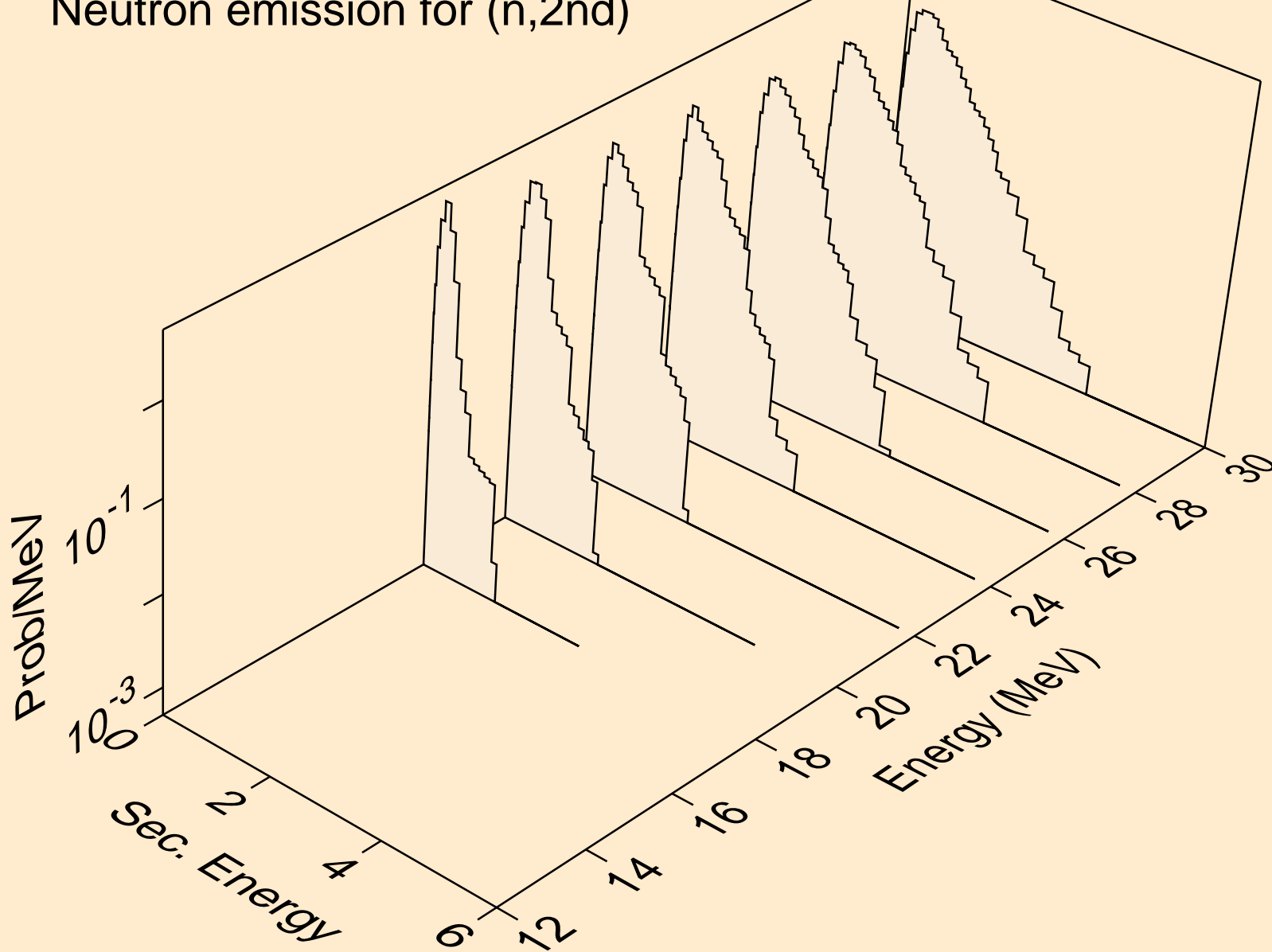

MD260 NEUTRON ACER TENDL-2019 LIBRARY; T=293.16K
Neutron emission for (n,2n)

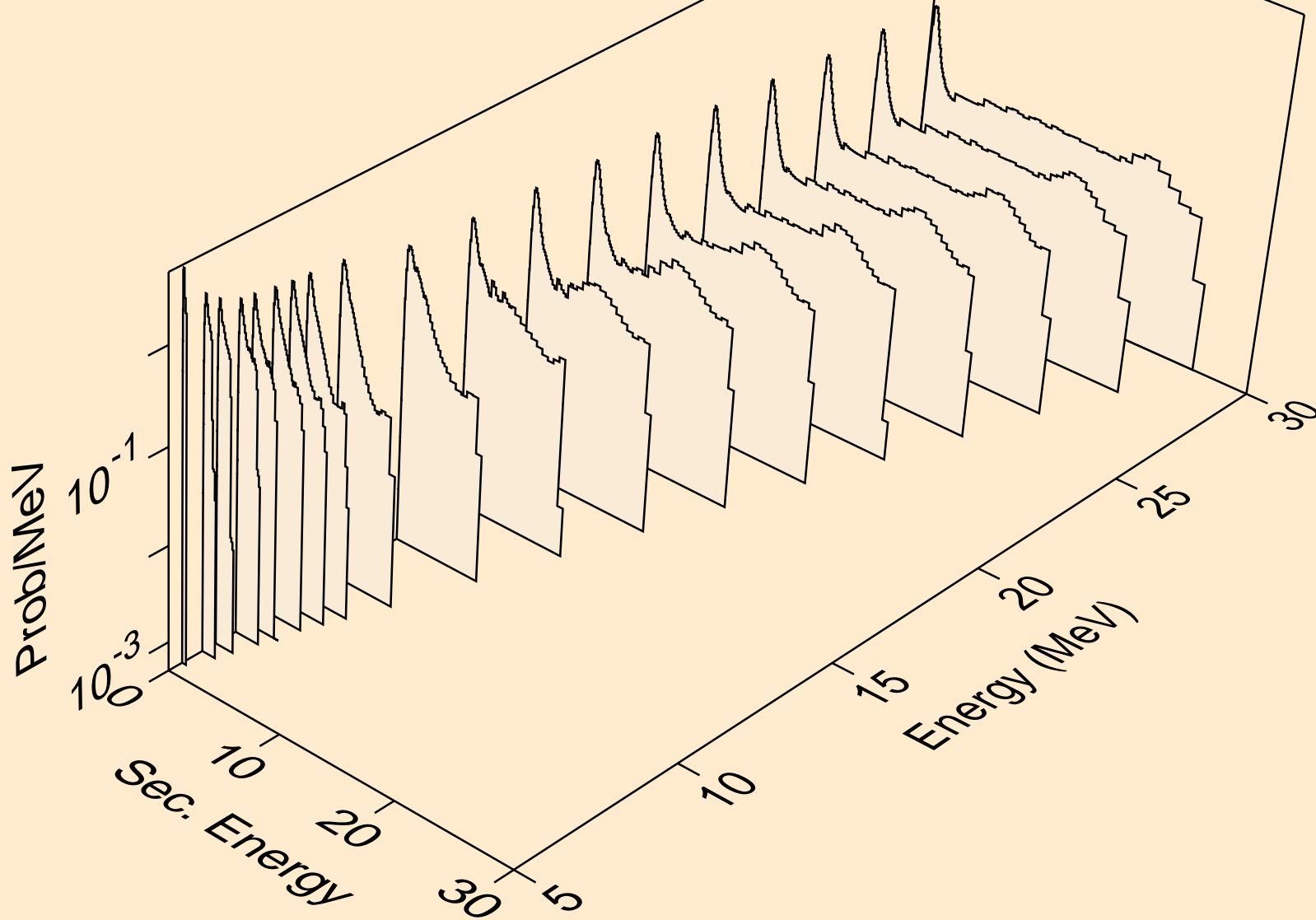

MD260 NEUTRON ACER TENDL-2019 LIBRARY; T=293.16K
Neutron emission for (n,3n)

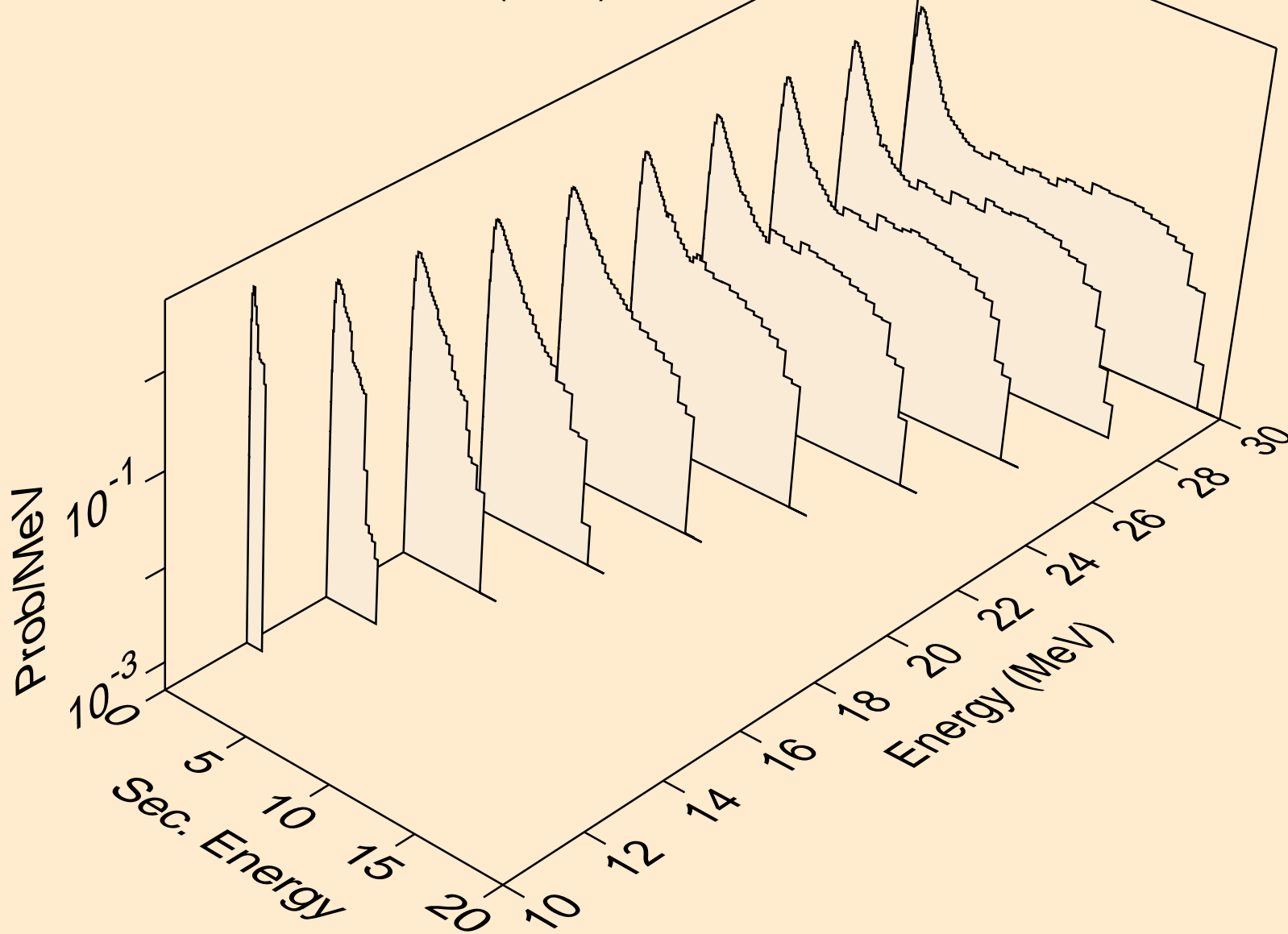

MD260 NEUTRON ACER TENDL-2019 LIBRARY; T=293.16K
Neutron emission for fission

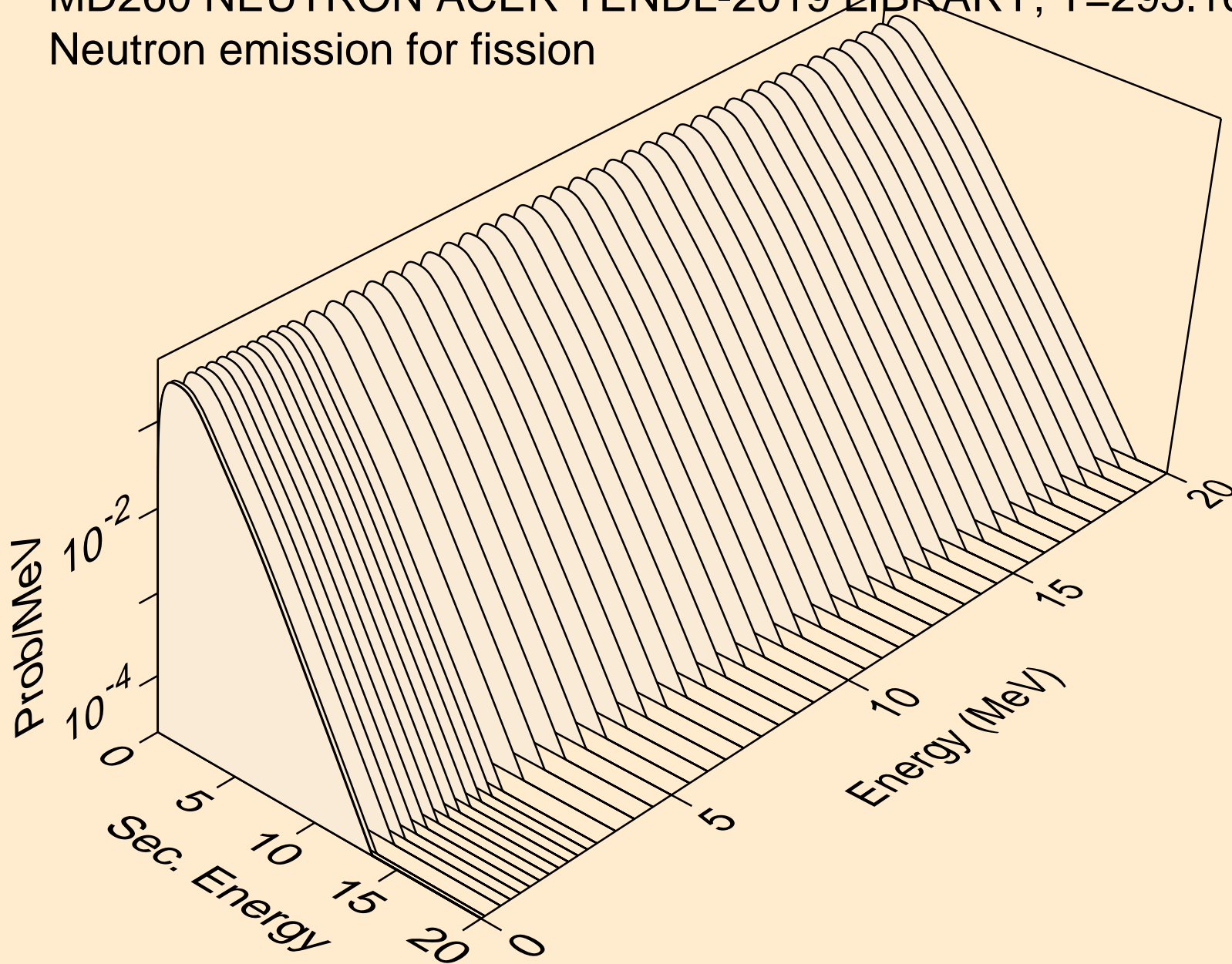

MD260 NEUTRON ACER TENDL-2019 LIBRARY; T=293.16K
Neutron emission for (n,n*)a

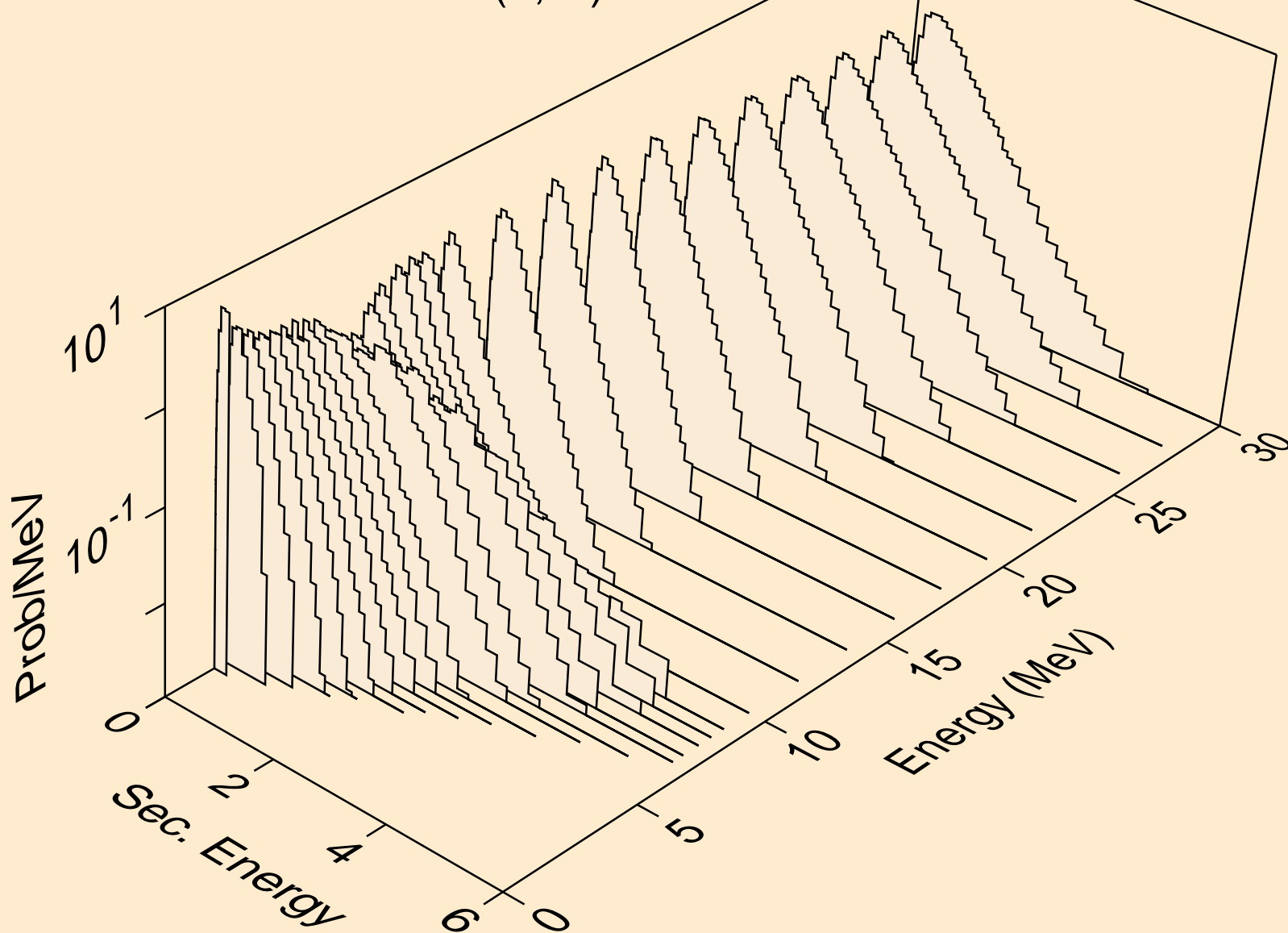

MD260 NEUTRON ACER TENDL-2019 LIBRARY; T=293.16K
Neutron emission for (n,2n)a

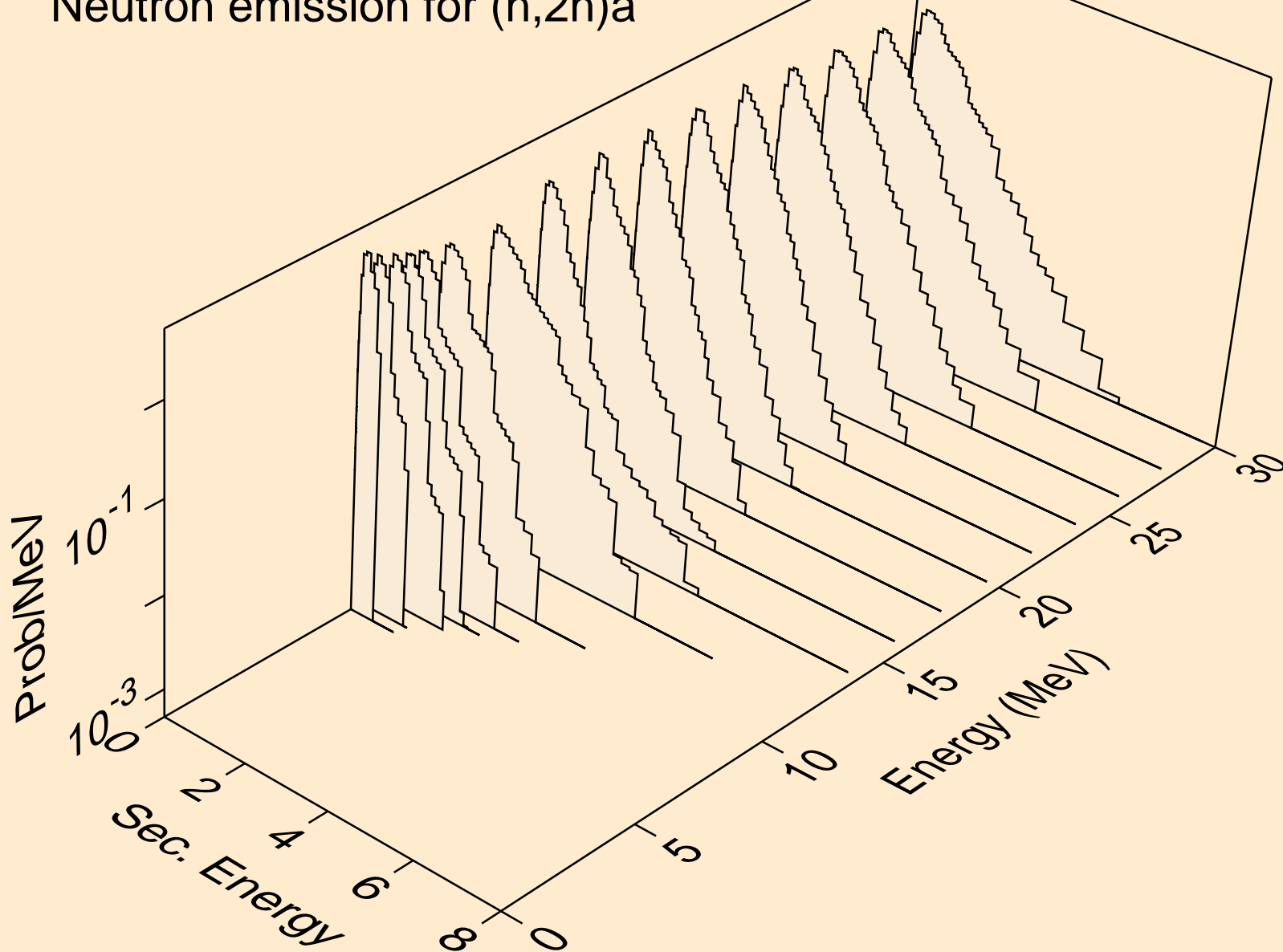

MD260 NEUTRON ACER TENDL-2019 LIBRARY; T=293.16K
Neutron emission for (n,3n)a

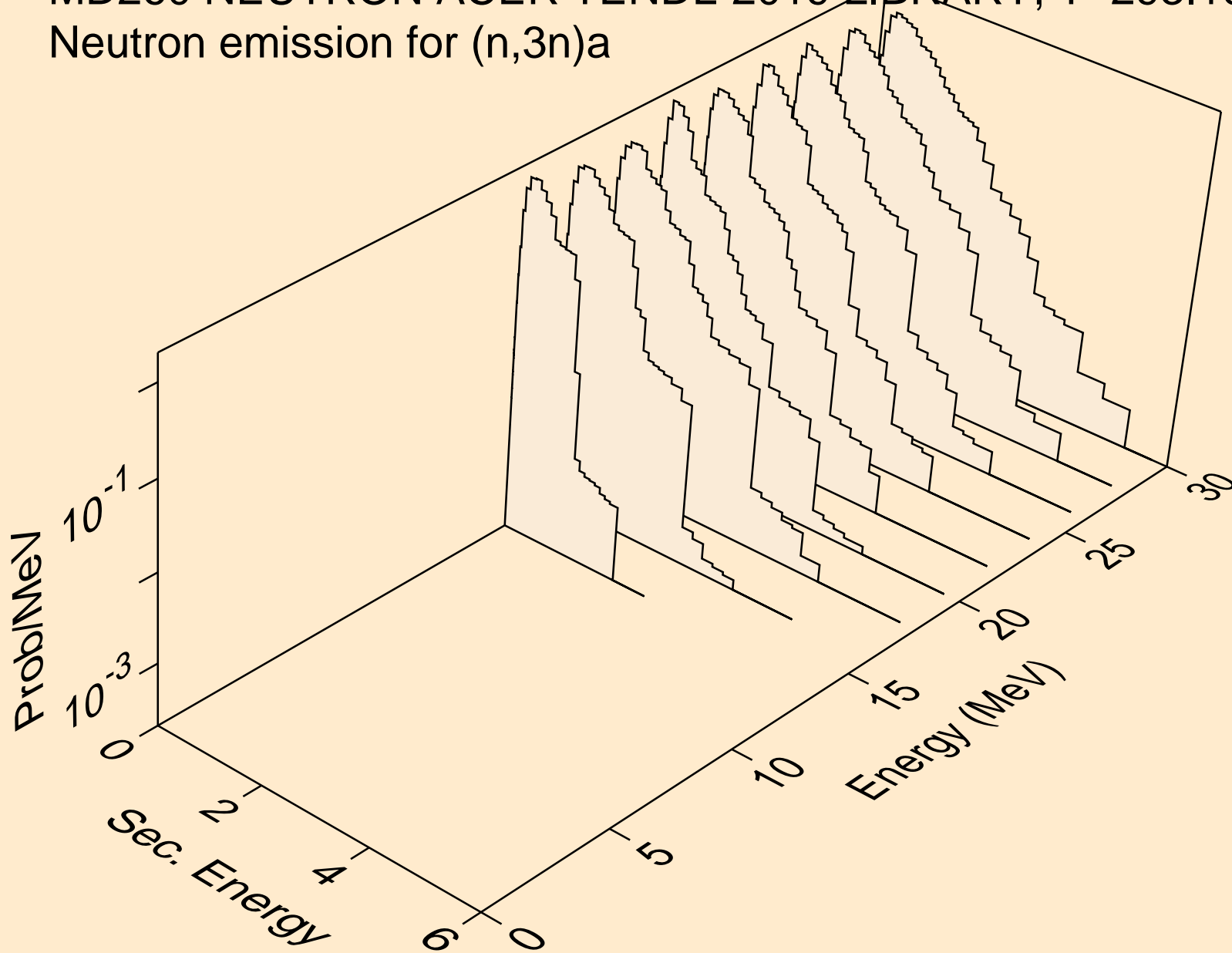

MD260 NEUTRON ACER TENDL-2019 LIBRARY; T=293.16K
Neutron emission for (n,n*)p

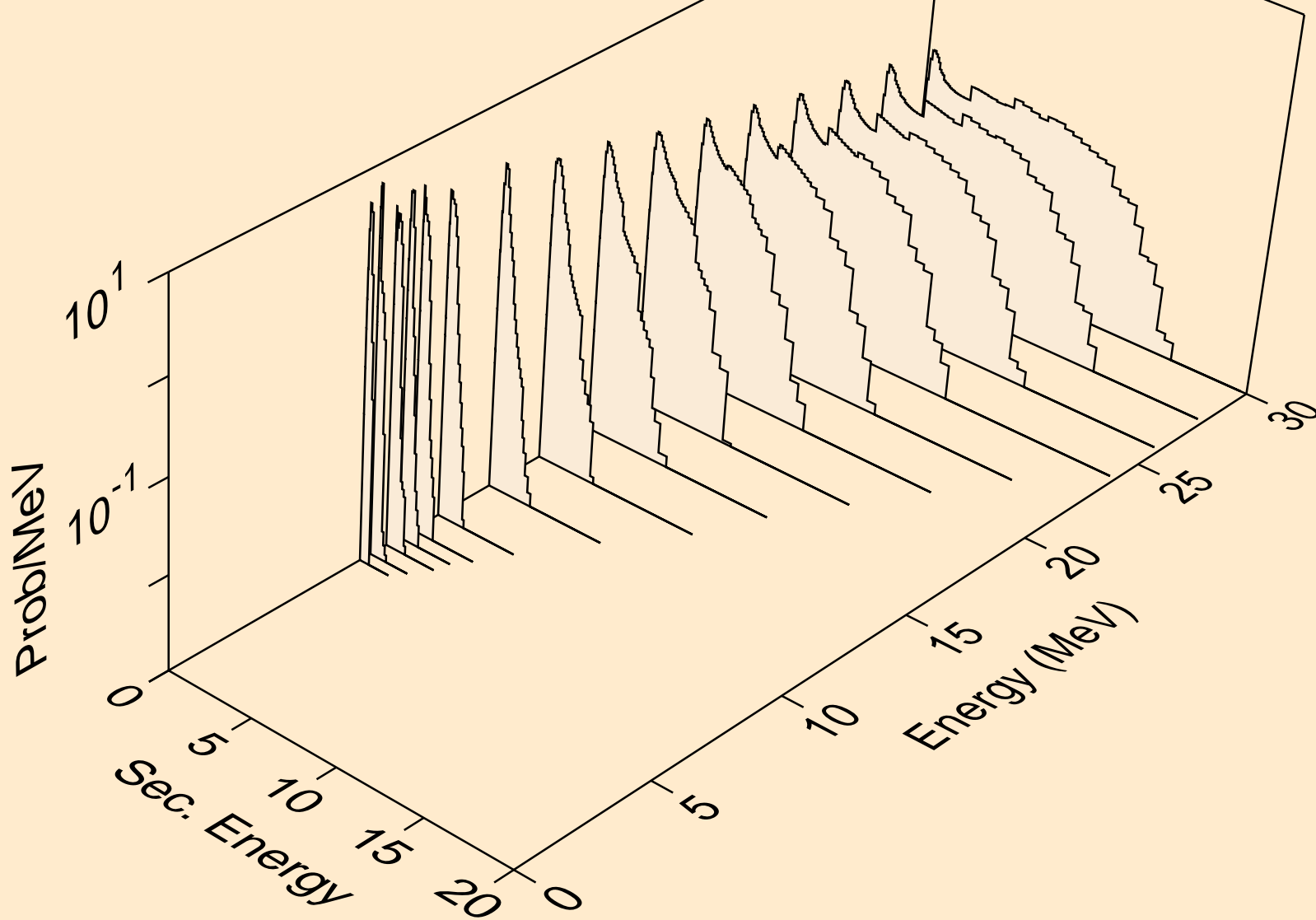

MD260 NEUTRON ACER TENDL-2019 LIBRARY; T=293.16K
Neutron emission for (n,n*)d

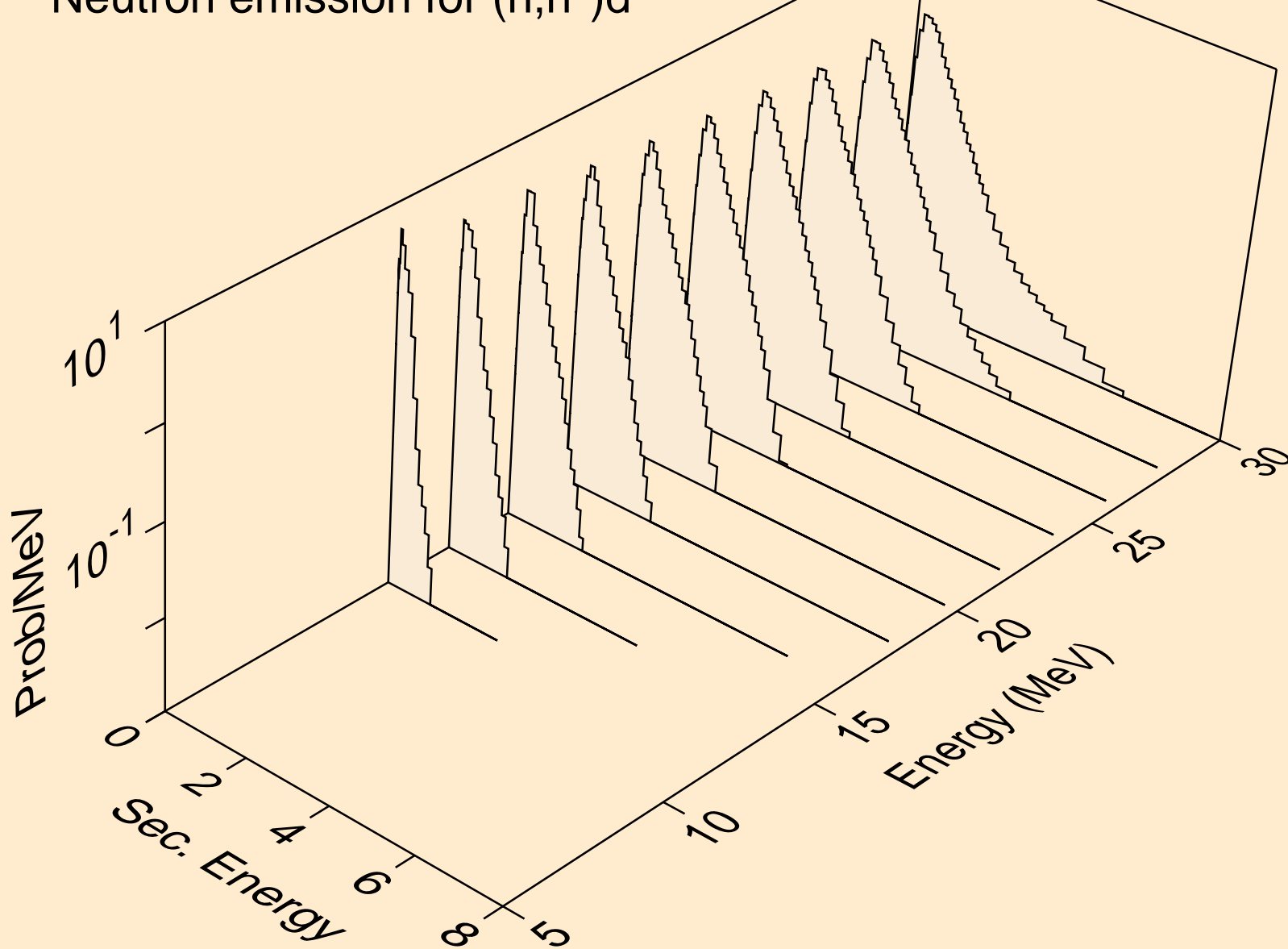

MD260 NEUTRON ACER TENDL-2019 LIBRARY; T=293.16K
Neutron emission for (n,n*)t

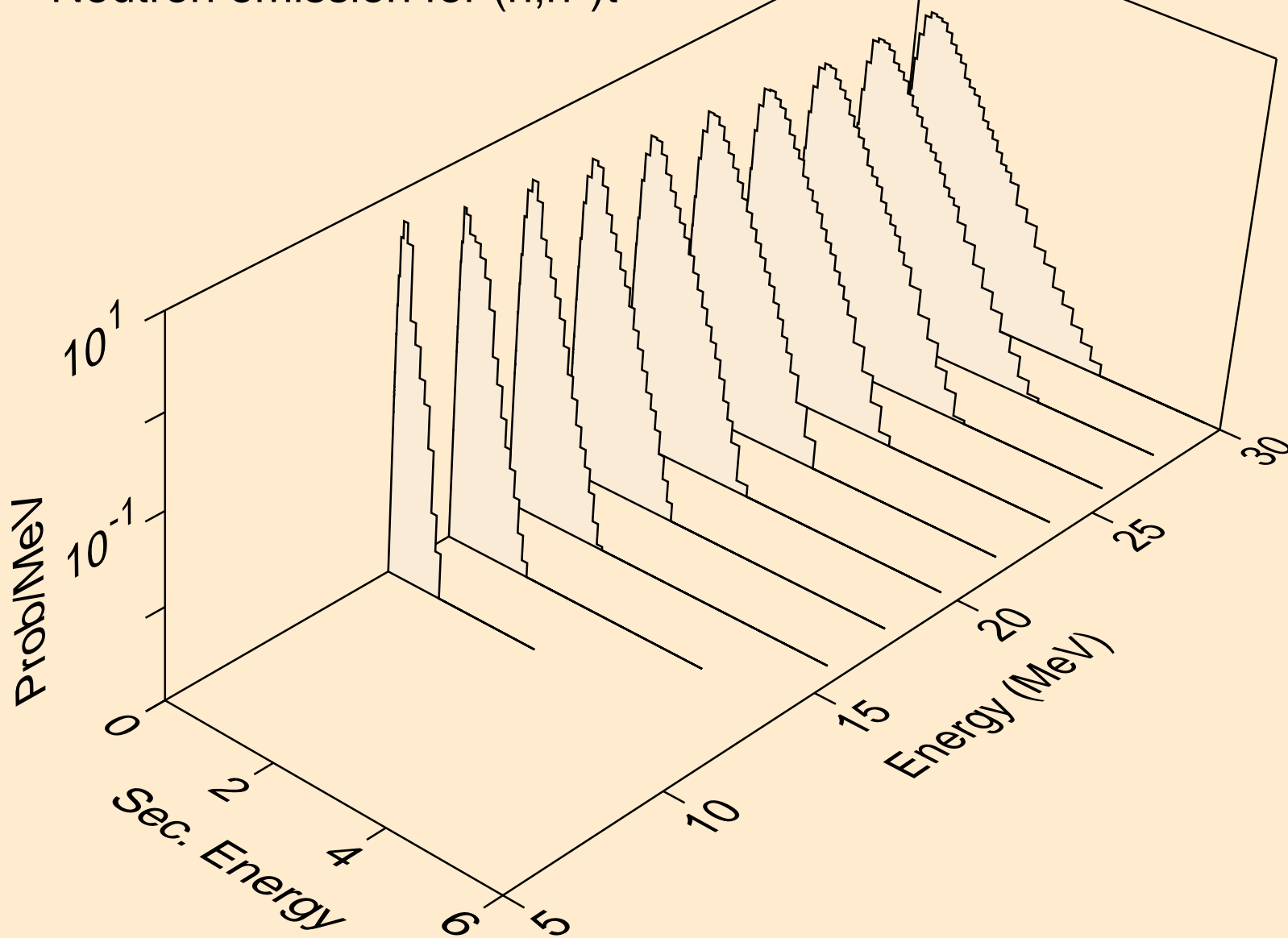

MD260 NEUTRON ACER TENDL-2019 LIBRARY; T=293.16K
Neutron emission for (n,n*)he3

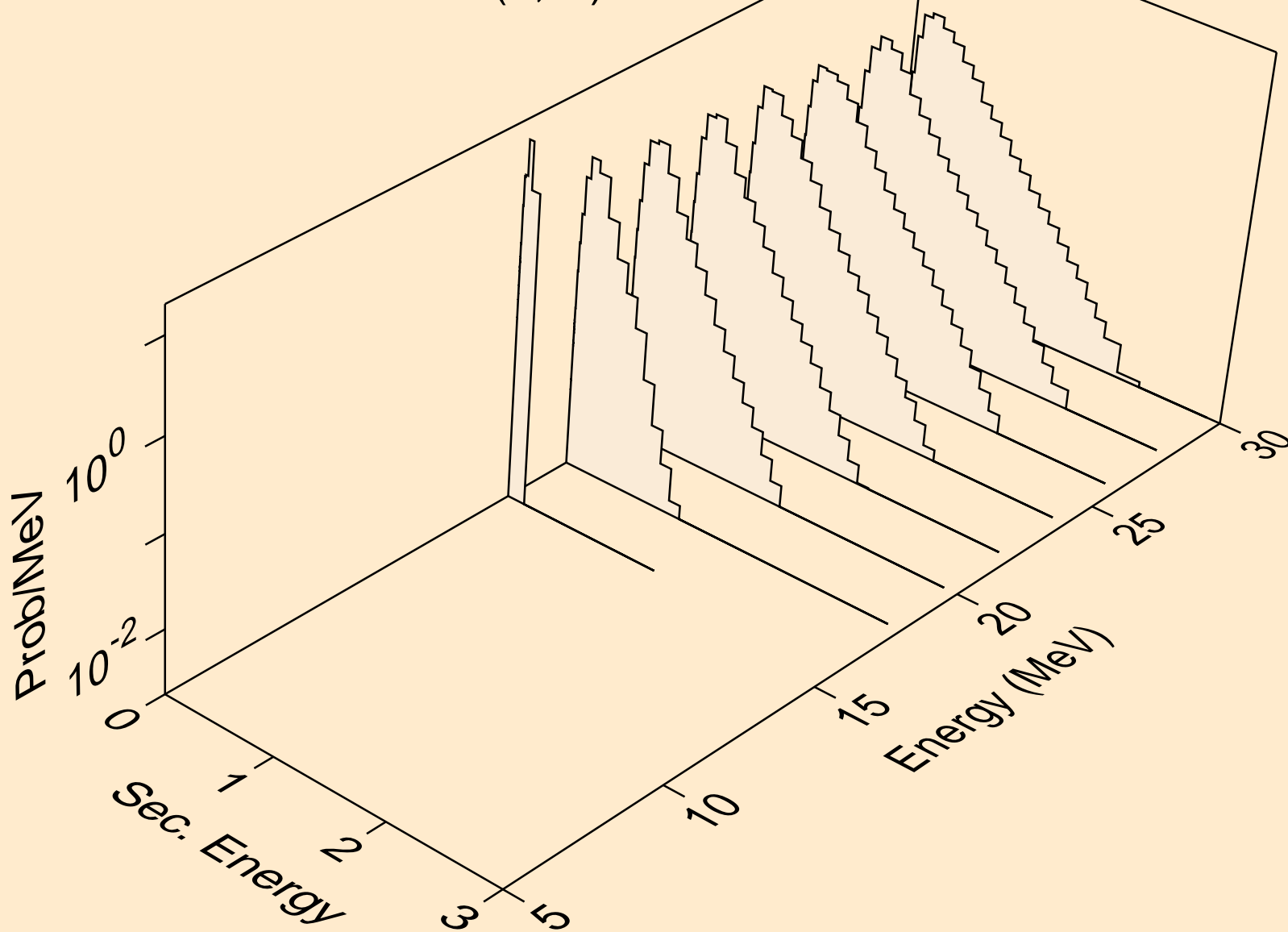

MD260 NEUTRON ACER TENDL-2019 LIBRARY; T=293.16K
Neutron emission for (n,4n)

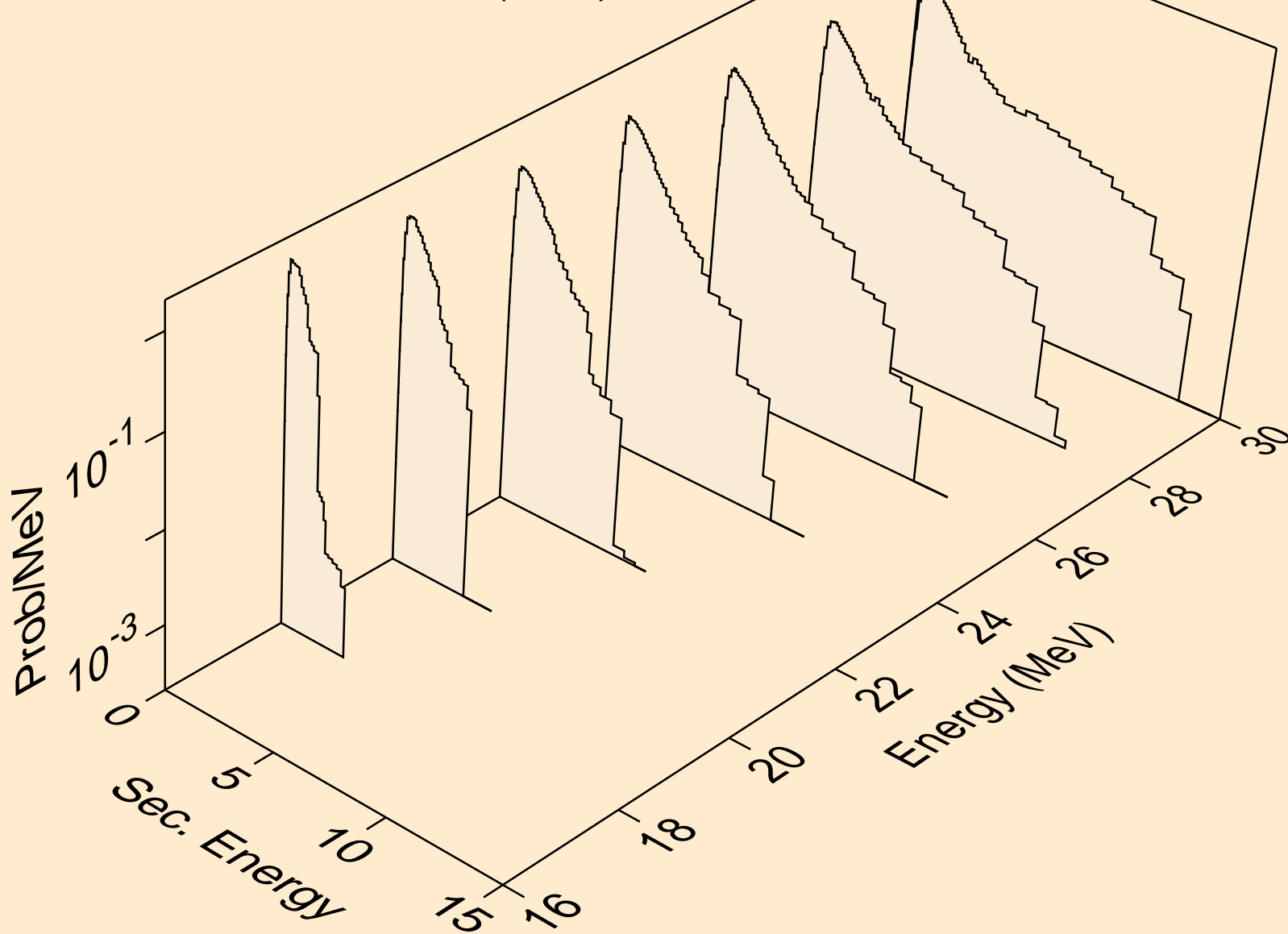

MD260 NEUTRON ACER TENDL-2019 LIBRARY; T=293.16K
Neutron emission for (n,2np)

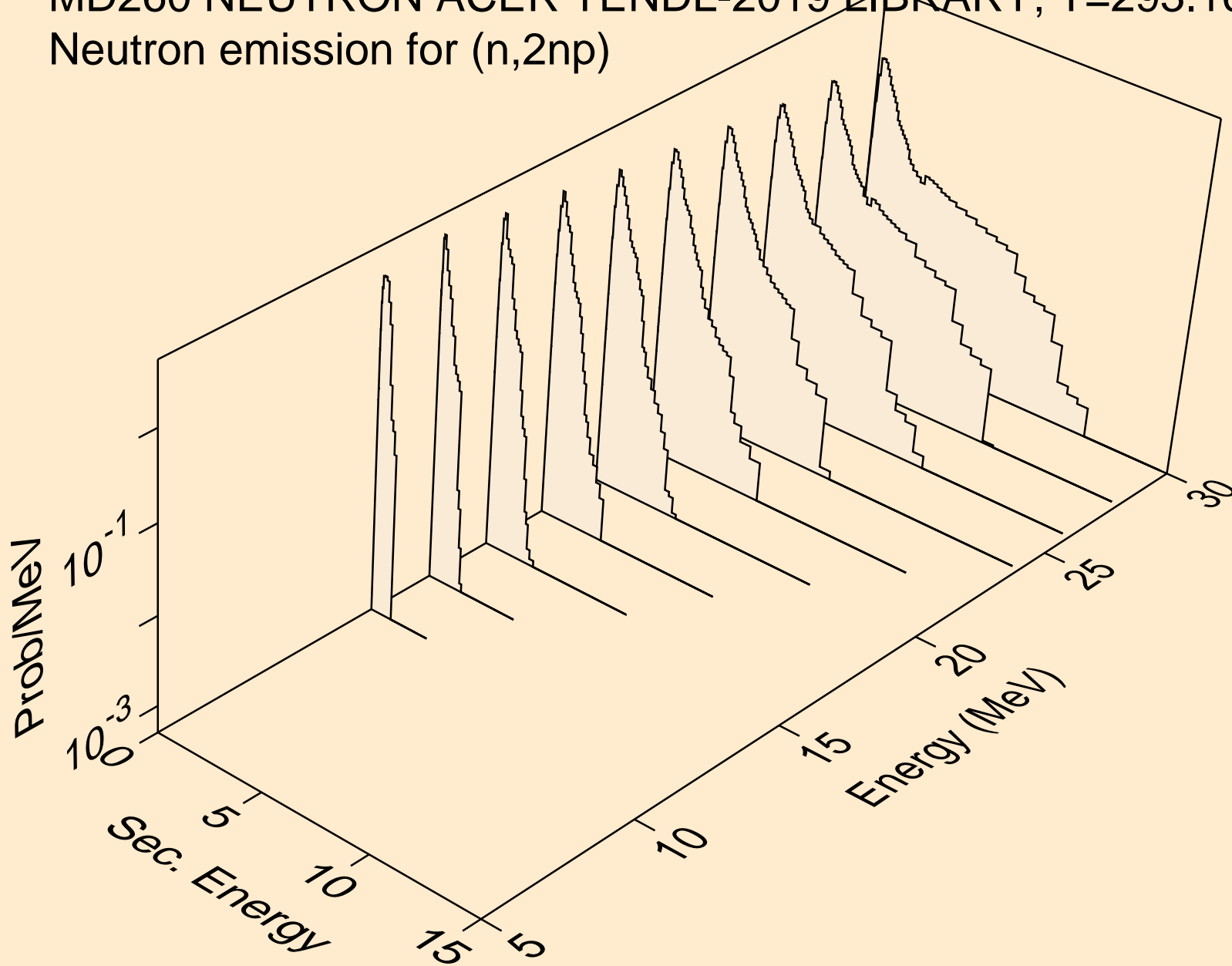

MD260 NEUTRON ACER TENDL-2019 LIBRARY; T=293.16K
Neutron emission for (n,3np)

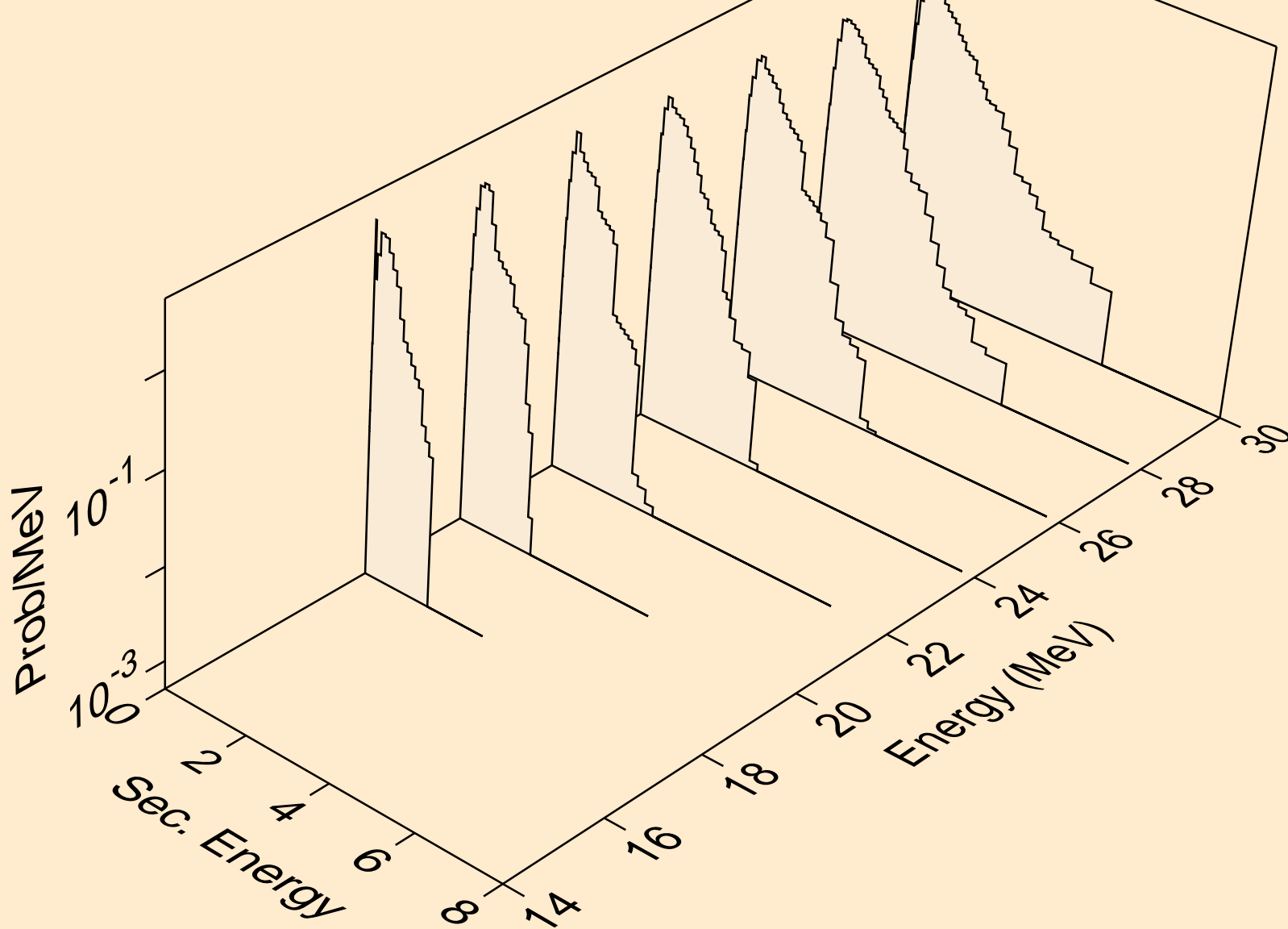

MD260 NEUTRON ACER TENDL-2019 LIBRARY; T=293.16K
Neutron emission for (n,2np)

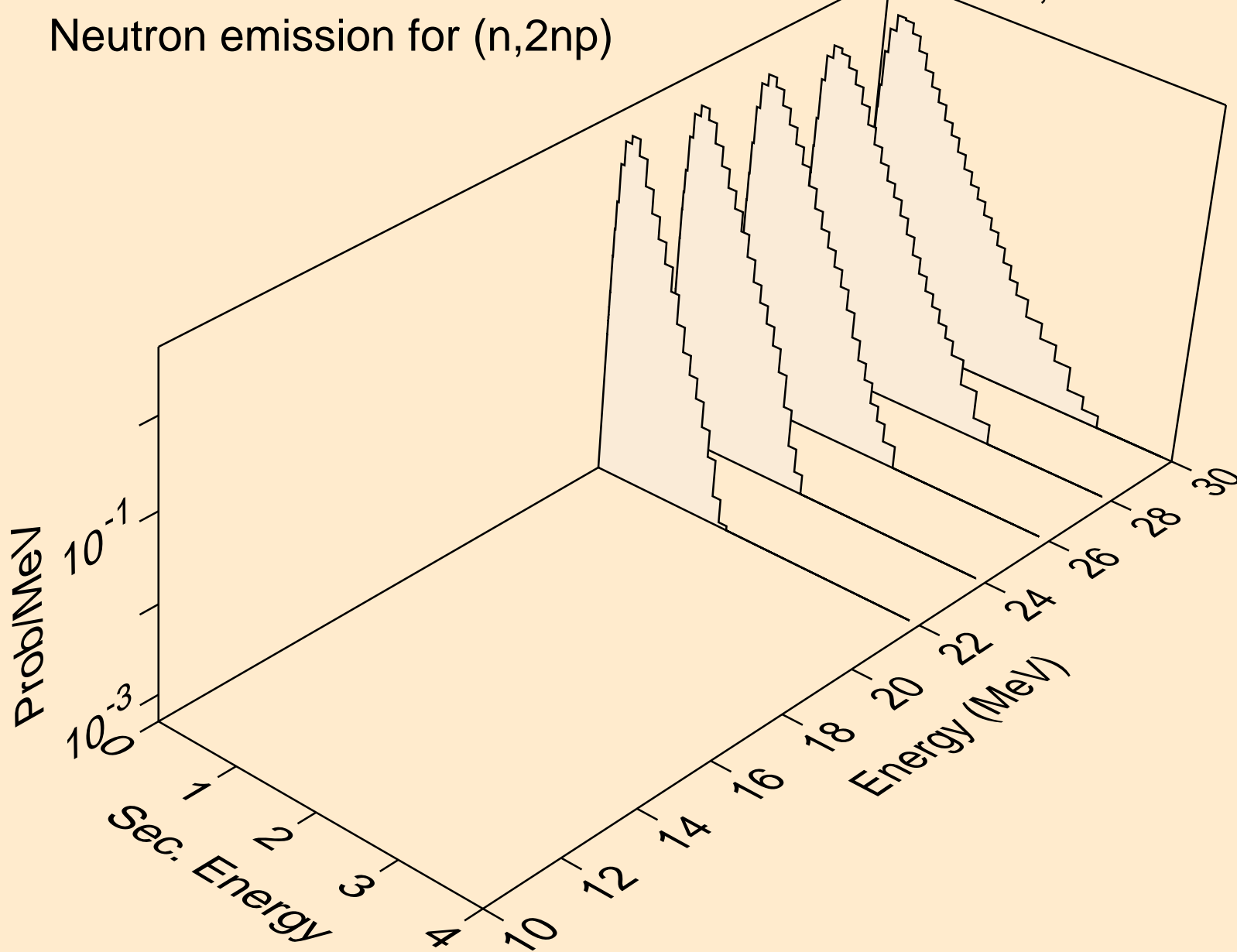

MD260 NEUTRON ACER TENDL-2019 LIBRARY; T=293.16K
Neutron emission for (n,n*c)

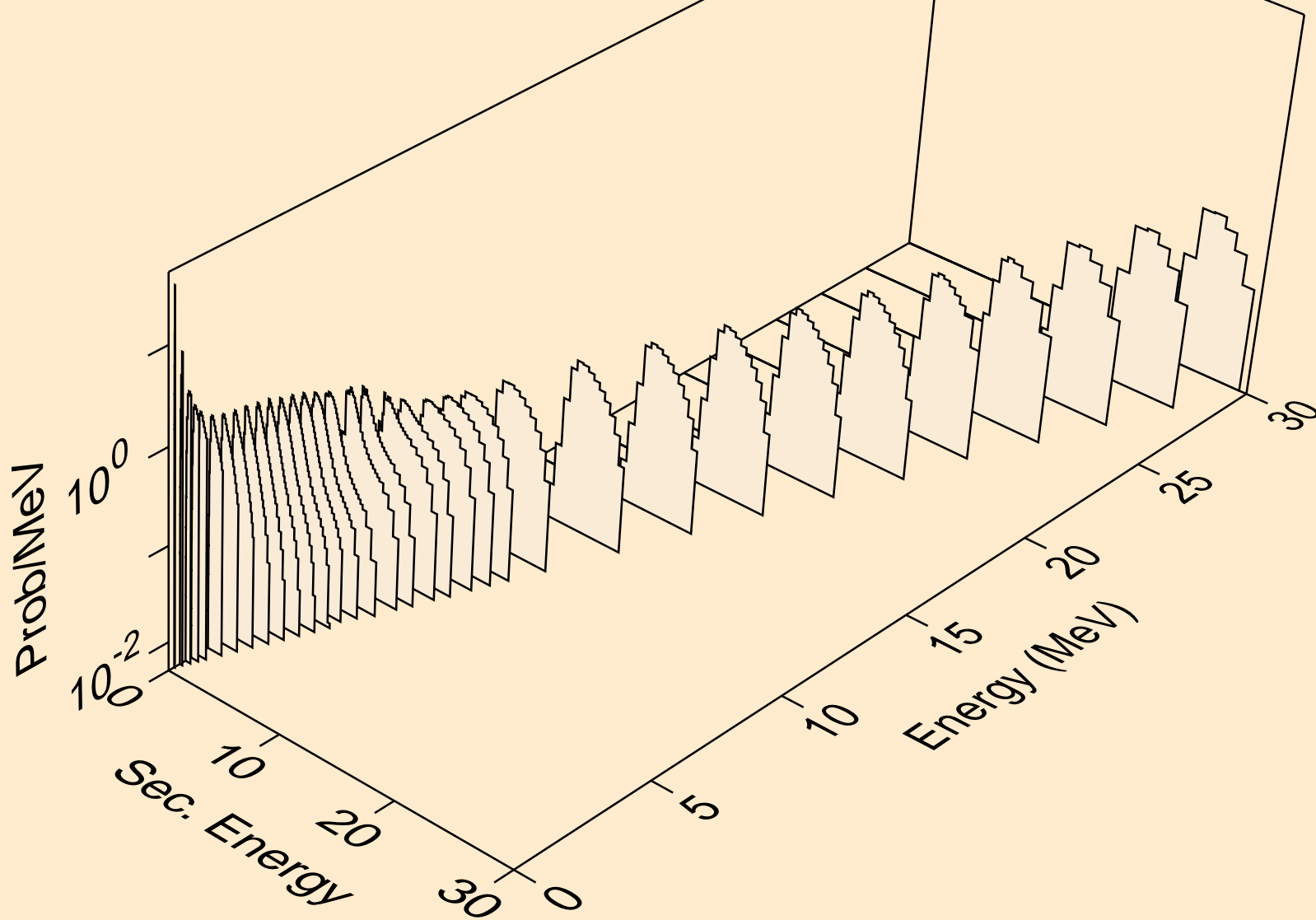

MD260 NEUTRON ACER TENDL-2019 LIBRARY; T=293.16K

Delayed nubar

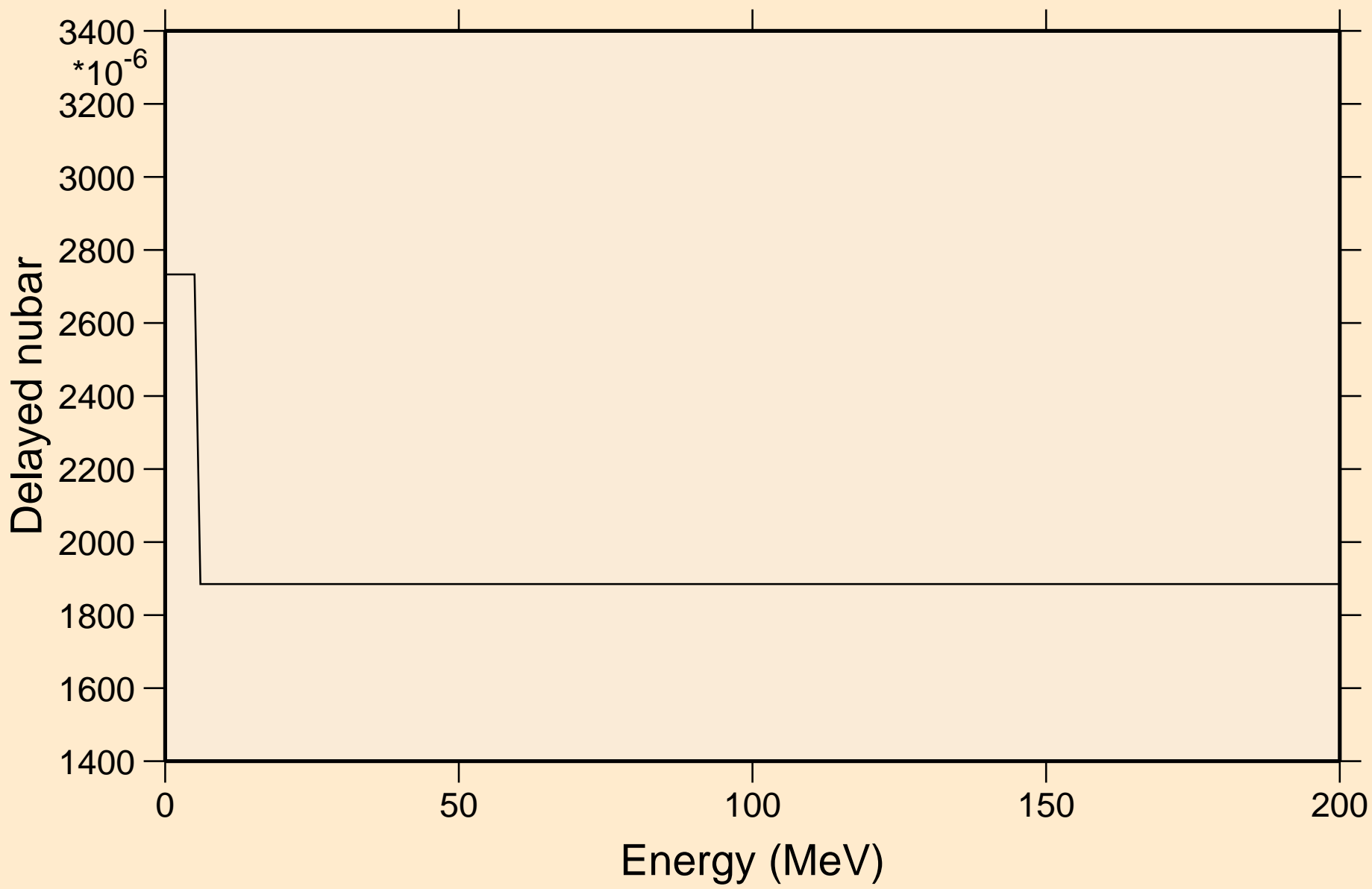

MD260 NEUTRON ACER TENDL-2019 LIBRARY; T=293.16K

Delayed neutron spectra

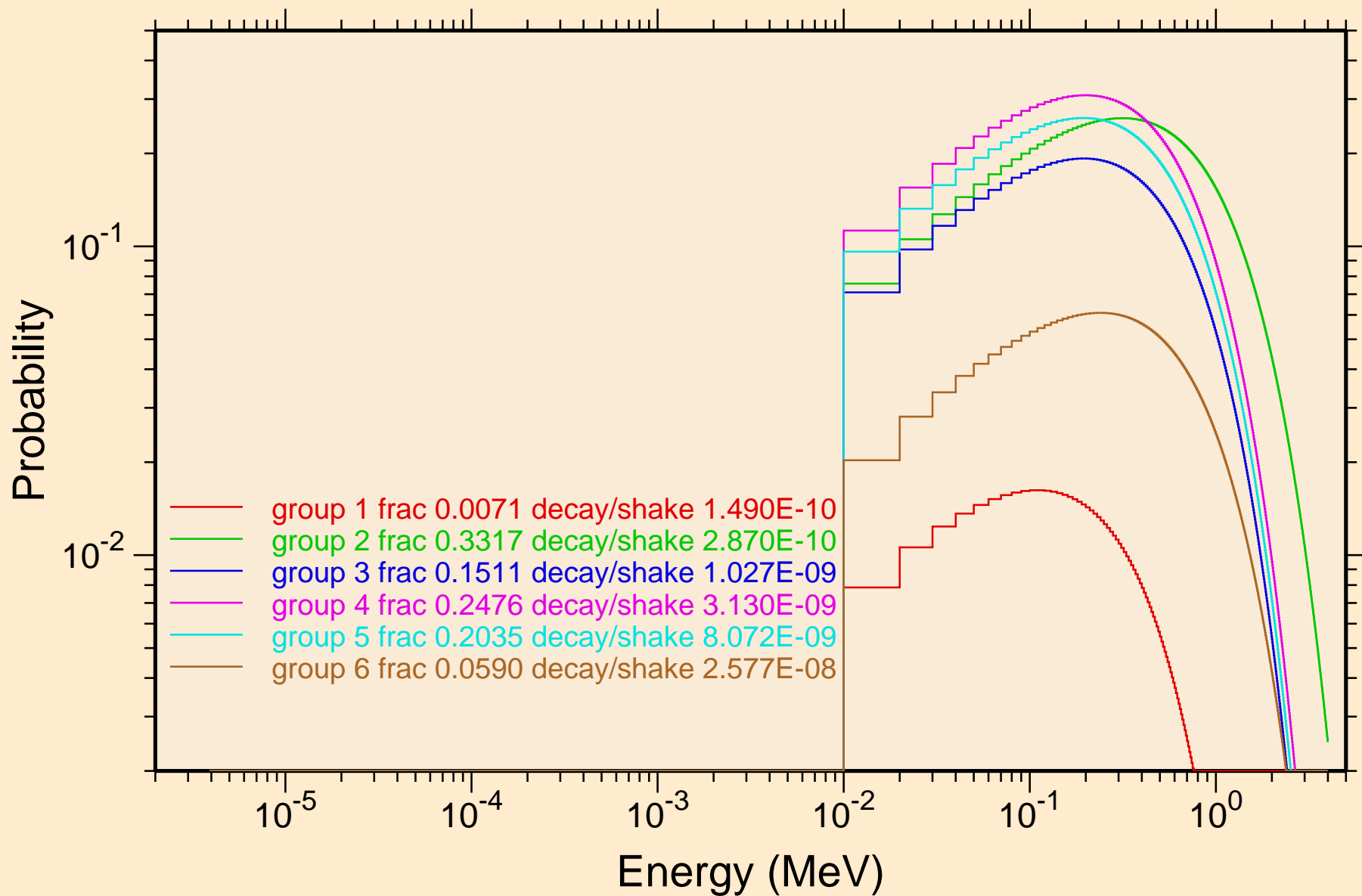

MD260 NEUTRON ACER TENDL-2019 LIBRARY; T=293.16K
Photon emission for (n,x)

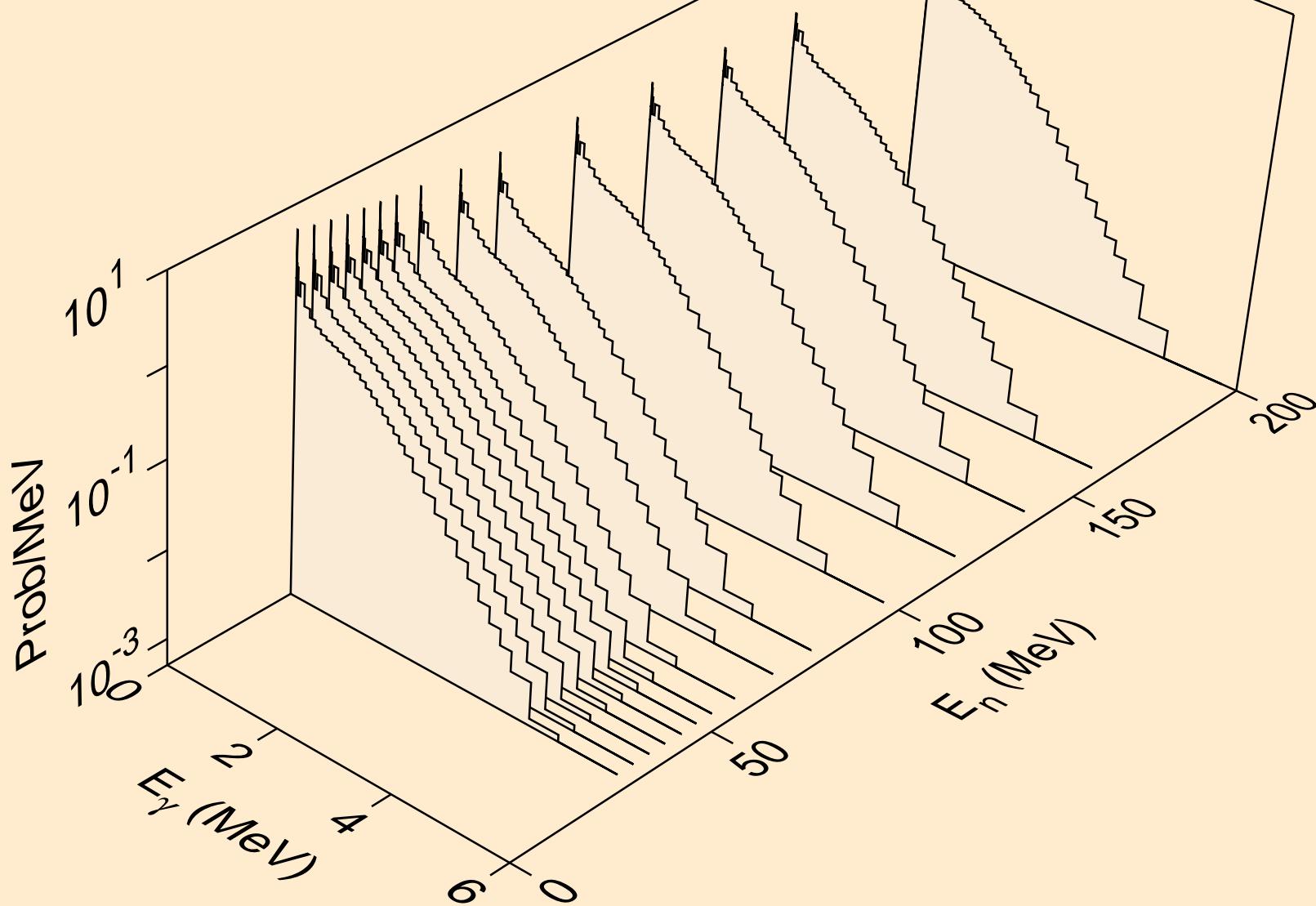

MD260 NEUTRON ACER TENDL-2019 LIBRARY; T=293.16K
Photon emission for (n,2nd)

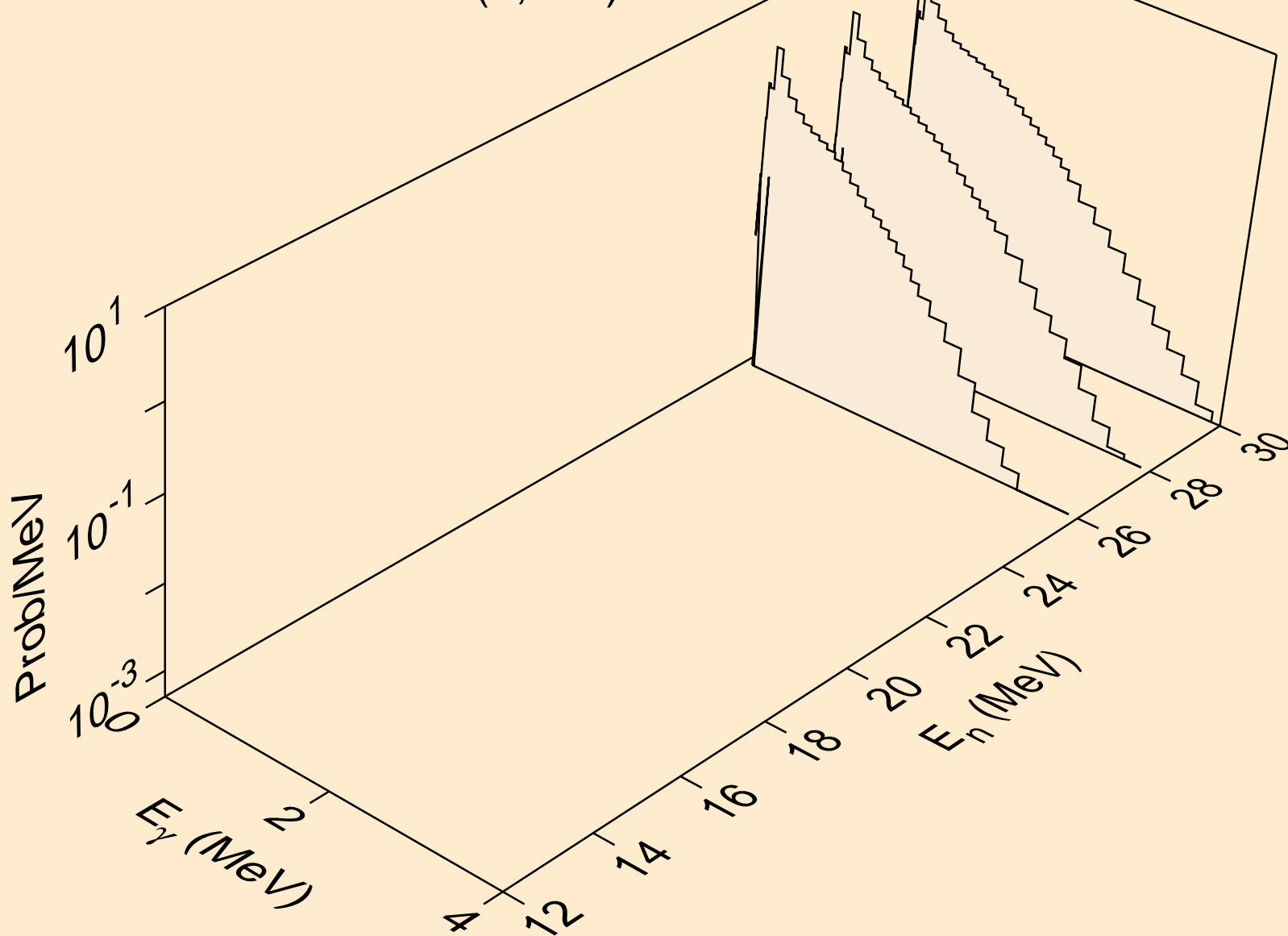

MD260 NEUTRON ACER TENDL-2019 LIBRARY; T=293.16K
Photon emission for (n,2n)

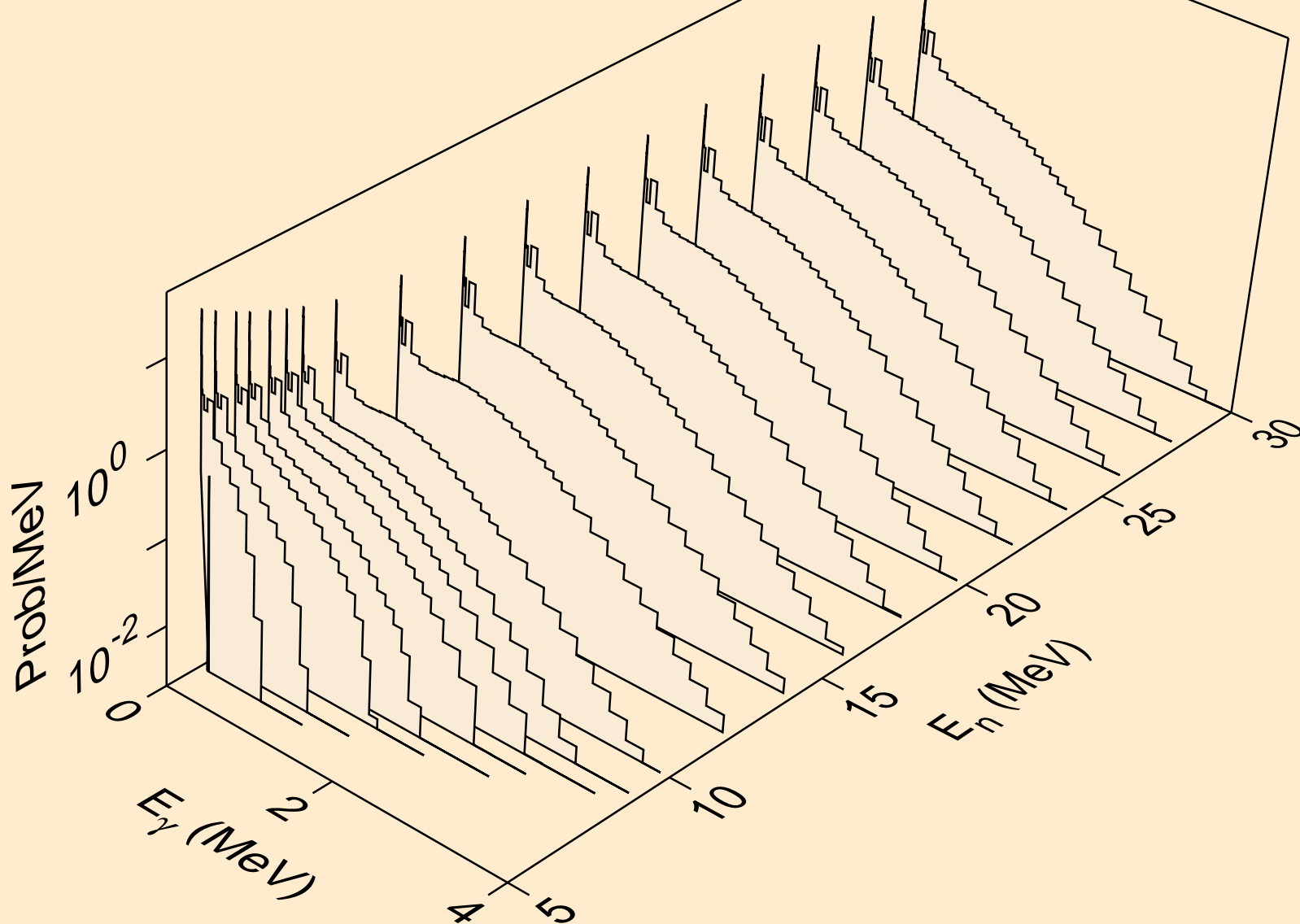

MD260 NEUTRON ACER TENDL-2019 LIBRARY; T=293.16K
Photon emission for (n,3n)

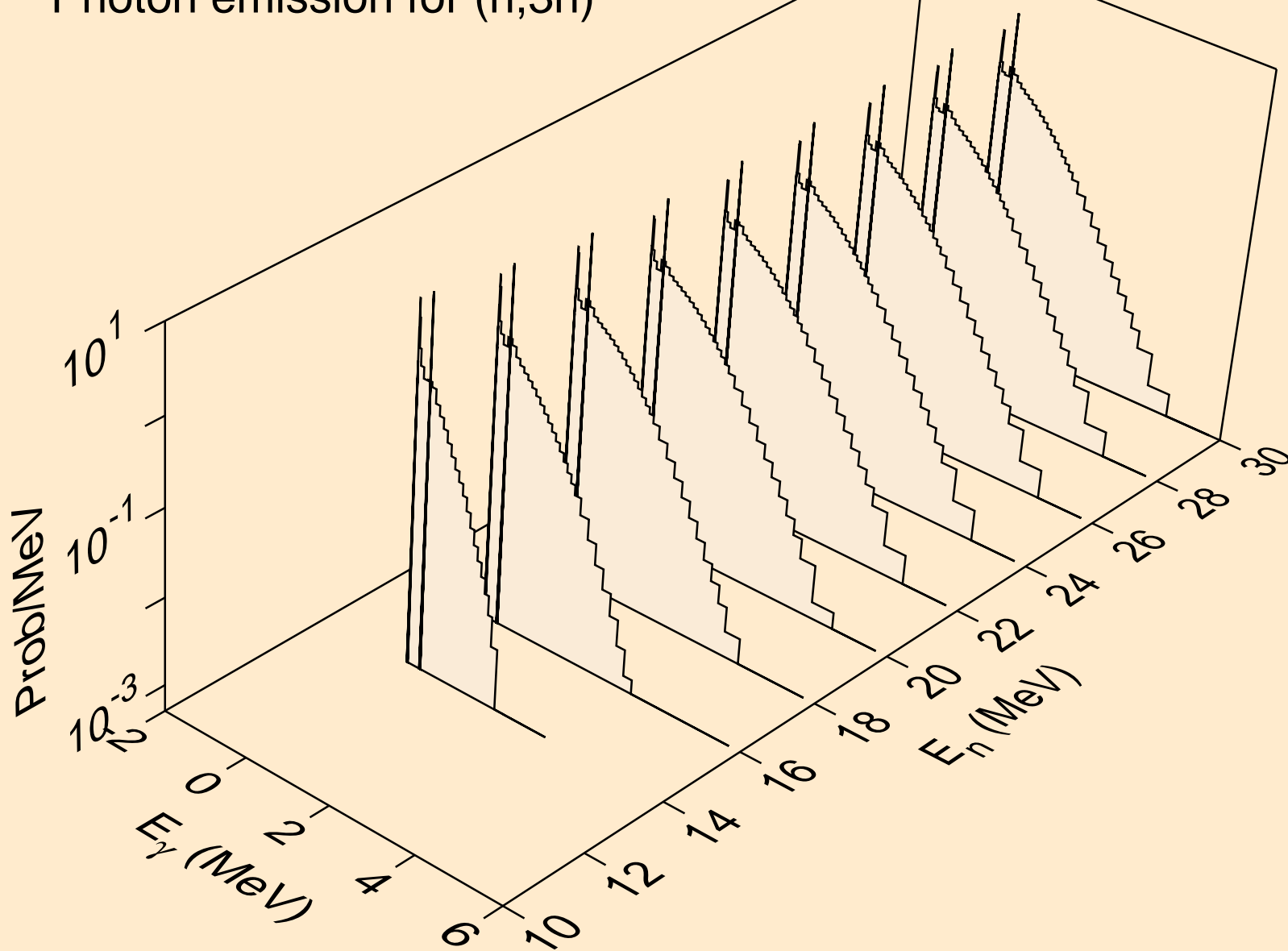

MD260 NEUTRON ACER TENDL-2019 LIBRARY; T=293.16K
Photon emission for (n,n*)a

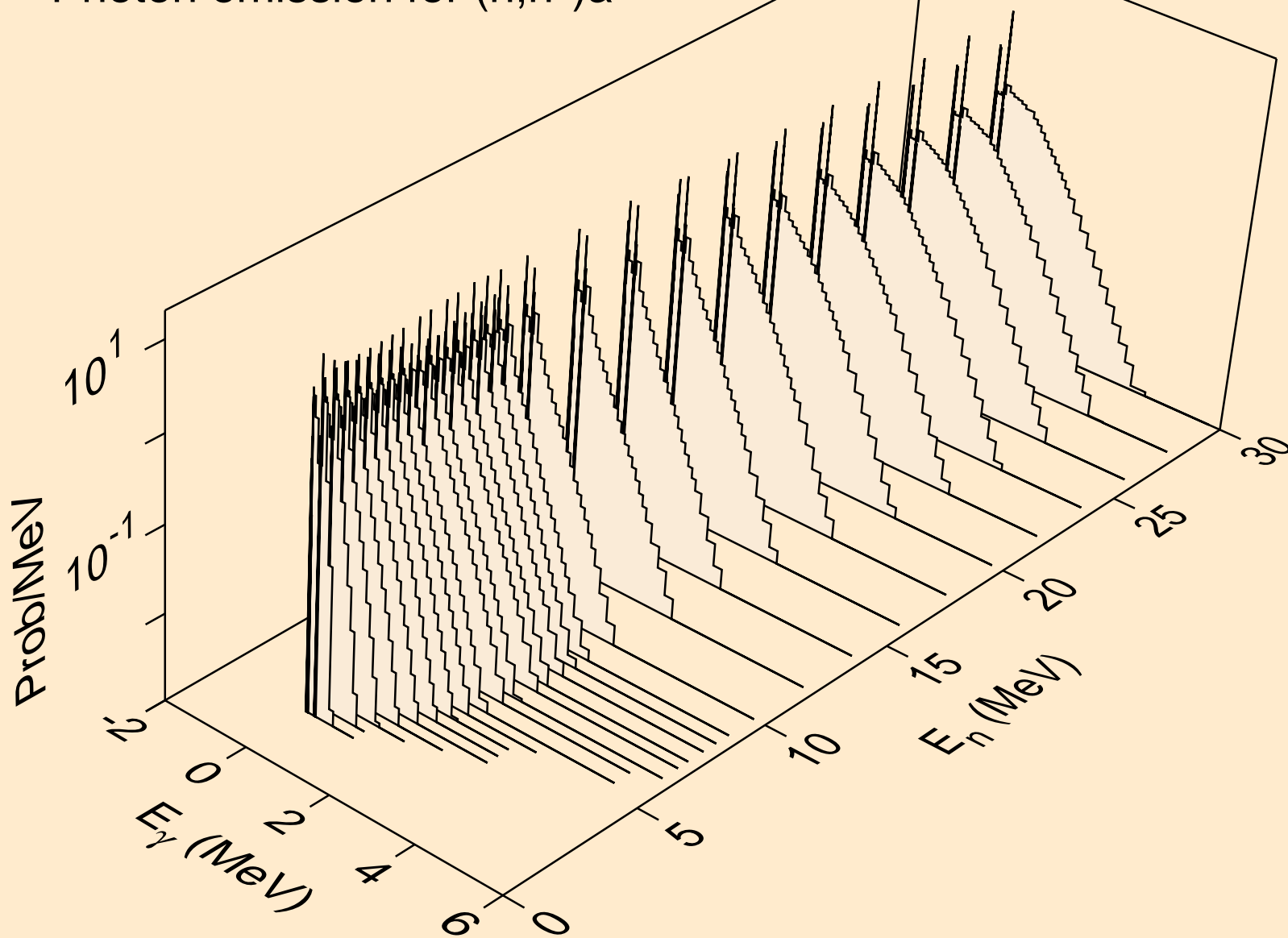

MD260 NEUTRON ACER TENDL-2019 LIBRARY; T=293.16K
Photon emission for (n,2n)a

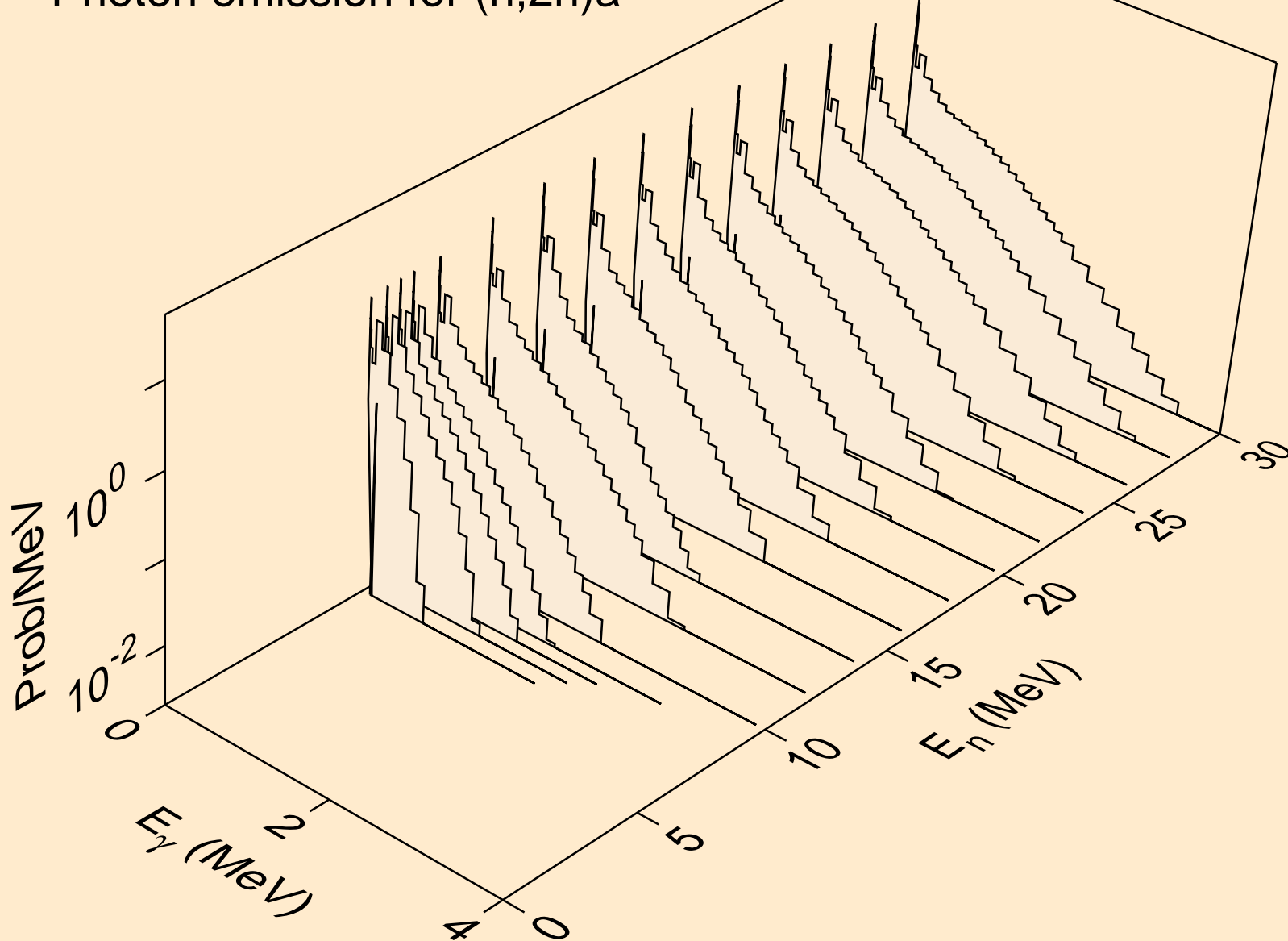

MD260 NEUTRON ACER TENDL-2019 LIBRARY; T=293.16K
Photon emission for (n,3n)a

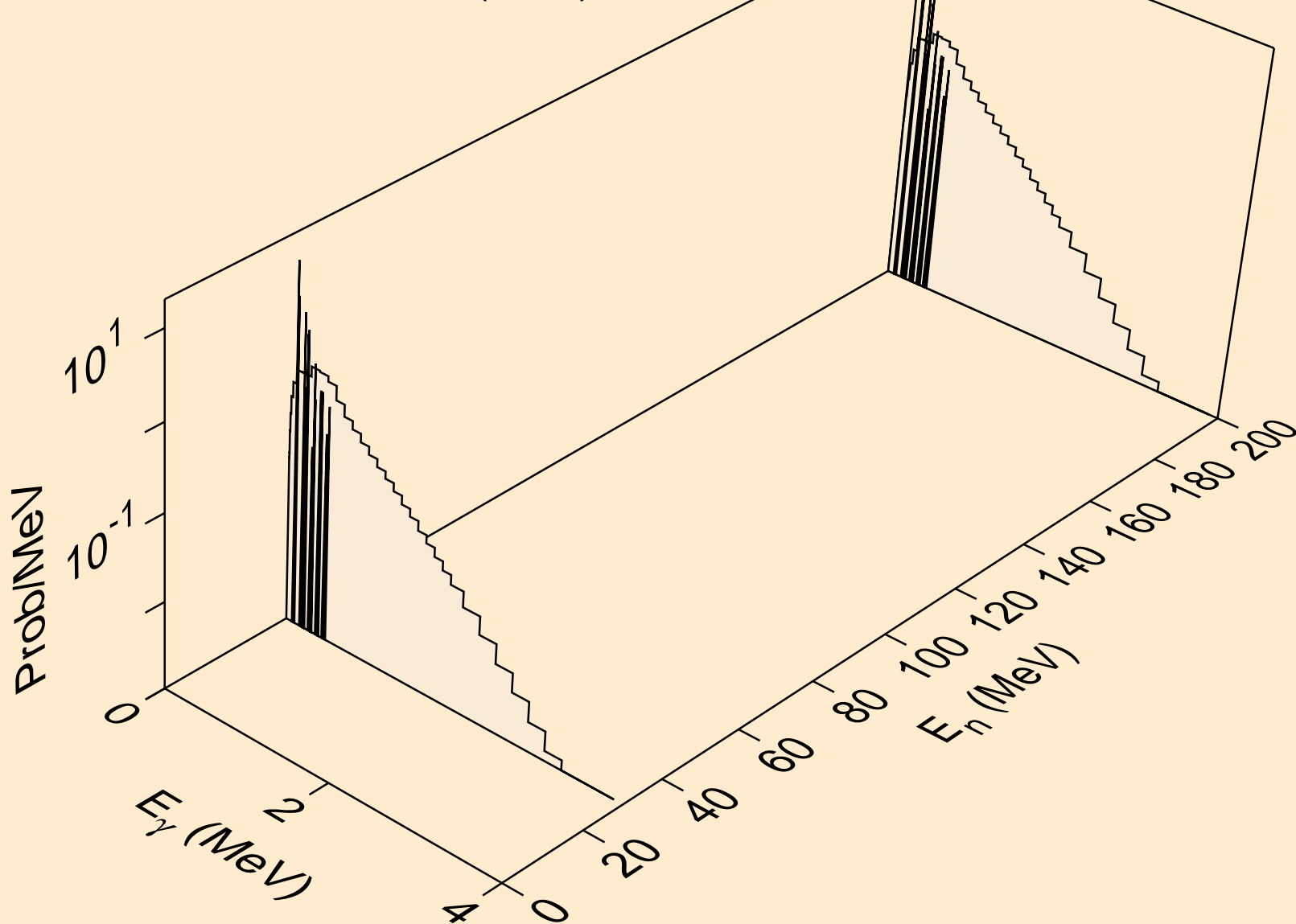

MD260 NEUTRON ACER TENDL-2019 LIBRARY; T=293.16K
Photon emission for (n,n*)p

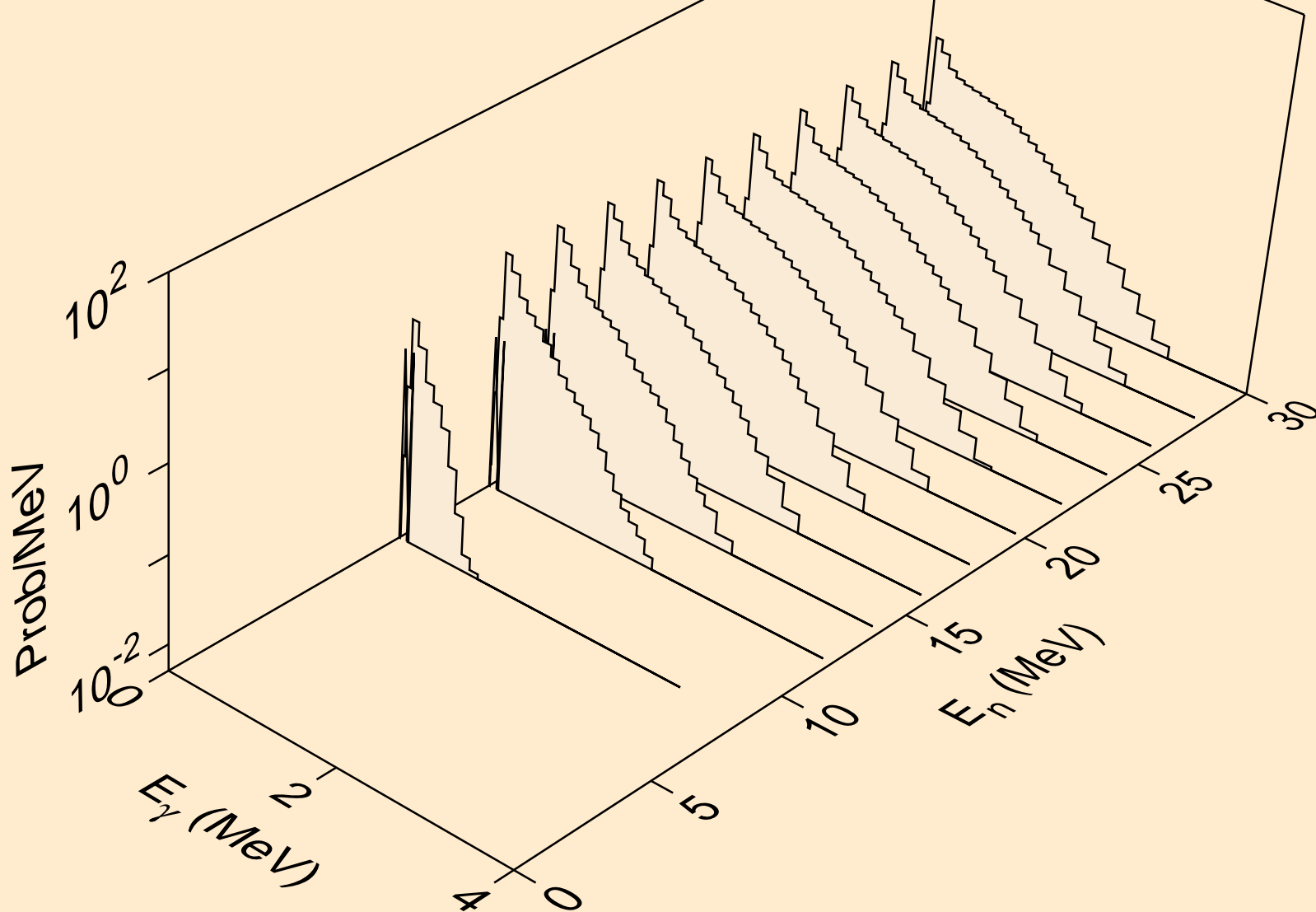

MD260 NEUTRON ACER TENDL-2019 LIBRARY; T=293.16K
Photon emission for (n,n*)d

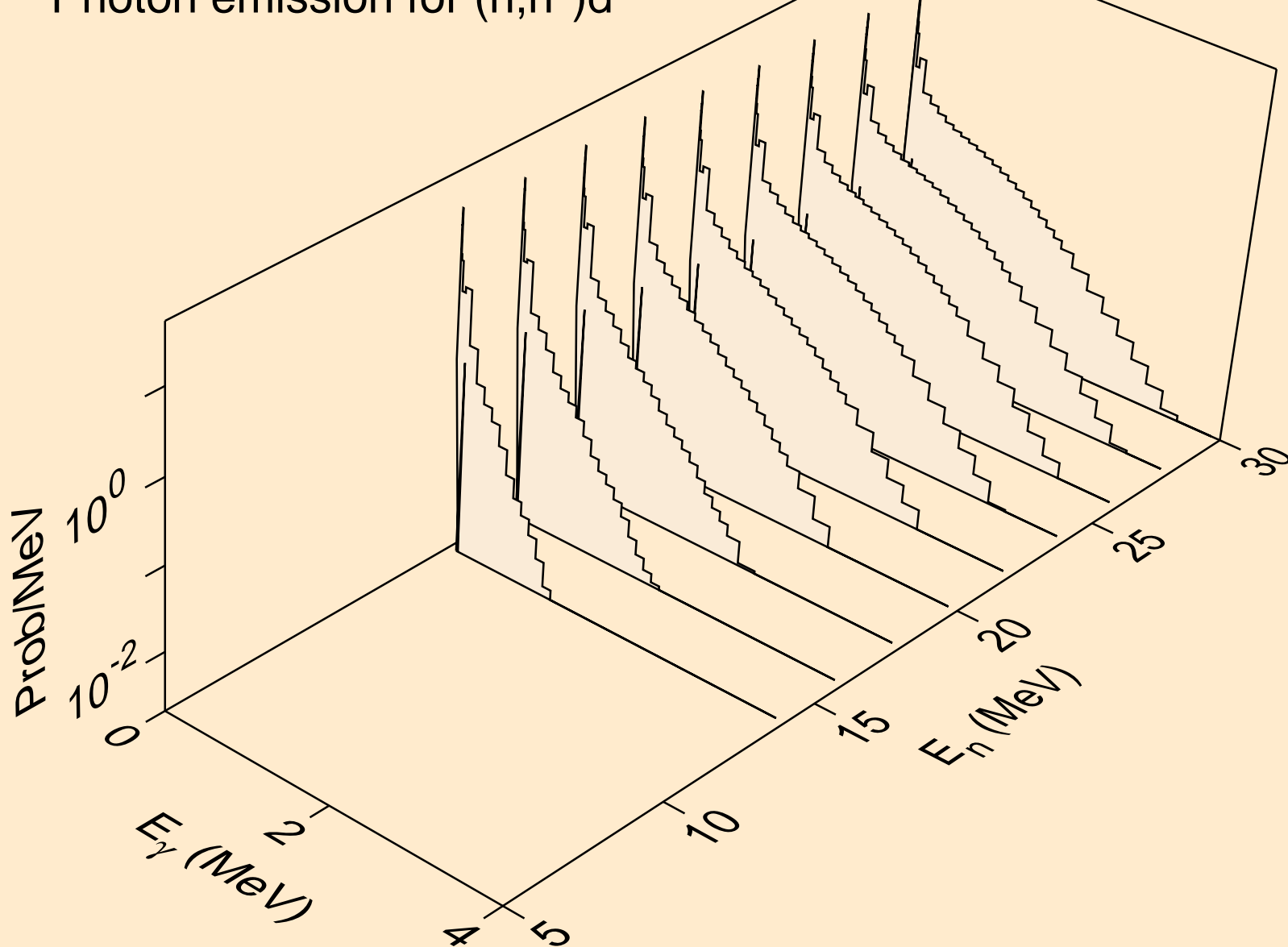

MD260 NEUTRON ACER TENDL-2019 LIBRARY; T=293.16K
Photon emission for (n,n*)t

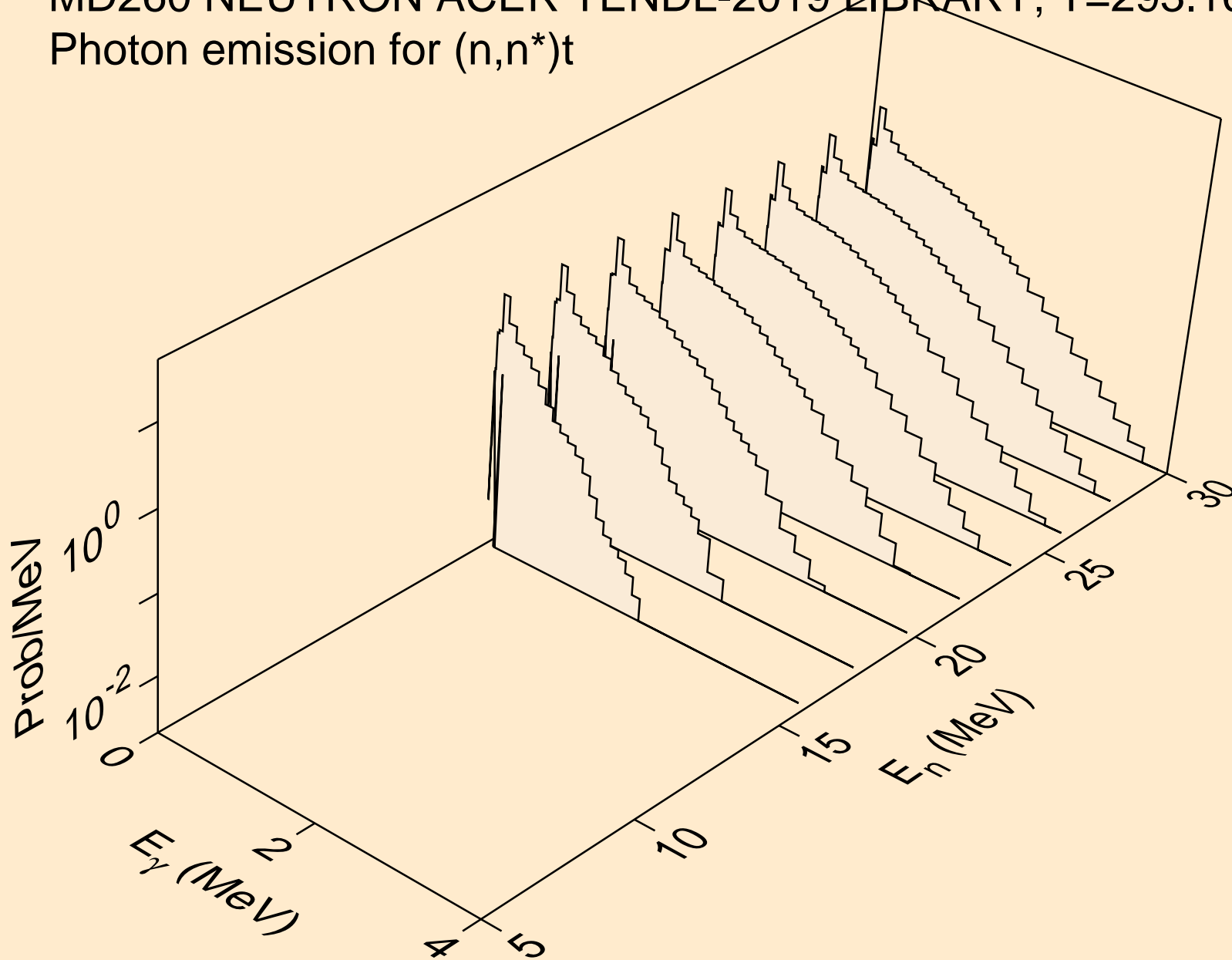

MD260 NEUTRON ACER TENDL-2019 LIBRARY; T=293.16K
Photon emission for (n,n*)he3

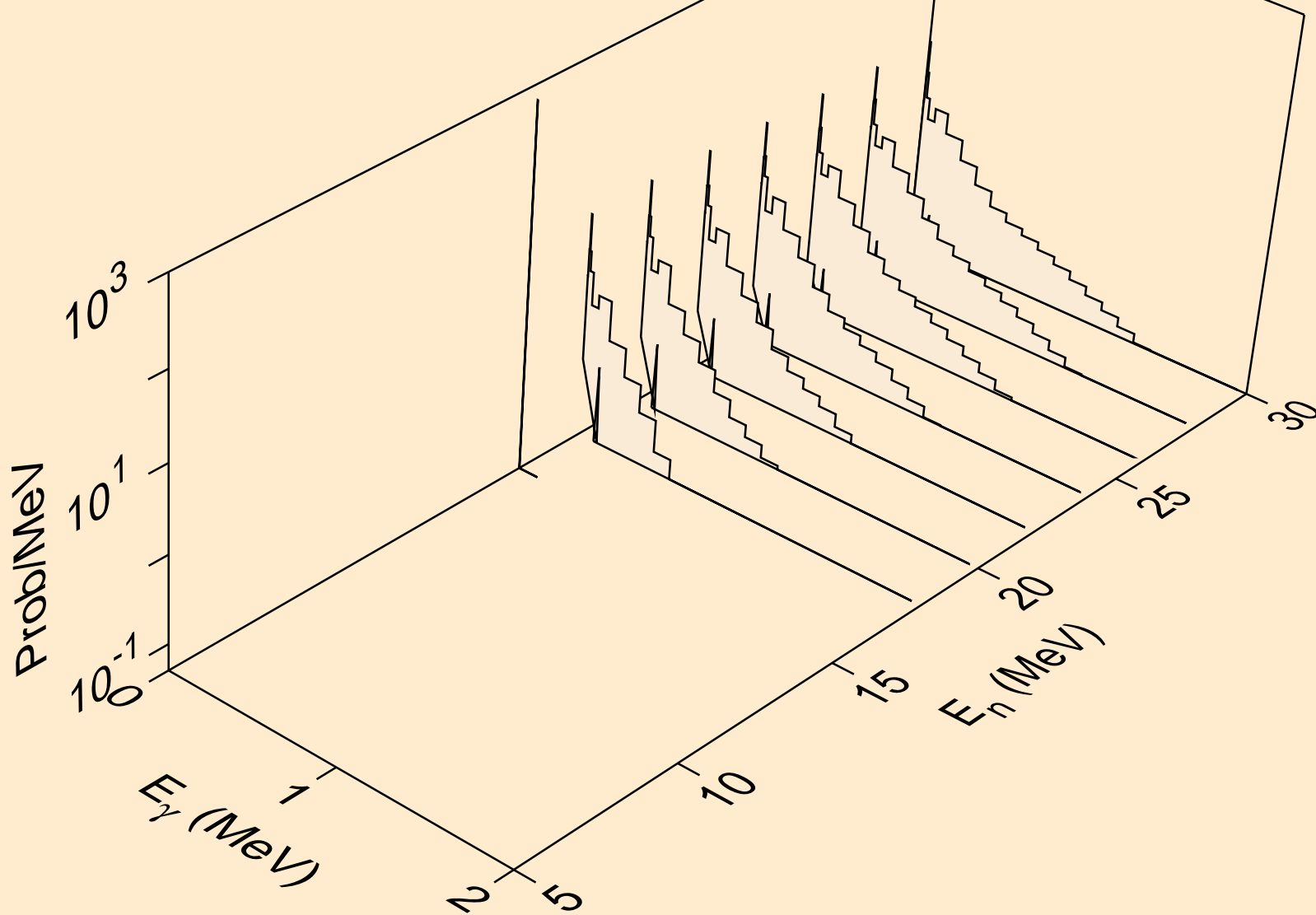

MD260 NEUTRON ACER TENDL-2019 LIBRARY; T=293.16K
Photon emission for (n,4n)

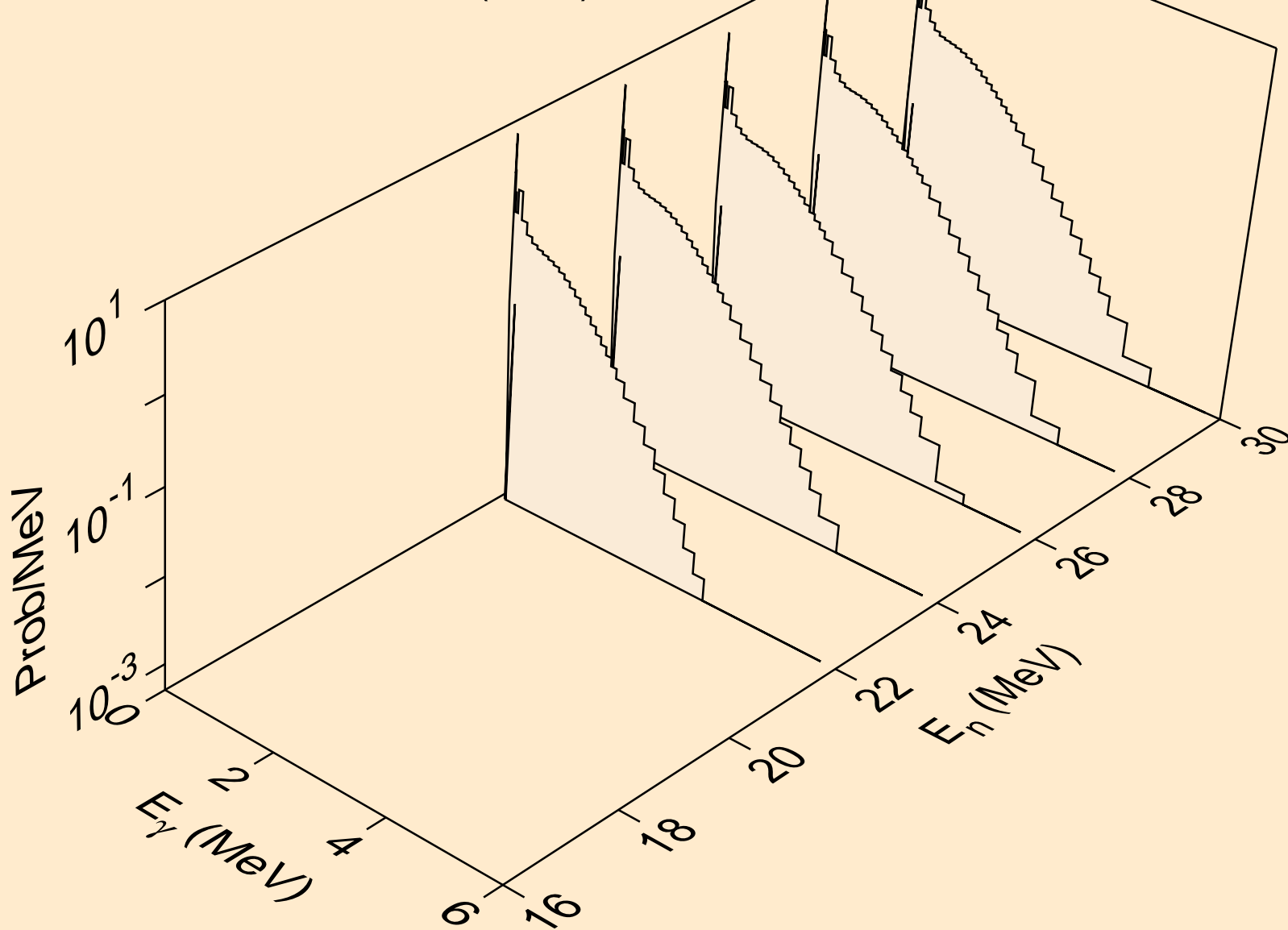

MD260 NEUTRON ACER TENDL-2019 LIBRARY; T=293.16K
Photon emission for (n,2np)

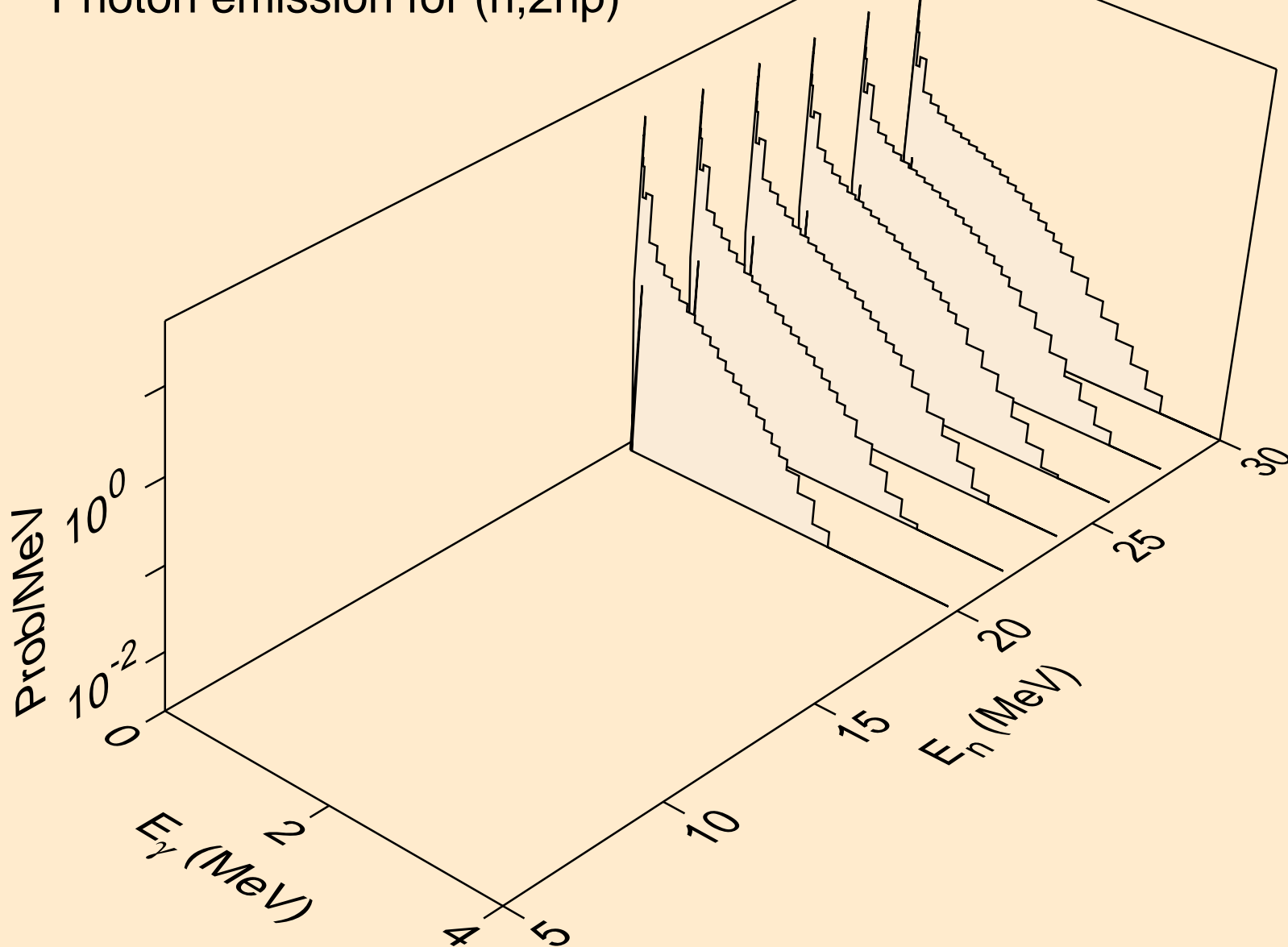

MD260 NEUTRON ACER TENDL-2019 LIBRARY; T=293.16K
Photon emission for (n,3np)

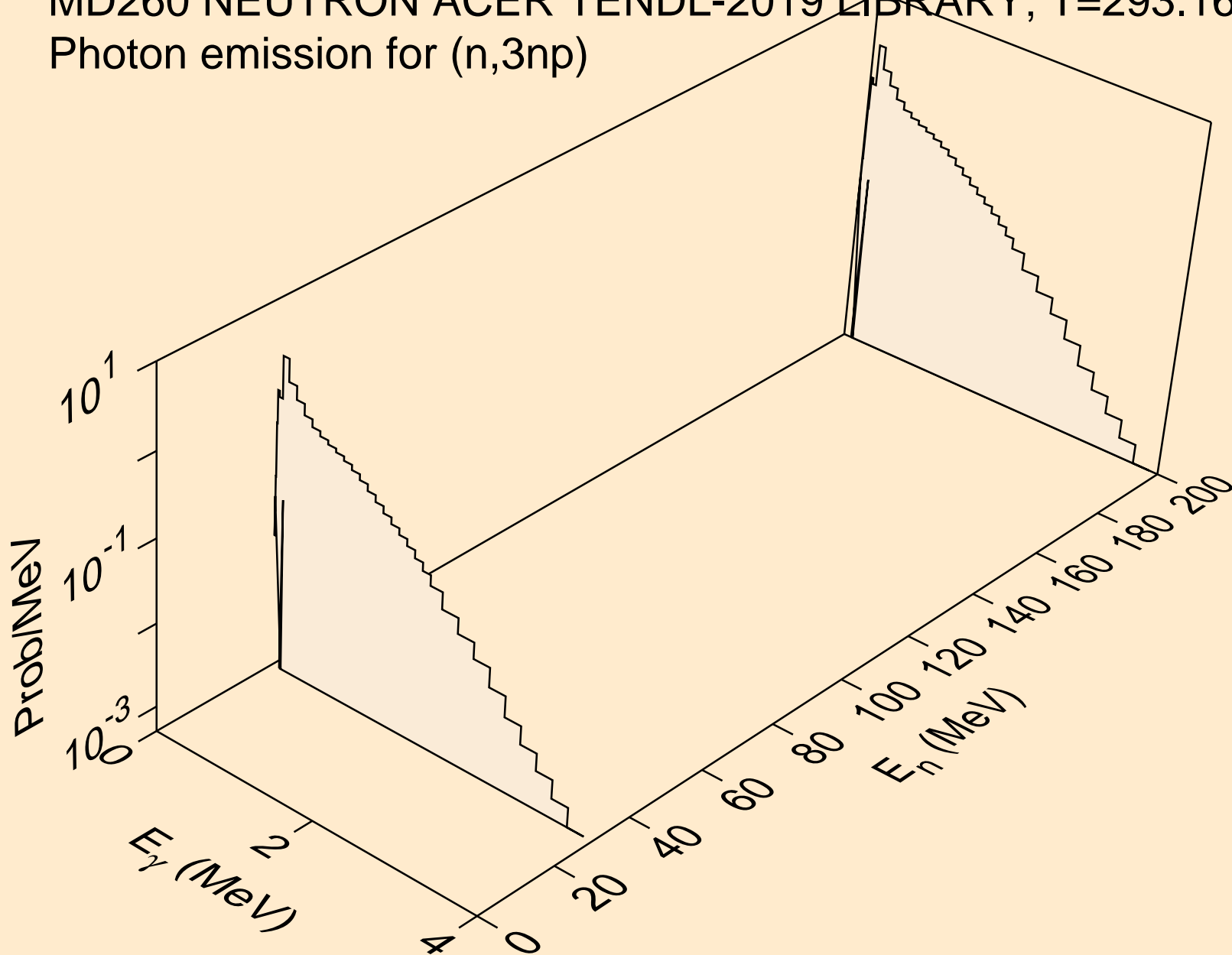

MD260 NEUTRON ACER TENDL-2019 LIBRARY; T=293.16K
Photon emission for (n,2np)

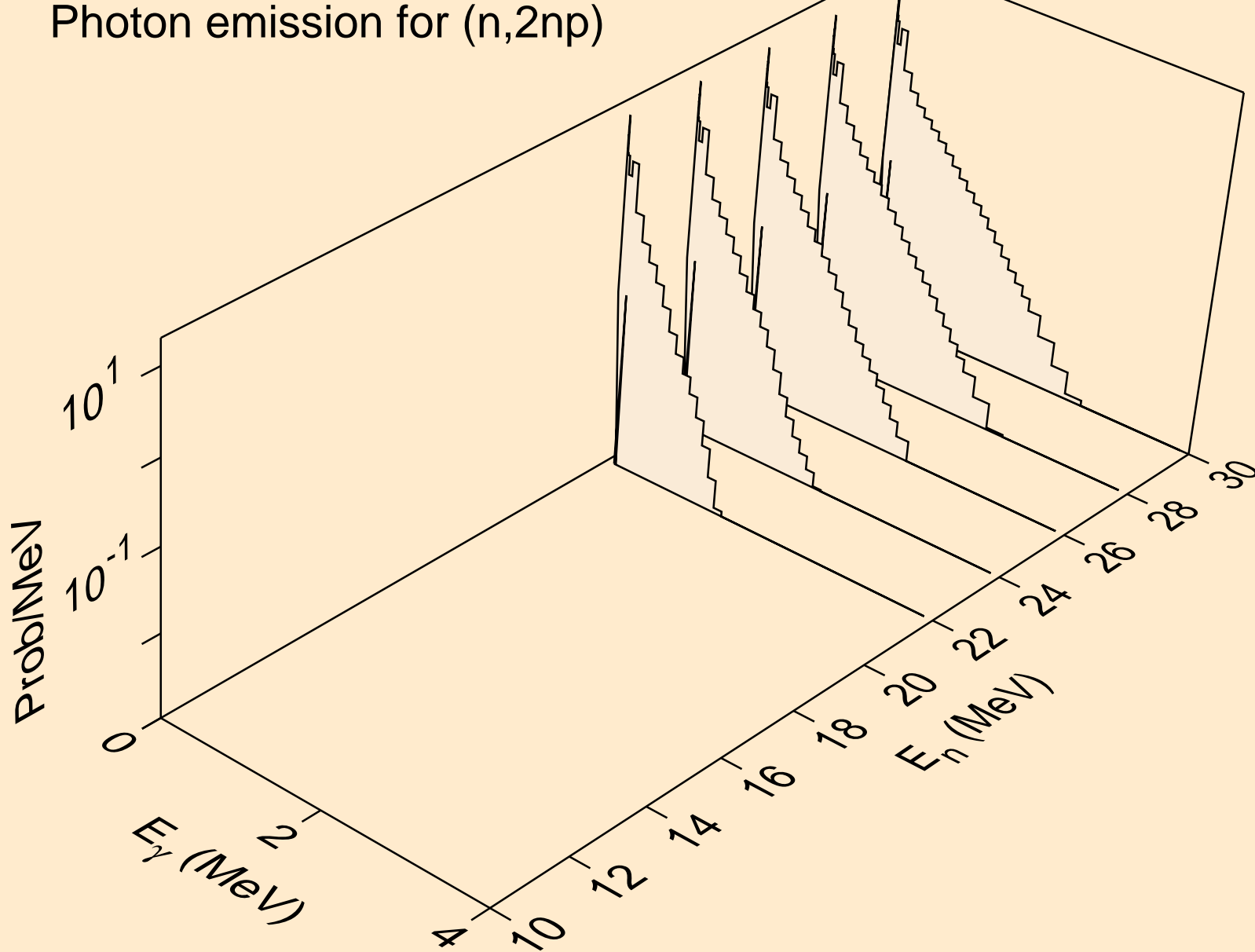

MD260 NEUTRON ACER TENDL-2019 LIBRARY; T=293.16K
Photon emission for (n,n*c)

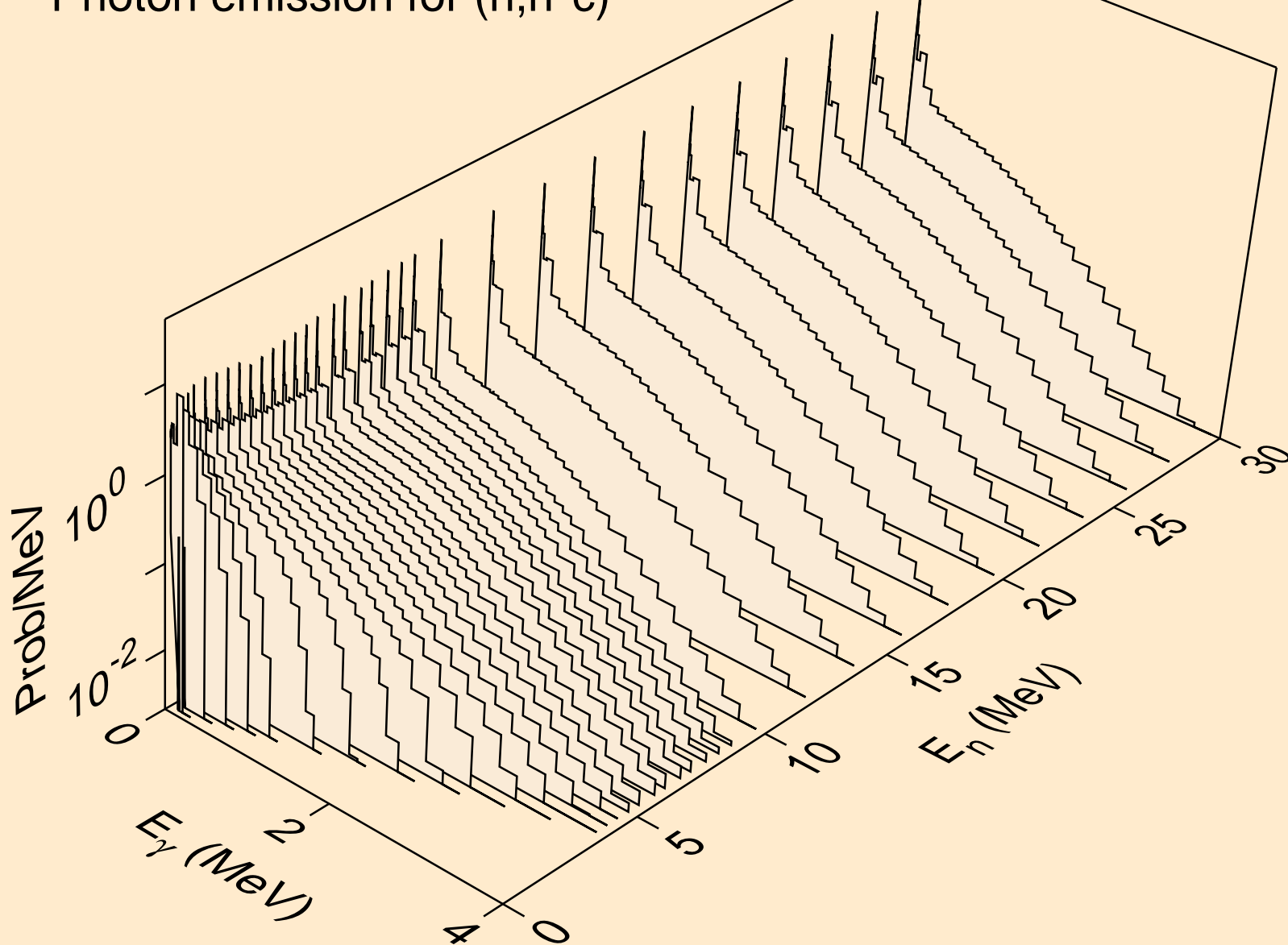

MD260 NEUTRON ACER TENDL-2019 LIBRARY; T=293.16K
Photon emission for (n,gma)

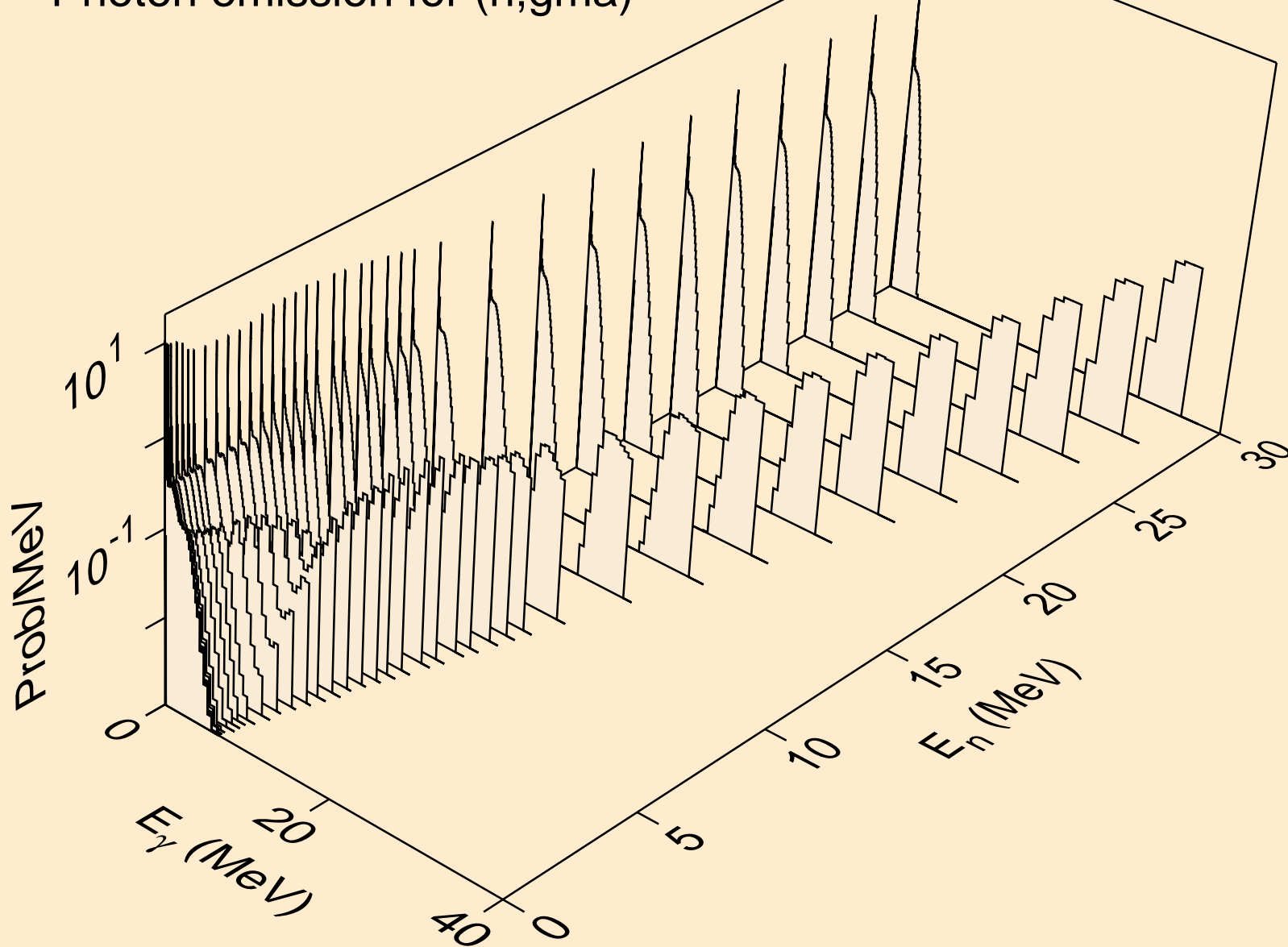

MD260 NEUTRON ACER TENDL-2019 LIBRARY; T=293.16K
Photon emission for (n,p)

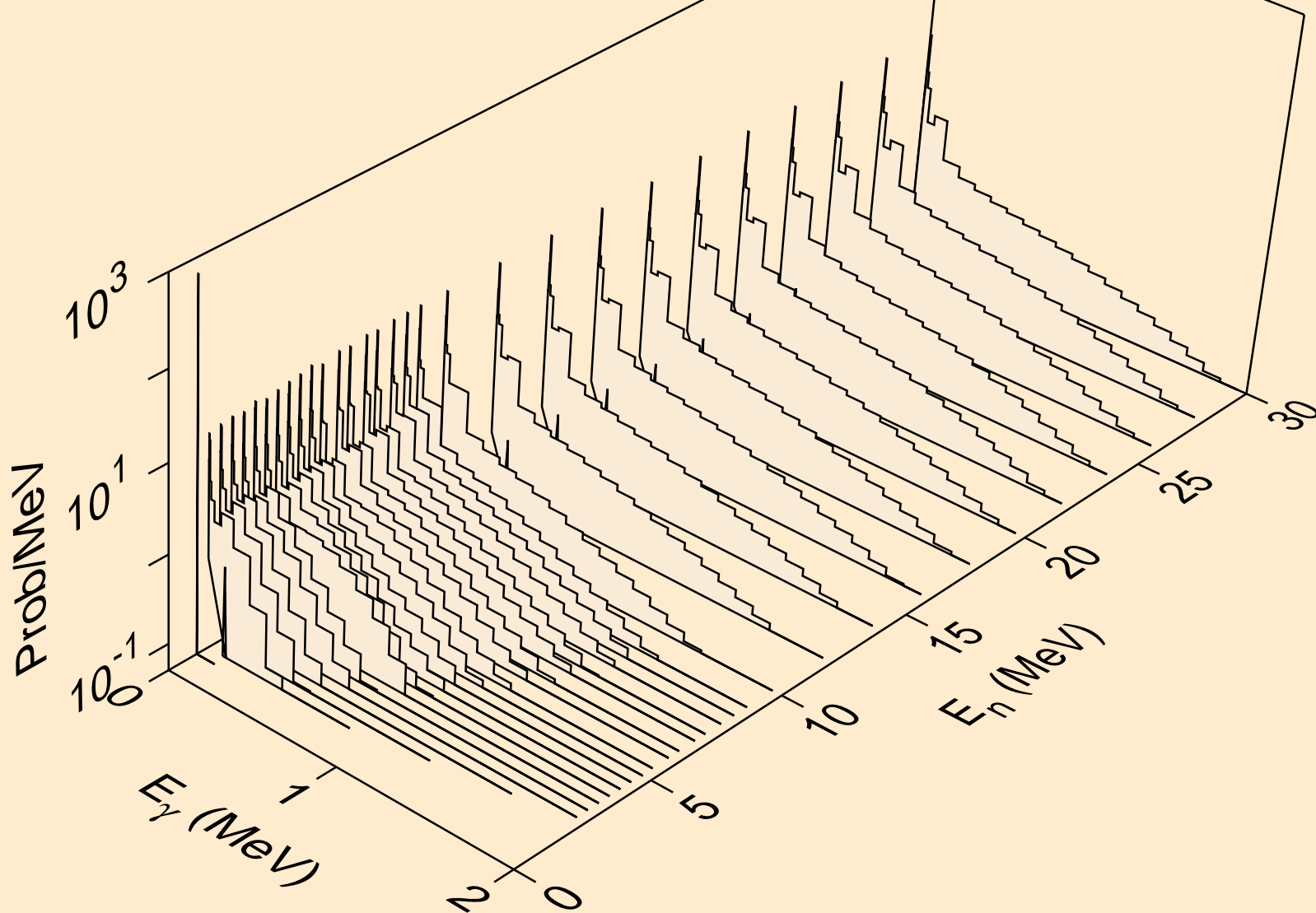

MD260 NEUTRON ACER TENDL-2019 LIBRARY; T=293.16K
Photon emission for (n,d)

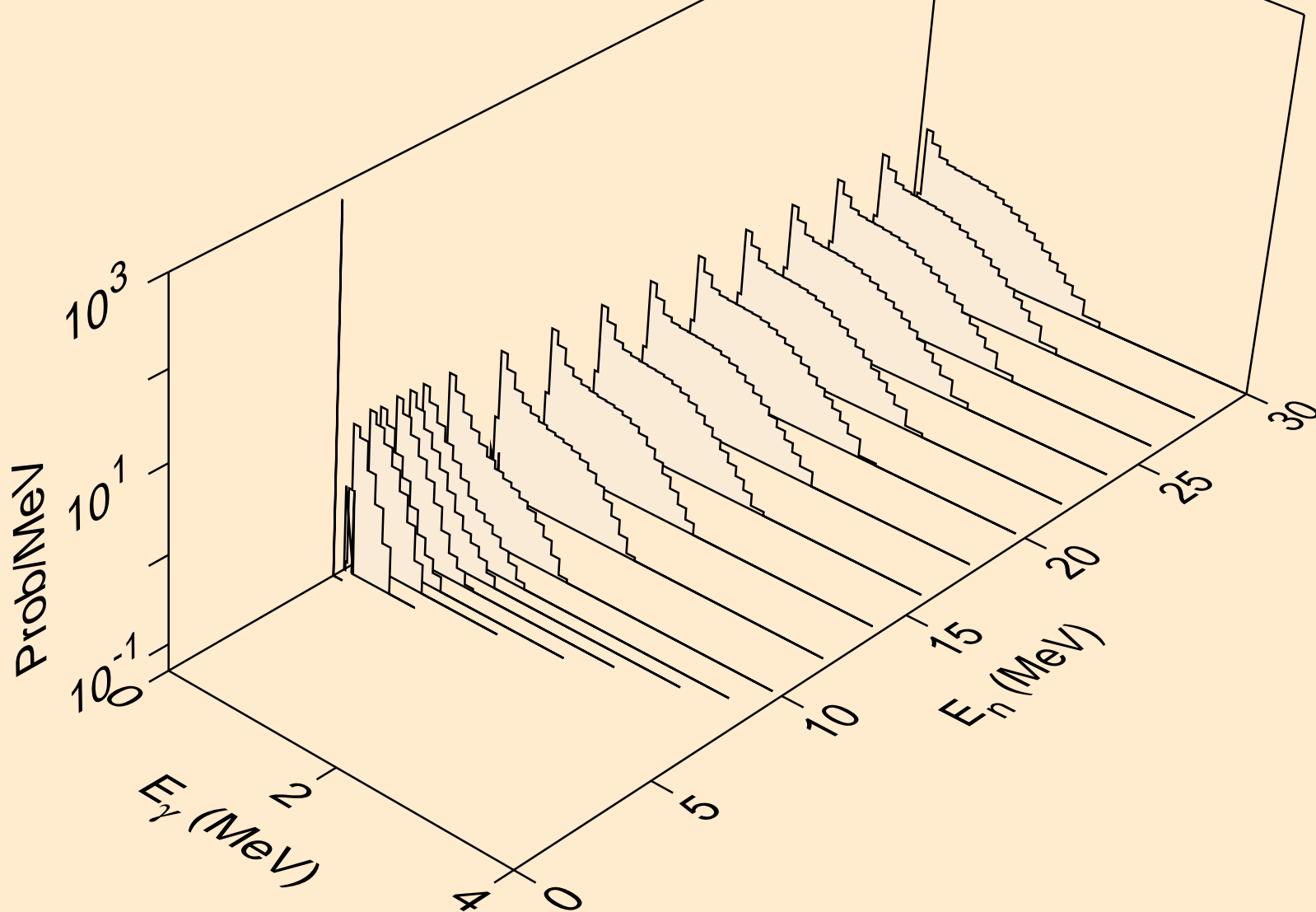

MD260 NEUTRON ACER TENDL-2019 LIBRARY; T=293.16K
Photon emission for (n,t)

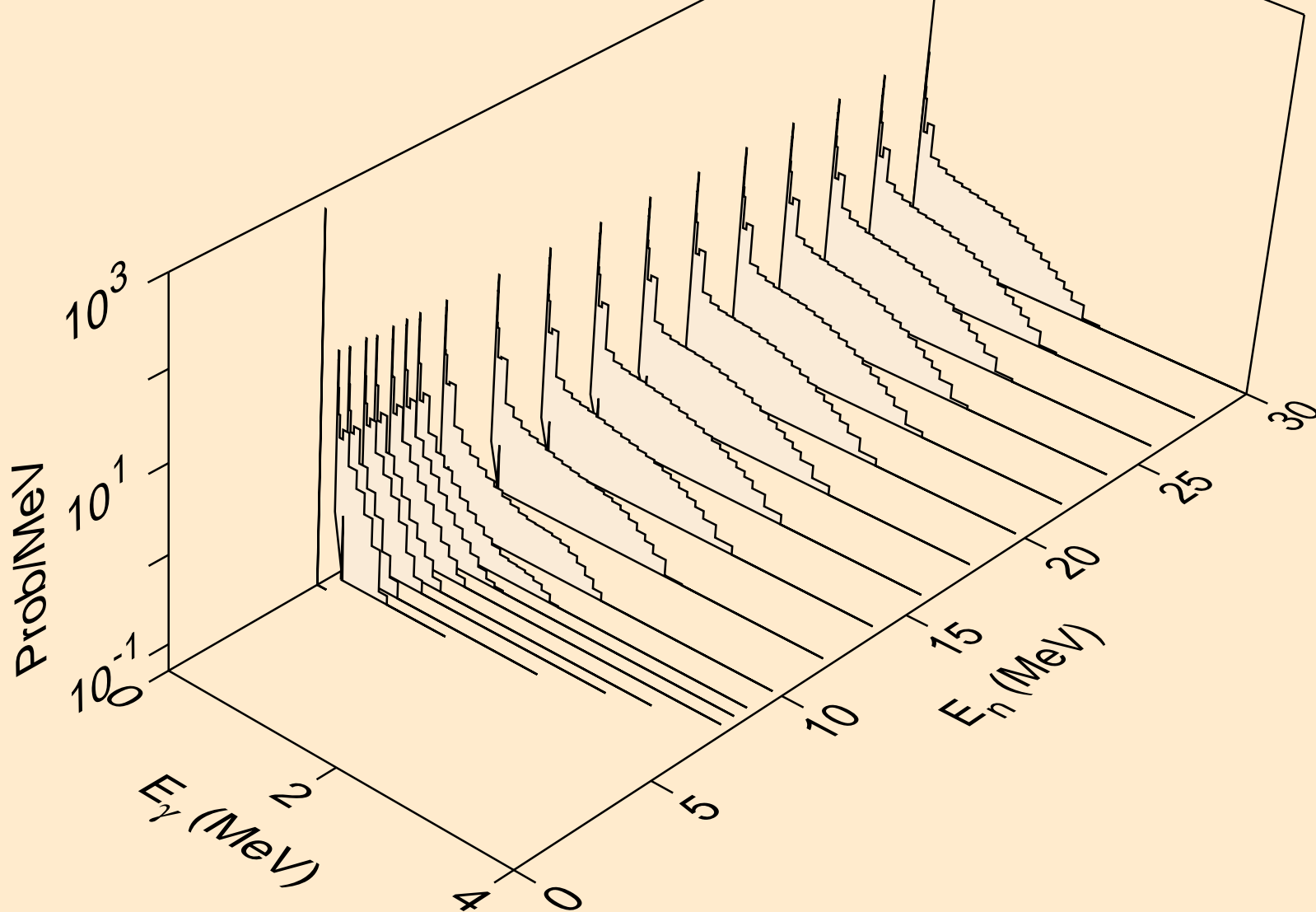

MD260 NEUTRON ACER TENDL-2019 LIBRARY; T=293.16K
Photon emission for (n,he3)

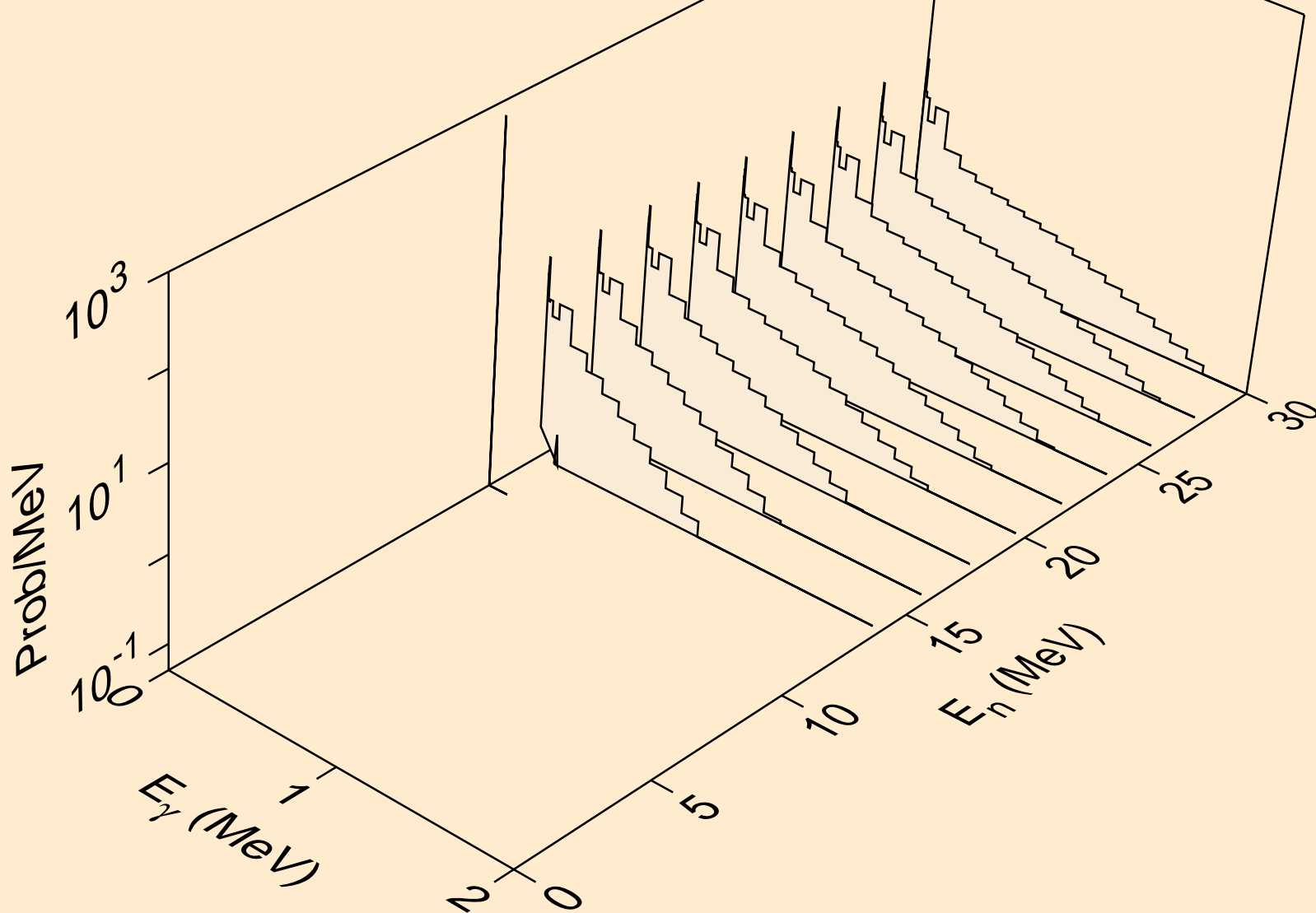

MD260 NEUTRON ACER TENDL-2019 LIBRARY; T=293.16K
Photon emission for (n,a)

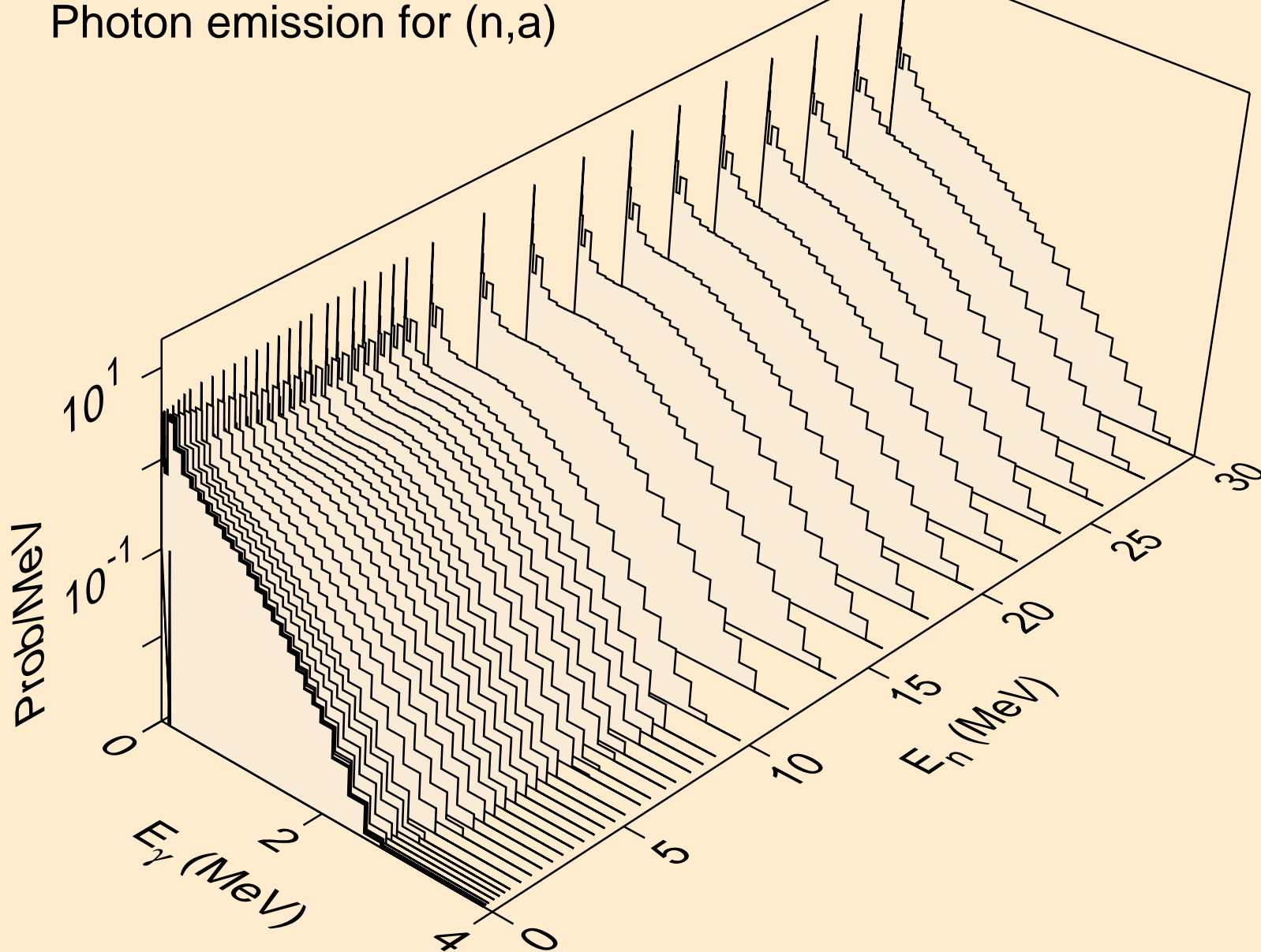

MD260 NEUTRON ACER TENDL-2019 LIBRARY; T=293.16K
Photon emission for (n,2p)

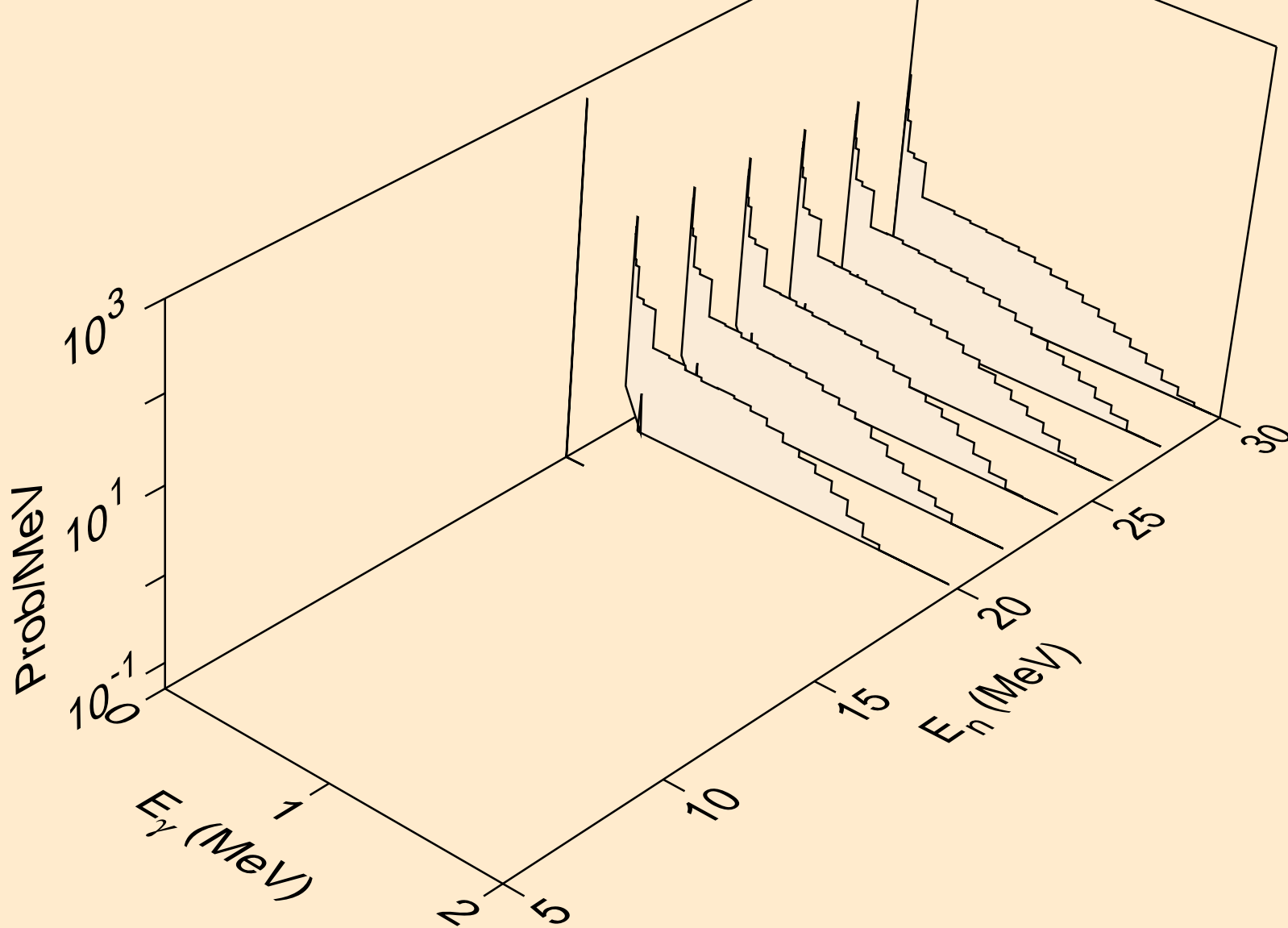

MD260 NEUTRON ACER TENDL-2019 LIBRARY; T=293.16K
thermal capture photon spectrum

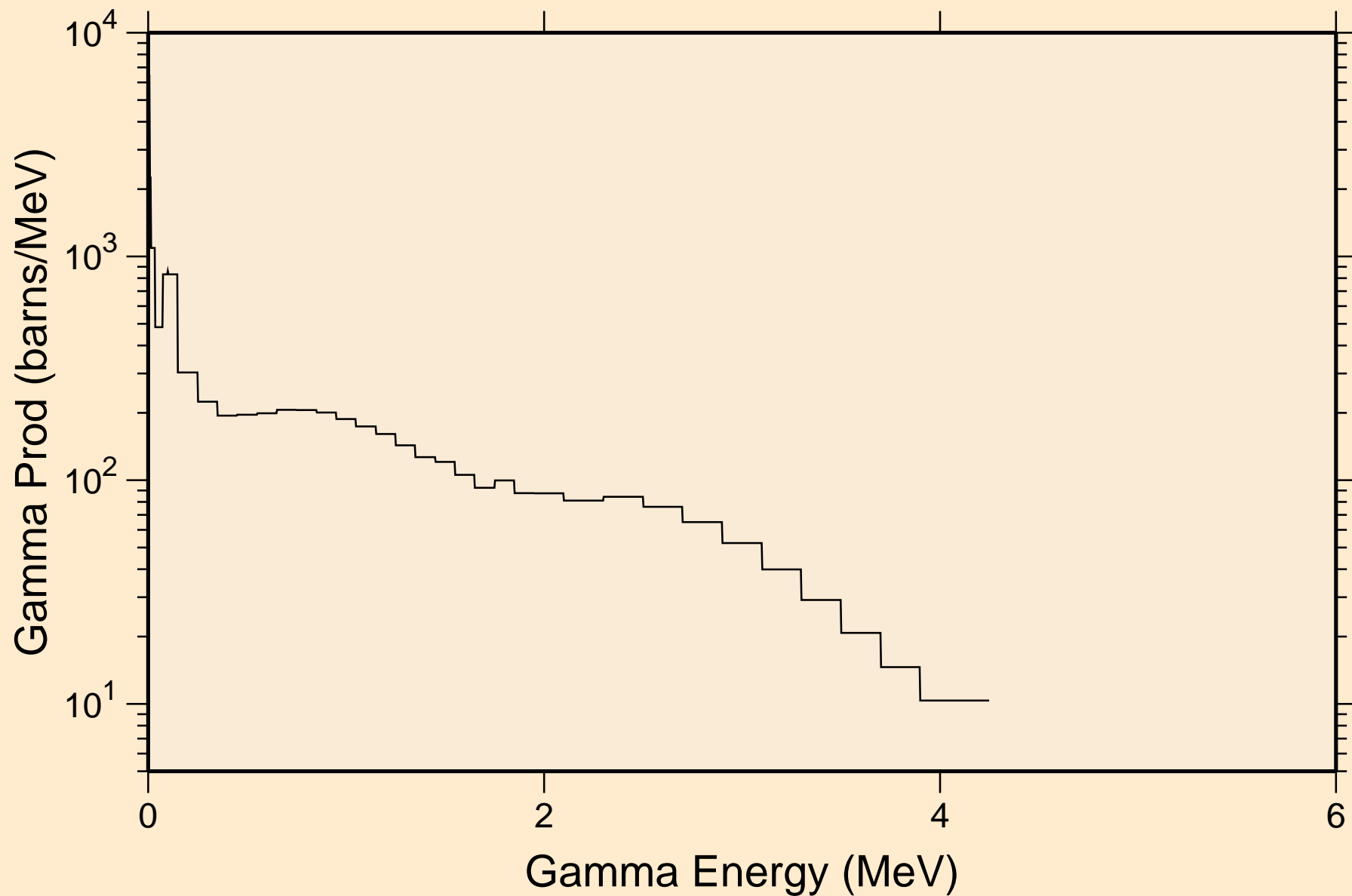

MD260 NEUTRON ACER TENDL-2019 LIBRARY; T=293.16K
14 MeV photon spectrum

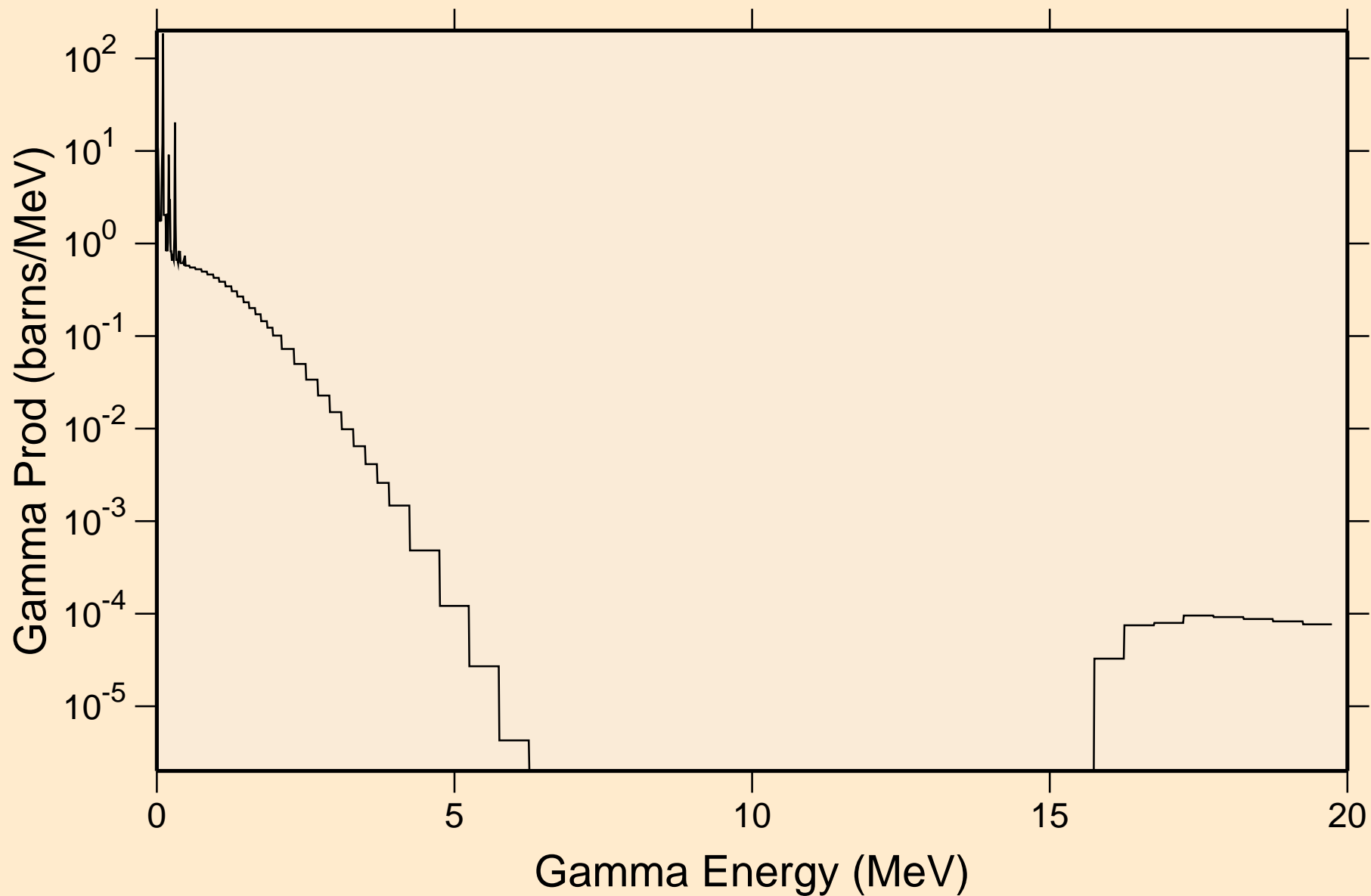

MD260 NEUTRON ACER TENDL-2019 LIBRARY; T=293.16K

Particle heating contributions

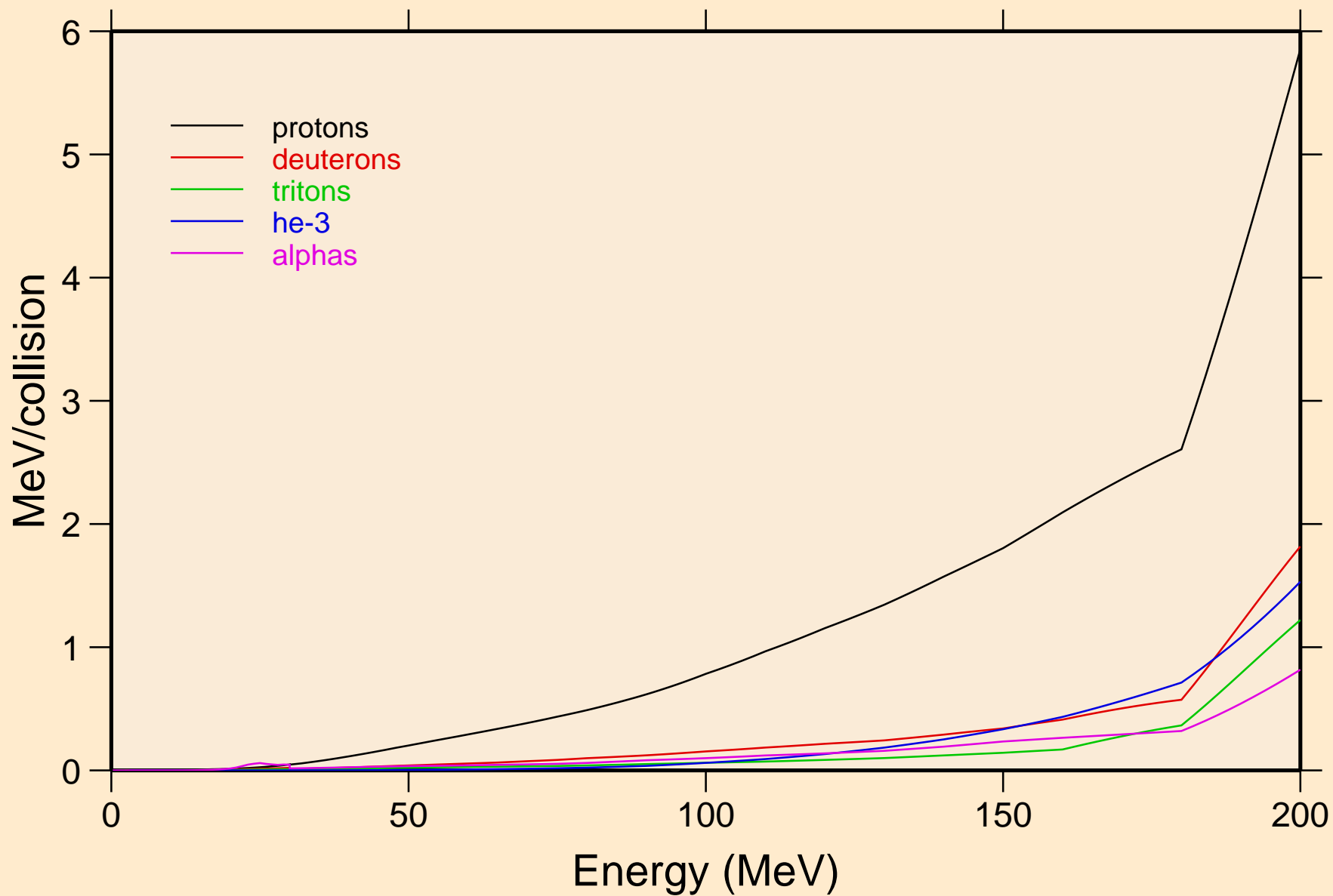

MD260 NEUTRON ACER TENDL-2019 LIBRARY; T=293.16K
Recoil Heating

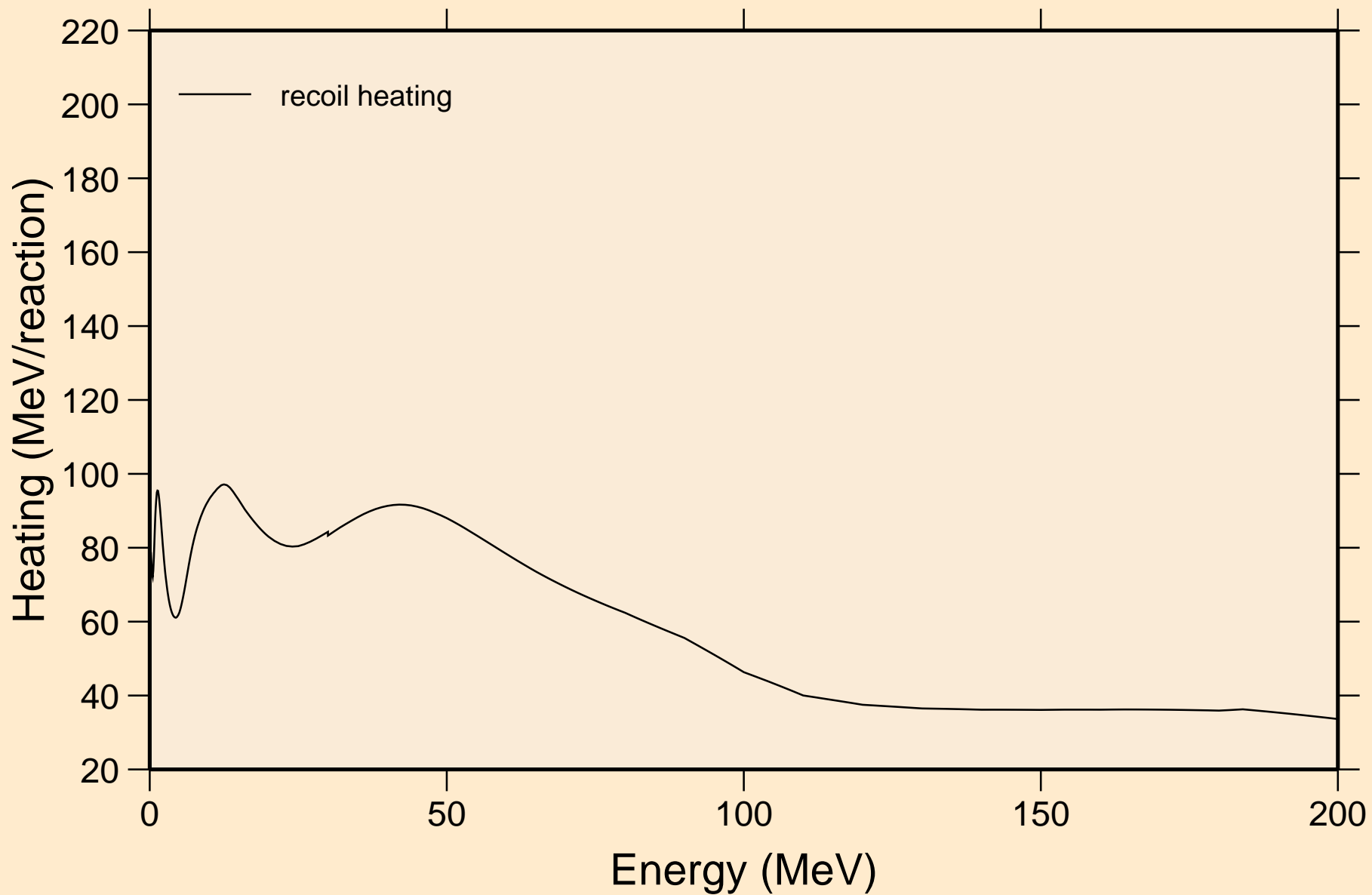

MD260 NEUTRON ACER TENDL-2019 LIBRARY; T=293.16K
Particle production cross sections

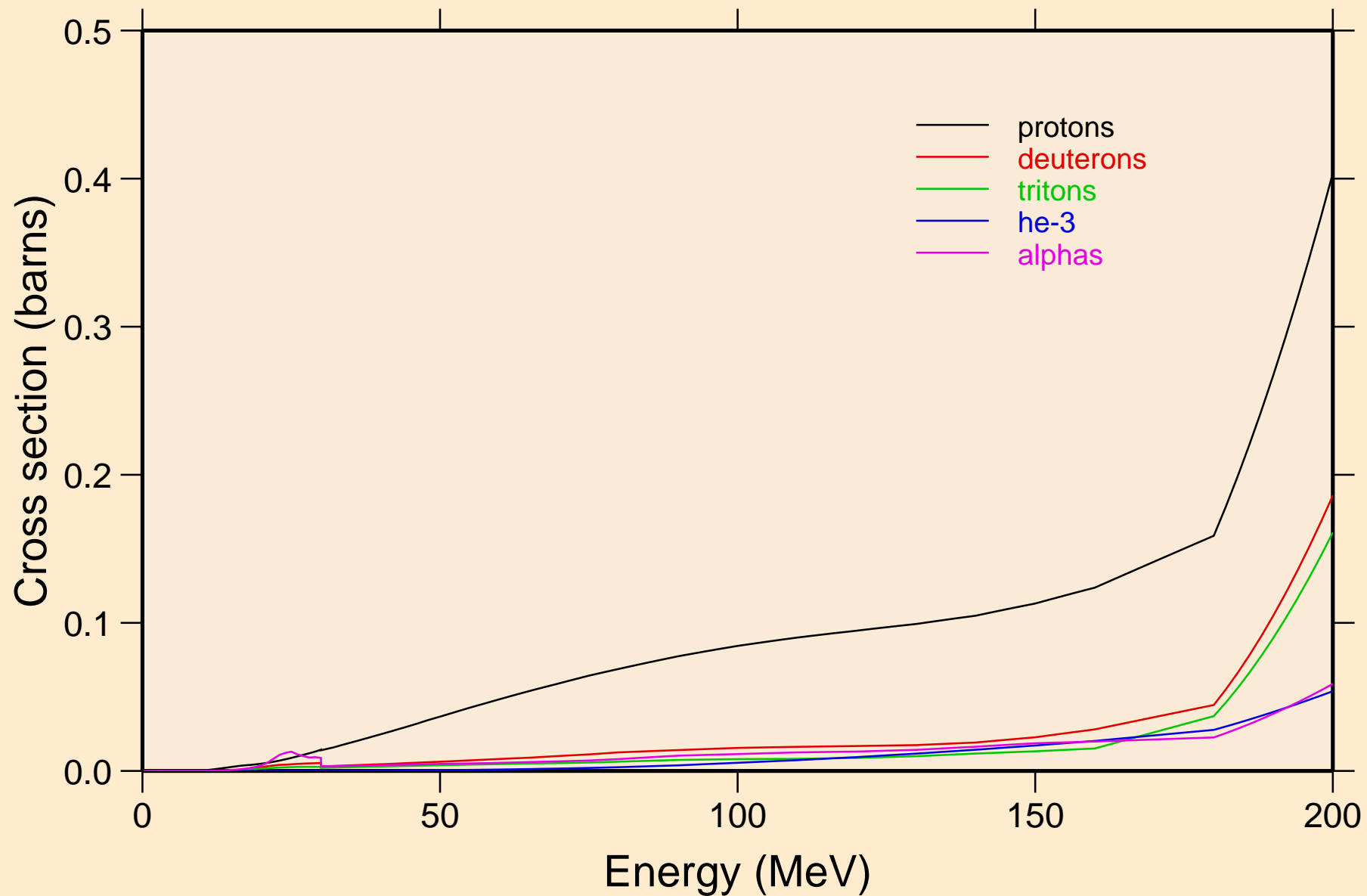

MD260 NEUTRON ACER TENDL-2019 LIBRARY; T=293.16K
protons from (n,x)

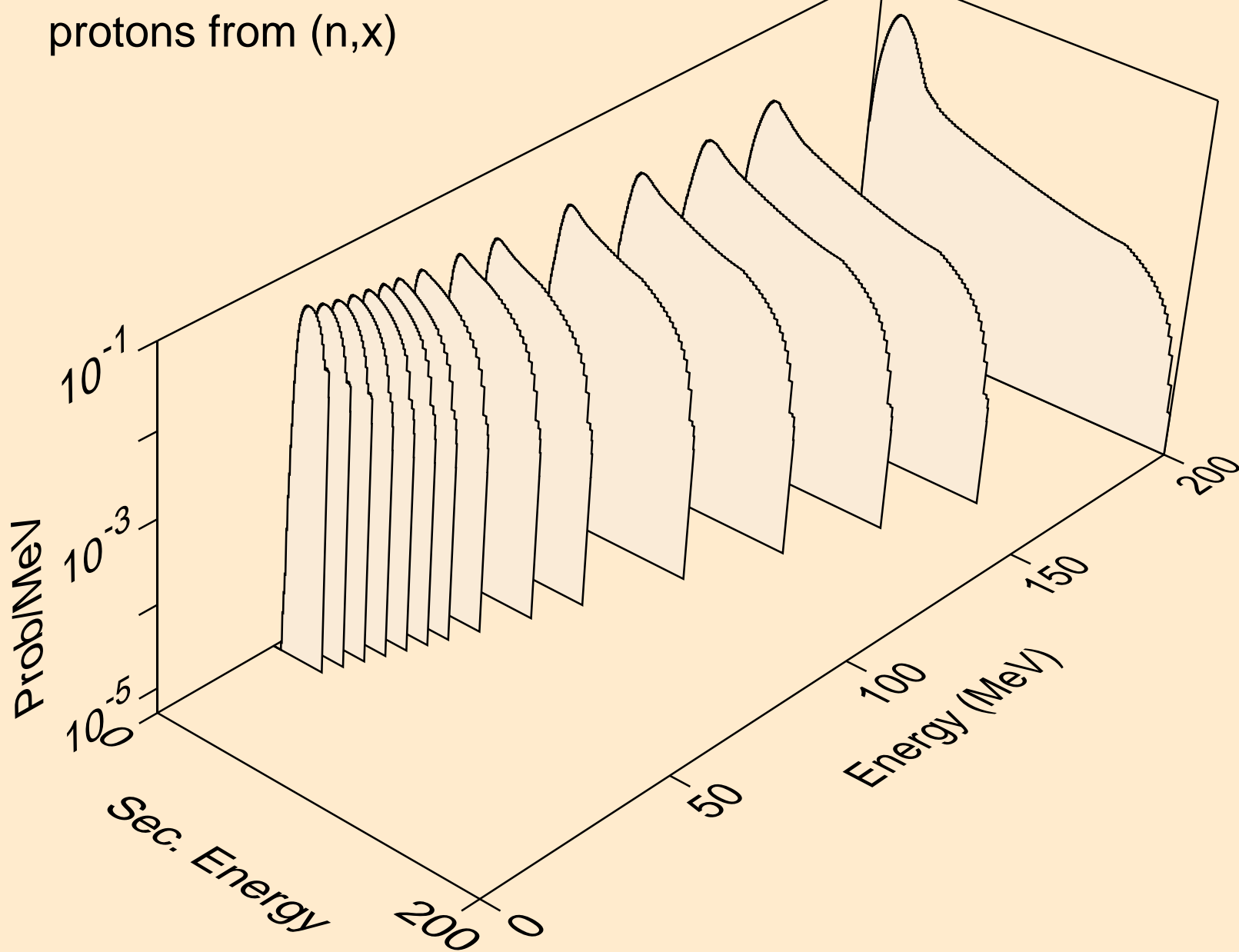

MD260 NEUTRON ACER TENDL-2019 LIBRARY; T=293.16K
protons from (n,n*)p

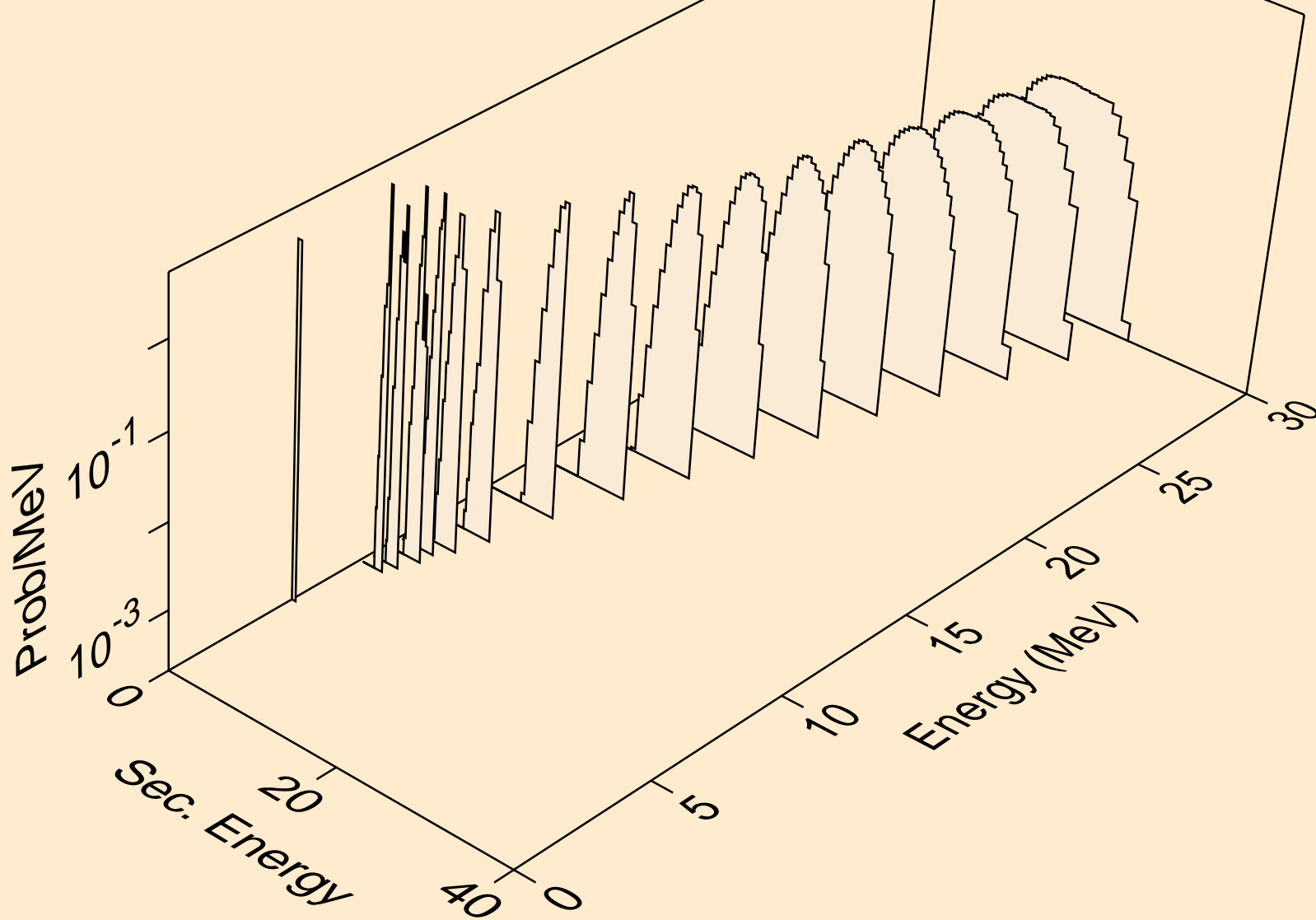

MD260 NEUTRON ACER TENDL-2019 LIBRARY; T=293.16K
protons from (n,2np)

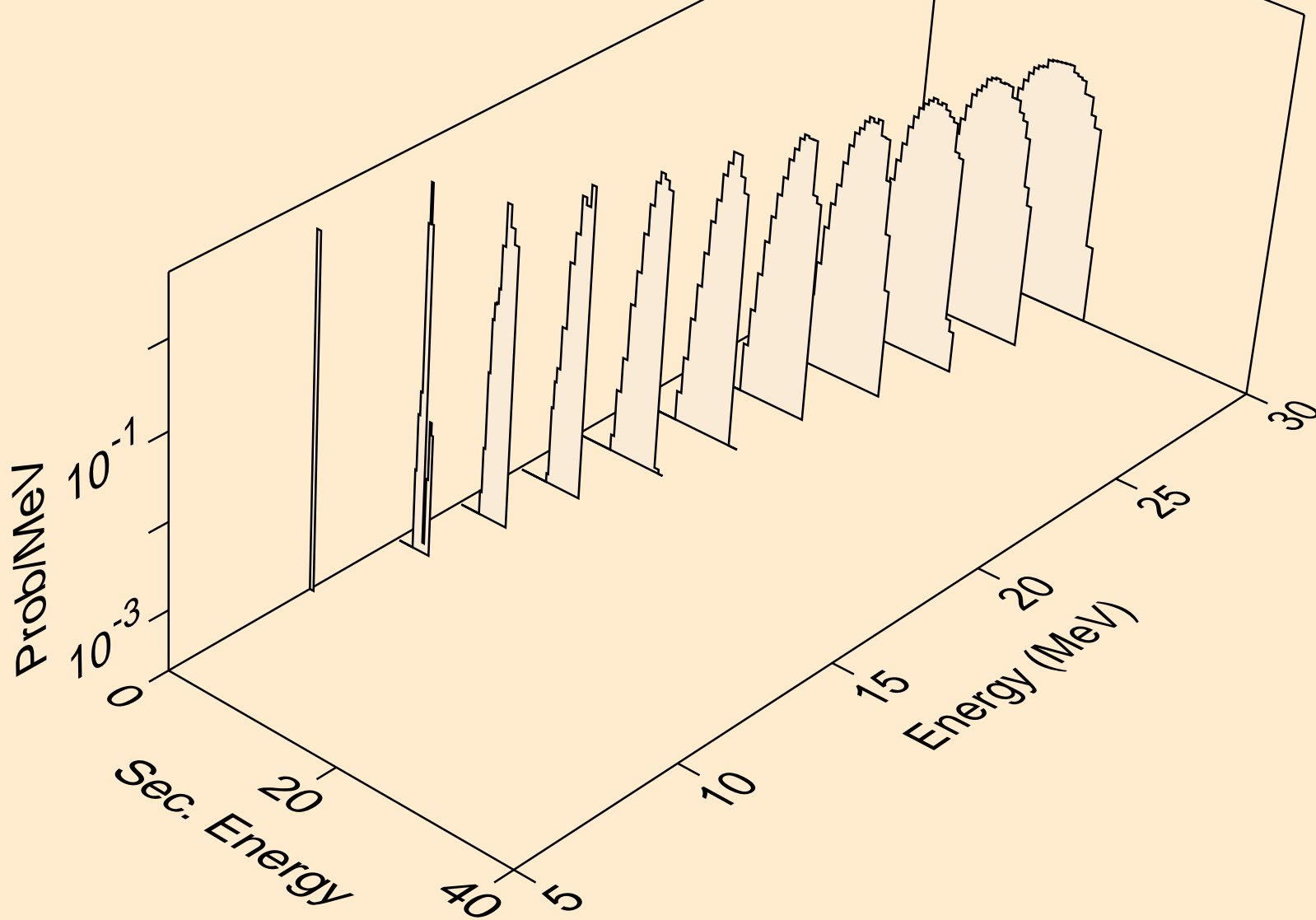

MD260 NEUTRON ACER TENDL-2019 LIBRARY; T=293.16K
protons from (n,3np)

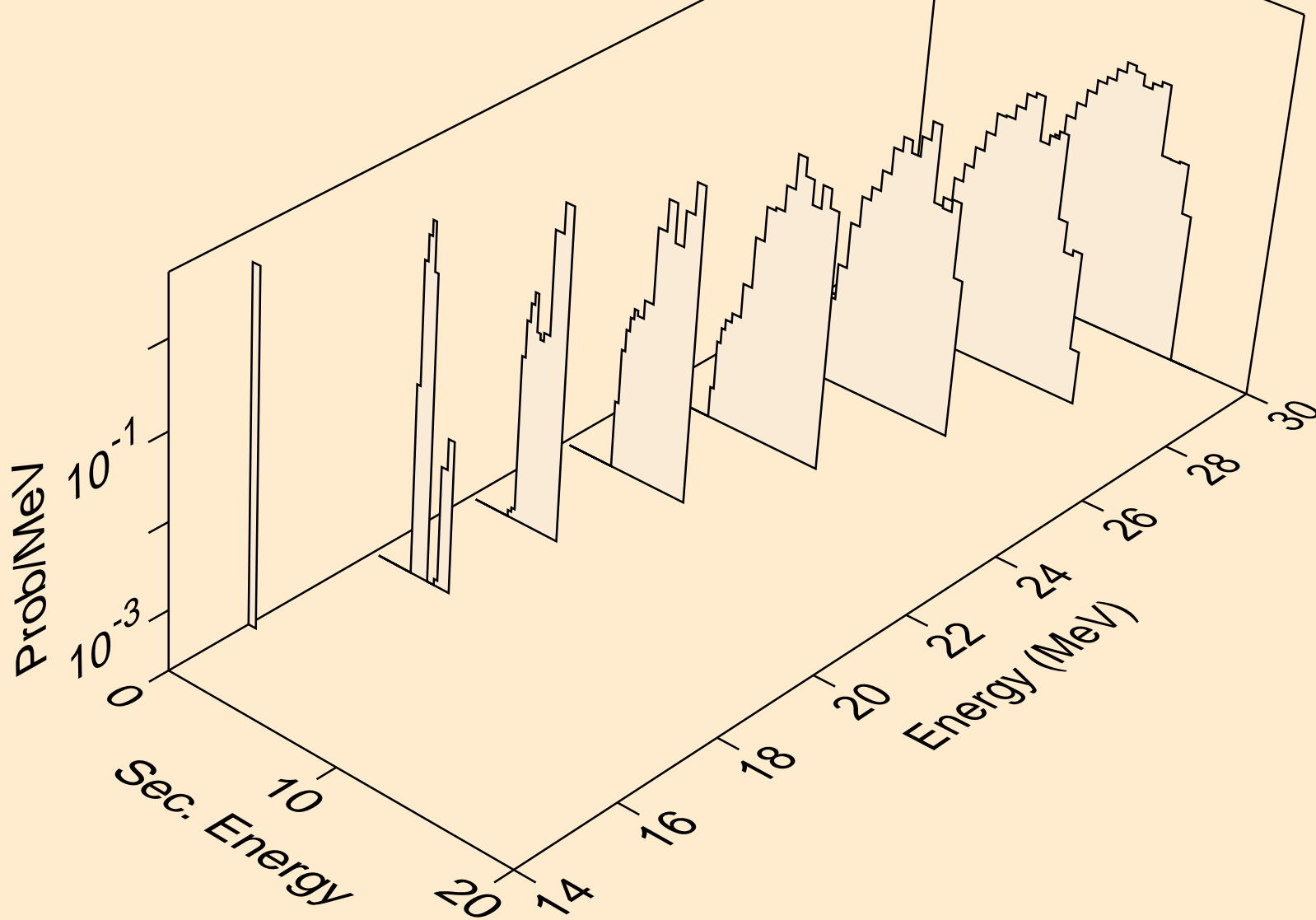

MD260 NEUTRON ACER TENDL-2019 LIBRARY; T=293.16K
protons from (n,2np)

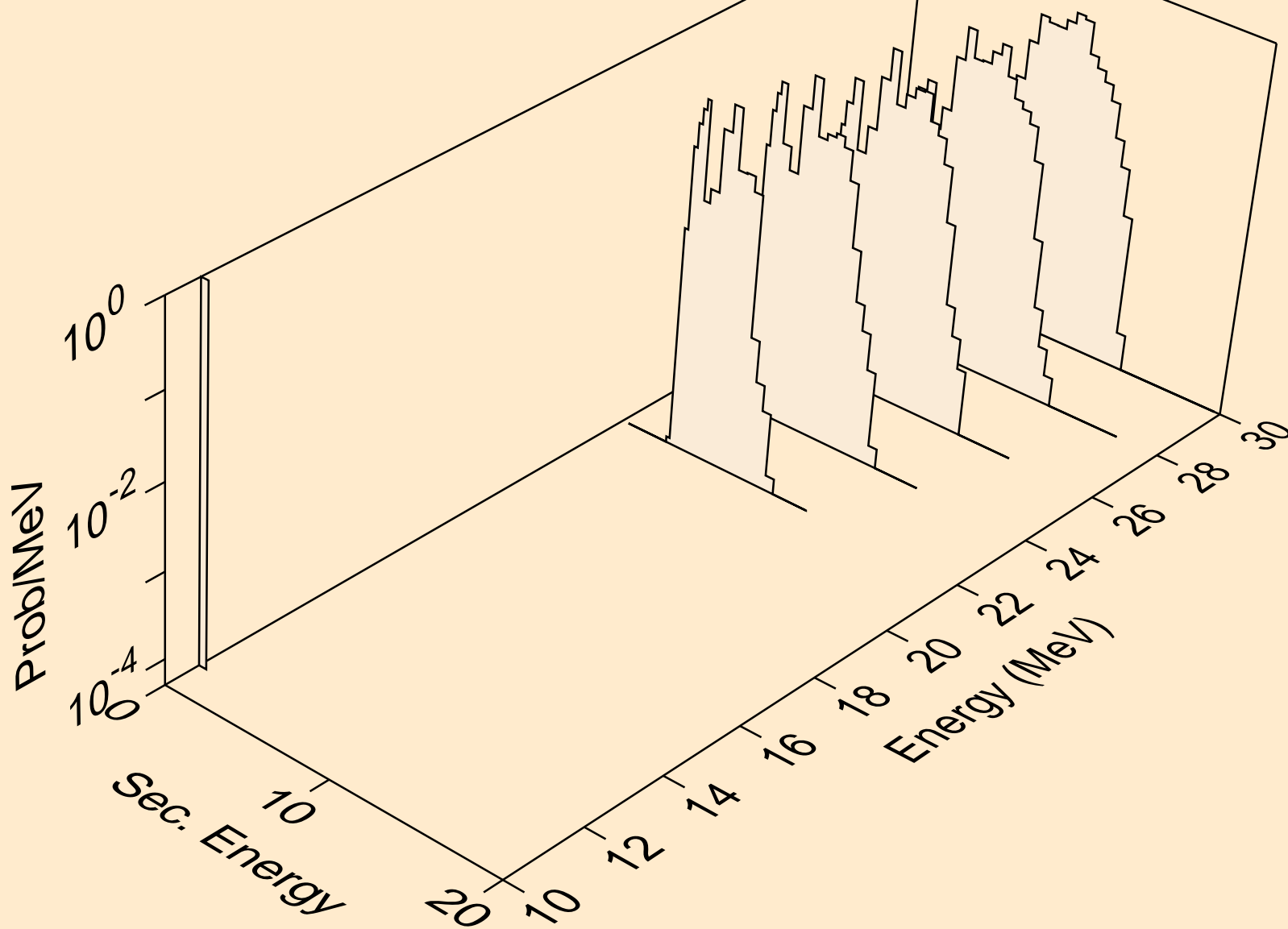

MD260 NEUTRON ACER TENDL-2019 LIBRARY; T=293.16K
protons from (n,p)

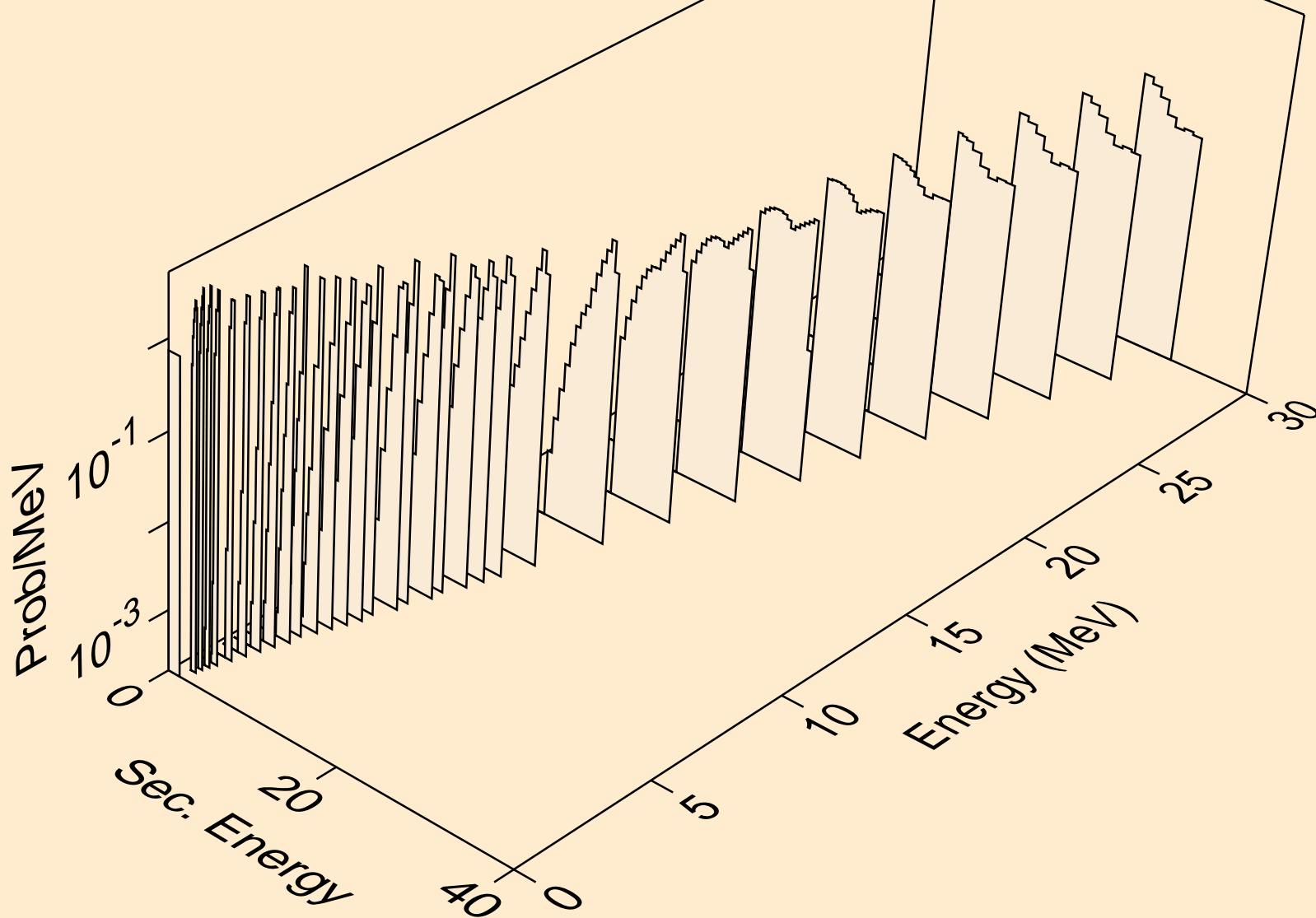

MD260 NEUTRON ACER TENDL-2019 LIBRARY; T=293.16K
protons from (n,2p)

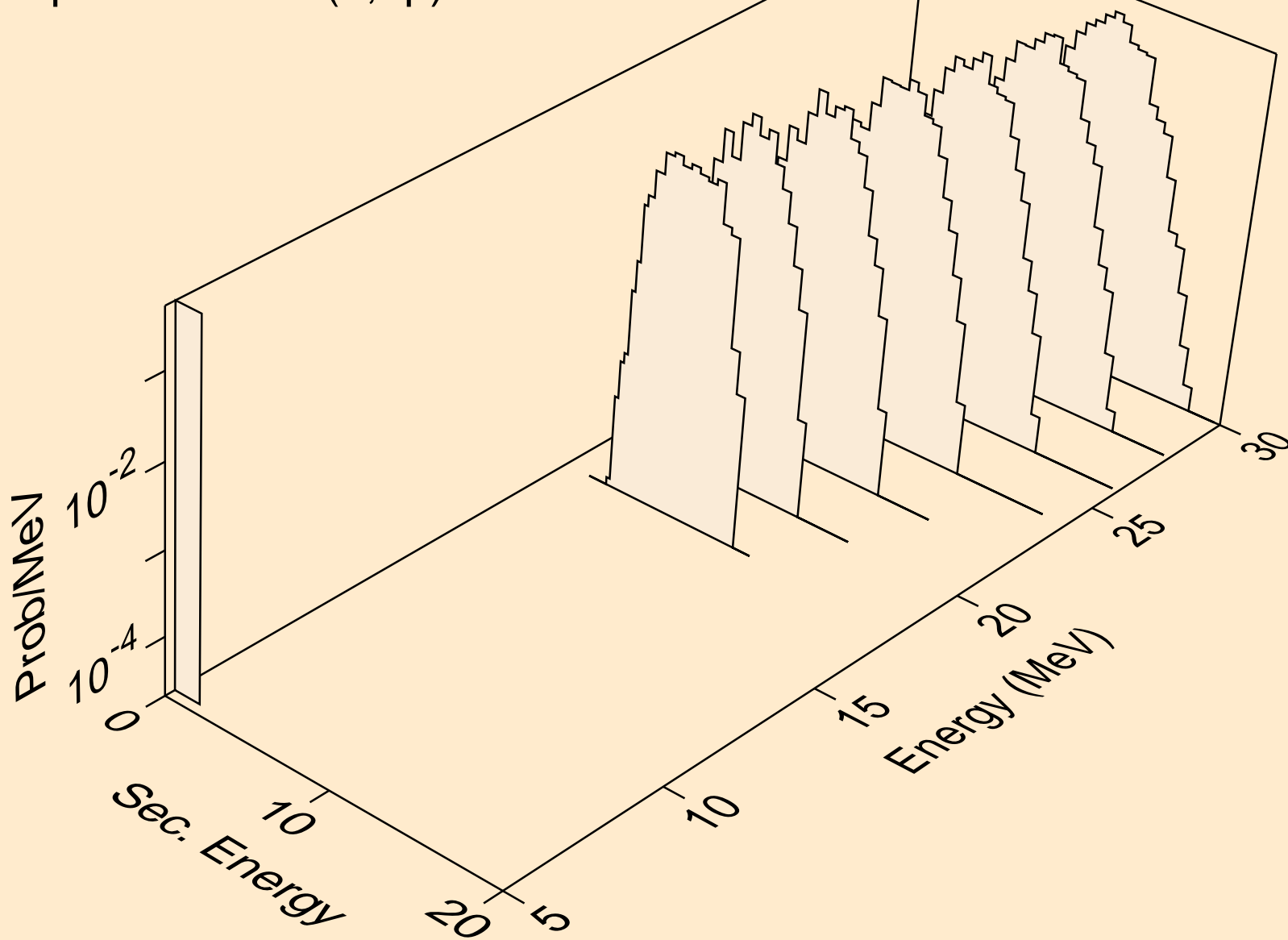

MD260 NEUTRON ACER TENDL-2019 LIBRARY; T=293.16K
deuterons from (n,x)

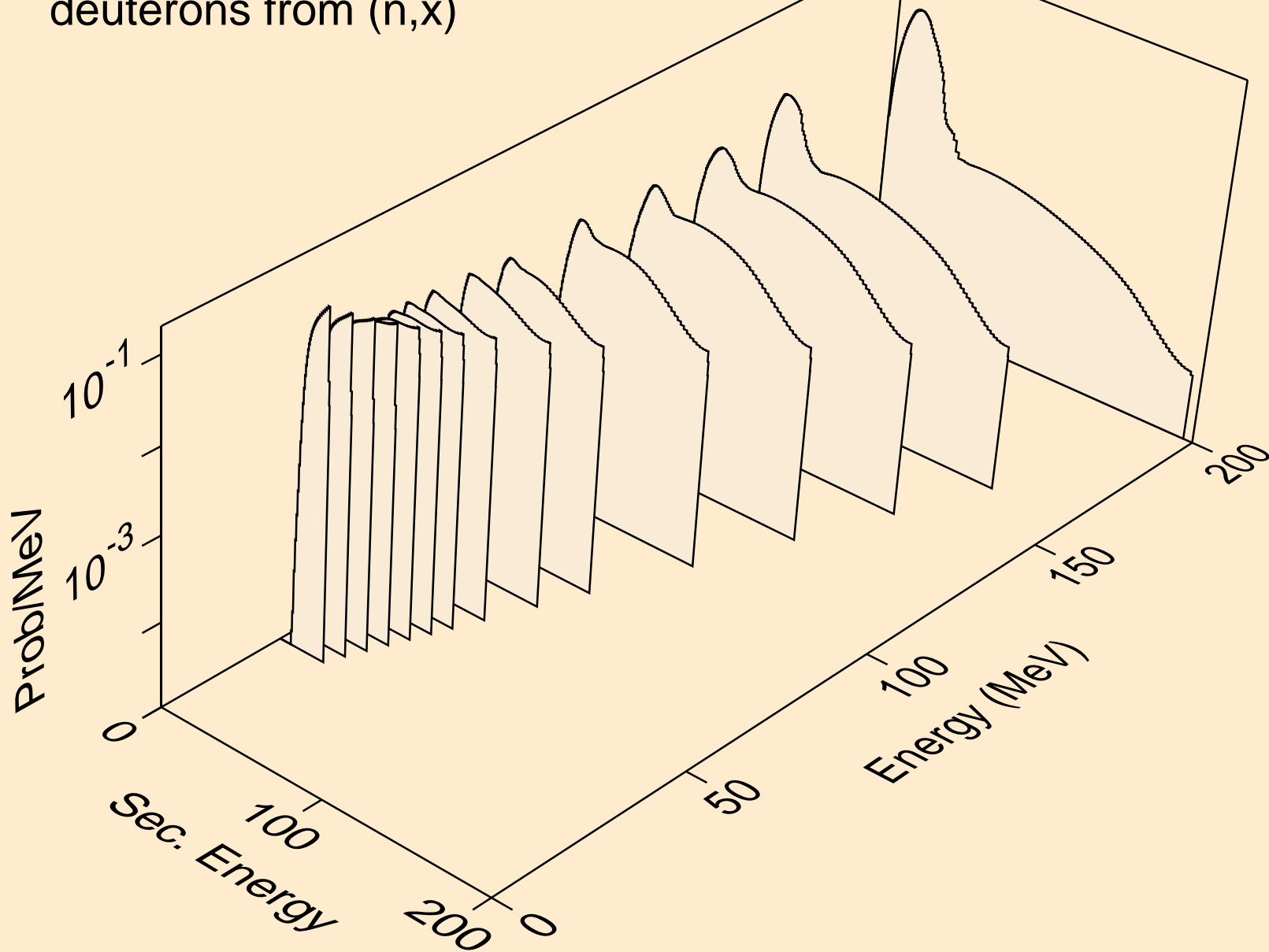

MD260 NEUTRON ACER TENDL-2019 LIBRARY; T=293.16K
deuterons from (n,2nd)

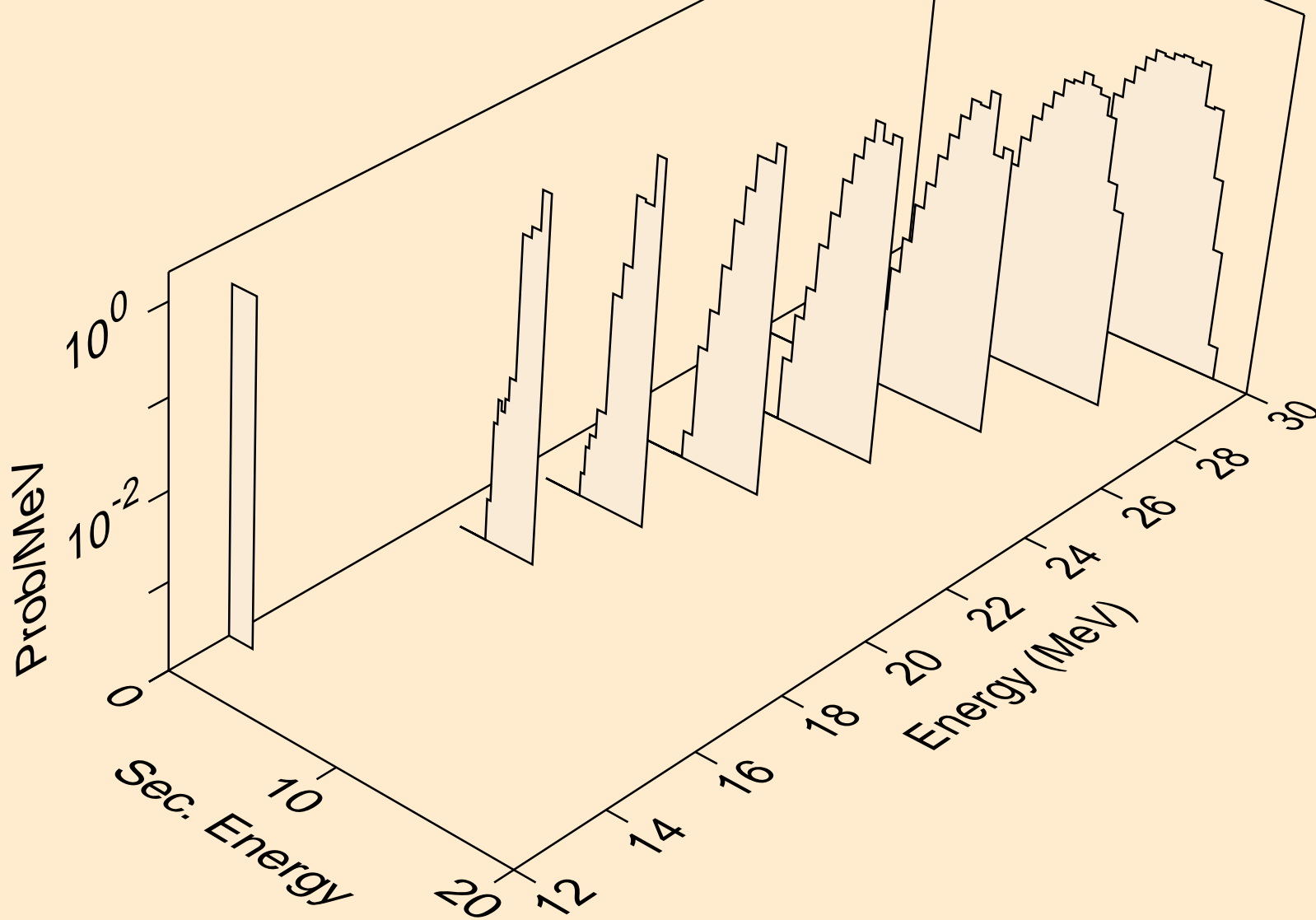

MD260 NEUTRON ACER TENDL-2019 LIBRARY; T=293.16K
deuterons from (n,n*)d

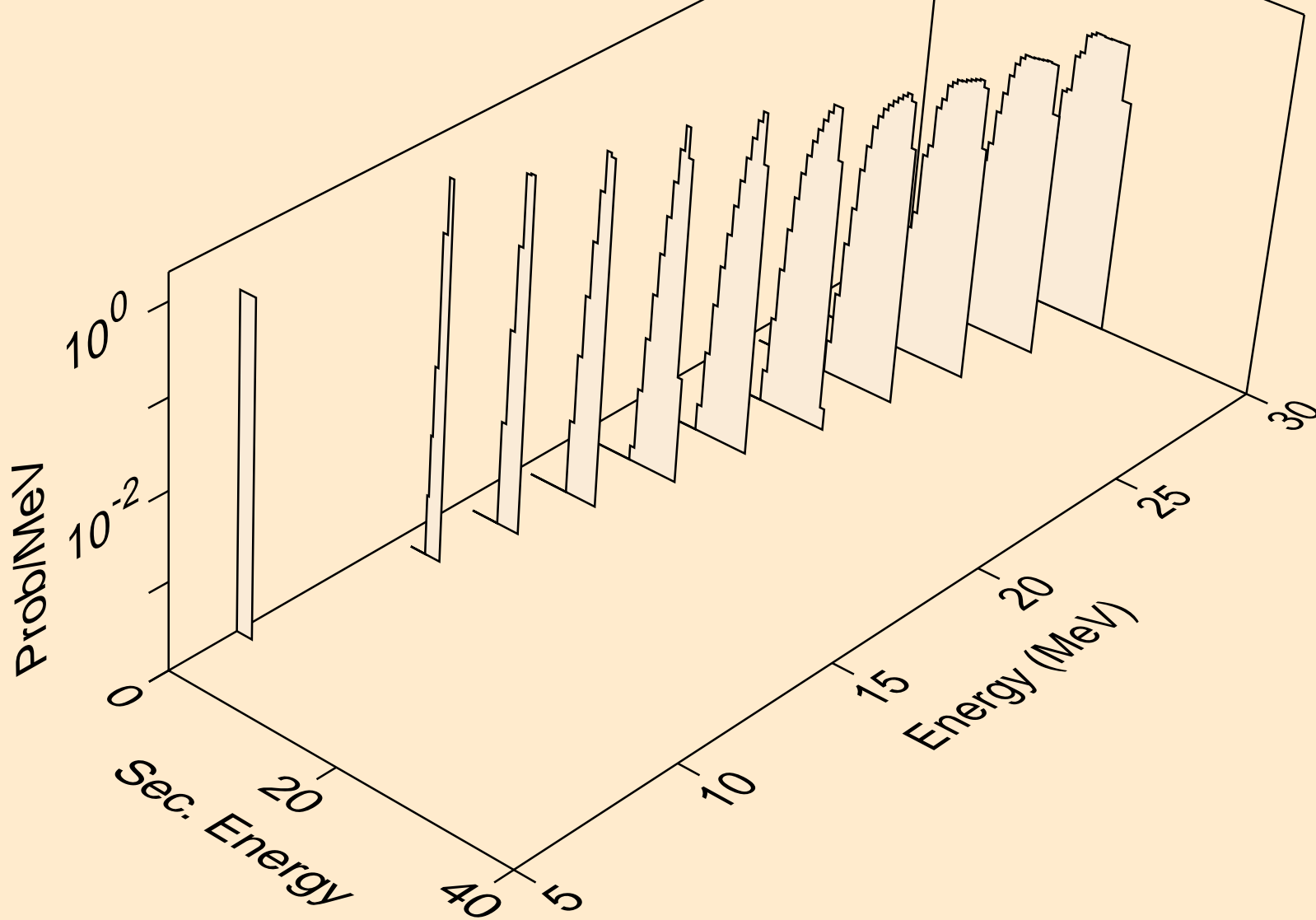

MD260 NEUTRON ACER TENDL-2019 LIBRARY; T=293.16K
deuterons from (n,d)

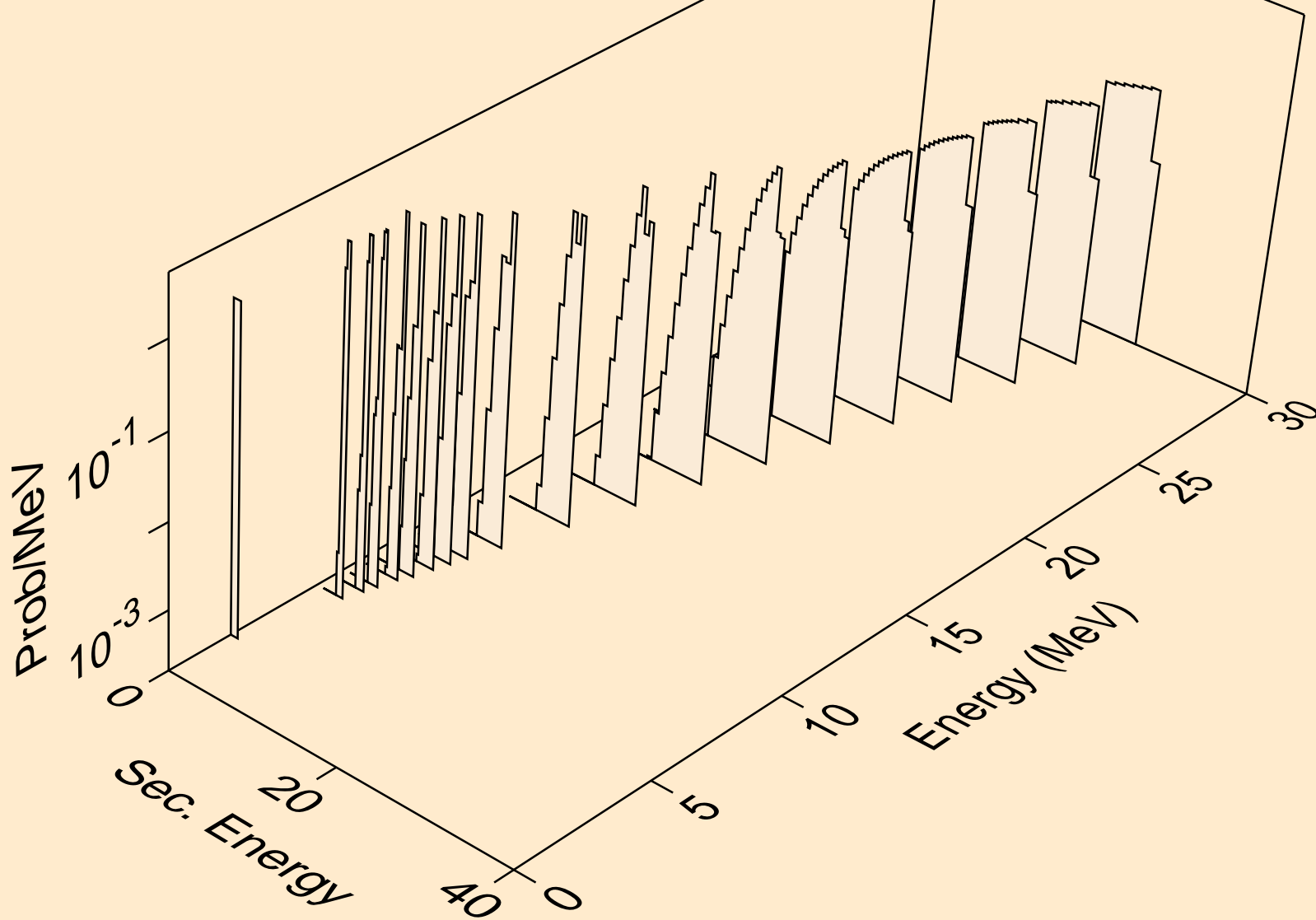

MD260 NEUTRON ACER TENDL-2019 LIBRARY; T=293.16K
tritons from (n,x)

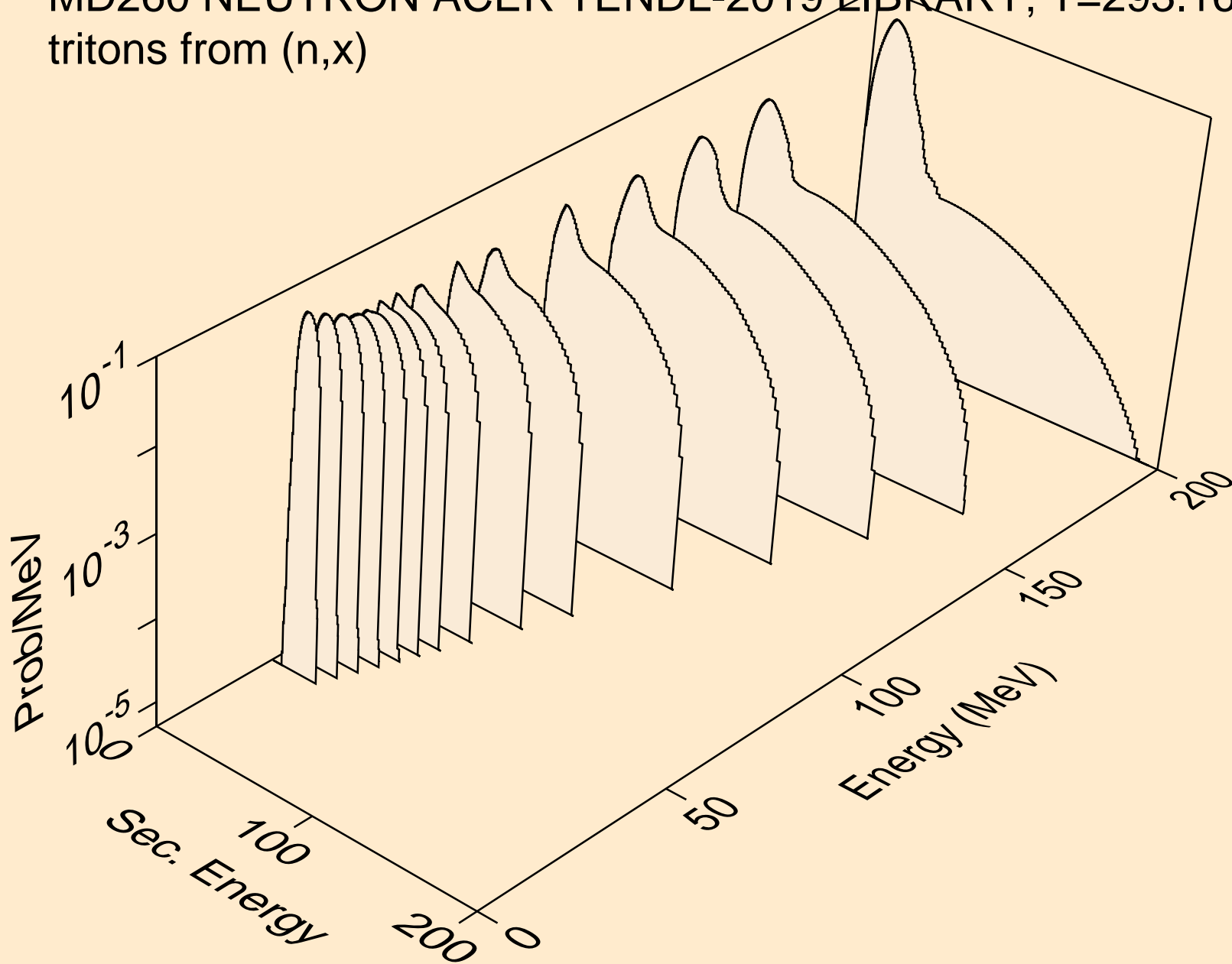

MD260 NEUTRON ACER TENDL-2019 LIBRARY; T=293.16K
tritons from (n,n*)t

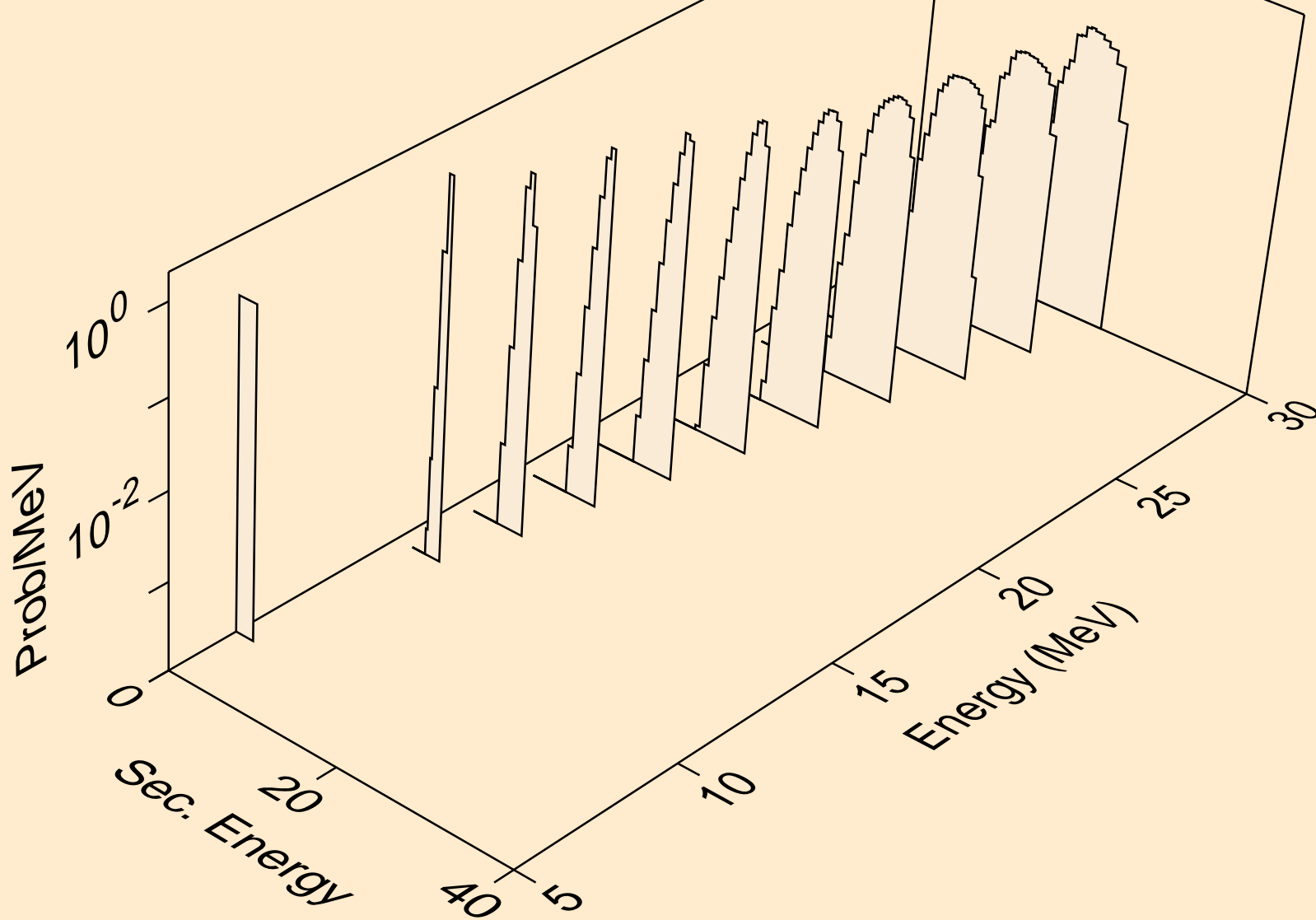

MD260 NEUTRON ACER TENDL-2019 LIBRARY; T=293.16K
tritons from (n,t)

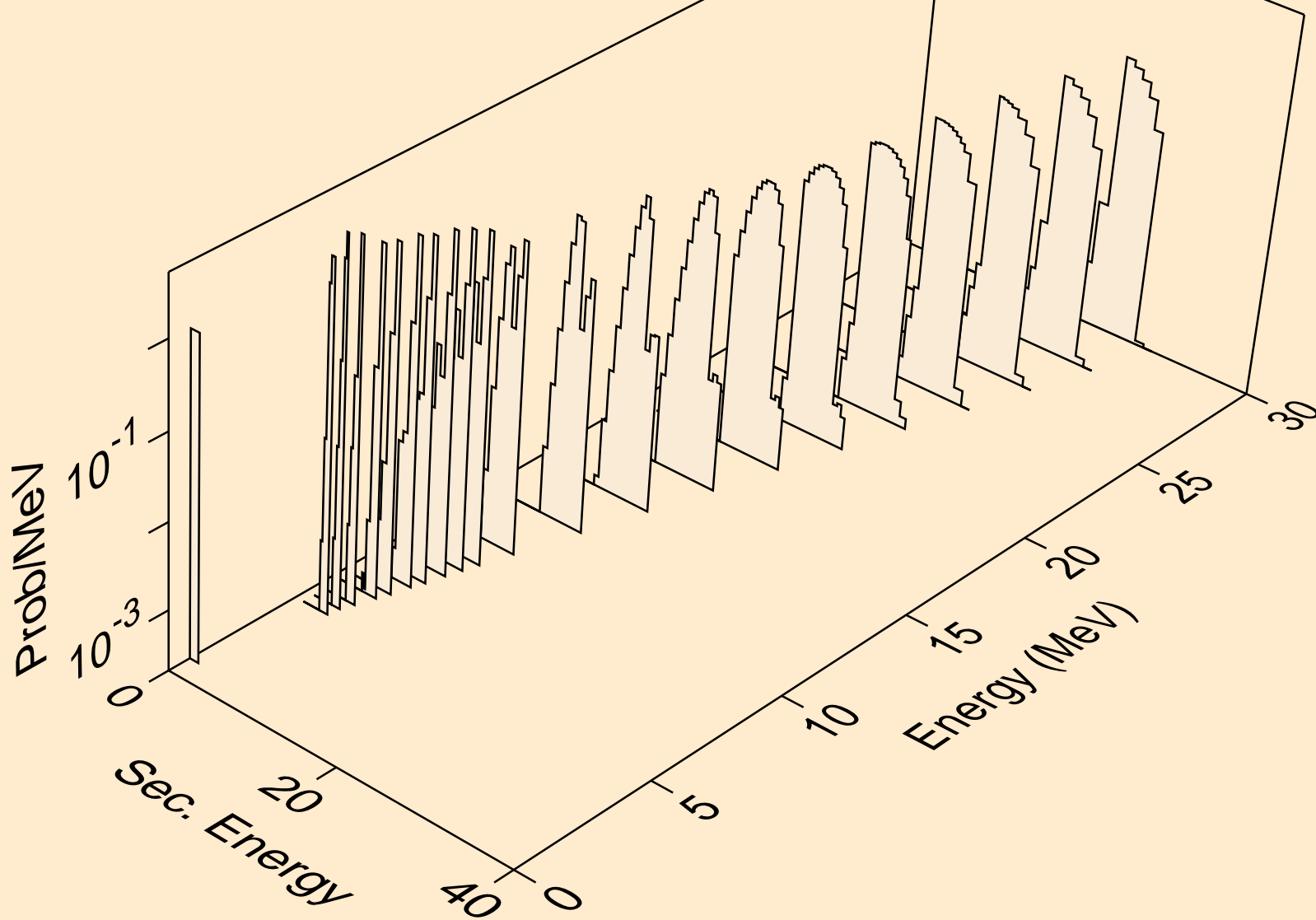

MD260 NEUTRON ACER TENDL-2019 LIBRARY; T=293.16K
he3s from (n,x)

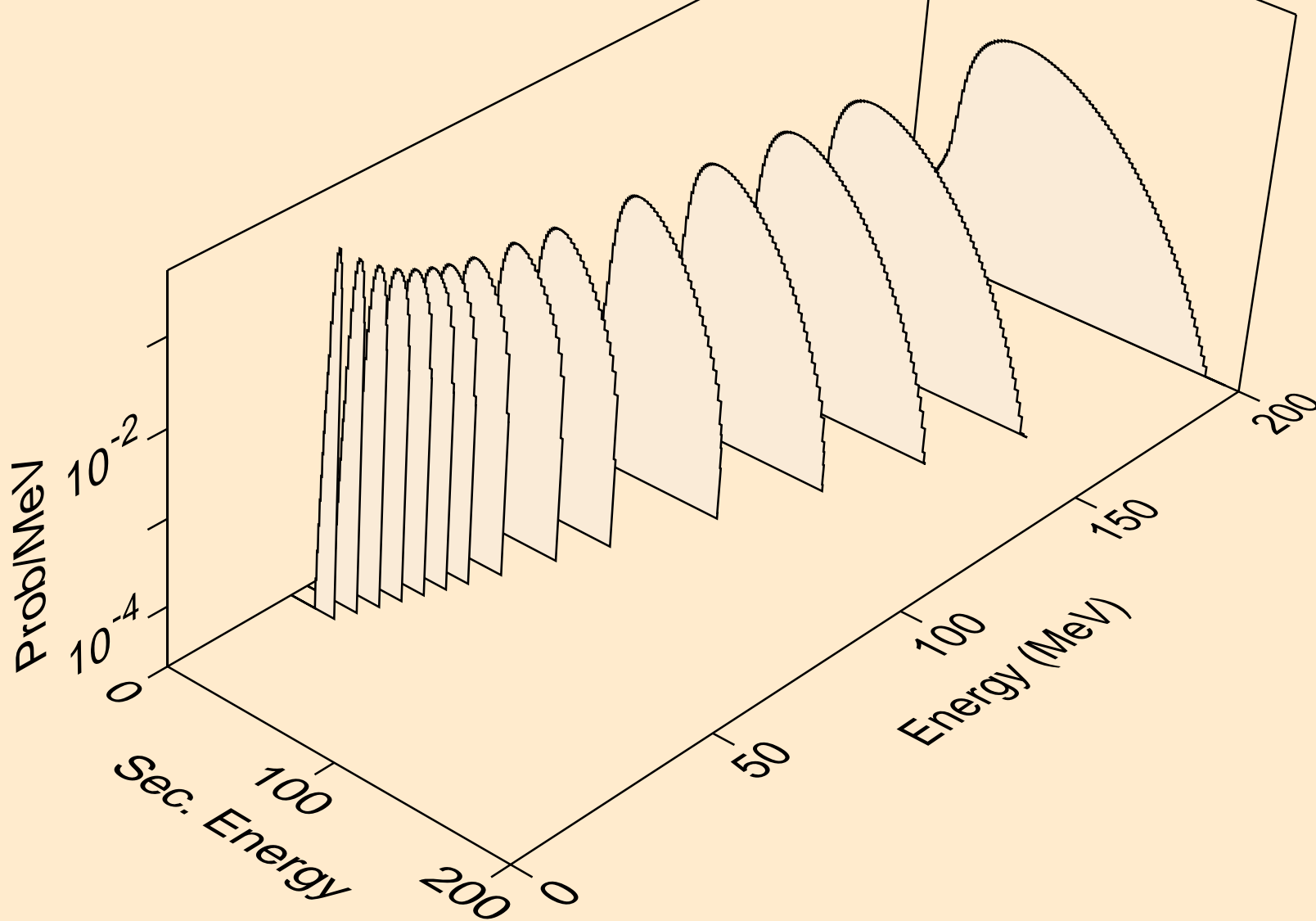

MD260 NEUTRON ACER TENDL-2019 LIBRARY; T=293.16K
he3s from (n,n*)he3

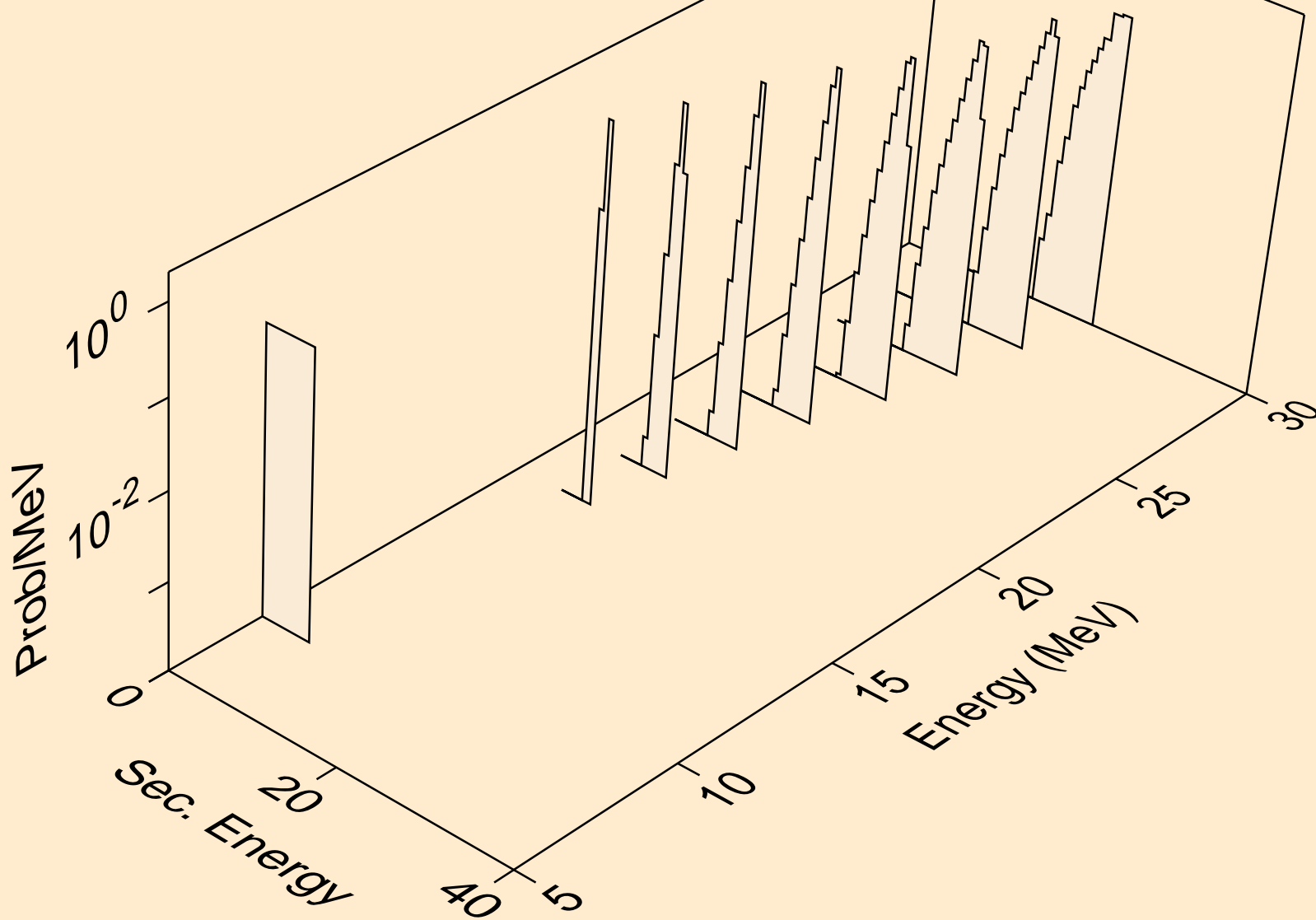

MD260 NEUTRON ACER TENDL-2019 LIBRARY; T=293.16K
he3s from (n,he3)

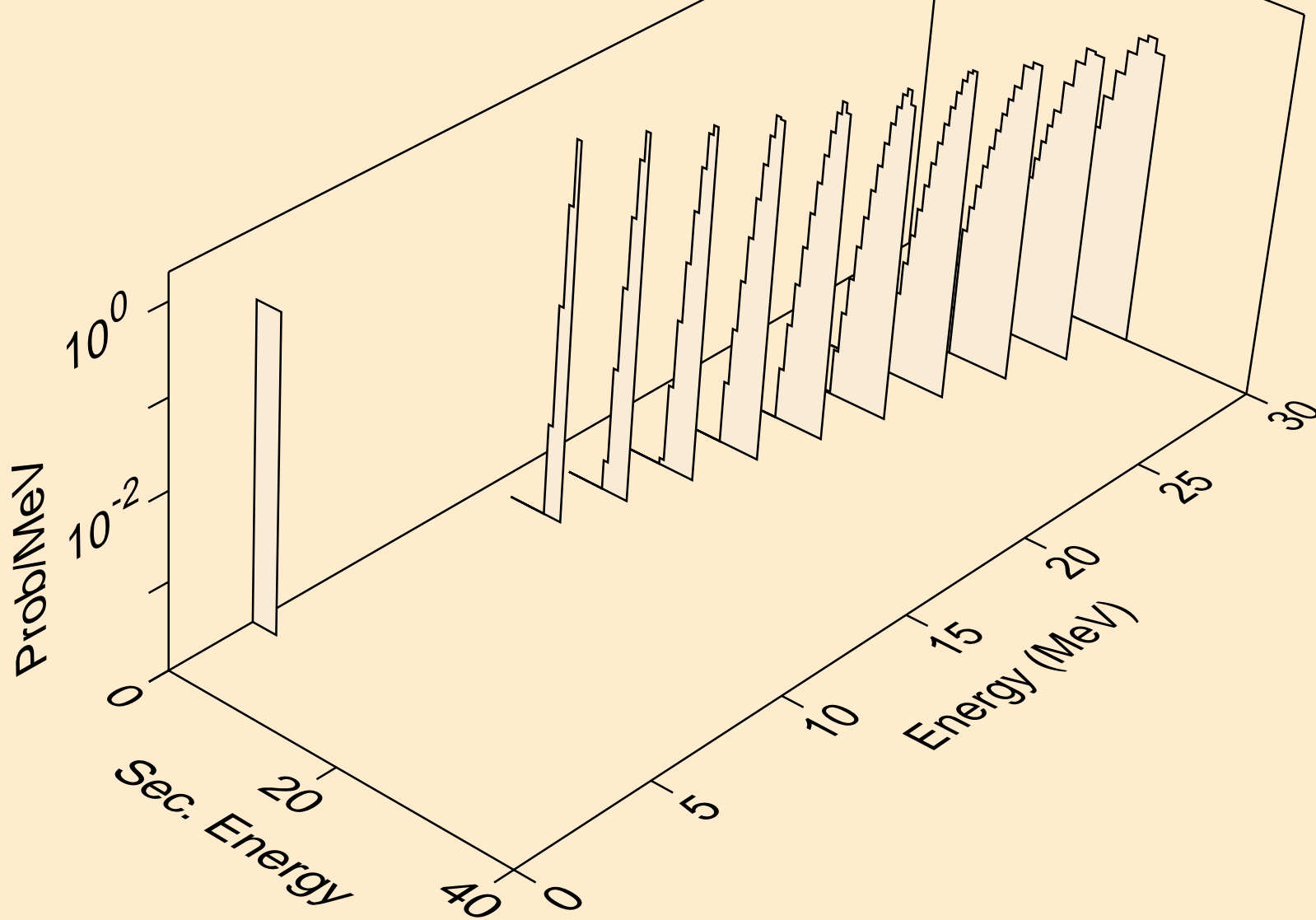

MD260 NEUTRON ACER TENDL-2019 LIBRARY; T=293.16K
alphas from (n,x)

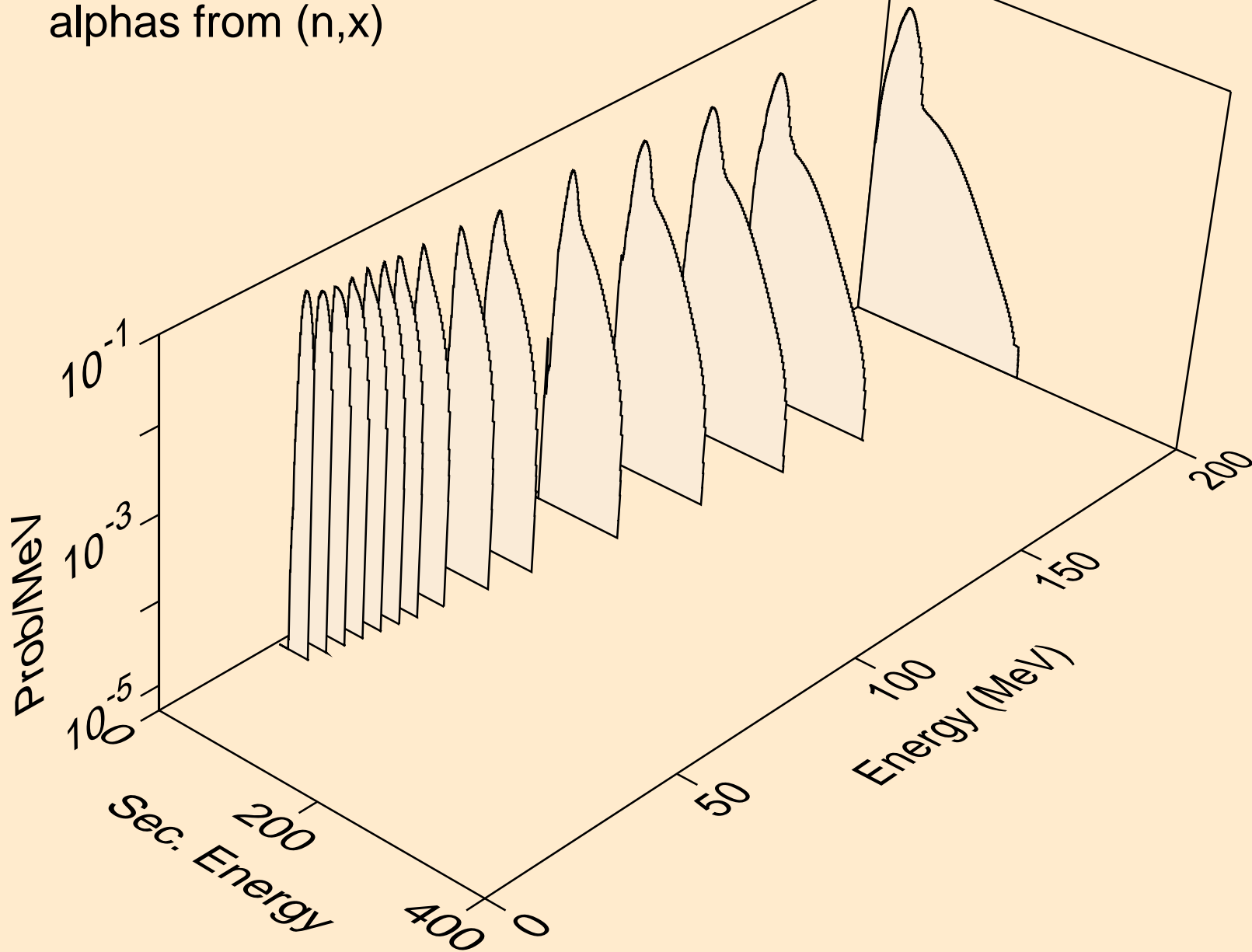

MD260 NEUTRON ACER TENDL-2019 LIBRARY; T=293.16K
alphas from (n,n*)a

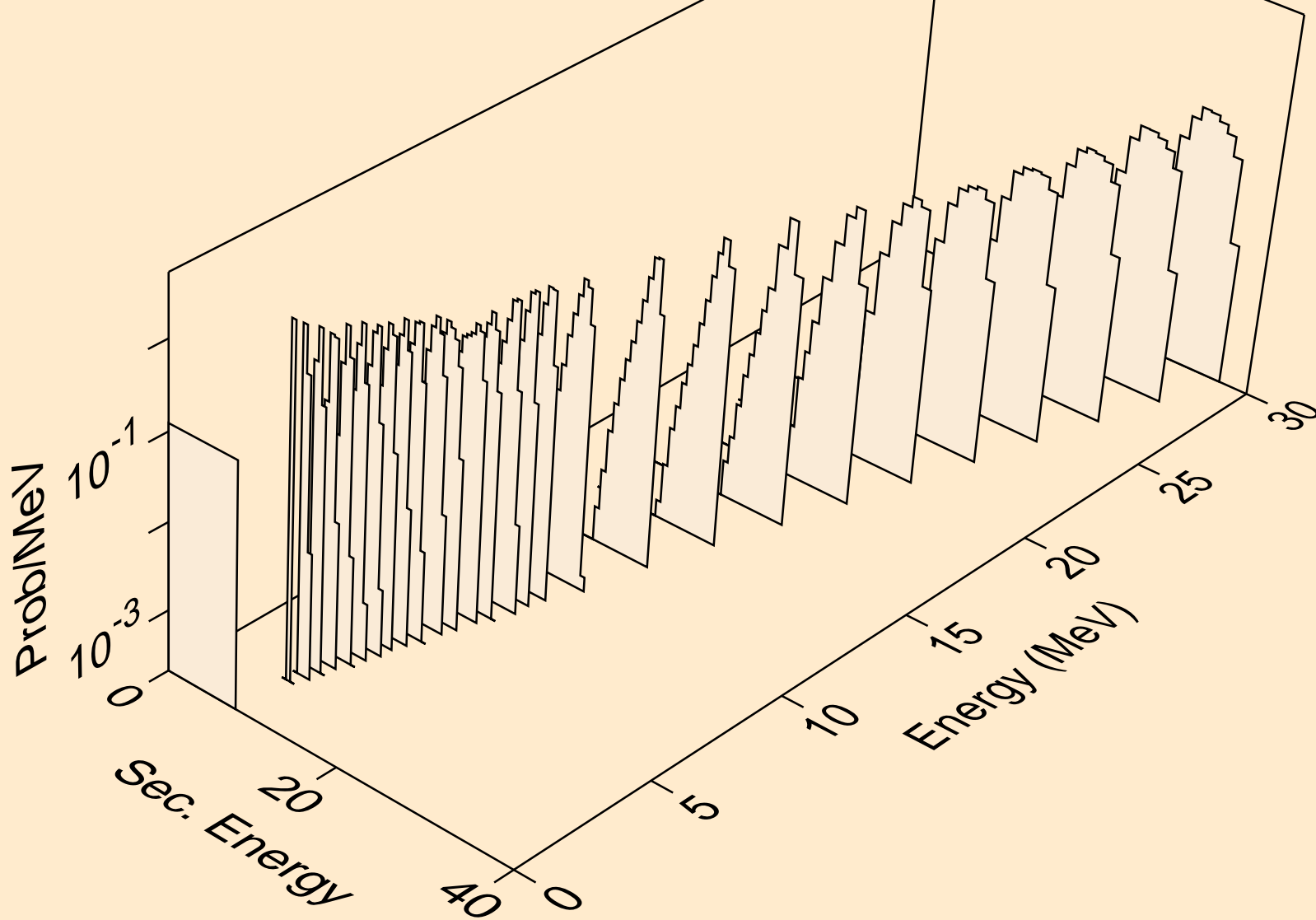

MD260 NEUTRON ACER TENDL-2019 LIBRARY; T=293.16K
alphas from (n,2n)a

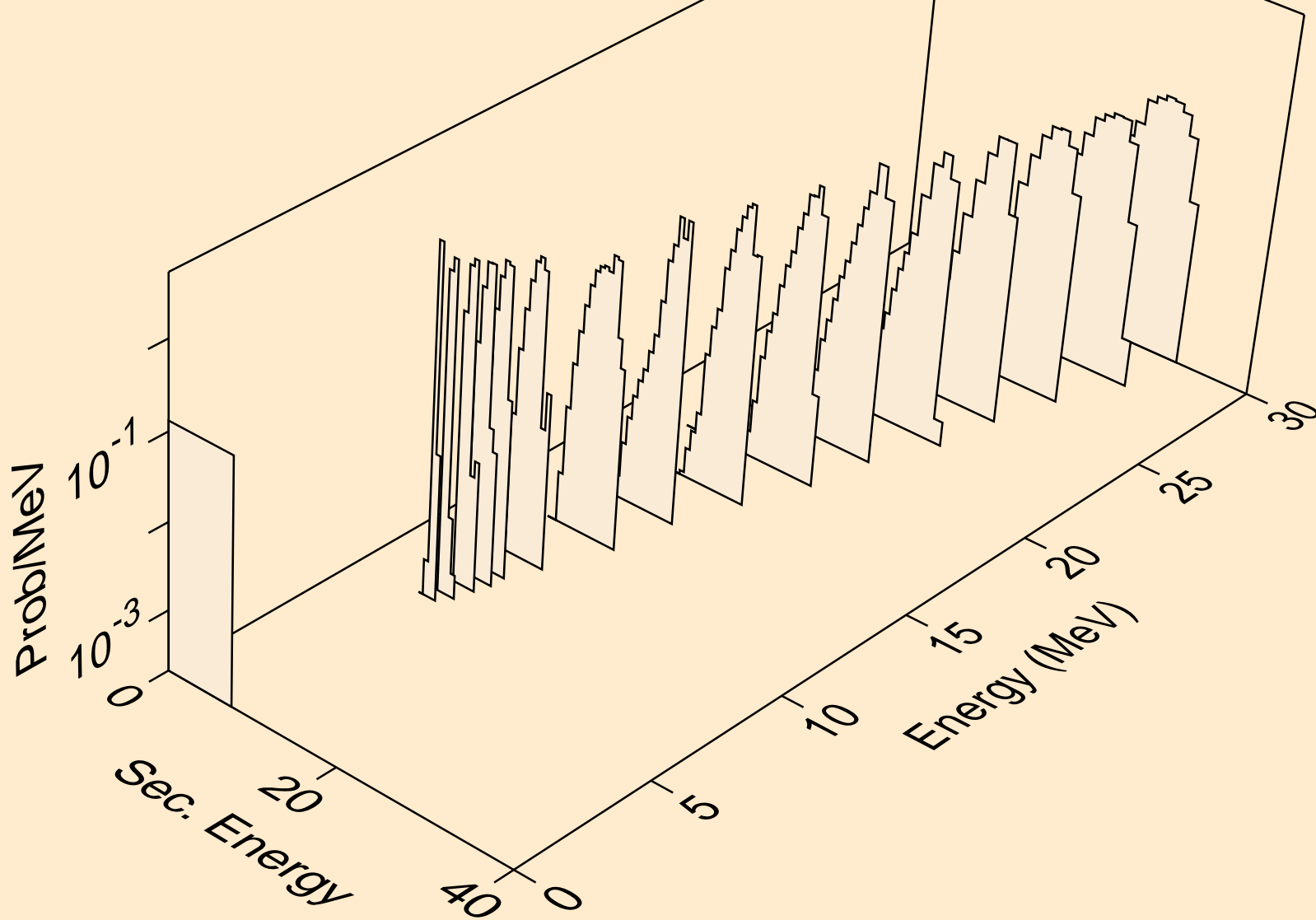

MD260 NEUTRON ACER TENDL-2019 LIBRARY; T=293.16K
alphas from (n,3n)a

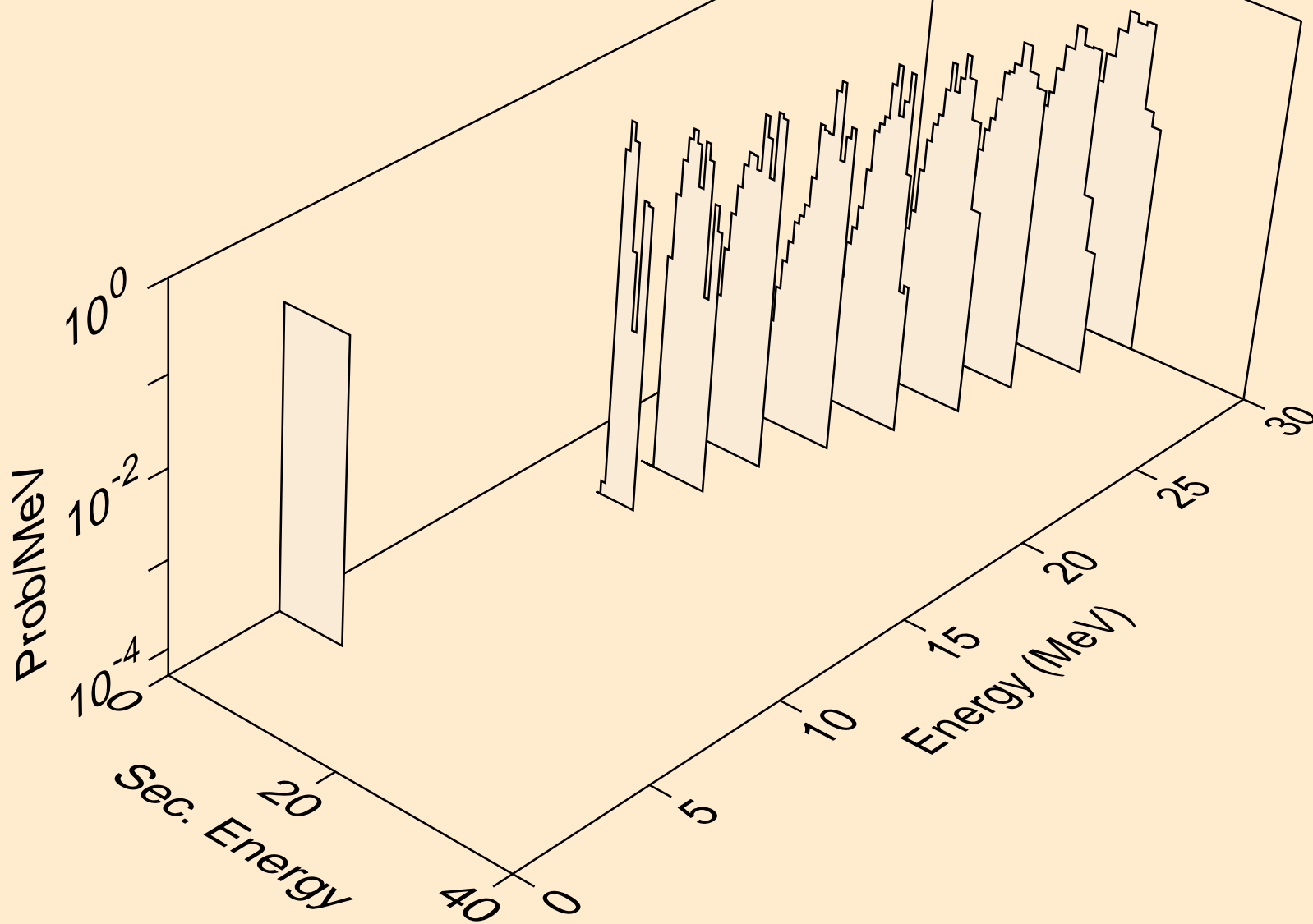

MD260 NEUTRON ACER TENDL-2019 LIBRARY; T=293.16K
alphas from (n,a)

