

MD262 NEUTRON ACER TENDL-2019 LIBRARY; T=293.16K
Principal cross sections

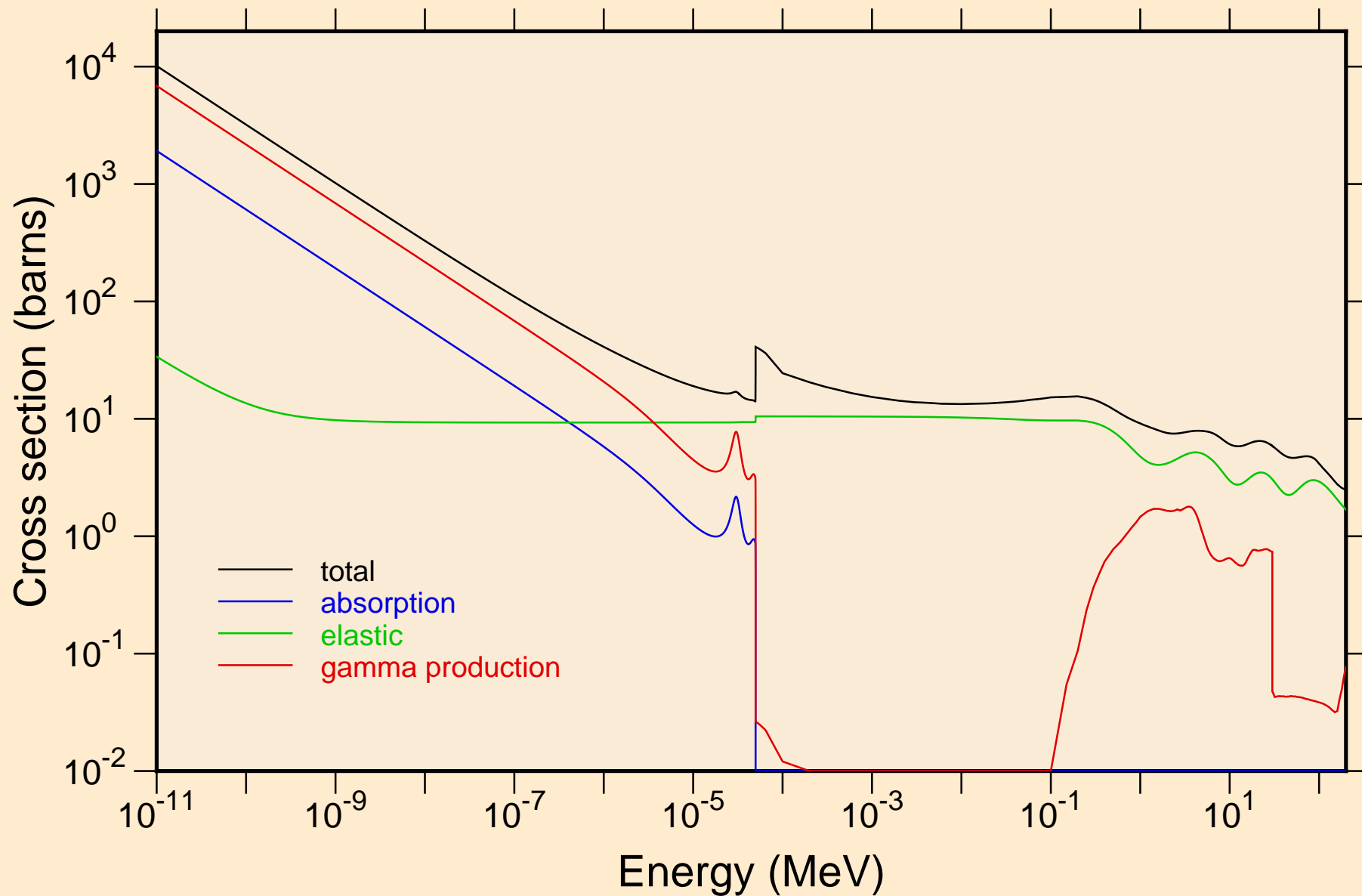

MD262 NEUTRON ACER TENDL-2019 LIBRARY; T=293.16K
Heating

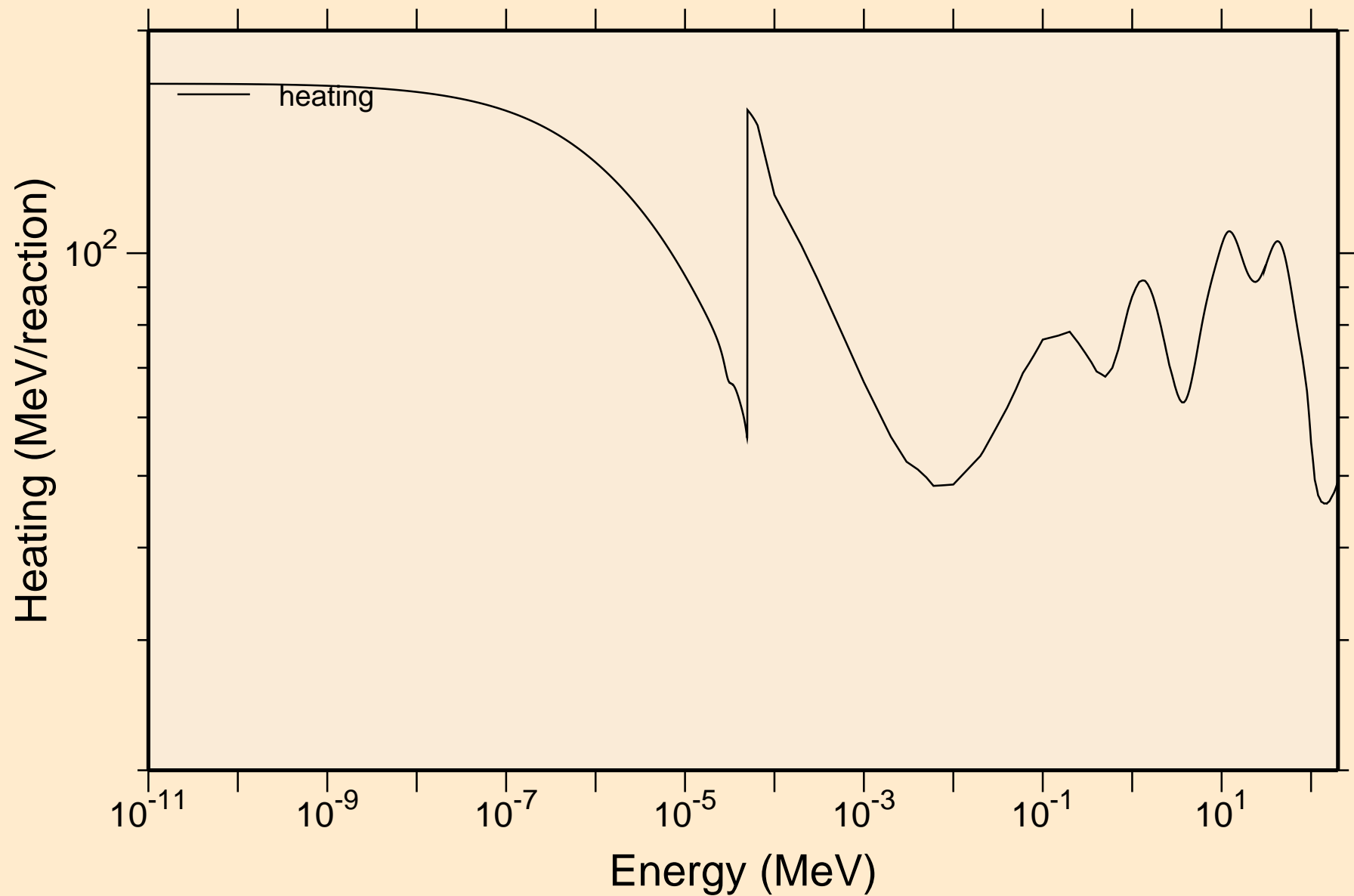

MD262 NEUTRON ACER TENDL-2019 LIBRARY; T=293.16K
Damage

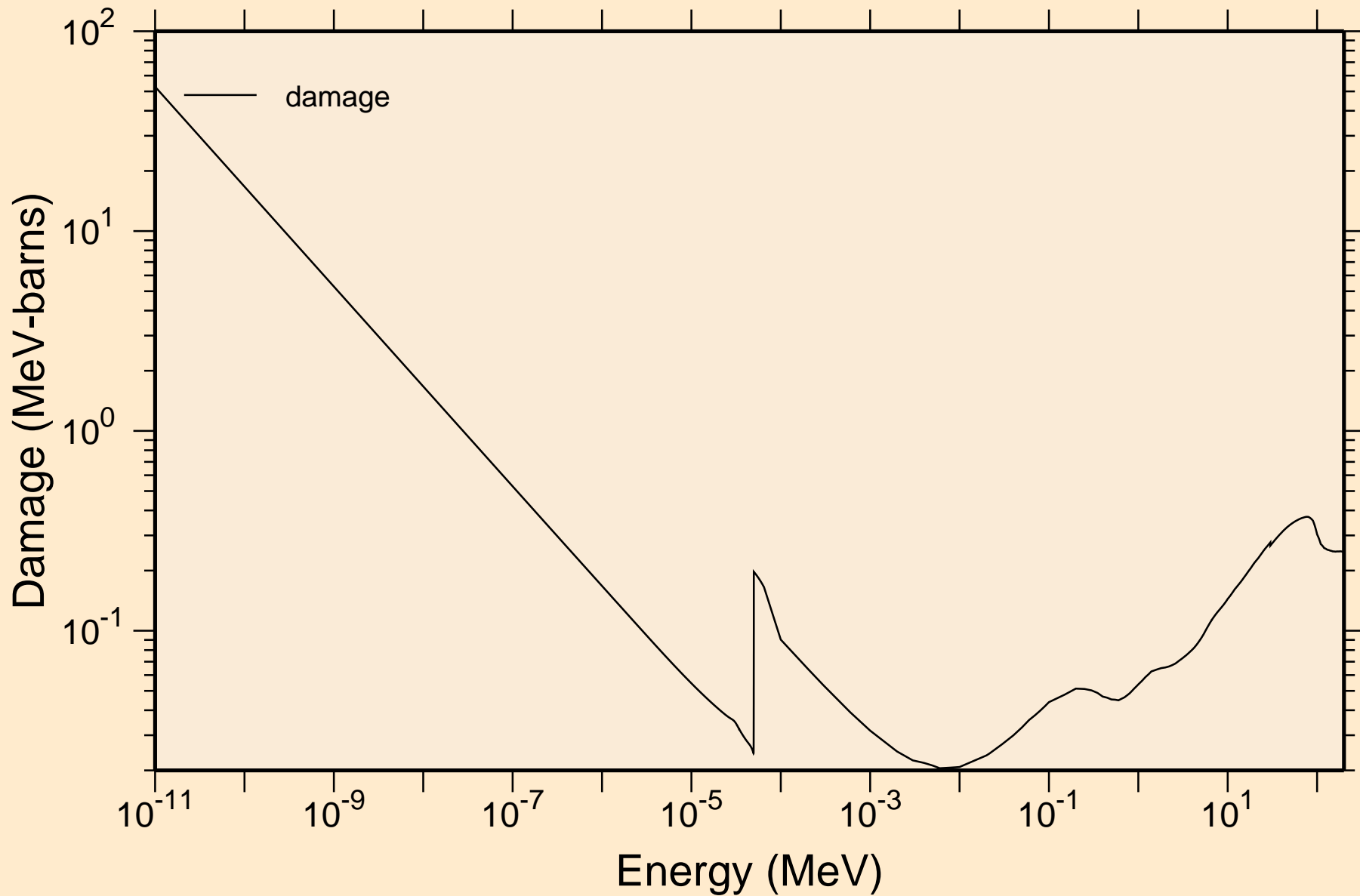

MD262 NEUTRON ACER TENDL-2019 LIBRARY; T=293.16K
Non-threshold reactions

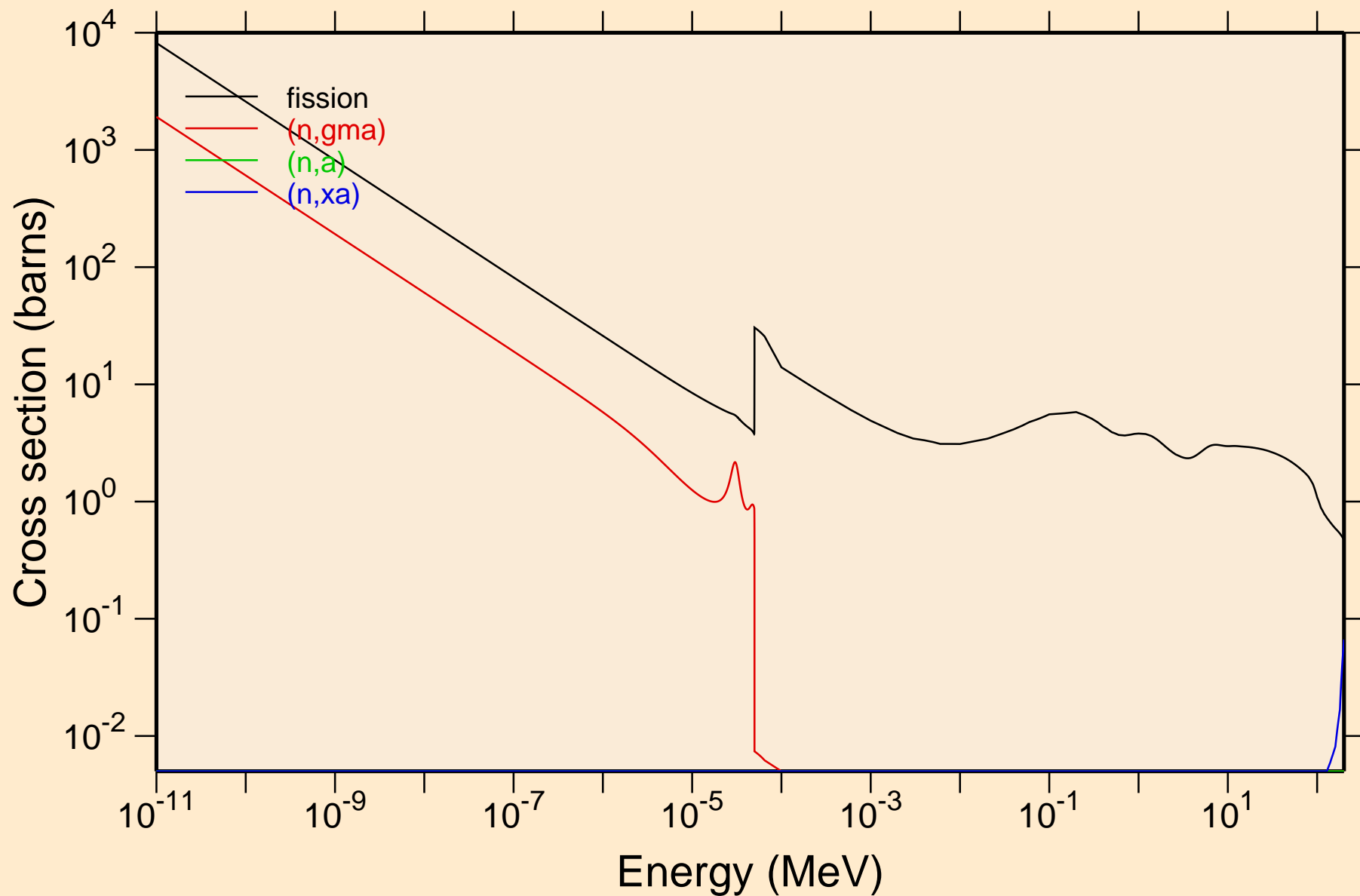

MD262 NEUTRON ACER TENDL-2019 LIBRARY; T=293.16K

Principal cross sections

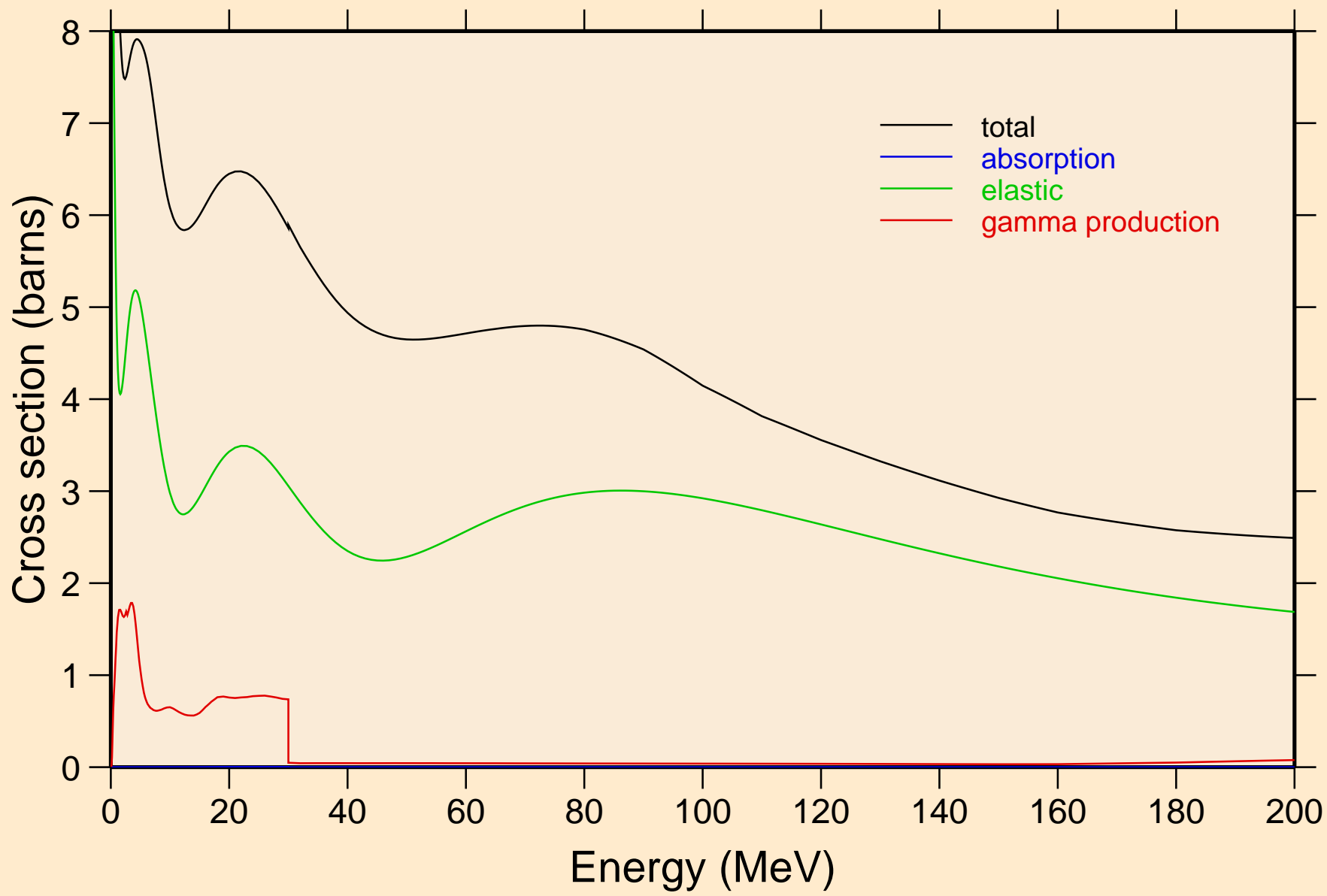

MD262 NEUTRON ACER TENDL-2019 LIBRARY; T=293.16K
Heating

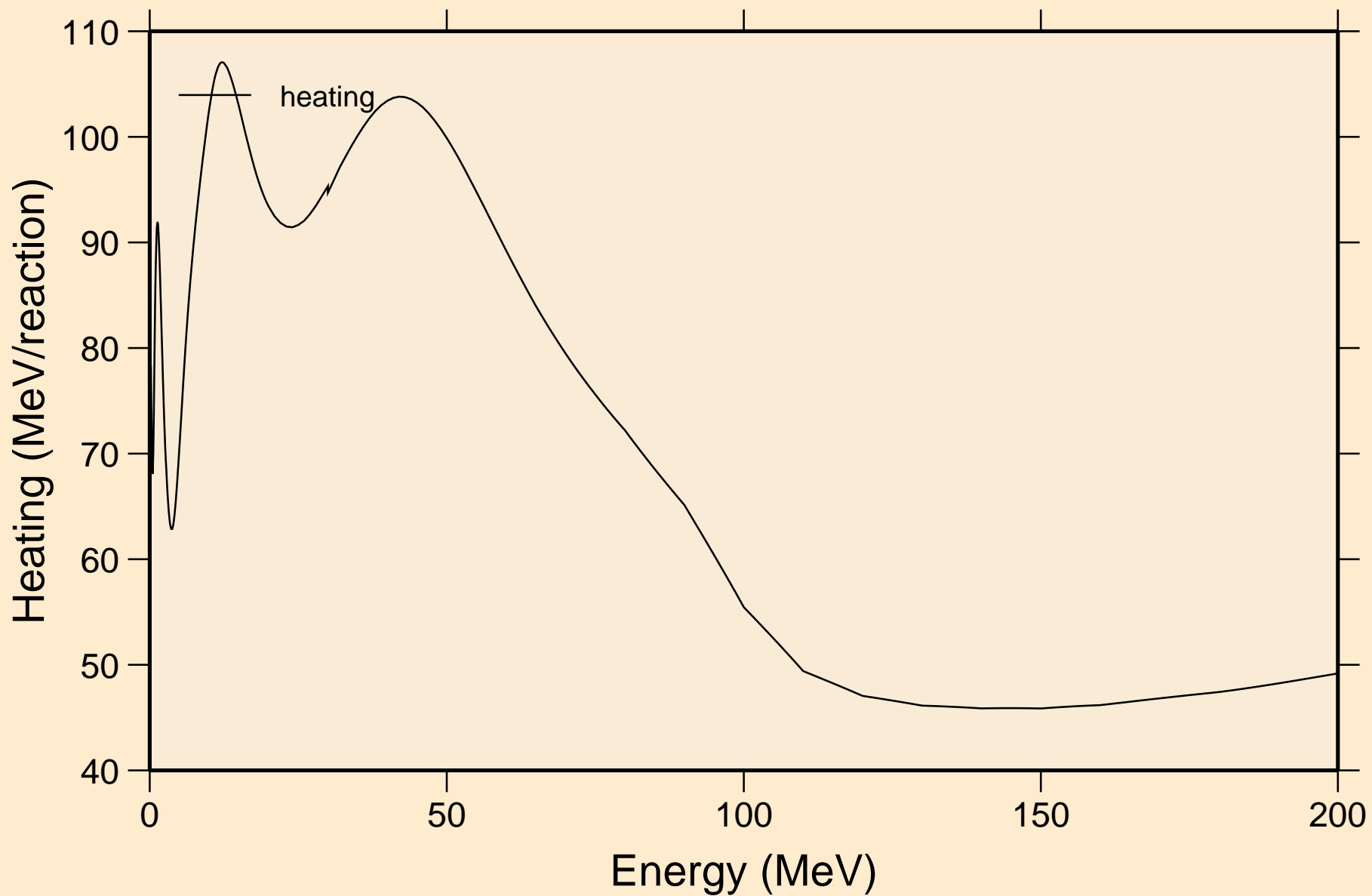

MD262 NEUTRON ACER TENDL-2019 LIBRARY; T=293.16K
Damage

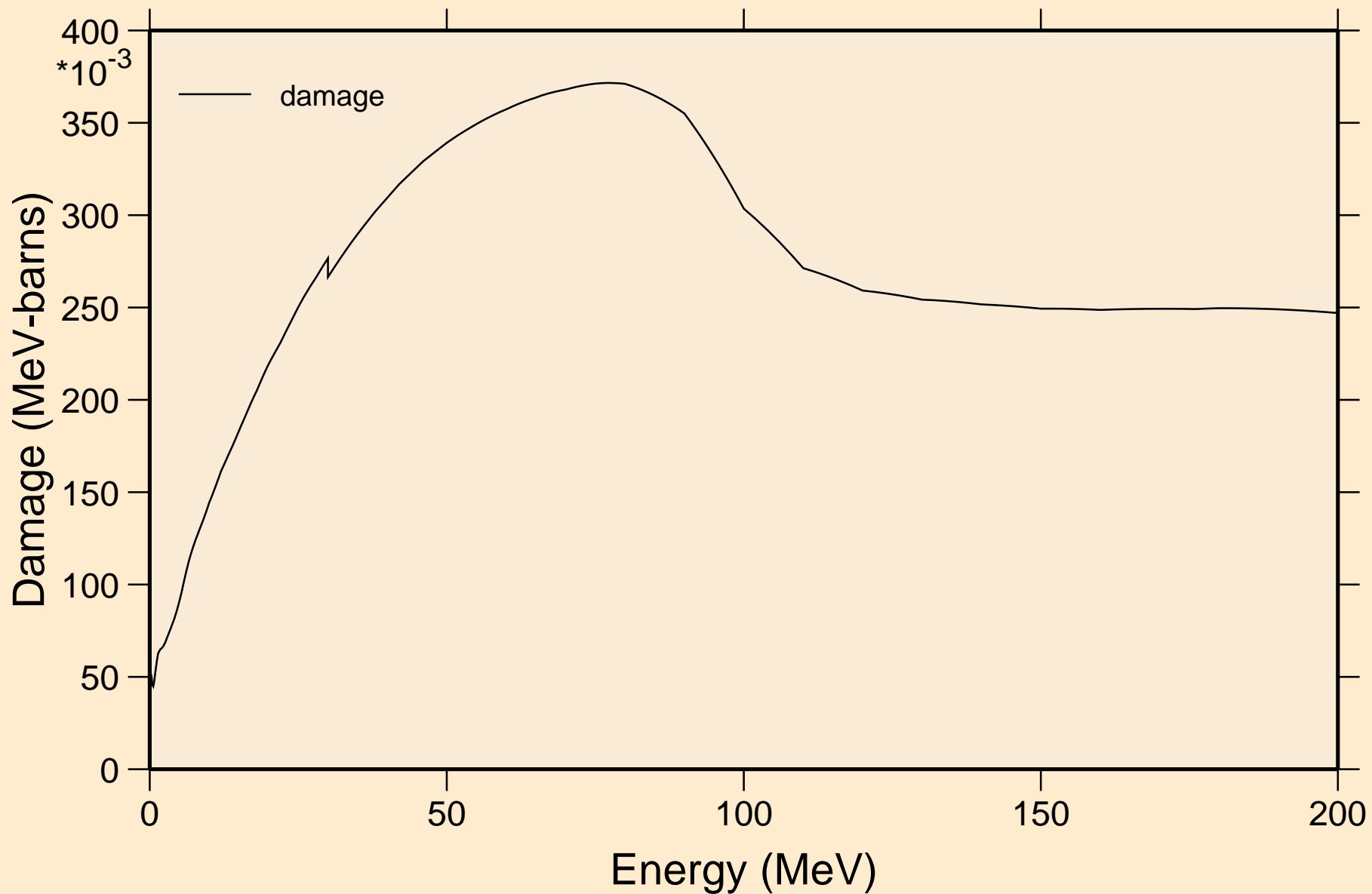

MD262 NEUTRON ACER TENDL-2019 LIBRARY; T=293.16K
Non-threshold reactions

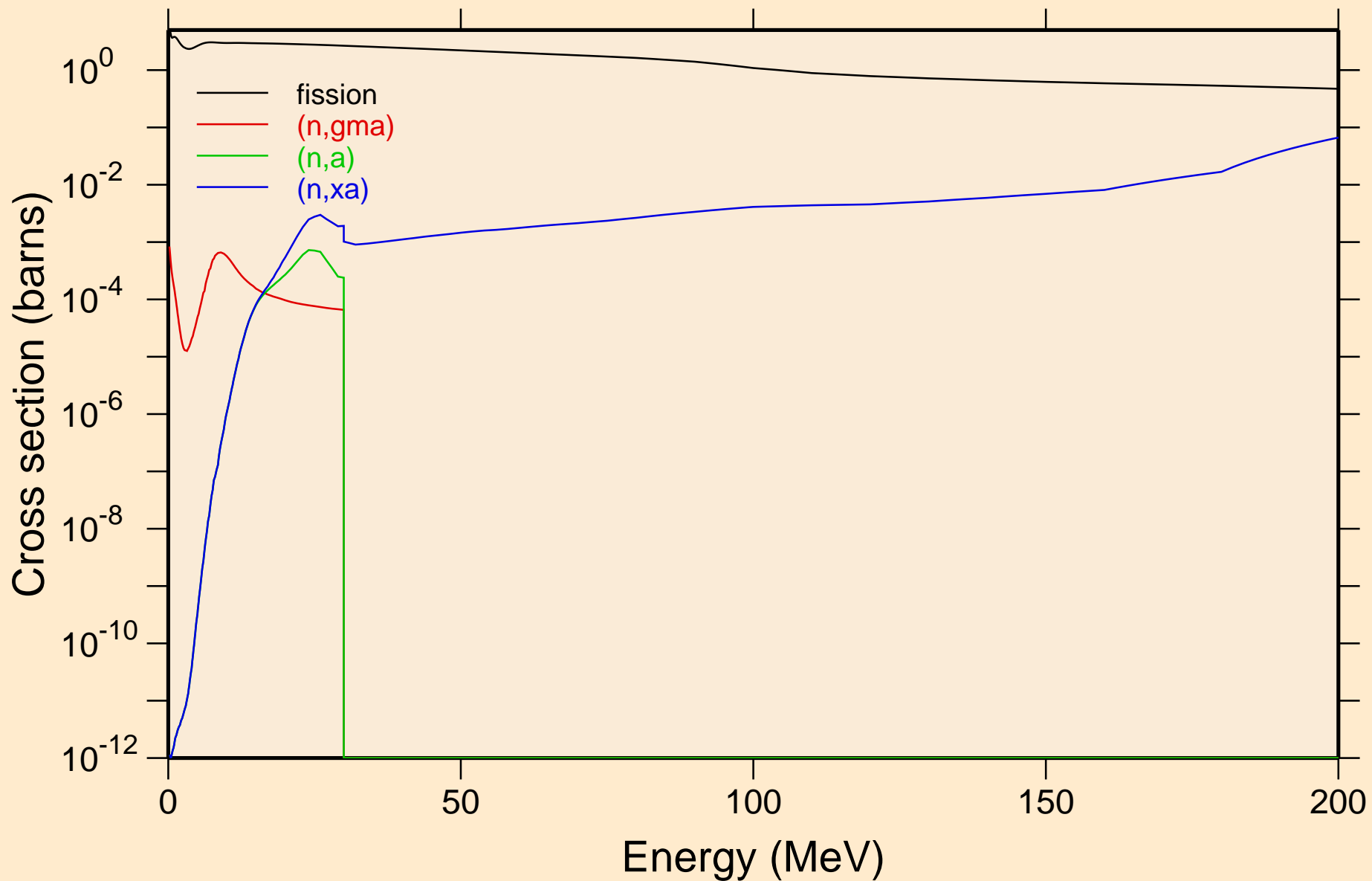

MD262 NEUTRON ACER TENDL-2019 LIBRARY; T=293.16K
Inelastic levels

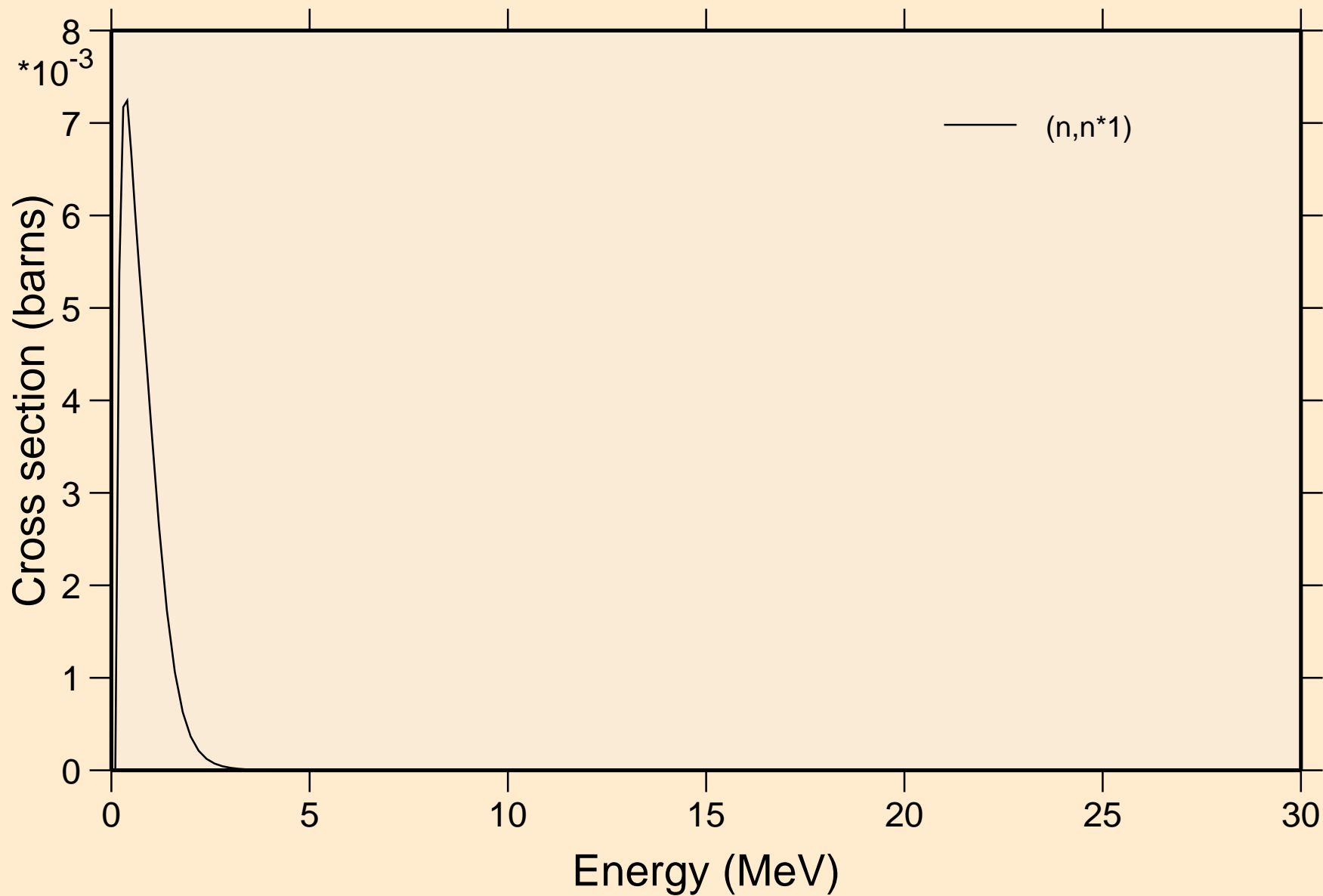

MD262 NEUTRON ACER TENDL-2019 LIBRARY; T=293.16K
Threshold reactions

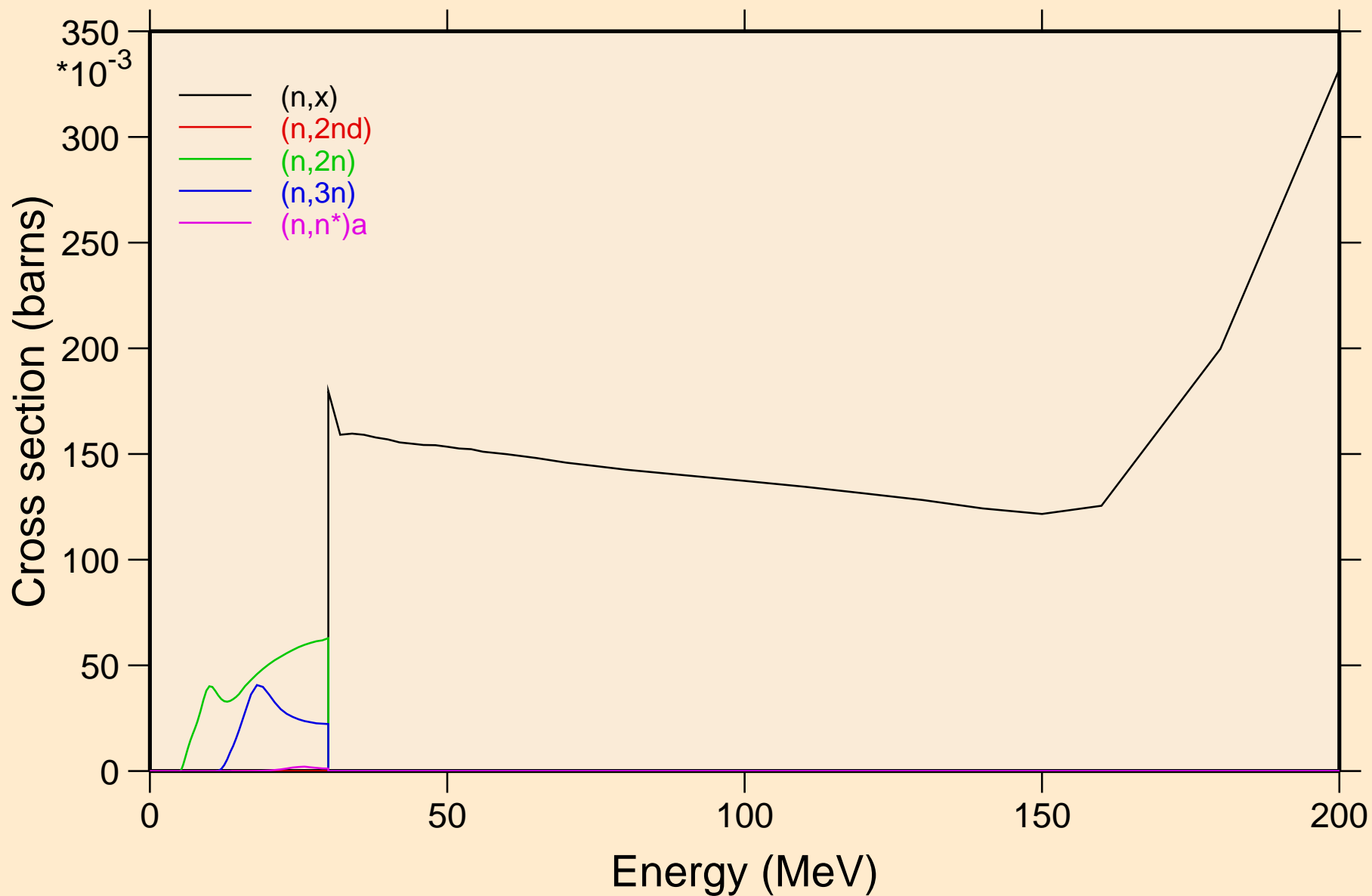

MD262 NEUTRON ACER TENDL-2019 LIBRARY; T=293.16K
Threshold reactions

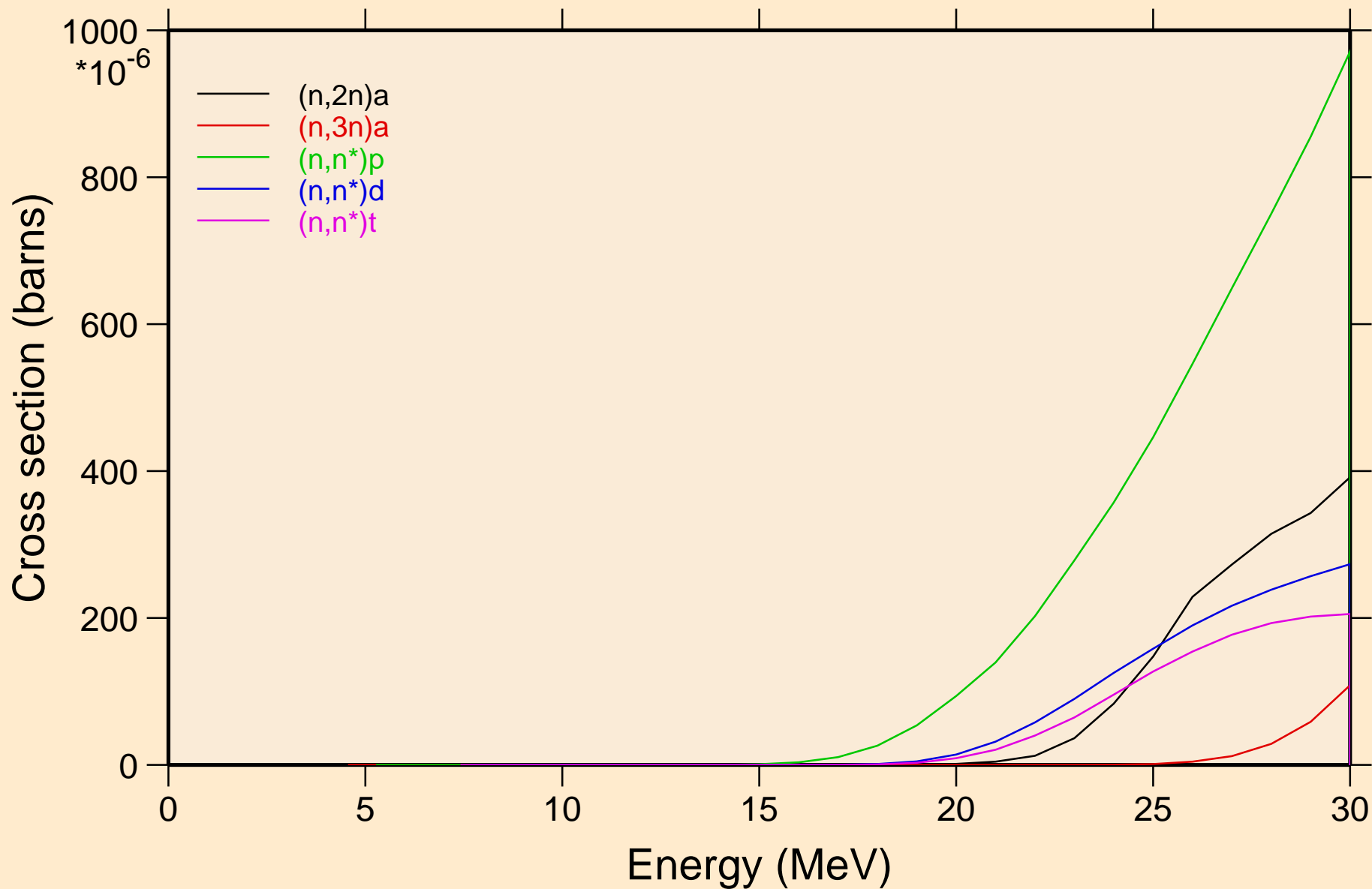

MD262 NEUTRON ACER TENDL-2019 LIBRARY; T=293.16K
Threshold reactions

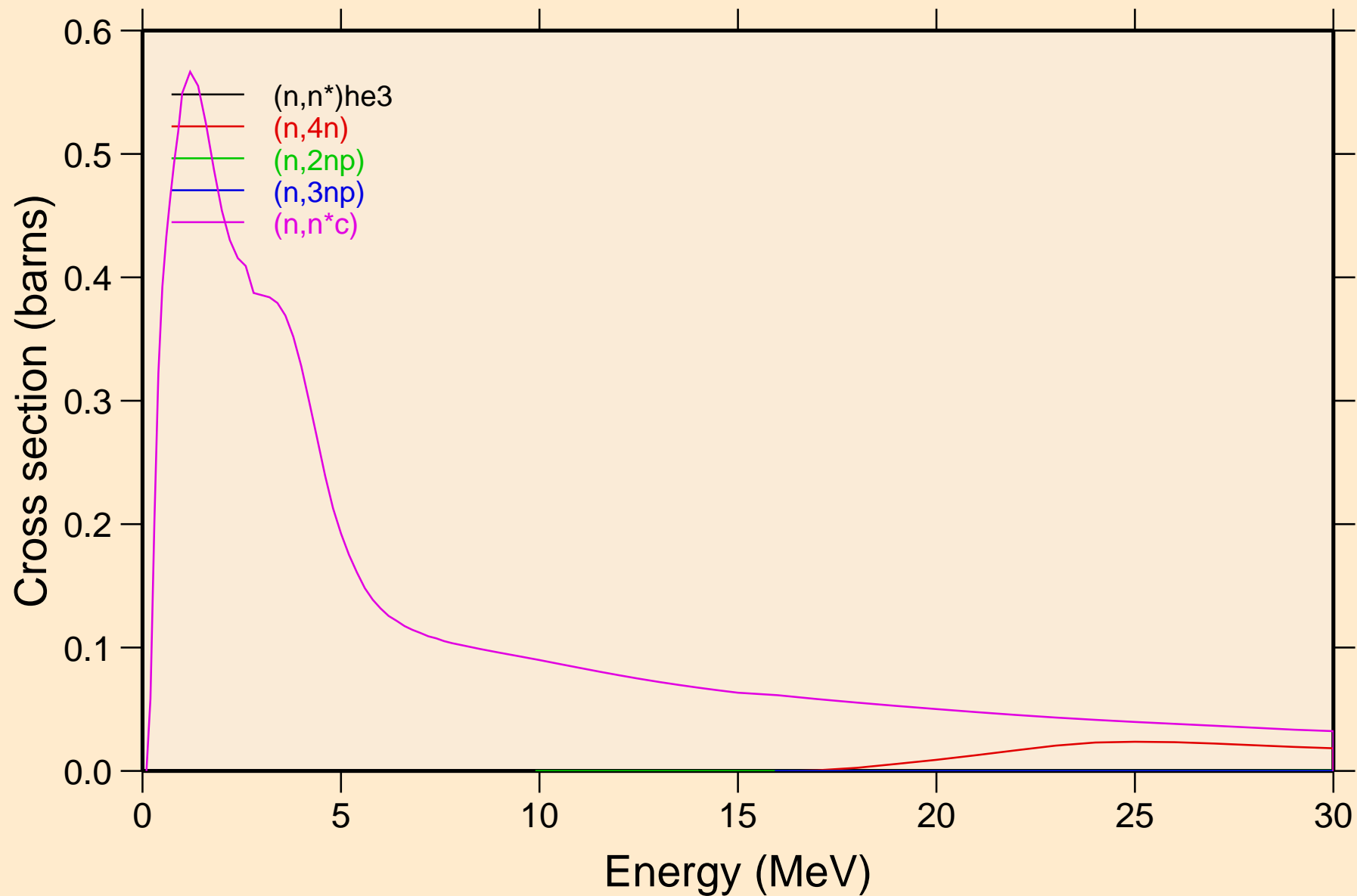

MD262 NEUTRON ACER TENDL-2019 LIBRARY; T=293.16K
Threshold reactions

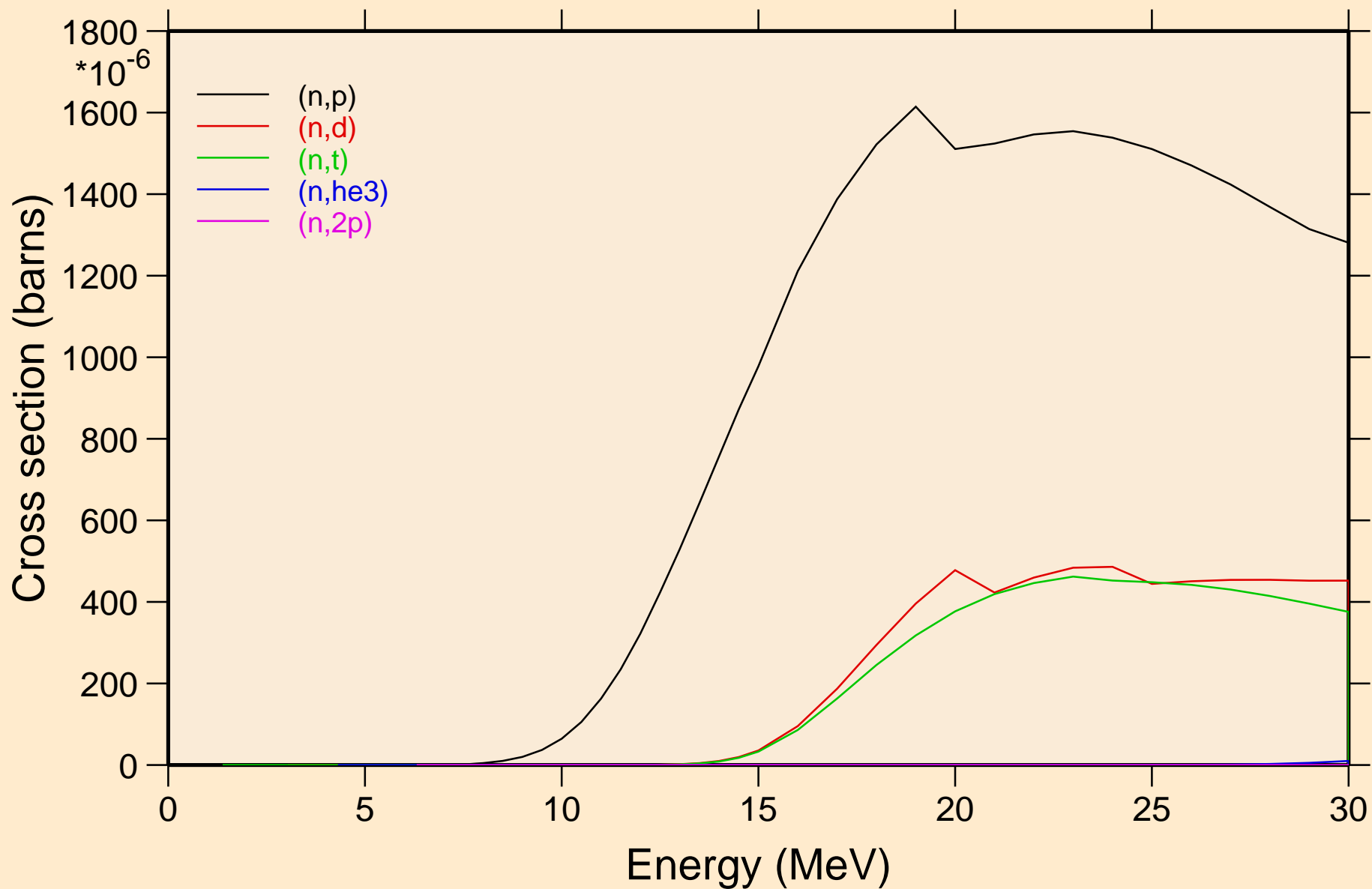

MD262 NEUTRON ACER TENDL-2019 LIBRARY; T=293.16K
Threshold reactions

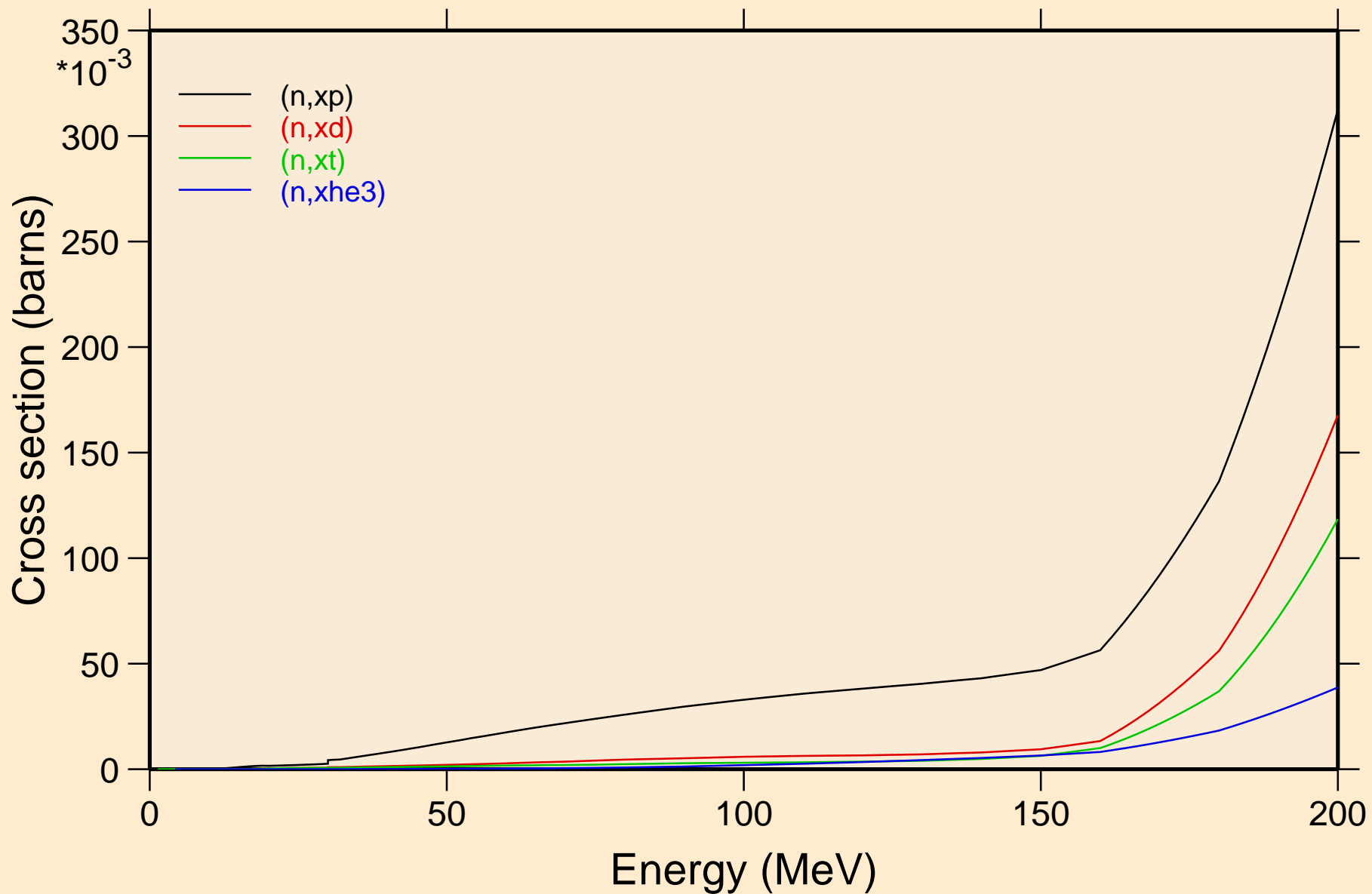

MD262 NEUTRON ACER TENDL-2019 LIBRARY; T=293.16K
angular distribution for elastic

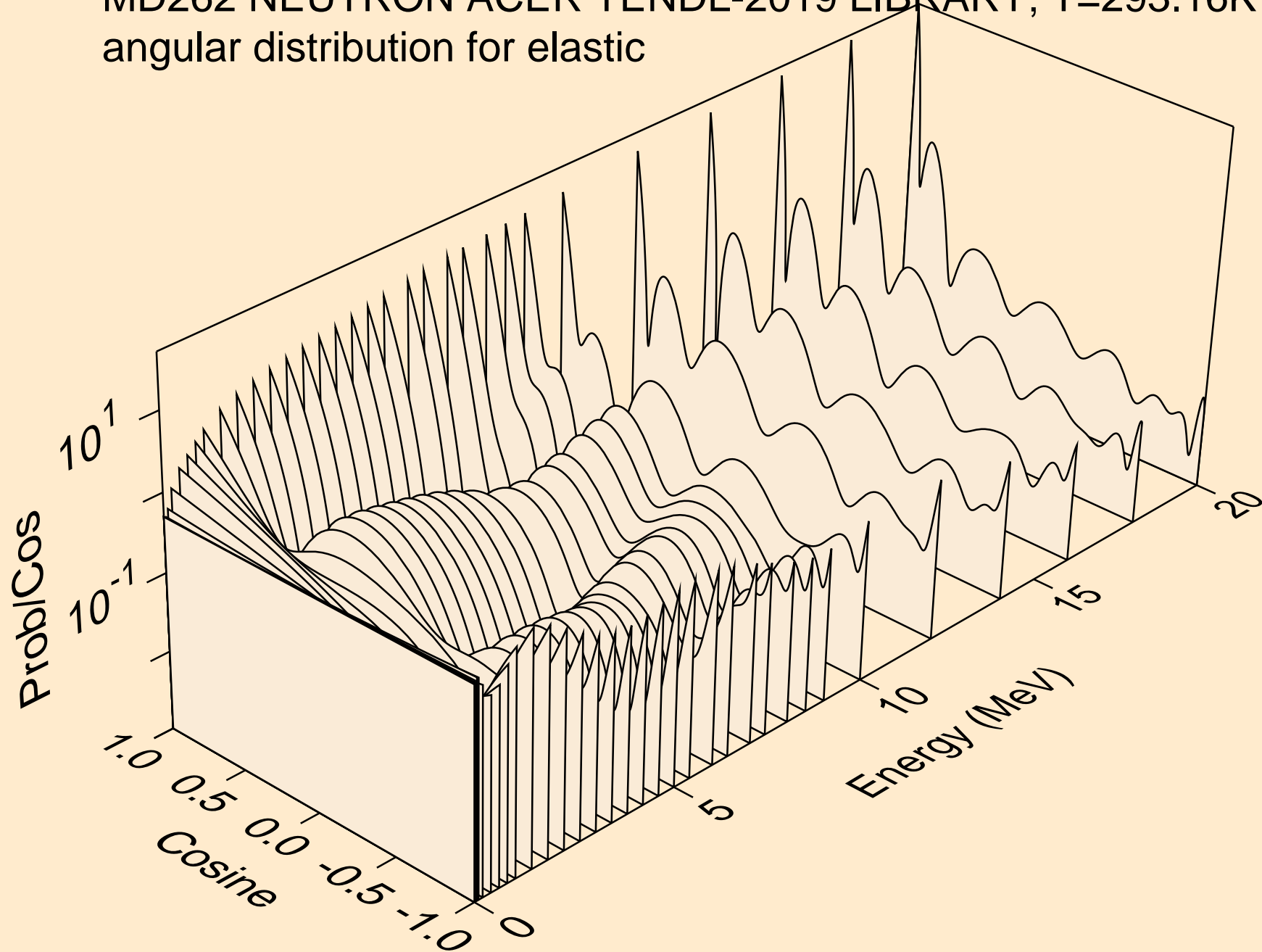

MD262 NEUTRON ACER TENDL-2019 LIBRARY; T=293.16K
angular distribution for elastic

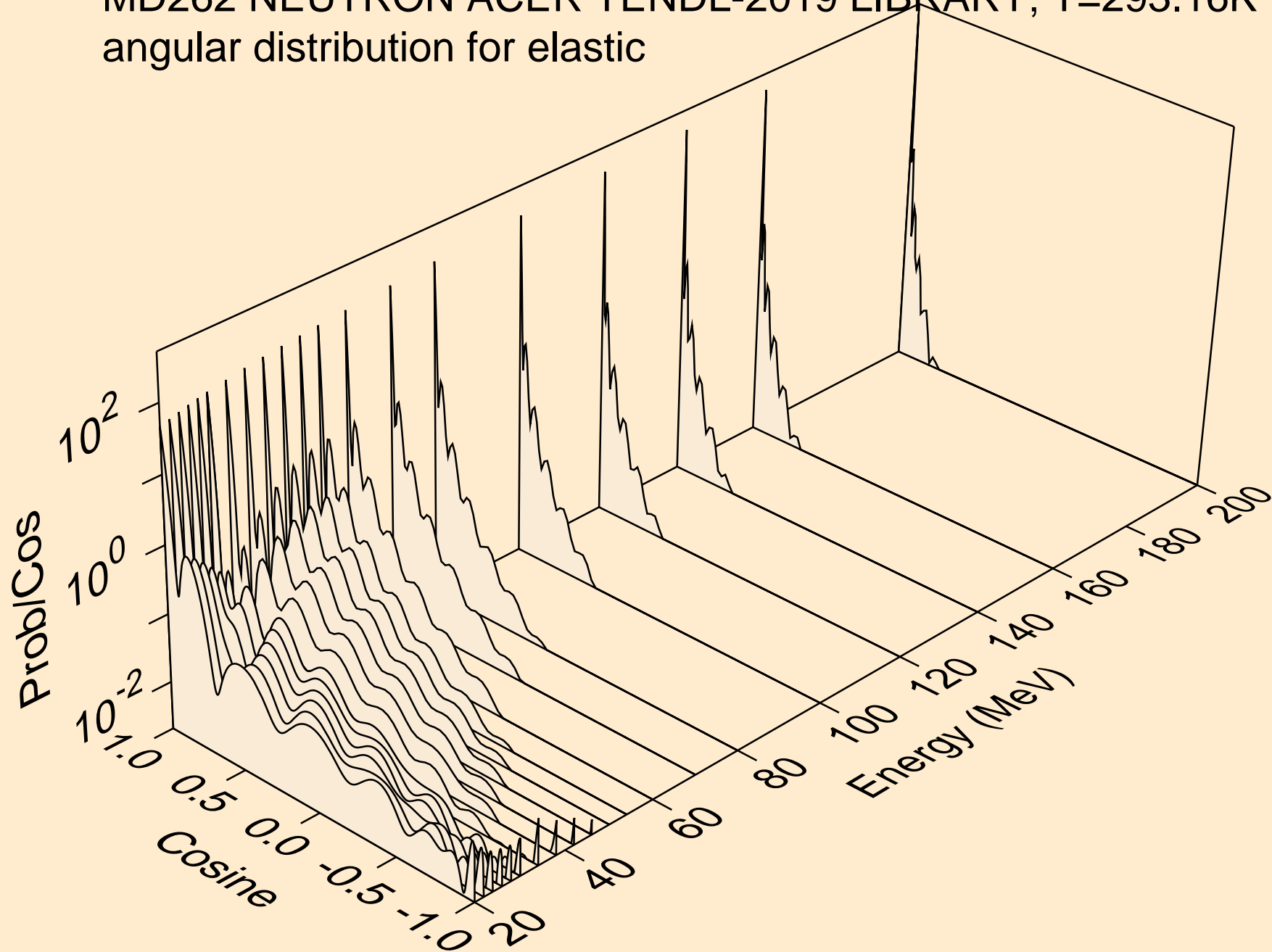

MD262 NEUTRON ACER TENDL-2019 LIBRARY; T=293.16K
angular distribution for (n,n*1)

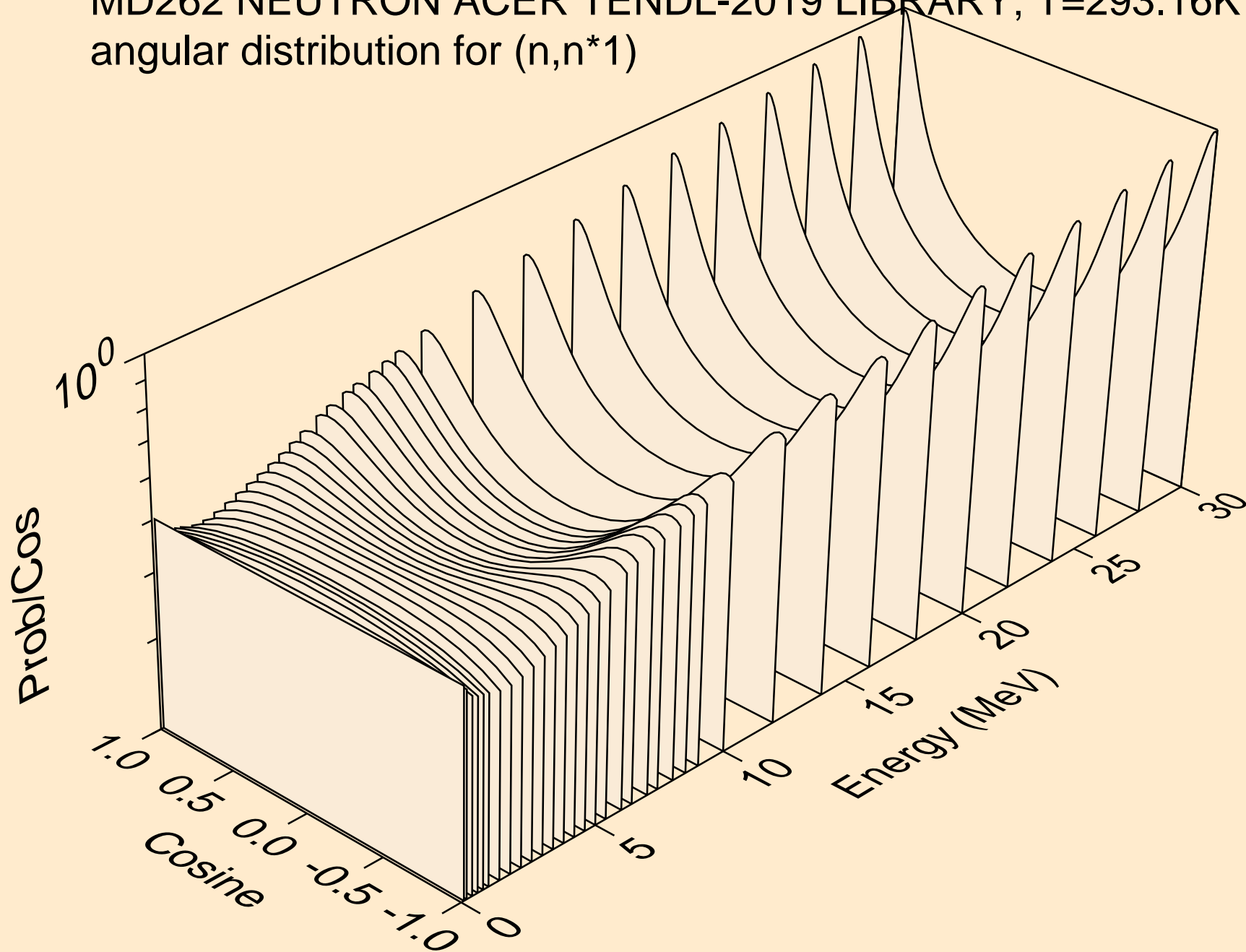

MD262 NEUTRON ACER TENDL-2019 LIBRARY; T=293.16K
Total fission nuubar

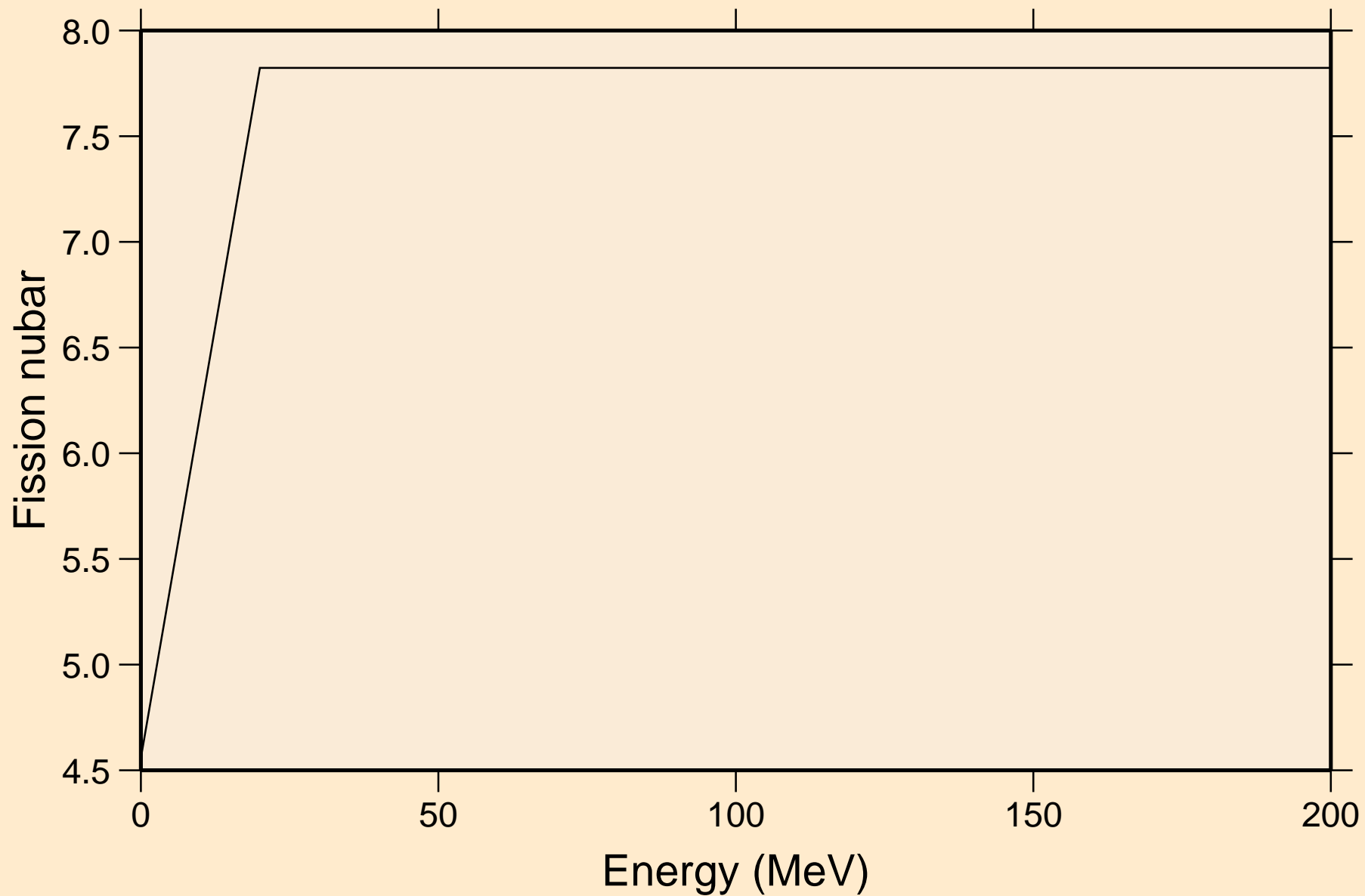

MD262 NEUTRON ACER TENDL-2019 LIBRARY; T=293.16K
Neutron emission for (n,x)

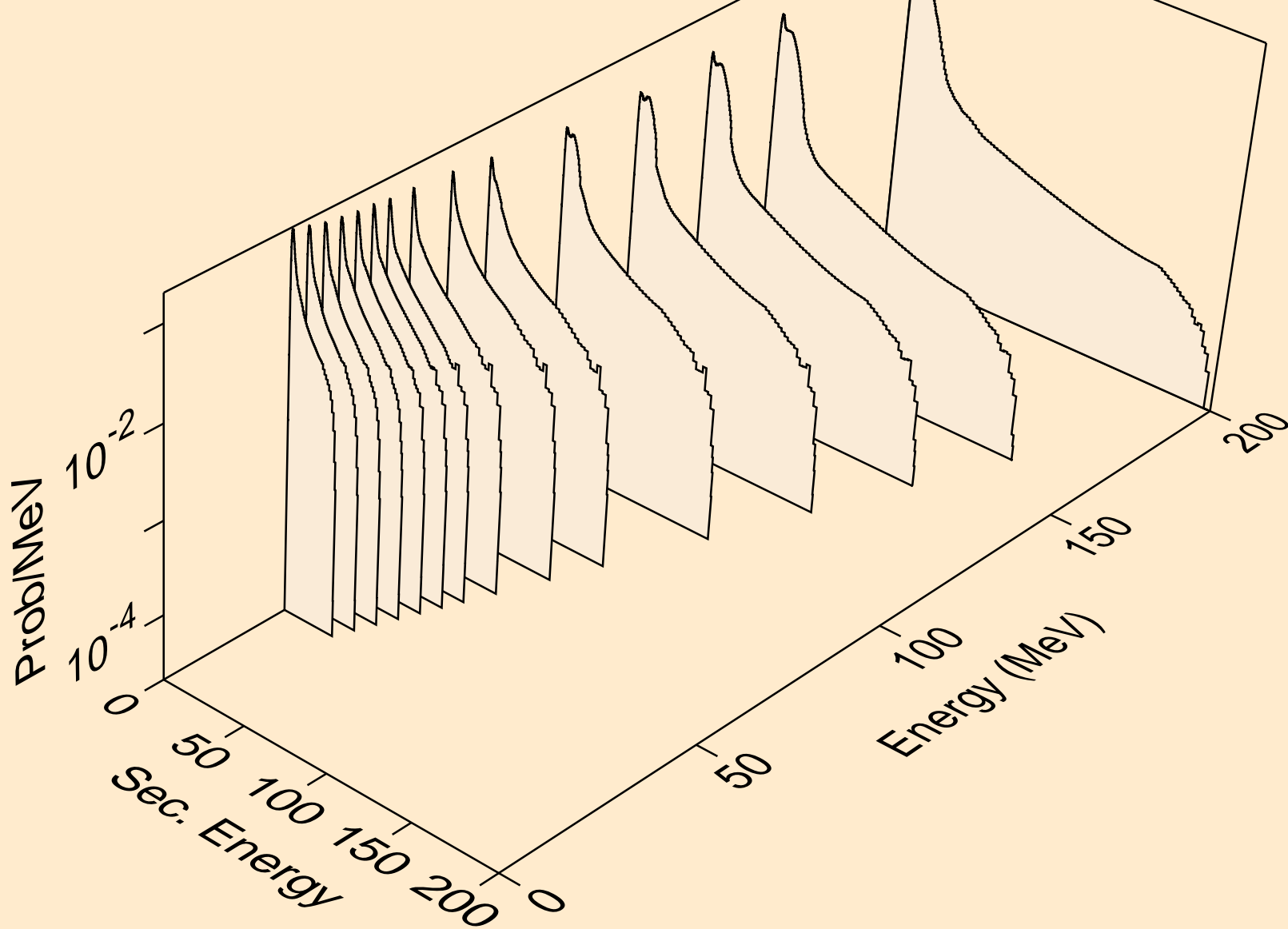

MD262 NEUTRON ACER TENDL-2019 LIBRARY; T=293.16K
Neutron emission for (n,2nd)

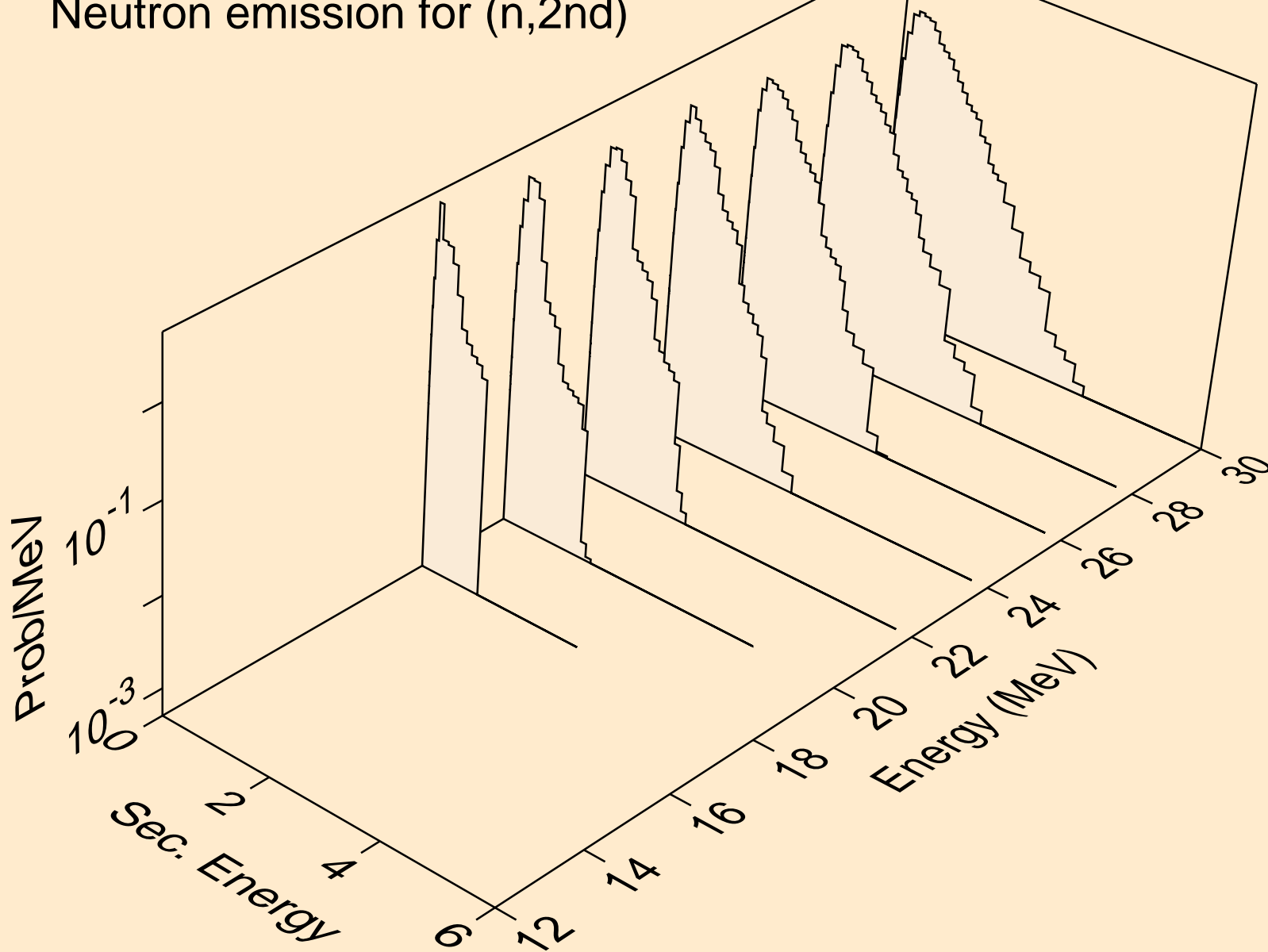

MD262 NEUTRON ACER TENDL-2019 LIBRARY; T=293.16K
Neutron emission for (n,2n)

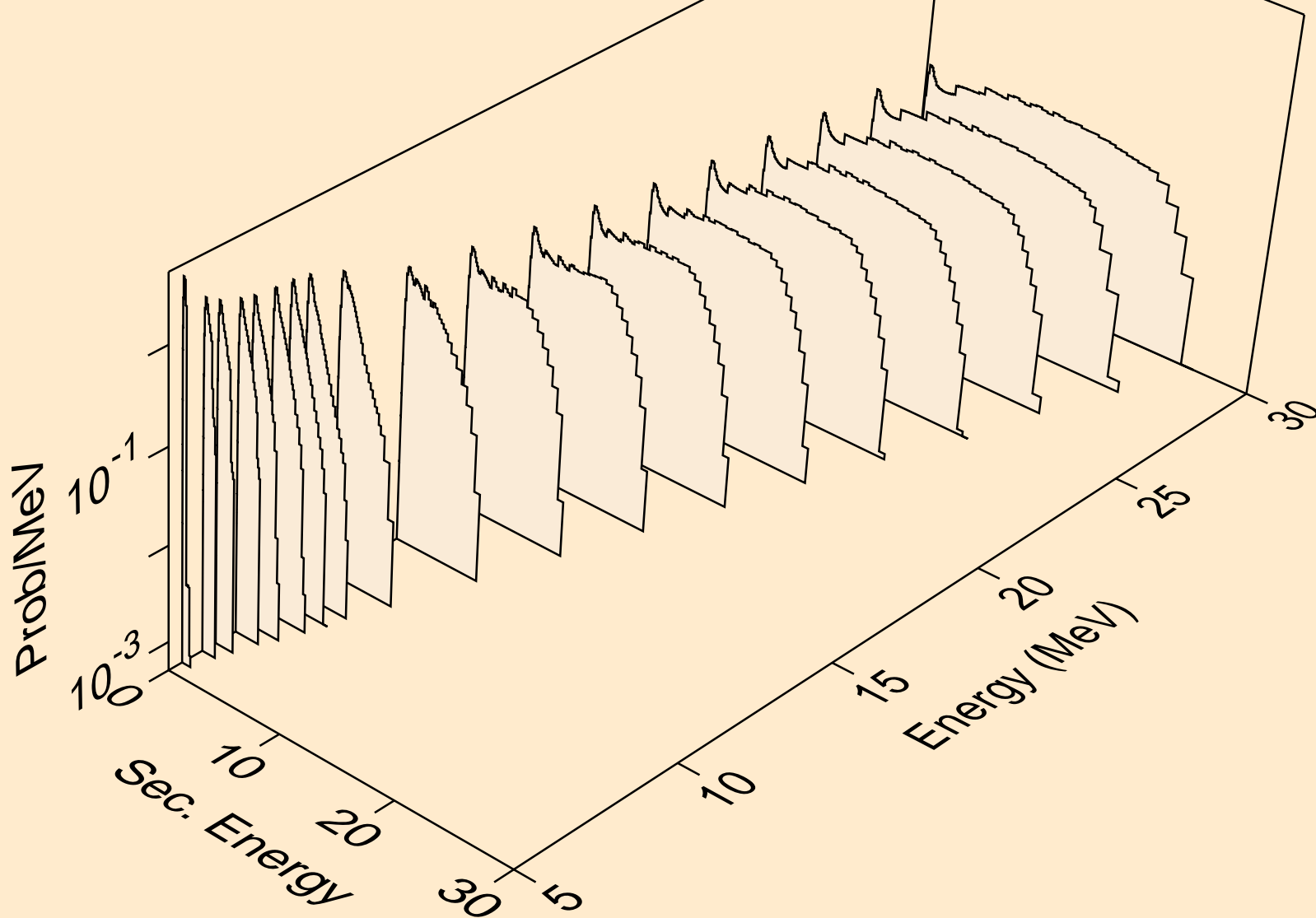

MD262 NEUTRON ACER TENDL-2019 LIBRARY; T=293.16K
Neutron emission for (n,3n)

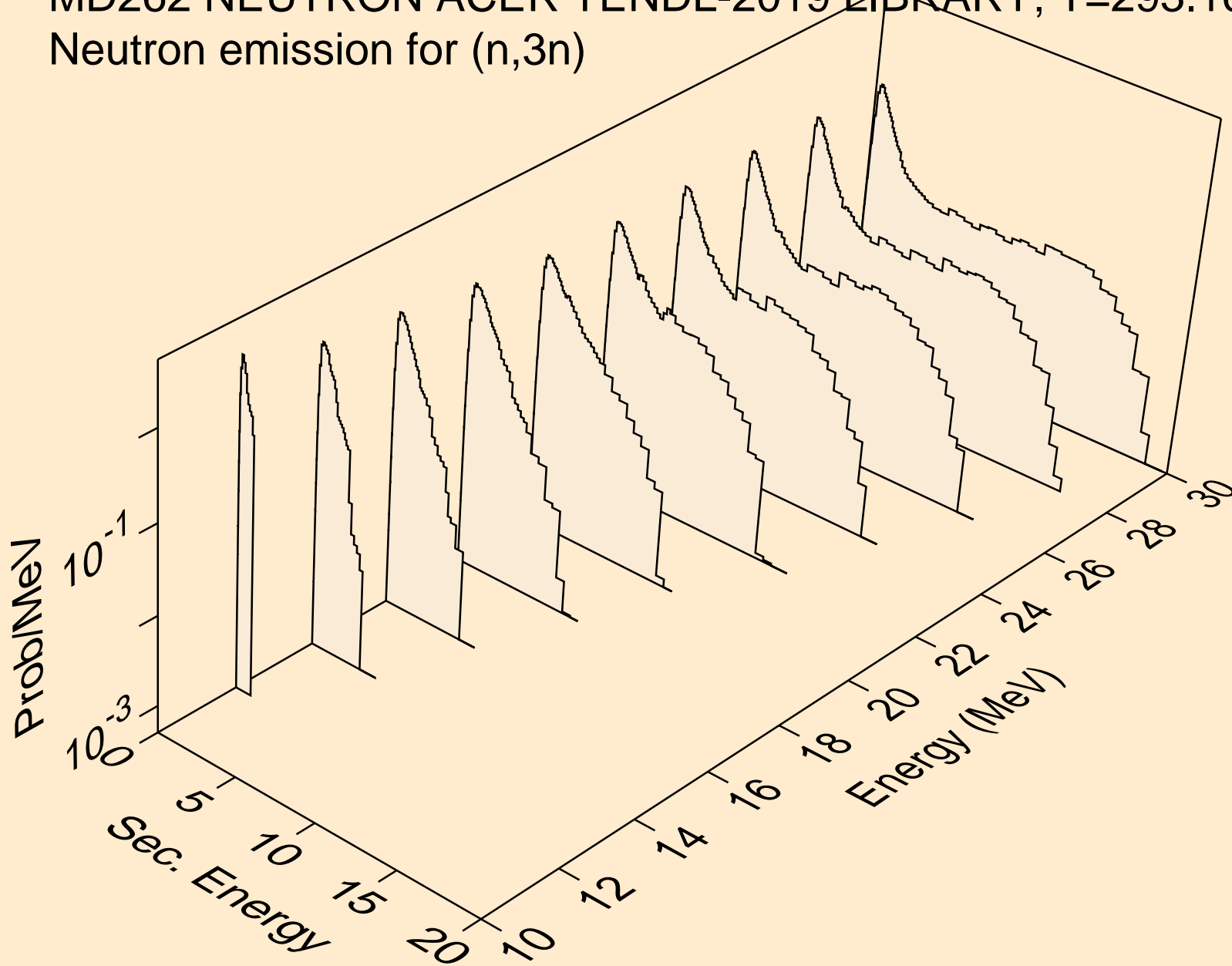

MD262 NEUTRON ACER TENDL-2019 LIBRARY; T=293.16K
Neutron emission for fission

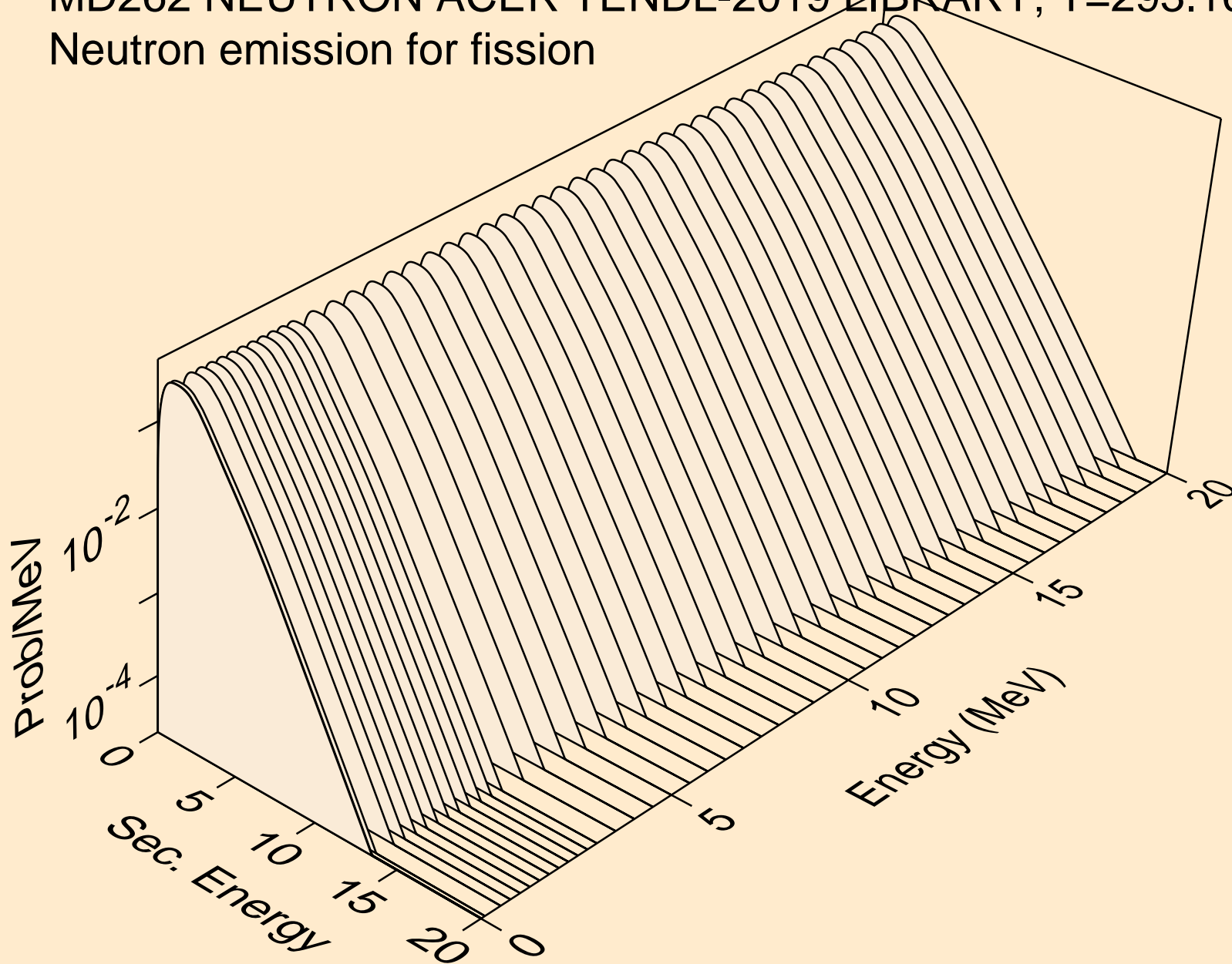

MD262 NEUTRON ACER TENDL-2019 LIBRARY; T=293.16K
Neutron emission for (n,n*)a

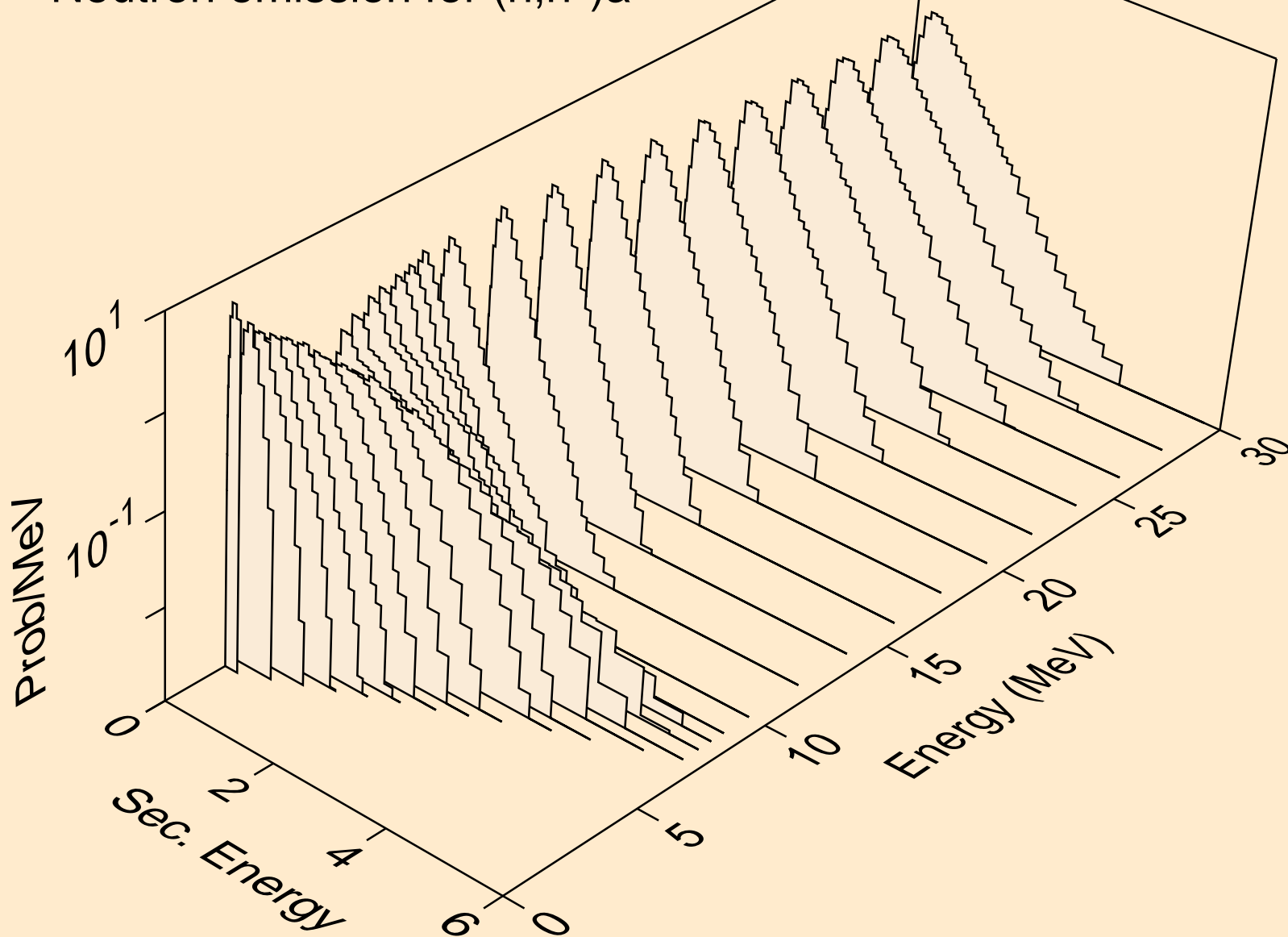

MD262 NEUTRON ACER TENDL-2019 LIBRARY; T=293.16K
Neutron emission for (n,2n)a

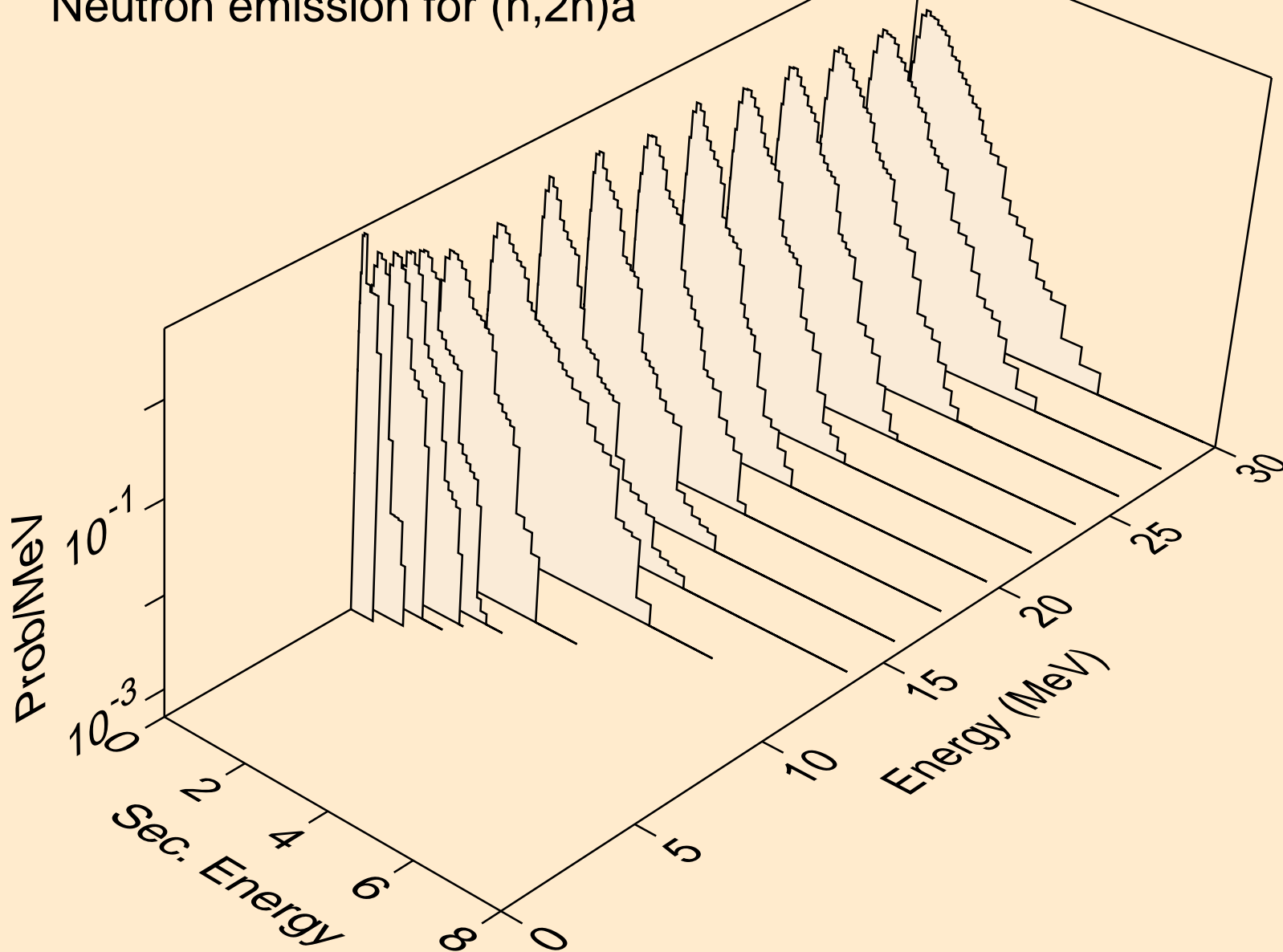

MD262 NEUTRON ACER TENDL-2019 LIBRARY; T=293.16K
Neutron emission for (n,3n)a

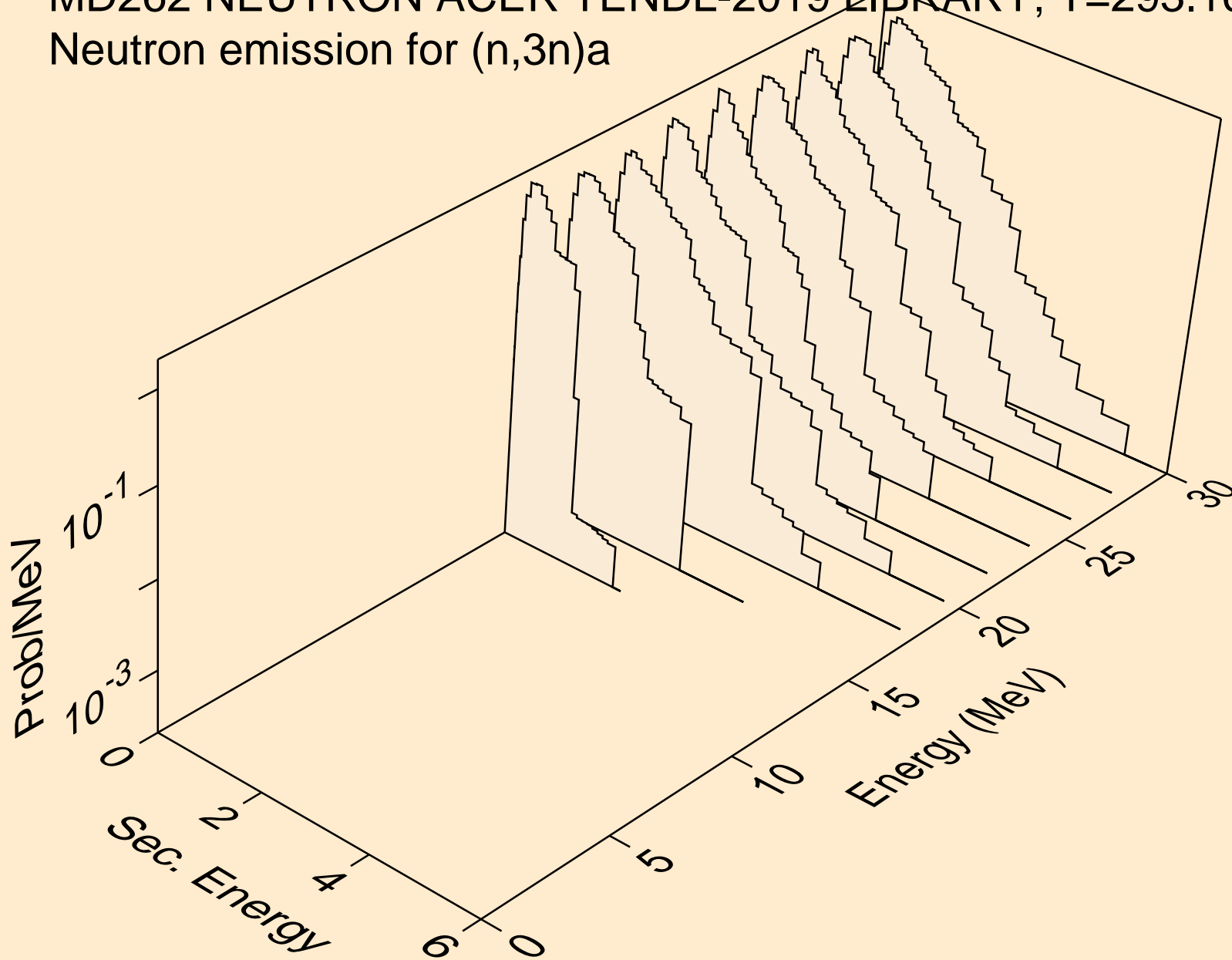

MD262 NEUTRON ACER TENDL-2019 LIBRARY; T=293.16K
Neutron emission for (n,n*)p

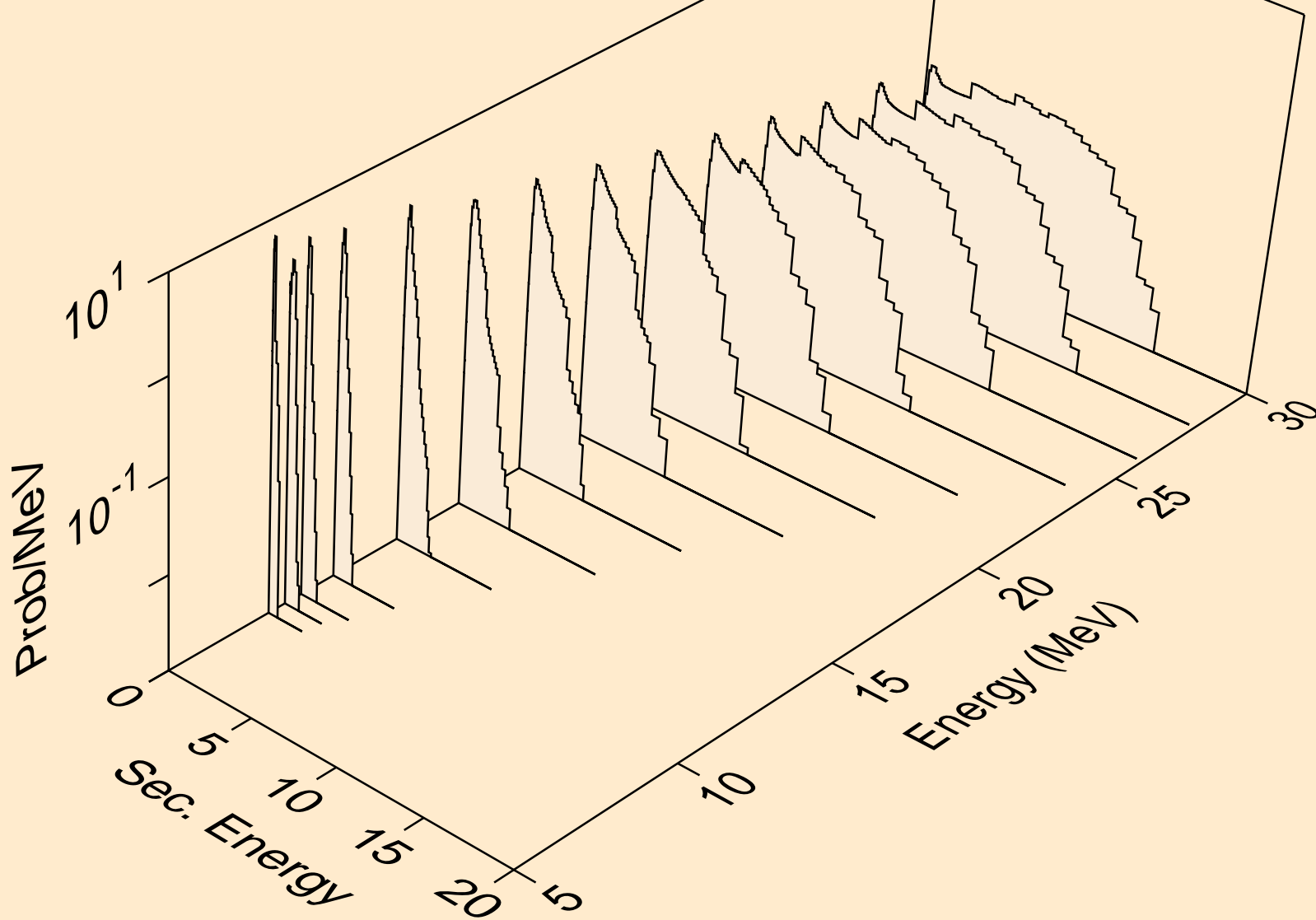

MD262 NEUTRON ACER TENDL-2019 LIBRARY; T=293.16K
Neutron emission for (n,n*)d

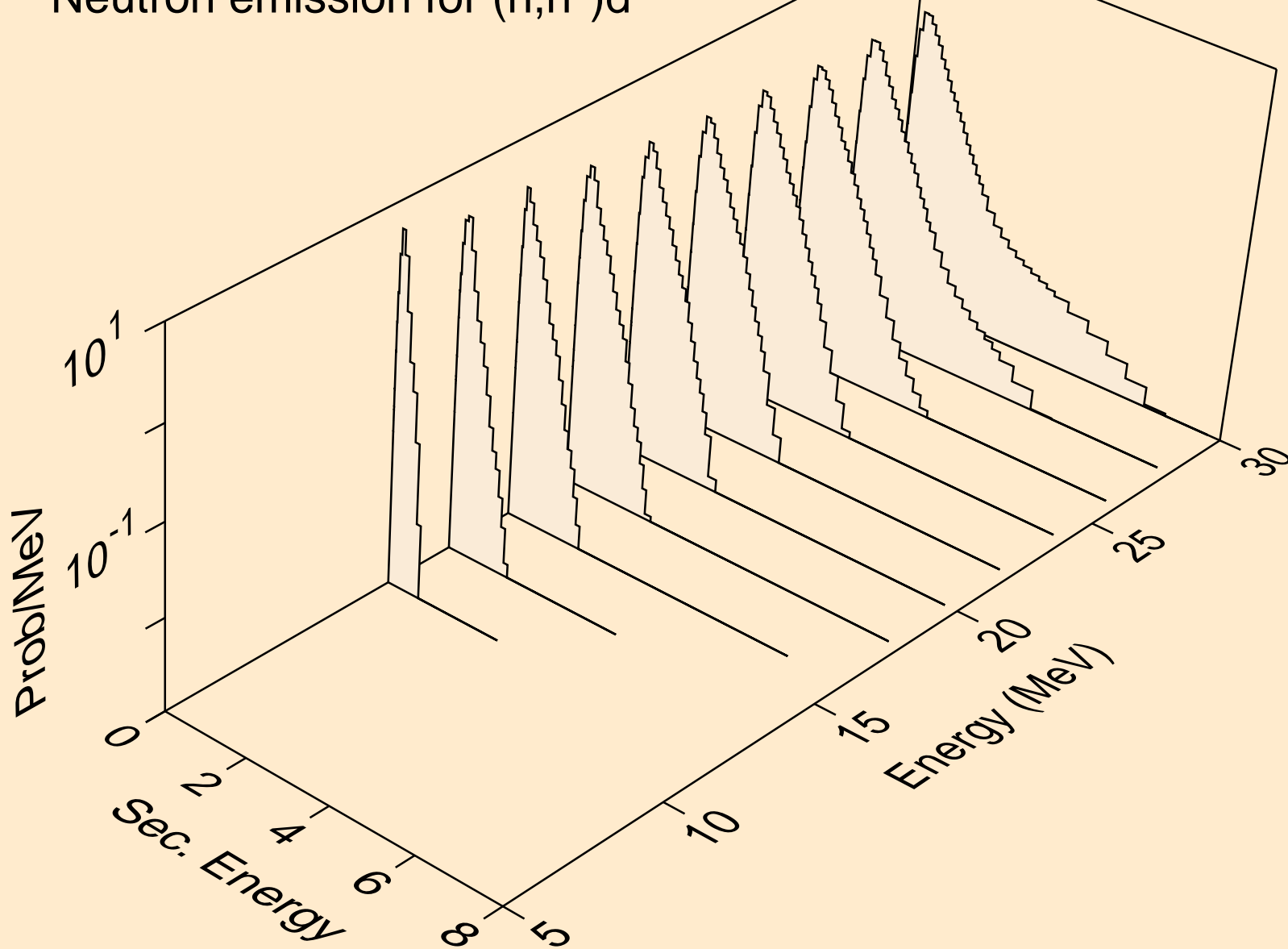

MD262 NEUTRON ACER TENDL-2019 LIBRARY; T=293.16K
Neutron emission for (n,n*)t

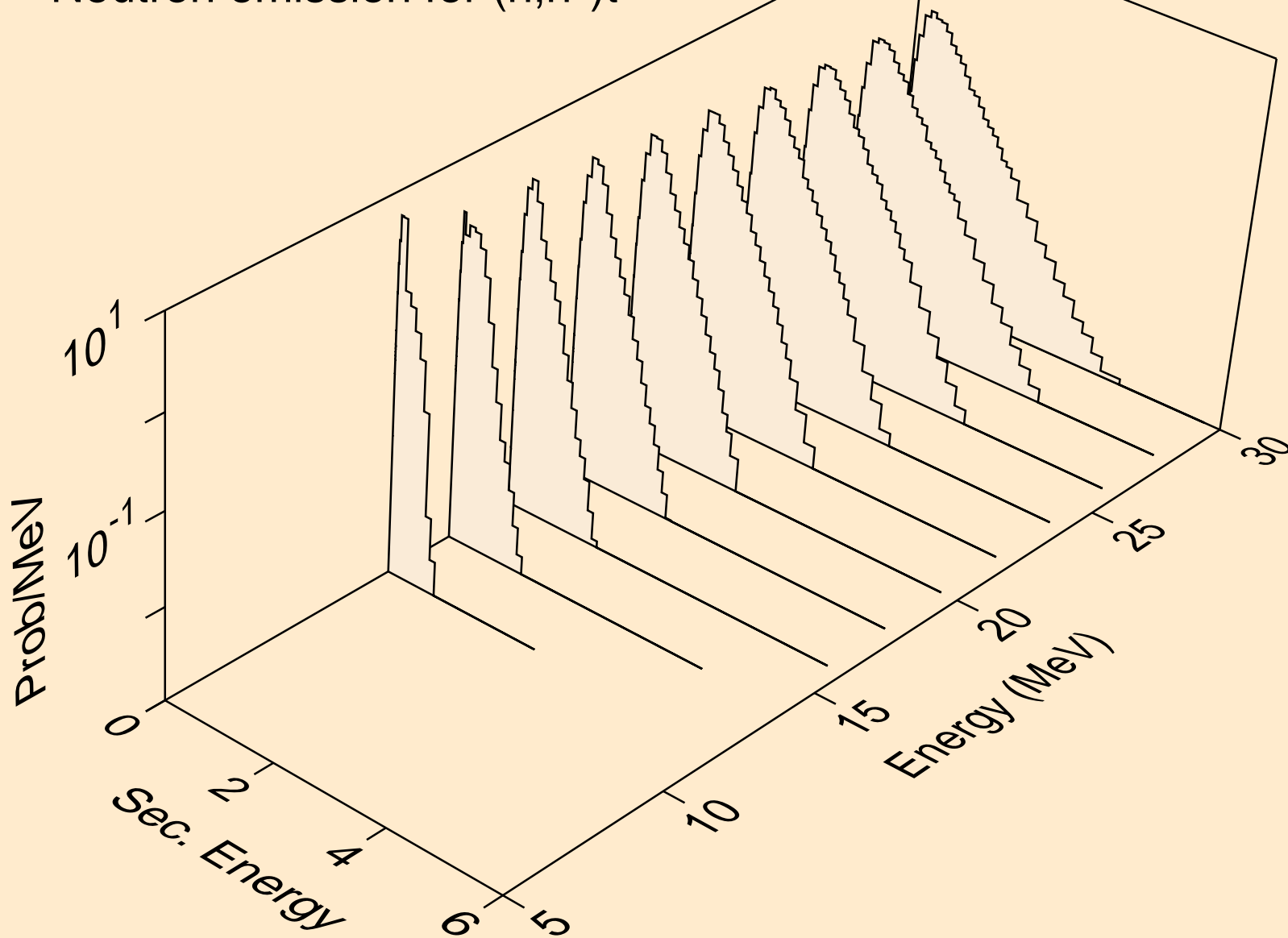

MD262 NEUTRON ACER TENDL-2019 LIBRARY; T=293.16K
Neutron emission for (n,n*)he3

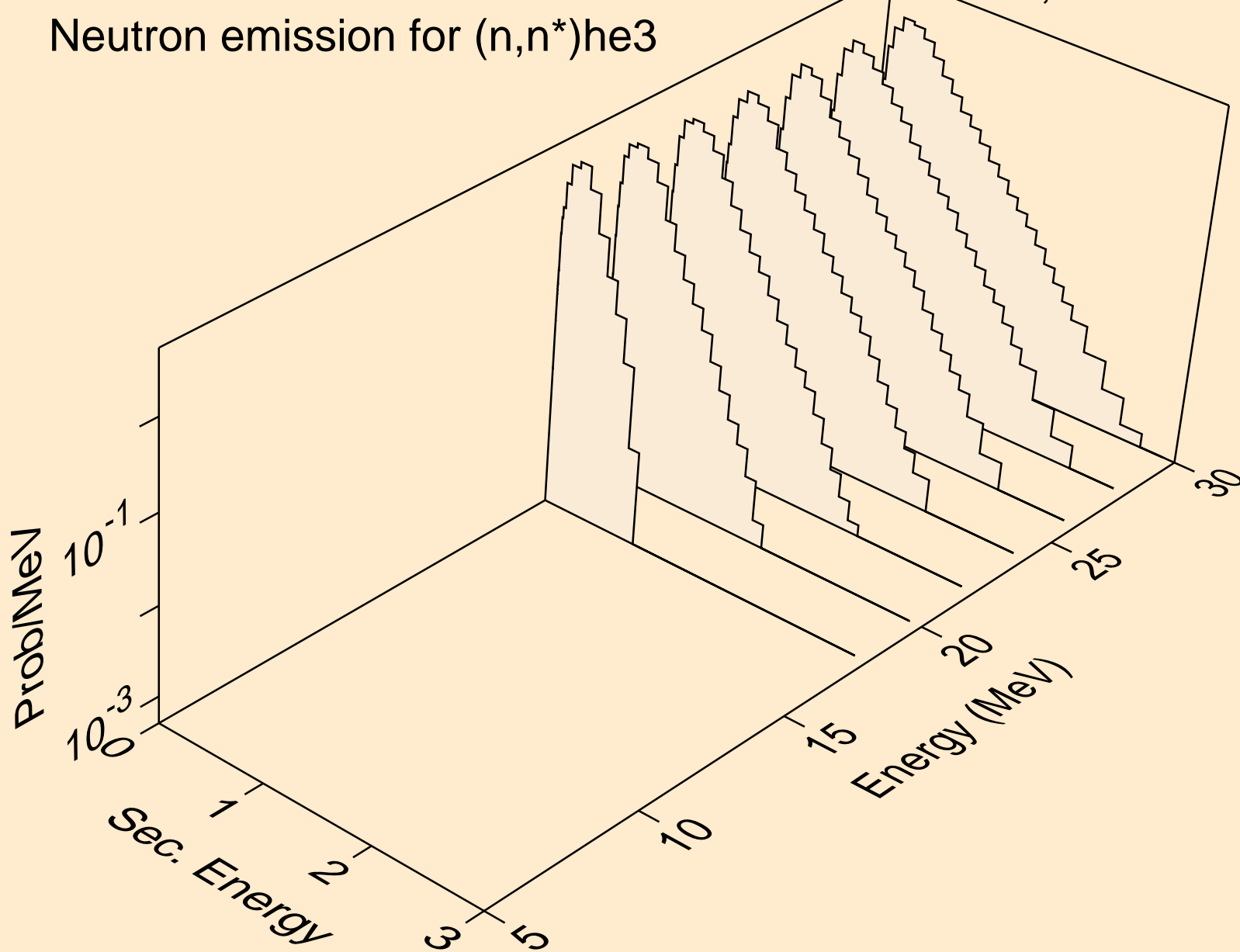

MD262 NEUTRON ACER TENDL-2019 LIBRARY; T=293.16K
Neutron emission for (n,4n)

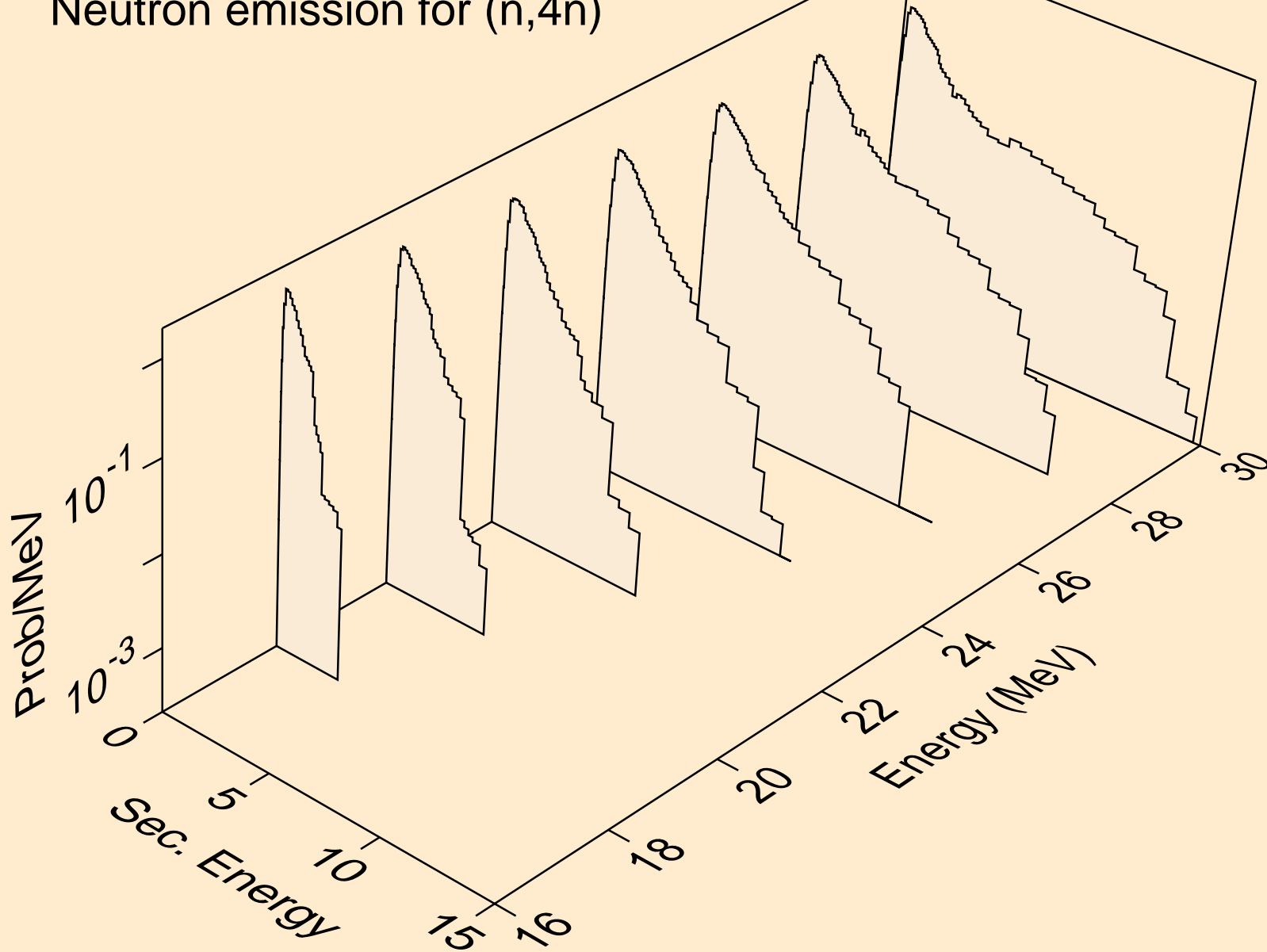

MD262 NEUTRON ACER TENDL-2019 LIBRARY; T=293.16K
Neutron emission for (n,2np)

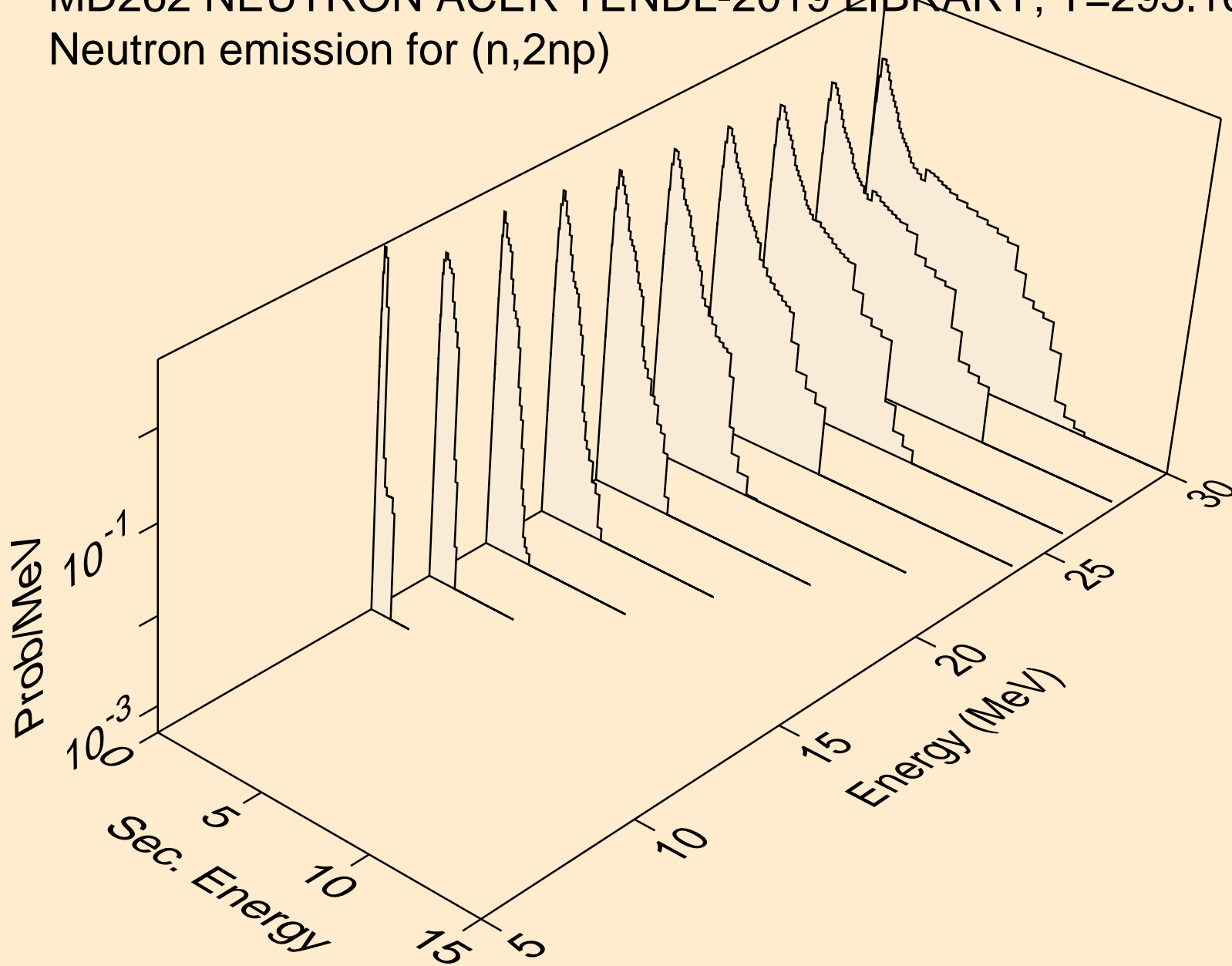

MD262 NEUTRON ACER TENDL-2019 LIBRARY; T=293.16K
Neutron emission for (n,3np)

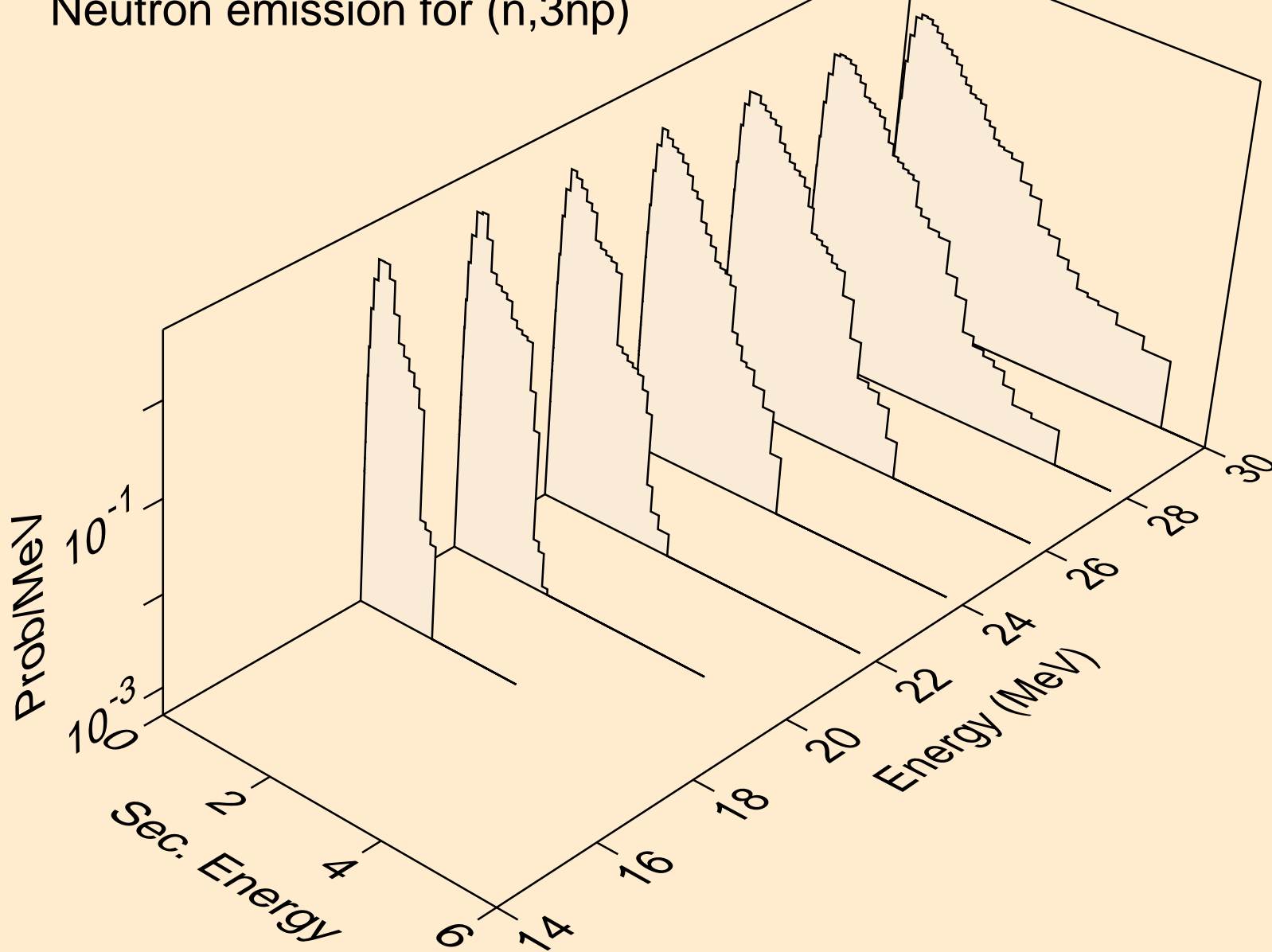

MD262 NEUTRON ACER TENDL-2019 LIBRARY; T=293.16K
Neutron emission for (n,n*c)

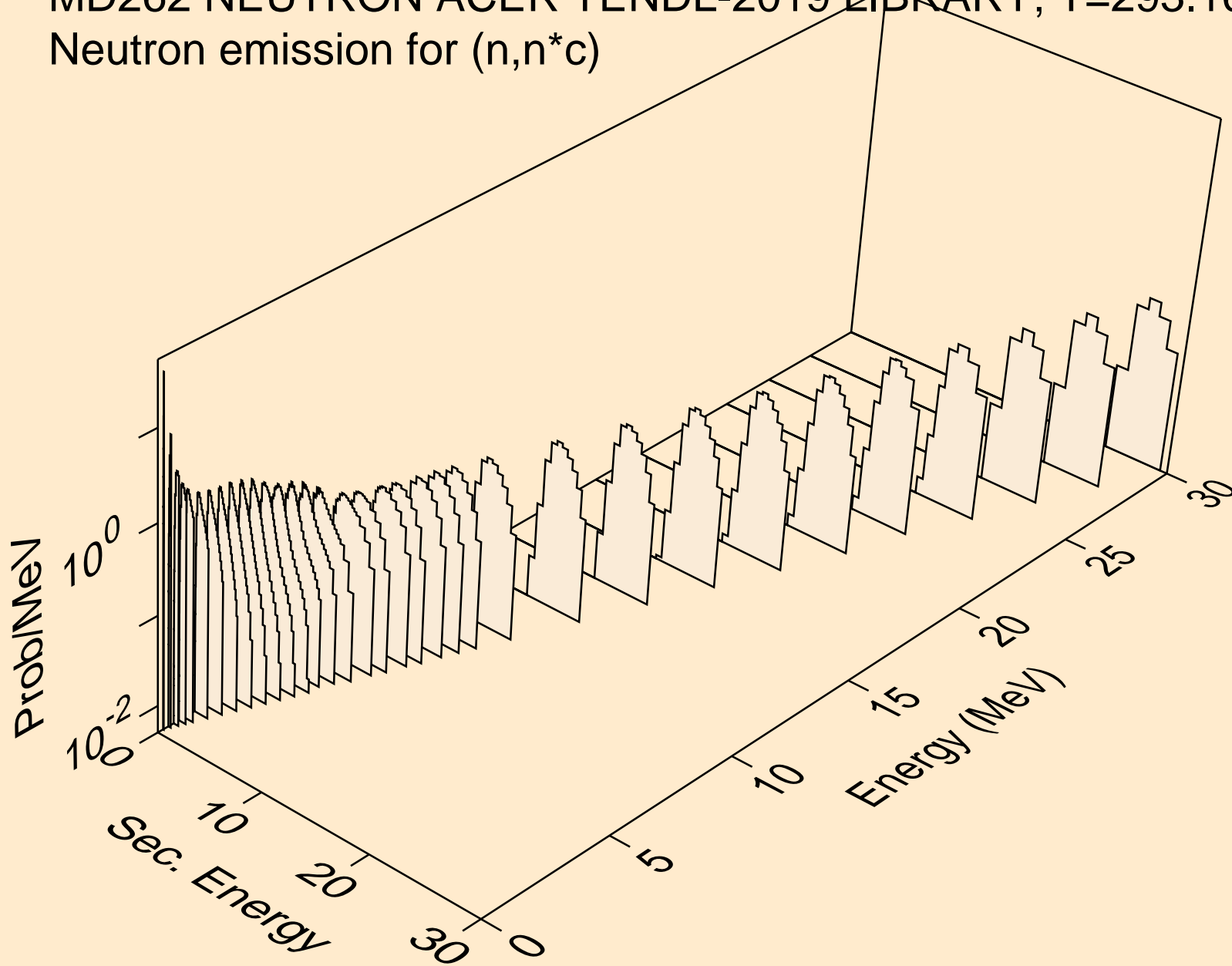

MD262 NEUTRON ACER TENDL-2019 LIBRARY; T=293.16K

Delayed nubar

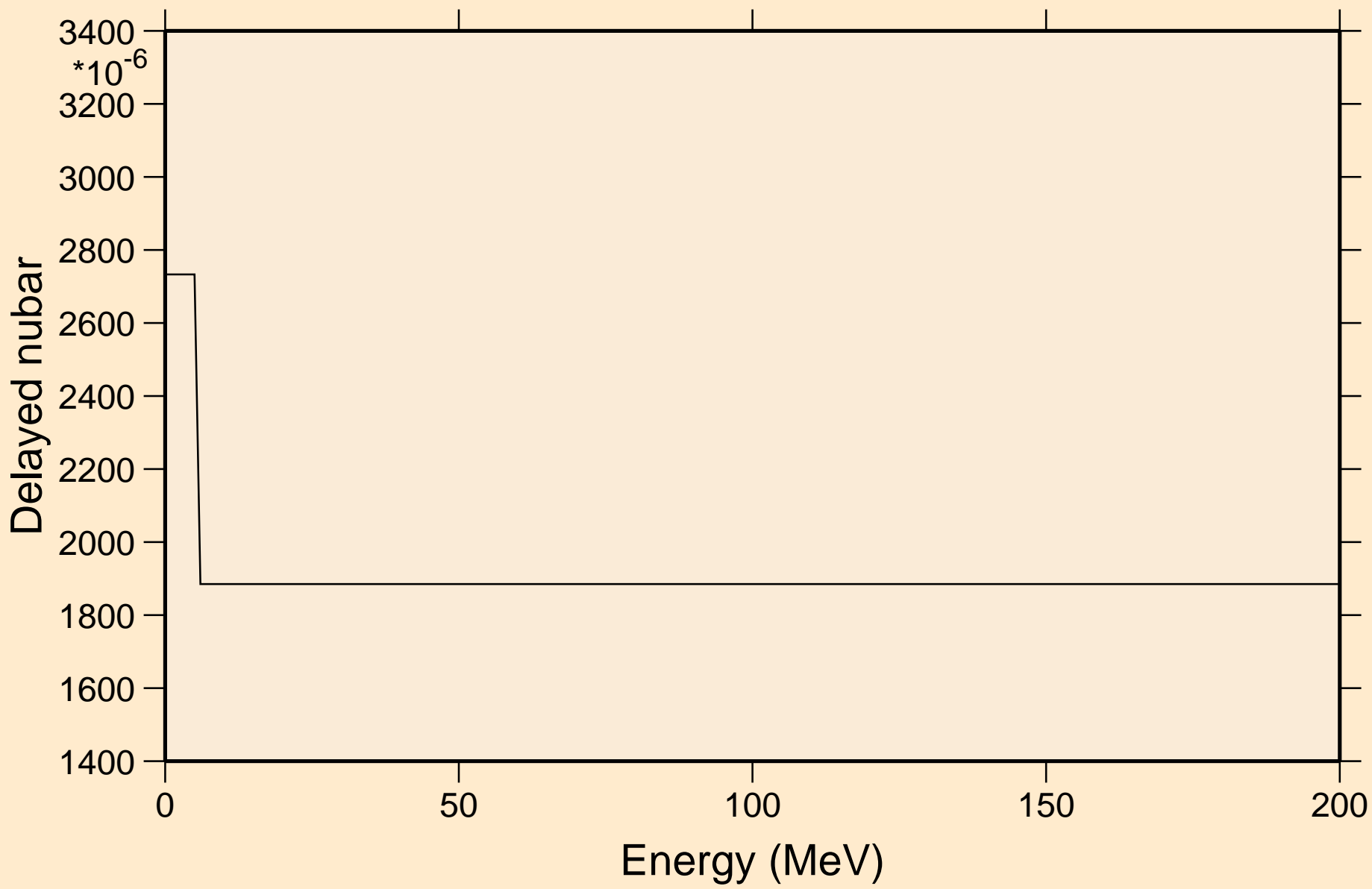

MD262 NEUTRON ACER TENDL-2019 LIBRARY; T=293.16K

Delayed neutron spectra

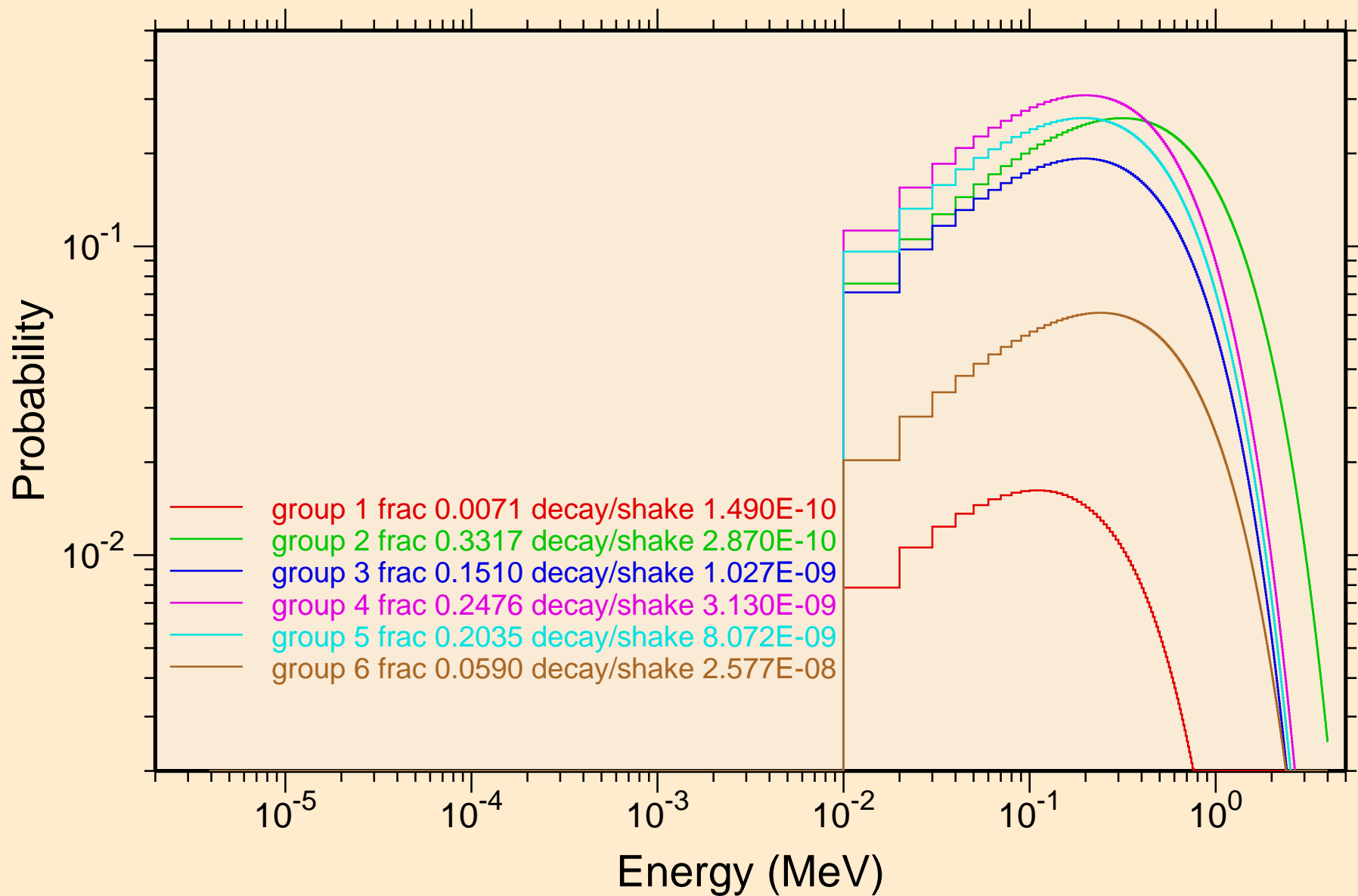

MD262 NEUTRON ACER TENDL-2019 LIBRARY; T=293.16K
Photon emission for (n,x)

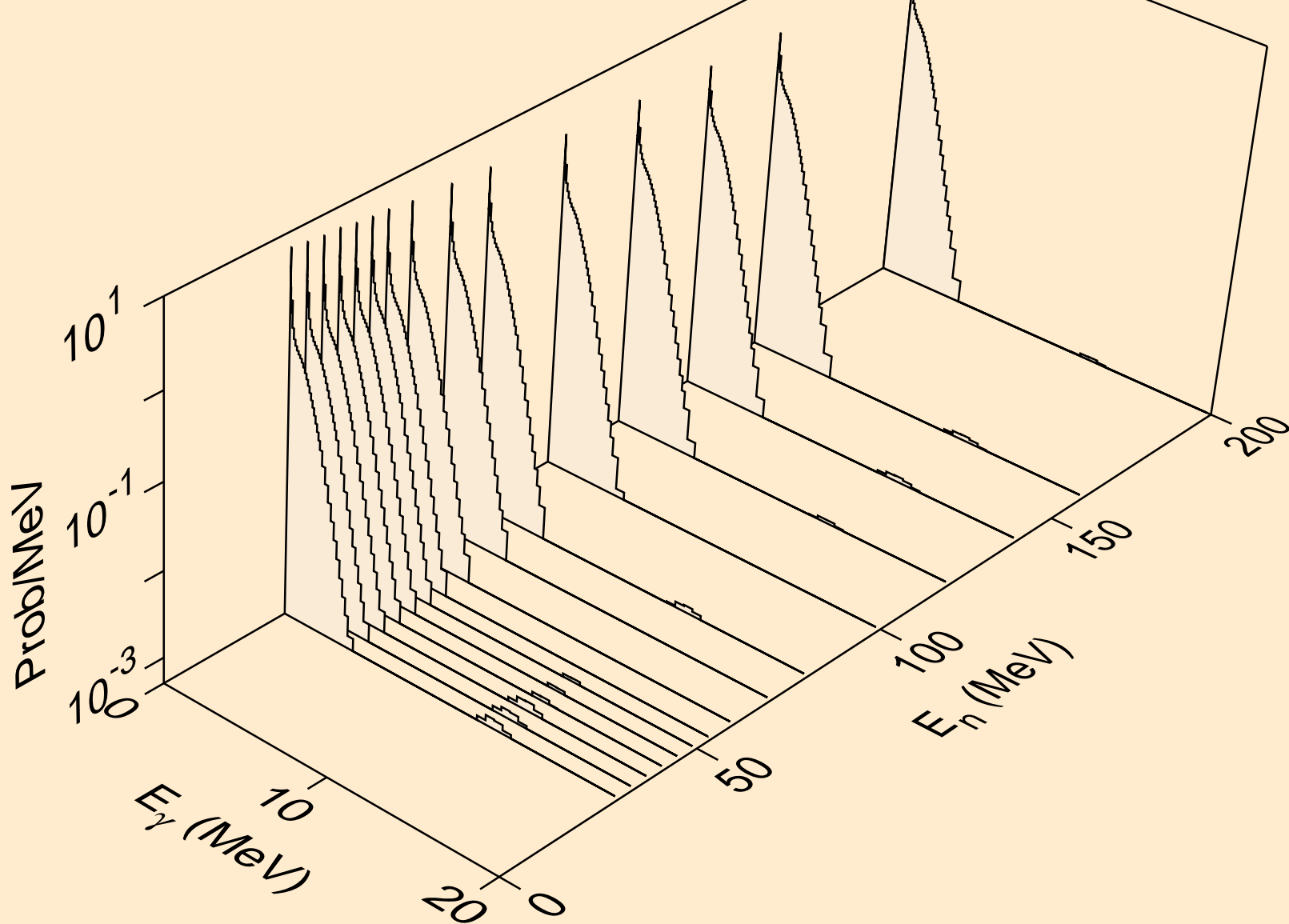

MD262 NEUTRON ACER TENDL-2019 LIBRARY; T=293.16K
Photon emission for (n,2nd)

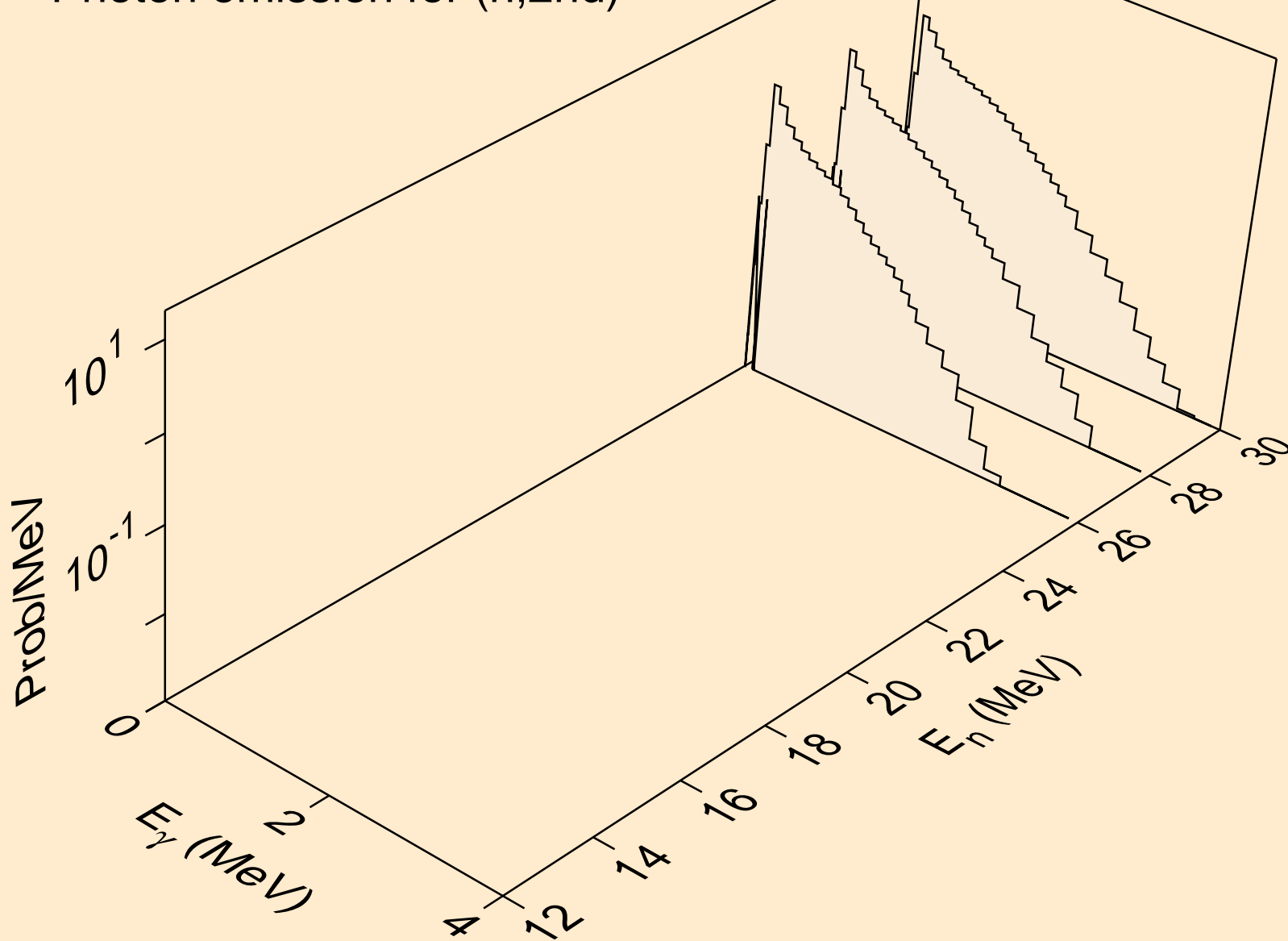

MD262 NEUTRON ACER TENDL-2019 LIBRARY; T=293.16K
Photon emission for (n,2n)

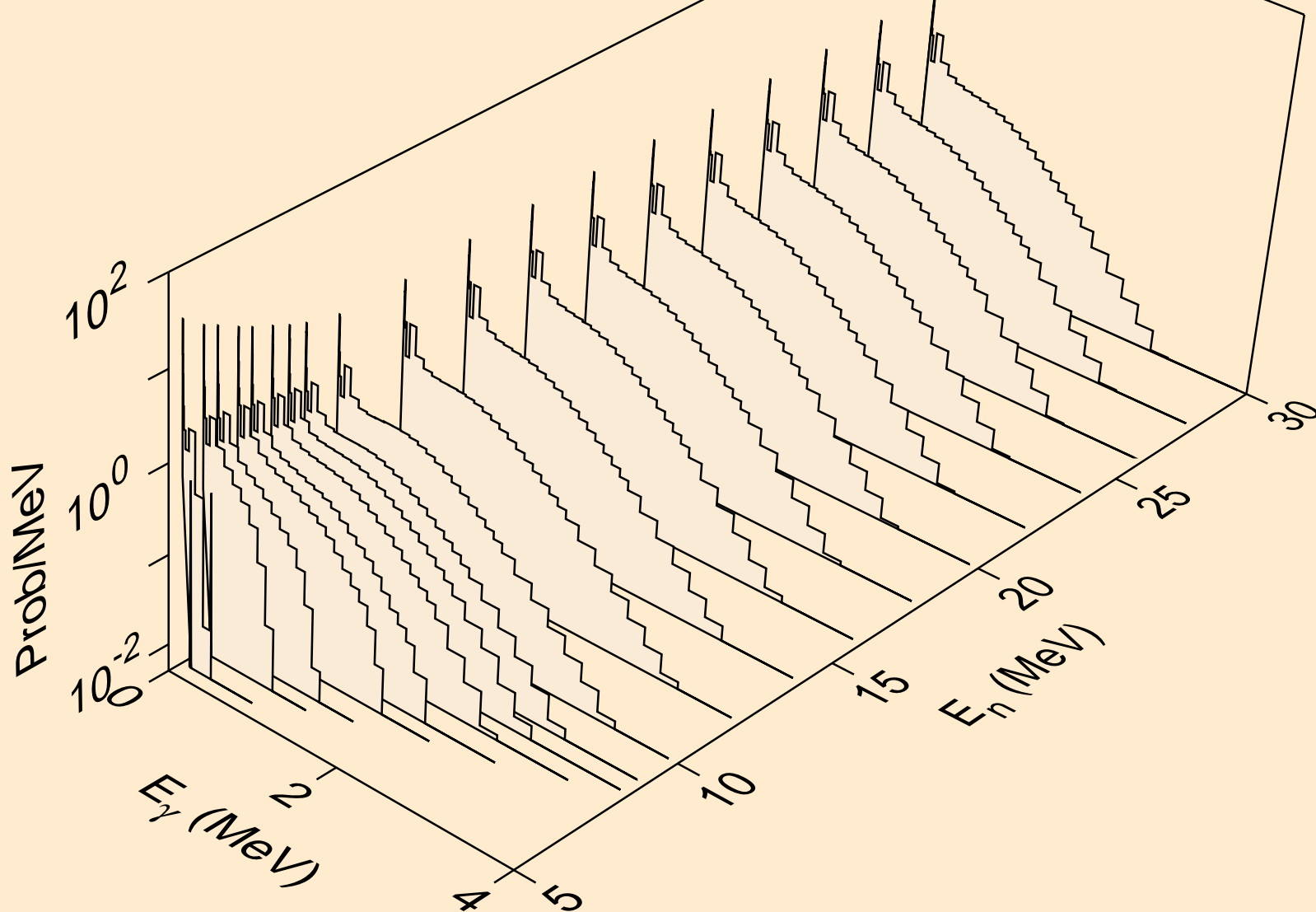

MD262 NEUTRON ACER TENDL-2019 LIBRARY; T=293.16K
Photon emission for (n,3n)

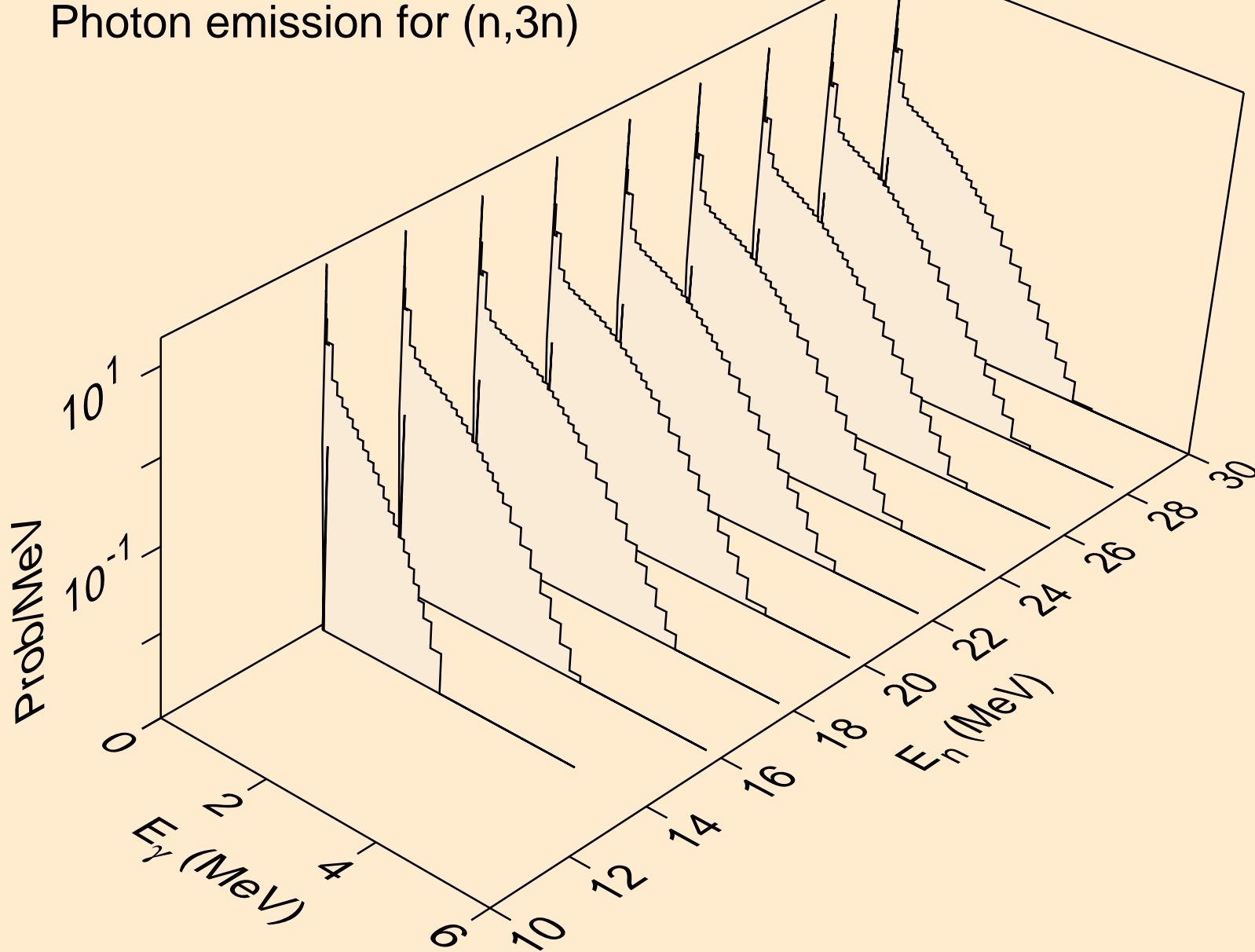

MD262 NEUTRON ACER TENDL-2019 LIBRARY; T=293.16K
Photon emission for (n,n*)a

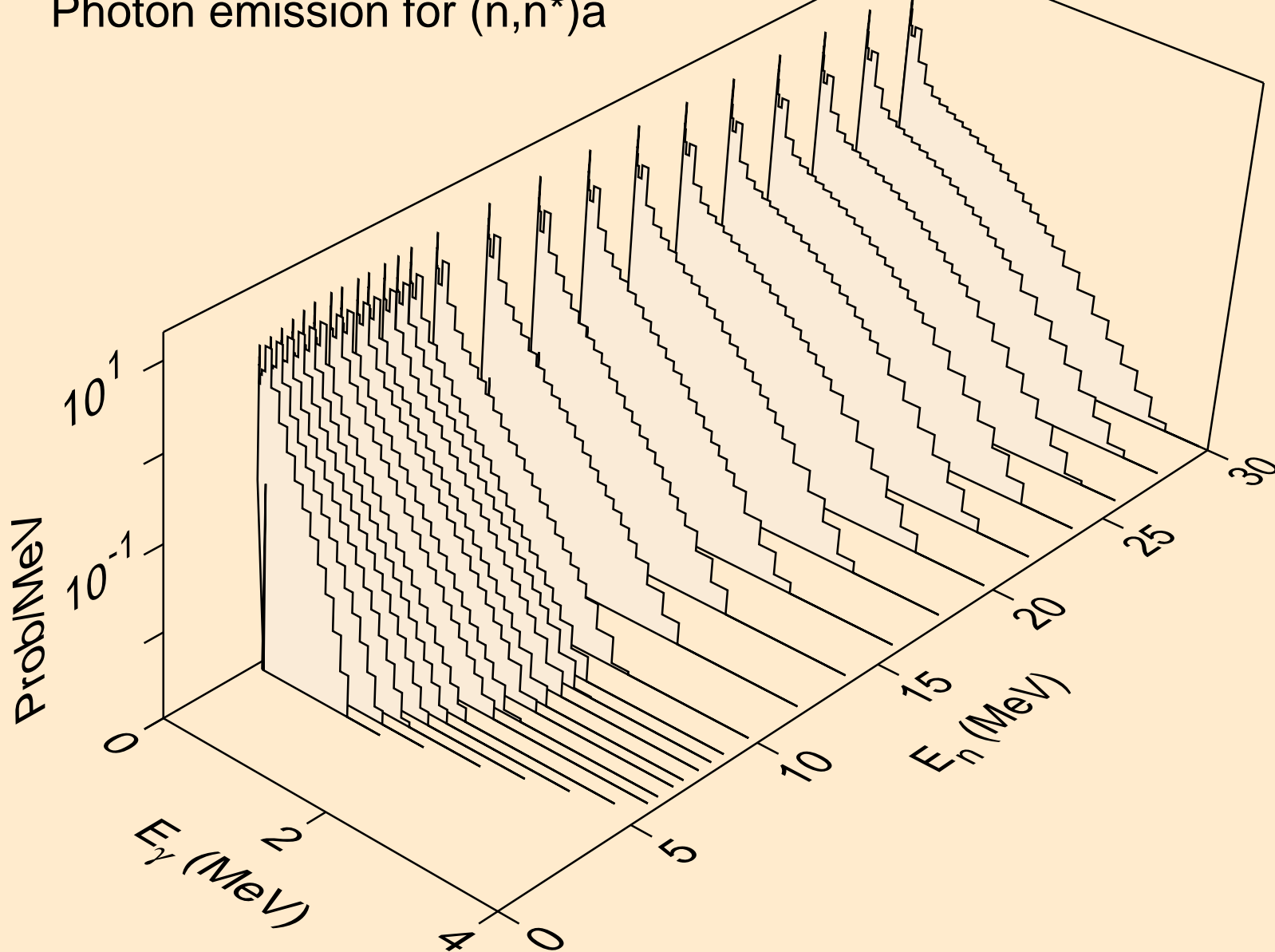

MD262 NEUTRON ACER TENDL-2019 LIBRARY; T=293.16K
Photon emission for (n,2n)a

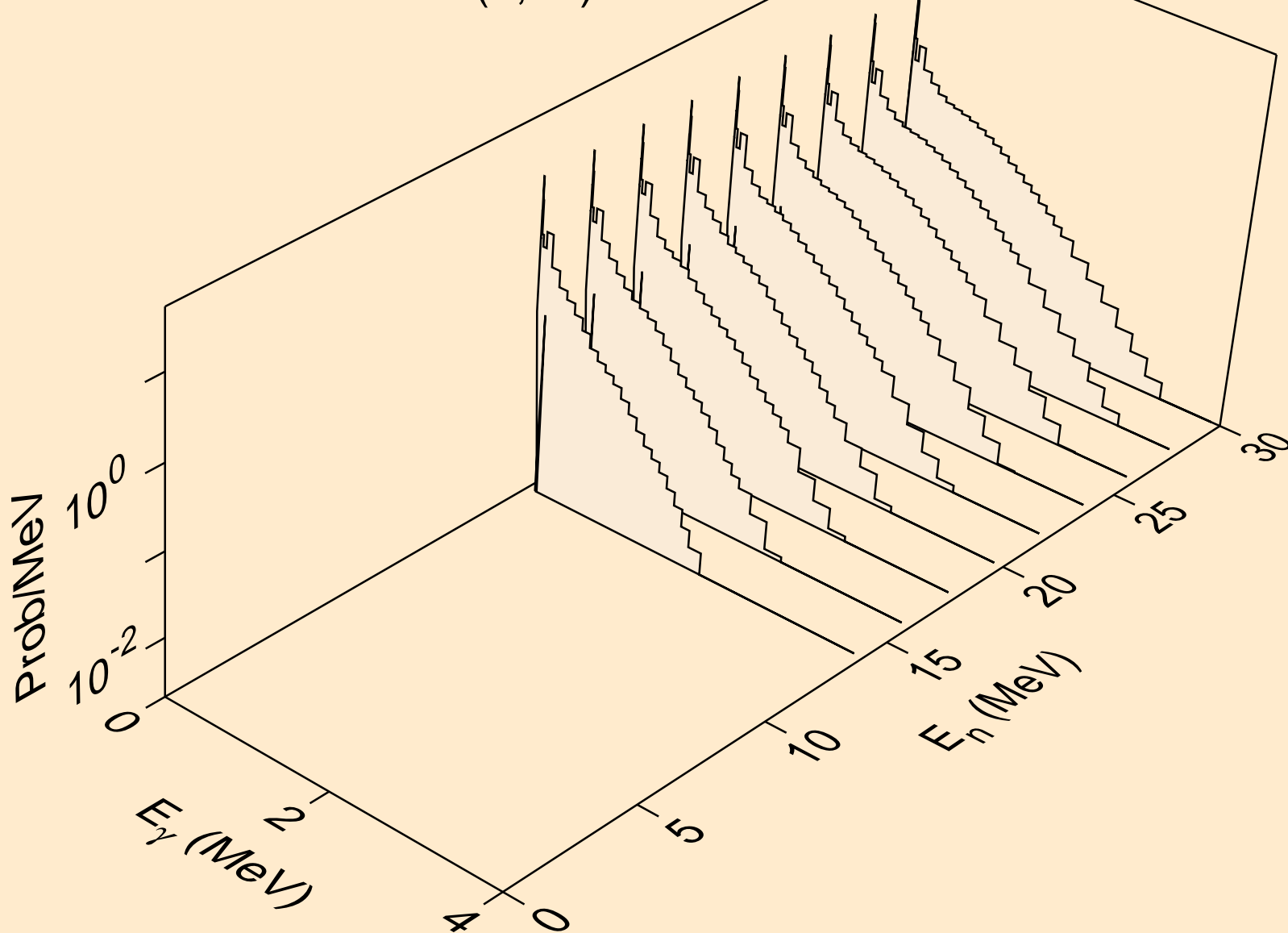

MD262 NEUTRON ACER TENDL-2019 LIBRARY; T=293.16K
Photon emission for (n,3n)a

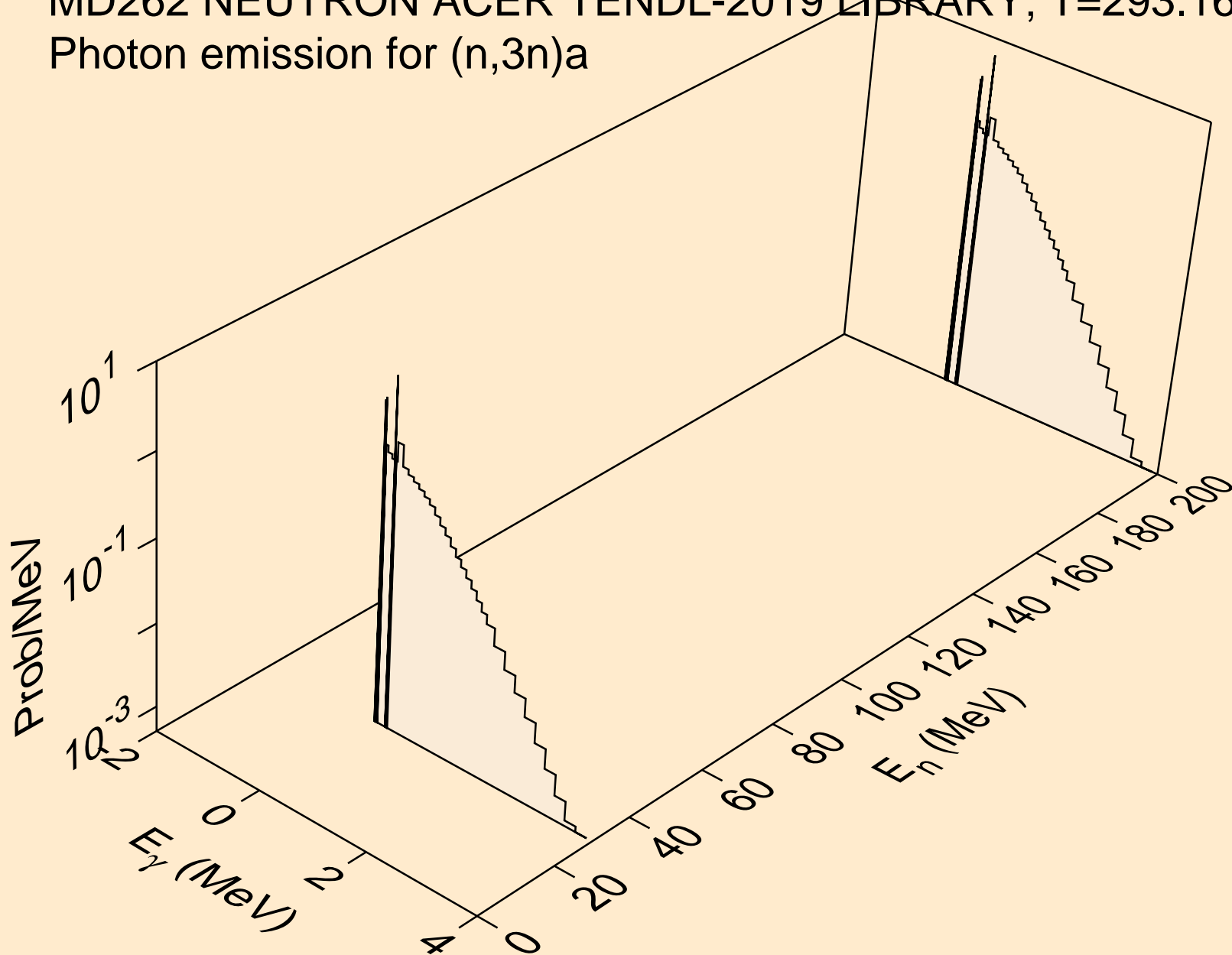

MD262 NEUTRON ACER TENDL-2019 LIBRARY; T=293.16K
Photon emission for (n,n*)p

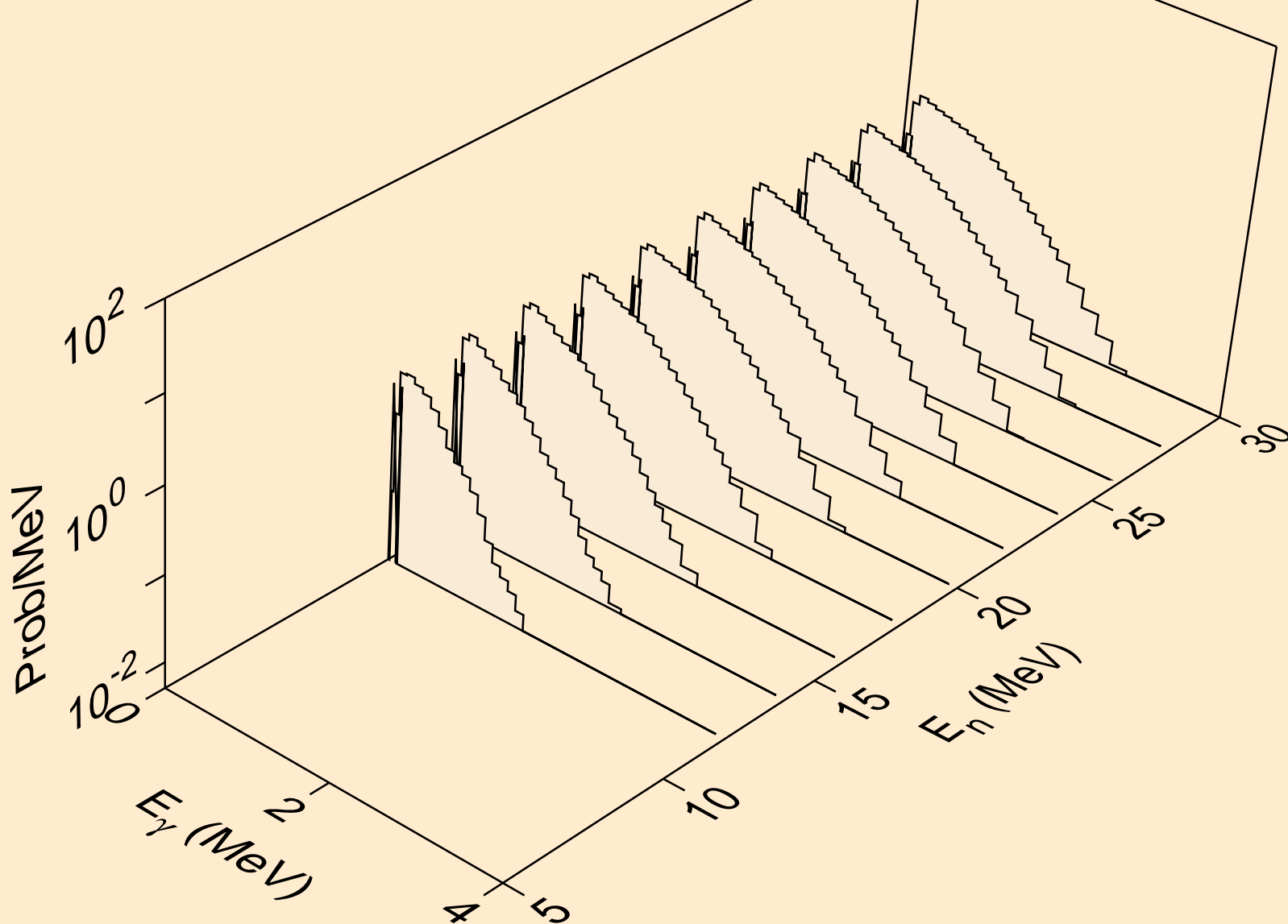

MD262 NEUTRON ACER TENDL-2019 LIBRARY; T=293.16K
Photon emission for (n,n*)d

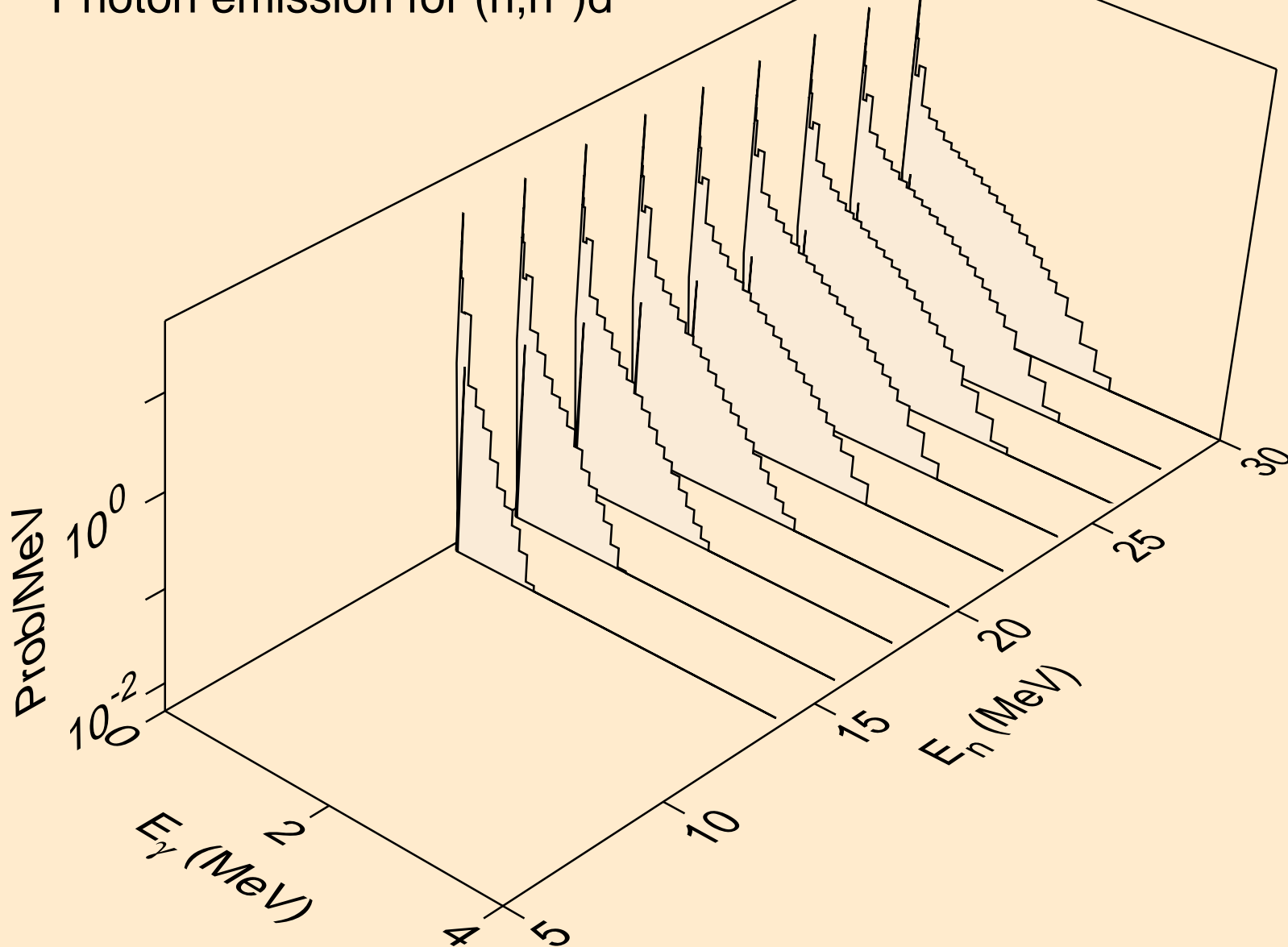

MD262 NEUTRON ACER TENDL-2019 LIBRARY; T=293.16K
Photon emission for (n,n*)t

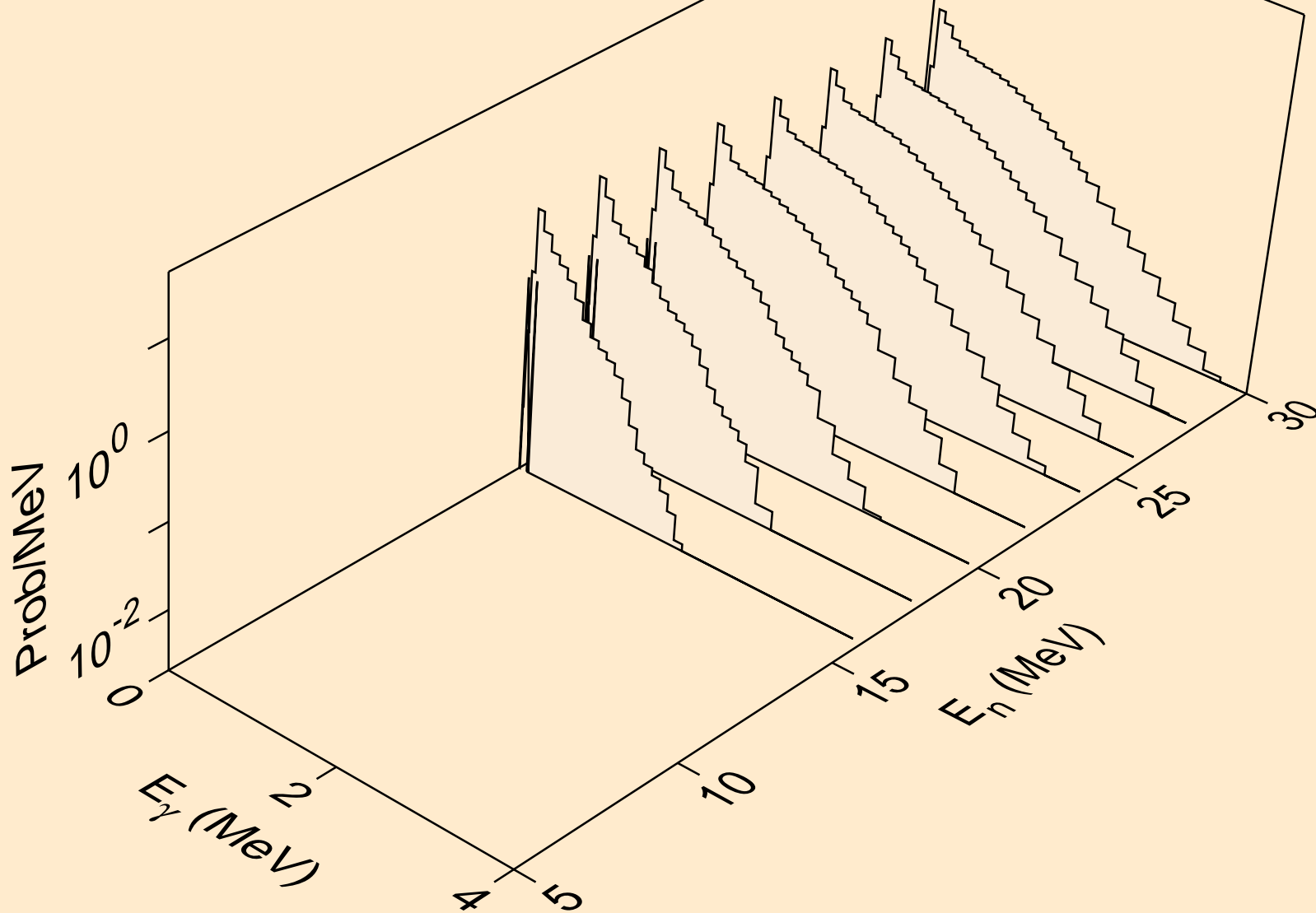

MD262 NEUTRON ACER TENDL-2019 LIBRARY; T=293.16K
Photon emission for (n,n*)he3

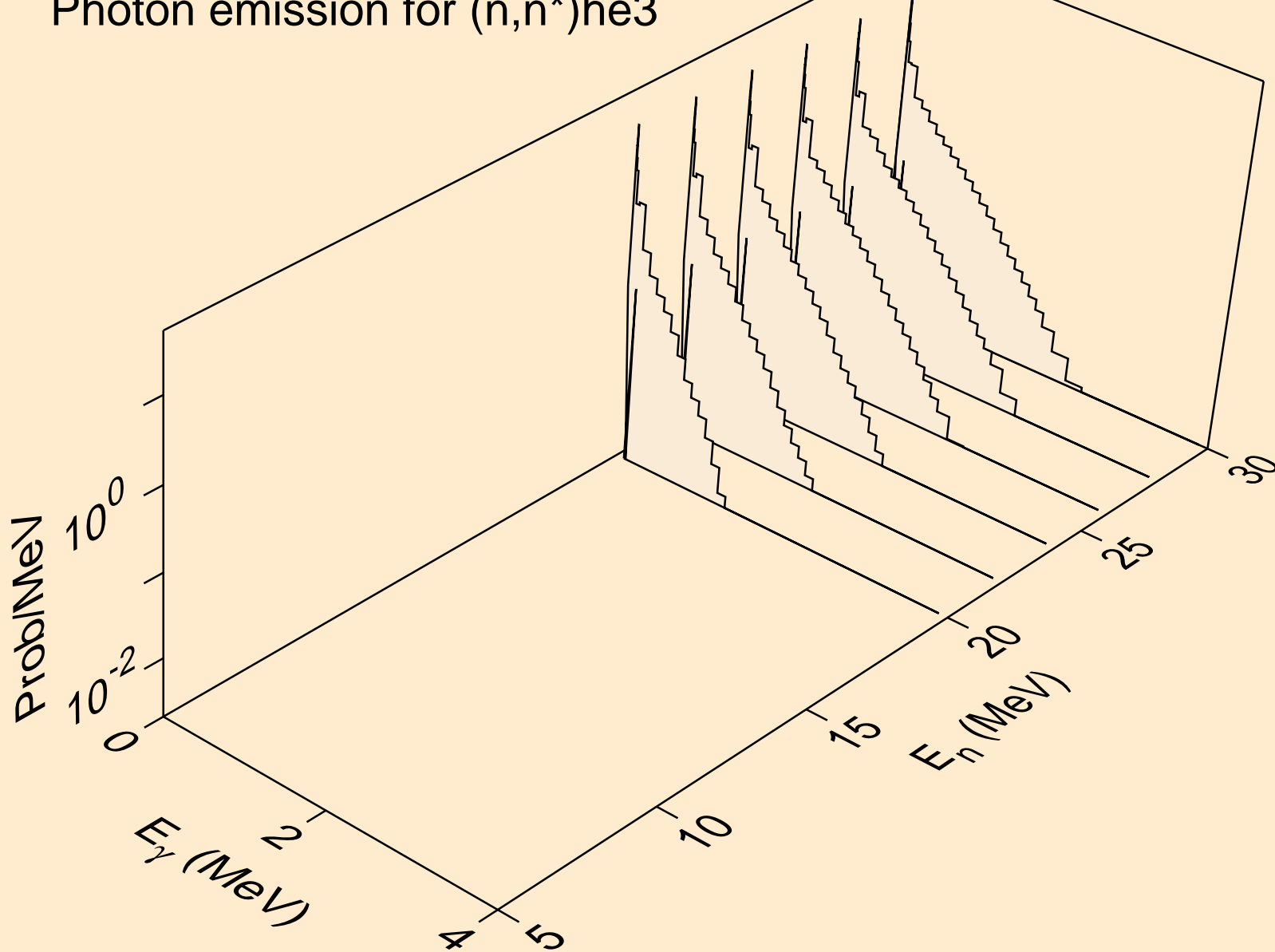

MD262 NEUTRON ACER TENDL-2019 LIBRARY; T=293.16K
Photon emission for (n,4n)

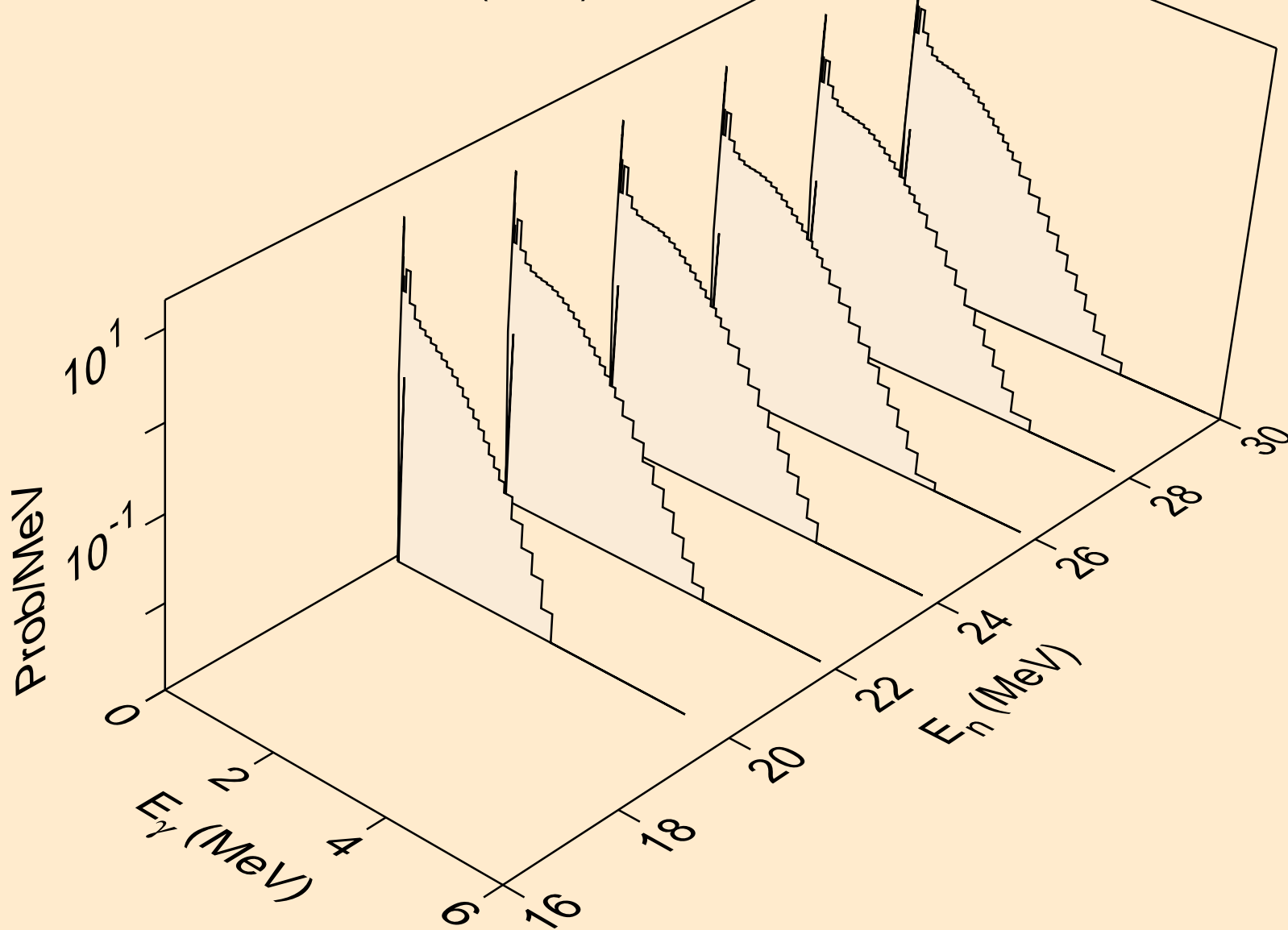

MD262 NEUTRON ACER TENDL-2019 LIBRARY; T=293.16K
Photon emission for (n,2np)

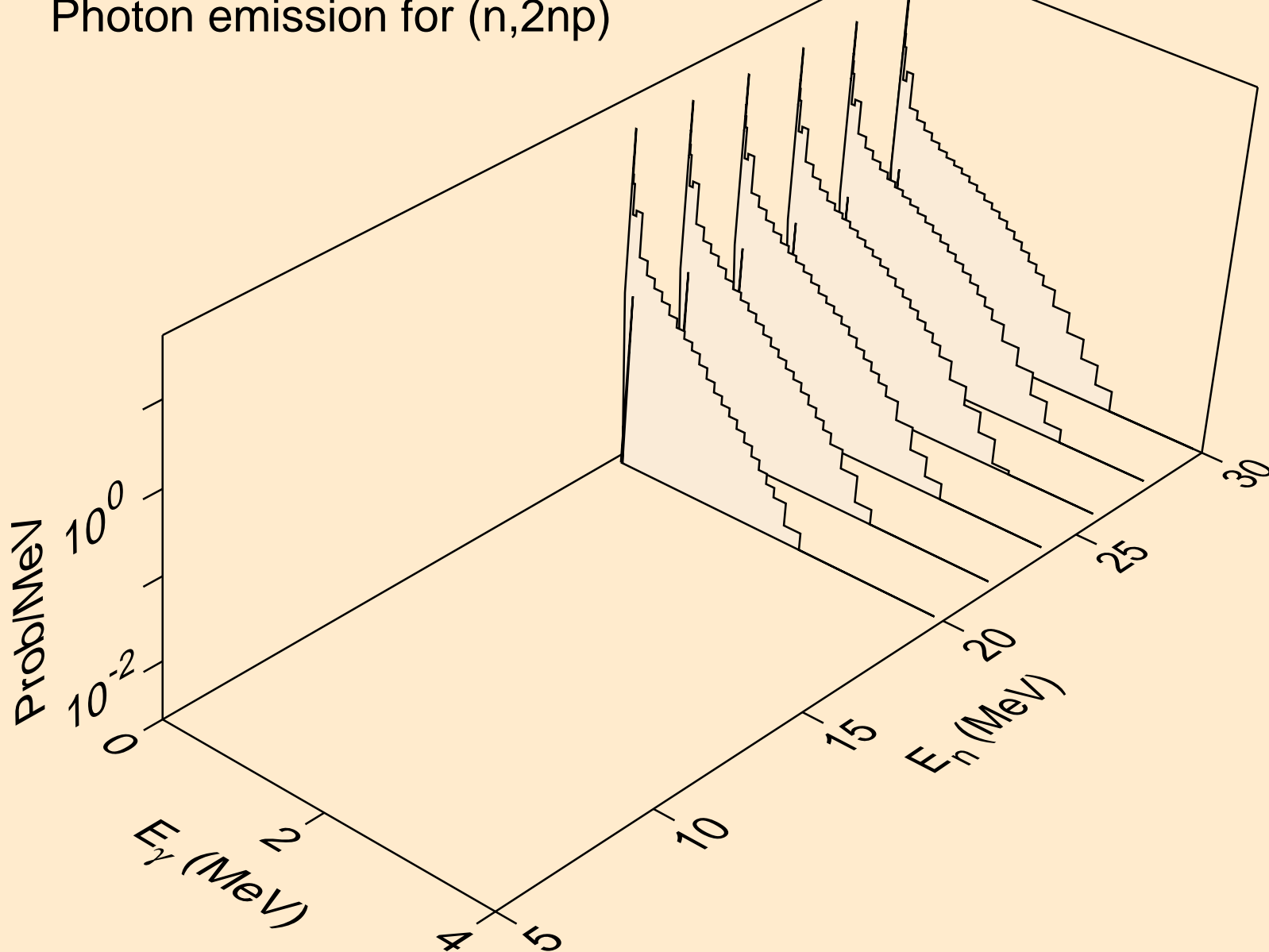

MD262 NEUTRON ACER TENDL-2019 LIBRARY; T=293.16K
Photon emission for (n,3np)

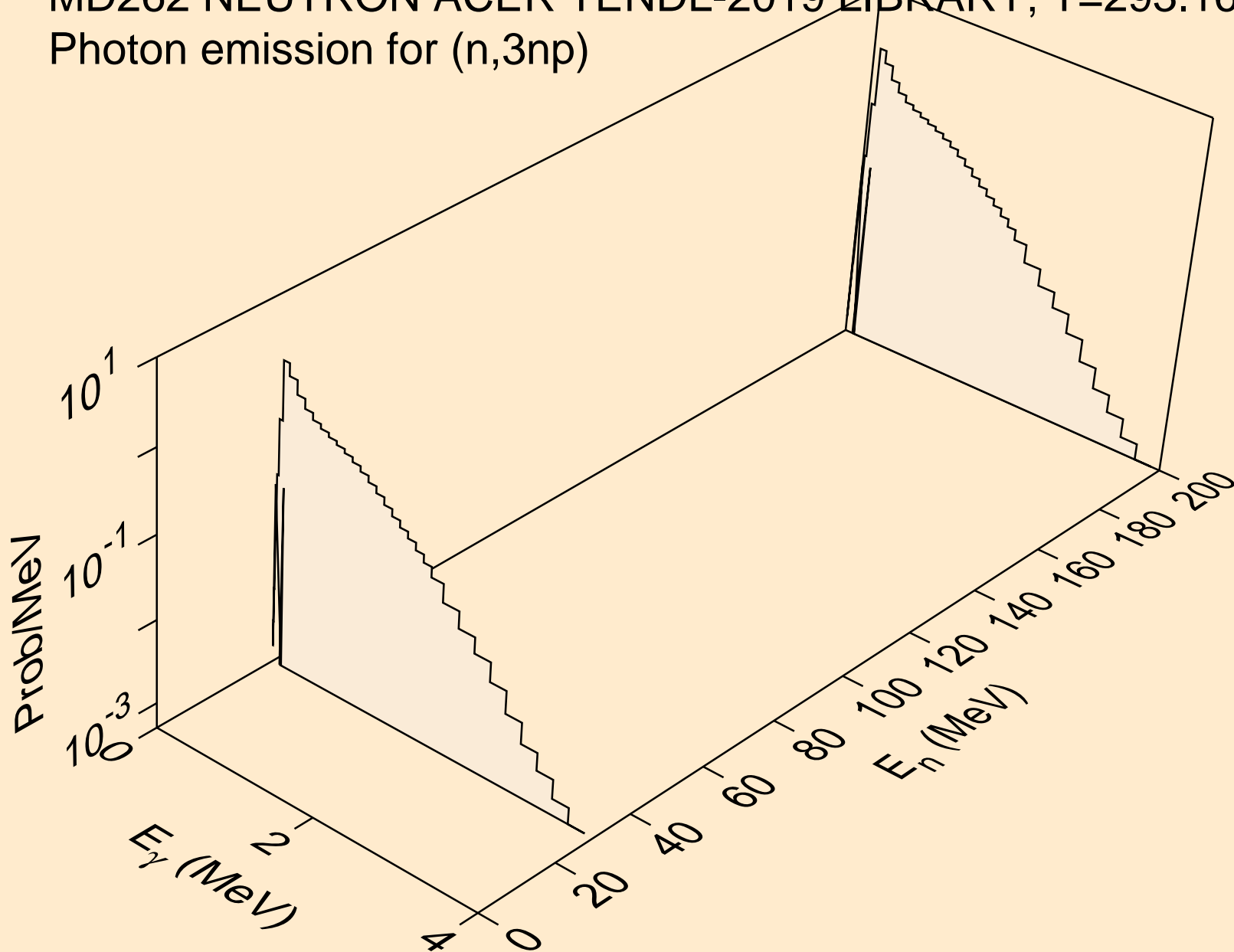

MD262 NEUTRON ACER TENDL-2019 LIBRARY; T=293.16K
Photon emission for (n,n*c)

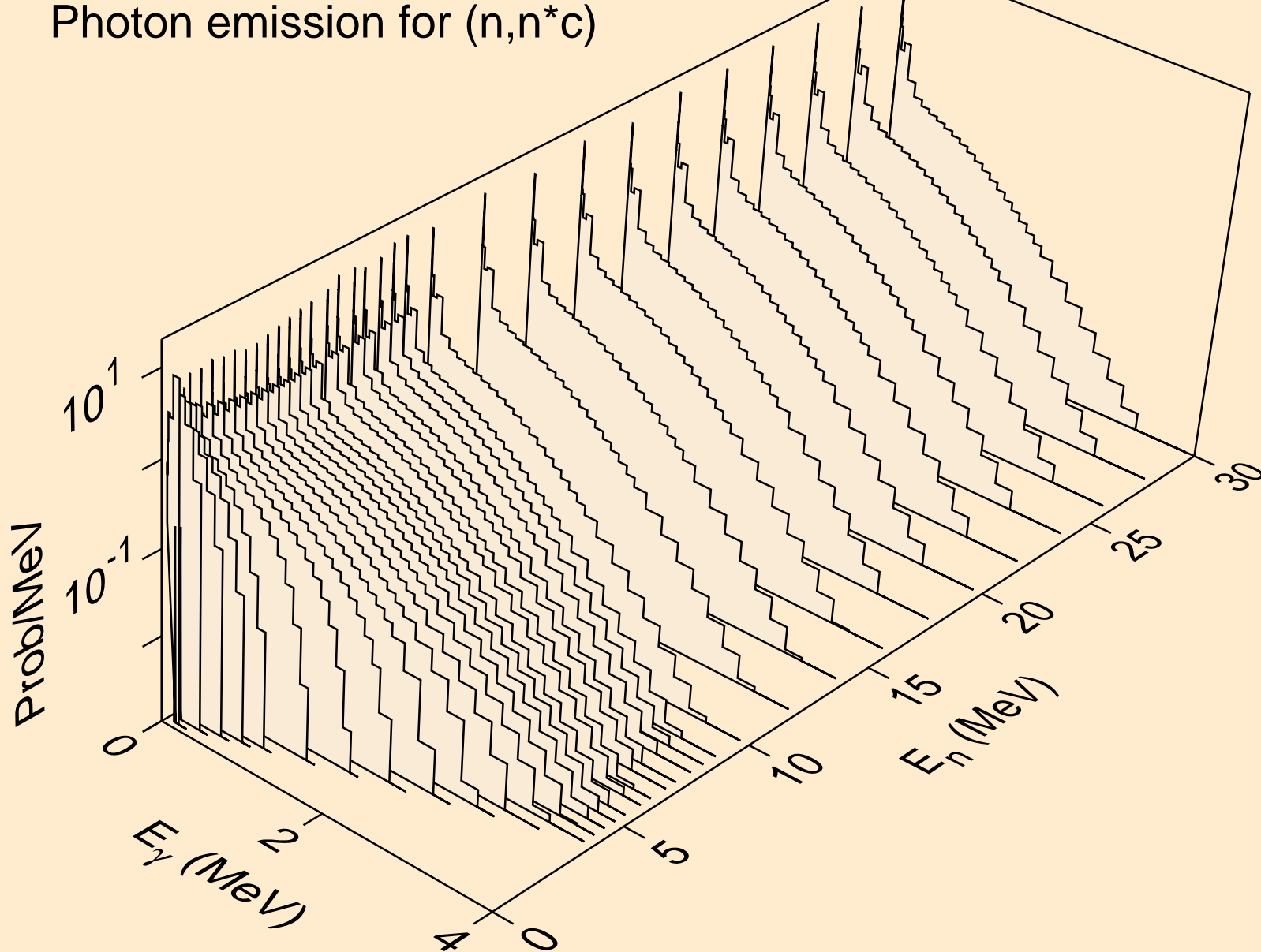

MD262 NEUTRON ACER TENDL-2019 LIBRARY; T=293.16K
Photon emission for (n,gma)

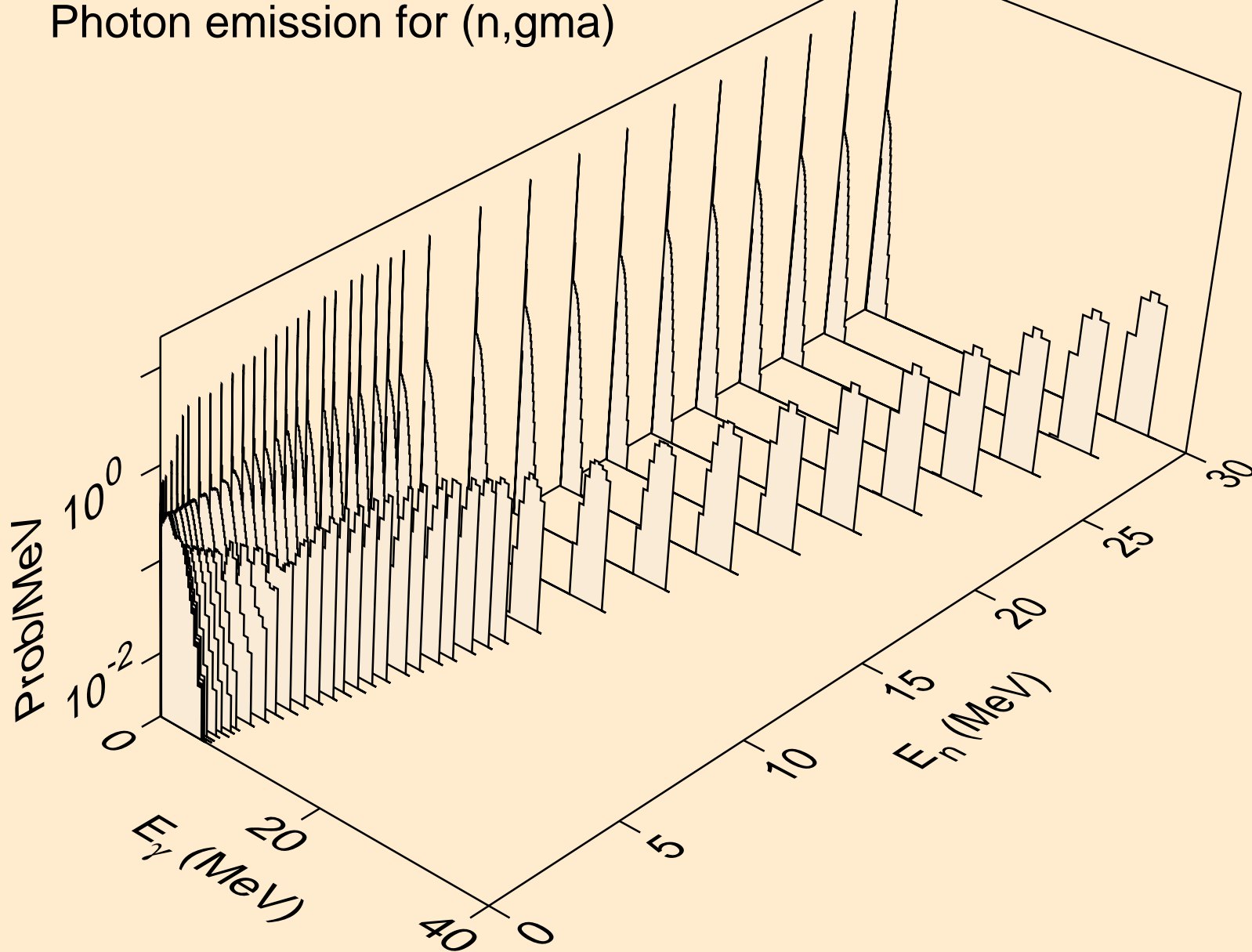

MD262 NEUTRON ACER TENDL-2019 LIBRARY; T=293.16K
Photon emission for (n,p)

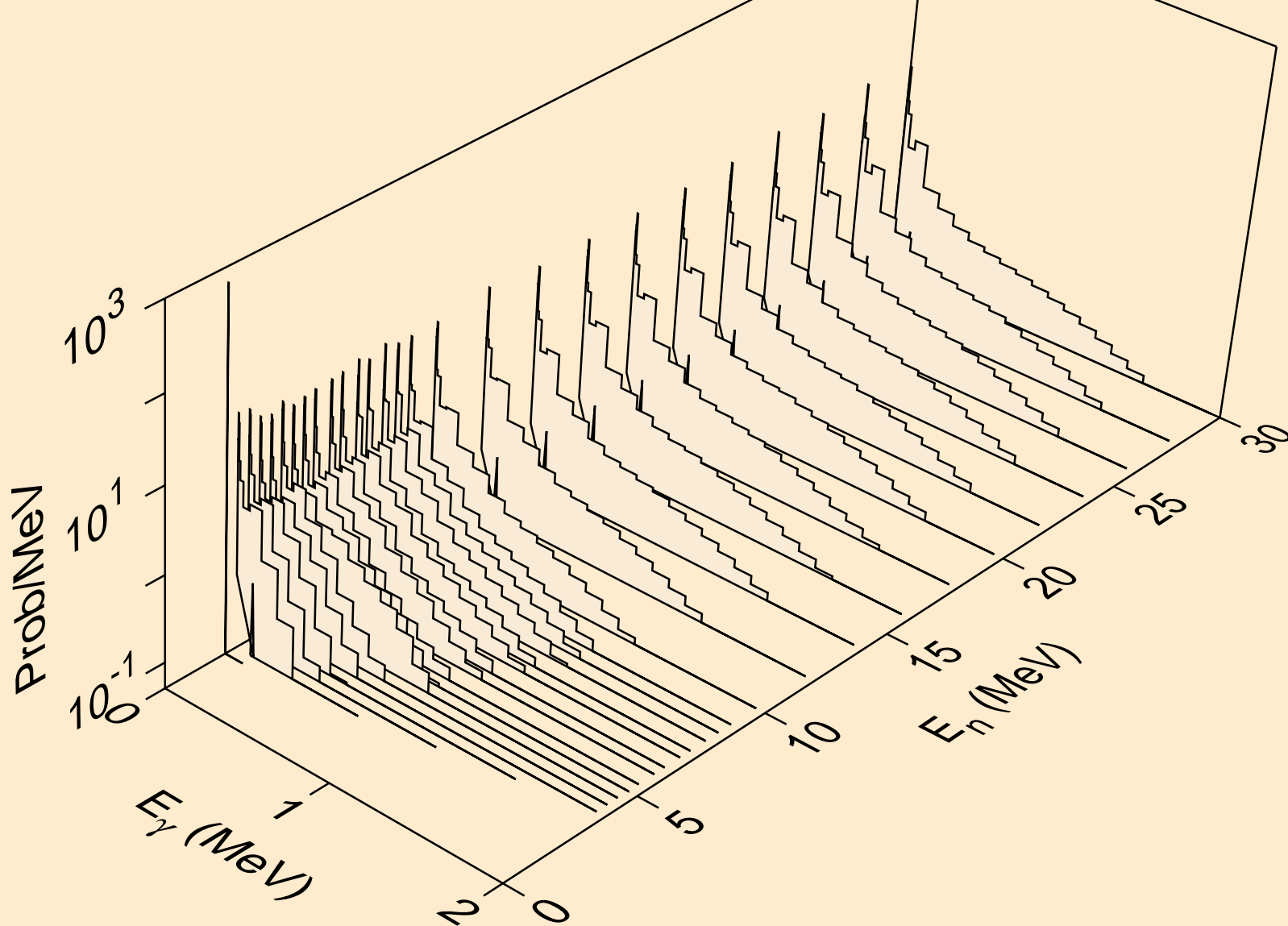

MD262 NEUTRON ACER TENDL-2019 LIBRARY; T=293.16K
Photon emission for (n,d)

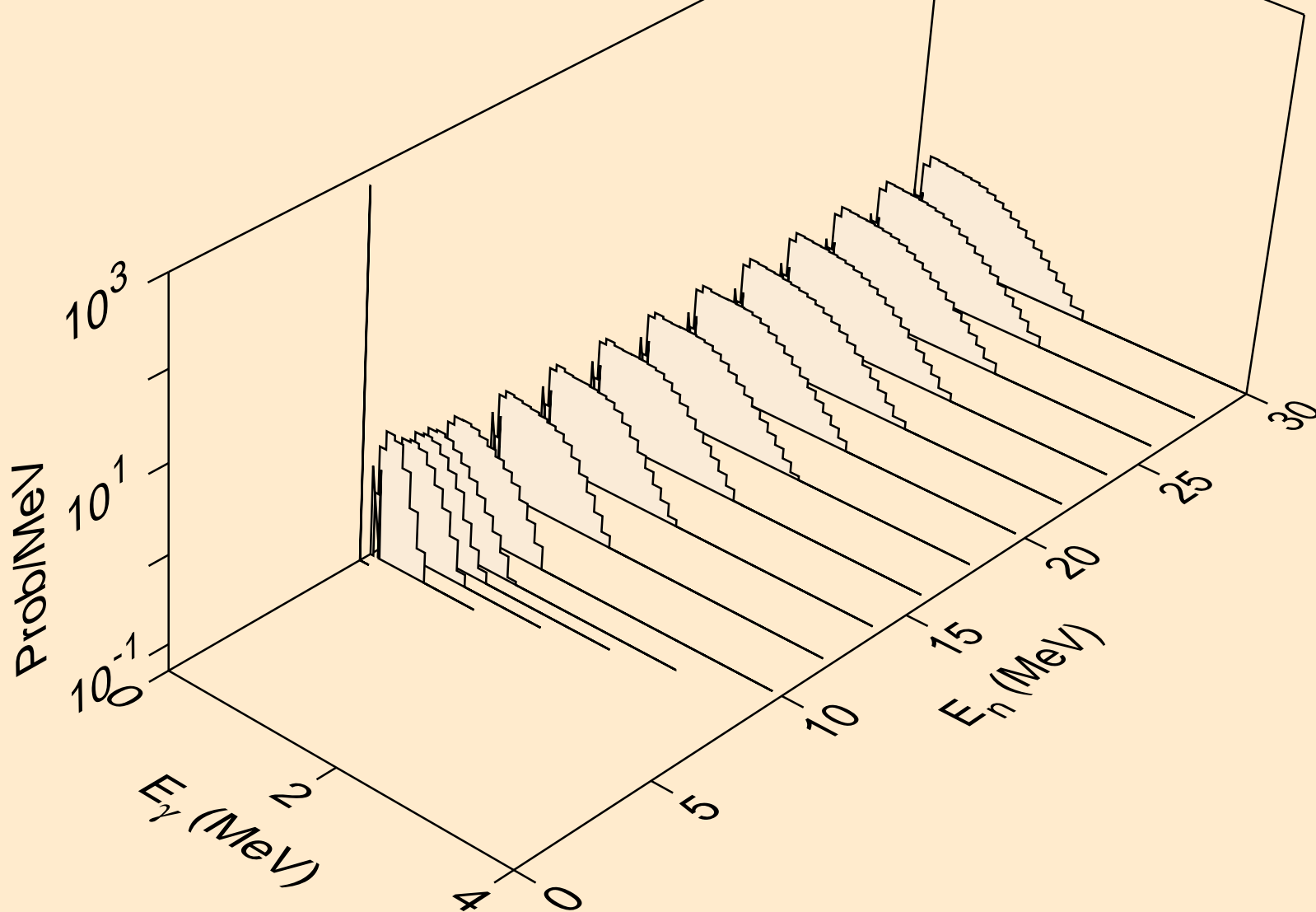

MD262 NEUTRON ACER TENDL-2019 LIBRARY; T=293.16K
Photon emission for (n,t)

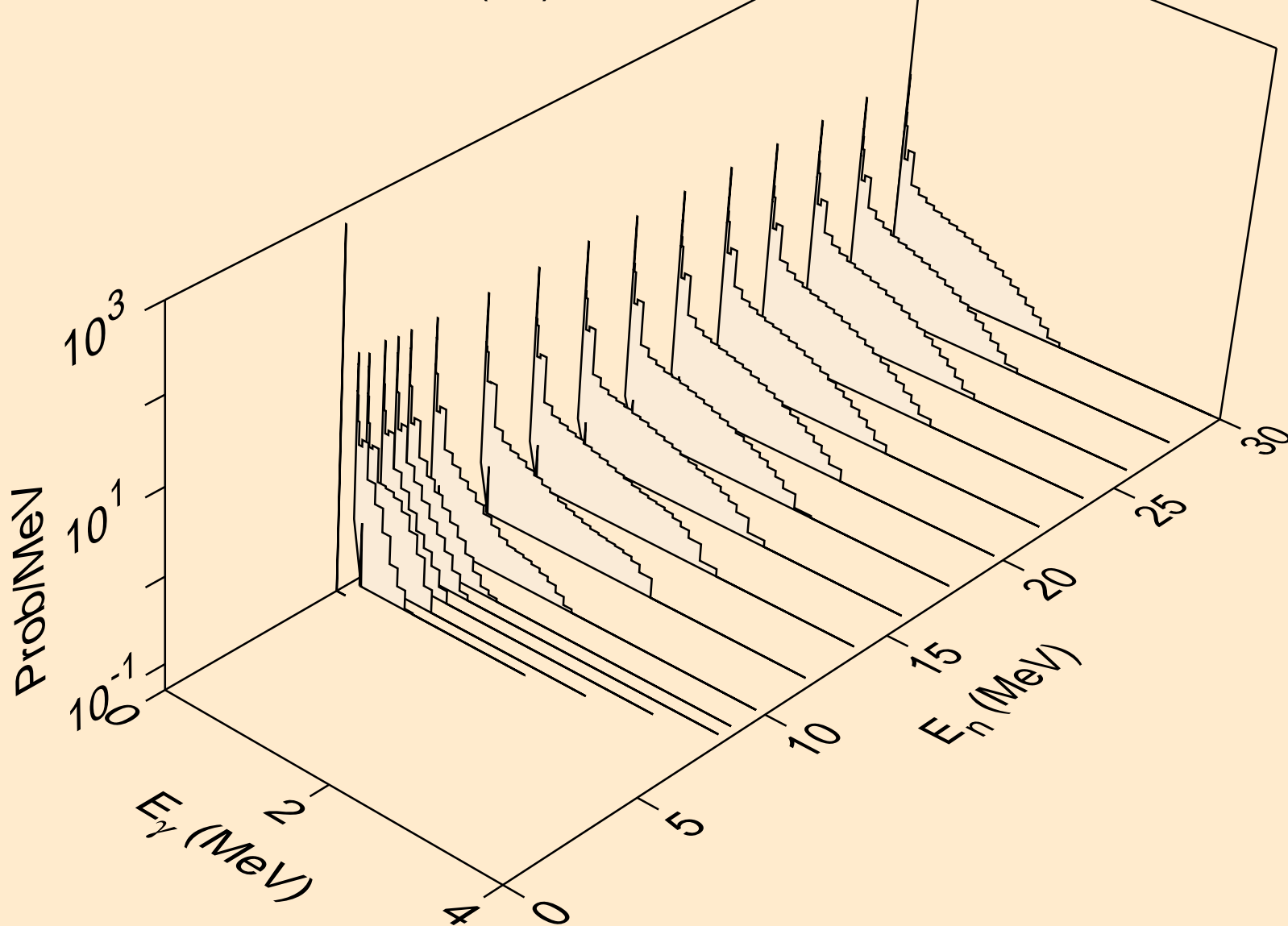

MD262 NEUTRON ACER TENDL-2019 LIBRARY; T=293.16K
Photon emission for (n,he3)

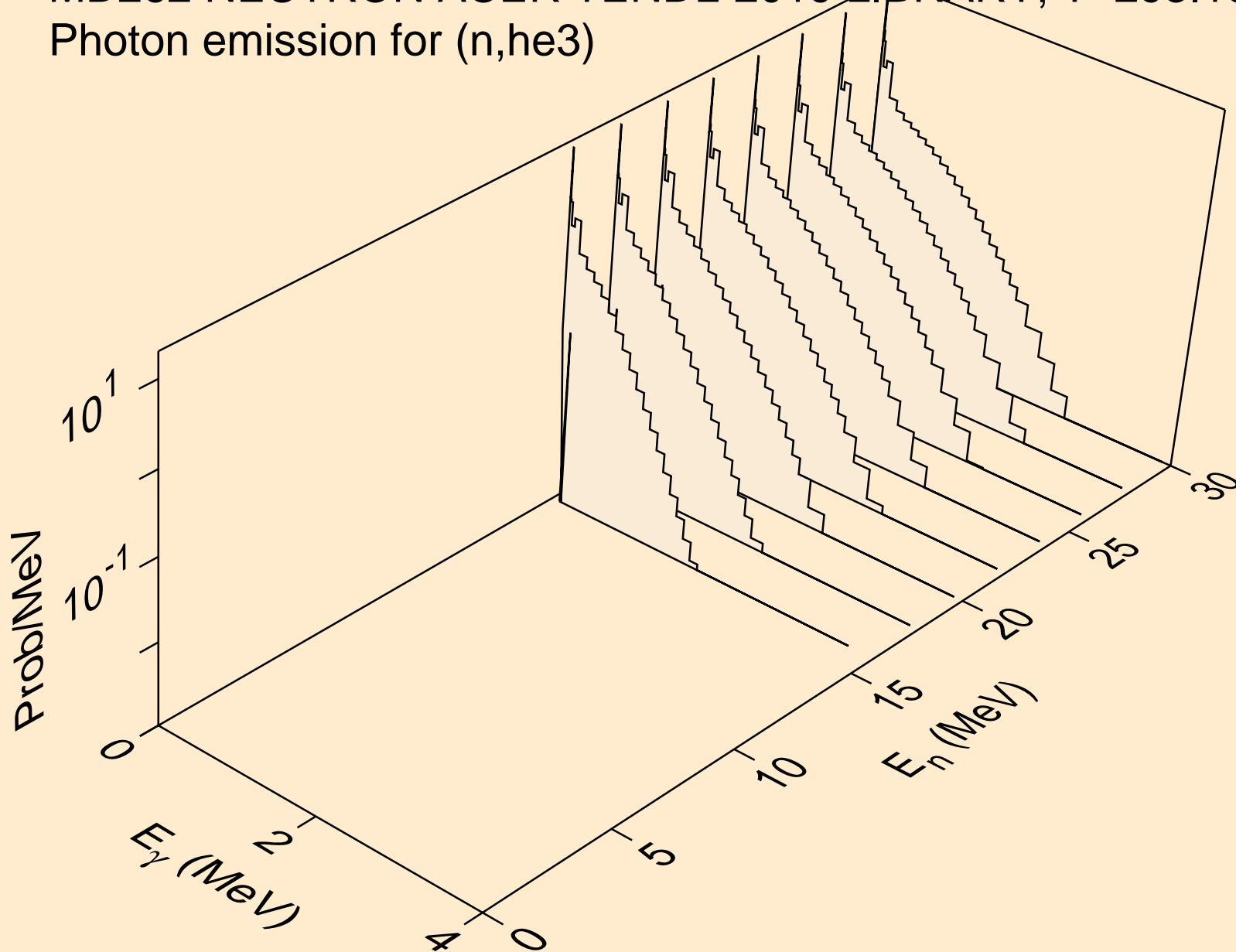

MD262 NEUTRON ACER TENDL-2019 LIBRARY; T=293.16K
Photon emission for (n,a)

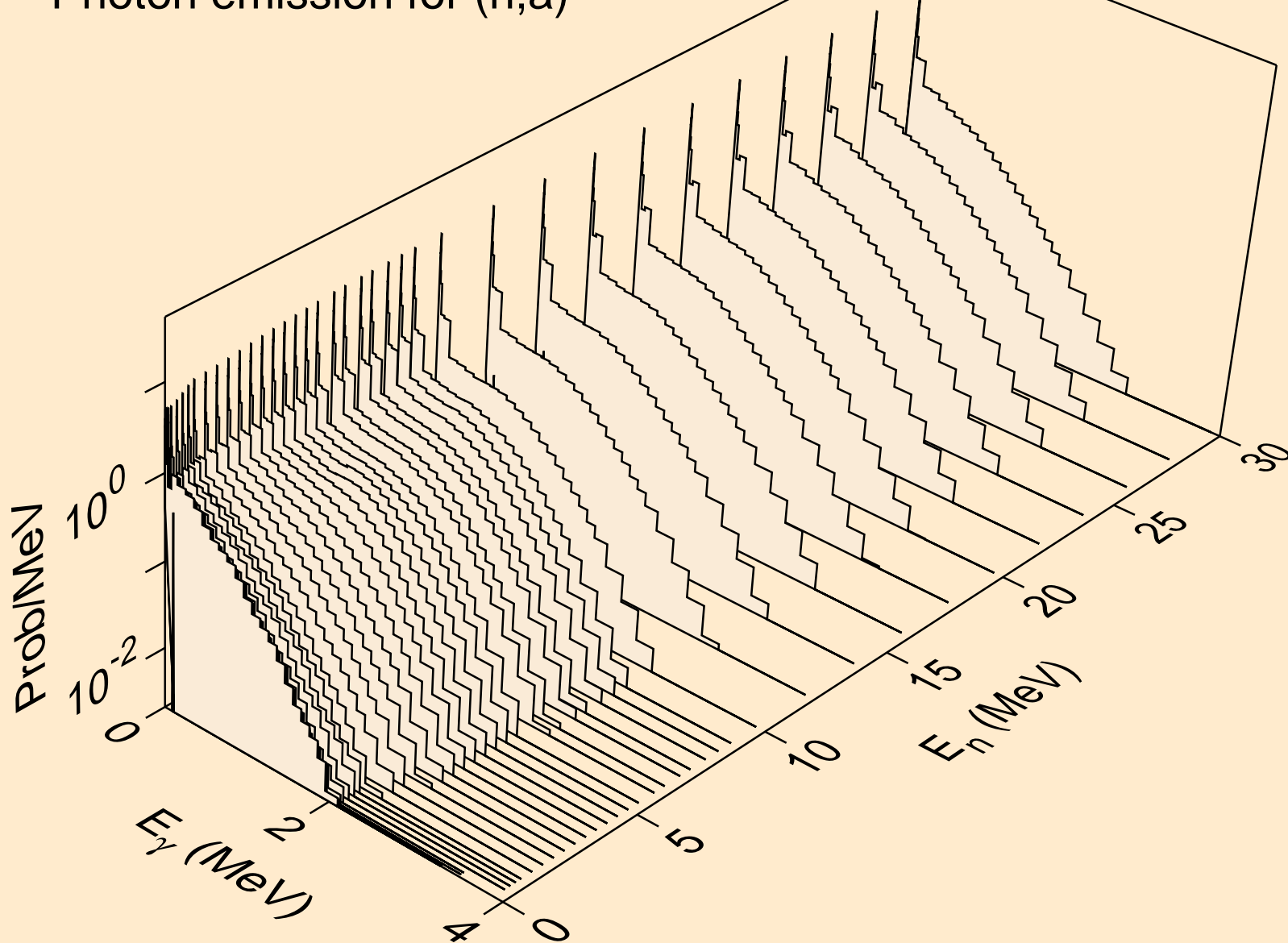

MD262 NEUTRON ACER TENDL-2019 LIBRARY; T=293.16K
Photon emission for (n,2p)

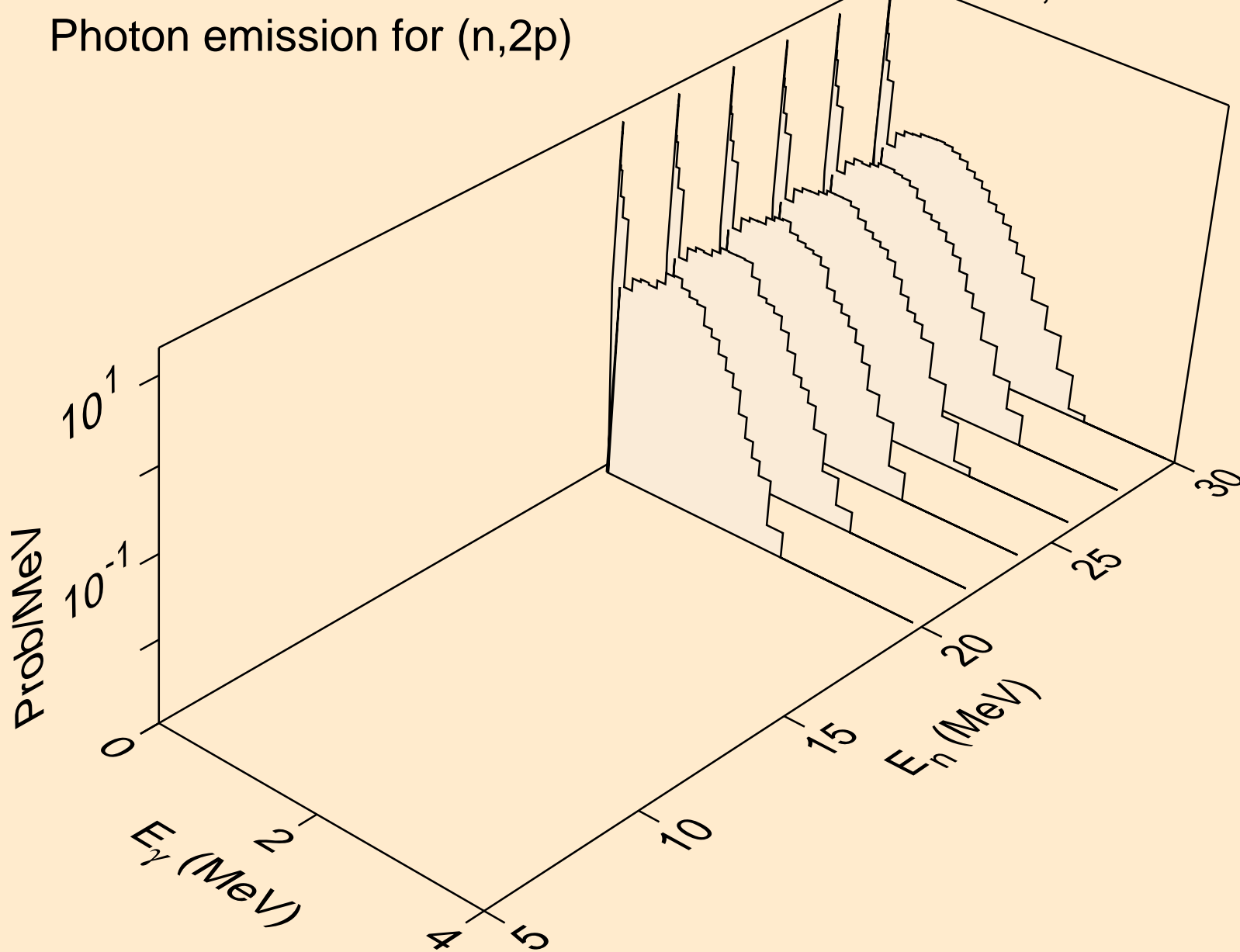

MD262 NEUTRON ACER TENDL-2019 LIBRARY; T=293.16K
thermal capture photon spectrum

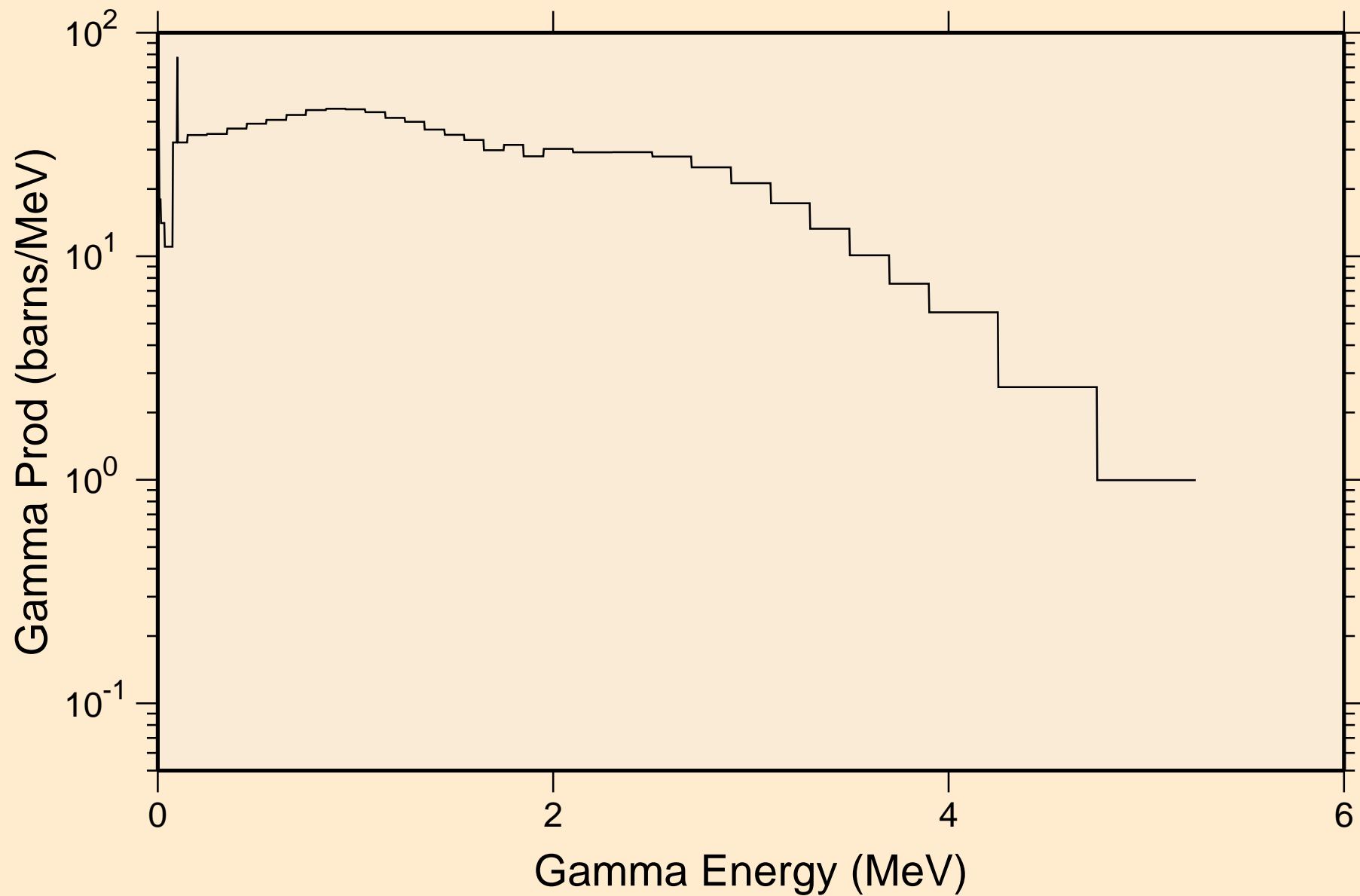

MD262 NEUTRON ACER TENDL-2019 LIBRARY; T=293.16K
14 MeV photon spectrum

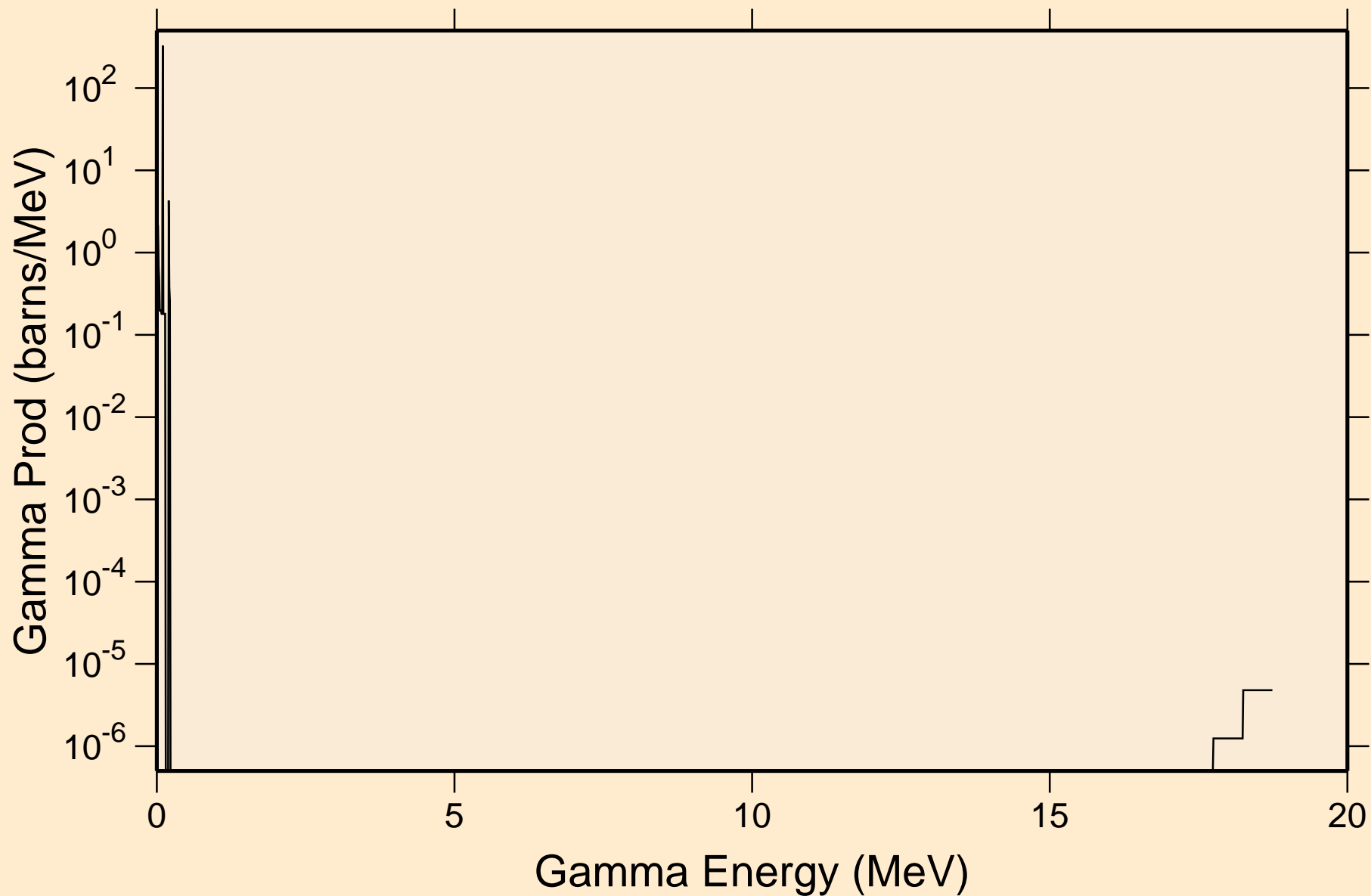

MD262 NEUTRON ACER TENDL-2019 LIBRARY; T=293.16K
Particle heating contributions

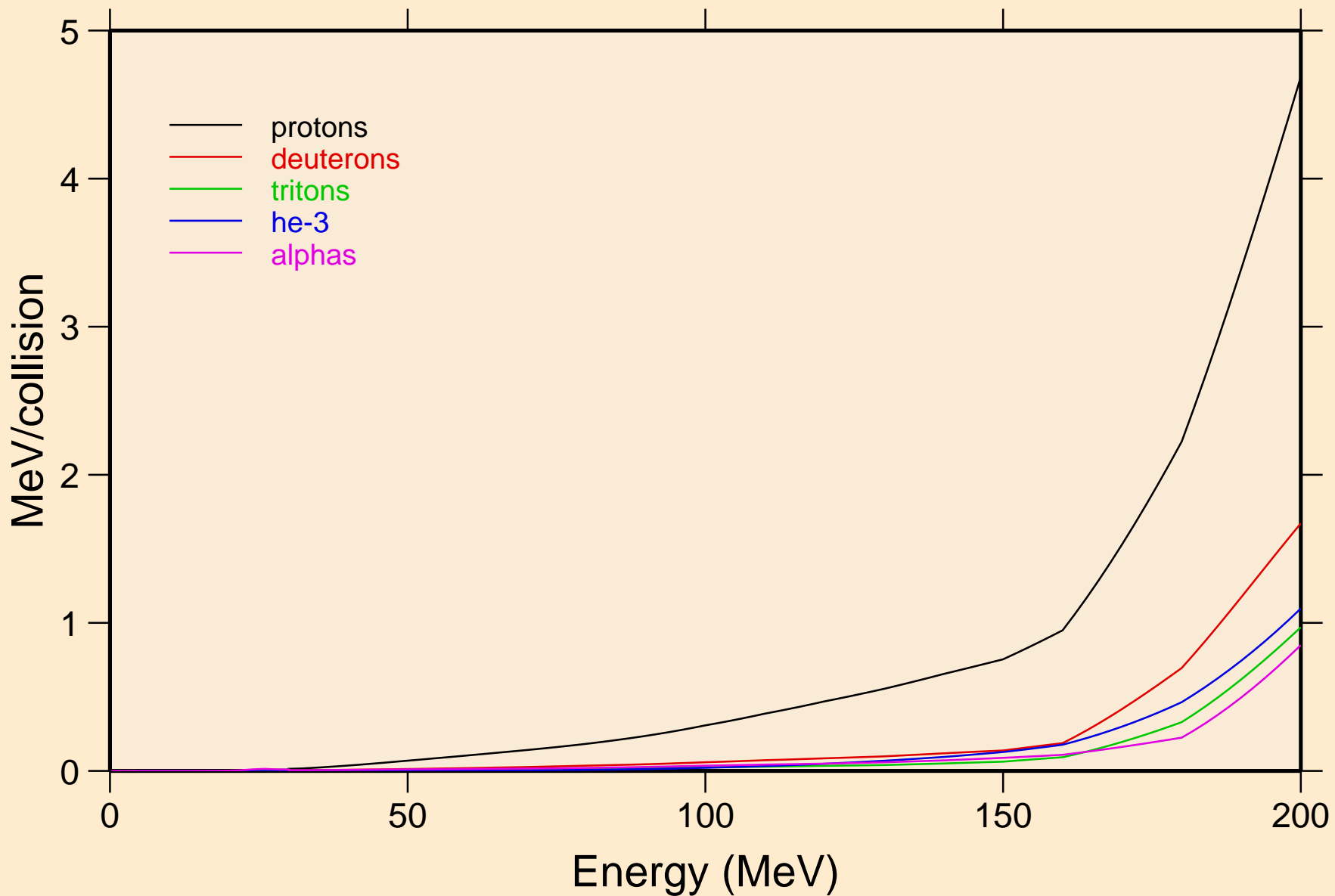

MD262 NEUTRON ACER TENDL-2019 LIBRARY; T=293.16K
Recoil Heating

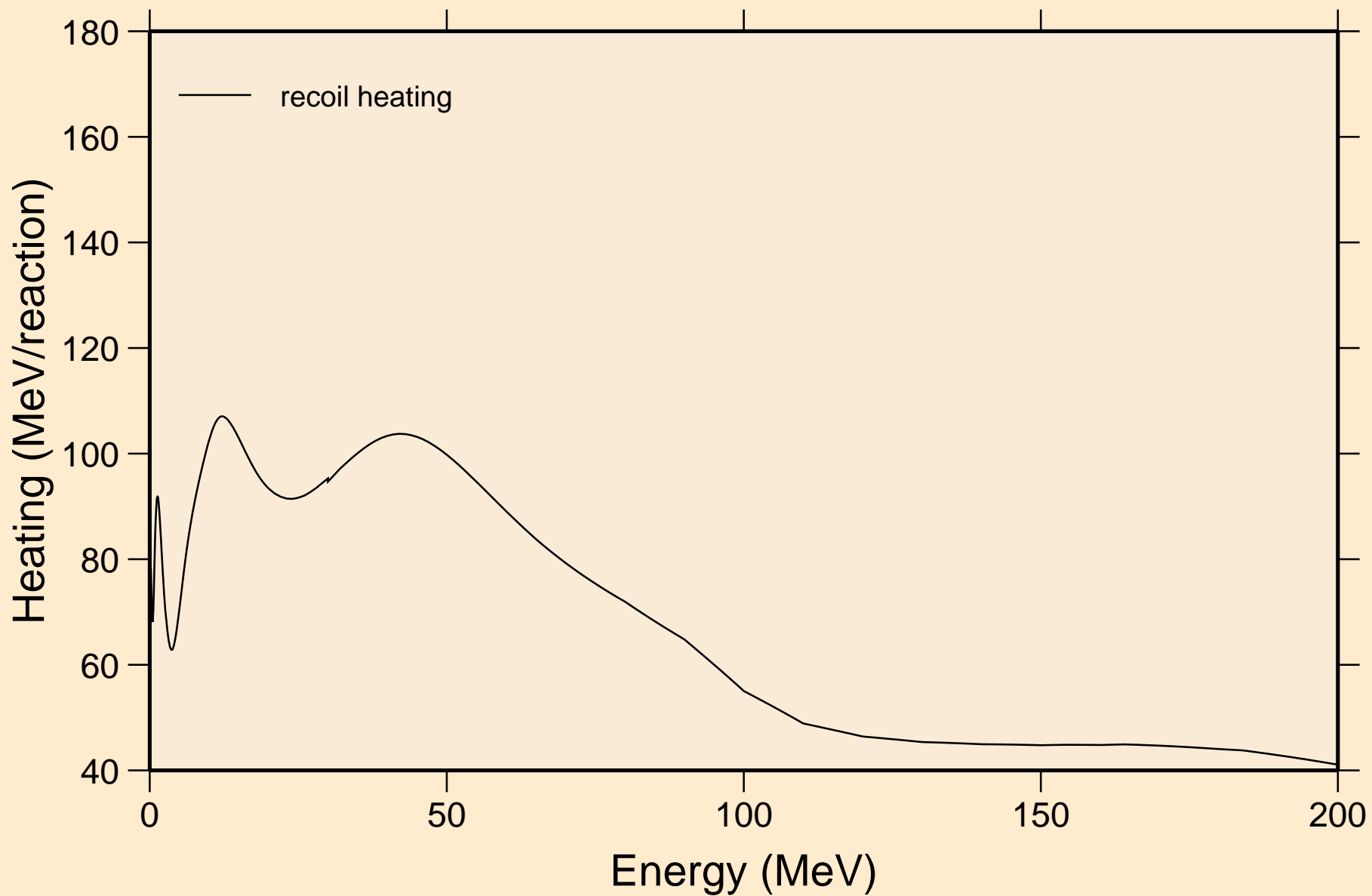

MD262 NEUTRON ACER TENDL-2019 LIBRARY; T=293.16K
Particle production cross sections

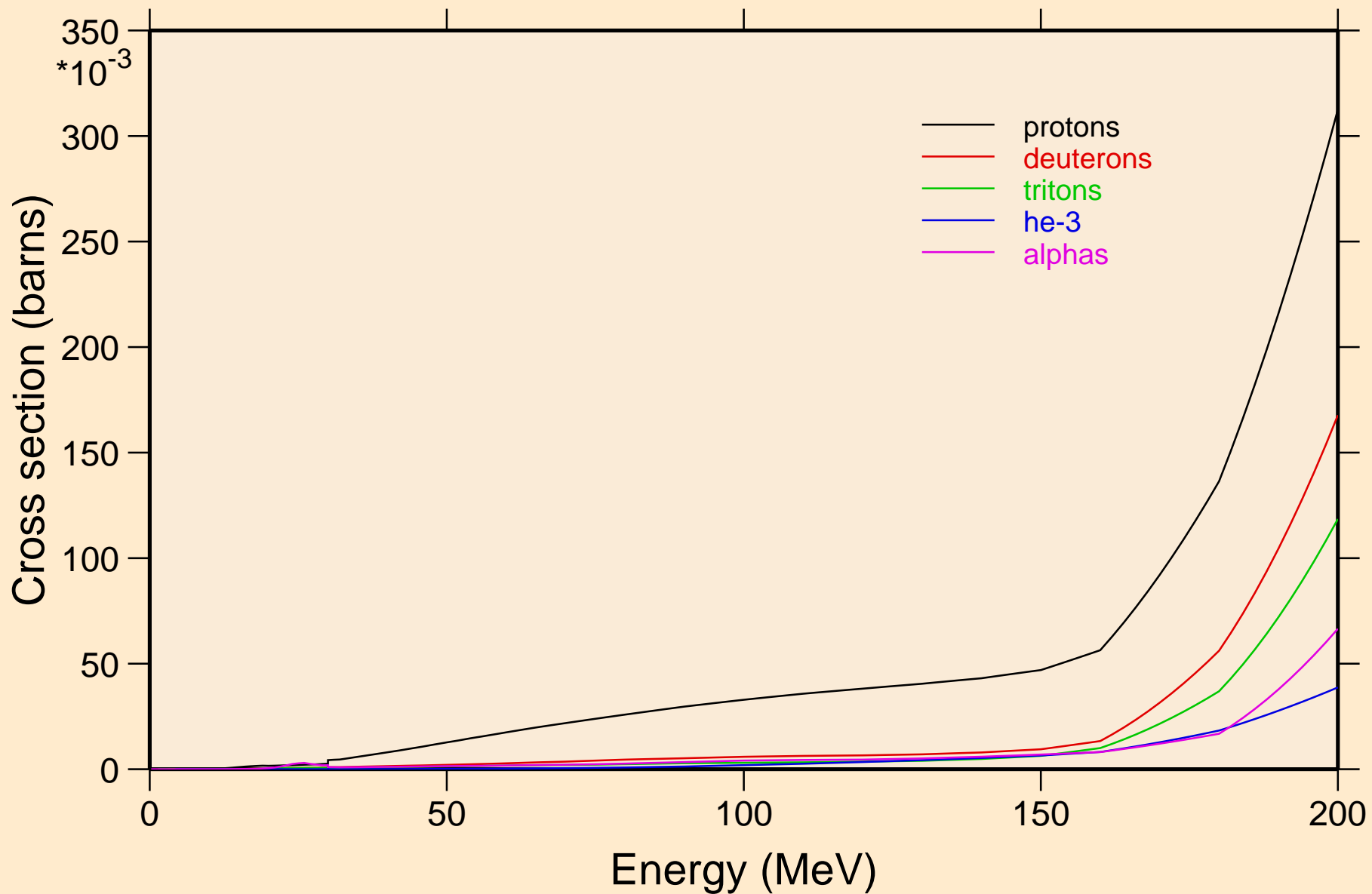

MD262 NEUTRON ACER TENDL-2019 LIBRARY; T=293.16K
protons from (n,x)

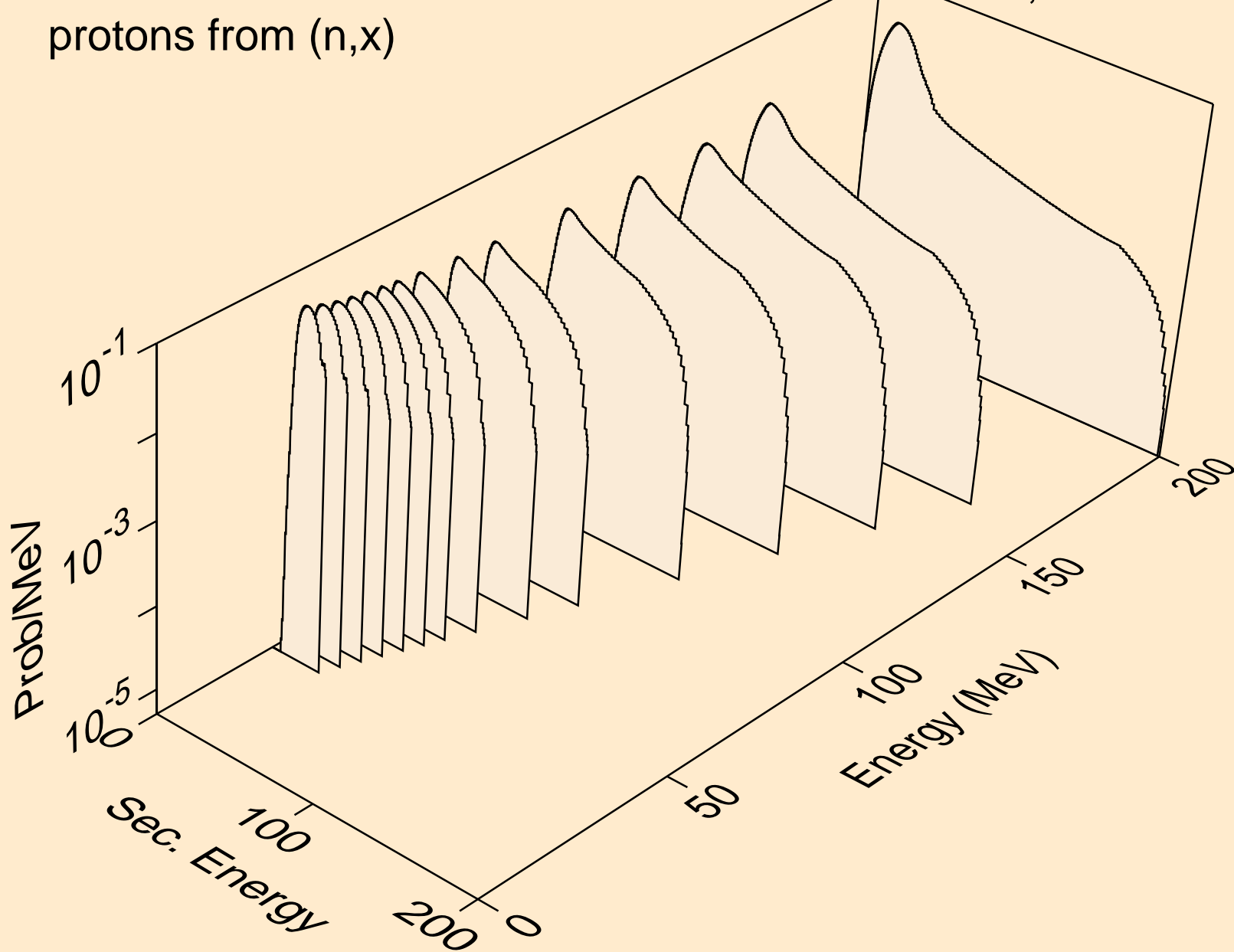

MD262 NEUTRON ACER TENDL-2019 LIBRARY; T=293.16K
protons from (n,n*)p

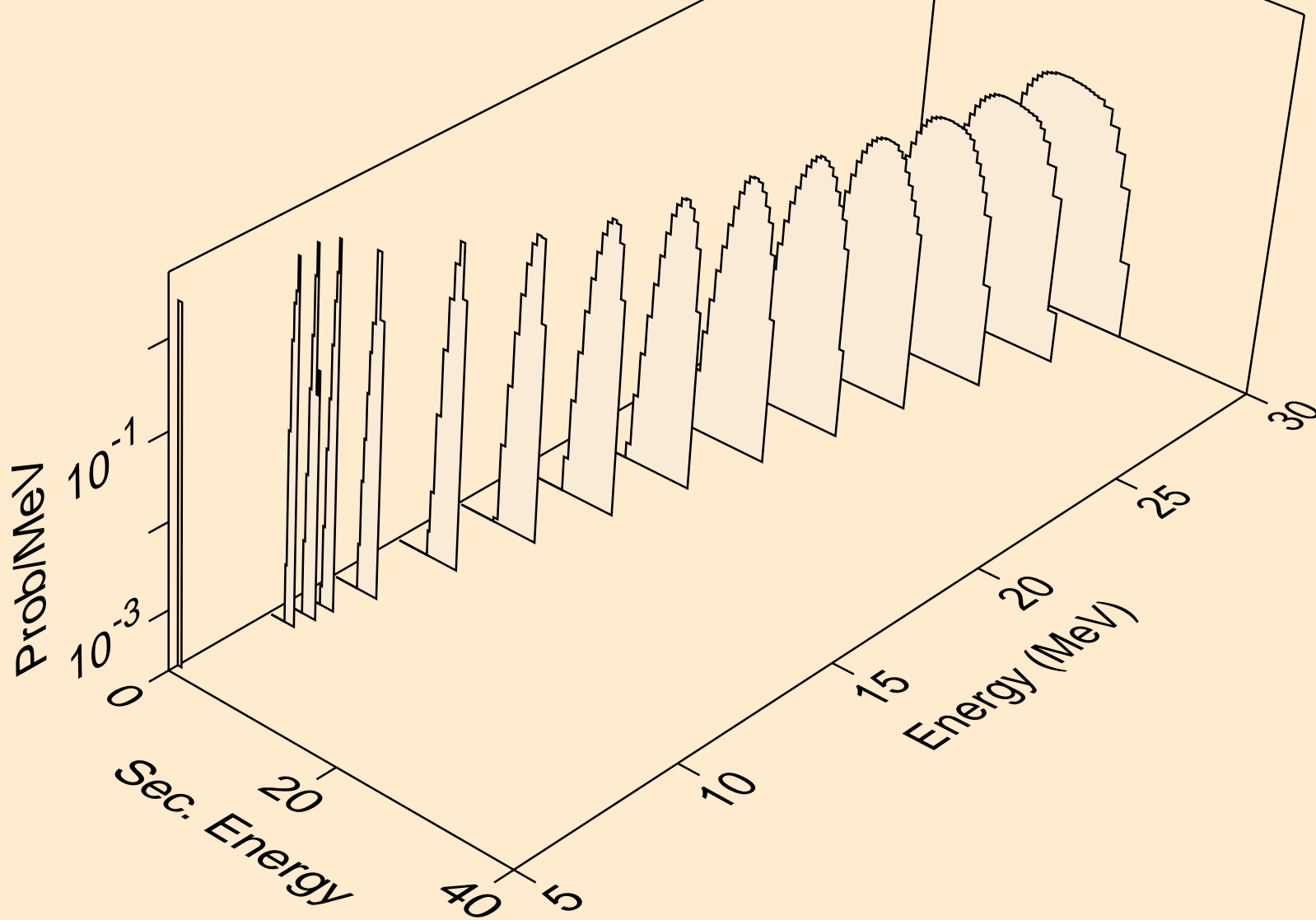

MD262 NEUTRON ACER TENDL-2019 LIBRARY; T=293.16K
protons from (n,2np)

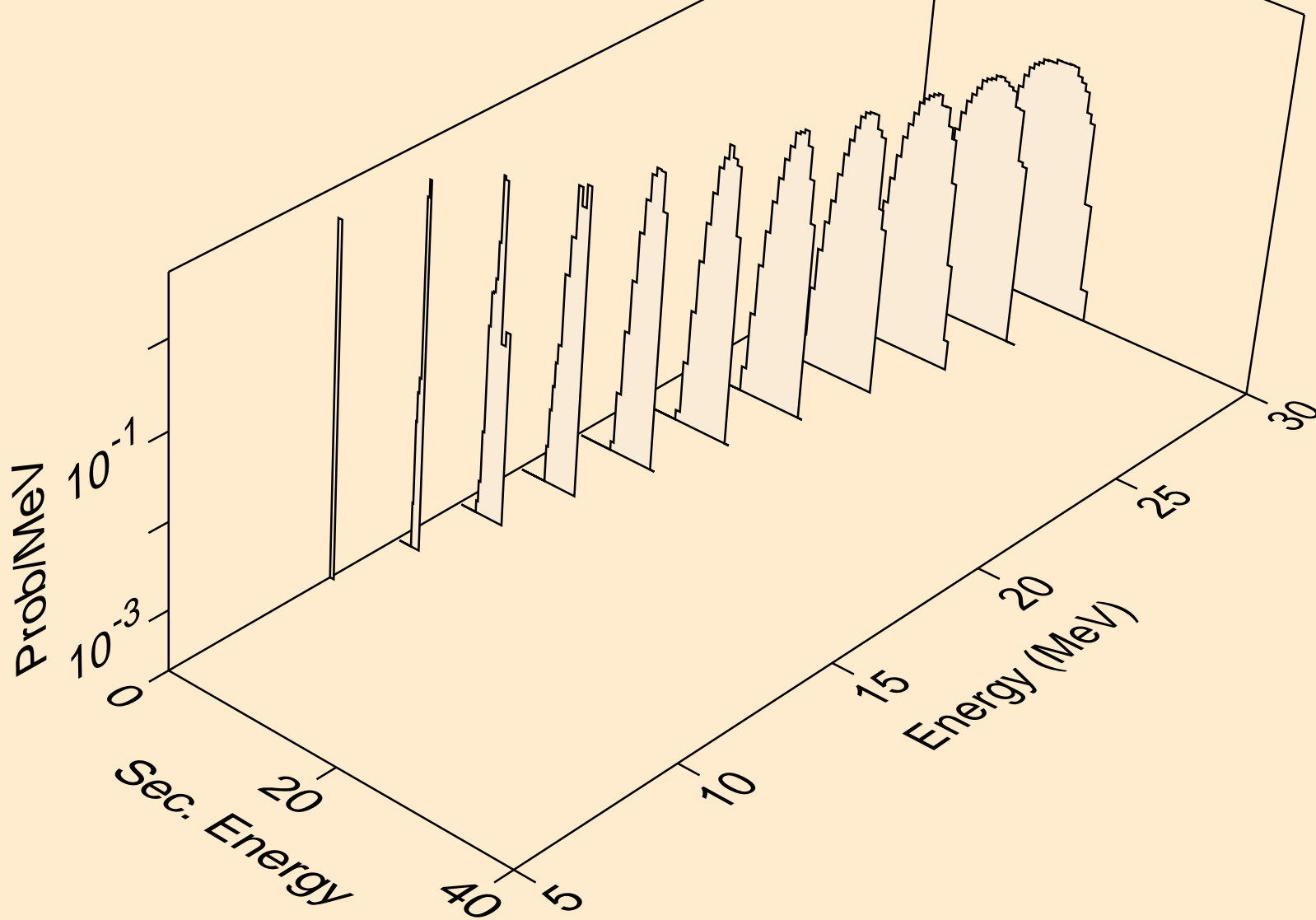

MD262 NEUTRON ACER TENDL-2019 LIBRARY; T=293.16K
protons from (n,3np)

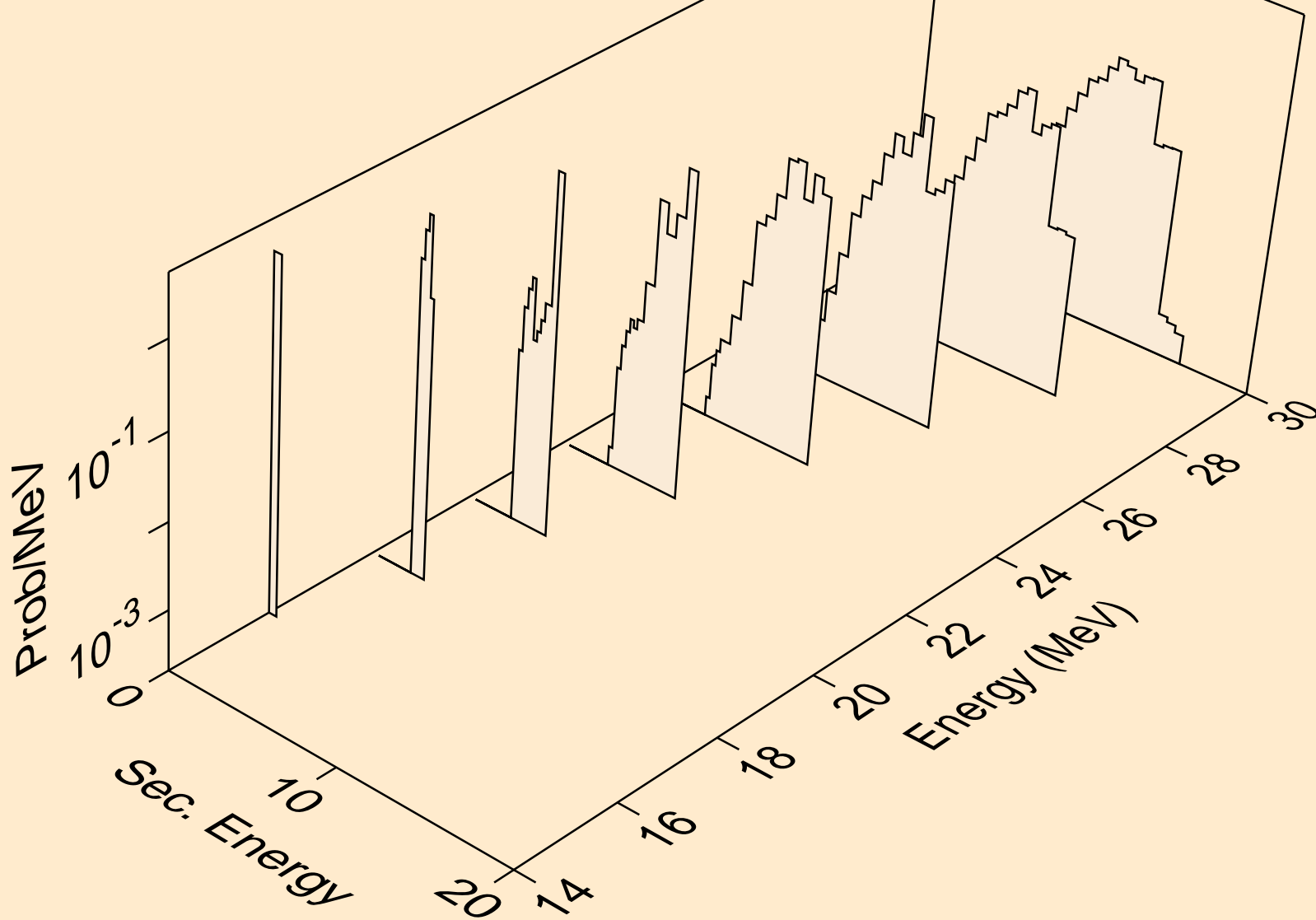

MD262 NEUTRON ACER TENDL-2019 LIBRARY; T=293.16K
protons from (n,p)

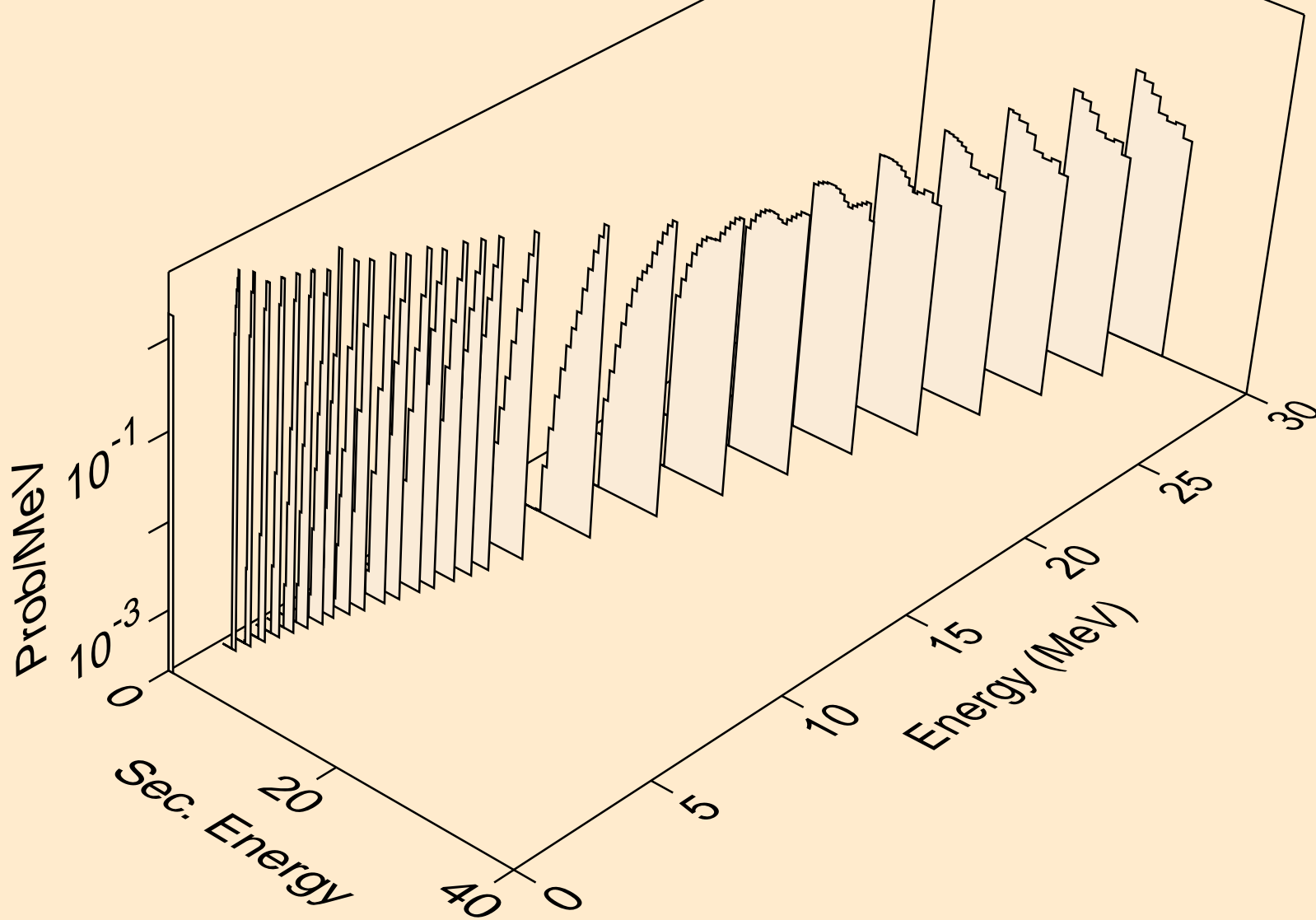

MD262 NEUTRON ACER TENDL-2019 LIBRARY; T=293.16K
protons from (n,2p)

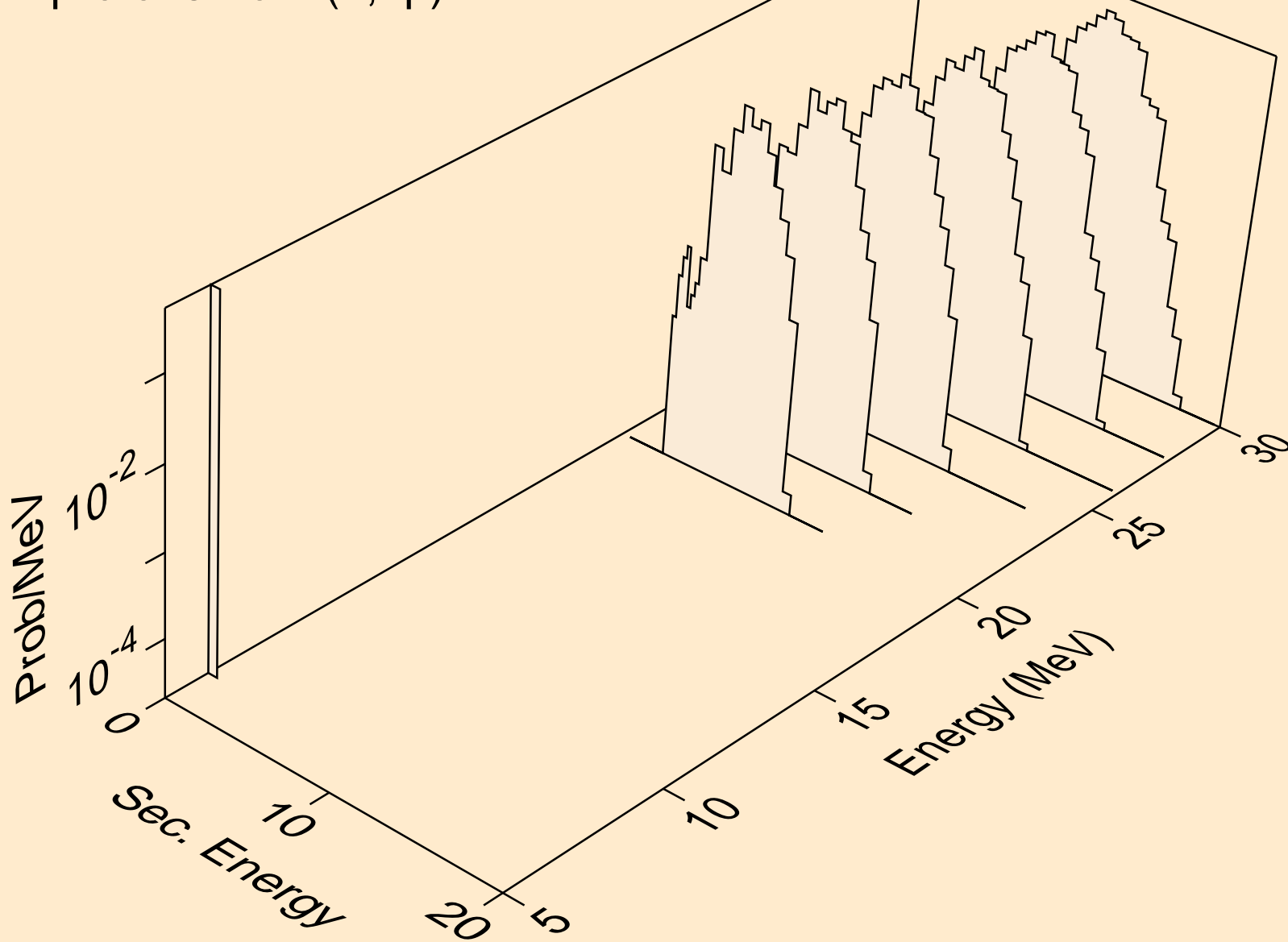

MD262 NEUTRON ACER TENDL-2019 LIBRARY; T=293.16K
deuterons from (n,x)

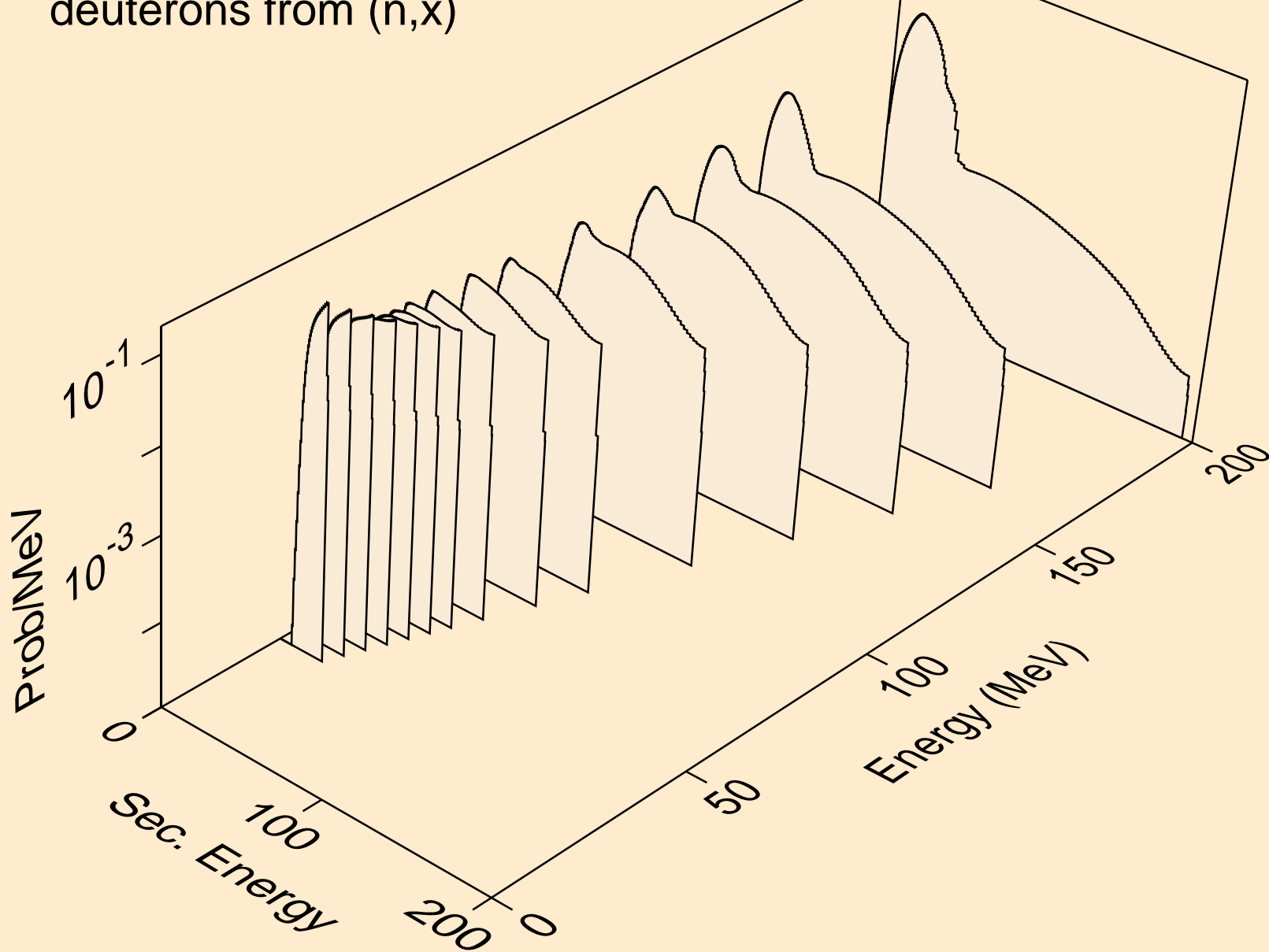

MD262 NEUTRON ACER TENDL-2019 LIBRARY; T=293.16K
deuterons from (n,2nd)

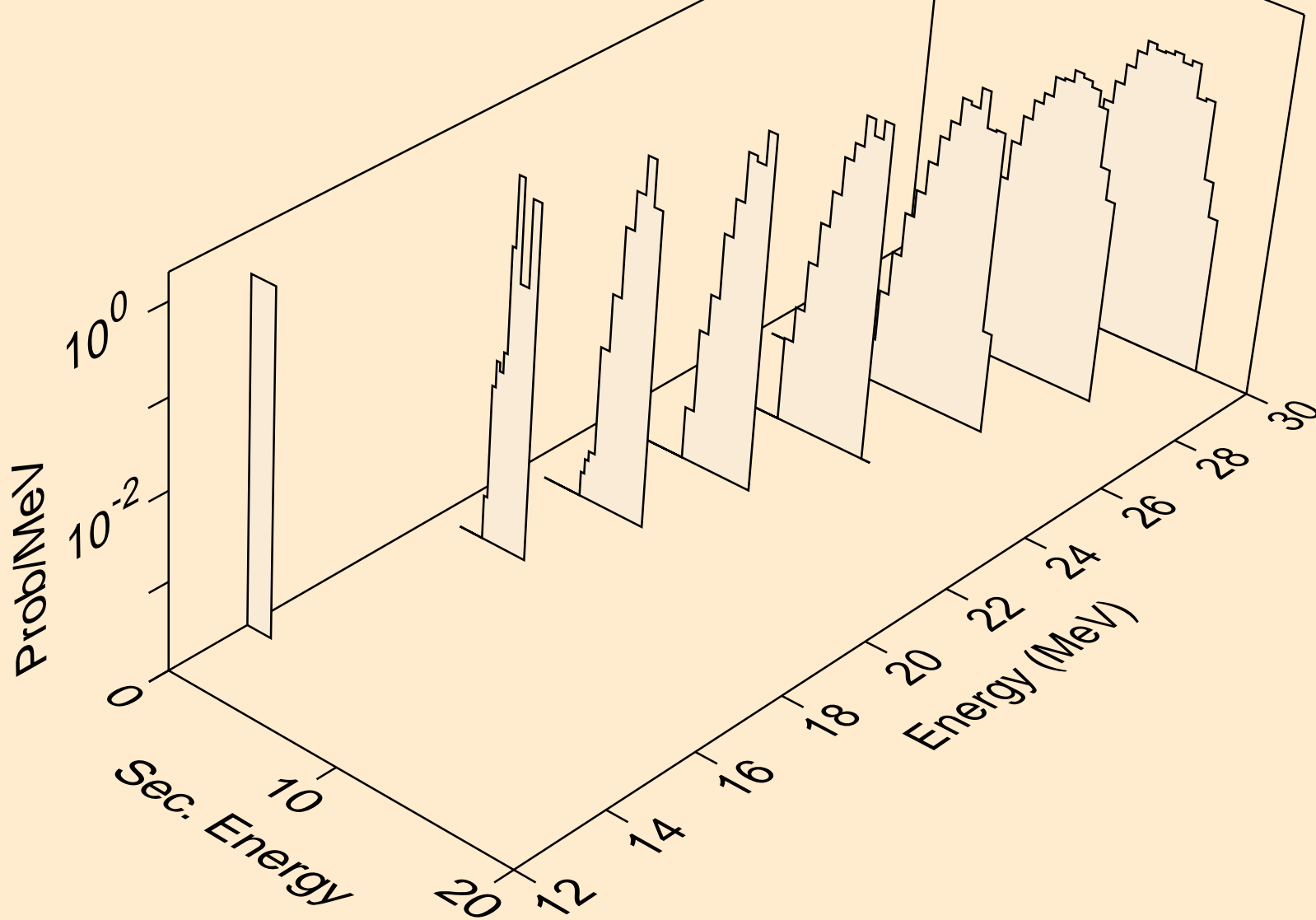

MD262 NEUTRON ACER TENDL-2019 LIBRARY; T=293.16K
deuterons from (n,n*)d

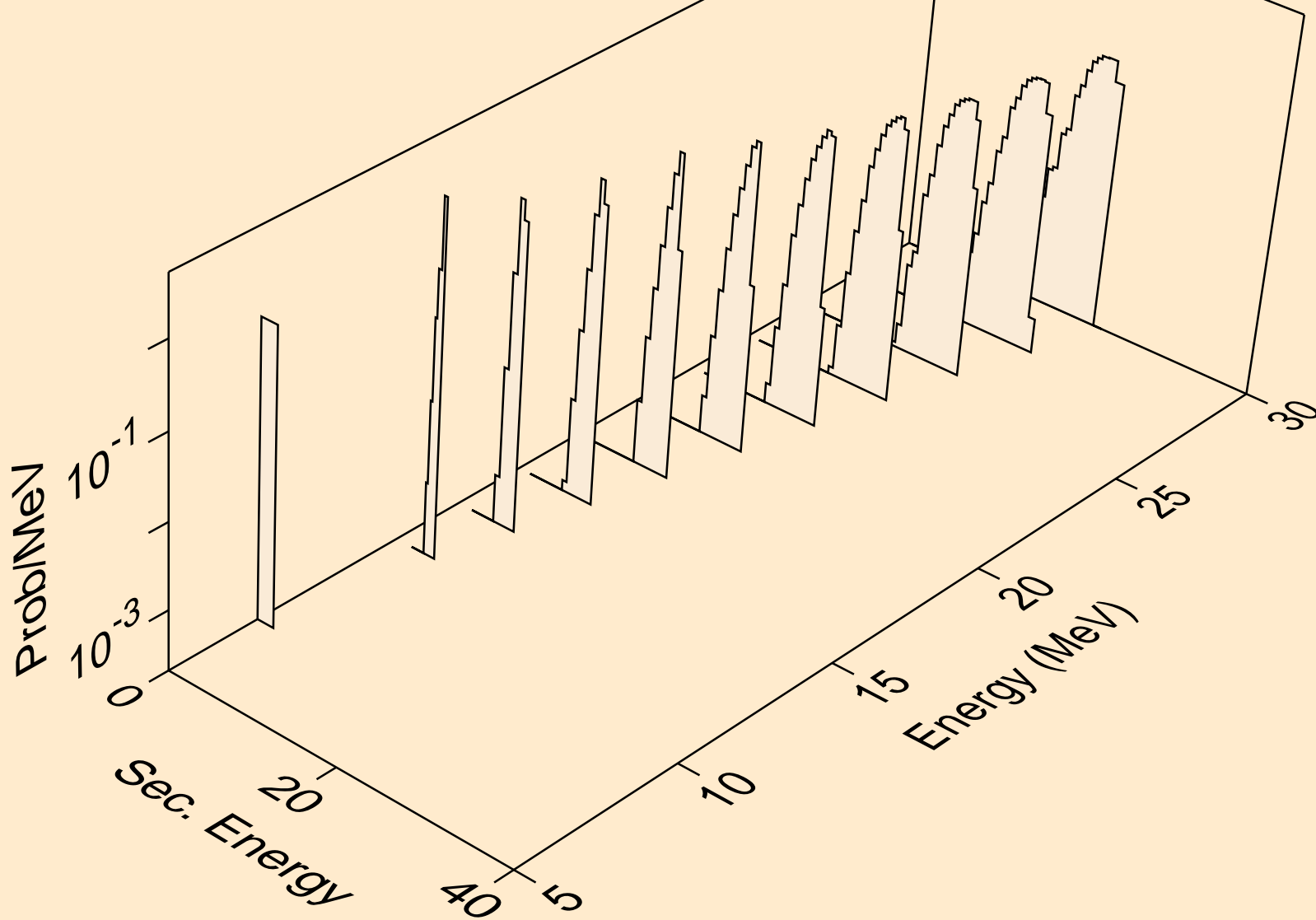

MD262 NEUTRON ACER TENDL-2019 LIBRARY; T=293.16K
deuterons from (n,d)

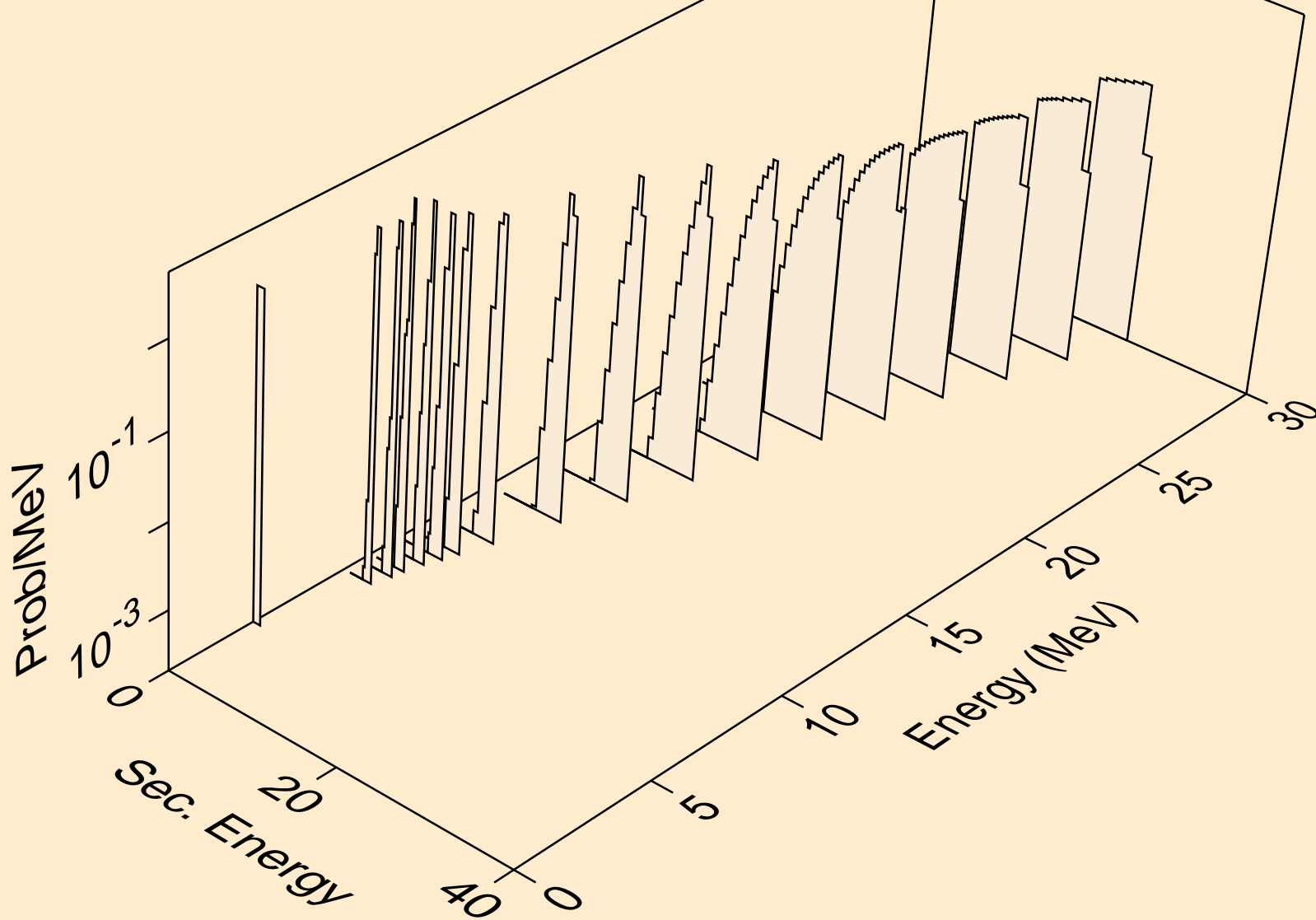

MD262 NEUTRON ACER TENDL-2019 LIBRARY; T=293.16K
tritons from (n,x)

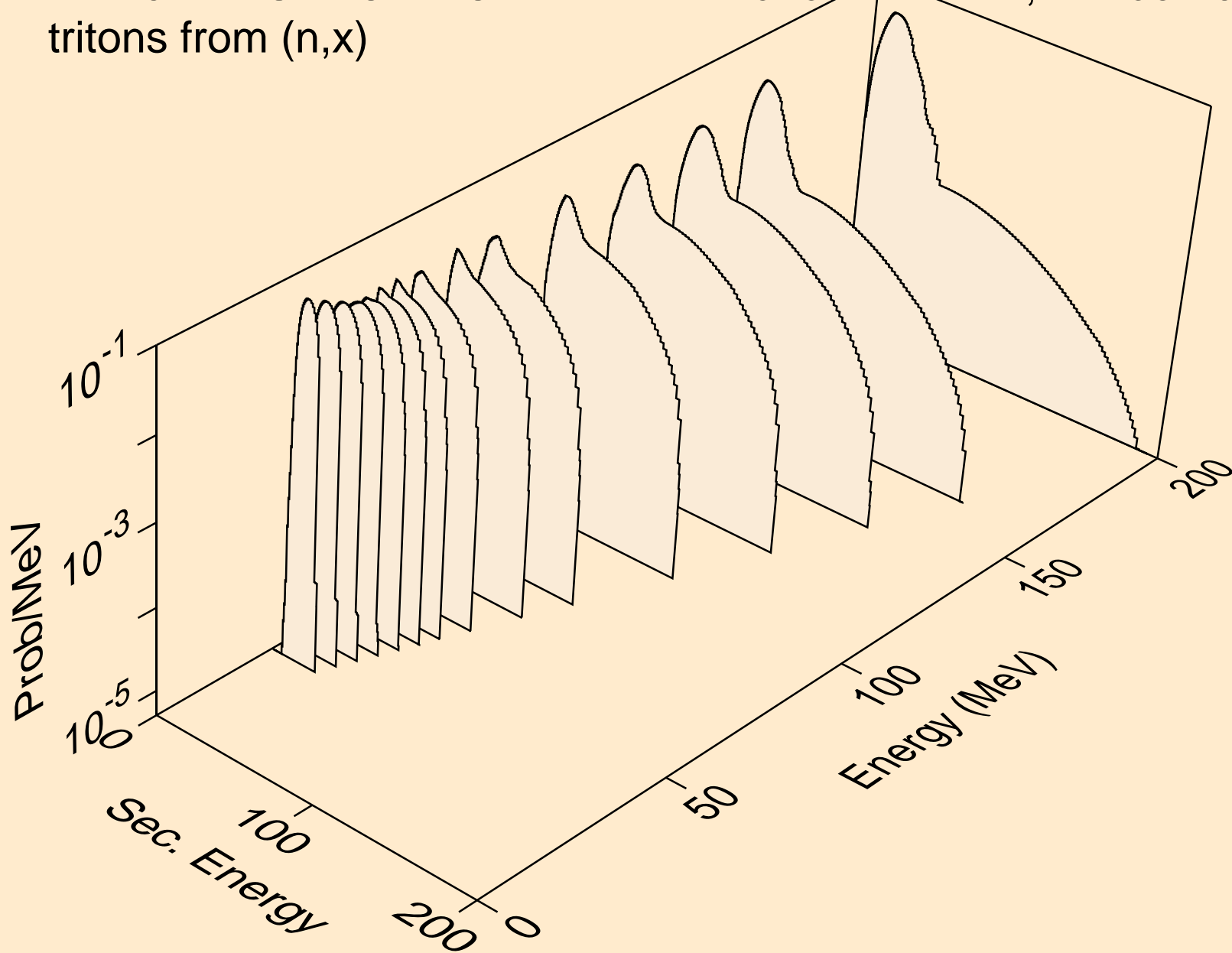

MD262 NEUTRON ACER TENDL-2019 LIBRARY; T=293.16K
tritons from (n,n*)t

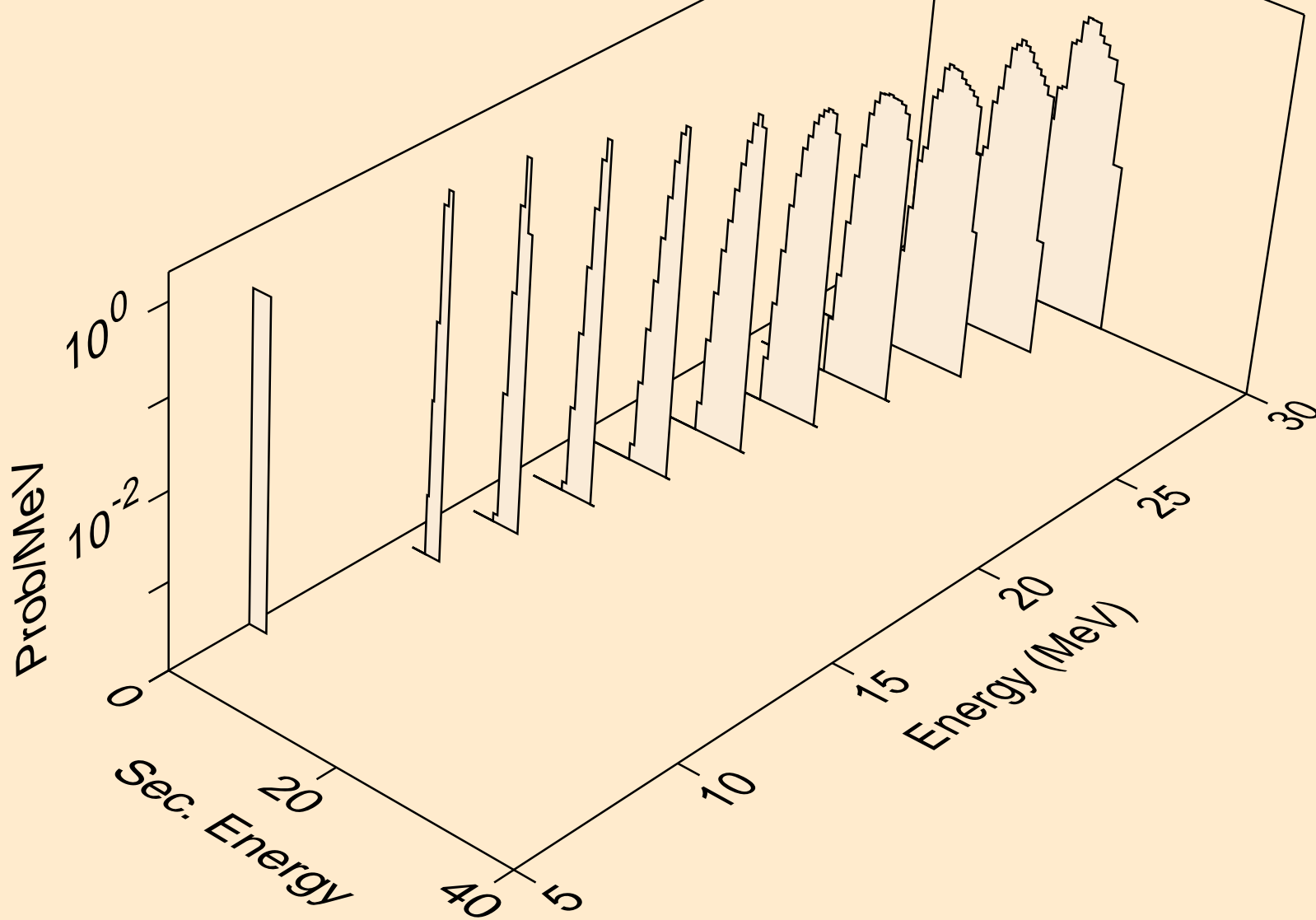

MD262 NEUTRON ACER TENDL-2019 LIBRARY; T=293.16K
tritons from (n,t)

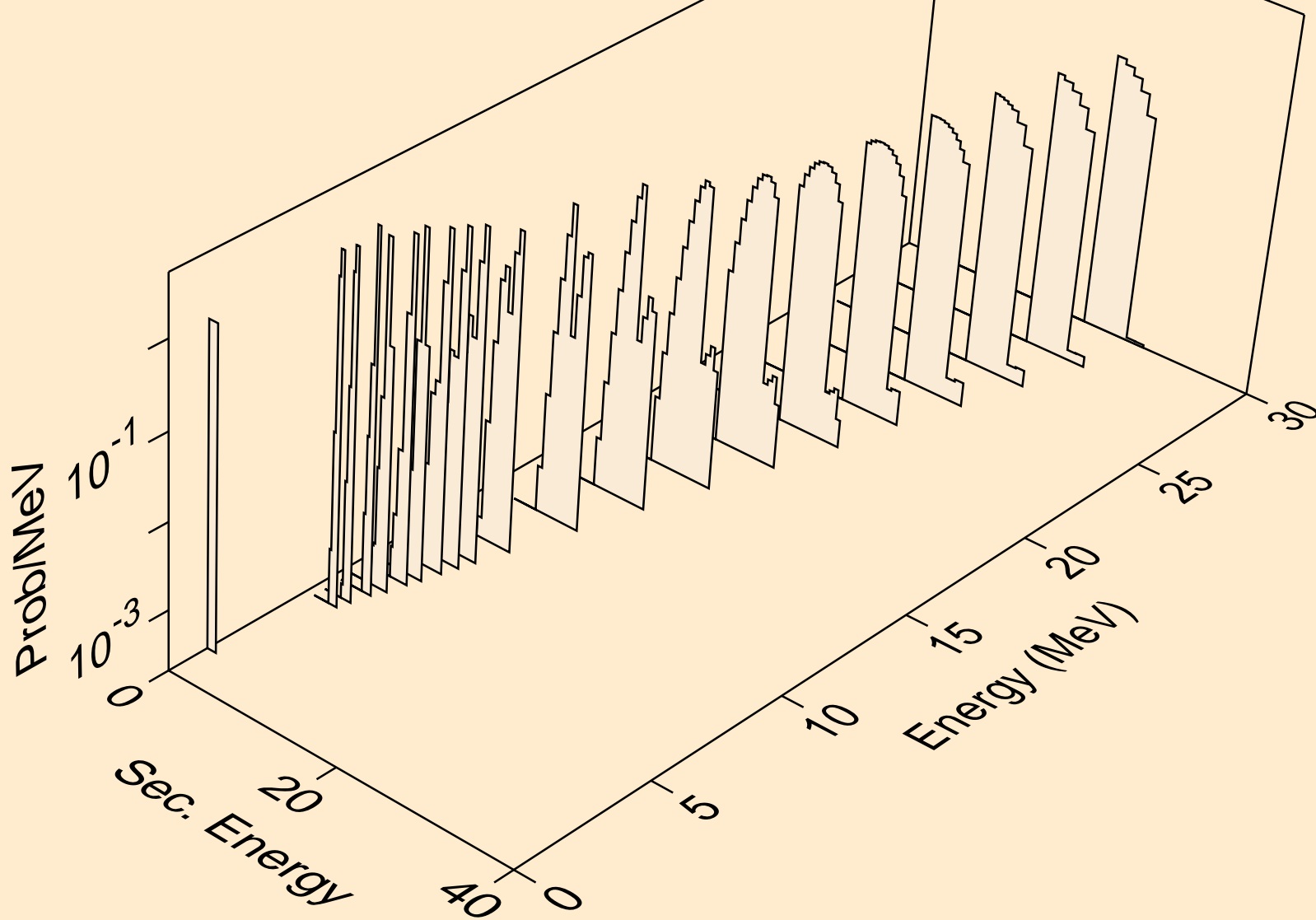

MD262 NEUTRON ACER TENDL-2019 LIBRARY; T=293.16K
he3s from (n,x)

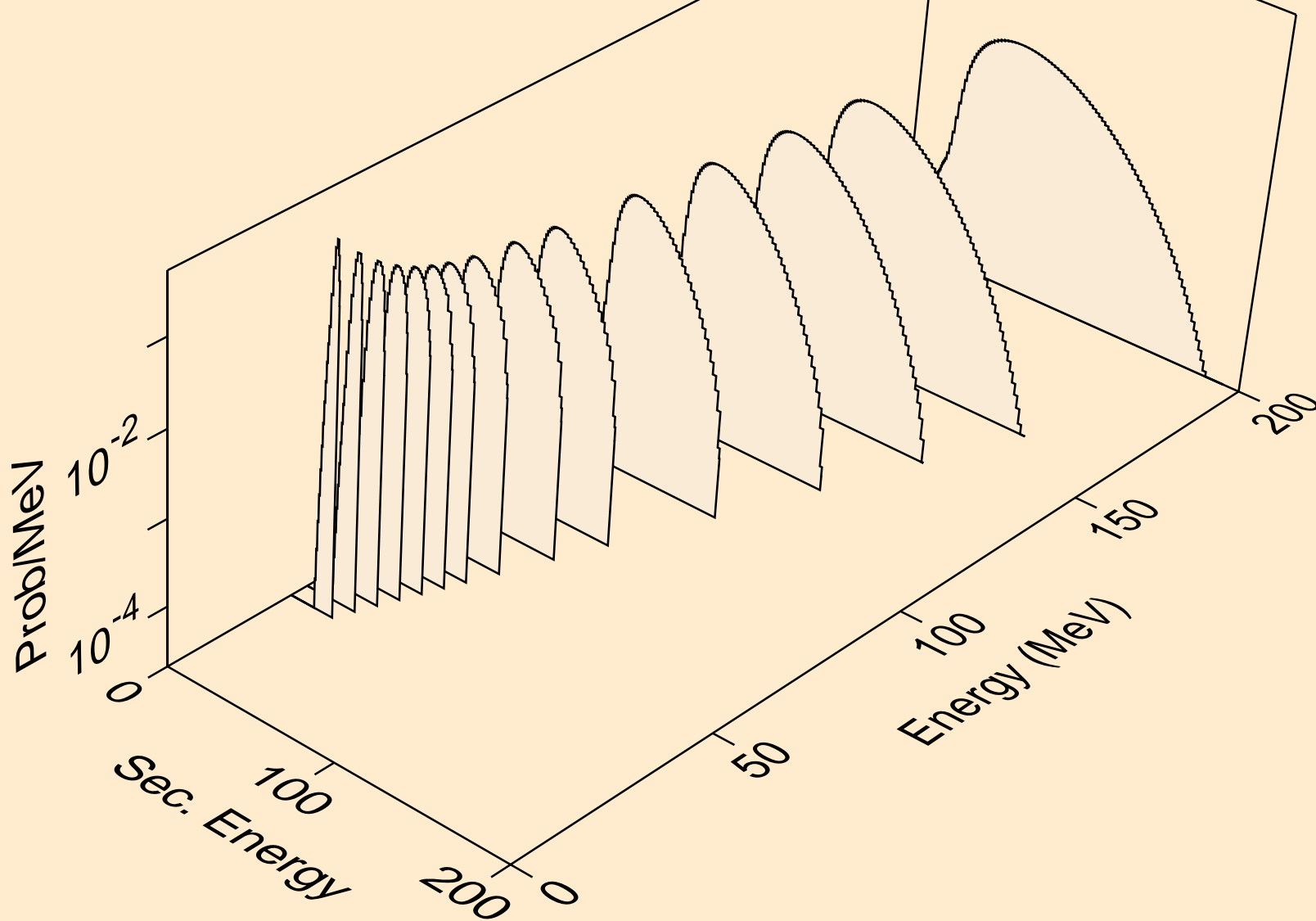

MD262 NEUTRON ACER TENDL-2019 LIBRARY; T=293.16K
he3s from (n,n*)he3

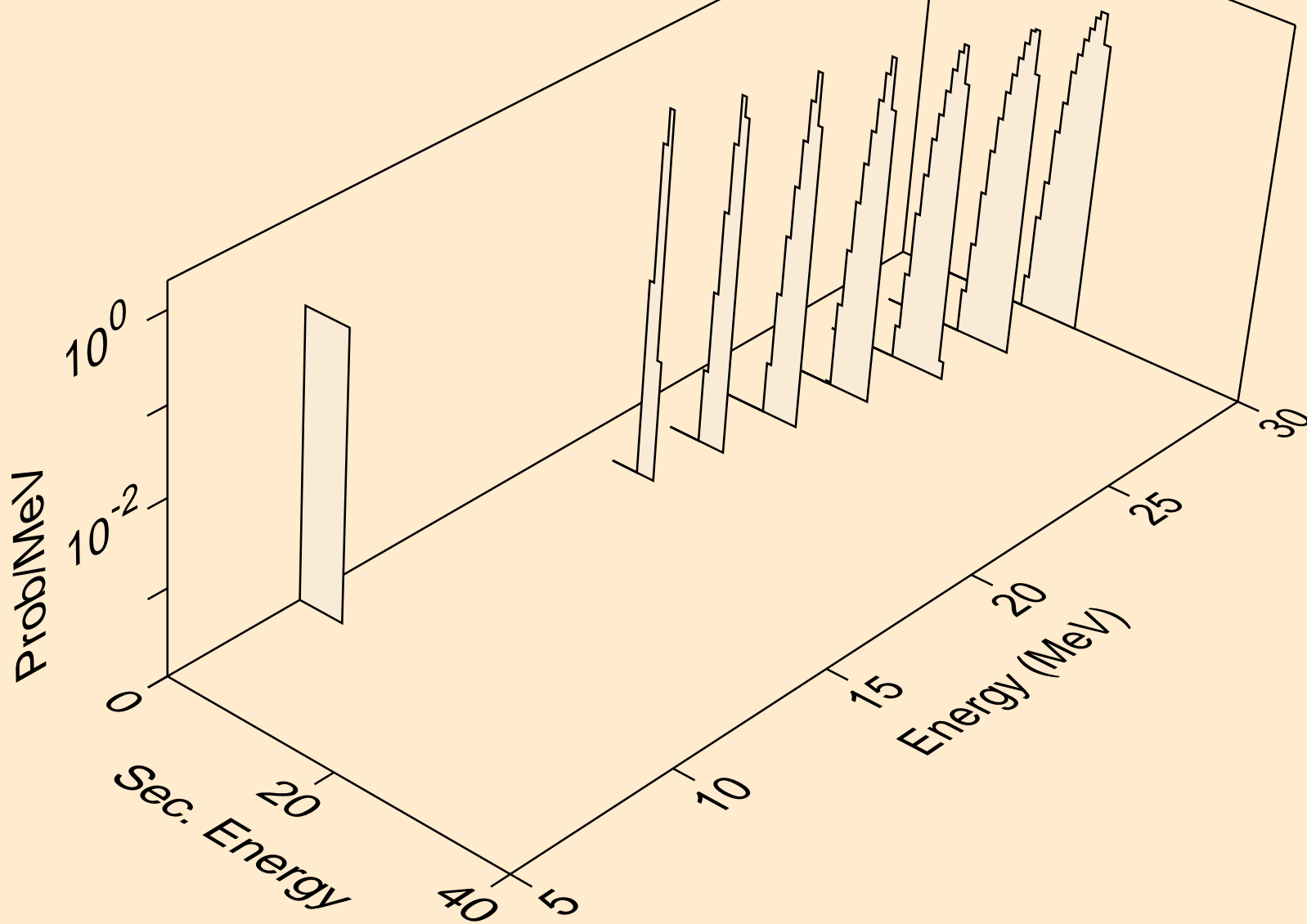

MD262 NEUTRON ACER TENDL-2019 LIBRARY; T=293.16K
he3s from (n,he3)

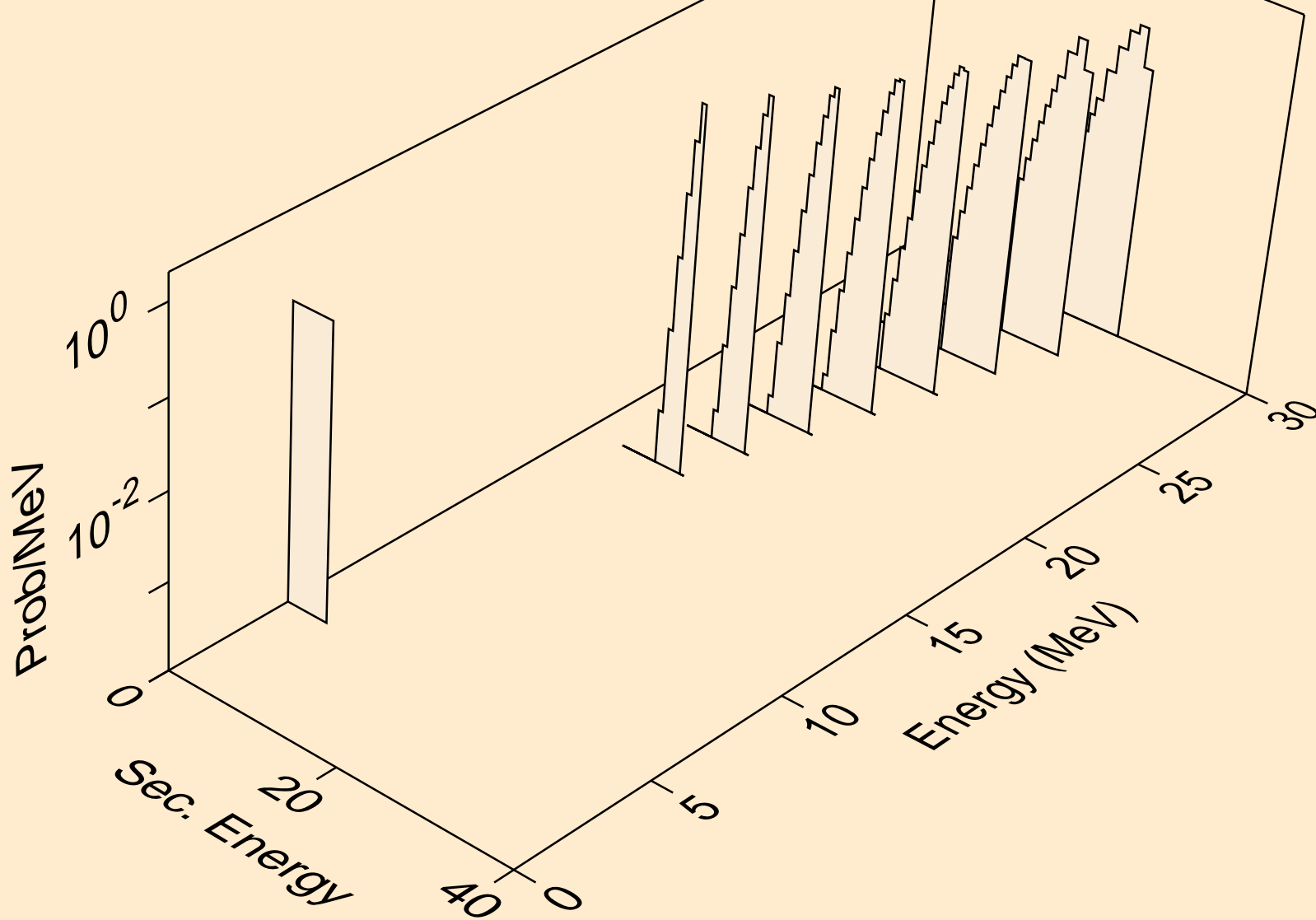

MD262 NEUTRON ACER TENDL-2019 LIBRARY; T=293.16K
alphas from (n,x)

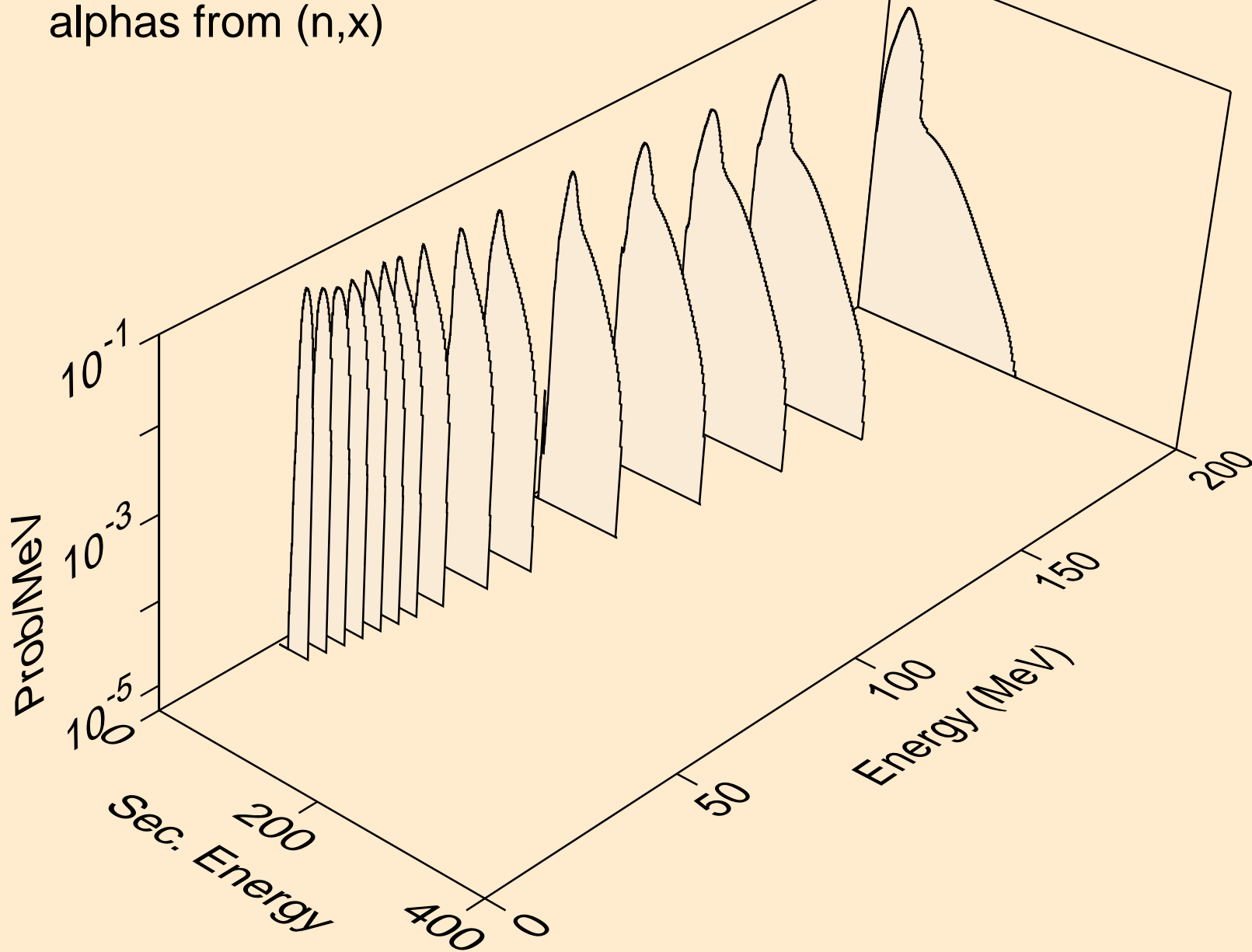

MD262 NEUTRON ACER TENDL-2019 LIBRARY; T=293.16K
alphas from (n,n*)a

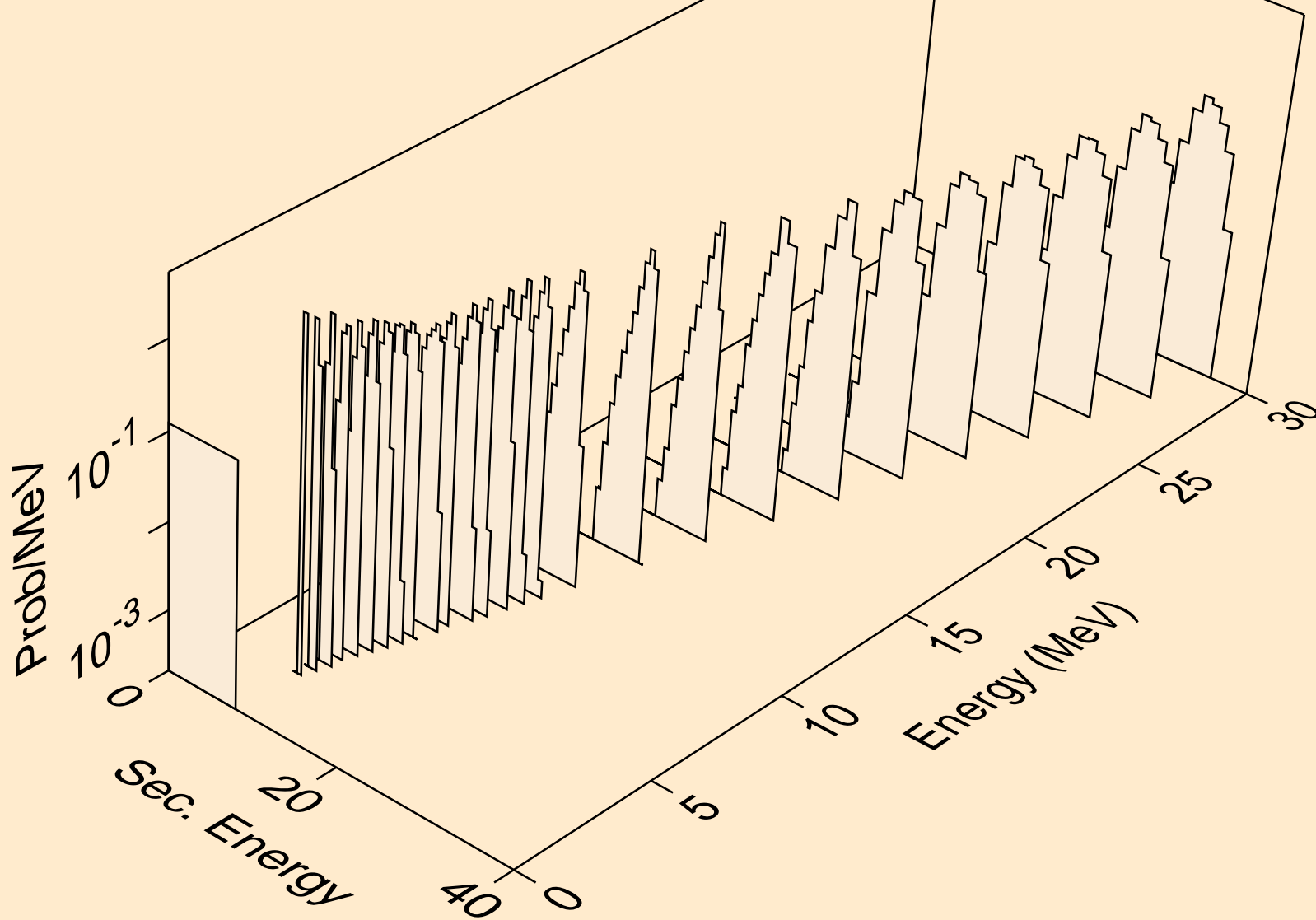

MD262 NEUTRON ACER TENDL-2019 LIBRARY; T=293.16K
alphas from (n,2n)a

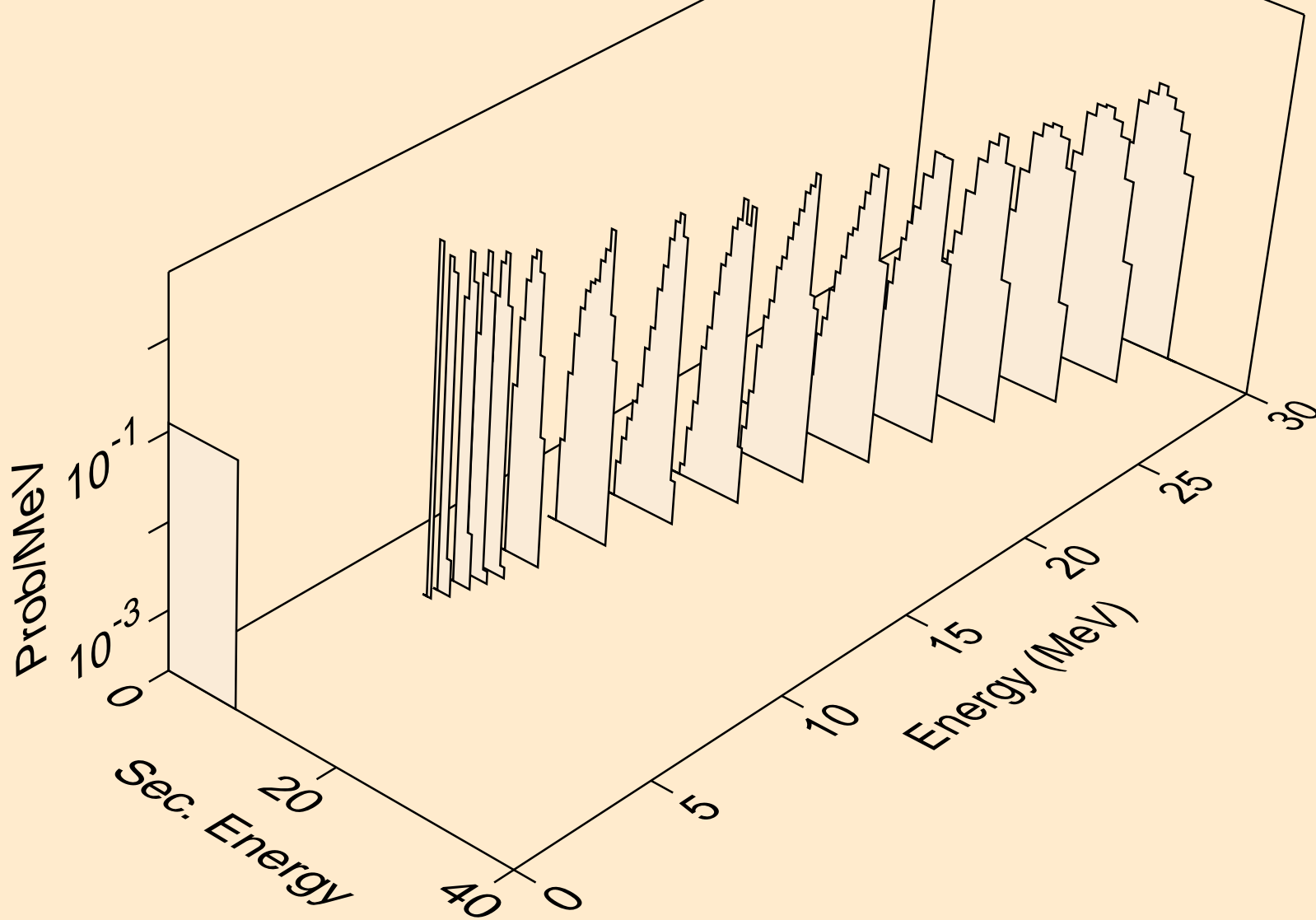

MD262 NEUTRON ACER TENDL-2019 LIBRARY; T=293.16K
alphas from (n,3n)a

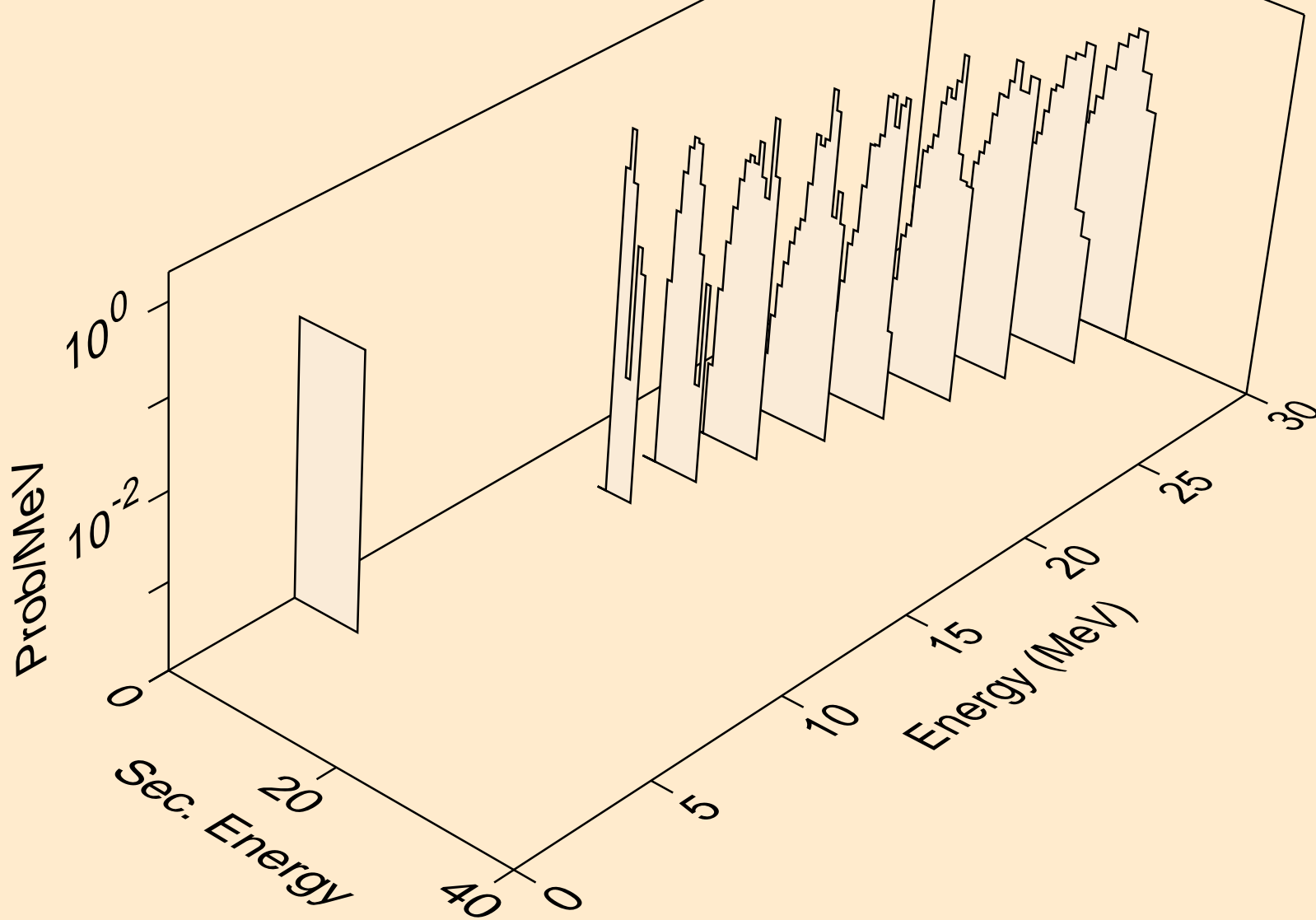

MD262 NEUTRON ACER TENDL-2019 LIBRARY; T=293.16K
alphas from (n,a)

