

NO257 NEUTRON ACER TENDL-2019 LIBRARY; T=293.16K
Principal cross sections

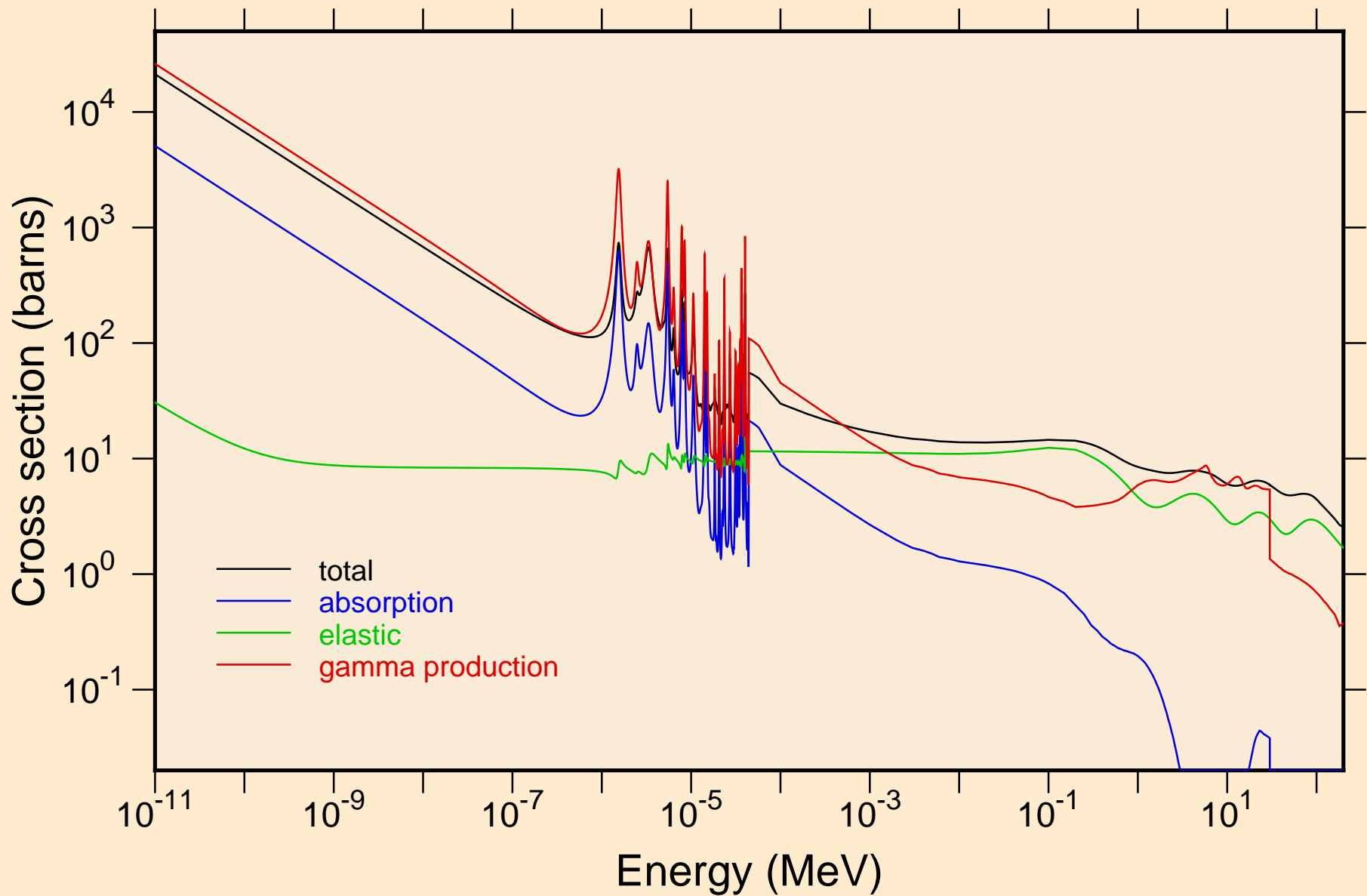

NO257 NEUTRON ACER TENDL-2019 LIBRARY; T=293.16K
resonance total cross section

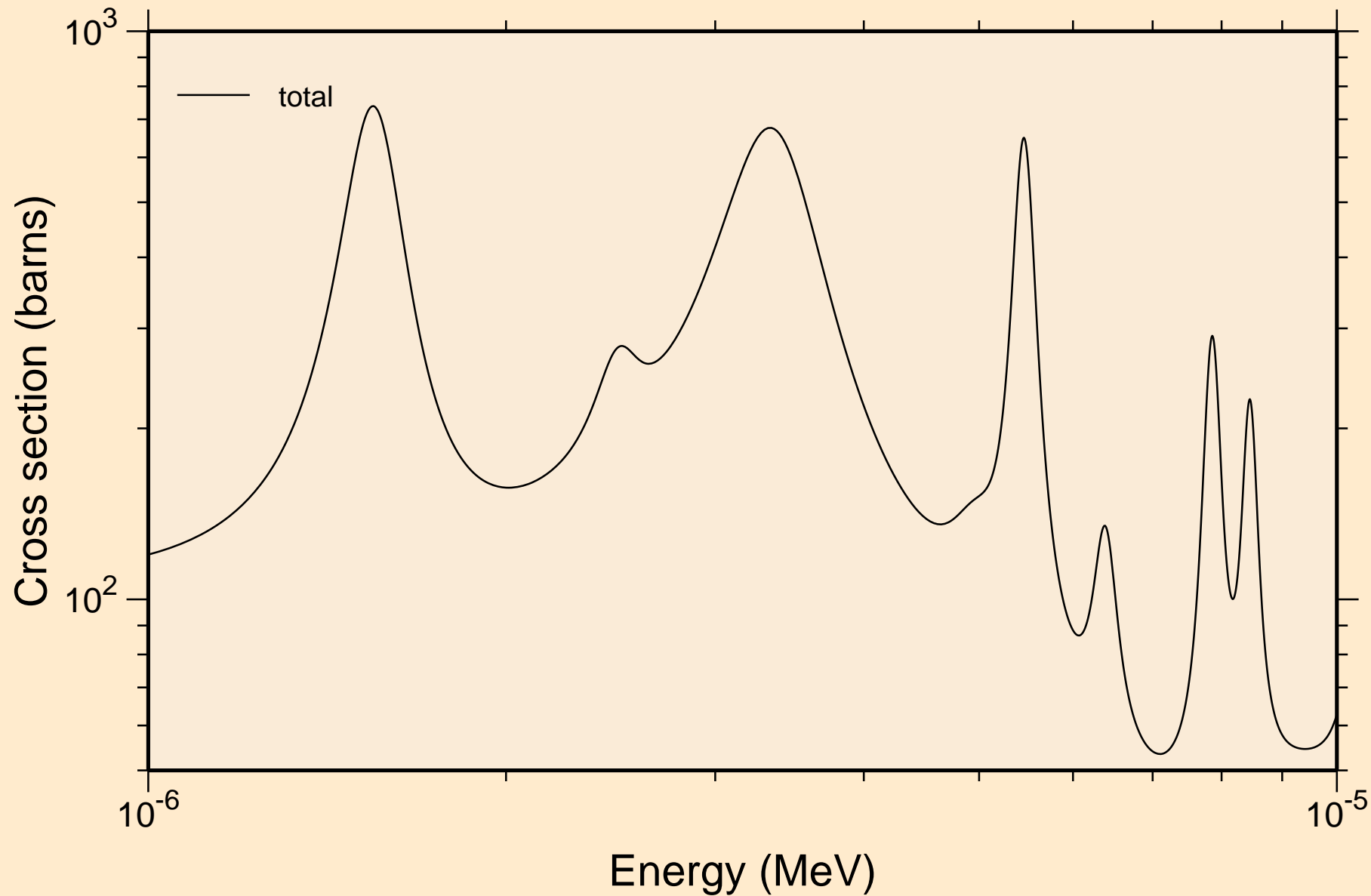

NO257 NEUTRON ACER TENDL-2019 LIBRARY; T=293.16K
resonance total cross section

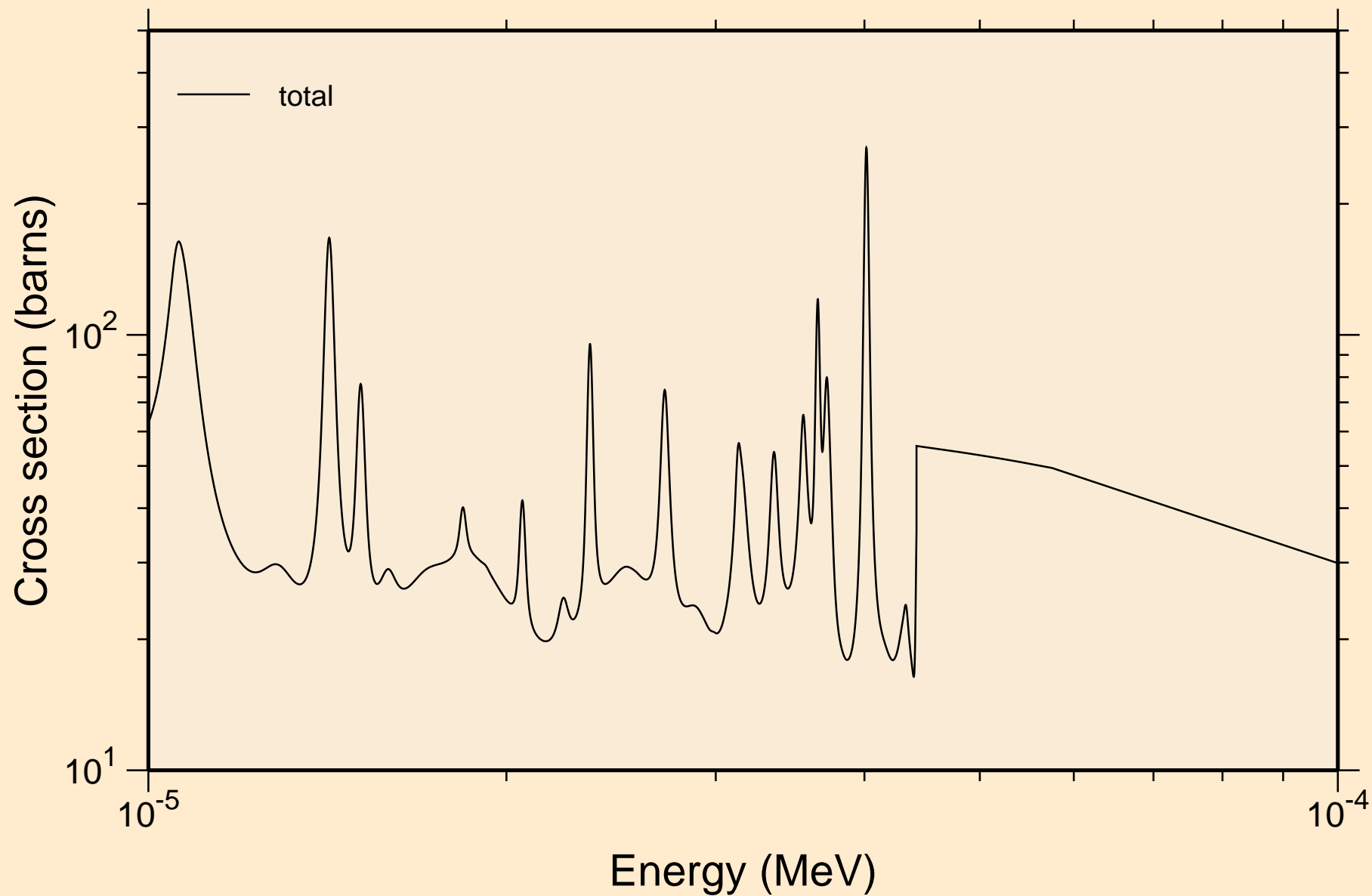

NO257 NEUTRON ACER TENDL-2019 LIBRARY; T=293.16K
resonance total cross section

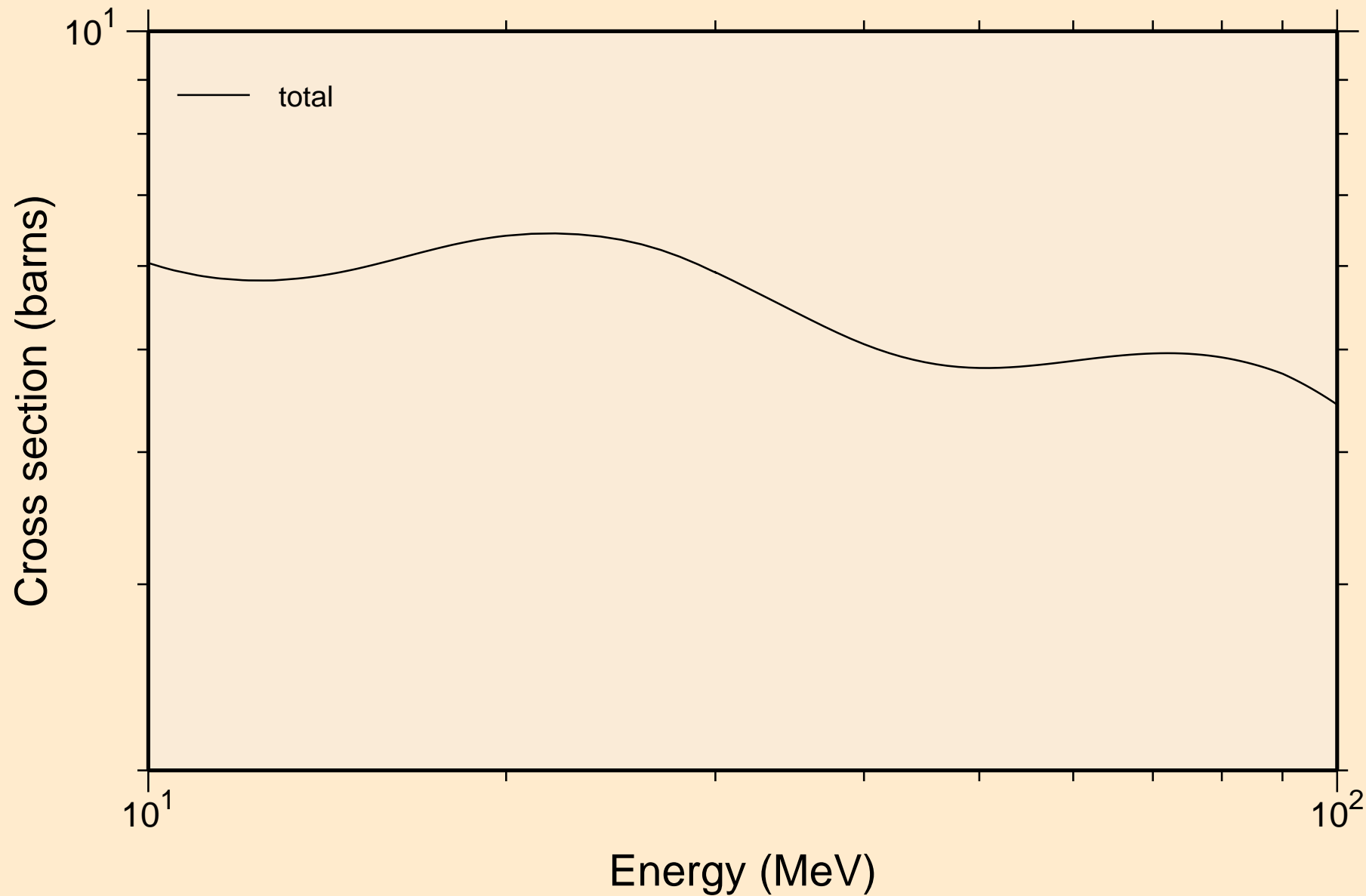

NO257 NEUTRON ACER TENDL-2019 LIBRARY; T=293.16K
resonance absorption cross sections

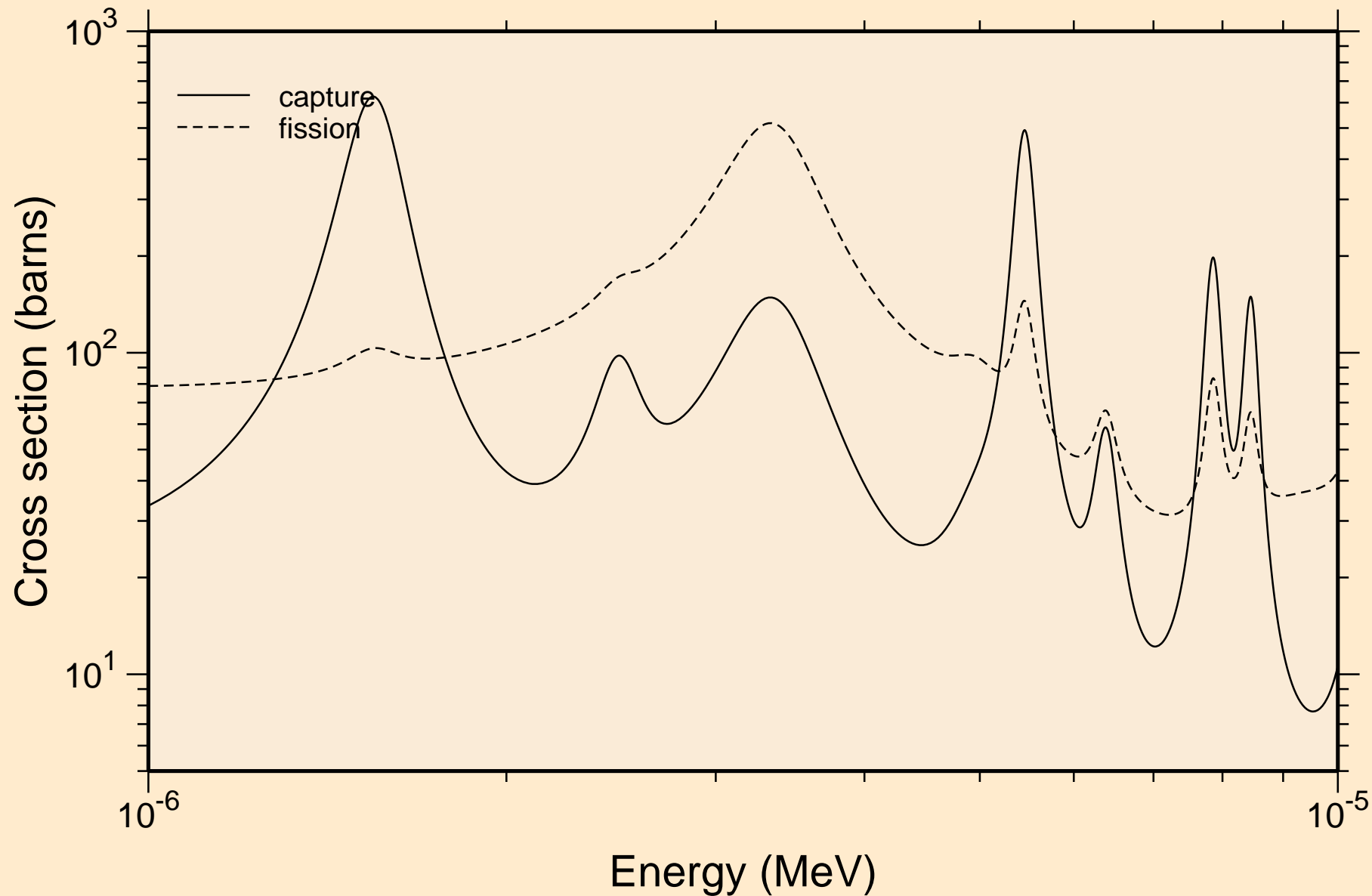

NO257 NEUTRON ACER TENDL-2019 LIBRARY; T=293.16K
resonance absorption cross sections

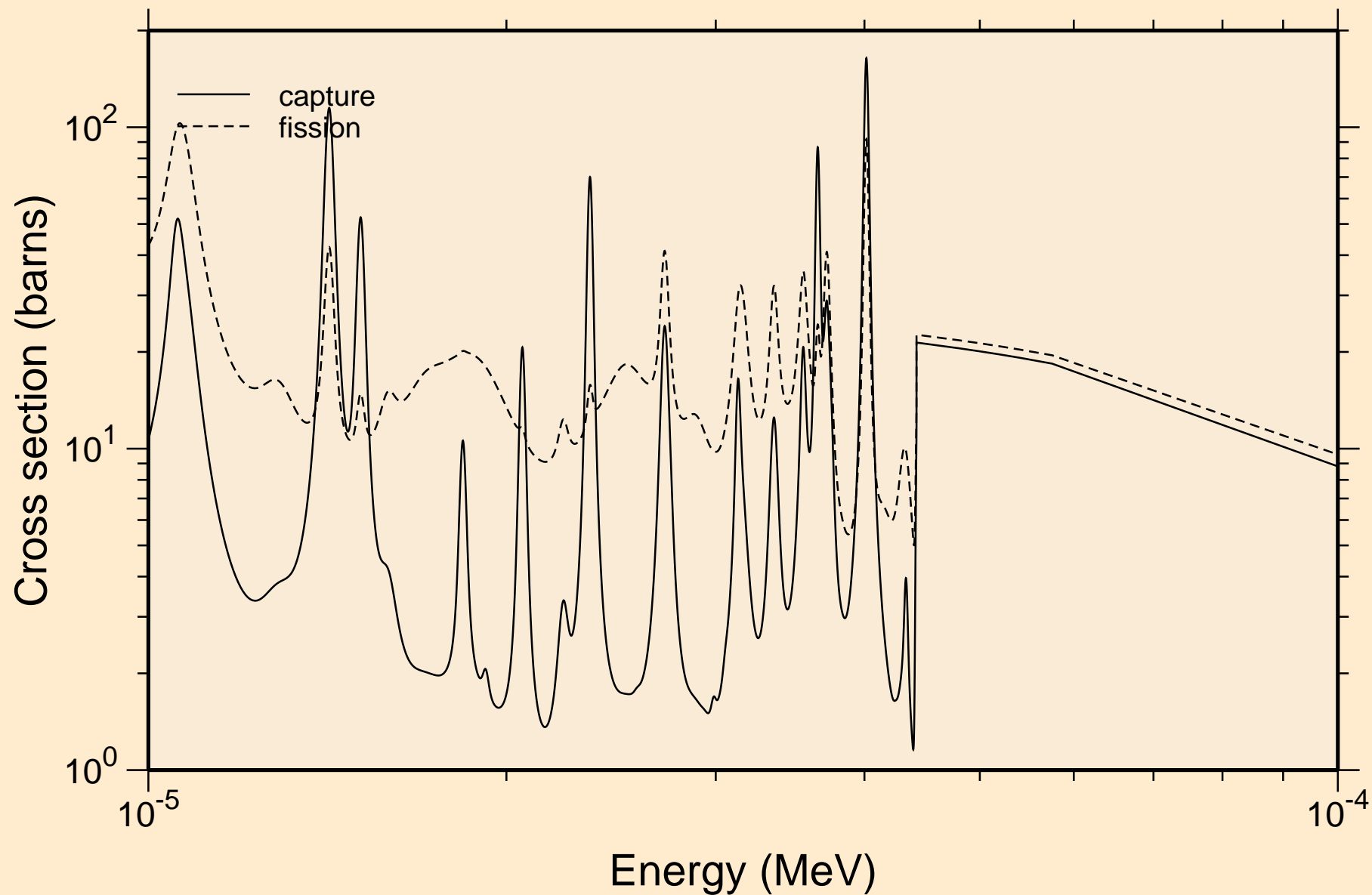

NO257 NEUTRON ACER TENDL-2019 LIBRARY; T=293.16K
resonance absorption cross sections

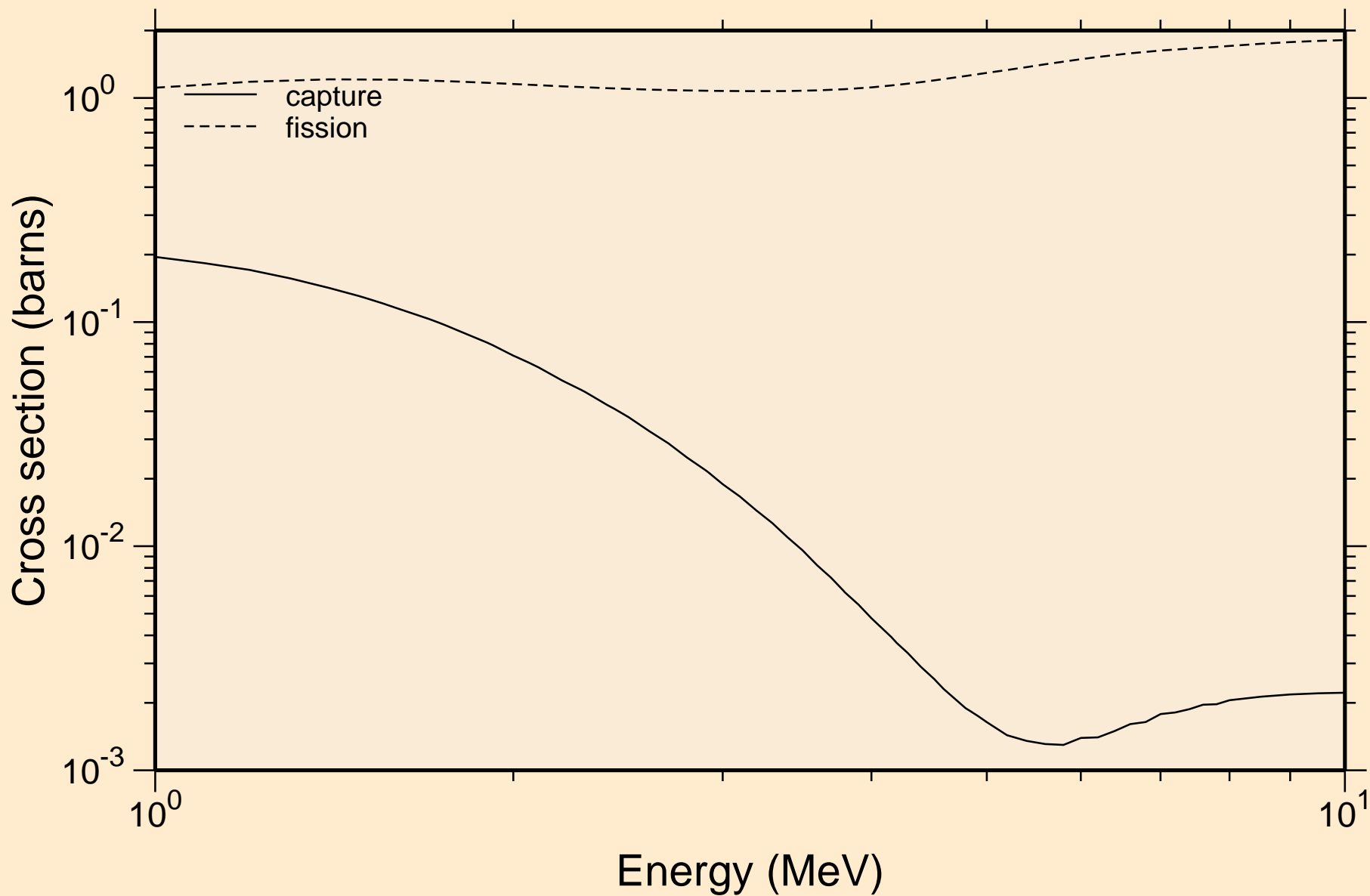

NO257 NEUTRON ACER TENDL-2019 LIBRARY; T=293.16K
Heating

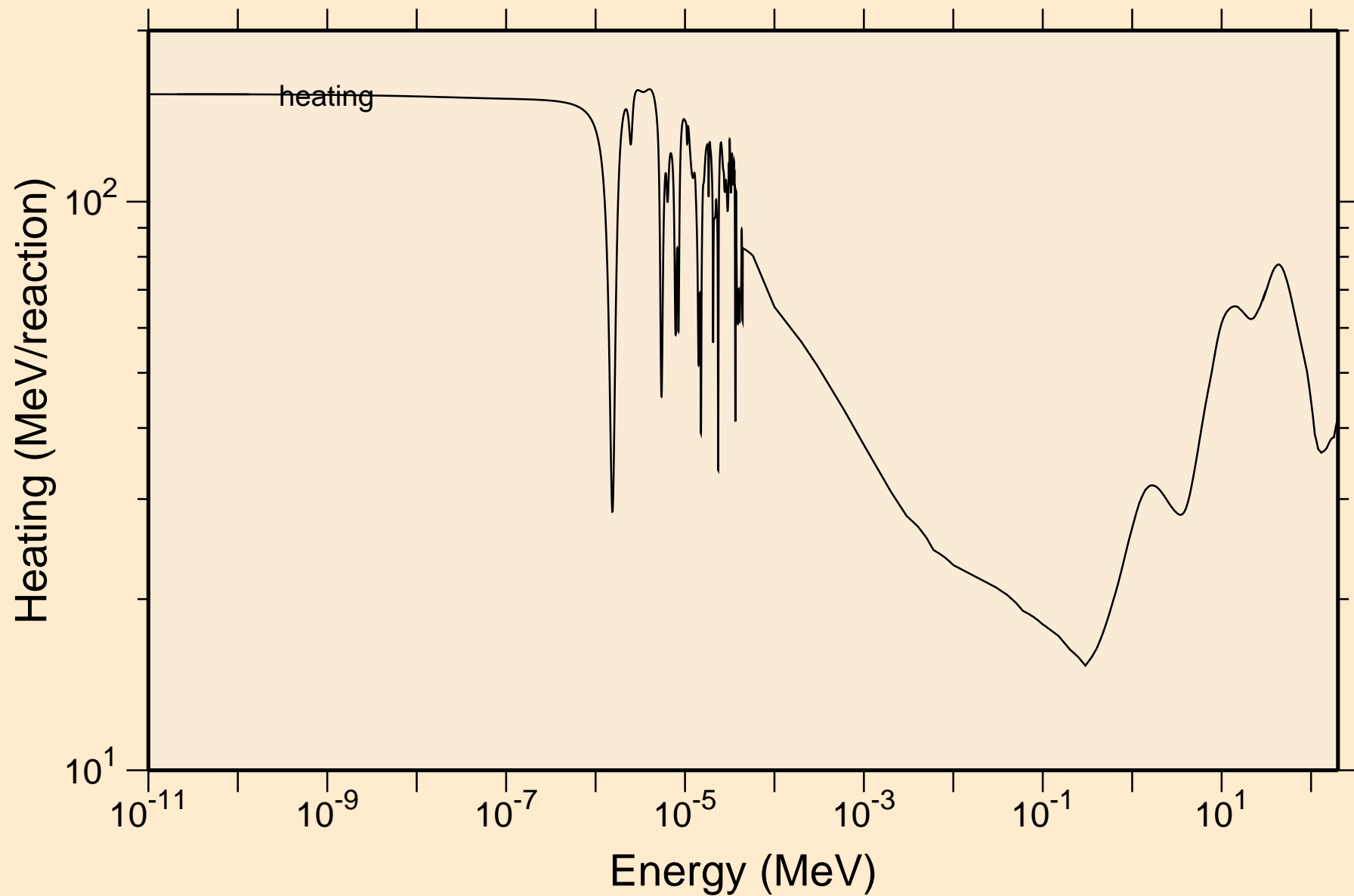

NO257 NEUTRON ACER TENDL-2019 LIBRARY; T=293.16K
Damage

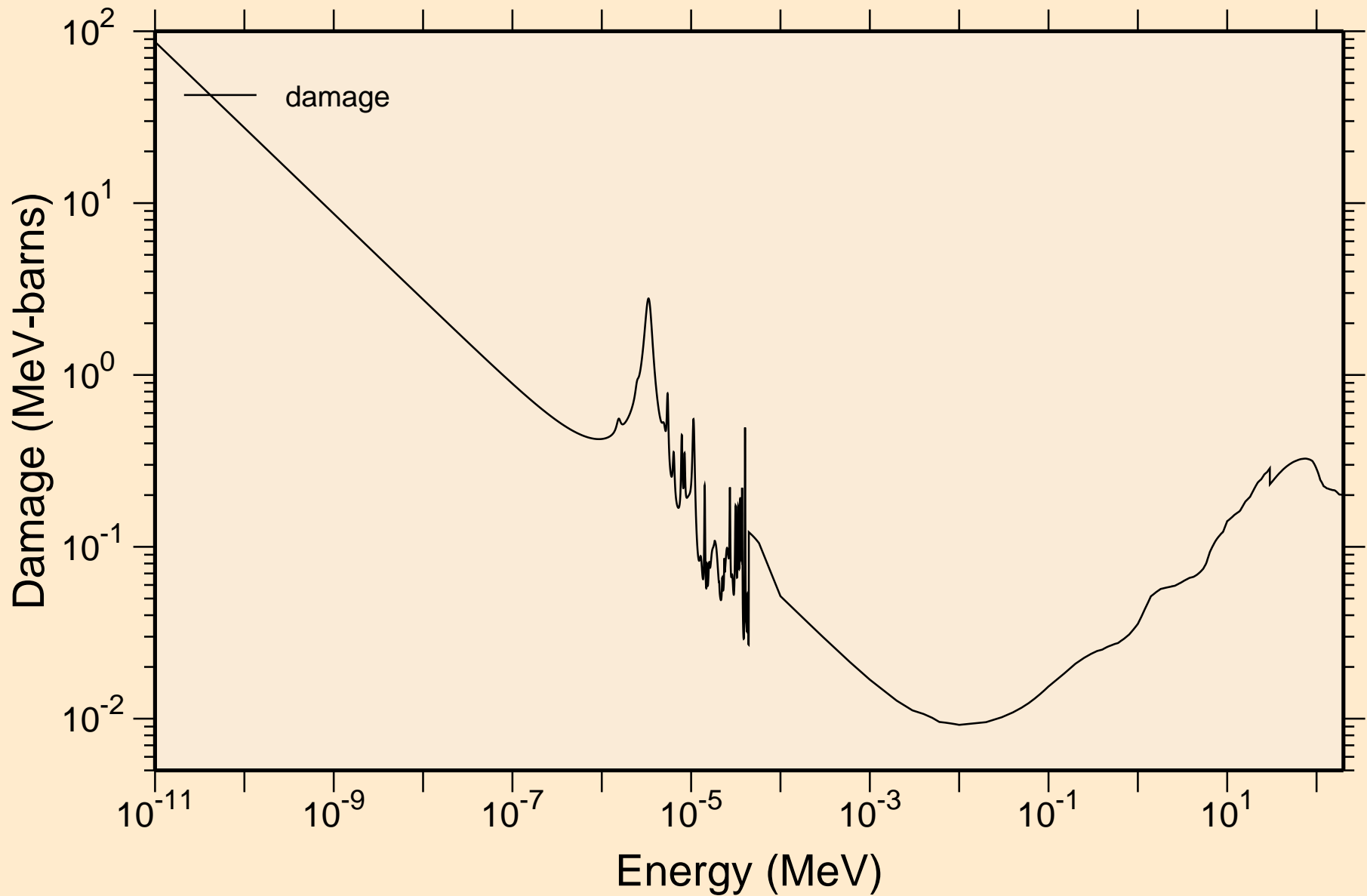

NO257 NEUTRON ACER TENDL-2019 LIBRARY; T=293.16K
Non-threshold reactions

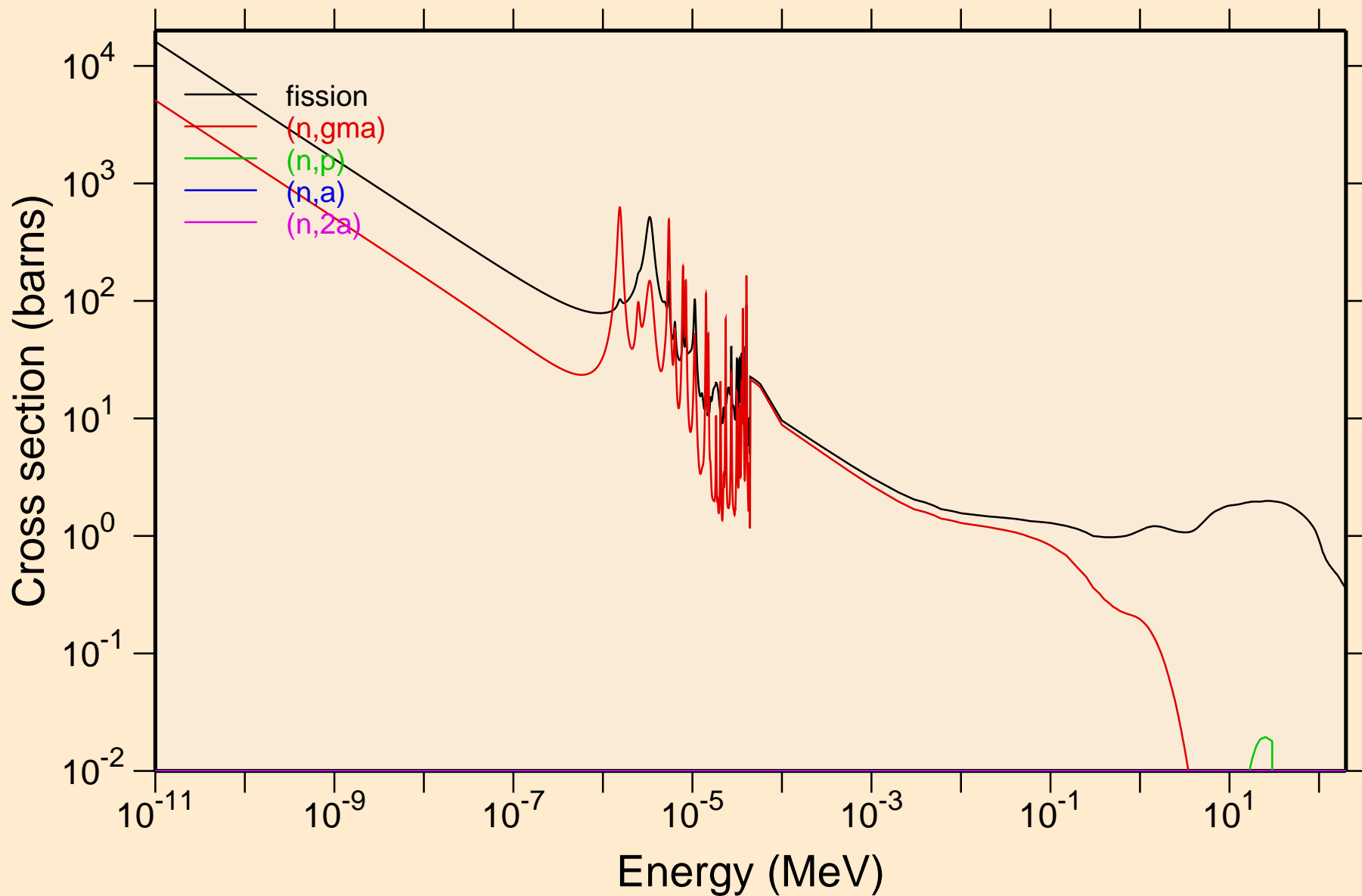

NO257 NEUTRON ACER TENDL-2019 LIBRARY; T=293.16K
Non-threshold reactions

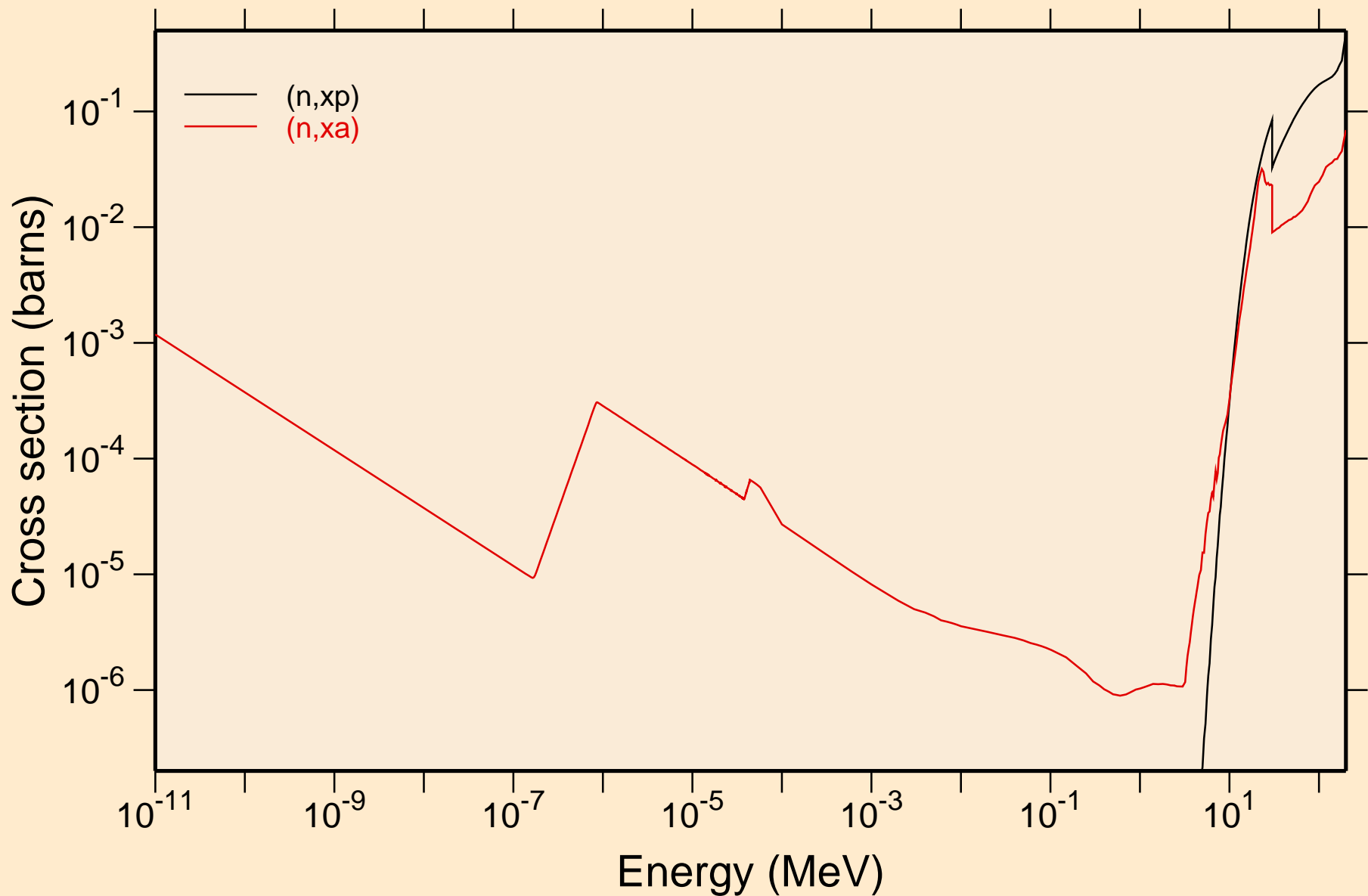

NO257 NEUTRON ACER TENDL-2019 LIBRARY; T=293.16K
Principal cross sections

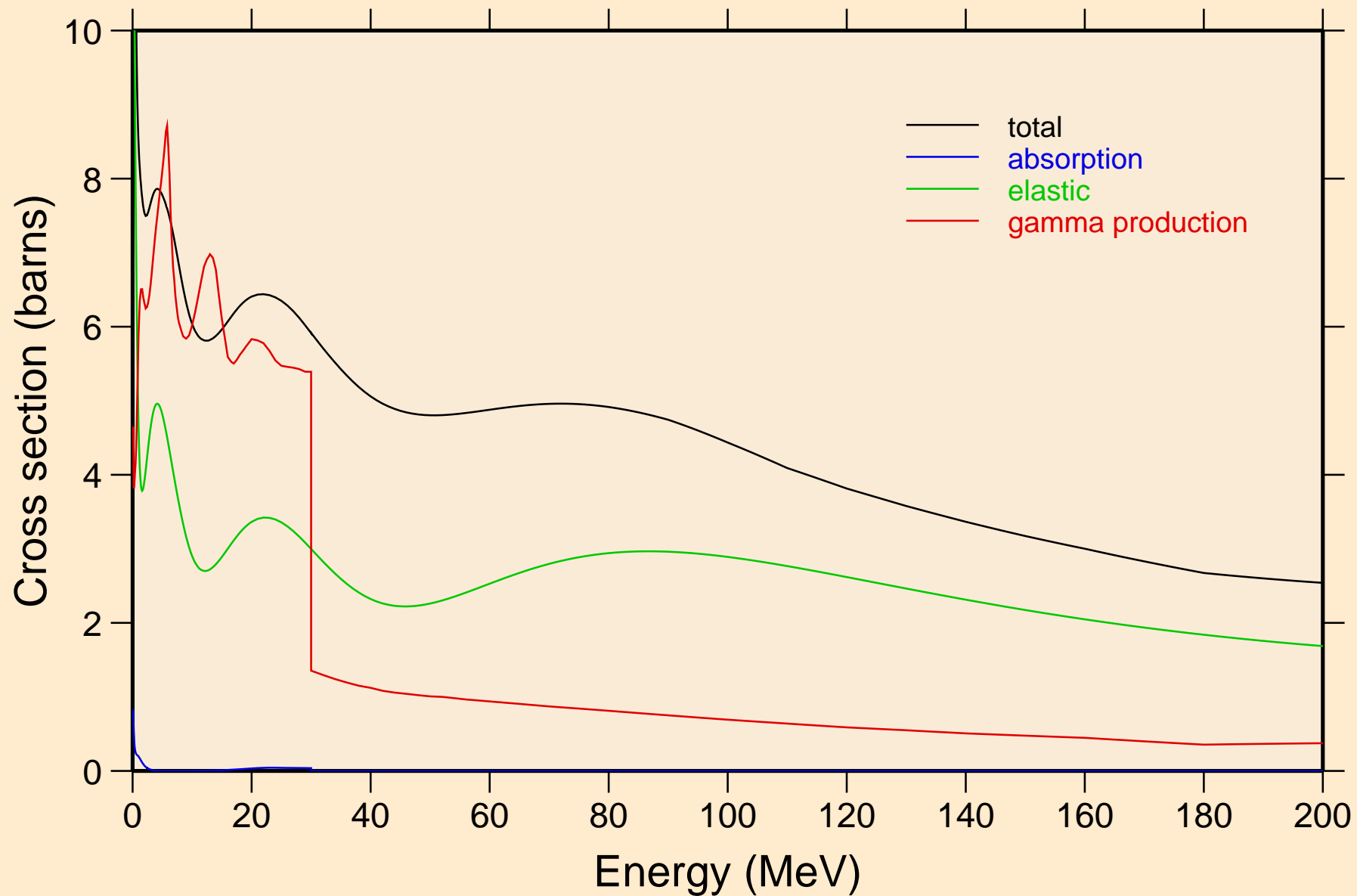

NO257 NEUTRON ACER TENDL-2019 LIBRARY; T=293.16K
Heating

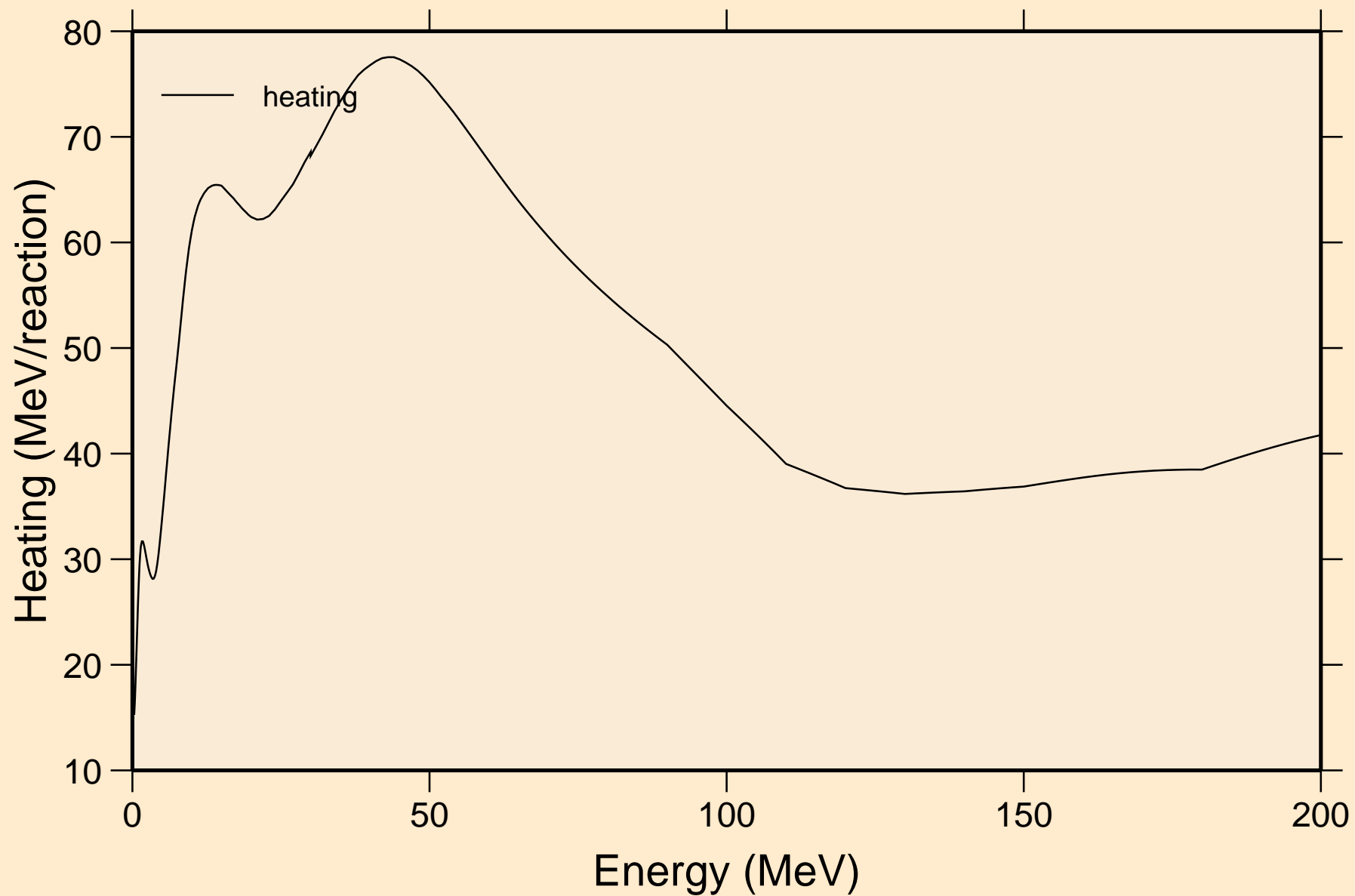

NO257 NEUTRON ACER TENDL-2019 LIBRARY; T=293.16K
Damage

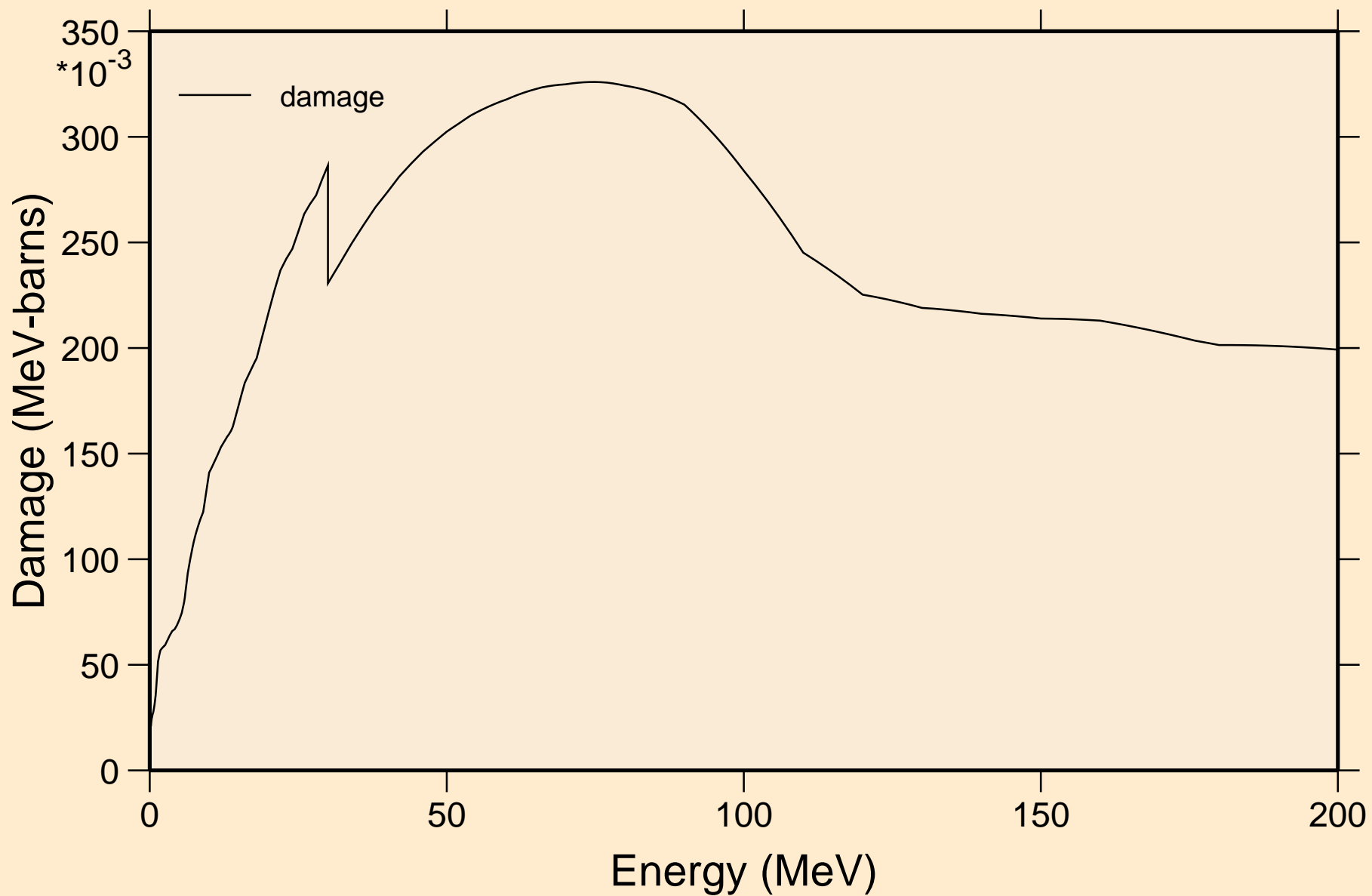

NO257 NEUTRON ACER TENDL-2019 LIBRARY; T=293.16K
Non-threshold reactions

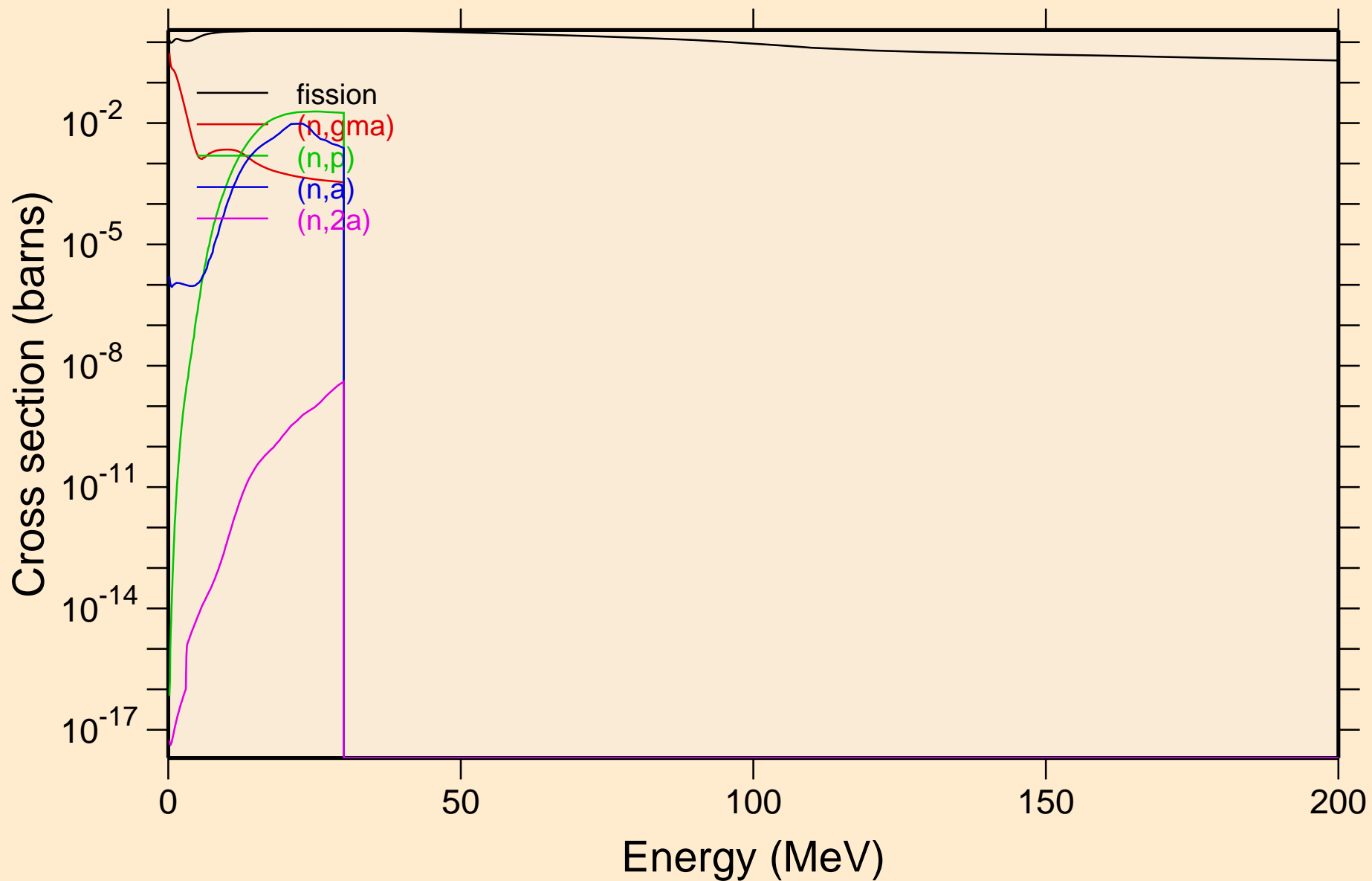

NO257 NEUTRON ACER TENDL-2019 LIBRARY; T=293.16K
Non-threshold reactions

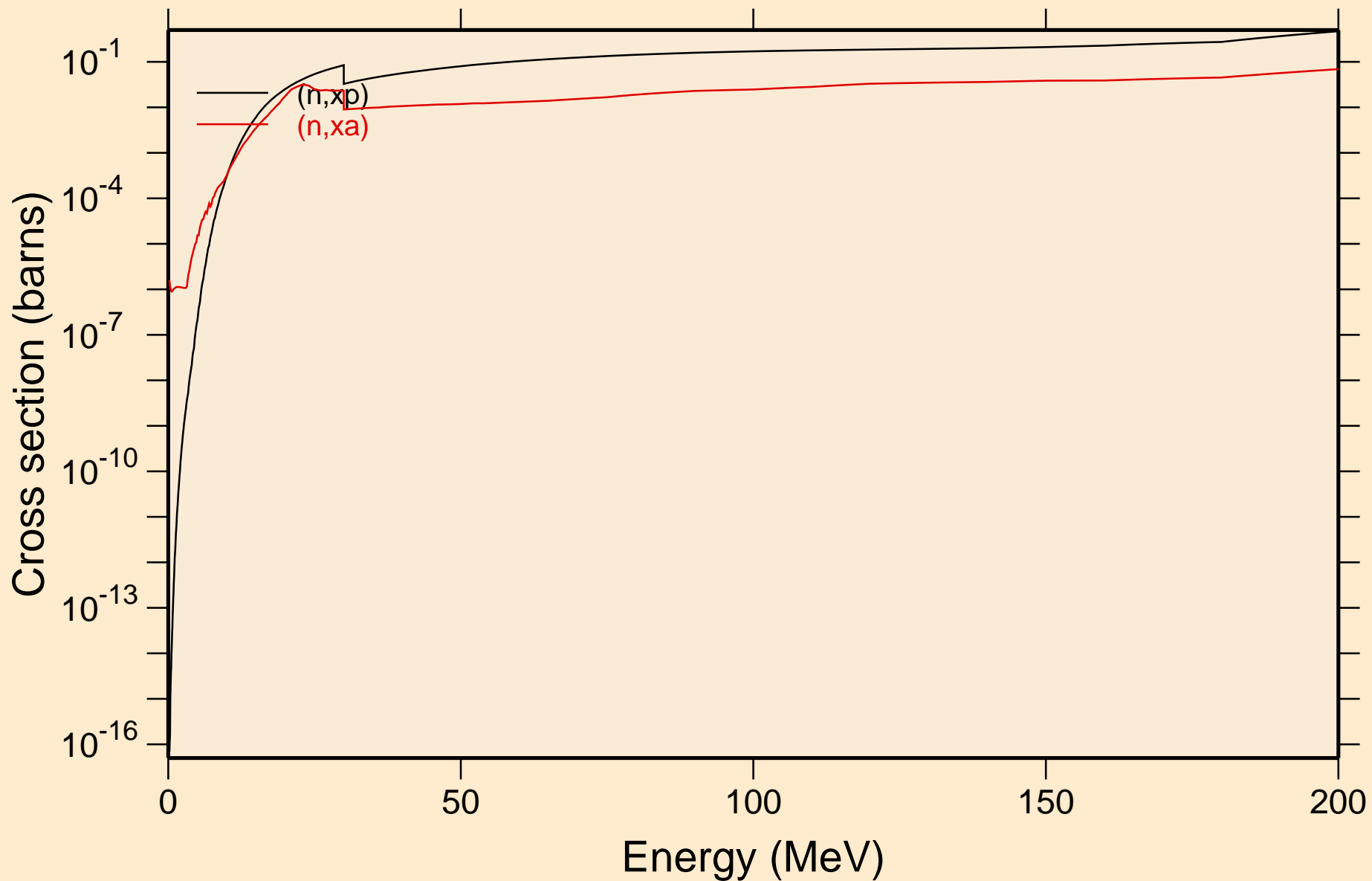

NO257 NEUTRON ACER TENDL-2019 LIBRARY; T=293.16K
Inelastic levels

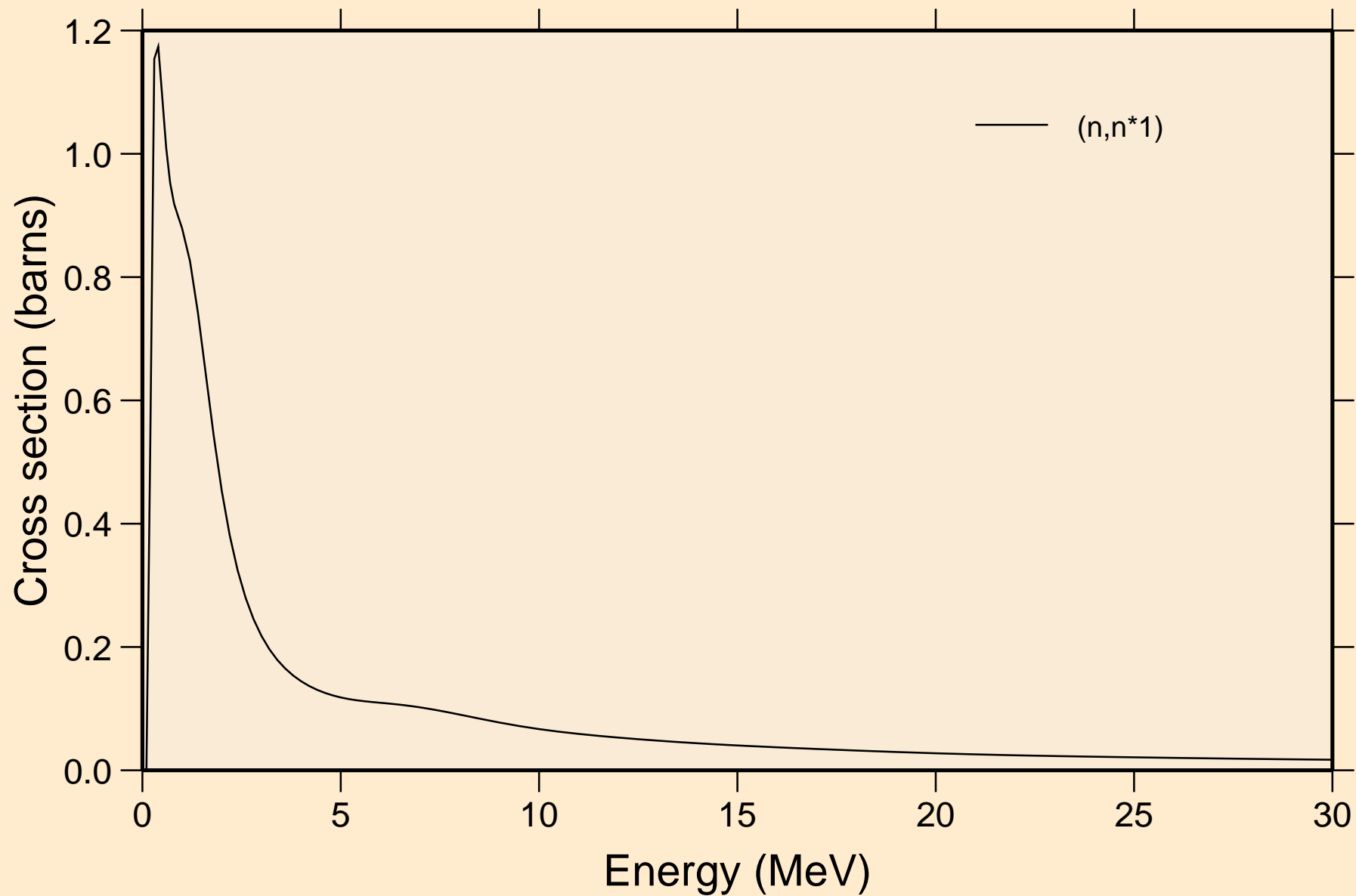

NO257 NEUTRON ACER TENDL-2019 LIBRARY; T=293.16K
Threshold reactions

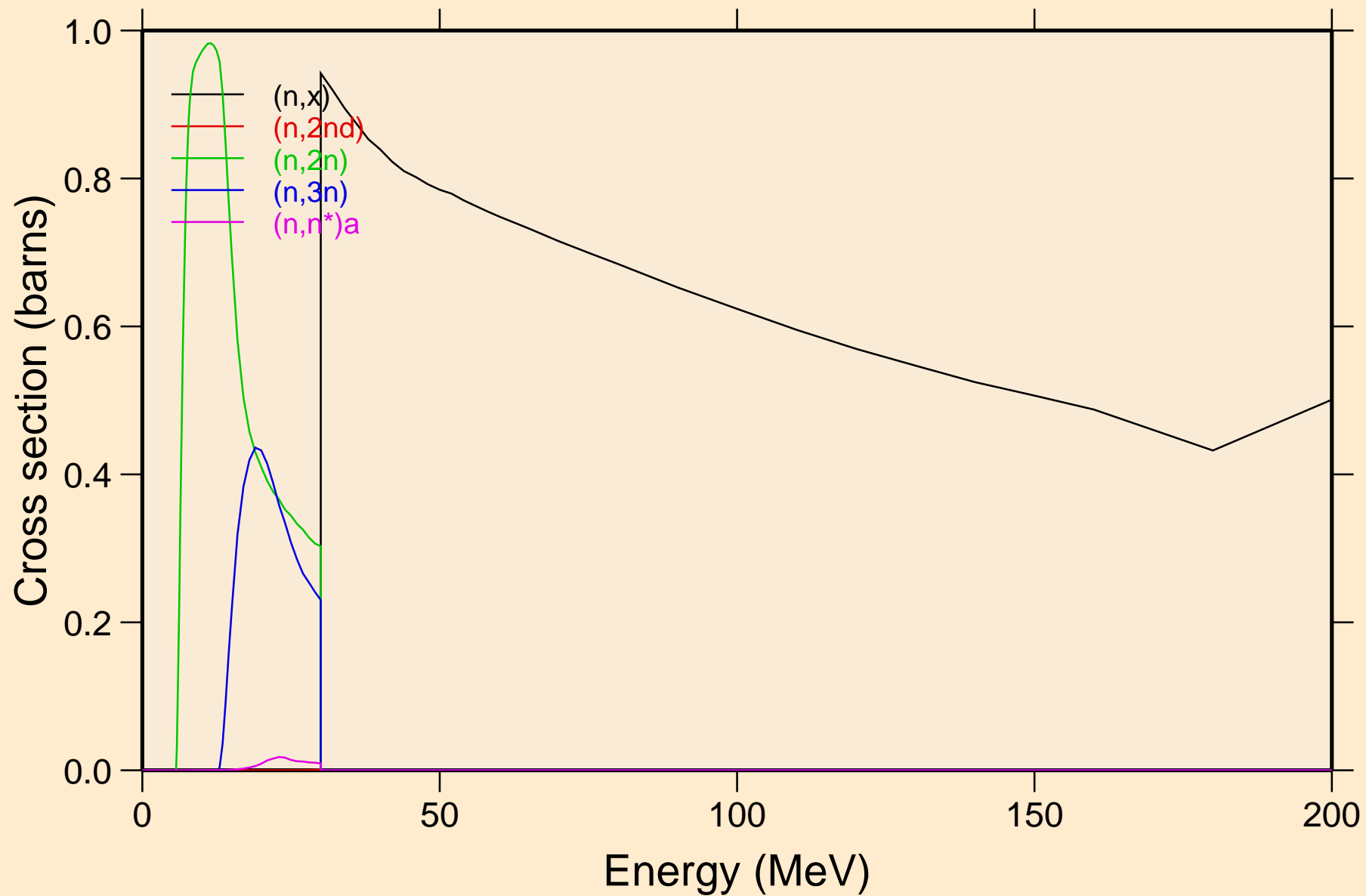

NO257 NEUTRON ACER TENDL-2019 LIBRARY; T=293.16K
Threshold reactions

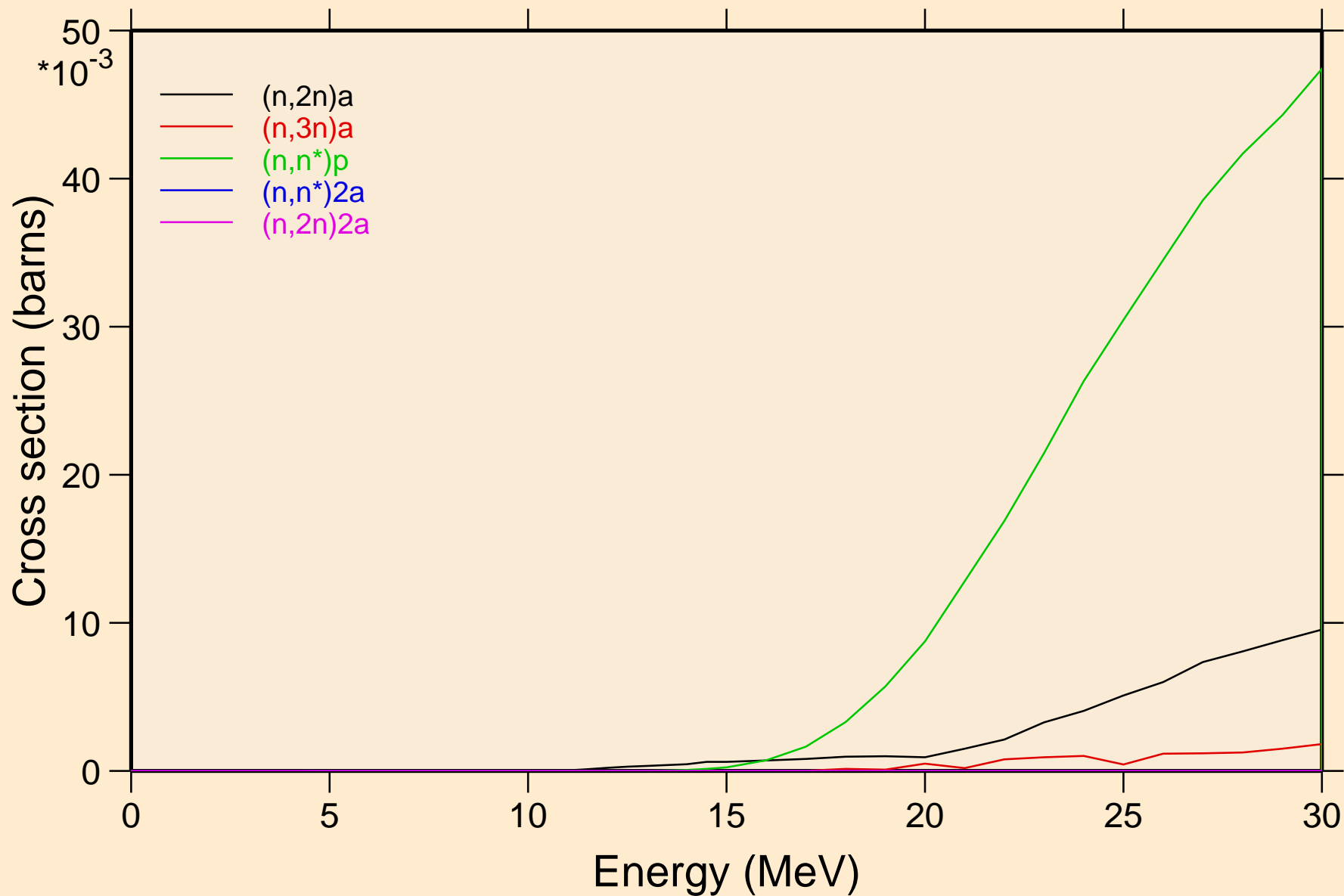

NO257 NEUTRON ACER TENDL-2019 LIBRARY; T=293.16K
Threshold reactions

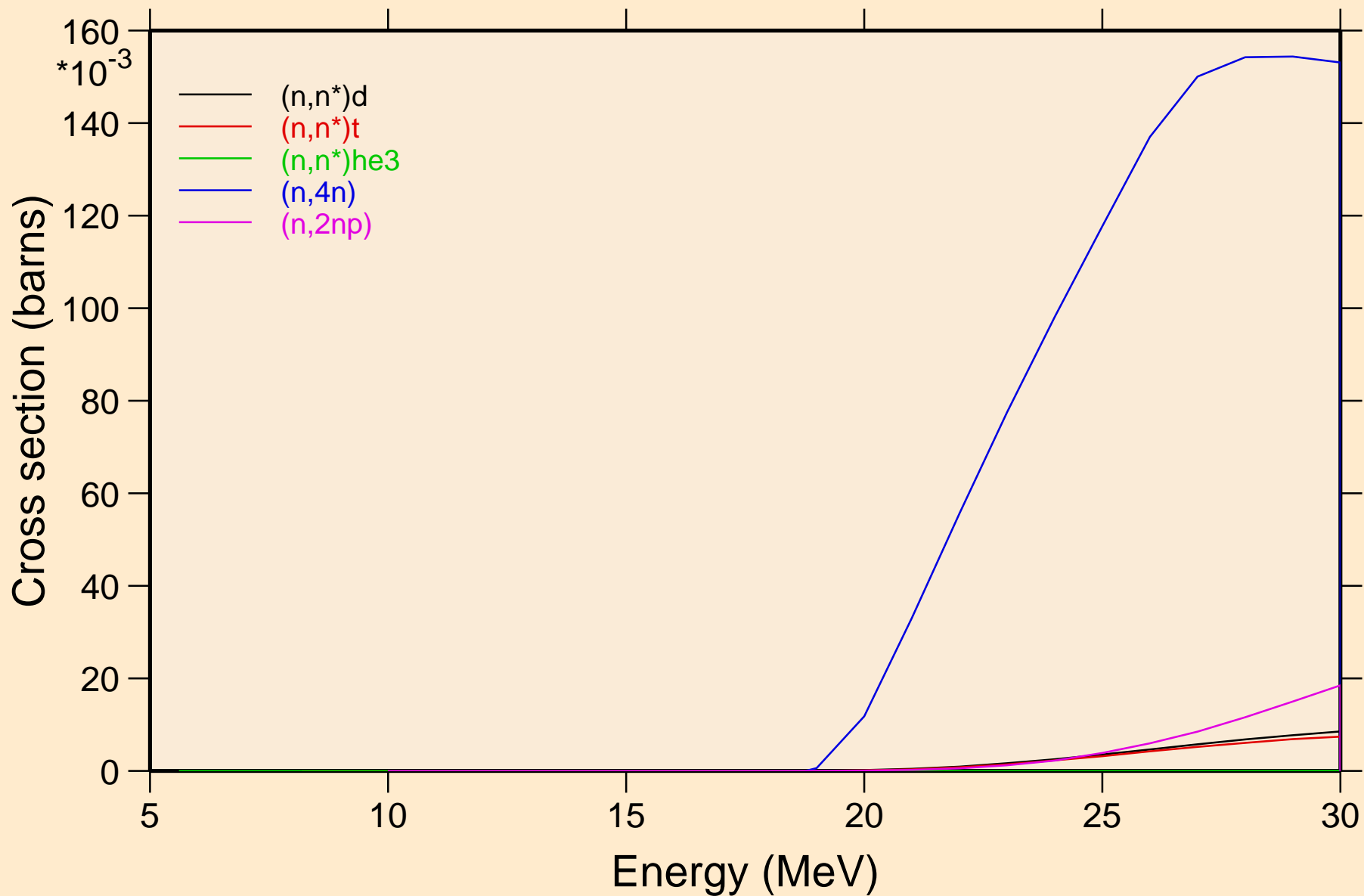

NO257 NEUTRON ACER TENDL-2019 LIBRARY; T=293.16K
Threshold reactions

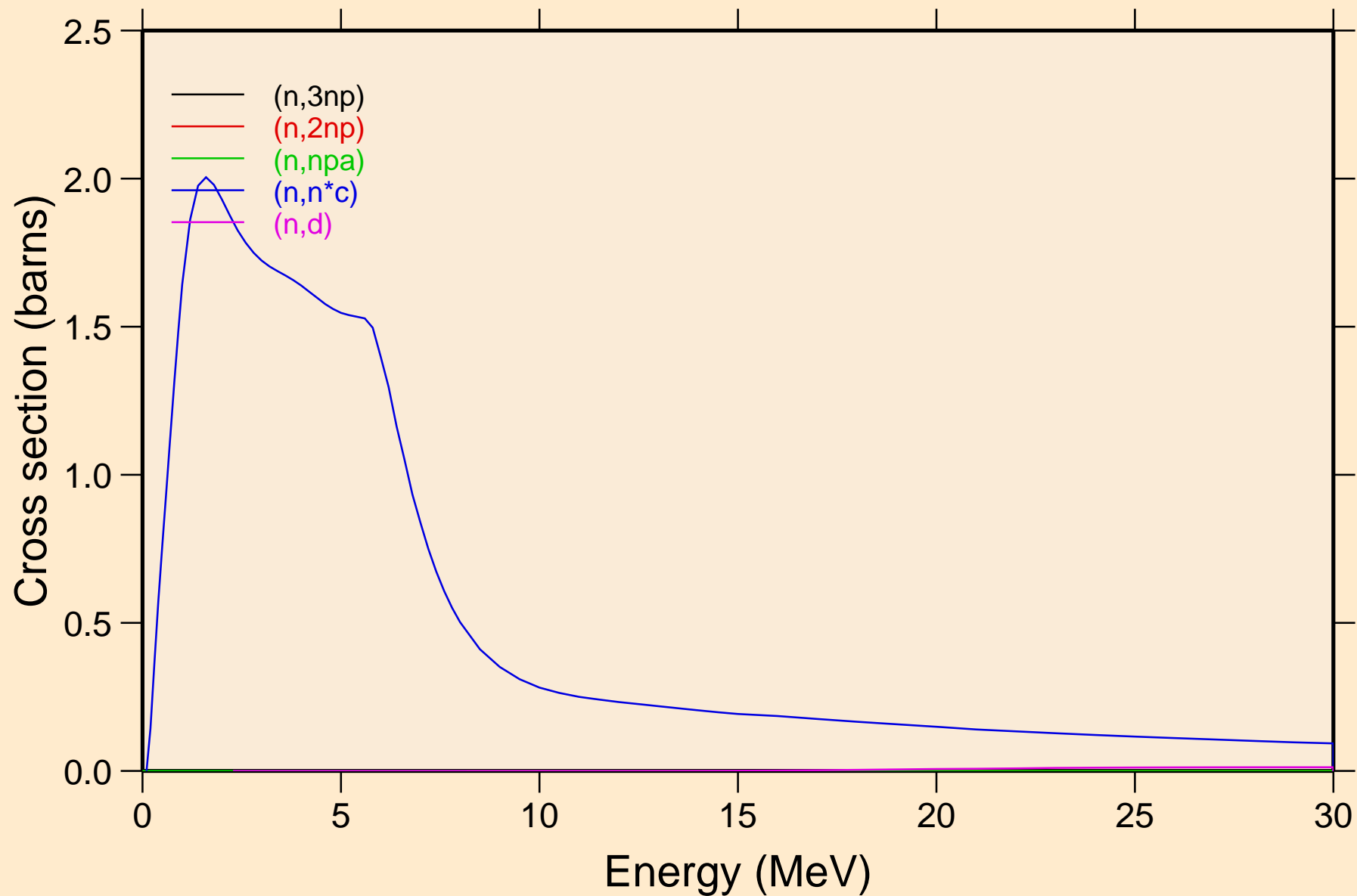

NO257 NEUTRON ACER TENDL-2019 LIBRARY; T=293.16K
Threshold reactions

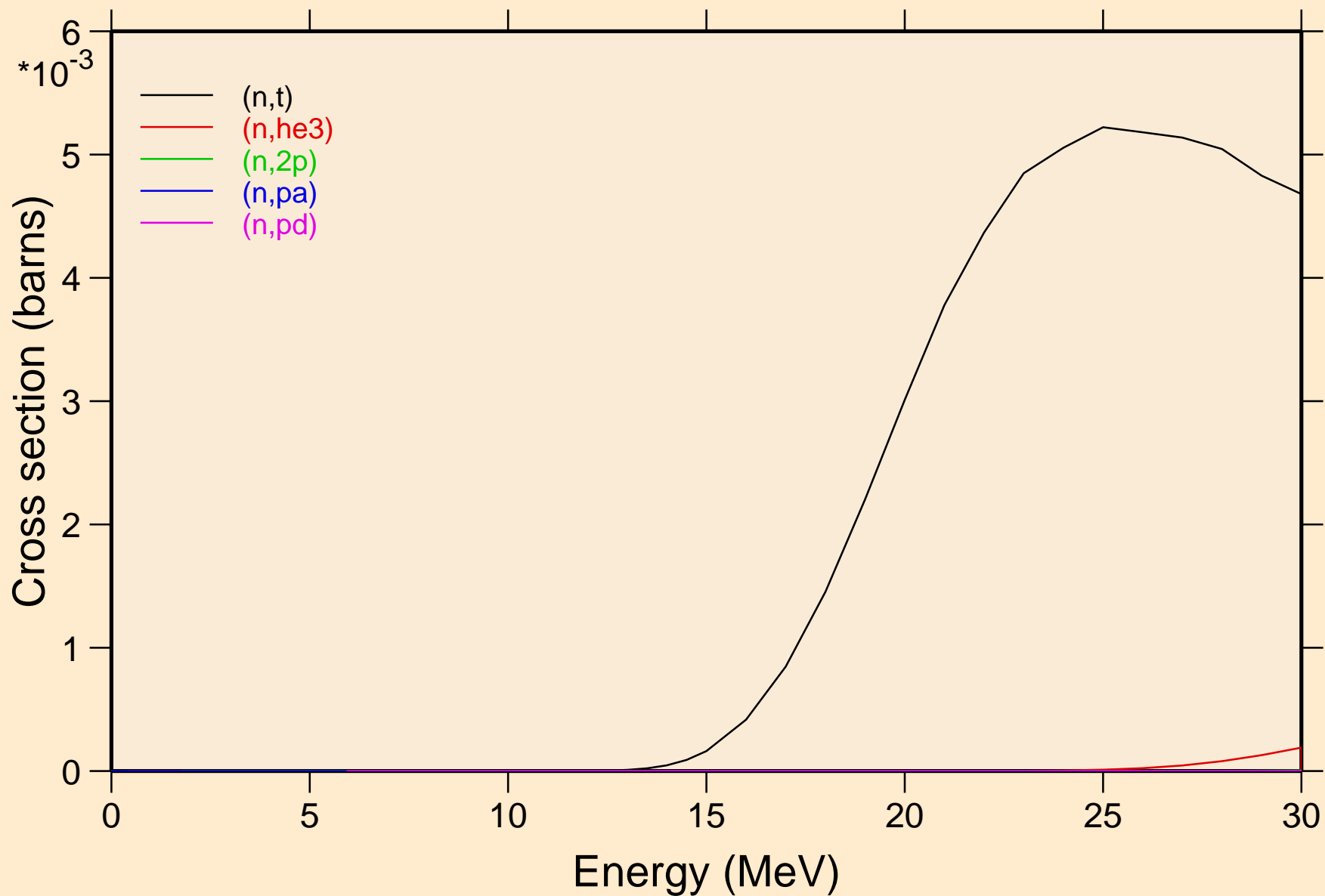

NO257 NEUTRON ACER TENDL-2019 LIBRARY; T=293.16K
Threshold reactions

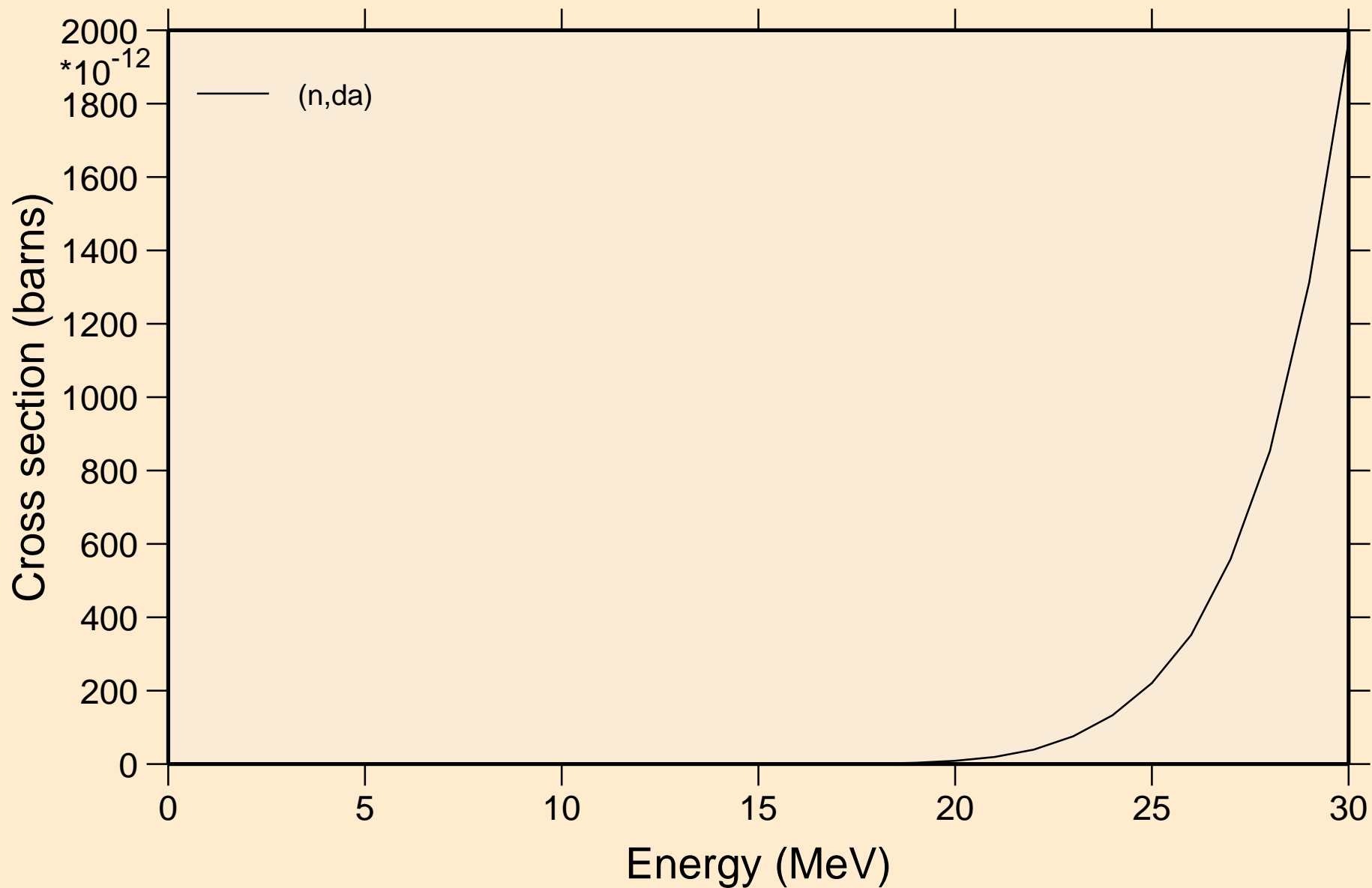

NO257 NEUTRON ACER TENDL-2019 LIBRARY; T=293.16K
Threshold reactions

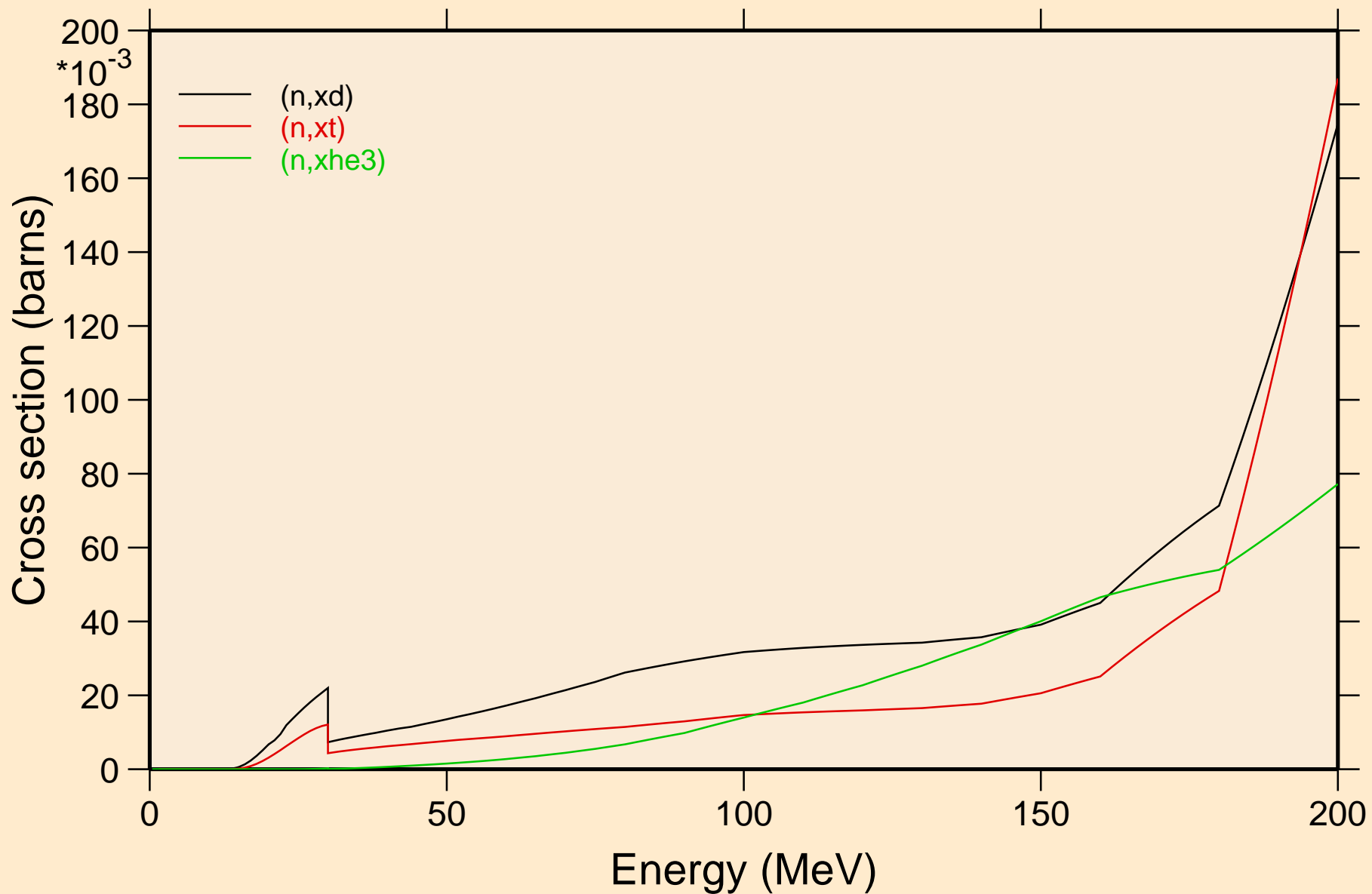

NO257 NEUTRON ACER TENDL-2019 LIBRARY; T=293.16K
angular distribution for elastic

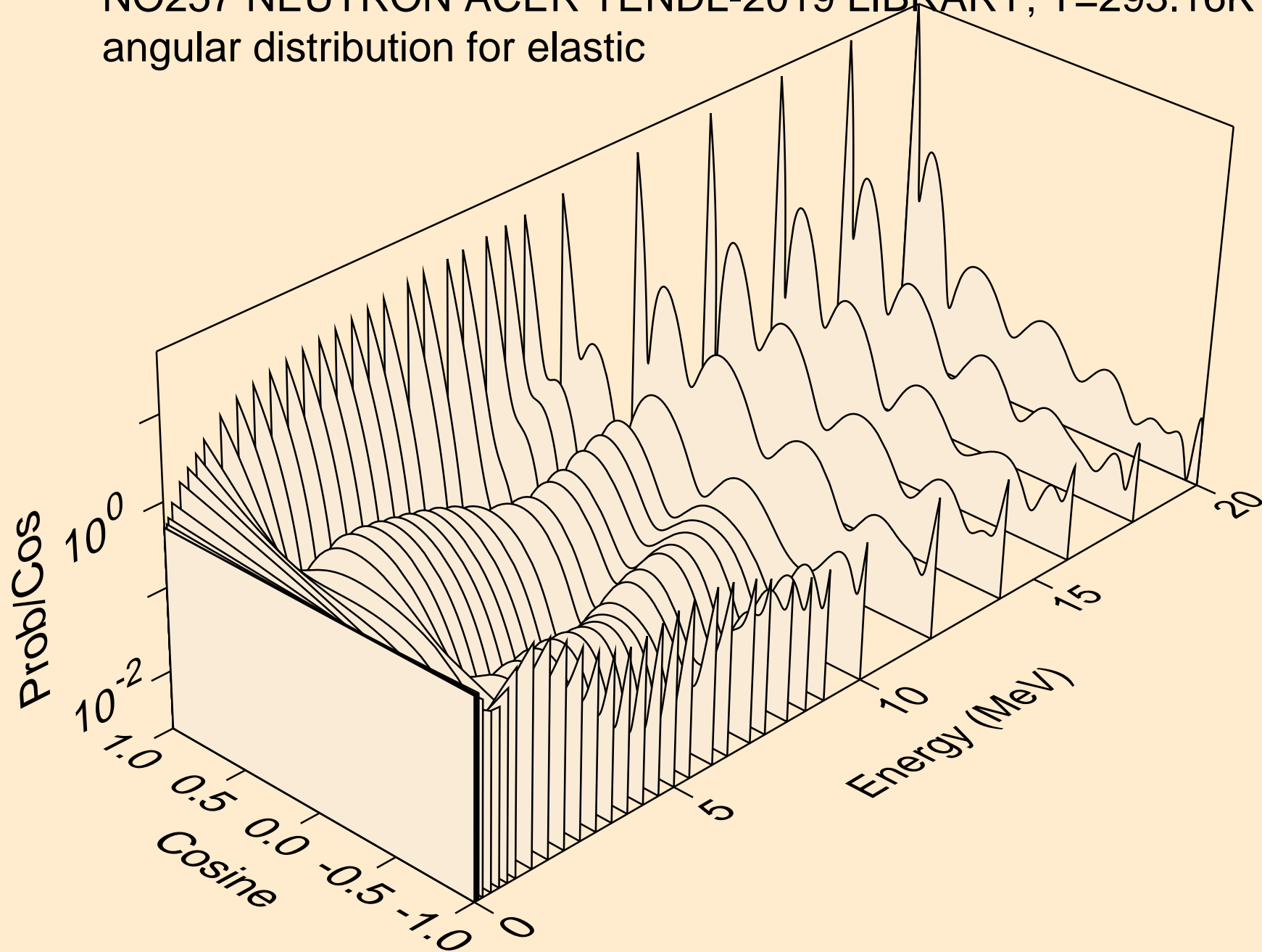

NO257 NEUTRON ACER TENDL-2019 LIBRARY; T=293.16K
angular distribution for elastic

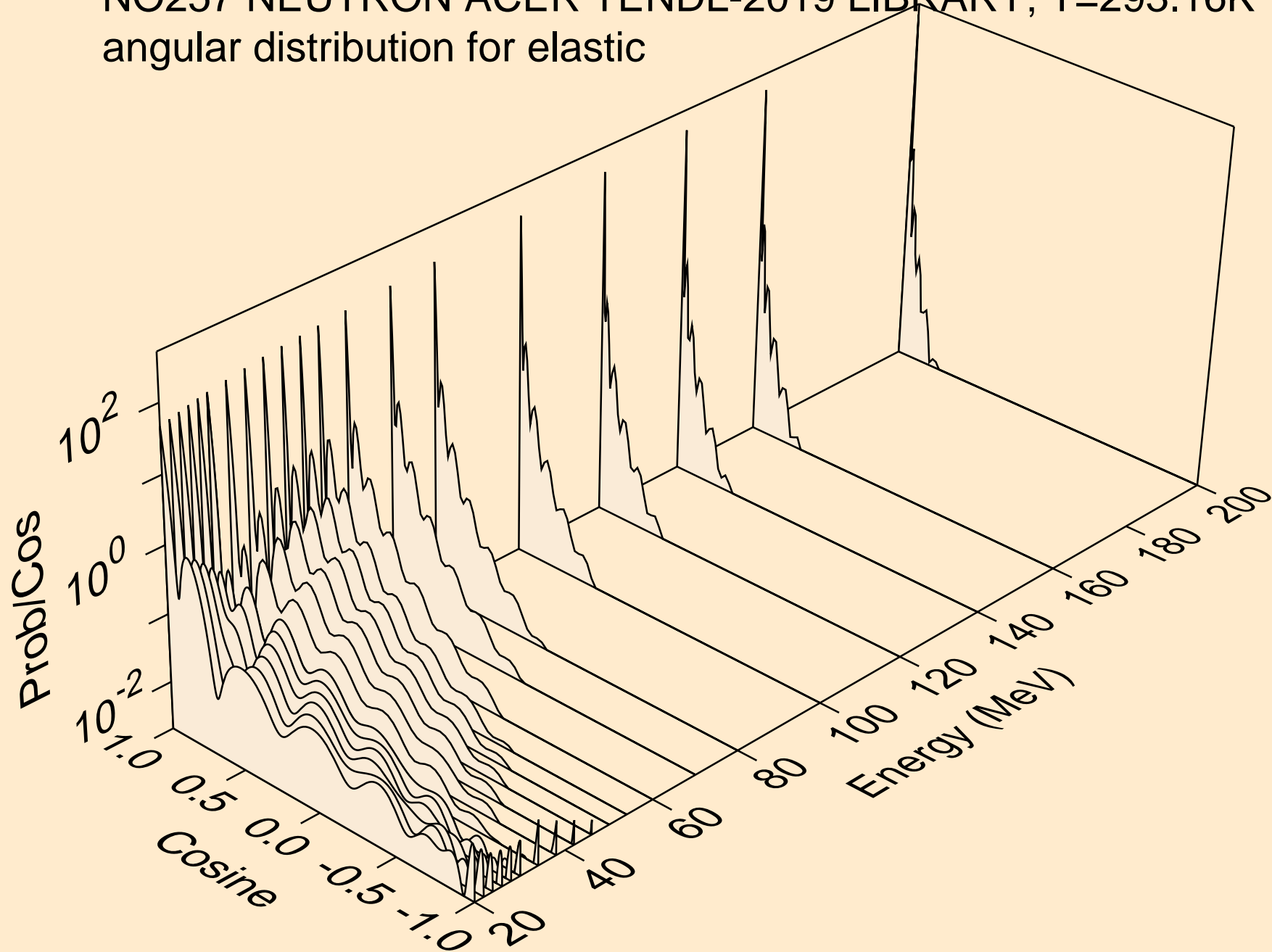

NO257 NEUTRON ACER TENDL-2019 LIBRARY; T=293.16K
angular distribution for (n,n*1)

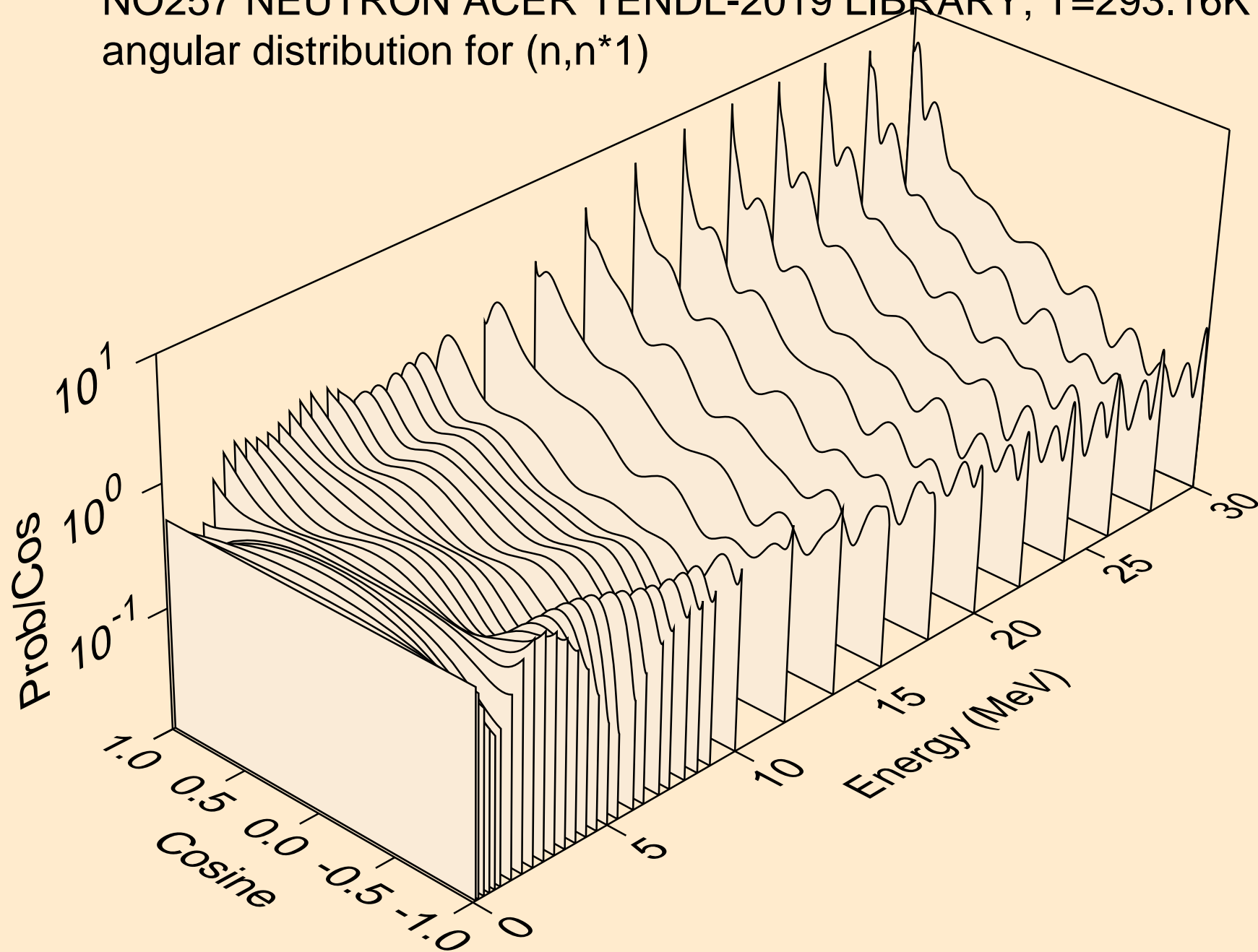

NO257 NEUTRON ACER TENDL-2019 LIBRARY; T=293.16K
Total fission nubar

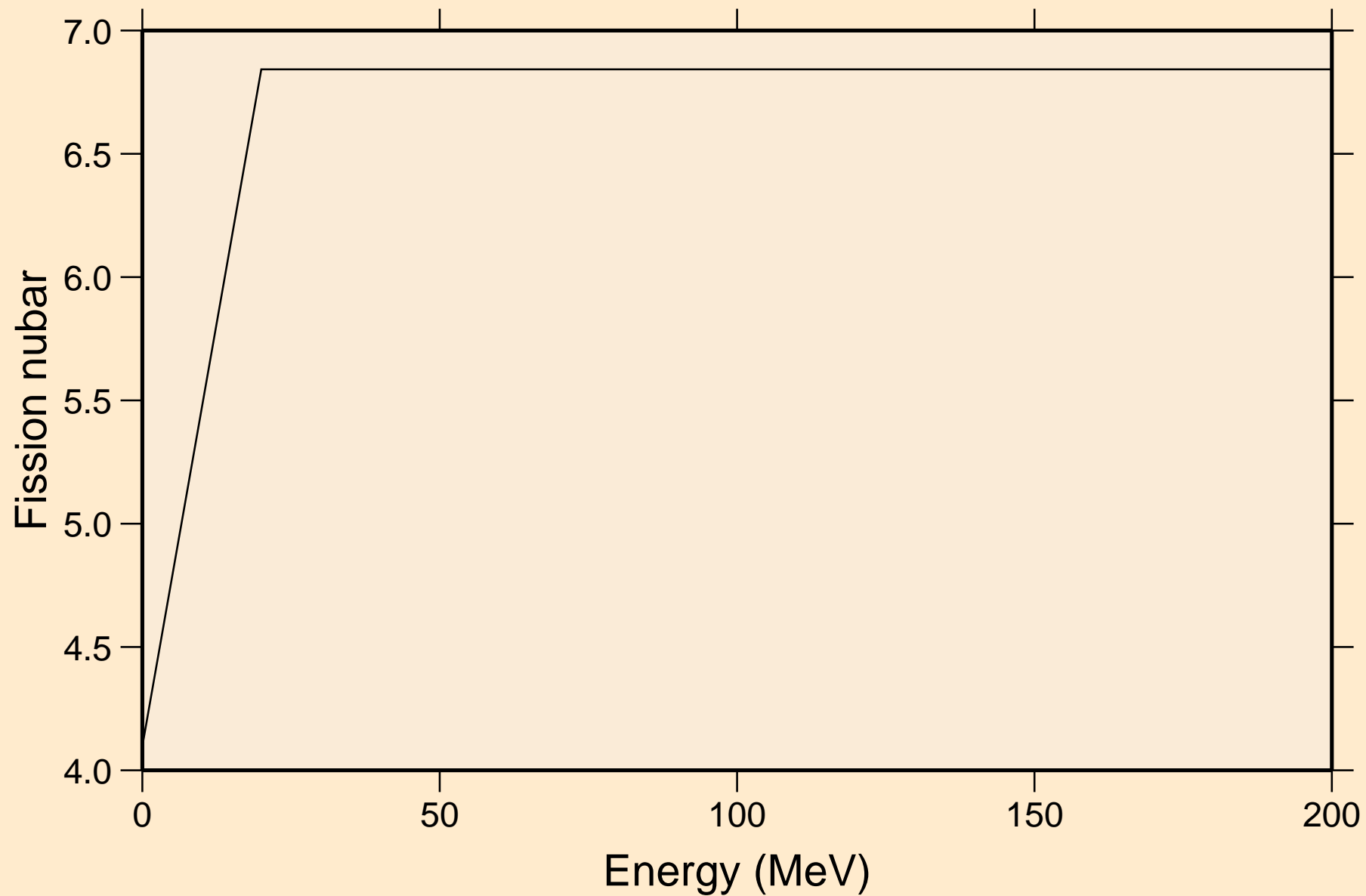

NO257 NEUTRON ACER TENDL-2019 LIBRARY; T=293.16K
Neutron emission for (n,x)

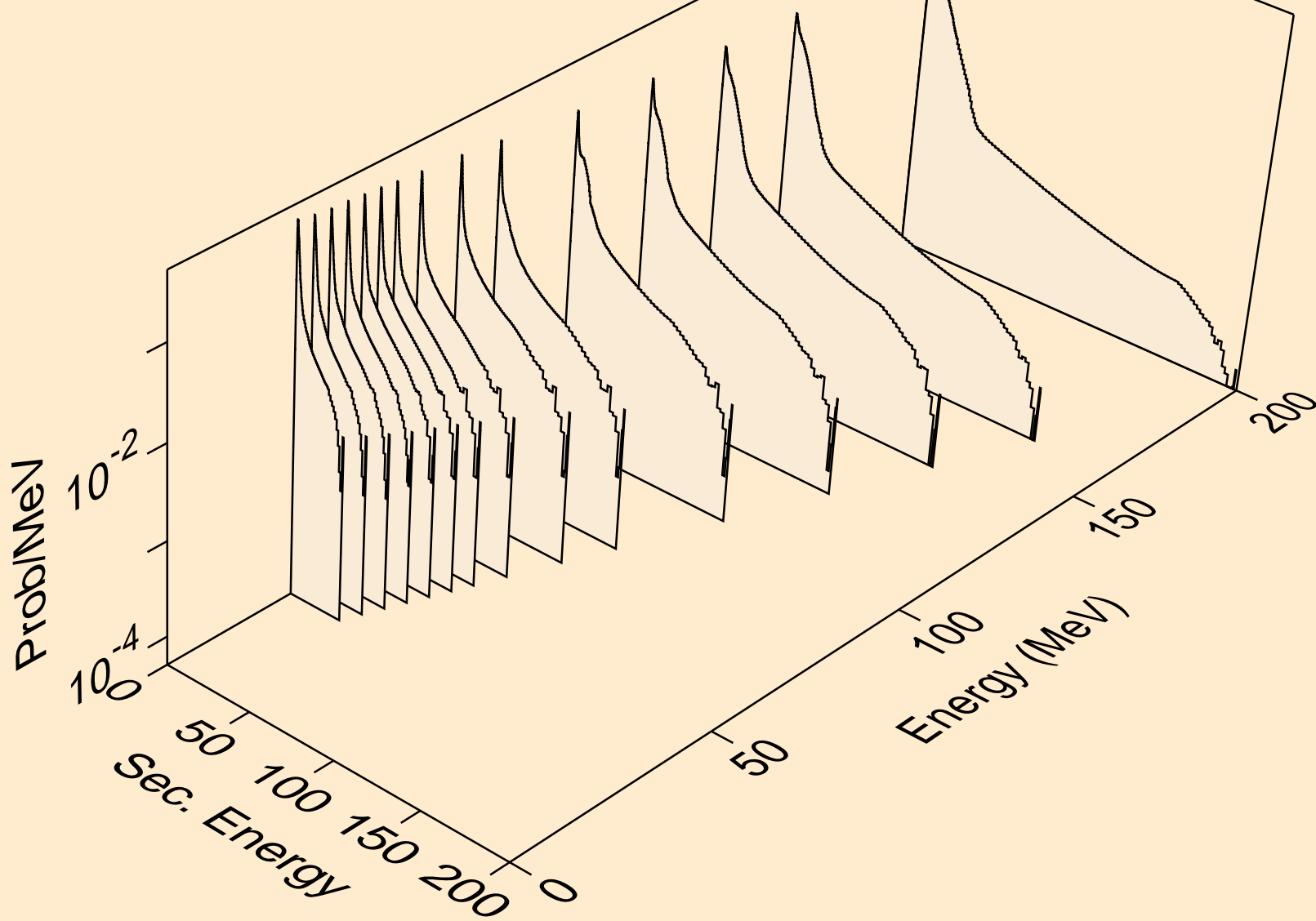

NO257 NEUTRON ACER TENDL-2019 LIBRARY; T=293.16K
Neutron emission for (n,2nd)

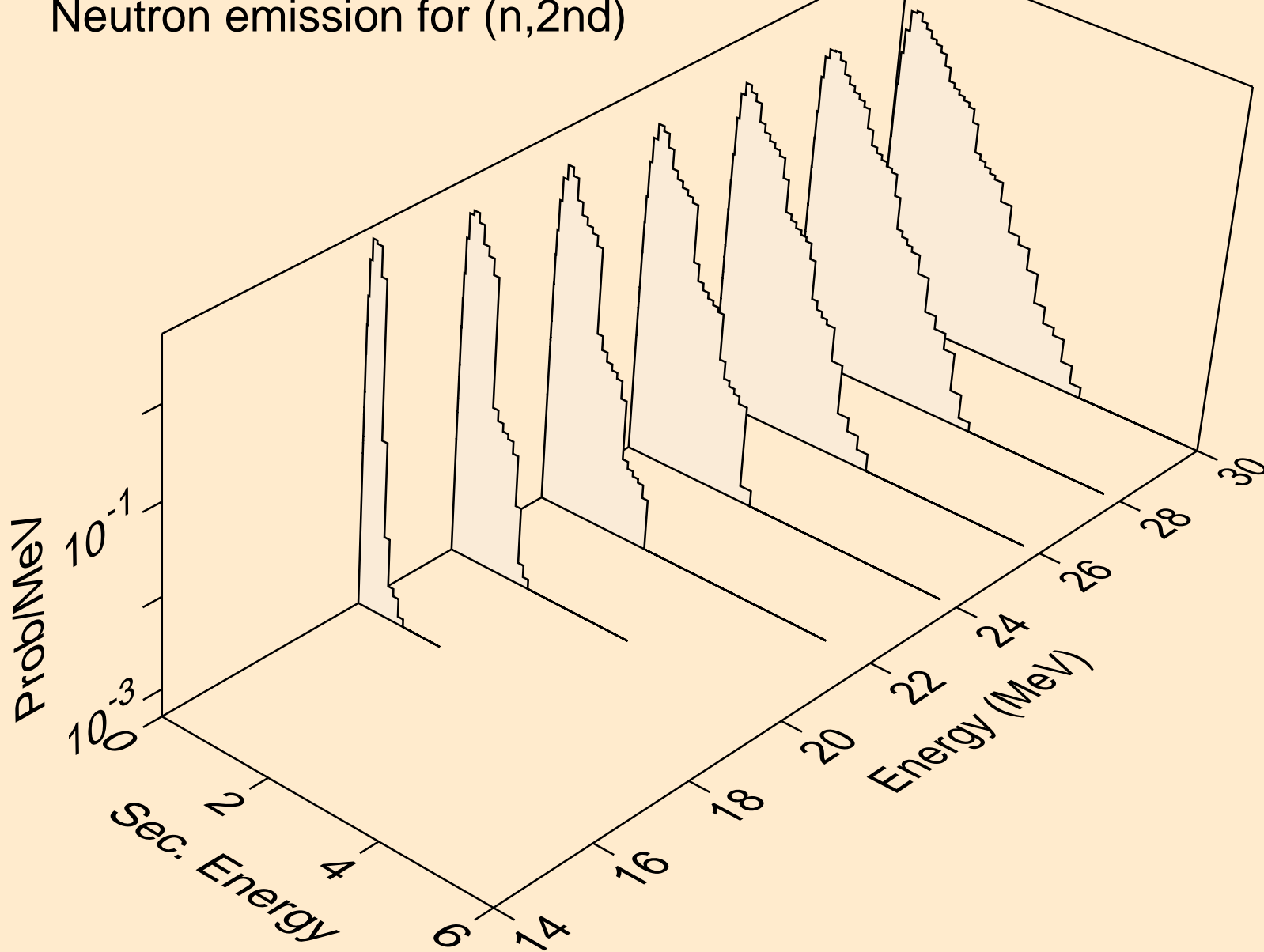

NO257 NEUTRON ACER TENDL-2019 LIBRARY; T=293.16K
Neutron emission for (n,2n)

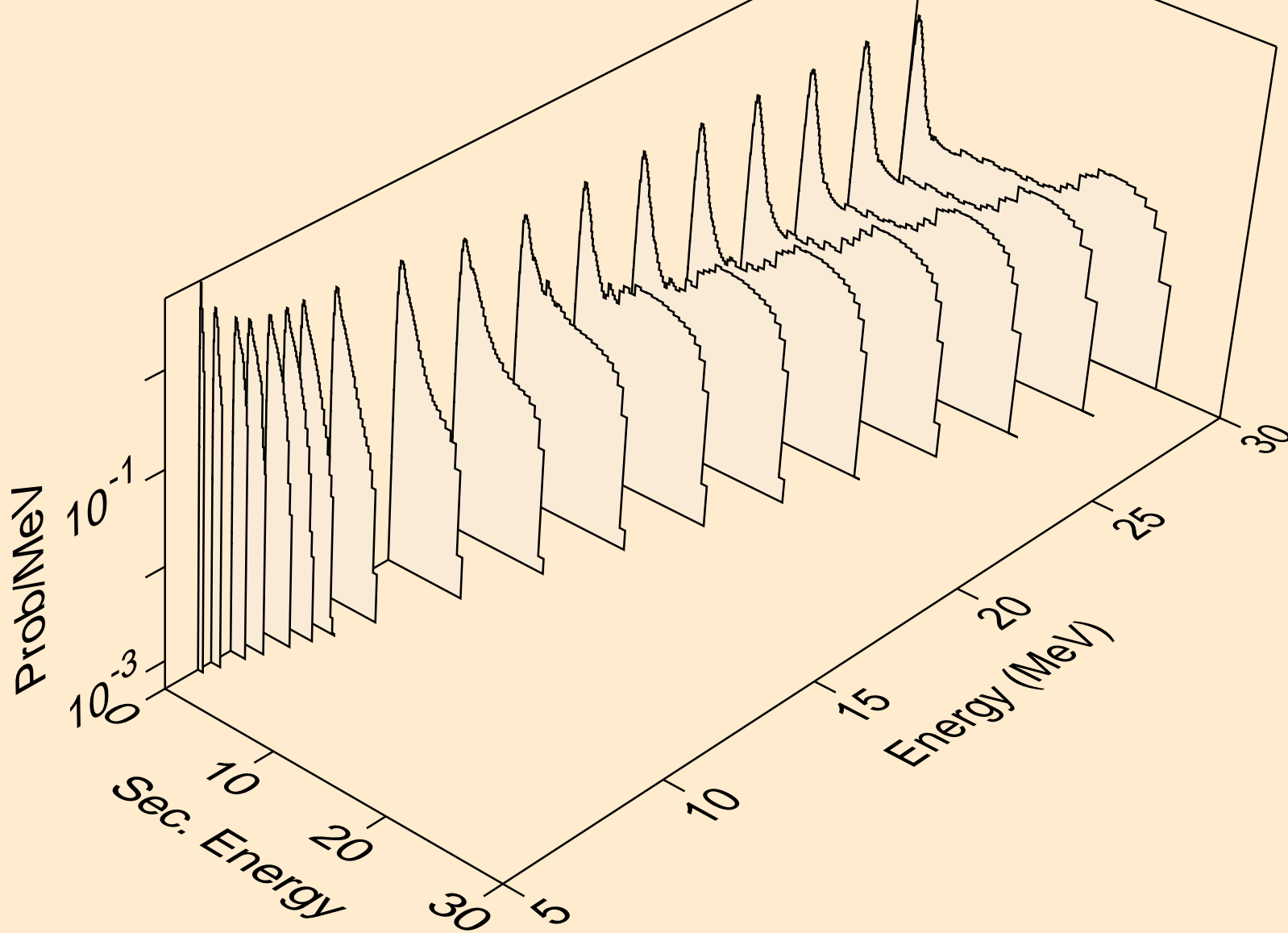

NO257 NEUTRON ACER TENDL-2019 LIBRARY; T=293.16K
Neutron emission for (n,3n)

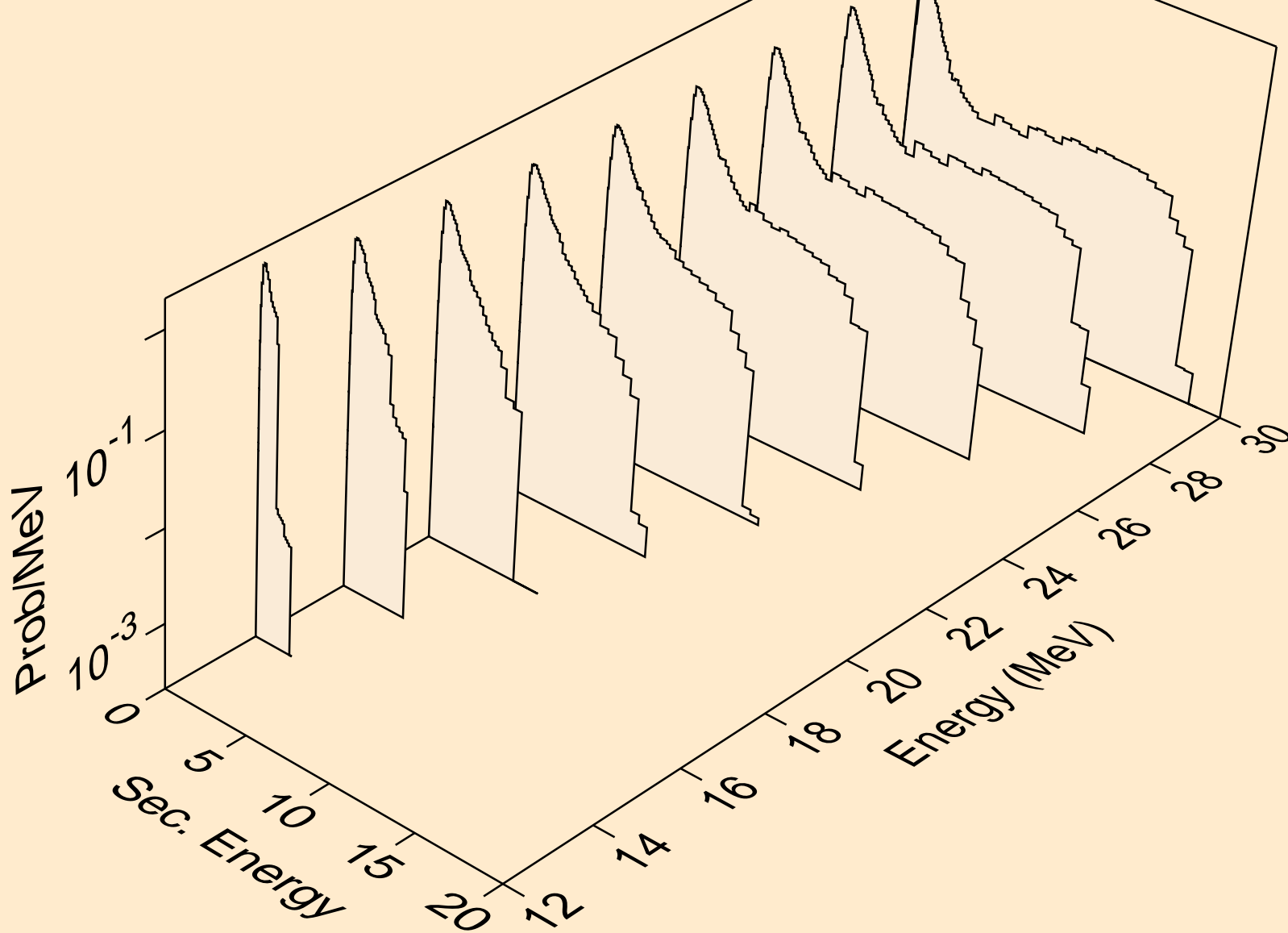

NO257 NEUTRON ACER TENDL-2019 LIBRARY; T=293.16K
Neutron emission for fission

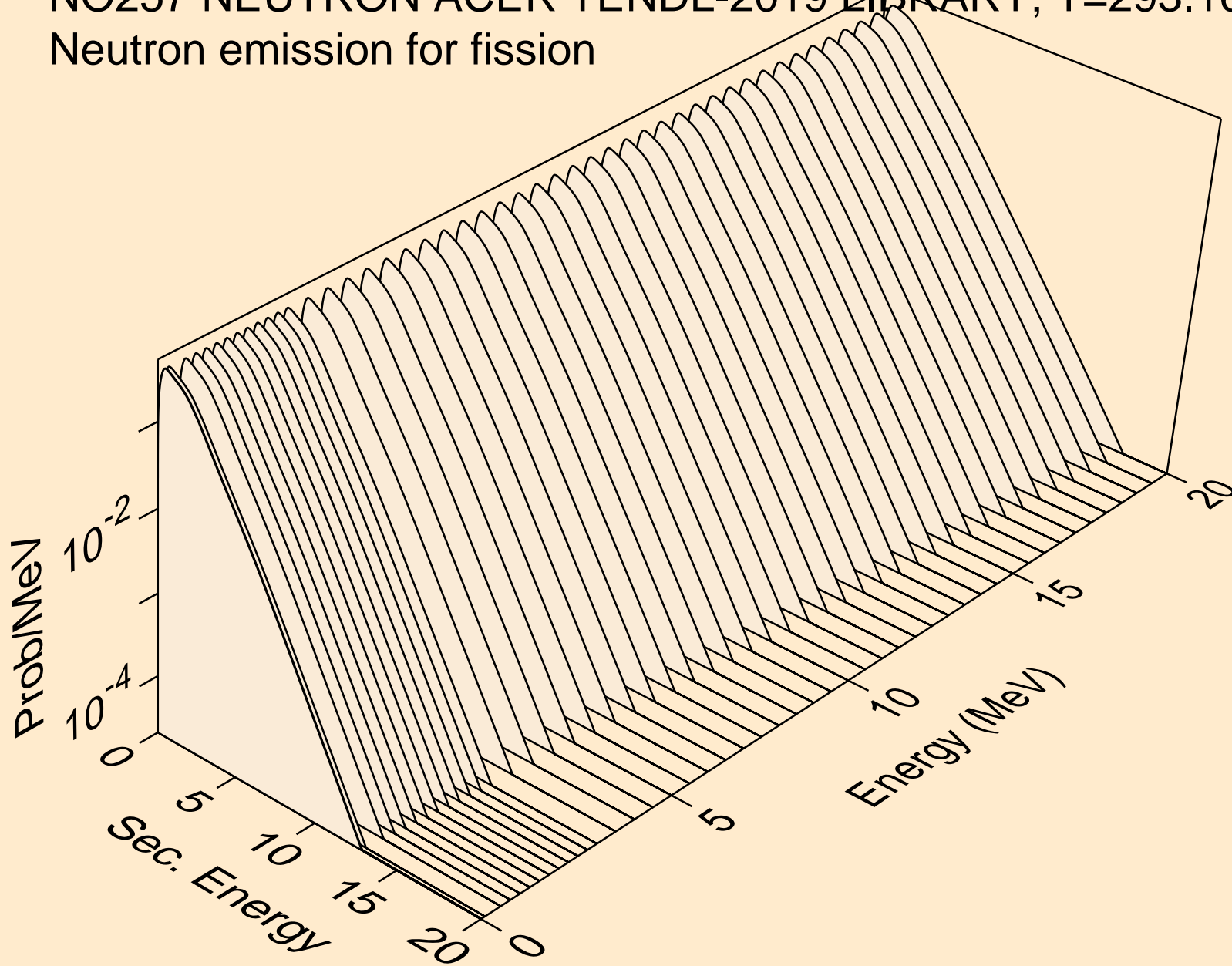

NO257 NEUTRON ACER TENDL-2019 LIBRARY; T=293.16K
Neutron emission for (n,n*)a

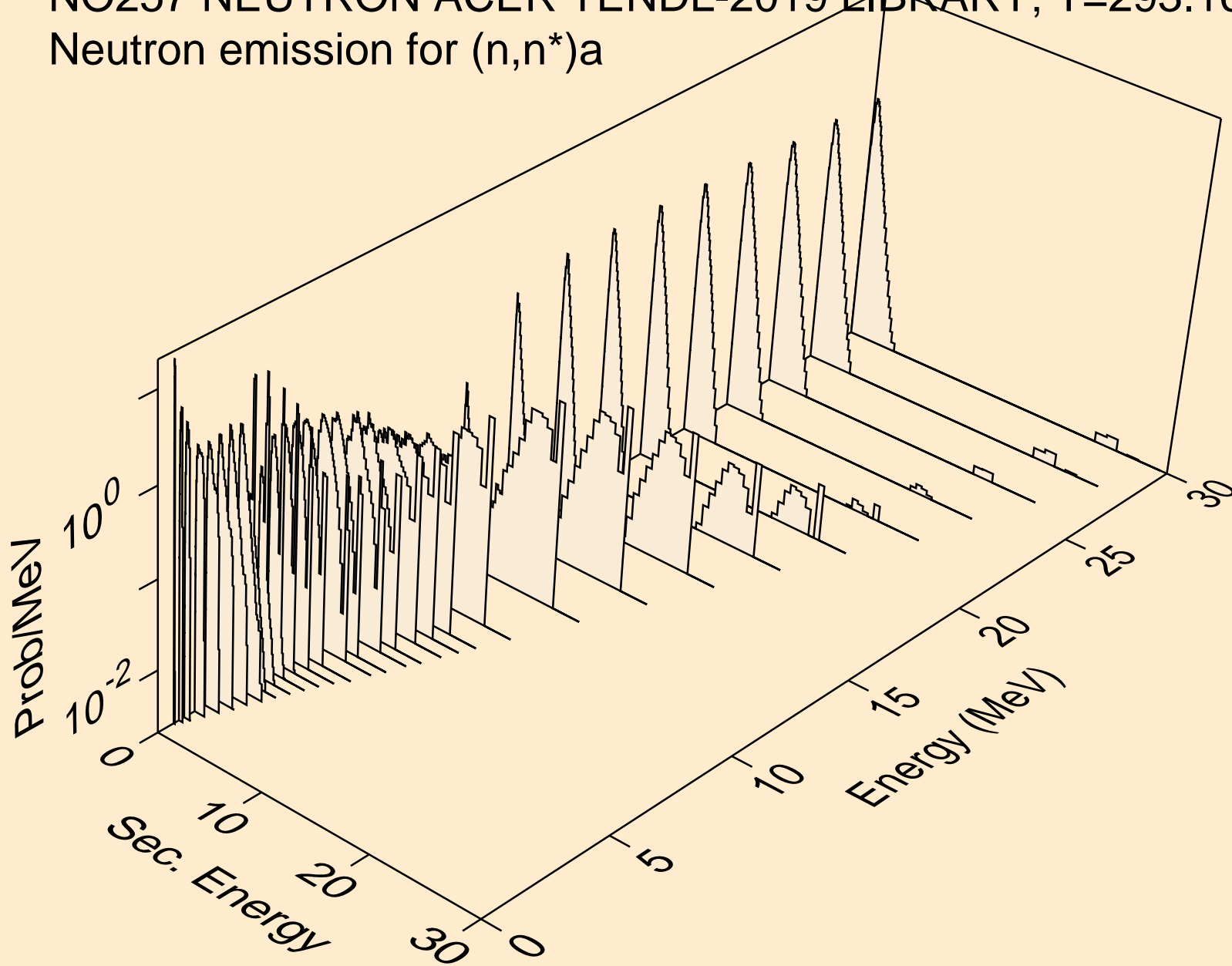

NO257 NEUTRON ACER TENDL-2019 LIBRARY; T=293.16K
Neutron emission for (n,2n)a

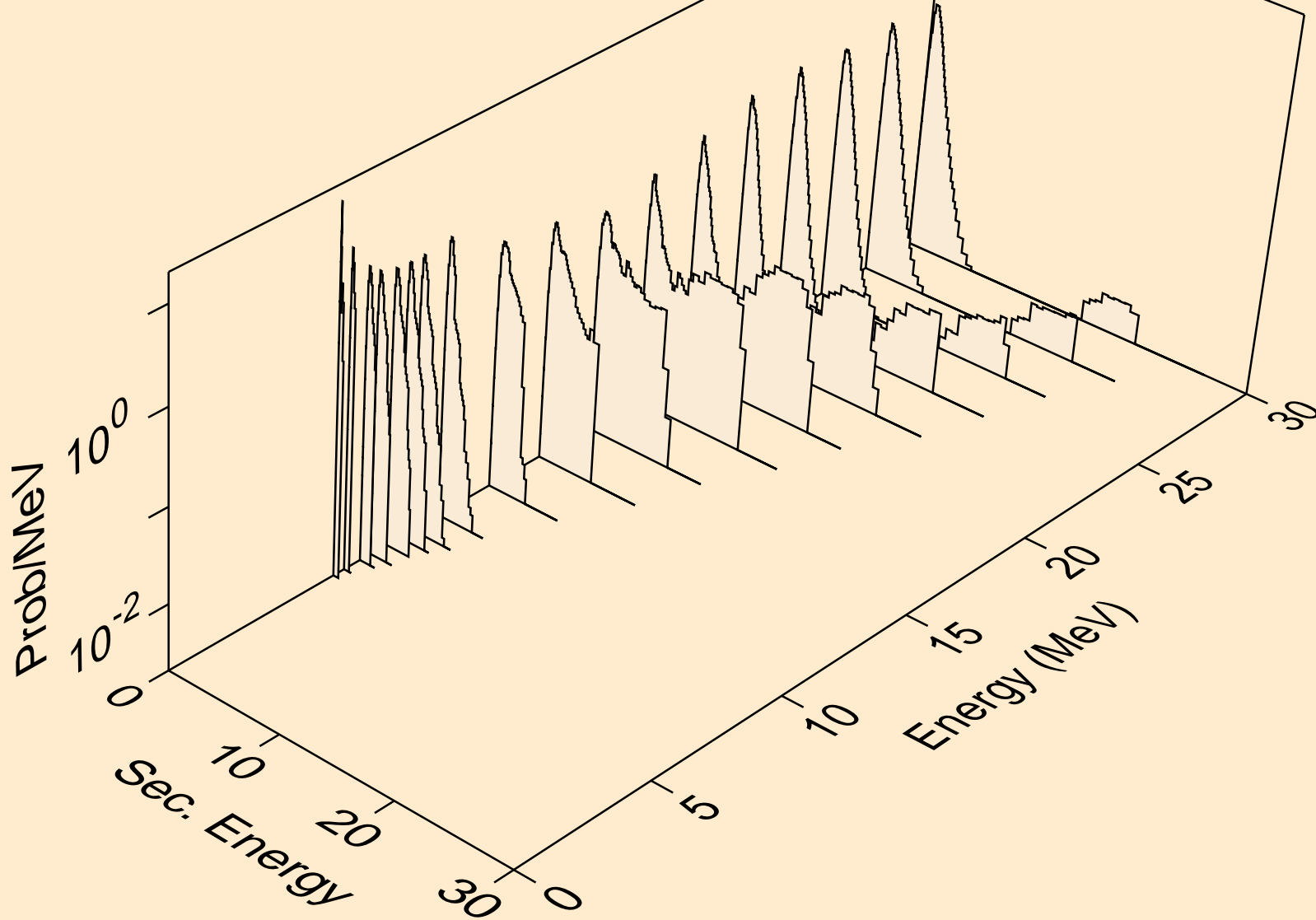

NO257 NEUTRON ACER TENDL-2019 LIBRARY; T=293.16K
Neutron emission for (n,3n)a

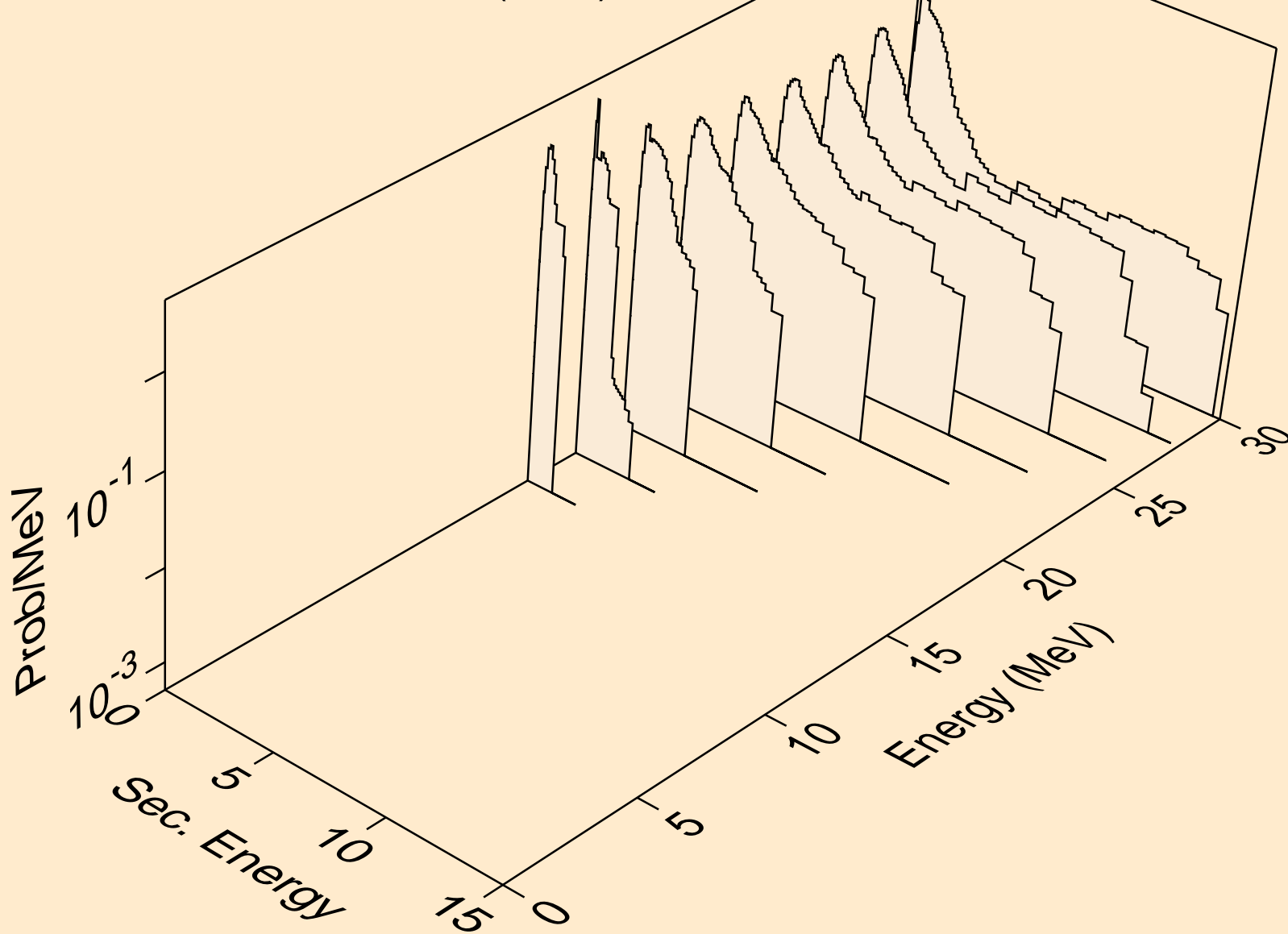

NO257 NEUTRON ACER TENDL-2019 LIBRARY; T=293.16K
Neutron emission for (n,n*)p

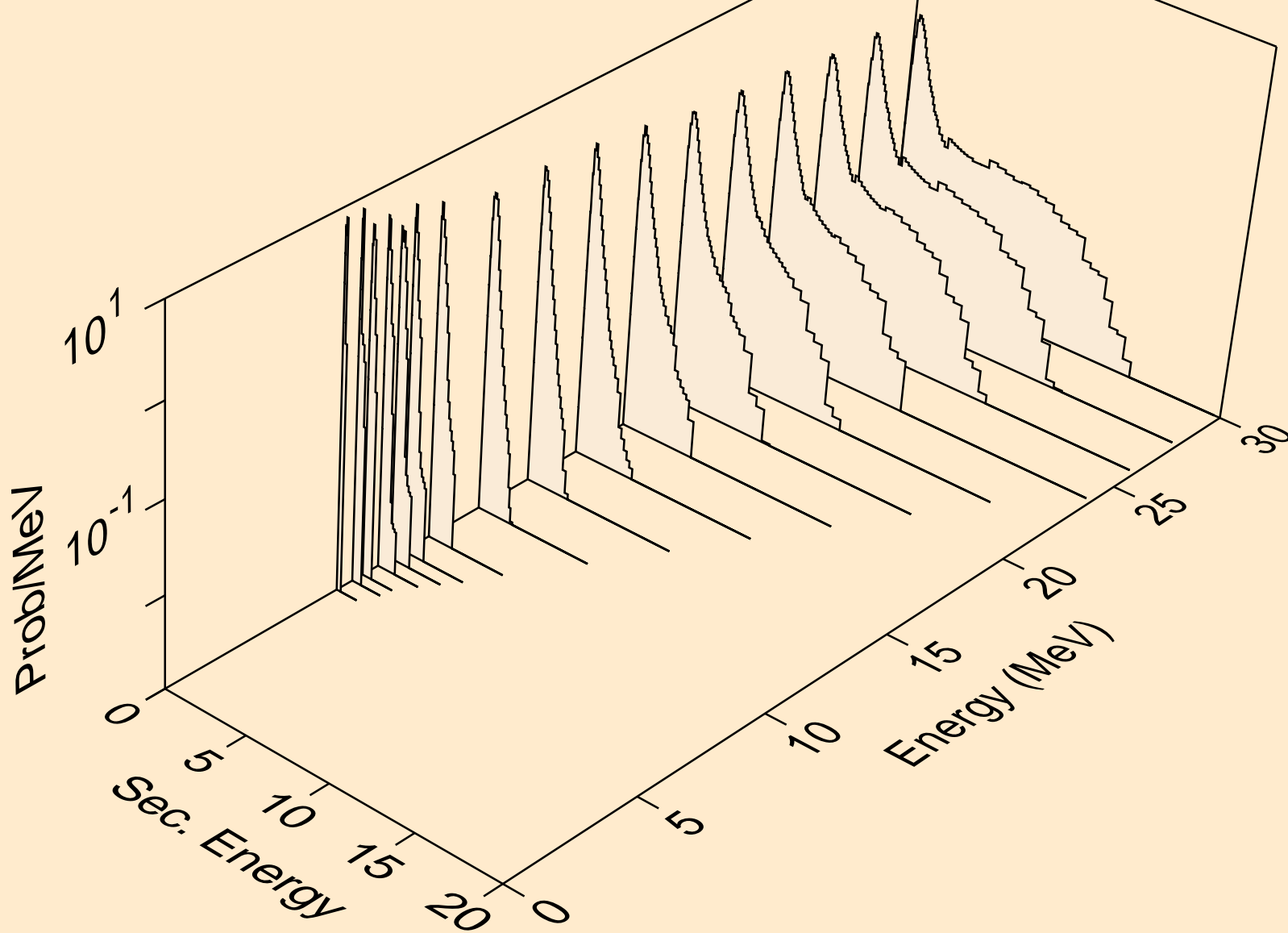

NO257 NEUTRON ACER TENDL-2019 LIBRARY; T=293.16K
Neutron emission for (n,n*)2a

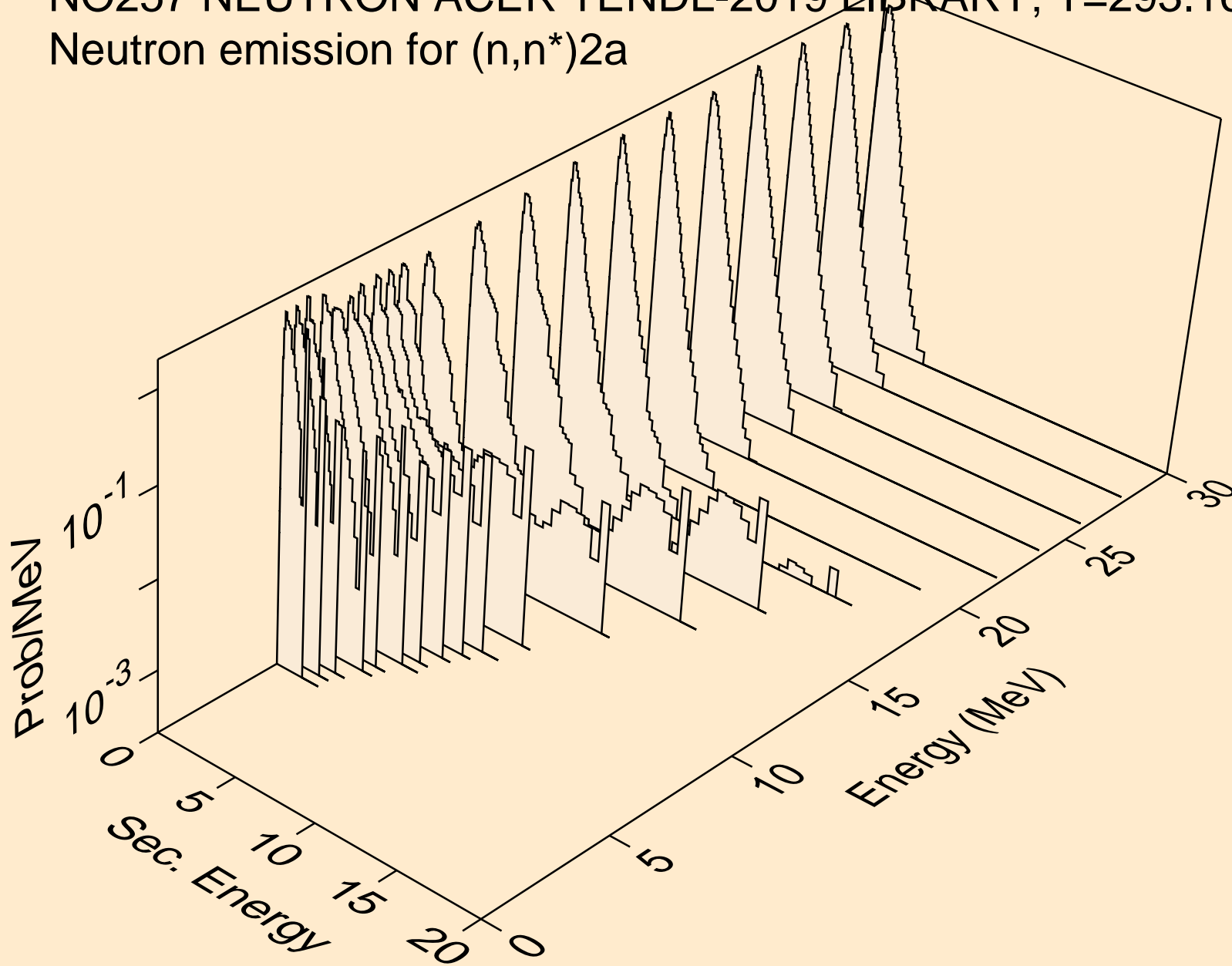

NO257 NEUTRON ACER TENDL-2019 LIBRARY; T=293.16K
Neutron emission for (n,2n)2a

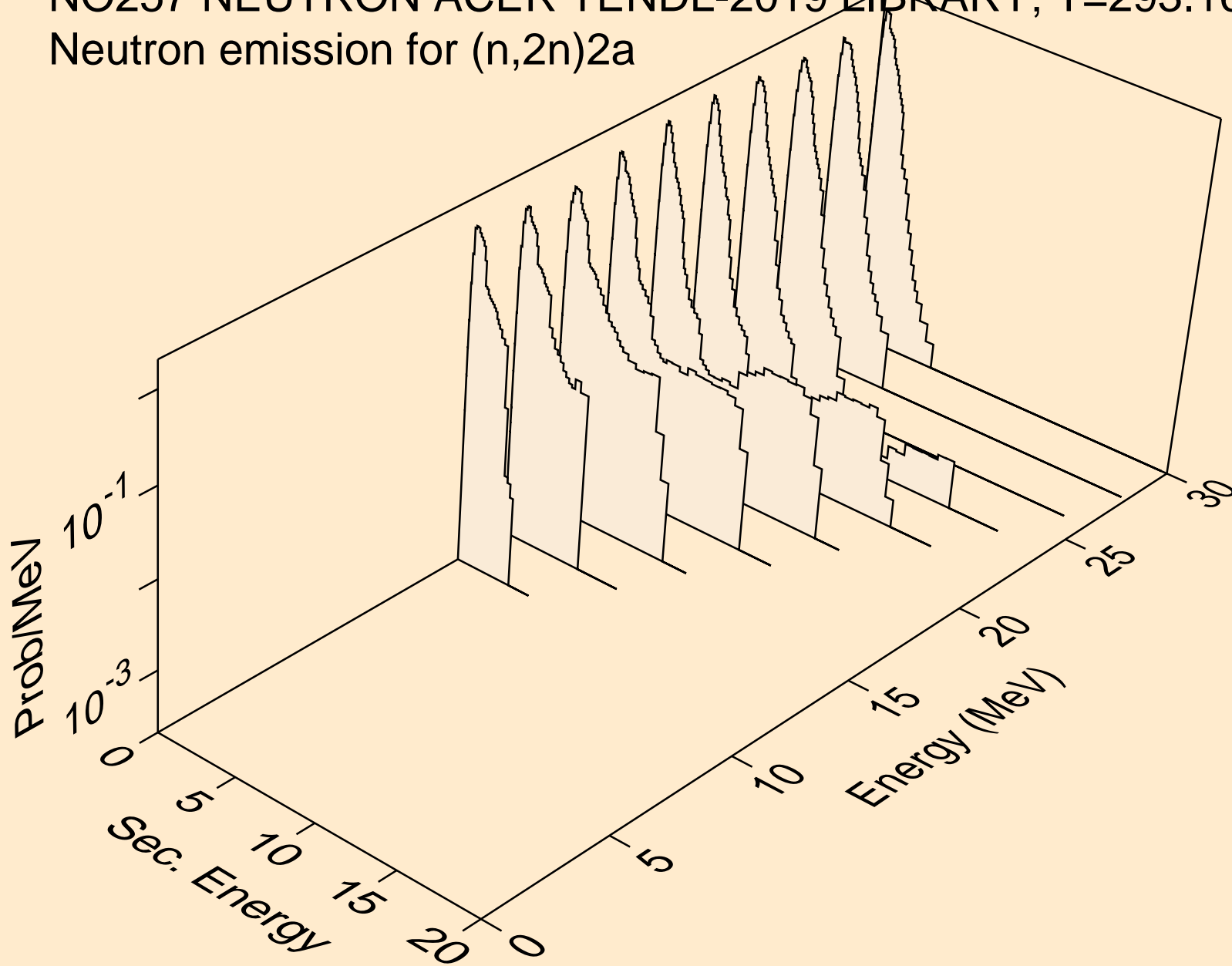

NO257 NEUTRON ACER TENDL-2019 LIBRARY; T=293.16K
Neutron emission for (n,n*)d

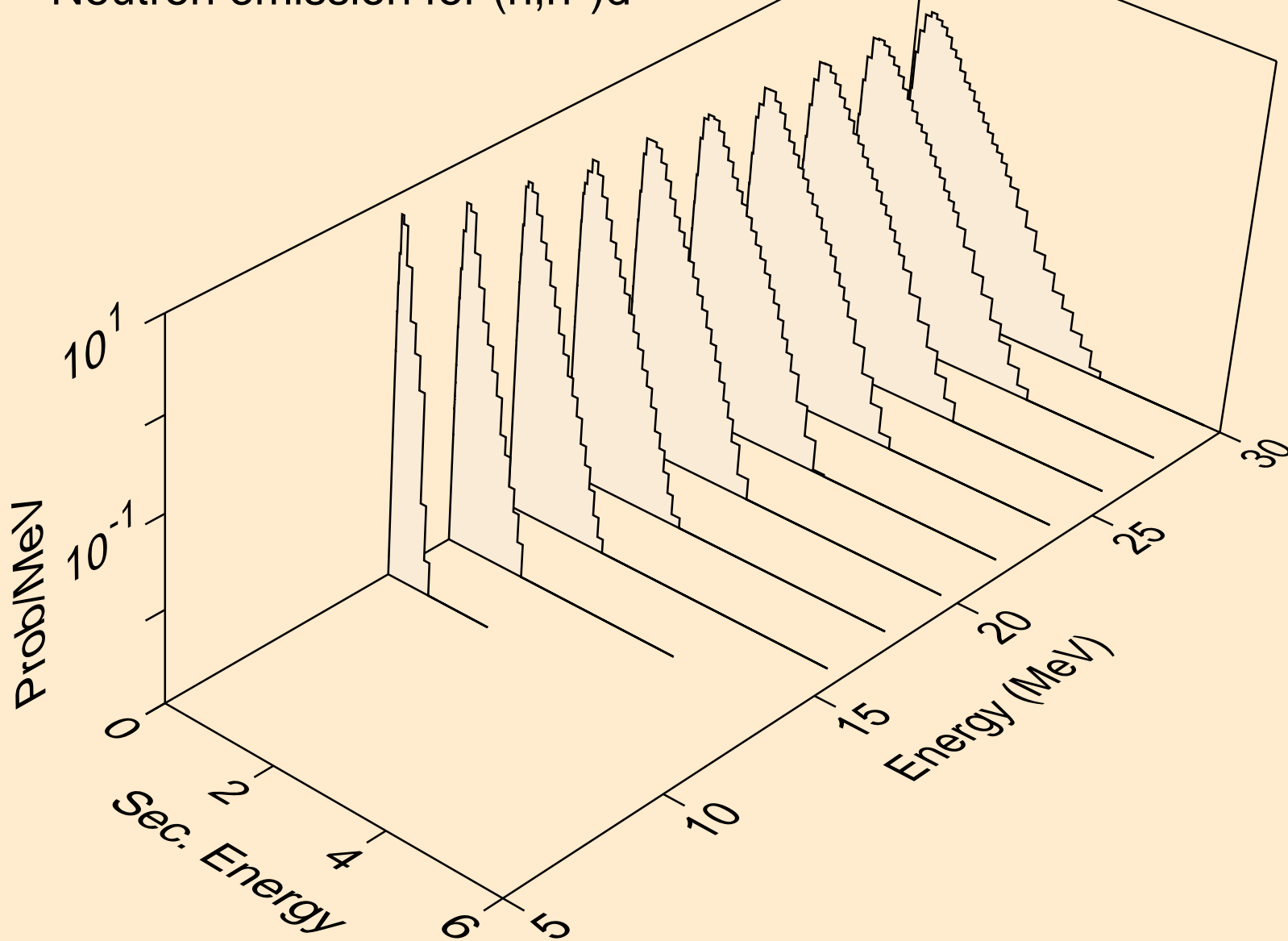

NO257 NEUTRON ACER TENDL-2019 LIBRARY; T=293.16K
Neutron emission for (n,n*)t

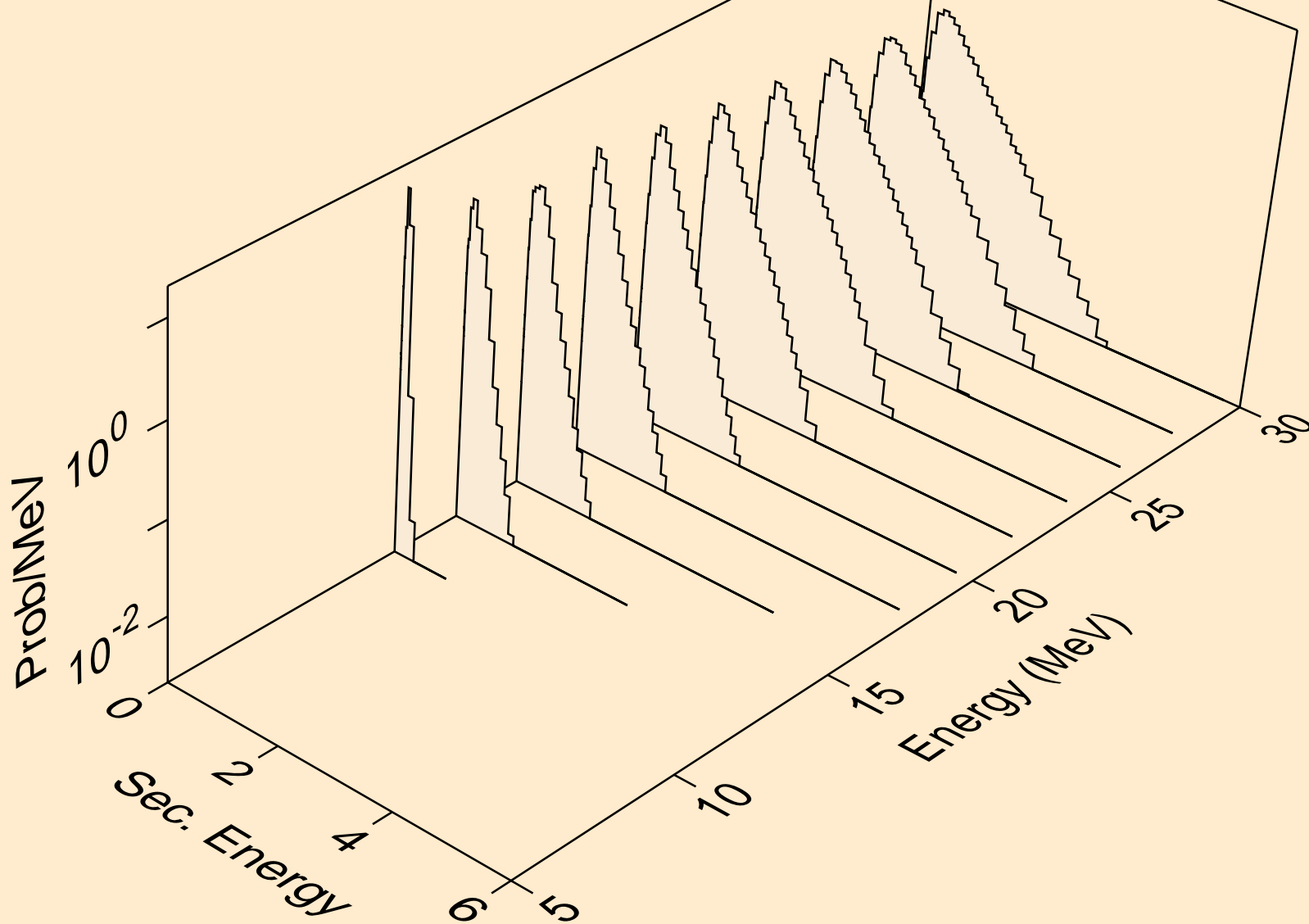

NO257 NEUTRON ACER TENDL-2019 LIBRARY; T=293.16K
Neutron emission for (n,n*)he3

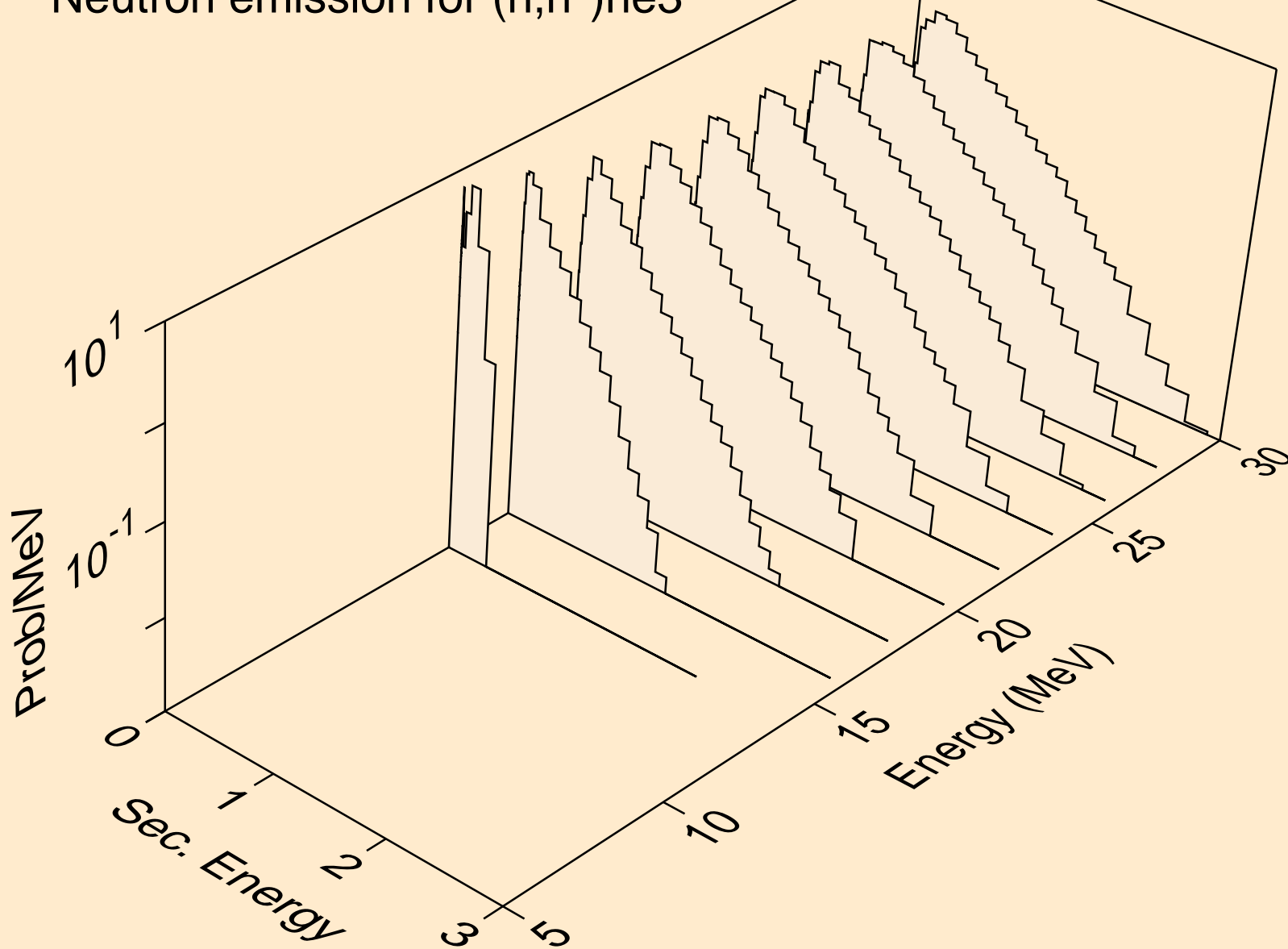

NO257 NEUTRON ACER TENDL-2019 LIBRARY; T=293.16K
Neutron emission for (n,4n)

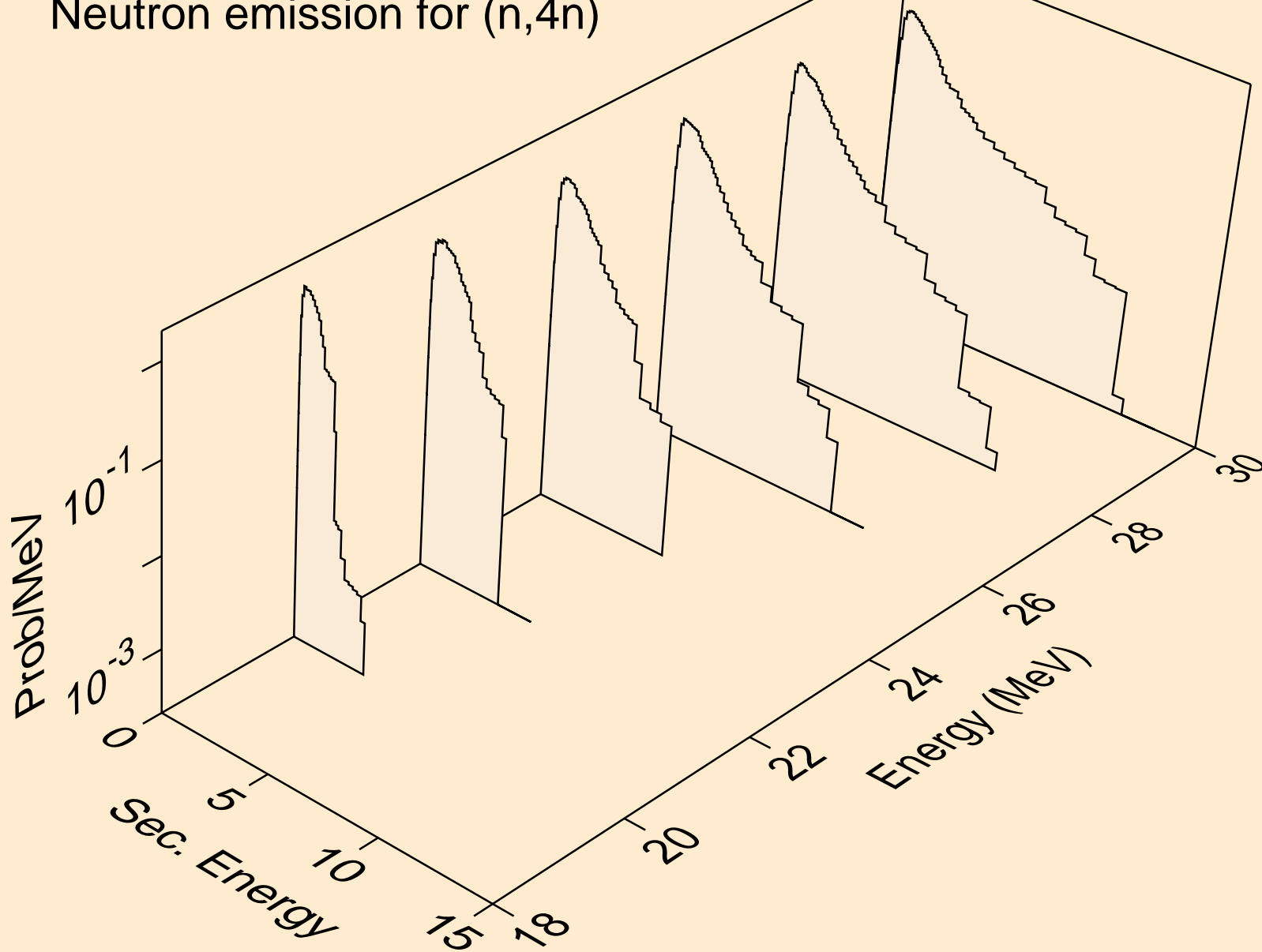

NO257 NEUTRON ACER TENDL-2019 LIBRARY; T=293.16K
Neutron emission for (n,2np)

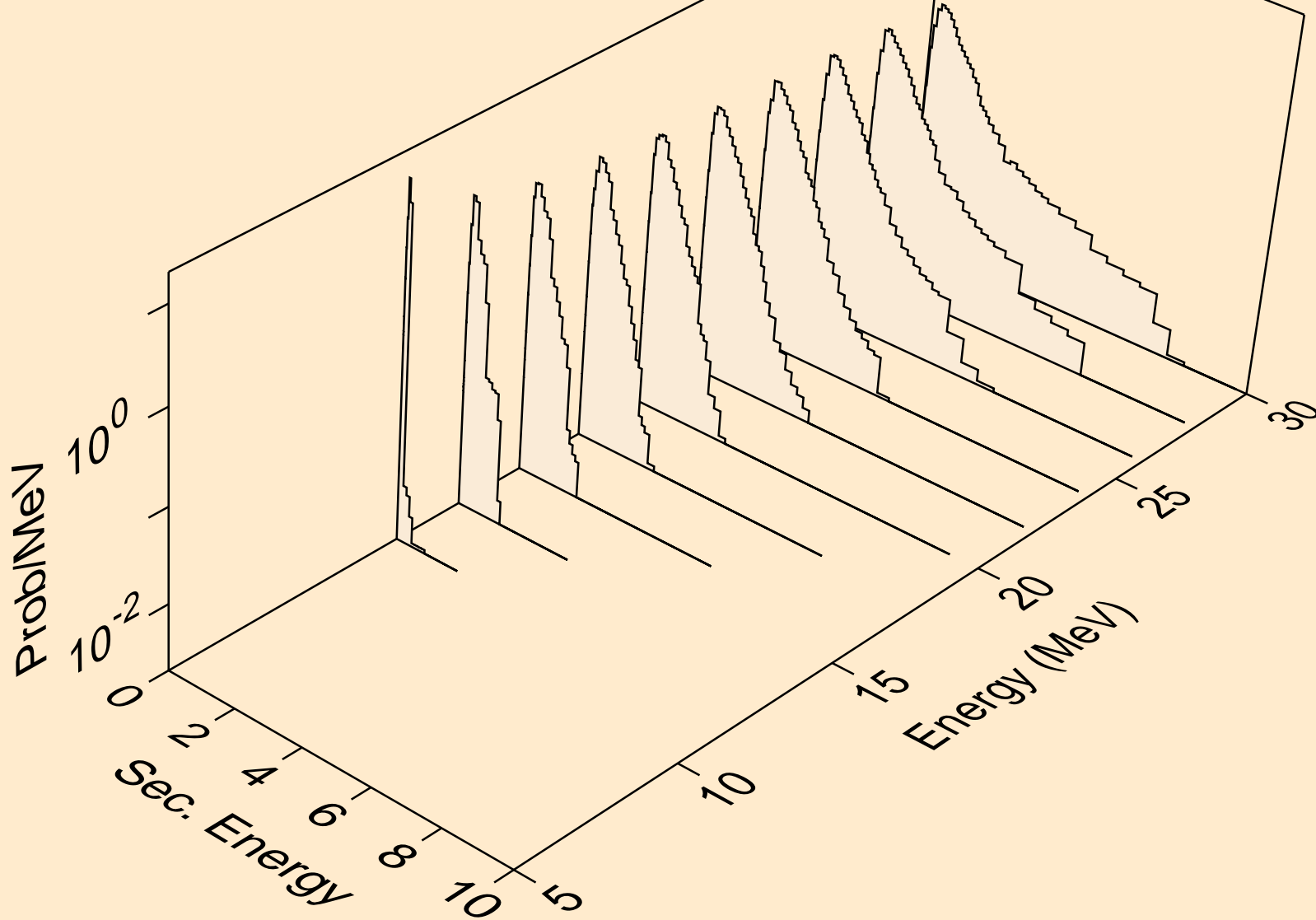

NO257 NEUTRON ACER TENDL-2019 LIBRARY; T=293.16K
Neutron emission for (n,3np)

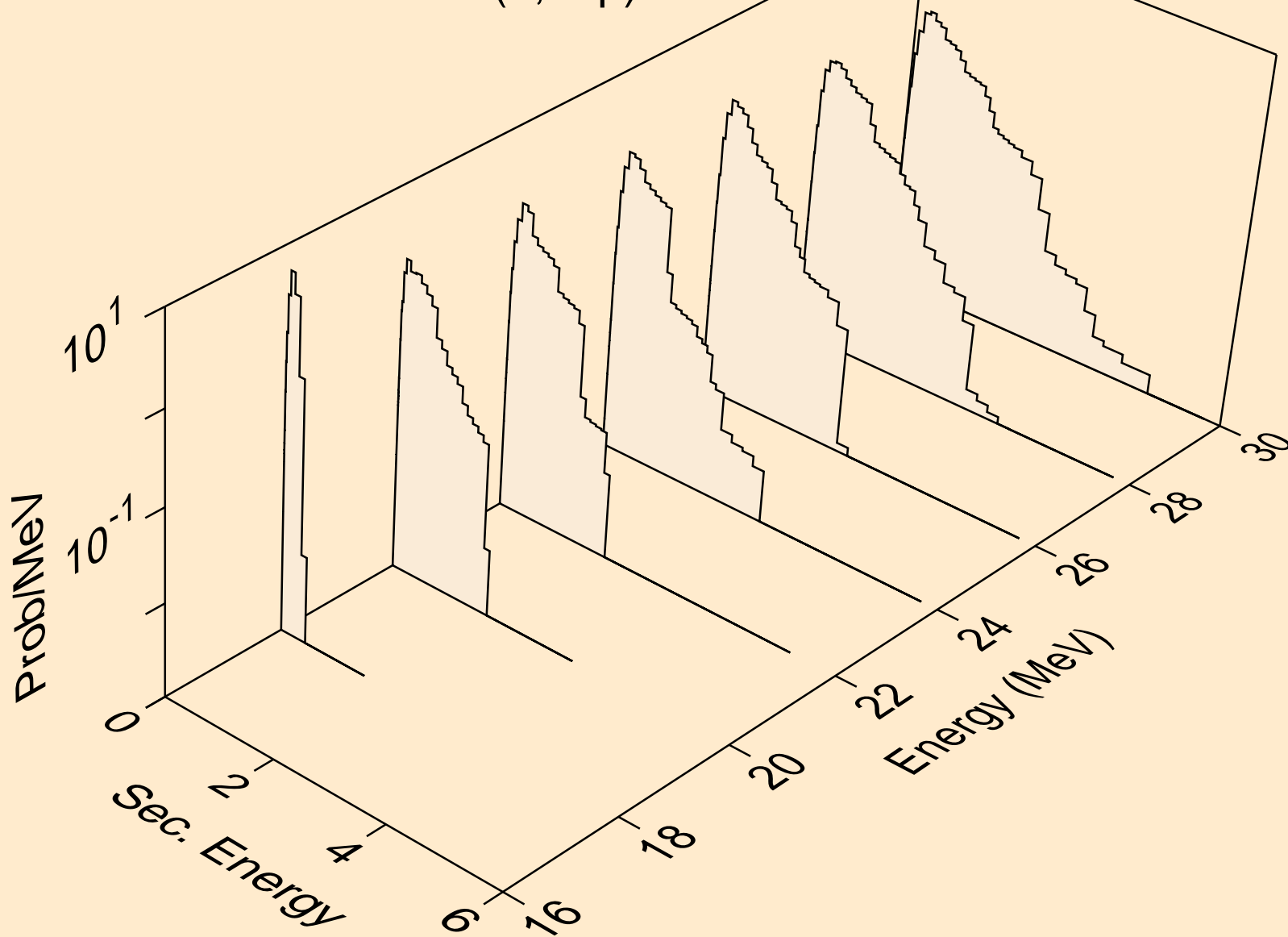

NO257 NEUTRON ACER TENDL-2019 LIBRARY; T=293.16K
Neutron emission for (n,2np)

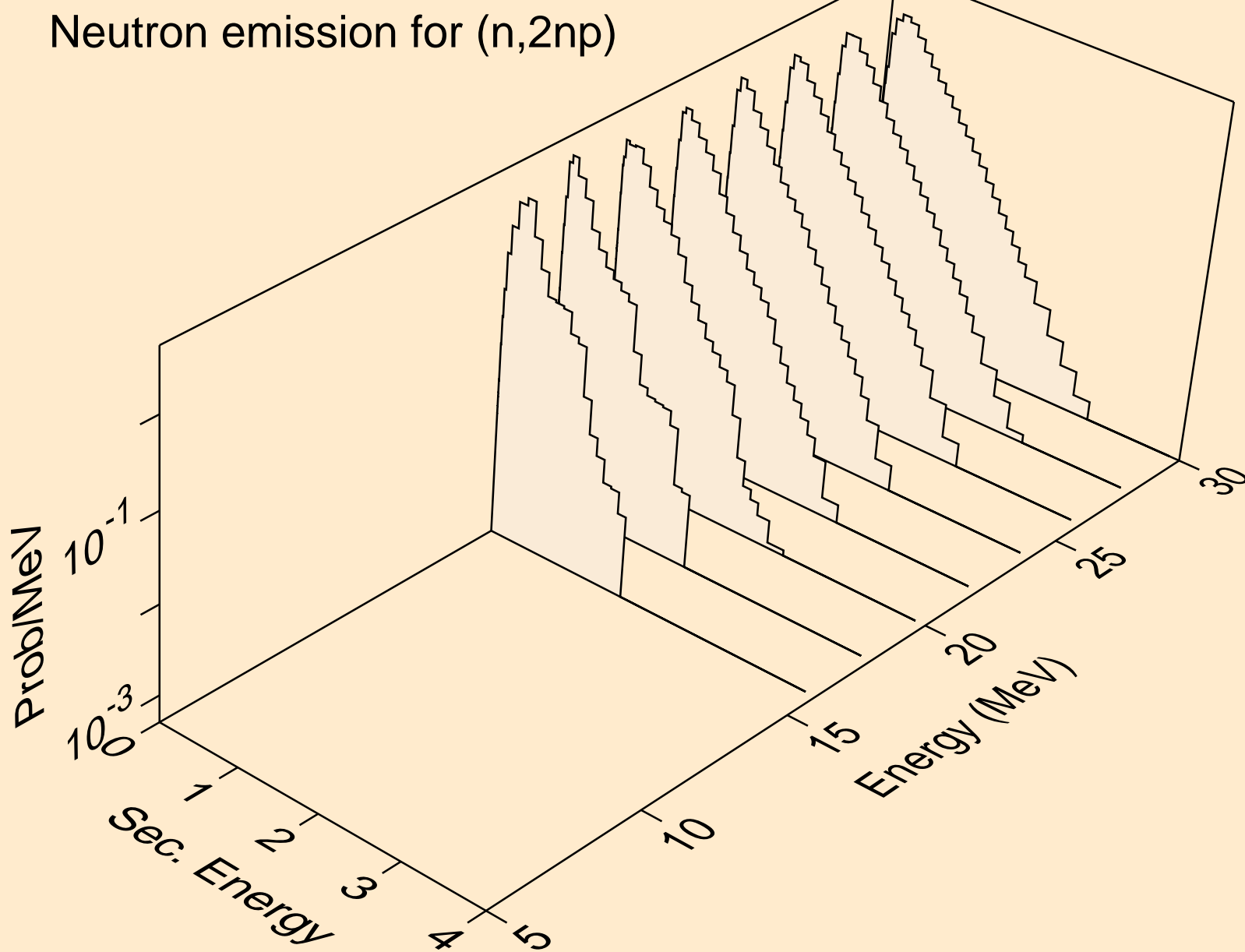

NO257 NEUTRON ACER TENDL-2019 LIBRARY; T=293.16K
Neutron emission for (n,npa)

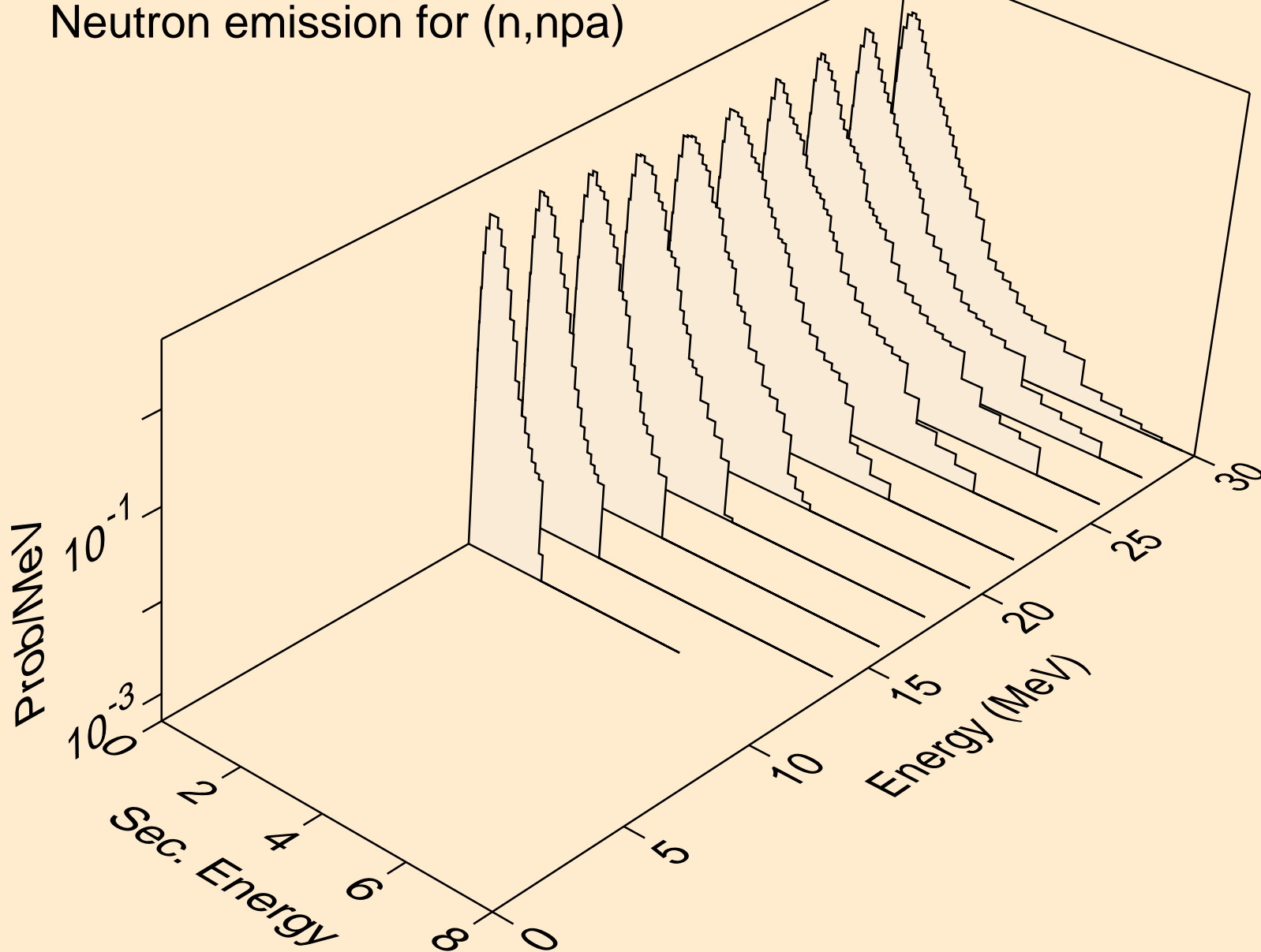

NO257 NEUTRON ACER TENDL-2019 LIBRARY; T=293.16K
Neutron emission for (n,n*c)

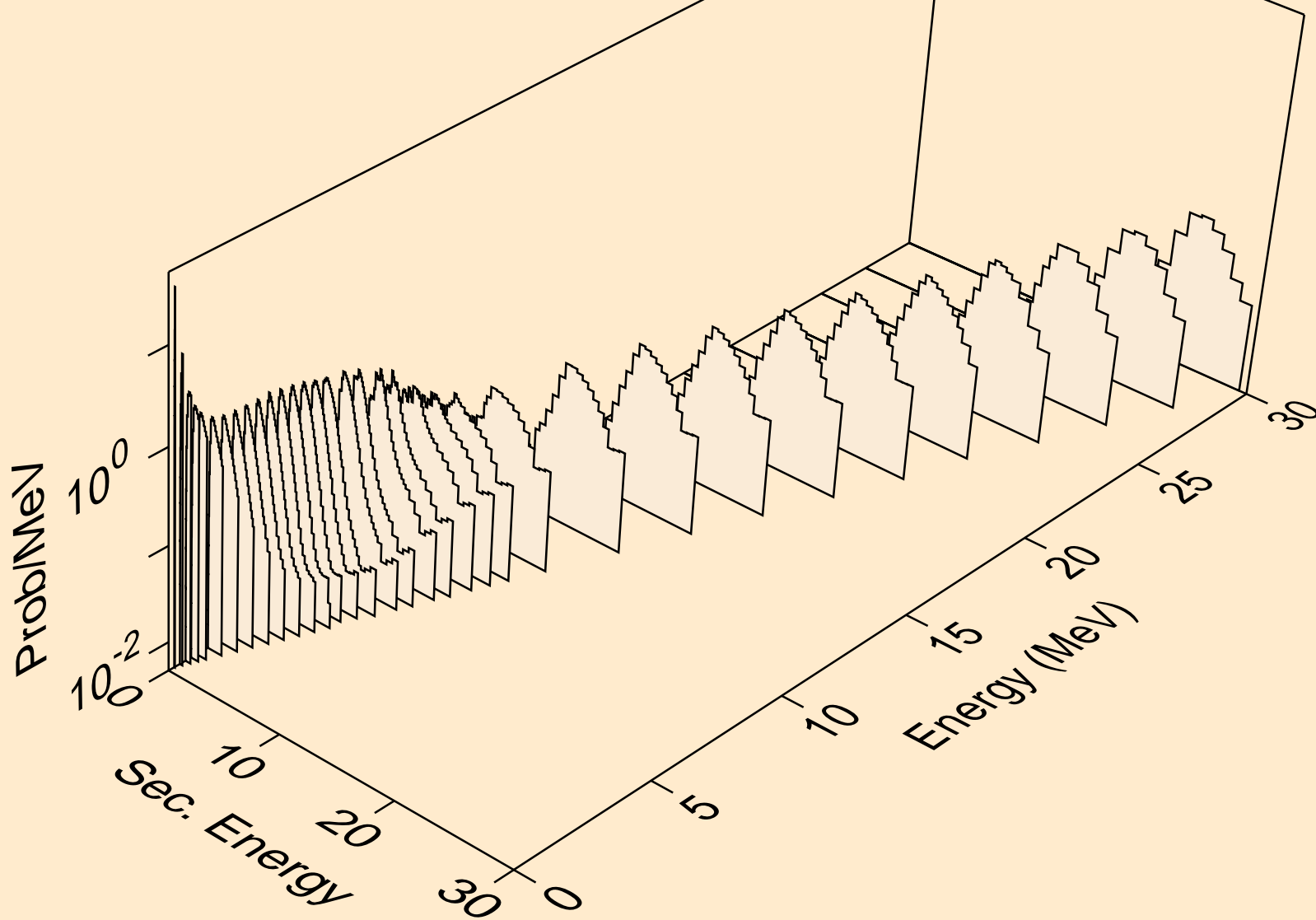

NO257 NEUTRON ACER TENDL-2019 LIBRARY; T=293.16K

Delayed nubar

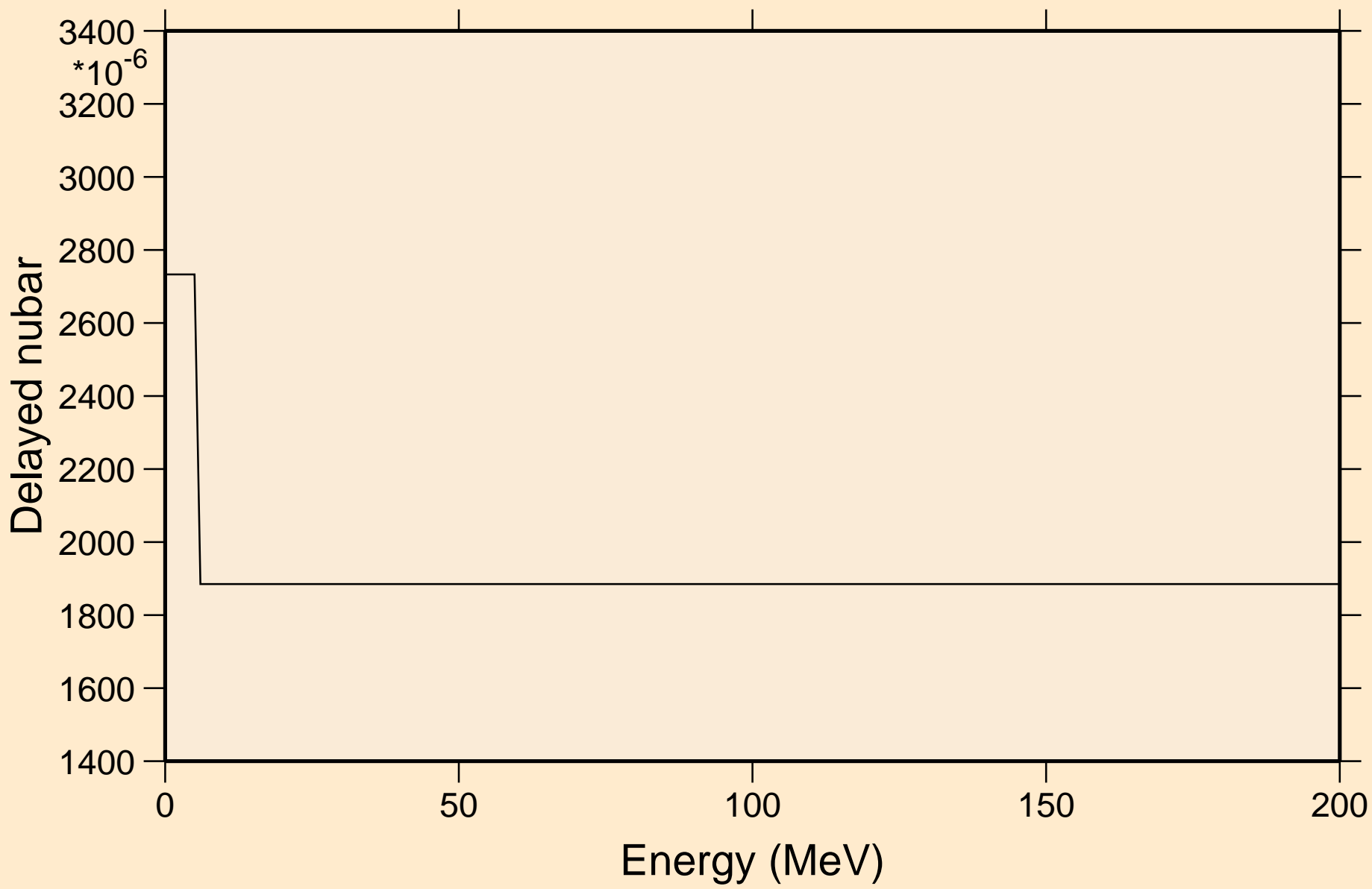

NO257 NEUTRON ACER TENDL-2019 LIBRARY; T=293.16K

Delayed neutron spectra

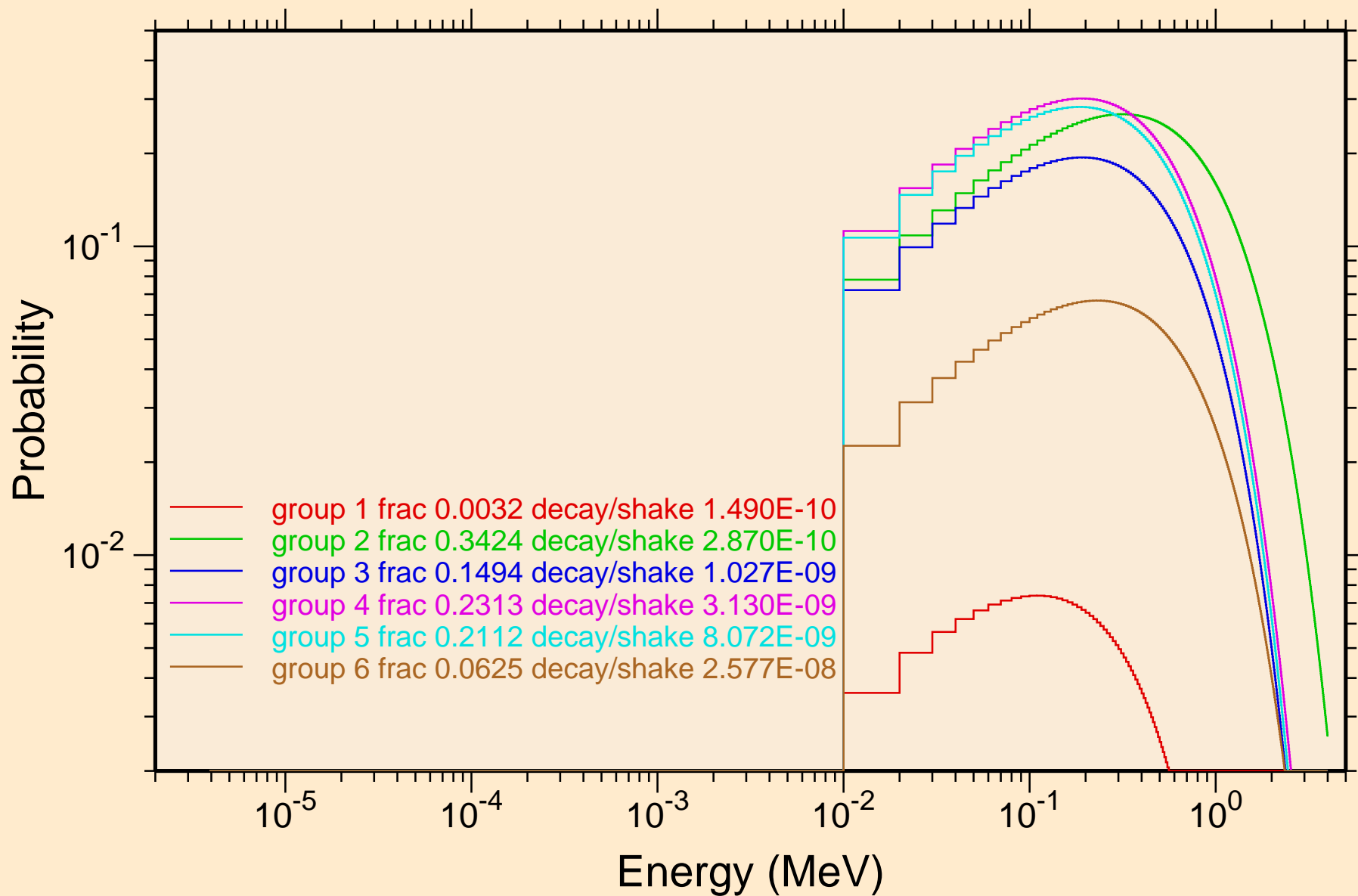

NO257 NEUTRON ACER TENDL-2019 LIBRARY; T=293.16K
Photon emission for (n,x)

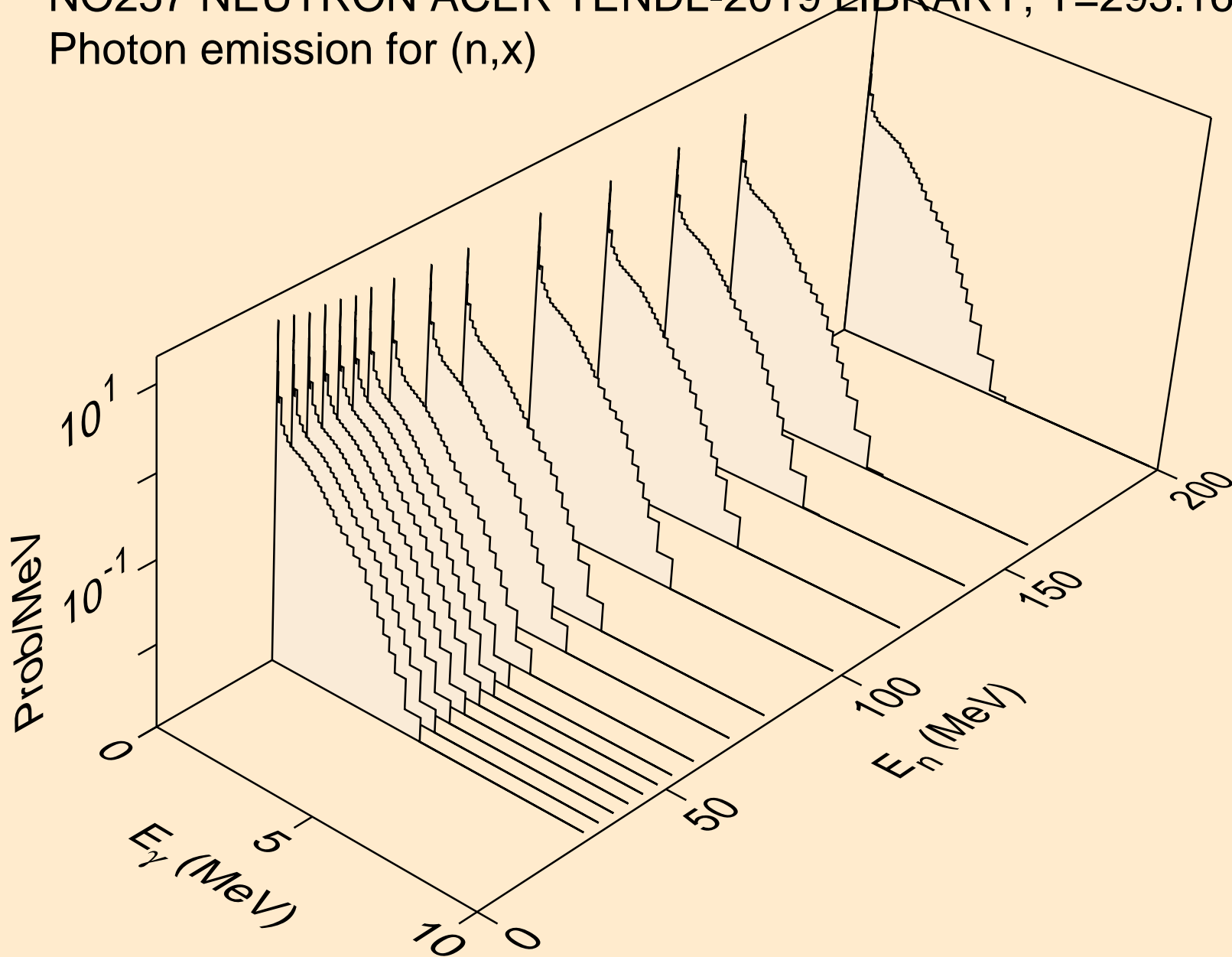

NO257 NEUTRON ACER TENDL-2019 LIBRARY; T=293.16K
Photon emission for (n,2nd)

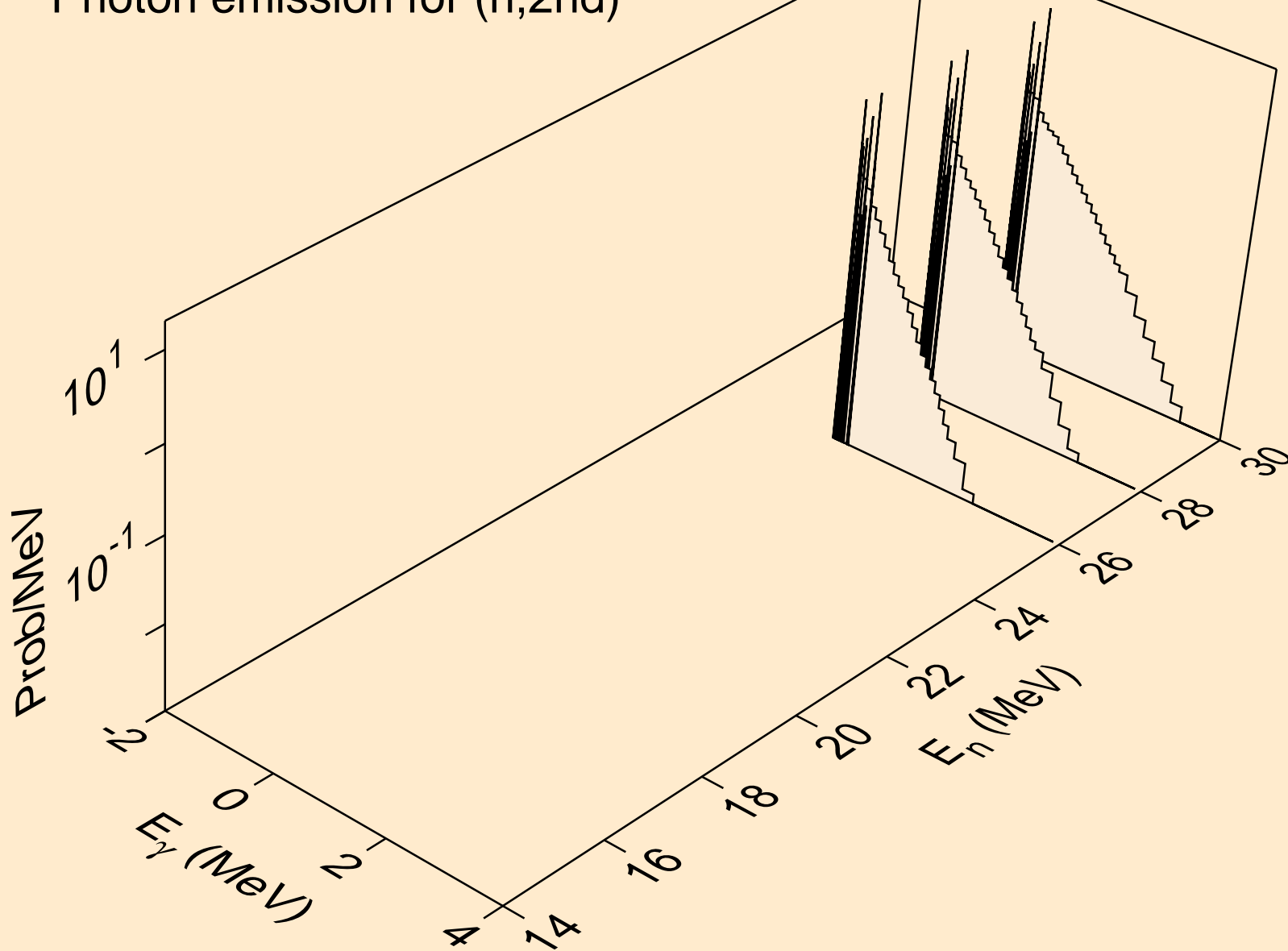

NO257 NEUTRON ACER TENDL-2019 LIBRARY; T=293.16K
Photon emission for (n,2n)

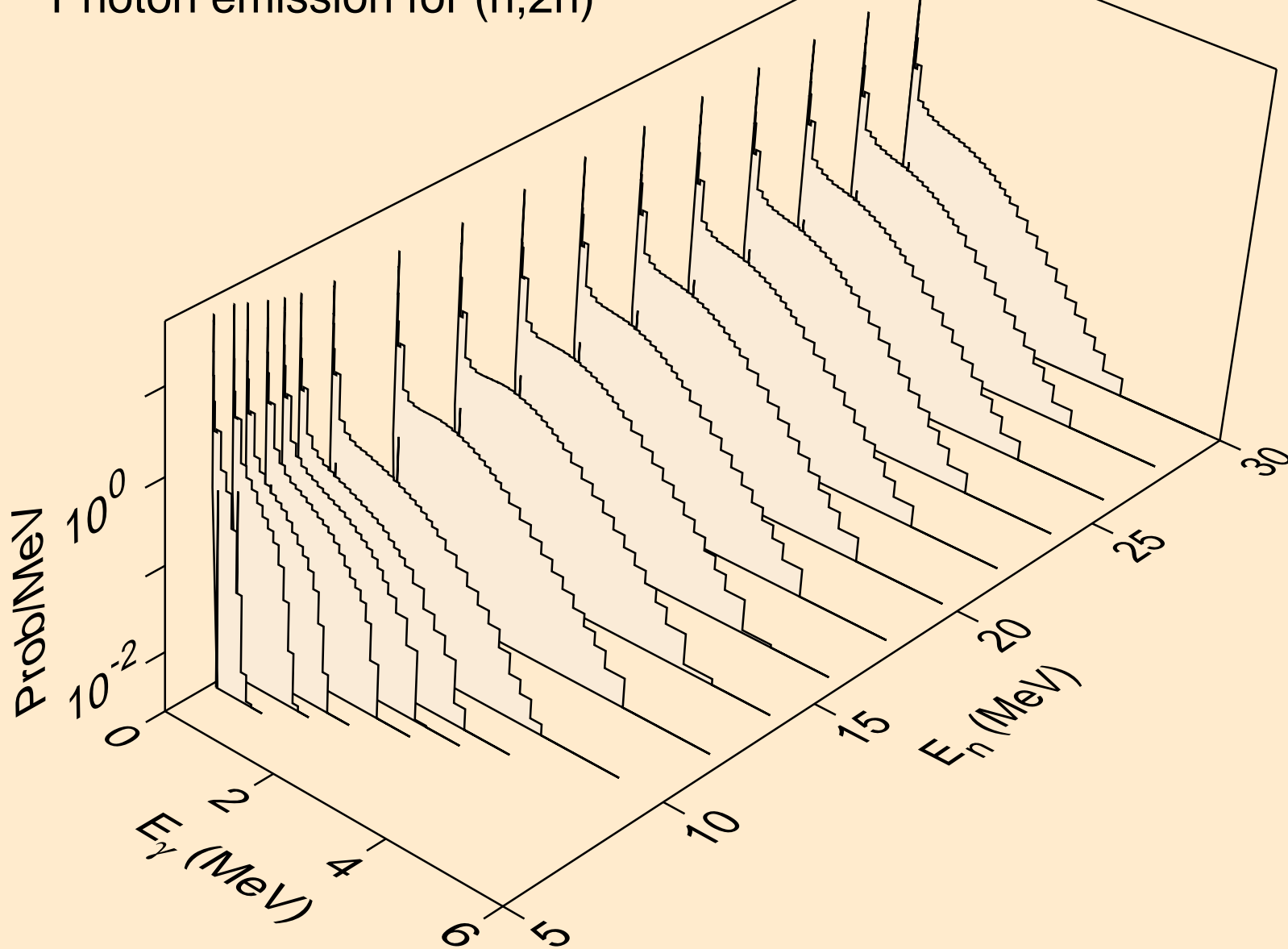

NO257 NEUTRON ACER TENDL-2019 LIBRARY; T=293.16K
Photon emission for (n,3n)

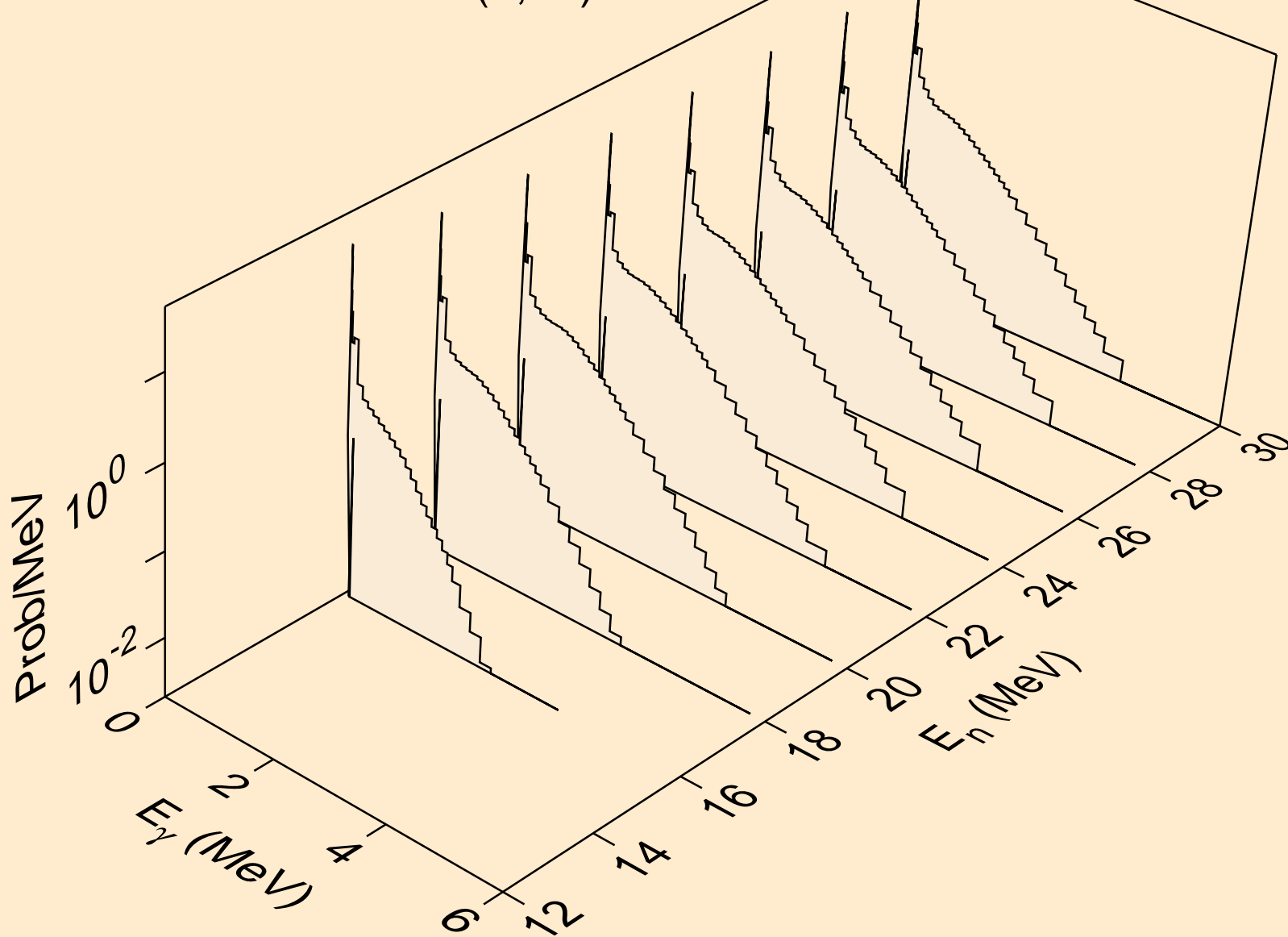

NO257 NEUTRON ACER TENDL-2019 LIBRARY; T=293.16K
Photon emission for (n,n*)a

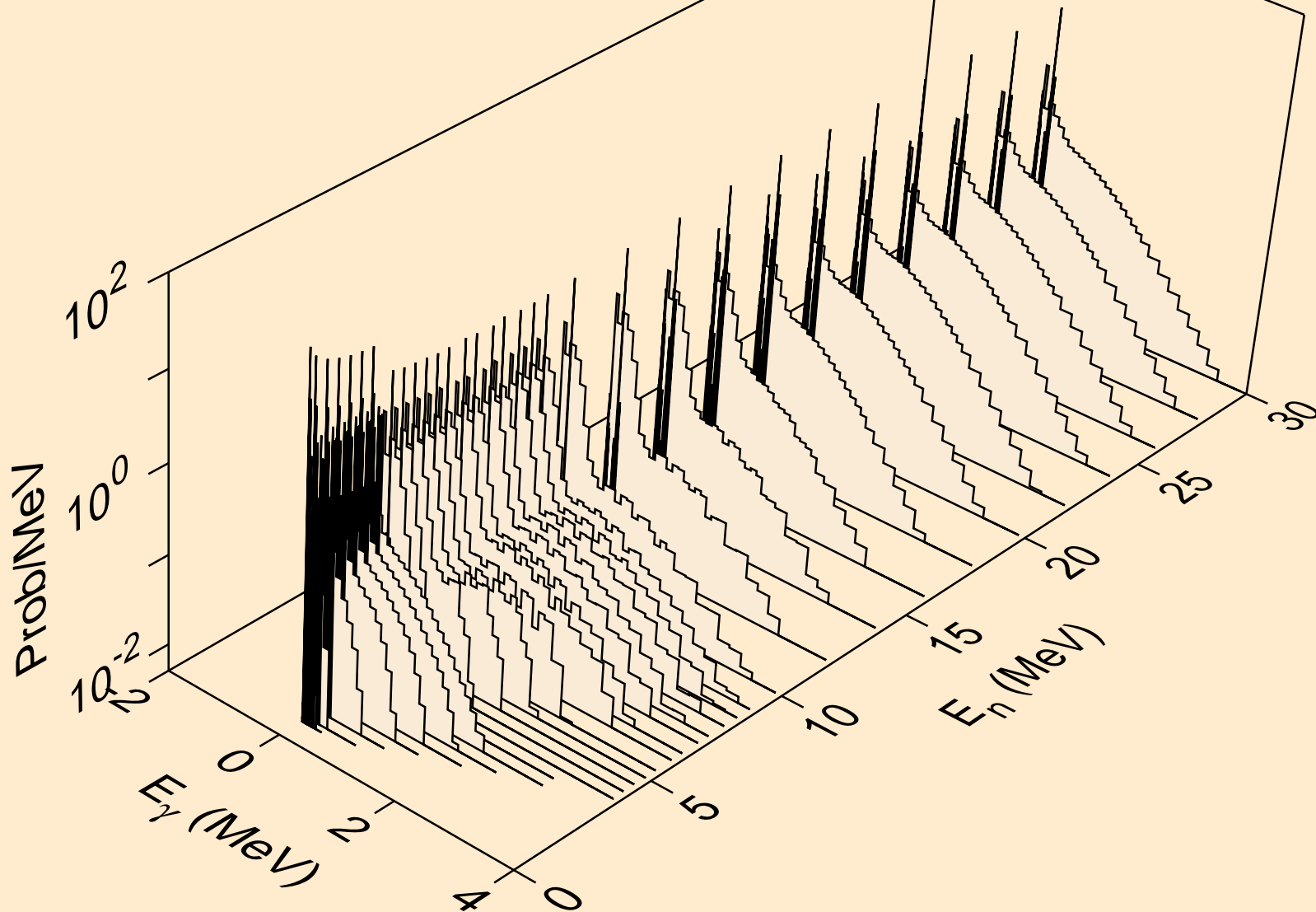

NO257 NEUTRON ACER TENDL-2019 LIBRARY; T=293.16K
Photon emission for (n,2n) α

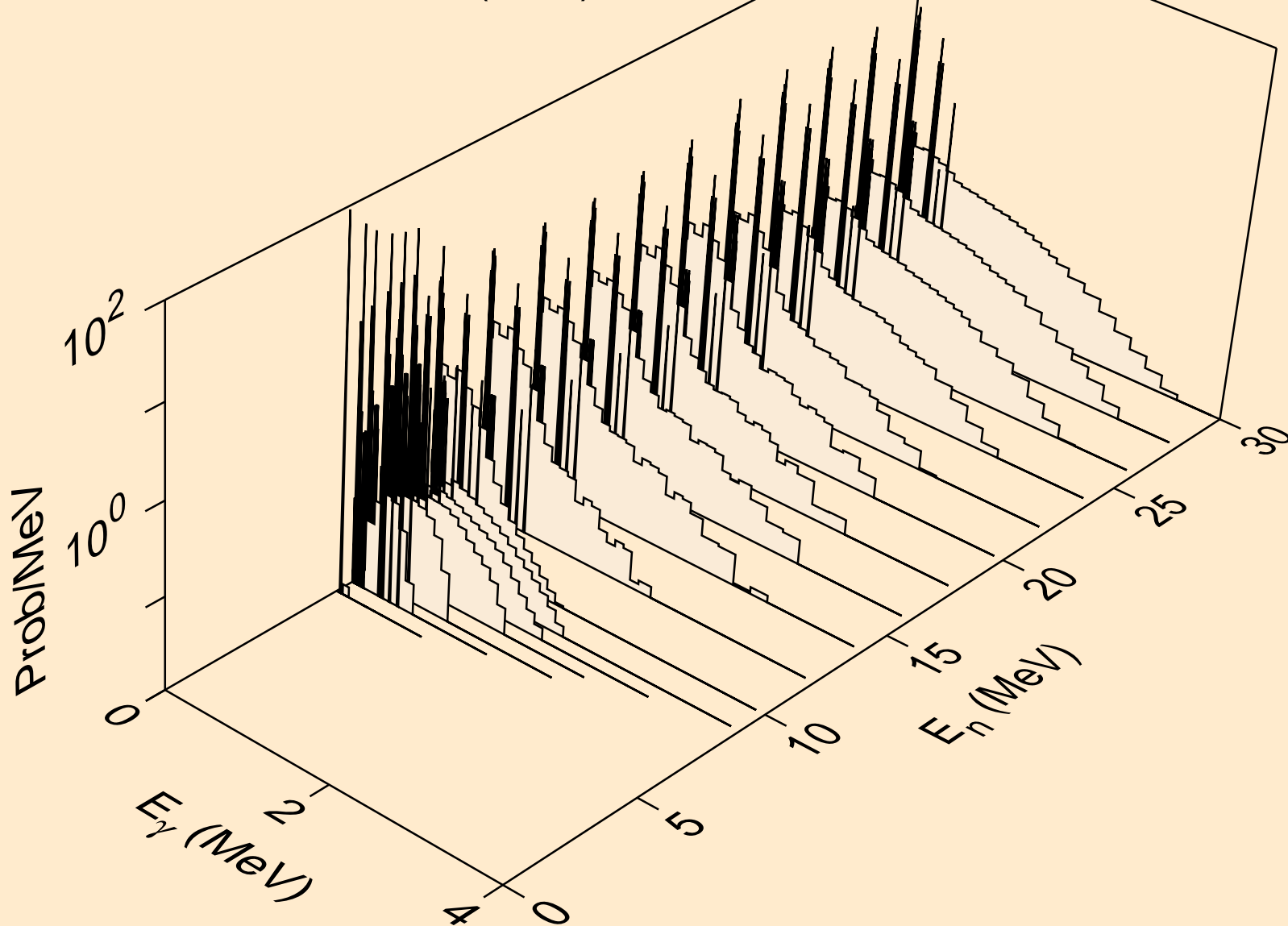

NO257 NEUTRON ACER TENDL-2019 LIBRARY; T=293.16K
Photon emission for (n,3n)a

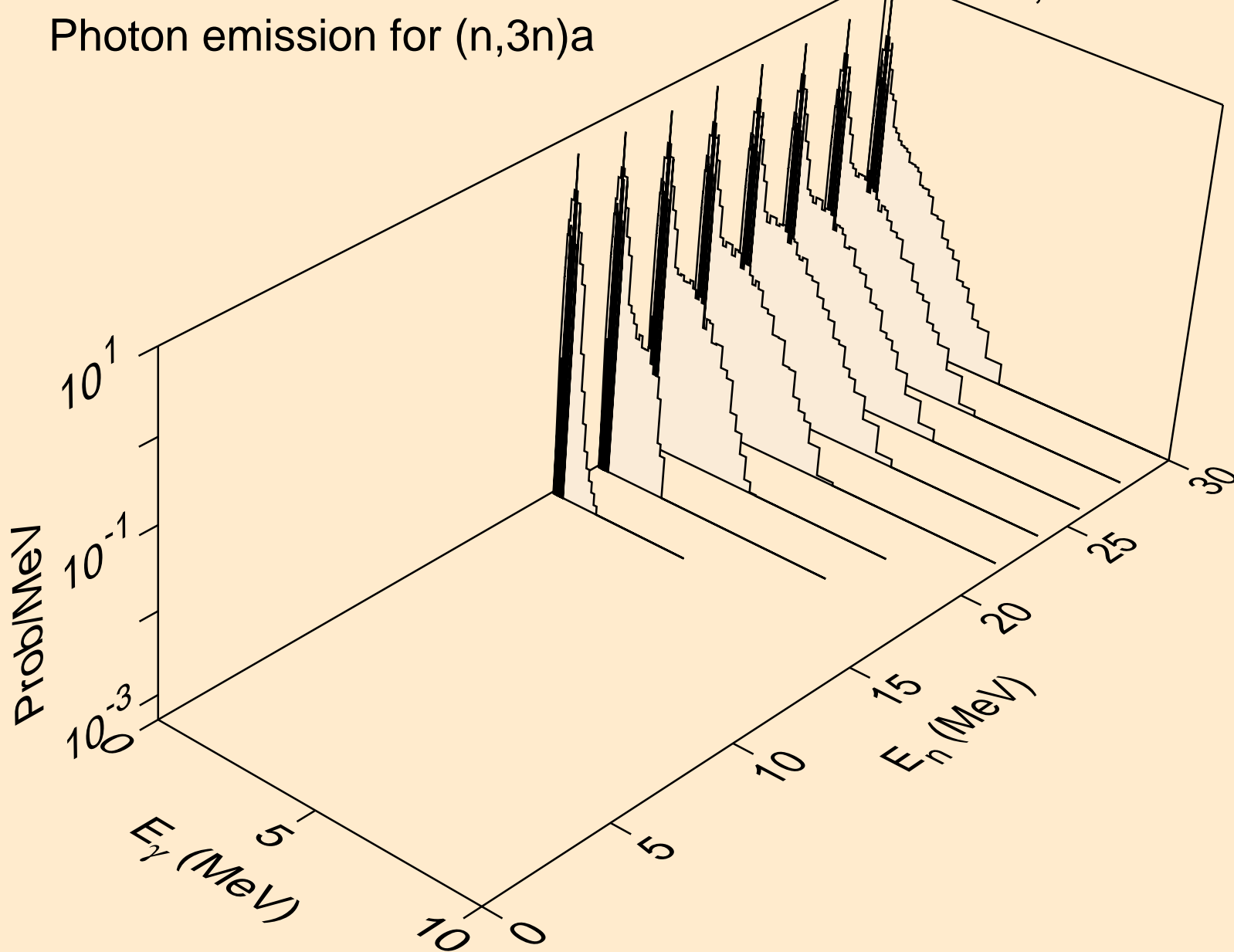

NO257 NEUTRON ACER TENDL-2019 LIBRARY; T=293.16K
Photon emission for (n,n*)p

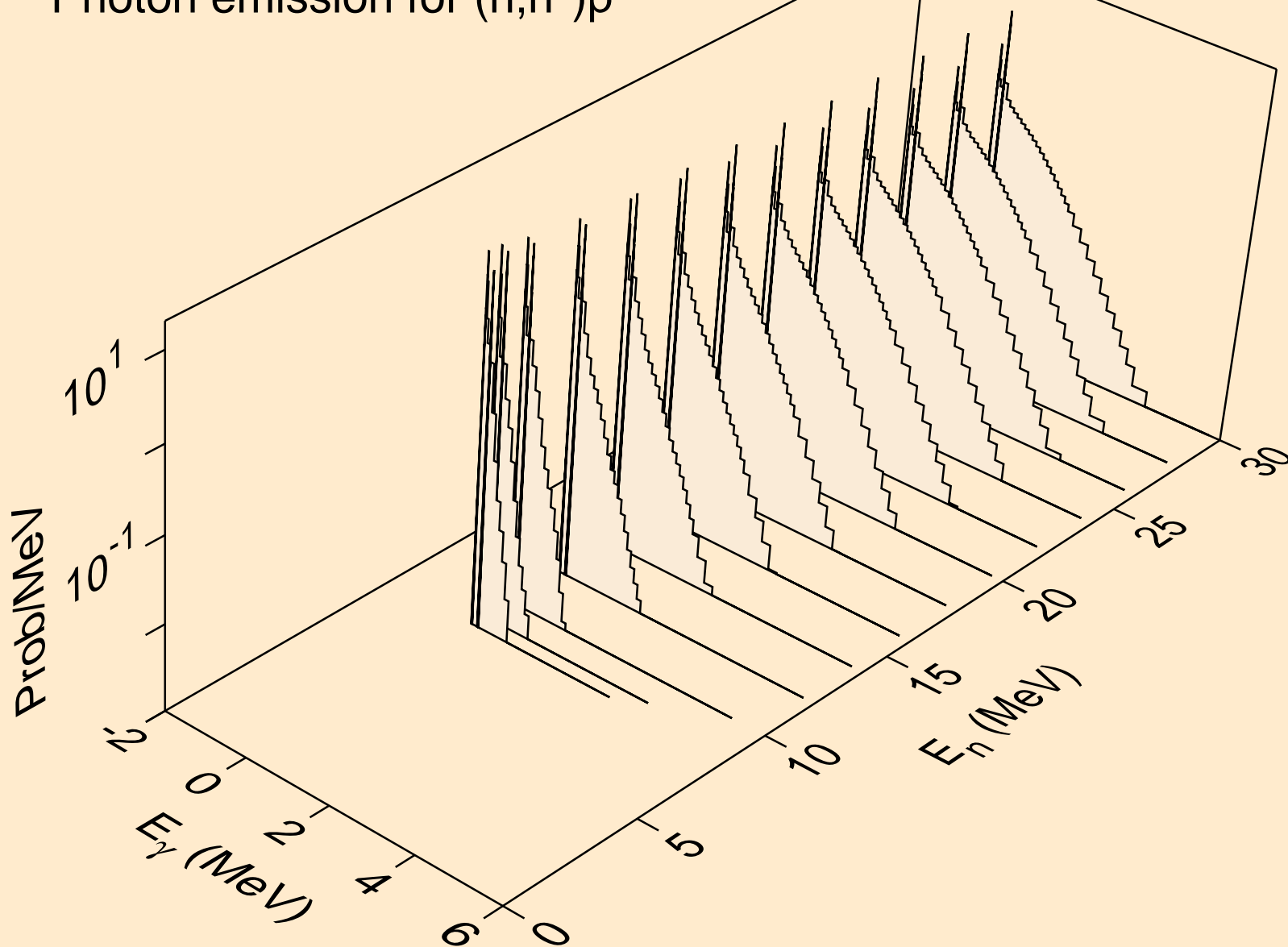

NO257 NEUTRON ACER TENDL-2019 LIBRARY; T=293.16K
Photon emission for (n,n*)2a

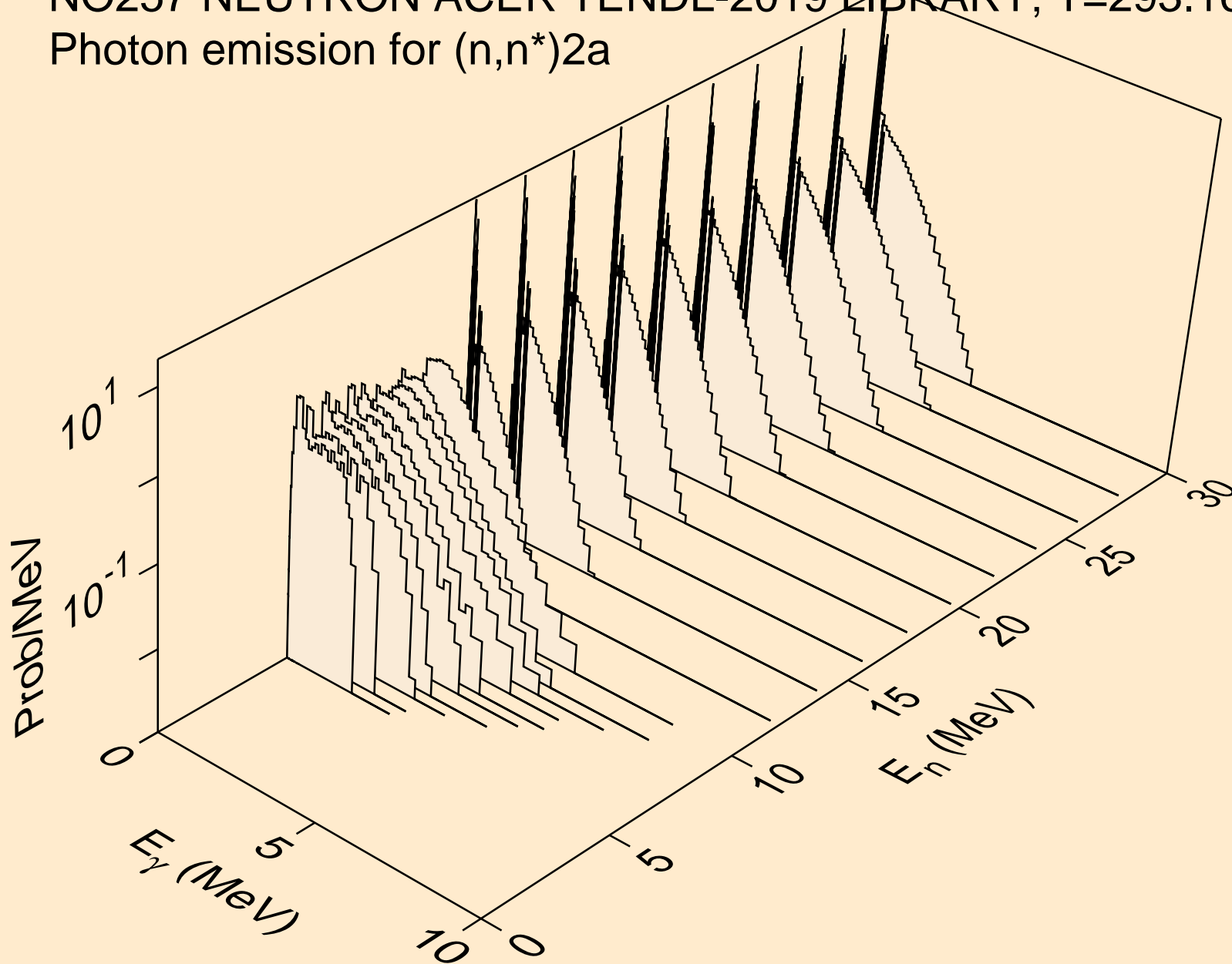

NO257 NEUTRON ACER TENDL-2019 LIBRARY; T=293.16K
Photon emission for (n,2n)2a

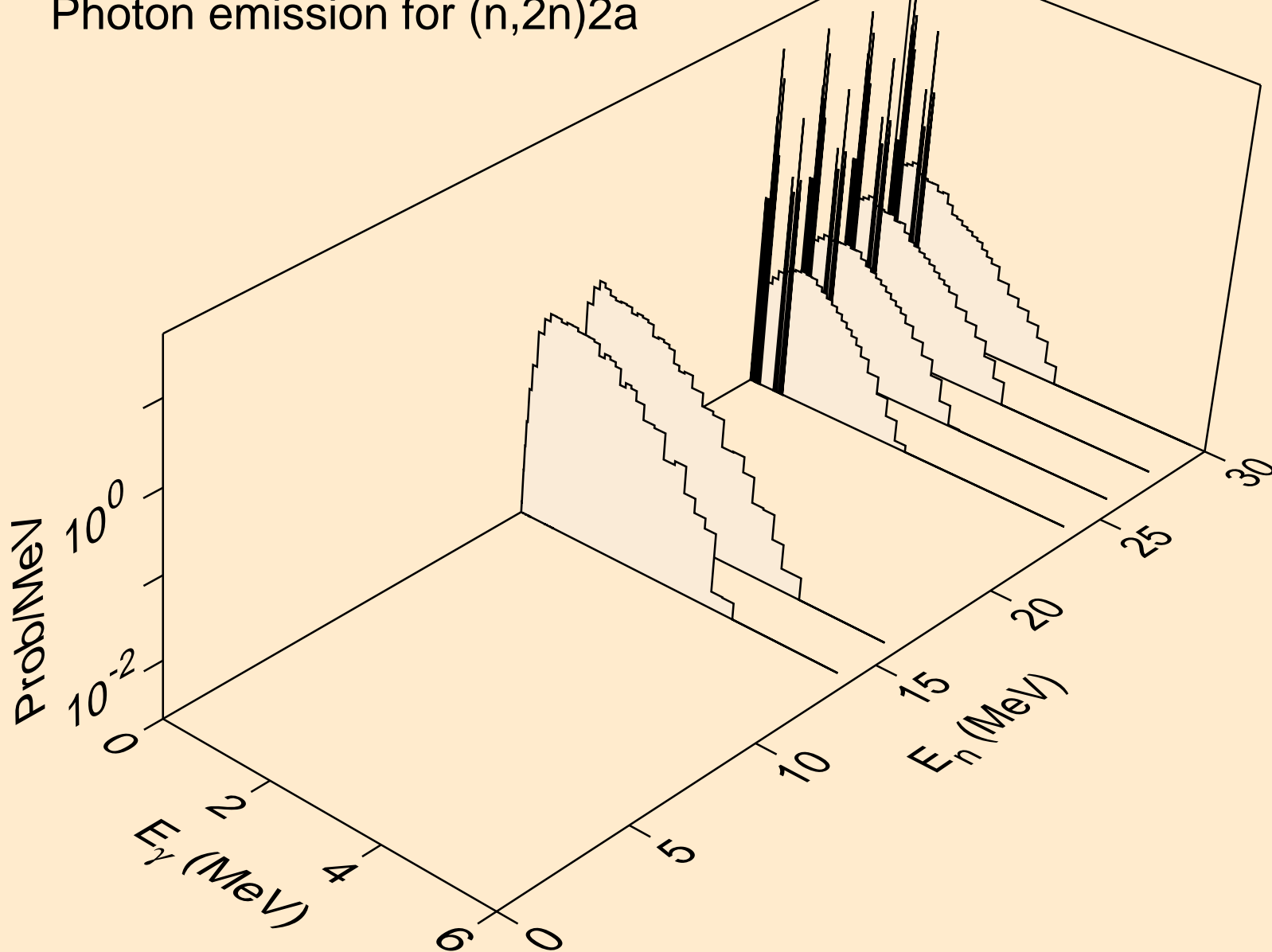

NO257 NEUTRON ACER TENDL-2019 LIBRARY; T=293.16K
Photon emission for (n,n*)d

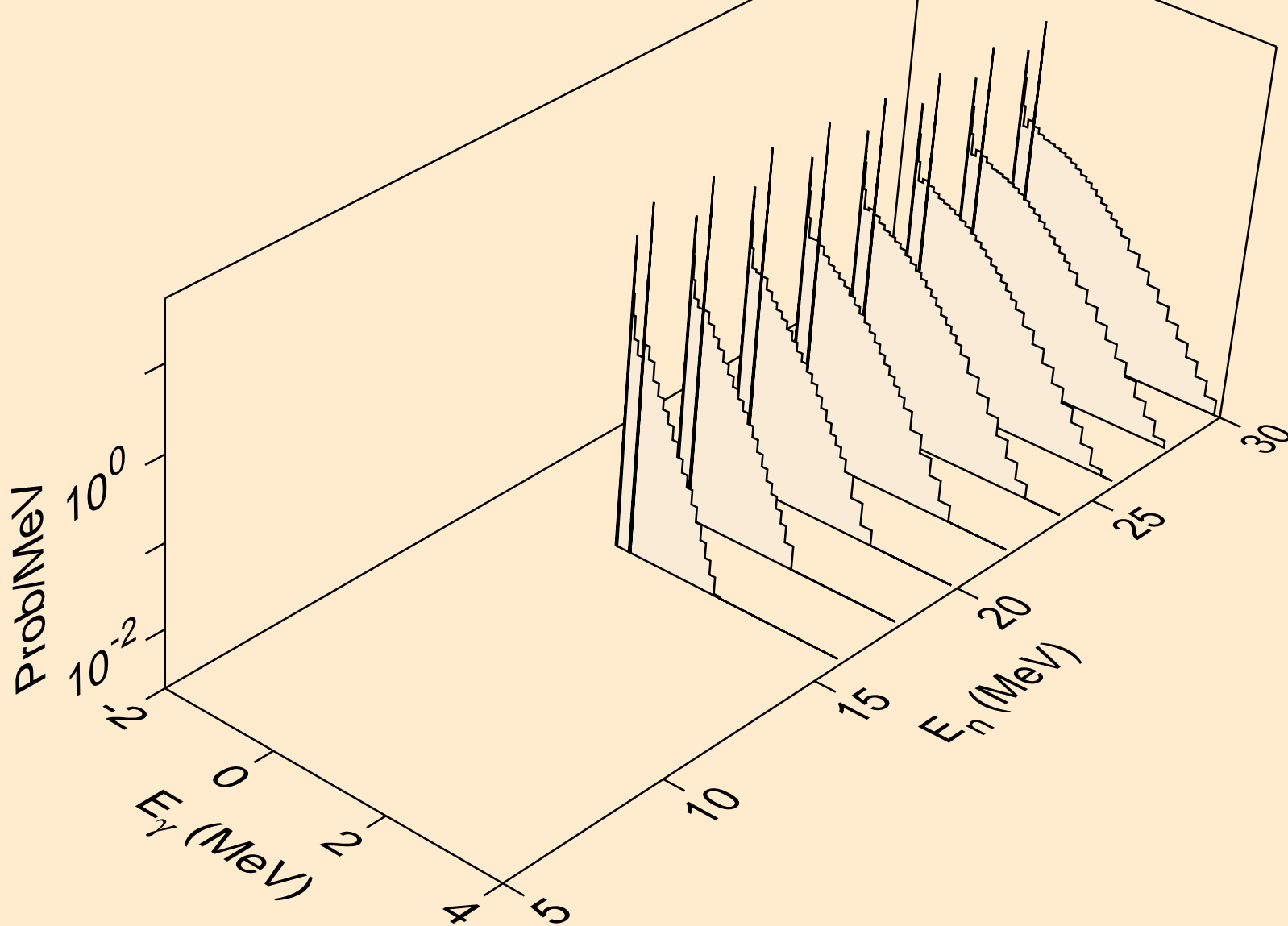

NO257 NEUTRON ACER TENDL-2019 LIBRARY; T=293.16K
Photon emission for (n,n*)t

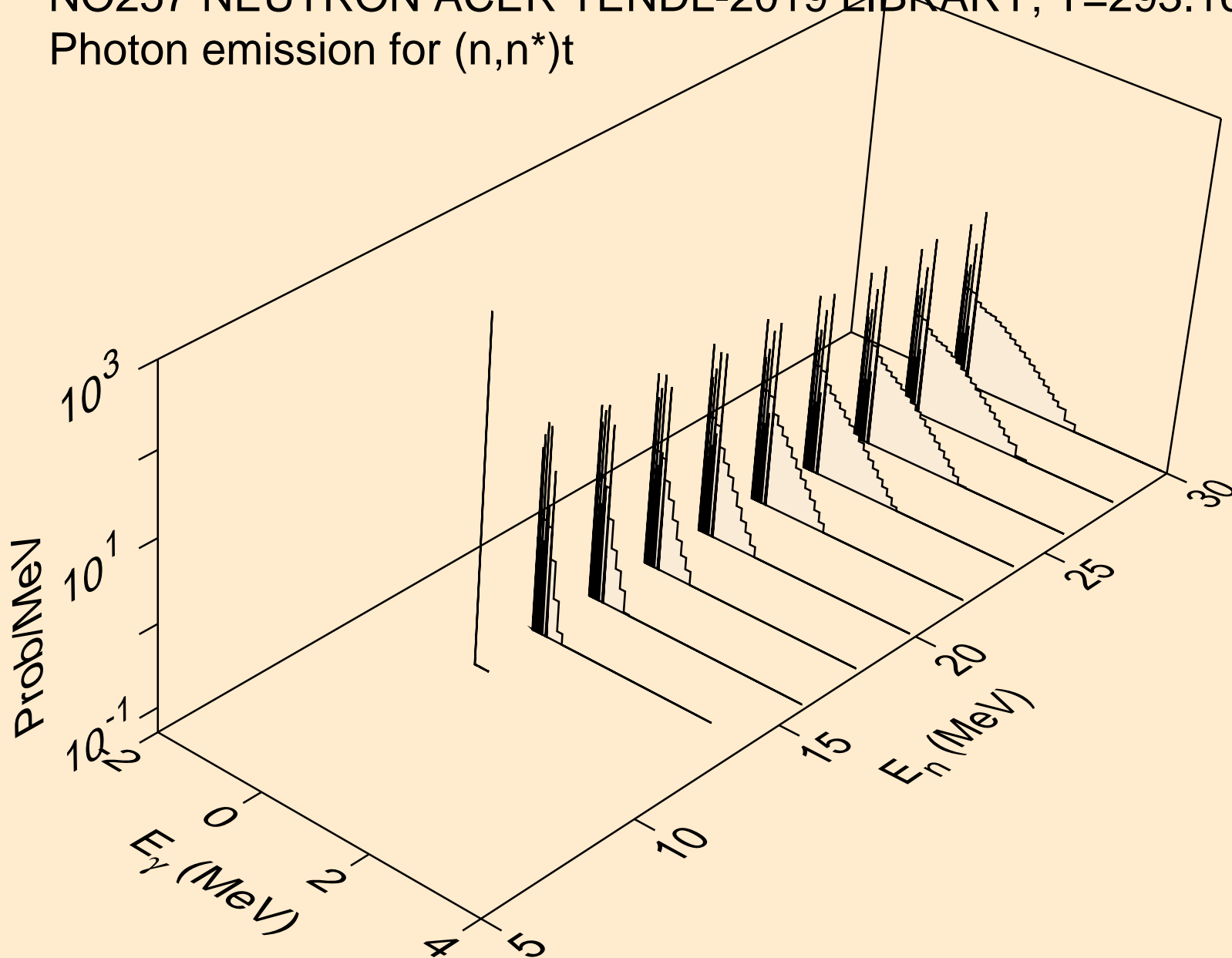

NO257 NEUTRON ACER TENDL-2019 LIBRARY; T=293.16K
Photon emission for (n,n*)he3

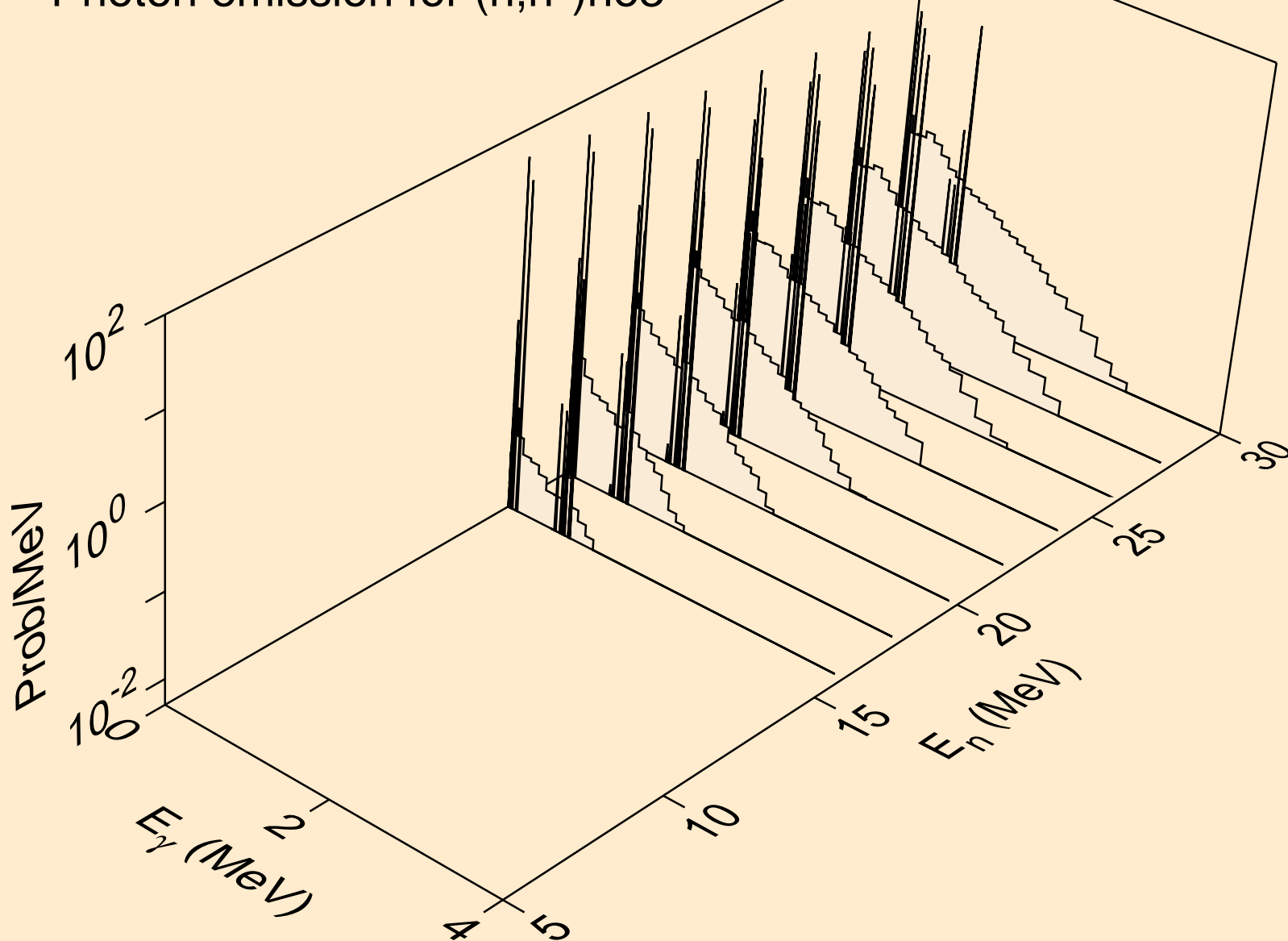

NO257 NEUTRON ACER TENDL-2019 LIBRARY; T=293.16K
Photon emission for (n,4n)

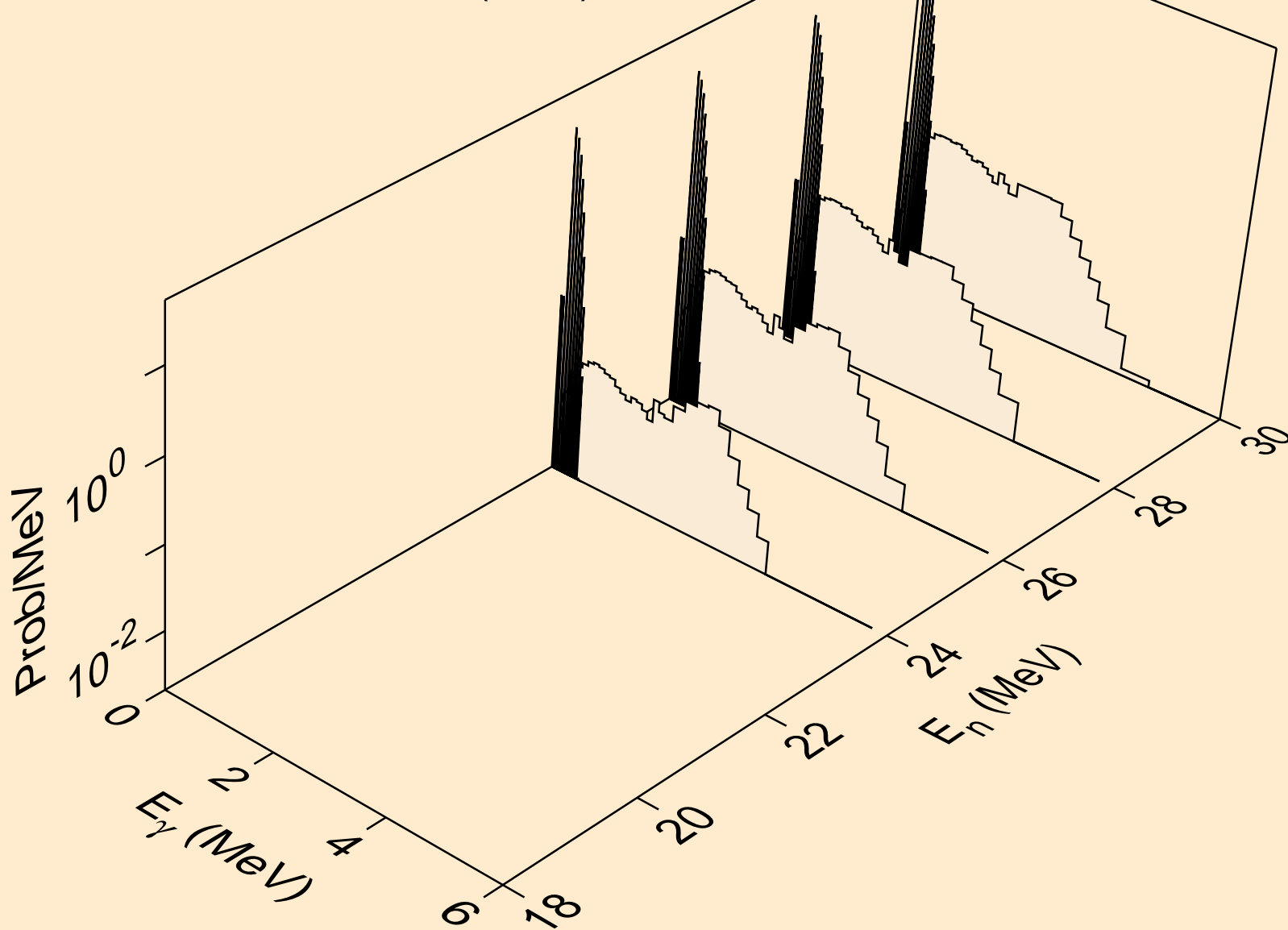

NO257 NEUTRON ACER TENDL-2019 LIBRARY; T=293.16K
Photon emission for (n,2np)

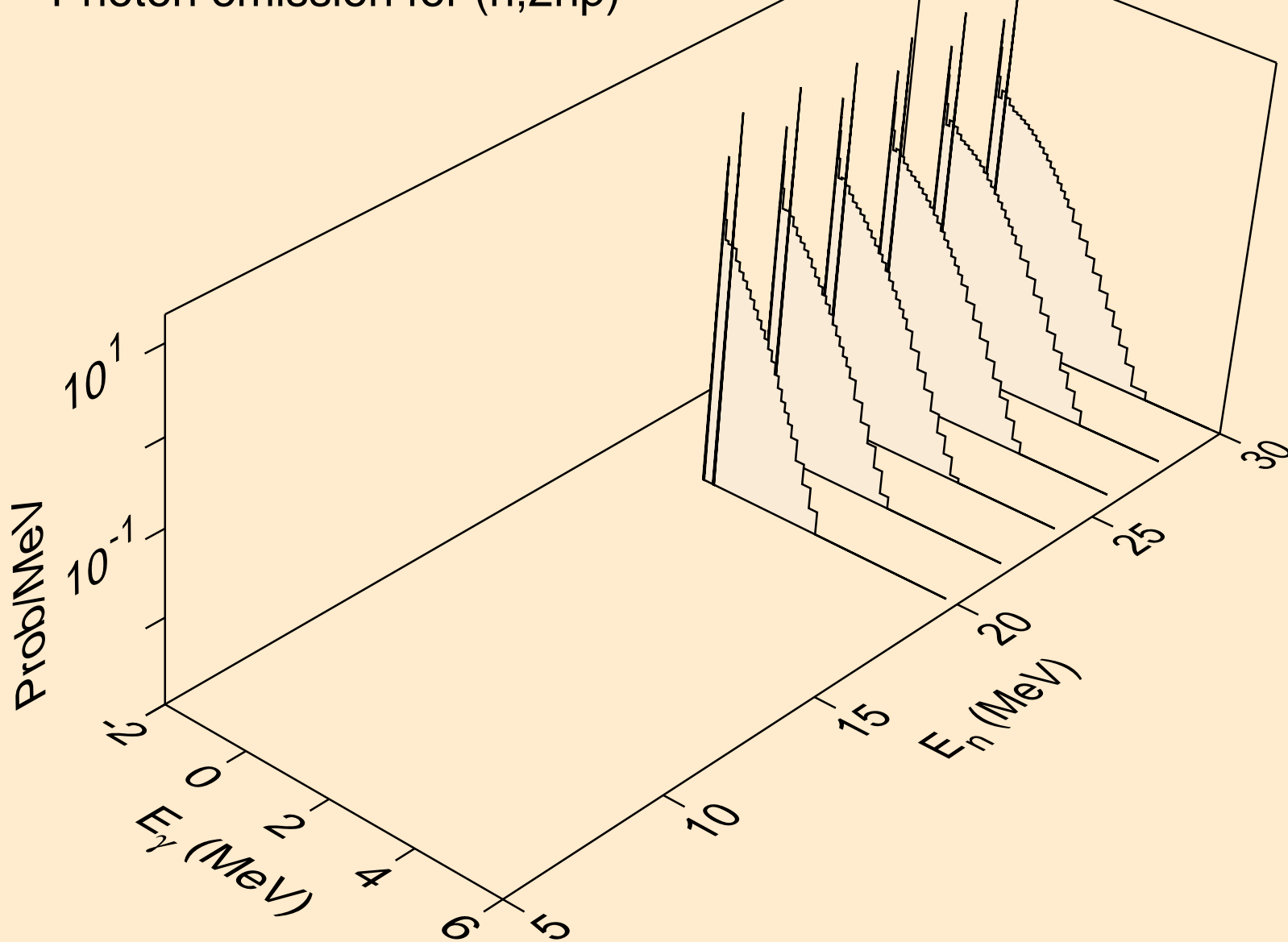

NO257 NEUTRON ACER TENDL-2019 LIBRARY; T=293.16K
Photon emission for (n,3np)

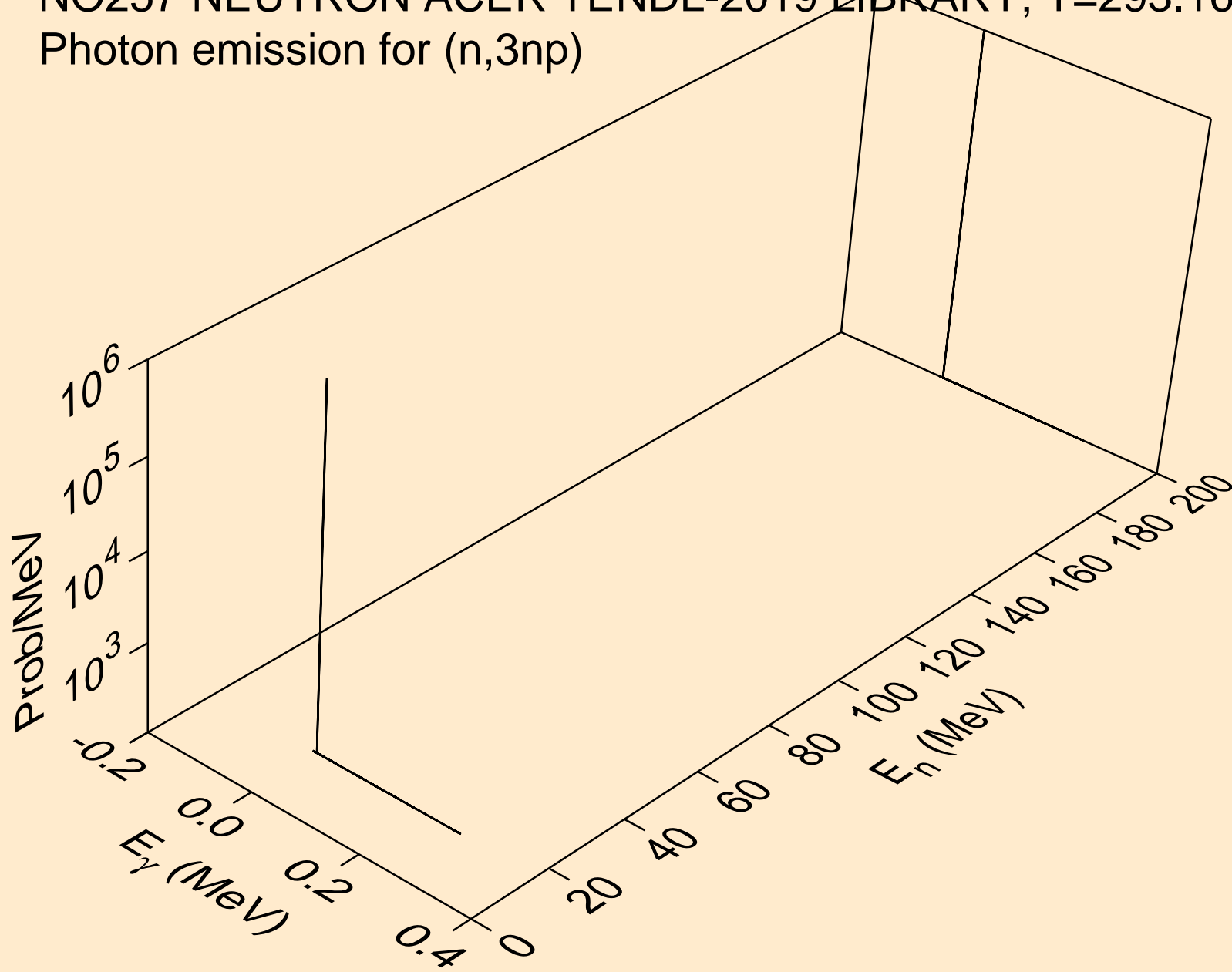

NO257 NEUTRON ACER TENDL-2019 LIBRARY; T=293.16K
Photon emission for (n,2np)

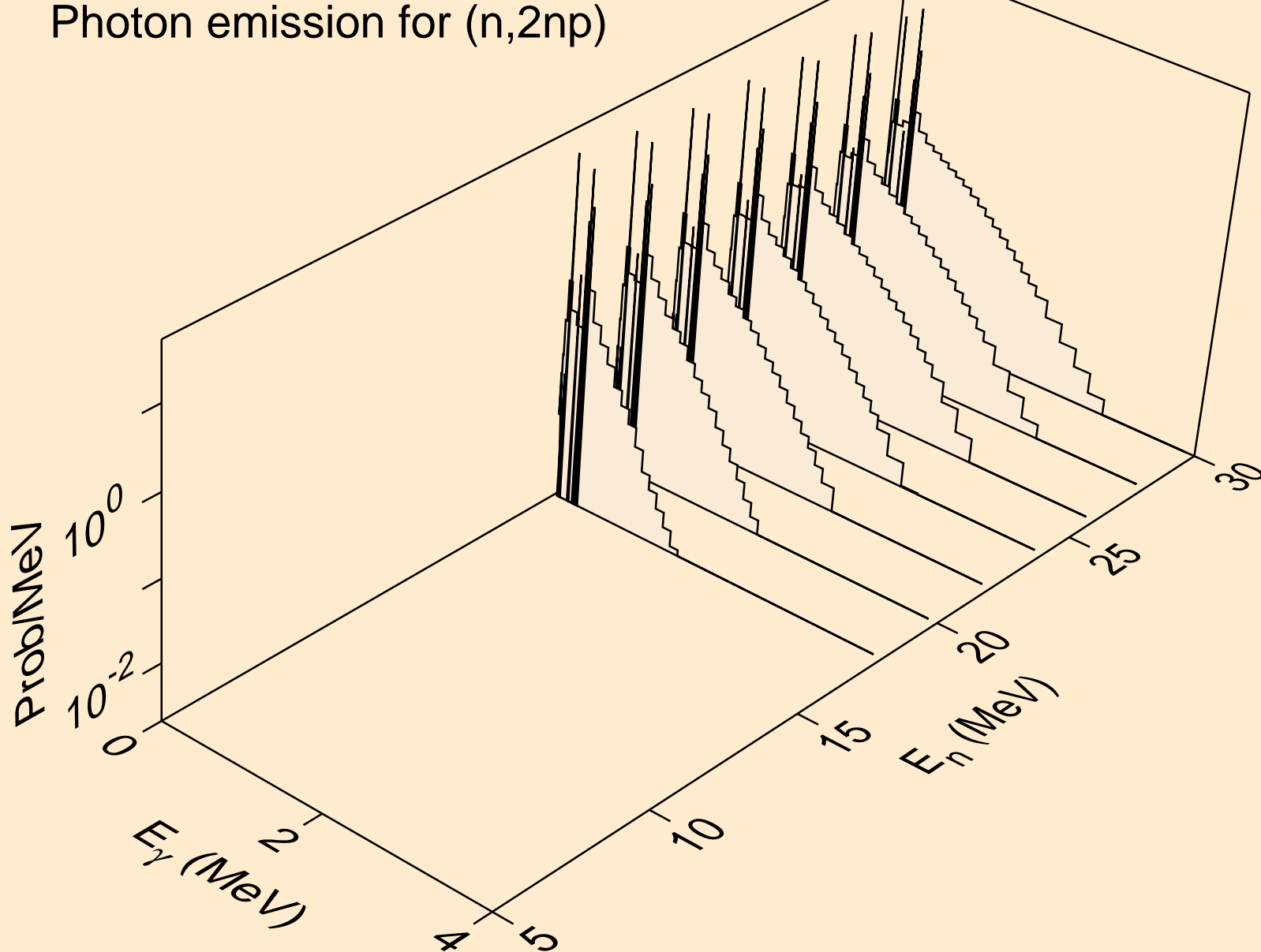

NO257 NEUTRON ACER TENDL-2019 LIBRARY; T=293.16K
Photon emission for (n,npa)

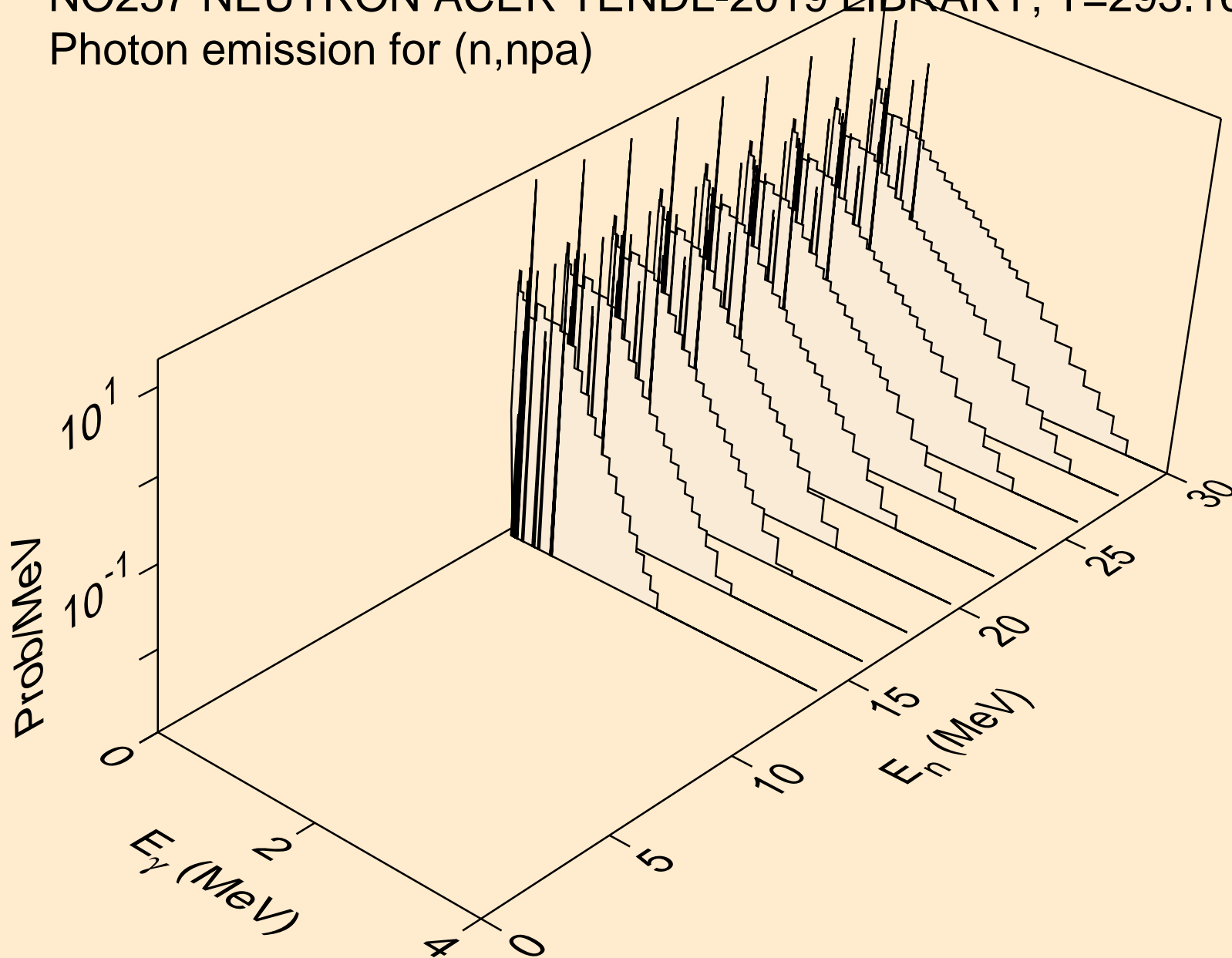

NO257 NEUTRON ACER TENDL-2019 LIBRARY; T=293.16K
Photon emission for (n,n*c)

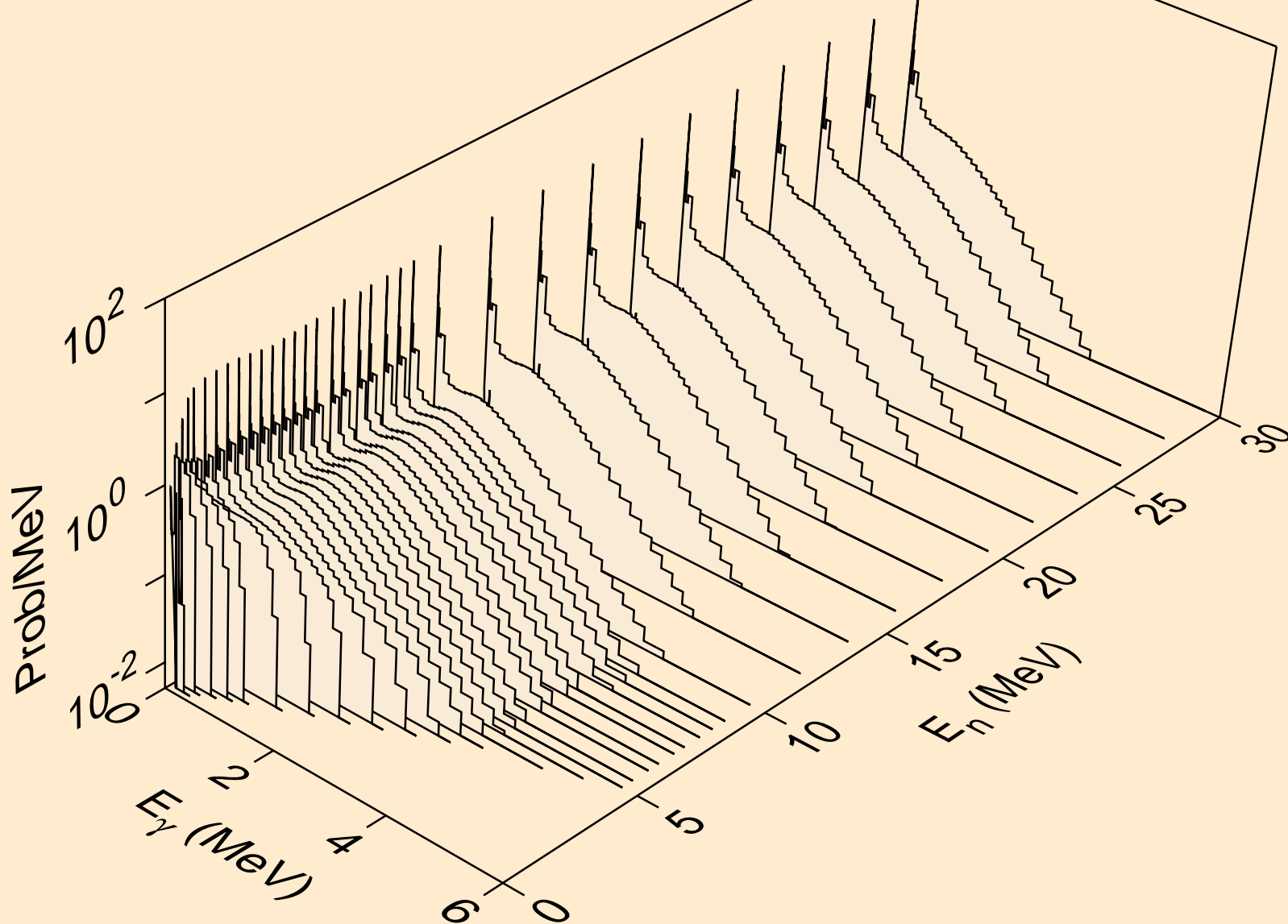

NO257 NEUTRON ACER TENDL-2019 LIBRARY; T=293.16K
Photon emission for (n,gma)

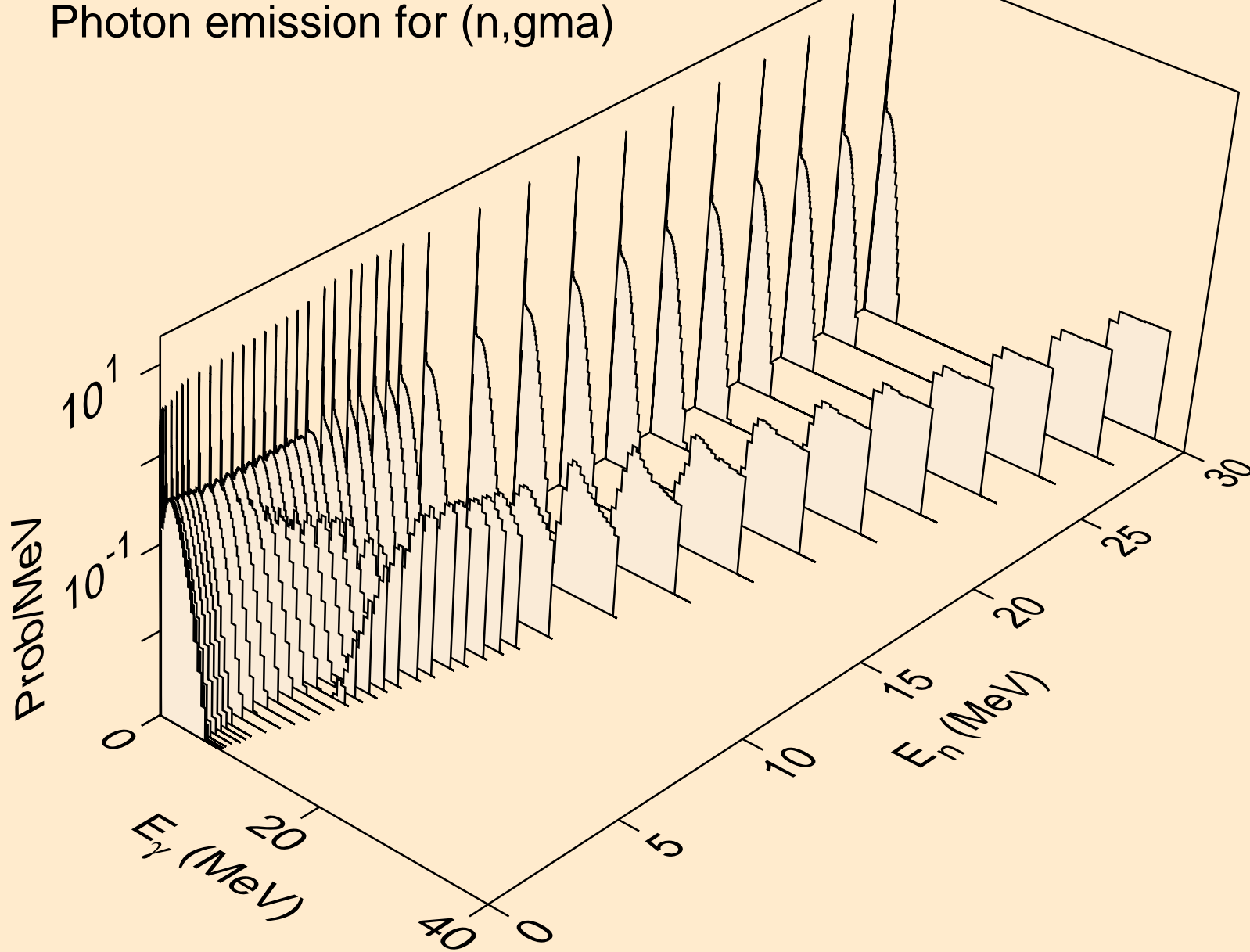

NO257 NEUTRON ACER TENDL-2019 LIBRARY; T=293.16K
Photon emission for (n,p)

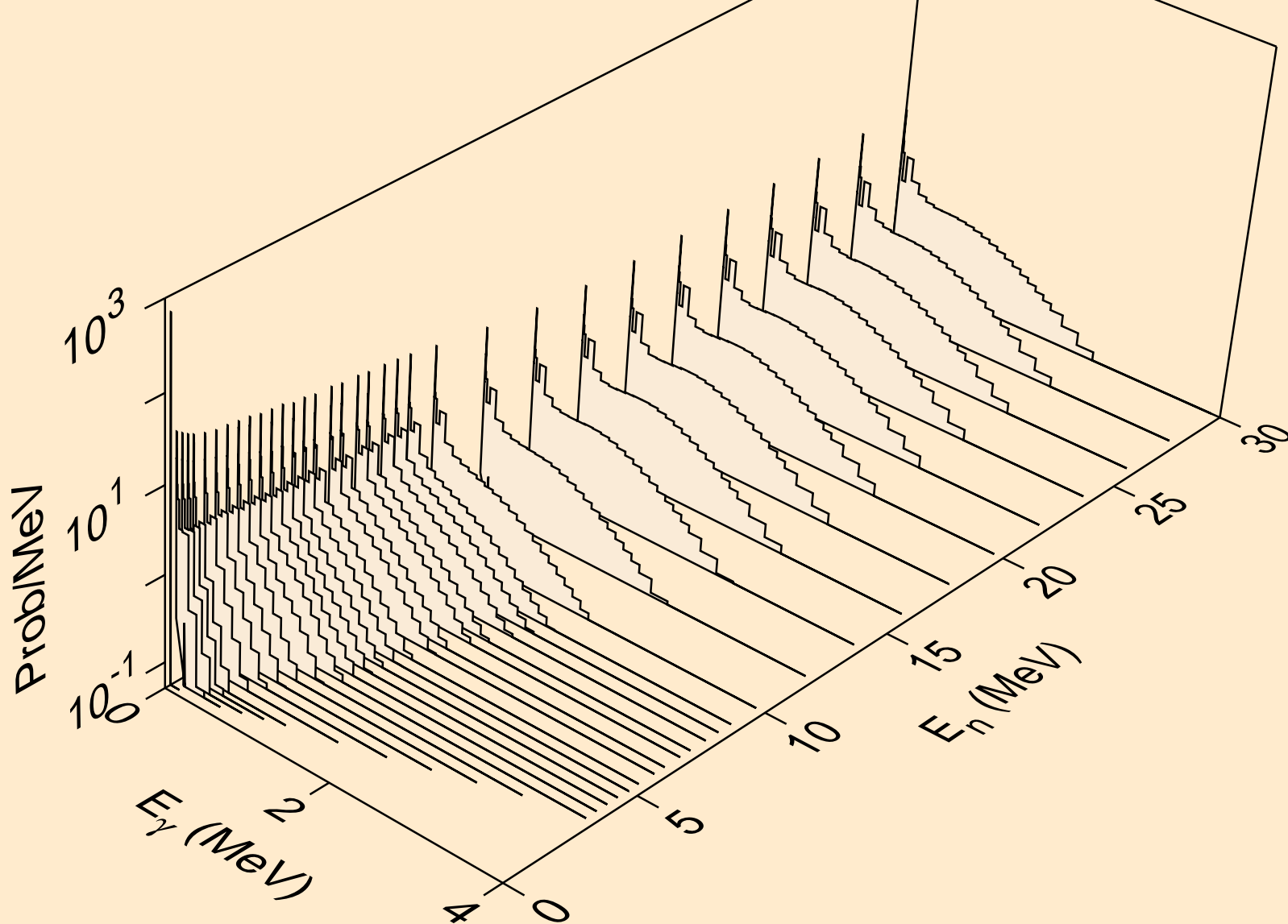

NO257 NEUTRON ACER TENDL-2019 LIBRARY; T=293.16K
Photon emission for (n,d)

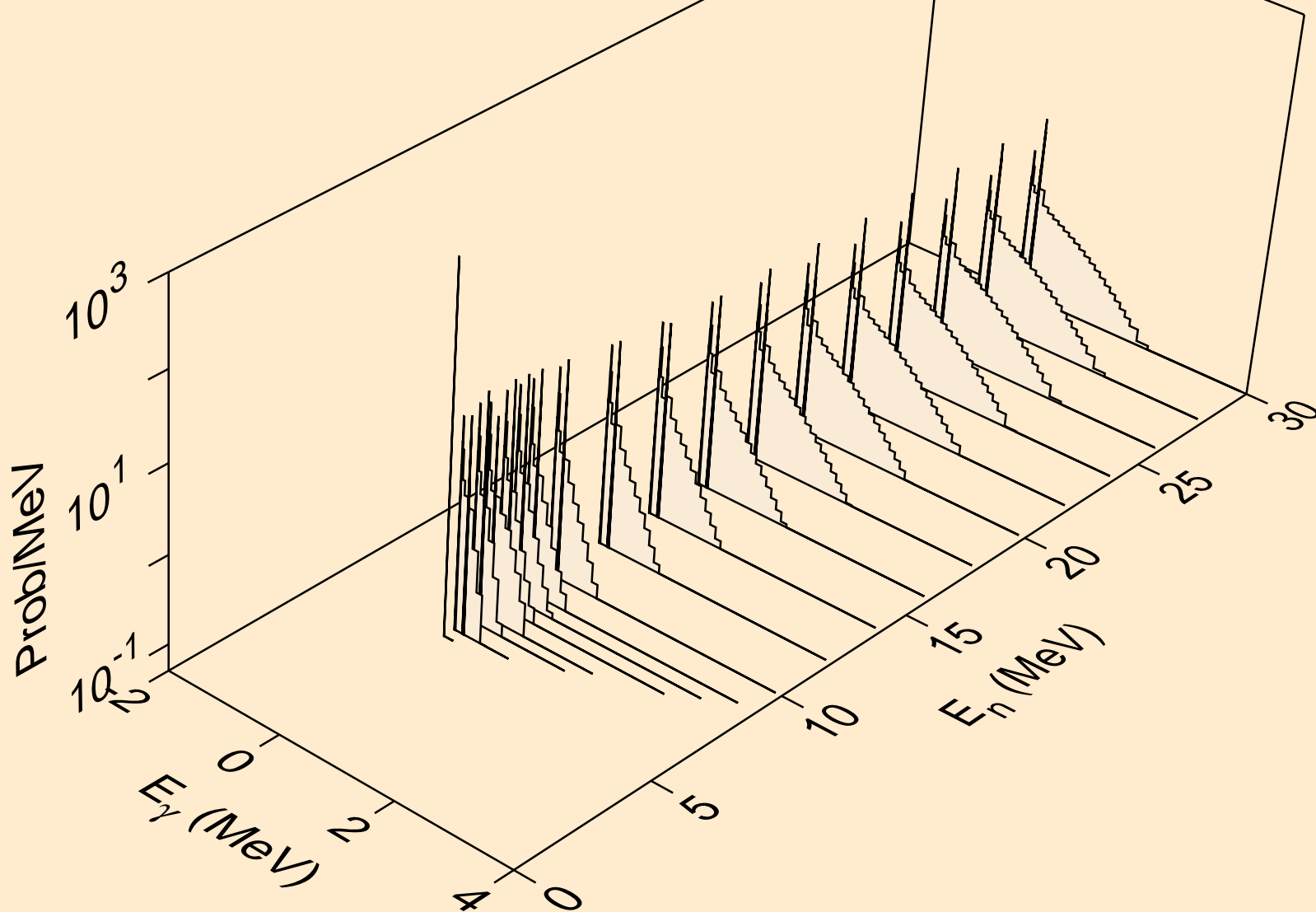

NO257 NEUTRON ACER TENDL-2019 LIBRARY; T=293.16K
Photon emission for (n,t)

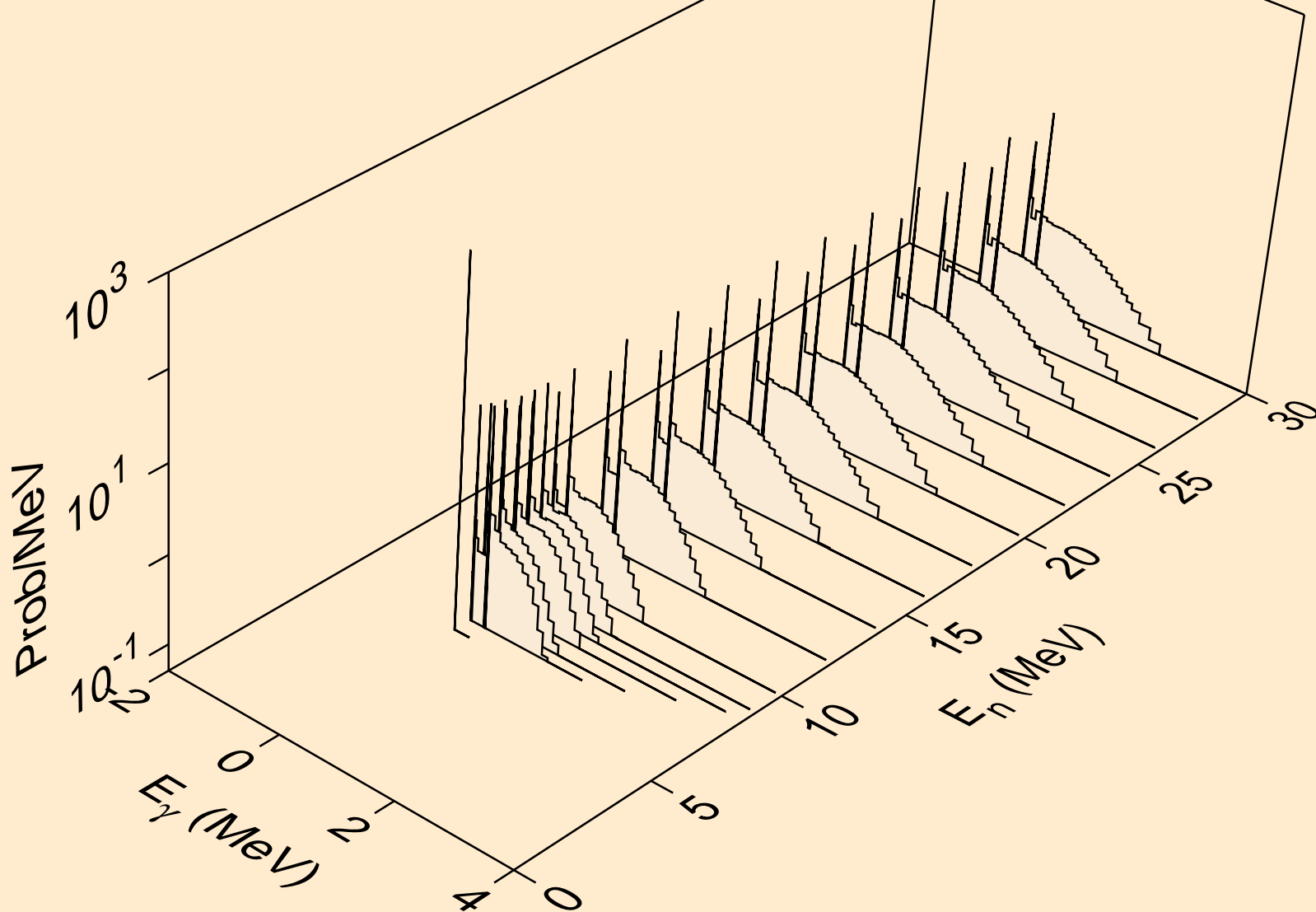

NO257 NEUTRON ACER TENDL-2019 LIBRARY; T=293.16K
Photon emission for (n,he3)

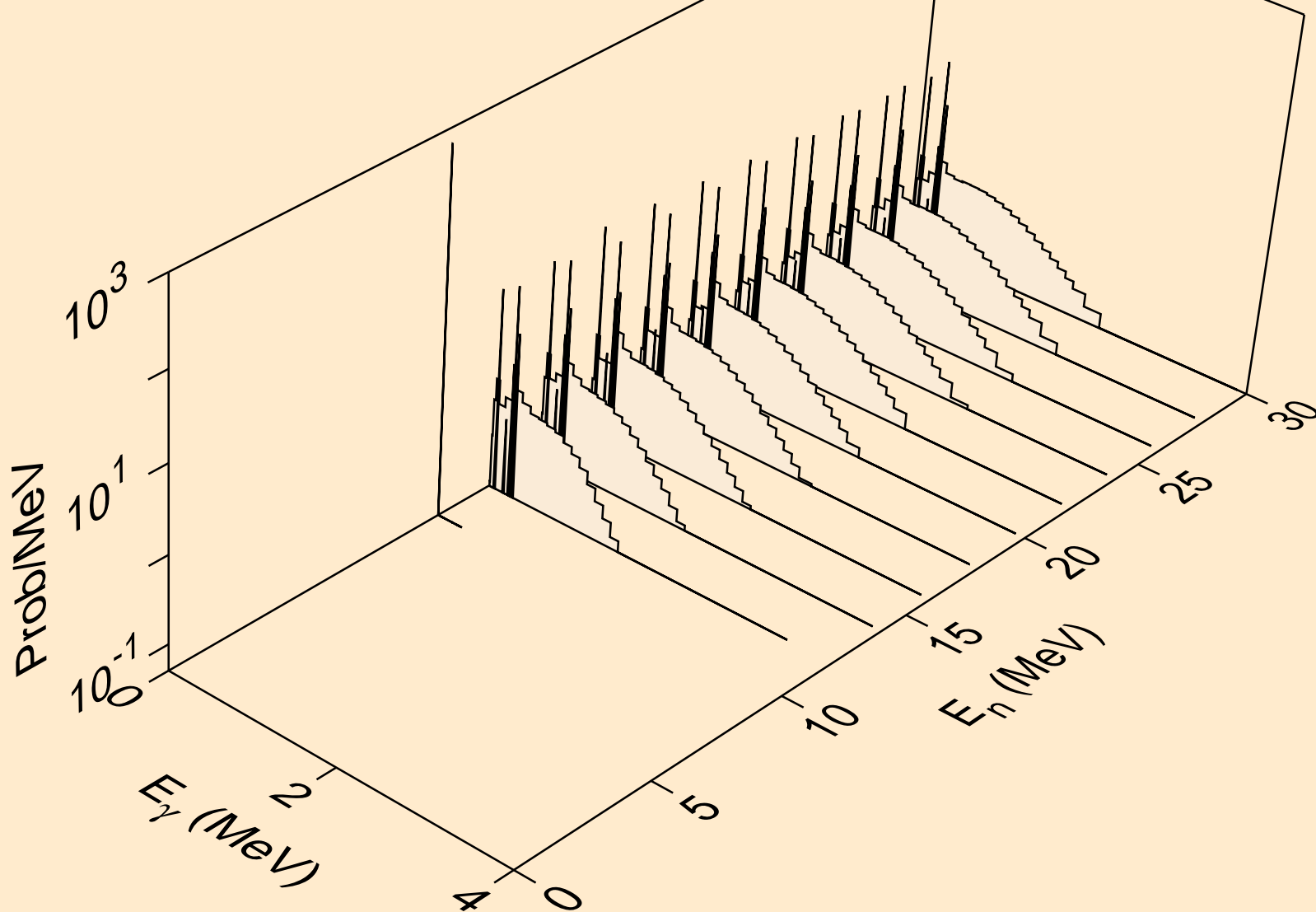

NO257 NEUTRON ACER TENDL-2019 LIBRARY; T=293.16K
Photon emission for (n,a)

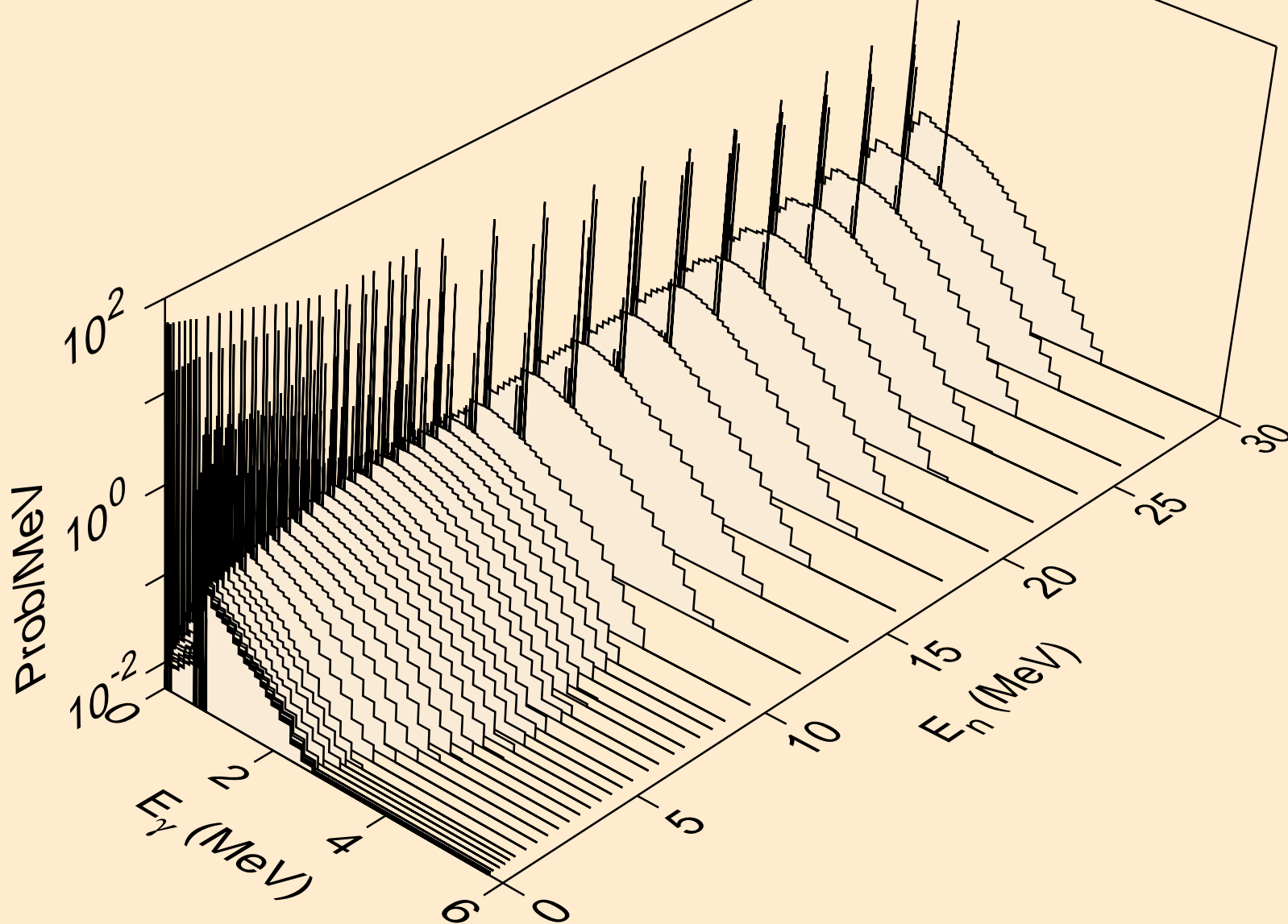

NO257 NEUTRON ACER TENDL-2019 LIBRARY; T=293.16K
Photon emission for (n,2a)

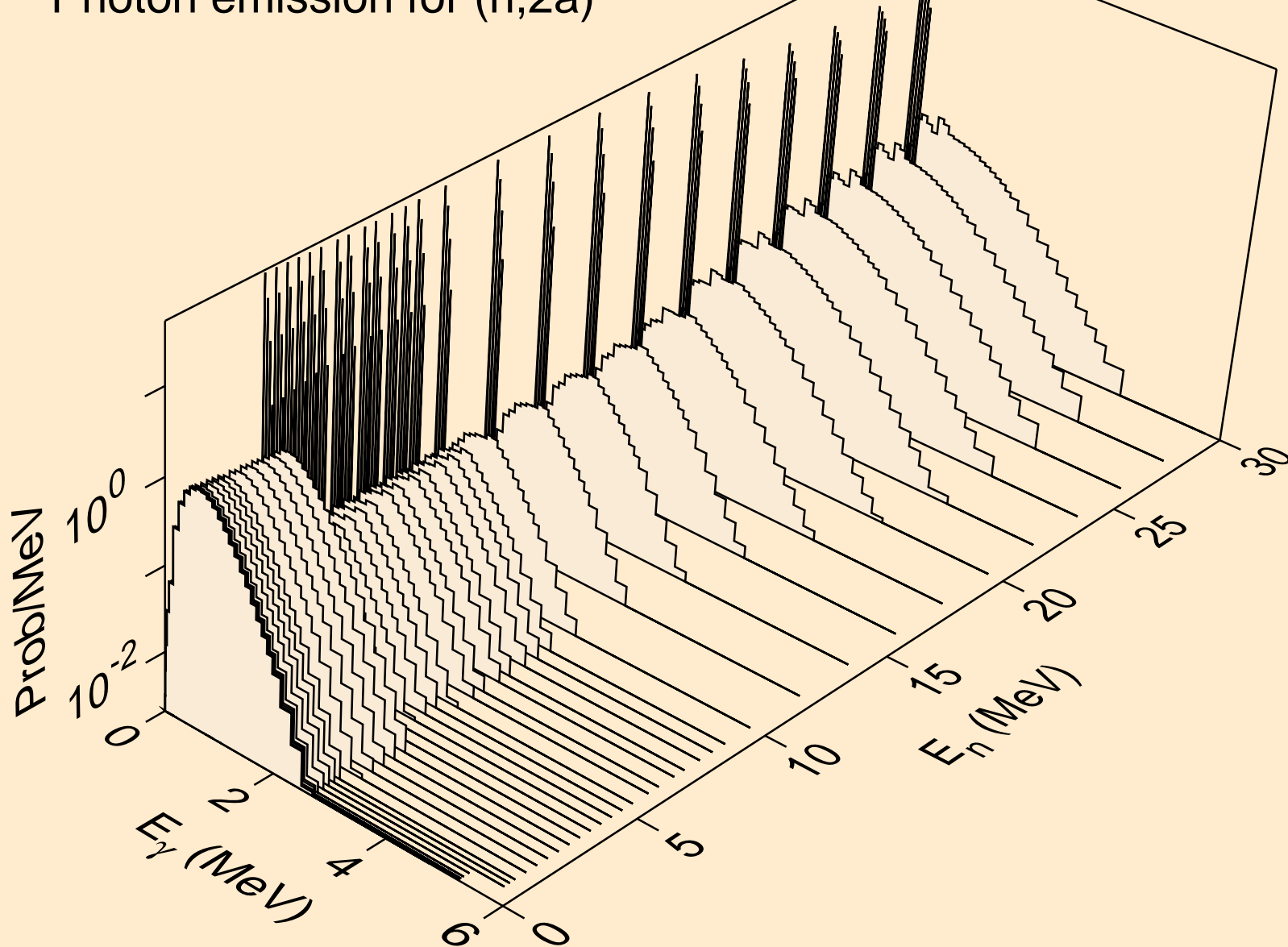

NO257 NEUTRON ACER TENDL-2019 LIBRARY; T=293.16K
Photon emission for (n,2p)

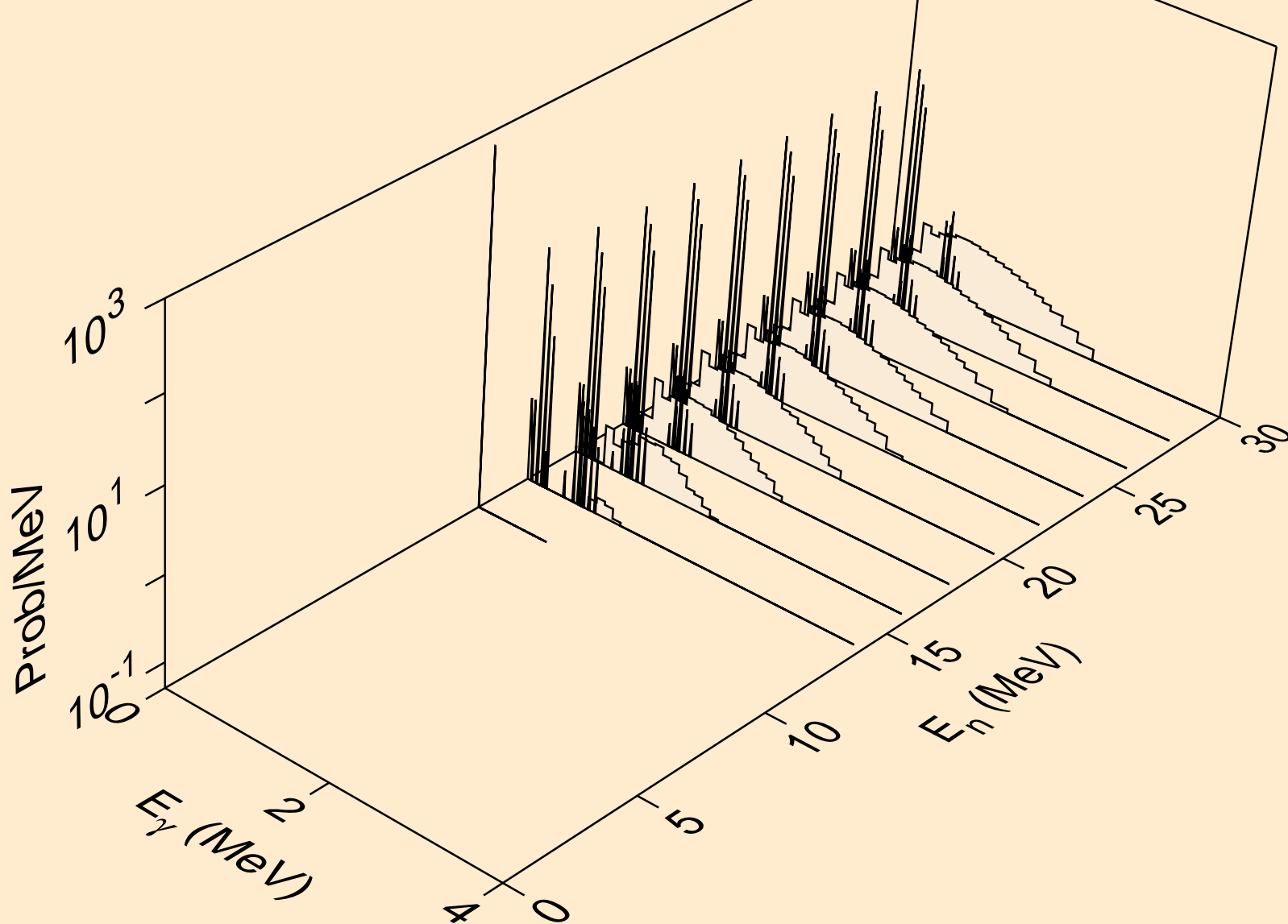

NO257 NEUTRON ACER TENDL-2019 LIBRARY; T=293.16K
Photon emission for (n,p α)

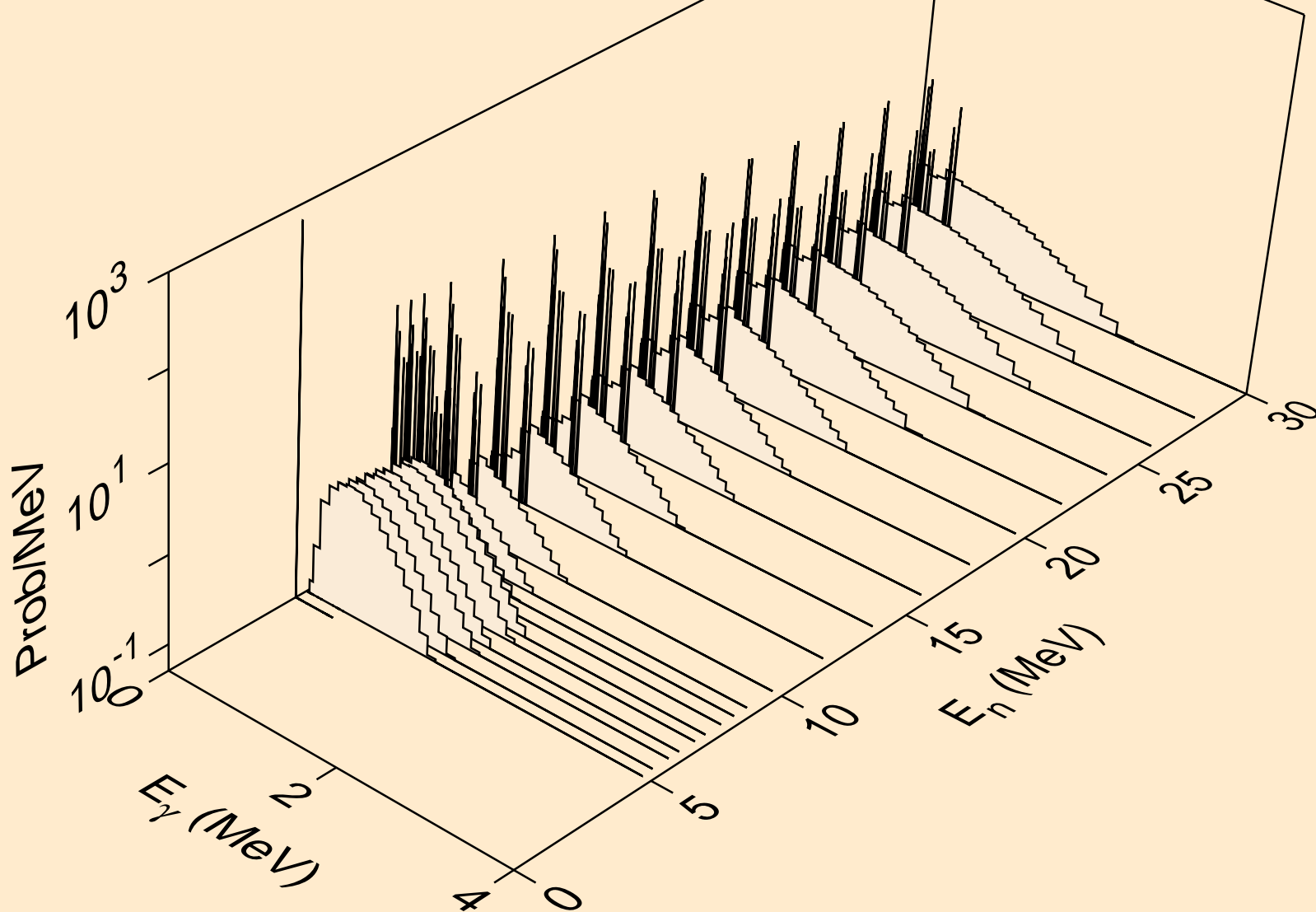

NO257 NEUTRON ACER TENDL-2019 LIBRARY; T=293.16K
Photon emission for (n,pd)

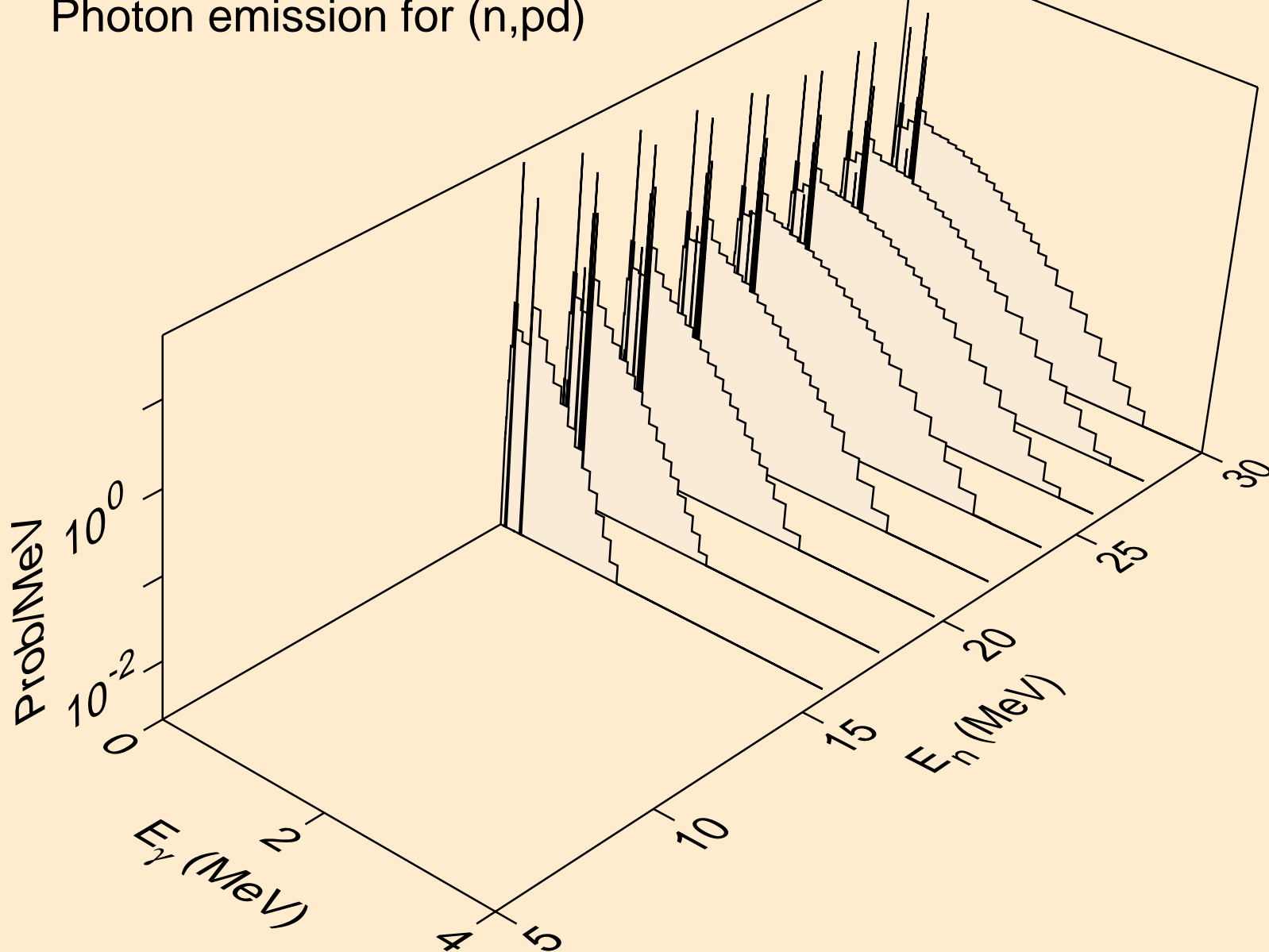

NO257 NEUTRON ACER TENDL-2019 LIBRARY; T=293.16K
Photon emission for (n,da)

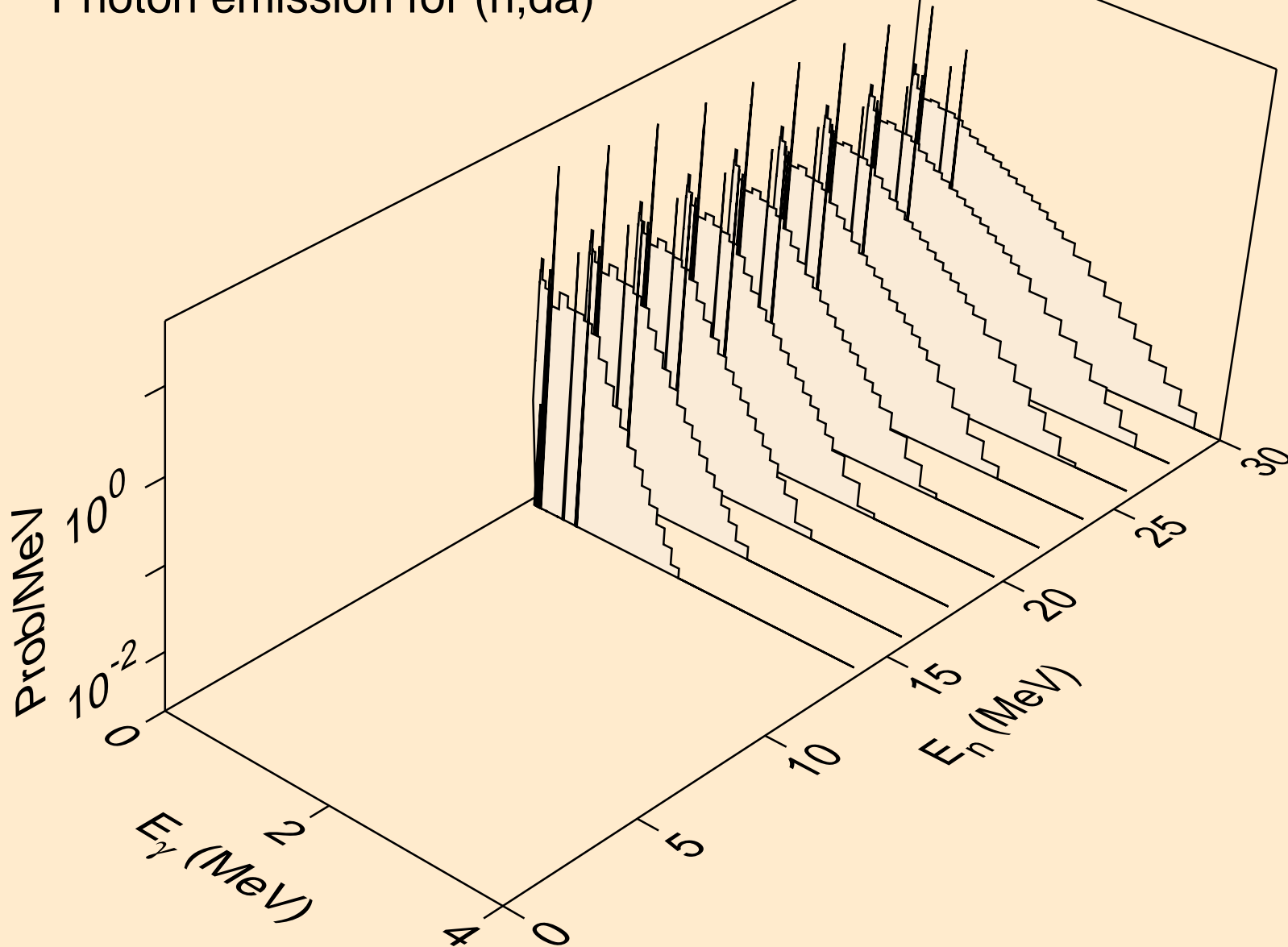

NO257 NEUTRON ACER TENDL-2019 LIBRARY; T=293.16K
thermal capture photon spectrum

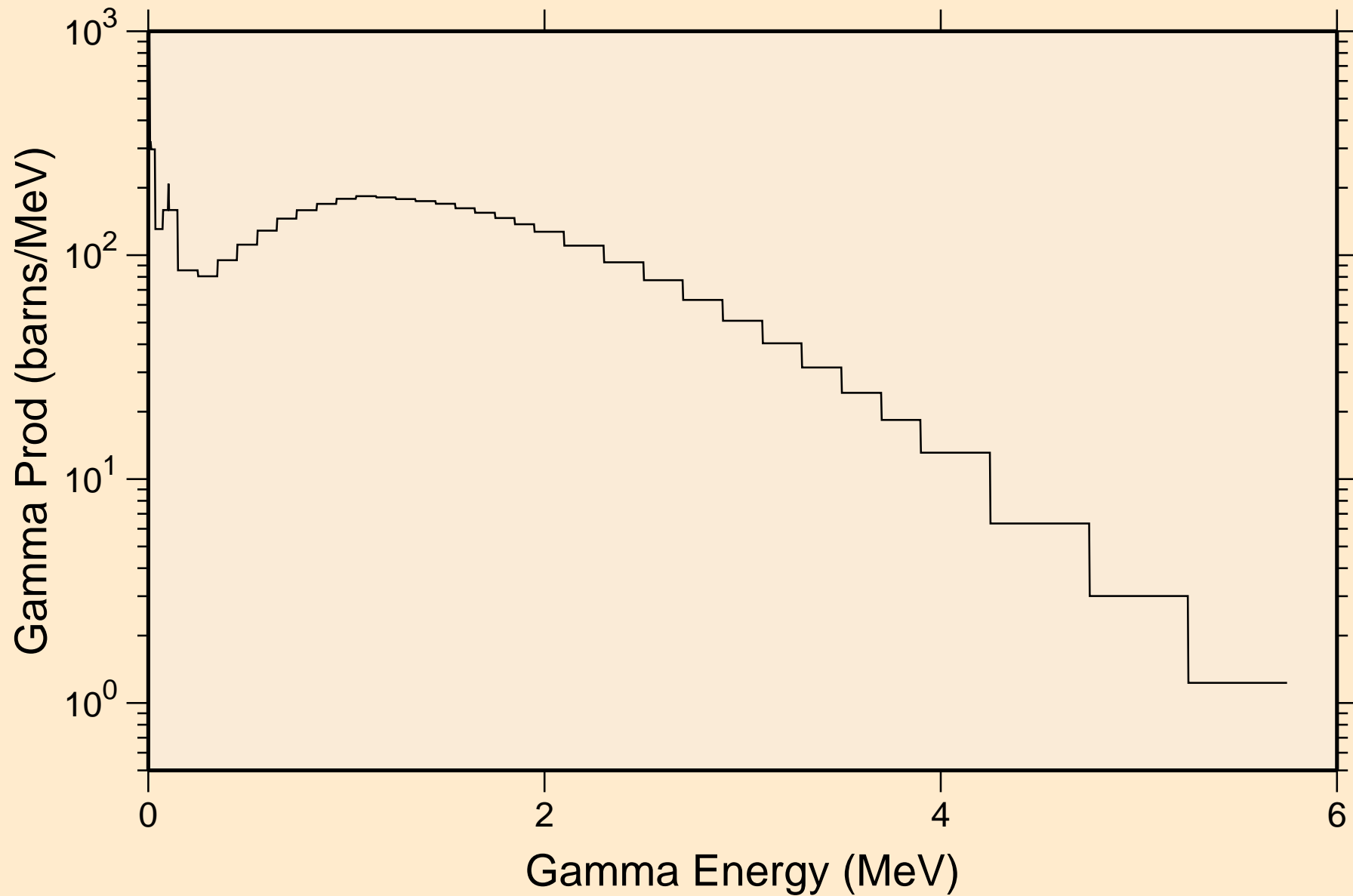

NO257 NEUTRON ACER TENDL-2019 LIBRARY; T=293.16K
14 MeV photon spectrum

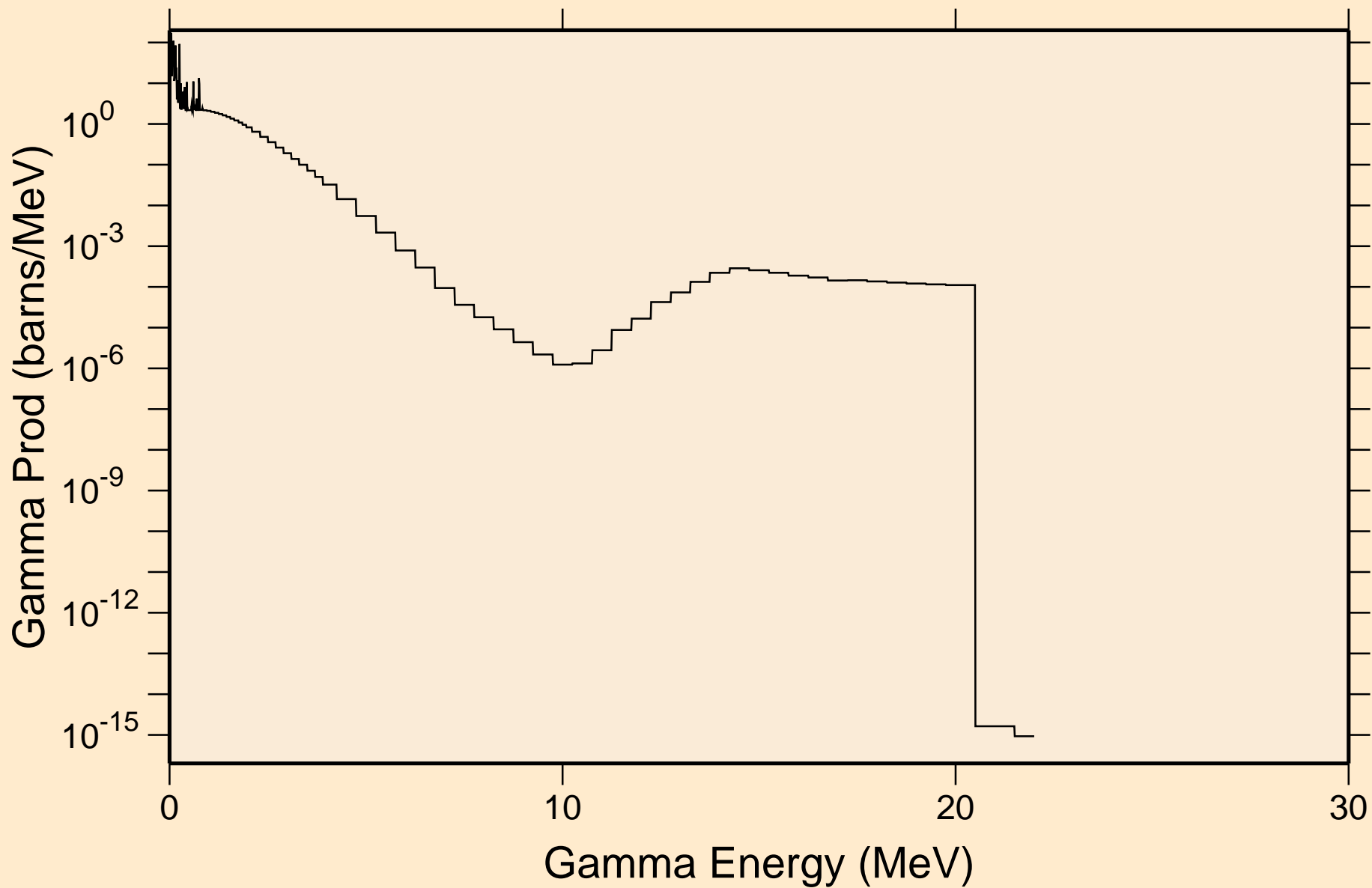

NO257 NEUTRON ACER TENDL-2019 LIBRARY; T=293.16K
Particle heating contributions

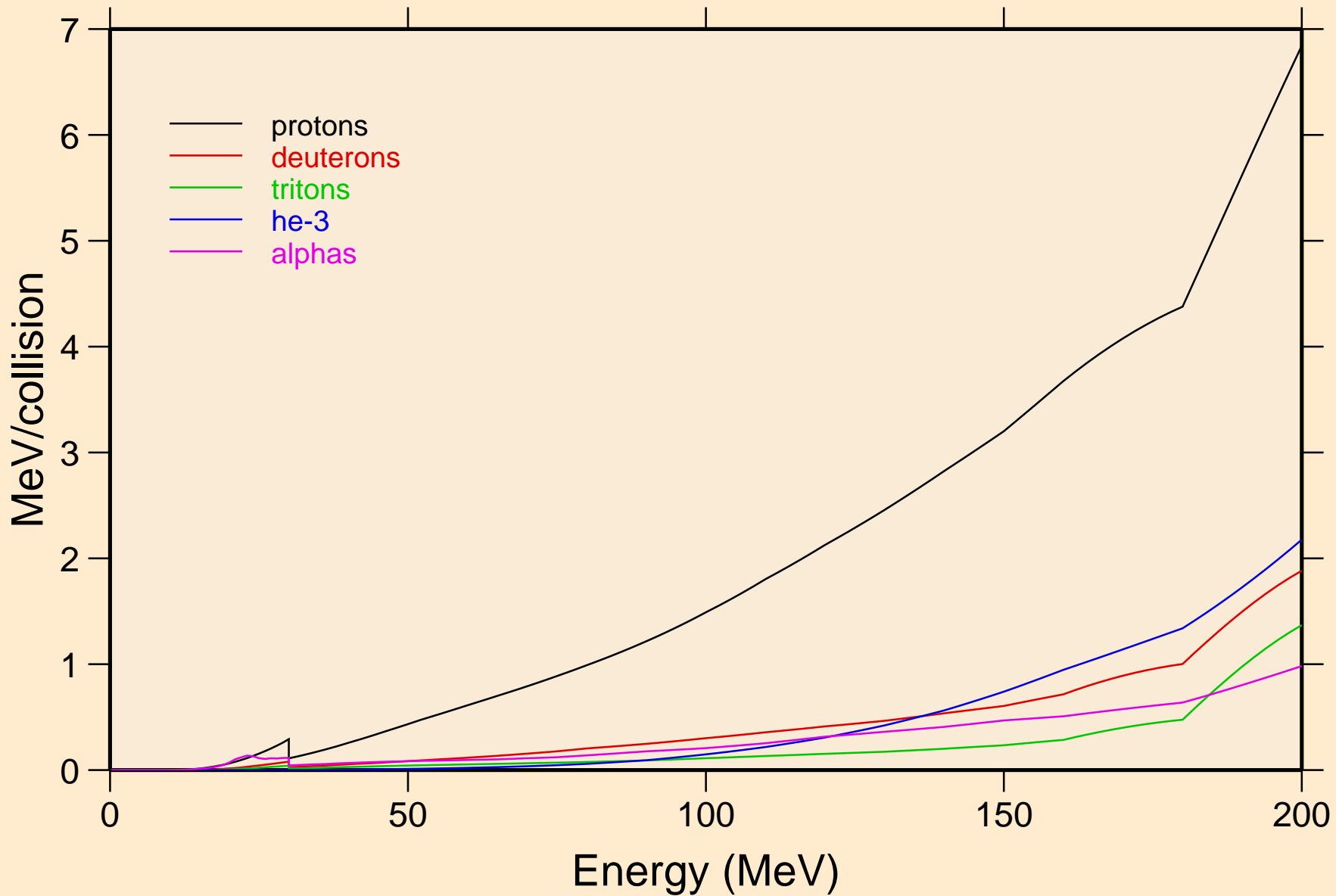

NO257 NEUTRON ACER TENDL-2019 LIBRARY; T=293.16K
Recoil Heating

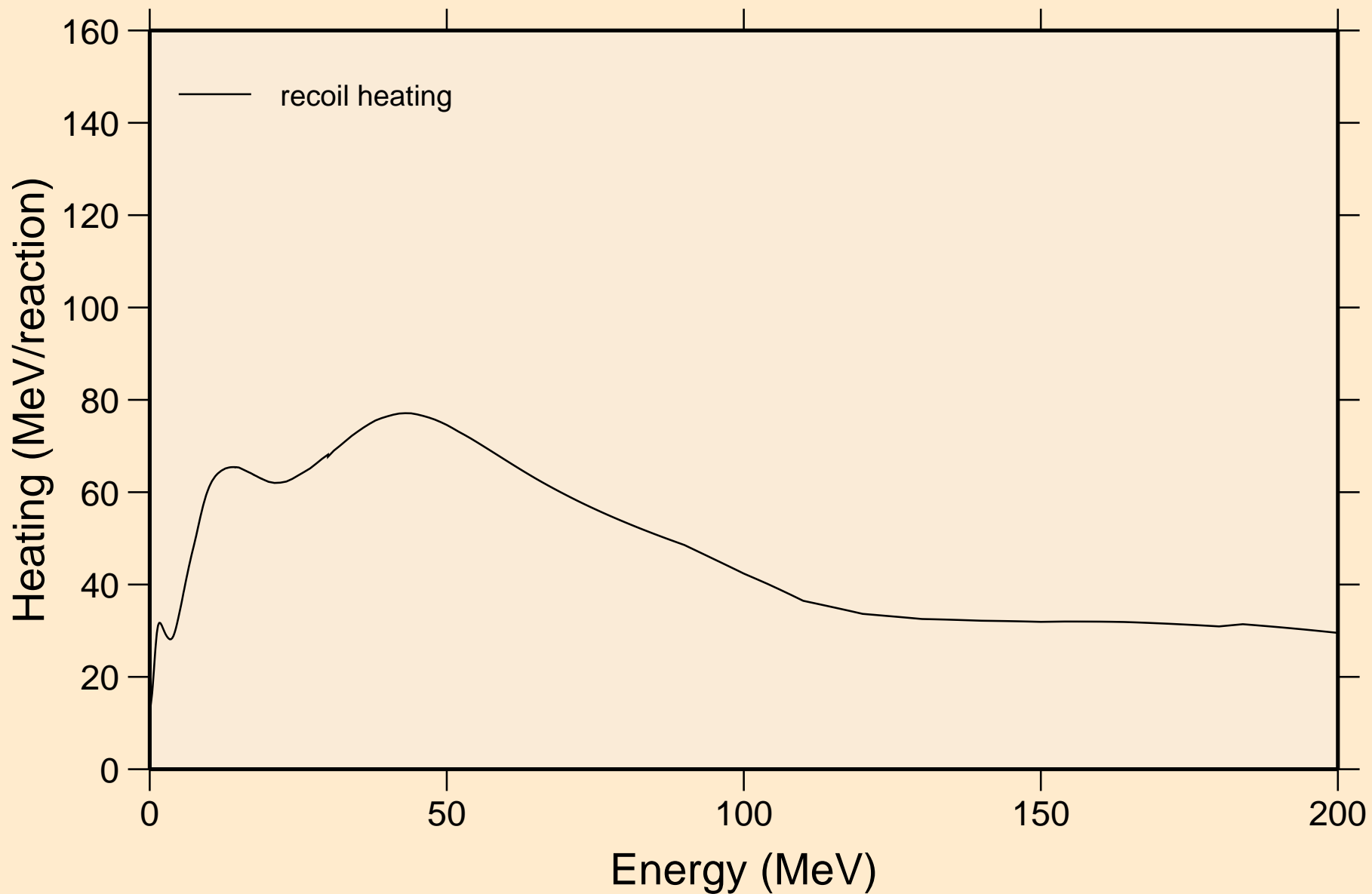

NO257 NEUTRON ACER TENDL-2019 LIBRARY; T=293.16K
Particle production cross sections

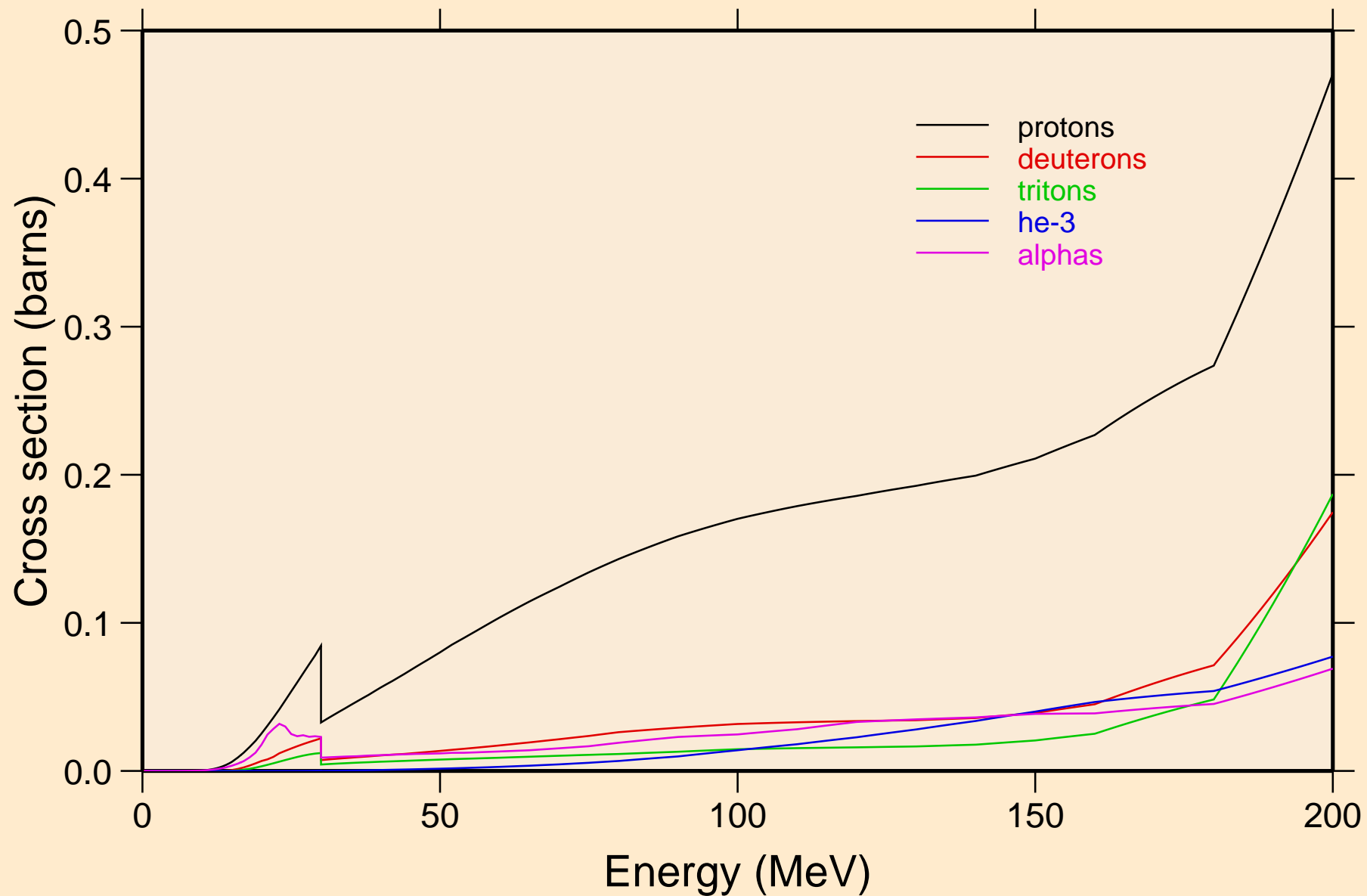

NO257 NEUTRON ACER TENDL-2019 LIBRARY; T=293.16K
protons from (n,x)

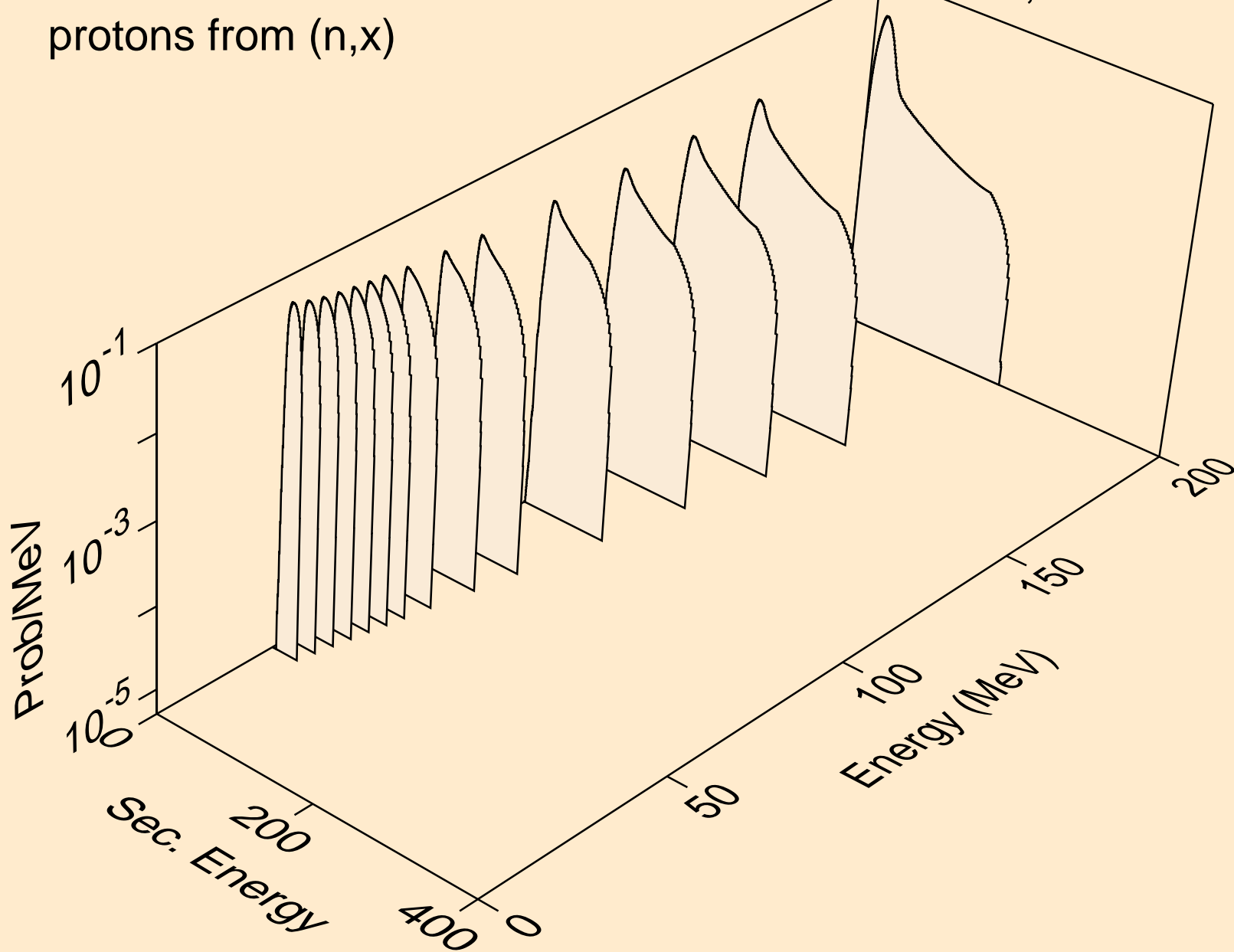

NO257 NEUTRON ACER TENDL-2019 LIBRARY; T=293.16K
protons from (n,n*)p

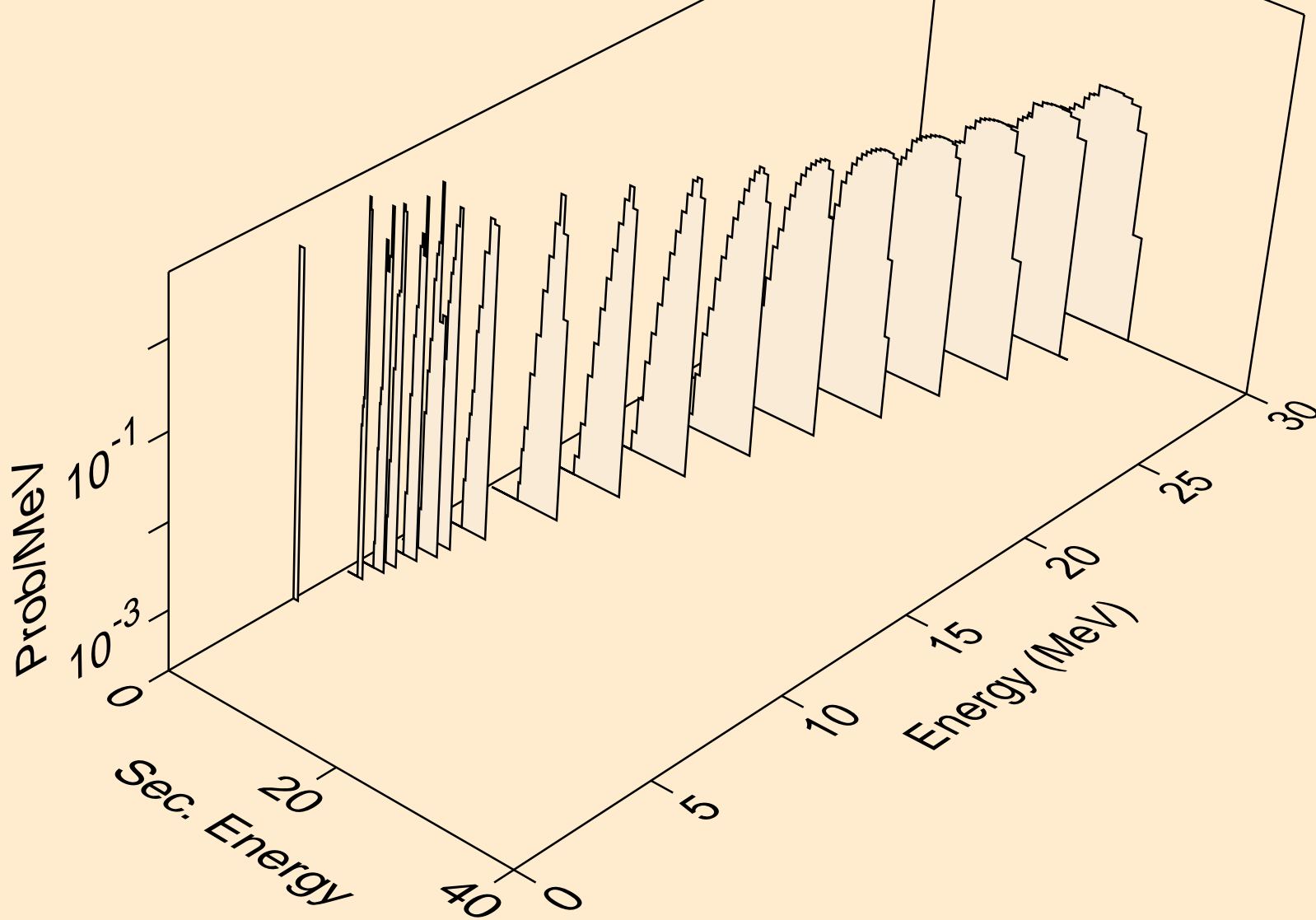

NO257 NEUTRON ACER TENDL-2019 LIBRARY; T=293.16K
protons from (n,2np)

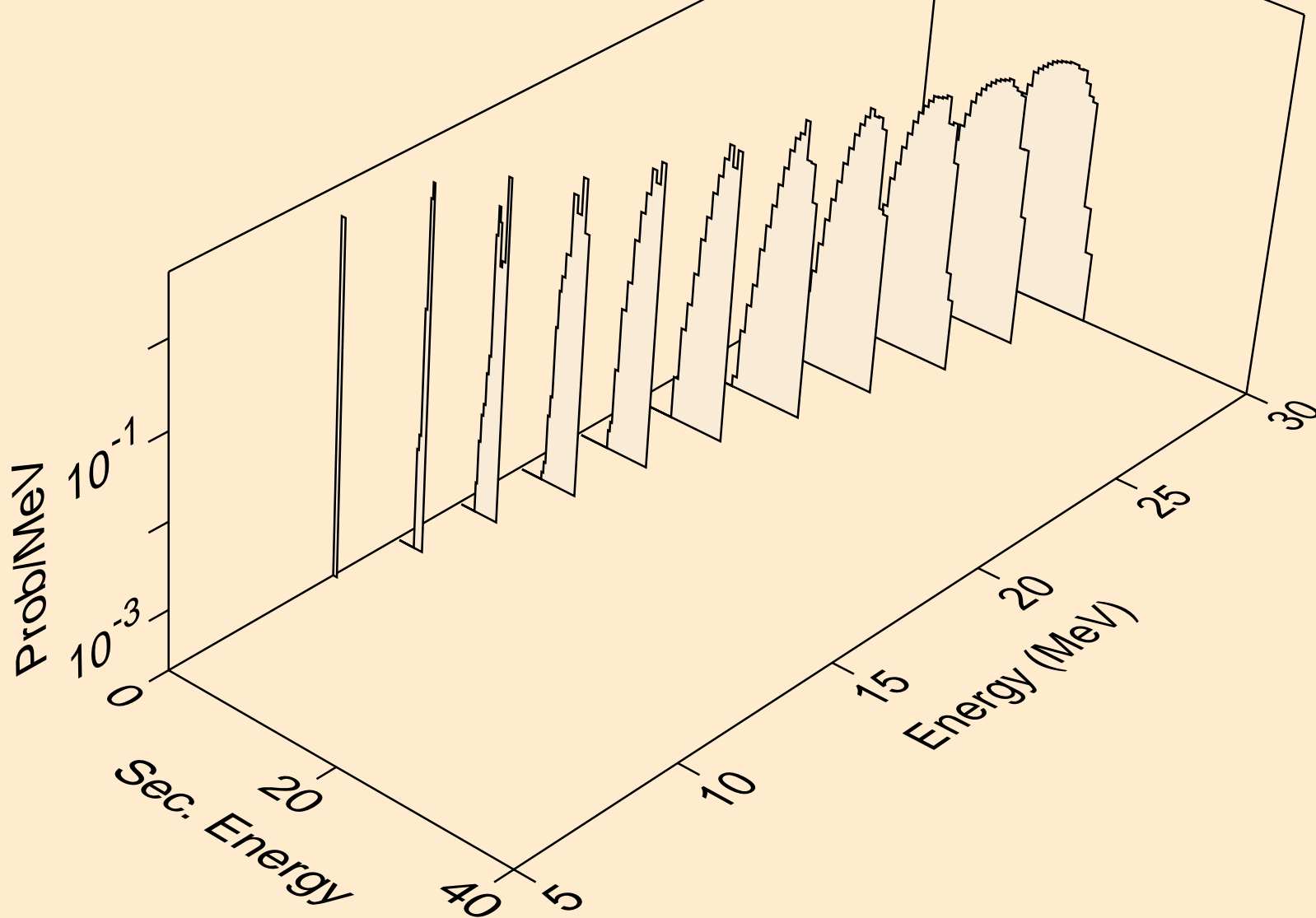

NO257 NEUTRON ACER TENDL-2019 LIBRARY; T=293.16K
protons from (n,3np)

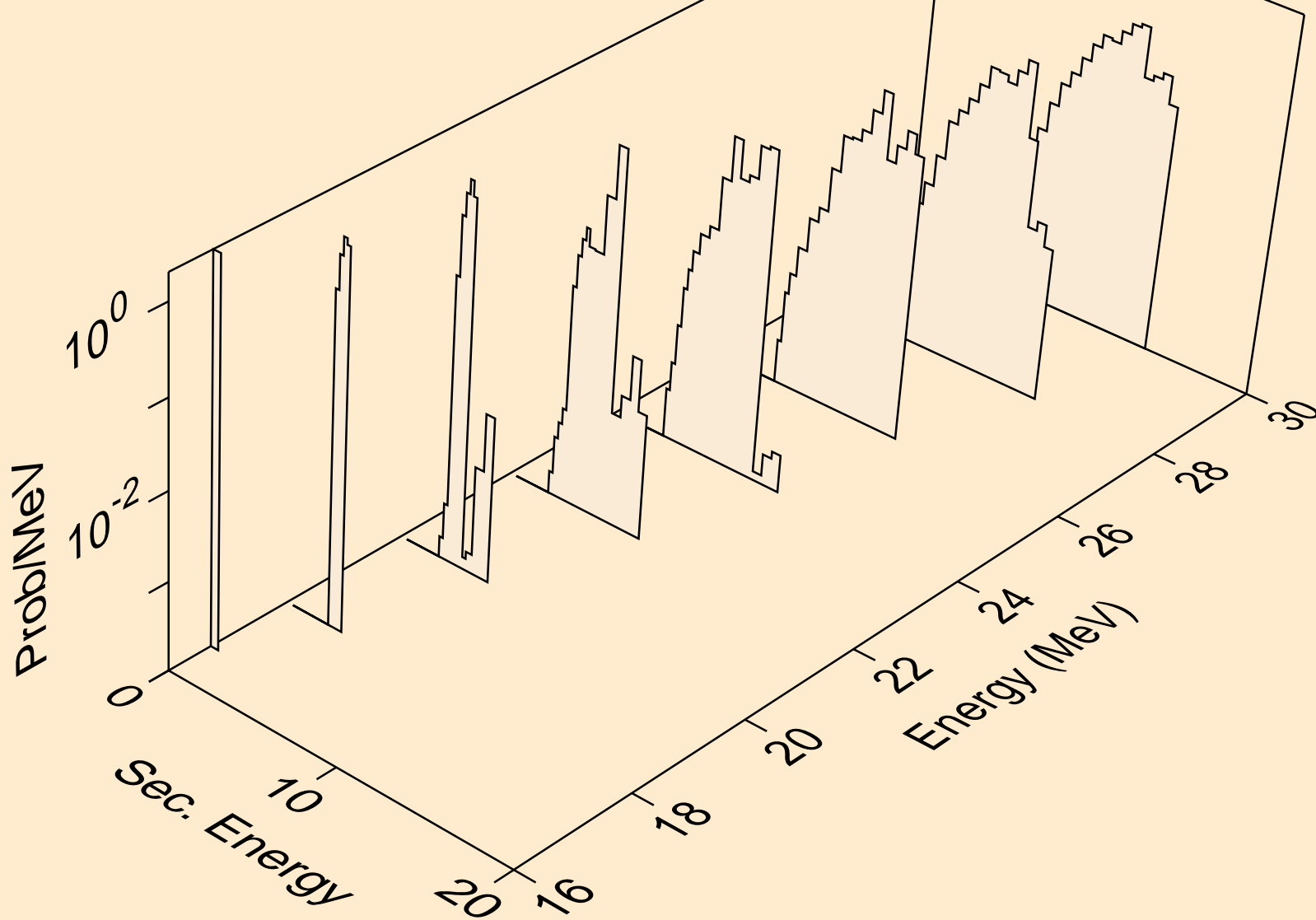

NO257 NEUTRON ACER TENDL-2019 LIBRARY; T=293.16K
protons from (n,2np)

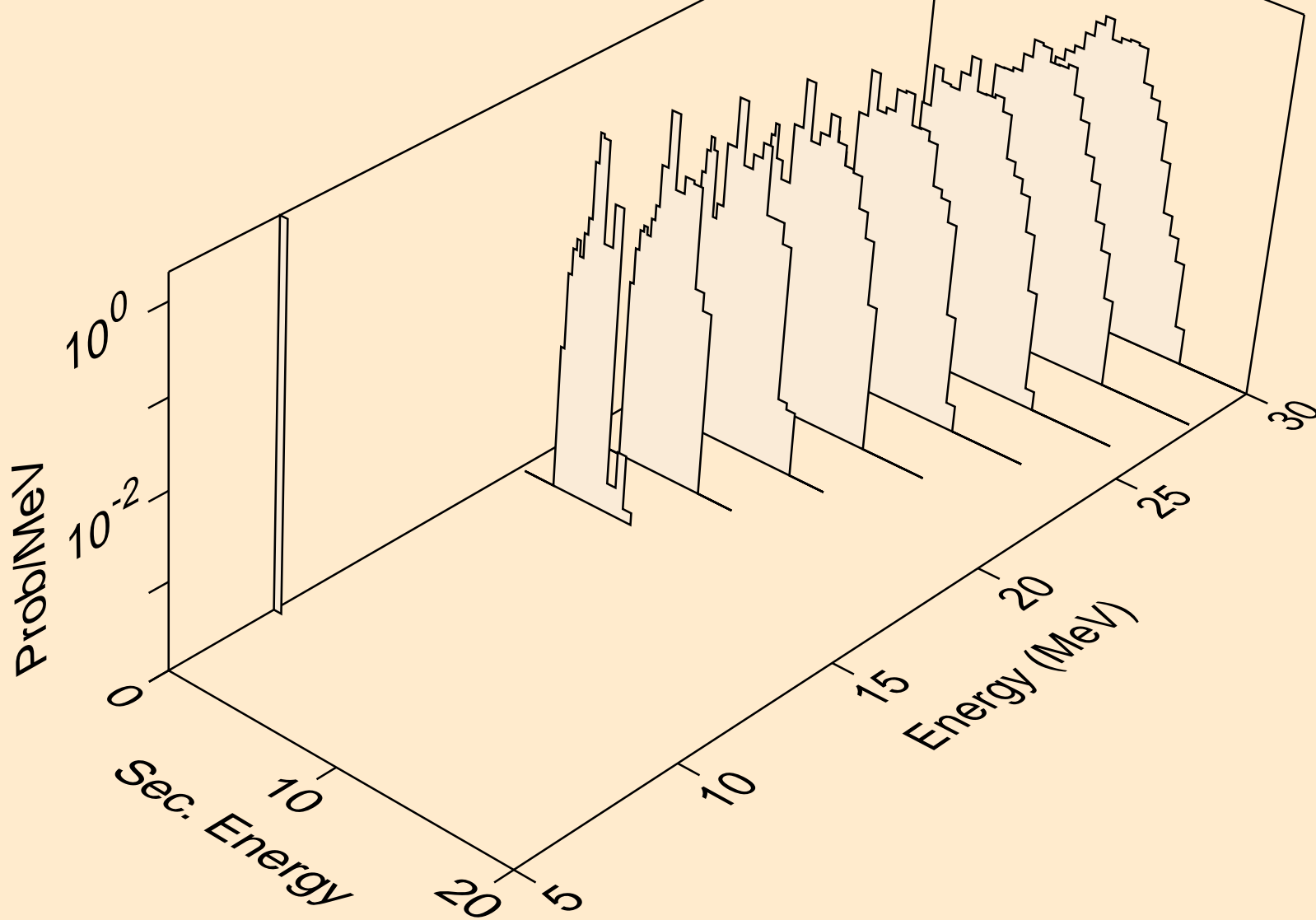

NO257 NEUTRON ACER TENDL-2019 LIBRARY; T=293.16K
protons from (n,npa)

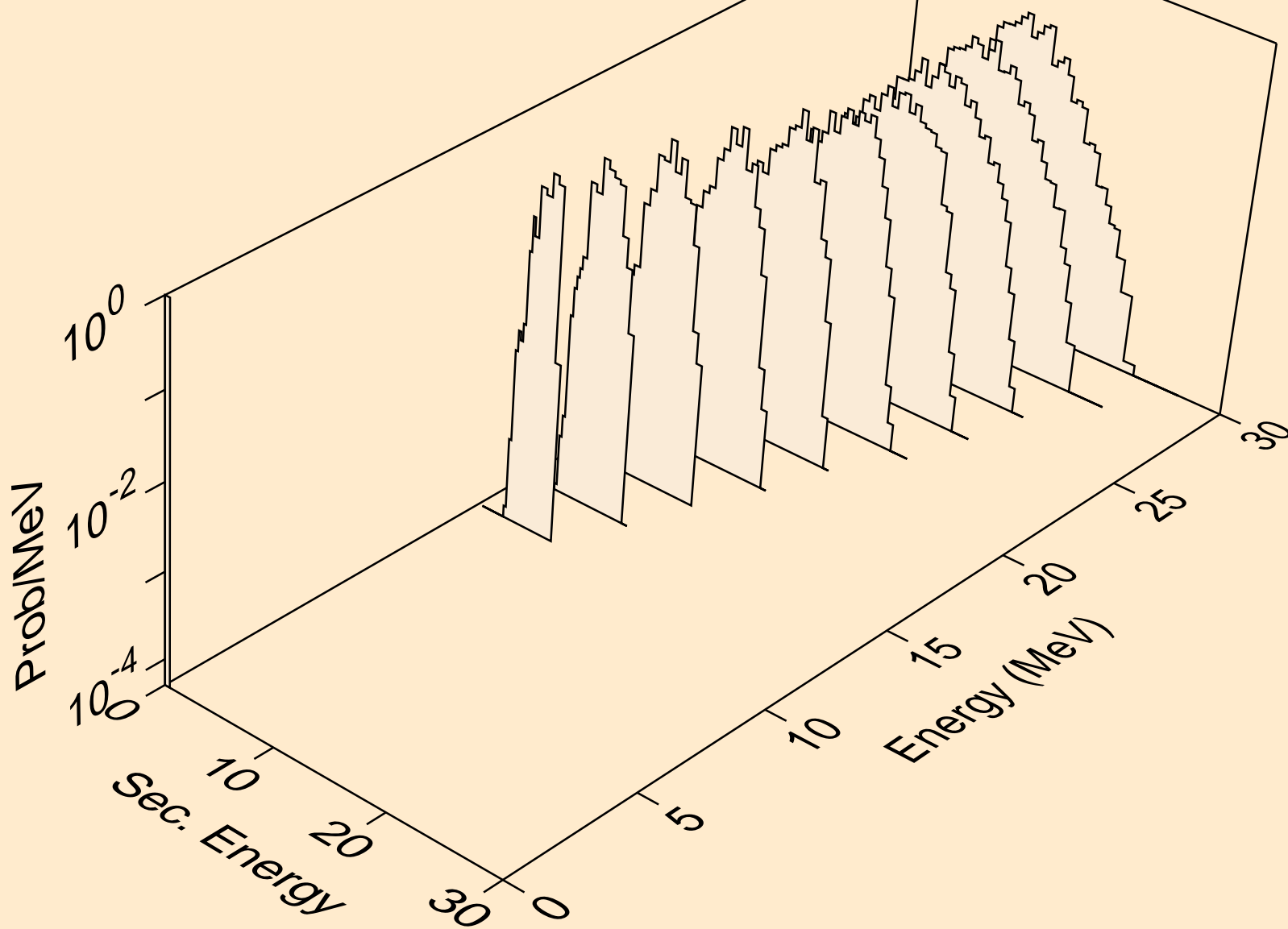

NO257 NEUTRON ACER TENDL-2019 LIBRARY; T=293.16K
protons from (n,p)

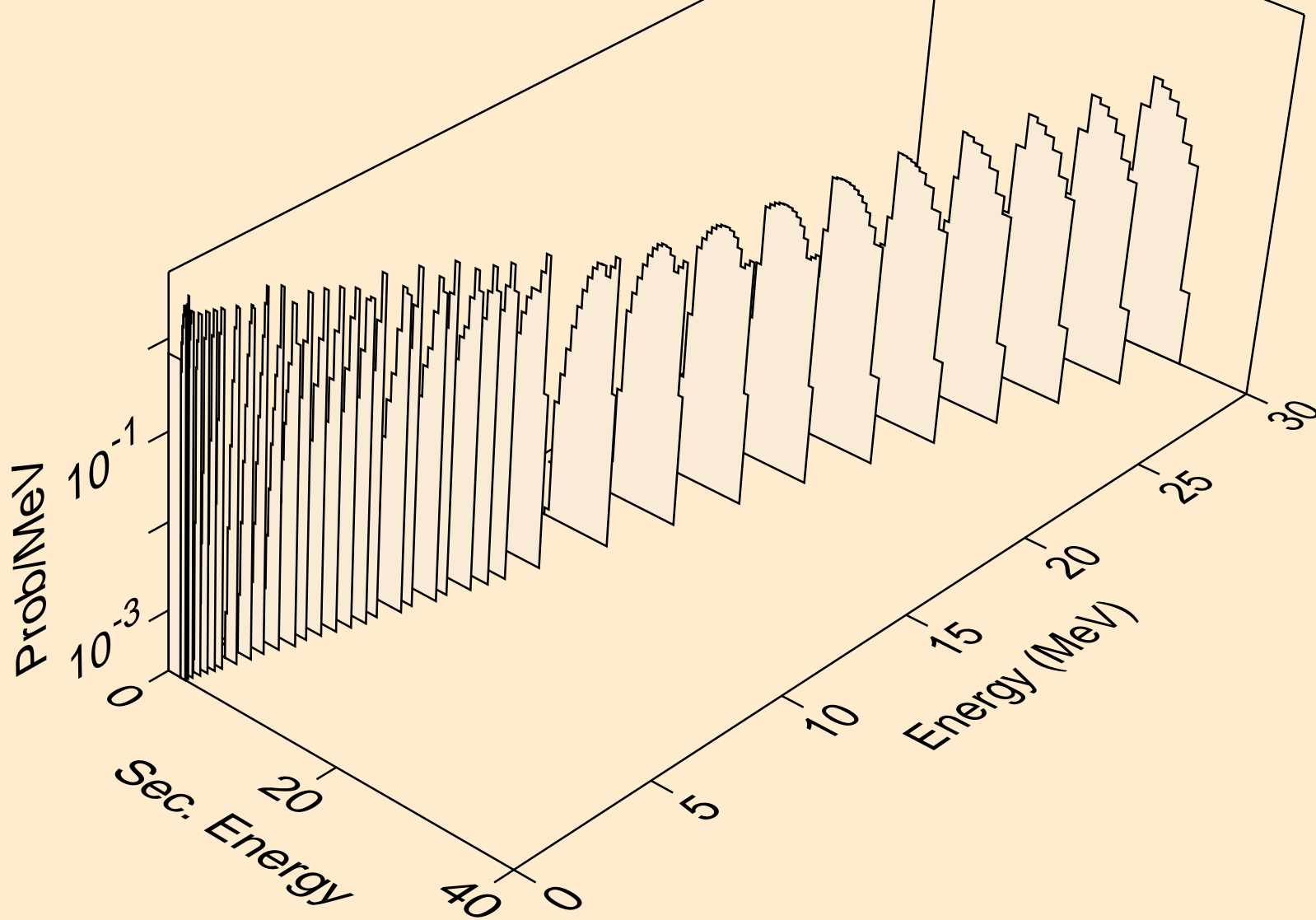

NO257 NEUTRON ACER TENDL-2019 LIBRARY; T=293.16K
protons from (n,2p)

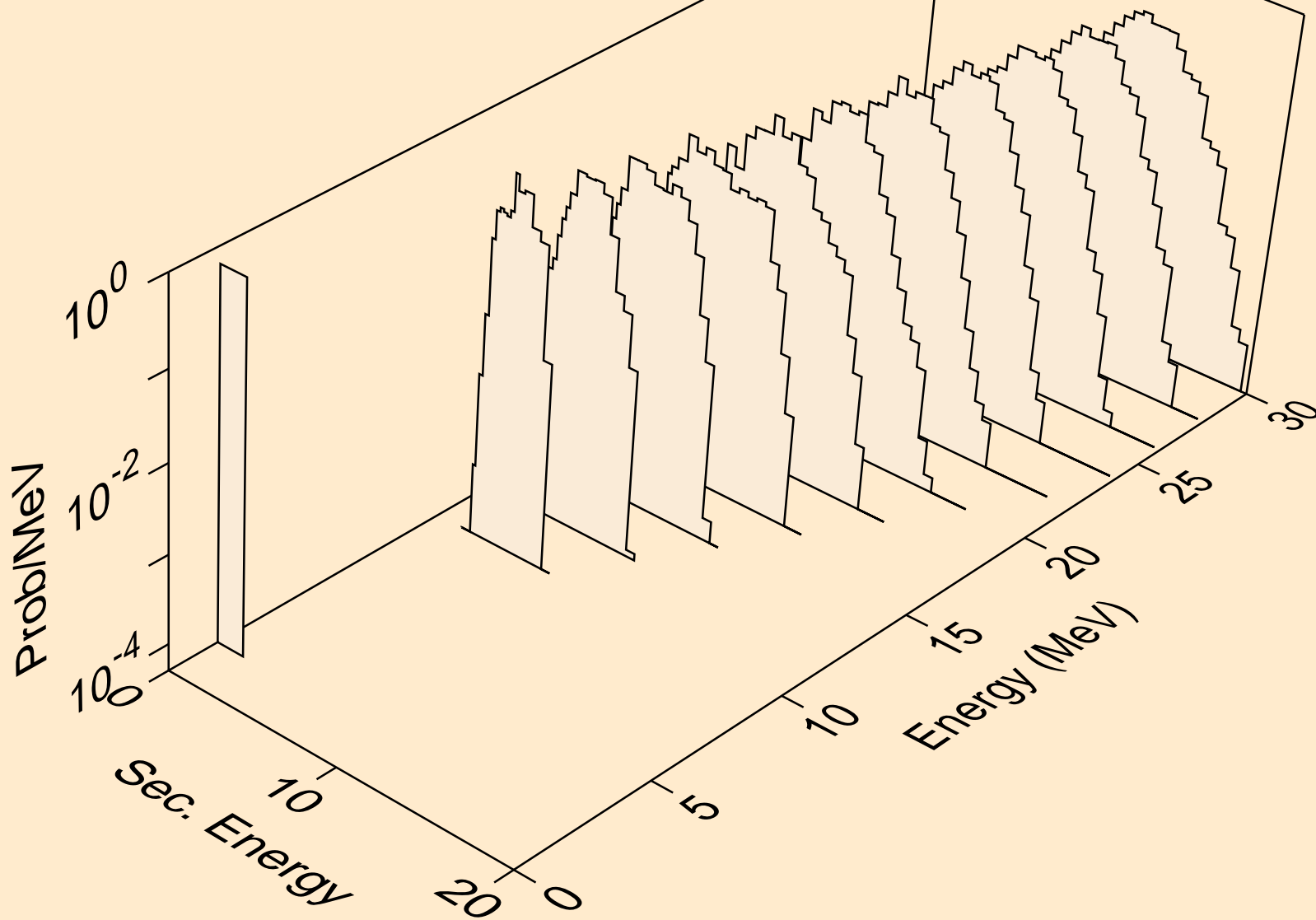

NO257 NEUTRON ACER TENDL-2019 LIBRARY; T=293.16K
protons from (n,p)

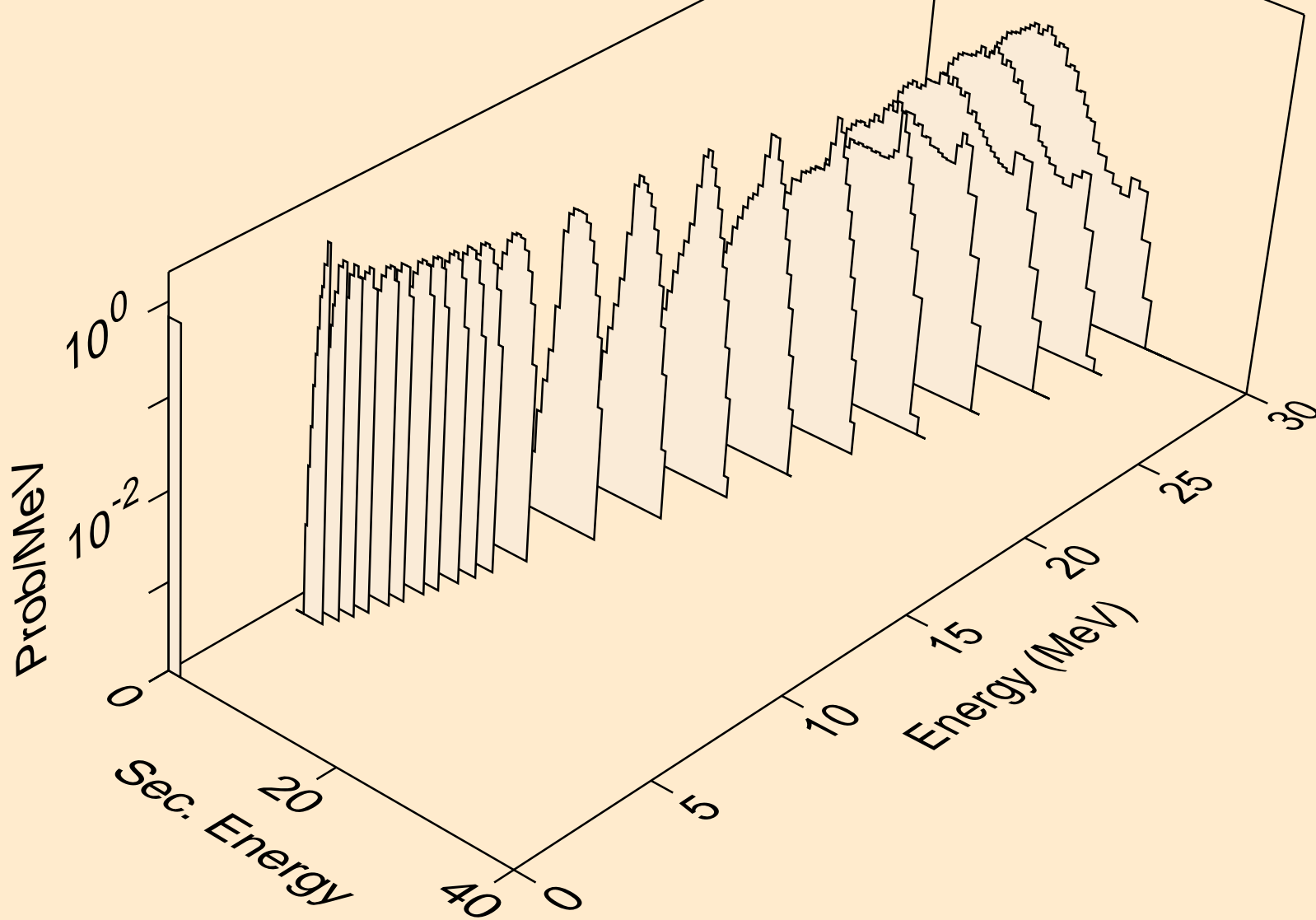

NO257 NEUTRON ACER TENDL-2019 LIBRARY; T=293.16K
protons from (n,pd)

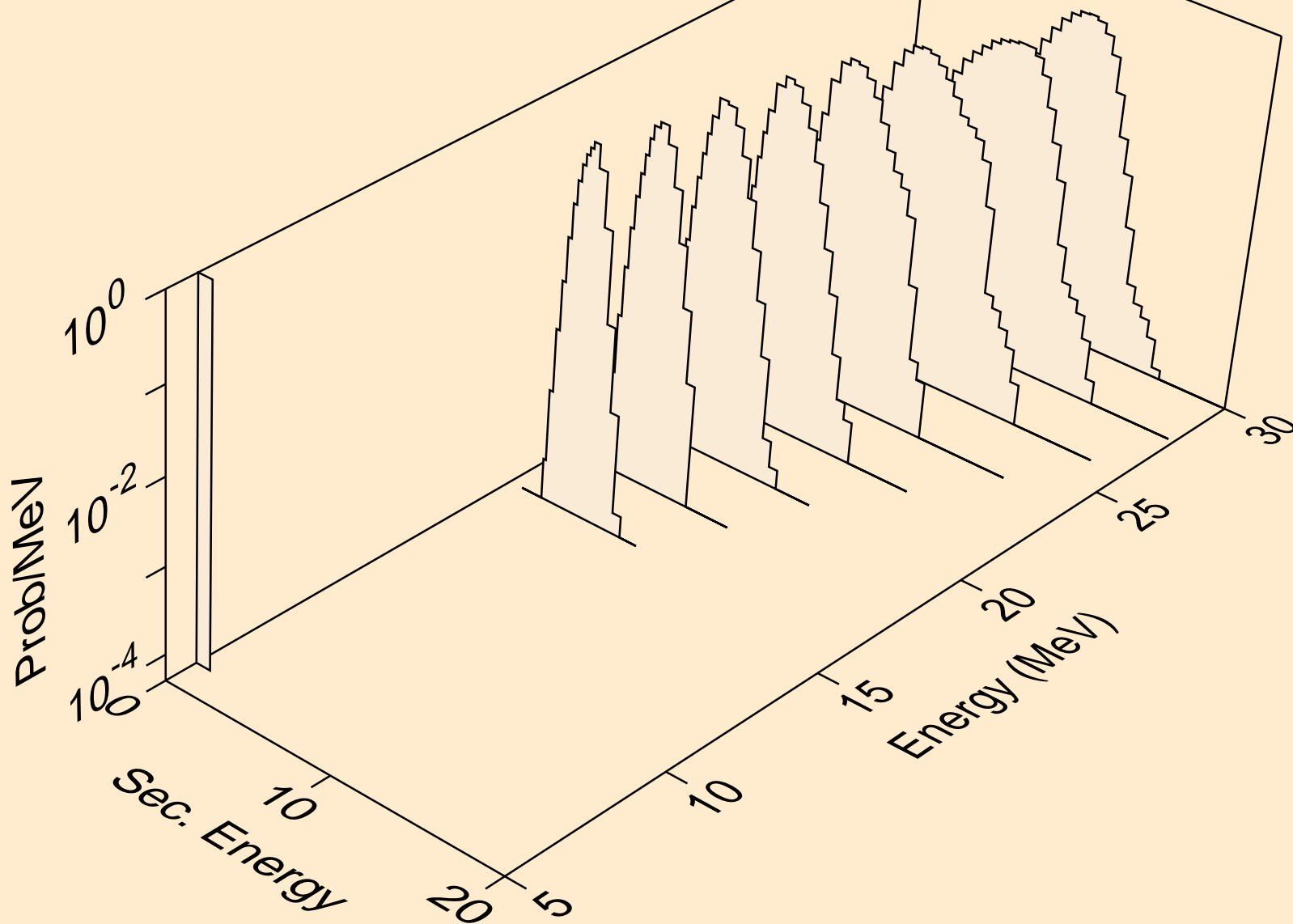

NO257 NEUTRON ACER TENDL-2019 LIBRARY; T=293.16K
deuterons from (n,x)

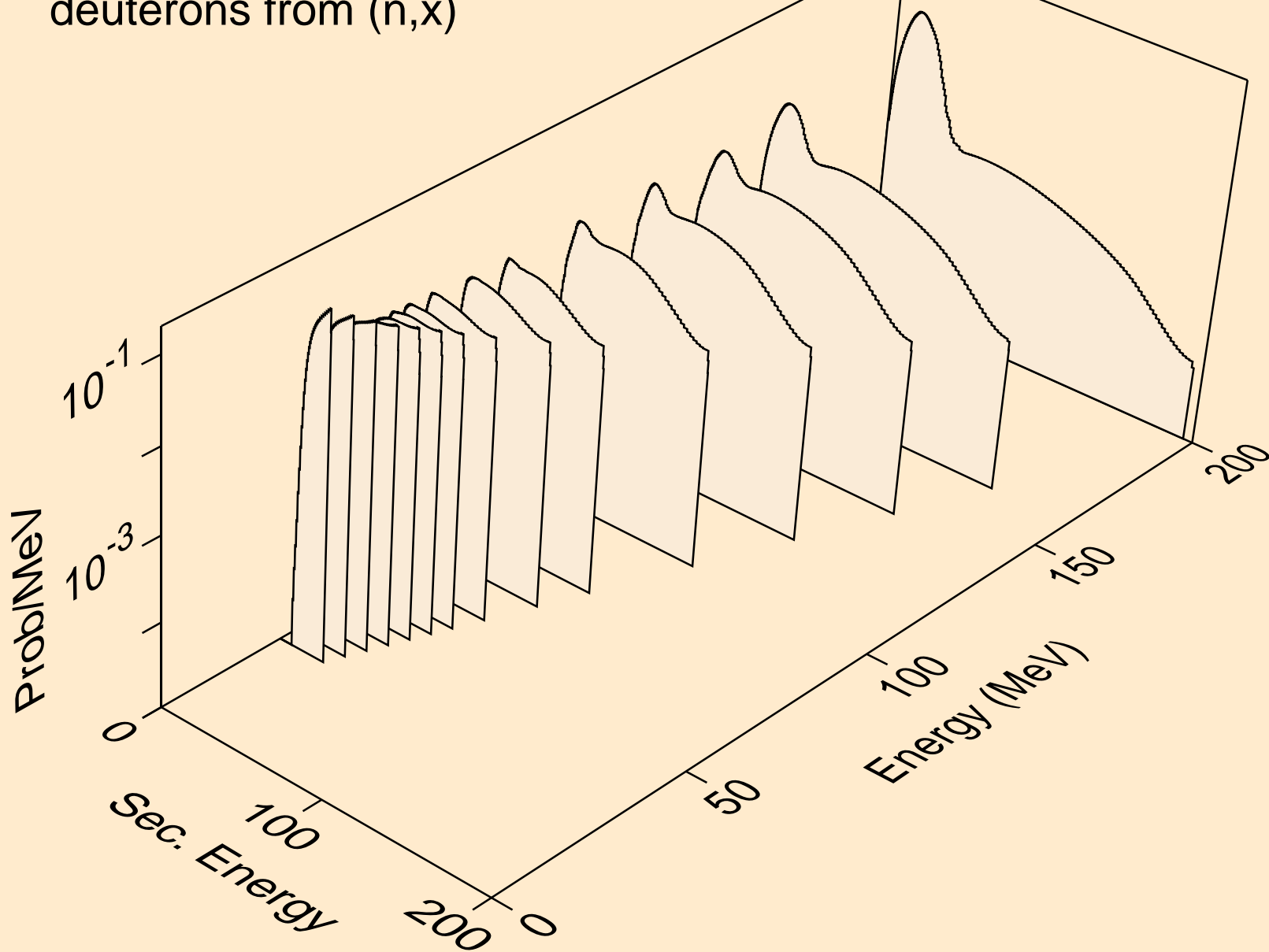

NO257 NEUTRON ACER TENDL-2019 LIBRARY; T=293.16K
deuterons from (n,2nd)

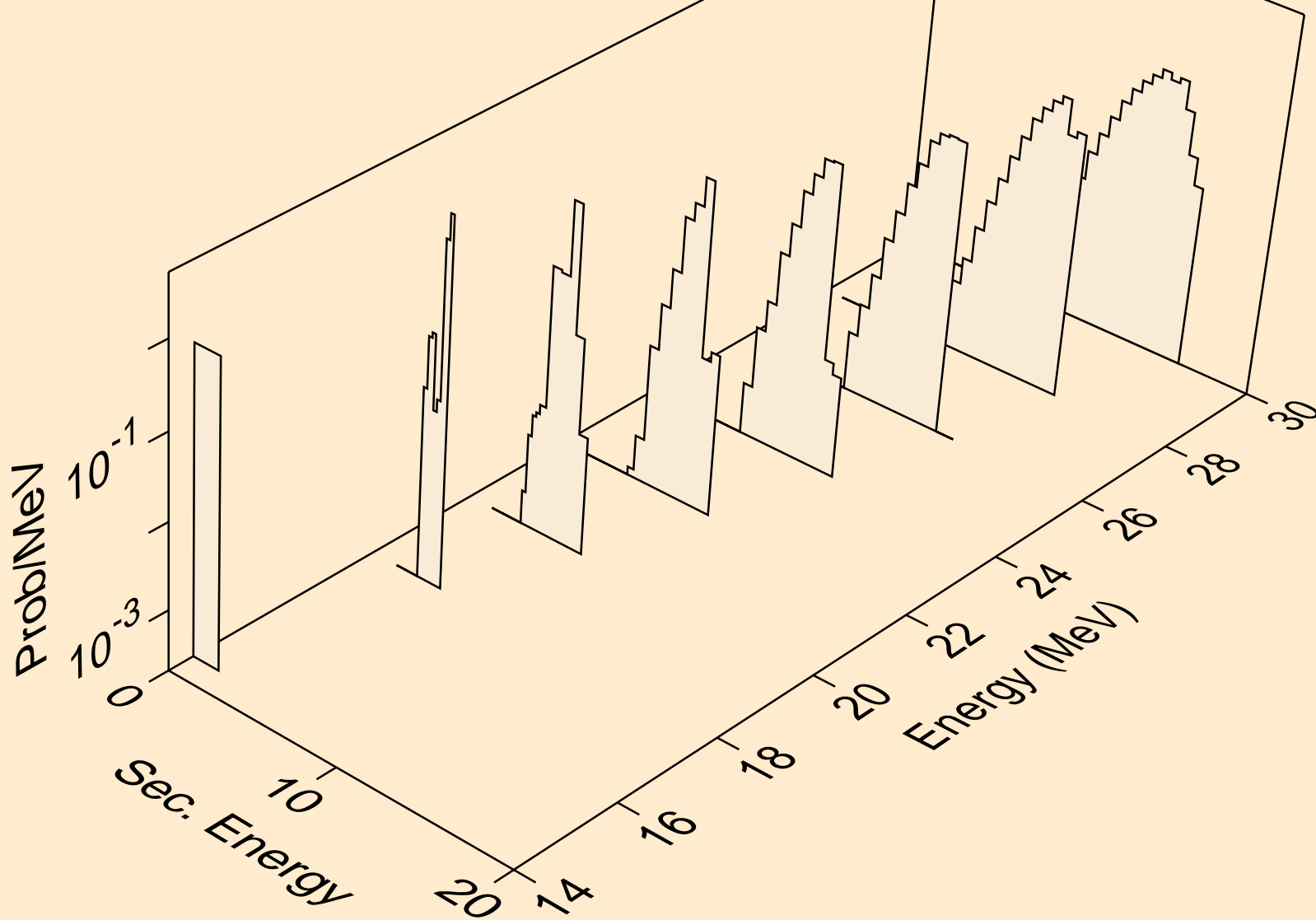

NO257 NEUTRON ACER TENDL-2019 LIBRARY; T=293.16K
deuterons from (n,n*)d

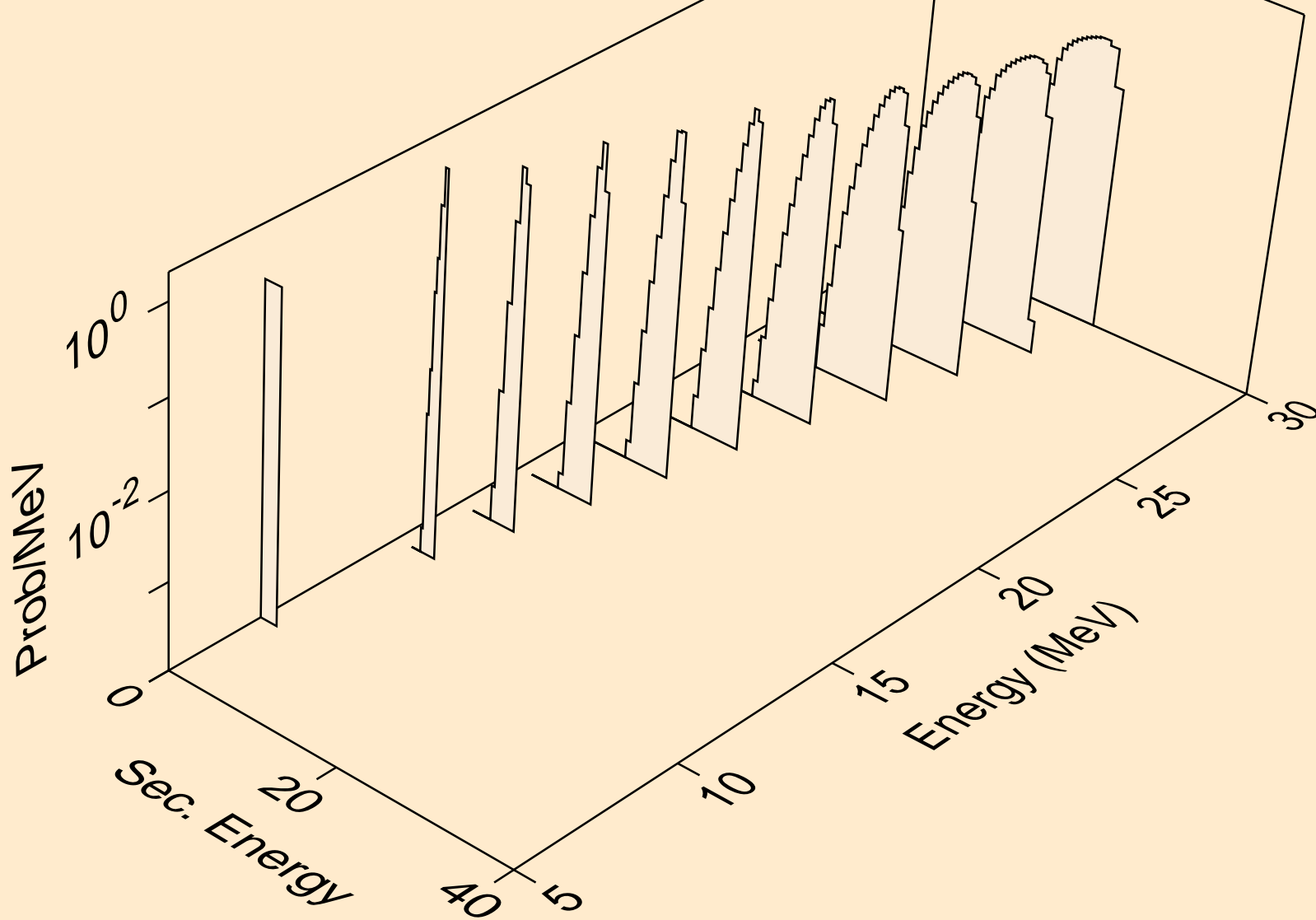

NO257 NEUTRON ACER TENDL-2019 LIBRARY; T=293.16K
deuterons from (n,d)

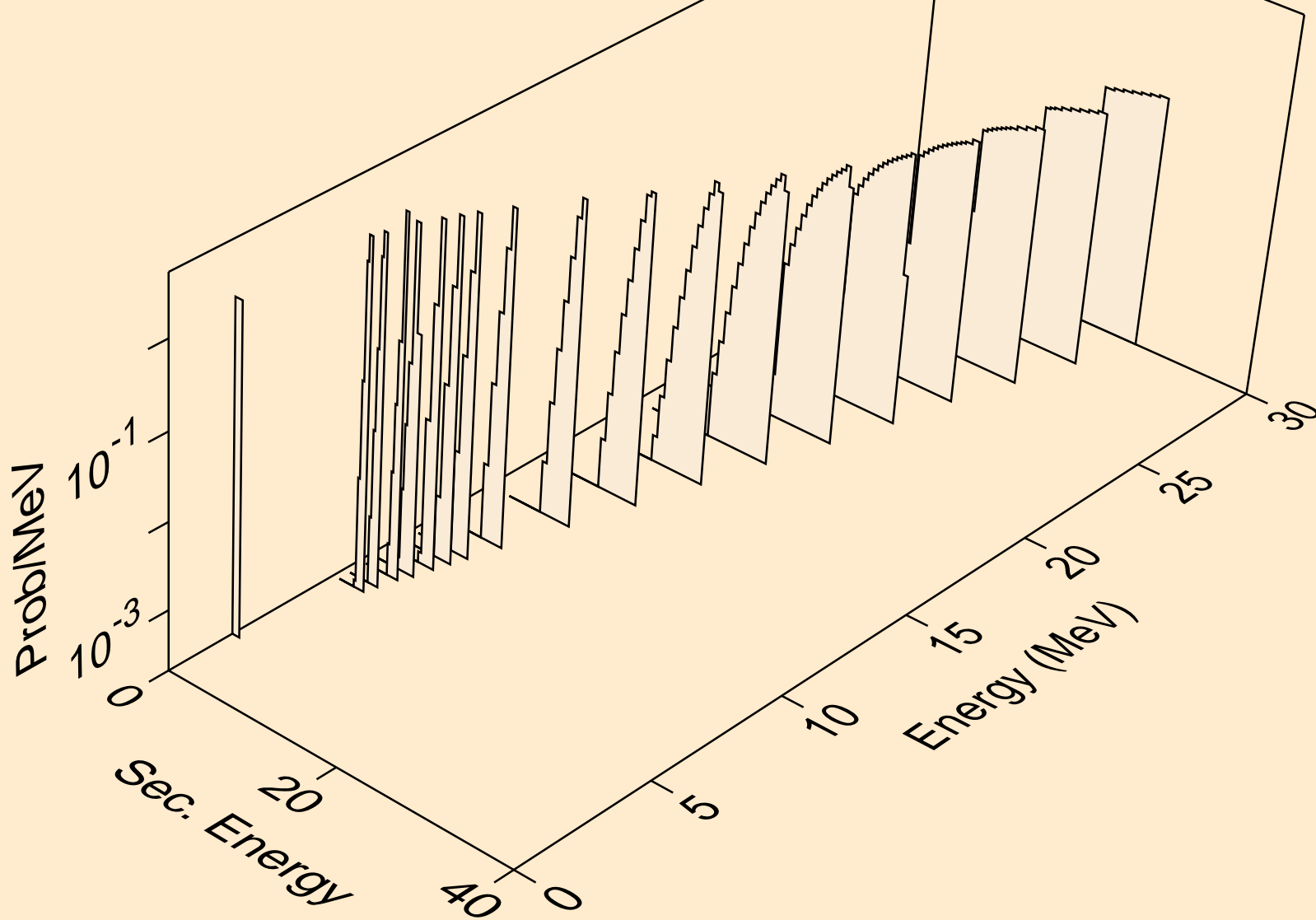

NO257 NEUTRON ACER TENDL-2019 LIBRARY; T=293.16K
deuterons from (n,pd)

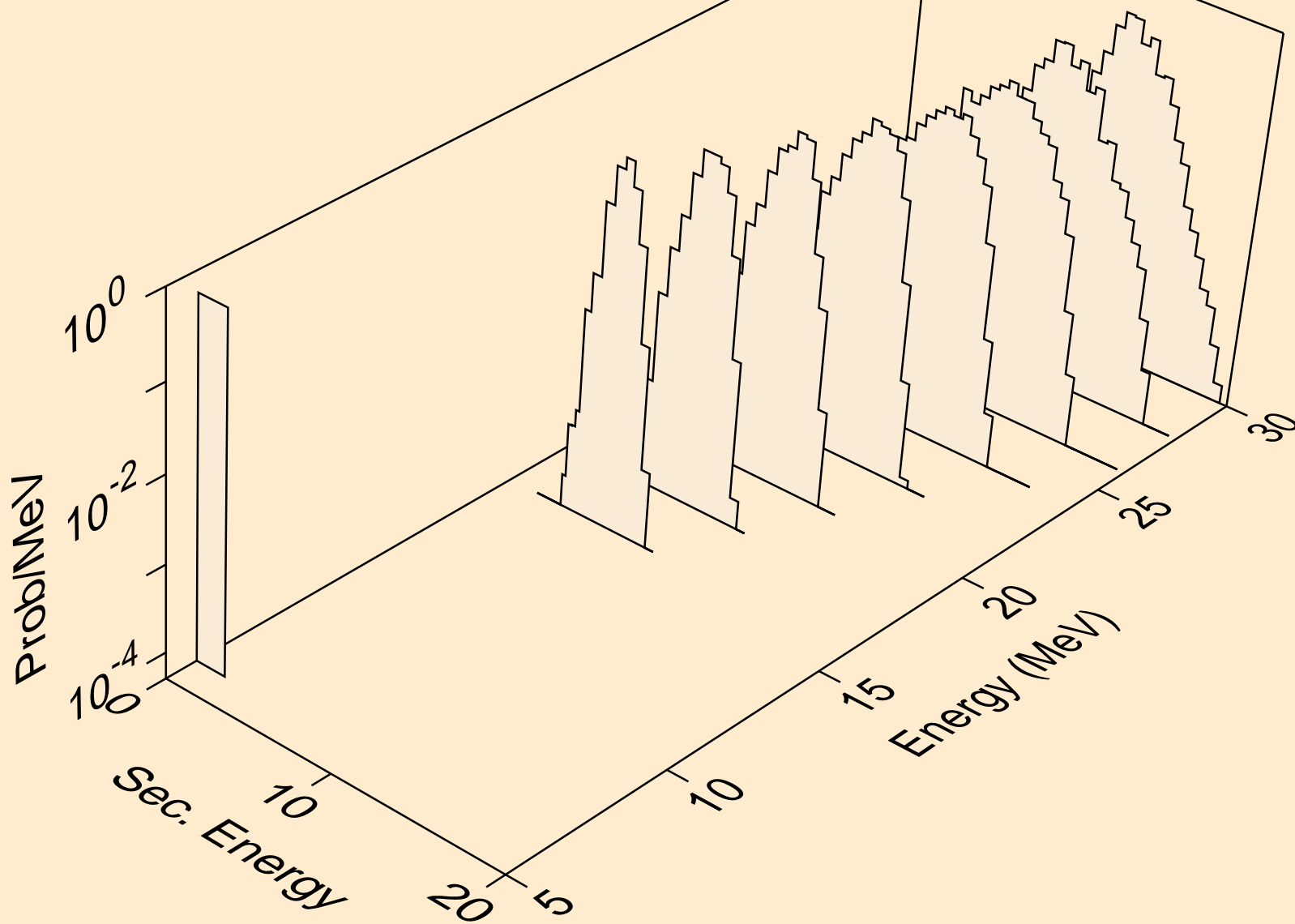

NO257 NEUTRON ACER TENDL-2019 LIBRARY; T=293.16K
deuterons from (n,da)

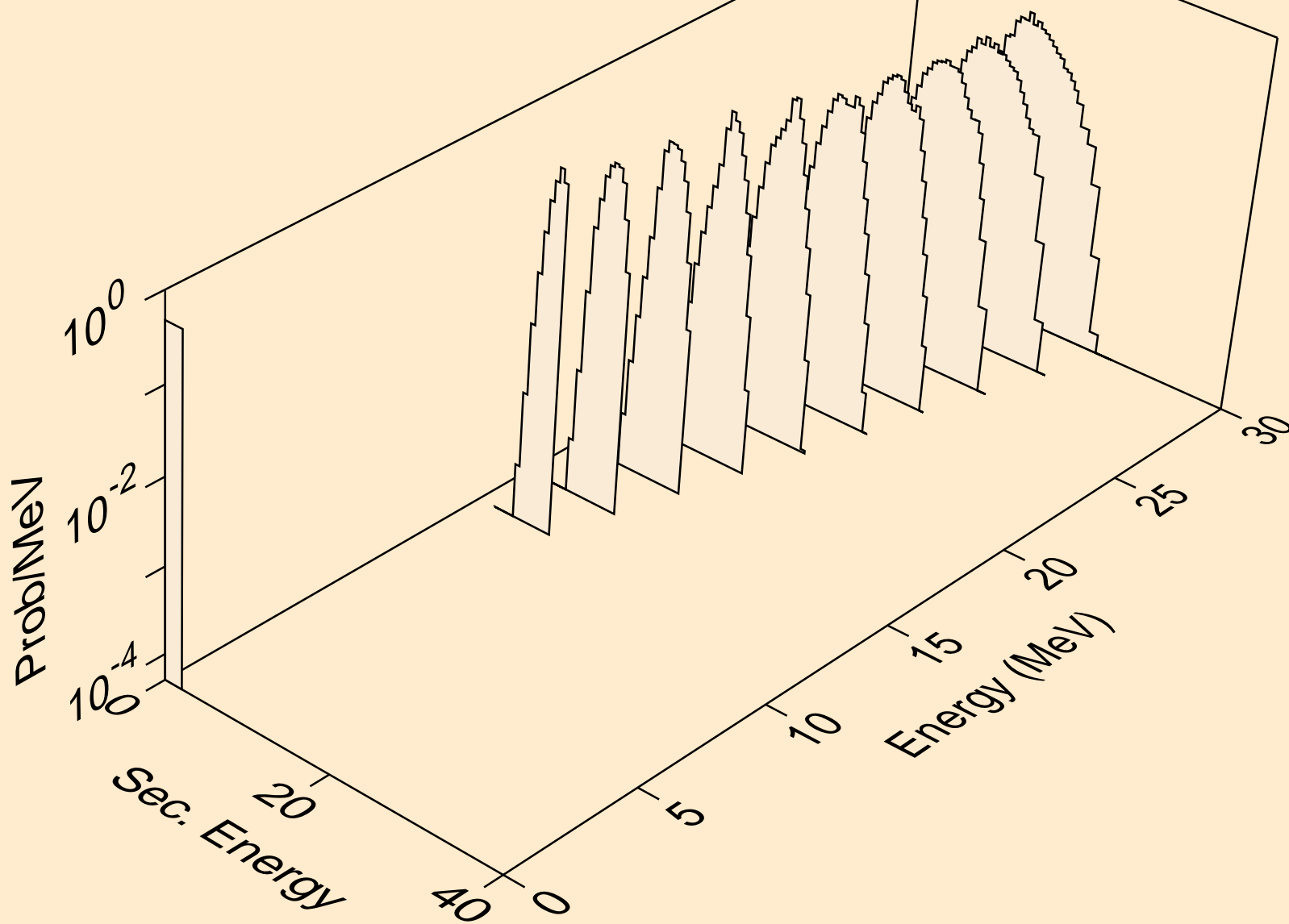

NO257 NEUTRON ACER TENDL-2019 LIBRARY; T=293.16K
tritons from (n,x)

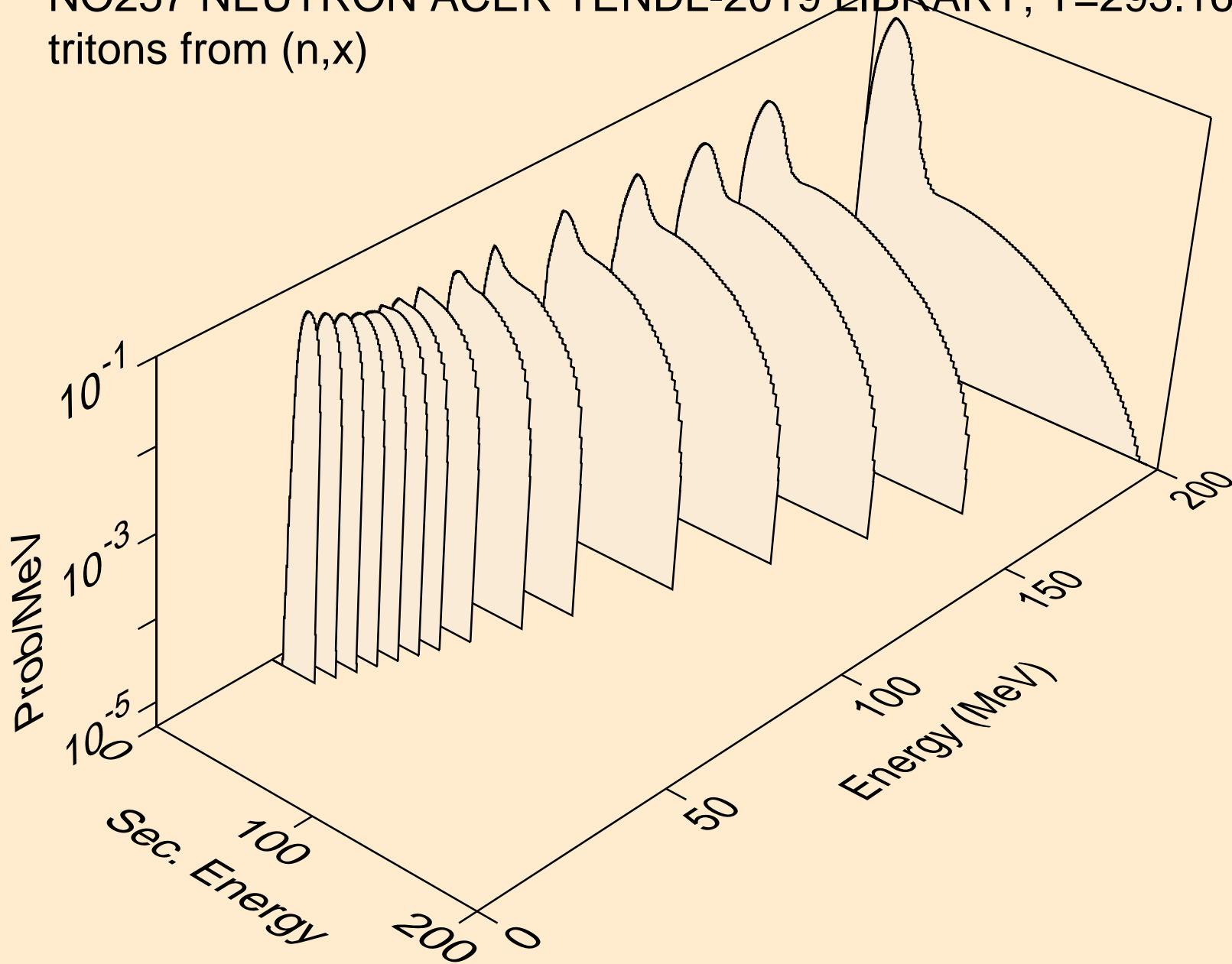

NO257 NEUTRON ACER TENDL-2019 LIBRARY; T=293.16K
tritons from (n,n*)t

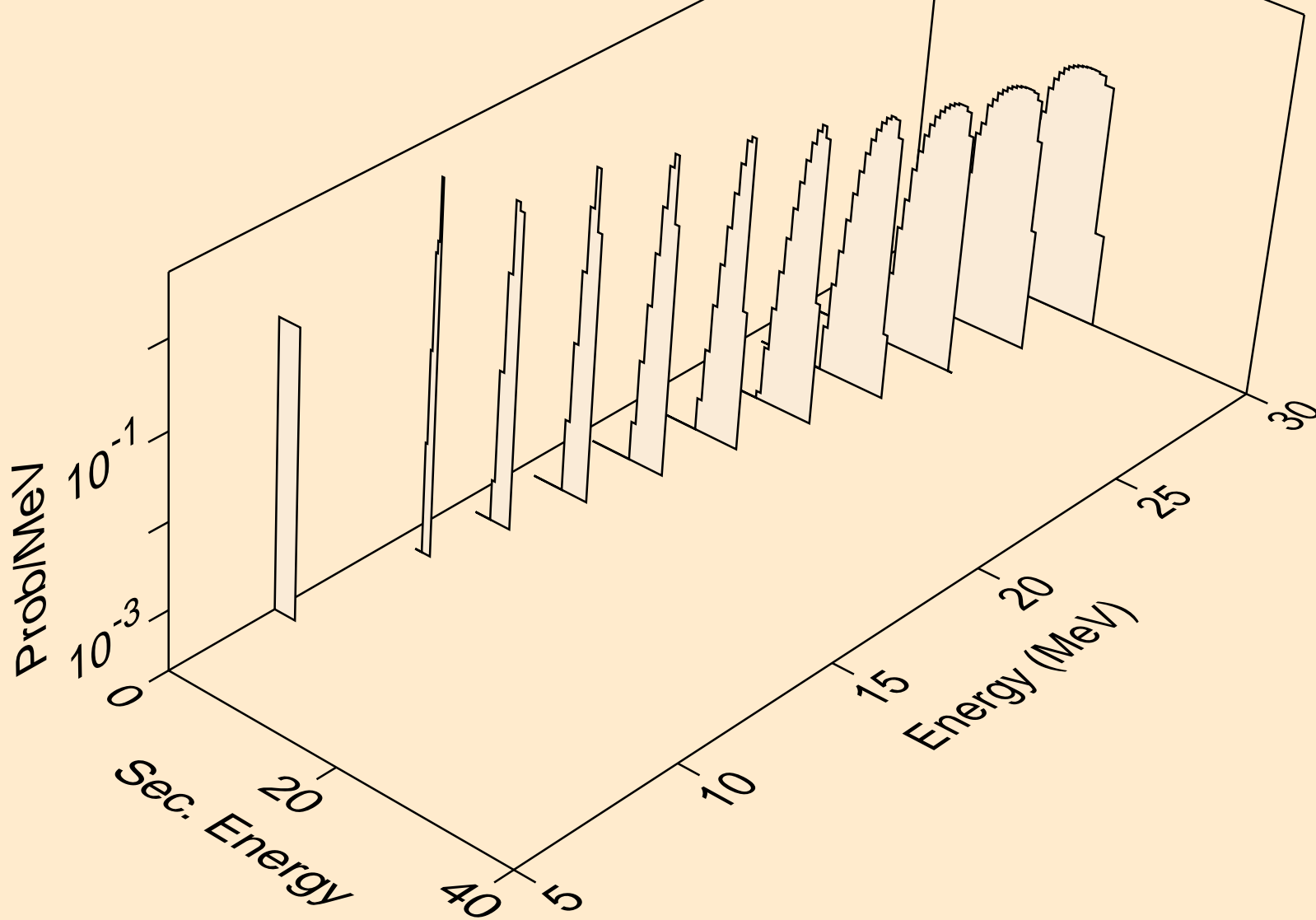

NO257 NEUTRON ACER TENDL-2019 LIBRARY; T=293.16K
tritons from (n,t)

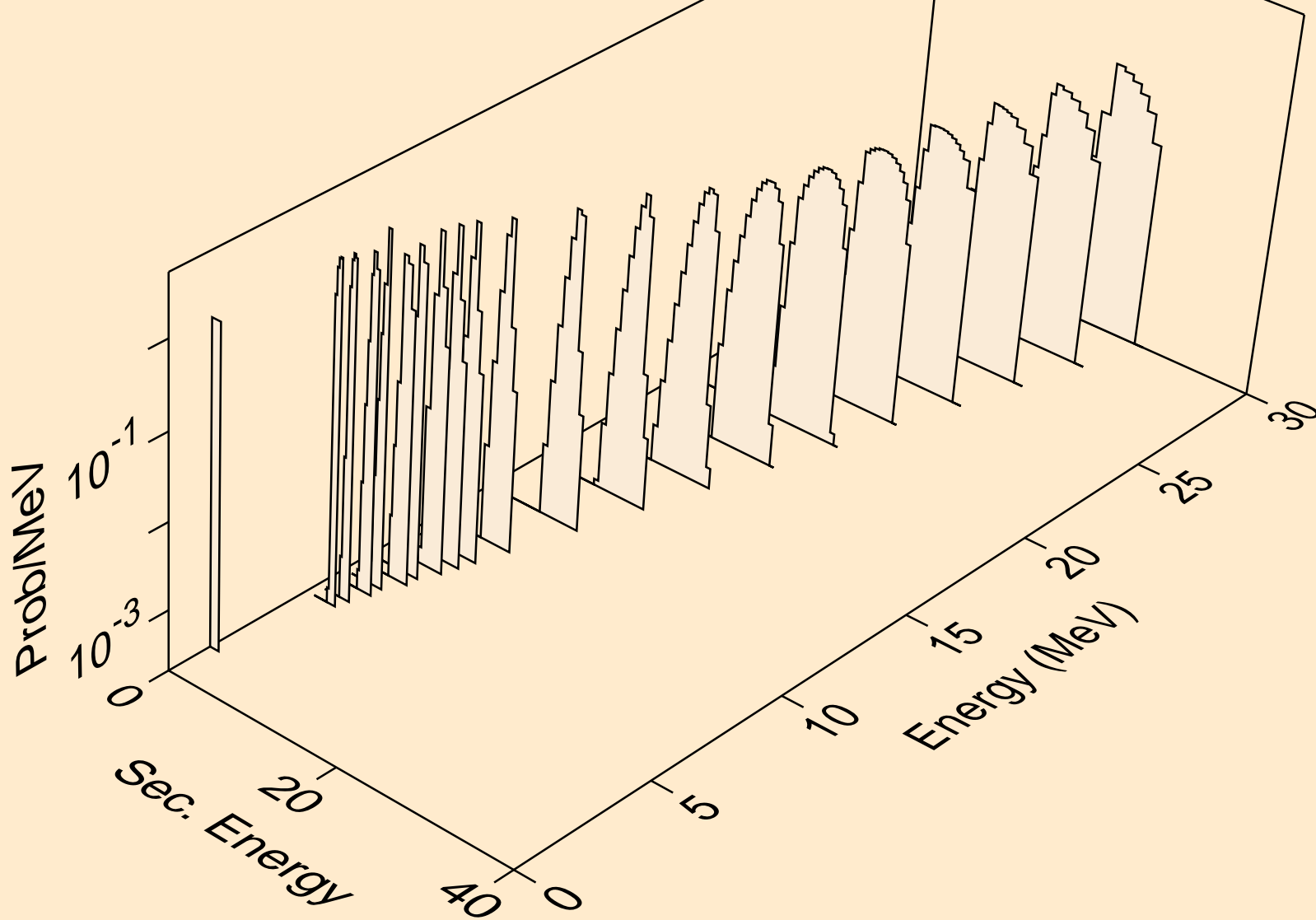

NO257 NEUTRON ACER TENDL-2019 LIBRARY; T=293.16K
he3s from (n,x)

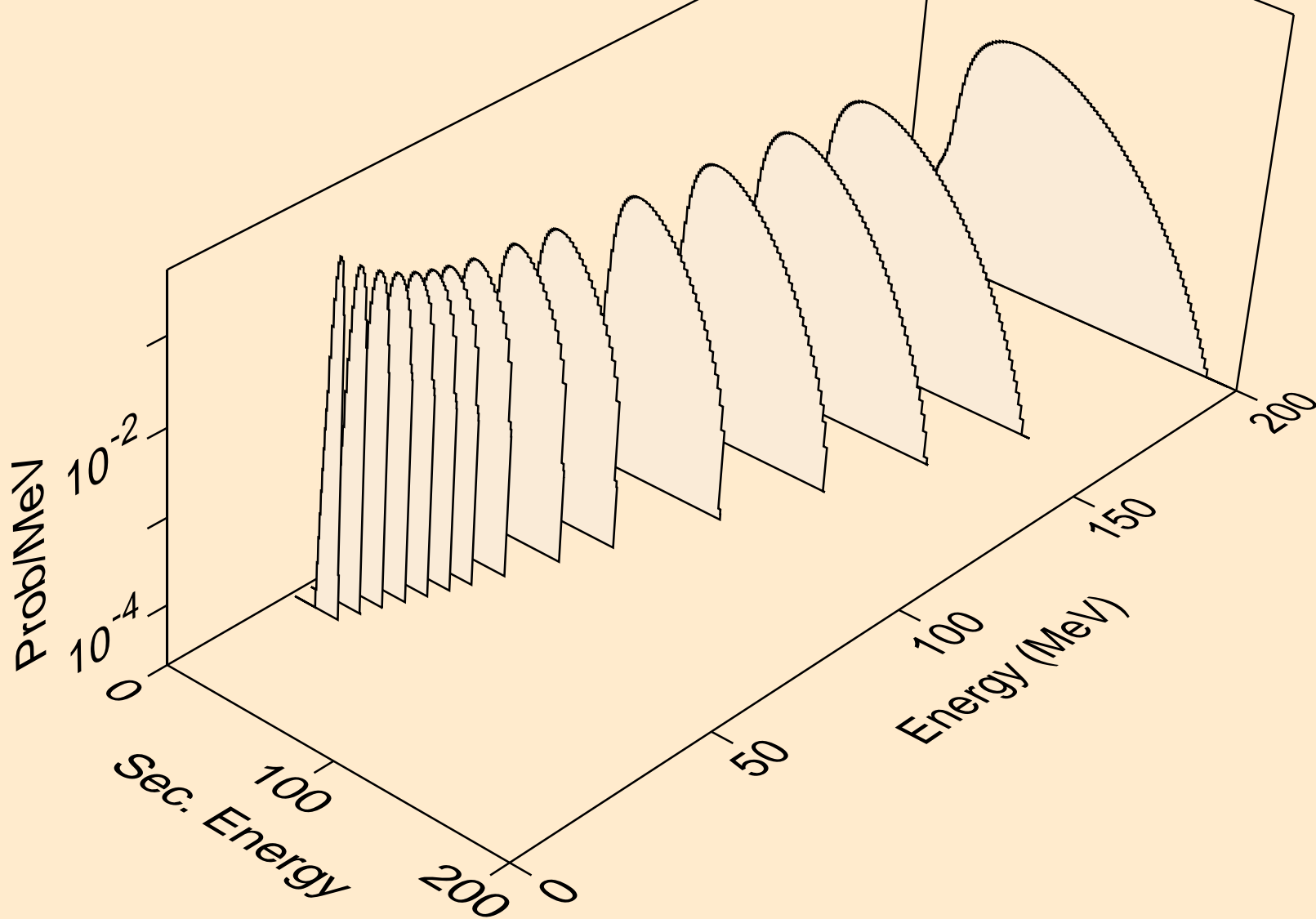

NO257 NEUTRON ACER TENDL-2019 LIBRARY; T=293.16K
he3s from (n,n*)he3

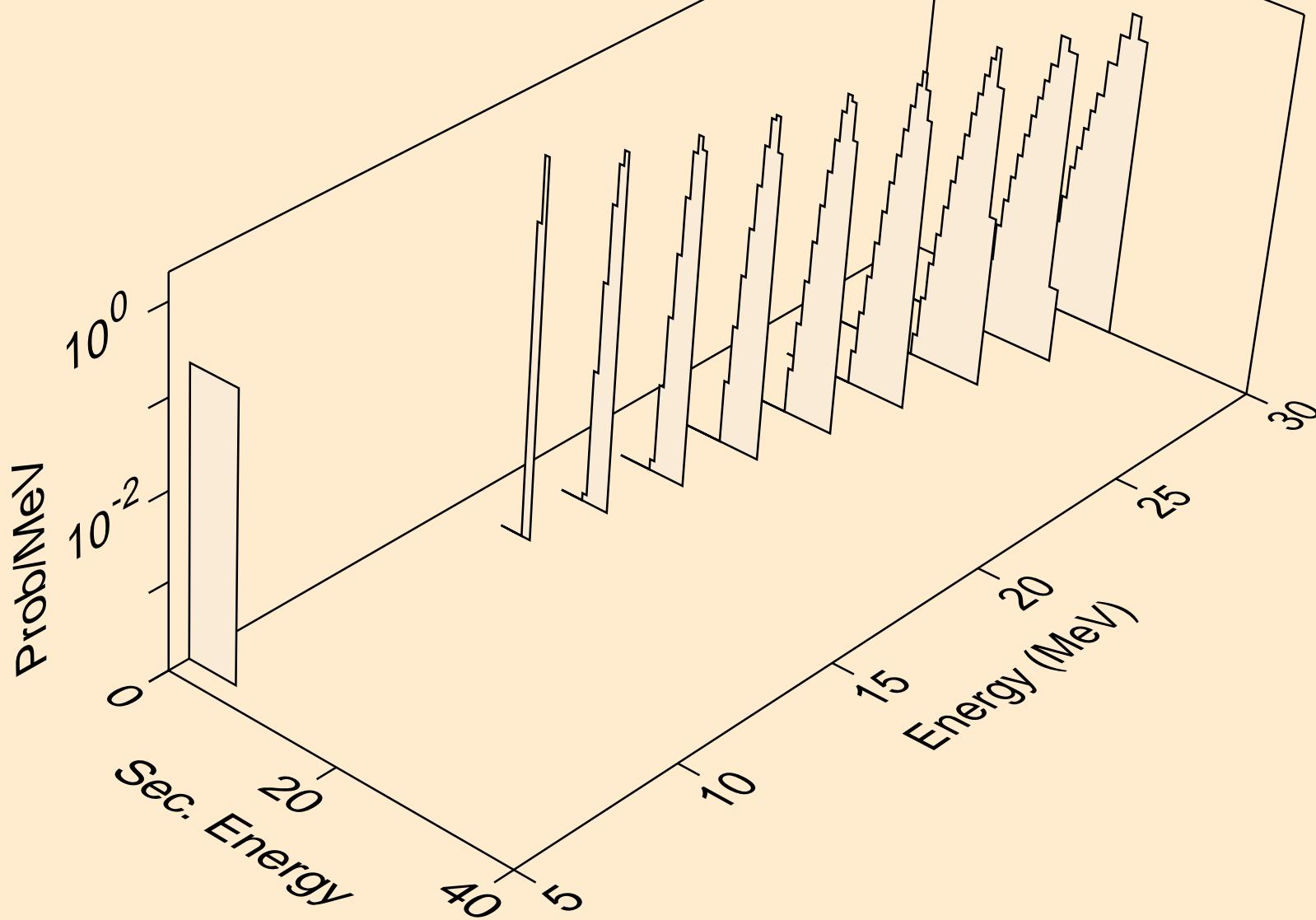

NO257 NEUTRON ACER TENDL-2019 LIBRARY; T=293.16K
he3s from (n,he3)

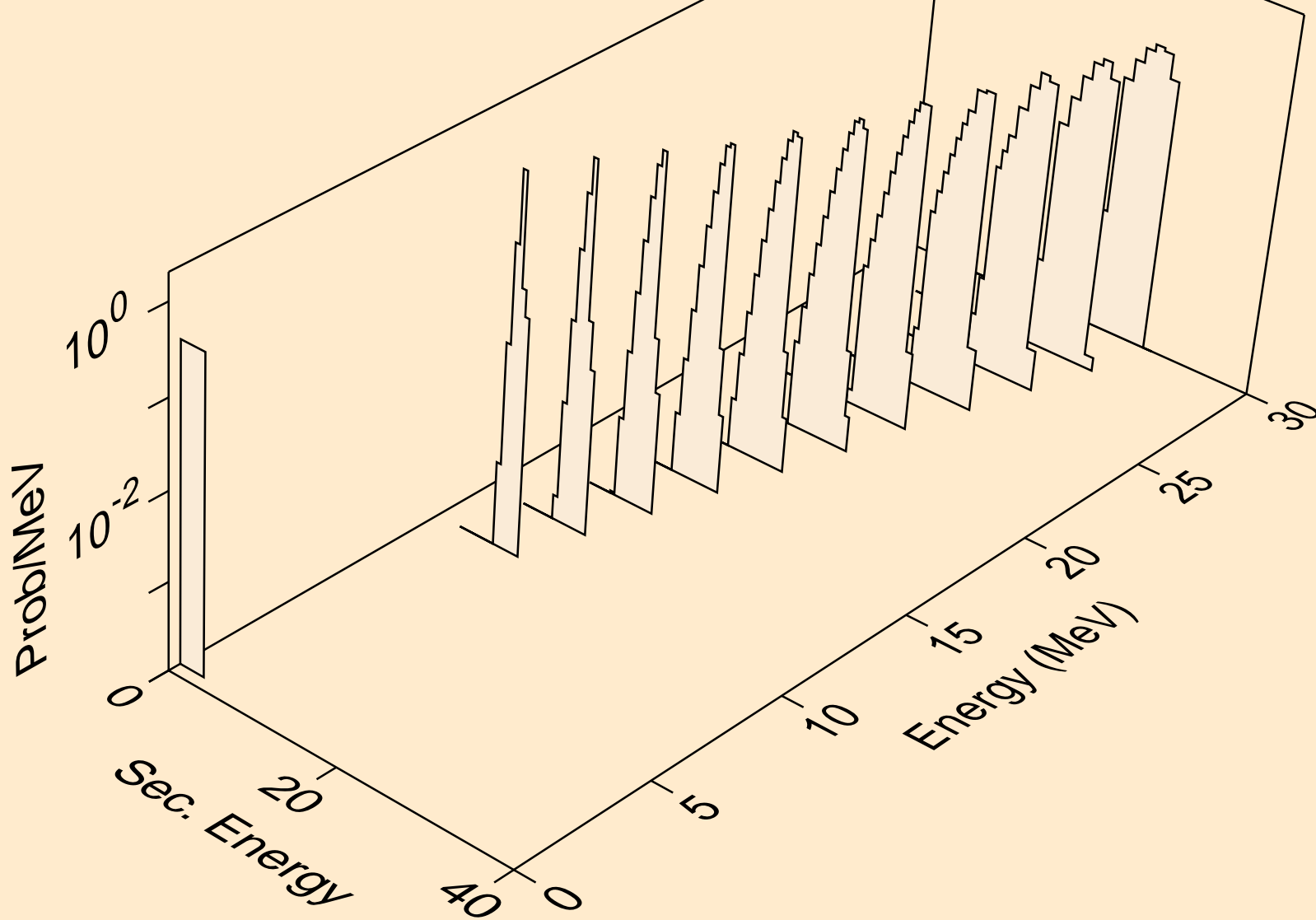

NO257 NEUTRON ACER TENDL-2019 LIBRARY; T=293.16K
alphas from (n,x)

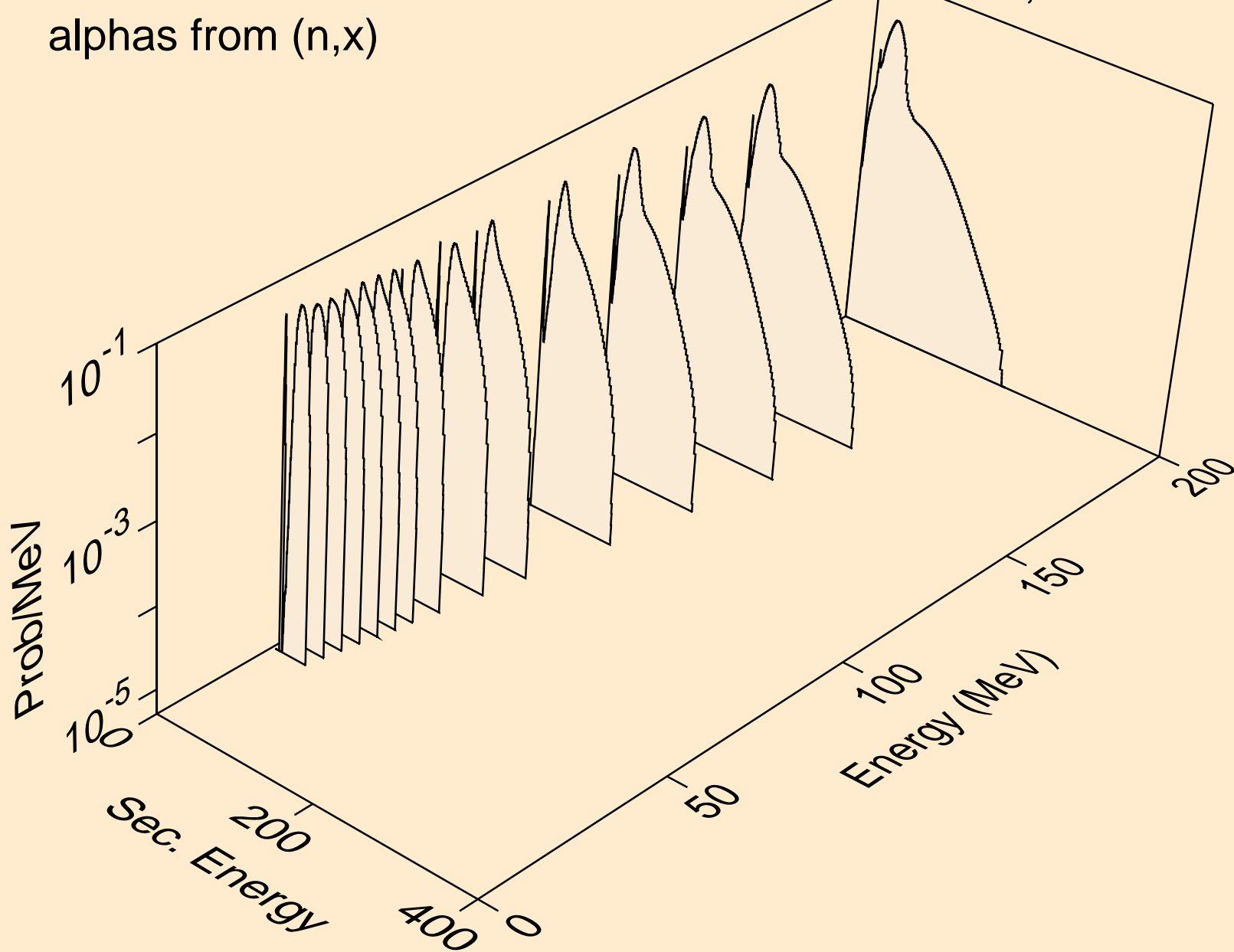

NO257 NEUTRON ACER TENDL-2019 LIBRARY; T=293.16K
alphas from (n,n*)a

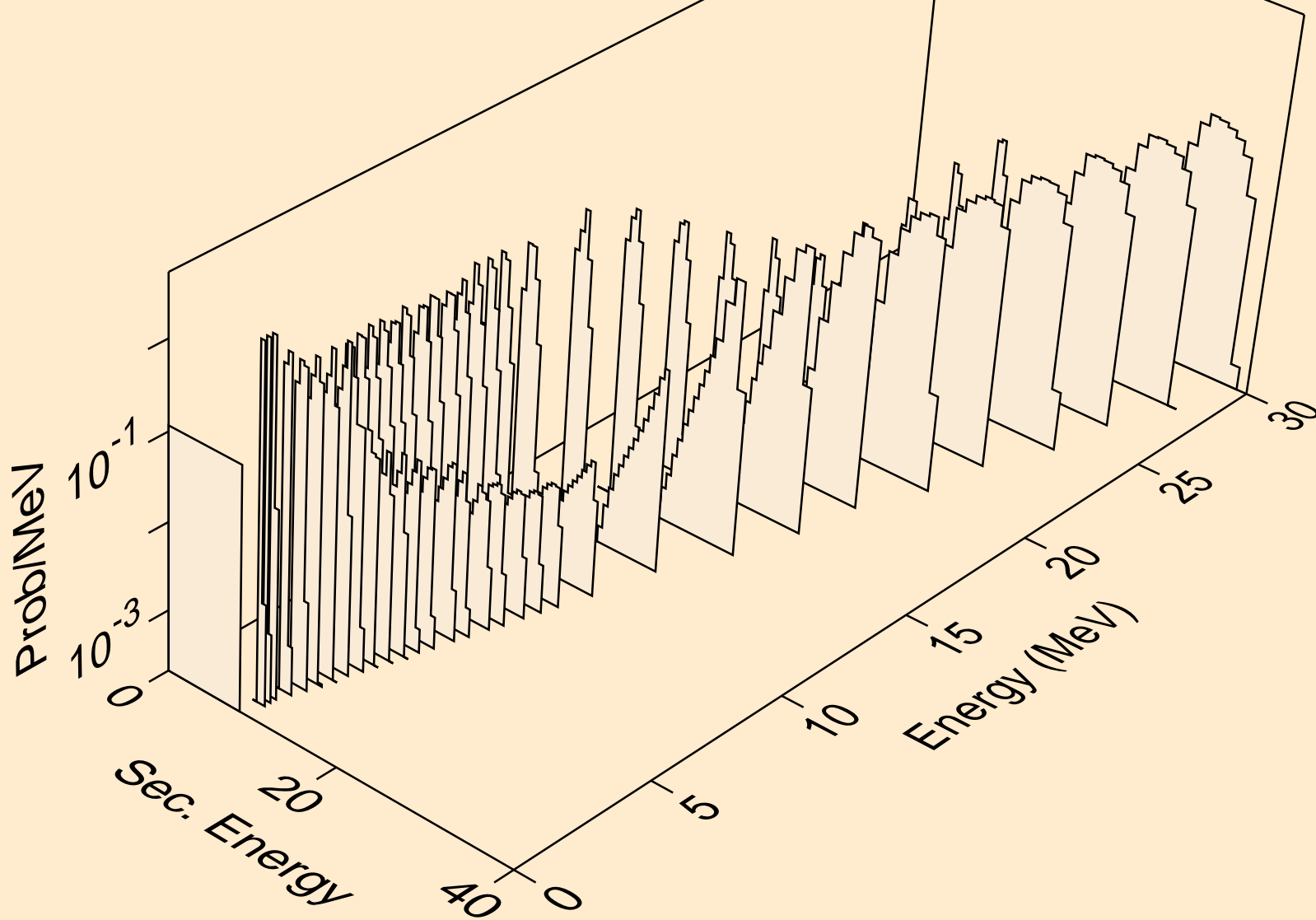

NO257 NEUTRON ACER TENDL-2019 LIBRARY; T=293.16K
alphas from (n,2n)a

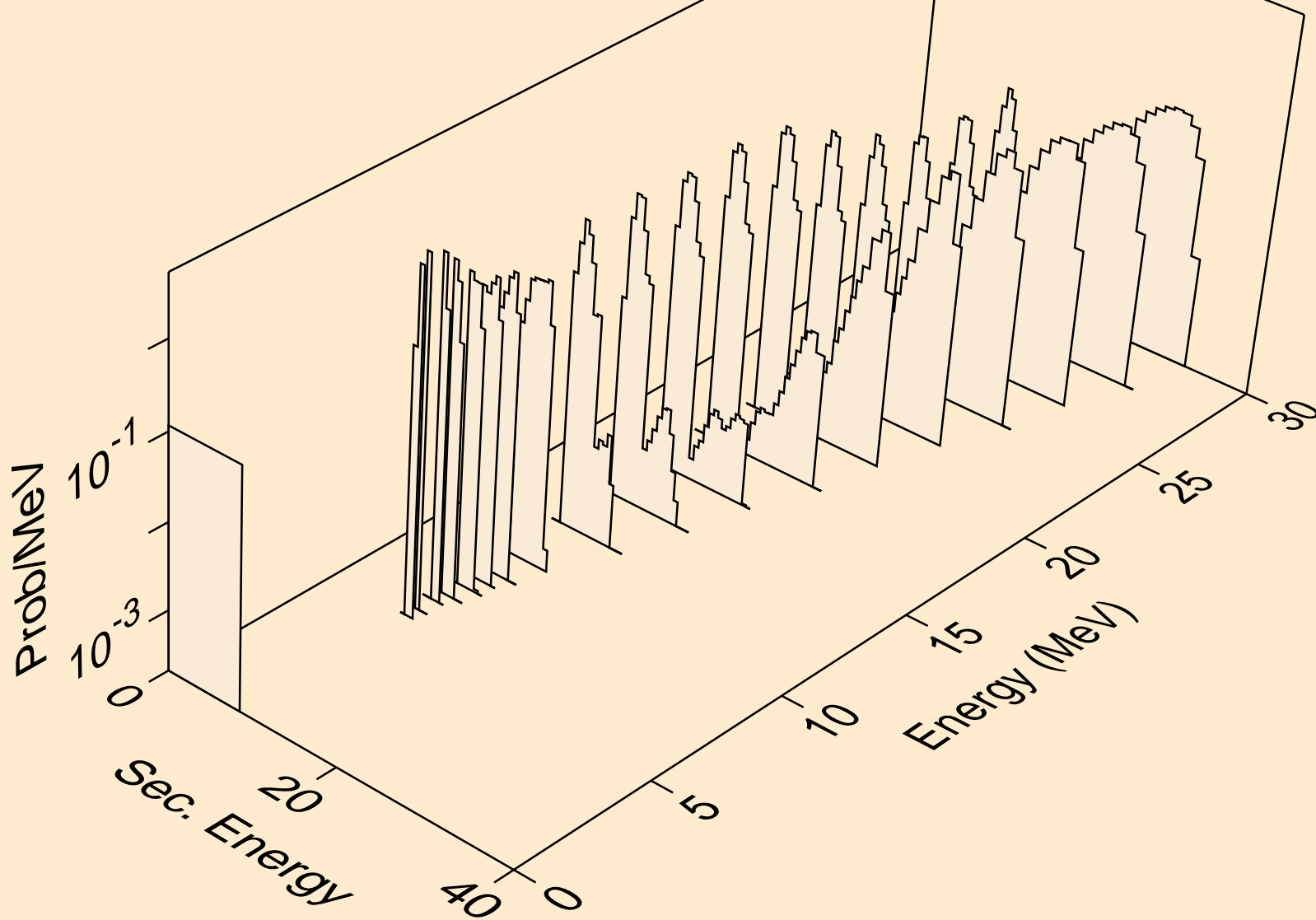

NO257 NEUTRON ACER TENDL-2019 LIBRARY; T=293.16K
alphas from (n,3n)a

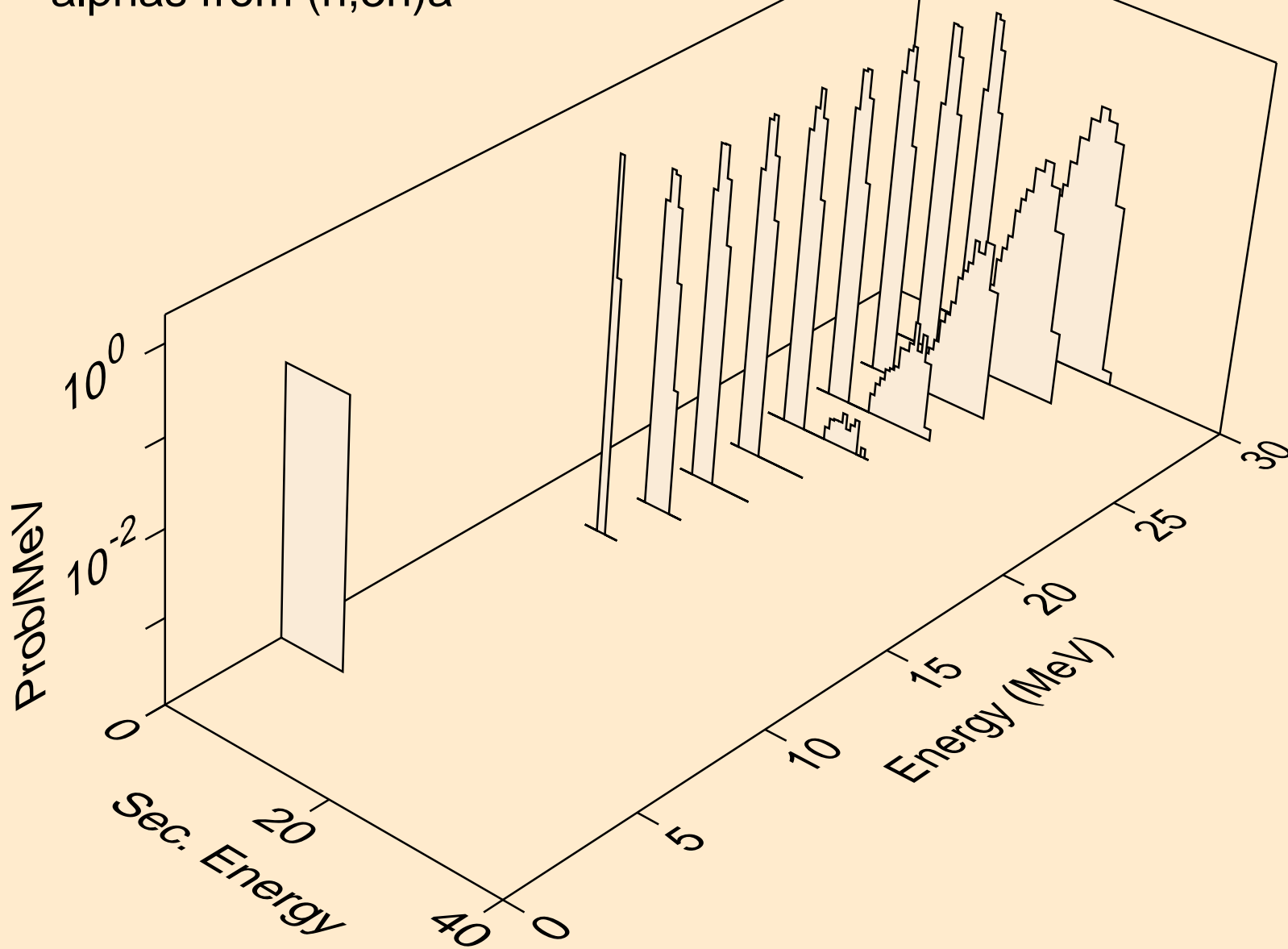

NO257 NEUTRON ACER TENDL-2019 LIBRARY; T=293.16K
alphas from (n,n*)2a

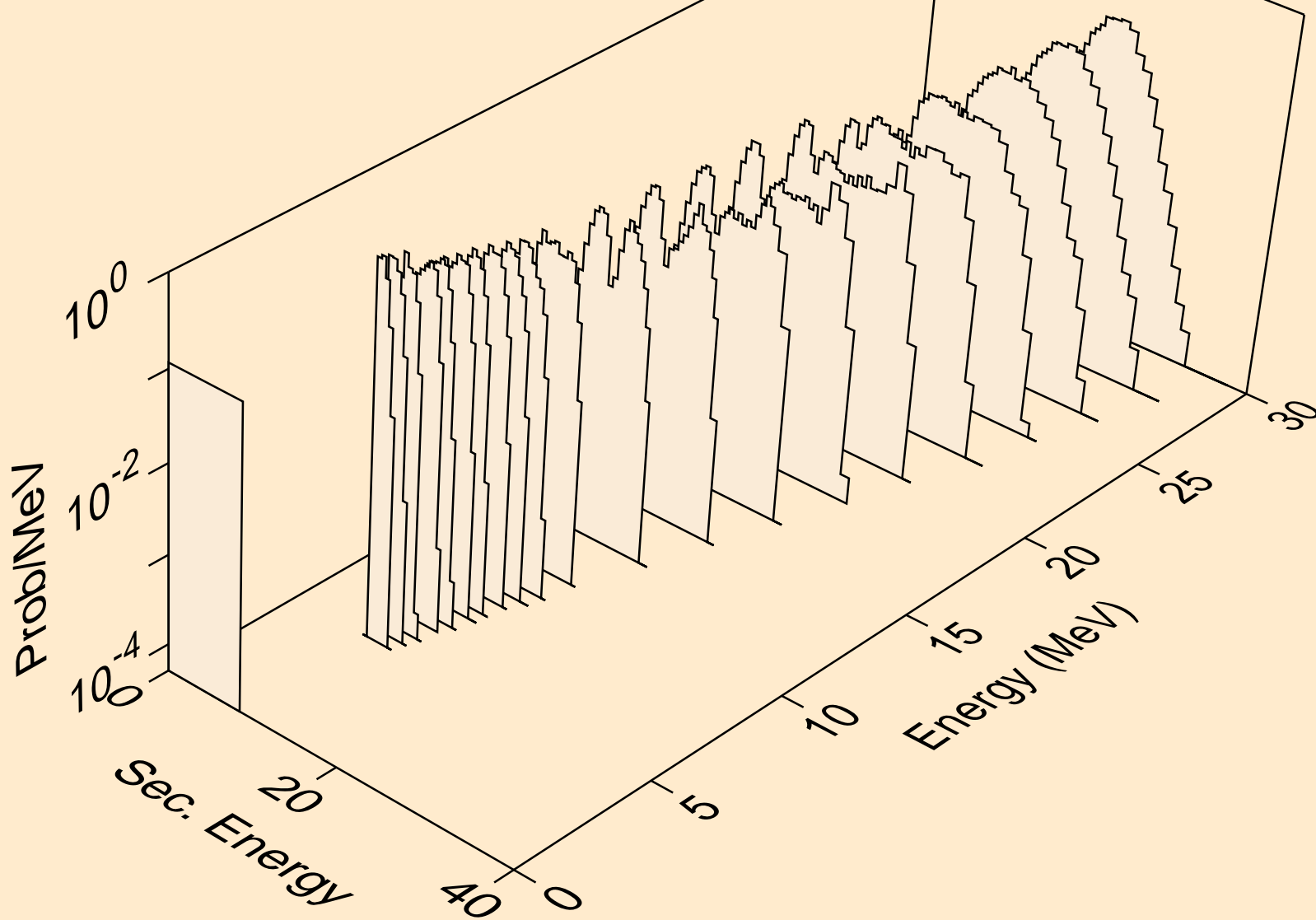

NO257 NEUTRON ACER TENDL-2019 LIBRARY; T=293.16K
alphas from (n,2n)2a

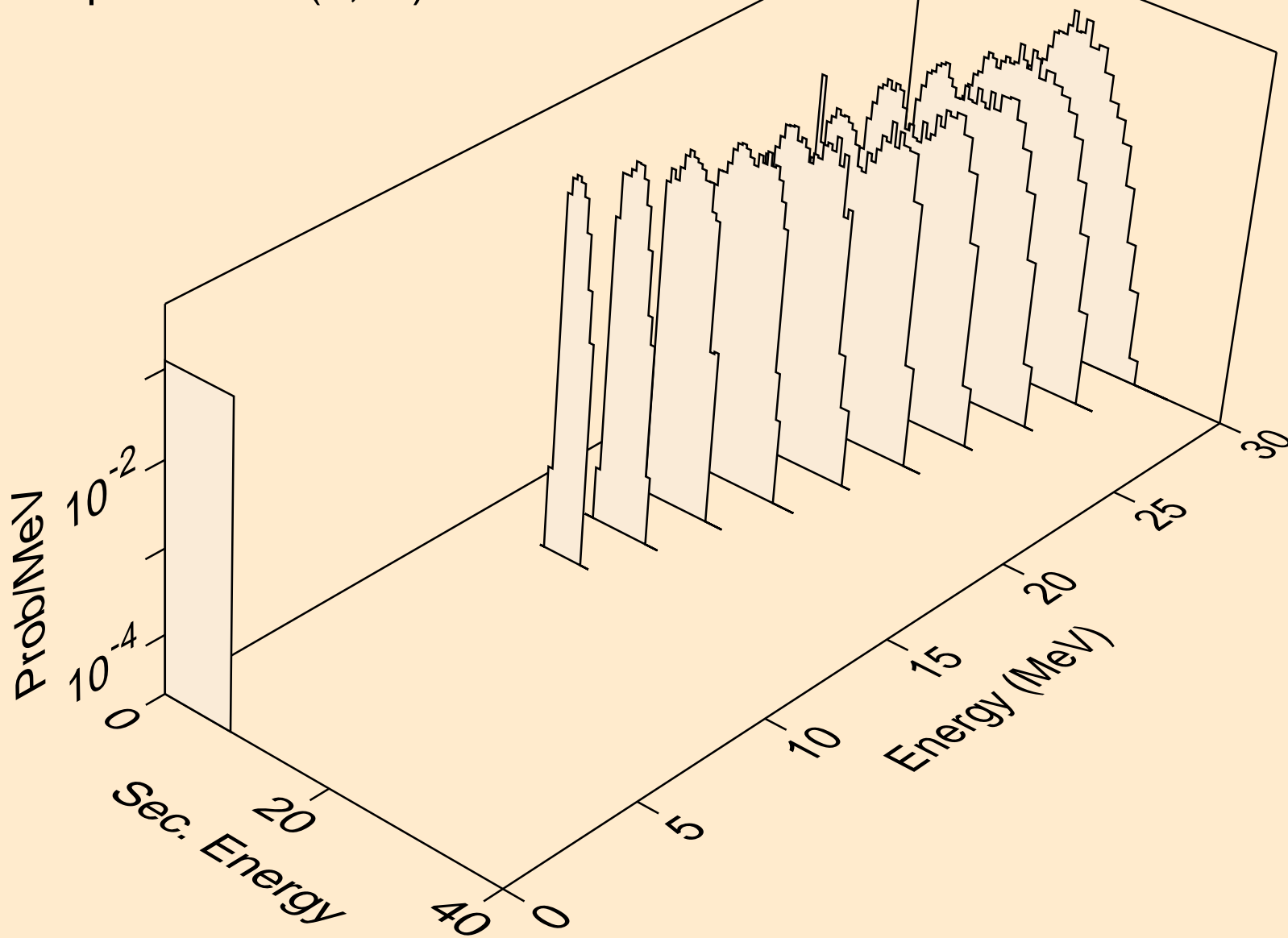

NO257 NEUTRON ACER TENDL-2019 LIBRARY; T=293.16K
alphas from (n,npa)

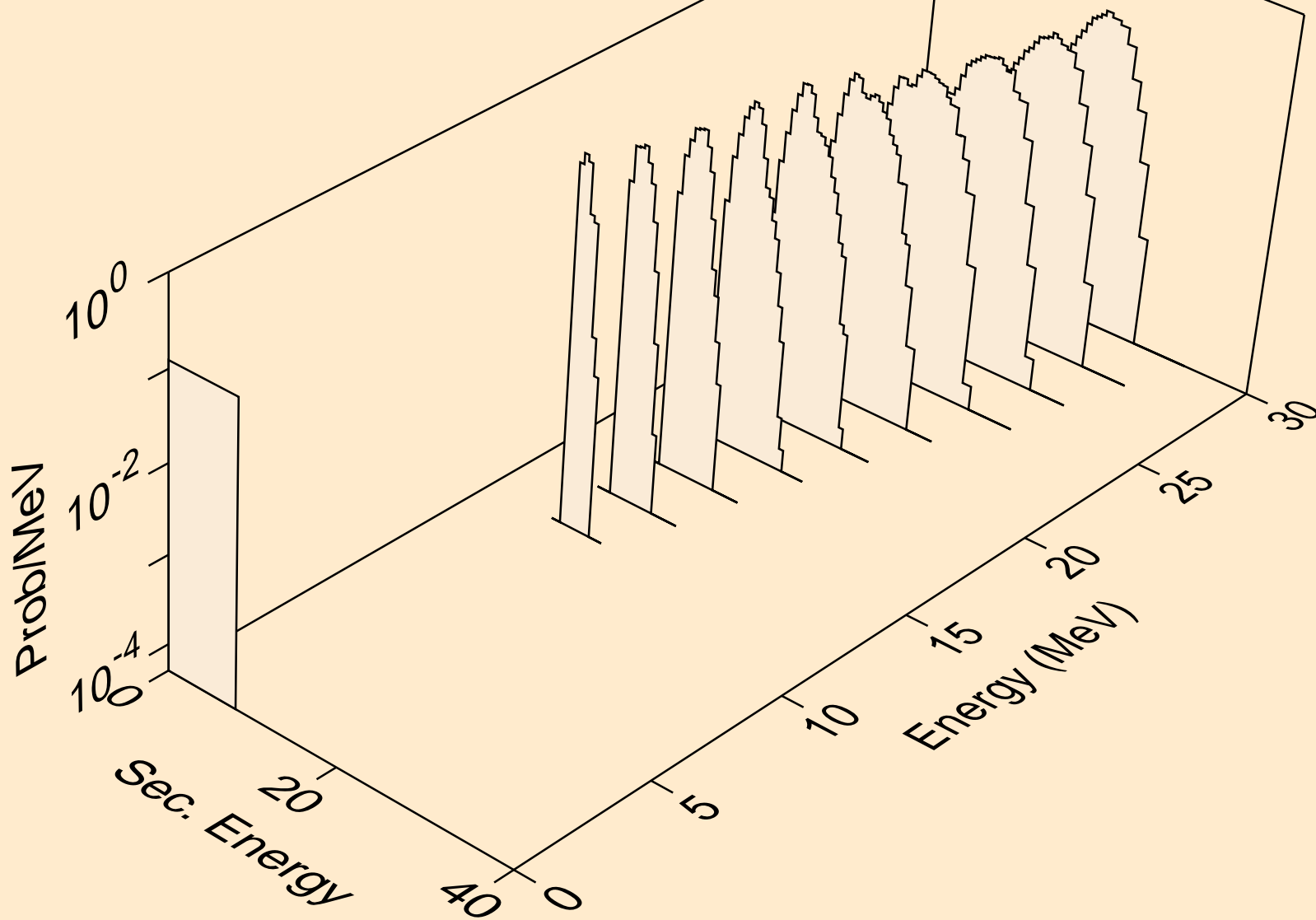

NO257 NEUTRON ACER TENDL-2019 LIBRARY; T=293.16K
alphas from (n,a)

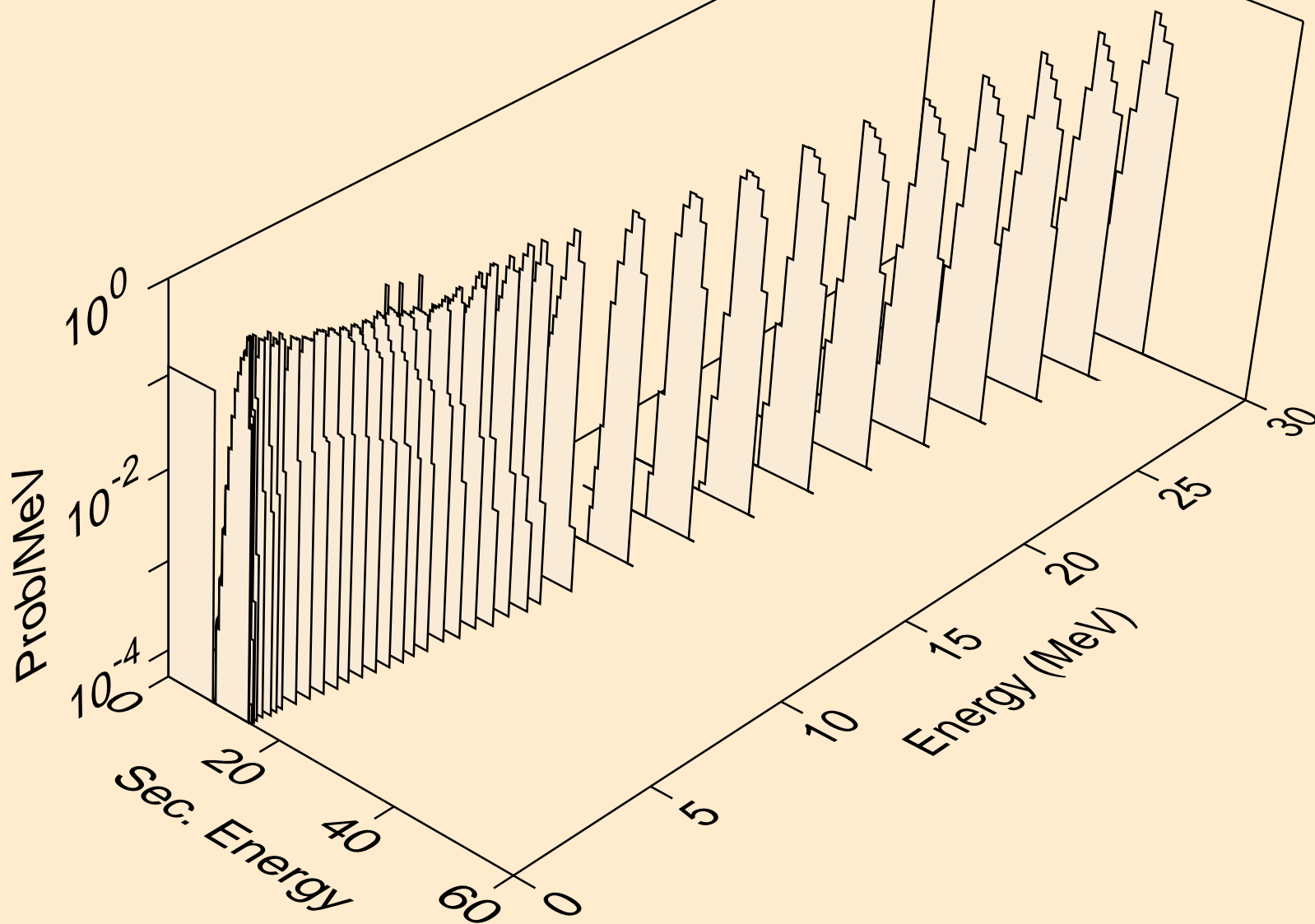

NO257 NEUTRON ACER TENDL-2019 LIBRARY; T=293.16K
alphas from (n,2a)

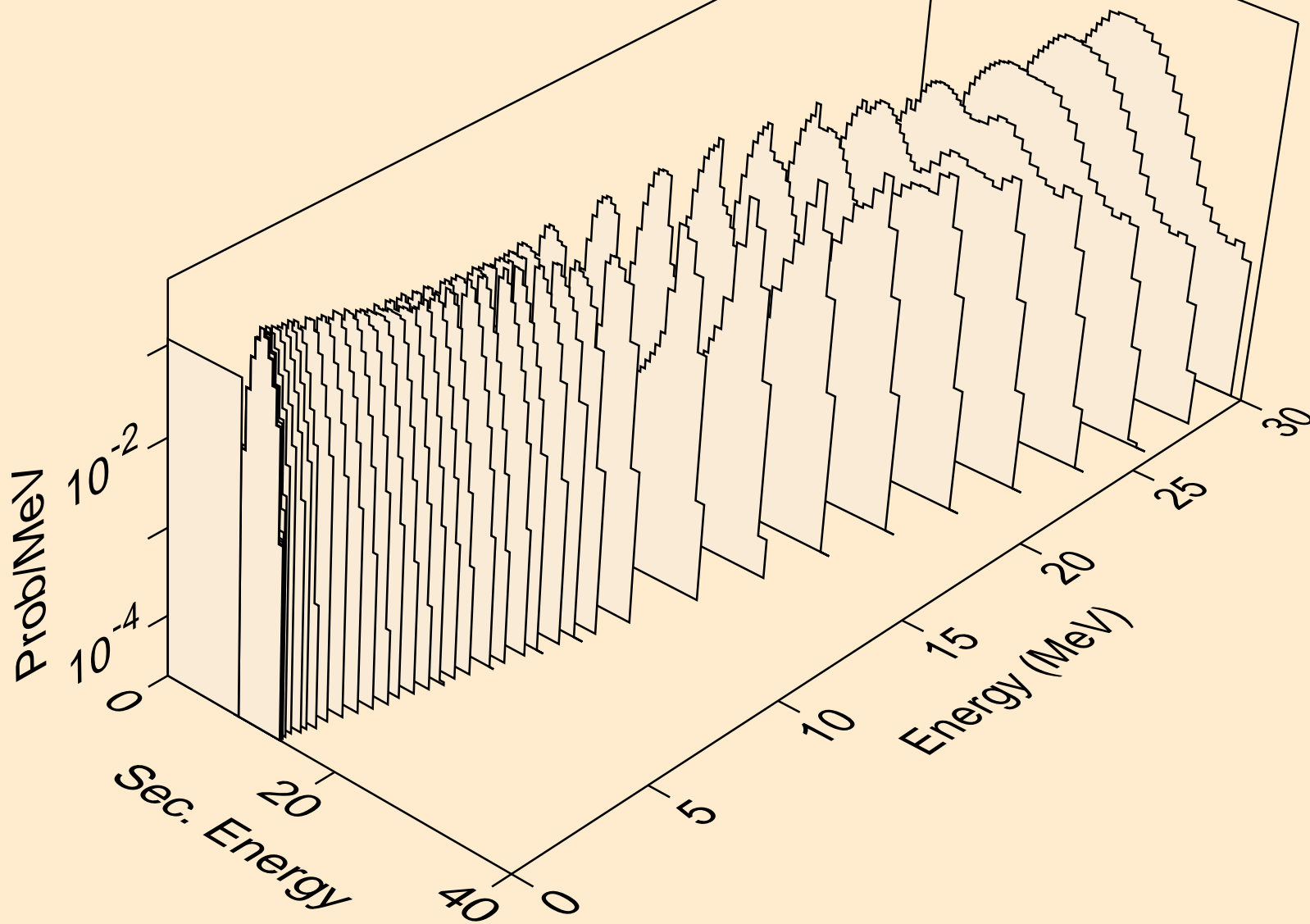

NO257 NEUTRON ACER TENDL-2019 LIBRARY; T=293.16K
alphas from (n,pa)

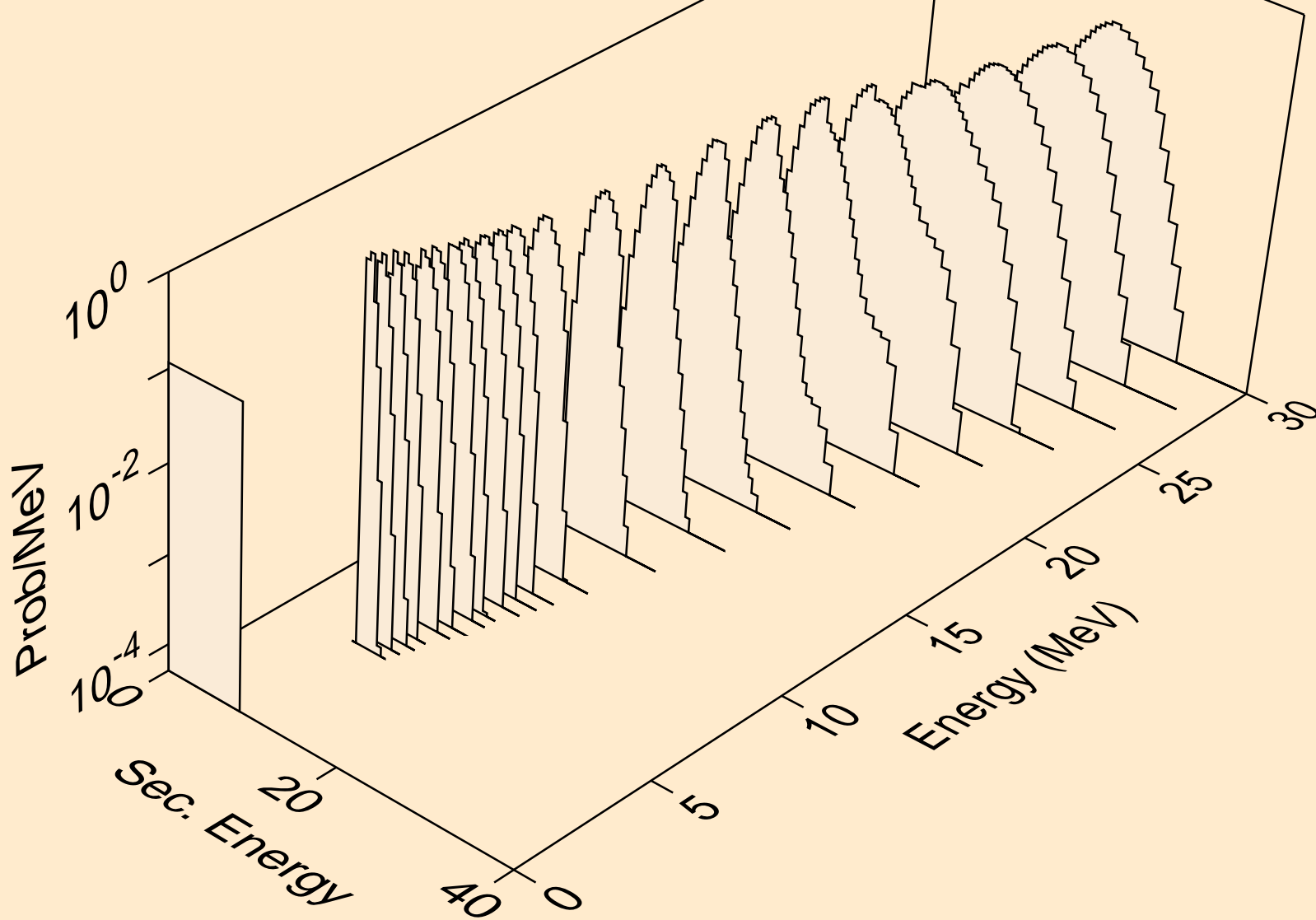

NO257 NEUTRON ACER TENDL-2019 LIBRARY; T=293.16K
alphas from (n,da)

