

NP232 NEUTRON ACER TENDL-2019 LIBRARY; T=293.16K
Principal cross sections

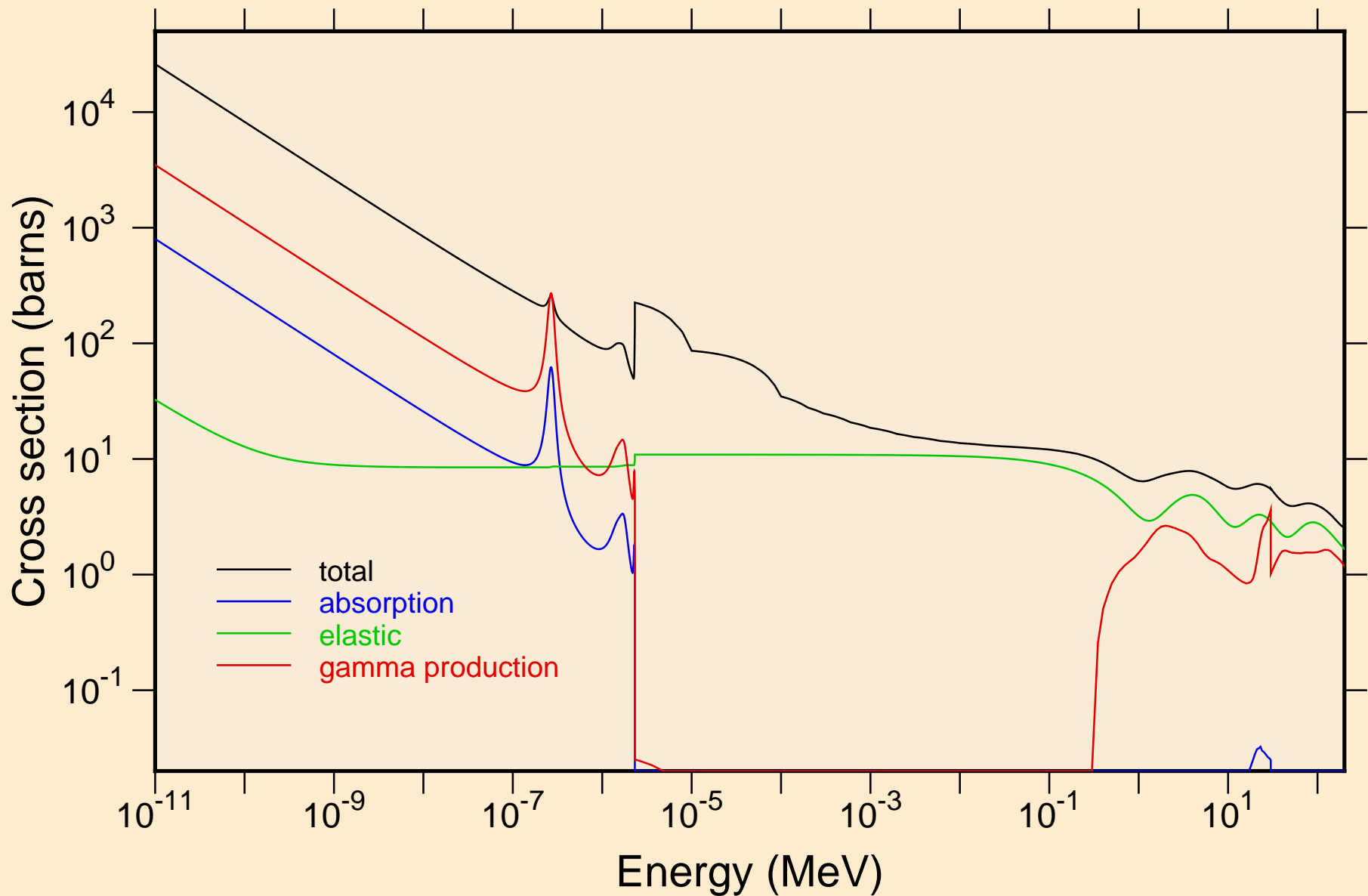

NP232 NEUTRON ACER TENDL-2019 LIBRARY; T=293.16K
Heating

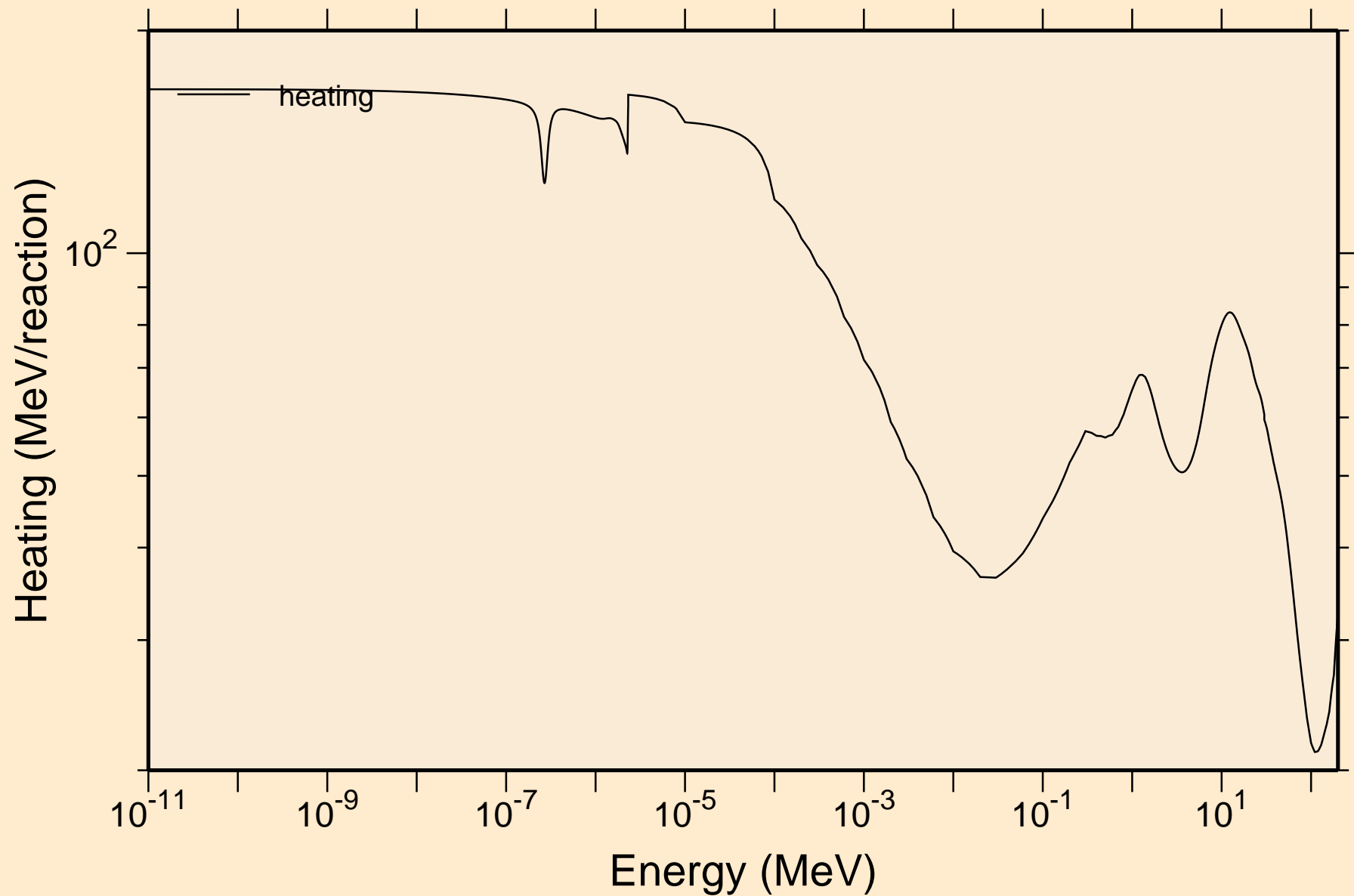

NP232 NEUTRON ACER TENDL-2019 LIBRARY; T=293.16K
Damage

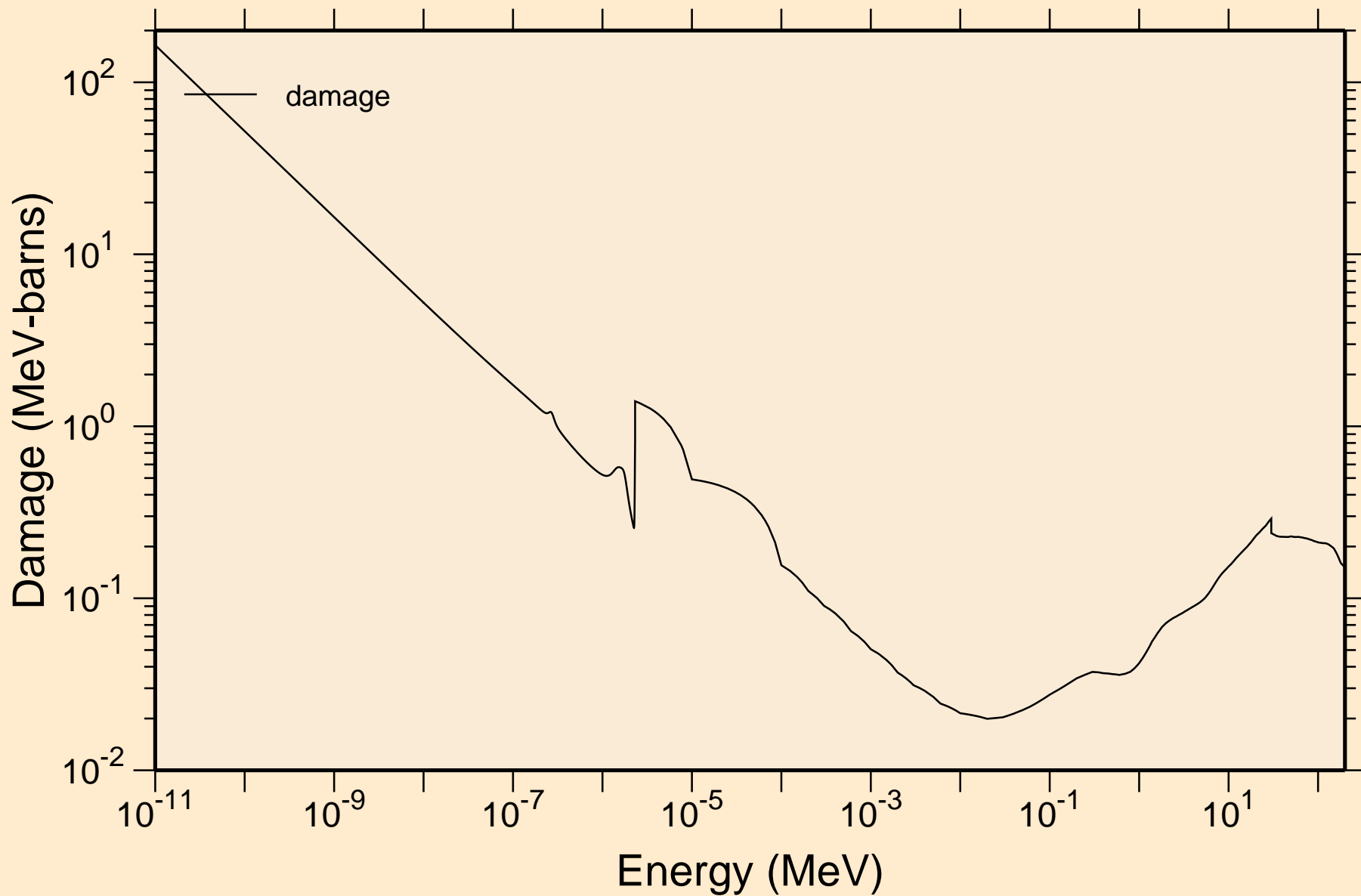

NP232 NEUTRON ACER TENDL-2019 LIBRARY; T=293.16K
Non-threshold reactions

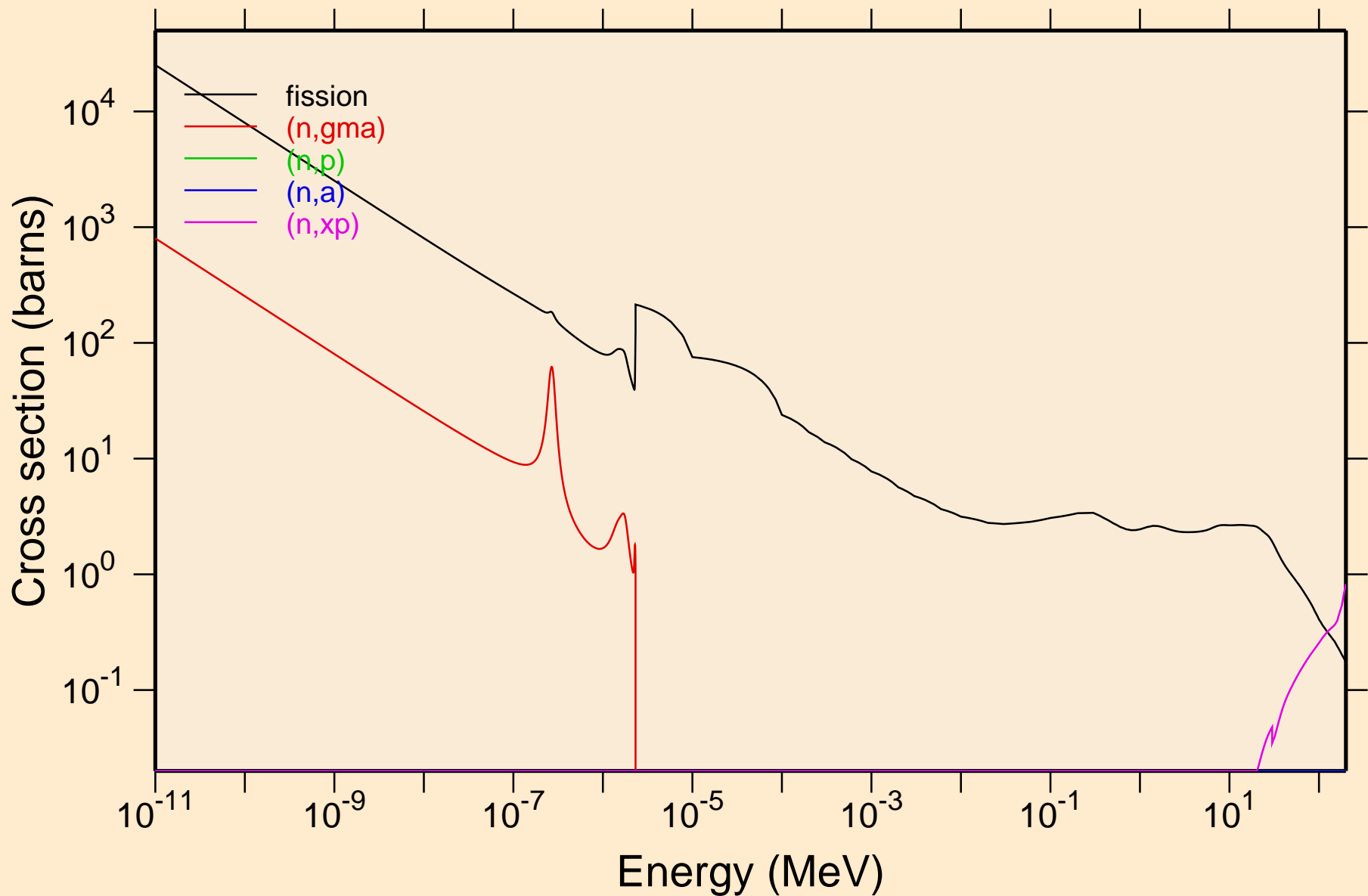

NP232 NEUTRON ACER TENDL-2019 LIBRARY; T=293.16K
Non-threshold reactions

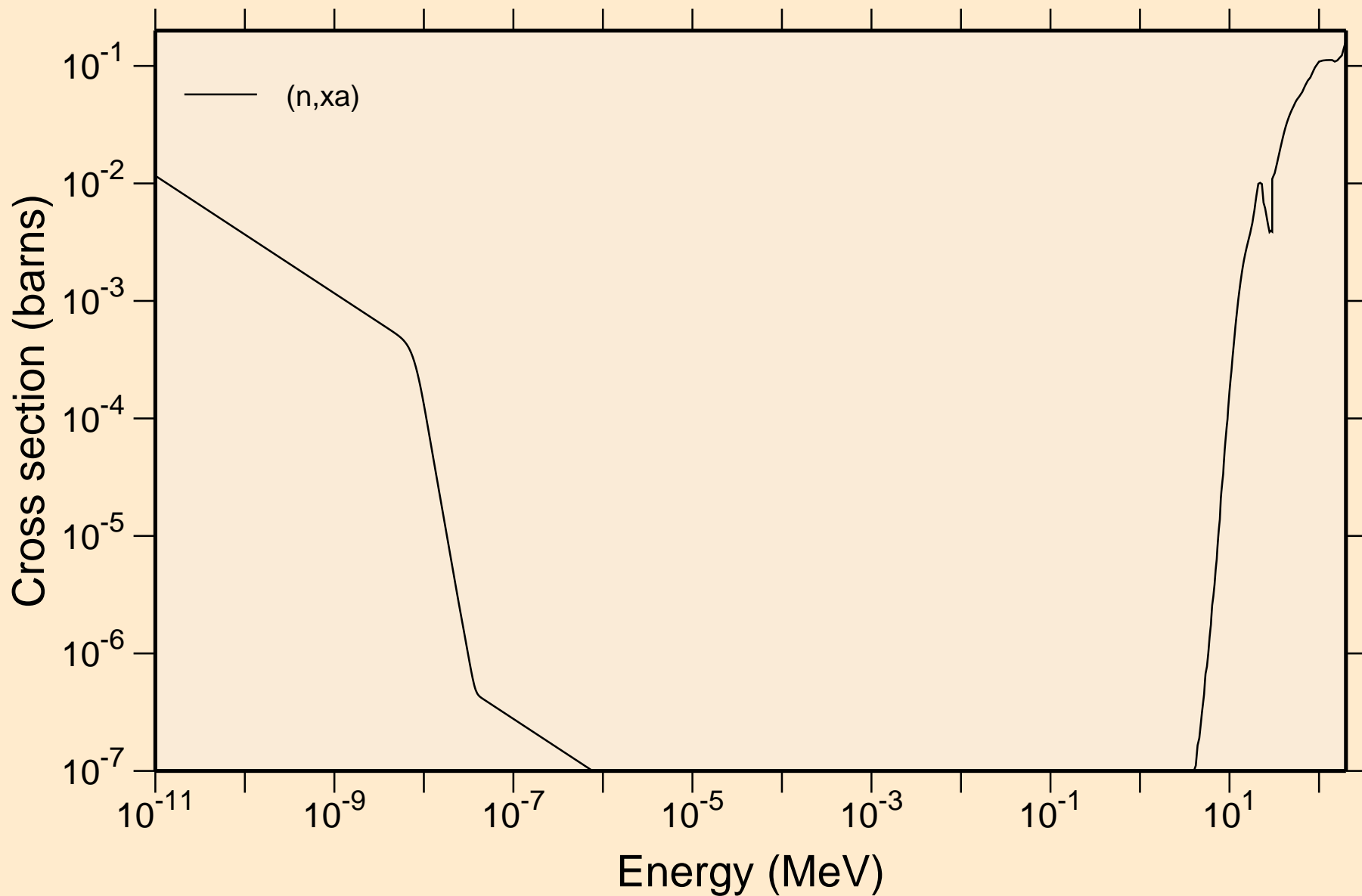

NP232 NEUTRON ACER TENDL-2019 LIBRARY; T=293.16K
Principal cross sections

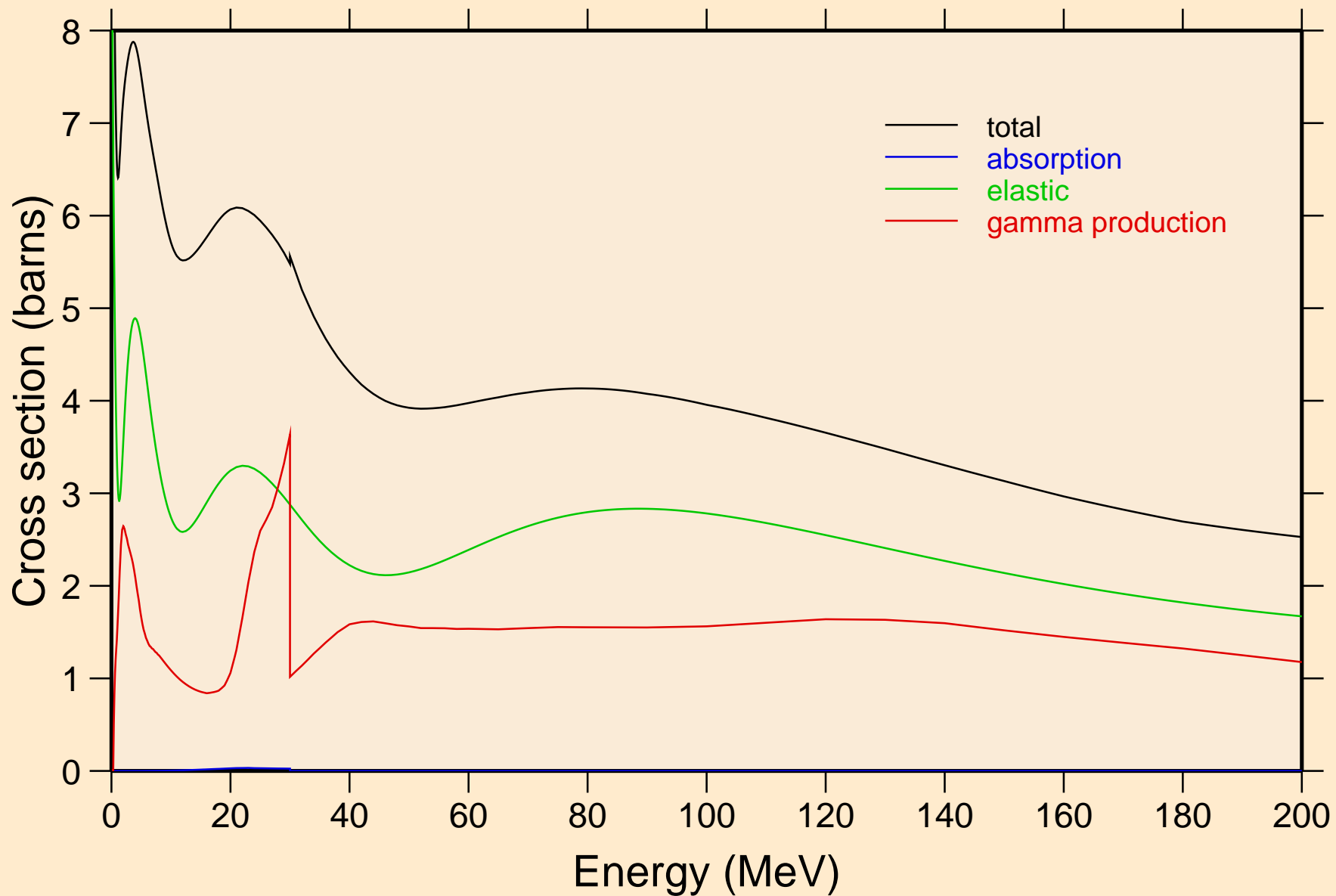

NP232 NEUTRON ACER TENDL-2019 LIBRARY; T=293.16K
Heating

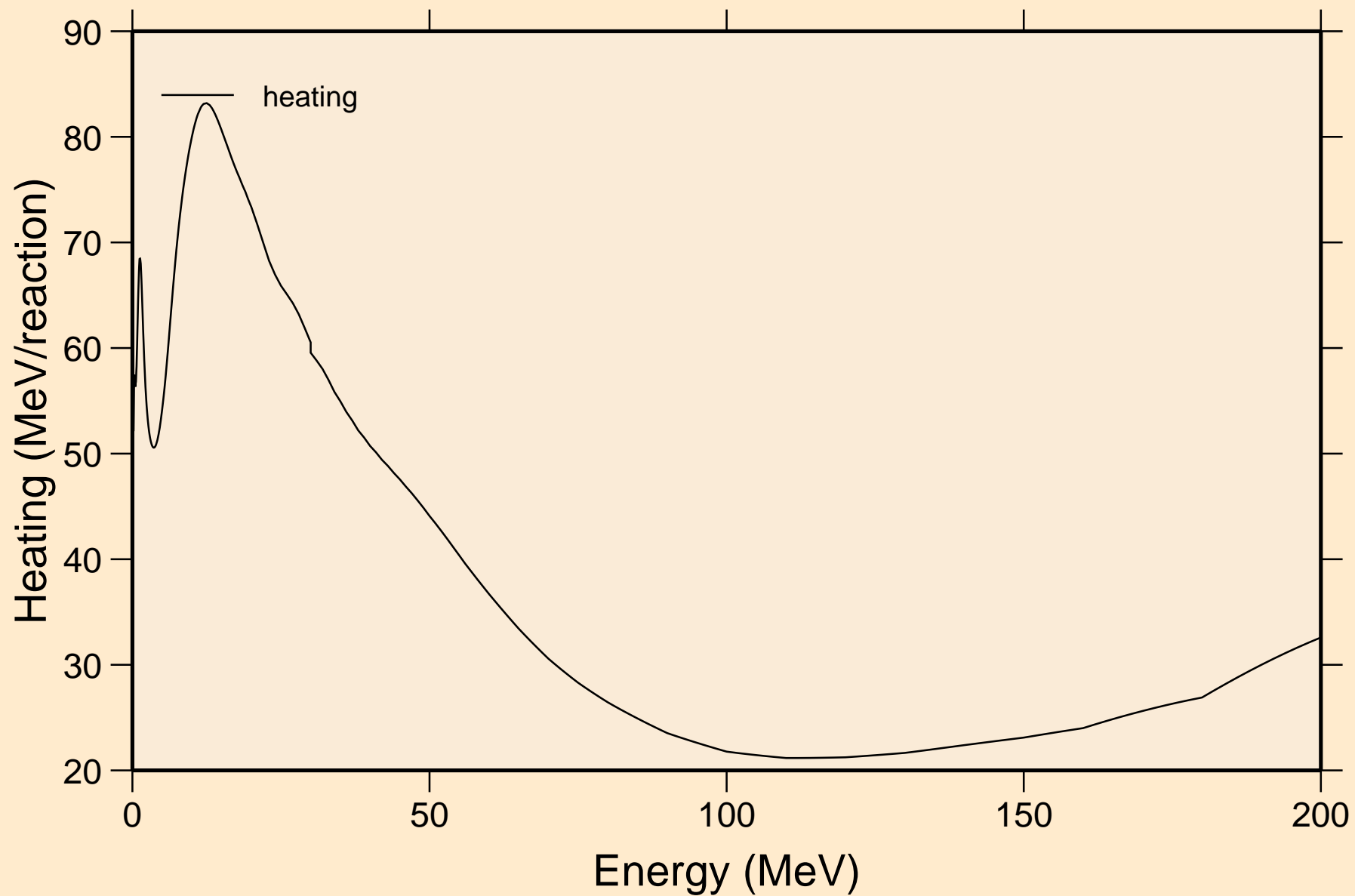

NP232 NEUTRON ACER TENDL-2019 LIBRARY; T=293.16K
Damage

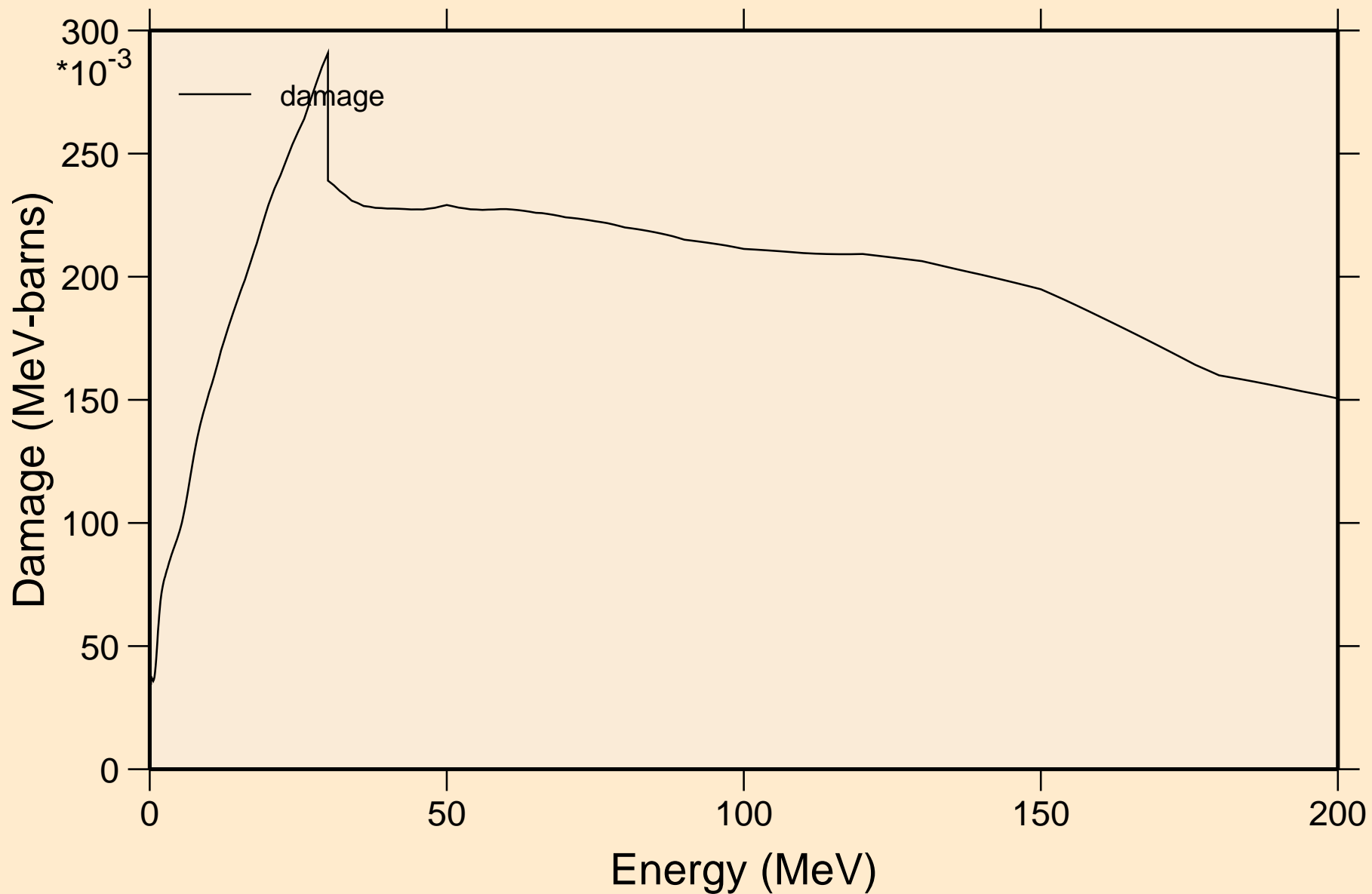

NP232 NEUTRON ACER TENDL-2019 LIBRARY; T=293.16K
Non-threshold reactions

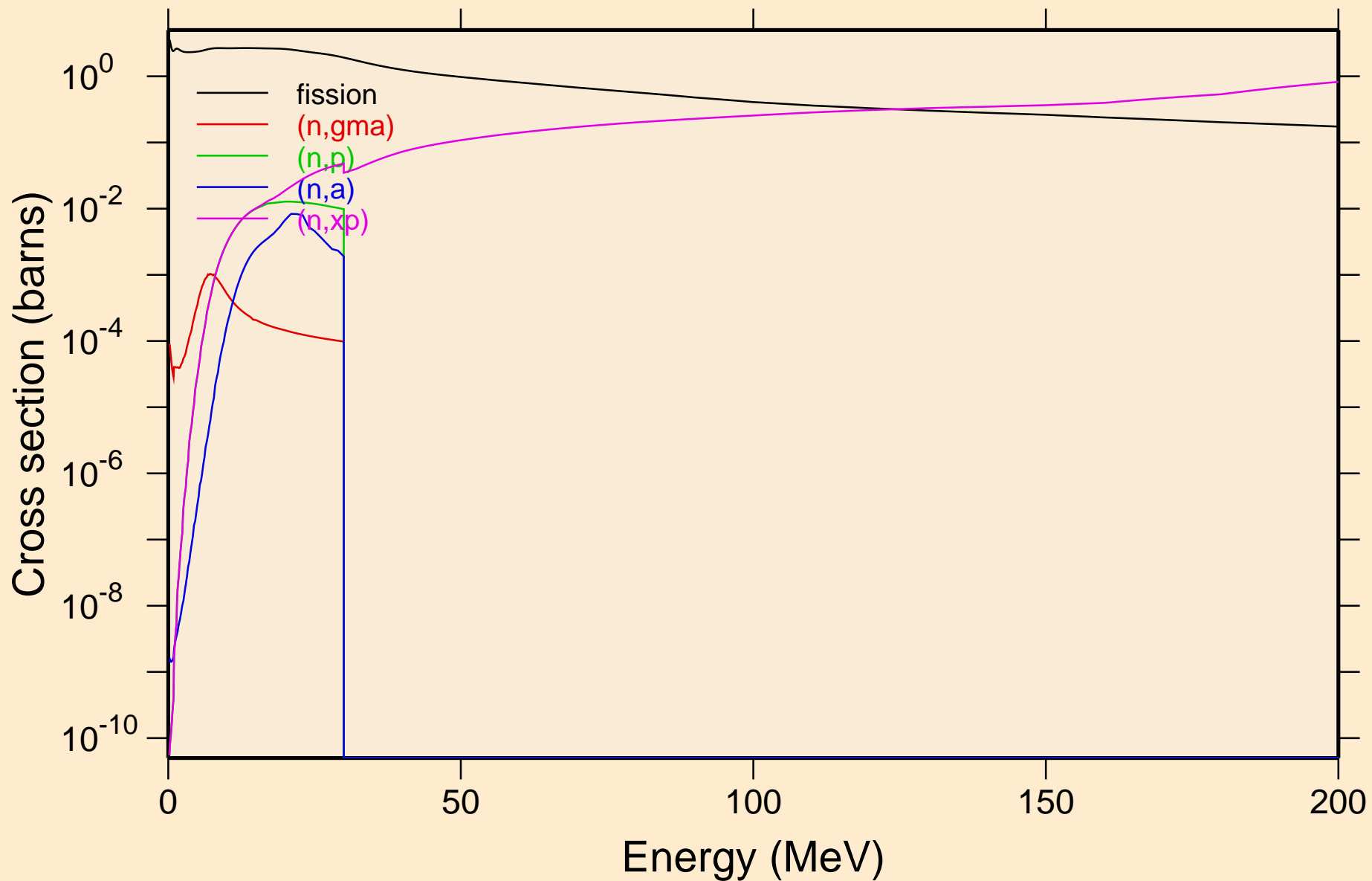

NP232 NEUTRON ACER TENDL-2019 LIBRARY; T=293.16K
Non-threshold reactions

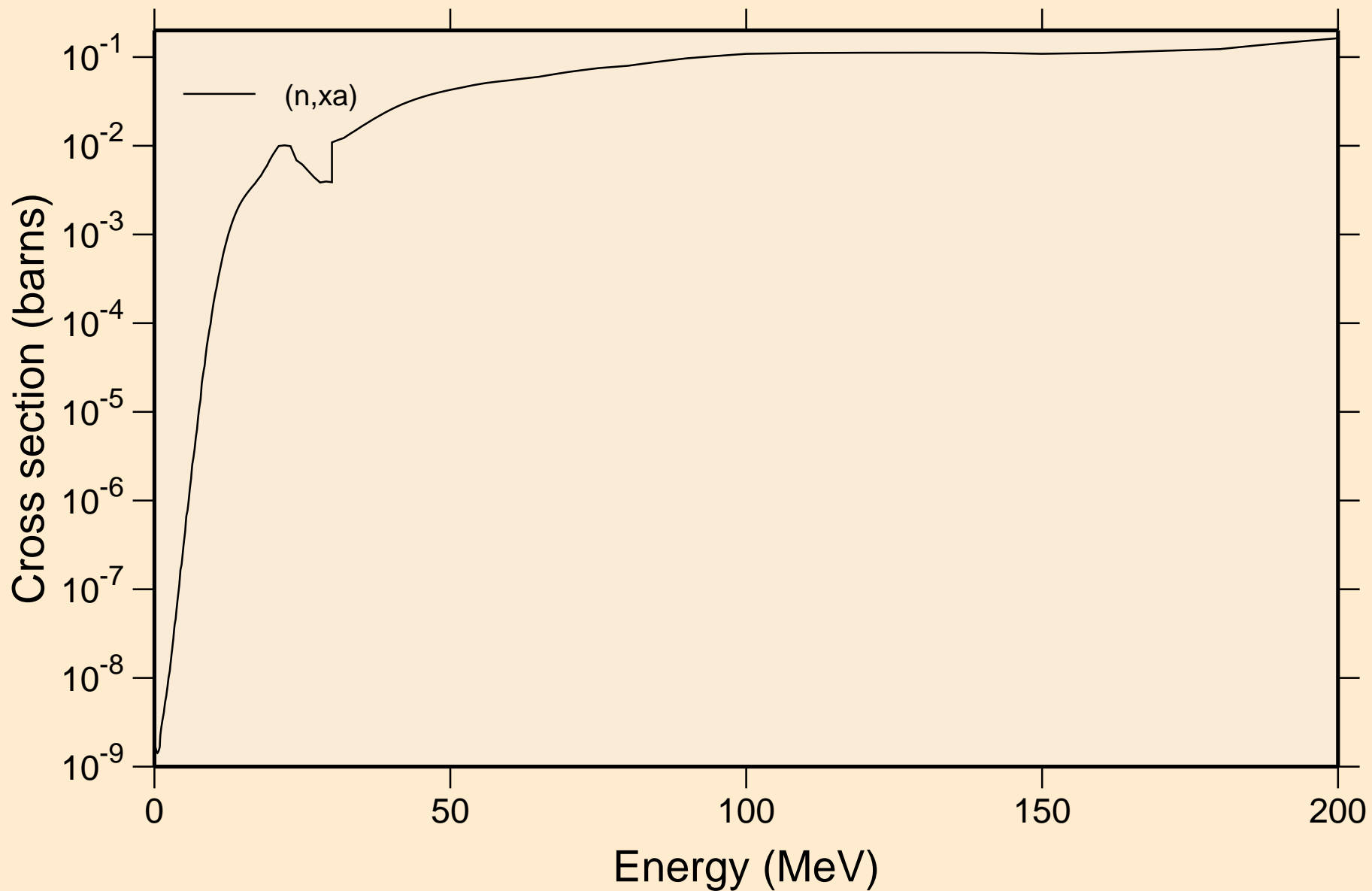

NP232 NEUTRON ACER TENDL-2019 LIBRARY; T=293.16K
Inelastic levels

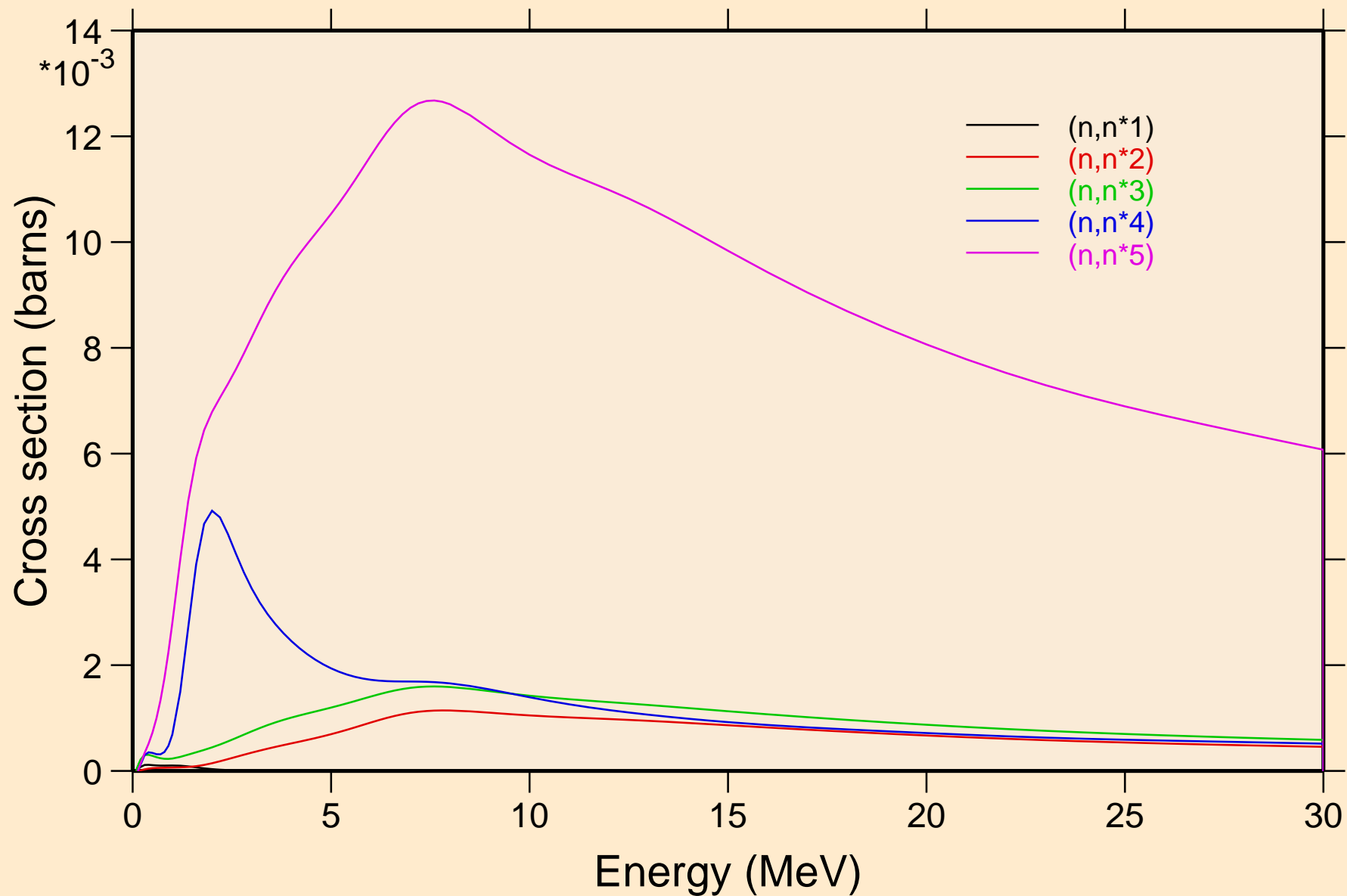

NP232 NEUTRON ACER TENDL-2019 LIBRARY; T=293.16K
Inelastic levels

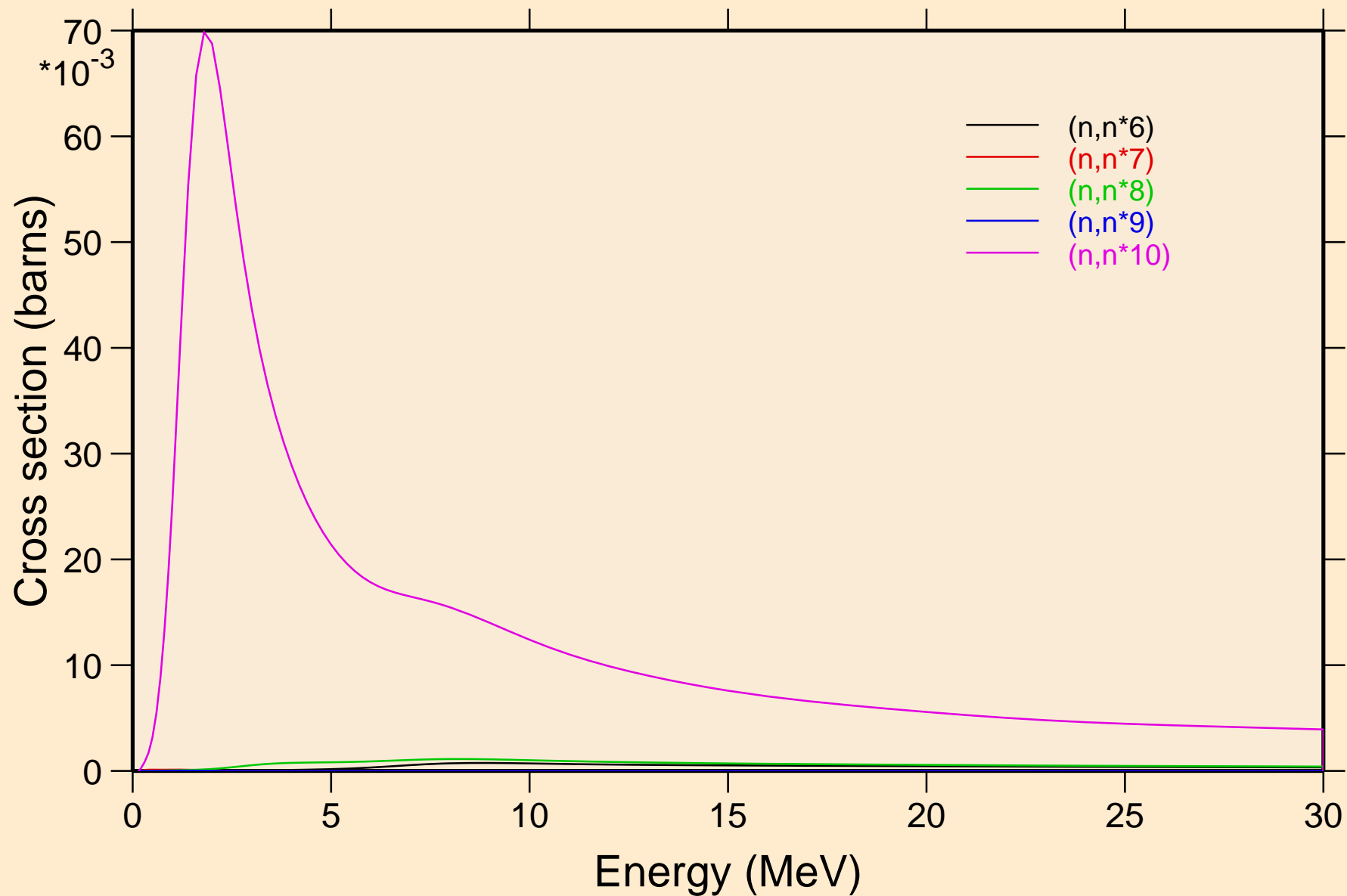

NP232 NEUTRON ACER TENDL-2019 LIBRARY; T=293.16K
Inelastic levels

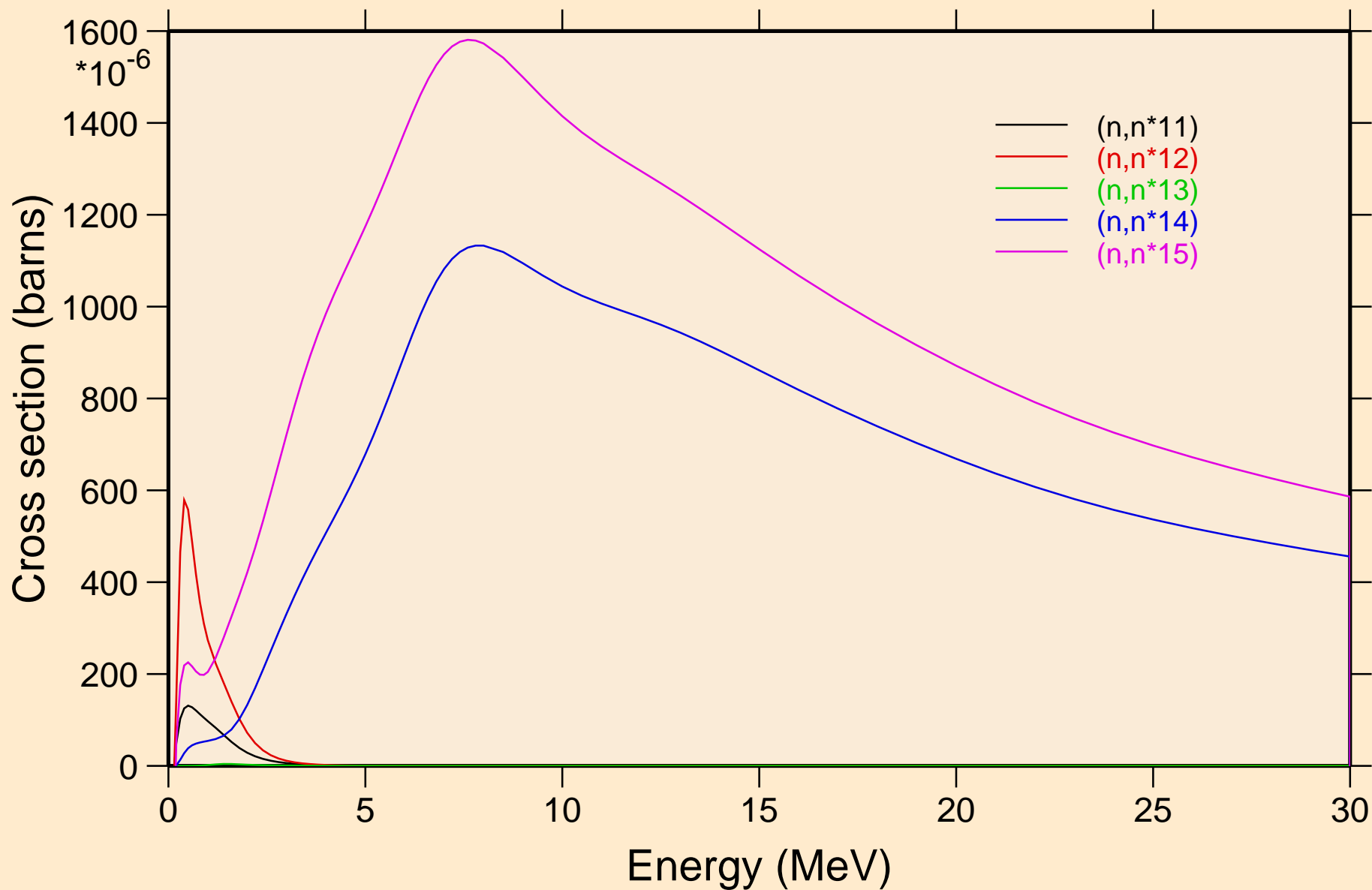

NP232 NEUTRON ACER TENDL-2019 LIBRARY; T=293.16K
Inelastic levels

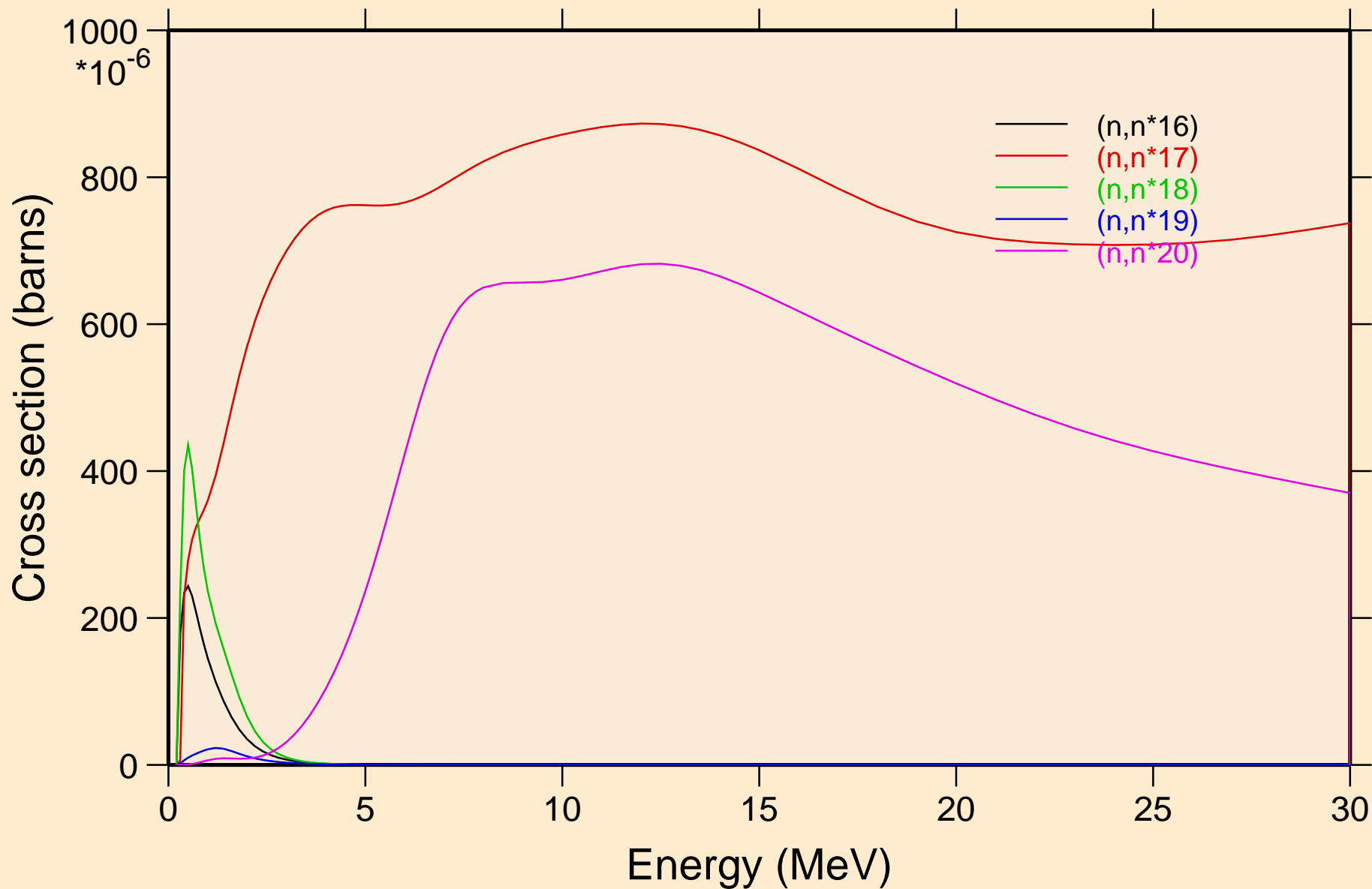

NP232 NEUTRON ACER TENDL-2019 LIBRARY; T=293.16K
Inelastic levels

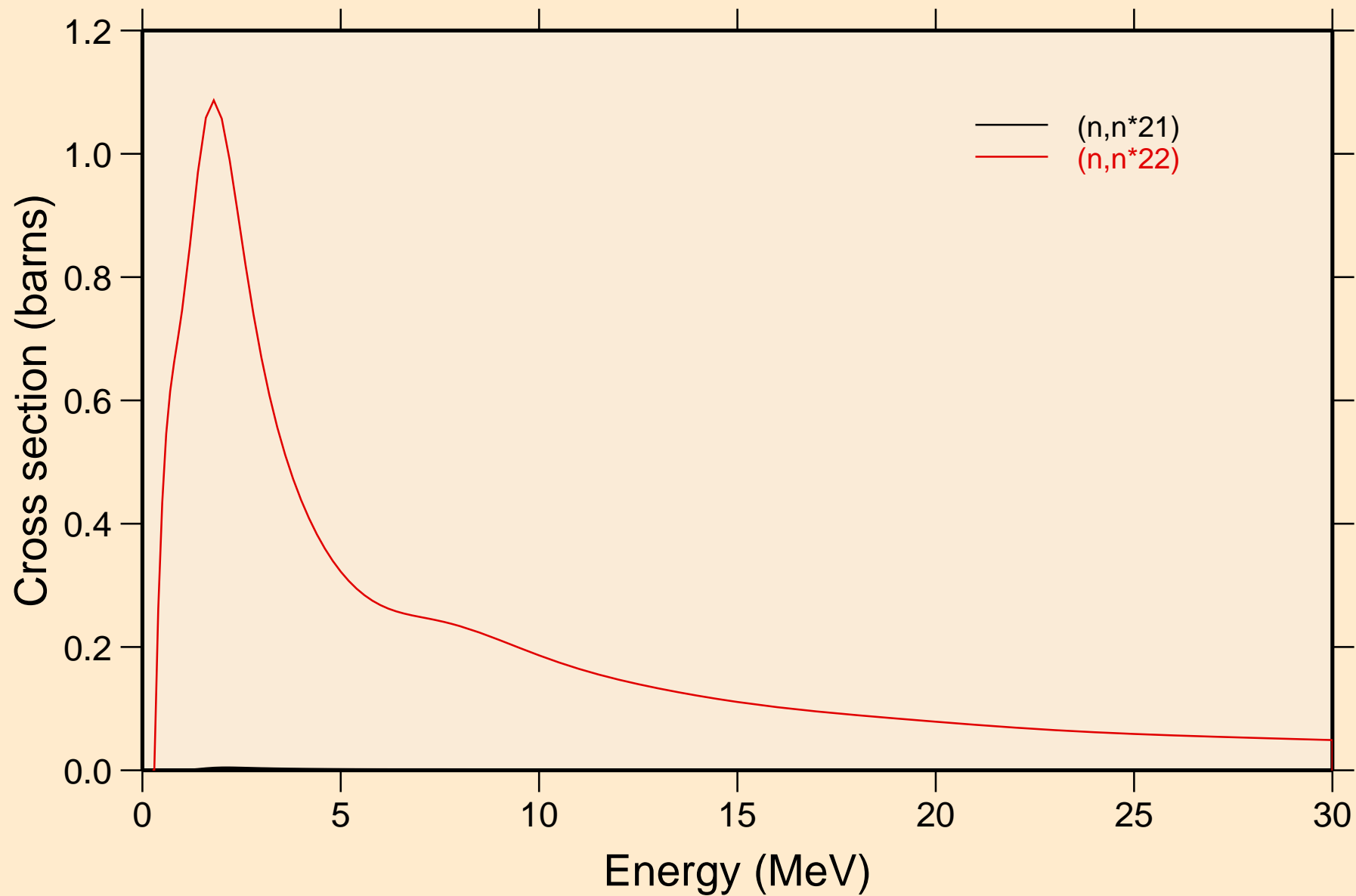

NP232 NEUTRON ACER TENDL-2019 LIBRARY; T=293.16K
Threshold reactions

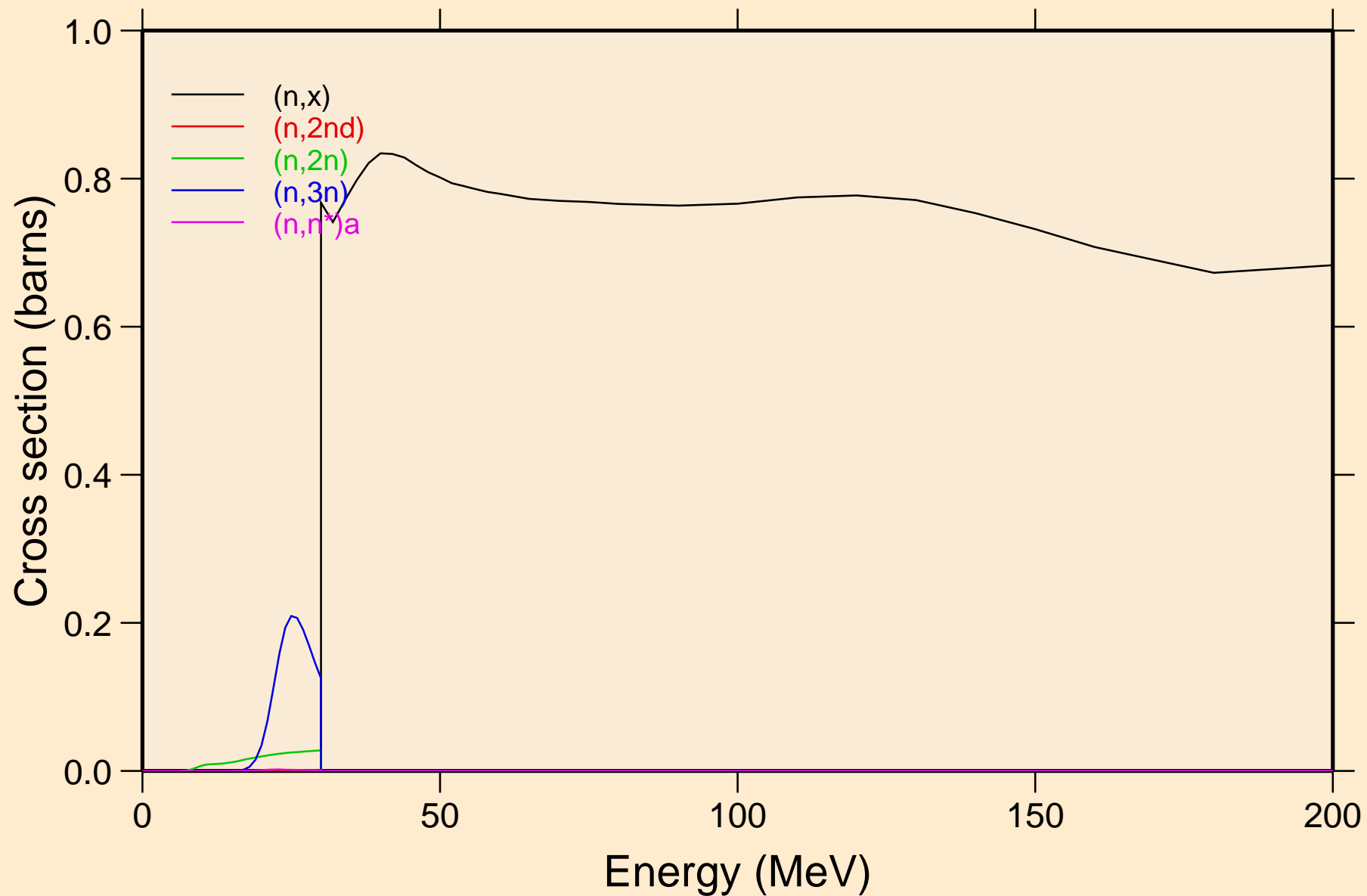

NP232 NEUTRON ACER TENDL-2019 LIBRARY; T=293.16K
Threshold reactions

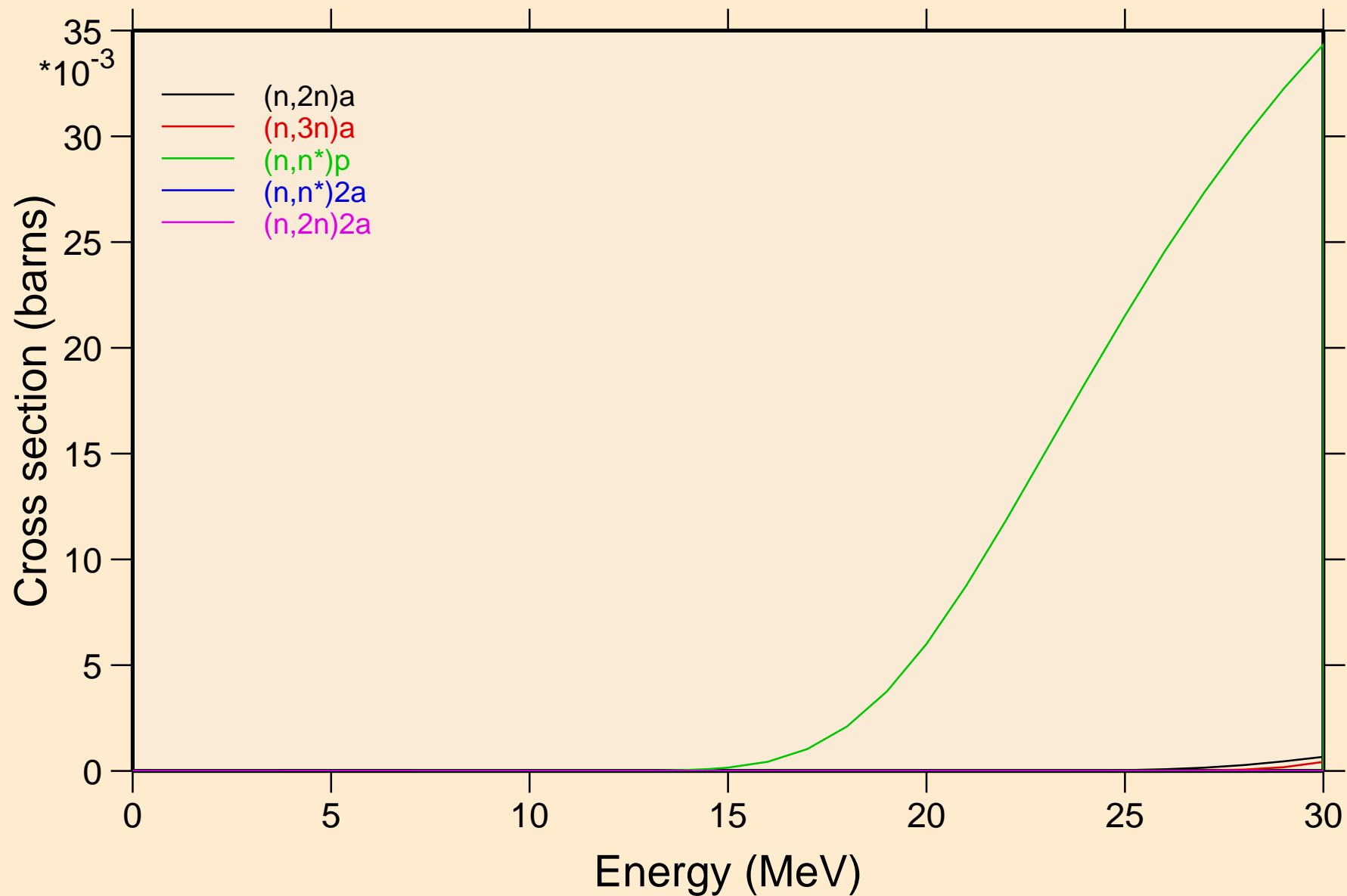

NP232 NEUTRON ACER TENDL-2019 LIBRARY; T=293.16K

Threshold reactions

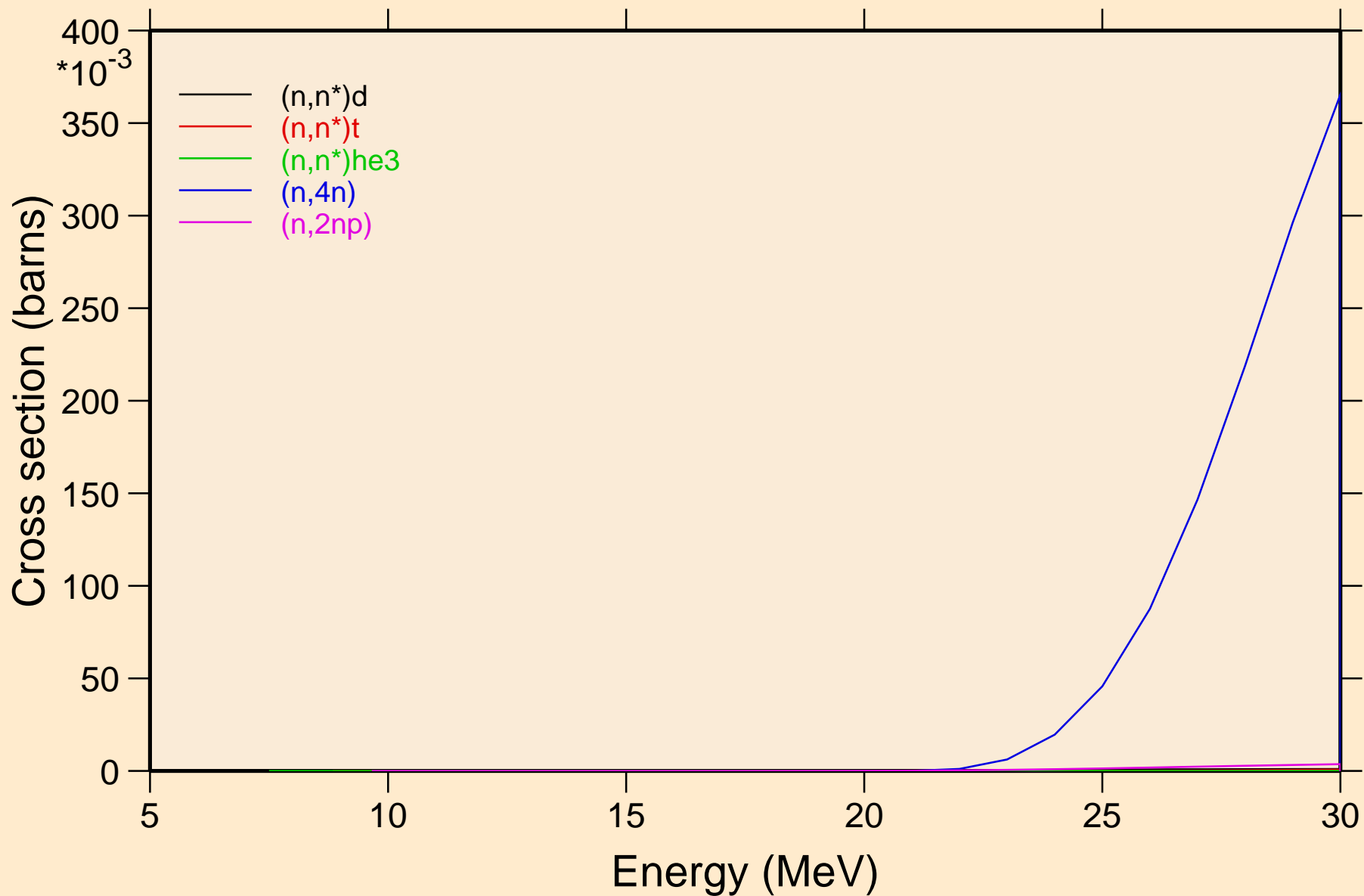

NP232 NEUTRON ACER TENDL-2019 LIBRARY; T=293.16K

Threshold reactions

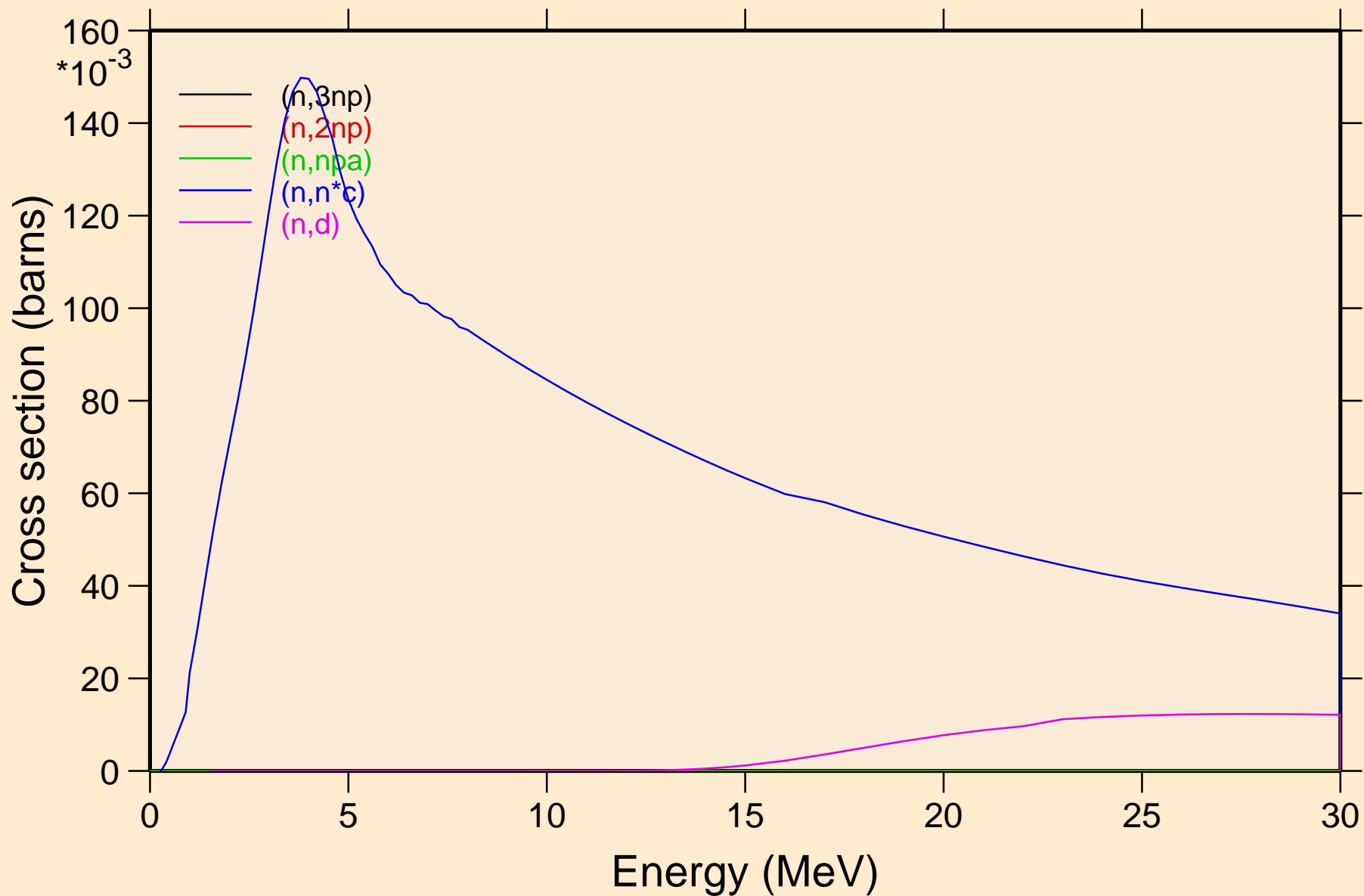

NP232 NEUTRON ACER TENDL-2019 LIBRARY; T=293.16K
Threshold reactions

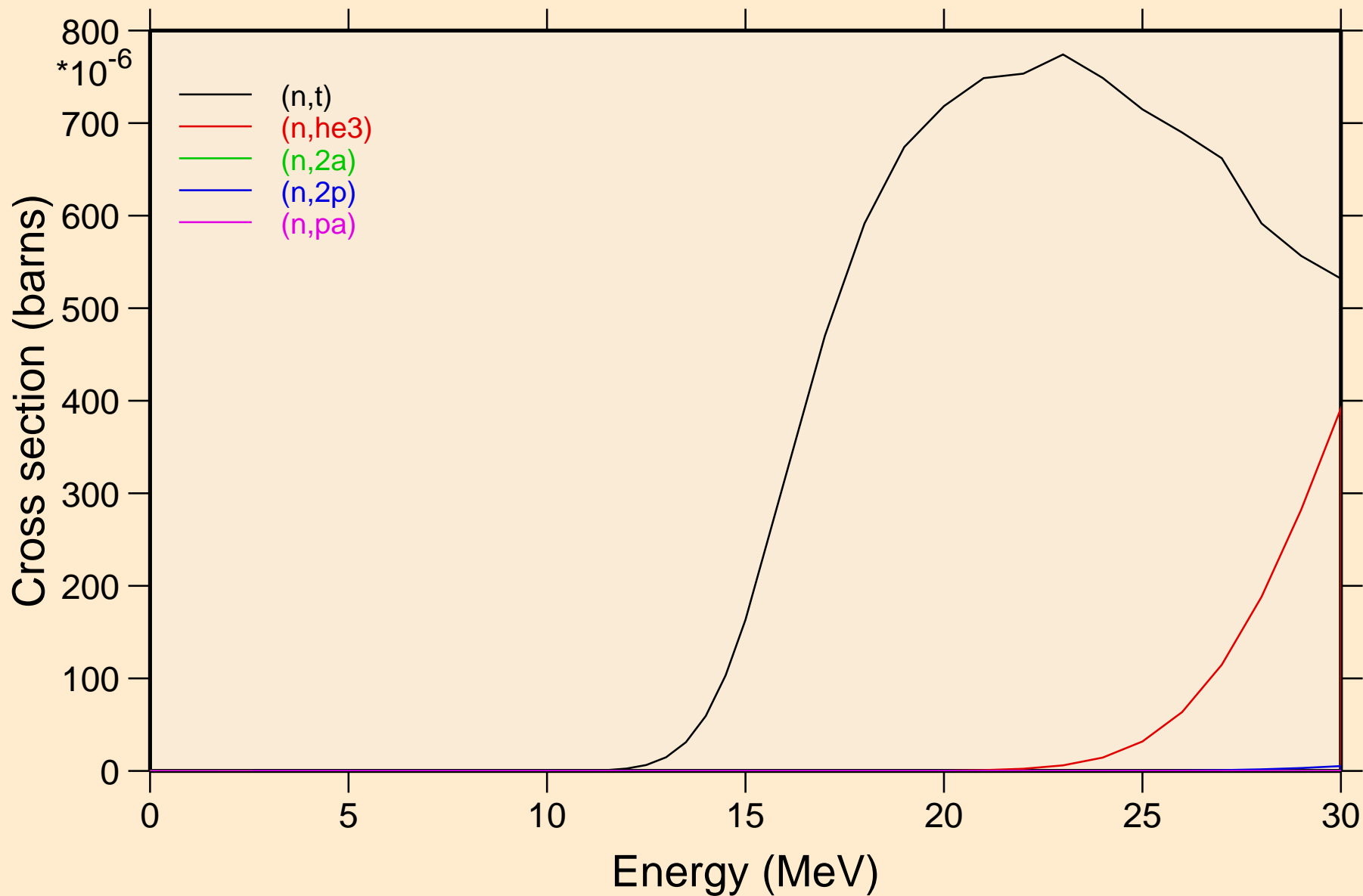

NP232 NEUTRON ACER TENDL-2019 LIBRARY; T=293.16K
Threshold reactions

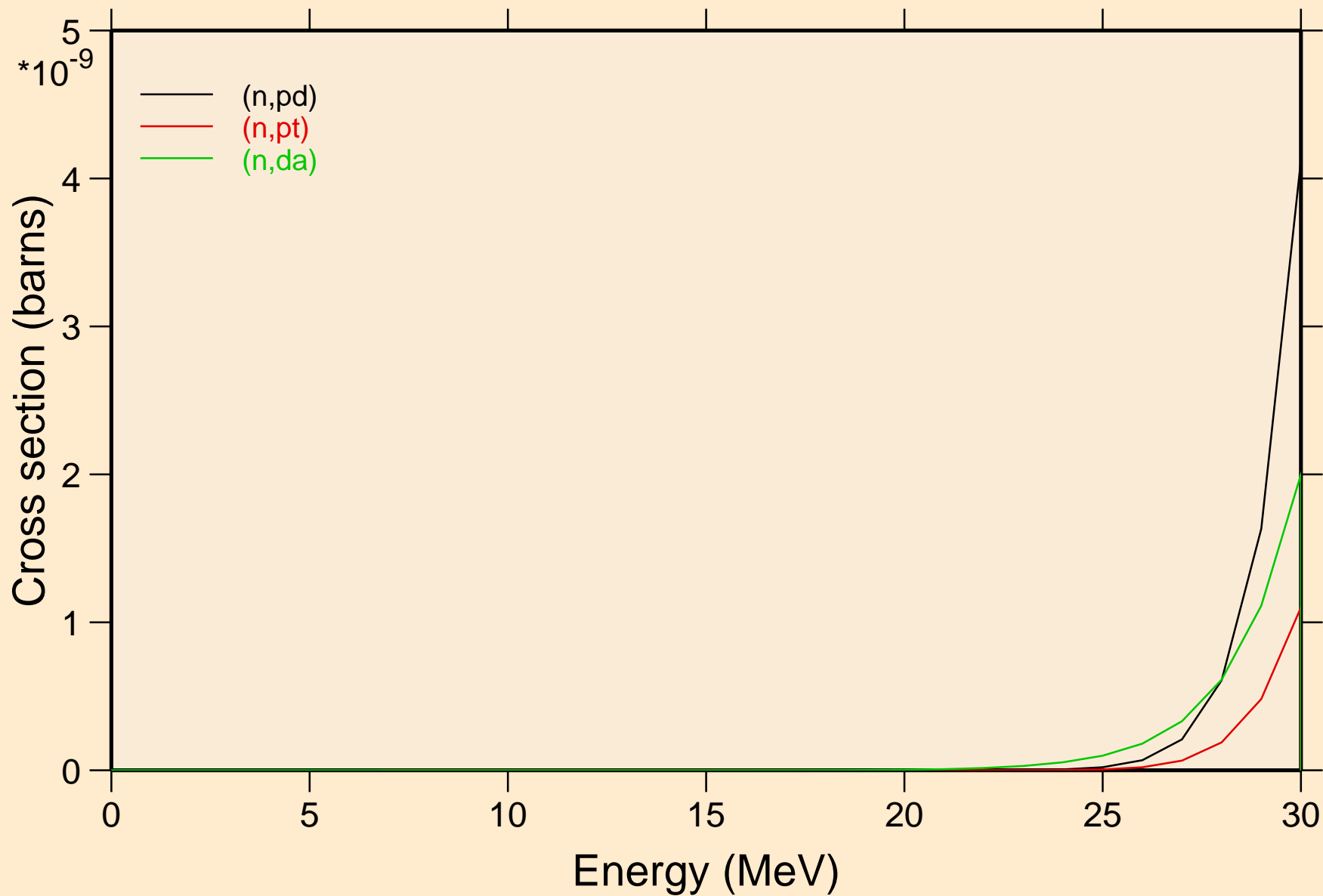

NP232 NEUTRON ACER TENDL-2019 LIBRARY; T=293.16K
Threshold reactions

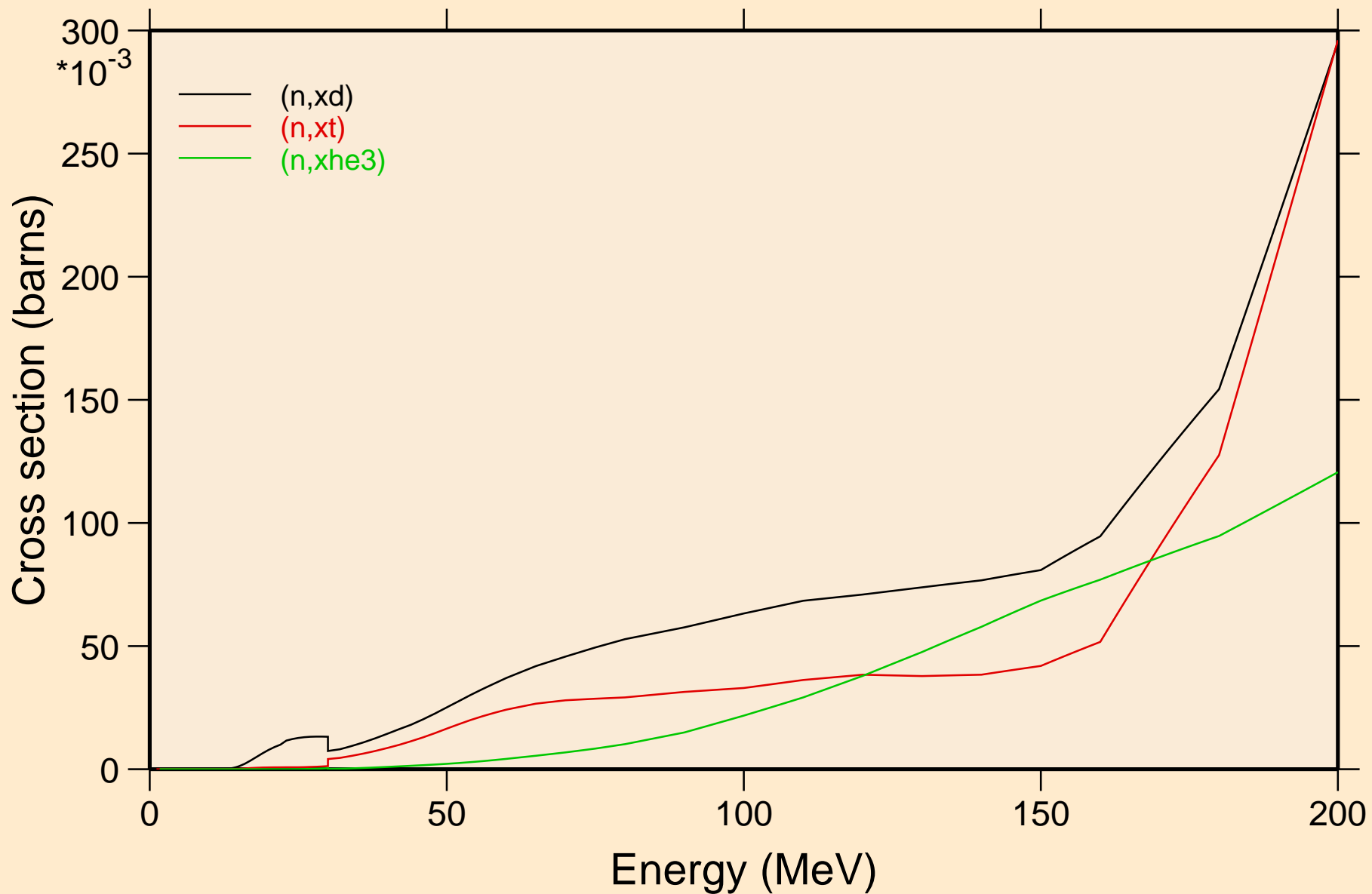

NP232 NEUTRON ACER TENDL-2019 LIBRARY; T=293.16K
angular distribution for elastic

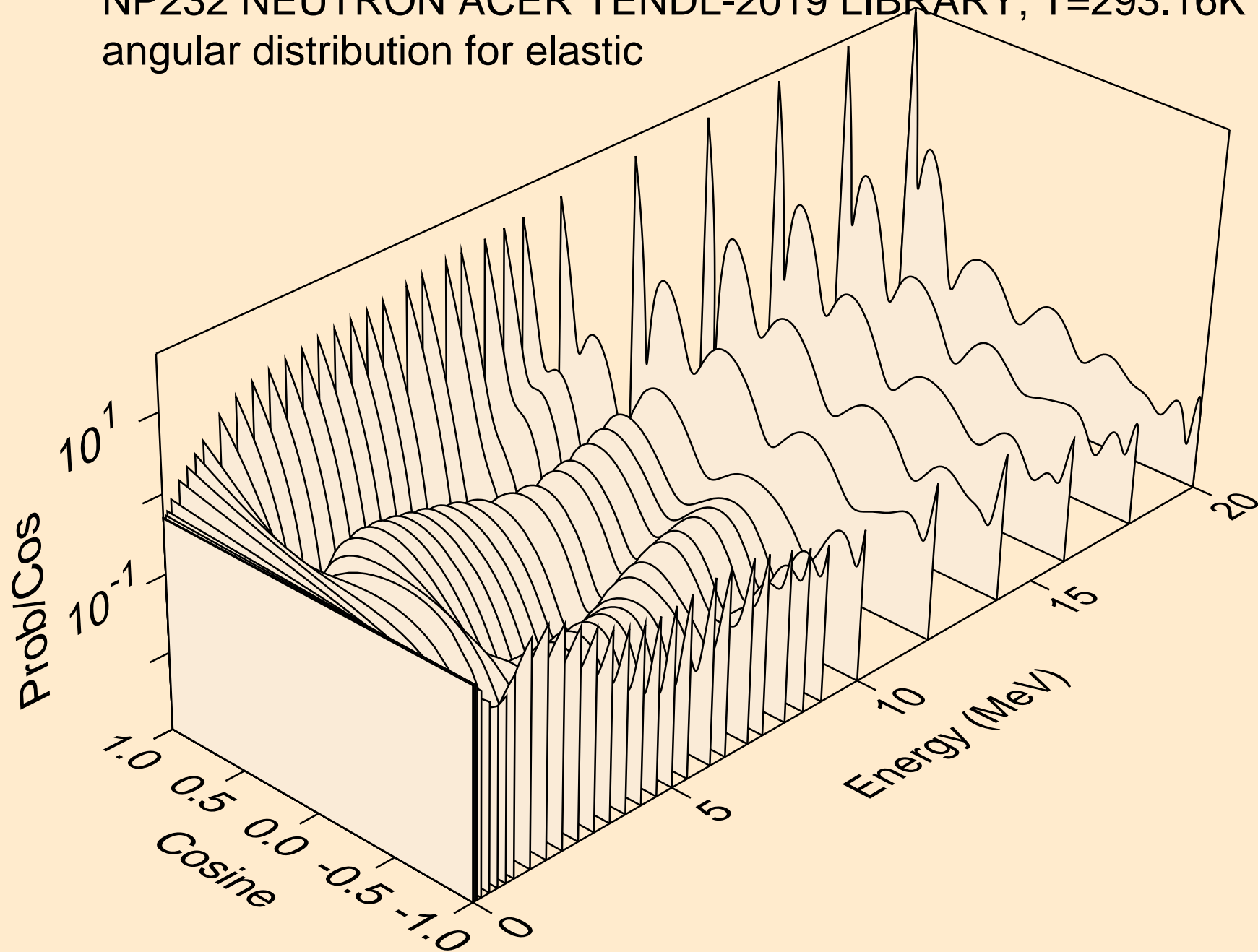

NP232 NEUTRON ACER TENDL-2019 LIBRARY; T=293.16K
angular distribution for elastic

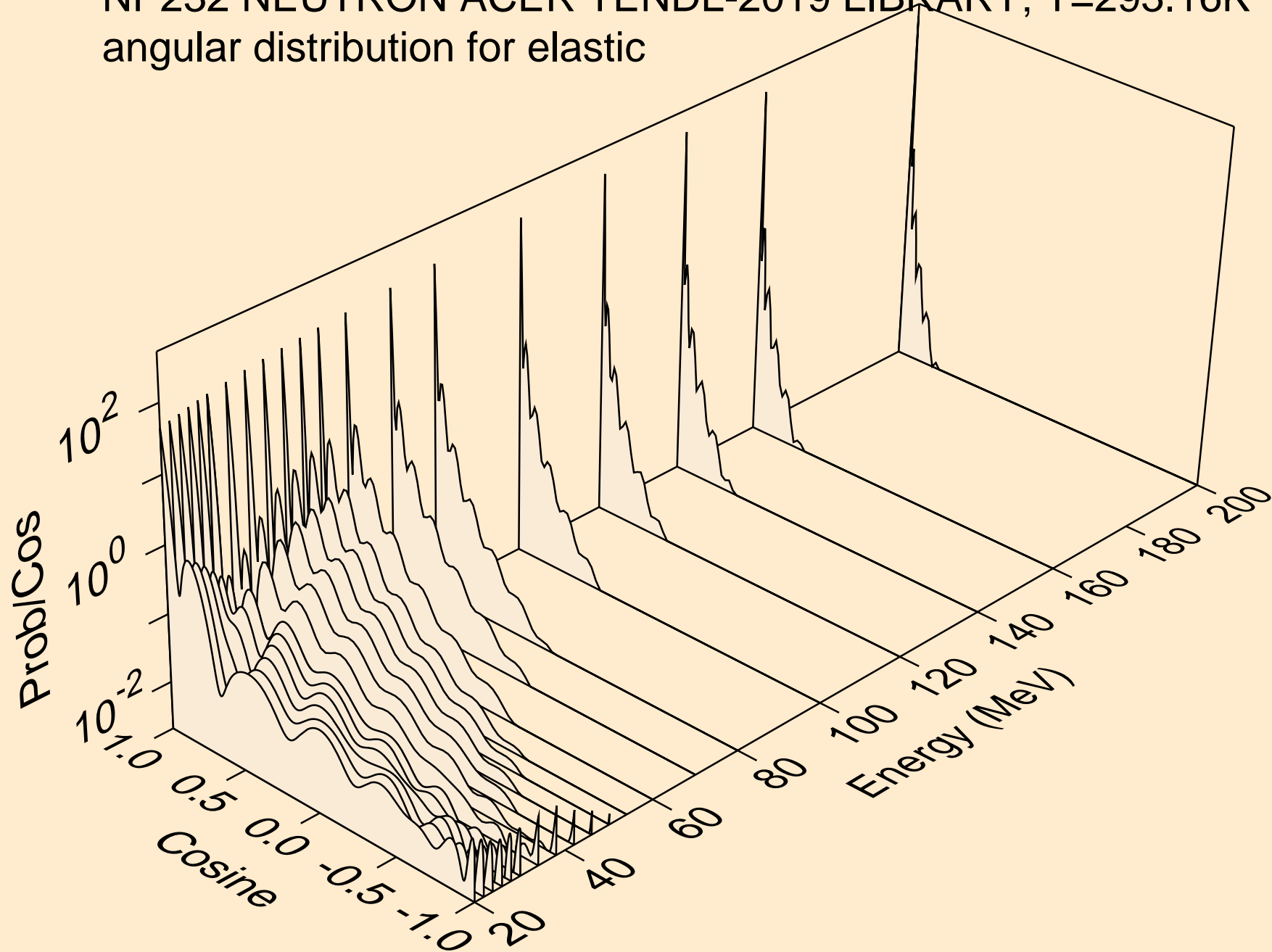

NP232 NEUTRON ACER TENDL-2019 LIBRARY; T=293.16K
angular distribution for (n,n*1)

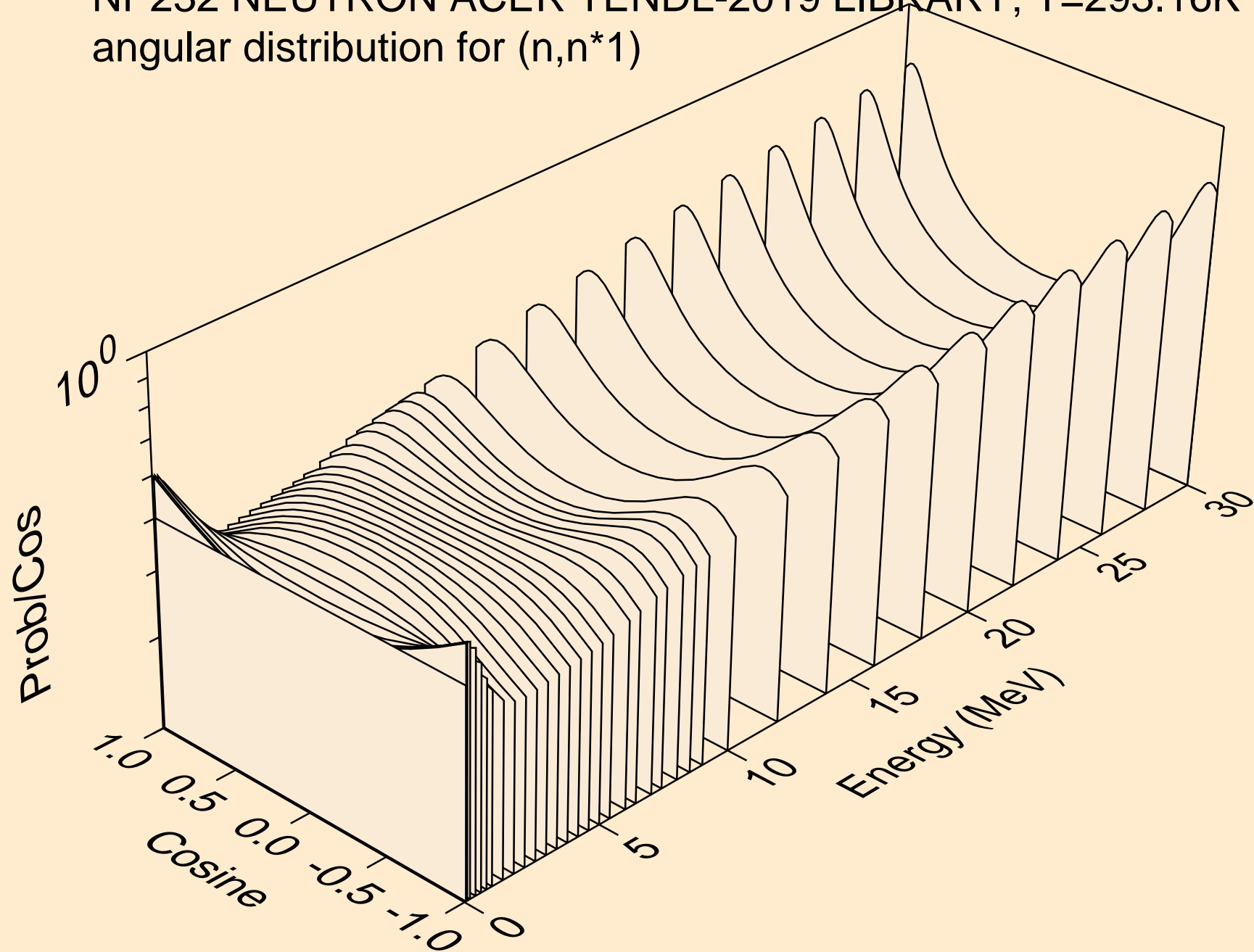

NP232 NEUTRON ACER TENDL-2019 LIBRARY; T=293.16K
angular distribution for (n,n*2)

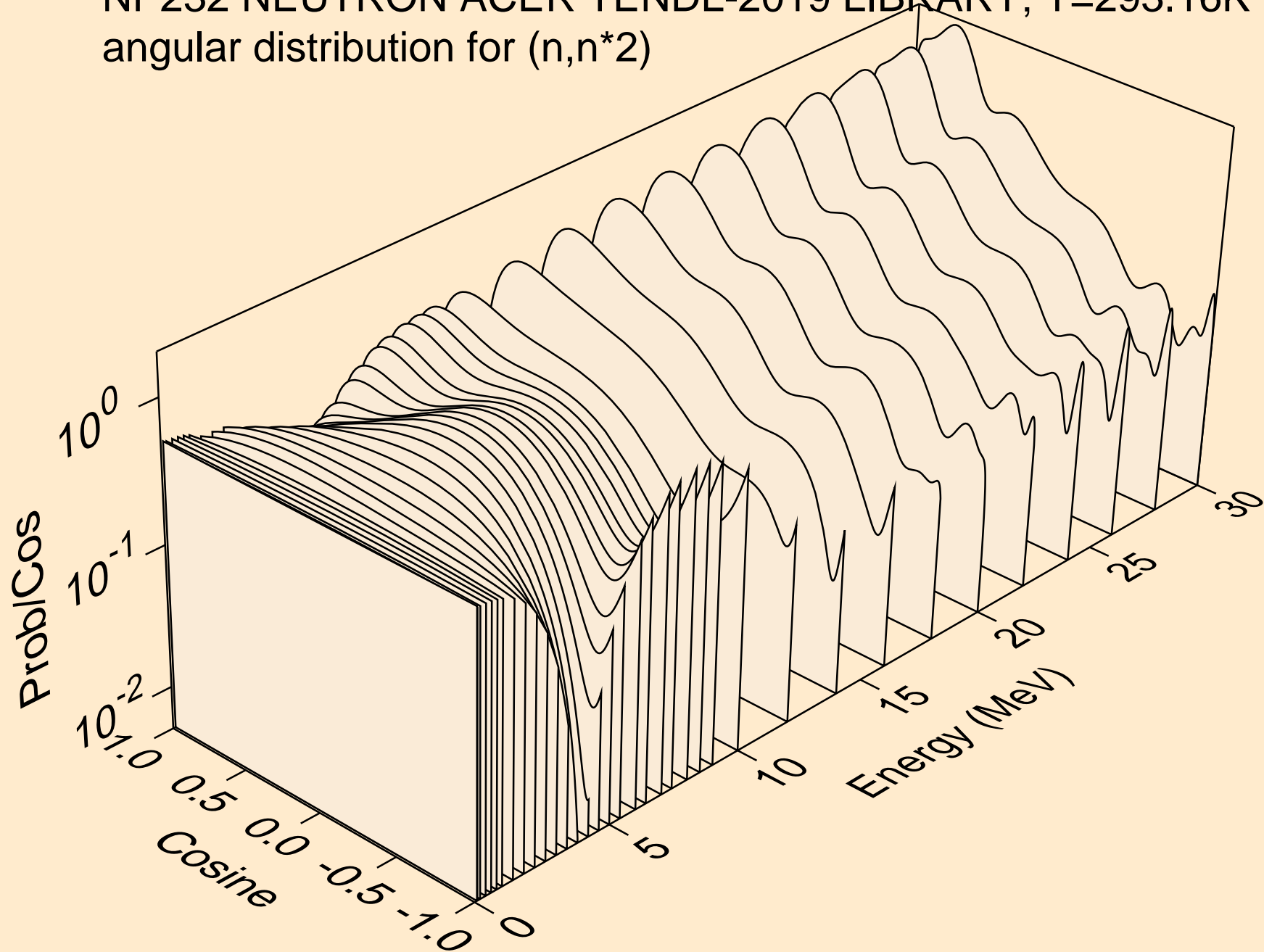

NP232 NEUTRON ACER TENDL-2019 LIBRARY; T=293.16K
angular distribution for (n,n*3)

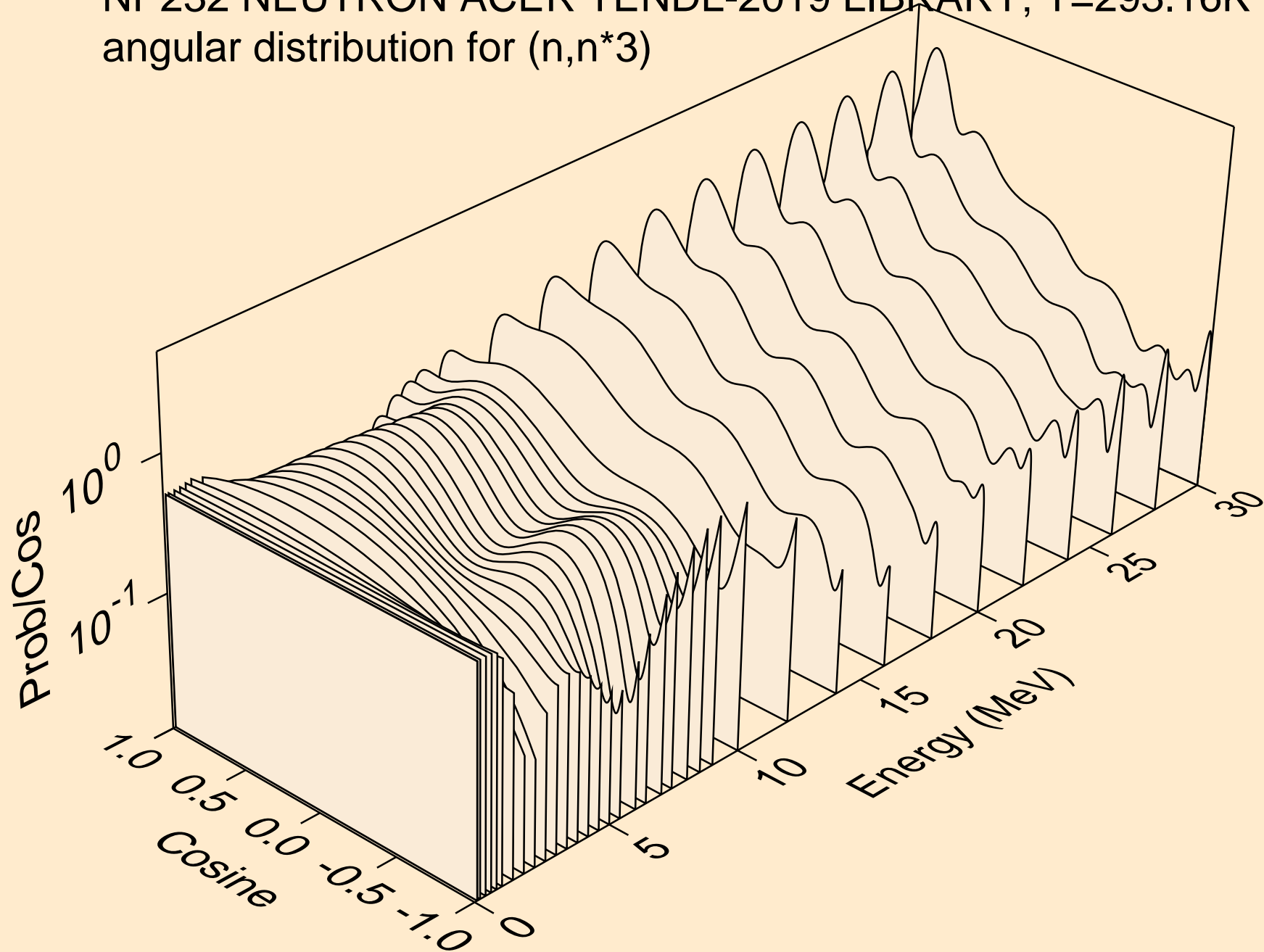

NP232 NEUTRON ACER TENDL-2019 LIBRARY; T=293.16K
angular distribution for (n,n*4)

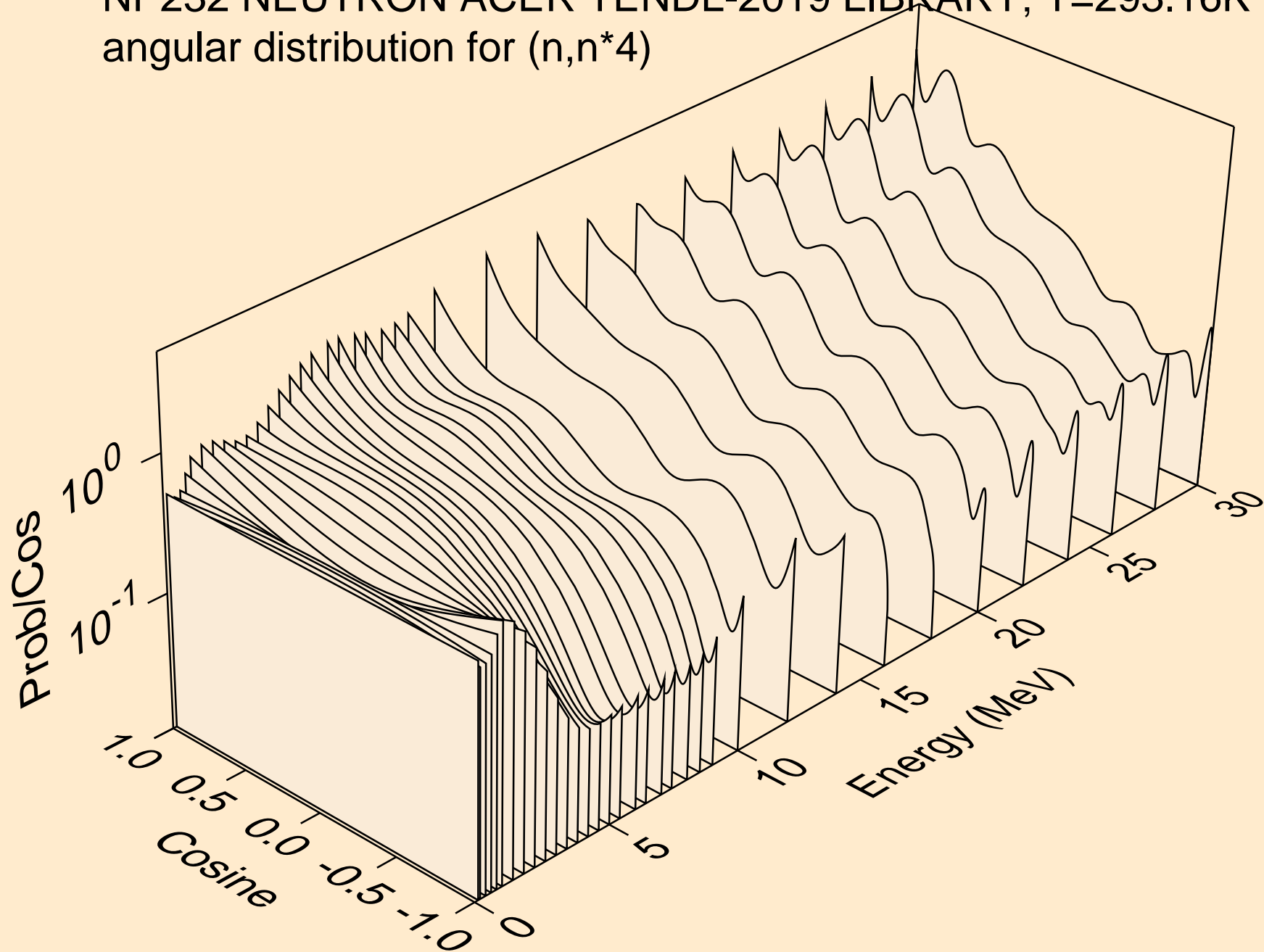

NP232 NEUTRON ACER TENDL-2019 LIBRARY; T=293.16K
angular distribution for (n,n*5)

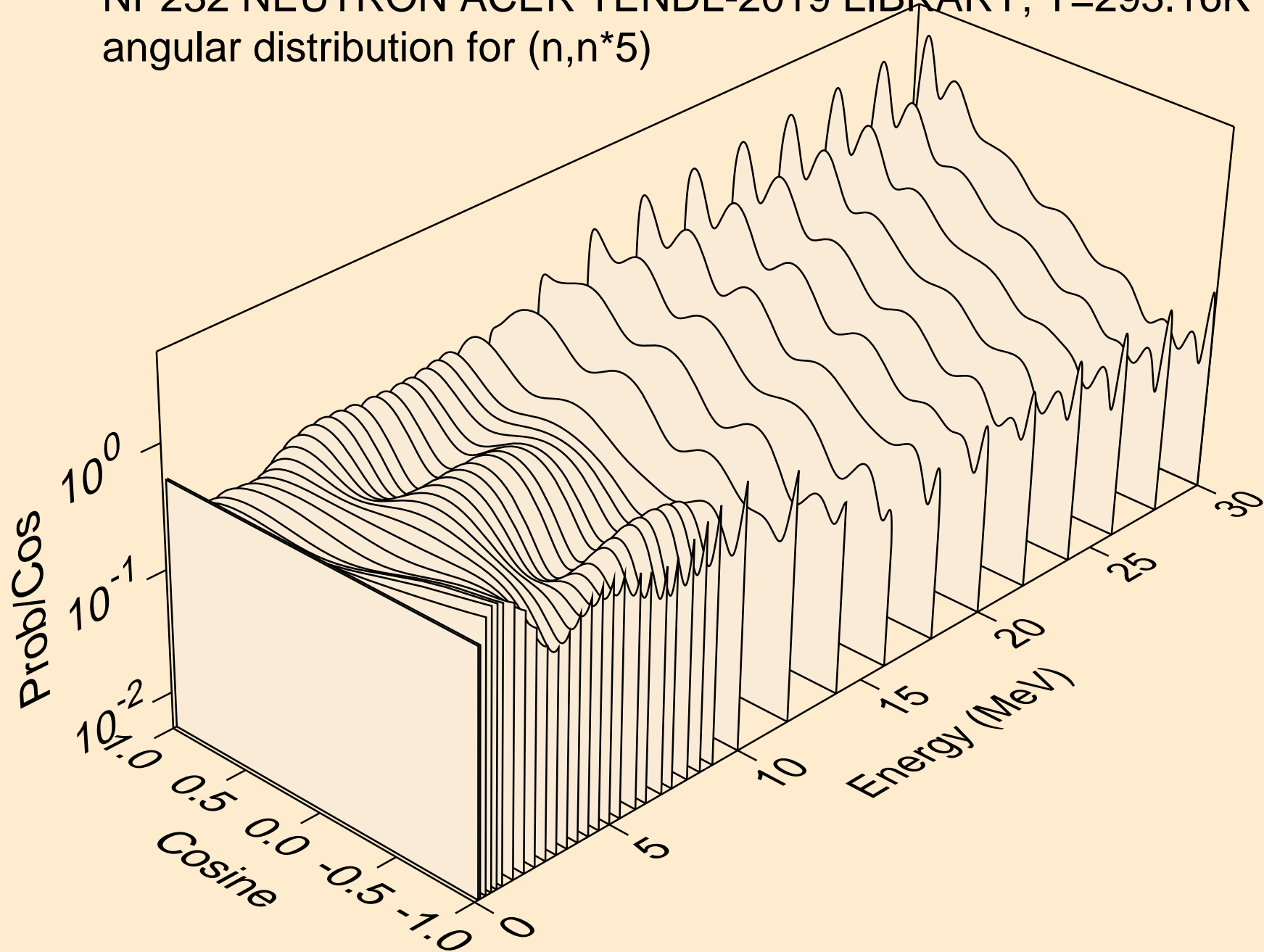

NP232 NEUTRON ACER TENDL-2019 LIBRARY; T=293.16K
angular distribution for (n,n*6)

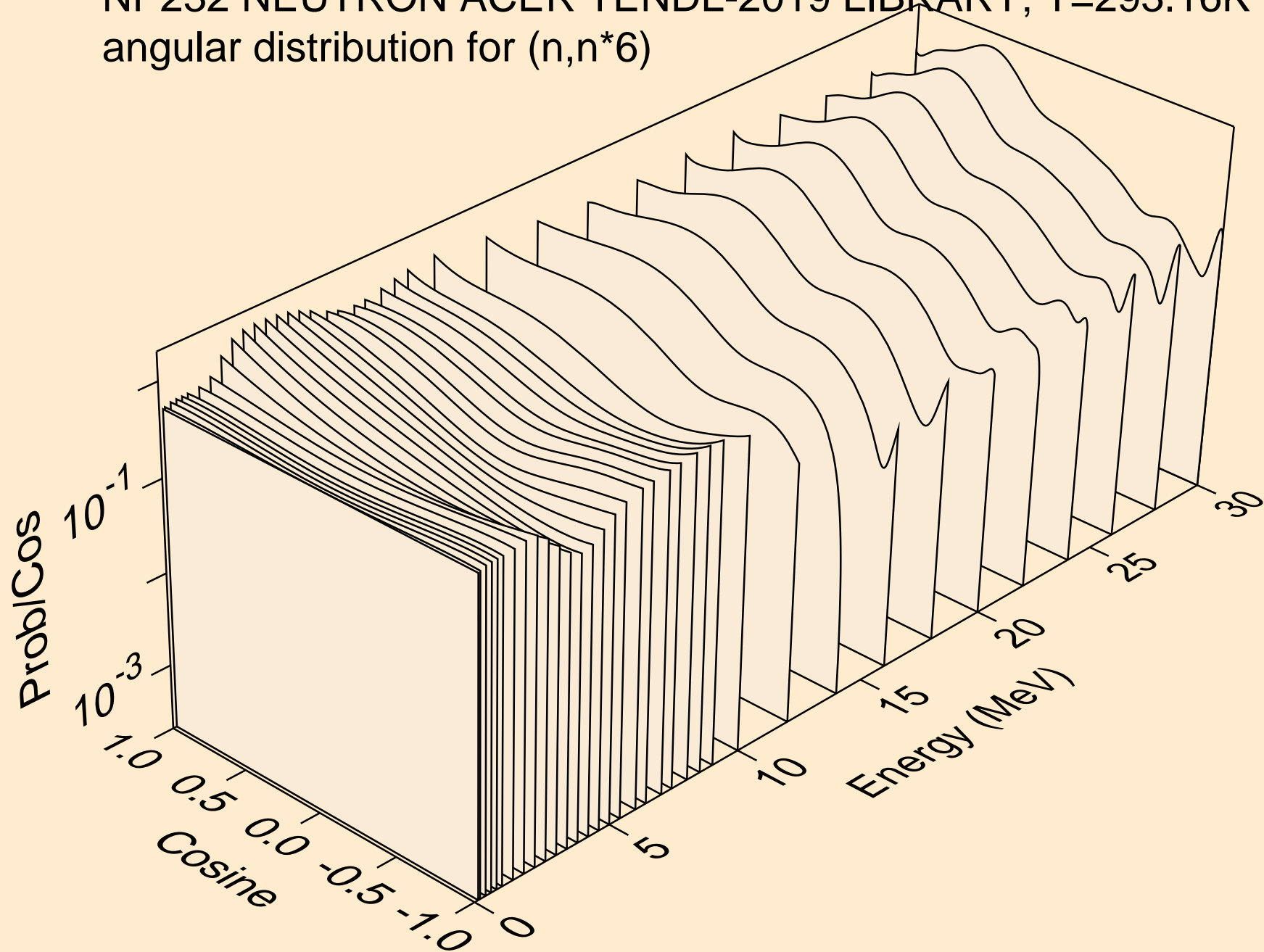

NP232 NEUTRON ACER TENDL-2019 LIBRARY; T=293.16K
angular distribution for (n,n*7)

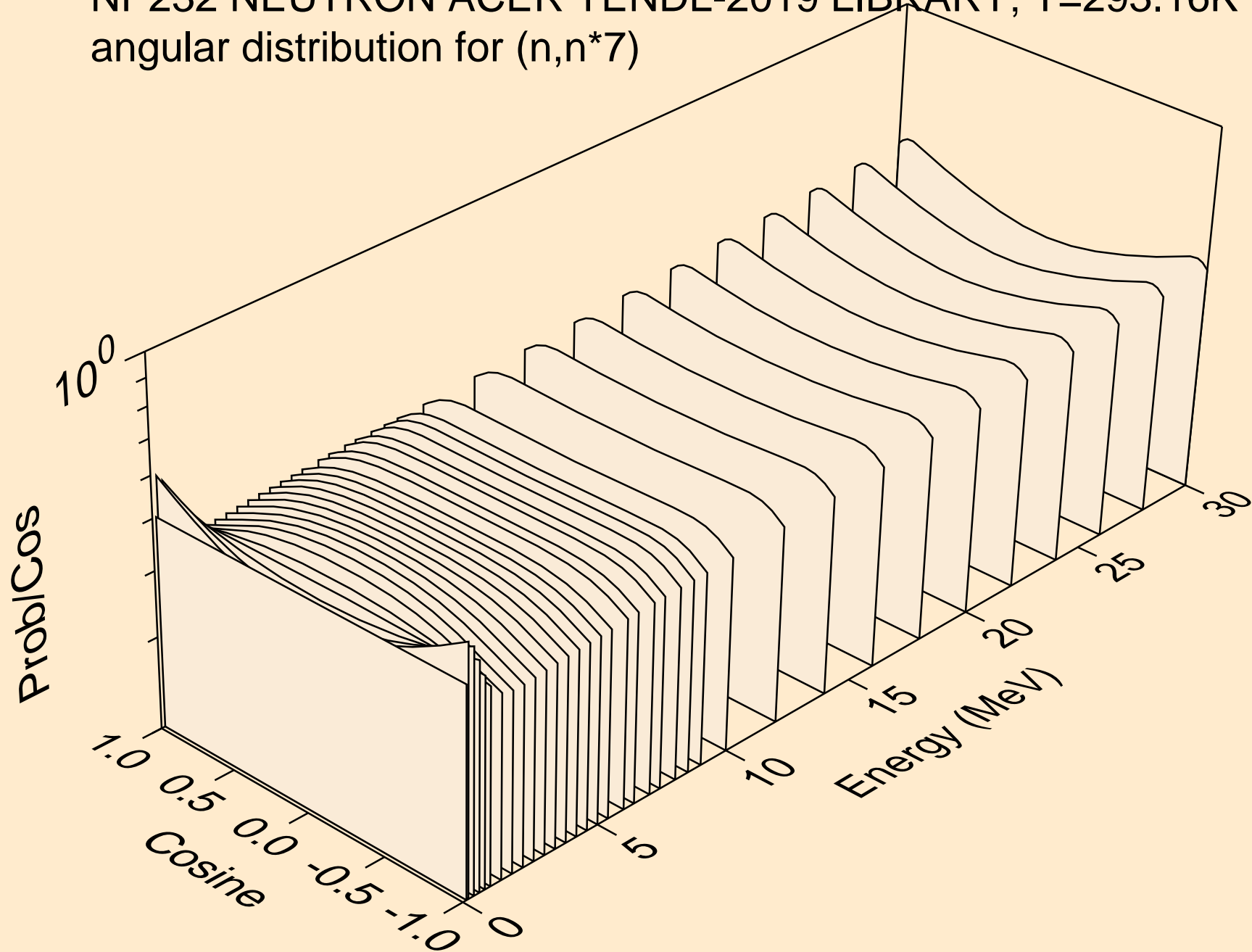

NP232 NEUTRON ACER TENDL-2019 LIBRARY; T=293.16K
angular distribution for (n,n*8)

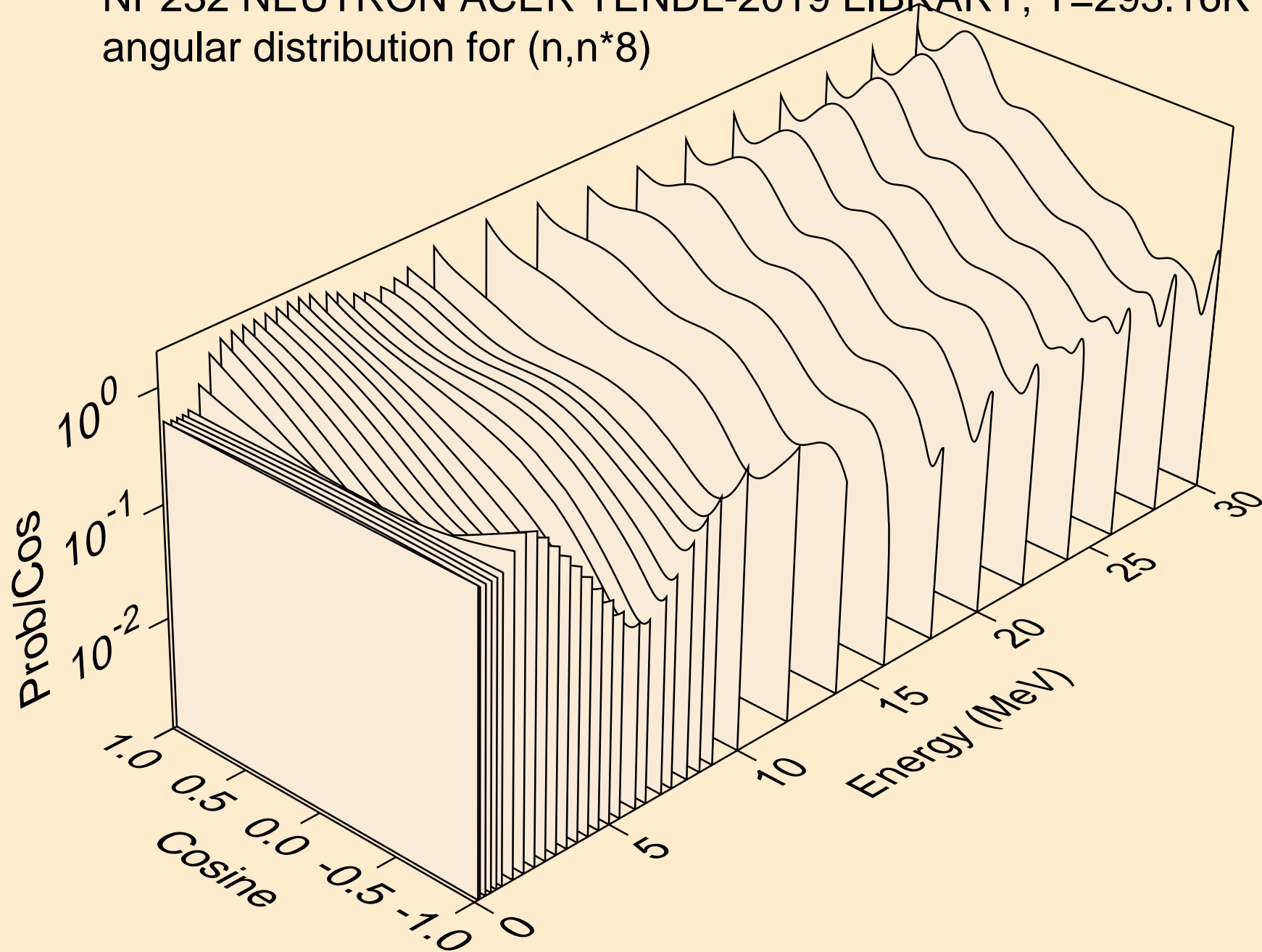

NP232 NEUTRON ACER TENDL-2019 LIBRARY; T=293.16K
angular distribution for (n,n*9)

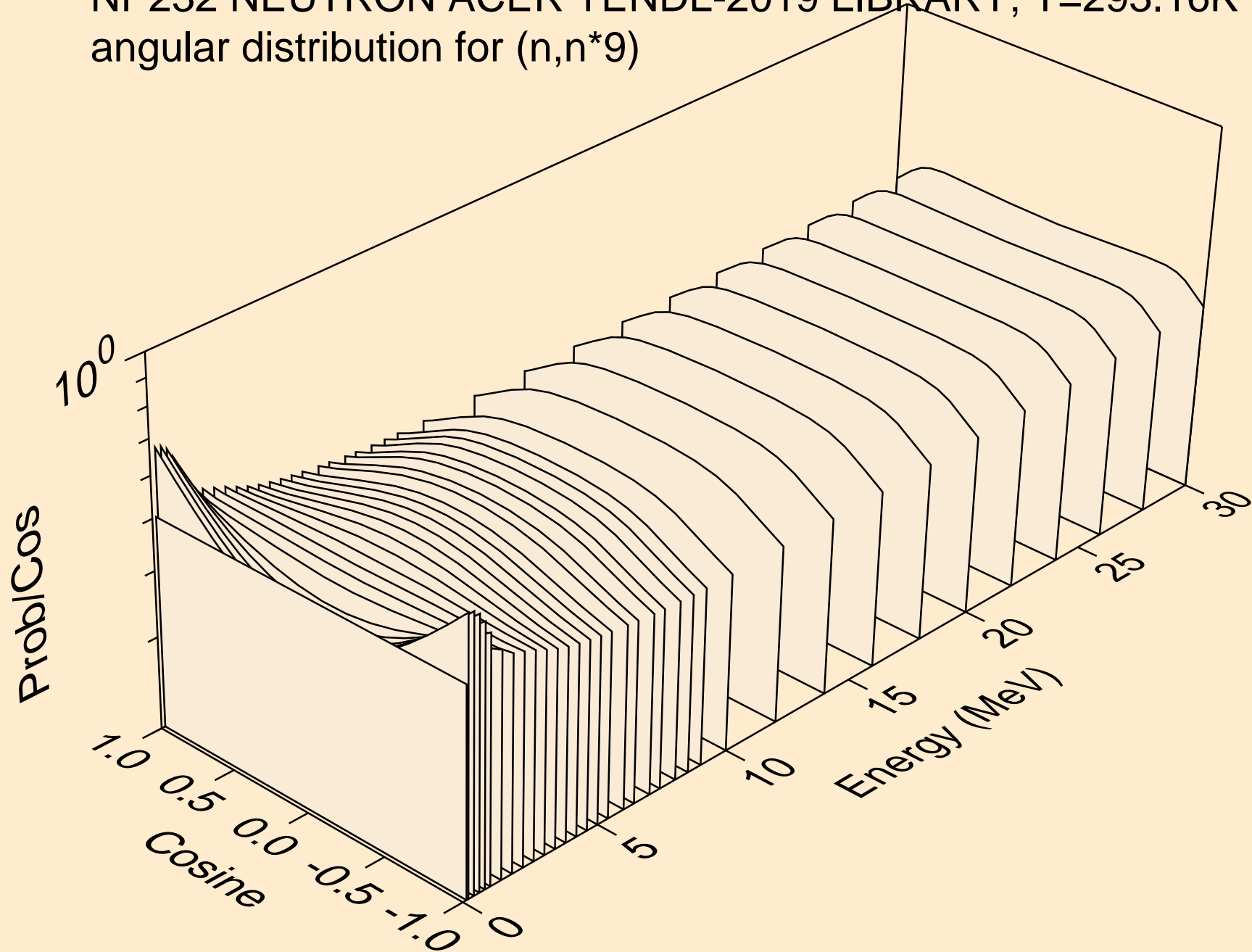

NP232 NEUTRON ACER TENDL-2019 LIBRARY; T=293.16K
angular distribution for (n,n*10)

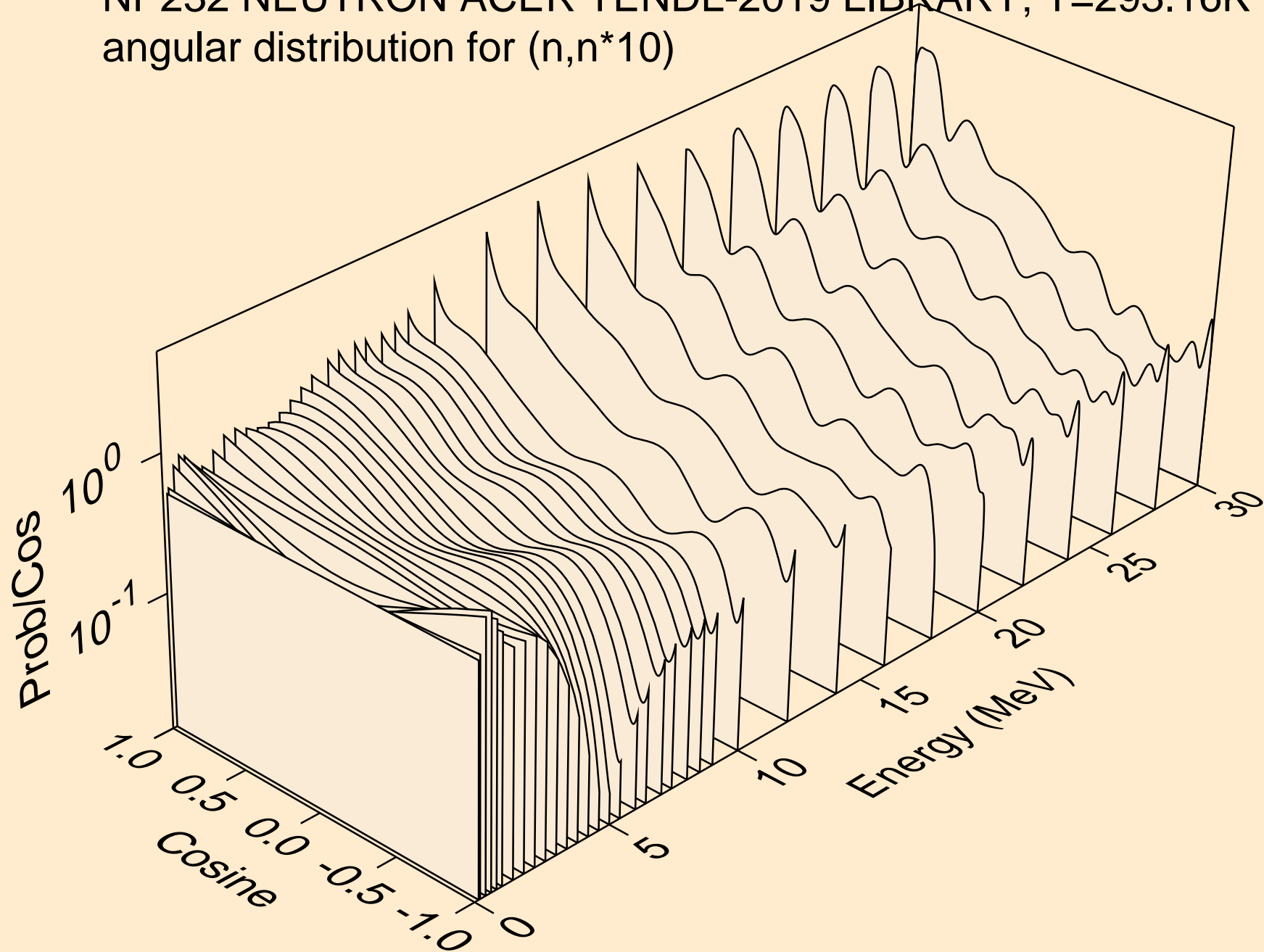

NP232 NEUTRON ACER TENDL-2019 LIBRARY; T=293.16K
angular distribution for (n,n*11)

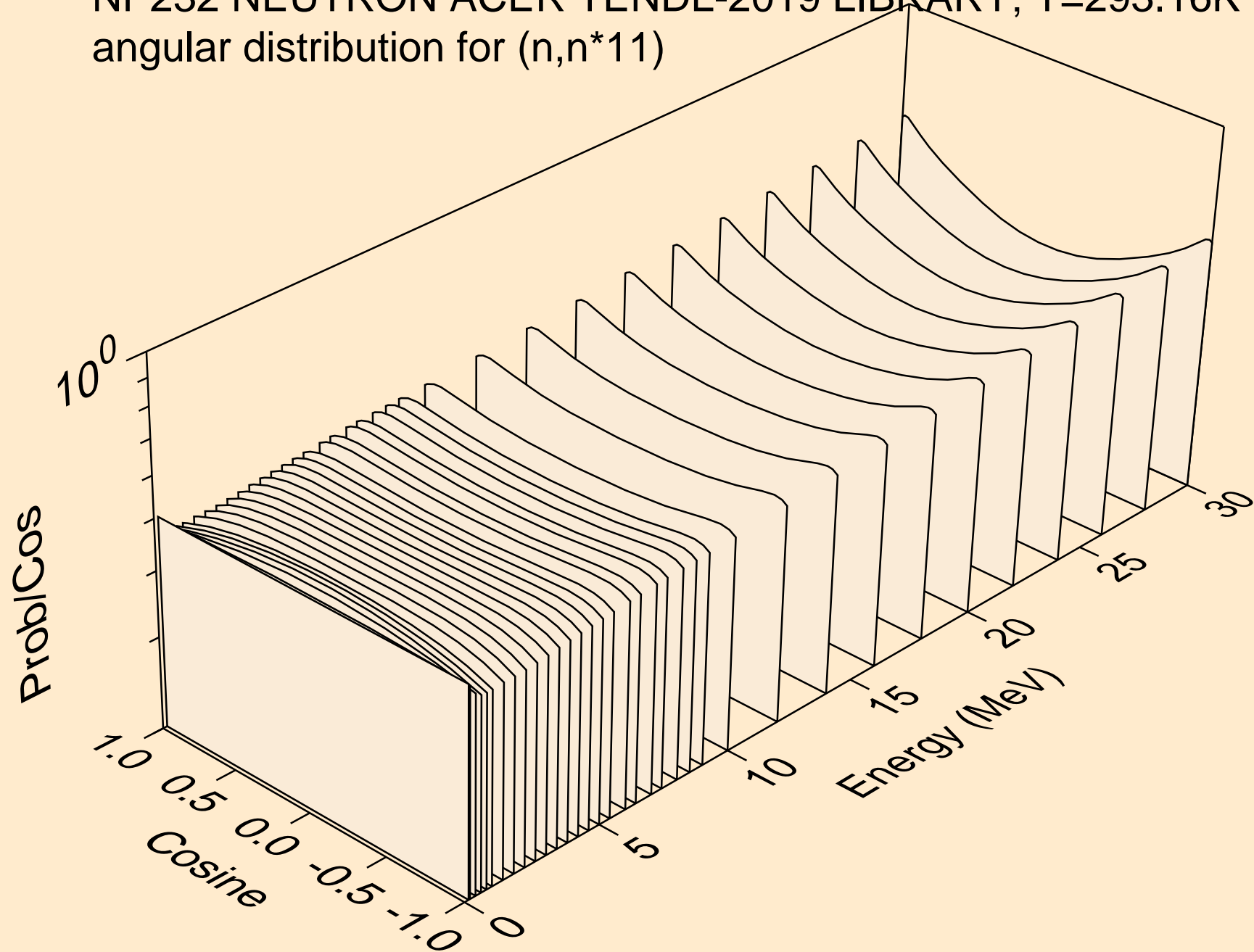

NP232 NEUTRON ACER TENDL-2019 LIBRARY; T=293.16K
angular distribution for (n,n*12)

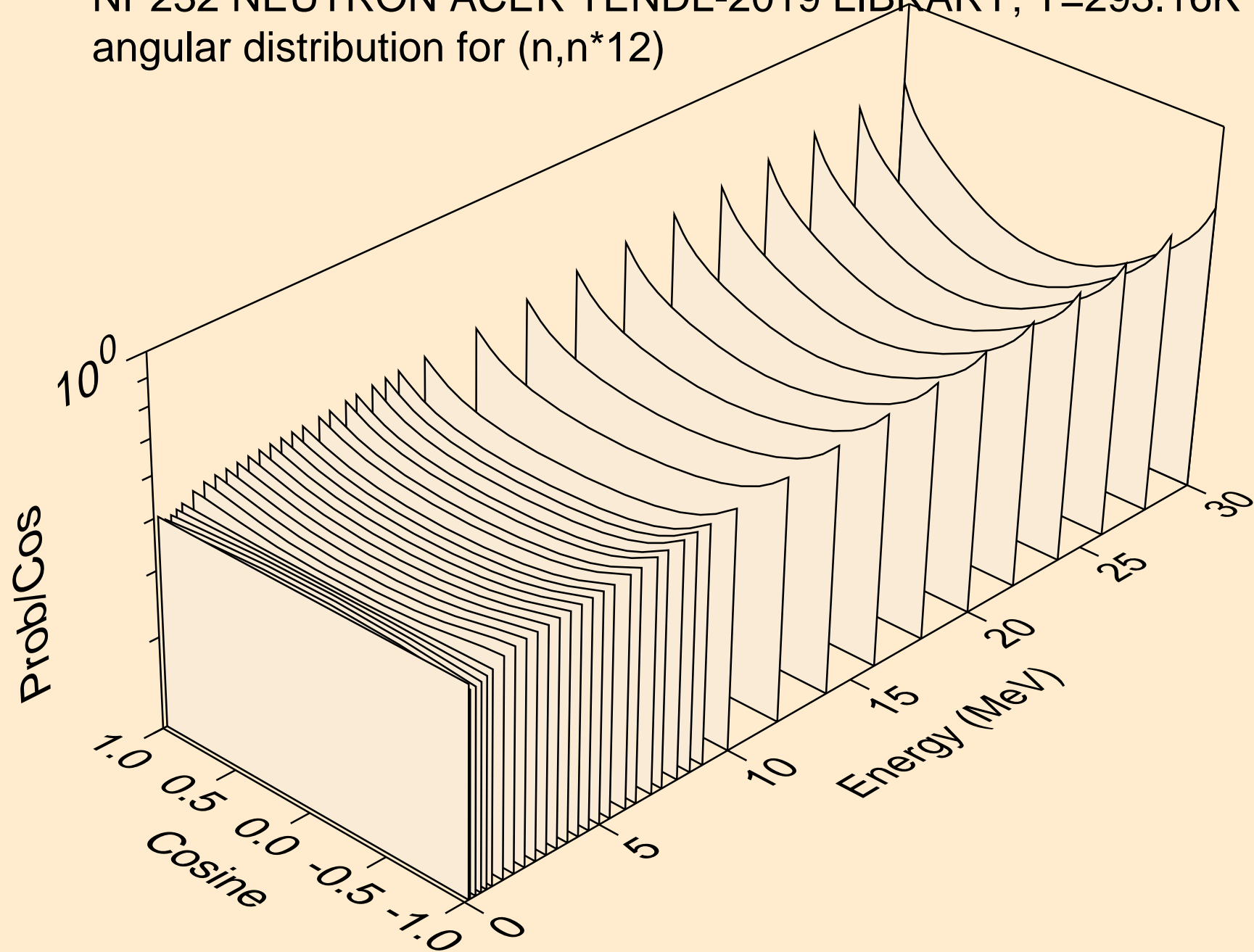

NP232 NEUTRON ACER TENDL-2019 LIBRARY; T=293.16K
angular distribution for (n,n*13)

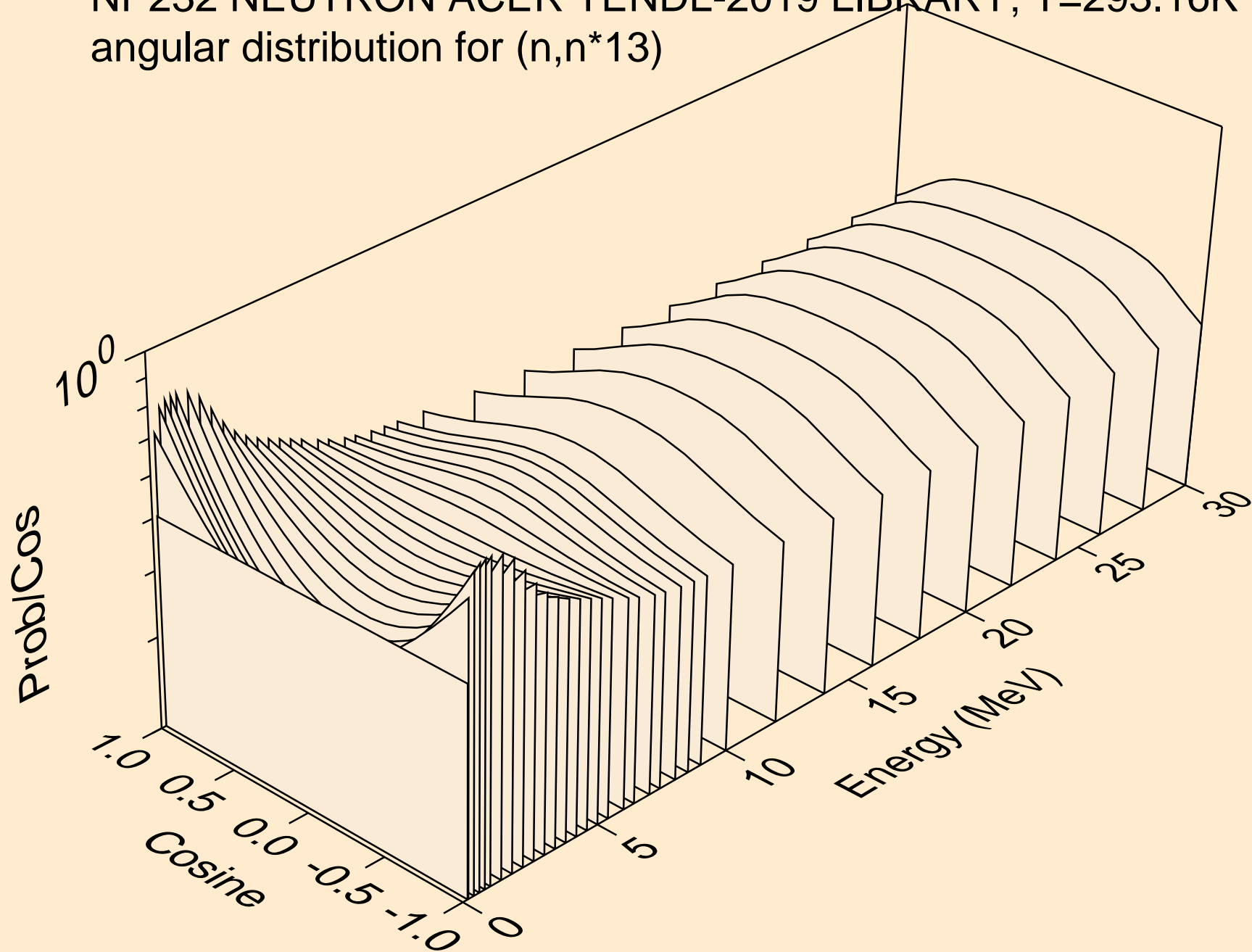

NP232 NEUTRON ACER TENDL-2019 LIBRARY; T=293.16K
angular distribution for (n,n*14)

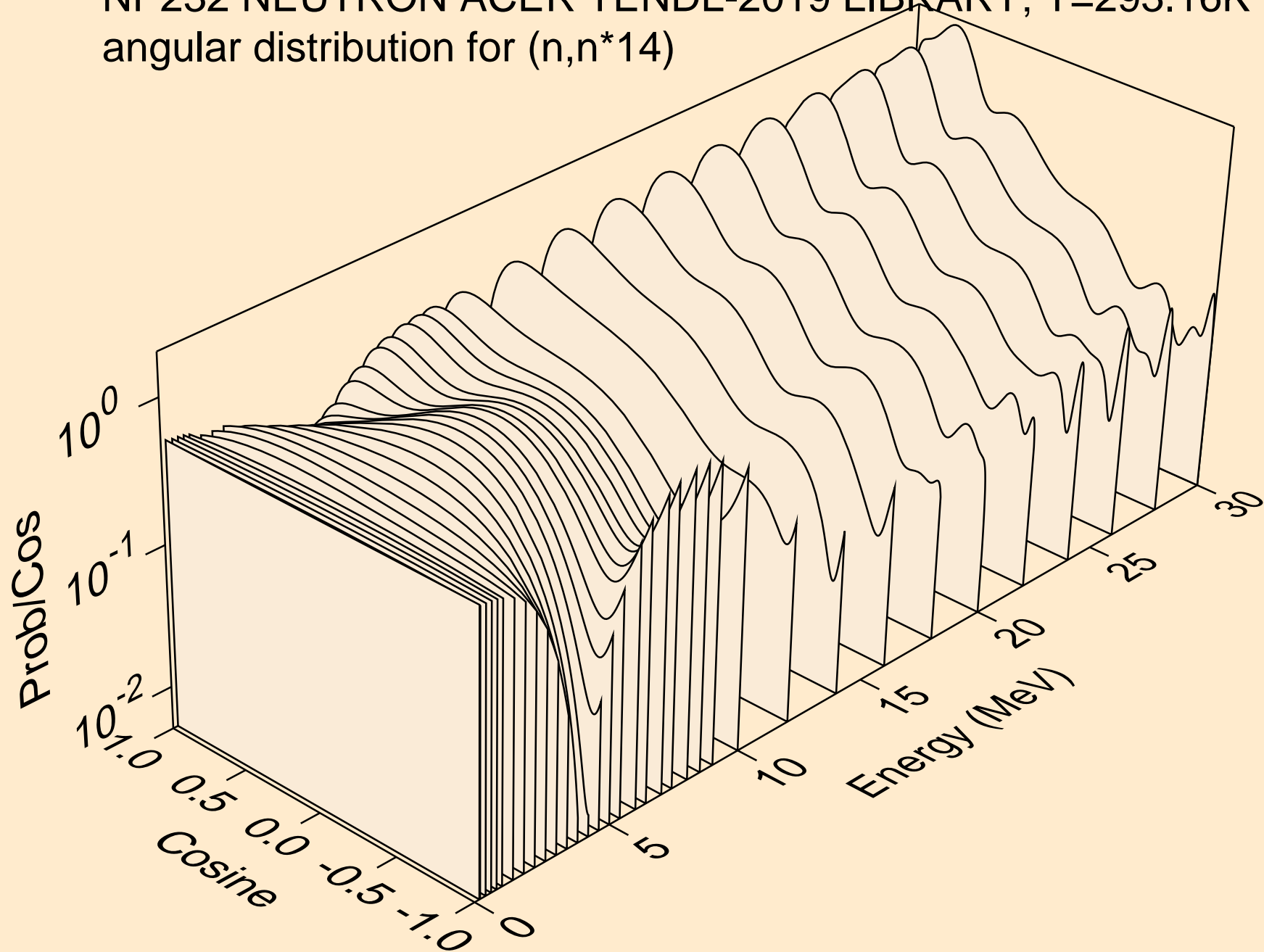

NP232 NEUTRON ACER TENDL-2019 LIBRARY; T=293.16K
angular distribution for (n,n*15)

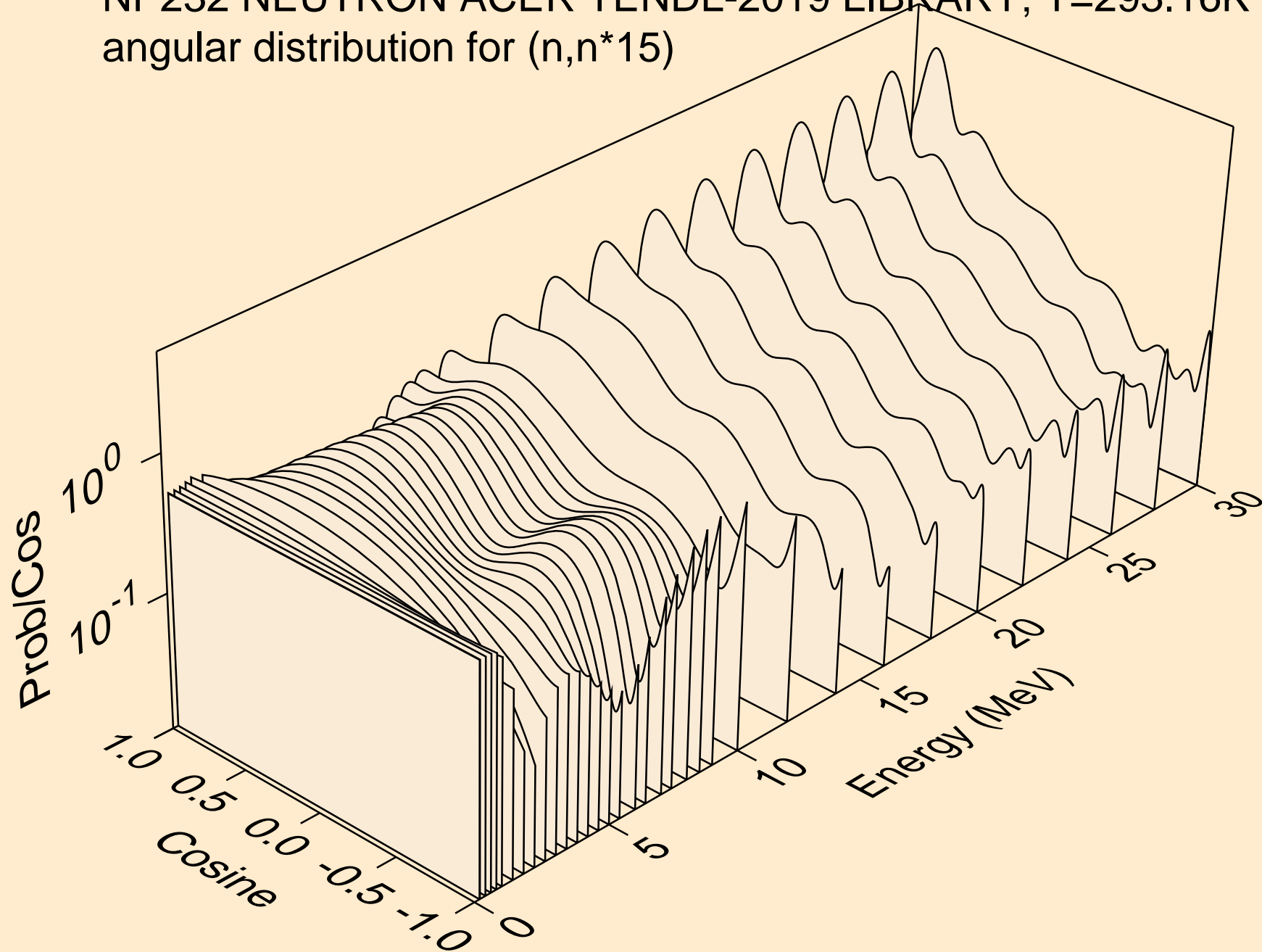

NP232 NEUTRON ACER TENDL-2019 LIBRARY; T=293.16K
angular distribution for (n,n*16)

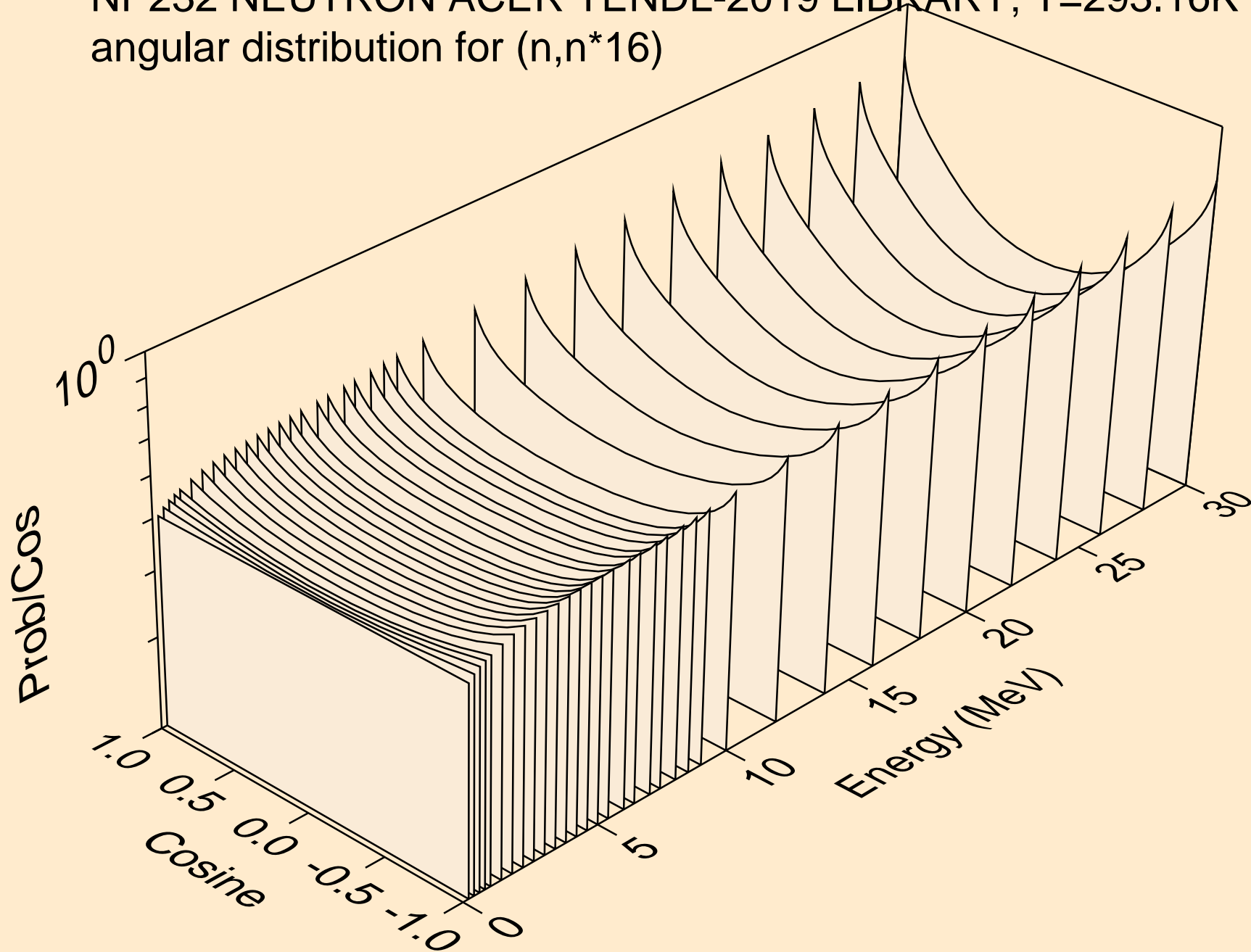

NP232 NEUTRON ACER TENDL-2019 LIBRARY; T=293.16K
angular distribution for (n,n*17)

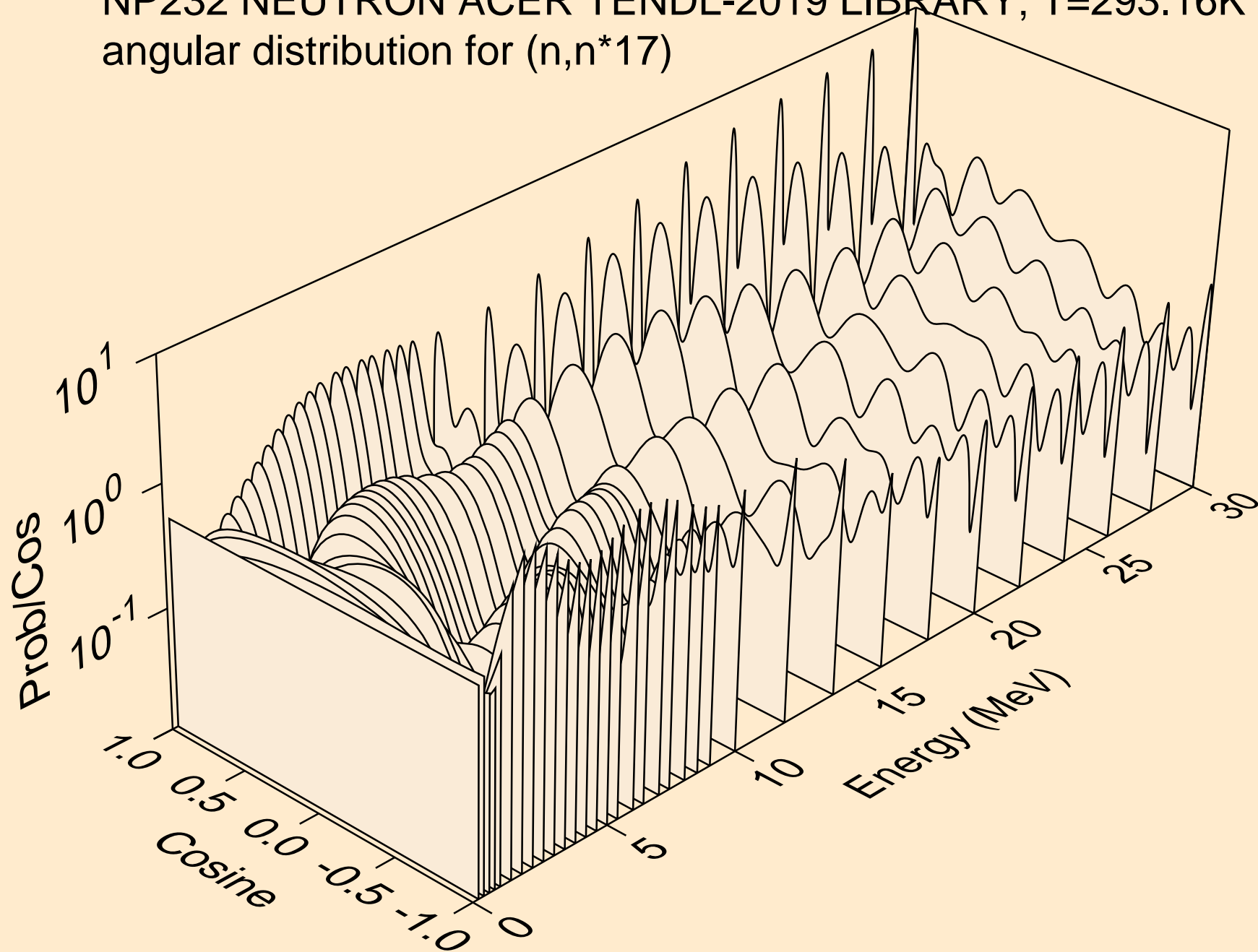

NP232 NEUTRON ACER TENDL-2019 LIBRARY; T=293.16K
angular distribution for (n,n*18)

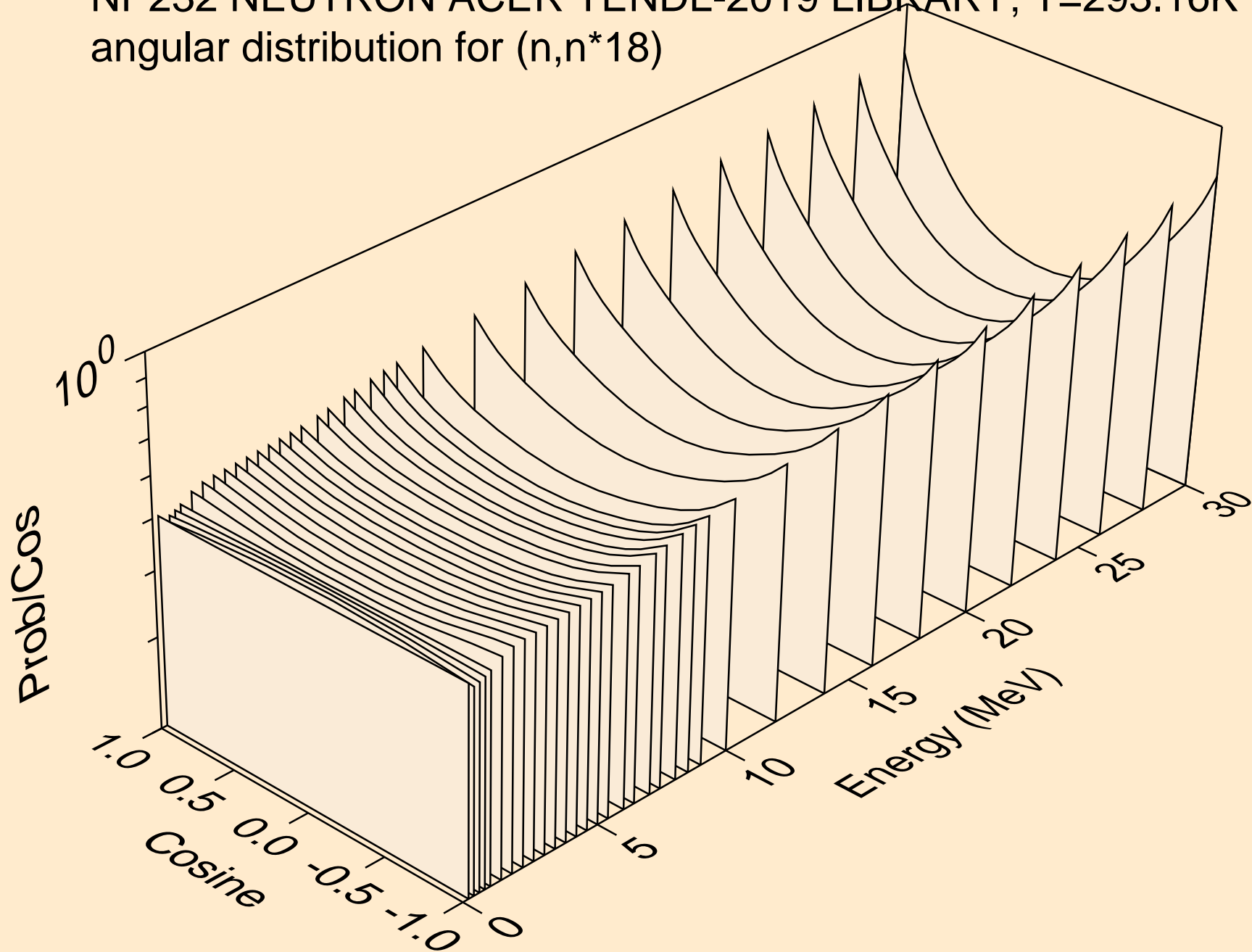

NP232 NEUTRON ACER TENDL-2019 LIBRARY; T=293.16K
angular distribution for (n,n*19)

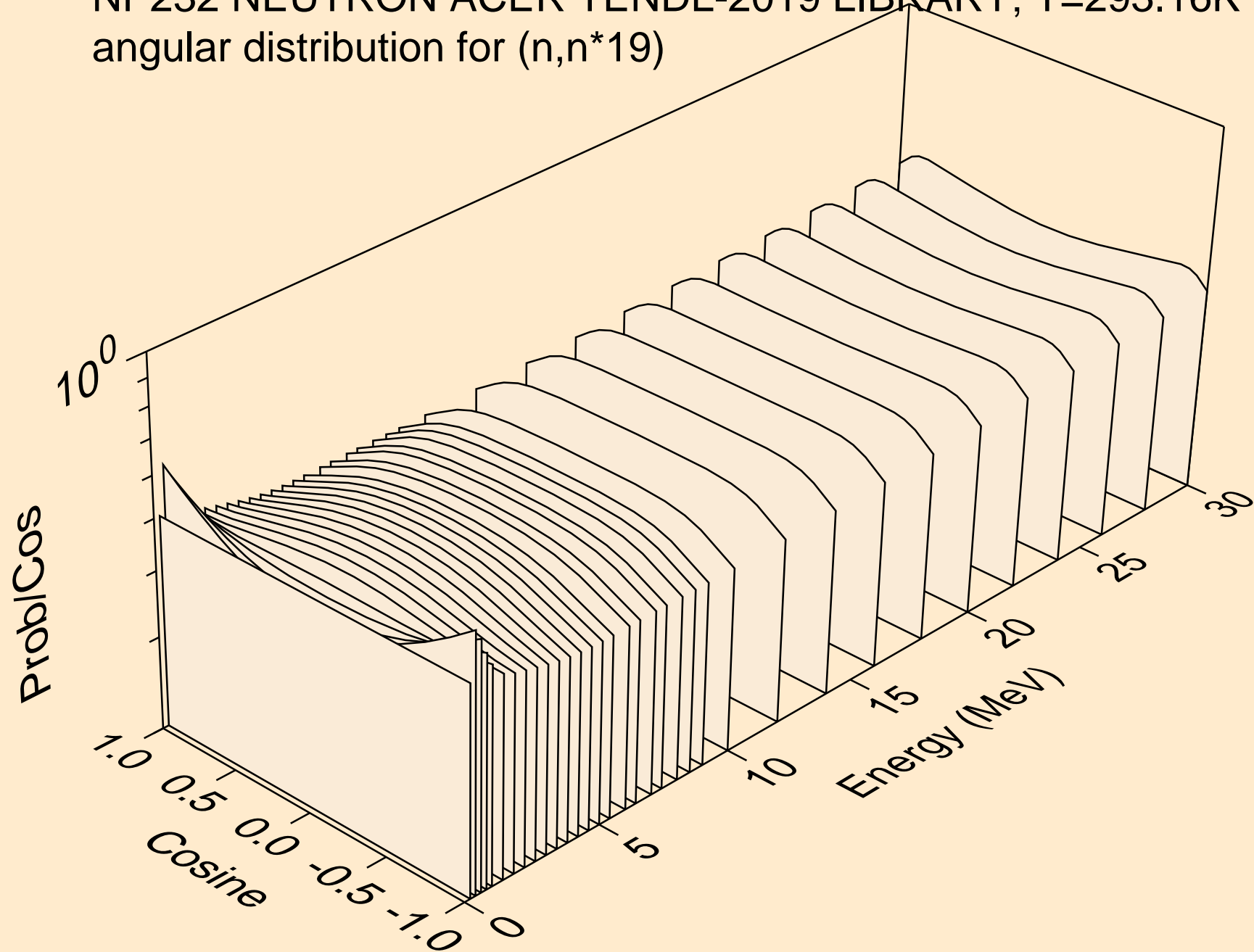

NP232 NEUTRON ACER TENDL-2019 LIBRARY; T=293.16K
angular distribution for (n,n*20)

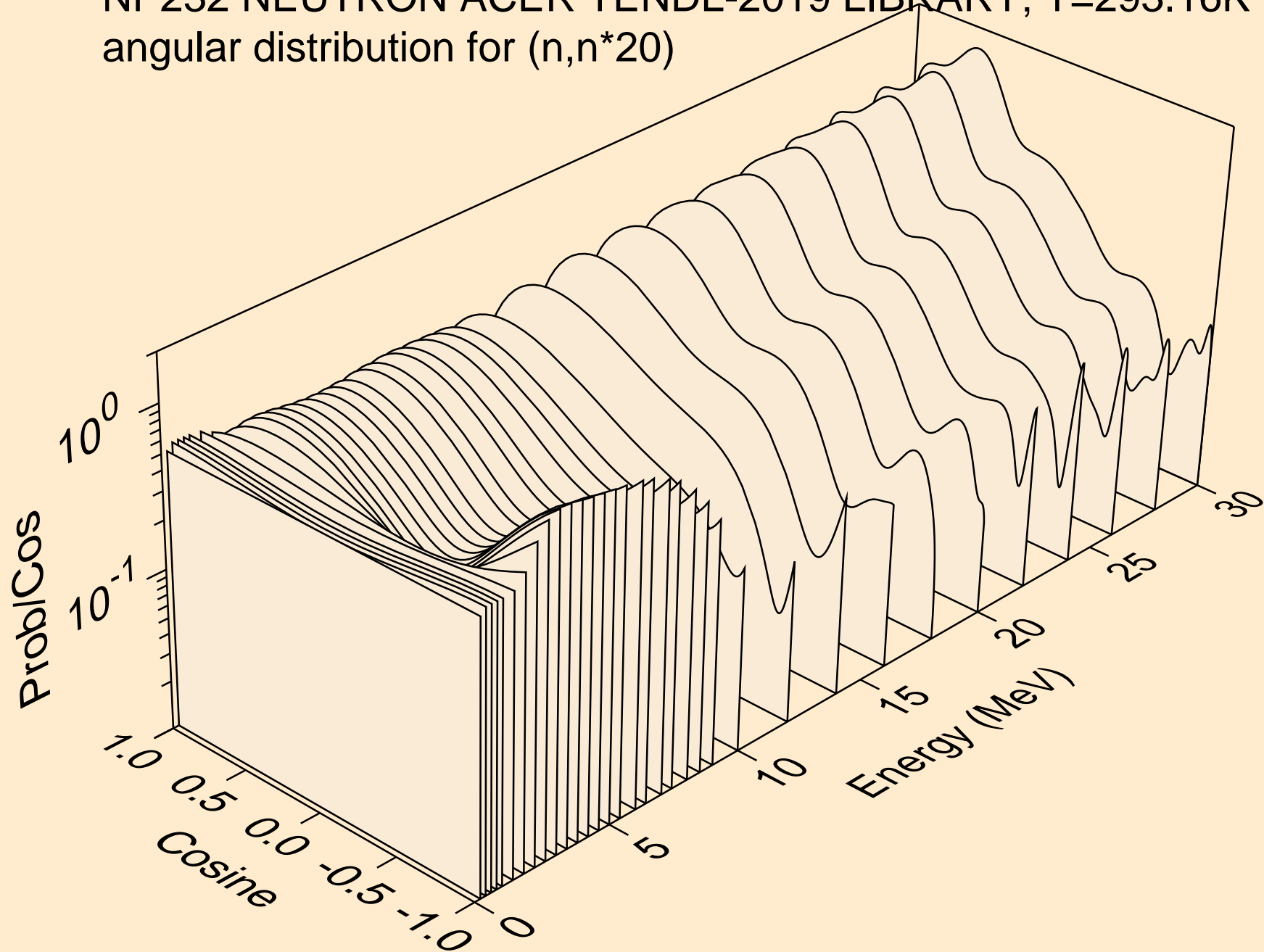

NP232 NEUTRON ACER TENDL-2019 LIBRARY; T=293.16K
angular distribution for (n,n*21)

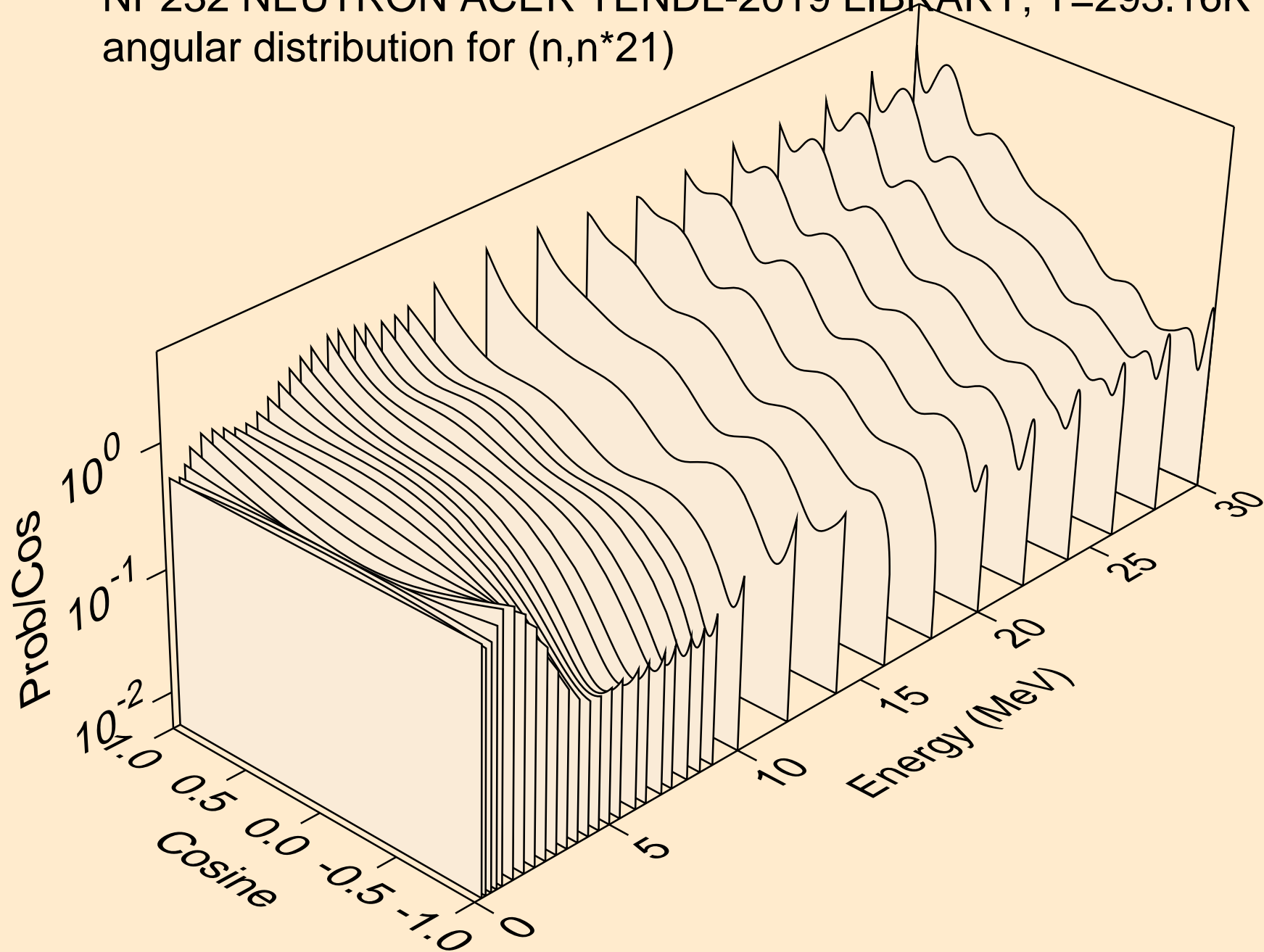

NP232 NEUTRON ACER TENDL-2019 LIBRARY; T=293.16K
angular distribution for (n,n*22)

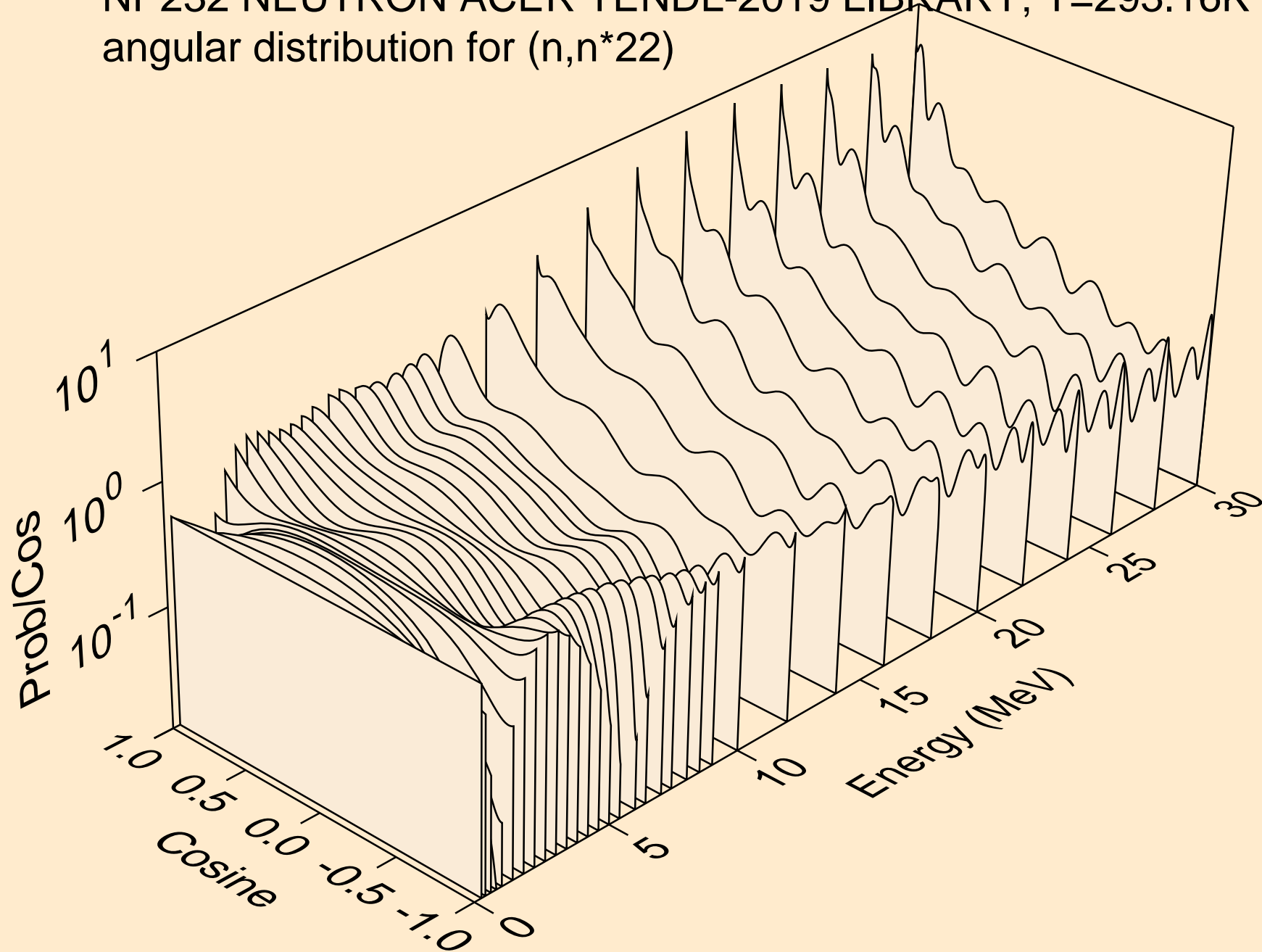

NP232 NEUTRON ACER TENDL-2019 LIBRARY; T=293.16K
Total fission nubar

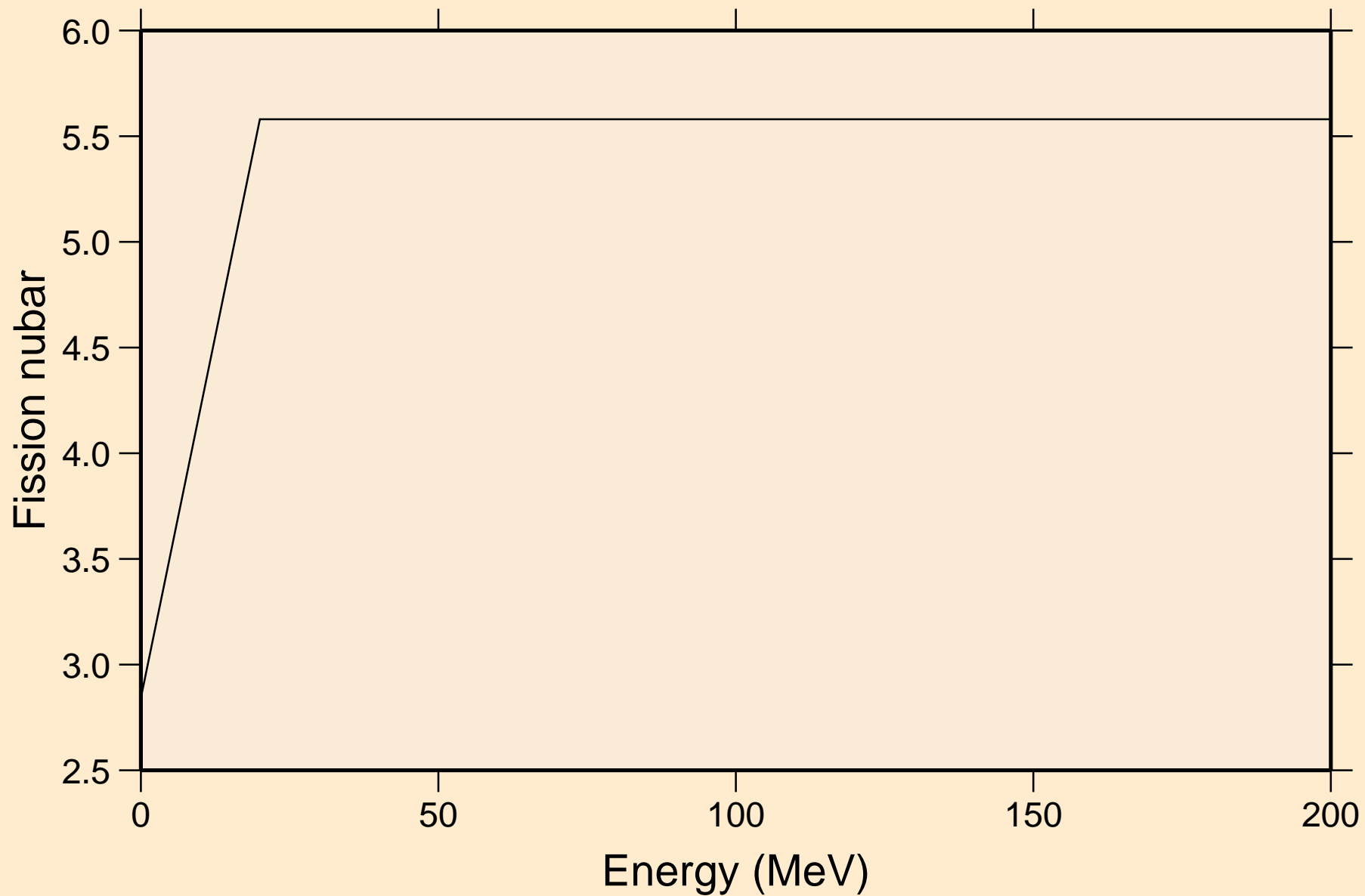

NP232 NEUTRON ACER TENDL-2019 LIBRARY; T=293.16K
Neutron emission for (n,x)

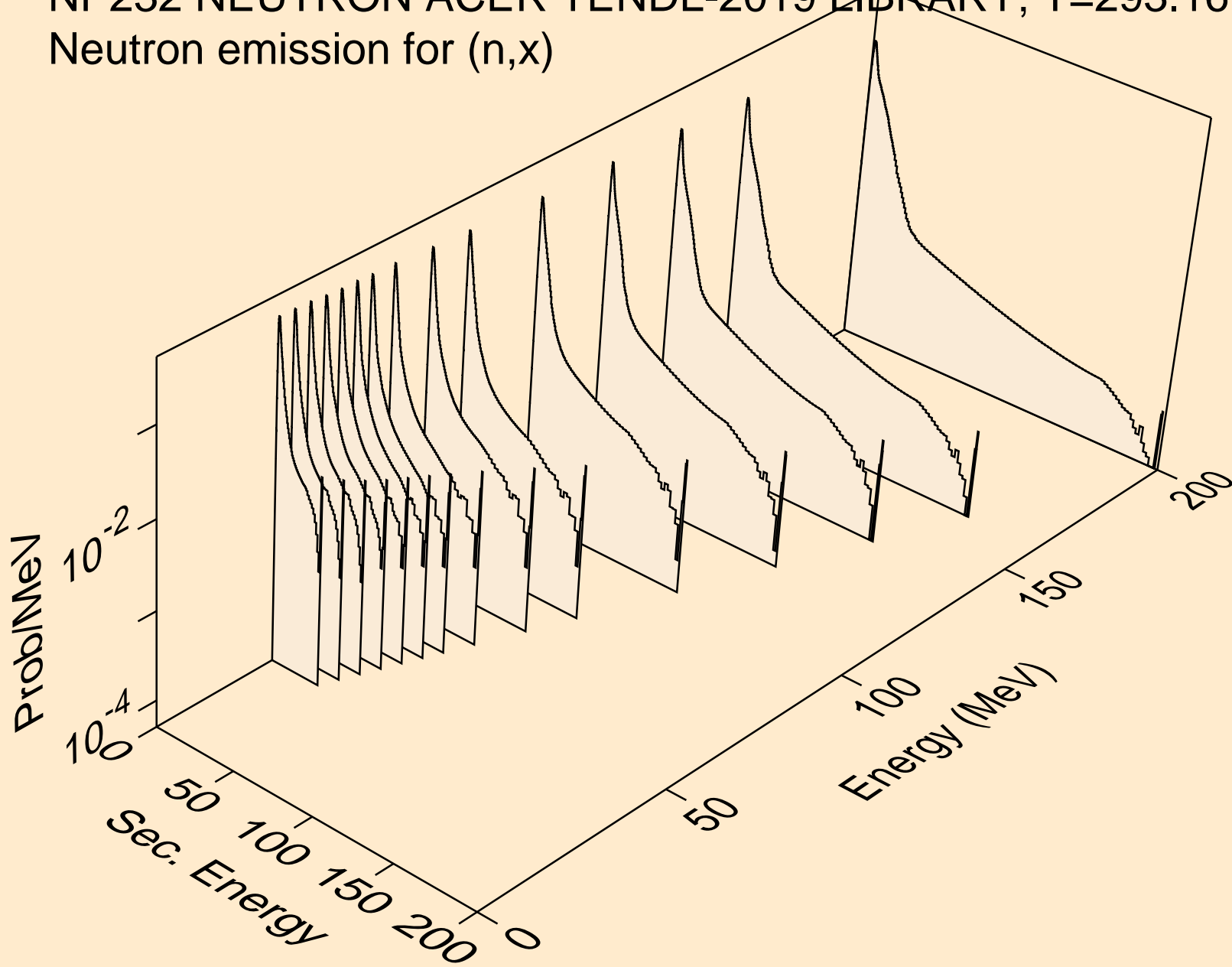

NP232 NEUTRON ACER TENDL-2019 LIBRARY; T=293.16K
Neutron emission for (n,2nd)

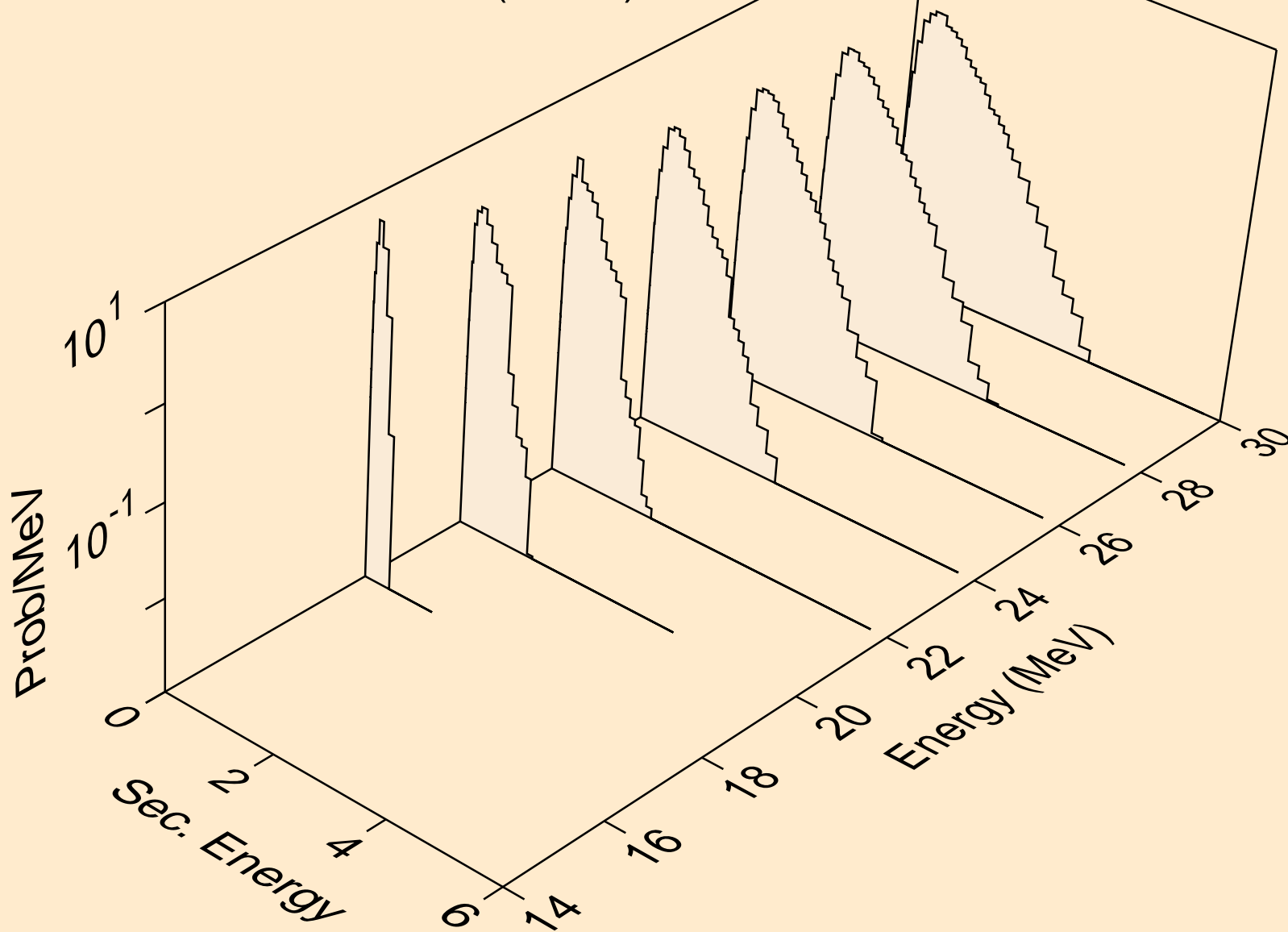

NP232 NEUTRON ACER TENDL-2019 LIBRARY; T=293.16K
Neutron emission for (n,2n)

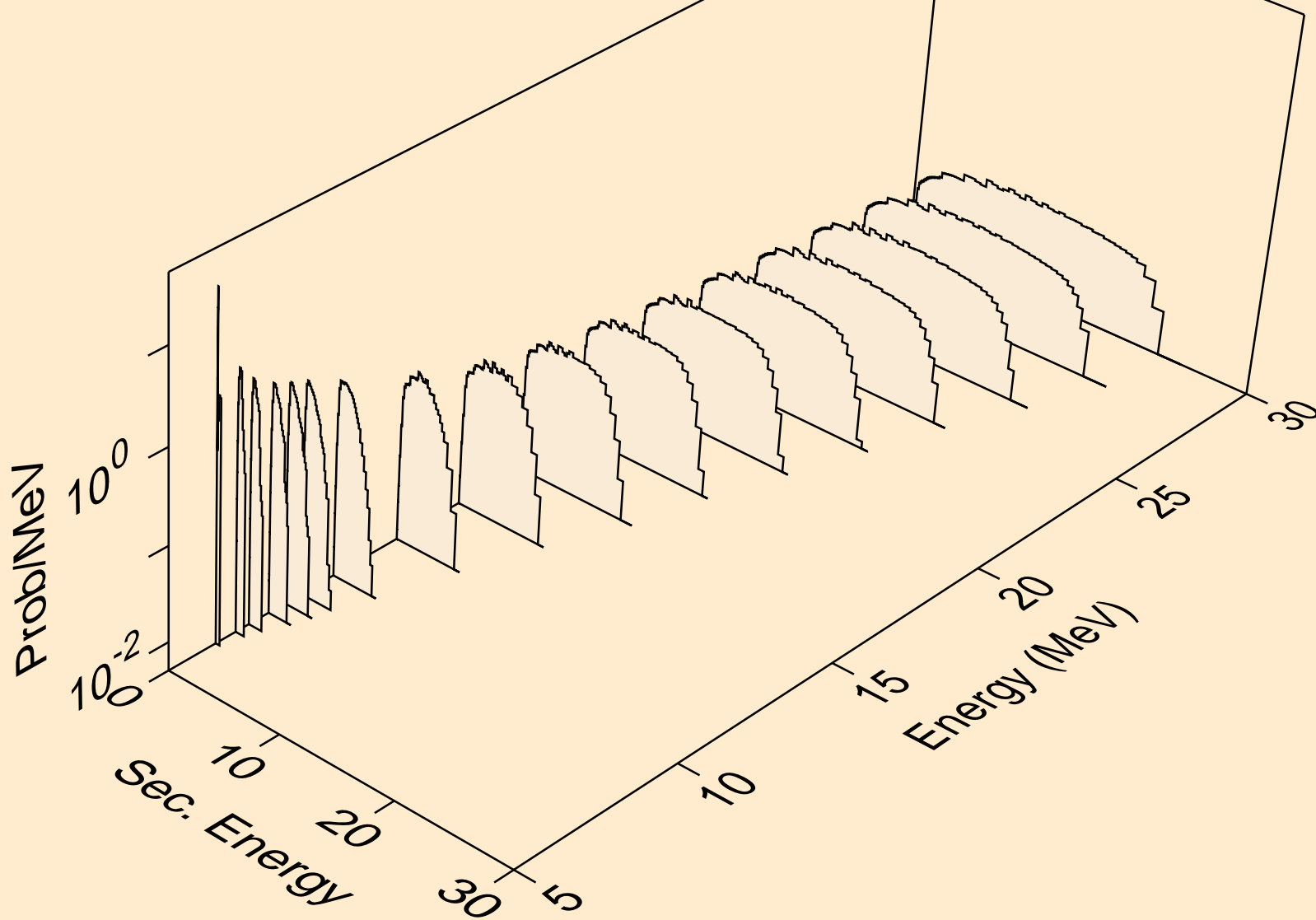

NP232 NEUTRON ACER TENDL-2019 LIBRARY; T=293.16K
Neutron emission for (n,3n)

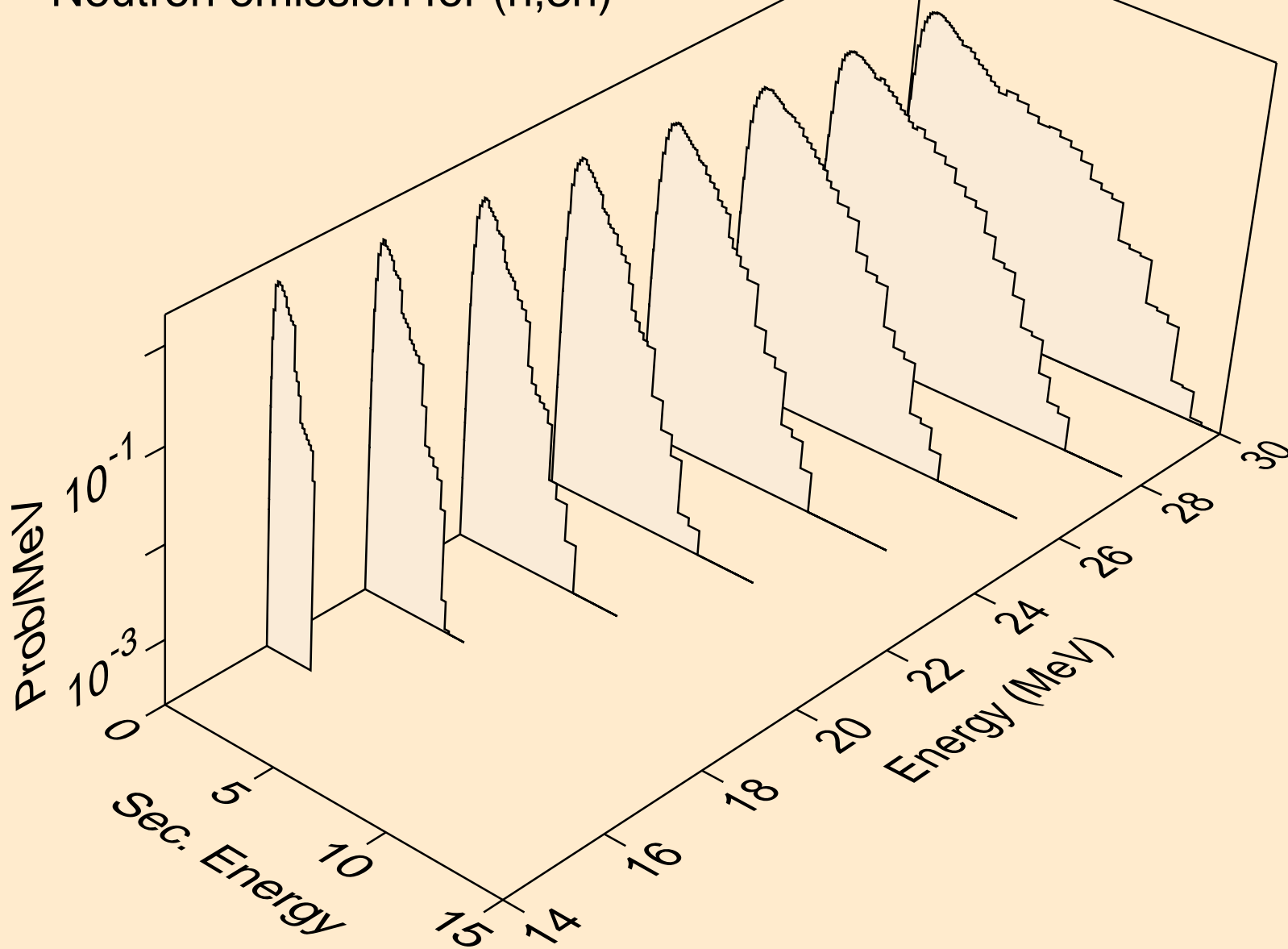

NP232 NEUTRON ACER TENDL-2019 LIBRARY; T=293.16K
Neutron emission for fission

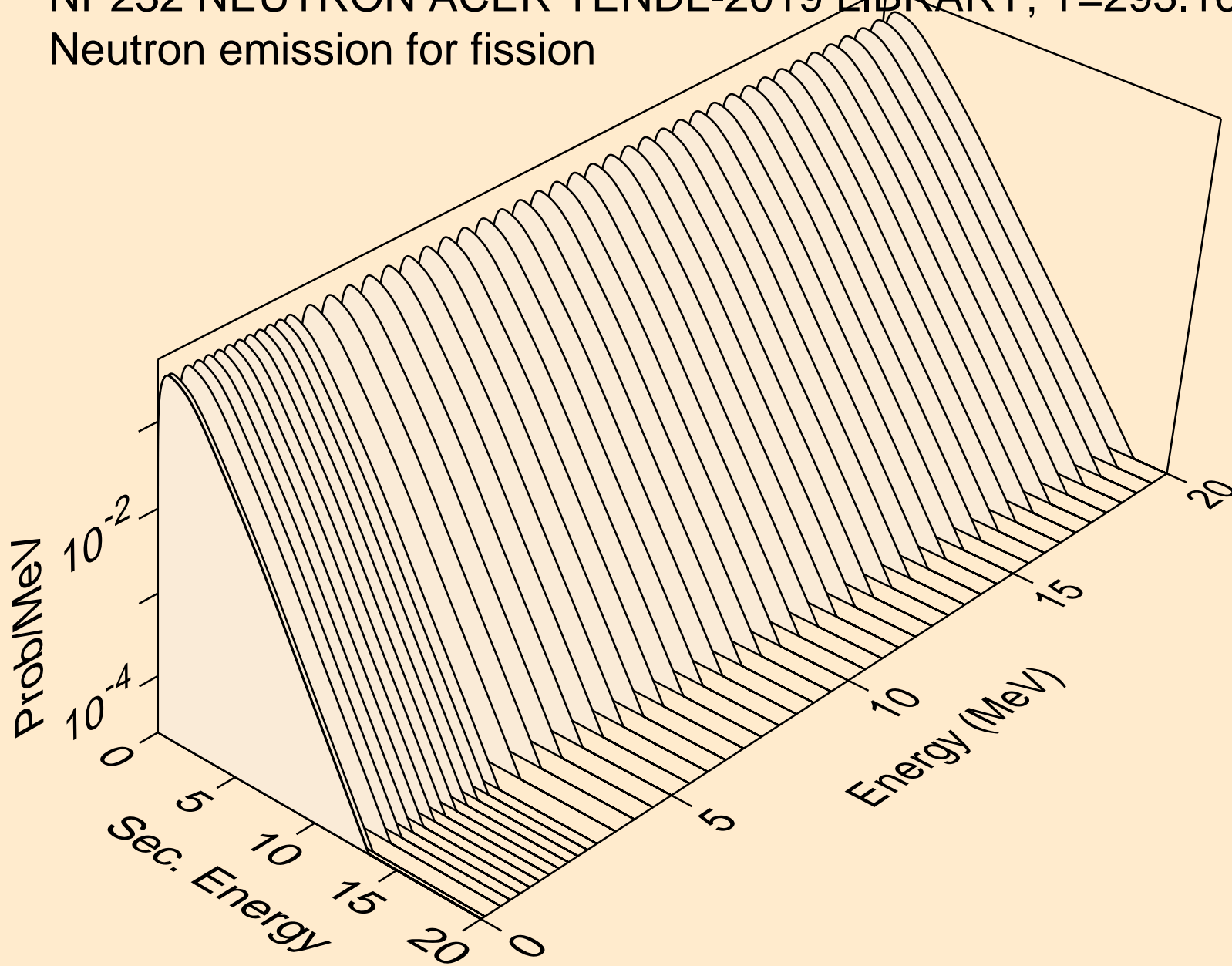

NP232 NEUTRON ACER TENDL-2019 LIBRARY; T=293.16K
Neutron emission for (n,n*)a

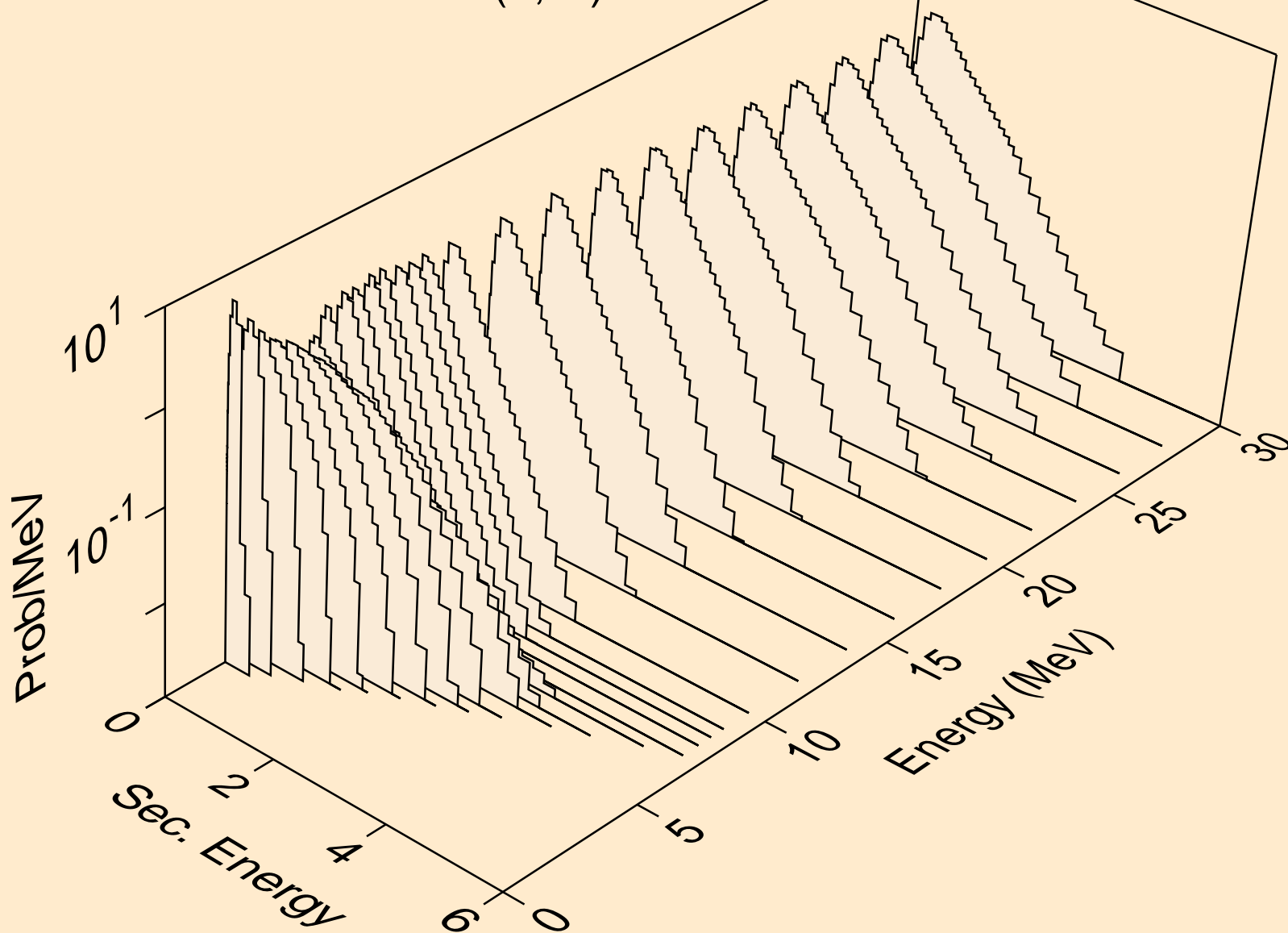

NP232 NEUTRON ACER TENDL-2019 LIBRARY; T=293.16K
Neutron emission for (n,2n)a

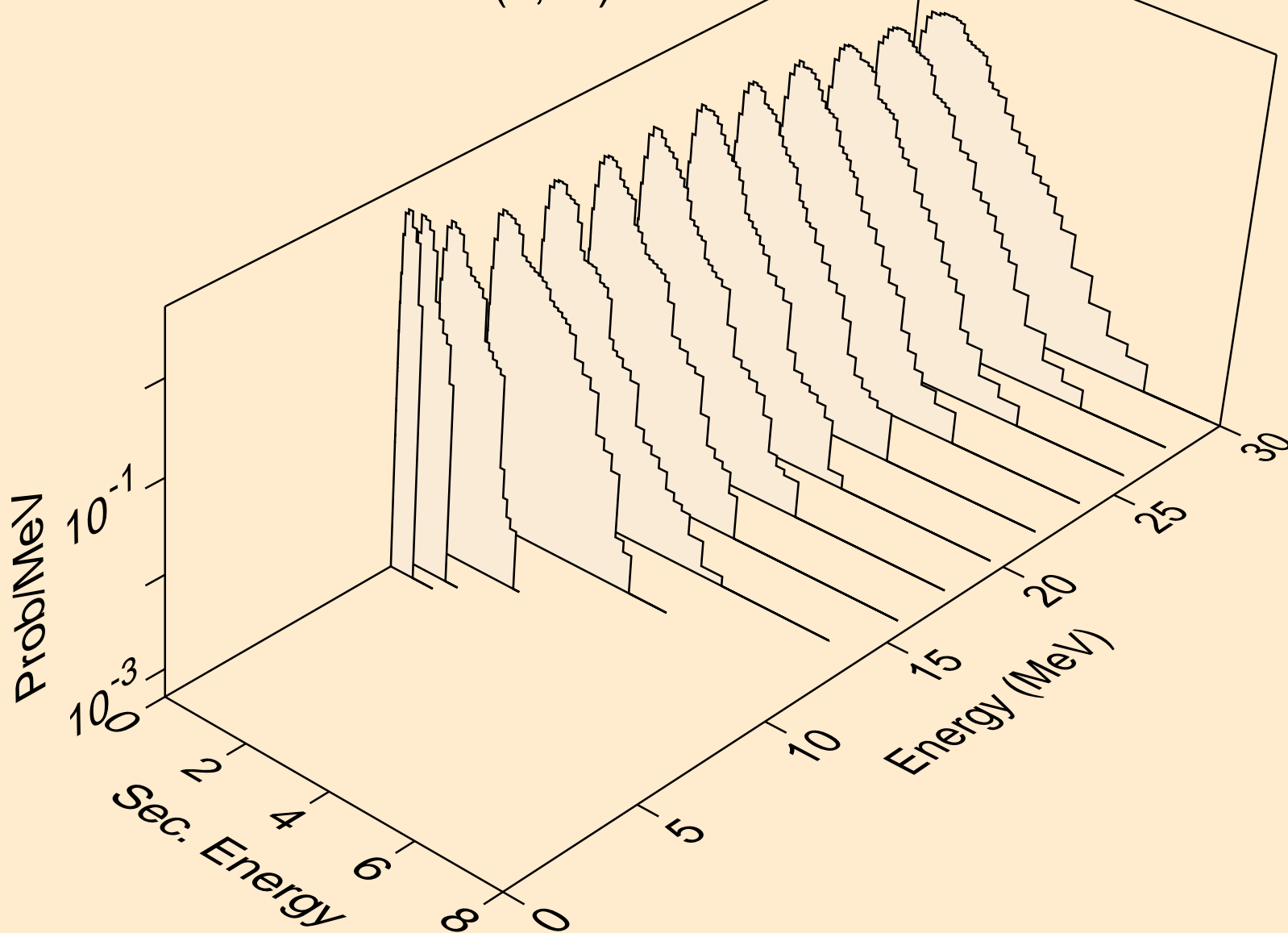

NP232 NEUTRON ACER TENDL-2019 LIBRARY; T=293.16K
Neutron emission for (n,3n)a

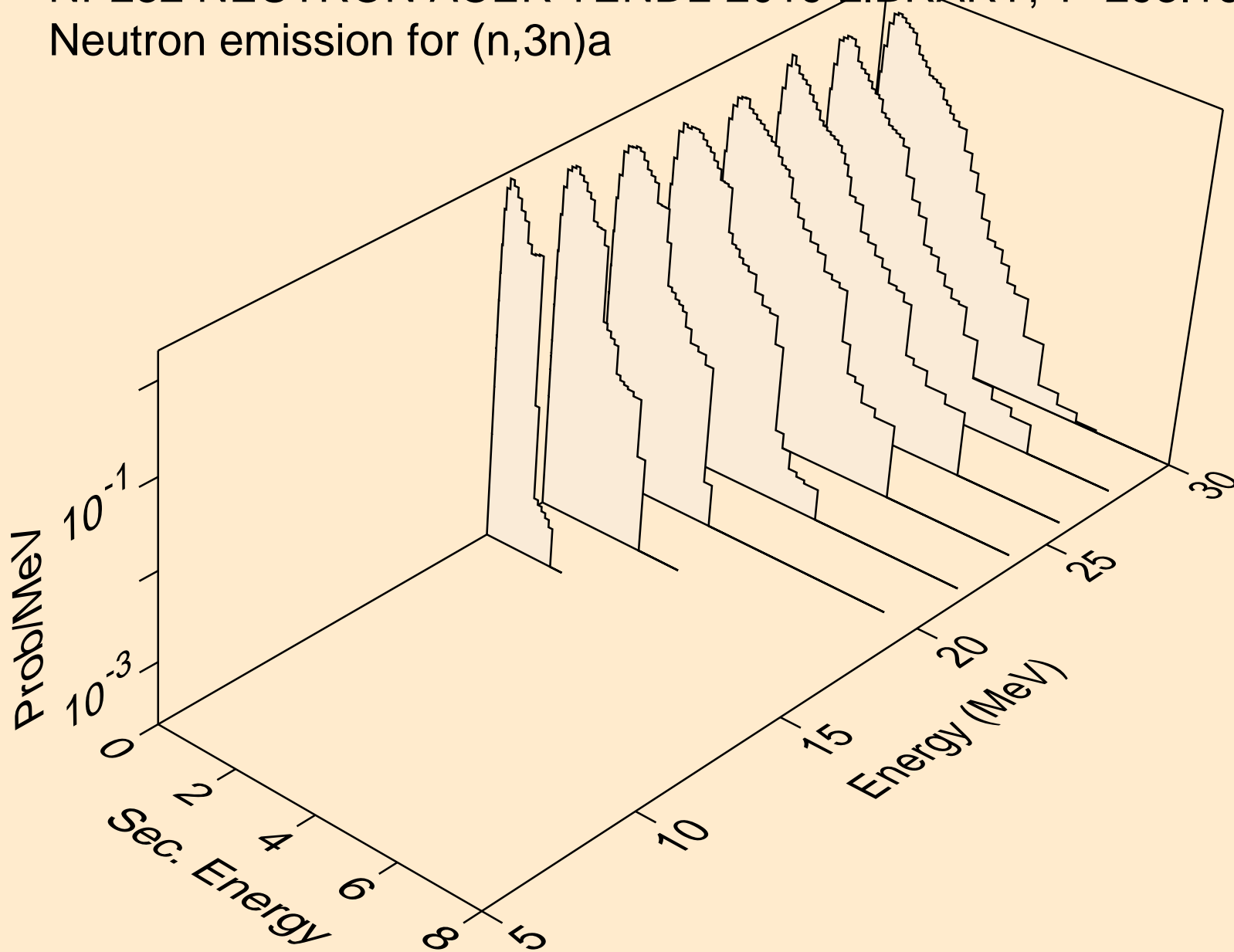

NP232 NEUTRON ACER TENDL-2019 LIBRARY; T=293.16K
Neutron emission for (n,n*)p

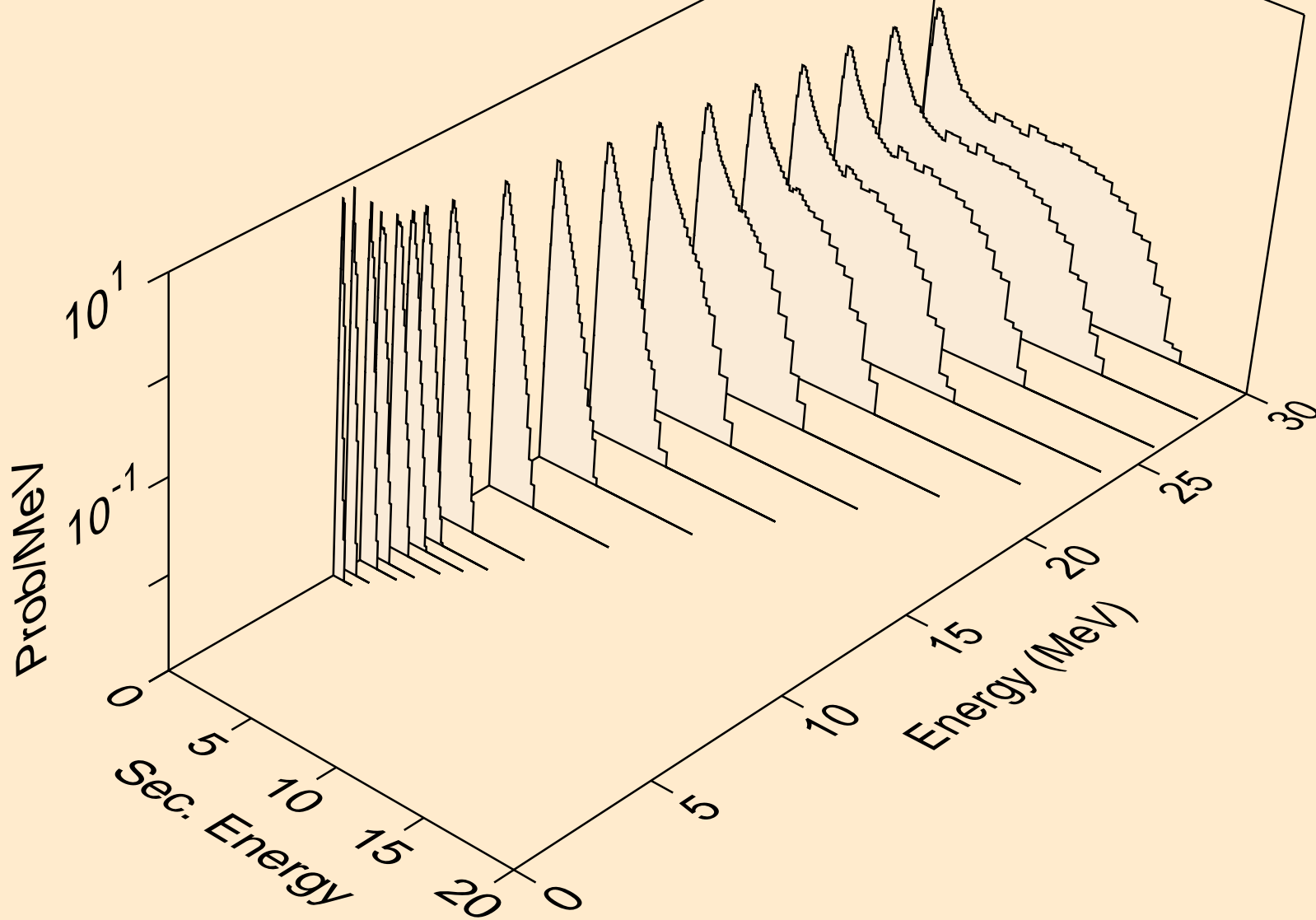

NP232 NEUTRON ACER TENDL-2019 LIBRARY; T=293.16K
Neutron emission for (n,n*)2a

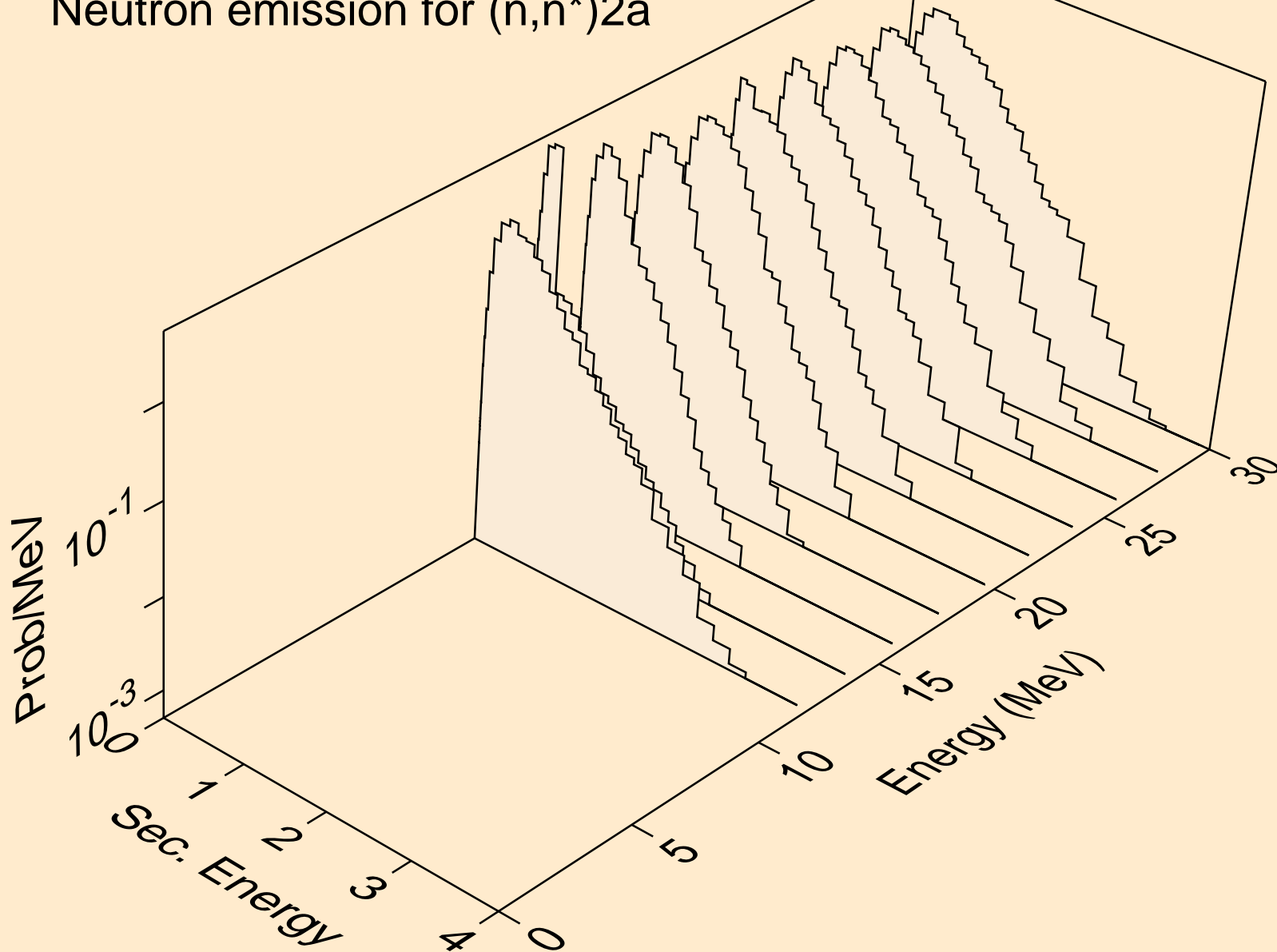

NP232 NEUTRON ACER TENDL-2019 LIBRARY; T=293.16K
Neutron emission for (n,2n)2a

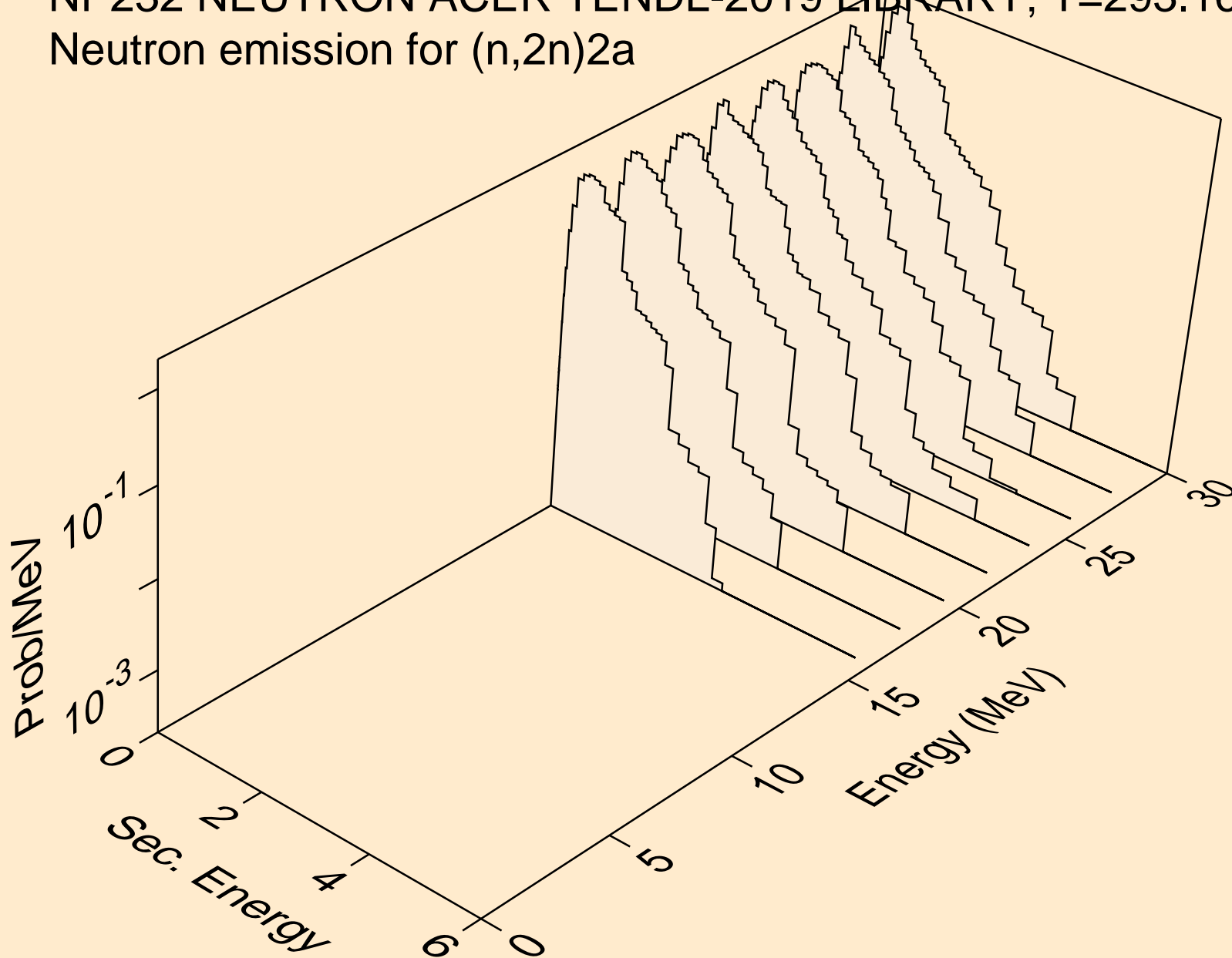

NP232 NEUTRON ACER TENDL-2019 LIBRARY; T=293.16K
Neutron emission for (n,n*)d

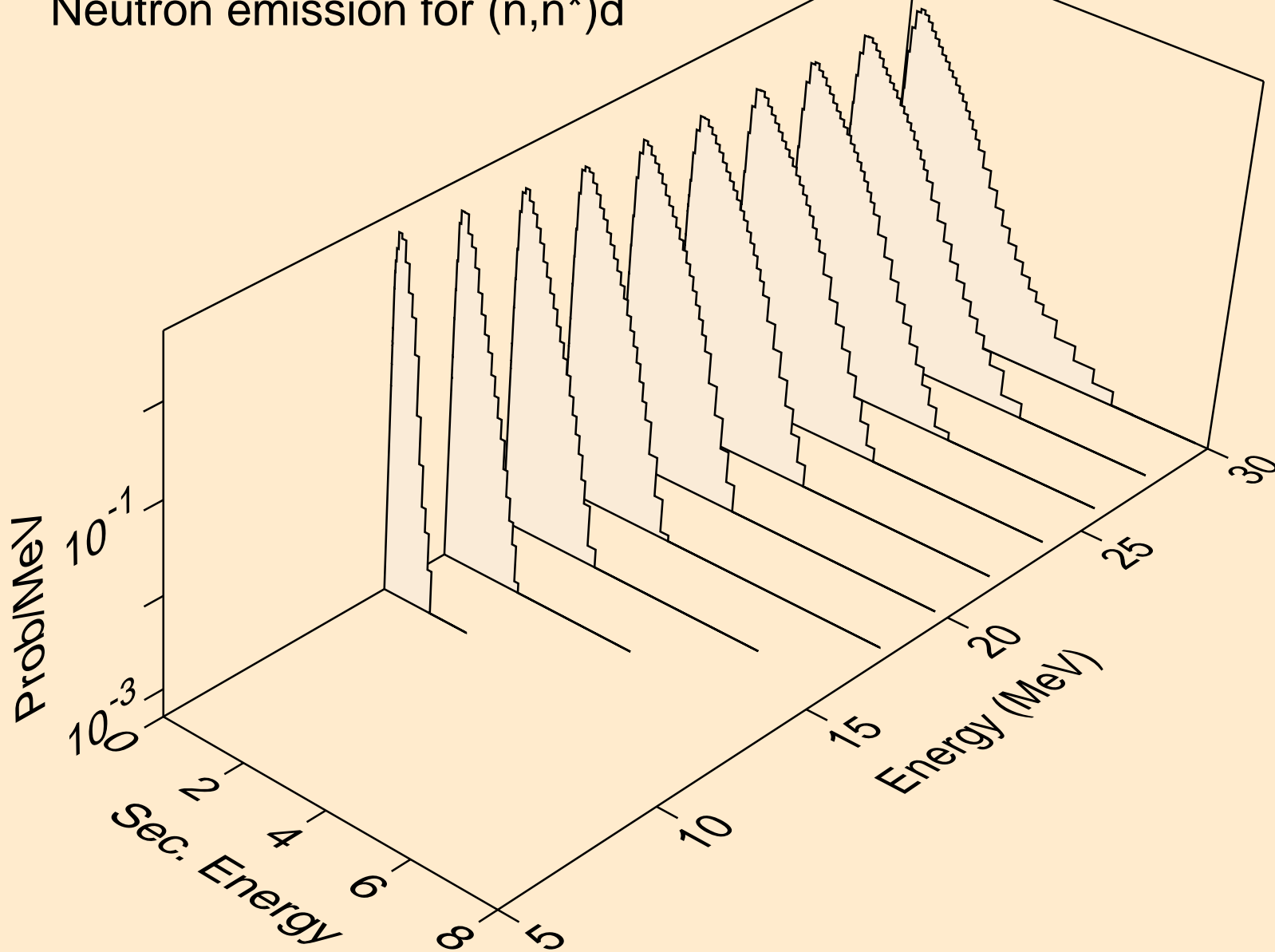

NP232 NEUTRON ACER TENDL-2019 LIBRARY; T=293.16K
Neutron emission for (n,n*)t

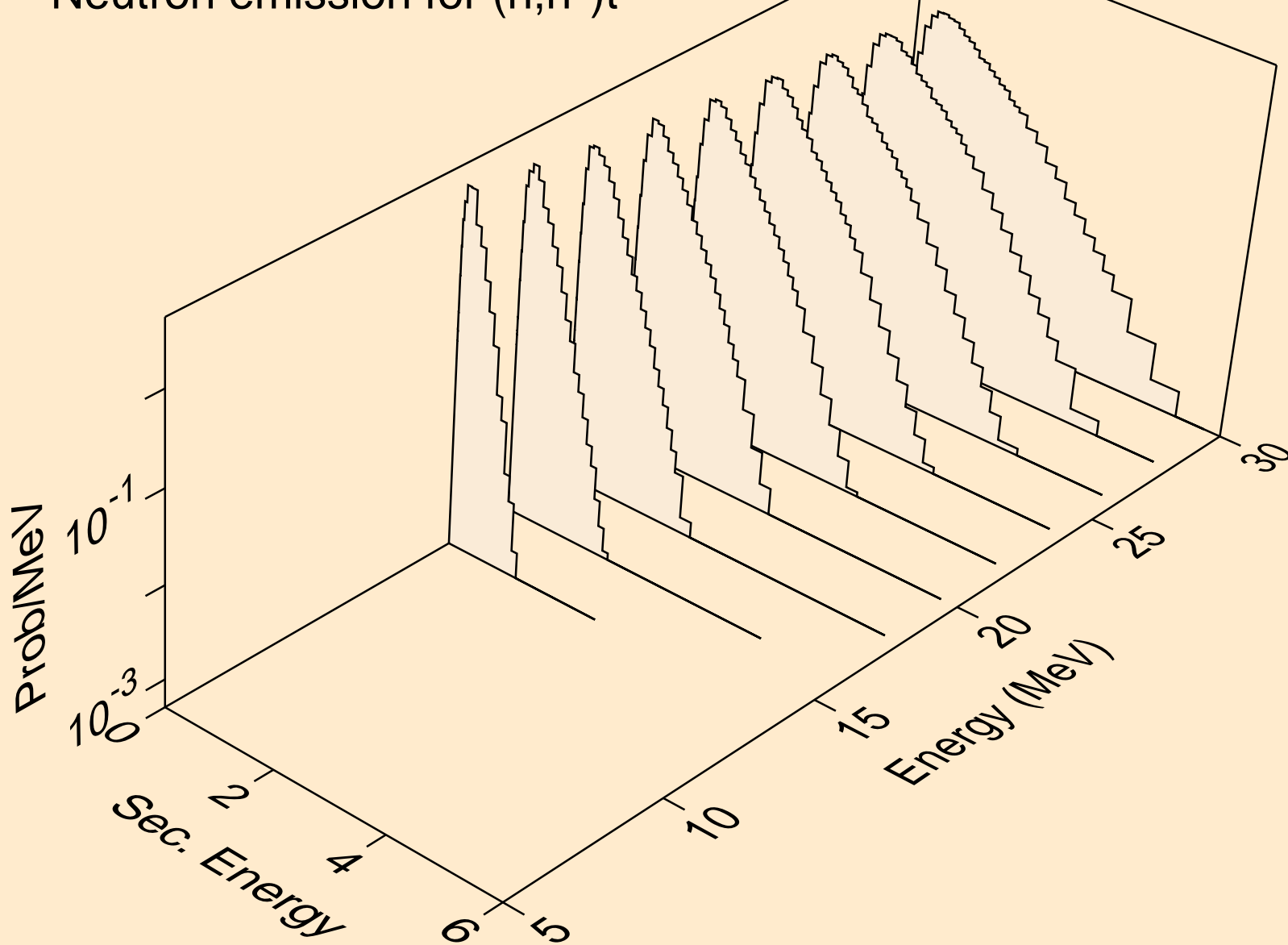

NP232 NEUTRON ACER TENDL-2019 LIBRARY; T=293.16K
Neutron emission for (n,n*)he3

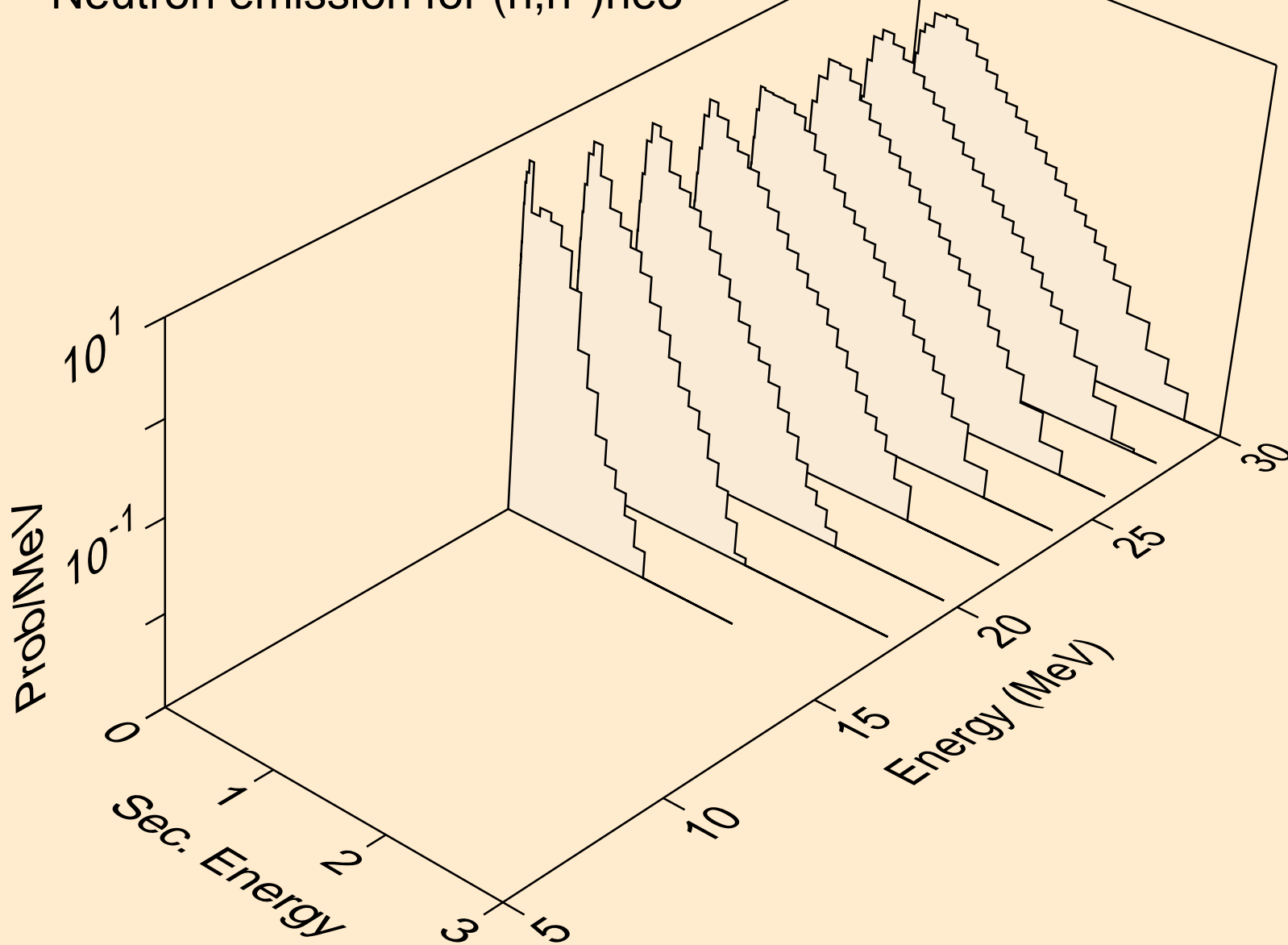

NP232 NEUTRON ACER TENDL-2019 LIBRARY; T=293.16K
Neutron emission for (n,4n)

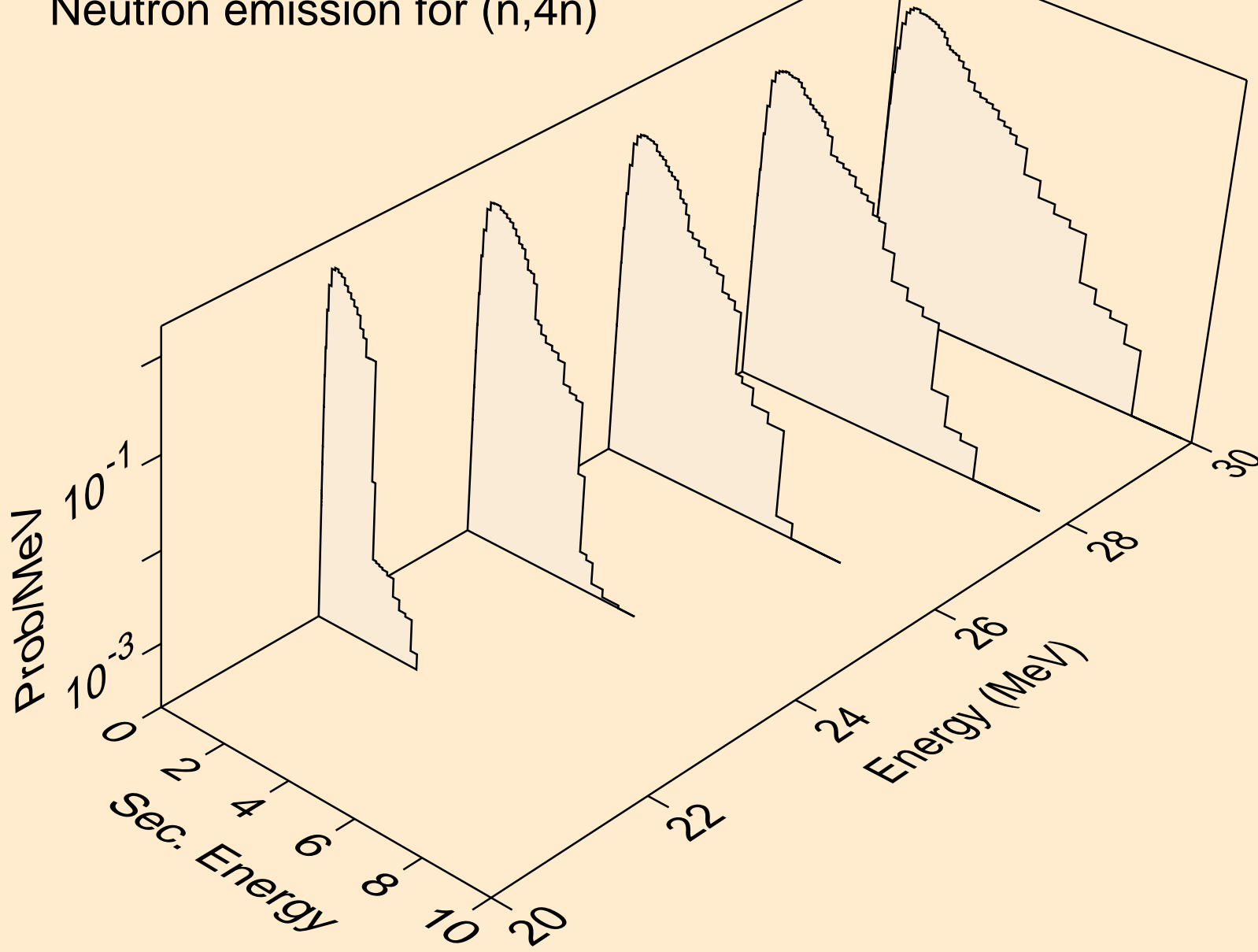

NP232 NEUTRON ACER TENDL-2019 LIBRARY; T=293.16K
Neutron emission for (n,2np)

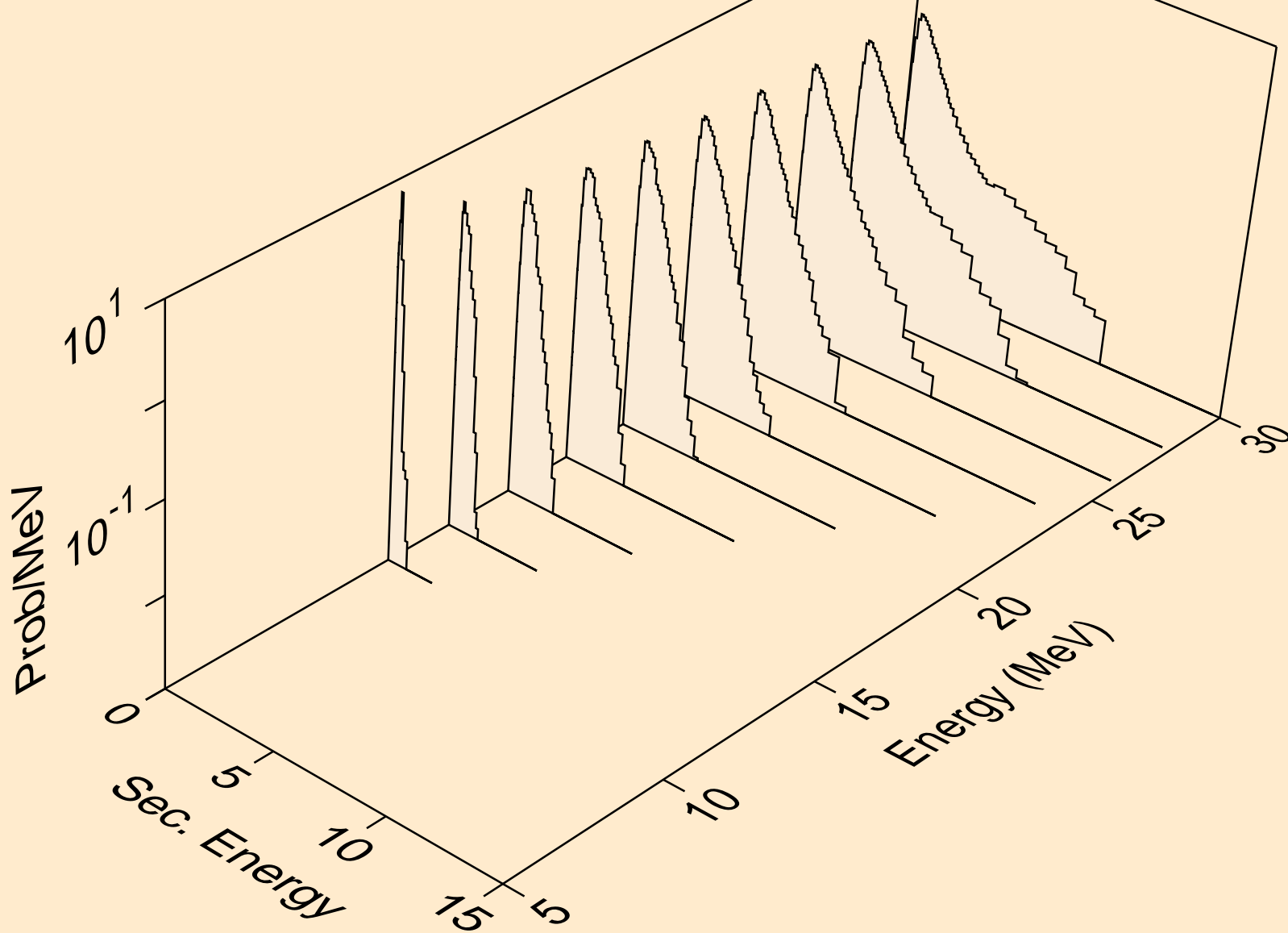

NP232 NEUTRON ACER TENDL-2019 LIBRARY; T=293.16K
Neutron emission for (n,3np)

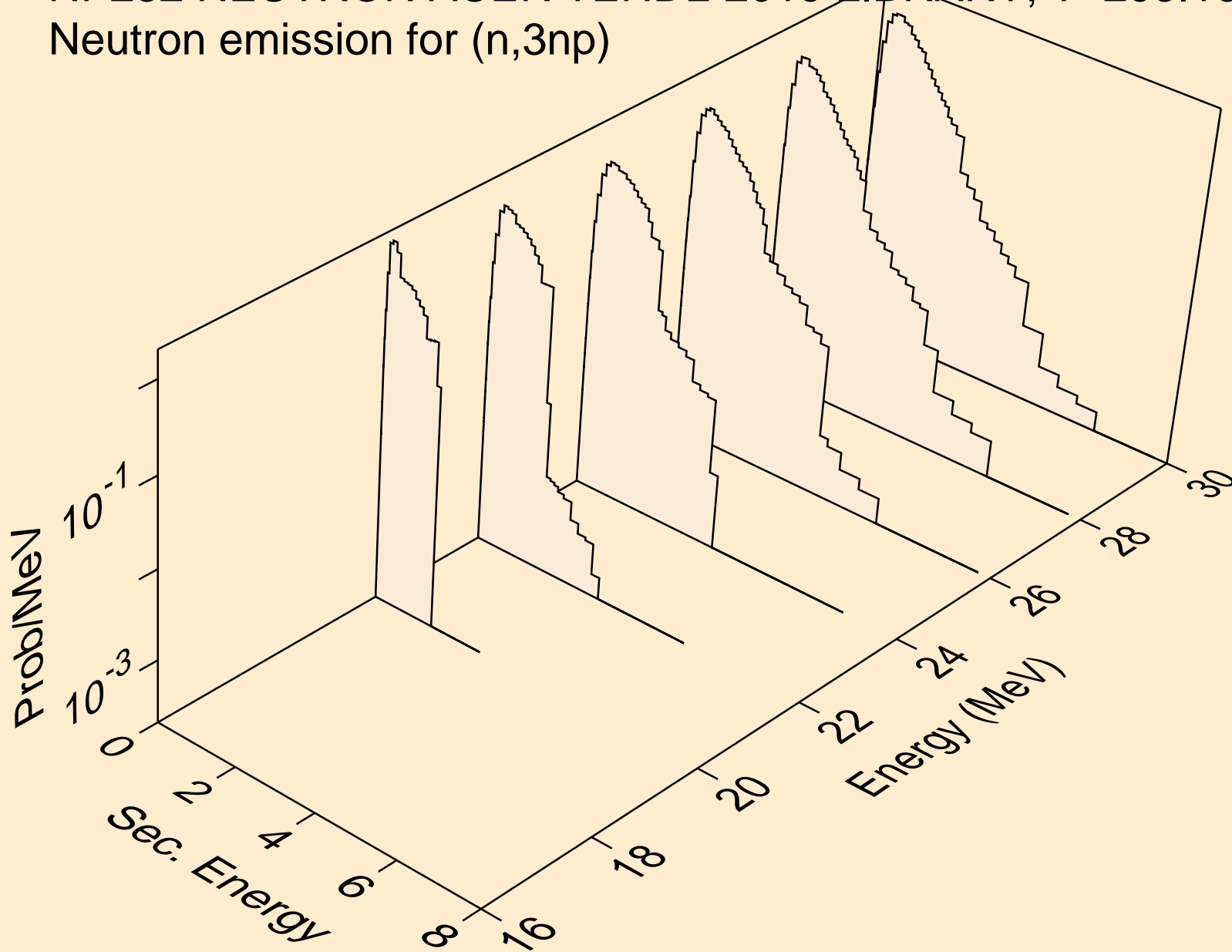

NP232 NEUTRON ACER TENDL-2019 LIBRARY; T=293.16K
Neutron emission for (n,2np)

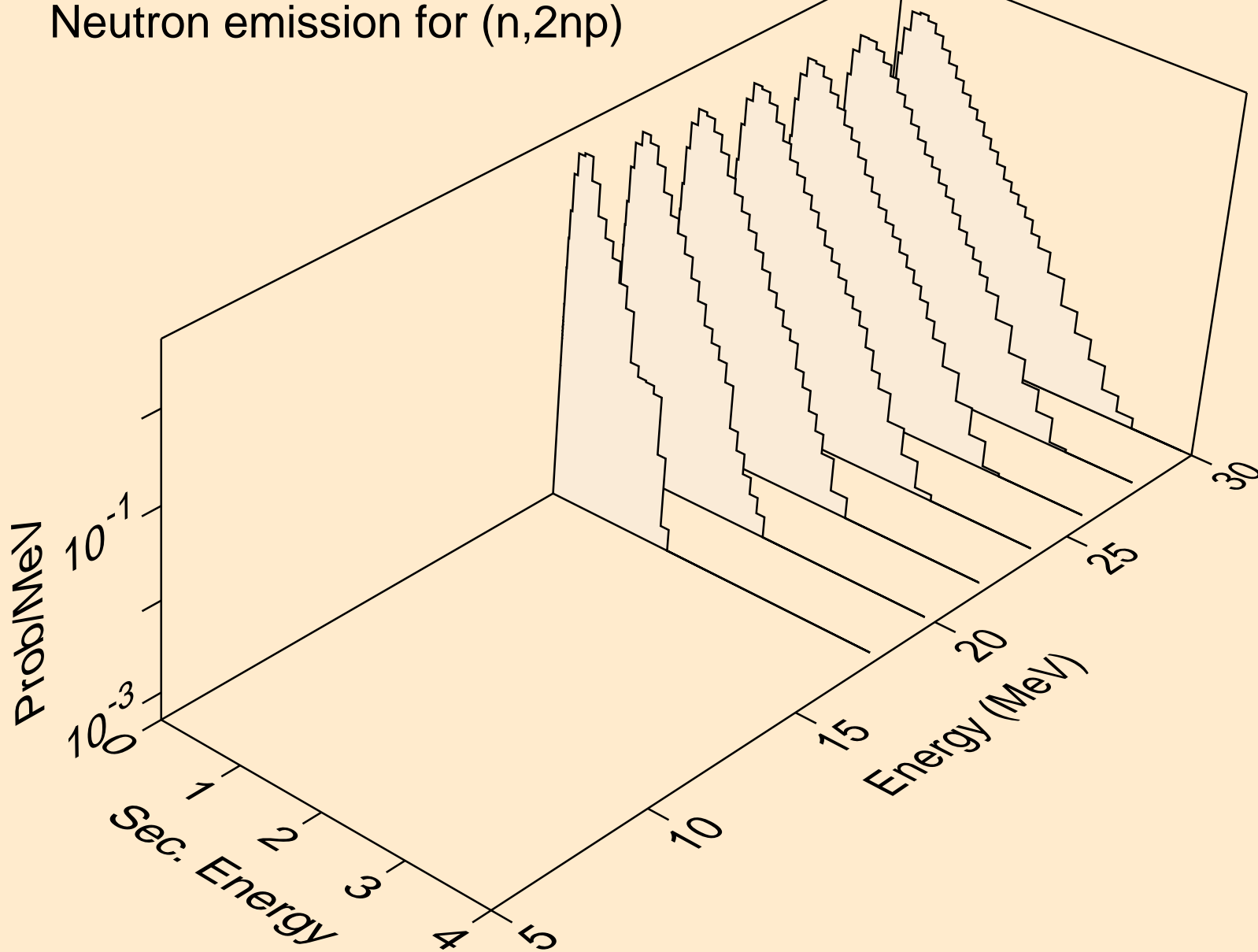

NP232 NEUTRON ACER TENDL-2019 LIBRARY; T=293.16K
Neutron emission for (n,npa)

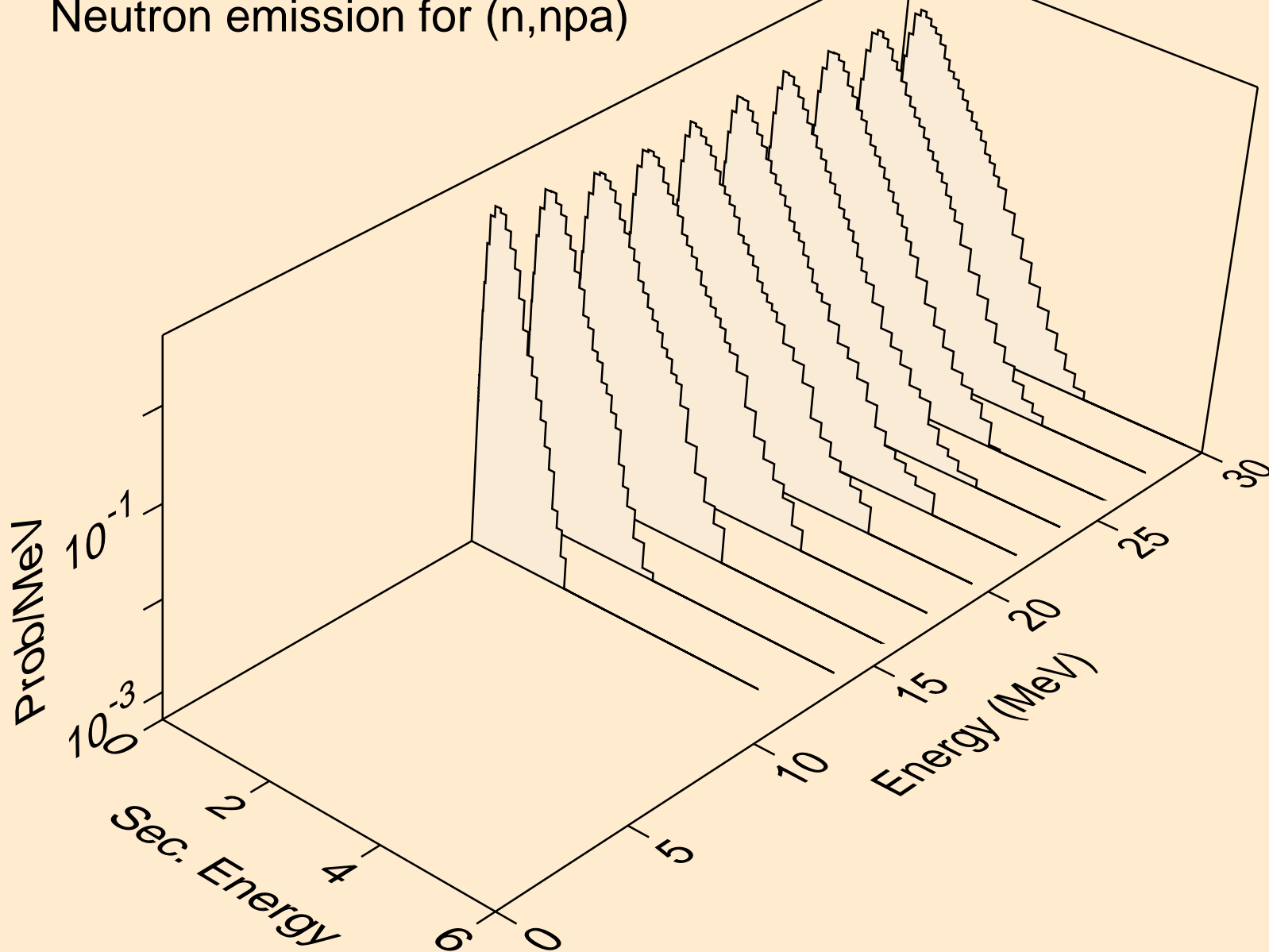

NP232 NEUTRON ACER TENDL-2019 LIBRARY; T=293.16K
Neutron emission for (n,n*c)

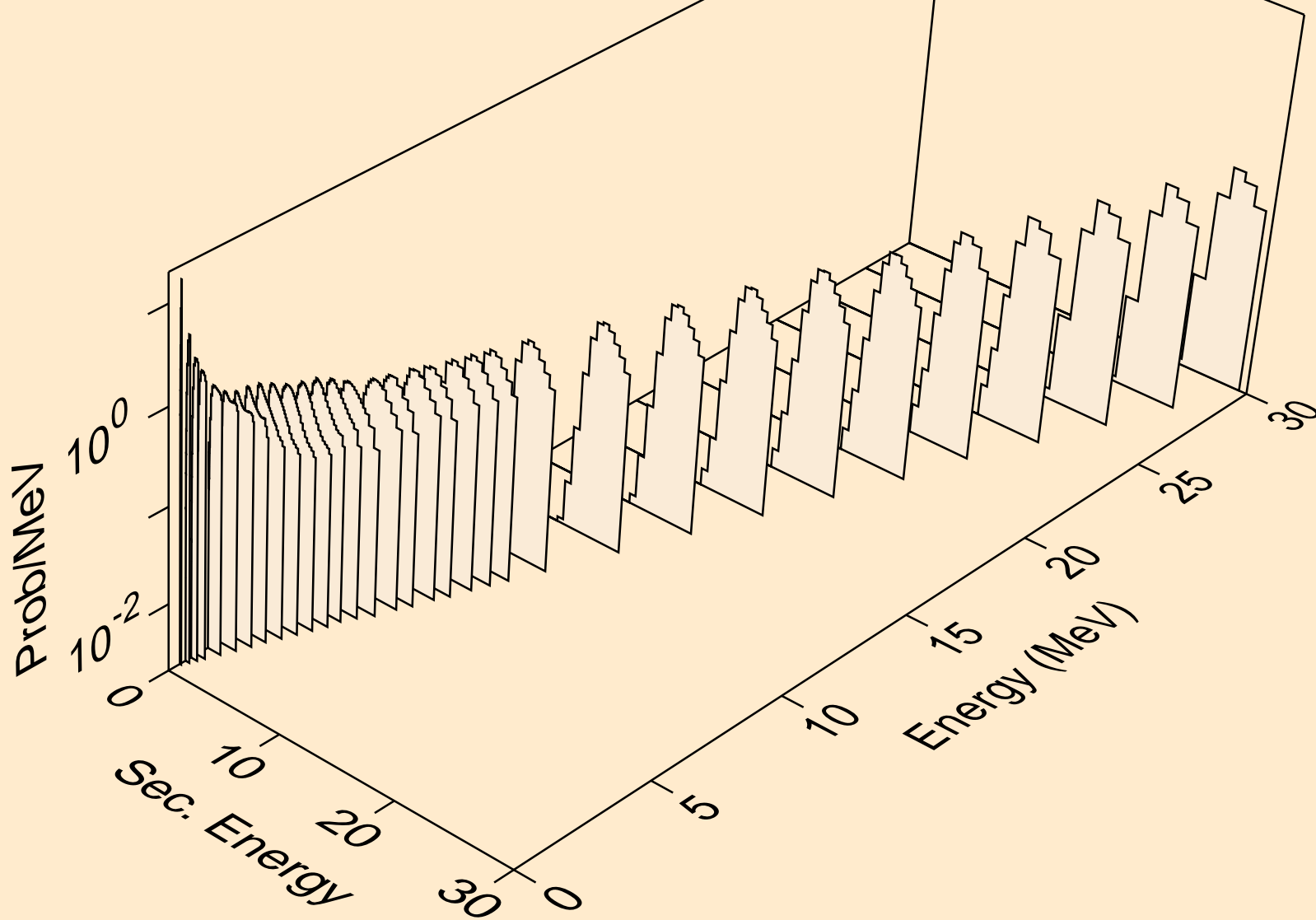

NP232 NEUTRON ACER TENDL-2019 LIBRARY; T=293.16K
Delayed nubar

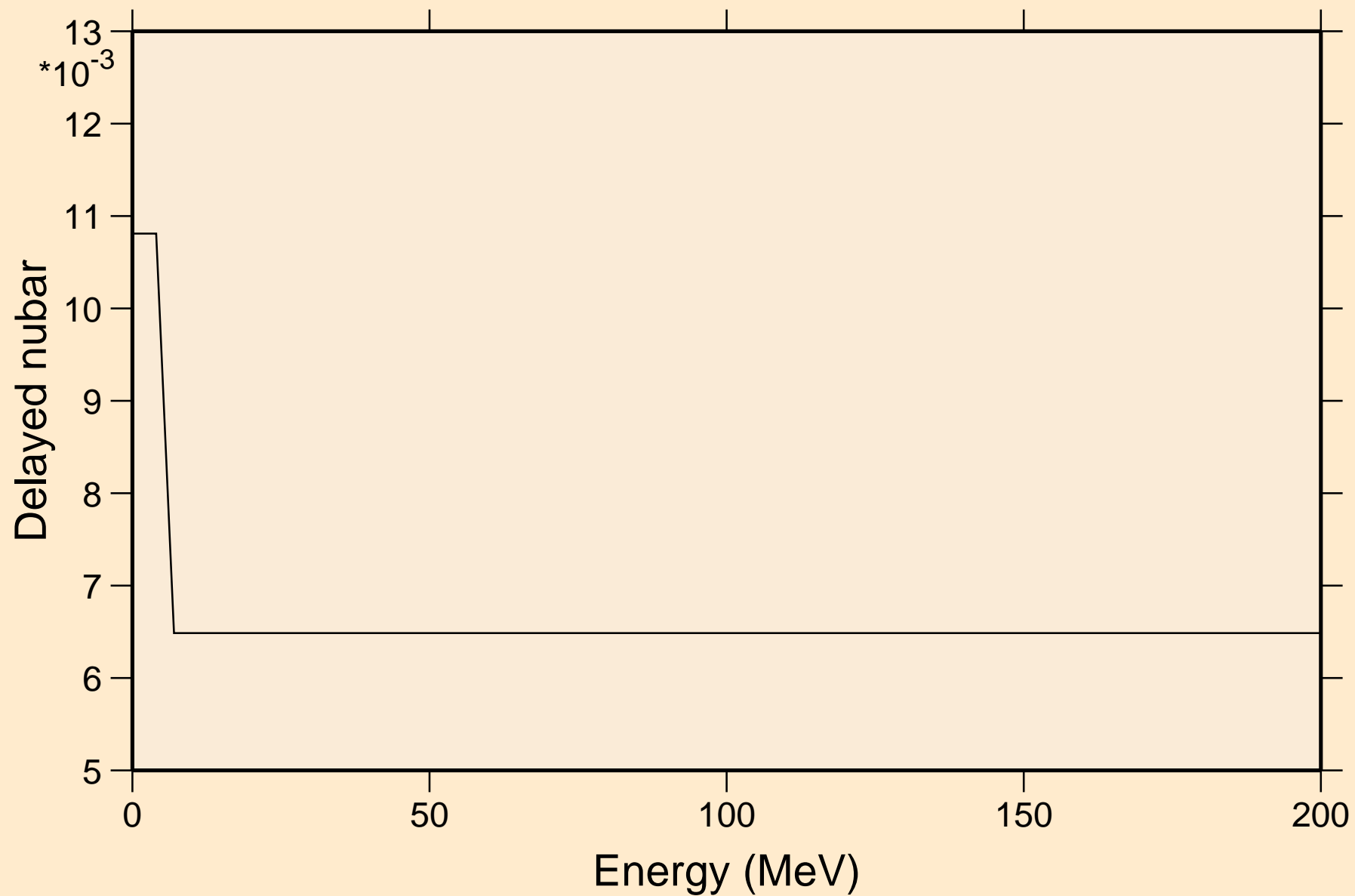

NP232 NEUTRON ACER TENDL-2019 LIBRARY; T=293.16K

Delayed neutron spectra

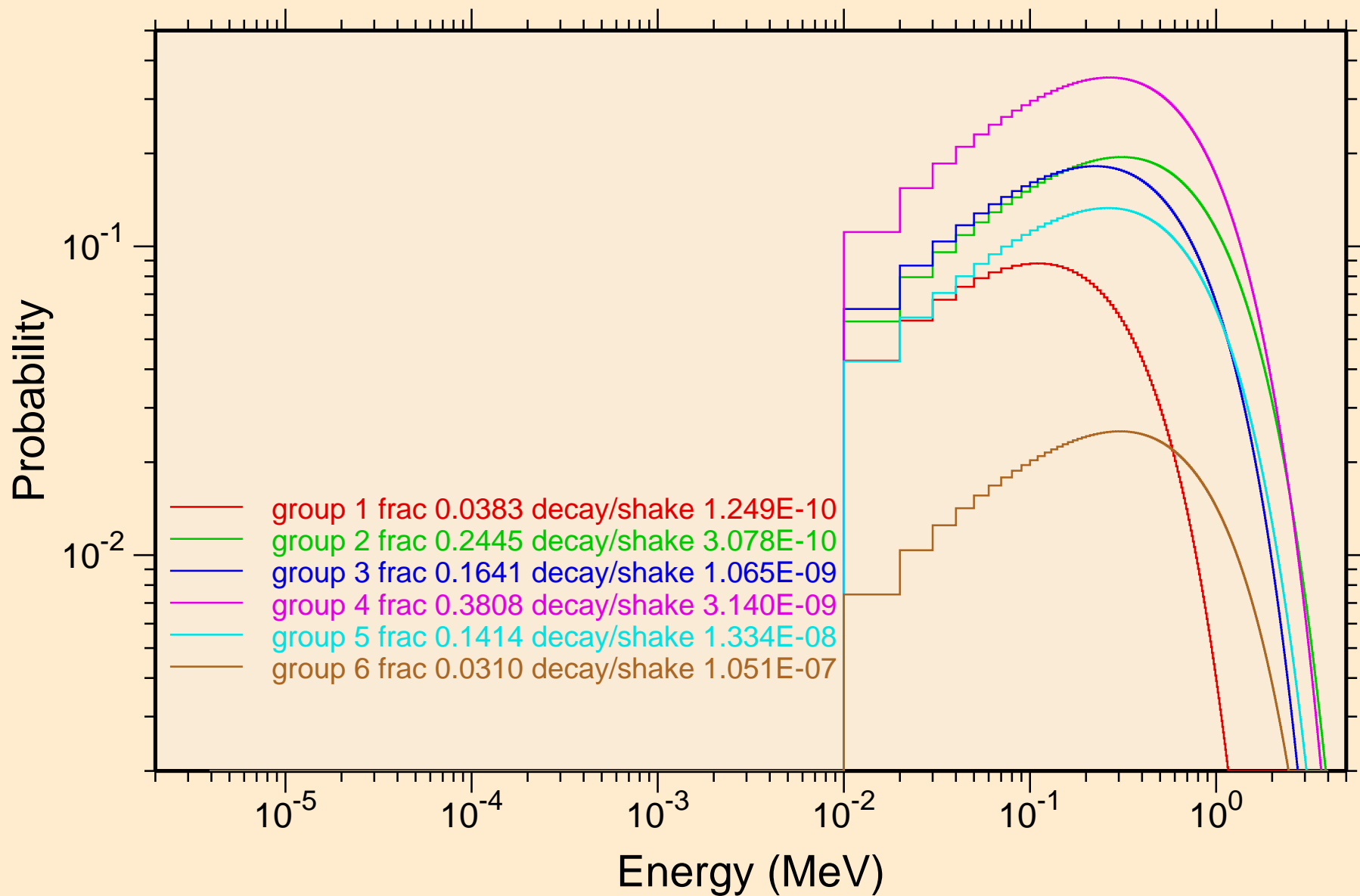

NP232 NEUTRON ACER TENDL-2019 LIBRARY; T=293.16K
Photon emission for (n,x)

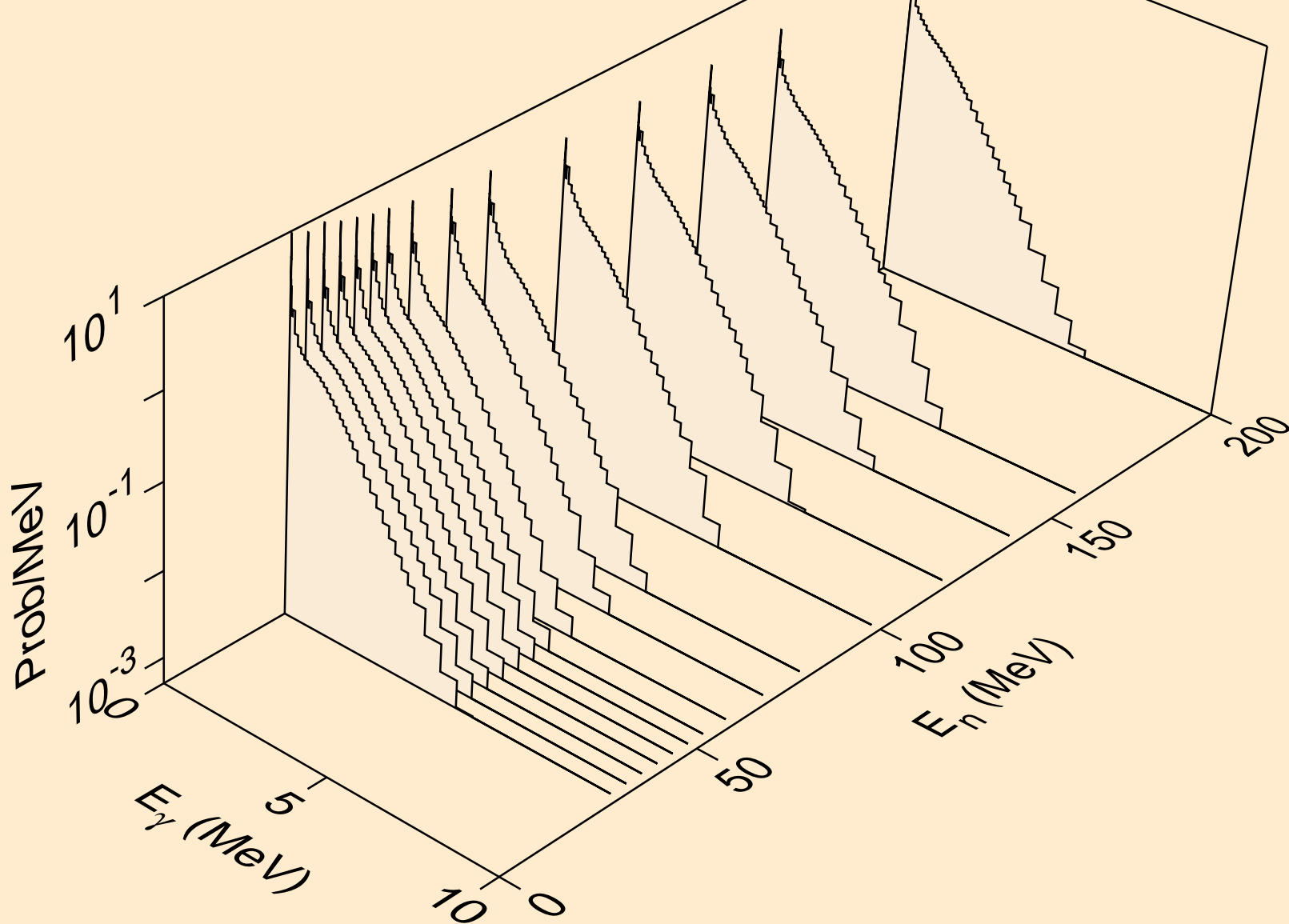

NP232 NEUTRON ACER TENDL-2019 LIBRARY; T=293.16K
Photon emission for (n,2nd)

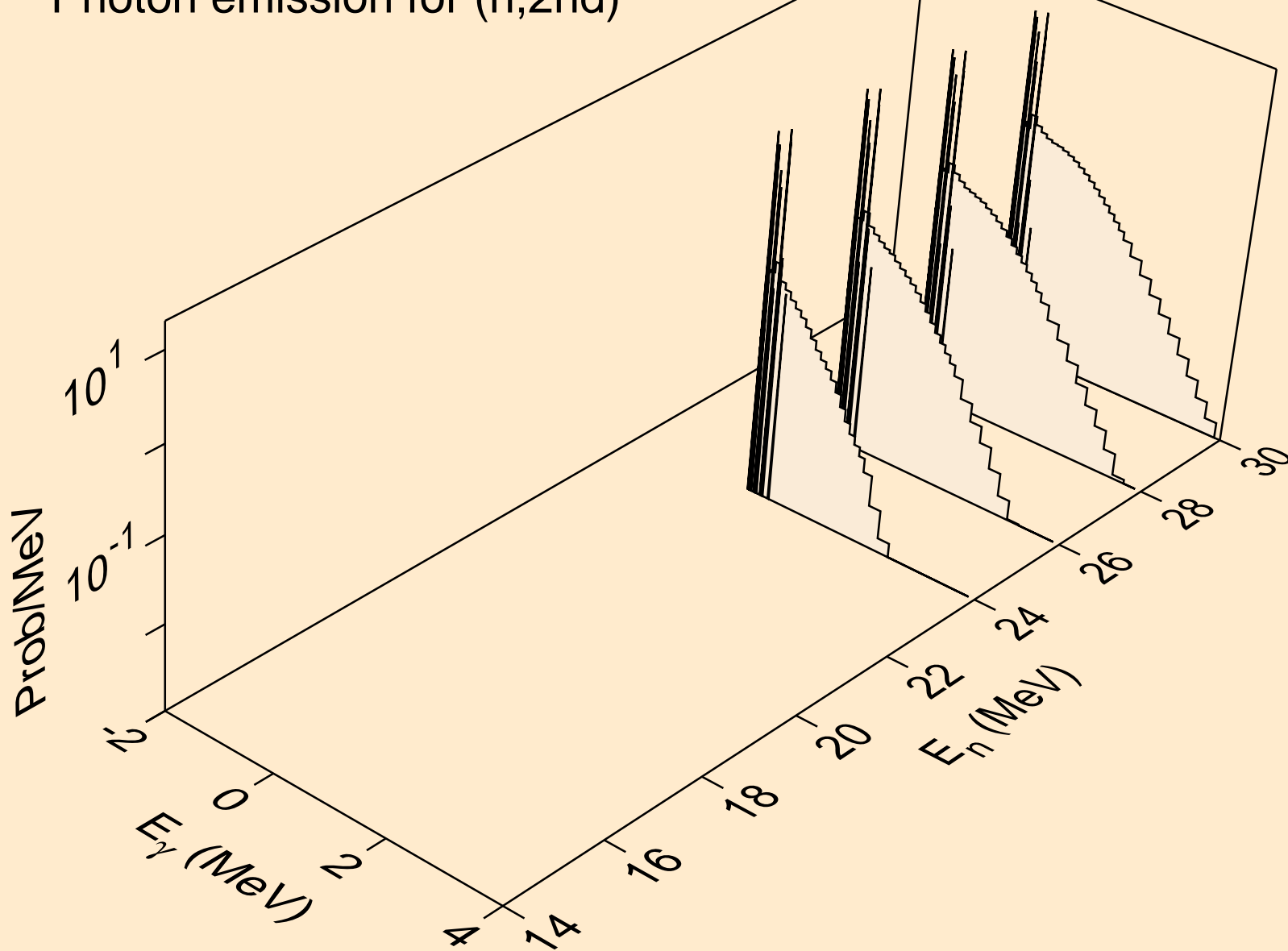

NP232 NEUTRON ACER TENDL-2019 LIBRARY; T=293.16K
Photon emission for (n,2n)

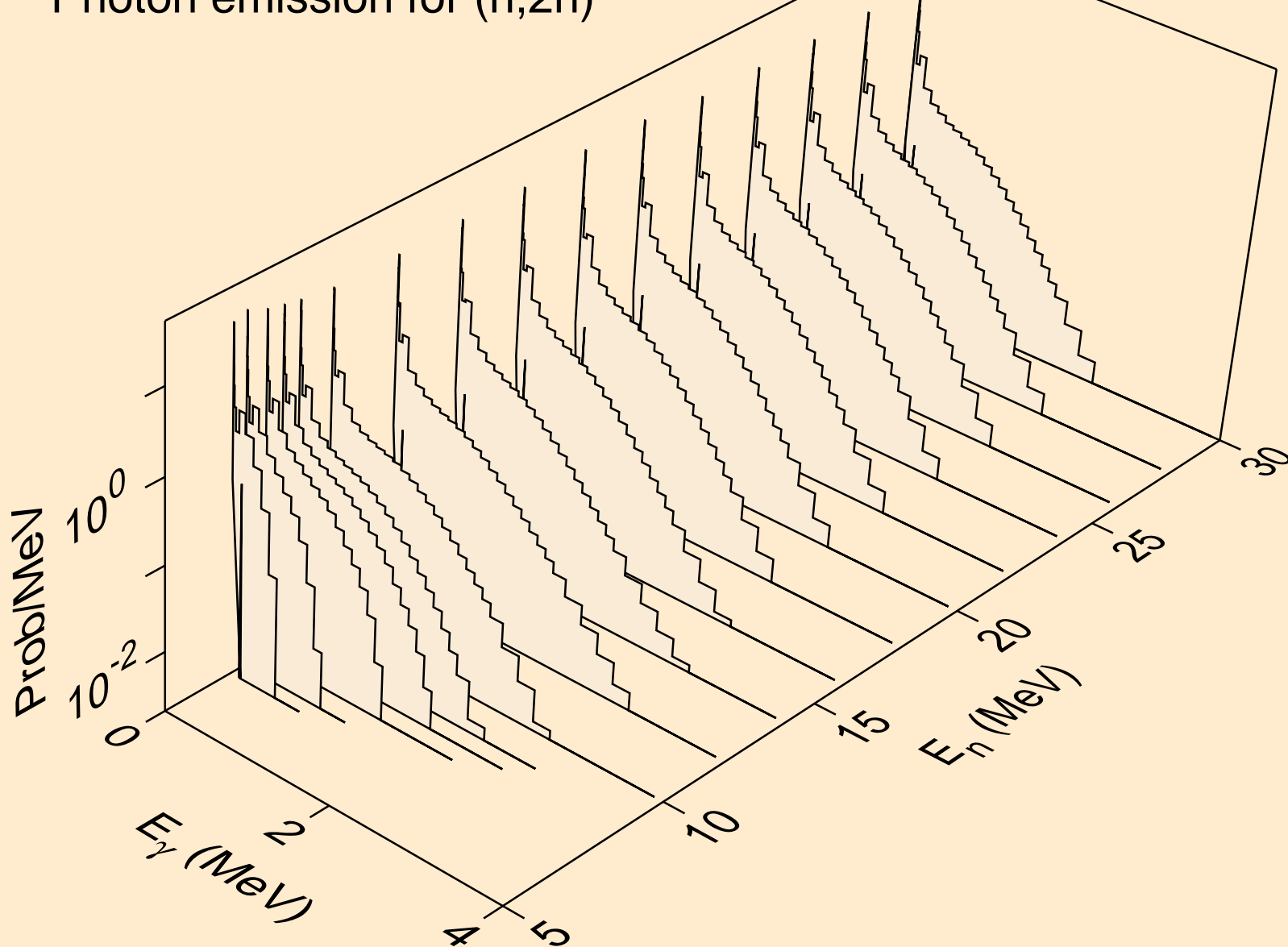

NP232 NEUTRON ACER TENDL-2019 LIBRARY; T=293.16K
Photon emission for (n,3n)

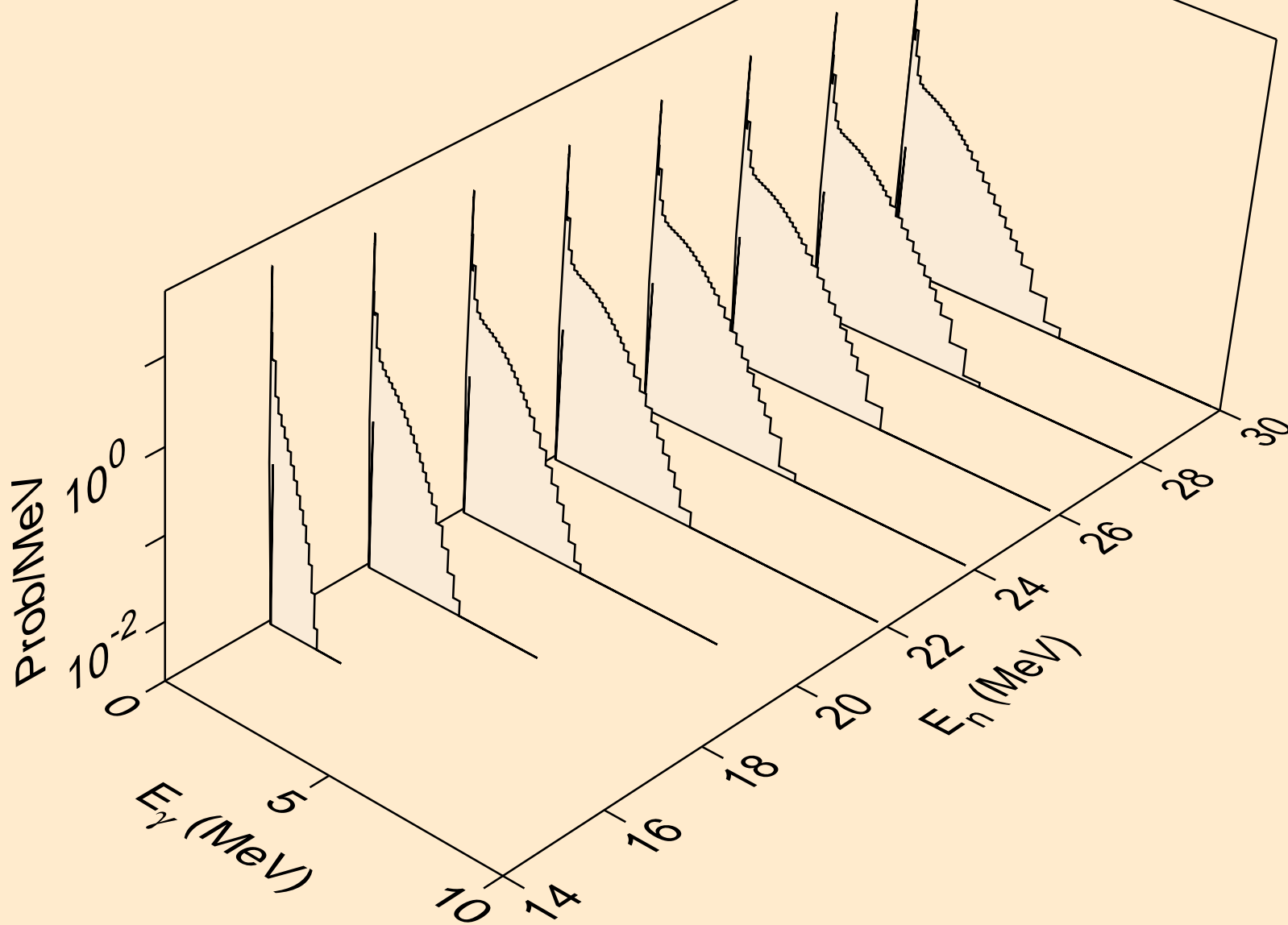

NP232 NEUTRON ACER TENDL-2019 LIBRARY; T=293.16K
Photon emission for (n,n*)a

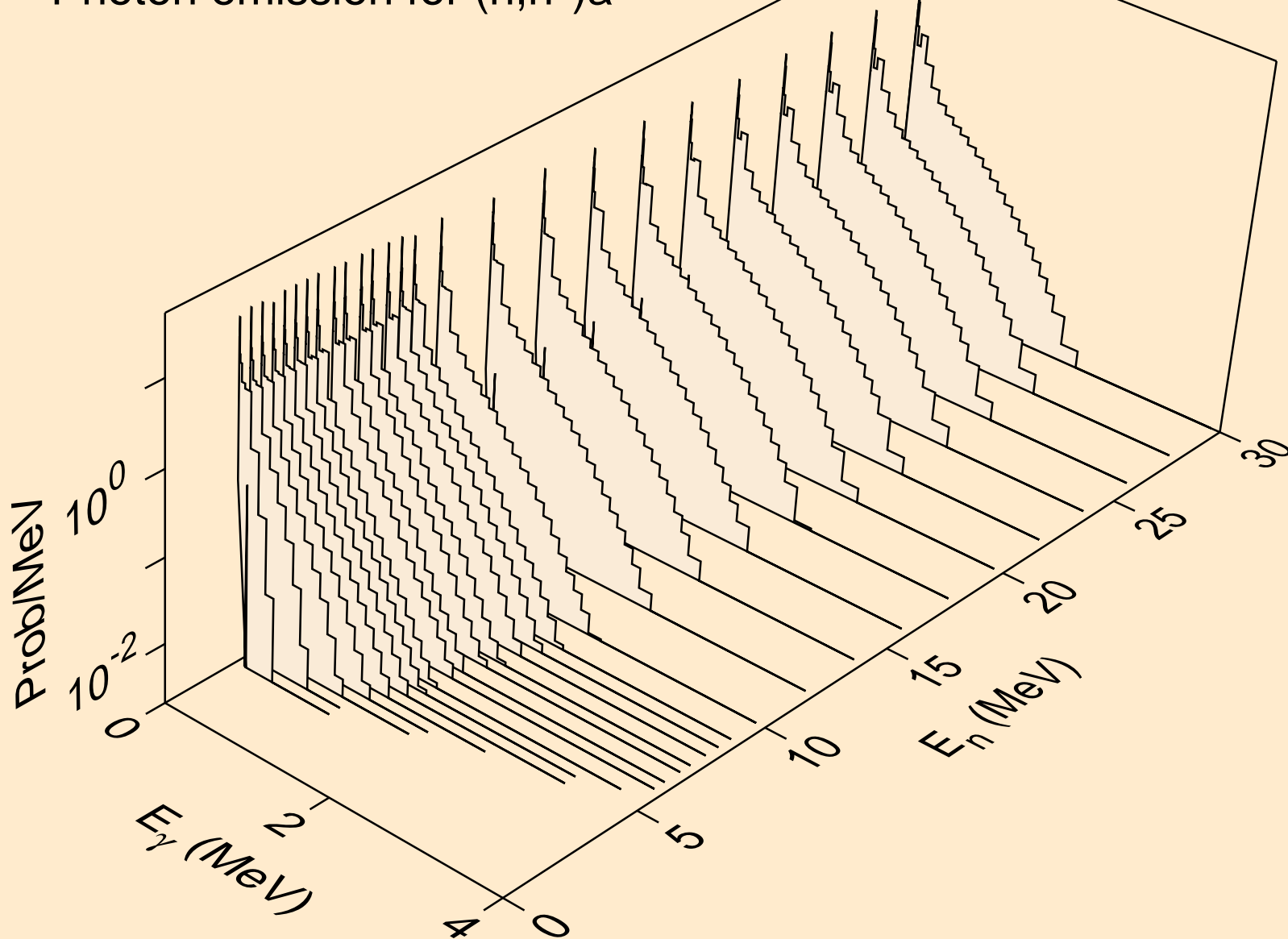

NP232 NEUTRON ACER TENDL-2019 LIBRARY; T=293.16K
Photon emission for (n,2n)a

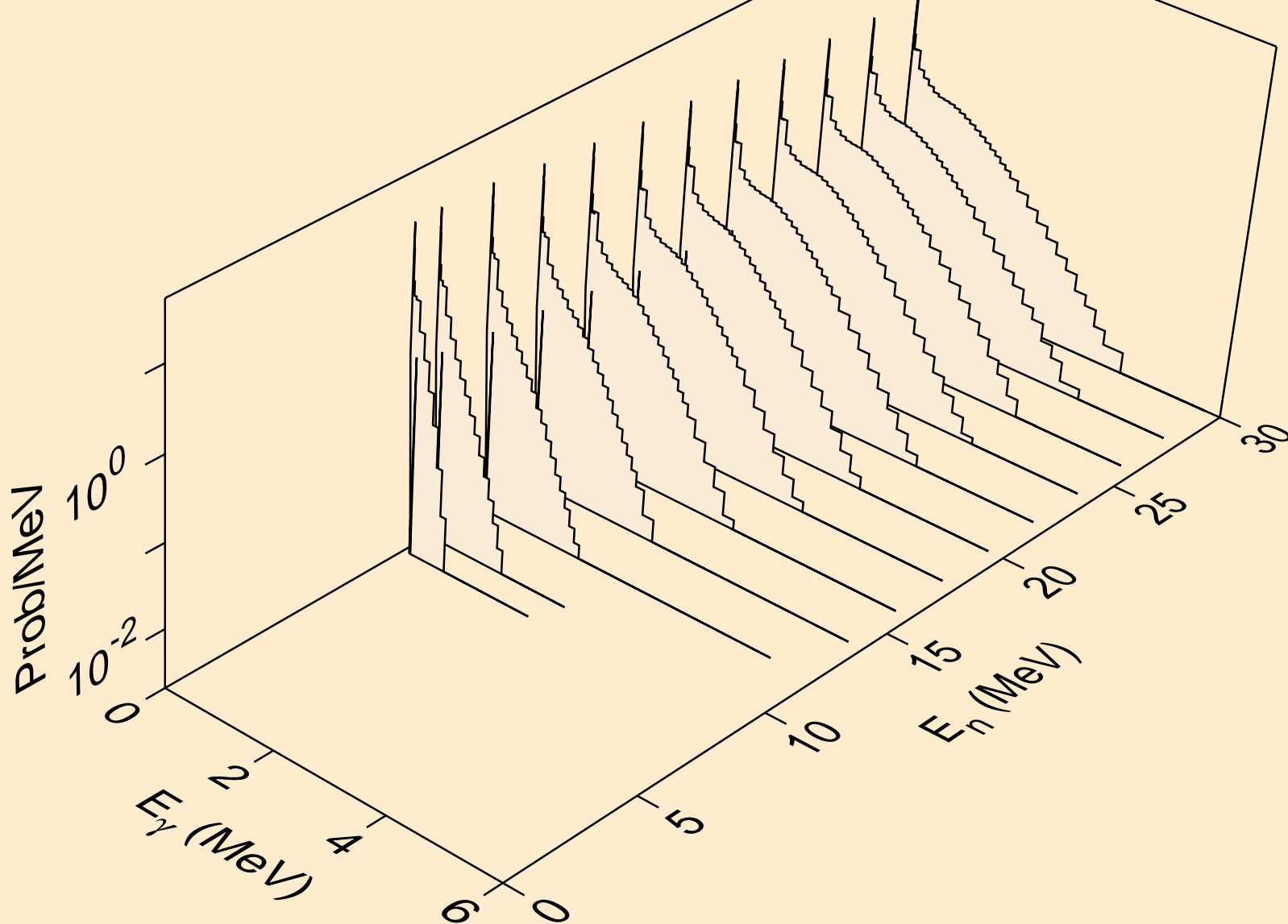

NP232 NEUTRON ACER TENDL-2019 LIBRARY; T=293.16K
Photon emission for (n,3n)a

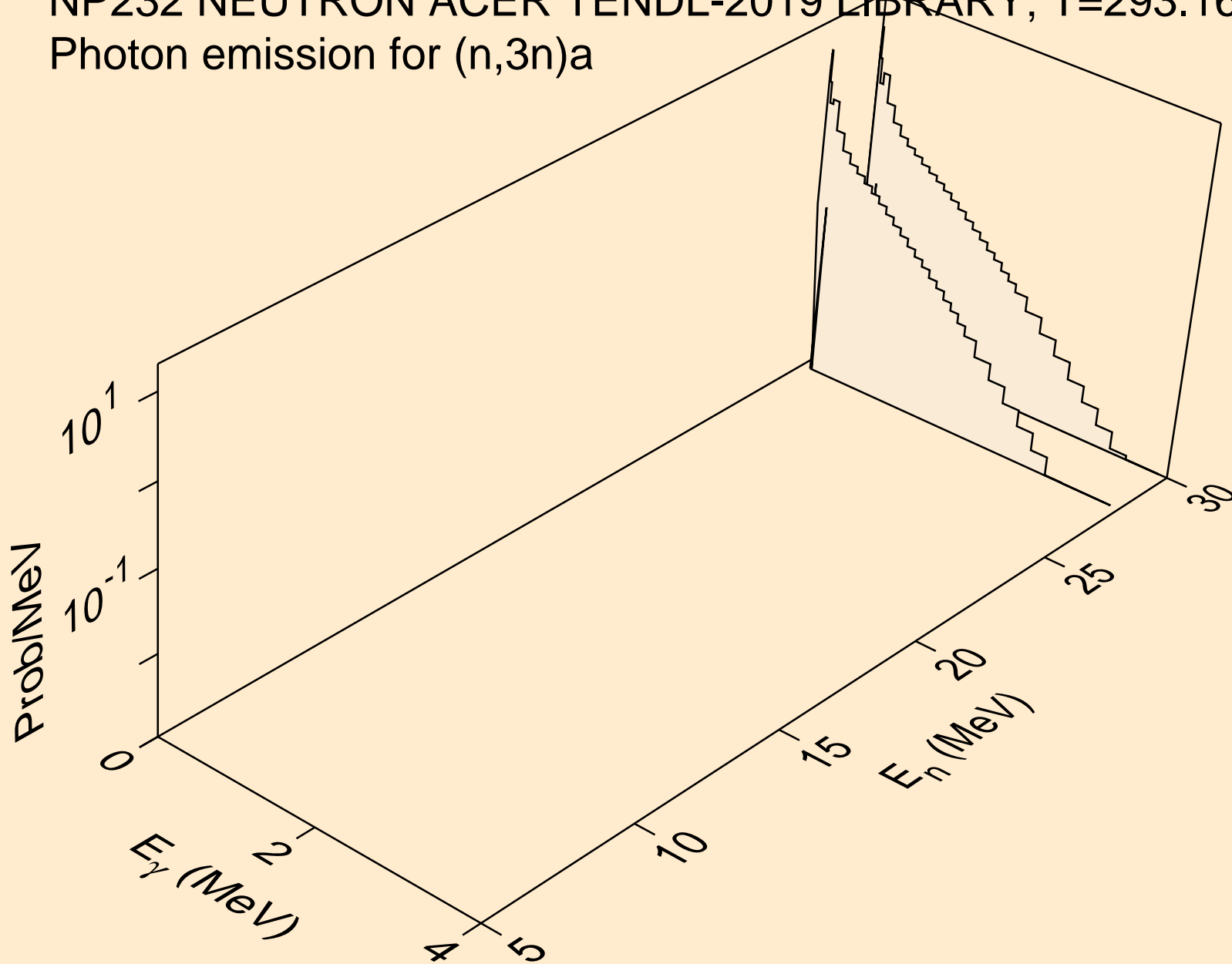

NP232 NEUTRON ACER TENDL-2019 LIBRARY; T=293.16K
Photon emission for (n,n*)p

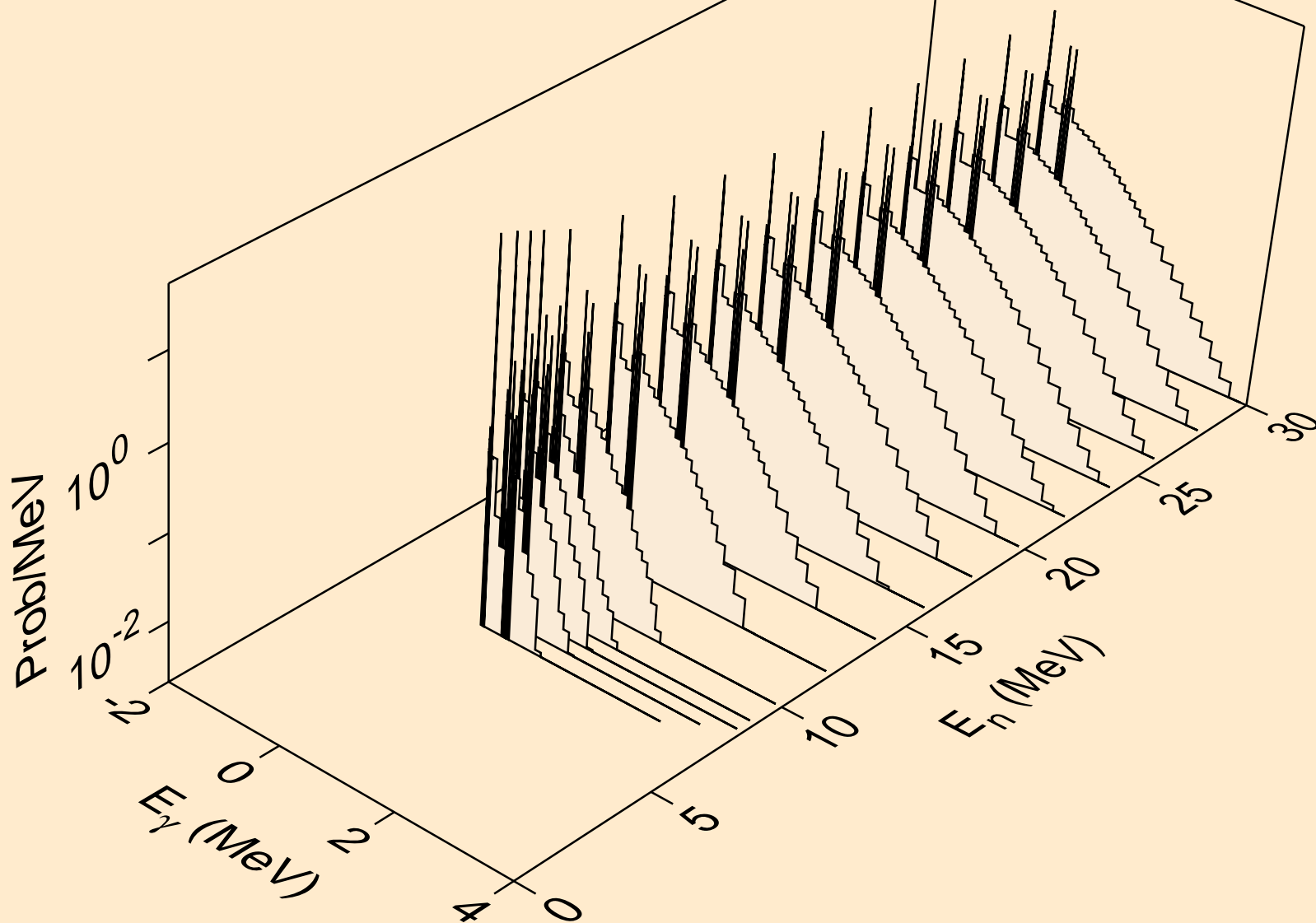

NP232 NEUTRON ACER TENDL-2019 LIBRARY; T=293.16K
Photon emission for (n,n*)2a

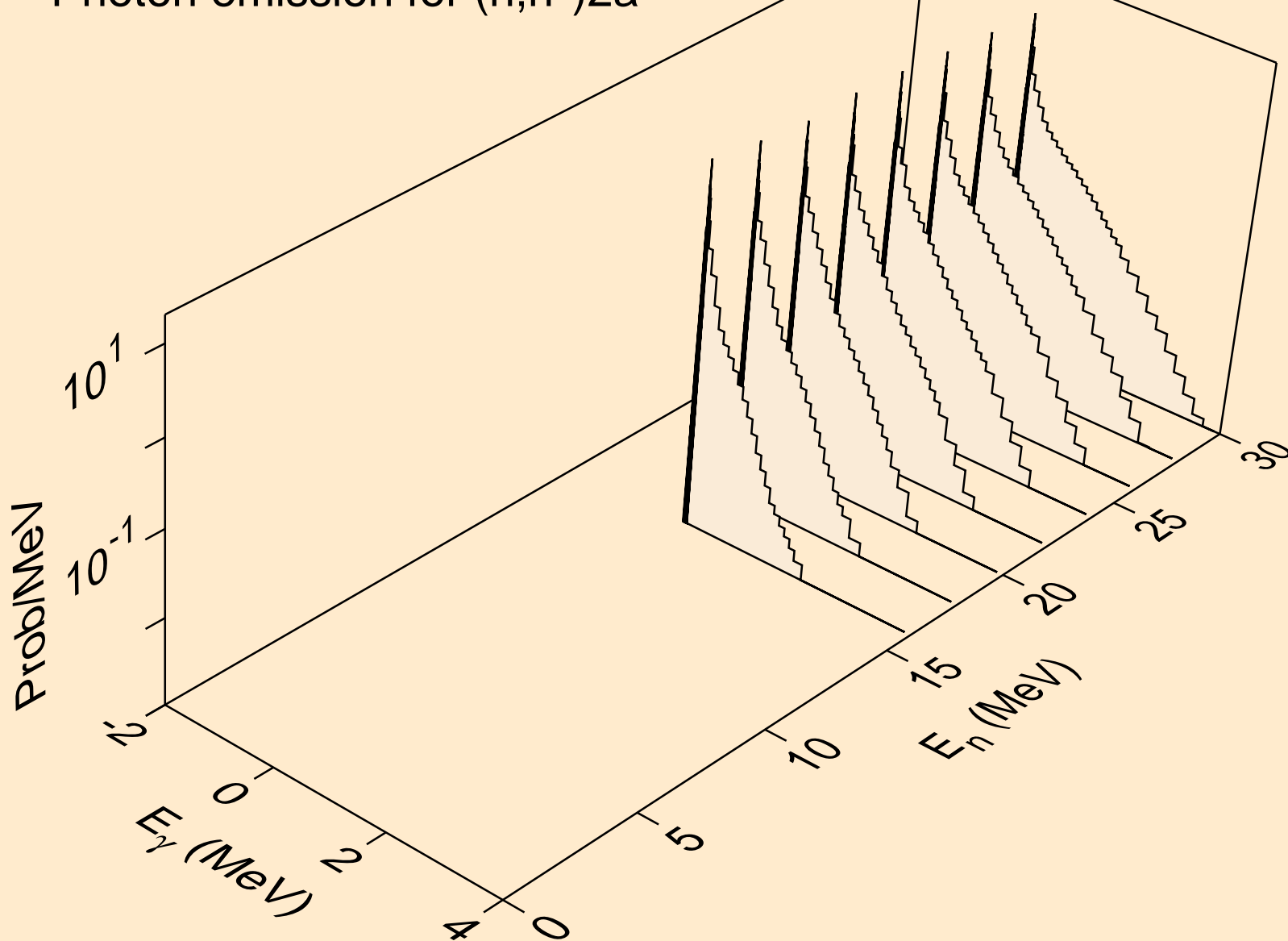

NP232 NEUTRON ACER TENDL-2019 LIBRARY; T=293.16K
Photon emission for (n,2n)2a

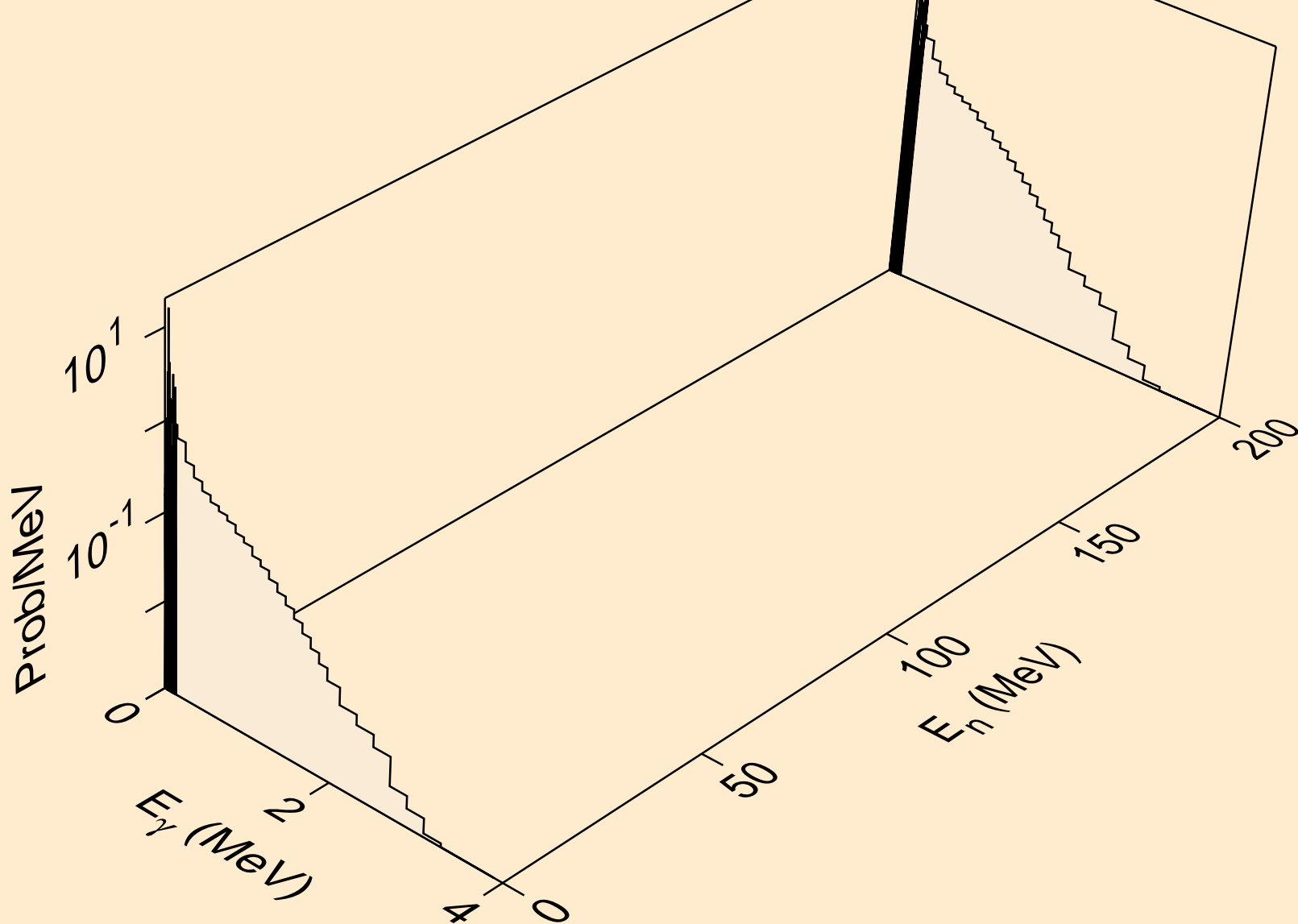

NP232 NEUTRON ACER TENDL-2019 LIBRARY; T=293.16K
Photon emission for (n,n*)d

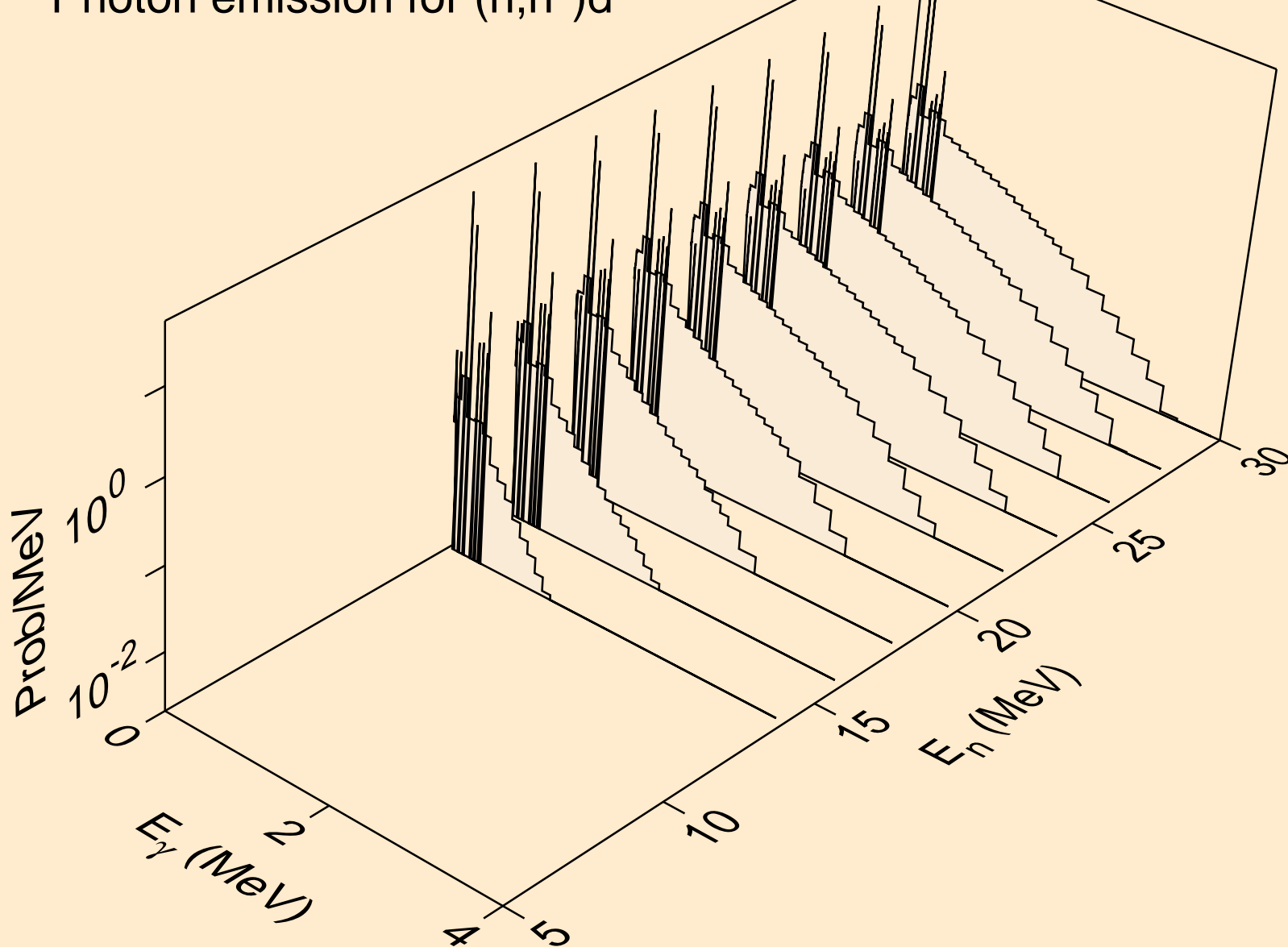

NP232 NEUTRON ACER TENDL-2019 LIBRARY; T=293.16K
Photon emission for (n,n*)t

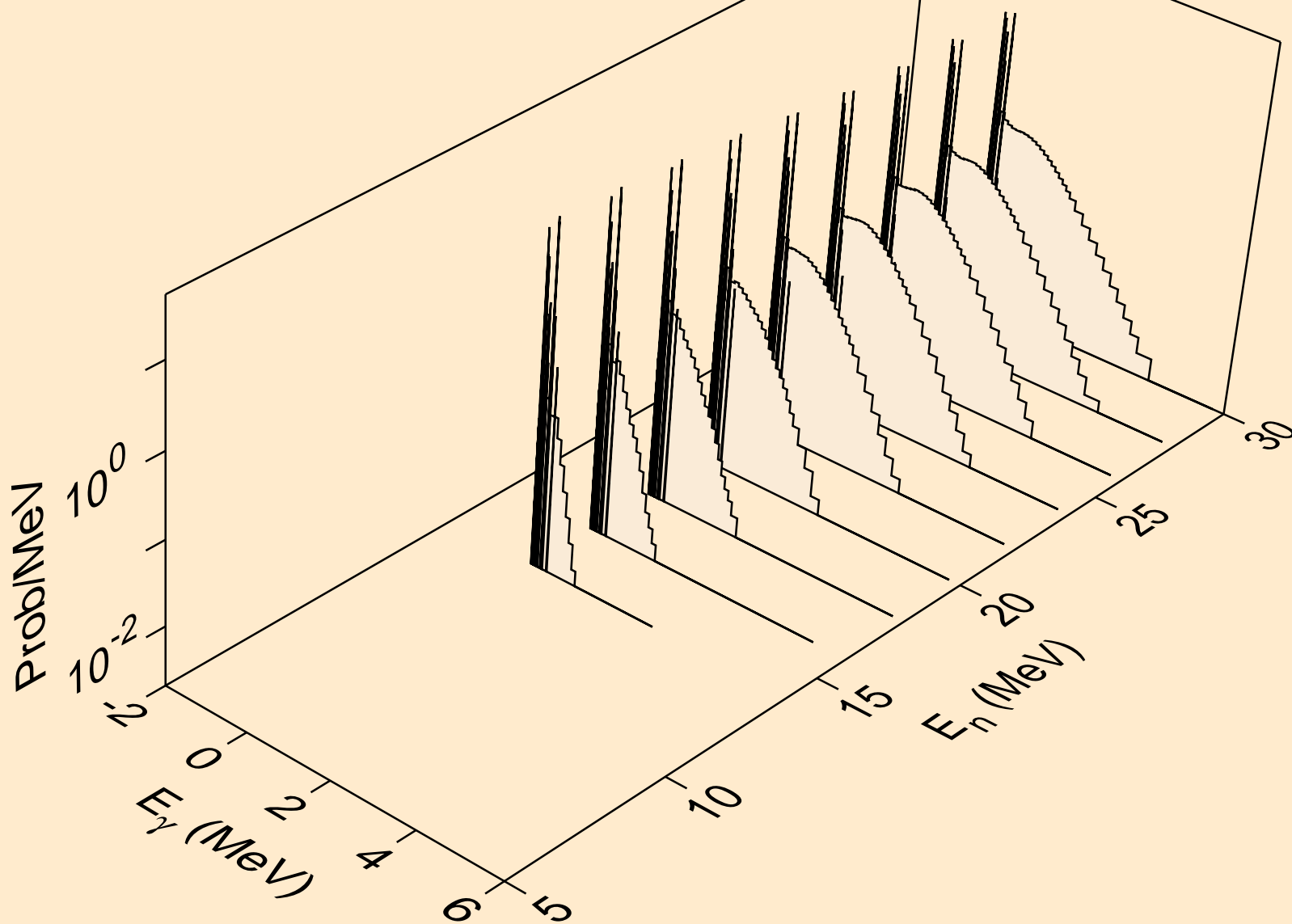

NP232 NEUTRON ACER TENDL-2019 LIBRARY; T=293.16K
Photon emission for (n,n*)he3

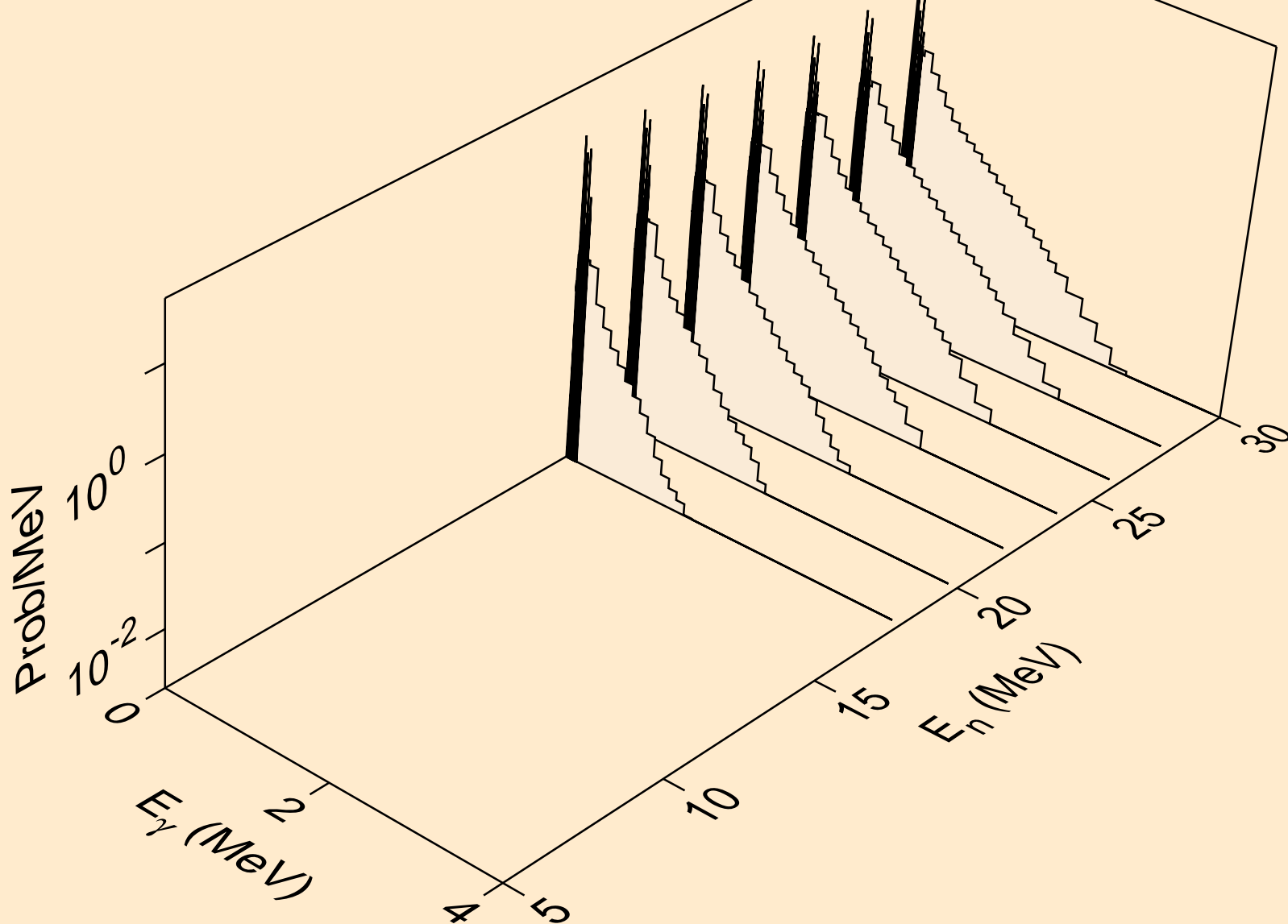

NP232 NEUTRON ACER TENDL-2019 LIBRARY; T=293.16K
Photon emission for (n,4n)

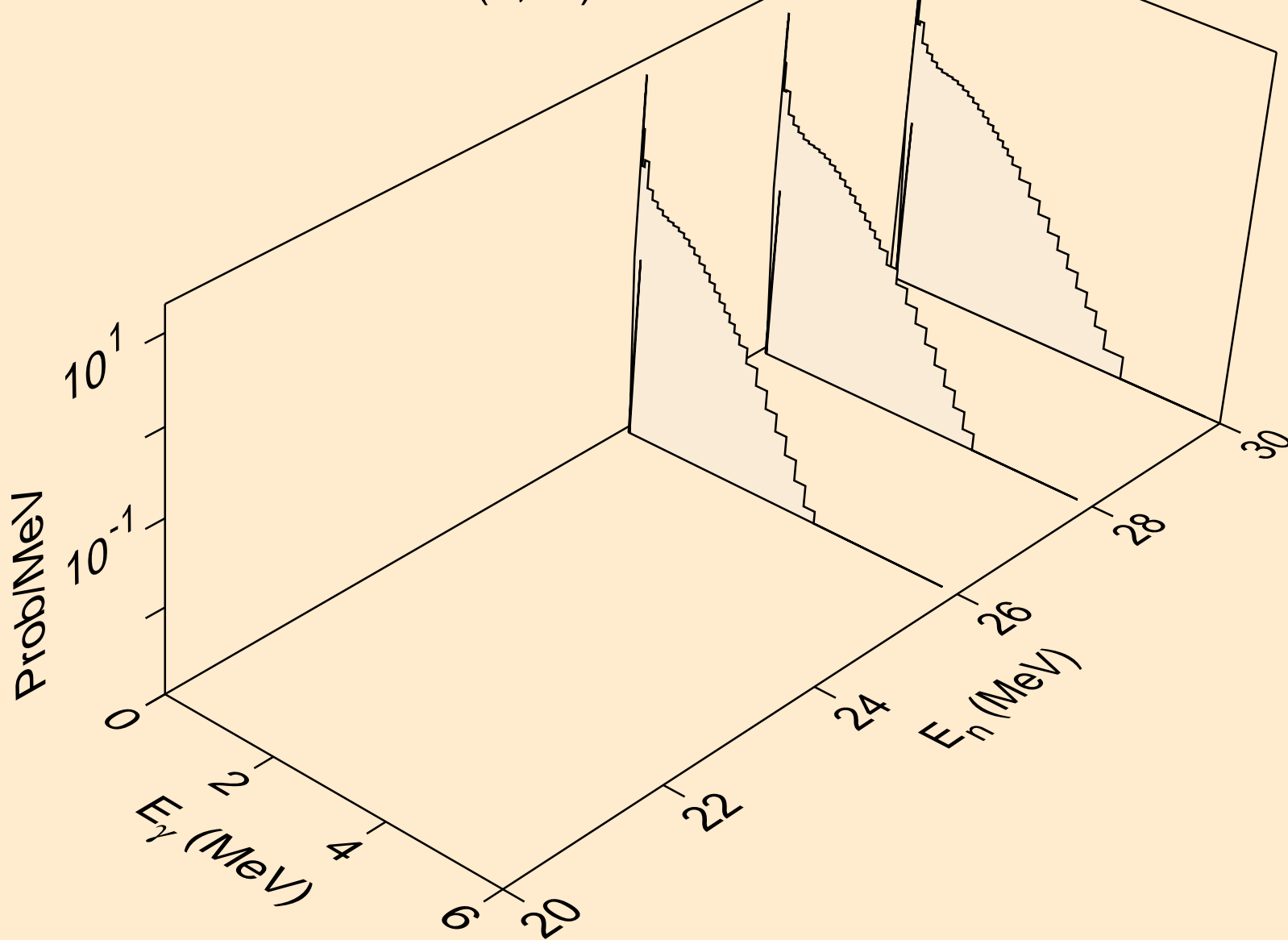

NP232 NEUTRON ACER TENDL-2019 LIBRARY; T=293.16K
Photon emission for (n,2np)

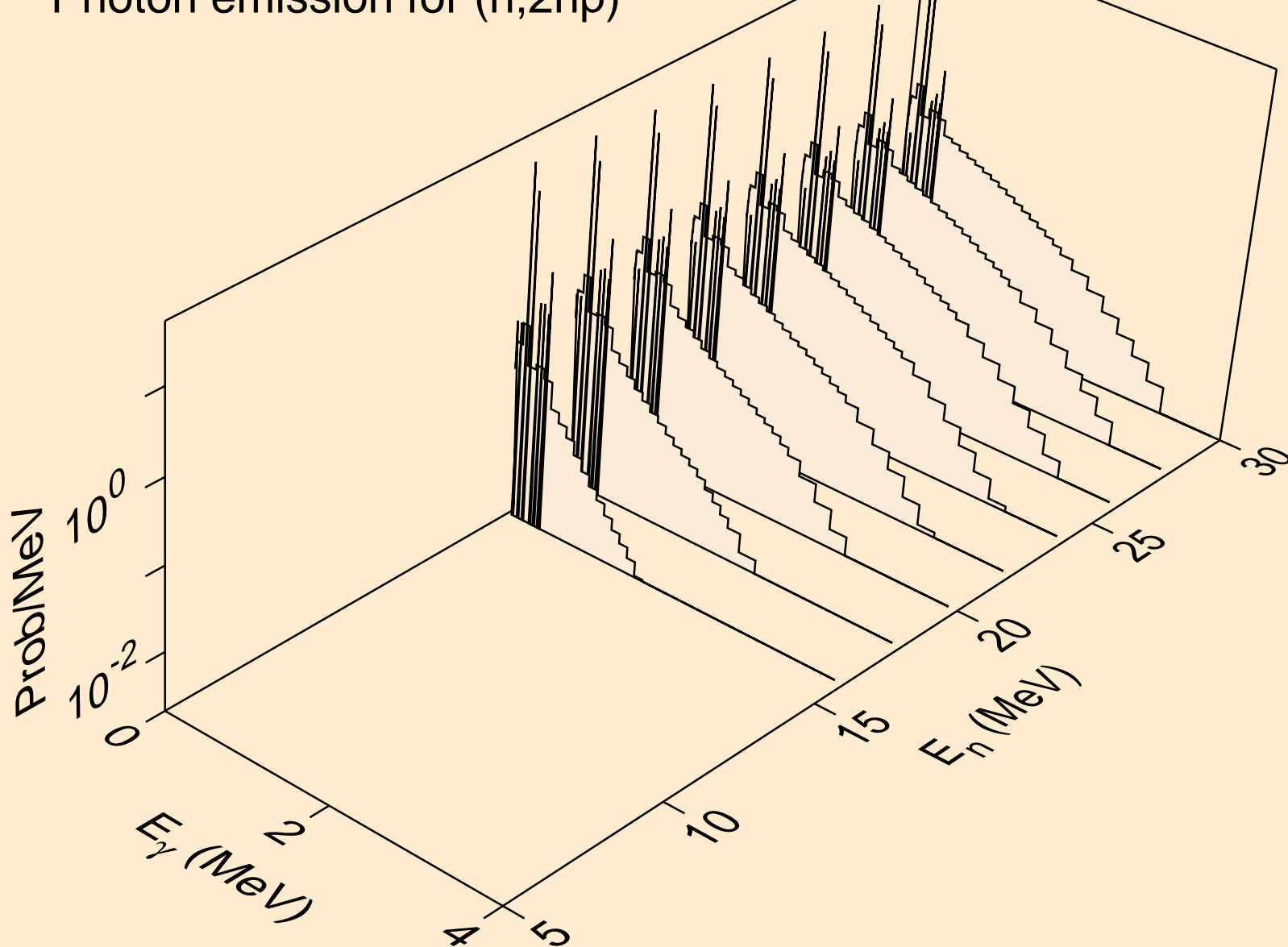

NP232 NEUTRON ACER TENDL-2019 LIBRARY; T=293.16K
Photon emission for (n,3np)

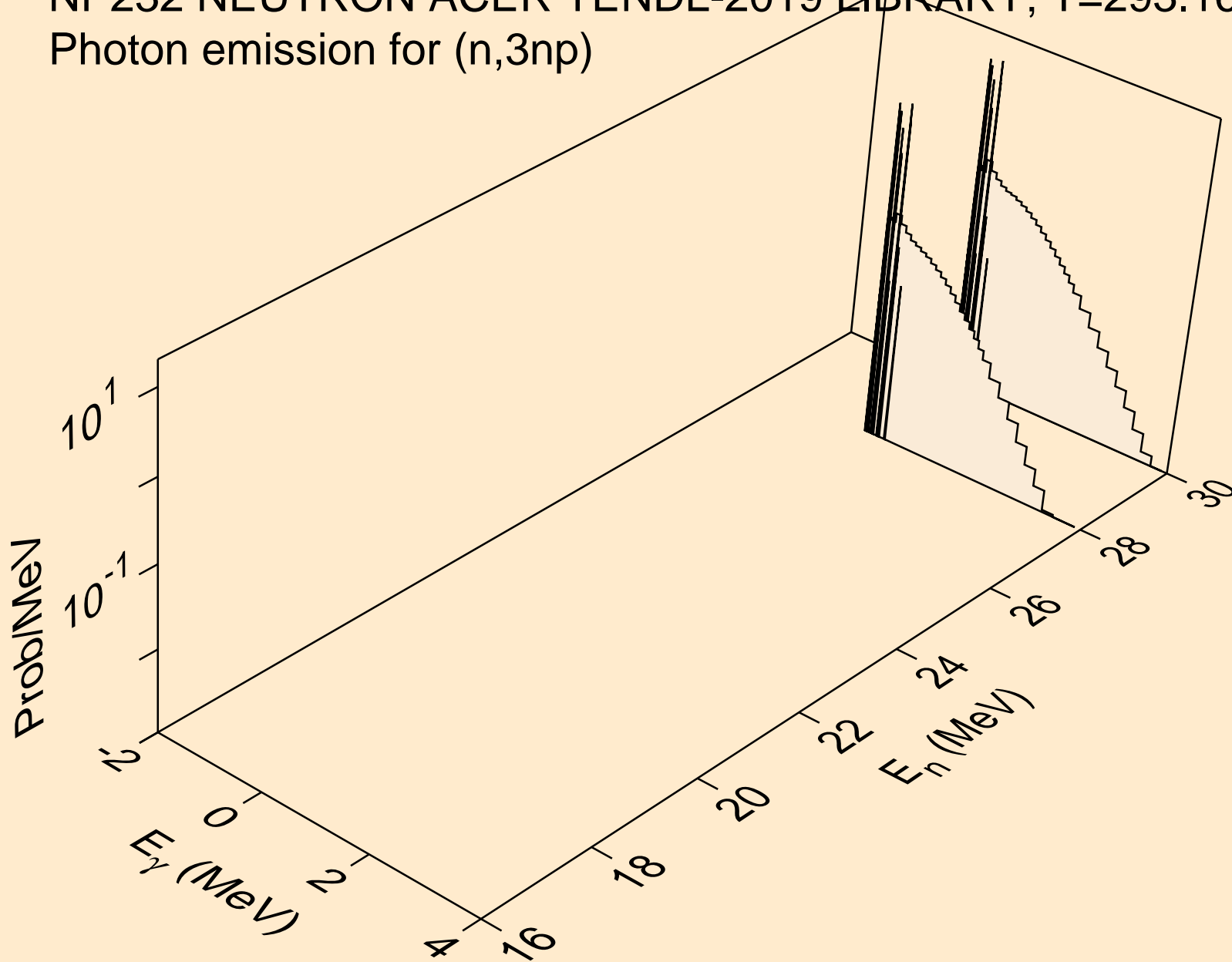

NP232 NEUTRON ACER TENDL-2019 LIBRARY; T=293.16K
Photon emission for (n,2np)

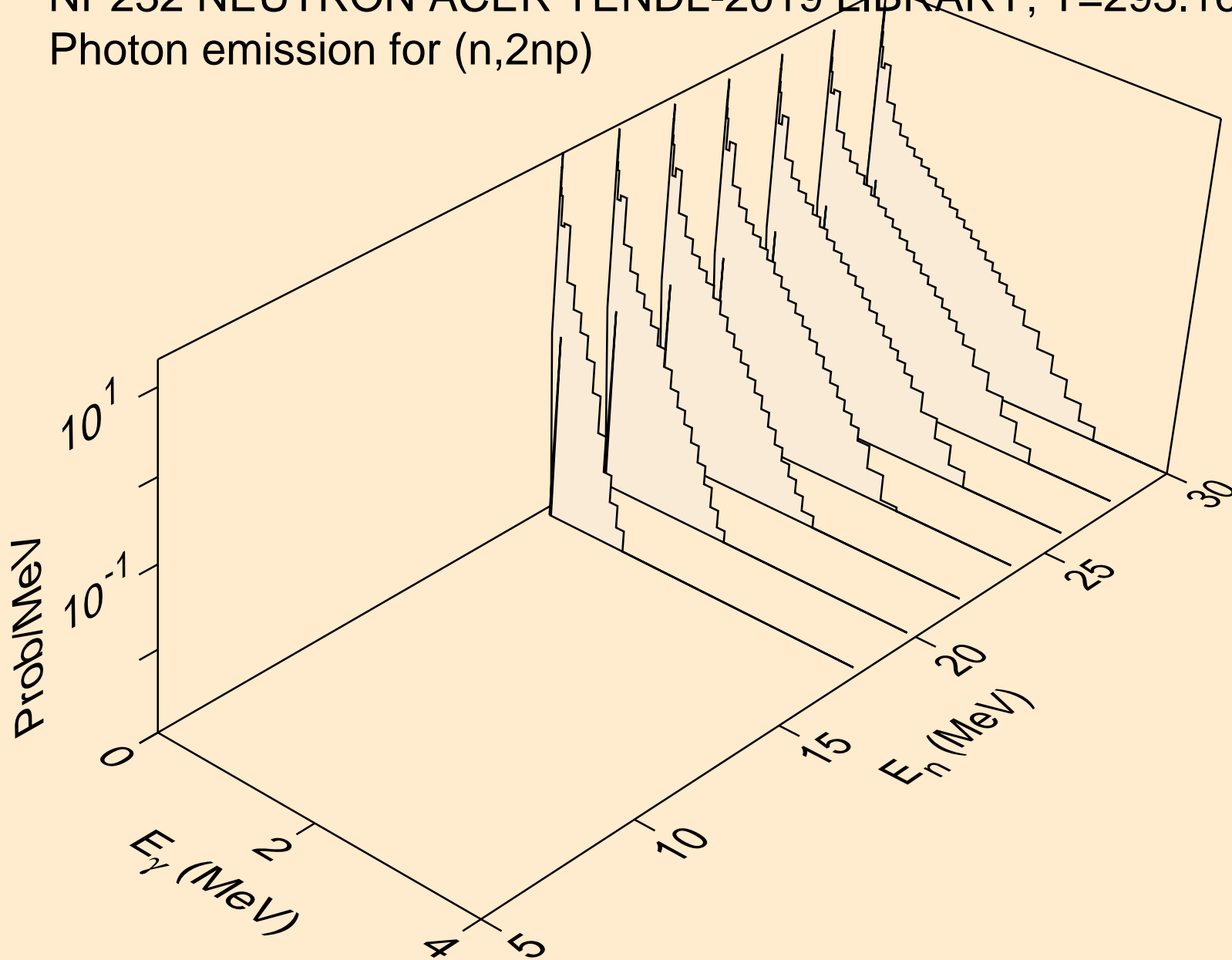

NP232 NEUTRON ACER TENDL-2019 LIBRARY; T=293.16K
Photon emission for (n,npa)

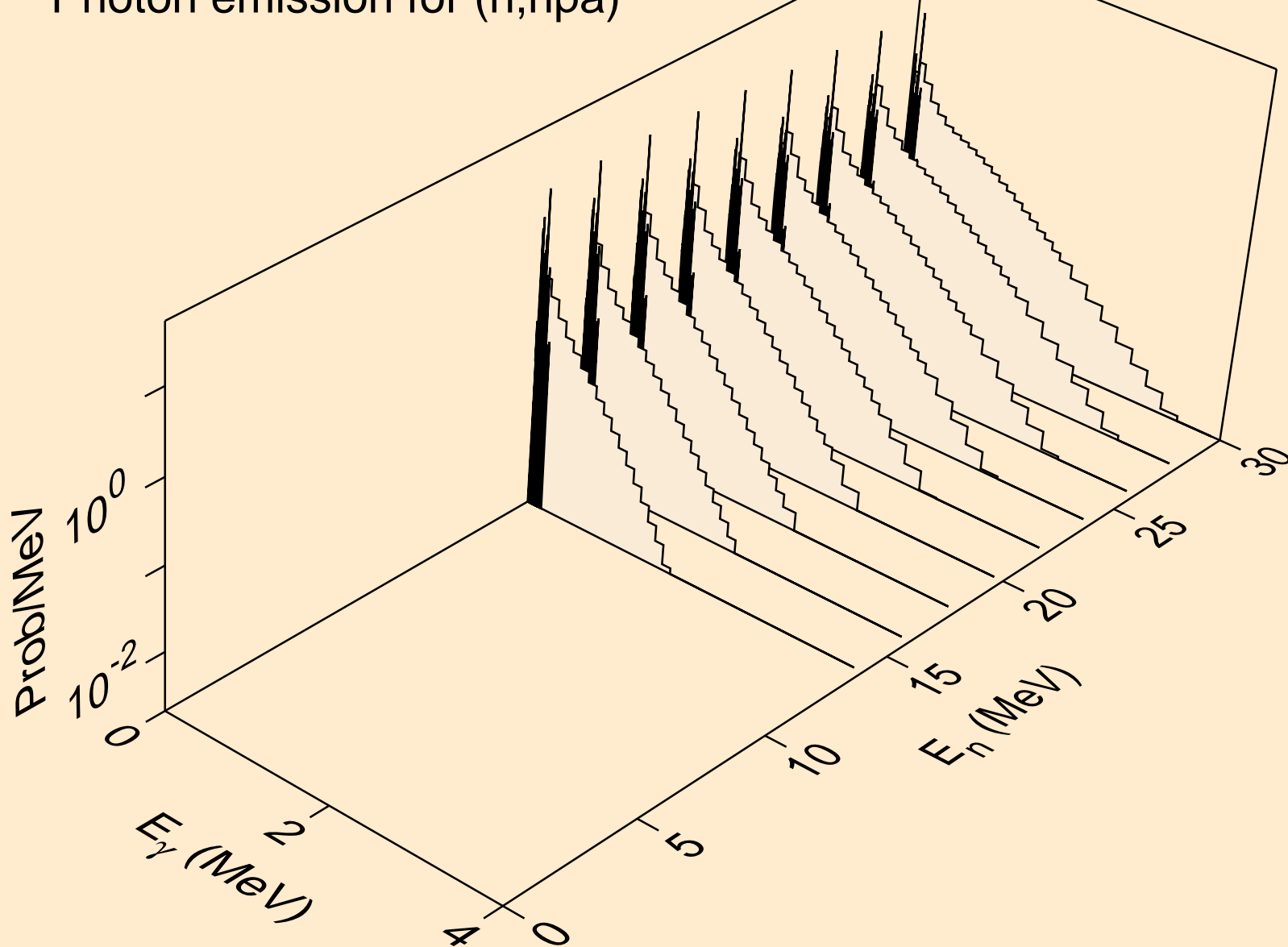

NP232 NEUTRON ACER TENDL-2019 LIBRARY; T=293.16K
Photon emission for (n,n*c)

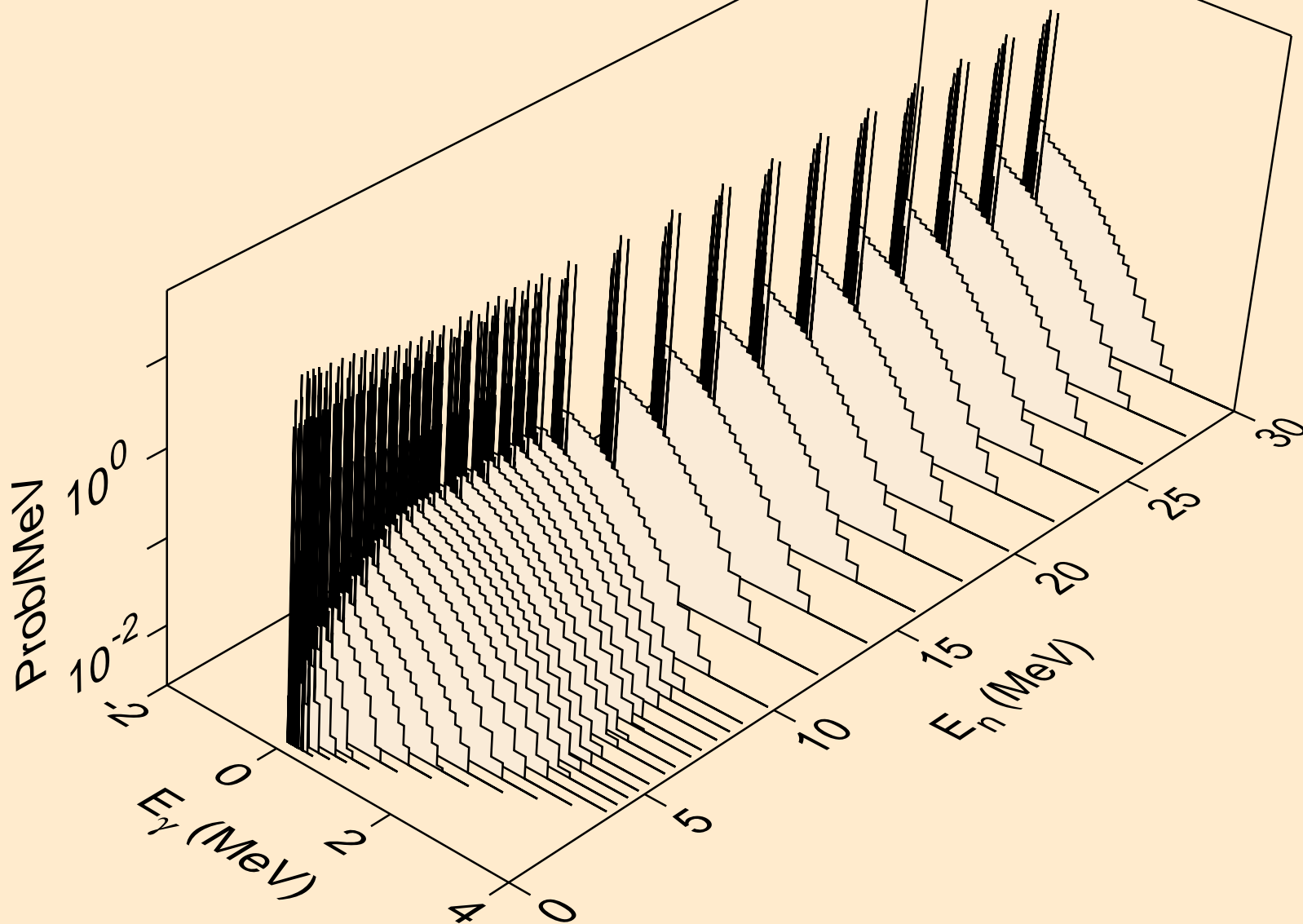

NP232 NEUTRON ACER TENDL-2019 LIBRARY; T=293.16K
Photon emission for (n,gma)

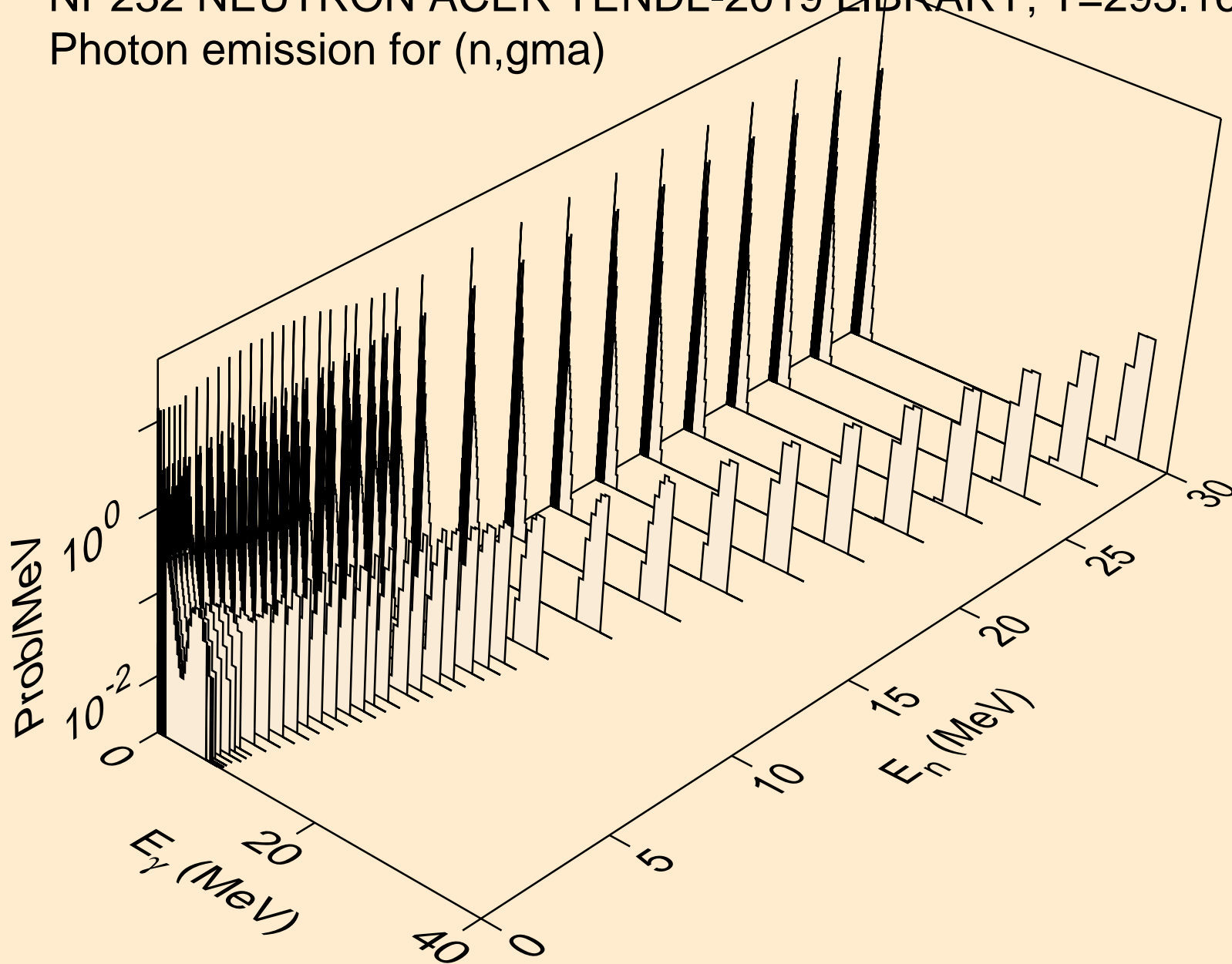

NP232 NEUTRON ACER TENDL-2019 LIBRARY; T=293.16K
Photon emission for (n,p)

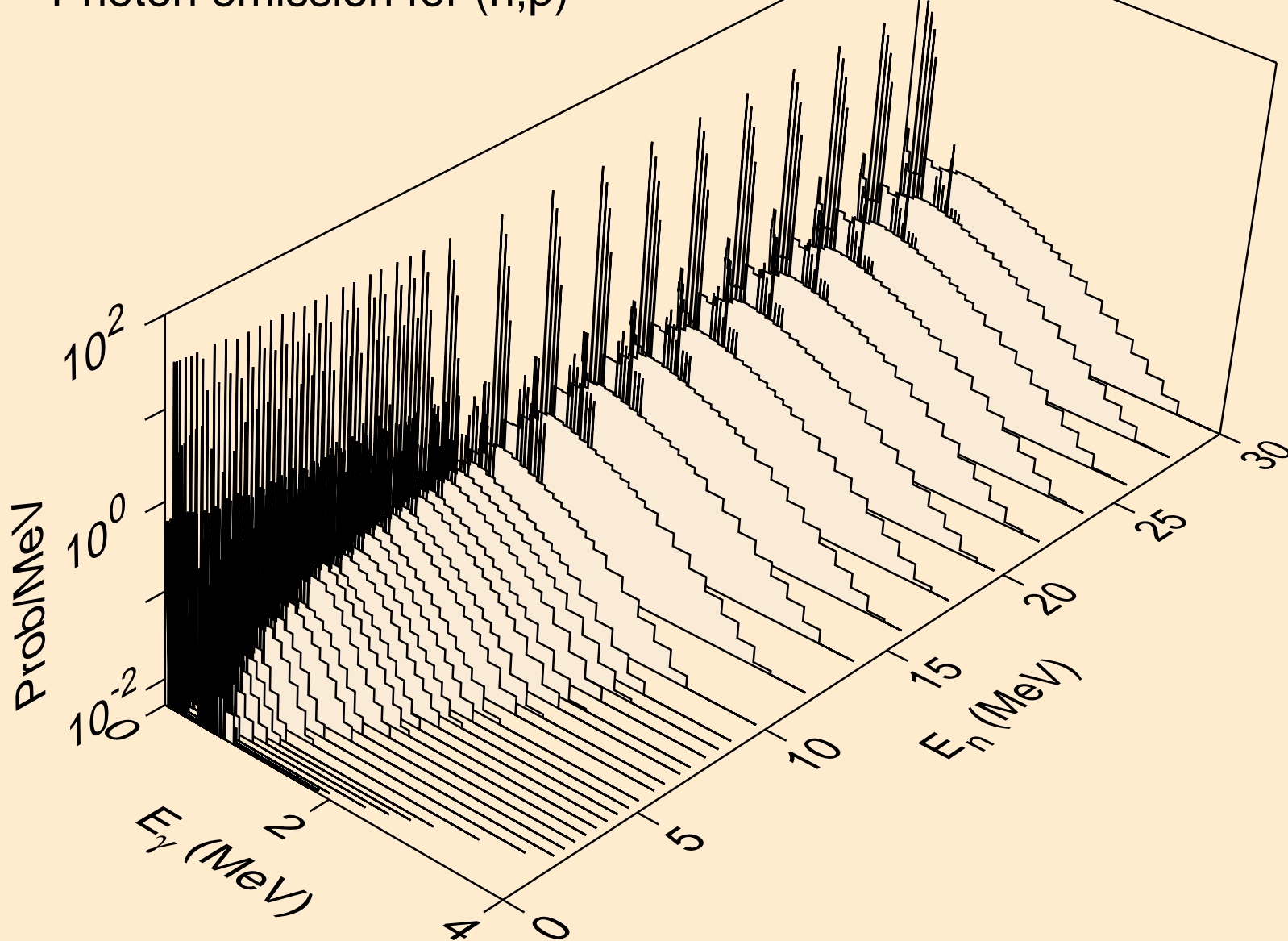

NP232 NEUTRON ACER TENDL-2019 LIBRARY; T=293.16K
Photon emission for (n,d)

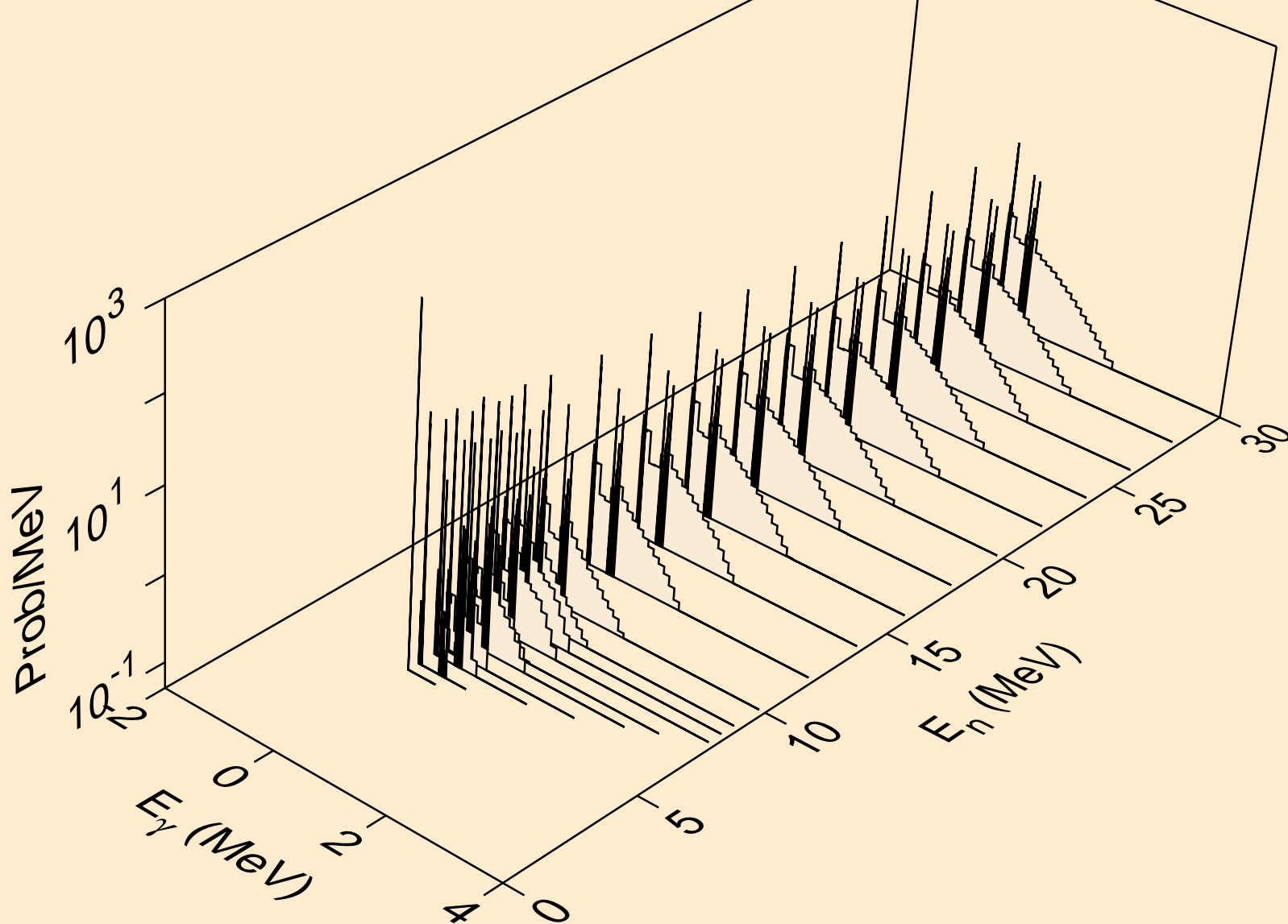

NP232 NEUTRON ACER TENDL-2019 LIBRARY; T=293.16K
Photon emission for (n,t)

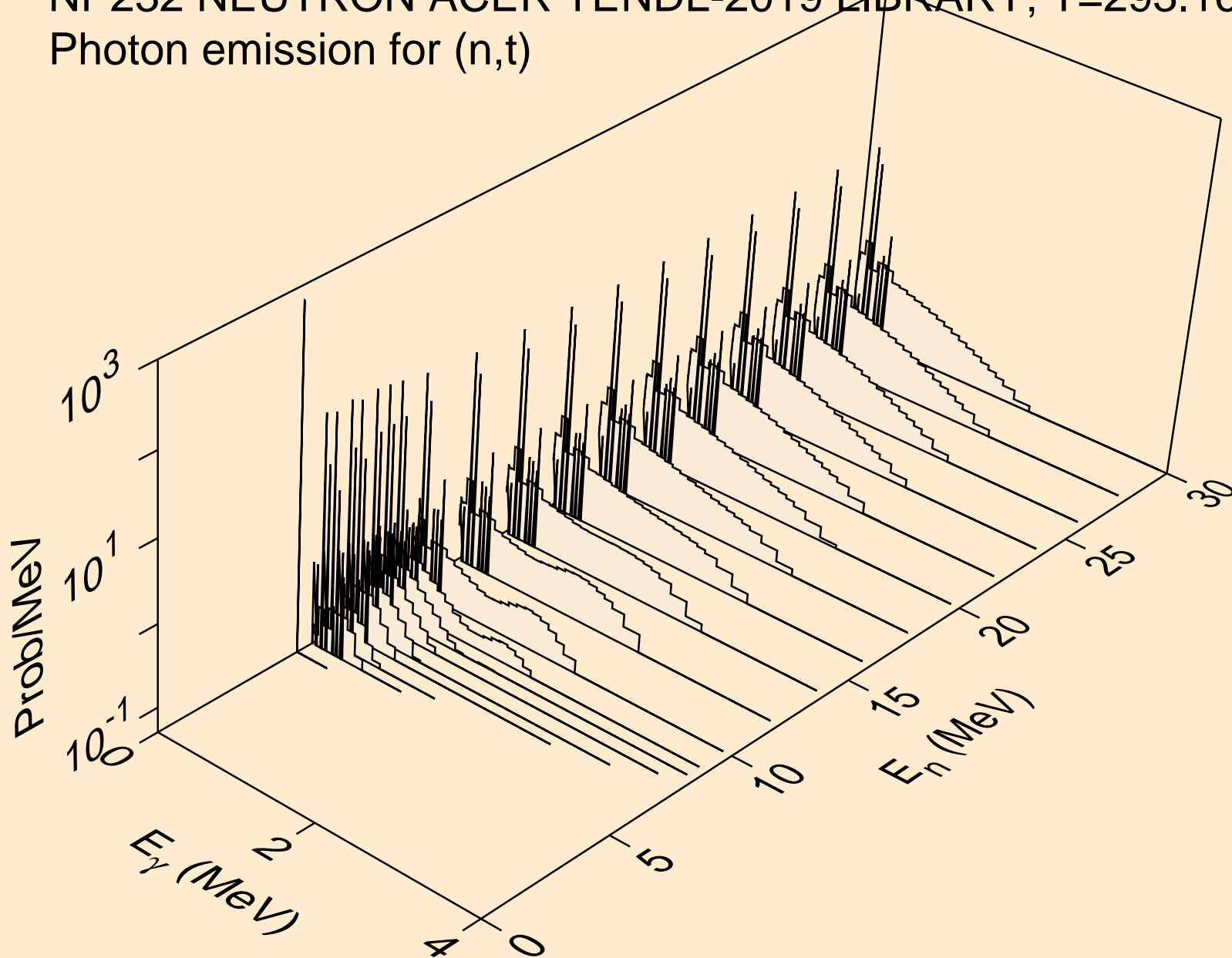

NP232 NEUTRON ACER TENDL-2019 LIBRARY; T=293.16K
Photon emission for (n,he3)

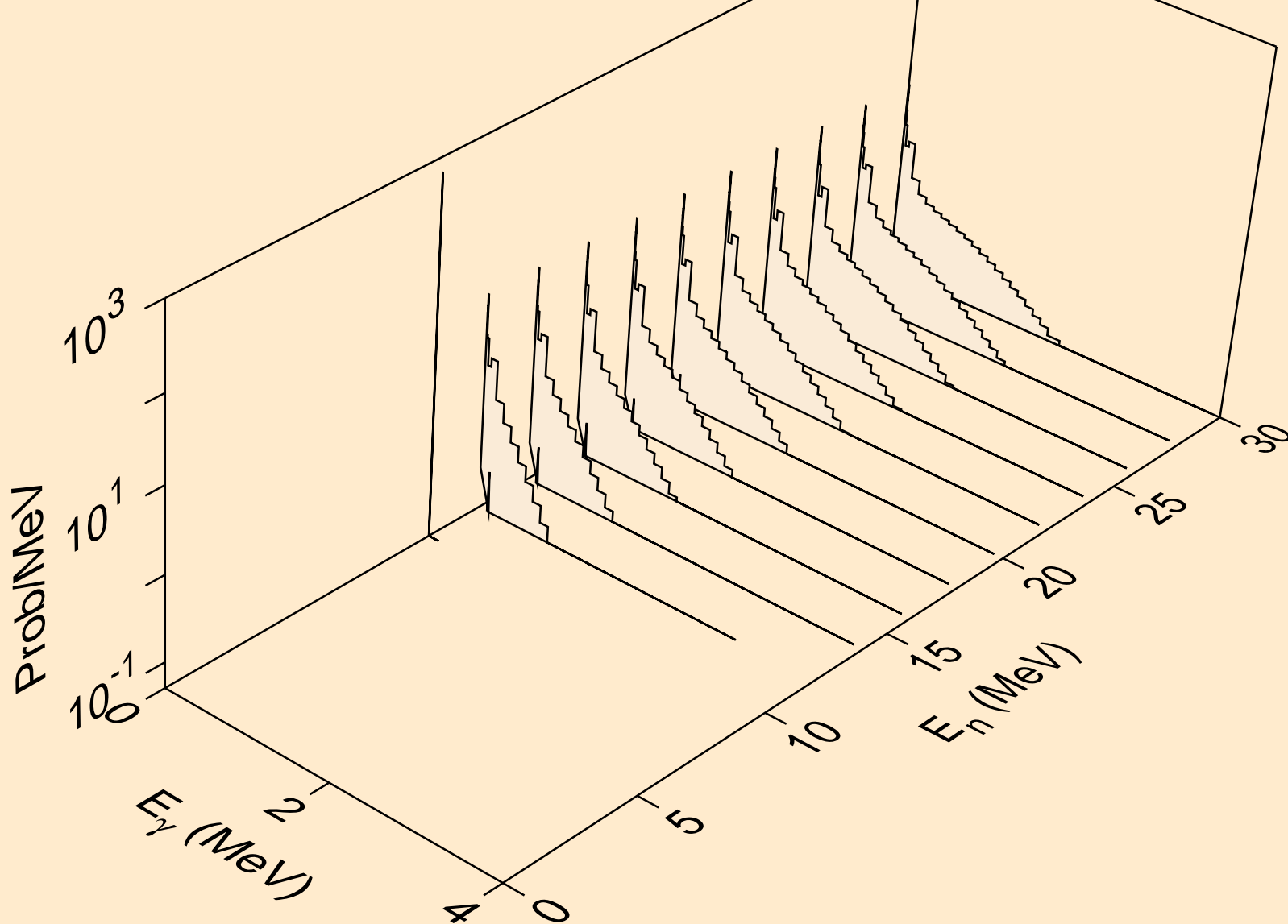

NP232 NEUTRON ACER TENDL-2019 LIBRARY; T=293.16K
Photon emission for (n,a)

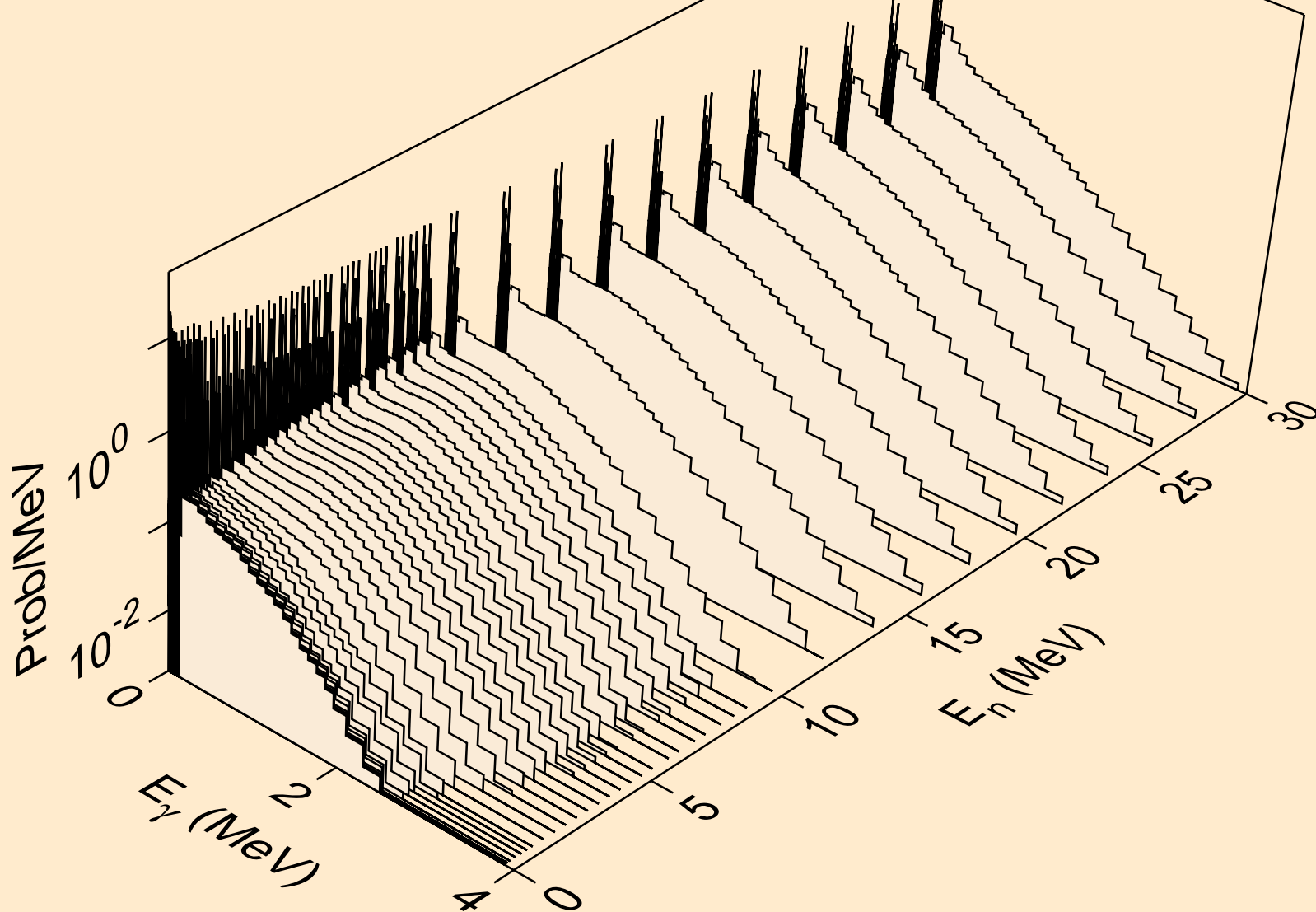

NP232 NEUTRON ACER TENDL-2019 LIBRARY; T=293.16K
Photon emission for (n,2a)

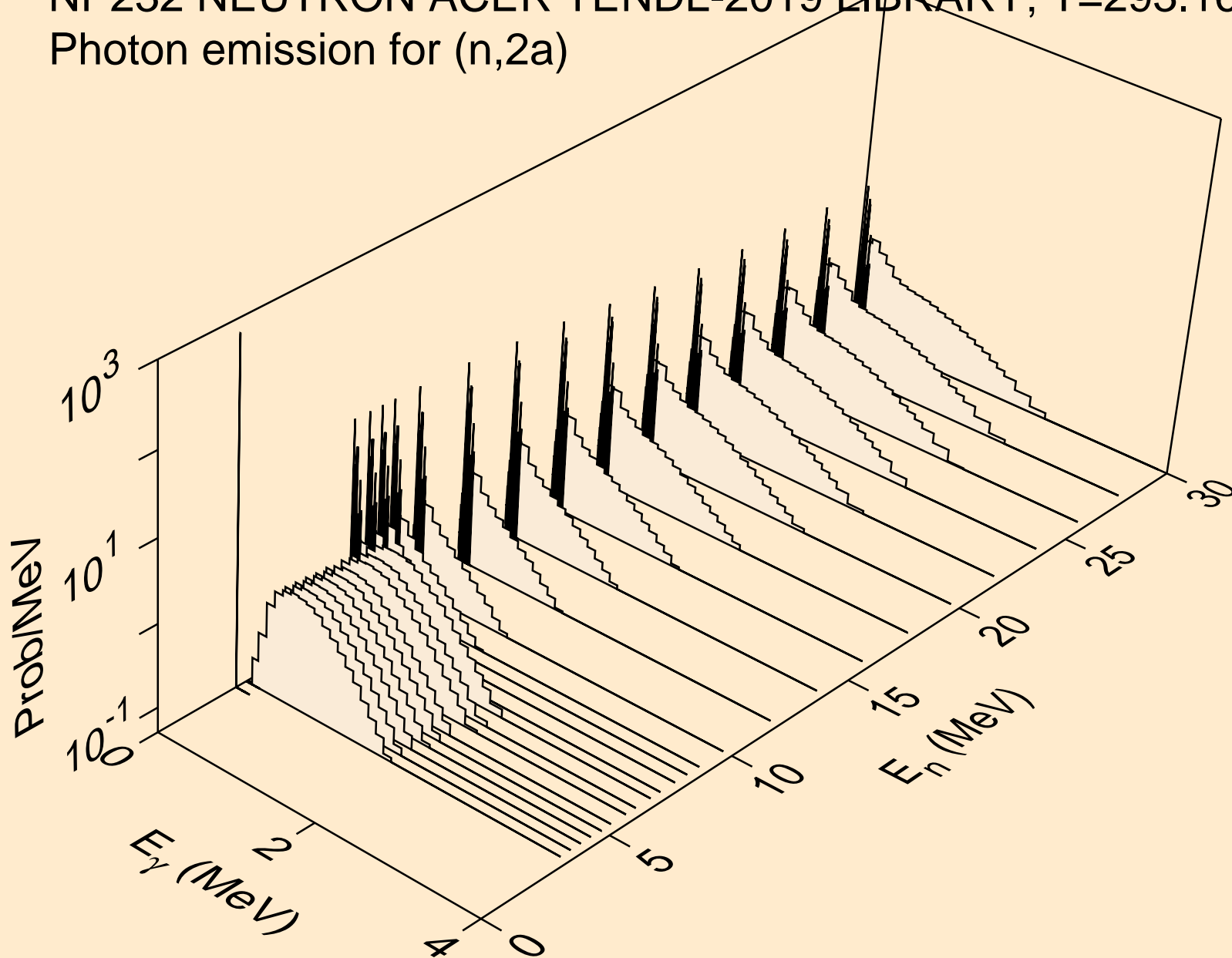

NP232 NEUTRON ACER TENDL-2019 LIBRARY; T=293.16K
Photon emission for (n,2p)

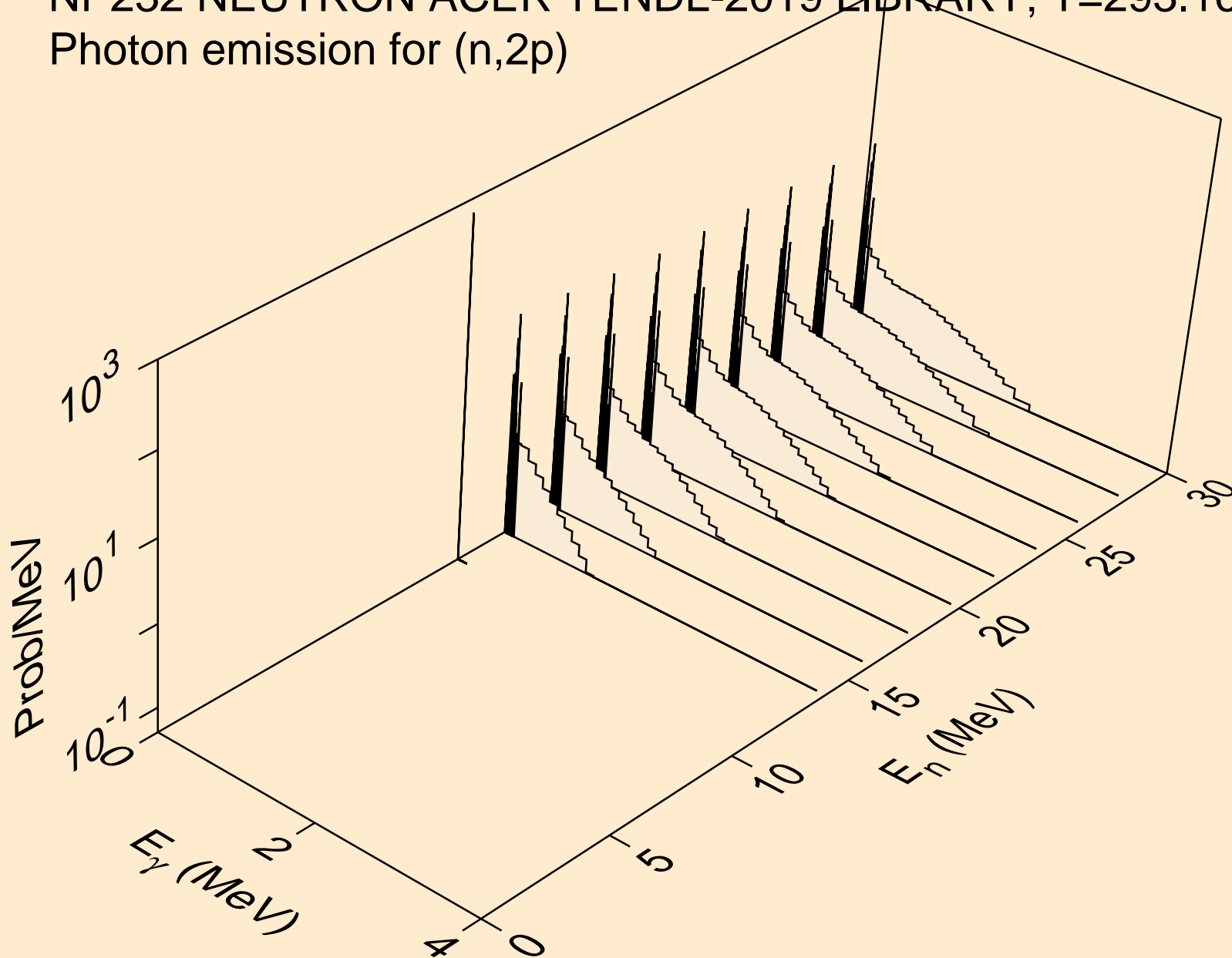

NP232 NEUTRON ACER TENDL-2019 LIBRARY; T=293.16K
Photon emission for (n,p α)

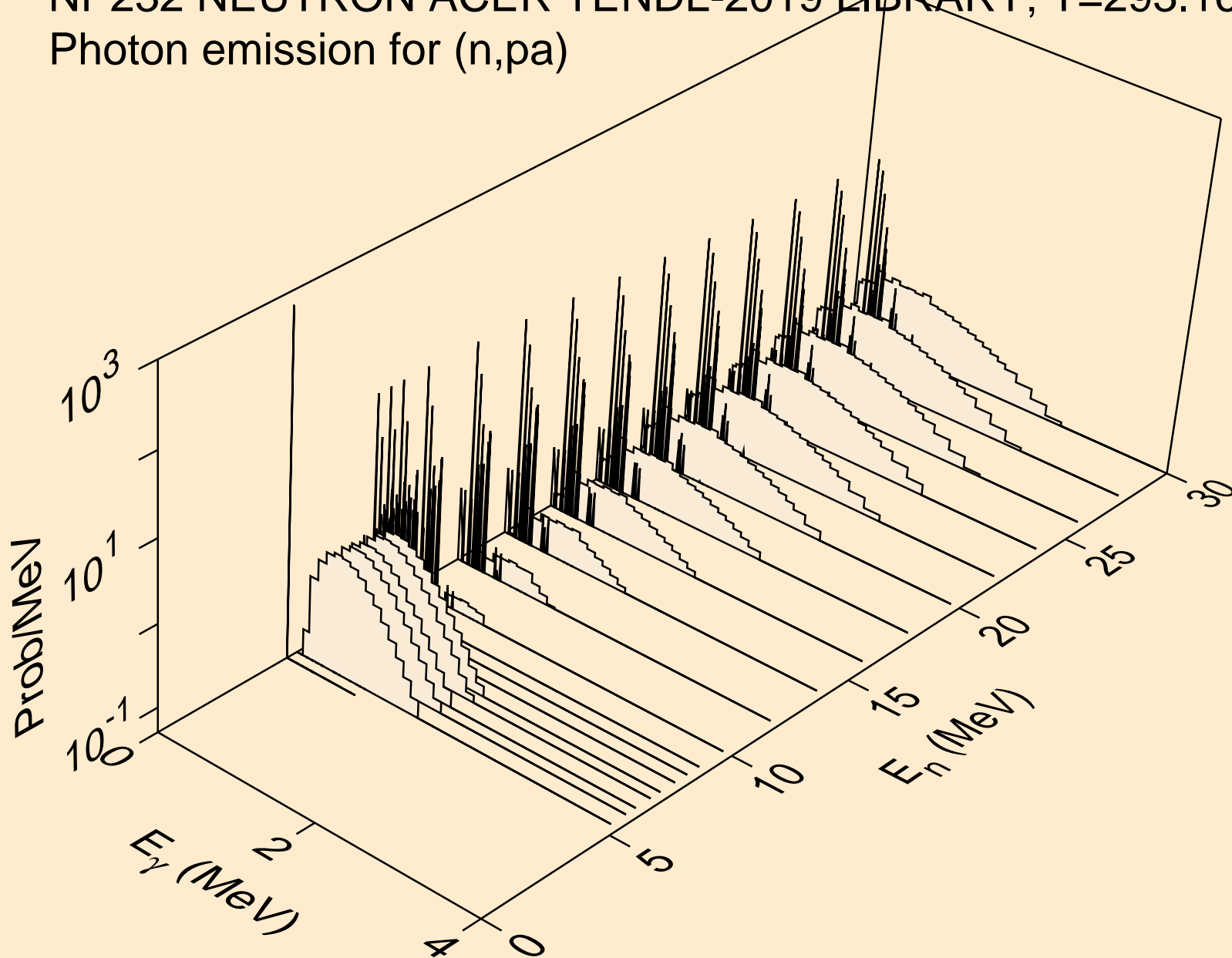

NP232 NEUTRON ACER TENDL-2019 LIBRARY; T=293.16K
Photon emission for (n,pd)

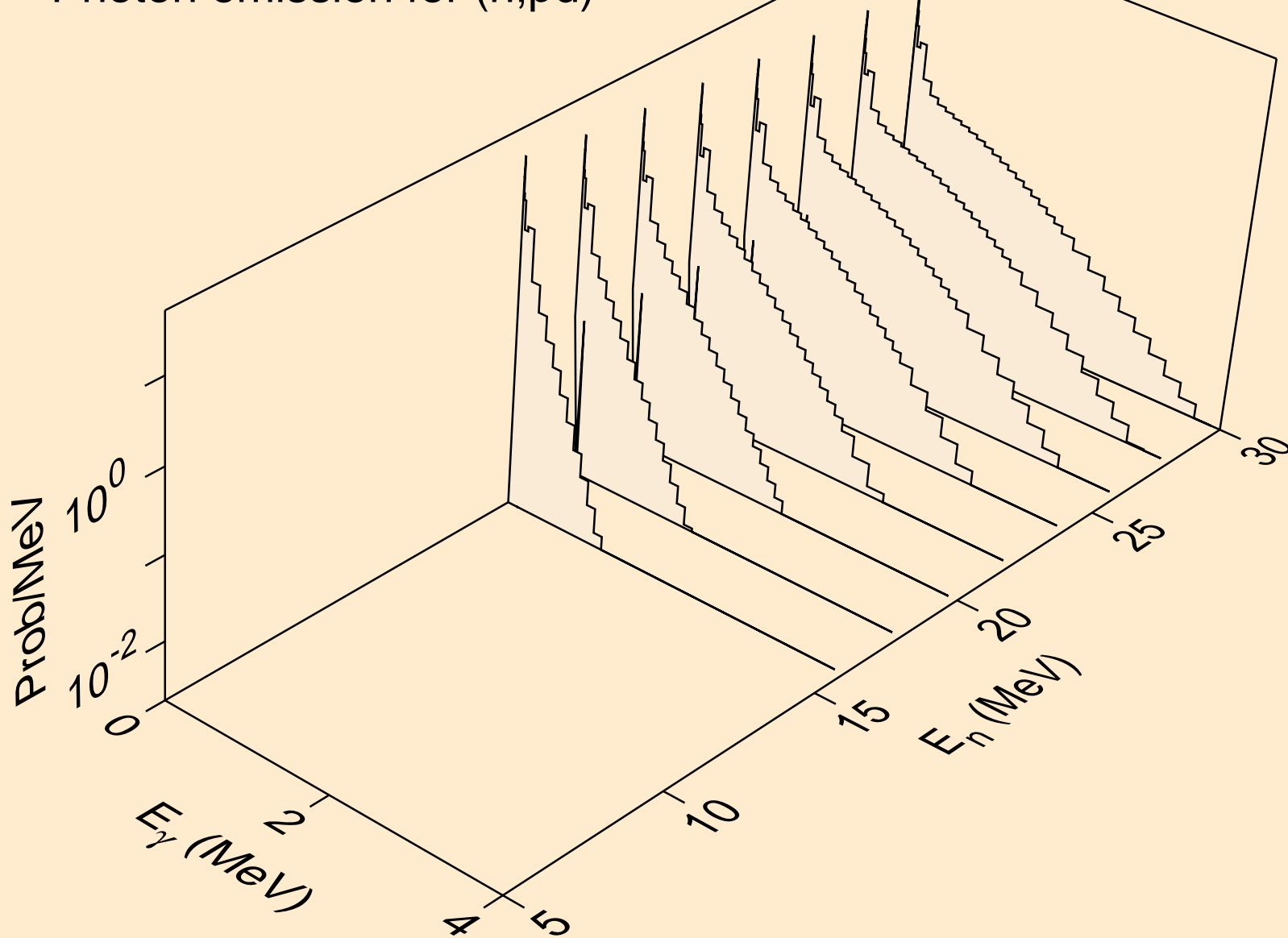

NP232 NEUTRON ACER TENDL-2019 LIBRARY; T=293.16K
Photon emission for (n,pt)

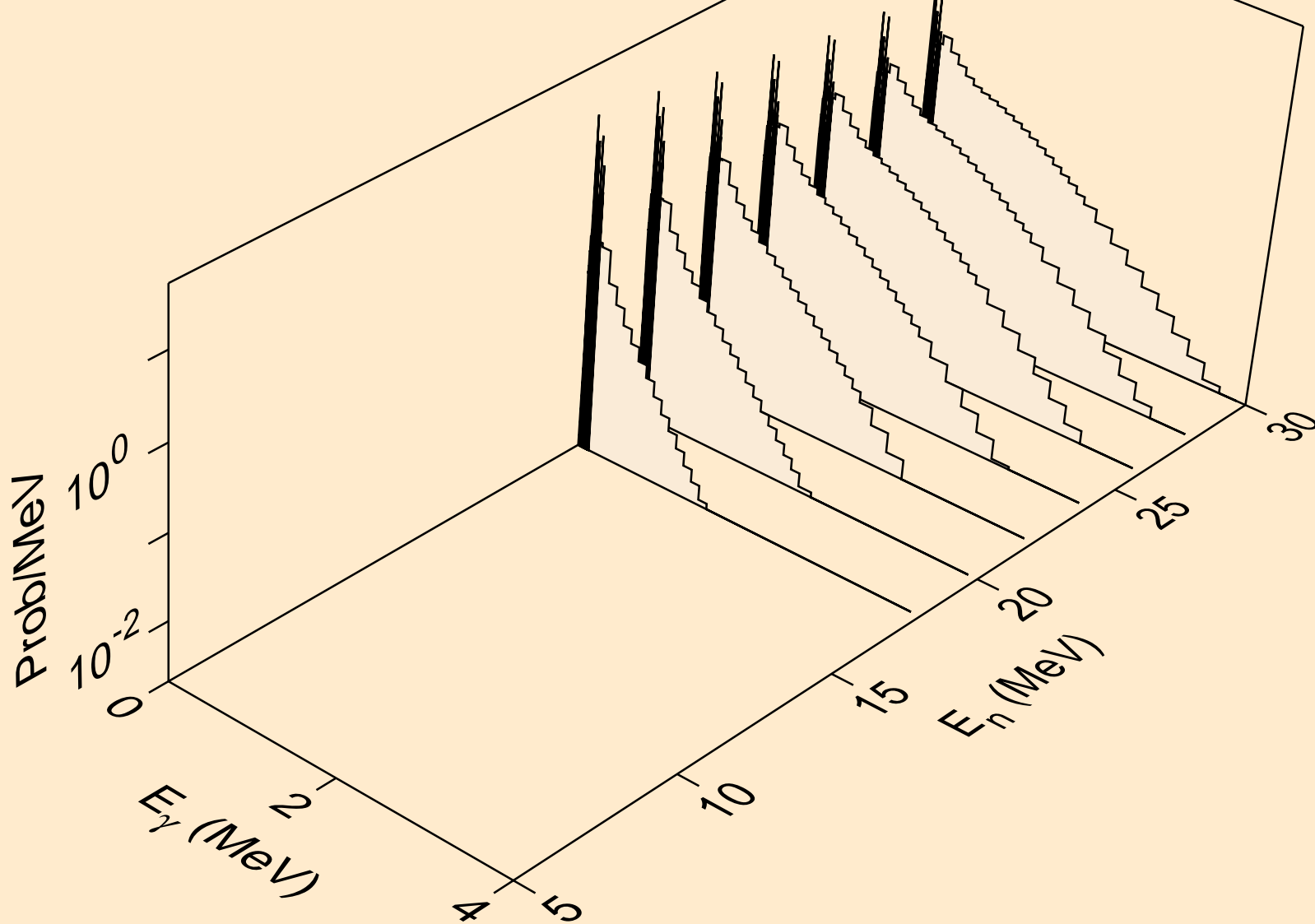

NP232 NEUTRON ACER TENDL-2019 LIBRARY; T=293.16K
Photon emission for (n,da)

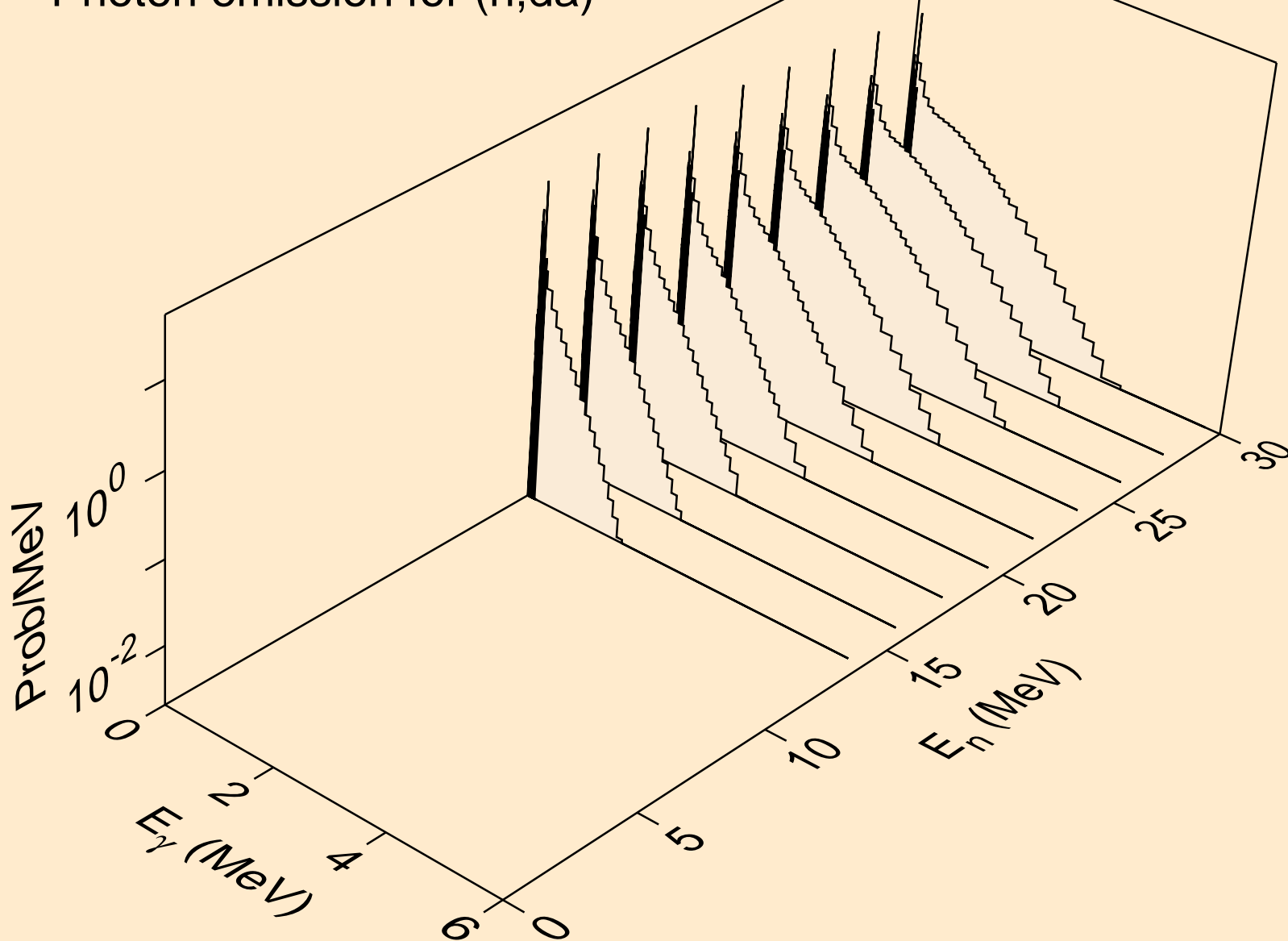

NP232 NEUTRON ACER TENDL-2019 LIBRARY; T=293.16K
thermal capture photon spectrum

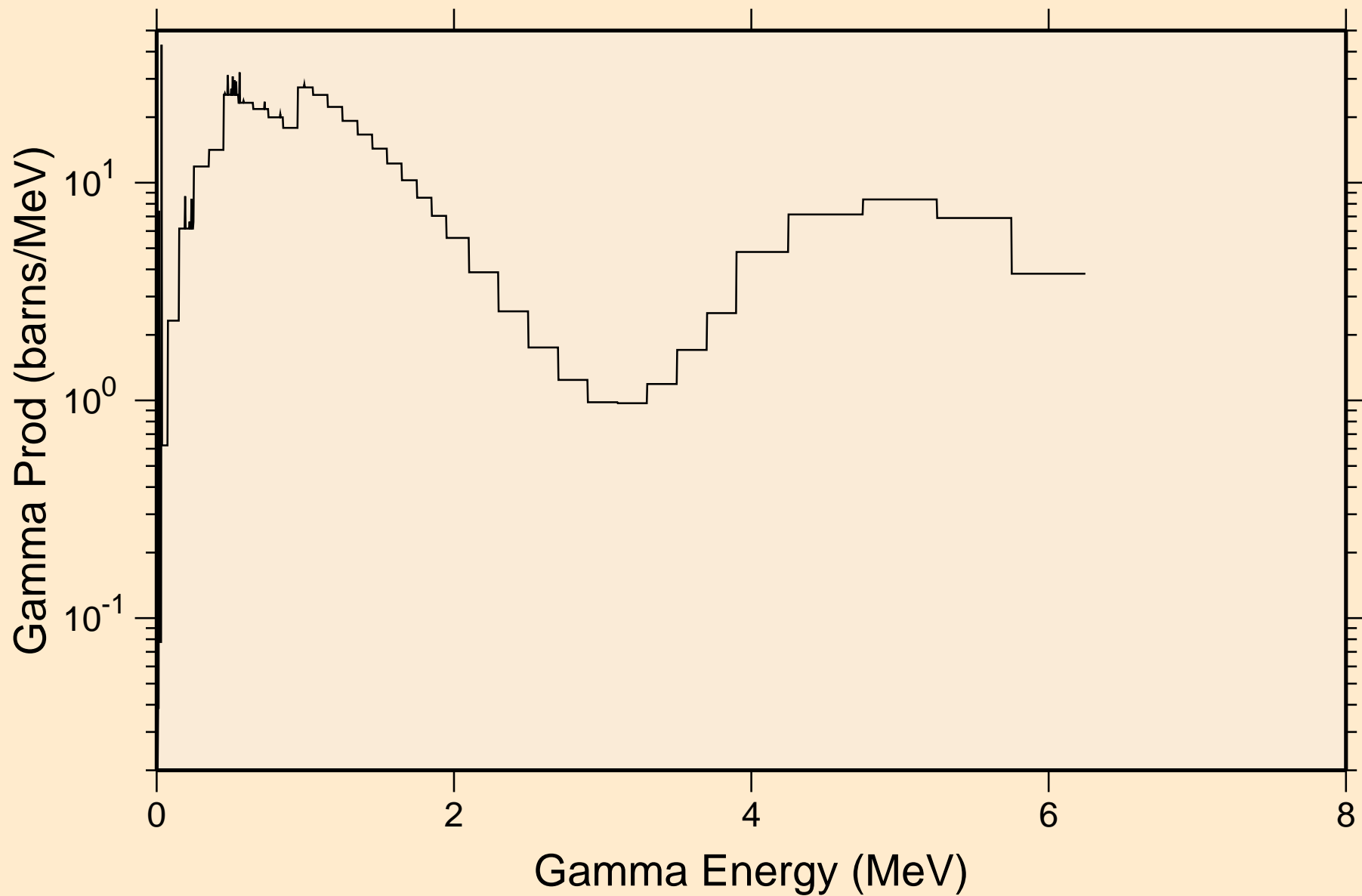

NP232 NEUTRON ACER TENDL-2019 LIBRARY; T=293.16K
14 MeV photon spectrum

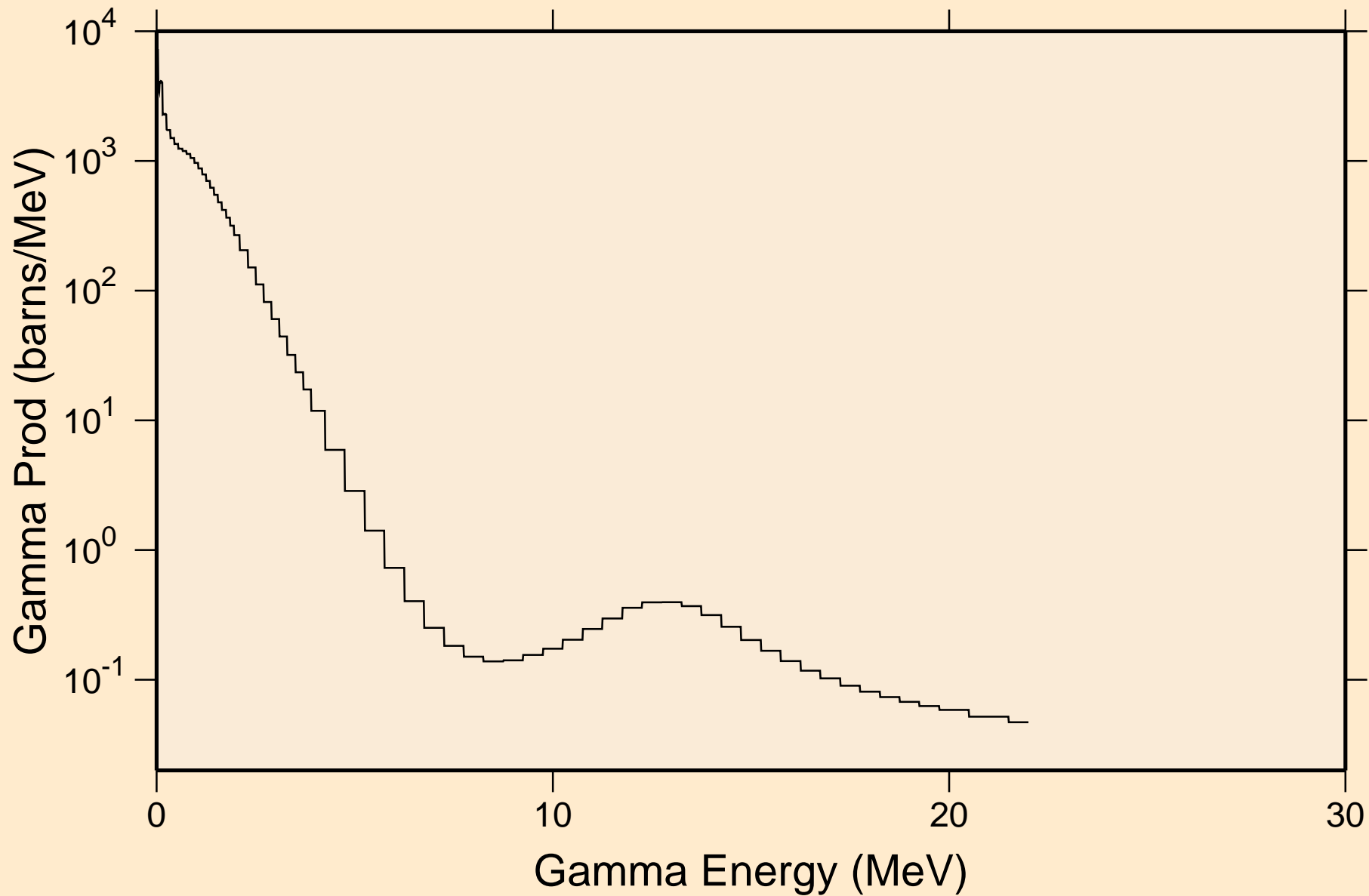

NP232 NEUTRON ACER TENDL-2019 LIBRARY; T=293.16K

Particle heating contributions

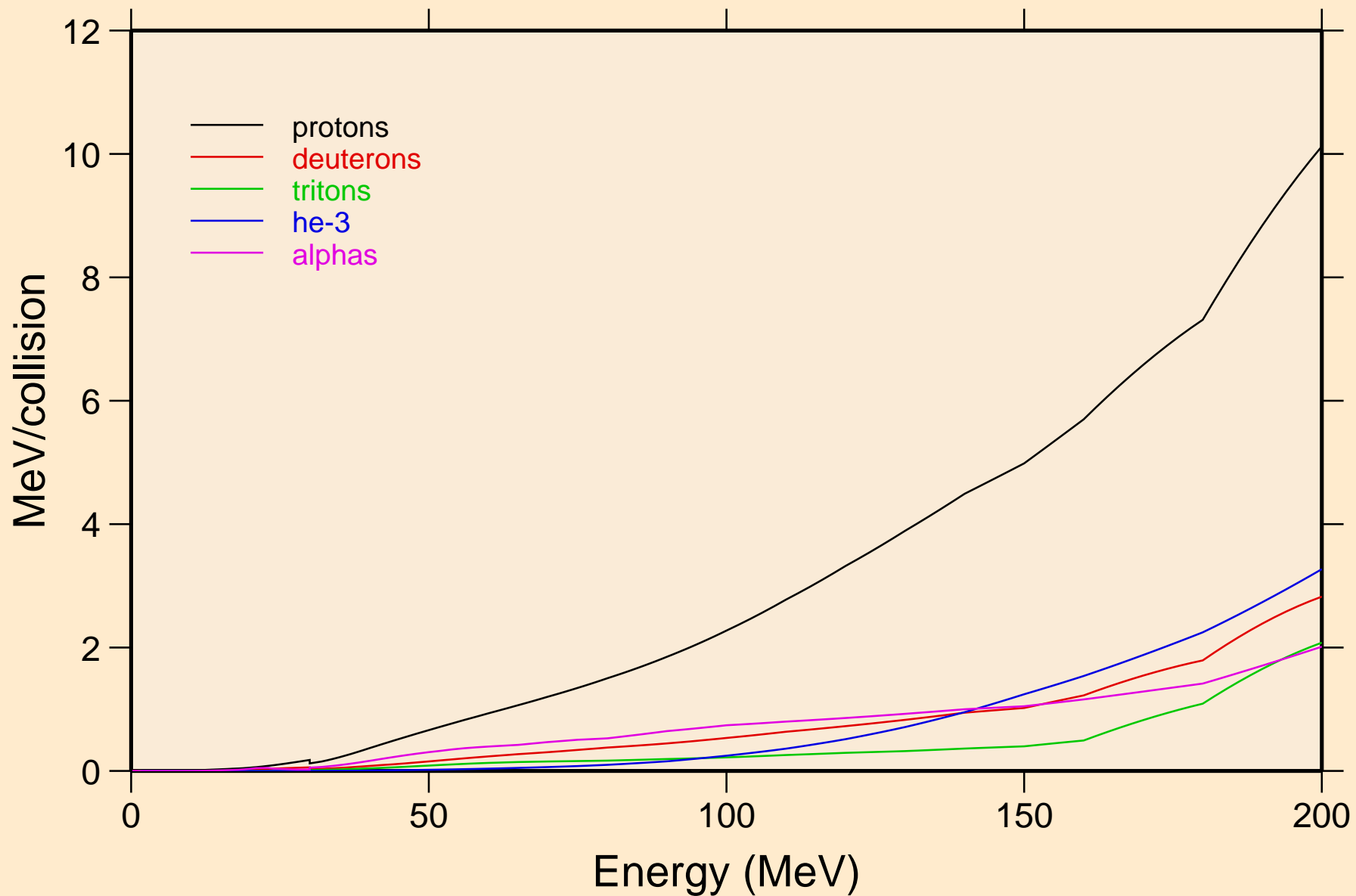

NP232 NEUTRON ACER TENDL-2019 LIBRARY; T=293.16K
Recoil Heating

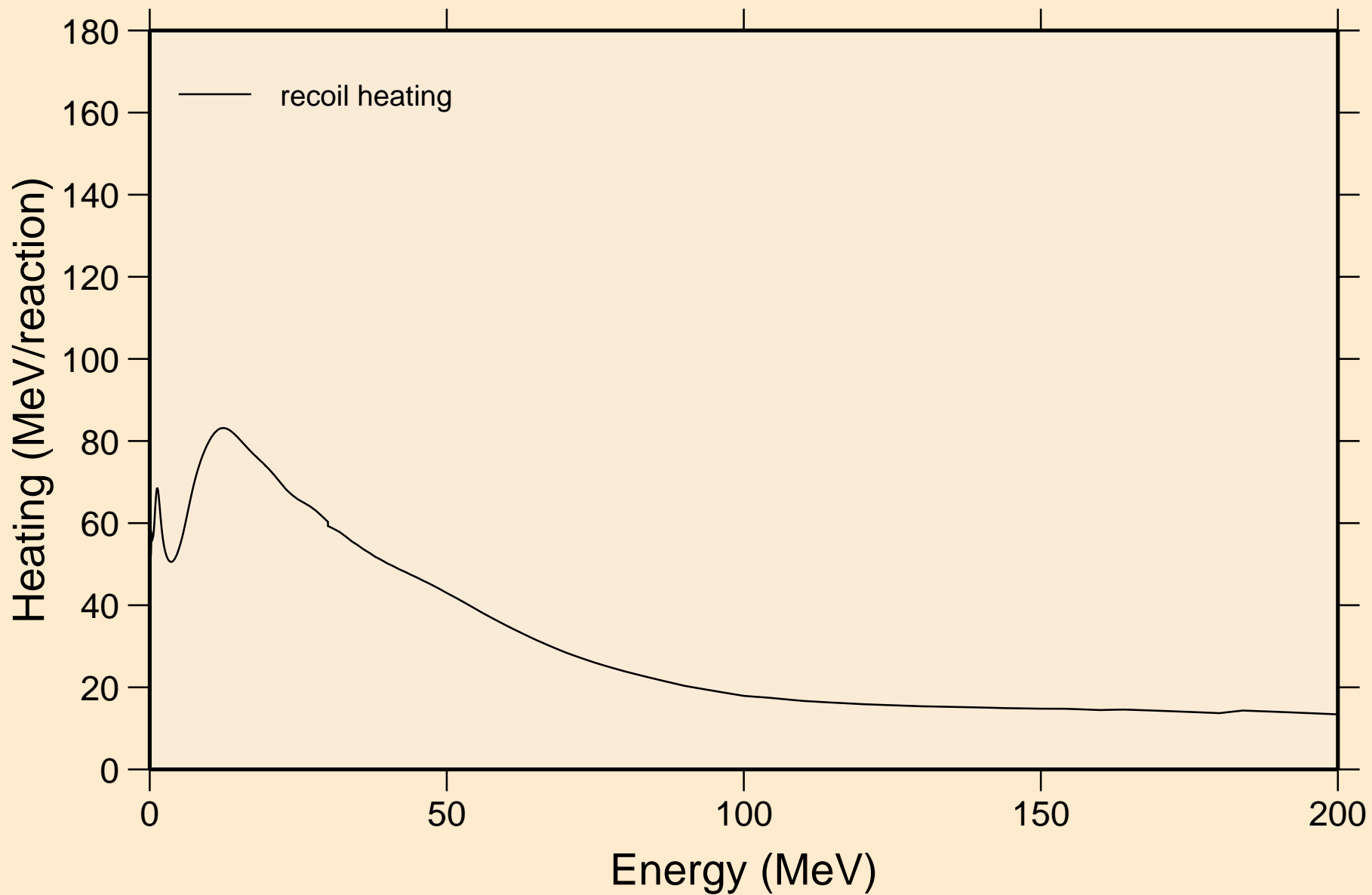

NP232 NEUTRON ACER TENDL-2019 LIBRARY; T=293.16K
Particle production cross sections

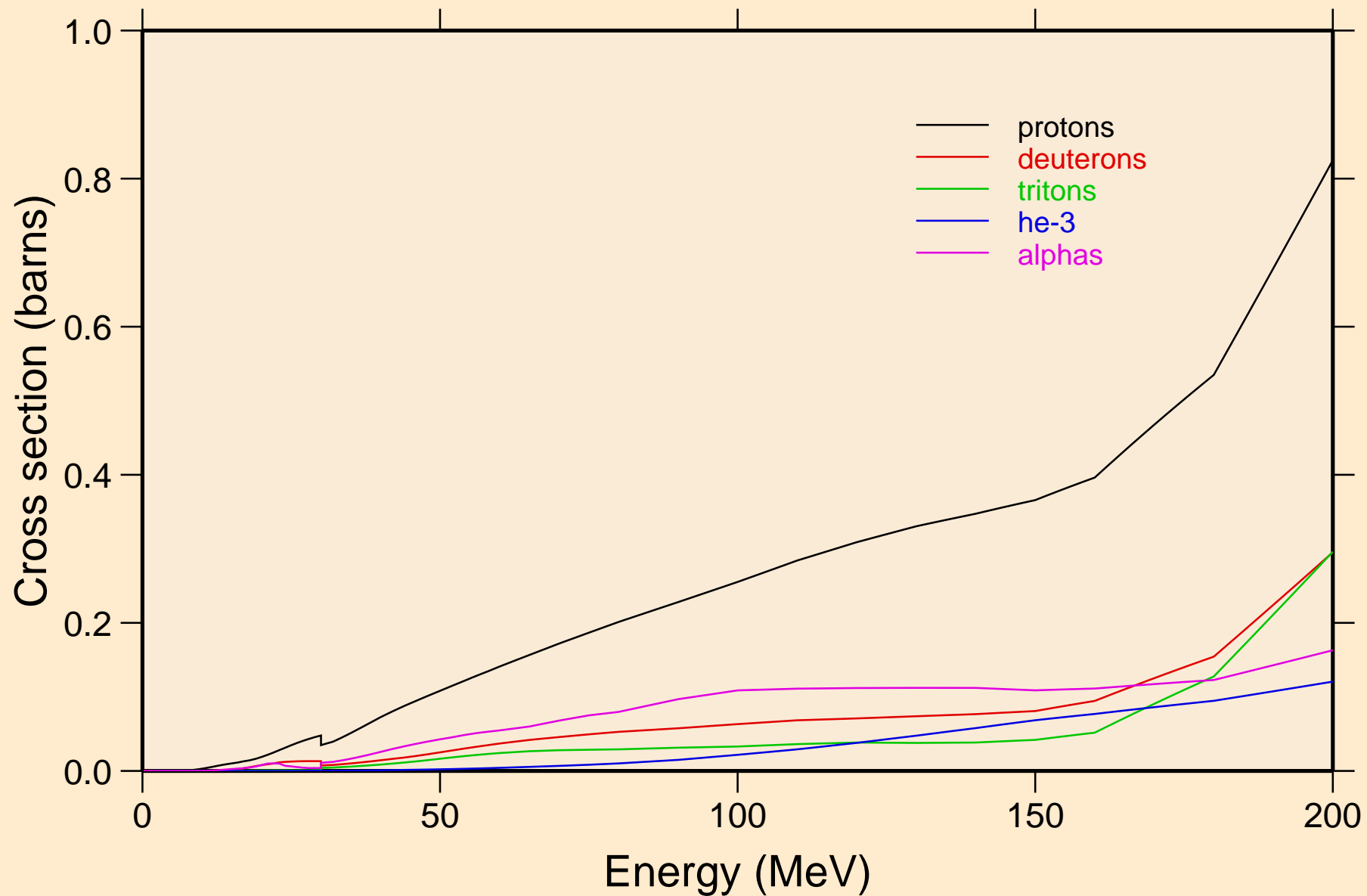

NP232 NEUTRON ACER TENDL-2019 LIBRARY; T=293.16K
protons from (n,x)

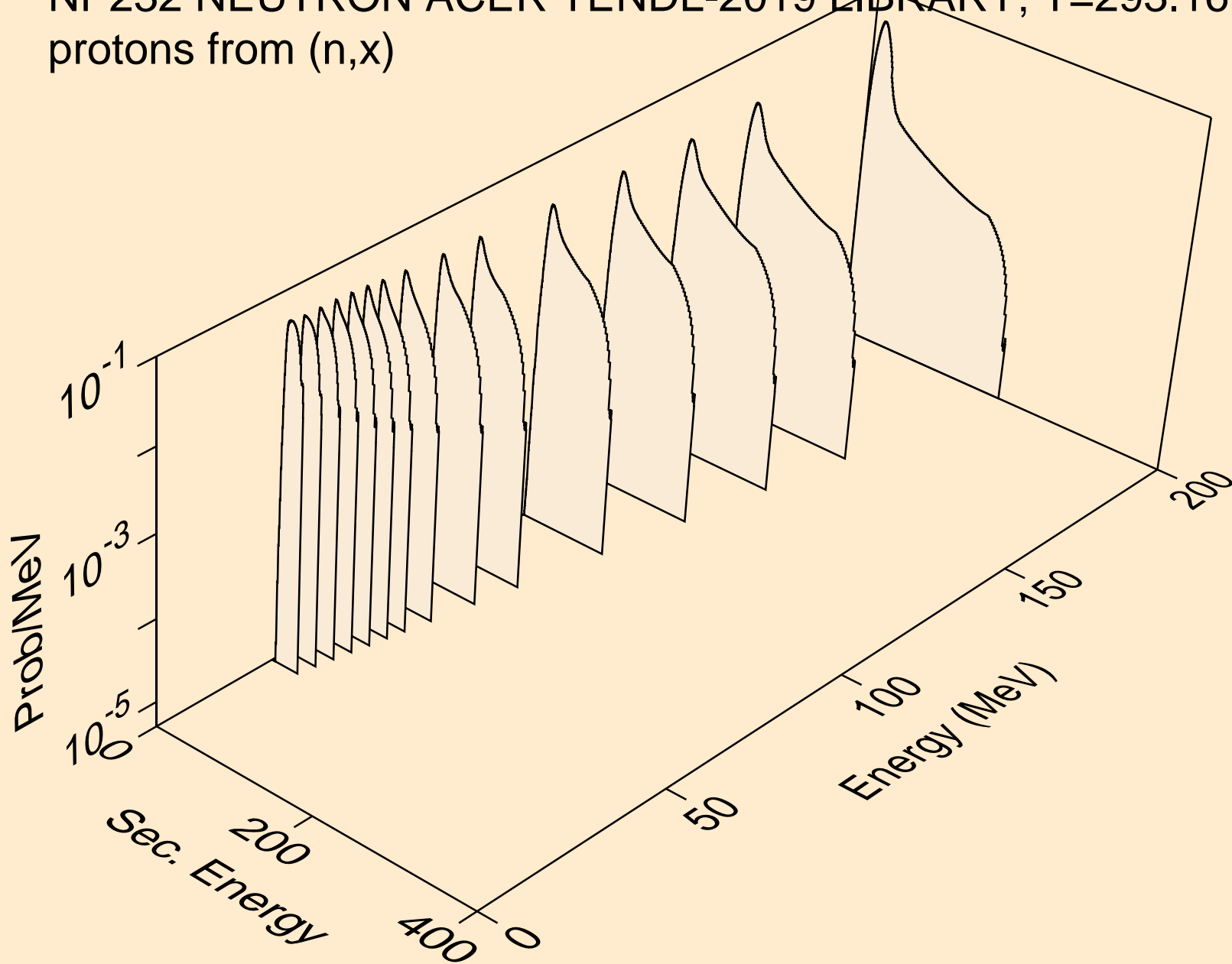

NP232 NEUTRON ACER TENDL-2019 LIBRARY; T=293.16K
protons from (n,n*)p

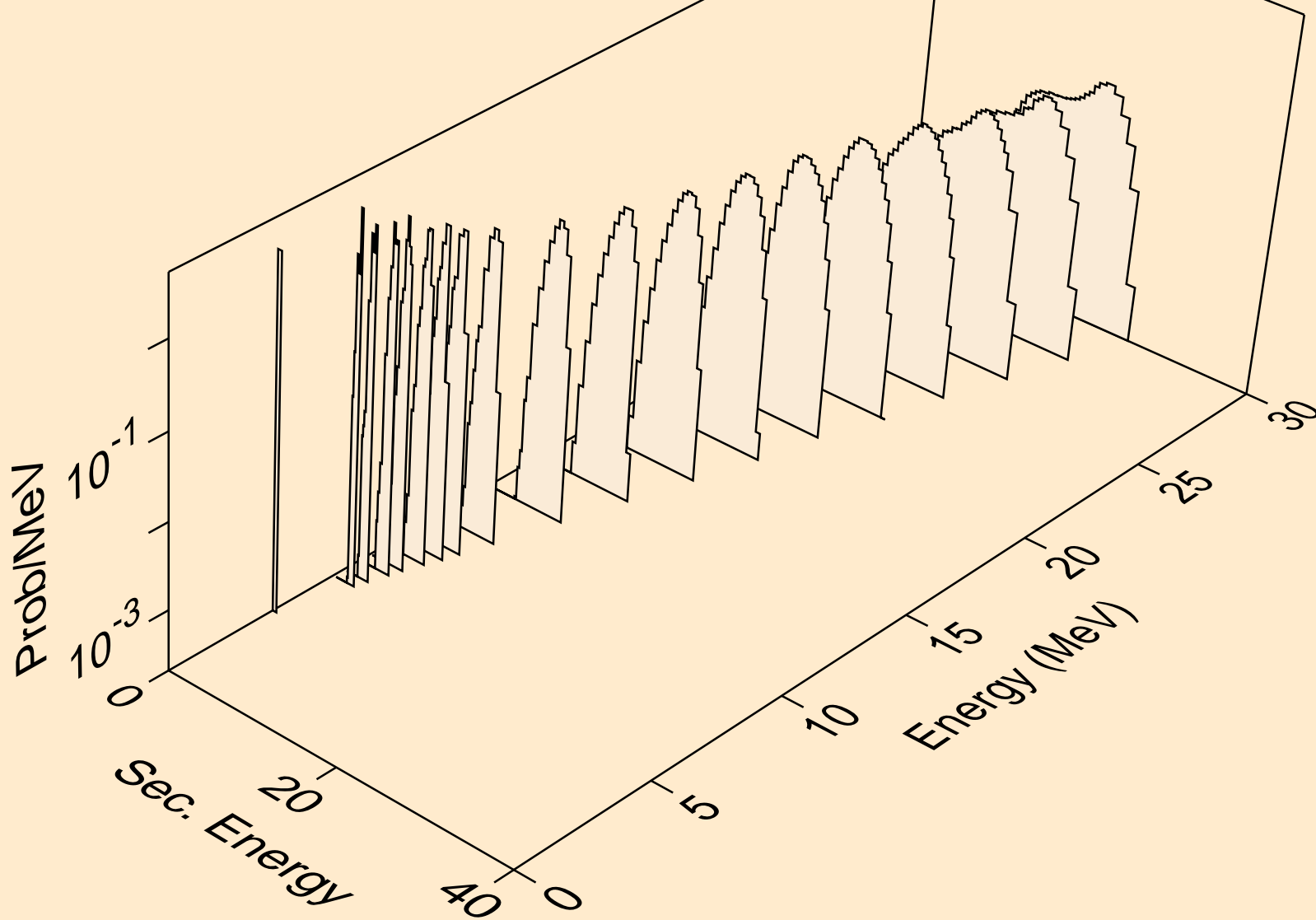

NP232 NEUTRON ACER TENDL-2019 LIBRARY; T=293.16K
protons from (n,2np)

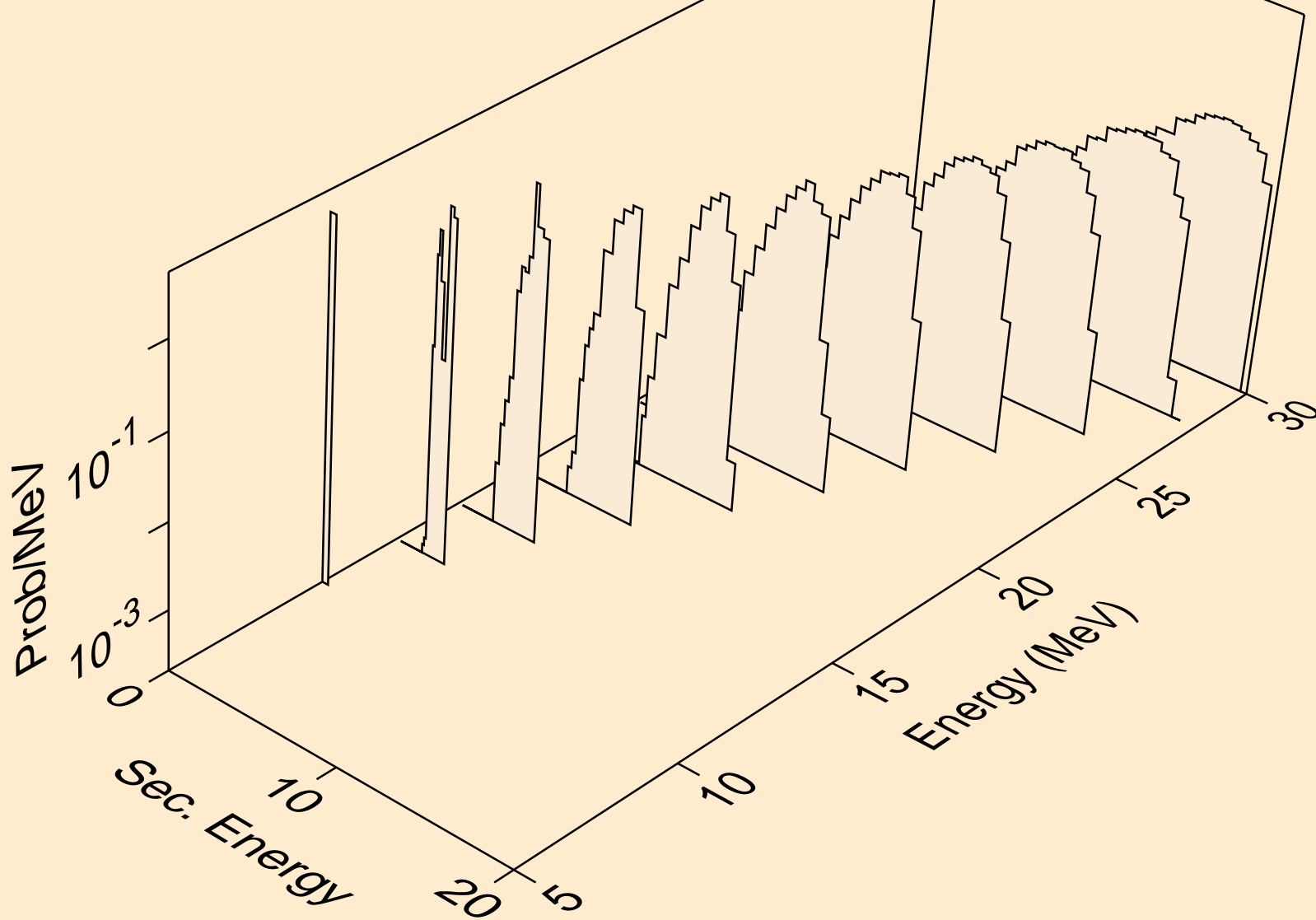

NP232 NEUTRON ACER TENDL-2019 LIBRARY; T=293.16K
protons from (n,3np)

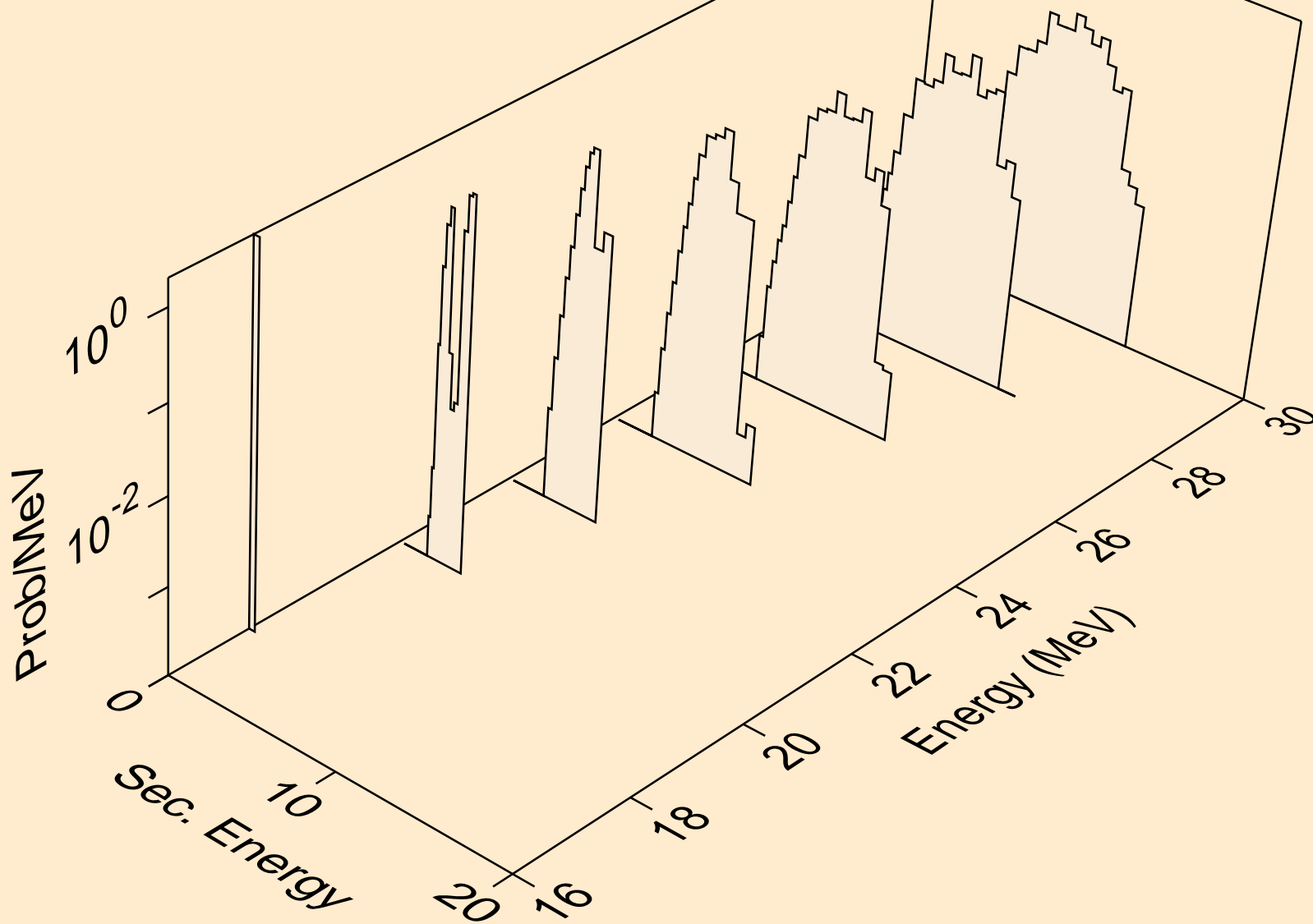

NP232 NEUTRON ACER TENDL-2019 LIBRARY; T=293.16K
protons from (n,2np)

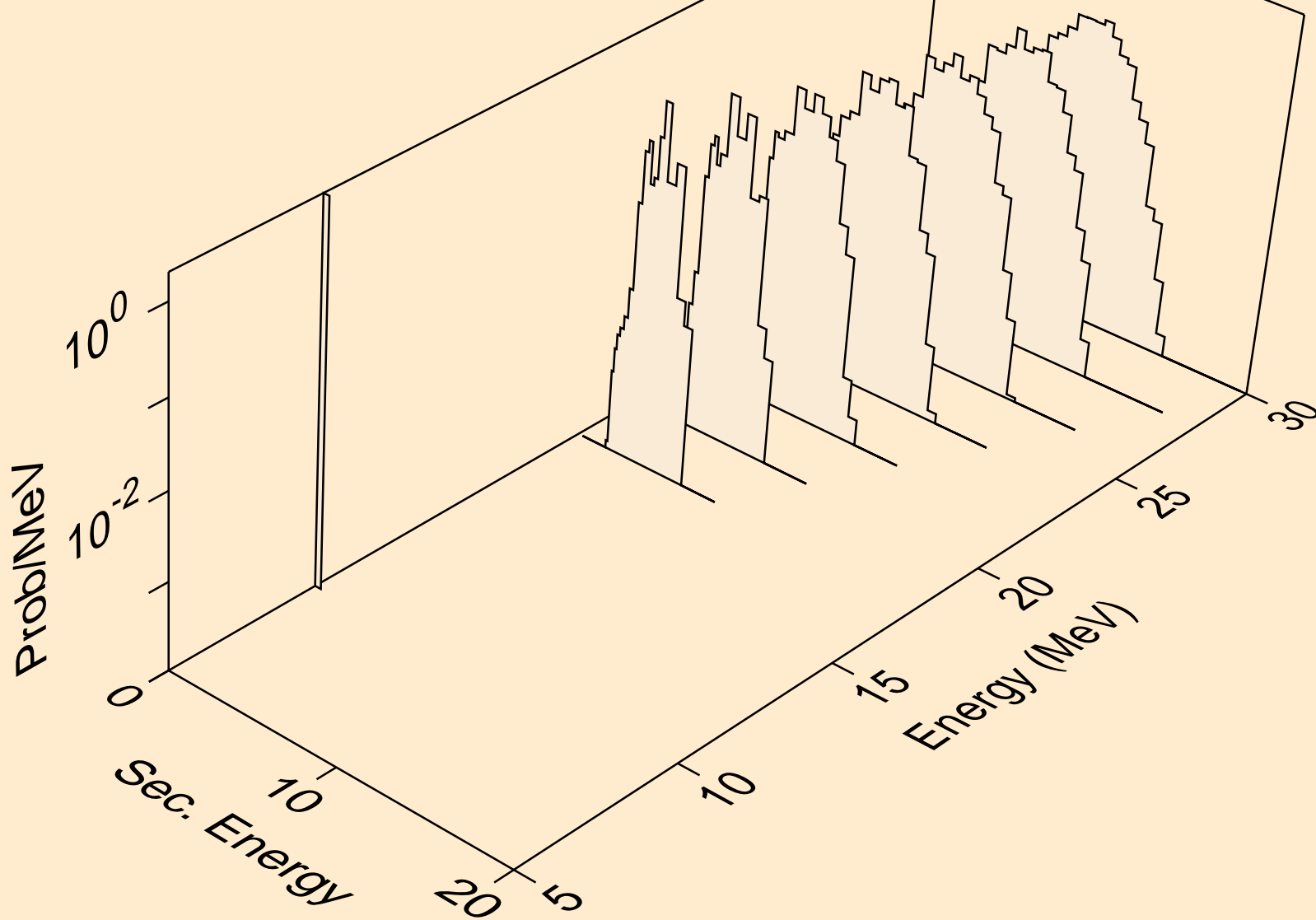

NP232 NEUTRON ACER TENDL-2019 LIBRARY; T=293.16K
protons from (n,npa)

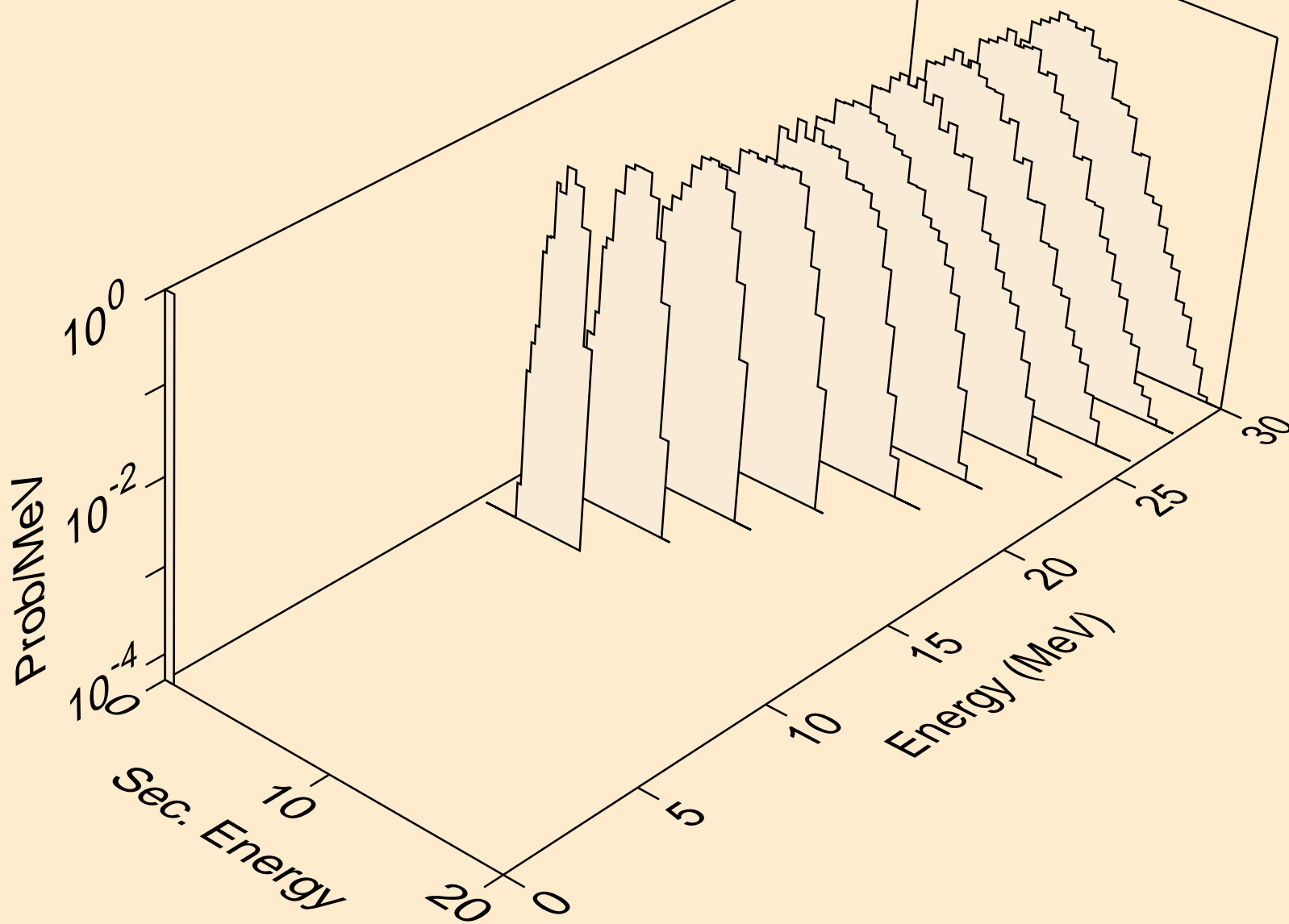

NP232 NEUTRON ACER TENDL-2019 LIBRARY; T=293.16K
protons from (n,p)

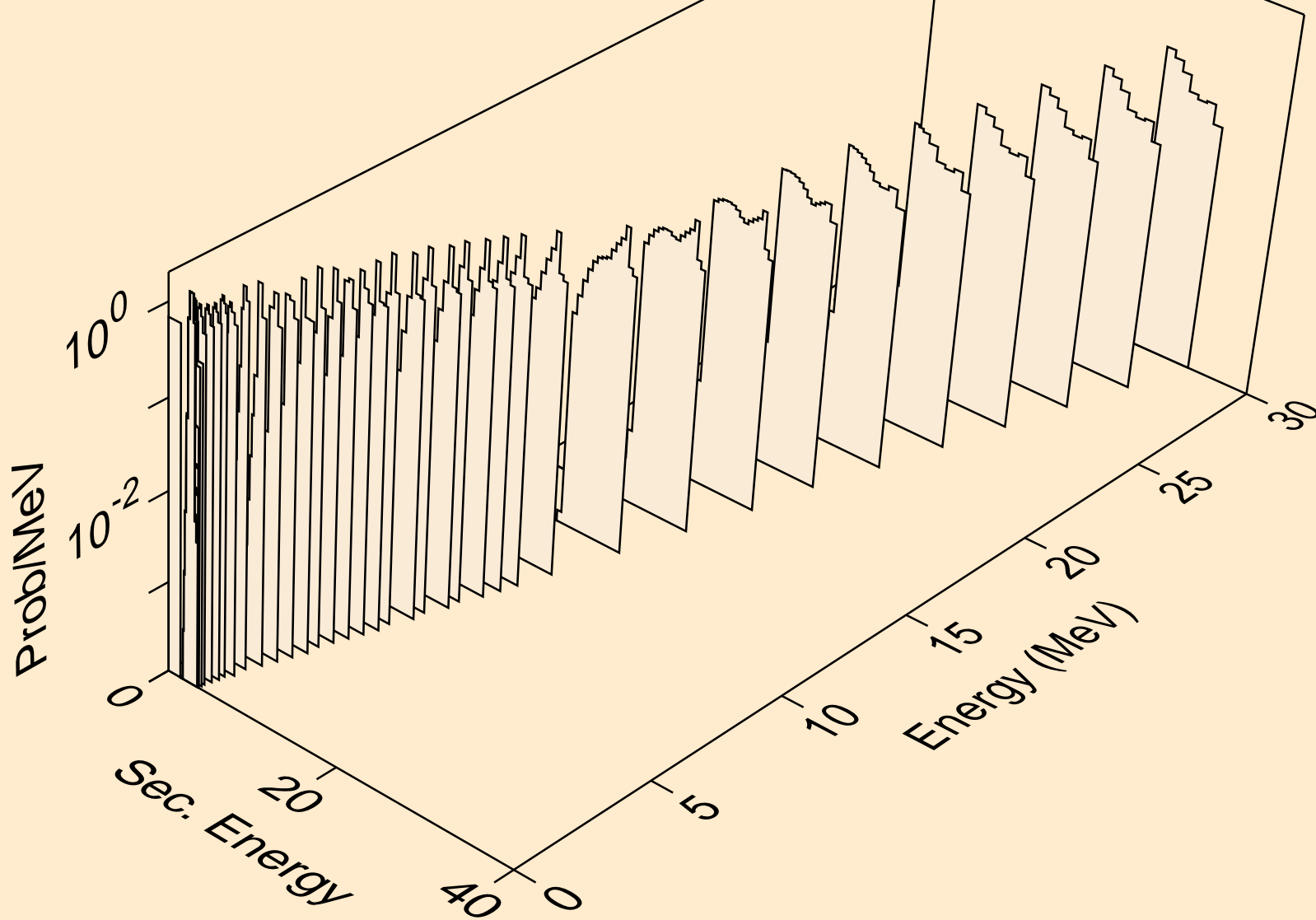

NP232 NEUTRON ACER TENDL-2019 LIBRARY; T=293.16K
protons from (n,2p)

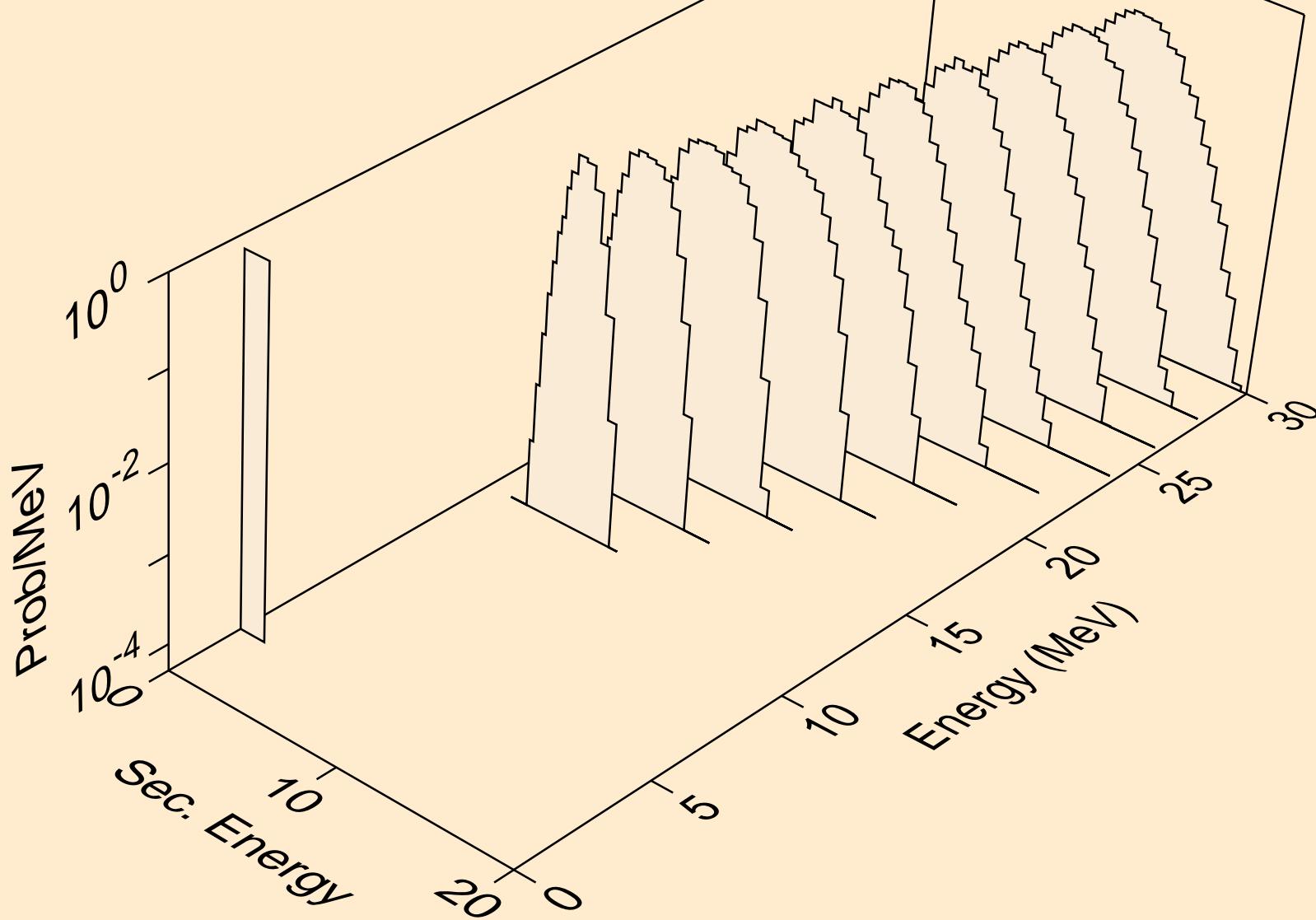

NP232 NEUTRON ACER TENDL-2019 LIBRARY; T=293.16K
protons from (n,p)

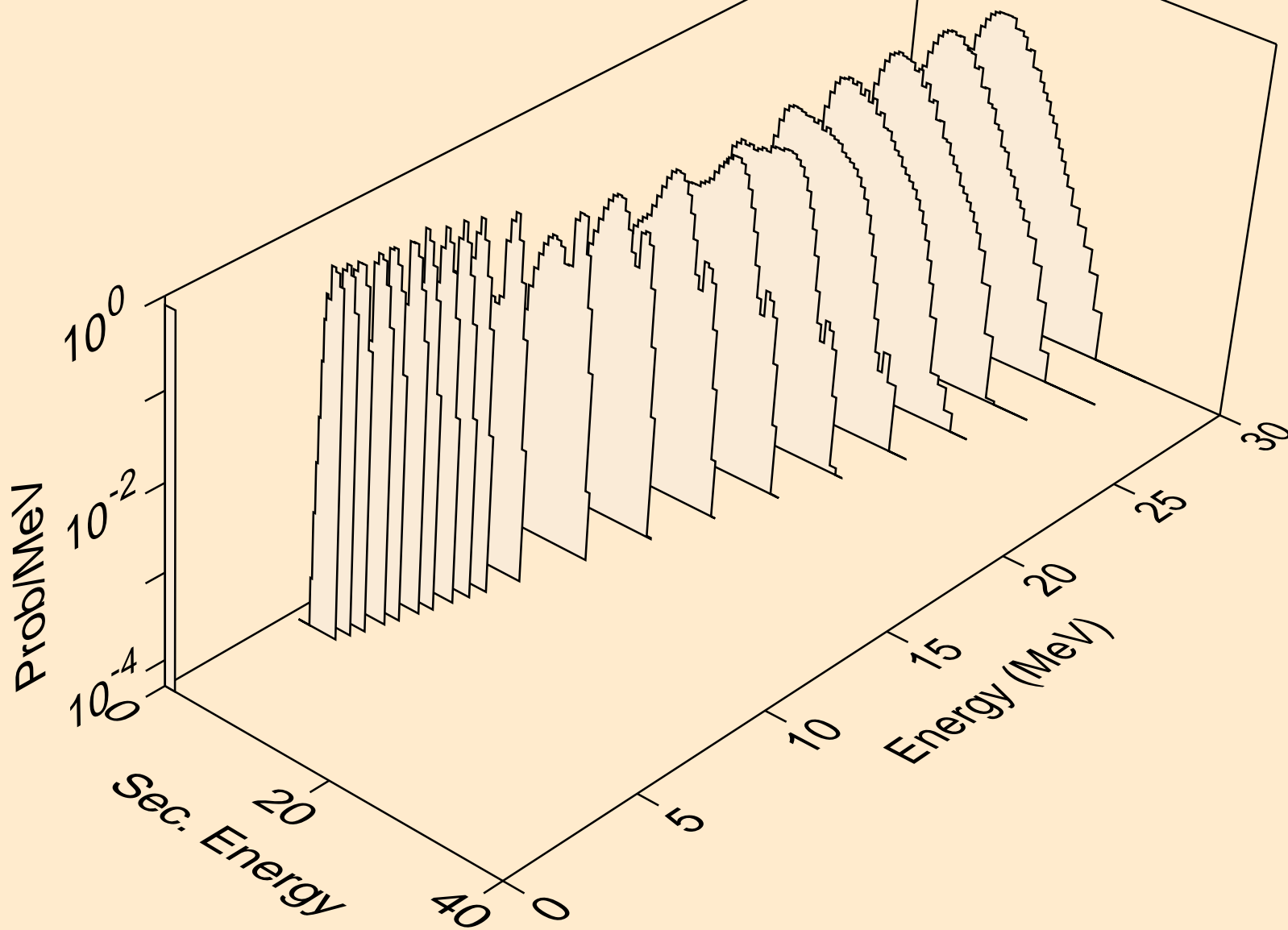

NP232 NEUTRON ACER TENDL-2019 LIBRARY; T=293.16K
protons from (n,pd)

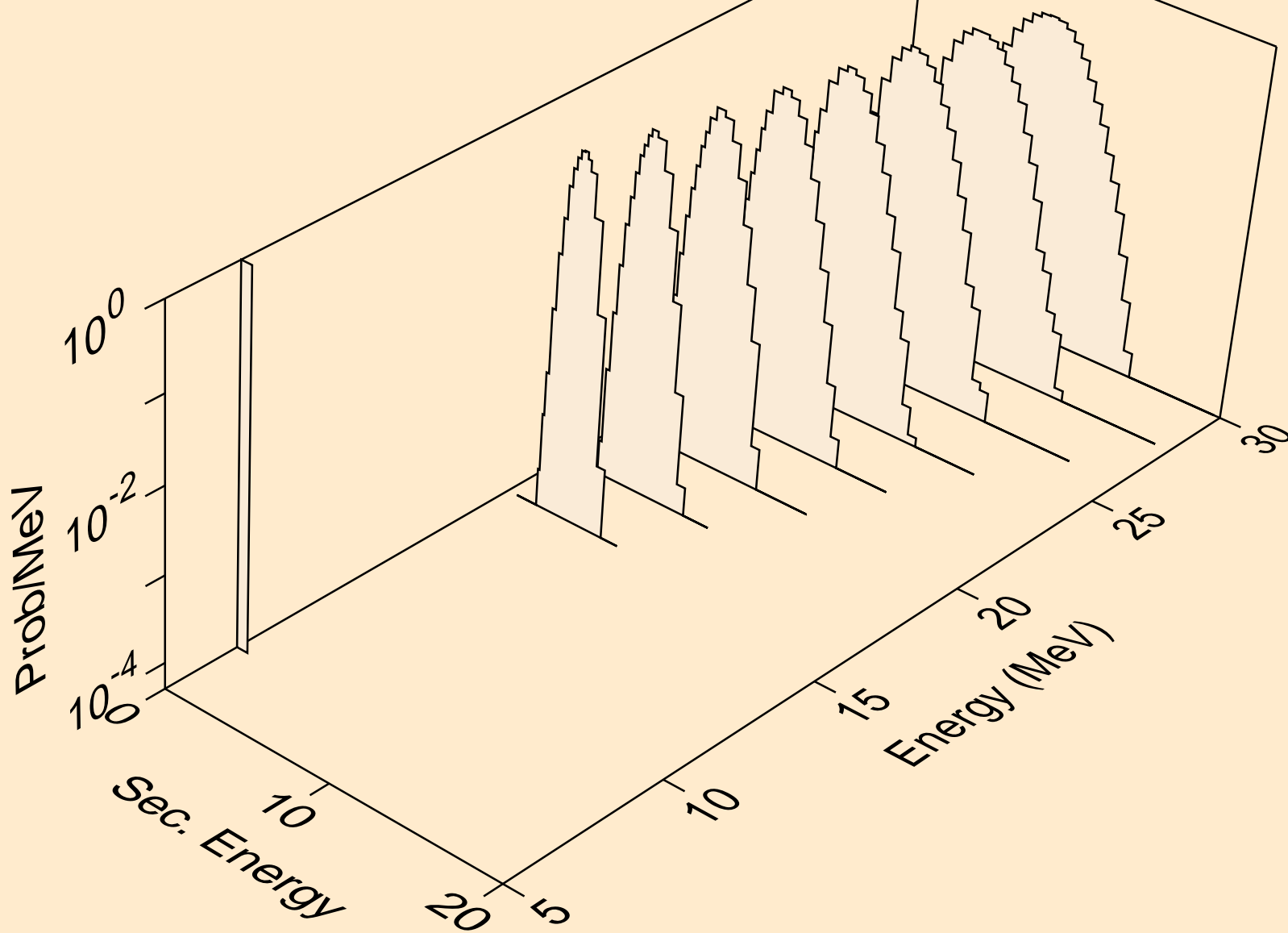

NP232 NEUTRON ACER TENDL-2019 LIBRARY; T=293.16K
protons from (n,pt)

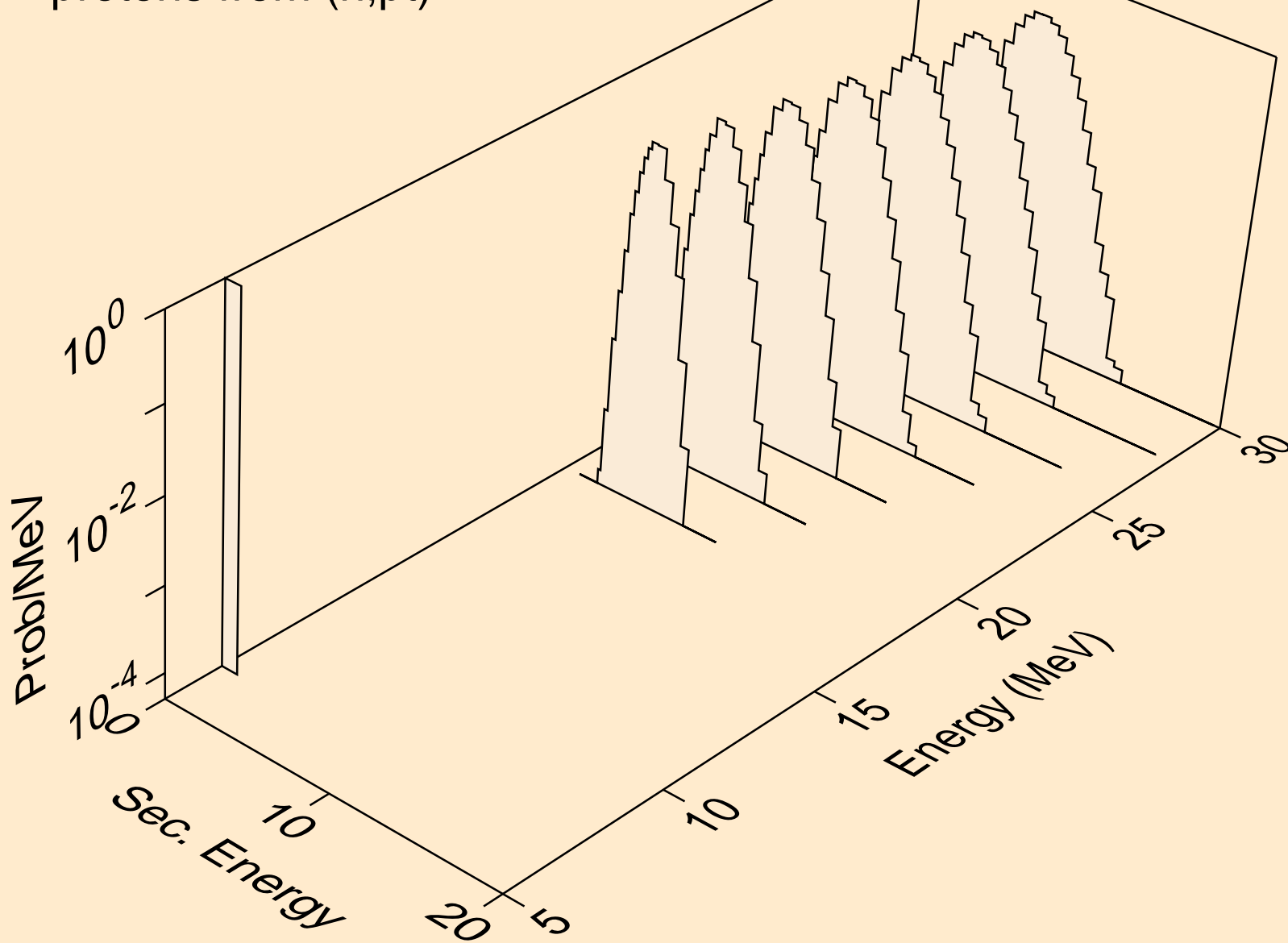

NP232 NEUTRON ACER TENDL-2019 LIBRARY; T=293.16K
deuterons from (n,x)

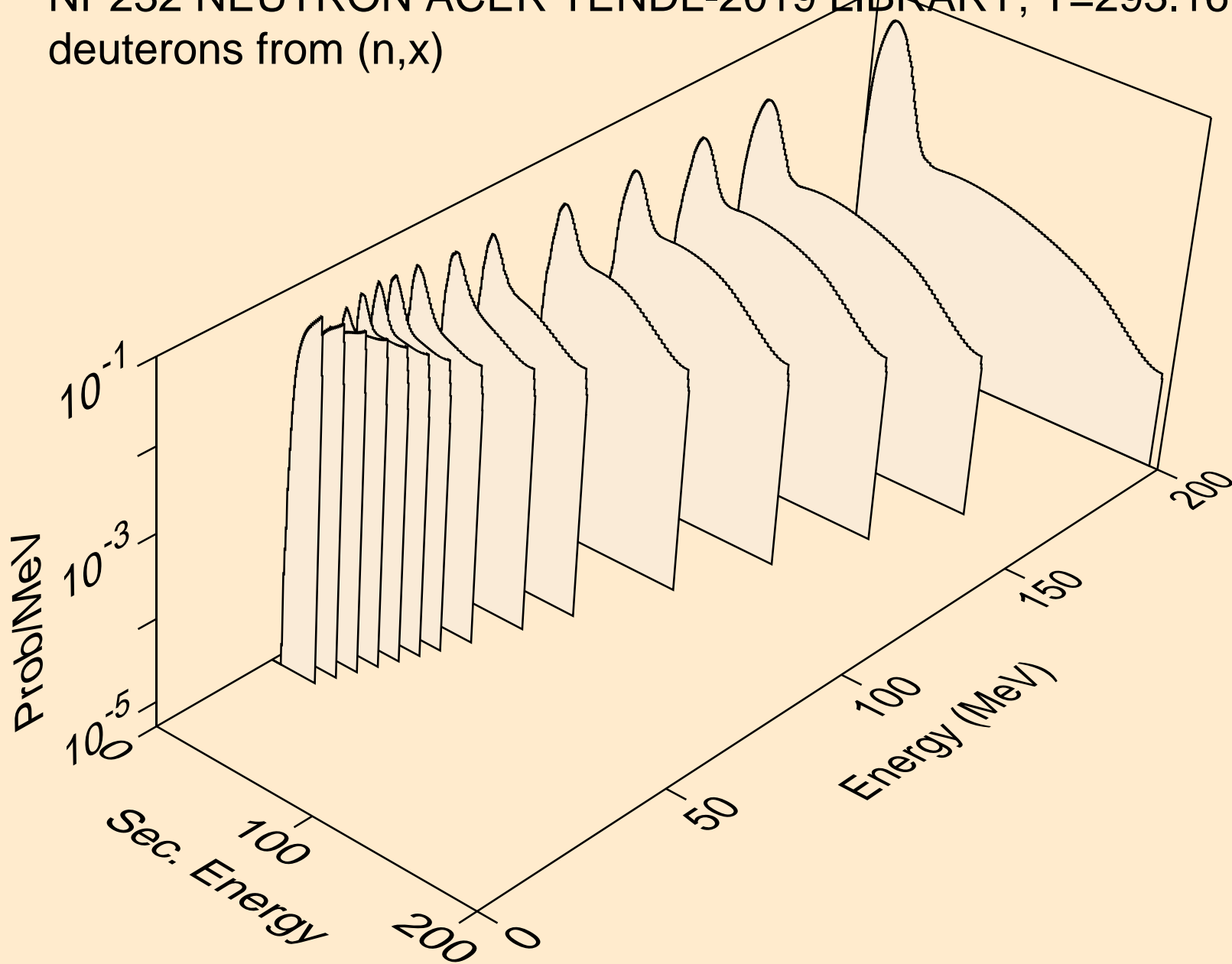

NP232 NEUTRON ACER TENDL-2019 LIBRARY; T=293.16K
deuterons from (n,2nd)

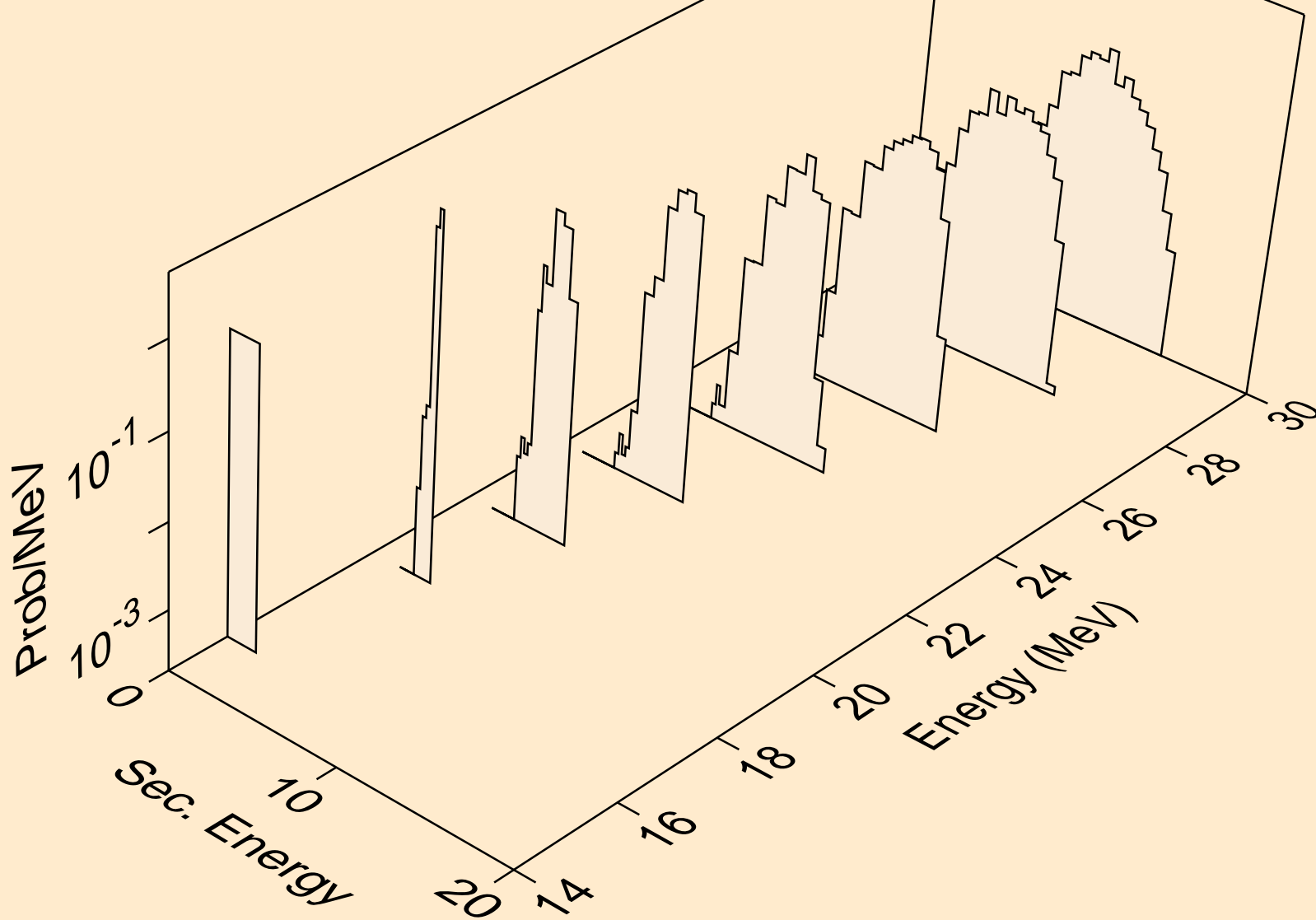

NP232 NEUTRON ACER TENDL-2019 LIBRARY; T=293.16K
deuterons from (n,n*)d

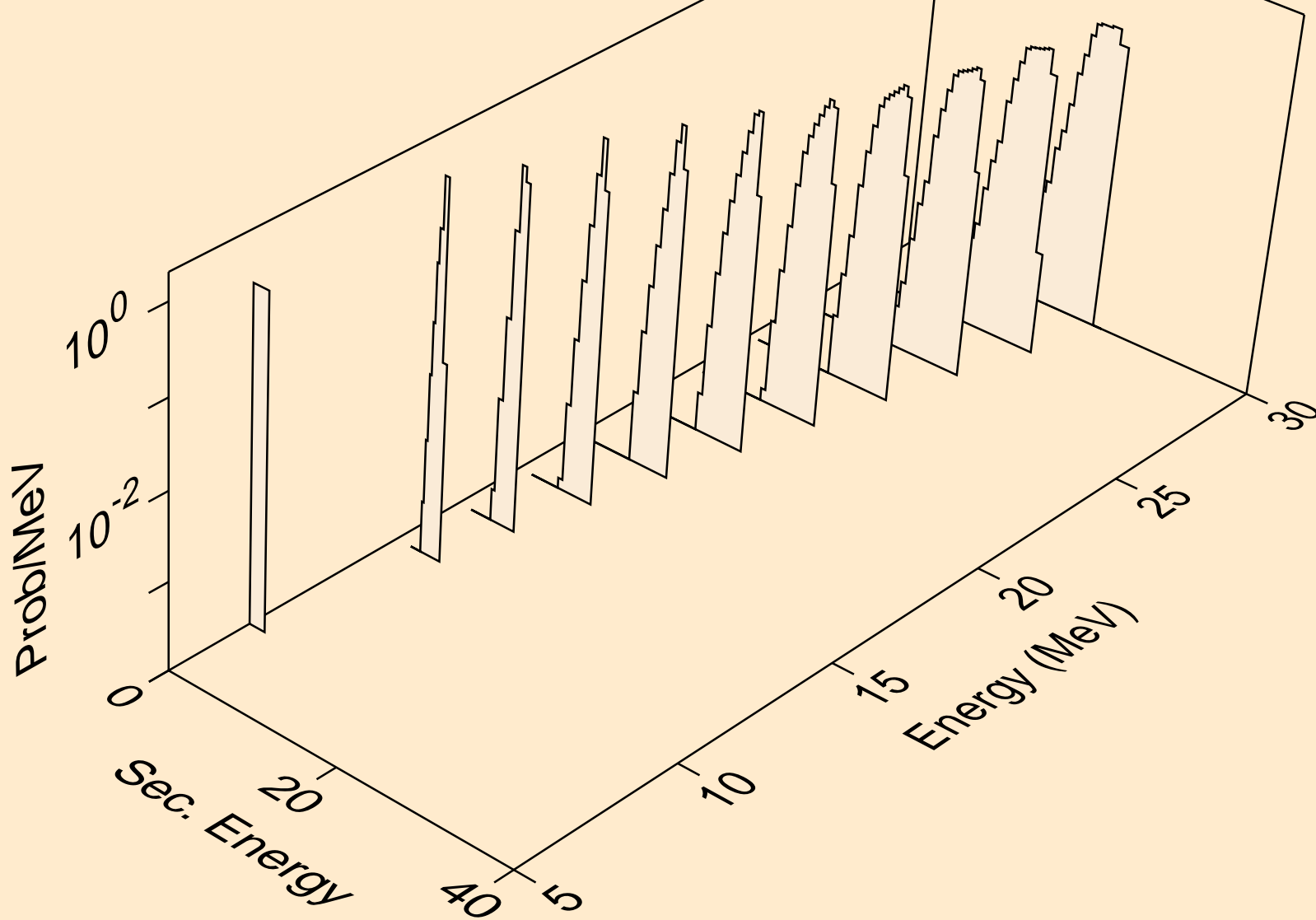

NP232 NEUTRON ACER TENDL-2019 LIBRARY; T=293.16K
deuterons from (n,d)

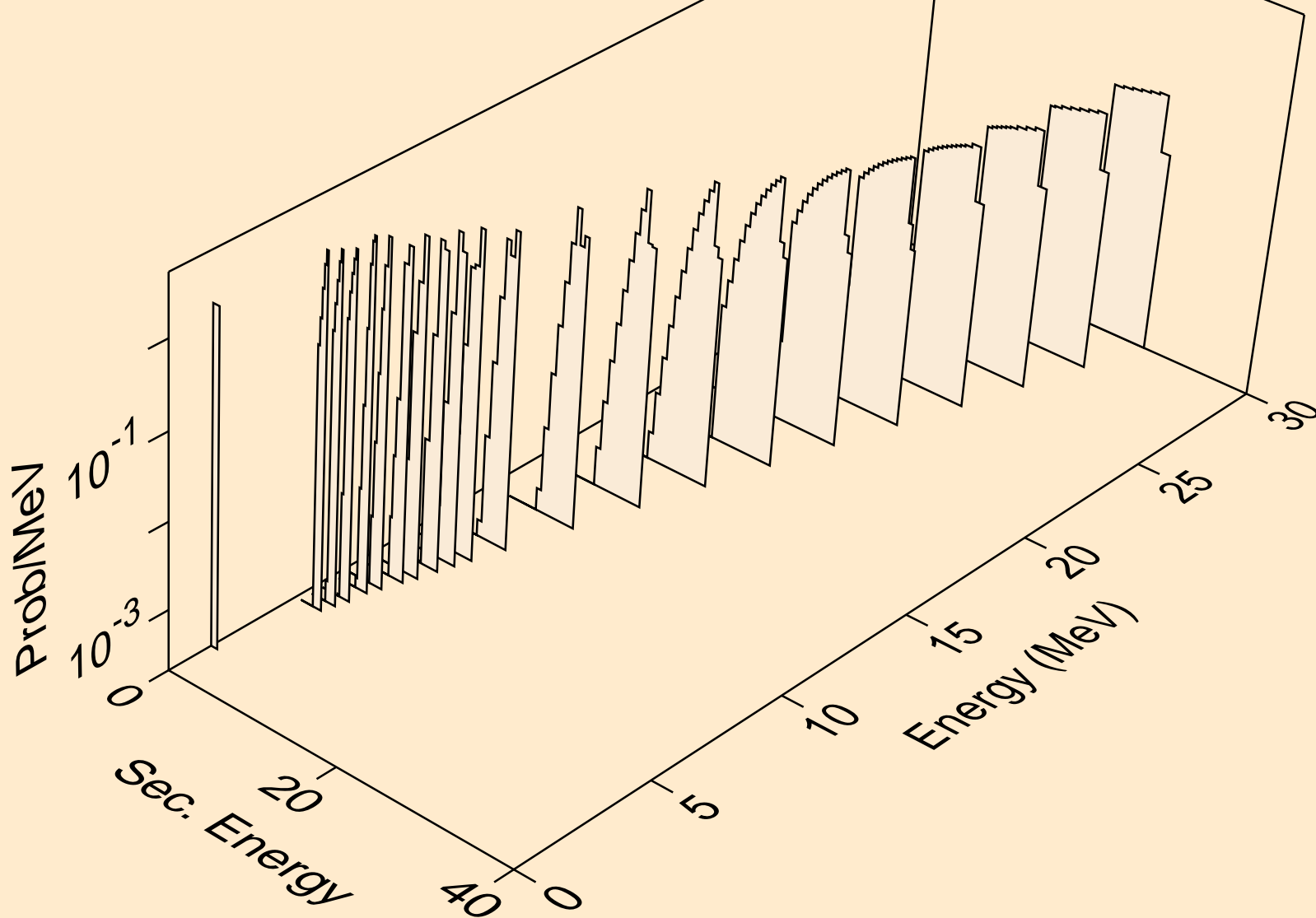

NP232 NEUTRON ACER TENDL-2019 LIBRARY; T=293.16K
deuterons from (n,pd)

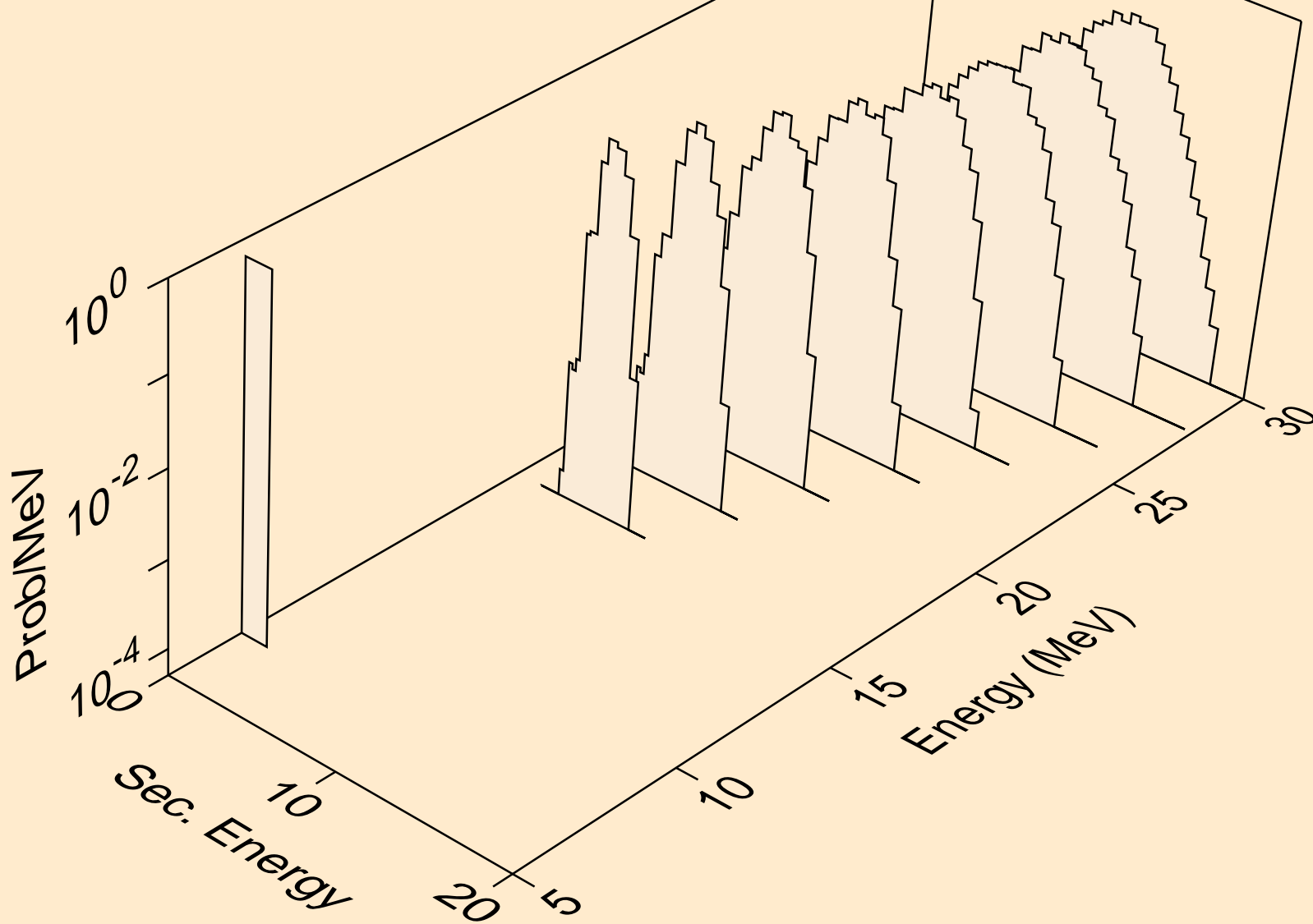

NP232 NEUTRON ACER TENDL-2019 LIBRARY; T=293.16K
deuterons from (n,da)

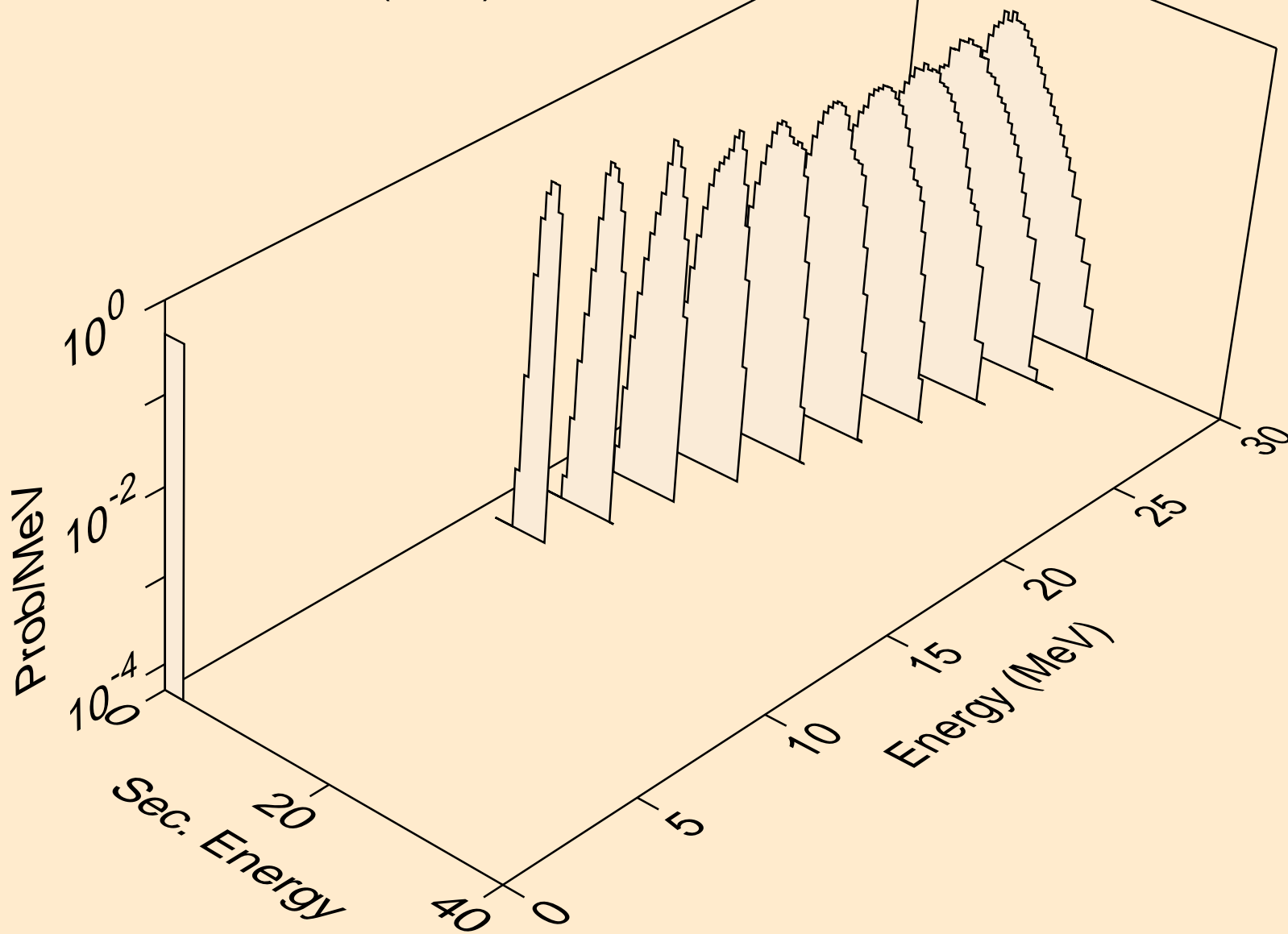

NP232 NEUTRON ACER TENDL-2019 LIBRARY; T=293.16K
tritons from (n,x)

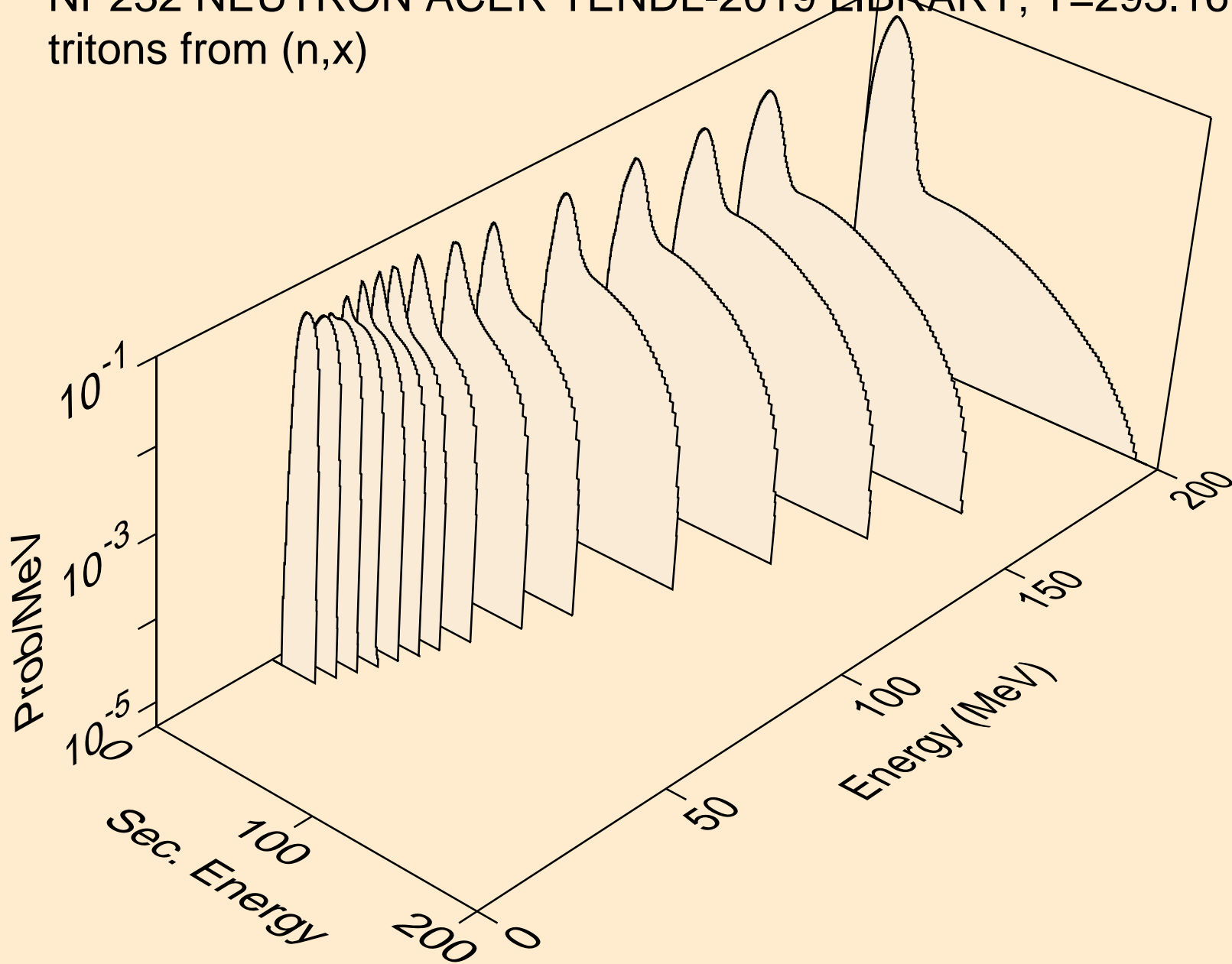

NP232 NEUTRON ACER TENDL-2019 LIBRARY; T=293.16K
tritons from (n,n*)t

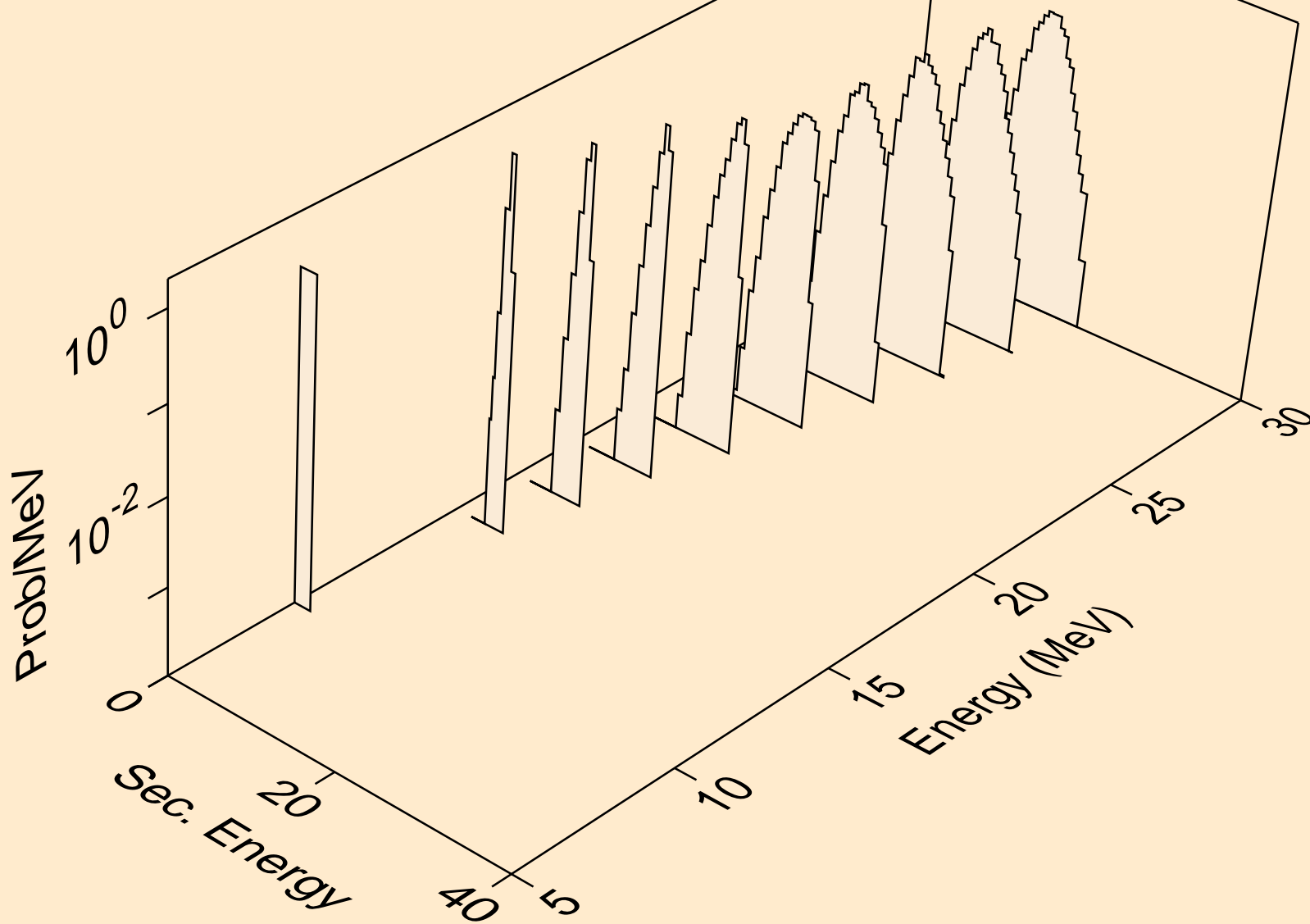

NP232 NEUTRON ACER TENDL-2019 LIBRARY; T=293.16K
tritons from (n,t)

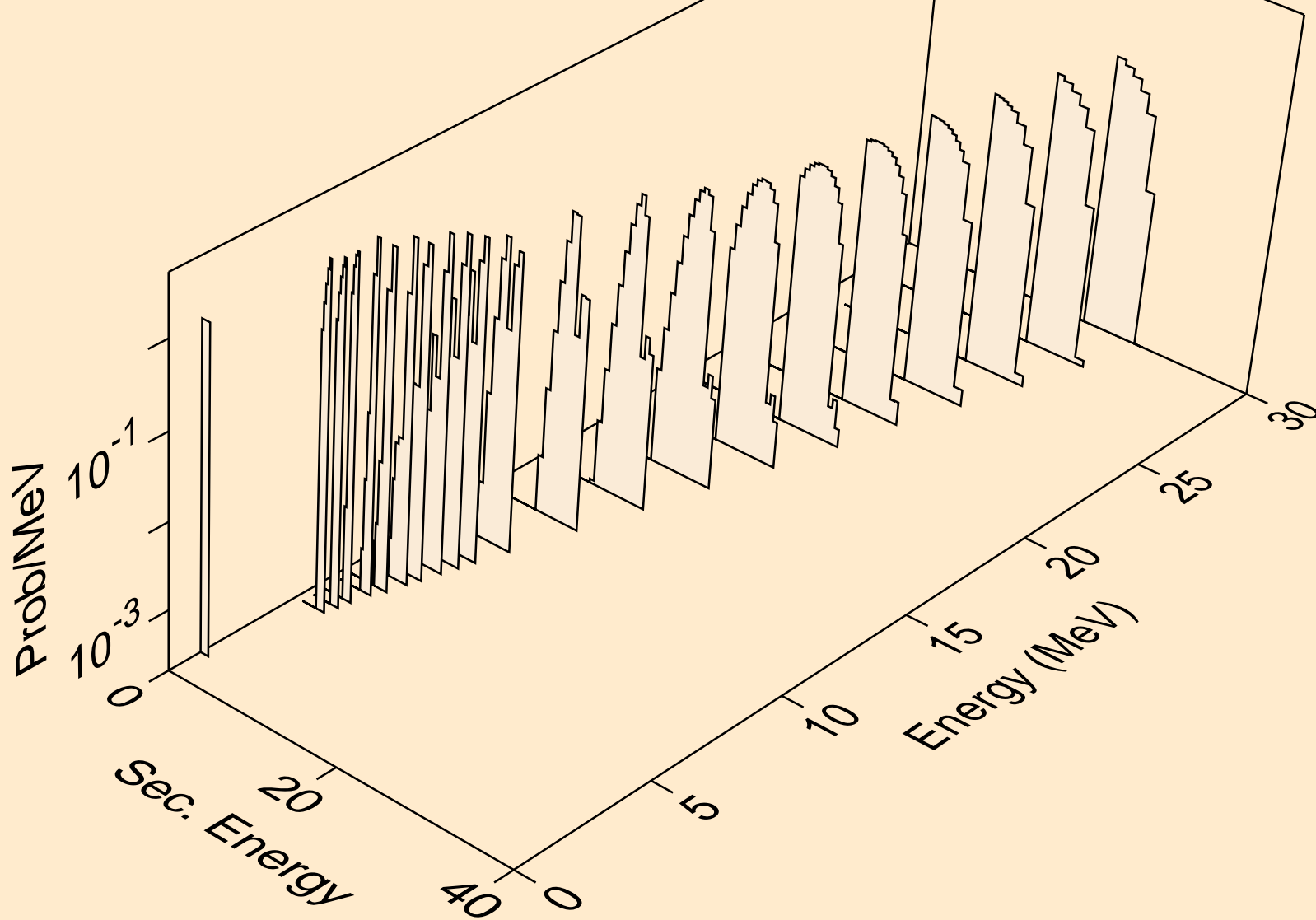

NP232 NEUTRON ACER TENDL-2019 LIBRARY; T=293.16K
tritons from (n,pt)

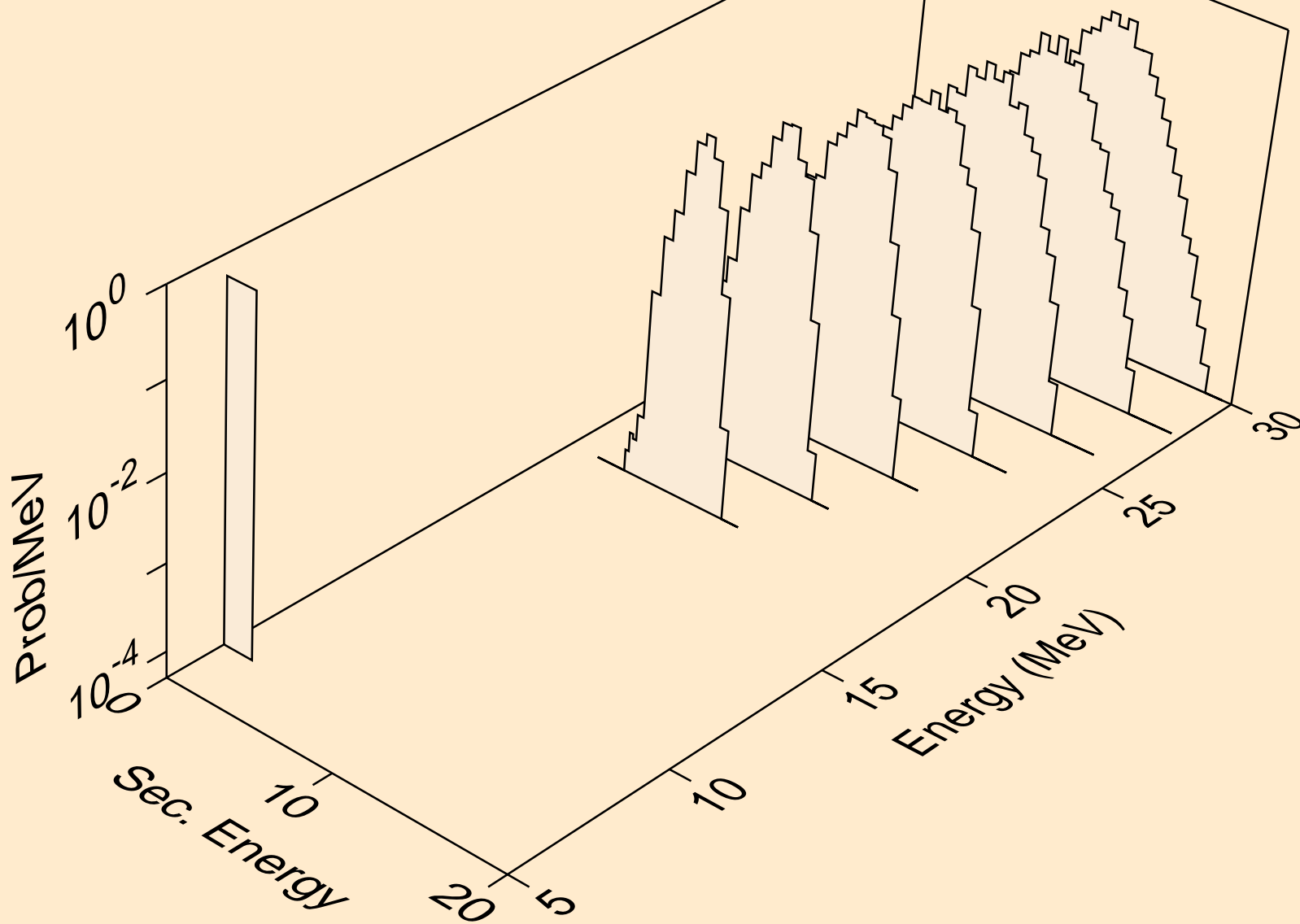

NP232 NEUTRON ACER TENDL-2019 LIBRARY; T=293.16K
he3s from (n,x)

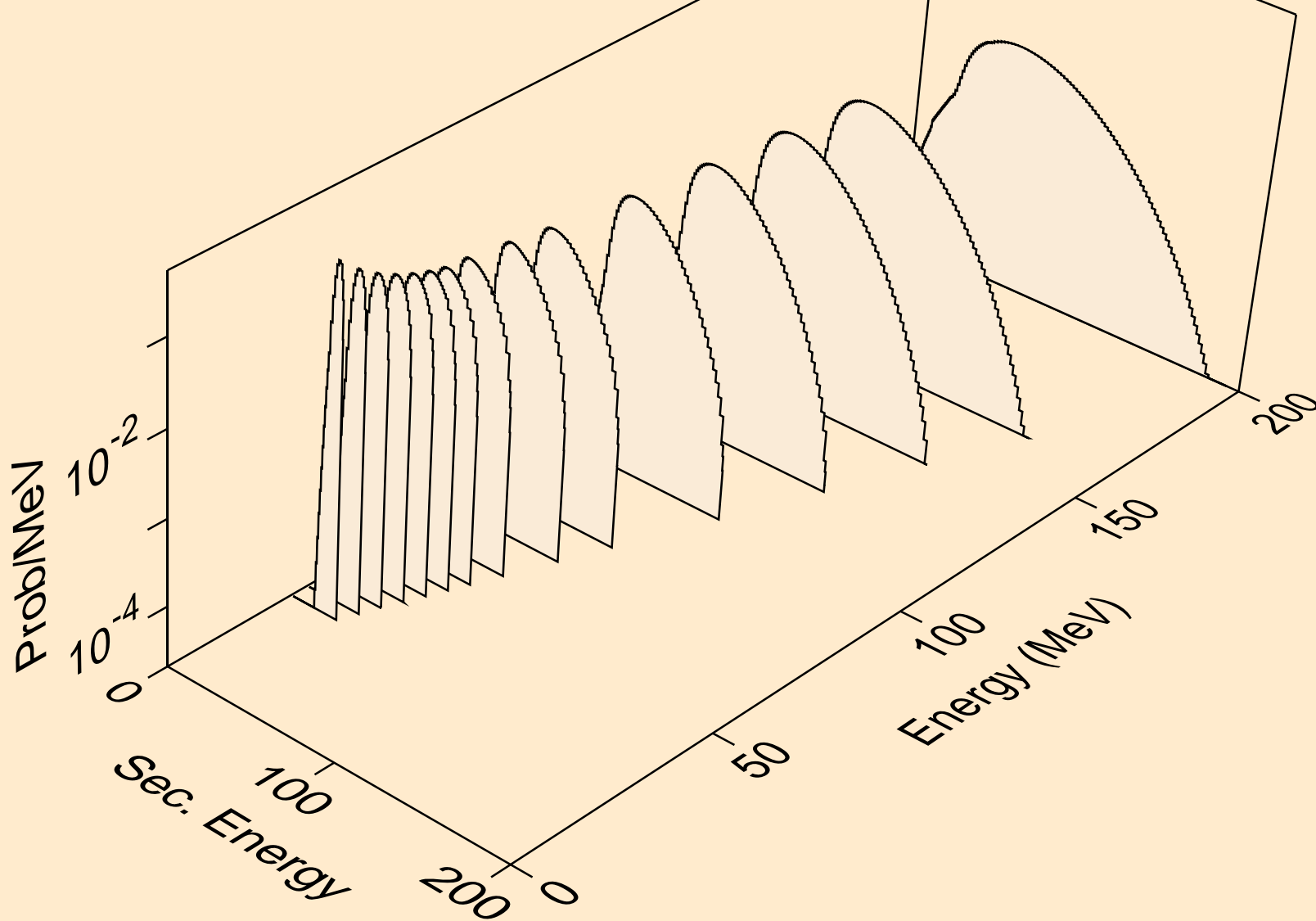

NP232 NEUTRON ACER TENDL-2019 LIBRARY; T=293.16K
he3s from (n,n*)he3

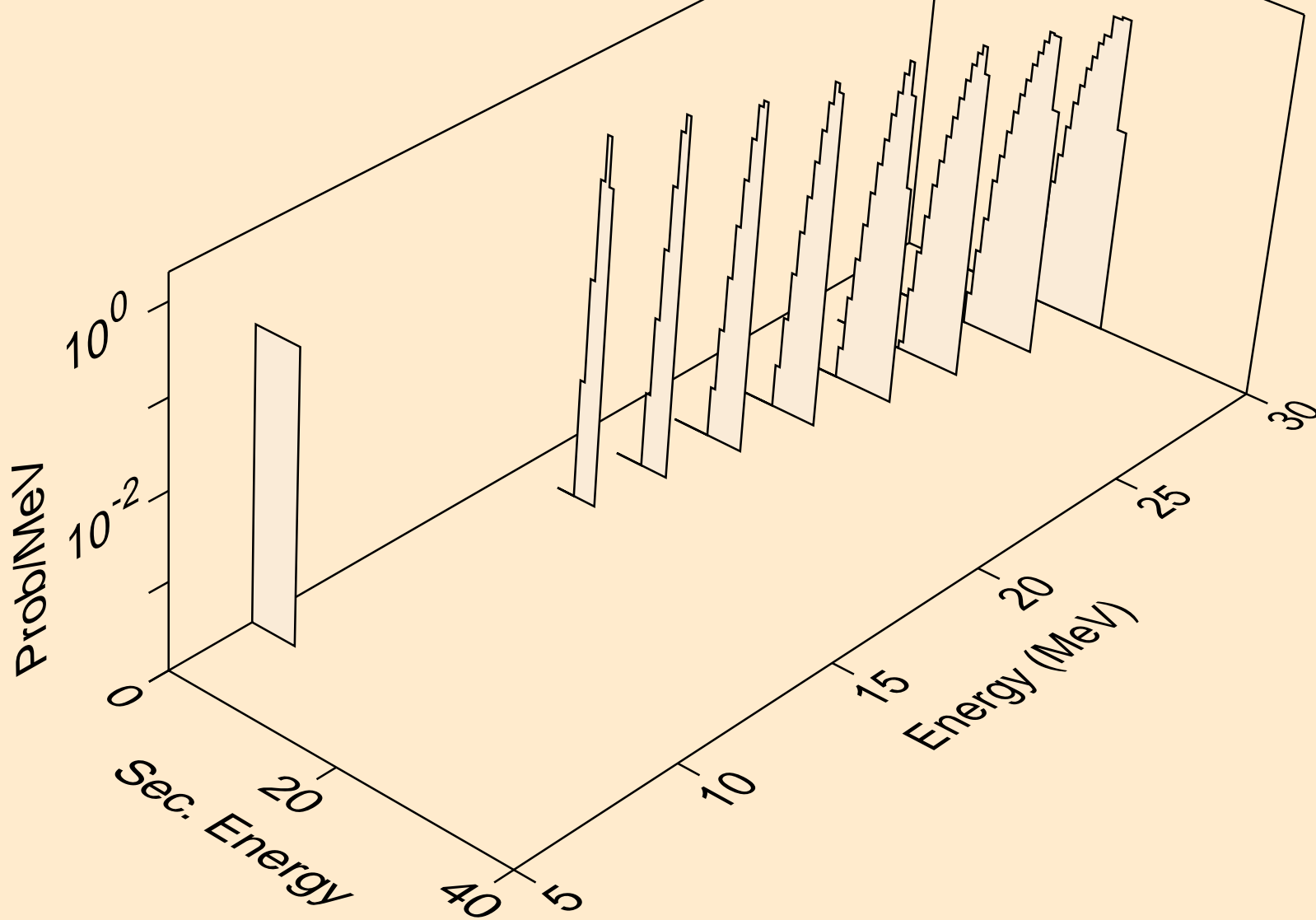

NP232 NEUTRON ACER TENDL-2019 LIBRARY; T=293.16K
he3s from (n,he3)

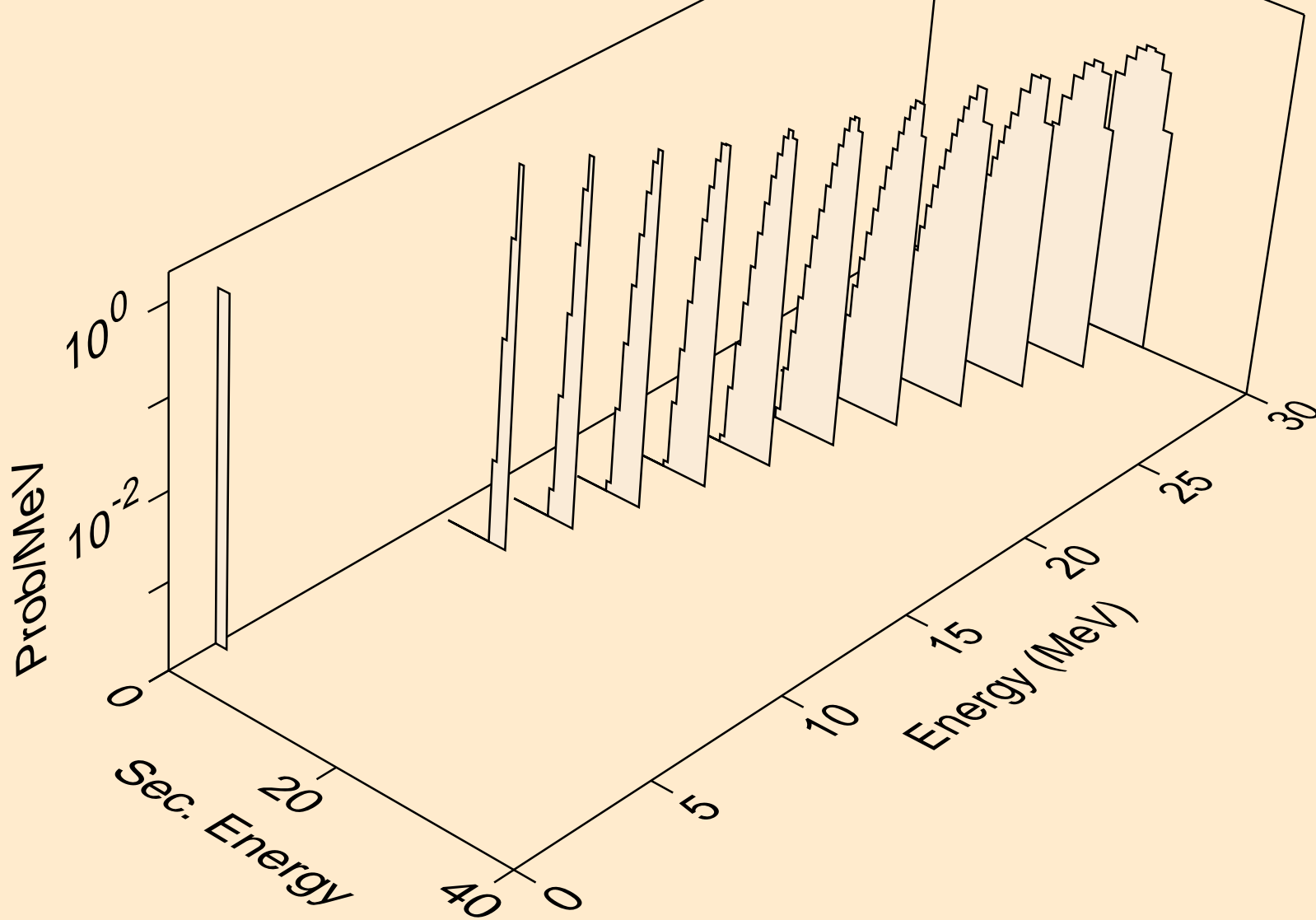

NP232 NEUTRON ACER TENDL-2019 LIBRARY; T=293.16K
alphas from (n,x)

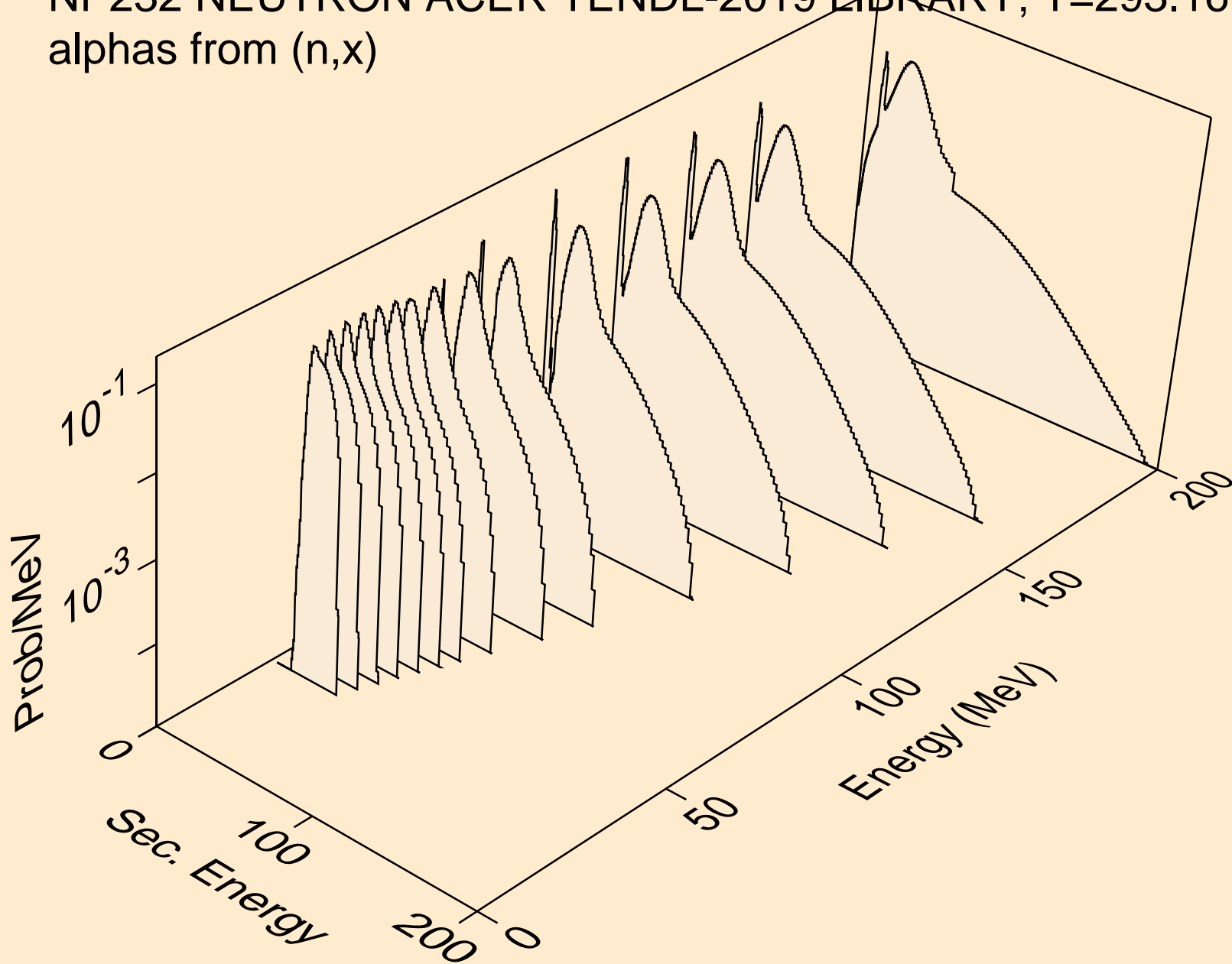

NP232 NEUTRON ACER TENDL-2019 LIBRARY; T=293.16K
alphas from (n,n*)a

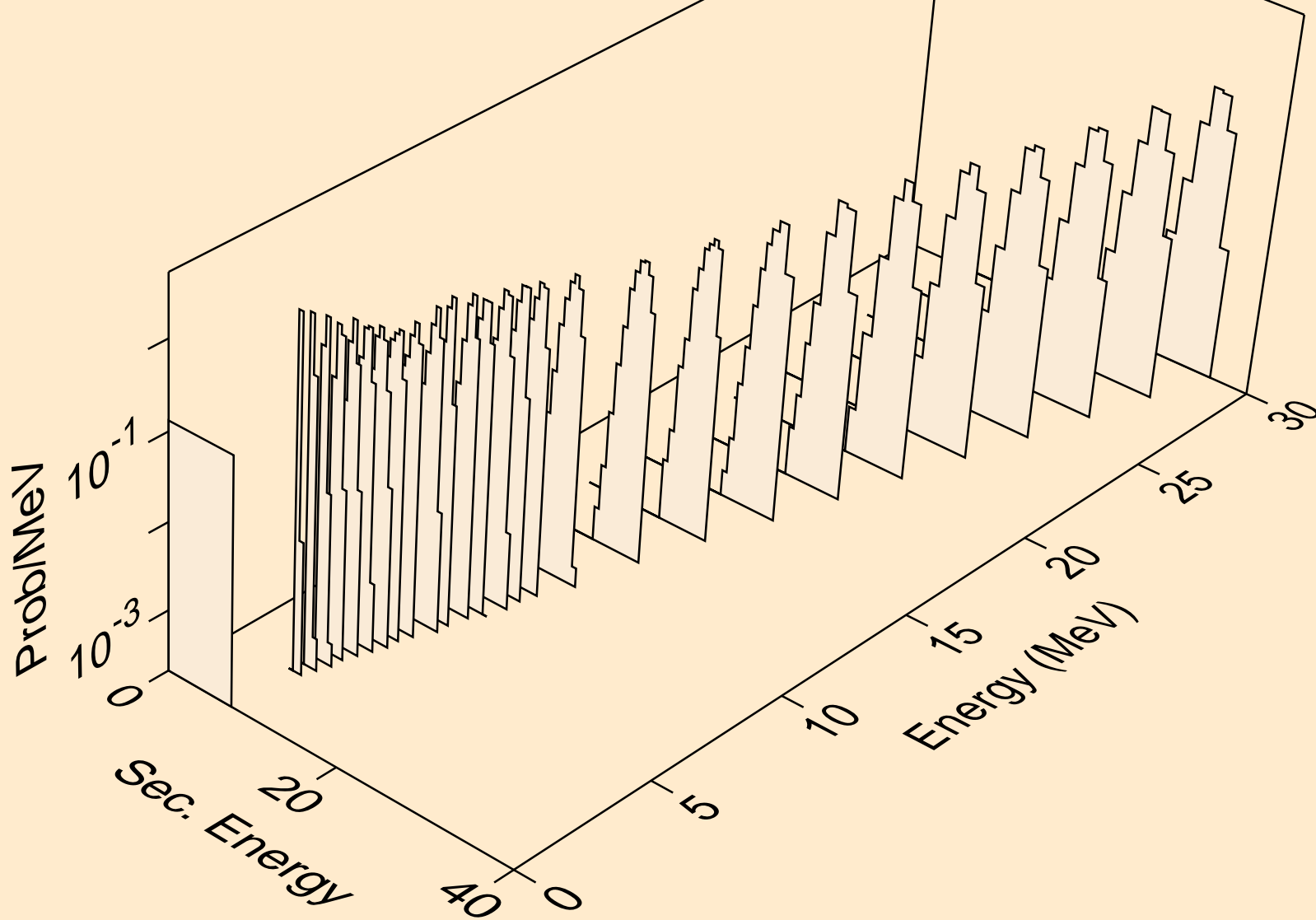

NP232 NEUTRON ACER TENDL-2019 LIBRARY; T=293.16K
alphas from (n,2n)a

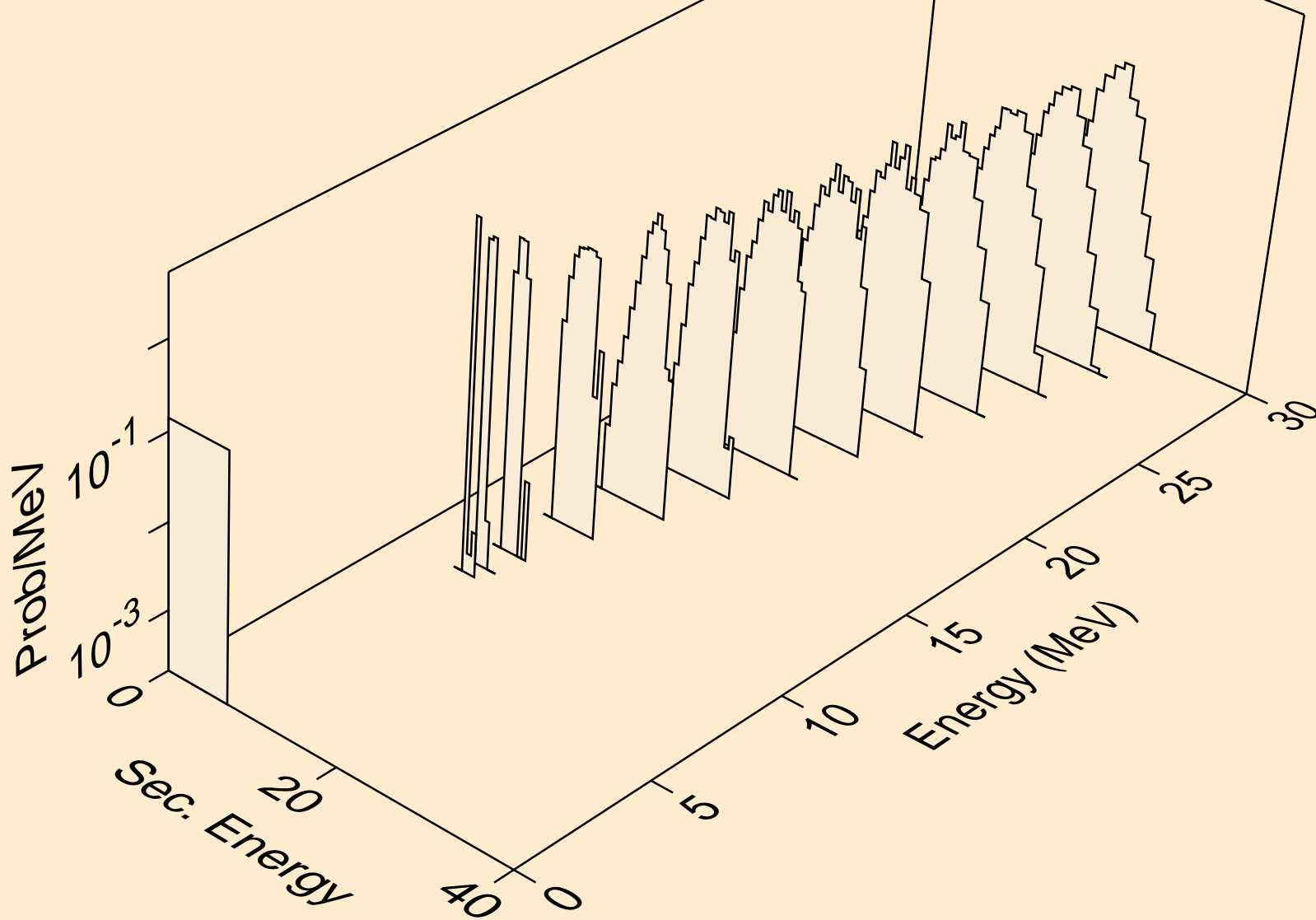

NP232 NEUTRON ACER TENDL-2019 LIBRARY; T=293.16K
alphas from (n,3n)a

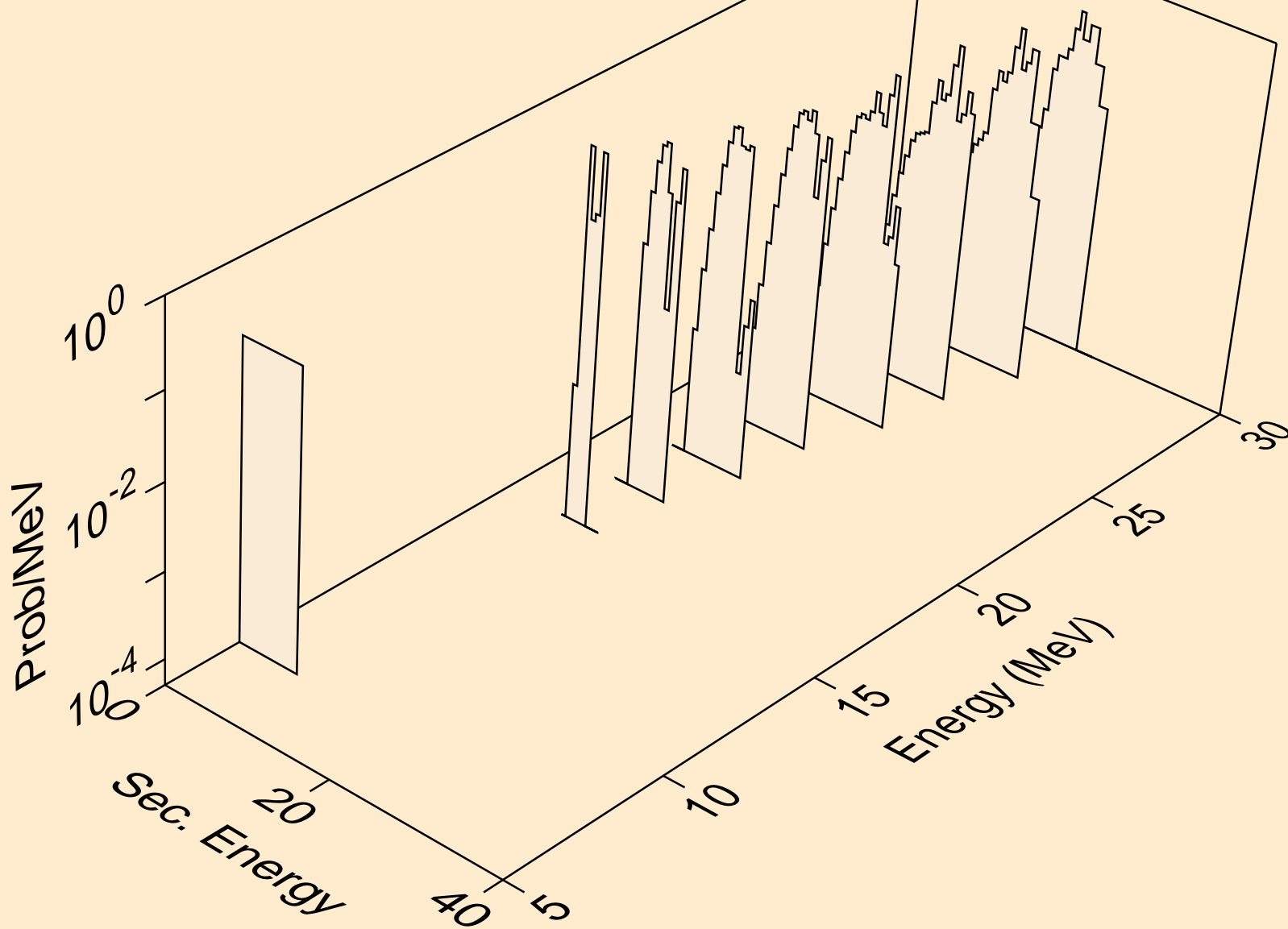

NP232 NEUTRON ACER TENDL-2019 LIBRARY; T=293.16K
alphas from (n,n*)2a

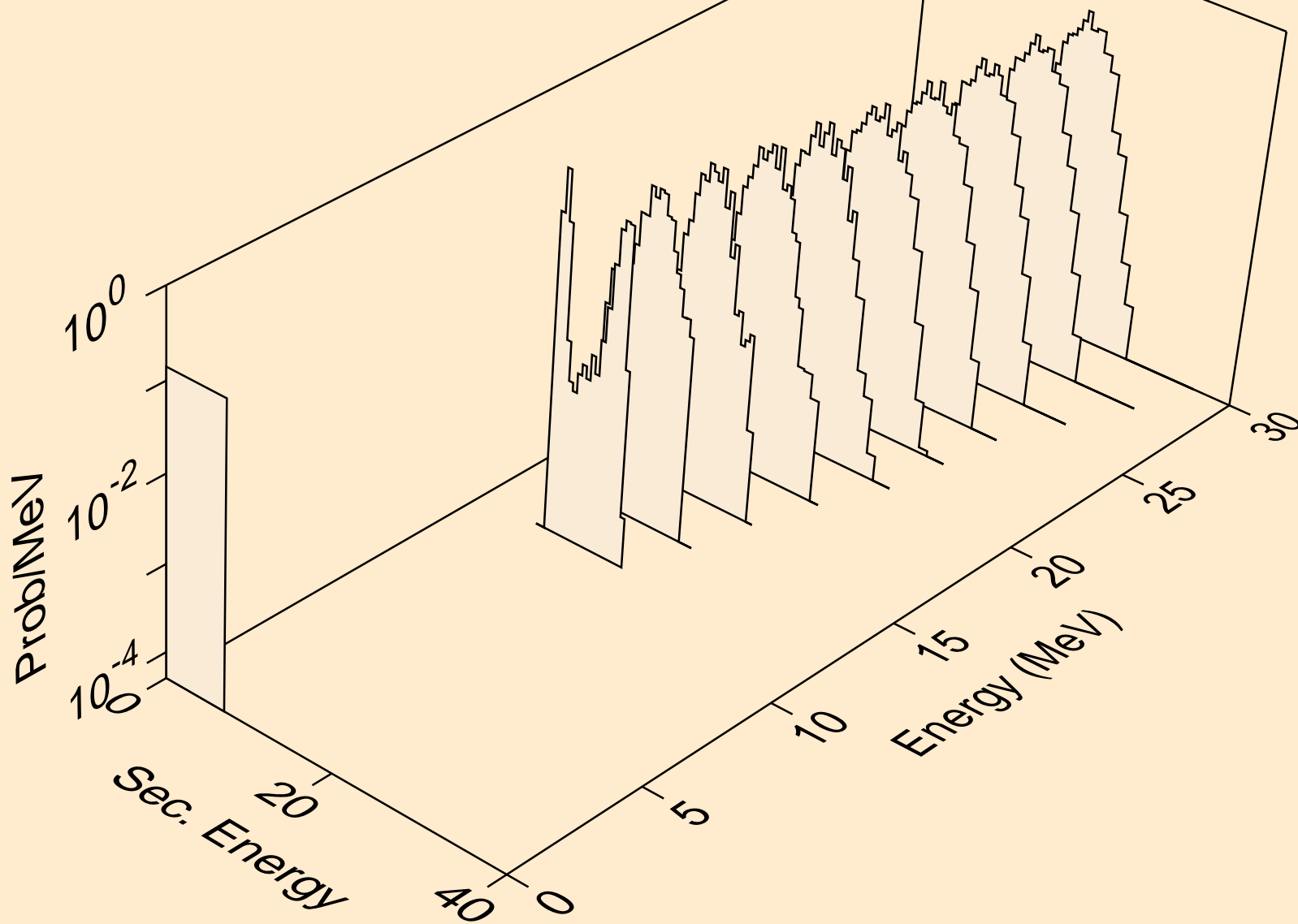

NP232 NEUTRON ACER TENDL-2019 LIBRARY; T=293.16K
alphas from (n,2n)2a

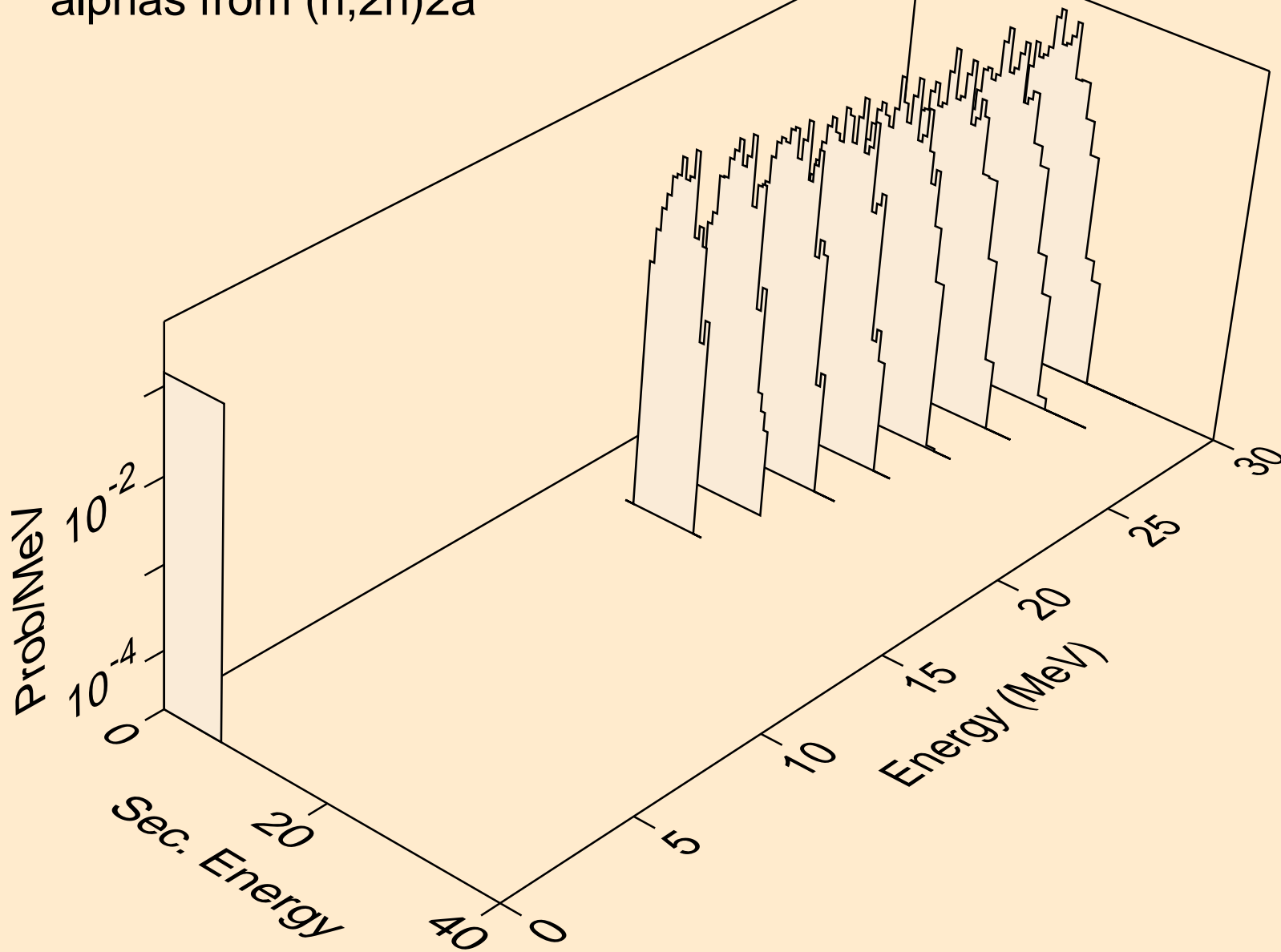

NP232 NEUTRON ACER TENDL-2019 LIBRARY; T=293.16K
alphas from (n,npa)

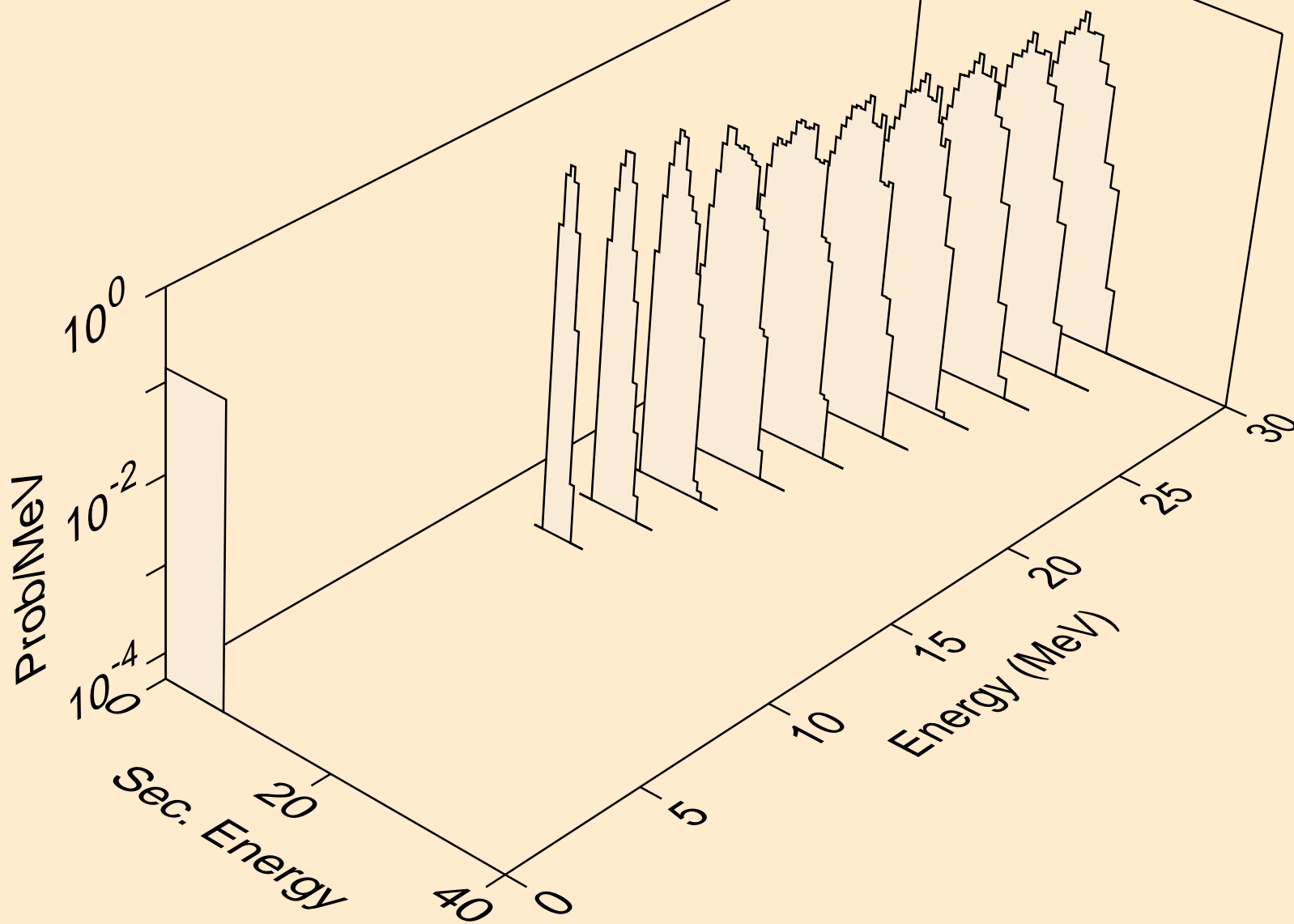

NP232 NEUTRON ACER TENDL-2019 LIBRARY; T=293.16K
alphas from (n,a)

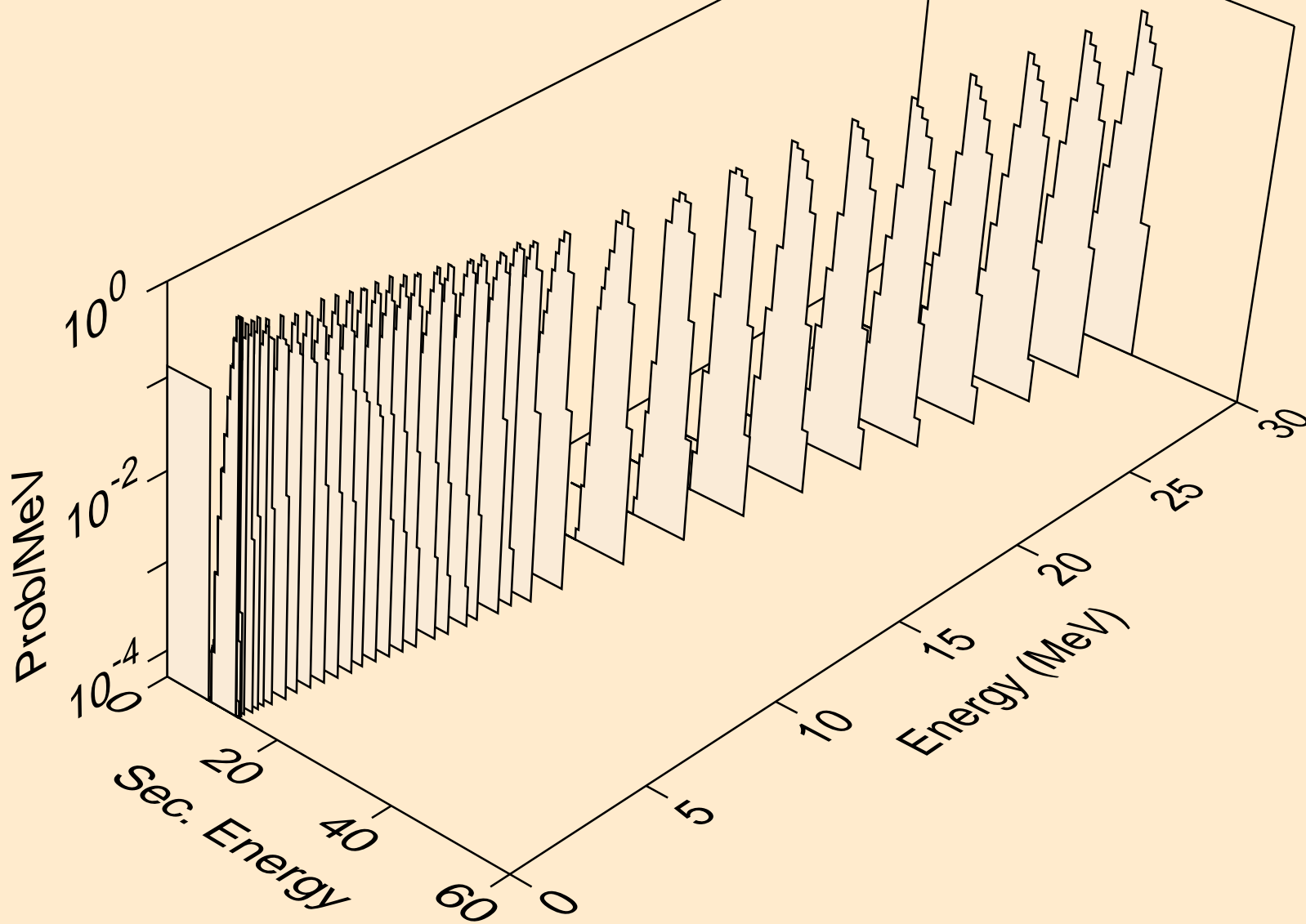

NP232 NEUTRON ACER TENDL-2019 LIBRARY; T=293.16K
alphas from (n,2a)

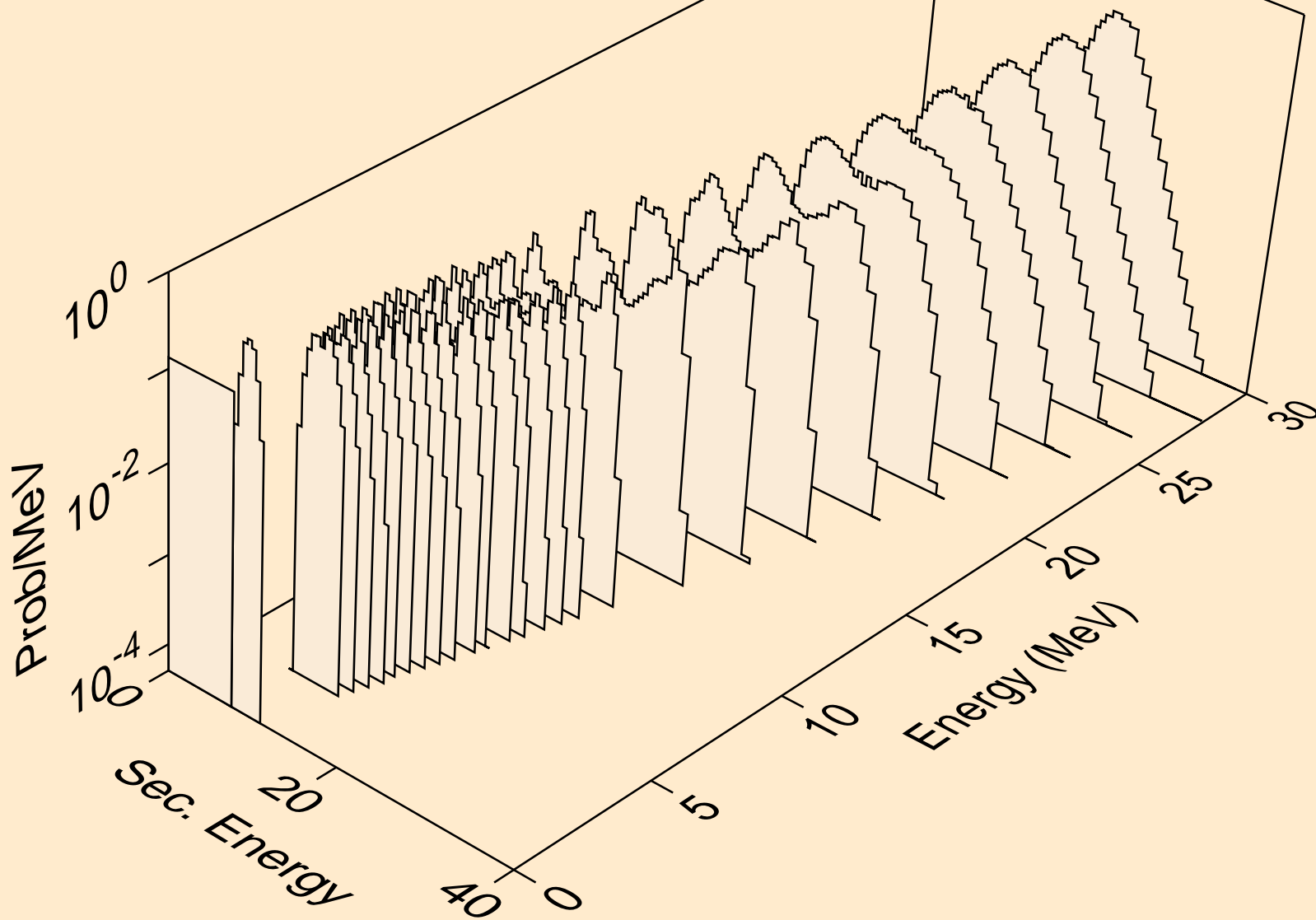

NP232 NEUTRON ACER TENDL-2019 LIBRARY; T=293.16K
alphas from (n,pa)

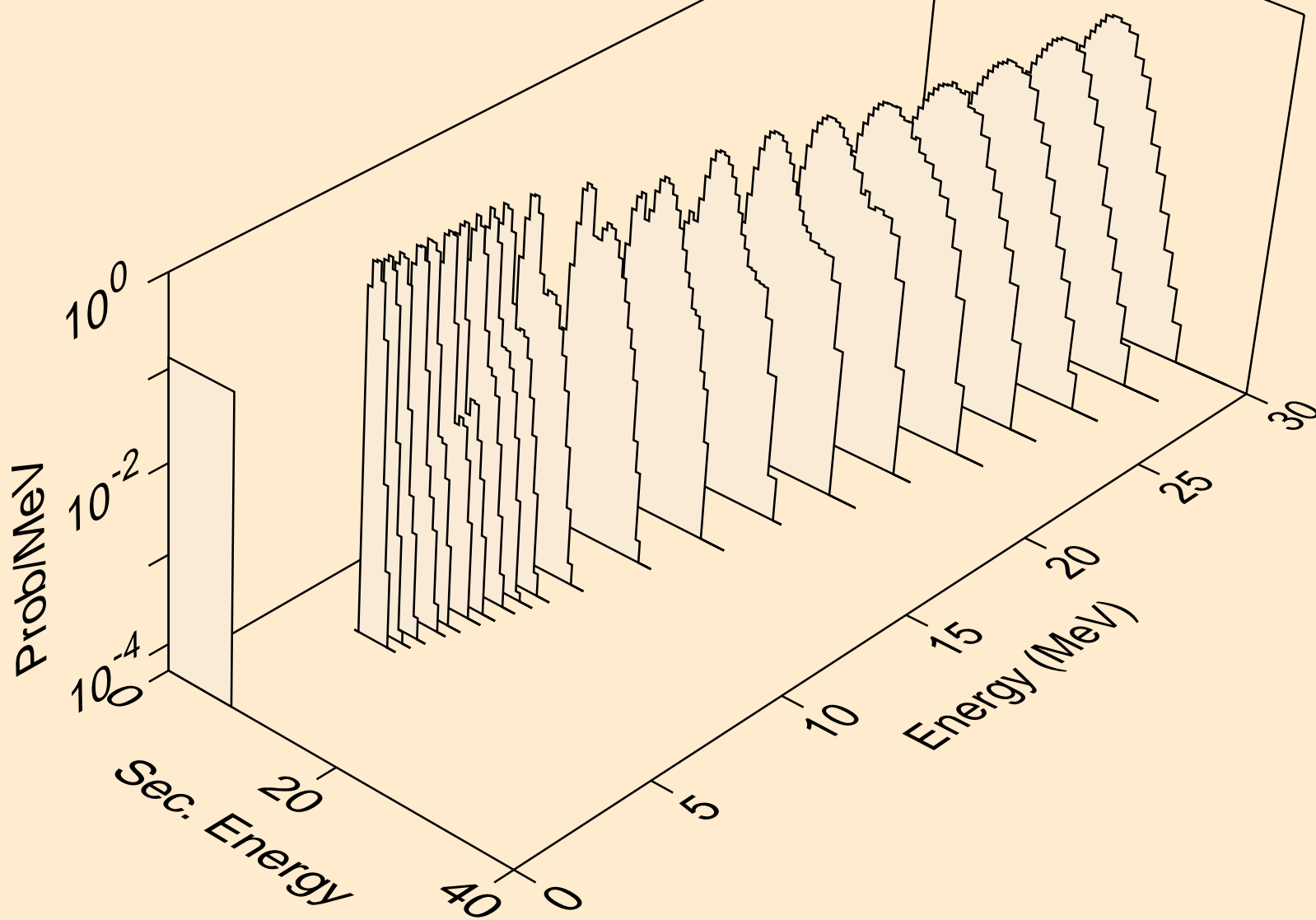

NP232 NEUTRON ACER TENDL-2019 LIBRARY; T=293.16K
alphas from (n,da)

