

NP237 NEUTRON ACER TENDL-2019 LIBRARY; T=293.16K
Principal cross sections

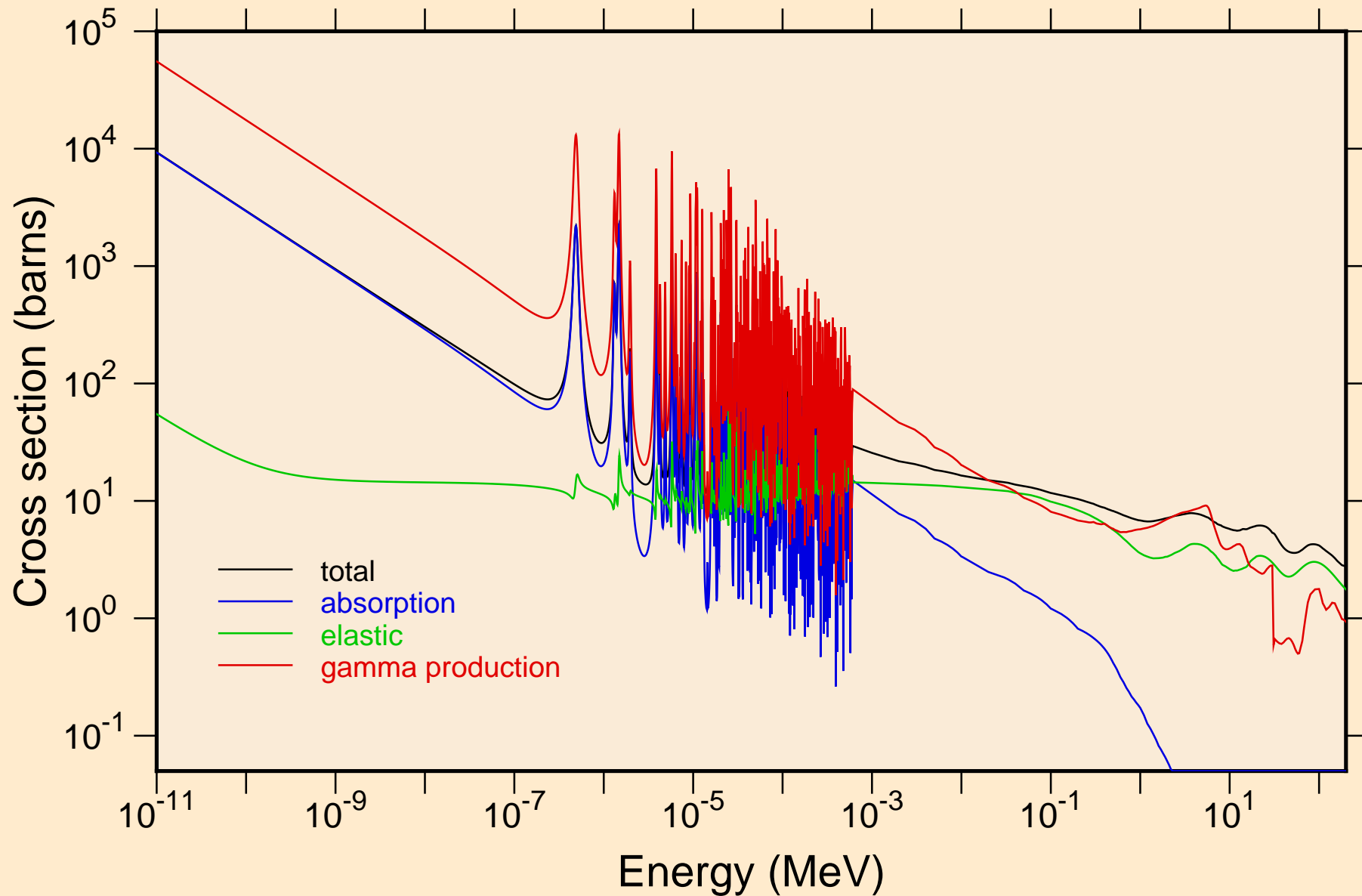

NP237 NEUTRON ACER TENDL-2019 LIBRARY; T=293.16K
resonance total cross section

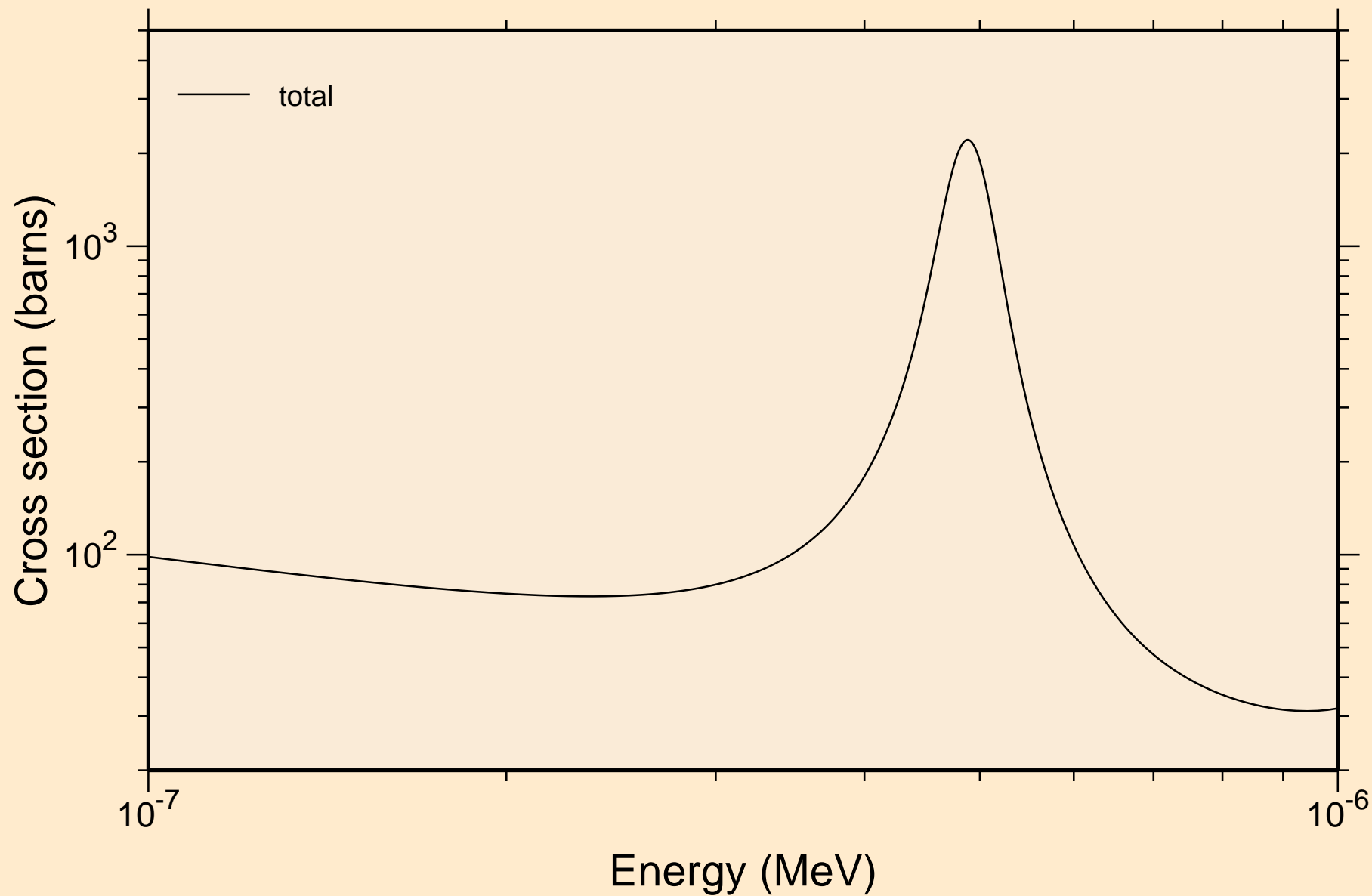

NP237 NEUTRON ACER TENDL-2019 LIBRARY; T=293.16K
resonance total cross section

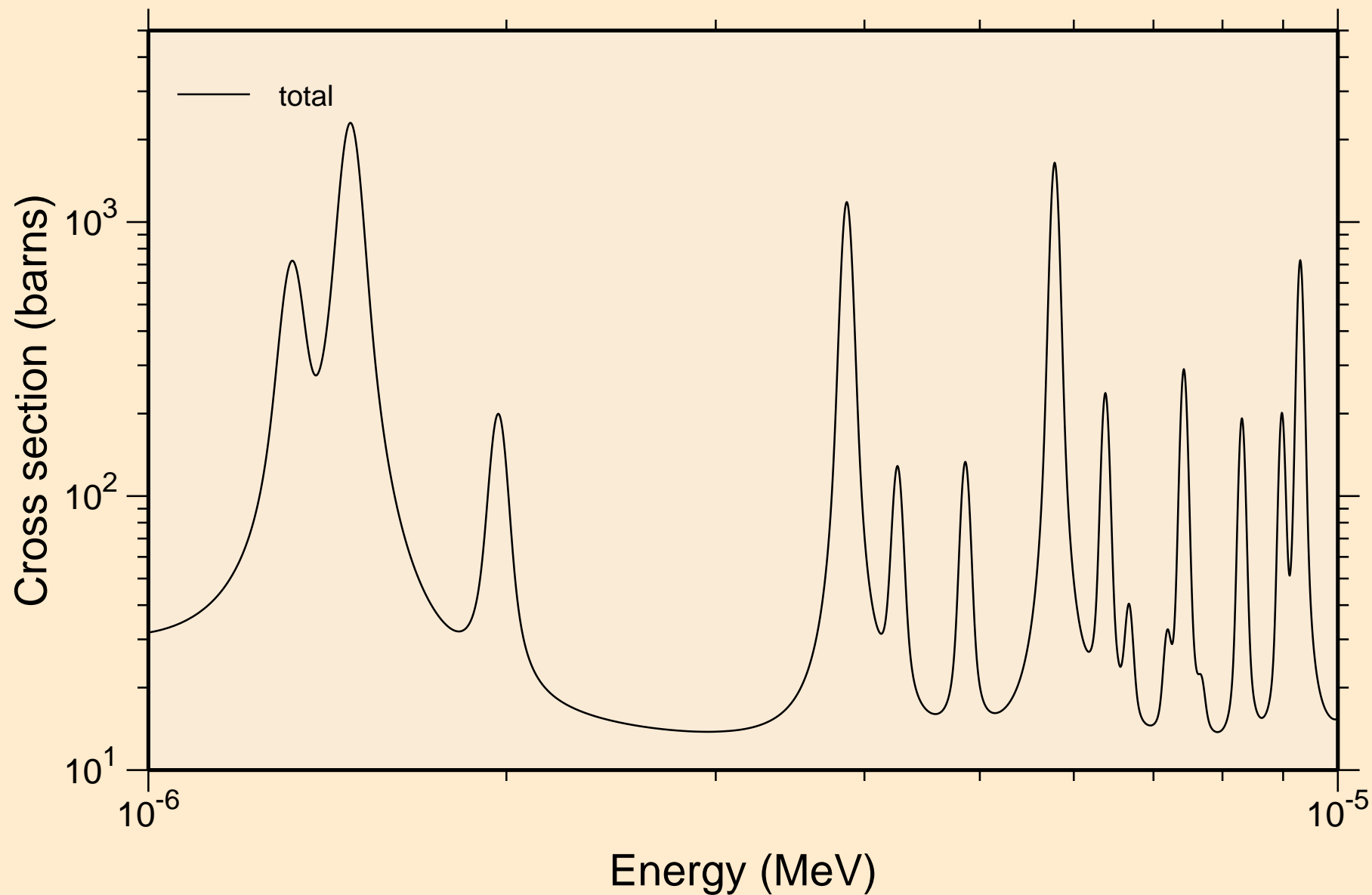

NP237 NEUTRON ACER TENDL-2019 LIBRARY; T=293.16K
resonance total cross section

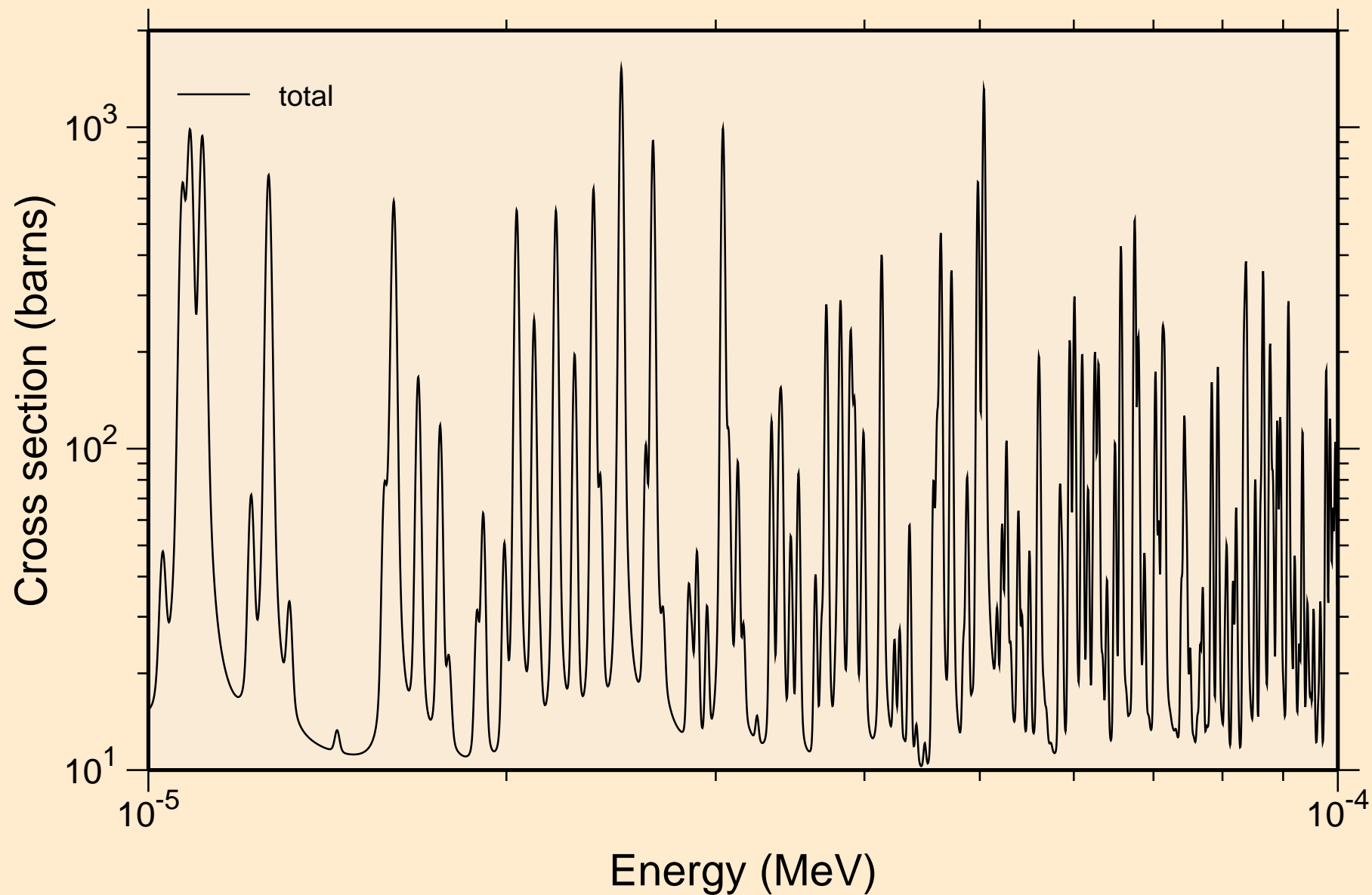

NP237 NEUTRON ACER TENDL-2019 LIBRARY; T=293.16K
resonance total cross section

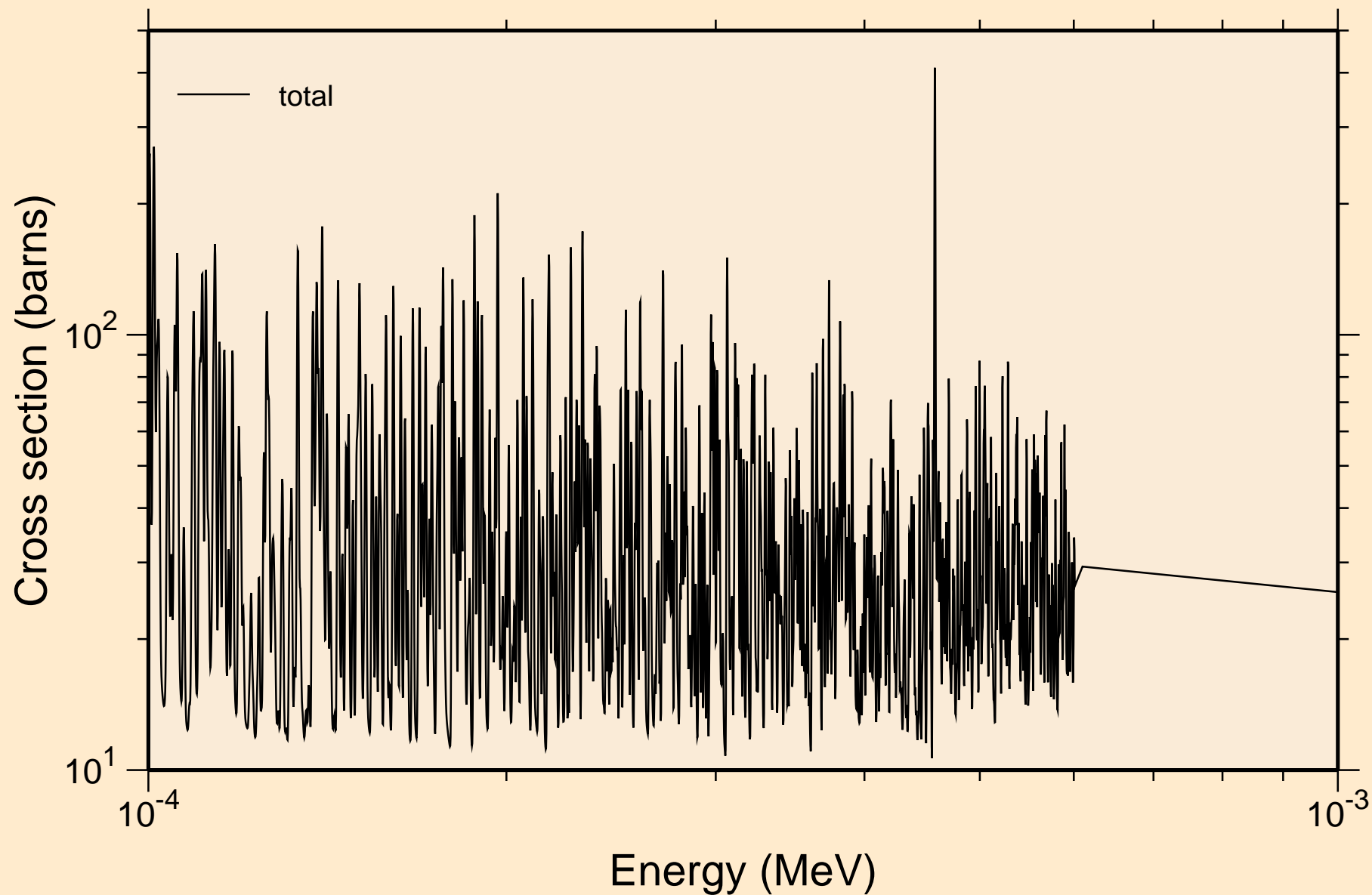

NP237 NEUTRON ACER TENDL-2019 LIBRARY; T=293.16K
resonance total cross section

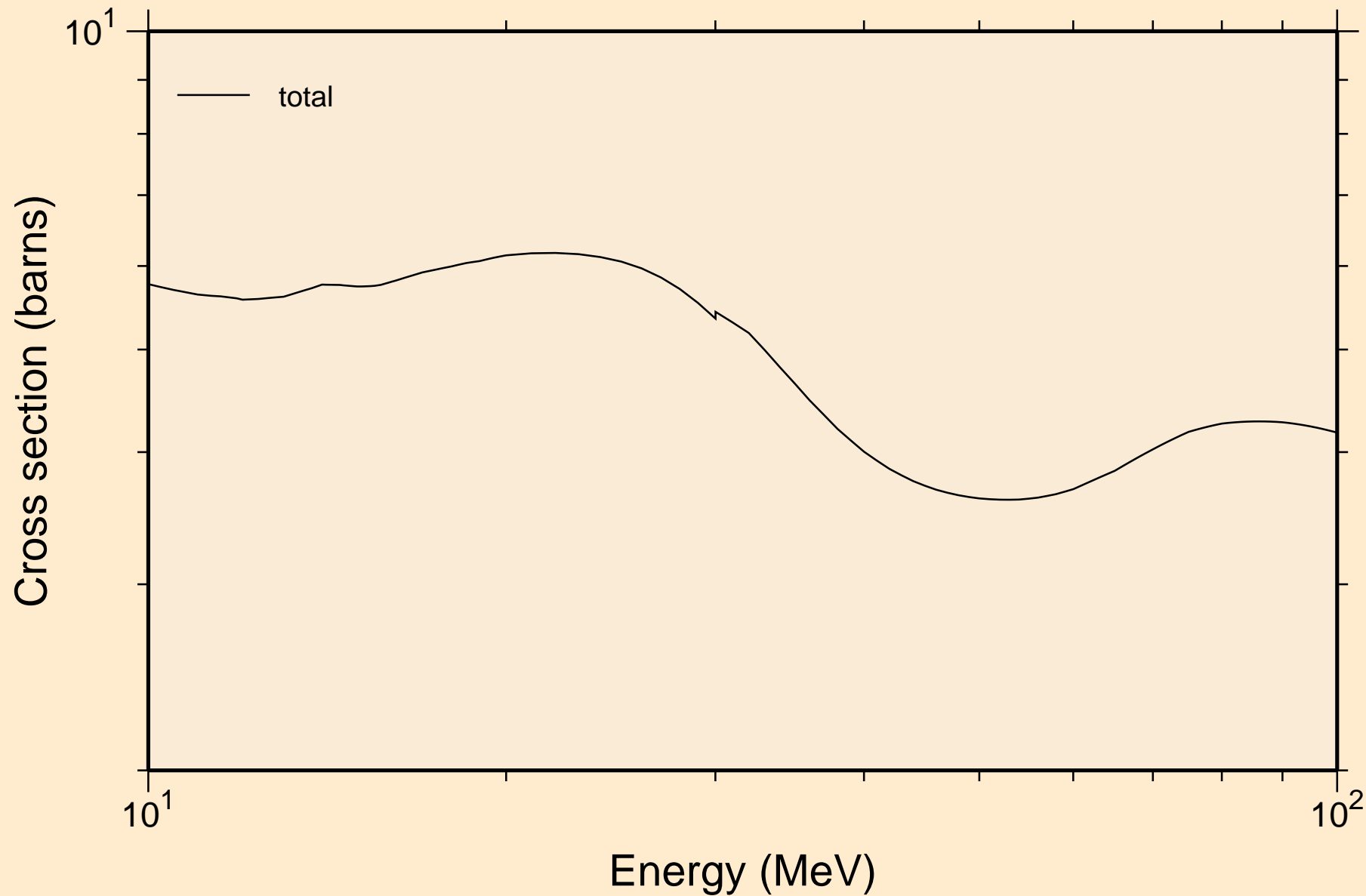

NP237 NEUTRON ACER TENDL-2019 LIBRARY; T=293.16K
resonance absorption cross sections

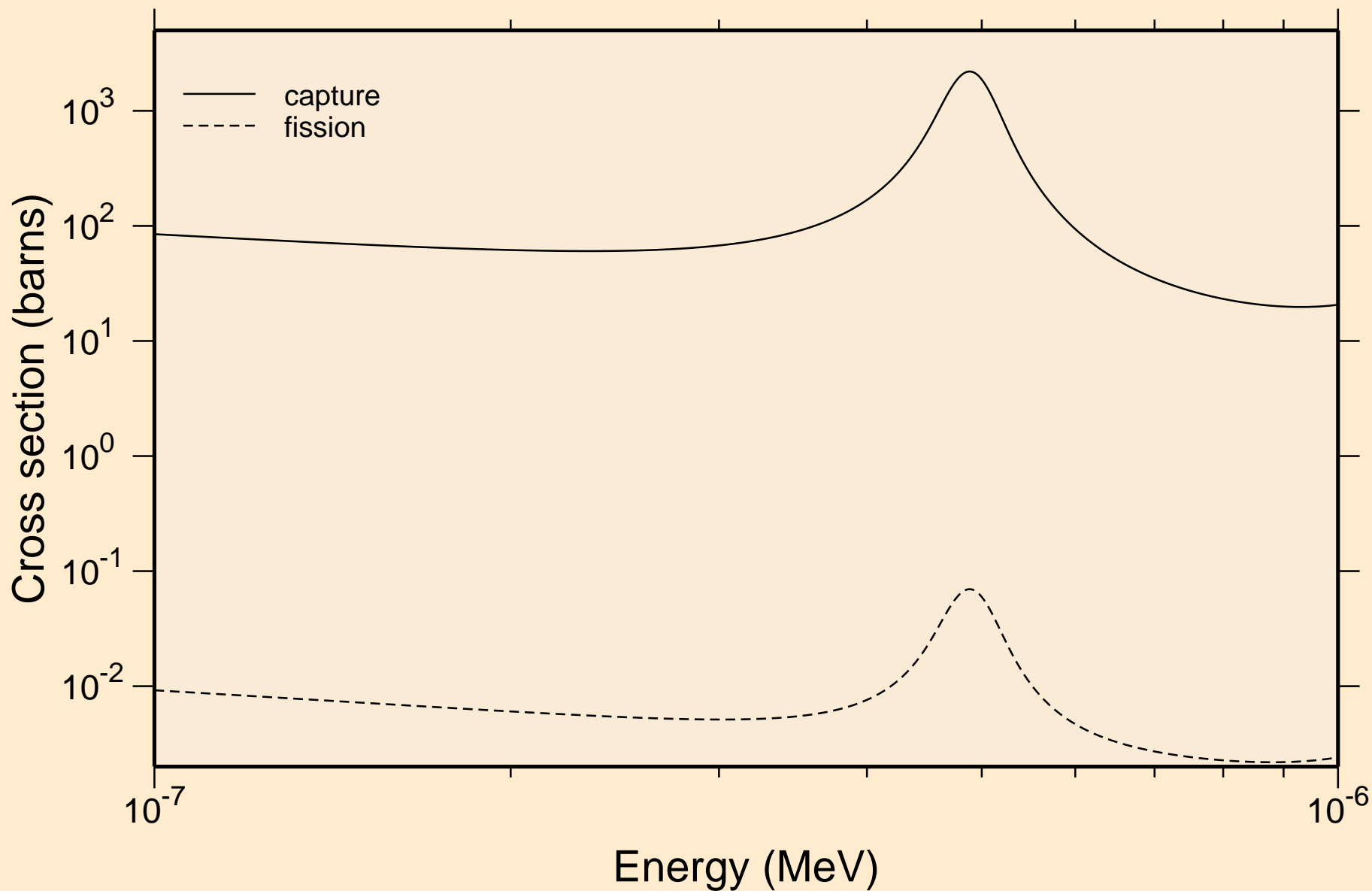

NP237 NEUTRON ACER TENDL-2019 LIBRARY; T=293.16K
resonance absorption cross sections

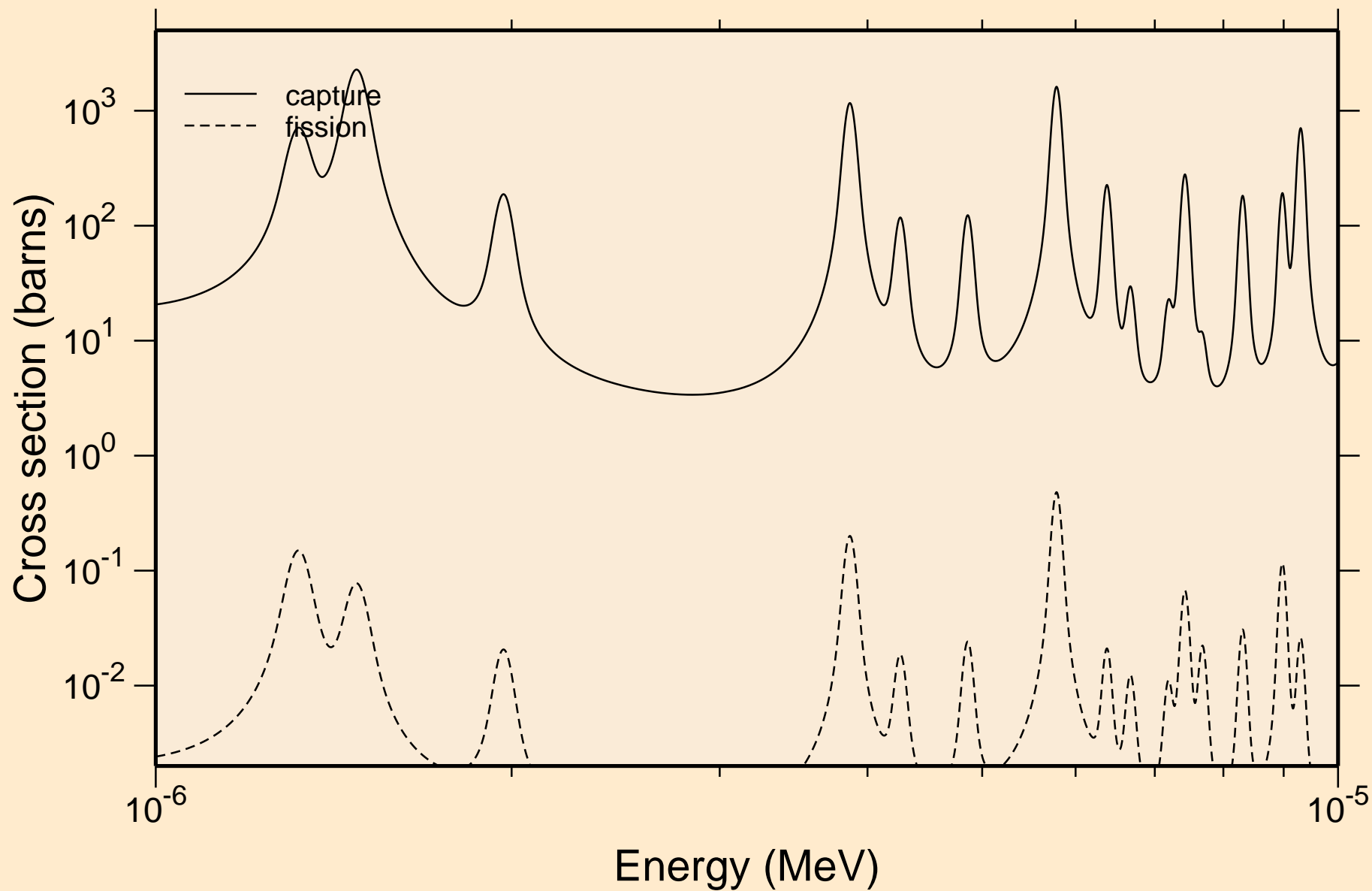

NP237 NEUTRON ACER TENDL-2019 LIBRARY; T=293.16K
resonance absorption cross sections

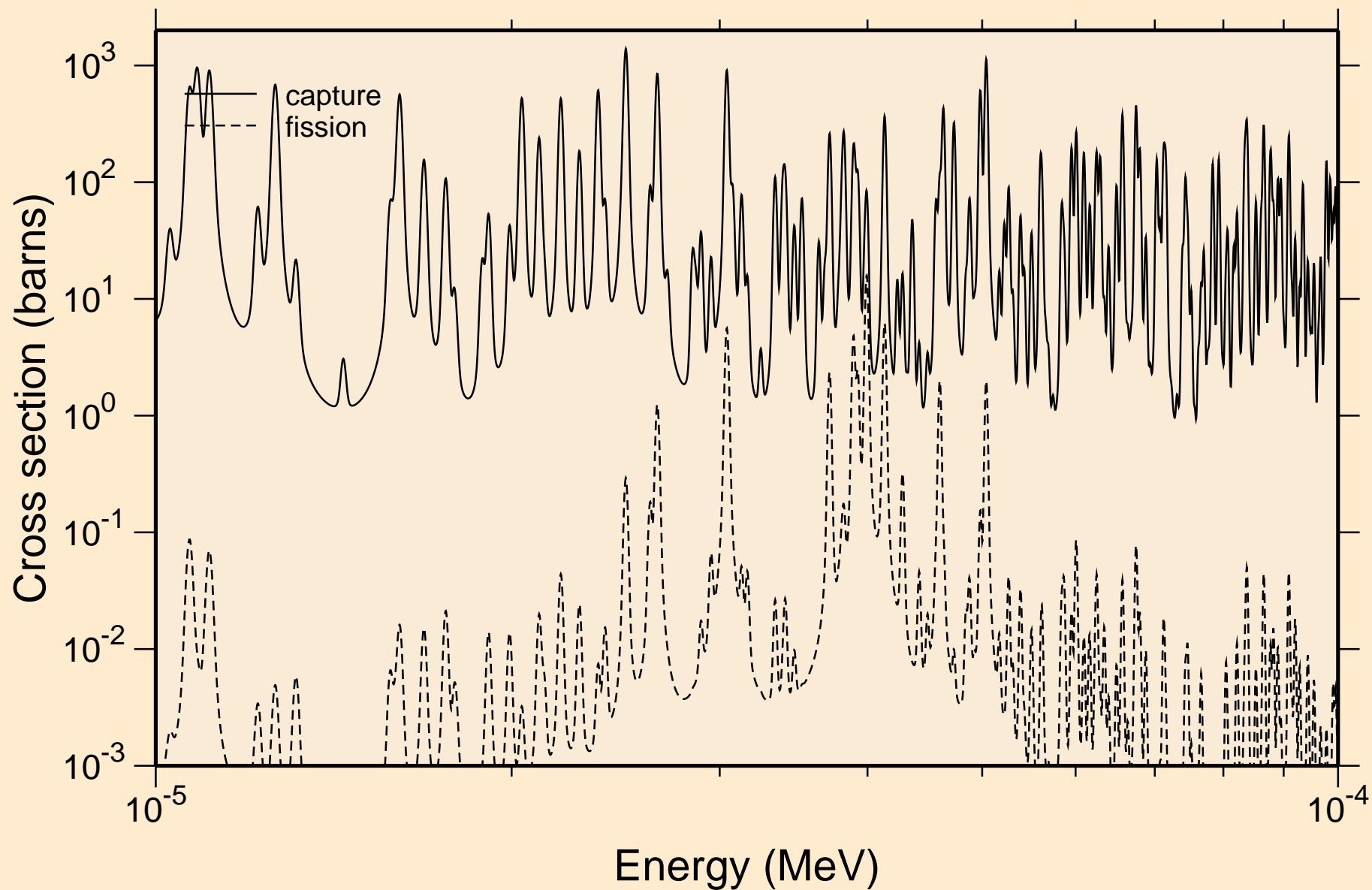

NP237 NEUTRON ACER TENDL-2019 LIBRARY; T=293.16K
resonance absorption cross sections

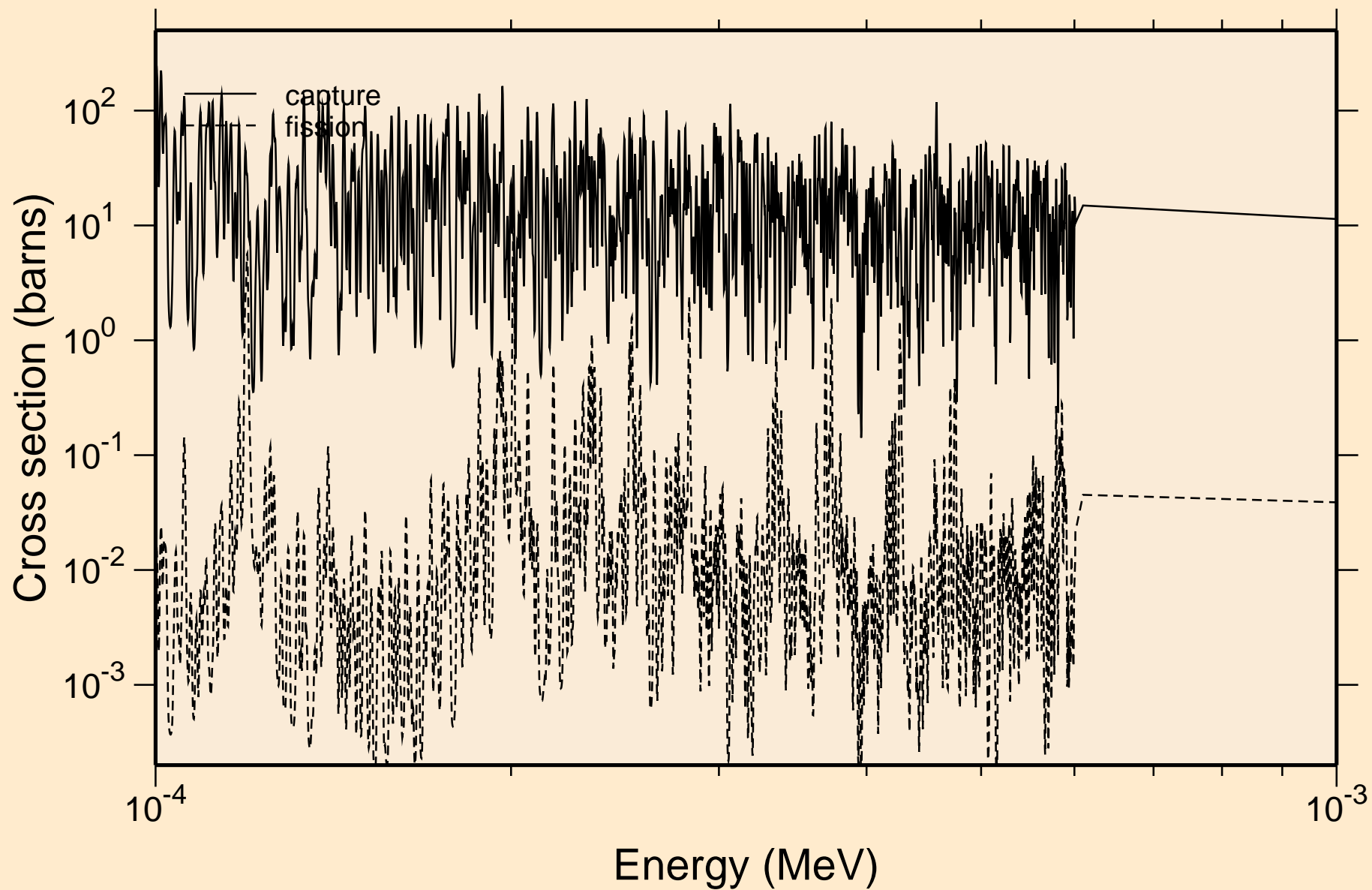

NP237 NEUTRON ACER TENDL-2019 LIBRARY; T=293.16K
resonance absorption cross sections

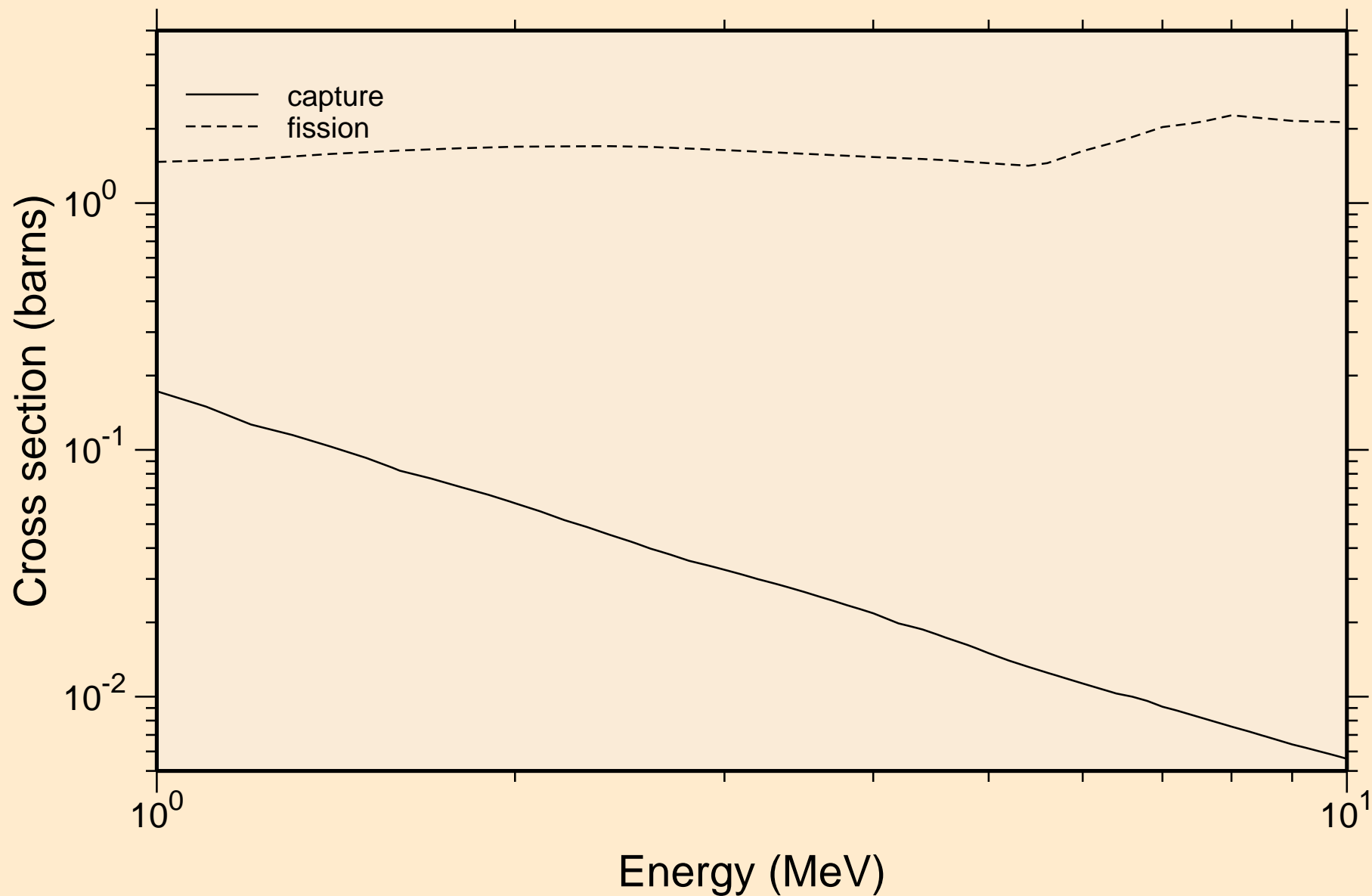

NP237 NEUTRON ACER TENDL-2019 LIBRARY; T=293.16K
Heating

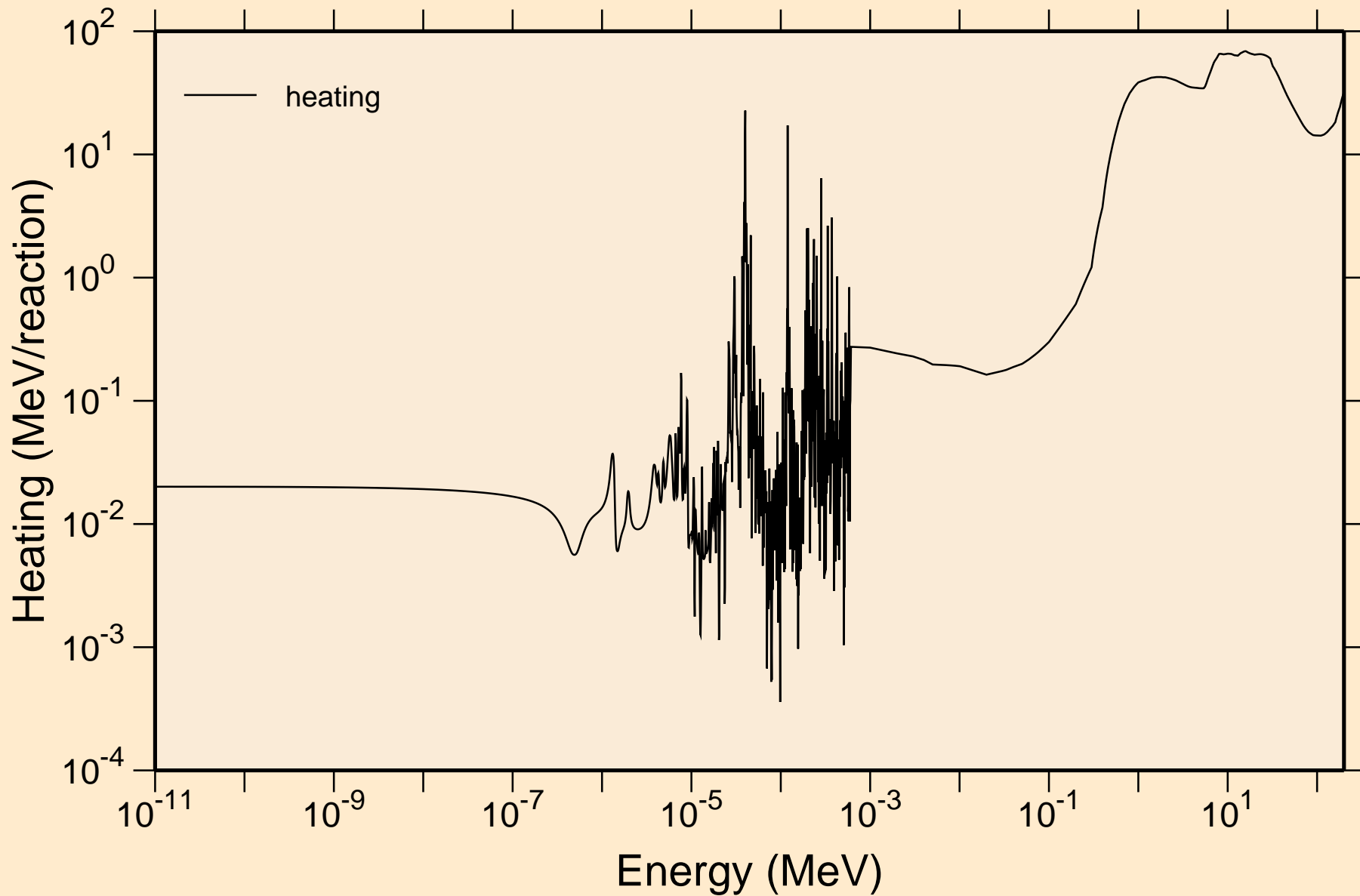

NP237 NEUTRON ACER TENDL-2019 LIBRARY; T=293.16K
Damage

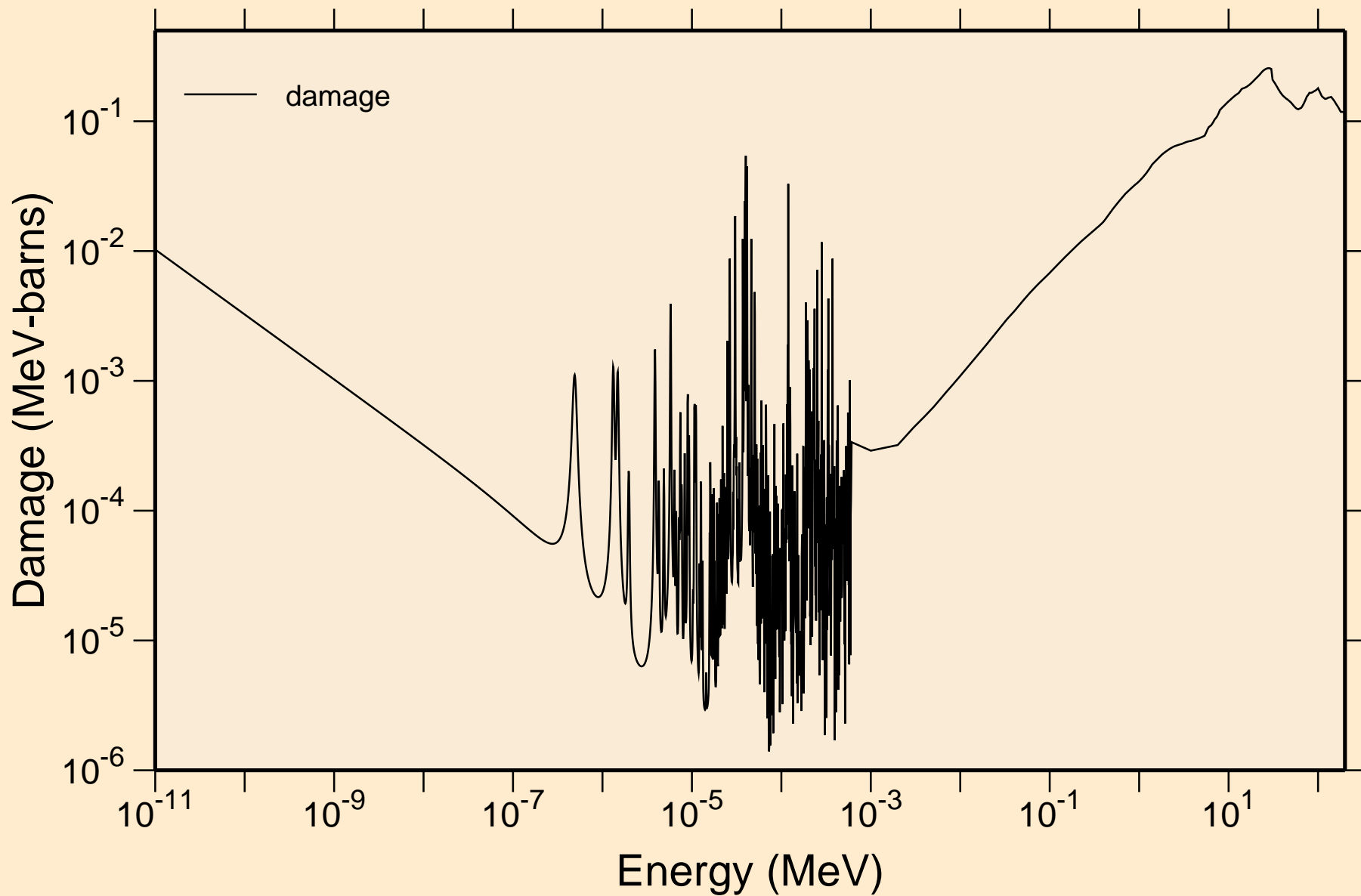

NP237 NEUTRON ACER TENDL-2019 LIBRARY; T=293.16K
Non-threshold reactions

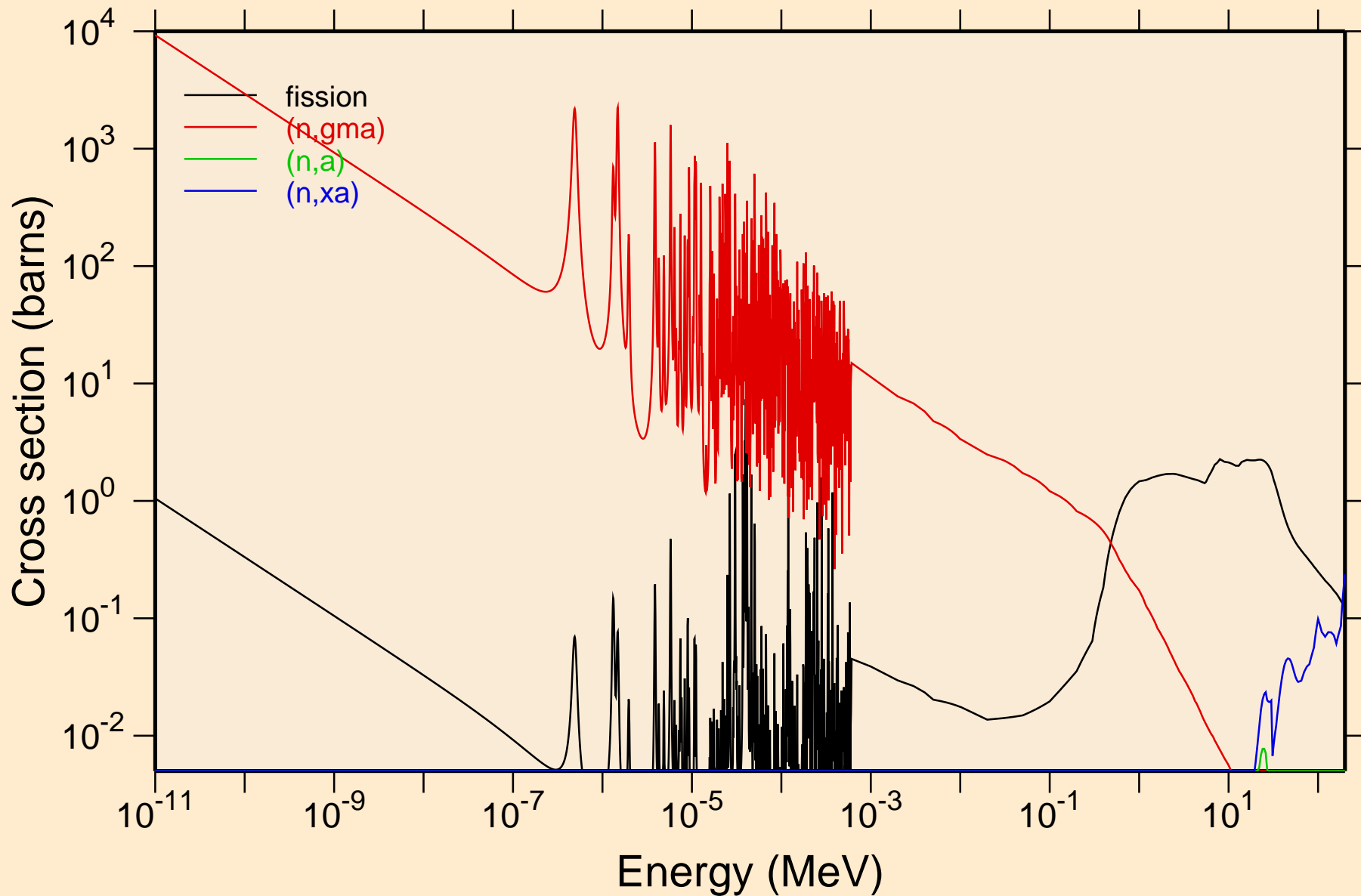

NP237 NEUTRON ACER TENDL-2019 LIBRARY; T=293.16K
Principal cross sections

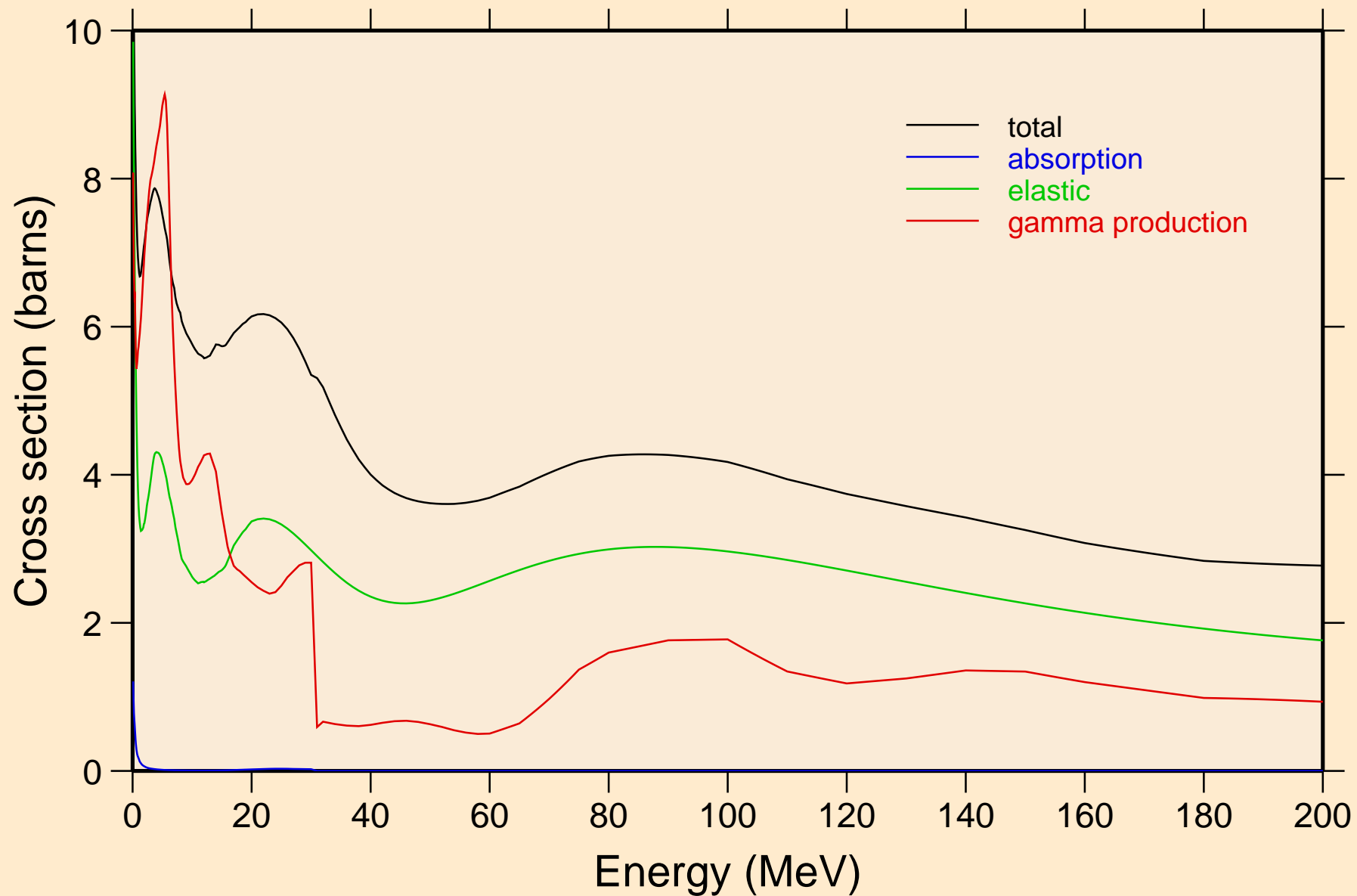

NP237 NEUTRON ACER TENDL-2019 LIBRARY; T=293.16K
Heating

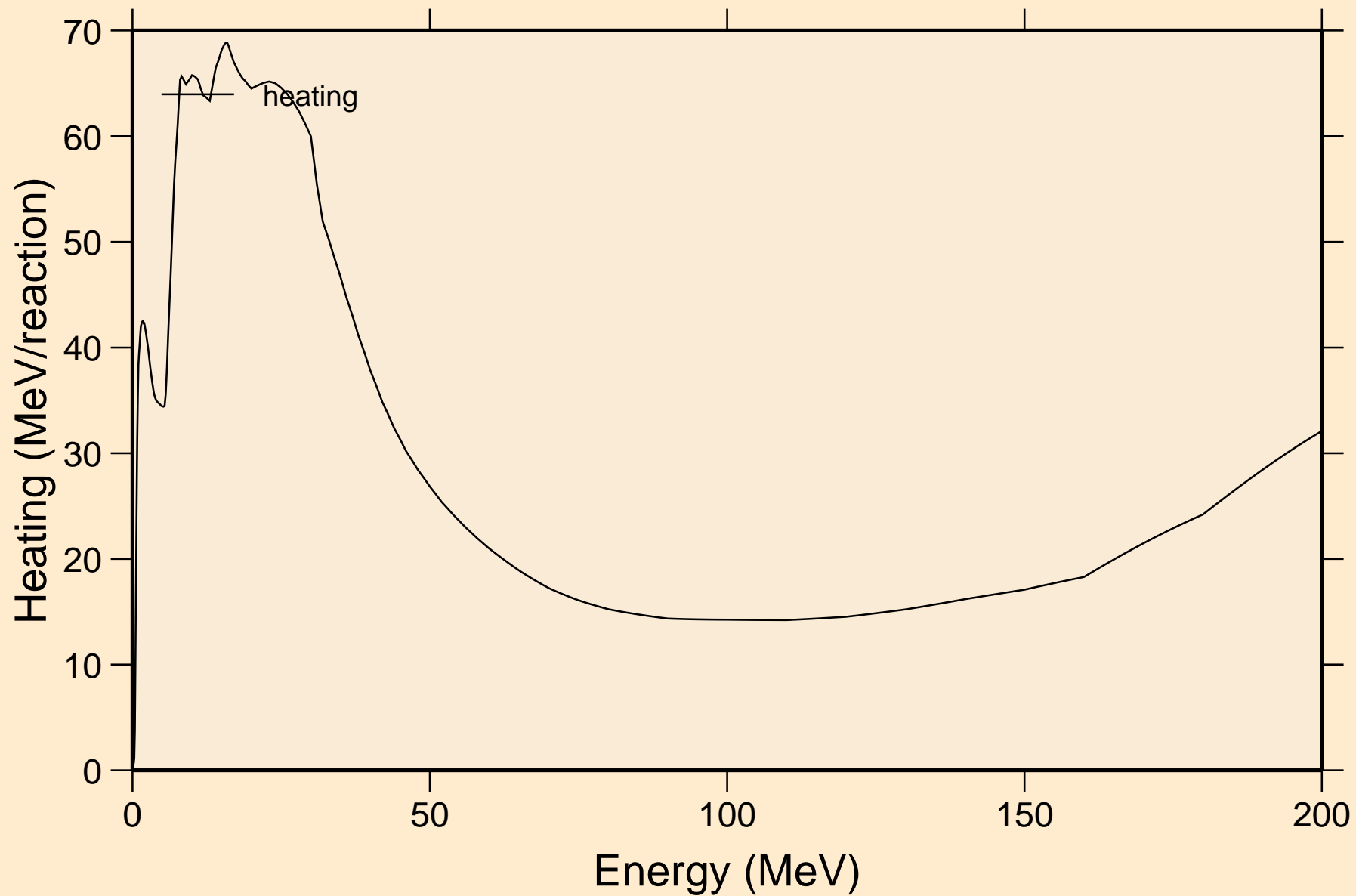

NP237 NEUTRON ACER TENDL-2019 LIBRARY; T=293.16K
Damage

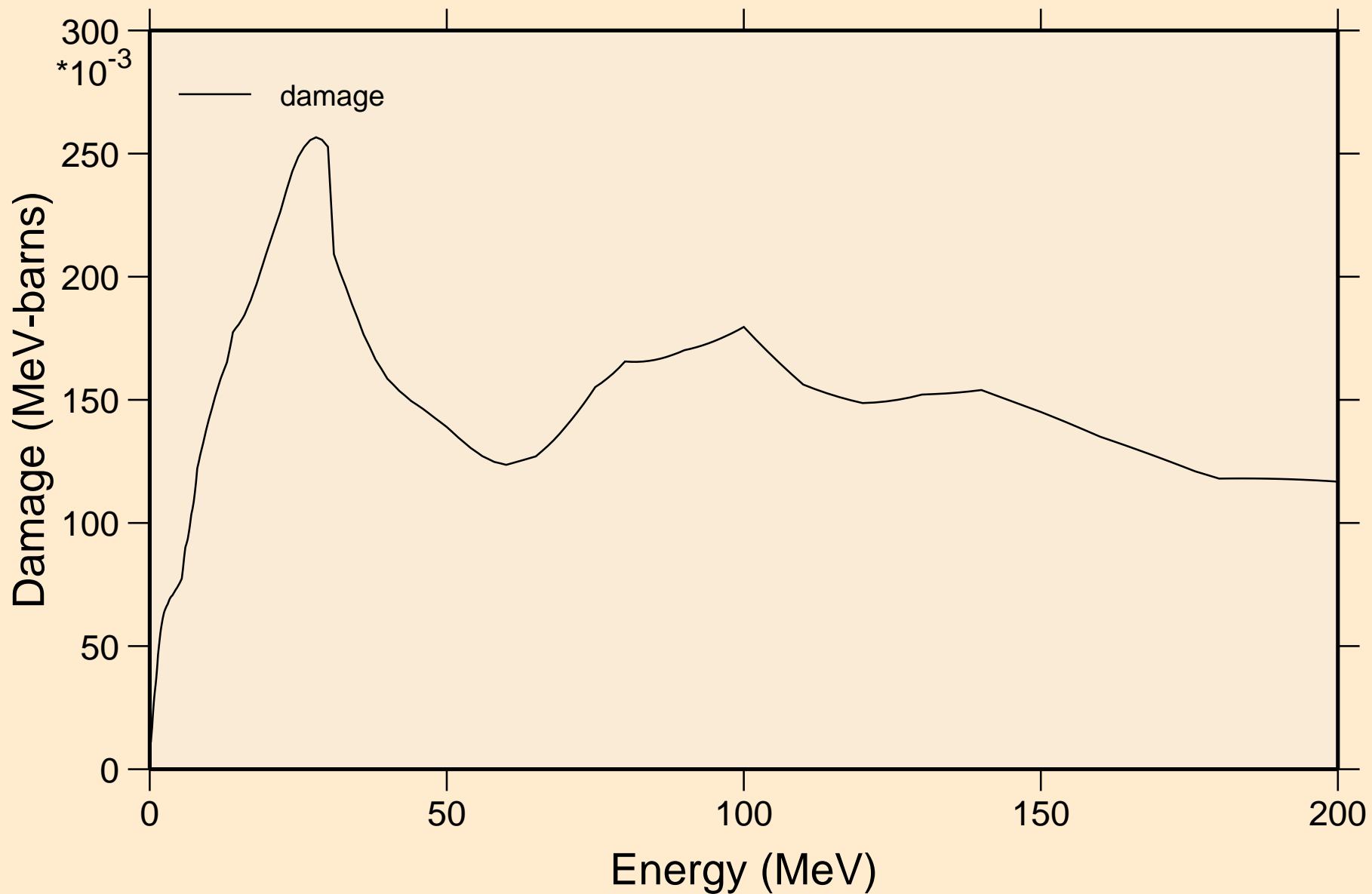

NP237 NEUTRON ACER TENDL-2019 LIBRARY; T=293.16K
Non-threshold reactions

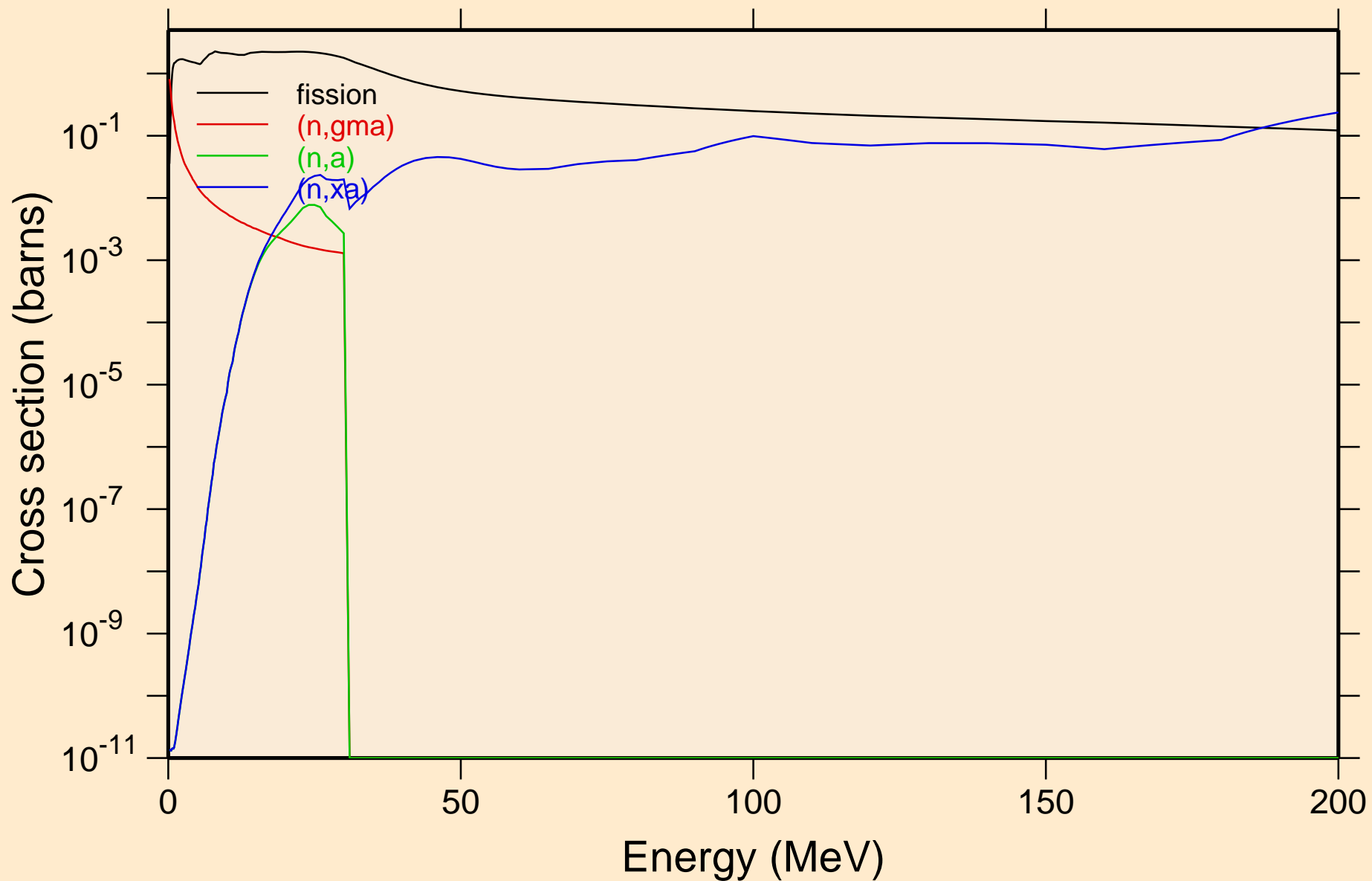

NP237 NEUTRON ACER TENDL-2019 LIBRARY; T=293.16K
Inelastic levels

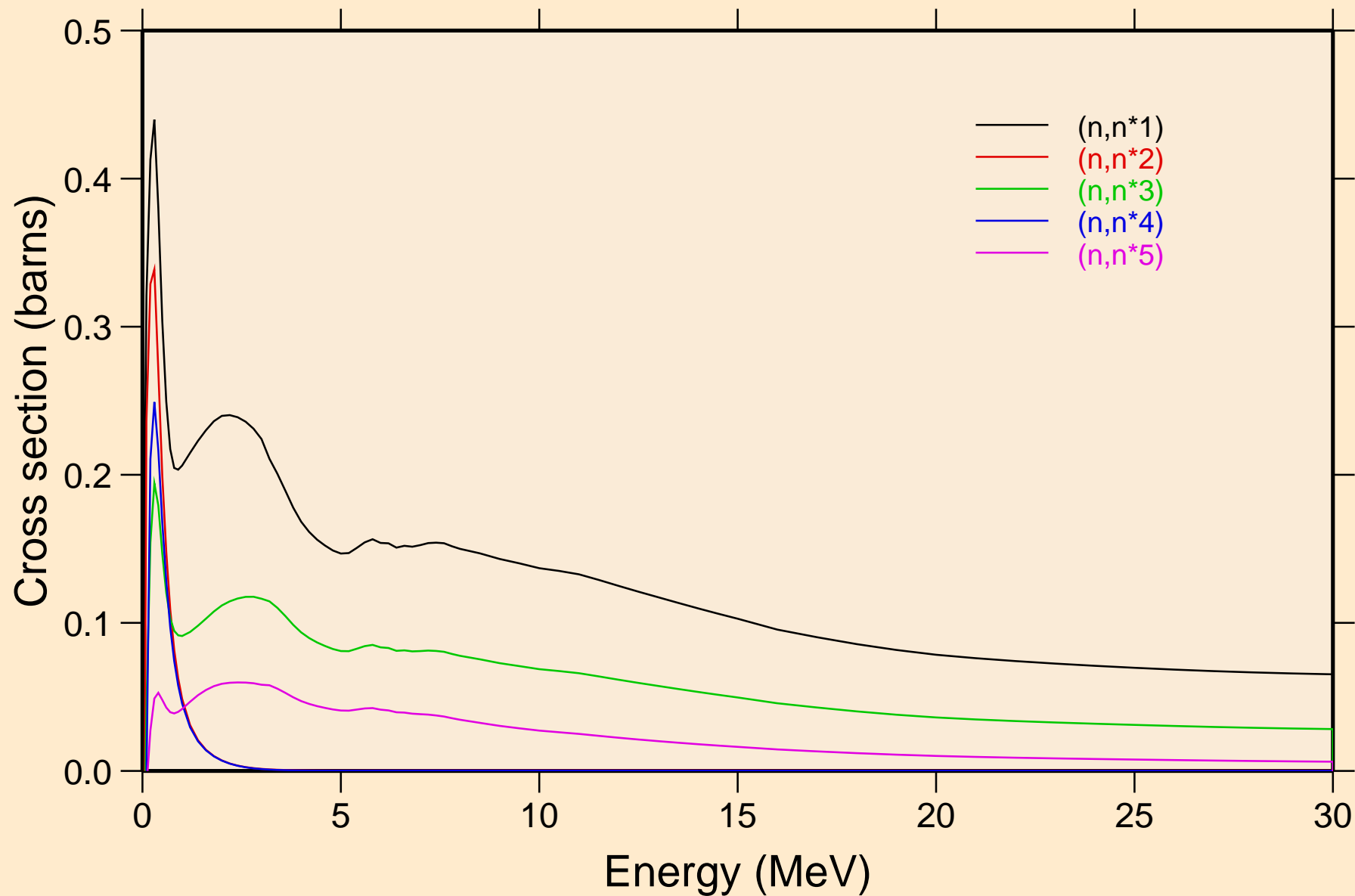

NP237 NEUTRON ACER TENDL-2019 LIBRARY; T=293.16K
Inelastic levels

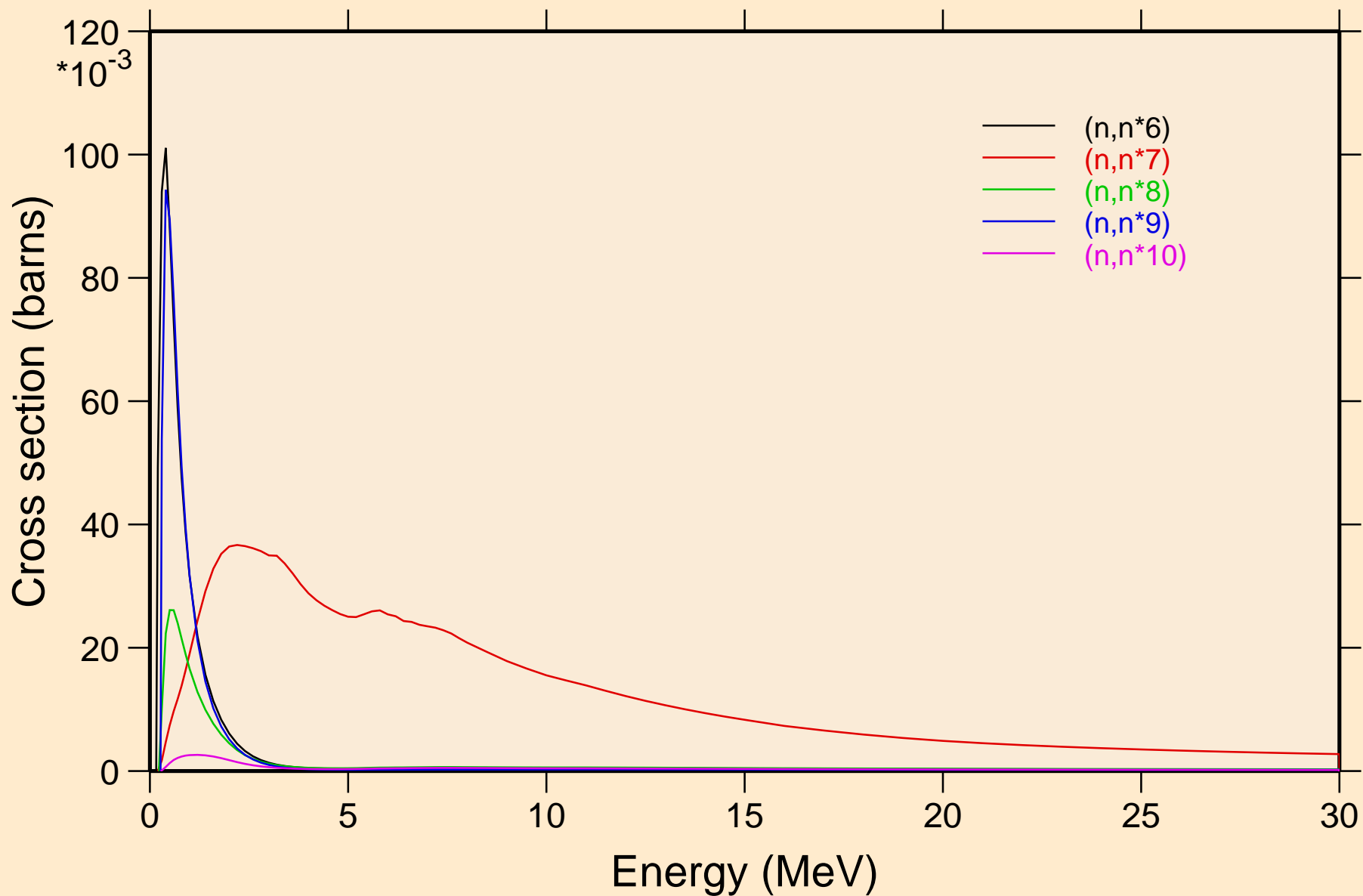

NP237 NEUTRON ACER TENDL-2019 LIBRARY; T=293.16K
Inelastic levels

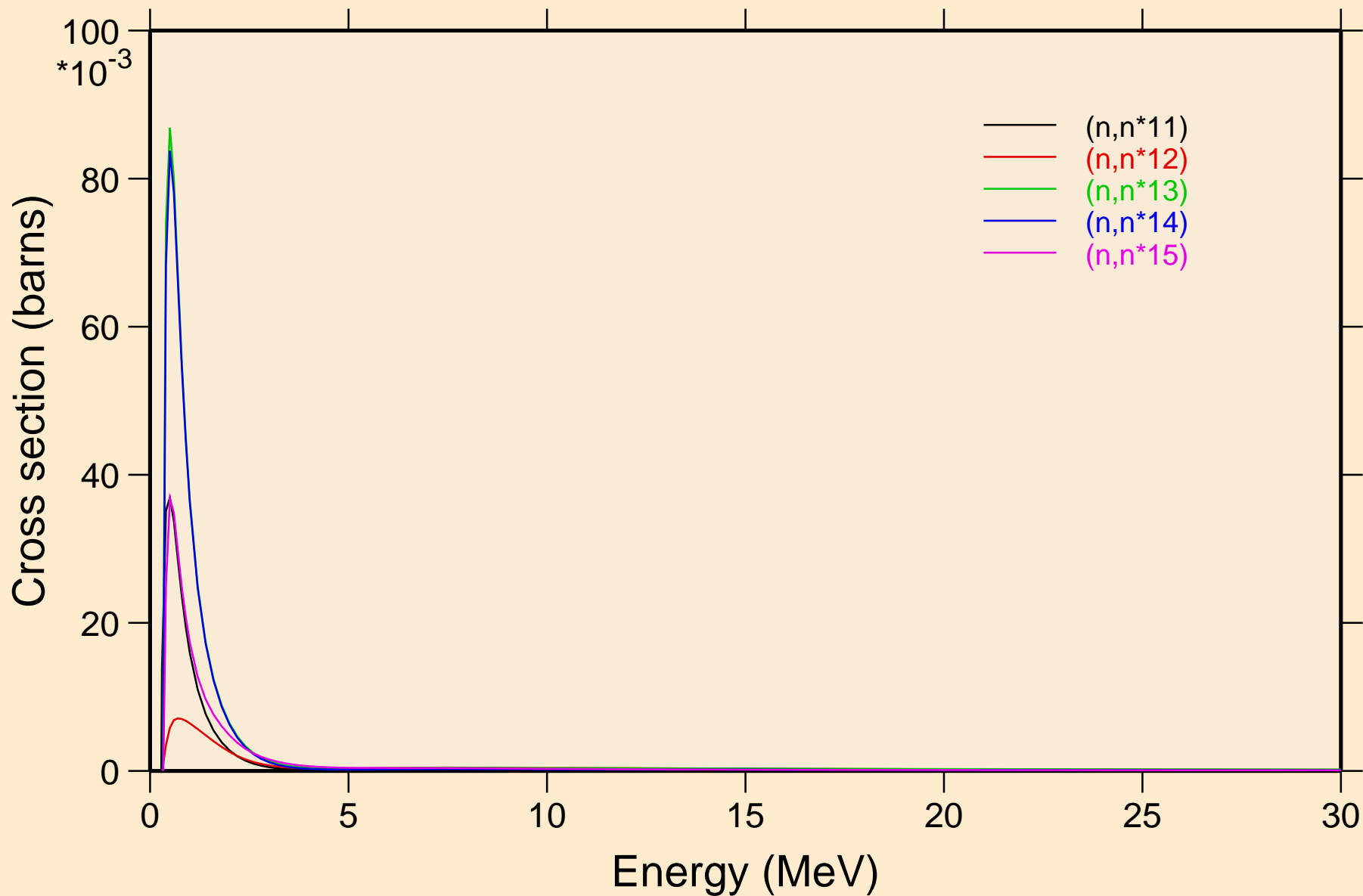

NP237 NEUTRON ACER TENDL-2019 LIBRARY; T=293.16K
Inelastic levels

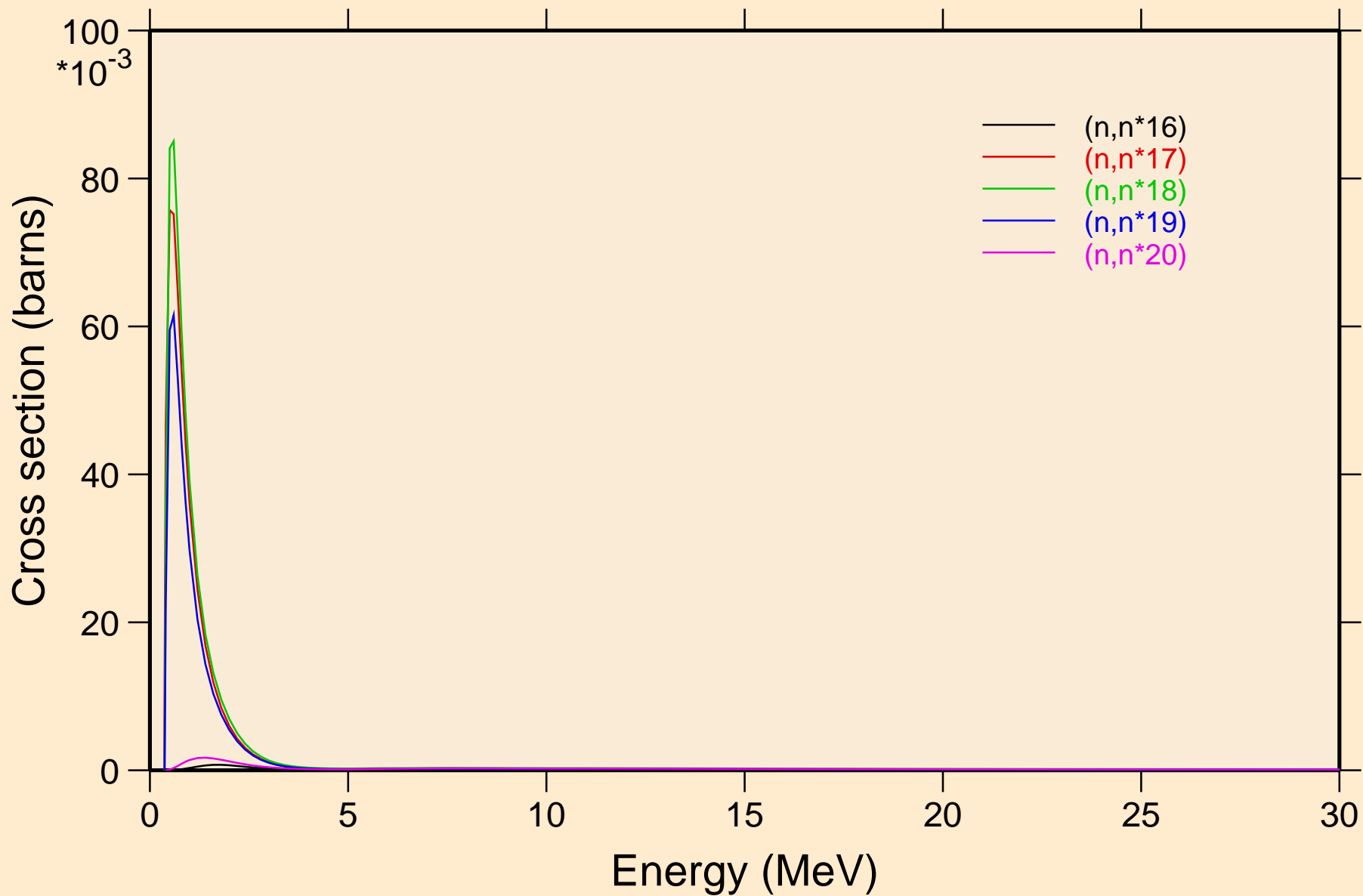

NP237 NEUTRON ACER TENDL-2019 LIBRARY; T=293.16K
Inelastic levels

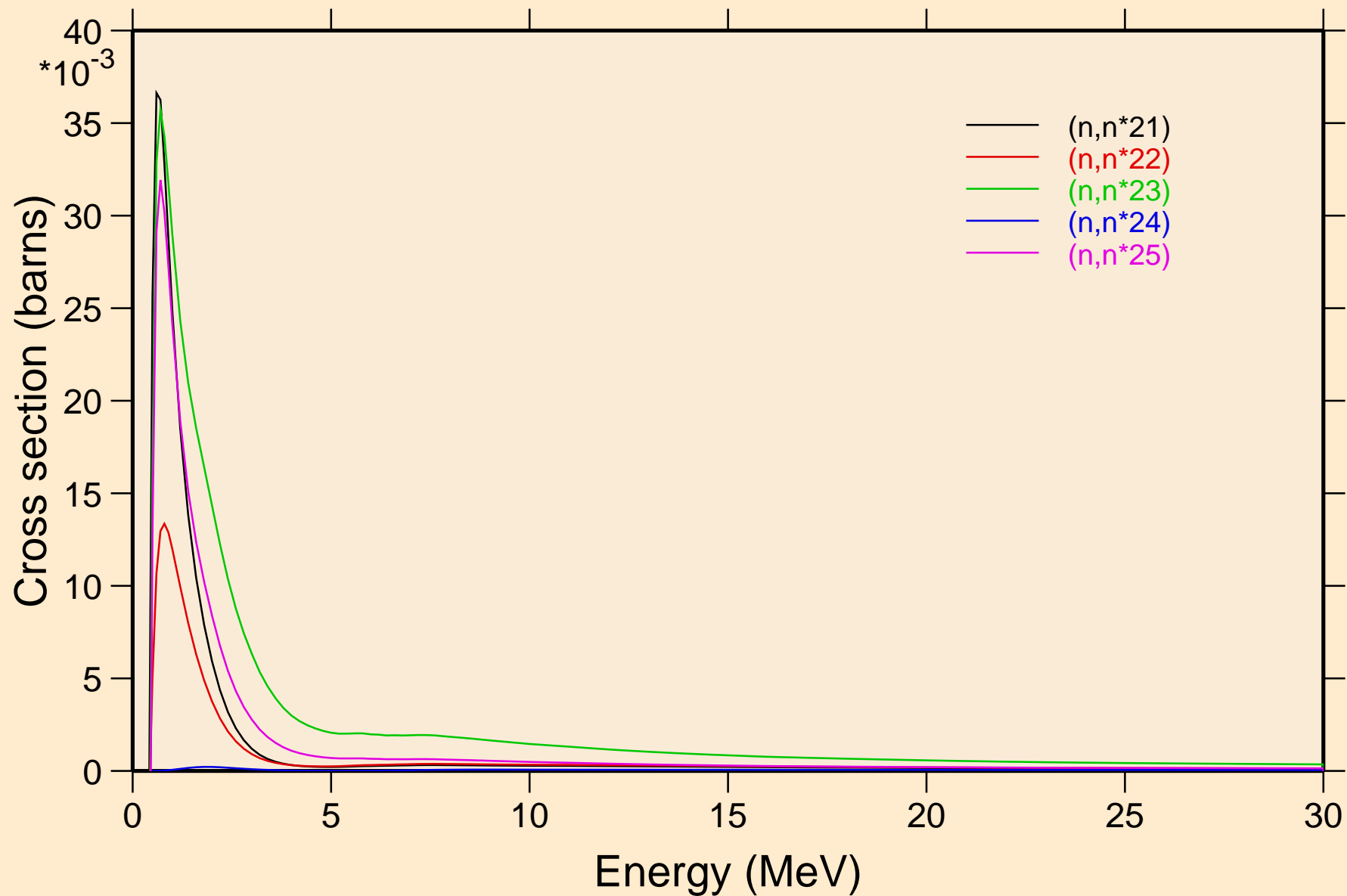

NP237 NEUTRON ACER TENDL-2019 LIBRARY; T=293.16K
Inelastic levels

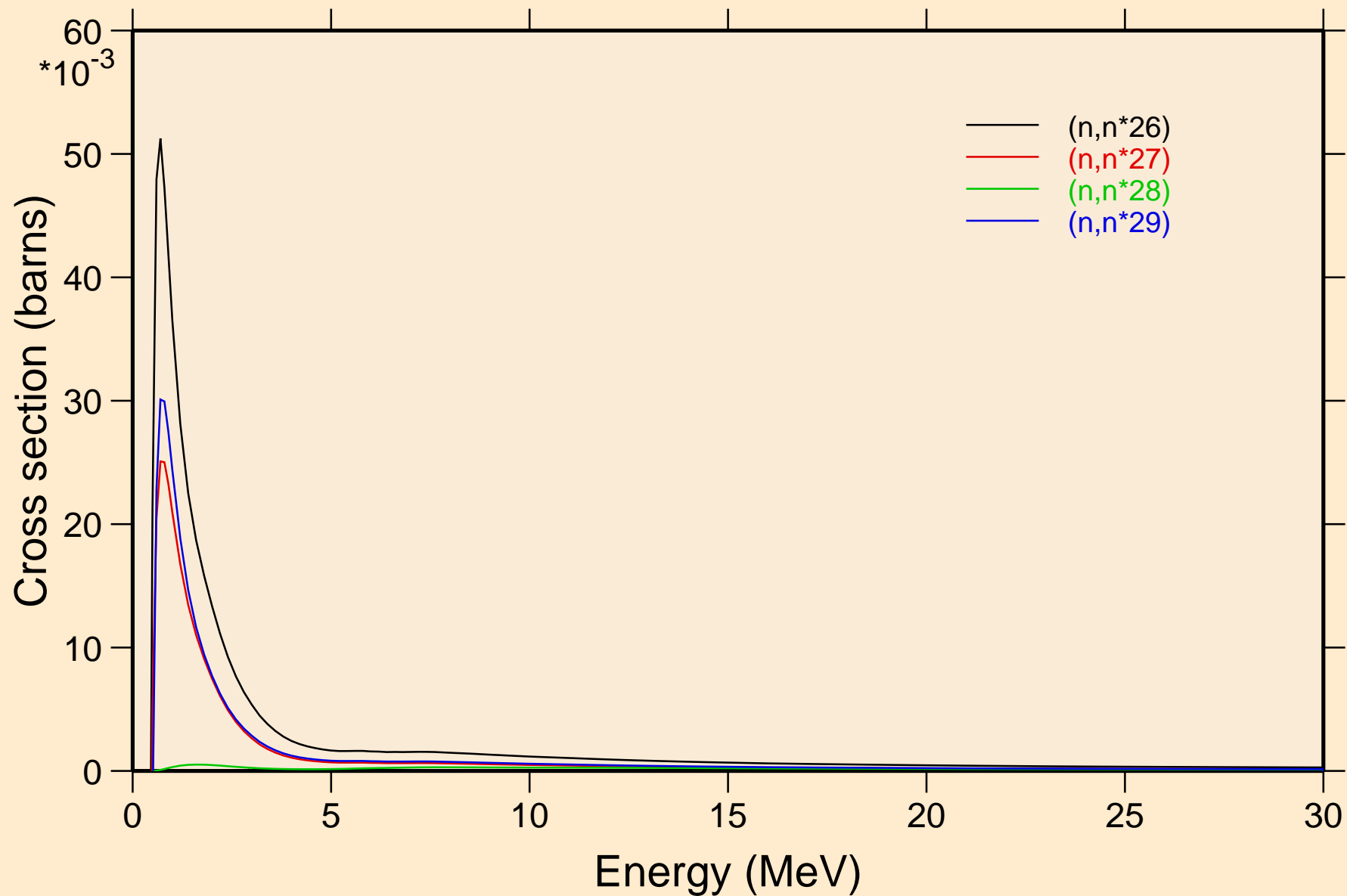

NP237 NEUTRON ACER TENDL-2019 LIBRARY; T=293.16K
Threshold reactions

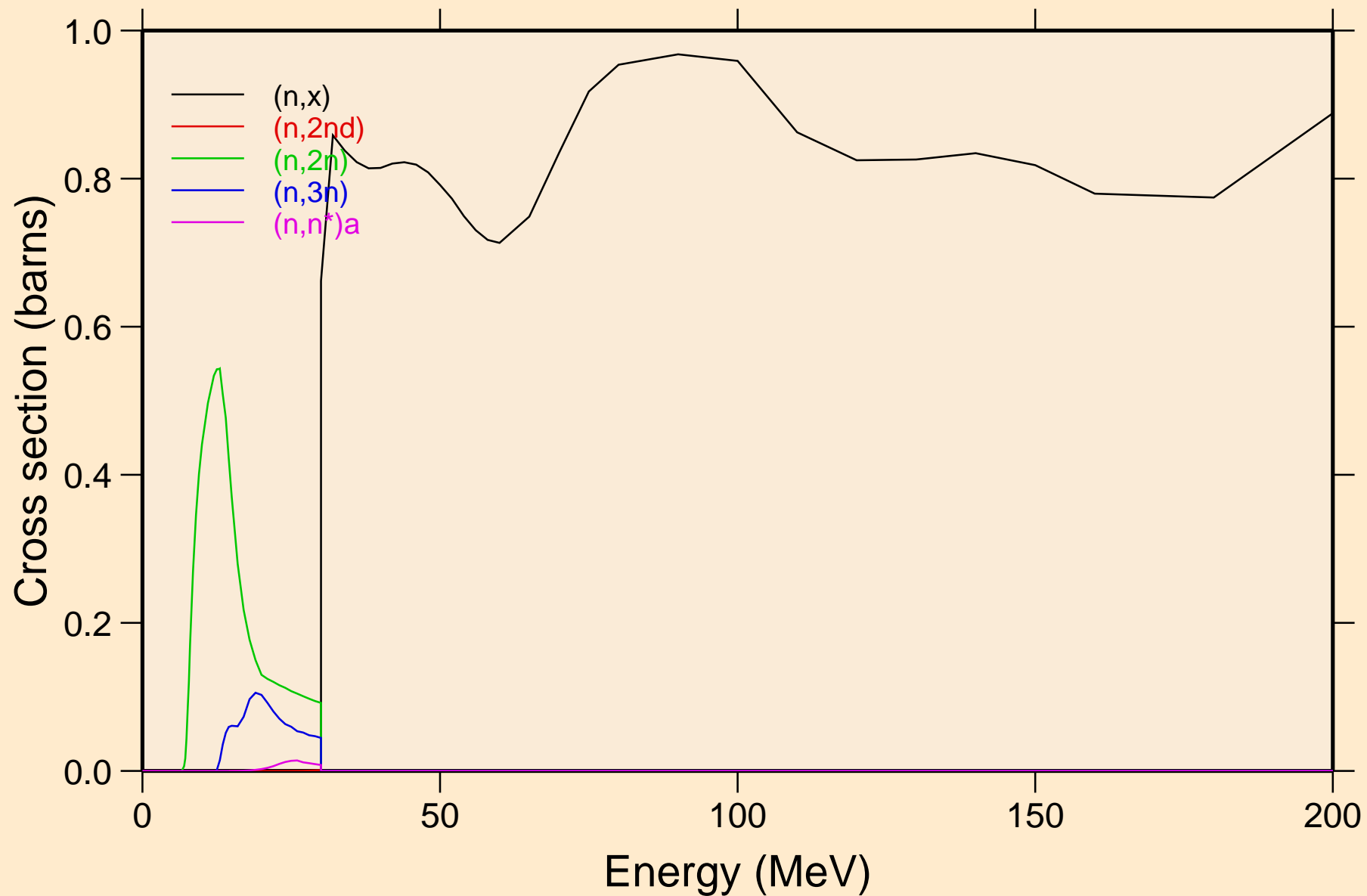

NP237 NEUTRON ACER TENDL-2019 LIBRARY; T=293.16K
Threshold reactions

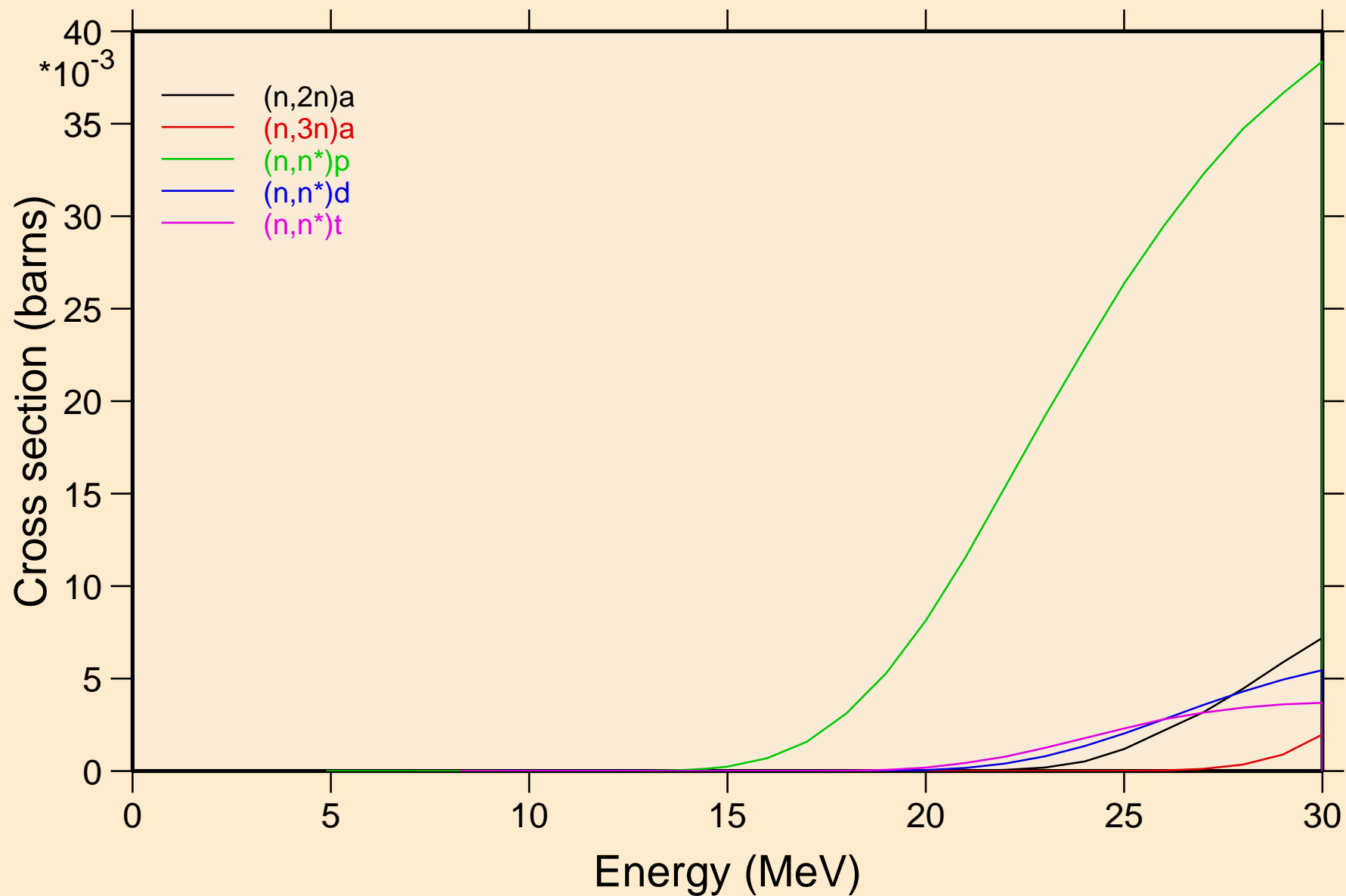

NP237 NEUTRON ACER TENDL-2019 LIBRARY; T=293.16K
Threshold reactions

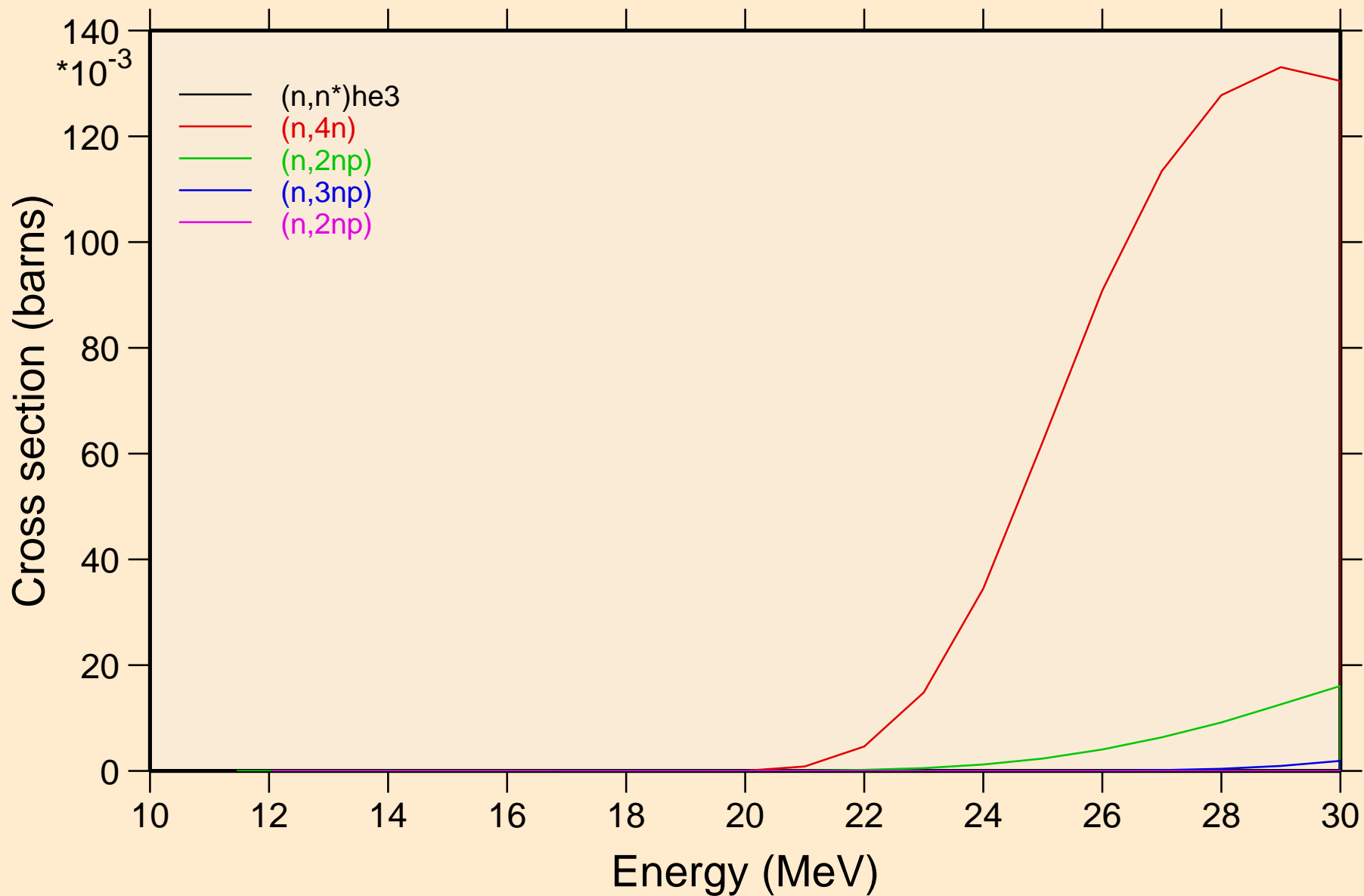

NP237 NEUTRON ACER TENDL-2019 LIBRARY; T=293.16K
Threshold reactions

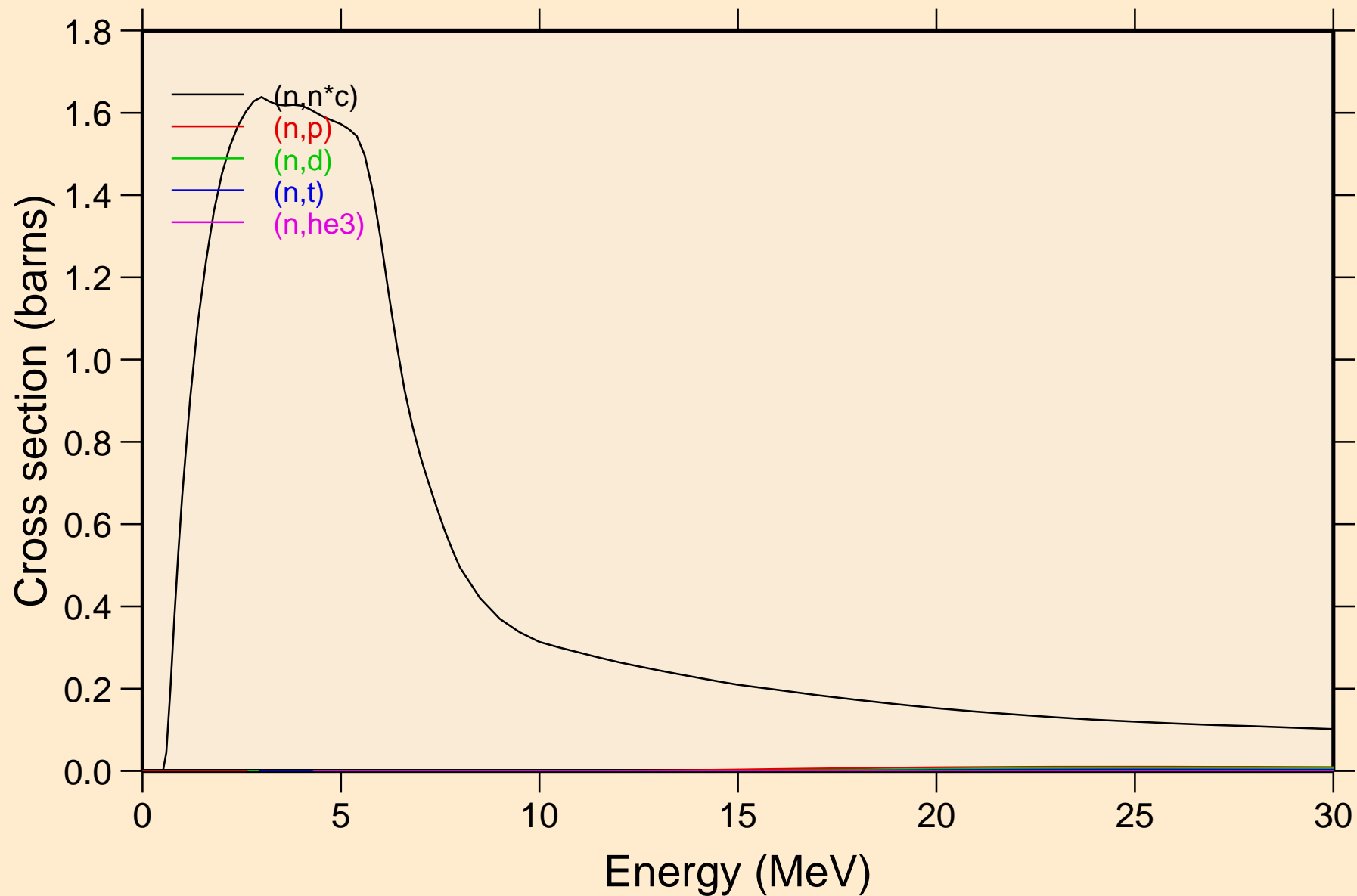

NP237 NEUTRON ACER TENDL-2019 LIBRARY; T=293.16K
Threshold reactions

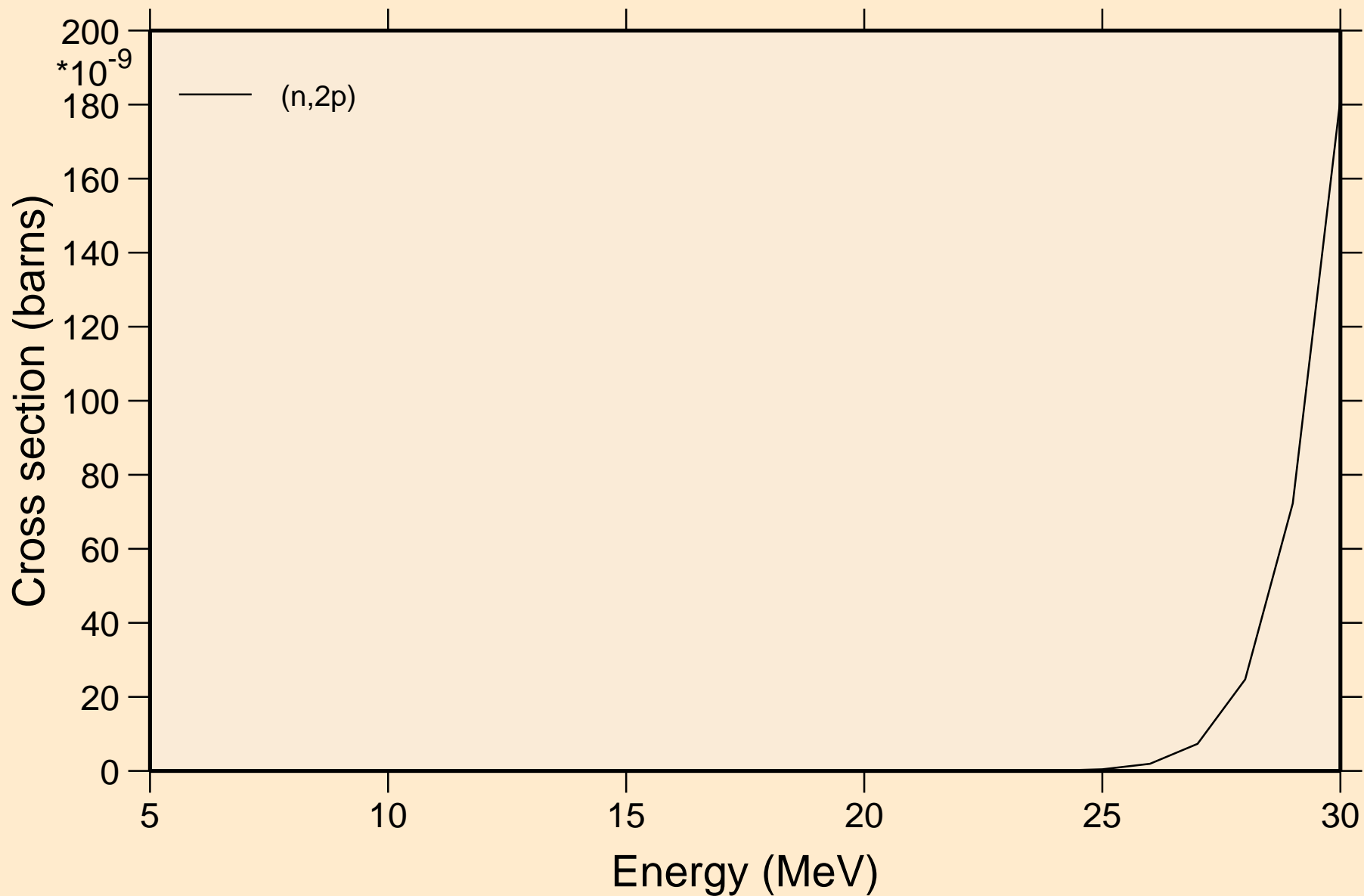

NP237 NEUTRON ACER TENDL-2019 LIBRARY; T=293.16K
Threshold reactions

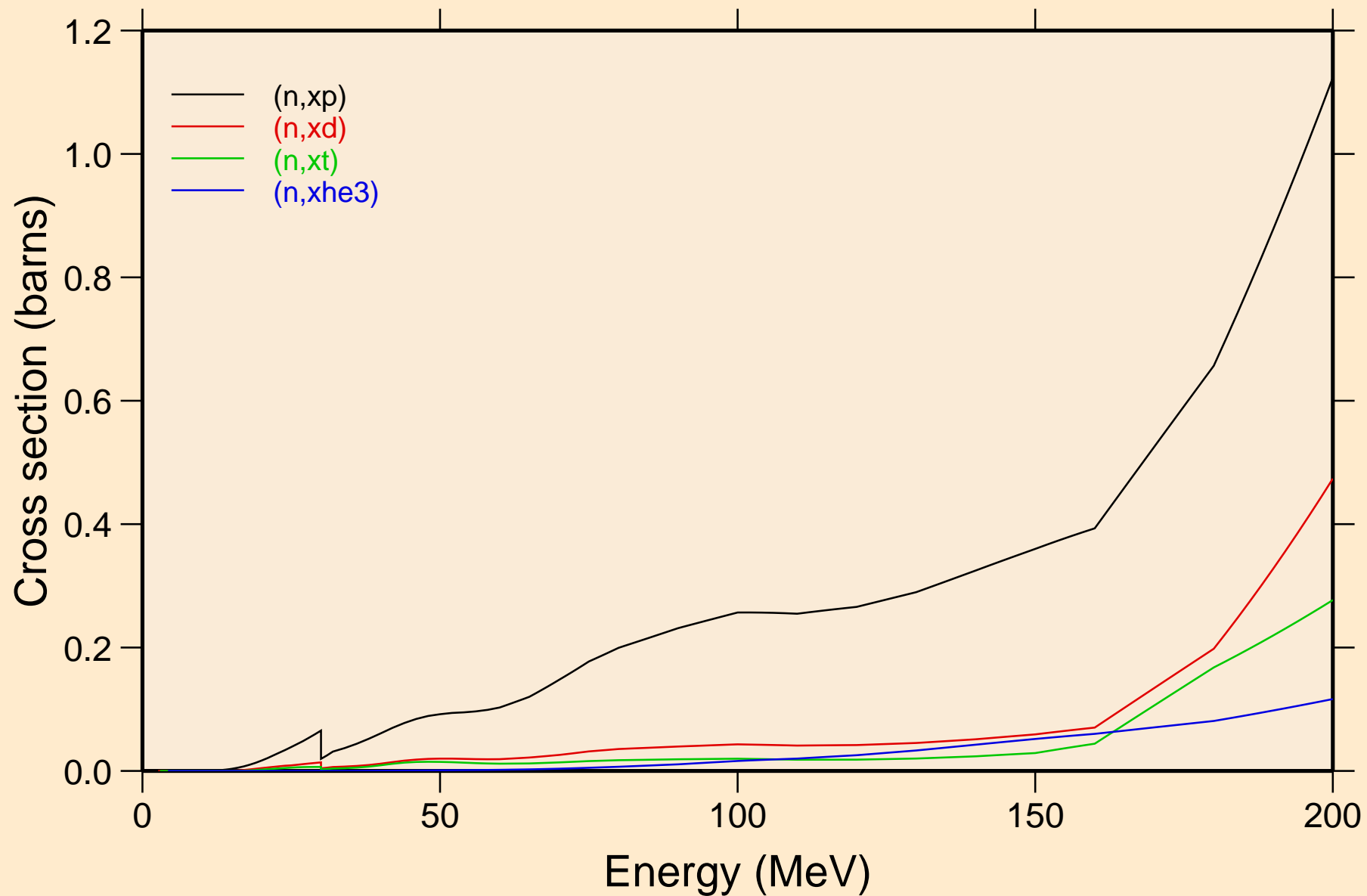

NP237 NEUTRON ACER TENDL-2019 LIBRARY; T=293.16K
angular distribution for elastic

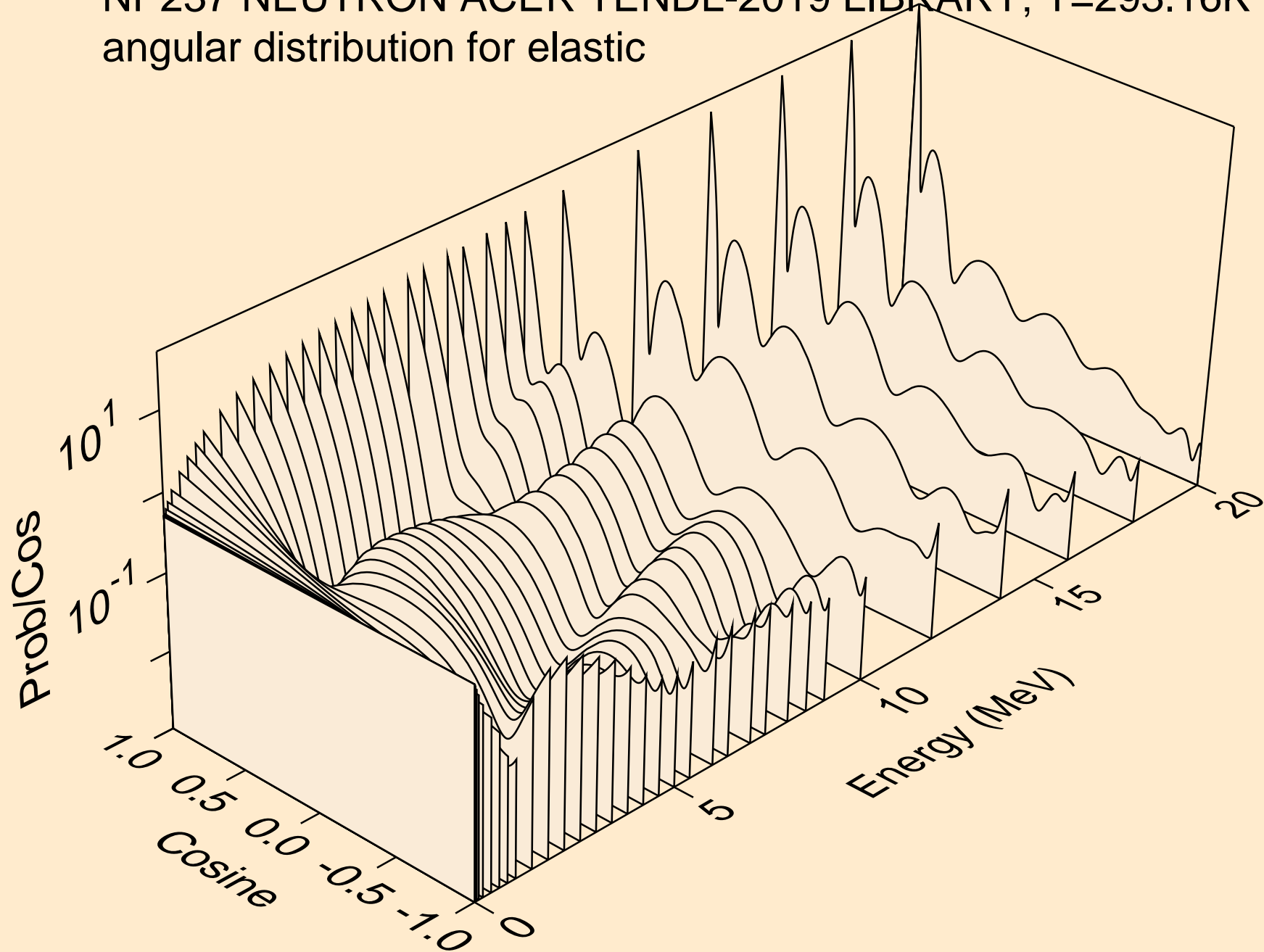

NP237 NEUTRON ACER TENDL-2019 LIBRARY; T=293.16K
angular distribution for elastic

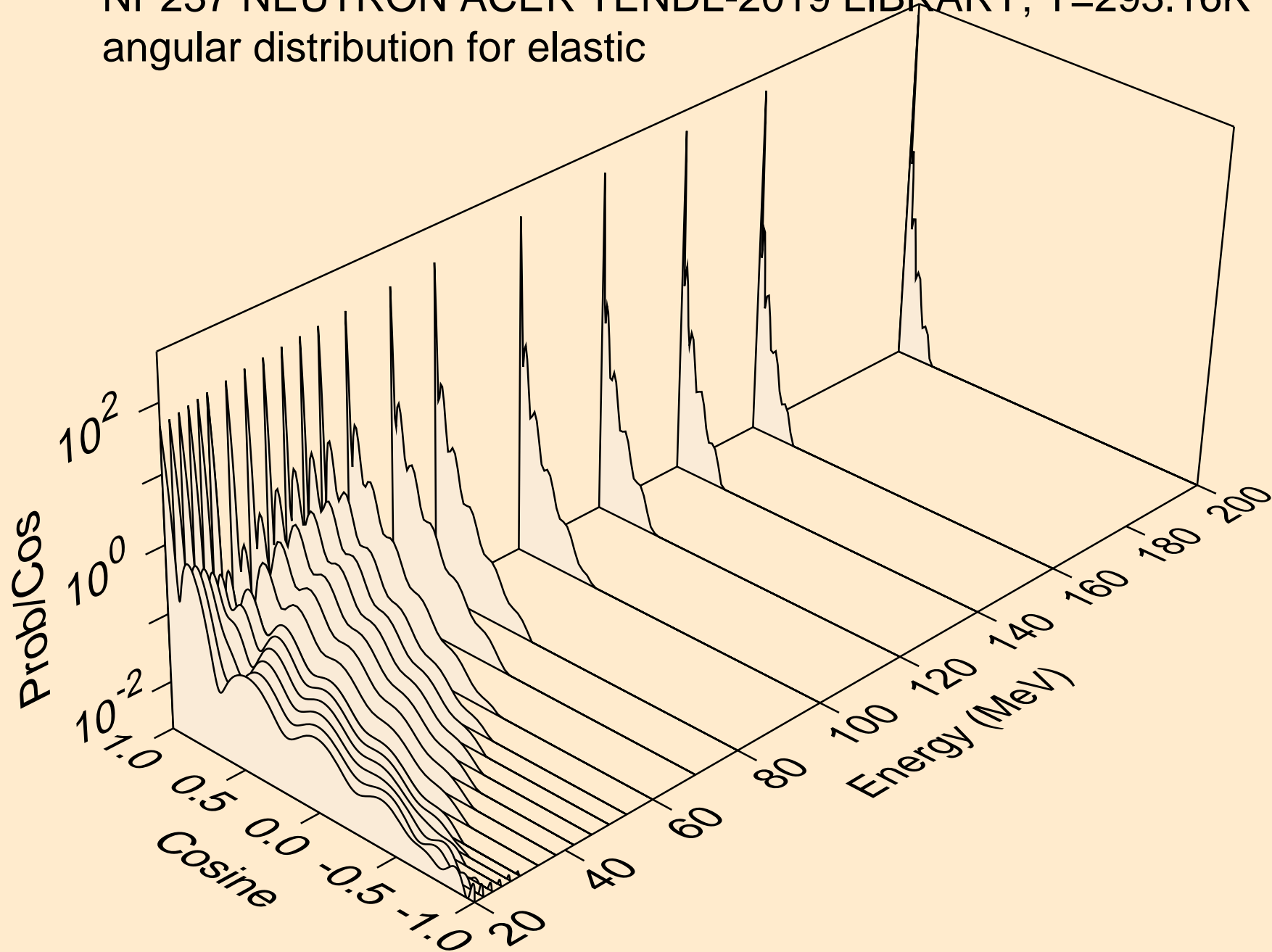

NP237 NEUTRON ACER TENDL-2019 LIBRARY; T=293.16K
angular distribution for (n,n*1)

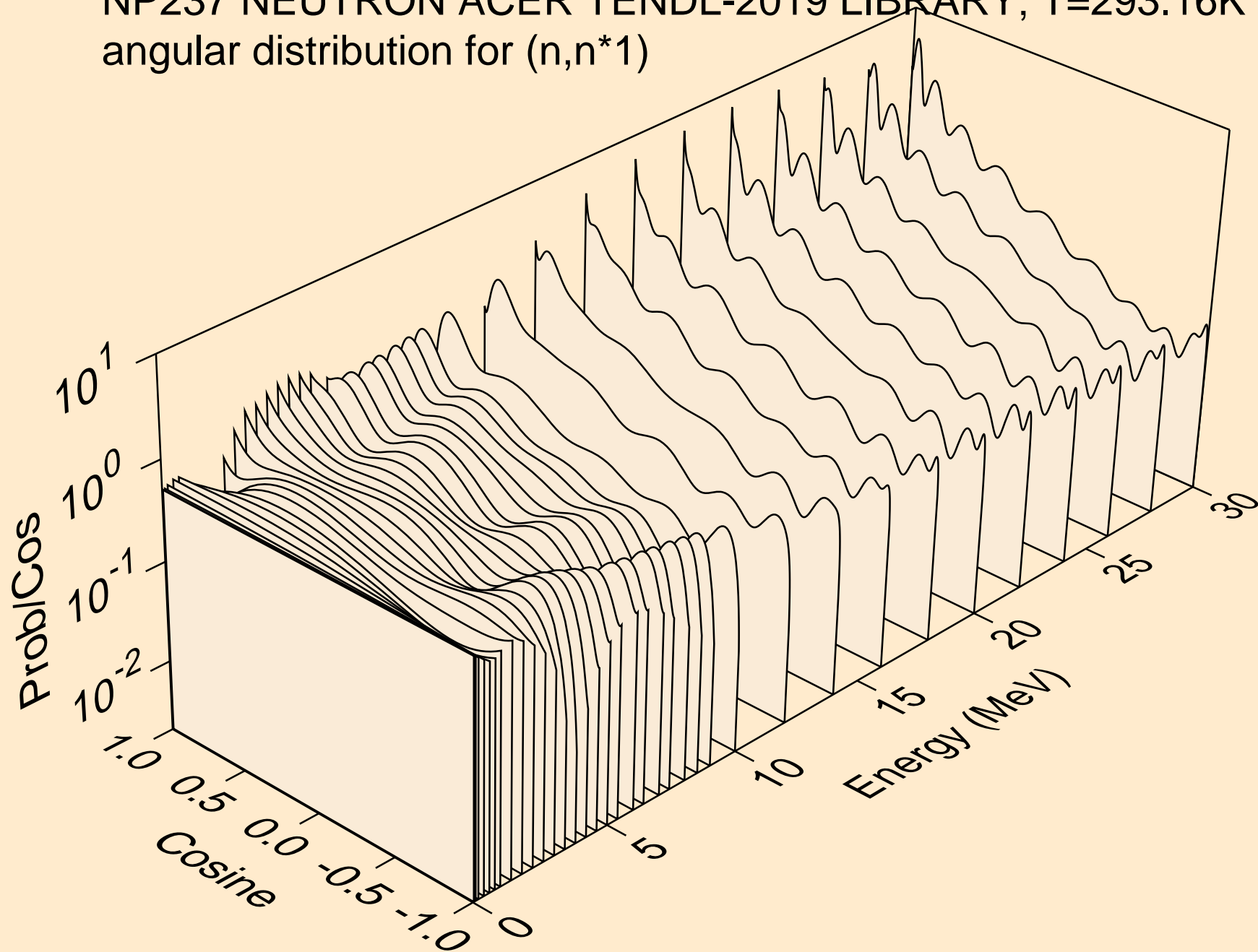

NP237 NEUTRON ACER TENDL-2019 LIBRARY; T=293.16K
angular distribution for (n,n*2)

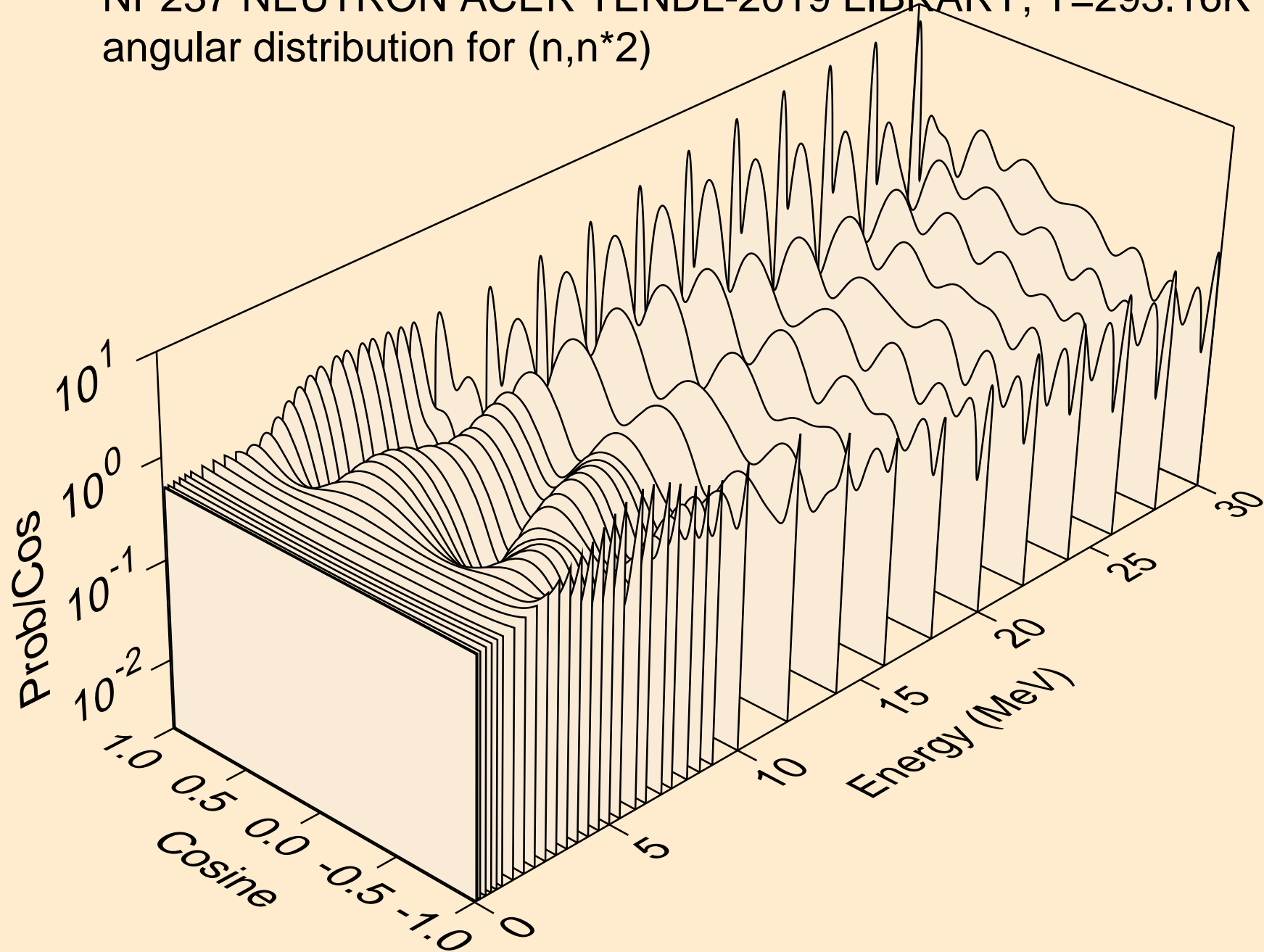

NP237 NEUTRON ACER TENDL-2019 LIBRARY; T=293.16K
angular distribution for (n,n*3)

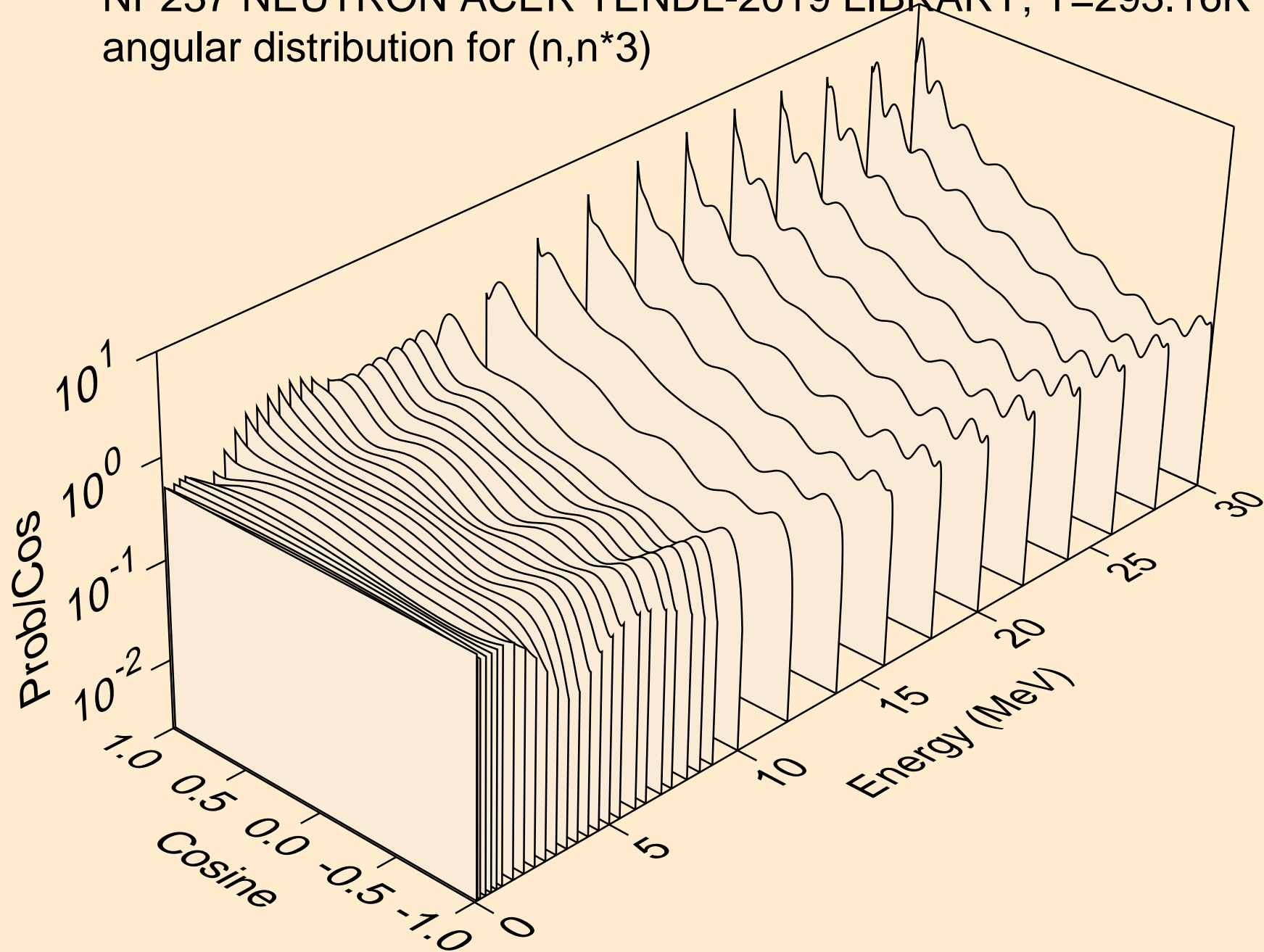

NP237 NEUTRON ACER TENDL-2019 LIBRARY; T=293.16K
angular distribution for (n,n*4)

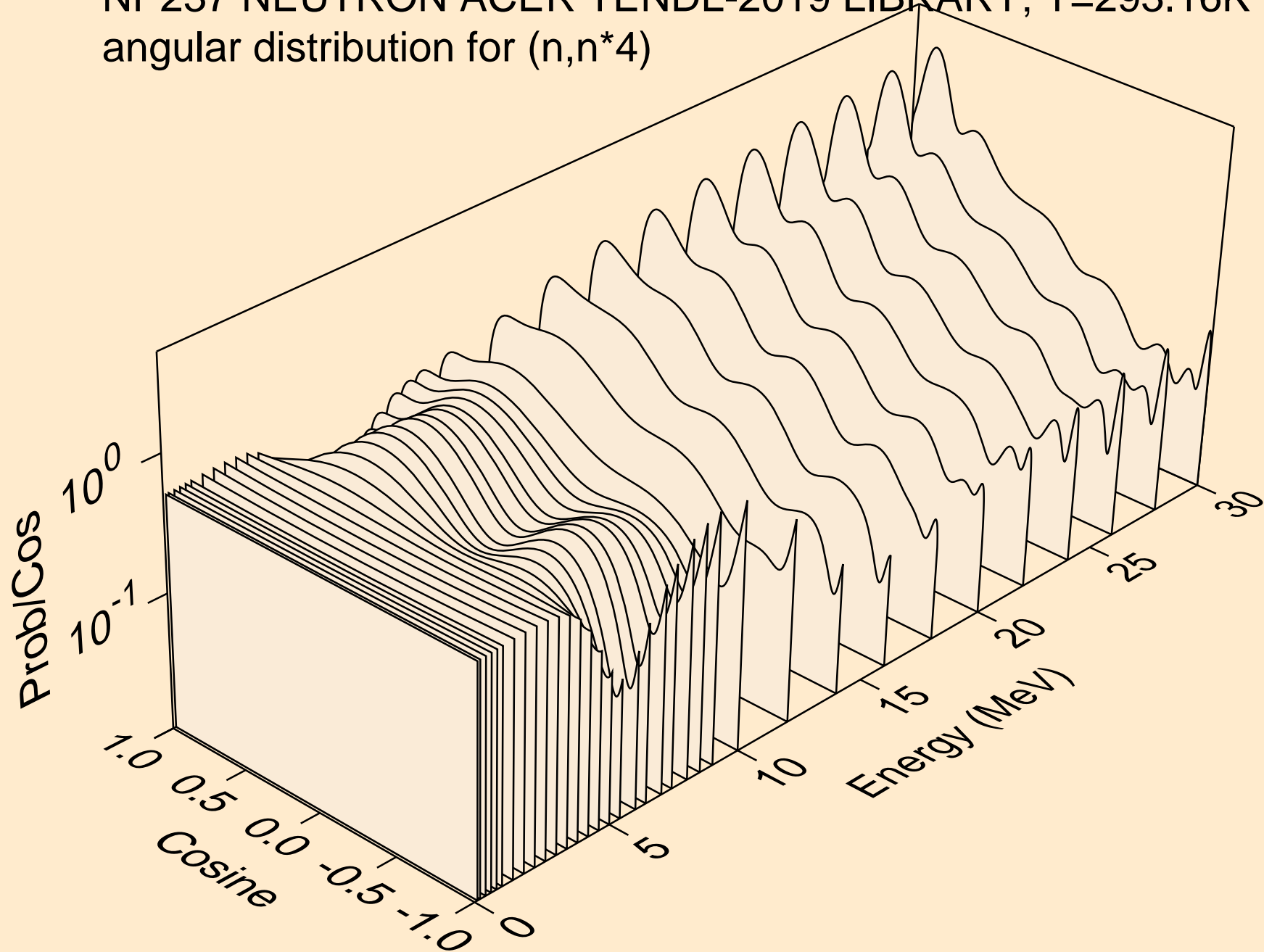

NP237 NEUTRON ACER TENDL-2019 LIBRARY; T=293.16K
angular distribution for (n,n*5)

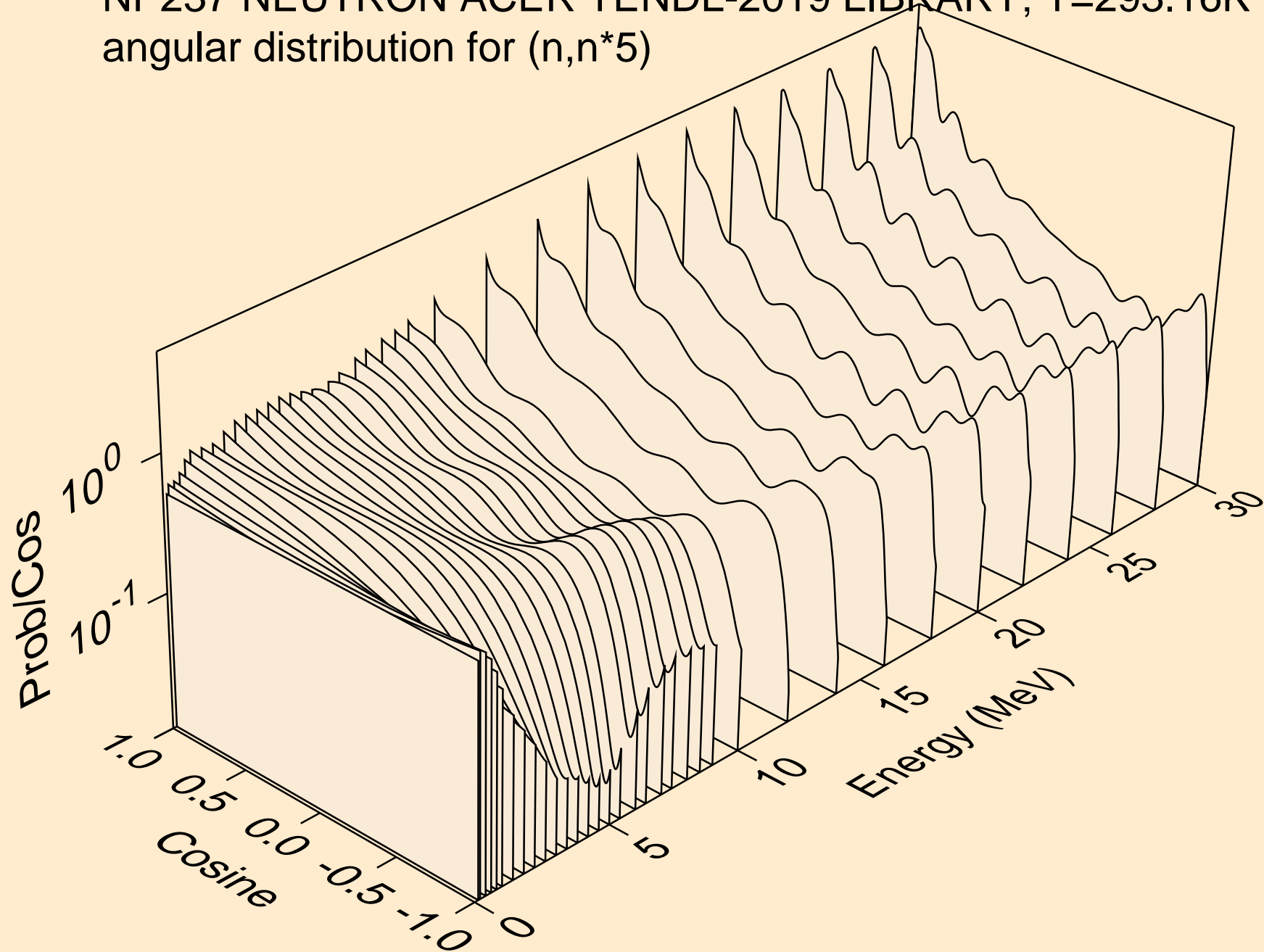

NP237 NEUTRON ACER TENDL-2019 LIBRARY; T=293.16K
angular distribution for (n,n*6)

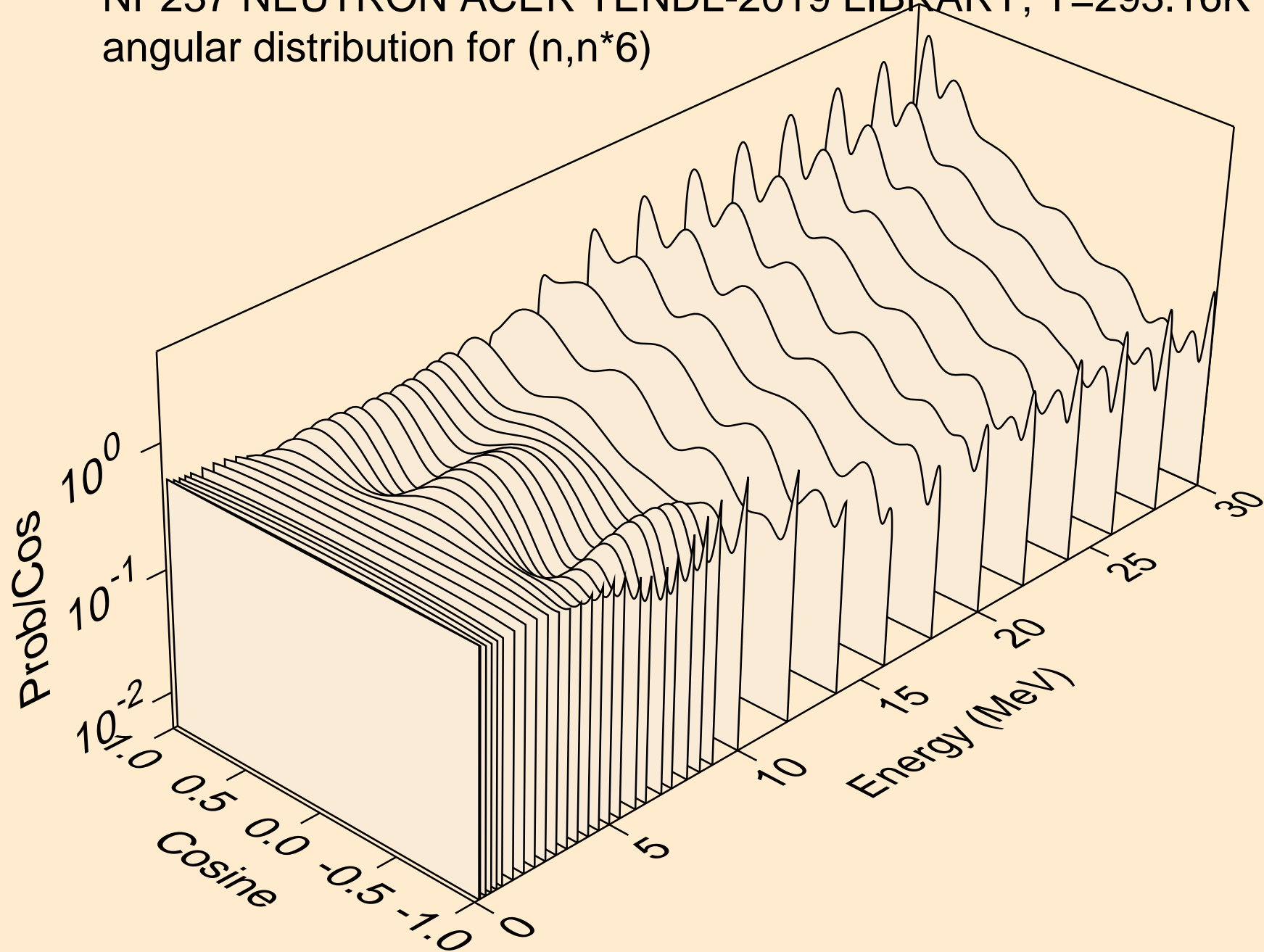

NP237 NEUTRON ACER TENDL-2019 LIBRARY; T=293.16K
angular distribution for (n,n*7)

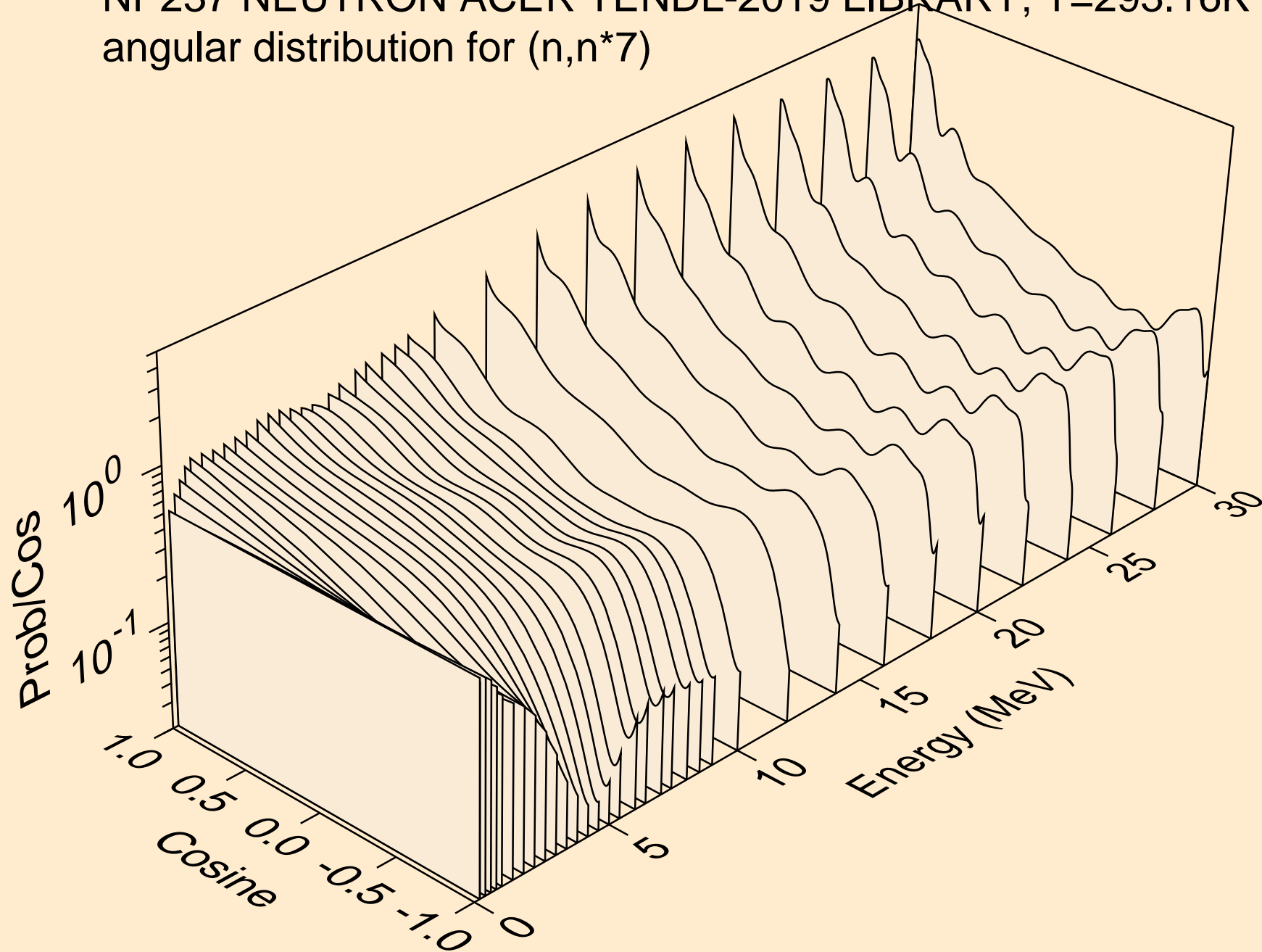

NP237 NEUTRON ACER TENDL-2019 LIBRARY; T=293.16K
angular distribution for (n,n*8)

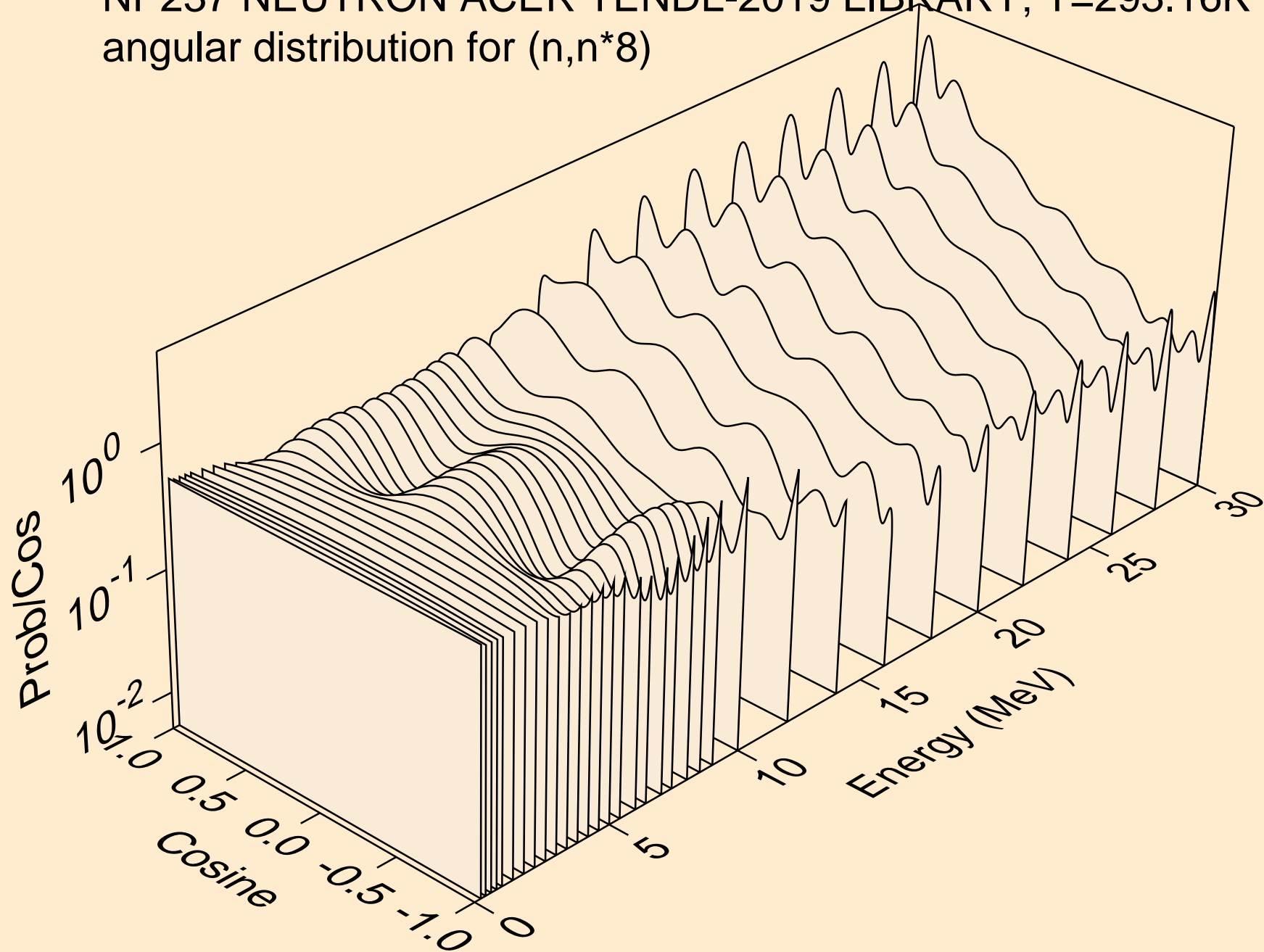

NP237 NEUTRON ACER TENDL-2019 LIBRARY; T=293.16K
angular distribution for (n,n*9)

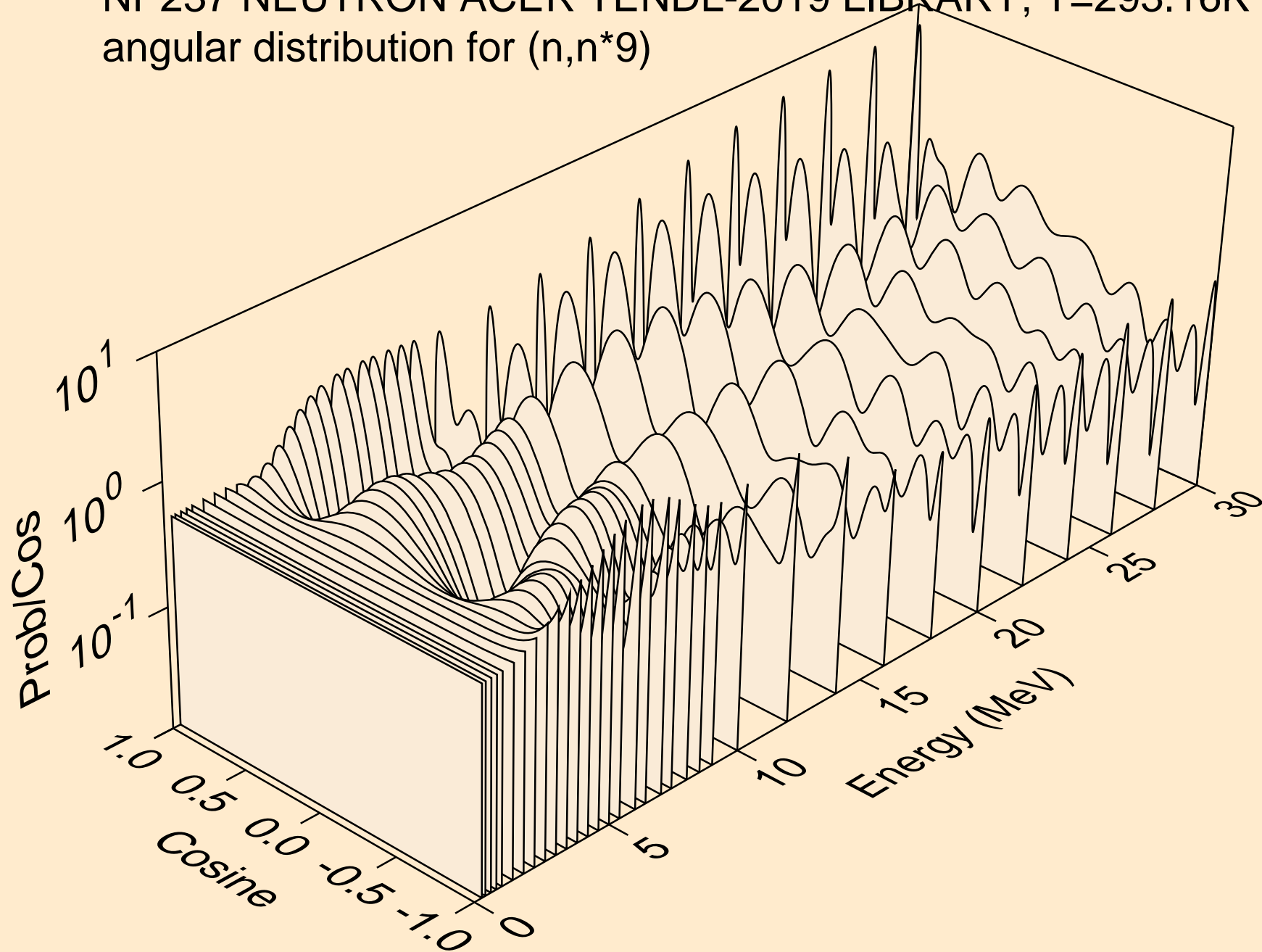

NP237 NEUTRON ACER TENDL-2019 LIBRARY; T=293.16K
angular distribution for (n,n*10)

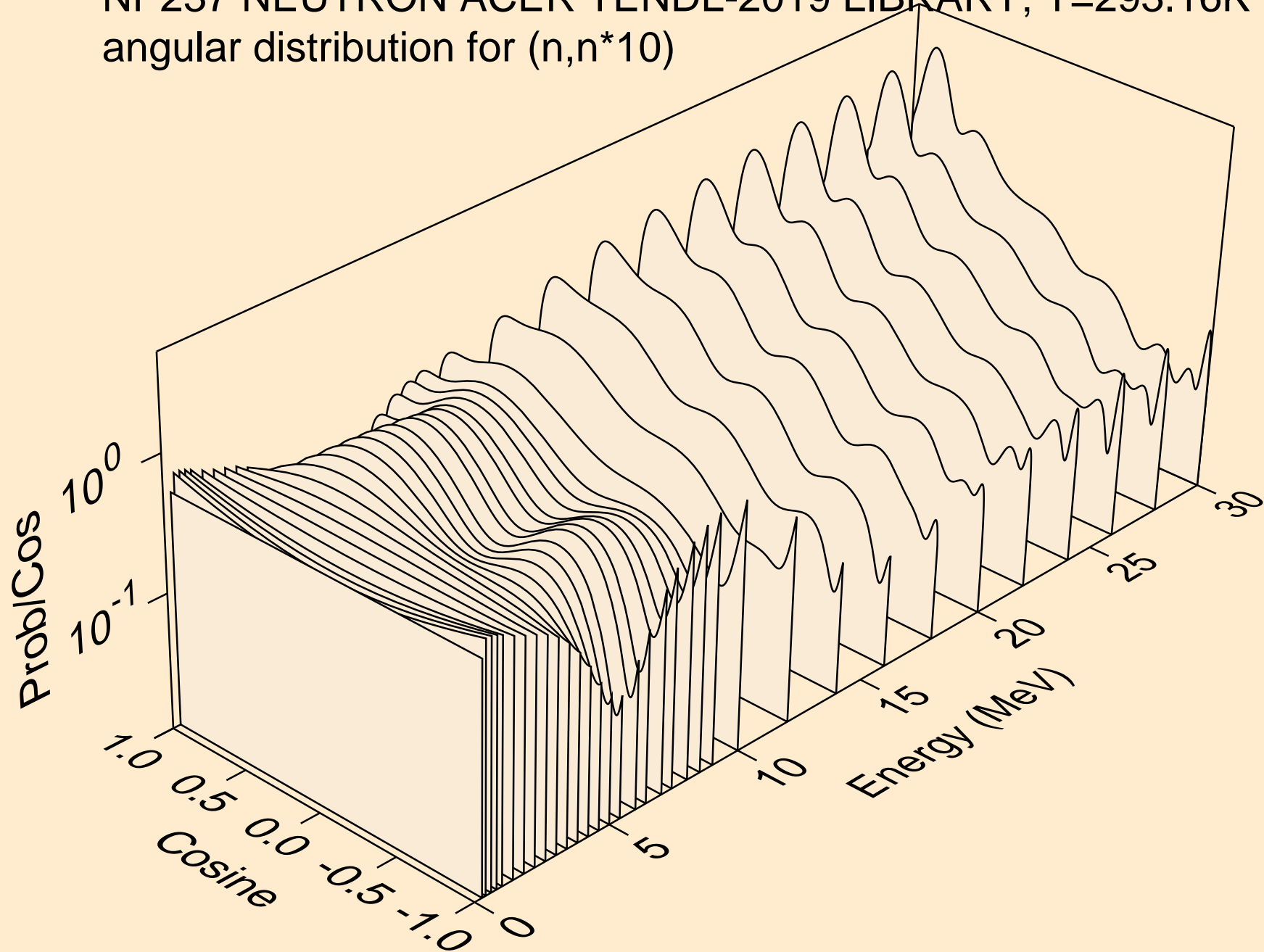

NP237 NEUTRON ACER TENDL-2019 LIBRARY; T=293.16K
angular distribution for (n,n*11)

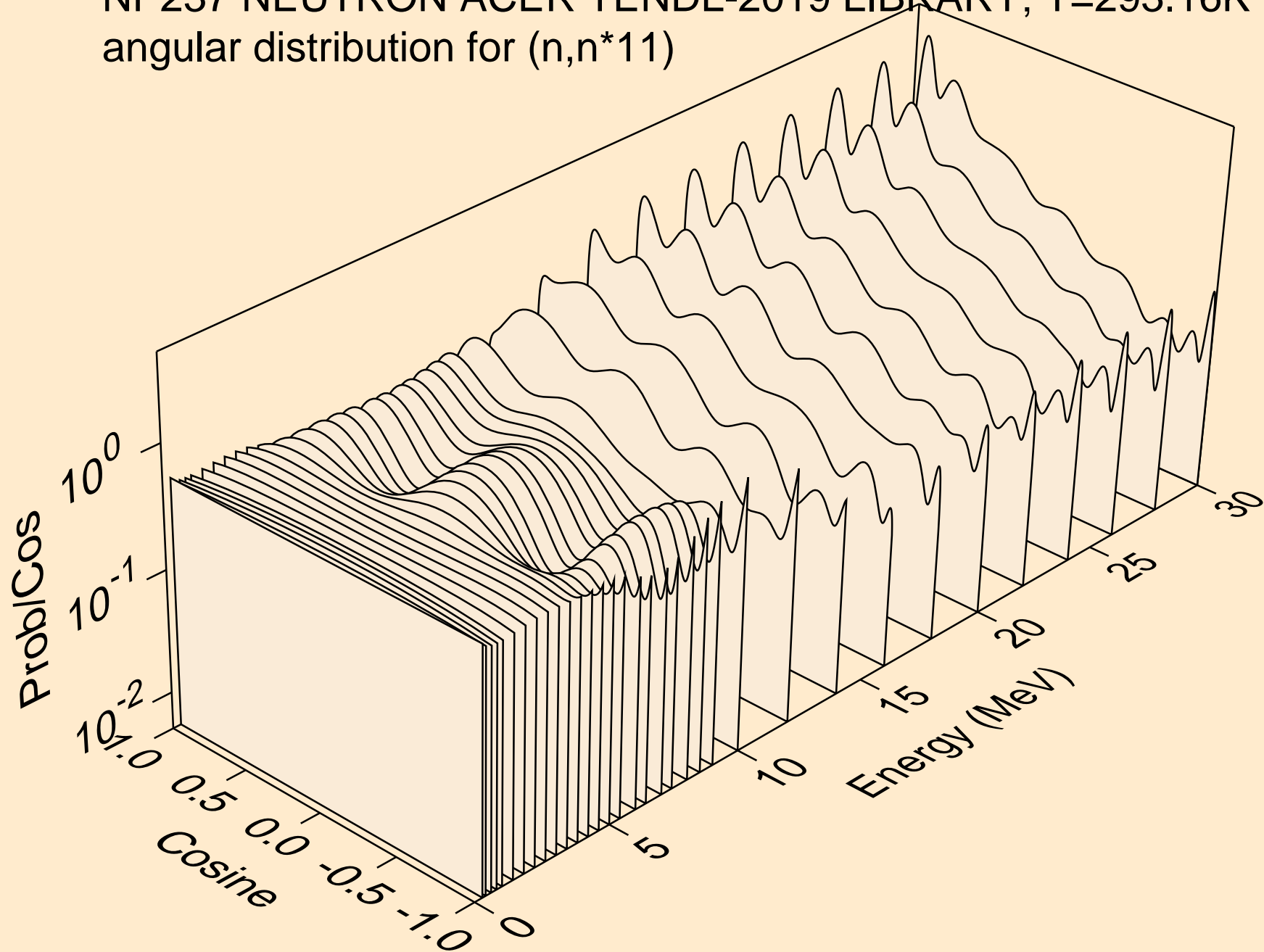

NP237 NEUTRON ACER TENDL-2019 LIBRARY; T=293.16K
angular distribution for (n,n*12)

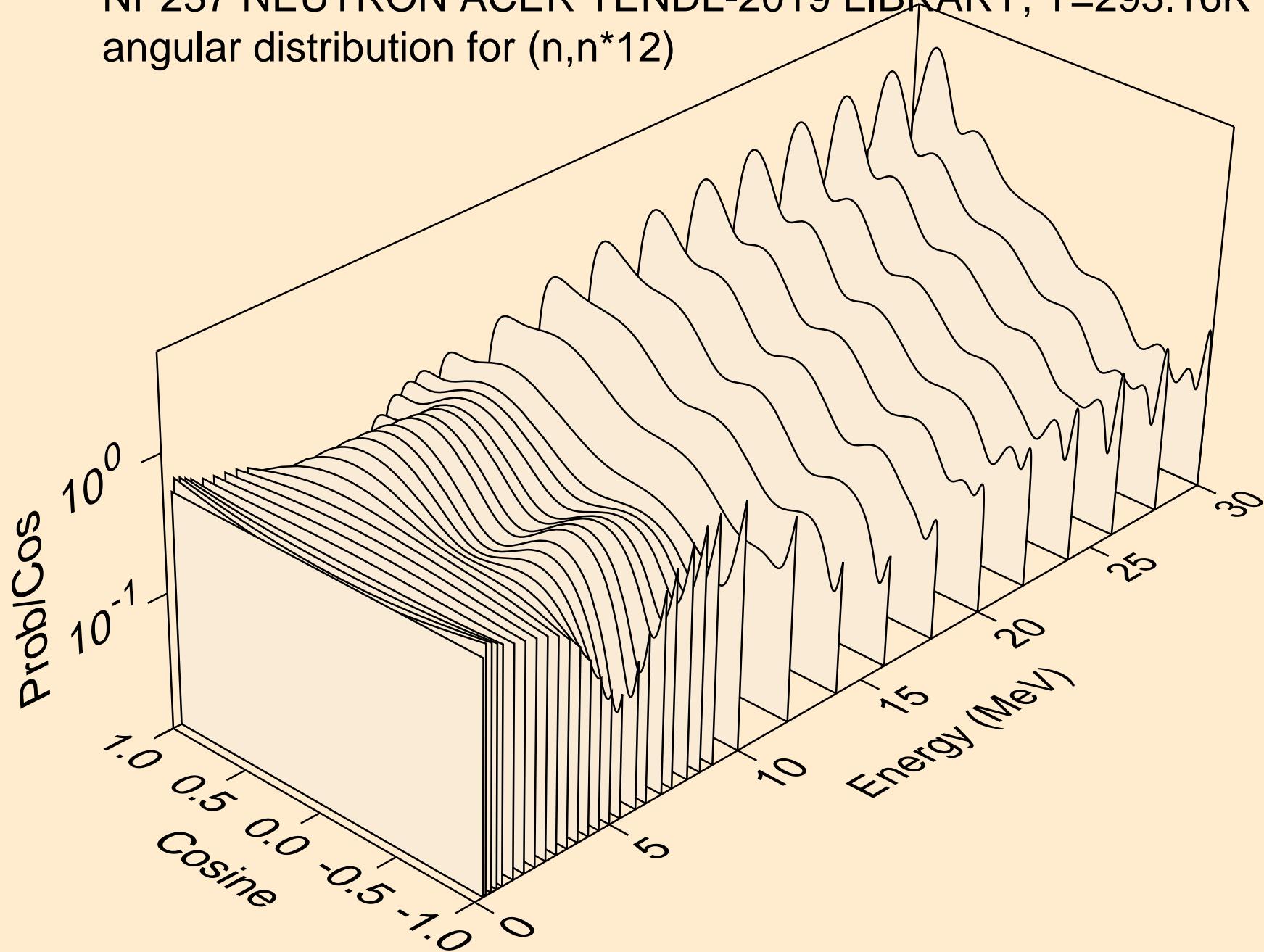

NP237 NEUTRON ACER TENDL-2019 LIBRARY; T=293.16K
angular distribution for (n,n*13)

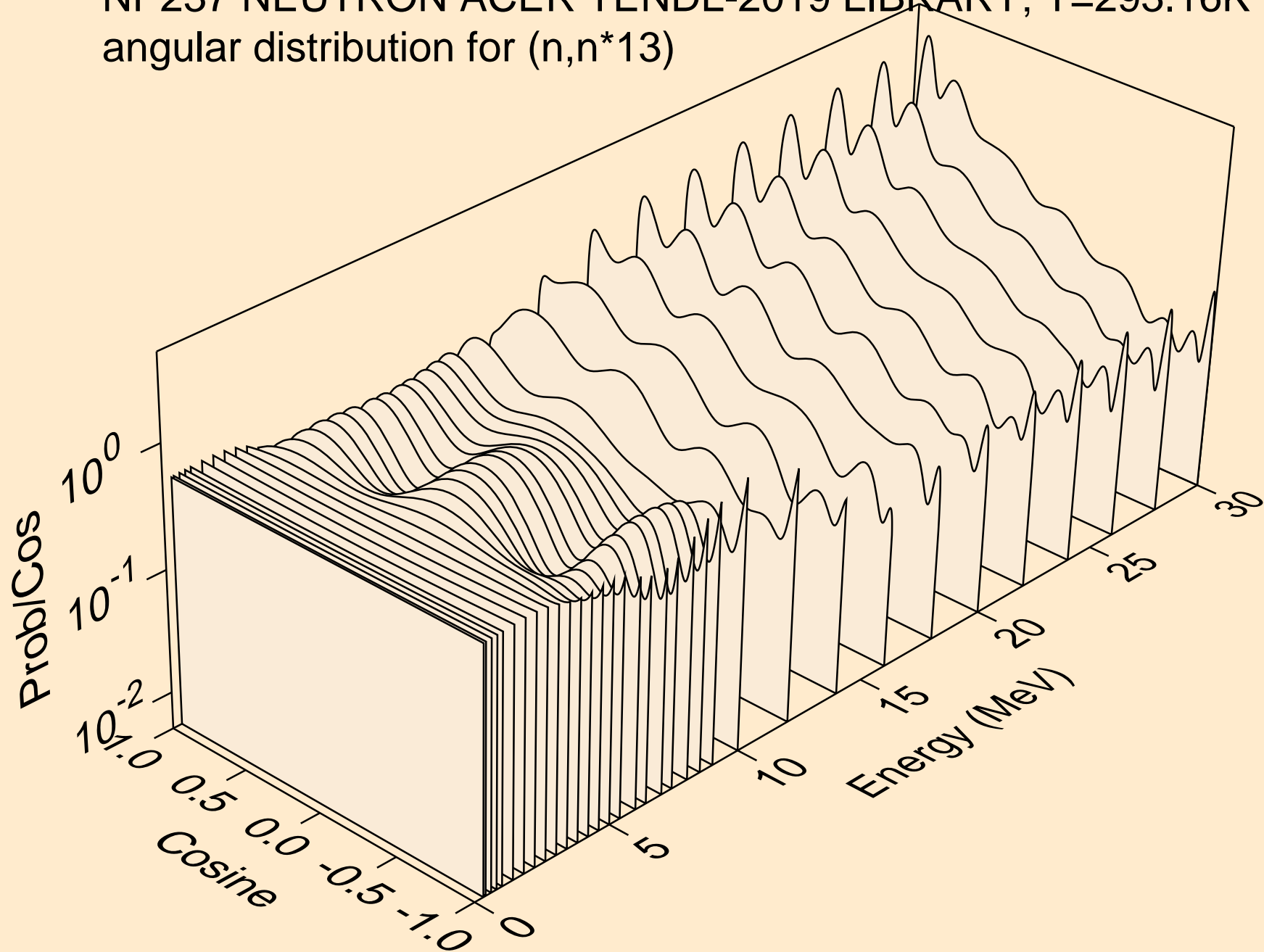

NP237 NEUTRON ACER TENDL-2019 LIBRARY; T=293.16K
angular distribution for (n,n*14)

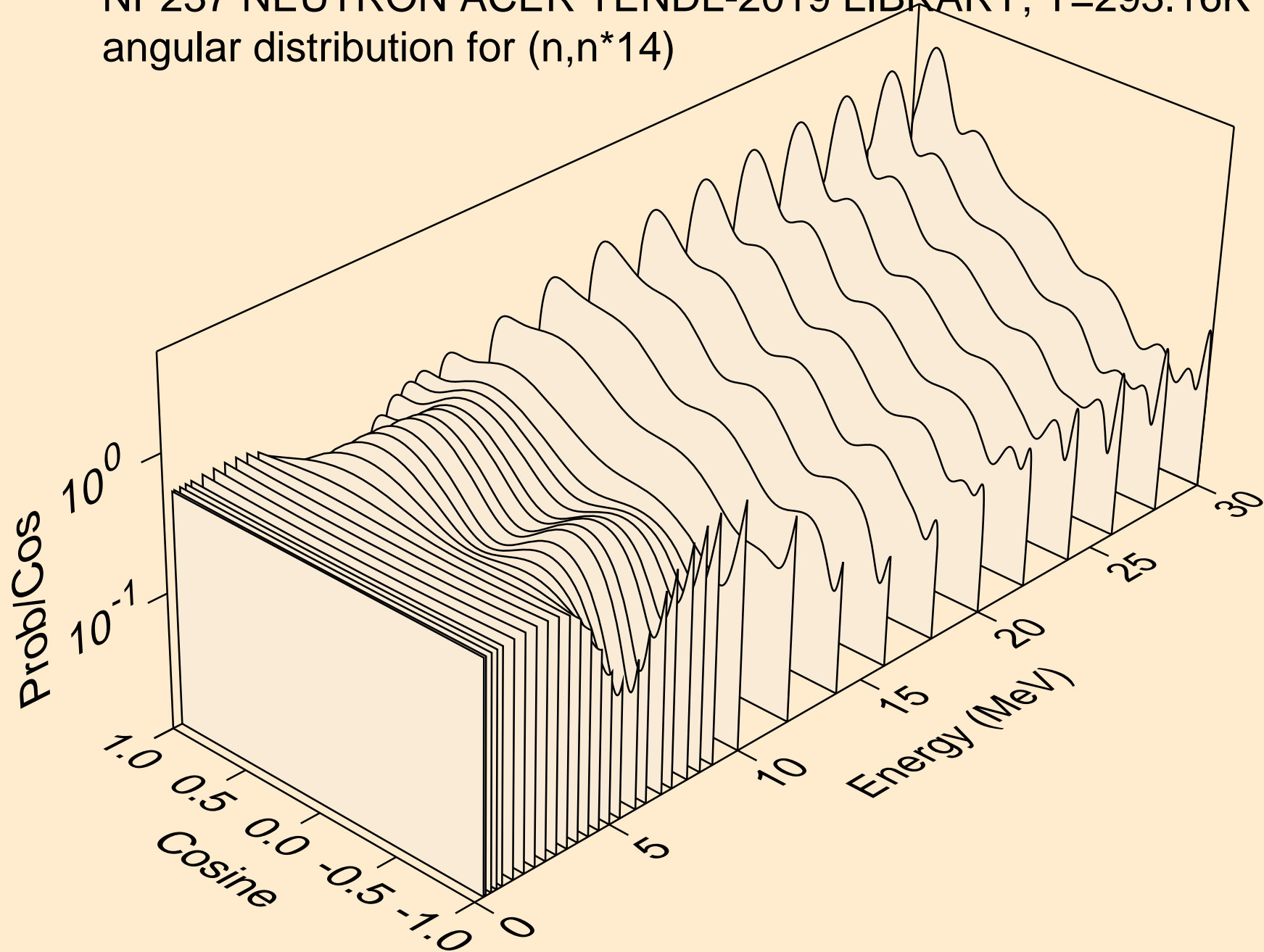

NP237 NEUTRON ACER TENDL-2019 LIBRARY; T=293.16K
angular distribution for (n,n*15)

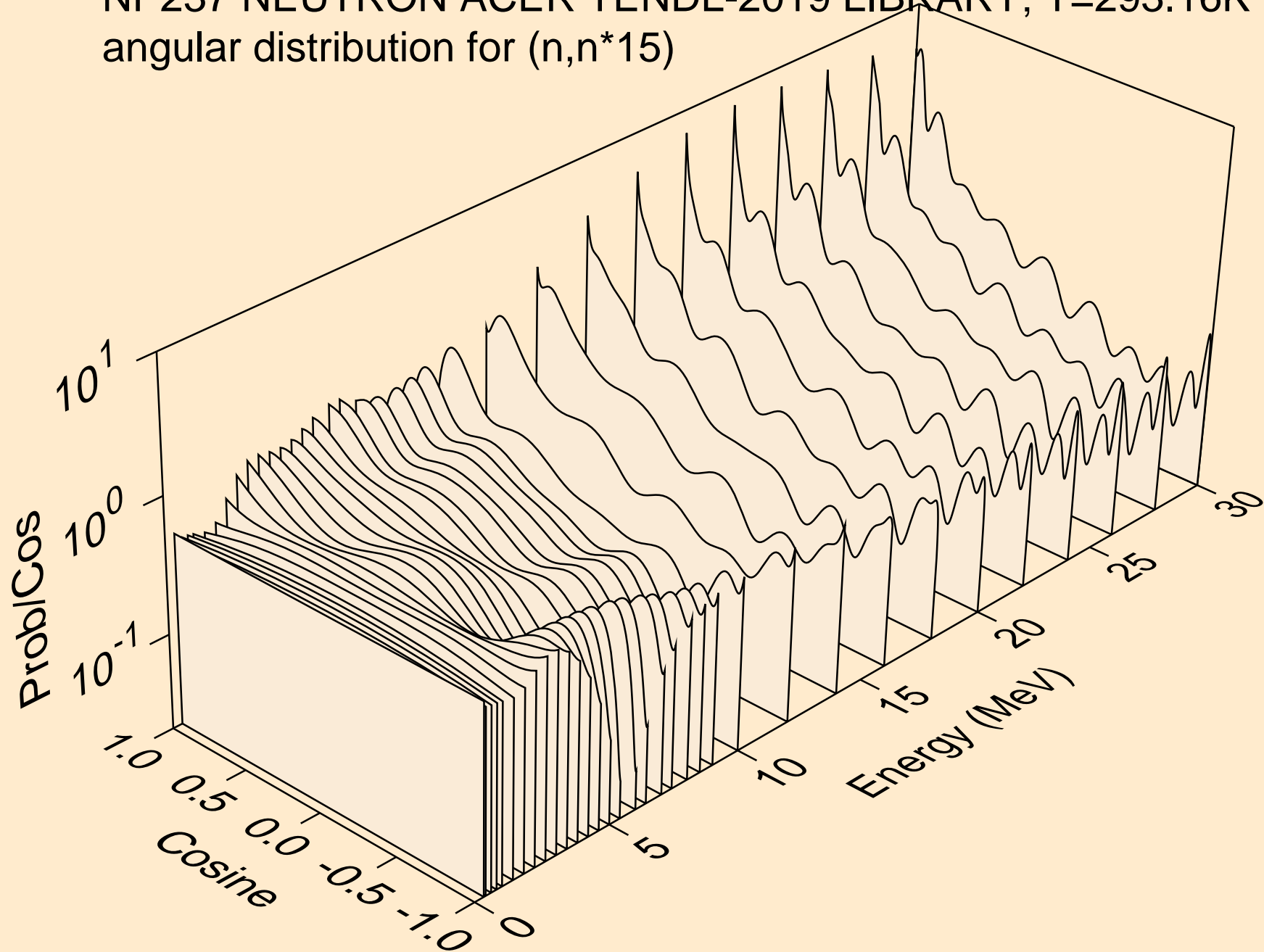

NP237 NEUTRON ACER TENDL-2019 LIBRARY; T=293.16K
angular distribution for (n,n*16)

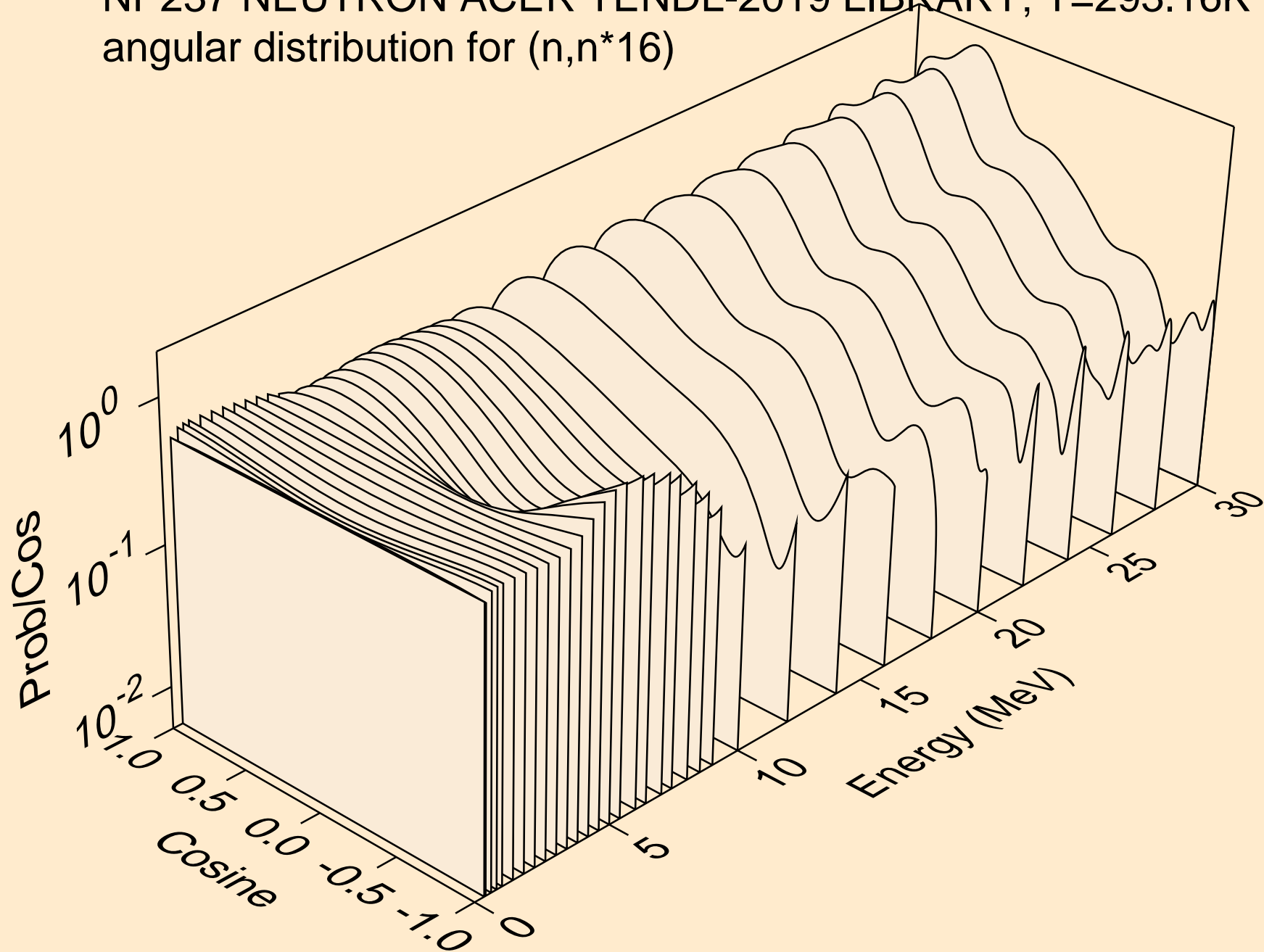

NP237 NEUTRON ACER TENDL-2019 LIBRARY; T=293.16K
angular distribution for (n,n*17)

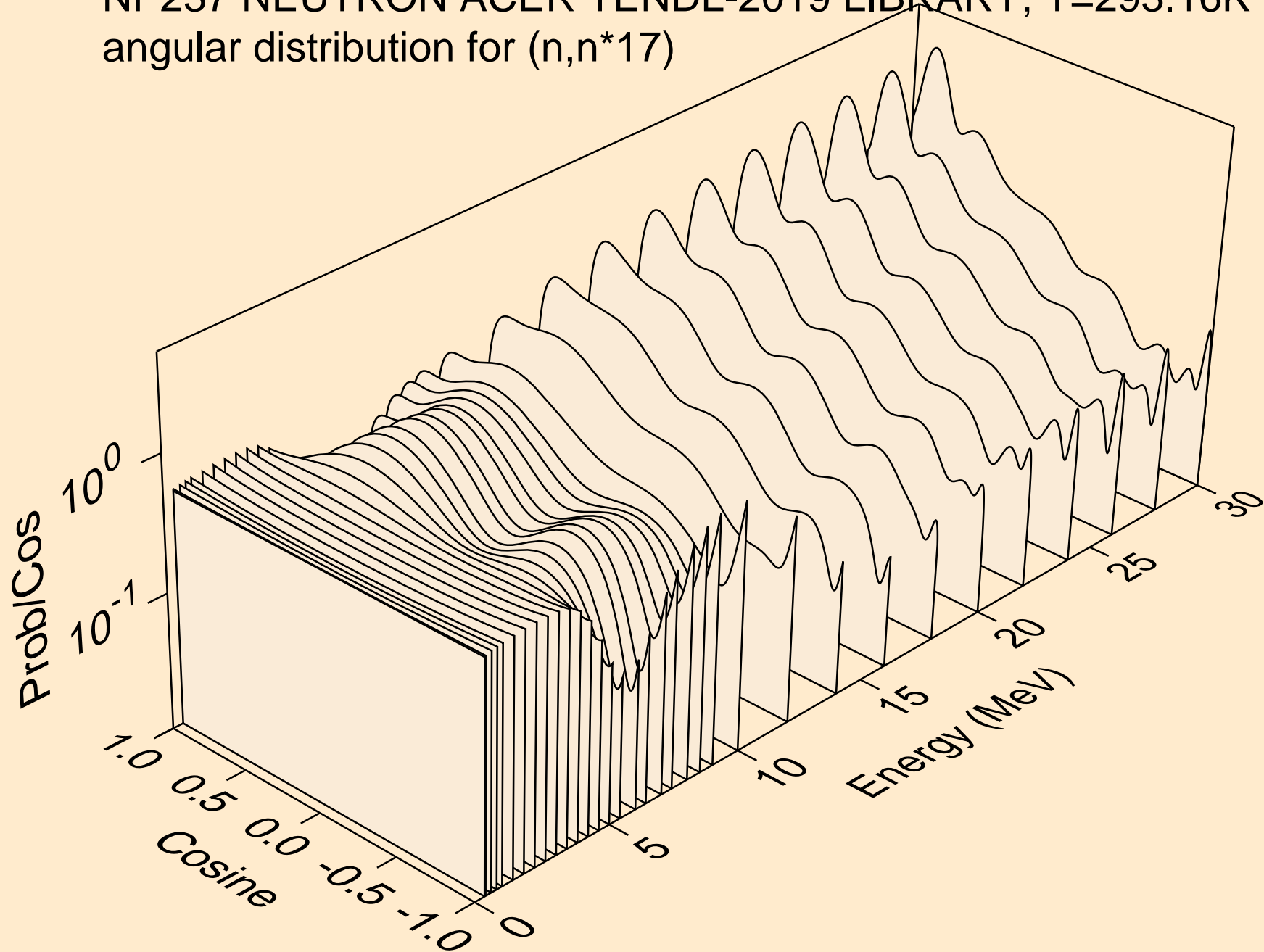

NP237 NEUTRON ACER TENDL-2019 LIBRARY; T=293.16K
angular distribution for (n,n*18)

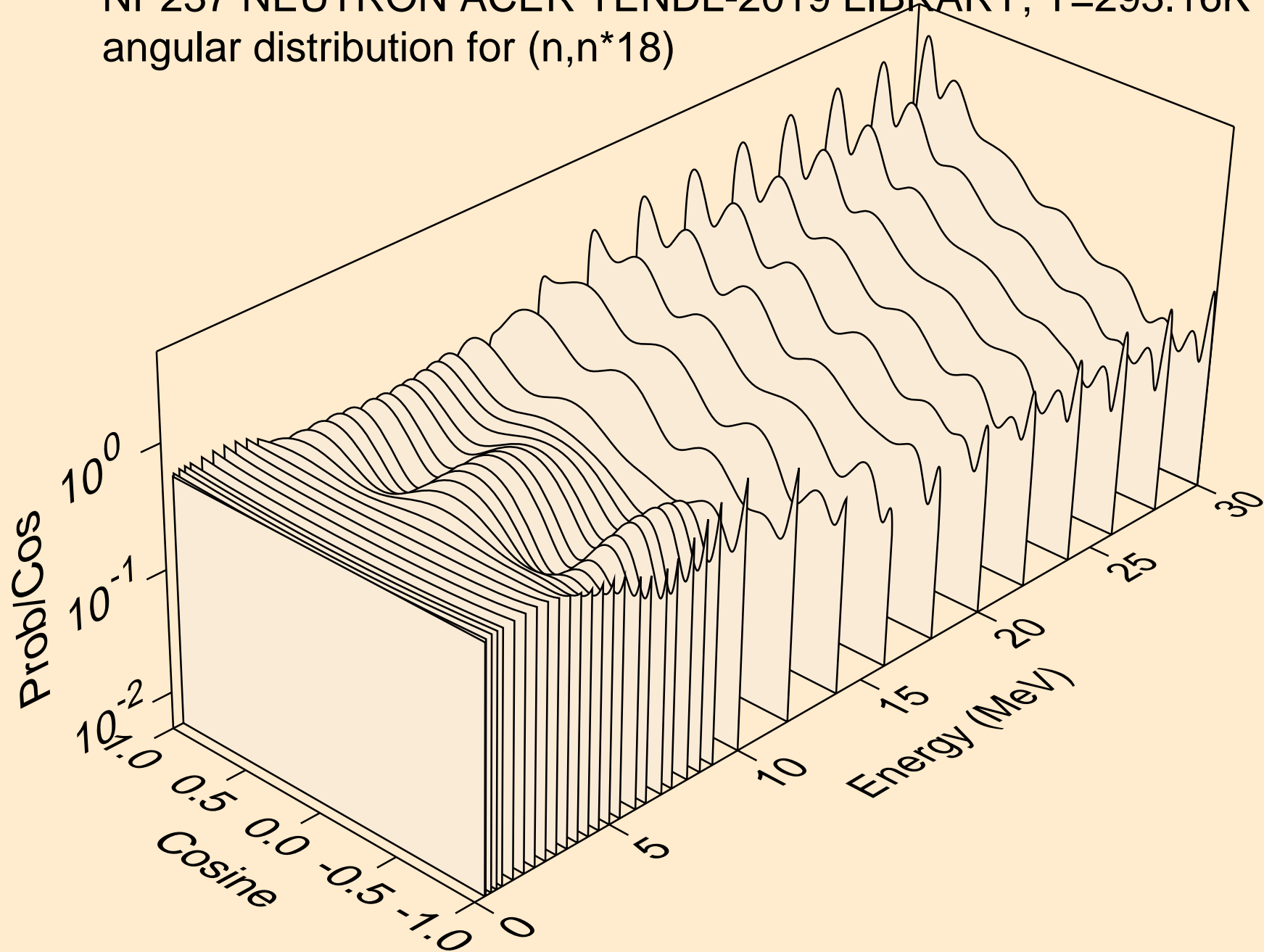

NP237 NEUTRON ACER TENDL-2019 LIBRARY; T=293.16K
angular distribution for (n,n*19)

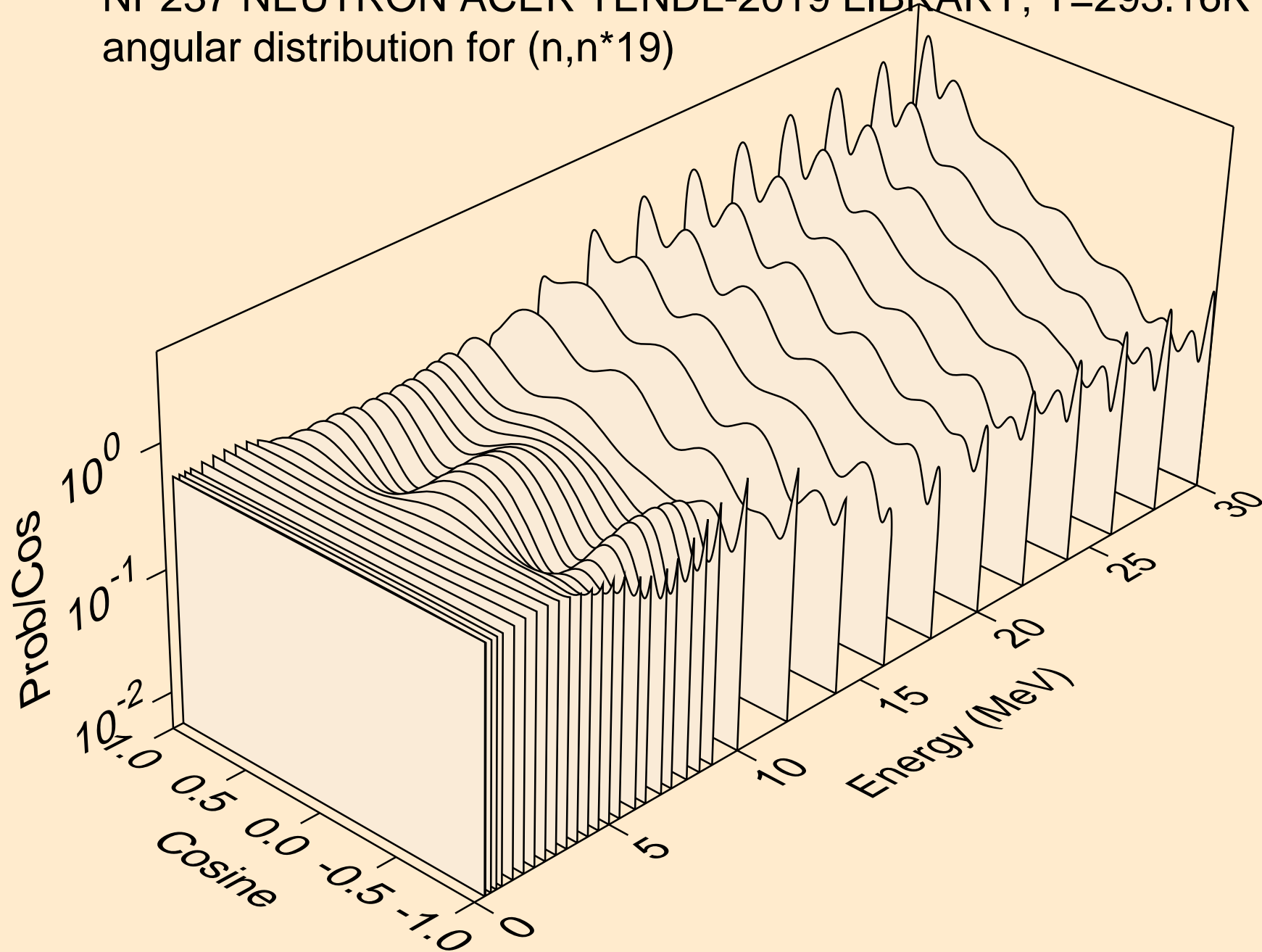

NP237 NEUTRON ACER TENDL-2019 LIBRARY; T=293.16K
angular distribution for (n,n*20)

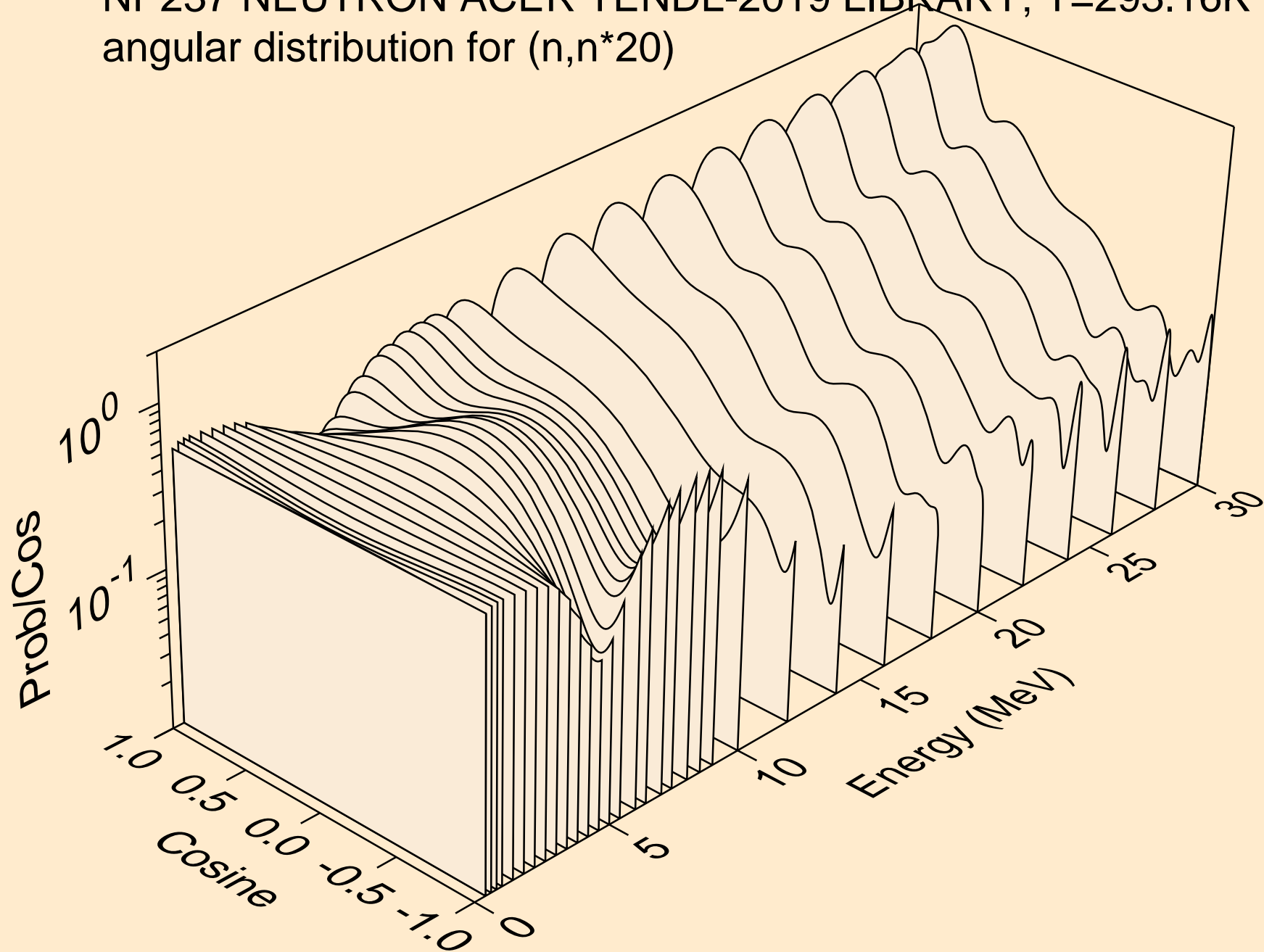

NP237 NEUTRON ACER TENDL-2019 LIBRARY; T=293.16K
angular distribution for (n,n*21)

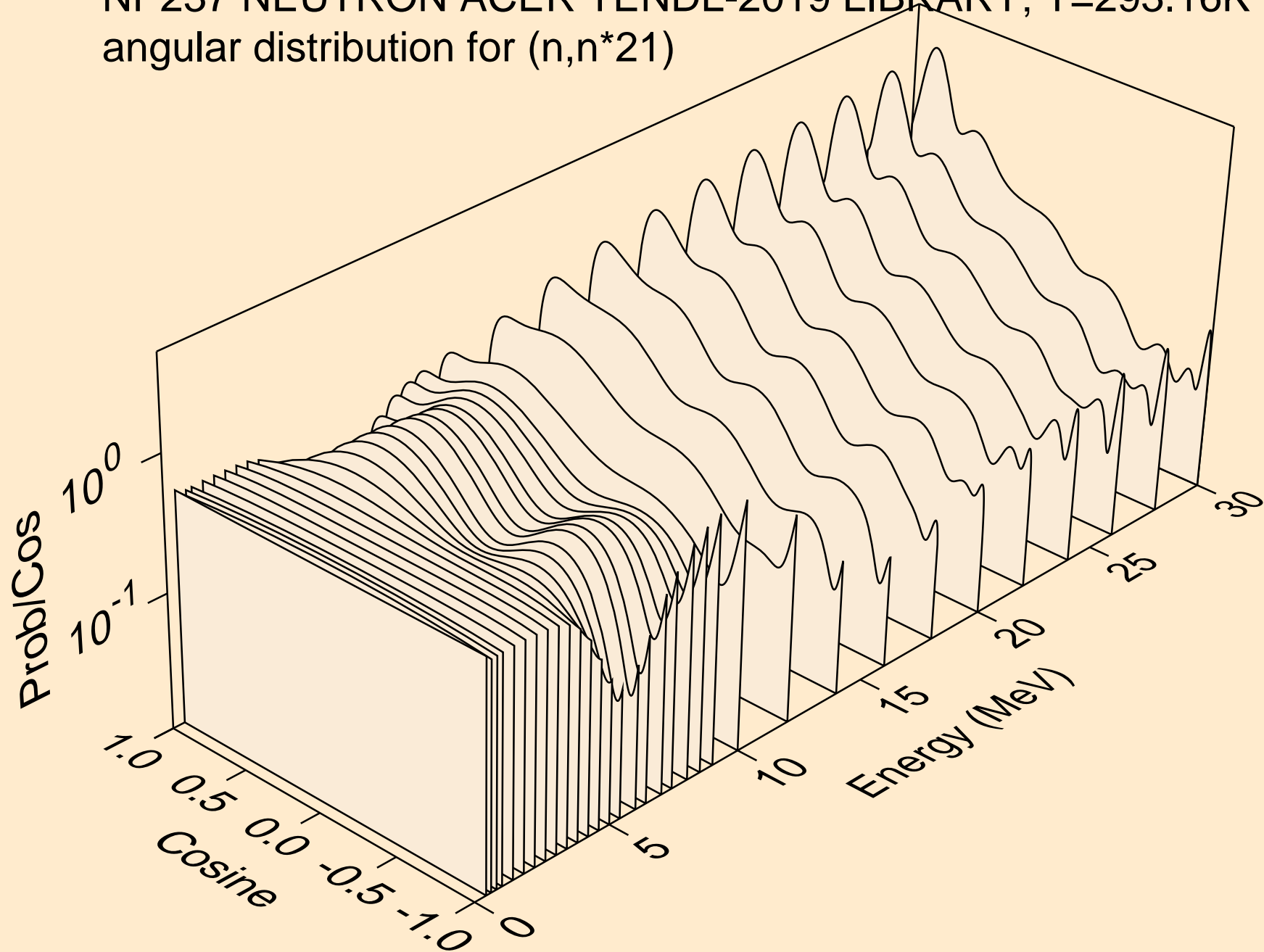

NP237 NEUTRON ACER TENDL-2019 LIBRARY; T=293.16K
angular distribution for (n,n*22)

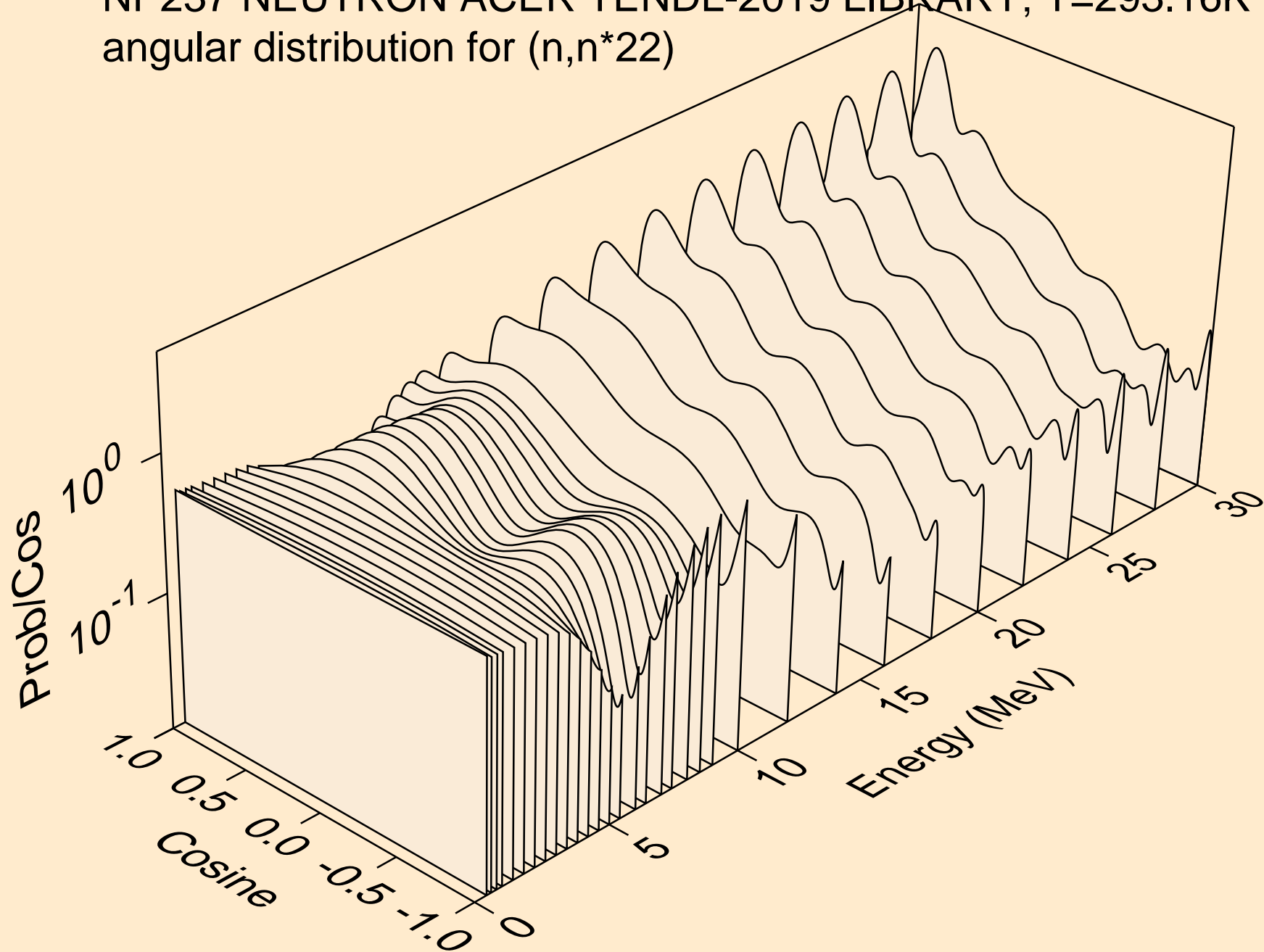

NP237 NEUTRON ACER TENDL-2019 LIBRARY; T=293.16K
angular distribution for (n,n*23)

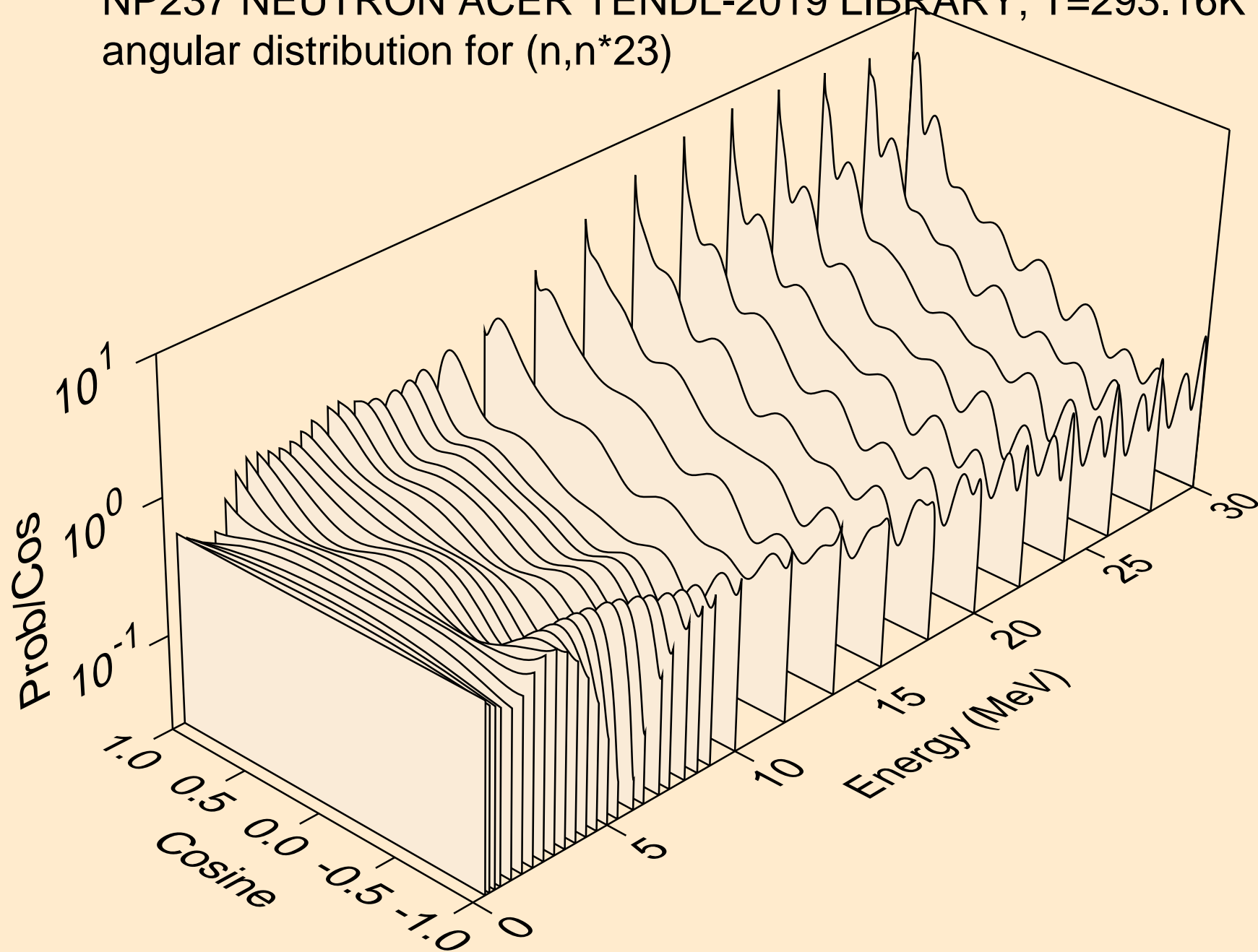

NP237 NEUTRON ACER TENDL-2019 LIBRARY; T=293.16K
angular distribution for (n,n*24)

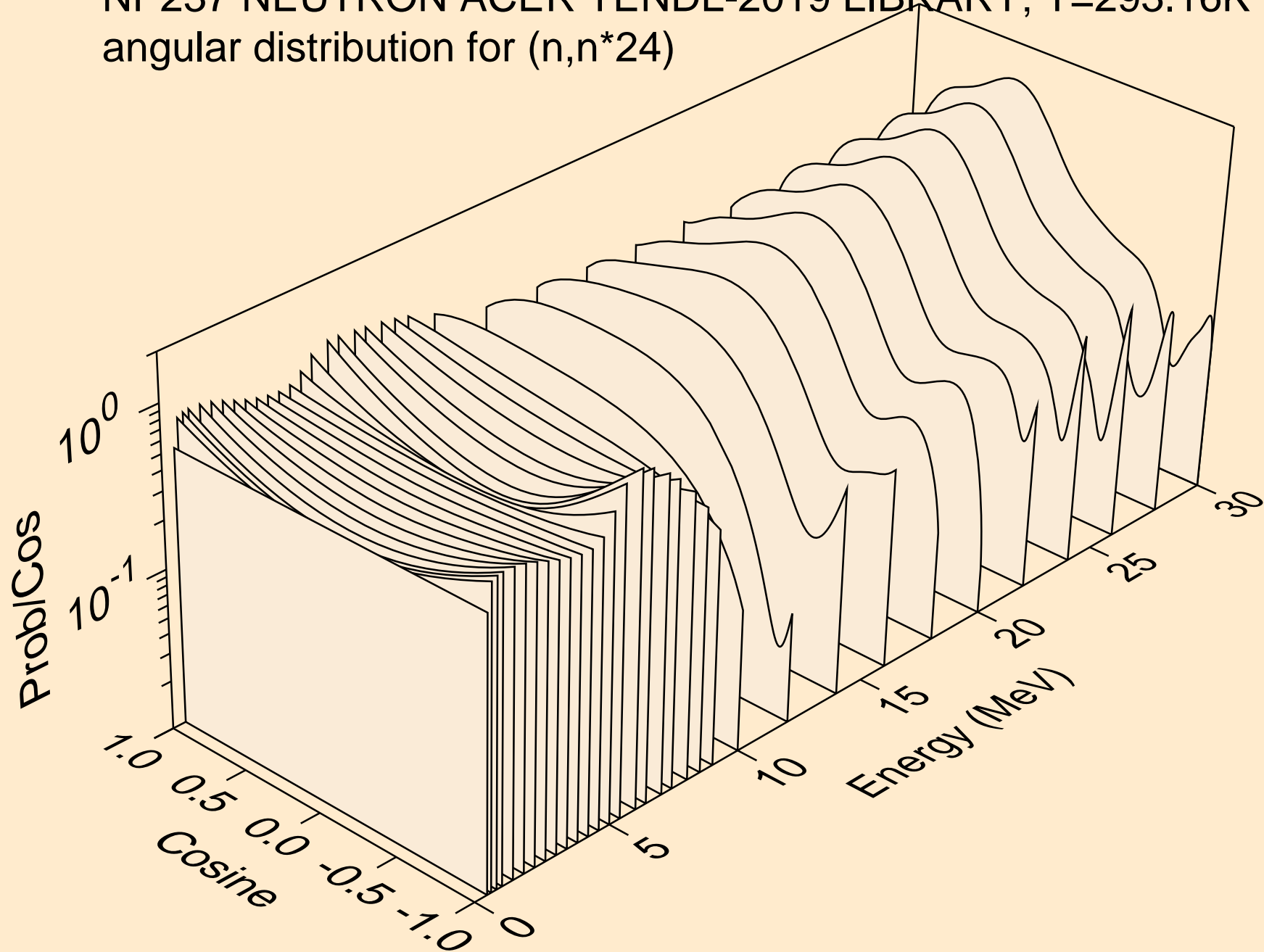

NP237 NEUTRON ACER TENDL-2019 LIBRARY; T=293.16K
angular distribution for (n,n*25)

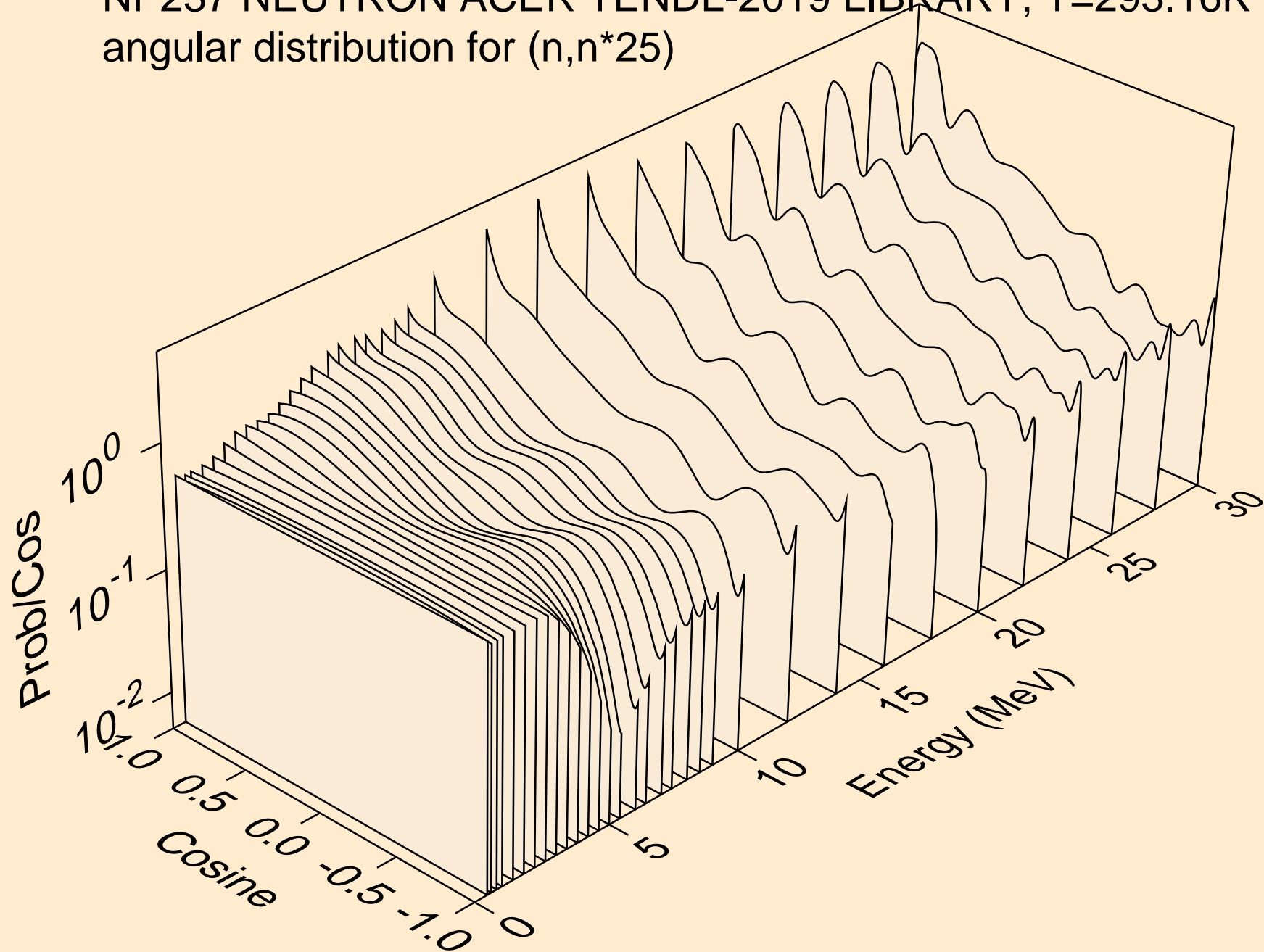

NP237 NEUTRON ACER TENDL-2019 LIBRARY; T=293.16K
angular distribution for (n,n*26)

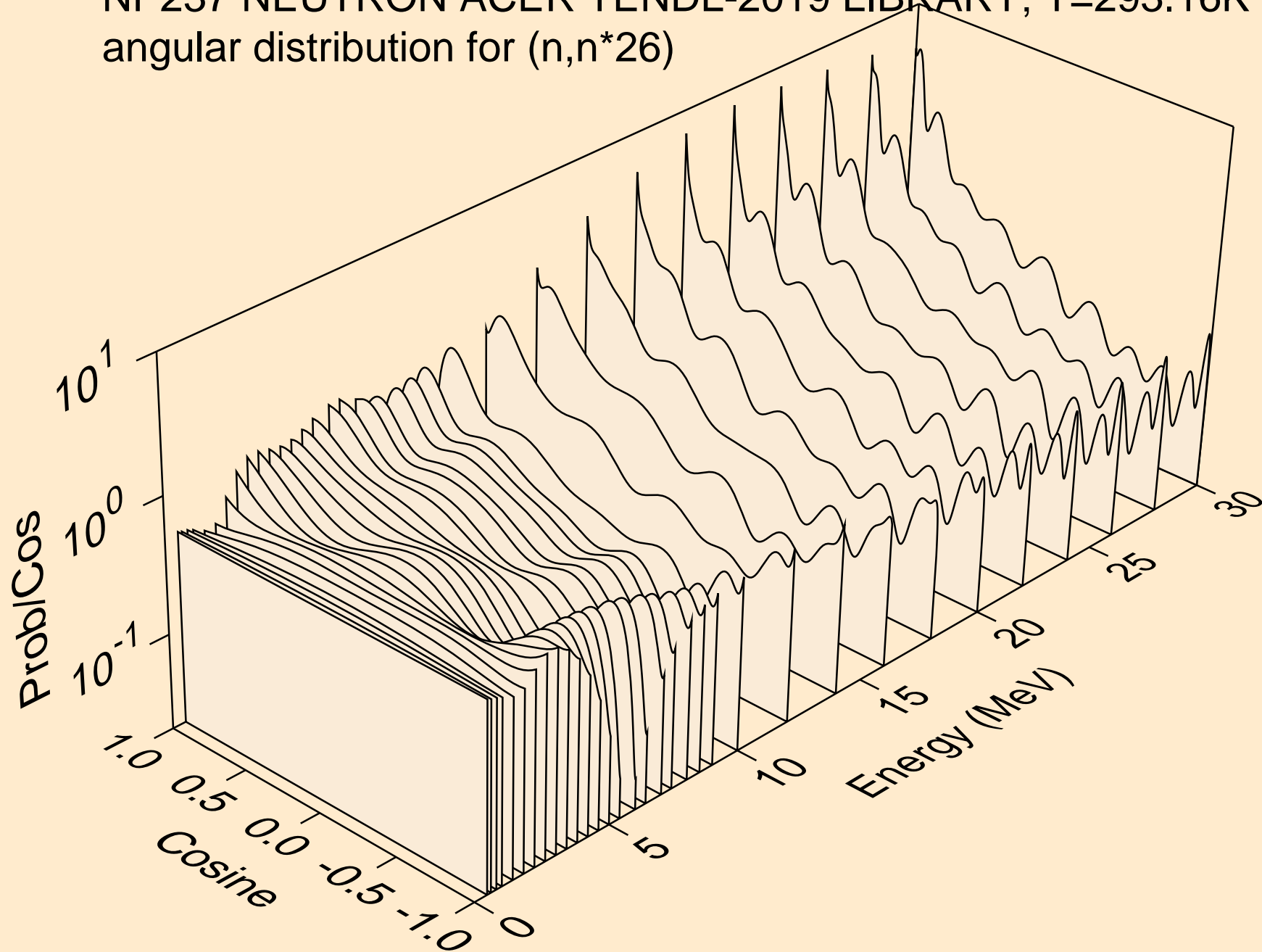

NP237 NEUTRON ACER TENDL-2019 LIBRARY; T=293.16K
angular distribution for (n,n*27)

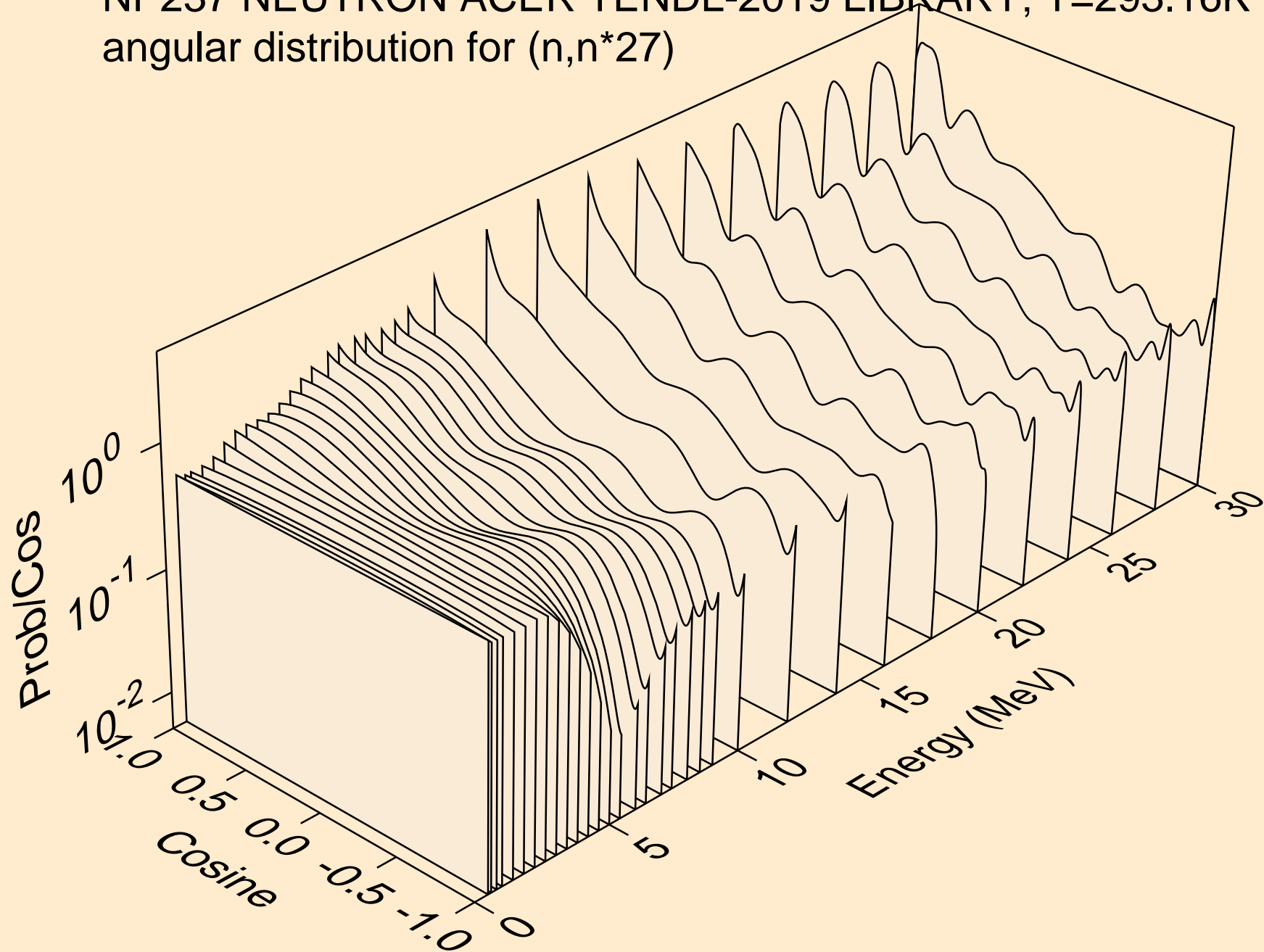

NP237 NEUTRON ACER TENDL-2019 LIBRARY; T=293.16K
angular distribution for (n,n*28)

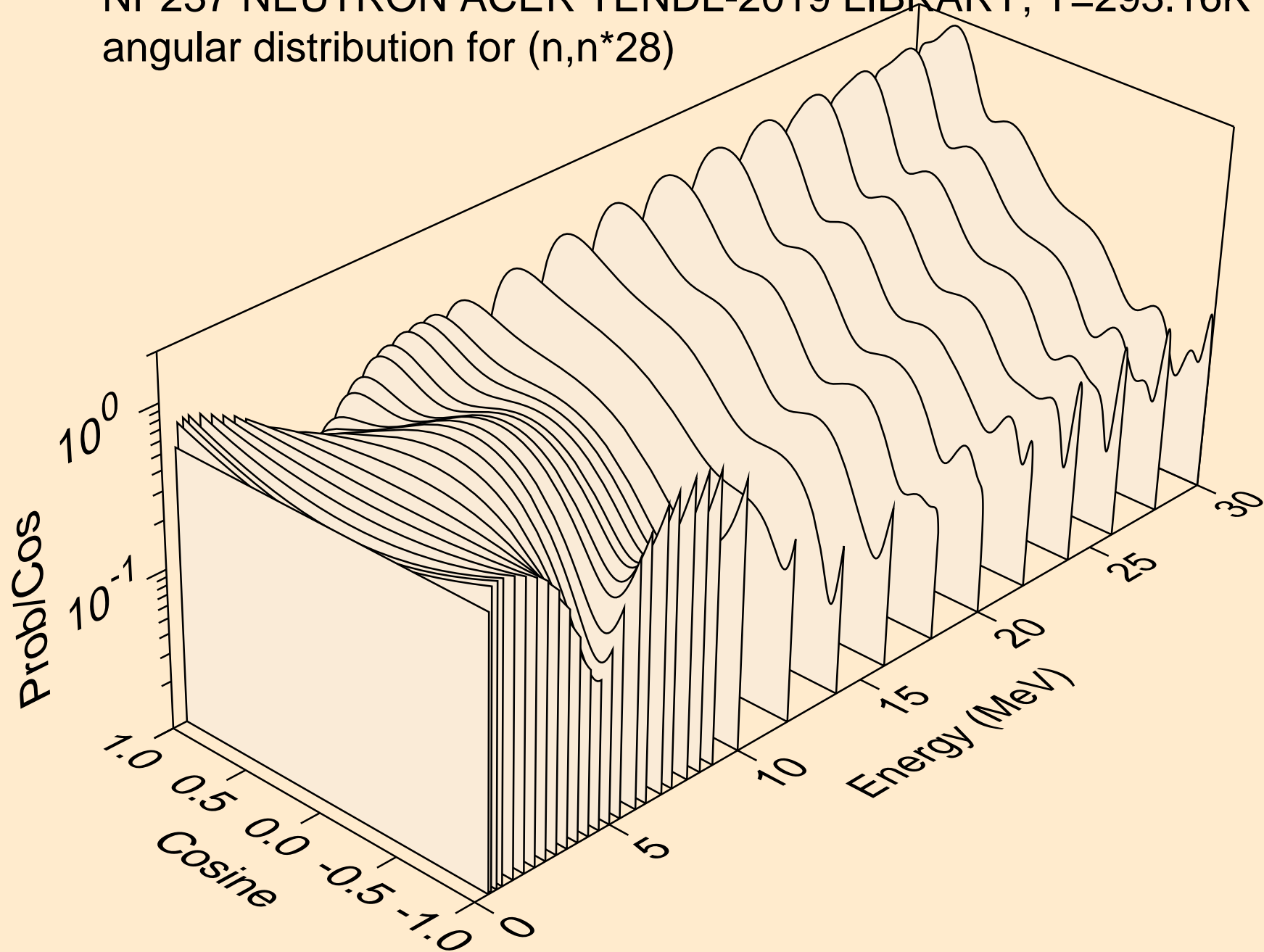

NP237 NEUTRON ACER TENDL-2019 LIBRARY; T=293.16K
angular distribution for (n,n*29)

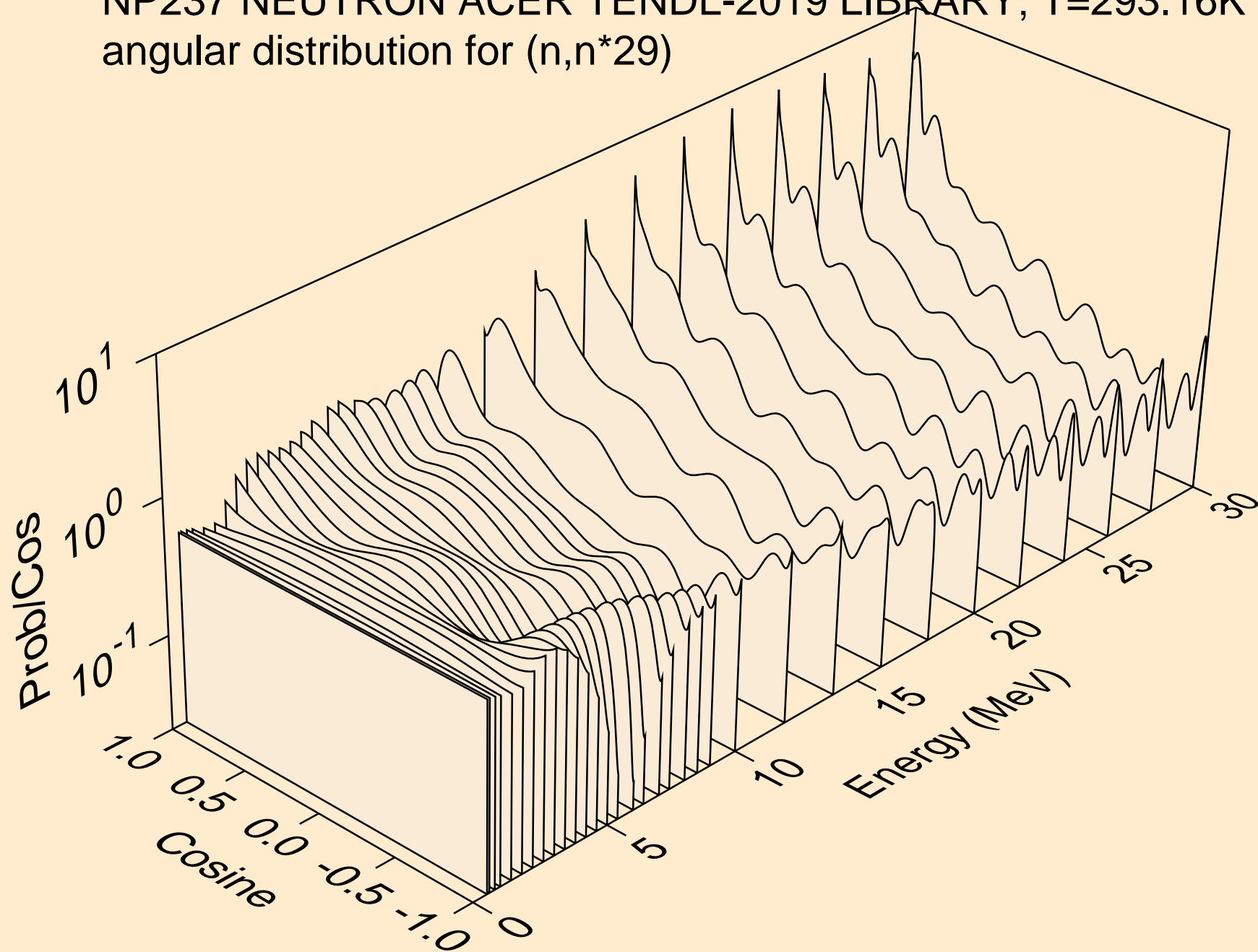

NP237 NEUTRON ACER TENDL-2019 LIBRARY; T=293.16K
Total fission nubar

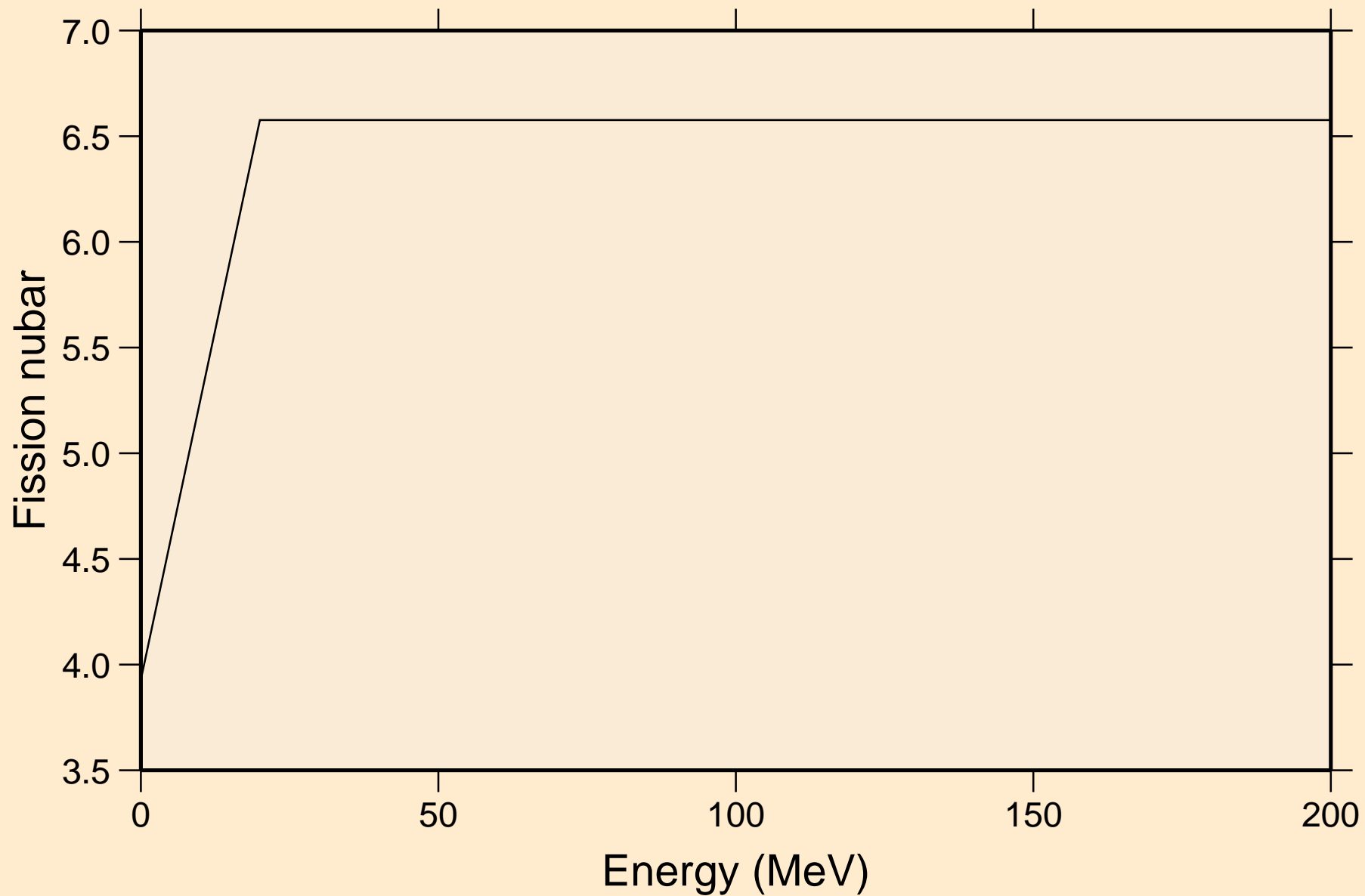

NP237 NEUTRON ACER TENDL-2019 LIBRARY; T=293.16K
Neutron emission for (n,x)

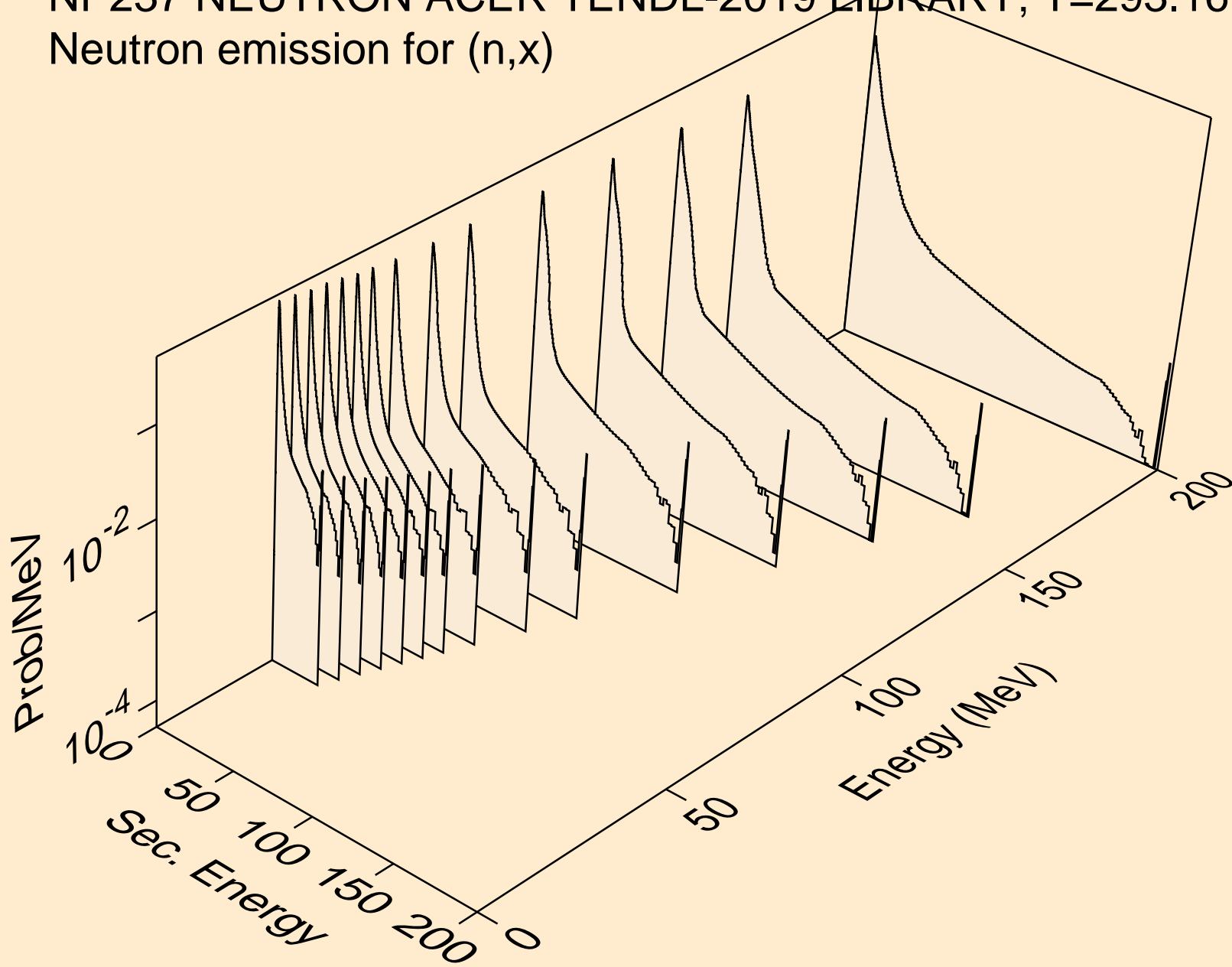

NP237 NEUTRON ACER TENDL-2019 LIBRARY; T=293.16K
Neutron emission for (n,2nd)

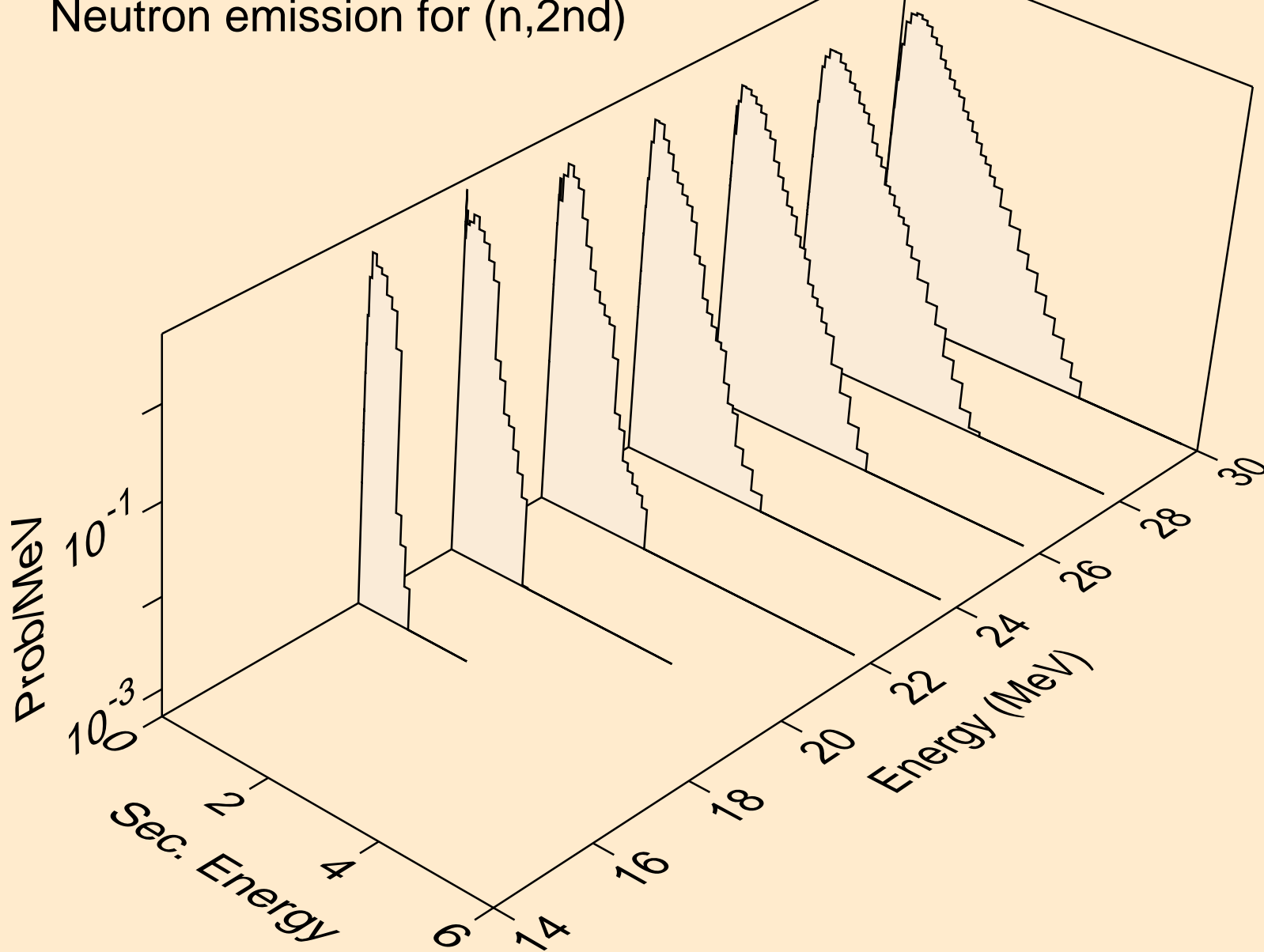

NP237 NEUTRON ACER TENDL-2019 LIBRARY; T=293.16K
Neutron emission for (n,2n)

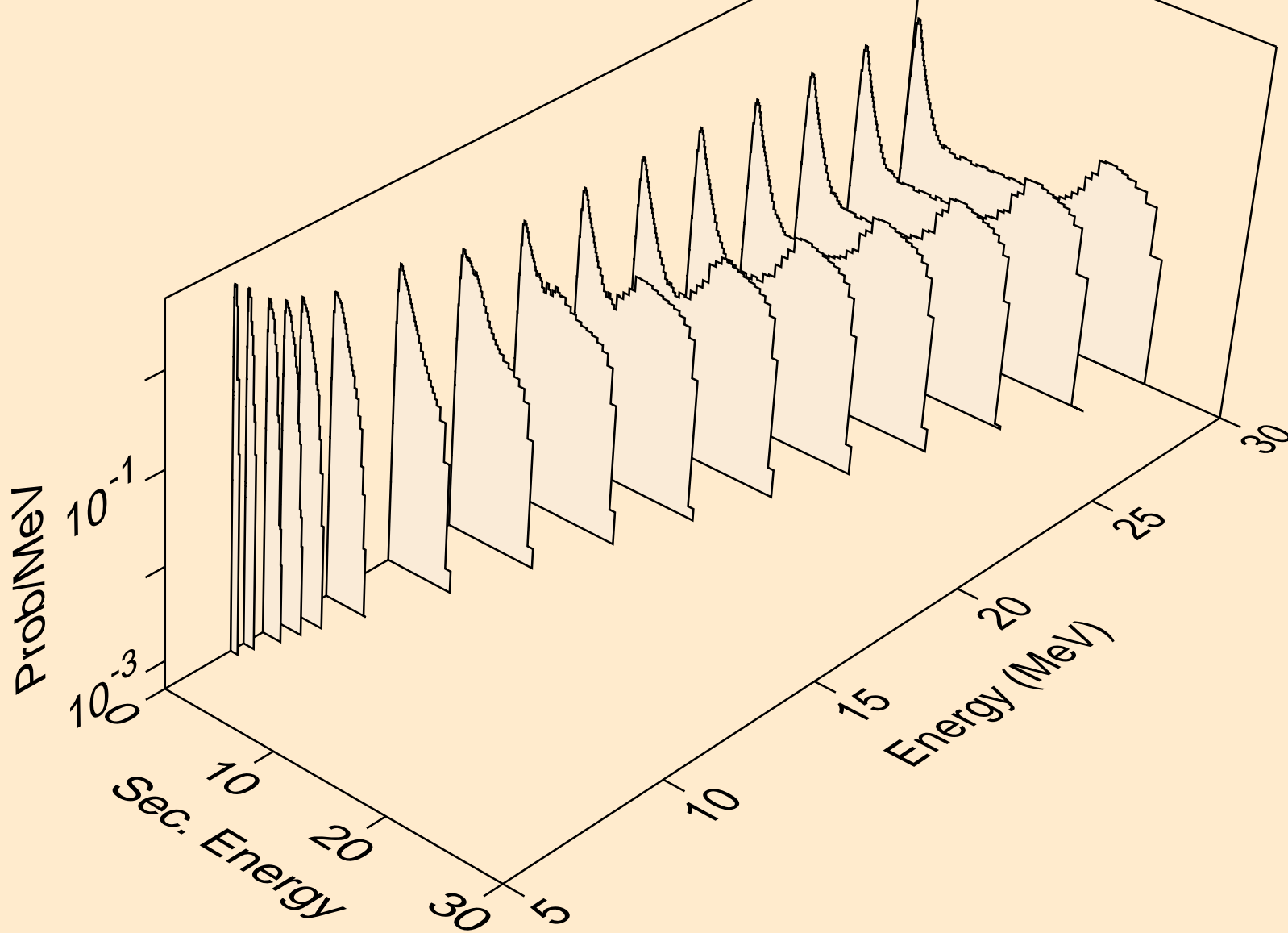

NP237 NEUTRON ACER TENDL-2019 LIBRARY; T=293.16K
Neutron emission for (n,3n)

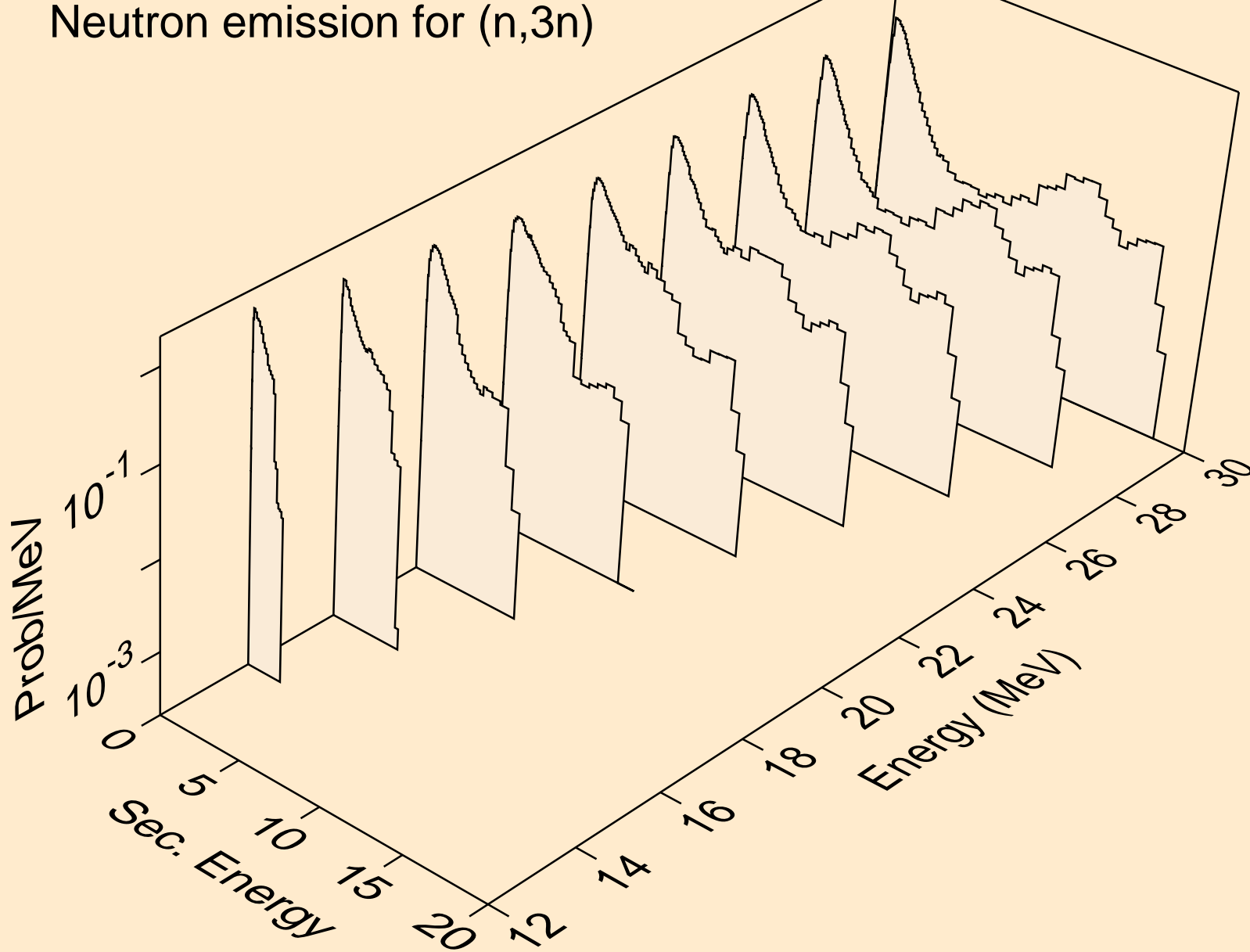

NP237 NEUTRON ACER TENDL-2019 LIBRARY; T=293.16K
Neutron emission for fission

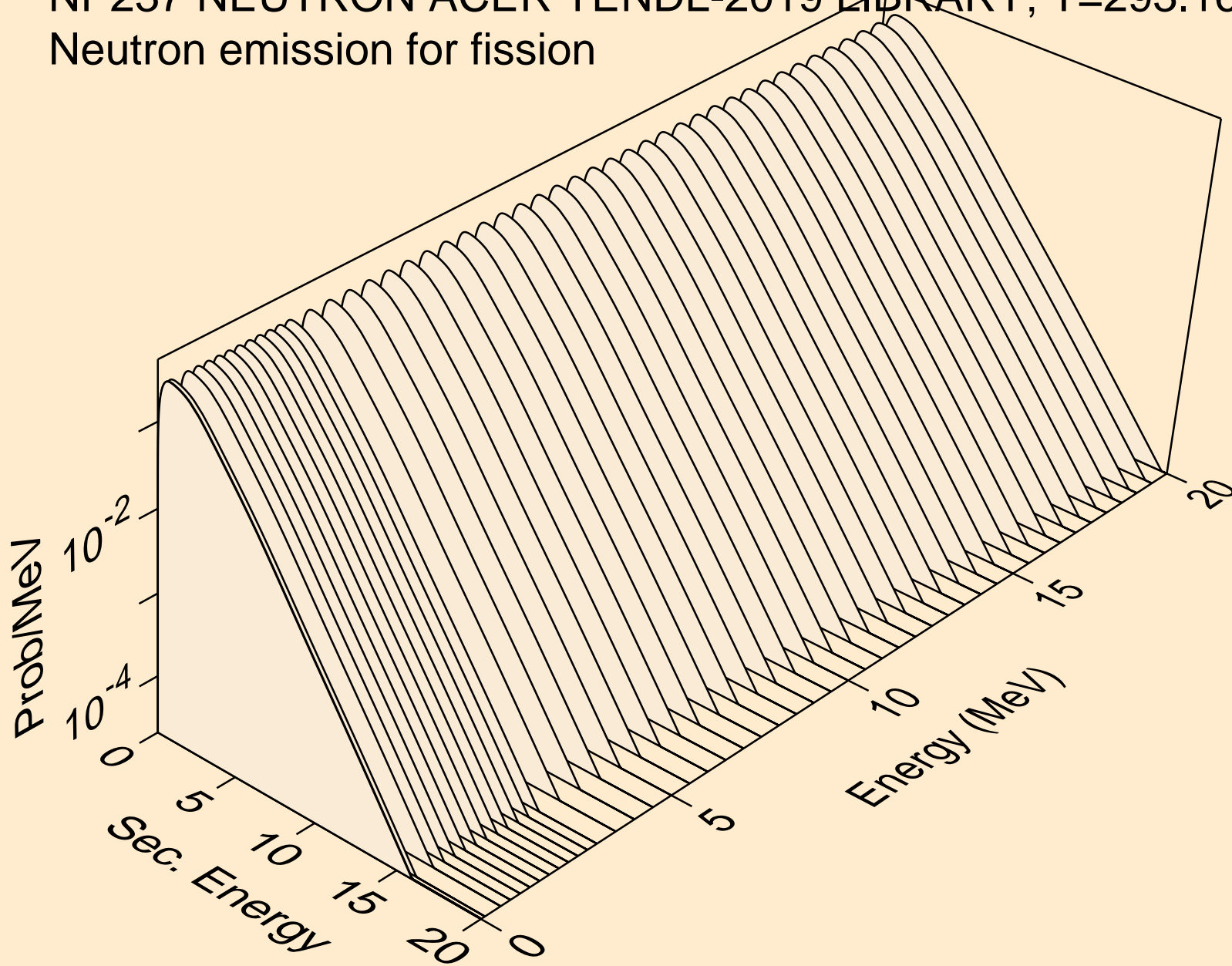

NP237 NEUTRON ACER TENDL-2019 LIBRARY; T=293.16K
Neutron emission for (n,n*)a

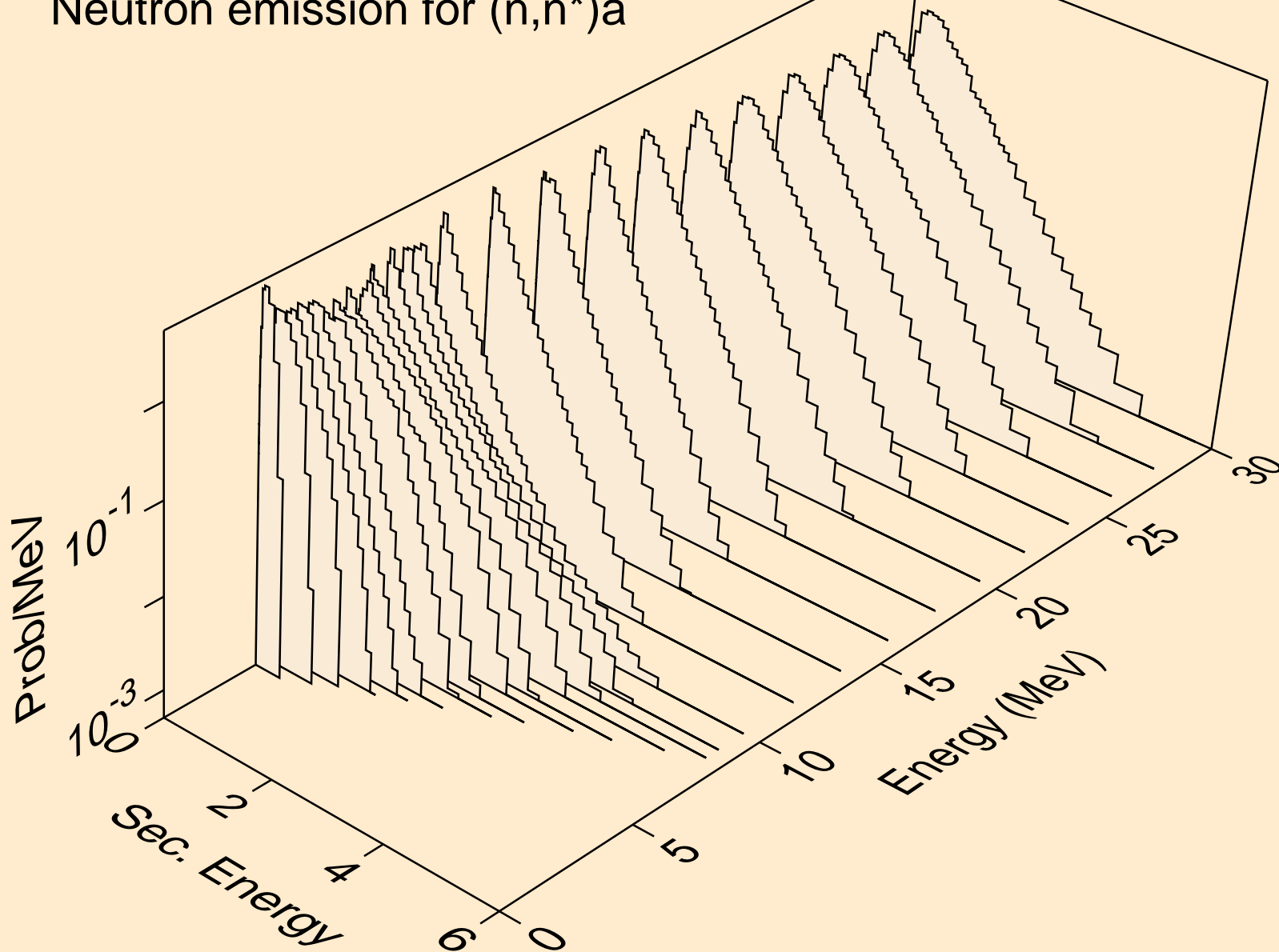

NP237 NEUTRON ACER TENDL-2019 LIBRARY; T=293.16K
Neutron emission for (n,2n)a

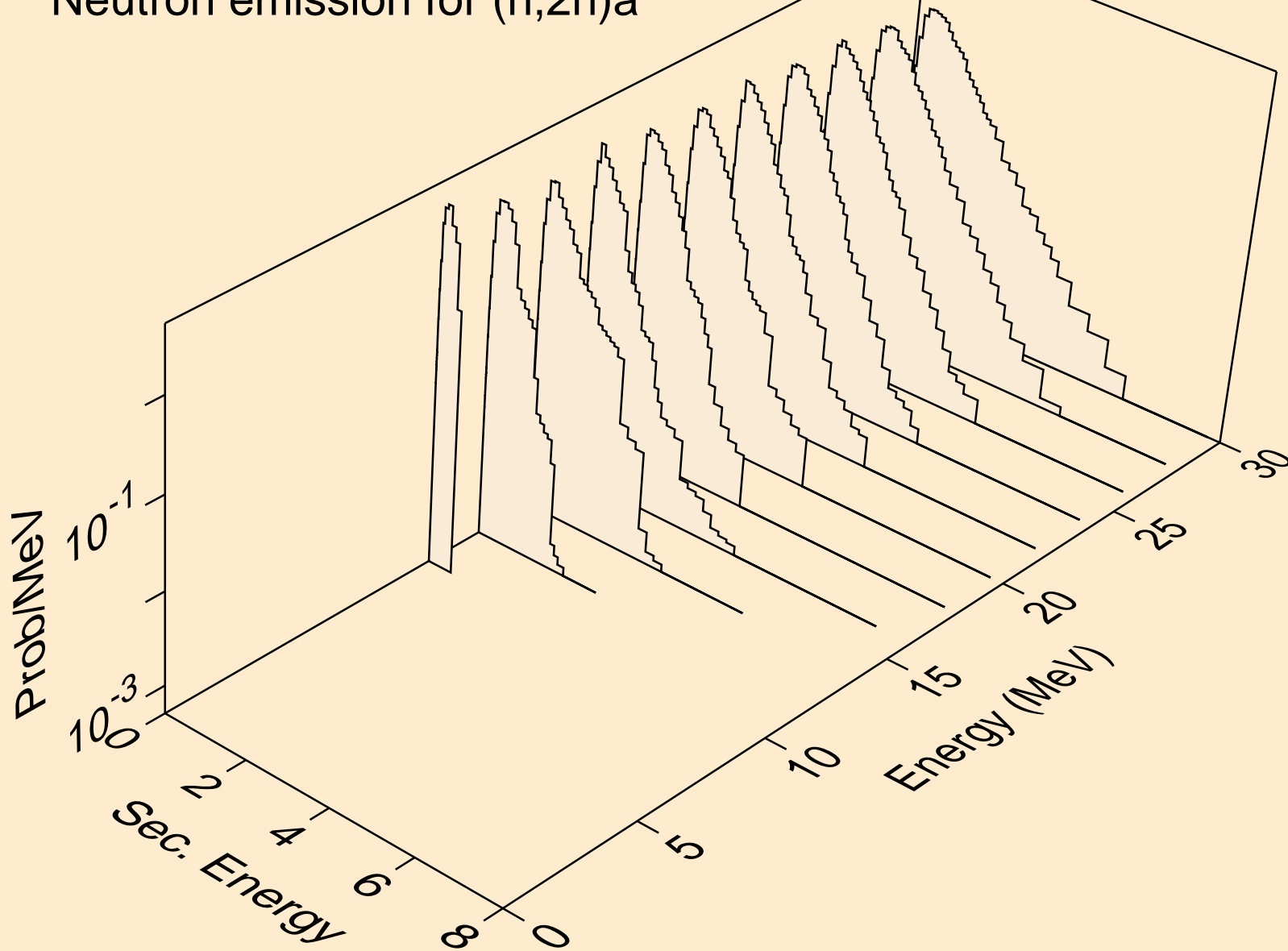

NP237 NEUTRON ACER TENDL-2019 LIBRARY; T=293.16K
Neutron emission for (n,3n)a

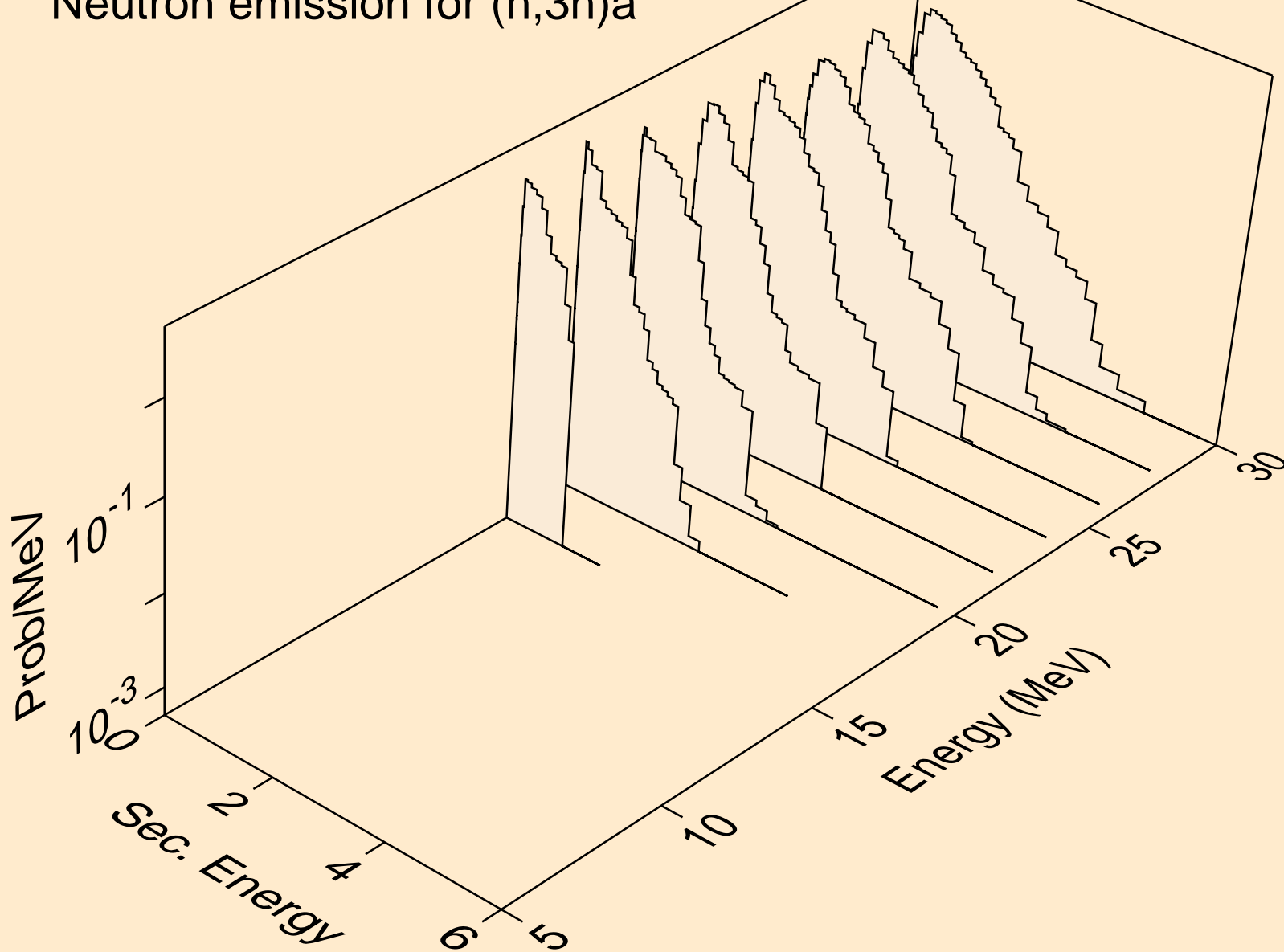

NP237 NEUTRON ACER TENDL-2019 LIBRARY; T=293.16K
Neutron emission for (n,n*)p

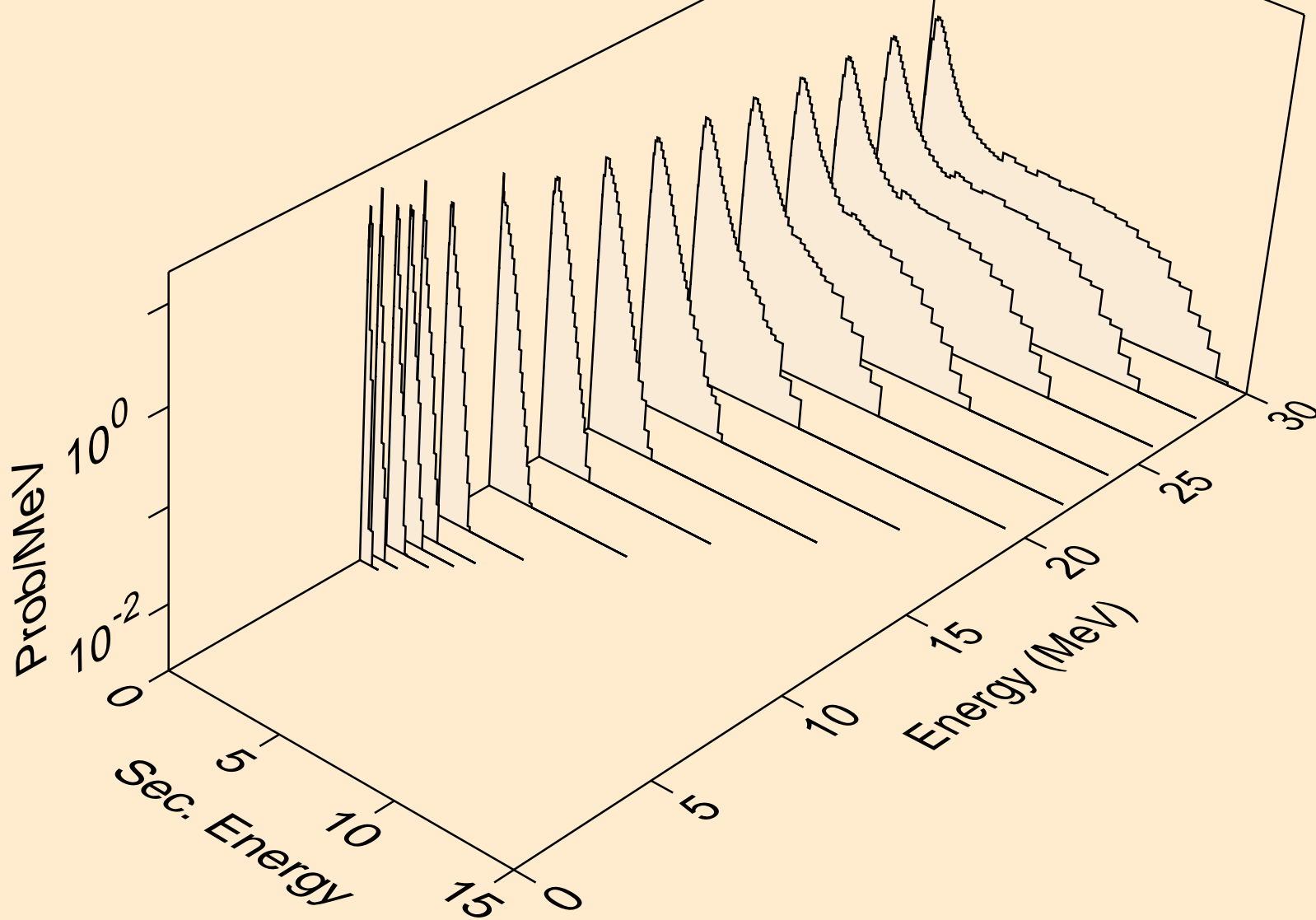

NP237 NEUTRON ACER TENDL-2019 LIBRARY; T=293.16K
Neutron emission for (n,n*)d

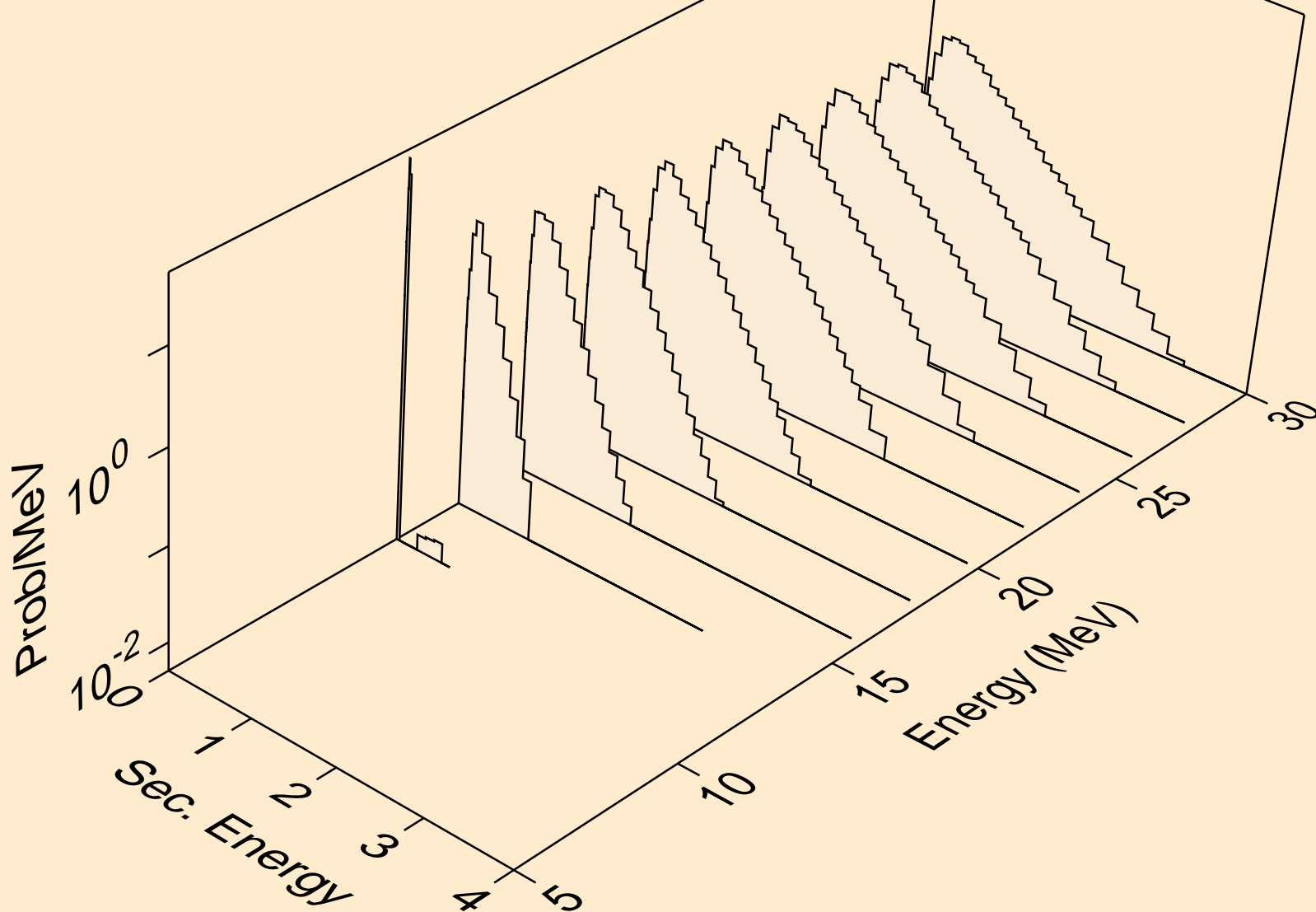

NP237 NEUTRON ACER TENDL-2019 LIBRARY; T=293.16K
Neutron emission for (n,n*)t

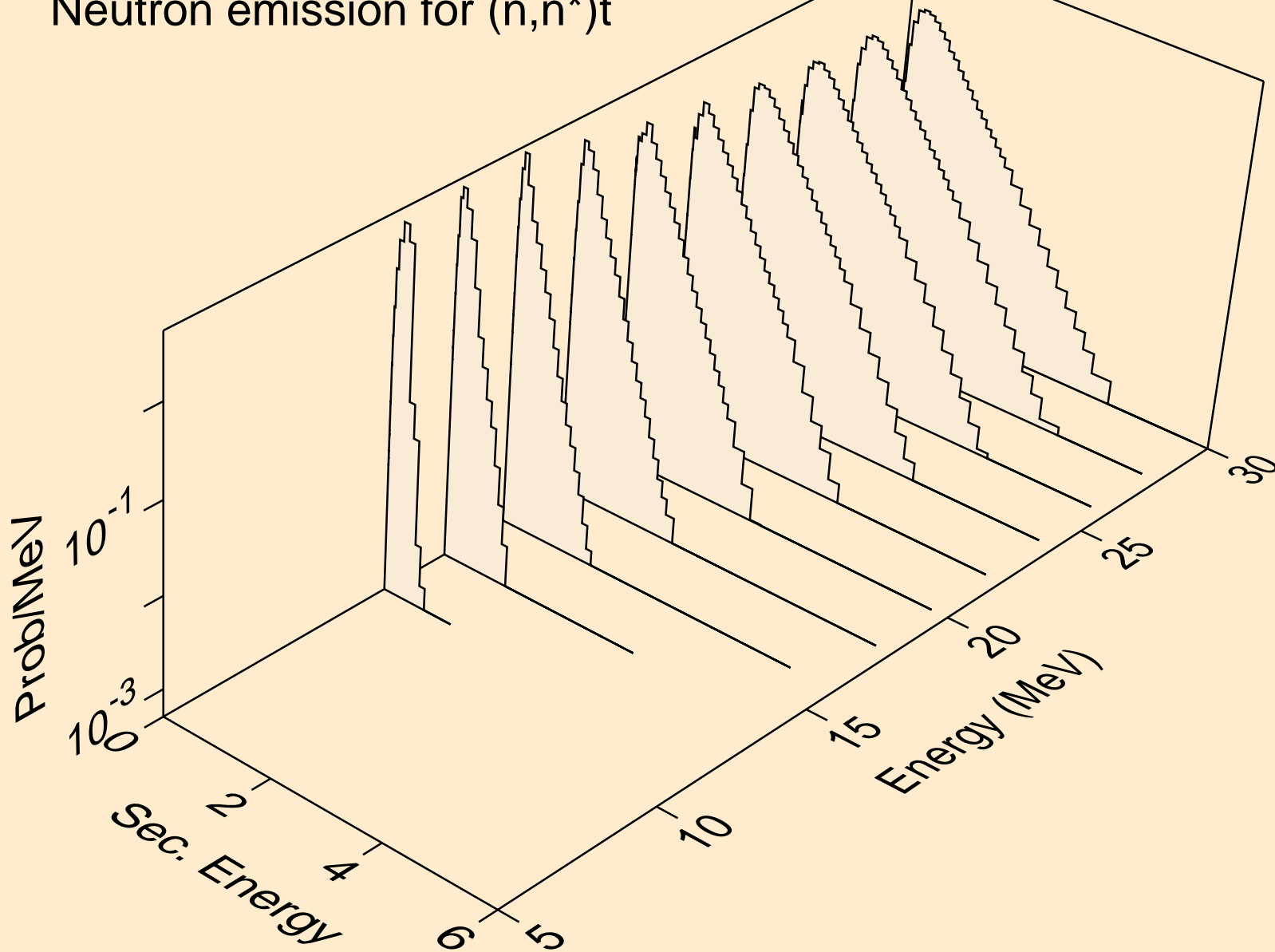

NP237 NEUTRON ACER TENDL-2019 LIBRARY; T=293.16K
Neutron emission for (n,n*)he3

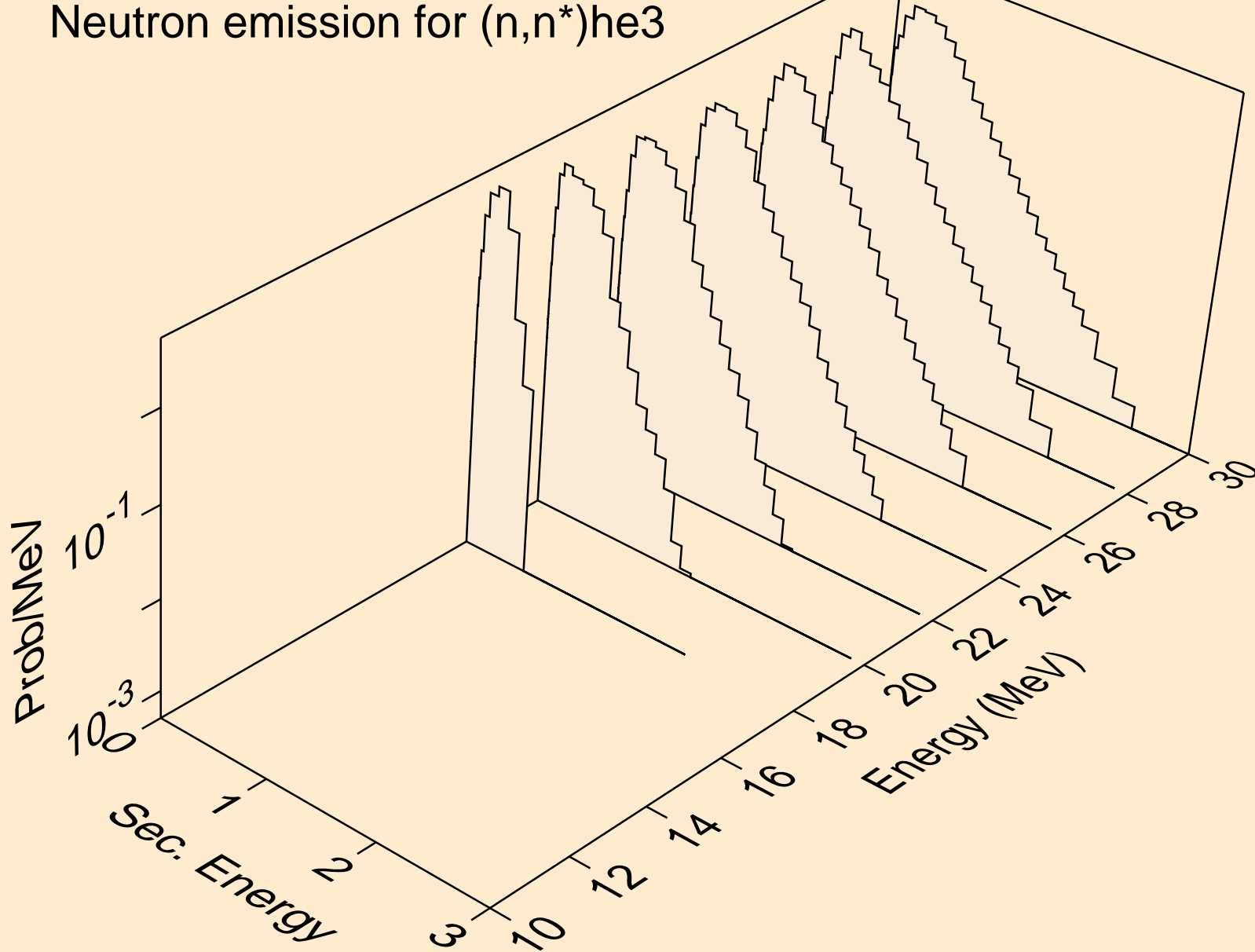

NP237 NEUTRON ACER TENDL-2019 LIBRARY; T=293.16K
Neutron emission for (n,4n)

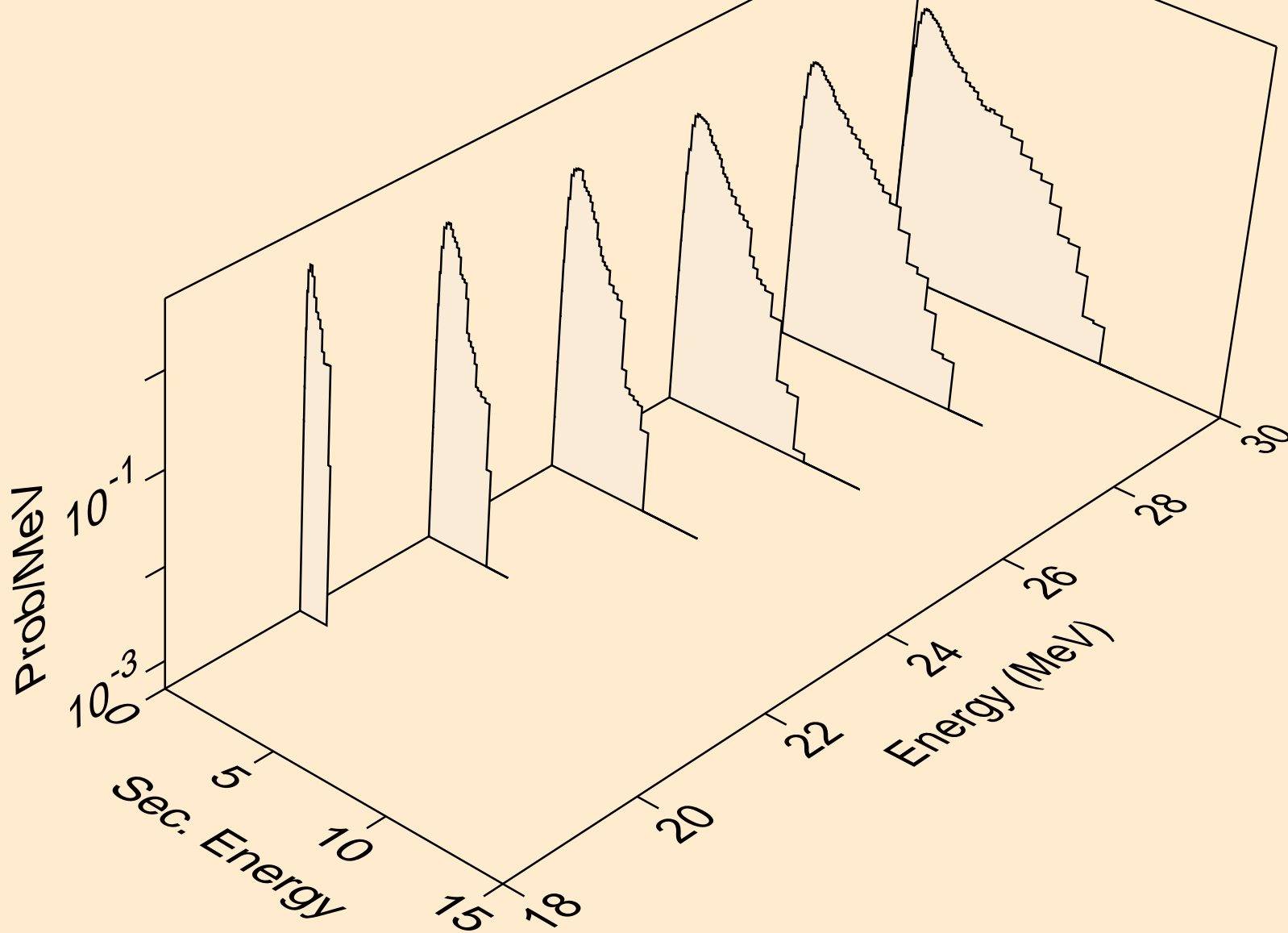

NP237 NEUTRON ACER TENDL-2019 LIBRARY; T=293.16K
Neutron emission for (n,2np)

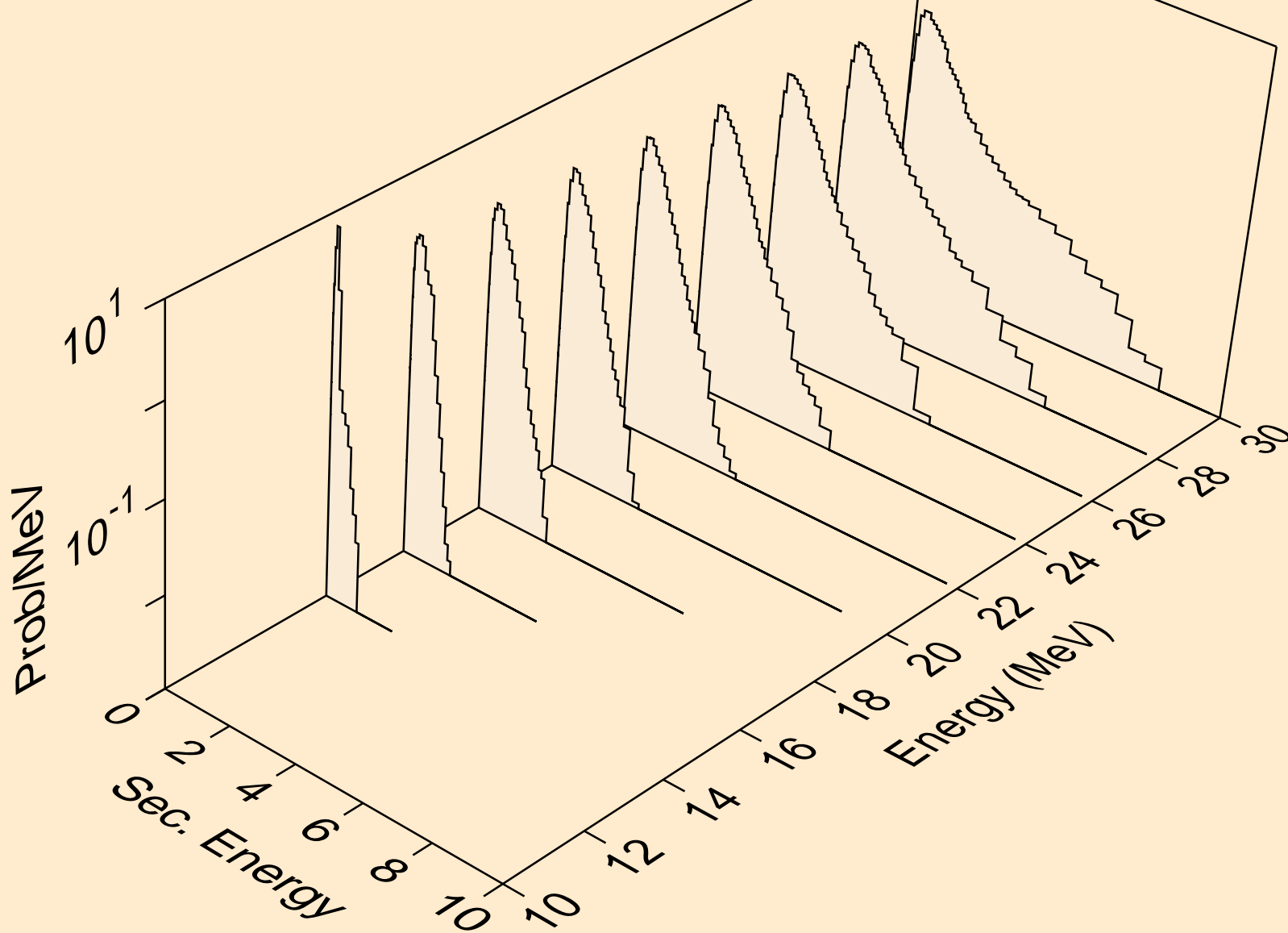

NP237 NEUTRON ACER TENDL-2019 LIBRARY; T=293.16K
Neutron emission for (n,3np)

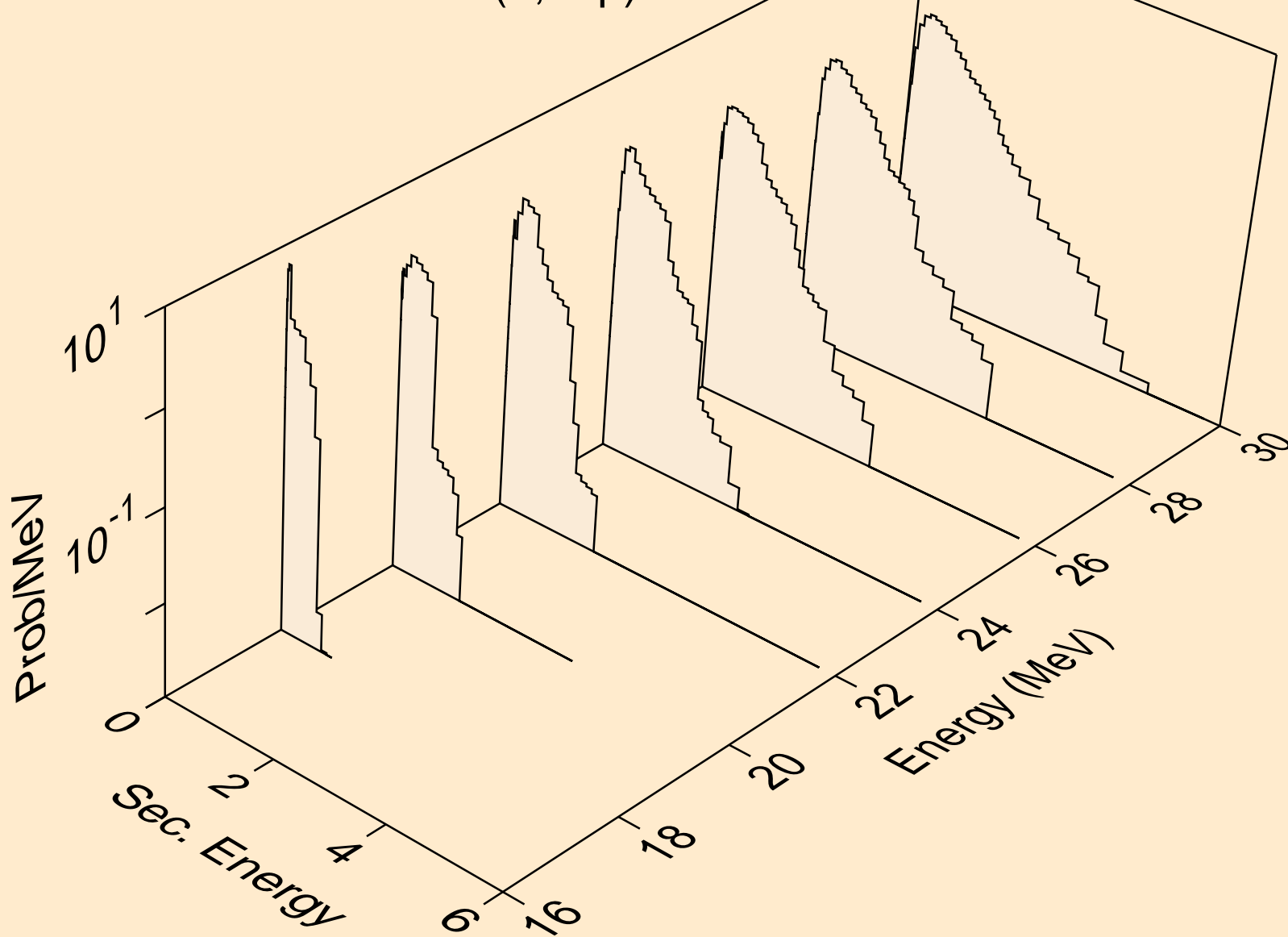

NP237 NEUTRON ACER TENDL-2019 LIBRARY; T=293.16K
Neutron emission for (n,2np)

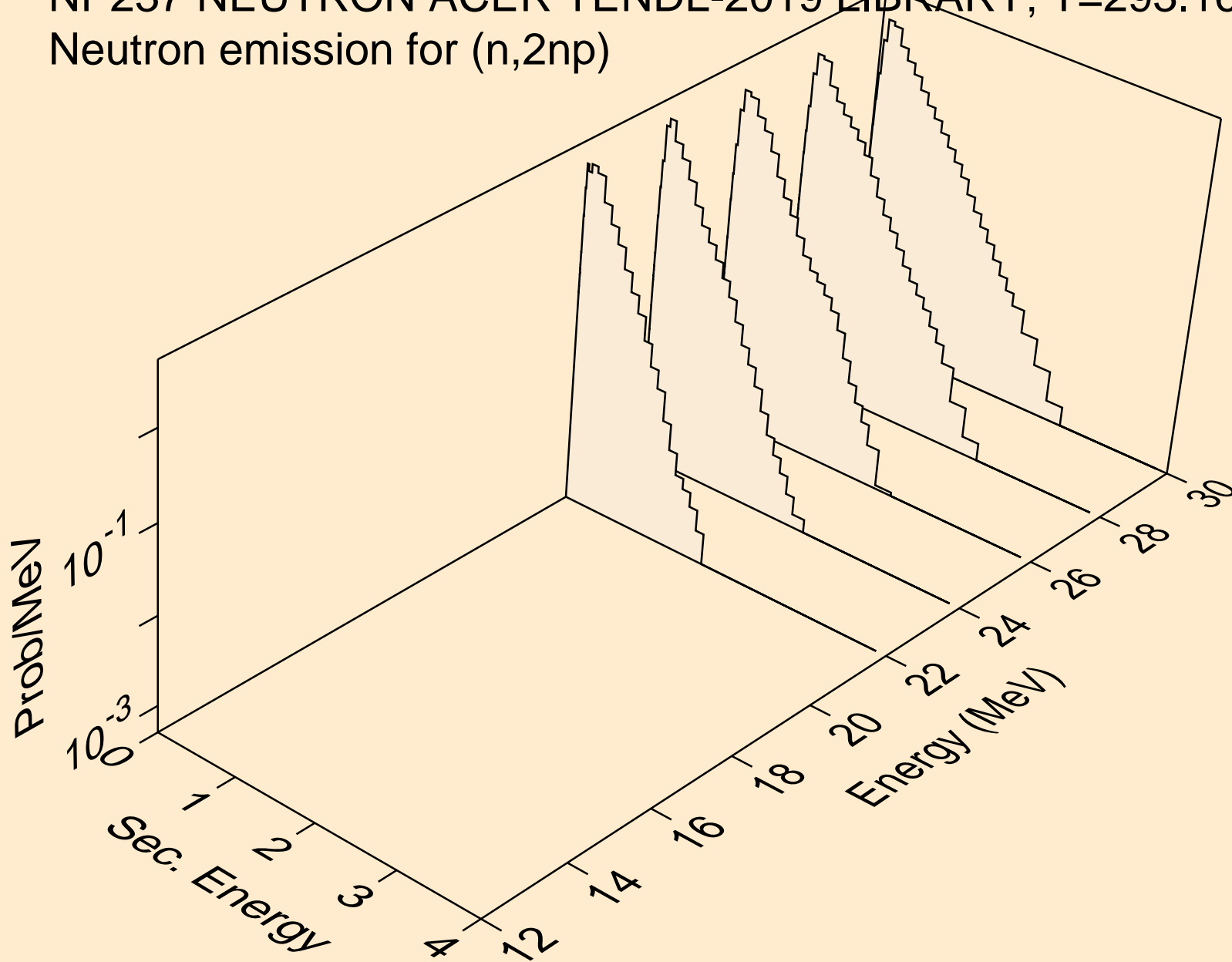

NP237 NEUTRON ACER TENDL-2019 LIBRARY; T=293.16K
Neutron emission for (n,n*c)

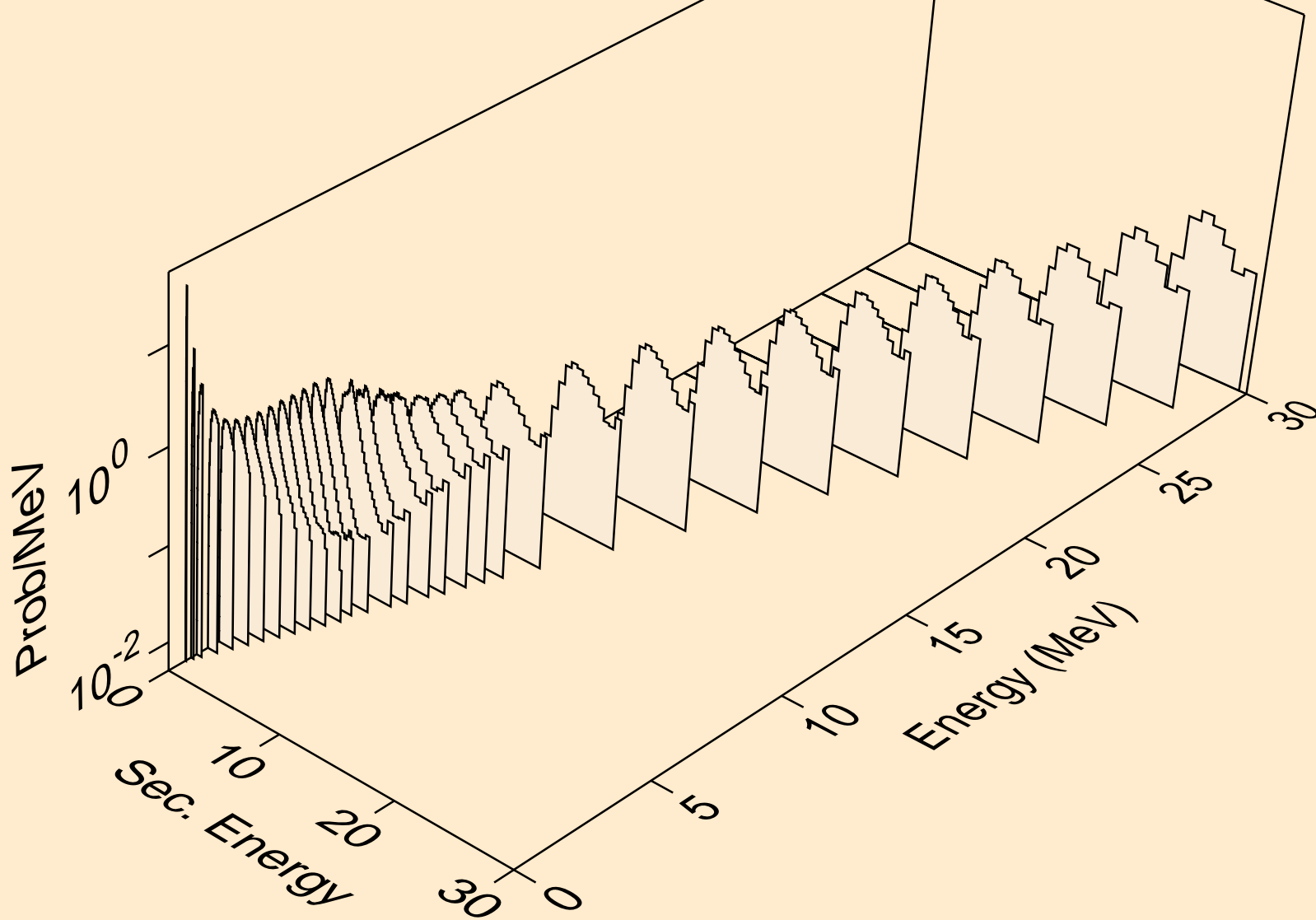

NP237 NEUTRON ACER TENDL-2019 LIBRARY; T=293.16K
Delayed nubar

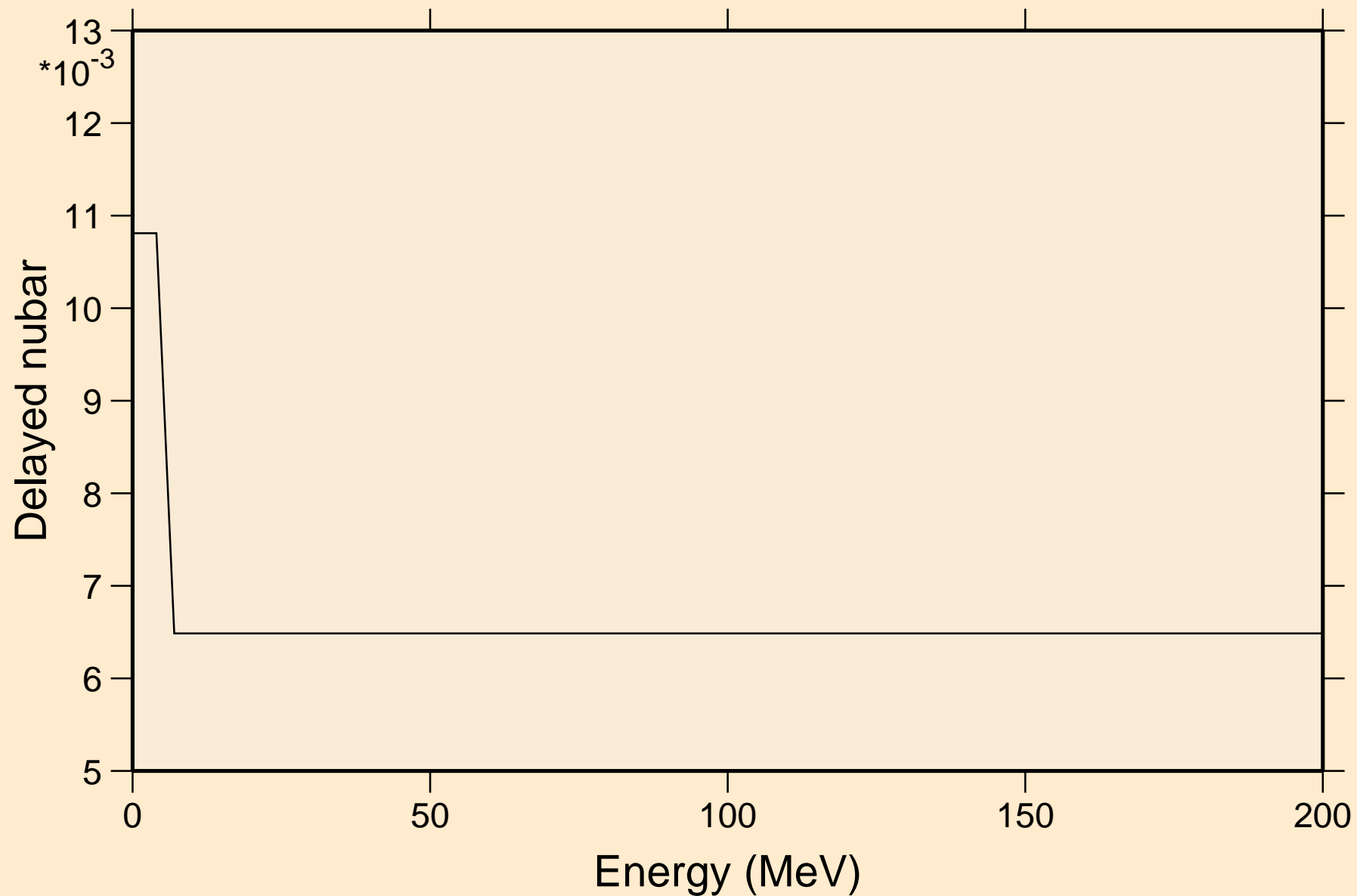

NP237 NEUTRON ACER TENDL-2019 LIBRARY; T=293.16K

Delayed neutron spectra

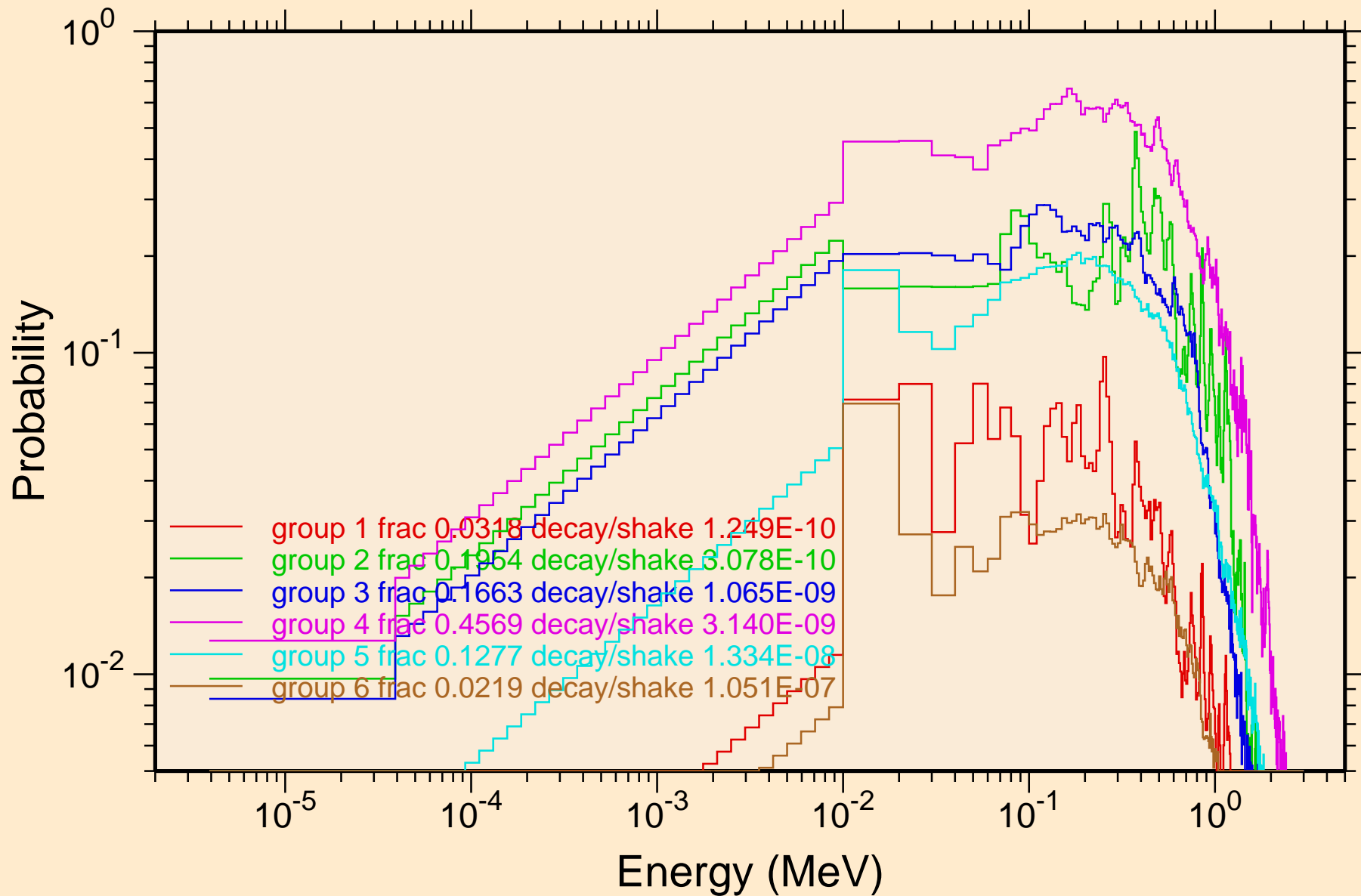

NP237 NEUTRON ACER TENDL-2019 LIBRARY; T=293.16K
Photon emission for (n,x)

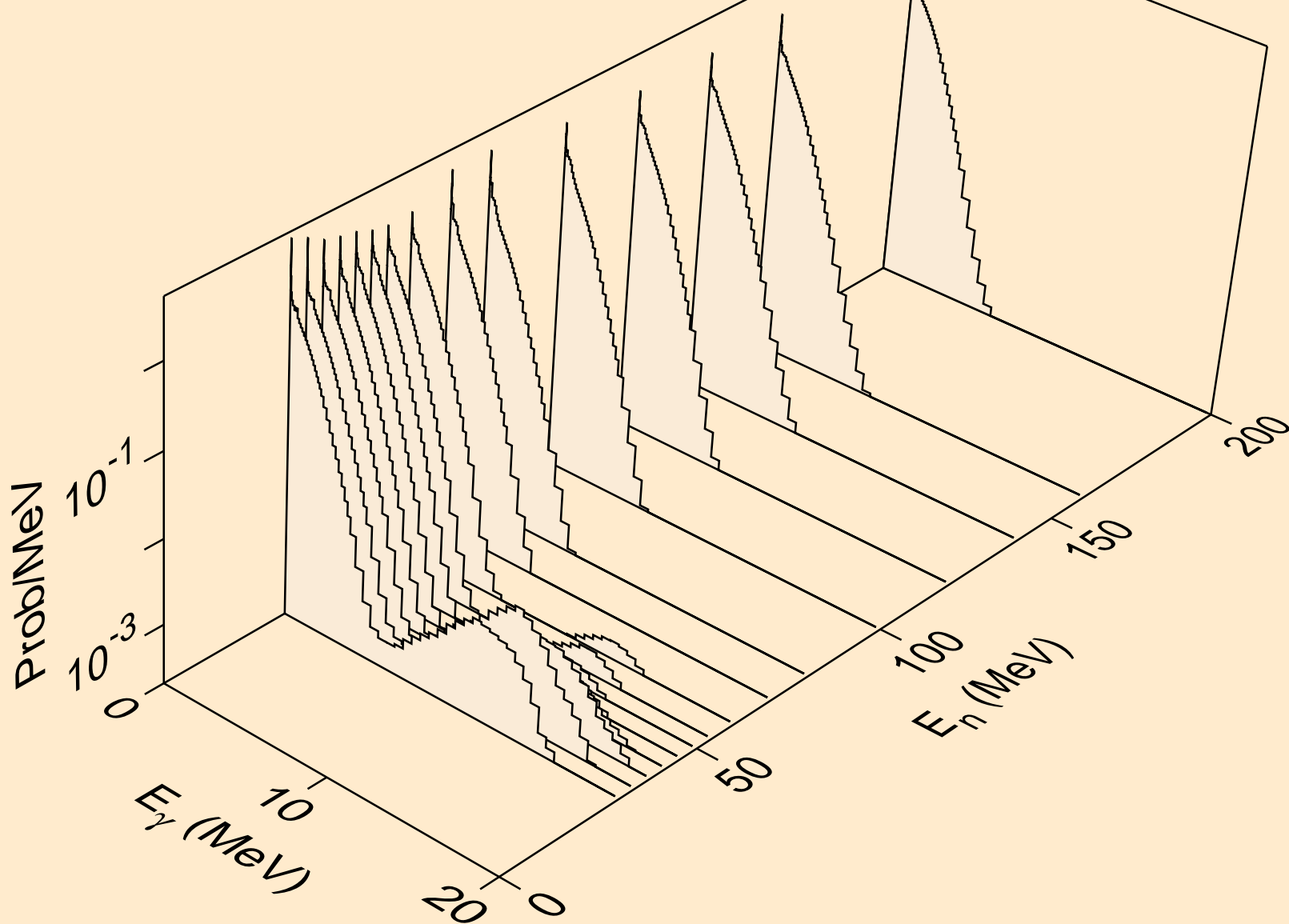

NP237 NEUTRON ACER TENDL-2019 LIBRARY; T=293.16K
Photon emission for (n,2nd)

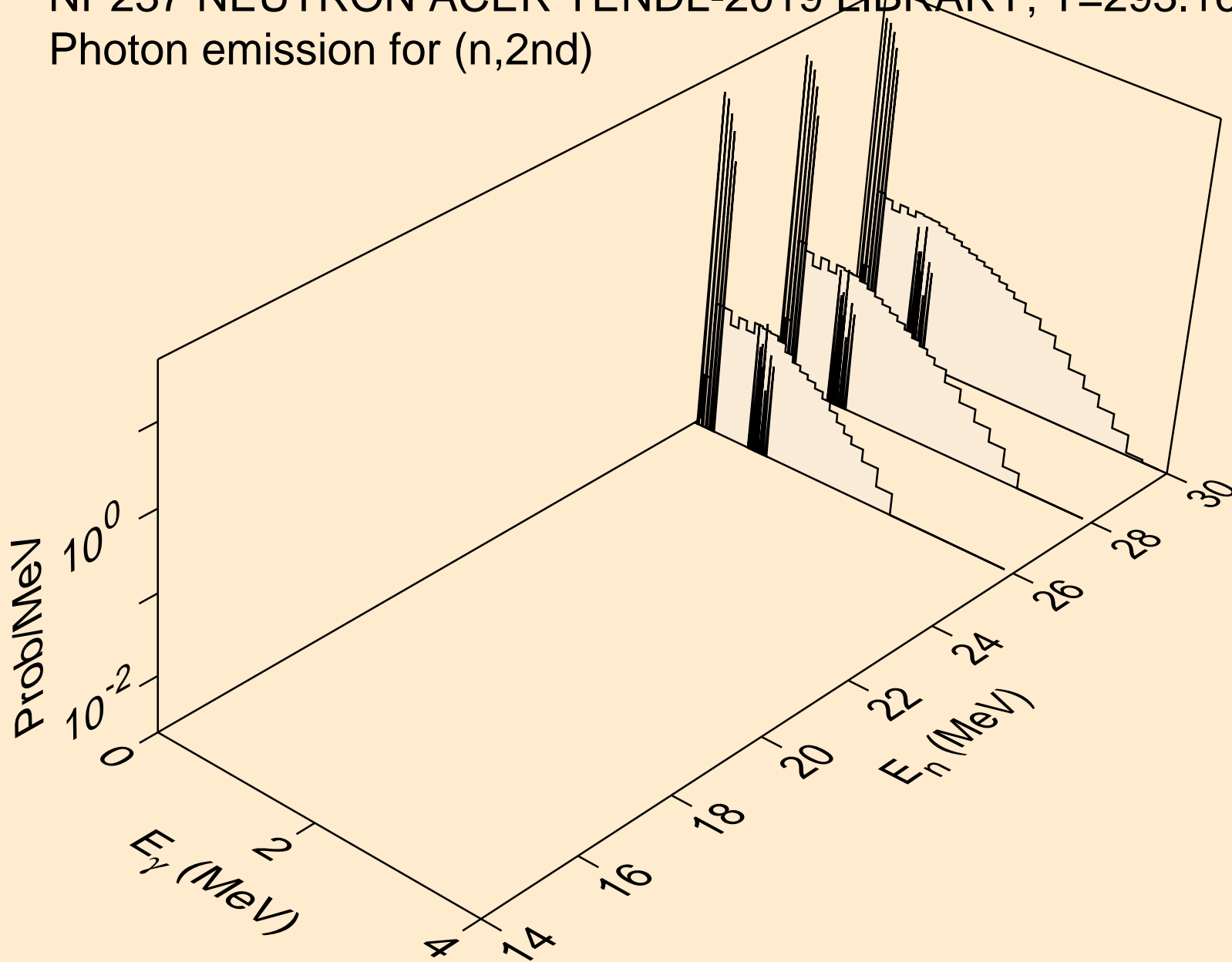

NP237 NEUTRON ACER TENDL-2019 LIBRARY; T=293.16K
Photon emission for (n,2n)

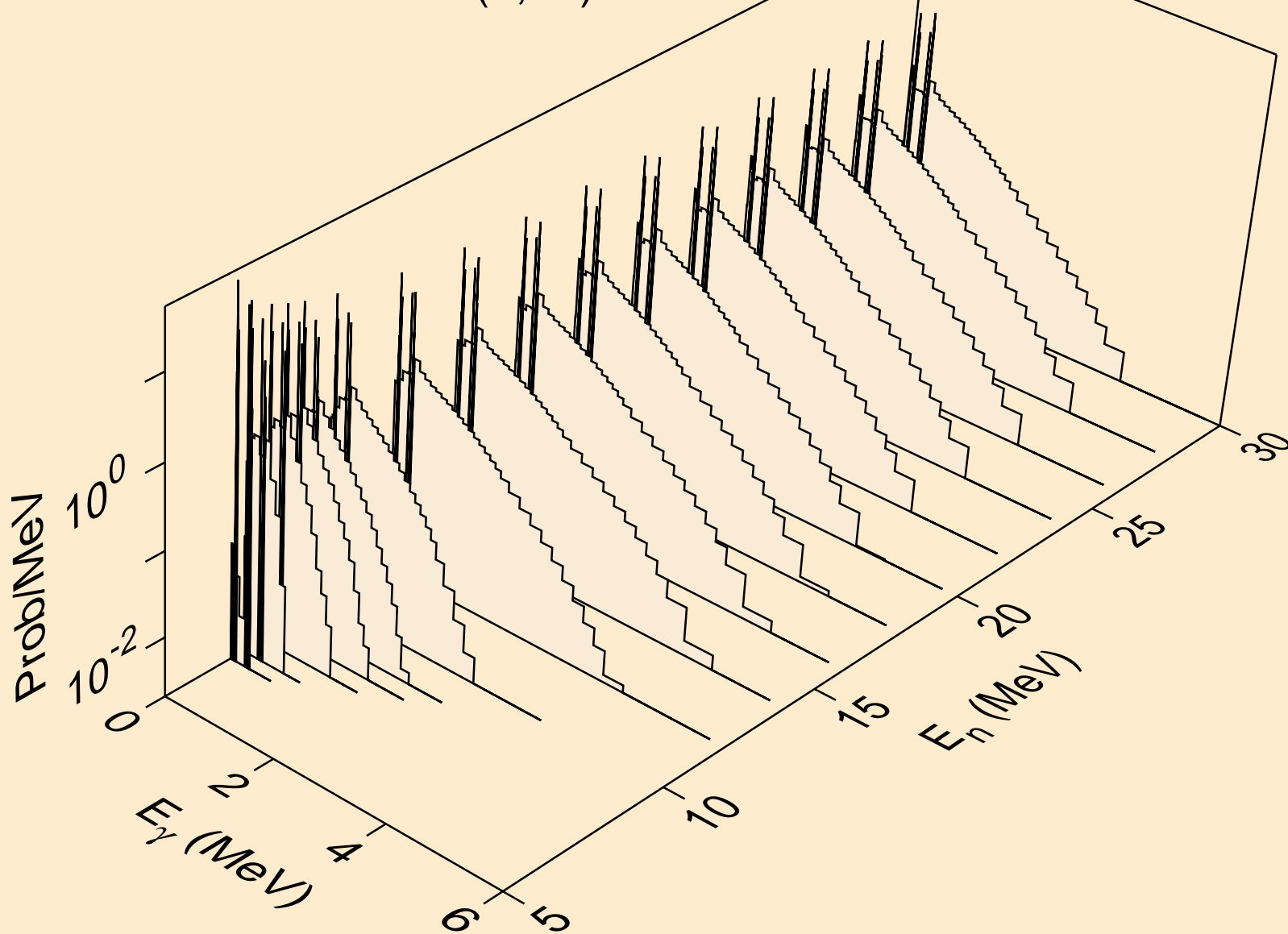

NP237 NEUTRON ACER TENDL-2019 LIBRARY; T=293.16K
Photon emission for (n,3n)

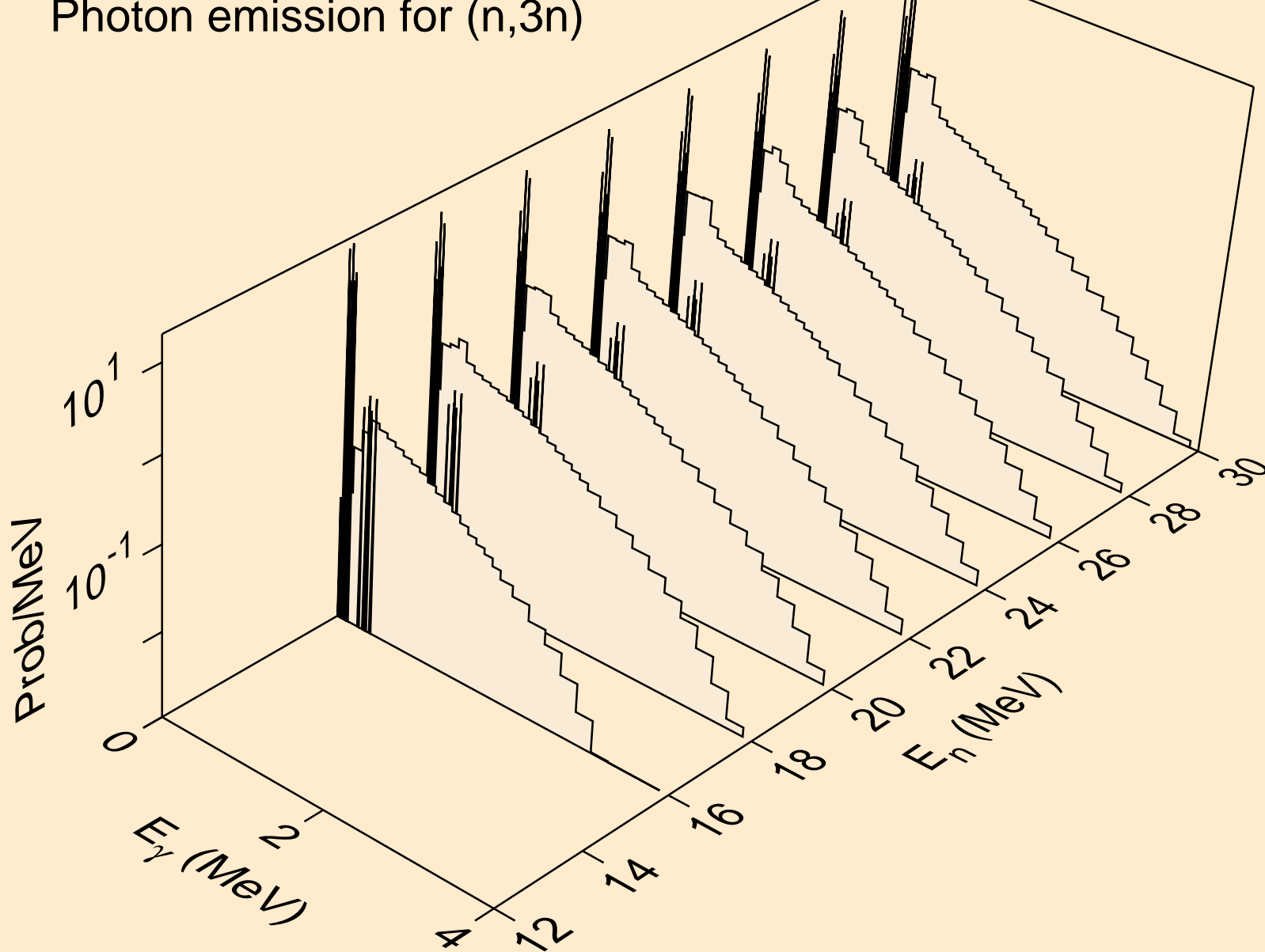

NP237 NEUTRON ACER TENDL-2019 LIBRARY; T=293.16K
Photon emission for (n,n*)a

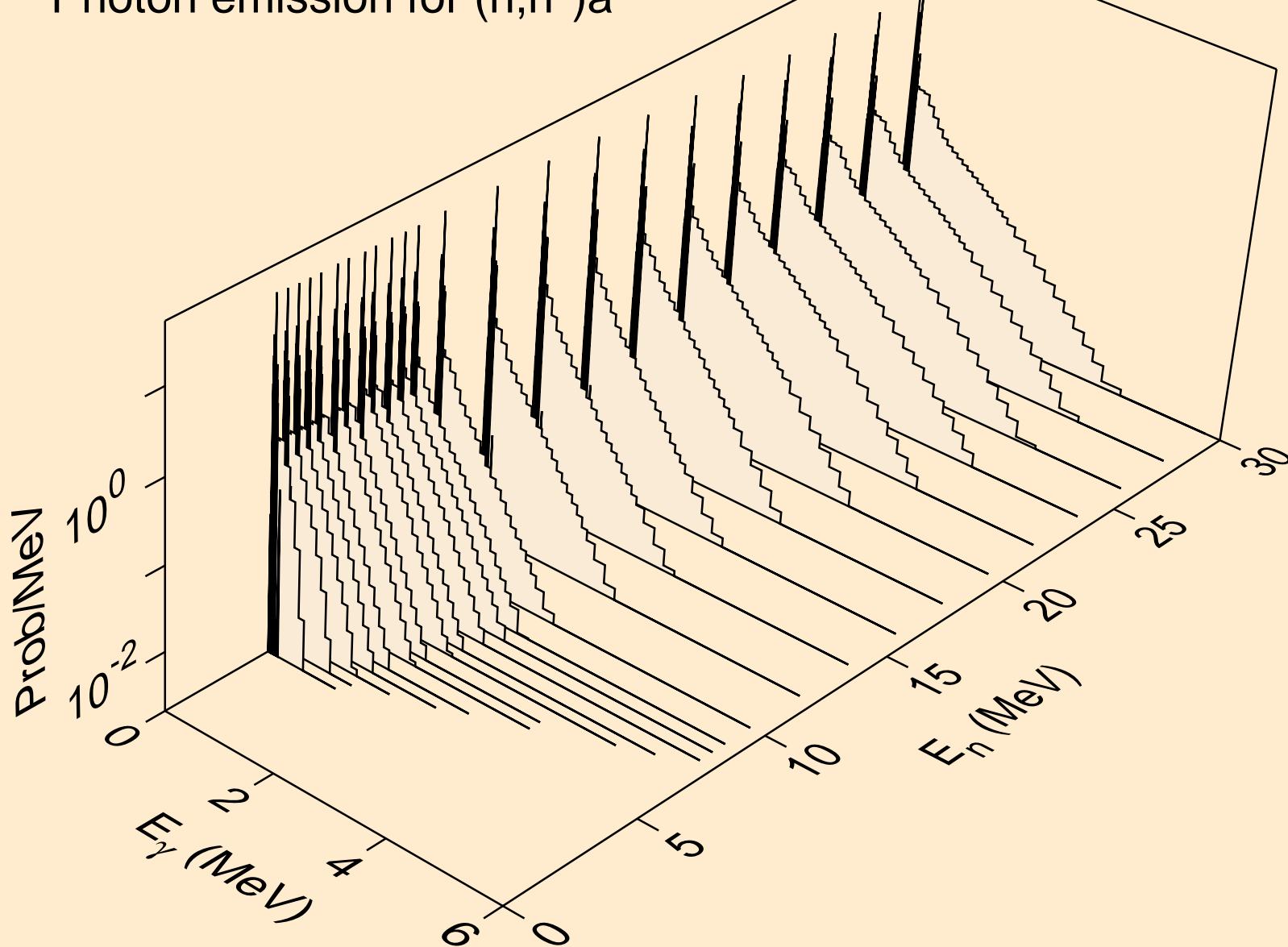

NP237 NEUTRON ACER TENDL-2019 LIBRARY; T=293.16K
Photon emission for (n,2n)a

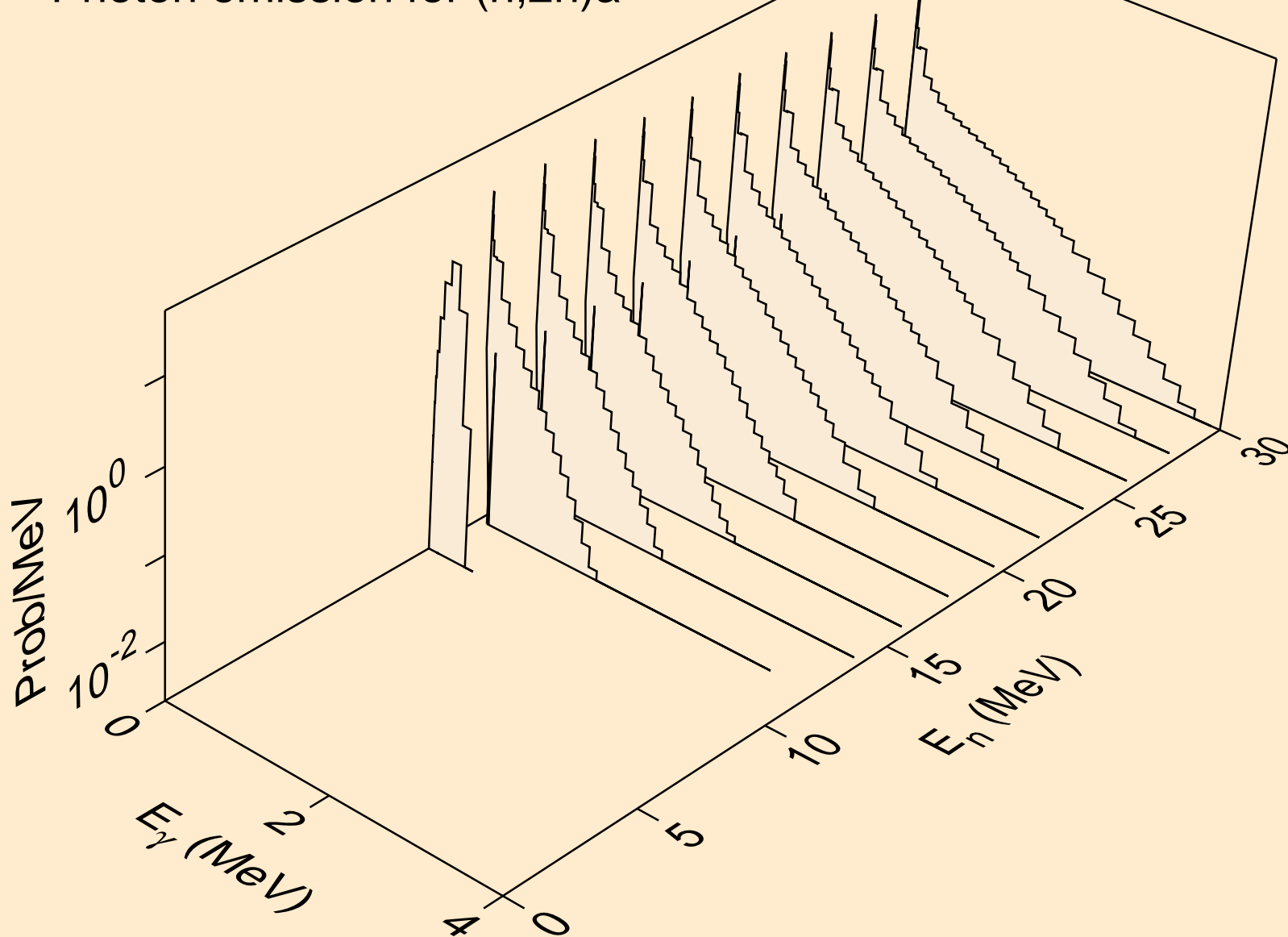

NP237 NEUTRON ACER TENDL-2019 LIBRARY; T=293.16K
Photon emission for (n,3n)a

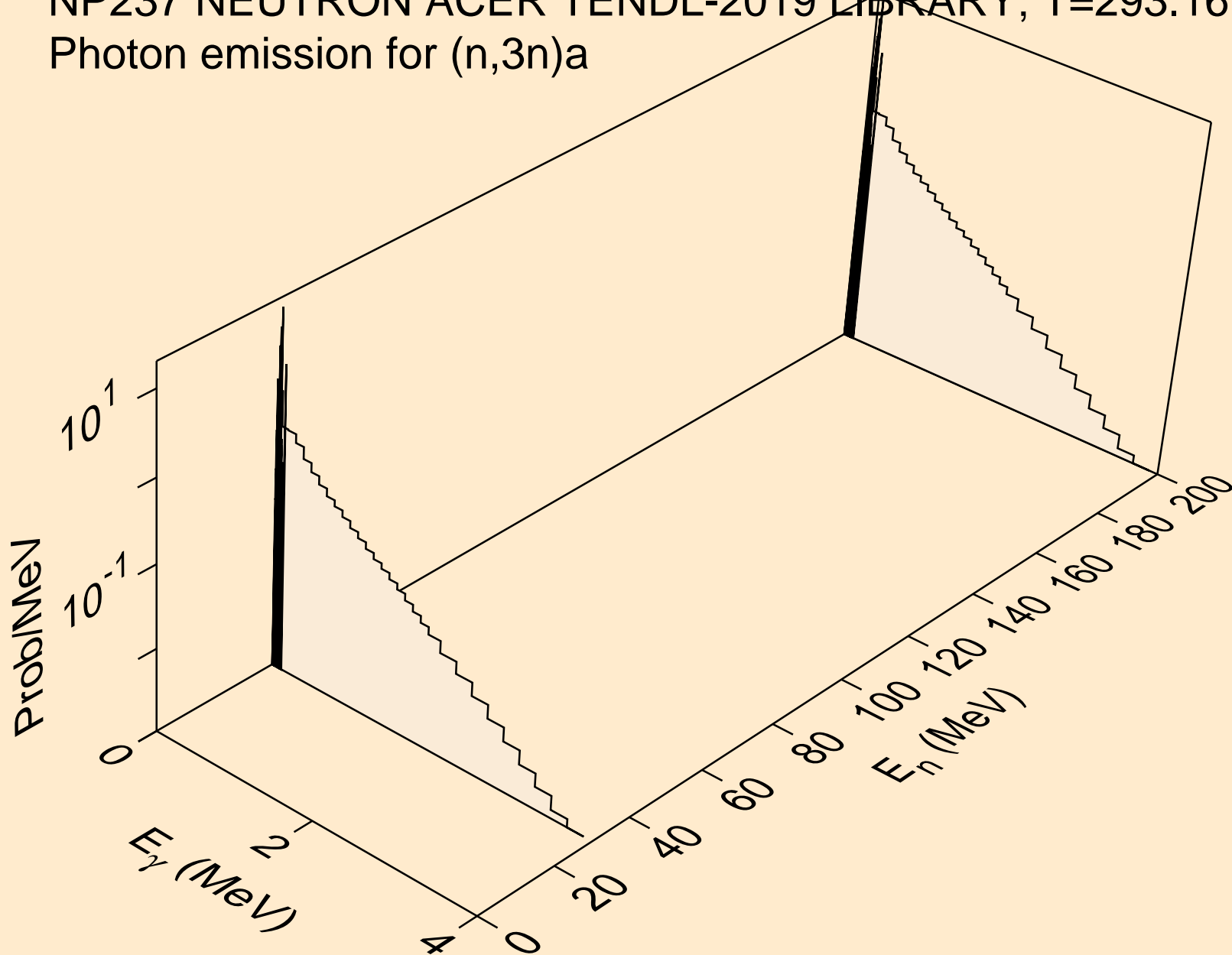

NP237 NEUTRON ACER TENDL-2019 LIBRARY; T=293.16K
Photon emission for (n,n*)p

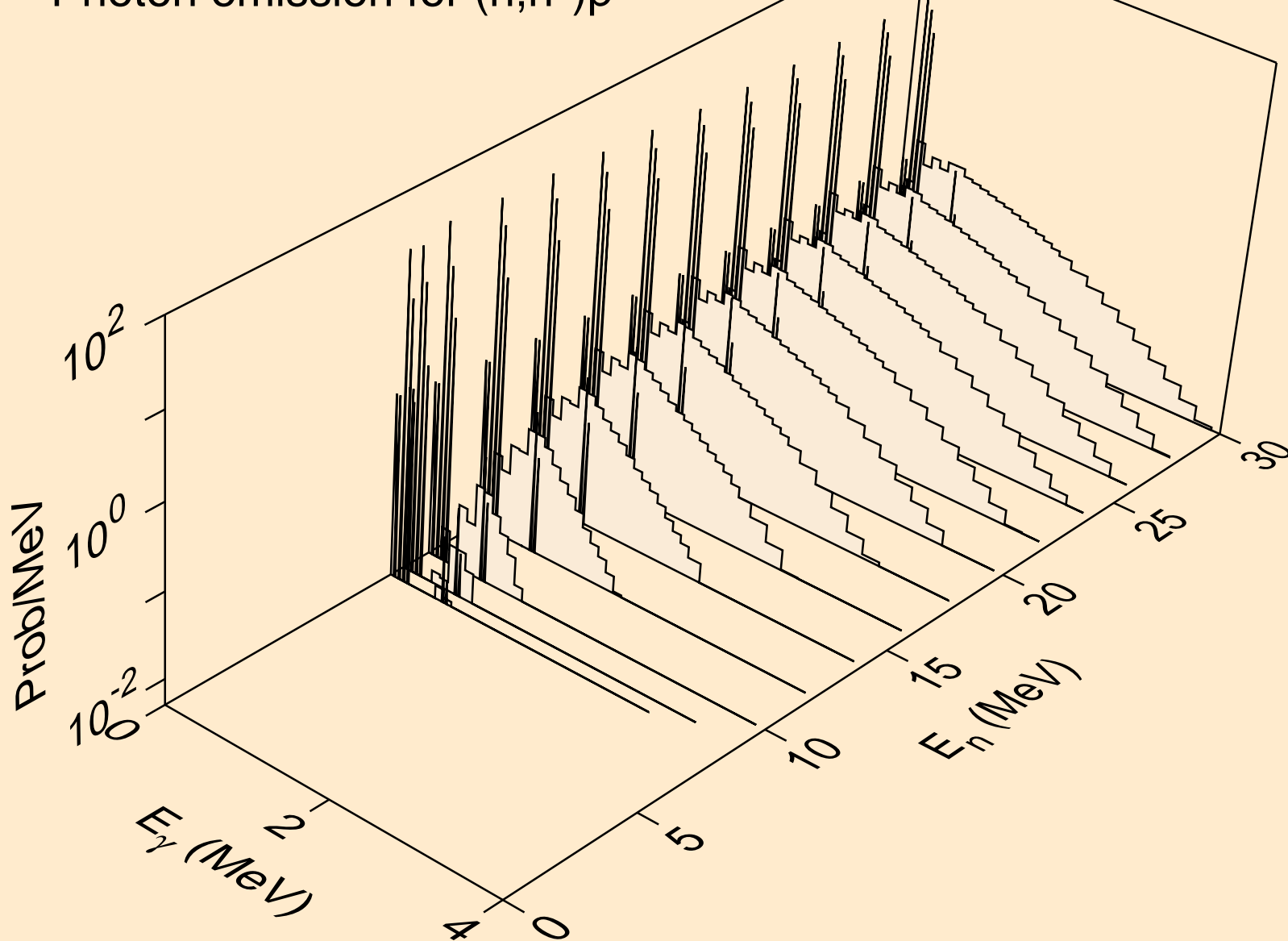

NP237 NEUTRON ACER TENDL-2019 LIBRARY; T=293.16K
Photon emission for (n,n*)d

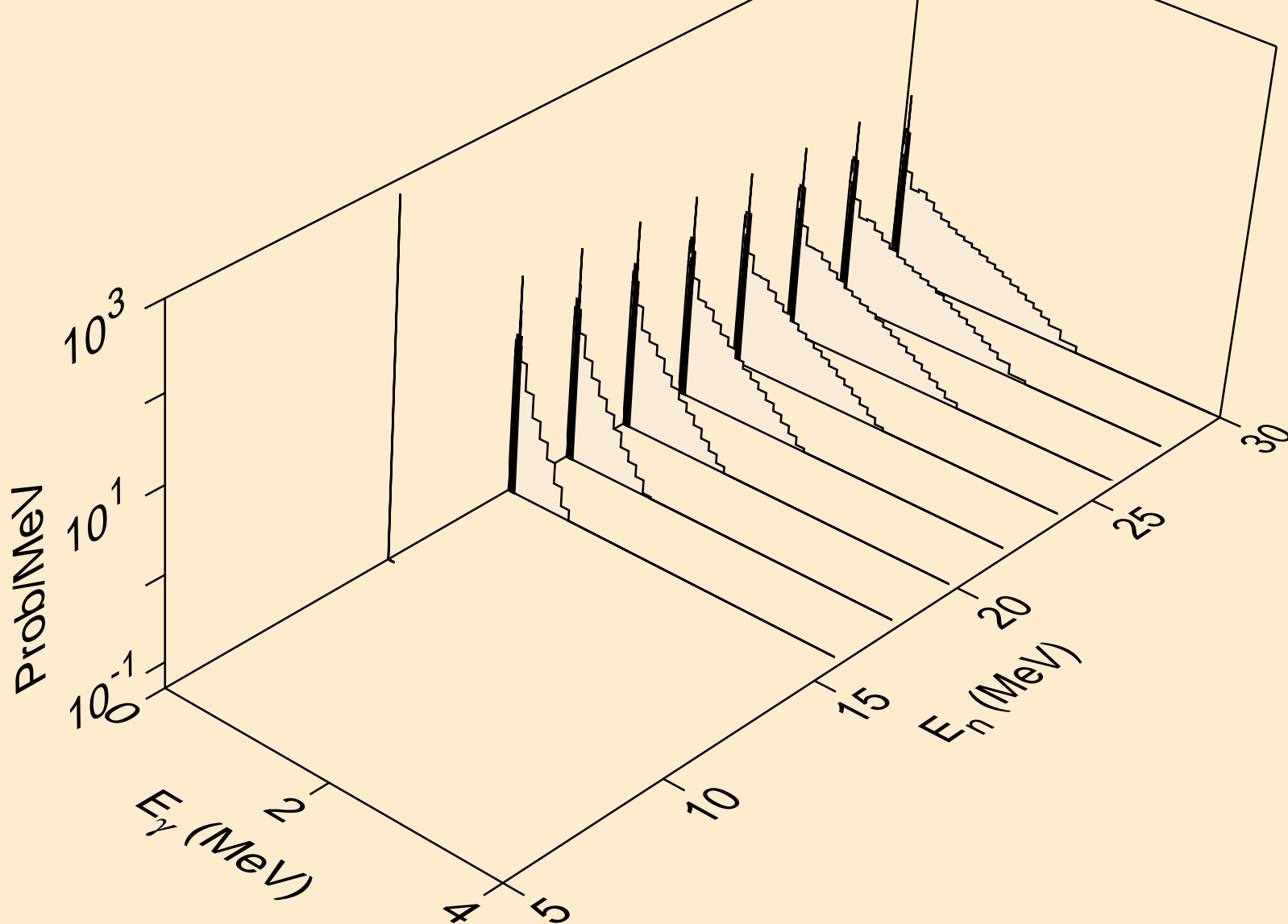

NP237 NEUTRON ACER TENDL-2019 LIBRARY; T=293.16K
Photon emission for (n,n*)t

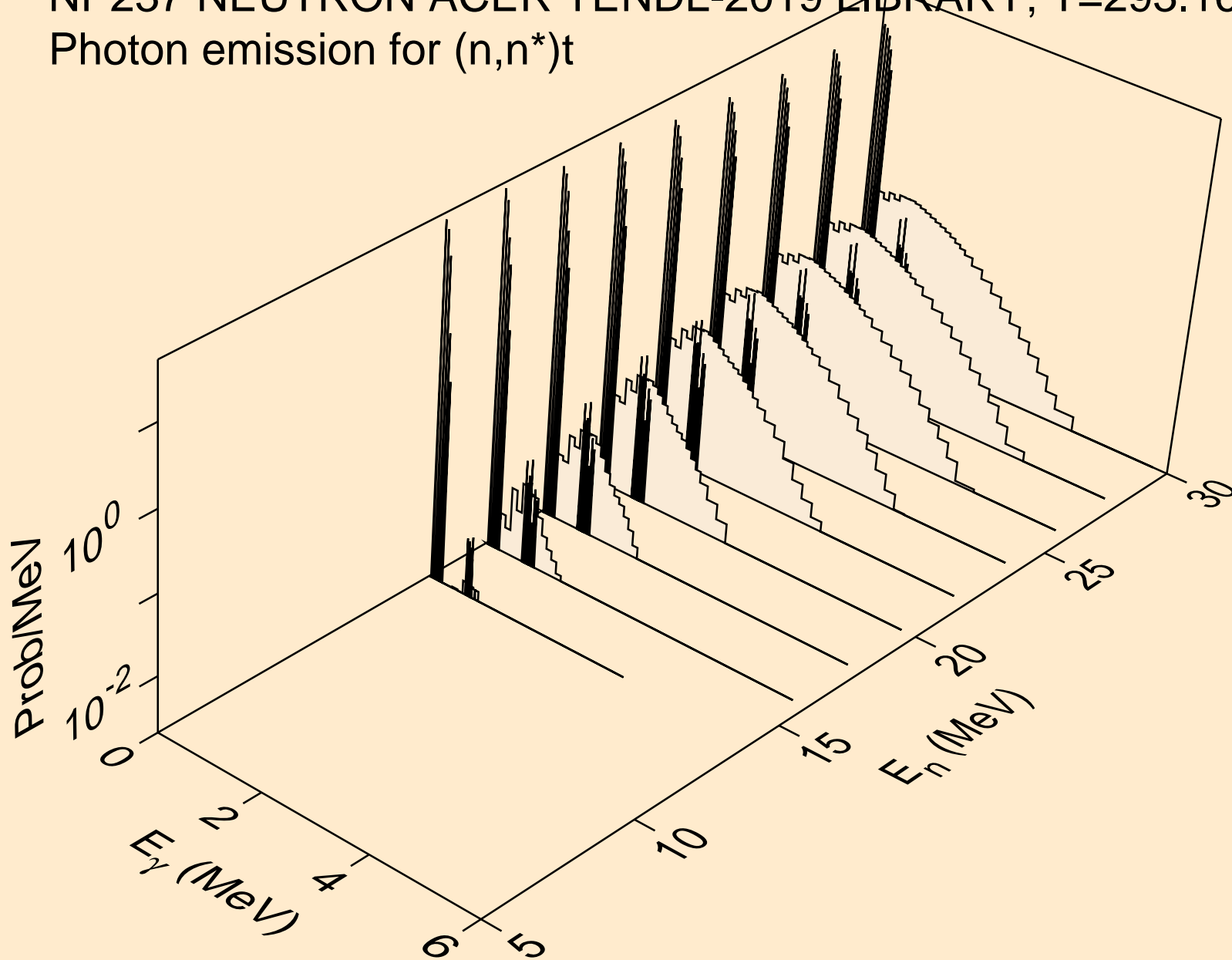

NP237 NEUTRON ACER TENDL-2019 LIBRARY; T=293.16K
Photon emission for (n,n*)he3

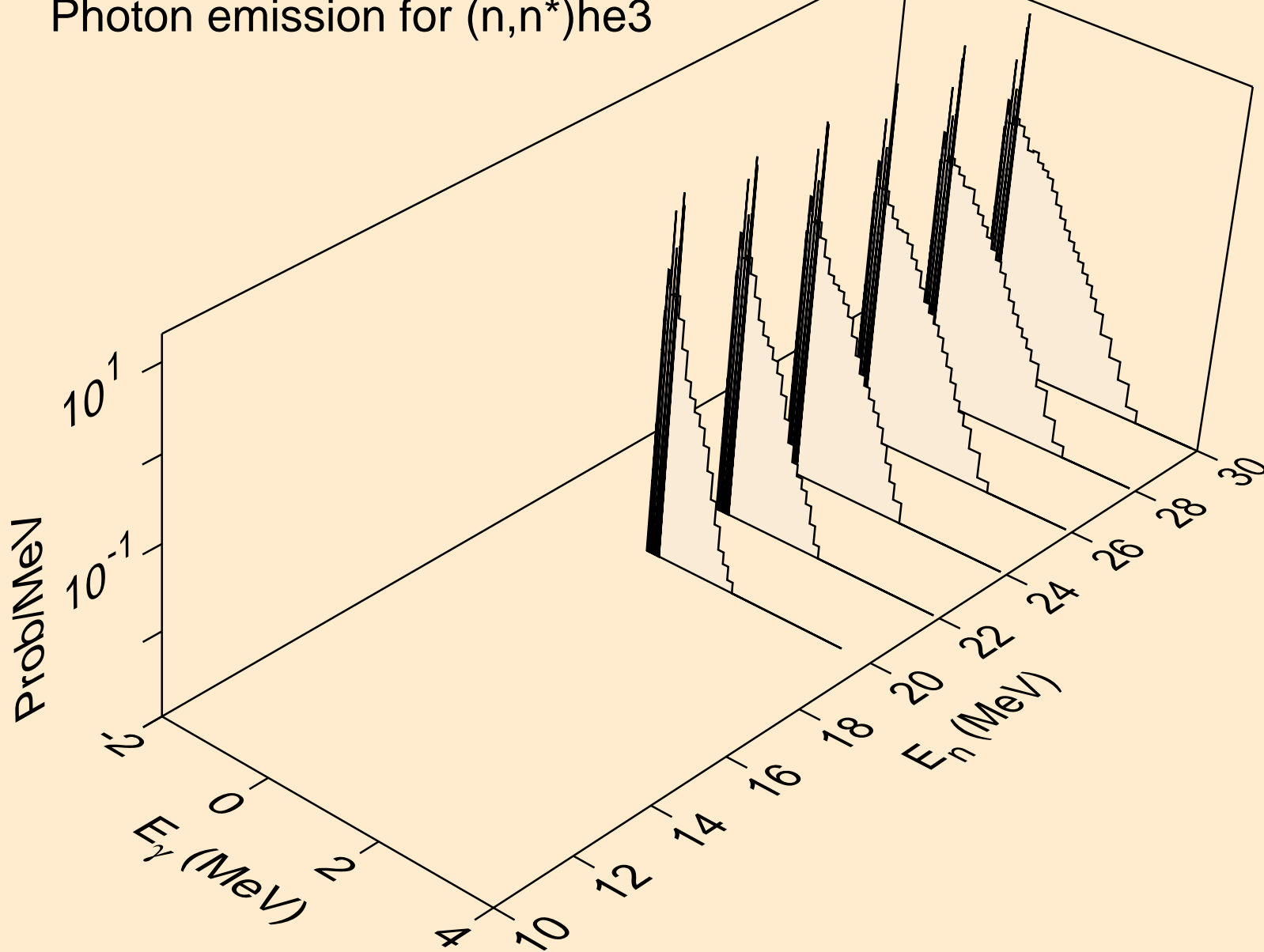

NP237 NEUTRON ACER TENDL-2019 LIBRARY; T=293.16K
Photon emission for (n,4n)

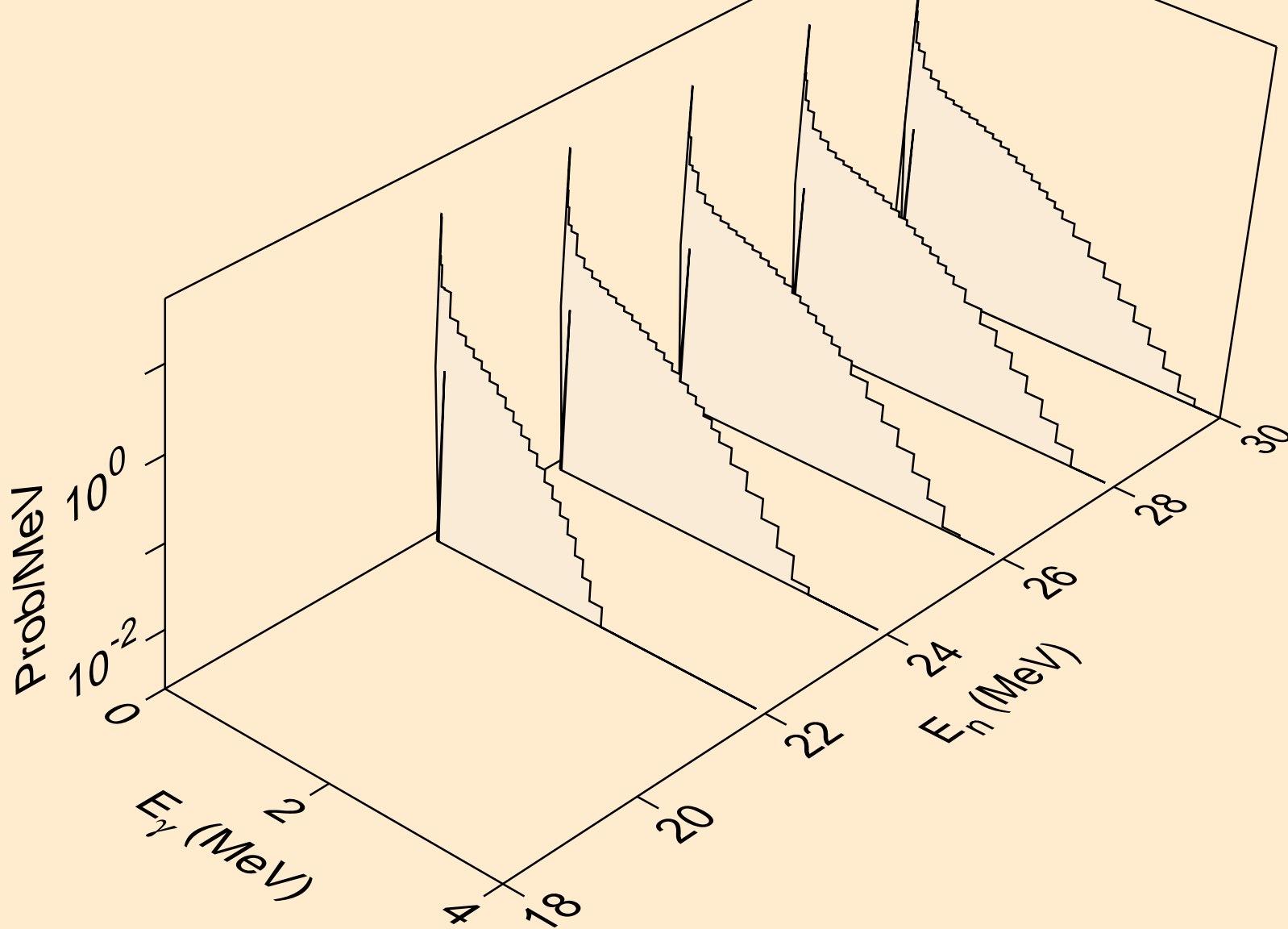

NP237 NEUTRON ACER TENDL-2019 LIBRARY; T=293.16K
Photon emission for (n,2np)

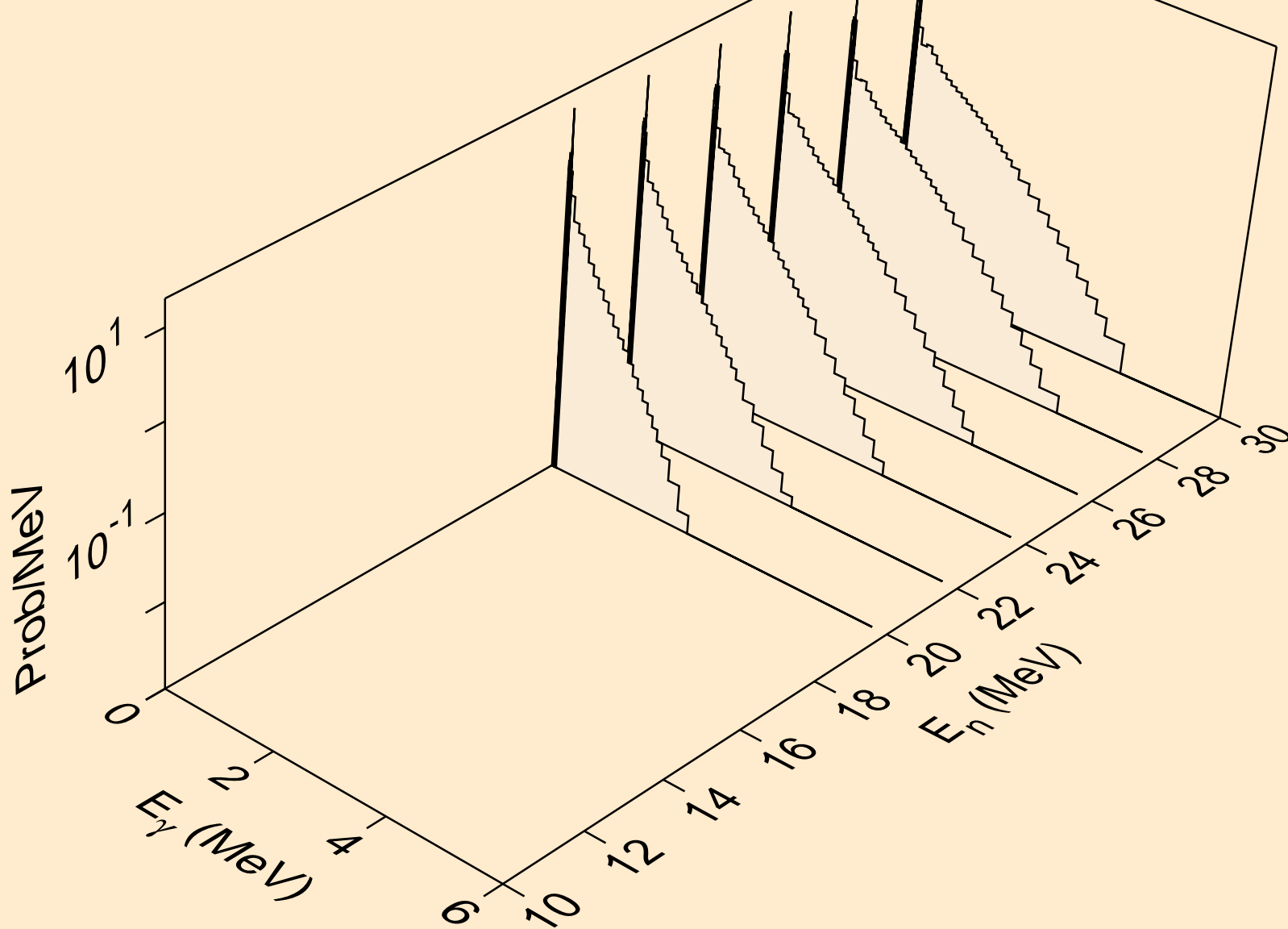

NP237 NEUTRON ACER TENDL-2019 LIBRARY; T=293.16K
Photon emission for (n,3np)

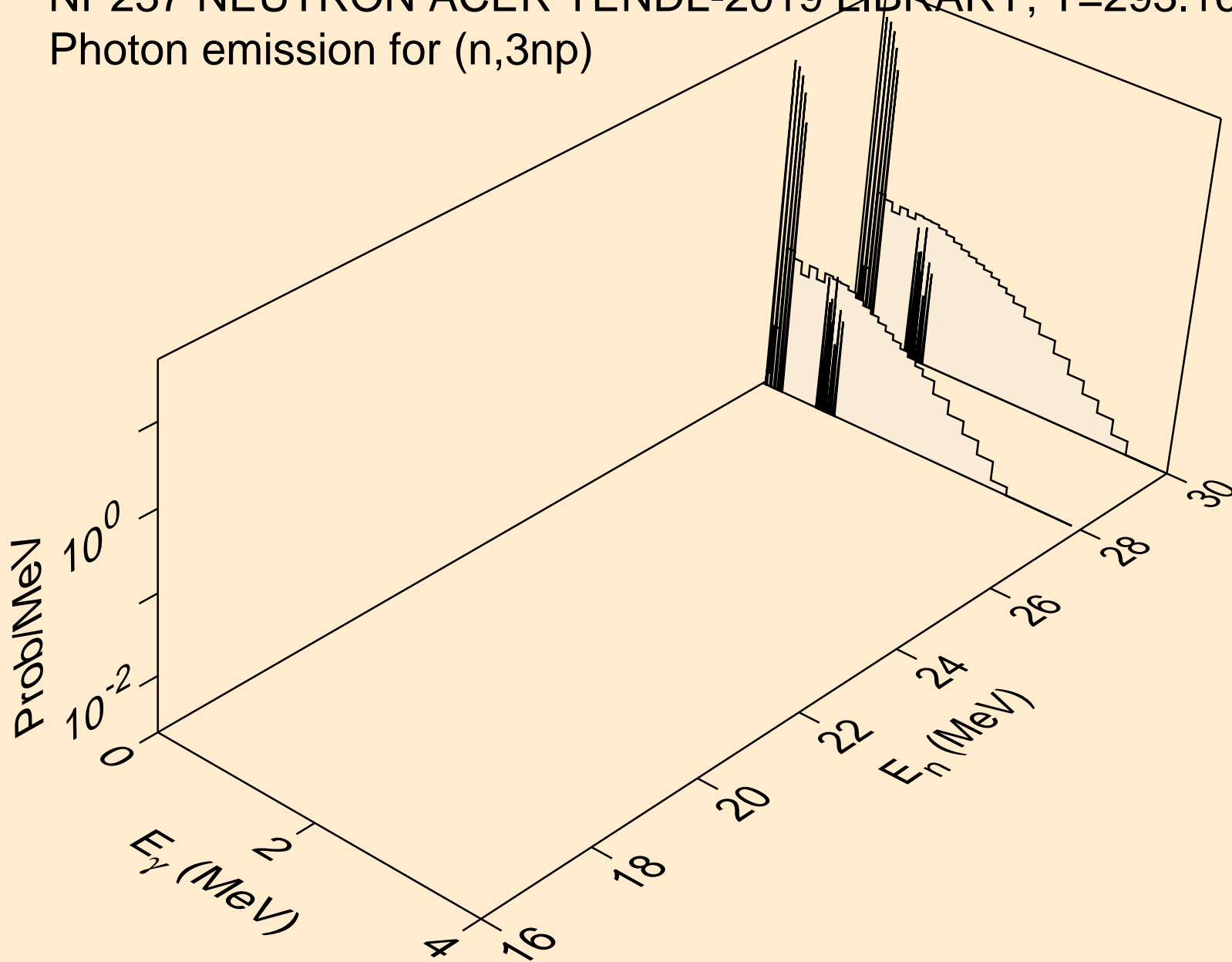

NP237 NEUTRON ACER TENDL-2019 LIBRARY; T=293.16K
Photon emission for (n,2np)

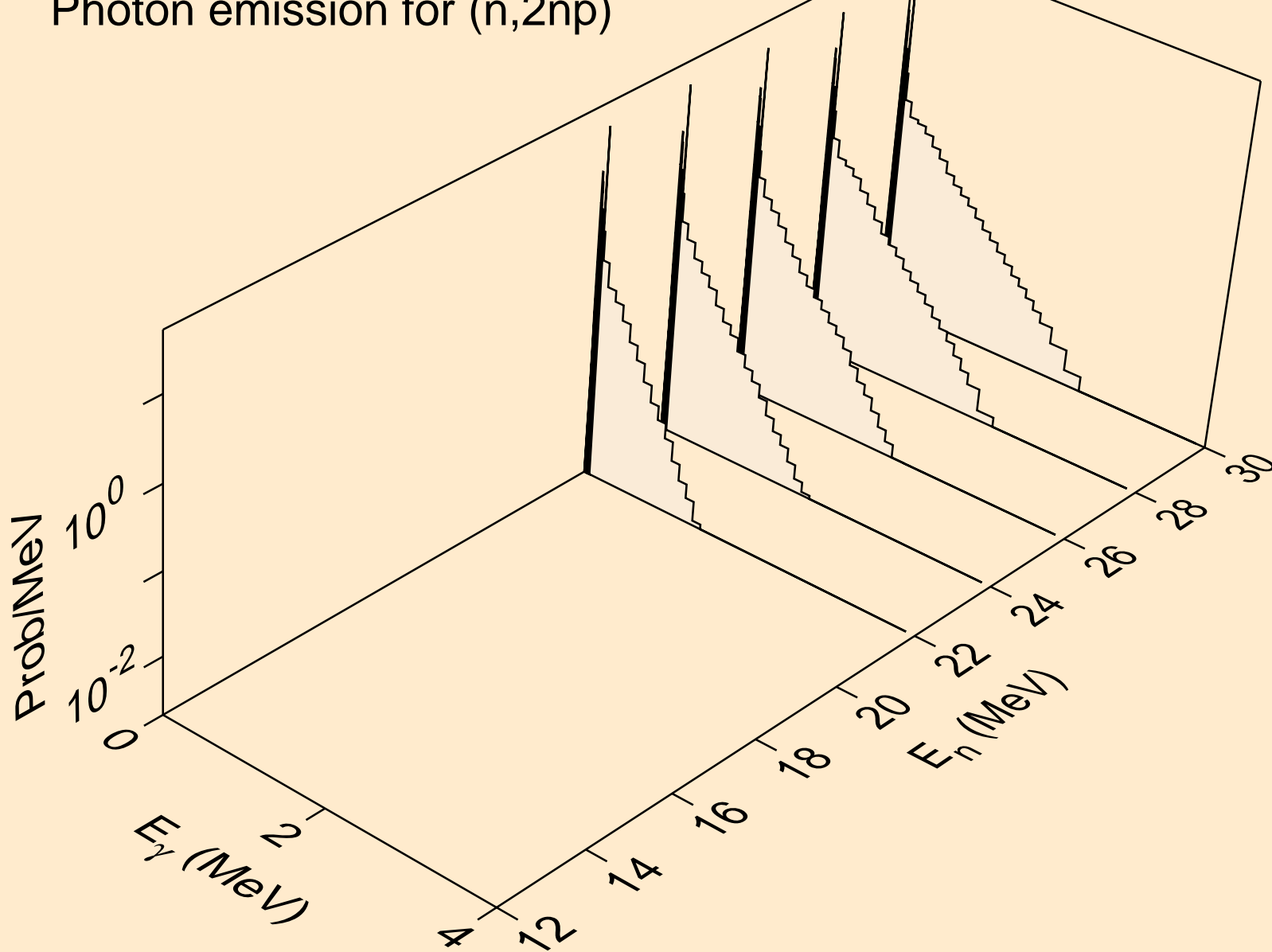

NP237 NEUTRON ACER TENDL-2019 LIBRARY; T=293.16K
Photon emission for (n,n*c)

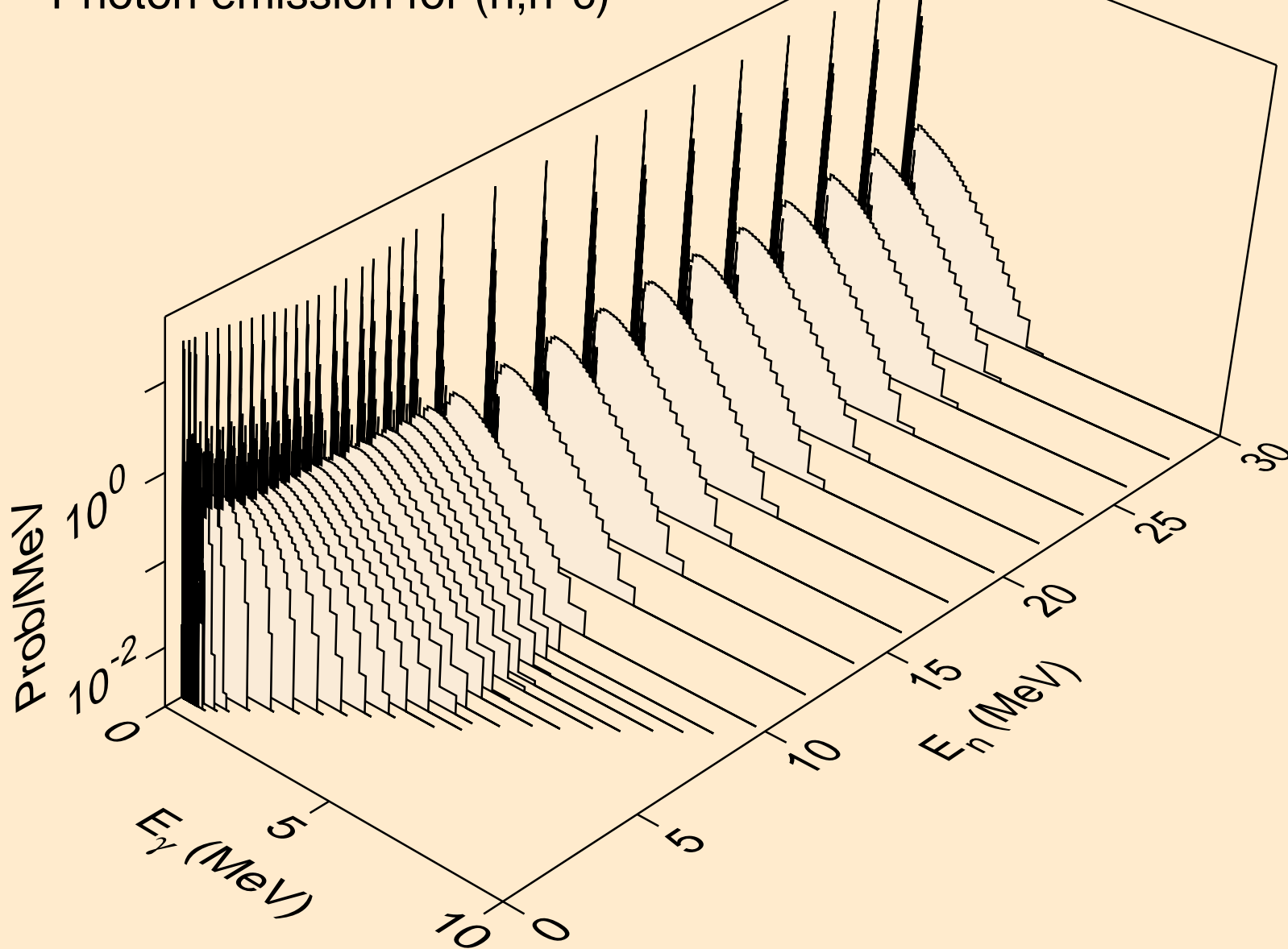

NP237 NEUTRON ACER TENDL-2019 LIBRARY; T=293.16K
Photon emission for (n,gma)

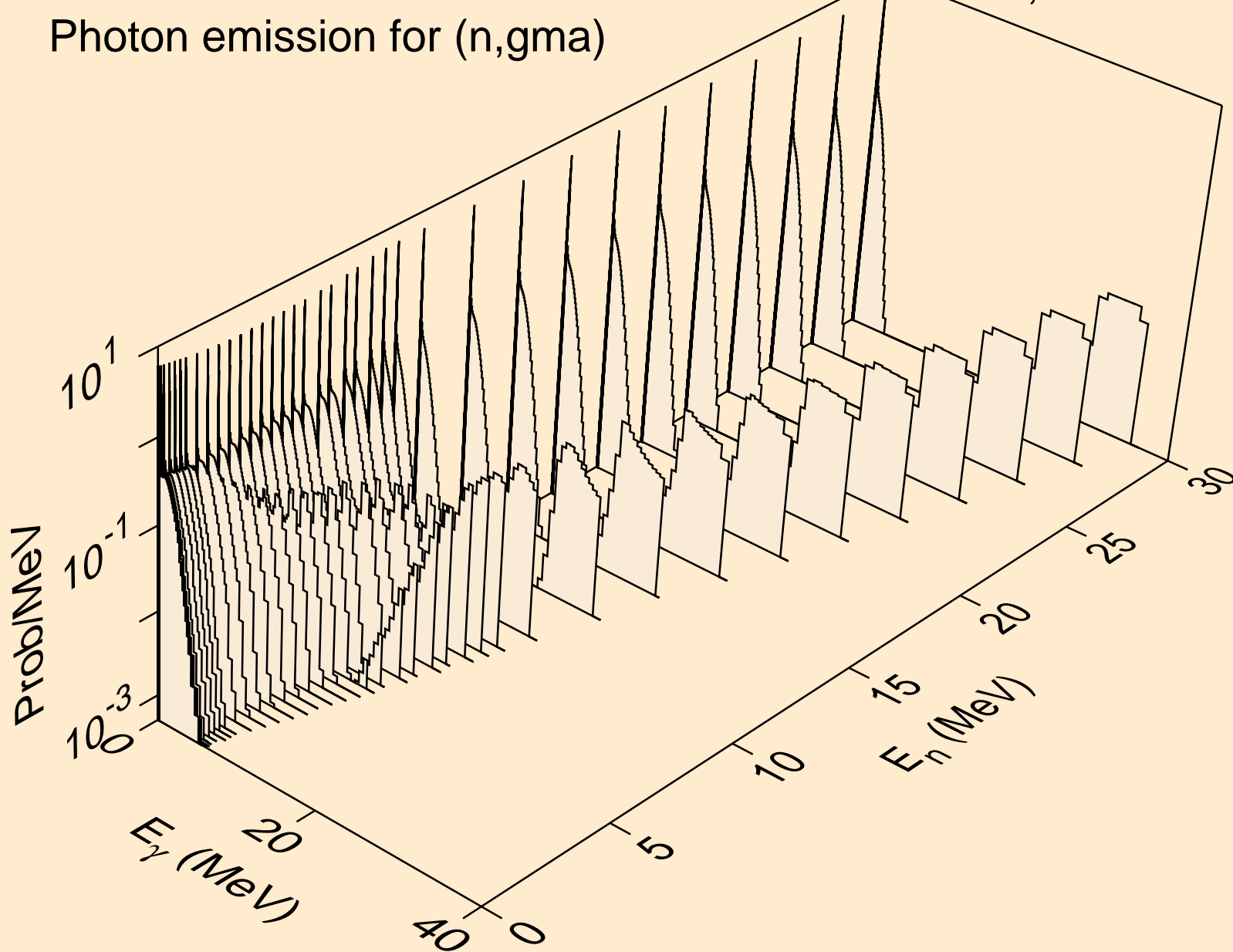

NP237 NEUTRON ACER TENDL-2019 LIBRARY; T=293.16K
Photon emission for (n,p)

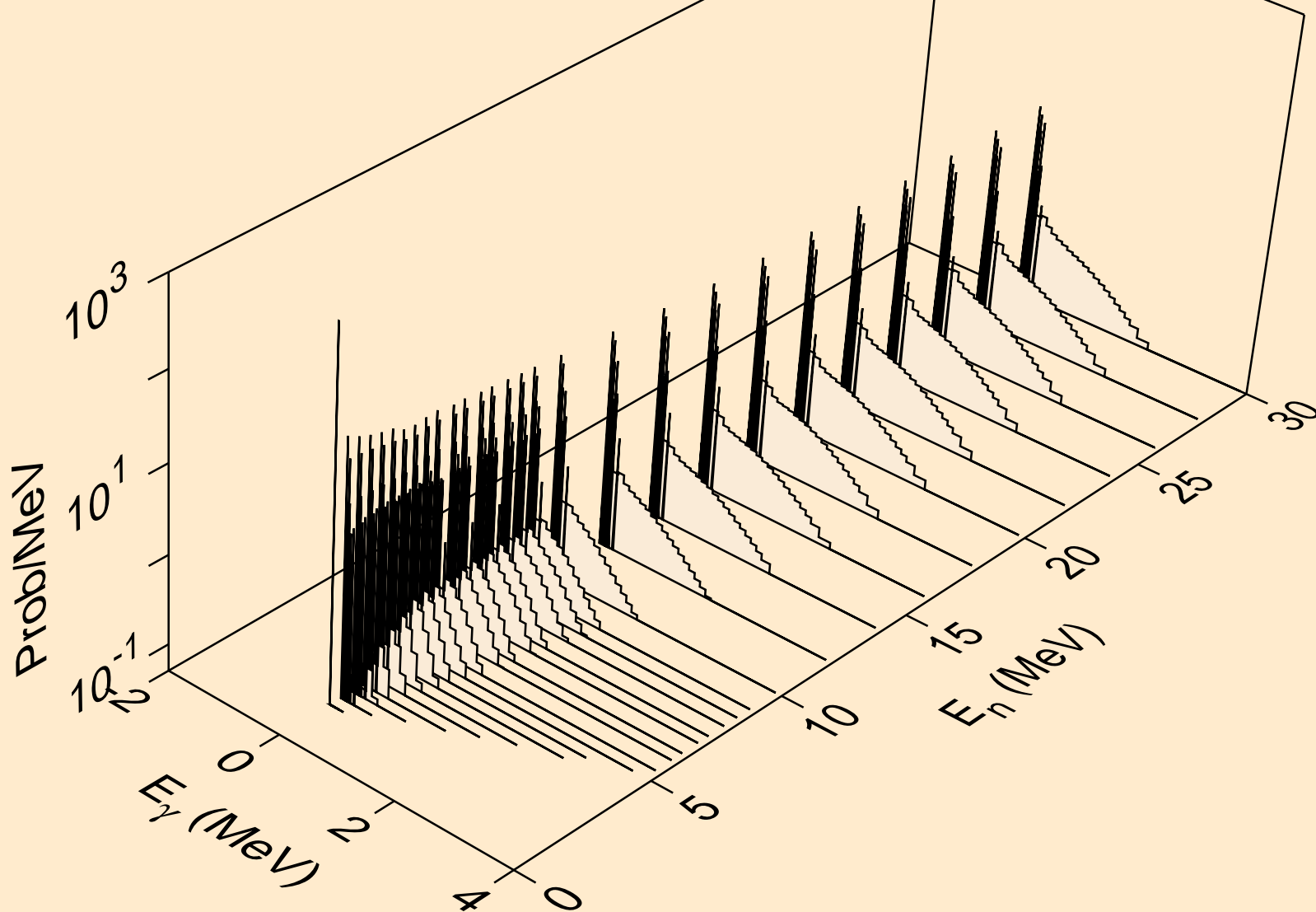

NP237 NEUTRON ACER TENDL-2019 LIBRARY; T=293.16K
Photon emission for (n,d)

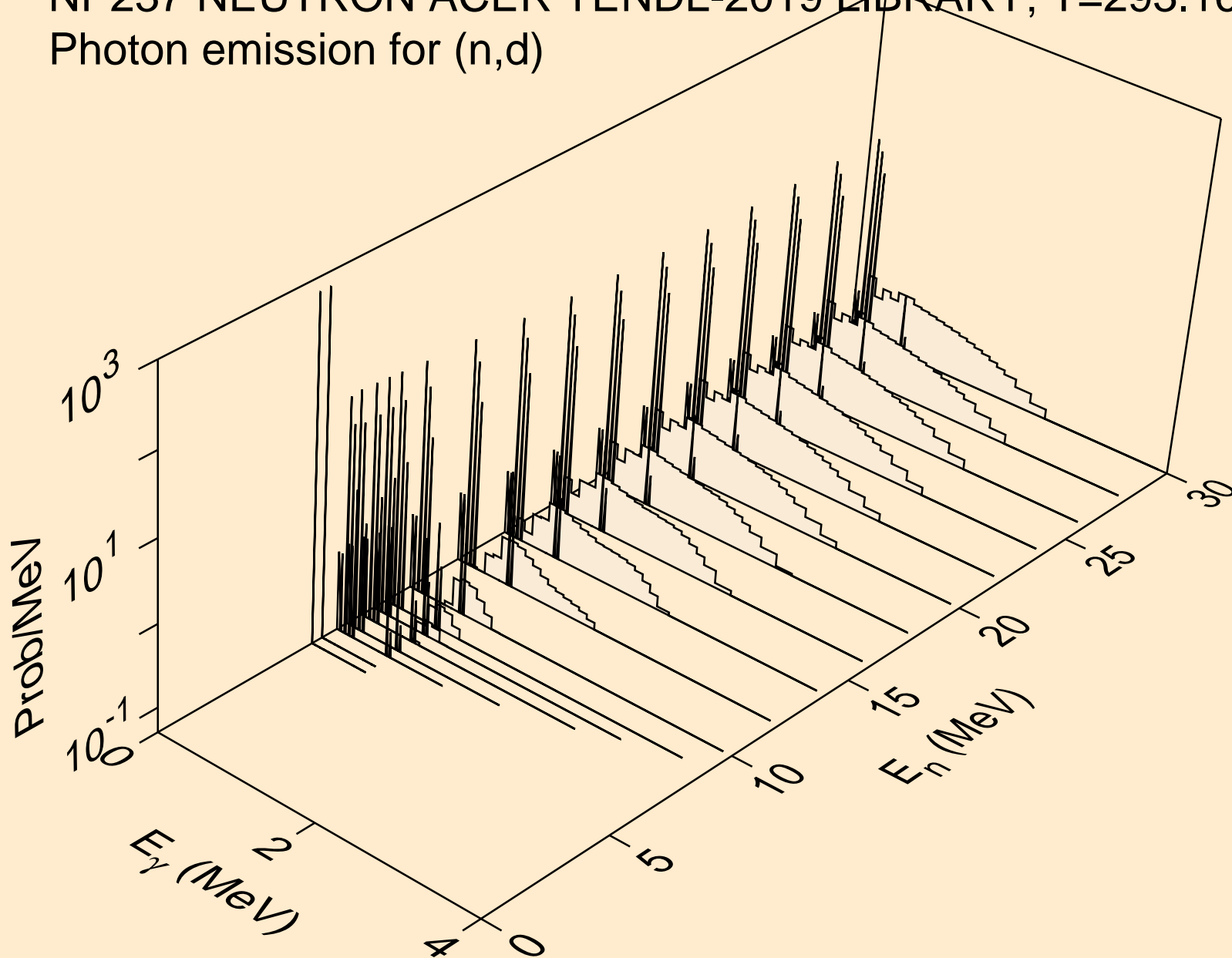

NP237 NEUTRON ACER TENDL-2019 LIBRARY; T=293.16K
Photon emission for (n,t)

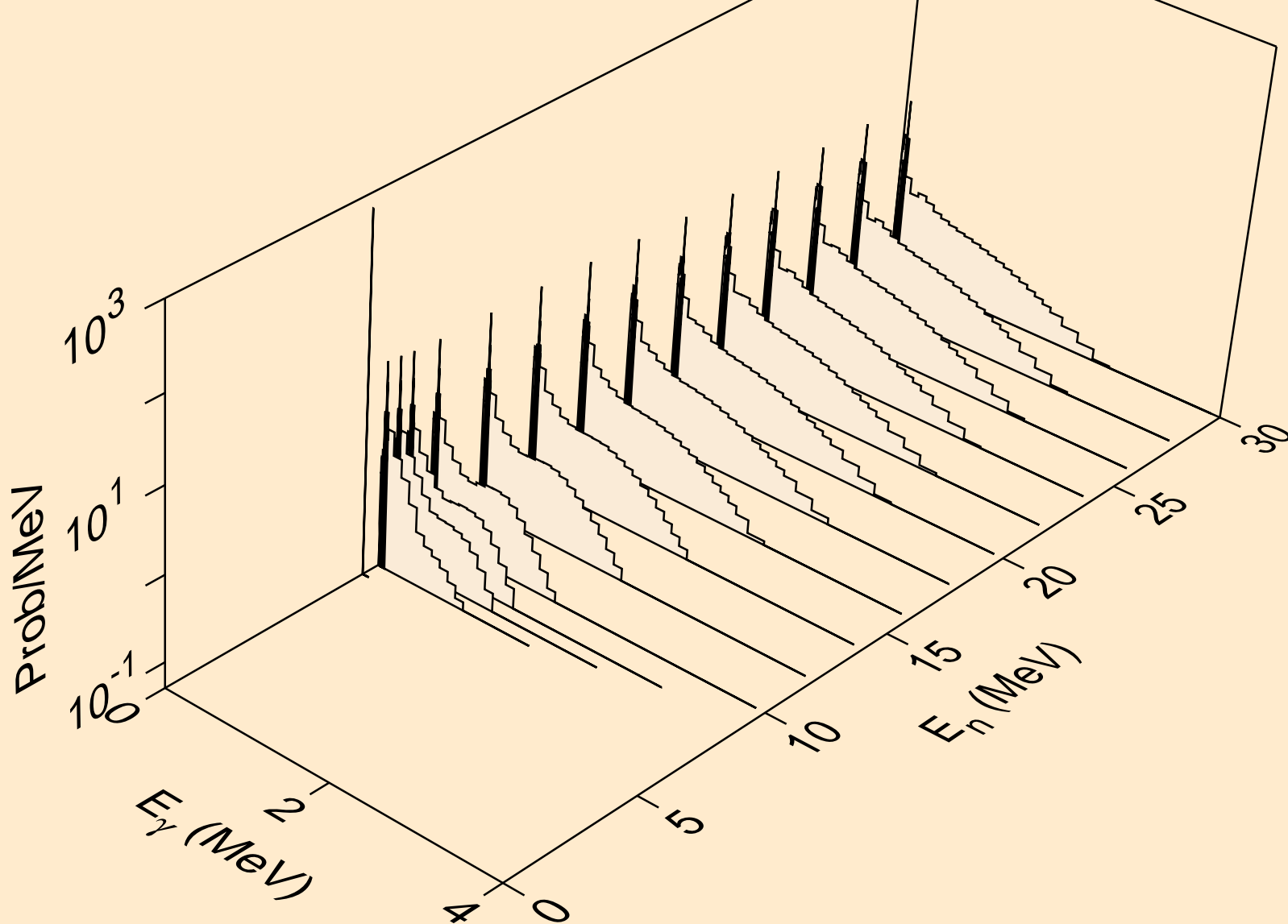

NP237 NEUTRON ACER TENDL-2019 LIBRARY; T=293.16K
Photon emission for (n,he3)

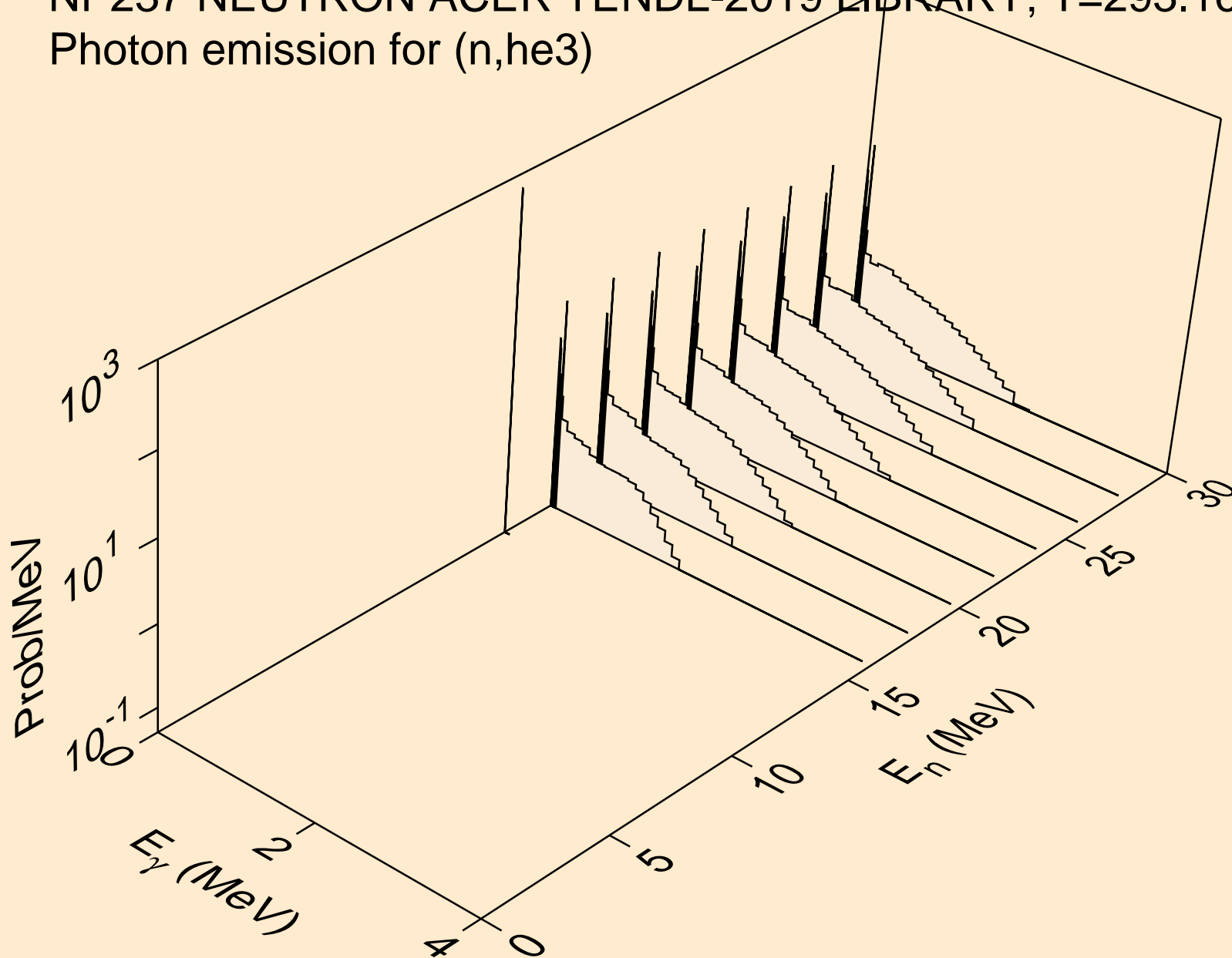

NP237 NEUTRON ACER TENDL-2019 LIBRARY; T=293.16K
Photon emission for (n,a)

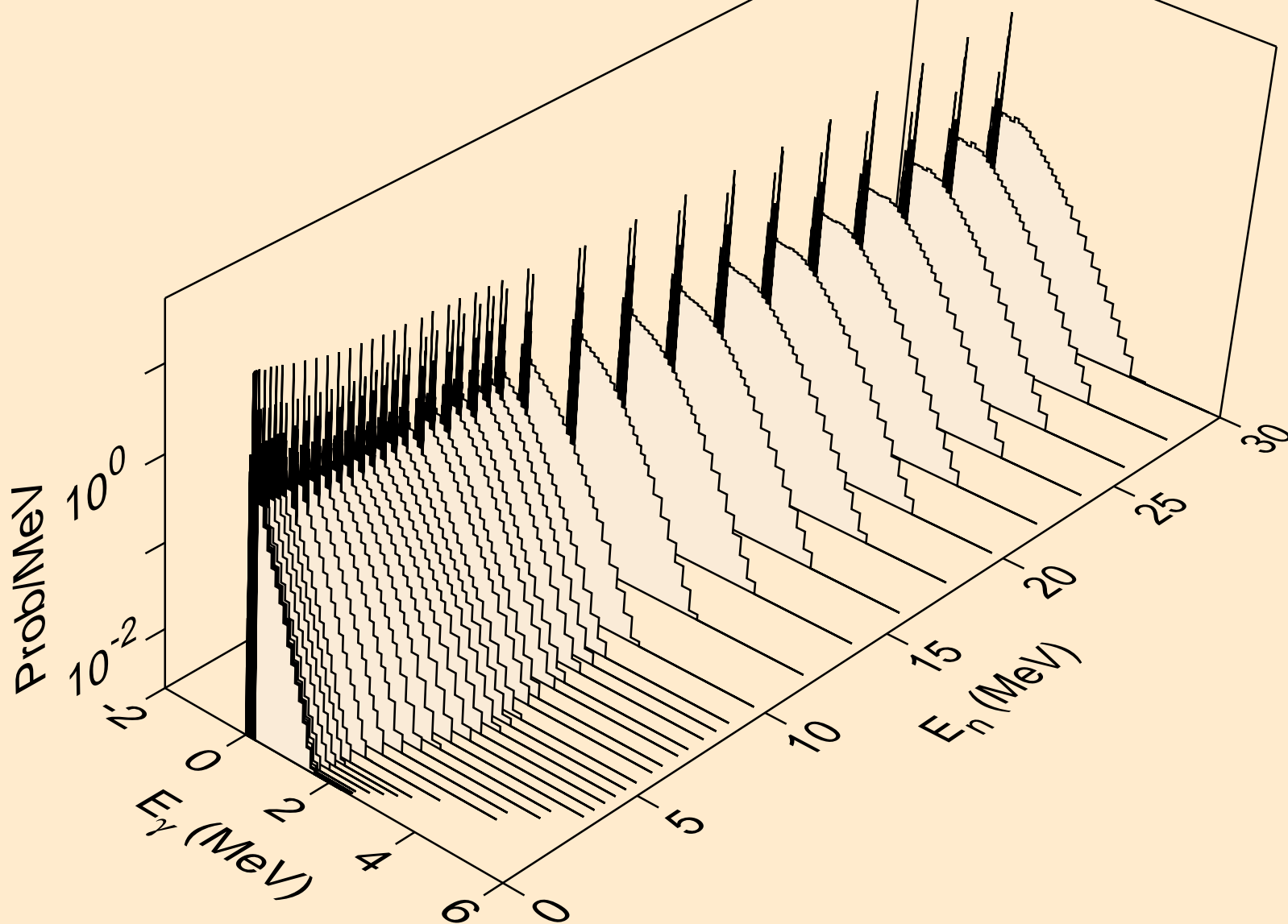

NP237 NEUTRON ACER TENDL-2019 LIBRARY; T=293.16K
Photon emission for (n,2p)

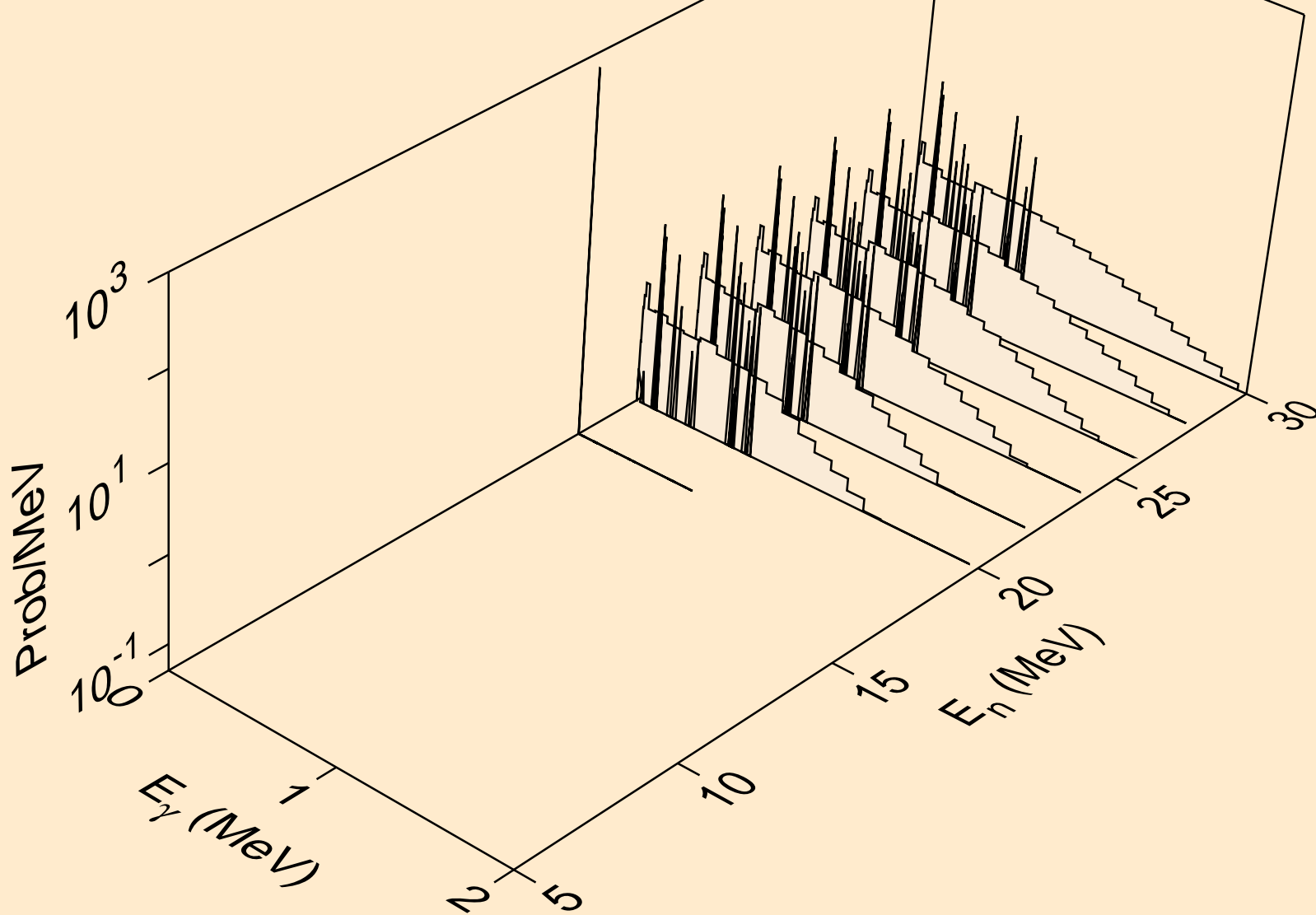

NP237 NEUTRON ACER TENDL-2019 LIBRARY; T=293.16K
thermal capture photon spectrum

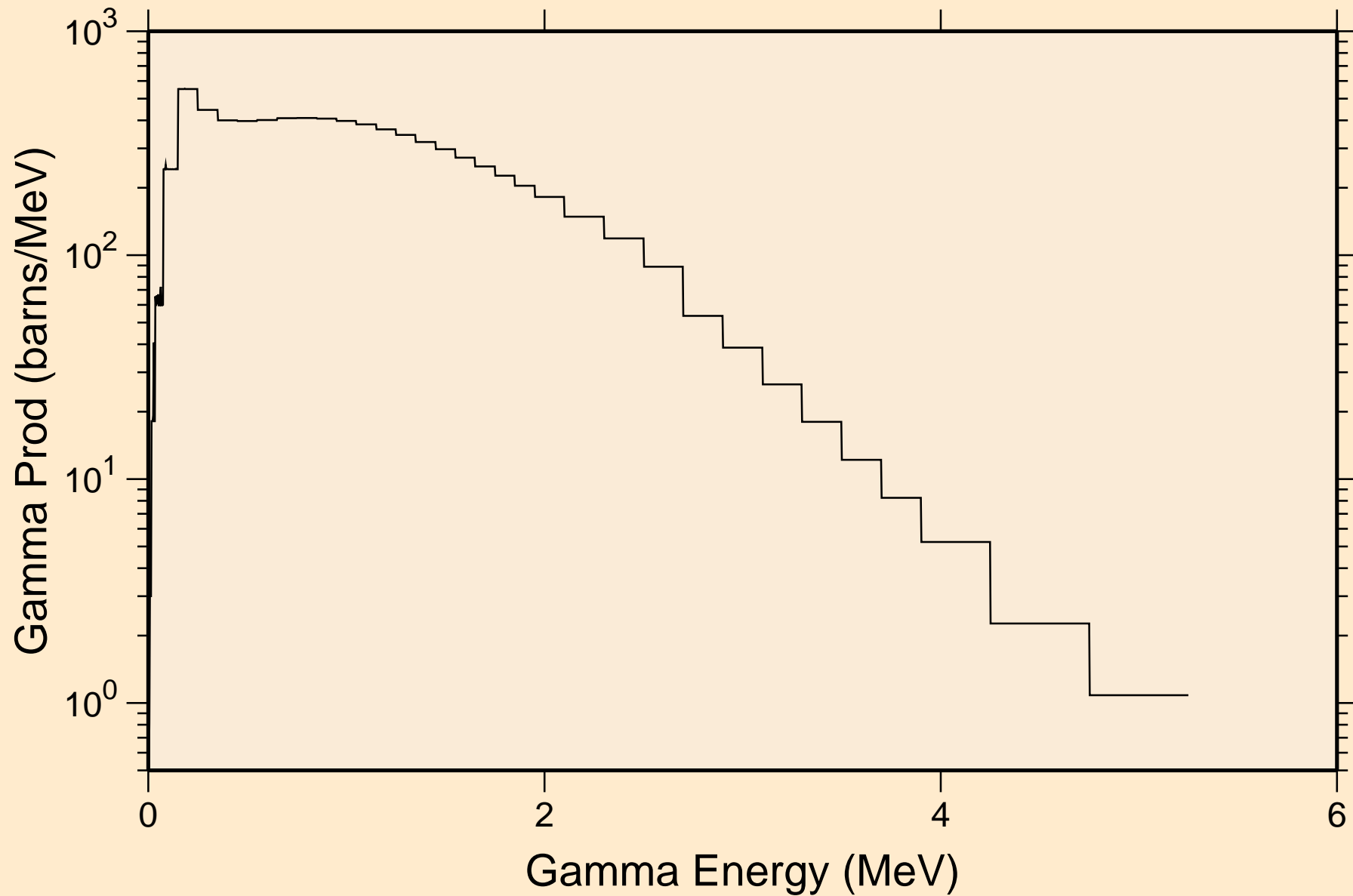

NP237 NEUTRON ACER TENDL-2019 LIBRARY; T=293.16K
14 MeV photon spectrum

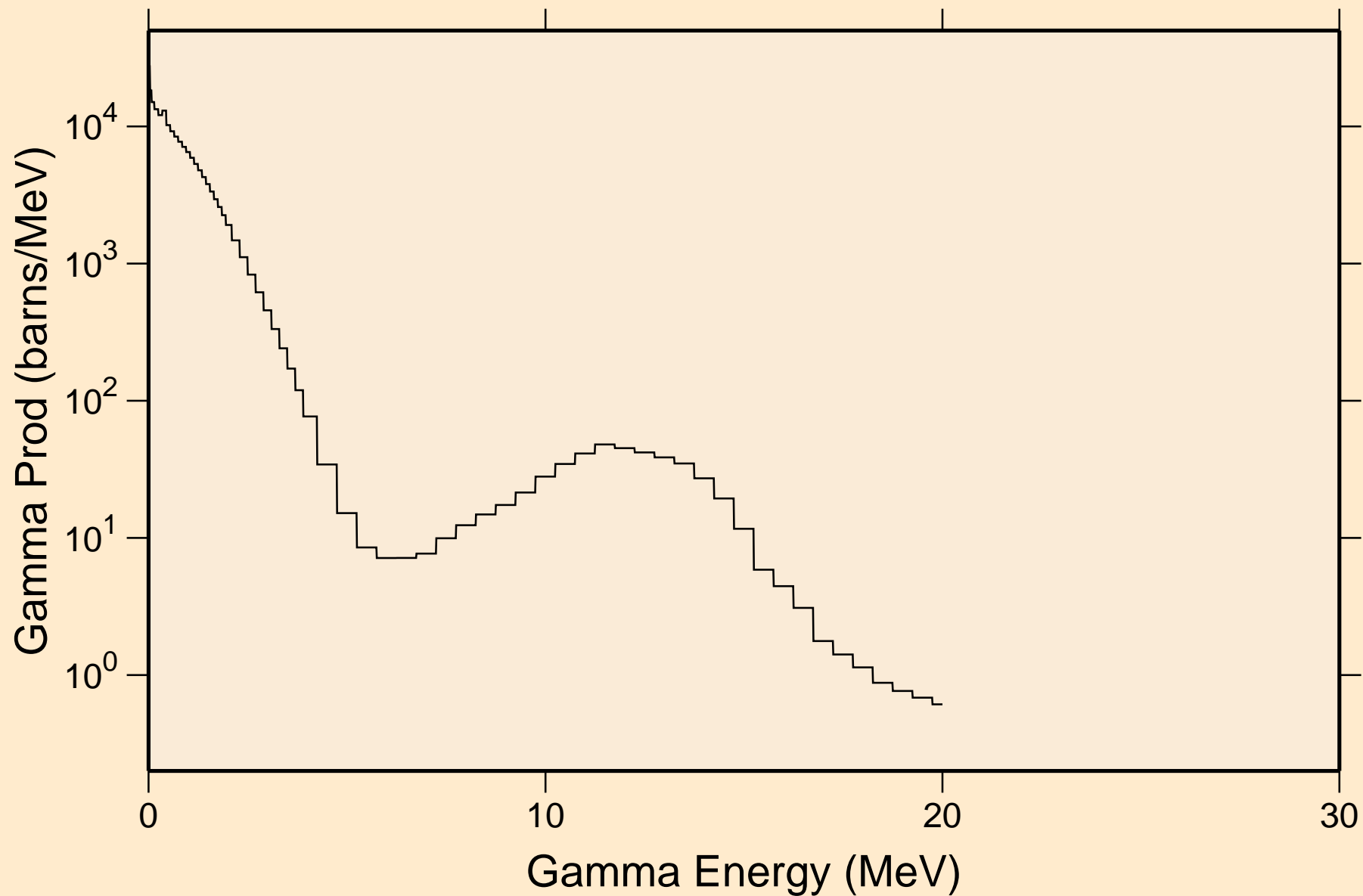

NP237 NEUTRON ACER TENDL-2019 LIBRARY; T=293.16K
Particle heating contributions

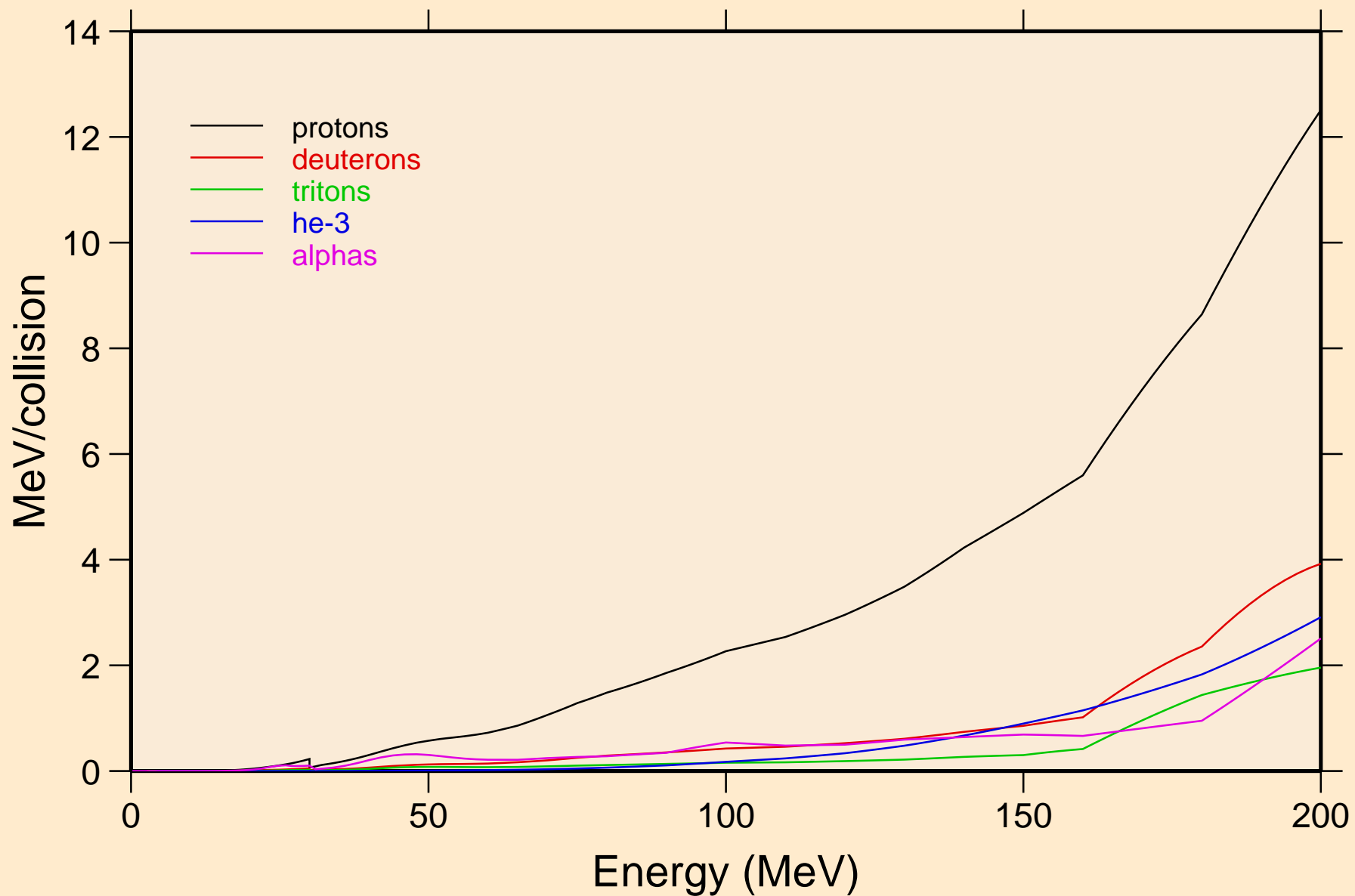

NP237 NEUTRON ACER TENDL-2019 LIBRARY; T=293.16K
Recoil Heating

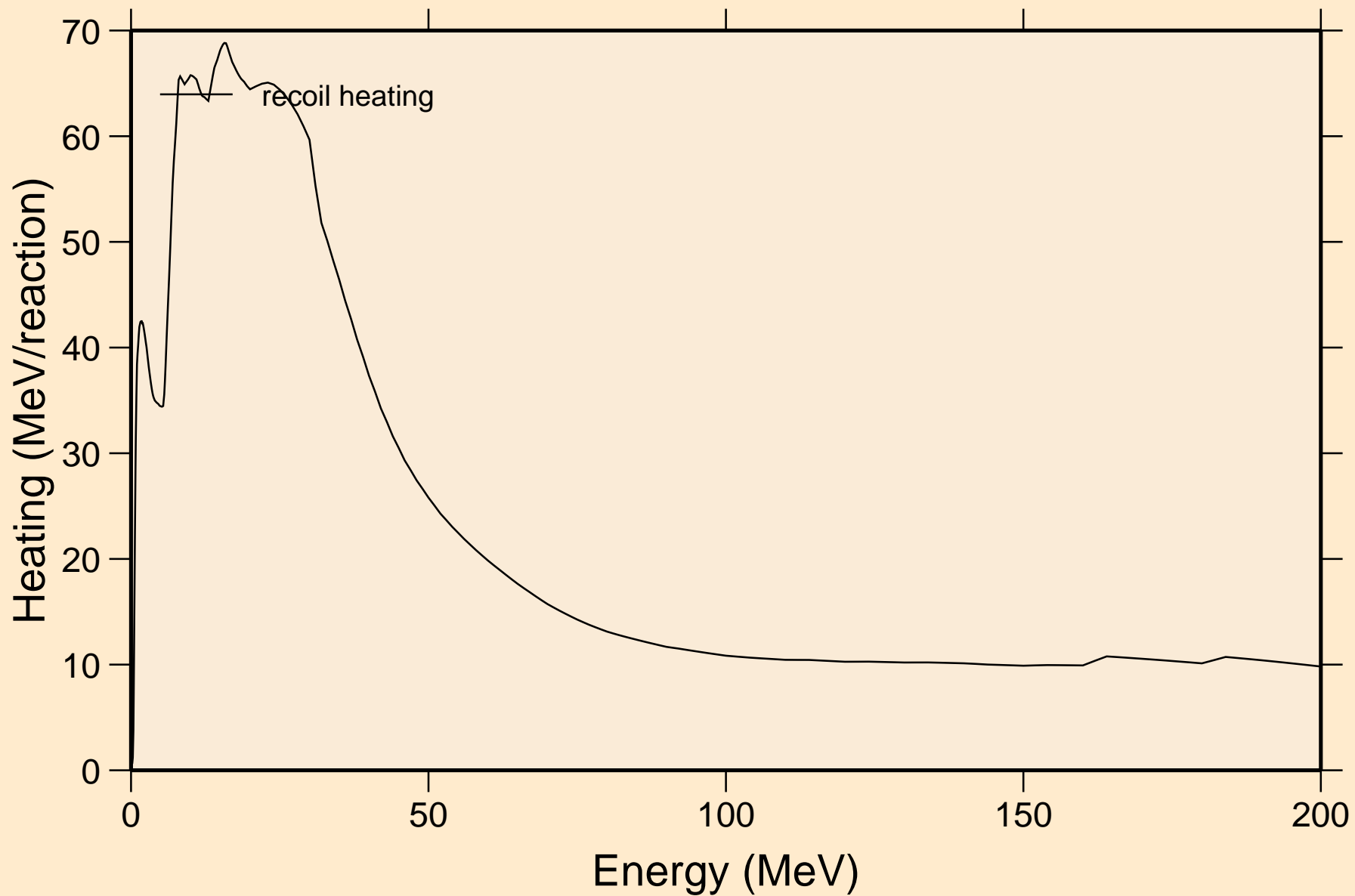

NP237 NEUTRON ACER TENDL-2019 LIBRARY; T=293.16K
Particle production cross sections

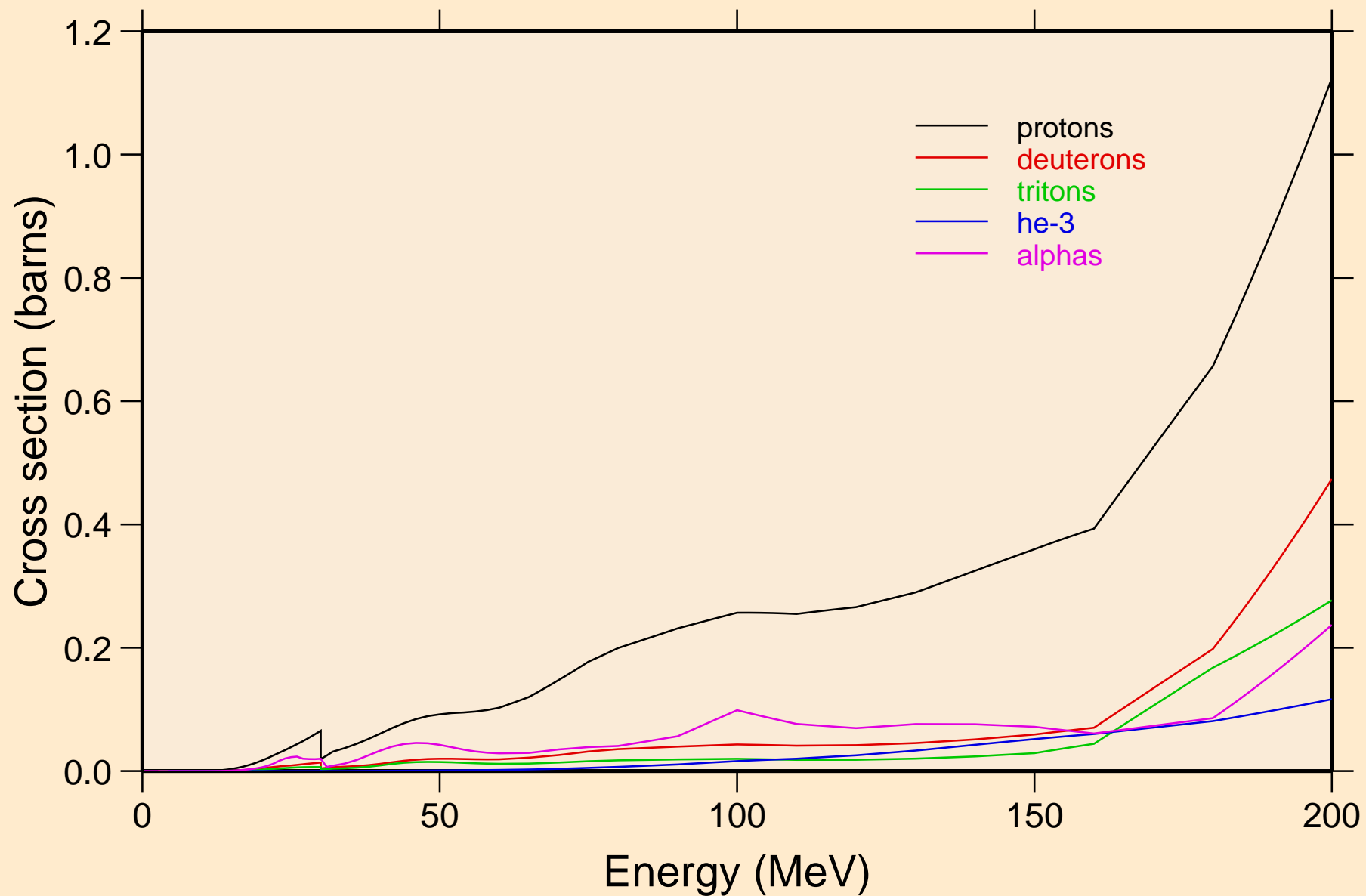

NP237 NEUTRON ACER TENDL-2019 LIBRARY; T=293.16K
protons from (n,x)

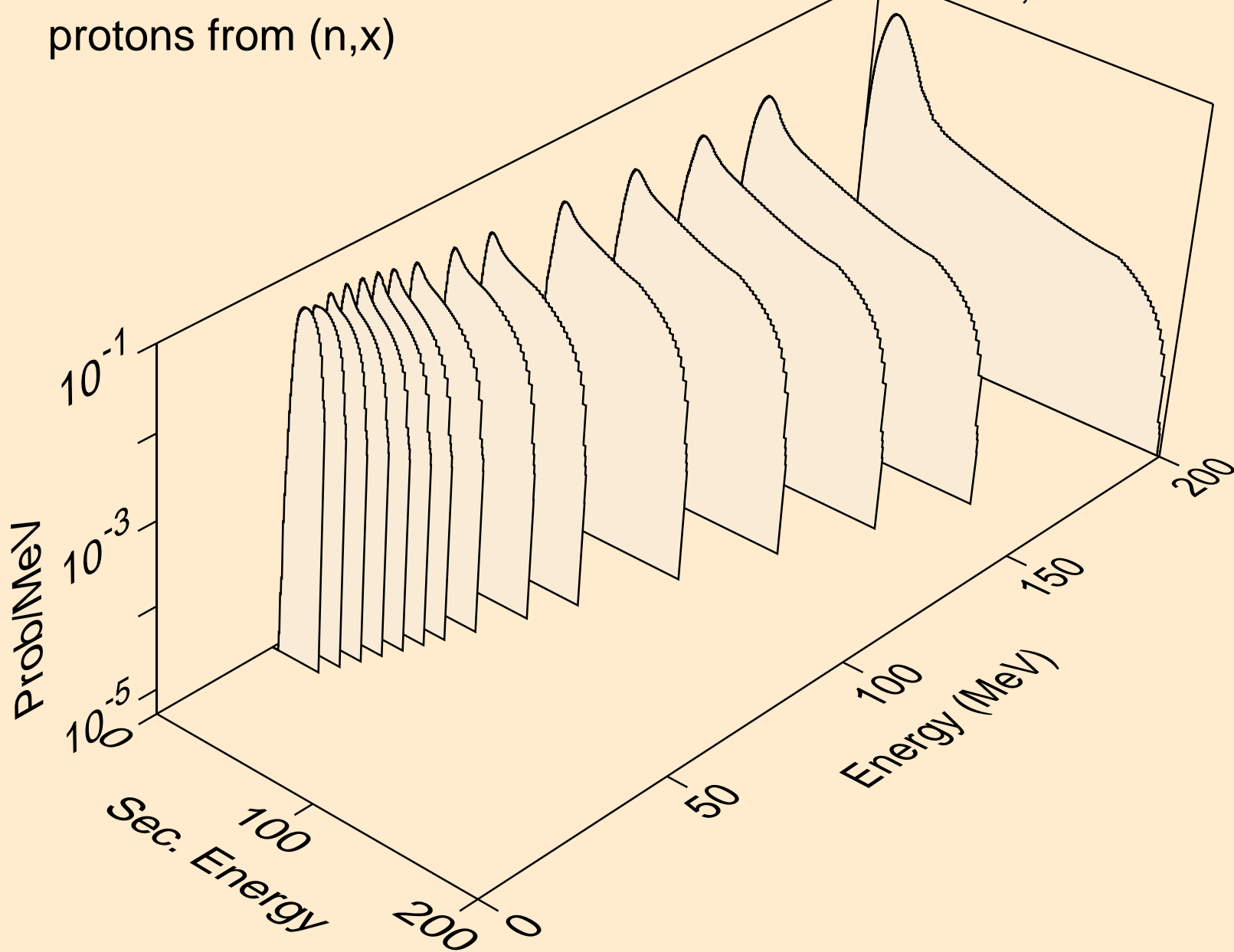

NP237 NEUTRON ACER TENDL-2019 LIBRARY; T=293.16K
protons from (n,n*)p

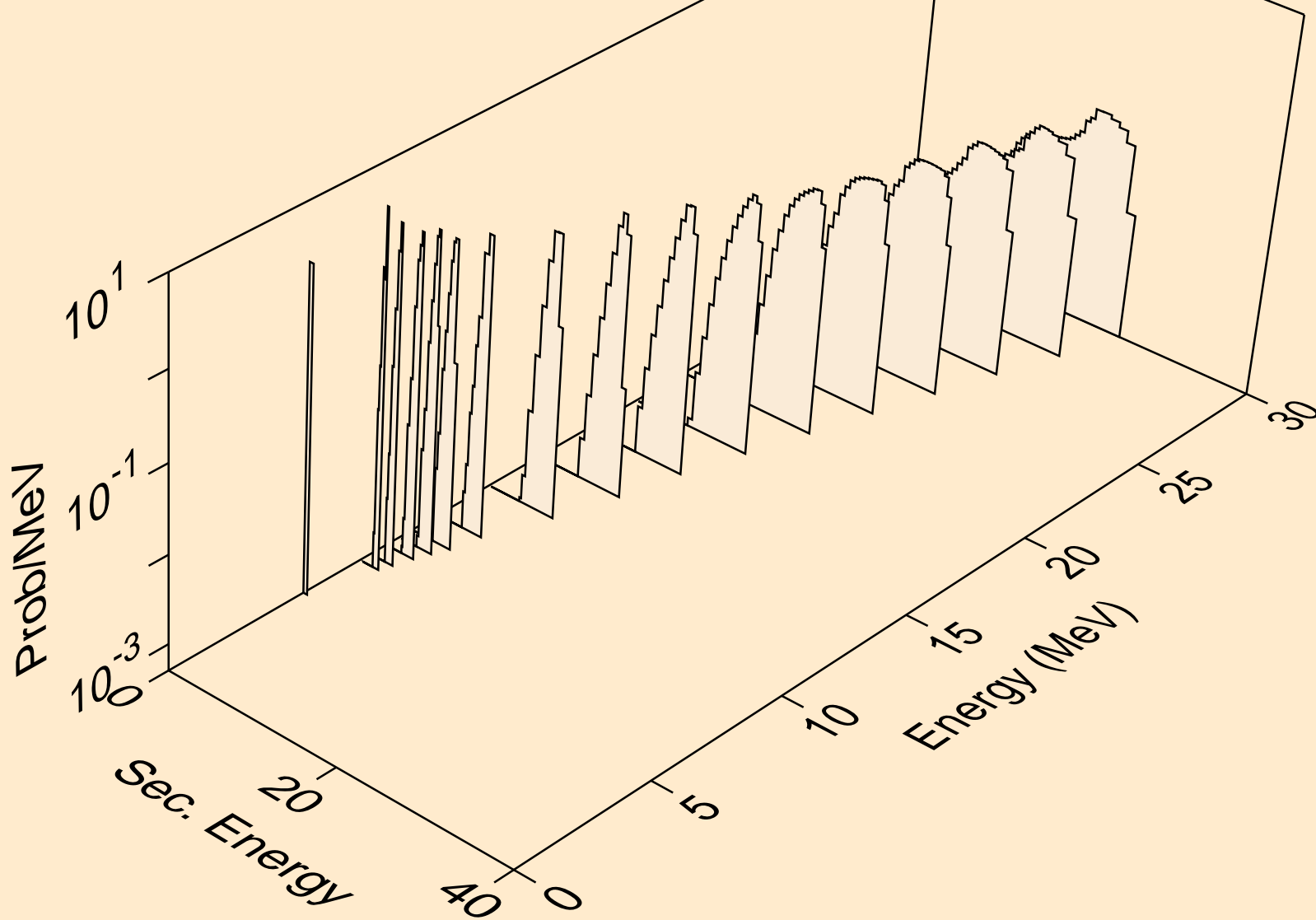

NP237 NEUTRON ACER TENDL-2019 LIBRARY; T=293.16K
protons from (n,2np)

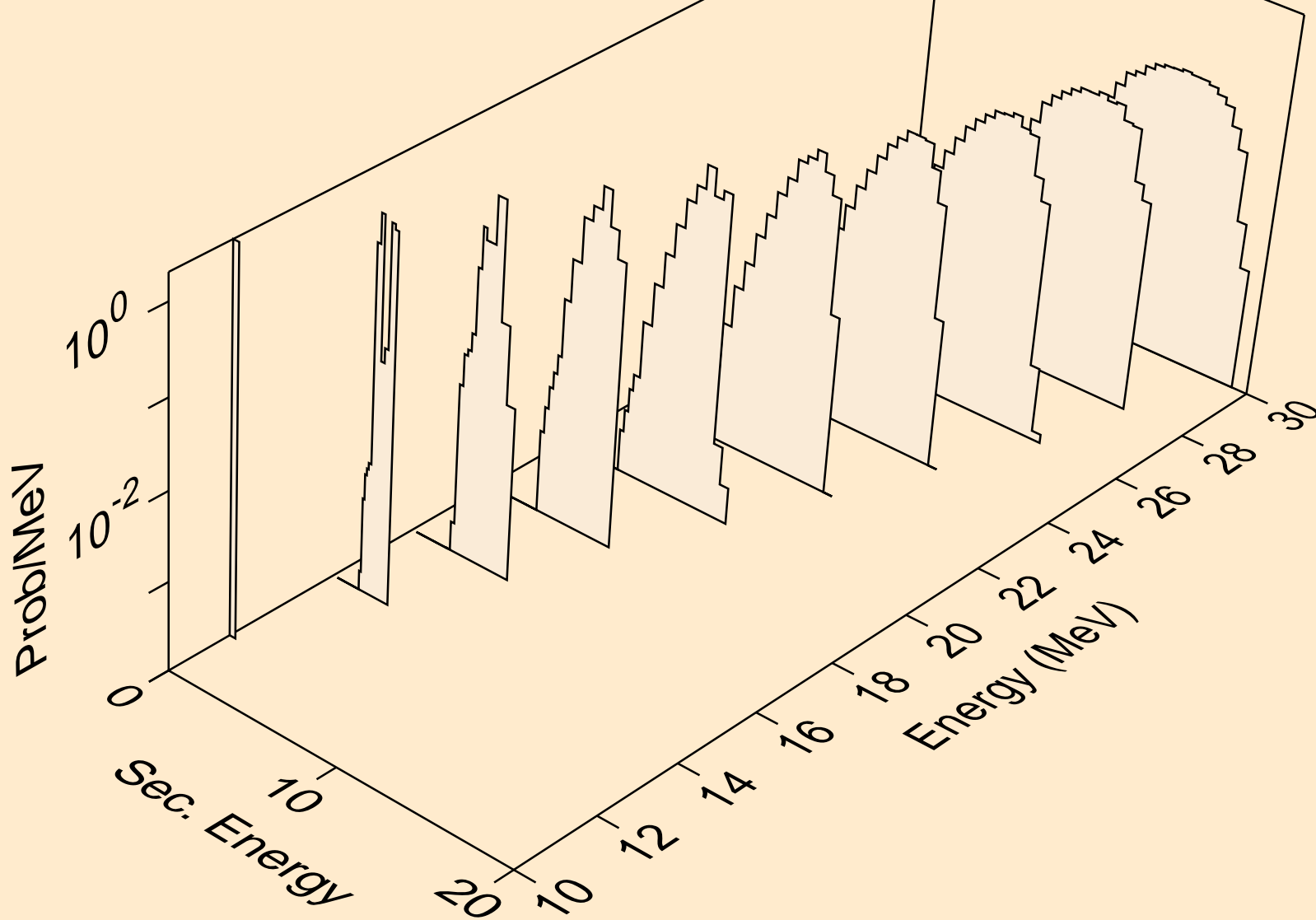

NP237 NEUTRON ACER TENDL-2019 LIBRARY; T=293.16K
protons from (n,3np)

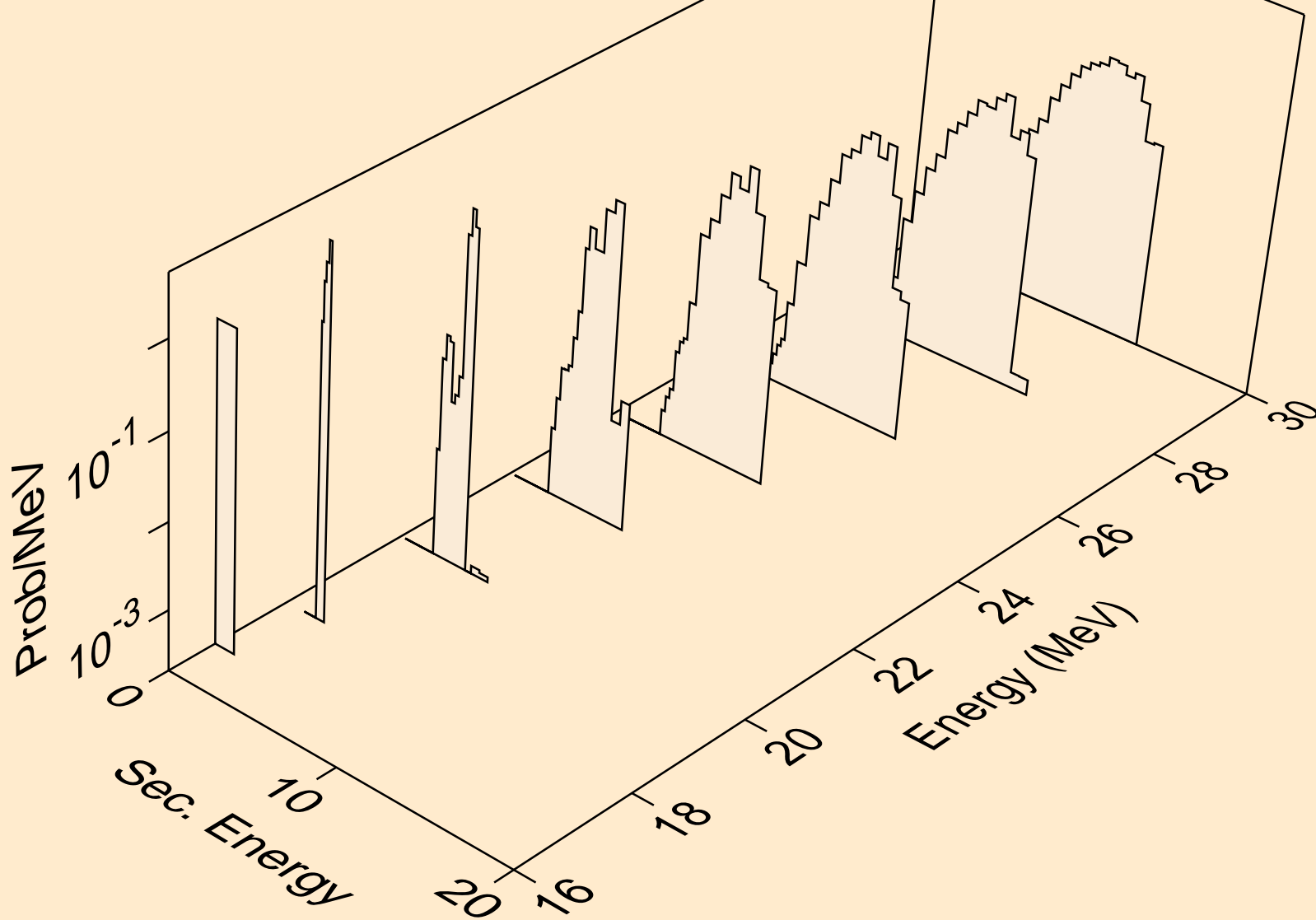

NP237 NEUTRON ACER TENDL-2019 LIBRARY; T=293.16K
protons from (n,2np)

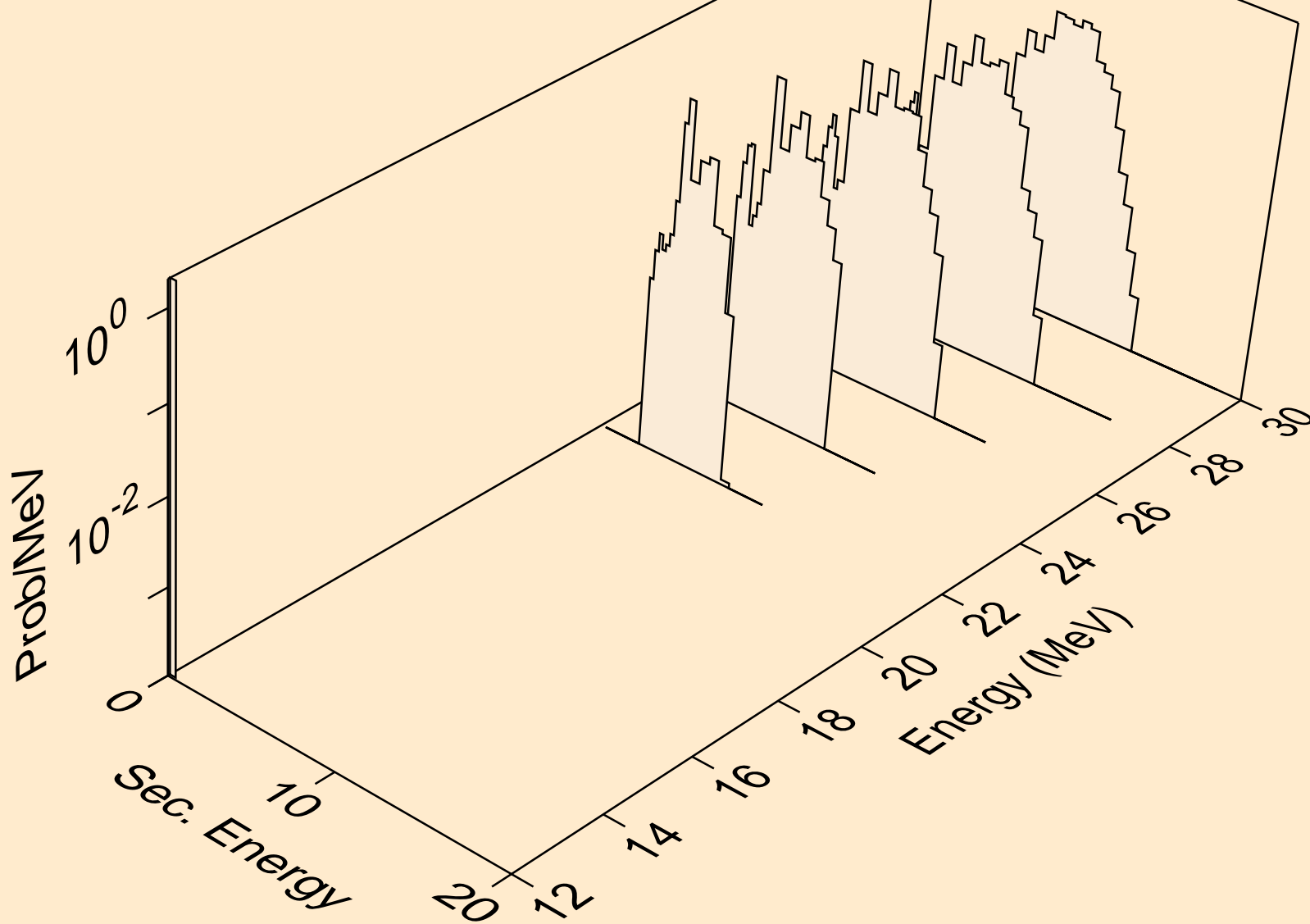

NP237 NEUTRON ACER TENDL-2019 LIBRARY; T=293.16K
protons from (n,p)

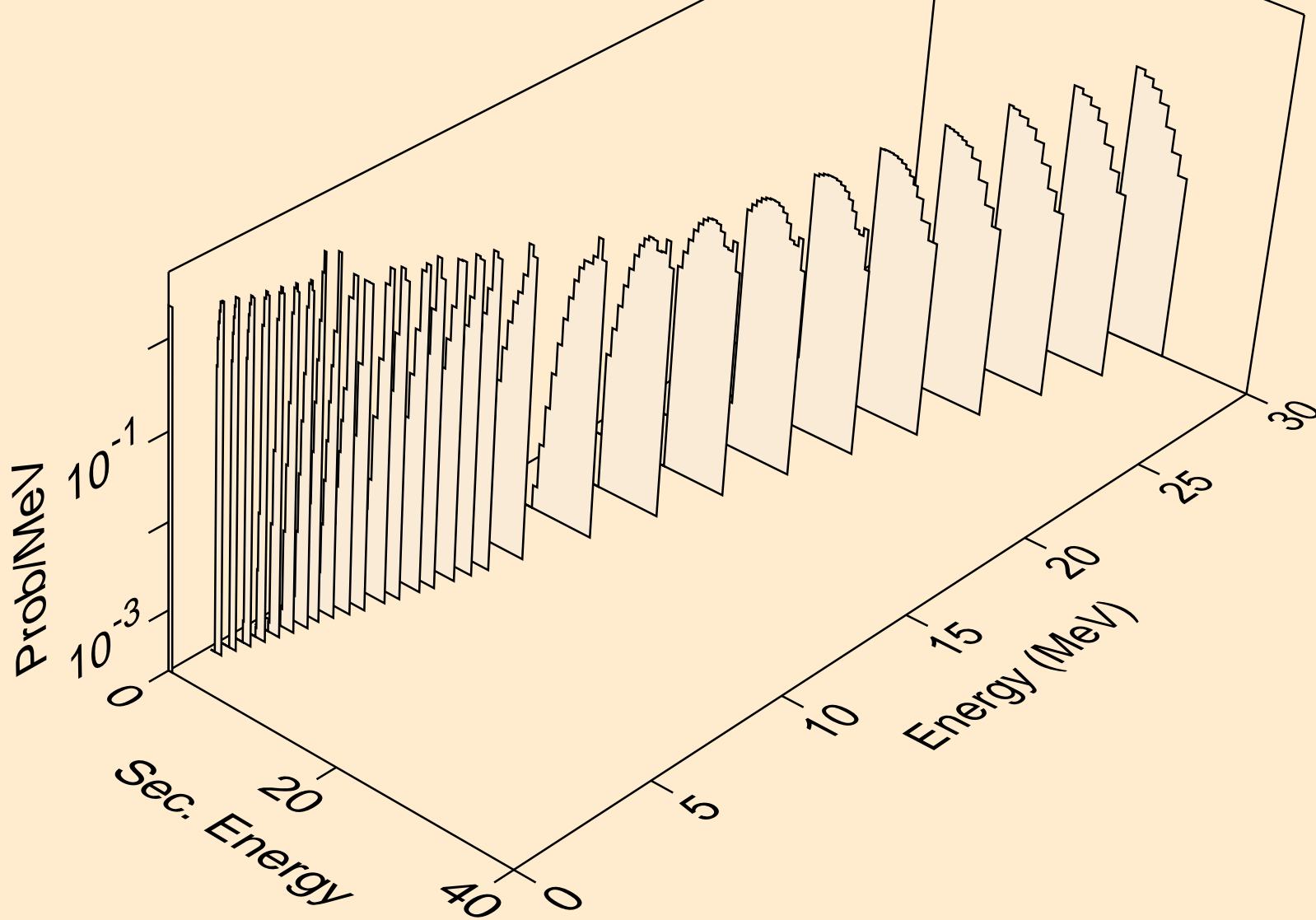

NP237 NEUTRON ACER TENDL-2019 LIBRARY; T=293.16K
protons from (n,2p)

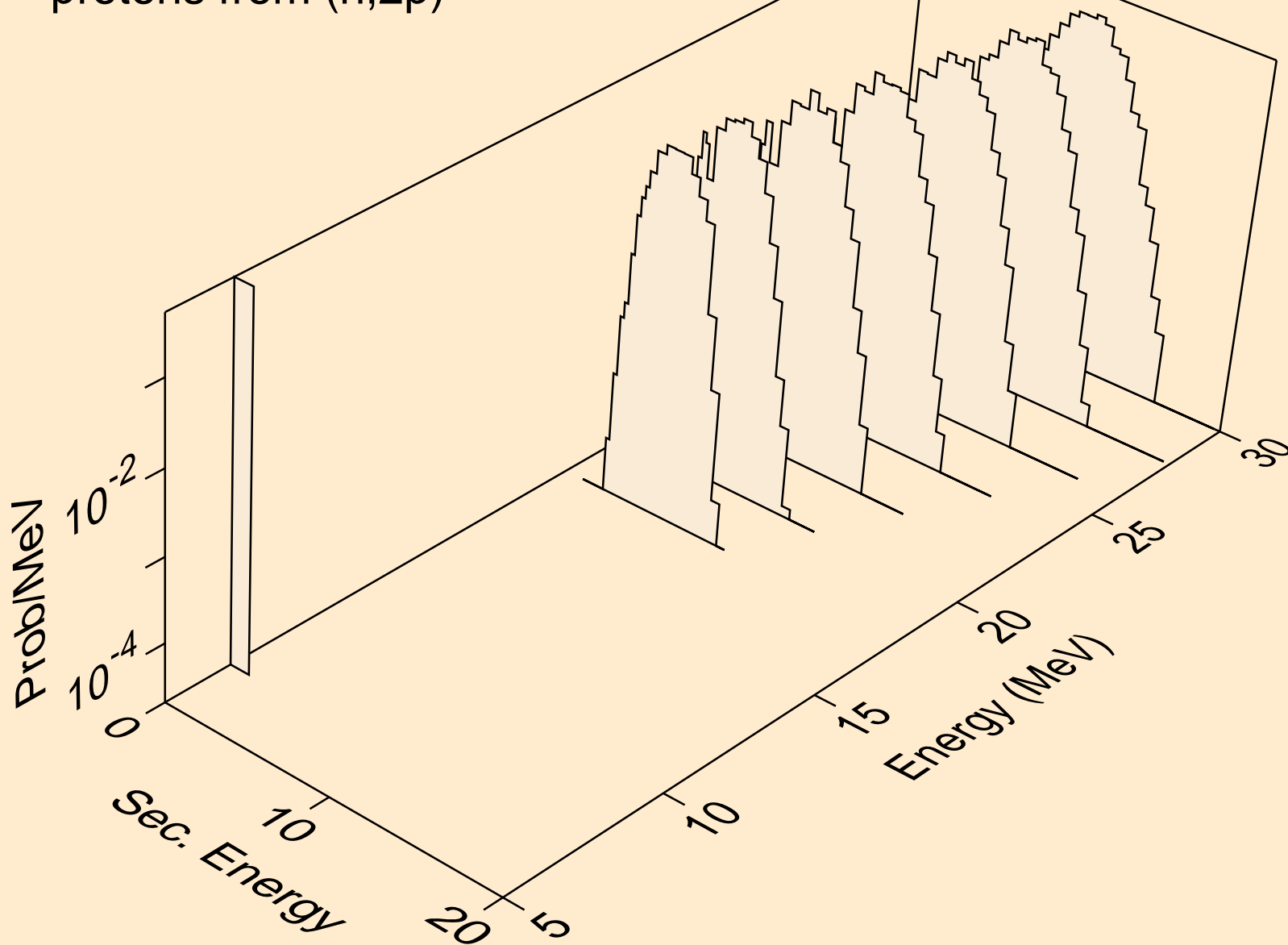

NP237 NEUTRON ACER TENDL-2019 LIBRARY; T=293.16K
deuterons from (n,x)

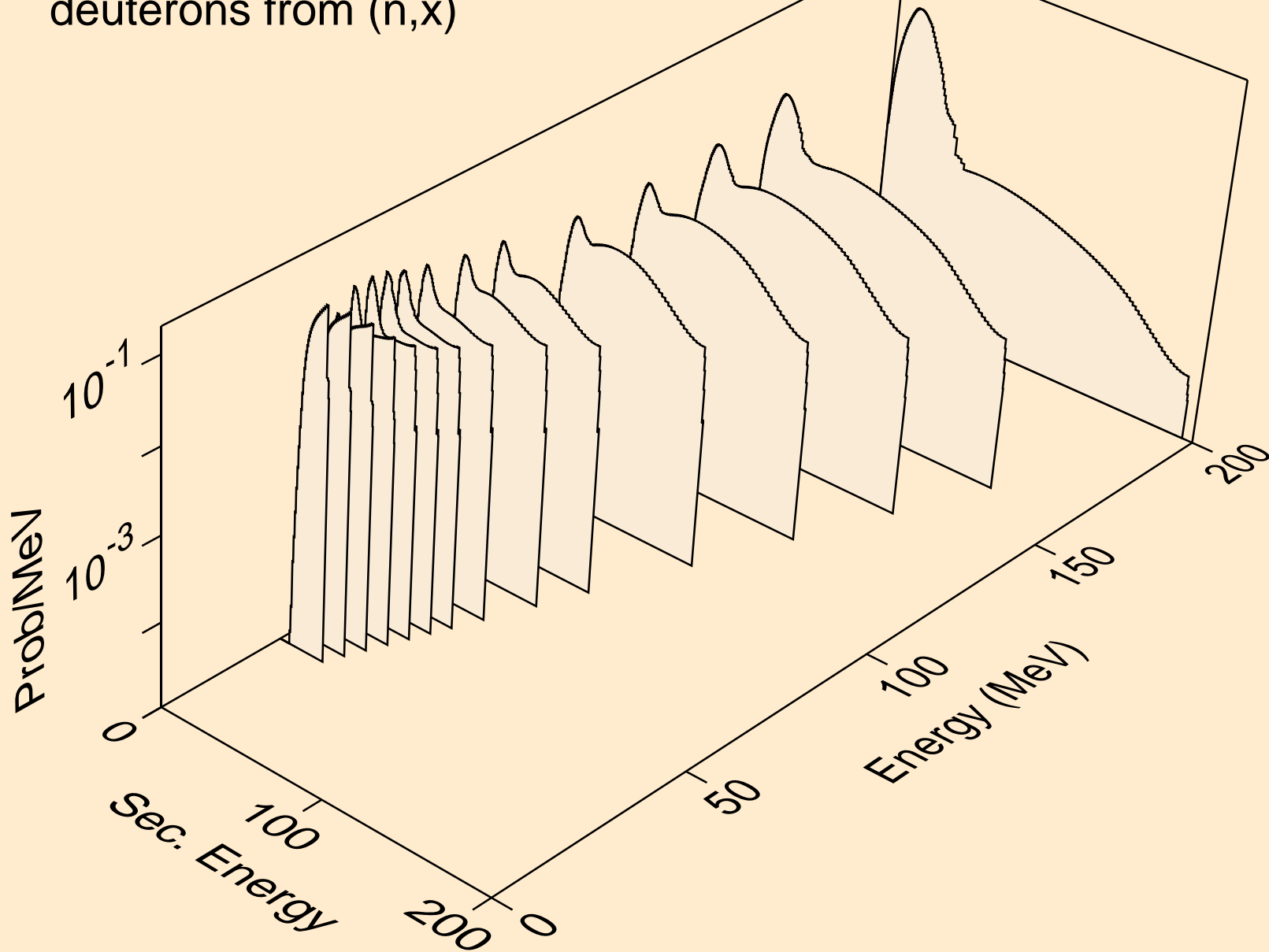

NP237 NEUTRON ACER TENDL-2019 LIBRARY; T=293.16K
deuterons from (n,2nd)

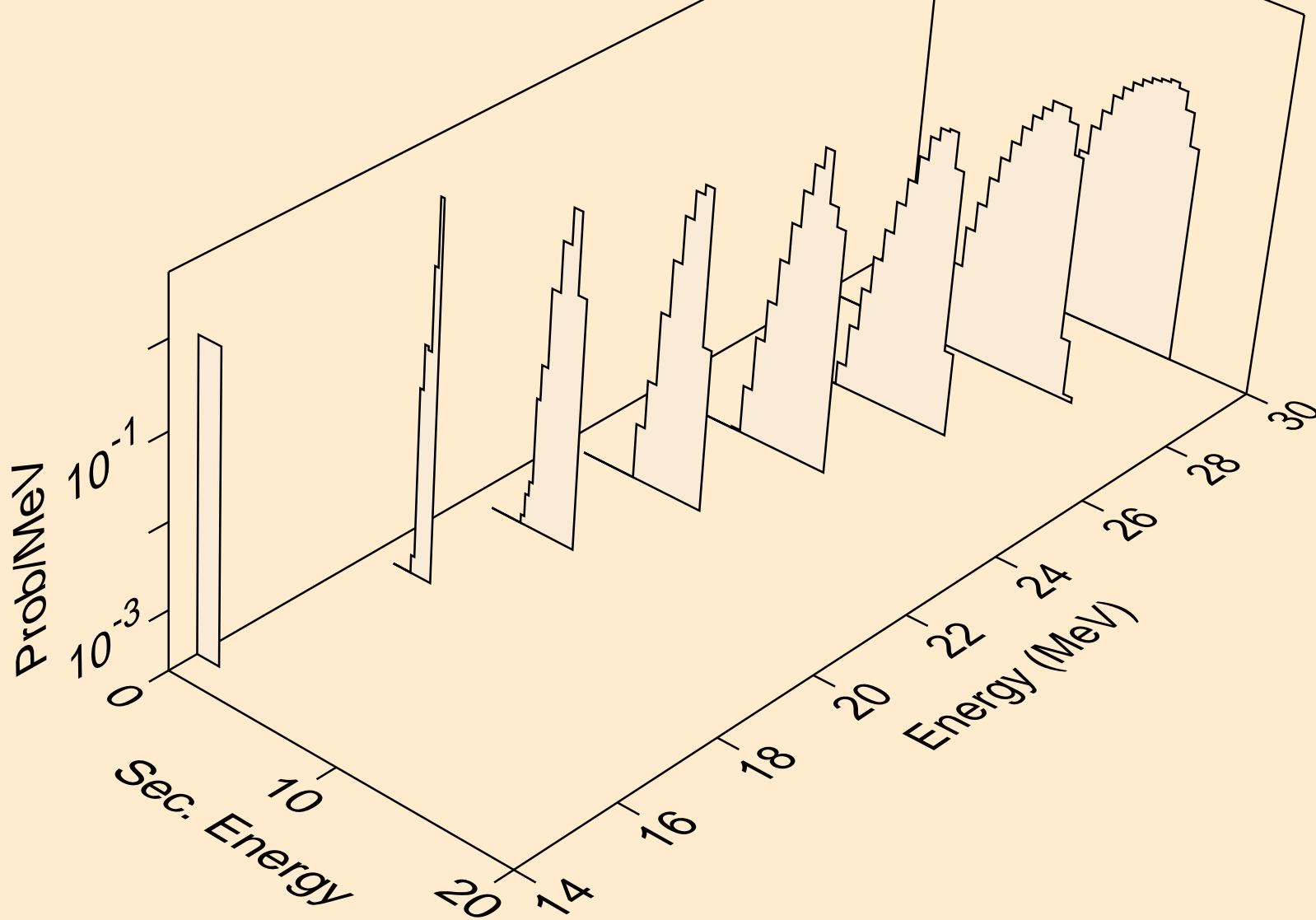

NP237 NEUTRON ACER TENDL-2019 LIBRARY; T=293.16K
deuterons from (n,n*)d

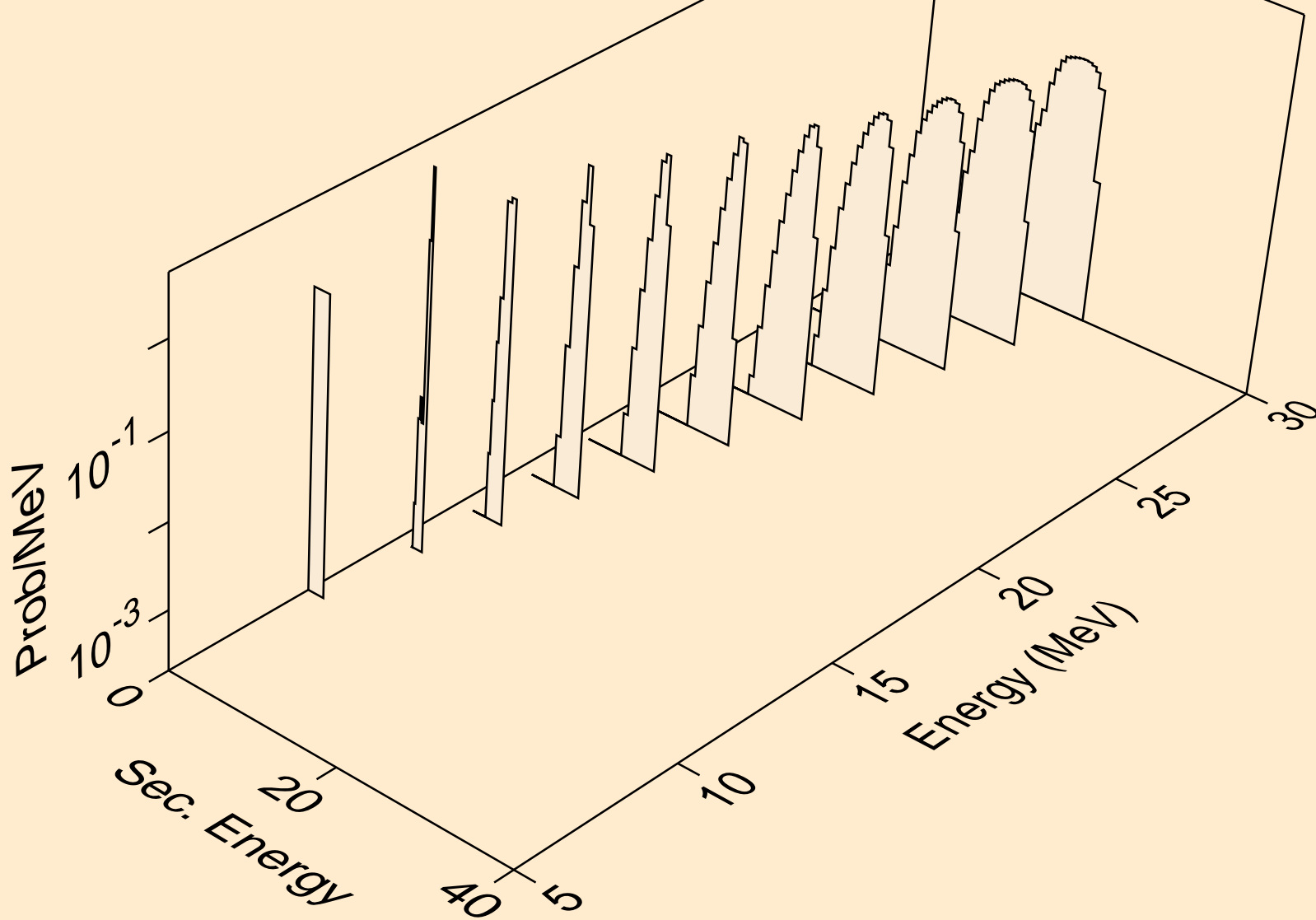

NP237 NEUTRON ACER TENDL-2019 LIBRARY; T=293.16K
deuterons from (n,d)

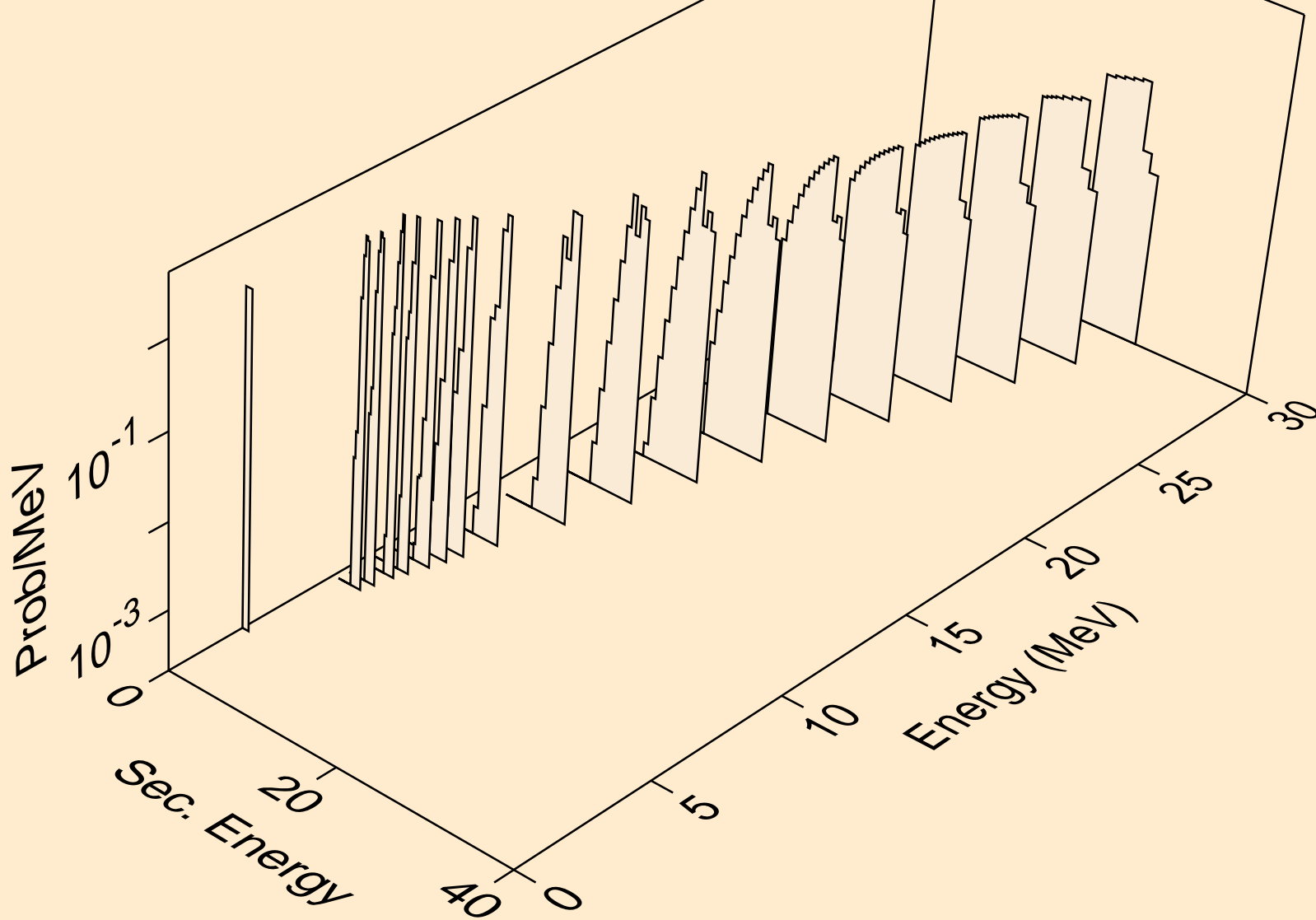

NP237 NEUTRON ACER TENDL-2019 LIBRARY; T=293.16K
tritons from (n,x)

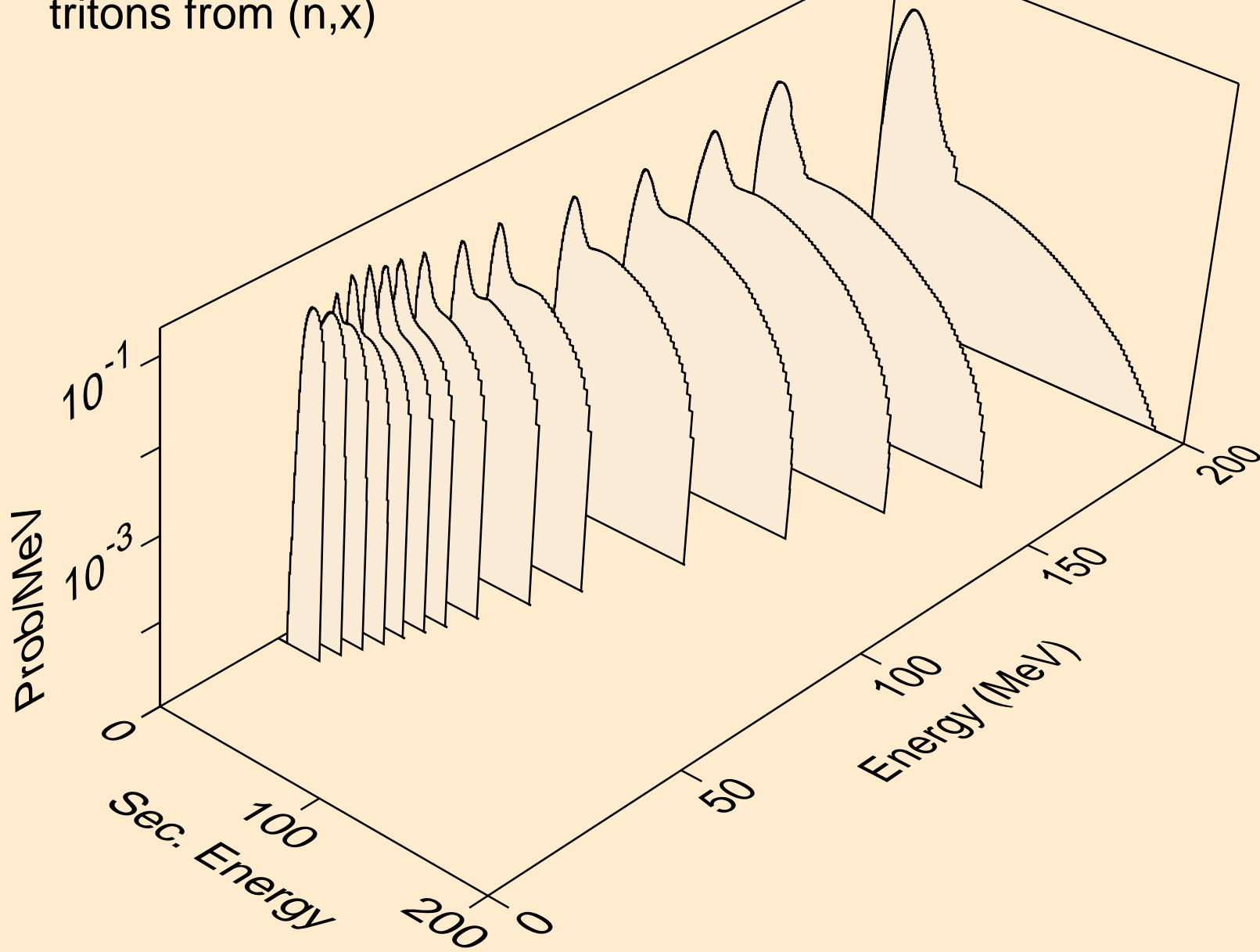

NP237 NEUTRON ACER TENDL-2019 LIBRARY; T=293.16K
tritons from (n,n*)t

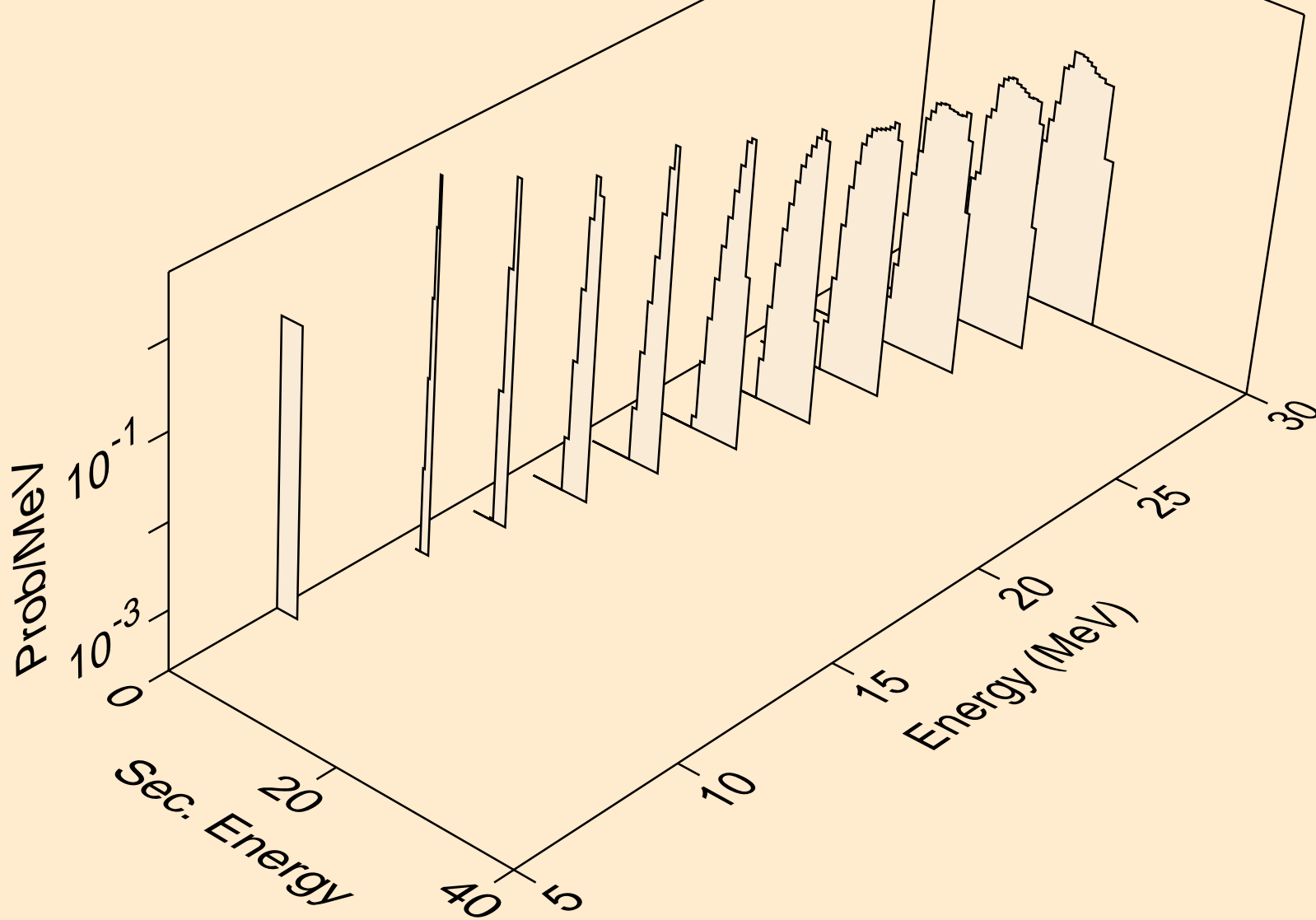

NP237 NEUTRON ACER TENDL-2019 LIBRARY; T=293.16K
tritons from (n,t)

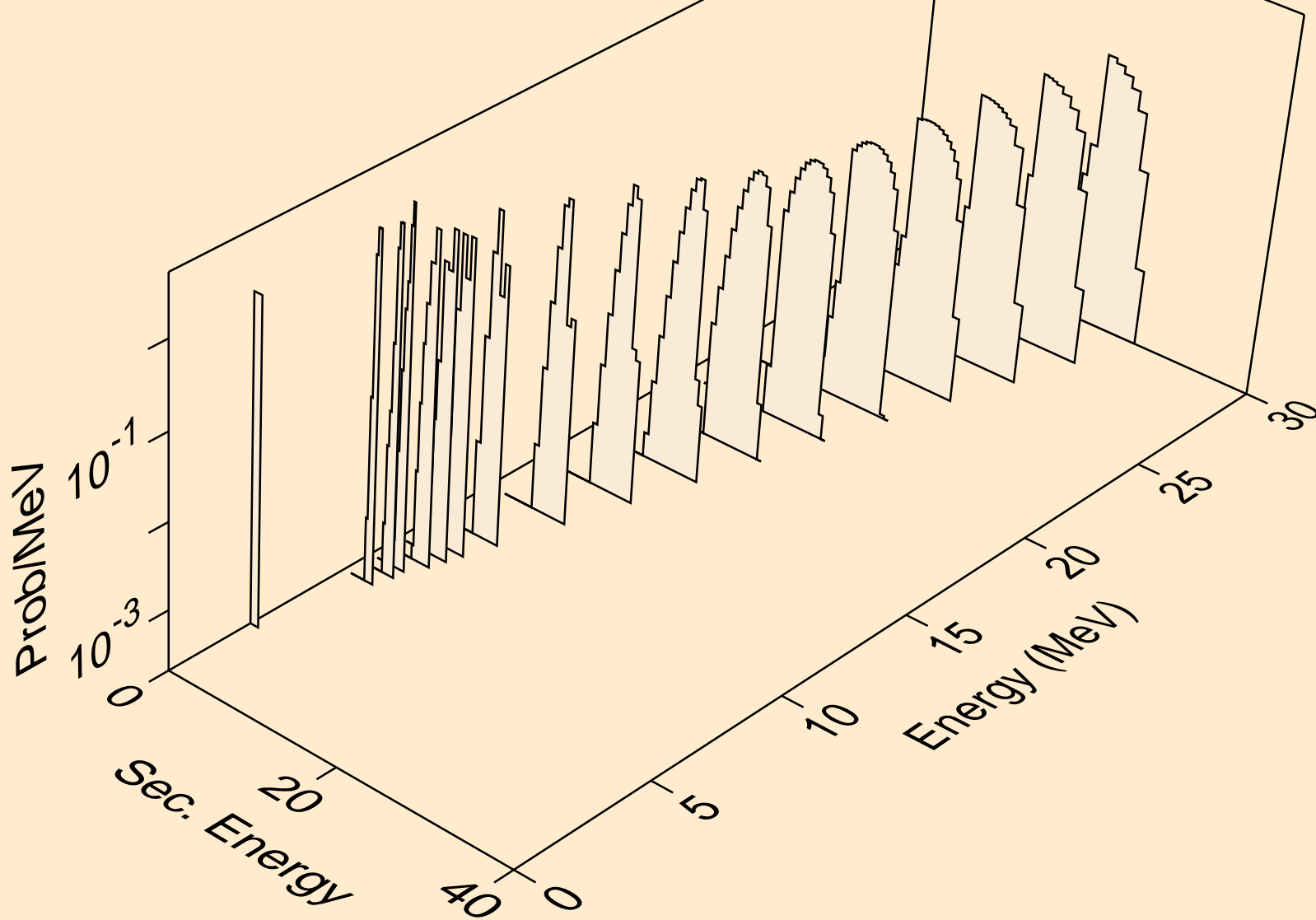

NP237 NEUTRON ACER TENDL-2019 LIBRARY; T=293.16K
he3s from (n,x)

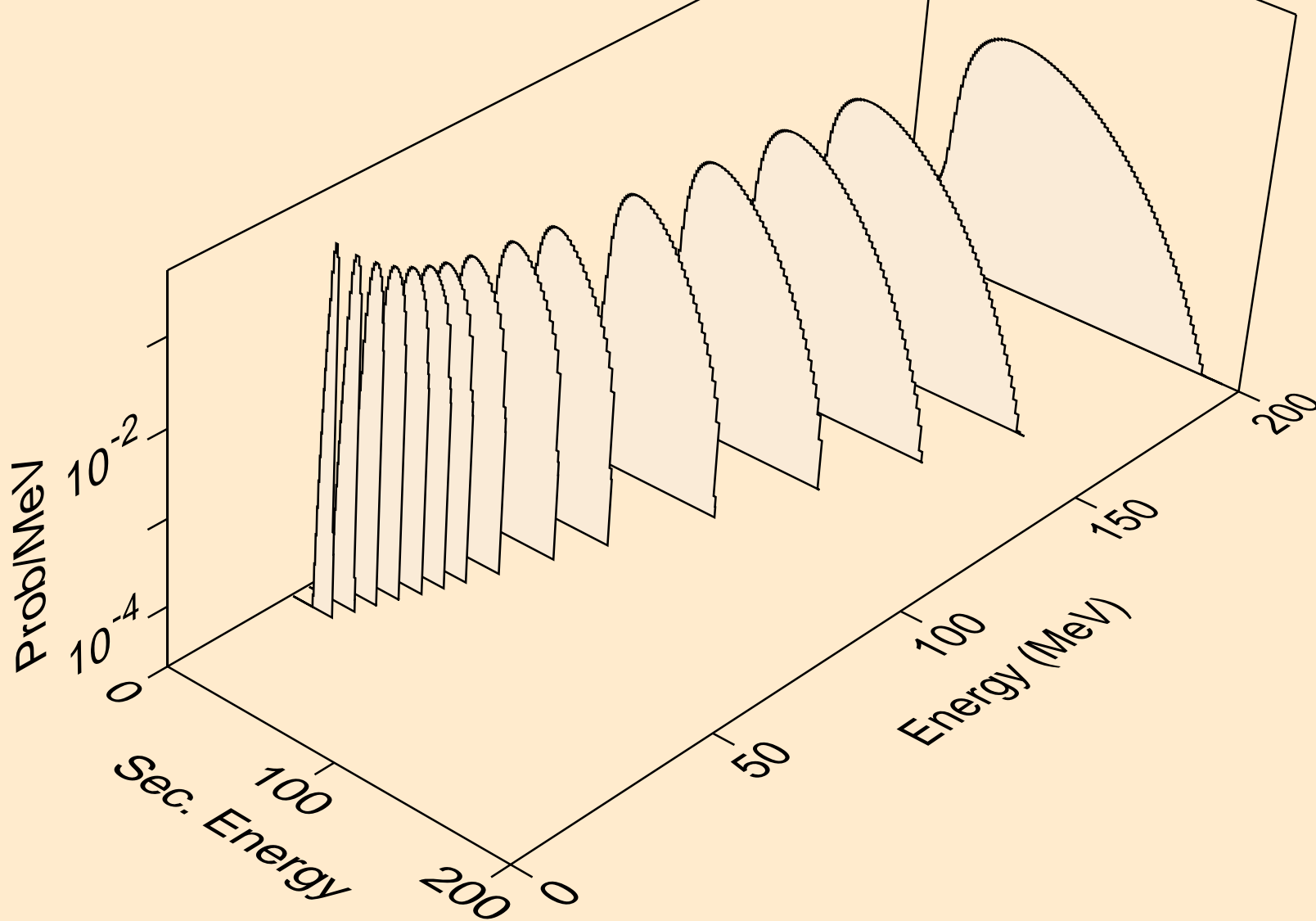

NP237 NEUTRON ACER TENDL-2019 LIBRARY; T=293.16K
he3s from (n,n*)he3

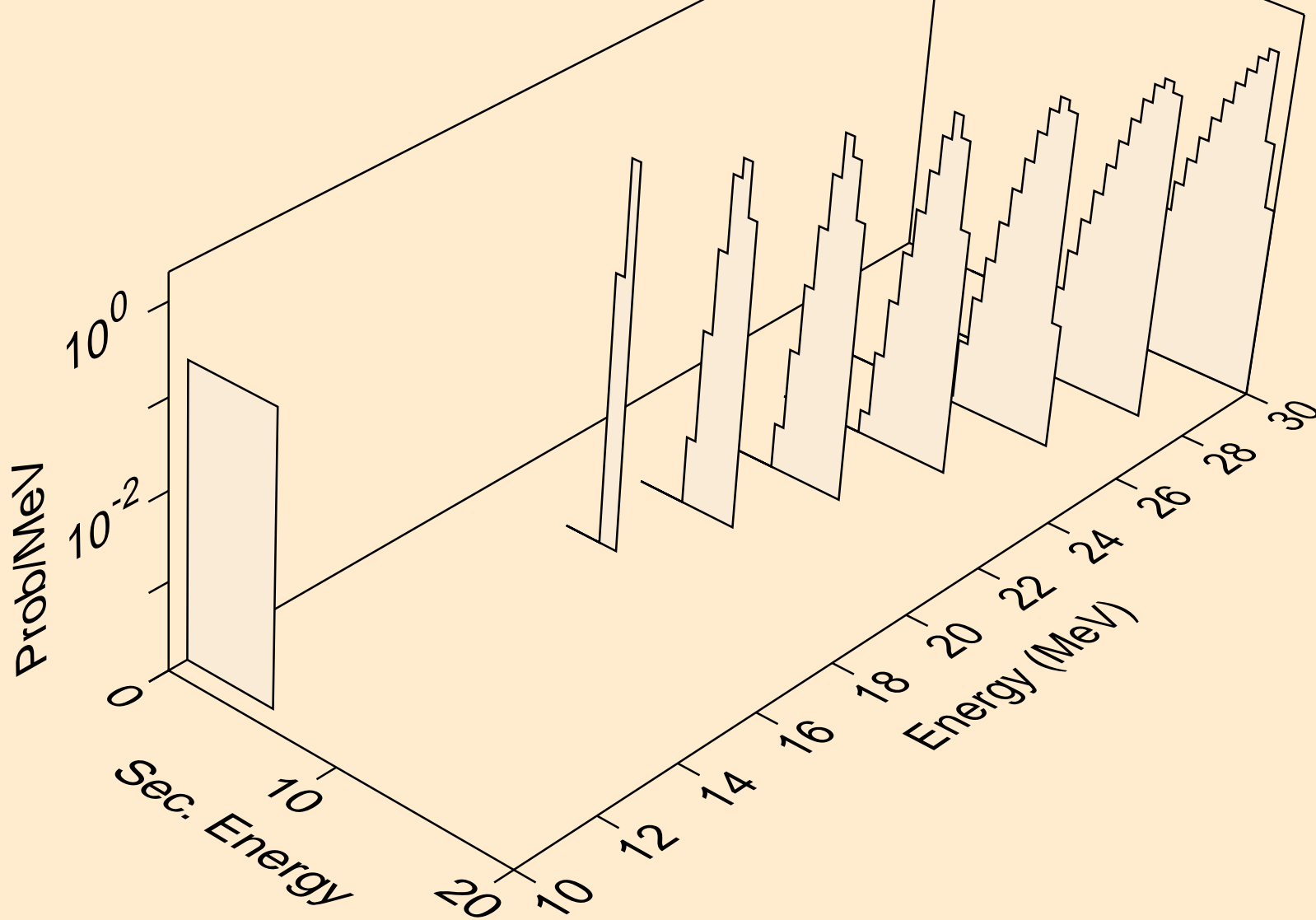

NP237 NEUTRON ACER TENDL-2019 LIBRARY; T=293.16K
he3s from (n,he3)

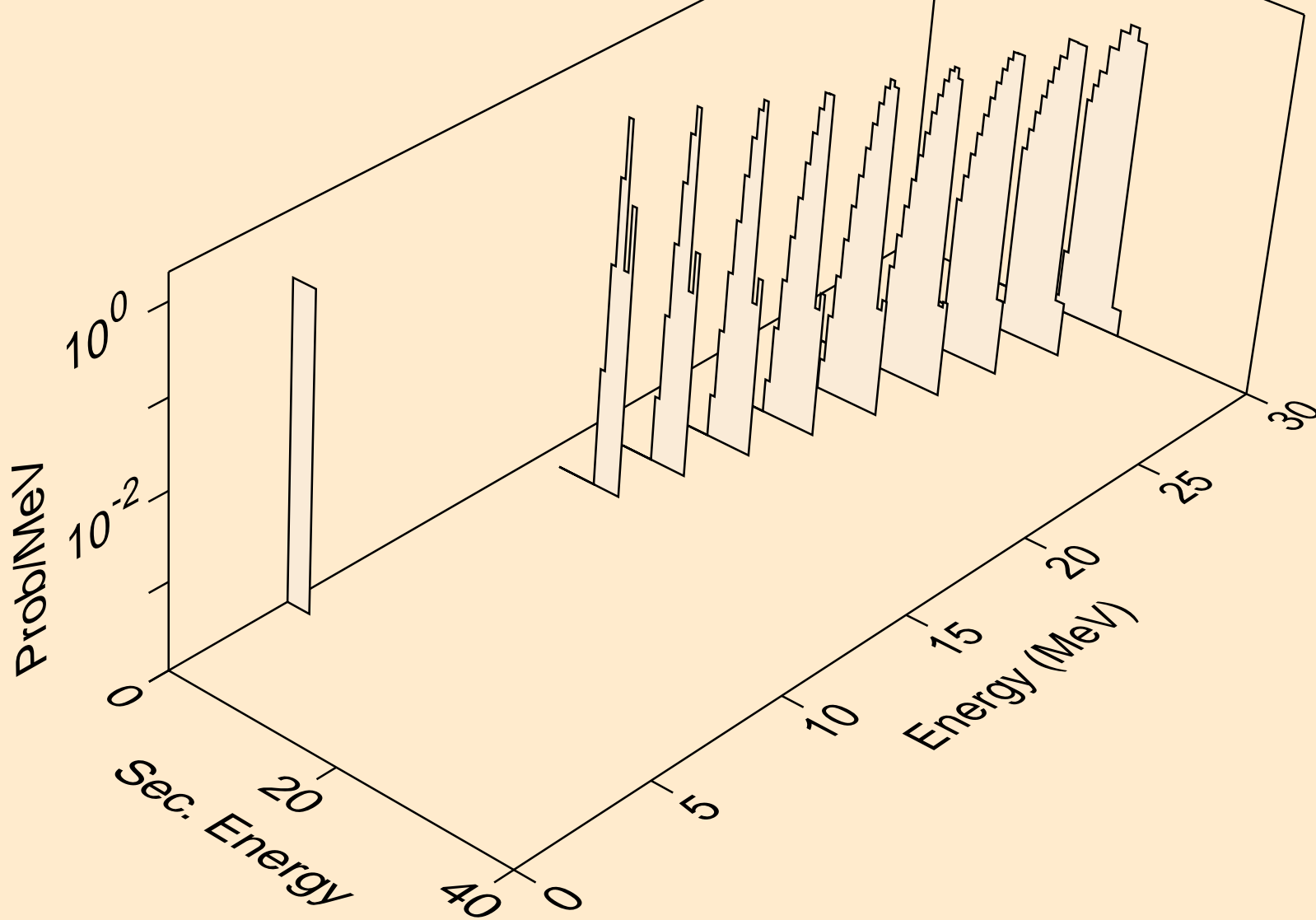

NP237 NEUTRON ACER TENDL-2019 LIBRARY; T=293.16K
alphas from (n,x)

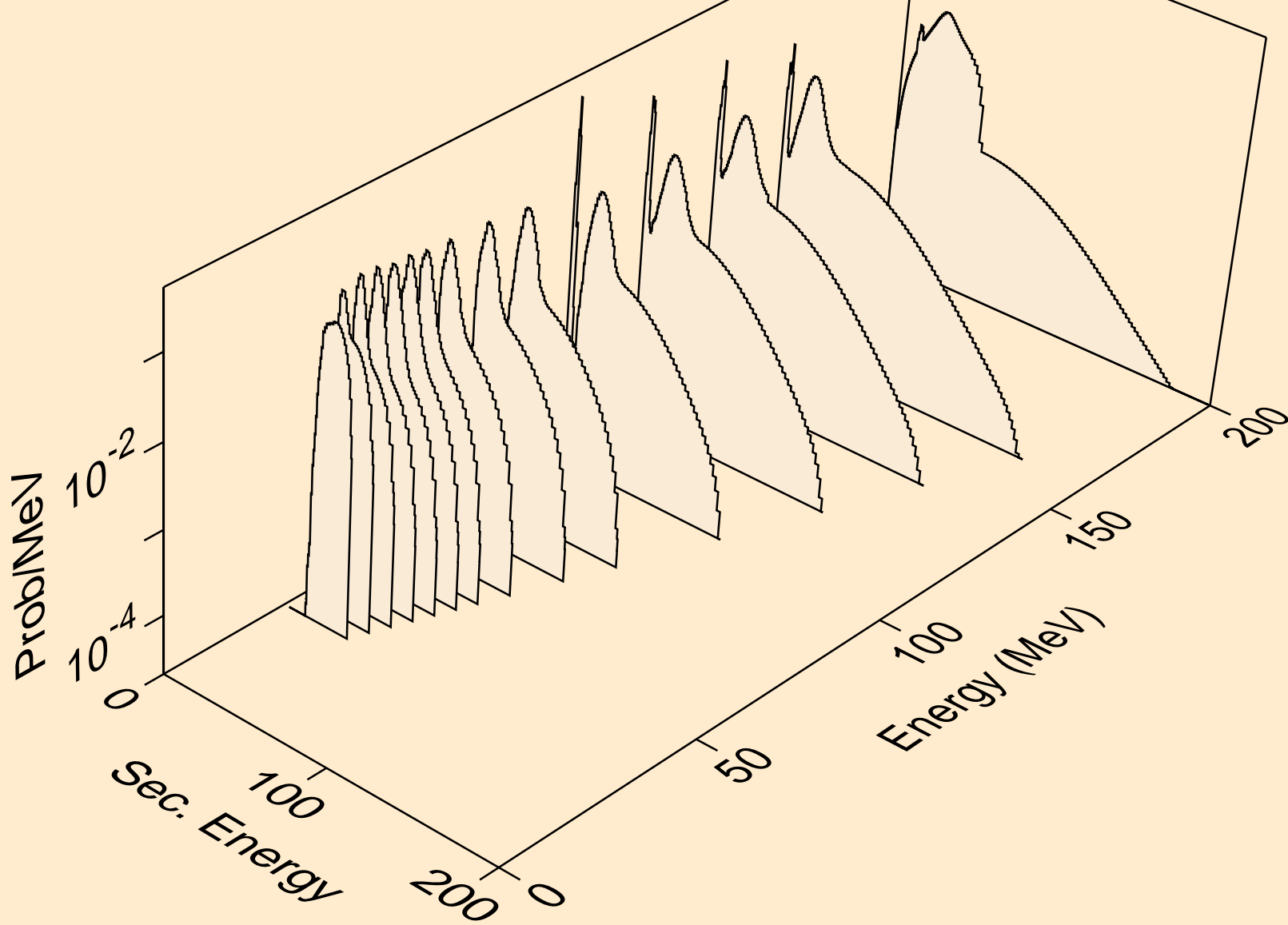

NP237 NEUTRON ACER TENDL-2019 LIBRARY; T=293.16K
alphas from (n,n*)a

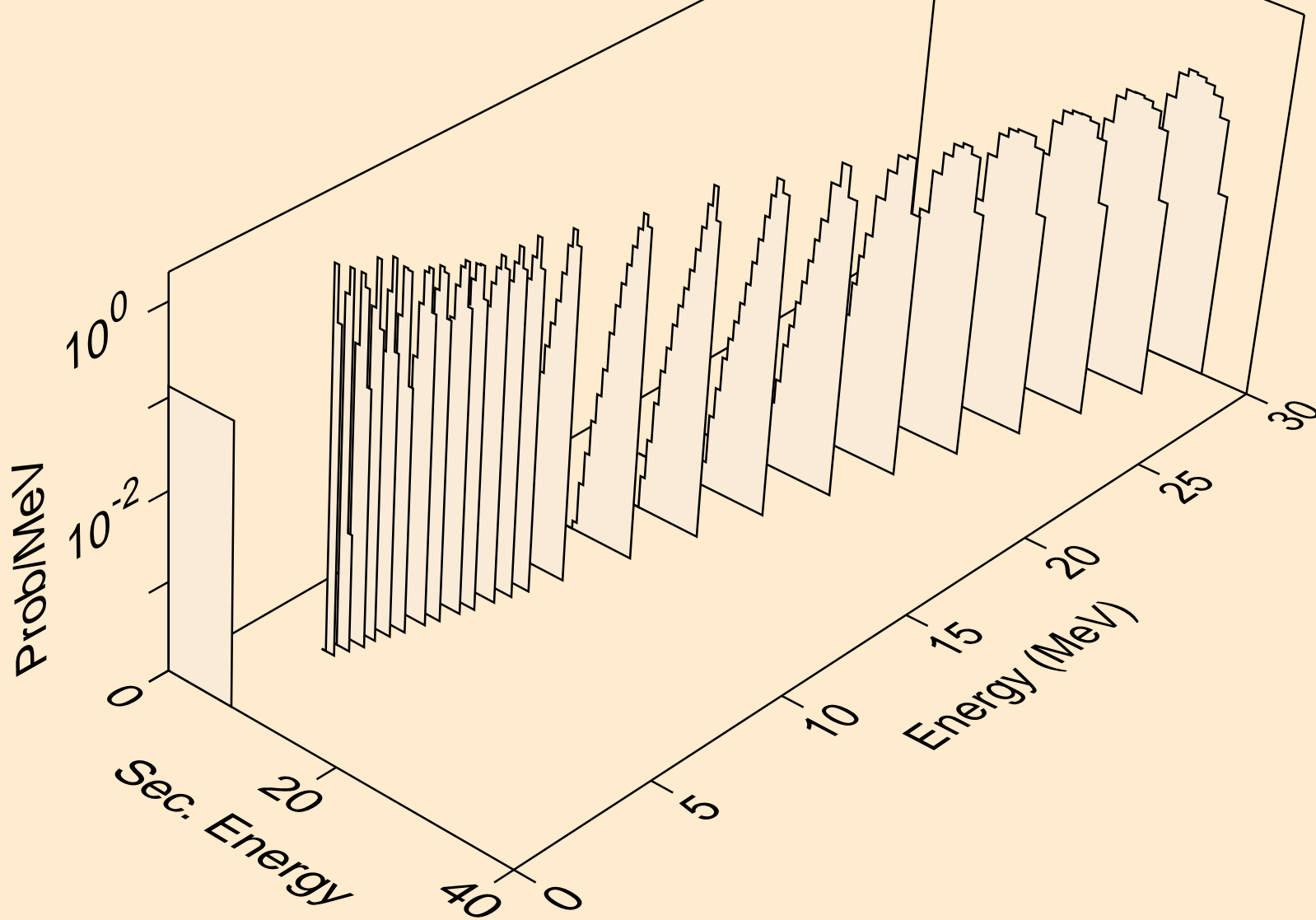

NP237 NEUTRON ACER TENDL-2019 LIBRARY; T=293.16K
alphas from (n,2n)a

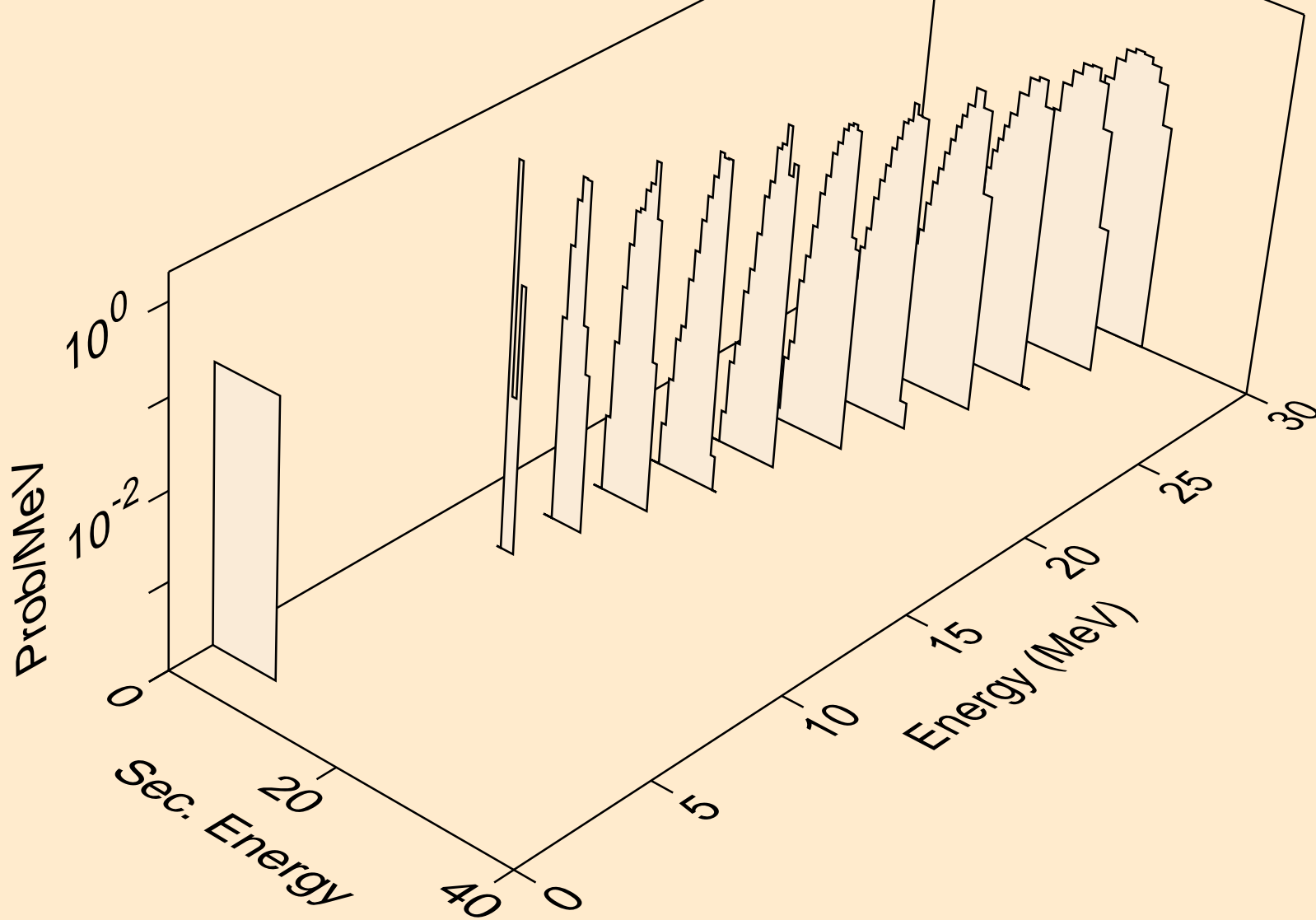

NP237 NEUTRON ACER TENDL-2019 LIBRARY; T=293.16K
alphas from (n,3n)a

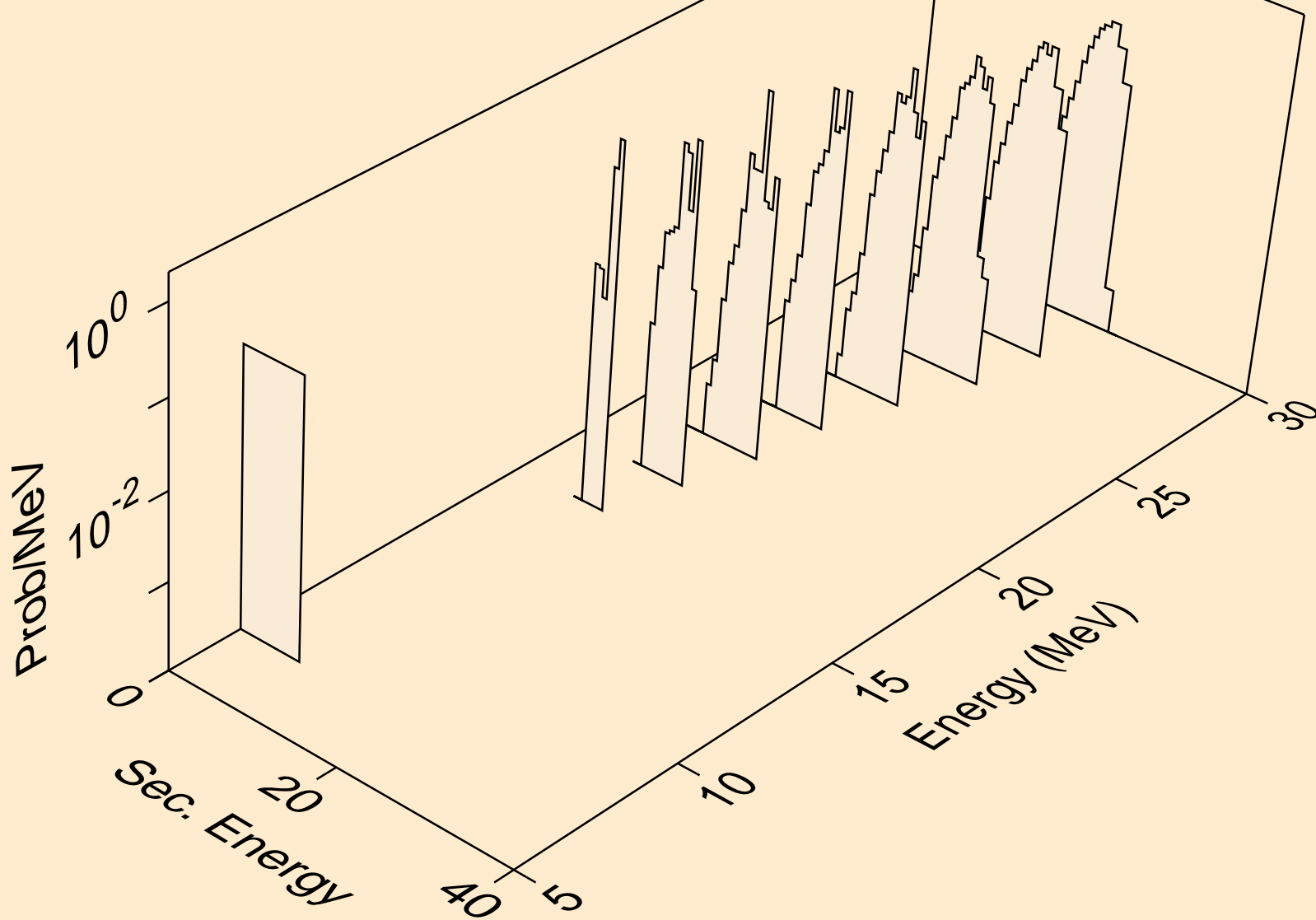

NP237 NEUTRON ACER TENDL-2019 LIBRARY; T=293.16K
alphas from (n,a)

