

PA235 NEUTRON ACER TENDL-2019 LIBRARY; T=293.16K
Principal cross sections

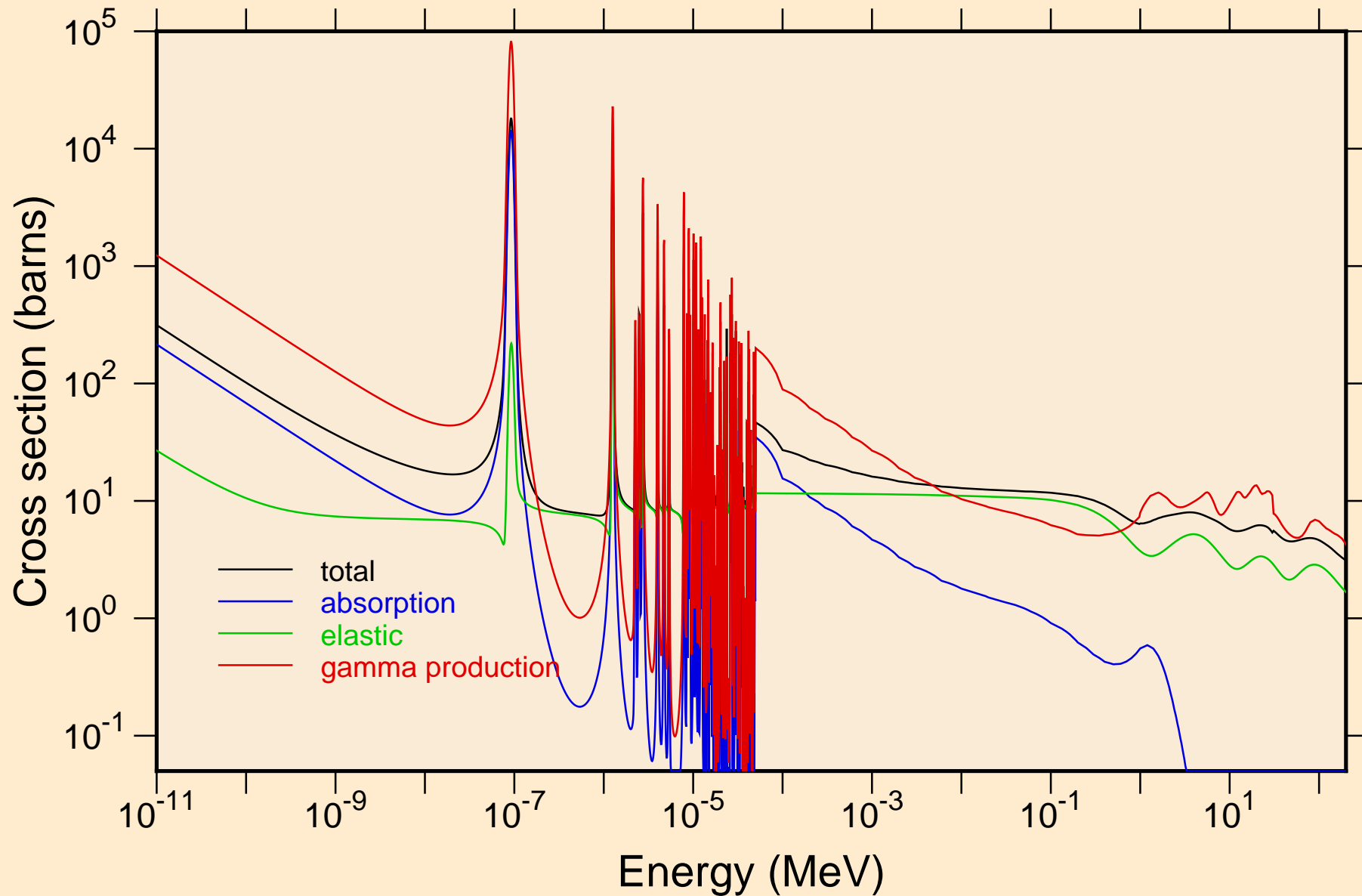

PA235 NEUTRON ACER TENDL-2019 LIBRARY; T=293.16K
resonance total cross section

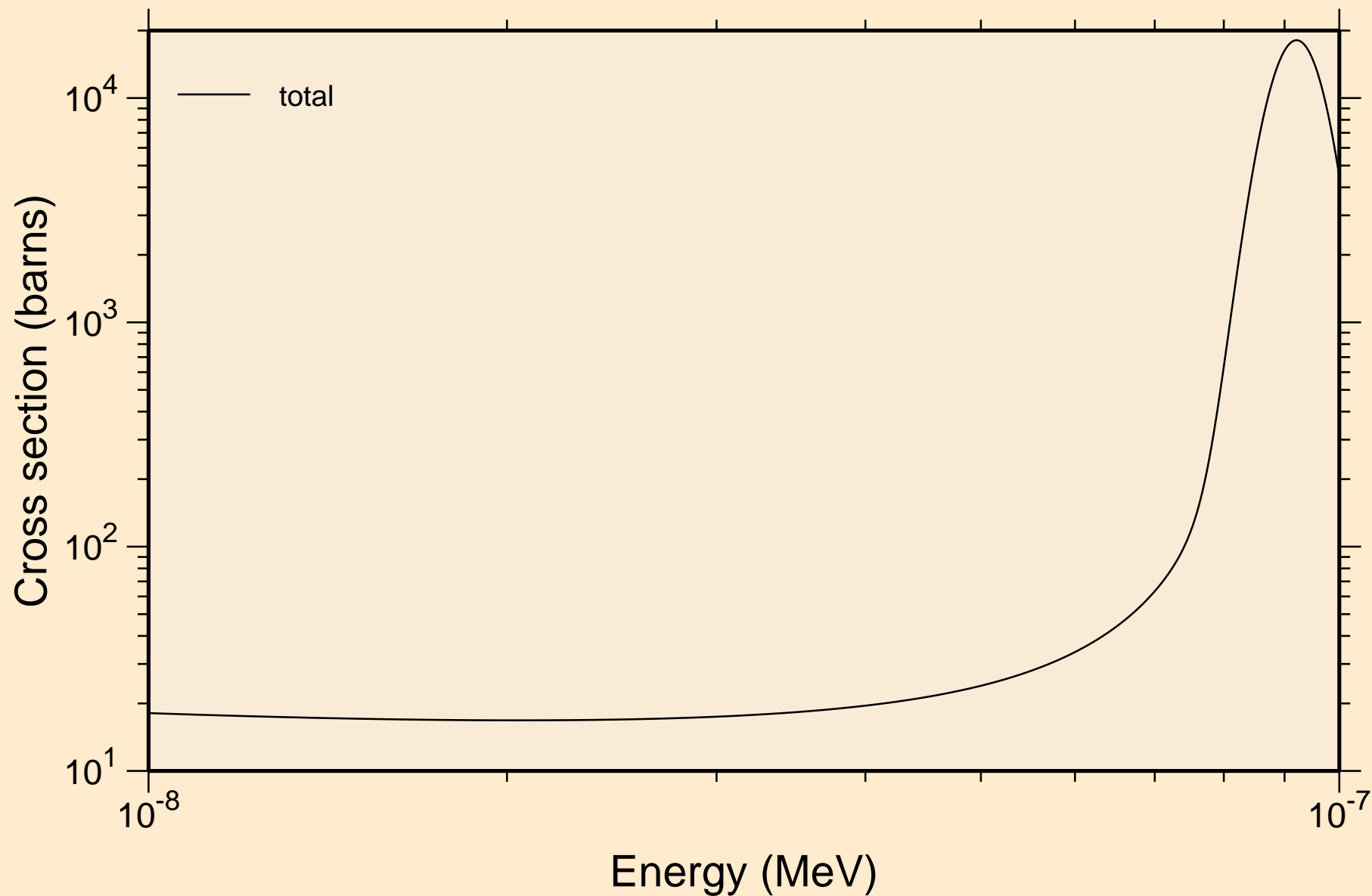

PA235 NEUTRON ACER TENDL-2019 LIBRARY; T=293.16K
resonance total cross section

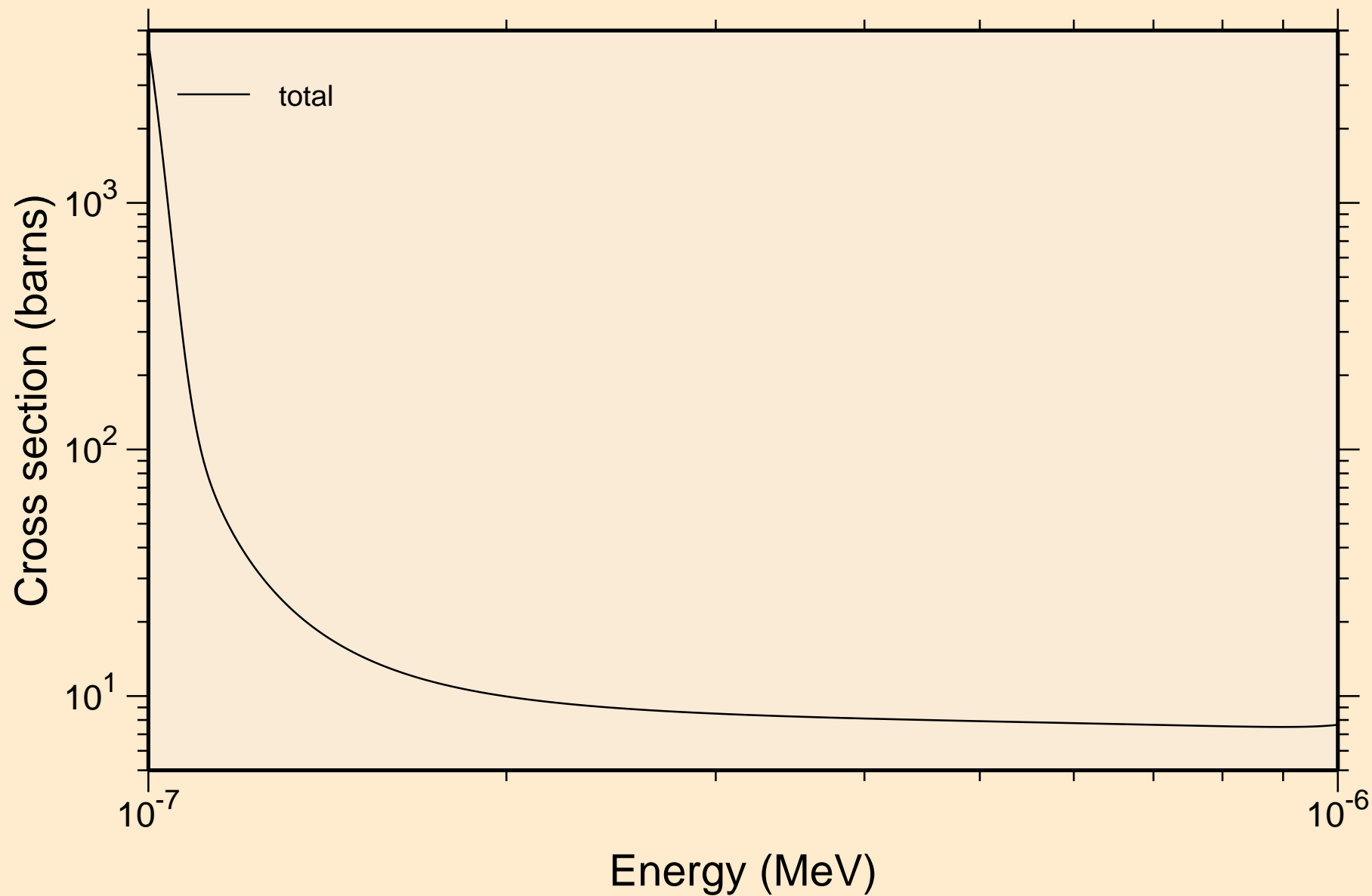

PA235 NEUTRON ACER TENDL-2019 LIBRARY; T=293.16K
resonance total cross section

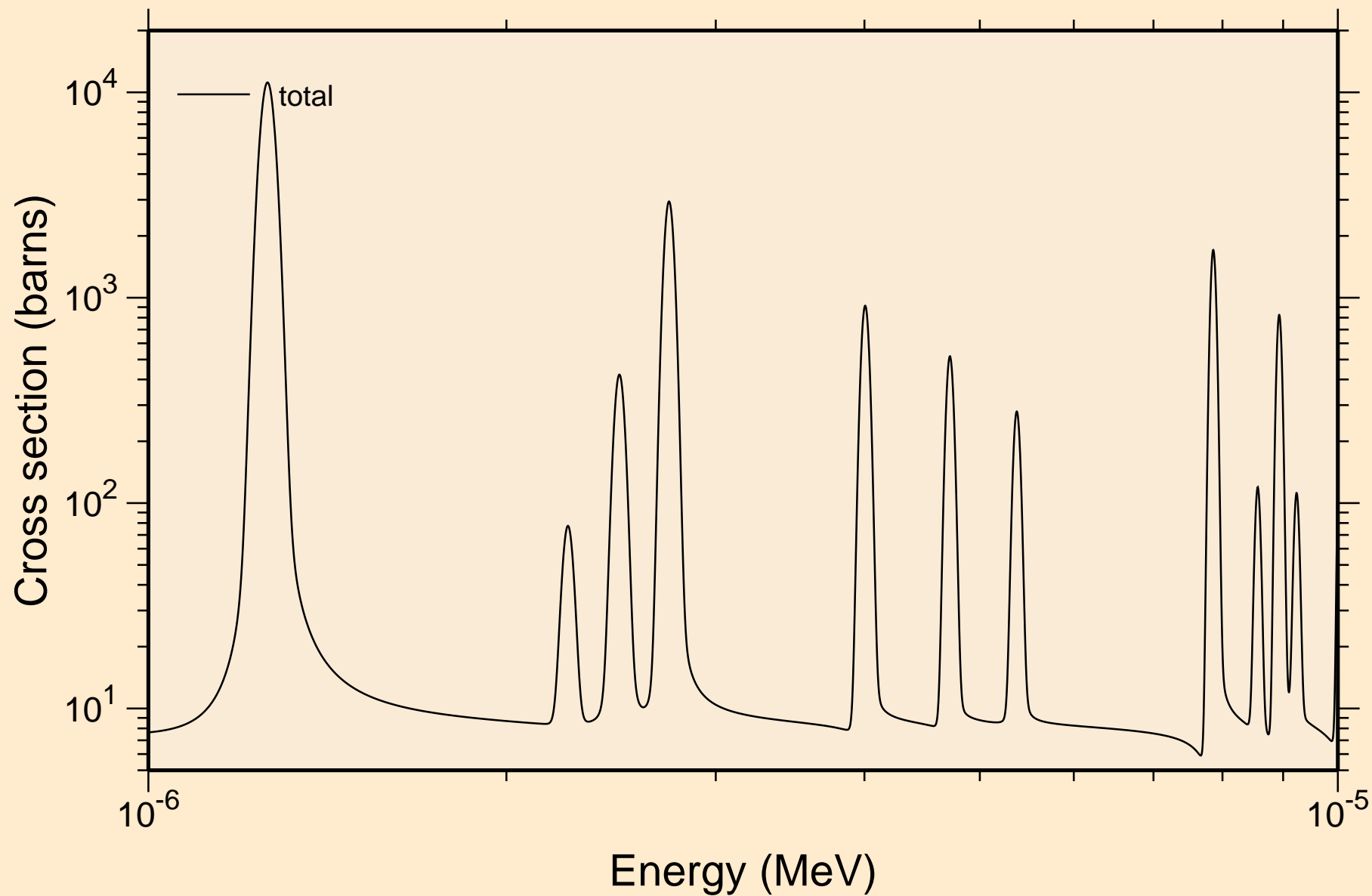

PA235 NEUTRON ACER TENDL-2019 LIBRARY; T=293.16K
resonance total cross section

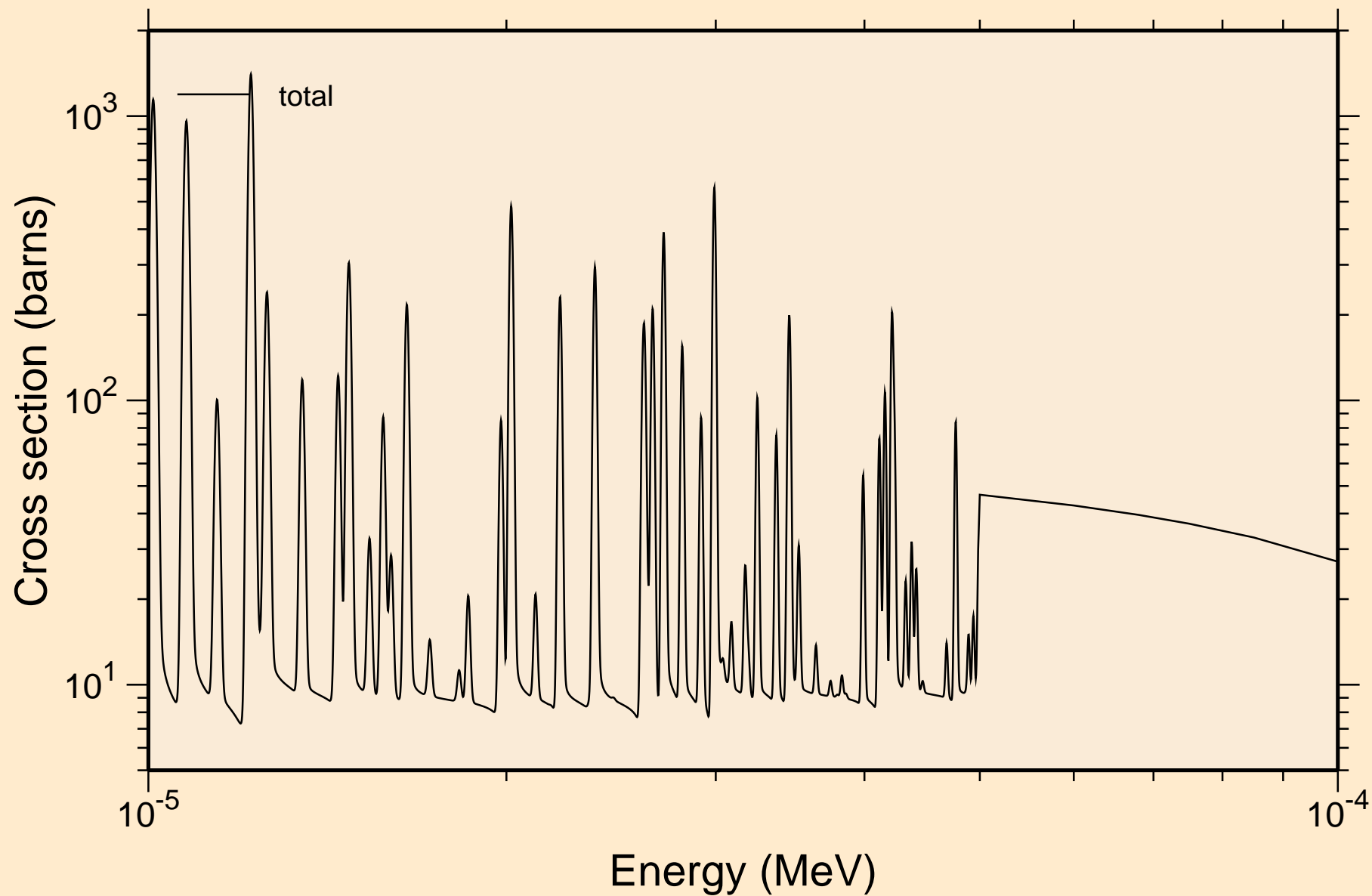

PA235 NEUTRON ACER TENDL-2019 LIBRARY; T=293.16K
resonance total cross section

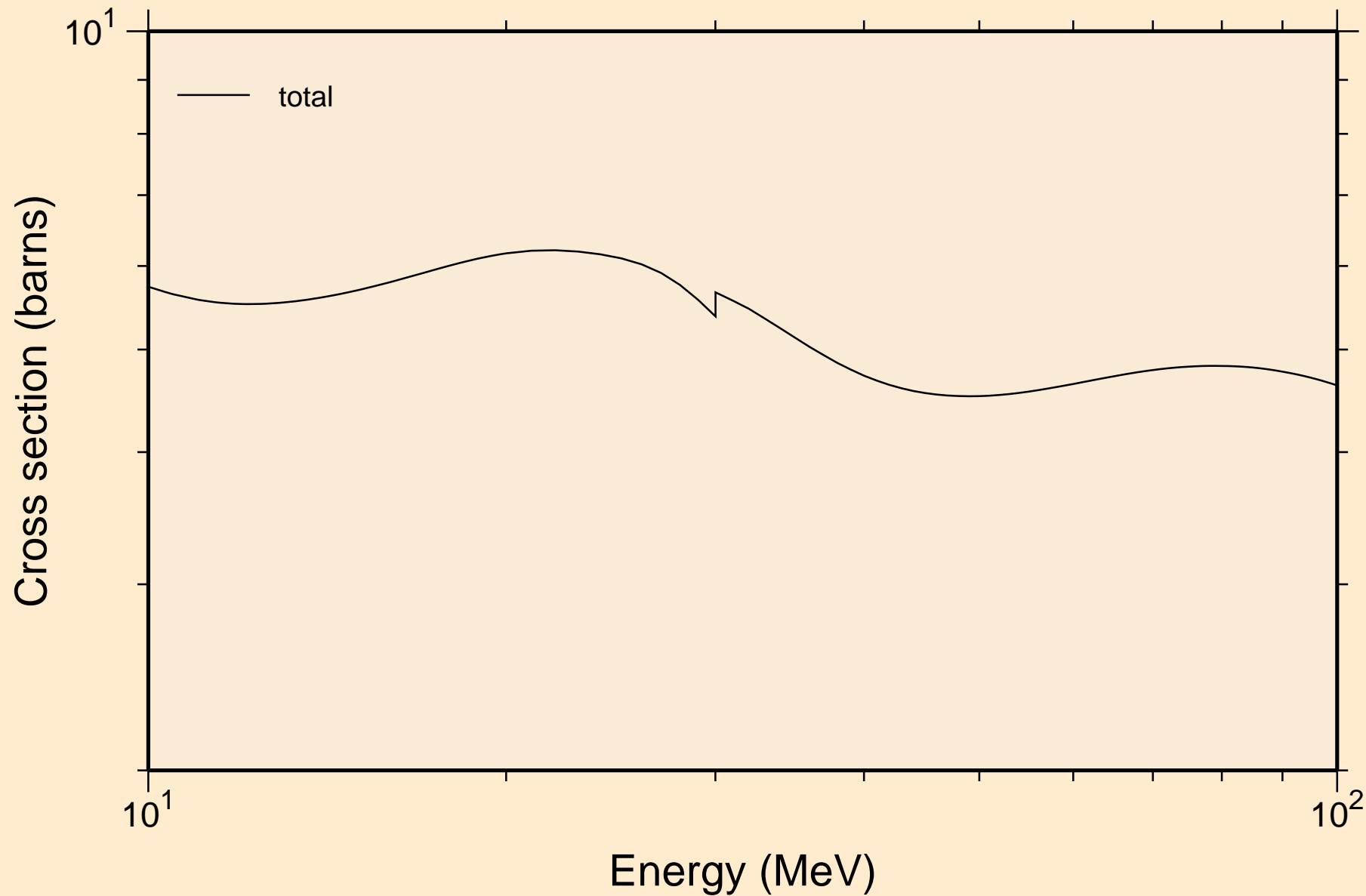

PA235 NEUTRON ACER TENDL-2019 LIBRARY; T=293.16K
resonance absorption cross sections

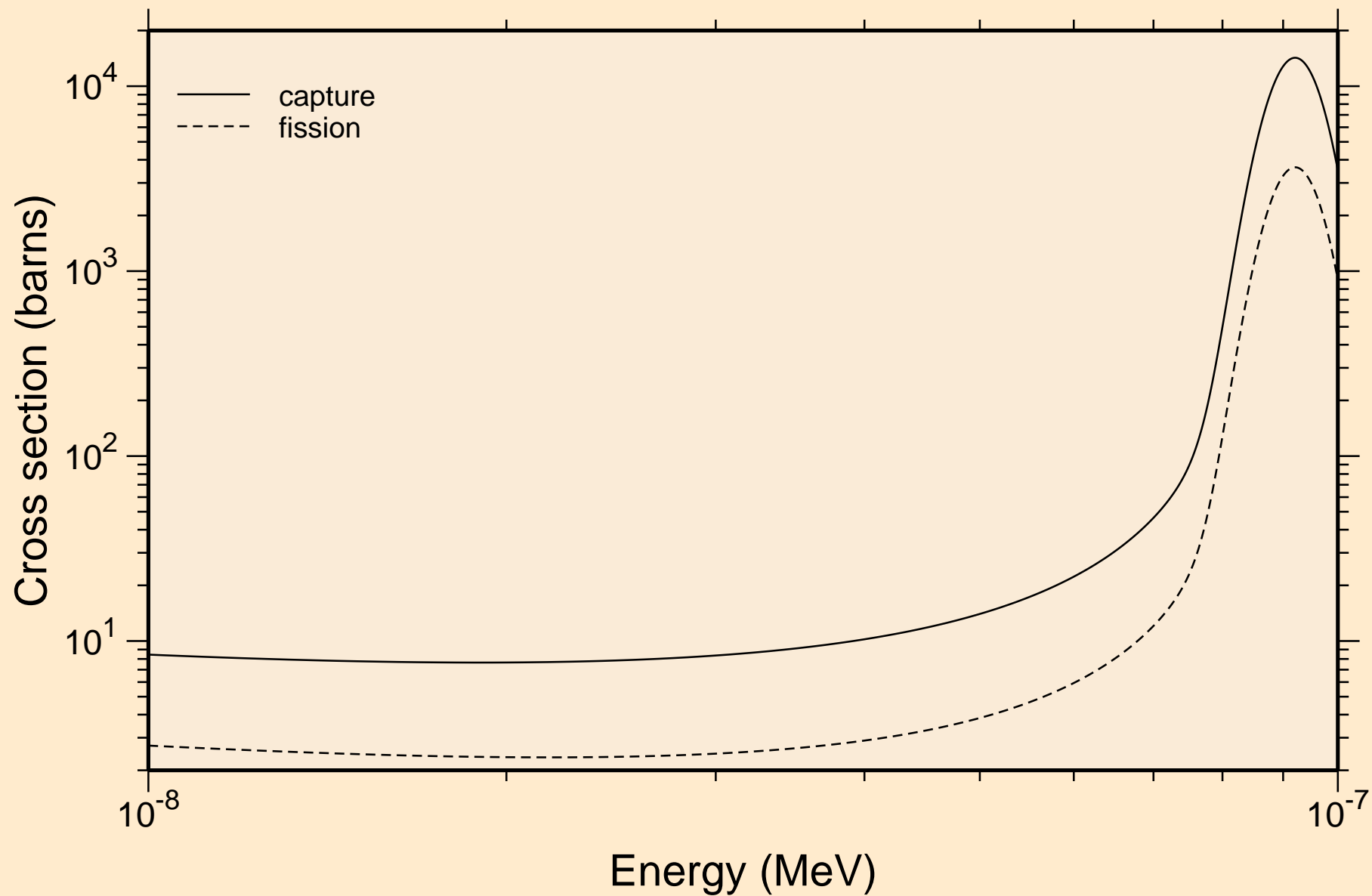

PA235 NEUTRON ACER TENDL-2019 LIBRARY; T=293.16K
resonance absorption cross sections

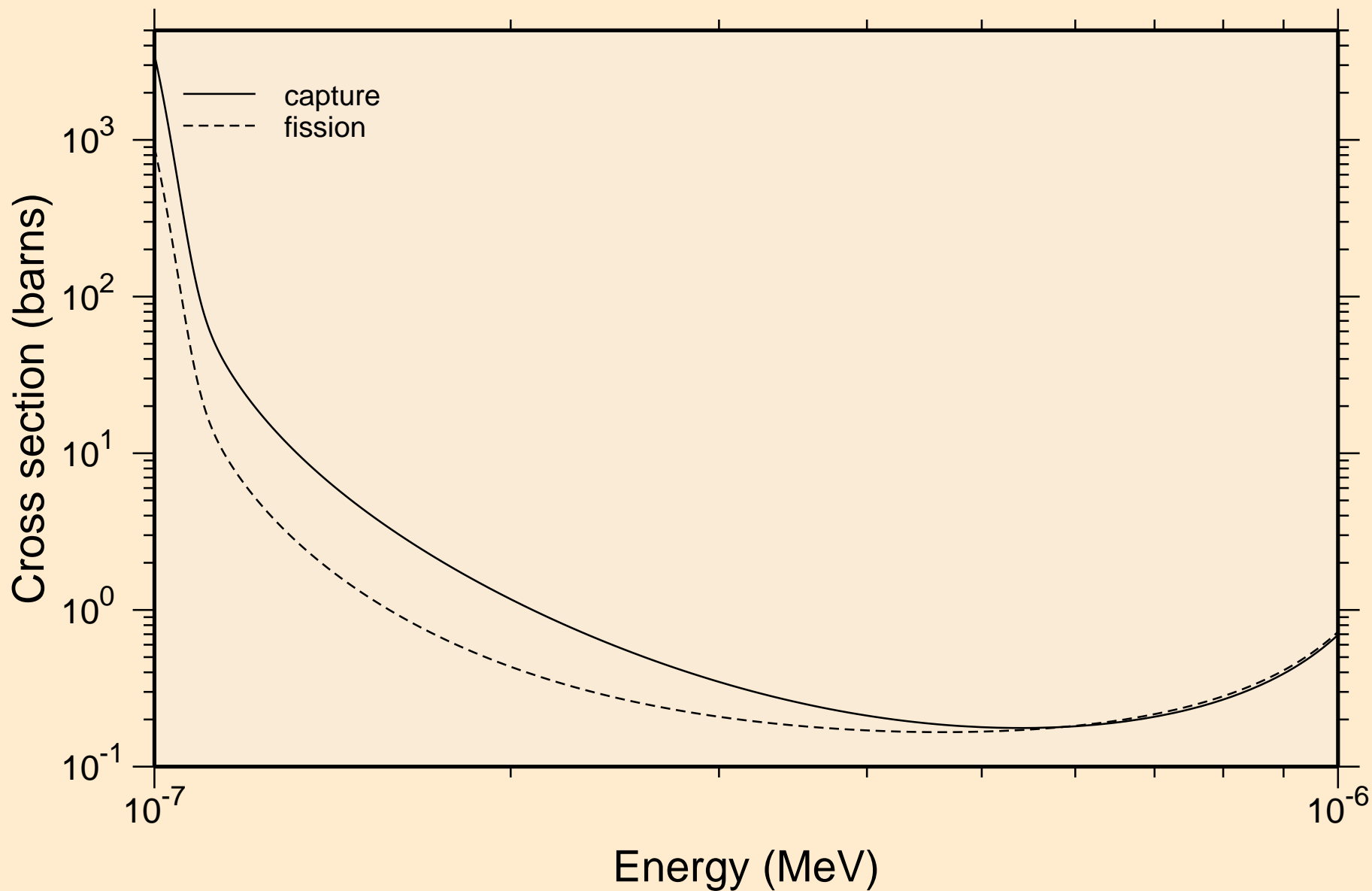

PA235 NEUTRON ACER TENDL-2019 LIBRARY; T=293.16K
resonance absorption cross sections

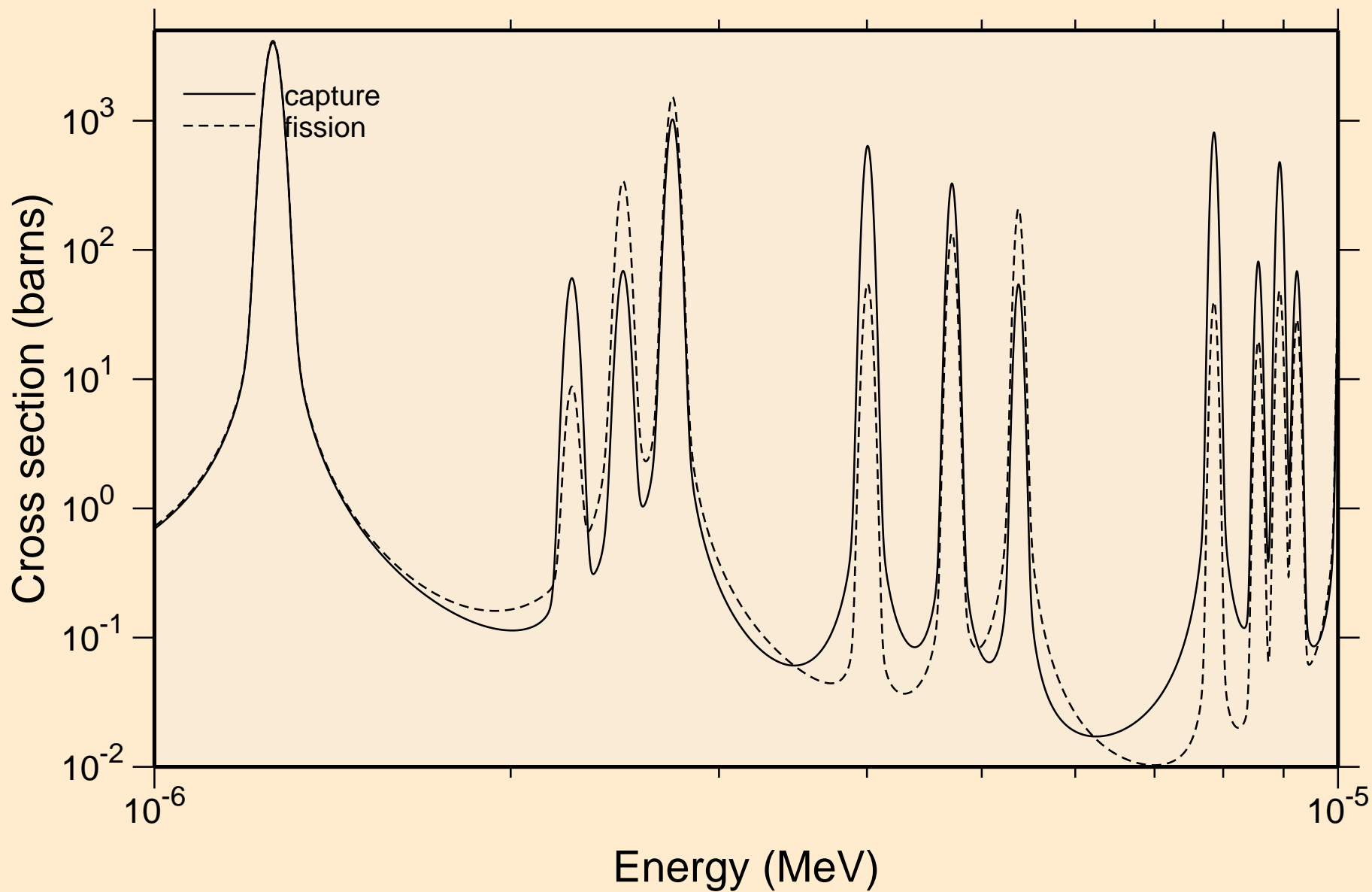

PA235 NEUTRON ACER TENDL-2019 LIBRARY; T=293.16K
resonance absorption cross sections

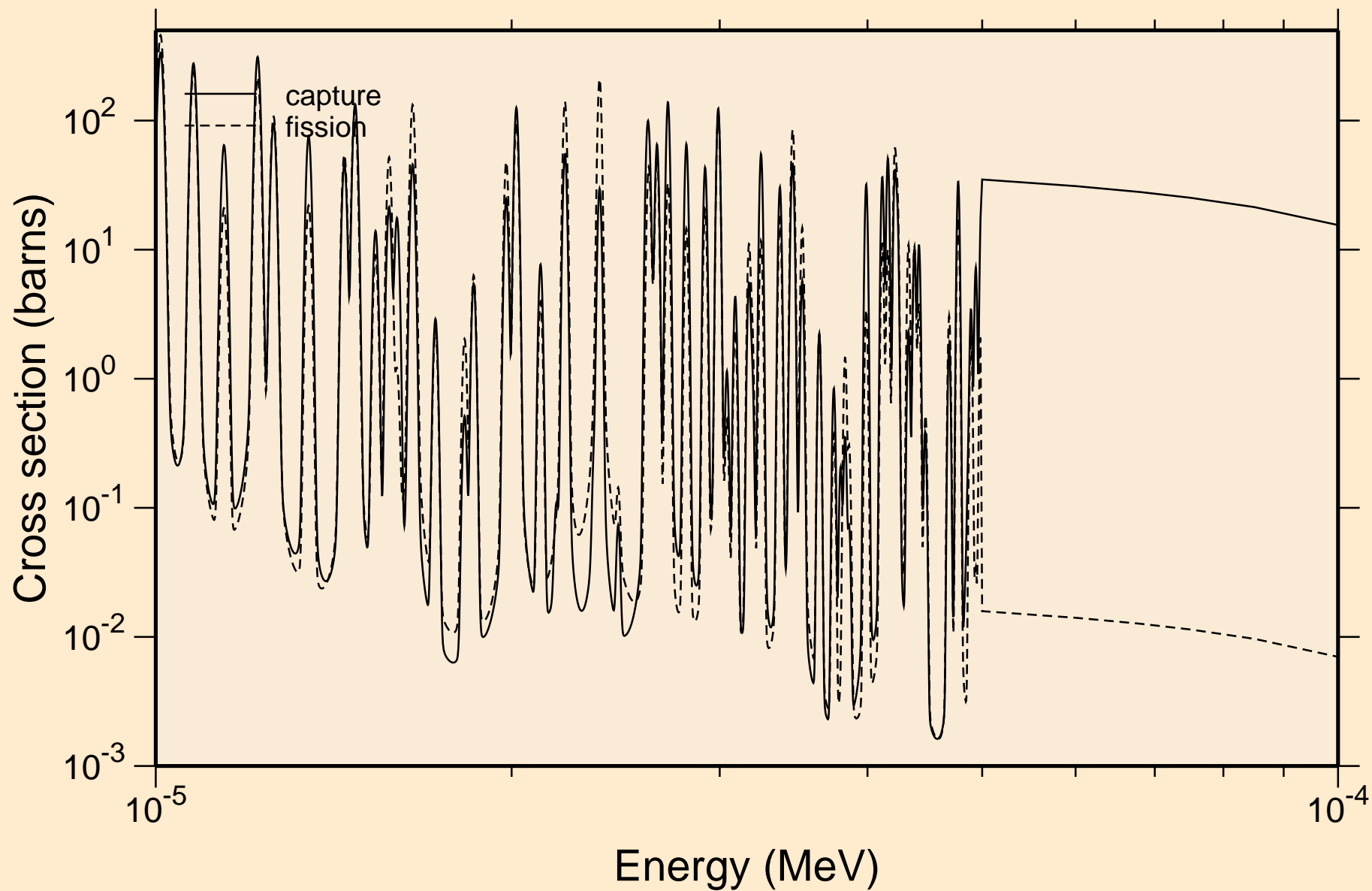

PA235 NEUTRON ACER TENDL-2019 LIBRARY; T=293.16K
resonance absorption cross sections

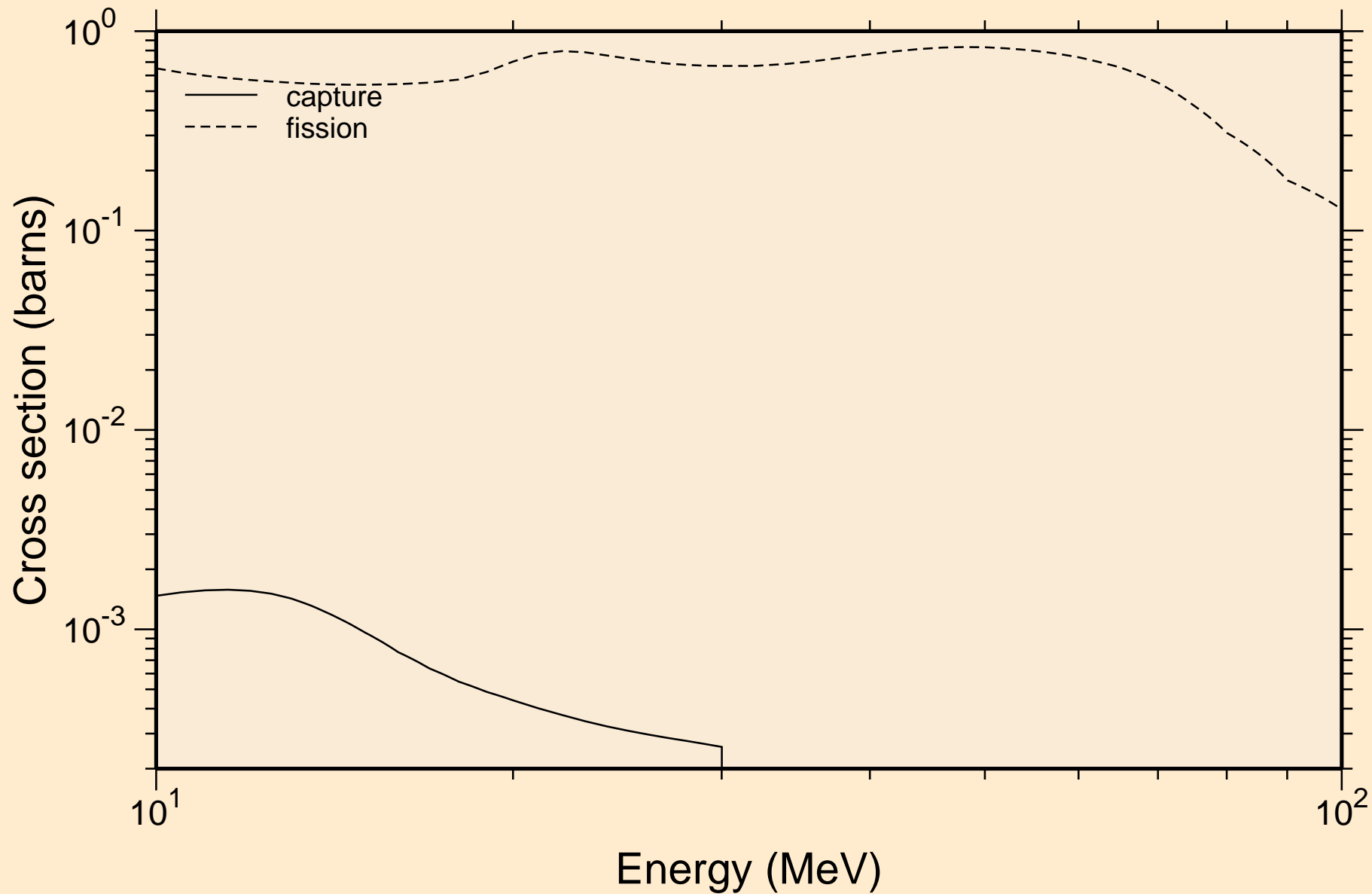

PA235 NEUTRON ACER TENDL-2019 LIBRARY; T=293.16K
Heating

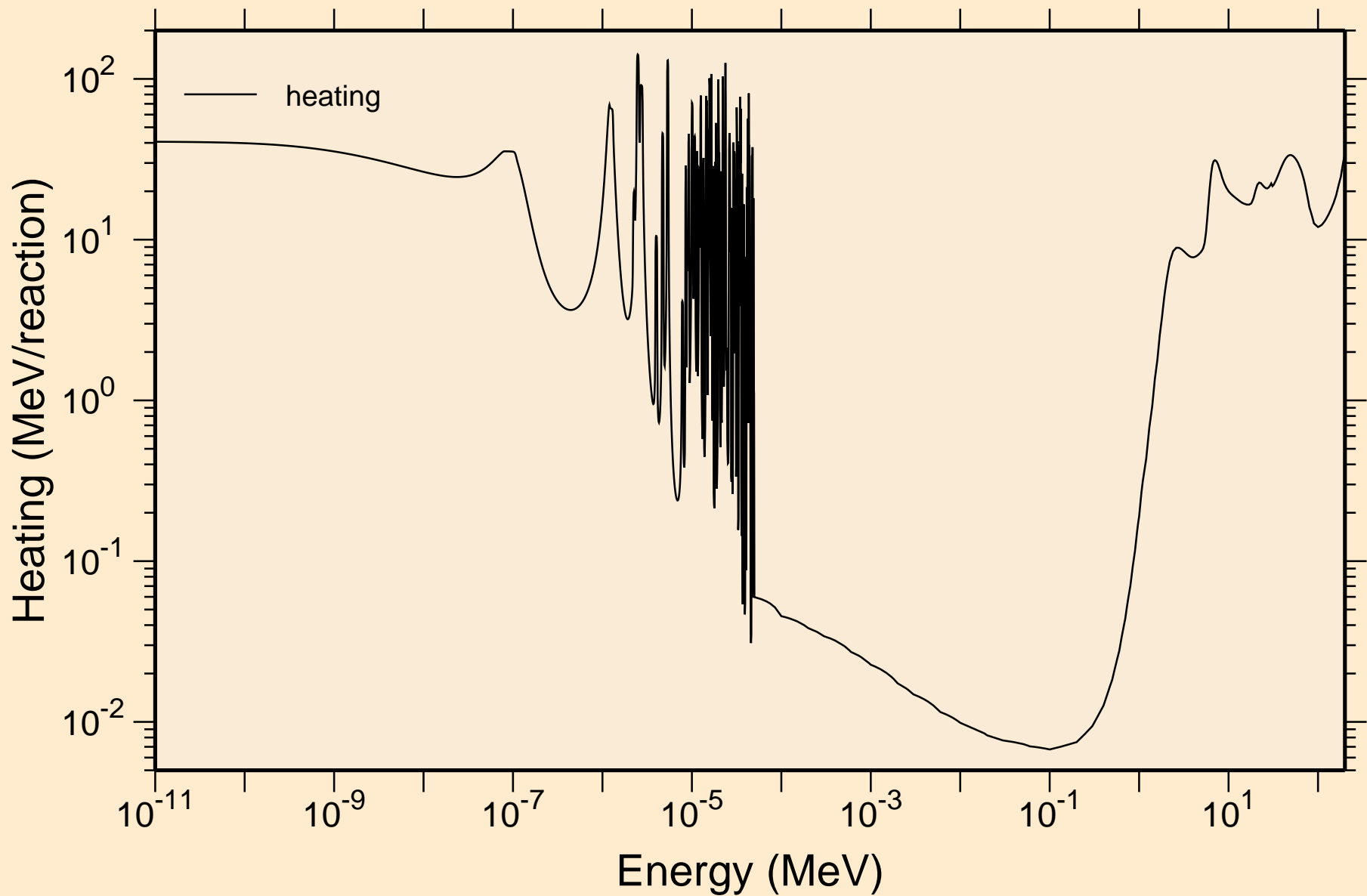

PA235 NEUTRON ACER TENDL-2019 LIBRARY; T=293.16K
Damage

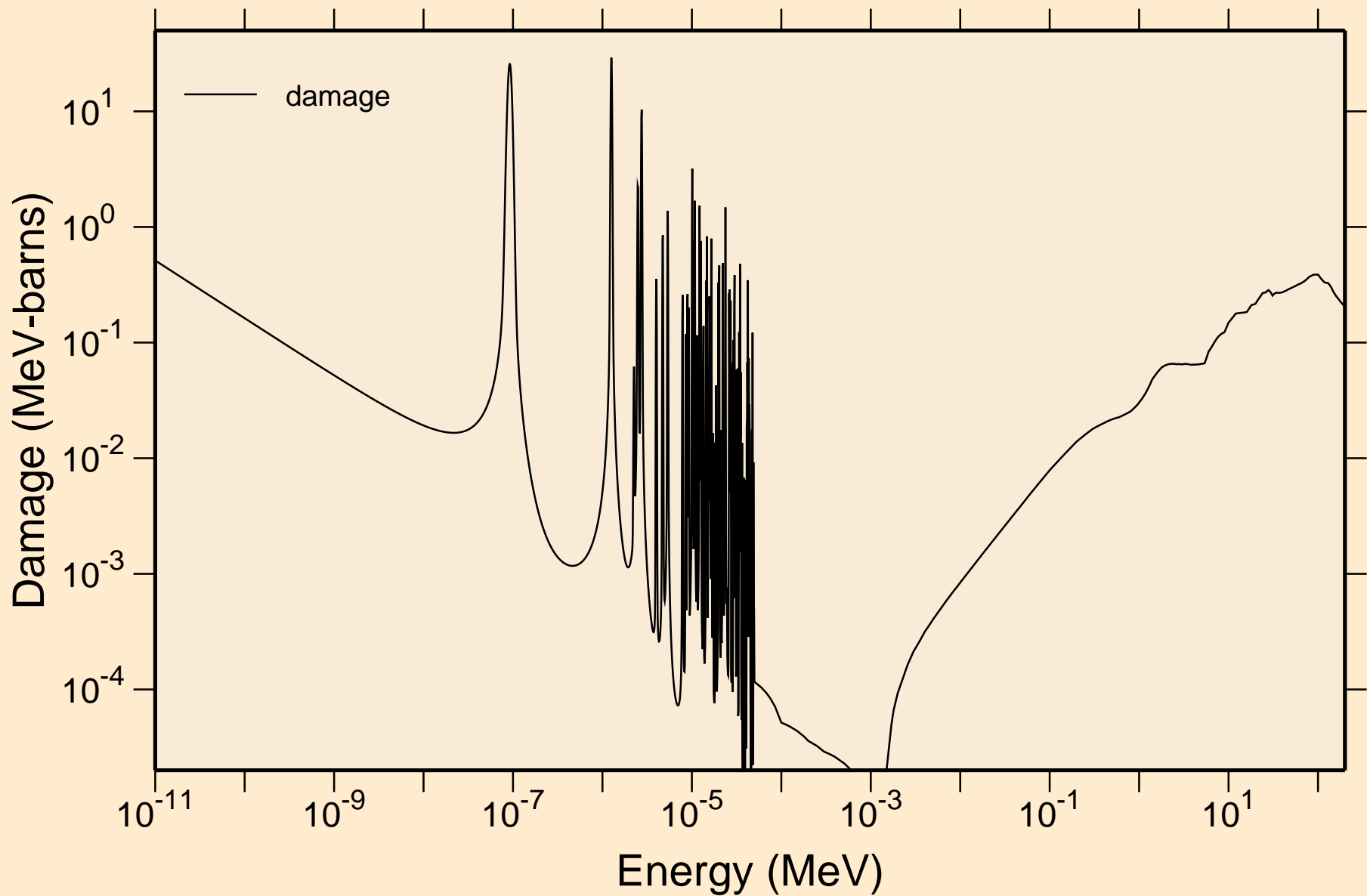

PA235 NEUTRON ACER TENDL-2019 LIBRARY; T=293.16K
Non-threshold reactions

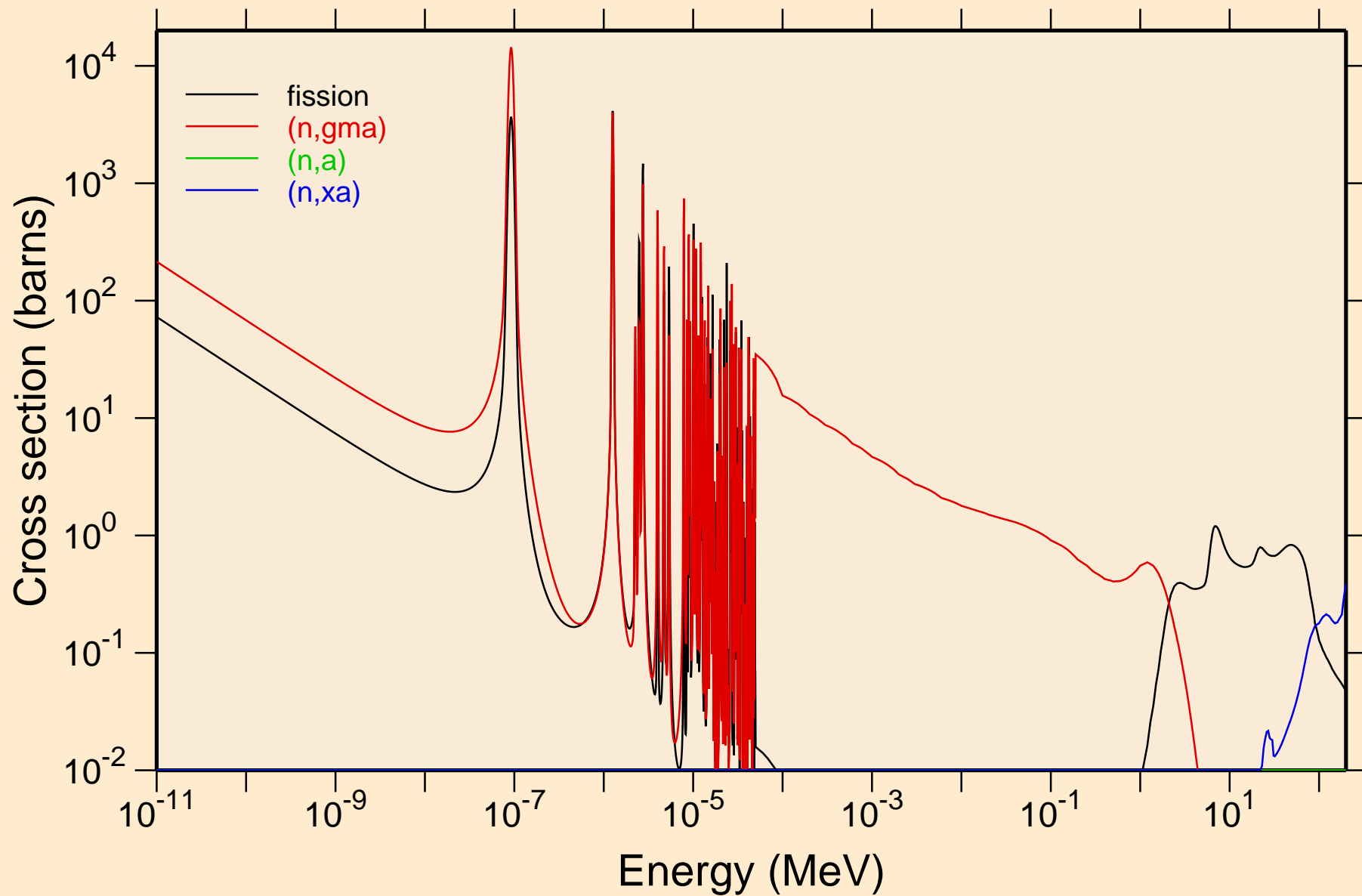

PA235 NEUTRON ACER TENDL-2019 LIBRARY; T=293.16K
Principal cross sections

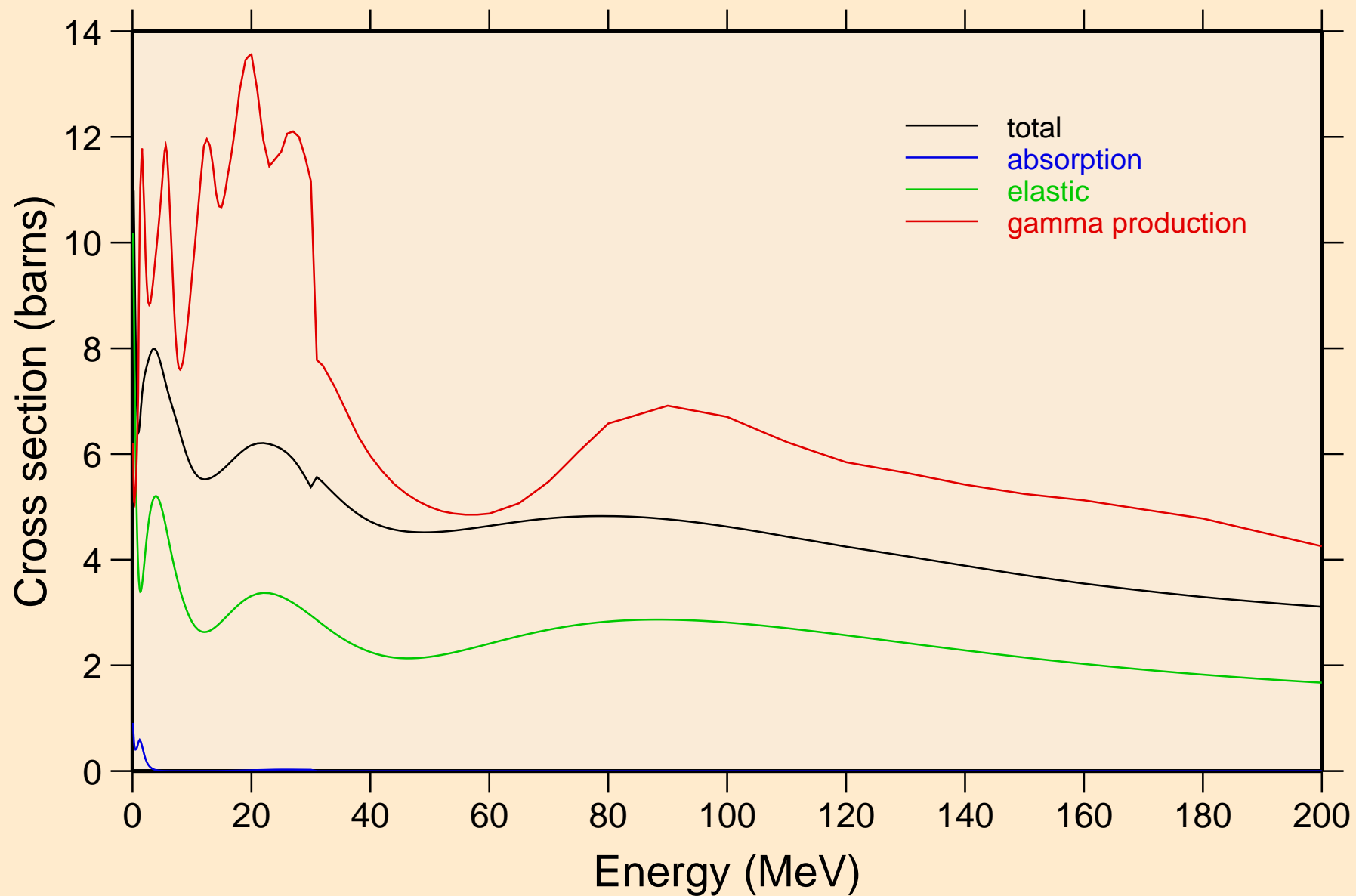

PA235 NEUTRON ACER TENDL-2019 LIBRARY; T=293.16K
Heating

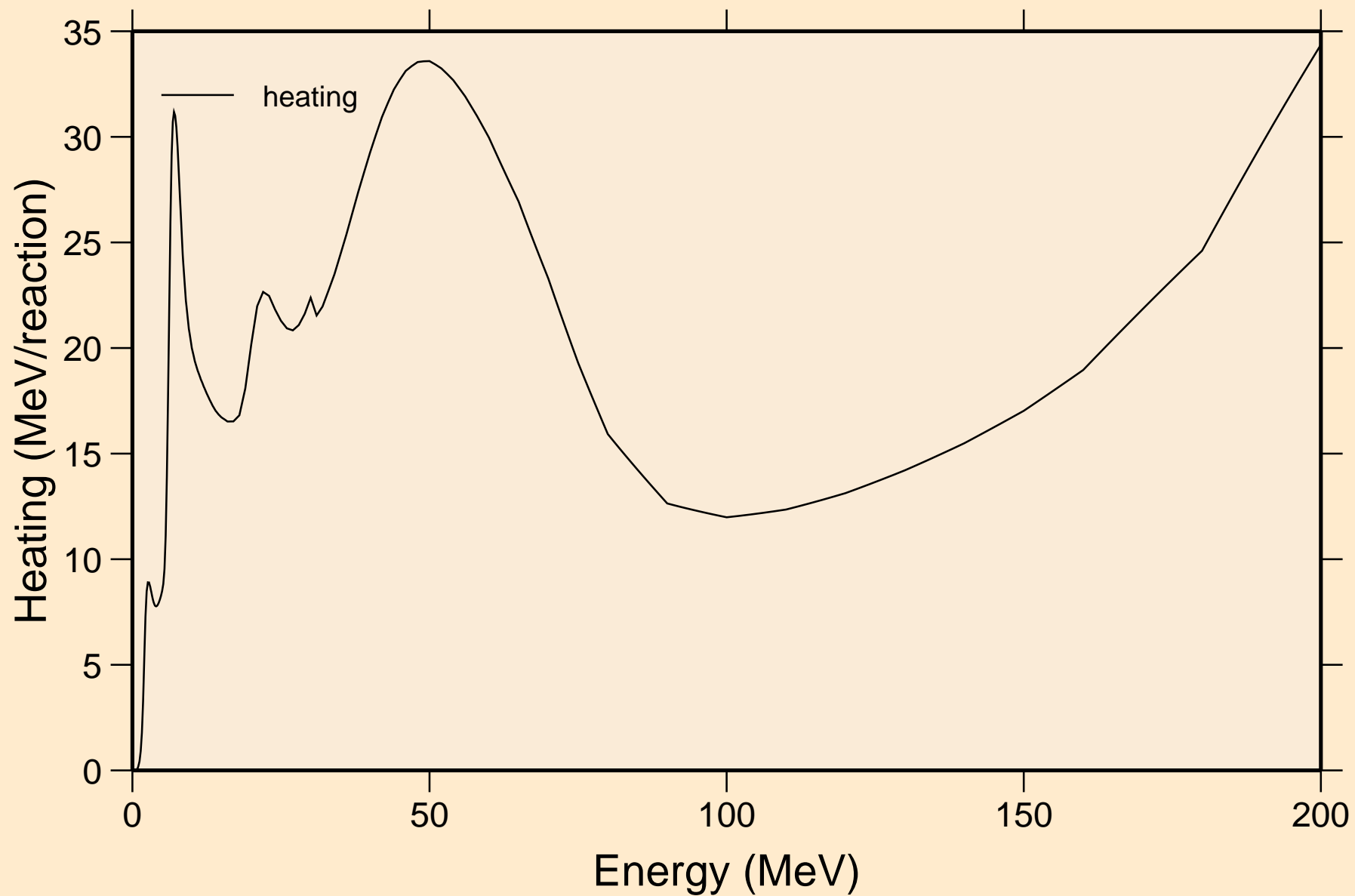

PA235 NEUTRON ACER TENDL-2019 LIBRARY; T=293.16K
Damage

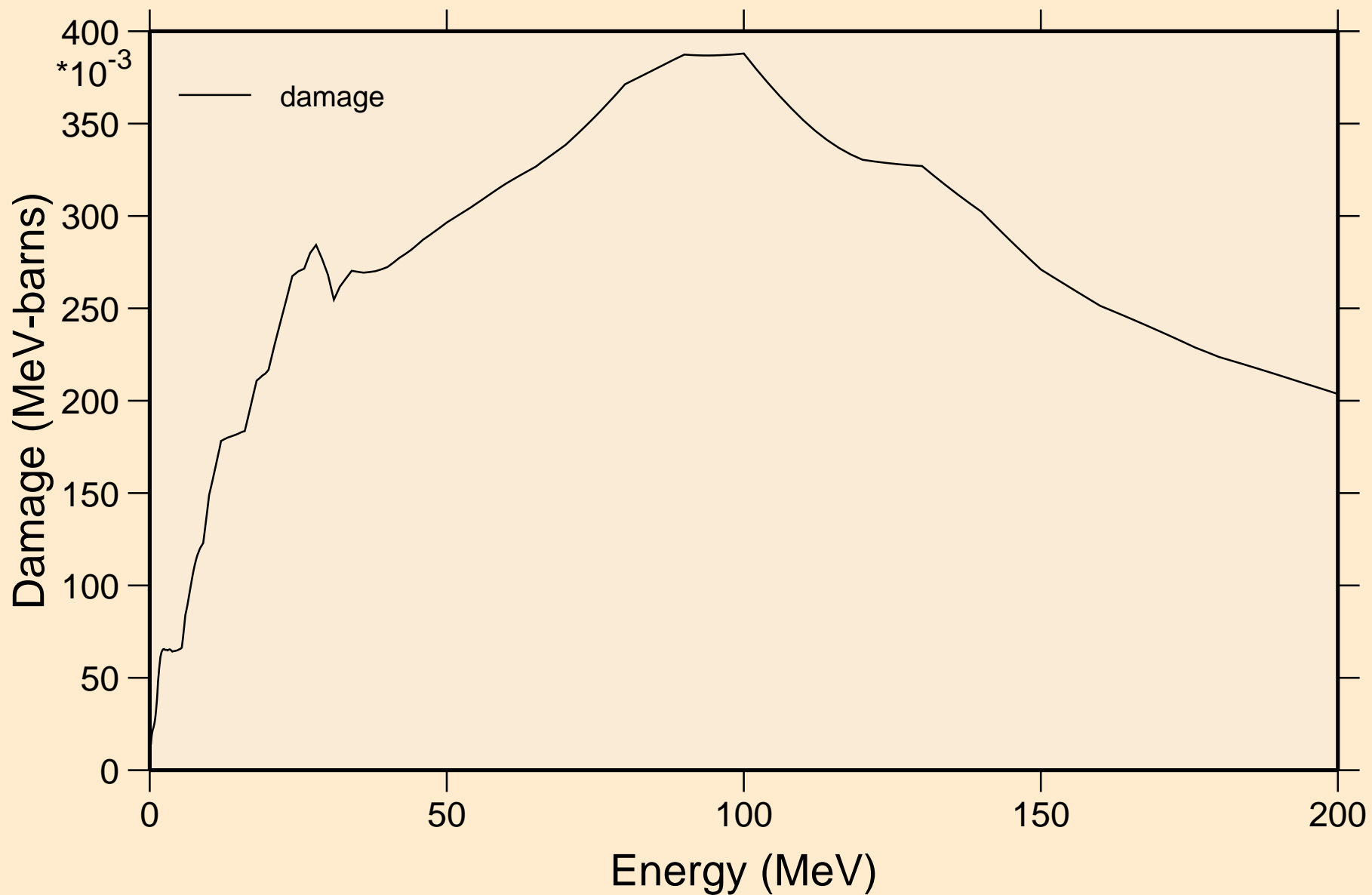

PA235 NEUTRON ACER TENDL-2019 LIBRARY; T=293.16K
Non-threshold reactions

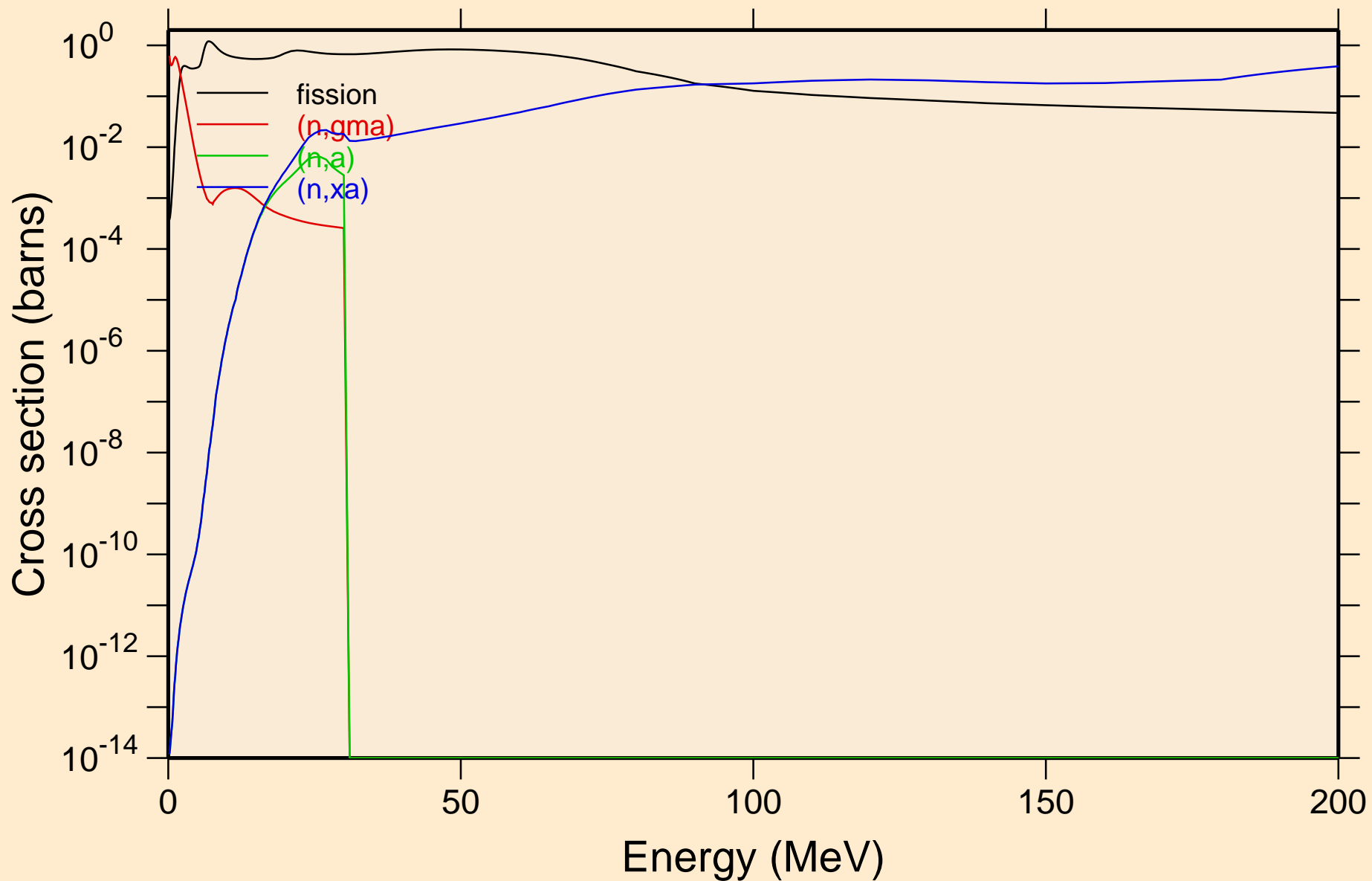

PA235 NEUTRON ACER TENDL-2019 LIBRARY; T=293.16K
Inelastic levels

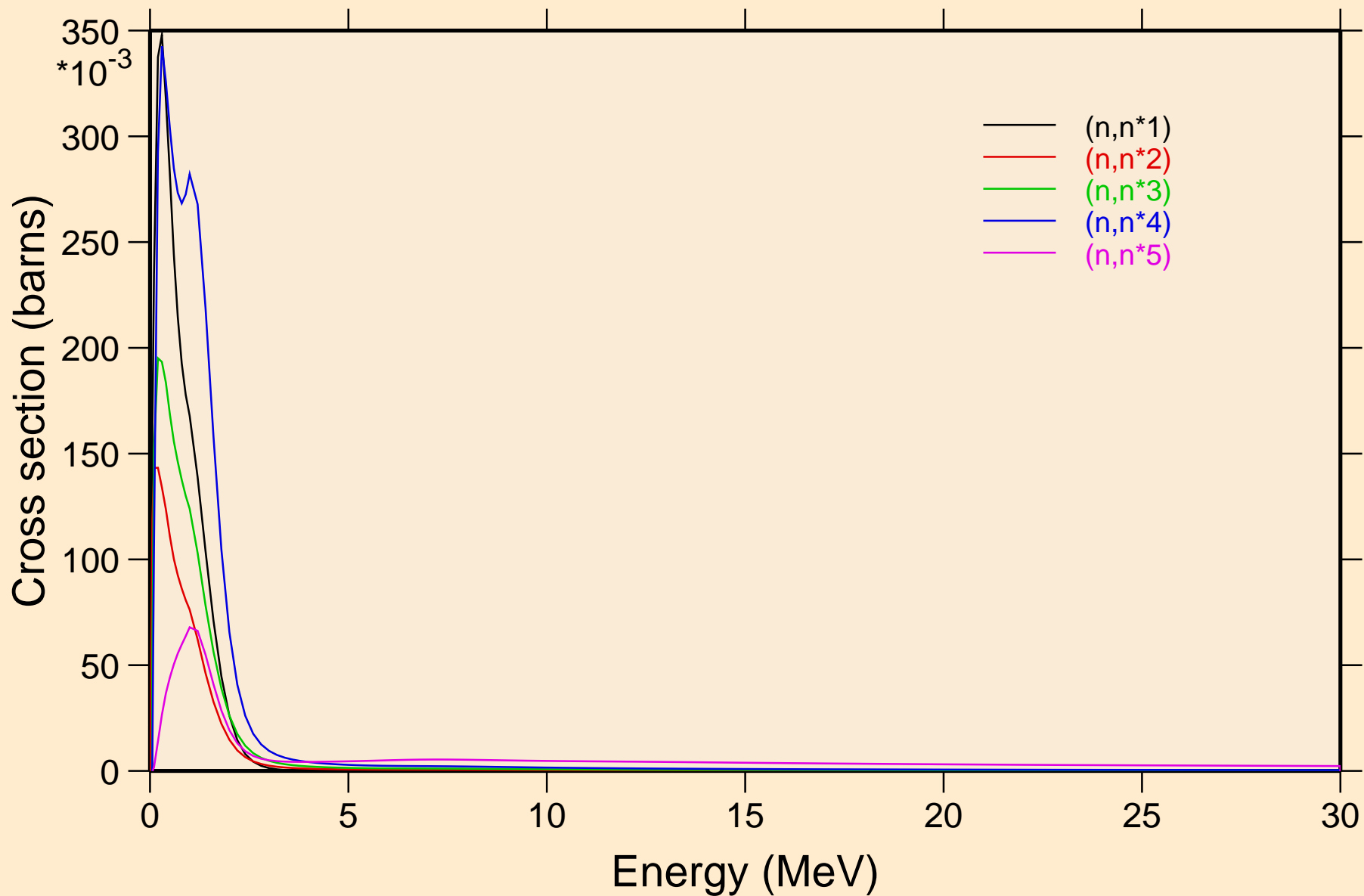

PA235 NEUTRON ACER TENDL-2019 LIBRARY; T=293.16K
Inelastic levels

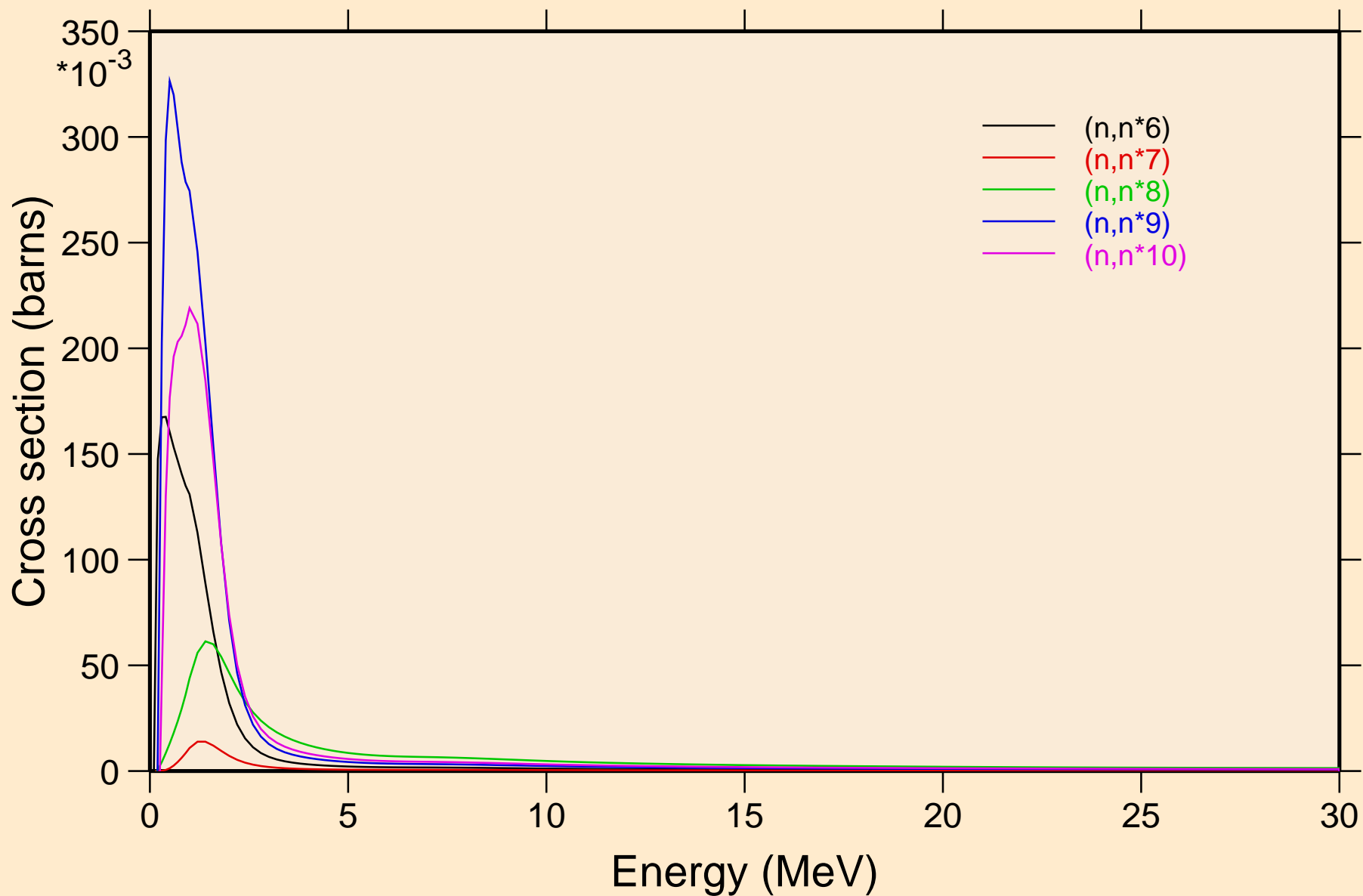

PA235 NEUTRON ACER TENDL-2019 LIBRARY; T=293.16K
Inelastic levels

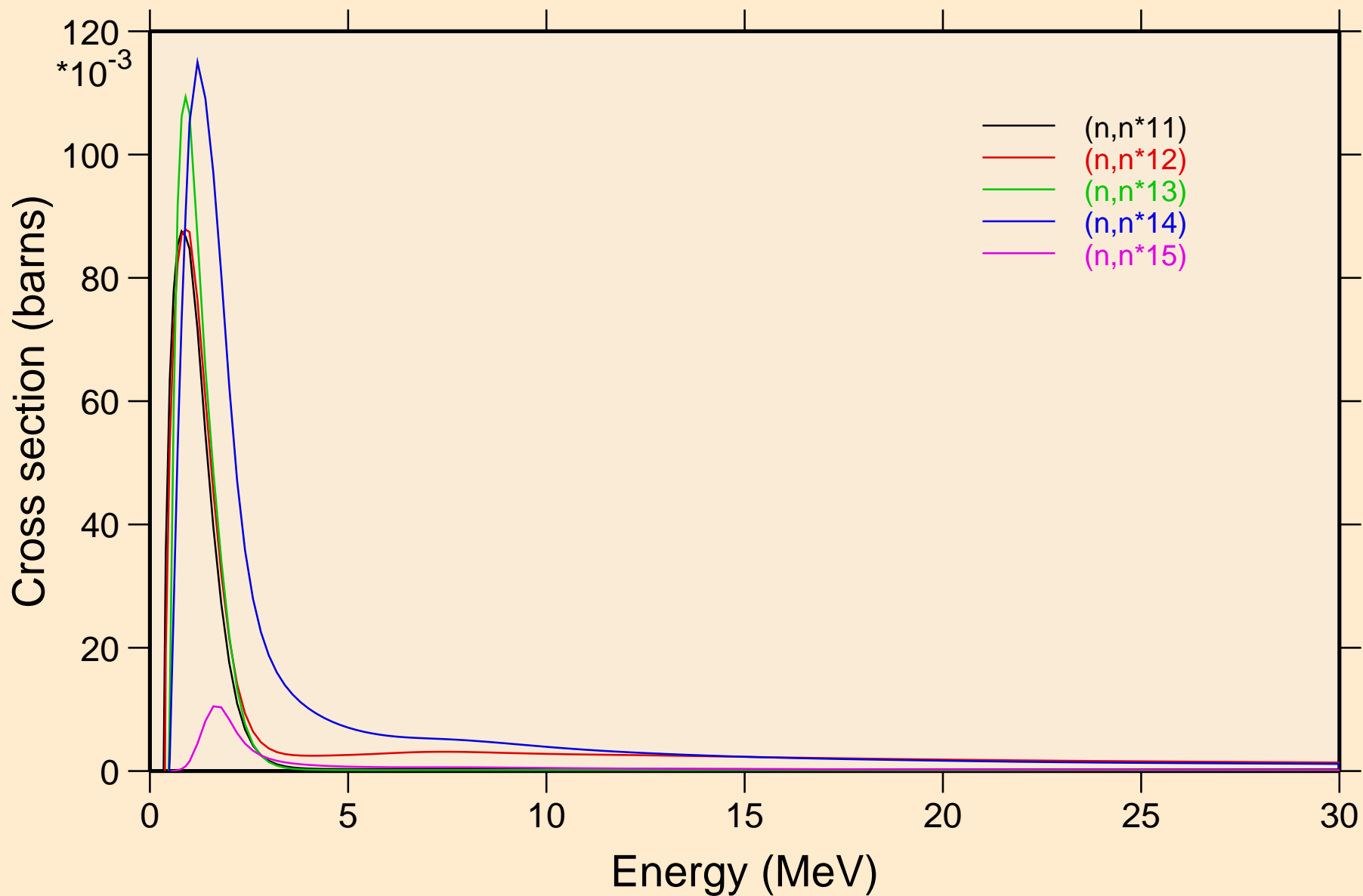

PA235 NEUTRON ACER TENDL-2019 LIBRARY; T=293.16K
Inelastic levels

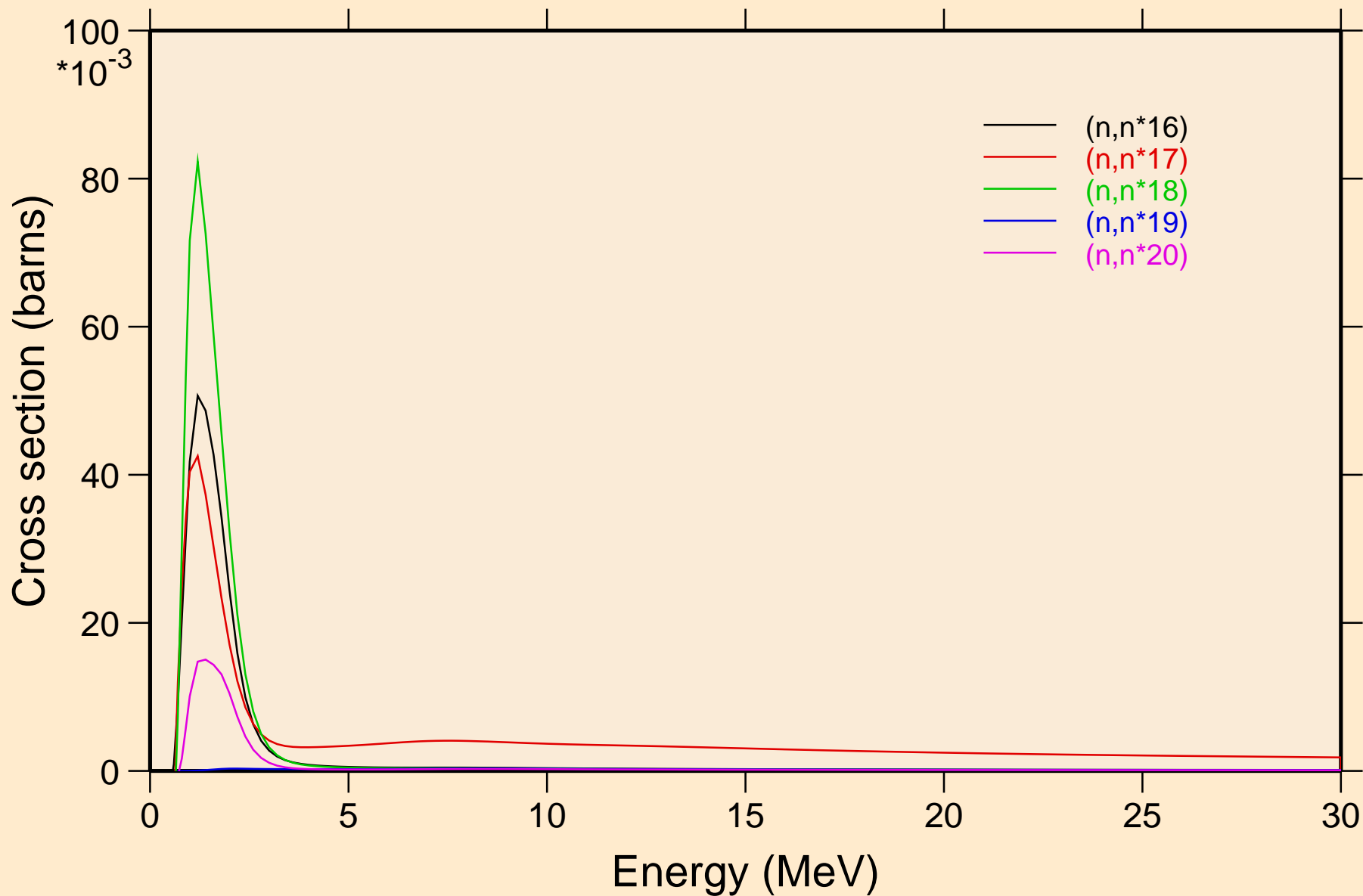

PA235 NEUTRON ACER TENDL-2019 LIBRARY; T=293.16K
Inelastic levels

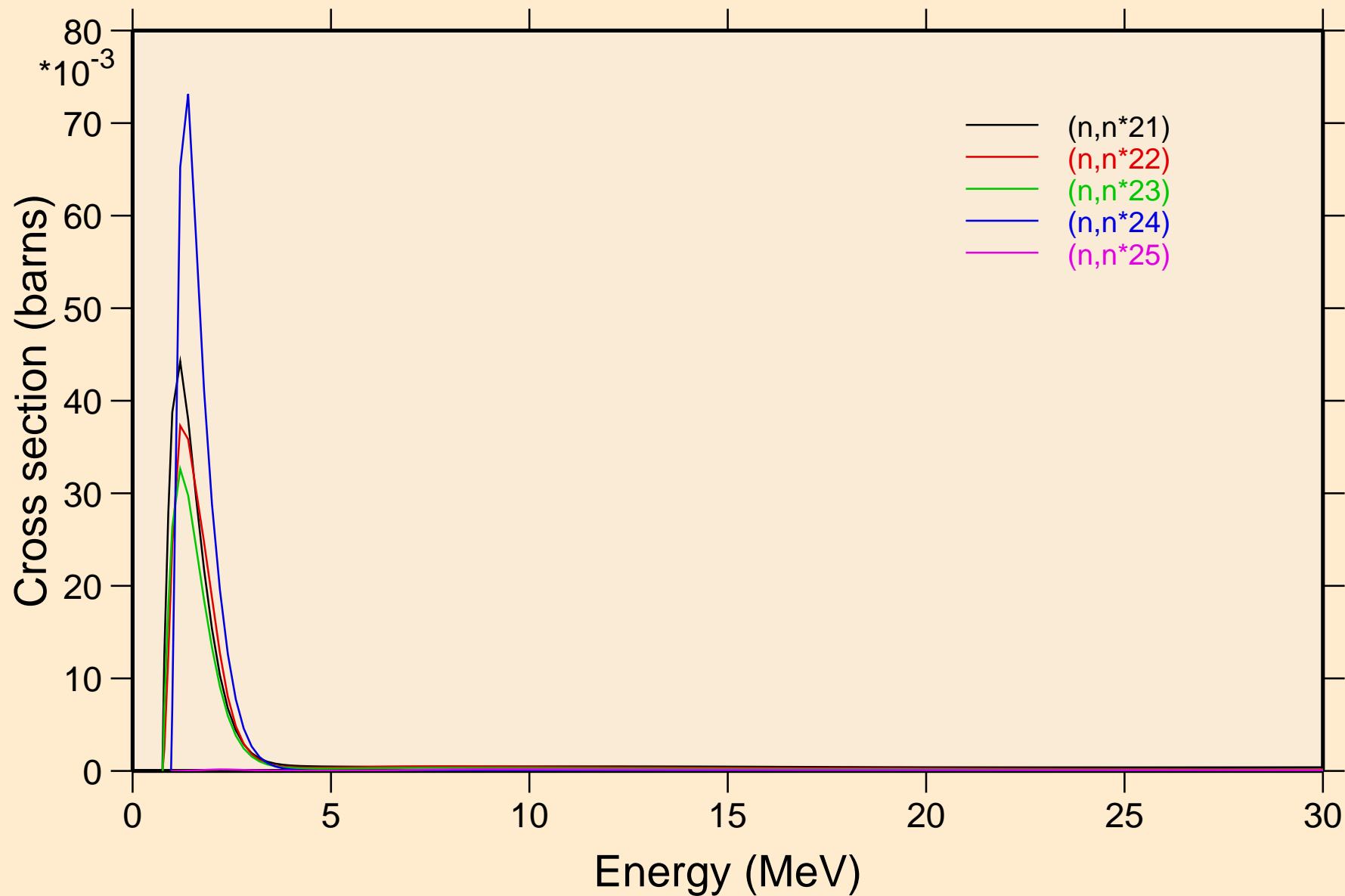

PA235 NEUTRON ACER TENDL-2019 LIBRARY; T=293.16K
Inelastic levels

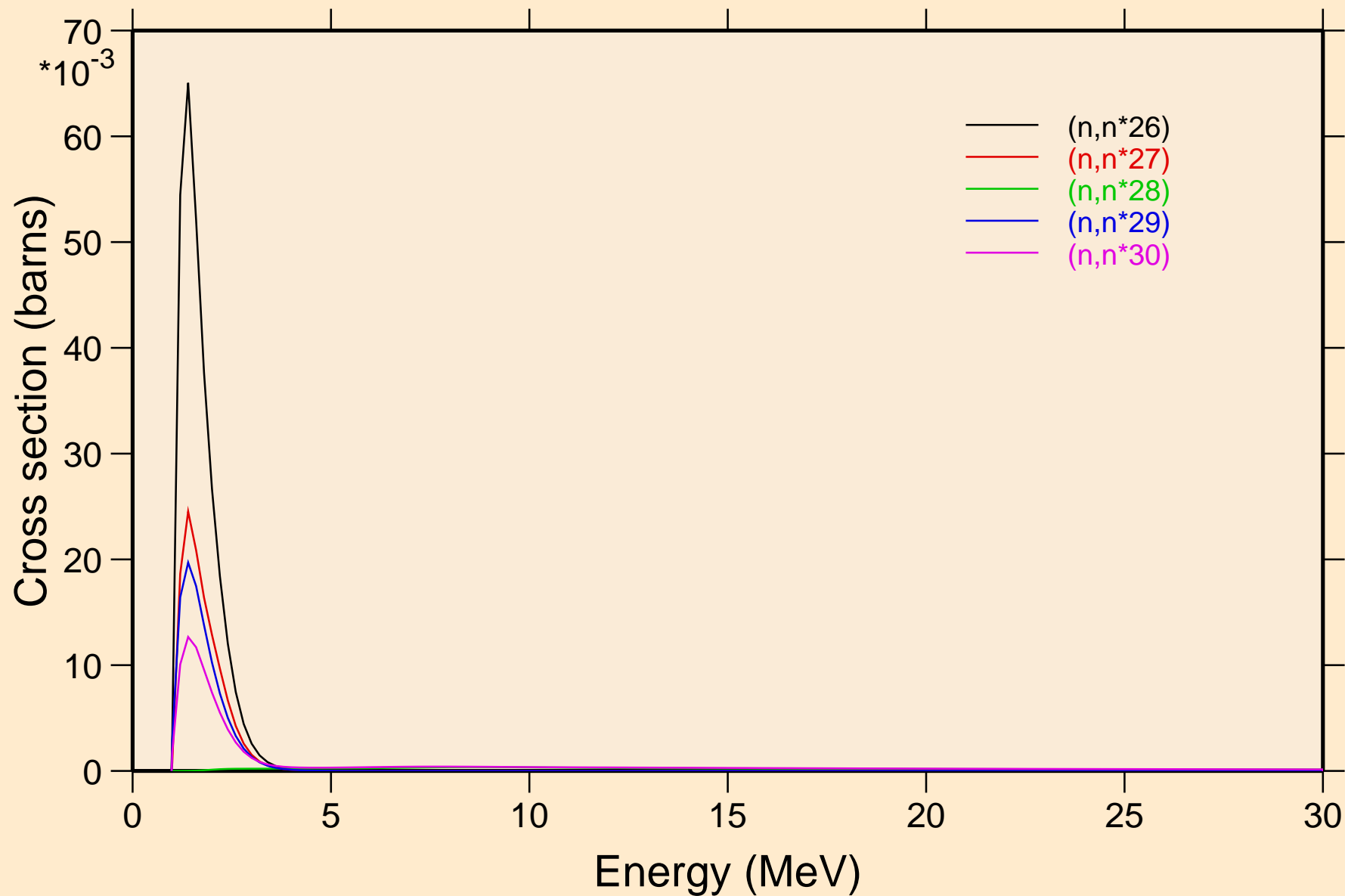

PA235 NEUTRON ACER TENDL-2019 LIBRARY; T=293.16K
Threshold reactions

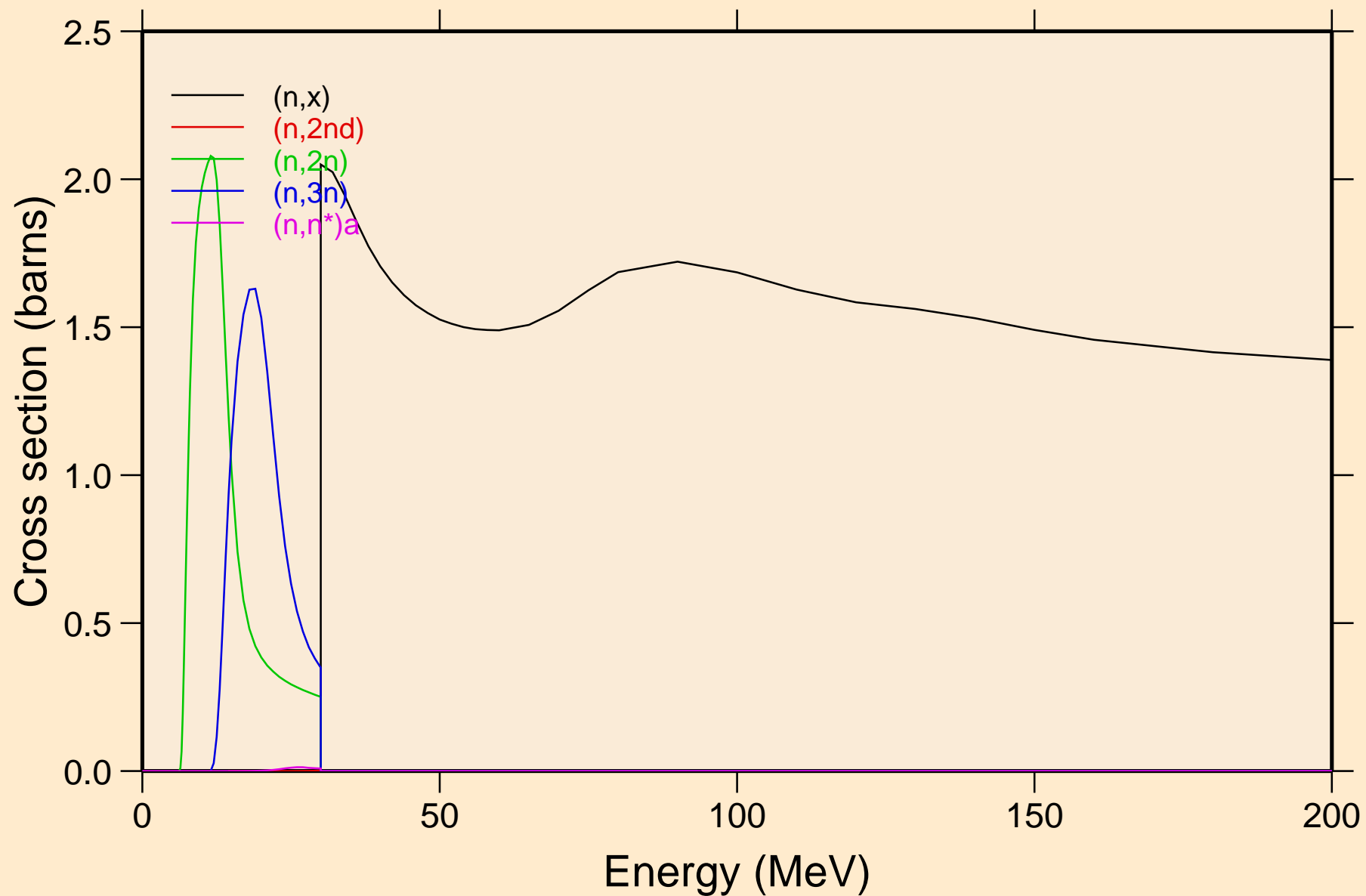

PA235 NEUTRON ACER TENDL-2019 LIBRARY; T=293.16K
Threshold reactions

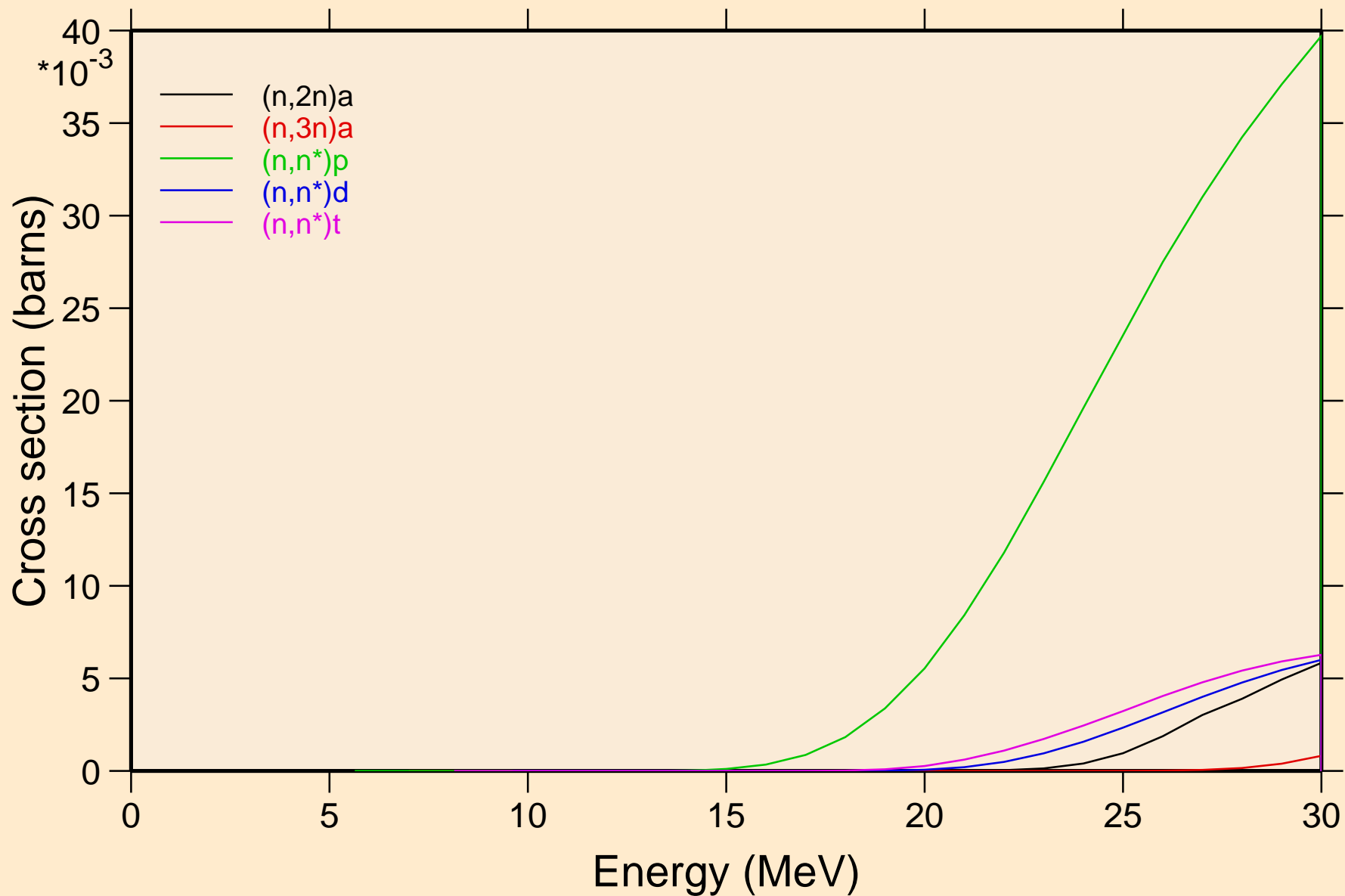

PA235 NEUTRON ACER TENDL-2019 LIBRARY; T=293.16K
Threshold reactions

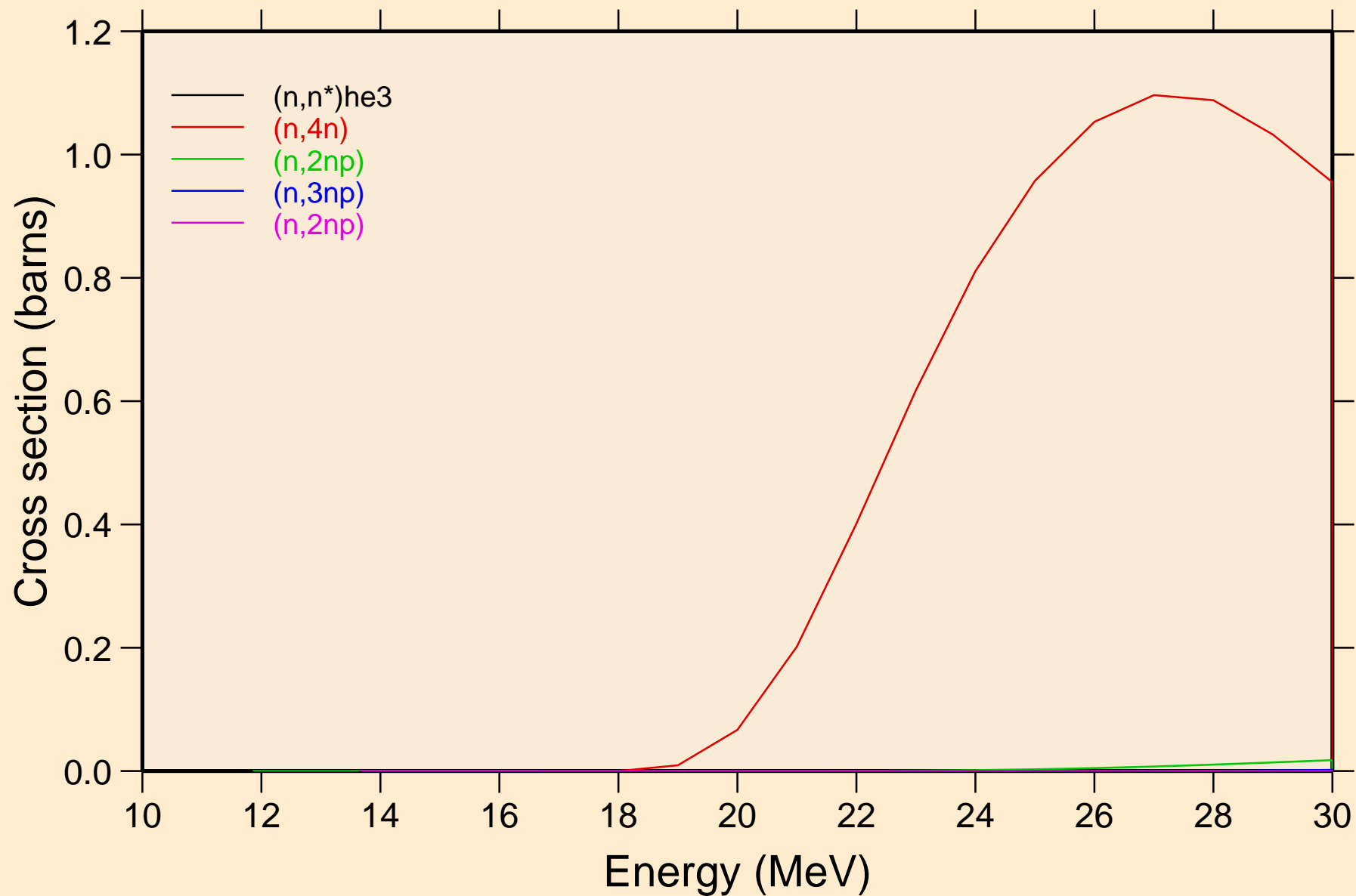

PA235 NEUTRON ACER TENDL-2019 LIBRARY; T=293.16K
Threshold reactions

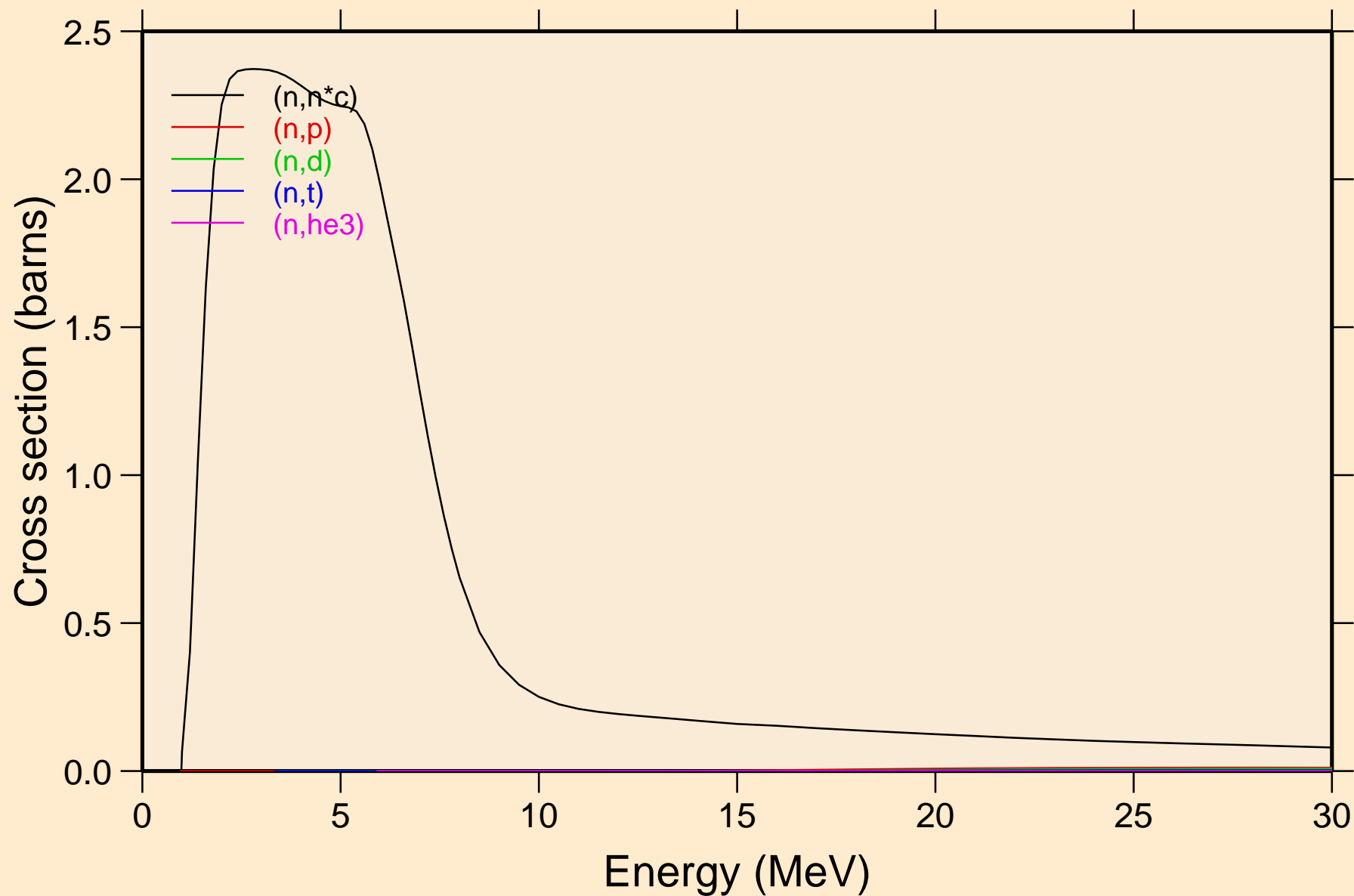

PA235 NEUTRON ACER TENDL-2019 LIBRARY; T=293.16K
Threshold reactions

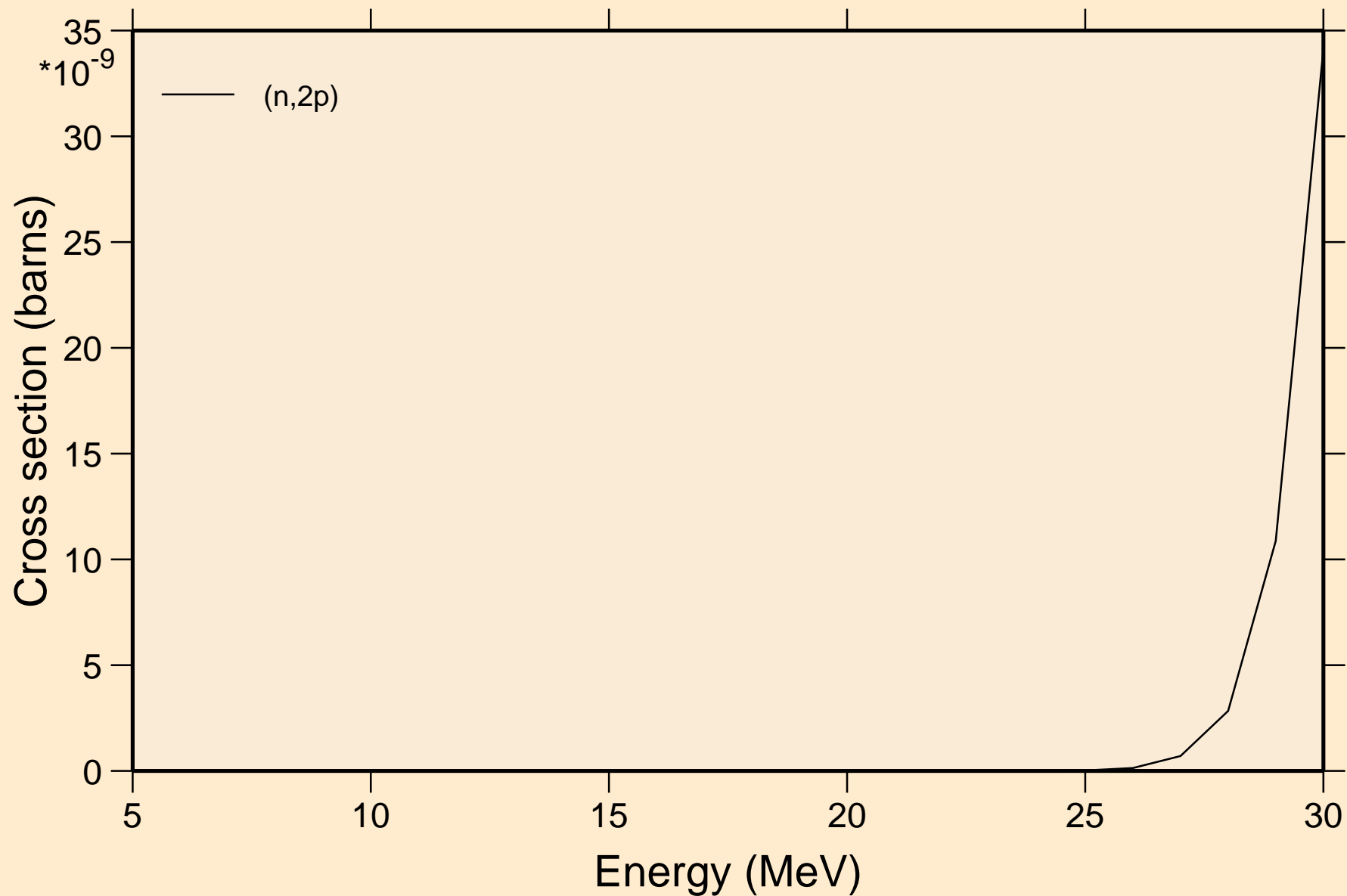

PA235 NEUTRON ACER TENDL-2019 LIBRARY; T=293.16K
Threshold reactions

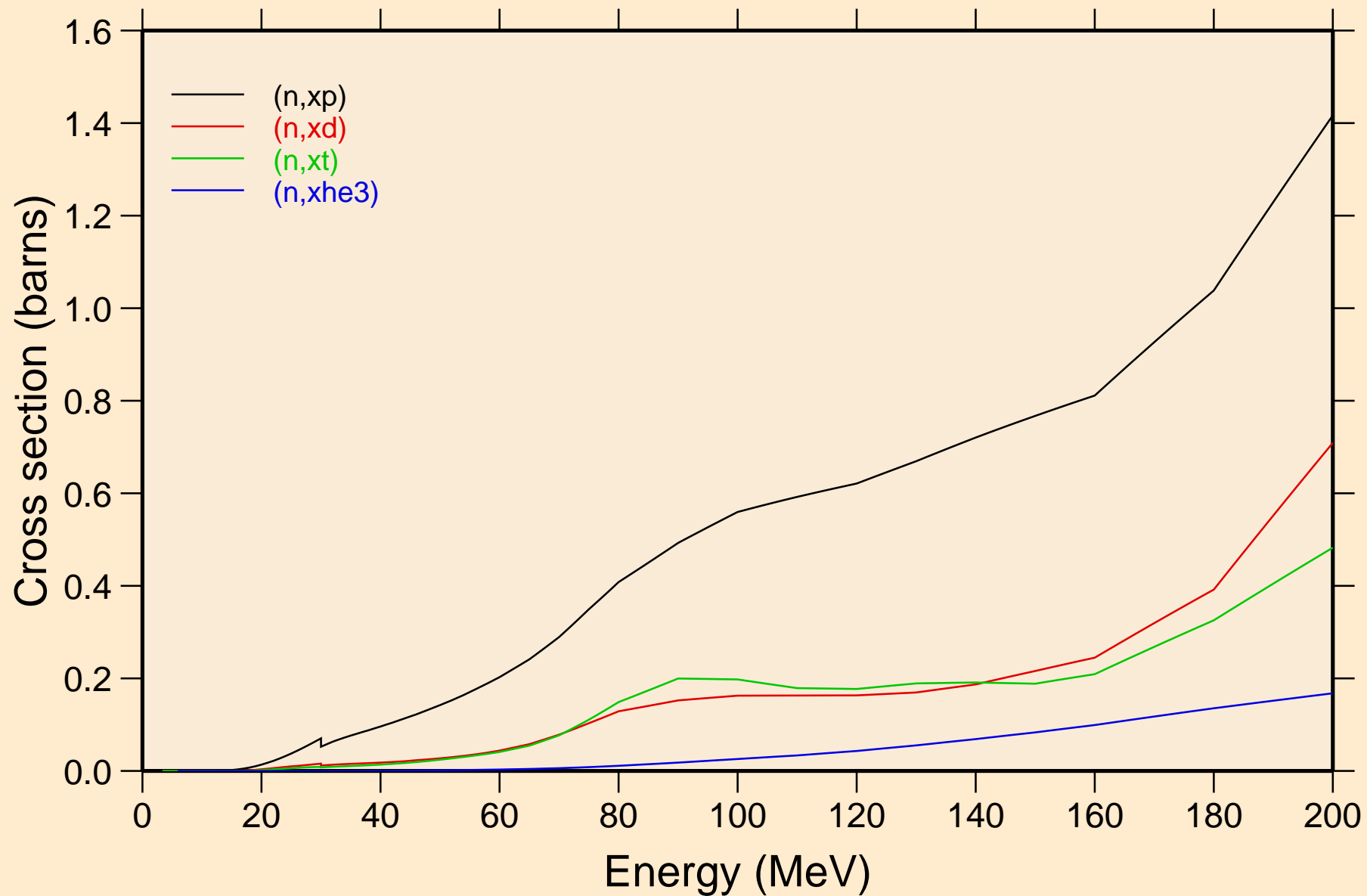

PA235 NEUTRON ACER TENDL-2019 LIBRARY; T=293.16K
angular distribution for elastic

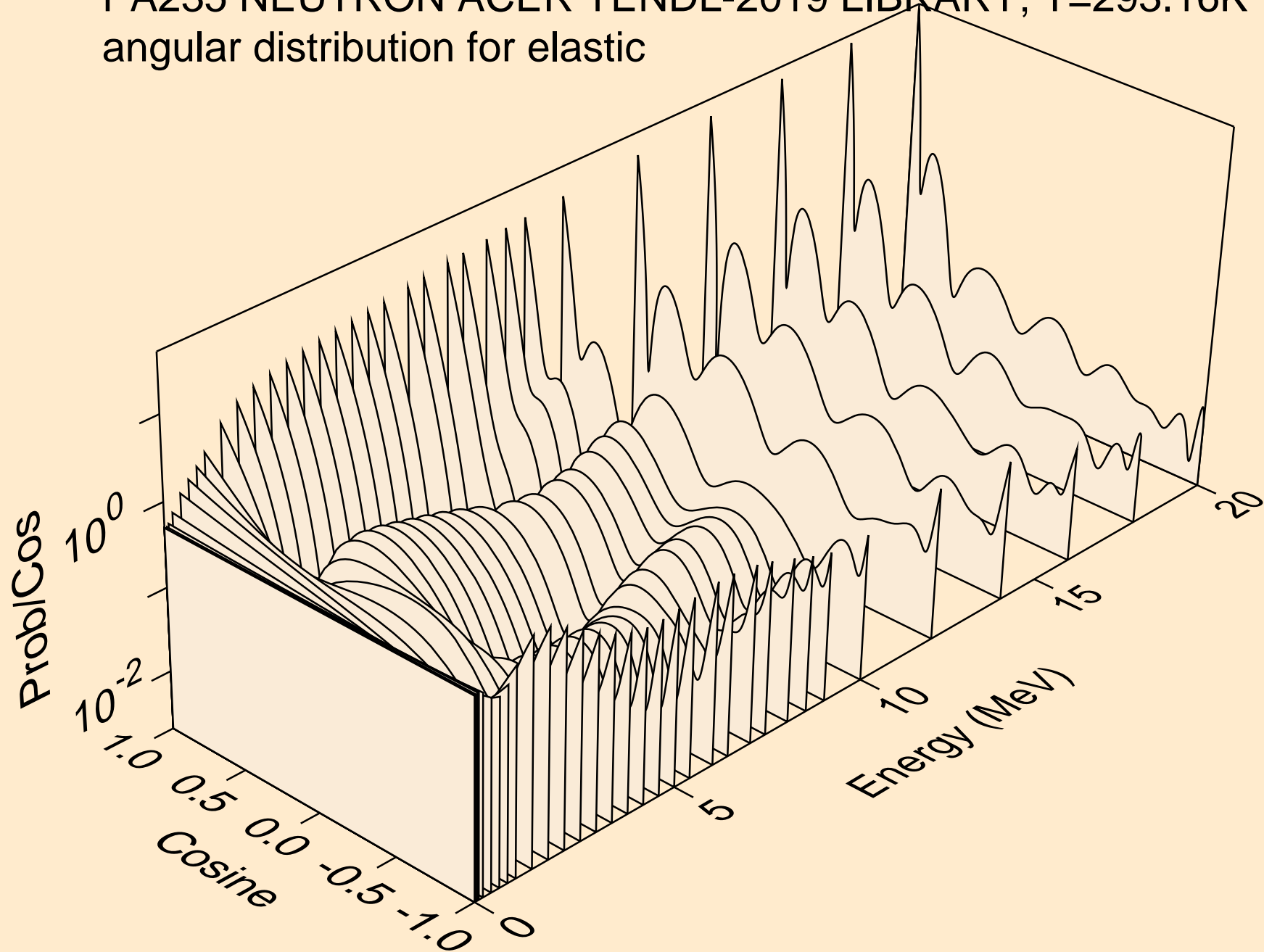

PA235 NEUTRON ACER TENDL-2019 LIBRARY; T=293.16K
angular distribution for elastic

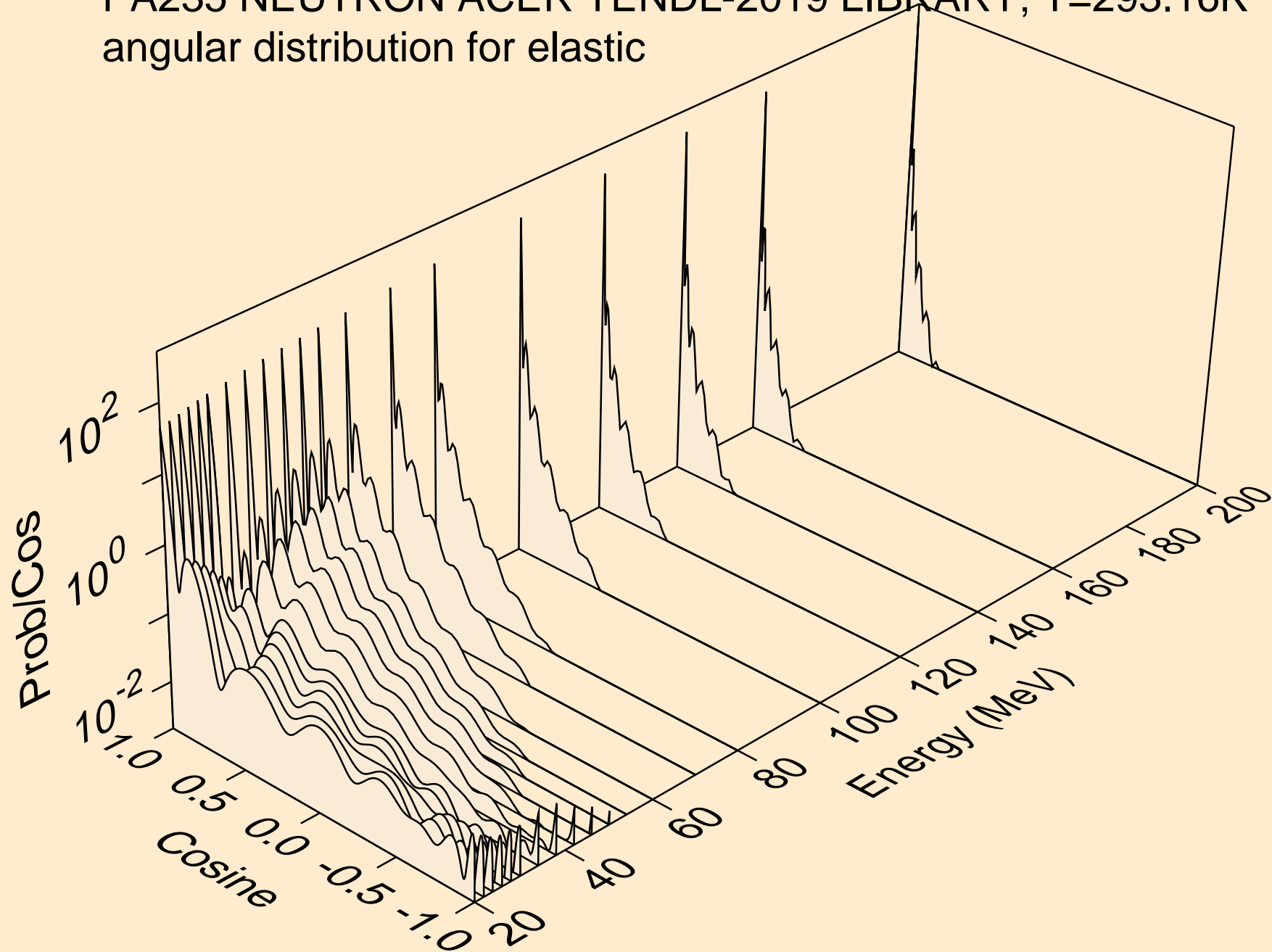

PA235 NEUTRON ACER TENDL-2019 LIBRARY; T=293.16K
angular distribution for (n,n*1)

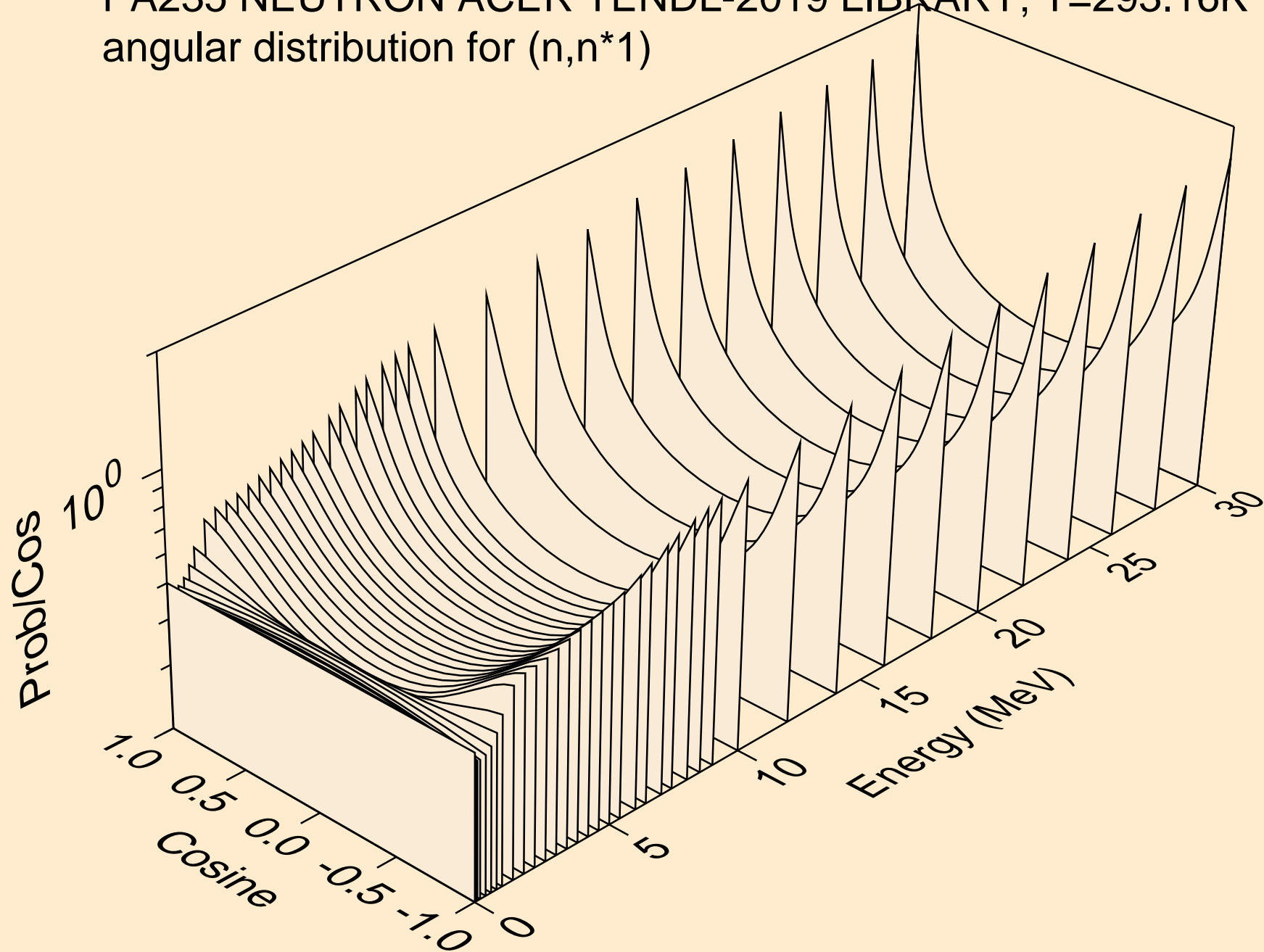

PA235 NEUTRON ACER TENDL-2019 LIBRARY; T=293.16K
angular distribution for (n,n*2)

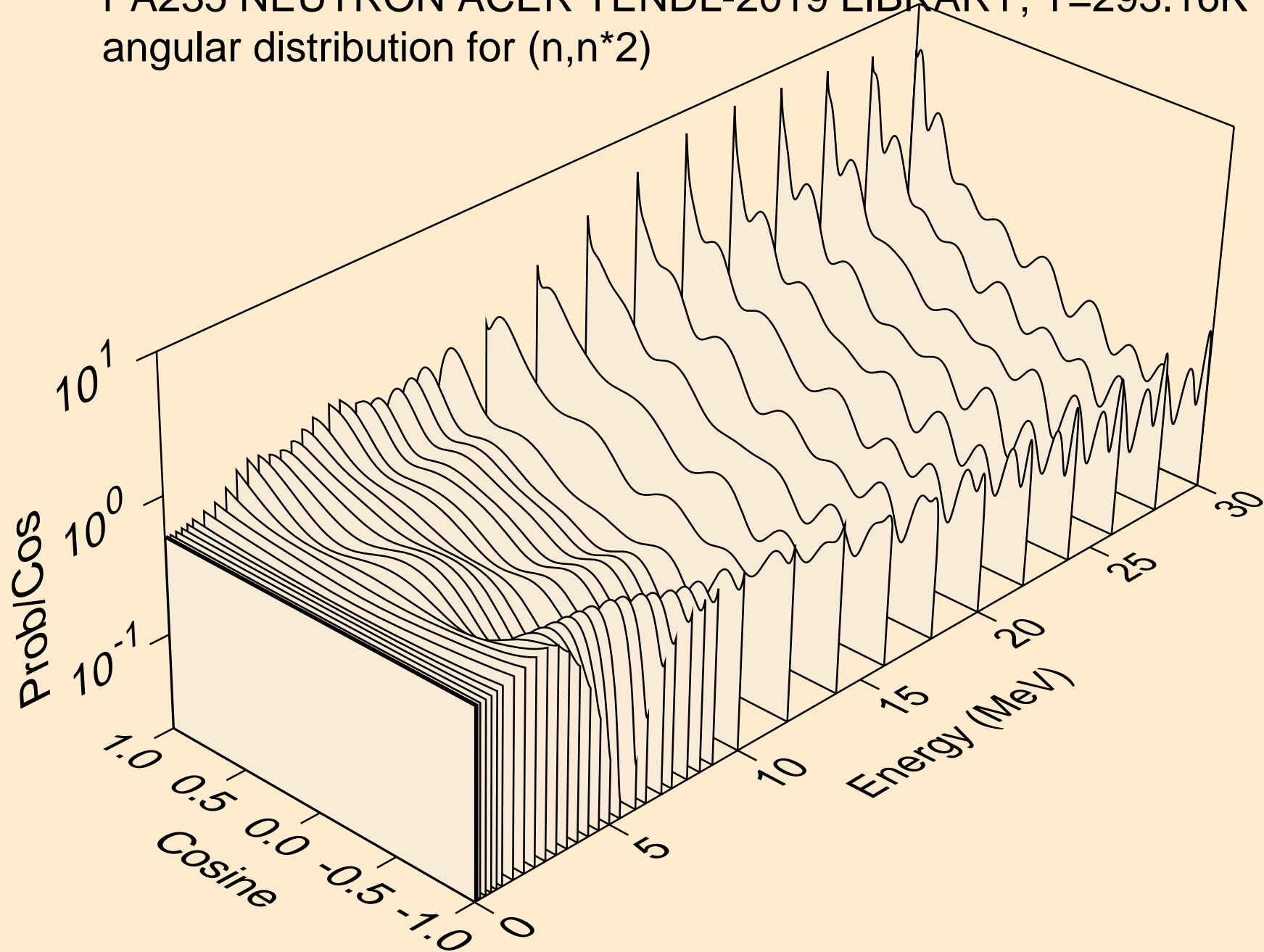

PA235 NEUTRON ACER TENDL-2019 LIBRARY; T=293.16K
angular distribution for (n,n*3)

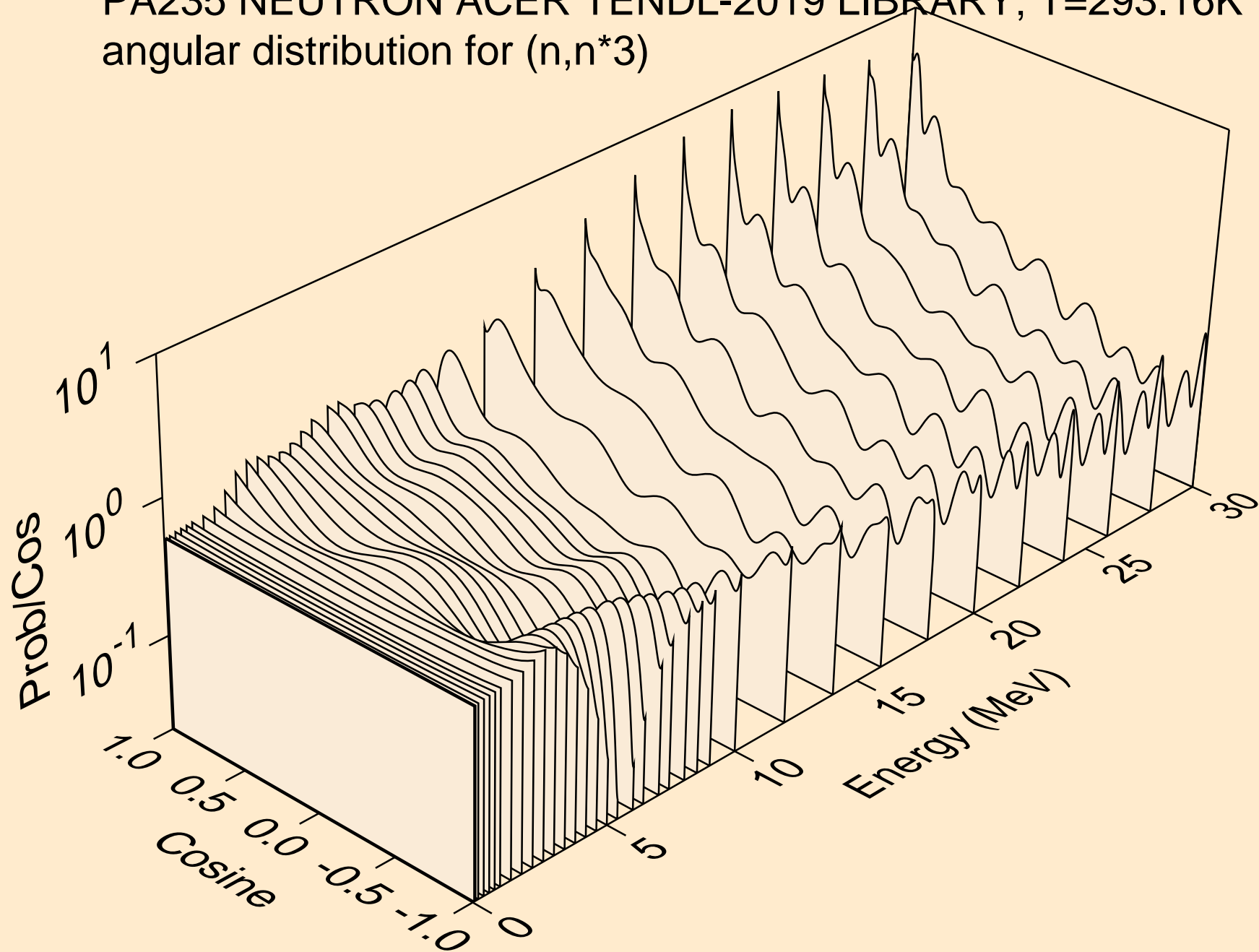

PA235 NEUTRON ACER TENDL-2019 LIBRARY; T=293.16K
angular distribution for (n,n*4)

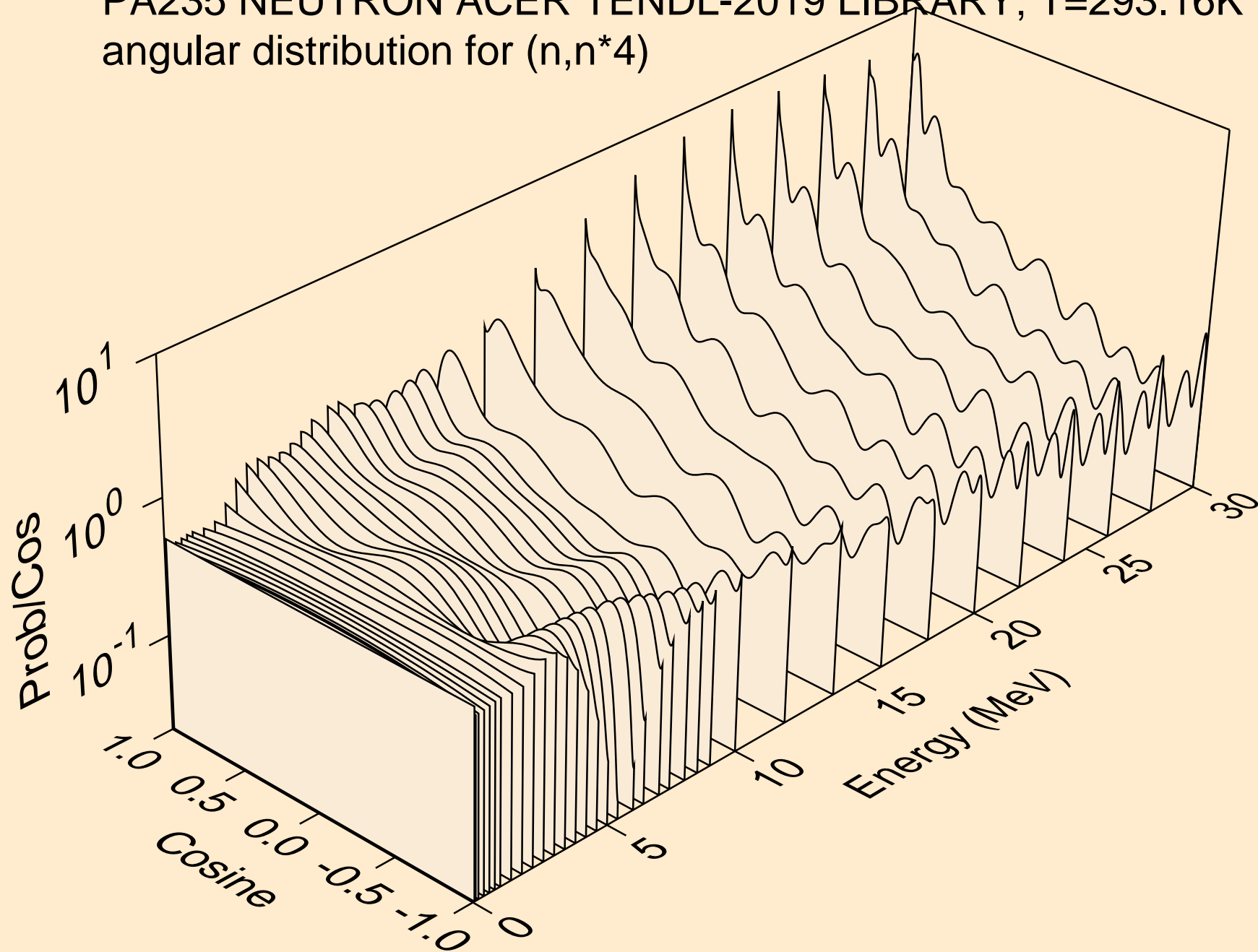

PA235 NEUTRON ACER TENDL-2019 LIBRARY; T=293.16K
angular distribution for (n,n*5)

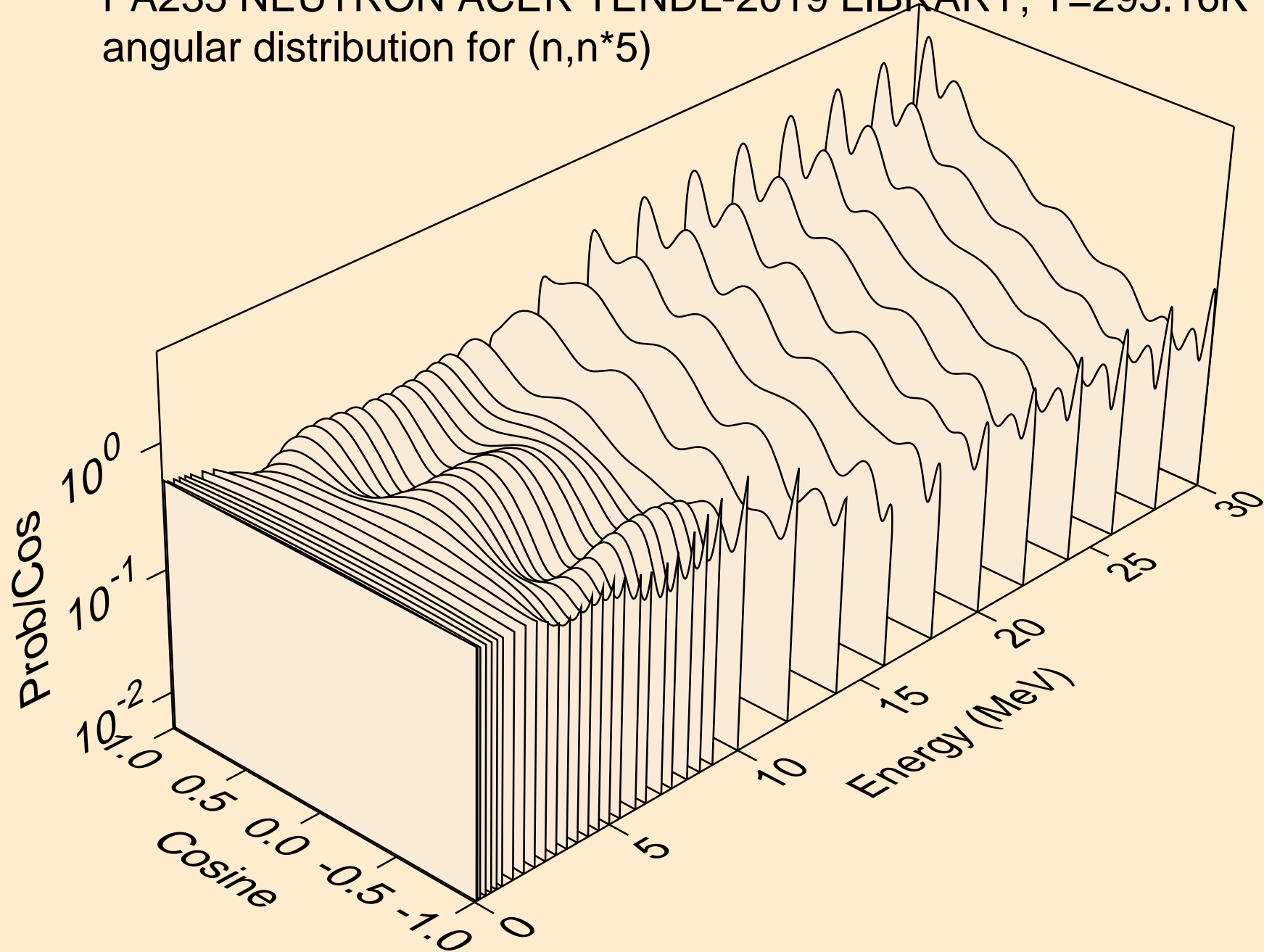

PA235 NEUTRON ACER TENDL-2019 LIBRARY; T=293.16K
angular distribution for (n,n*6)

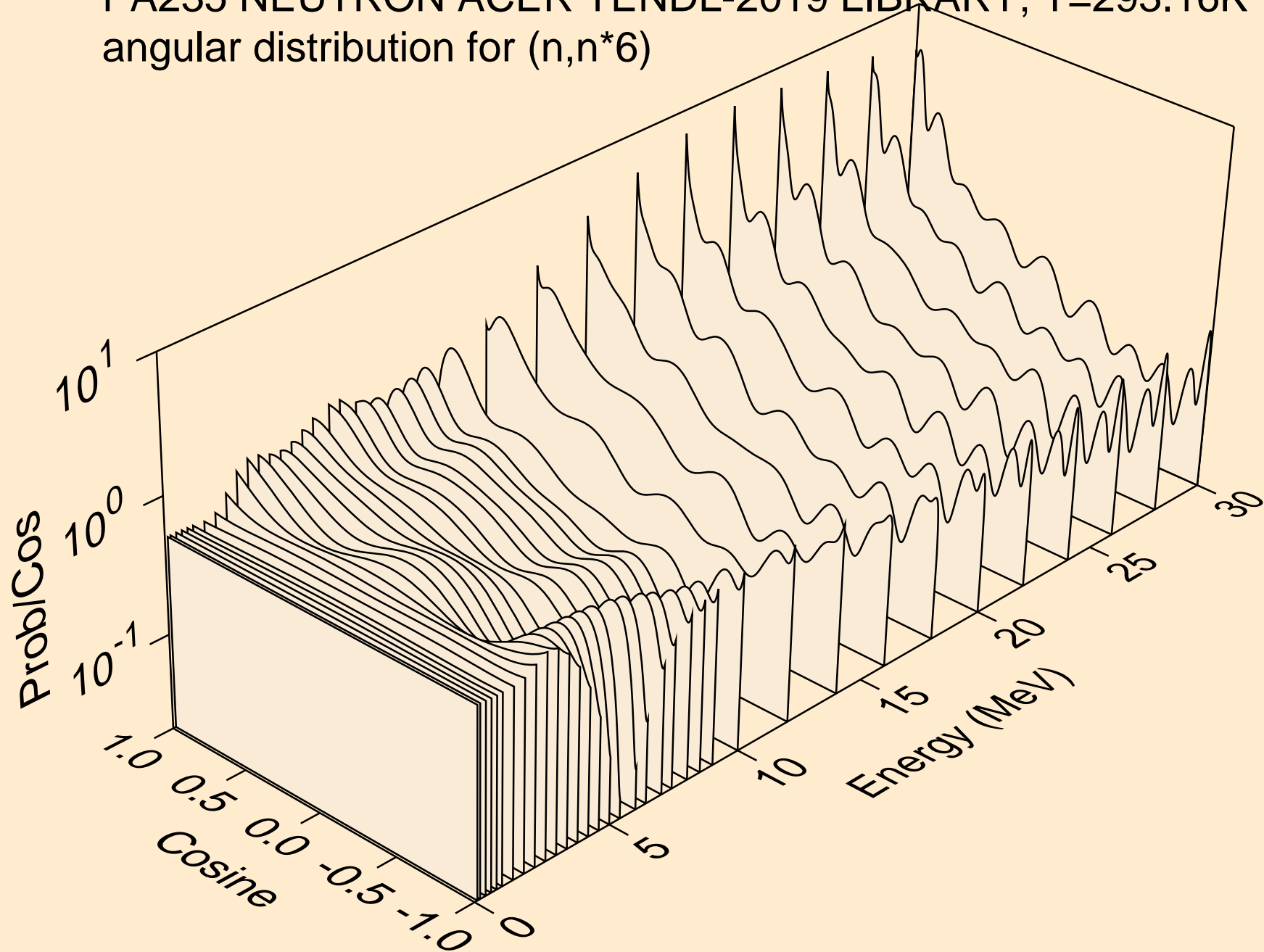

PA235 NEUTRON ACER TENDL-2019 LIBRARY; T=293.16K
angular distribution for (n,n*7)

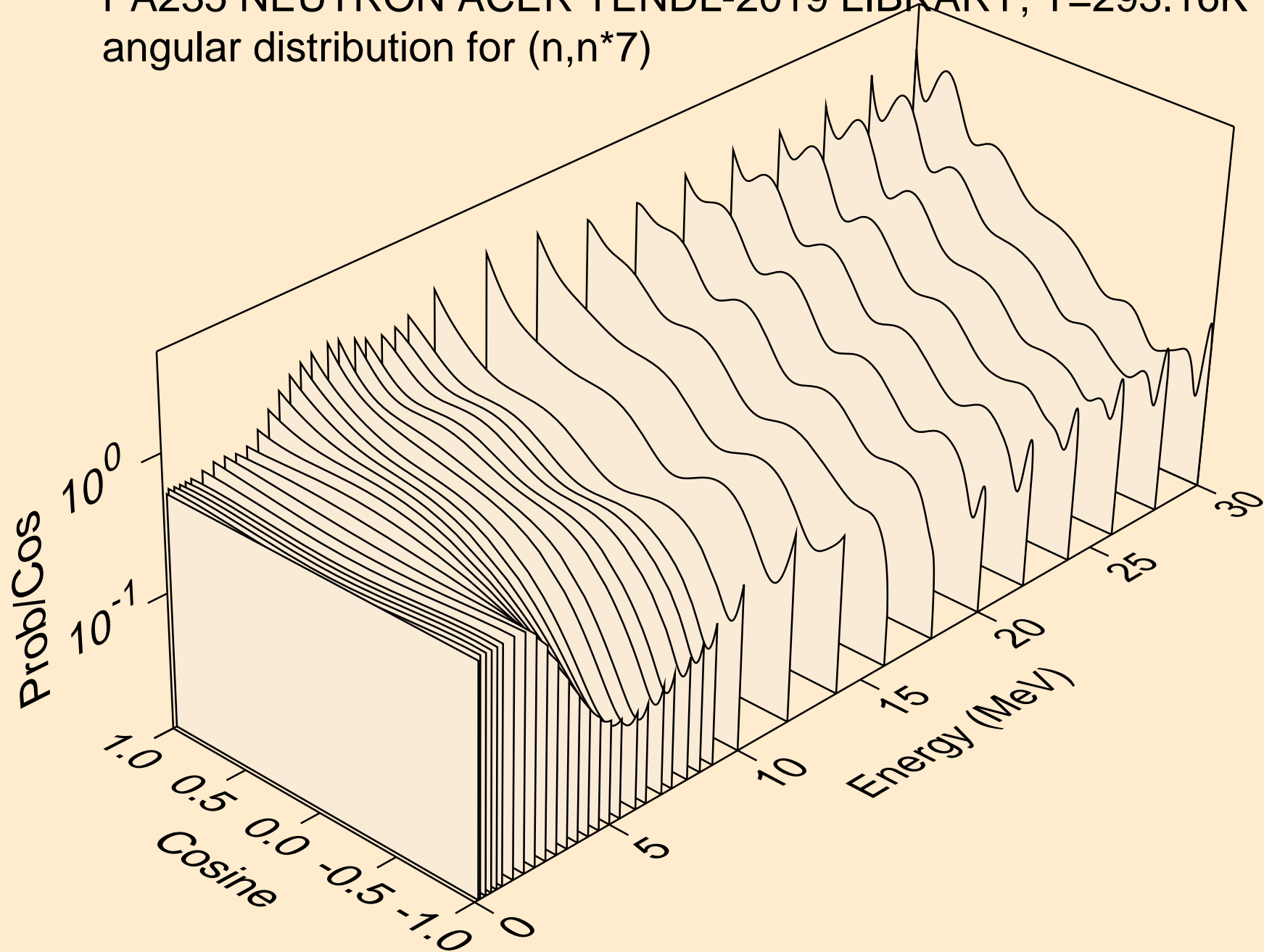

PA235 NEUTRON ACER TENDL-2019 LIBRARY; T=293.16K
angular distribution for (n,n*8)

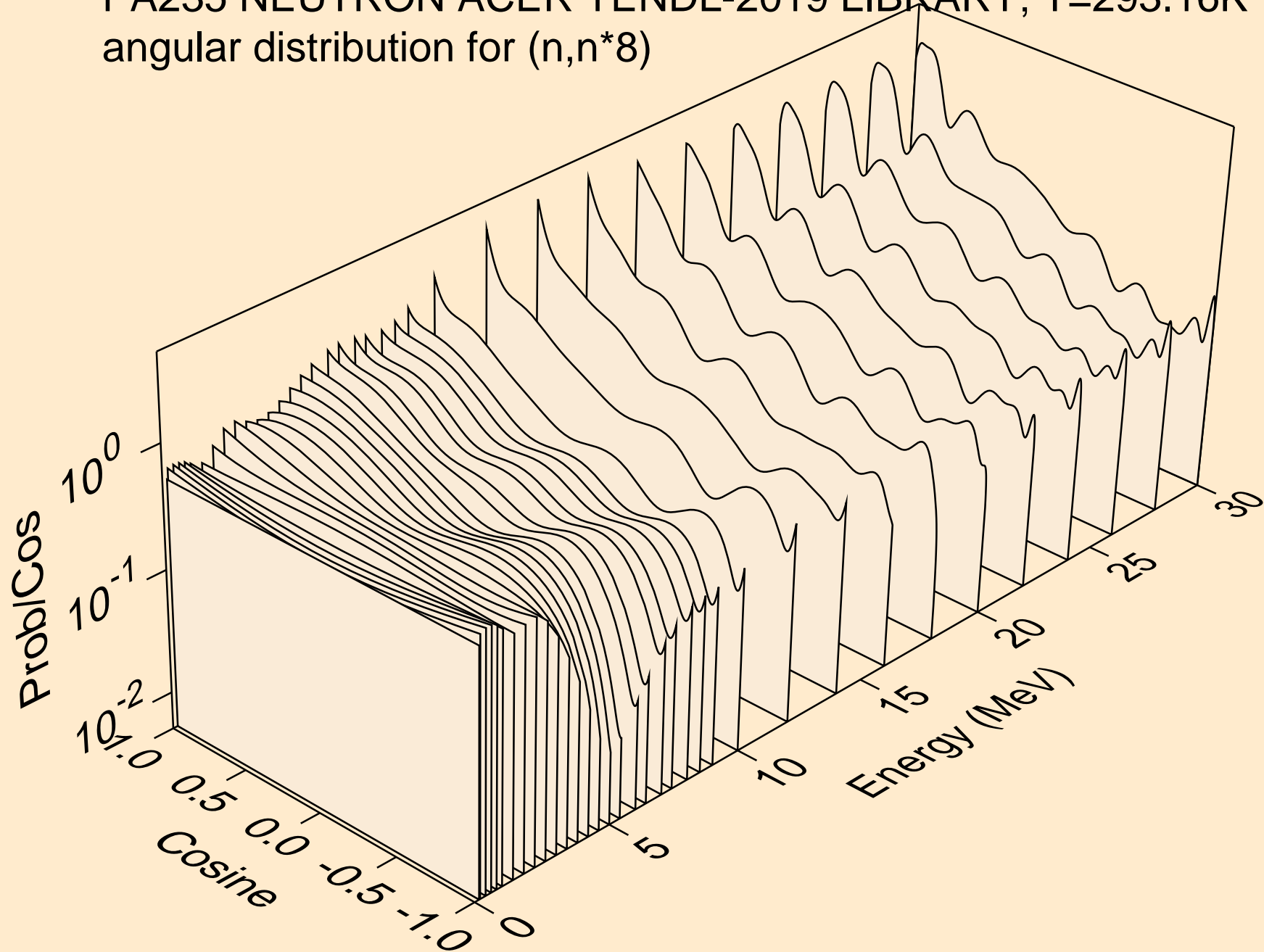

PA235 NEUTRON ACER TENDL-2019 LIBRARY; T=293.16K
angular distribution for (n,n*9)

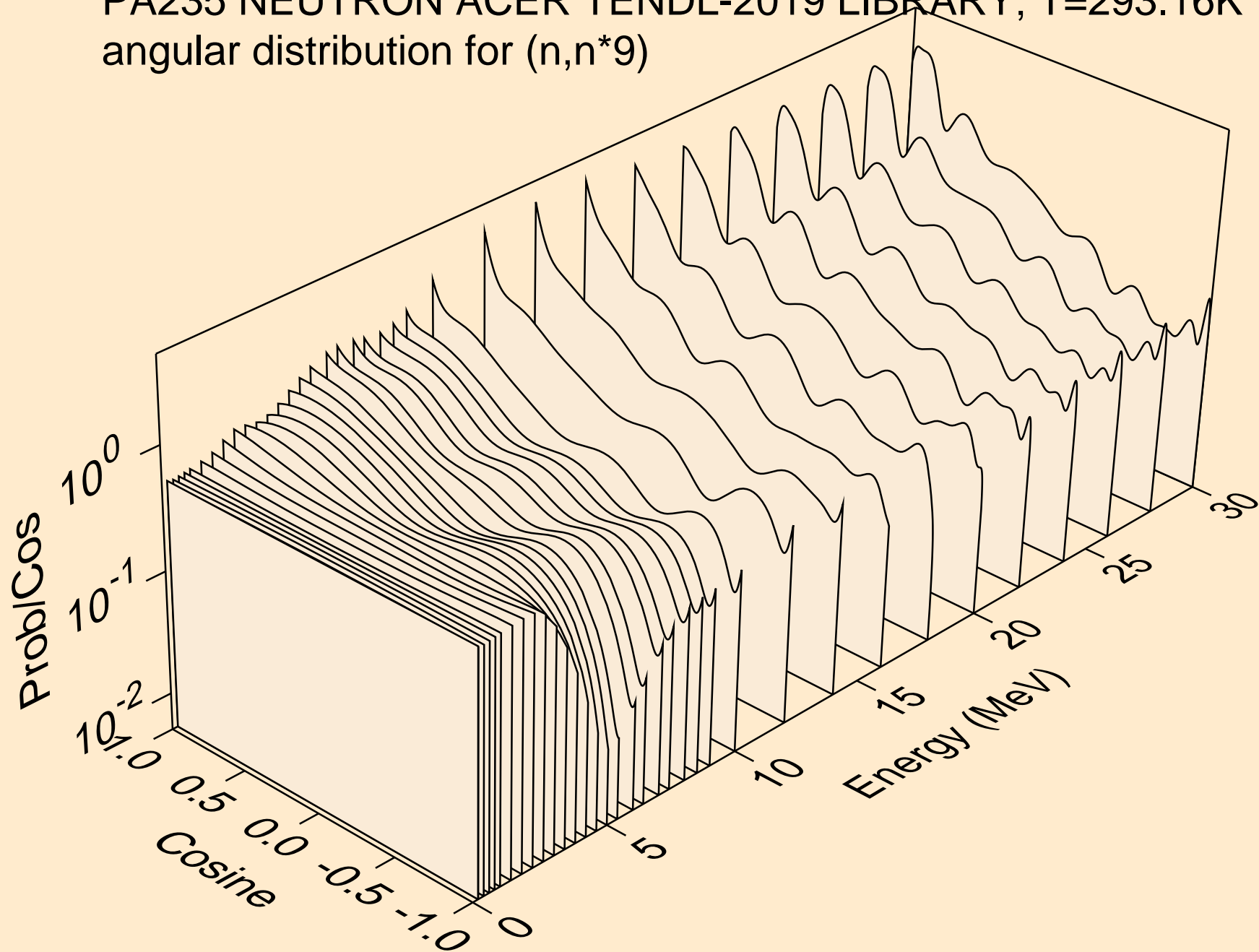

PA235 NEUTRON ACER TENDL-2019 LIBRARY; T=293.16K
angular distribution for (n,n*10)

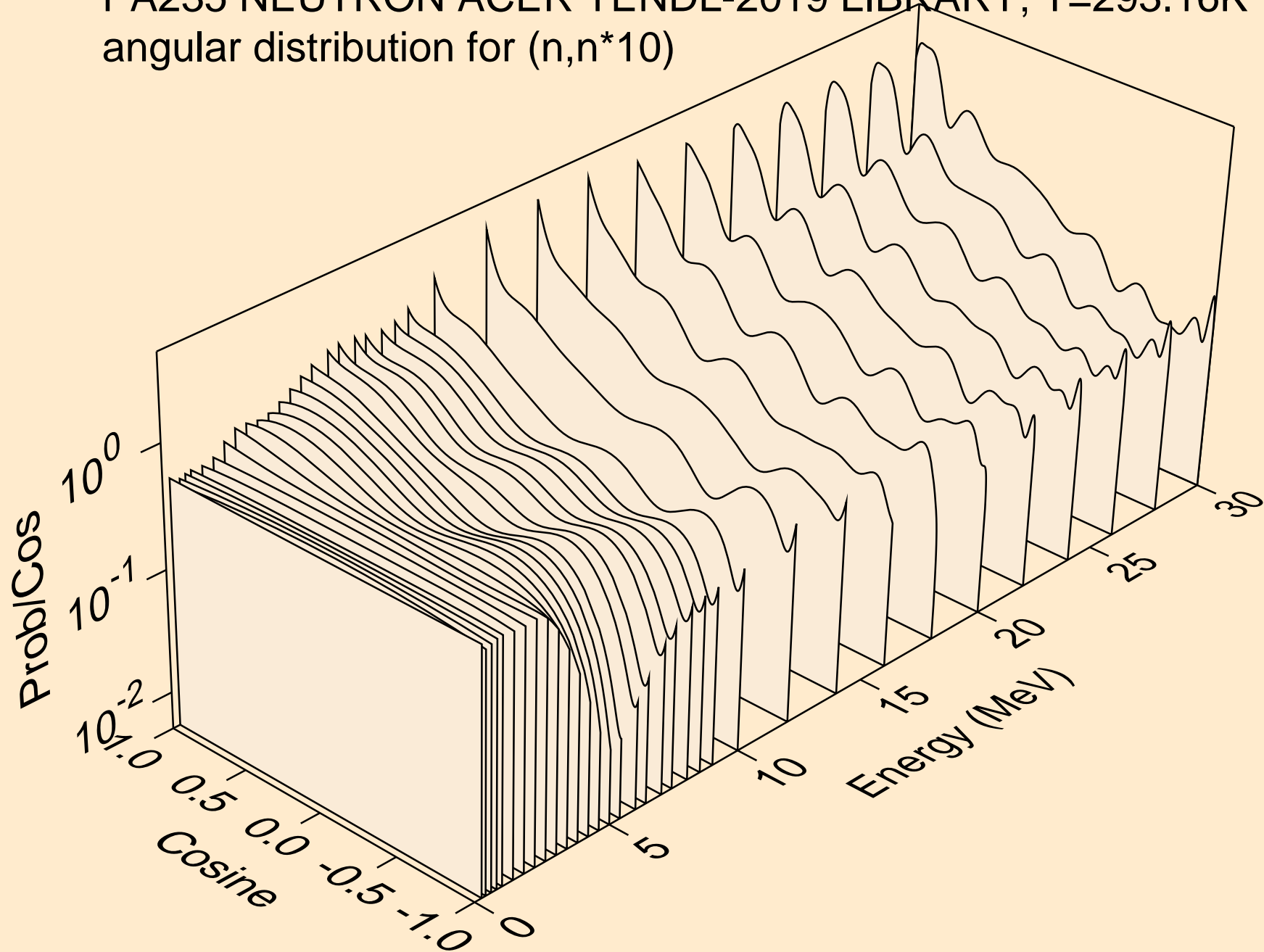

PA235 NEUTRON ACER TENDL-2019 LIBRARY; T=293.16K
angular distribution for (n,n*11)

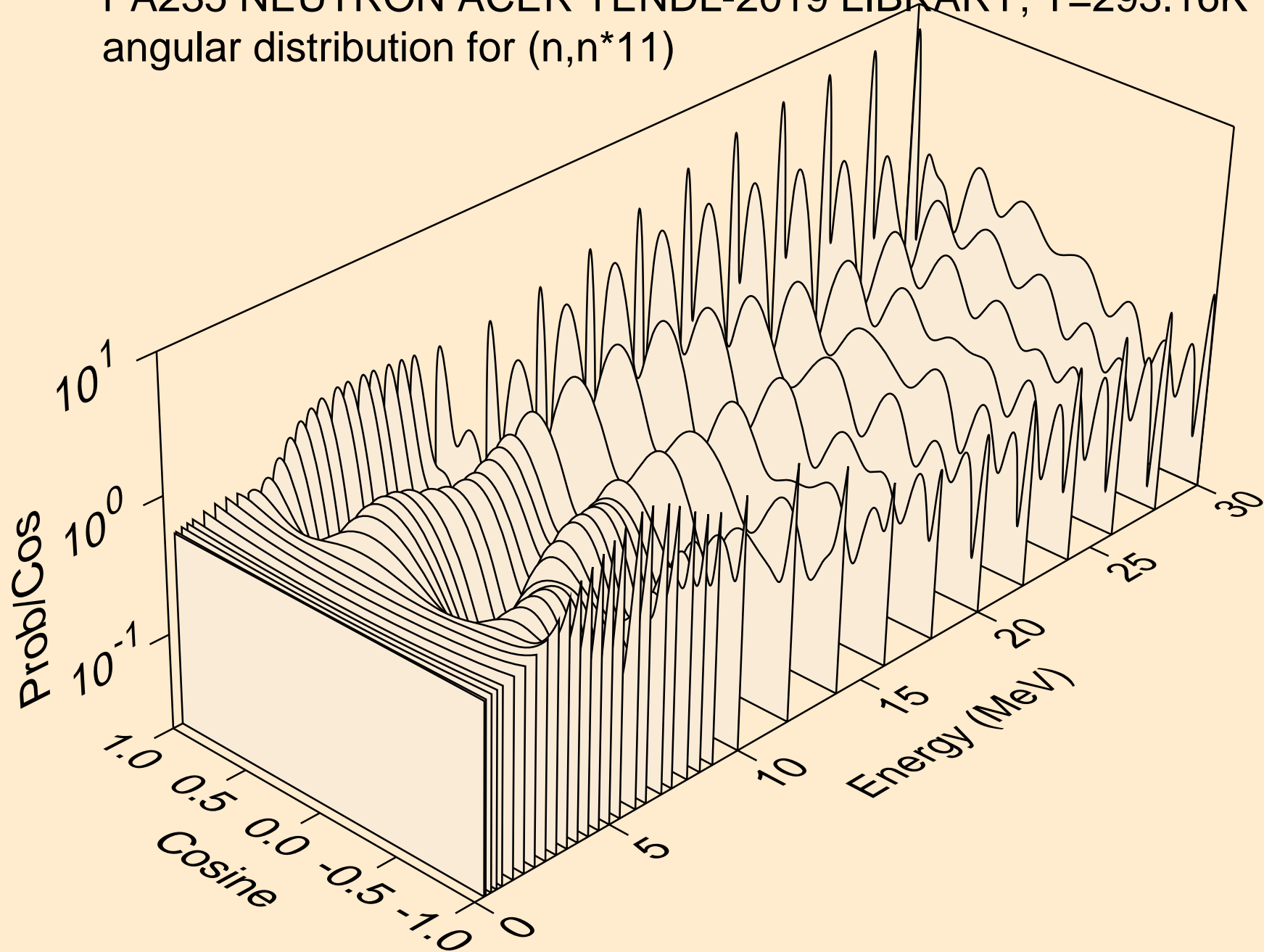

PA235 NEUTRON ACER TENDL-2019 LIBRARY; T=293.16K
angular distribution for (n,n*12)

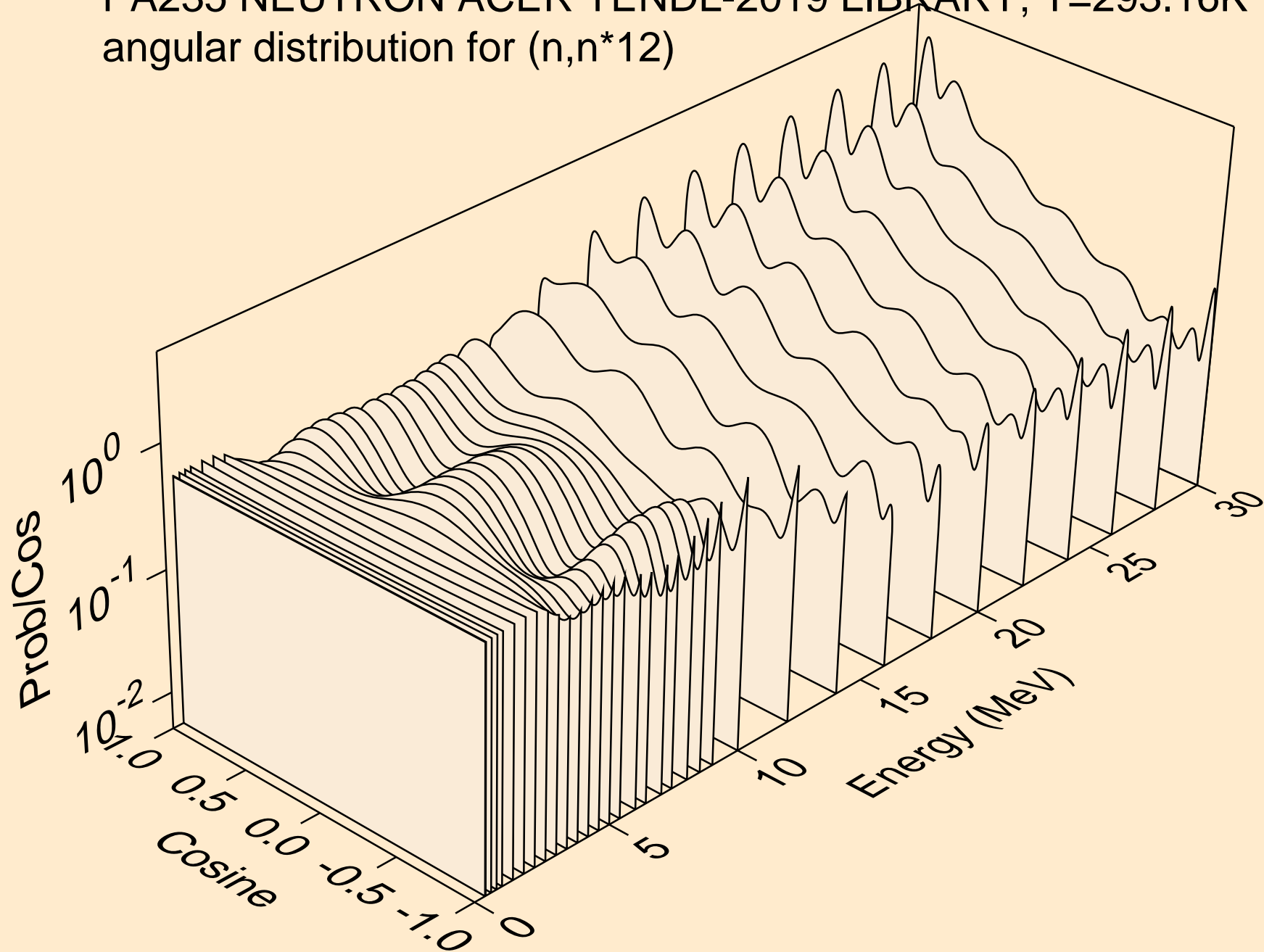

PA235 NEUTRON ACER TENDL-2019 LIBRARY; T=293.16K
angular distribution for (n,n*13)

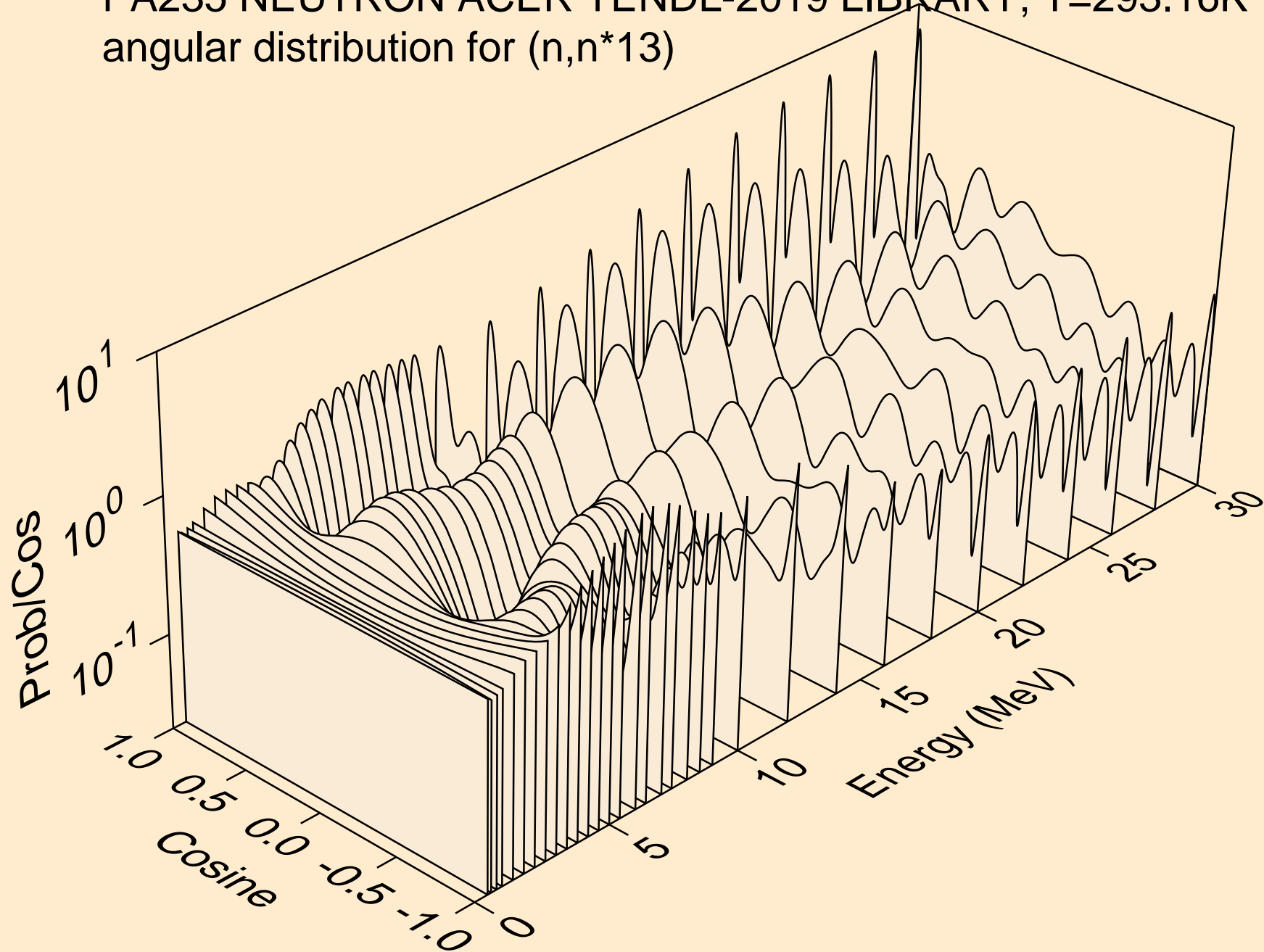

PA235 NEUTRON ACER TENDL-2019 LIBRARY; T=293.16K
angular distribution for (n,n*14)

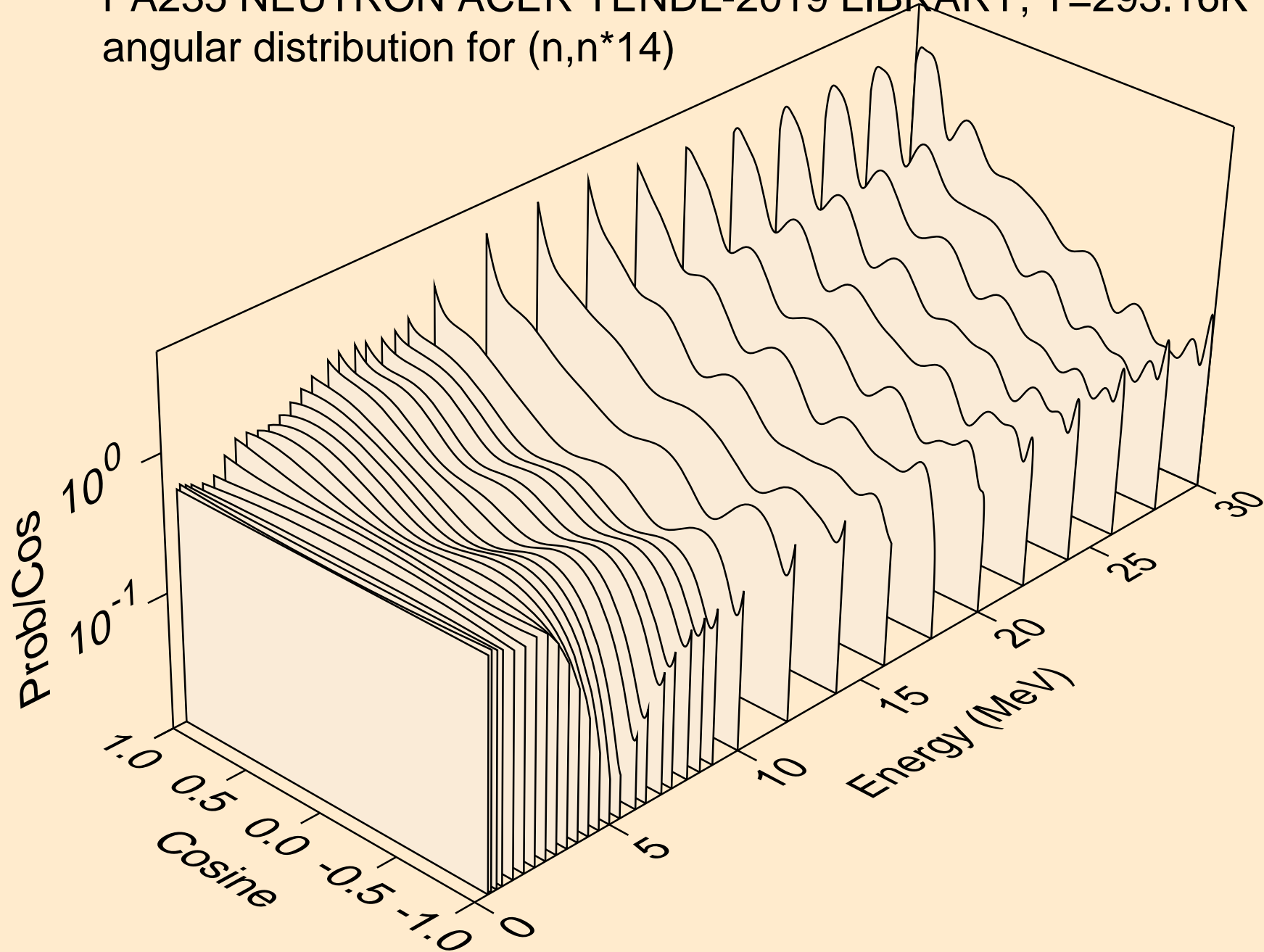

PA235 NEUTRON ACER TENDL-2019 LIBRARY; T=293.16K
angular distribution for (n,n*15)

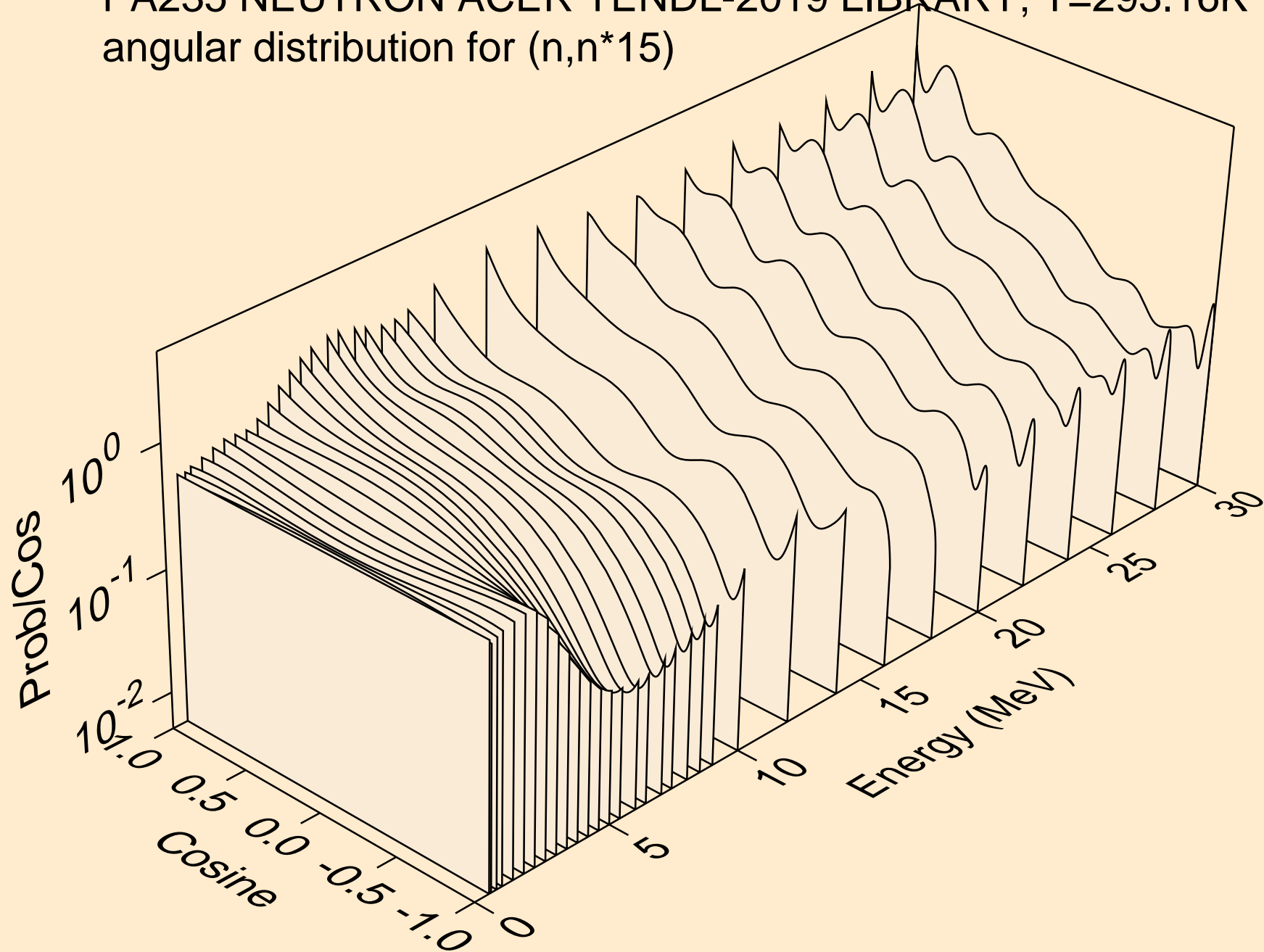

PA235 NEUTRON ACER TENDL-2019 LIBRARY; T=293.16K
angular distribution for (n,n*16)

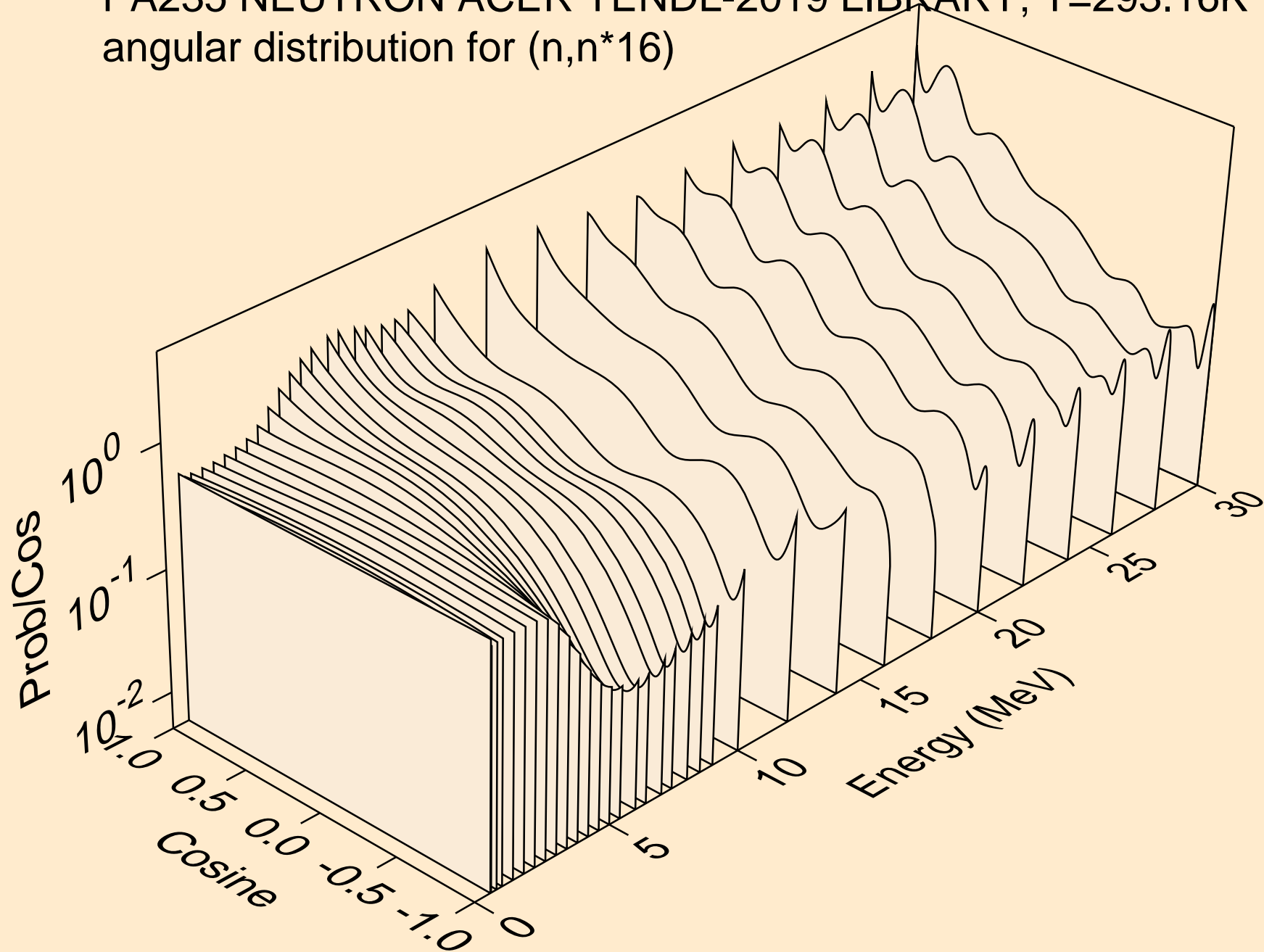

PA235 NEUTRON ACER TENDL-2019 LIBRARY; T=293.16K
angular distribution for (n,n*17)

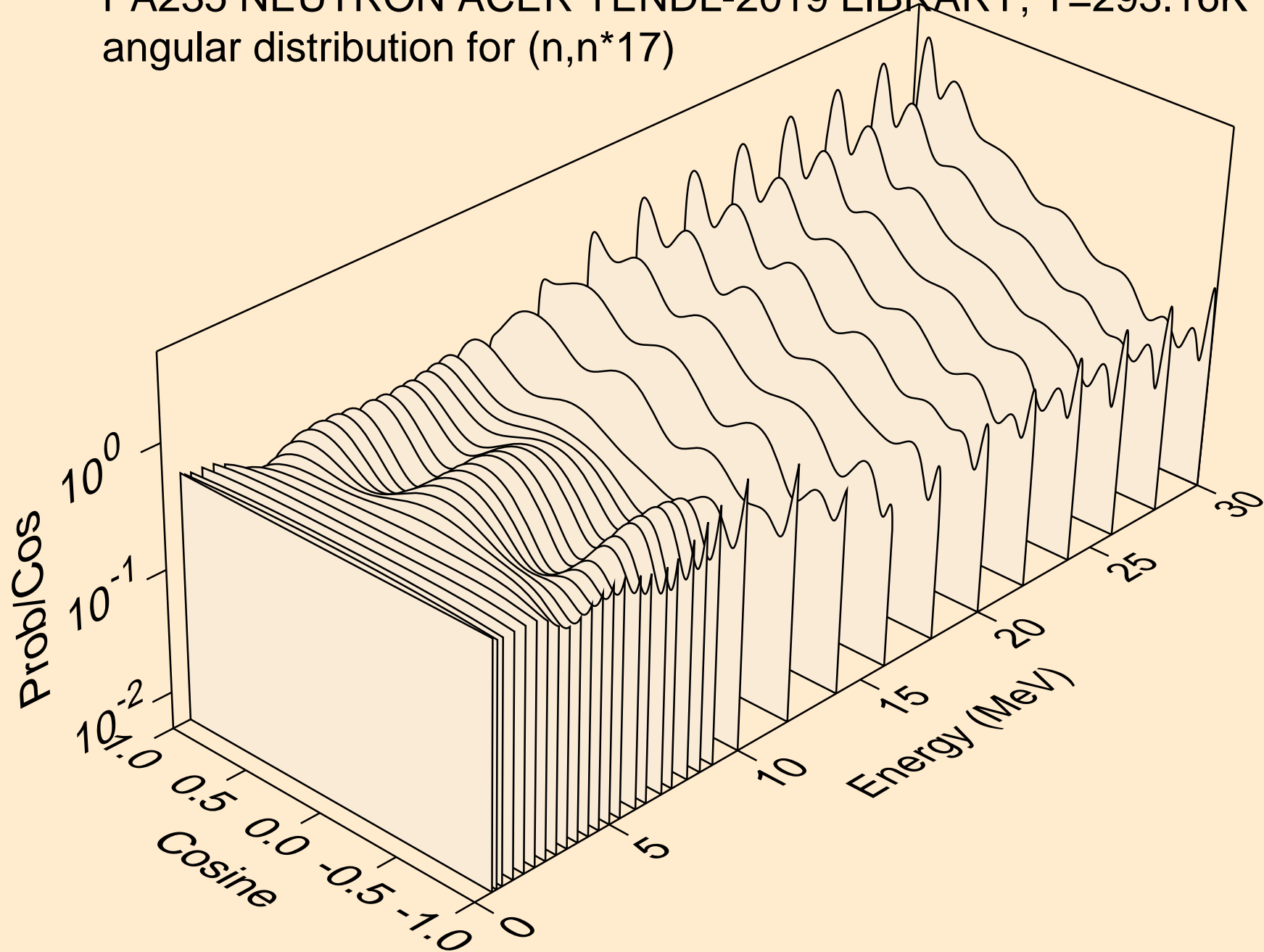

PA235 NEUTRON ACER TENDL-2019 LIBRARY; T=293.16K
angular distribution for (n,n*18)

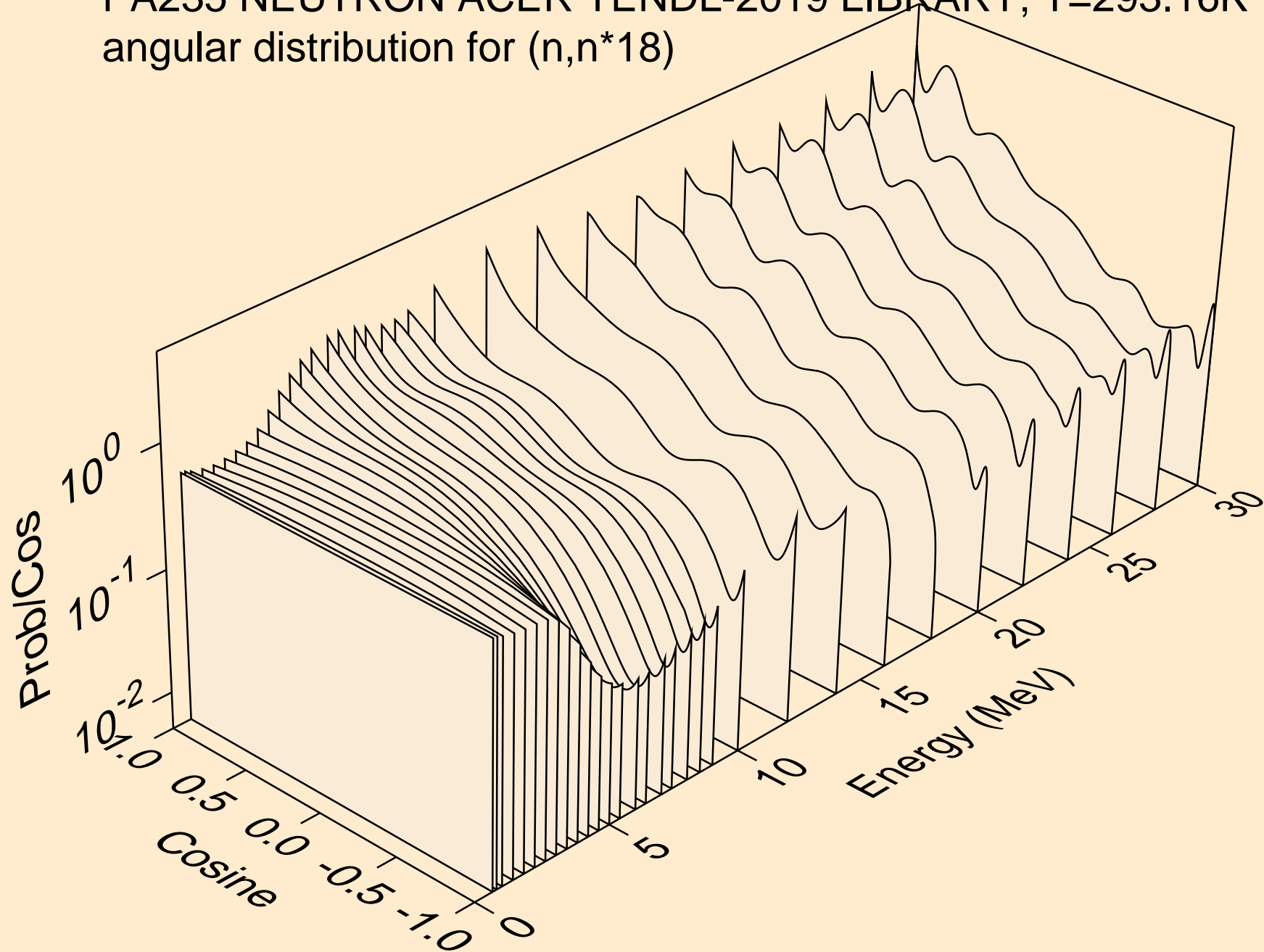

PA235 NEUTRON ACER TENDL-2019 LIBRARY; T=293.16K
angular distribution for (n,n*19)

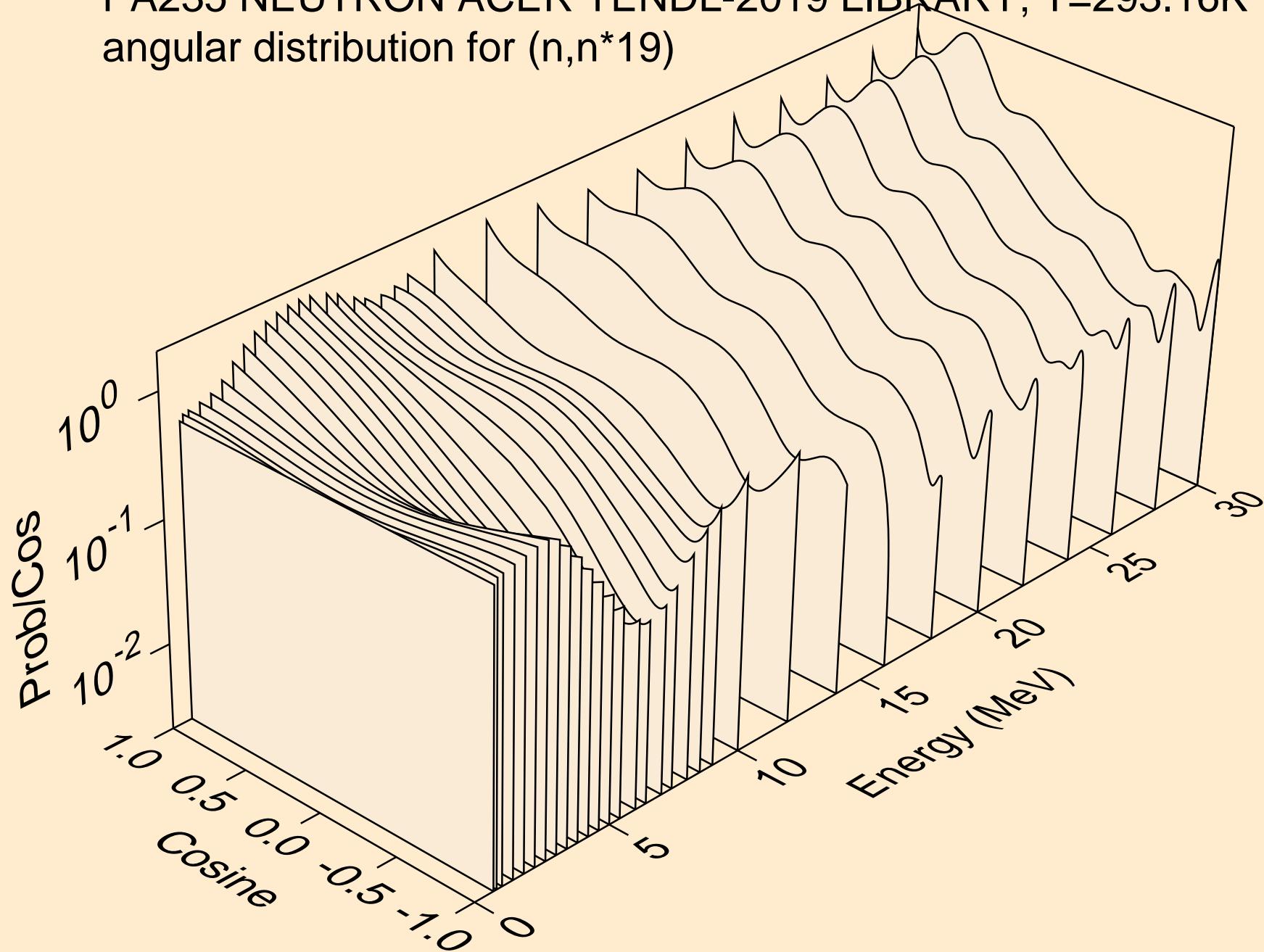

PA235 NEUTRON ACER TENDL-2019 LIBRARY; T=293.16K
angular distribution for (n,n*20)

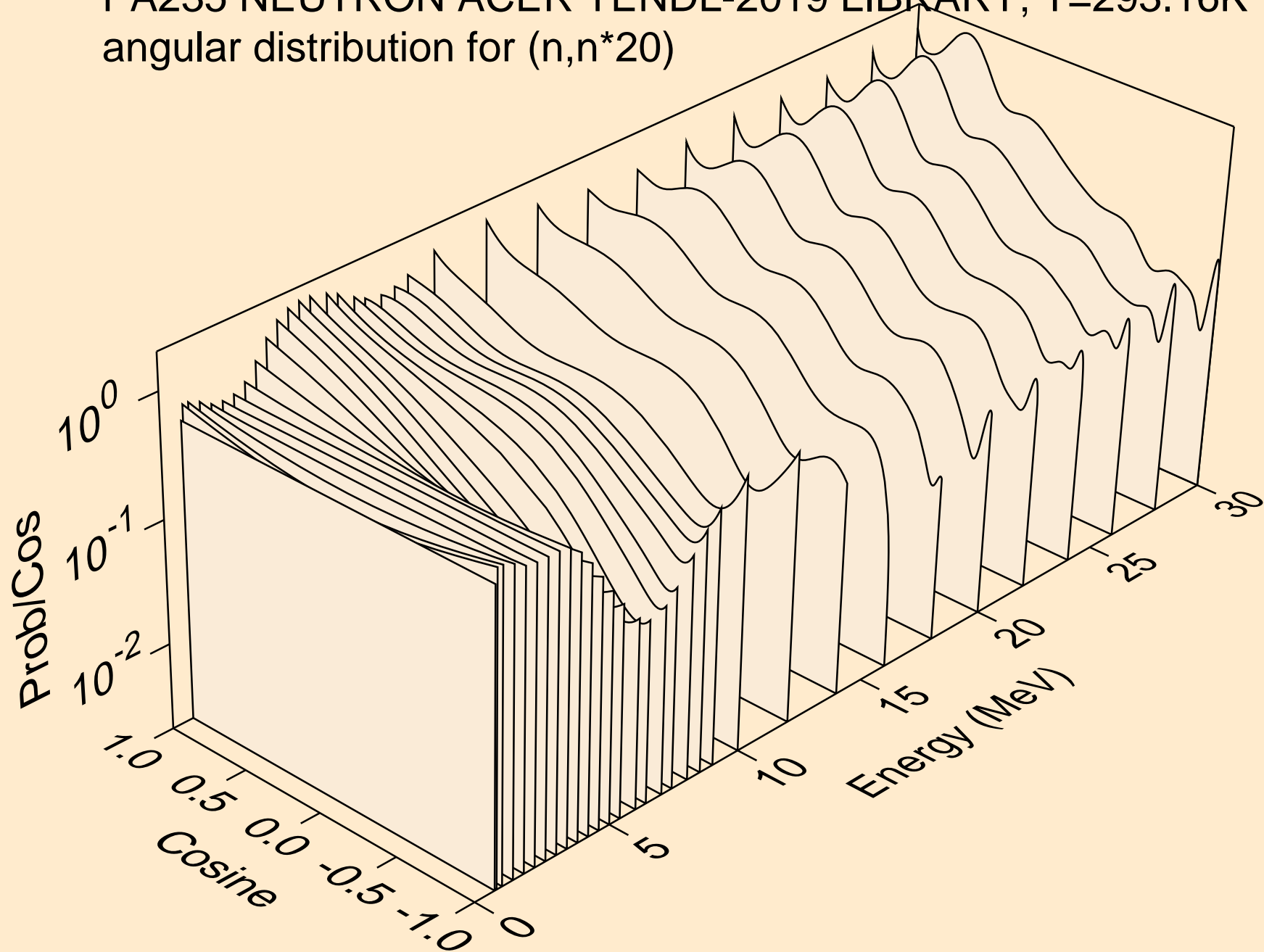

PA235 NEUTRON ACER TENDL-2019 LIBRARY; T=293.16K
angular distribution for (n,n*21)

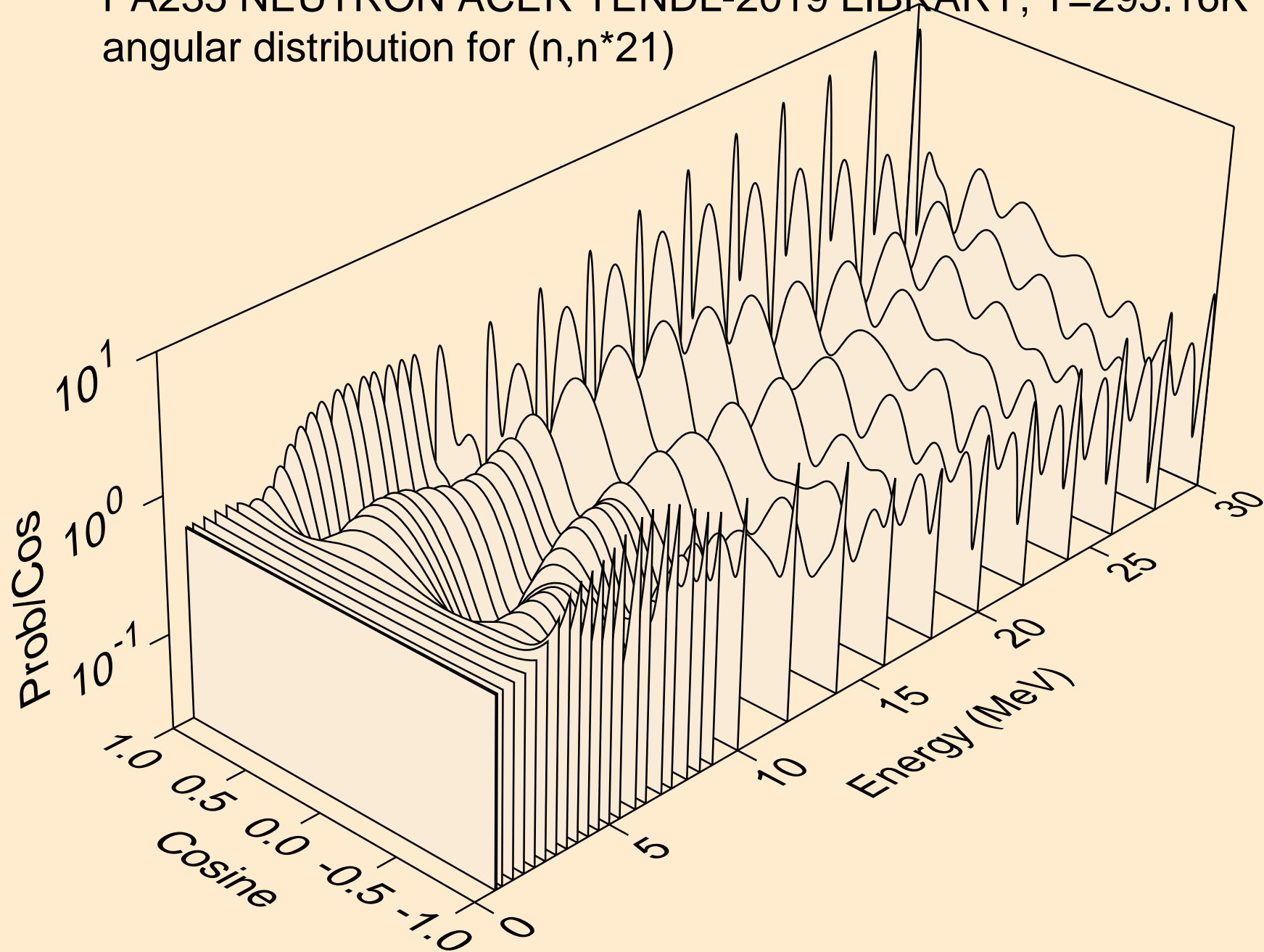

PA235 NEUTRON ACER TENDL-2019 LIBRARY; T=293.16K
angular distribution for (n,n*22)

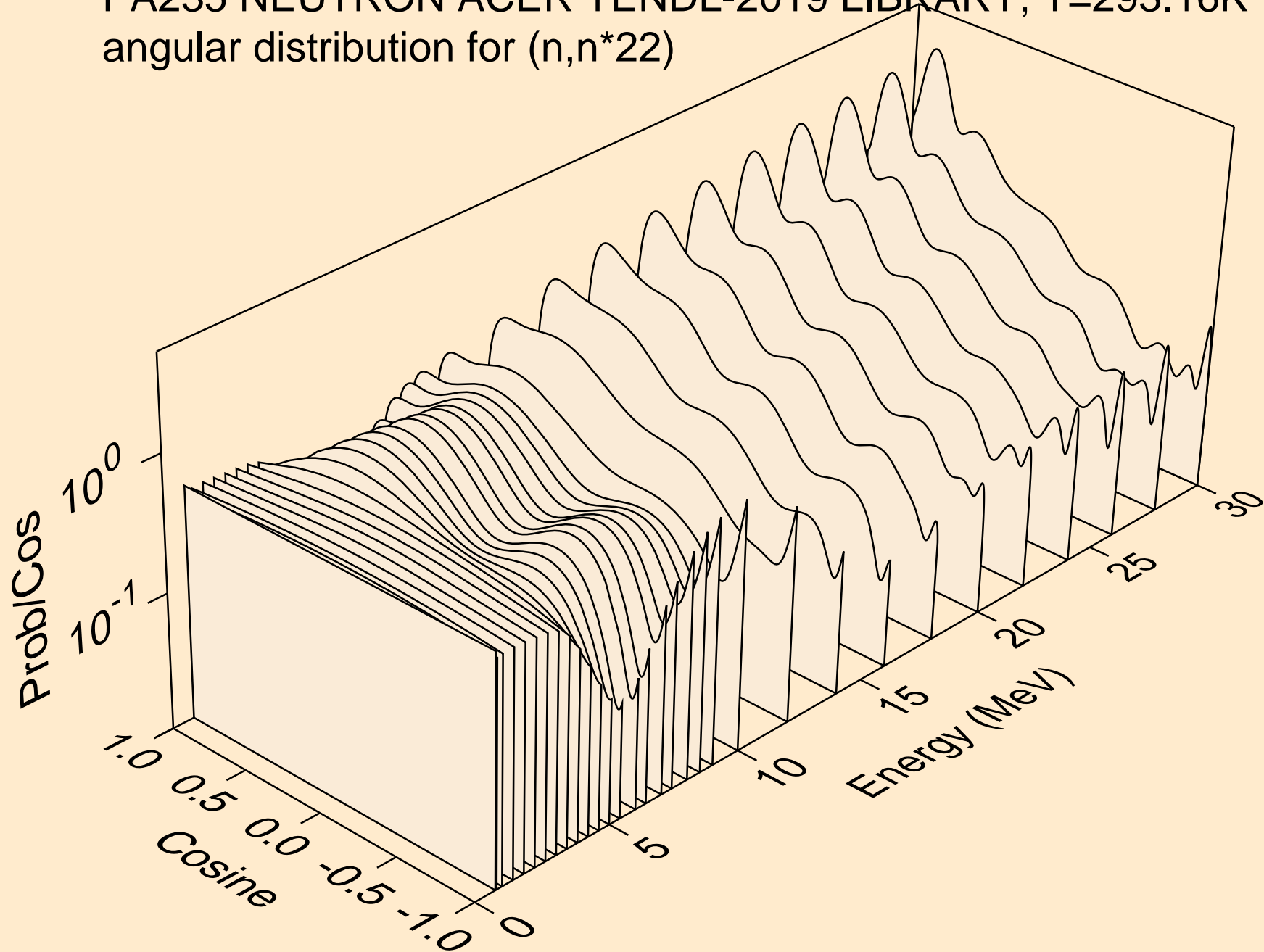

PA235 NEUTRON ACER TENDL-2019 LIBRARY; T=293.16K
angular distribution for (n,n*23)

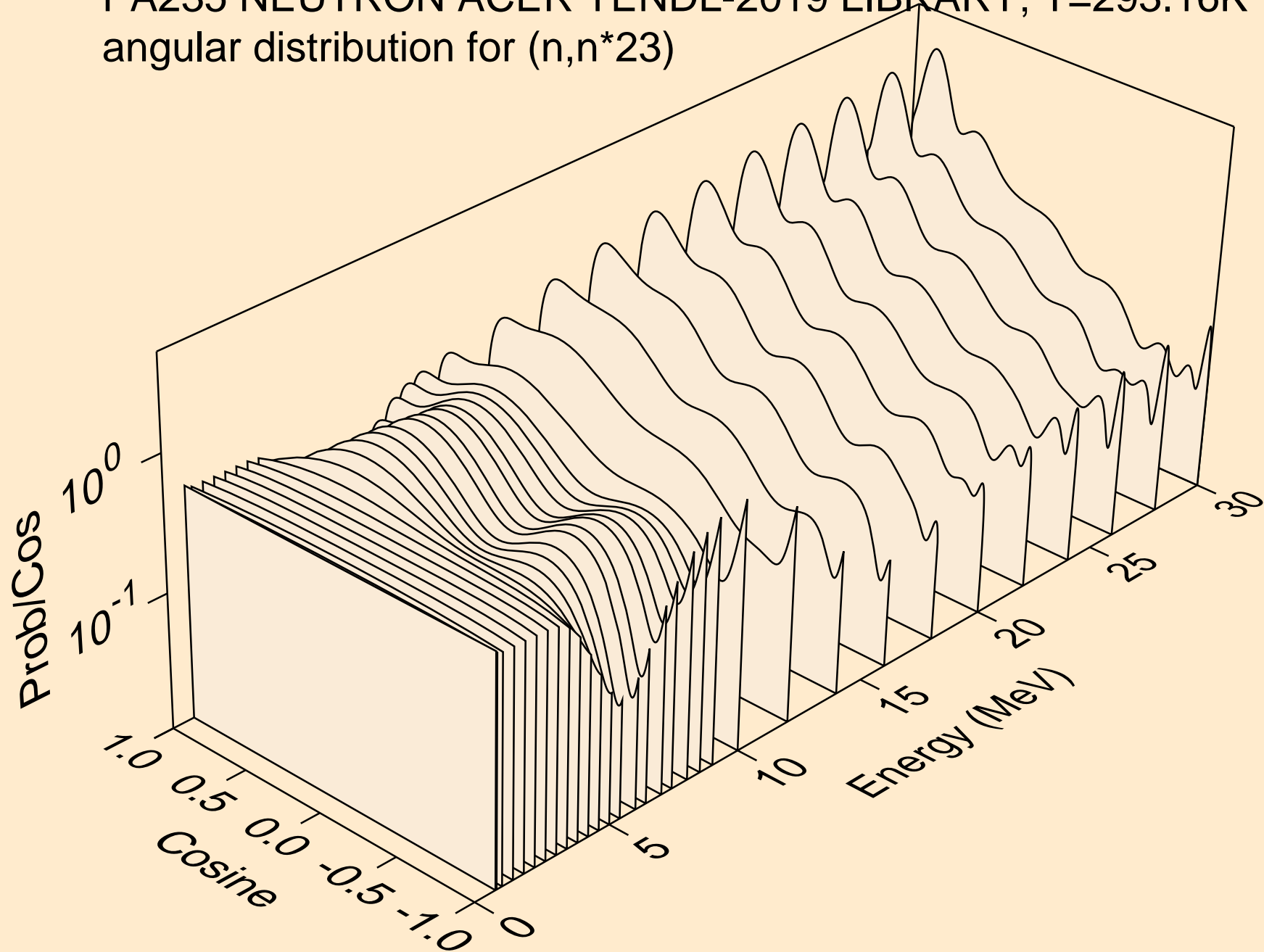

PA235 NEUTRON ACER TENDL-2019 LIBRARY; T=293.16K
angular distribution for (n,n*24)

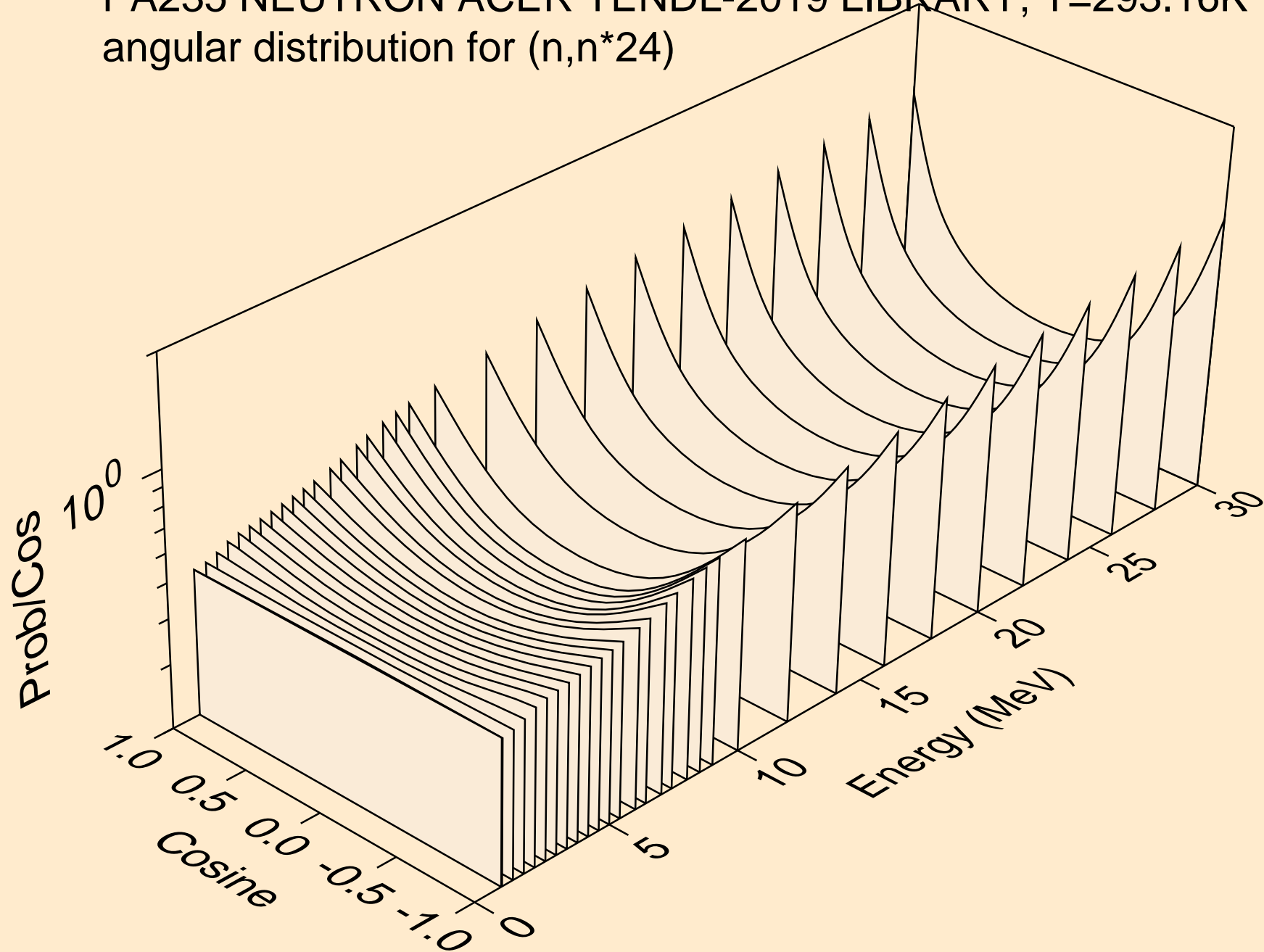

PA235 NEUTRON ACER TENDL-2019 LIBRARY; T=293.16K
angular distribution for (n,n*25)

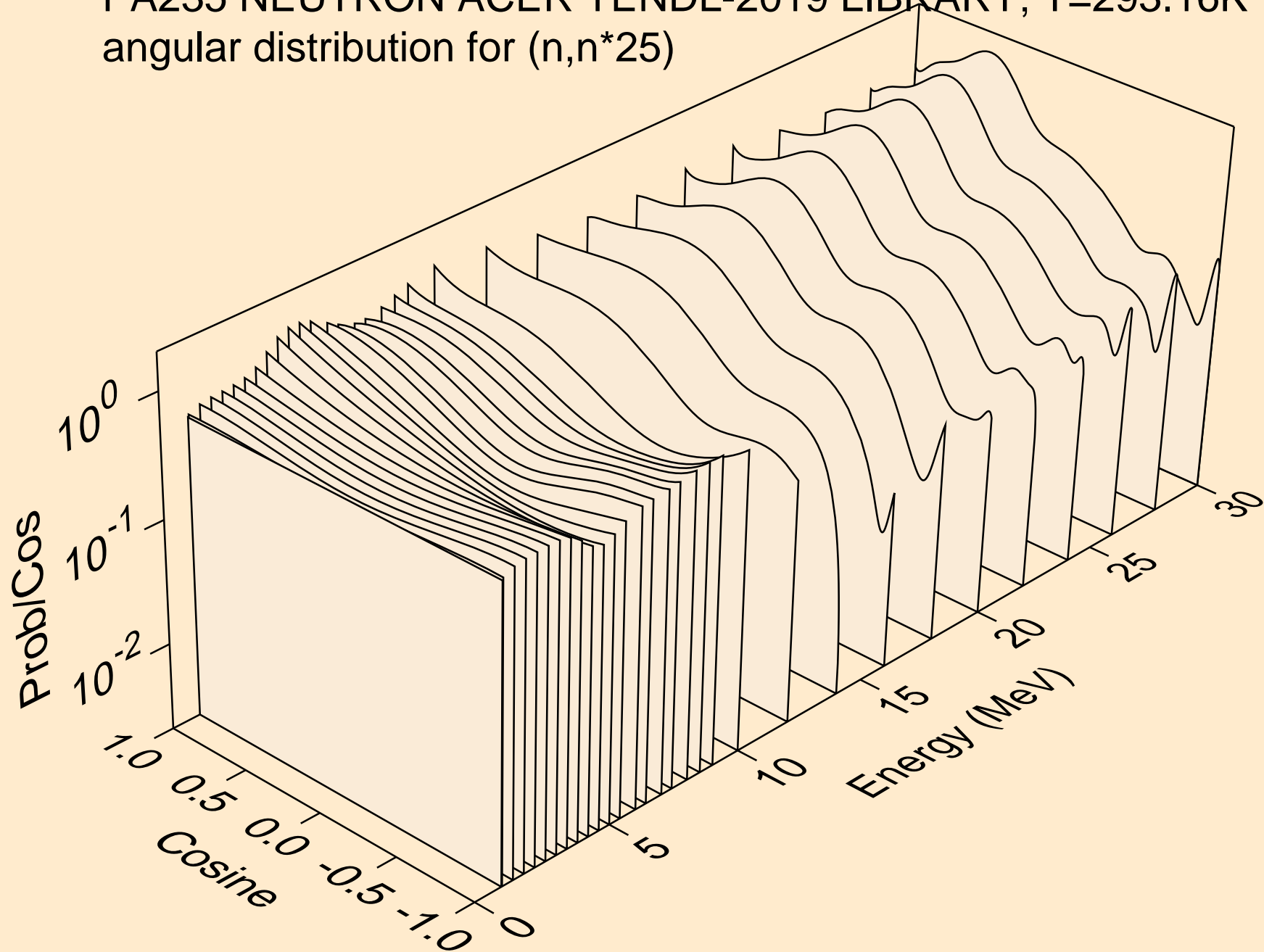

PA235 NEUTRON ACER TENDL-2019 LIBRARY; T=293.16K
angular distribution for (n,n*26)

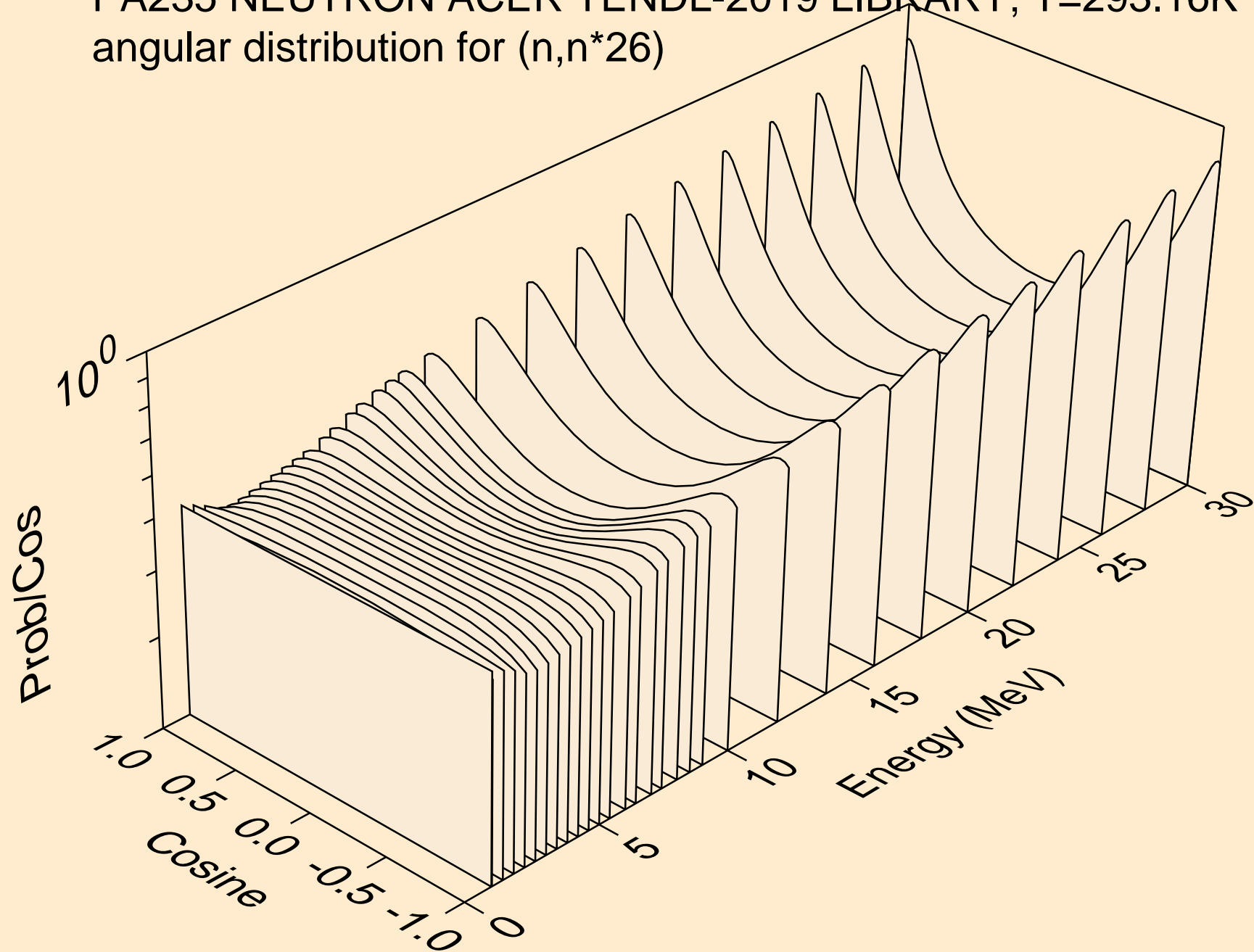

PA235 NEUTRON ACER TENDL-2019 LIBRARY; T=293.16K
angular distribution for (n,n*27)

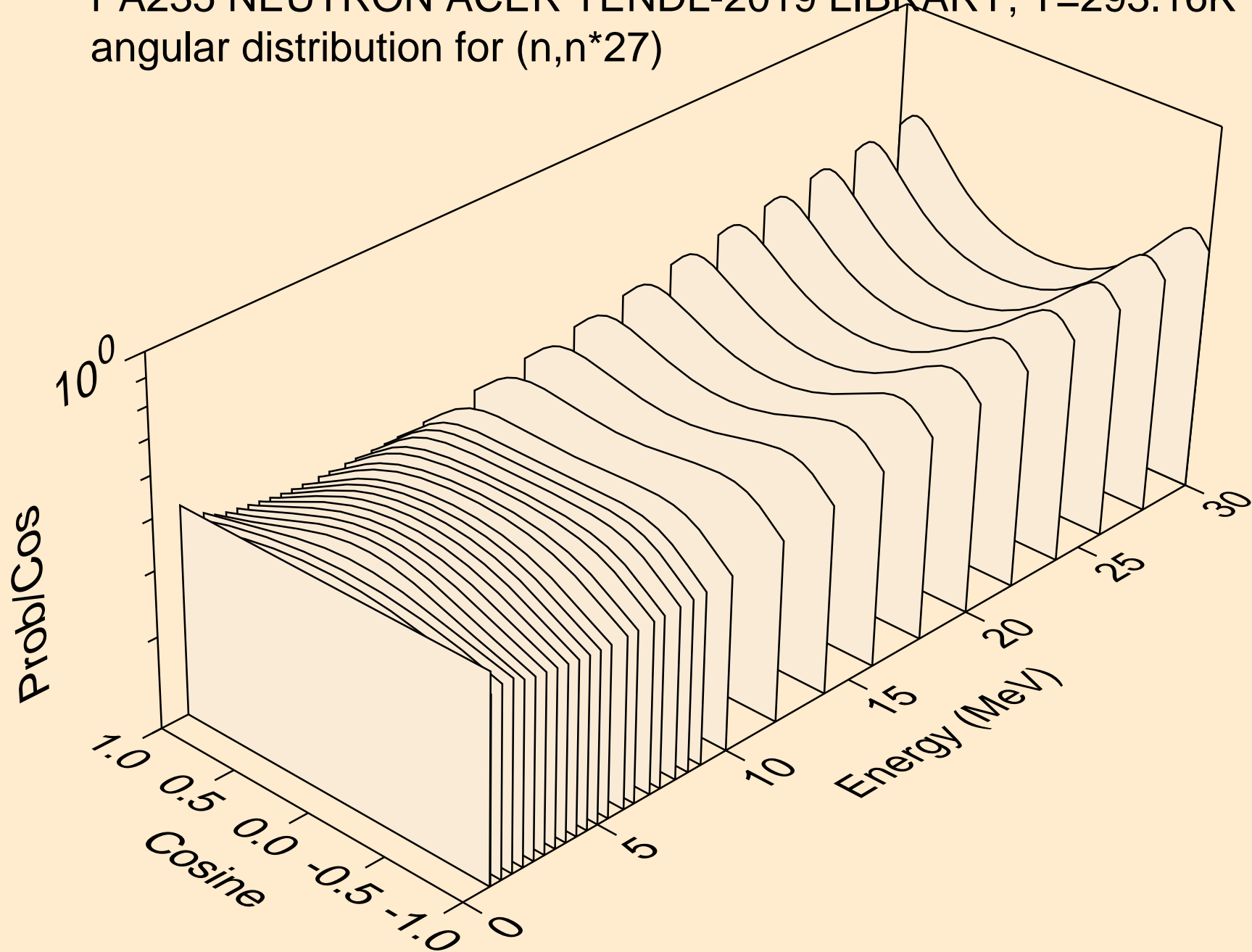

PA235 NEUTRON ACER TENDL-2019 LIBRARY; T=293.16K
angular distribution for (n,n*28)

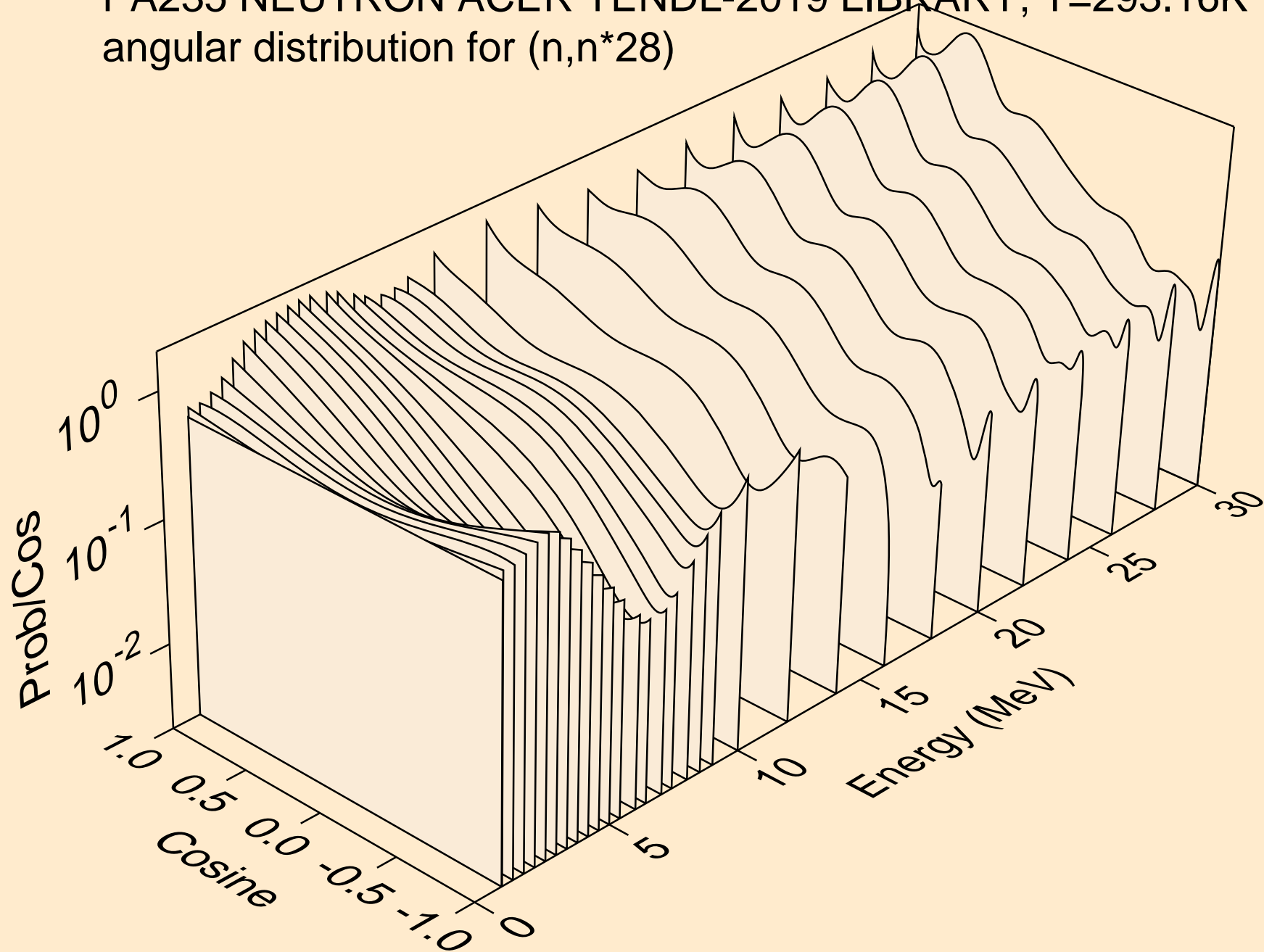

PA235 NEUTRON ACER TENDL-2019 LIBRARY; T=293.16K
angular distribution for (n,n*29)

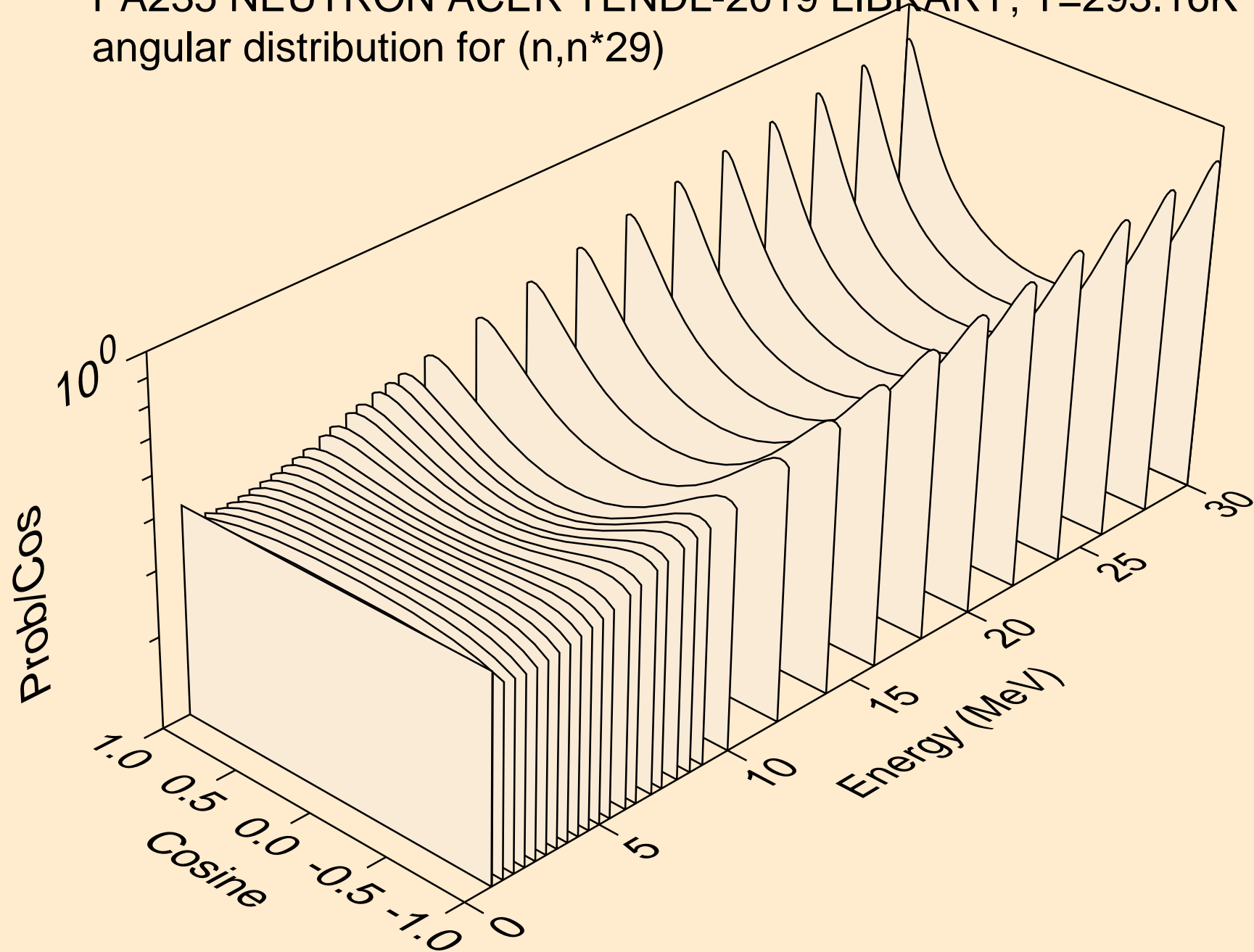

PA235 NEUTRON ACER TENDL-2019 LIBRARY; T=293.16K
angular distribution for (n,n*30)

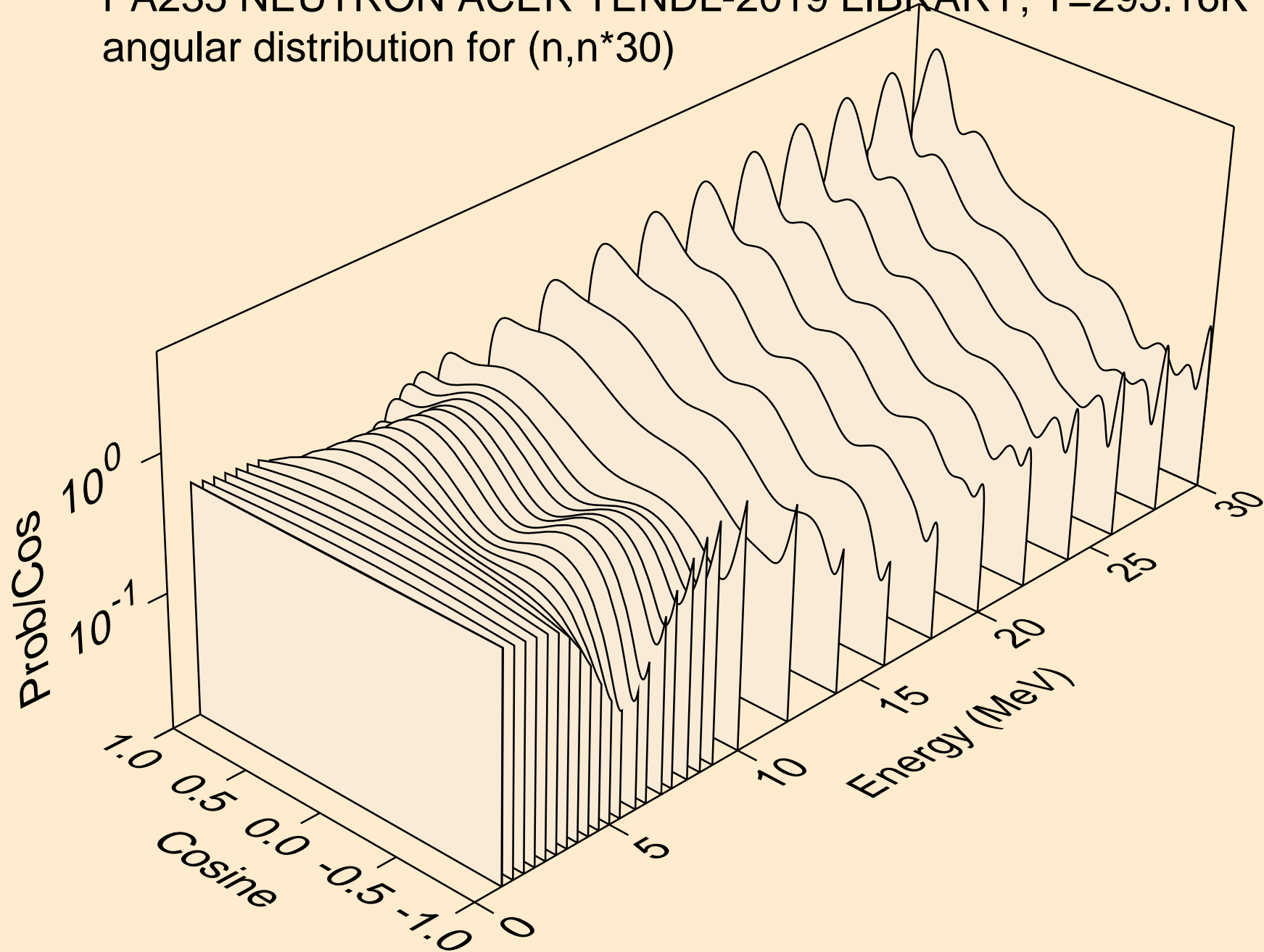

PA235 NEUTRON ACER TENDL-2019 LIBRARY; T=293.16K
Total fission nubar

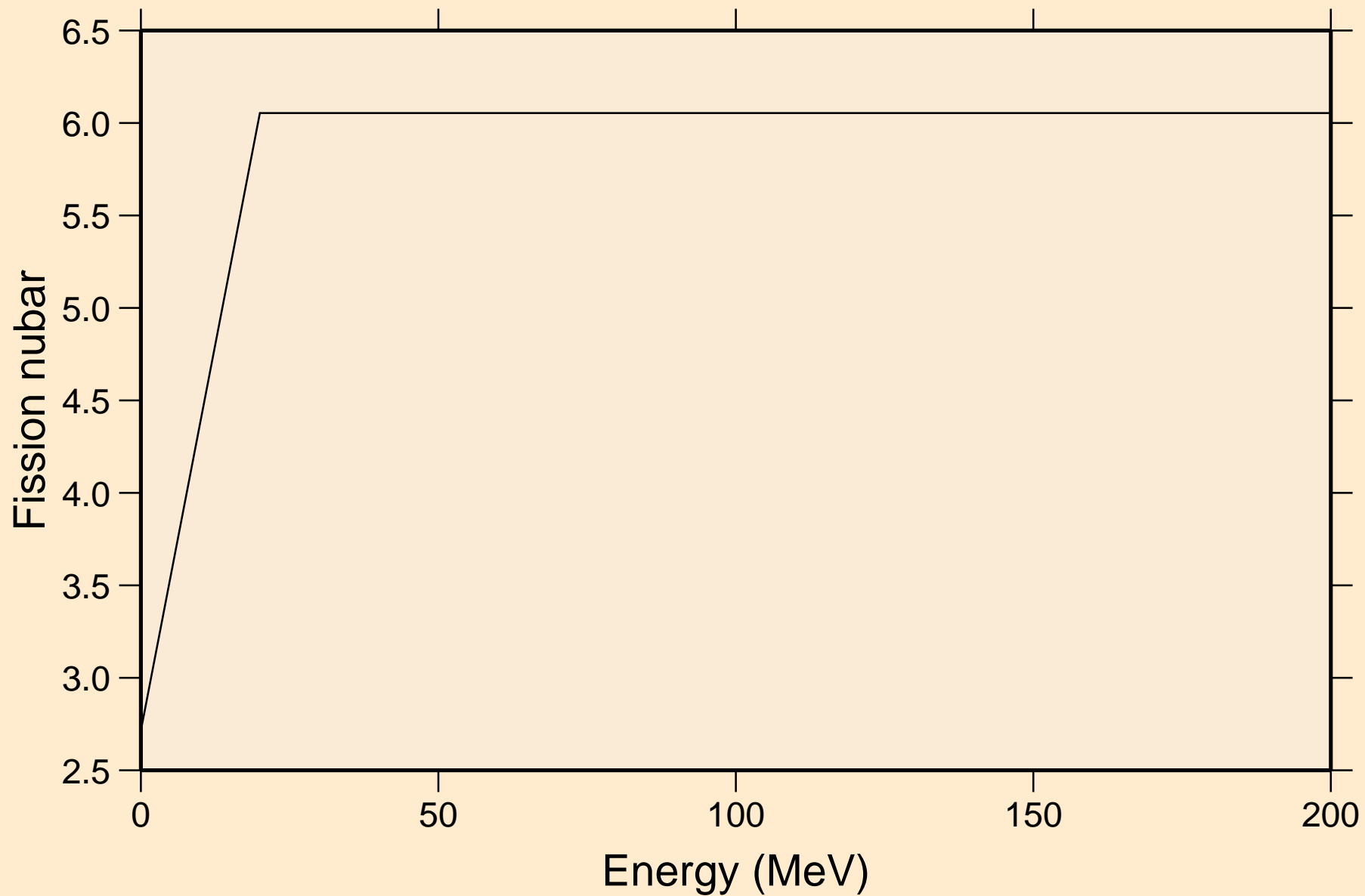

PA235 NEUTRON ACER TENDL-2019 LIBRARY; T=293.16K
Neutron emission for (n,x)

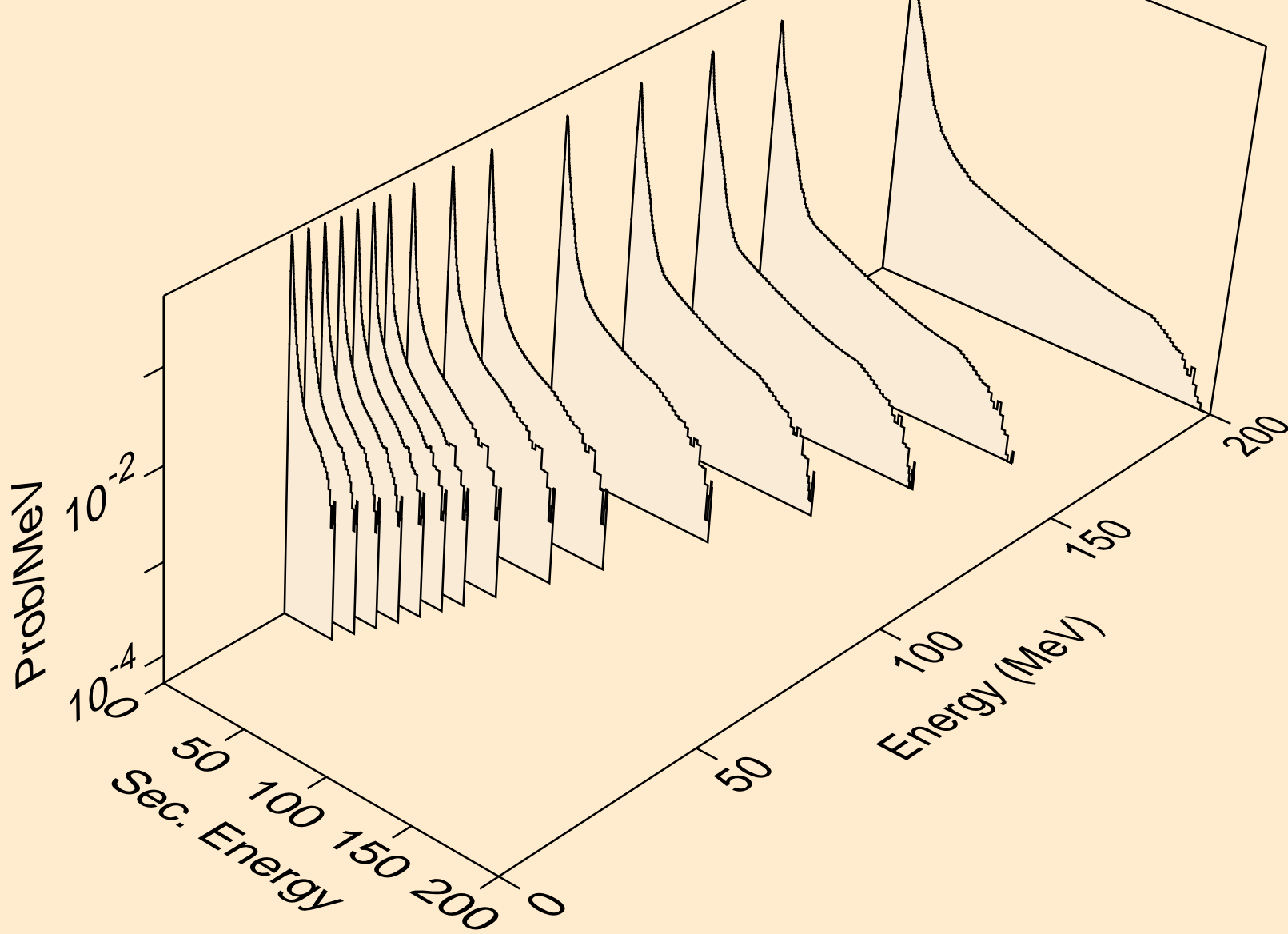

PA235 NEUTRON ACER TENDL-2019 LIBRARY; T=293.16K
Neutron emission for (n,2nd)

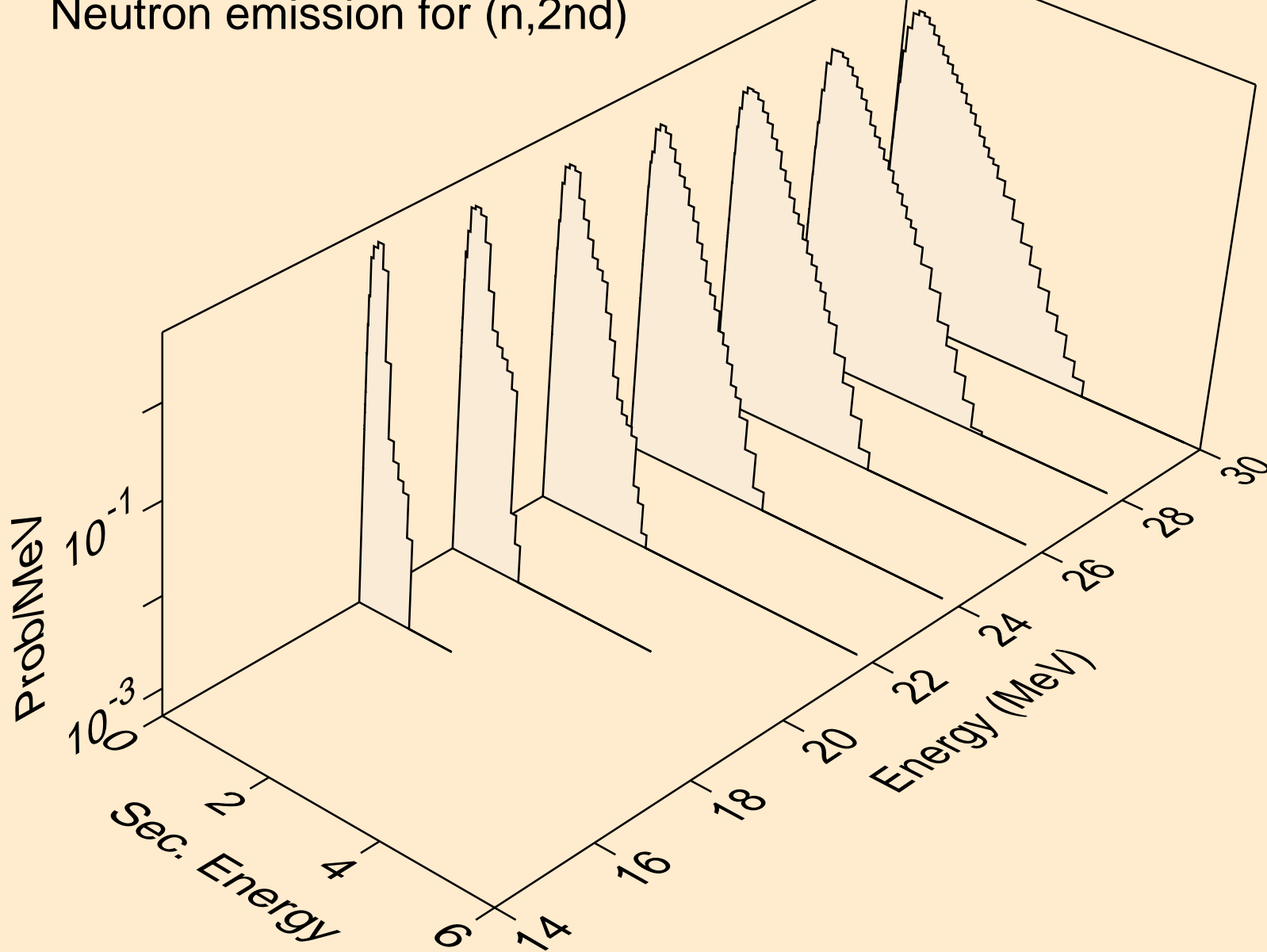

PA235 NEUTRON ACER TENDL-2019 LIBRARY; T=293.16K
Neutron emission for (n,2n)

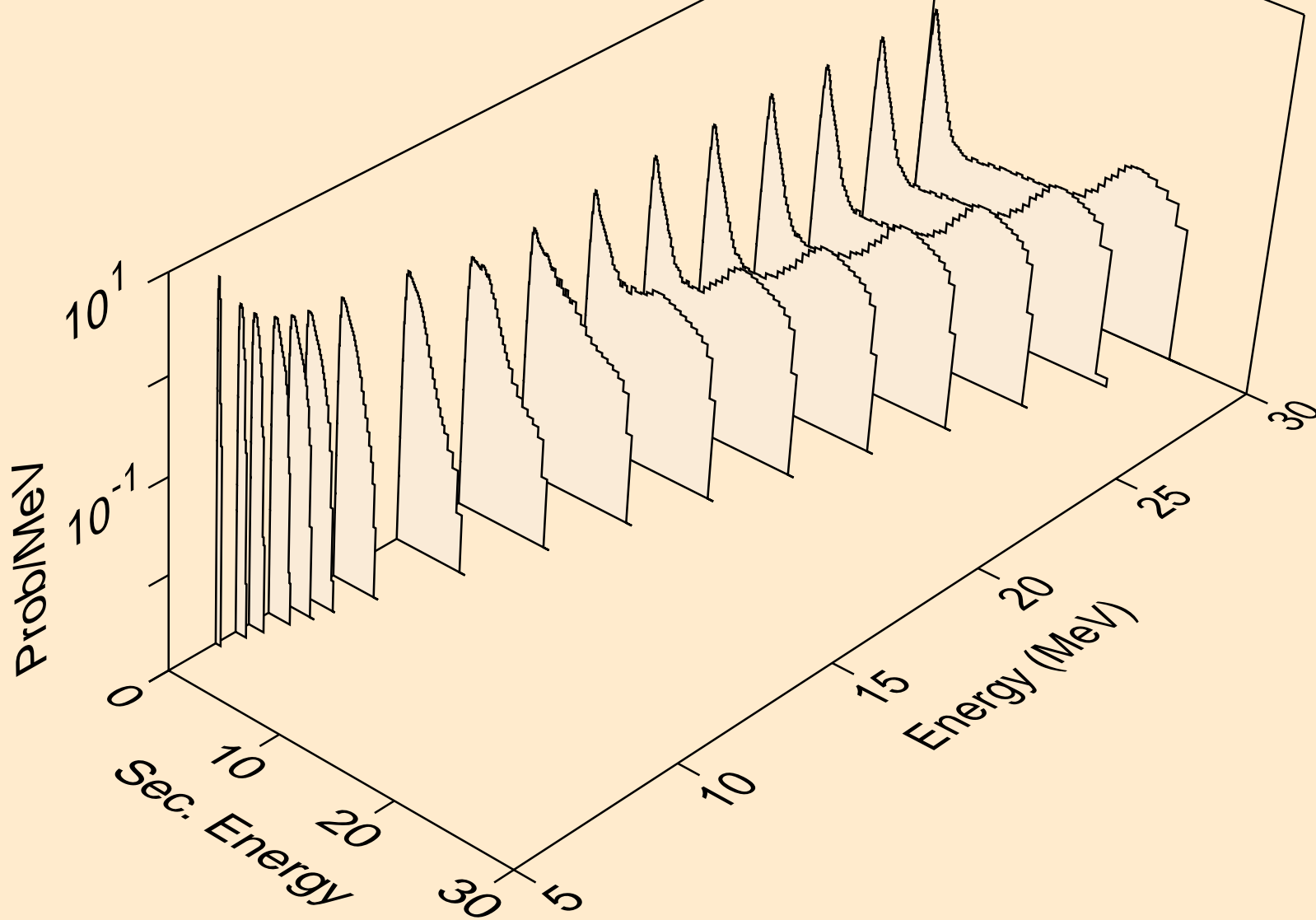

PA235 NEUTRON ACER TENDL-2019 LIBRARY; T=293.16K
Neutron emission for (n,3n)

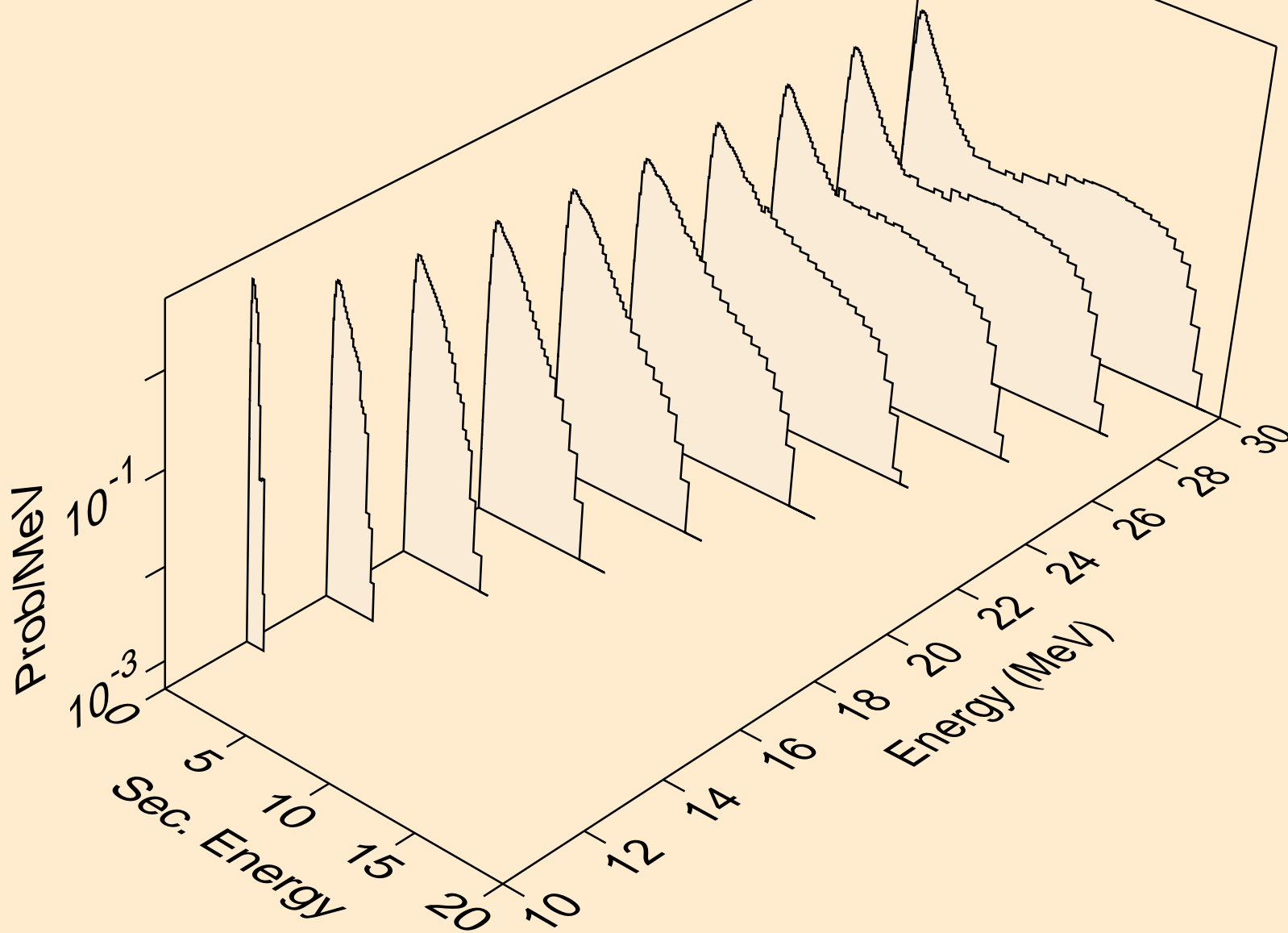

PA235 NEUTRON ACER TENDL-2019 LIBRARY; T=293.16K
Neutron emission for fission

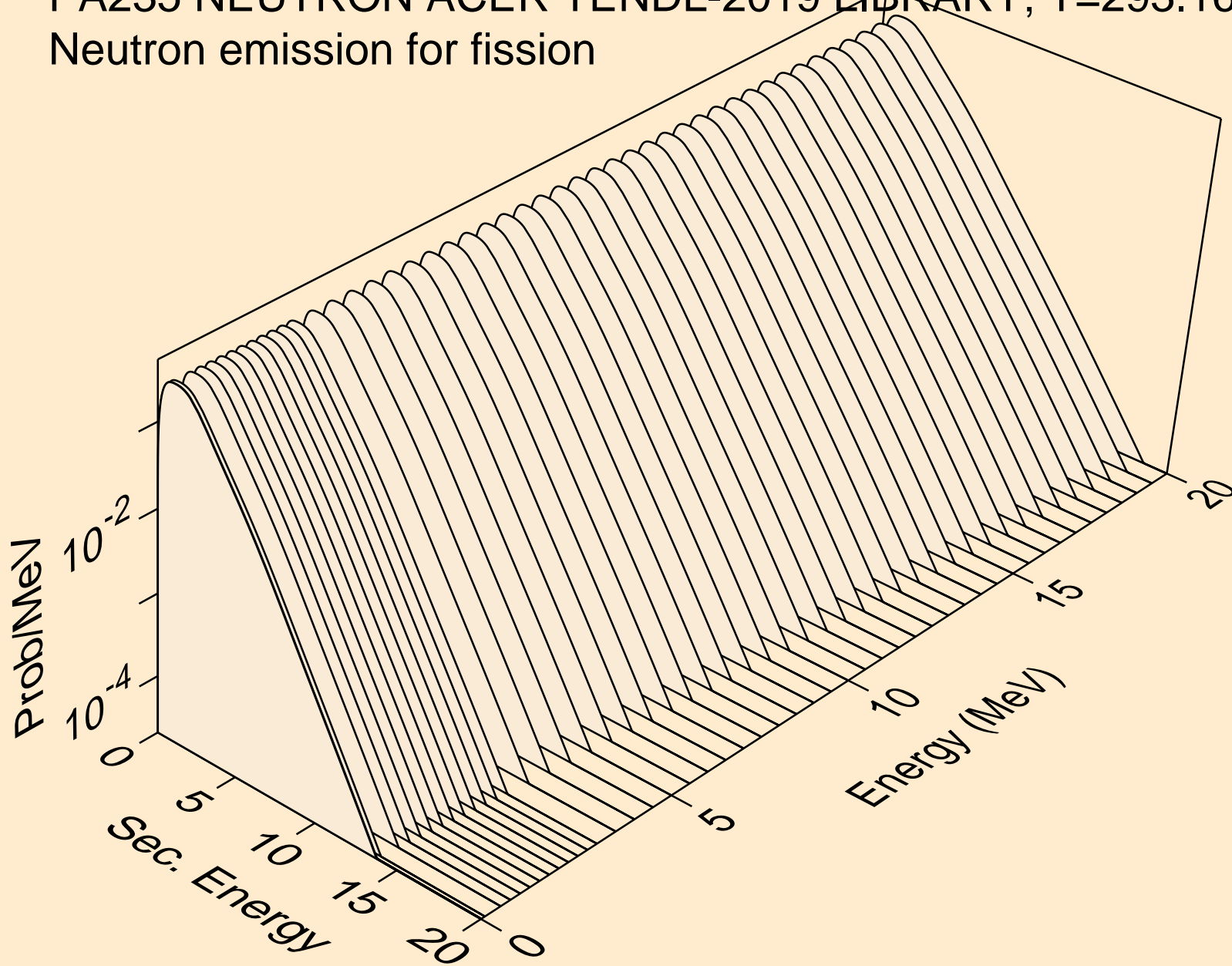

PA235 NEUTRON ACER TENDL-2019 LIBRARY; T=293.16K
Neutron emission for (n,n*)a

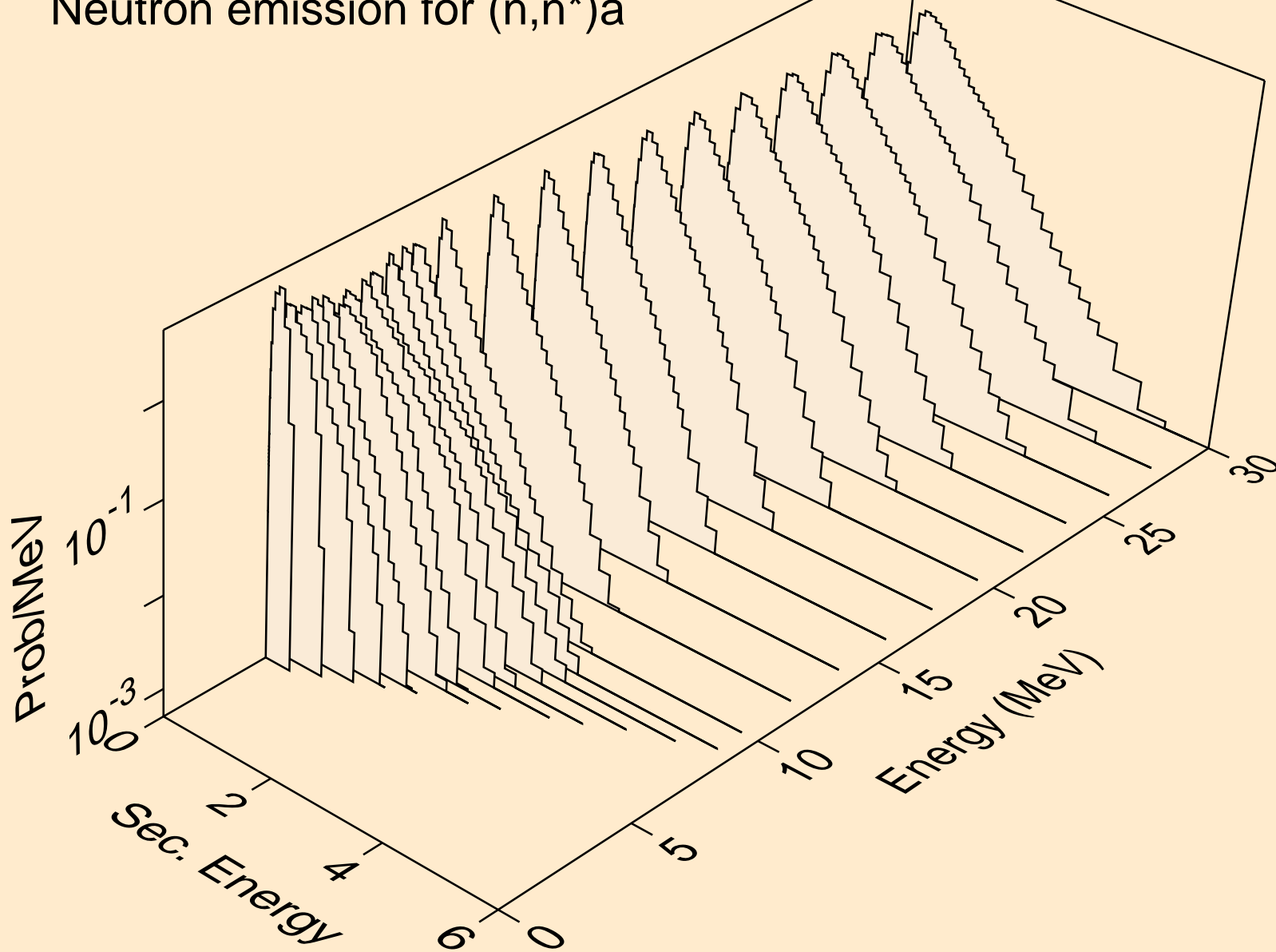

PA235 NEUTRON ACER TENDL-2019 LIBRARY; T=293.16K
Neutron emission for (n,2n)a

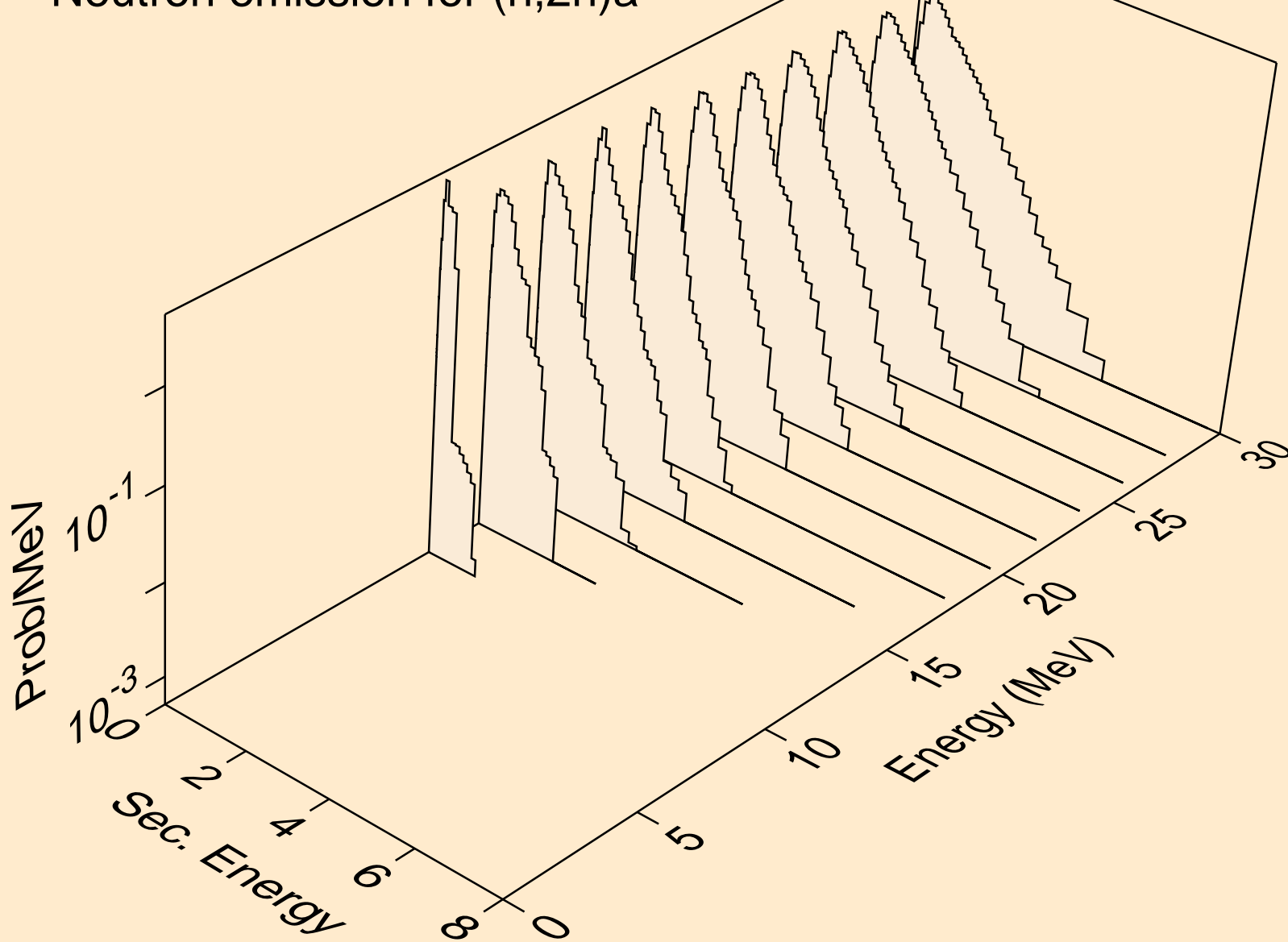

PA235 NEUTRON ACER TENDL-2019 LIBRARY; T=293.16K
Neutron emission for (n,3n)a

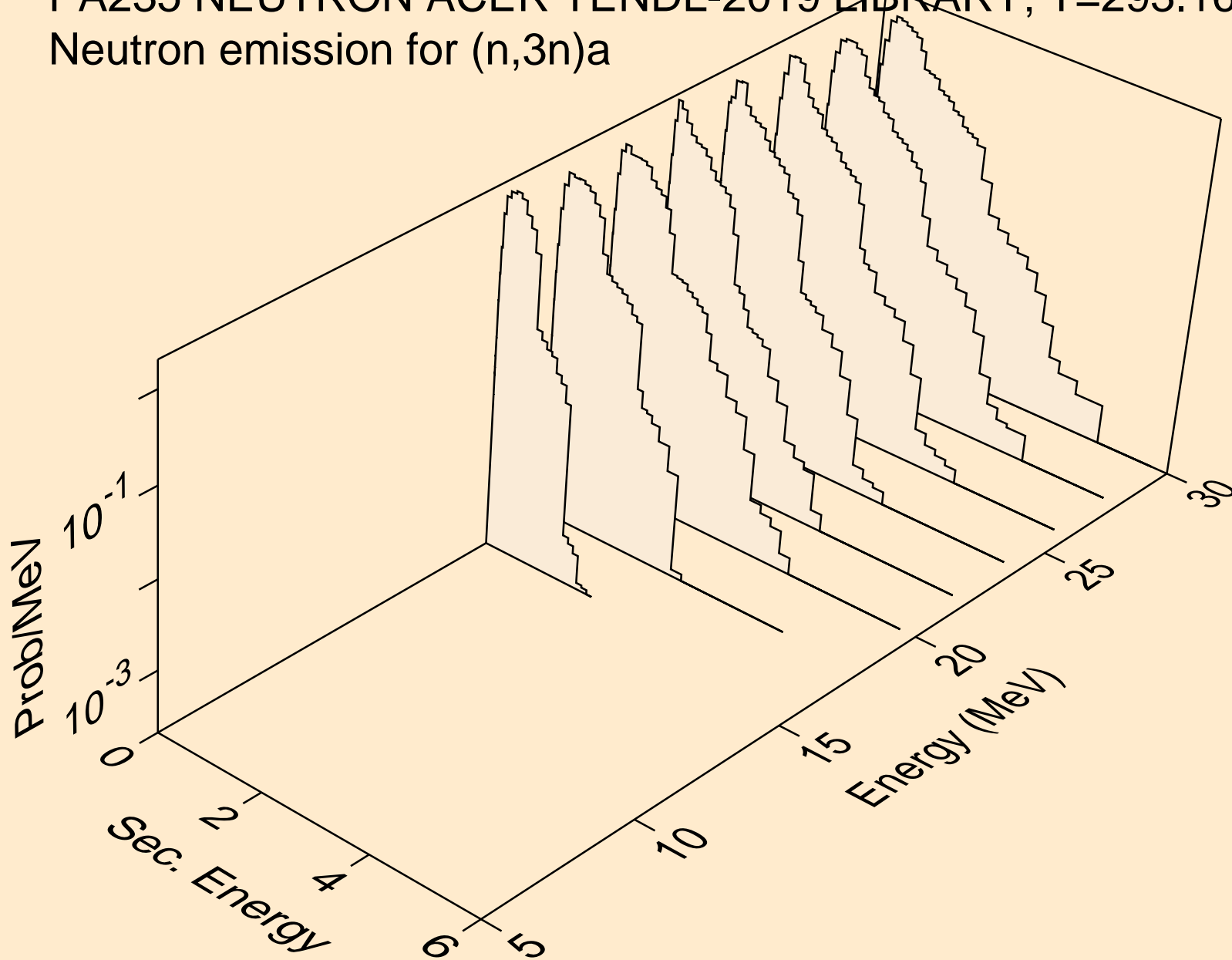

PA235 NEUTRON ACER TENDL-2019 LIBRARY; T=293.16K
Neutron emission for (n,n*)p

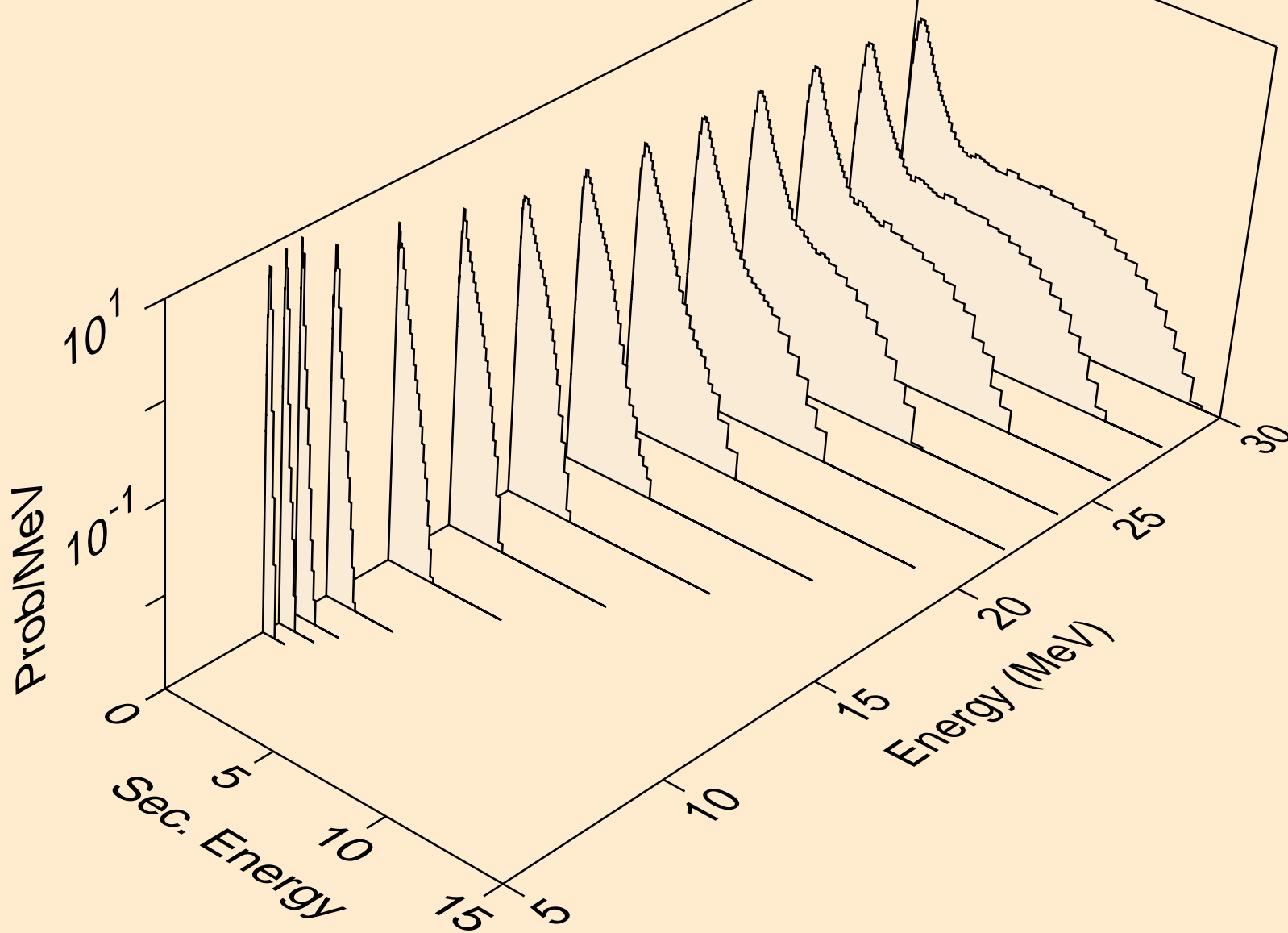

PA235 NEUTRON ACER TENDL-2019 LIBRARY; T=293.16K
Neutron emission for (n,n*)d

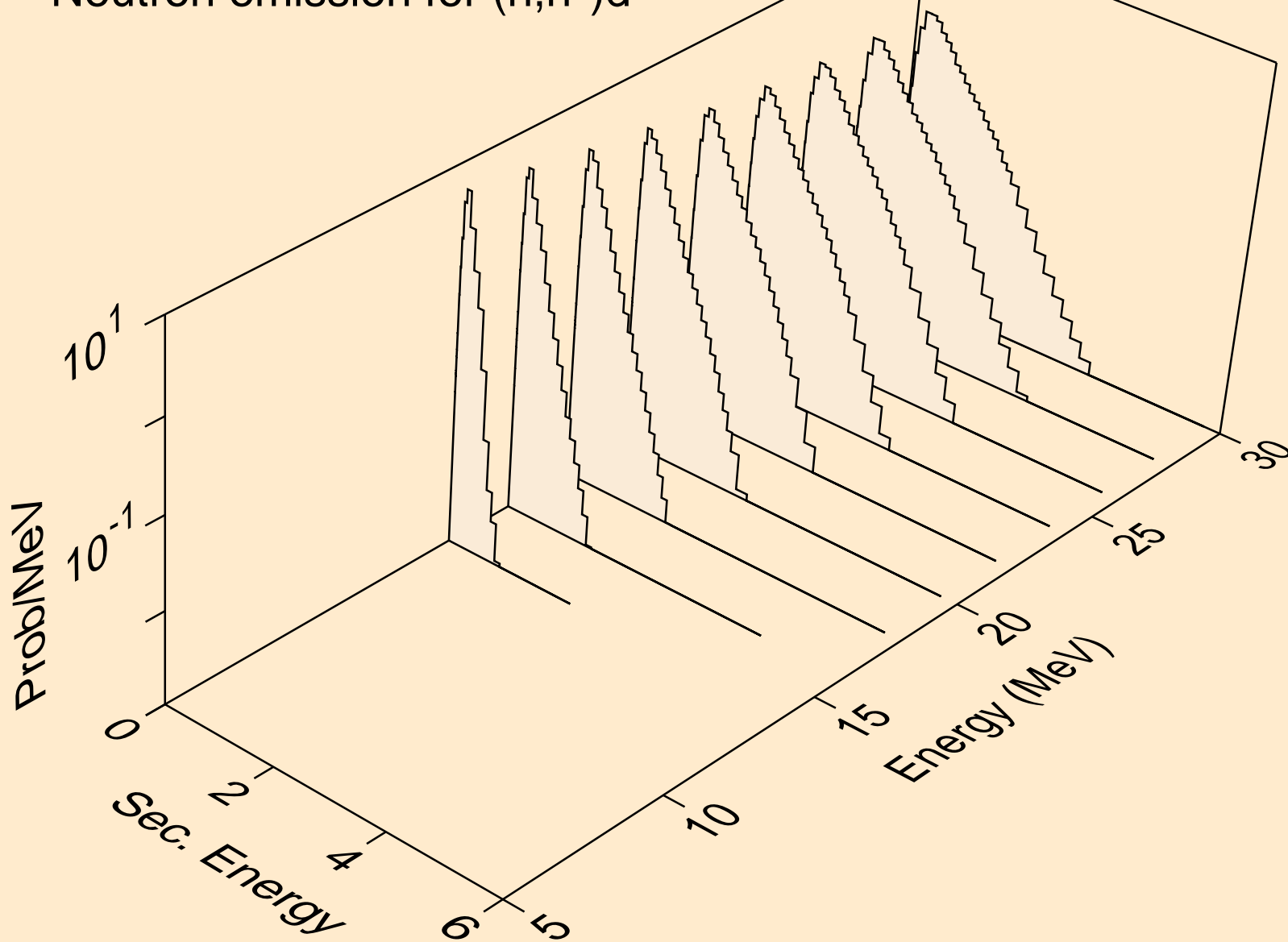

PA235 NEUTRON ACER TENDL-2019 LIBRARY; T=293.16K
Neutron emission for (n,n*)t

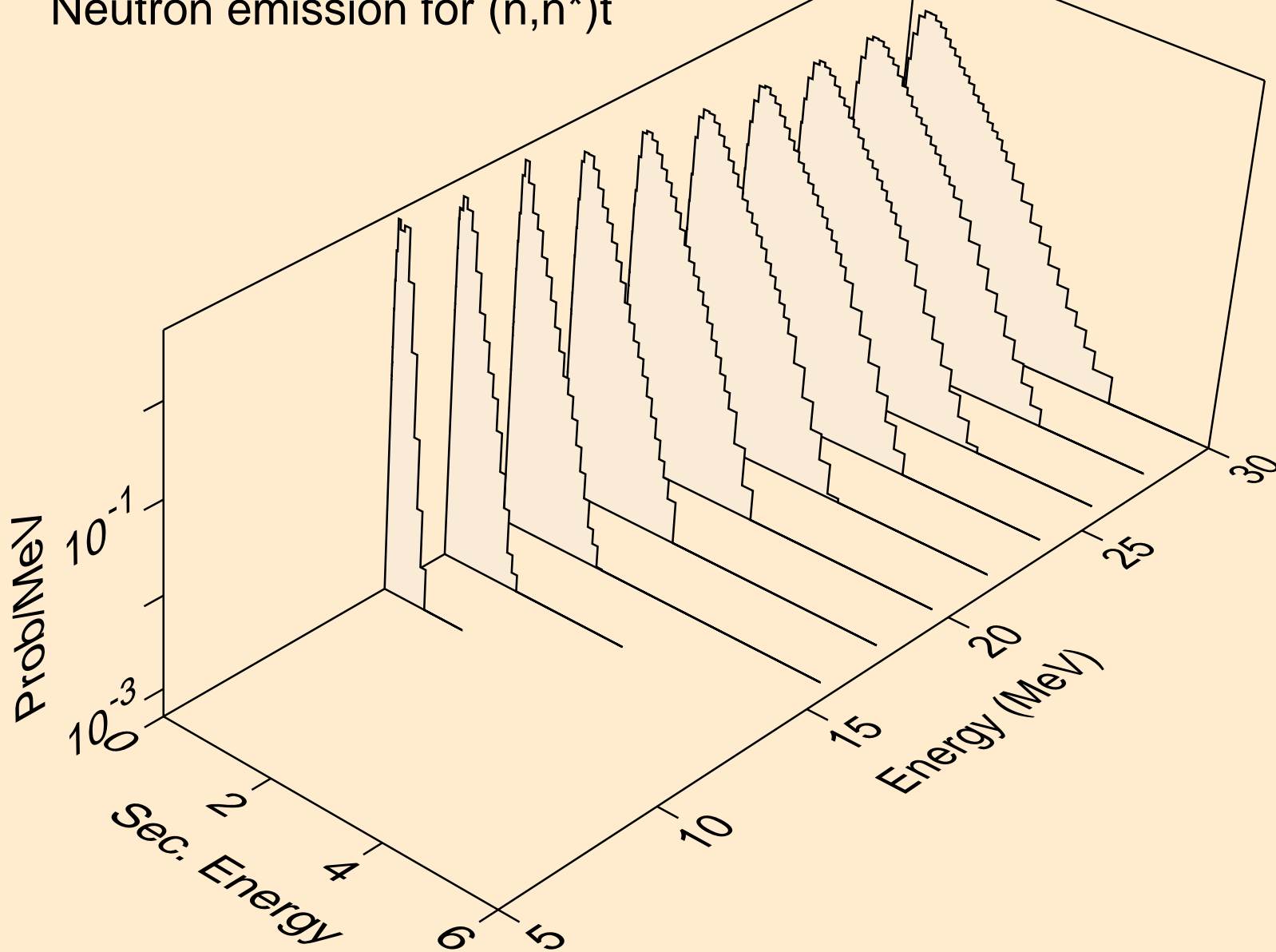

PA235 NEUTRON ACER TENDL-2019 LIBRARY; T=293.16K
Neutron emission for (n,n*)he3

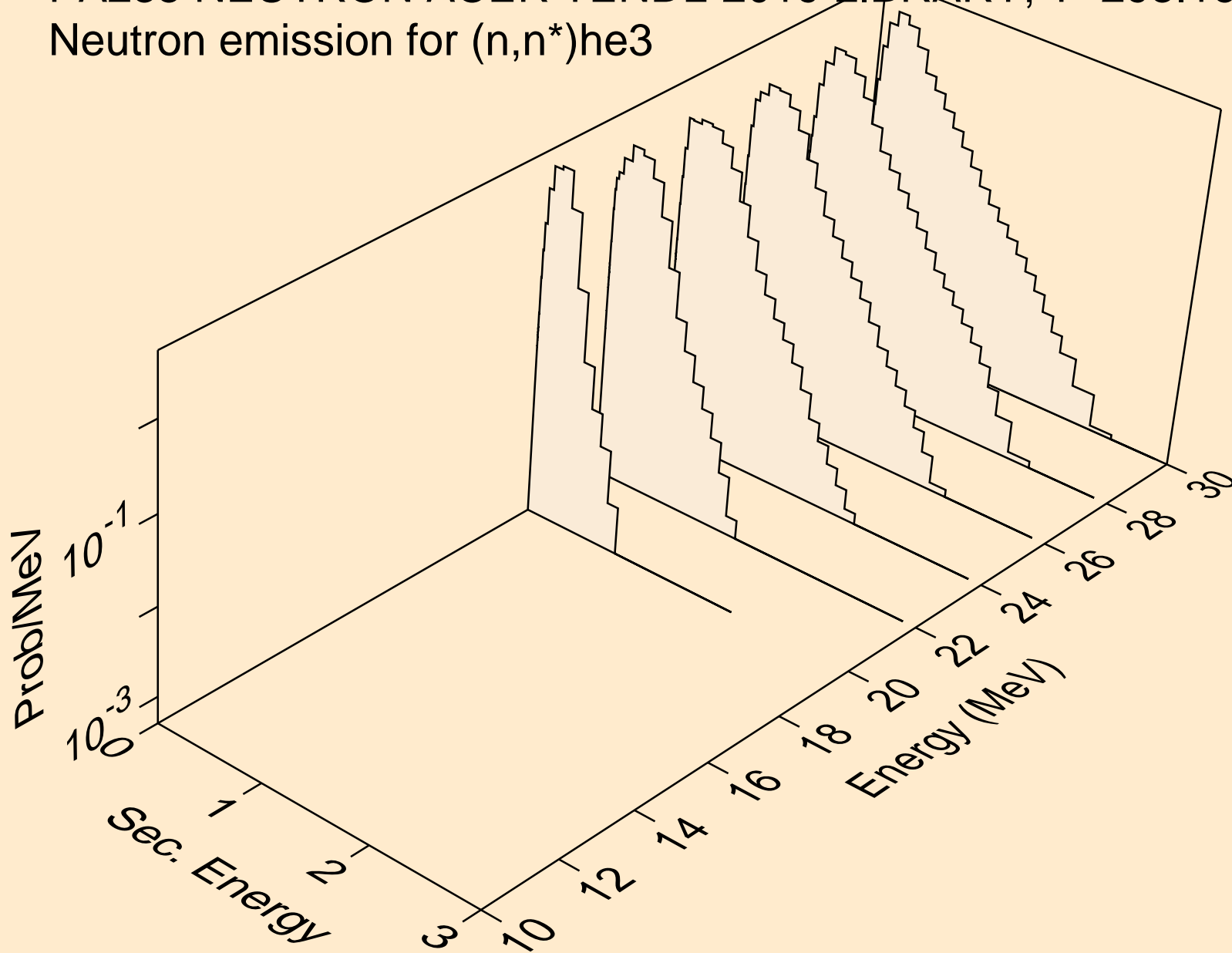

PA235 NEUTRON ACER TENDL-2019 LIBRARY; T=293.16K
Neutron emission for (n,4n)

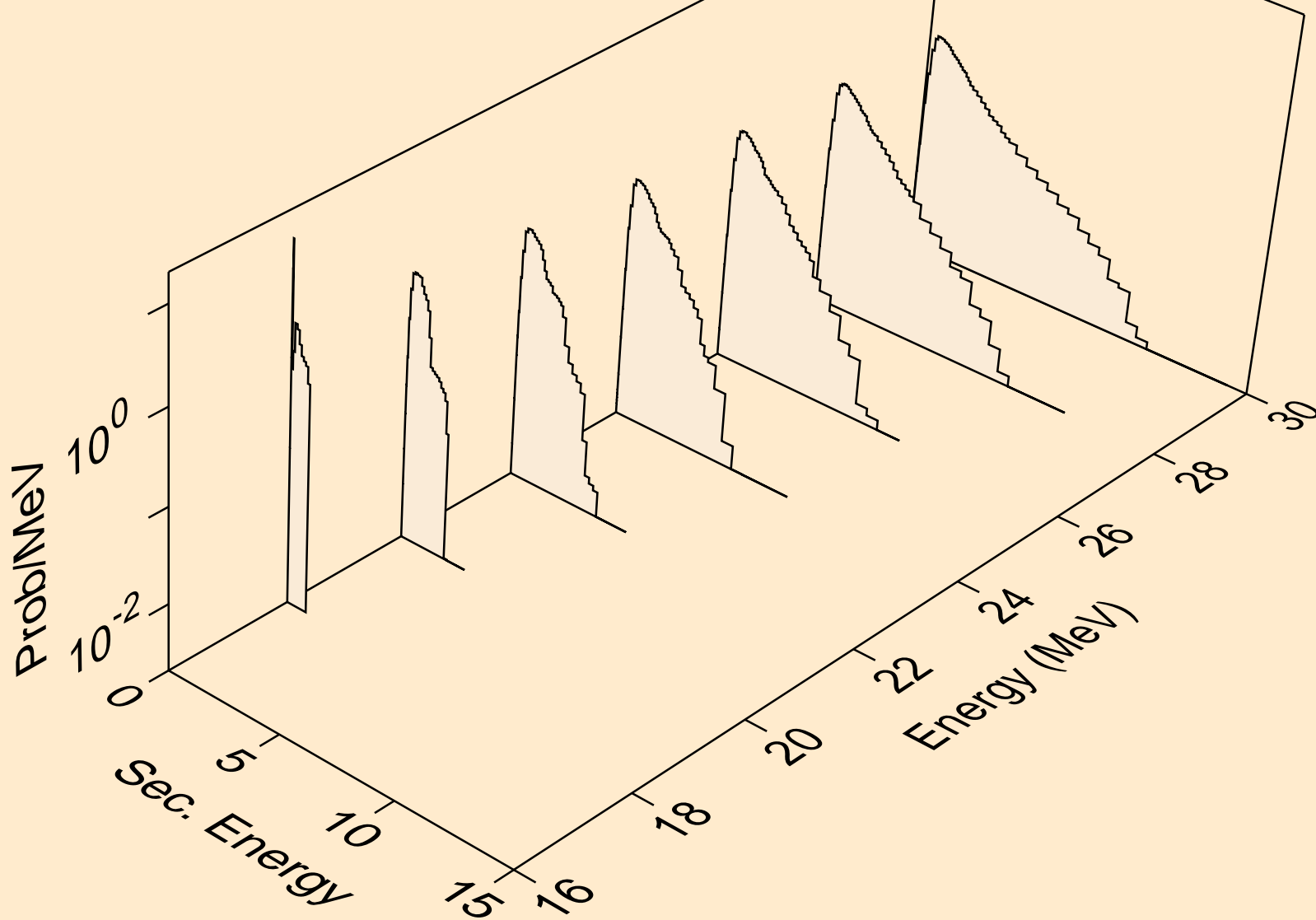

PA235 NEUTRON ACER TENDL-2019 LIBRARY; T=293.16K
Neutron emission for (n,2np)

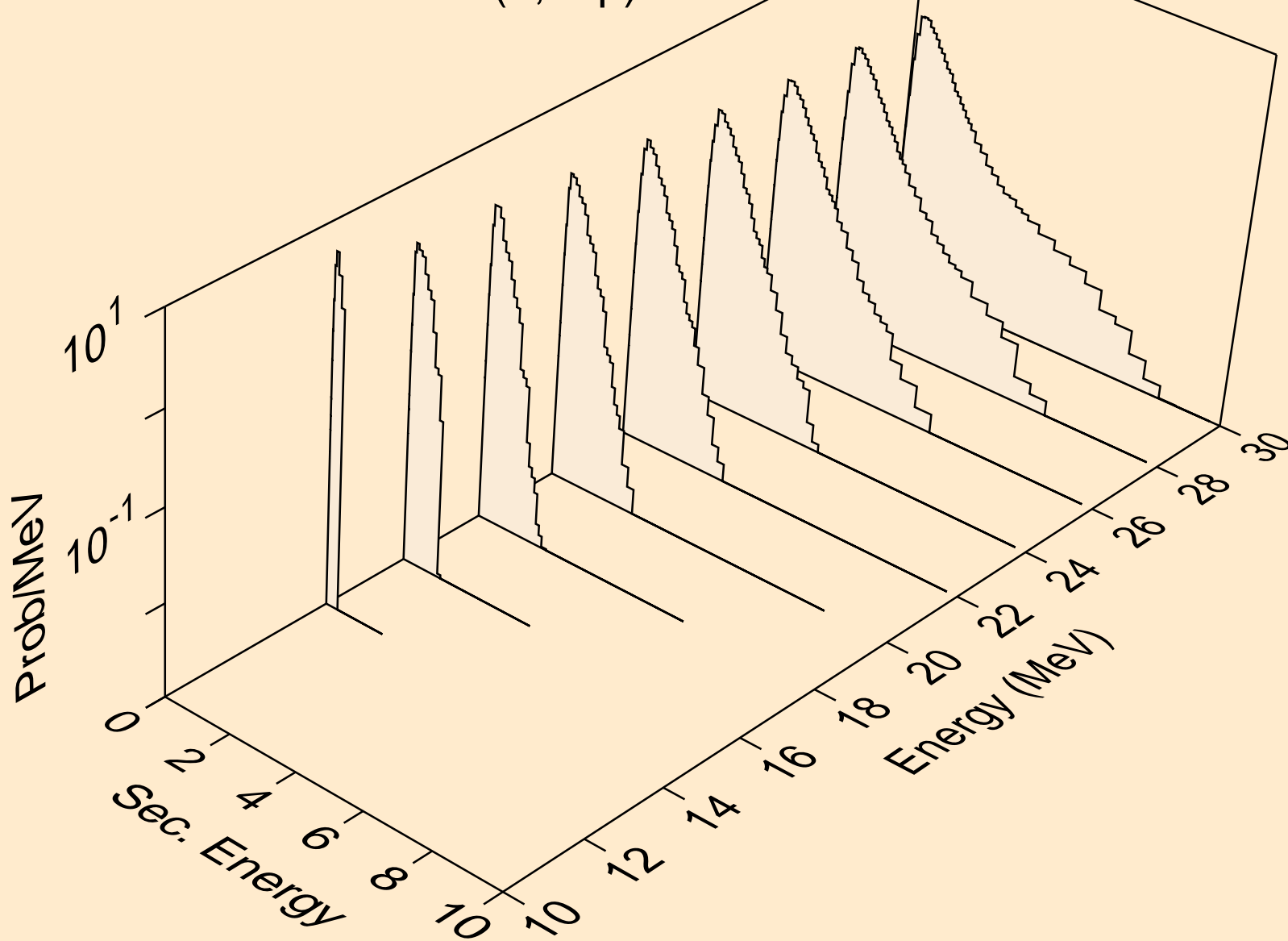

PA235 NEUTRON ACER TENDL-2019 LIBRARY; T=293.16K
Neutron emission for (n,3np)

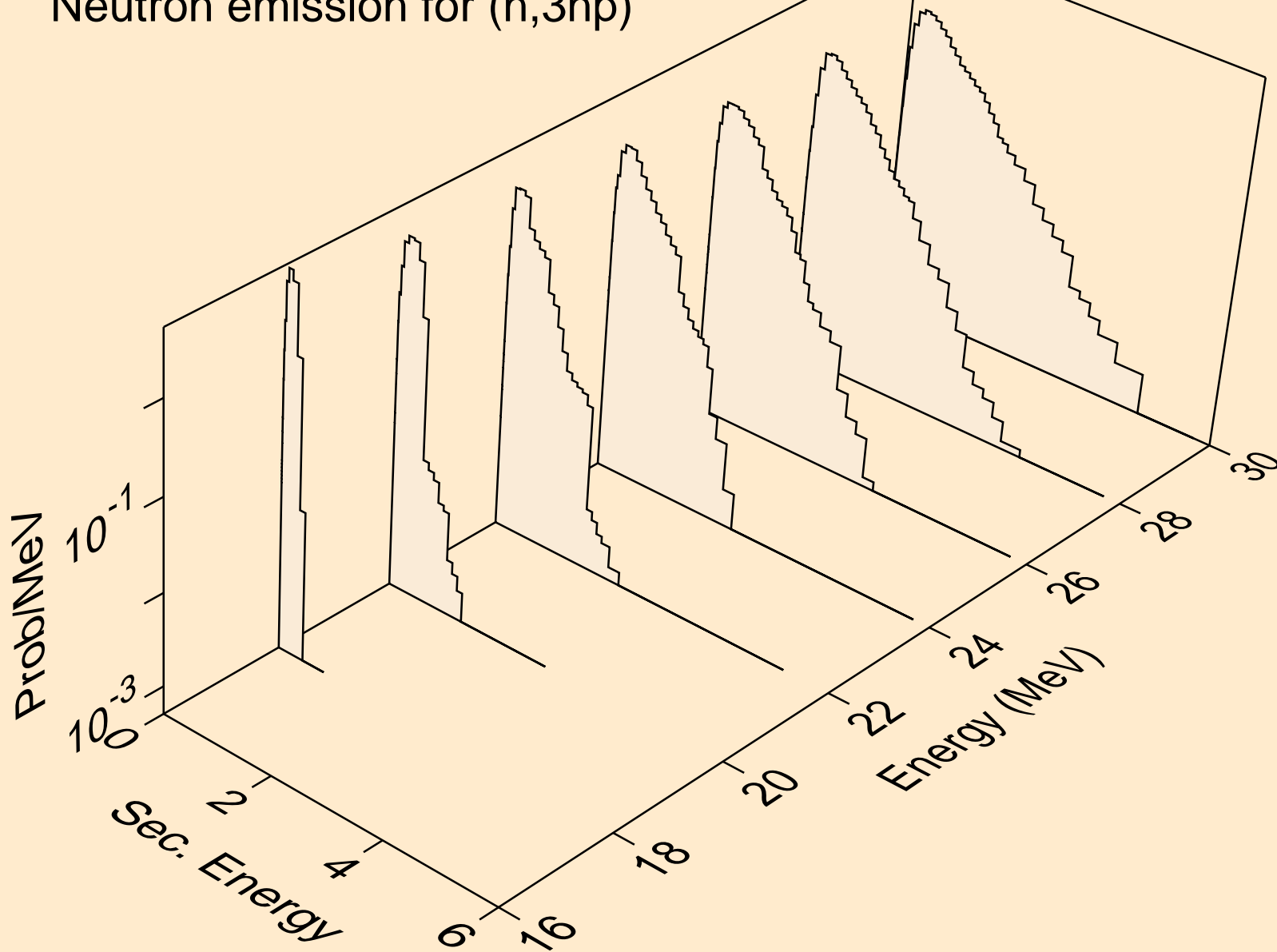

PA235 NEUTRON ACER TENDL-2019 LIBRARY; T=293.16K
Neutron emission for (n,2np)

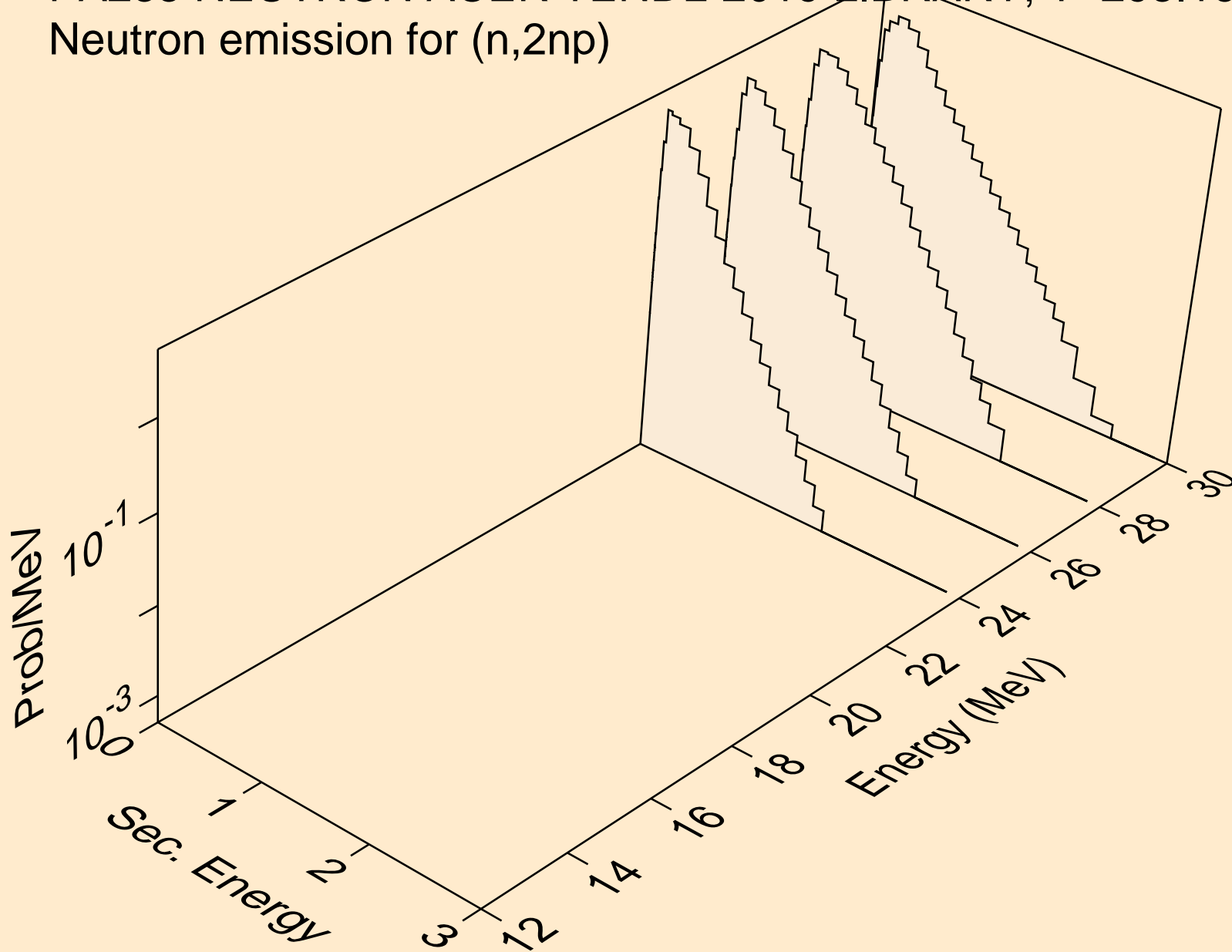

PA235 NEUTRON ACER TENDL-2019 LIBRARY; T=293.16K
Neutron emission for (n,n*c)

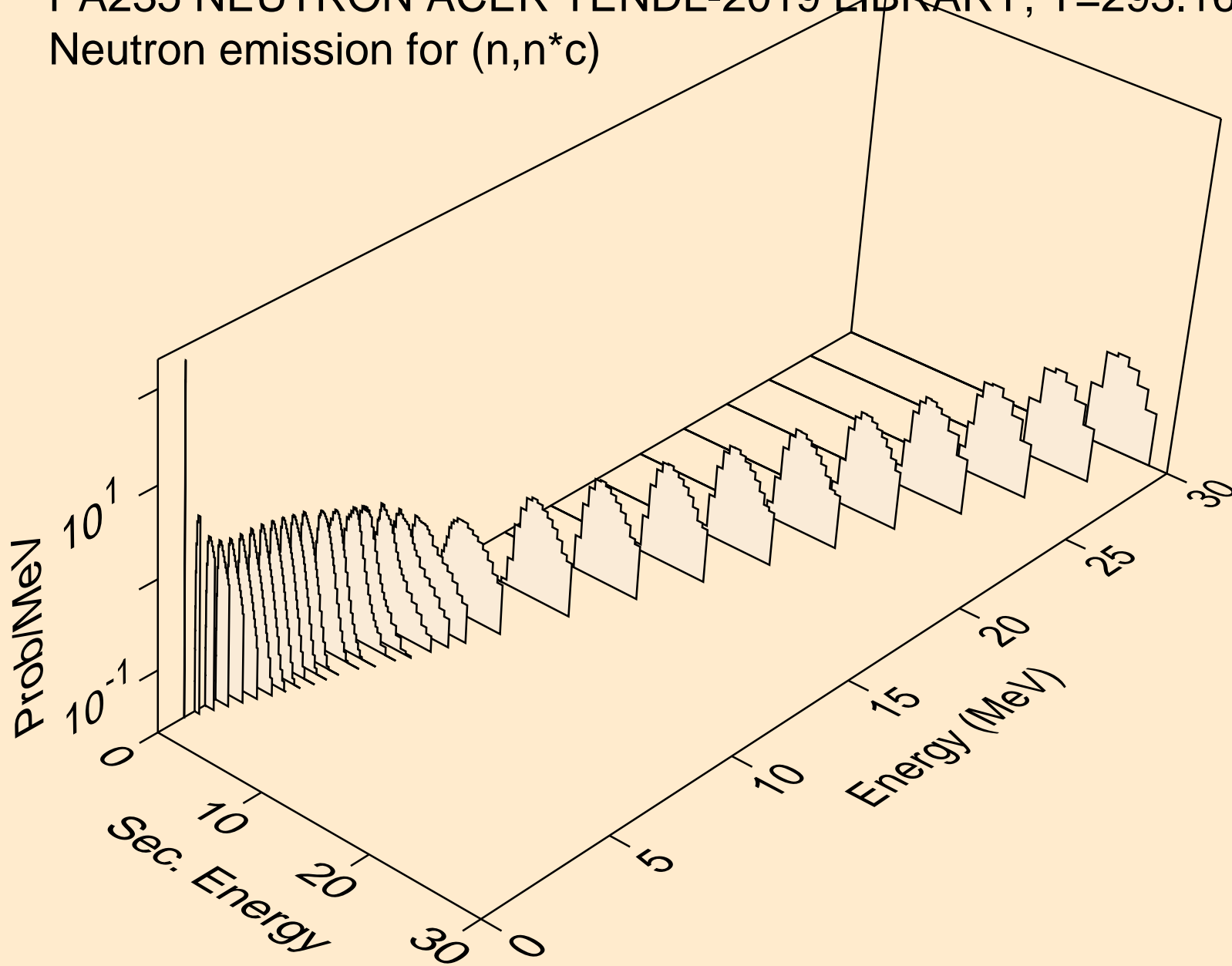

PA235 NEUTRON ACER TENDL-2019 LIBRARY; T=293.16K
Delayed nubar

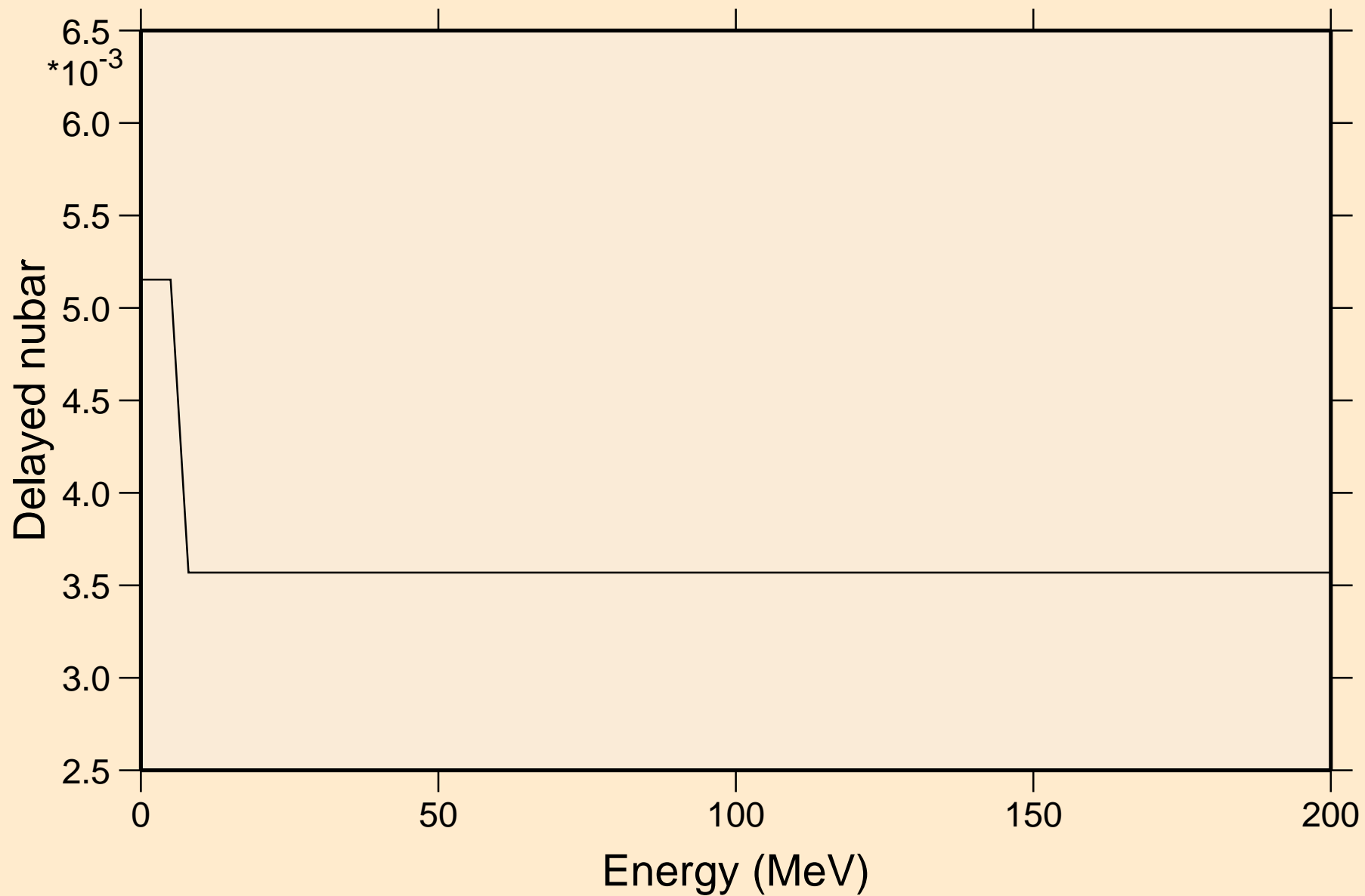

PA235 NEUTRON ACER TENDL-2019 LIBRARY; T=293.16K

Delayed neutron spectra

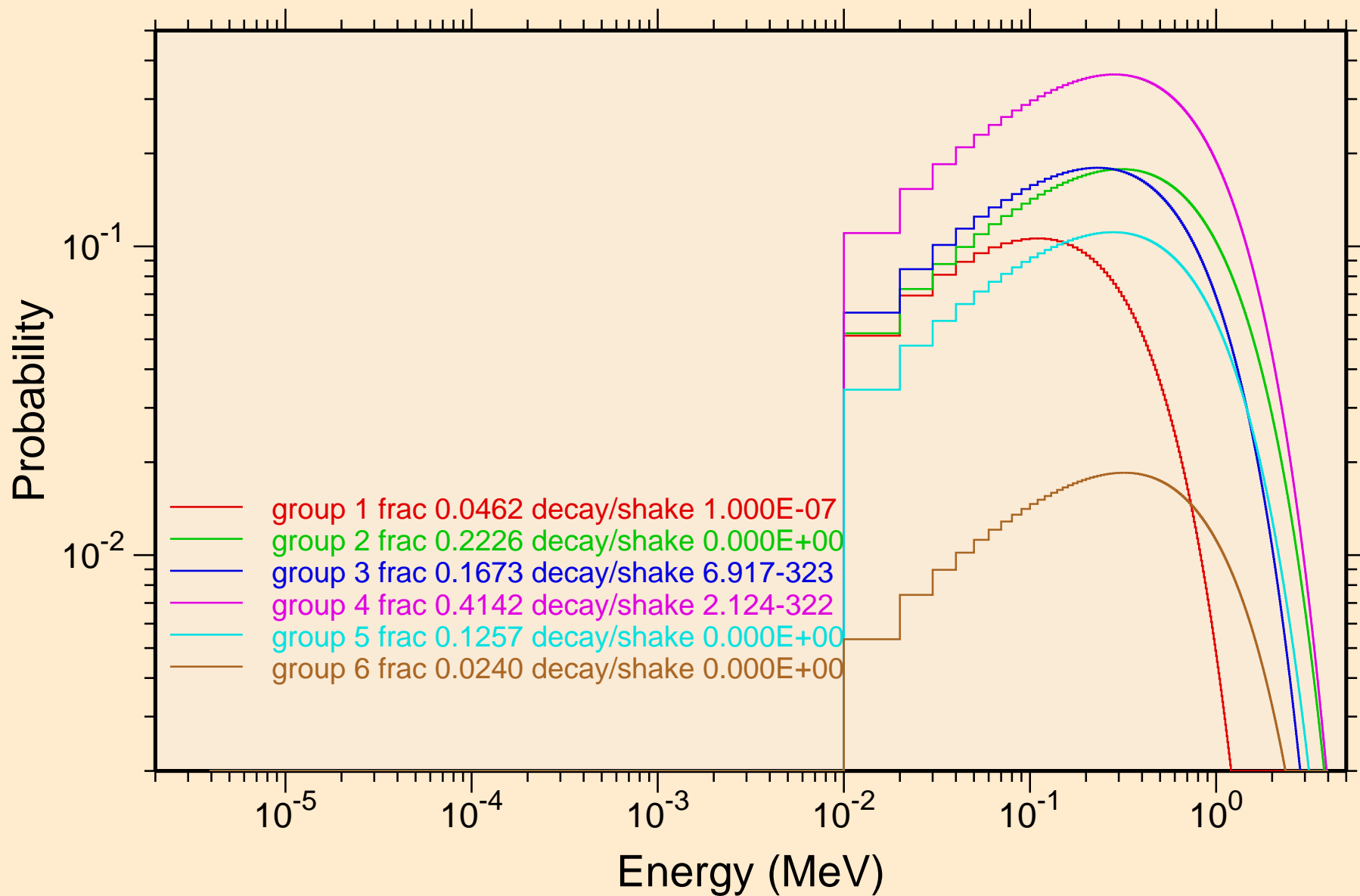

PA235 NEUTRON ACER TENDL-2019 LIBRARY; T=293.16K
Photon emission for (n,x)

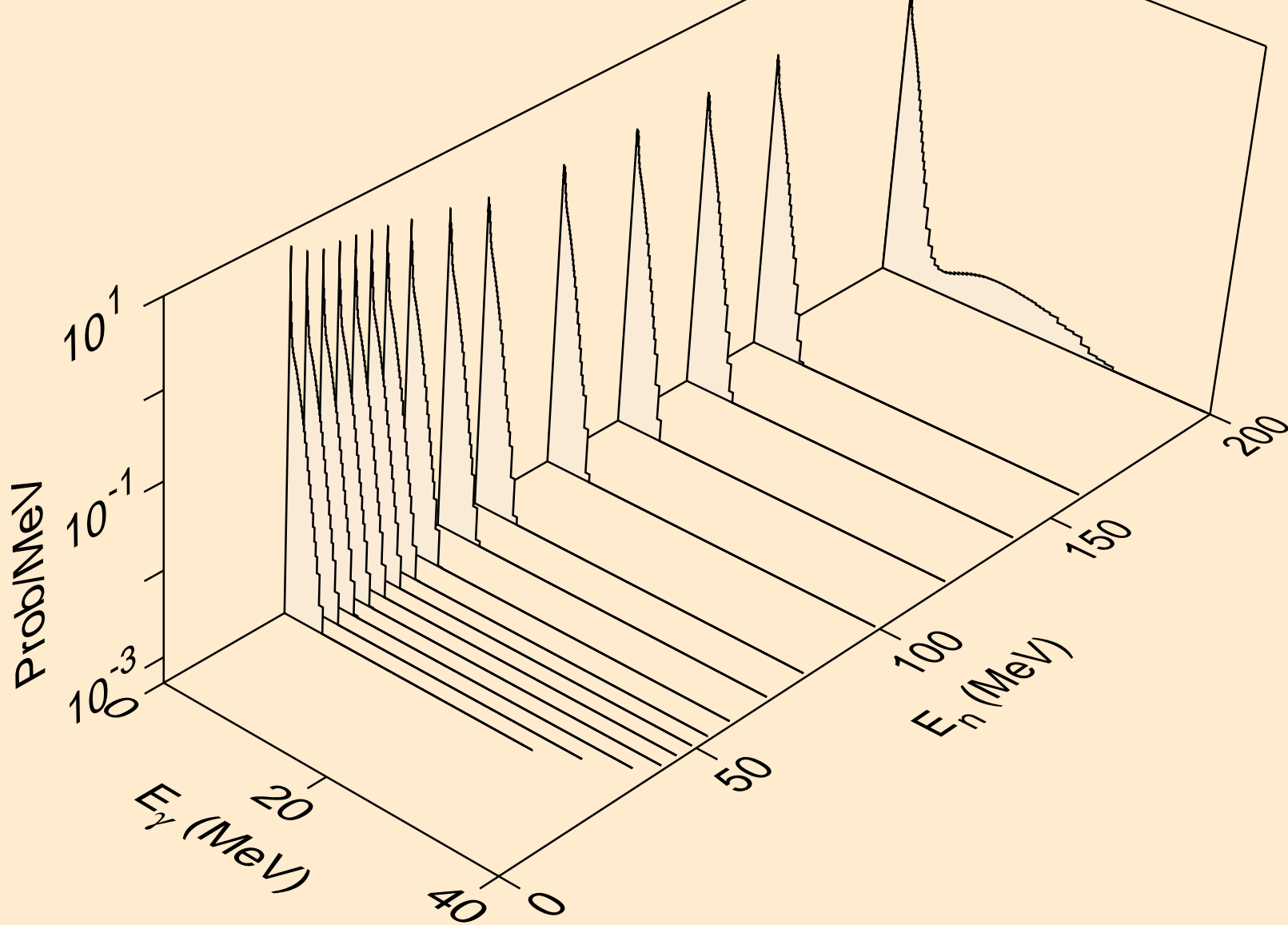

PA235 NEUTRON ACER TENDL-2019 LIBRARY; T=293.16K
Photon emission for (n,2nd)

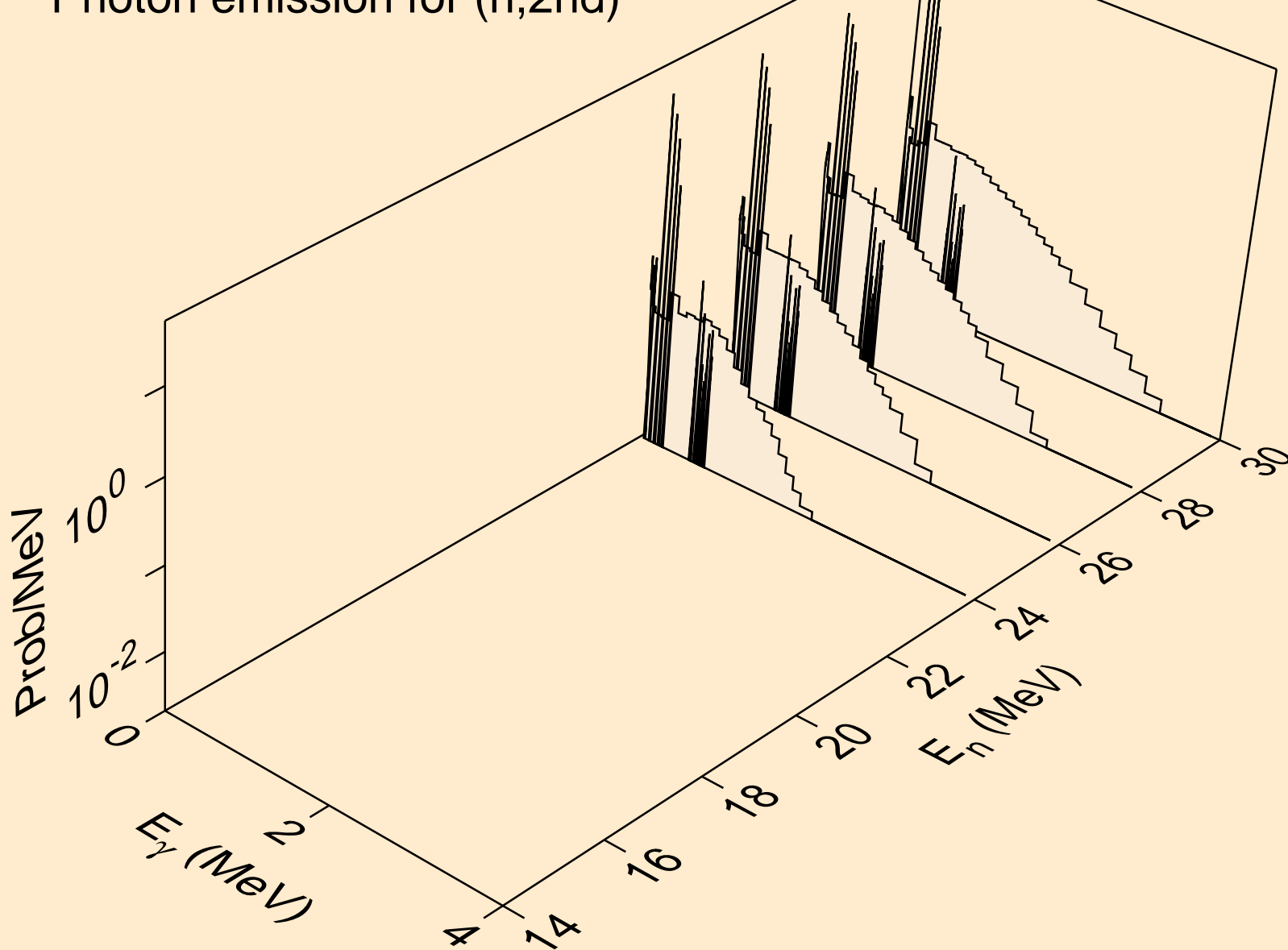

PA235 NEUTRON ACER TENDL-2019 LIBRARY; T=293.16K
Photon emission for (n,2n)

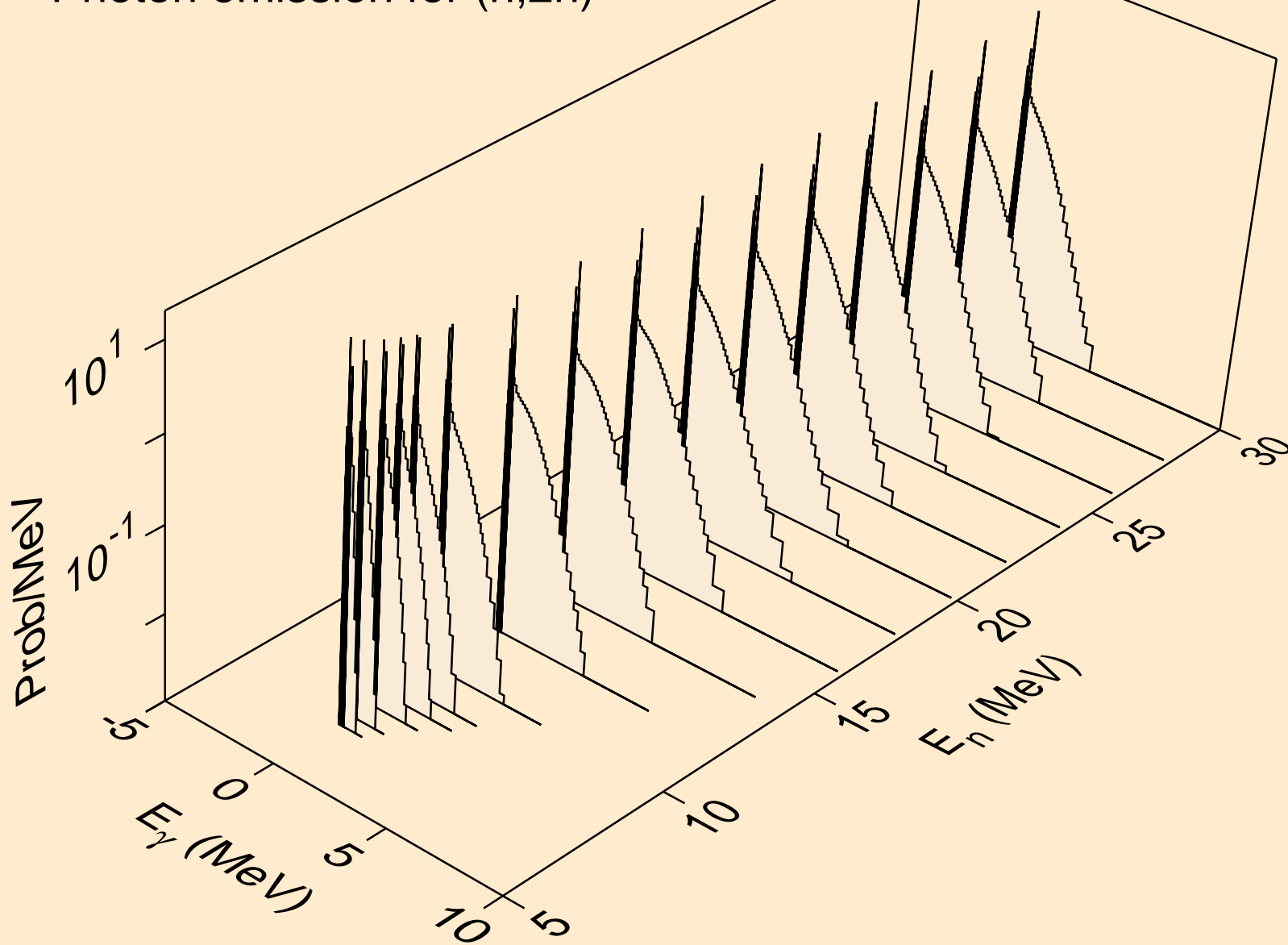

PA235 NEUTRON ACER TENDL-2019 LIBRARY; T=293.16K
Photon emission for (n,3n)

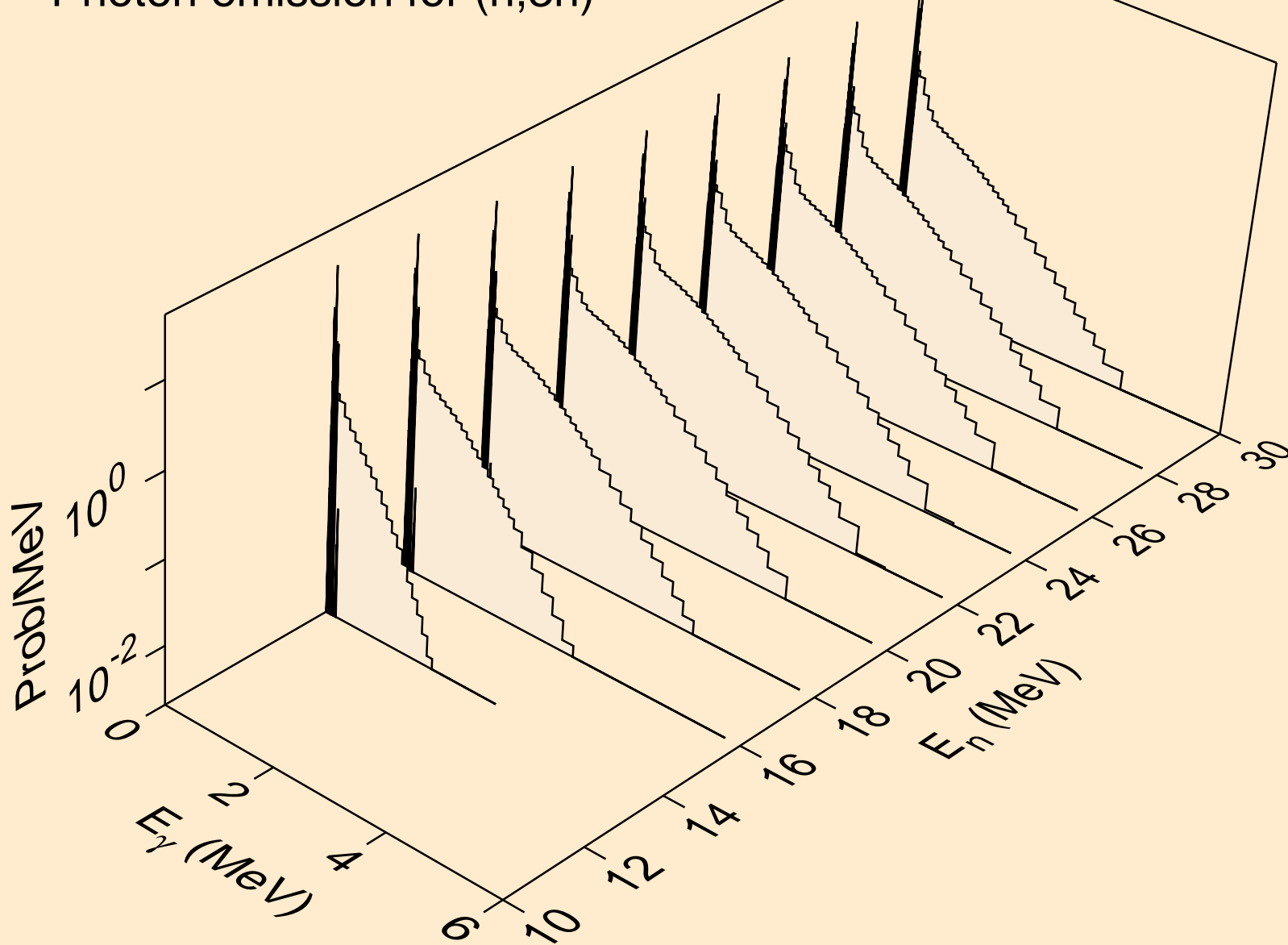

PA235 NEUTRON ACER TENDL-2019 LIBRARY; T=293.16K
Photon emission for (n,n*)a

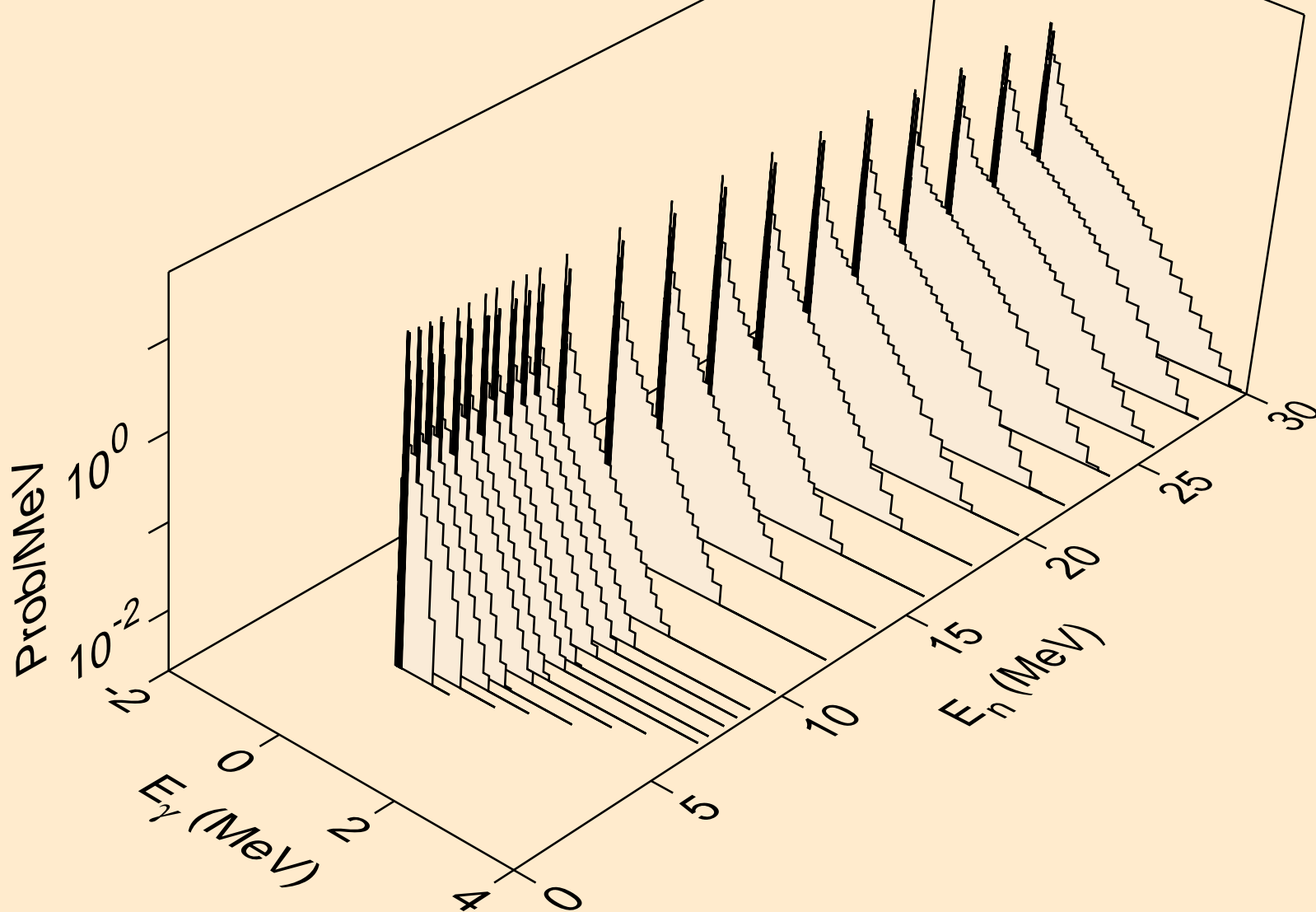

PA235 NEUTRON ACER TENDL-2019 LIBRARY; T=293.16K
Photon emission for (n,2n)a

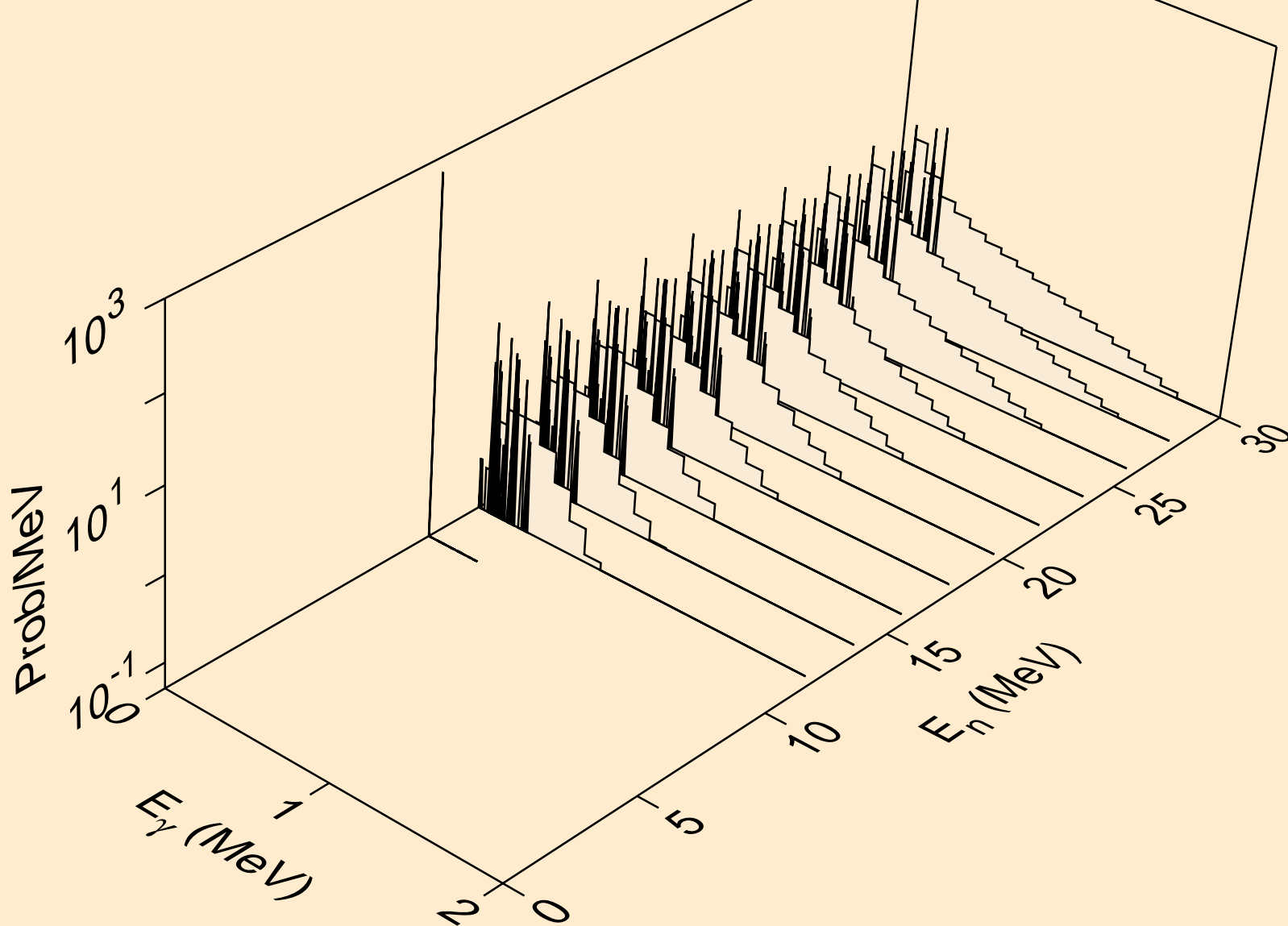

PA235 NEUTRON ACER TENDL-2019 LIBRARY; T=293.16K
Photon emission for (n,3n)a

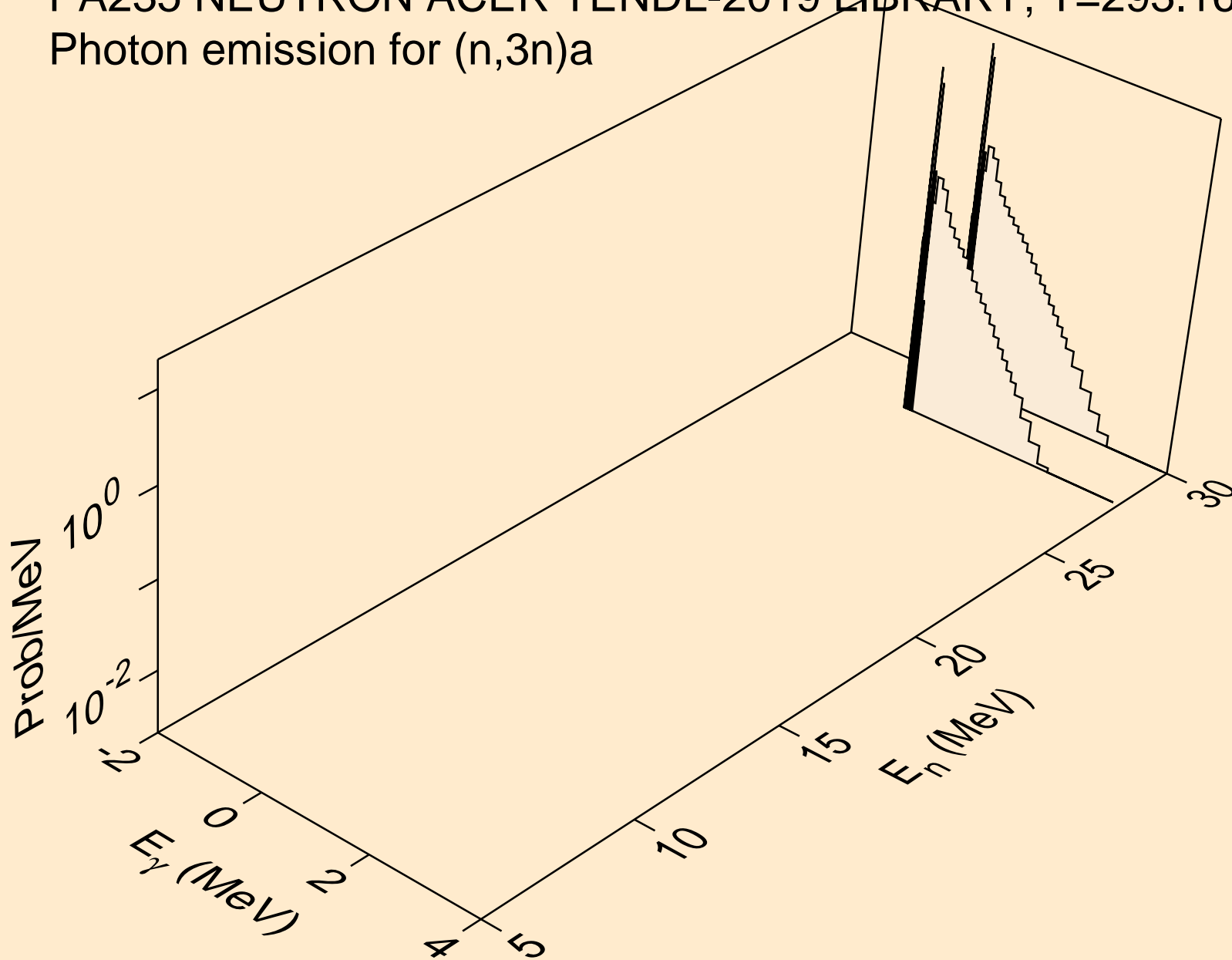

PA235 NEUTRON ACER TENDL-2019 LIBRARY; T=293.16K
Photon emission for (n,n*)p

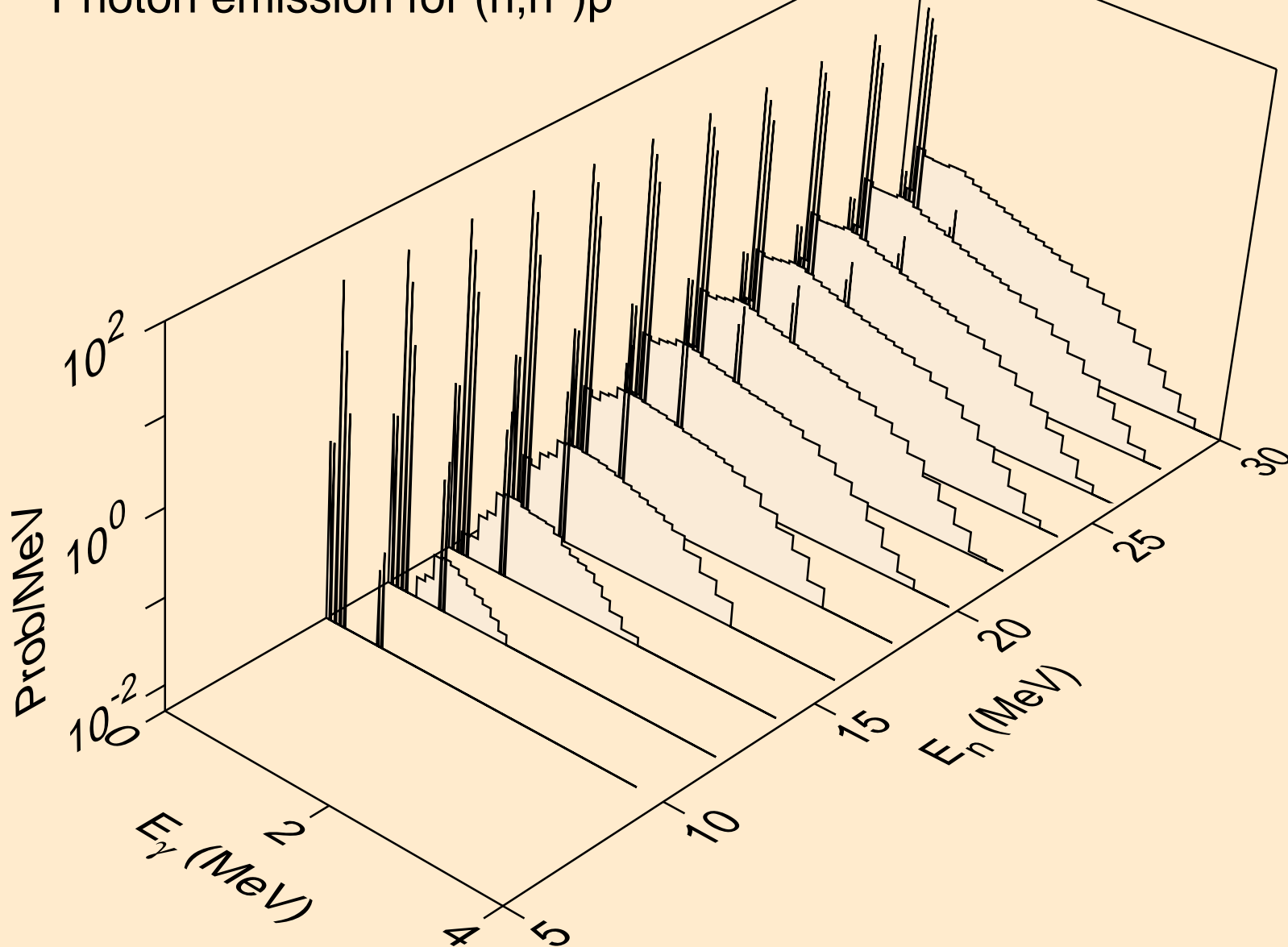

PA235 NEUTRON ACER TENDL-2019 LIBRARY; T=293.16K
Photon emission for (n,n*)d

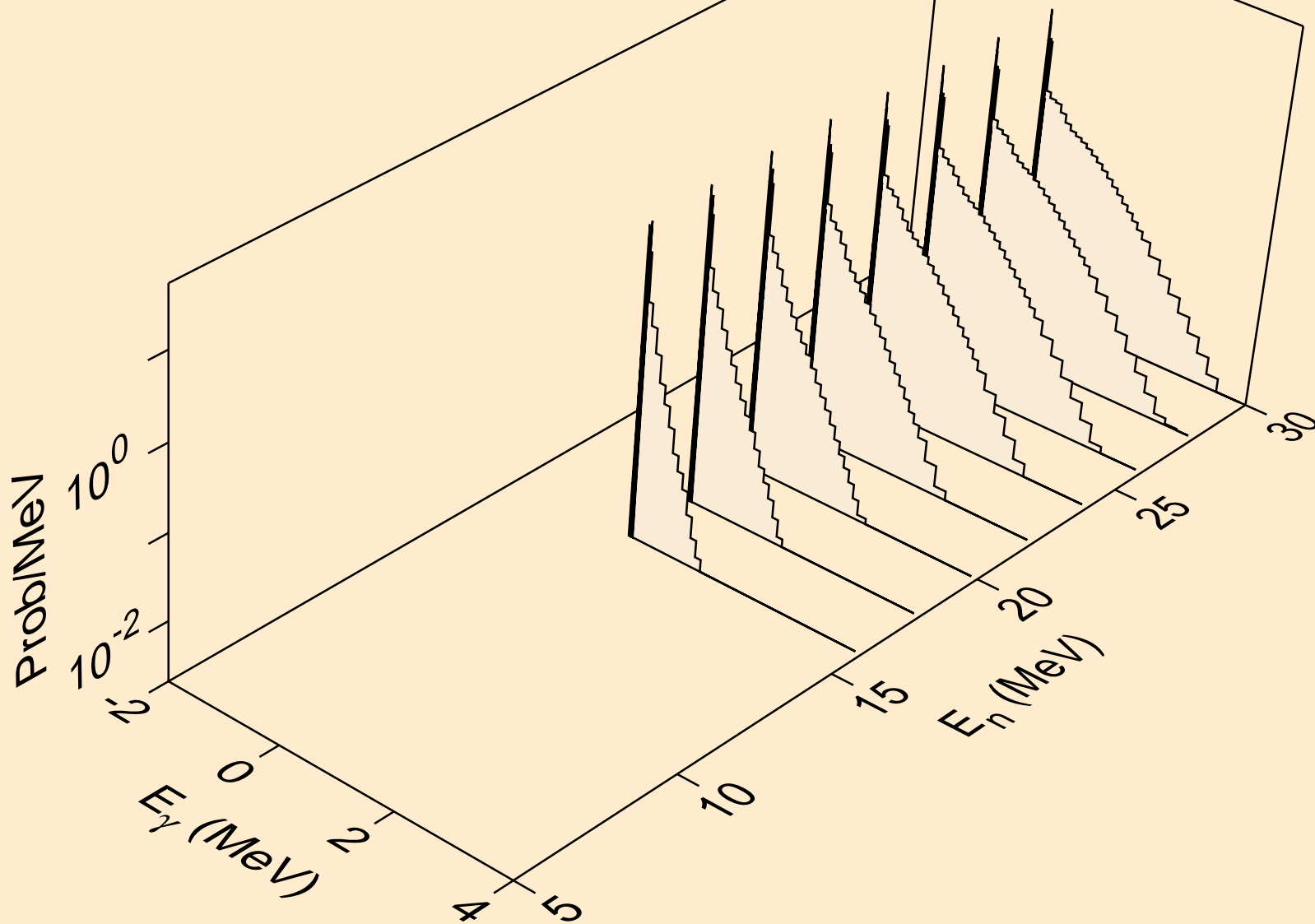

PA235 NEUTRON ACER TENDL-2019 LIBRARY; T=293.16K
Photon emission for (n,n*)t

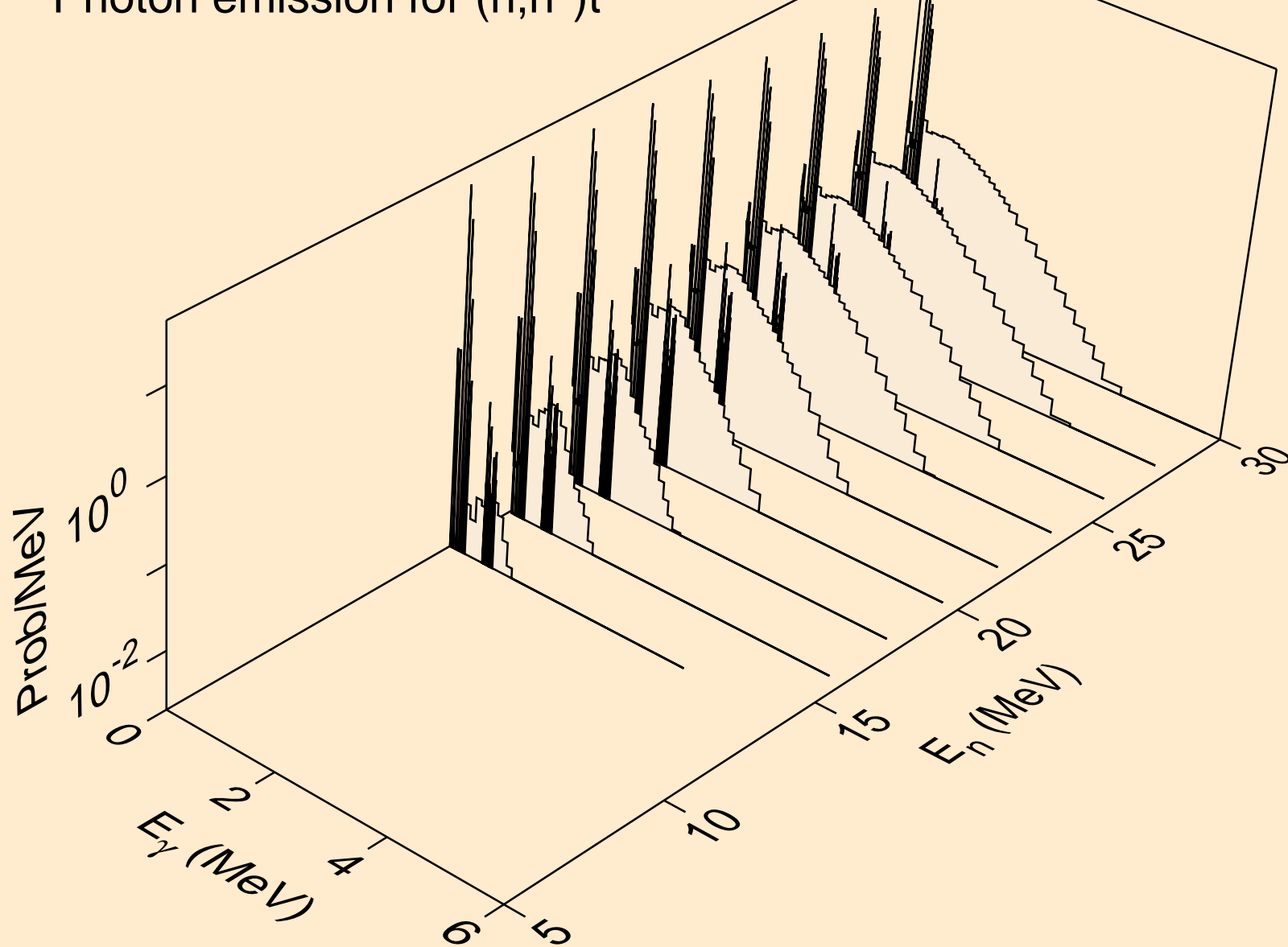

PA235 NEUTRON ACER TENDL-2019 LIBRARY; T=293.16K
Photon emission for (n,n*)he3

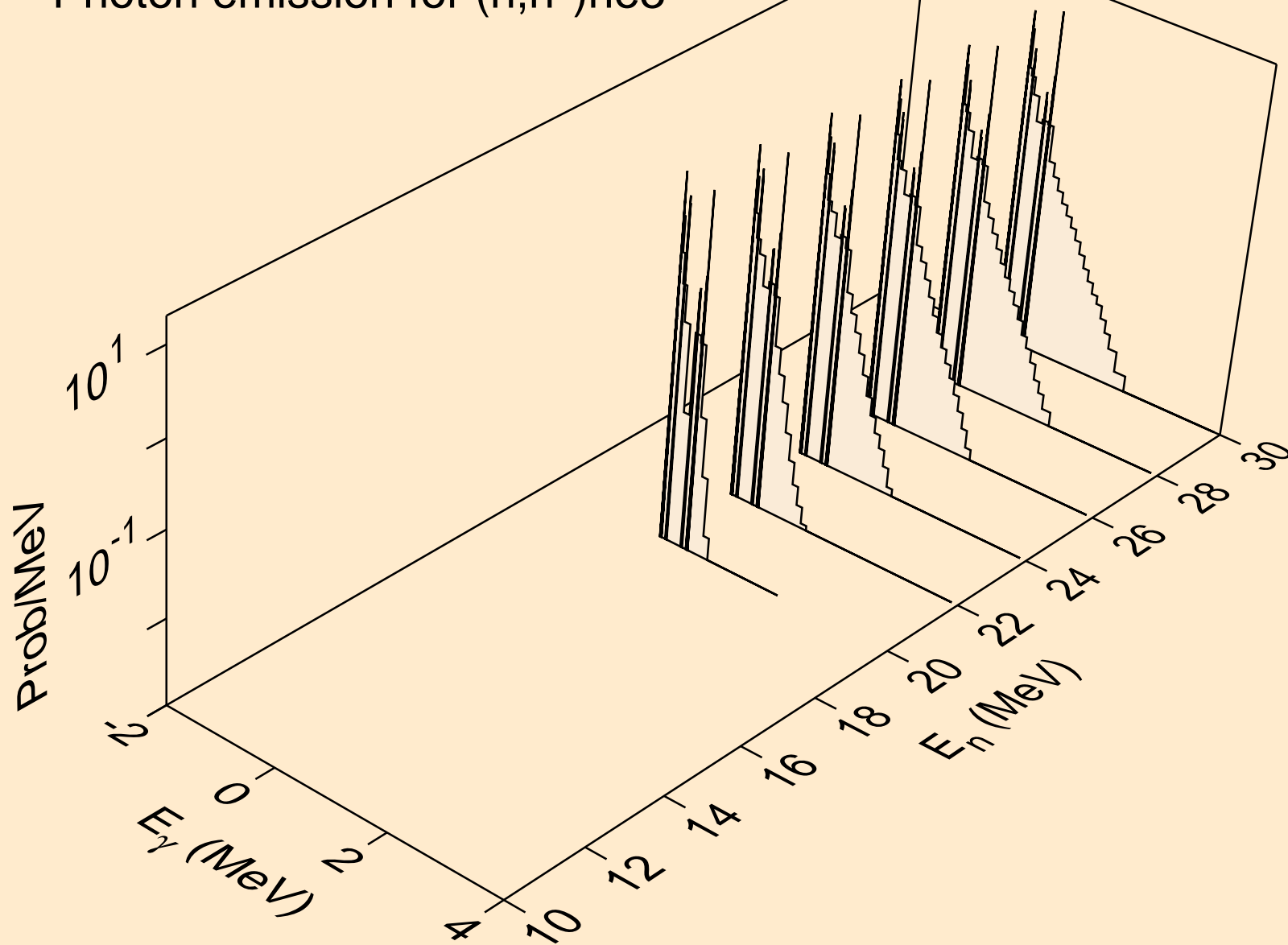

PA235 NEUTRON ACER TENDL-2019 LIBRARY; T=293.16K
Photon emission for (n,4n)

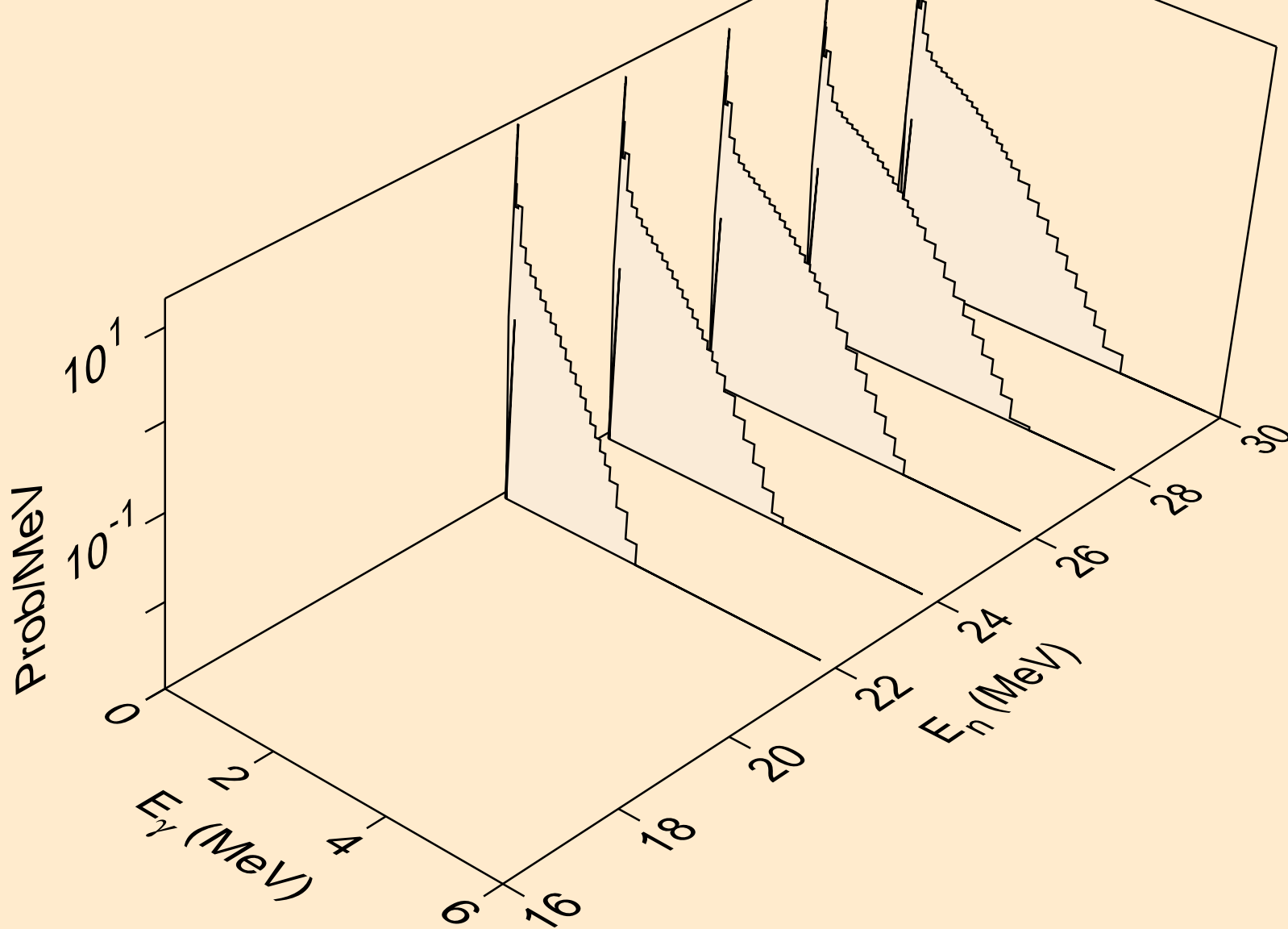

PA235 NEUTRON ACER TENDL-2019 LIBRARY; T=293.16K
Photon emission for (n,2np)

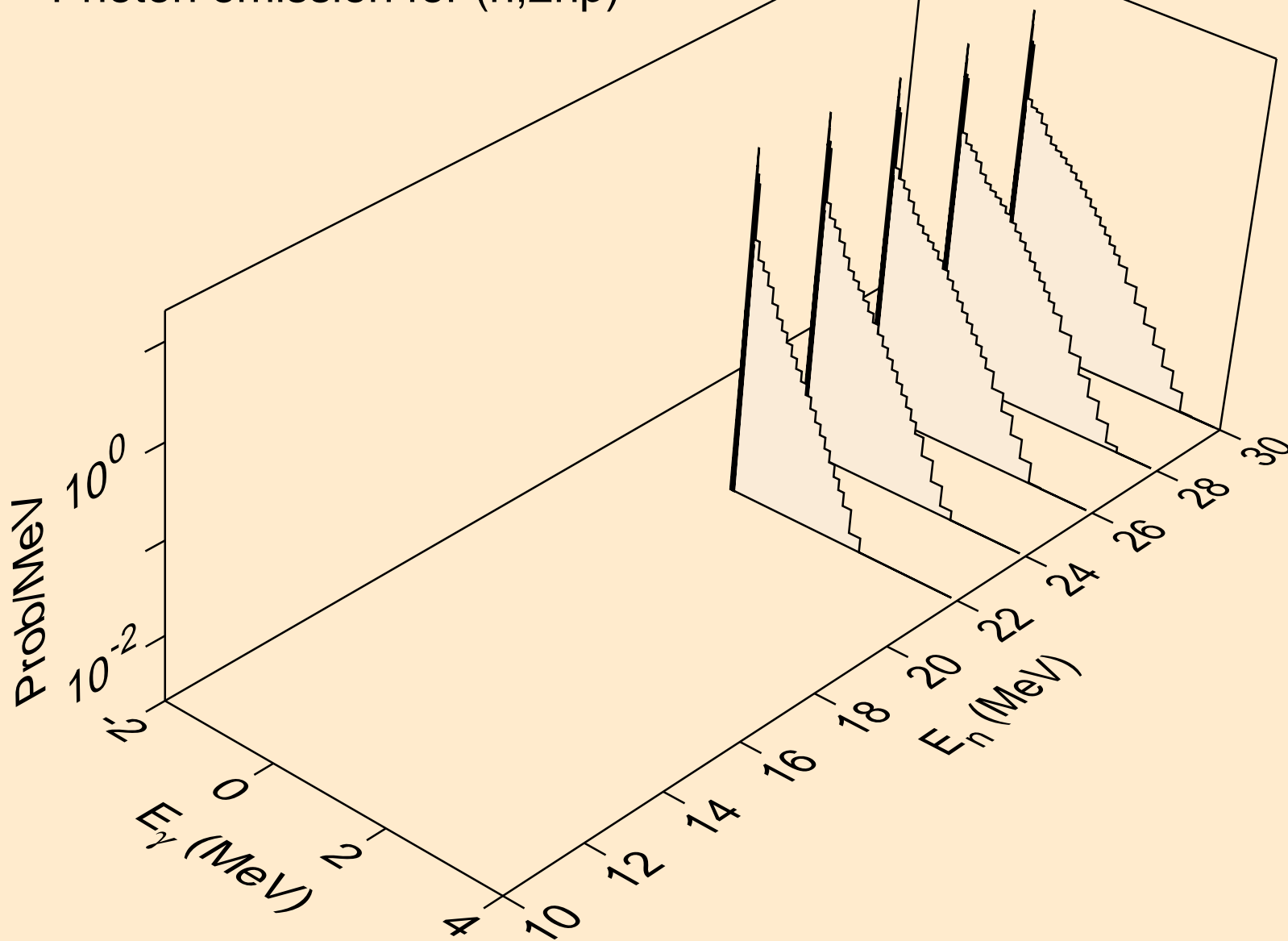

PA235 NEUTRON ACER TENDL-2019 LIBRARY; T=293.16K
Photon emission for (n,3np)

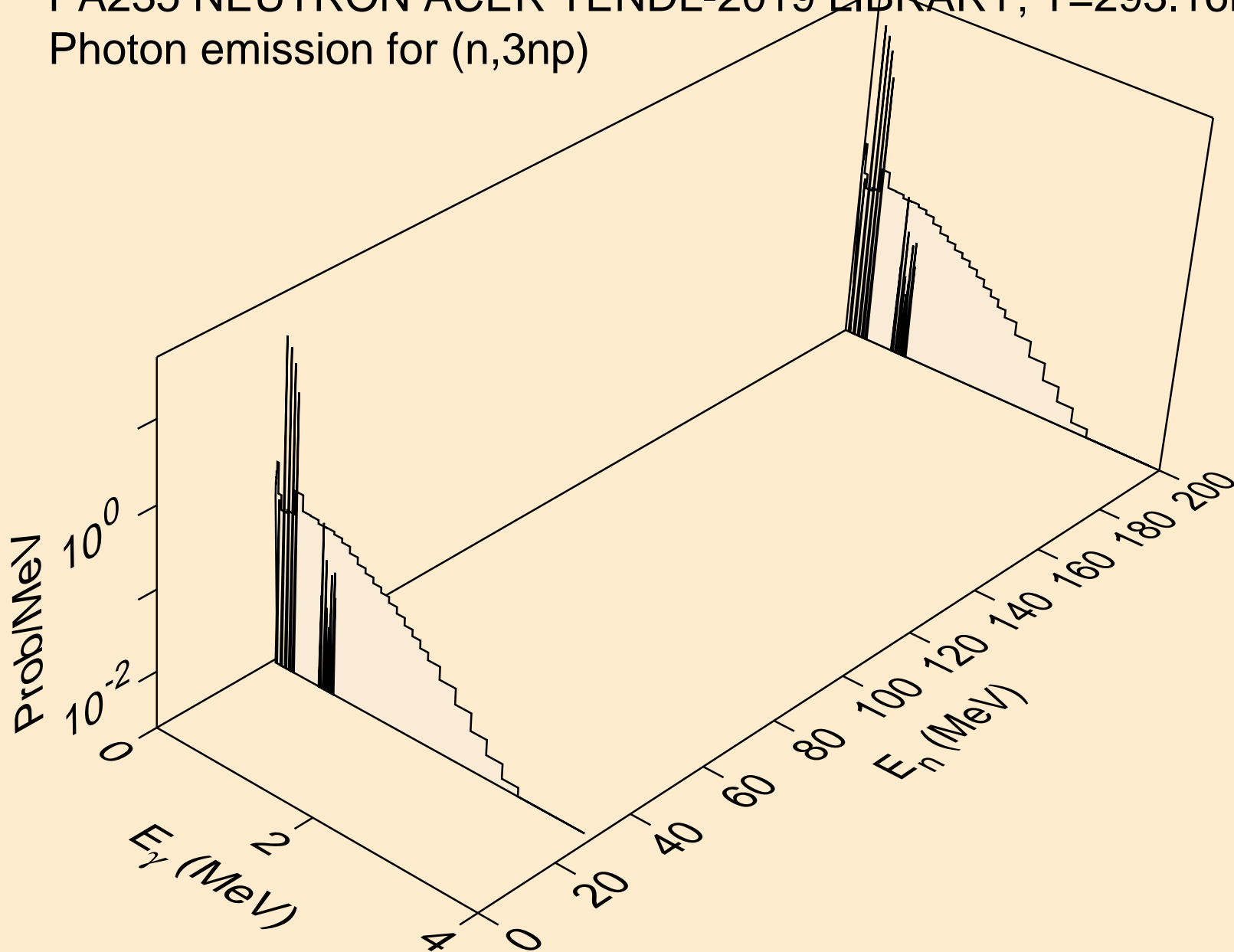

PA235 NEUTRON ACER TENDL-2019 LIBRARY; T=293.16K
Photon emission for (n,2np)

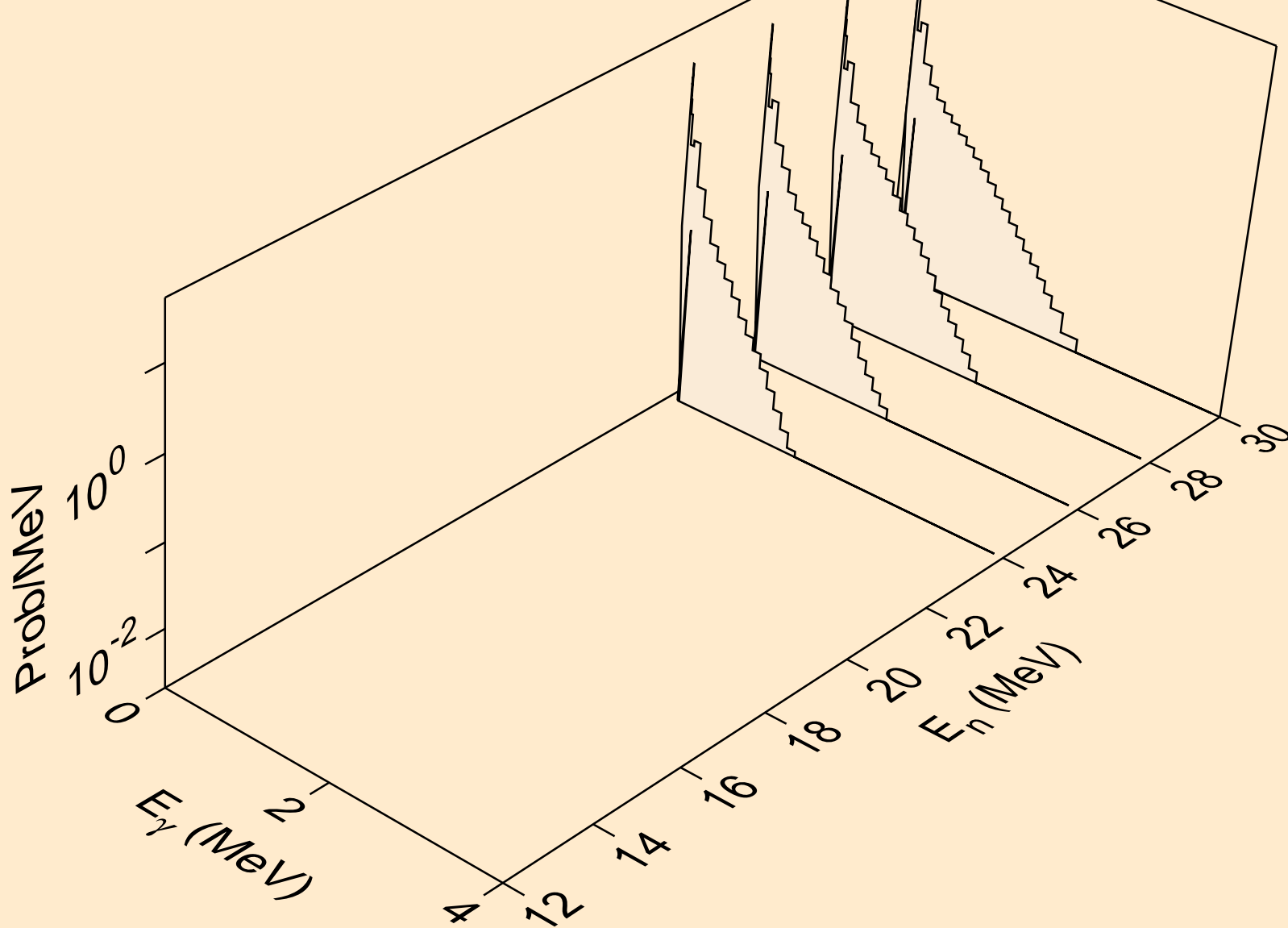

PA235 NEUTRON ACER TENDL-2019 LIBRARY; T=293.16K
Photon emission for (n,n*c)

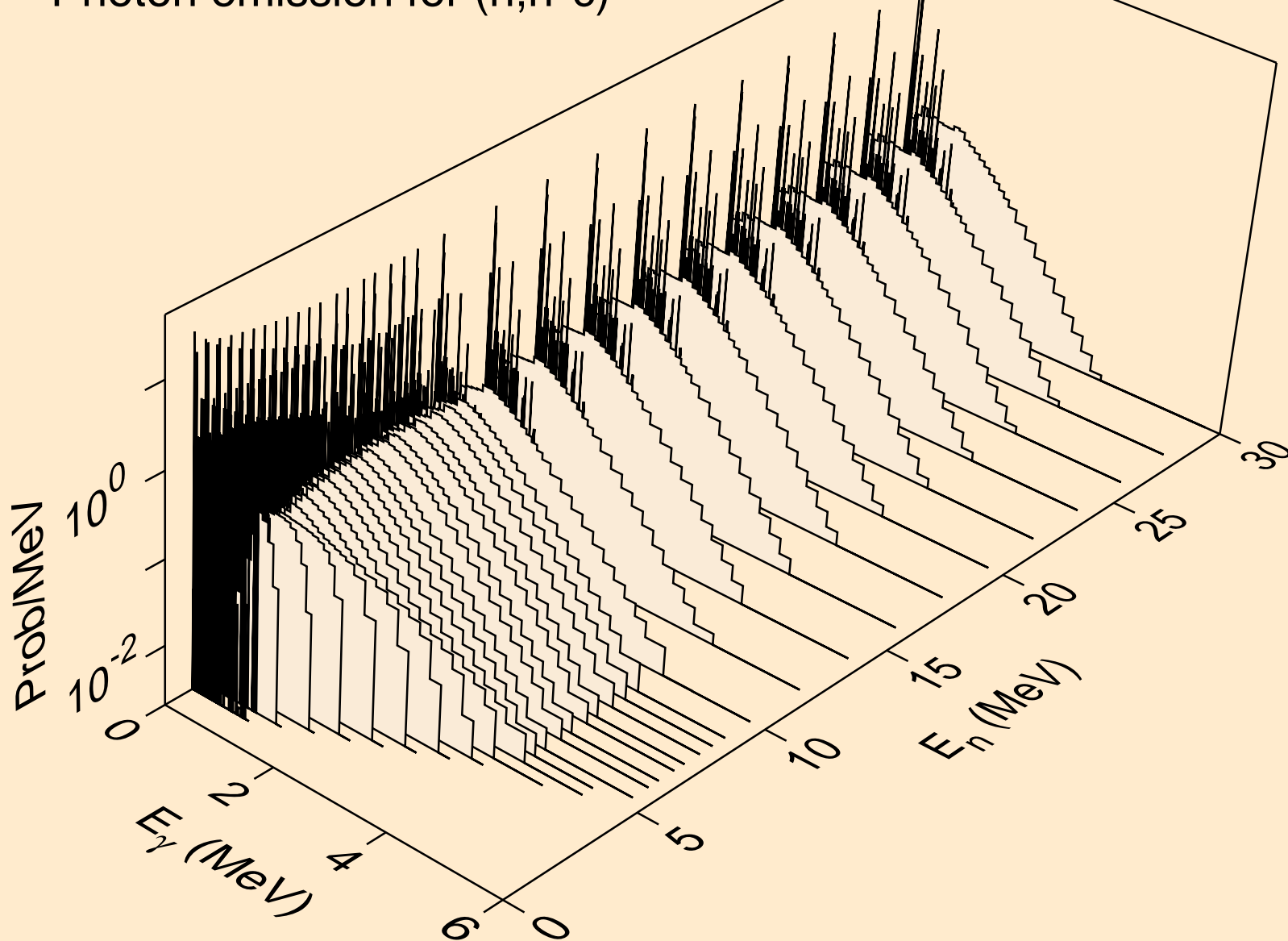

PA235 NEUTRON ACER TENDL-2019 LIBRARY; T=293.16K
Photon emission for (n,gma)

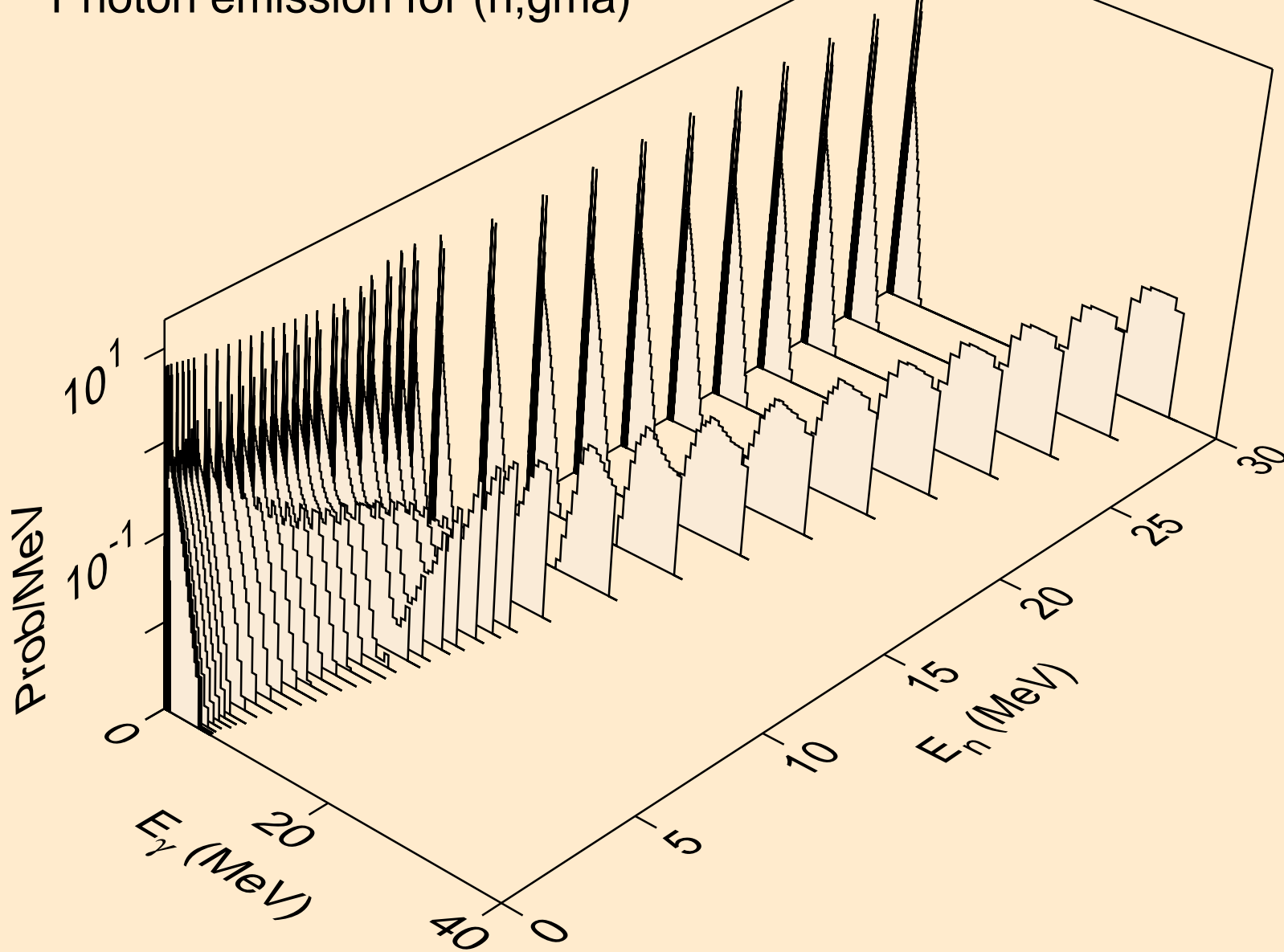

PA235 NEUTRON ACER TENDL-2019 LIBRARY; T=293.16K
Photon emission for (n,p)

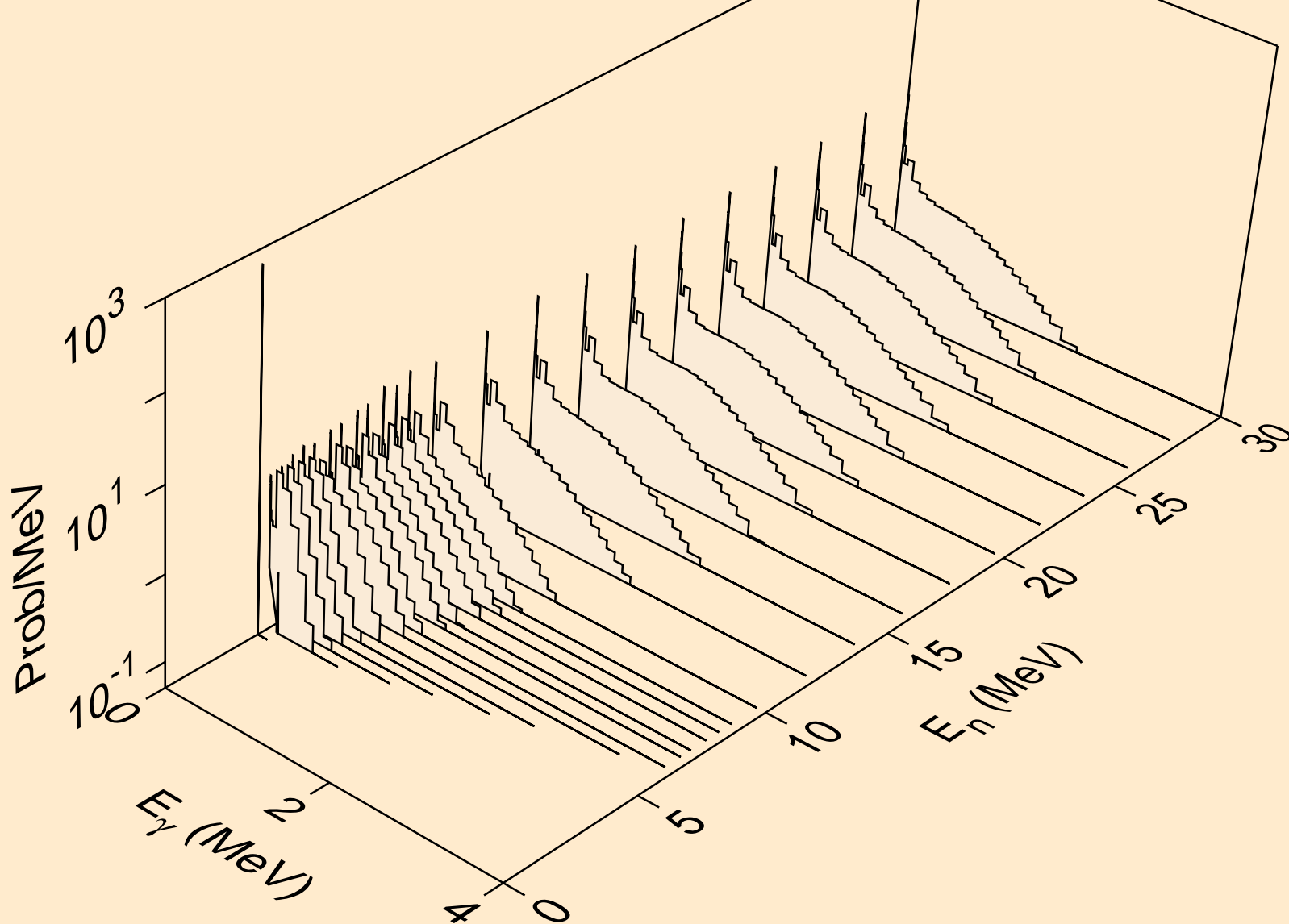

PA235 NEUTRON ACER TENDL-2019 LIBRARY; T=293.16K
Photon emission for (n,d)

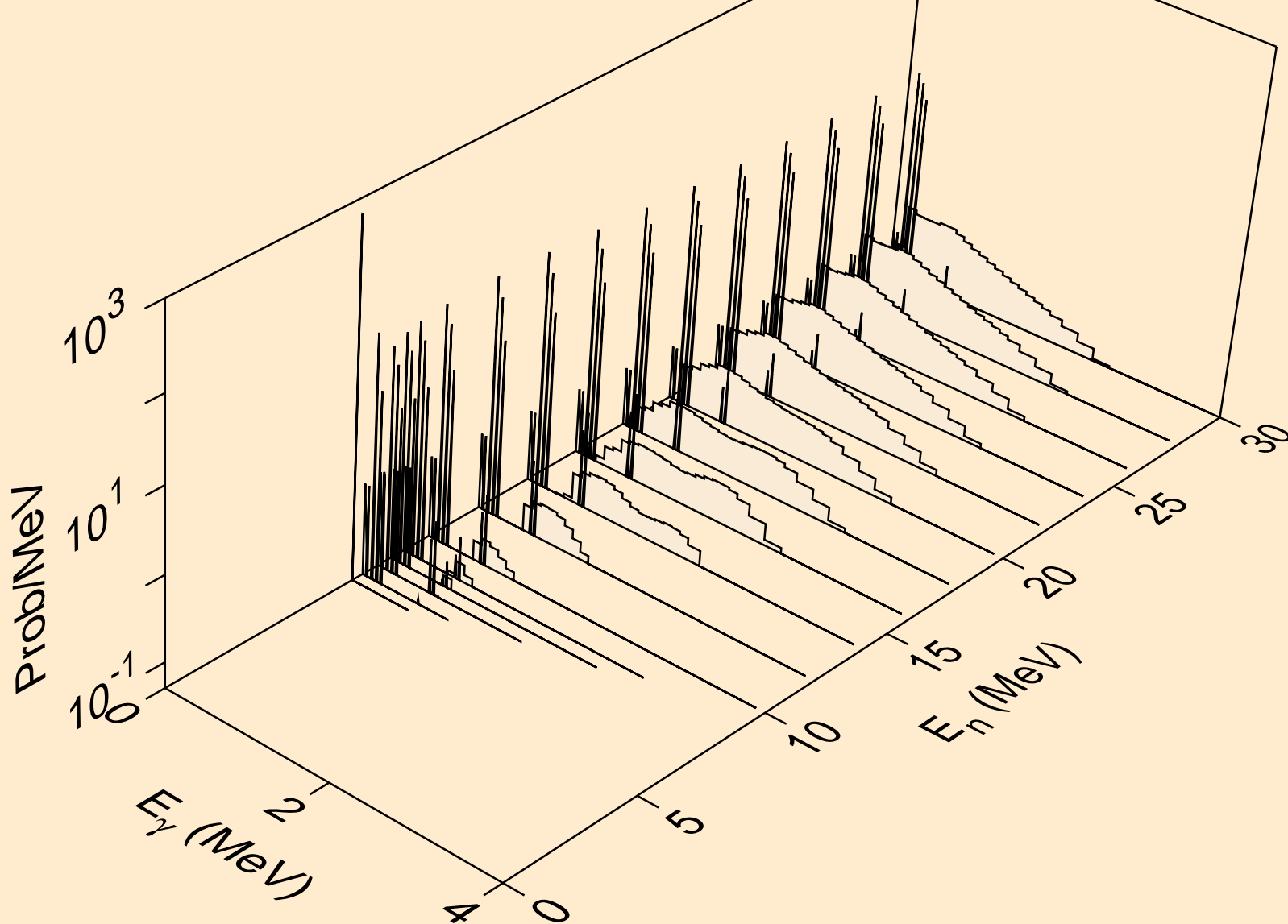

PA235 NEUTRON ACER TENDL-2019 LIBRARY; T=293.16K
Photon emission for (n,t)

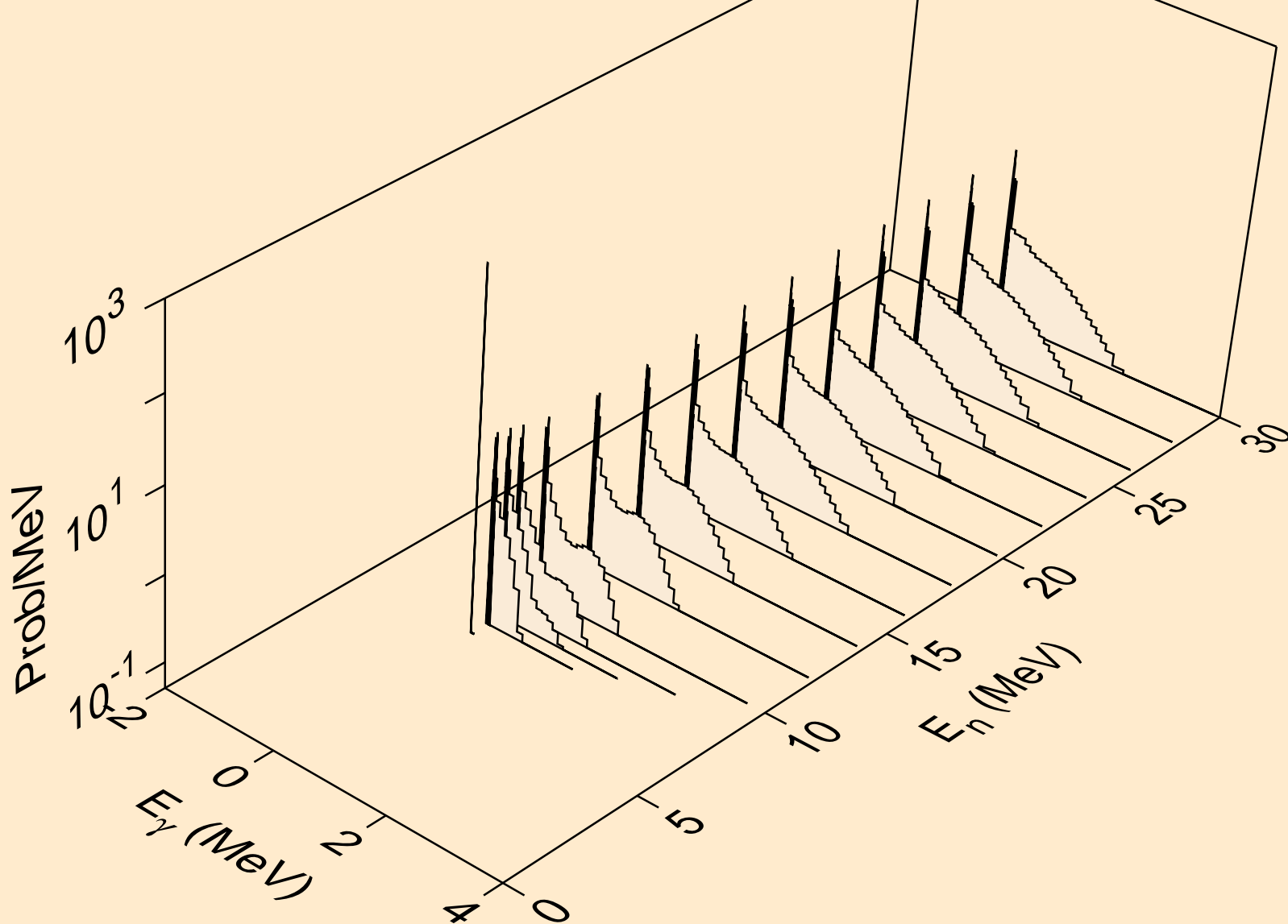

PA235 NEUTRON ACER TENDL-2019 LIBRARY; T=293.16K
Photon emission for (n,he3)

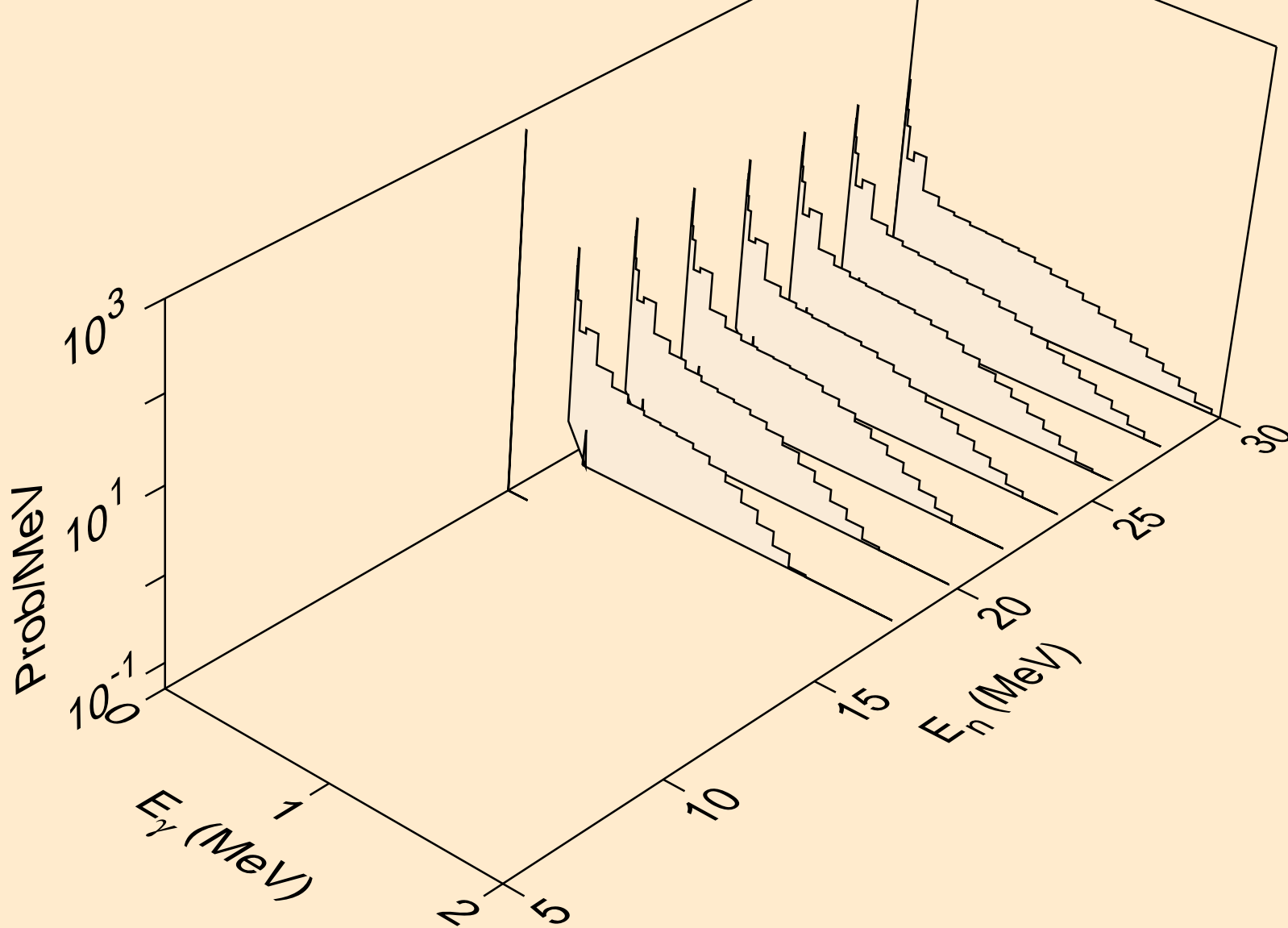

PA235 NEUTRON ACER TENDL-2019 LIBRARY; T=293.16K
Photon emission for (n,a)

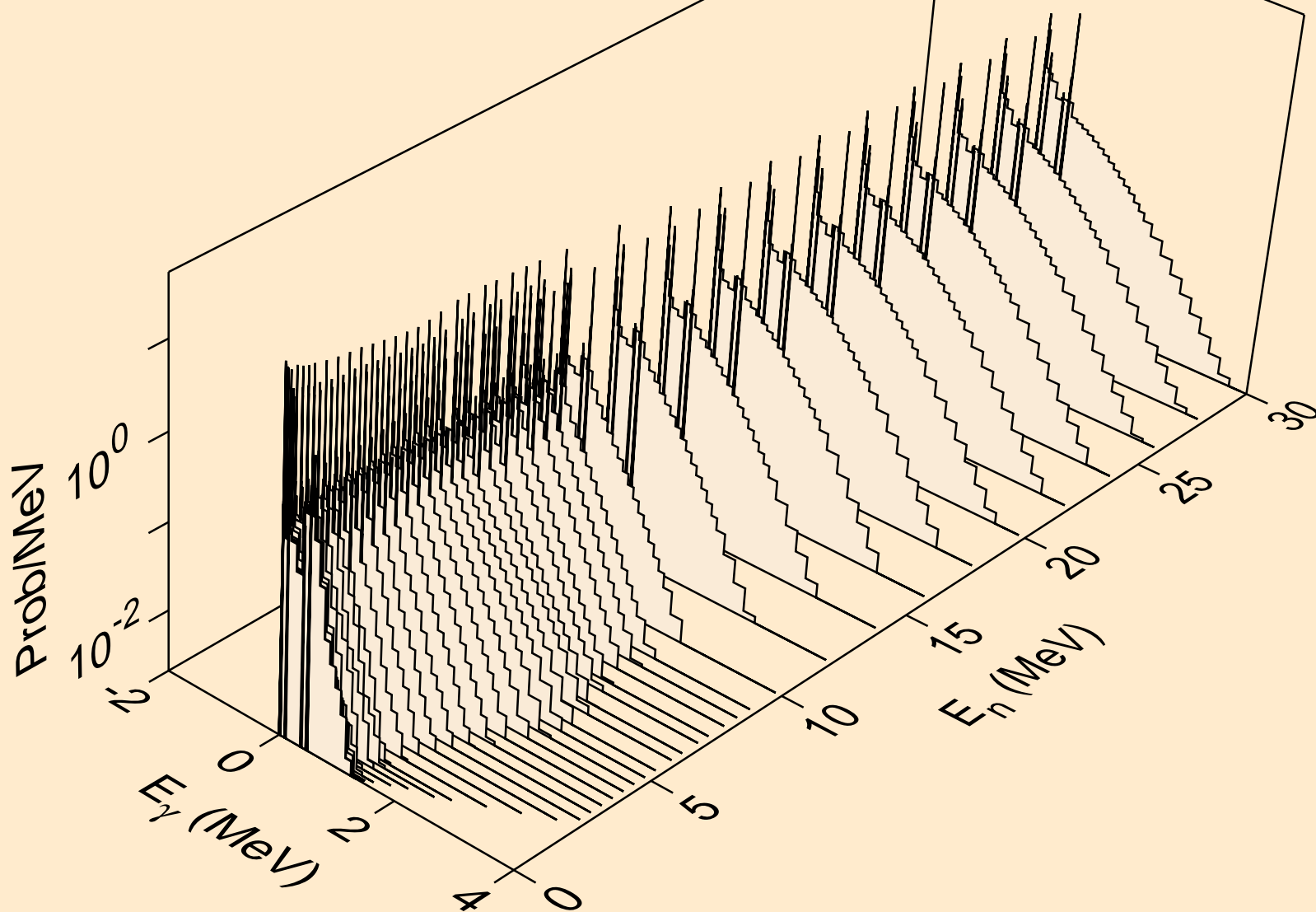

PA235 NEUTRON ACER TENDL-2019 LIBRARY; T=293.16K
Photon emission for (n,2p)

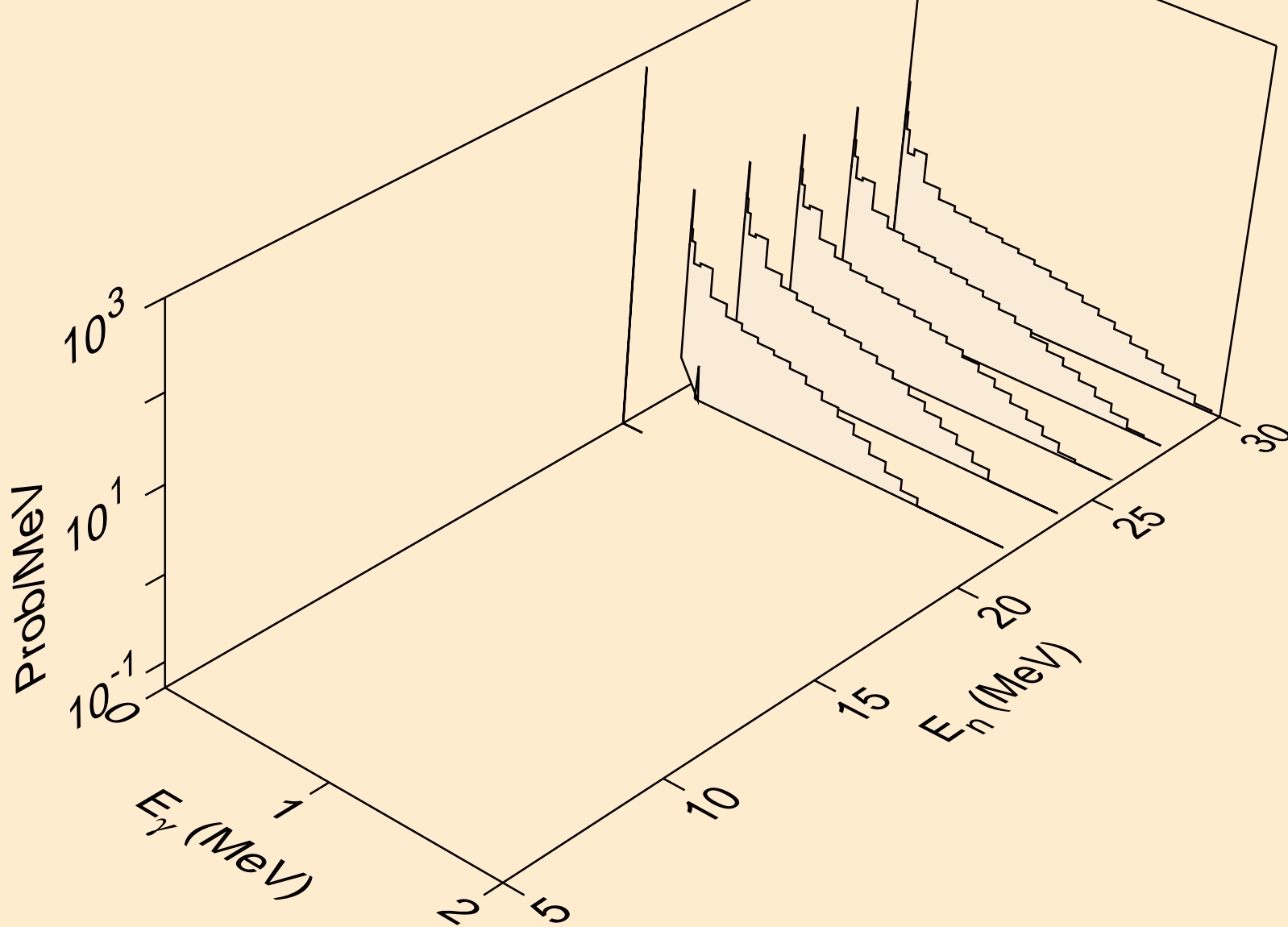

PA235 NEUTRON ACER TENDL-2019 LIBRARY; T=293.16K
thermal capture photon spectrum

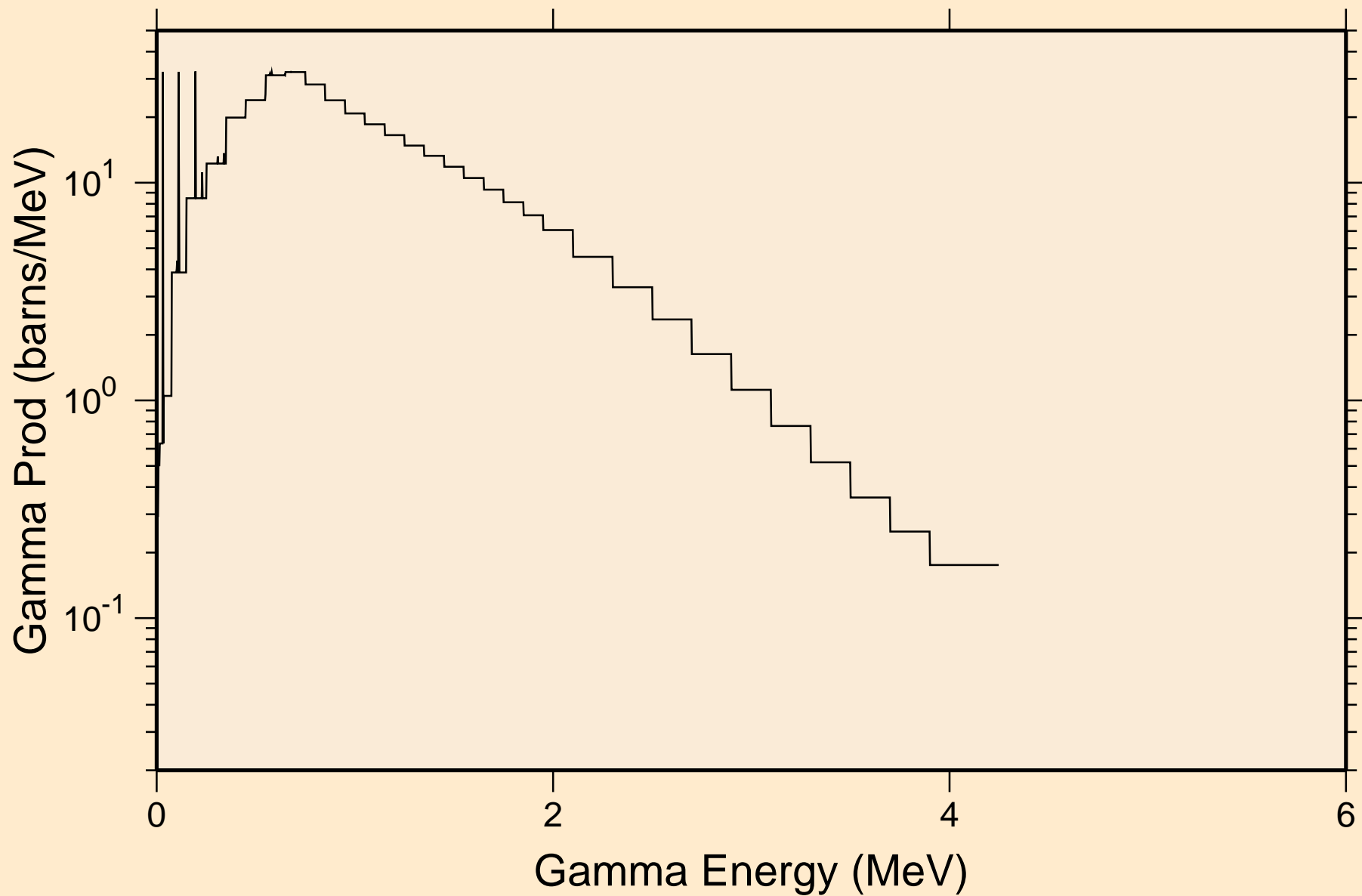

PA235 NEUTRON ACER TENDL-2019 LIBRARY; T=293.16K
14 MeV photon spectrum

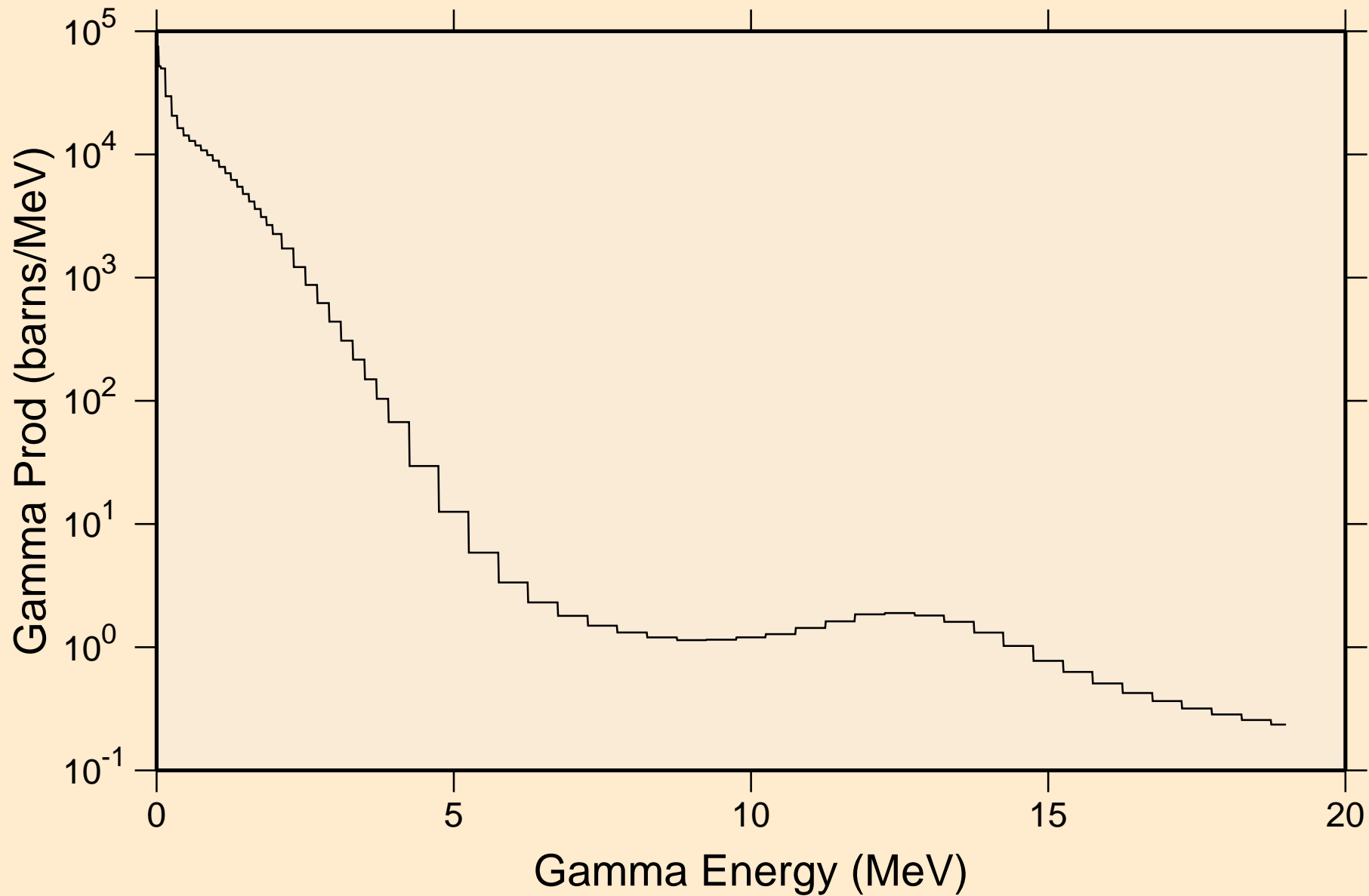

PA235 NEUTRON ACER TENDL-2019 LIBRARY; T=293.16K
Particle heating contributions

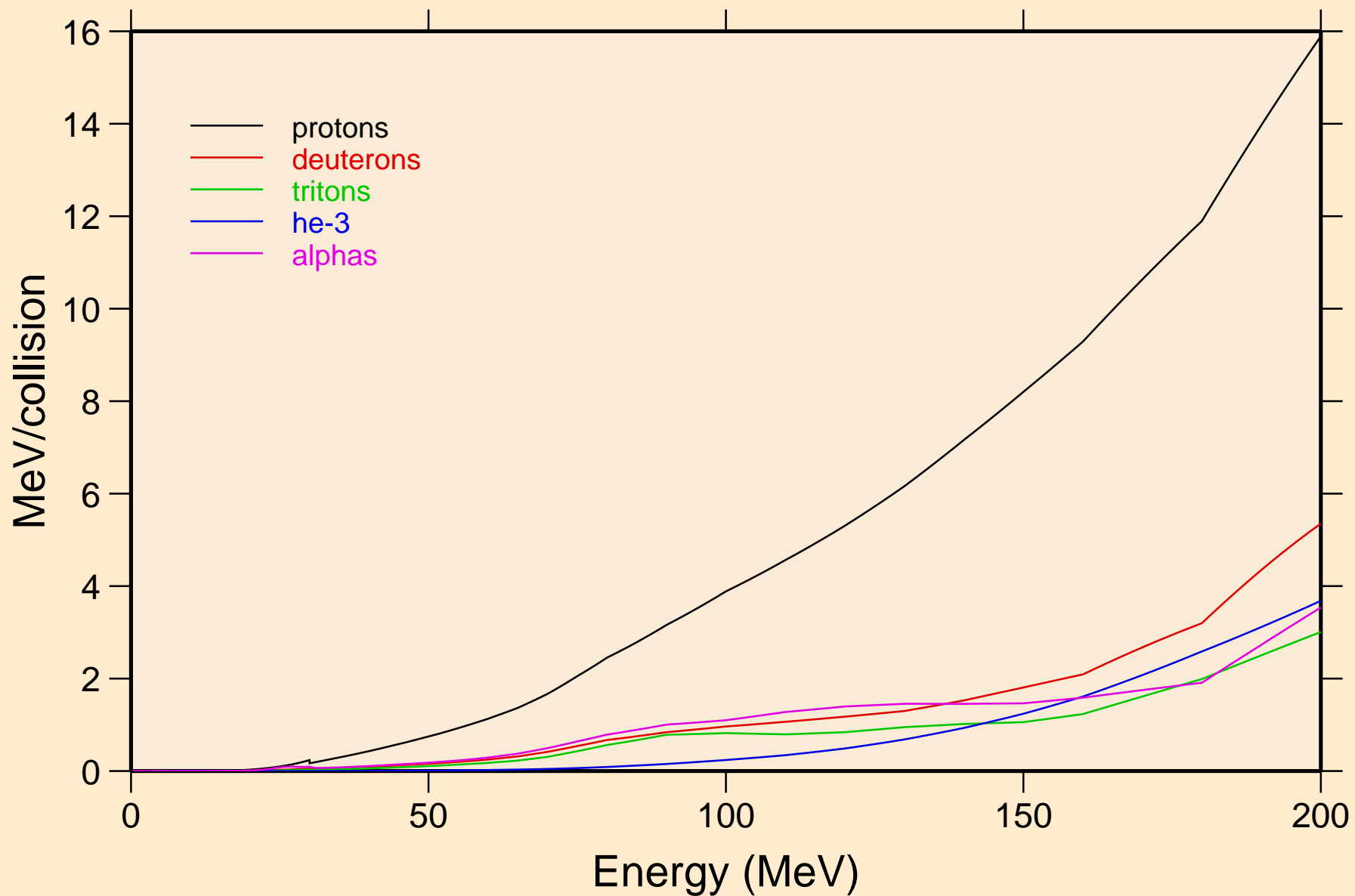

PA235 NEUTRON ACER TENDL-2019 LIBRARY; T=293.16K
Recoil Heating

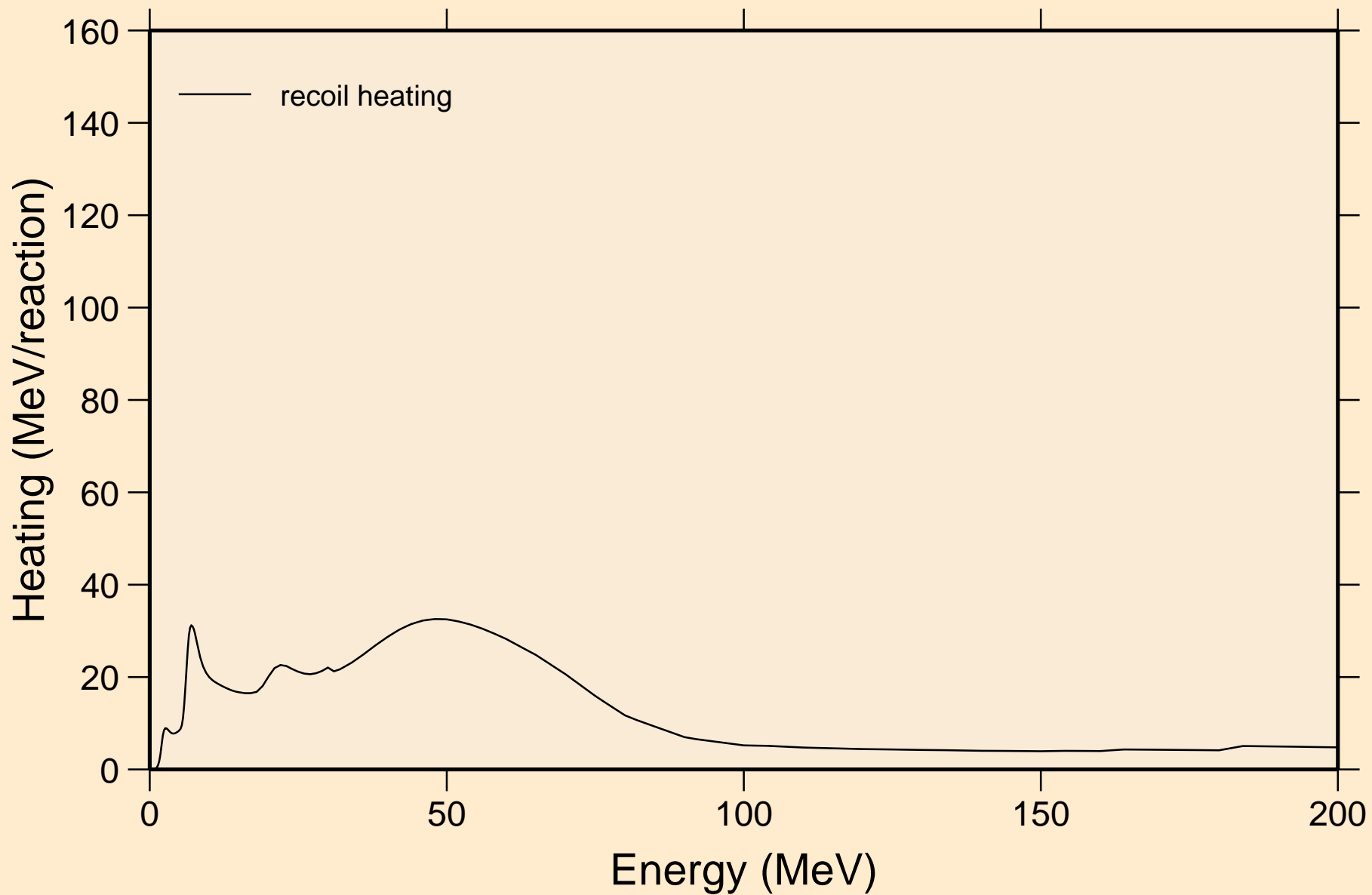

PA235 NEUTRON ACER TENDL-2019 LIBRARY; T=293.16K
Particle production cross sections

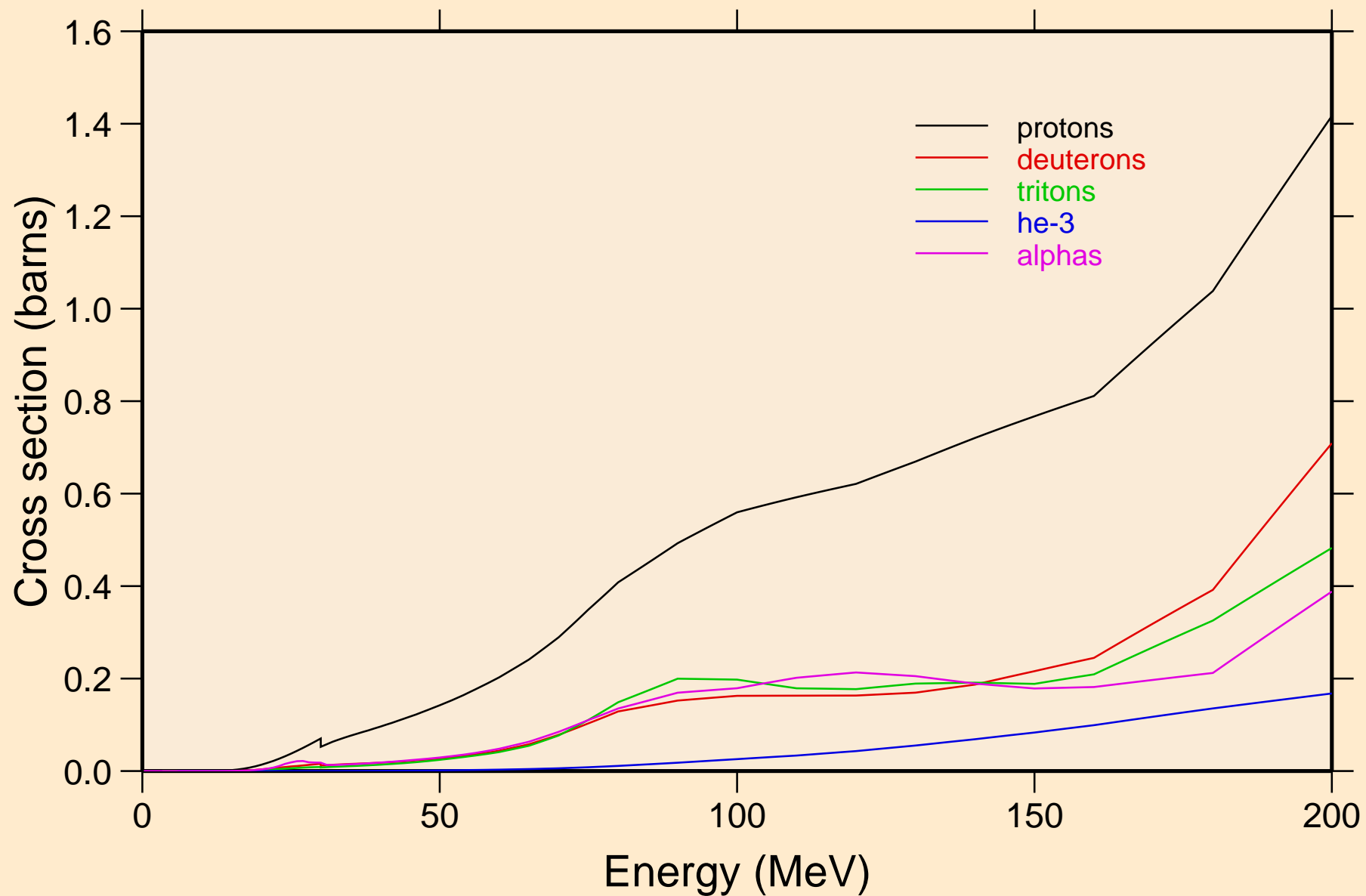

PA235 NEUTRON ACER TENDL-2019 LIBRARY; T=293.16K
protons from (n,x)

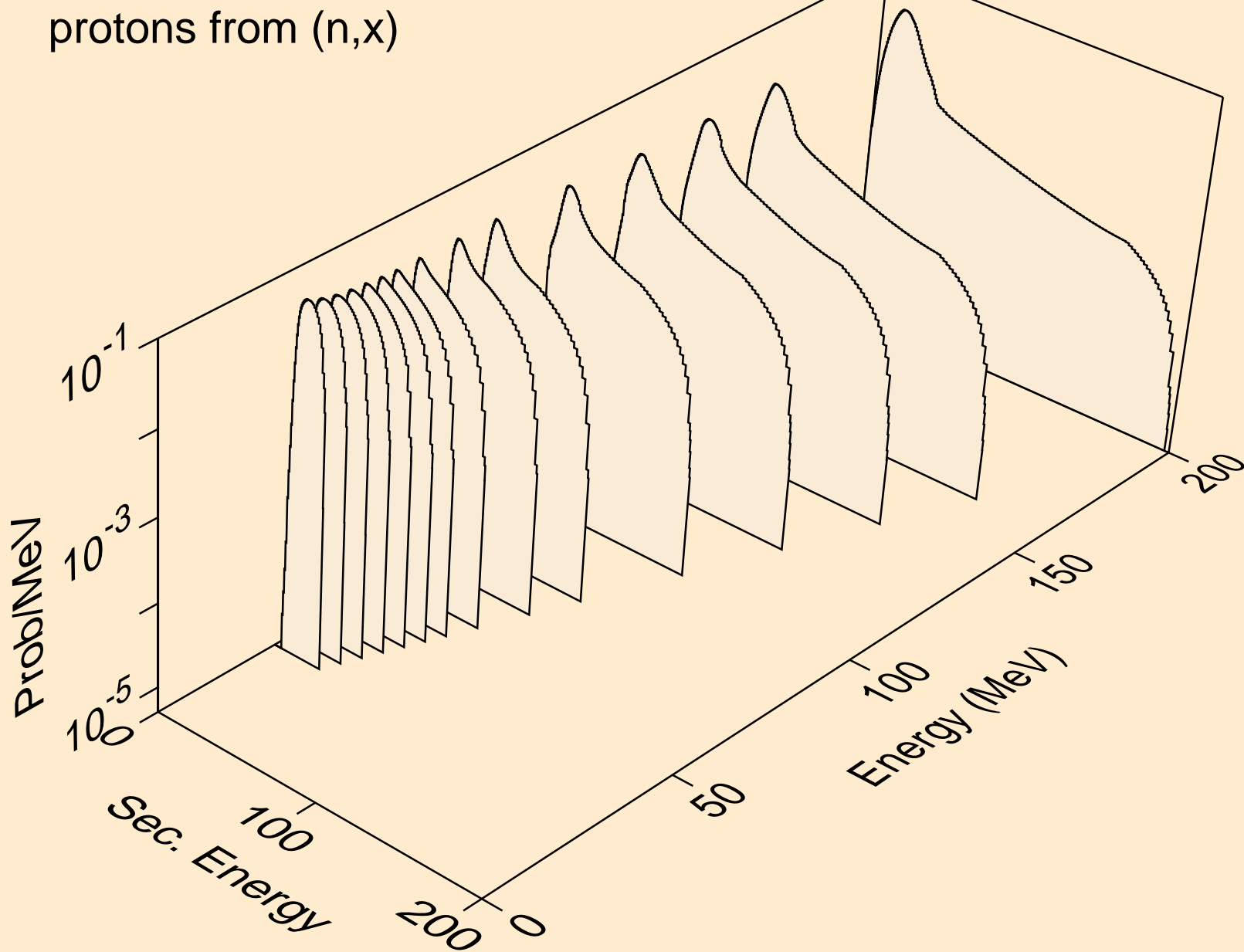

PA235 NEUTRON ACER TENDL-2019 LIBRARY; T=293.16K
protons from (n,n*)p

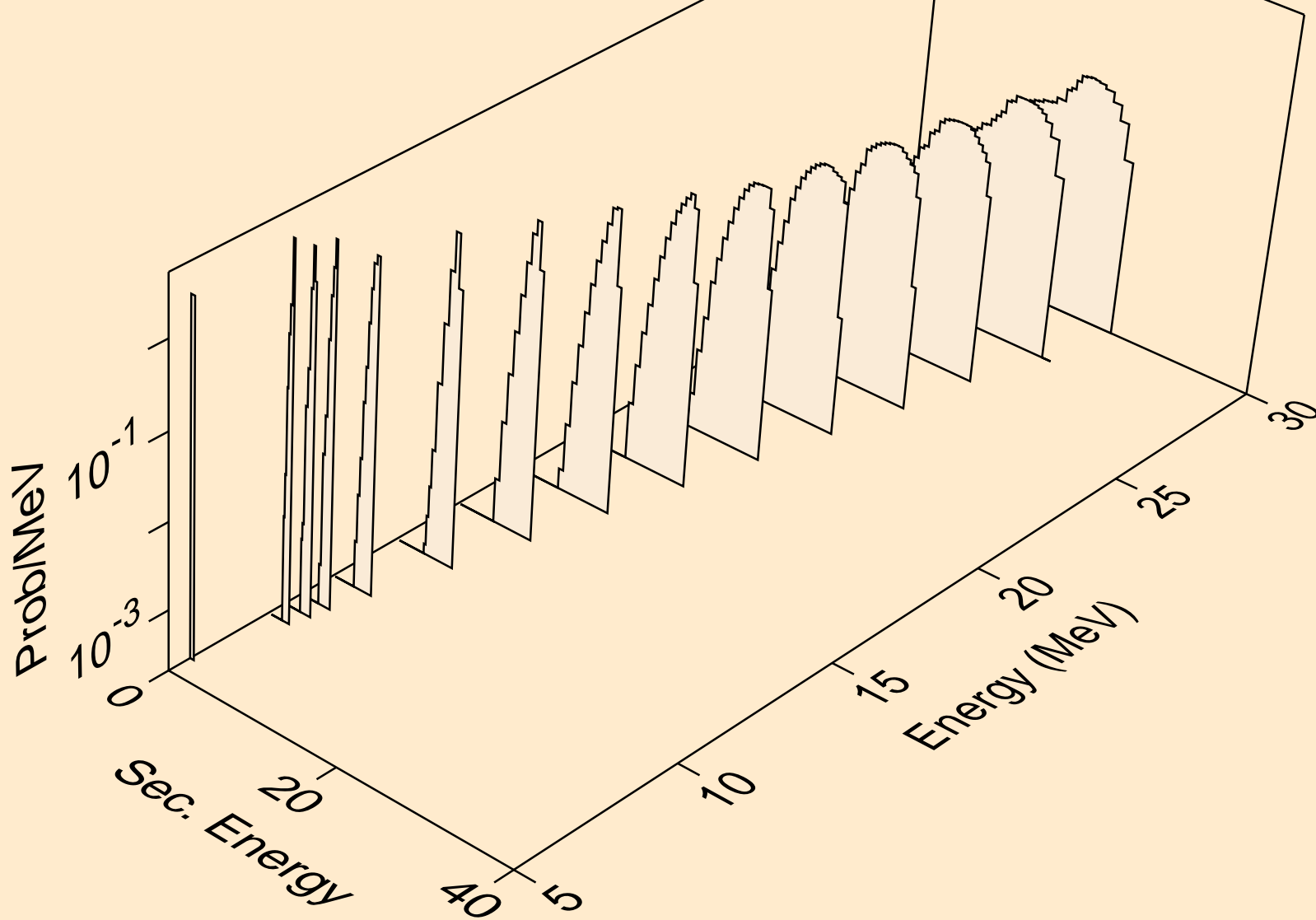

PA235 NEUTRON ACER TENDL-2019 LIBRARY; T=293.16K
protons from (n,2np)

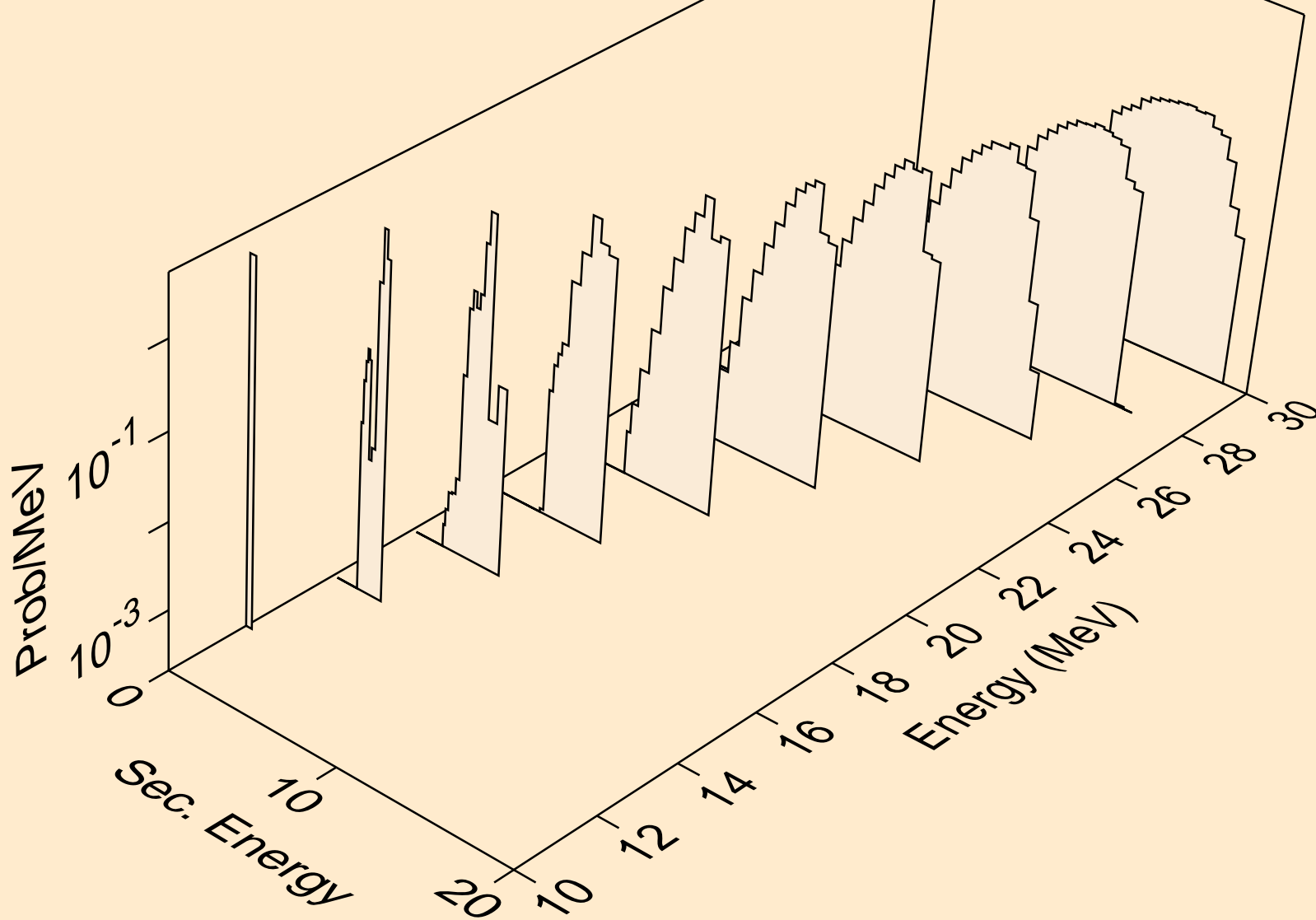

PA235 NEUTRON ACER TENDL-2019 LIBRARY; T=293.16K
protons from (n,3np)

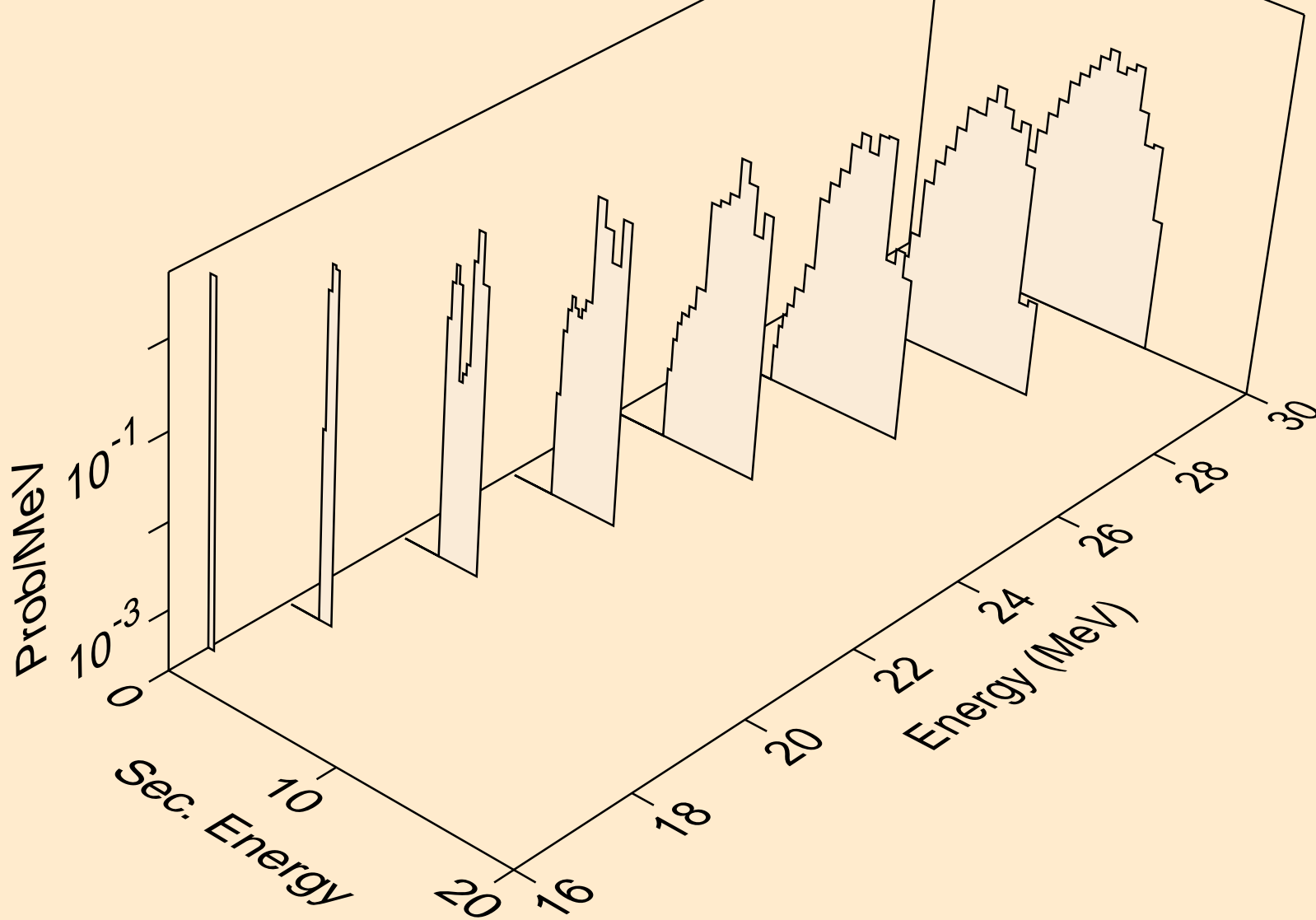

PA235 NEUTRON ACER TENDL-2019 LIBRARY; T=293.16K
protons from (n,2np)

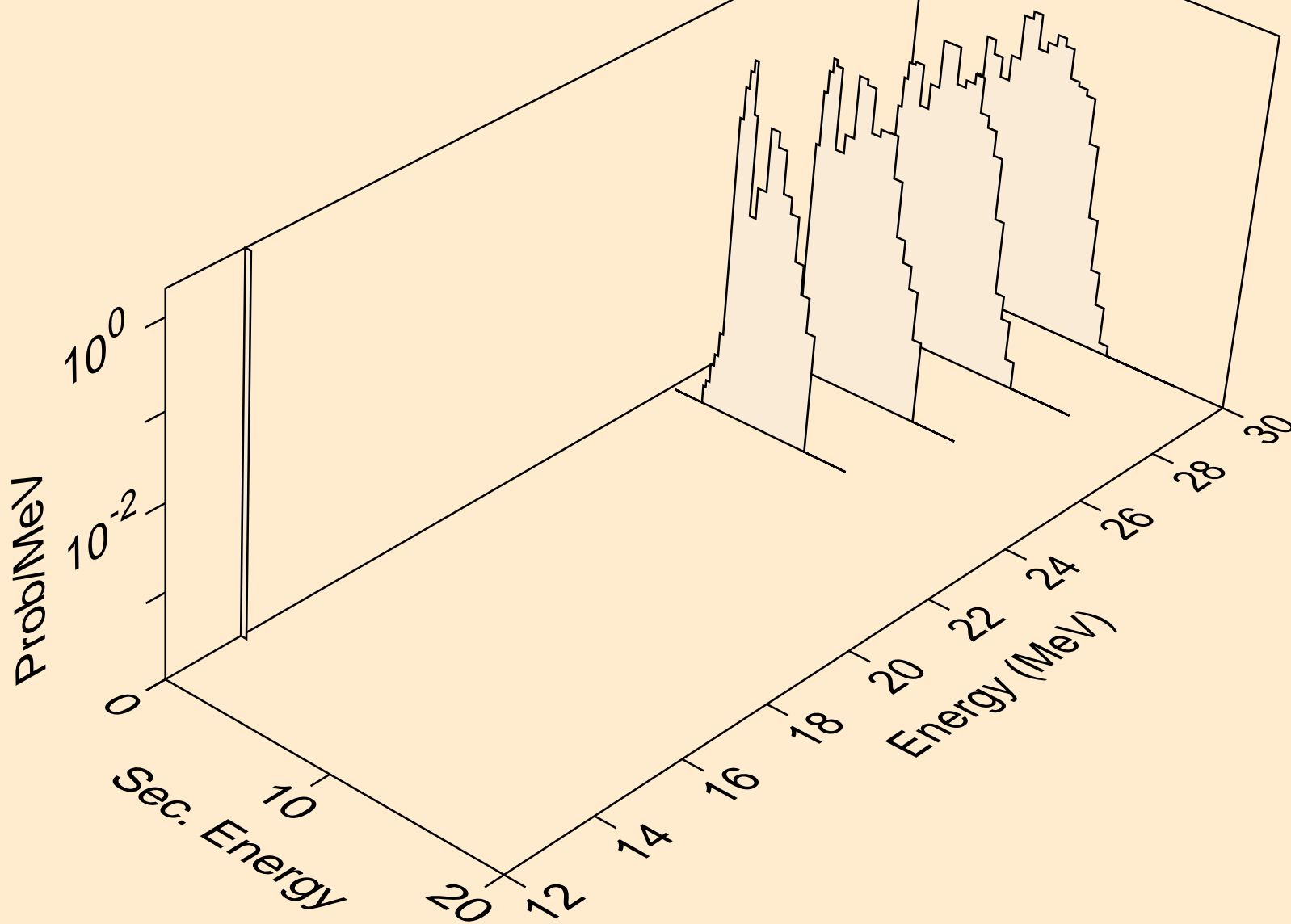

PA235 NEUTRON ACER TENDL-2019 LIBRARY; T=293.16K
protons from (n,p)

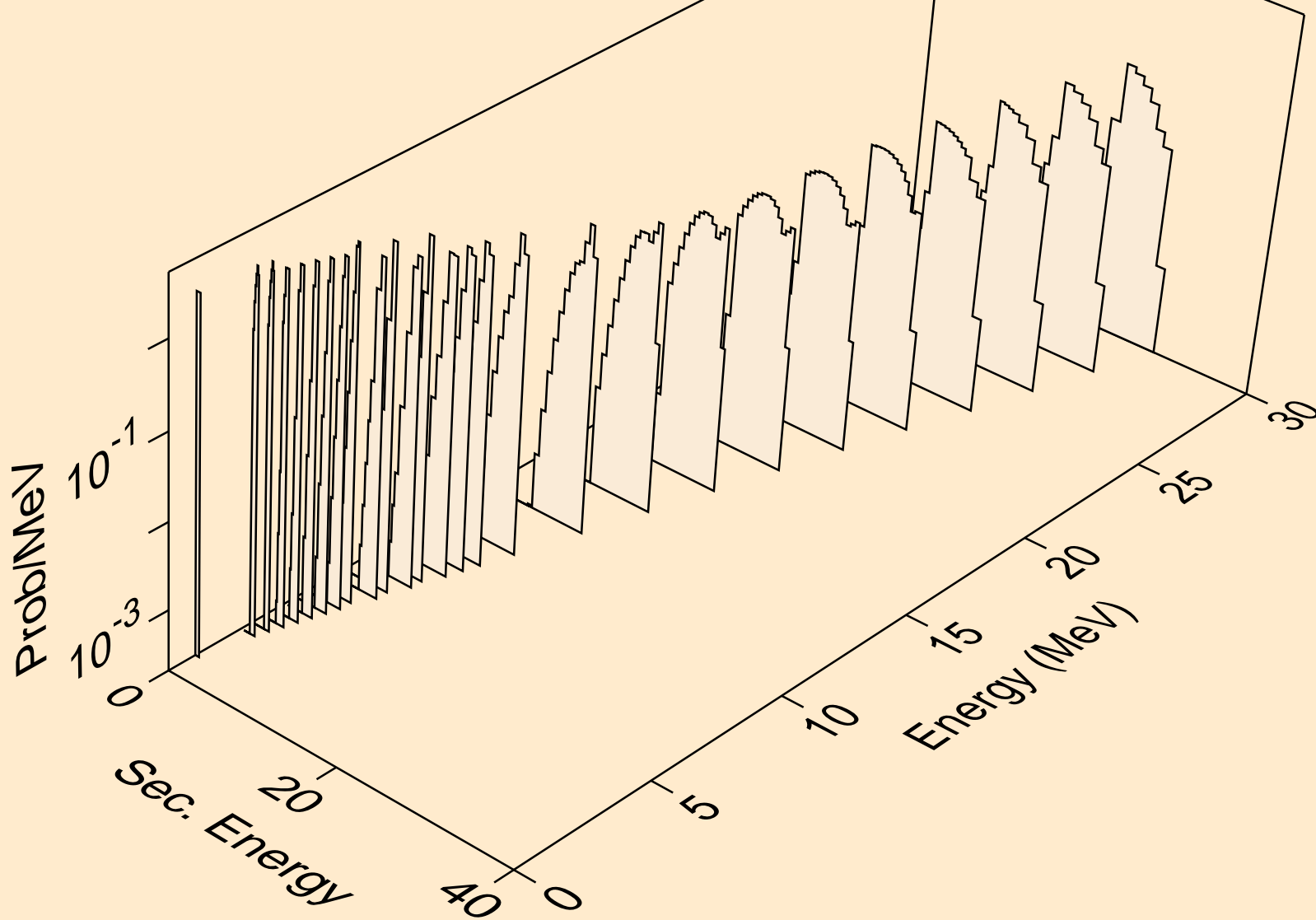

PA235 NEUTRON ACER TENDL-2019 LIBRARY; T=293.16K
protons from (n,2p)

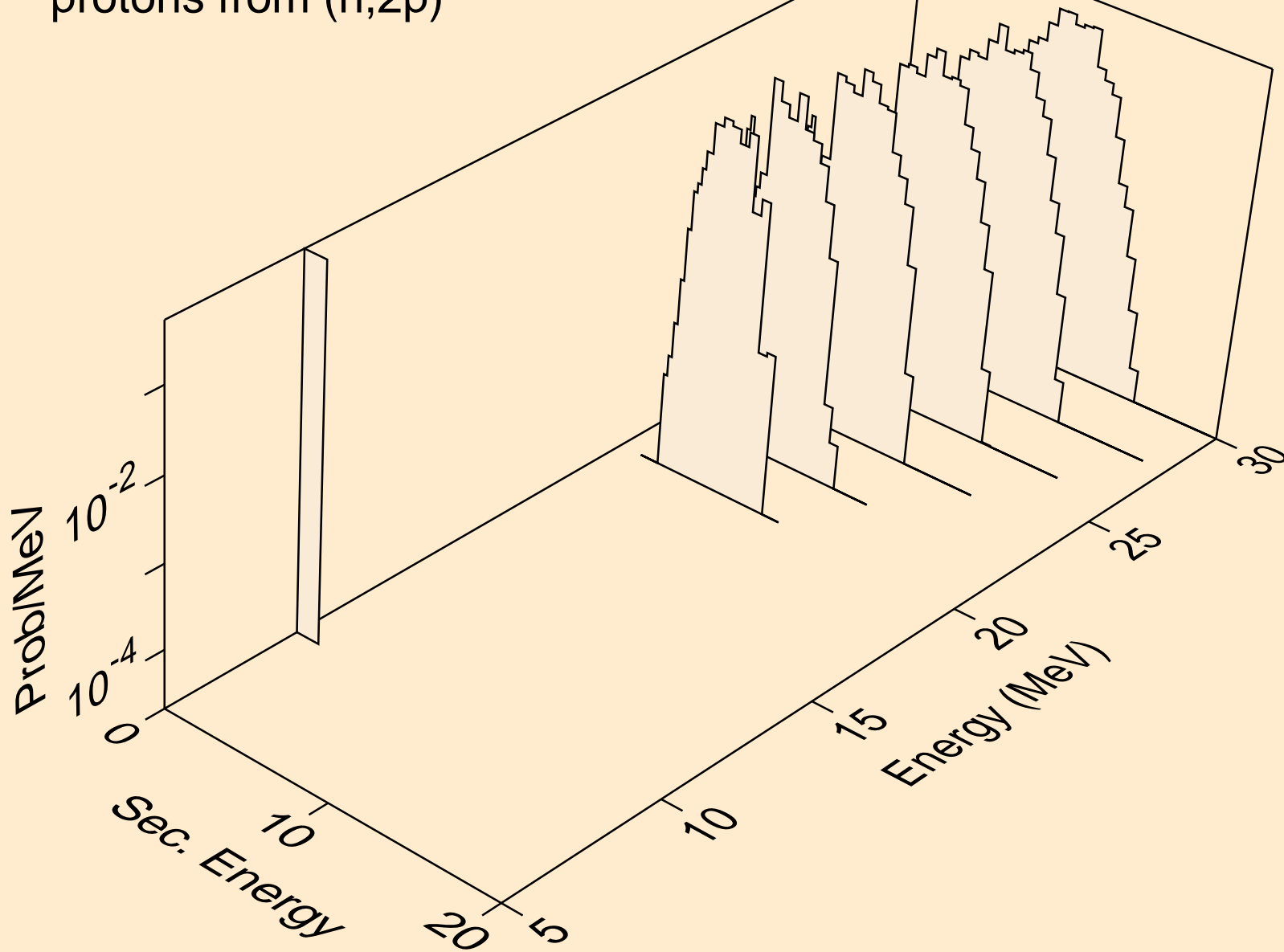

PA235 NEUTRON ACER TENDL-2019 LIBRARY; T=293.16K
deuterons from (n,x)

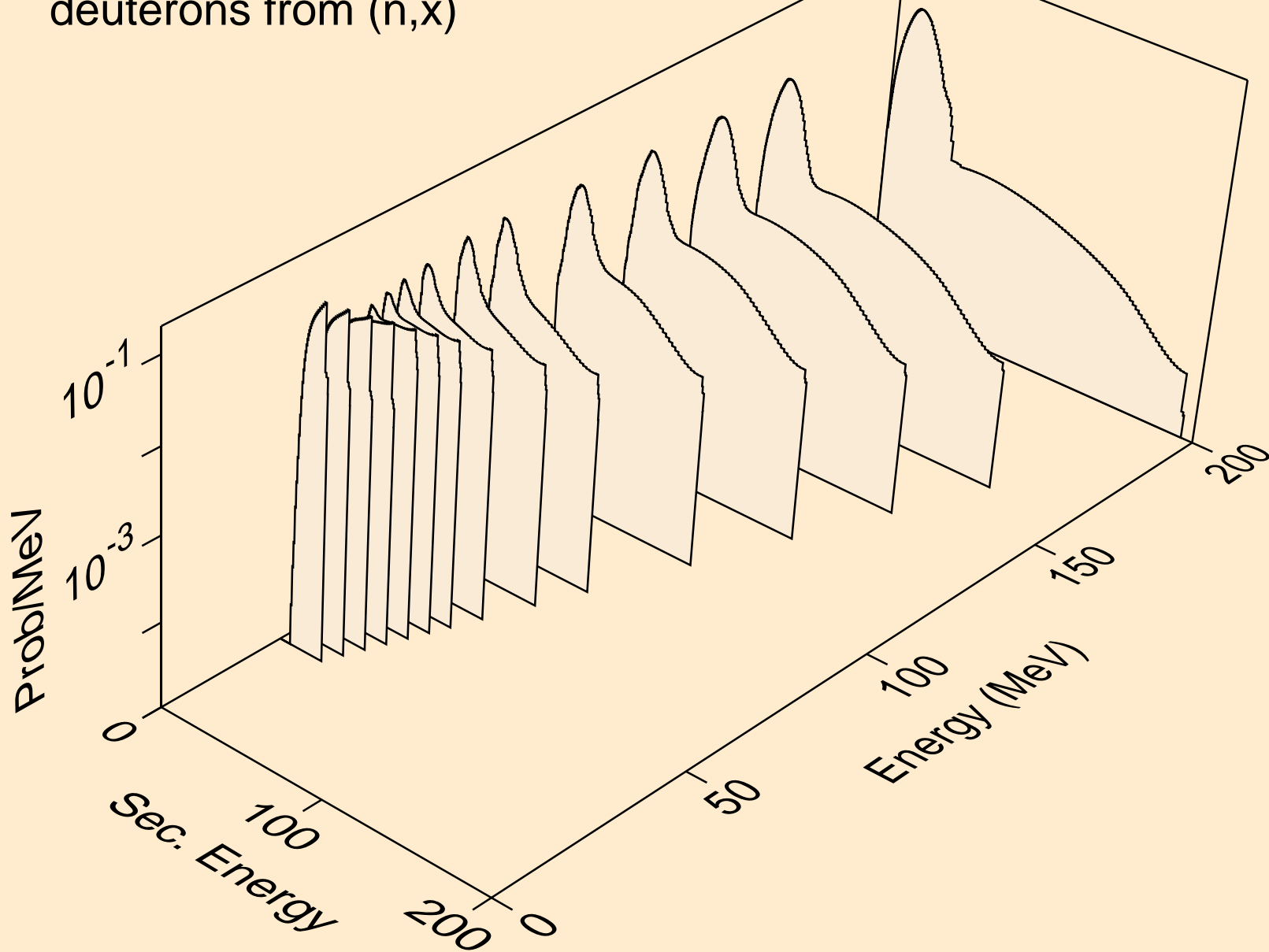

PA235 NEUTRON ACER TENDL-2019 LIBRARY; T=293.16K
deuterons from (n,2nd)

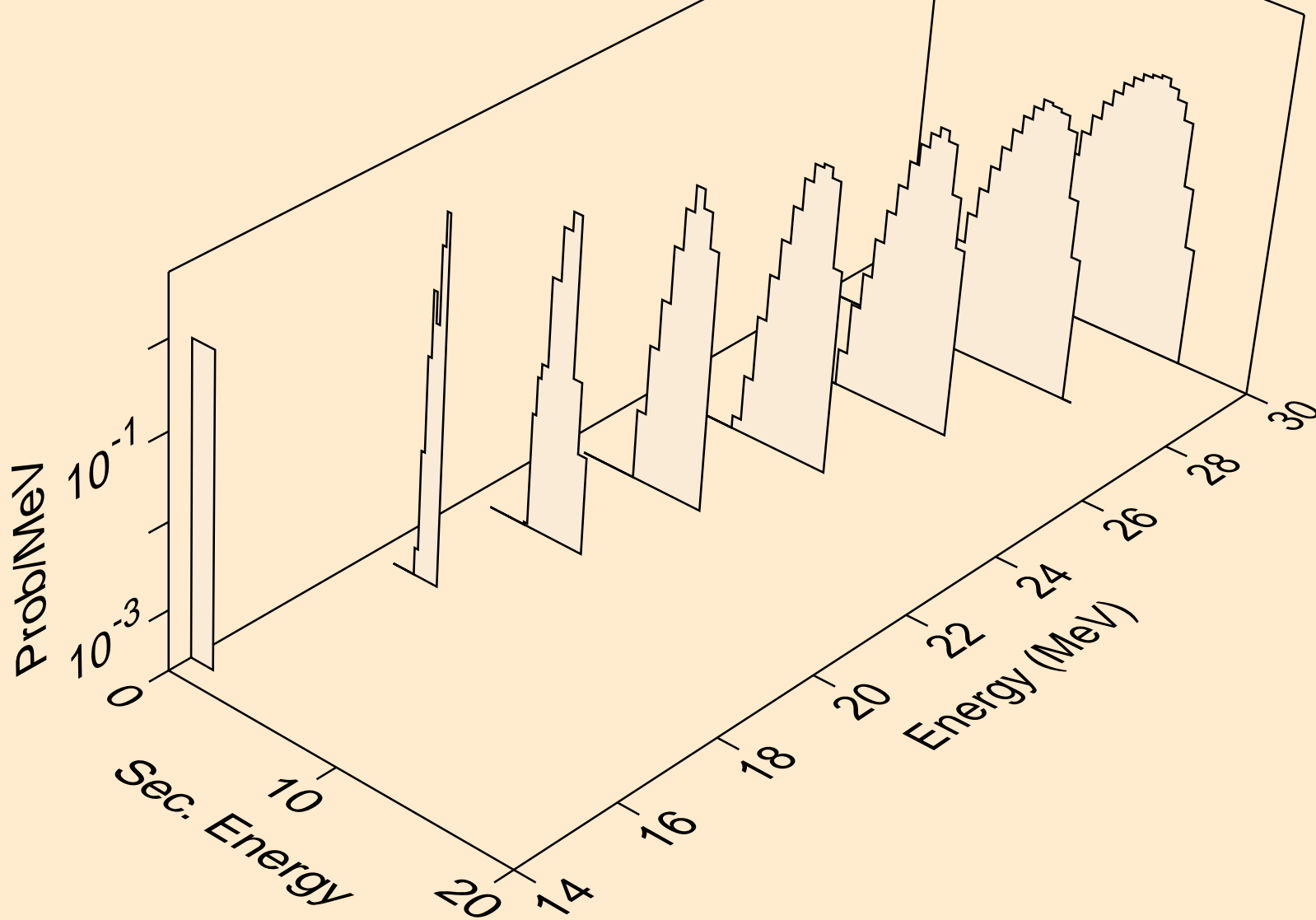

PA235 NEUTRON ACER TENDL-2019 LIBRARY; T=293.16K
deuterons from (n,n*)d

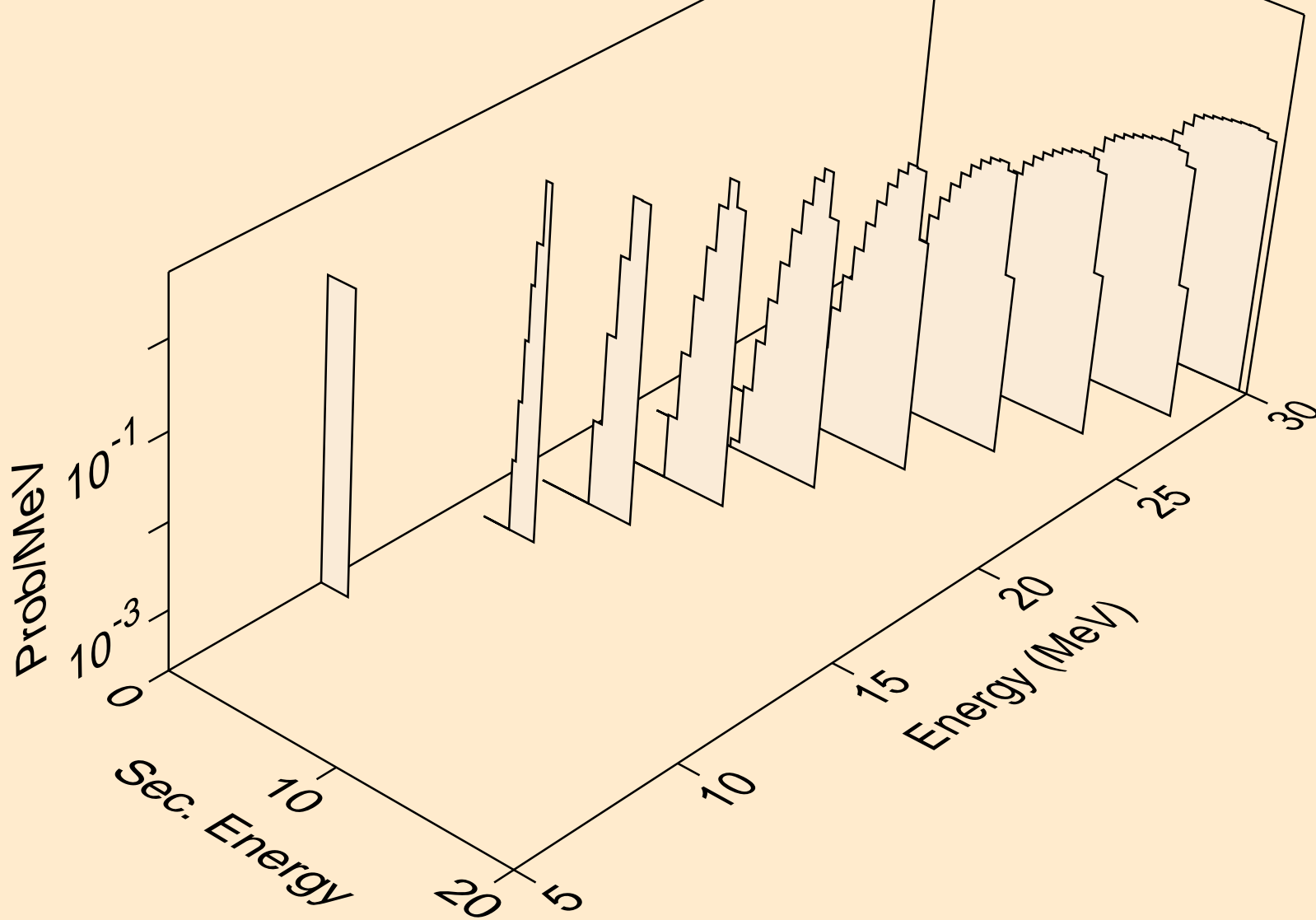

PA235 NEUTRON ACER TENDL-2019 LIBRARY; T=293.16K
deuterons from (n,d)

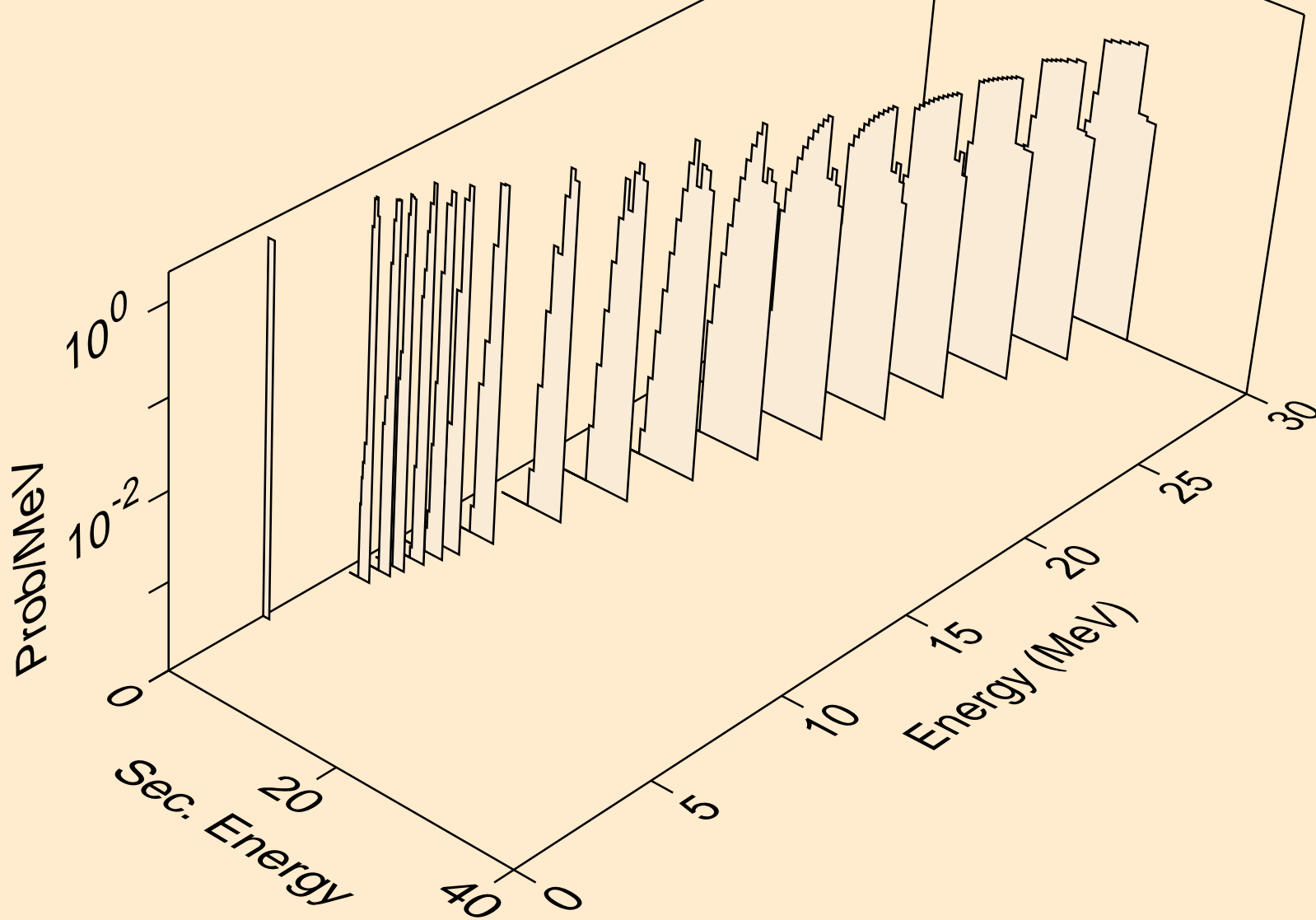

PA235 NEUTRON ACER TENDL-2019 LIBRARY; T=293.16K
tritons from (n,x)

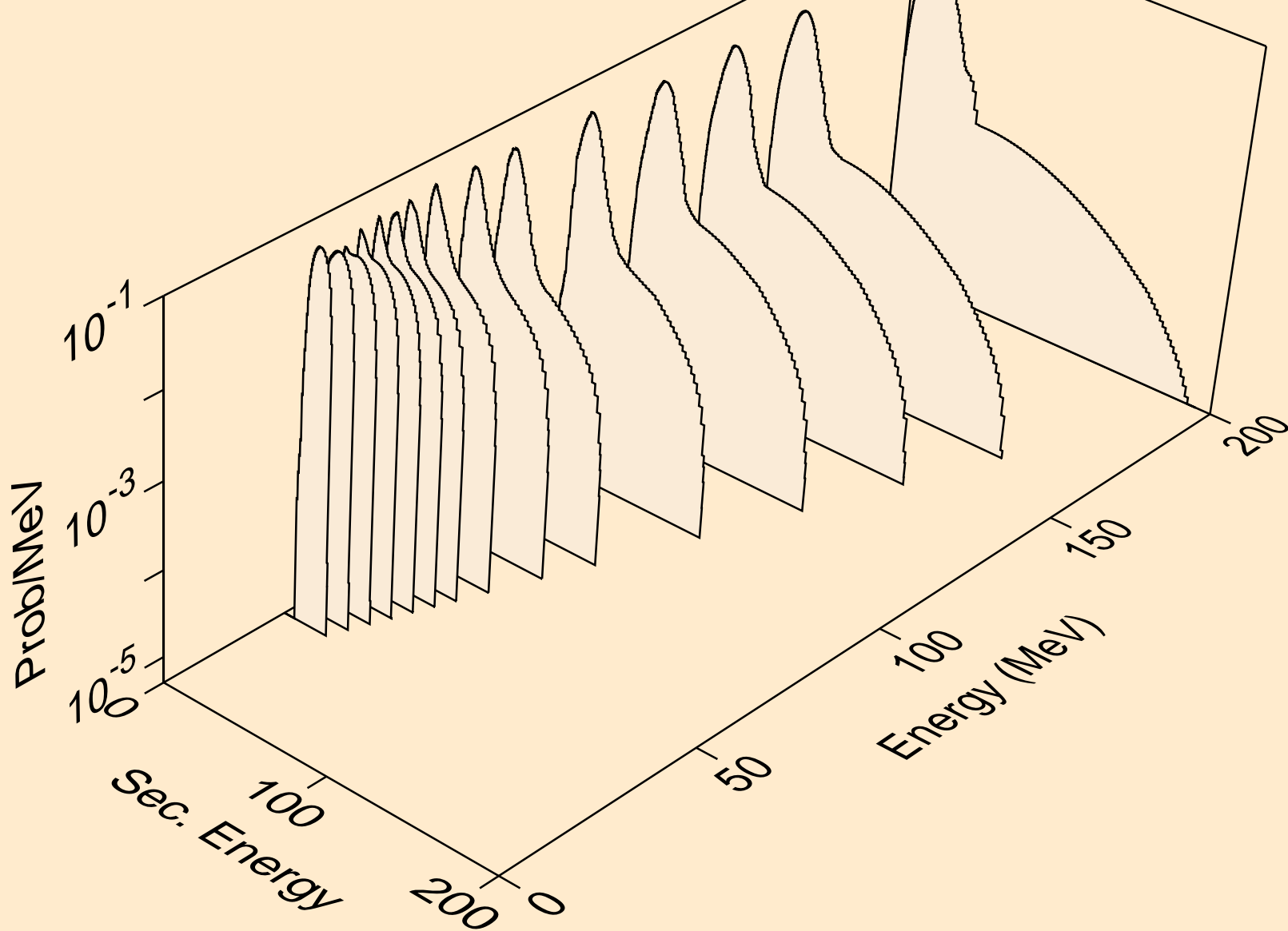

PA235 NEUTRON ACER TENDL-2019 LIBRARY; T=293.16K
tritons from (n,n*)t

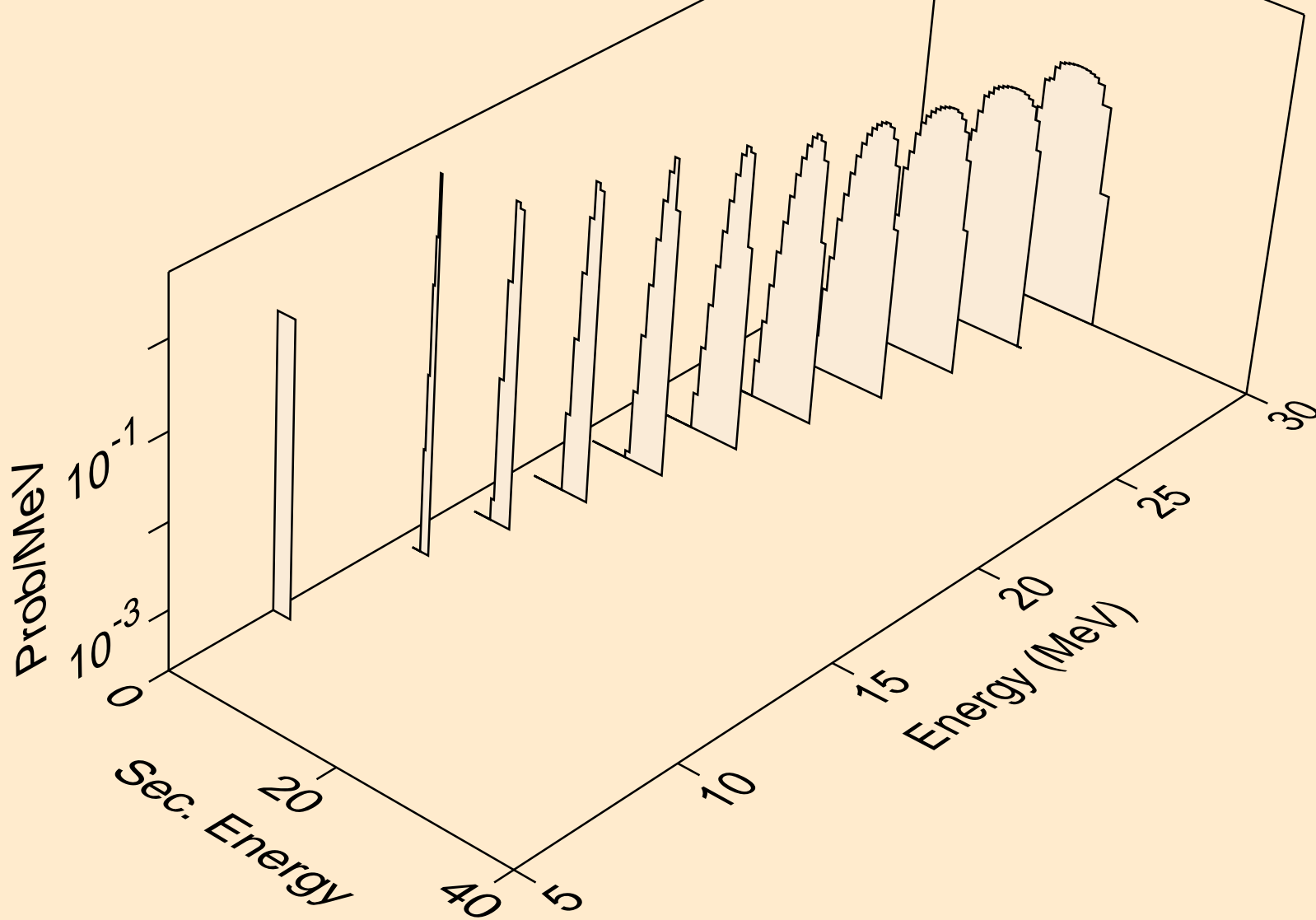

PA235 NEUTRON ACER TENDL-2019 LIBRARY; T=293.16K
tritons from (n,t)

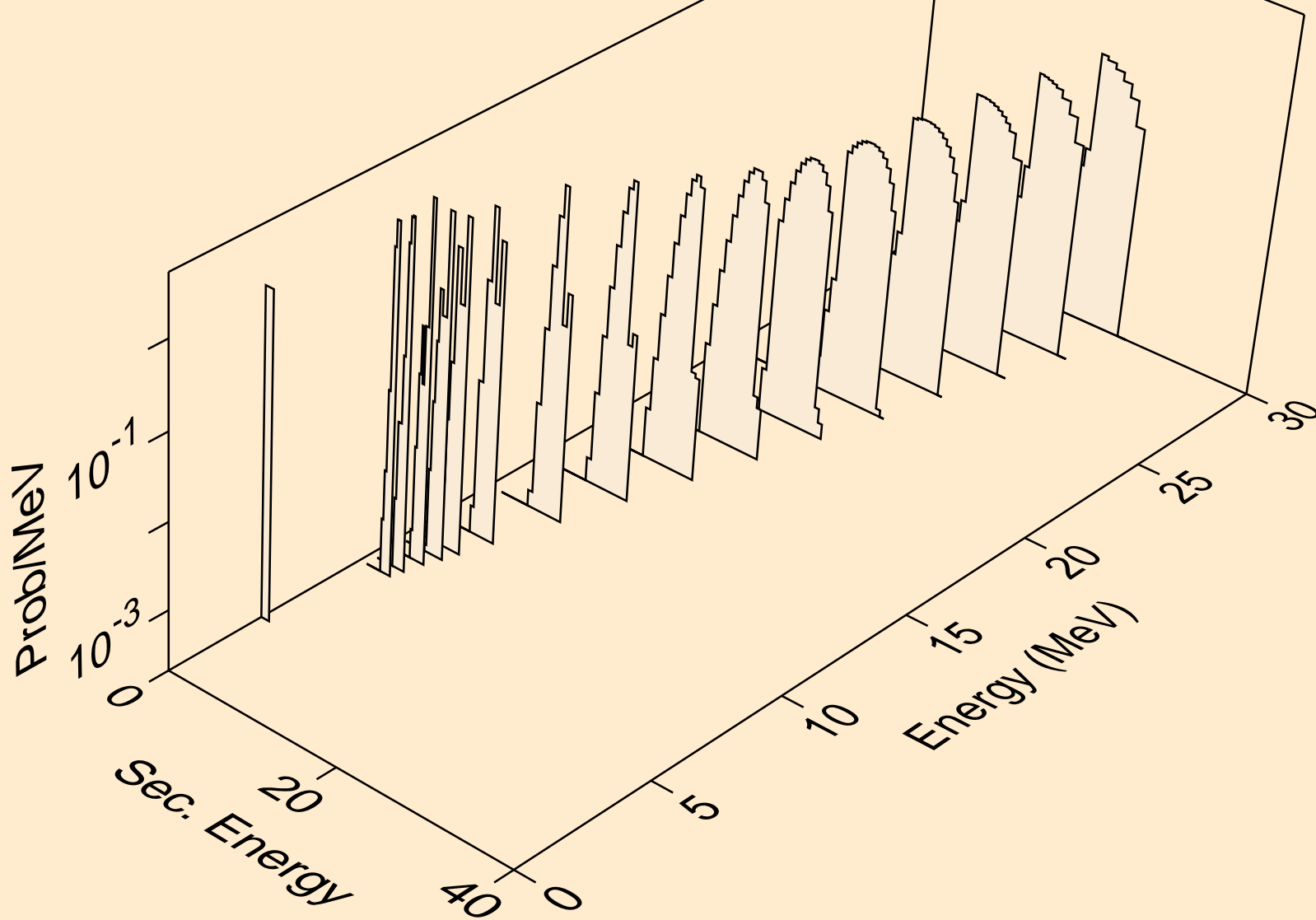

PA235 NEUTRON ACER TENDL-2019 LIBRARY; T=293.16K
he3s from (n,x)

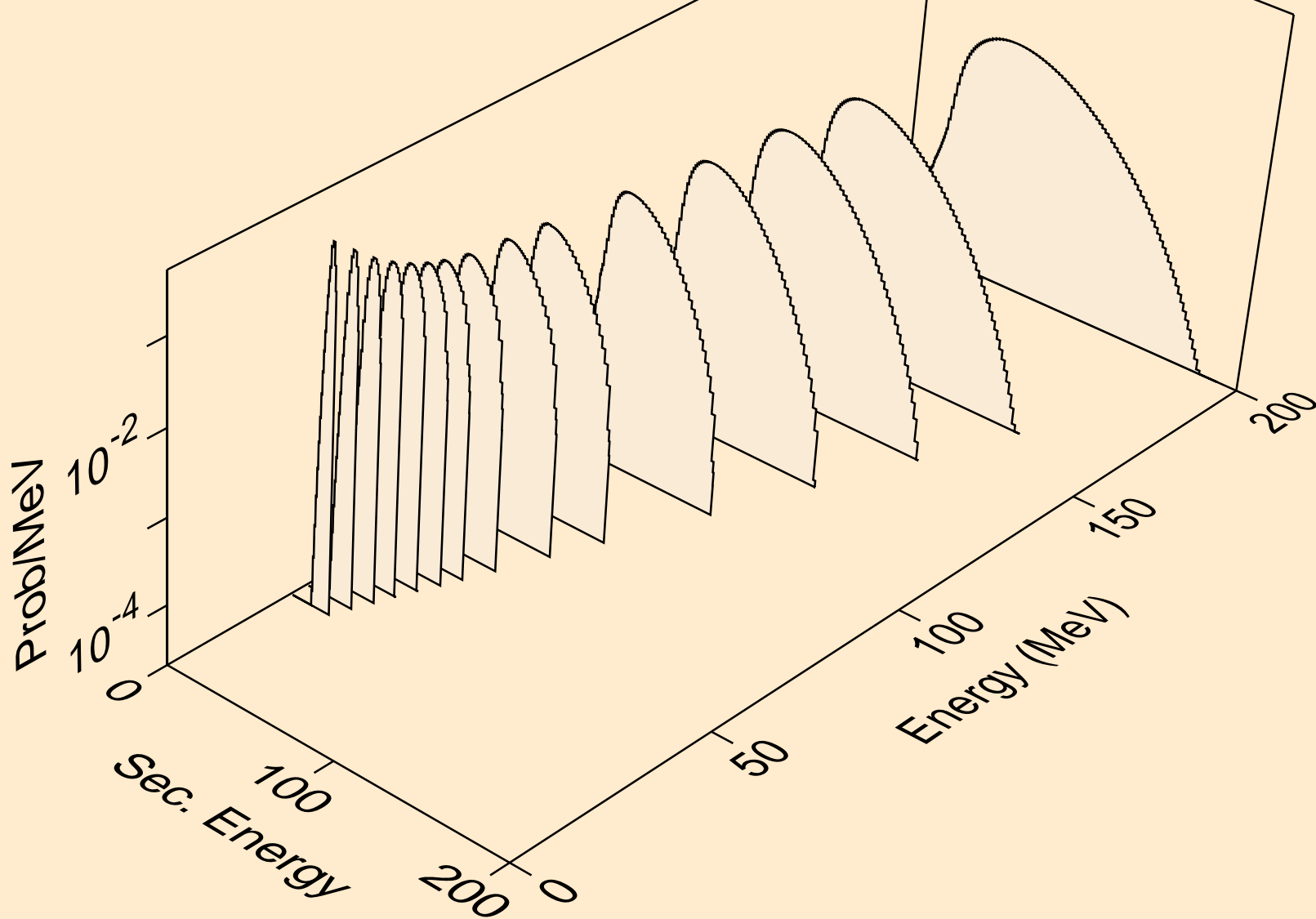

PA235 NEUTRON ACER TENDL-2019 LIBRARY; T=293.16K
he3s from (n,n*)he3

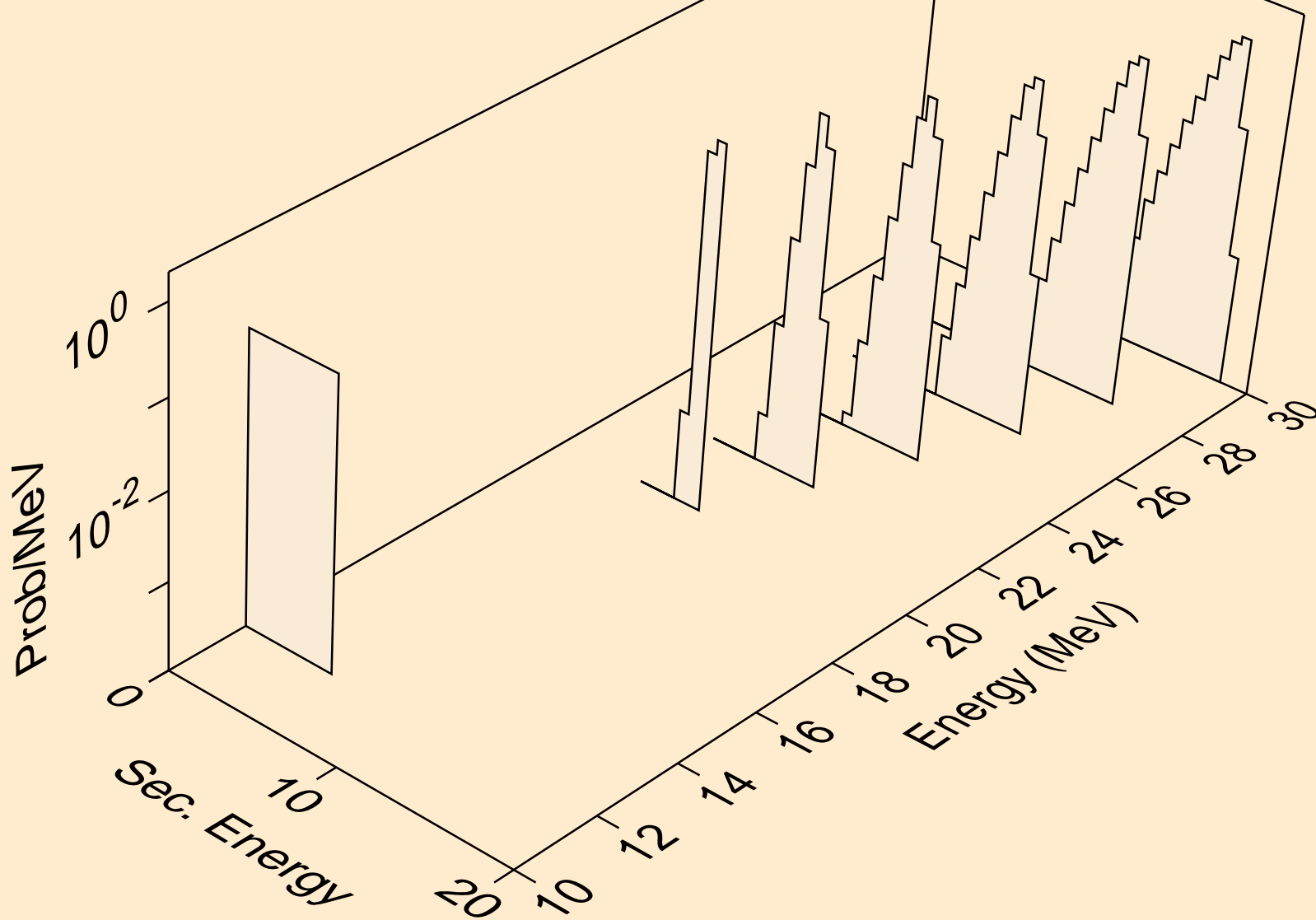

PA235 NEUTRON ACER TENDL-2019 LIBRARY; T=293.16K
he3s from (n,he3)

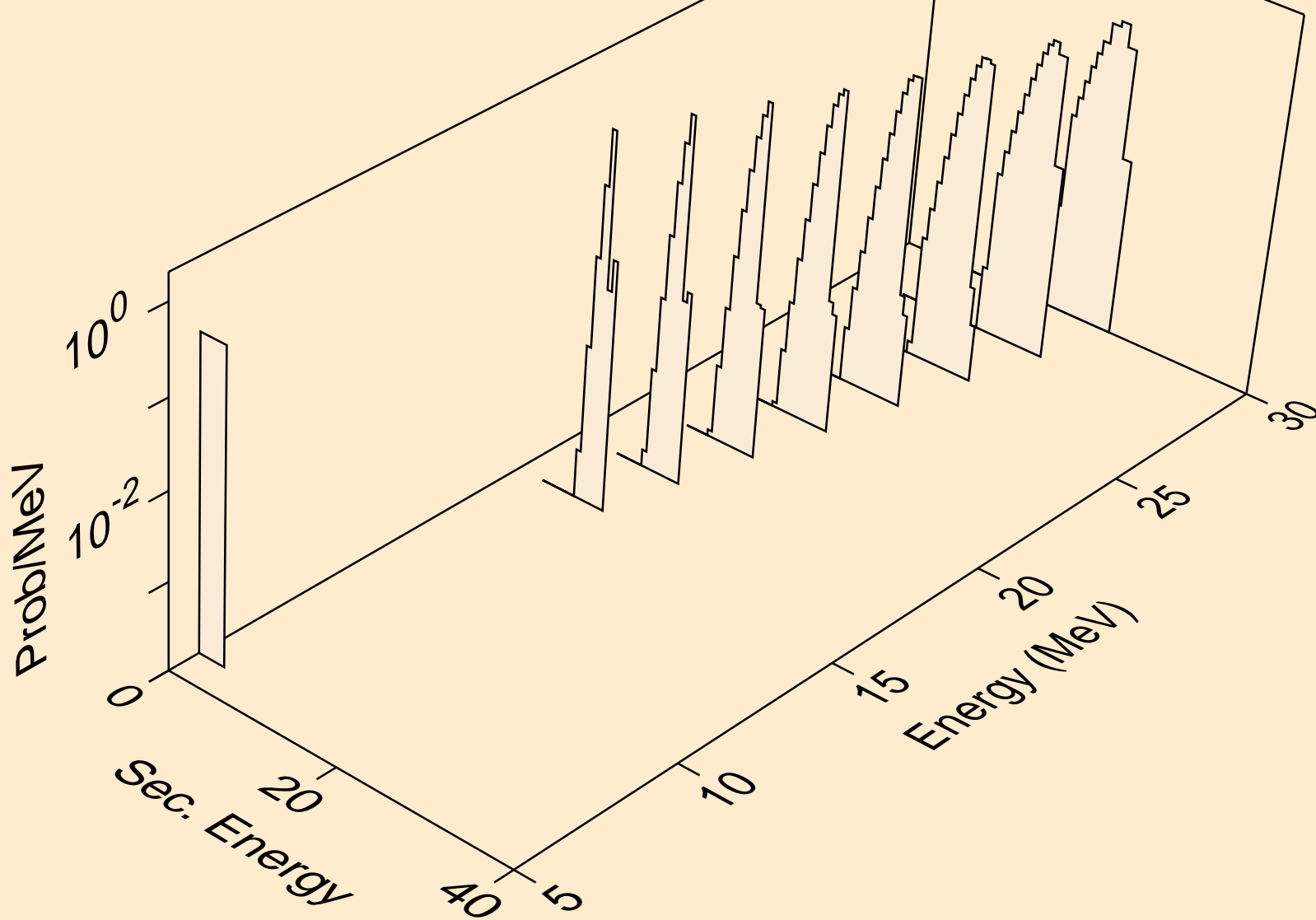

PA235 NEUTRON ACER TENDL-2019 LIBRARY; T=293.16K
alphas from (n,x)

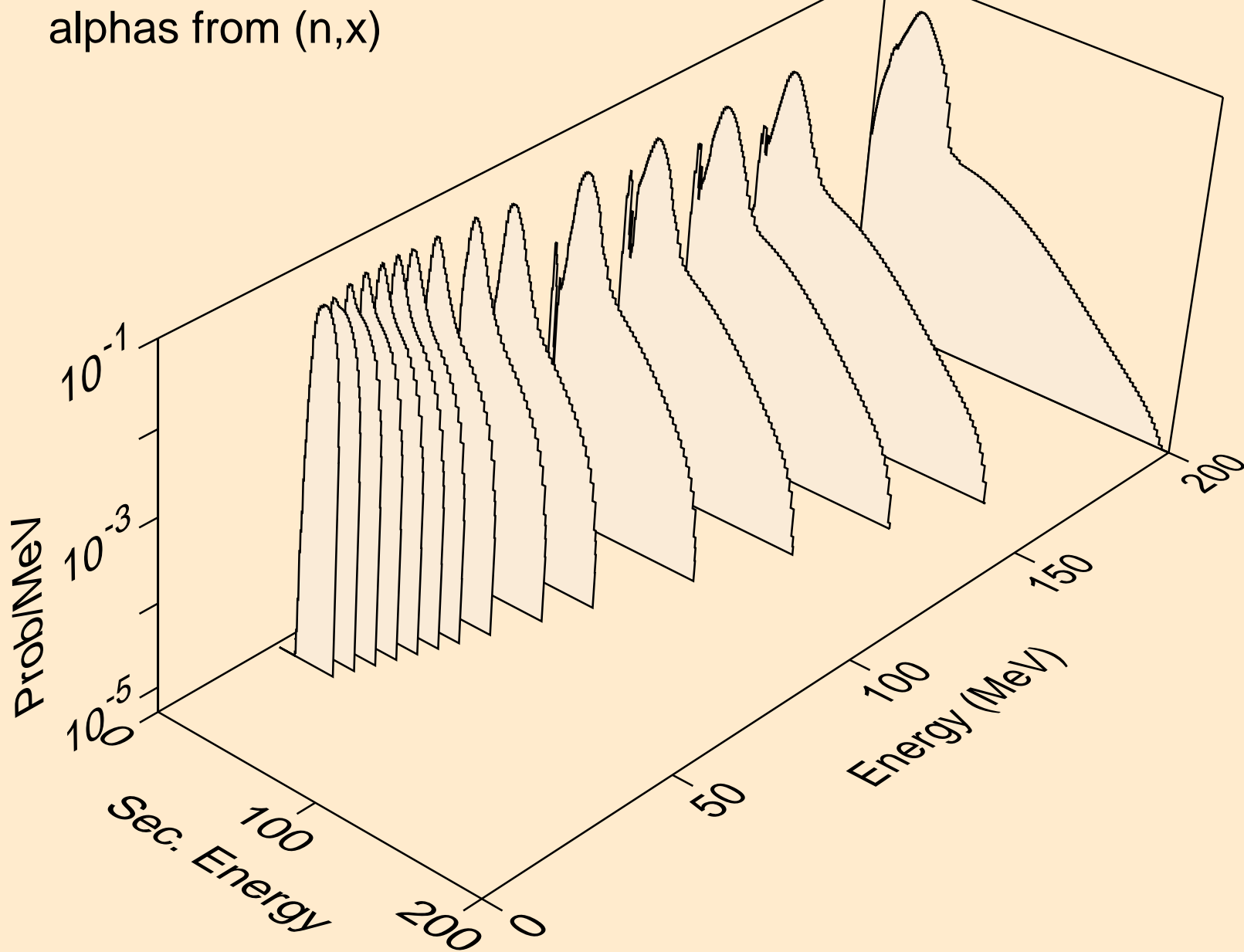

PA235 NEUTRON ACER TENDL-2019 LIBRARY; T=293.16K
alphas from (n,n*)a

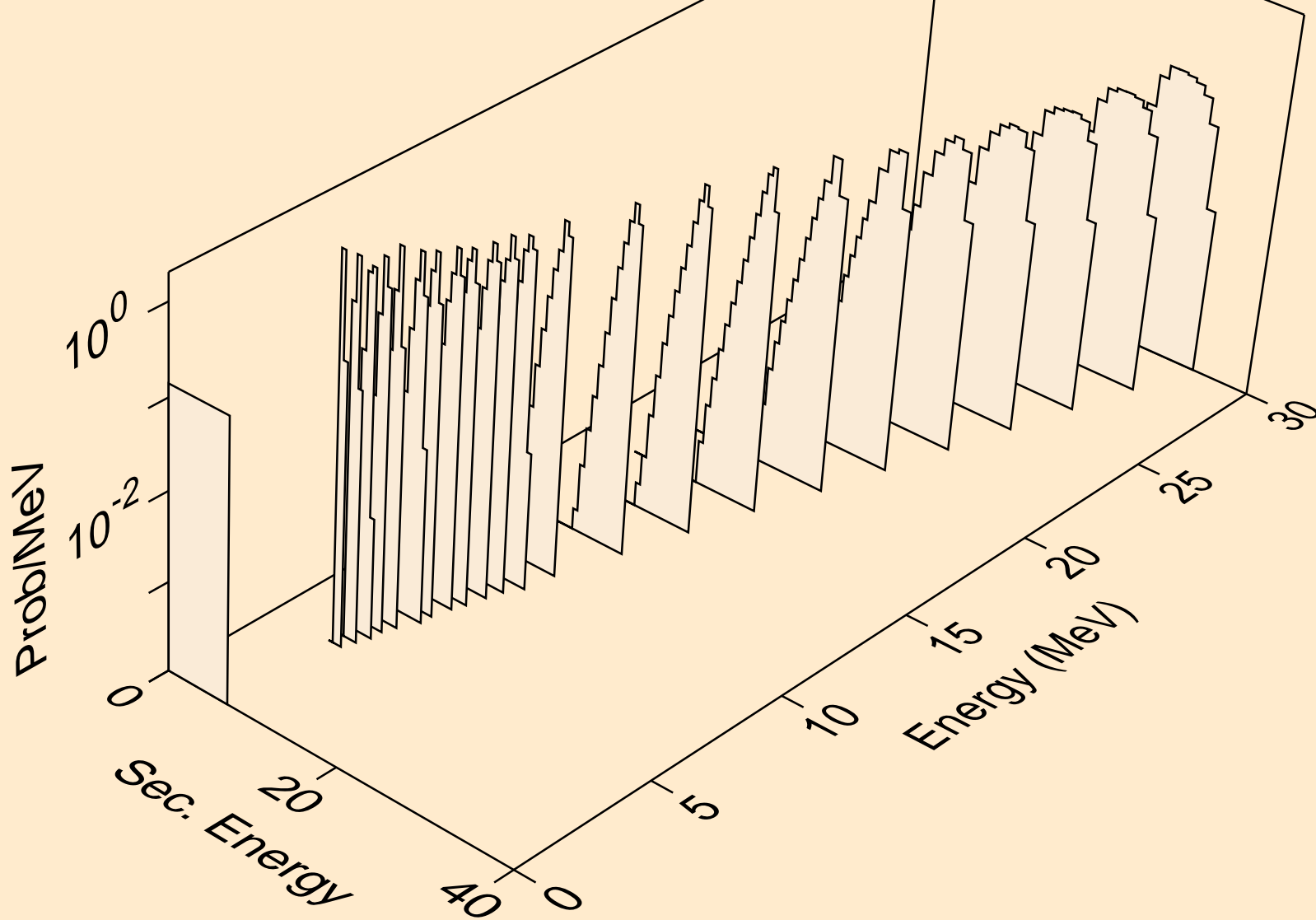

PA235 NEUTRON ACER TENDL-2019 LIBRARY; T=293.16K
alphas from (n,2n)a

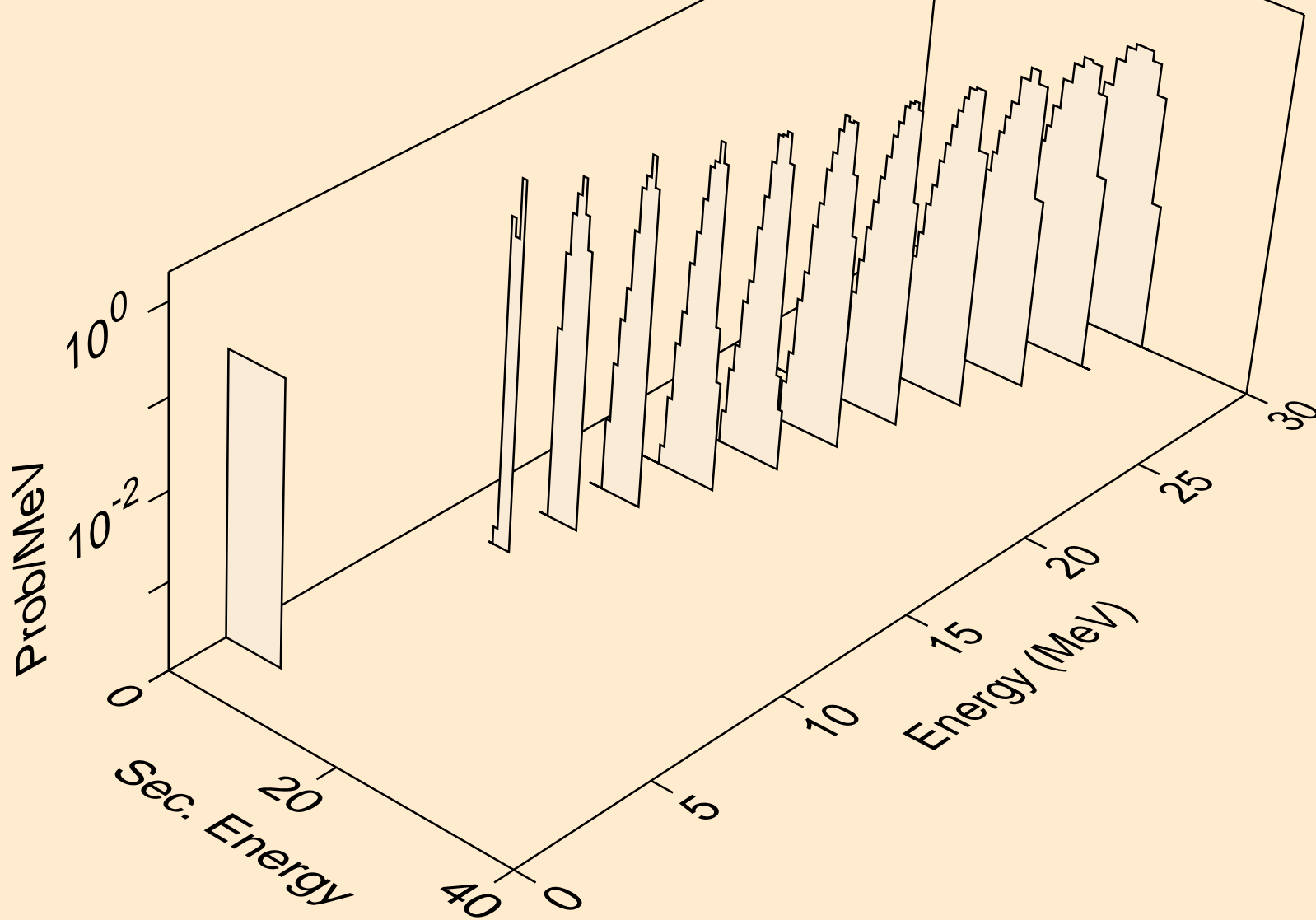

PA235 NEUTRON ACER TENDL-2019 LIBRARY; T=293.16K
alphas from (n,3n)a

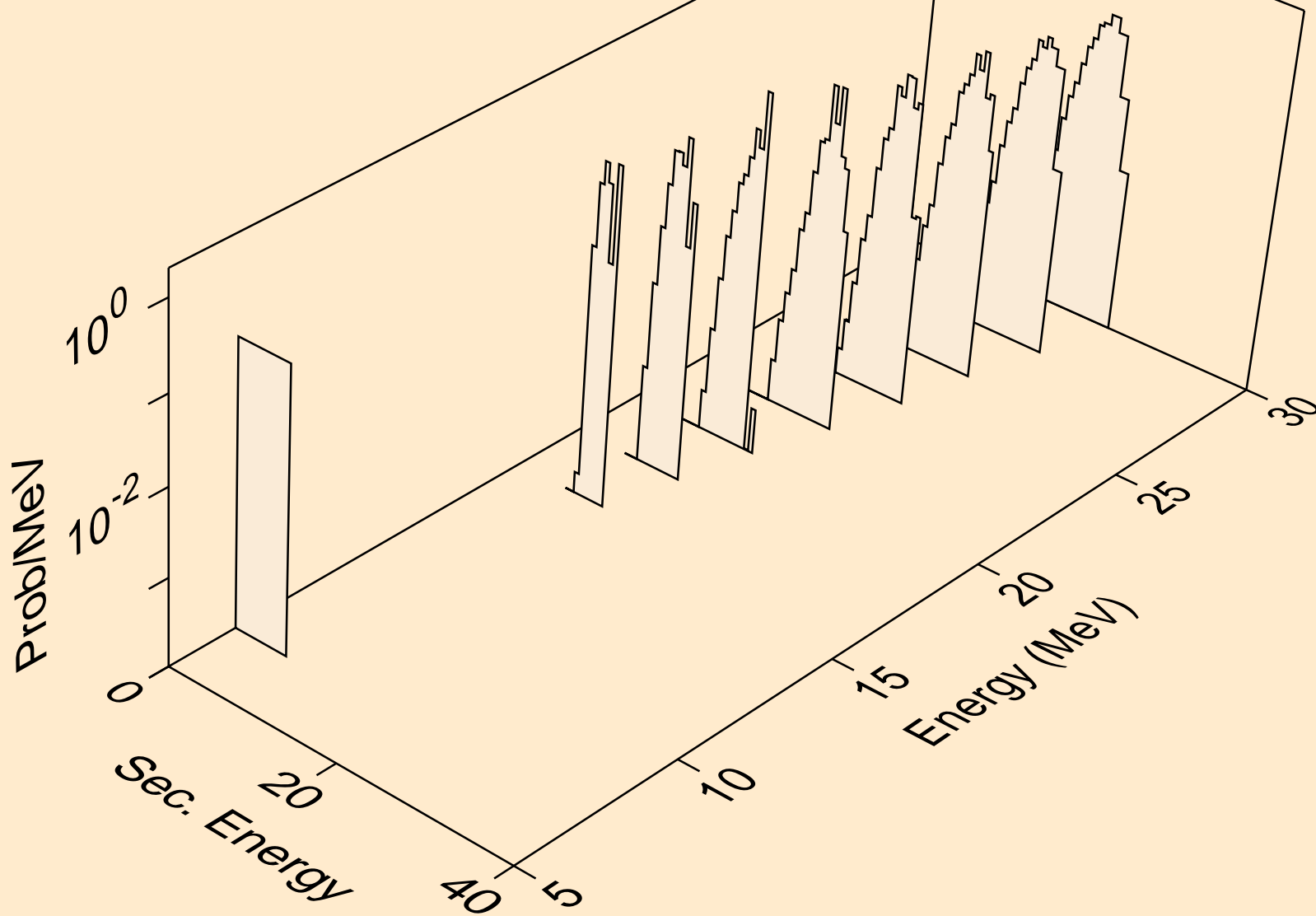

PA235 NEUTRON ACER TENDL-2019 LIBRARY; T=293.16K
alphas from (n,a)

