

PA239 NEUTRON ACER TENDL-2019 LIBRARY; T=293.16K
Principal cross sections

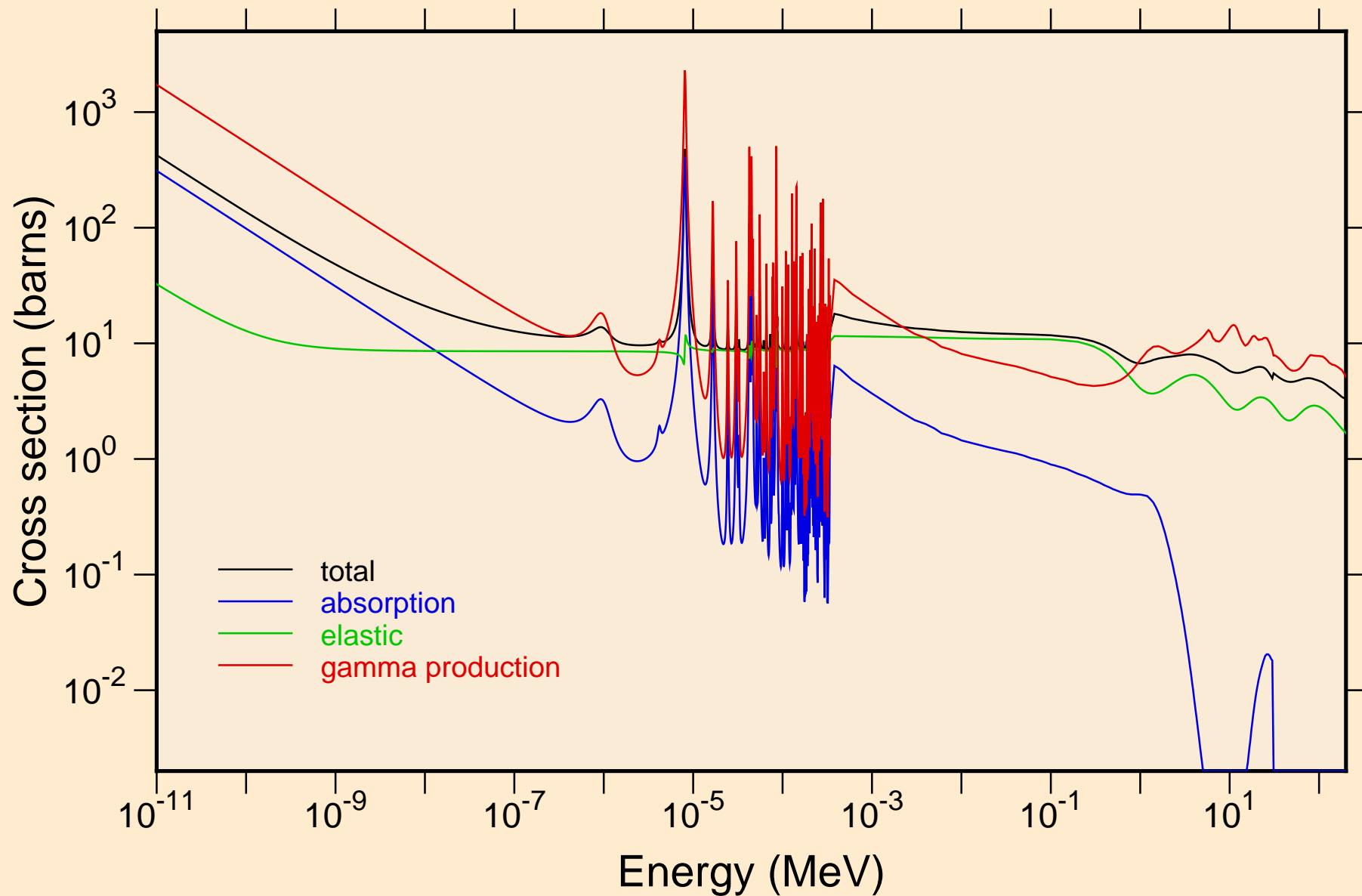

PA239 NEUTRON ACER TENDL-2019 LIBRARY; T=293.16K
resonance total cross section

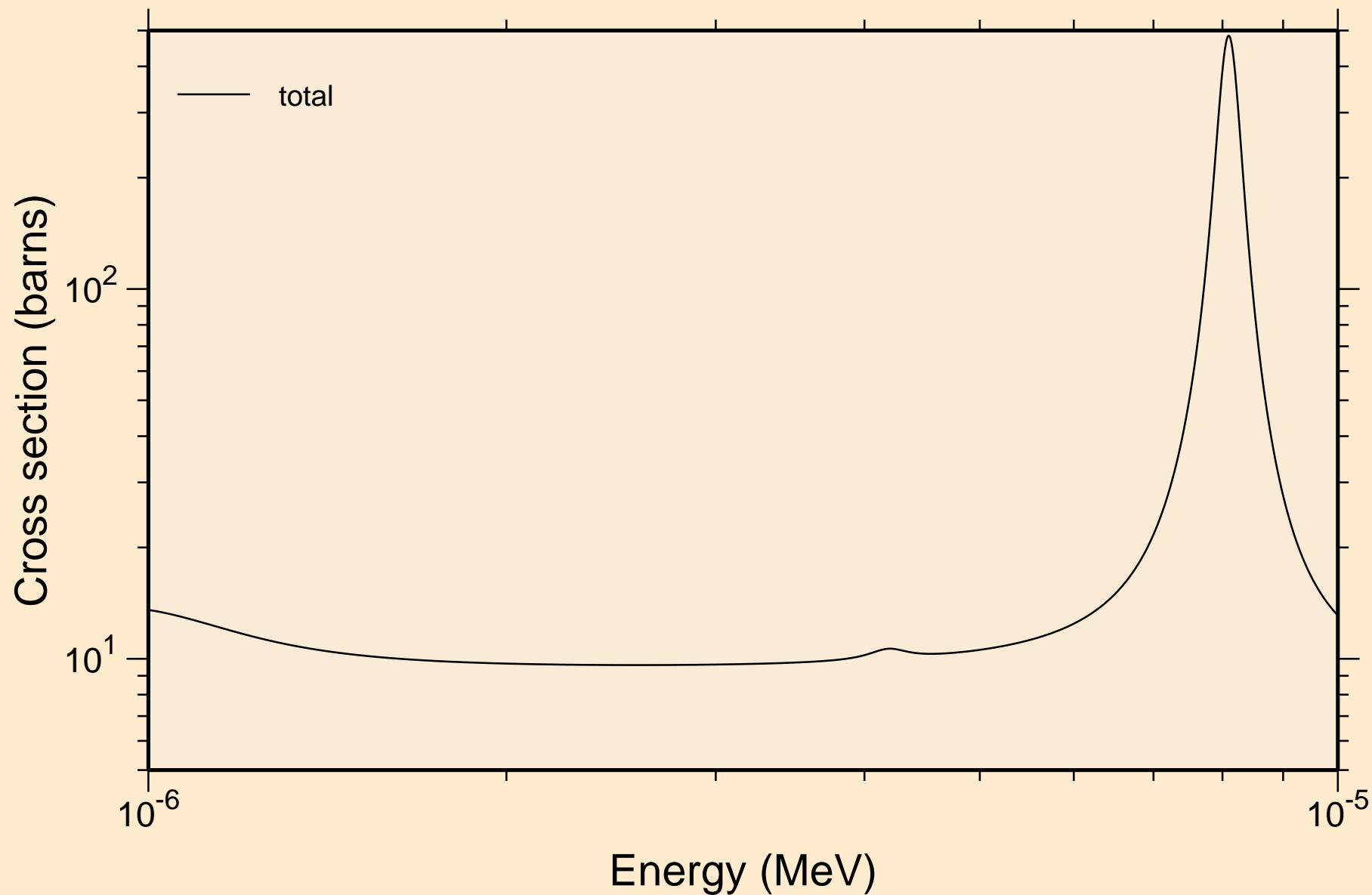

PA239 NEUTRON ACER TENDL-2019 LIBRARY; T=293.16K
resonance total cross section

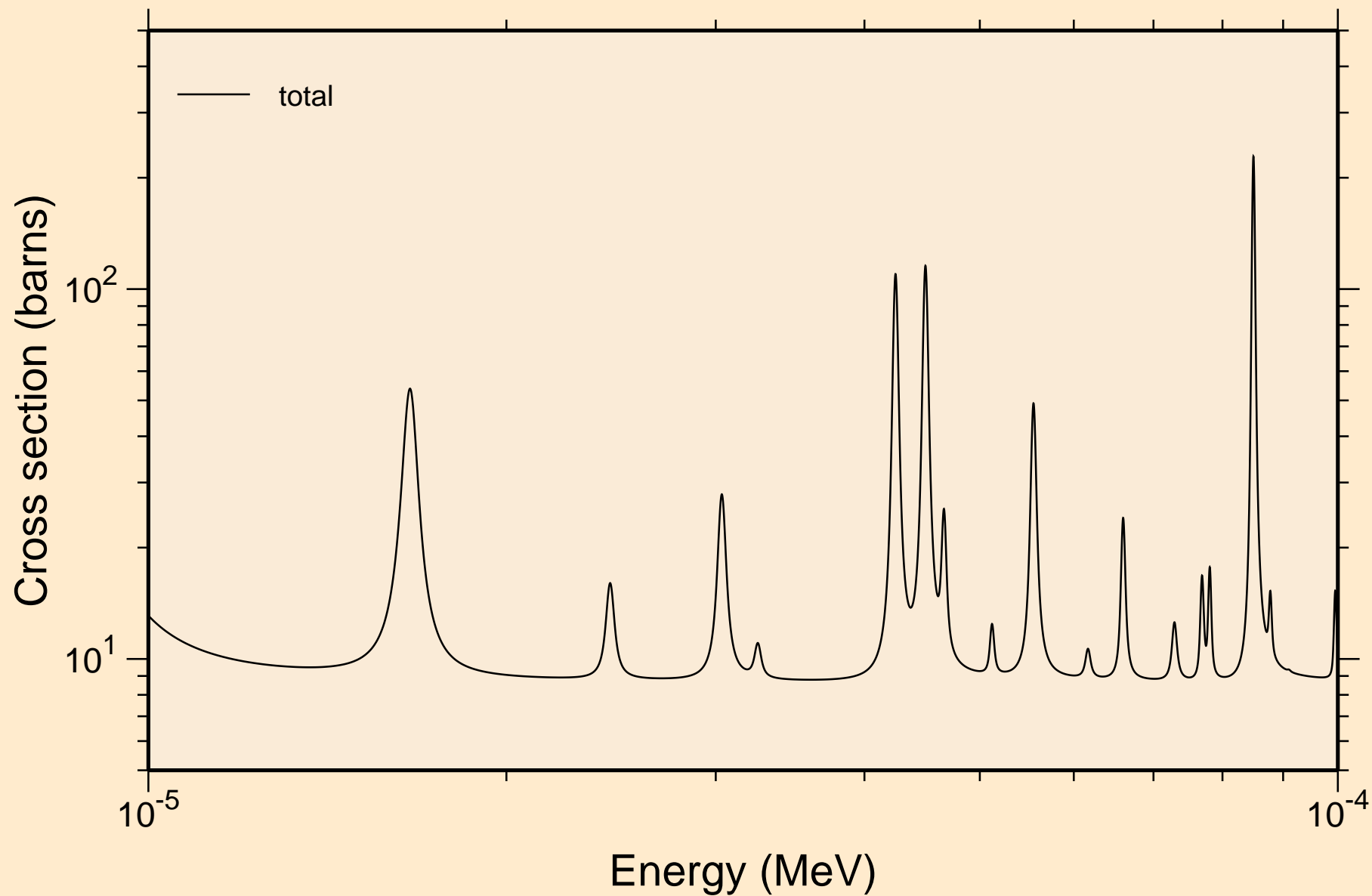

PA239 NEUTRON ACER TENDL-2019 LIBRARY; T=293.16K
resonance total cross section

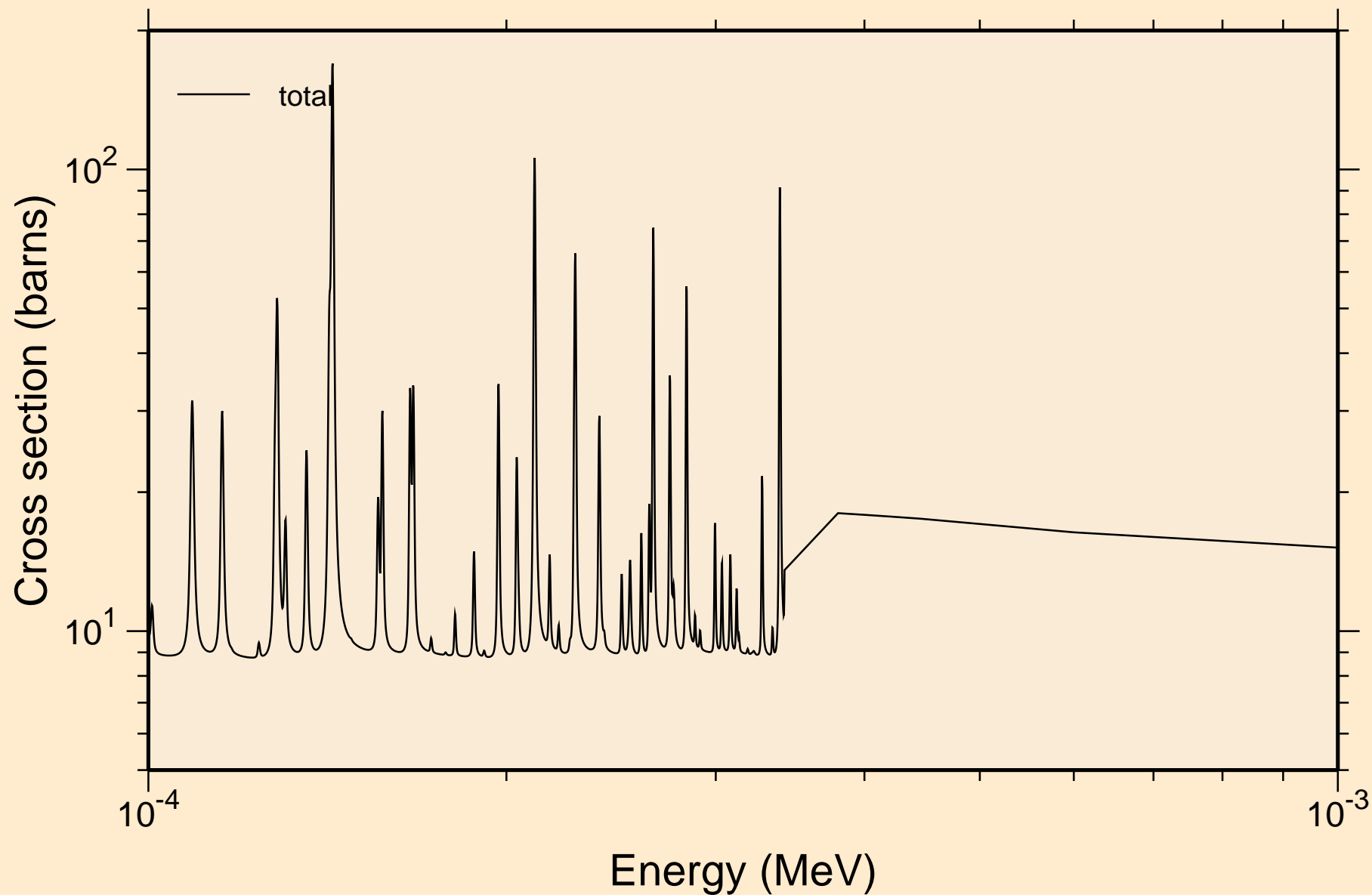

PA239 NEUTRON ACER TENDL-2019 LIBRARY; T=293.16K
resonance total cross section

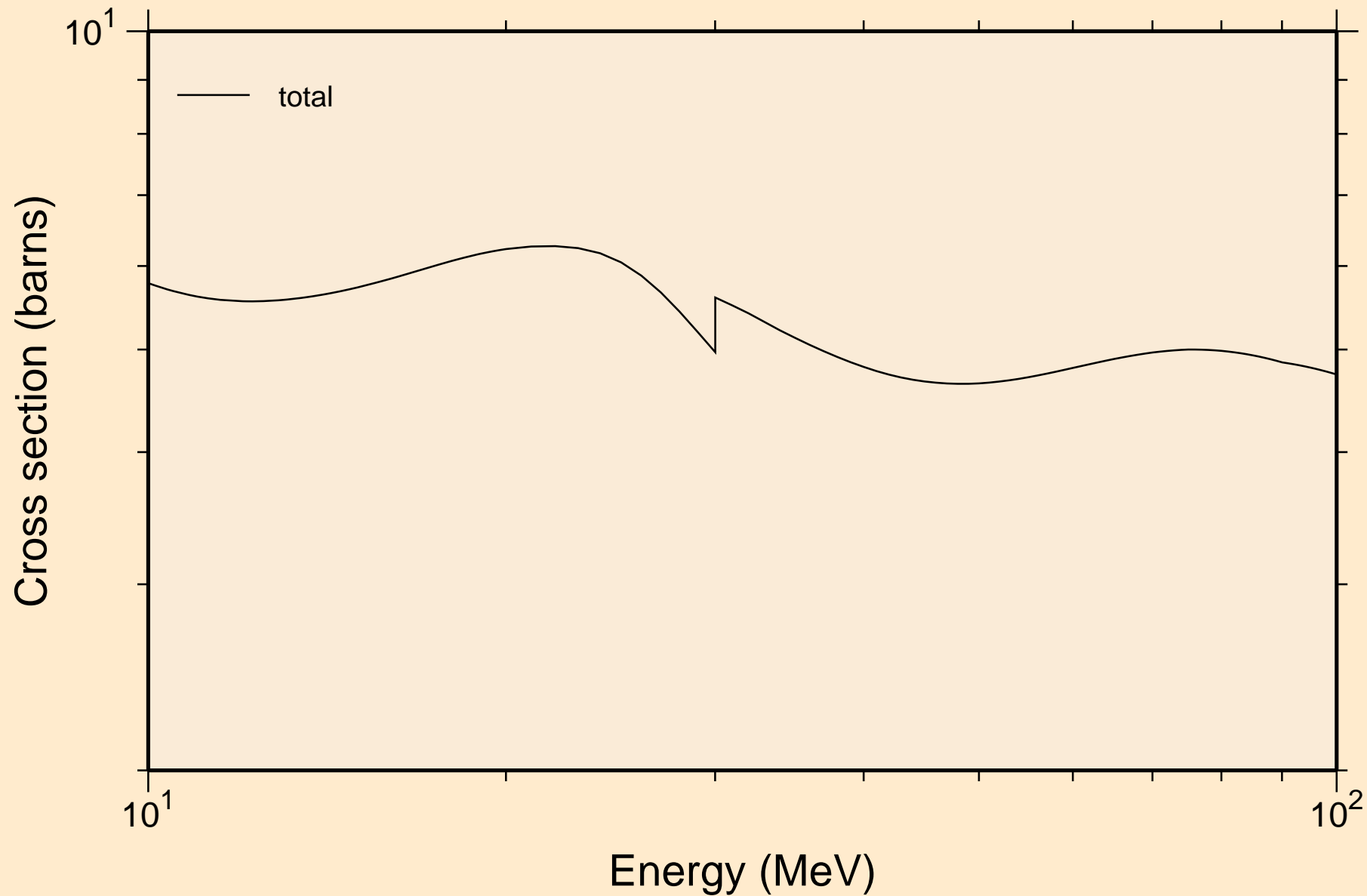

PA239 NEUTRON ACER TENDL-2019 LIBRARY; T=293.16K
resonance absorption cross sections

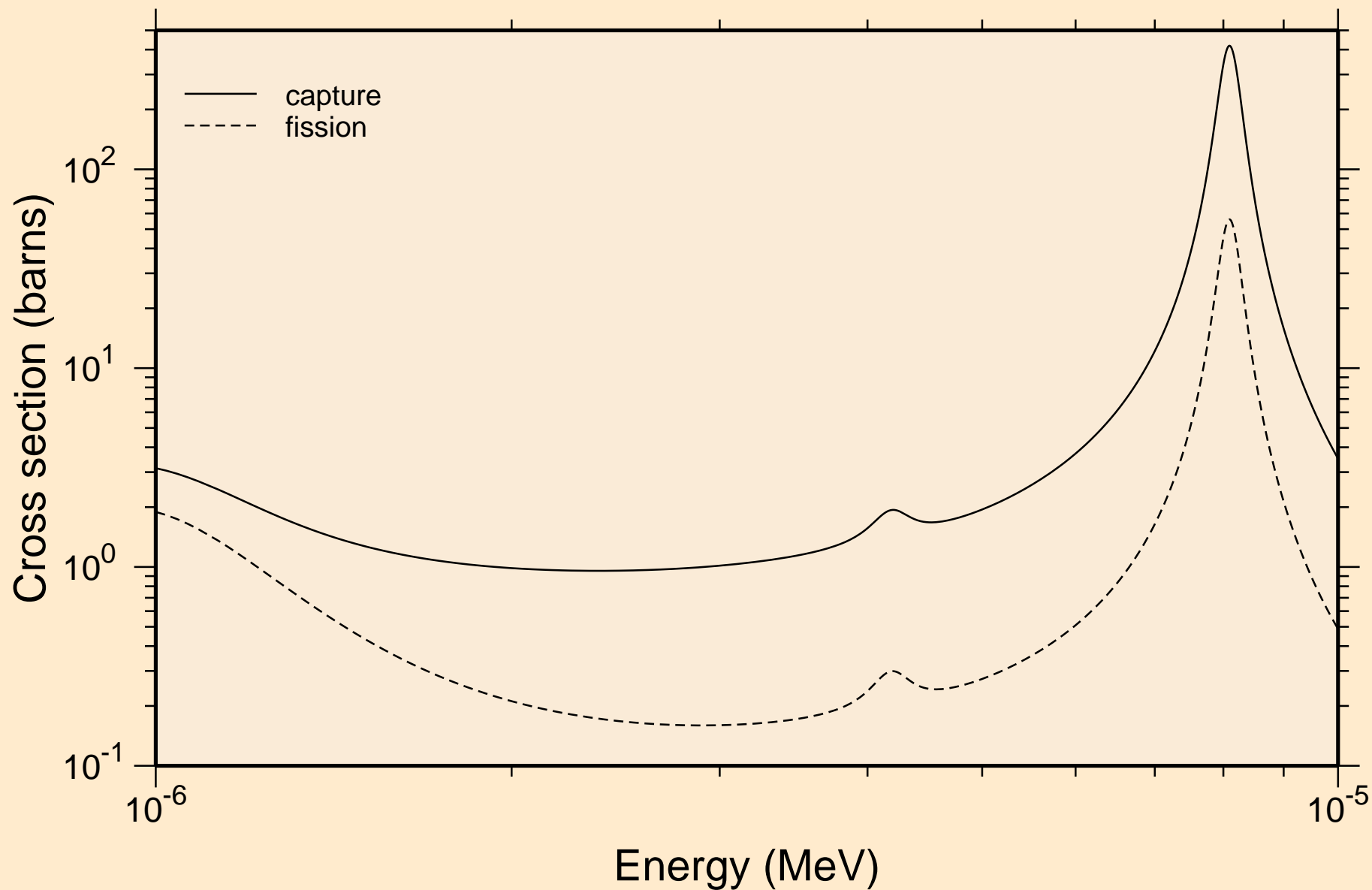

PA239 NEUTRON ACER TENDL-2019 LIBRARY; T=293.16K
resonance absorption cross sections

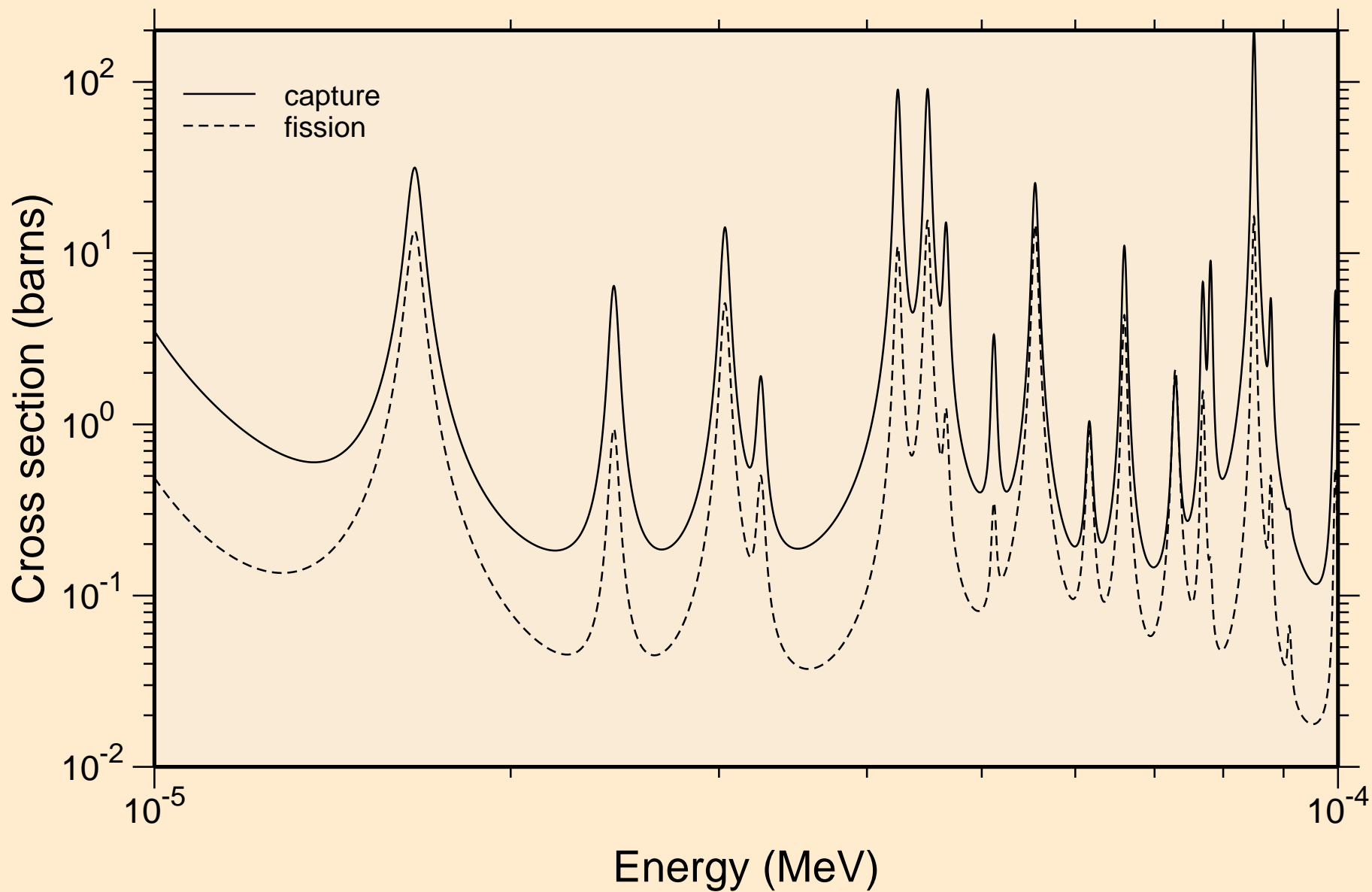

PA239 NEUTRON ACER TENDL-2019 LIBRARY; T=293.16K
resonance absorption cross sections

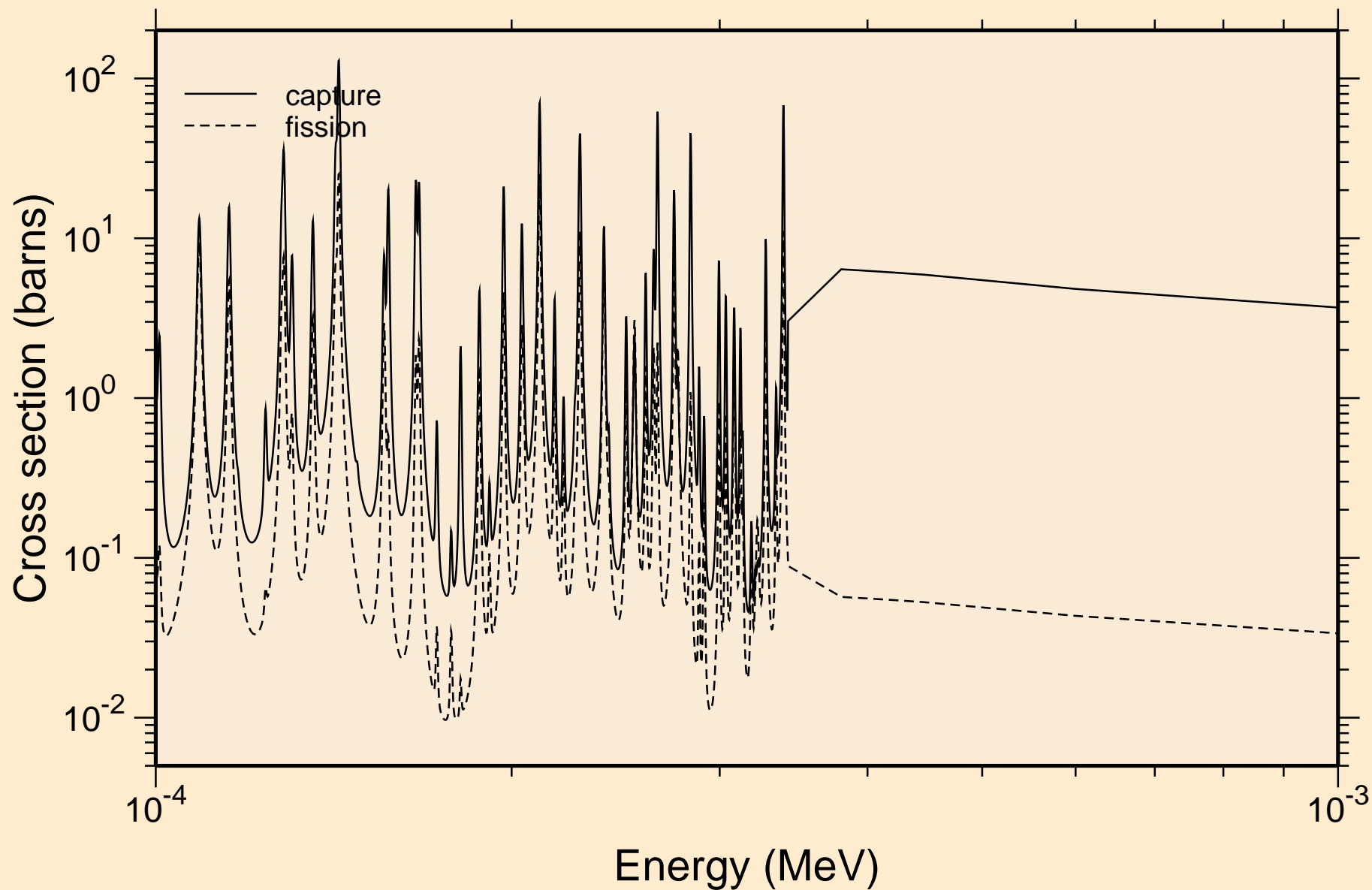

PA239 NEUTRON ACER TENDL-2019 LIBRARY; T=293.16K
resonance absorption cross sections

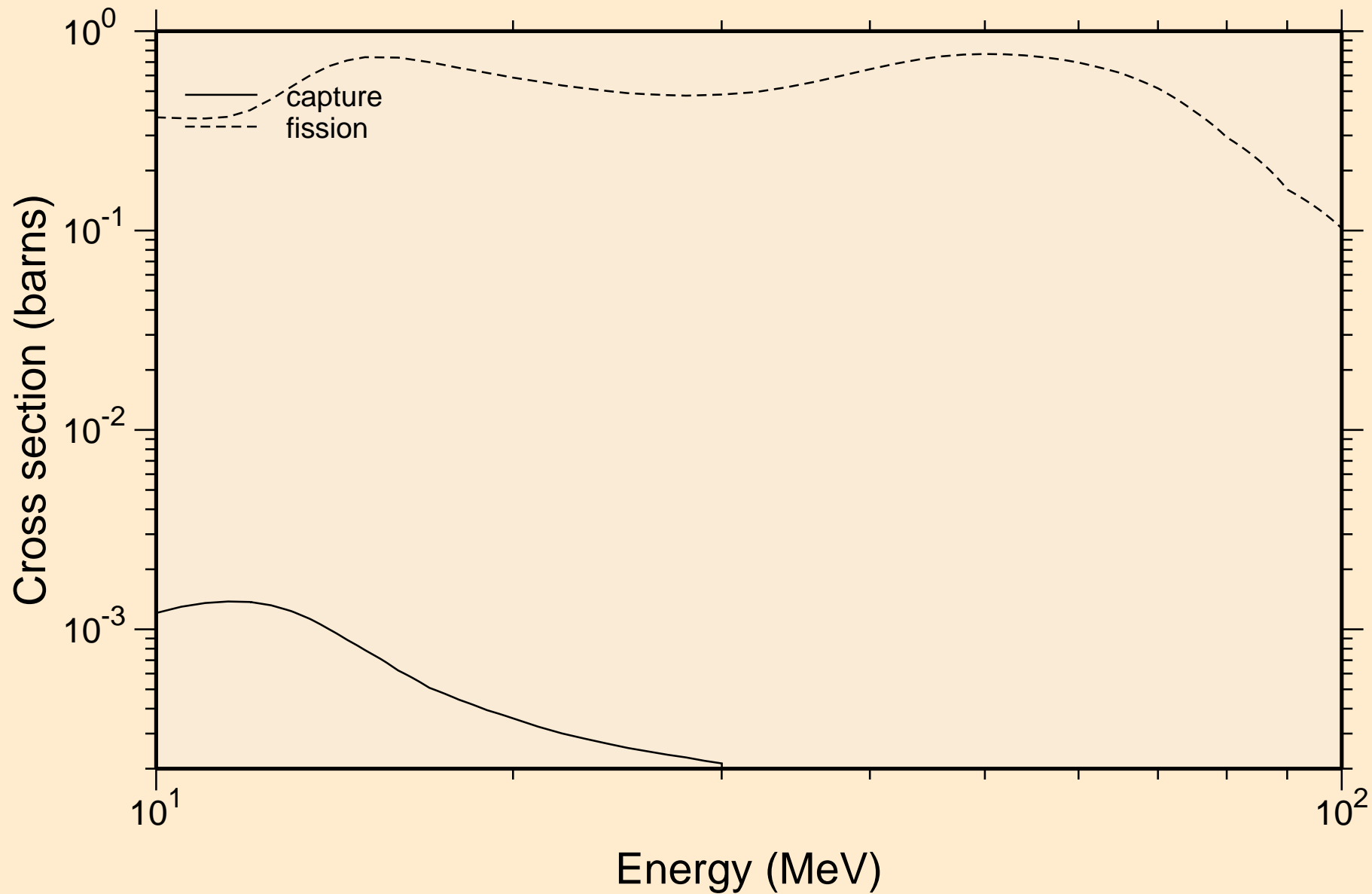

PA239 NEUTRON ACER TENDL-2019 LIBRARY; T=293.16K
Heating

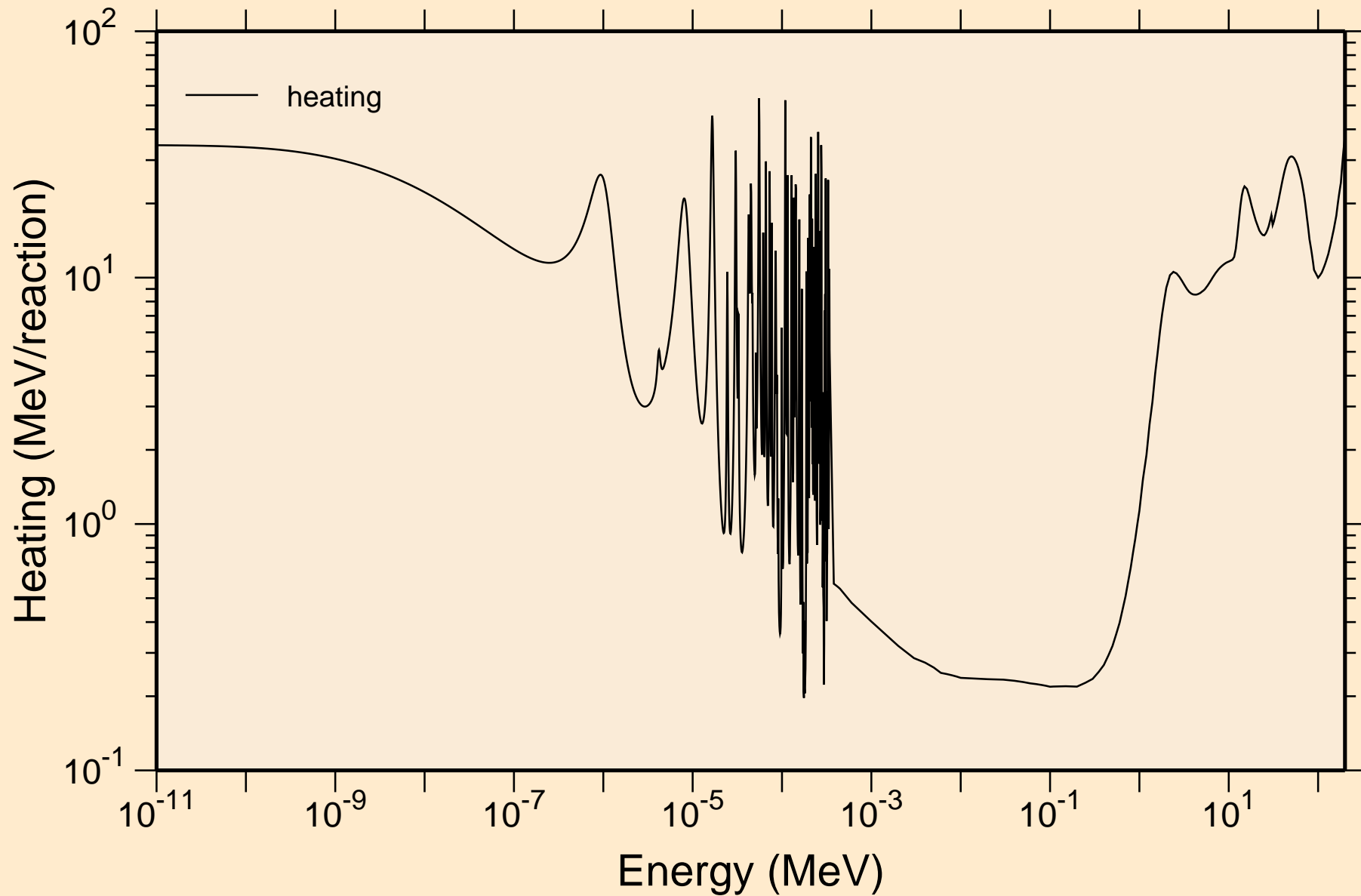

PA239 NEUTRON ACER TENDL-2019 LIBRARY; T=293.16K
Damage

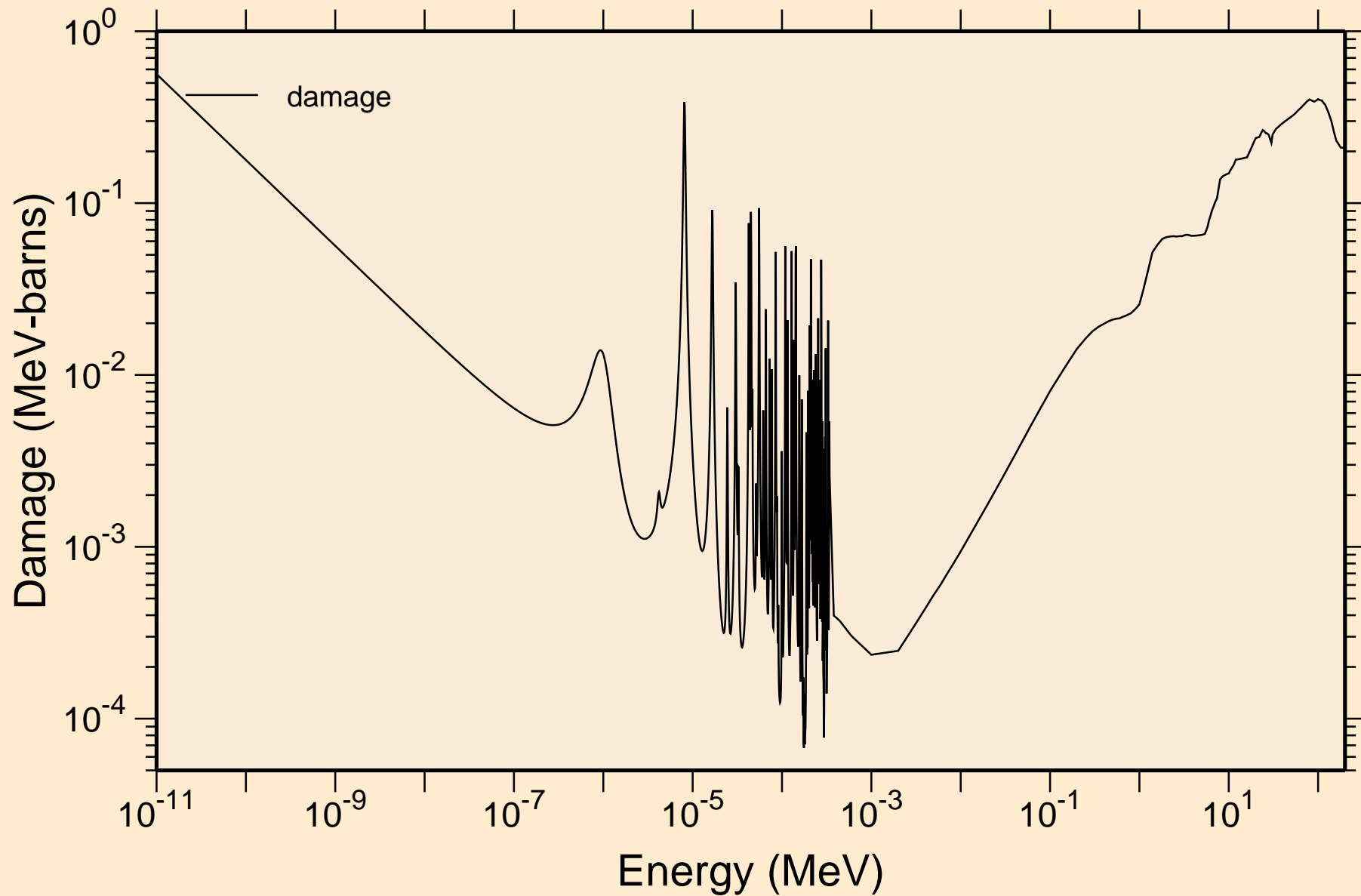

PA239 NEUTRON ACER TENDL-2019 LIBRARY; T=293.16K
Non-threshold reactions

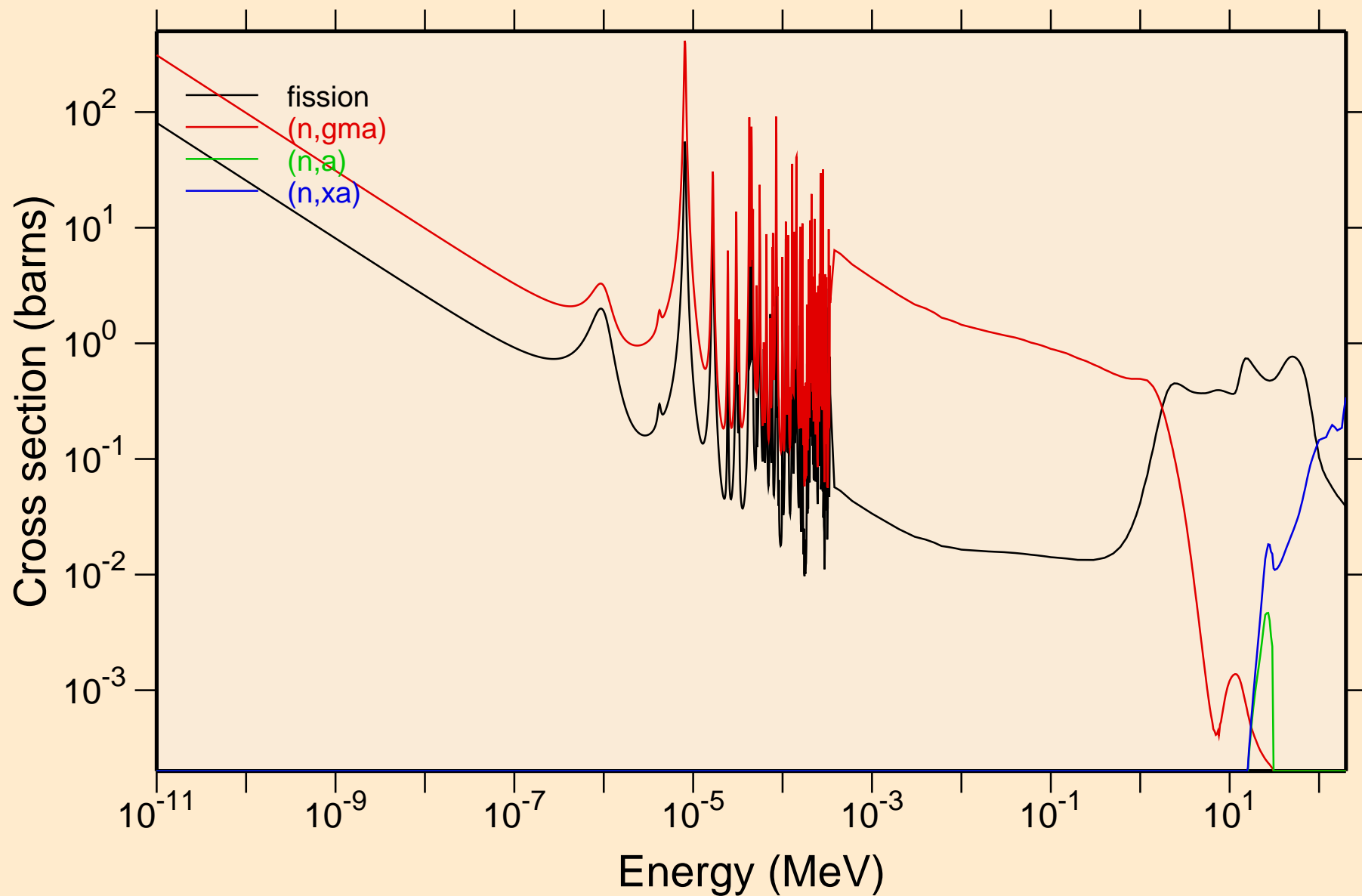

PA239 NEUTRON ACER TENDL-2019 LIBRARY; T=293.16K
Principal cross sections

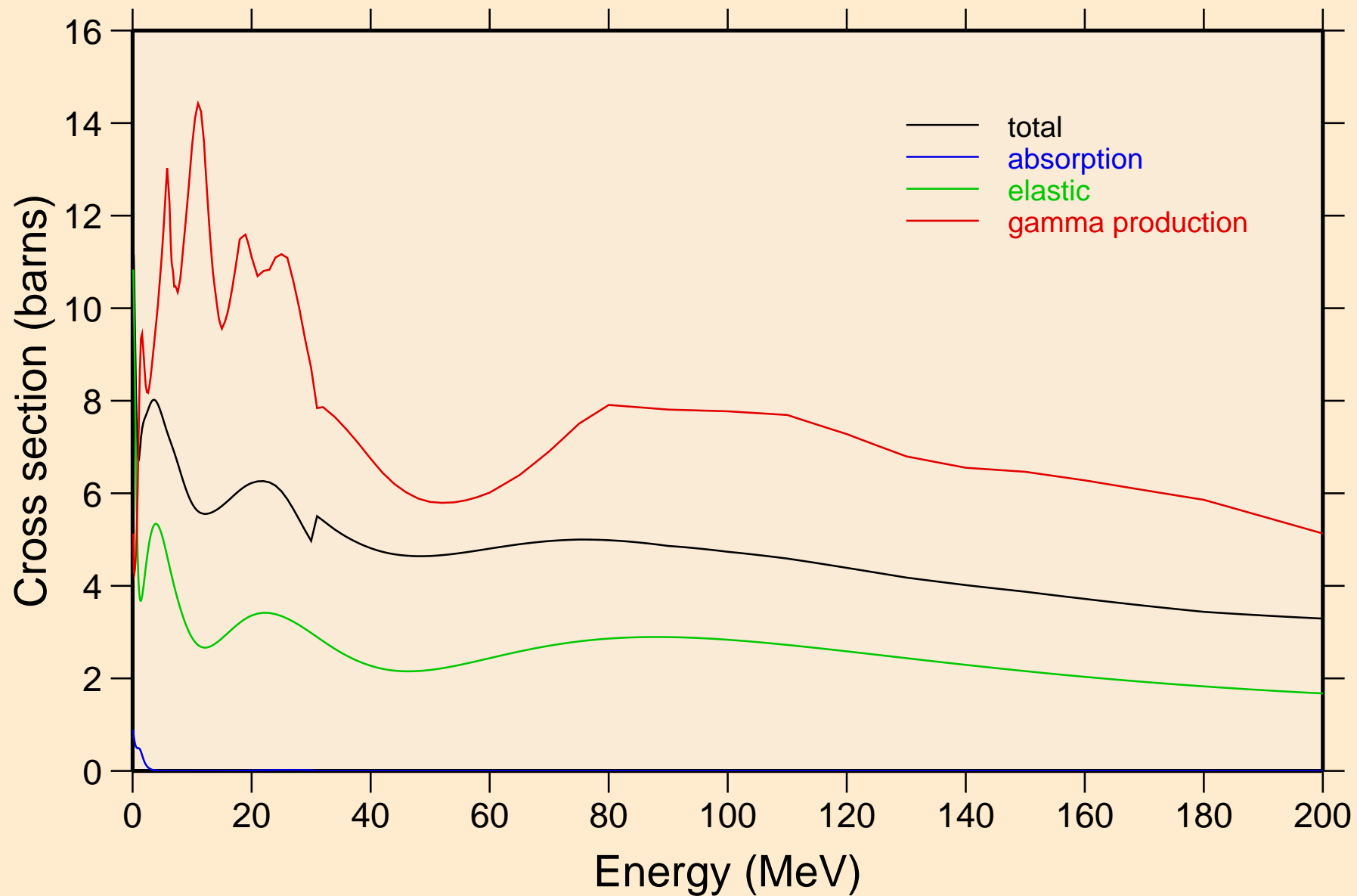

PA239 NEUTRON ACER TENDL-2019 LIBRARY; T=293.16K
Heating

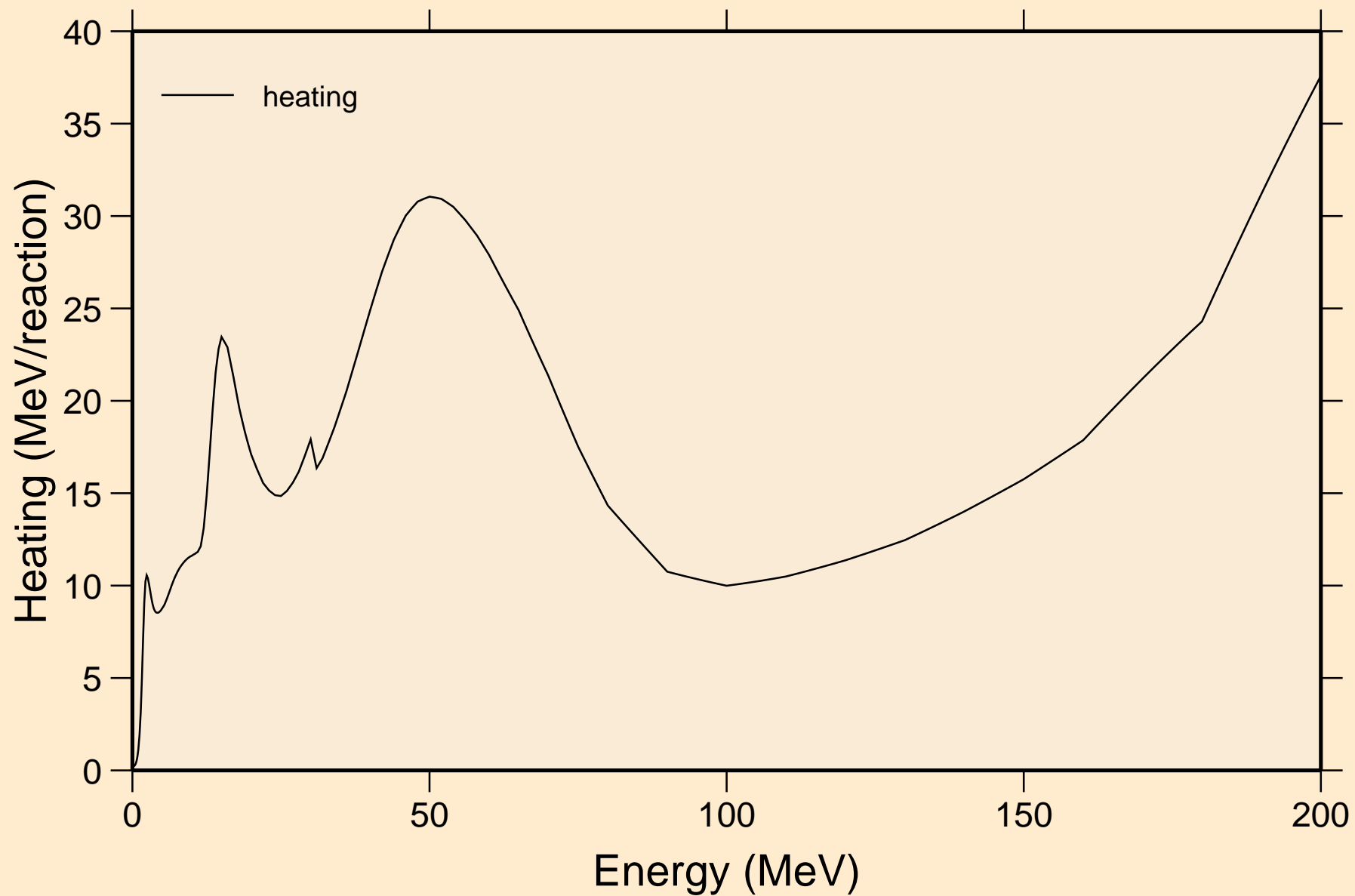

PA239 NEUTRON ACER TENDL-2019 LIBRARY; T=293.16K
Damage

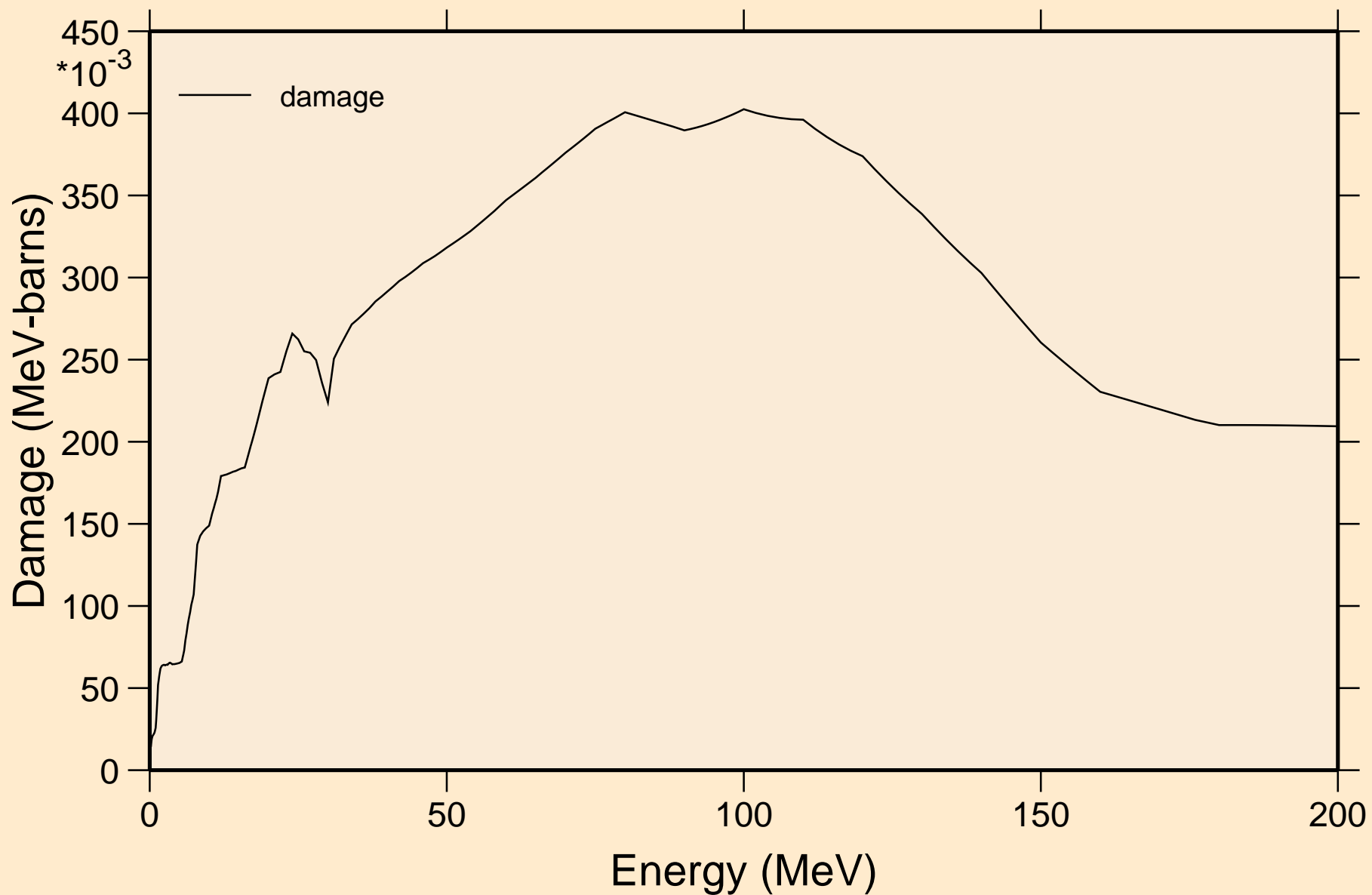

PA239 NEUTRON ACER TENDL-2019 LIBRARY; T=293.16K
Non-threshold reactions

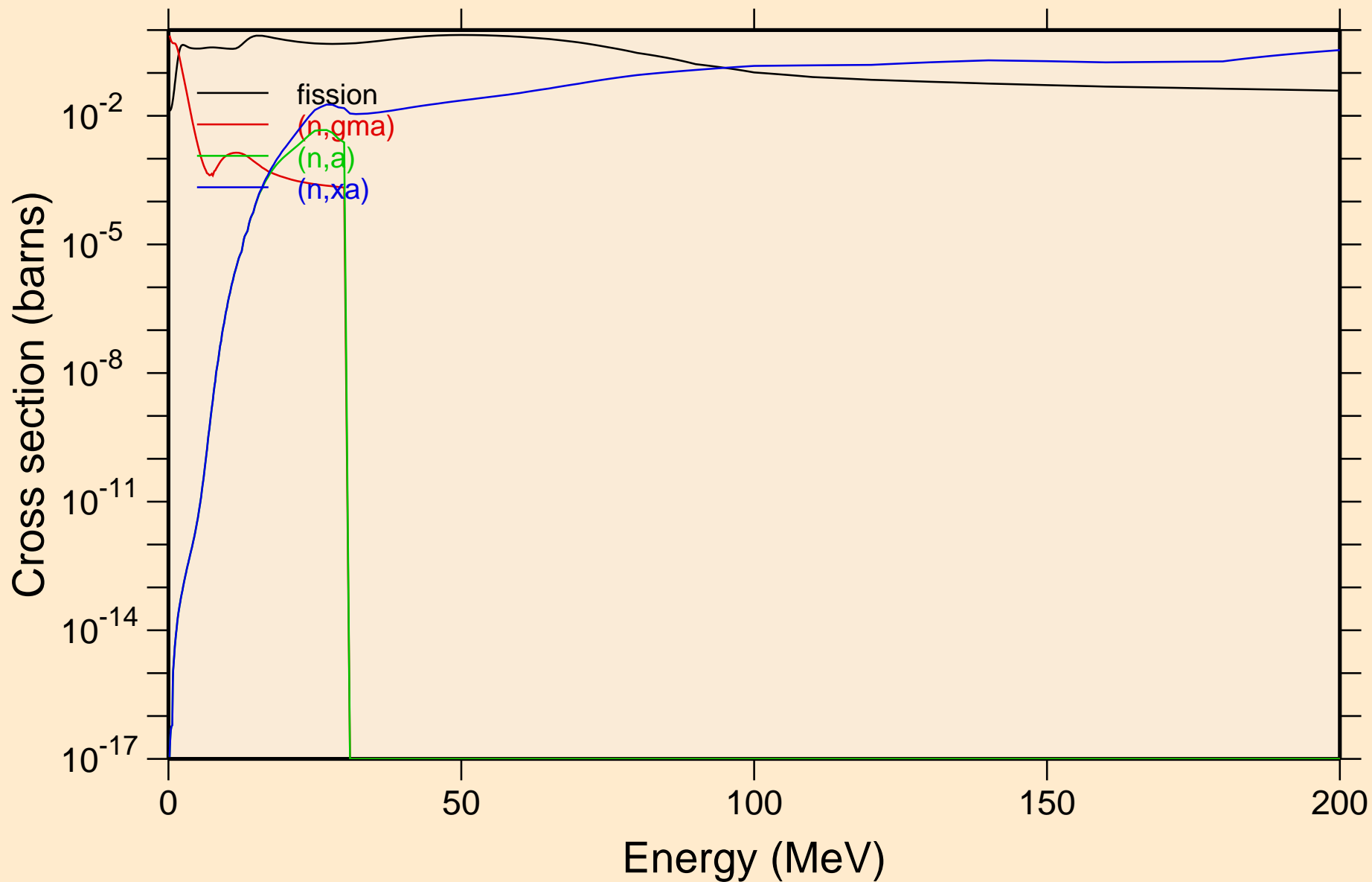

PA239 NEUTRON ACER TENDL-2019 LIBRARY; T=293.16K
Inelastic levels

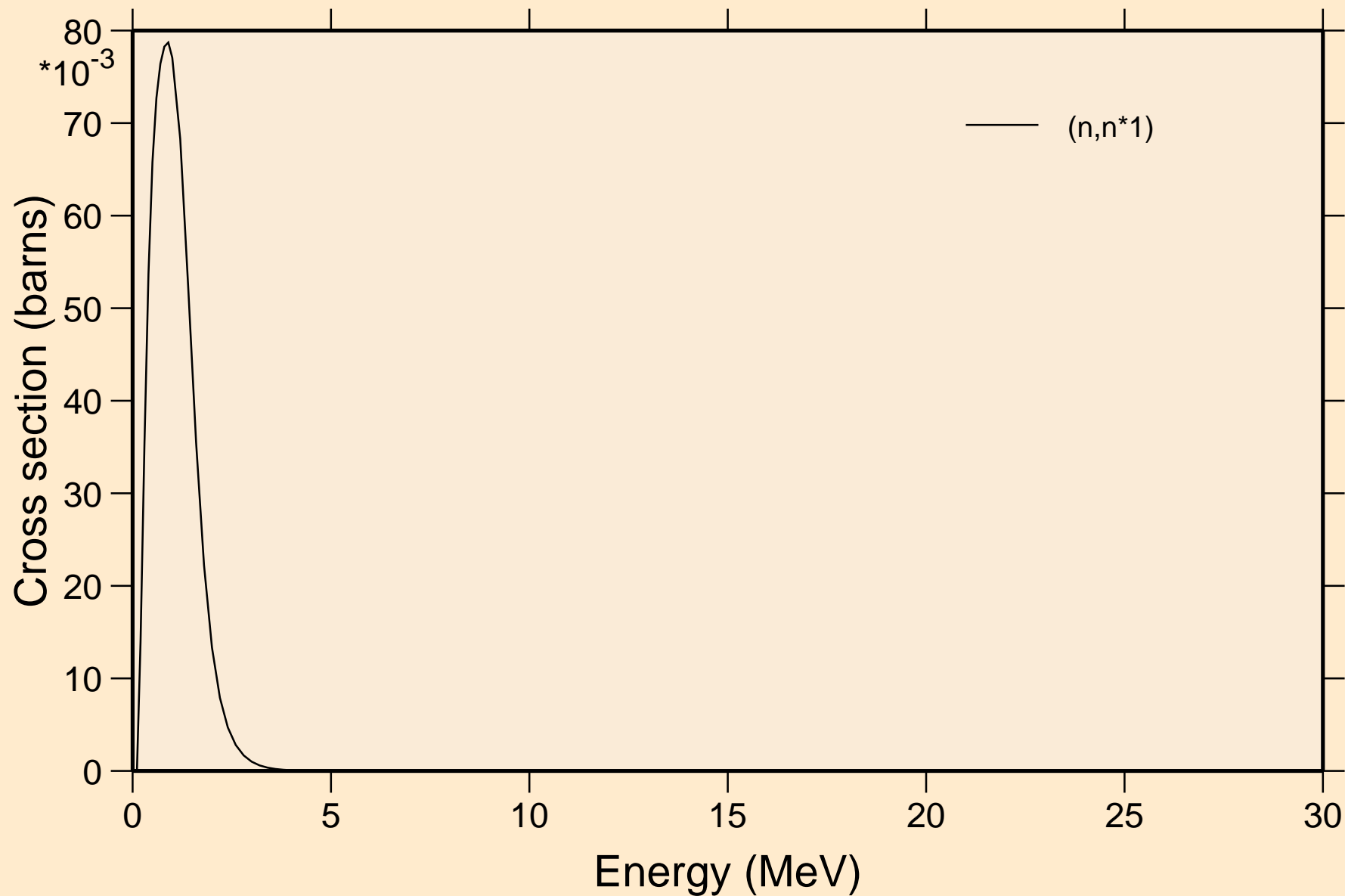

PA239 NEUTRON ACER TENDL-2019 LIBRARY; T=293.16K
Threshold reactions

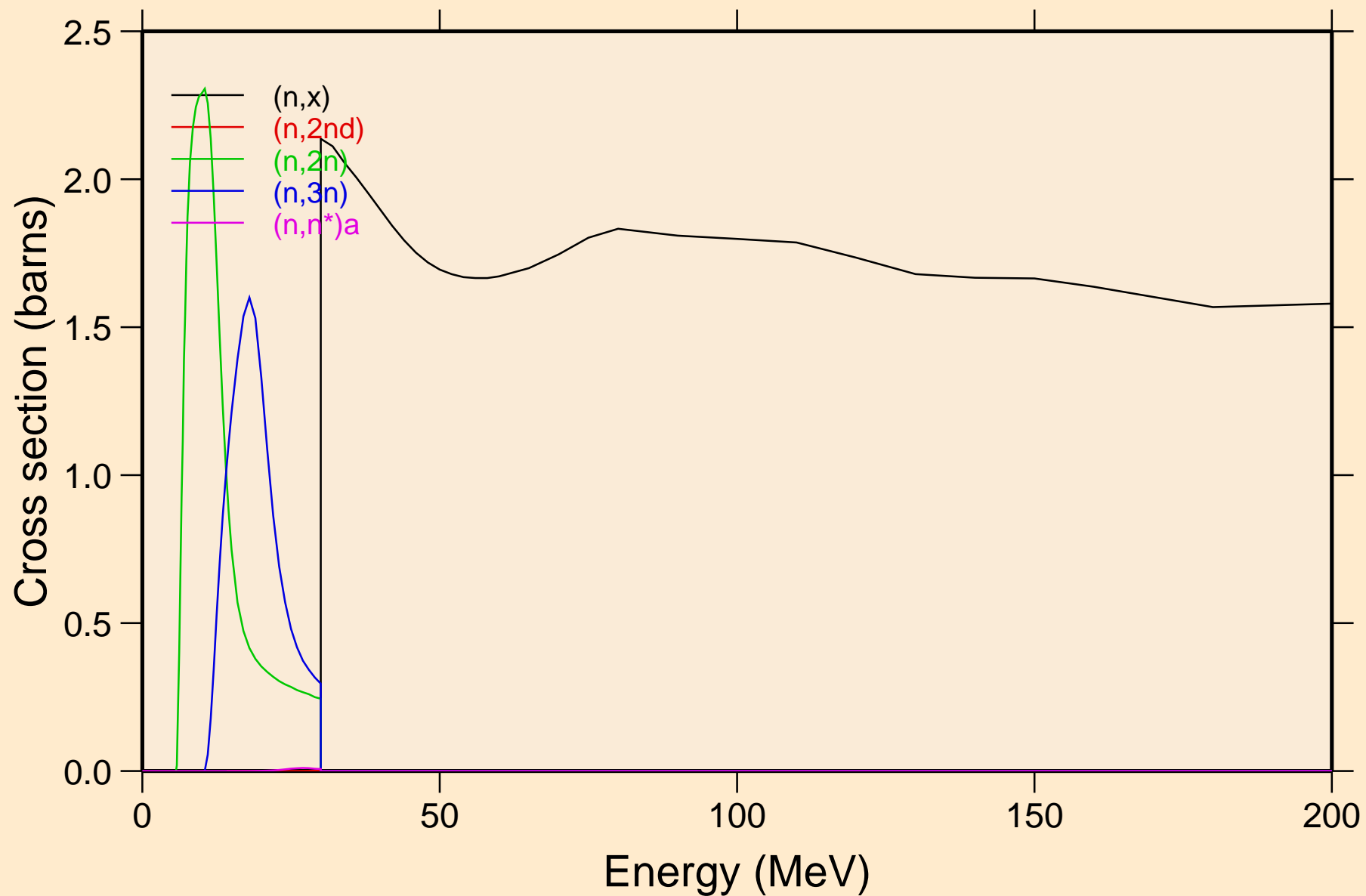

PA239 NEUTRON ACER TENDL-2019 LIBRARY; T=293.16K
Threshold reactions

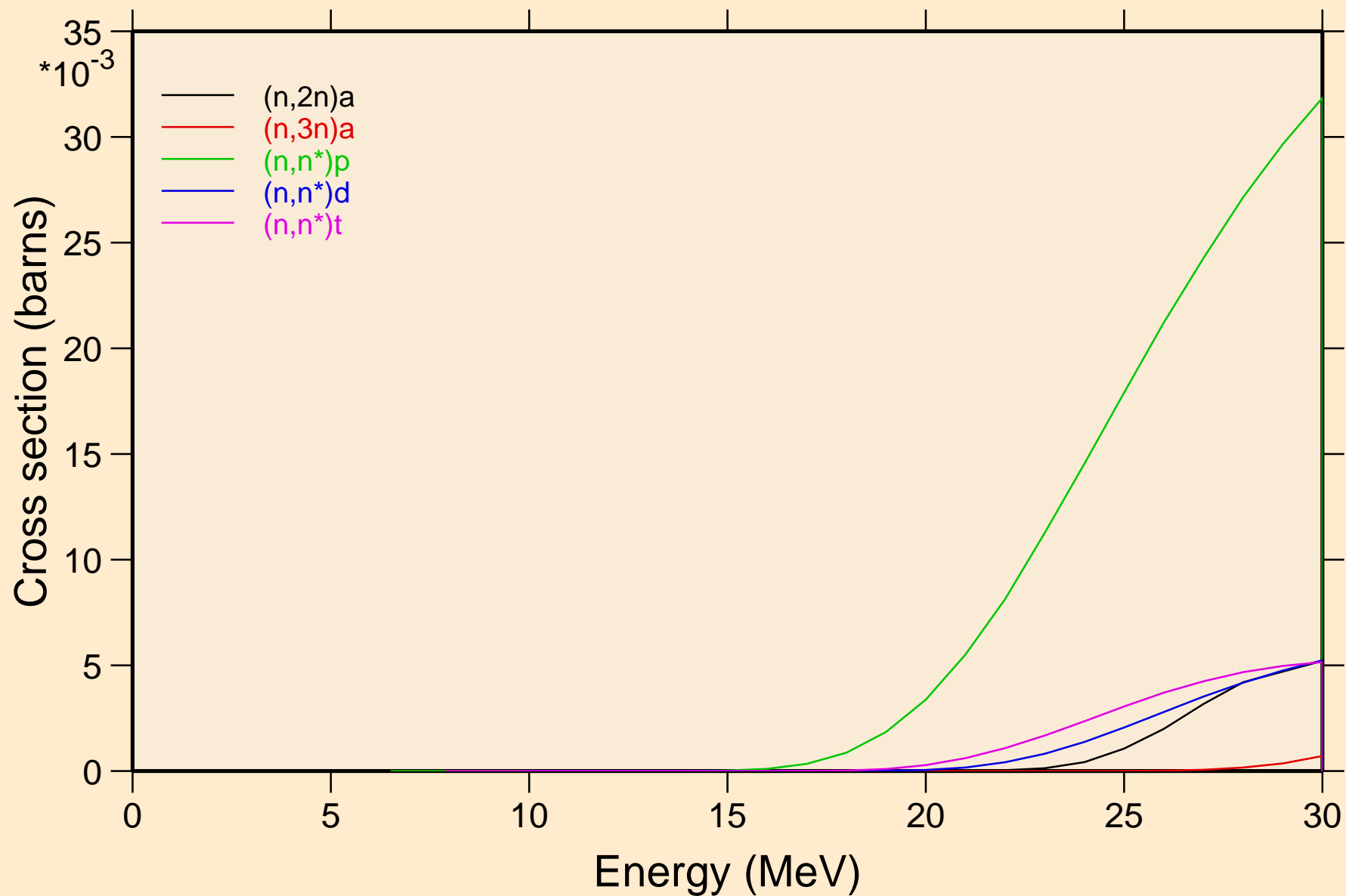

PA239 NEUTRON ACER TENDL-2019 LIBRARY; T=293.16K
Threshold reactions

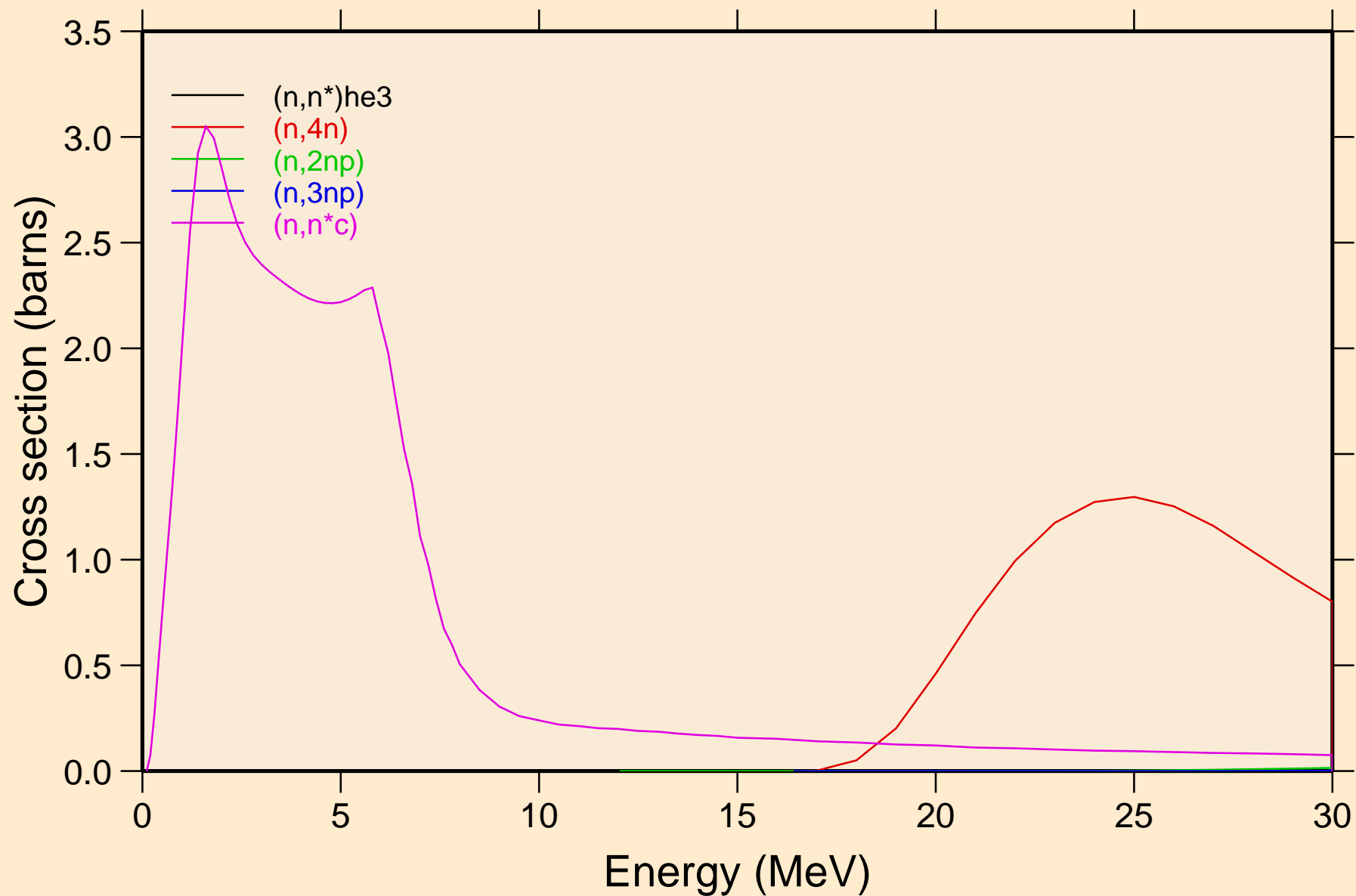

PA239 NEUTRON ACER TENDL-2019 LIBRARY; T=293.16K
Threshold reactions

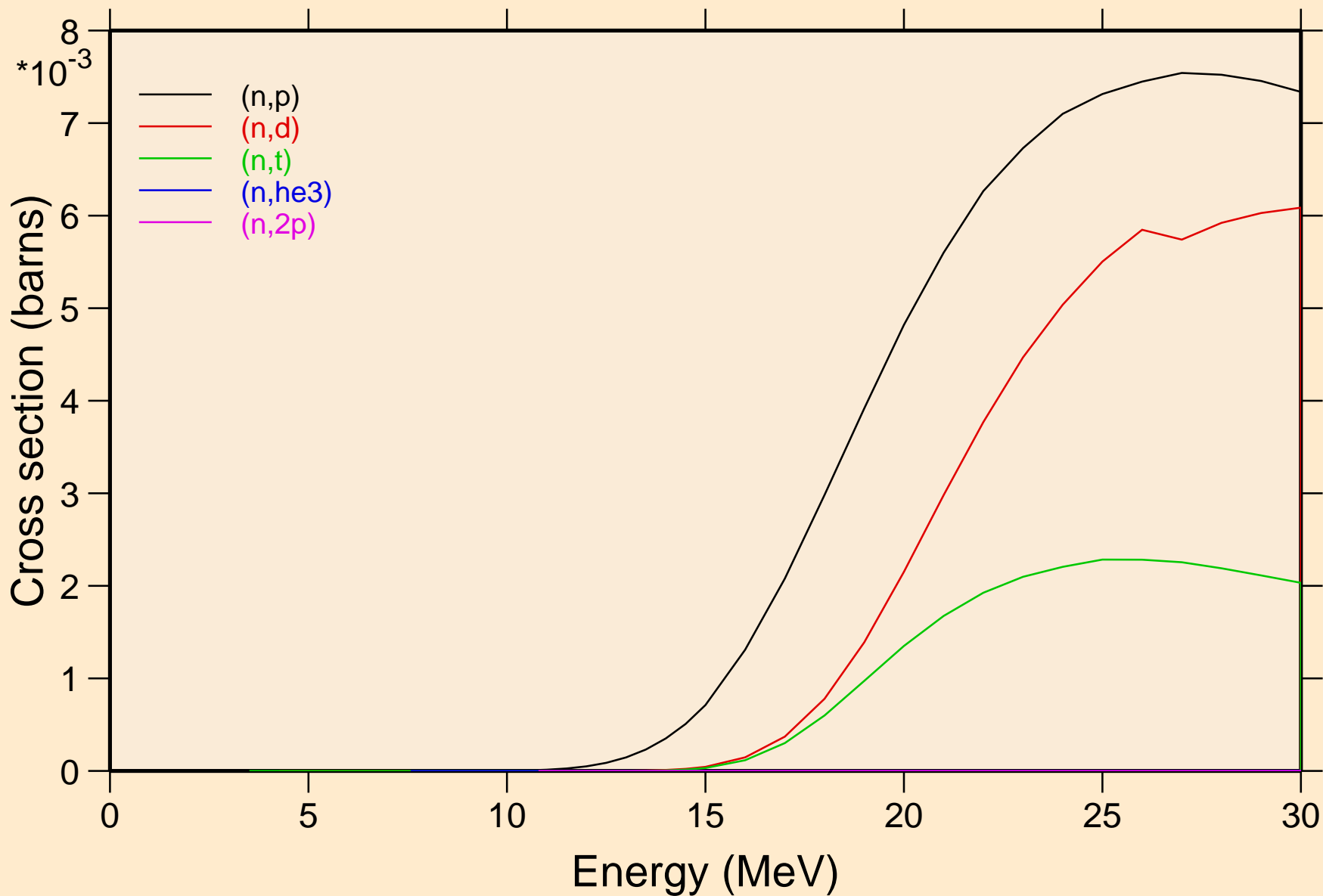

PA239 NEUTRON ACER TENDL-2019 LIBRARY; T=293.16K
Threshold reactions

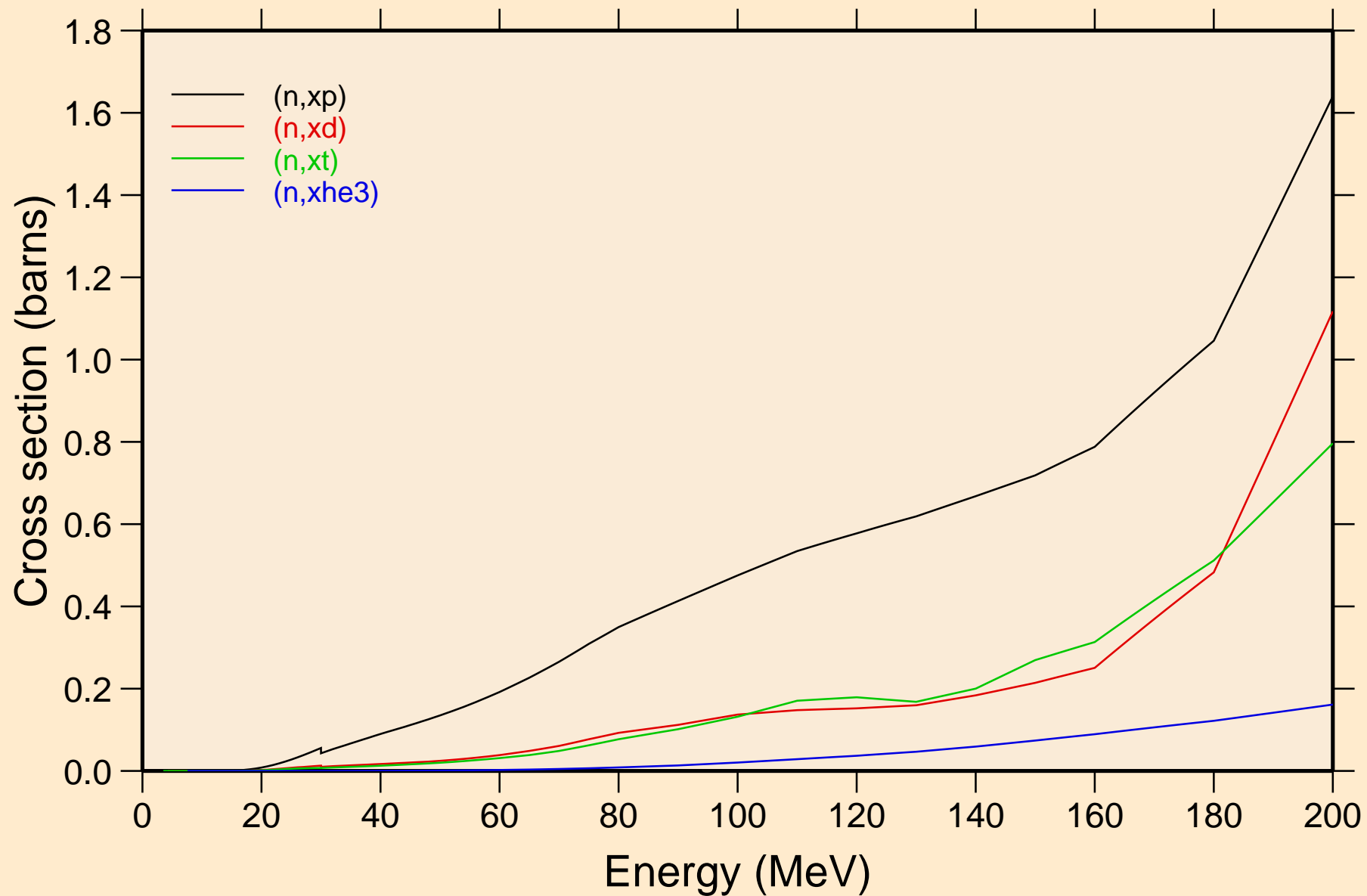

PA239 NEUTRON ACER TENDL-2019 LIBRARY; T=293.16K
angular distribution for elastic

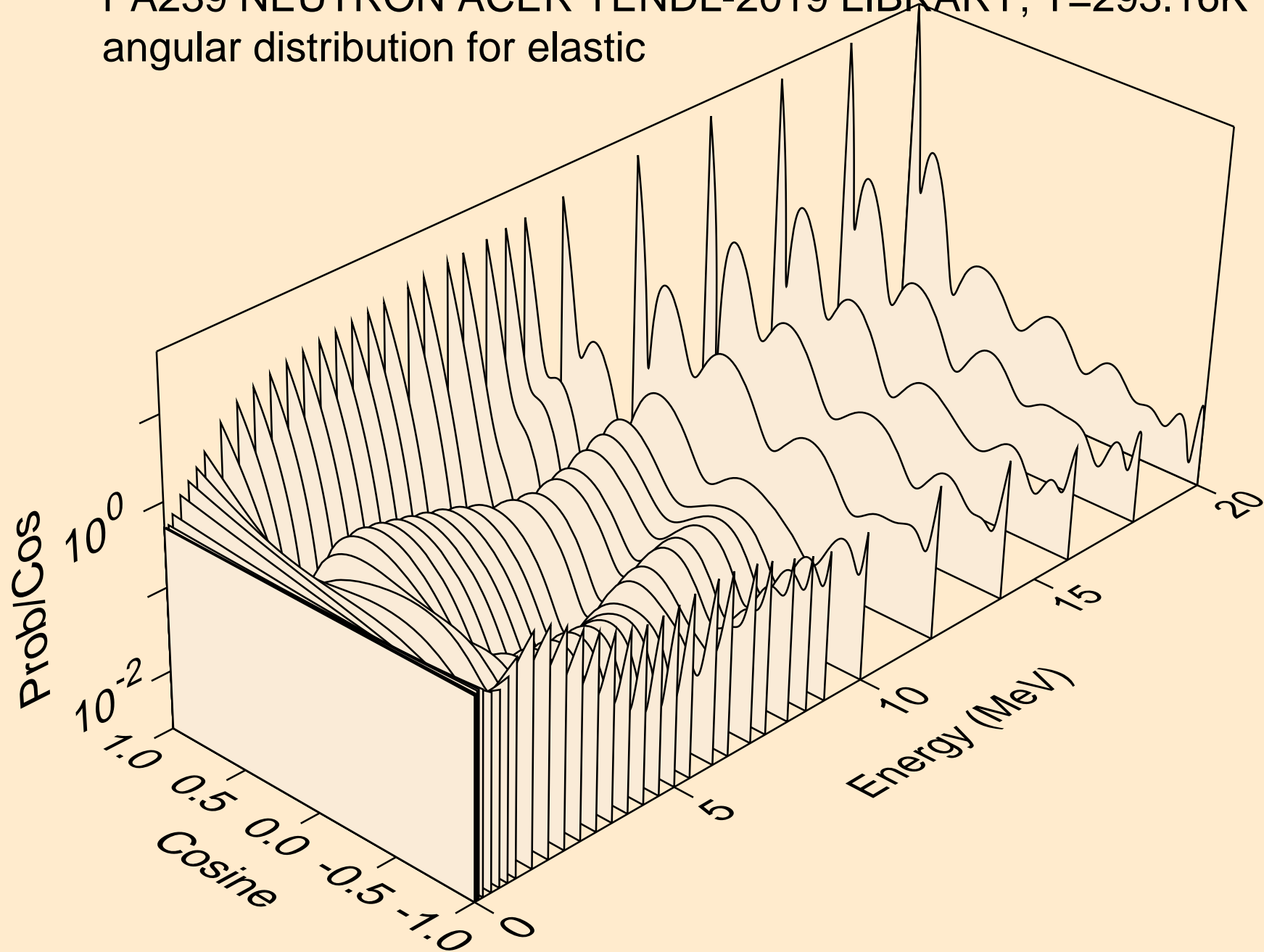

PA239 NEUTRON ACER TENDL-2019 LIBRARY; T=293.16K
angular distribution for elastic

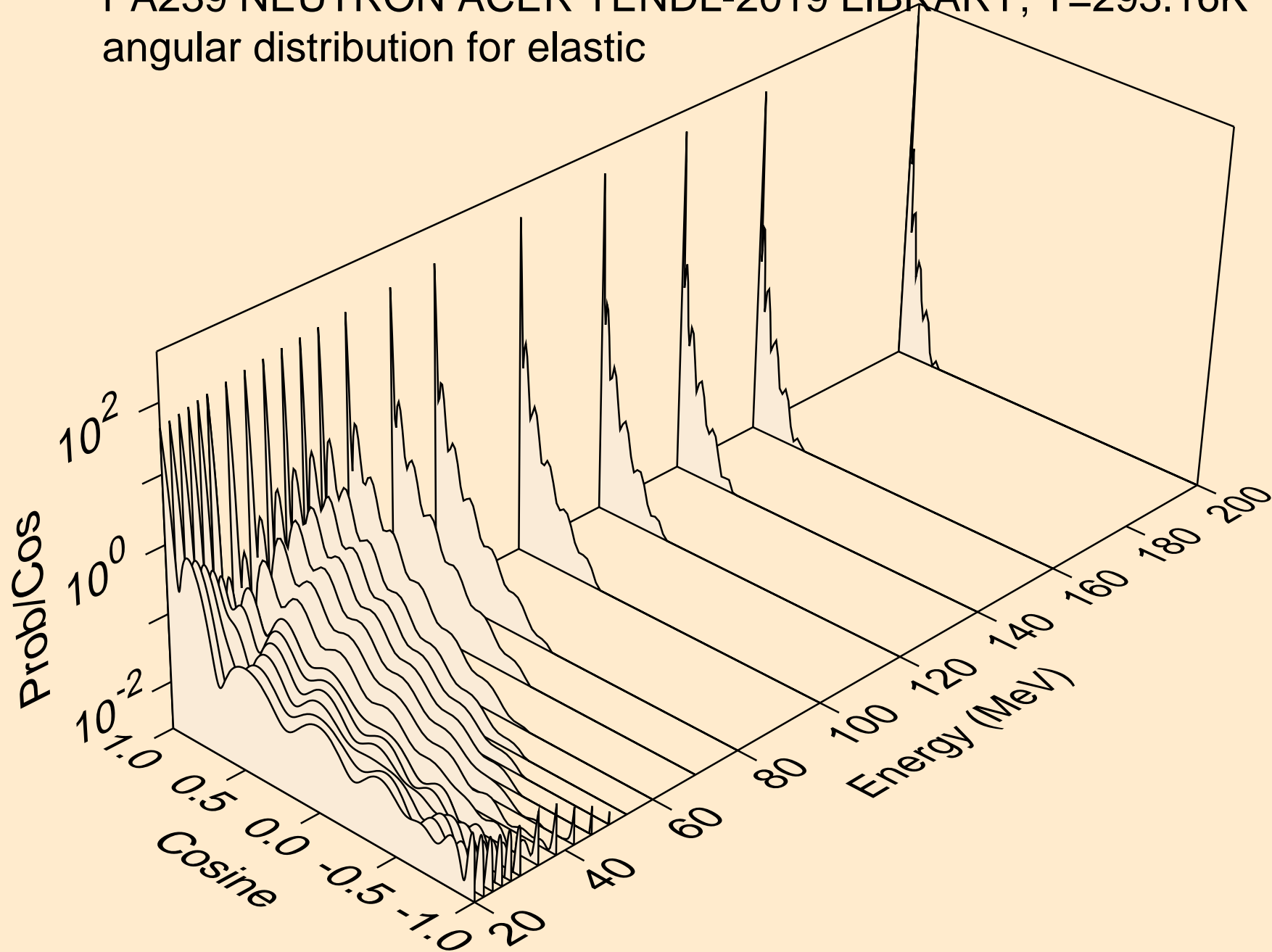

PA239 NEUTRON ACER TENDL-2019 LIBRARY; T=293.16K
angular distribution for (n,n*1)

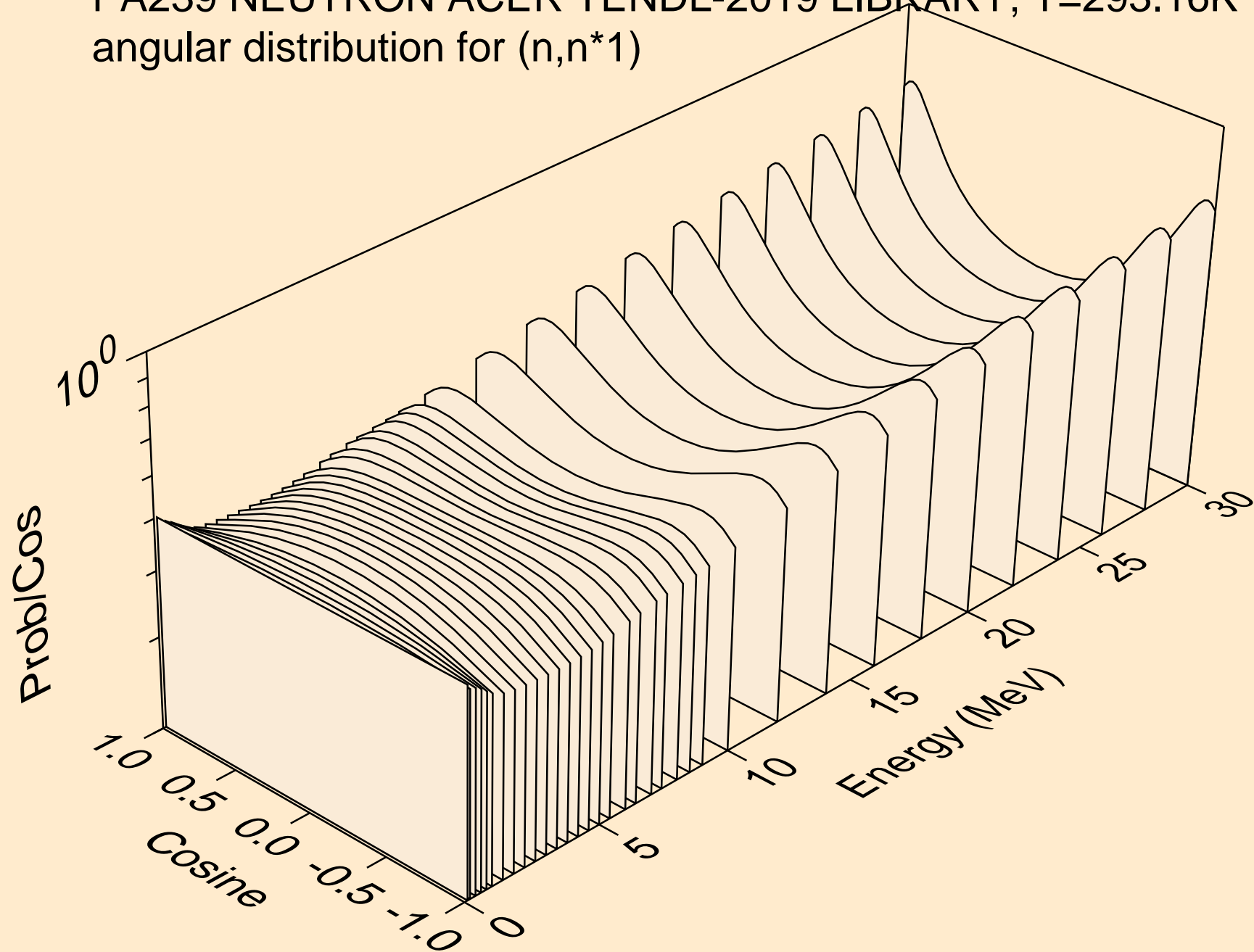

PA239 NEUTRON ACER TENDL-2019 LIBRARY; T=293.16K
Total fission nubar

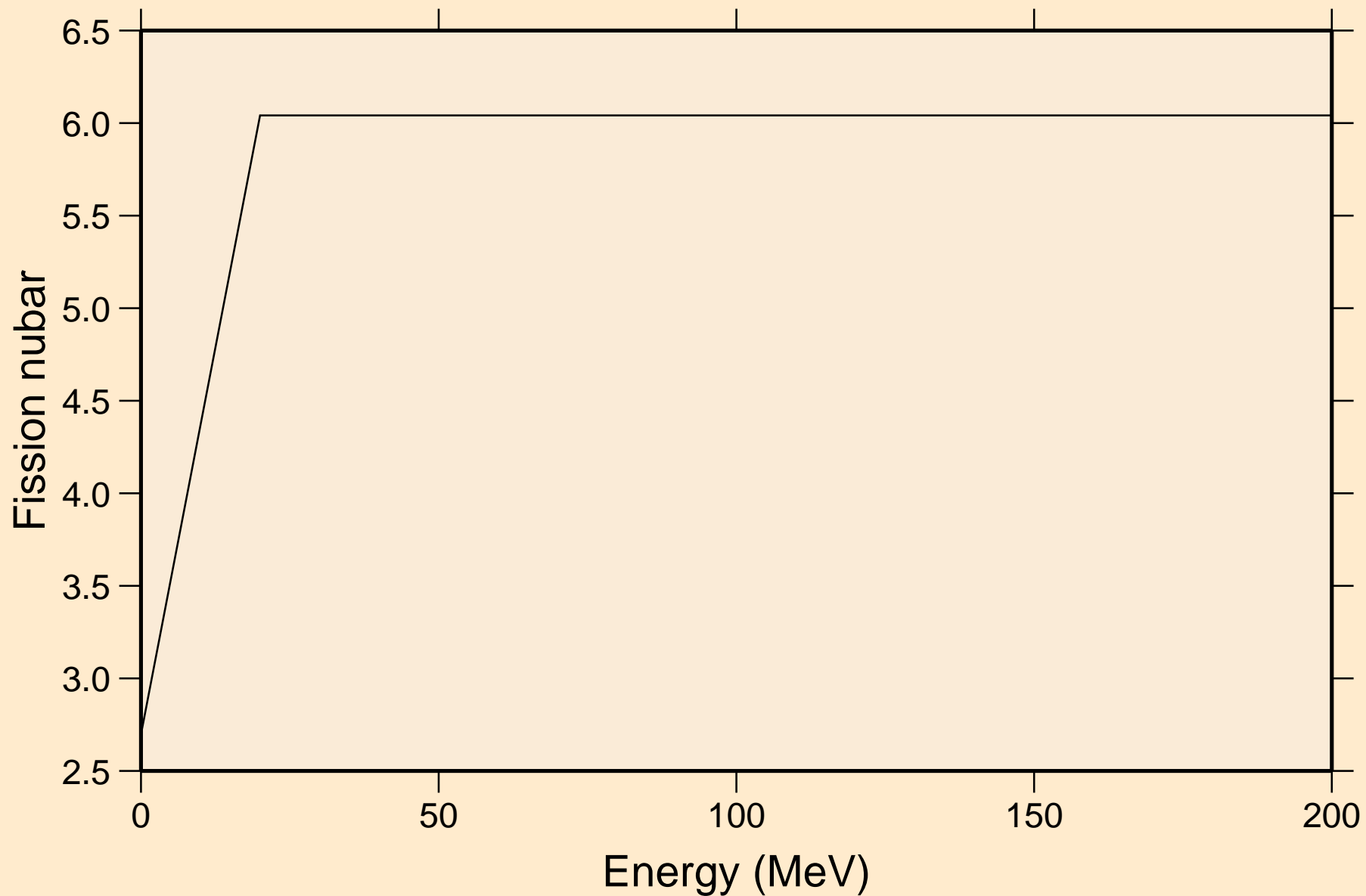

PA239 NEUTRON ACER TENDL-2019 LIBRARY; T=293.16K
Neutron emission for (n,x)

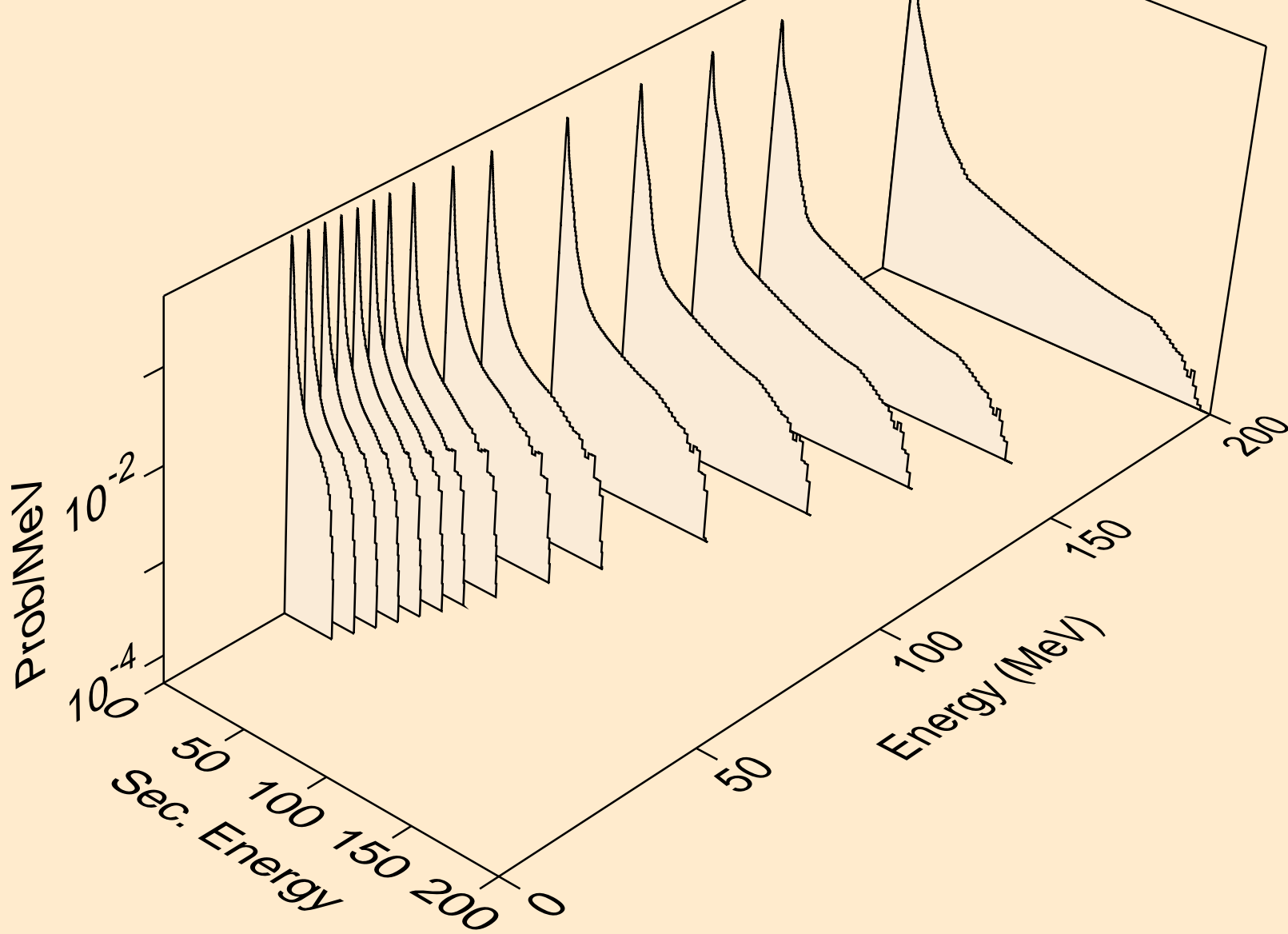

PA239 NEUTRON ACER TENDL-2019 LIBRARY; T=293.16K
Neutron emission for (n,2nd)

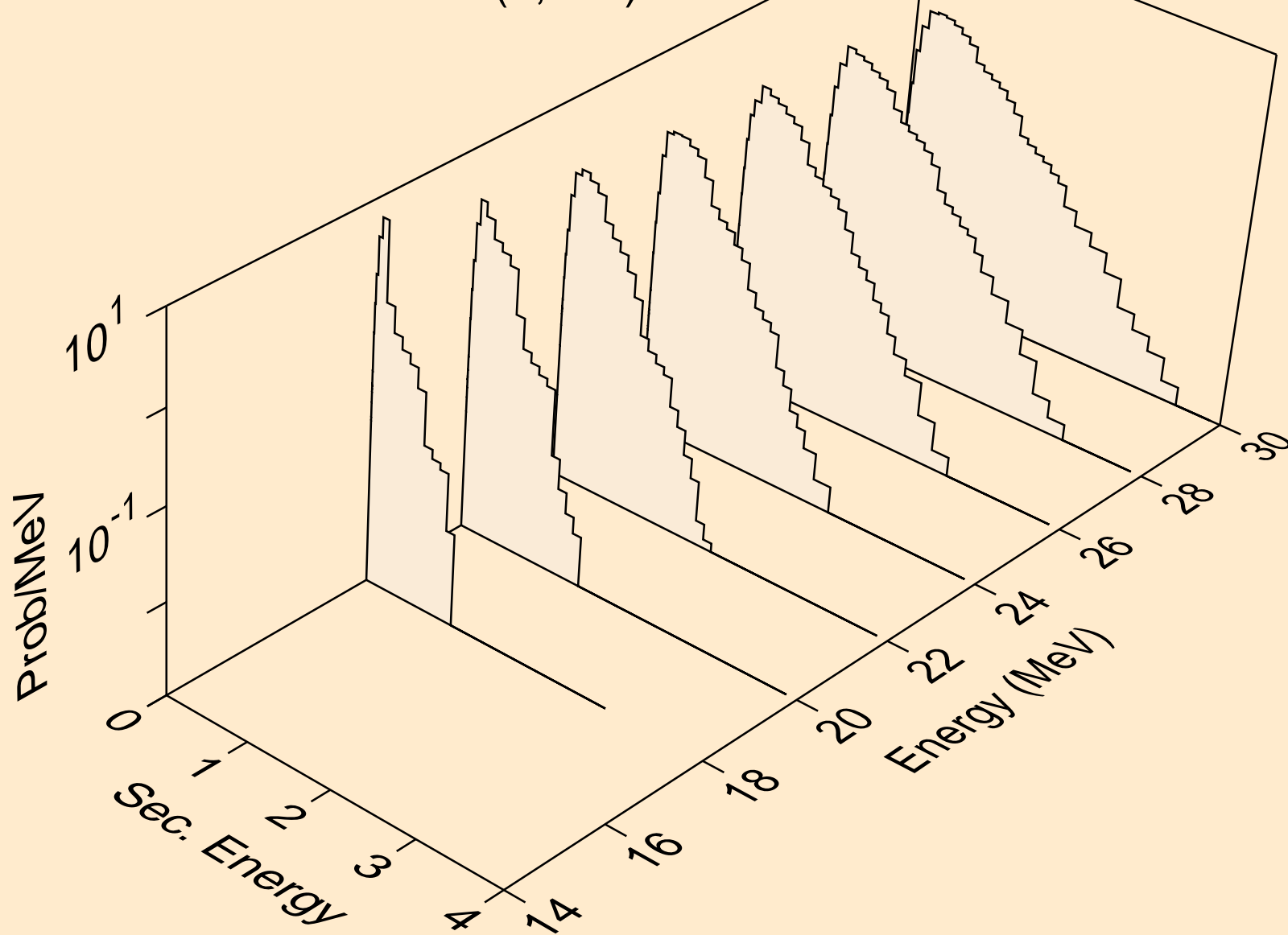

PA239 NEUTRON ACER TENDL-2019 LIBRARY; T=293.16K
Neutron emission for (n,2n)

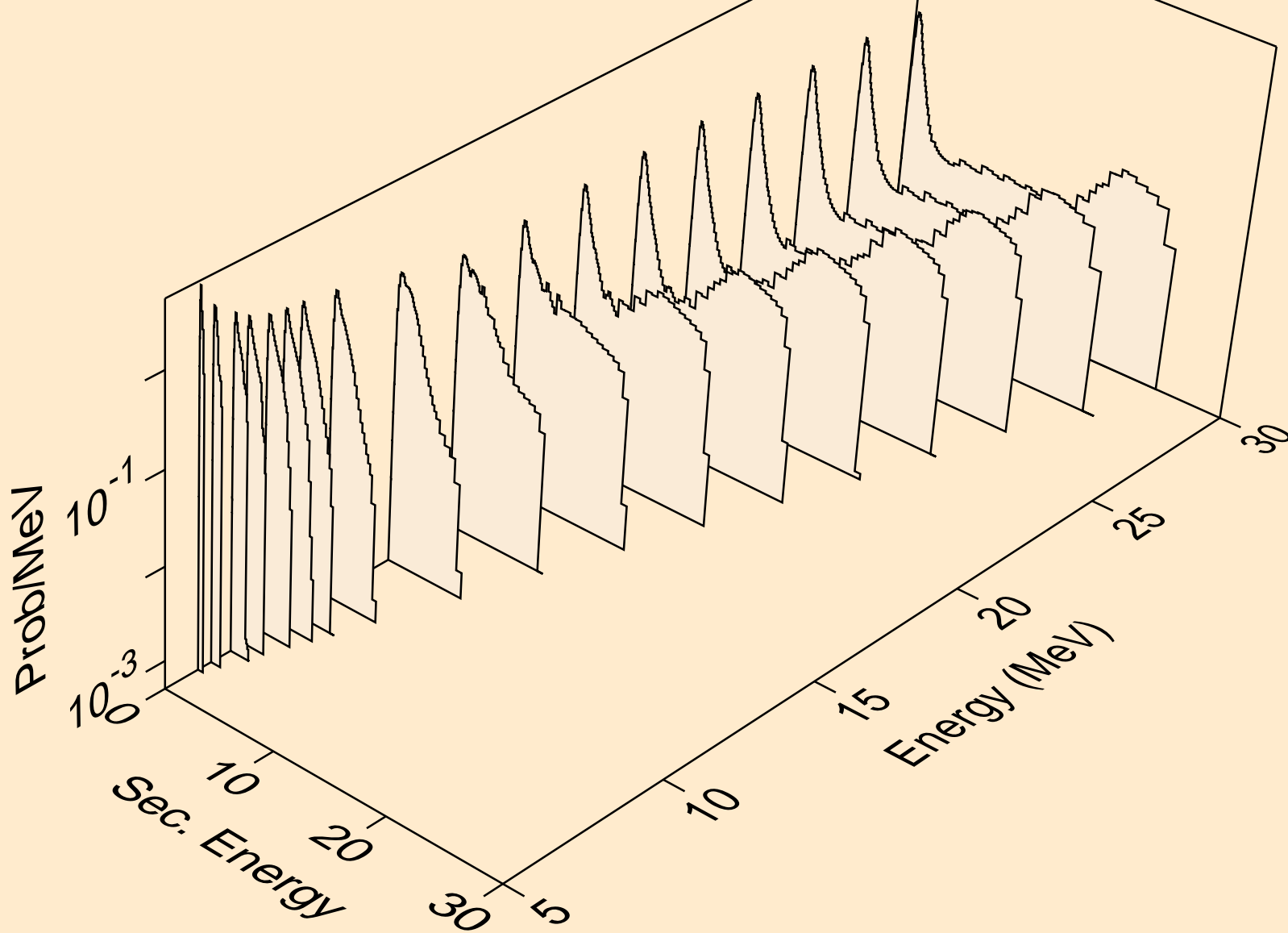

PA239 NEUTRON ACER TENDL-2019 LIBRARY; T=293.16K
Neutron emission for (n,3n)

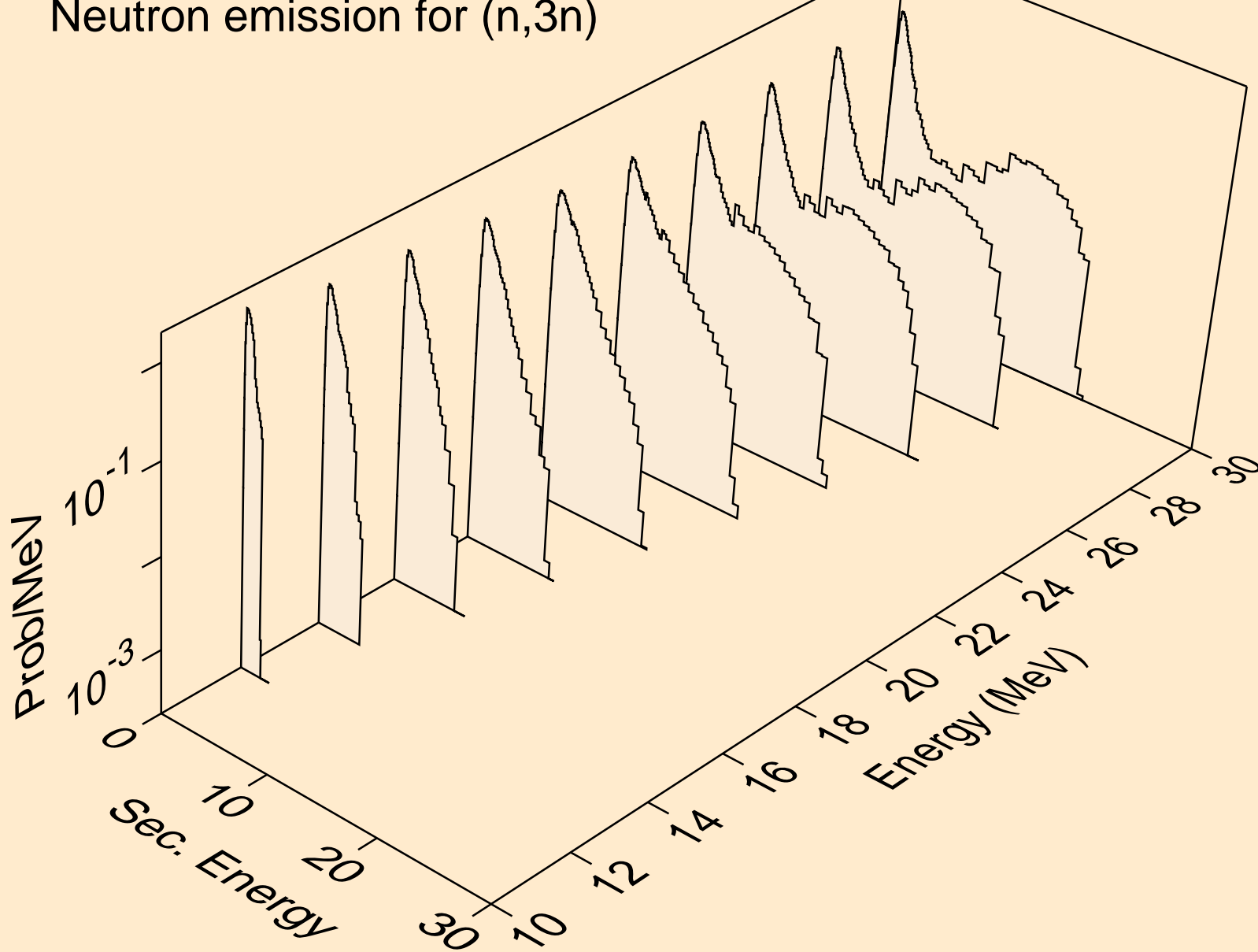

PA239 NEUTRON ACER TENDL-2019 LIBRARY; T=293.16K
Neutron emission for fission

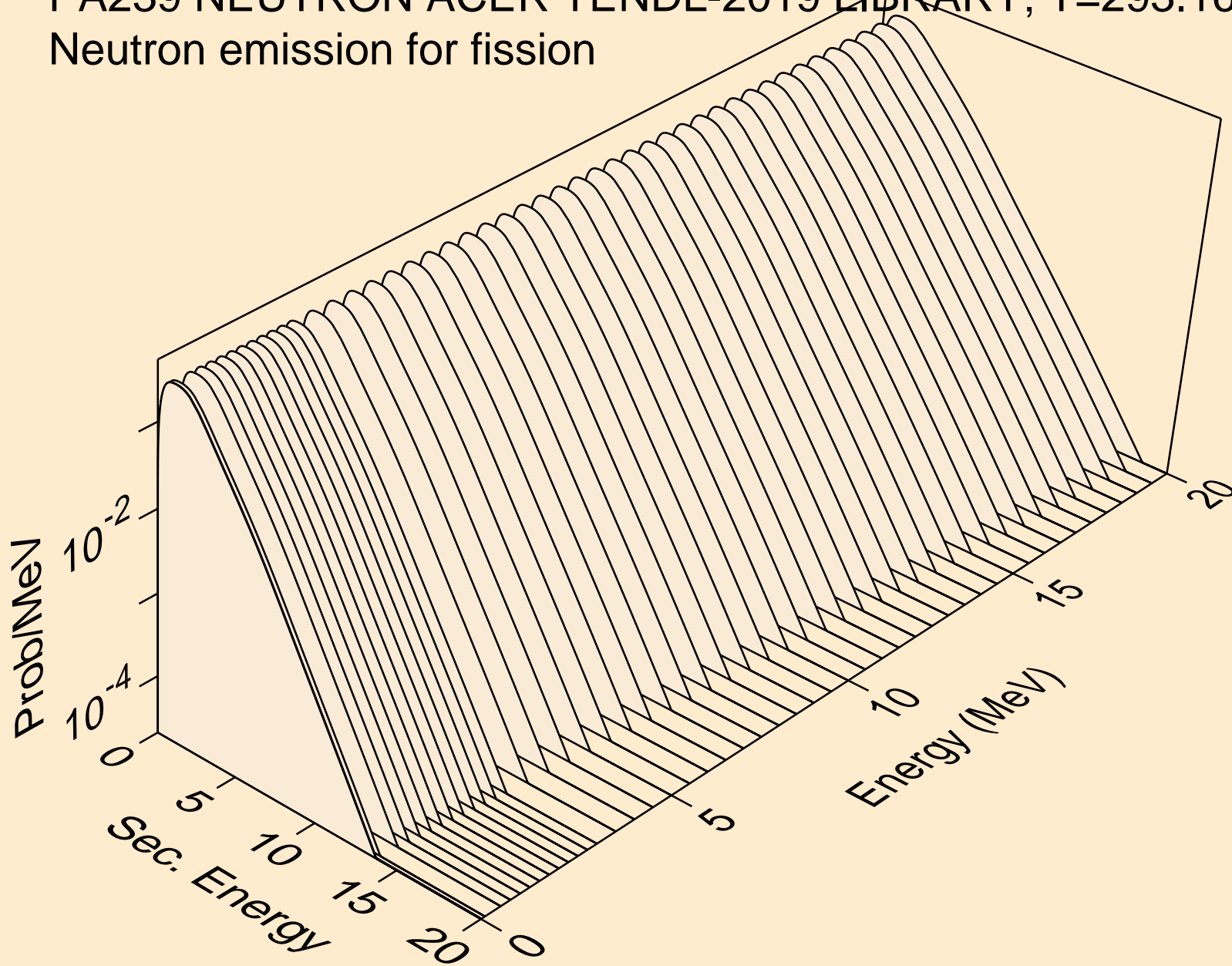

PA239 NEUTRON ACER TENDL-2019 LIBRARY; T=293.16K
Neutron emission for (n,n*)a

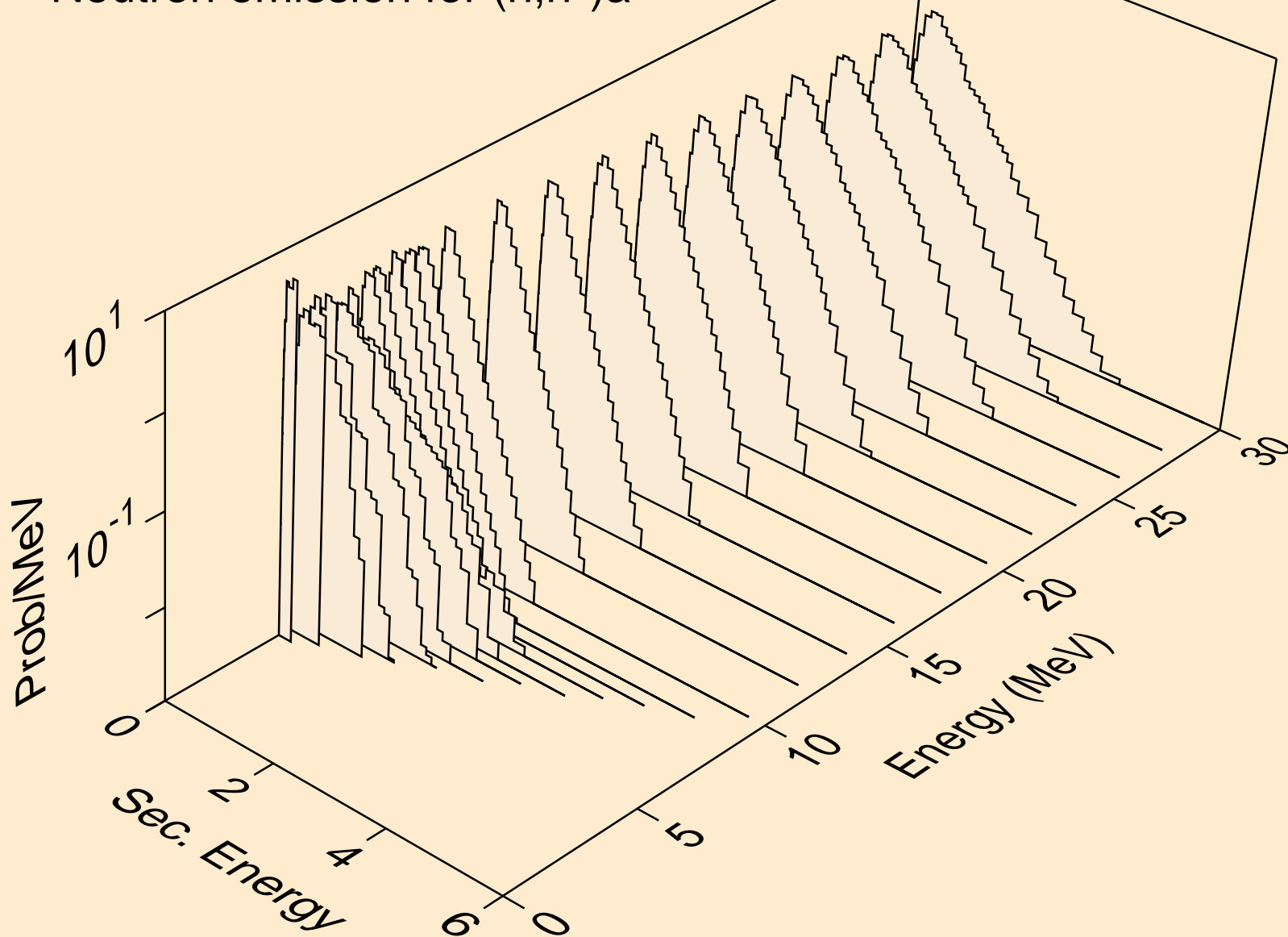

PA239 NEUTRON ACER TENDL-2019 LIBRARY; T=293.16K
Neutron emission for (n,2n)a

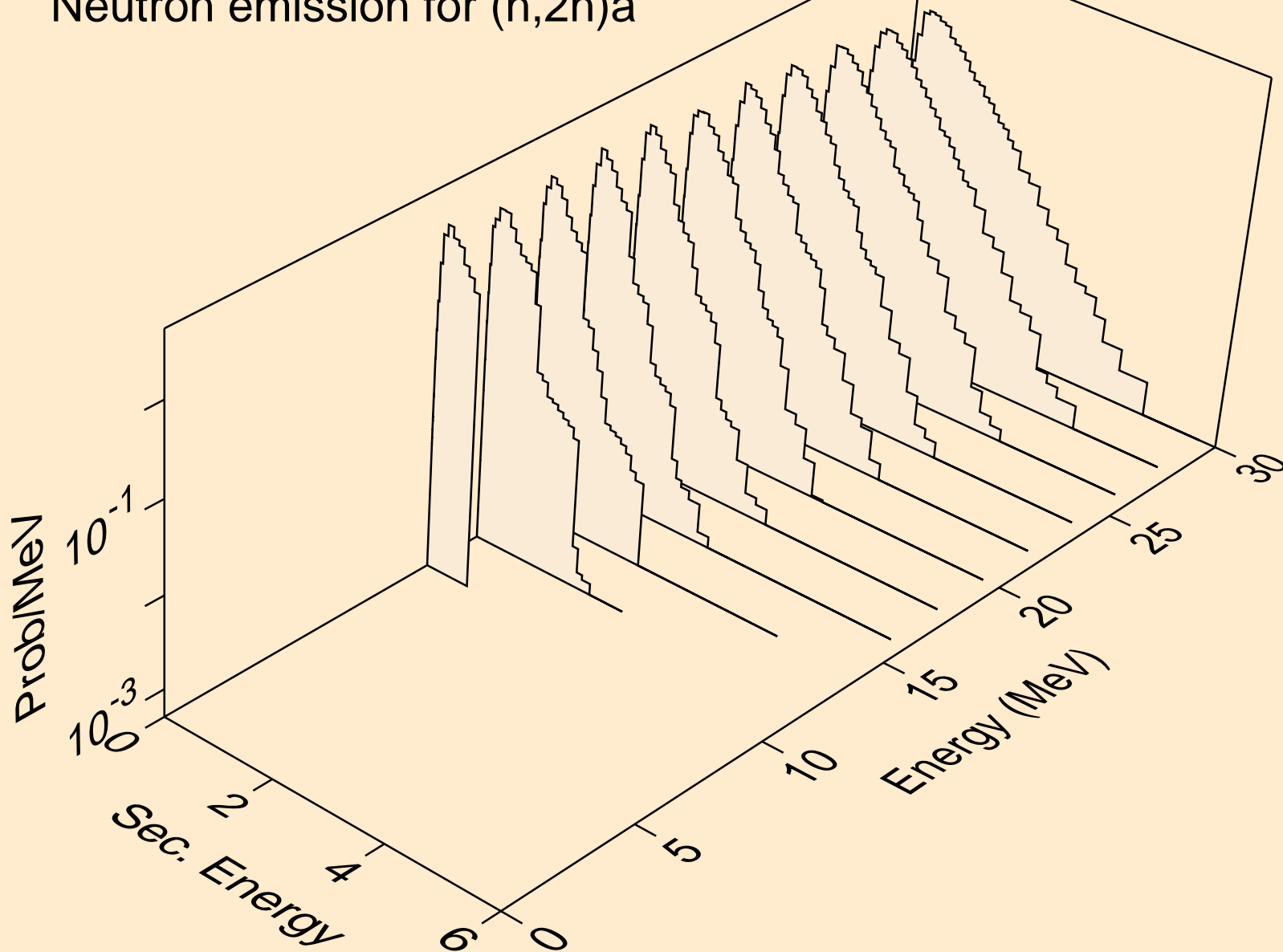

PA239 NEUTRON ACER TENDL-2019 LIBRARY; T=293.16K
Neutron emission for (n,3n)a

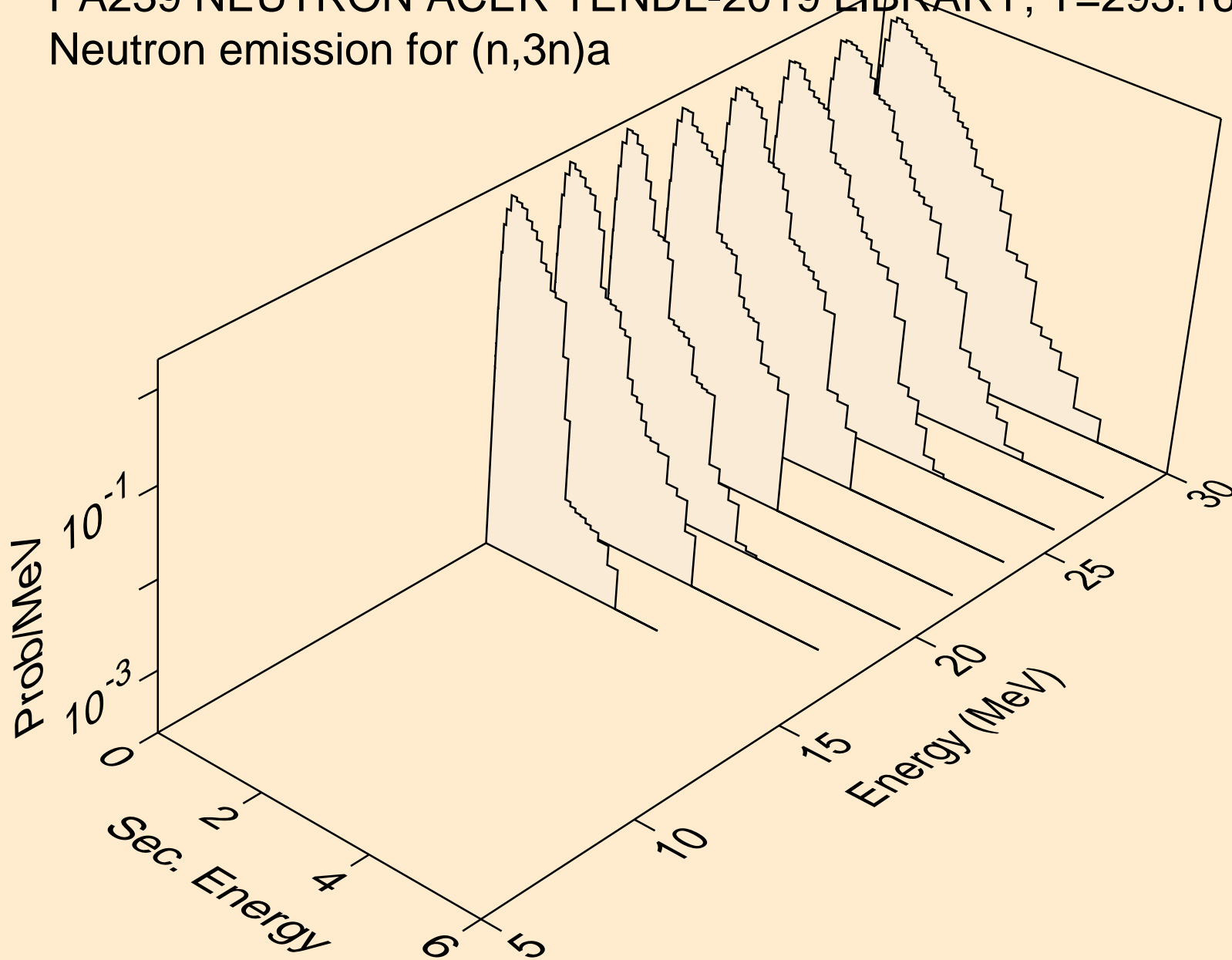

PA239 NEUTRON ACER TENDL-2019 LIBRARY; T=293.16K
Neutron emission for (n,n*)p

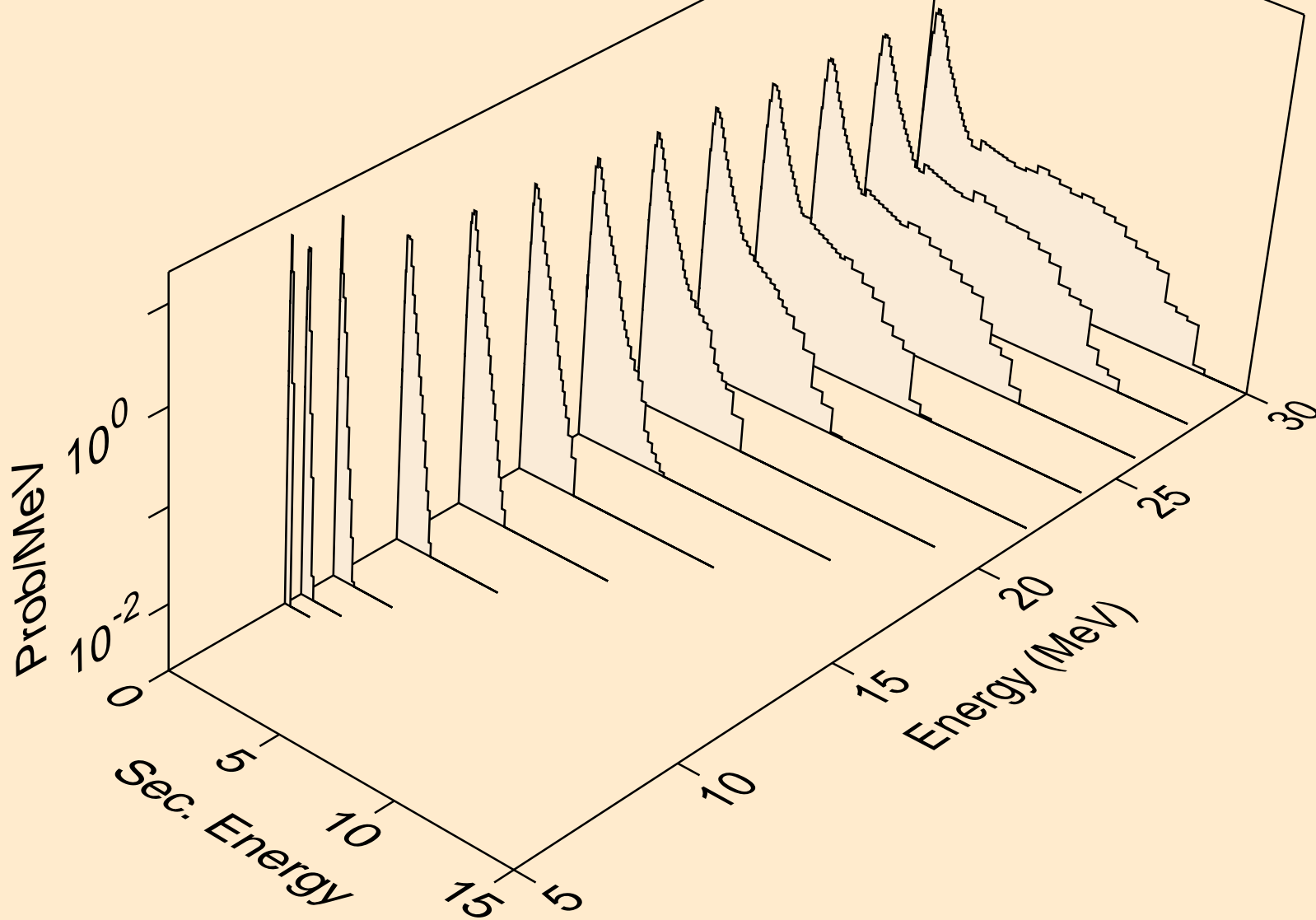

PA239 NEUTRON ACER TENDL-2019 LIBRARY; T=293.16K
Neutron emission for (n,n*)d

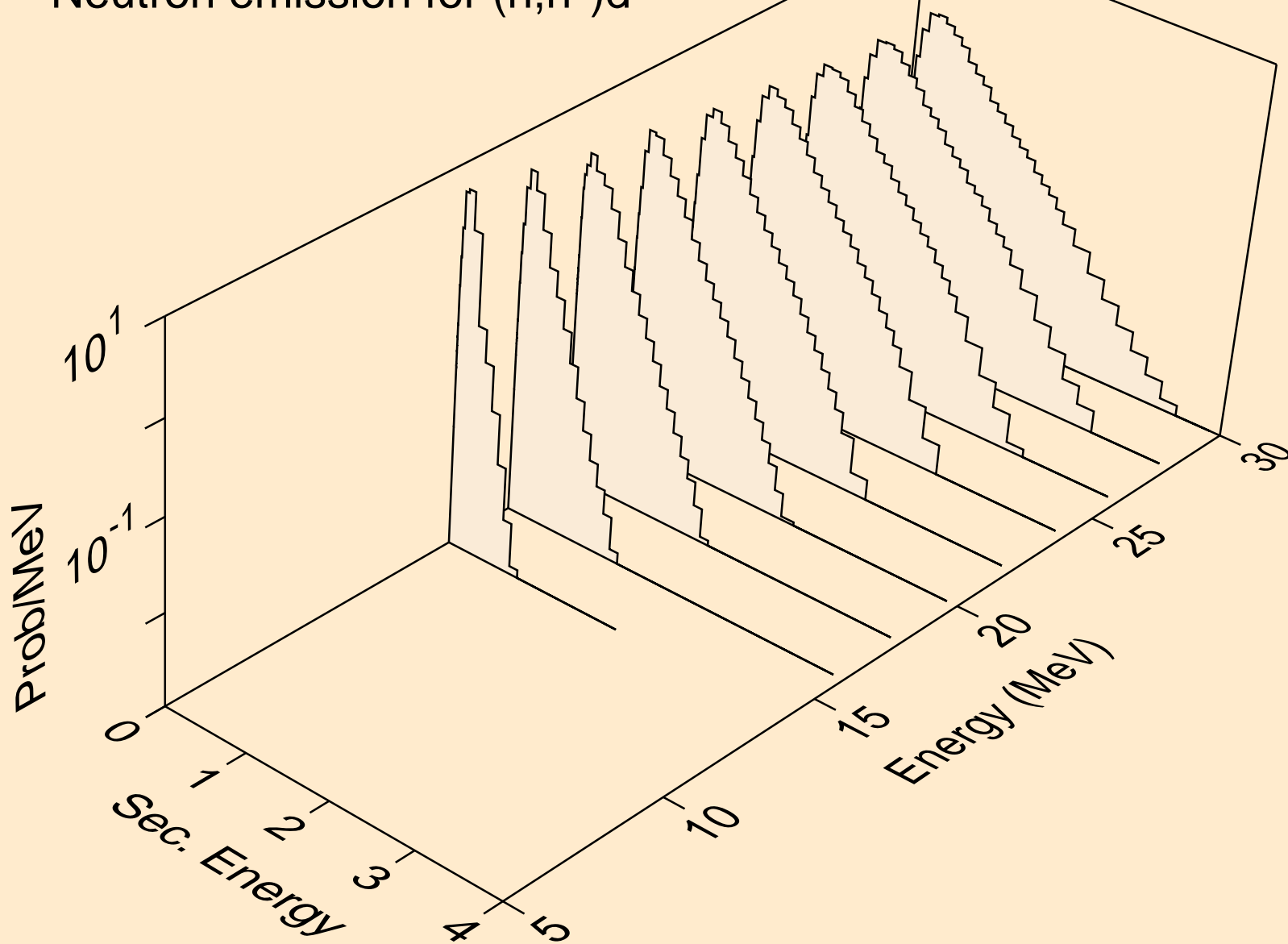

PA239 NEUTRON ACER TENDL-2019 LIBRARY; T=293.16K
Neutron emission for (n,n*)t

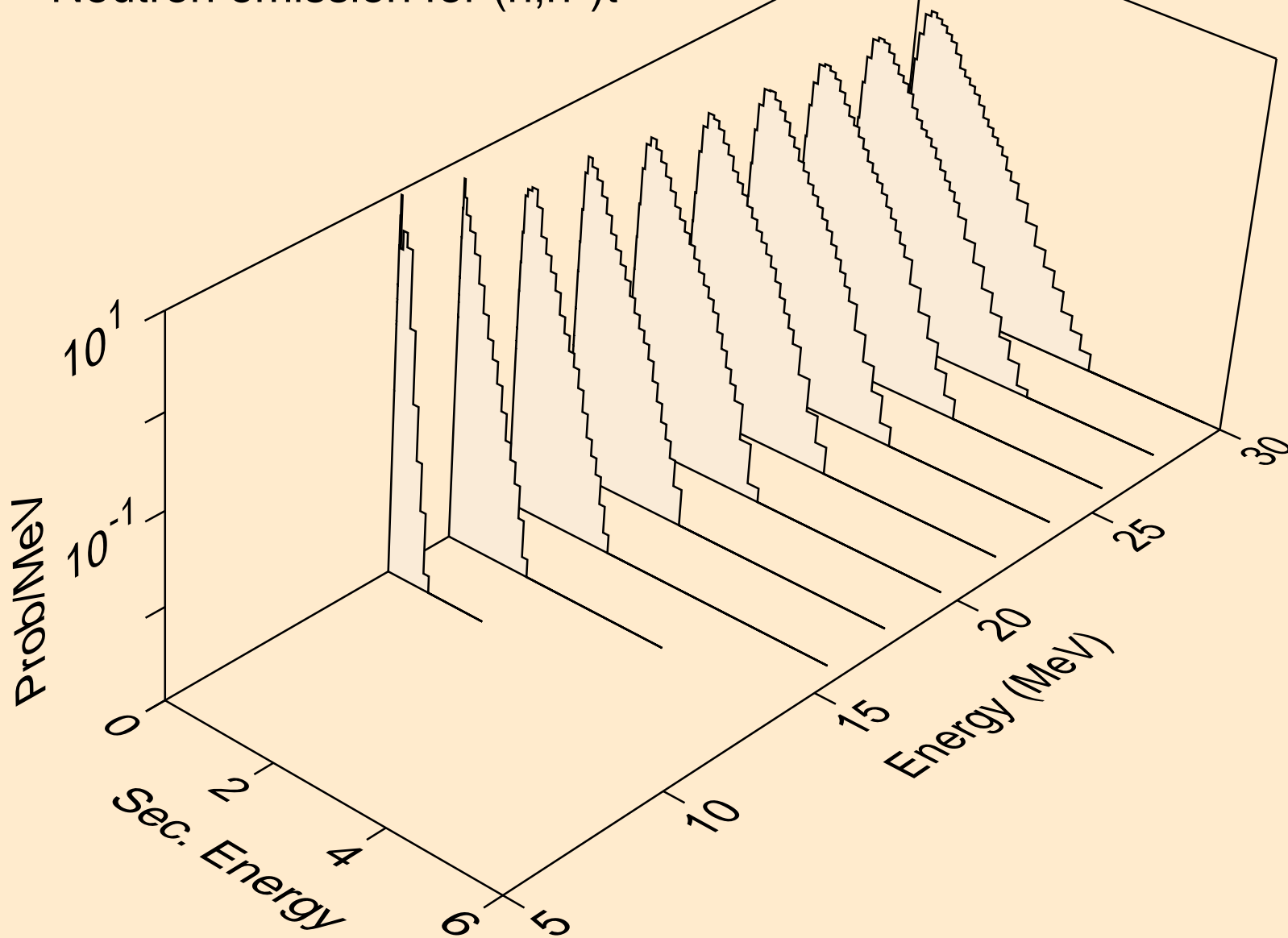

PA239 NEUTRON ACER TENDL-2019 LIBRARY; T=293.16K
Neutron emission for (n,n*)he3

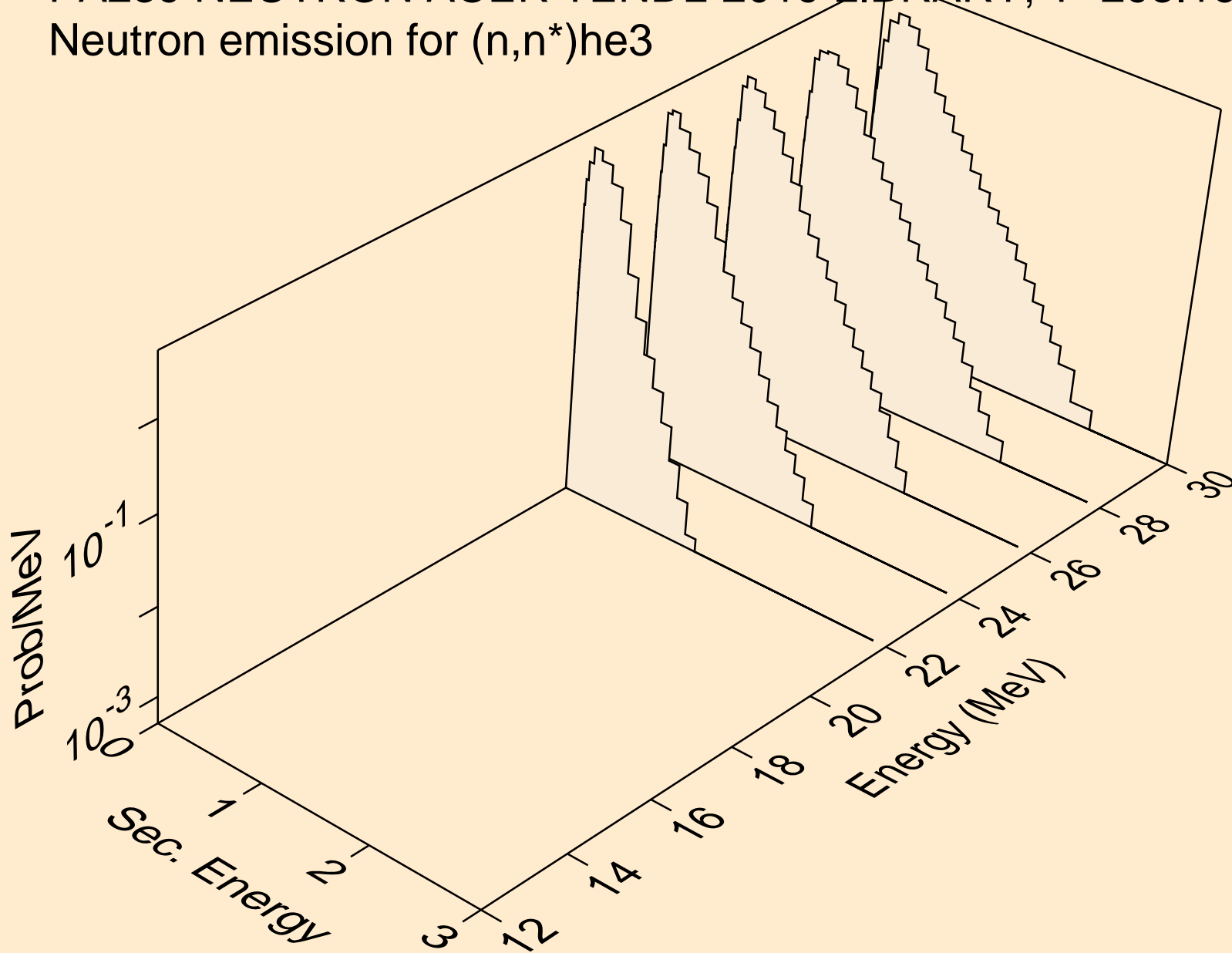

PA239 NEUTRON ACER TENDL-2019 LIBRARY; T=293.16K
Neutron emission for (n,4n)

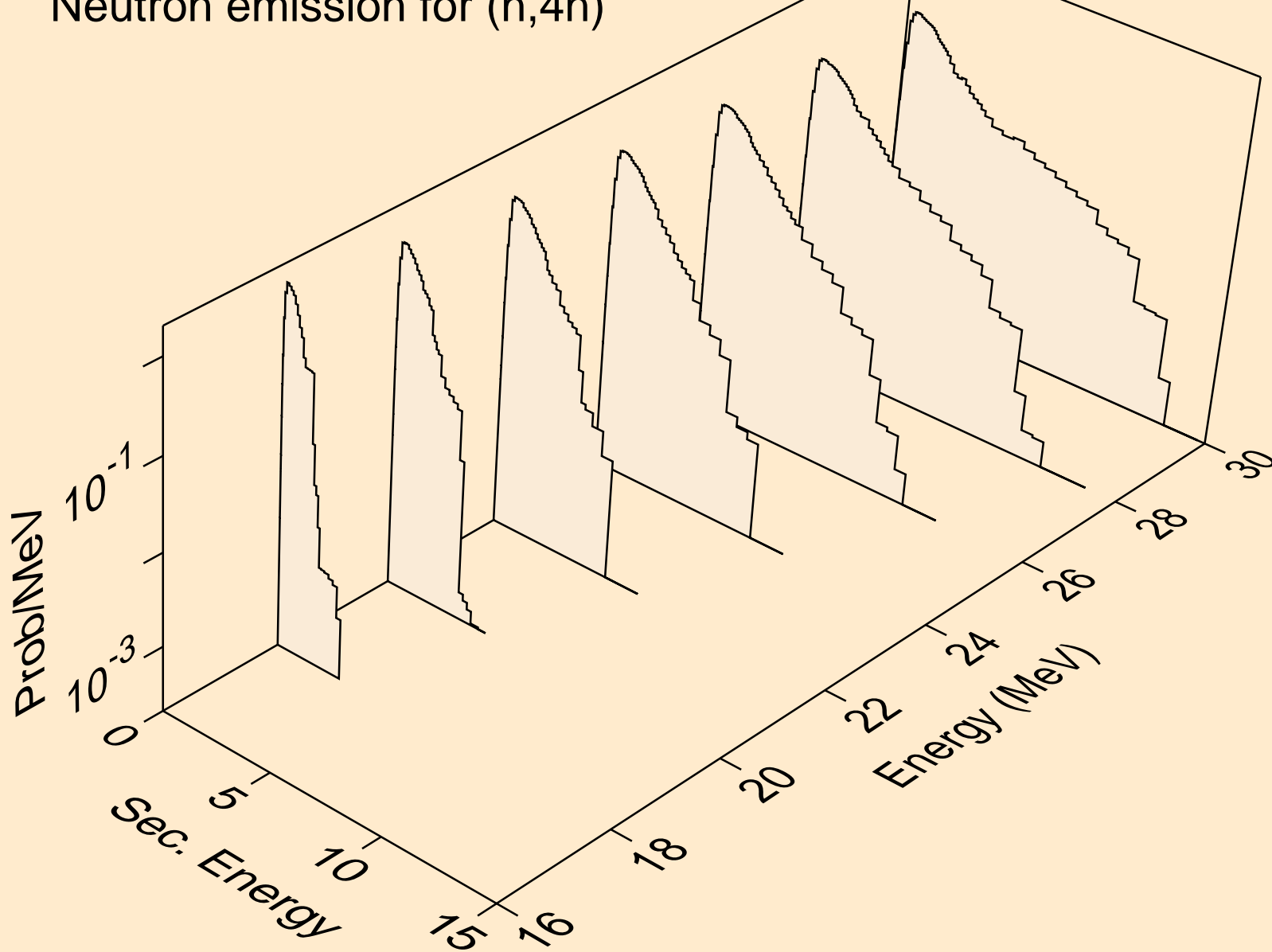

PA239 NEUTRON ACER TENDL-2019 LIBRARY; T=293.16K
Neutron emission for (n,2np)

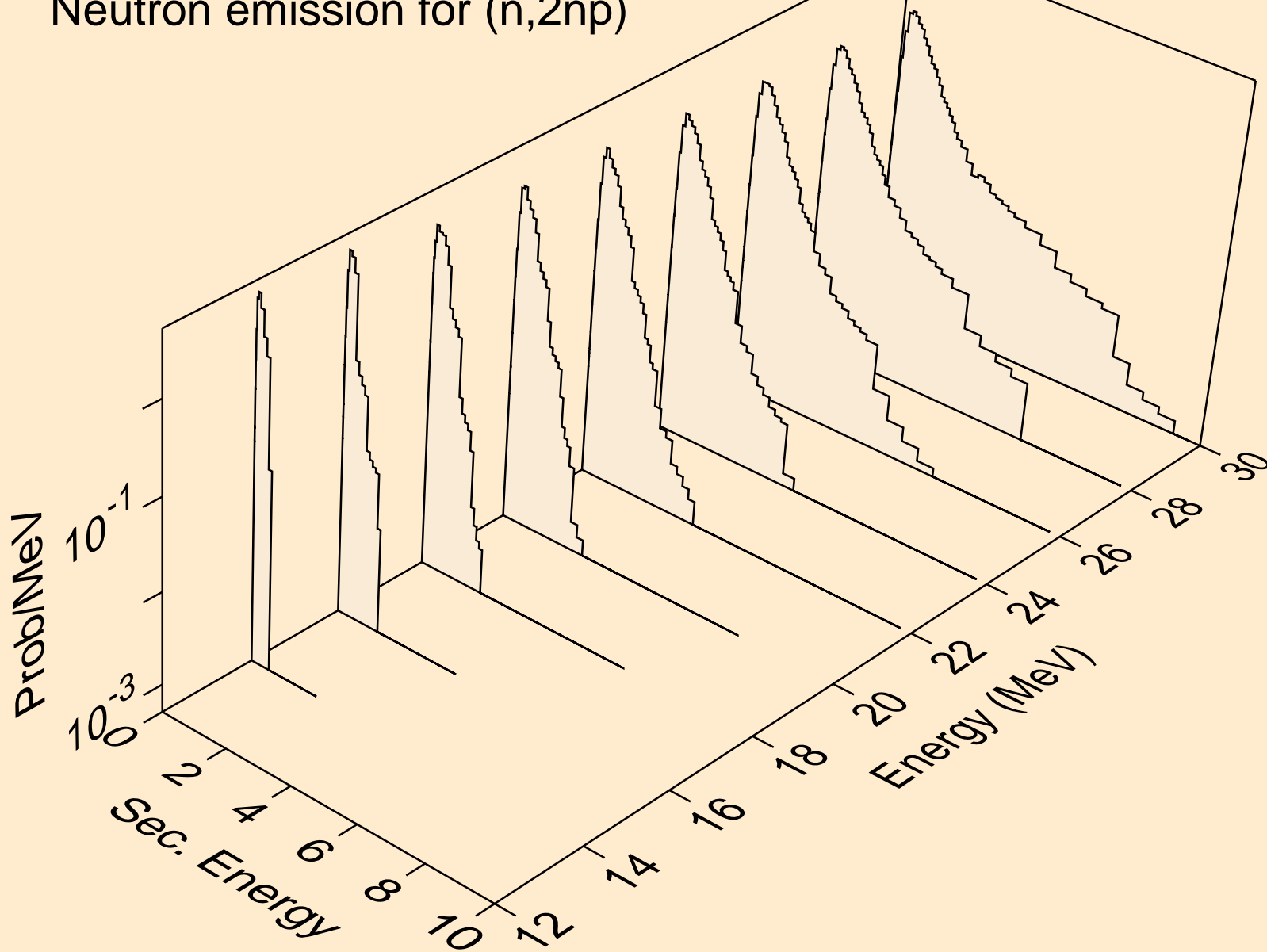

PA239 NEUTRON ACER TENDL-2019 LIBRARY; T=293.16K
Neutron emission for (n,3np)

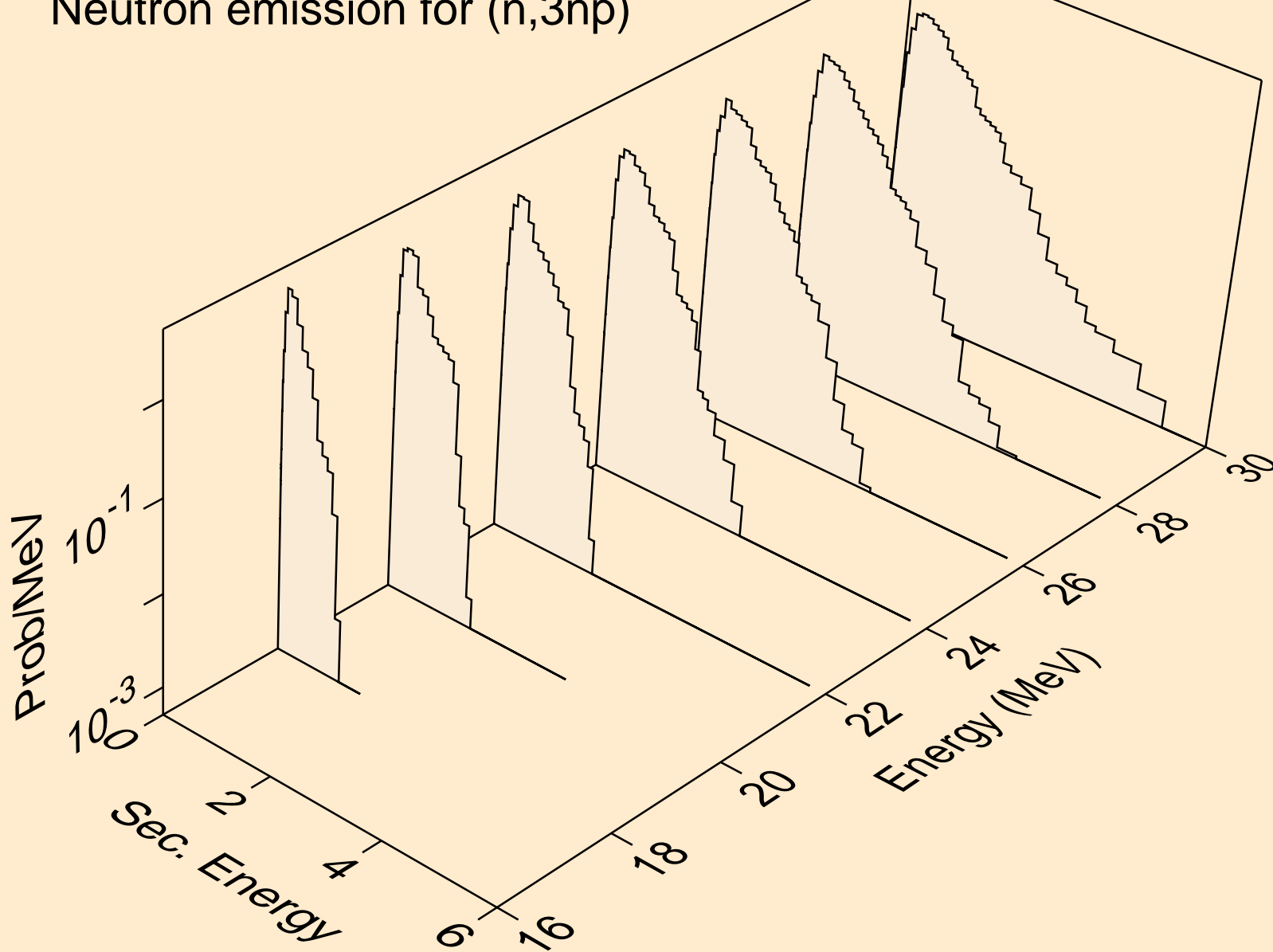

PA239 NEUTRON ACER TENDL-2019 LIBRARY; T=293.16K
Neutron emission for (n,n*c)

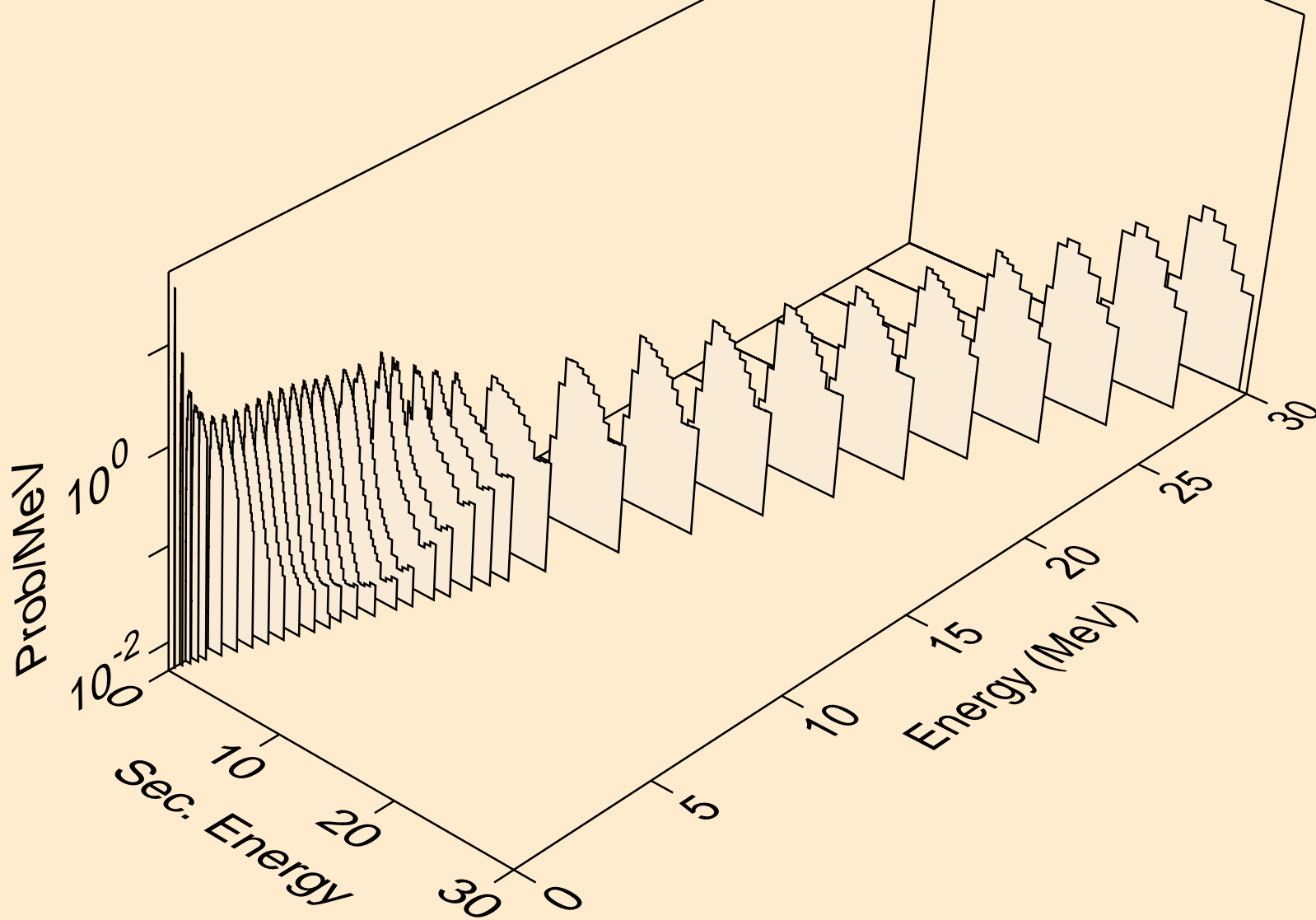

PA239 NEUTRON ACER TENDL-2019 LIBRARY; T=293.16K
Delayed nubar

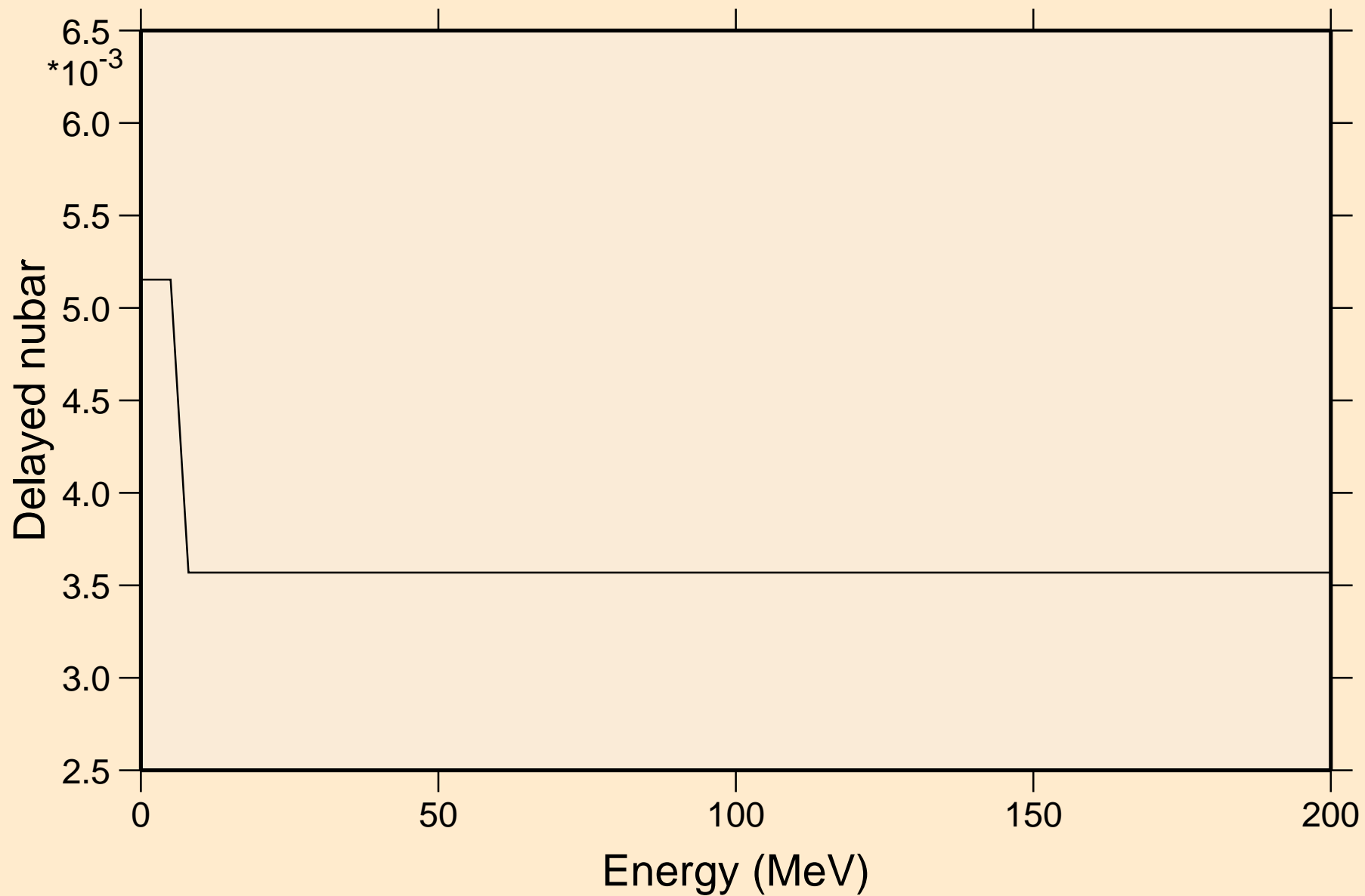

PA239 NEUTRON ACER TENDL-2019 LIBRARY; T=293.16K
Delayed neutron spectra

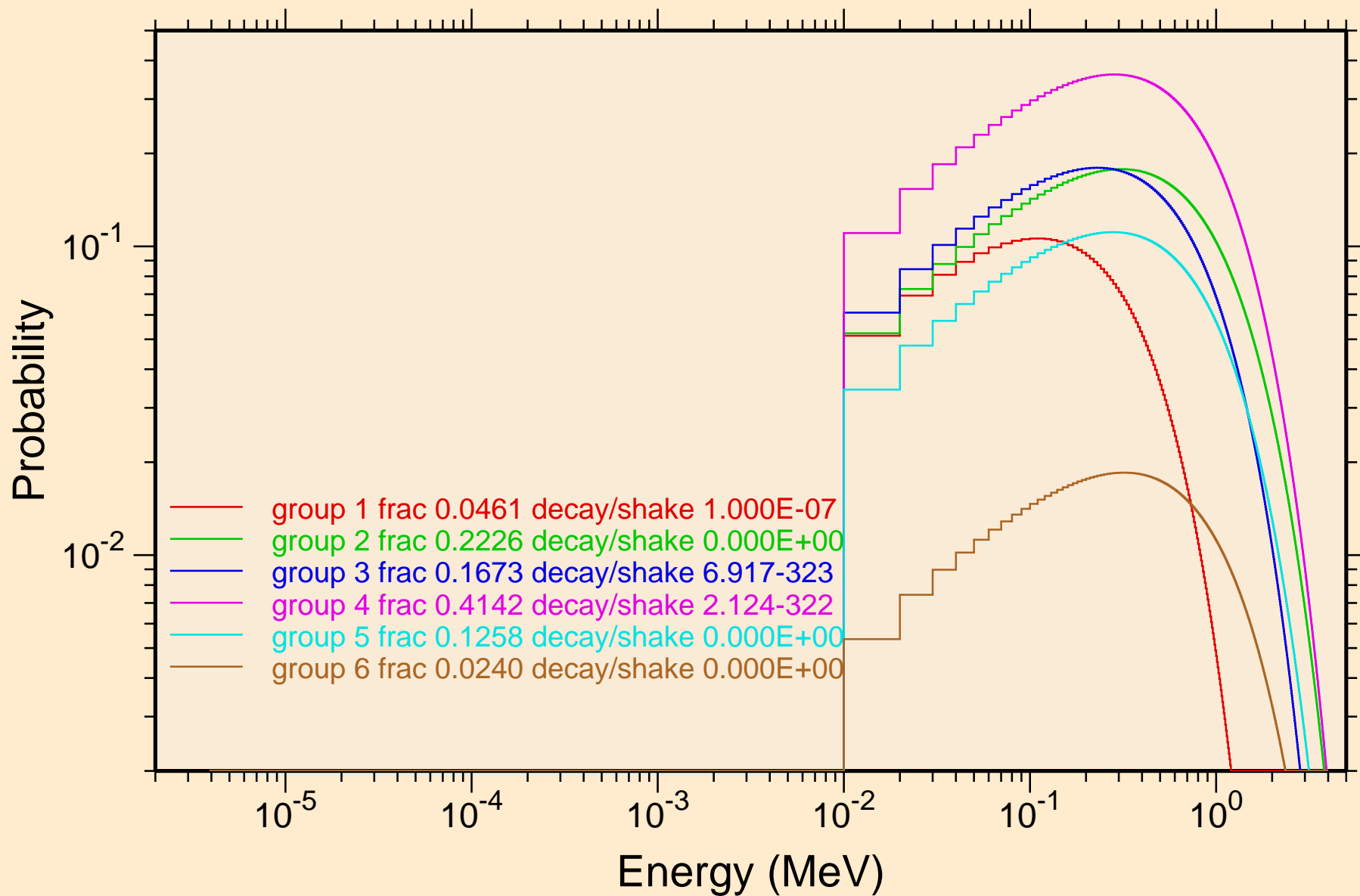

PA239 NEUTRON ACER TENDL-2019 LIBRARY; T=293.16K
Photon emission for (n,x)

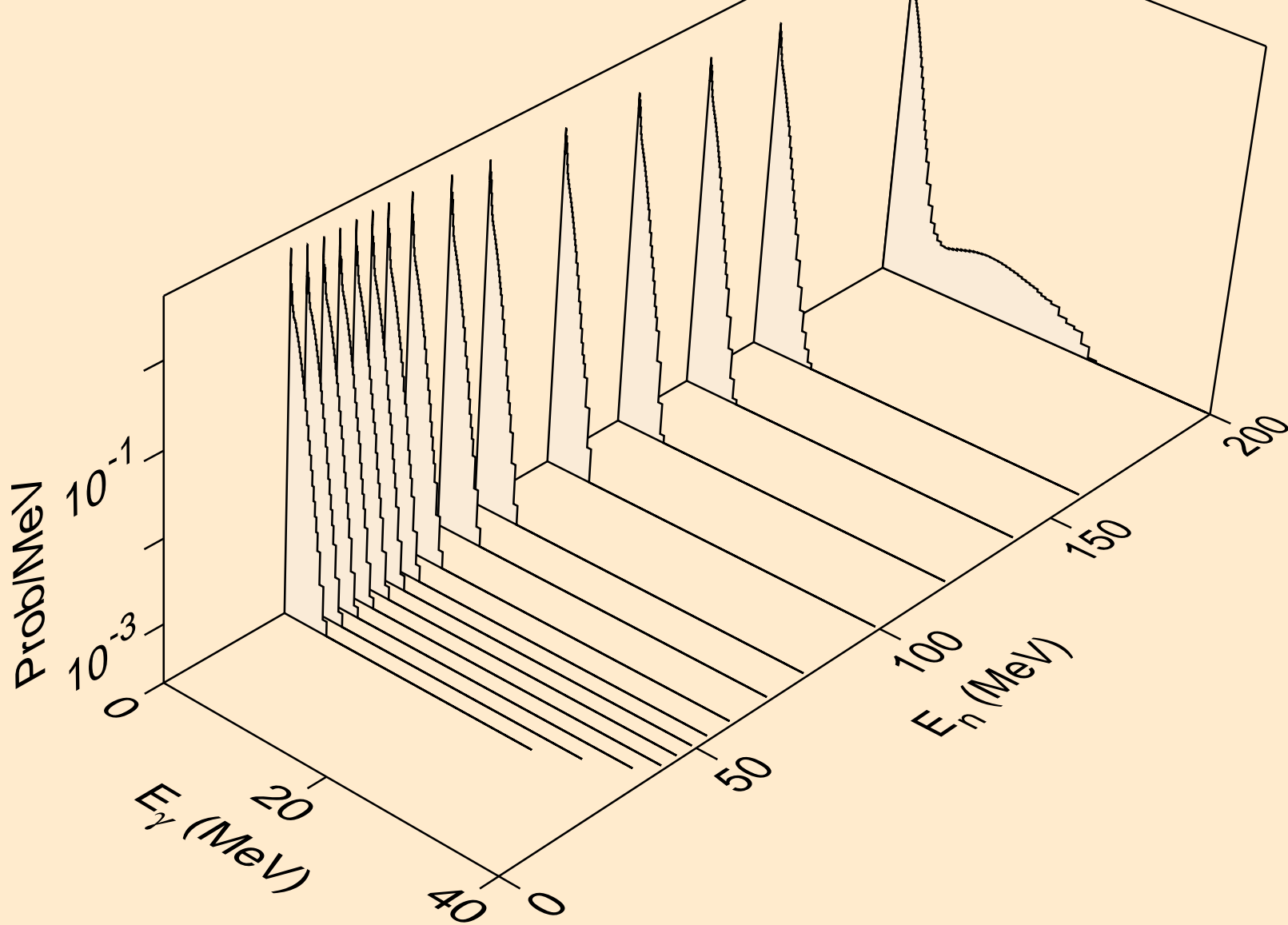

PA239 NEUTRON ACER TENDL-2019 LIBRARY; T=293.16K
Photon emission for (n,2nd)

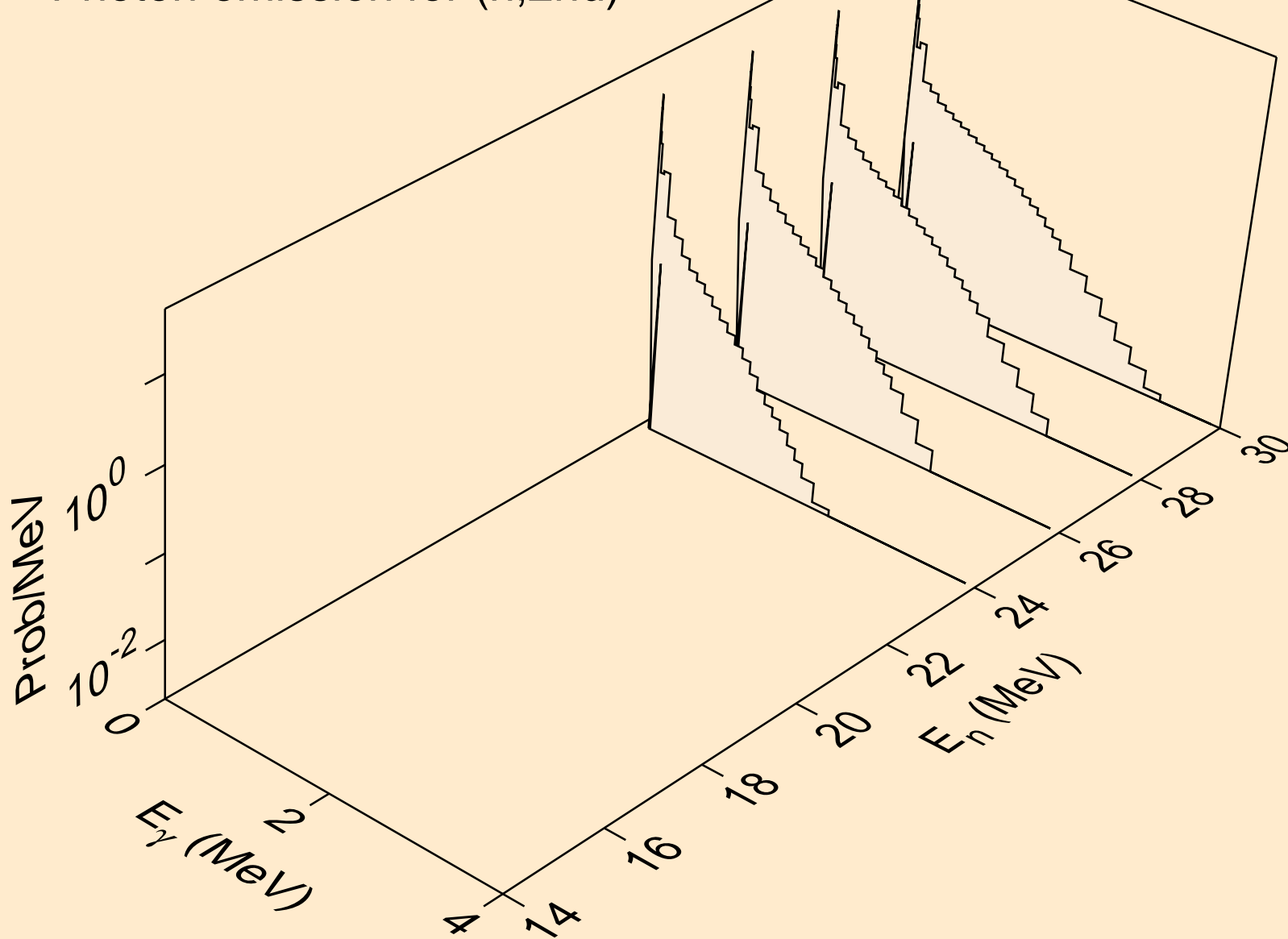

PA239 NEUTRON ACER TENDL-2019 LIBRARY; T=293.16K
Photon emission for (n,2n)

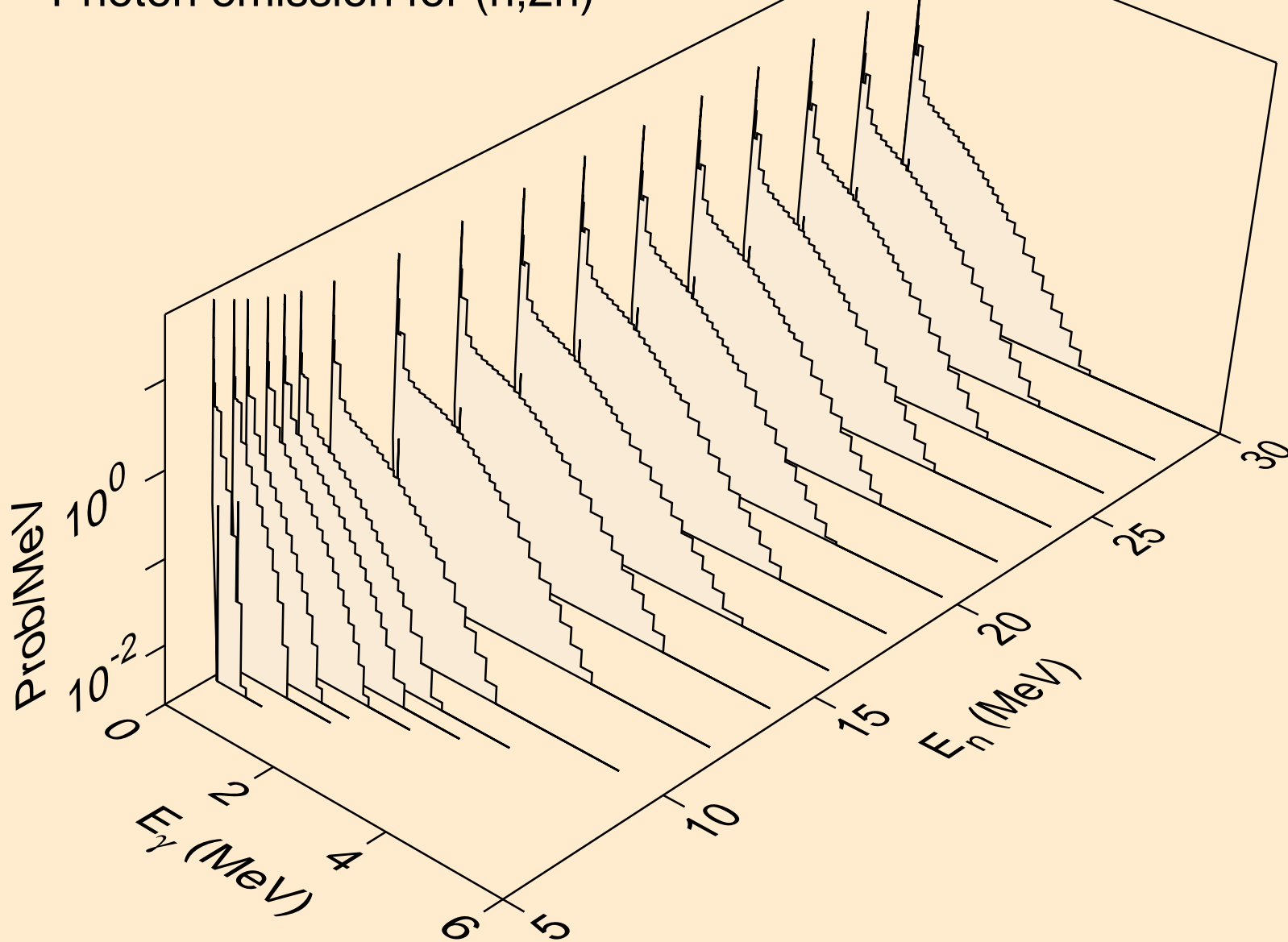

PA239 NEUTRON ACER TENDL-2019 LIBRARY; T=293.16K
Photon emission for (n,3n)

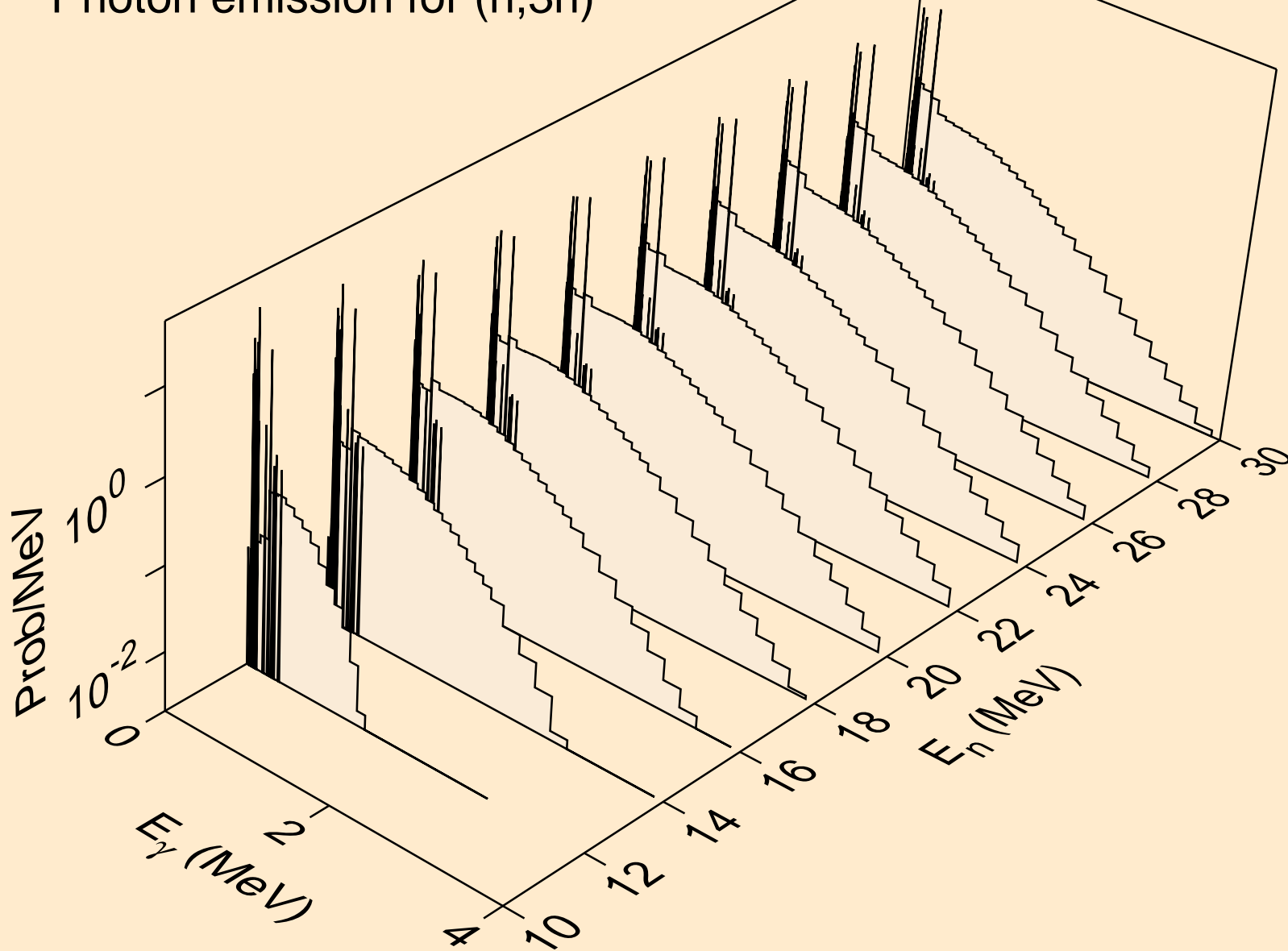

PA239 NEUTRON ACER TENDL-2019 LIBRARY; T=293.16K
Photon emission for (n,n*)a

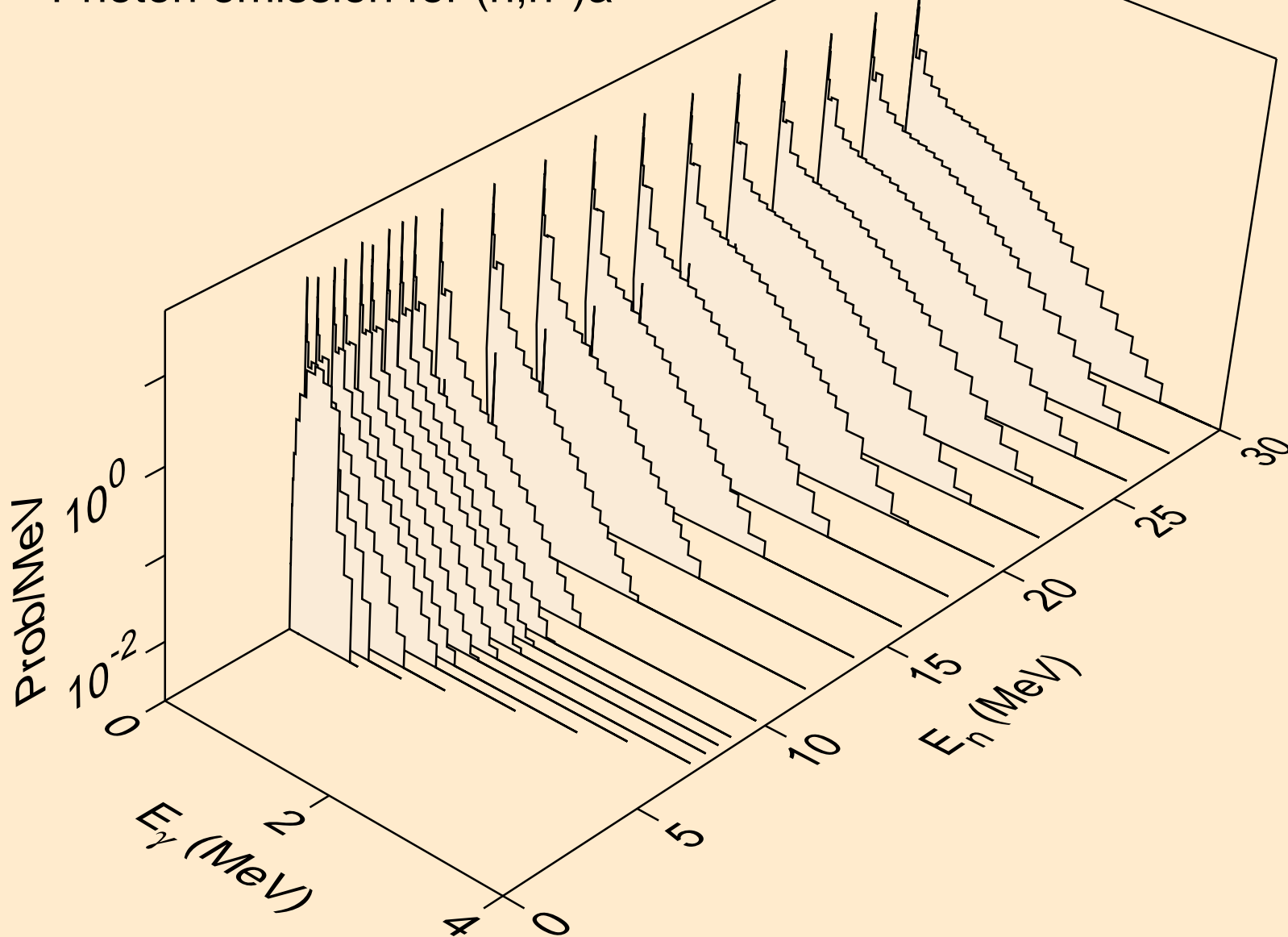

PA239 NEUTRON ACER TENDL-2019 LIBRARY; T=293.16K
Photon emission for (n,2n)a

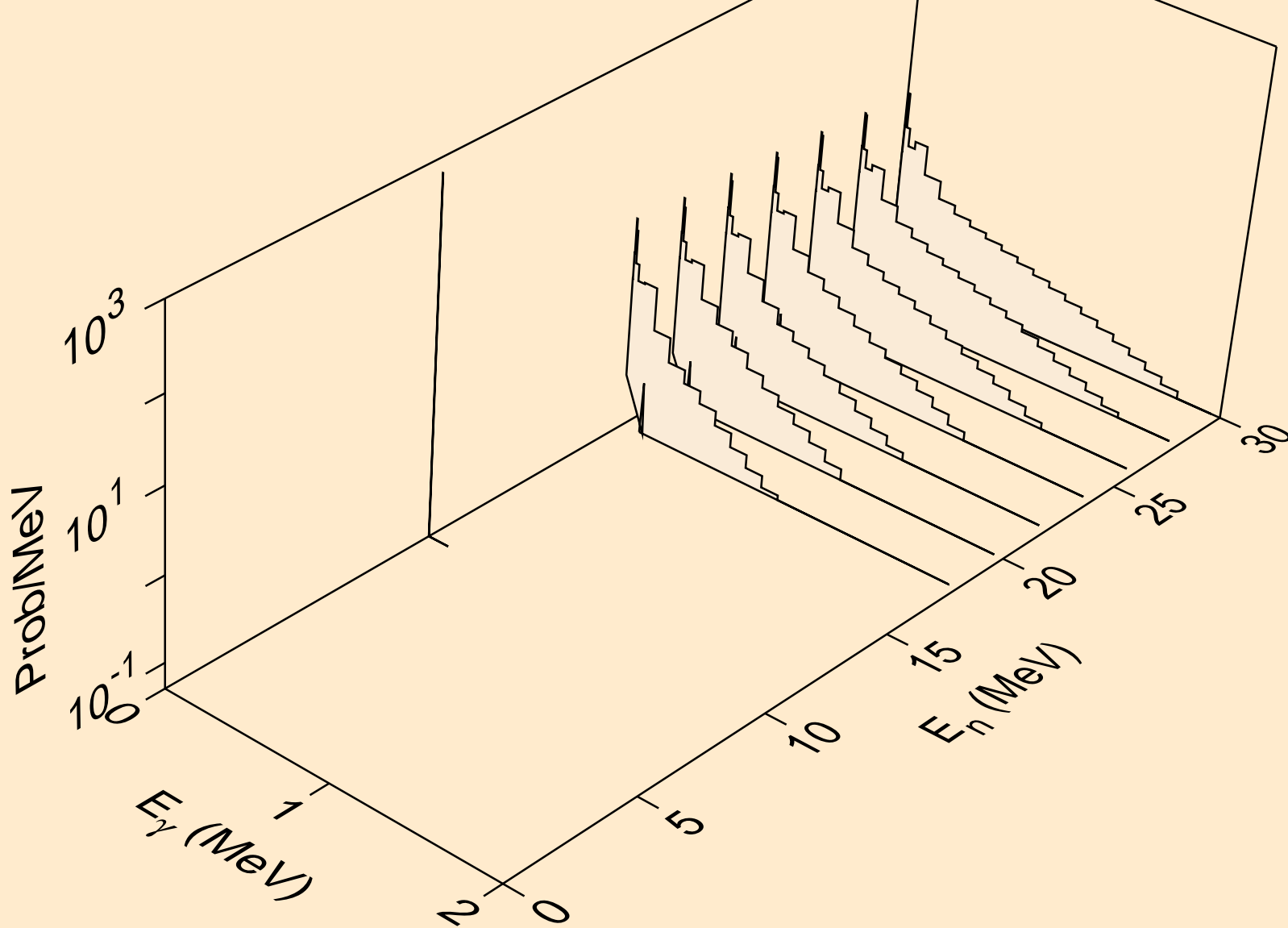

PA239 NEUTRON ACER TENDL-2019 LIBRARY; T=293.16K
Photon emission for (n,3n)a

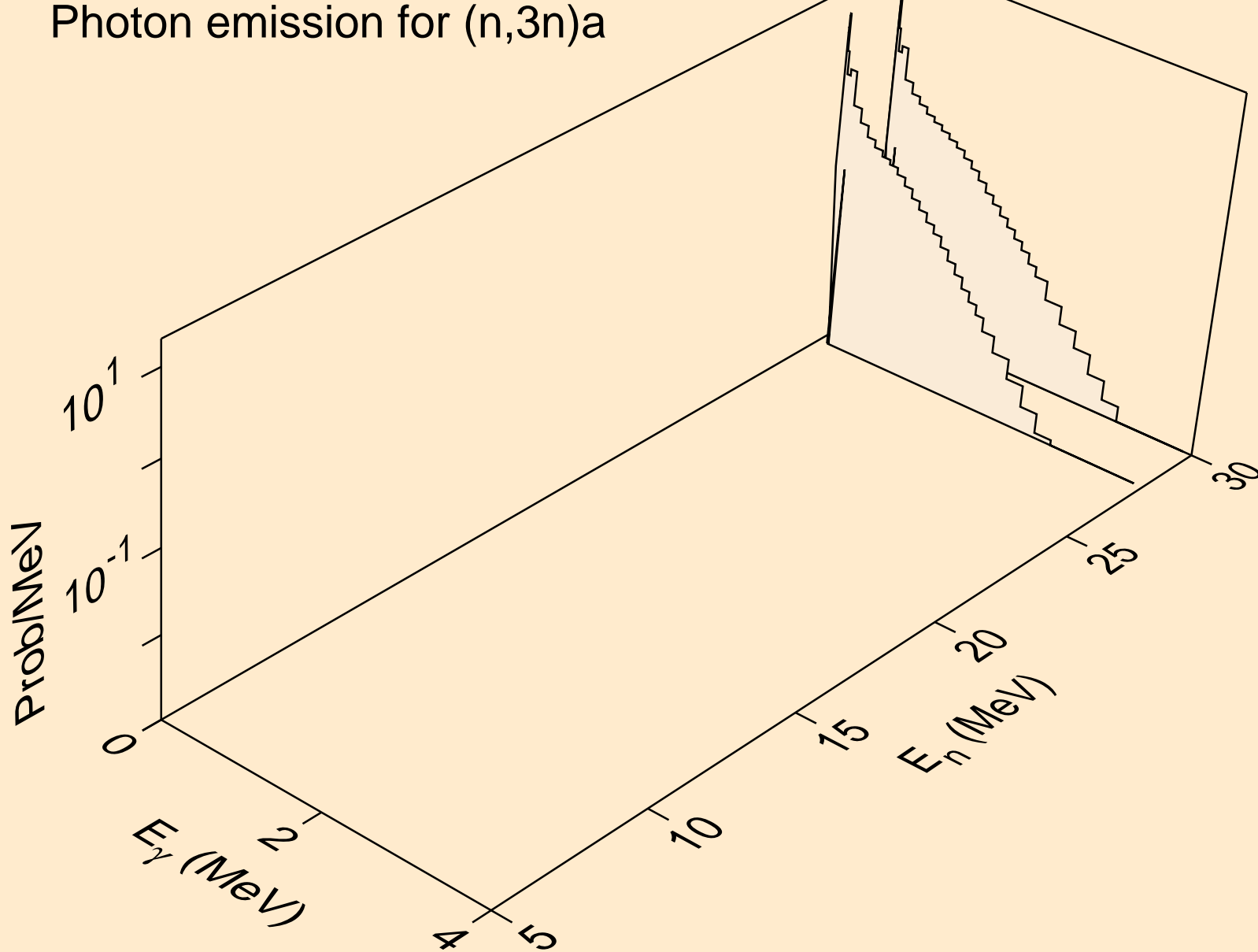

PA239 NEUTRON ACER TENDL-2019 LIBRARY; T=293.16K
Photon emission for (n,n*)p

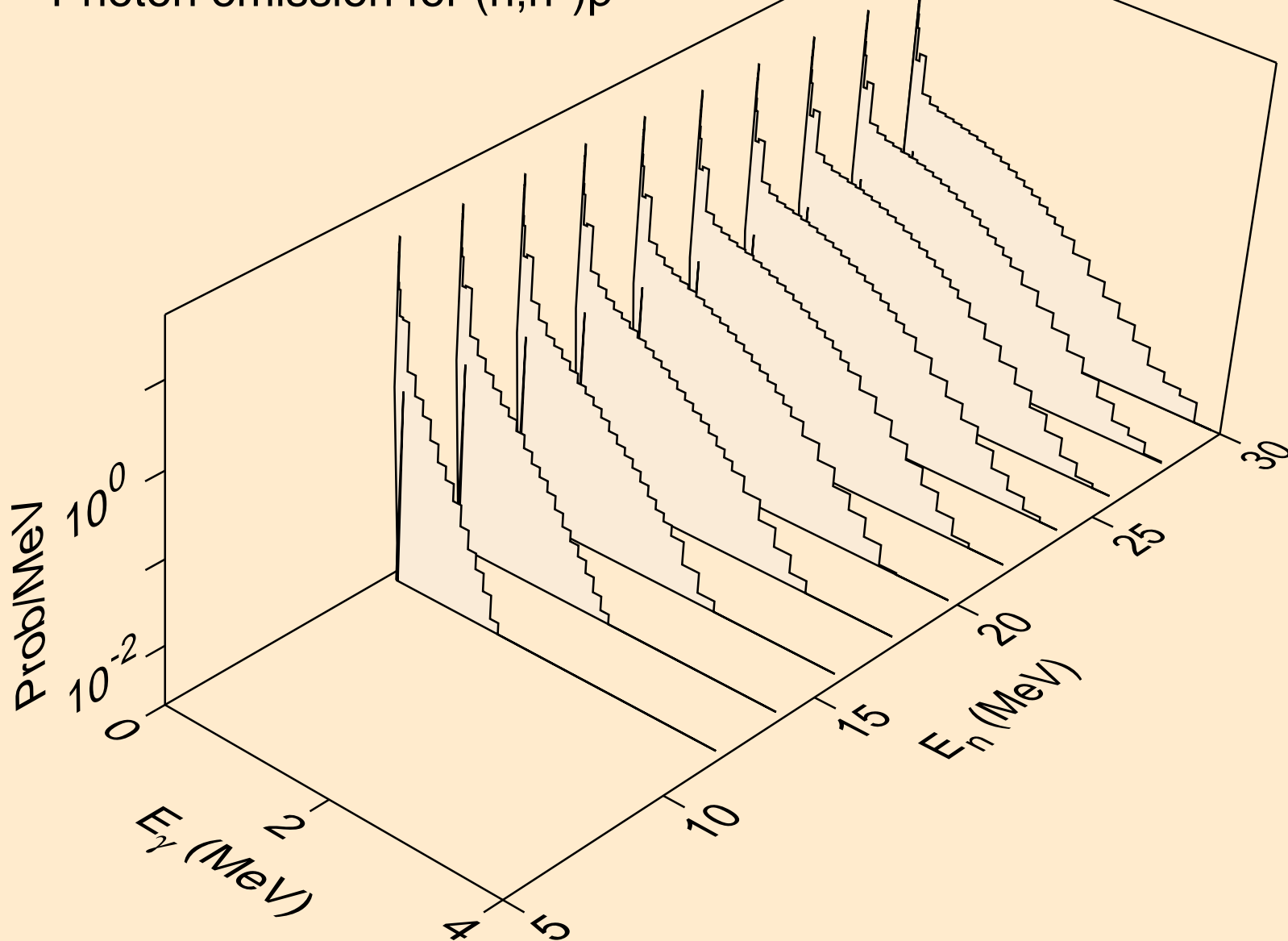

PA239 NEUTRON ACER TENDL-2019 LIBRARY; T=293.16K
Photon emission for (n,n*)d

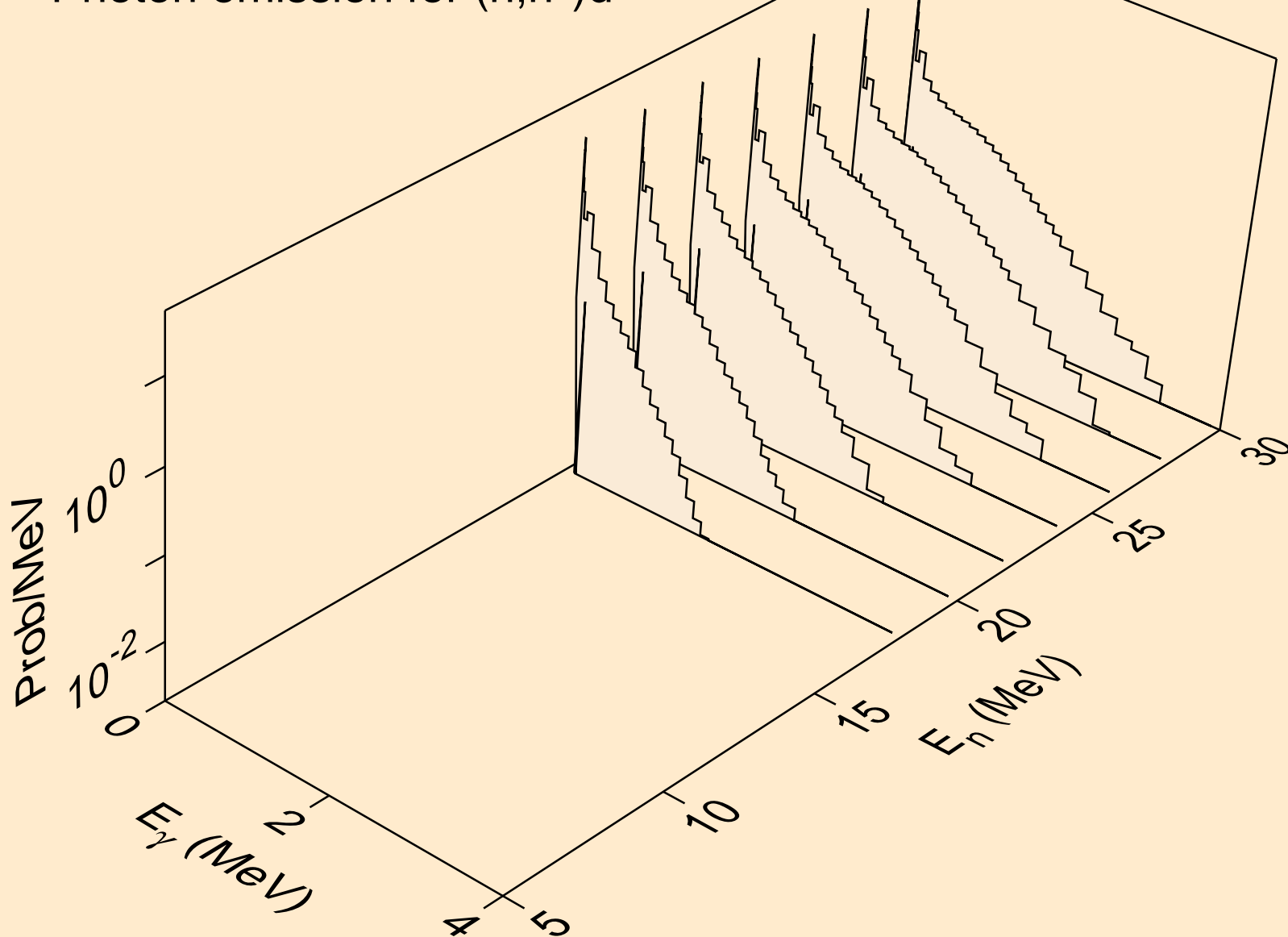

PA239 NEUTRON ACER TENDL-2019 LIBRARY; T=293.16K
Photon emission for (n,n*)t

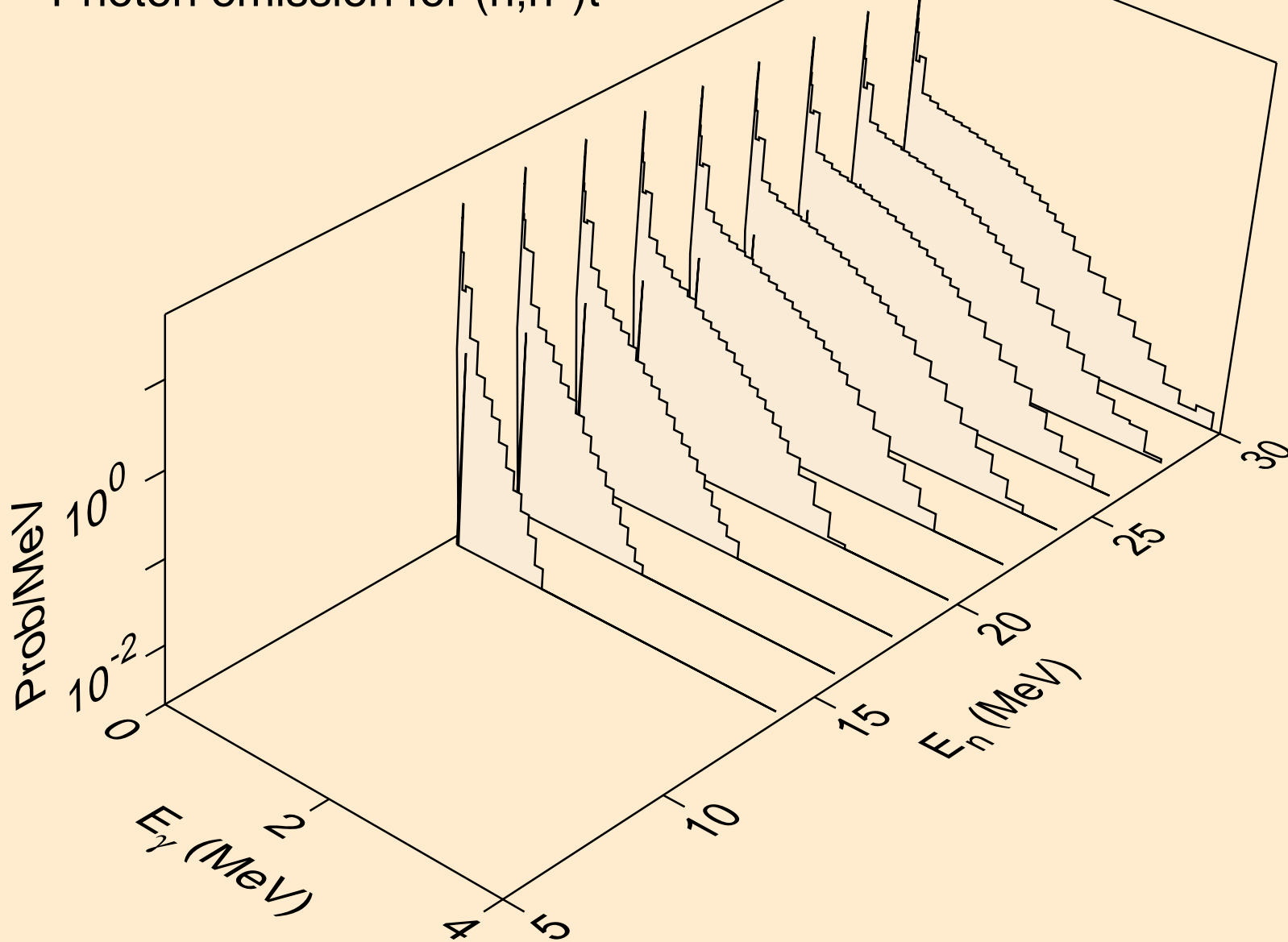

PA239 NEUTRON ACER TENDL-2019 LIBRARY; T=293.16K
Photon emission for (n,n*)he3

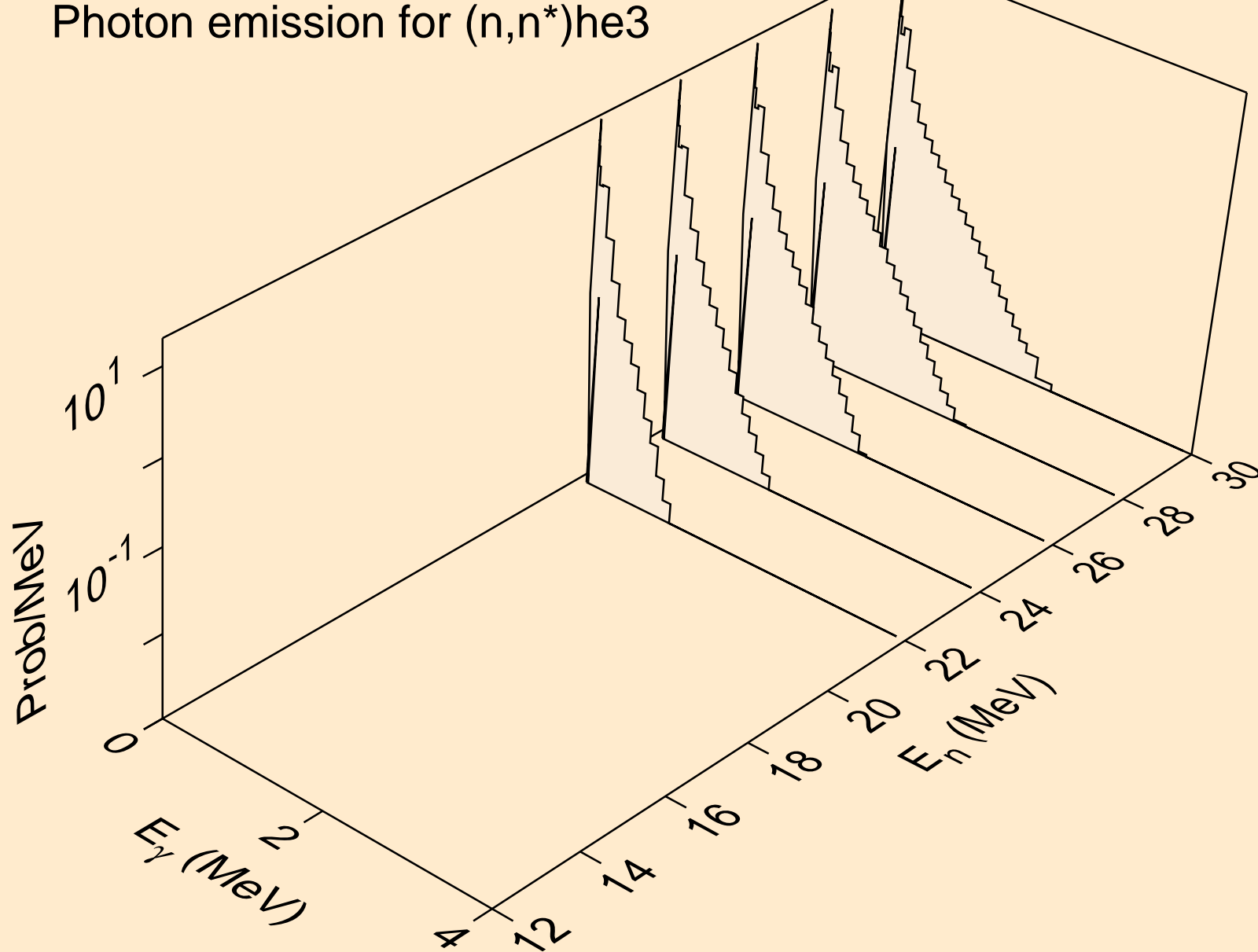

PA239 NEUTRON ACER TENDL-2019 LIBRARY; T=293.16K
Photon emission for (n,4n)

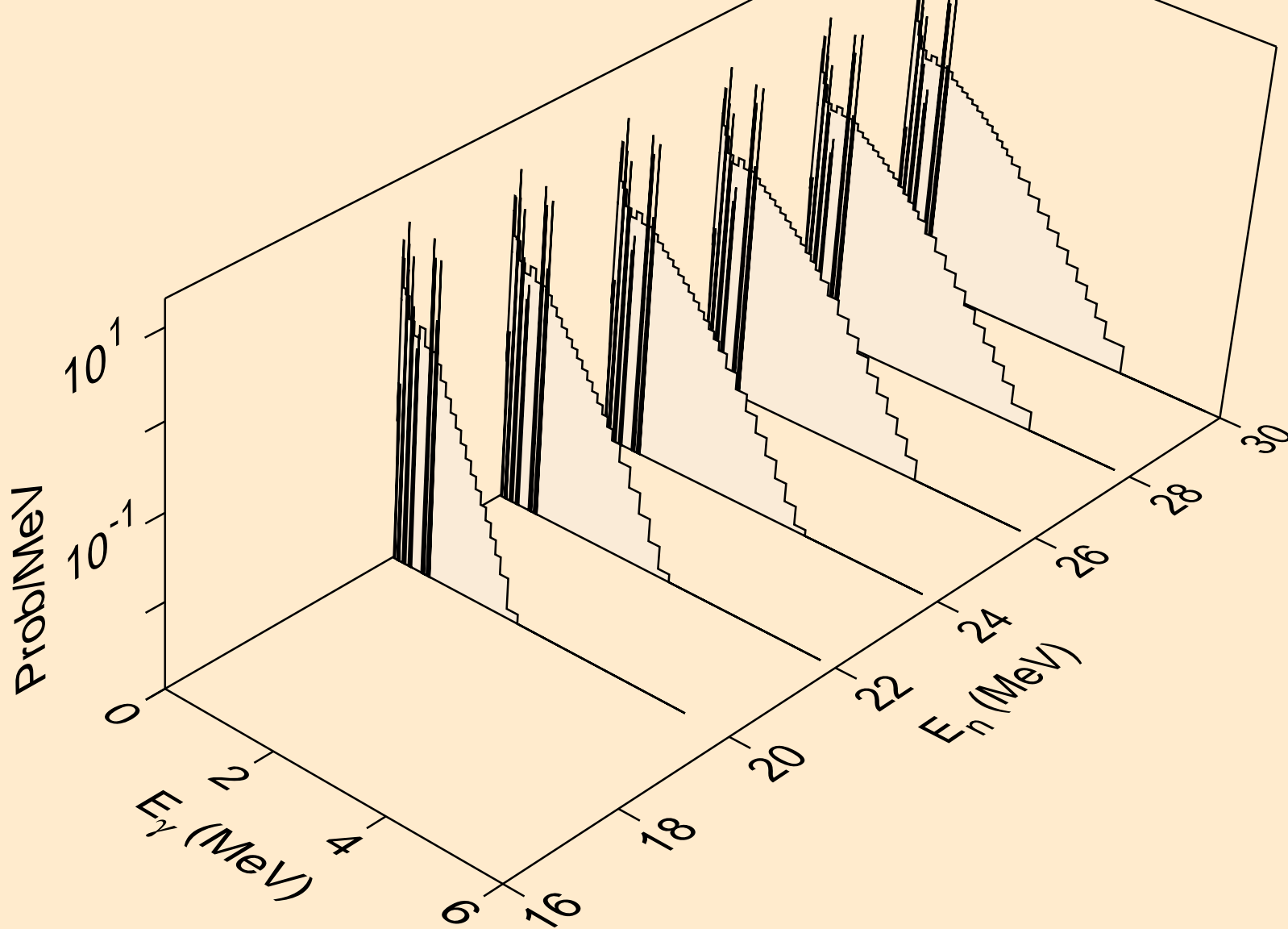

PA239 NEUTRON ACER TENDL-2019 LIBRARY; T=293.16K
Photon emission for (n,2np)

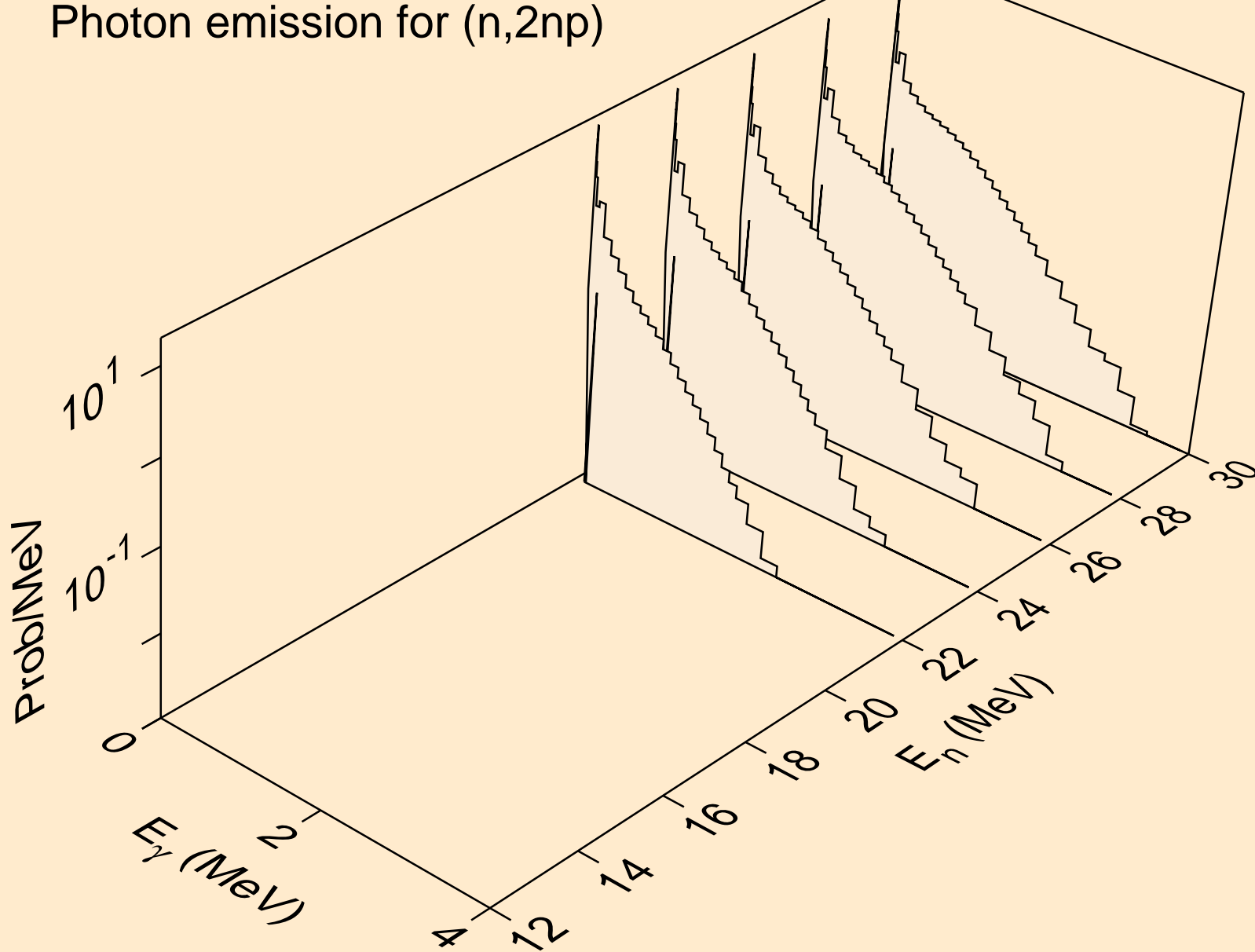

PA239 NEUTRON ACER TENDL-2019 LIBRARY; T=293.16K
Photon emission for (n,3np)

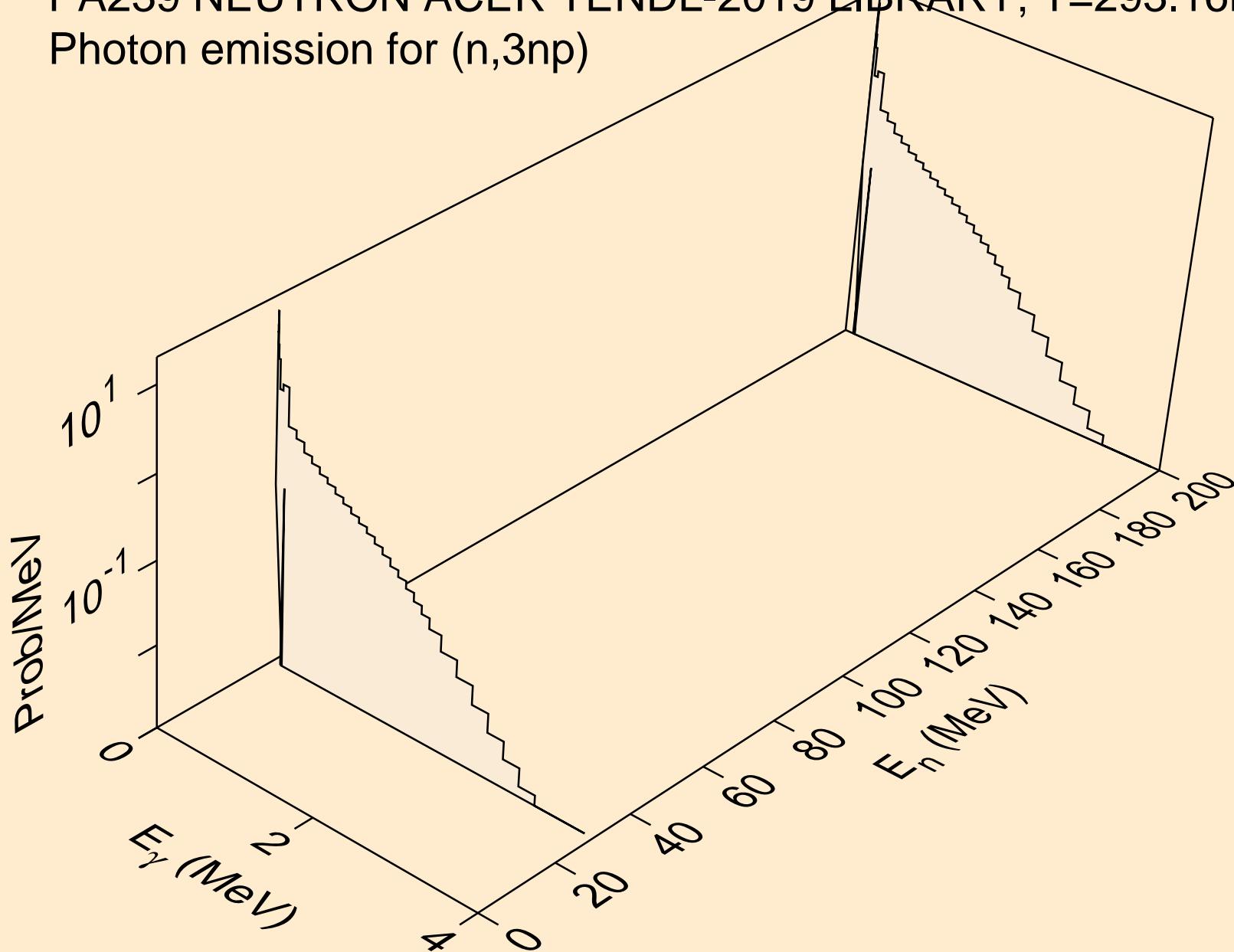

PA239 NEUTRON ACER TENDL-2019 LIBRARY; T=293.16K
Photon emission for (n,n*c)

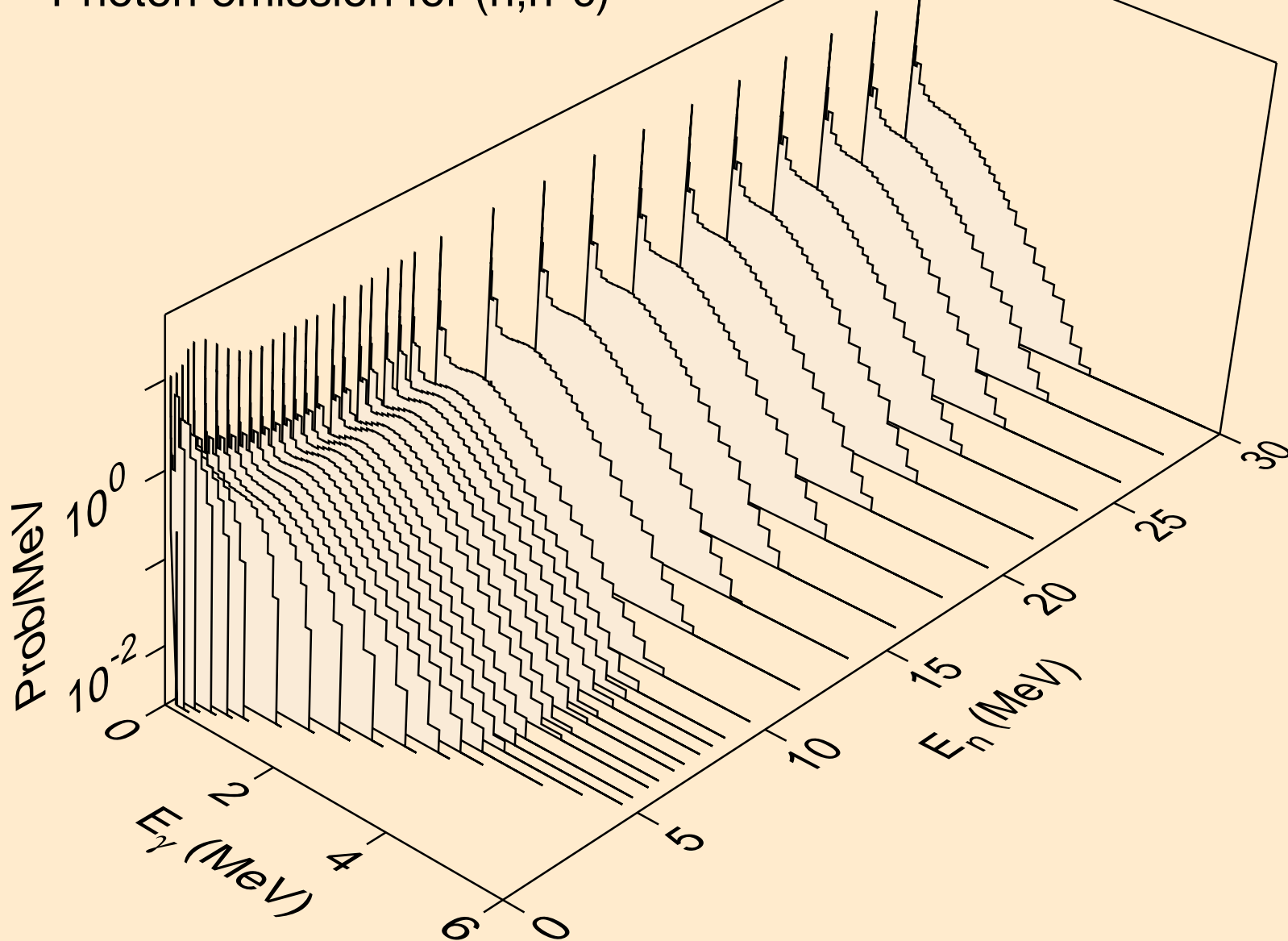

PA239 NEUTRON ACER TENDL-2019 LIBRARY; T=293.16K
Photon emission for (n,gma)

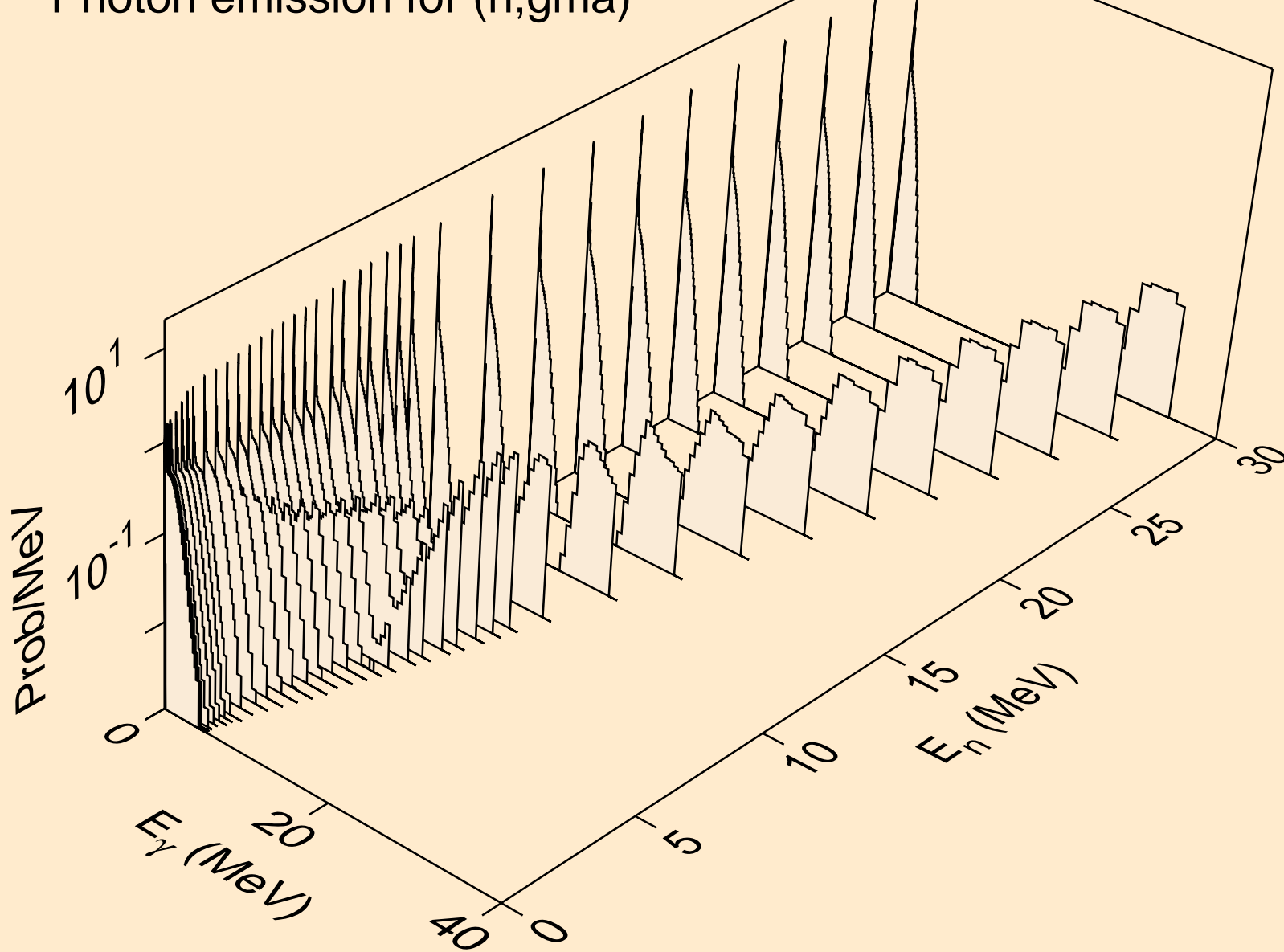

PA239 NEUTRON ACER TENDL-2019 LIBRARY; T=293.16K
Photon emission for (n,p)

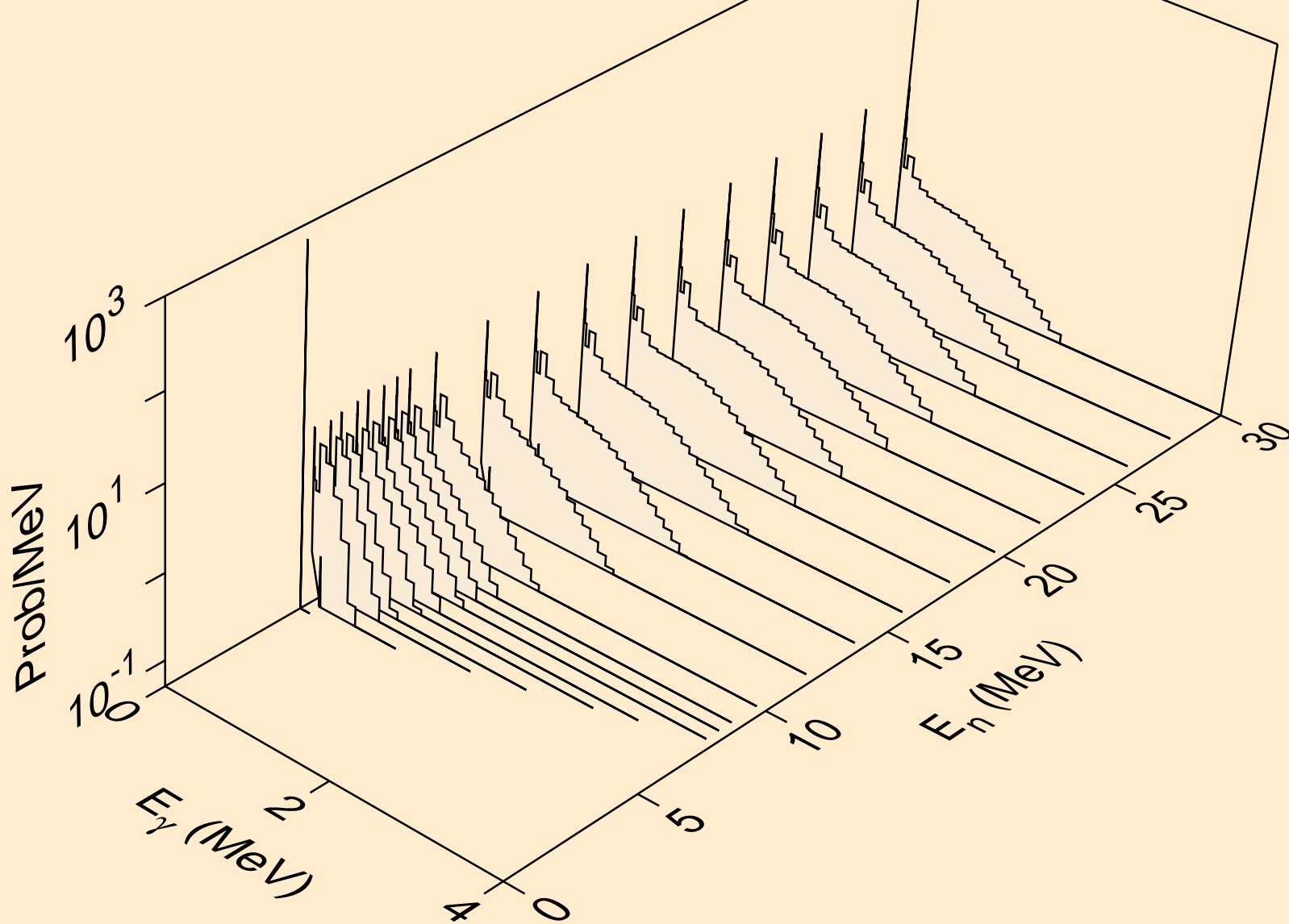

PA239 NEUTRON ACER TENDL-2019 LIBRARY; T=293.16K
Photon emission for (n,d)

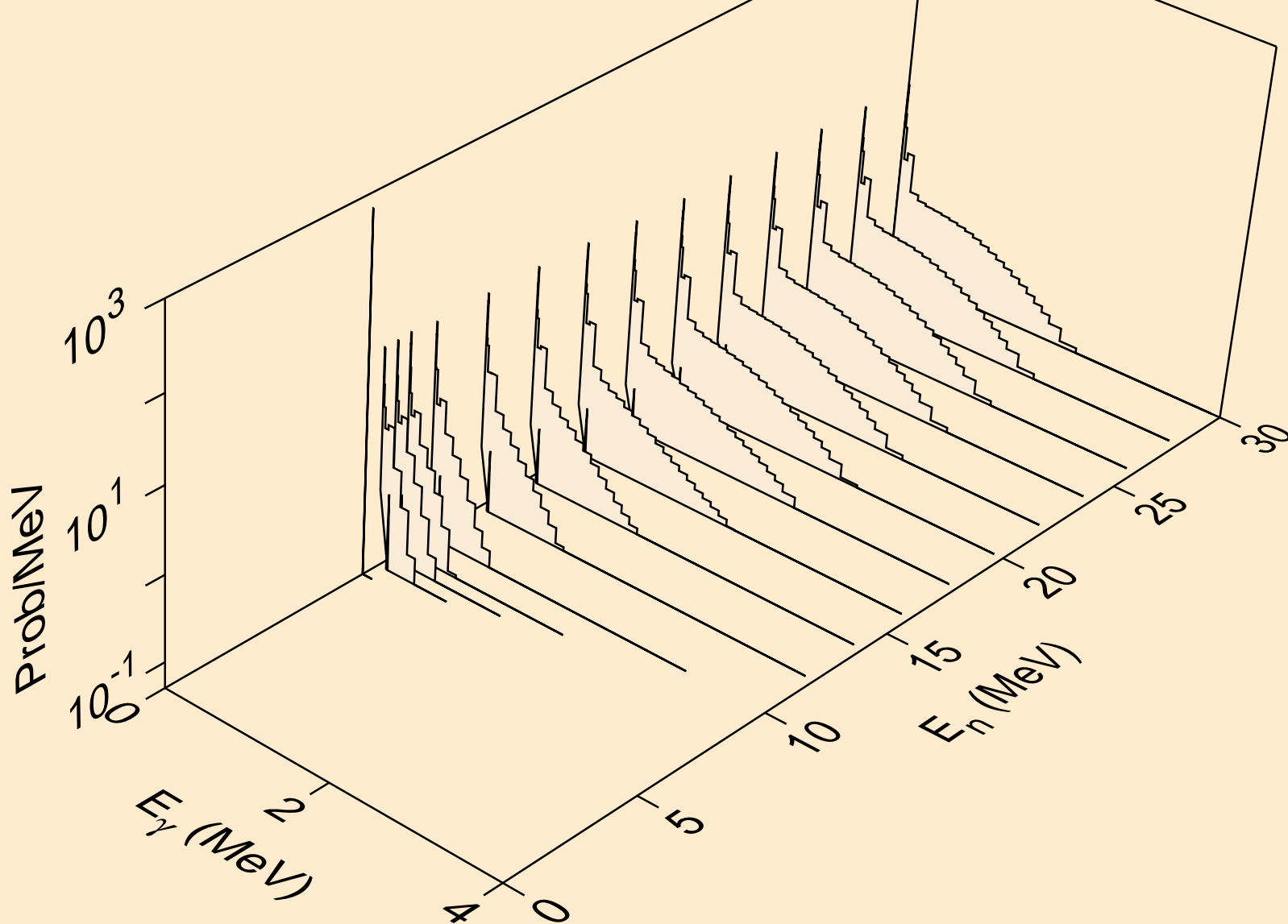

PA239 NEUTRON ACER TENDL-2019 LIBRARY; T=293.16K
Photon emission for (n,t)

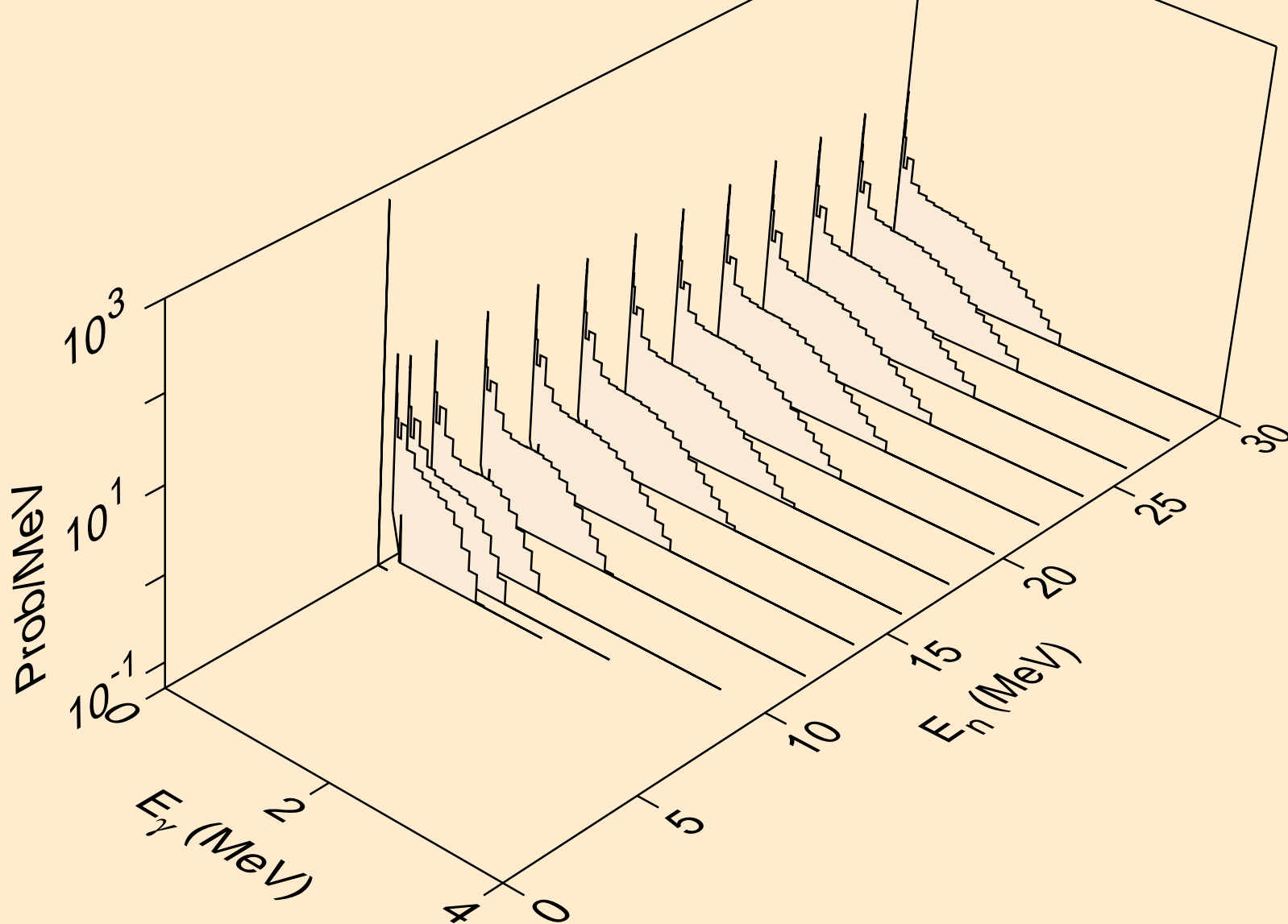

PA239 NEUTRON ACER TENDL-2019 LIBRARY; T=293.16K
Photon emission for (n,he3)

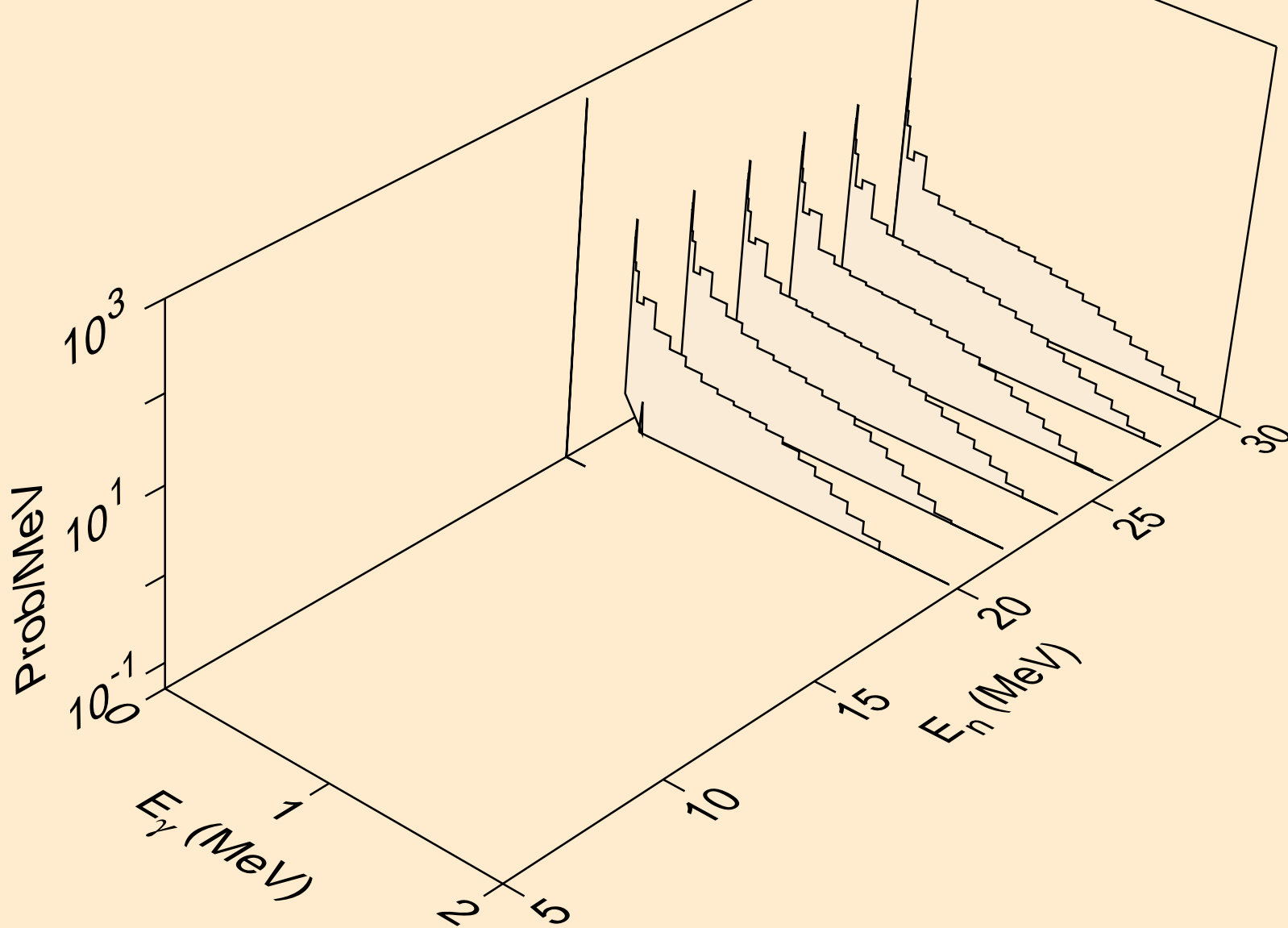

PA239 NEUTRON ACER TENDL-2019 LIBRARY; T=293.16K
Photon emission for (n,a)

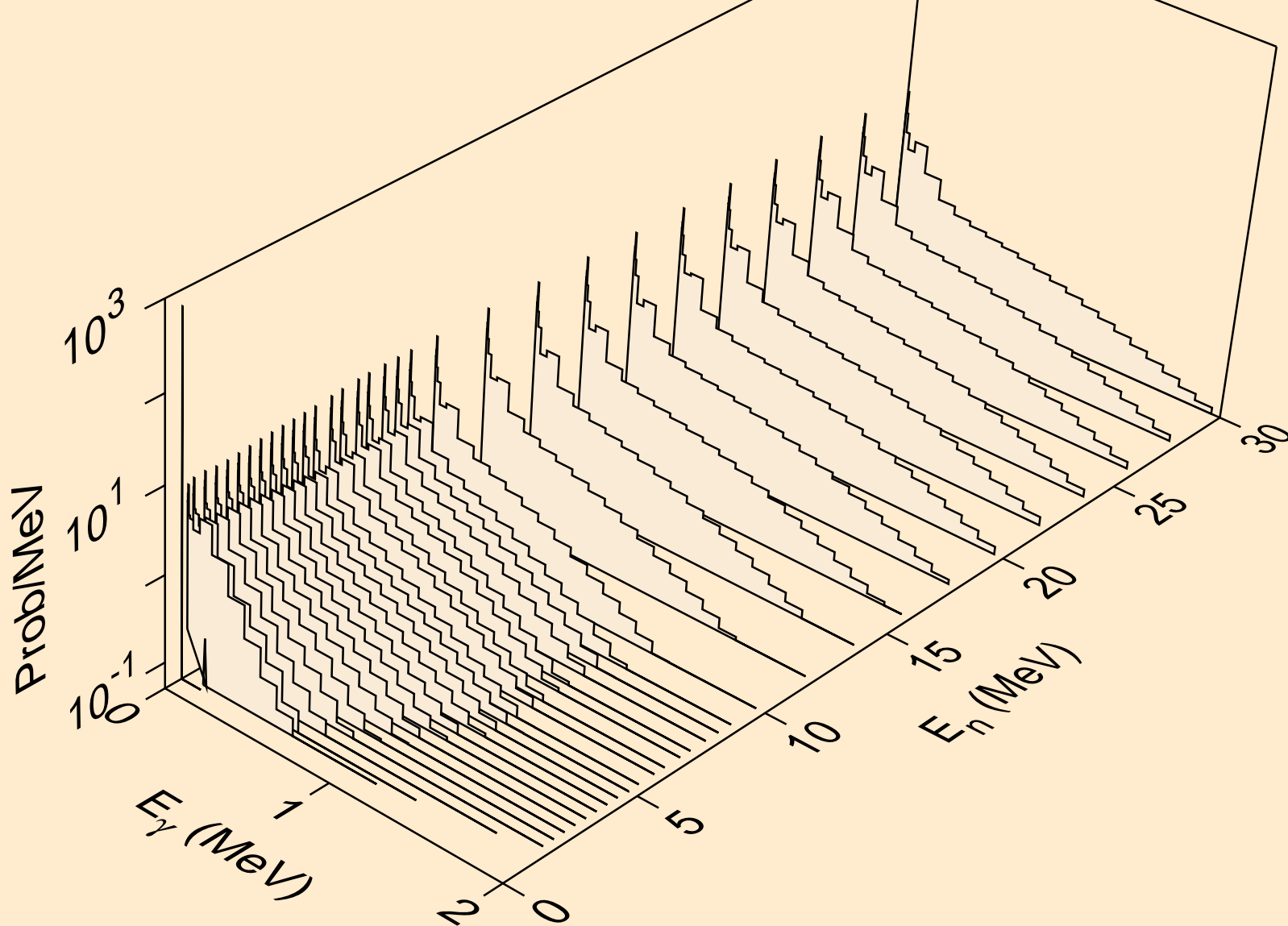

PA239 NEUTRON ACER TENDL-2019 LIBRARY; T=293.16K
Photon emission for (n,2p)

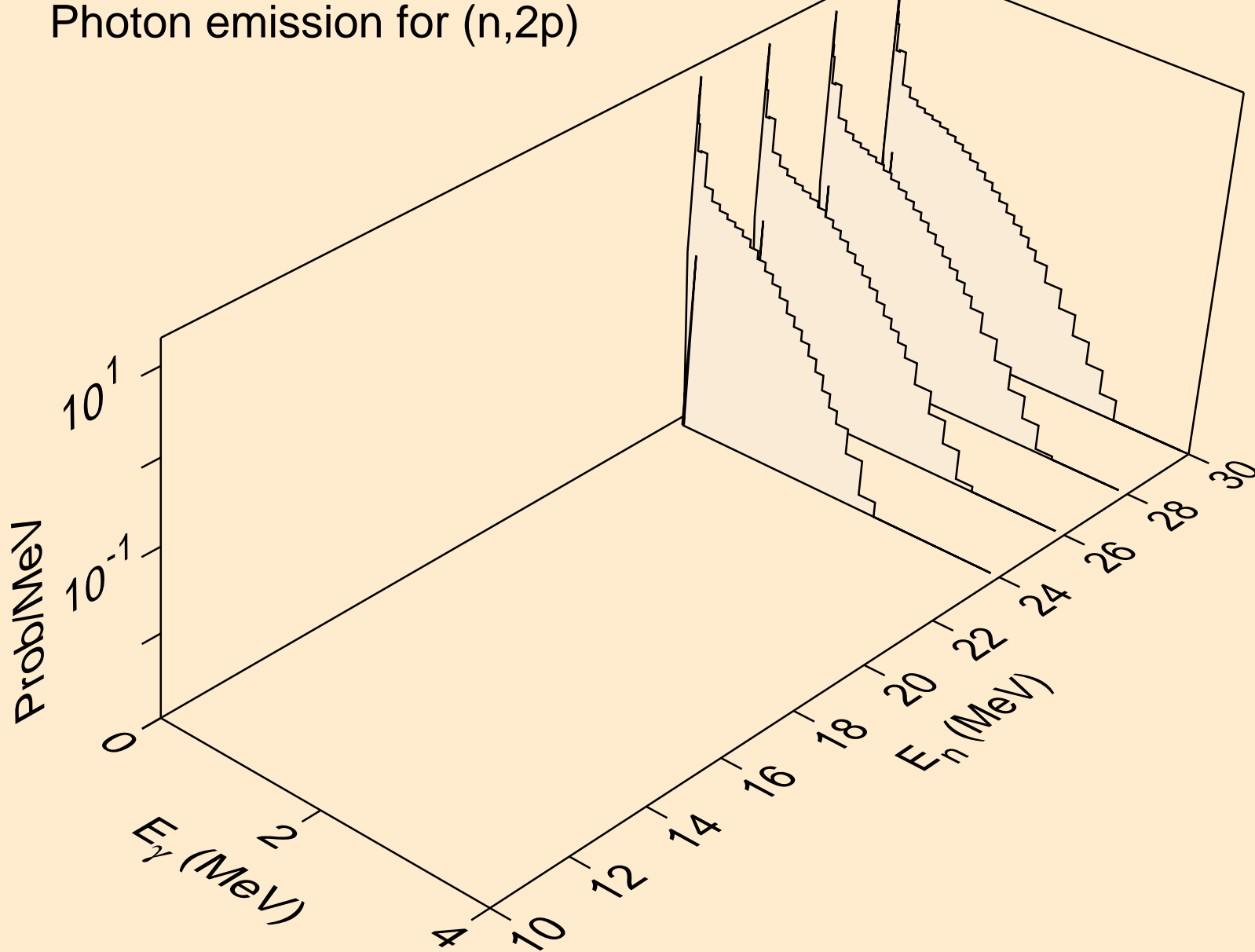

PA239 NEUTRON ACER TENDL-2019 LIBRARY; T=293.16K
thermal capture photon spectrum

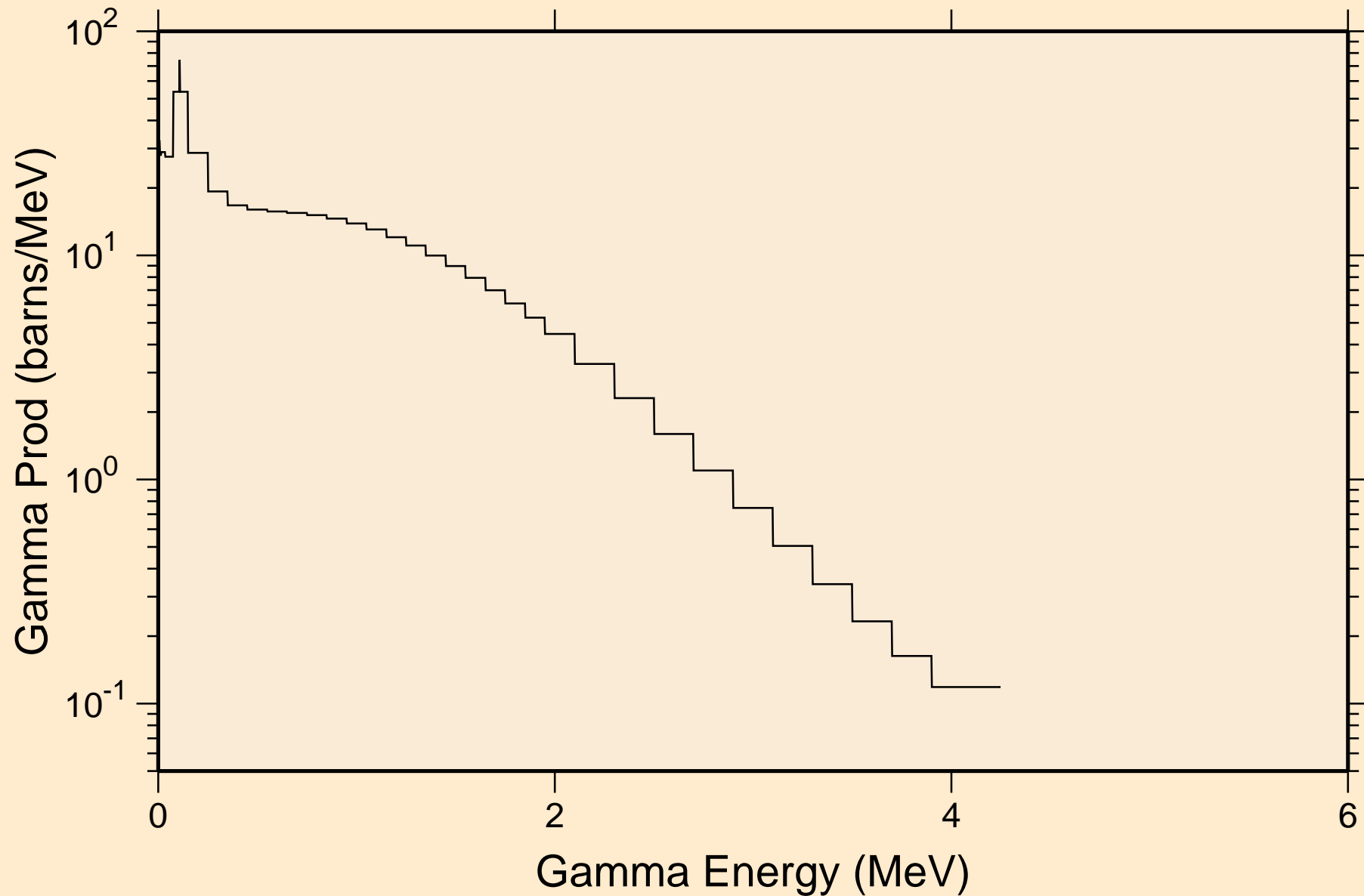

PA239 NEUTRON ACER TENDL-2019 LIBRARY; T=293.16K
14 MeV photon spectrum

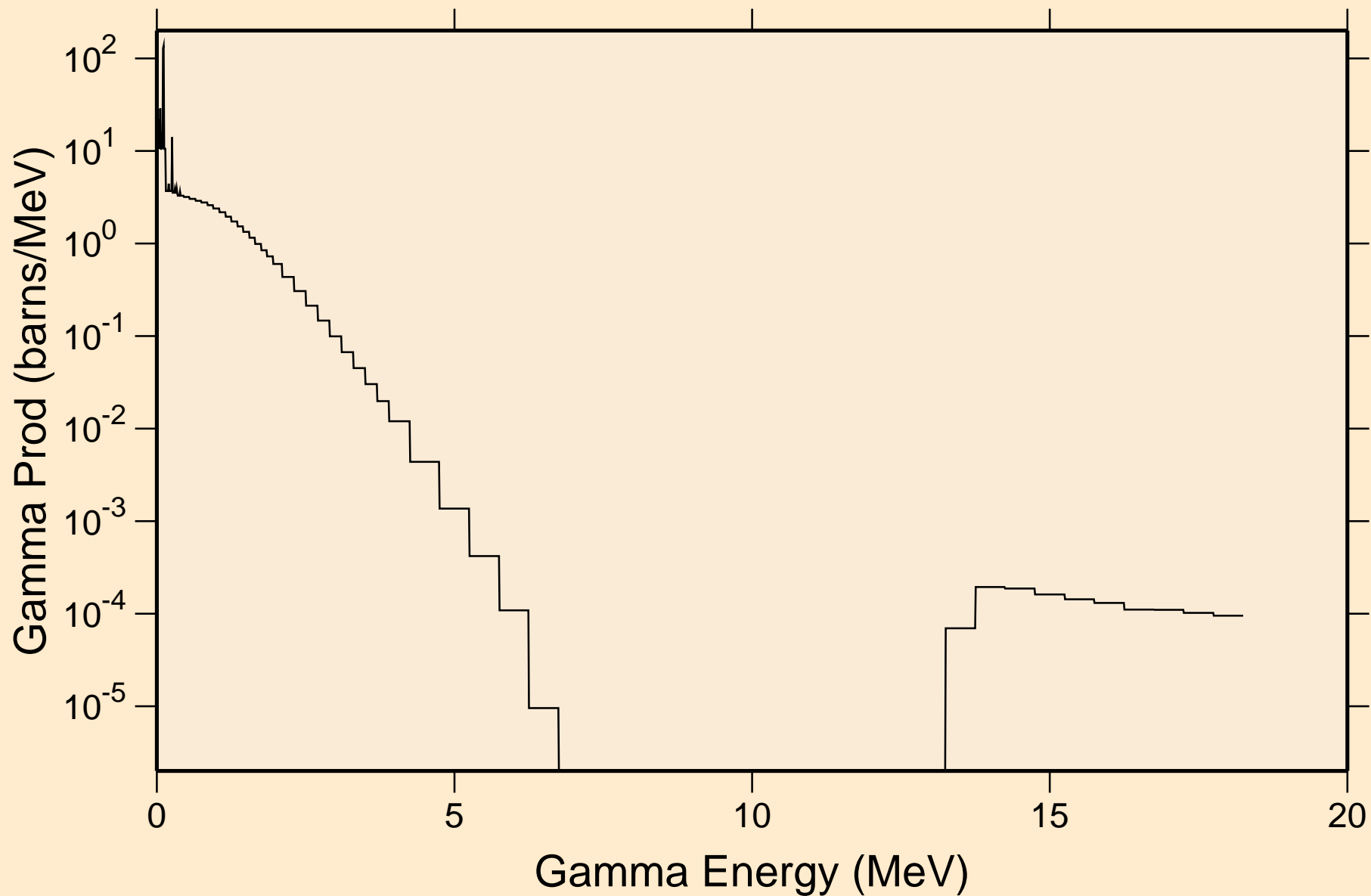

PA239 NEUTRON ACER TENDL-2019 LIBRARY; T=293.16K
Particle heating contributions

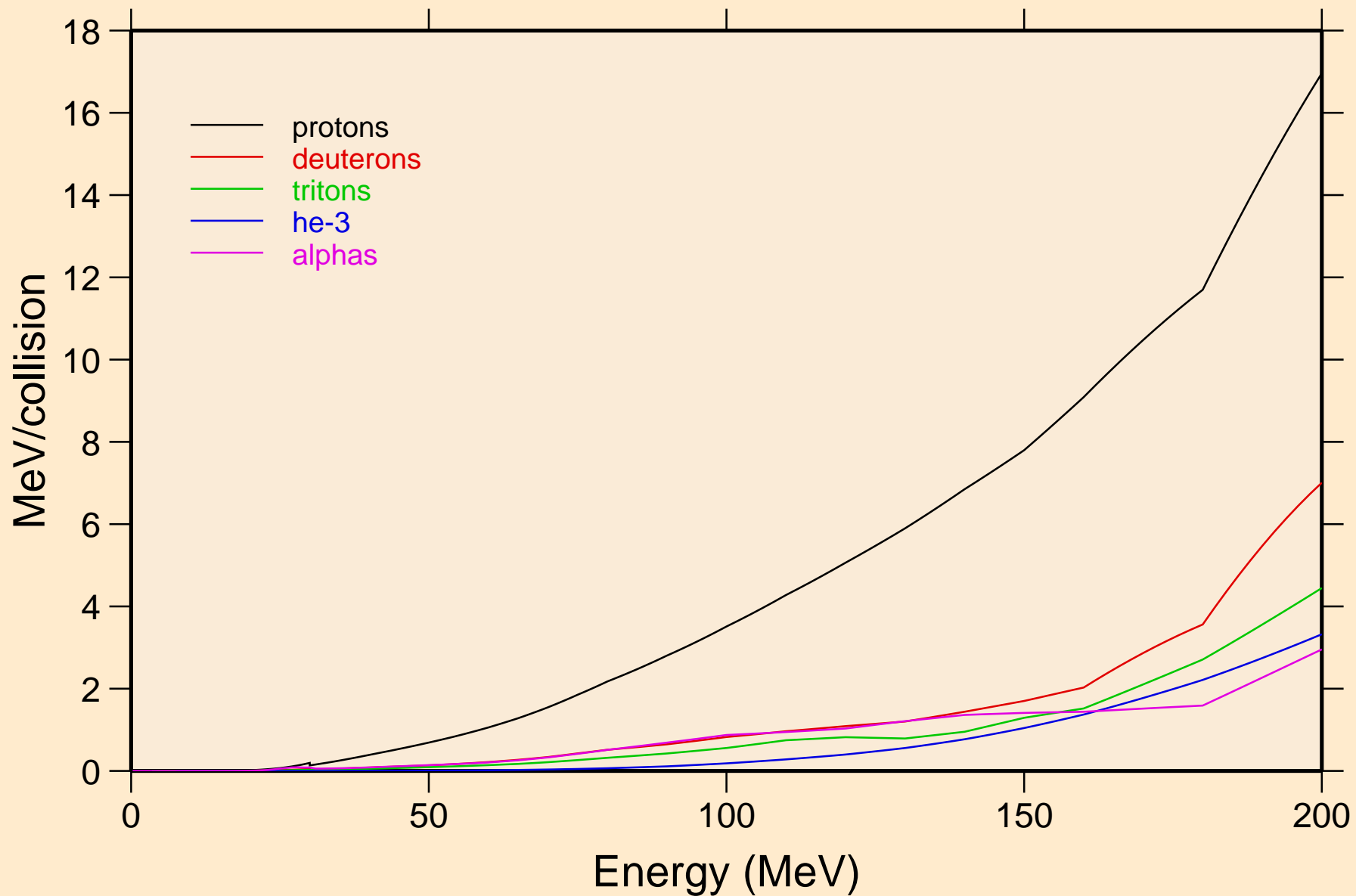

PA239 NEUTRON ACER TENDL-2019 LIBRARY; T=293.16K
Recoil Heating

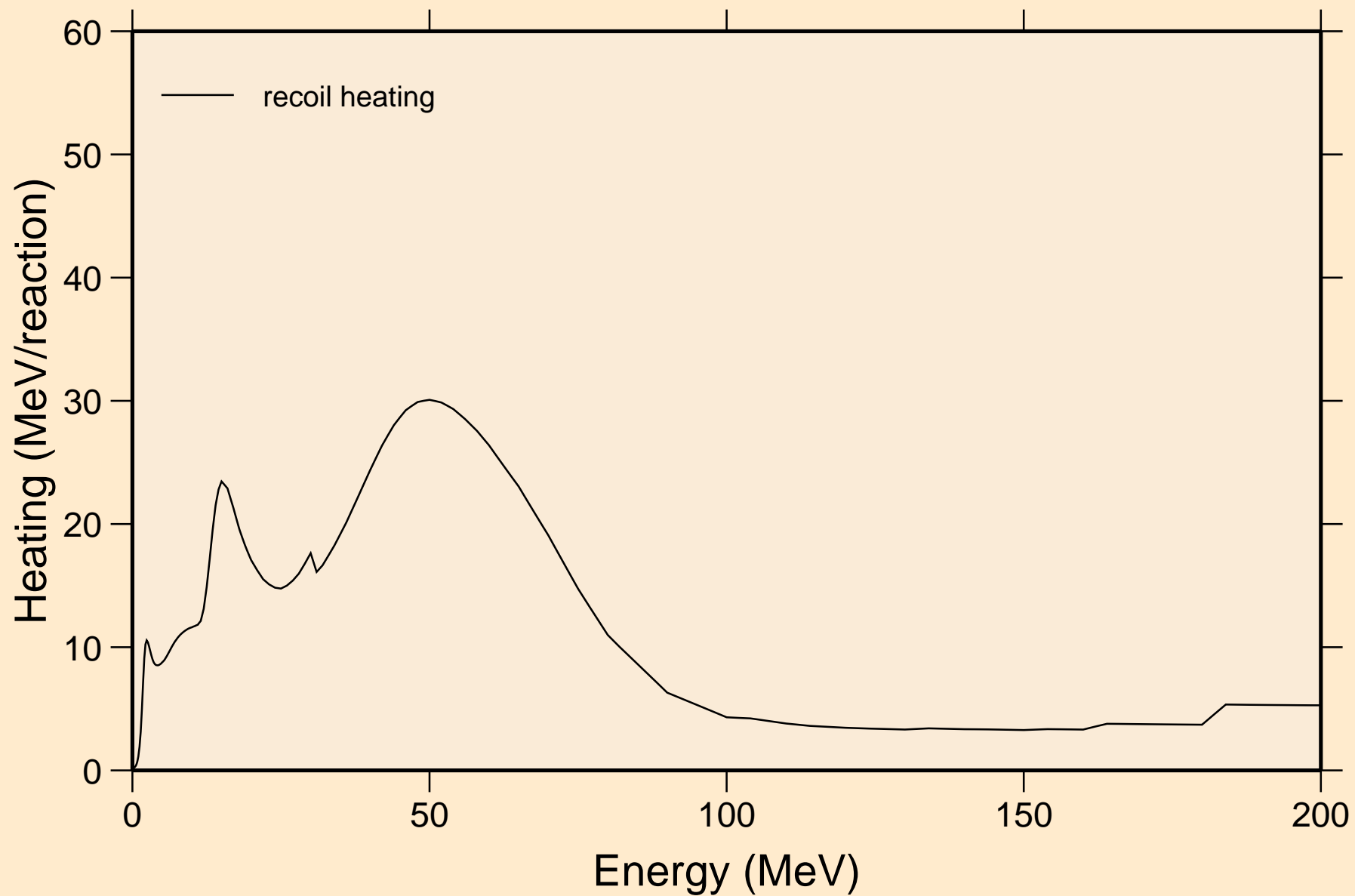

PA239 NEUTRON ACER TENDL-2019 LIBRARY; T=293.16K
Particle production cross sections

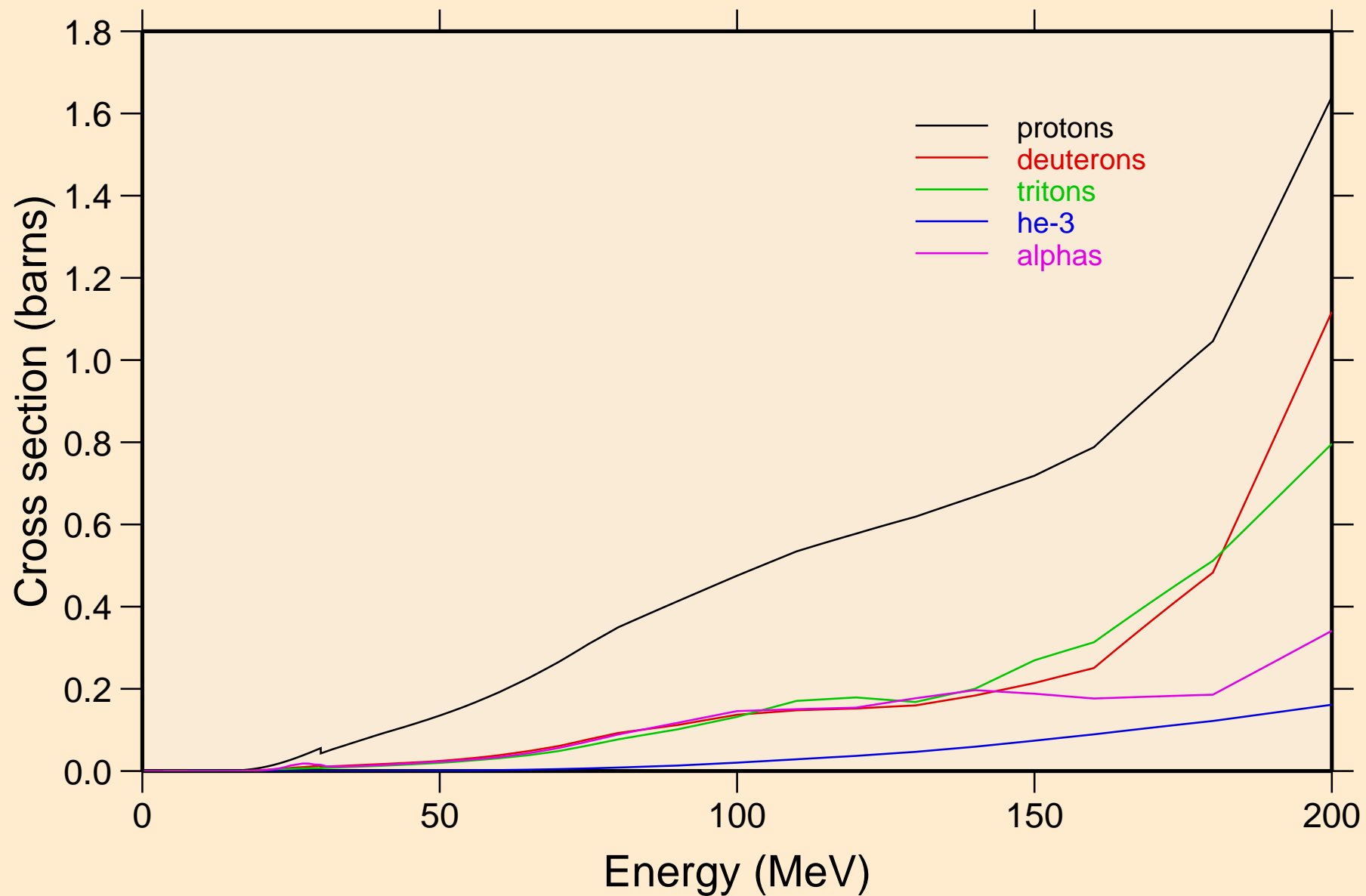

PA239 NEUTRON ACER TENDL-2019 LIBRARY; T=293.16K
protons from (n,x)

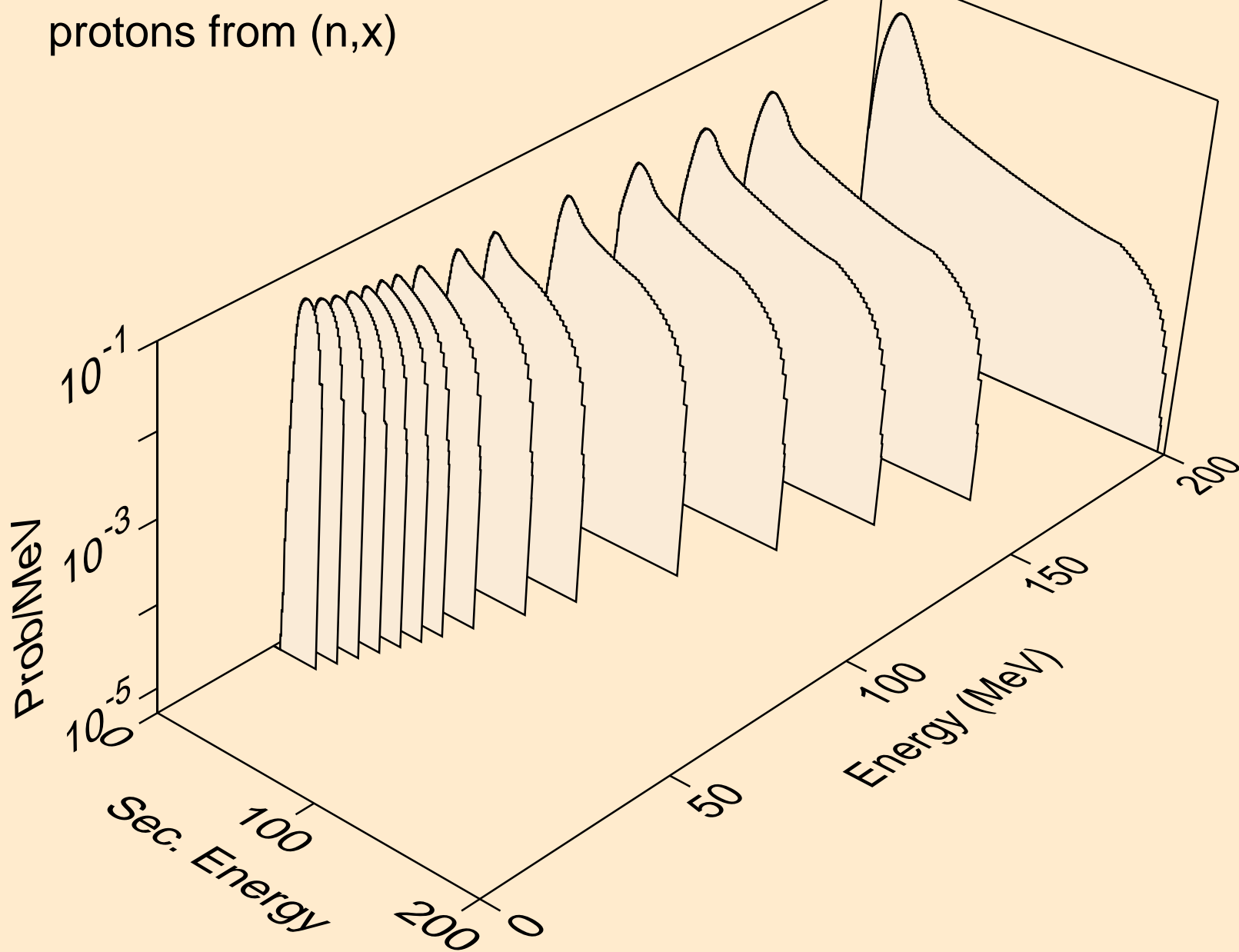

PA239 NEUTRON ACER TENDL-2019 LIBRARY; T=293.16K
protons from (n,n*)p

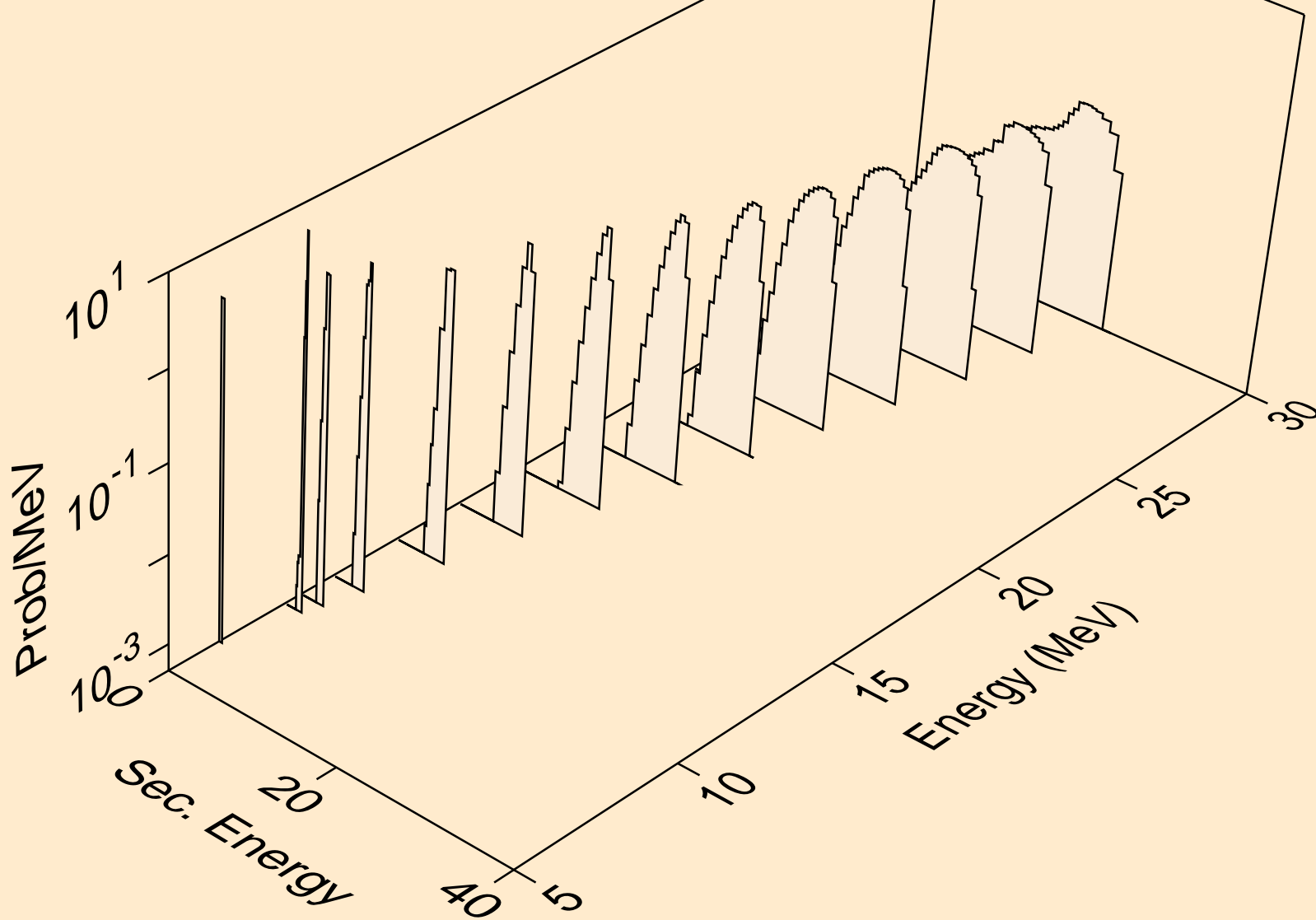

PA239 NEUTRON ACER TENDL-2019 LIBRARY; T=293.16K
protons from (n,2np)

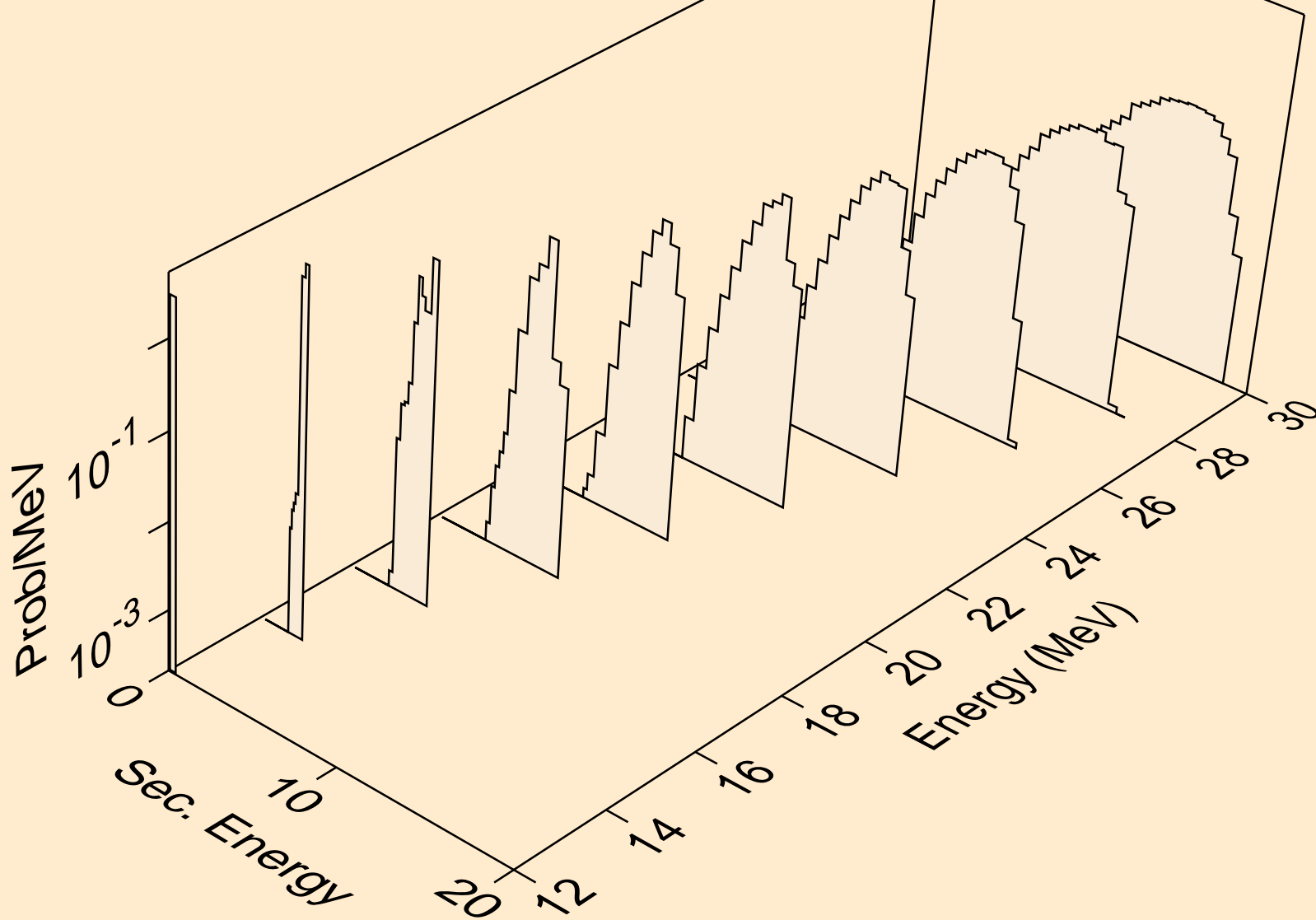

PA239 NEUTRON ACER TENDL-2019 LIBRARY; T=293.16K
protons from (n,3np)

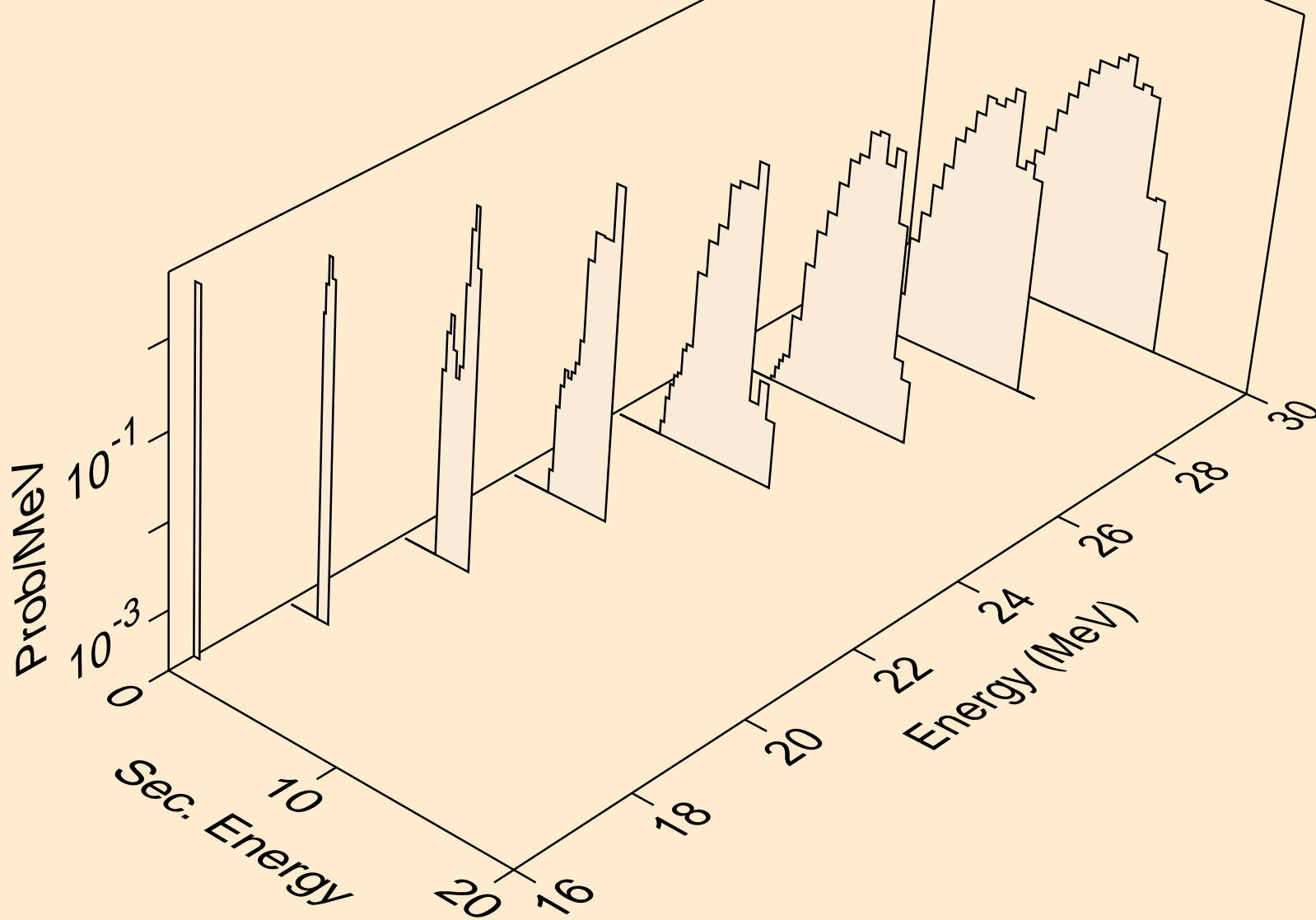

PA239 NEUTRON ACER TENDL-2019 LIBRARY; T=293.16K
protons from (n,p)

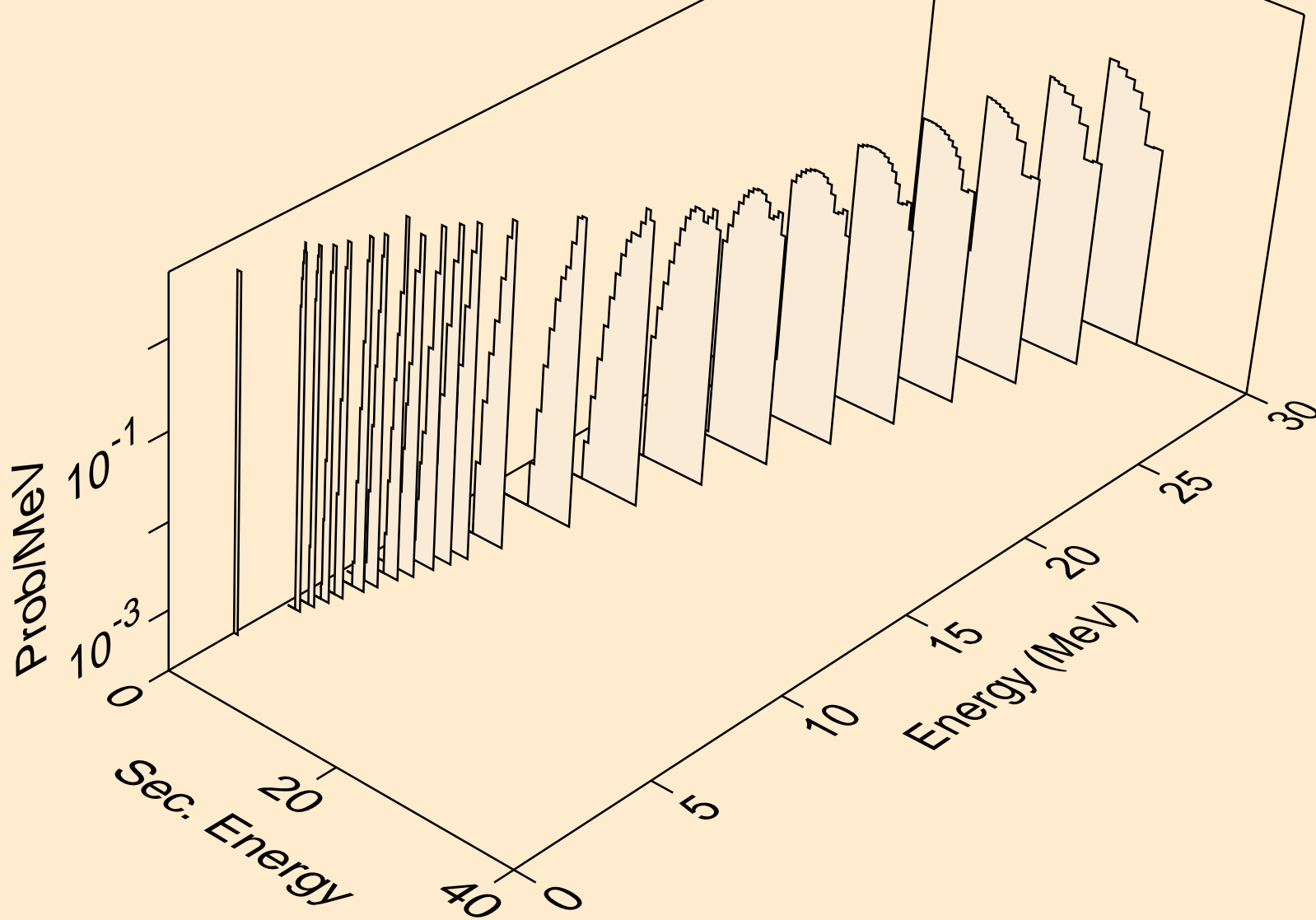

PA239 NEUTRON ACER TENDL-2019 LIBRARY; T=293.16K
protons from (n,2p)

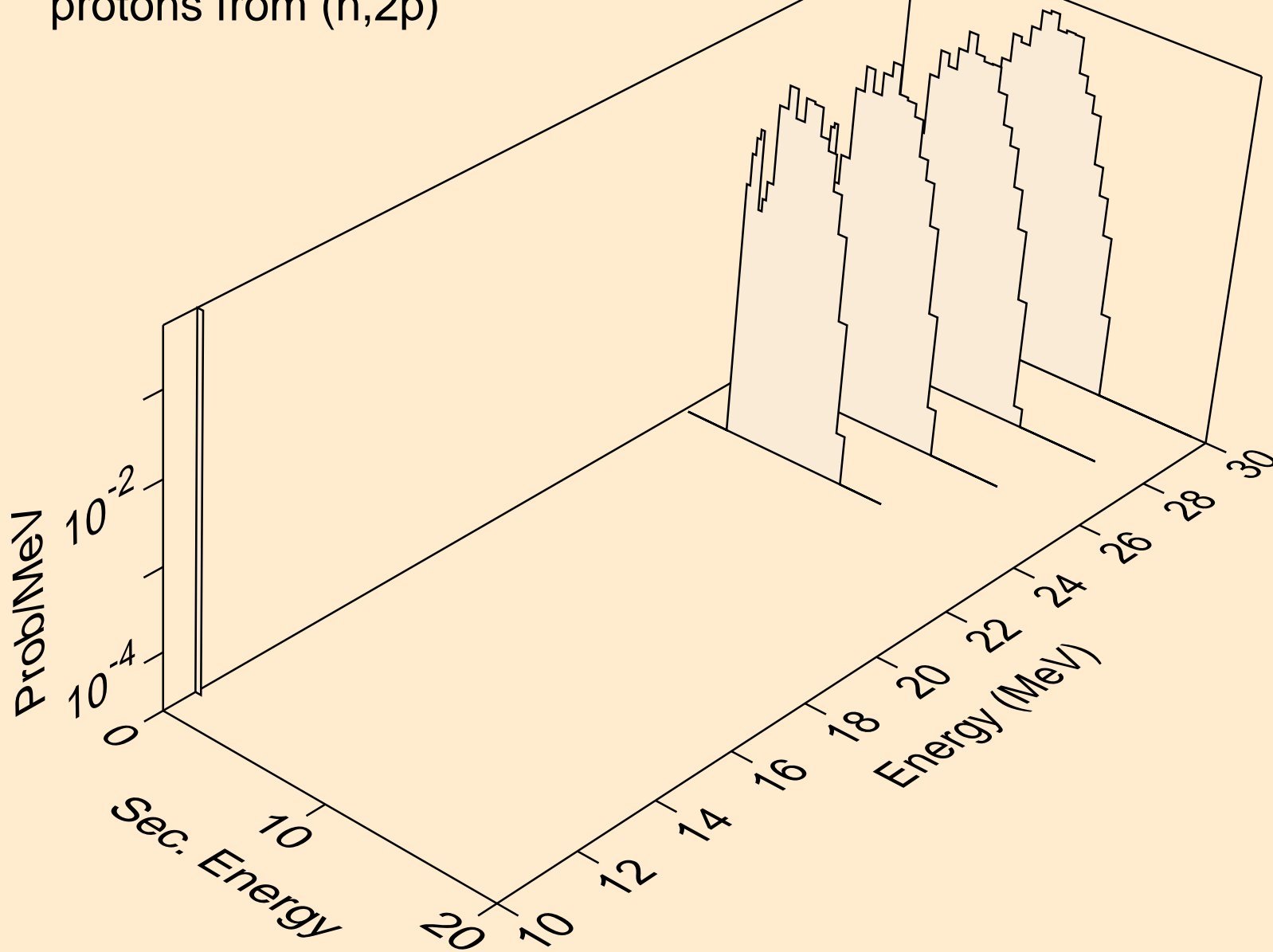

PA239 NEUTRON ACER TENDL-2019 LIBRARY; T=293.16K
deuterons from (n,x)

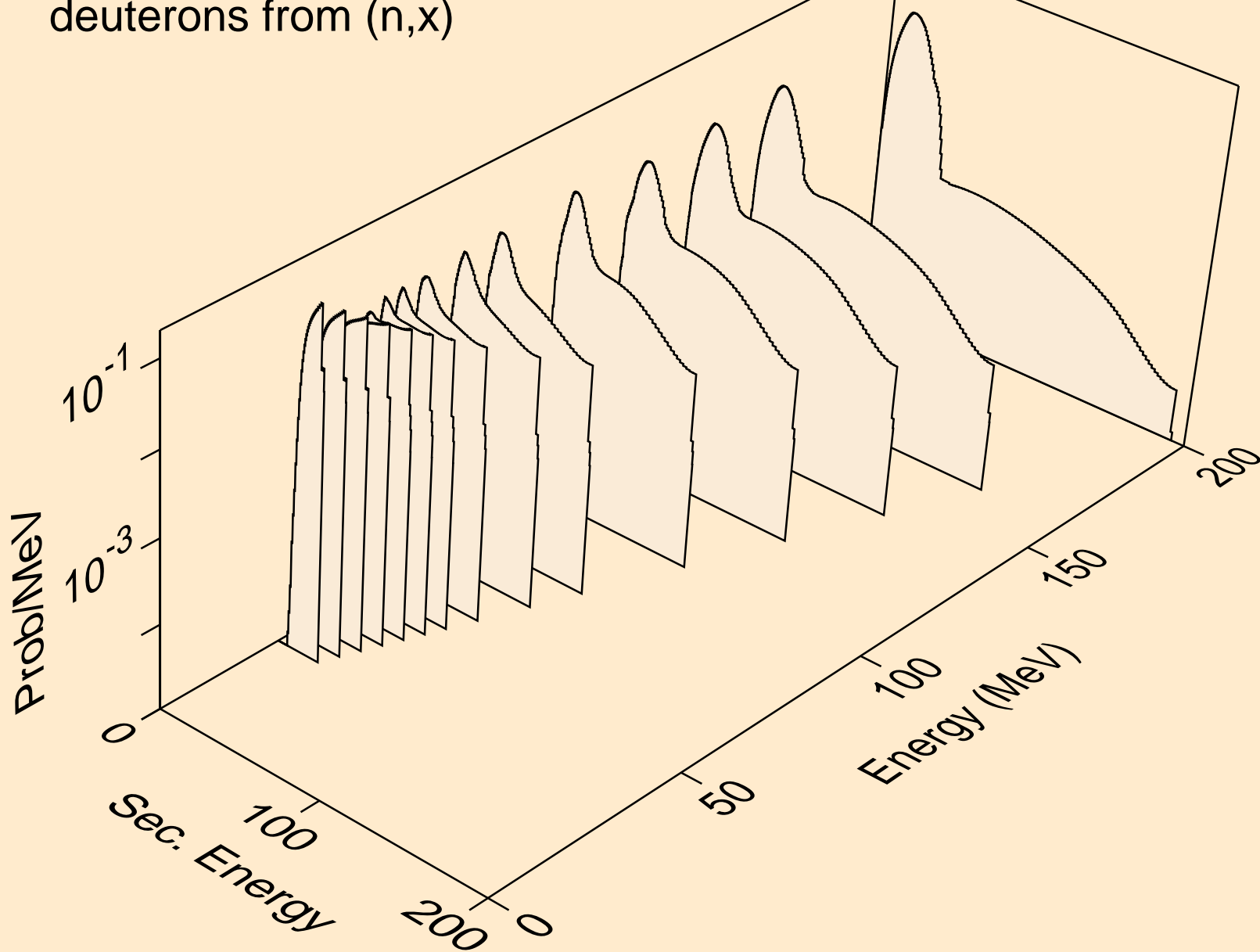

PA239 NEUTRON ACER TENDL-2019 LIBRARY; T=293.16K
deuterons from (n,2nd)

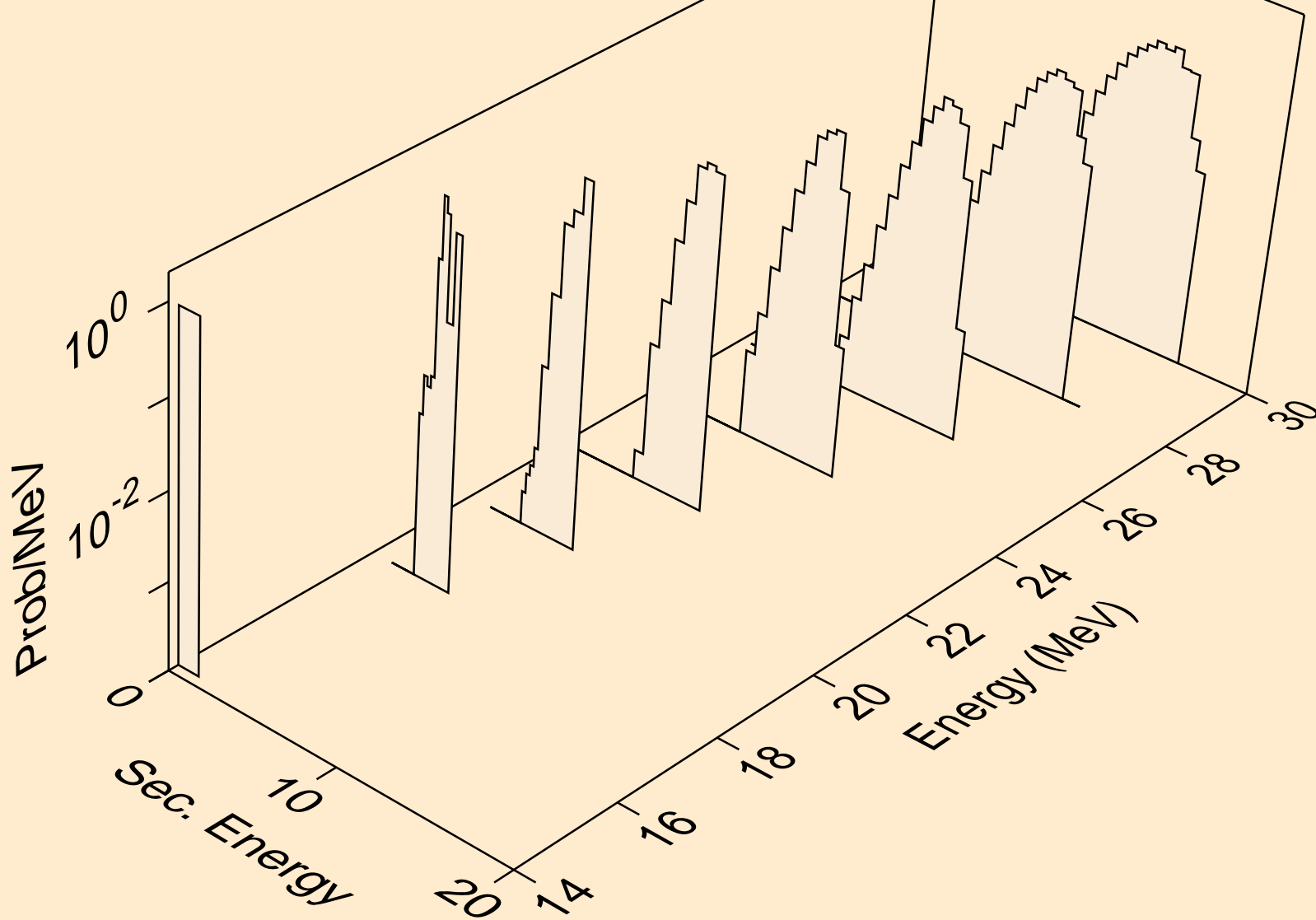

PA239 NEUTRON ACER TENDL-2019 LIBRARY; T=293.16K
deuterons from (n,n*)d

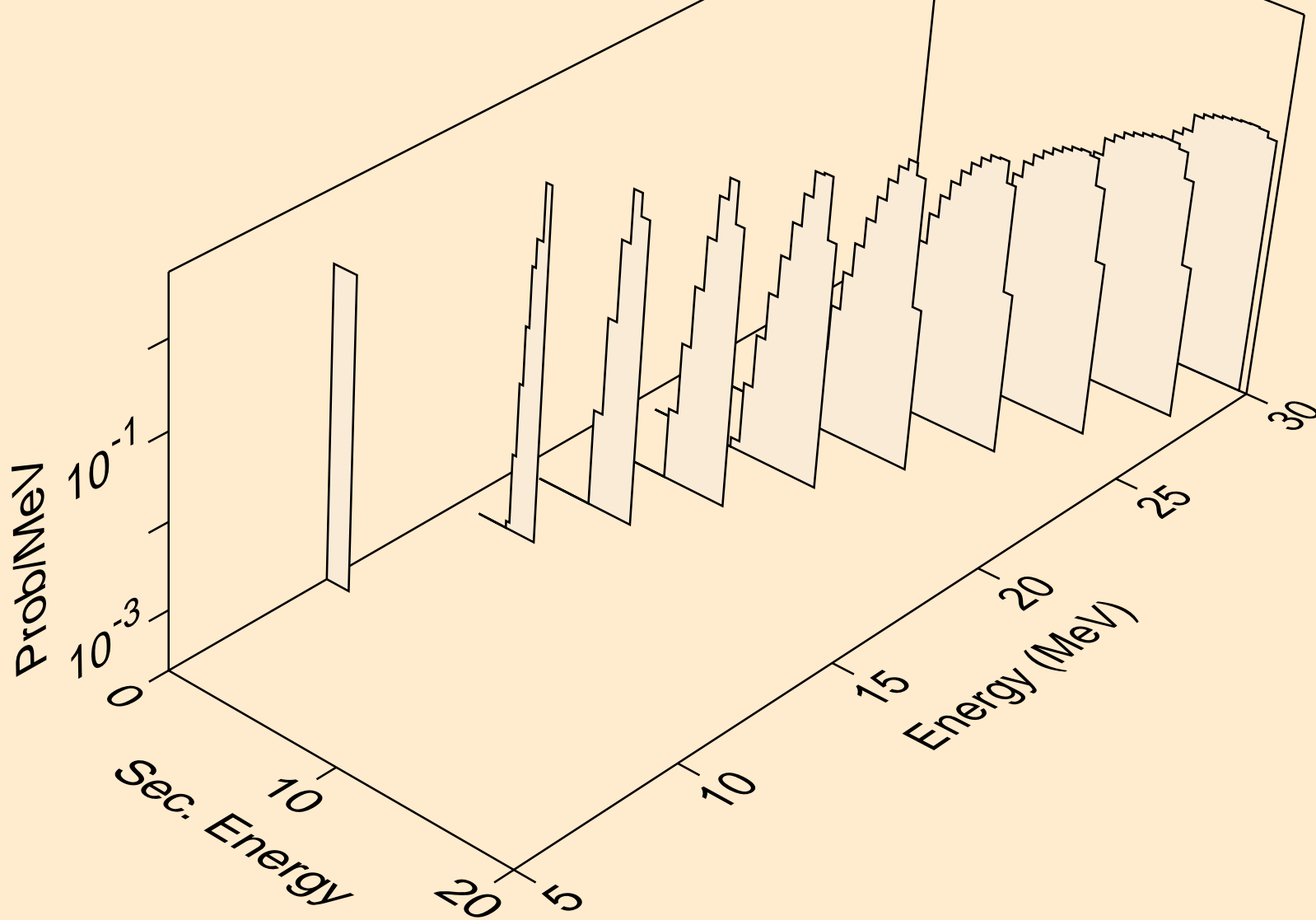

PA239 NEUTRON ACER TENDL-2019 LIBRARY; T=293.16K
deuterons from (n,d)

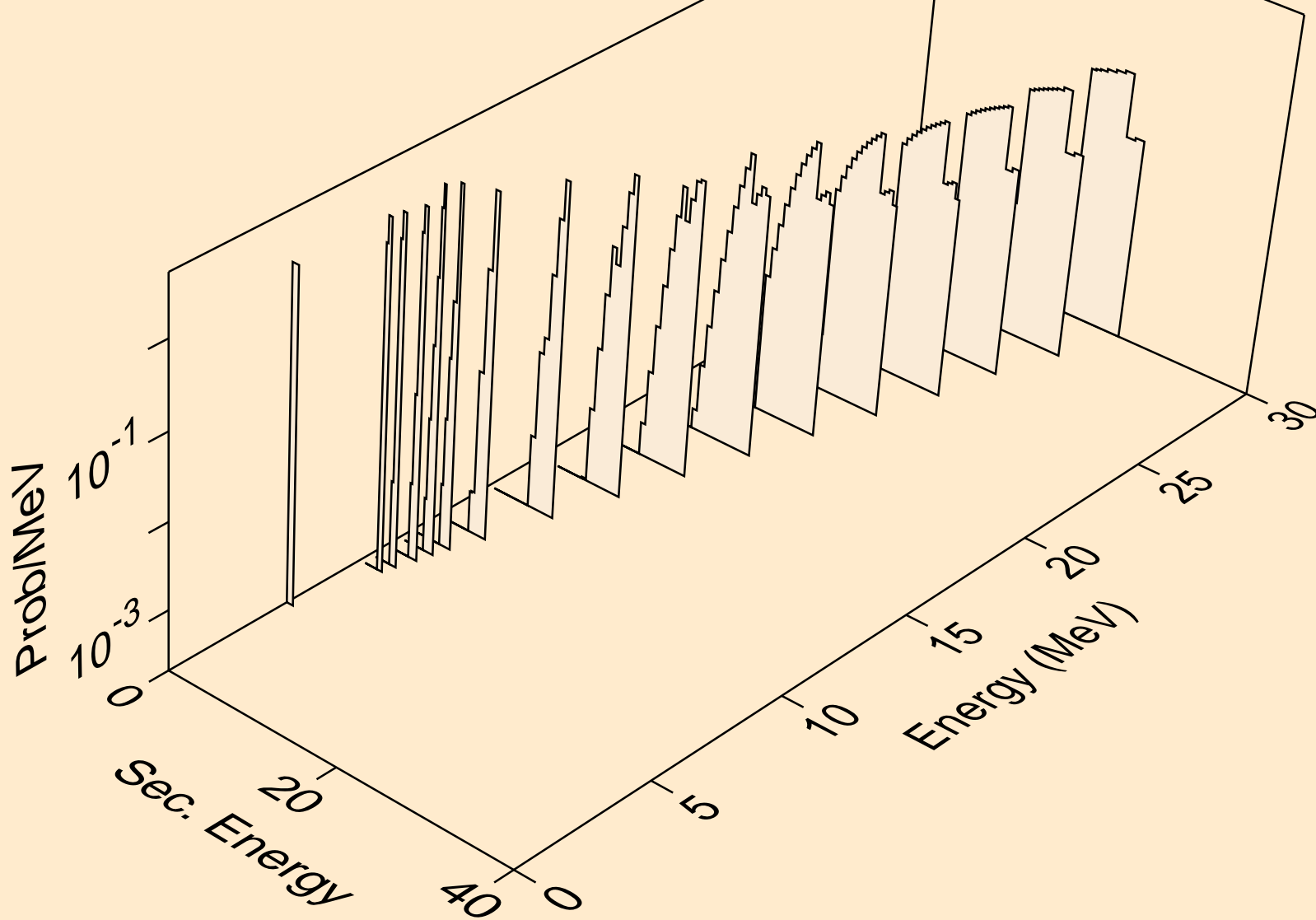

PA239 NEUTRON ACER TENDL-2019 LIBRARY; T=293.16K
tritons from (n,x)

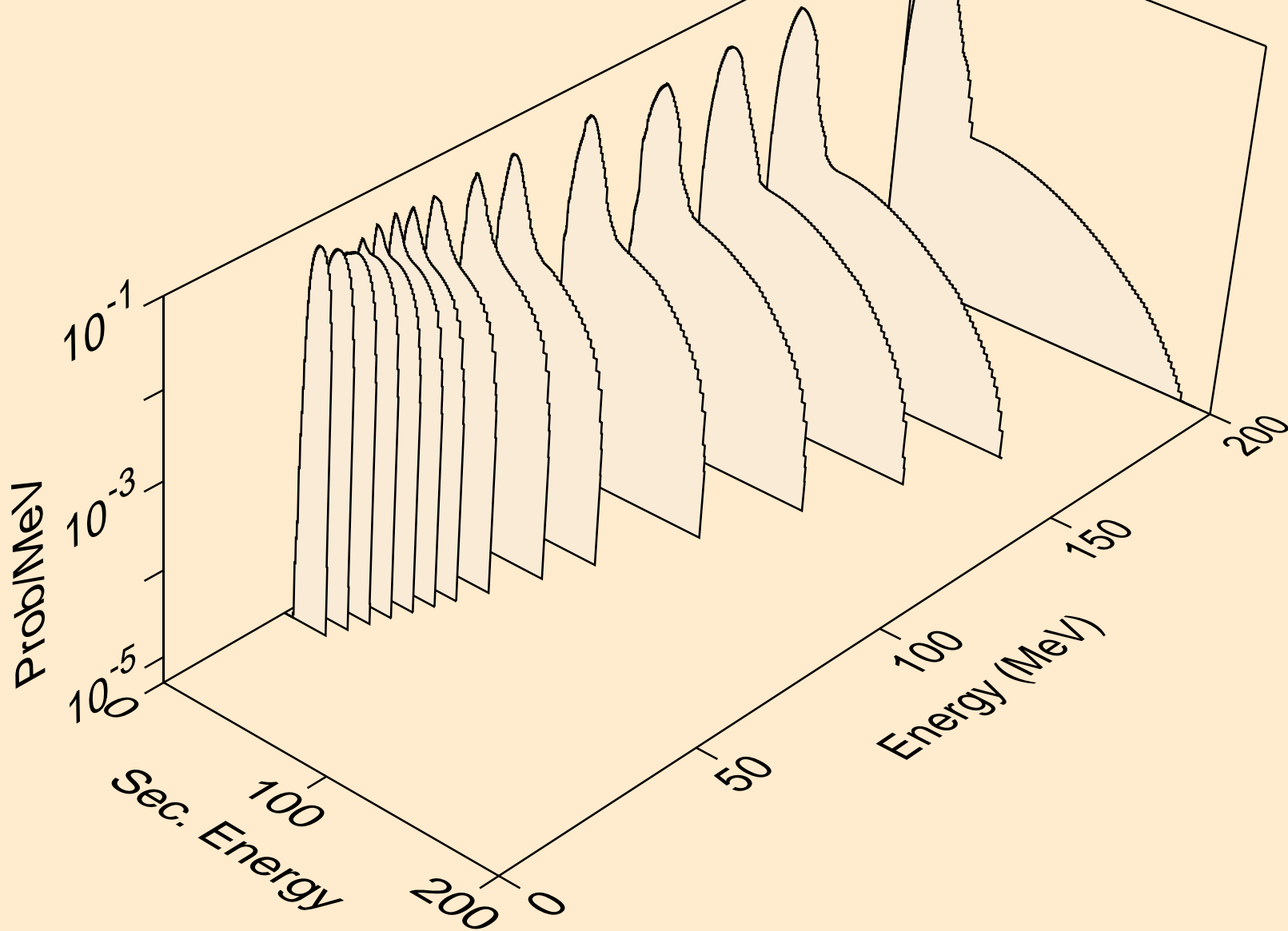

PA239 NEUTRON ACER TENDL-2019 LIBRARY; T=293.16K
tritons from (n,n*)t

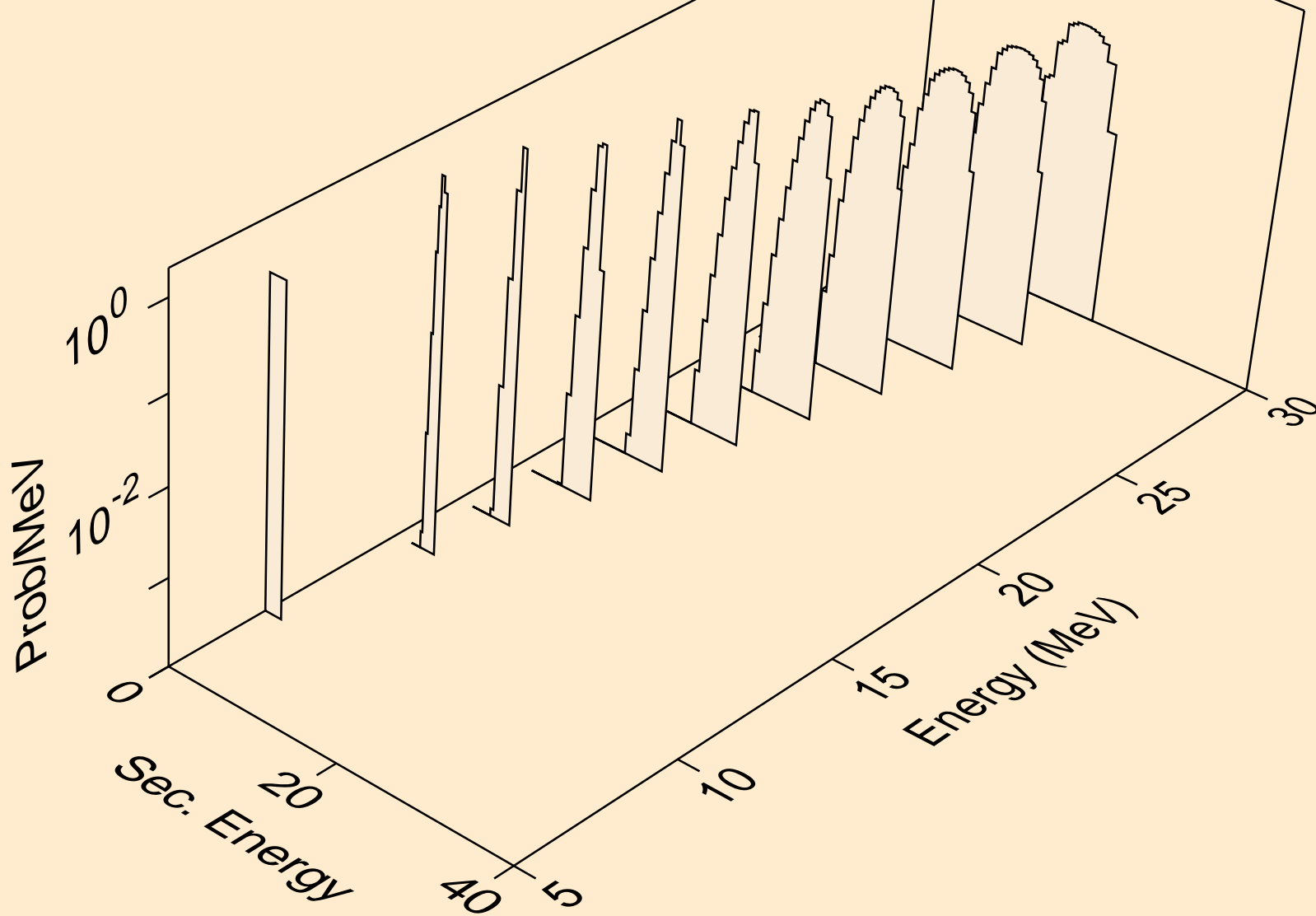

PA239 NEUTRON ACER TENDL-2019 LIBRARY; T=293.16K
tritons from (n,t)

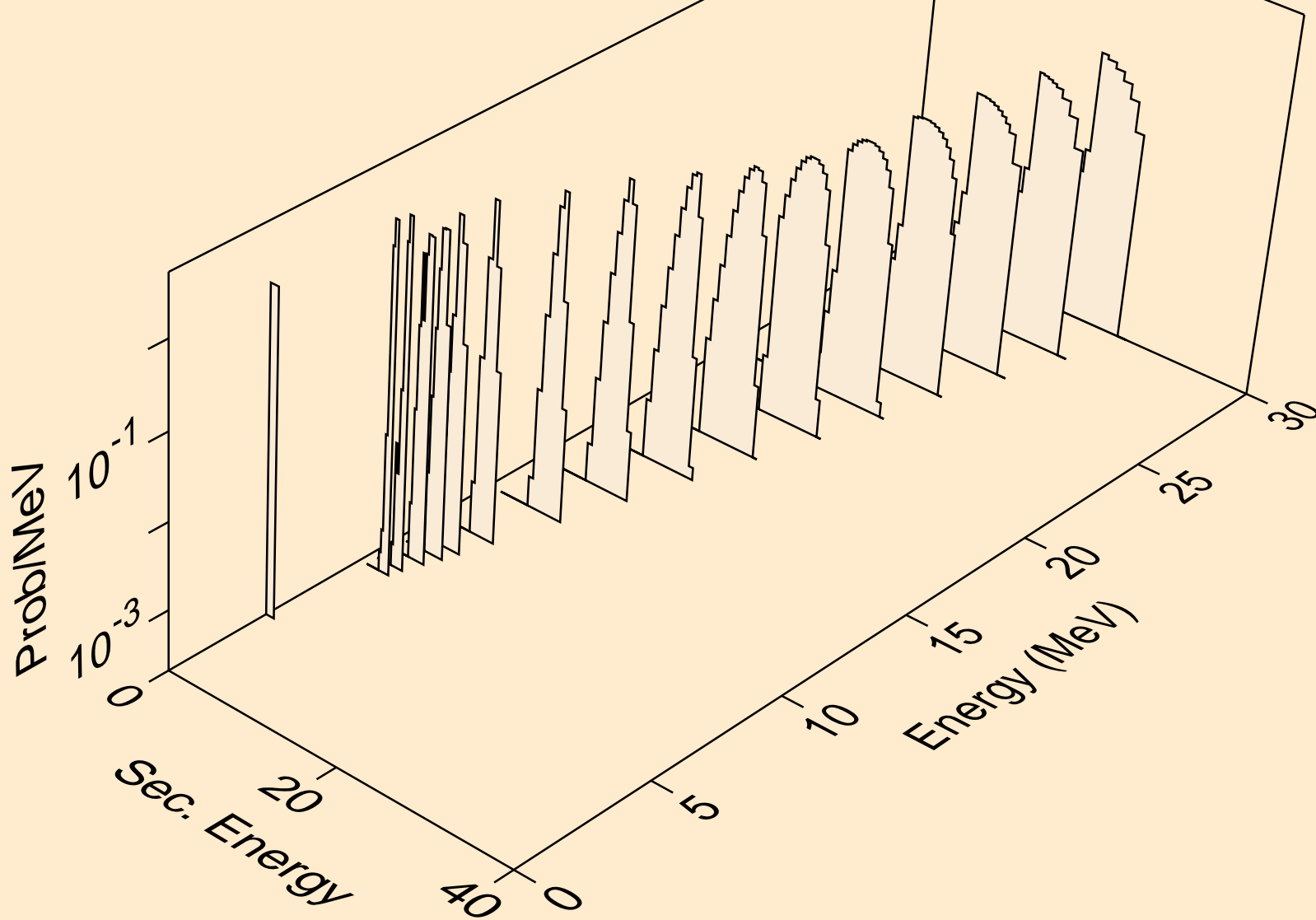

PA239 NEUTRON ACER TENDL-2019 LIBRARY; T=293.16K
he3s from (n,x)

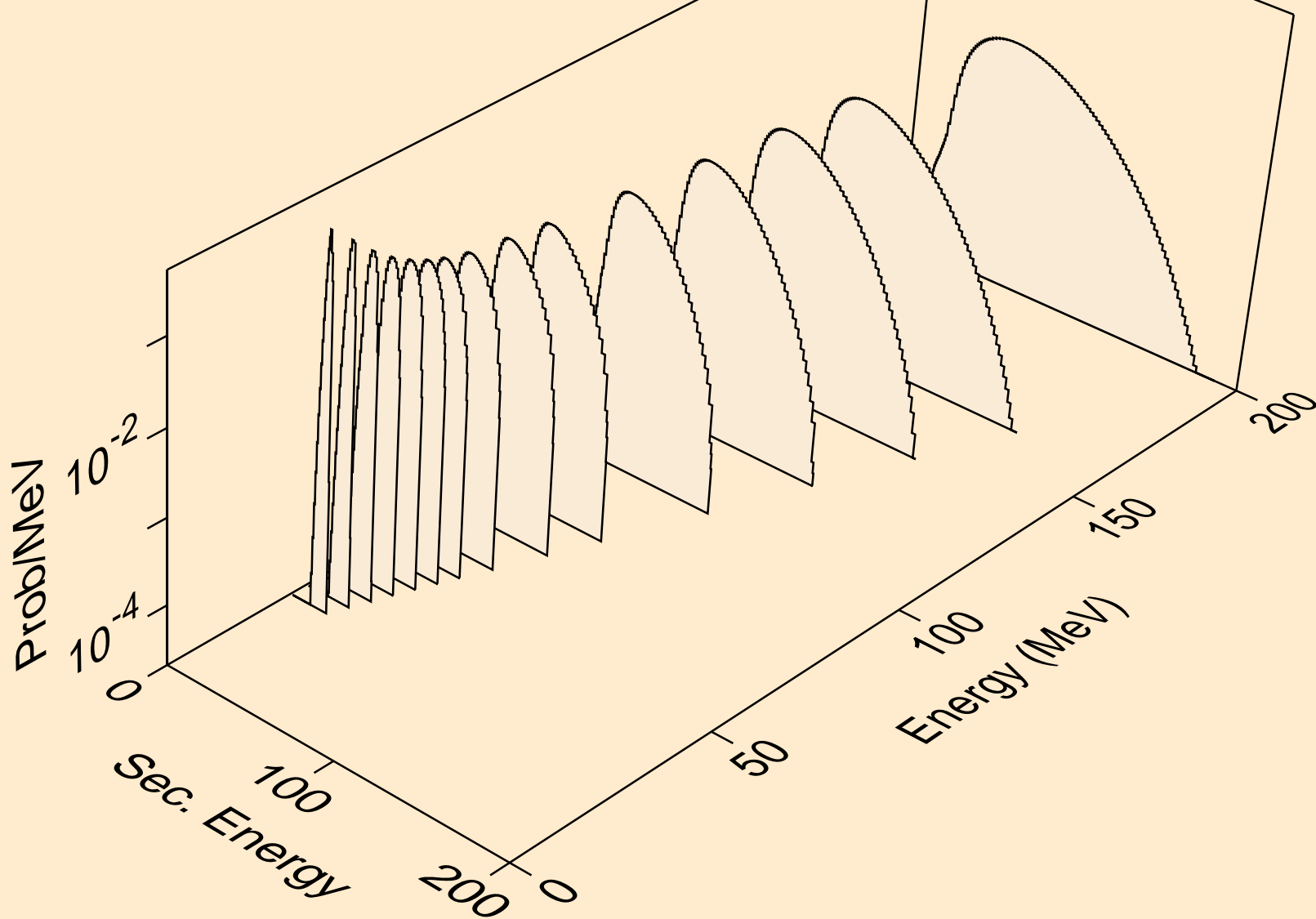

PA239 NEUTRON ACER TENDL-2019 LIBRARY; T=293.16K
he3s from (n,n*)he3

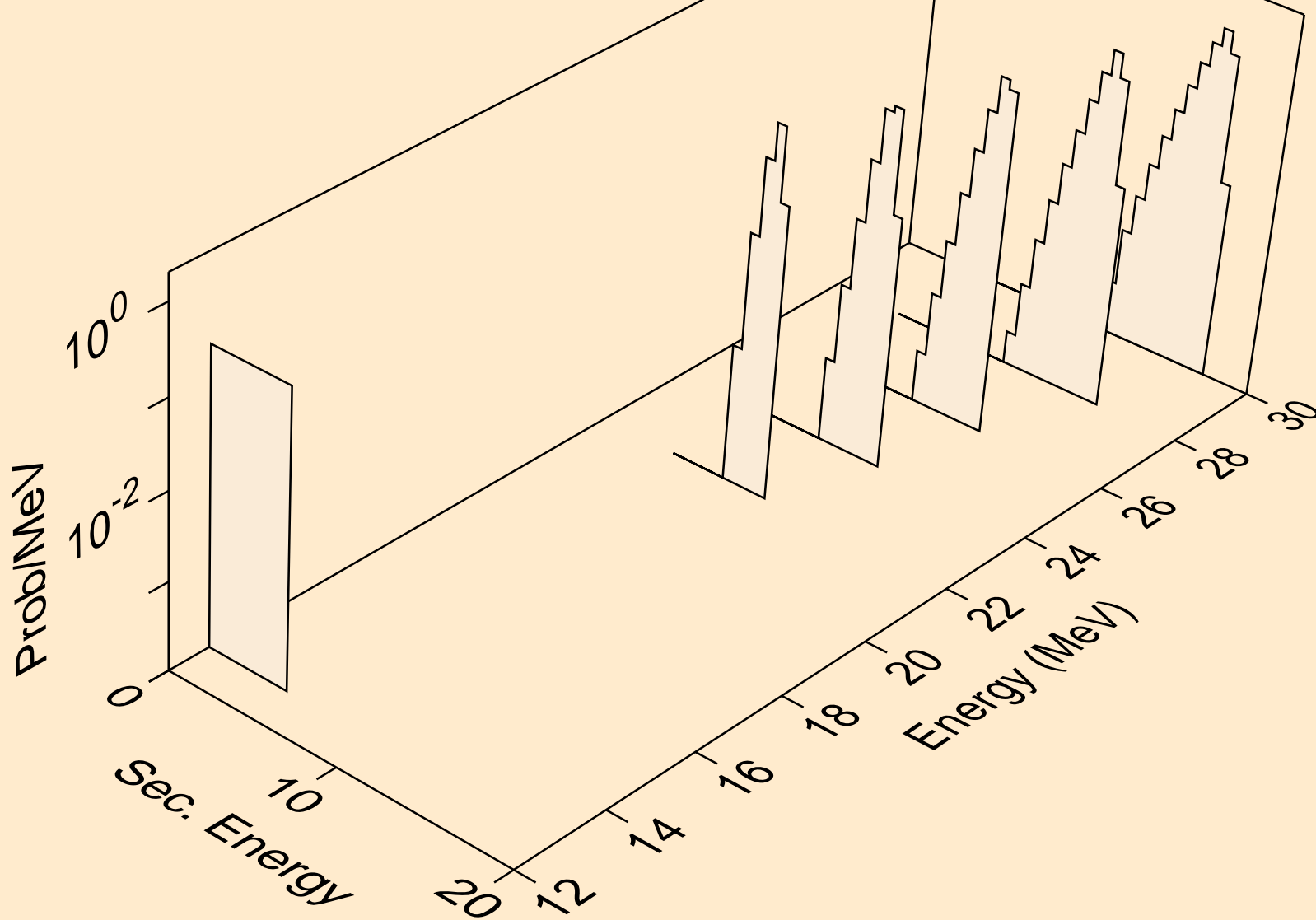

PA239 NEUTRON ACER TENDL-2019 LIBRARY; T=293.16K
he3s from (n,he3)

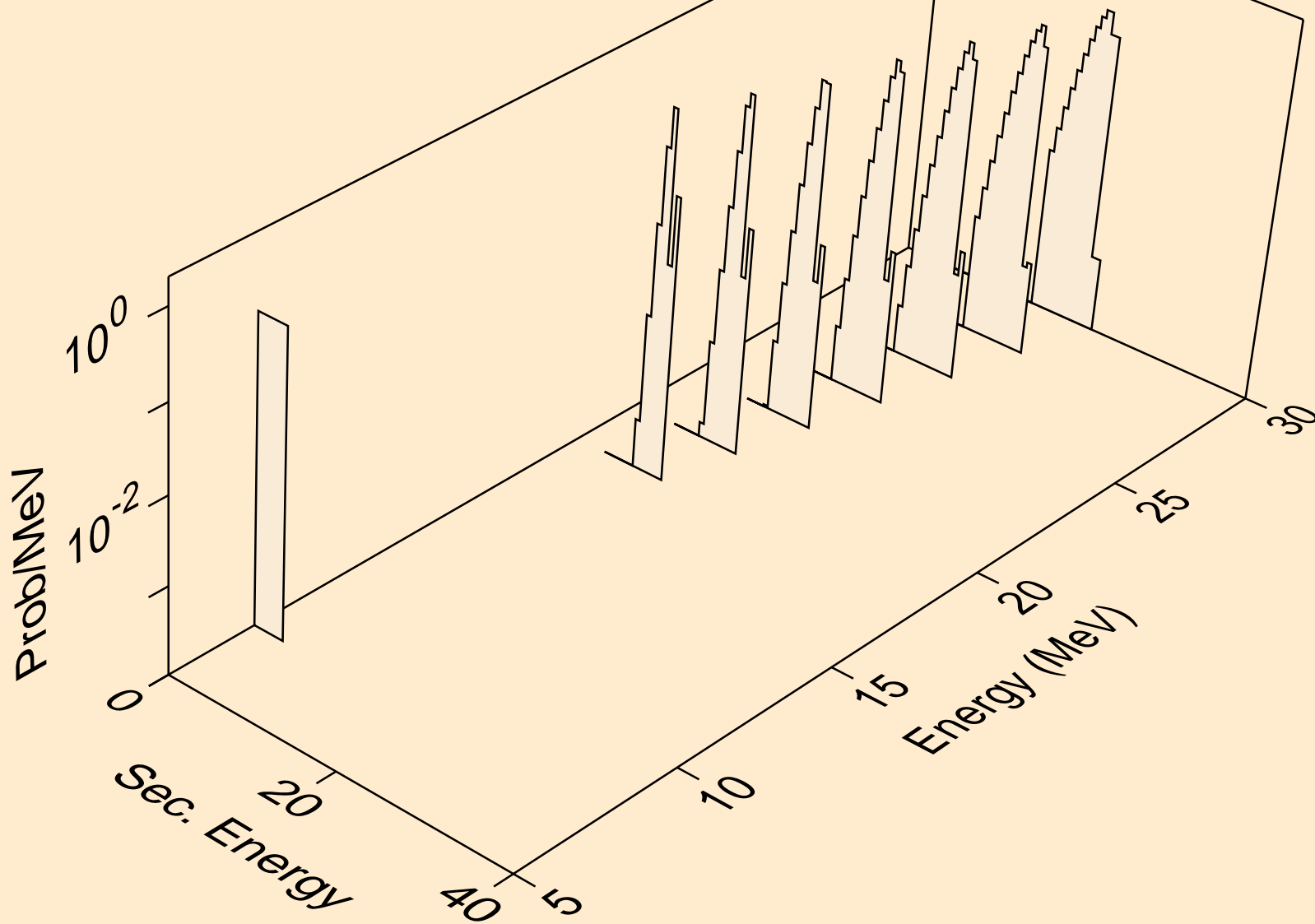

PA239 NEUTRON ACER TENDL-2019 LIBRARY; T=293.16K
alphas from (n,x)

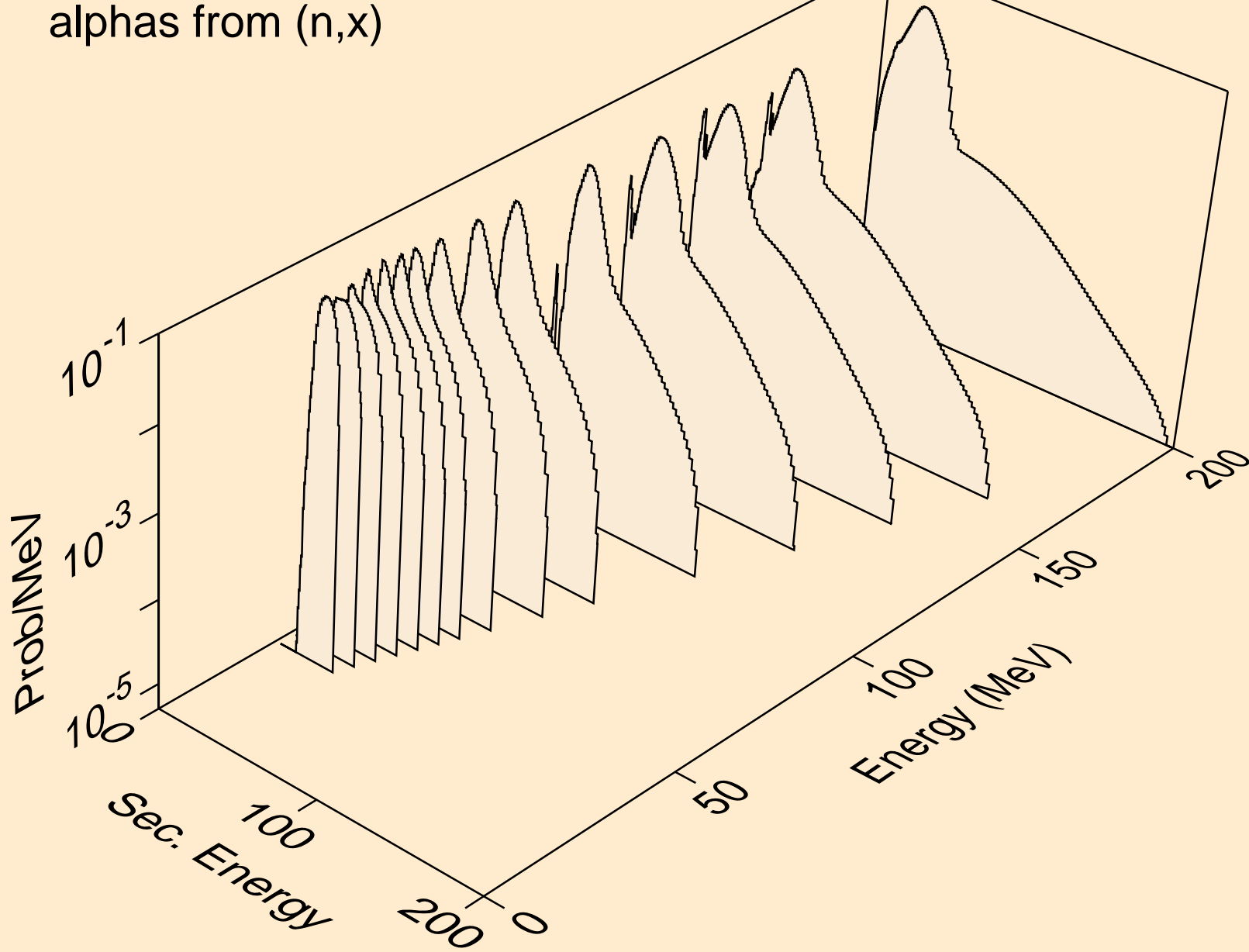

PA239 NEUTRON ACER TENDL-2019 LIBRARY; T=293.16K
alphas from (n,n*)a

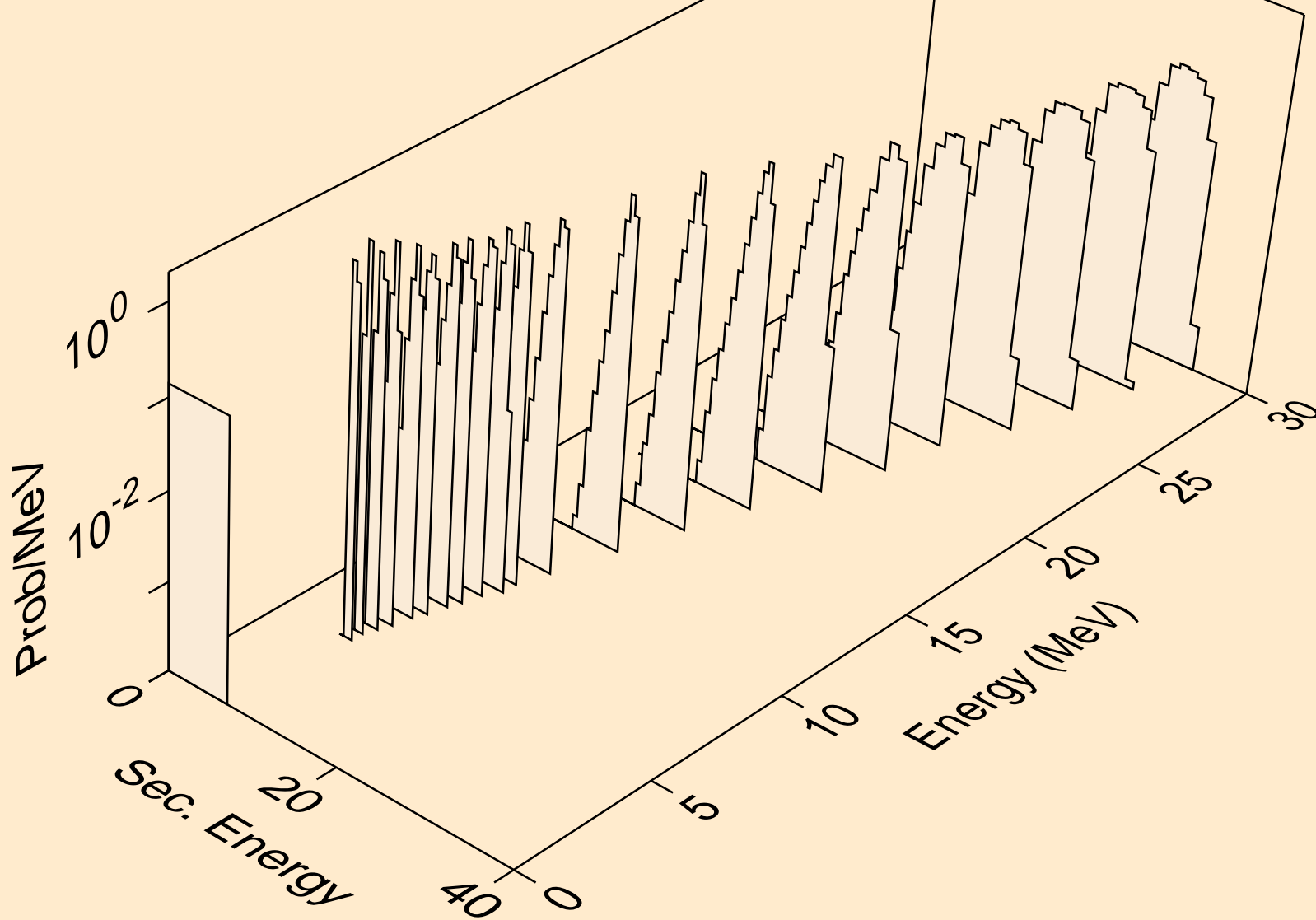

PA239 NEUTRON ACER TENDL-2019 LIBRARY; T=293.16K
alphas from (n,2n)a

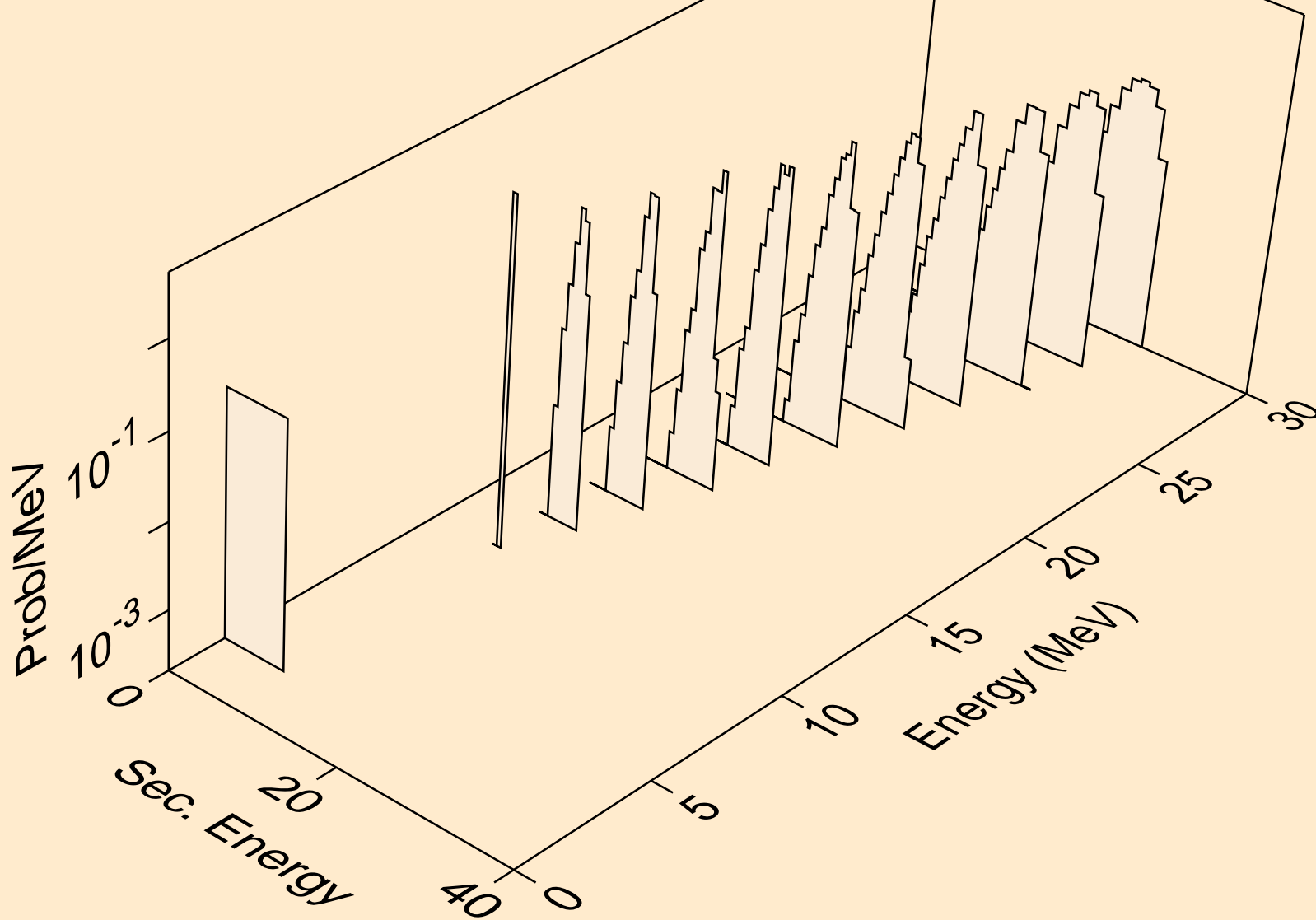

PA239 NEUTRON ACER TENDL-2019 LIBRARY; T=293.16K
alphas from (n,3n)a

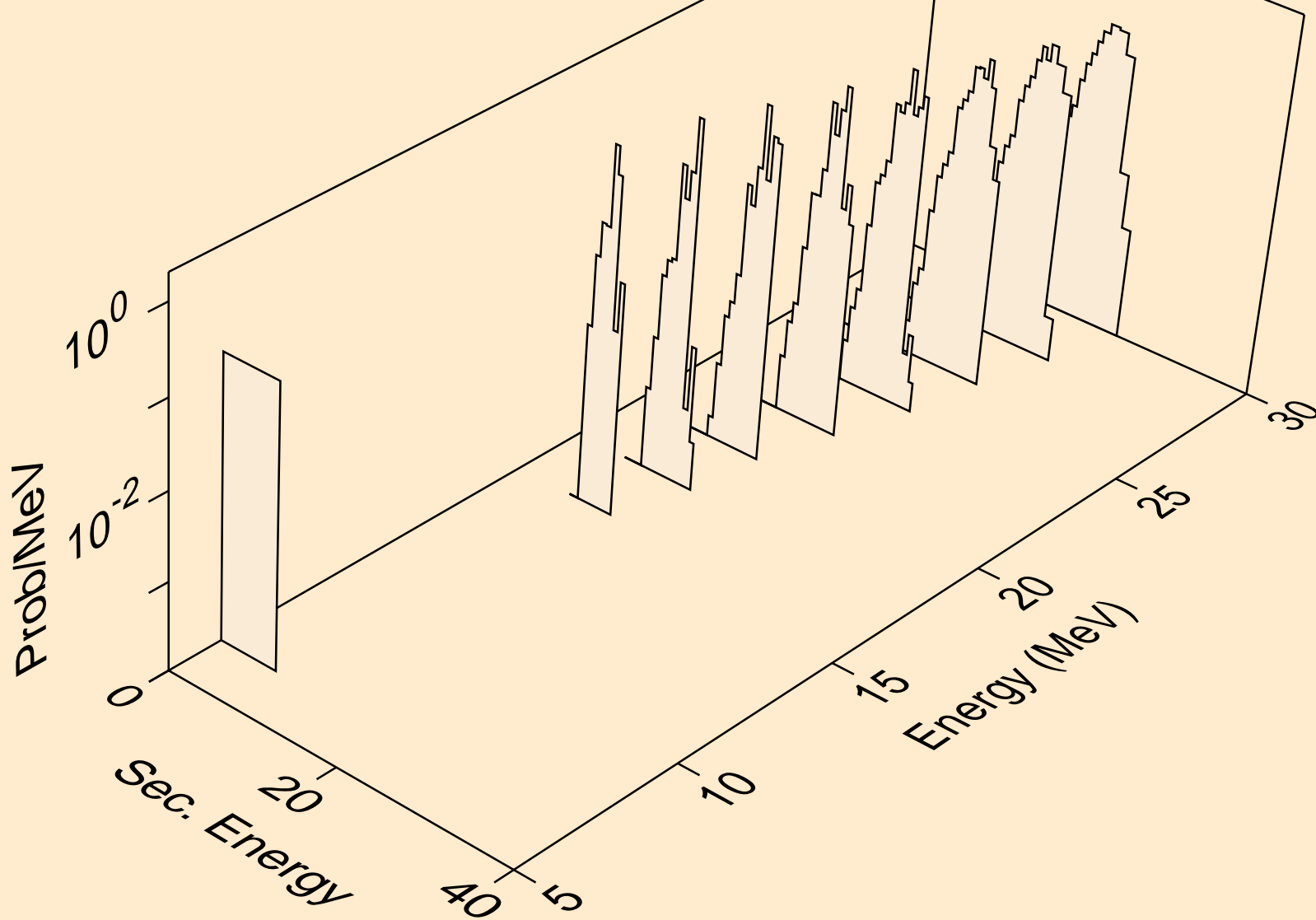

PA239 NEUTRON ACER TENDL-2019 LIBRARY; T=293.16K
alphas from (n,a)

