

PM140M NEUTRON ACER TENDL-2019 LIBRARY; T=293.16K
Principal cross sections

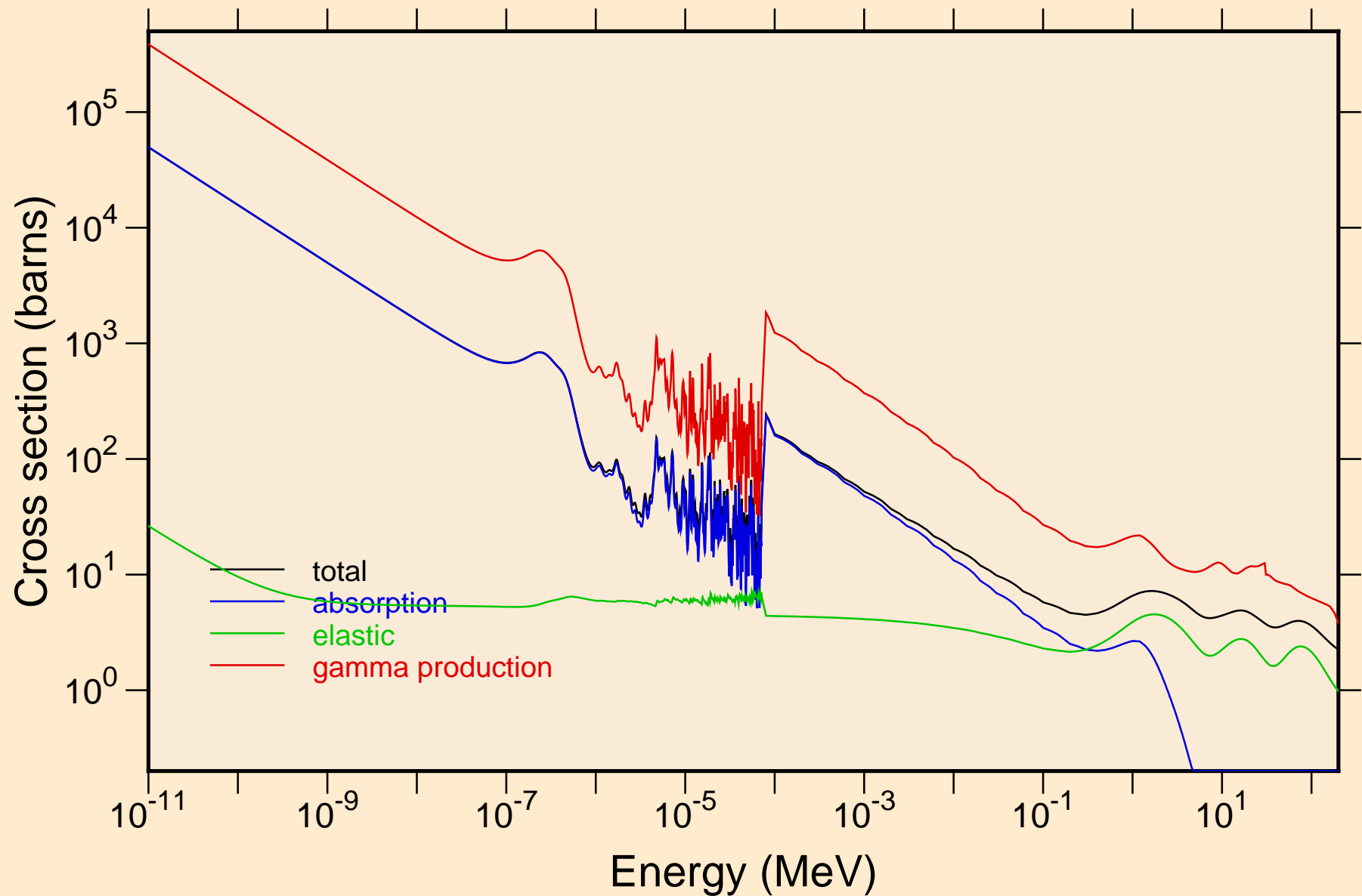

PM140M NEUTRON ACER TENDL-2019 LIBRARY; T=293.16K
resonance total cross section

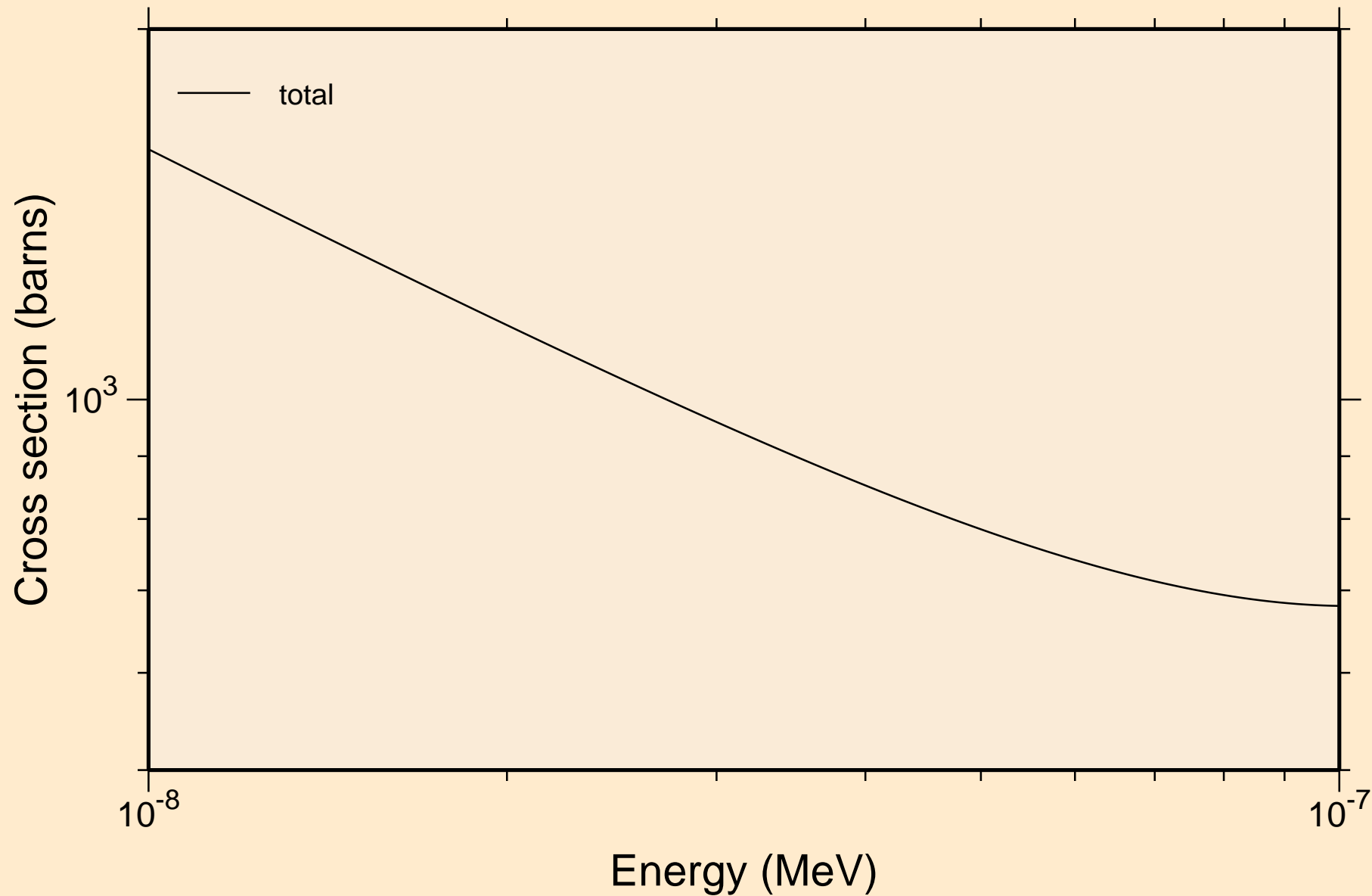

PM140M NEUTRON ACER TENDL-2019 LIBRARY; T=293.16K
resonance total cross section

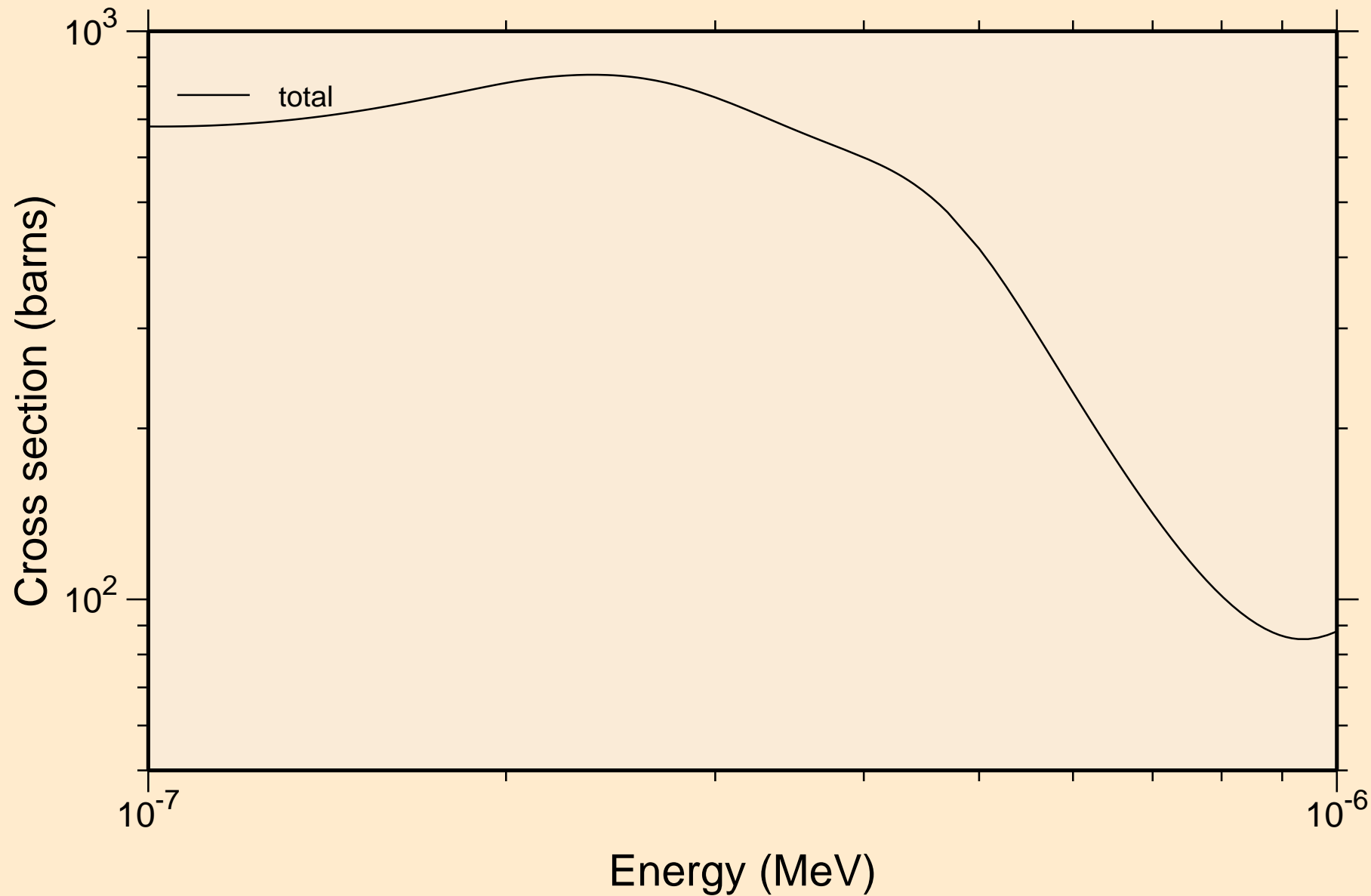

PM140M NEUTRON ACER TENDL-2019 LIBRARY; T=293.16K
resonance total cross section

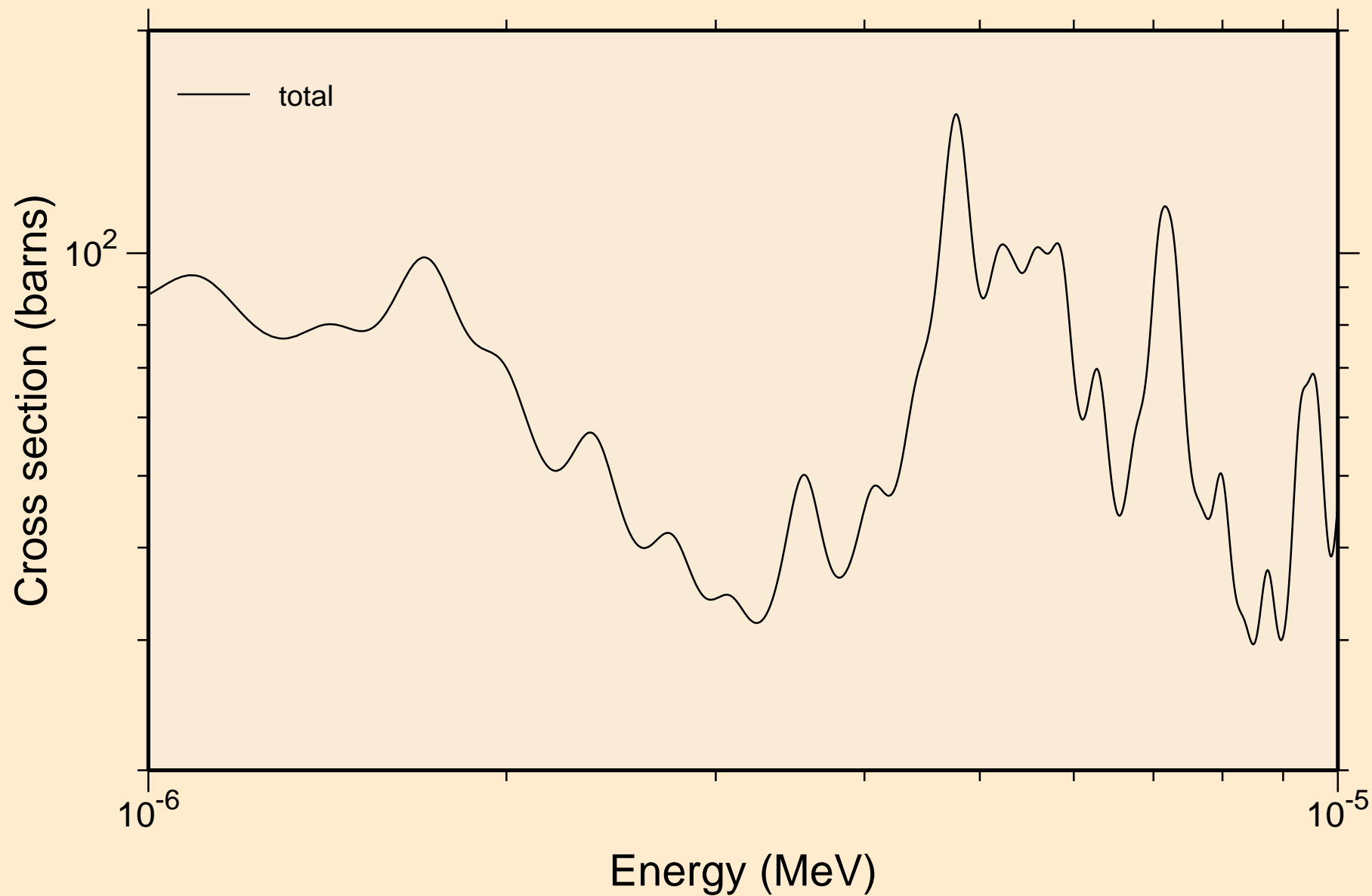

PM140M NEUTRON ACER TENDL-2019 LIBRARY; T=293.16K
resonance total cross section

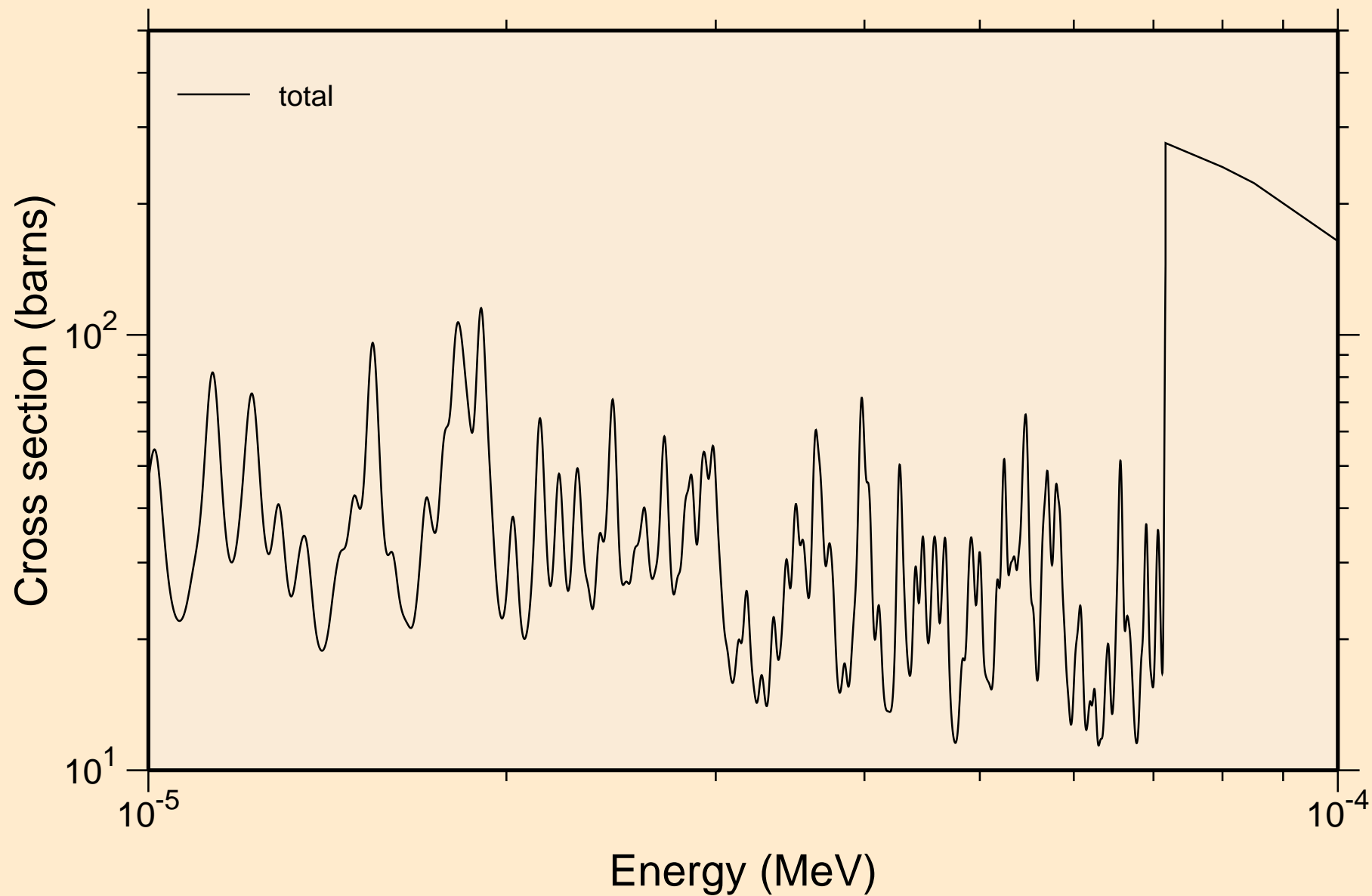

P̄M140M NEUTRON ACER TENDL-2019 LIBRARY; T=293.16K
resonance total cross section

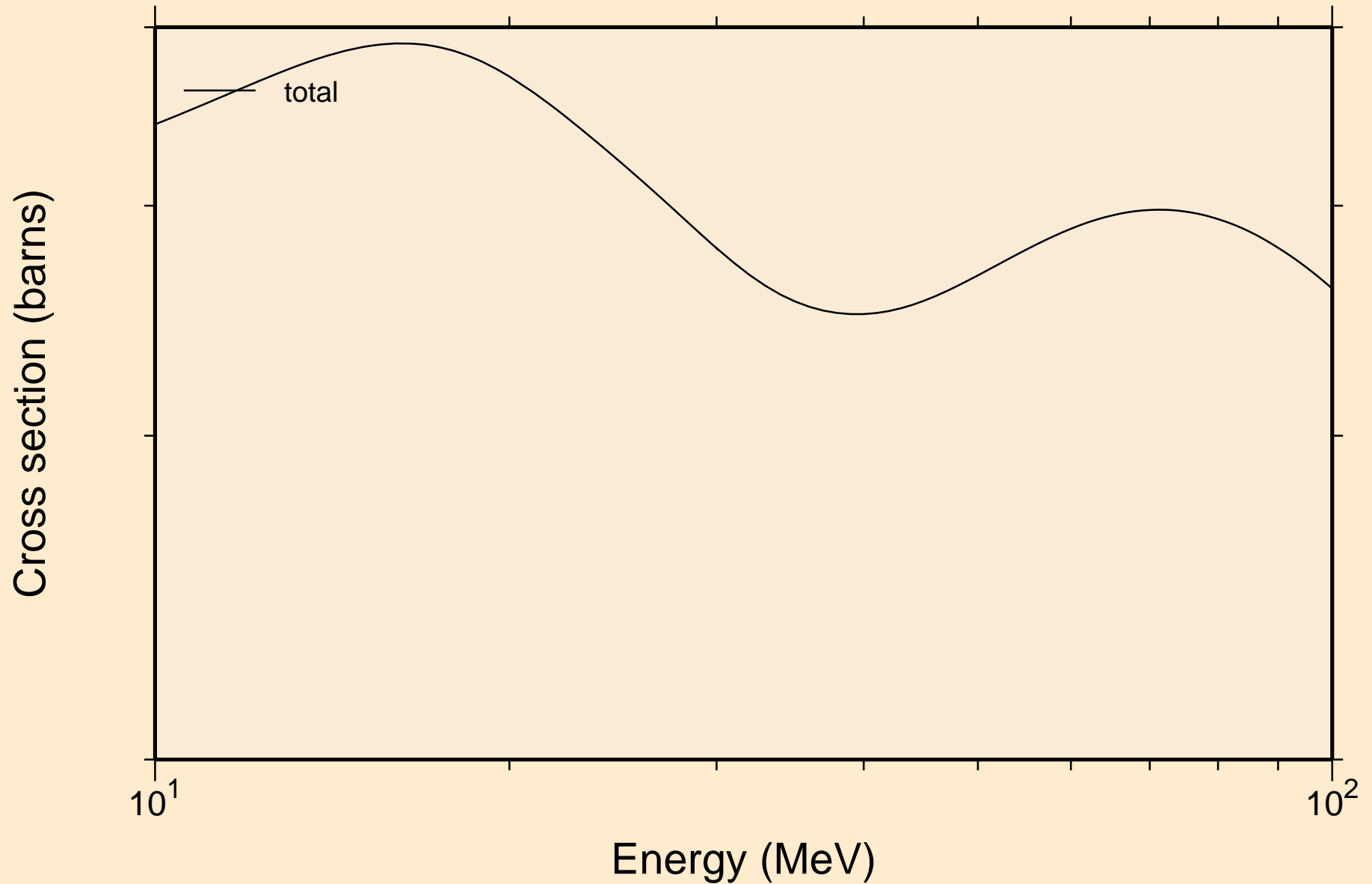

PM140M NEUTRON ACER TENDL-2019 LIBRARY; T=293.16K
resonance absorption cross sections

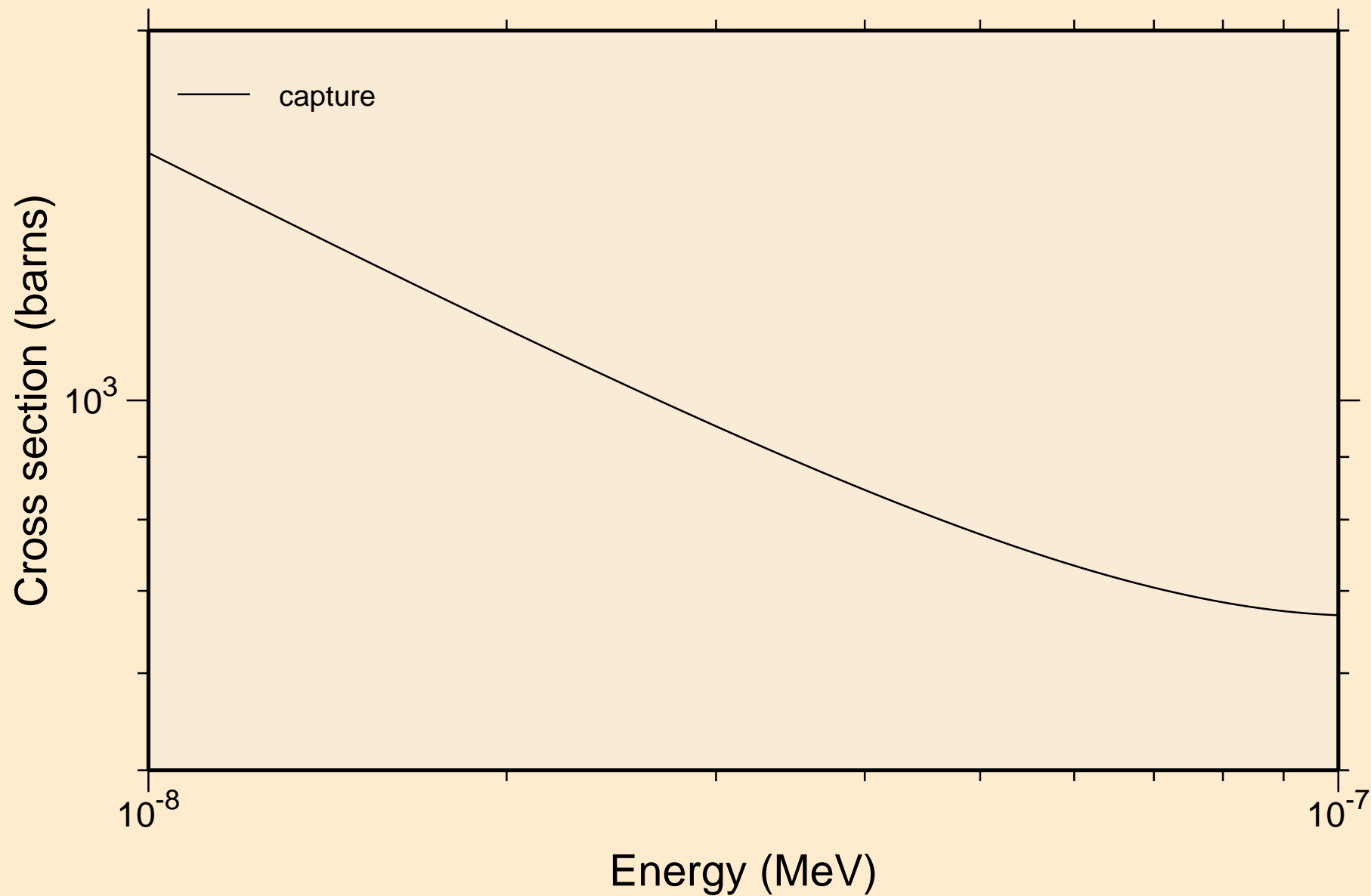

PM140M NEUTRON ACER TENDL-2019 LIBRARY; T=293.16K
resonance absorption cross sections

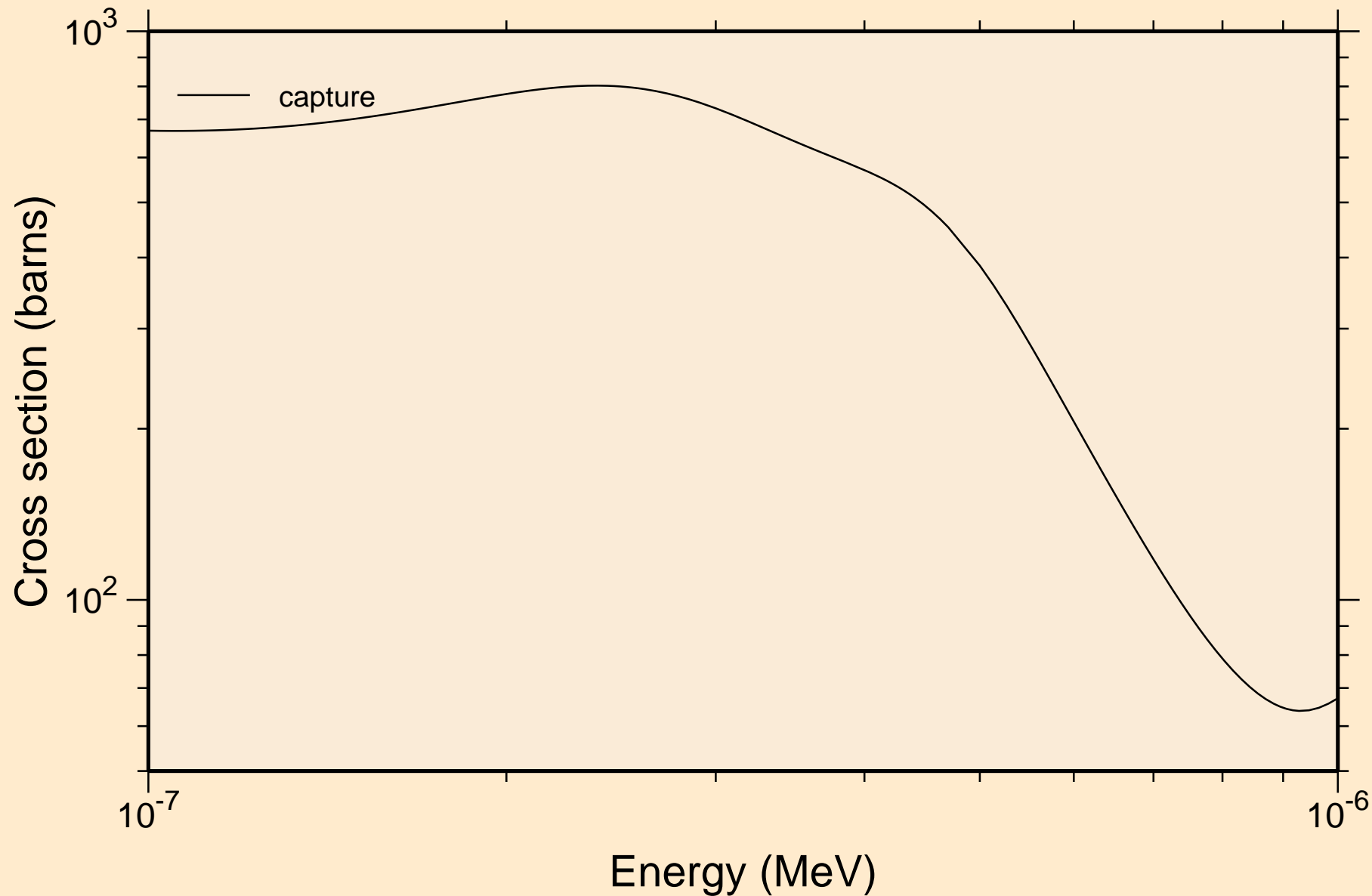

PM140M NEUTRON ACER TENDL-2019 LIBRARY; T=293.16K
resonance absorption cross sections

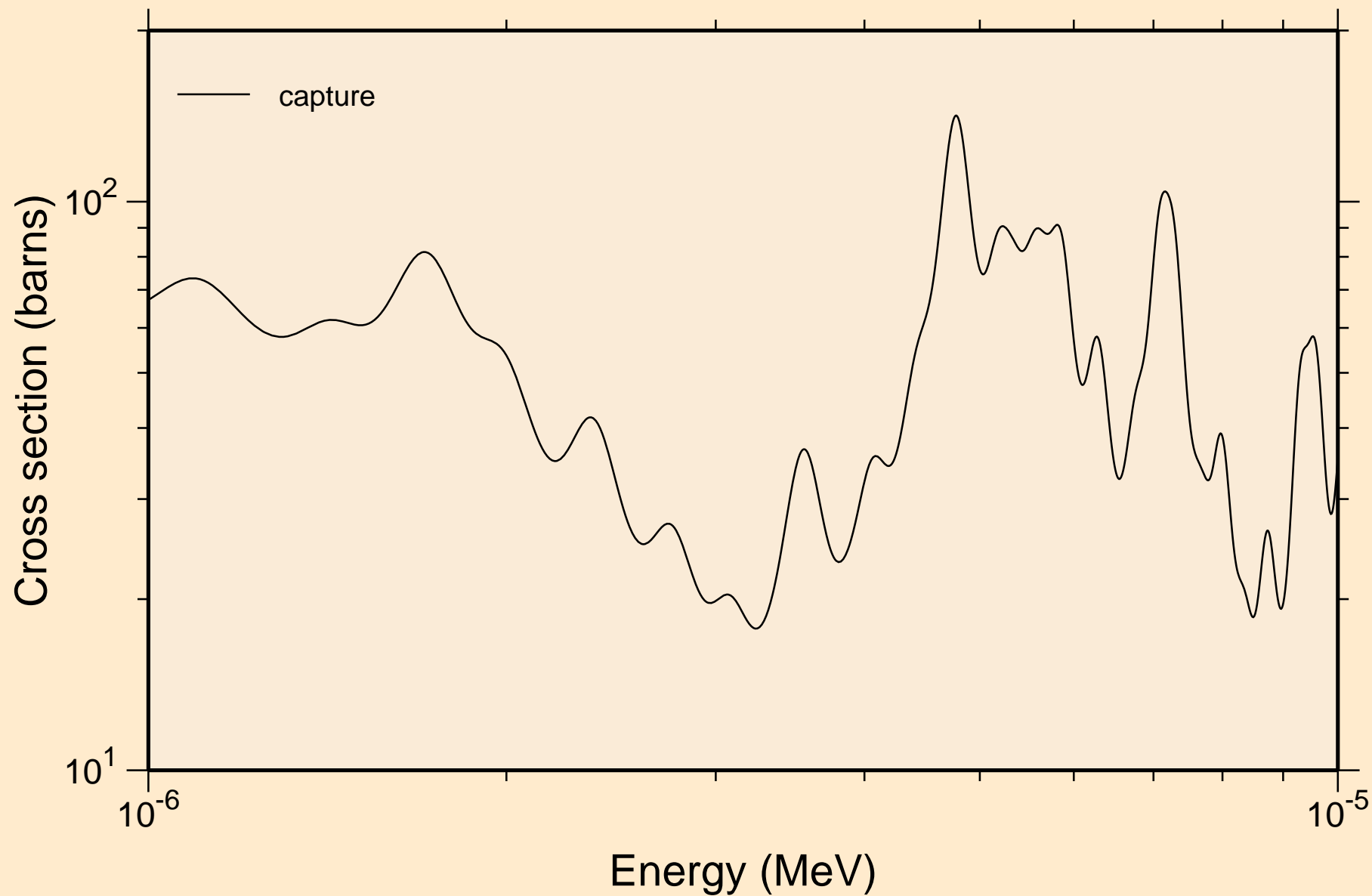

PM140M NEUTRON ACER TENDL-2019 LIBRARY; T=293.16K
resonance absorption cross sections

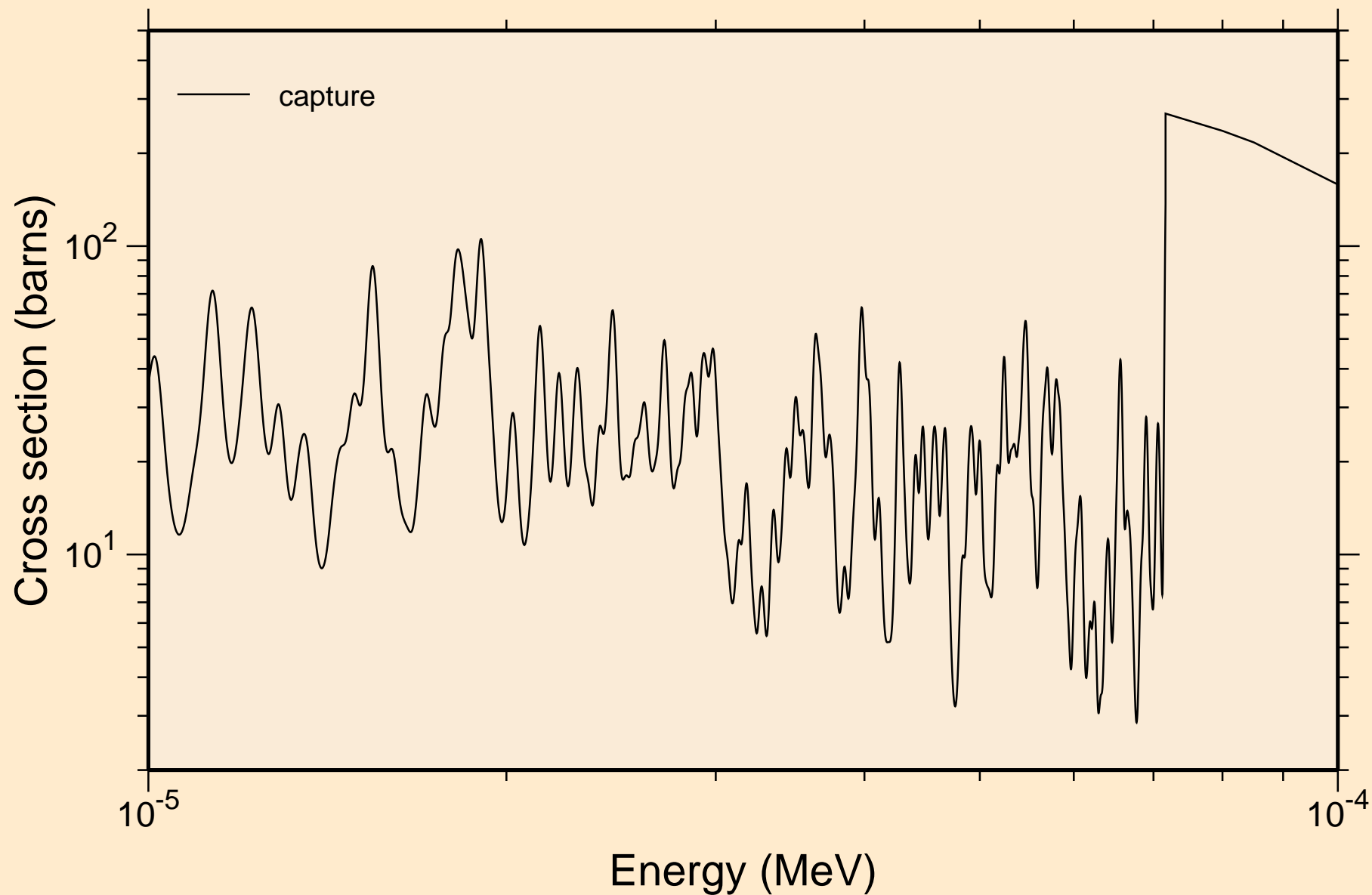

PM140M NEUTRON ACER TENDL-2019 LIBRARY; T=293.16K
resonance absorption cross sections

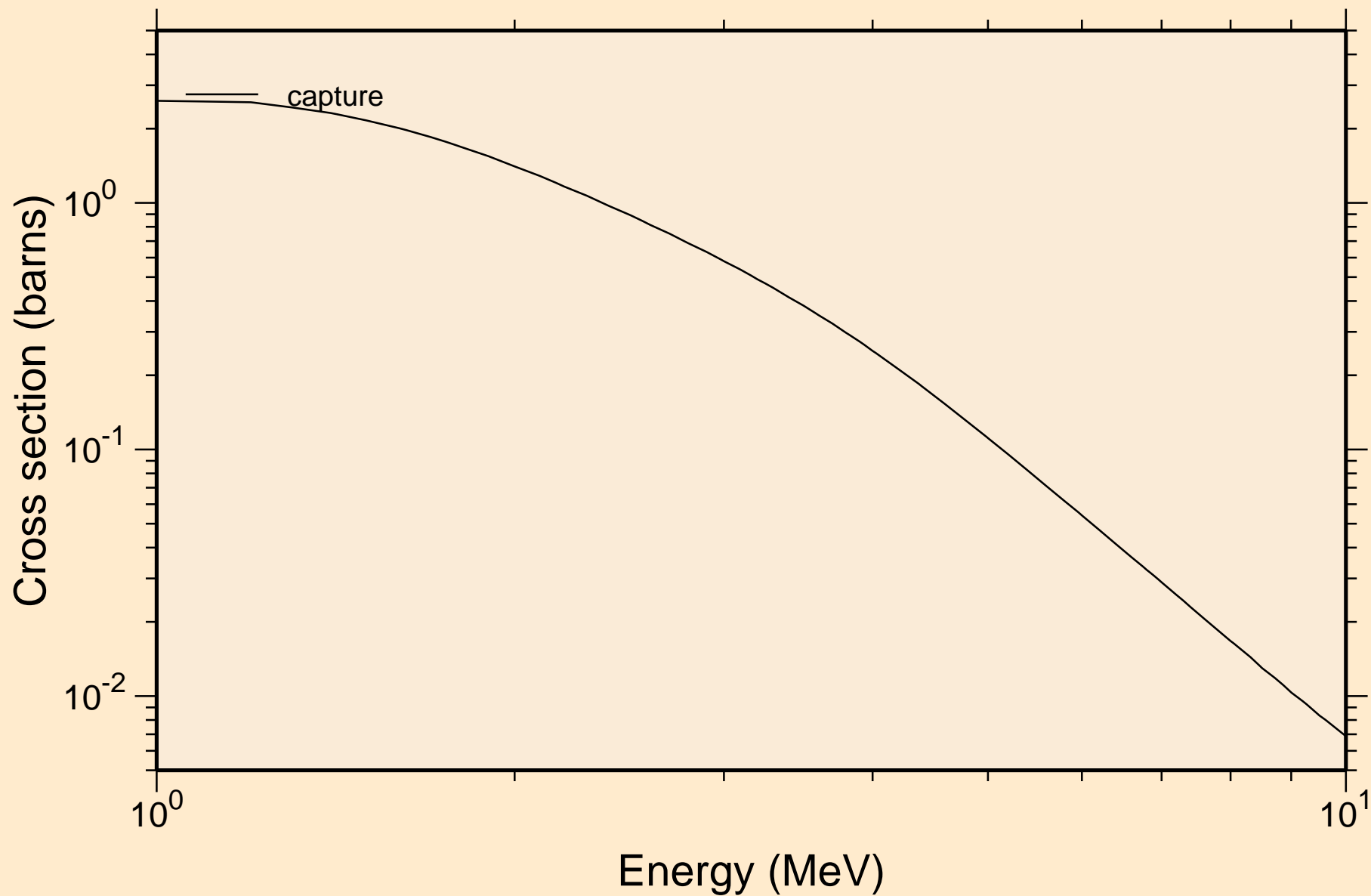

PM140M NEUTRON ACER TENDL-2019 LIBRARY; T=293.16K
Heating

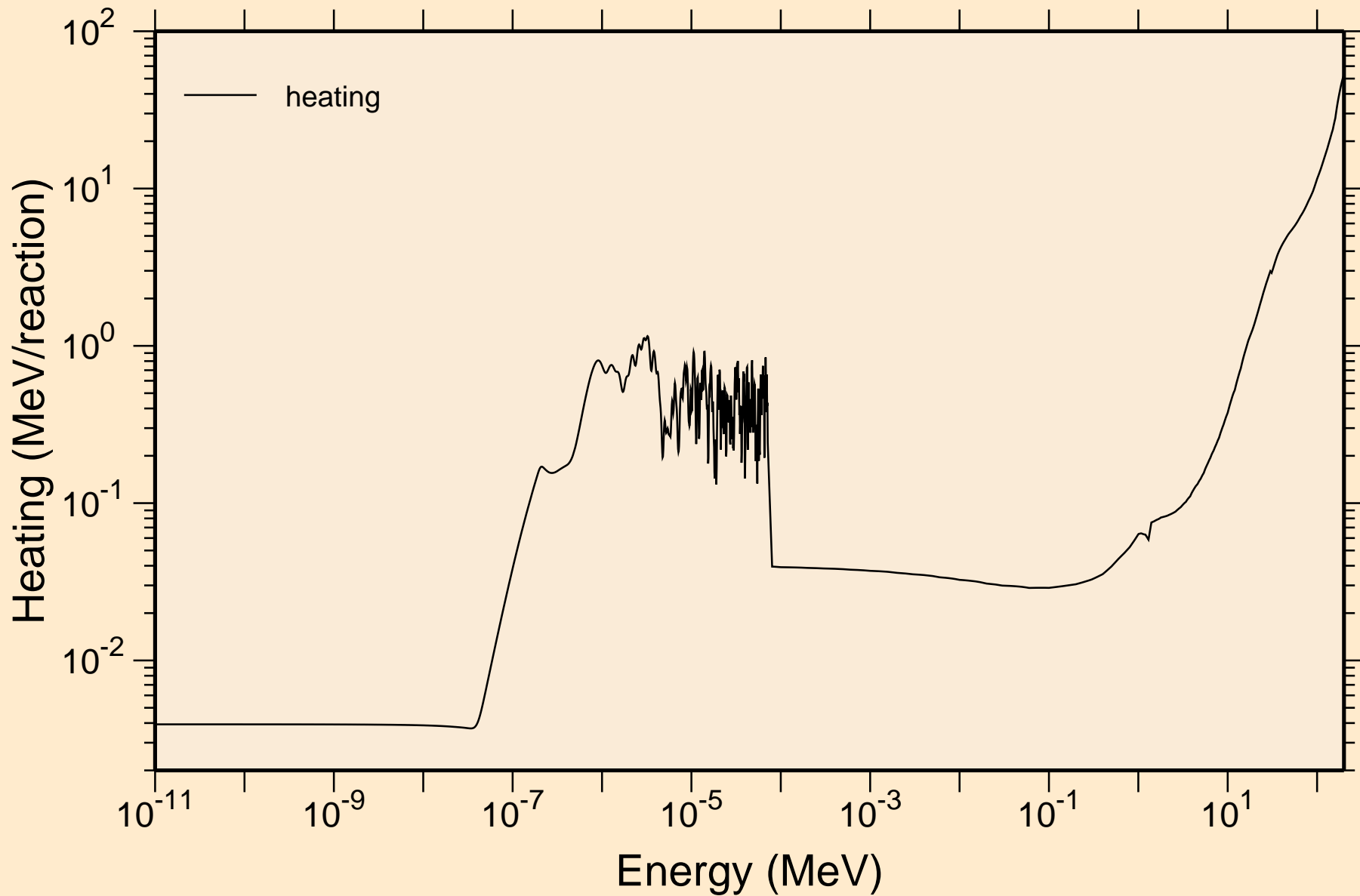

PM140M NEUTRON ACER TENDL-2019 LIBRARY; T=293.16K
Damage

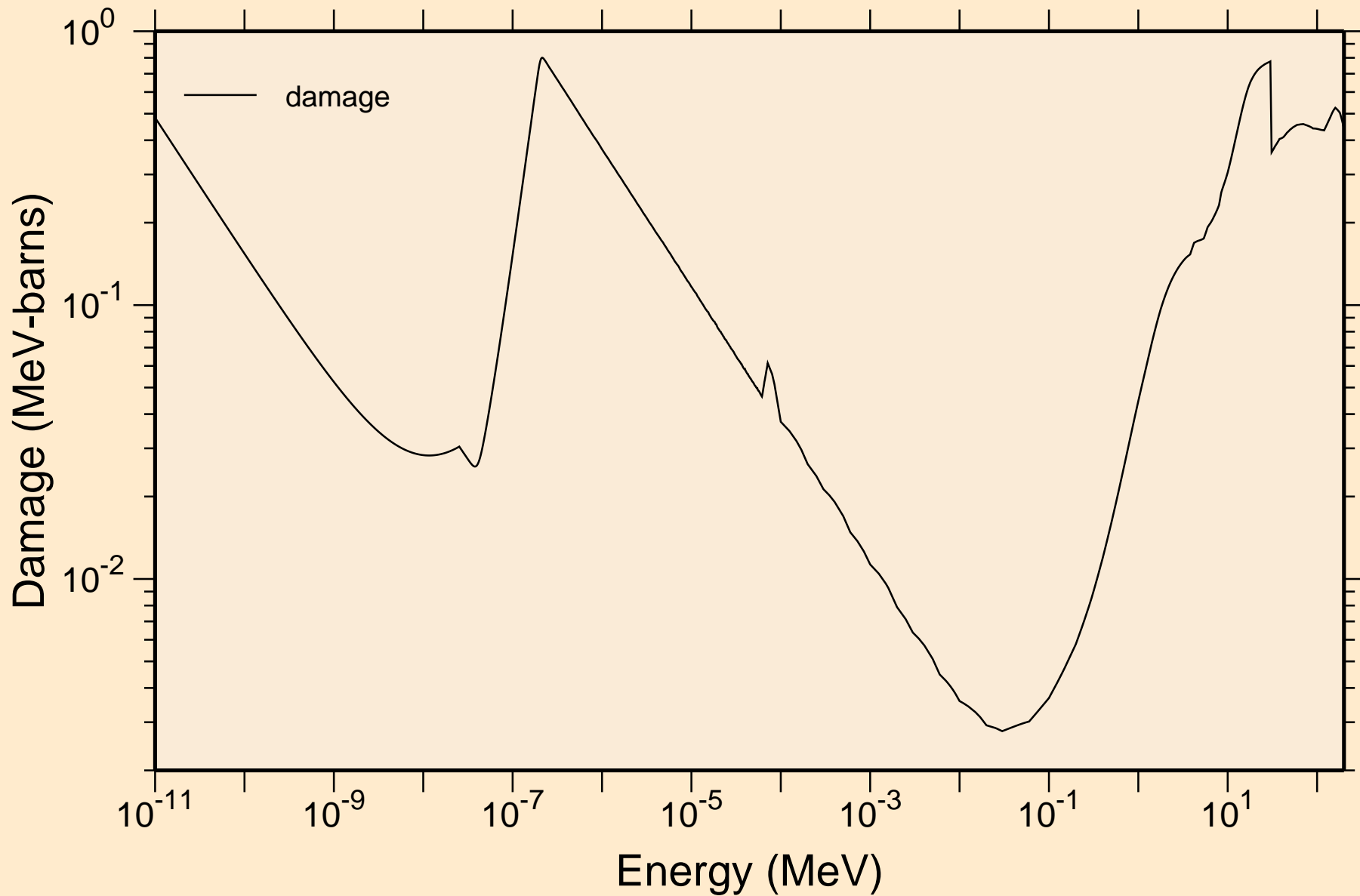

PM140M NEUTRON ACER TENDL-2019 LIBRARY; T=293.16K
Non-threshold reactions

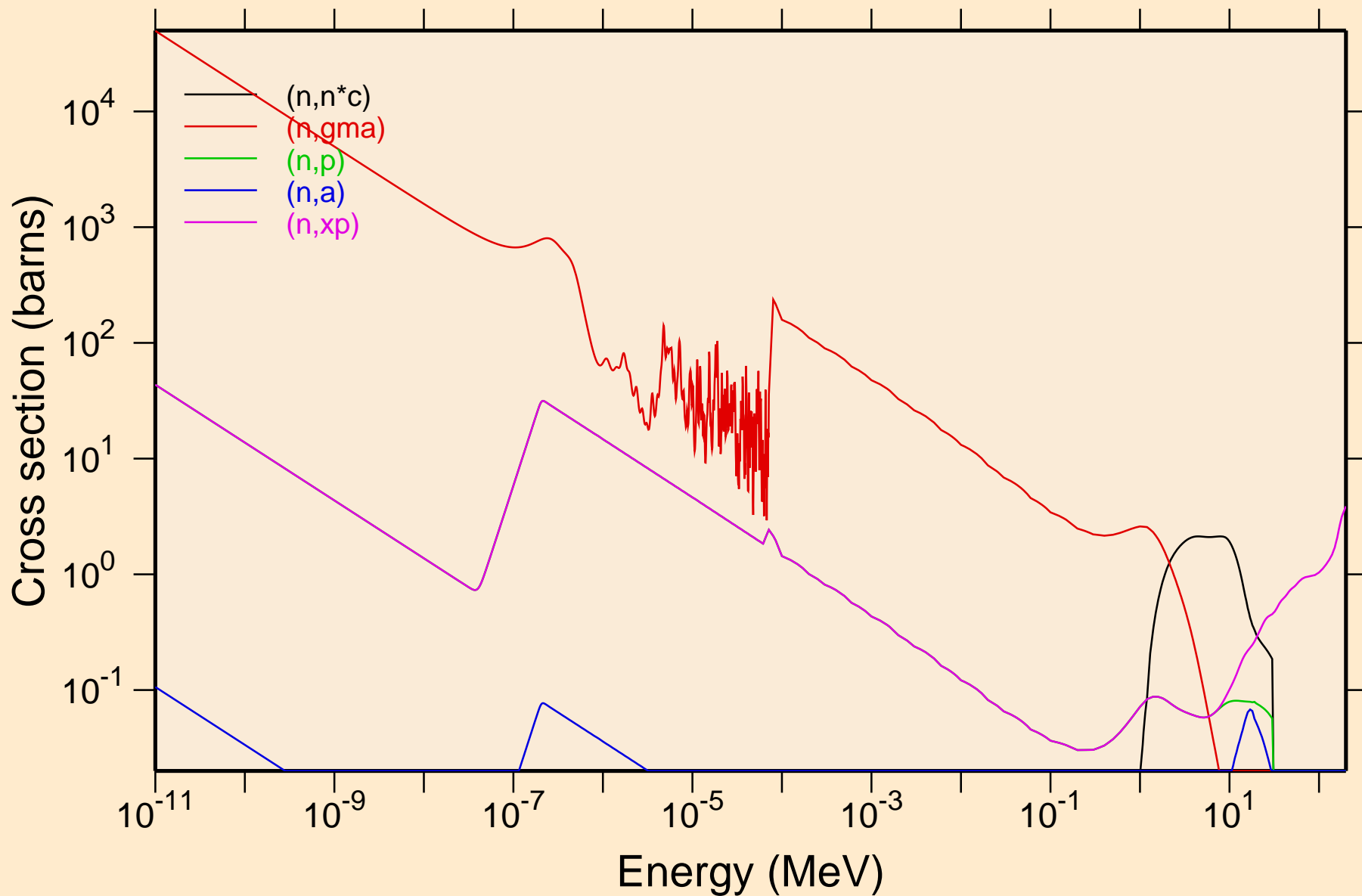

PM140M NEUTRON ACER TENDL-2019 LIBRARY; T=293.16K
Non-threshold reactions

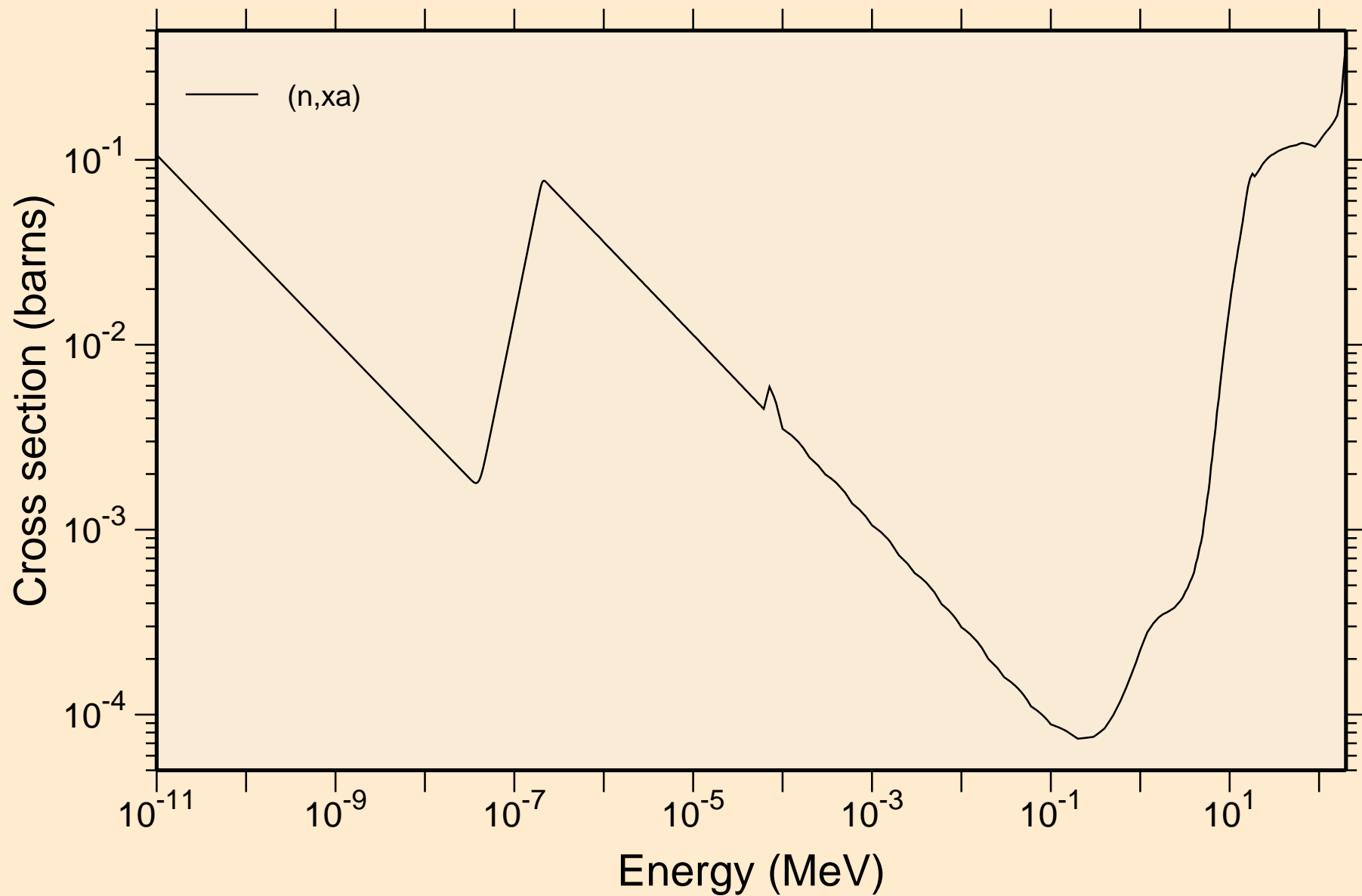

PM140M NEUTRON ACER TENDL-2019 LIBRARY; T=293.16K
Principal cross sections

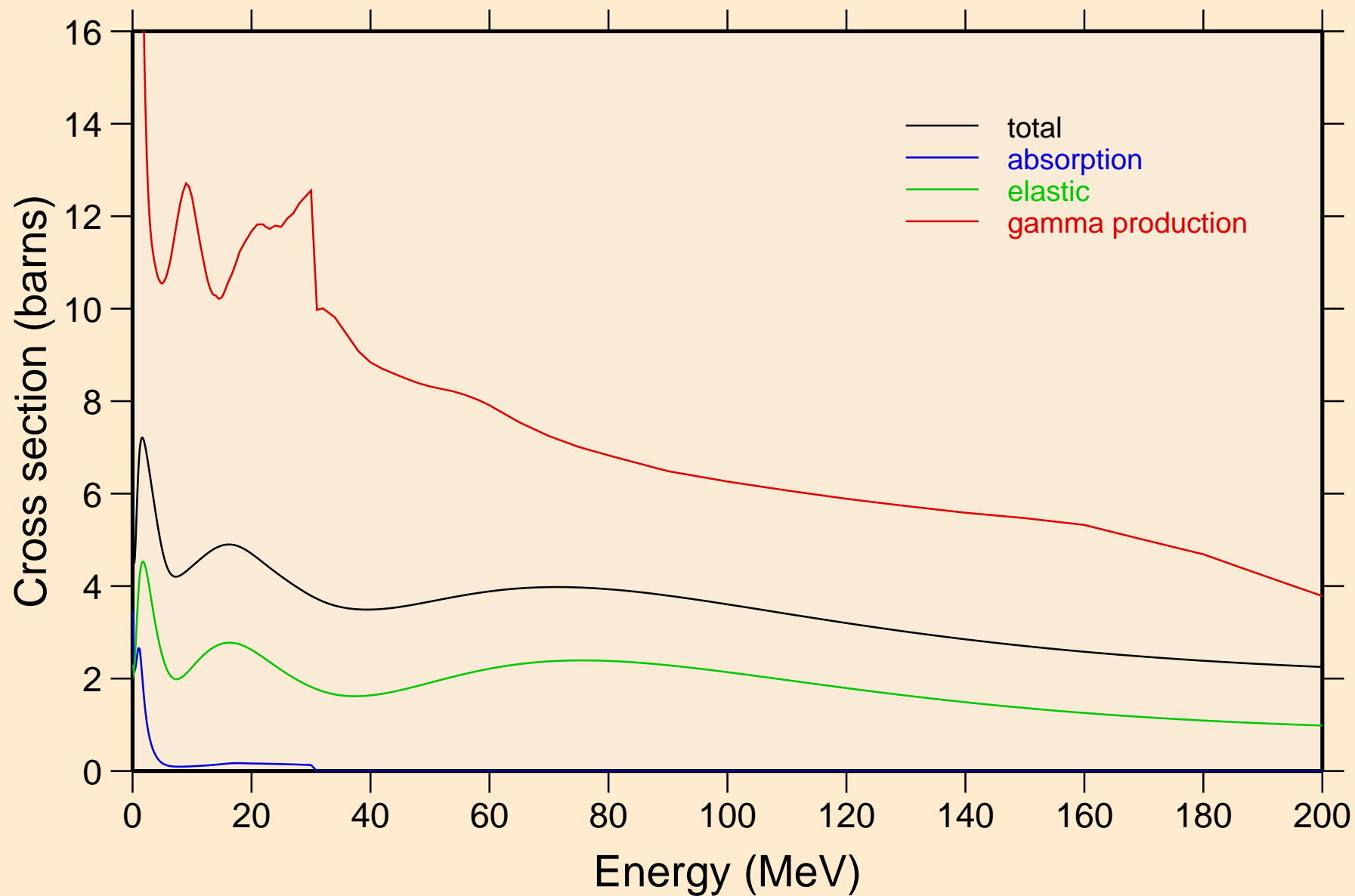

PM140M NEUTRON ACER TENDL-2019 LIBRARY; T=293.16K
Heating

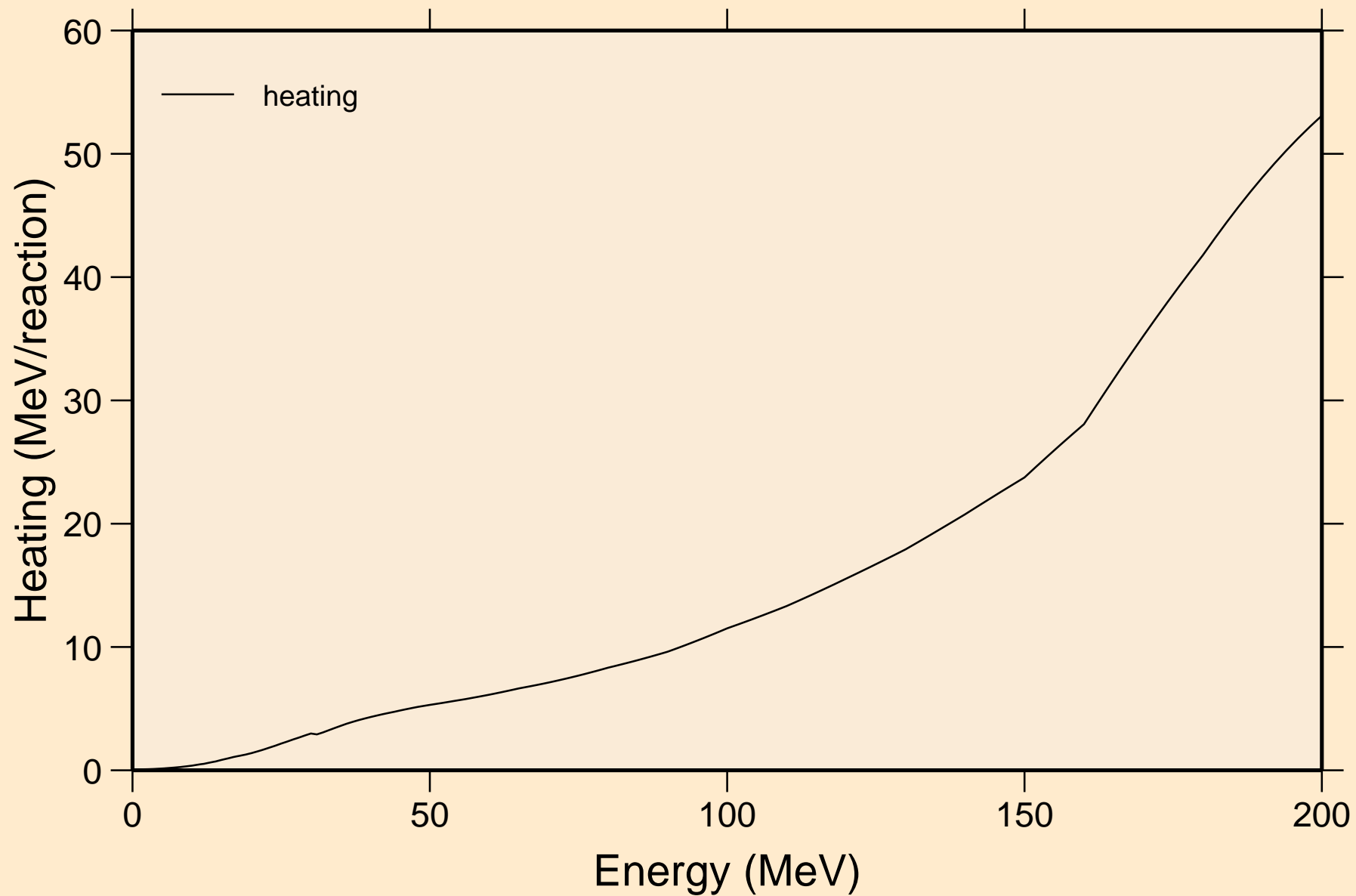

PM140M NEUTRON ACER TENDL-2019 LIBRARY; T=293.16K
Damage

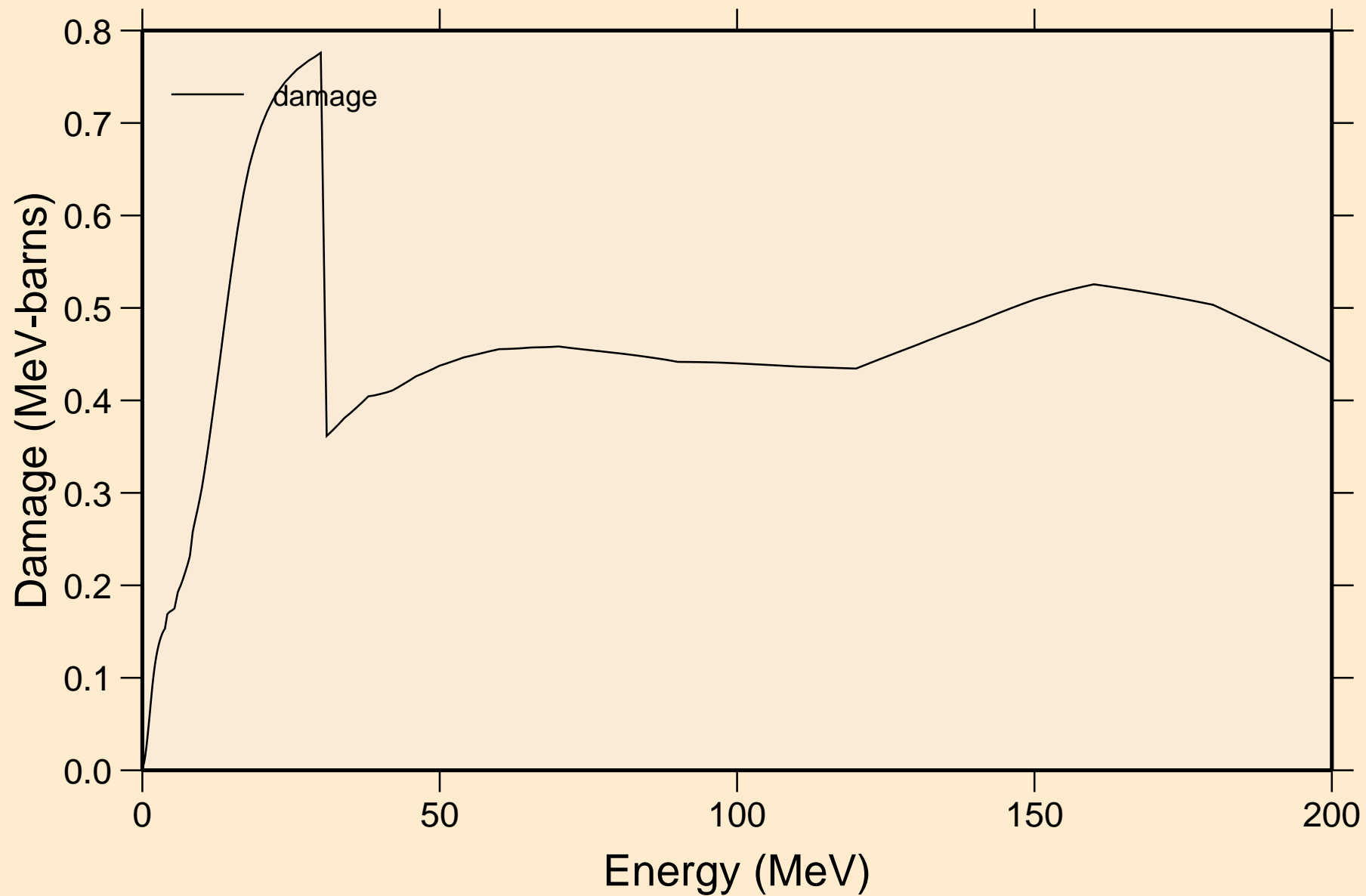

PM140M NEUTRON ACER TENDL-2019 LIBRARY; T=293.16K
Non-threshold reactions

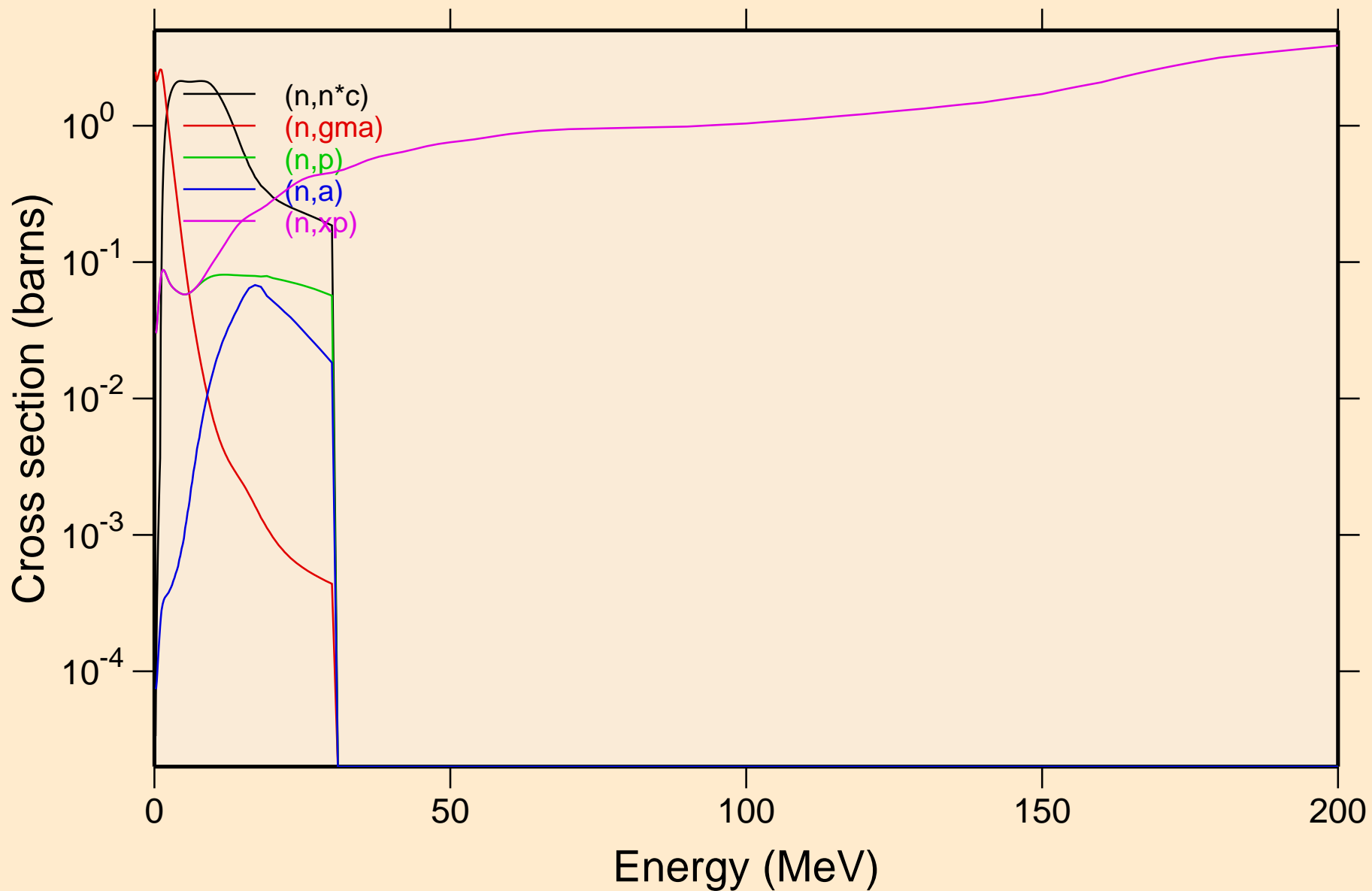

PM140M NEUTRON ACER TENDL-2019 LIBRARY; T=293.16K
Non-threshold reactions

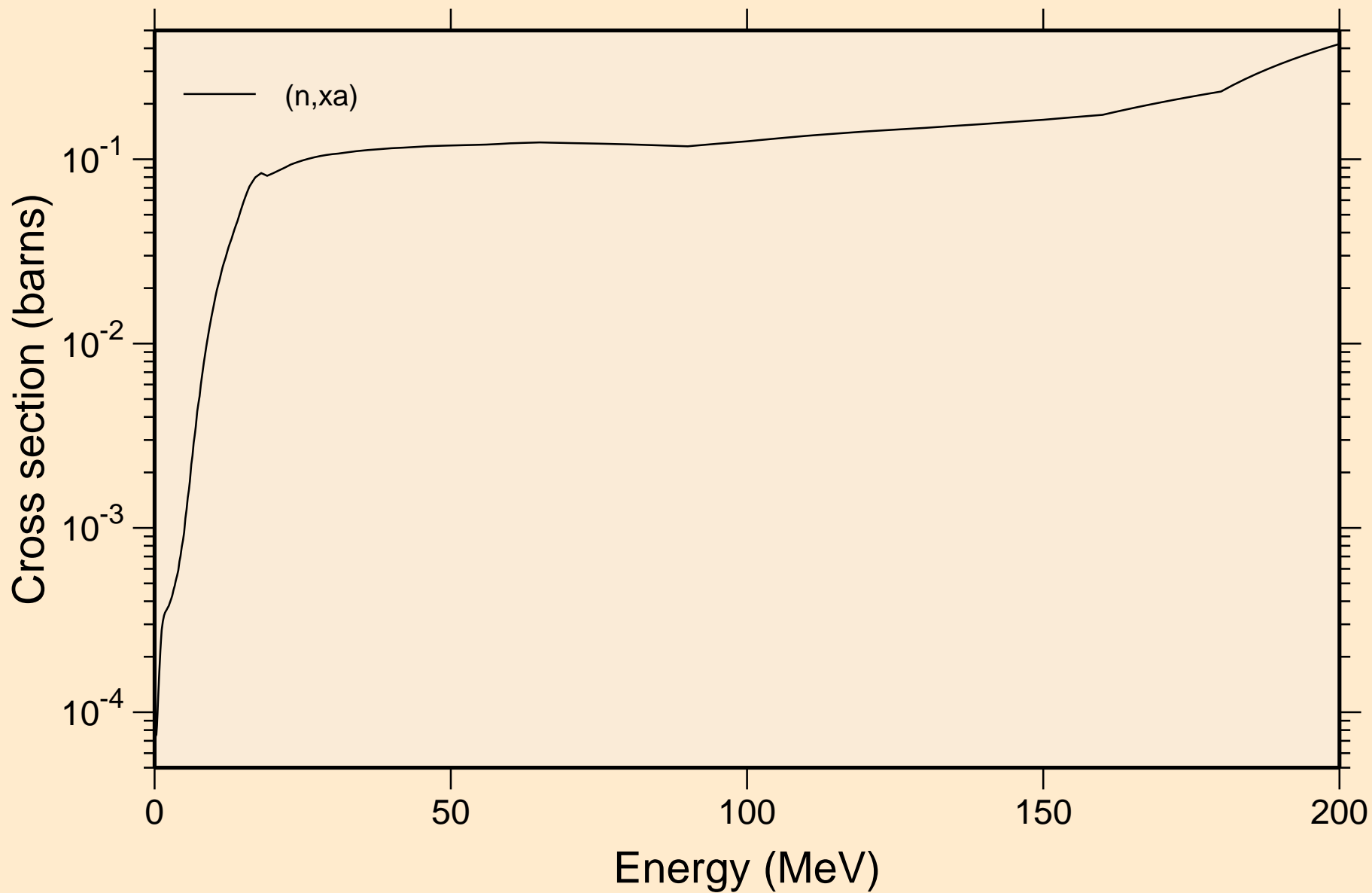

PM140M NEUTRON ACER TENDL-2019 LIBRARY; T=293.16K
Inelastic levels

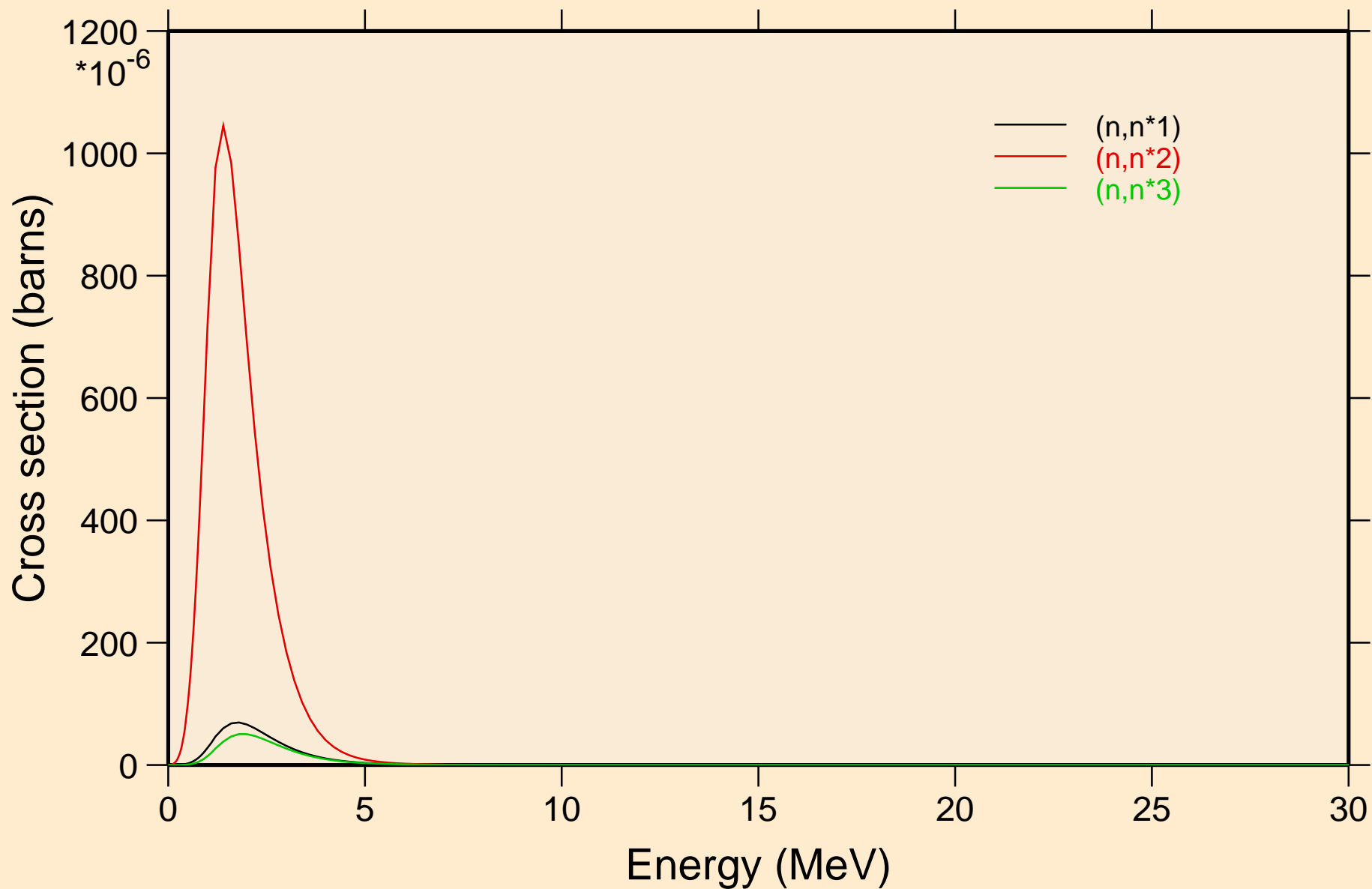

PM140M NEUTRON ACER TENDL-2019 LIBRARY; T=293.16K
Threshold reactions

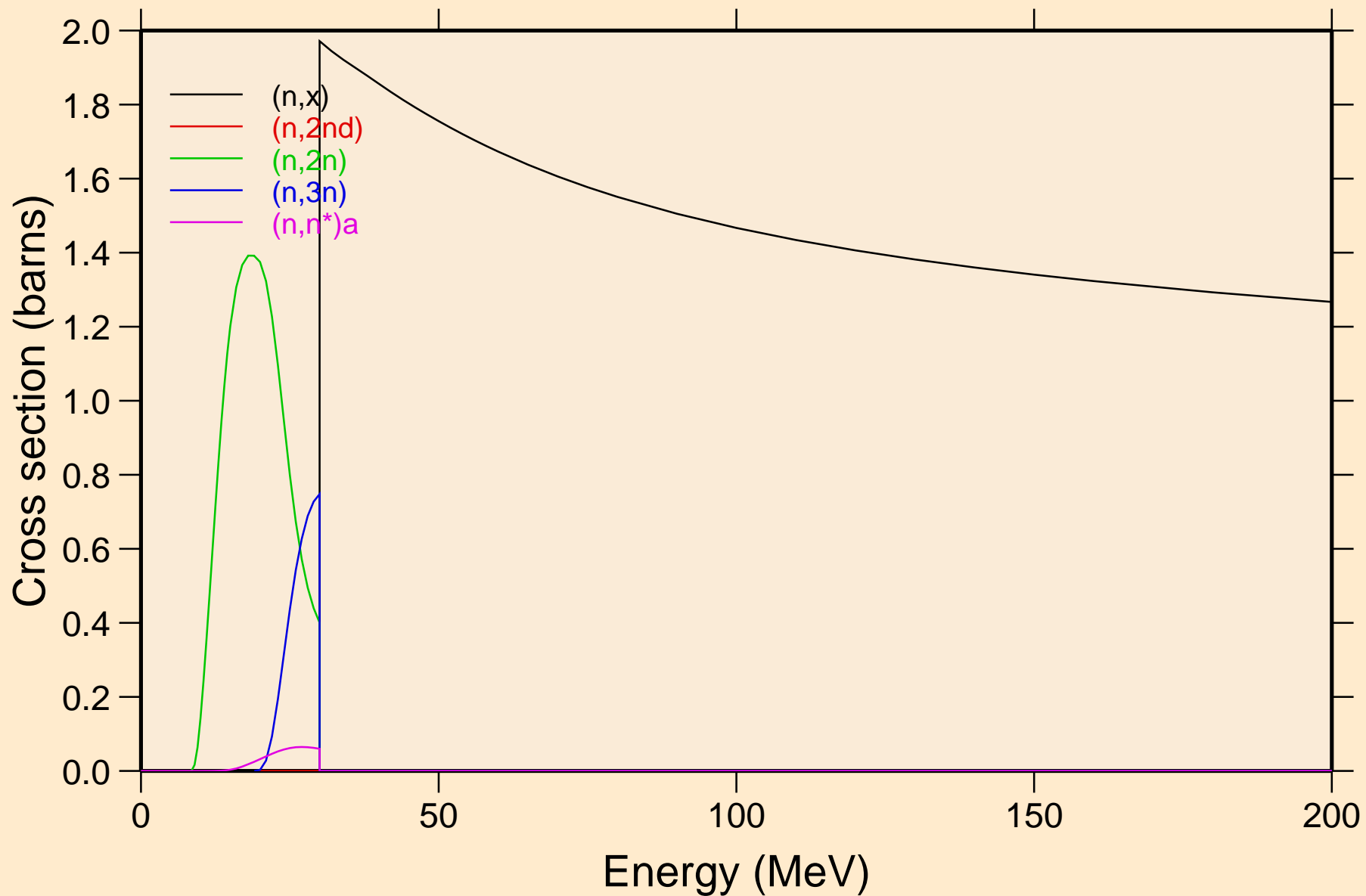

PM140M NEUTRON ACER TENDL-2019 LIBRARY; T=293.16K
Threshold reactions

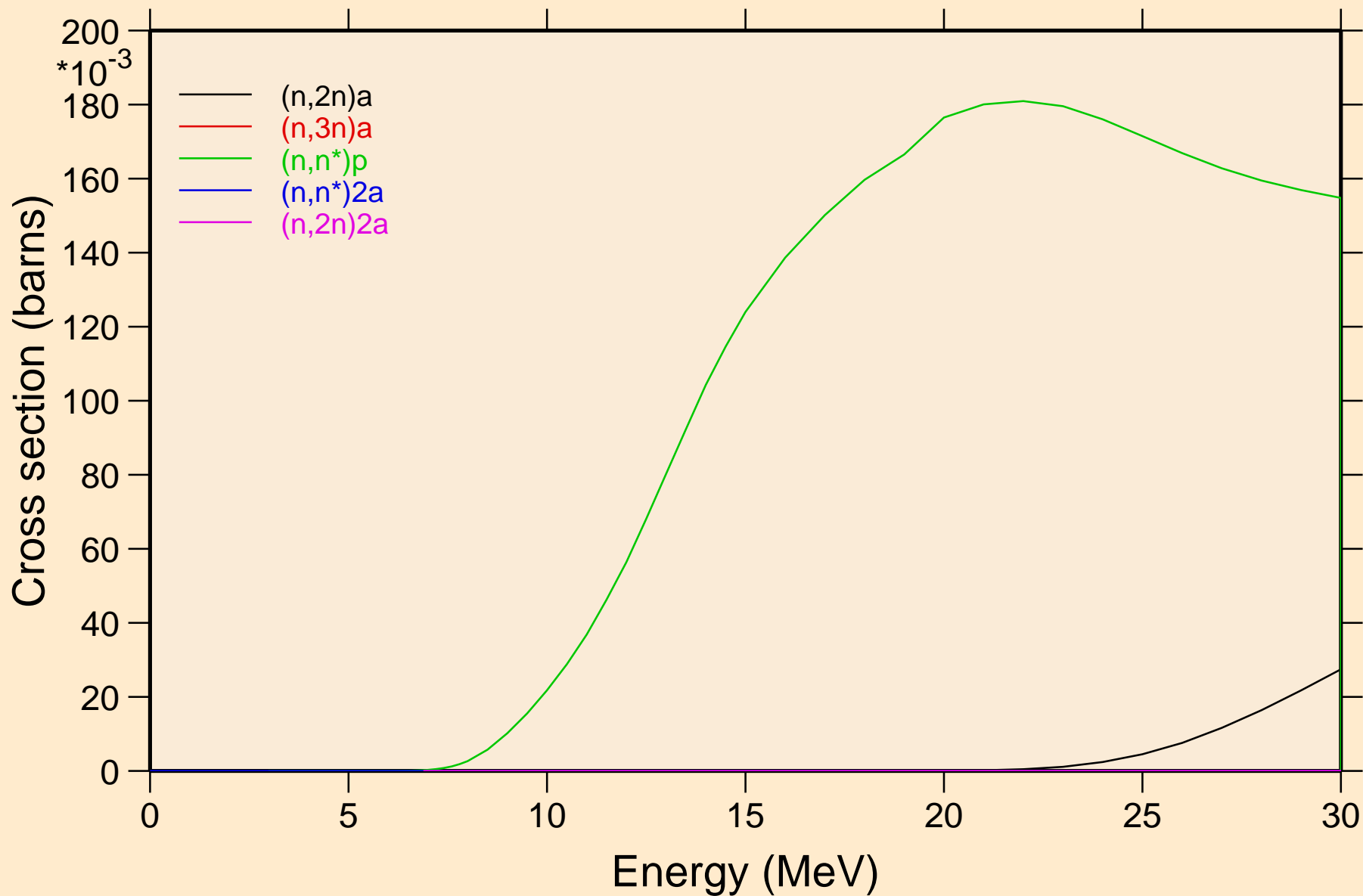

PM140M NEUTRON ACER TENDL-2019 LIBRARY; T=293.16K
Threshold reactions

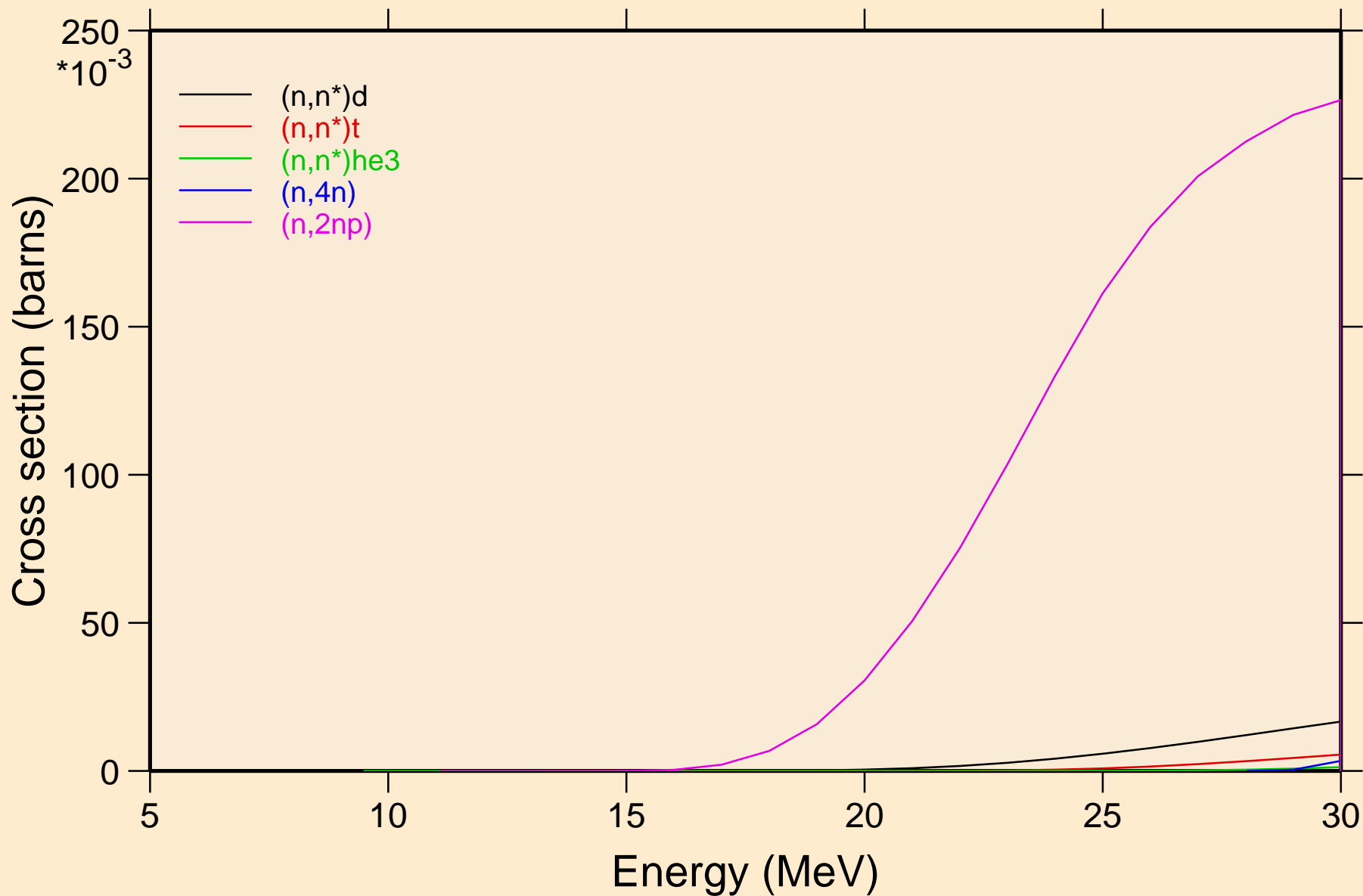

PM140M NEUTRON ACER TENDL-2019 LIBRARY; T=293.16K
Threshold reactions

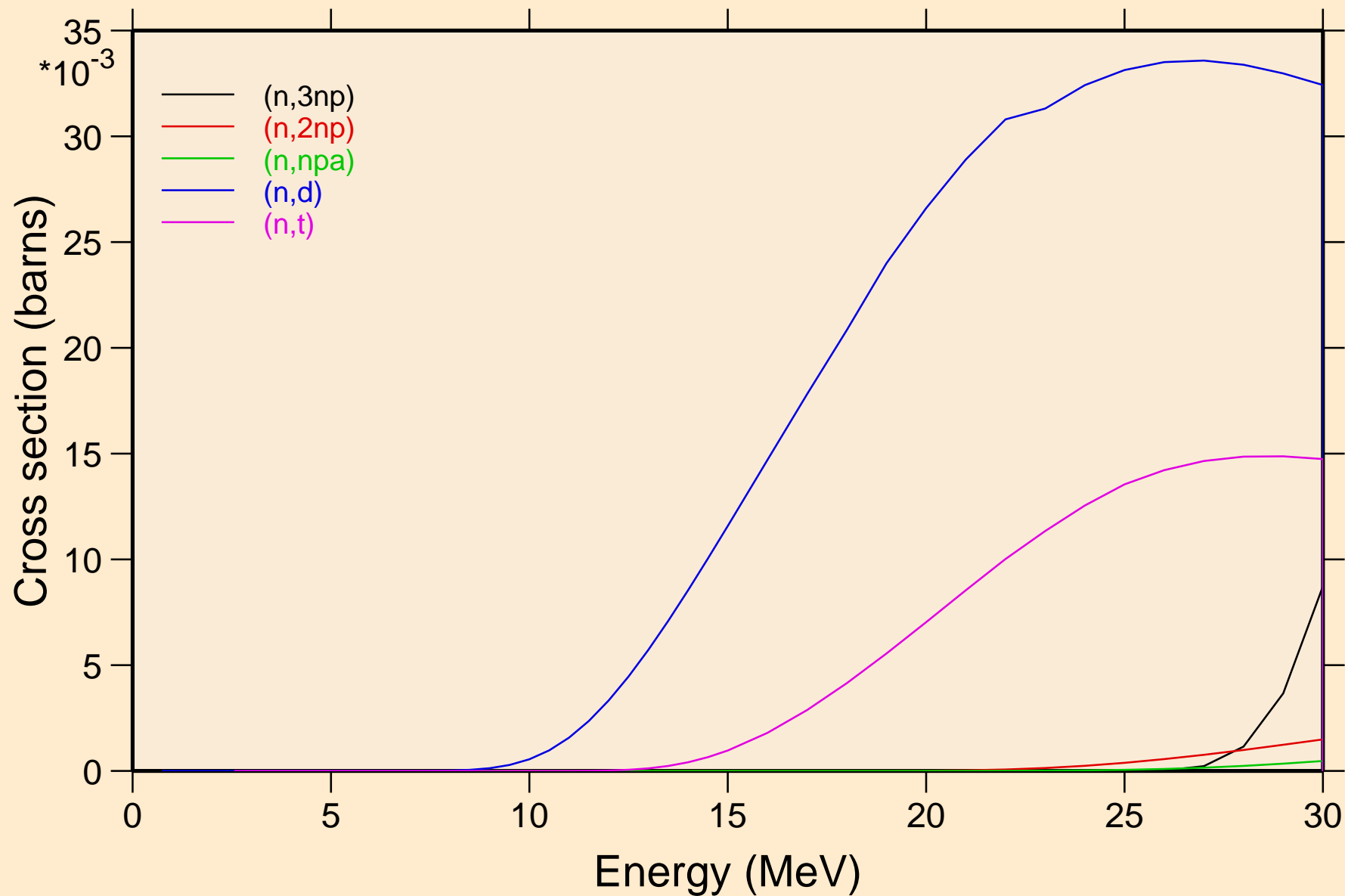

PM140M NEUTRON ACER TENDL-2019 LIBRARY; T=293.16K
Threshold reactions

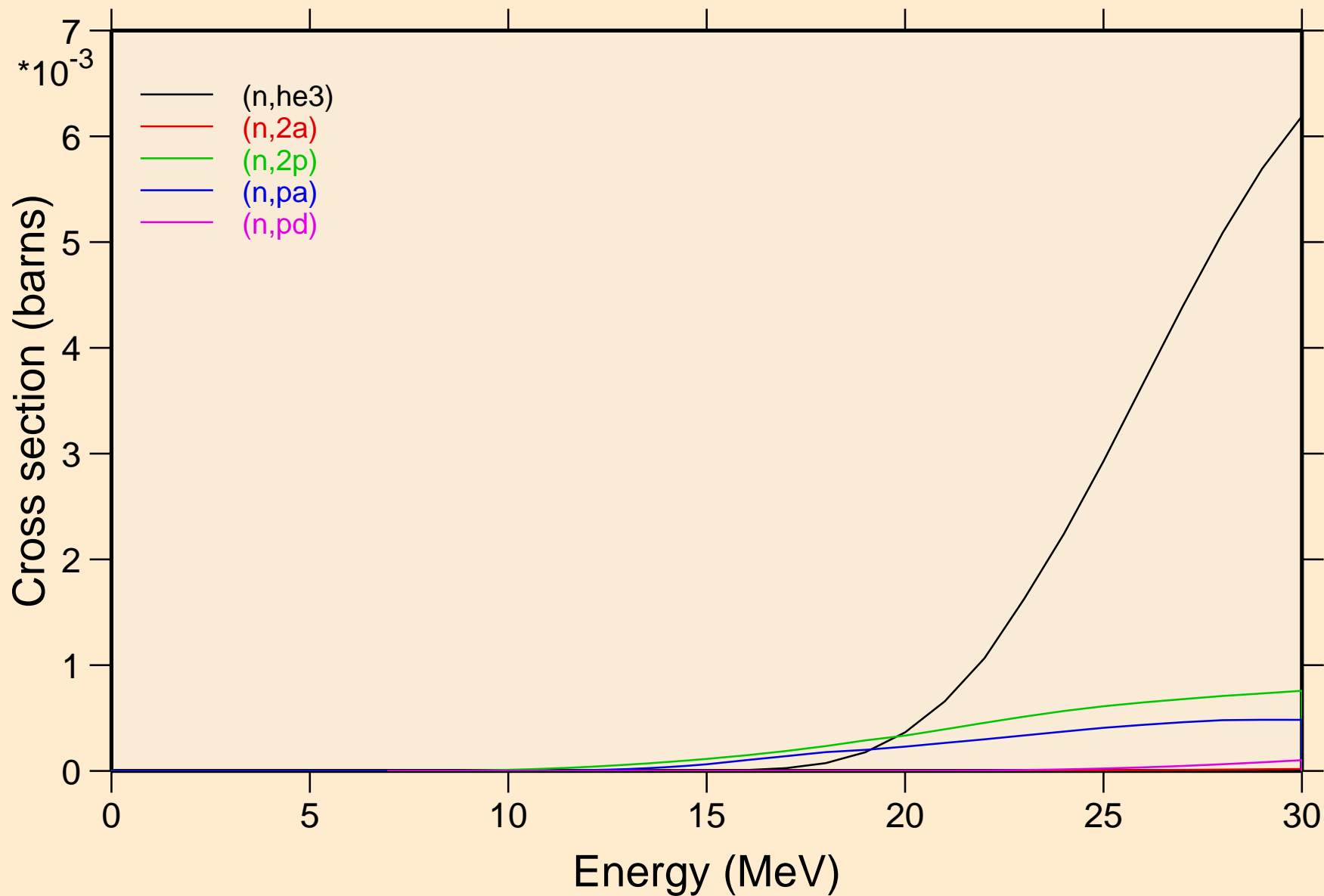

PM140M NEUTRON ACER TENDL-2019 LIBRARY; T=293.16K
Threshold reactions

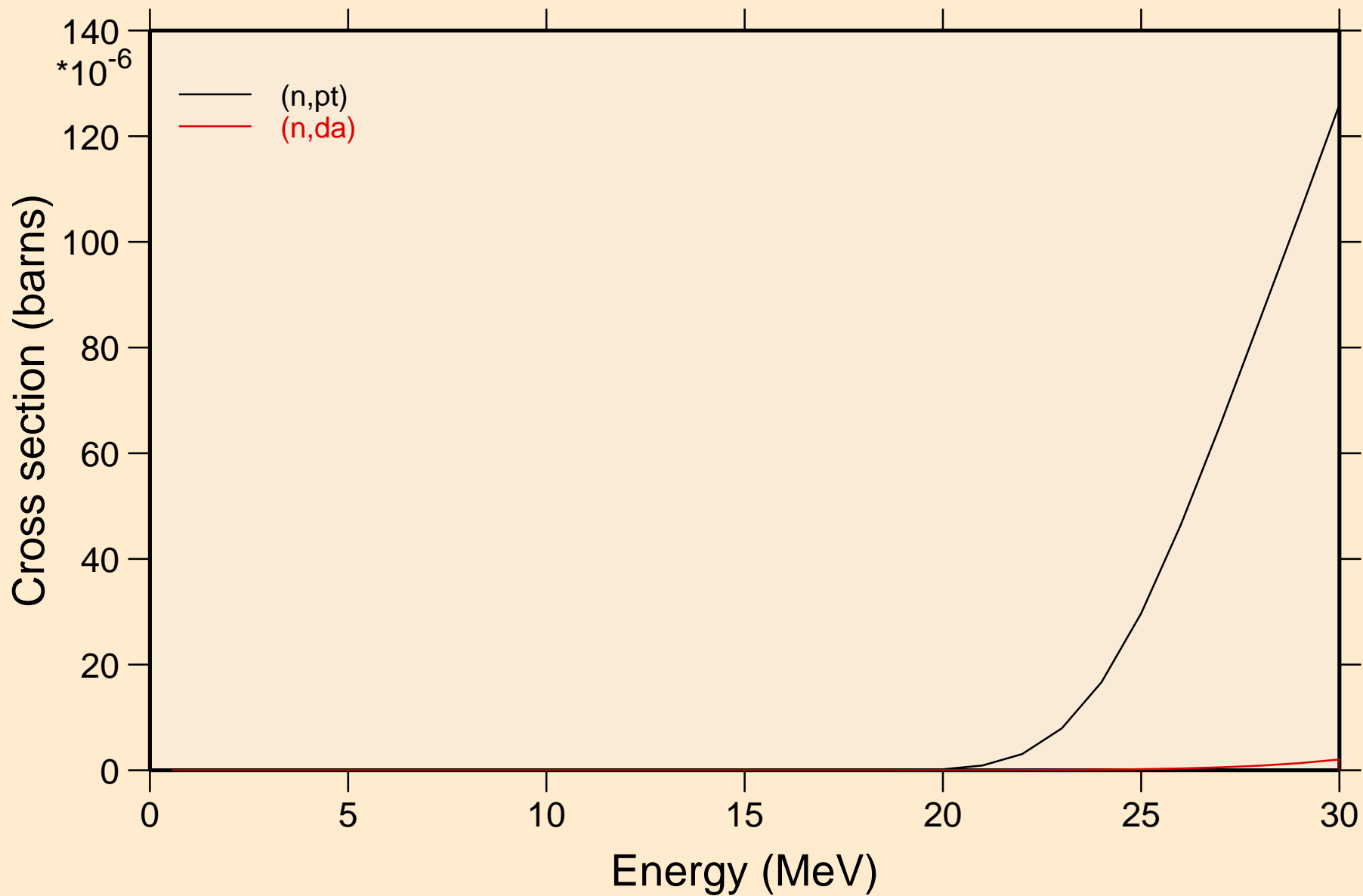

PM140M NEUTRON ACER TENDL-2019 LIBRARY; T=293.16K
Threshold reactions

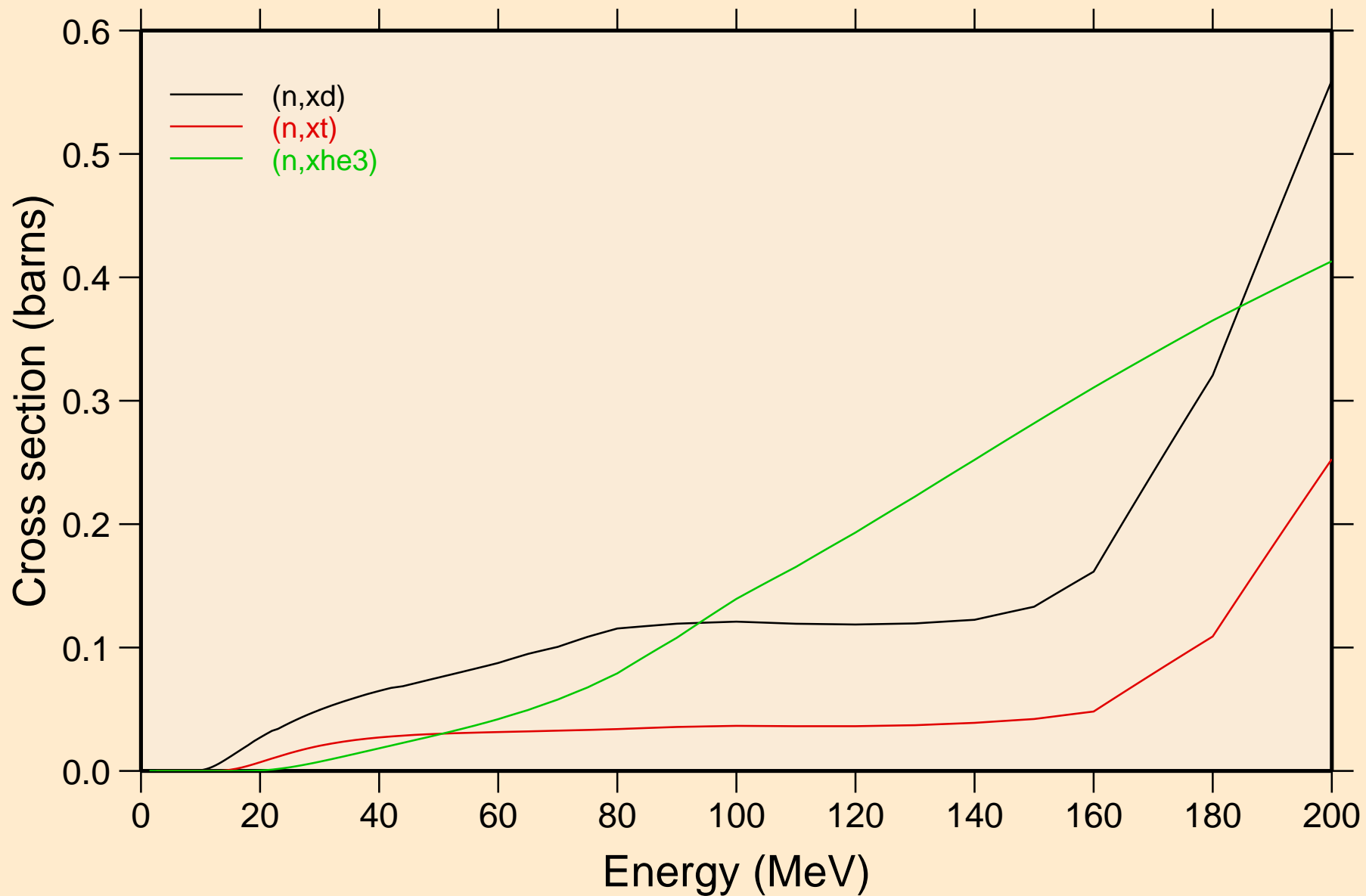

PM140M NEUTRON ACER TENDL-2019 LIBRARY; T=293.16K
angular distribution for elastic

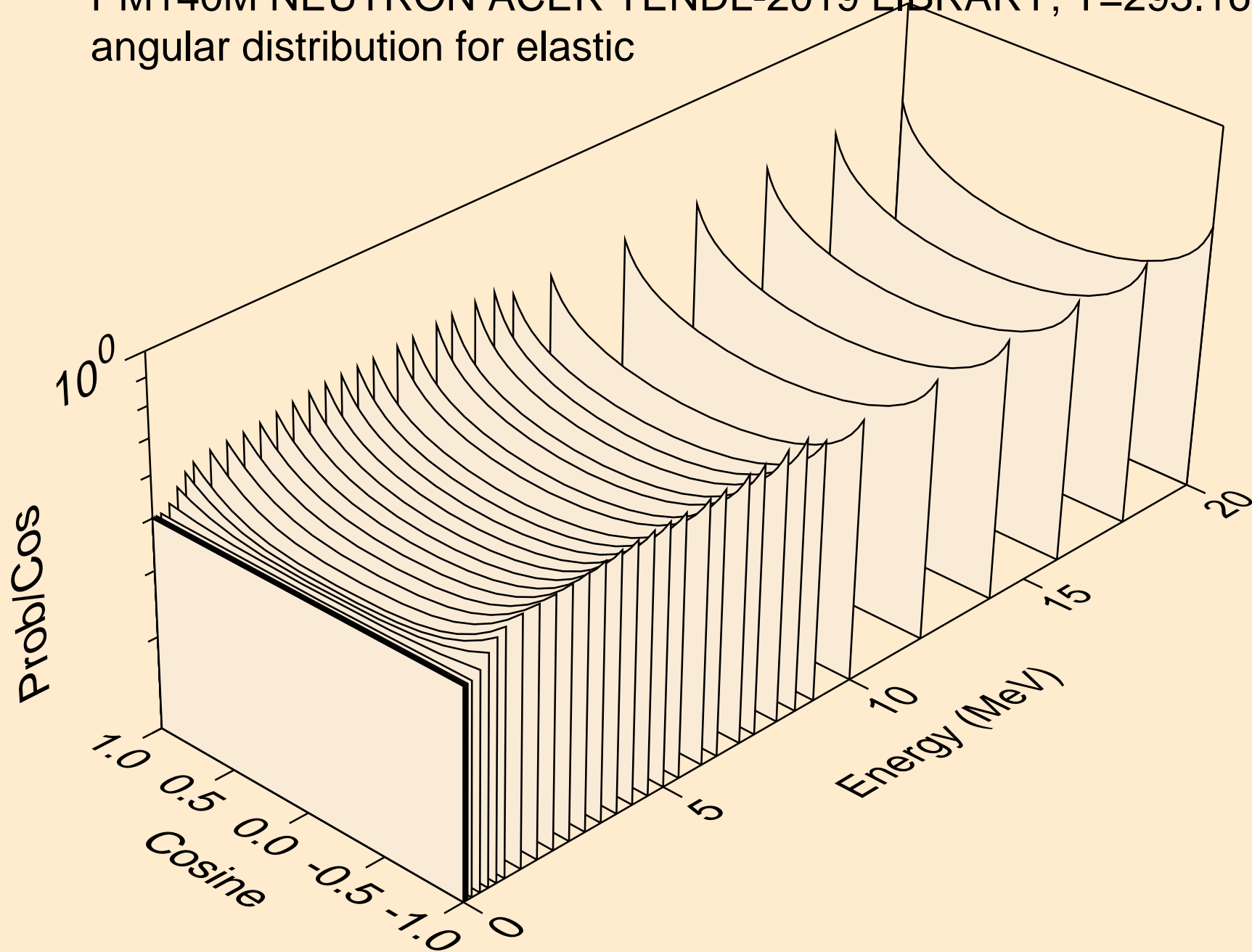

PM140M NEUTRON ACER TENDL-2019 LIBRARY; T=293.16K
angular distribution for elastic

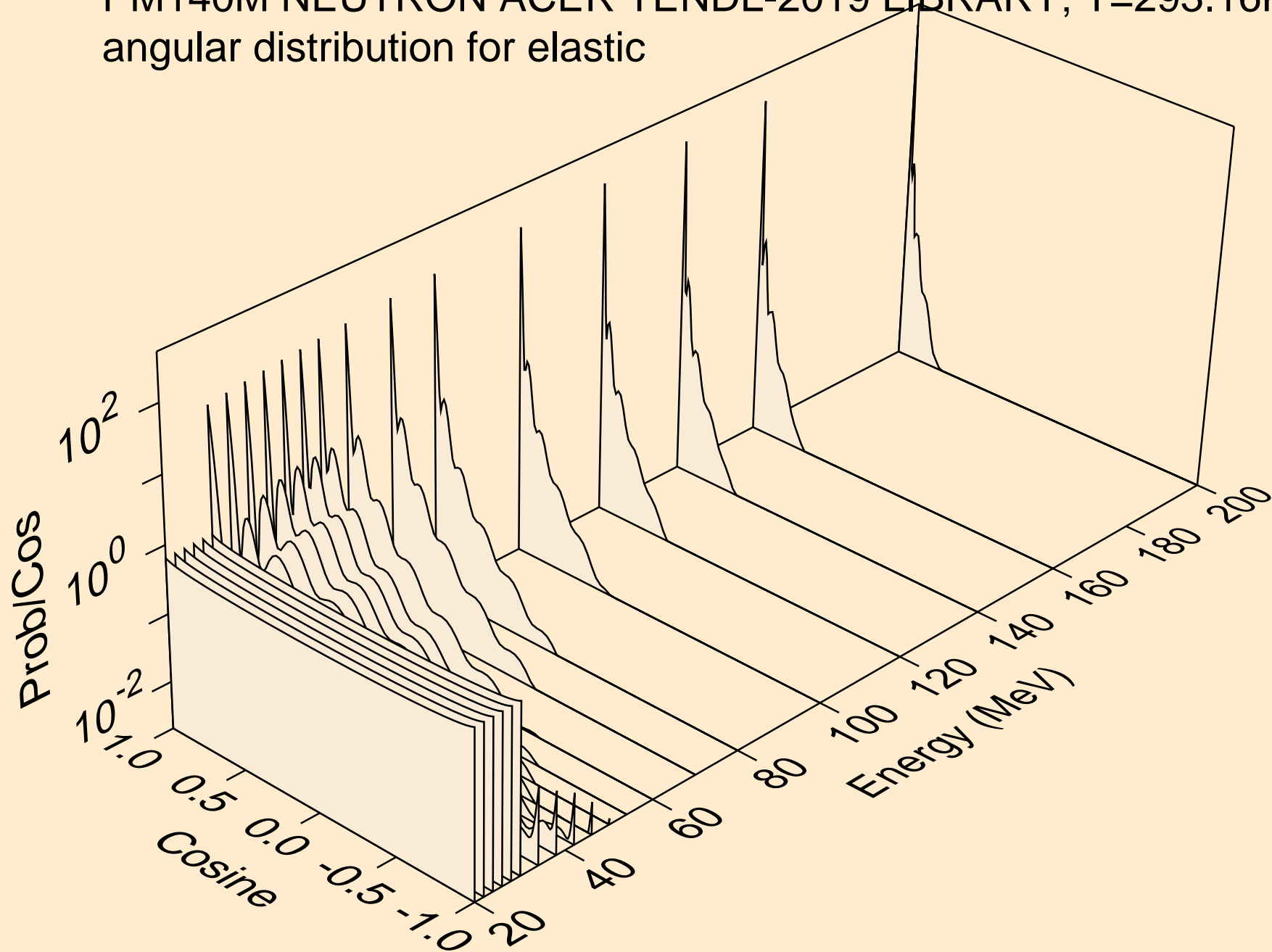

PM140M NEUTRON ACER TENDL-2019 LIBRARY; T=293.16K
angular distribution for (n,n*1)

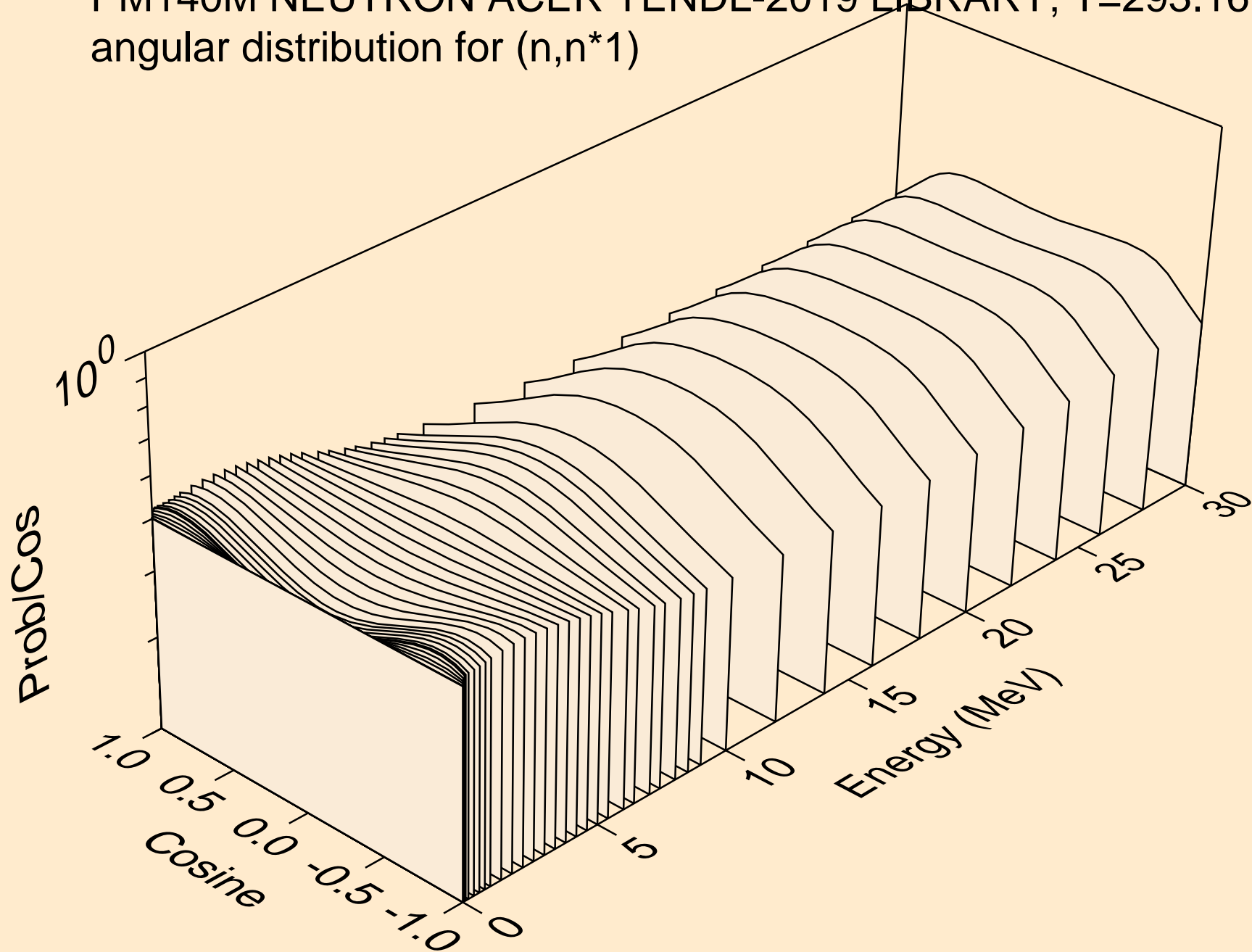

PM140M NEUTRON ACER TENDL-2019 LIBRARY; T=293.16K
angular distribution for (n,n*2)

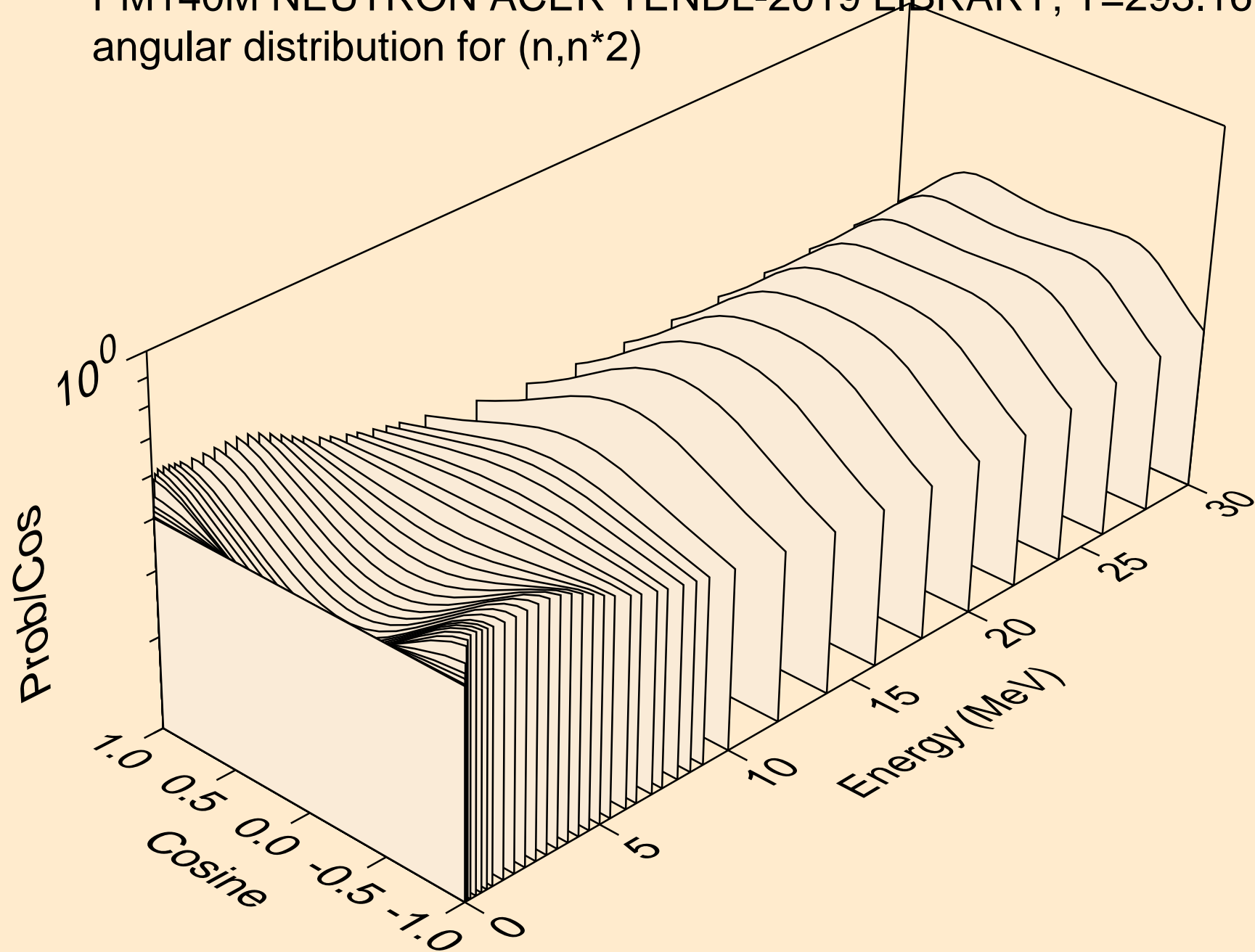

PM140M NEUTRON ACER TENDL-2019 LIBRARY; T=293.16K
angular distribution for (n,n*3)

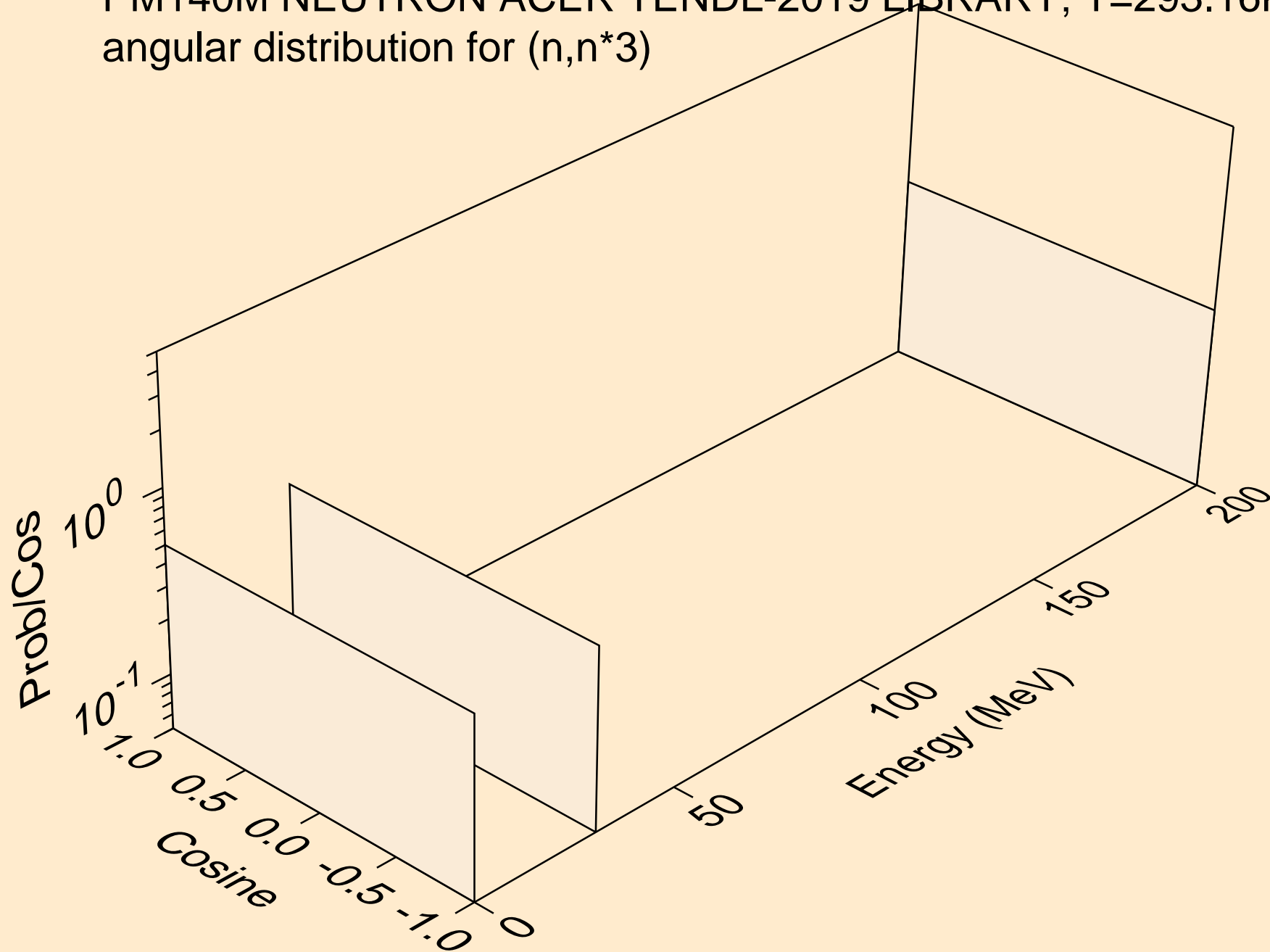

PM140M NEUTRON ACER TENDL-2019 LIBRARY; T=293.16K
Neutron emission for (n,x)

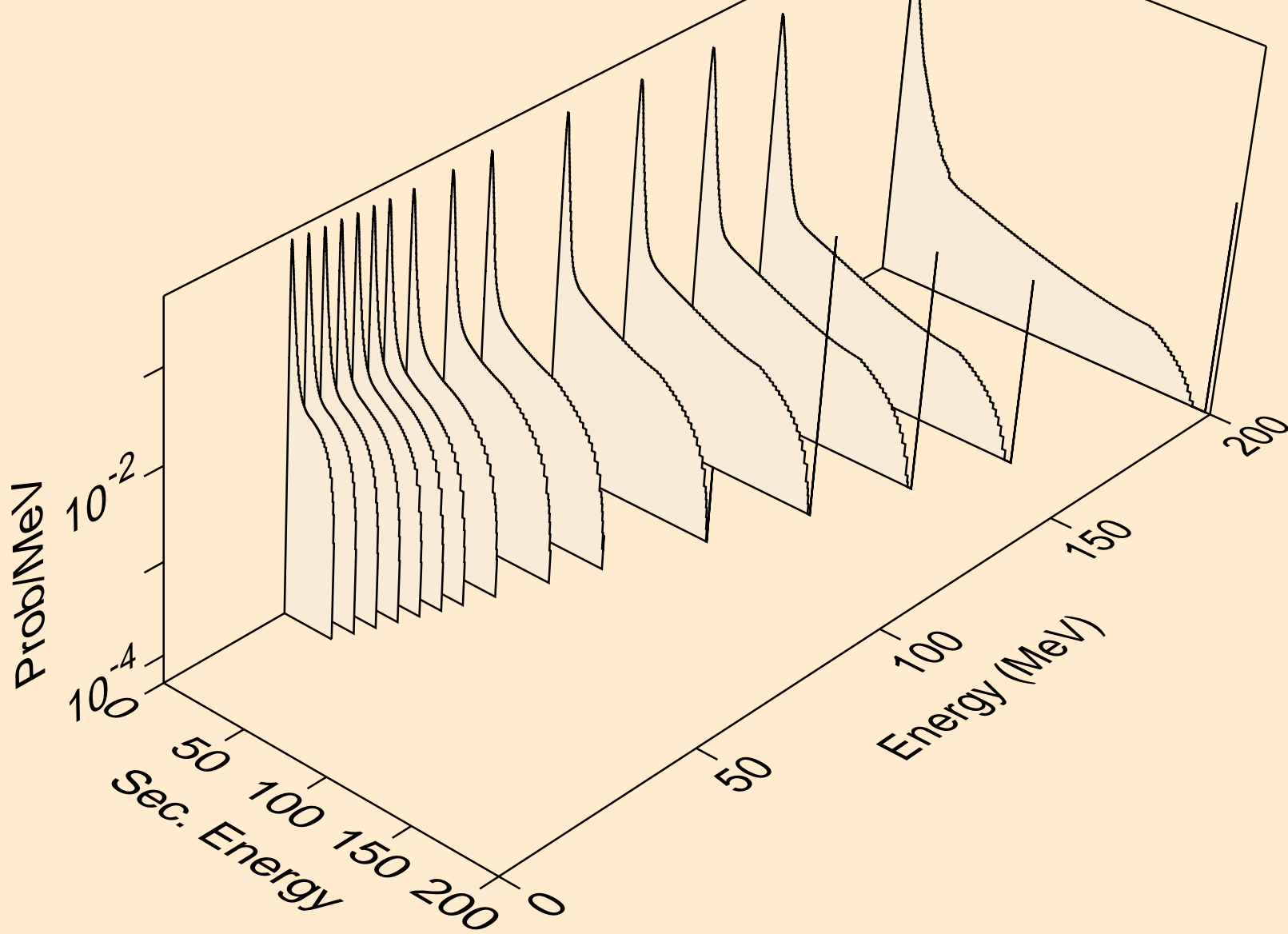

PM140M NEUTRON ACER TENDL-2019 LIBRARY; T=293.16K
Neutron emission for (n,2nd)

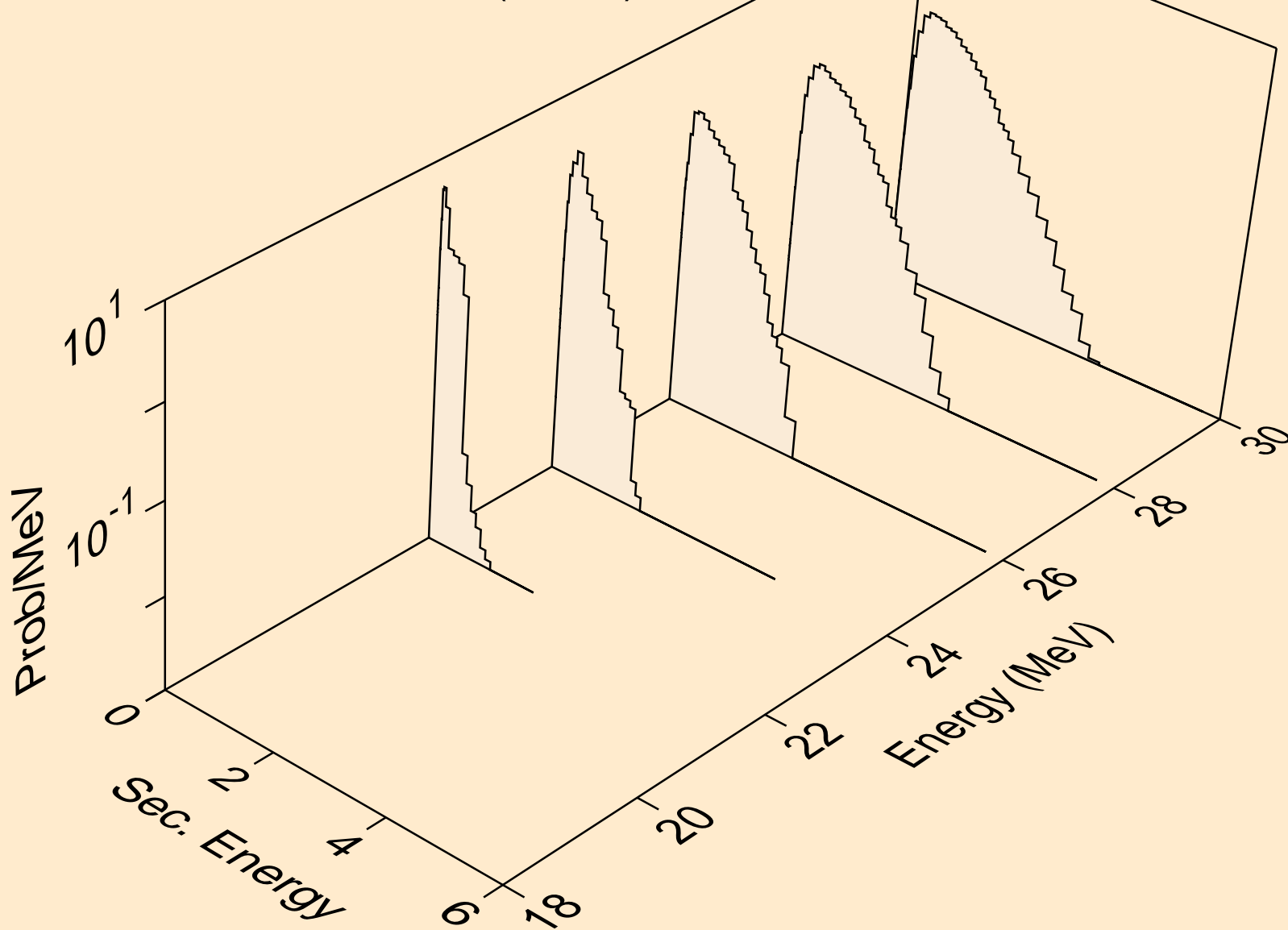

PM140M NEUTRON ACER TENDL-2019 LIBRARY; T=293.16K
Neutron emission for (n,2n)

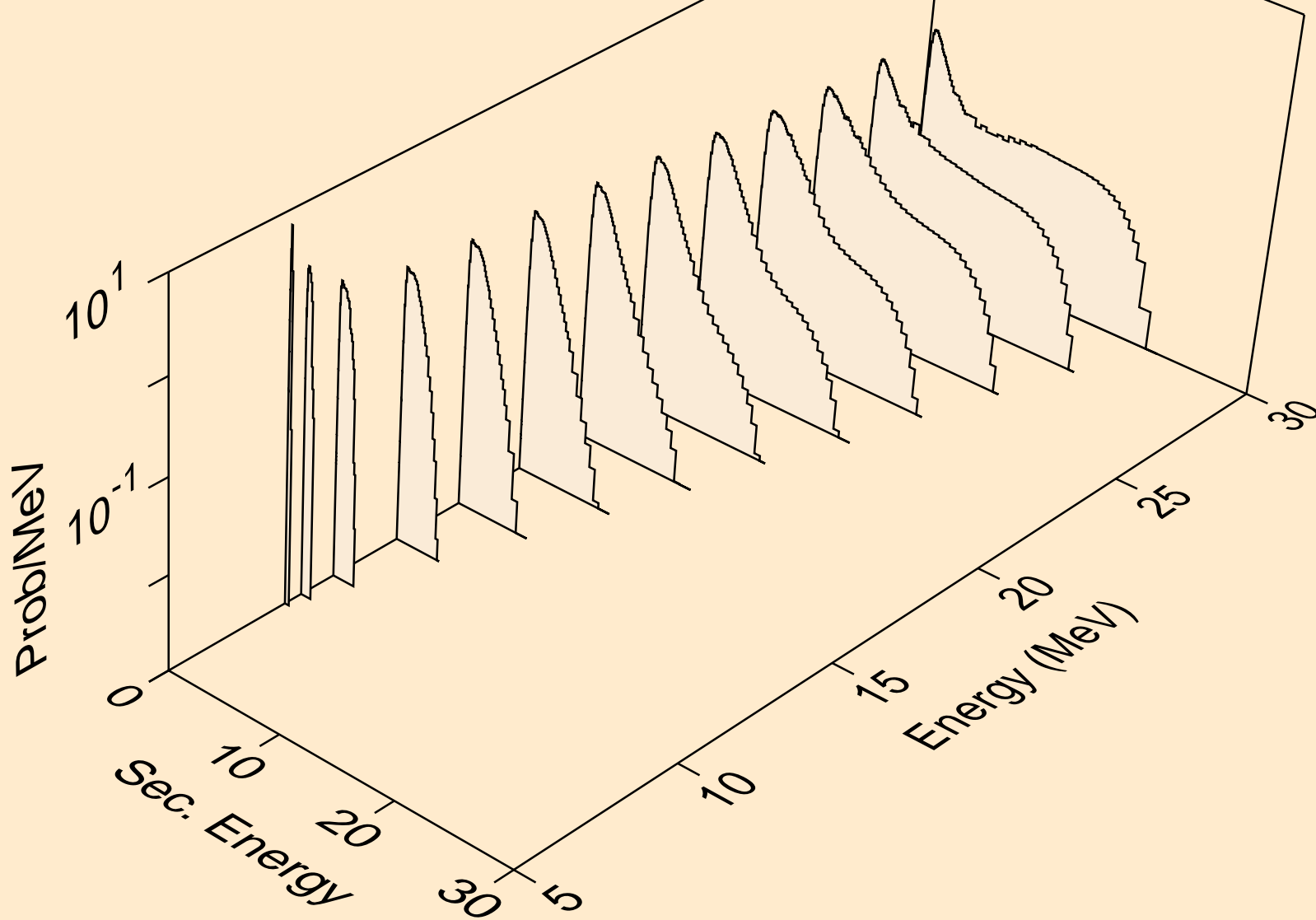

PM140M NEUTRON ACER TENDL-2019 LIBRARY; T=293.16K
Neutron emission for (n,3n)

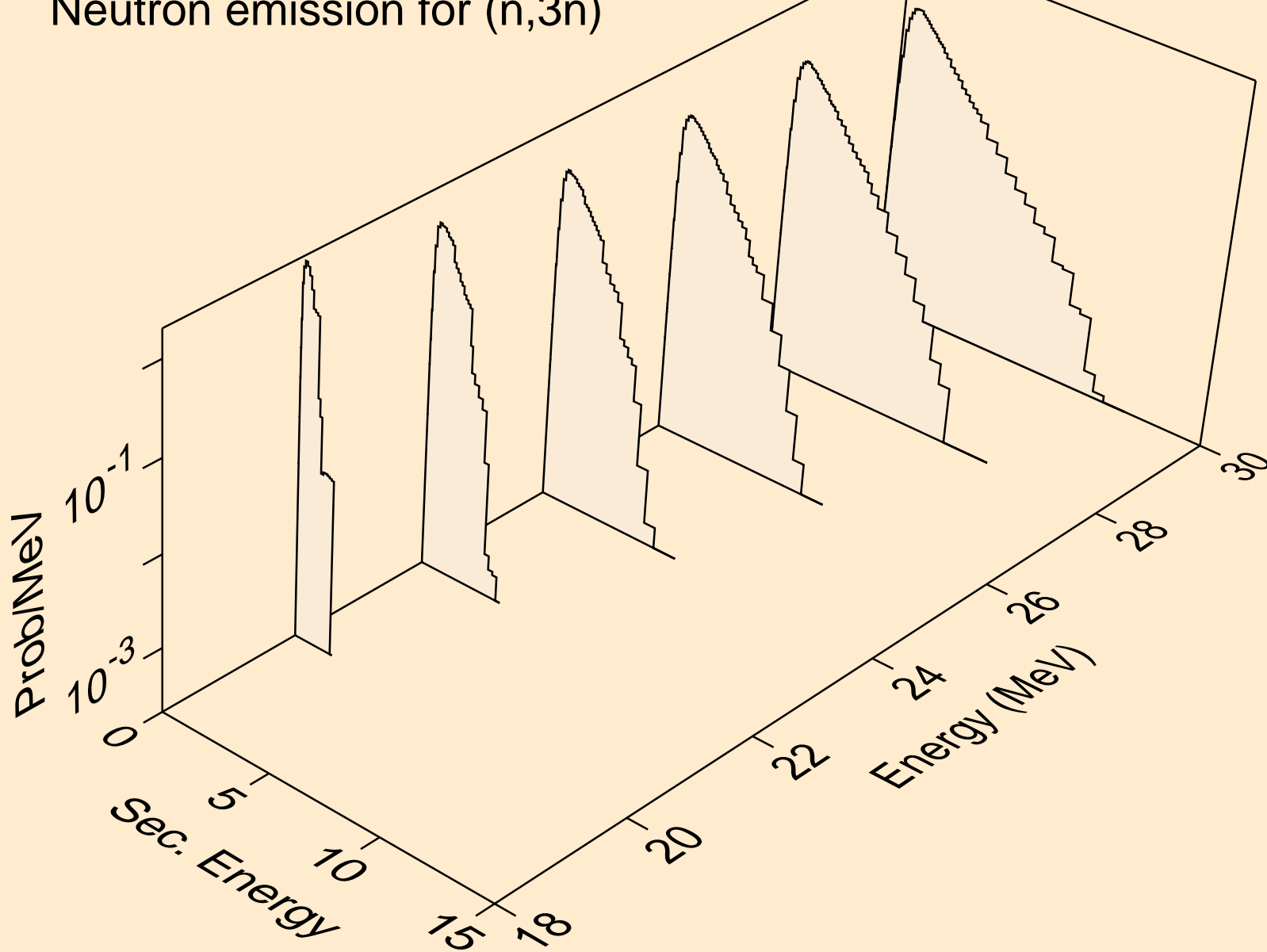

PM140M NEUTRON ACER TENDL-2019 LIBRARY; T=293.16K
Neutron emission for (n,n*)a

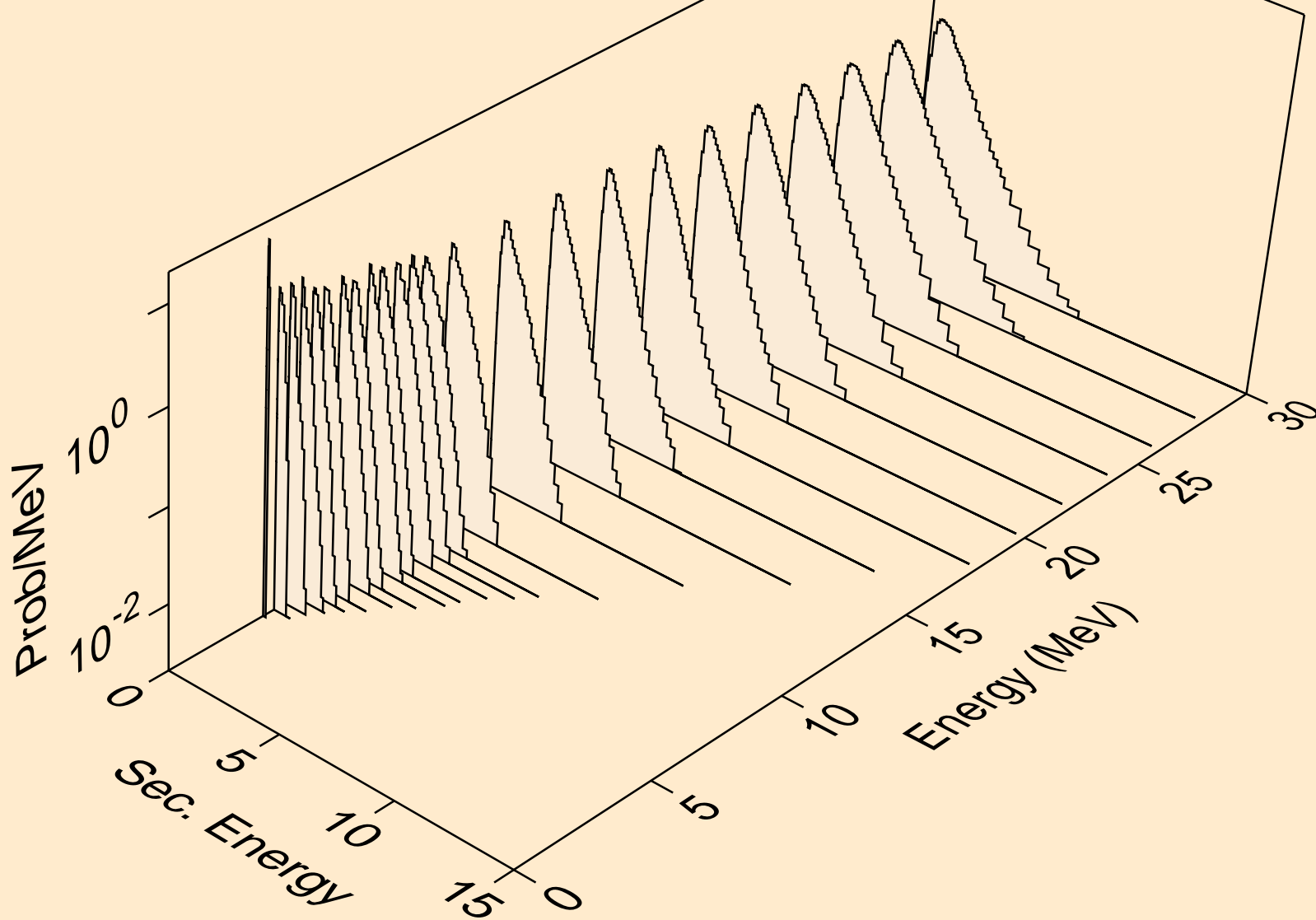

PM140M NEUTRON ACER TENDL-2019 LIBRARY; T=293.16K
Neutron emission for (n,2n)a

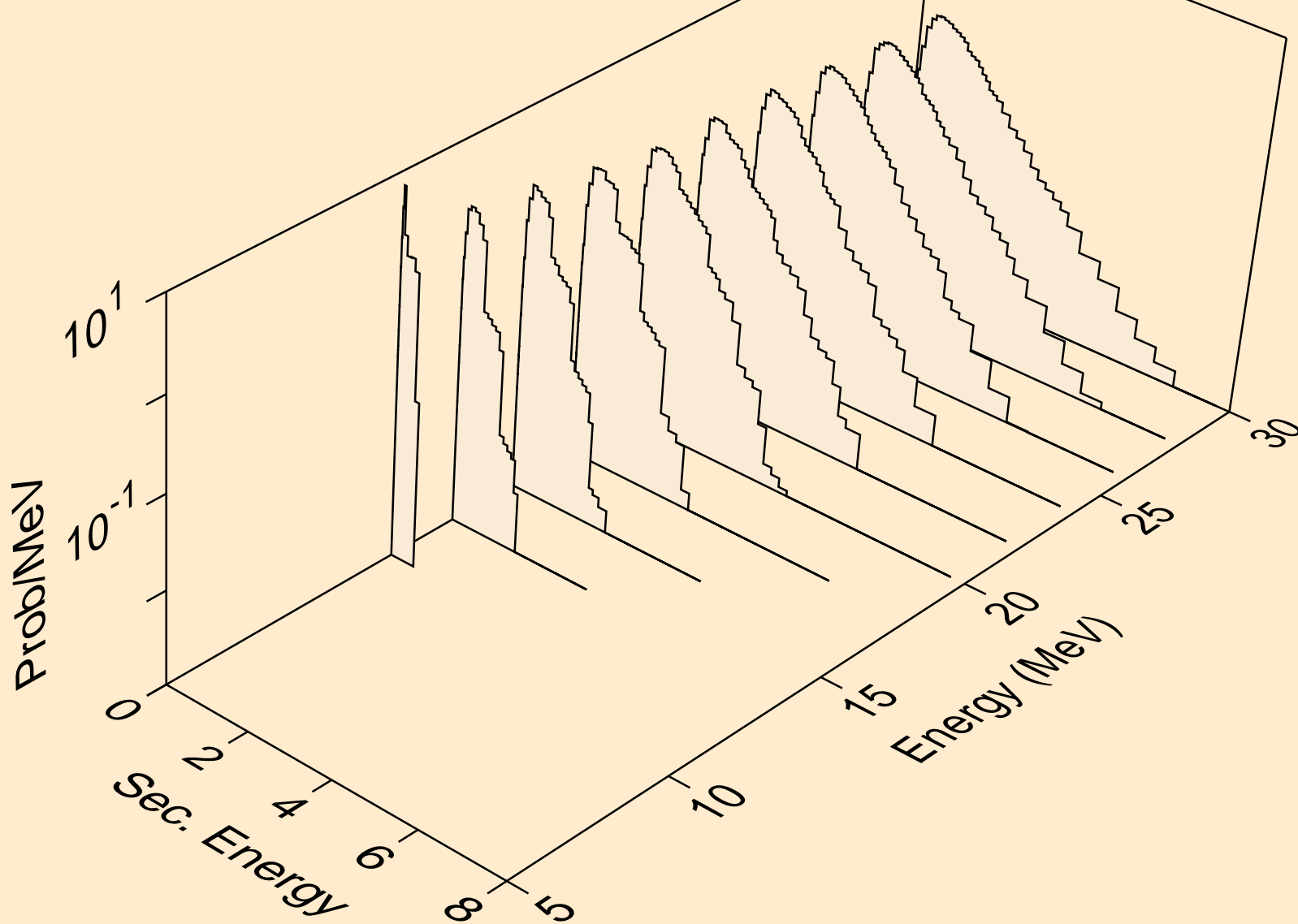

PM140M NEUTRON ACER TENDL-2019 LIBRARY; T=293.16K
Neutron emission for (n,3n)a

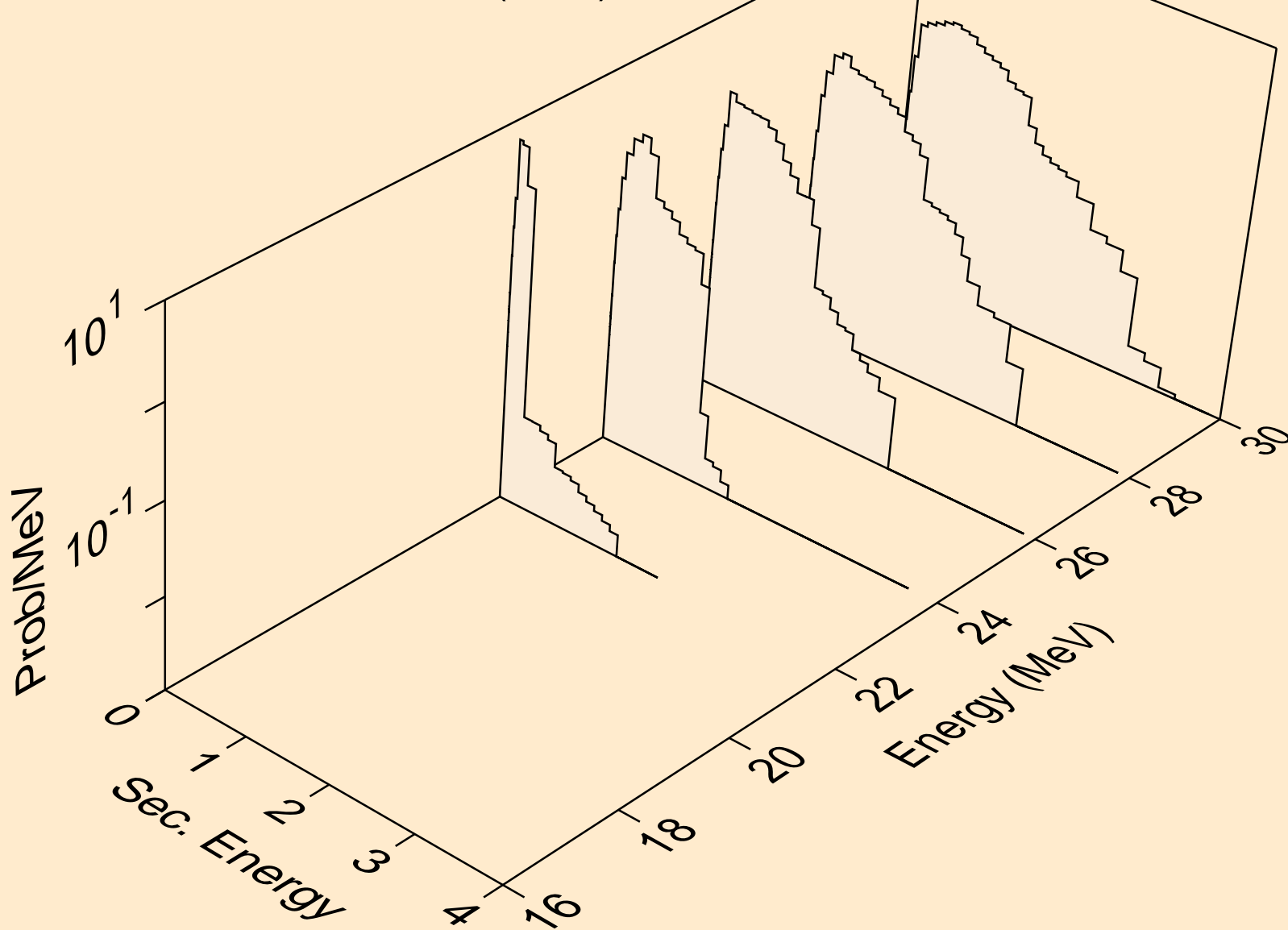

PM140M NEUTRON ACER TENDL-2019 LIBRARY; T=293.16K
Neutron emission for (n,n*)p

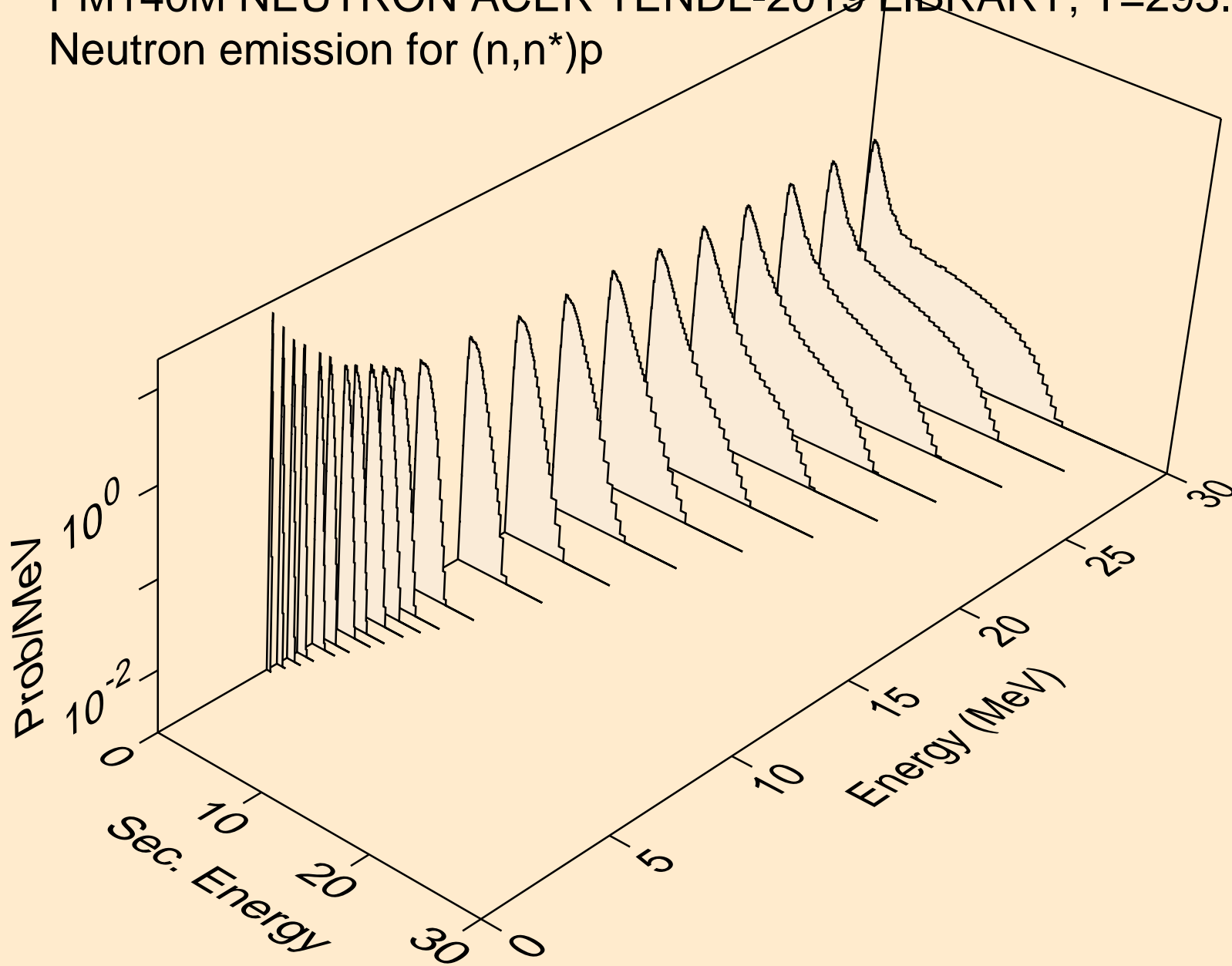

PM140M NEUTRON ACER TENDL-2019 LIBRARY; T=293.16K
Neutron emission for (n,n*)2a

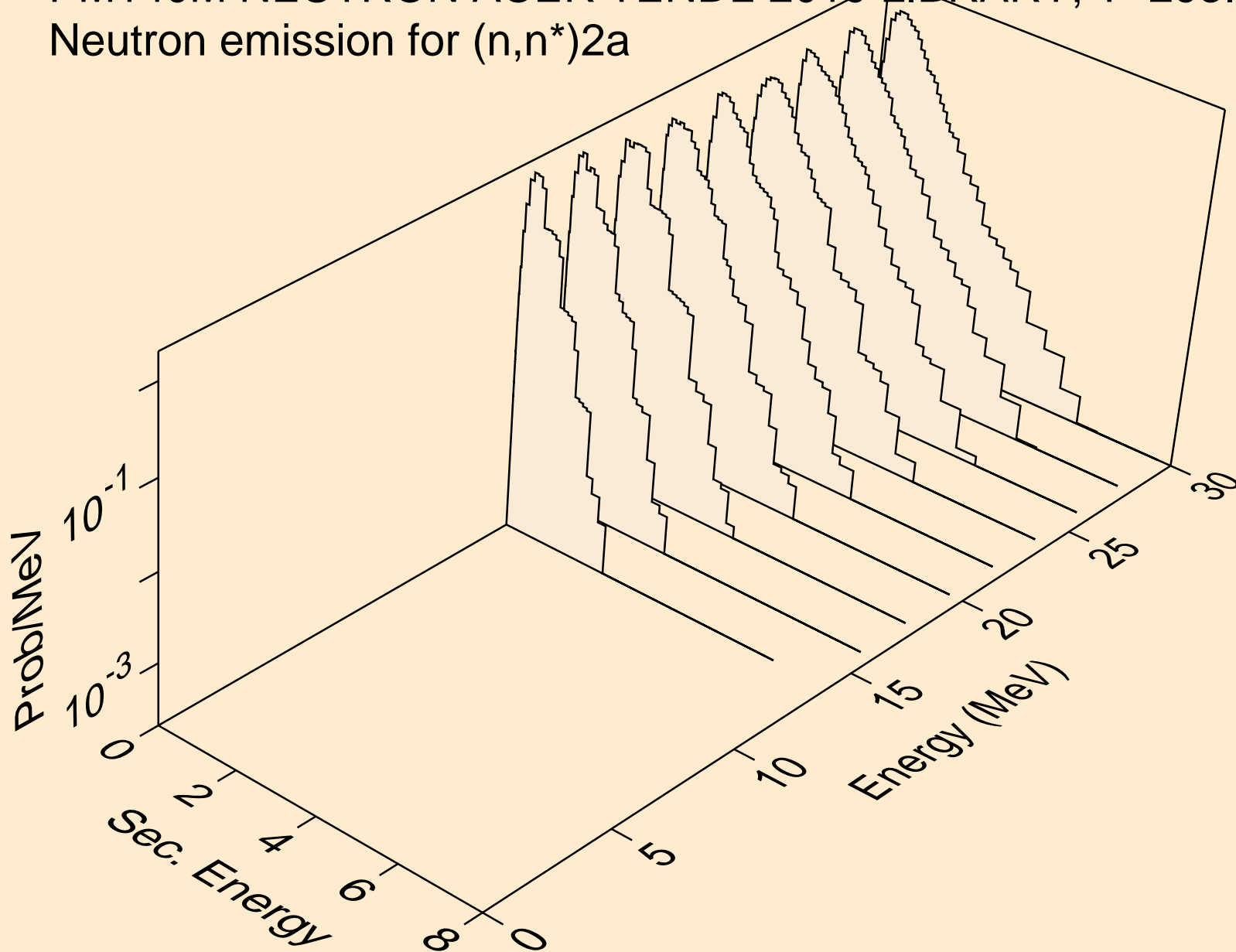

PM140M NEUTRON ACER TENDL-2019 LIBRARY; T=293.16K
Neutron emission for (n,2n)2a

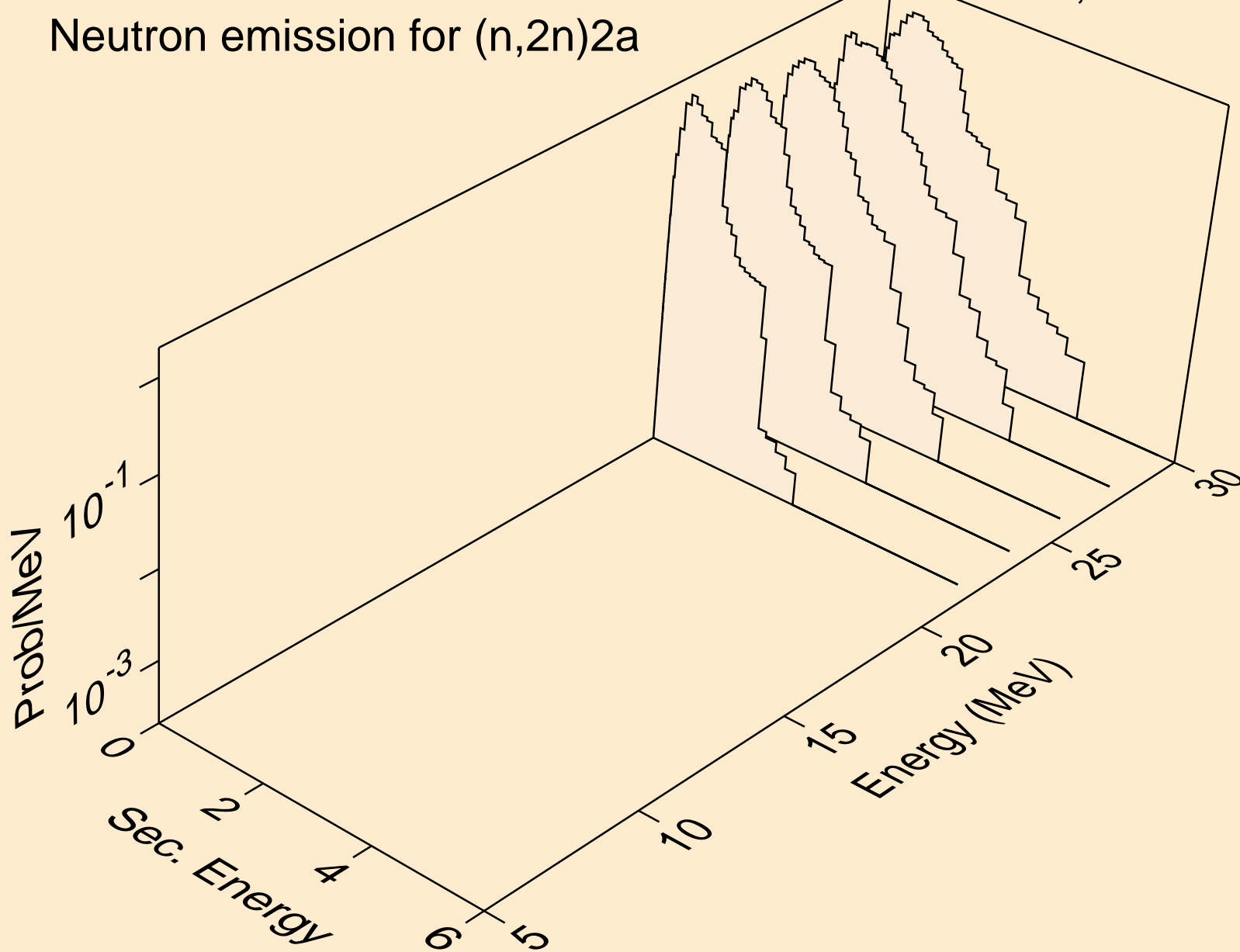

PM140M NEUTRON ACER TENDL-2019 LIBRARY; T=293.16K
Neutron emission for (n,n*)d

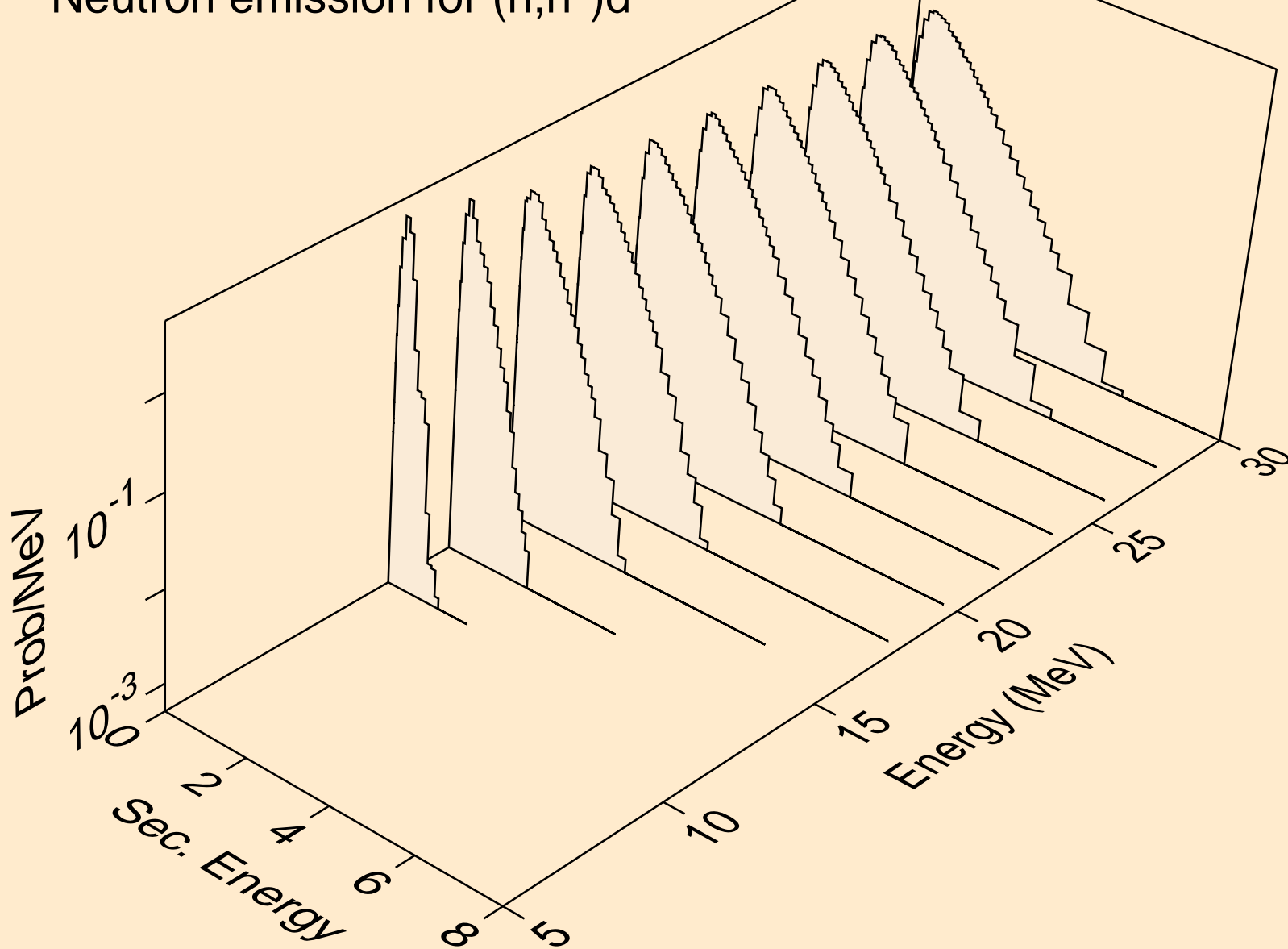

PM140M NEUTRON ACER TENDL-2019 LIBRARY; T=293.16K
Neutron emission for (n,n*)t

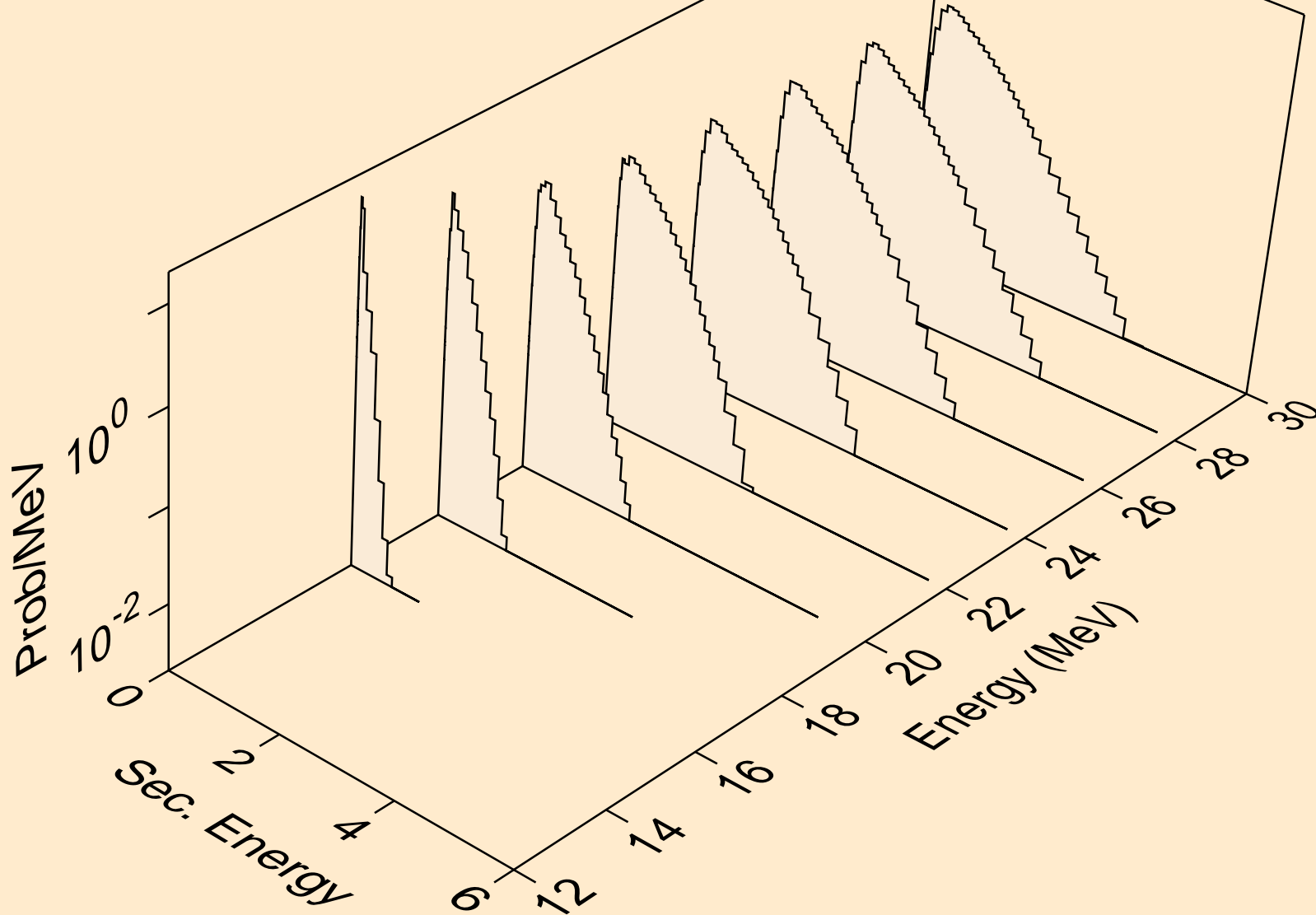

PM140M NEUTRON ACER TENDL-2019 LIBRARY; T=293.16K
Neutron emission for (n,n*)he3

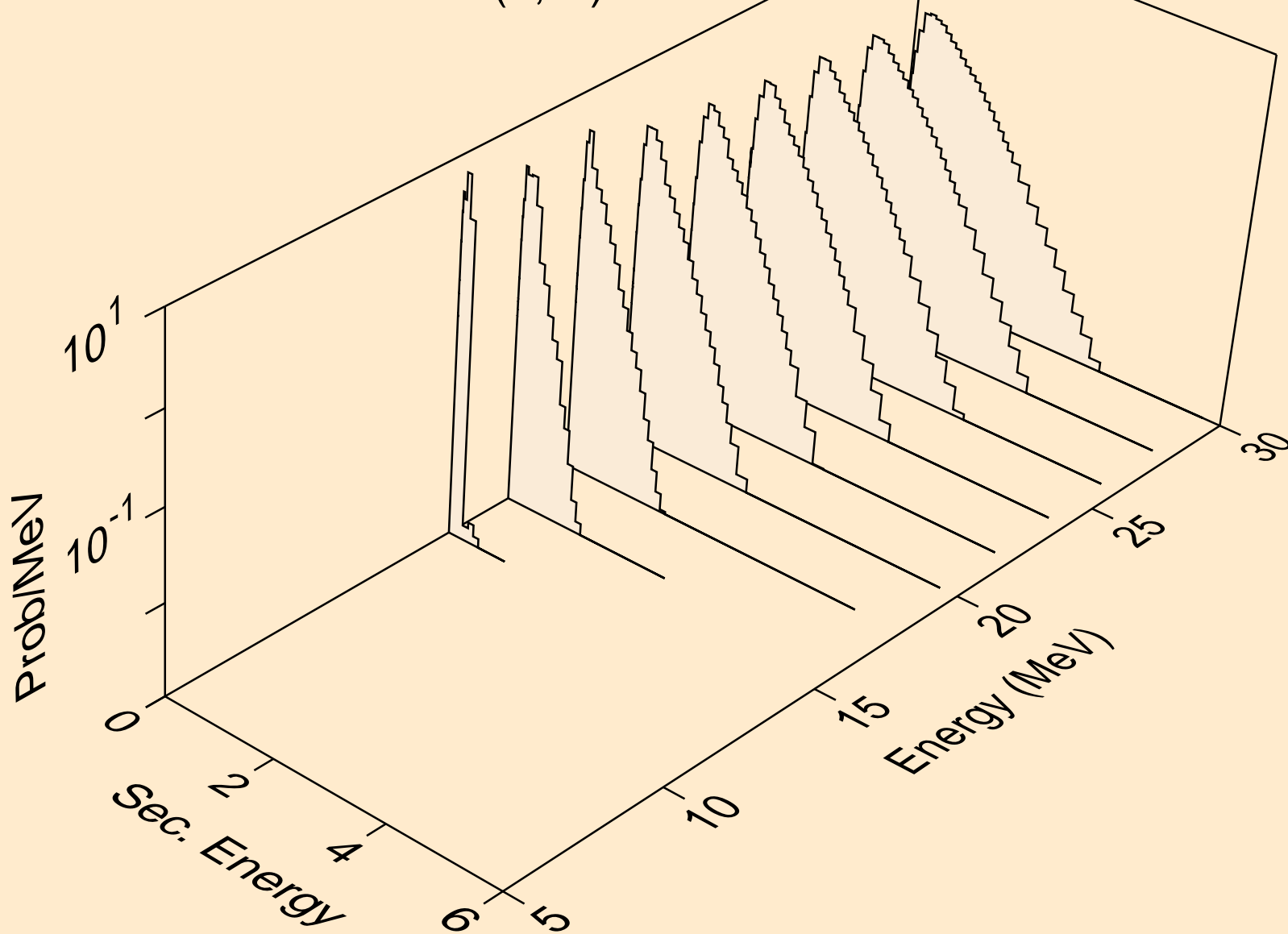

PM140M NEUTRON ACER TENDL-2019 LIBRARY; T=293.16K
Neutron emission for (n,4n)

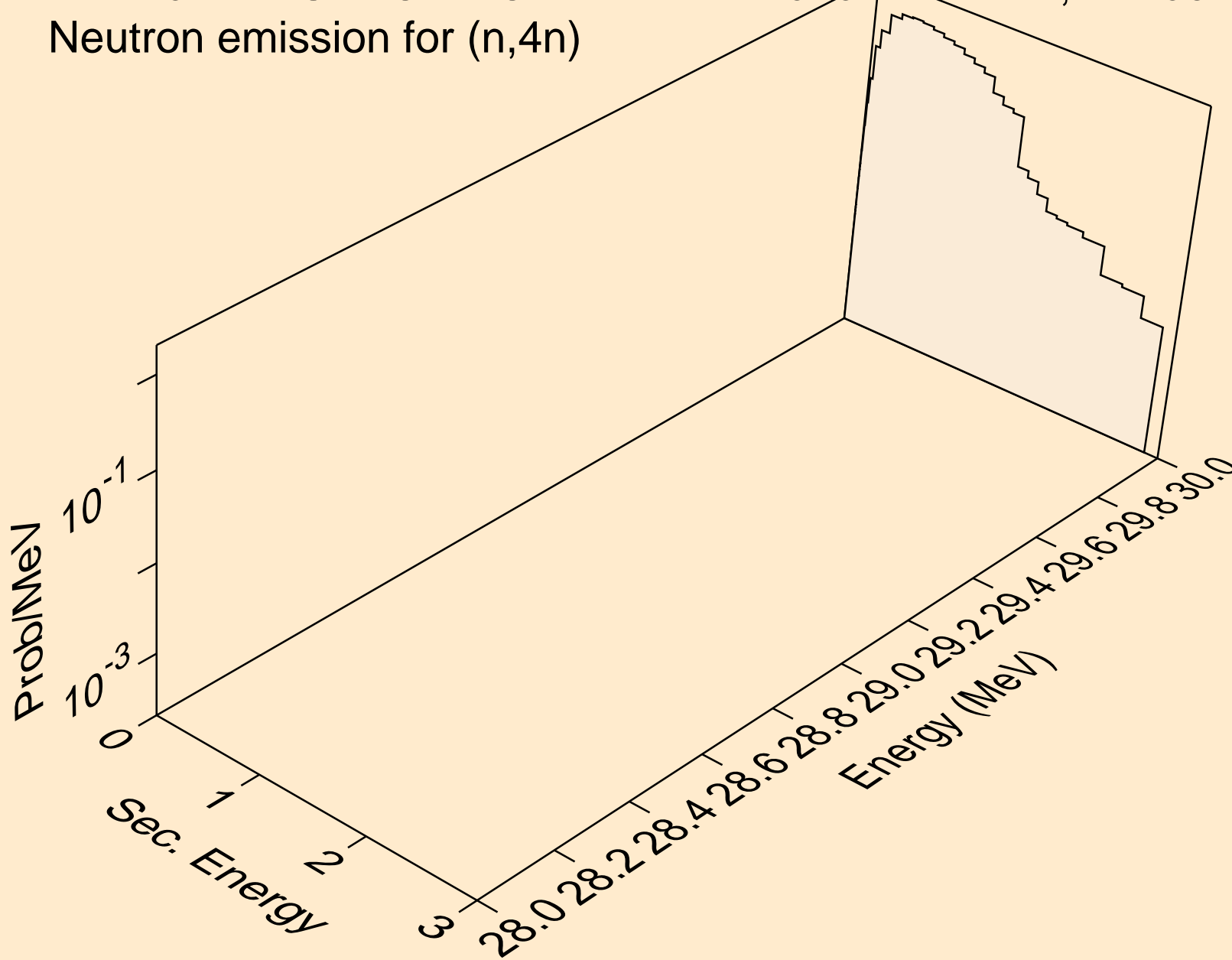

PM140M NEUTRON ACER TENDL-2019 LIBRARY; T=293.16K
Neutron emission for (n,2np)

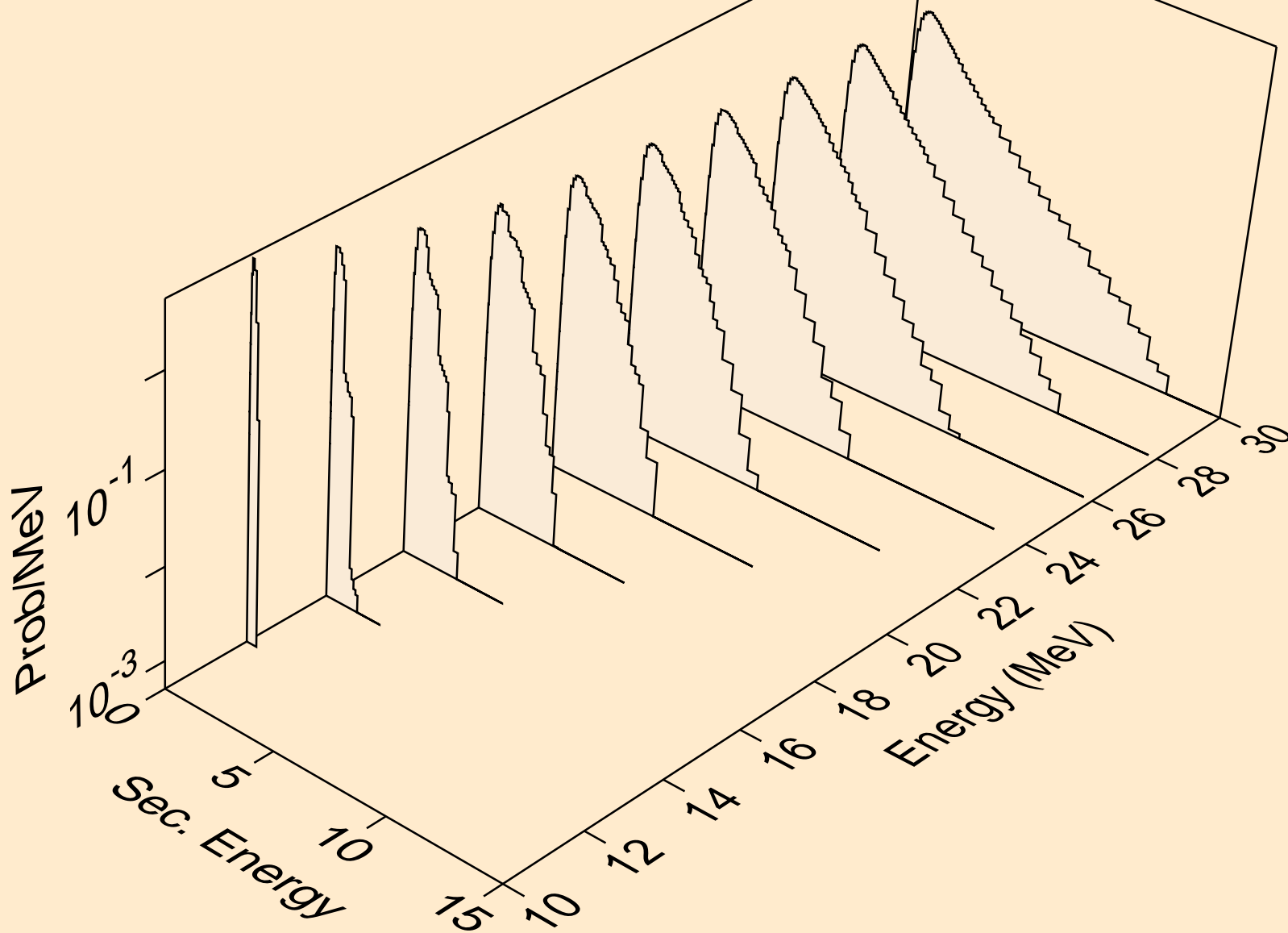

PM140M NEUTRON ACER TENDL-2019 LIBRARY; T=293.16K
Neutron emission for (n,3np)

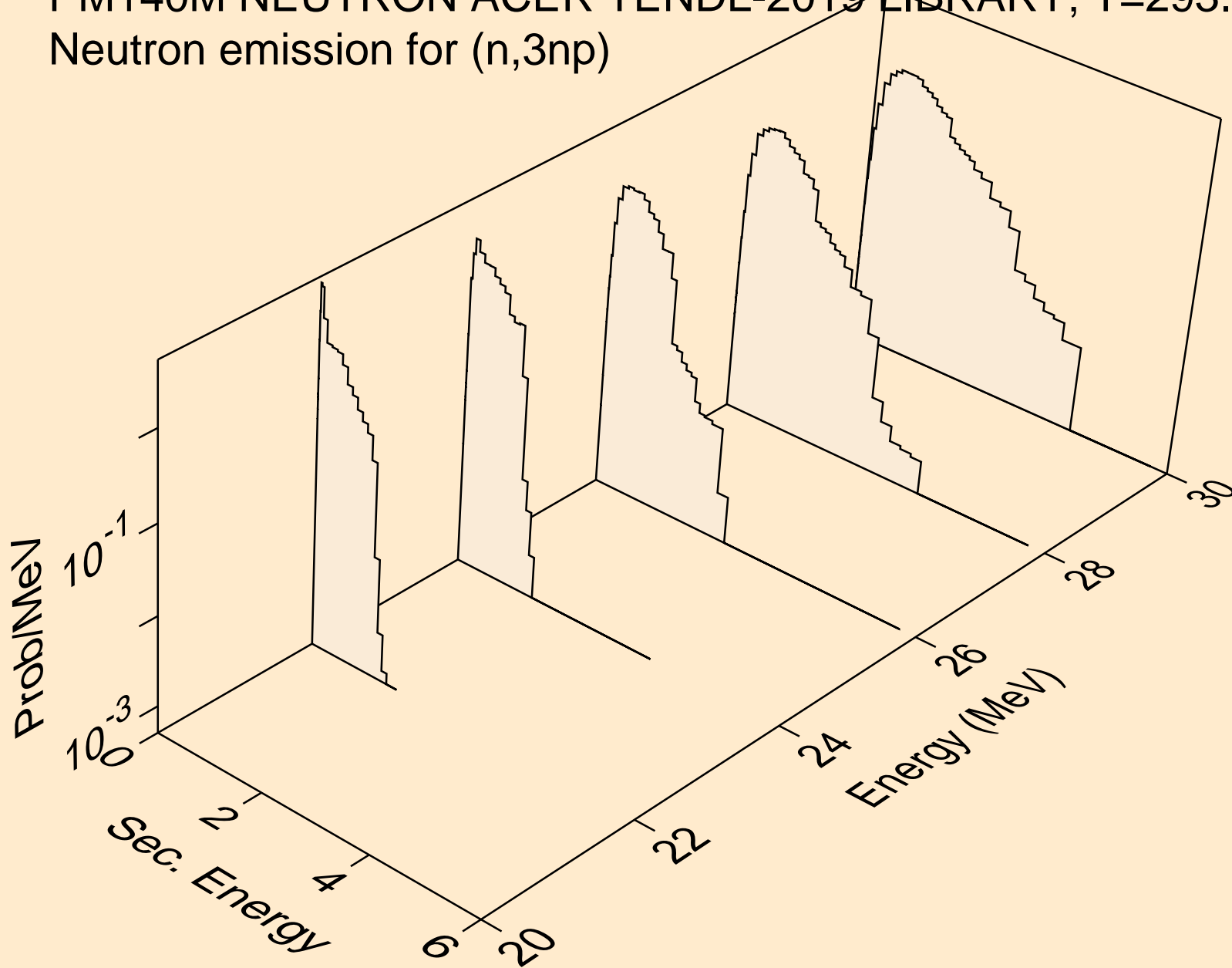

PM140M NEUTRON ACER TENDL-2019 LIBRARY; T=293.16K
Neutron emission for (n,2np)

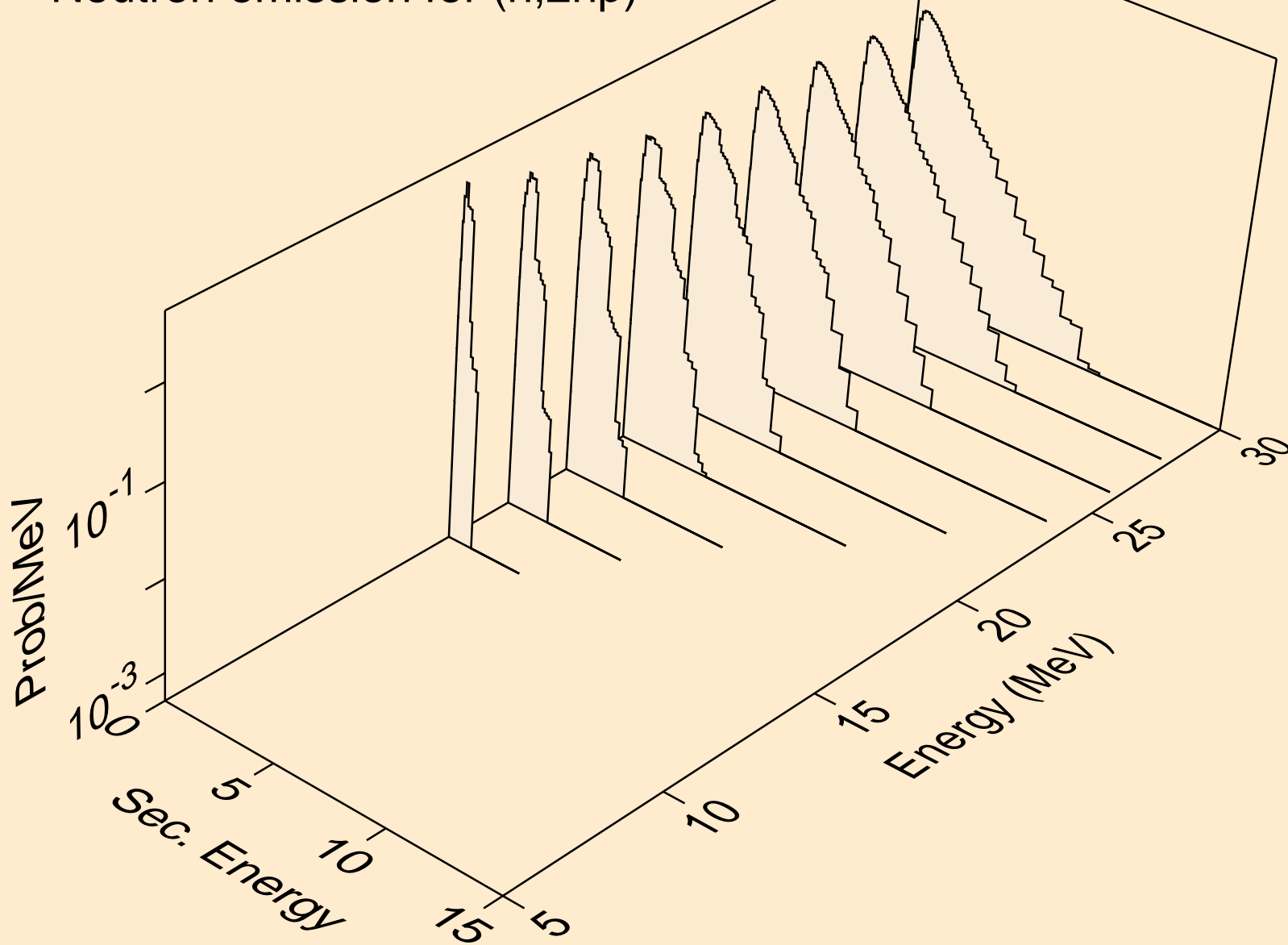

PM140M NEUTRON ACER TENDL-2019 LIBRARY; T=293.16K
Neutron emission for (n,npa)

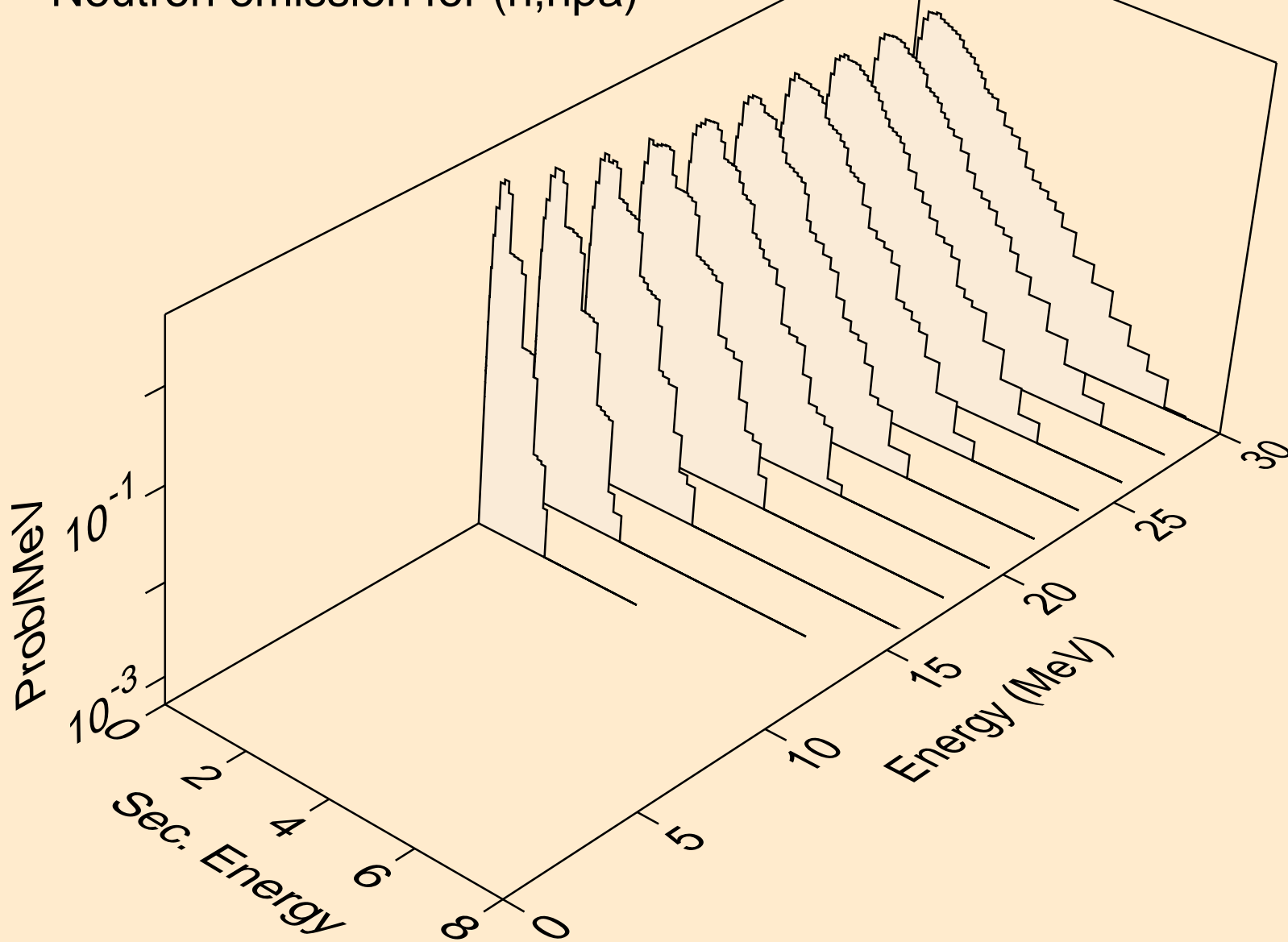

PM140M NEUTRON ACER TENDL-2019 LIBRARY; T=293.16K
Neutron emission for (n,n*c)

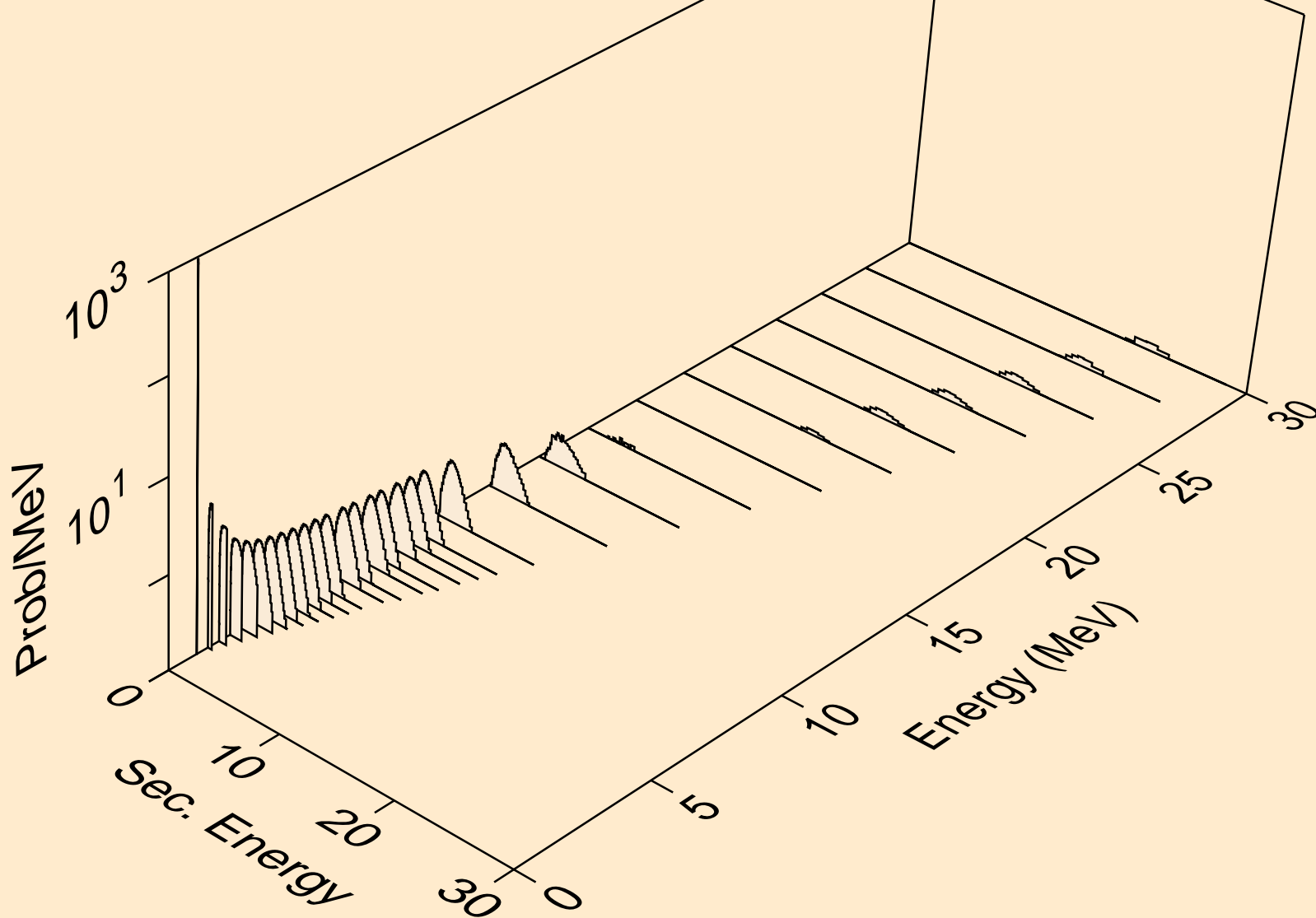

PM140M NEUTRON ACER TENDL-2019 LIBRARY; T=293.16K
Photon emission for (n,x)

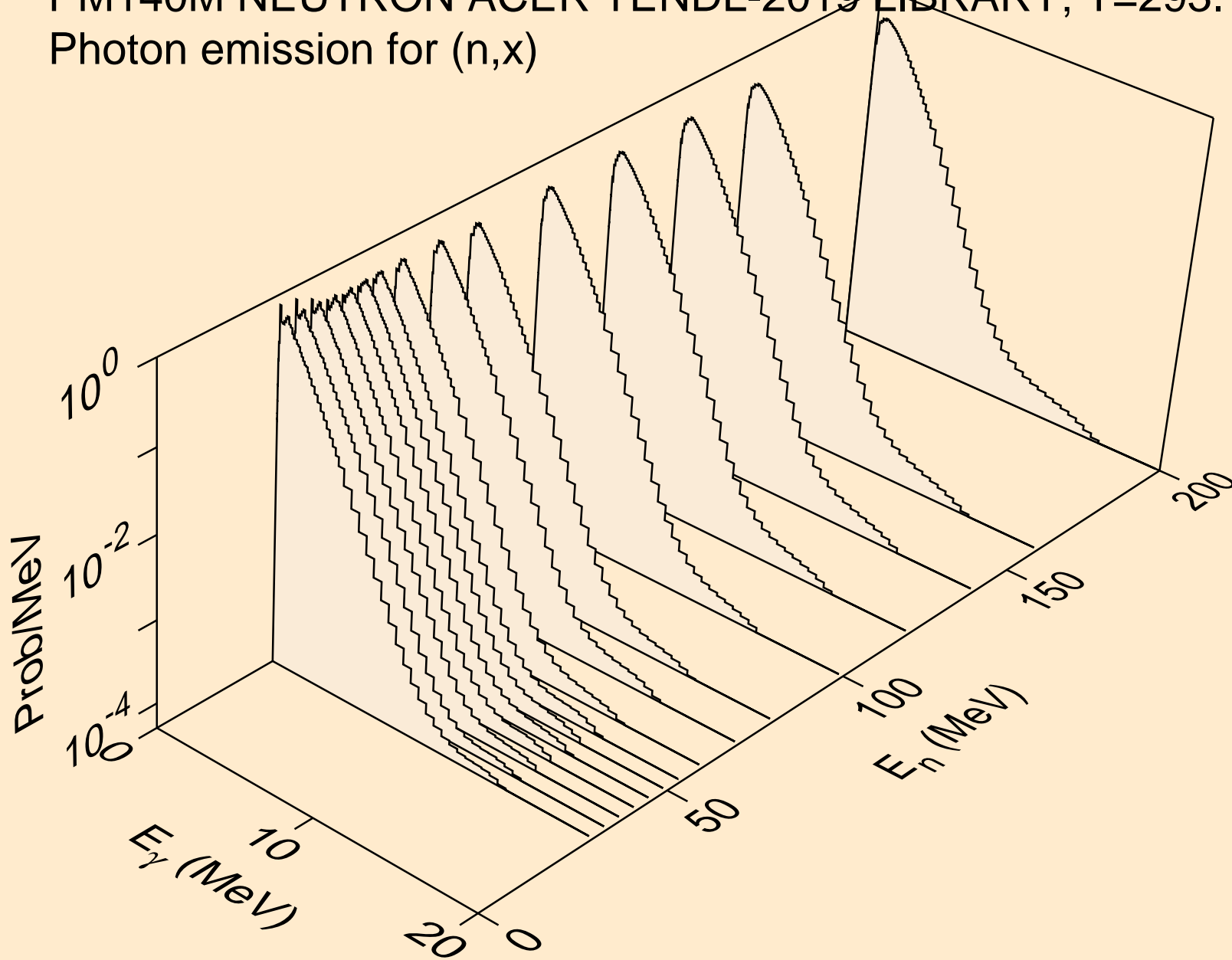

PM140M NEUTRON ACER TENDL-2019 LIBRARY; T=293.16K
Photon emission for (n,2nd)

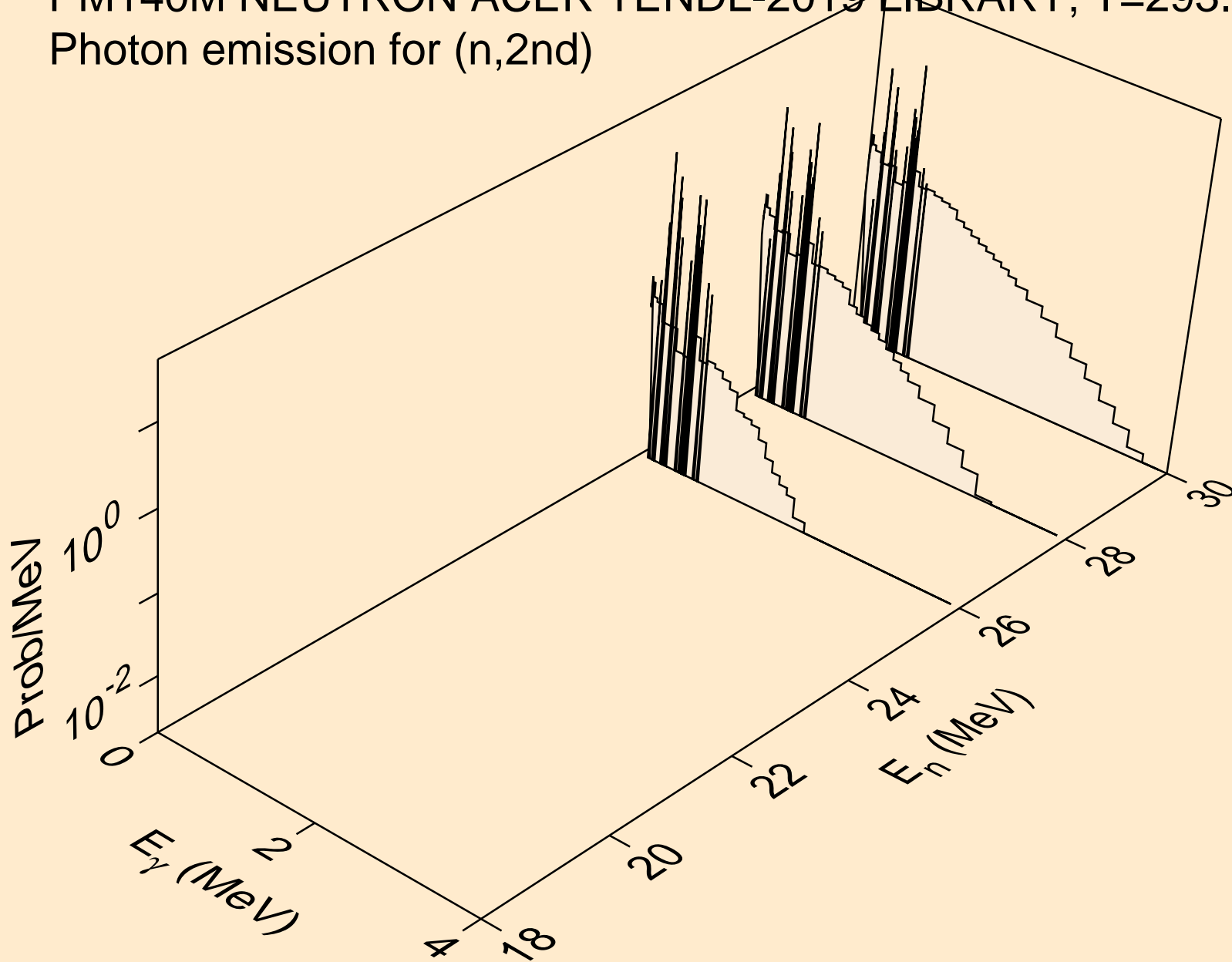

PM140M NEUTRON ACER TENDL-2019 LIBRARY; T=293.16K
Photon emission for (n,2n)

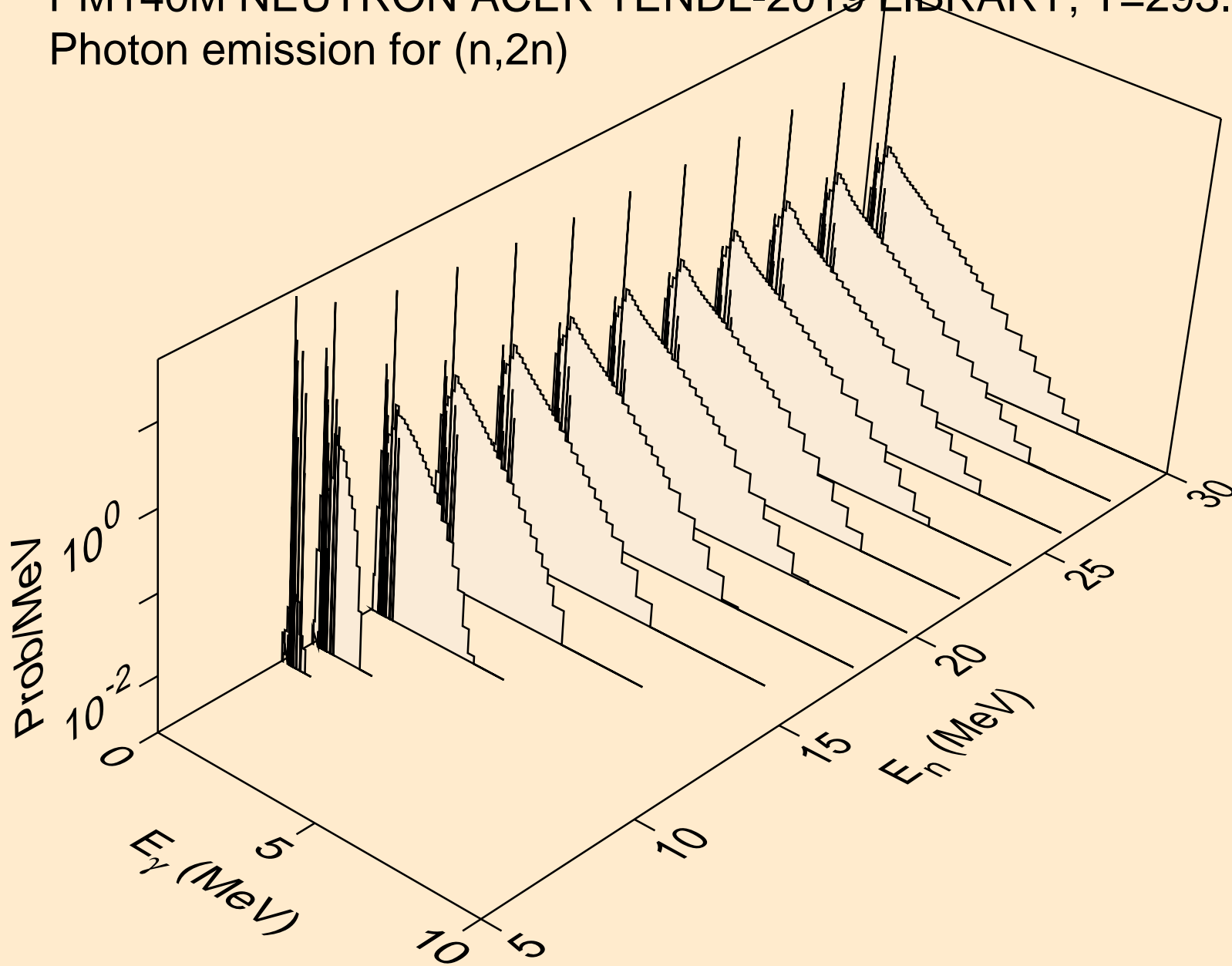

PM140M NEUTRON ACER TENDL-2019 LIBRARY; T=293.16K
Photon emission for (n,3n)

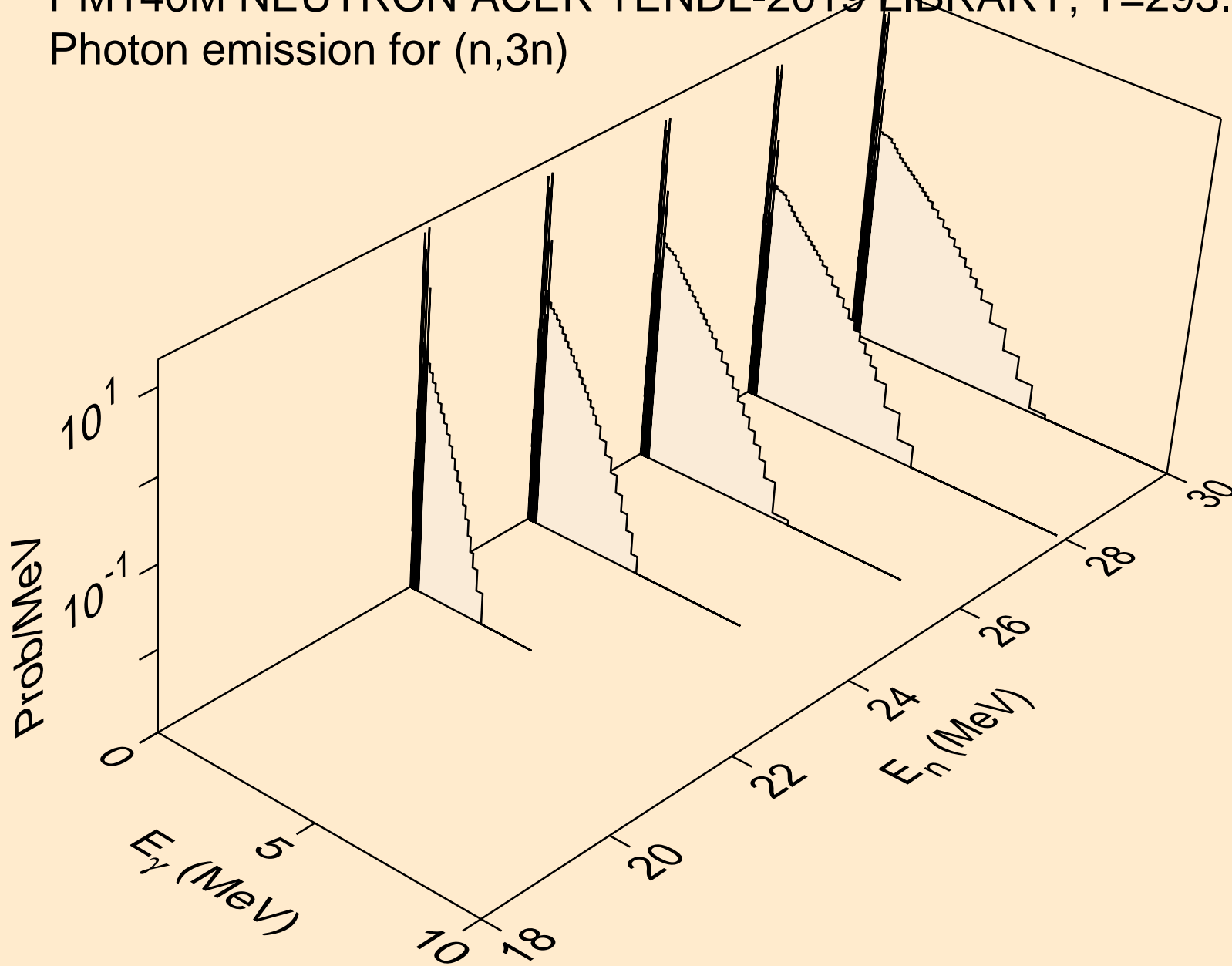

PM140M NEUTRON ACER TENDL-2019 LIBRARY; T=293.16K
Photon emission for (n,n*)a

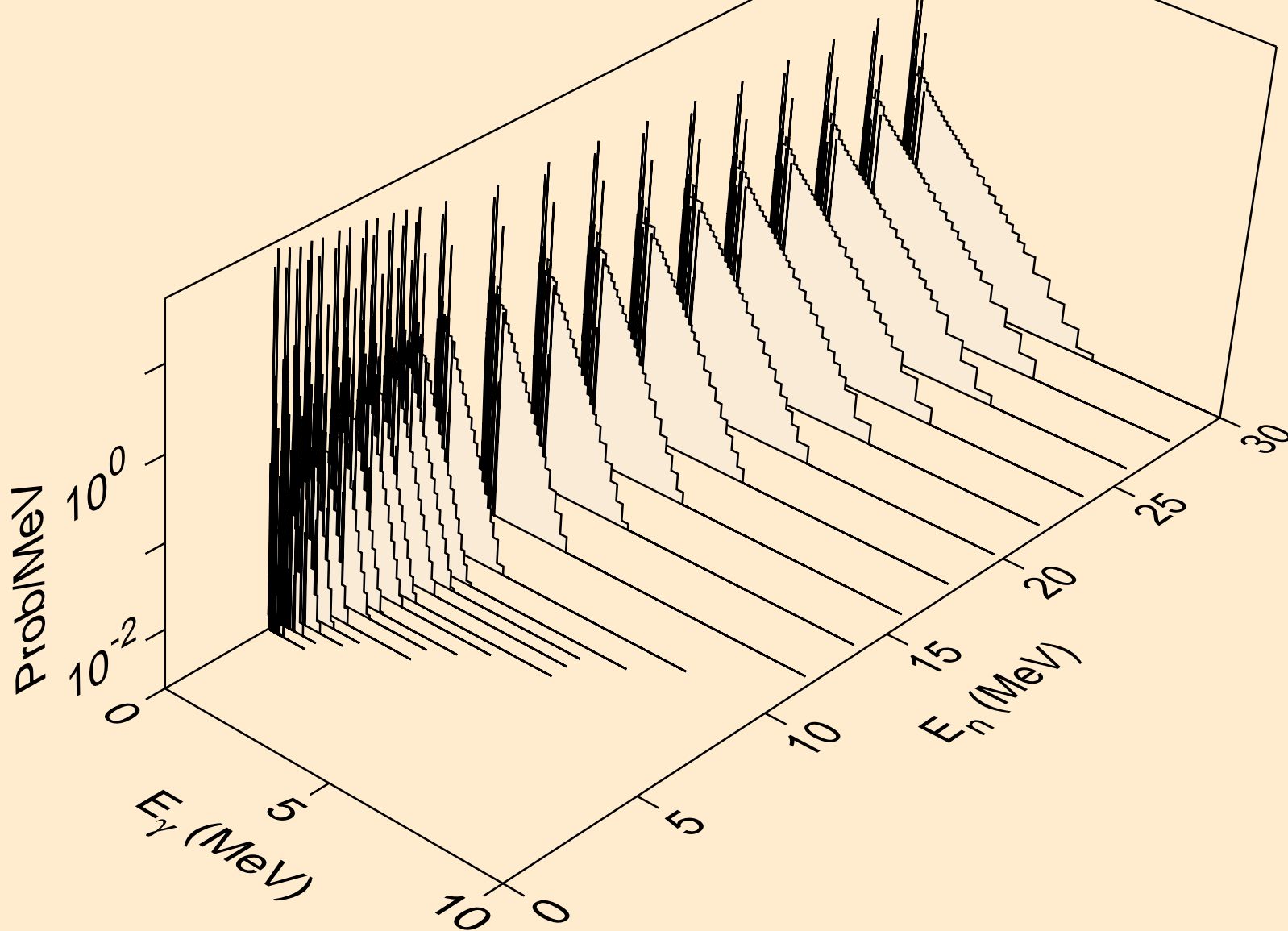

PM140M NEUTRON ACER TENDL-2019 LIBRARY; T=293.16K
Photon emission for (n,2n)a

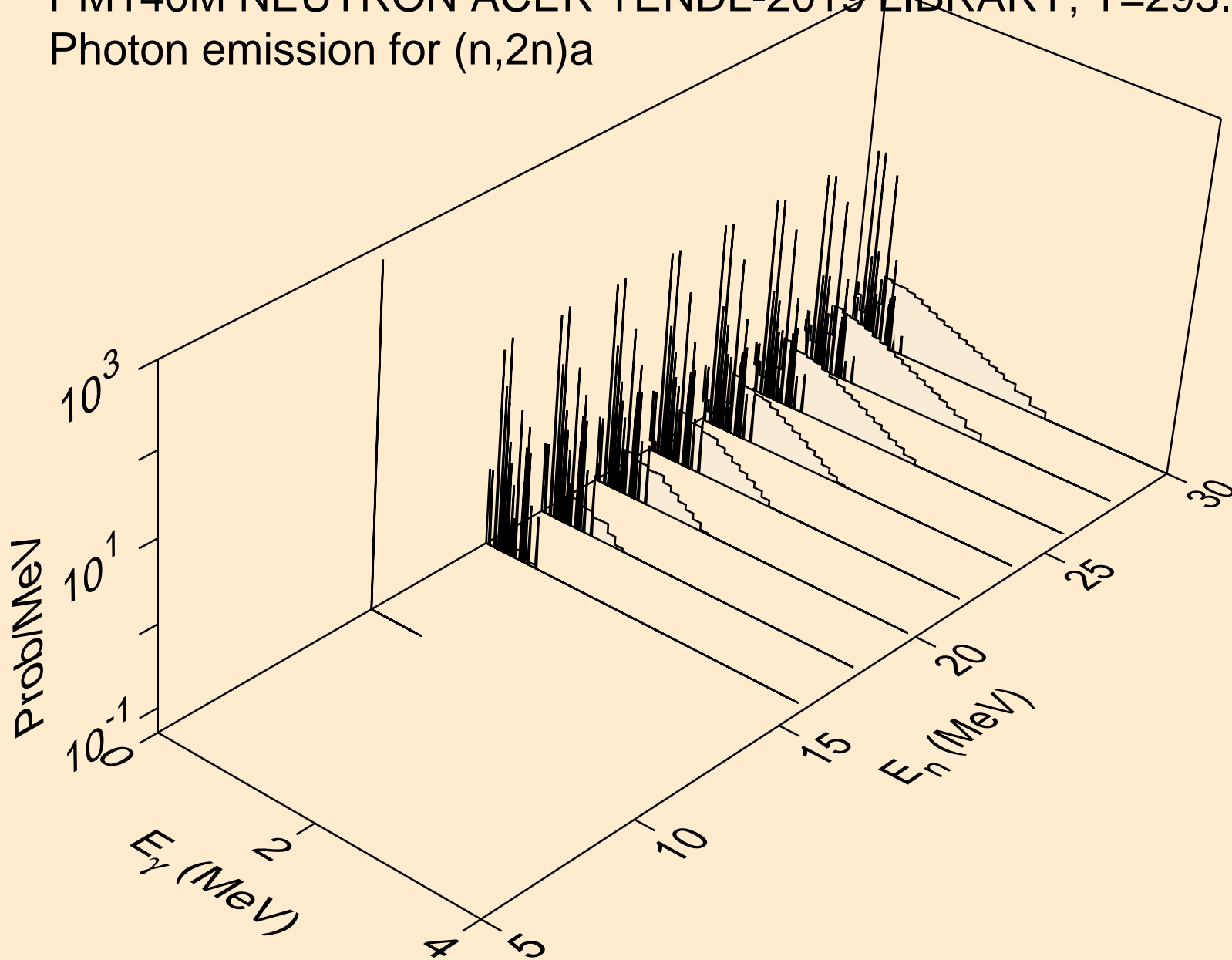

PM140M NEUTRON ACER TENDL-2019 LIBRARY; T=293.16K
Photon emission for (n,3n)a

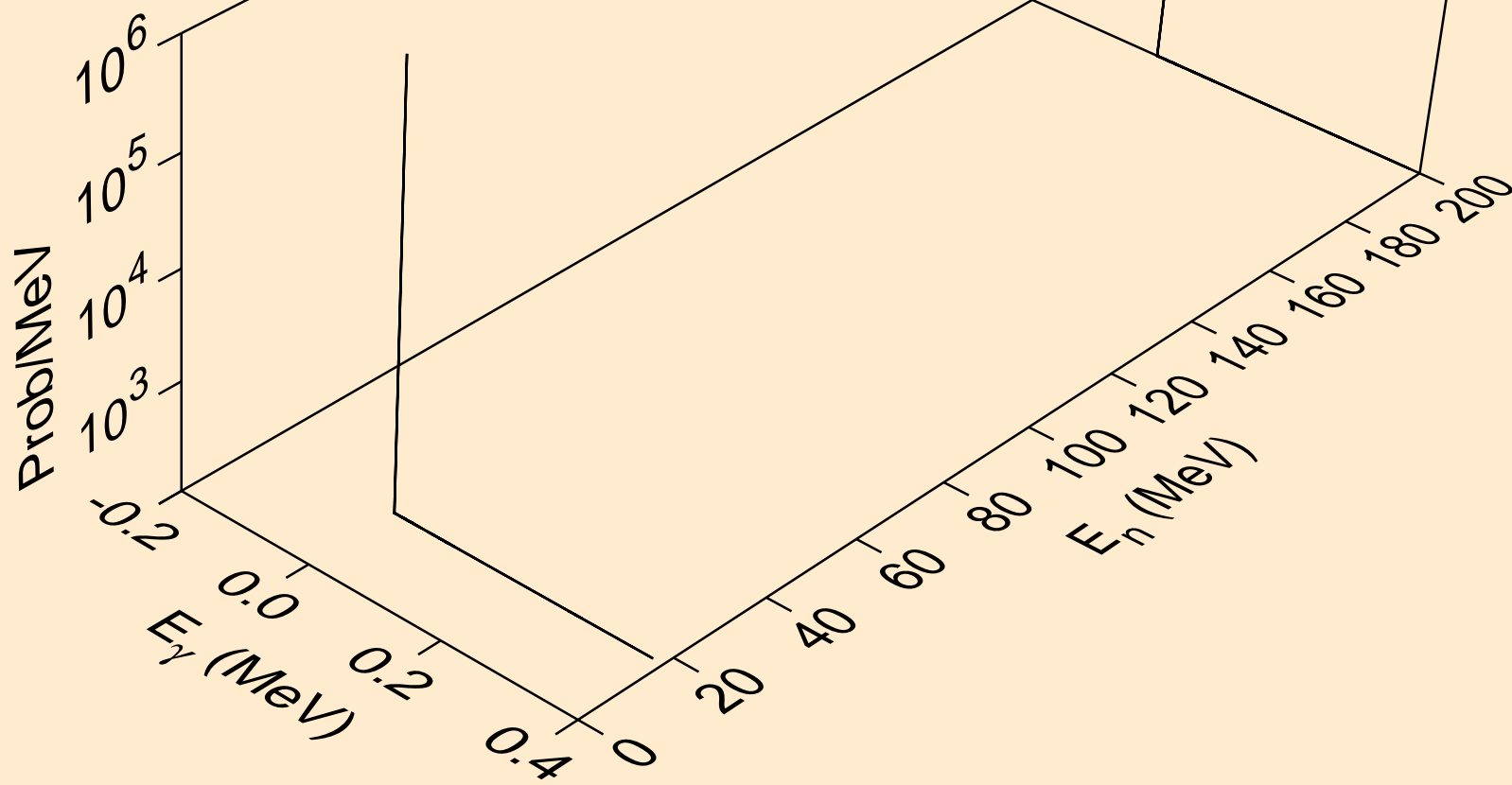

PM140M NEUTRON ACER TENDL-2019 LIBRARY; T=293.16K
Photon emission for (n,n*)p

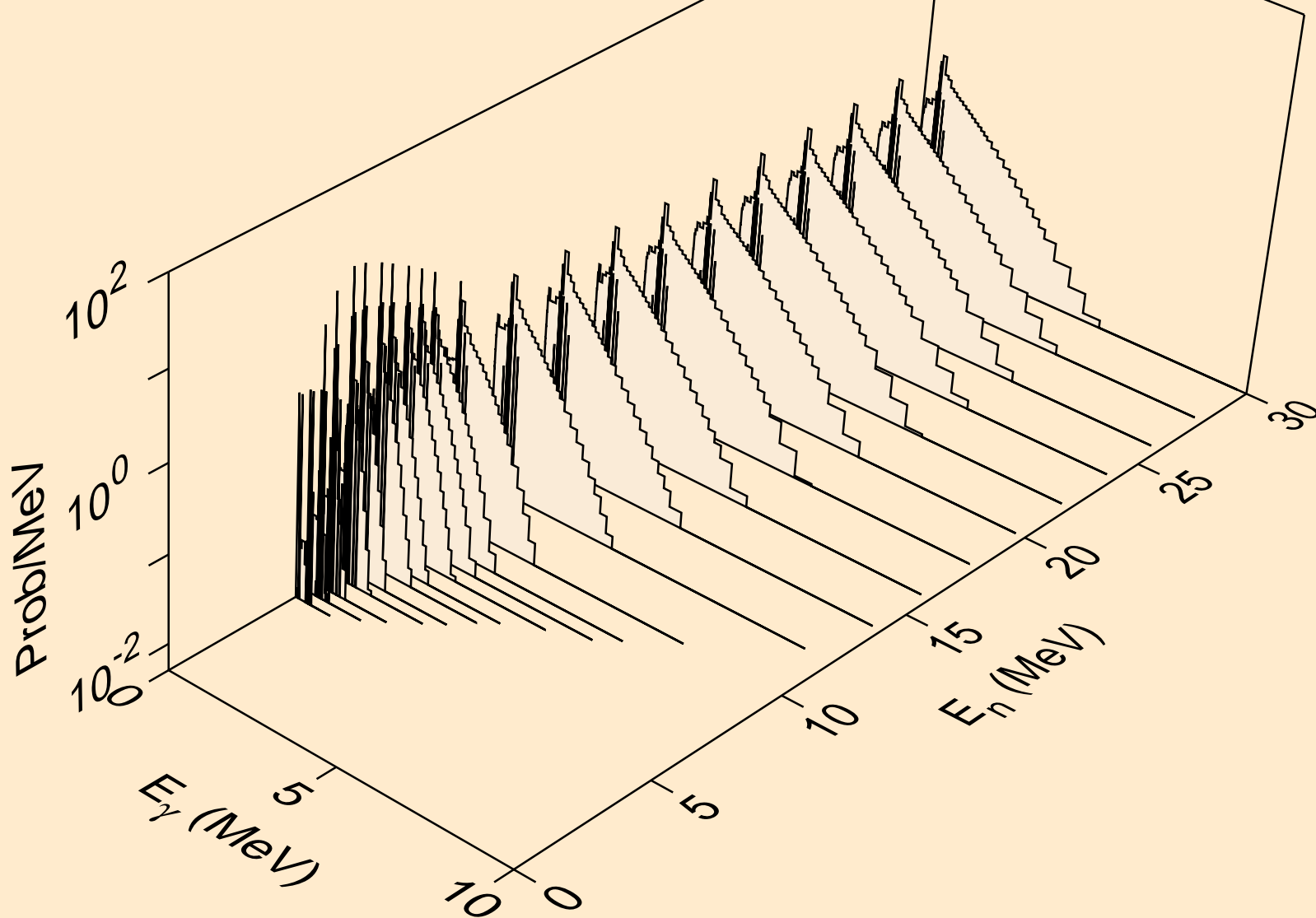

PM140M NEUTRON ACER TENDL-2019 LIBRARY; T=293.16K
Photon emission for (n,n*)2a

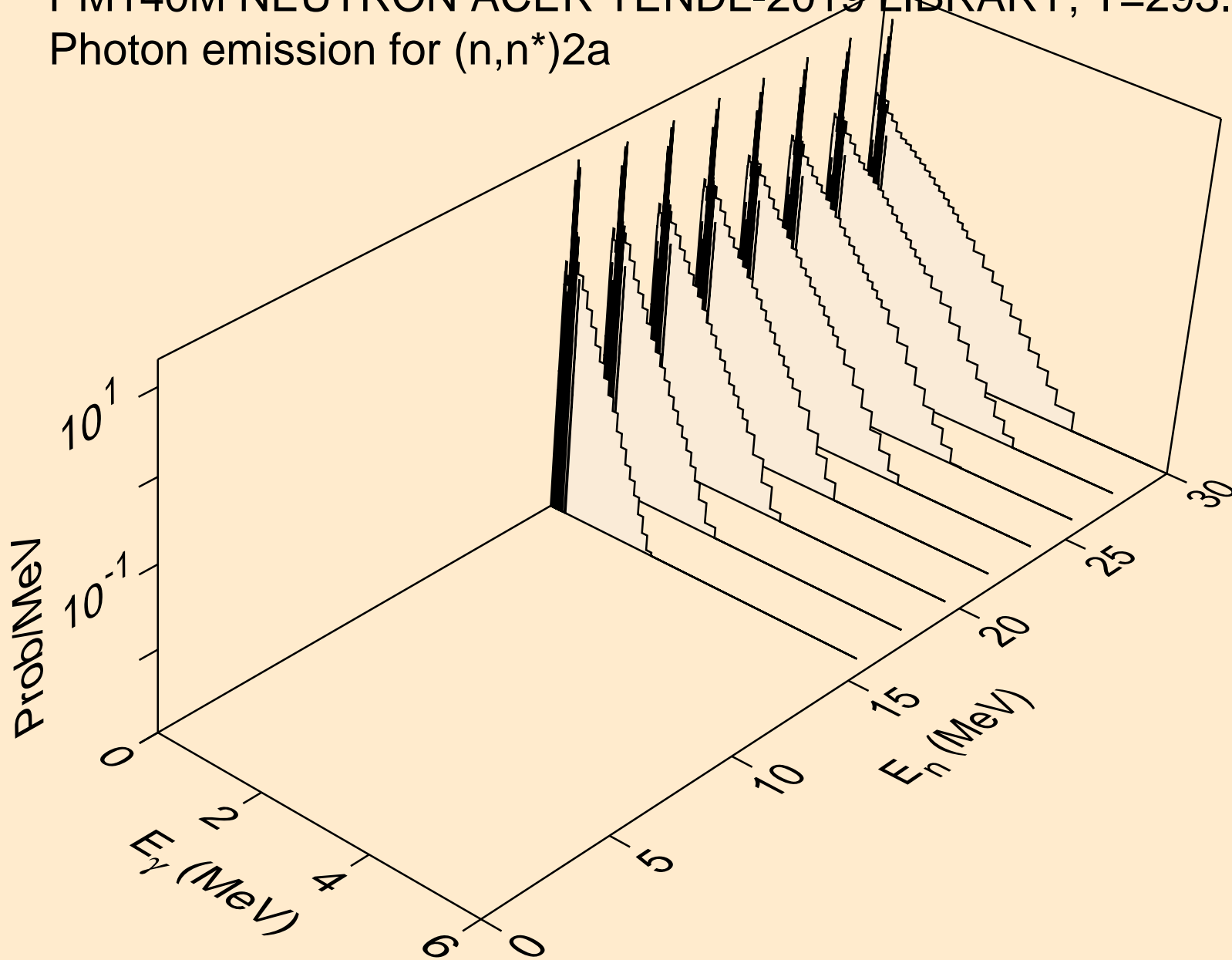

PM140M NEUTRON ACER TENDL-2019 LIBRARY; T=293.16K
Photon emission for (n,2n)2a

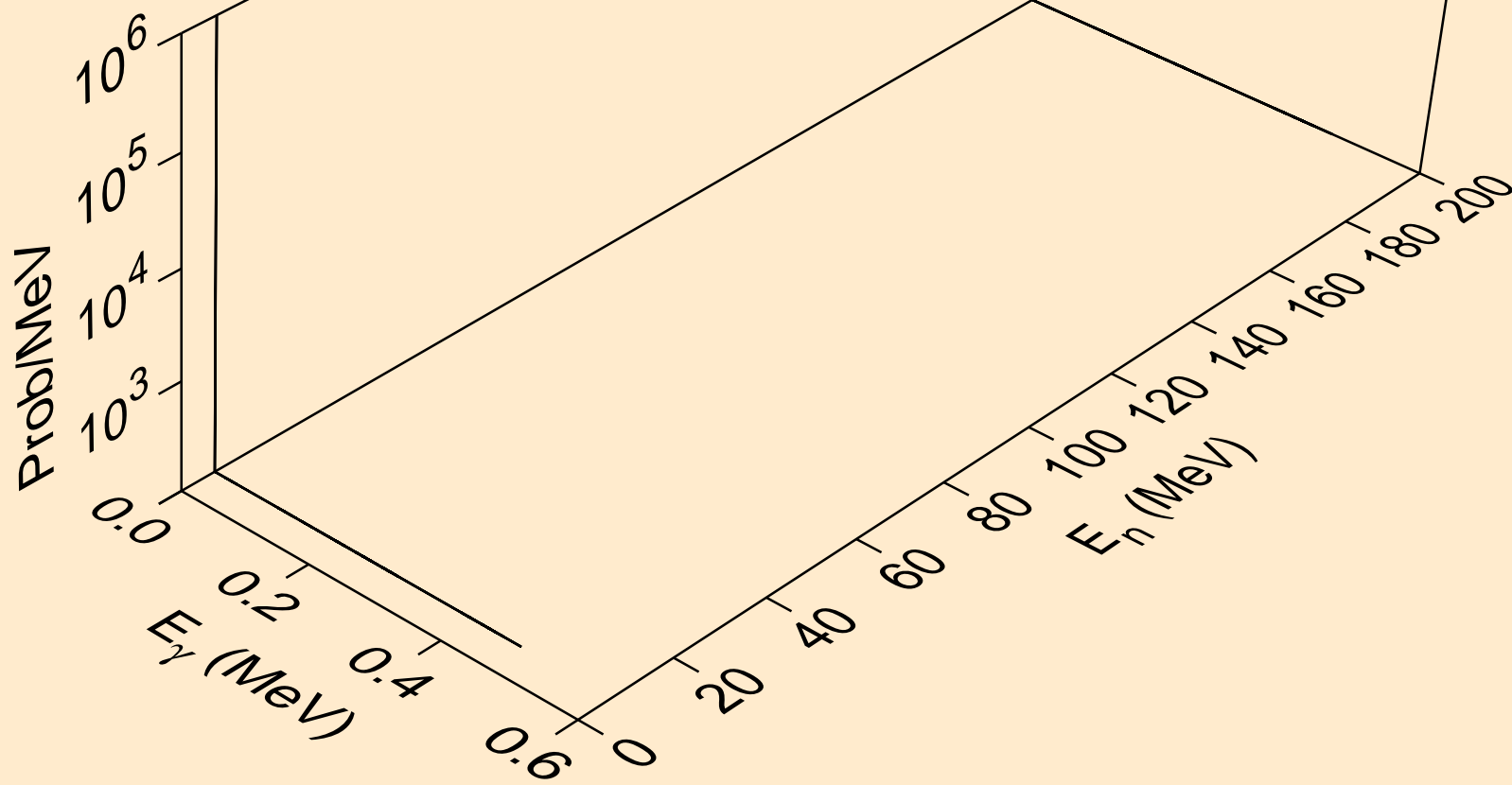

PM140M NEUTRON ACER TENDL-2019 LIBRARY; T=293.16K
Photon emission for (n,n*)d

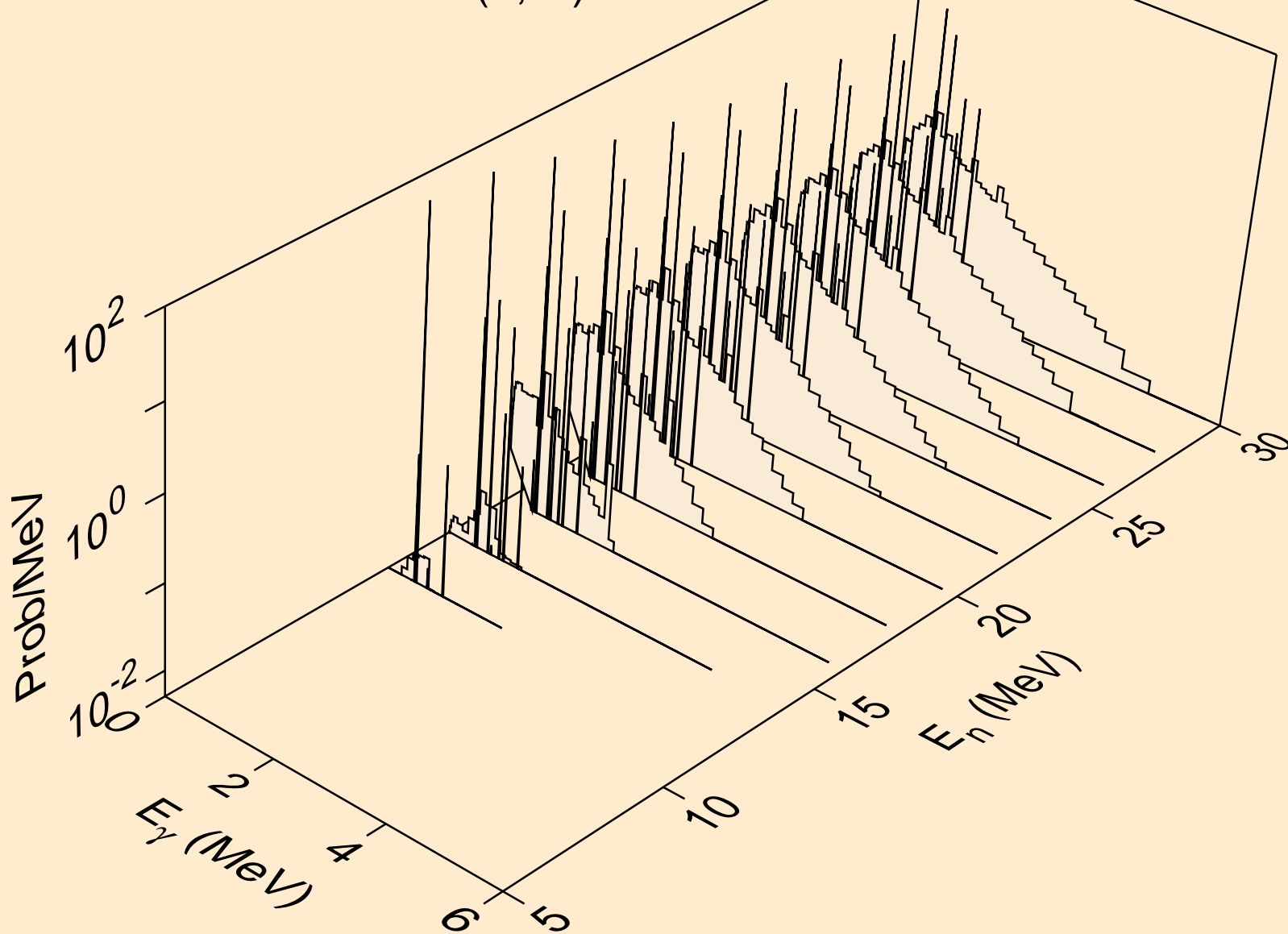

PM140M NEUTRON ACER TENDL-2019 LIBRARY; T=293.16K
Photon emission for (n,n*)t

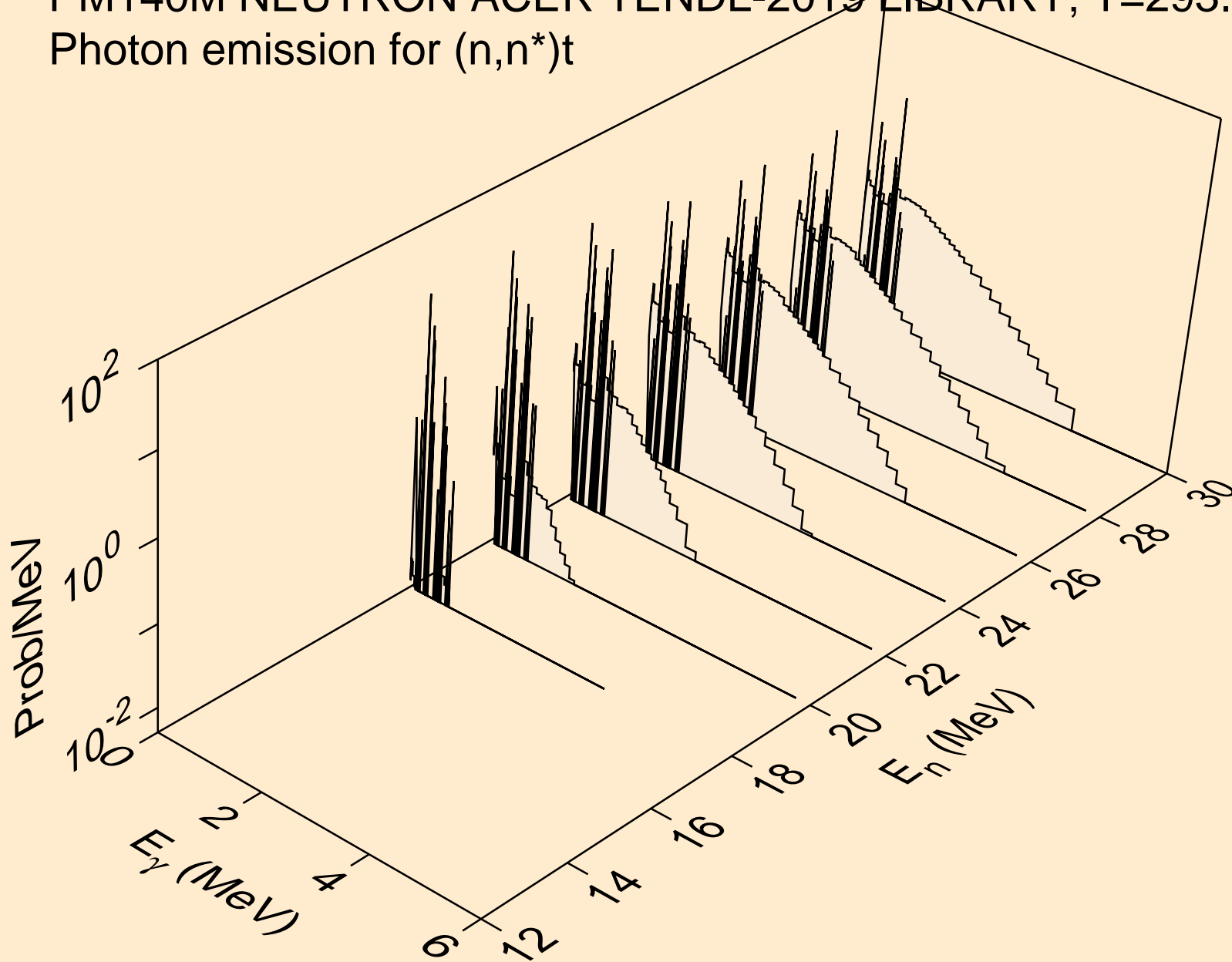

PM140M NEUTRON ACER TENDL-2019 LIBRARY; T=293.16K
Photon emission for (n,n*)he3

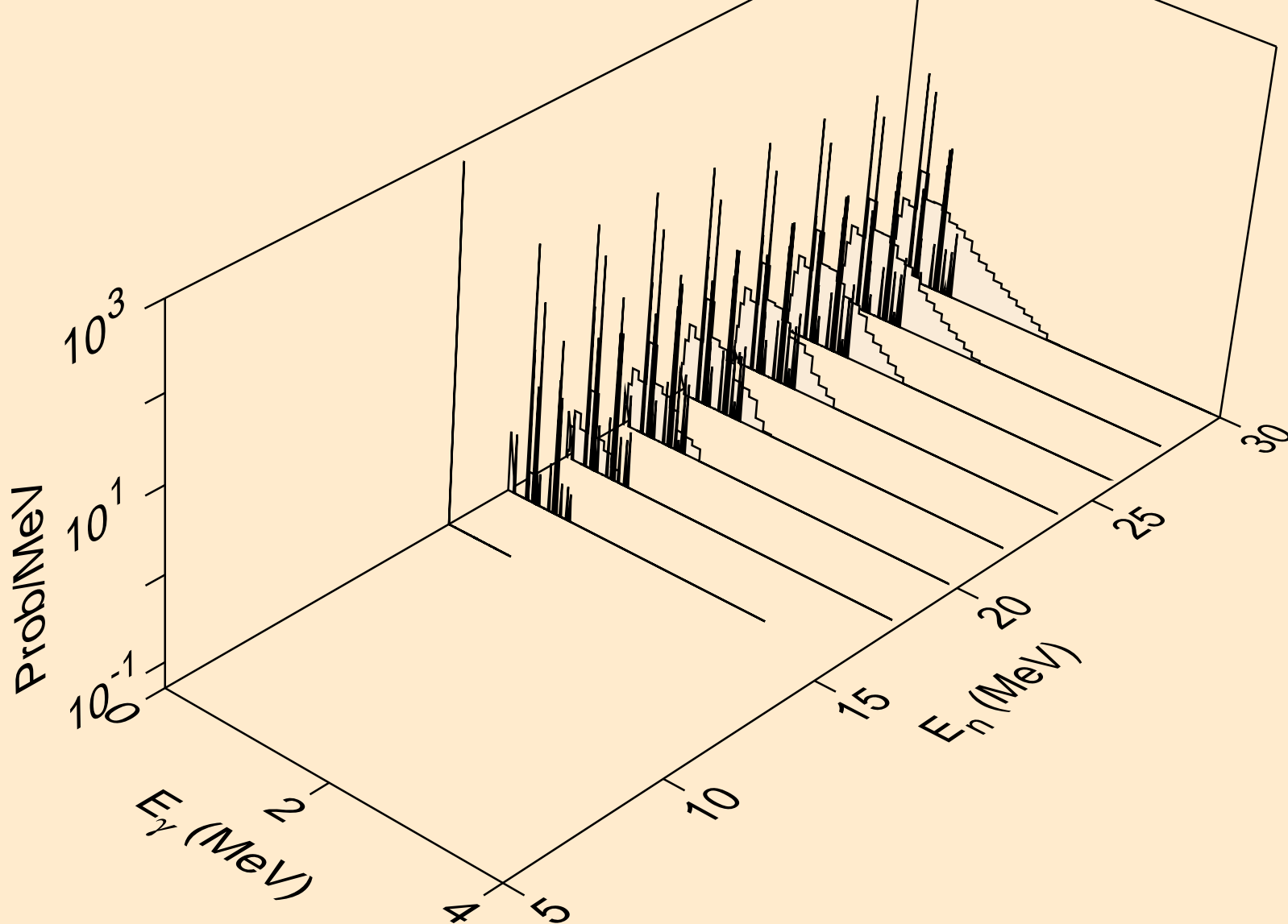

PM140M NEUTRON ACER TENDL-2019 LIBRARY; T=293.16K
Photon emission for (n,4n)

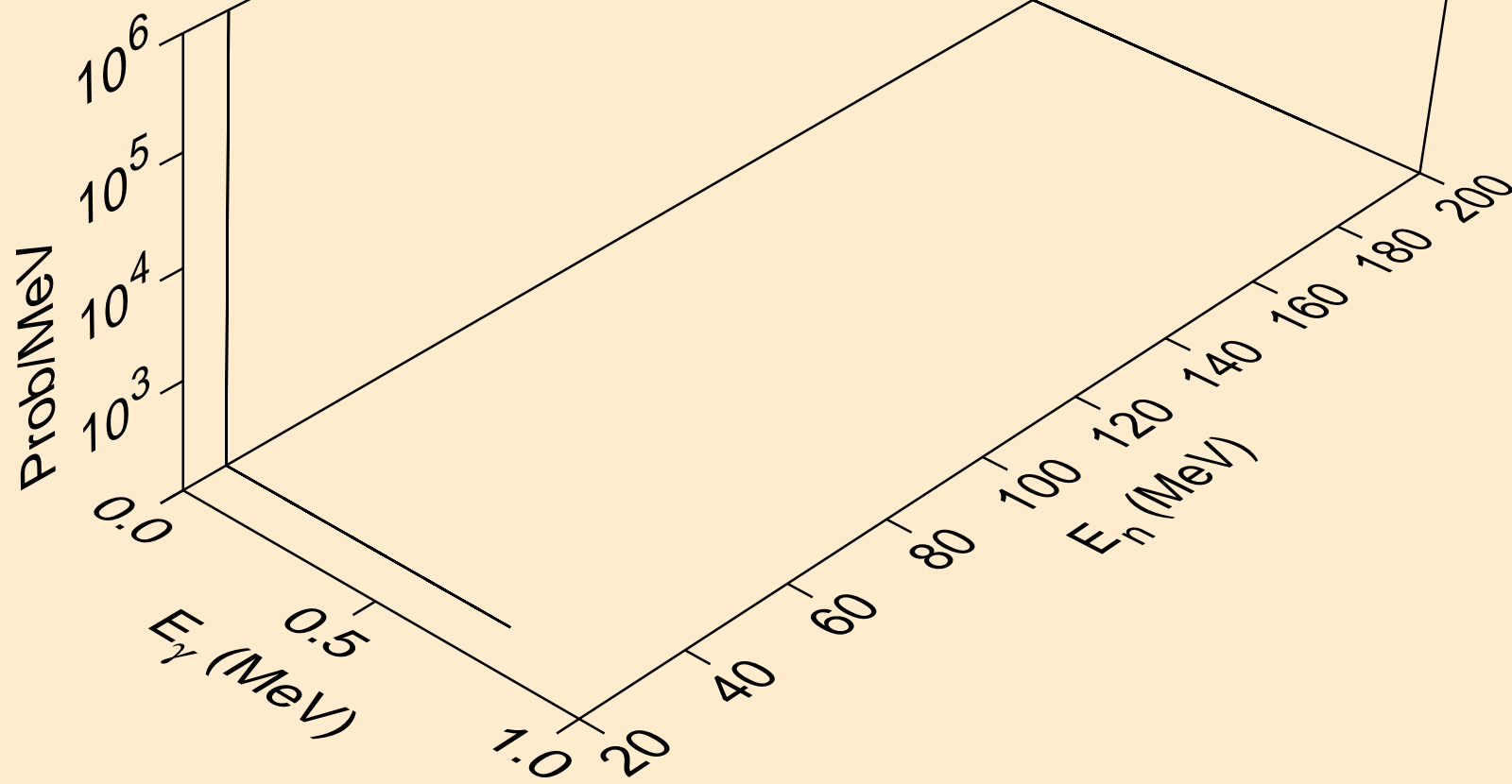

PM140M NEUTRON ACER TENDL-2019 LIBRARY; T=293.16K
Photon emission for (n,2np)

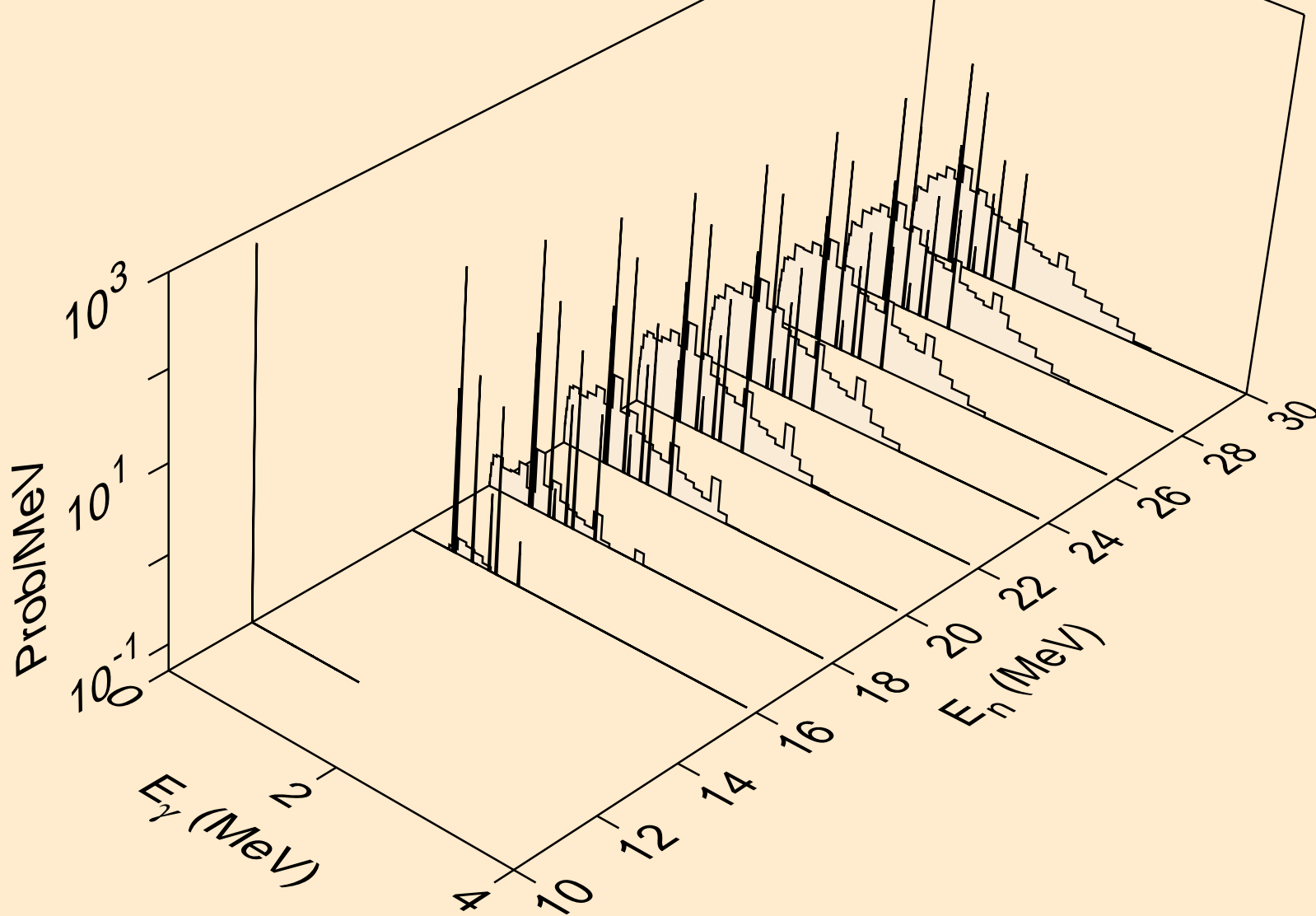

PM140M NEUTRON ACER TENDL-2019 LIBRARY; T=293.16K
Photon emission for (n,3np)

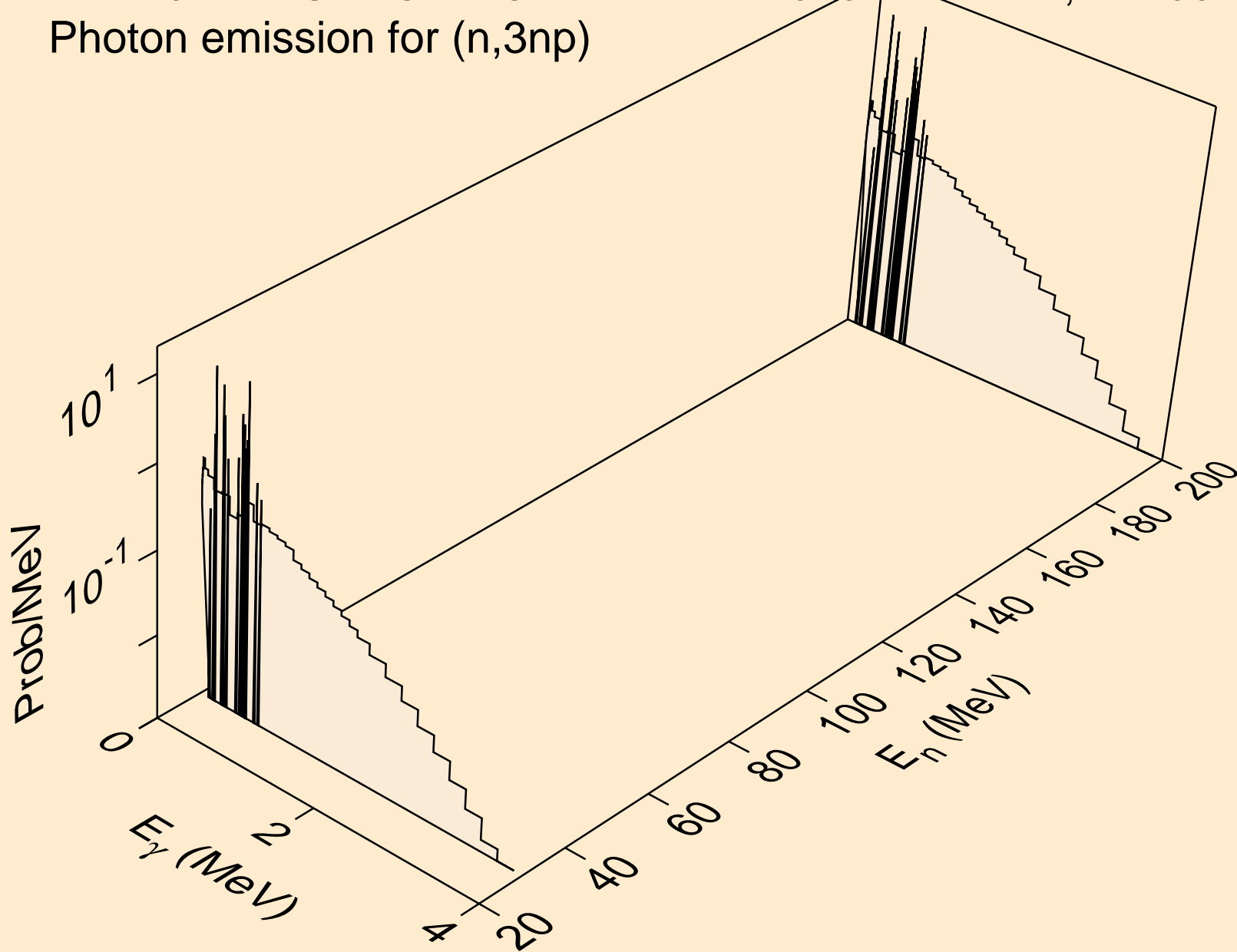

PM140M NEUTRON ACER TENDL-2019 LIBRARY; T=293.16K
Photon emission for (n,2np)

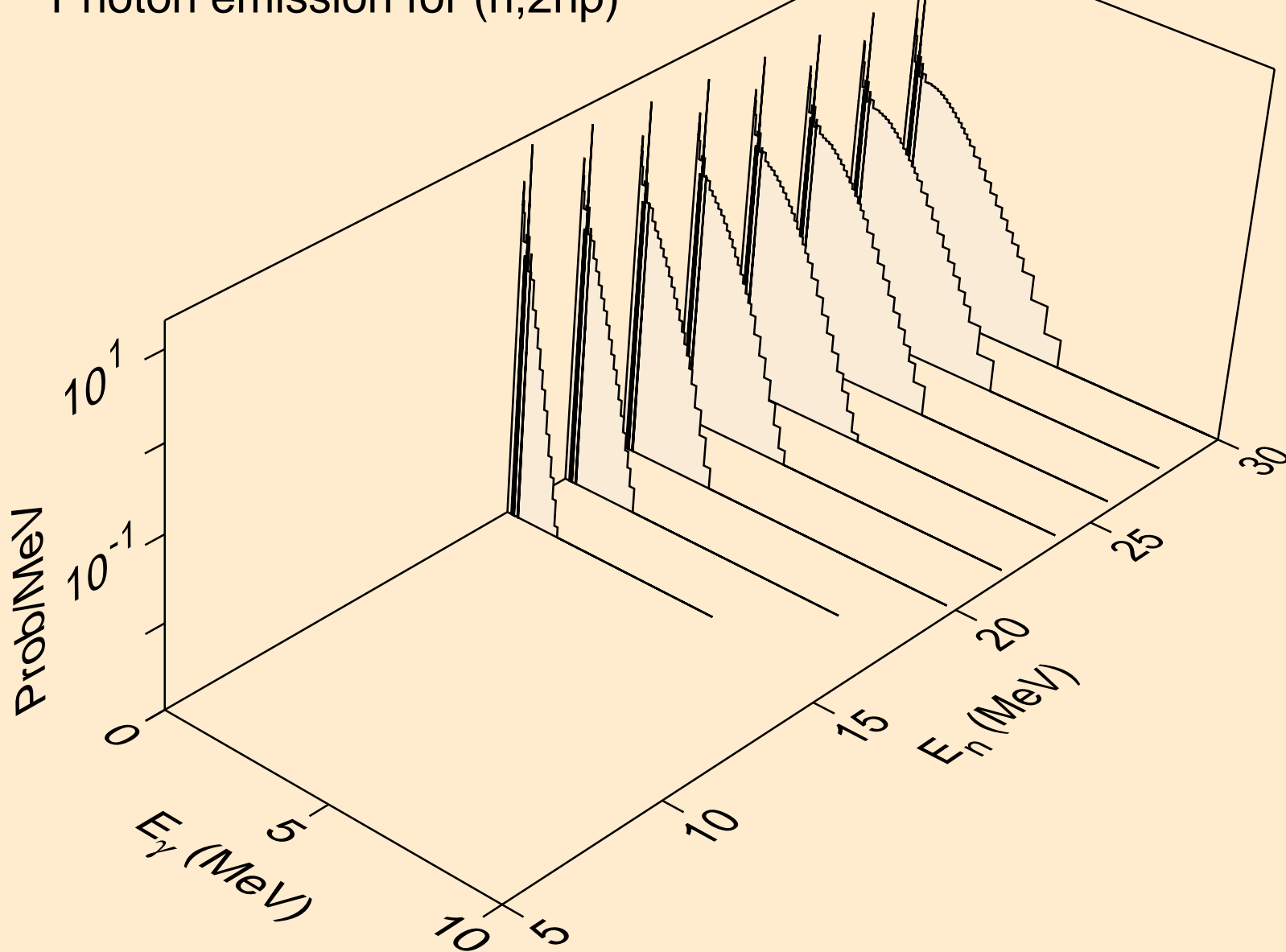

PM140M NEUTRON ACER TENDL-2019 LIBRARY; T=293.16K
Photon emission for (n,npa)

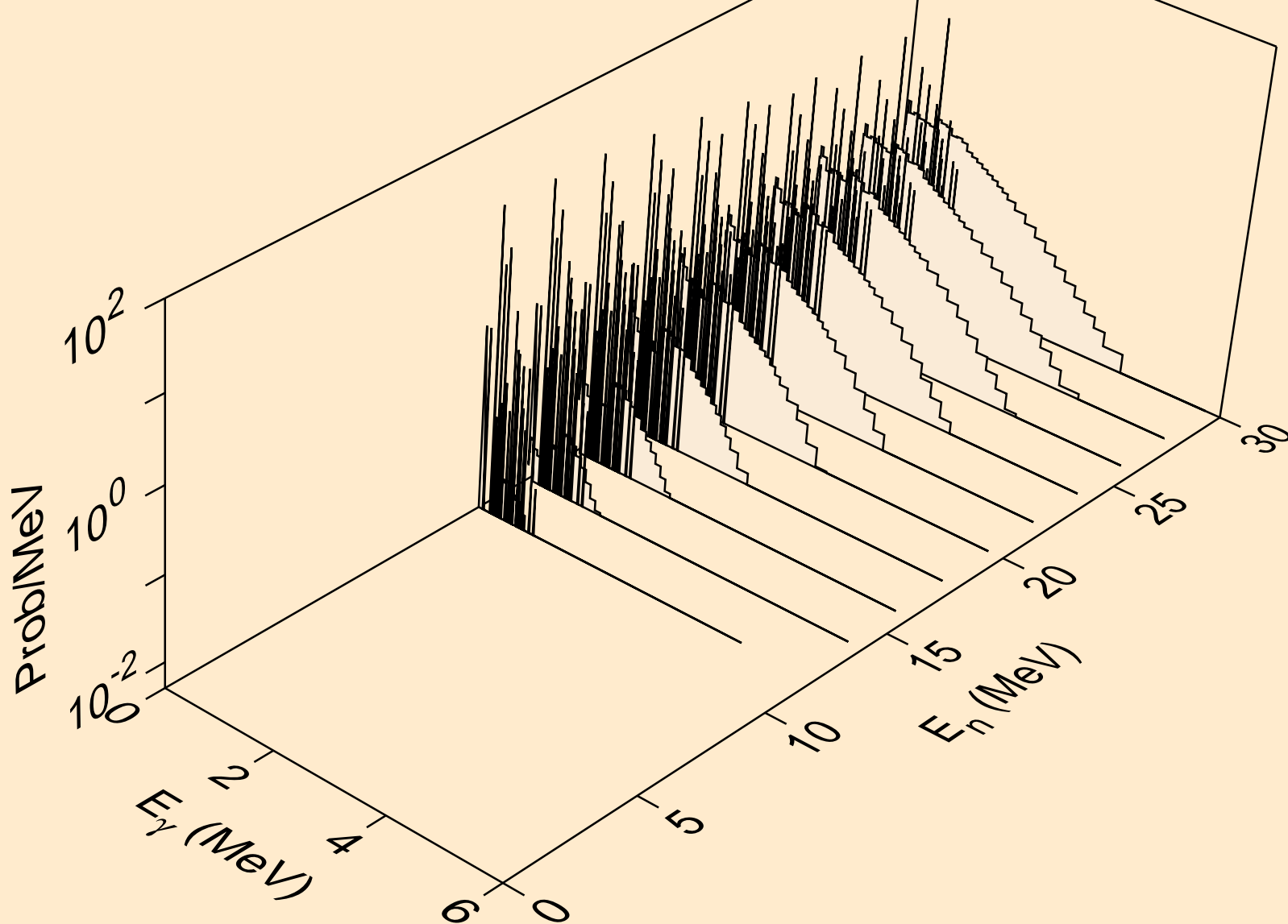

PM140M NEUTRON ACER TENDL-2019 LIBRARY; T=293.16K
Photon emission for (n,n*1)

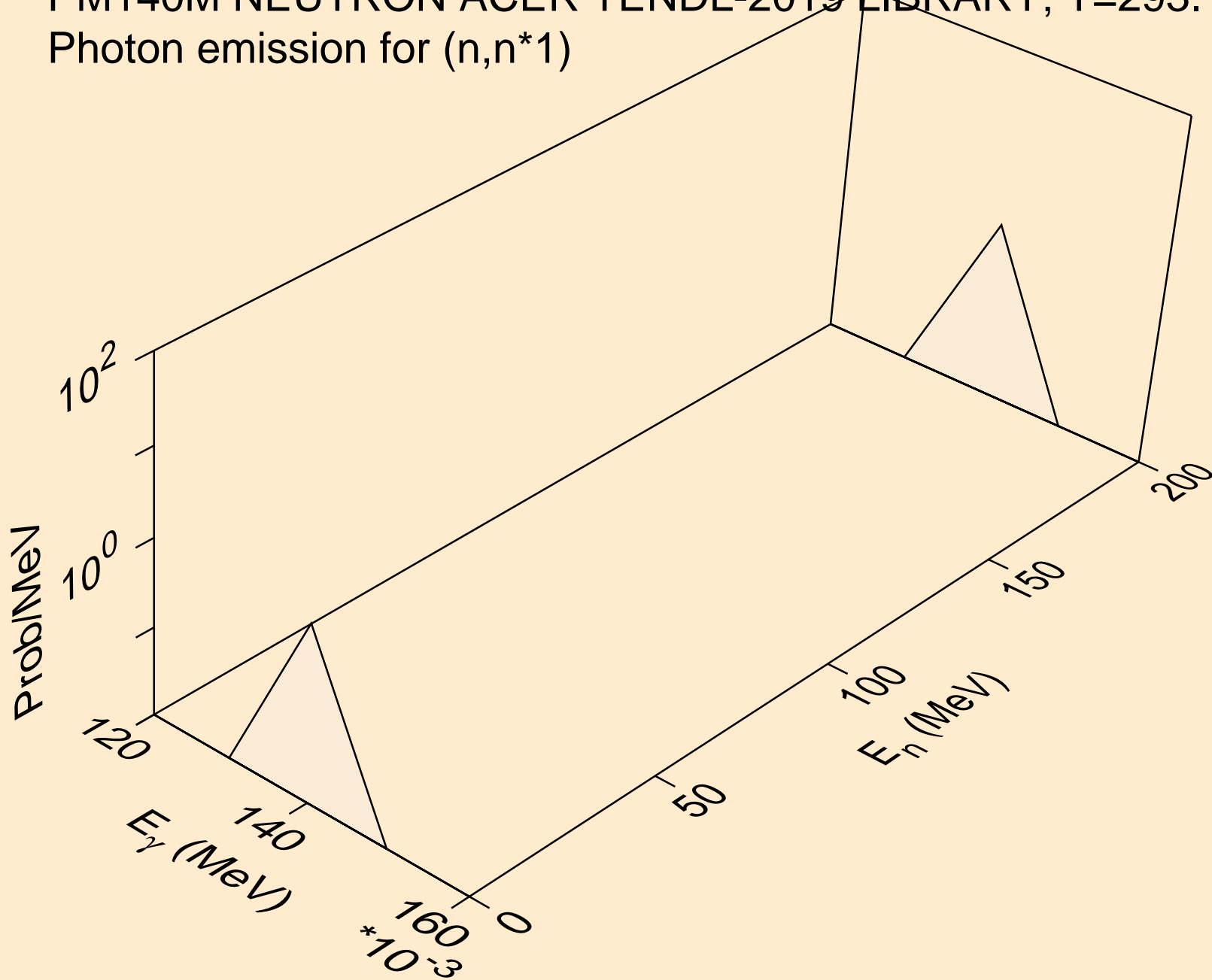

PM140M NEUTRON ACER TENDL-2019 LIBRARY; T=293.16K
Photon emission for (n,n*2)

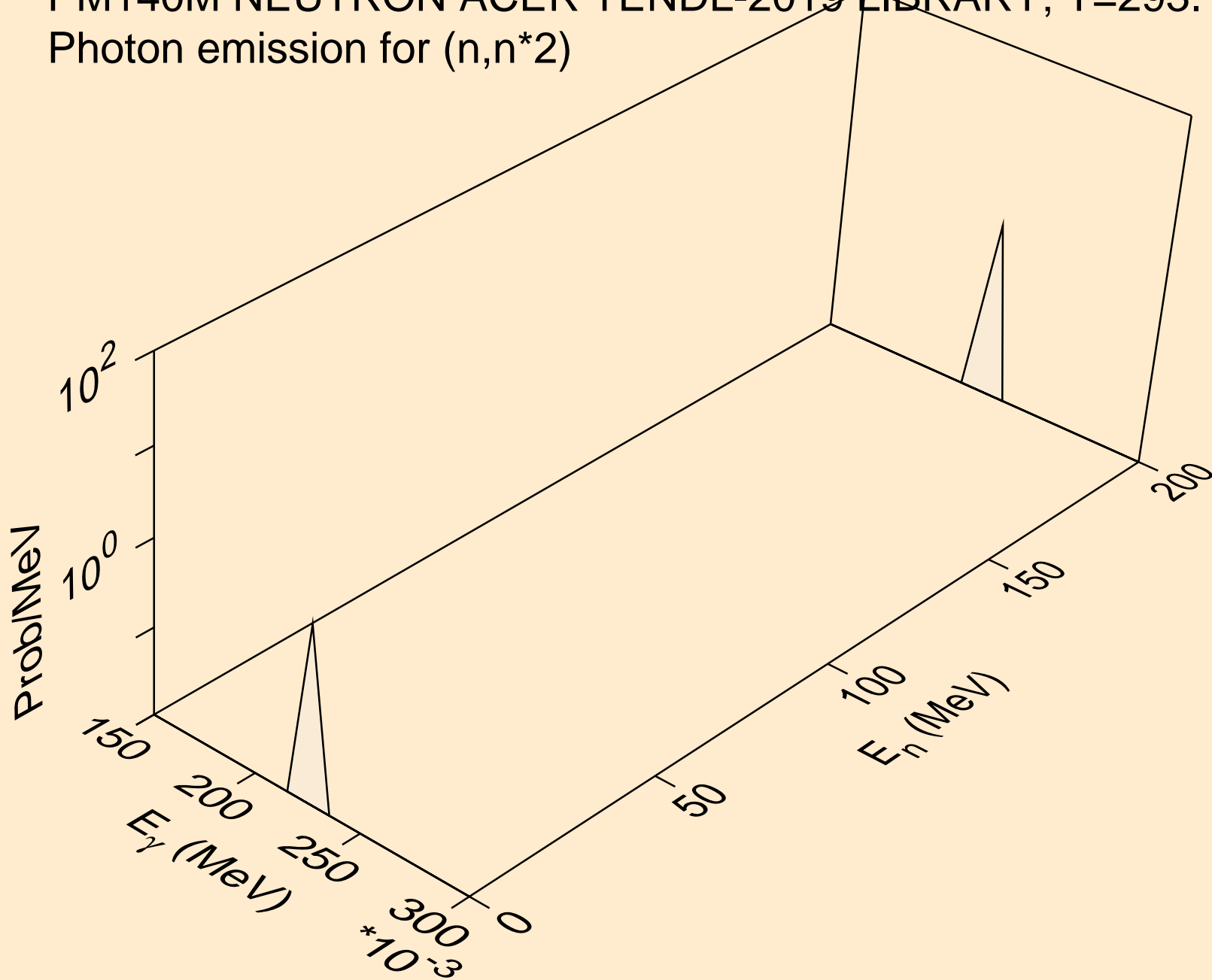

PM140M NEUTRON ACER TENDL-2019 LIBRARY; T=293.16K
Photon emission for (n,n*3)

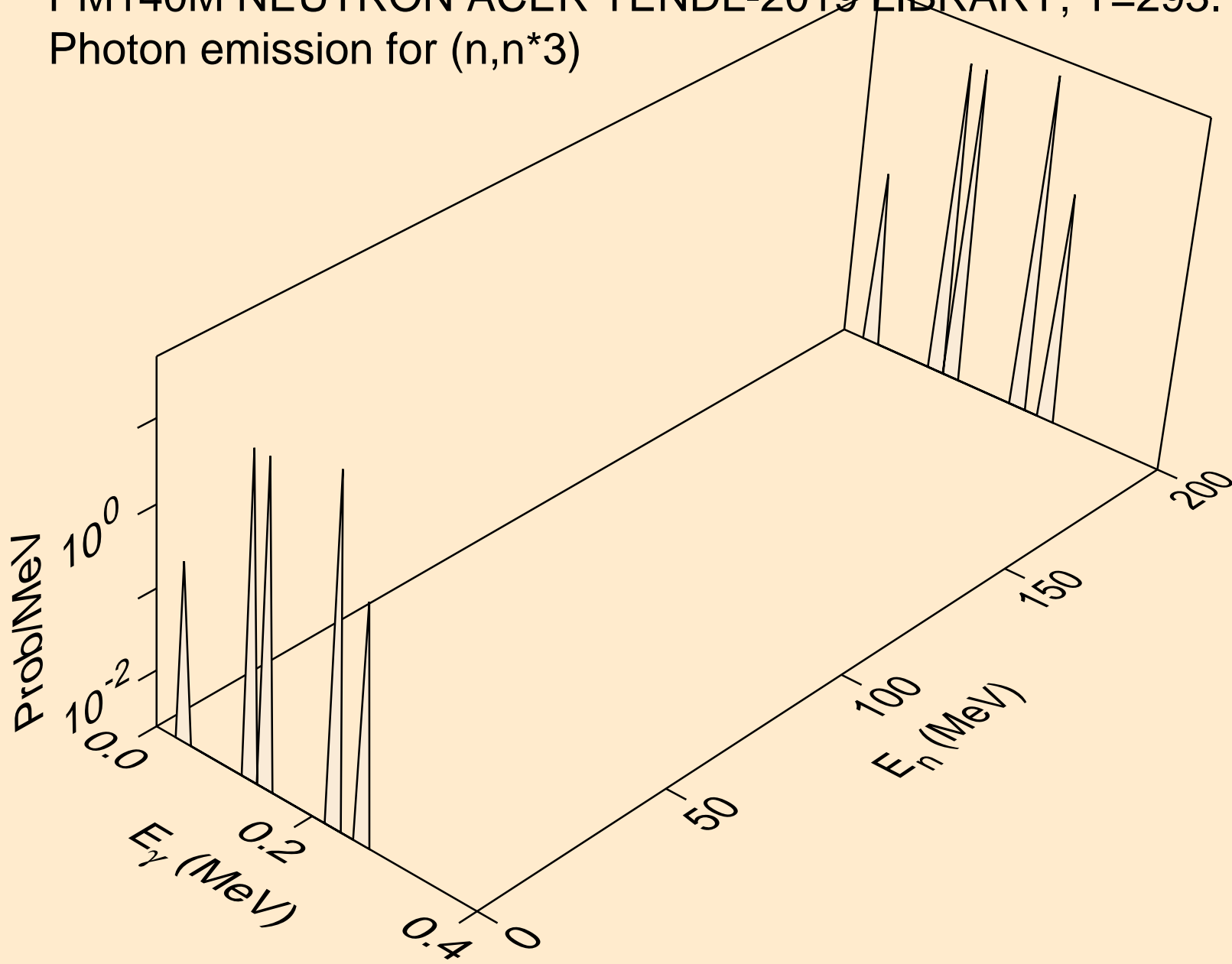

PM140M NEUTRON ACER TENDL-2019 LIBRARY; T=293.16K
Photon emission for (n,n*c)

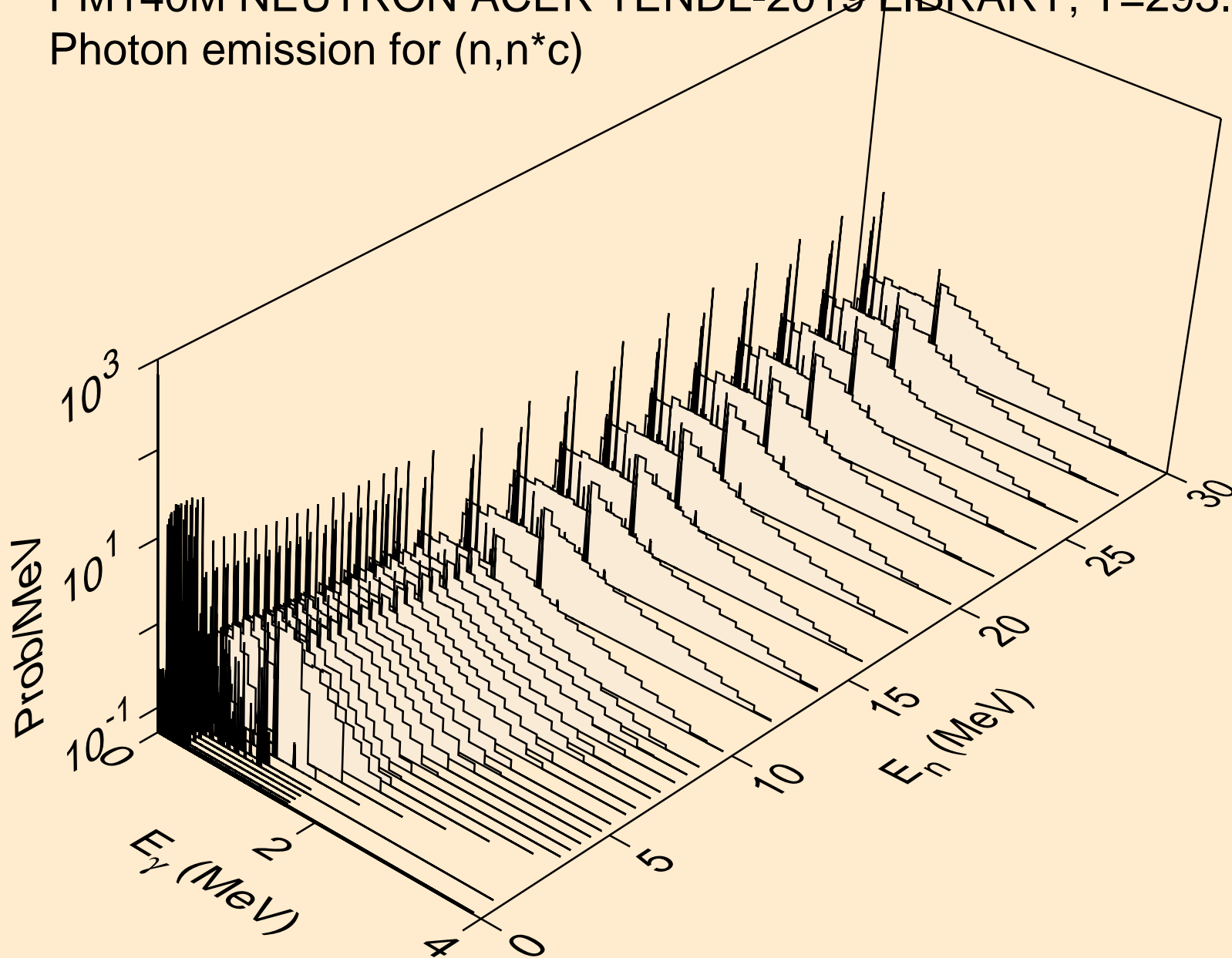

PM140M NEUTRON ACER TENDL-2019 LIBRARY; T=293.16K
Photon emission for (n,gma)

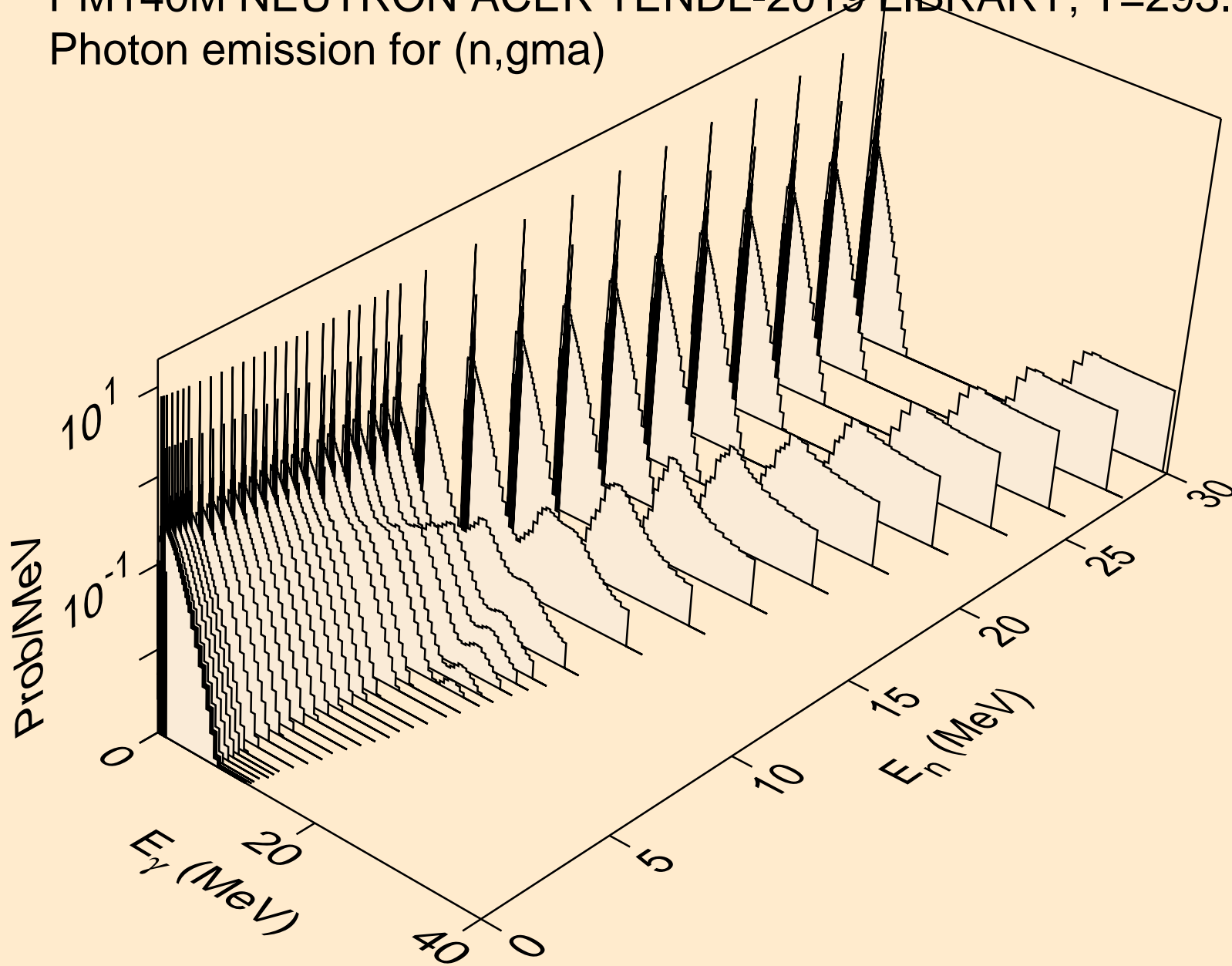

PM140M NEUTRON ACER TENDL-2019 LIBRARY; T=293.16K
Photon emission for (n,p)

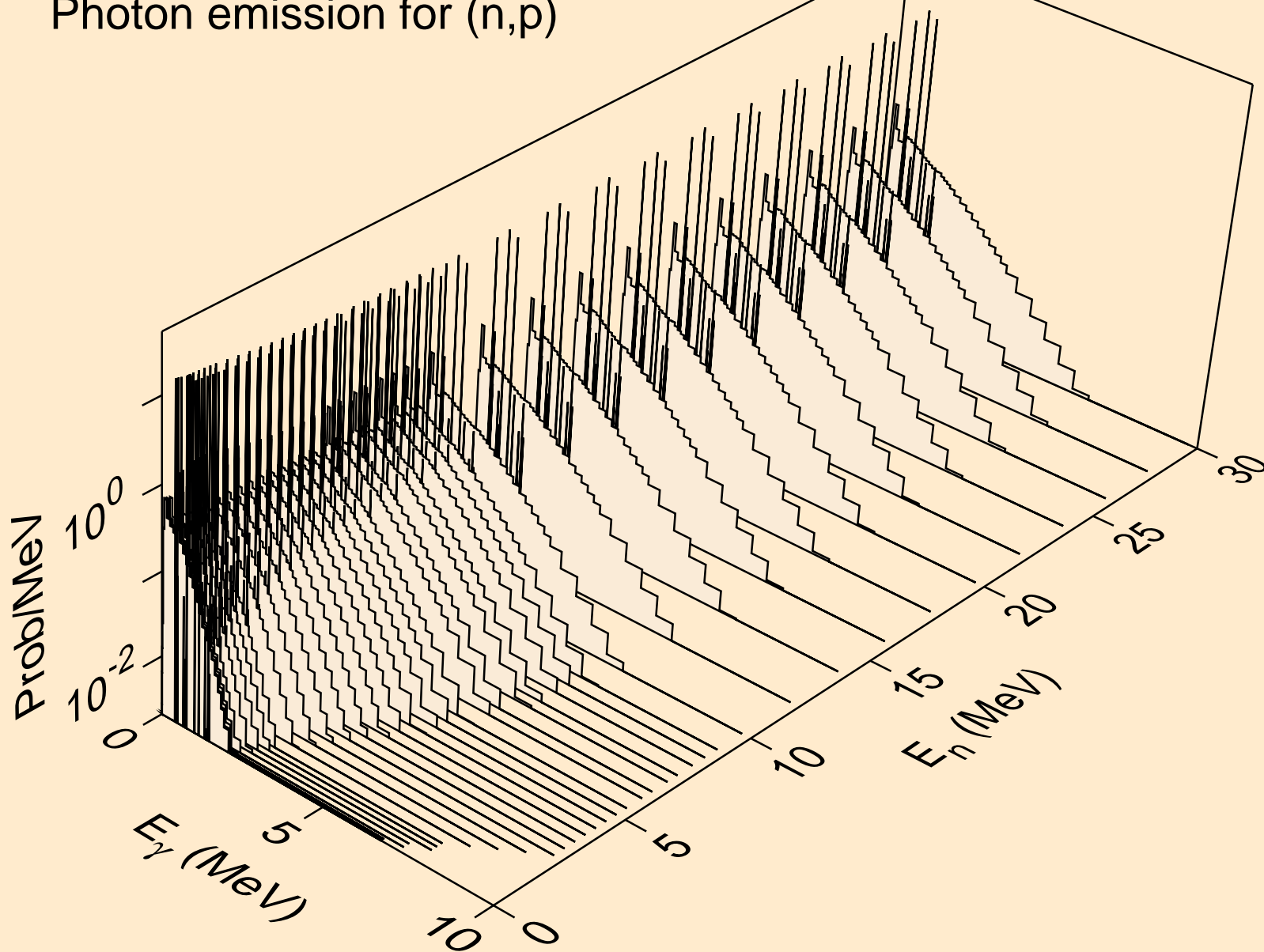

PM140M NEUTRON ACER TENDL-2019 LIBRARY; T=293.16K
Photon emission for (n,d)

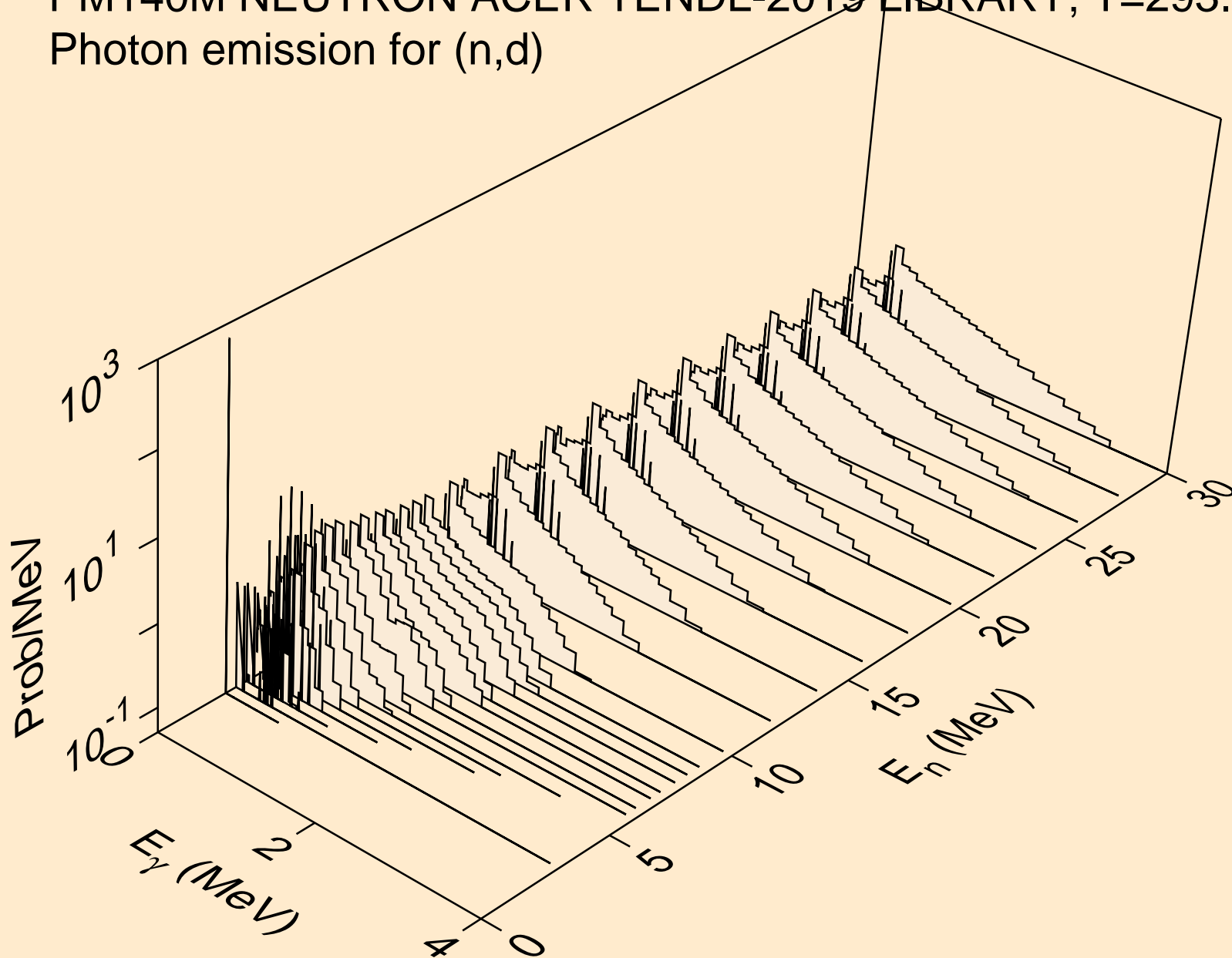

PM140M NEUTRON ACER TENDL-2019 LIBRARY; T=293.16K
Photon emission for (n,t)

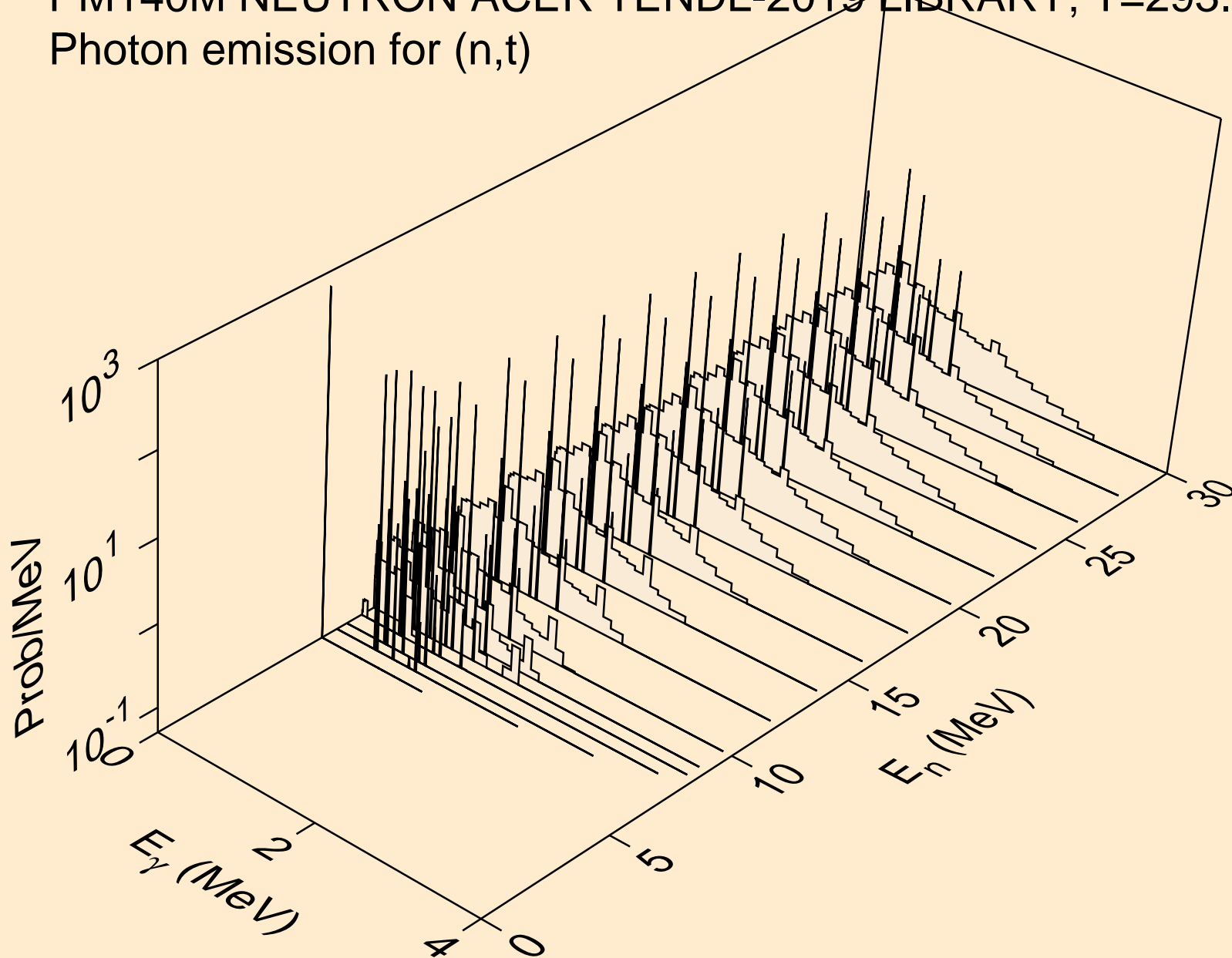

PM140M NEUTRON ACER TENDL-2019 LIBRARY; T=293.16K
Photon emission for (n,he3)

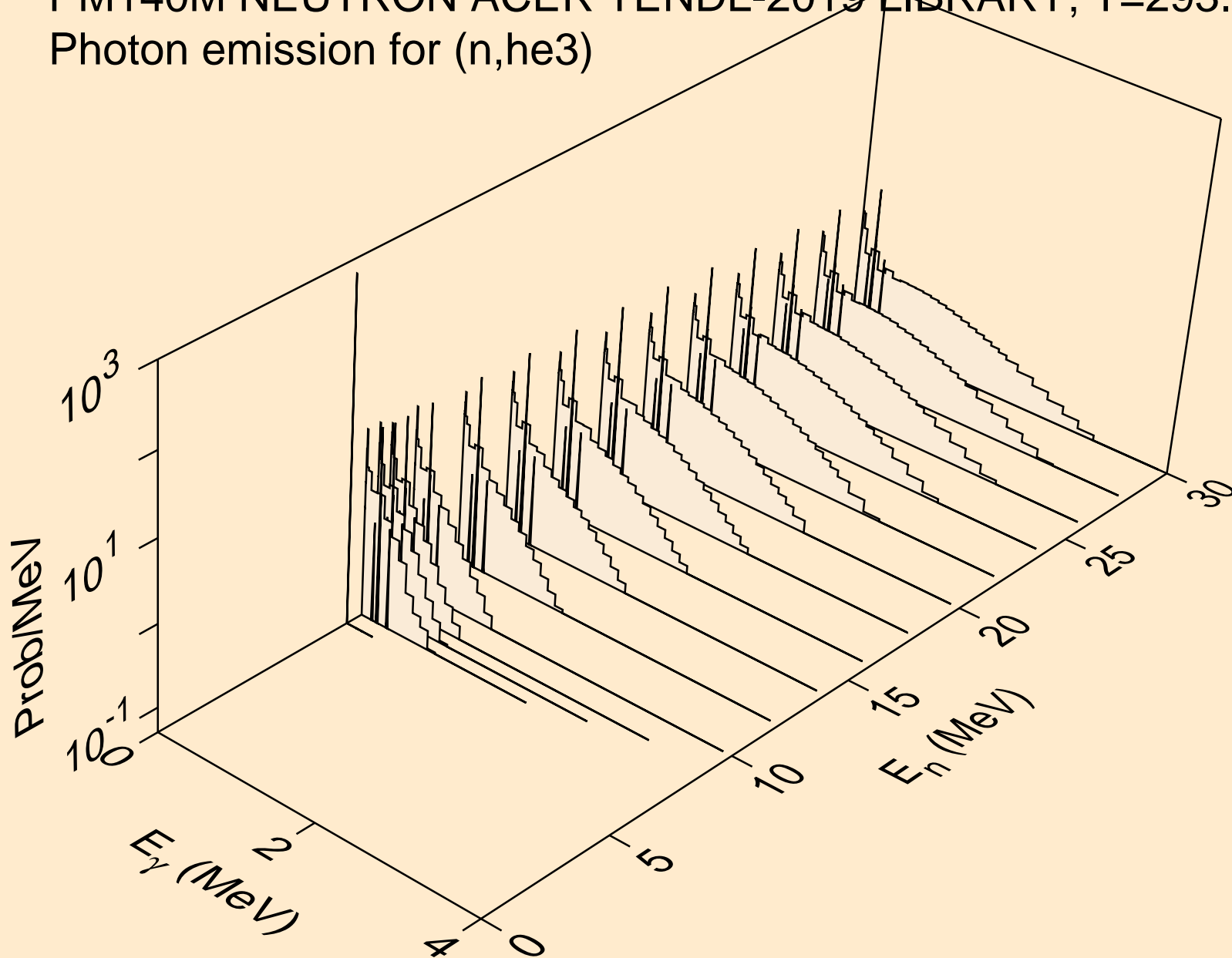

PM140M NEUTRON ACER TENDL-2019 LIBRARY; T=293.16K
Photon emission for (n,a)

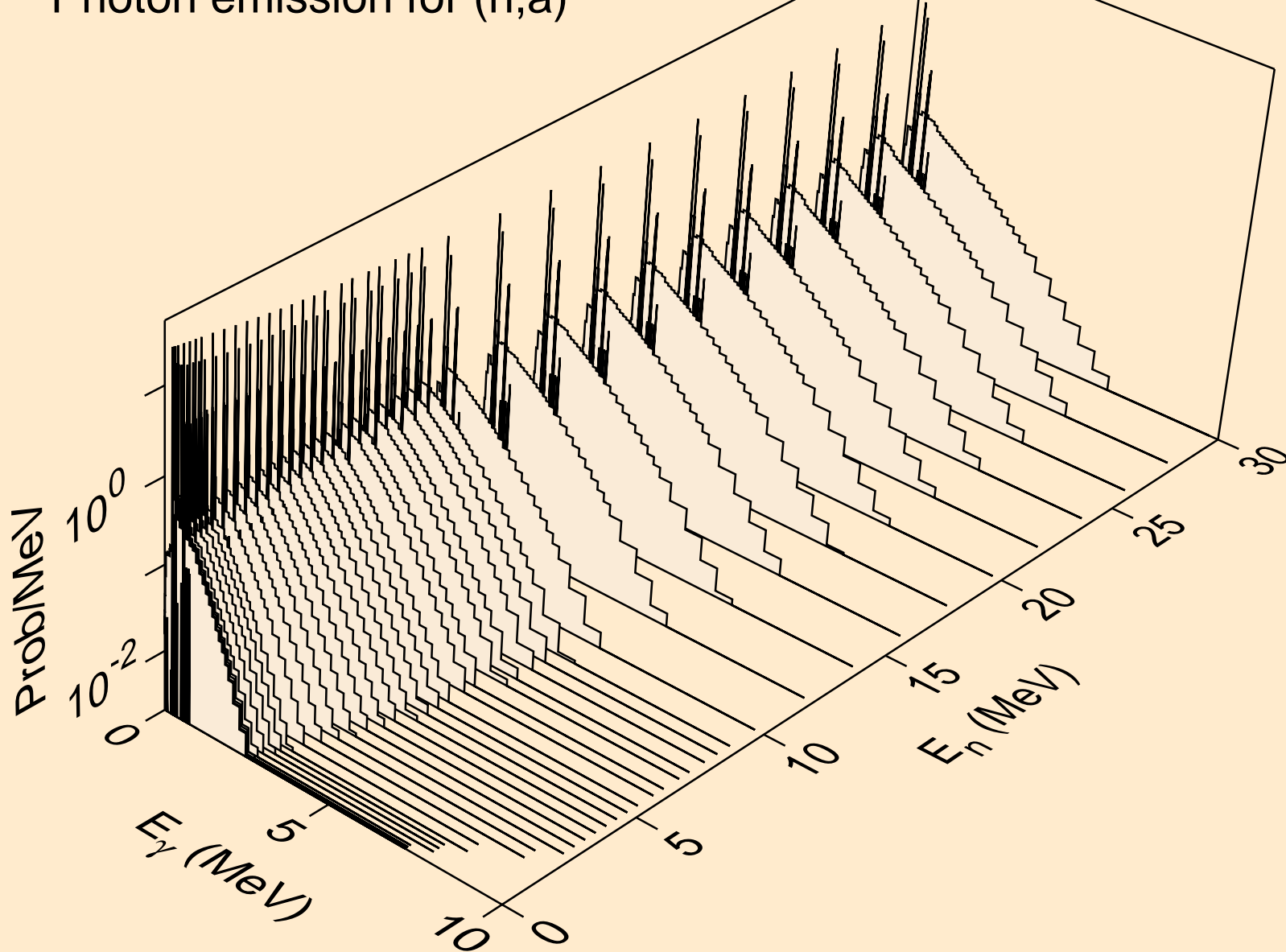

PM140M NEUTRON ACER TENDL-2019 LIBRARY; T=293.16K
Photon emission for (n,2a)

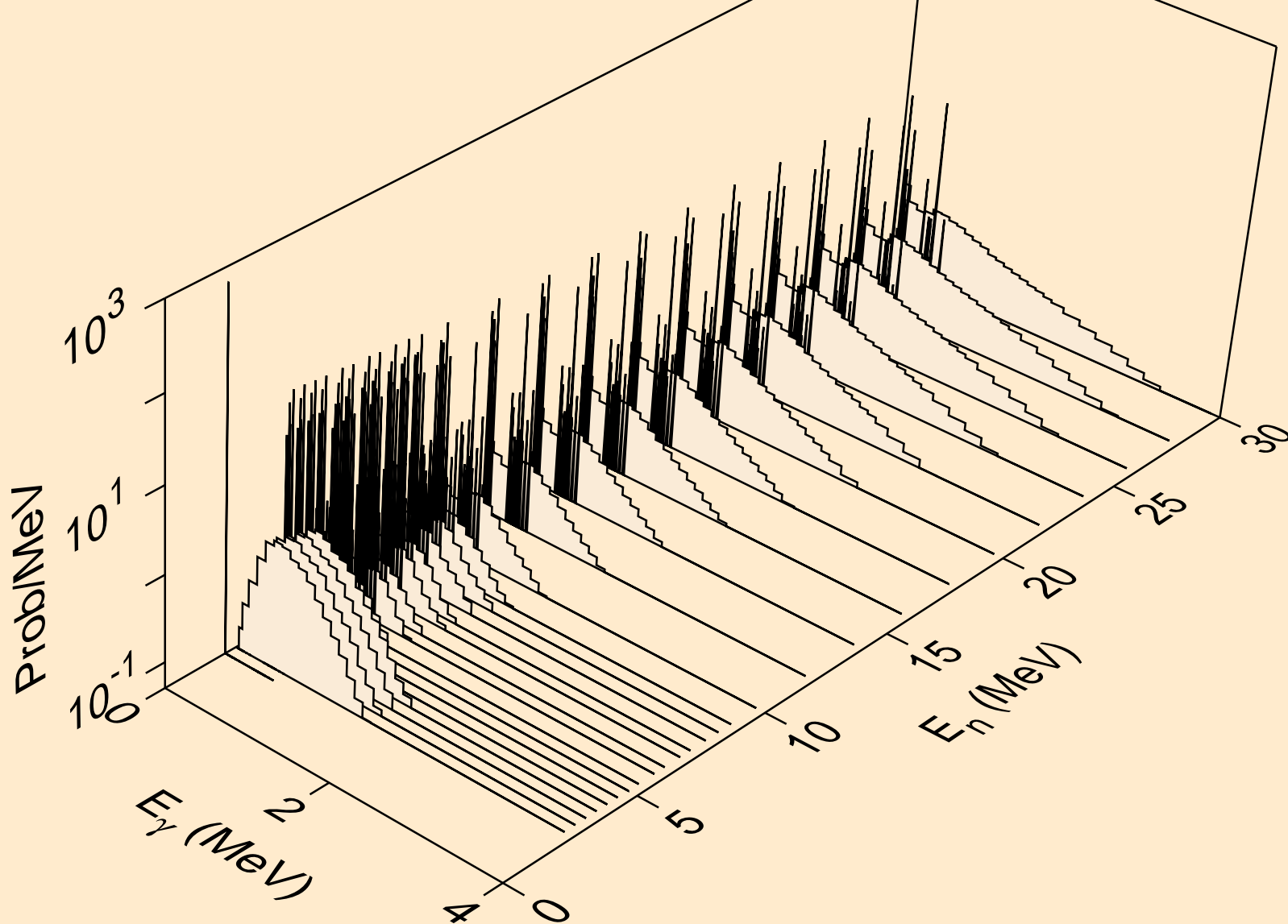

PM140M NEUTRON ACER TENDL-2019 LIBRARY; T=293.16K
Photon emission for (n,2p)

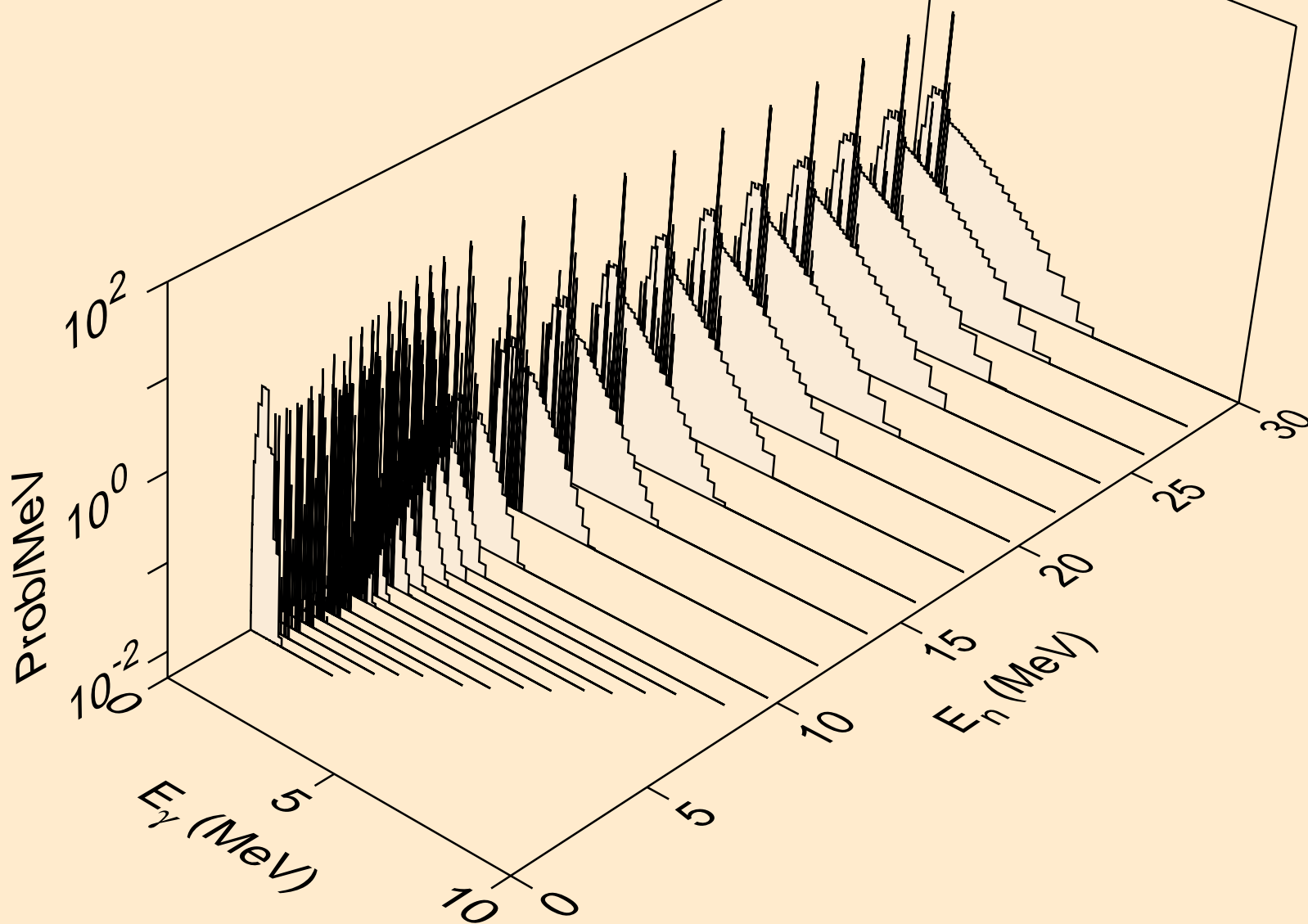

PM140M NEUTRON ACER TENDL-2019 LIBRARY; T=293.16K
Photon emission for (n,p)

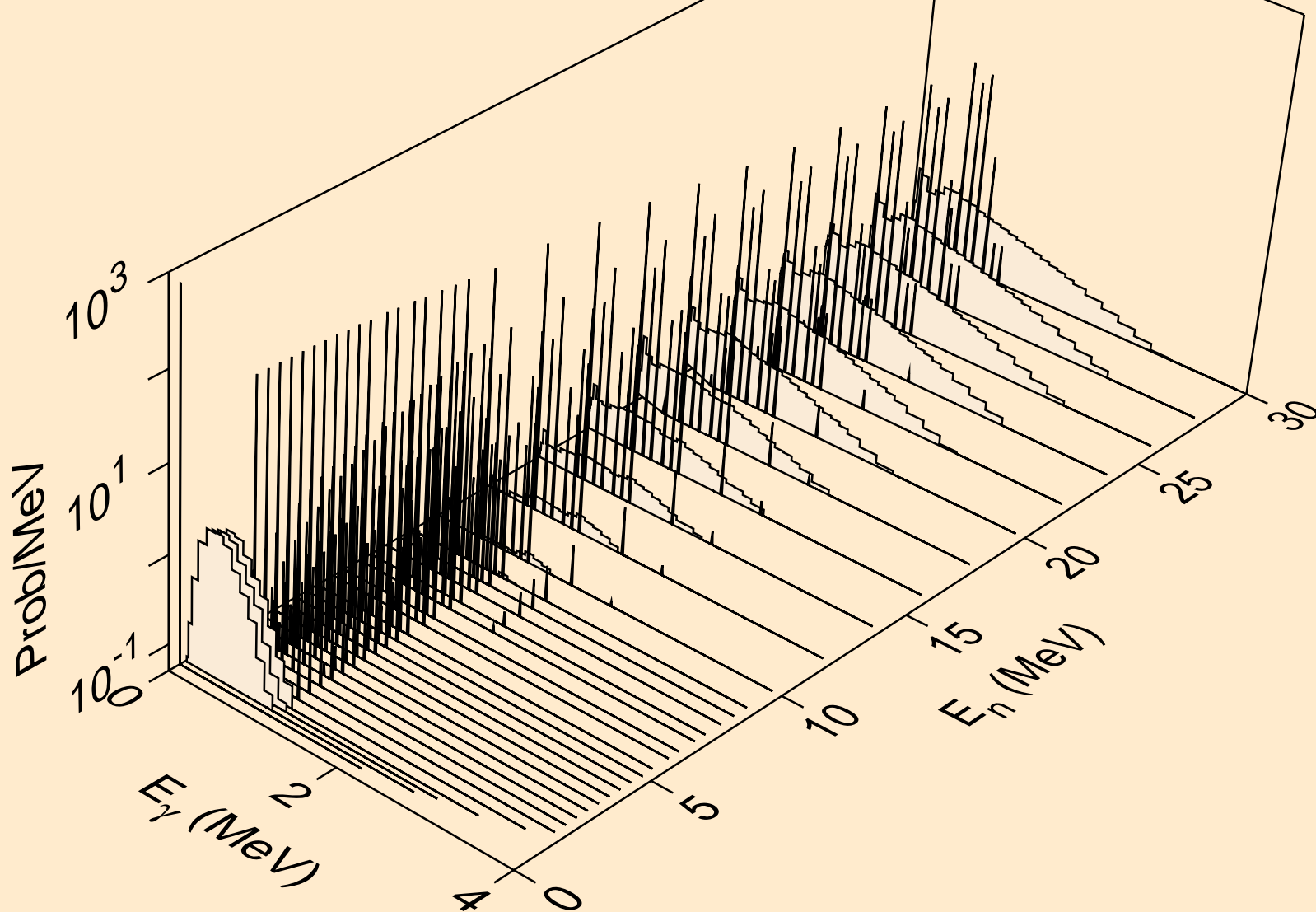

PM140M NEUTRON ACER TENDL-2019 LIBRARY; T=293.16K
Photon emission for (n,pd)

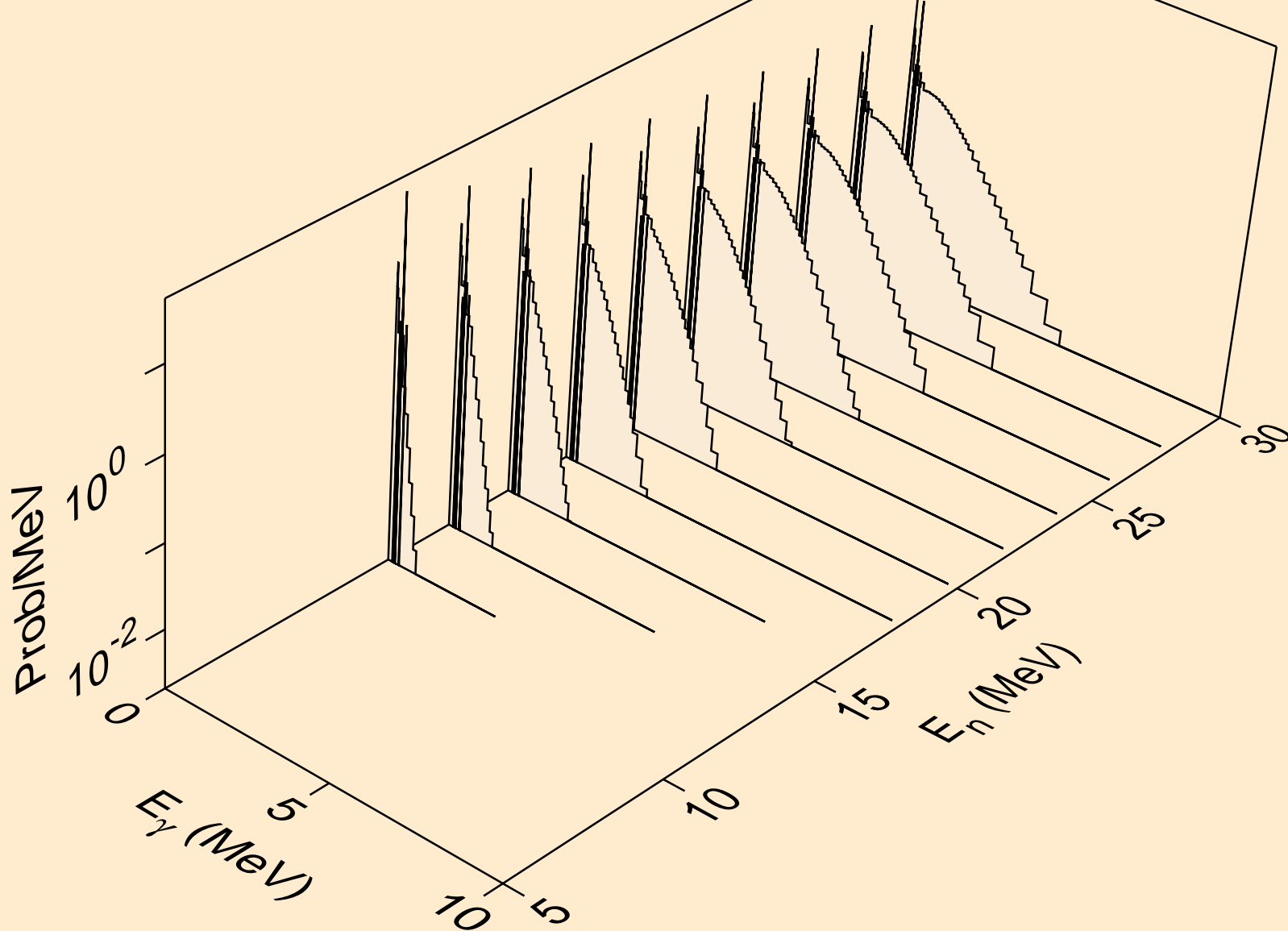

PM140M NEUTRON ACER TENDL-2019 LIBRARY; T=293.16K
Photon emission for (n,pt)

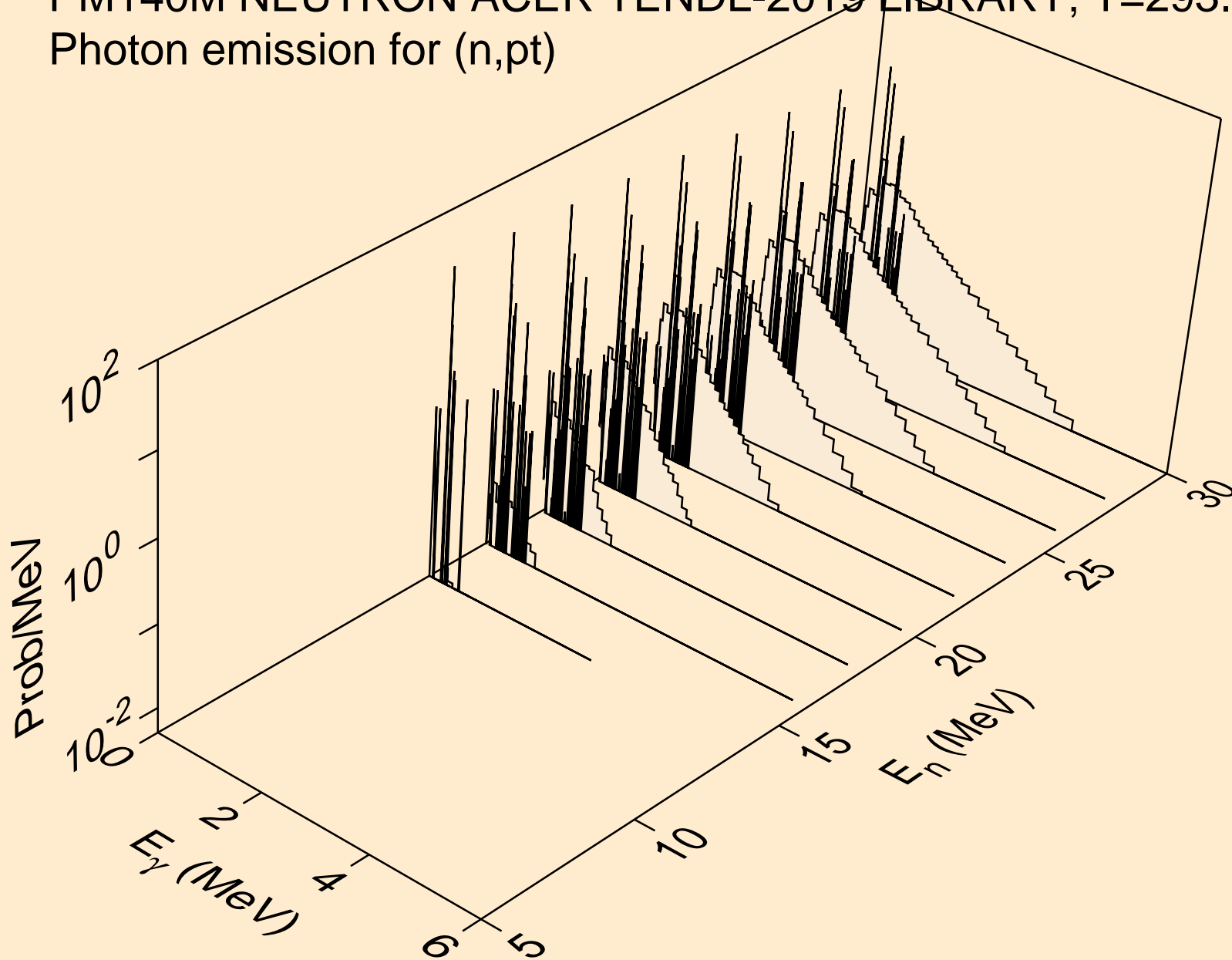

PM140M NEUTRON ACER TENDL-2019 LIBRARY; T=293.16K
Photon emission for (n,da)

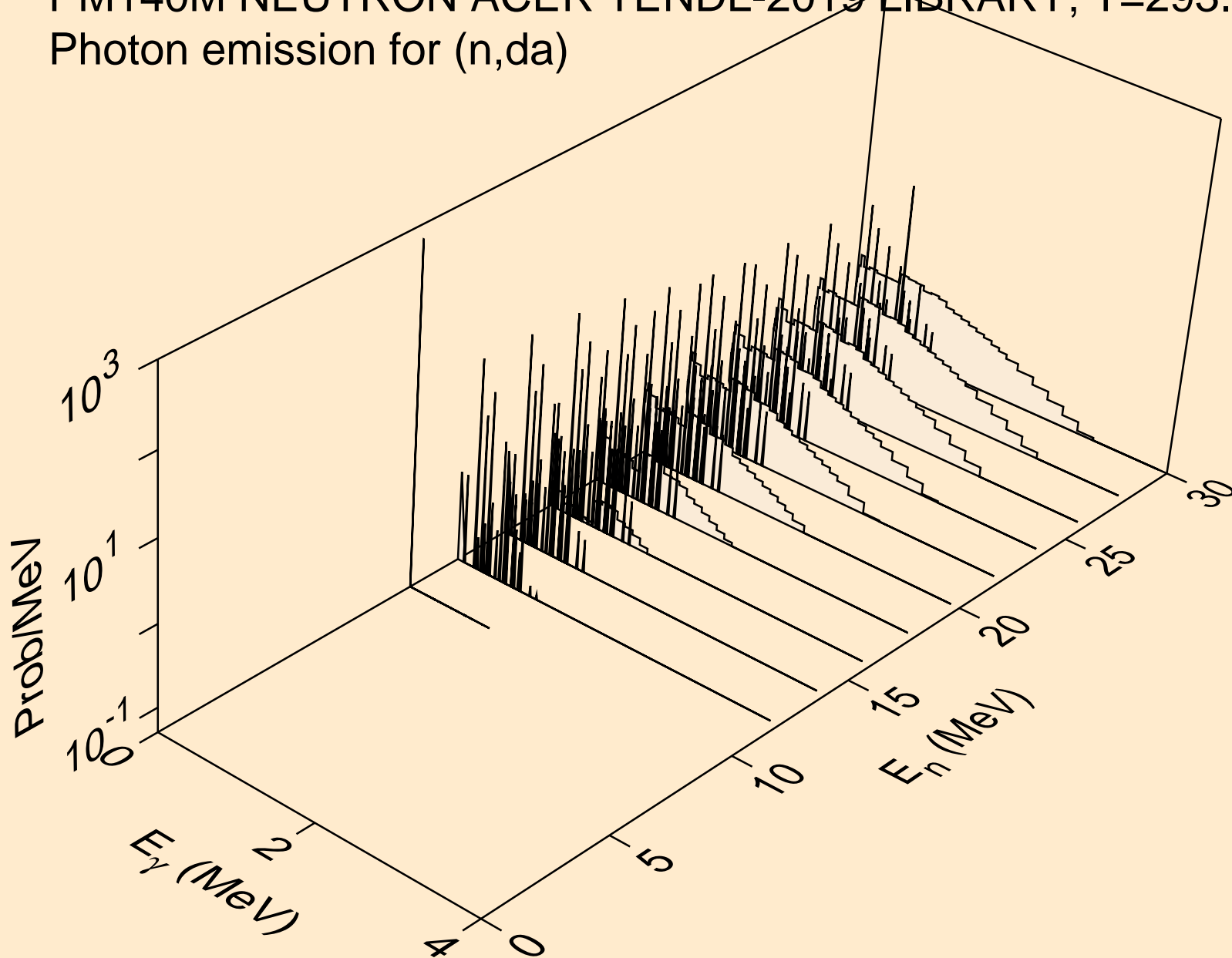

PM140M NEUTRON ACER TENDL-2019 LIBRARY; T=293.16K
thermal capture photon spectrum

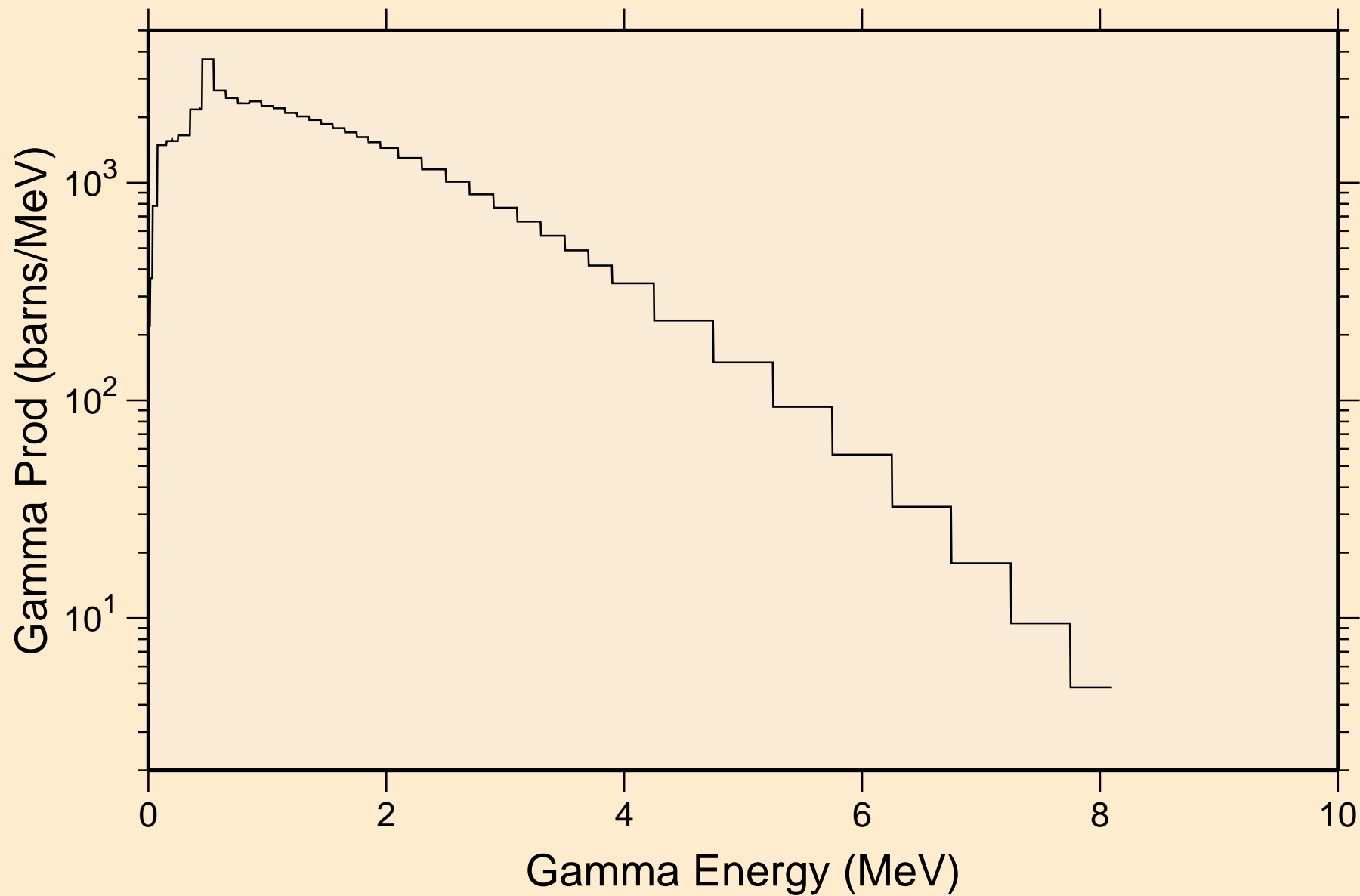

PM140M NEUTRON ACER TENDL-2019 LIBRARY; T=293.16K
14 MeV photon spectrum

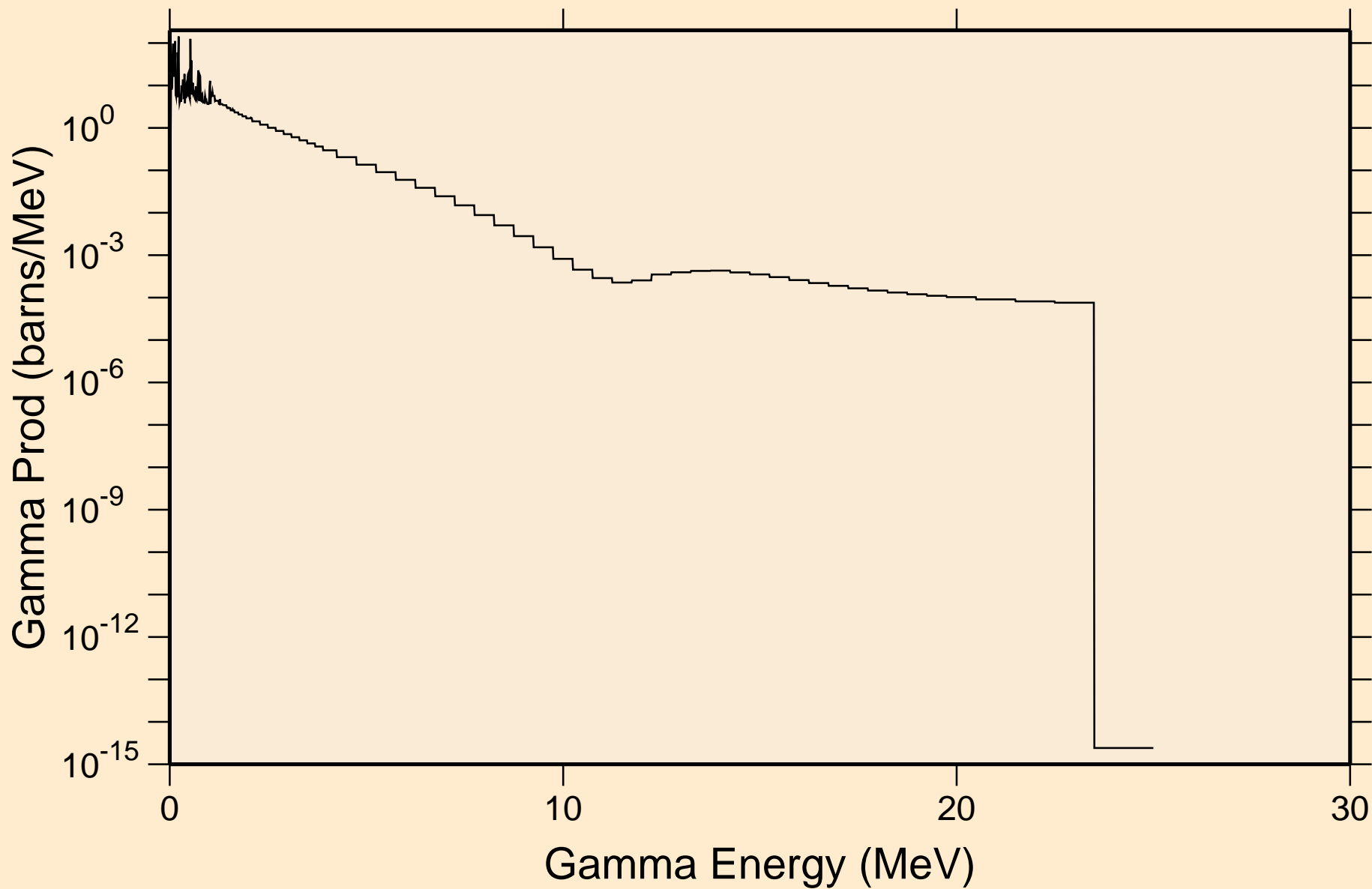

PM140M NEUTRON ACER TENDL-2019 LIBRARY; T=293.16K
Particle heating contributions

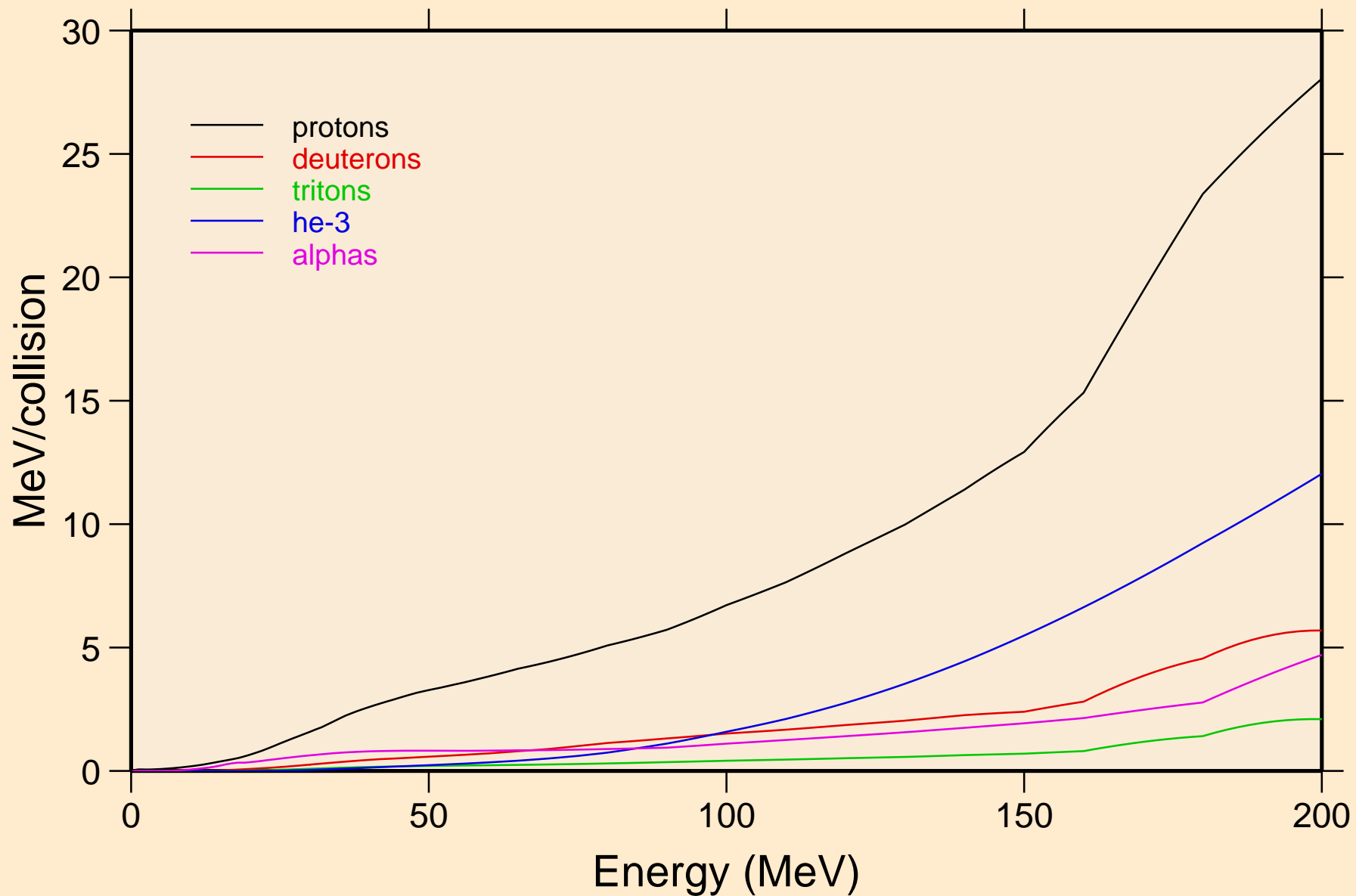

PM140M NEUTRON ACER TENDL-2019 LIBRARY; T=293.16K
Recoil Heating

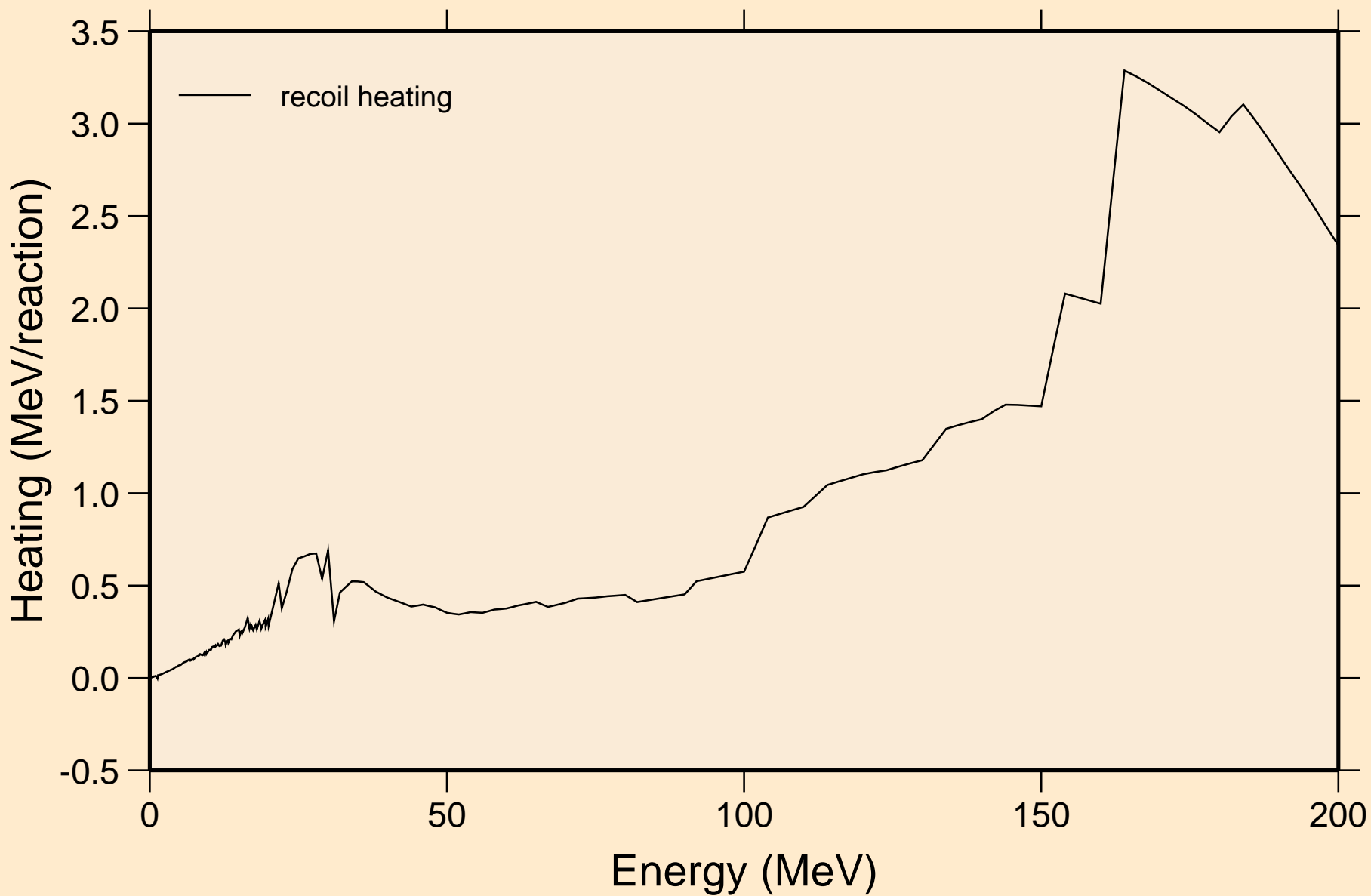

PM140M NEUTRON ACER TENDL-2019 LIBRARY; T=293.16K
Particle production cross sections

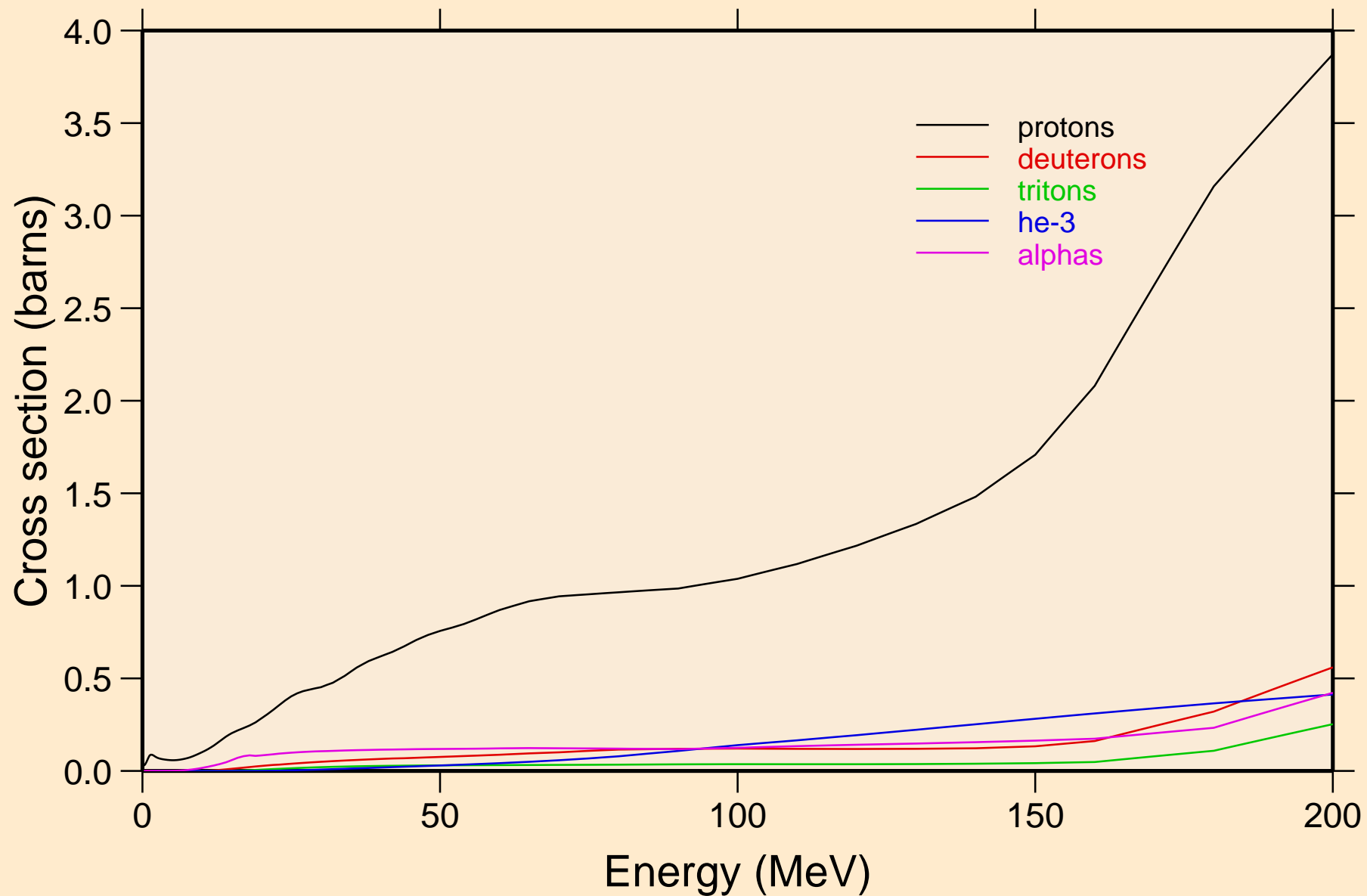

PM140M NEUTRON ACER TENDL-2019 LIBRARY; T=293.16K
protons from (n,x)

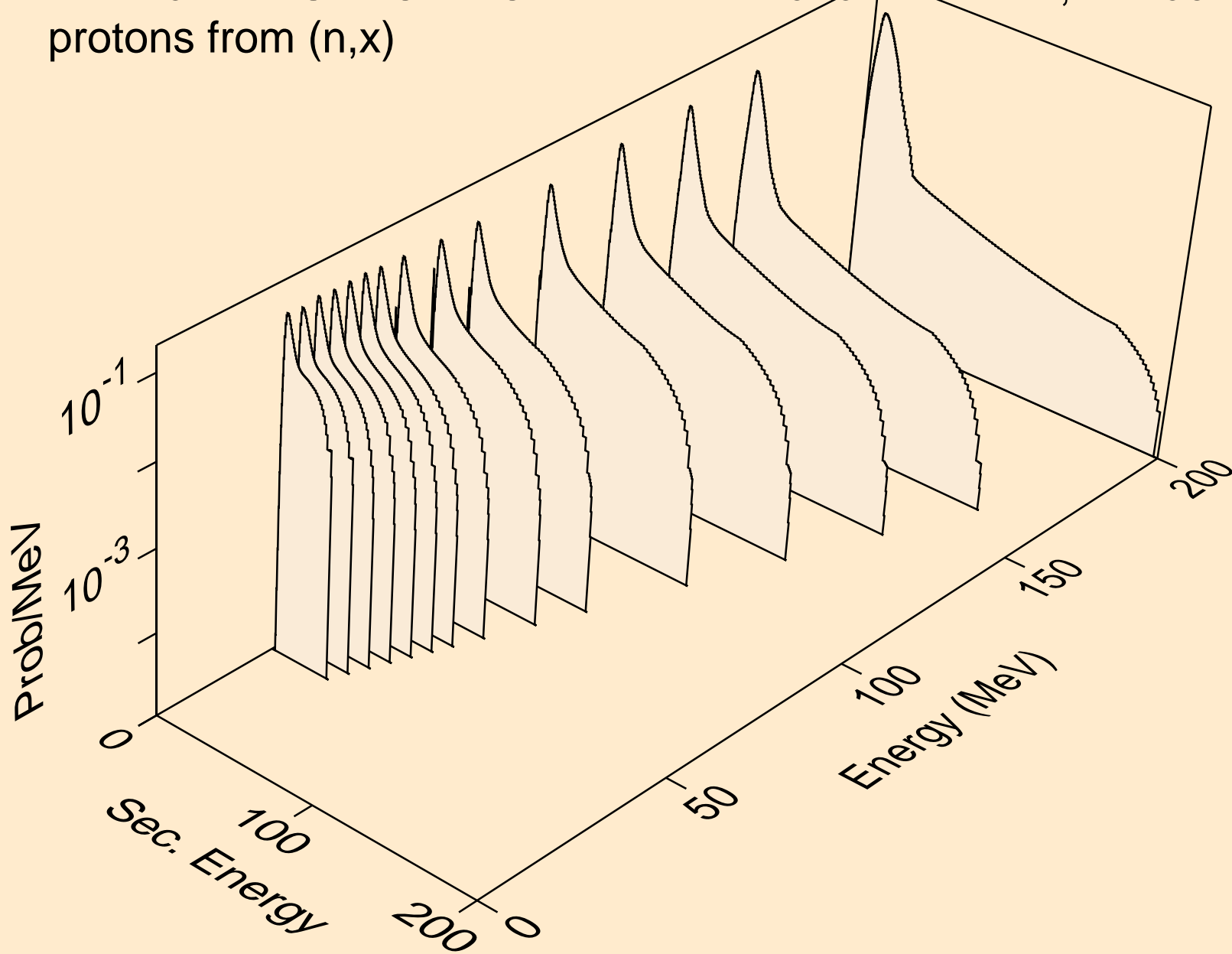

PM140M NEUTRON ACER TENDL-2019 LIBRARY; T=293.16K
protons from (n,n*)p

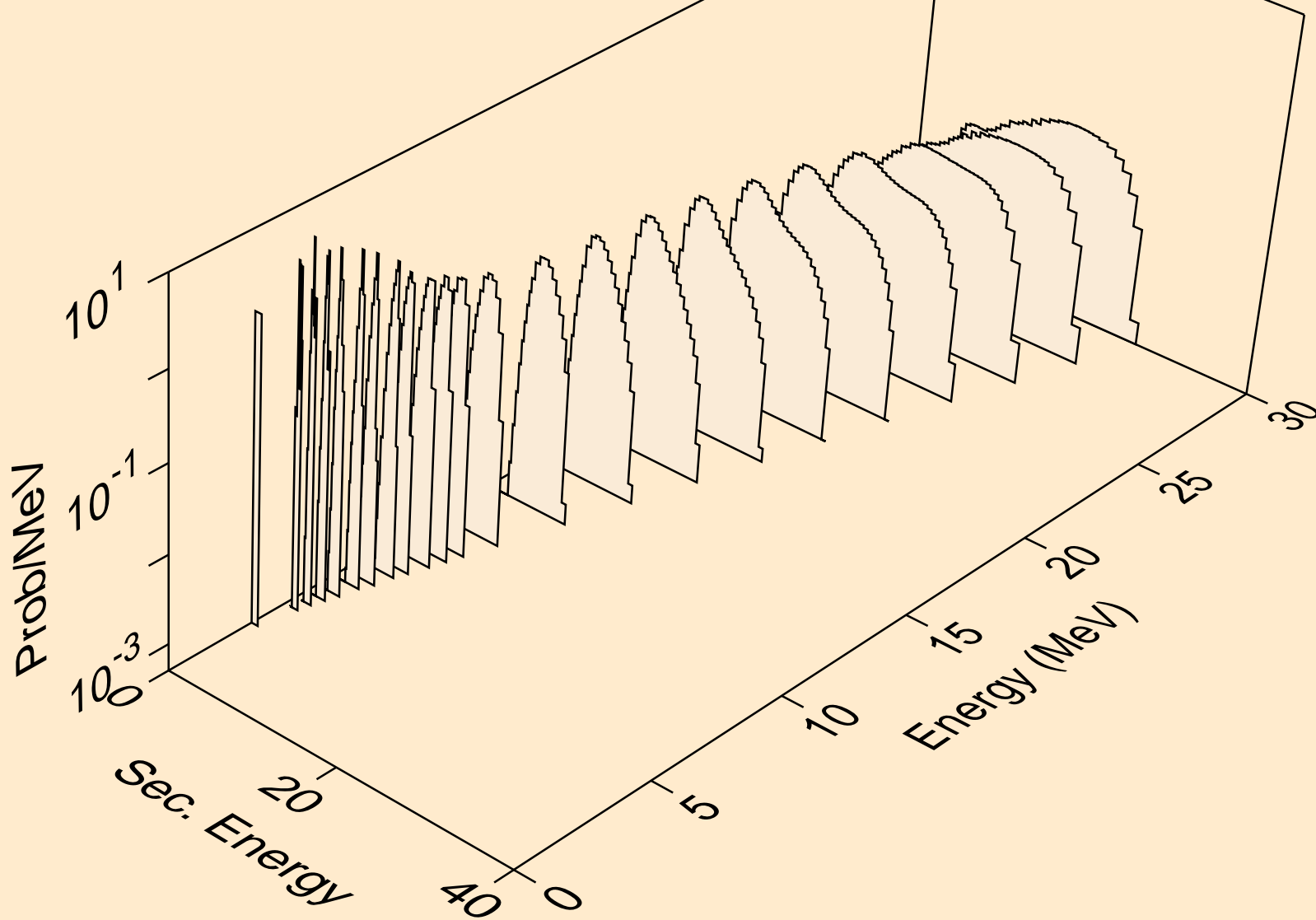

PM140M NEUTRON ACER TENDL-2019 LIBRARY; T=293.16K
protons from (n,2np)

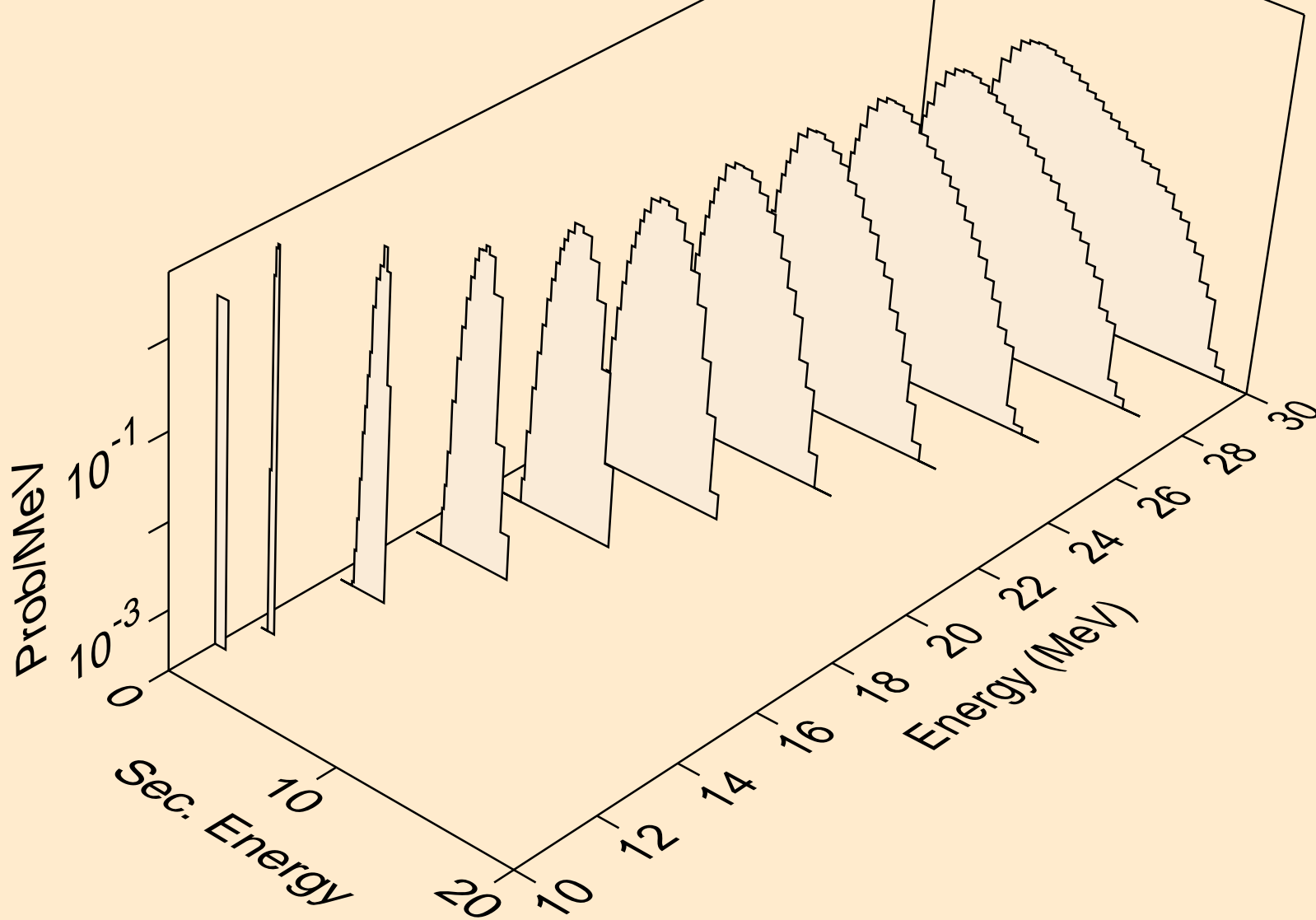

PM140M NEUTRON ACER TENDL-2019 LIBRARY; T=293.16K
protons from (n,3np)

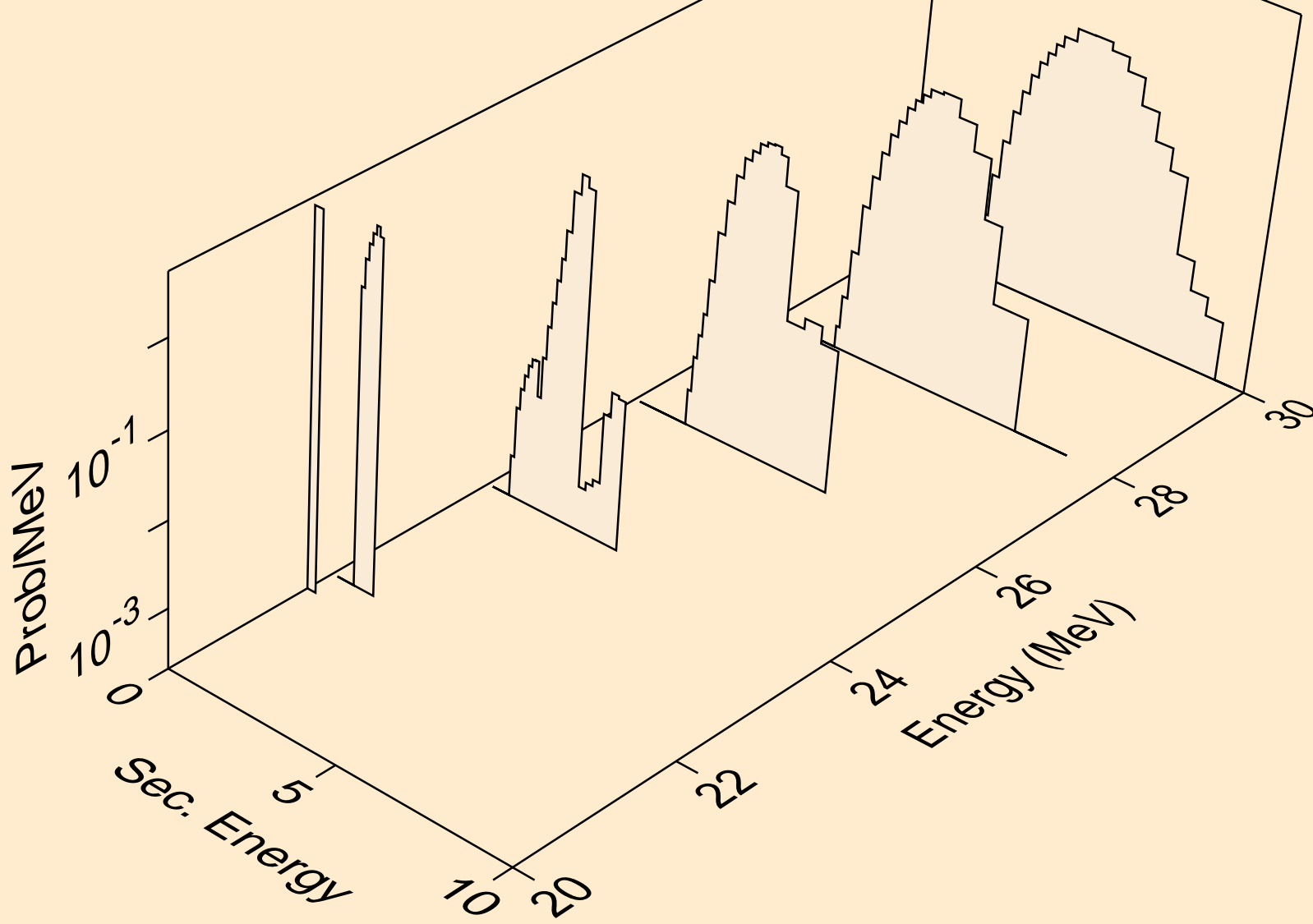

PM140M NEUTRON ACER TENDL-2019 LIBRARY; T=293.16K
protons from (n,2np)

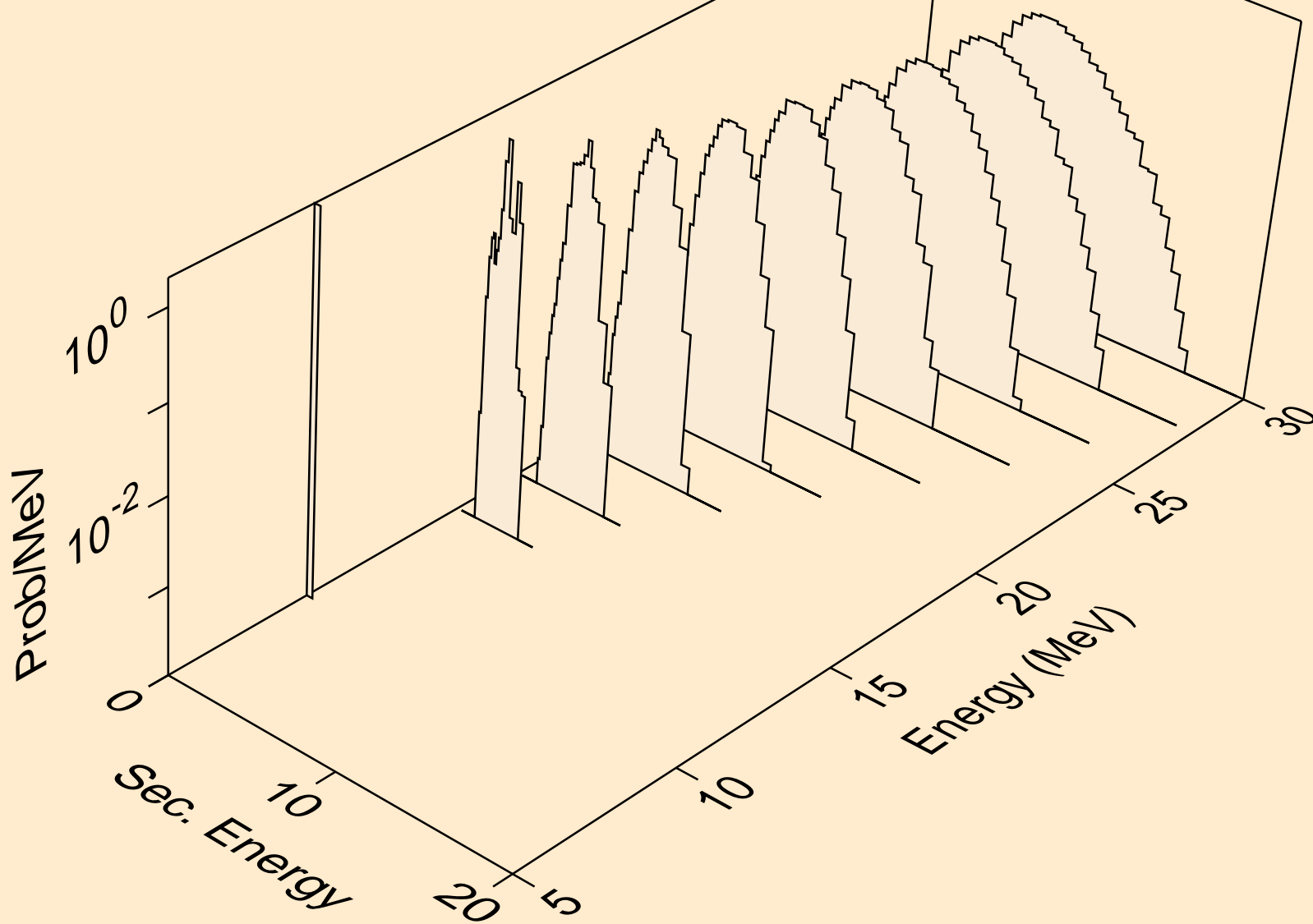

PM140M NEUTRON ACER TENDL-2019 LIBRARY; T=293.16K
protons from (n,npa)

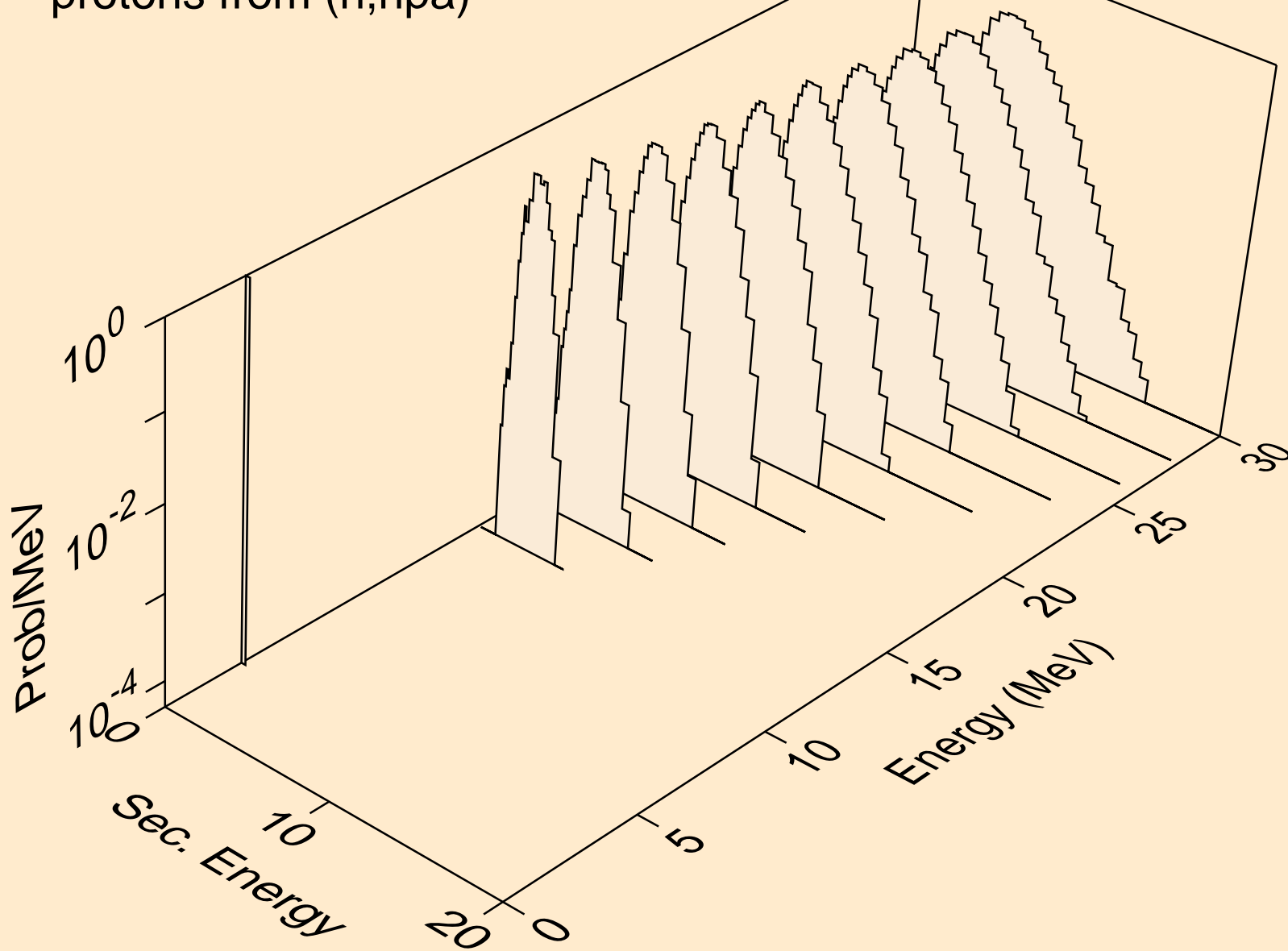

PM140M NEUTRON ACER TENDL-2019 LIBRARY; T=293.16K
protons from (n,p)

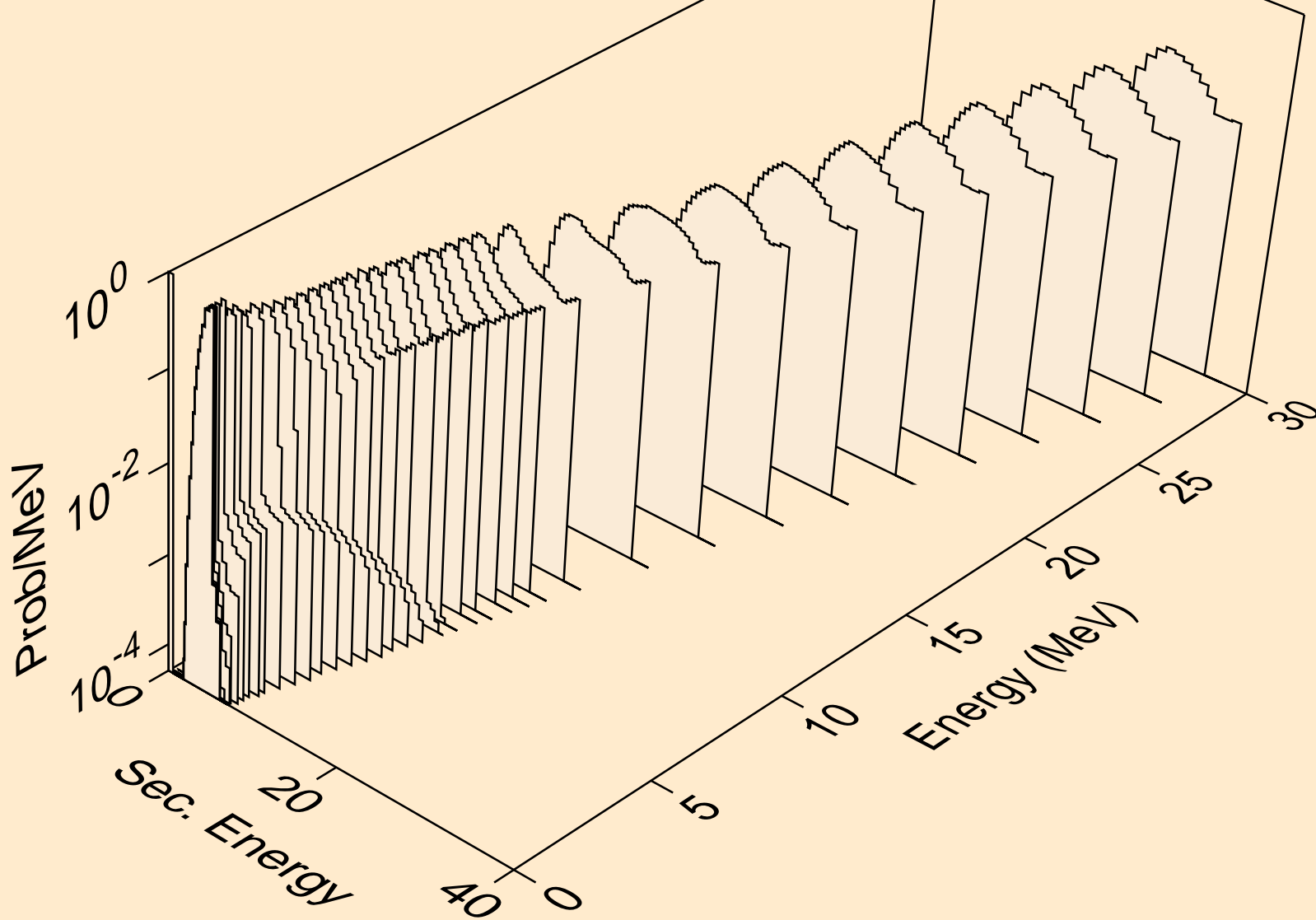

PM140M NEUTRON ACER TENDL-2019 LIBRARY; T=293.16K
protons from (n,2p)

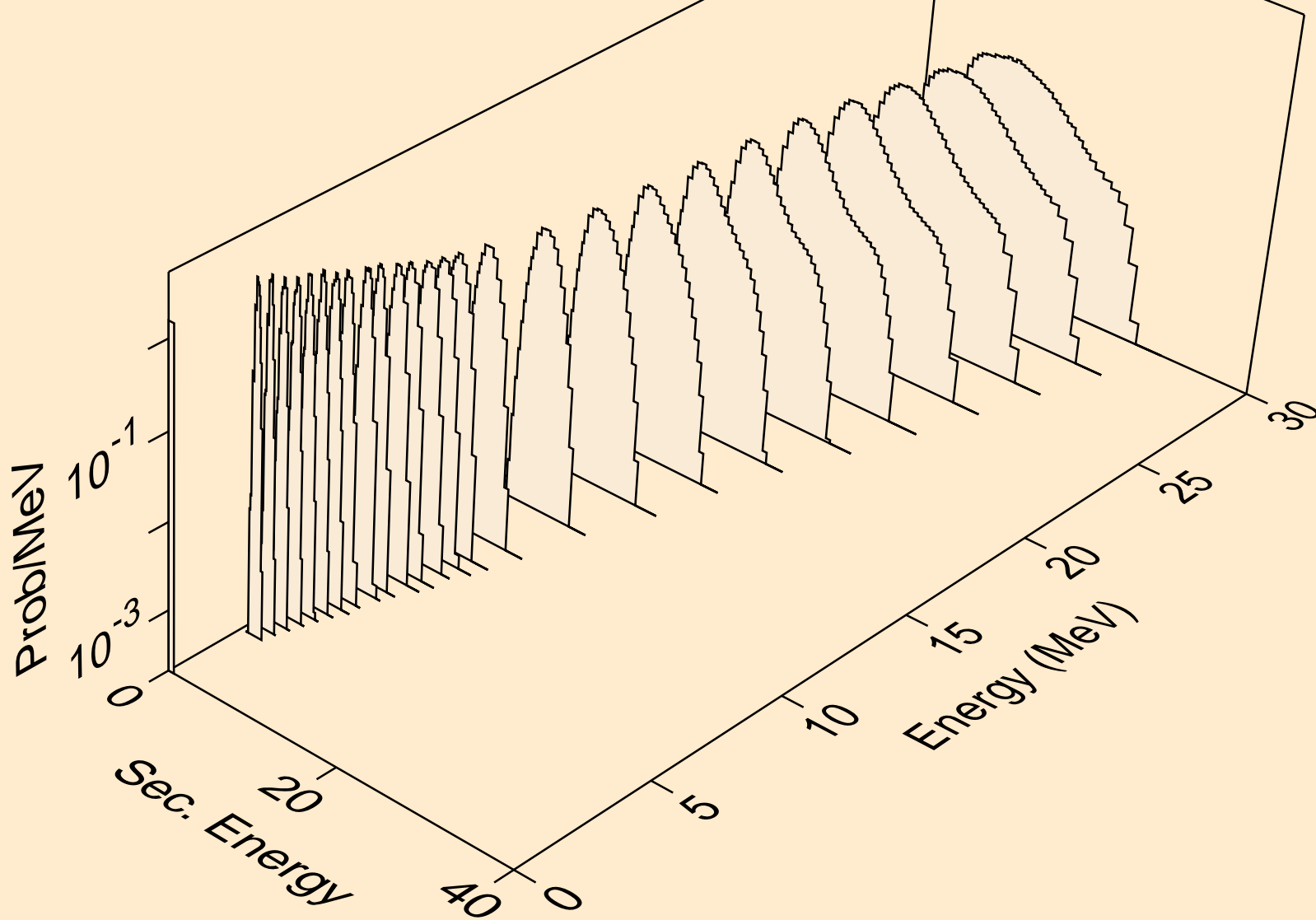

PM140M NEUTRON ACER TENDL-2019 LIBRARY; T=293.16K
protons from (n,p)

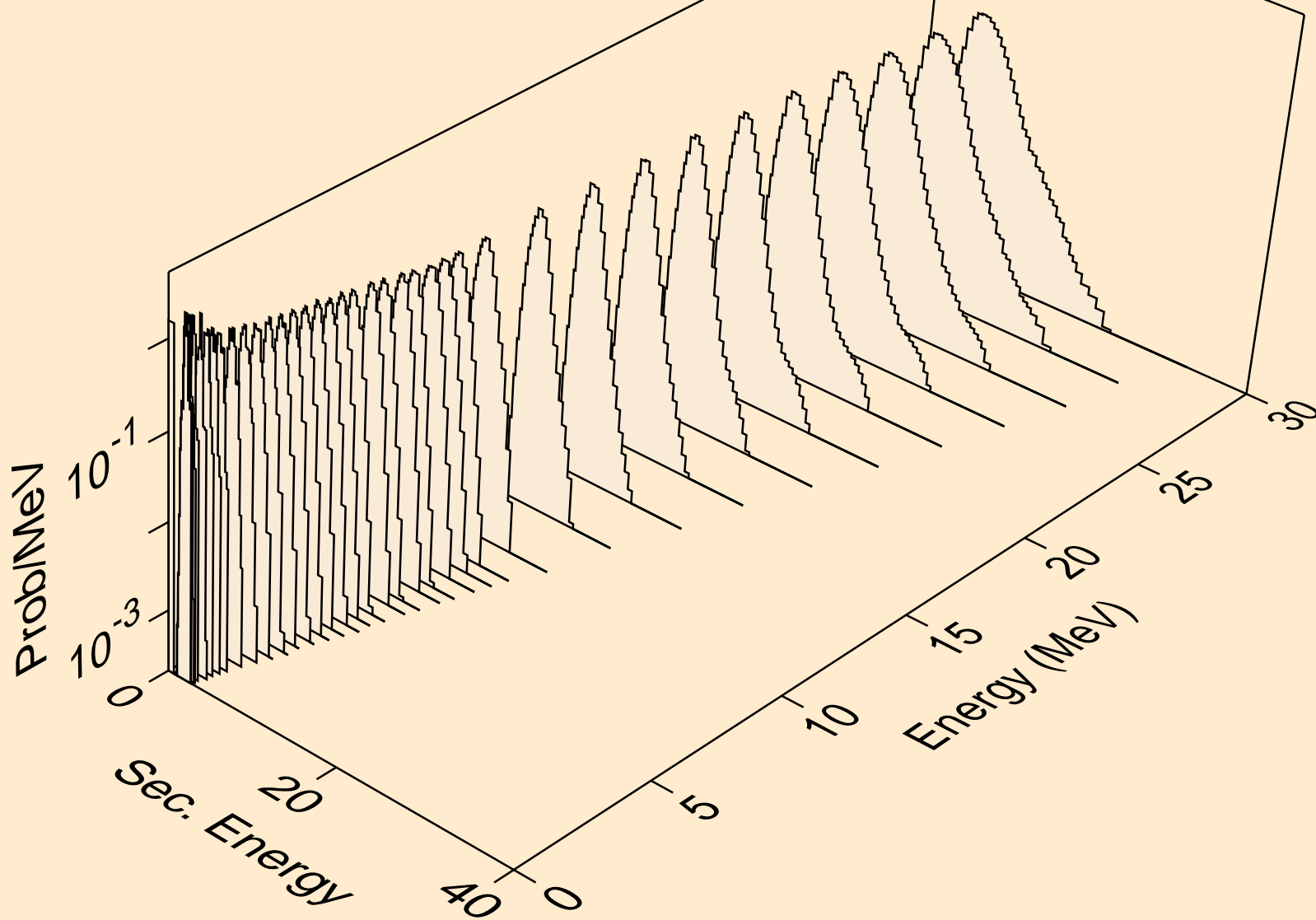

PM140M NEUTRON ACER TENDL-2019 LIBRARY; T=293.16K
protons from (n,pd)

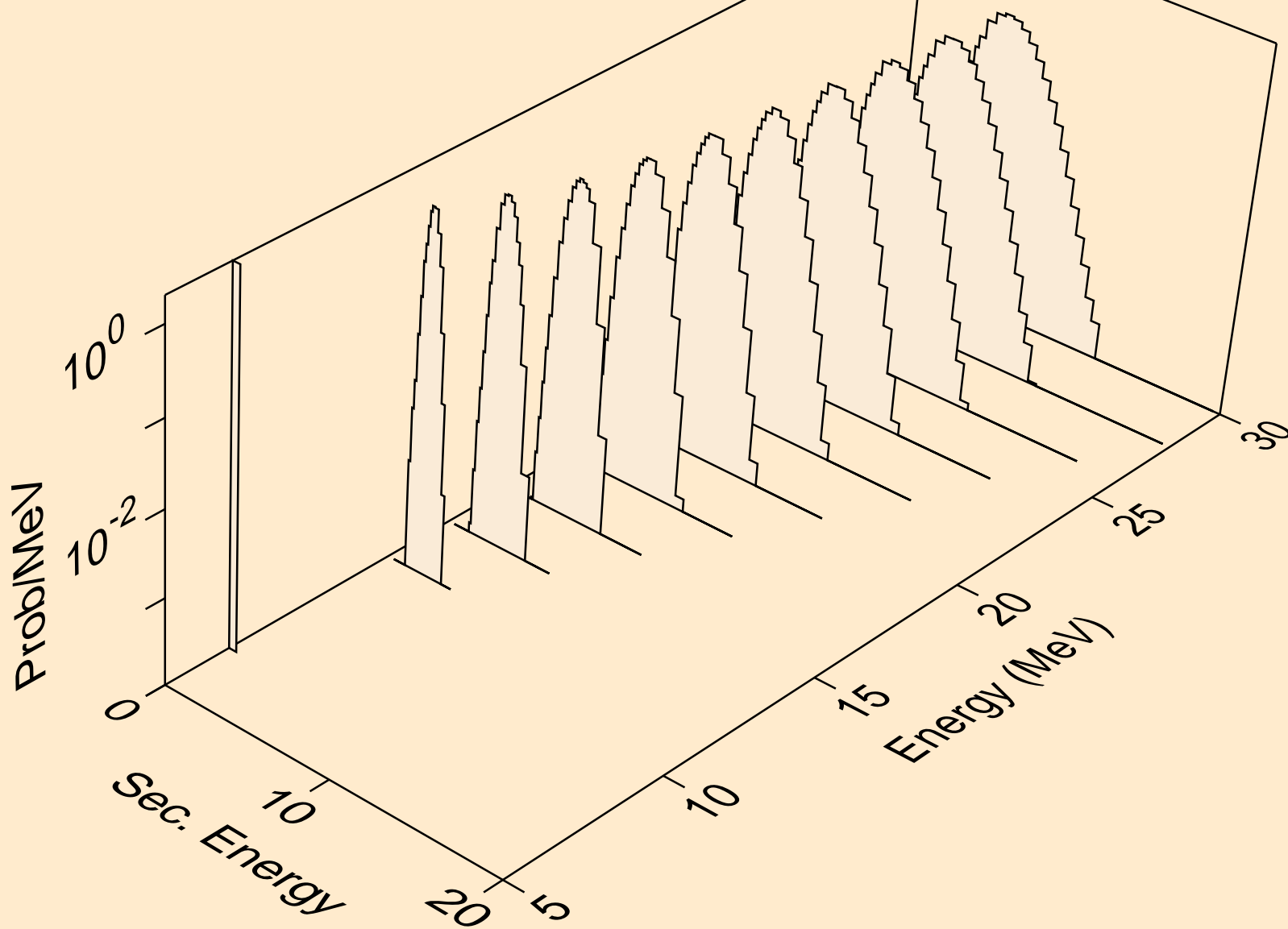

PM140M NEUTRON ACER TENDL-2019 LIBRARY; T=293.16K
protons from (n,pt)

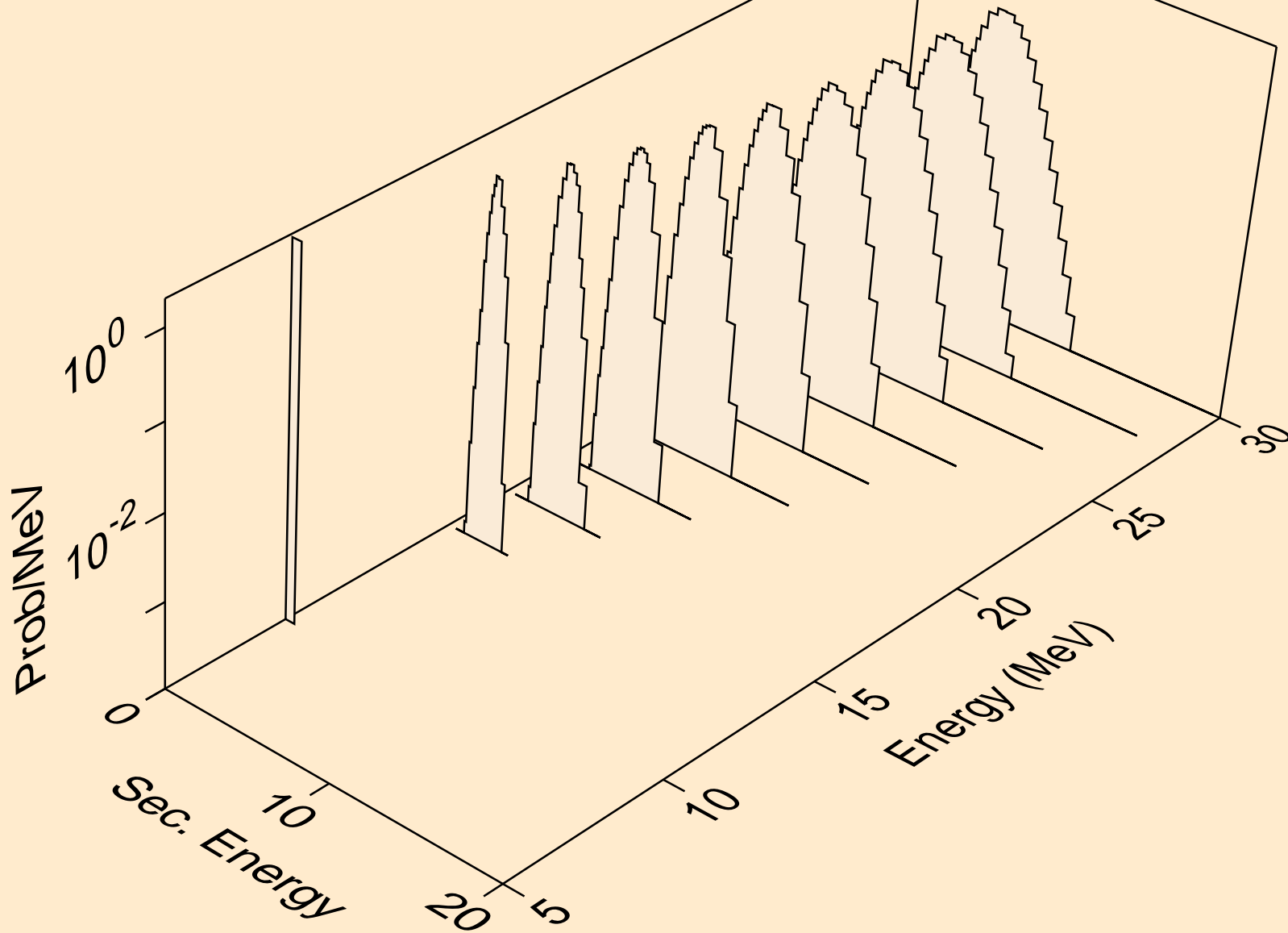

PM140M NEUTRON ACER TENDL-2019 LIBRARY; T=293.16K
deuterons from (n,x)

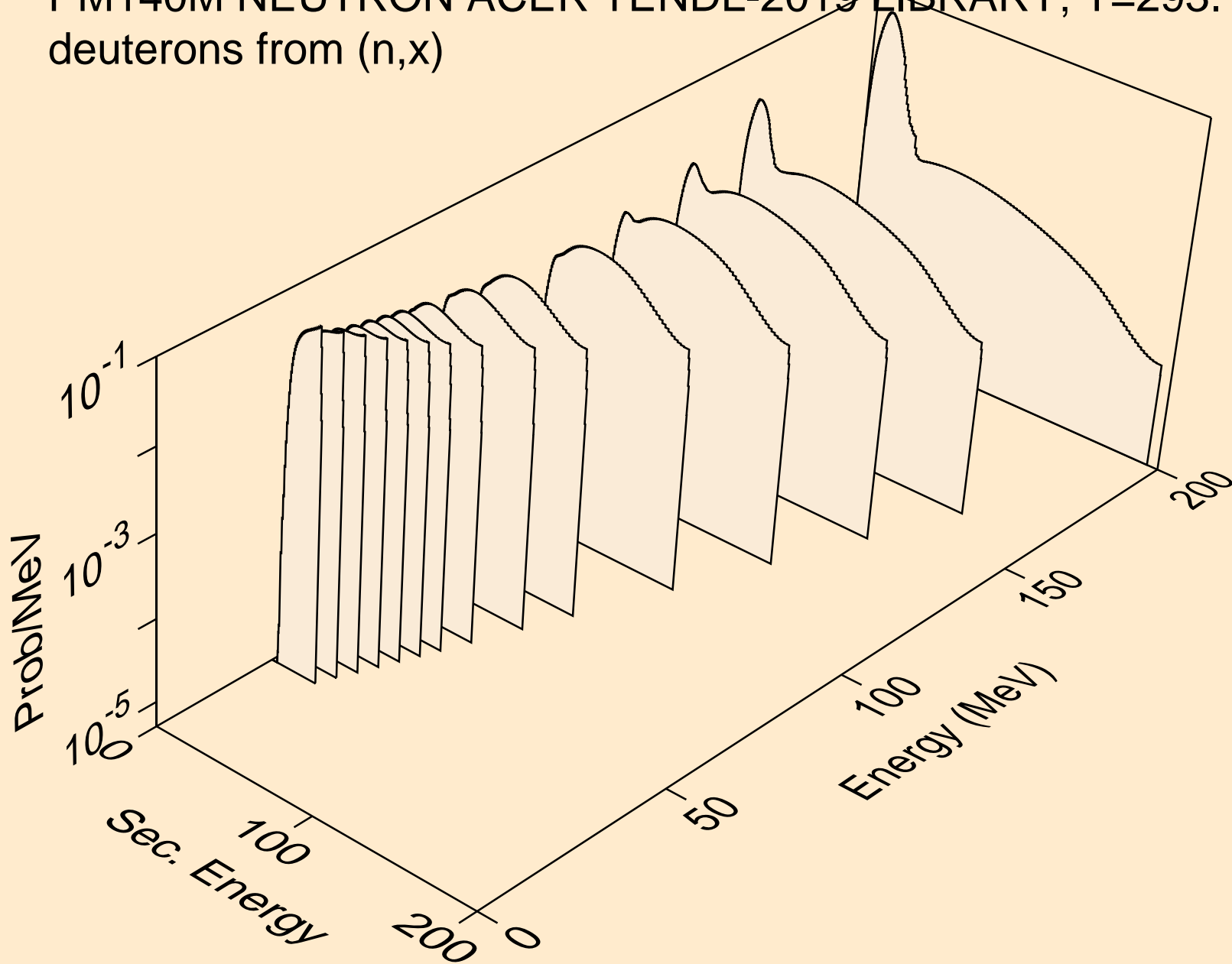

PM140M NEUTRON ACER TENDL-2019 LIBRARY; T=293.16K
deuterons from (n,2nd)

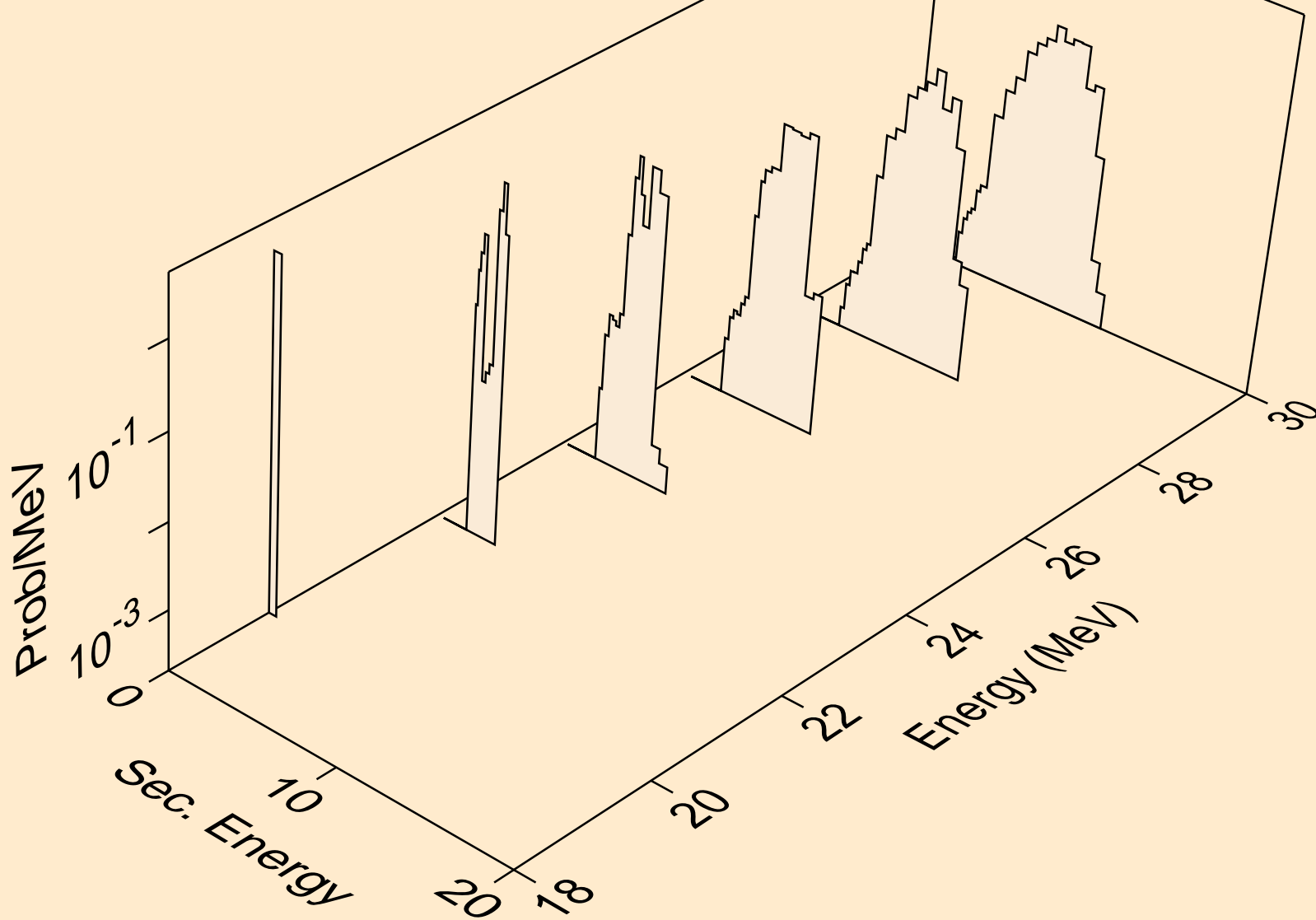

PM140M NEUTRON ACER TENDL-2019 LIBRARY; T=293.16K
deuterons from (n,n*)d

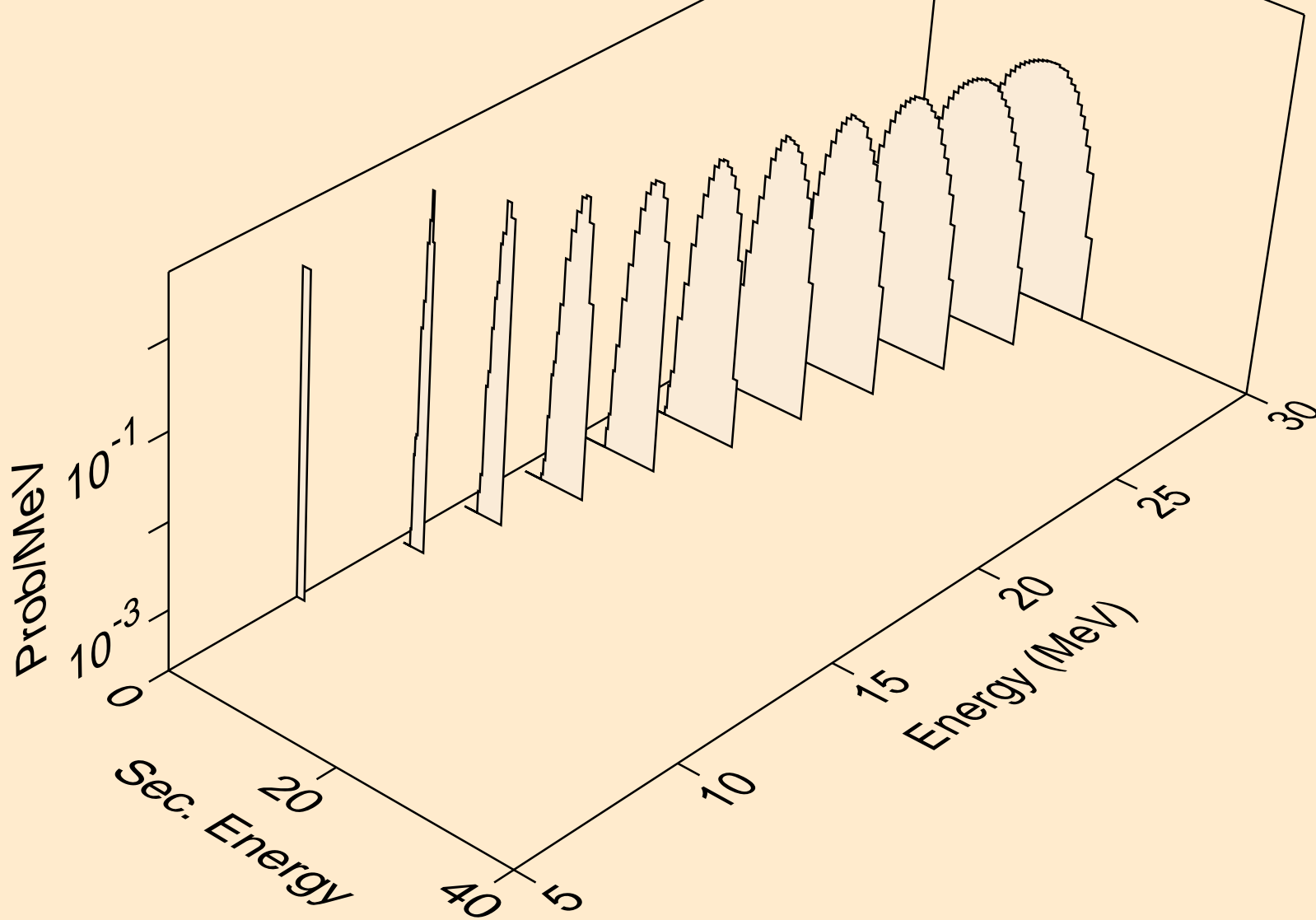

PM140M NEUTRON ACER TENDL-2019 LIBRARY; T=293.16K
deuterons from (n,d)

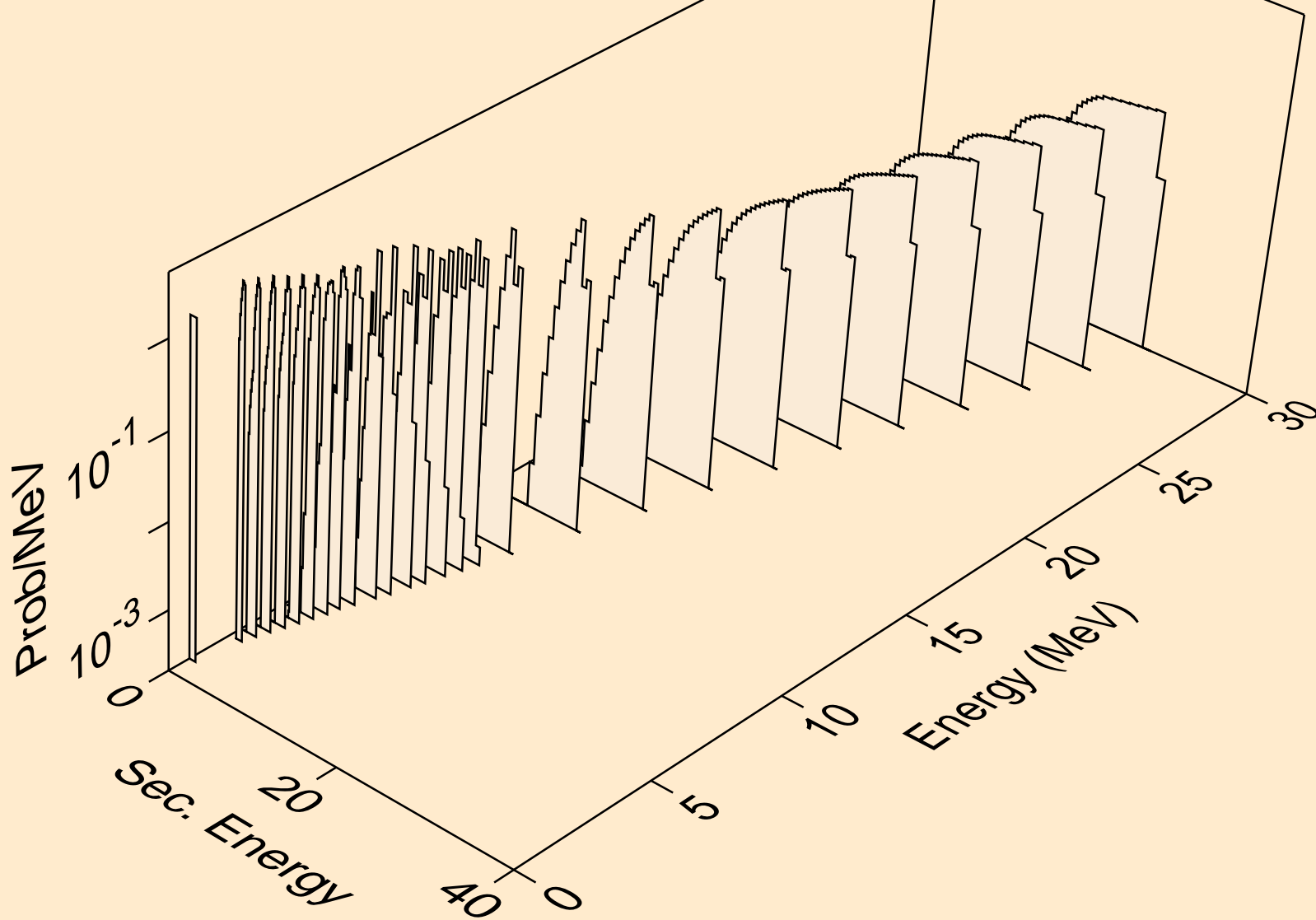

PM140M NEUTRON ACER TENDL-2019 LIBRARY; T=293.16K
deuterons from (n,pd)

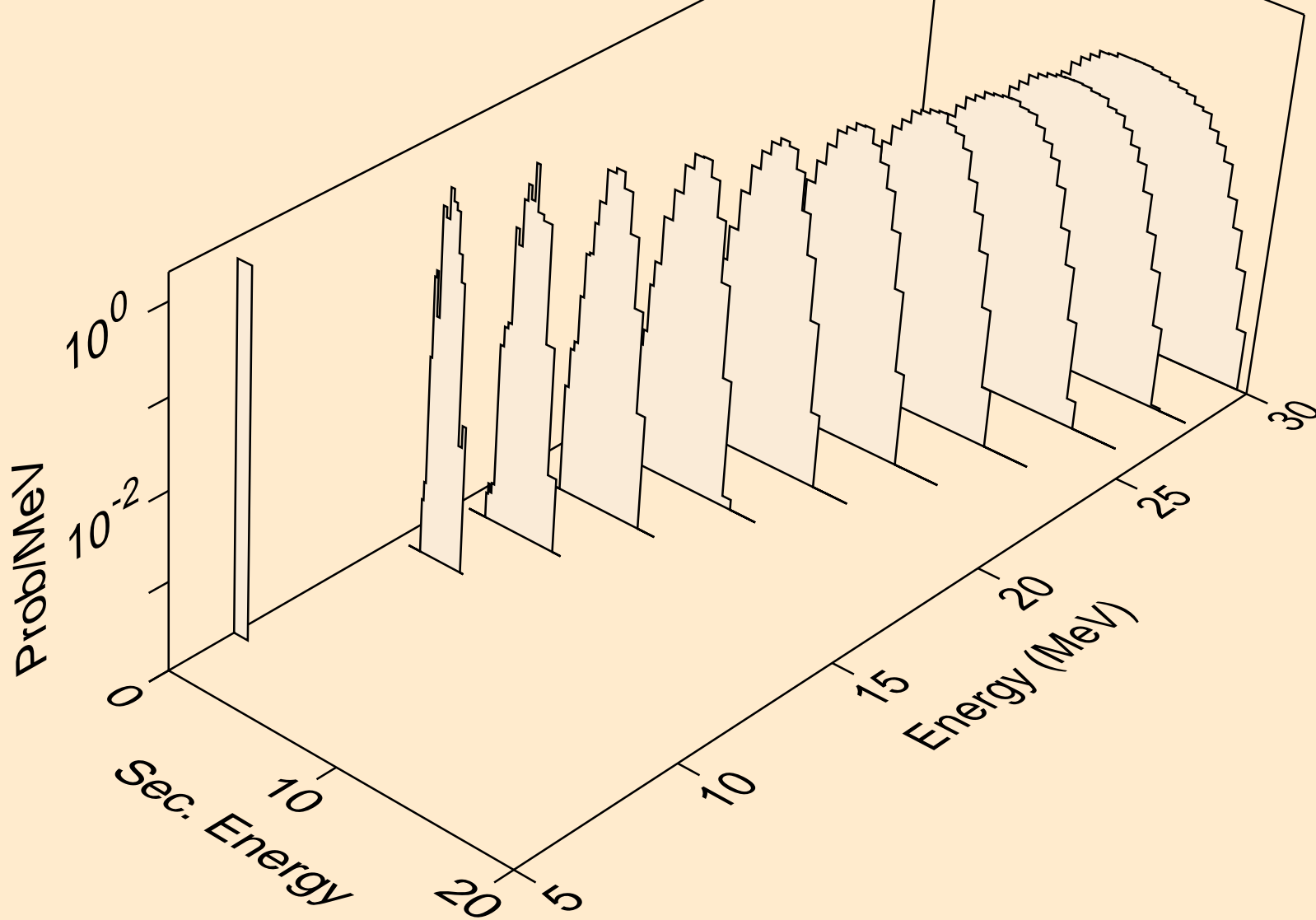

PM140M NEUTRON ACER TENDL-2019 LIBRARY; T=293.16K
deuterons from (n,da)

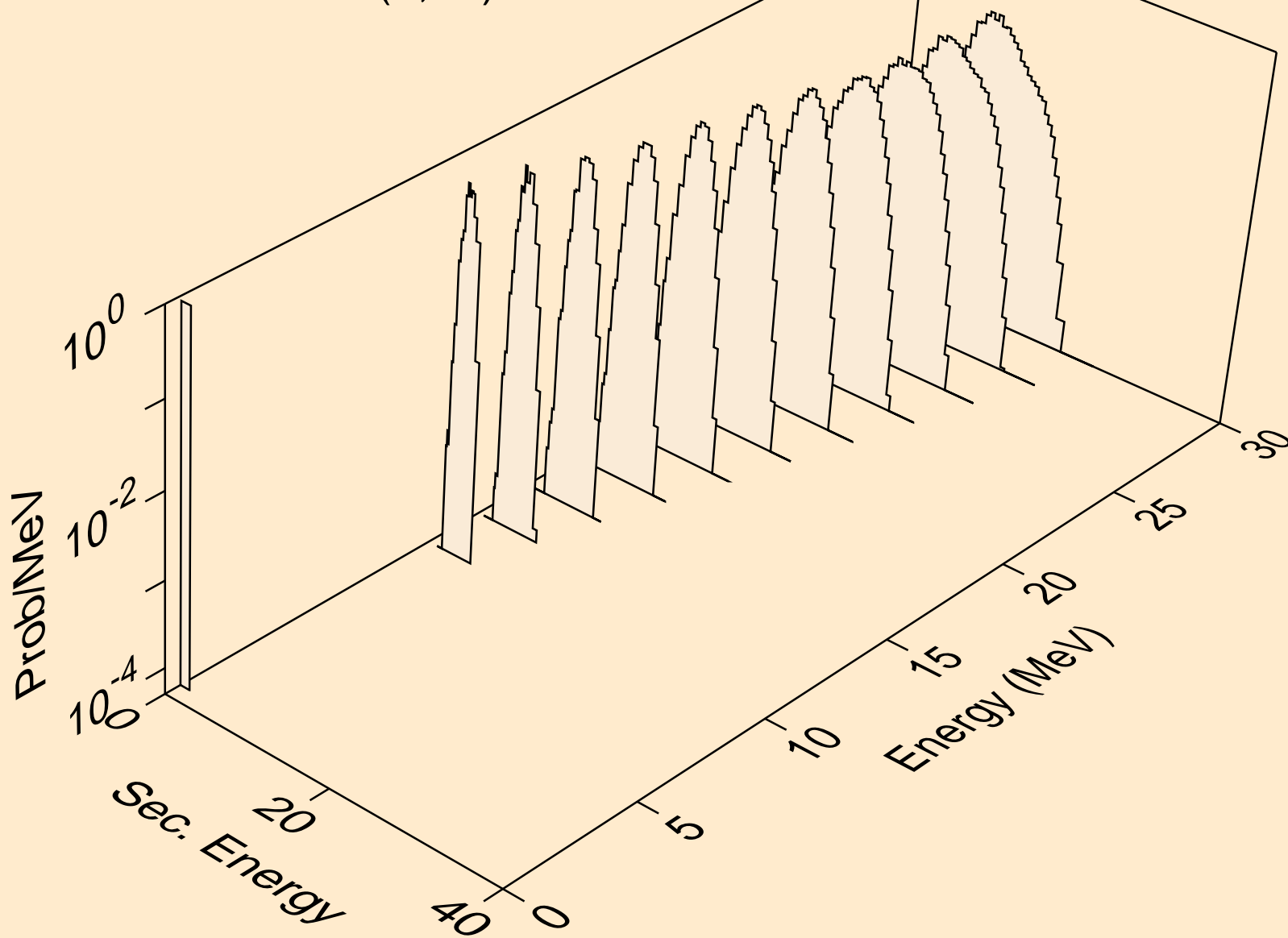

PM140M NEUTRON ACER TENDL-2019 LIBRARY; T=293.16K
tritons from (n,x)

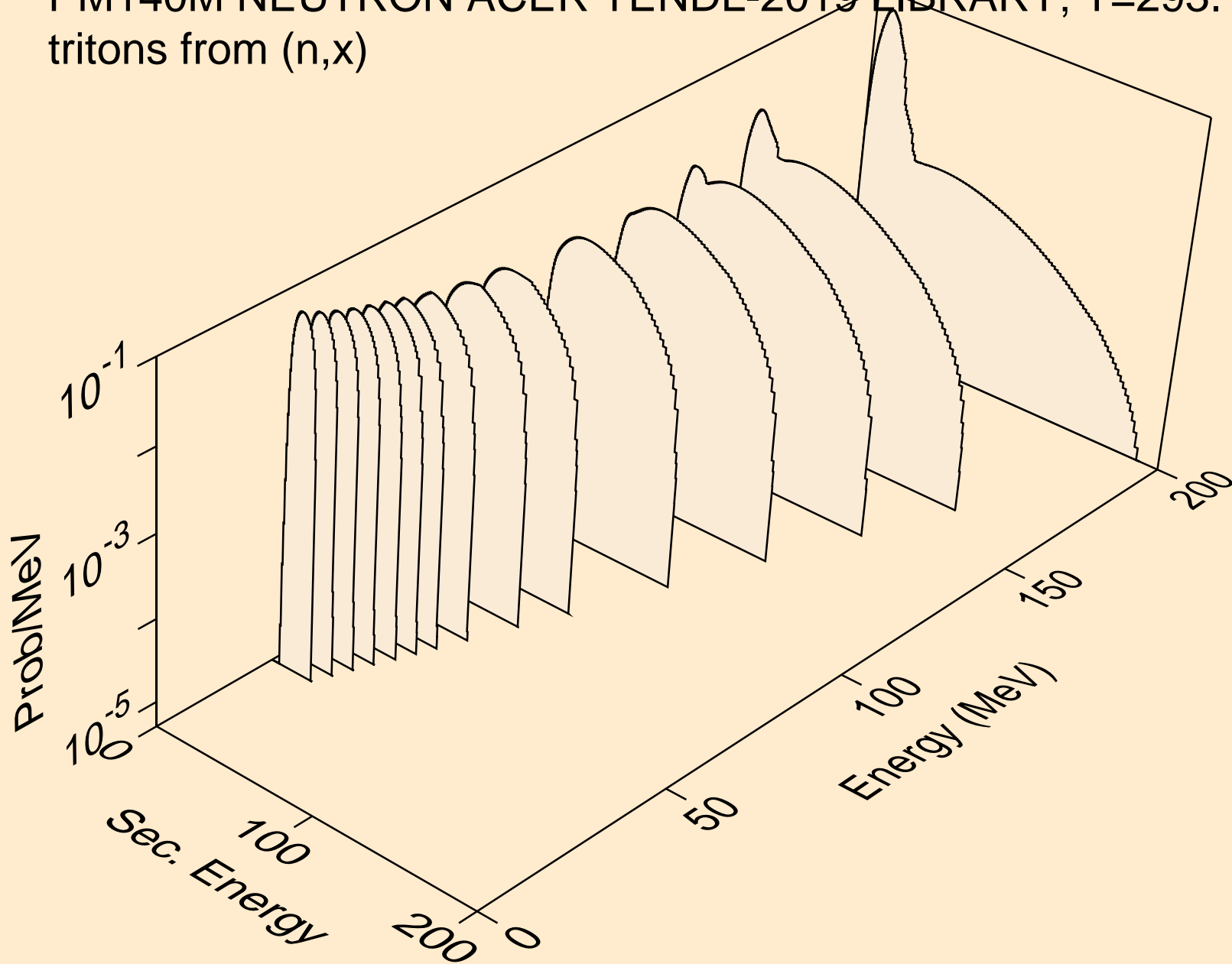

PM140M NEUTRON ACER TENDL-2019 LIBRARY; T=293.16K
tritons from (n,n*)t

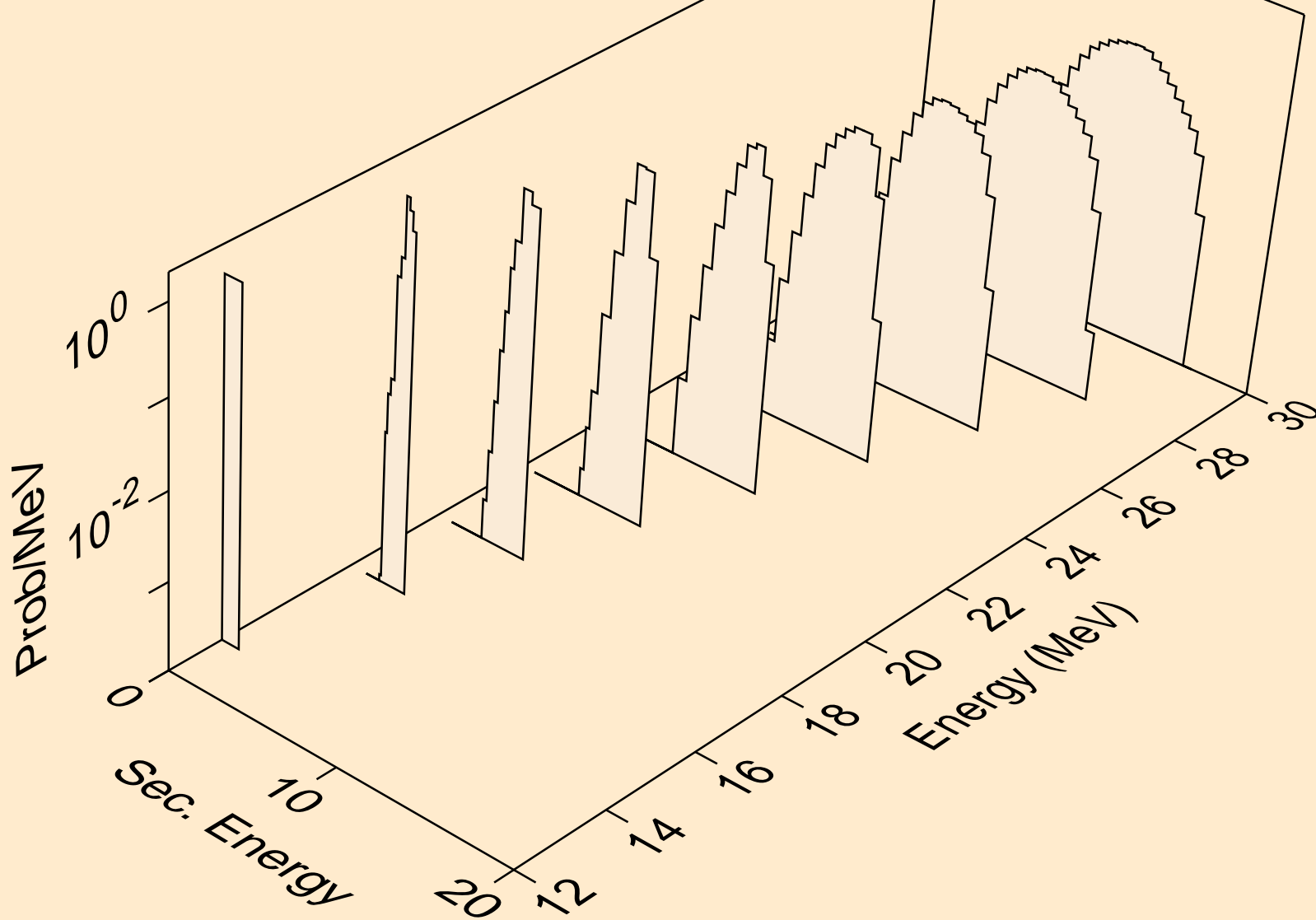

PM140M NEUTRON ACER TENDL-2019 LIBRARY; T=293.16K
tritons from (n,t)

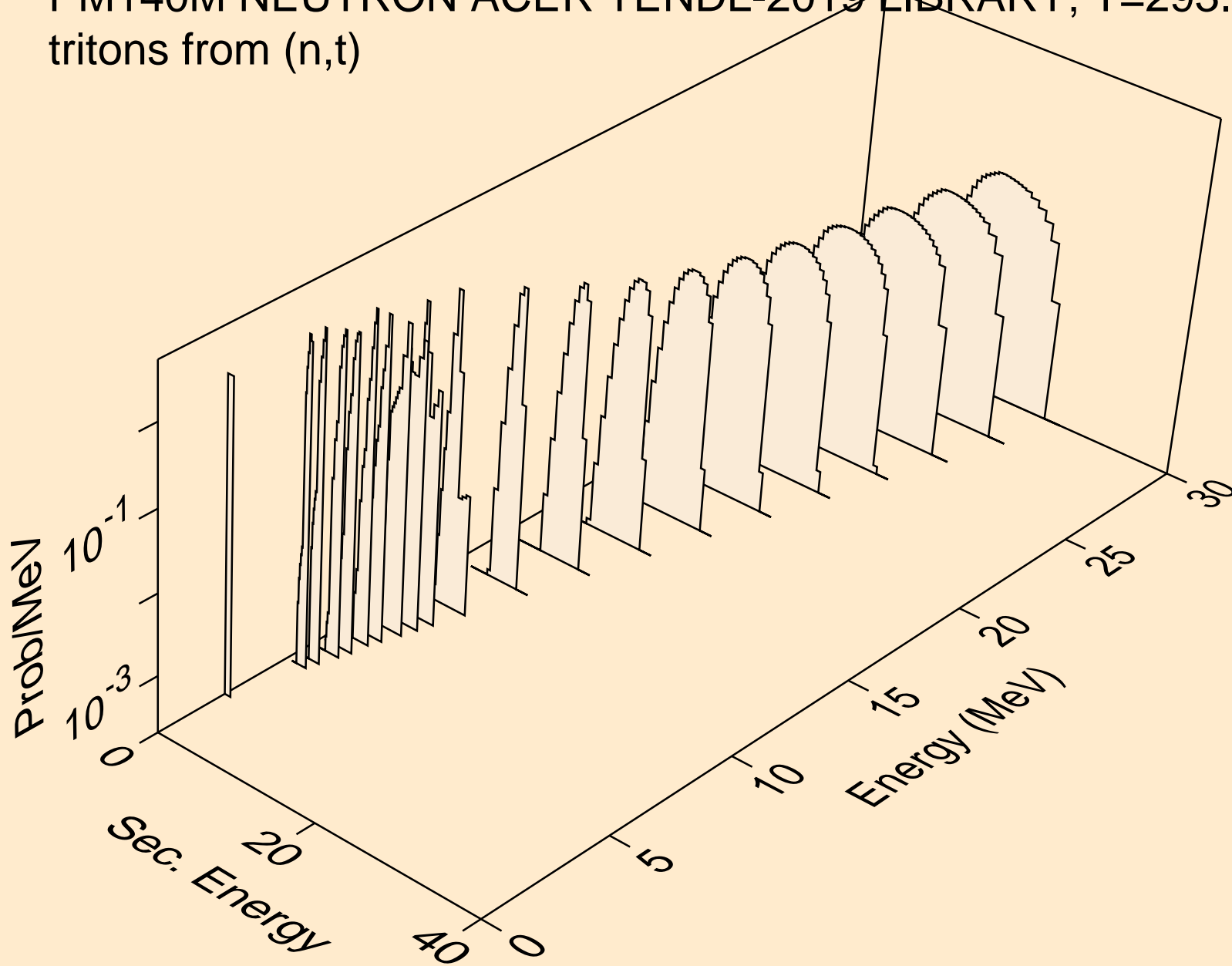

PM140M NEUTRON ACER TENDL-2019 LIBRARY; T=293.16K
tritons from (n,pt)

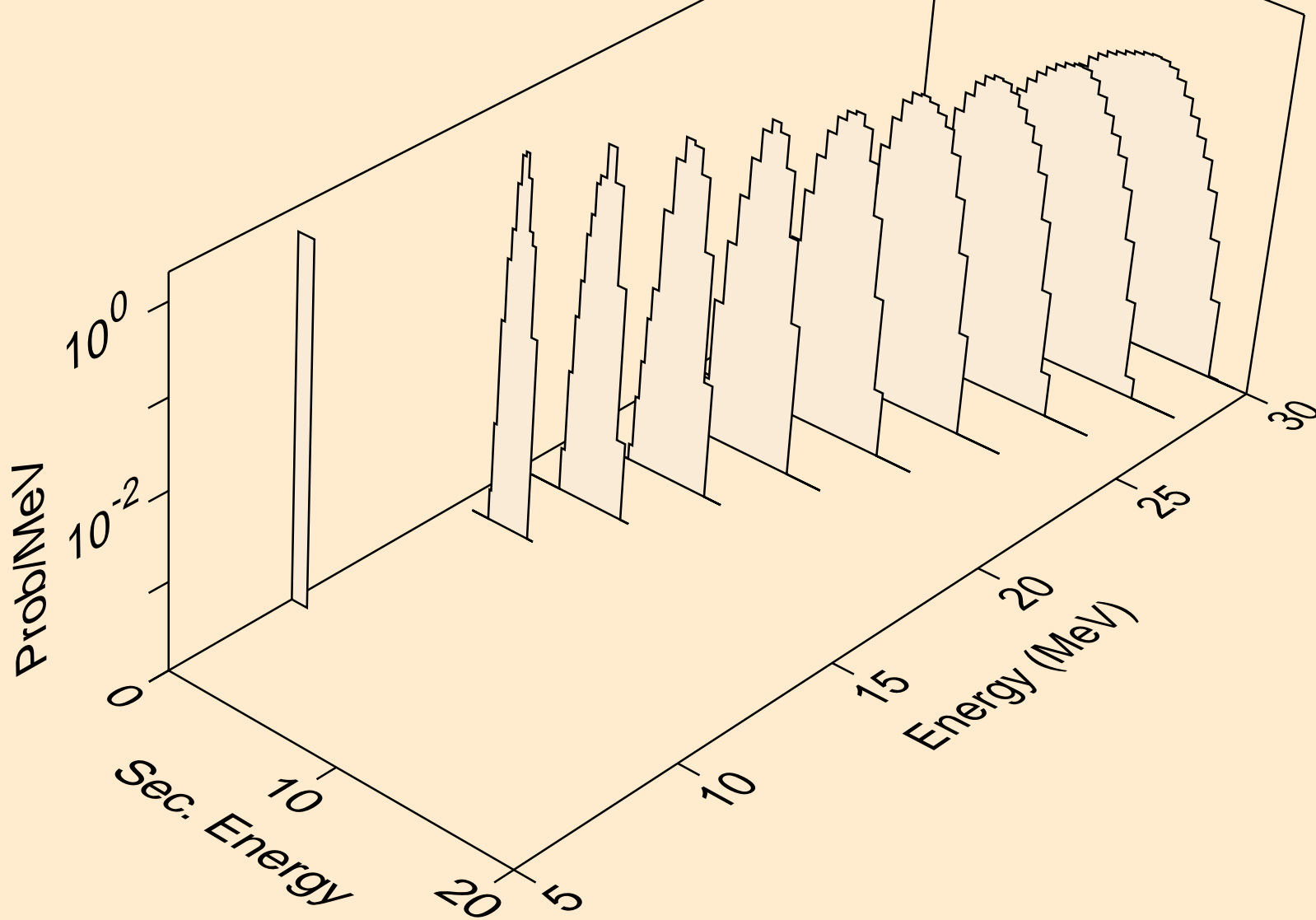

PM140M NEUTRON ACER TENDL-2019 LIBRARY; T=293.16K
he3s from (n,x)

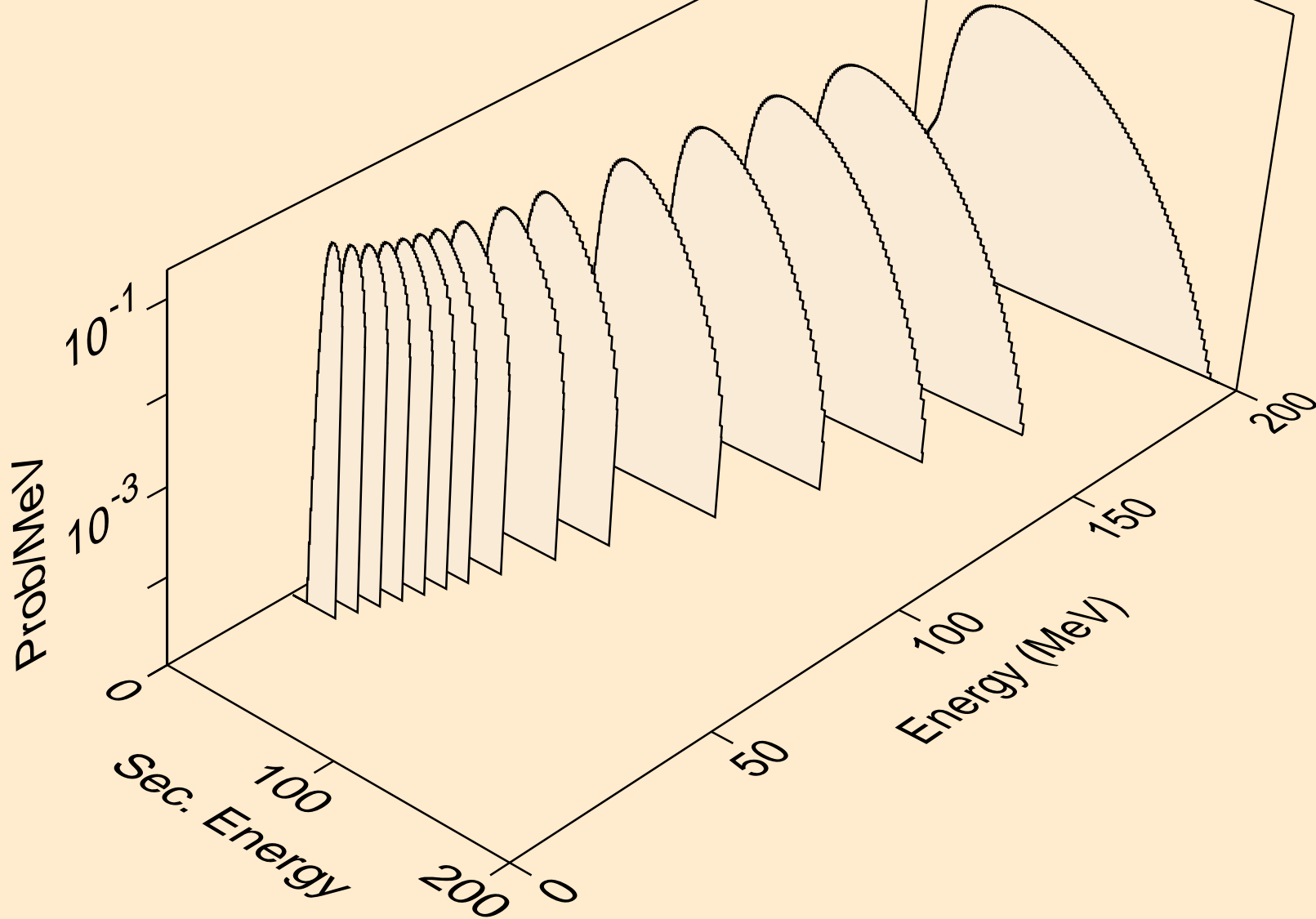

PM140M NEUTRON ACER TENDL-2019 LIBRARY; T=293.16K
he3s from (n,n*)he3

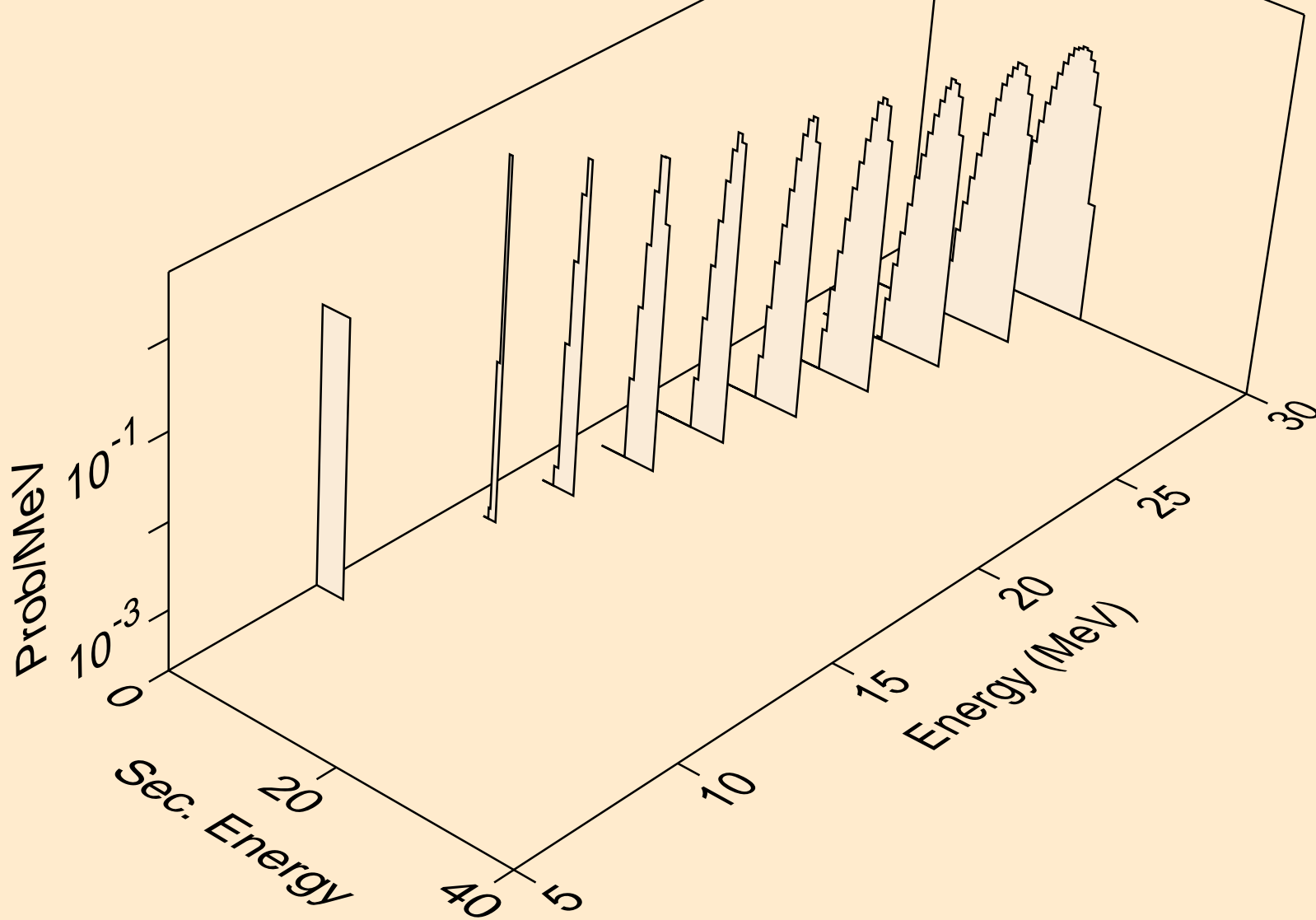

PM140M NEUTRON ACER TENDL-2019 LIBRARY; T=293.16K
he3s from (n,he3)

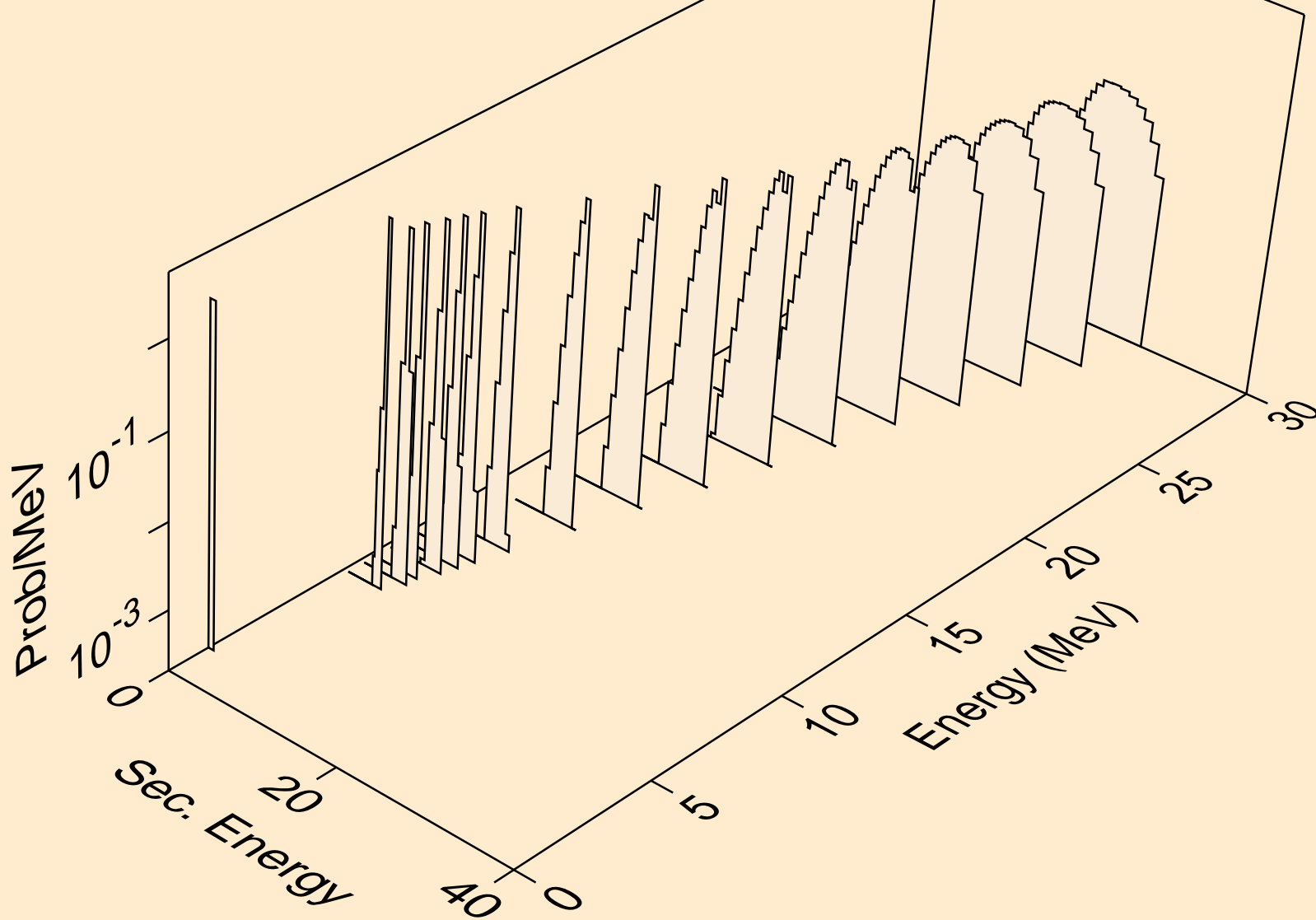

PM140M NEUTRON ACER TENDL-2019 LIBRARY; T=293.16K
alphas from (n,x)

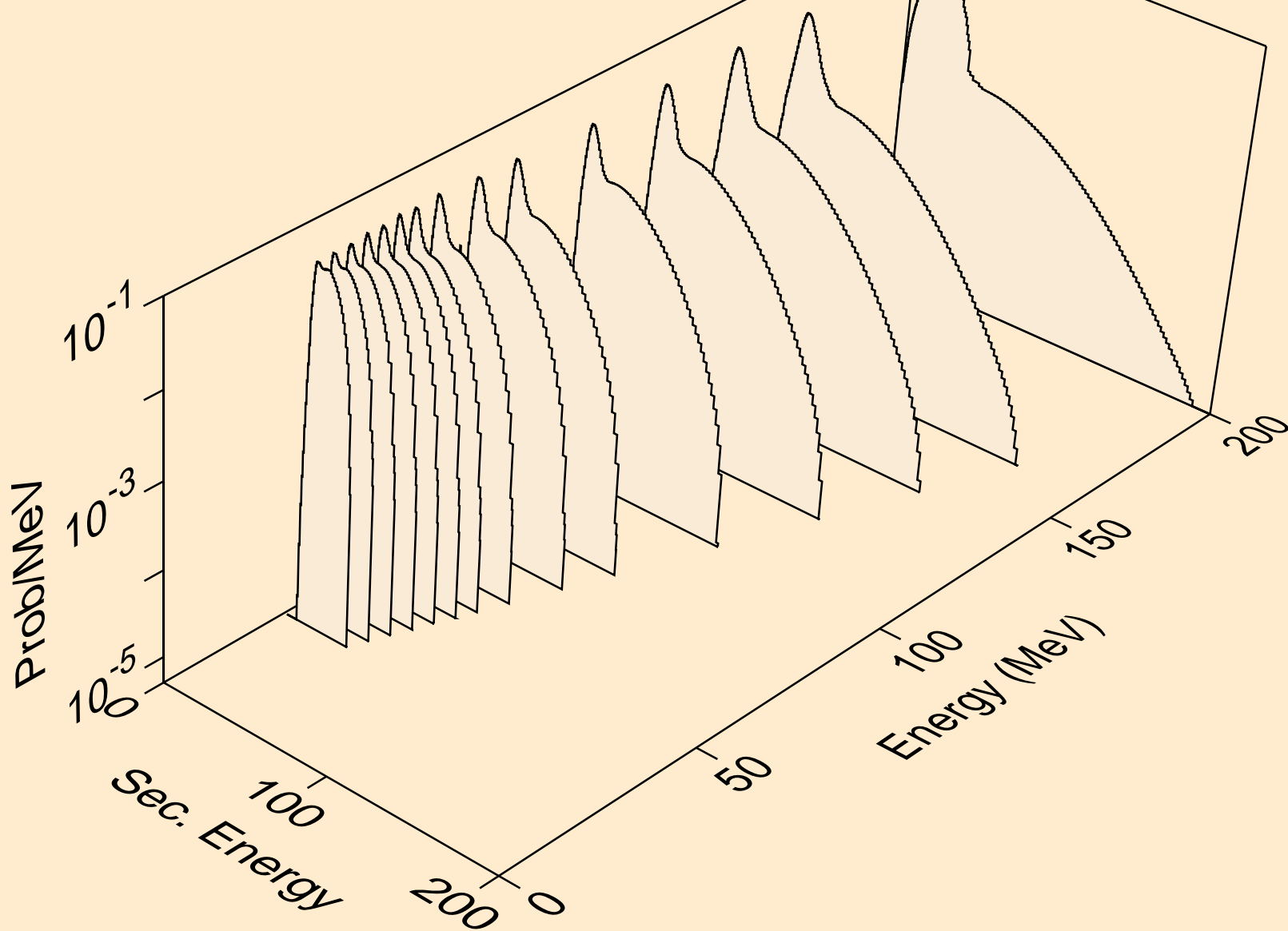

PM140M NEUTRON ACER TENDL-2019 LIBRARY; T=293.16K
alphas from (n,n*)a

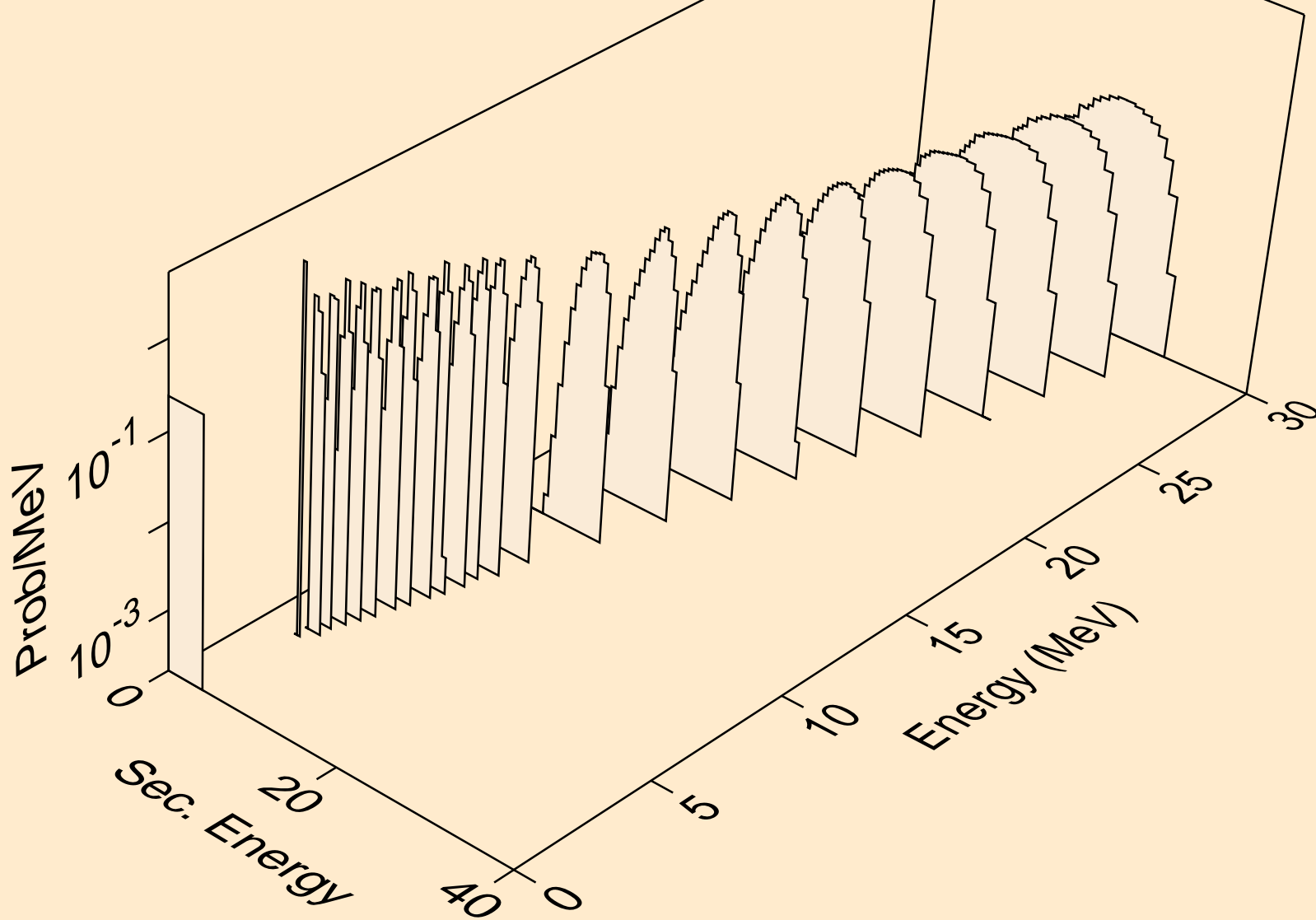

PM140M NEUTRON ACER TENDL-2019 LIBRARY; T=293.16K
alphas from (n,2n)a

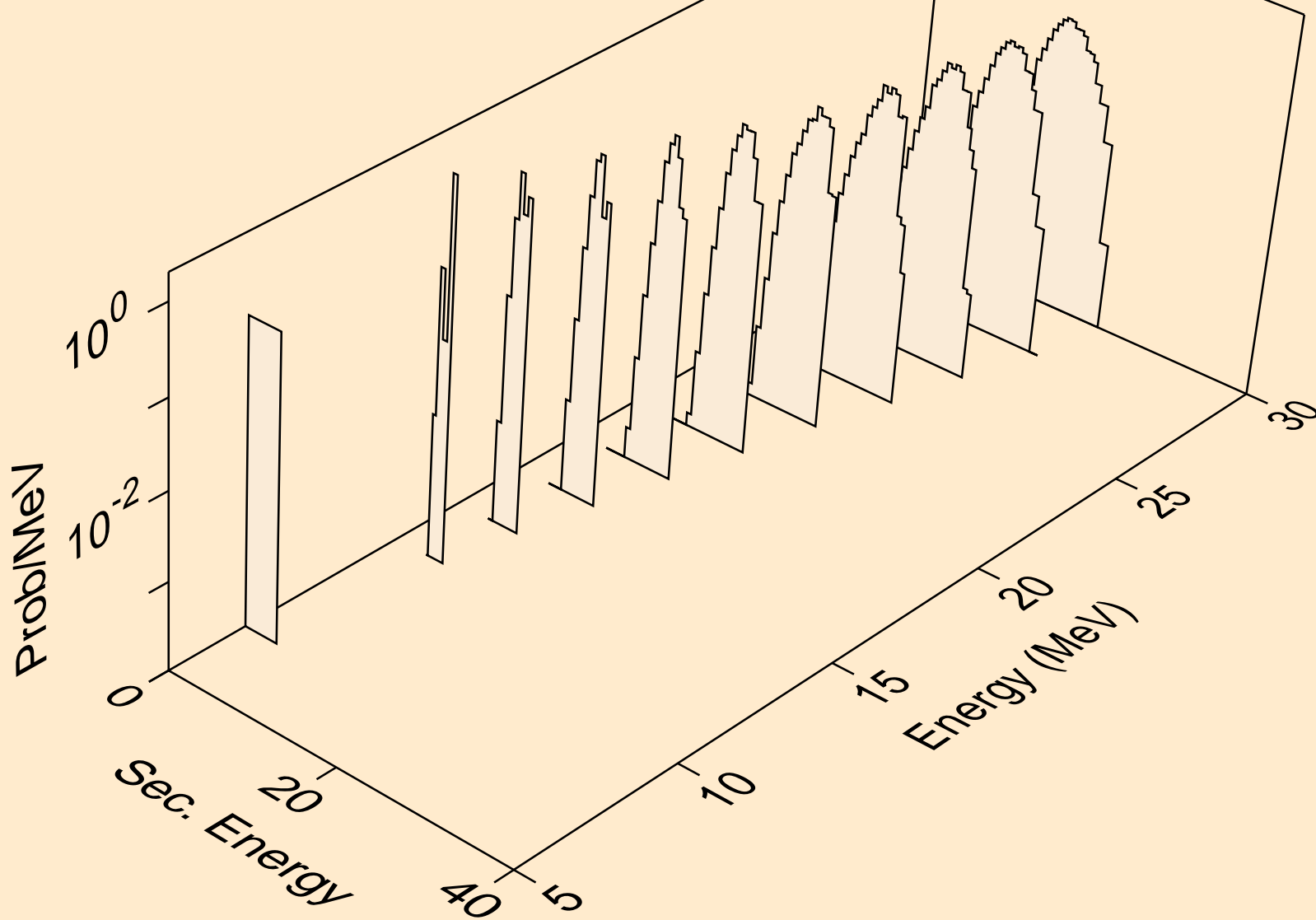

PM140M NEUTRON ACER TENDL-2019 LIBRARY; T=293.16K
alphas from (n,3n)a

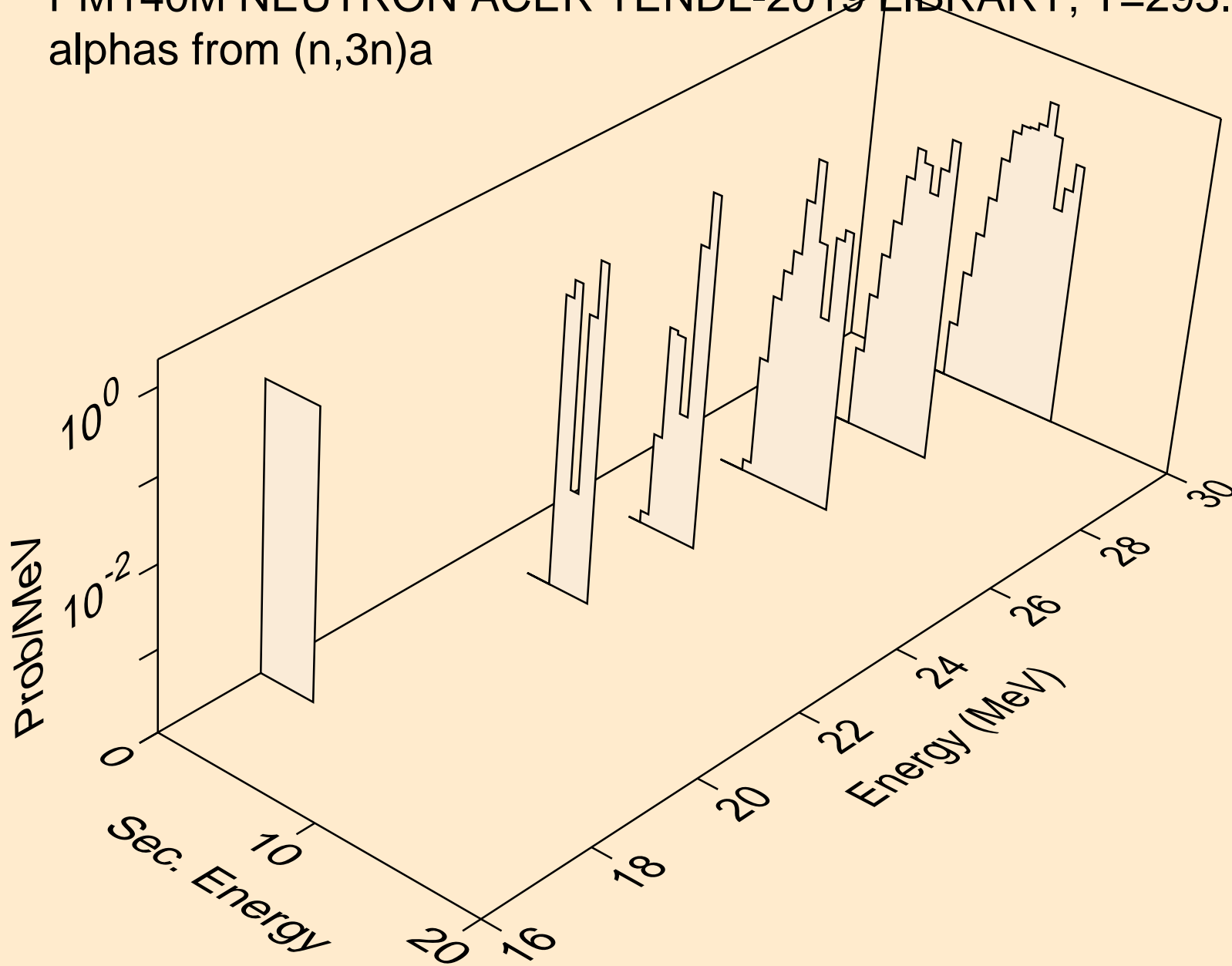

PM140M NEUTRON ACER TENDL-2019 LIBRARY; T=293.16K
alphas from (n,n*)2a

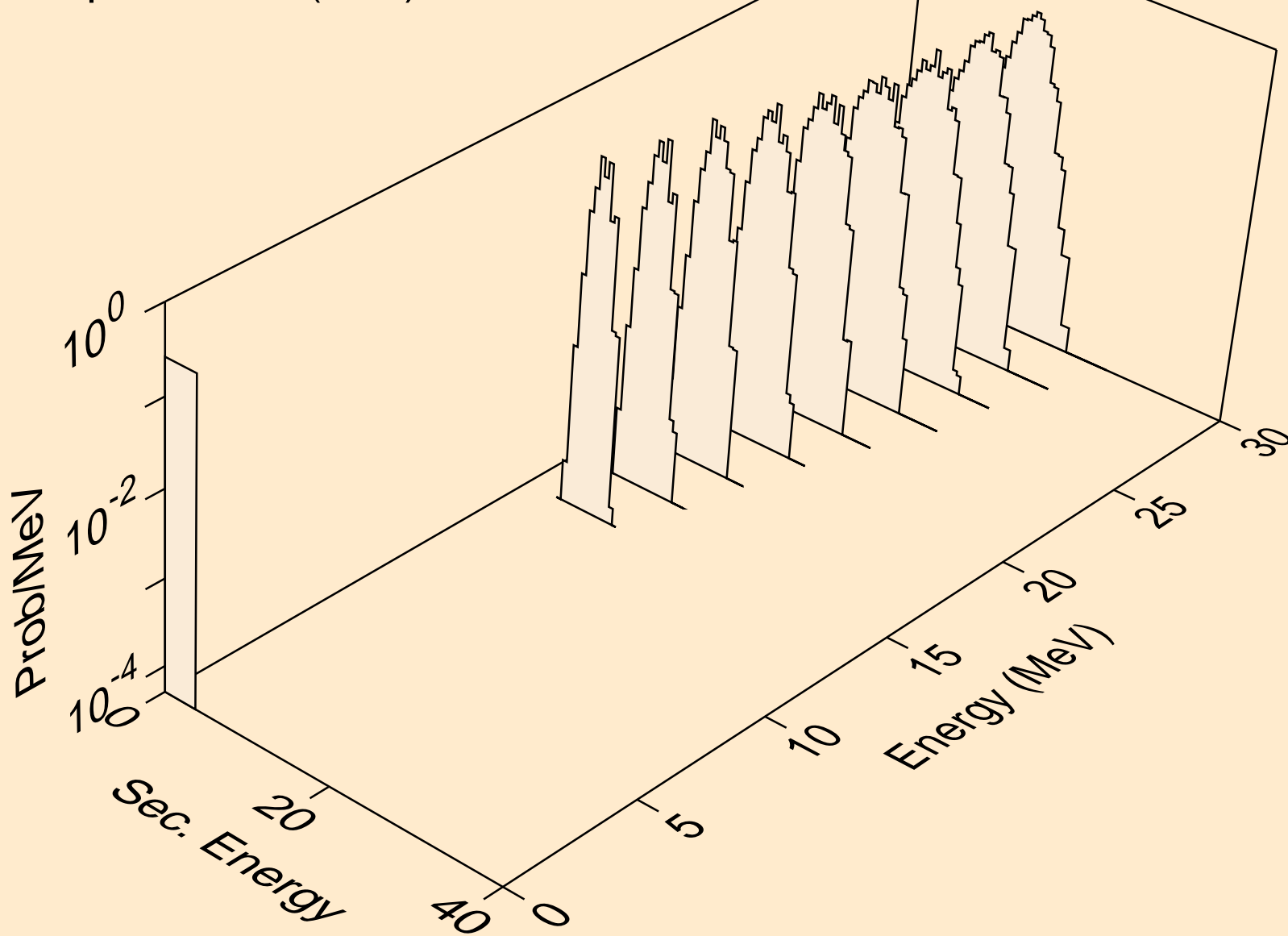

PM140M NEUTRON ACER TENDL-2019 LIBRARY; T=293.16K
alphas from (n,2n)2a

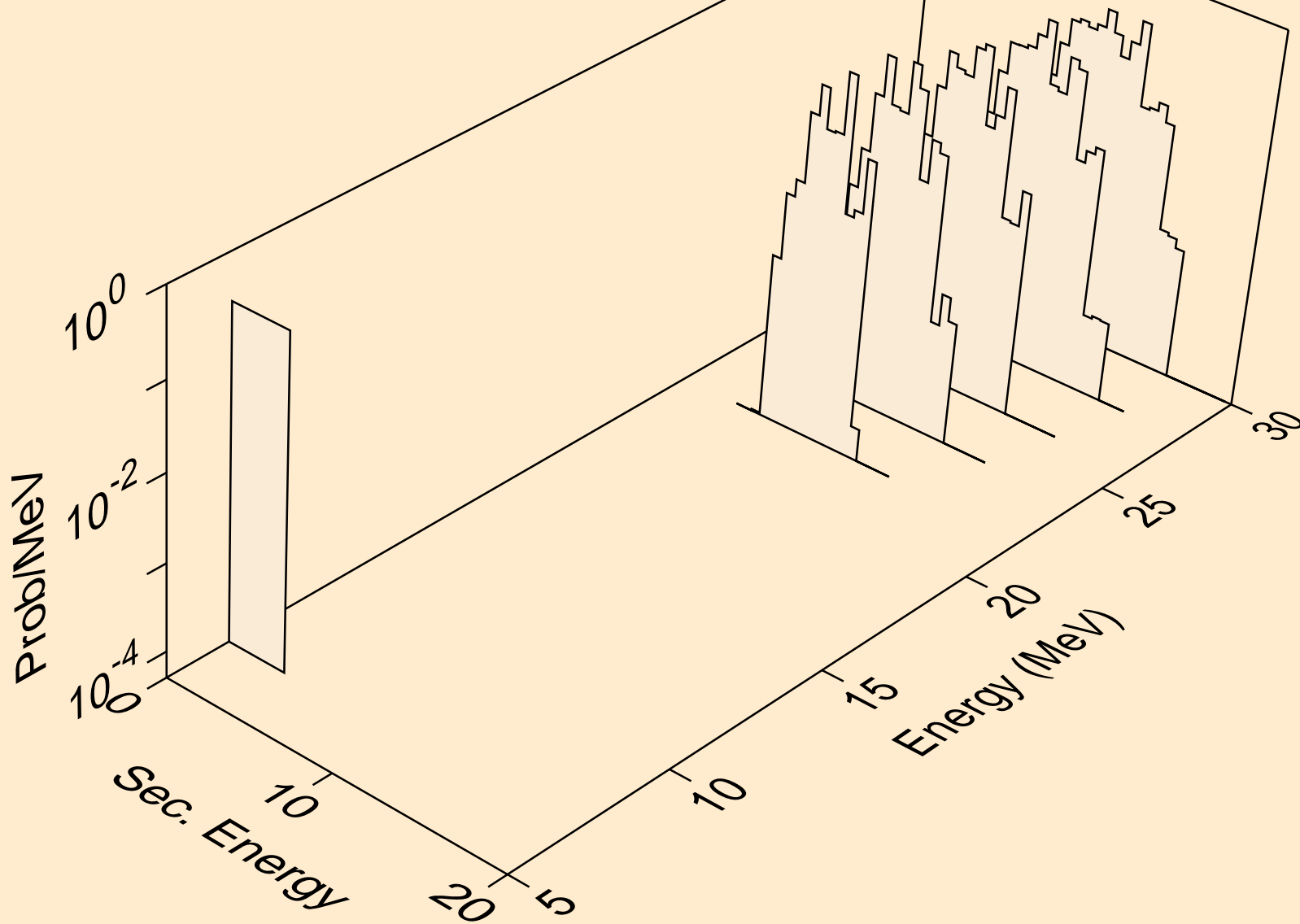

PM140M NEUTRON ACER TENDL-2019 LIBRARY; T=293.16K
alphas from (n,npa)

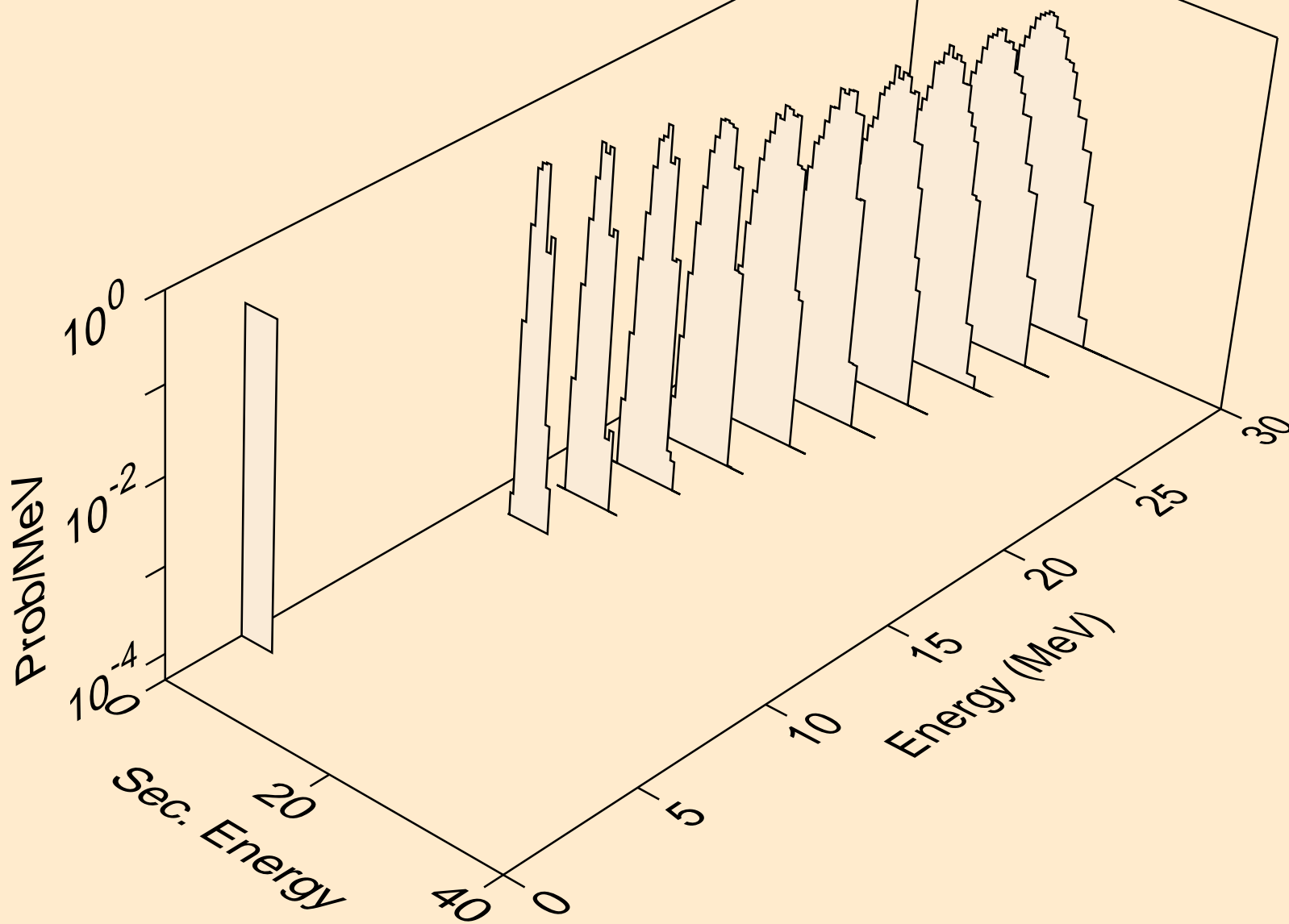

PM140M NEUTRON ACER TENDL-2019 LIBRARY; T=293.16K
alphas from (n,a)

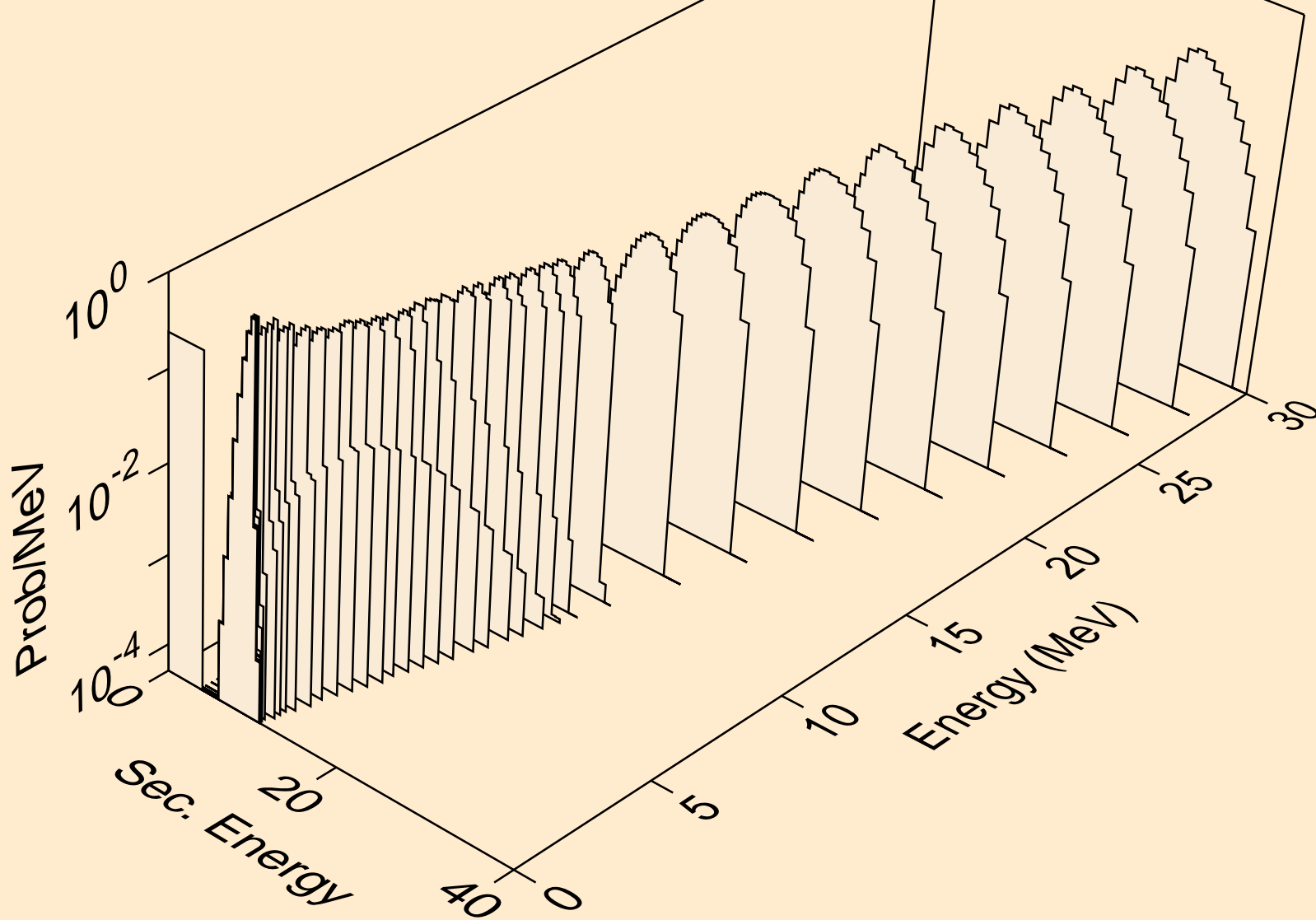

PM140M NEUTRON ACER TENDL-2019 LIBRARY; T=293.16K
alphas from (n,2a)

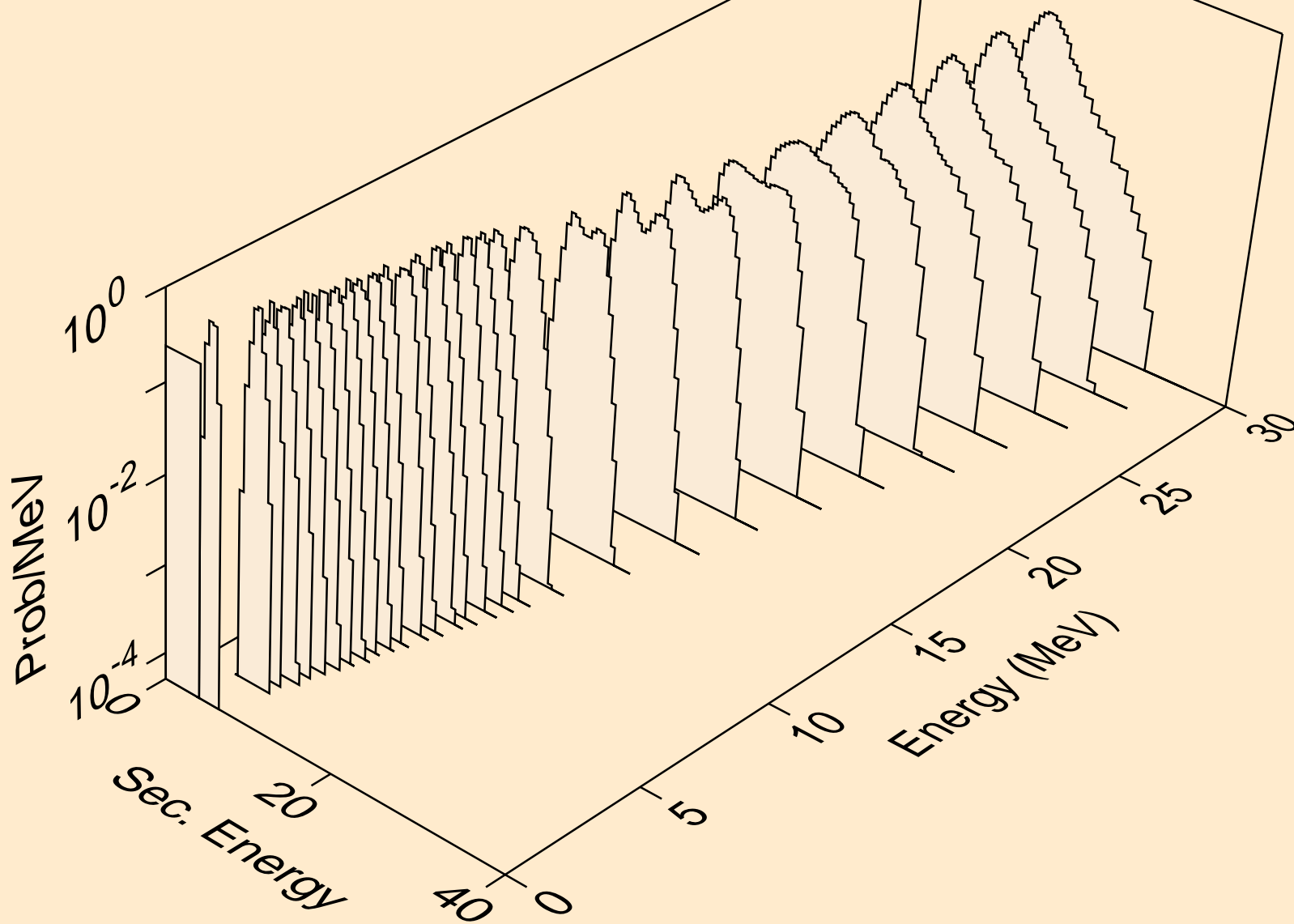

PM140M NEUTRON ACER TENDL-2019 LIBRARY; T=293.16K
alphas from (n,pa)

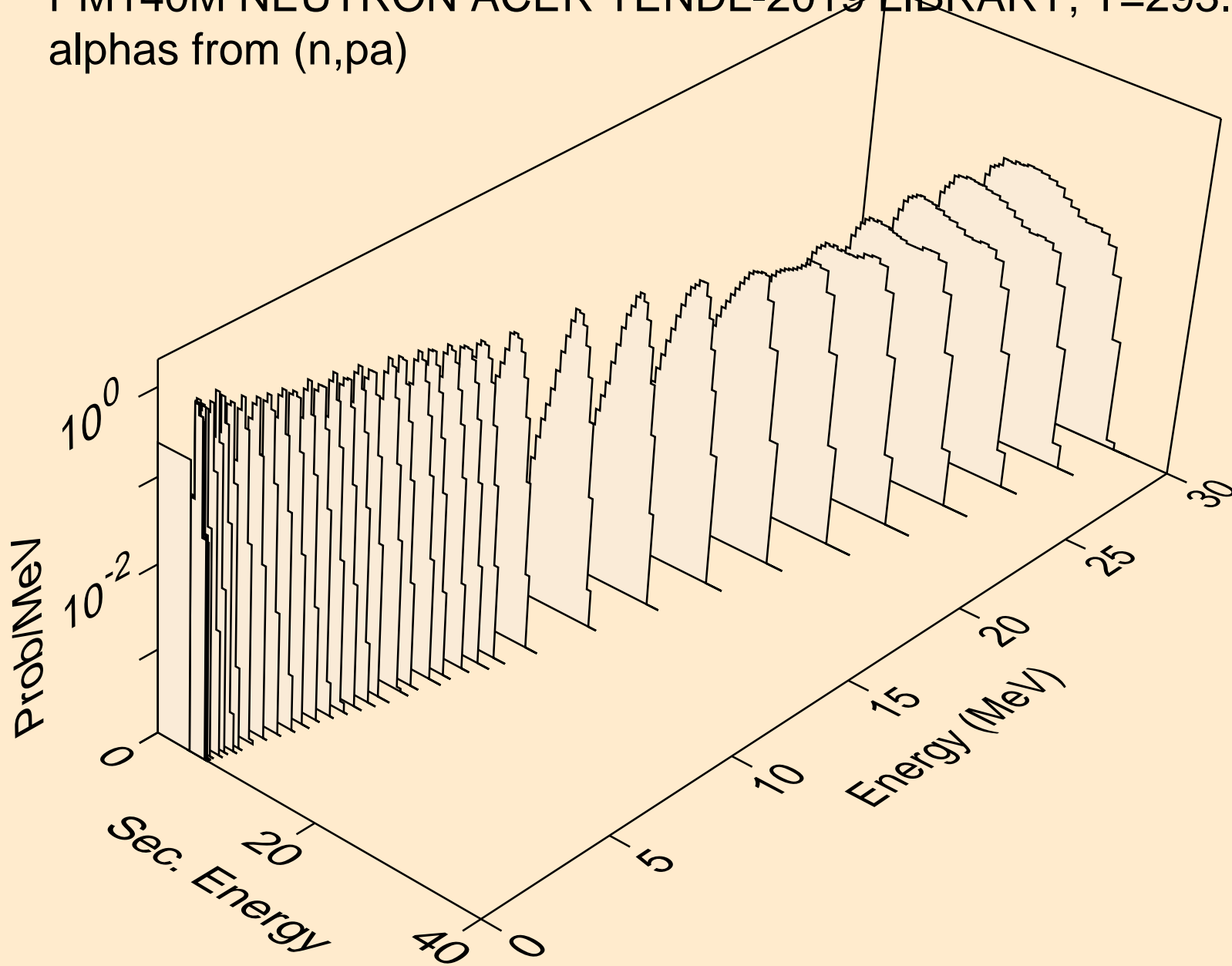

PM140M NEUTRON ACER TENDL-2019 LIBRARY; T=293.16K
alphas from (n,da)

