

PM152 NEUTRON ACER TENDL-2019 LIBRARY; T=293.16K
Principal cross sections

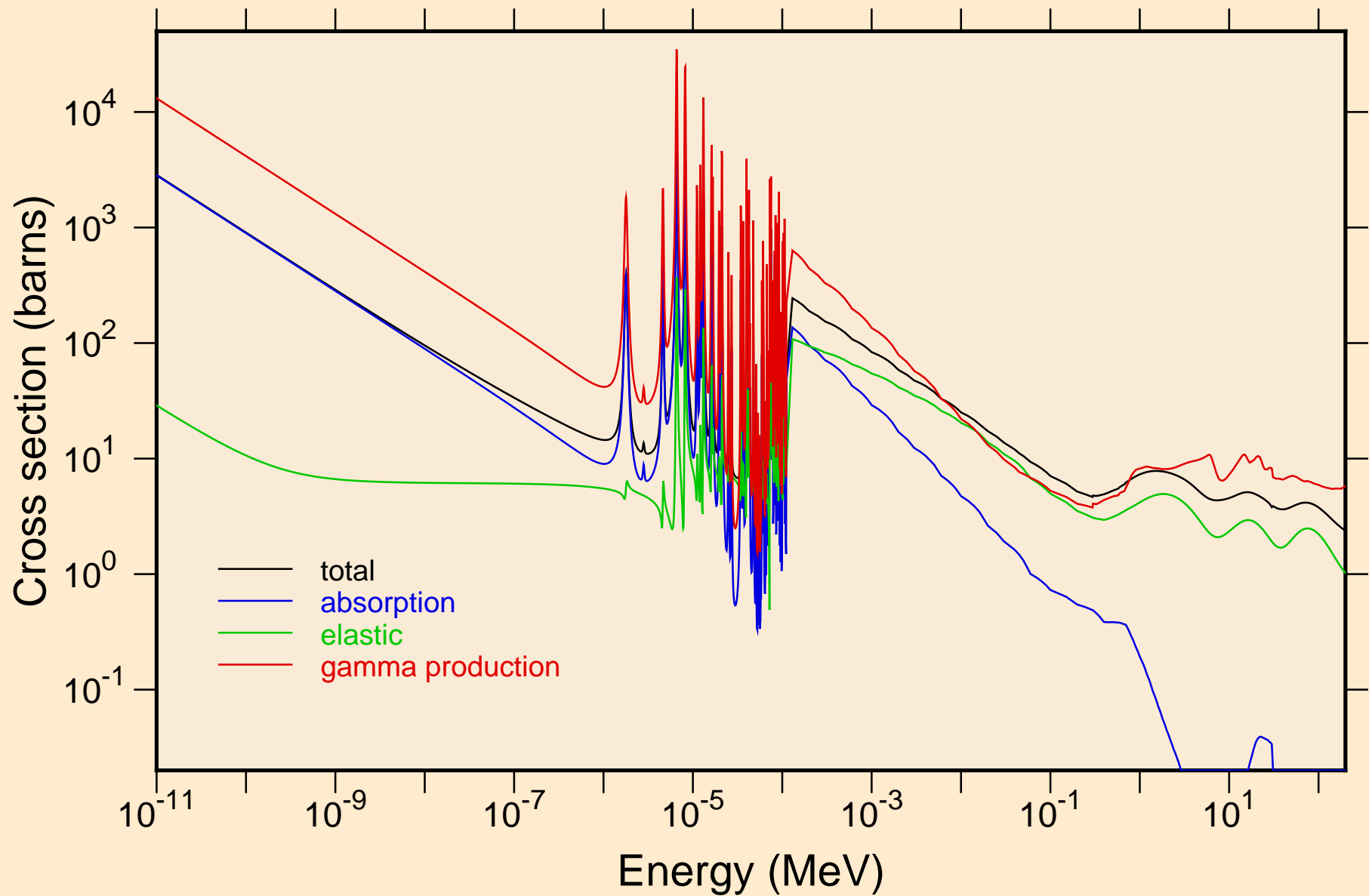

PM152 NEUTRON ACER TENDL-2019 LIBRARY; T=293.16K
resonance total cross section

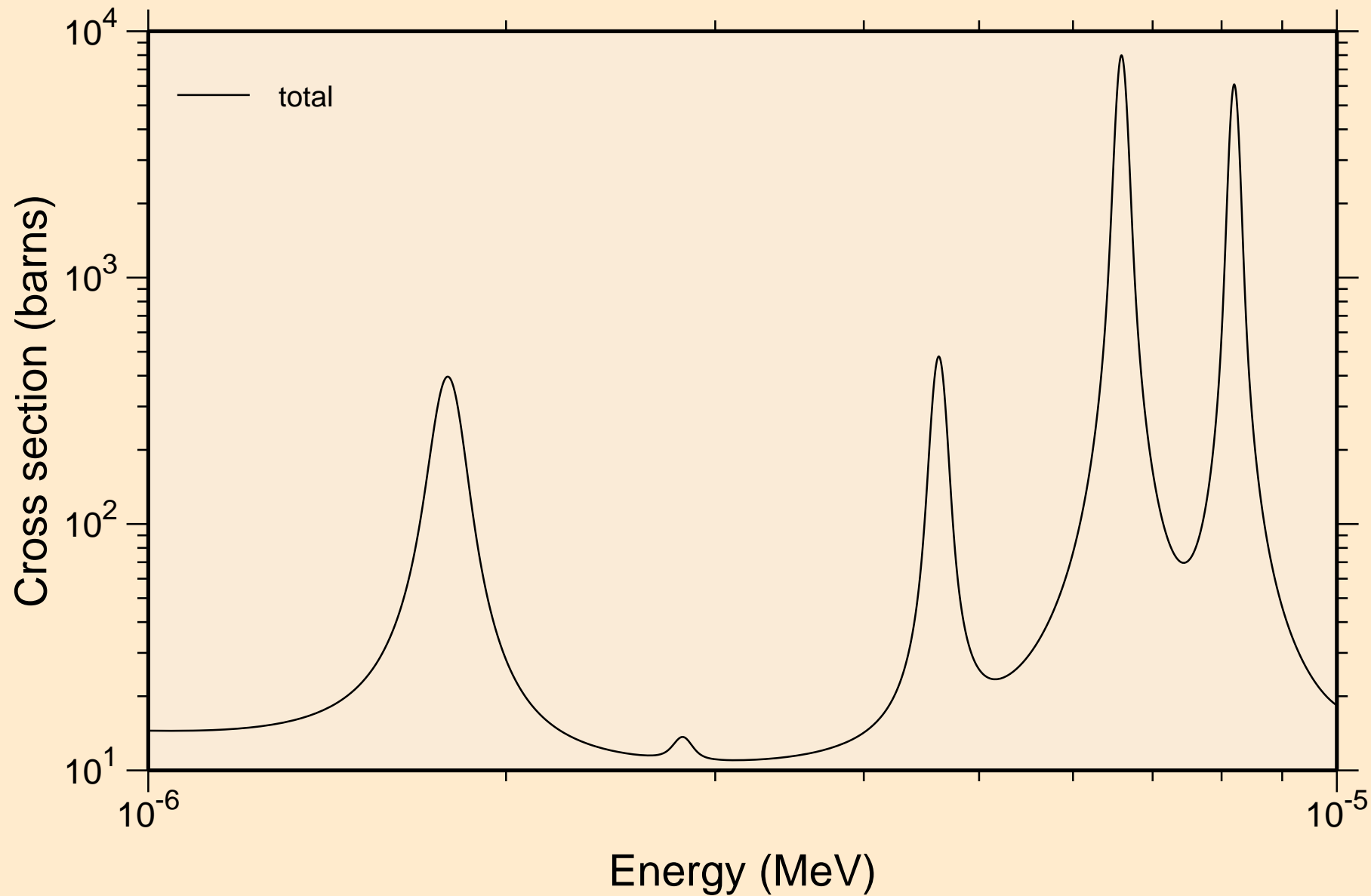

PM152 NEUTRON ACER TENDL-2019 LIBRARY; T=293.16K
resonance total cross section

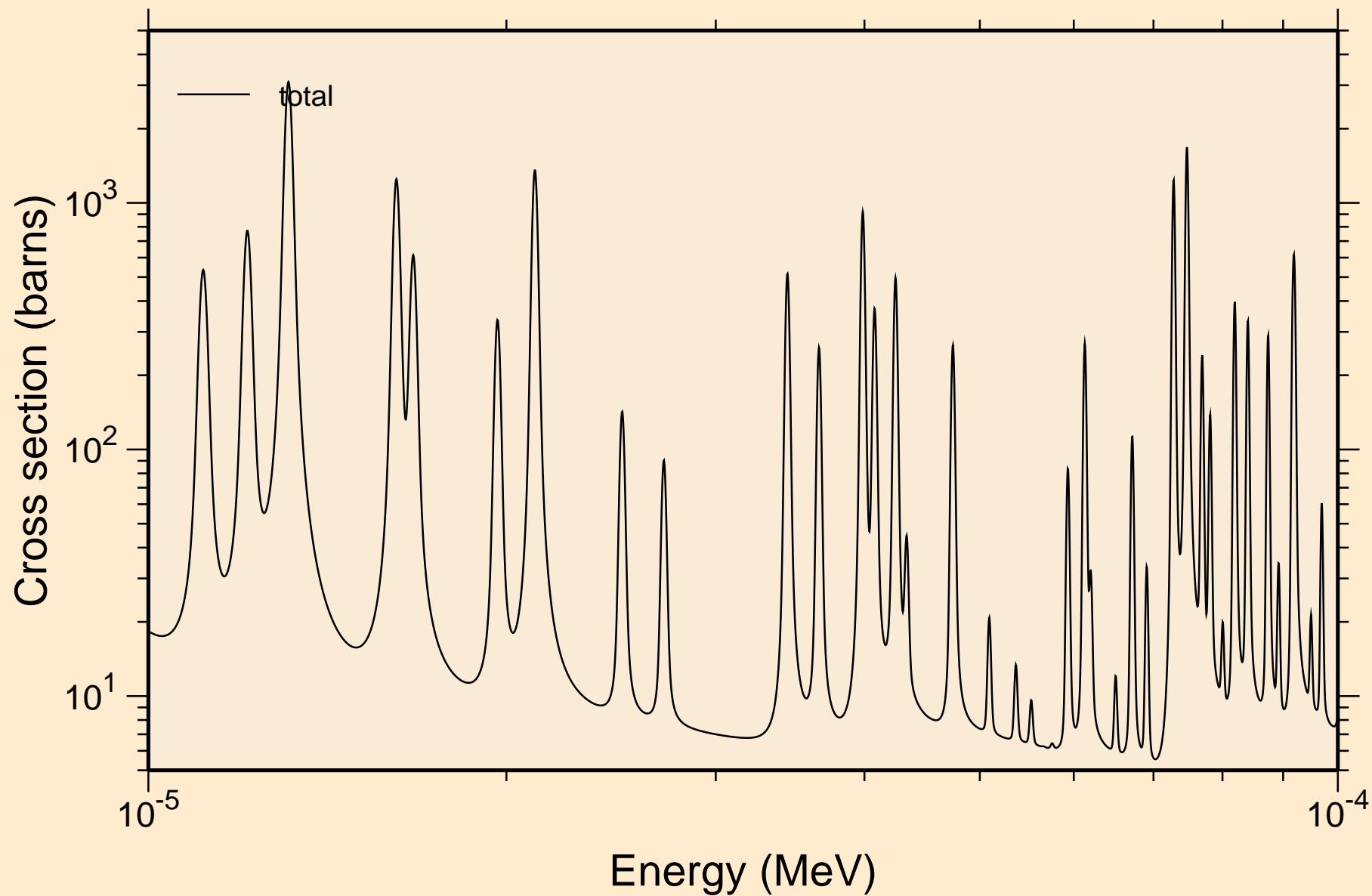

PM152 NEUTRON ACER TENDL-2019 LIBRARY; T=293.16K
resonance total cross section

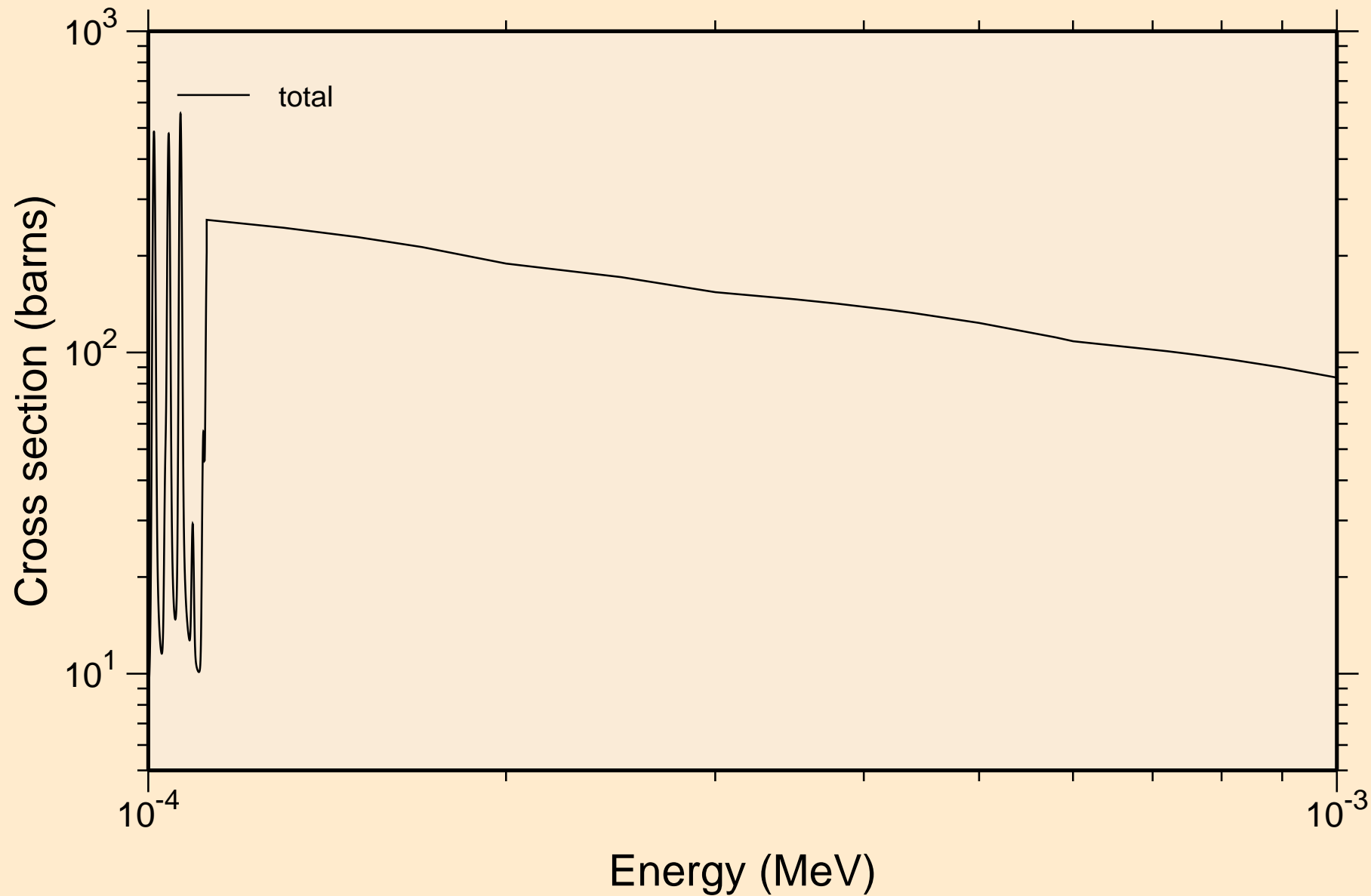

PM152 NEUTRON ACER TENDL-2019 LIBRARY; T=293.16K
resonance total cross section

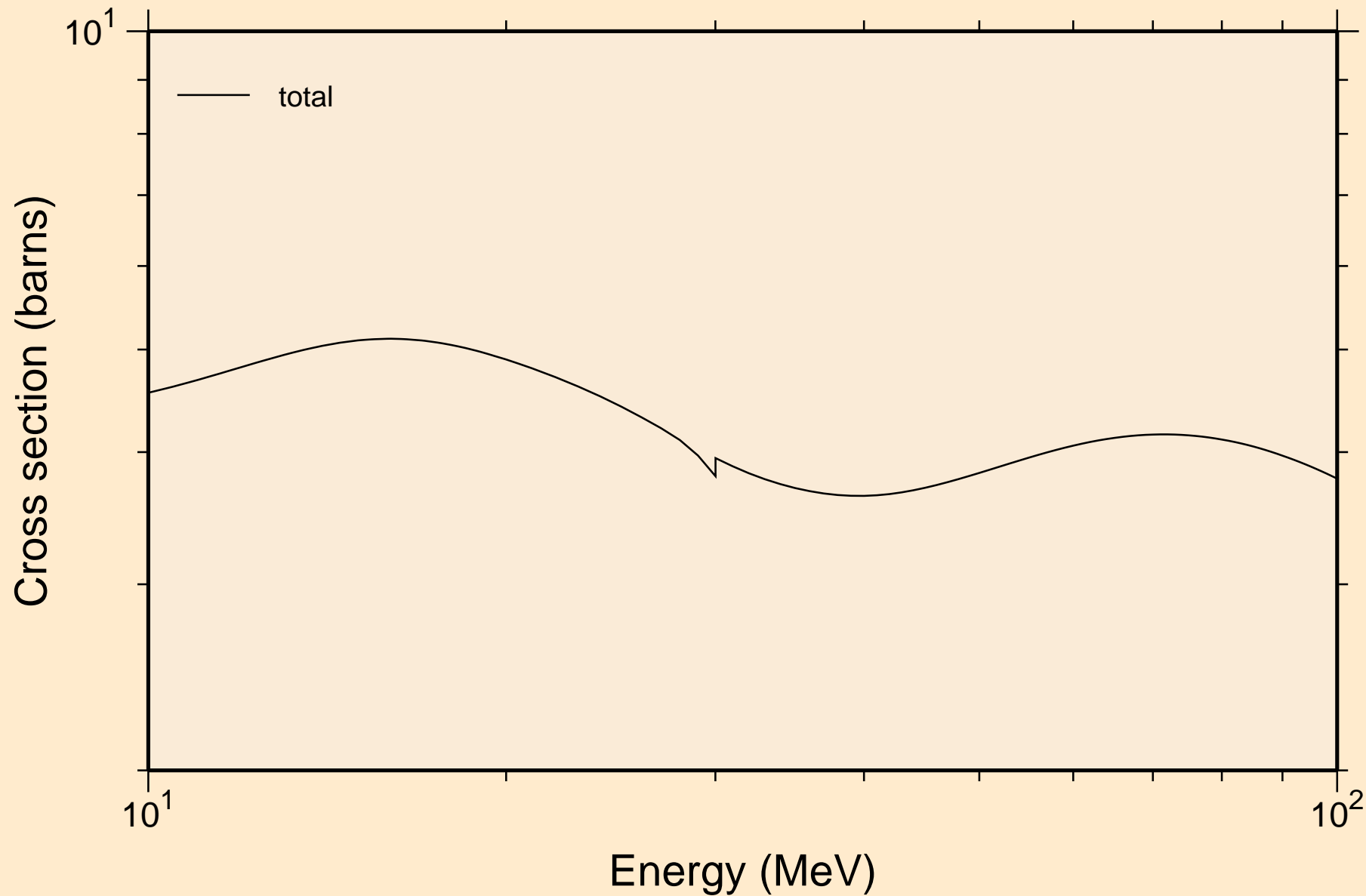

PM152 NEUTRON ACER TENDL-2019 LIBRARY; T=293.16K
resonance absorption cross sections

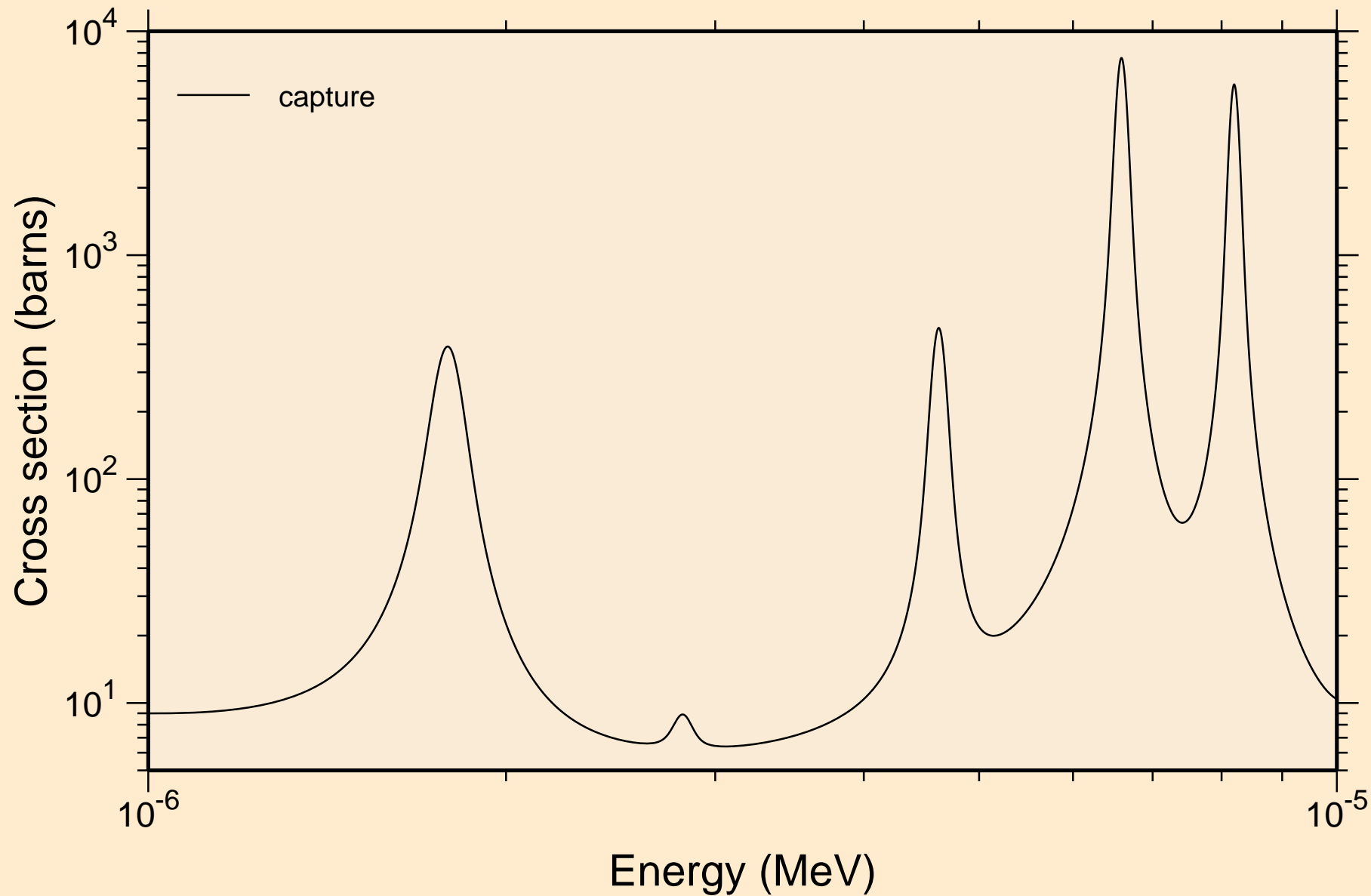

PM152 NEUTRON ACER TENDL-2019 LIBRARY; T=293.16K
resonance absorption cross sections

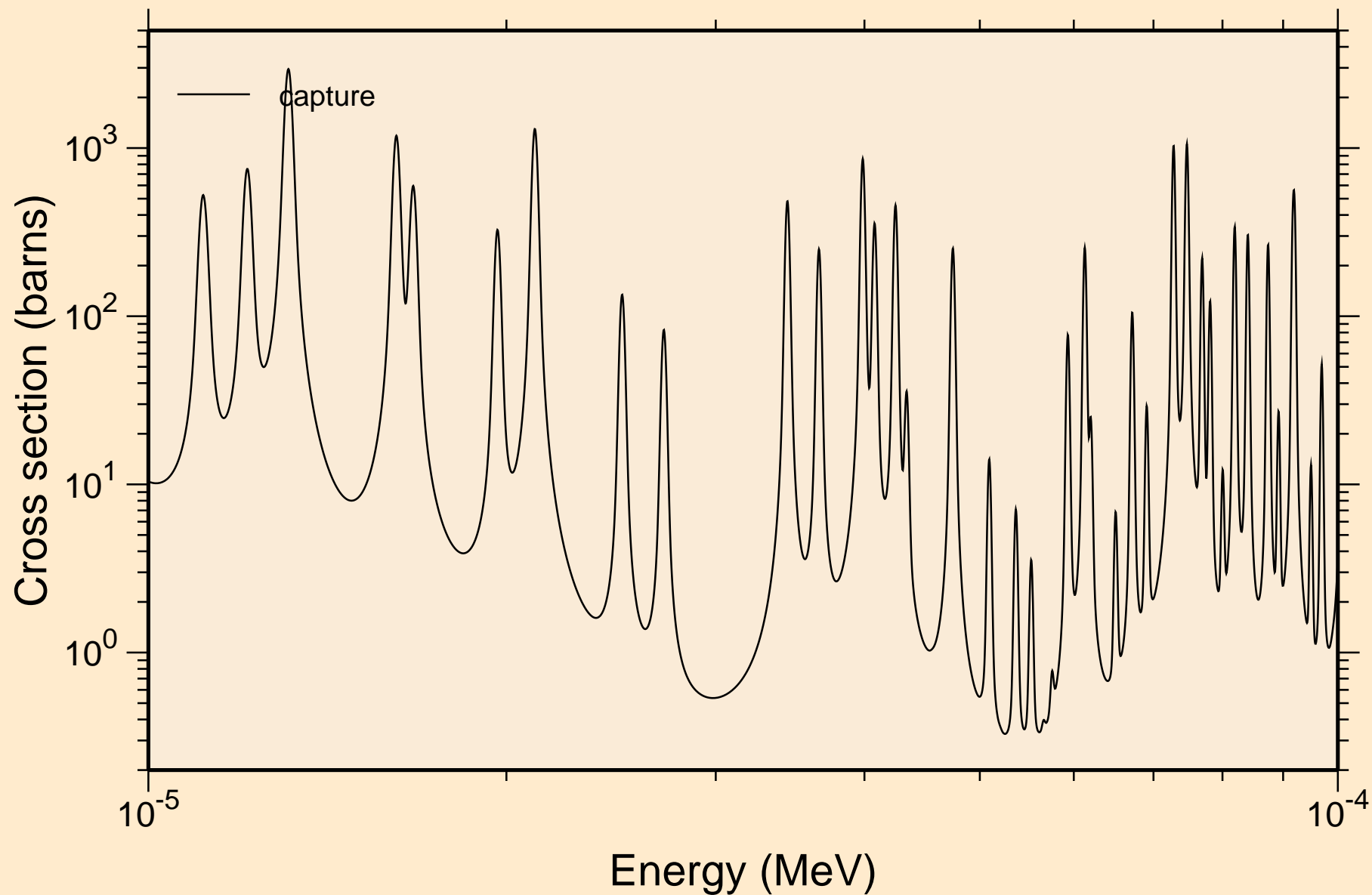

PM152 NEUTRON ACER TENDL-2019 LIBRARY; T=293.16K
resonance absorption cross sections

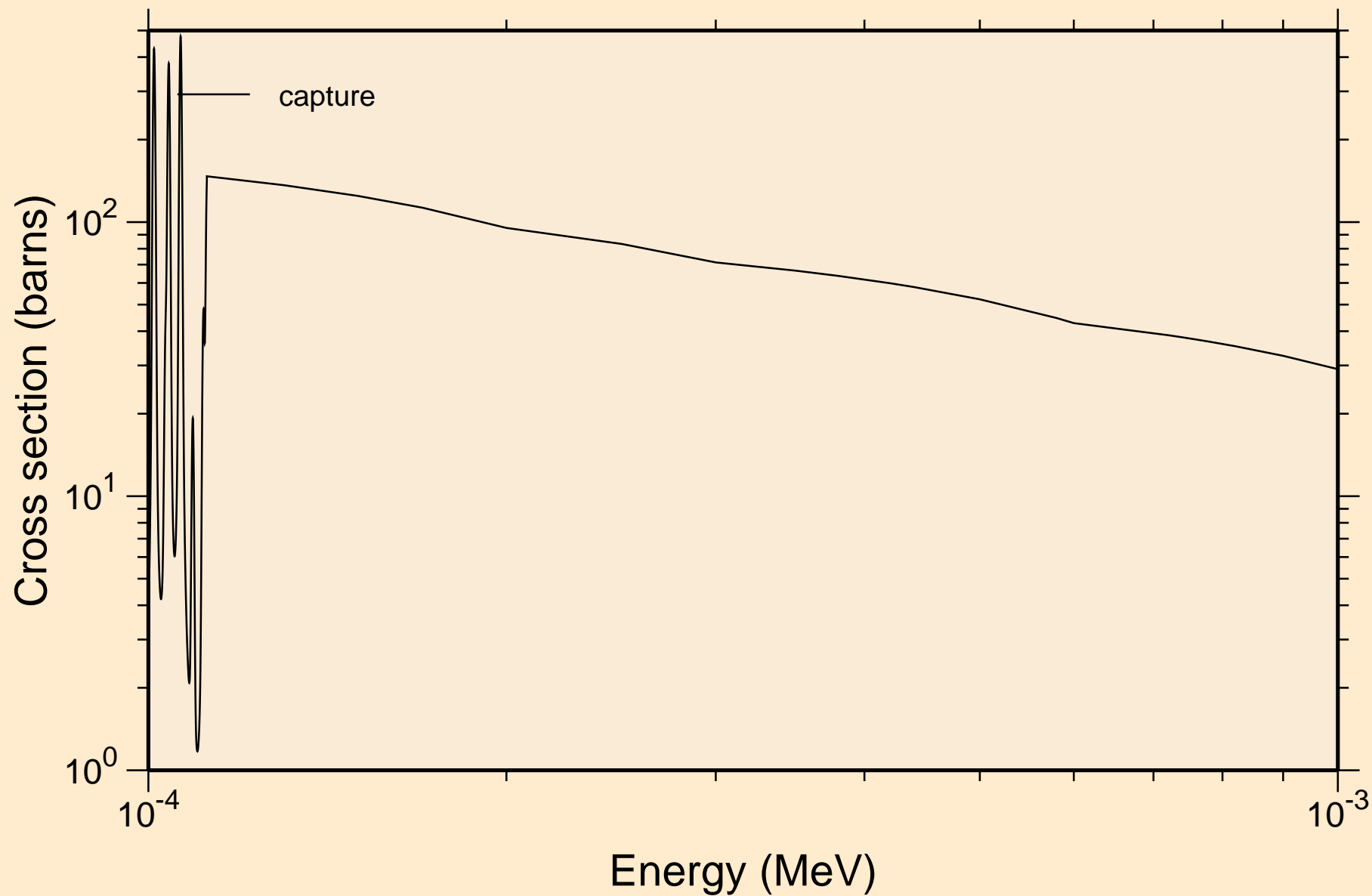

PM152 NEUTRON ACER TENDL-2019 LIBRARY; T=293.16K
resonance absorption cross sections

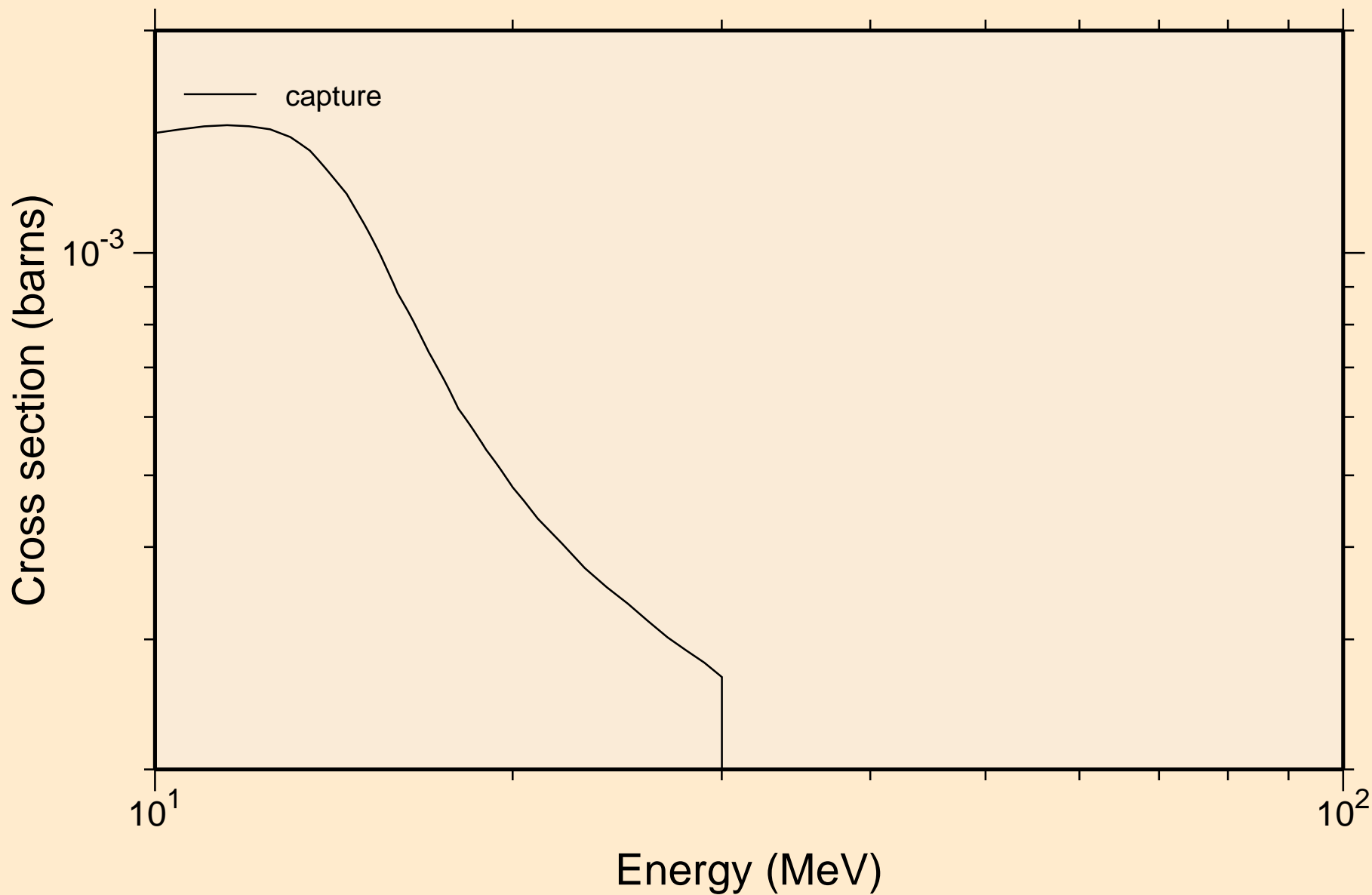

PM152 NEUTRON ACER TENDL-2019 LIBRARY; T=293.16K
Heating

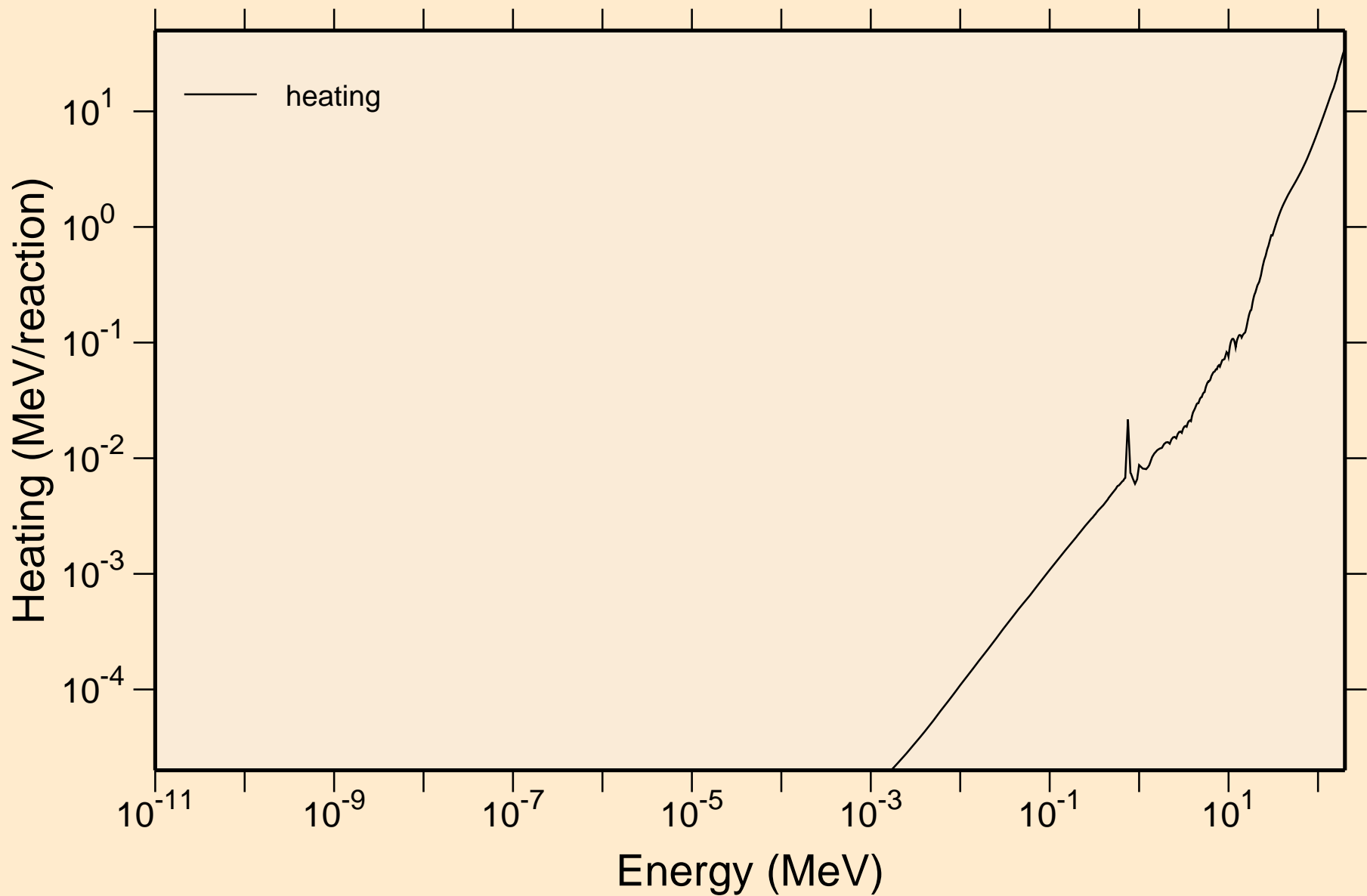

PM152 NEUTRON ACER TENDL-2019 LIBRARY; T=293.16K
Damage

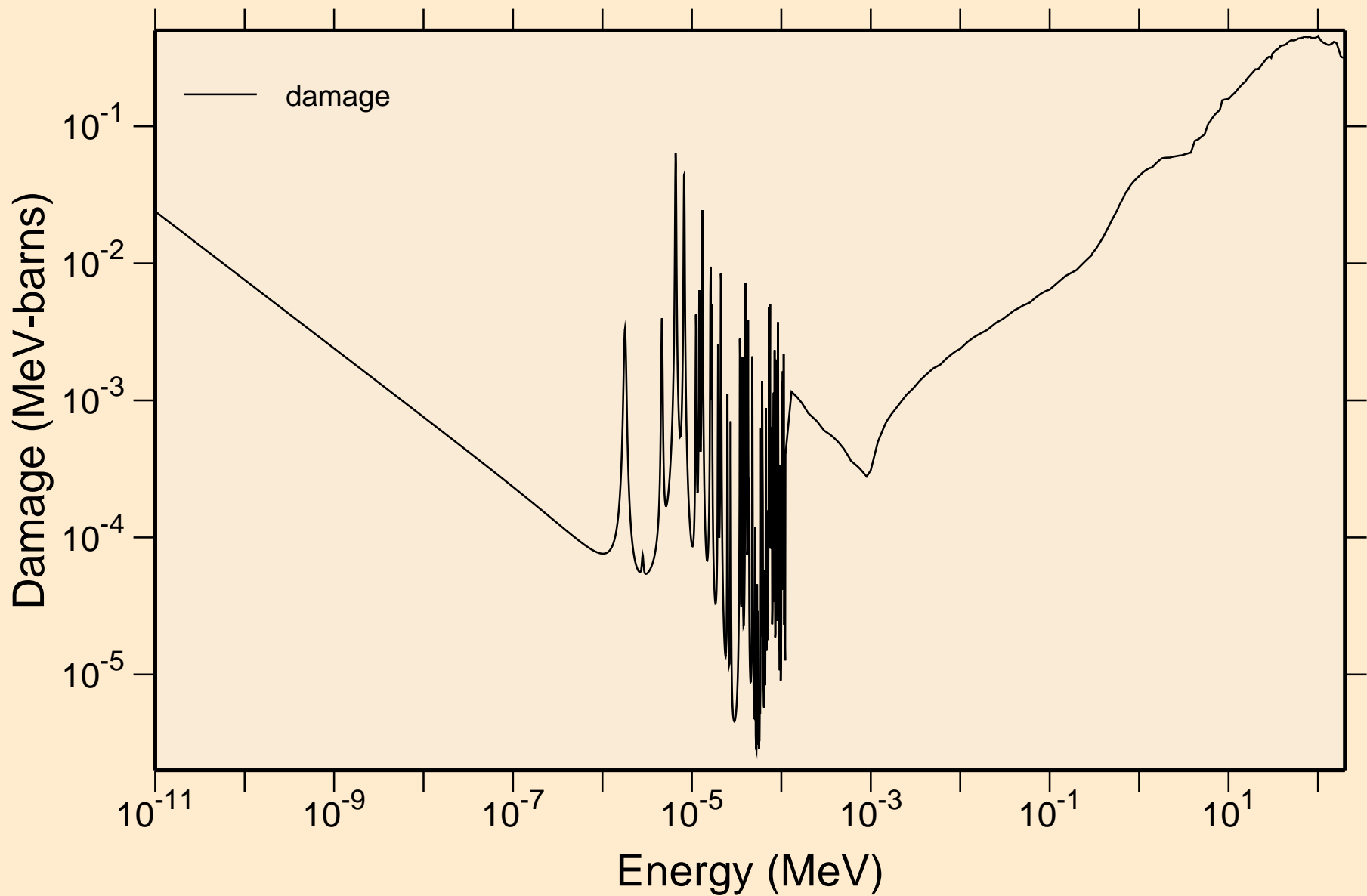

PM152 NEUTRON ACER TENDL-2019 LIBRARY; T=293.16K
Non-threshold reactions

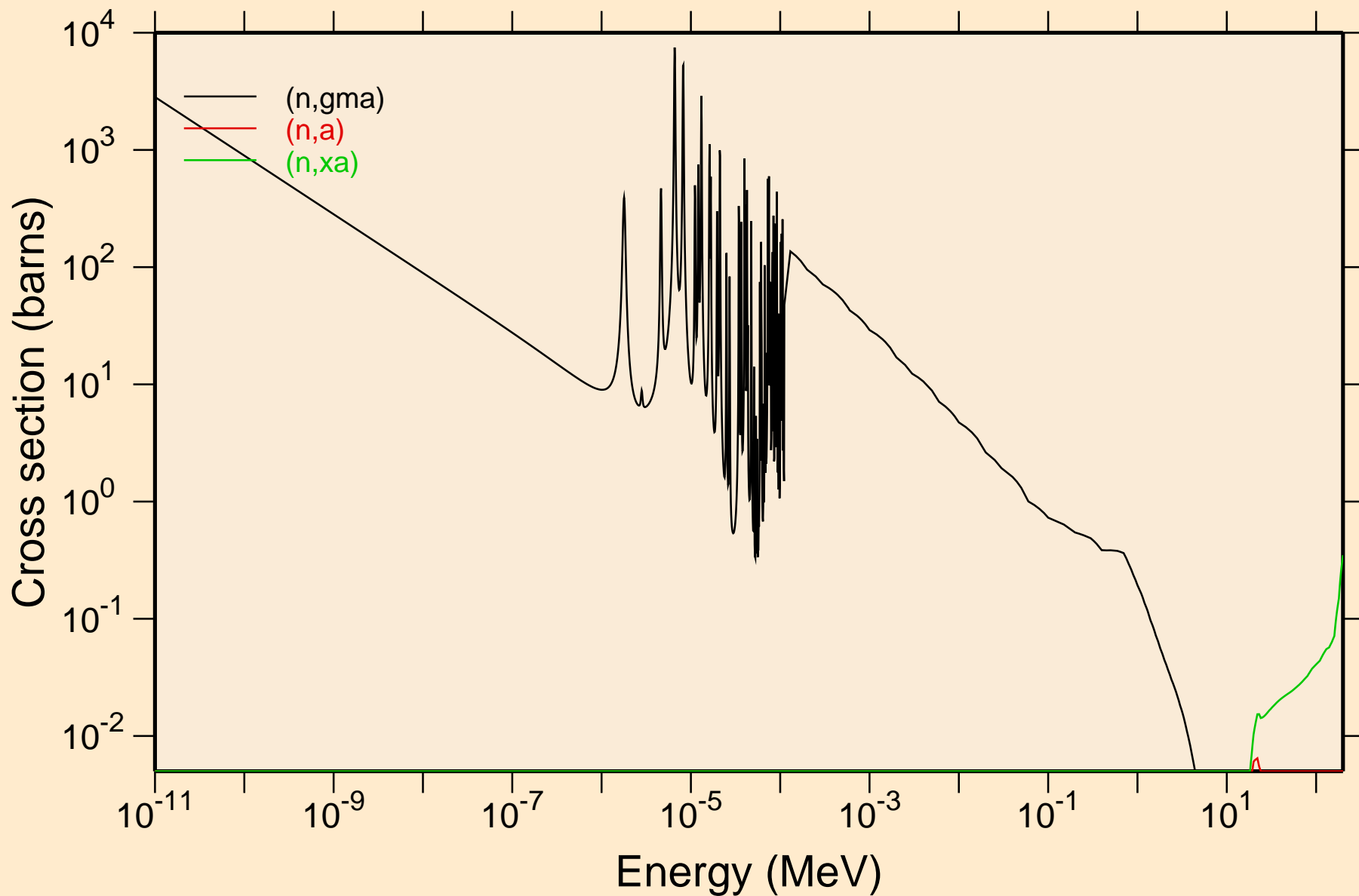

PM152 NEUTRON ACER TENDL-2019 LIBRARY; T=293.16K
Principal cross sections

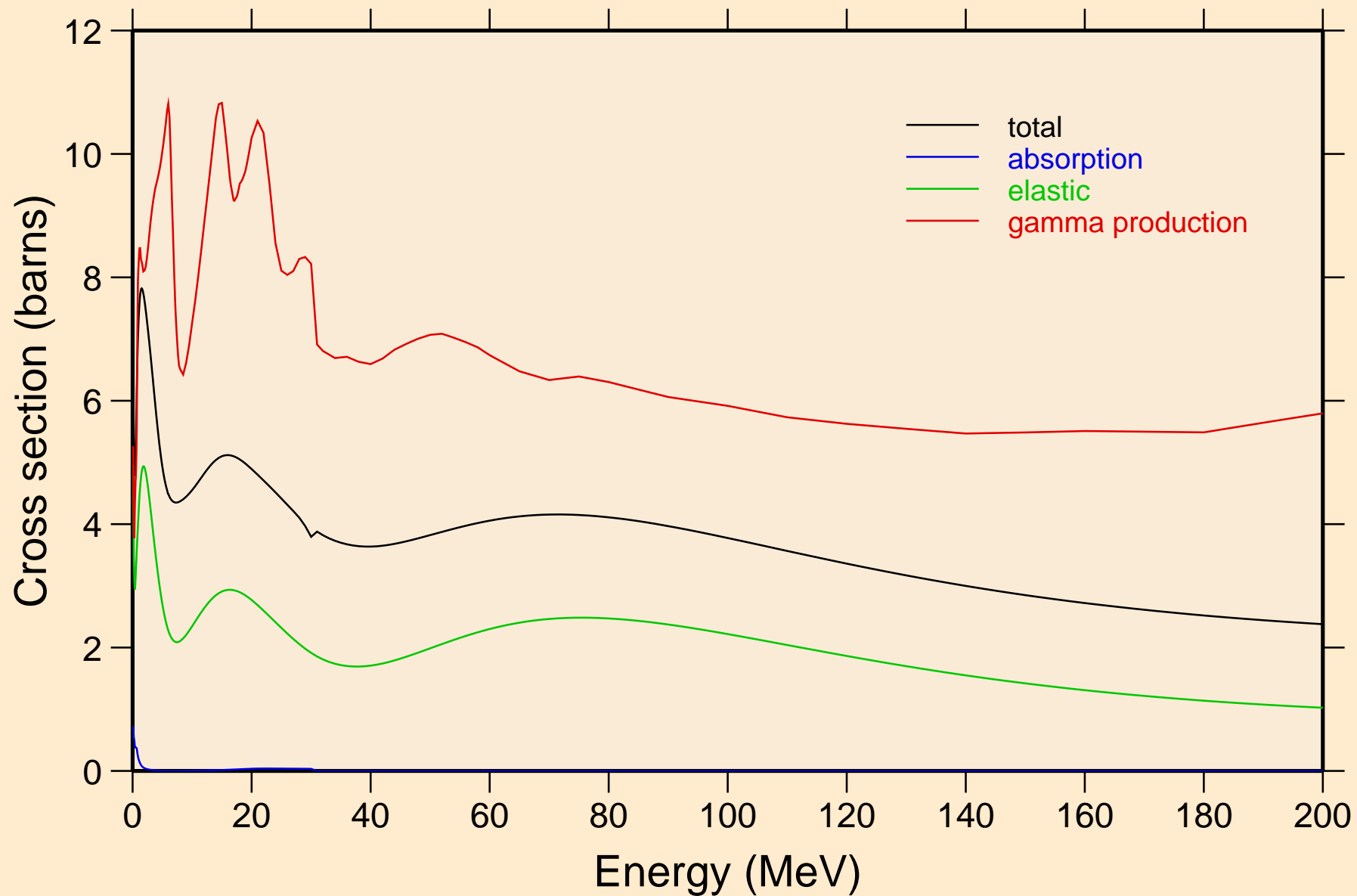

PM152 NEUTRON ACER TENDL-2019 LIBRARY; T=293.16K
Heating

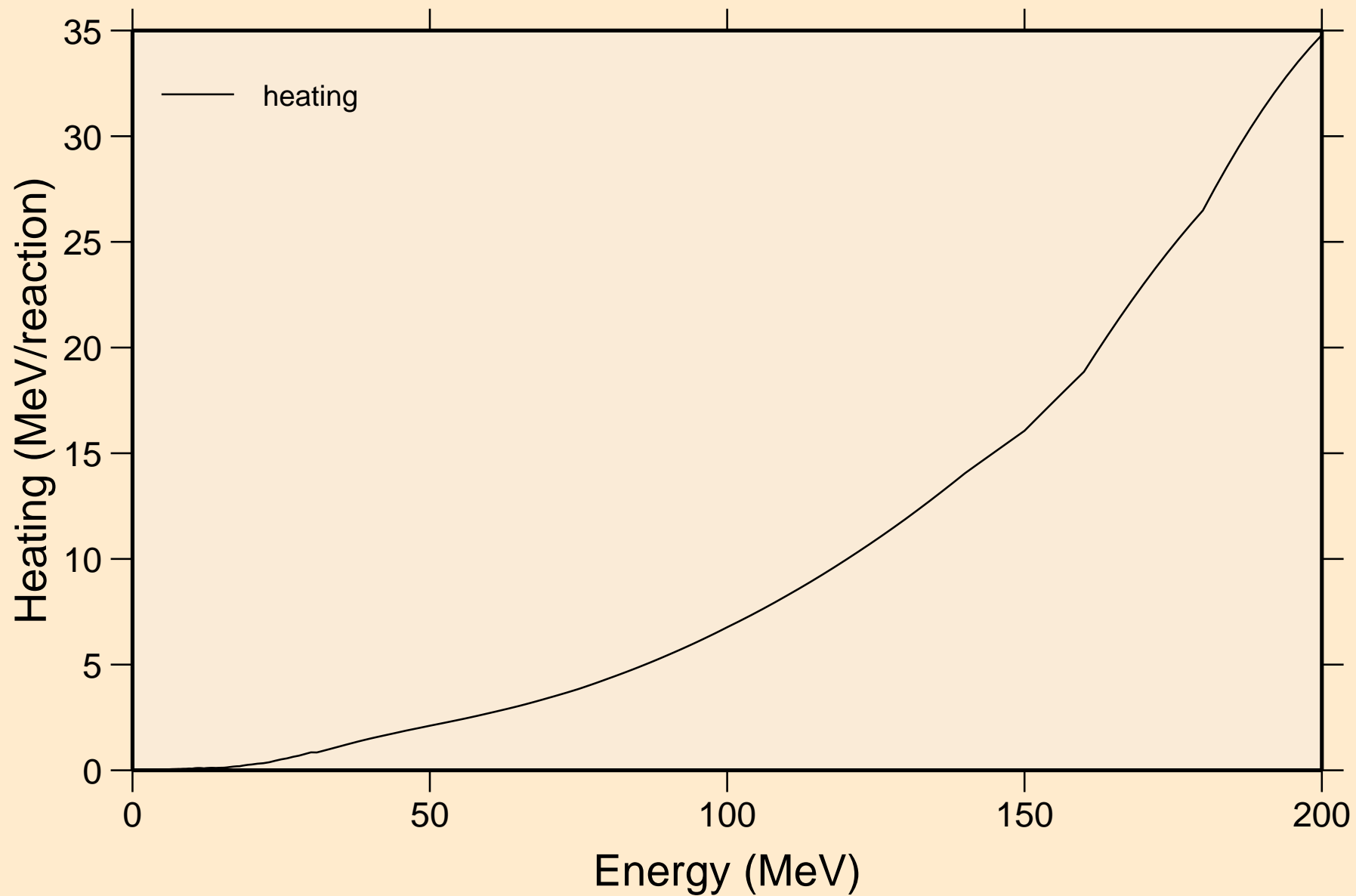

PM152 NEUTRON ACER TENDL-2019 LIBRARY; T=293.16K
Damage

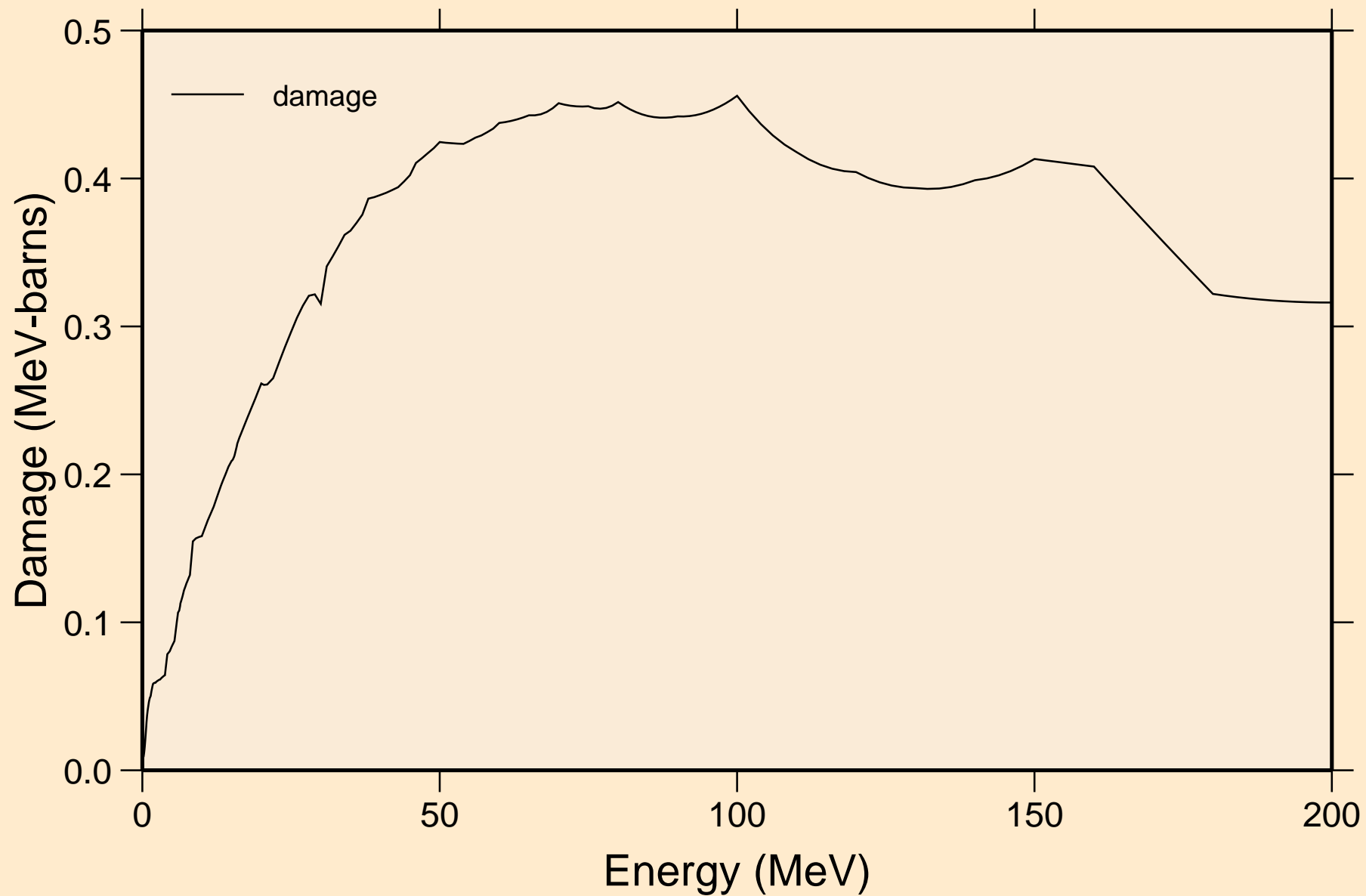

PM152 NEUTRON ACER TENDL-2019 LIBRARY; T=293.16K
Non-threshold reactions

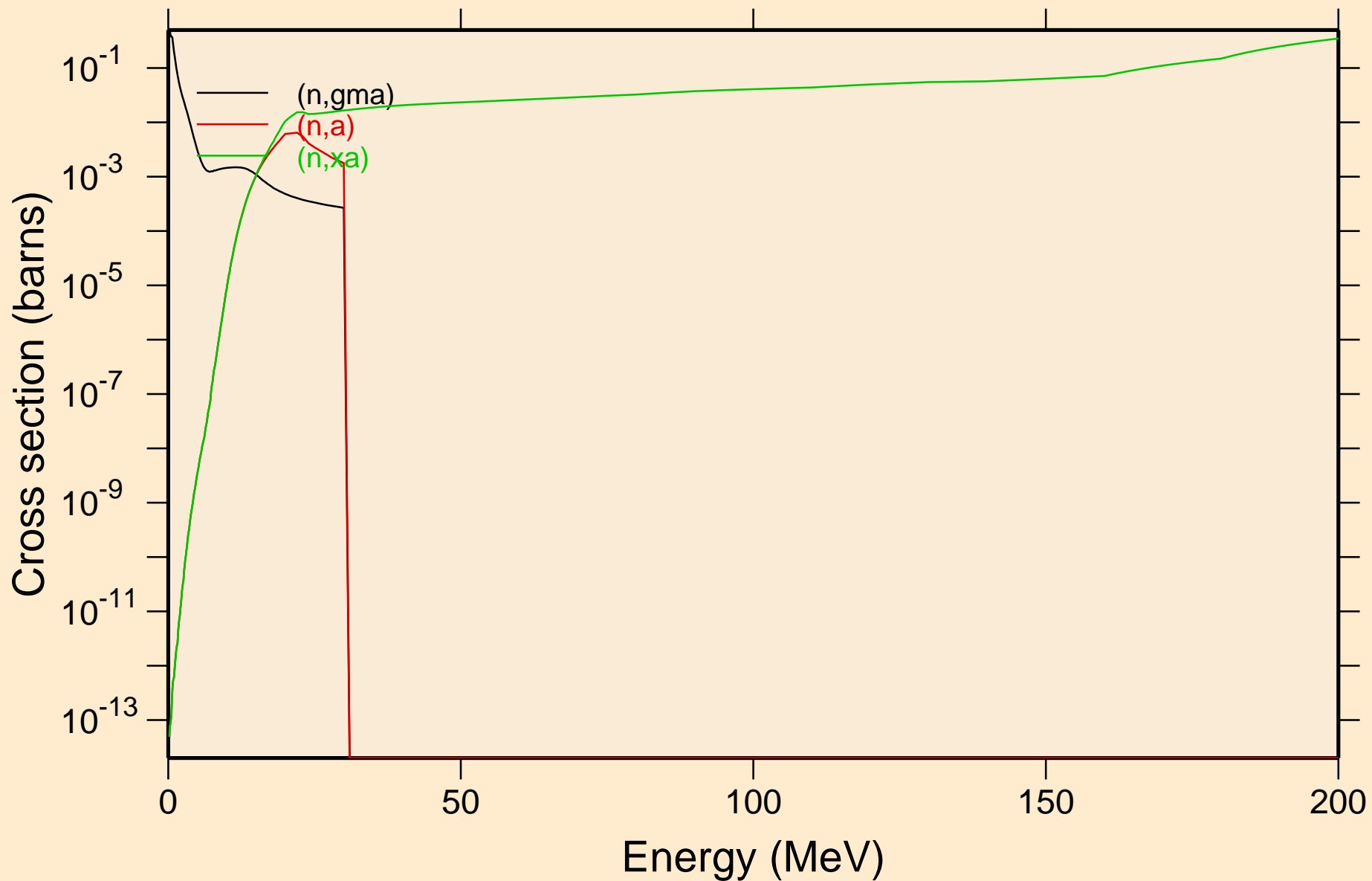

PM152 NEUTRON ACER TENDL-2019 LIBRARY; T=293.16K
Inelastic levels

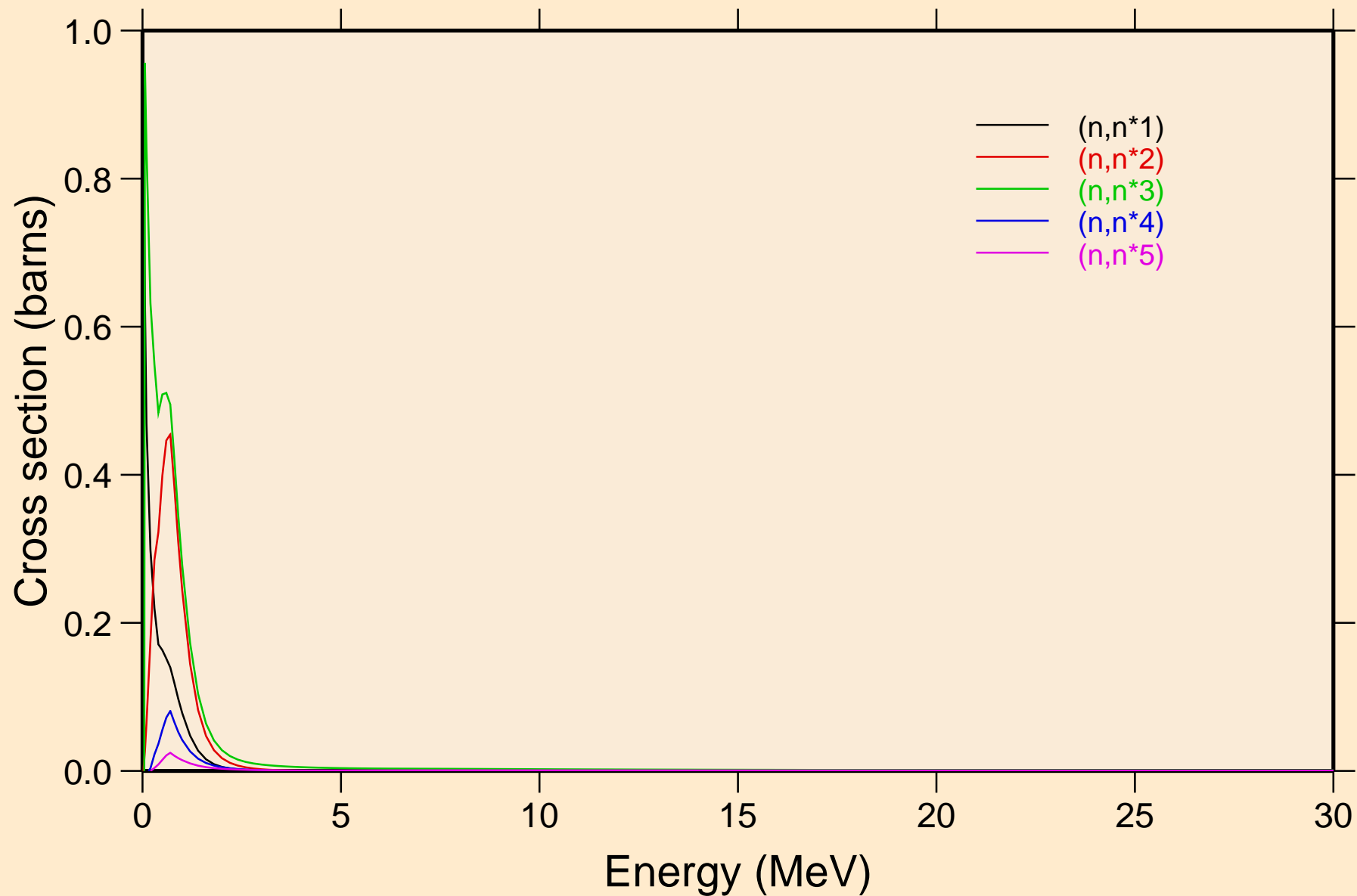

PM152 NEUTRON ACER TENDL-2019 LIBRARY; T=293.16K
Inelastic levels

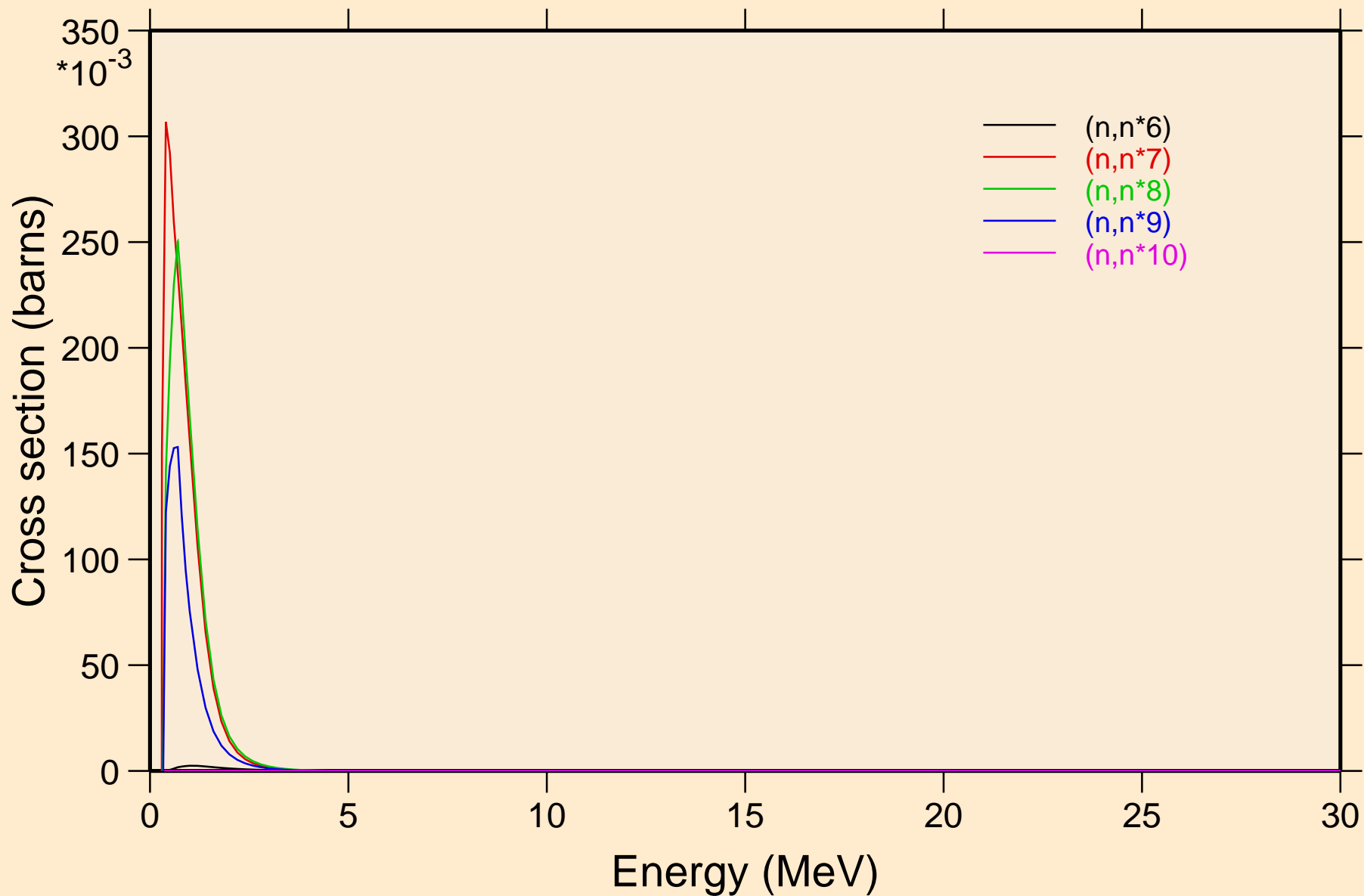

PM152 NEUTRON ACER TENDL-2019 LIBRARY; T=293.16K
Inelastic levels

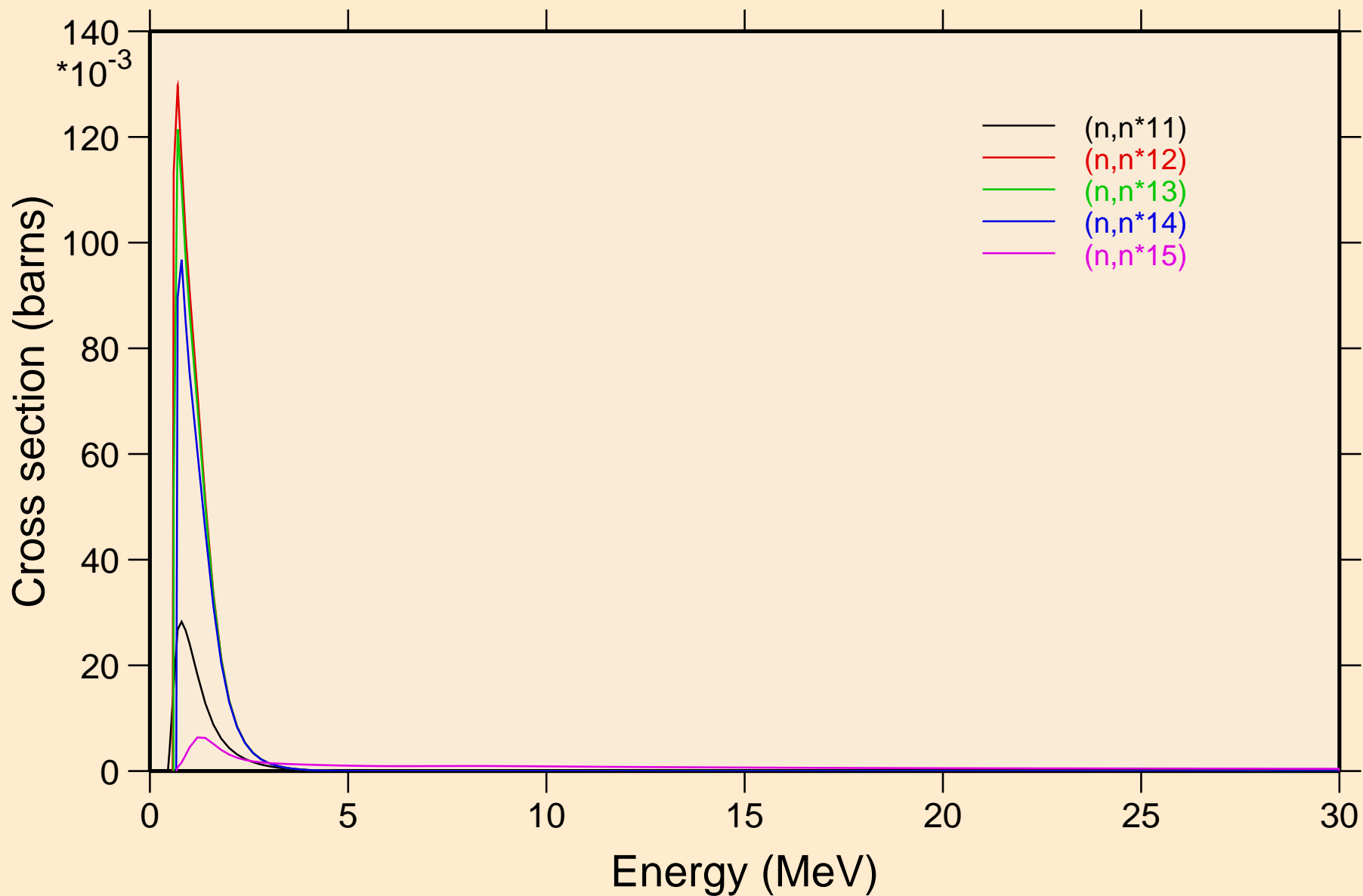

PM152 NEUTRON ACER TENDL-2019 LIBRARY; T=293.16K
Inelastic levels

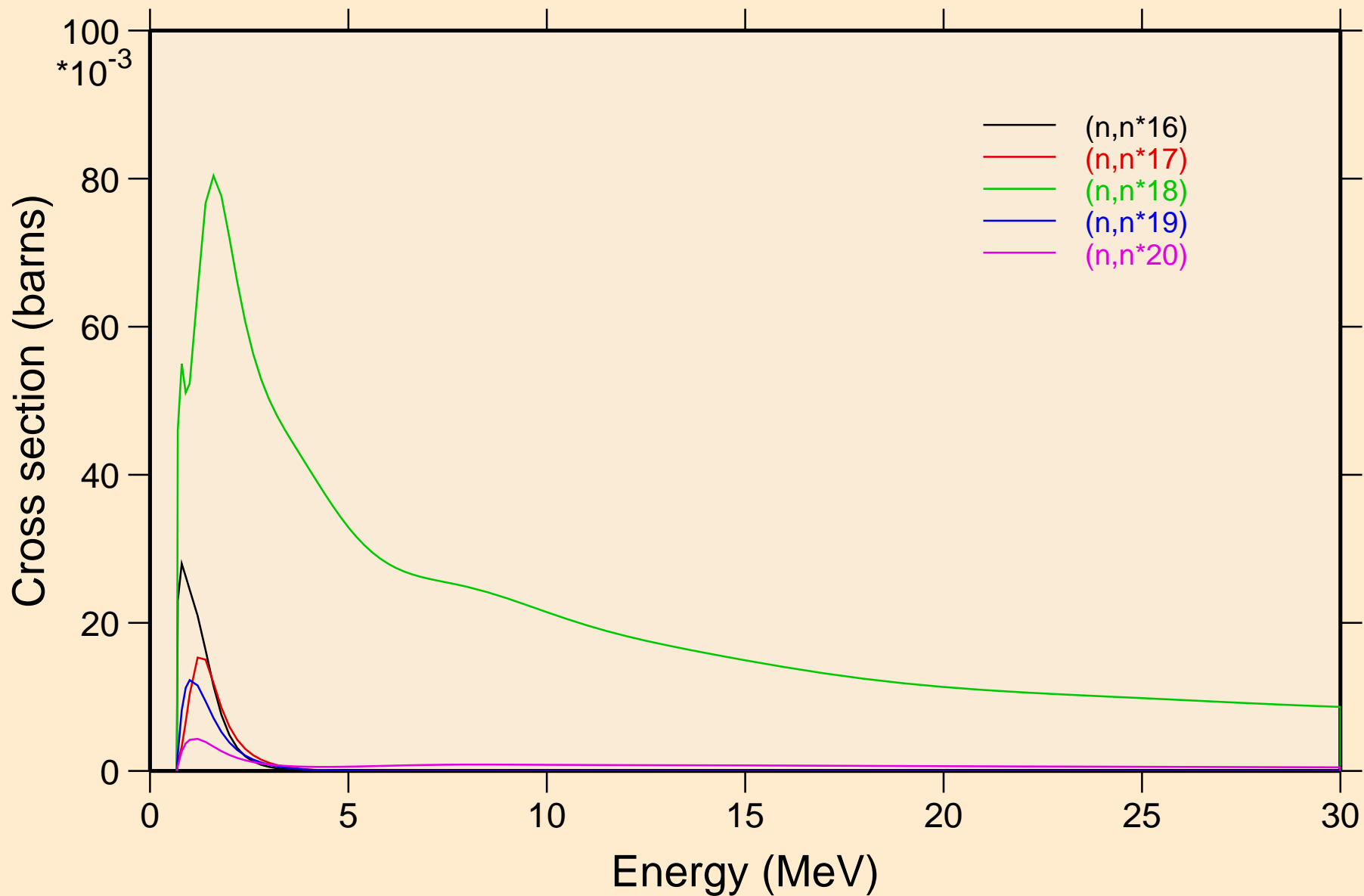

PM152 NEUTRON ACER TENDL-2019 LIBRARY; T=293.16K
Inelastic levels

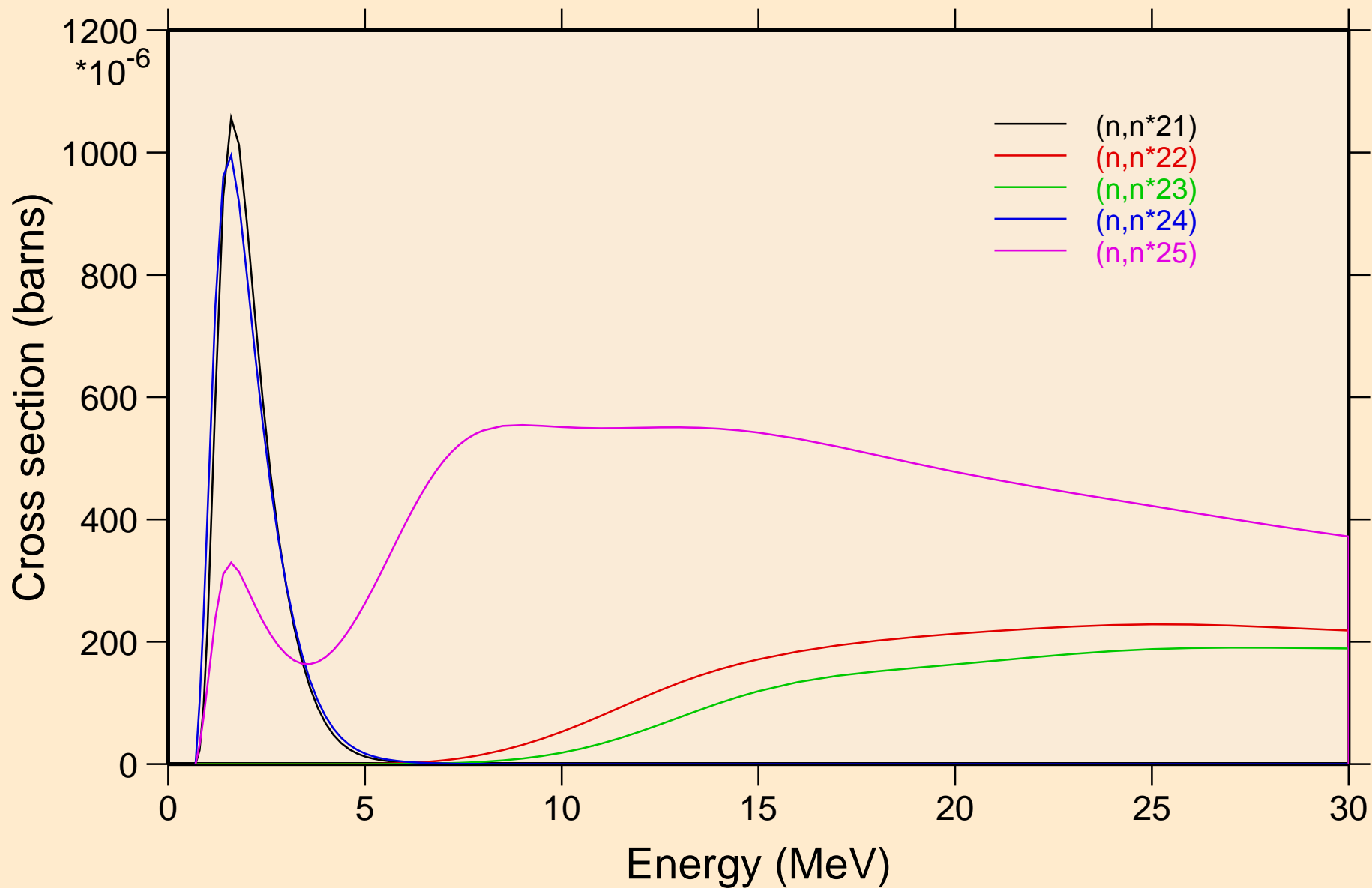

PM152 NEUTRON ACER TENDL-2019 LIBRARY; T=293.16K
Inelastic levels

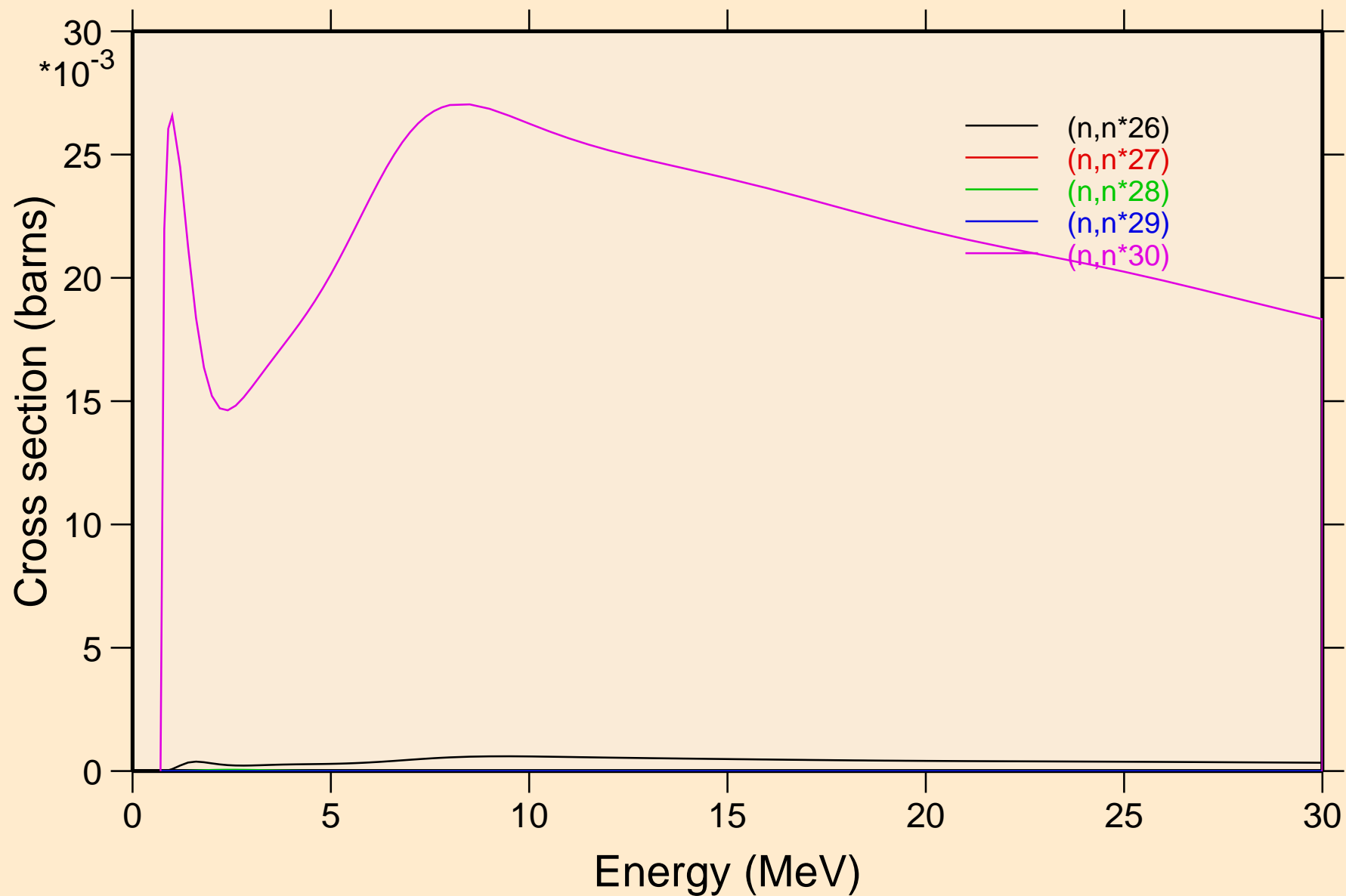

PM152 NEUTRON ACER TENDL-2019 LIBRARY; T=293.16K
Threshold reactions

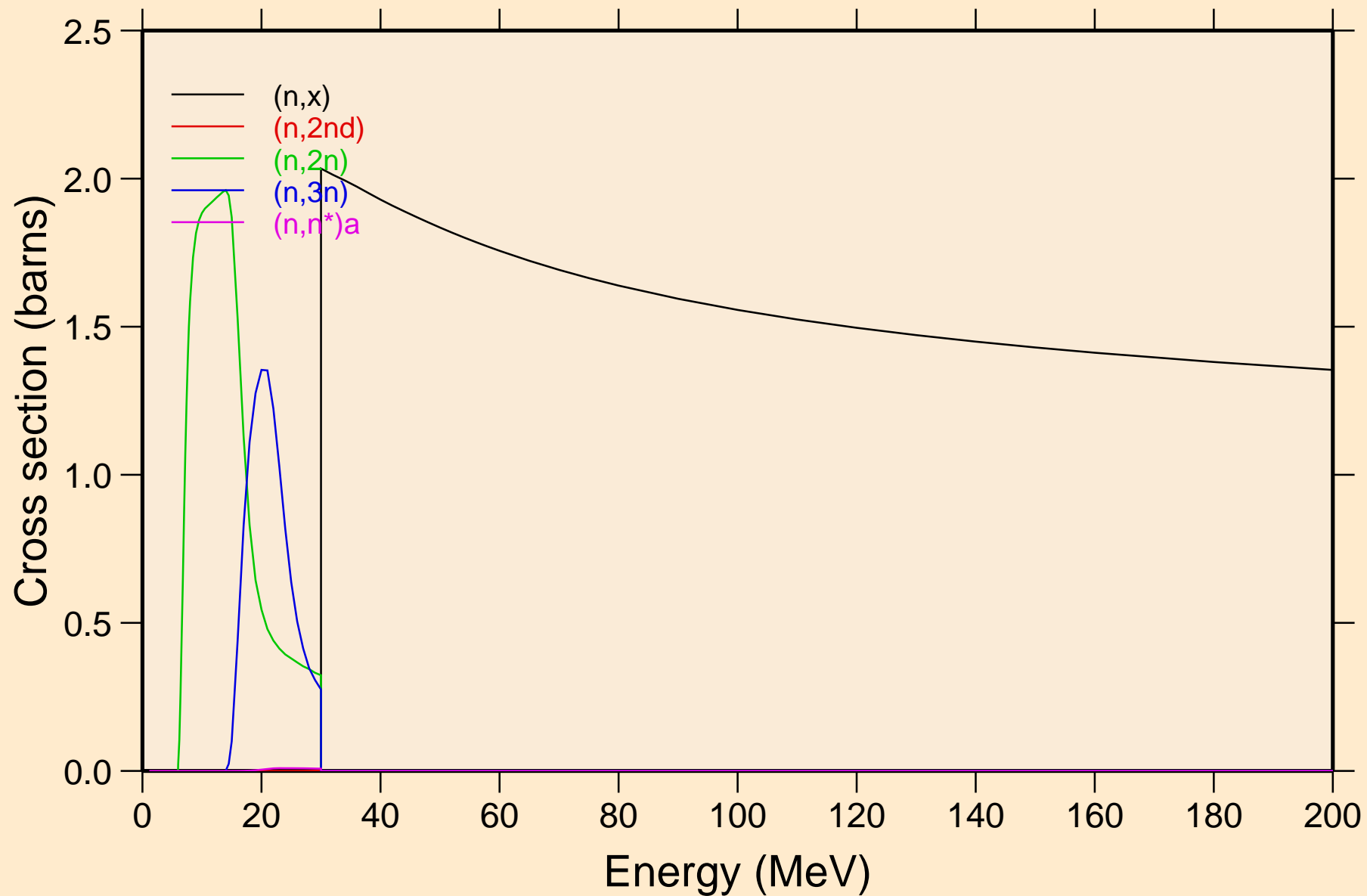

PM152 NEUTRON ACER TENDL-2019 LIBRARY; T=293.16K
Threshold reactions

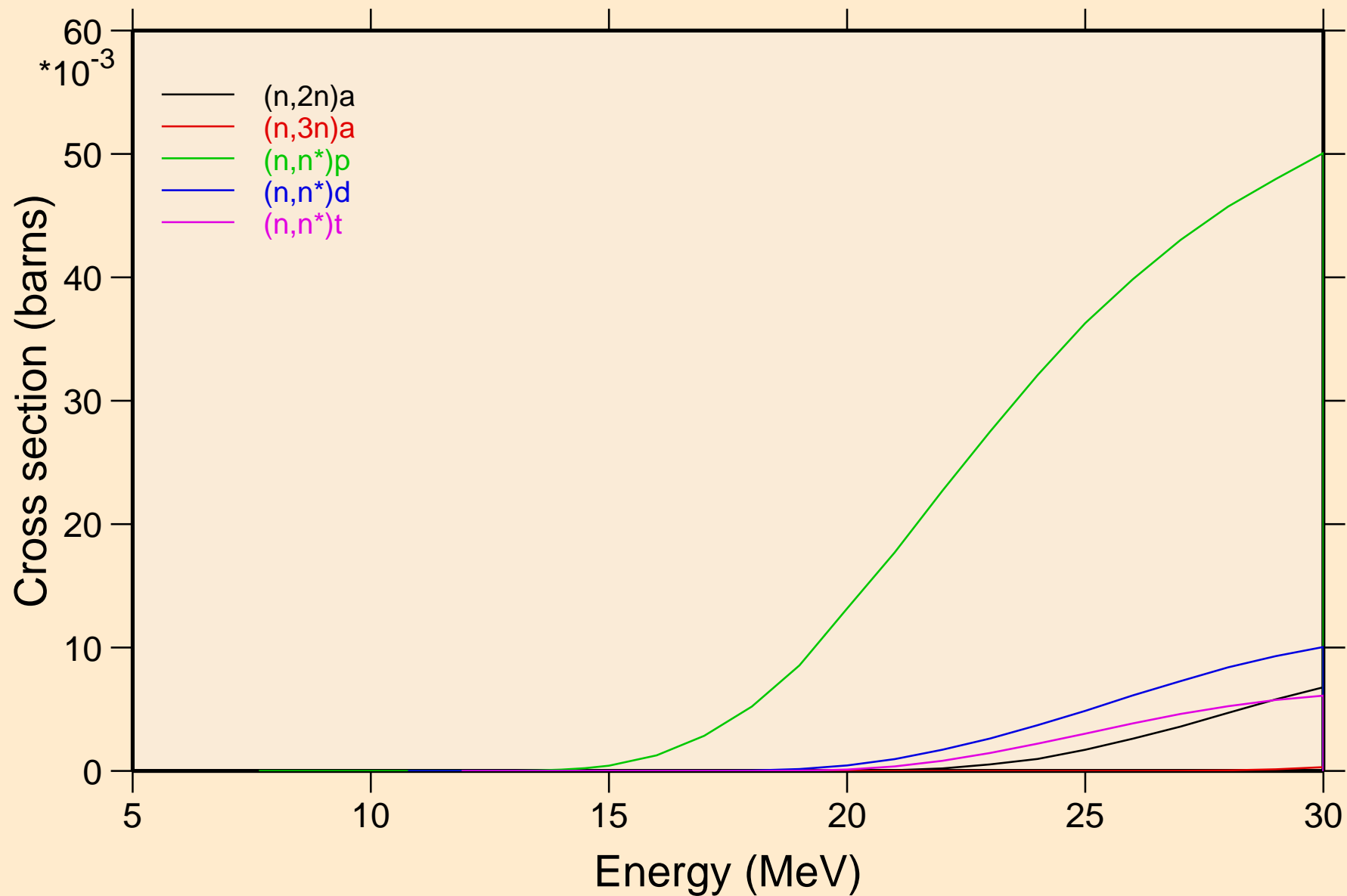

PM152 NEUTRON ACER TENDL-2019 LIBRARY; T=293.16K
Threshold reactions

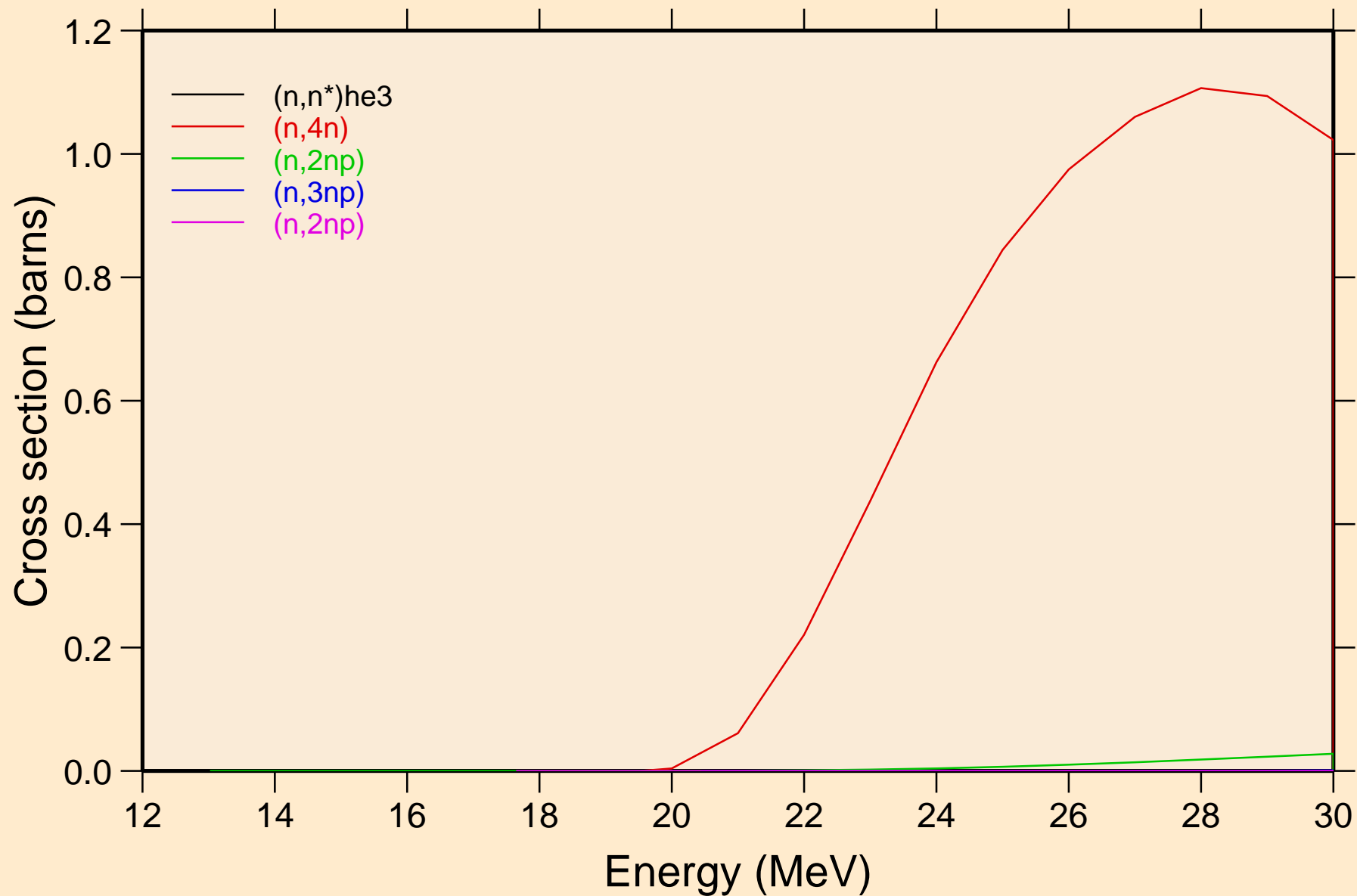

PM152 NEUTRON ACER TENDL-2019 LIBRARY; T=293.16K
Threshold reactions

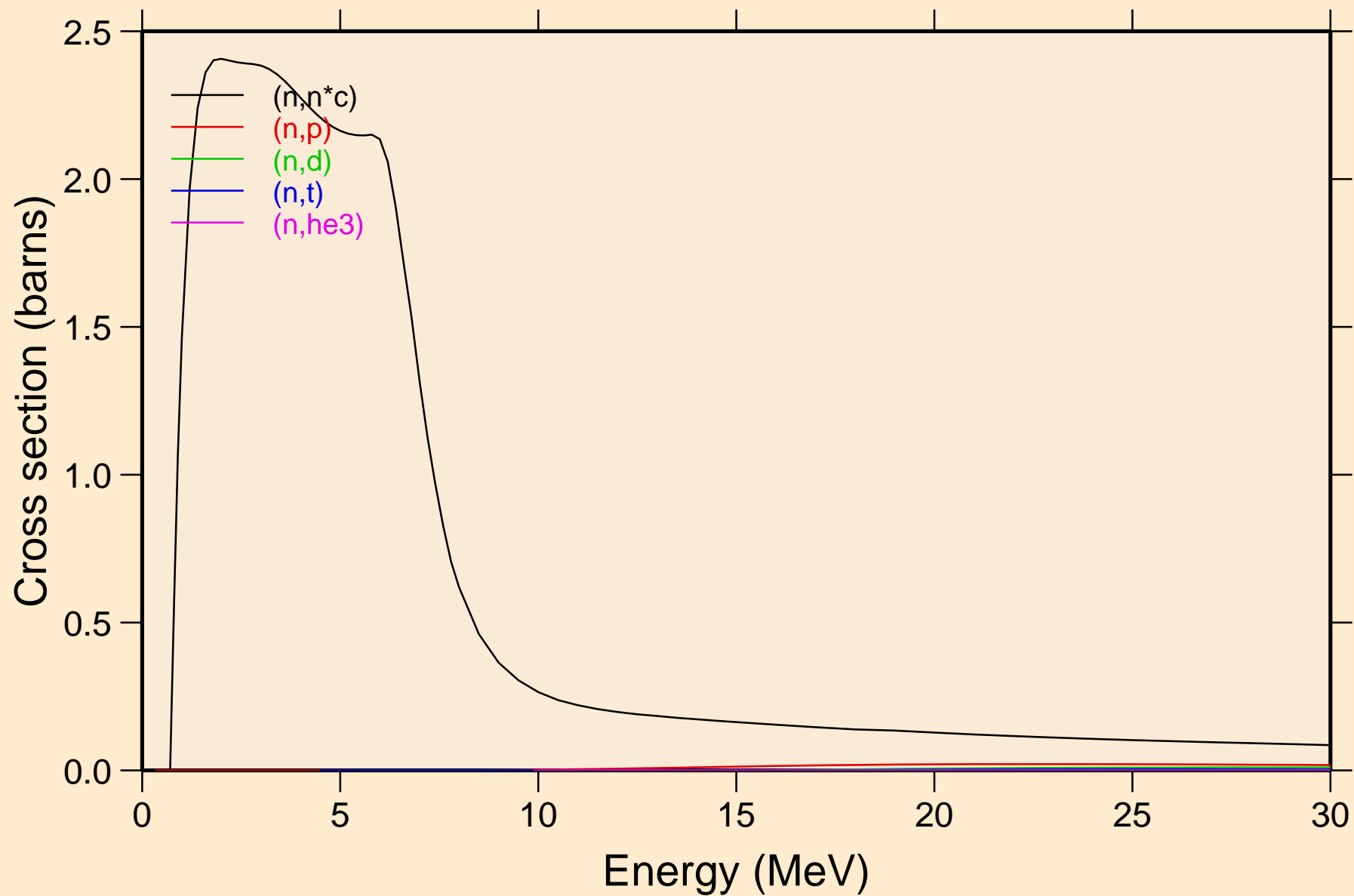

PM152 NEUTRON ACER TENDL-2019 LIBRARY; T=293.16K
Threshold reactions

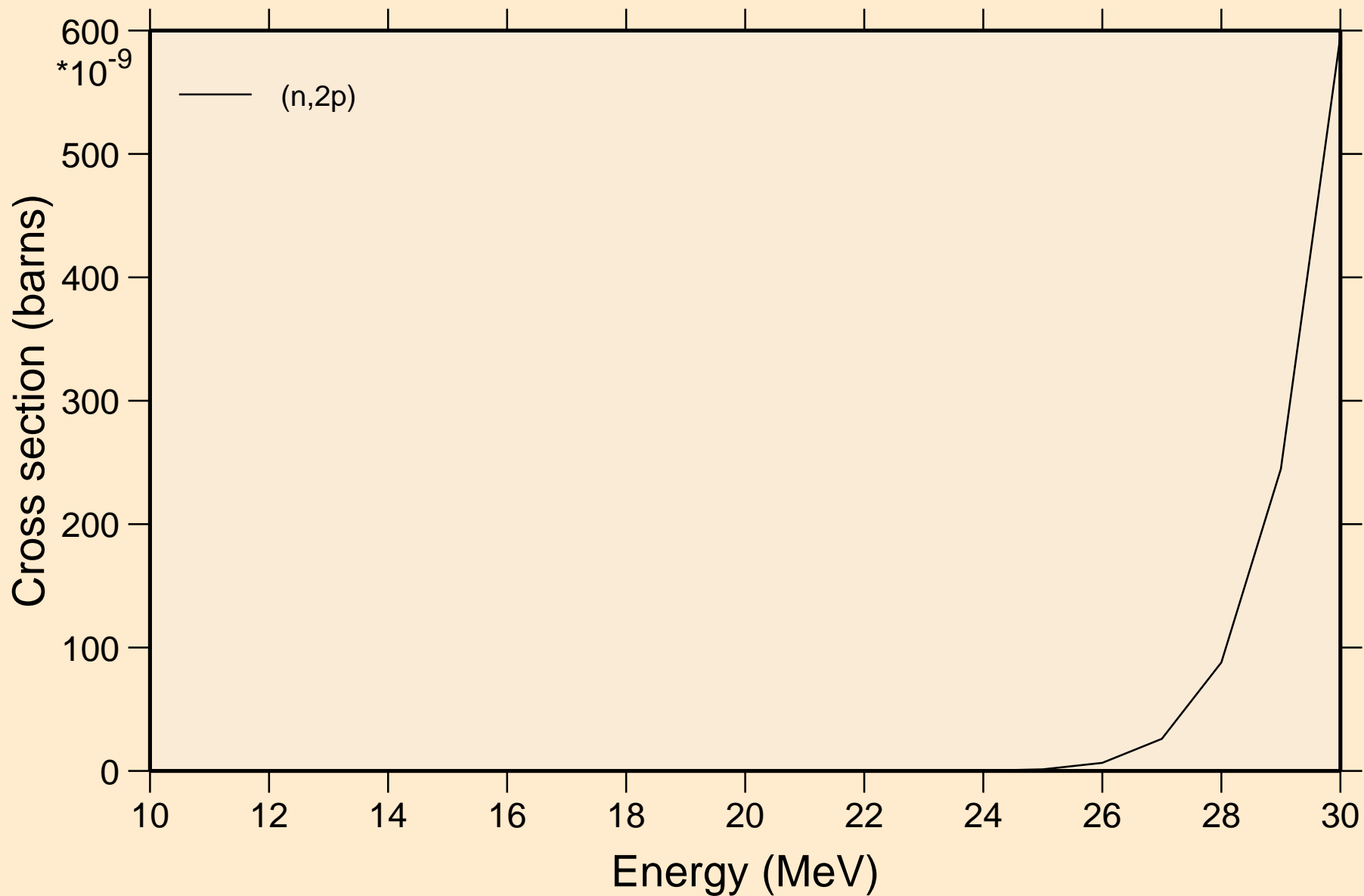

PM152 NEUTRON ACER TENDL-2019 LIBRARY; T=293.16K
Threshold reactions

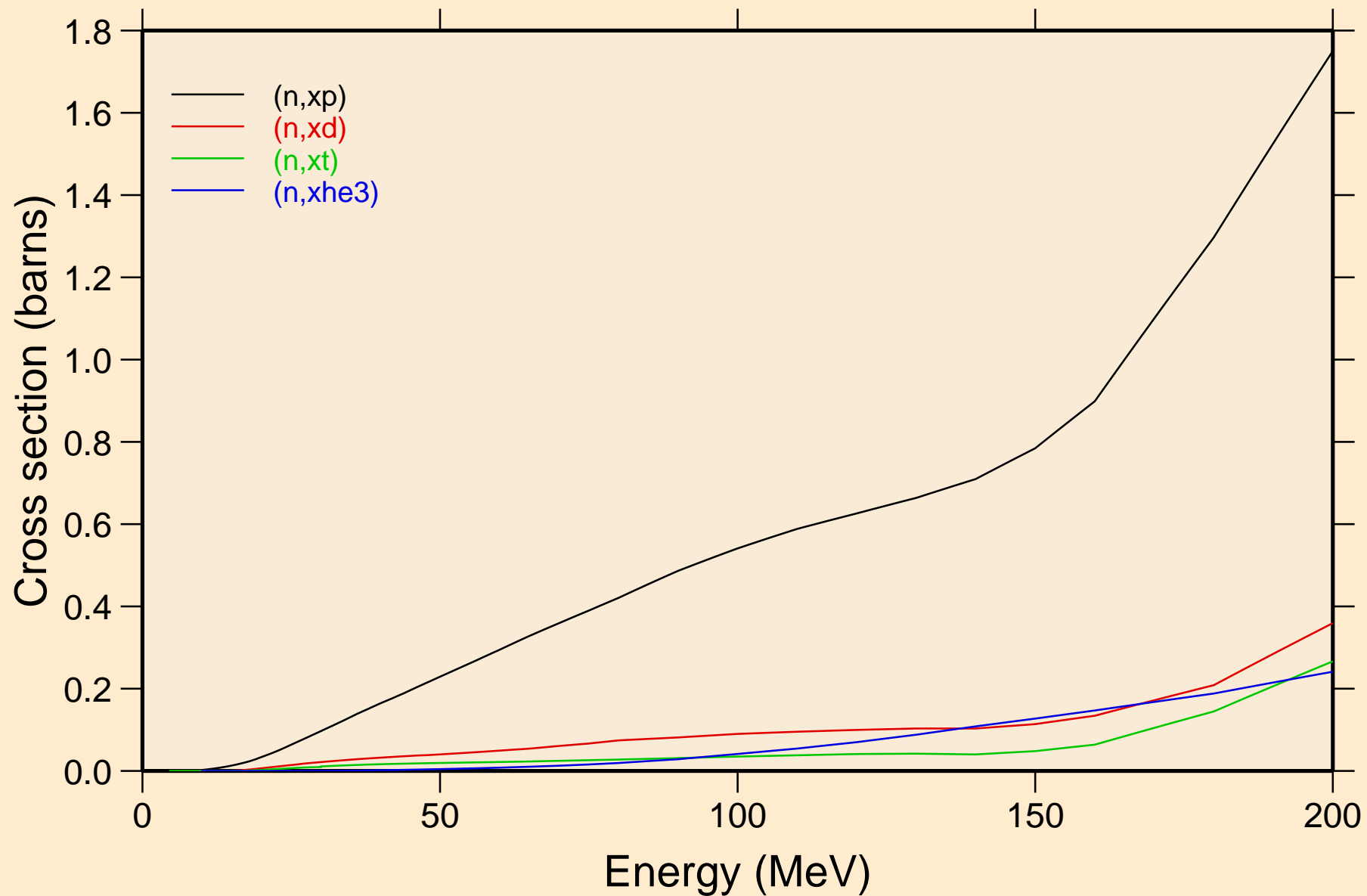

PM152 NEUTRON ACER TENDL-2019 LIBRARY; T=293.16K
angular distribution for elastic

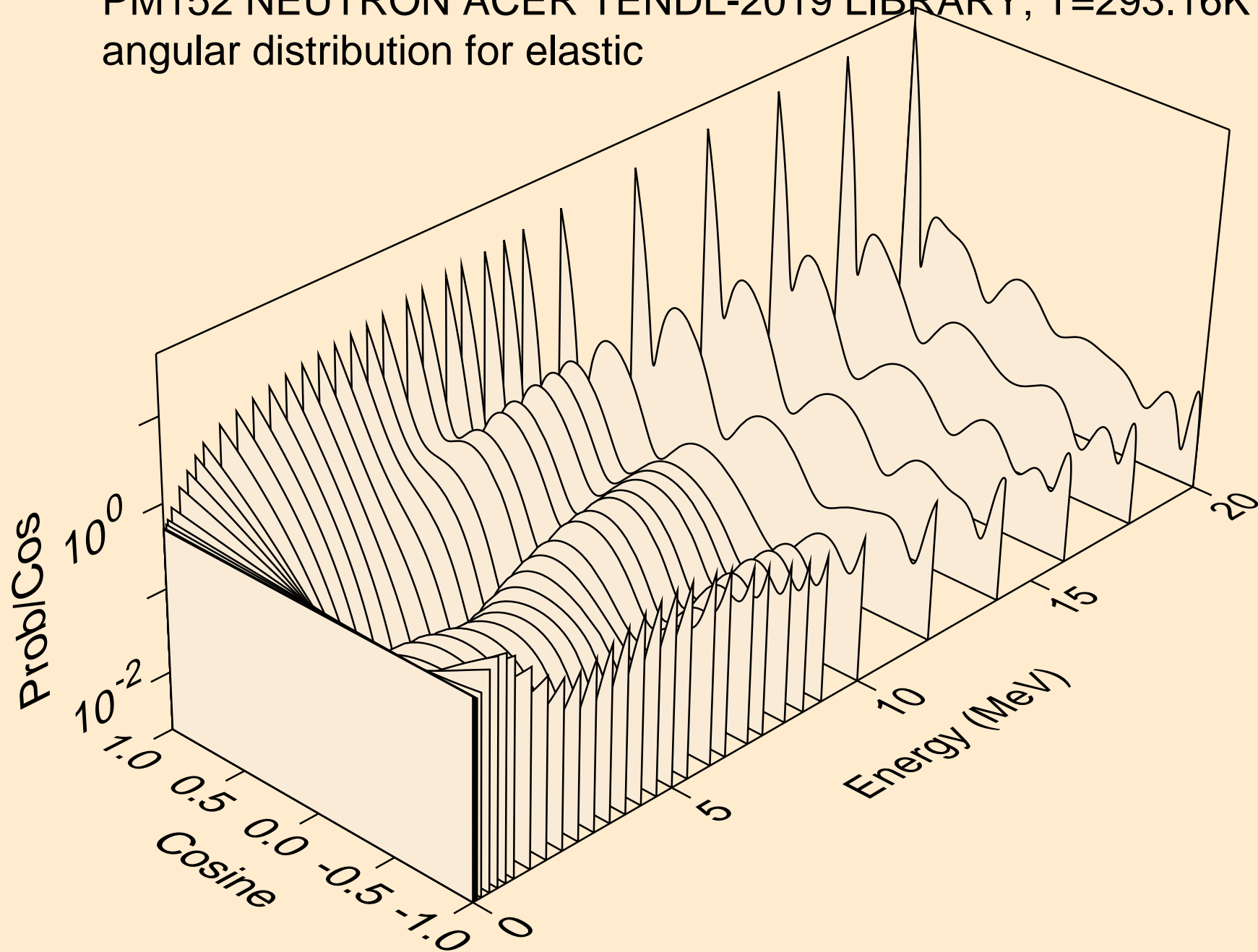

PM152 NEUTRON ACER TENDL-2019 LIBRARY; T=293.16K
angular distribution for elastic

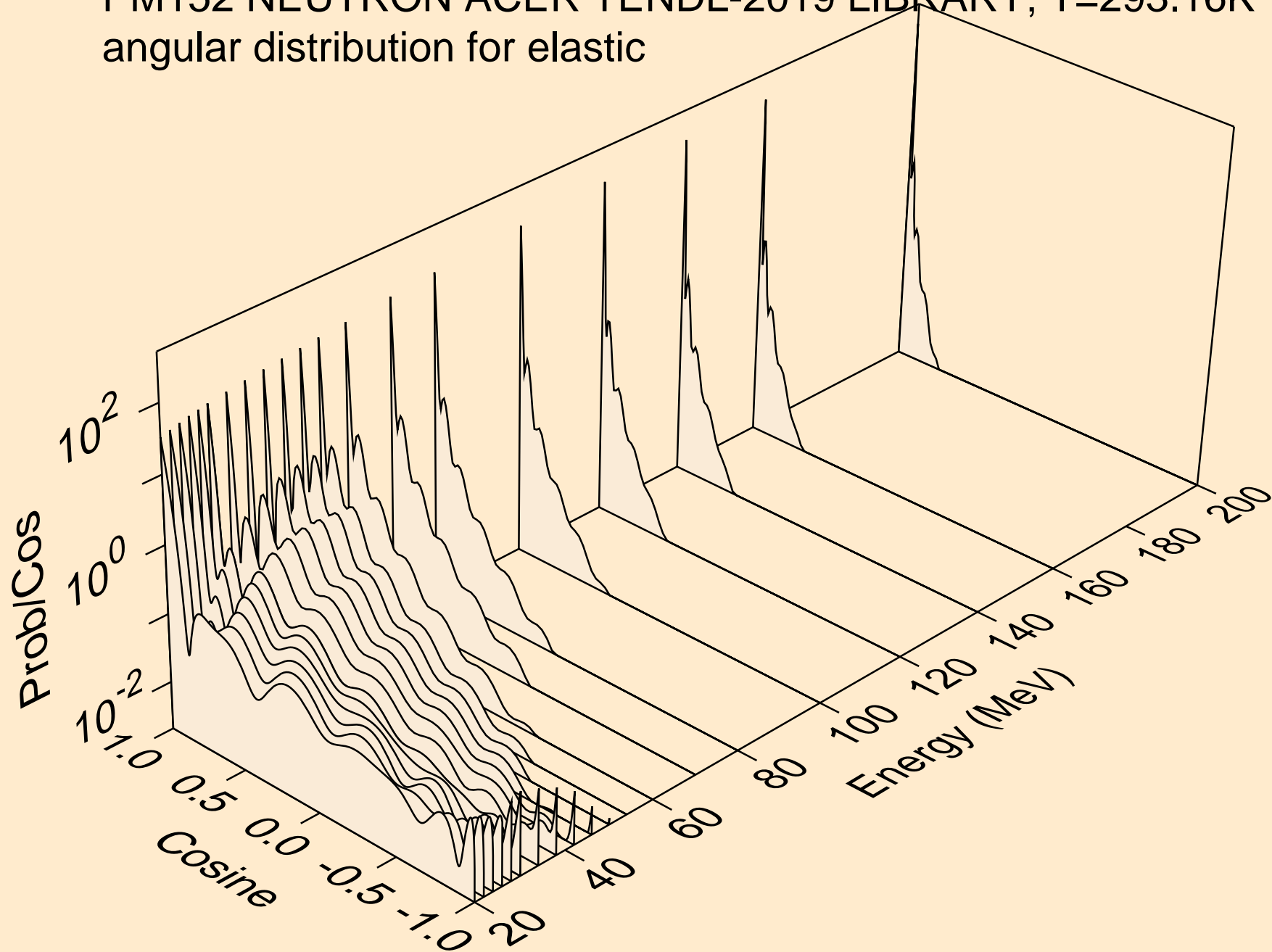

PM152 NEUTRON ACER TENDL-2019 LIBRARY; T=293.16K
angular distribution for (n,n*1)

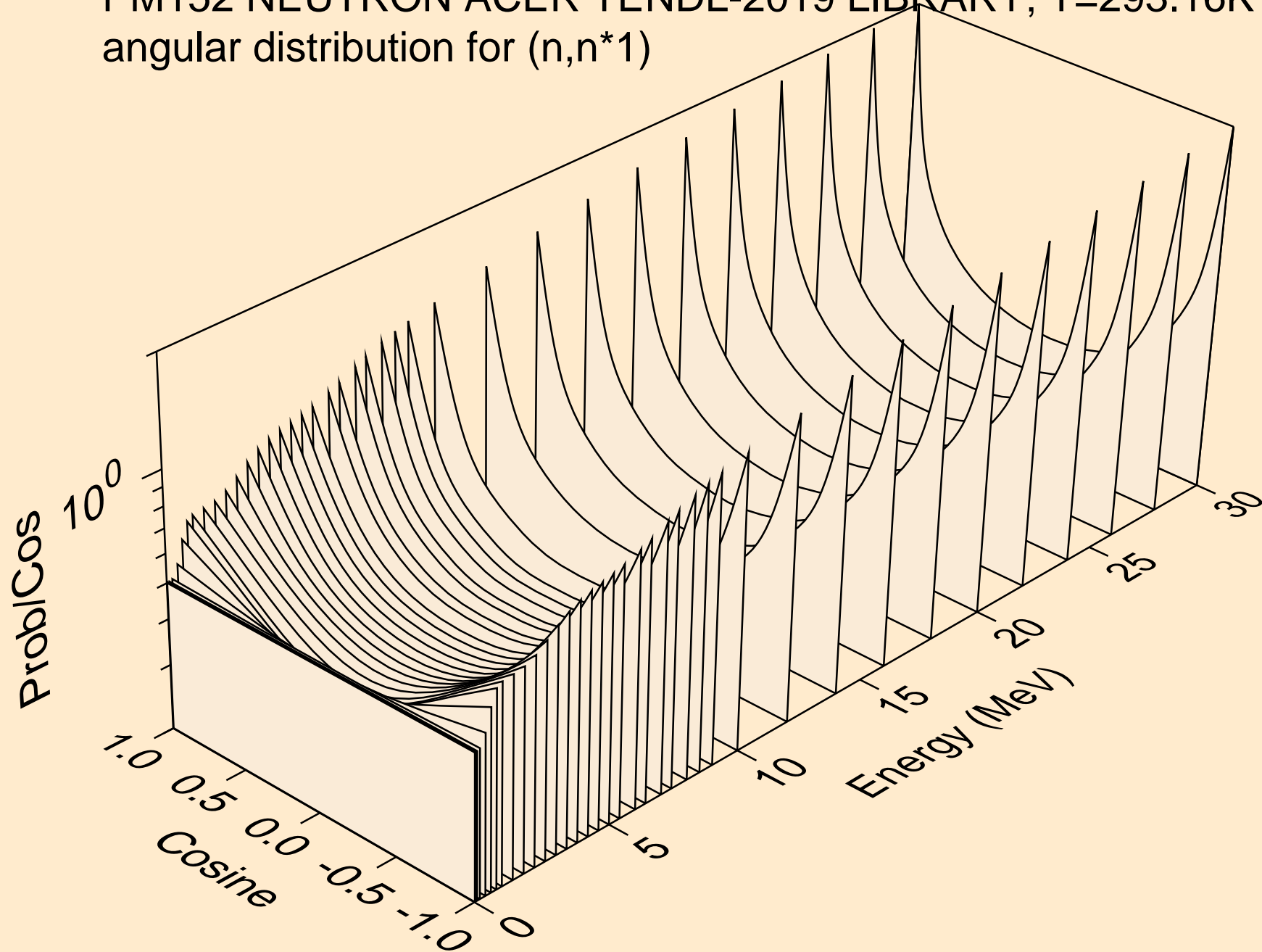

PM152 NEUTRON ACER TENDL-2019 LIBRARY; T=293.16K
angular distribution for (n,n*2)

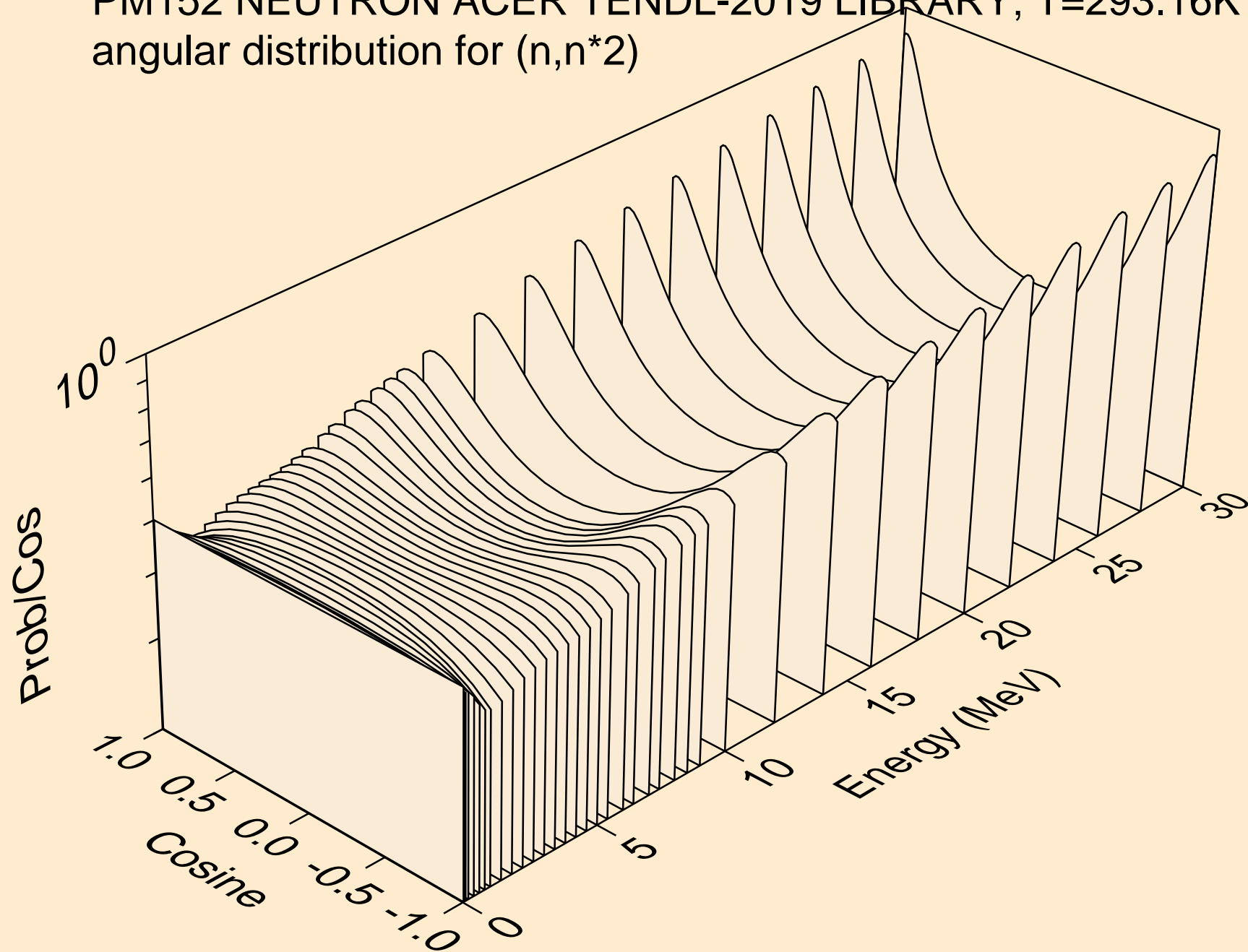

PM152 NEUTRON ACER TENDL-2019 LIBRARY; T=293.16K
angular distribution for (n,n*3)

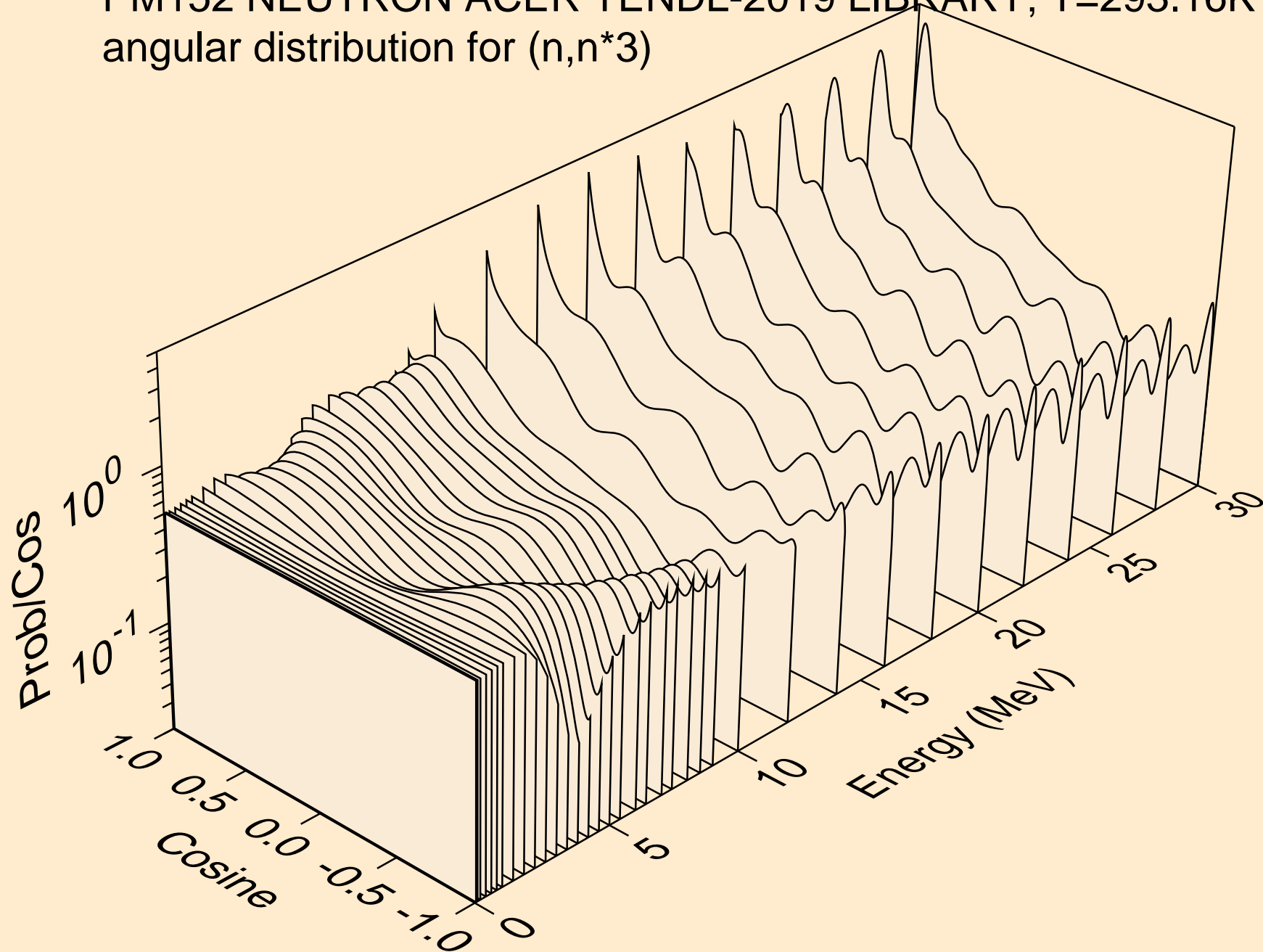

PM152 NEUTRON ACER TENDL-2019 LIBRARY; T=293.16K
angular distribution for (n,n*4)

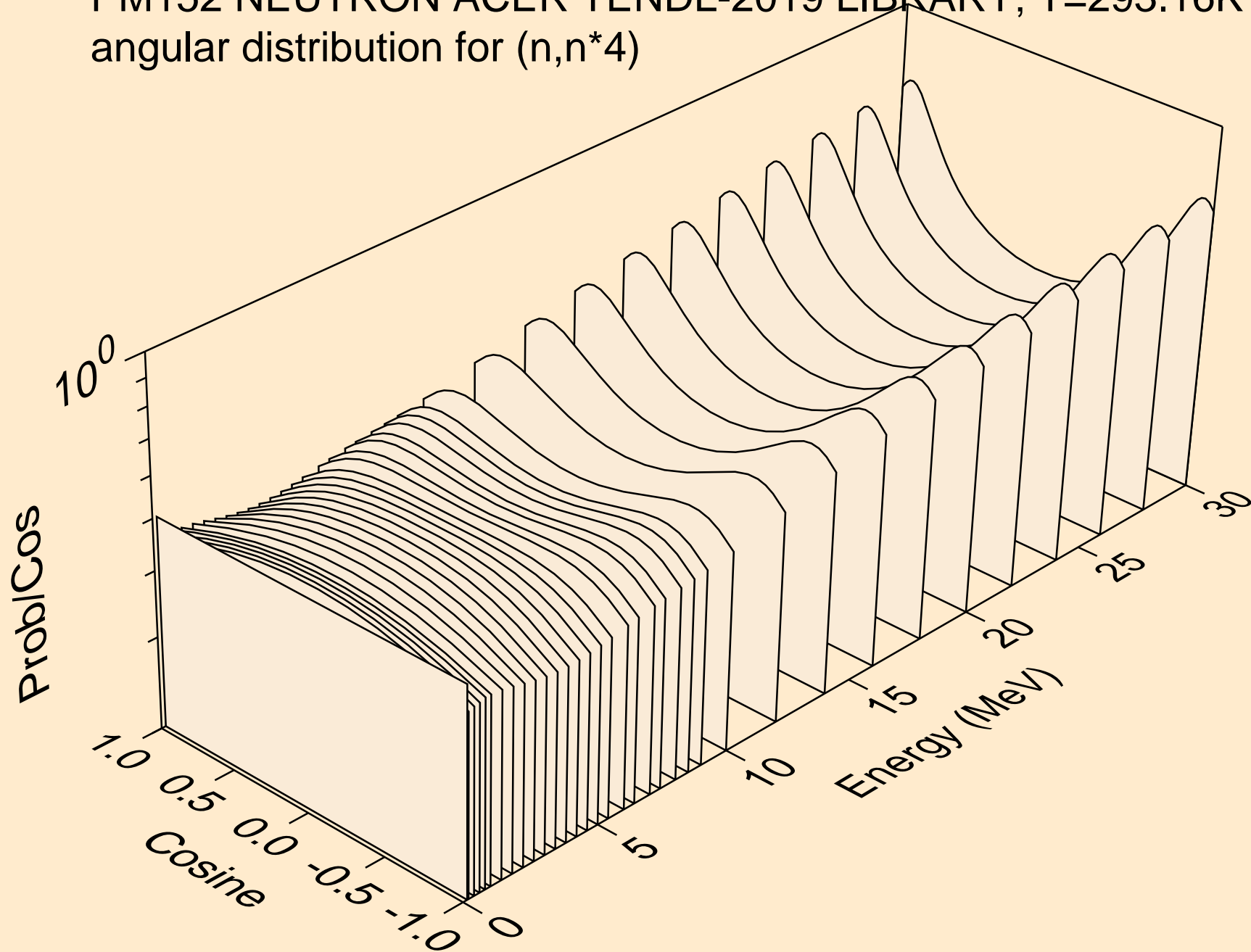

PM152 NEUTRON ACER TENDL-2019 LIBRARY; T=293.16K
angular distribution for (n,n*5)

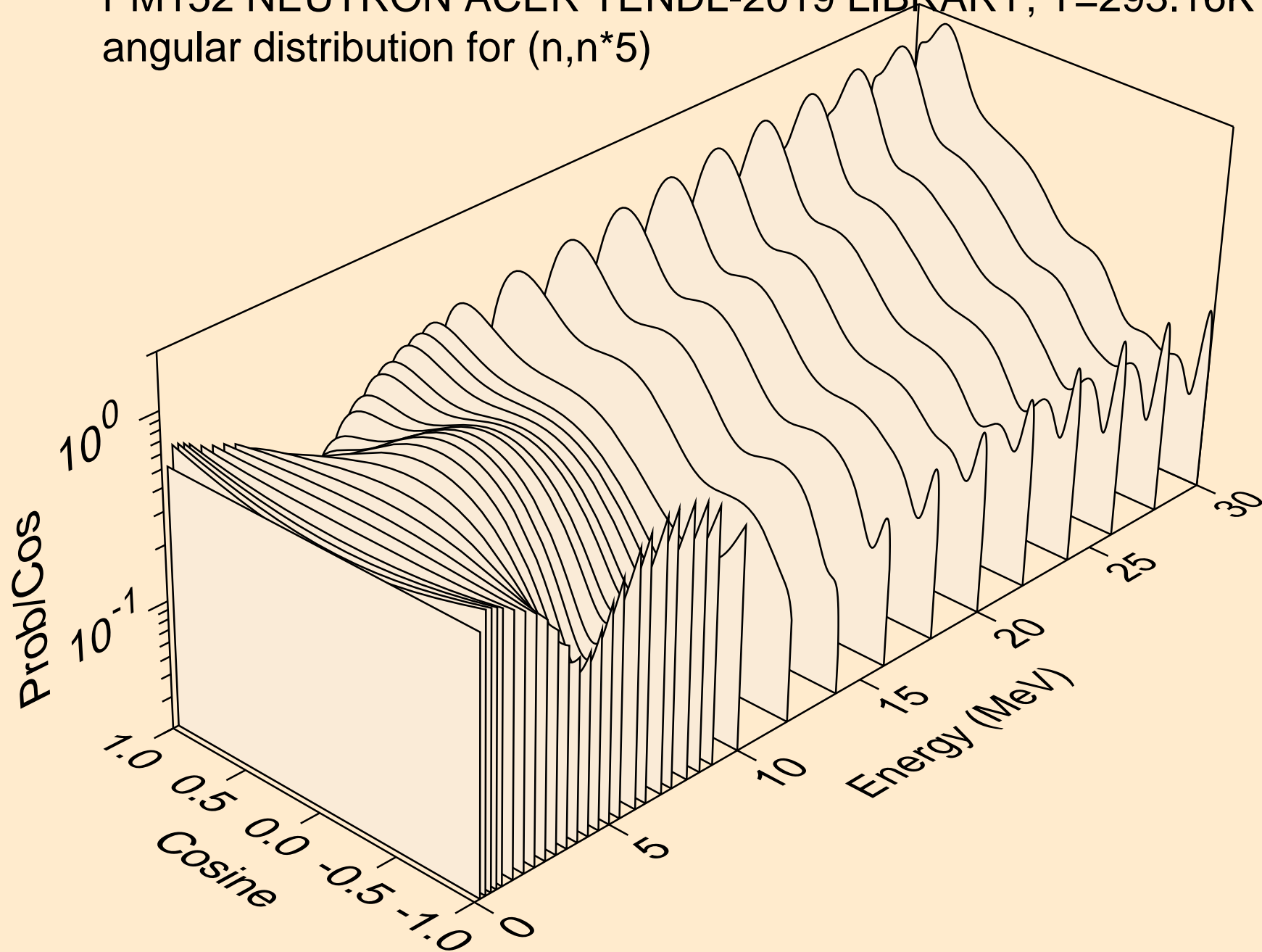

PM152 NEUTRON ACER TENDL-2019 LIBRARY; T=293.16K
angular distribution for (n,n*6)

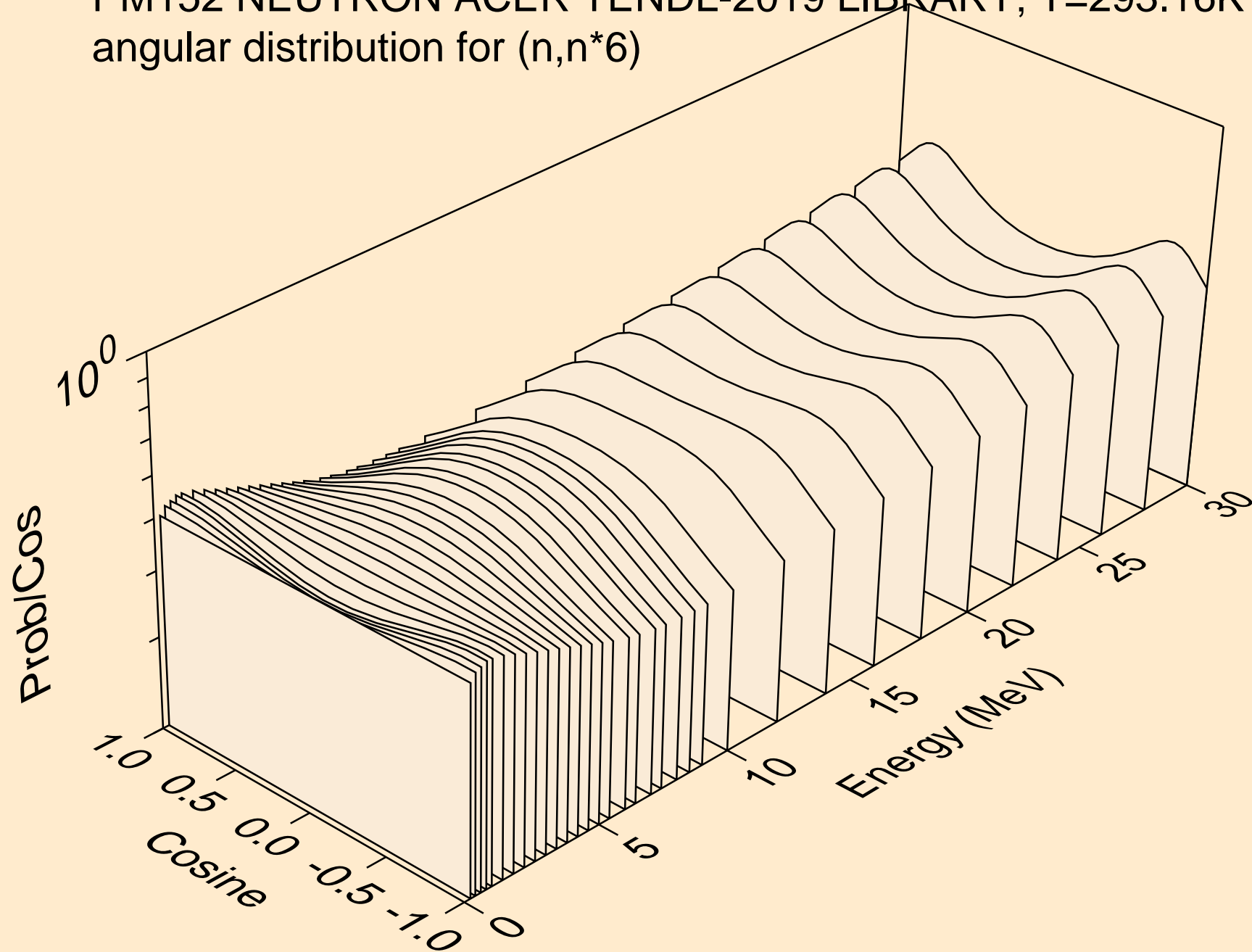

PM152 NEUTRON ACER TENDL-2019 LIBRARY; T=293.16K
angular distribution for (n,n*7)

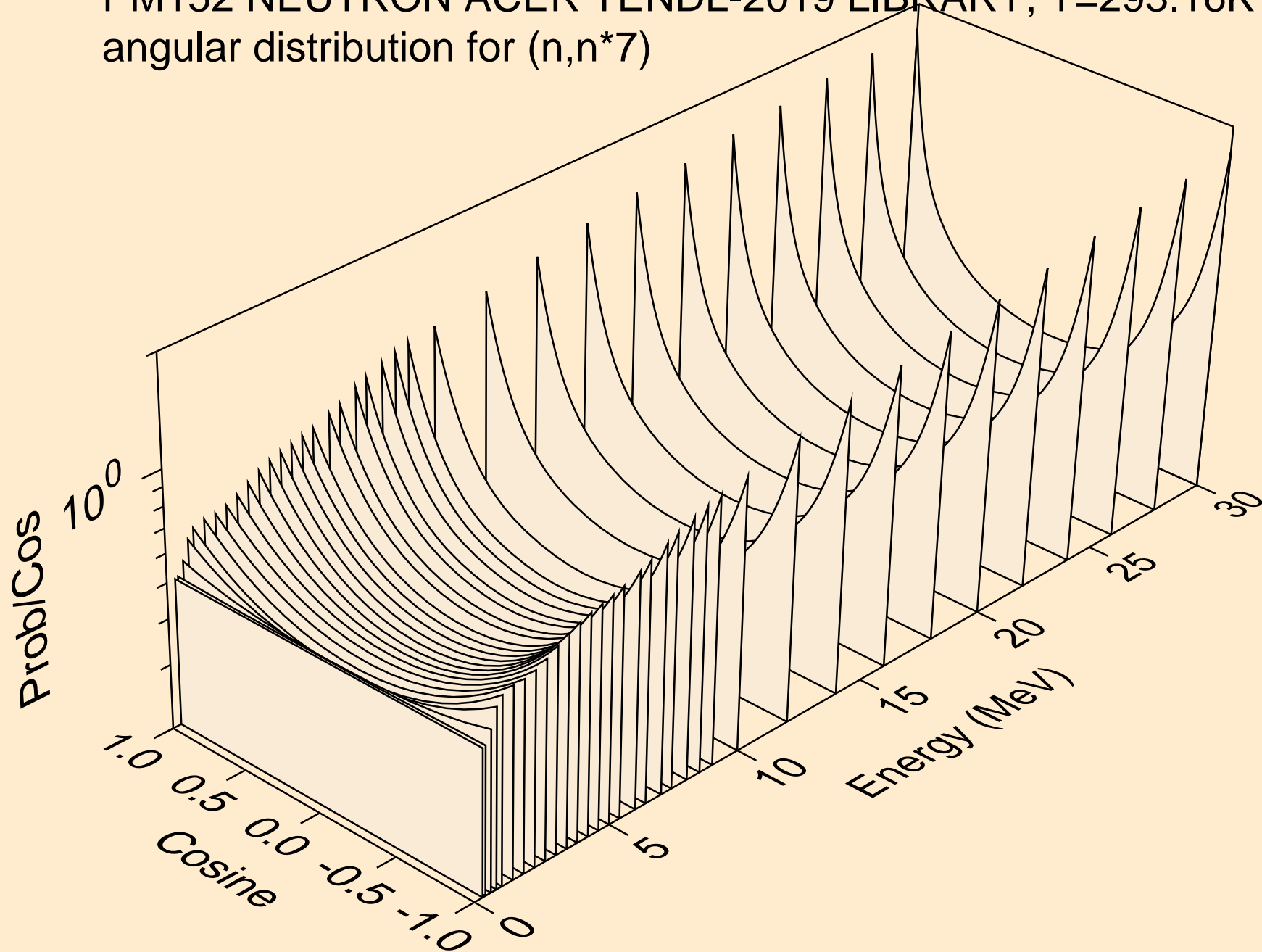

PM152 NEUTRON ACER TENDL-2019 LIBRARY; T=293.16K
angular distribution for (n,n*8)

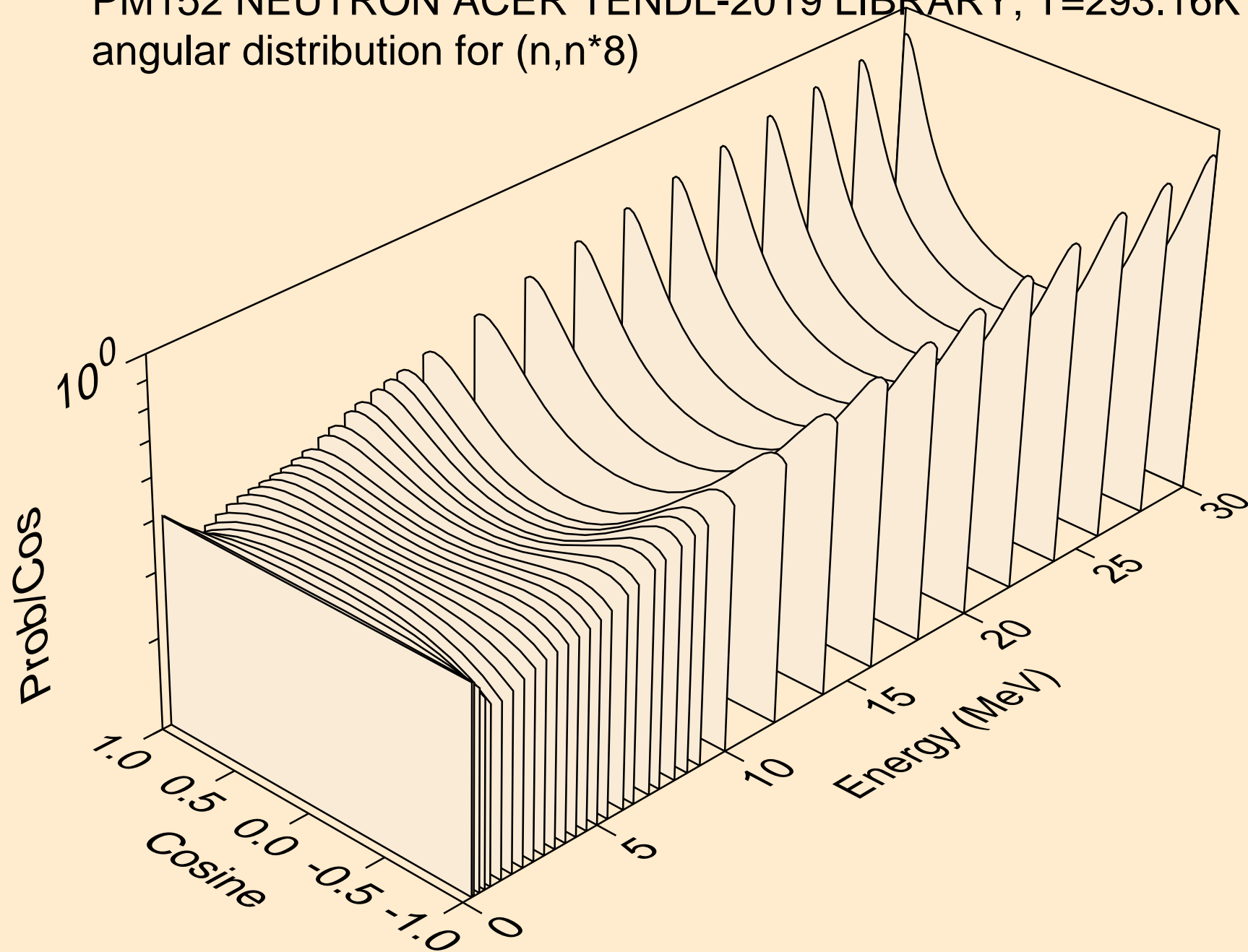

PM152 NEUTRON ACER TENDL-2019 LIBRARY; T=293.16K
angular distribution for (n,n*9)

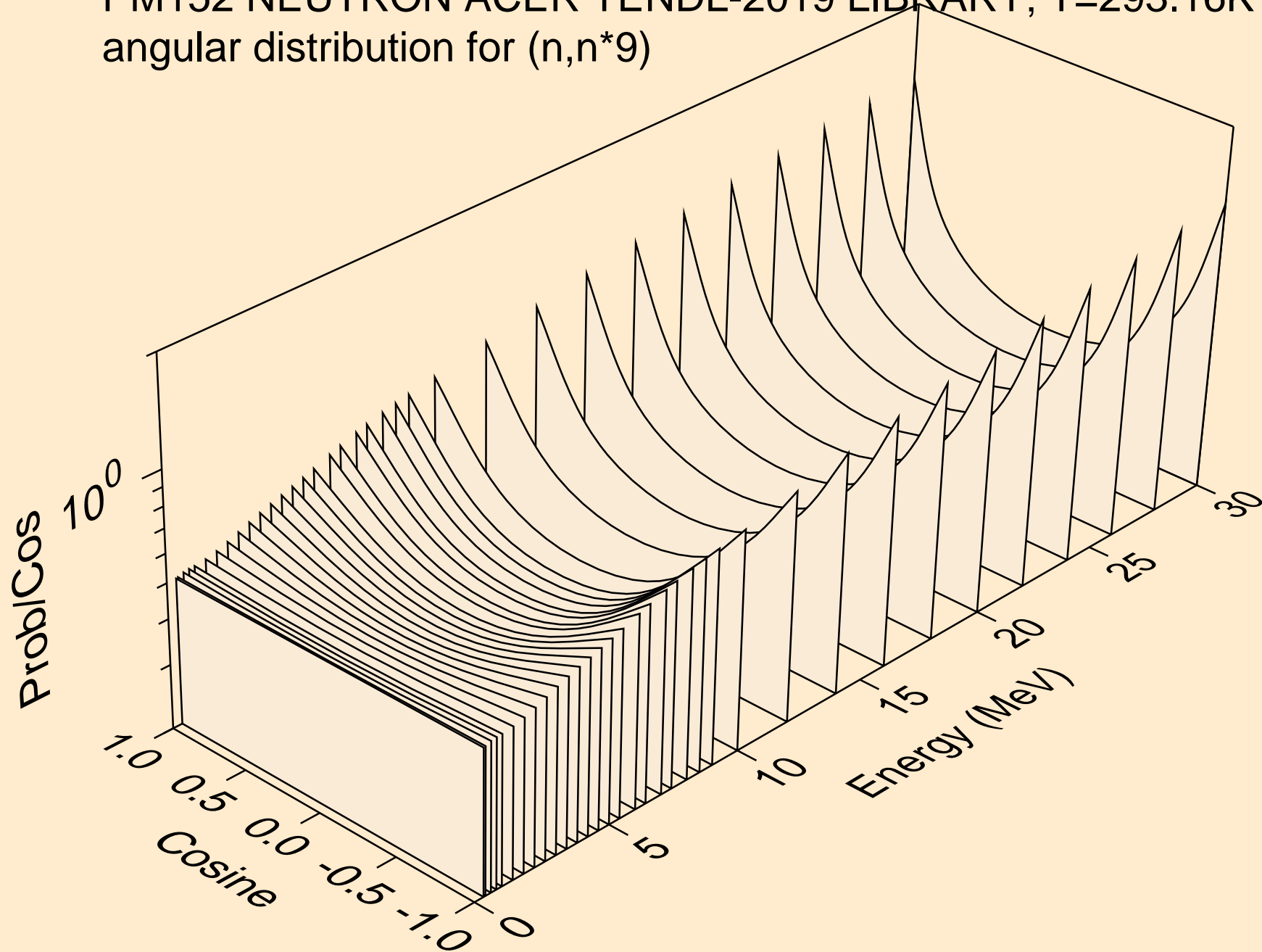

PM152 NEUTRON ACER TENDL-2019 LIBRARY; T=293.16K
angular distribution for (n,n*10)

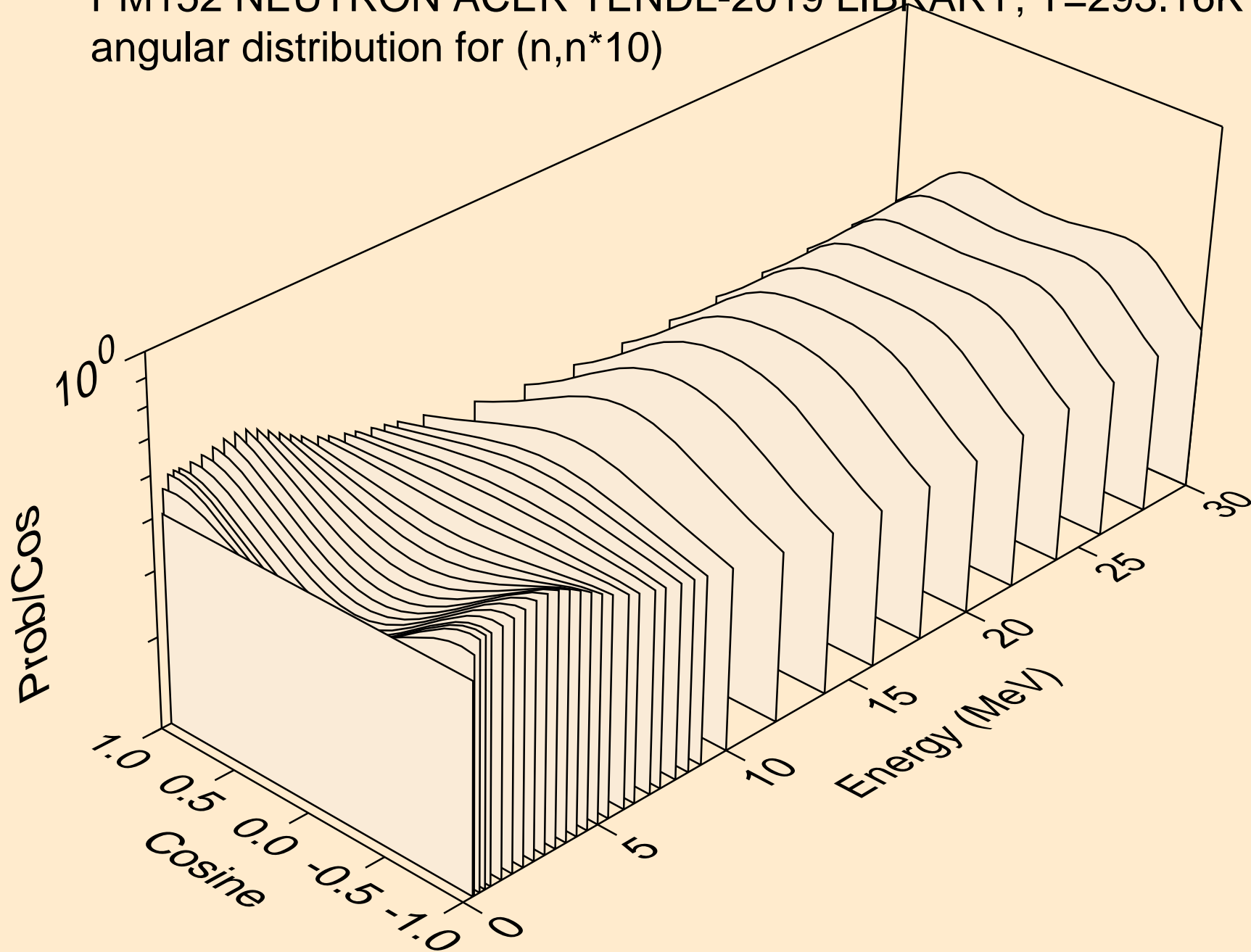

PM152 NEUTRON ACER TENDL-2019 LIBRARY; T=293.16K
angular distribution for (n,n*11)

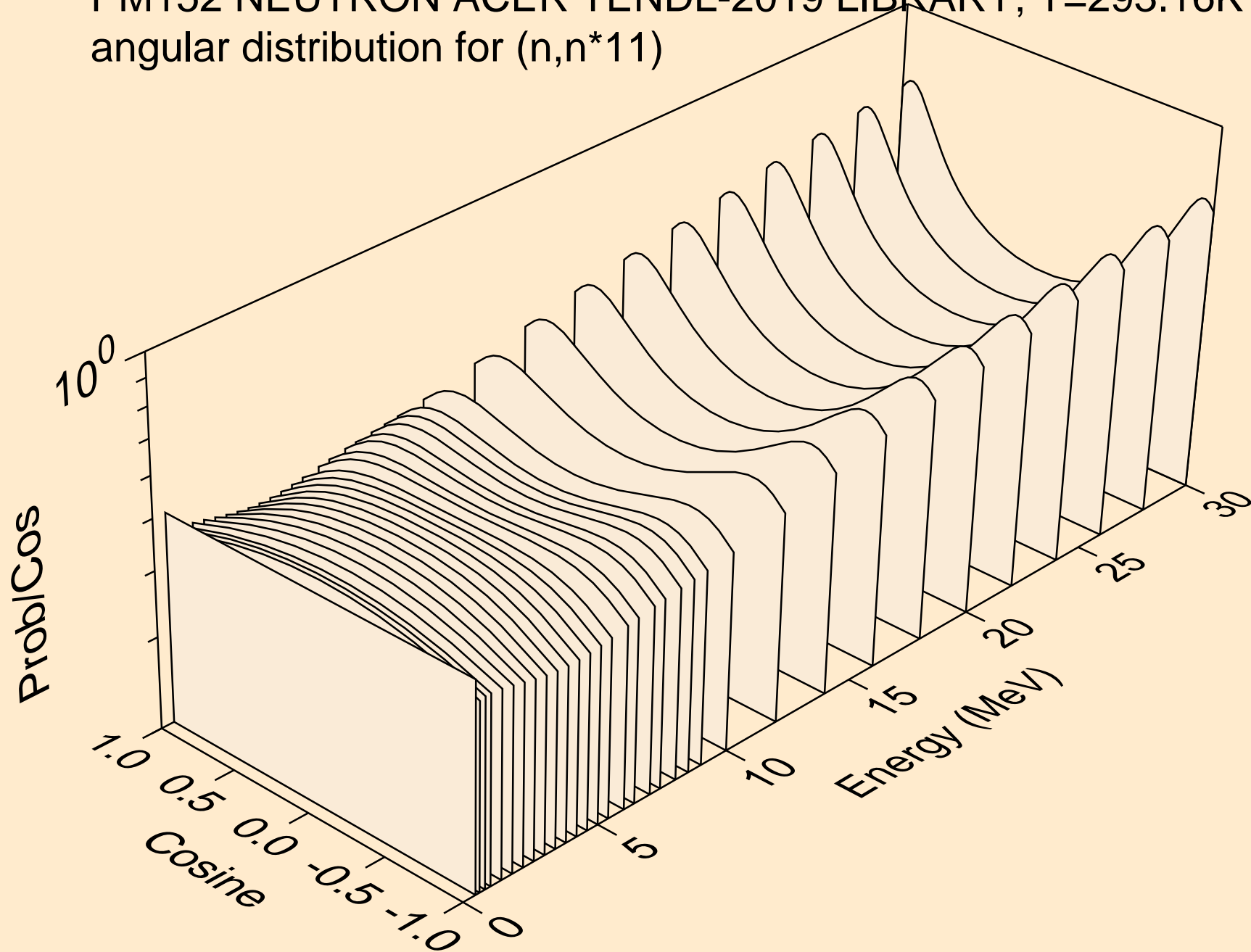

PM152 NEUTRON ACER TENDL-2019 LIBRARY; T=293.16K
angular distribution for (n,n*12)

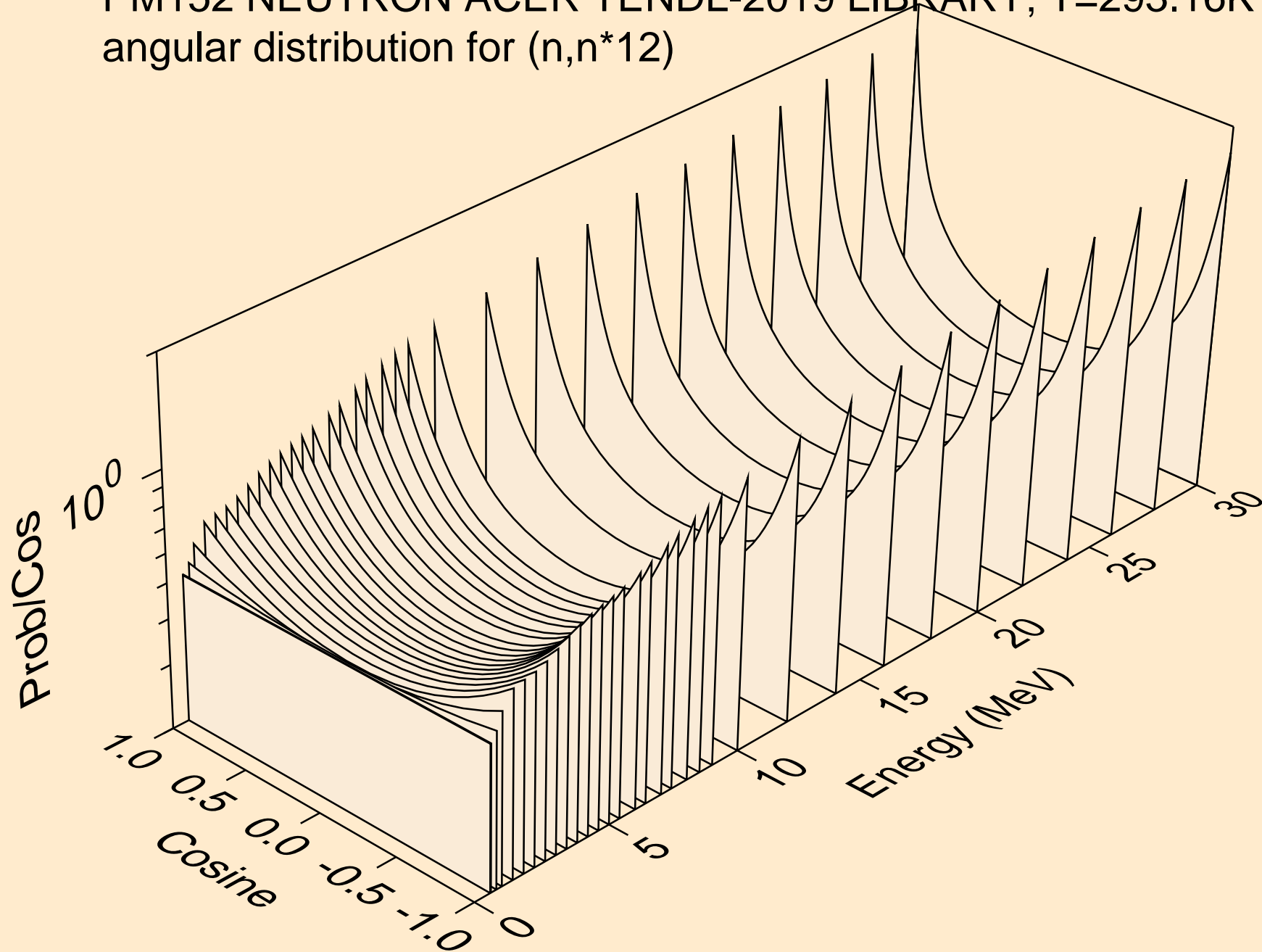

PM152 NEUTRON ACER TENDL-2019 LIBRARY; T=293.16K
angular distribution for (n,n*13)

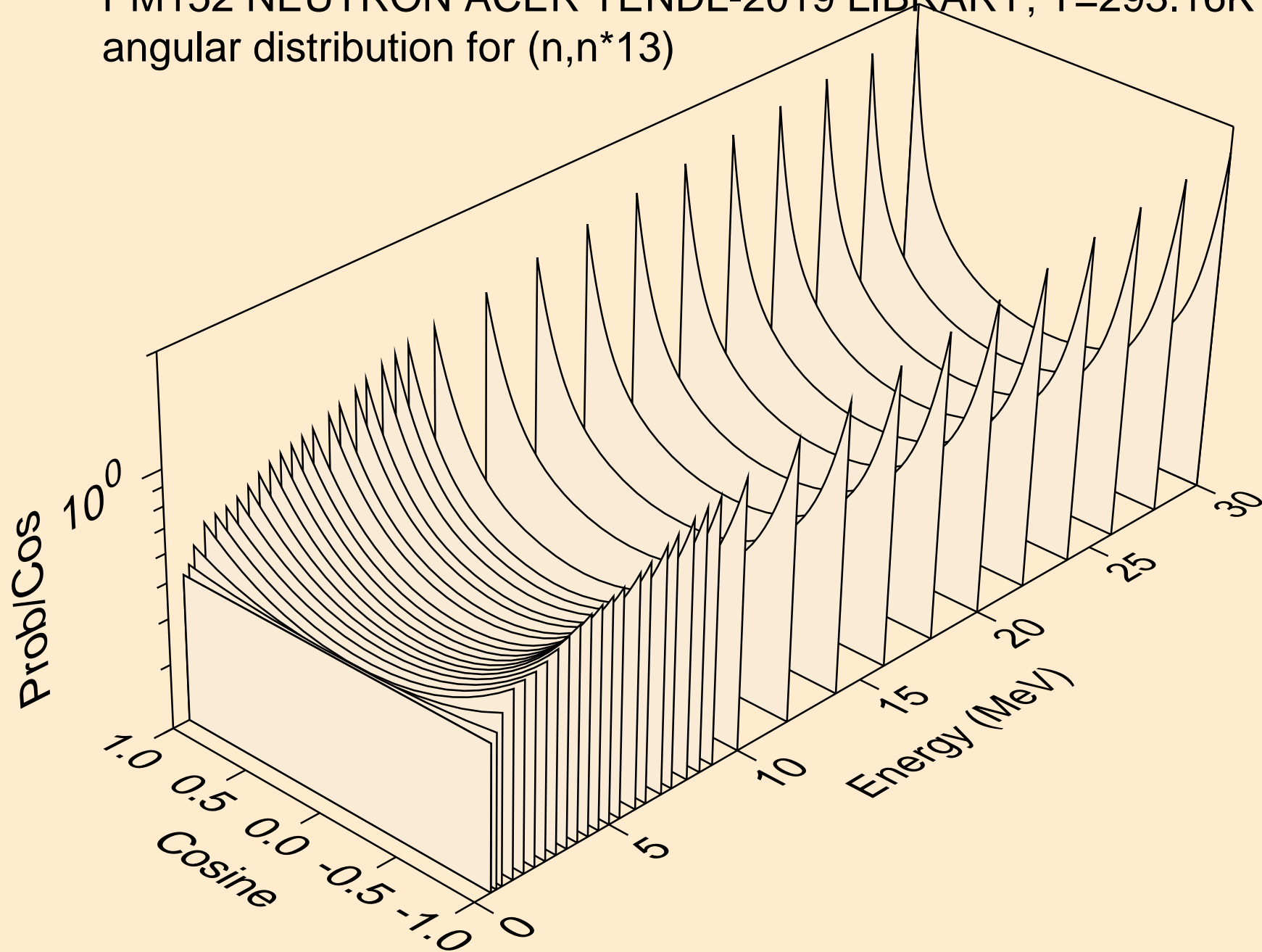

PM152 NEUTRON ACER TENDL-2019 LIBRARY; T=293.16K
angular distribution for (n,n*14)

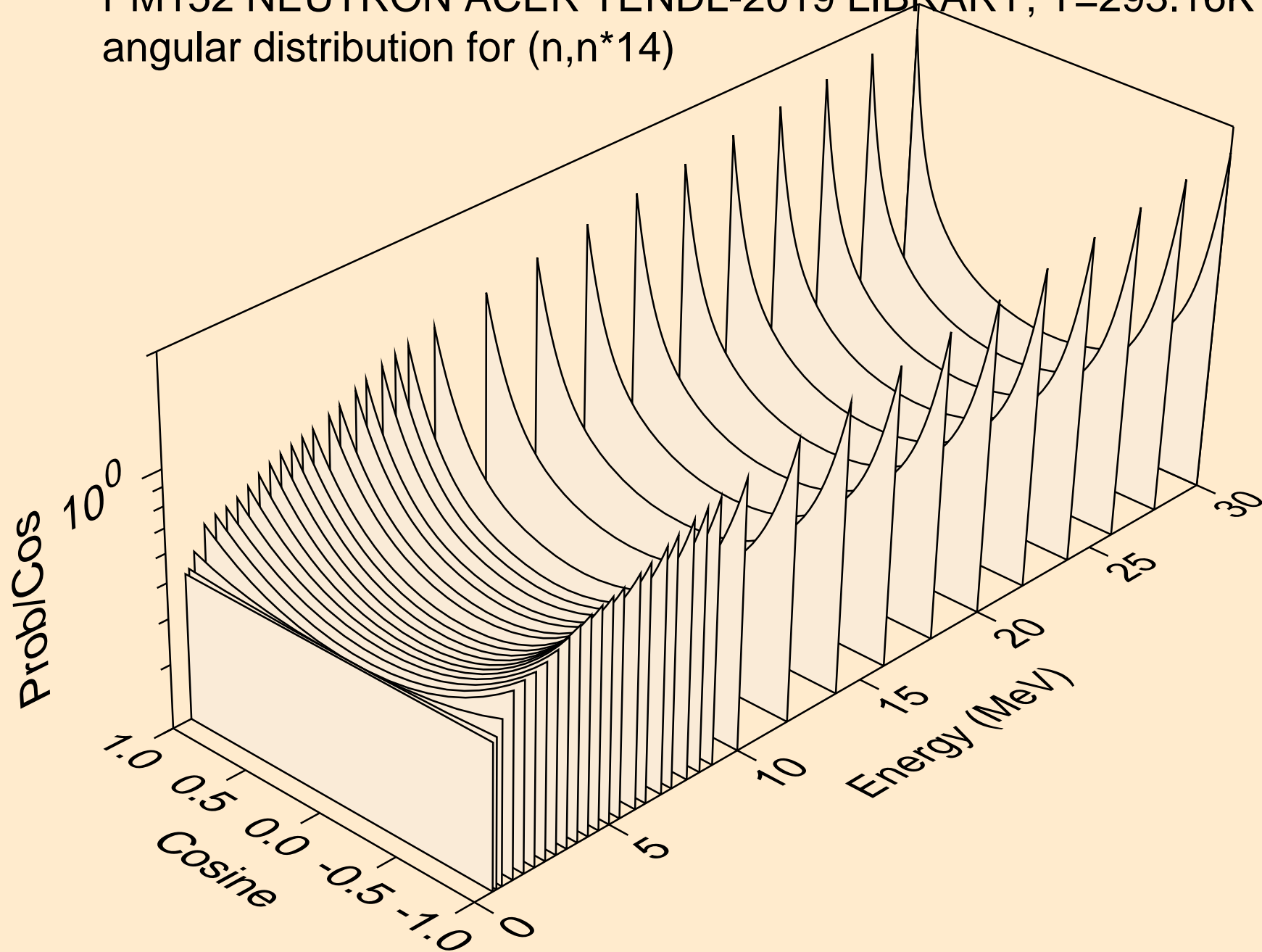

PM152 NEUTRON ACER TENDL-2019 LIBRARY; T=293.16K
angular distribution for (n,n*15)

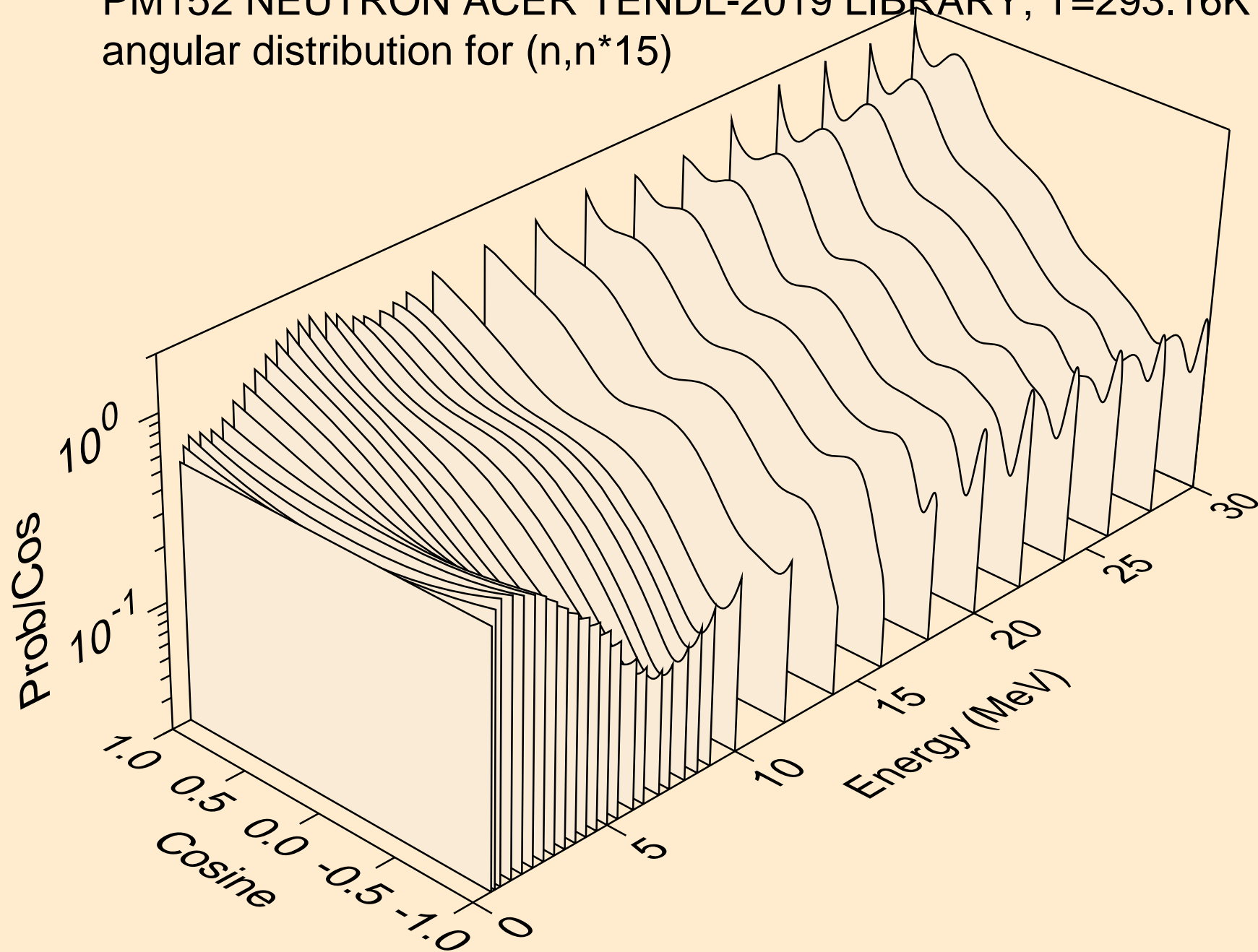

PM152 NEUTRON ACER TENDL-2019 LIBRARY; T=293.16K
angular distribution for (n,n*16)

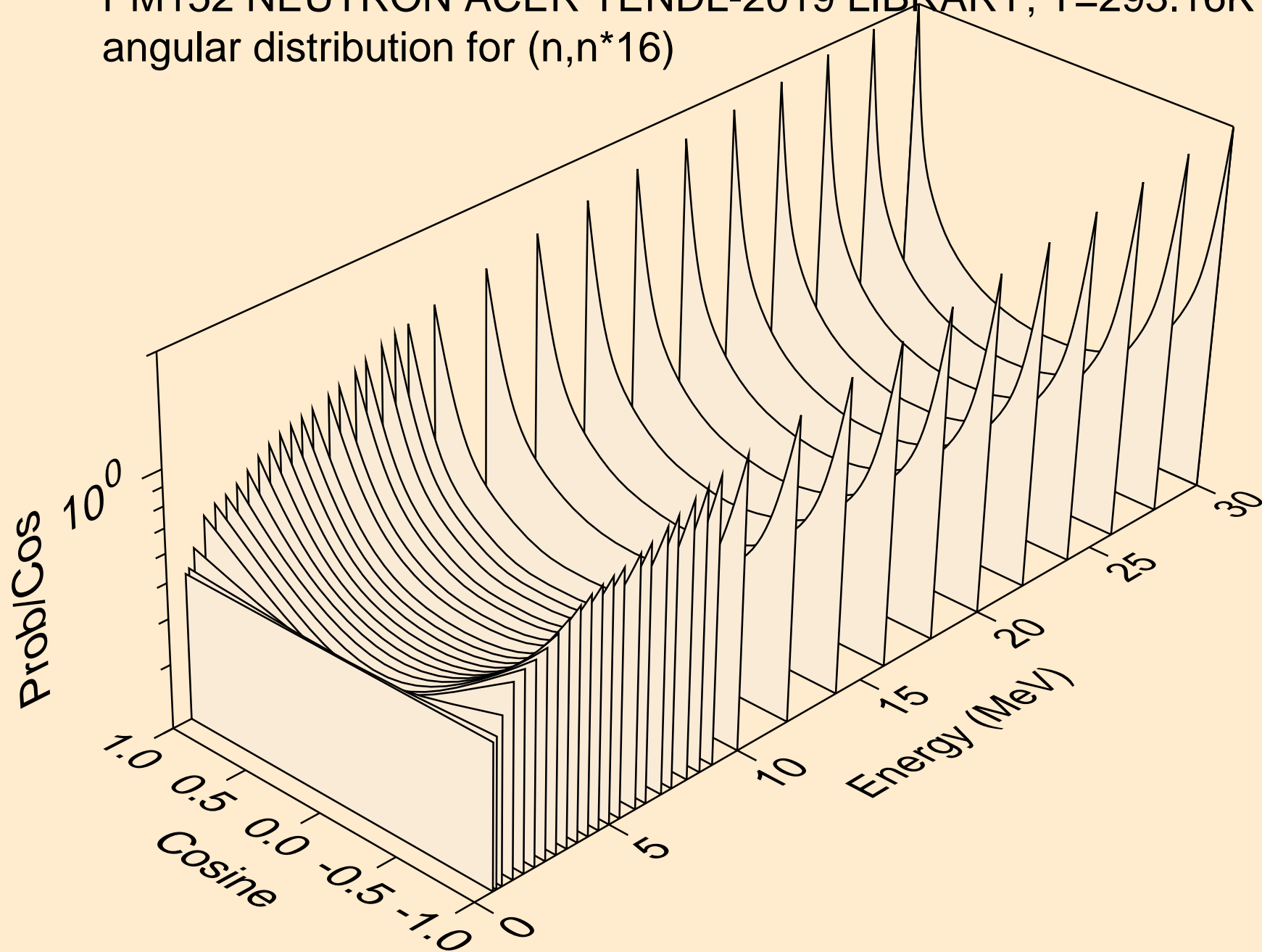

PM152 NEUTRON ACER TENDL-2019 LIBRARY; T=293.16K
angular distribution for (n,n*17)

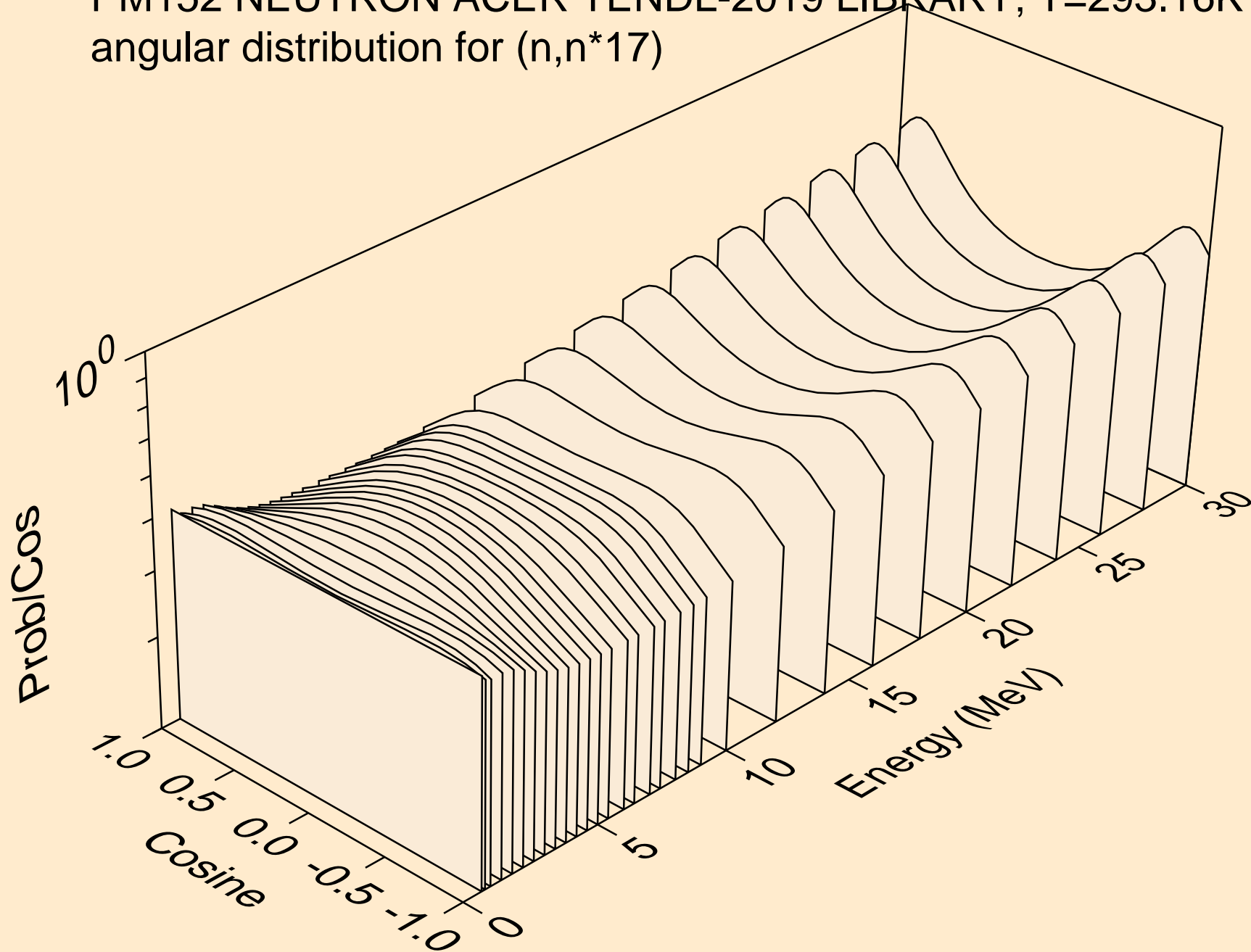

PM152 NEUTRON ACER TENDL-2019 LIBRARY; T=293.16K
angular distribution for (n,n*18)

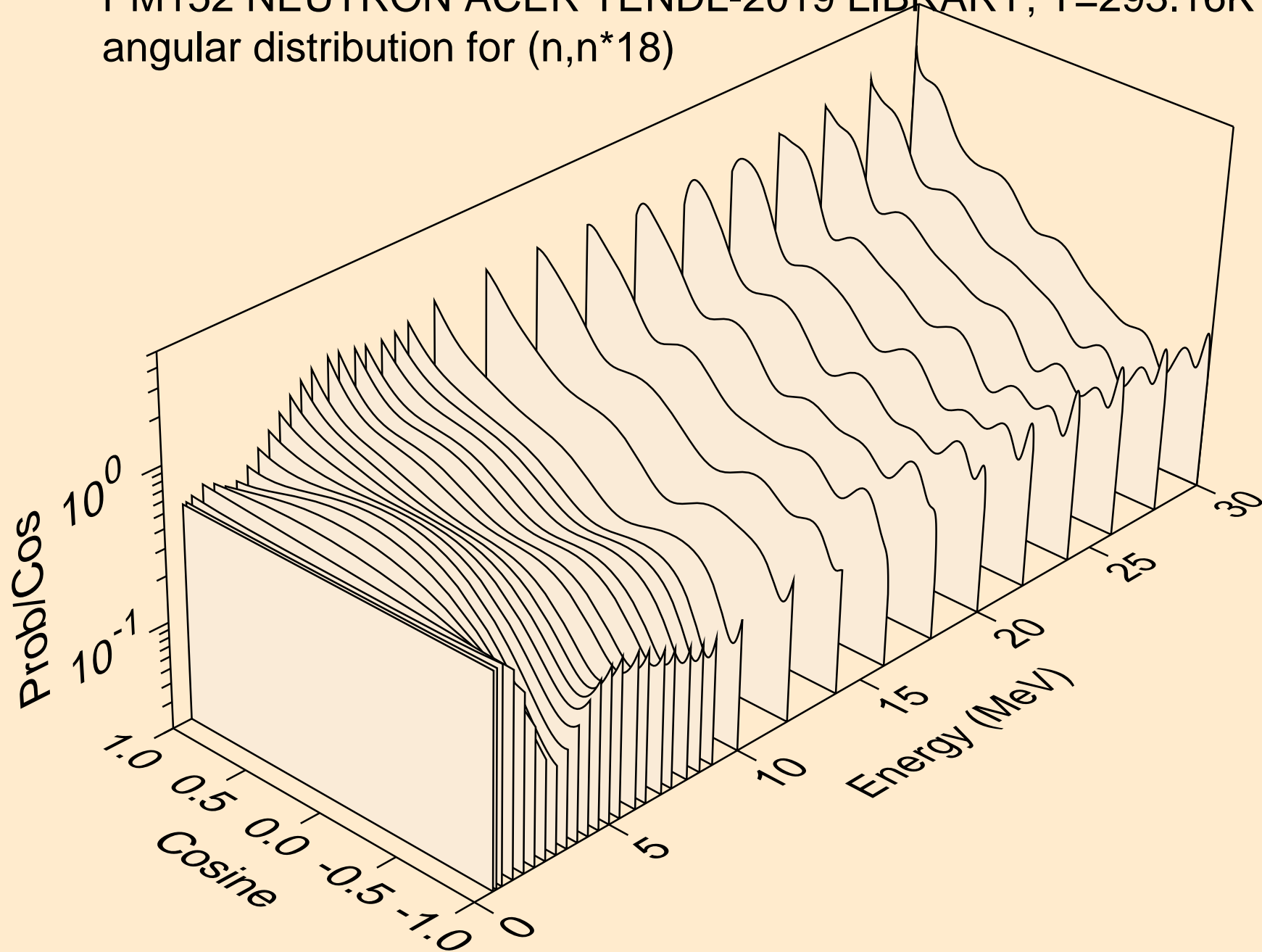

PM152 NEUTRON ACER TENDL-2019 LIBRARY; T=293.16K
angular distribution for (n,n*19)

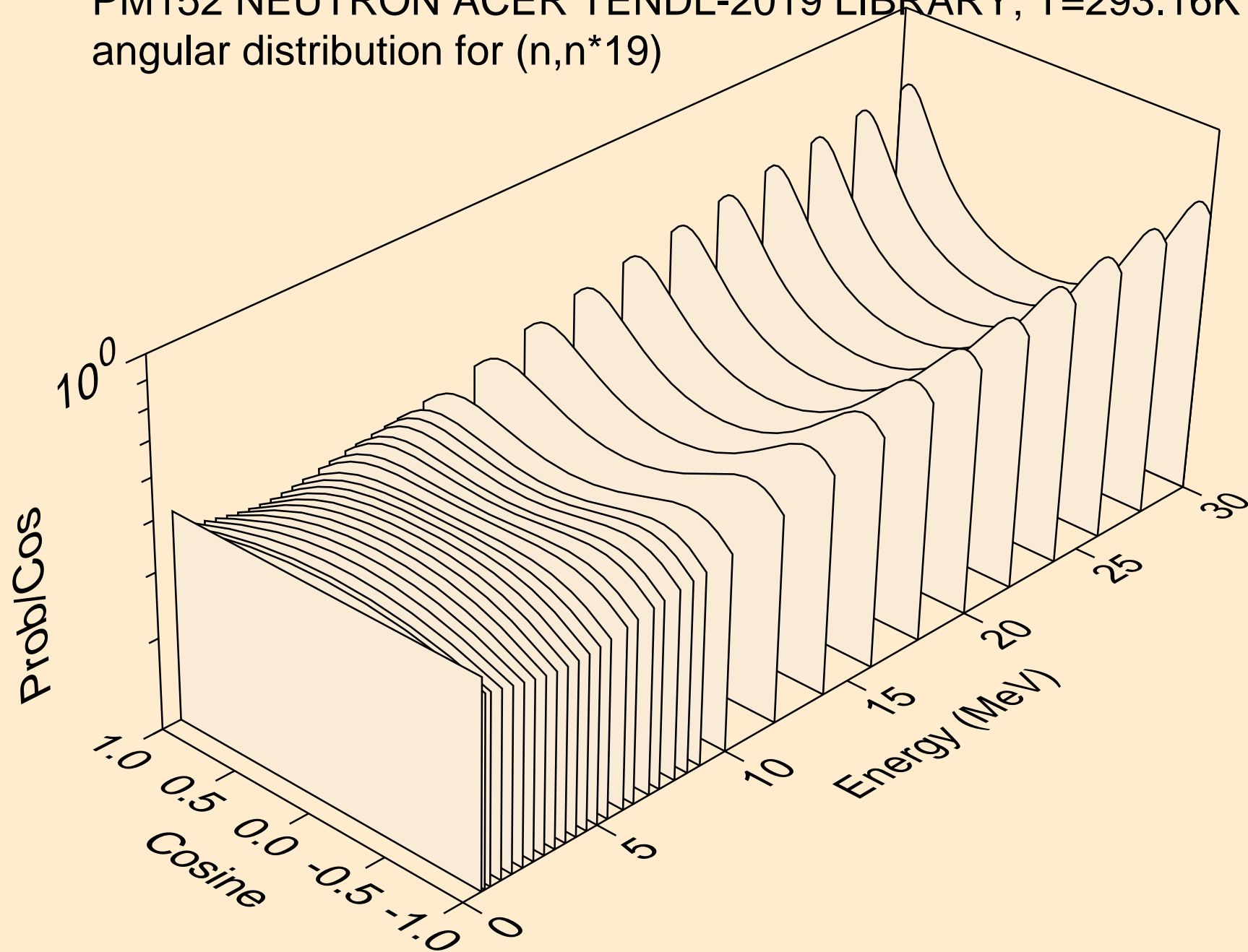

PM152 NEUTRON ACER TENDL-2019 LIBRARY; T=293.16K
angular distribution for (n,n*20)

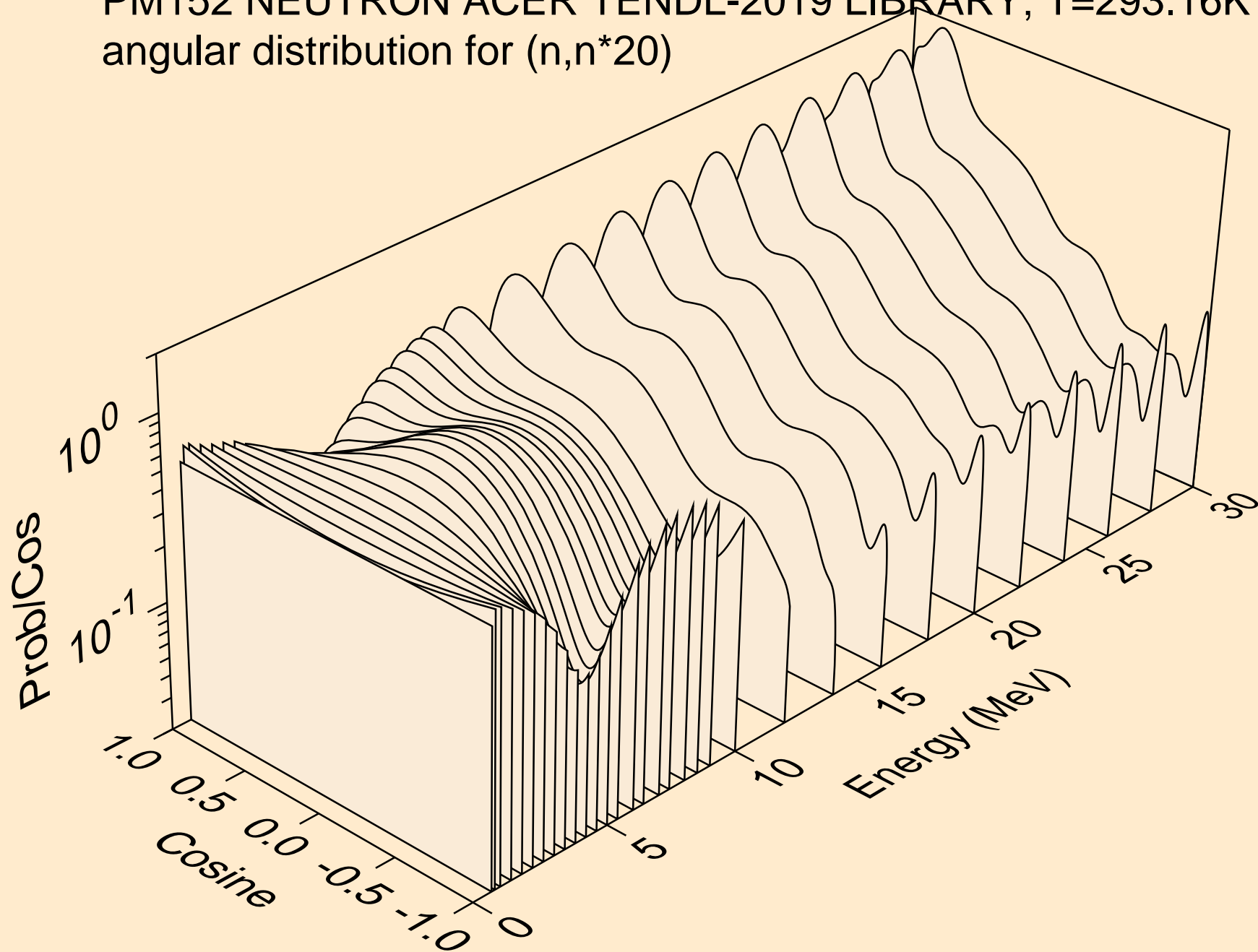

PM152 NEUTRON ACER TENDL-2019 LIBRARY; T=293.16K
angular distribution for (n,n*21)

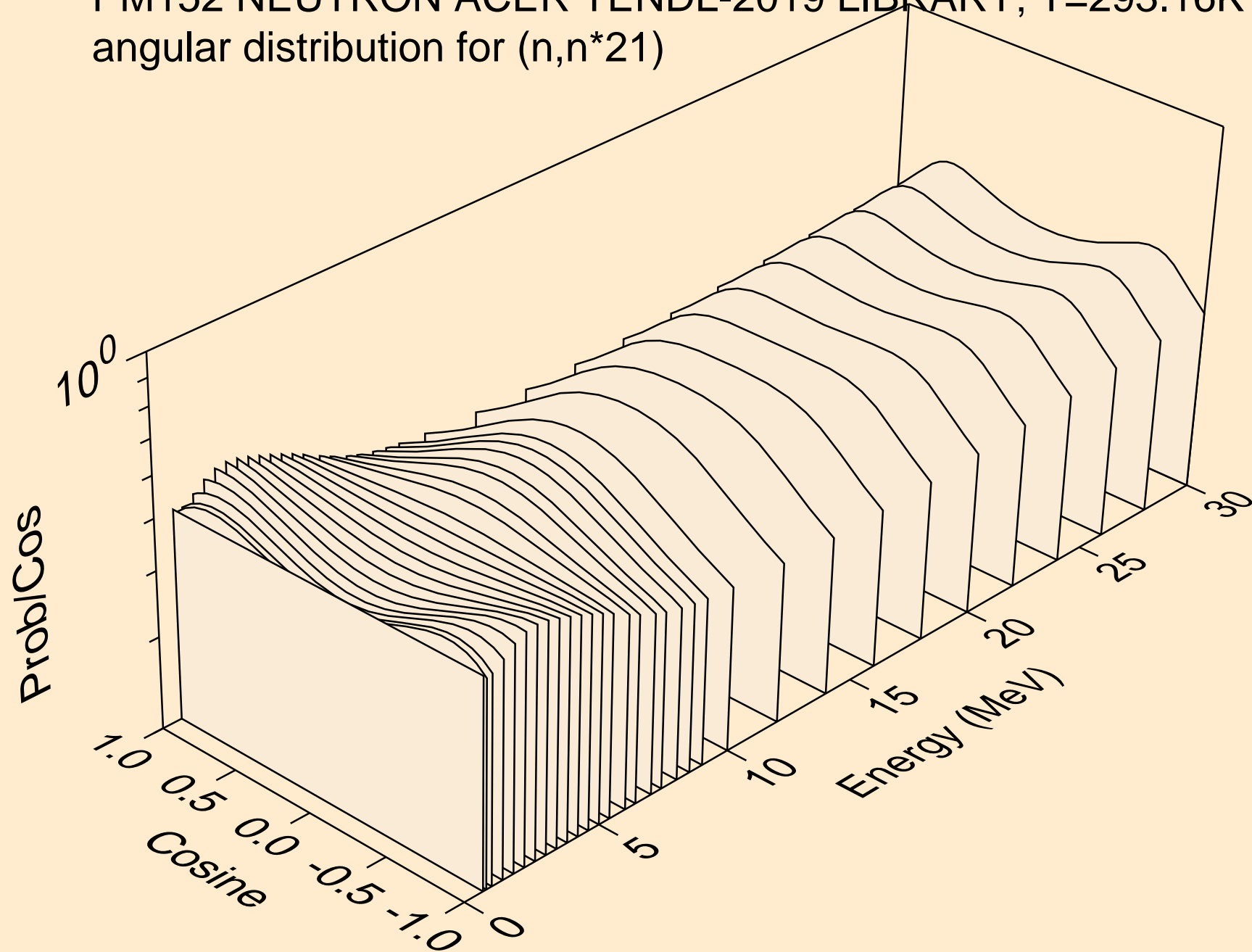

PM152 NEUTRON ACER TENDL-2019 LIBRARY; T=293.16K
angular distribution for (n,n*22)

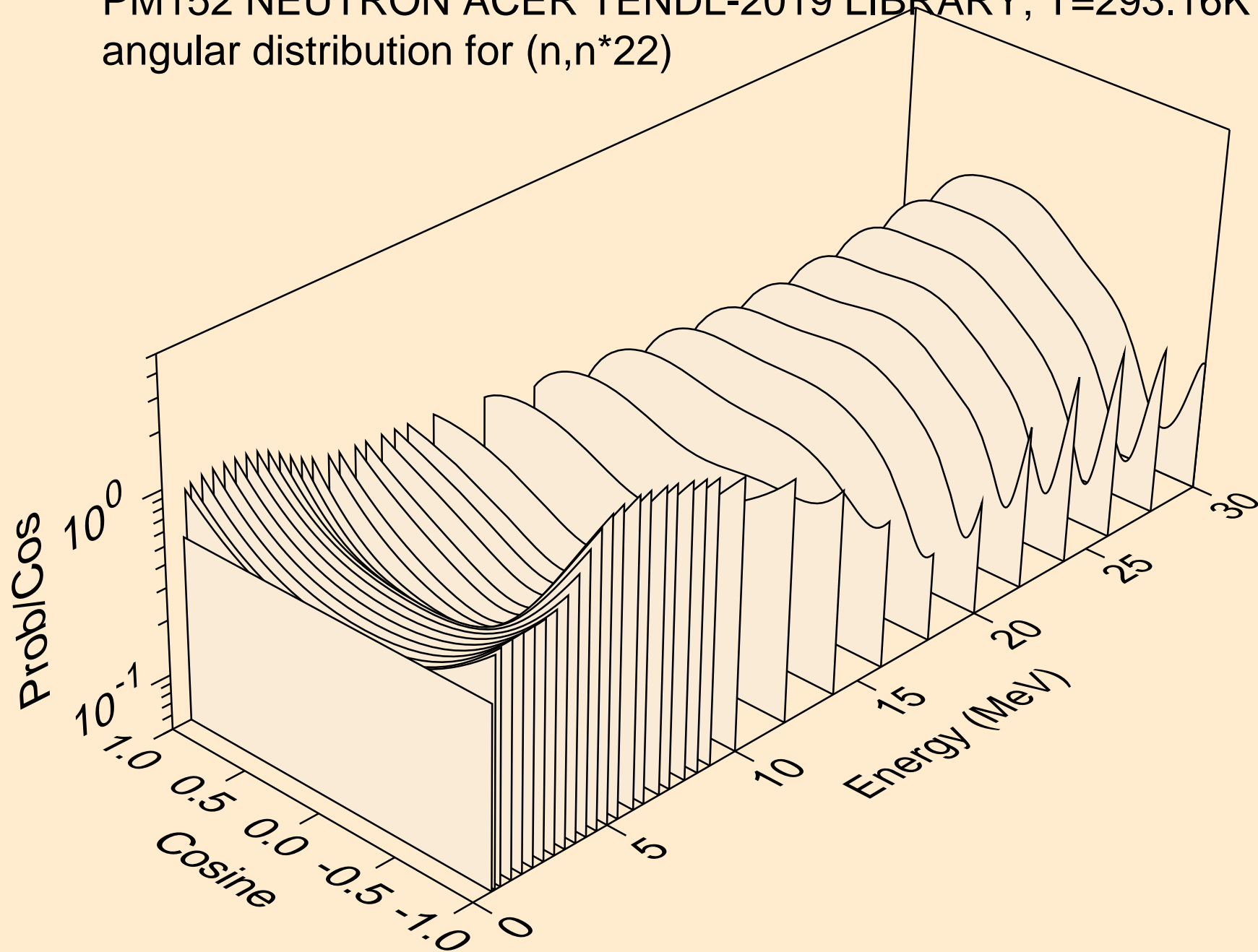

PM152 NEUTRON ACER TENDL-2019 LIBRARY; T=293.16K
angular distribution for (n,n*23)

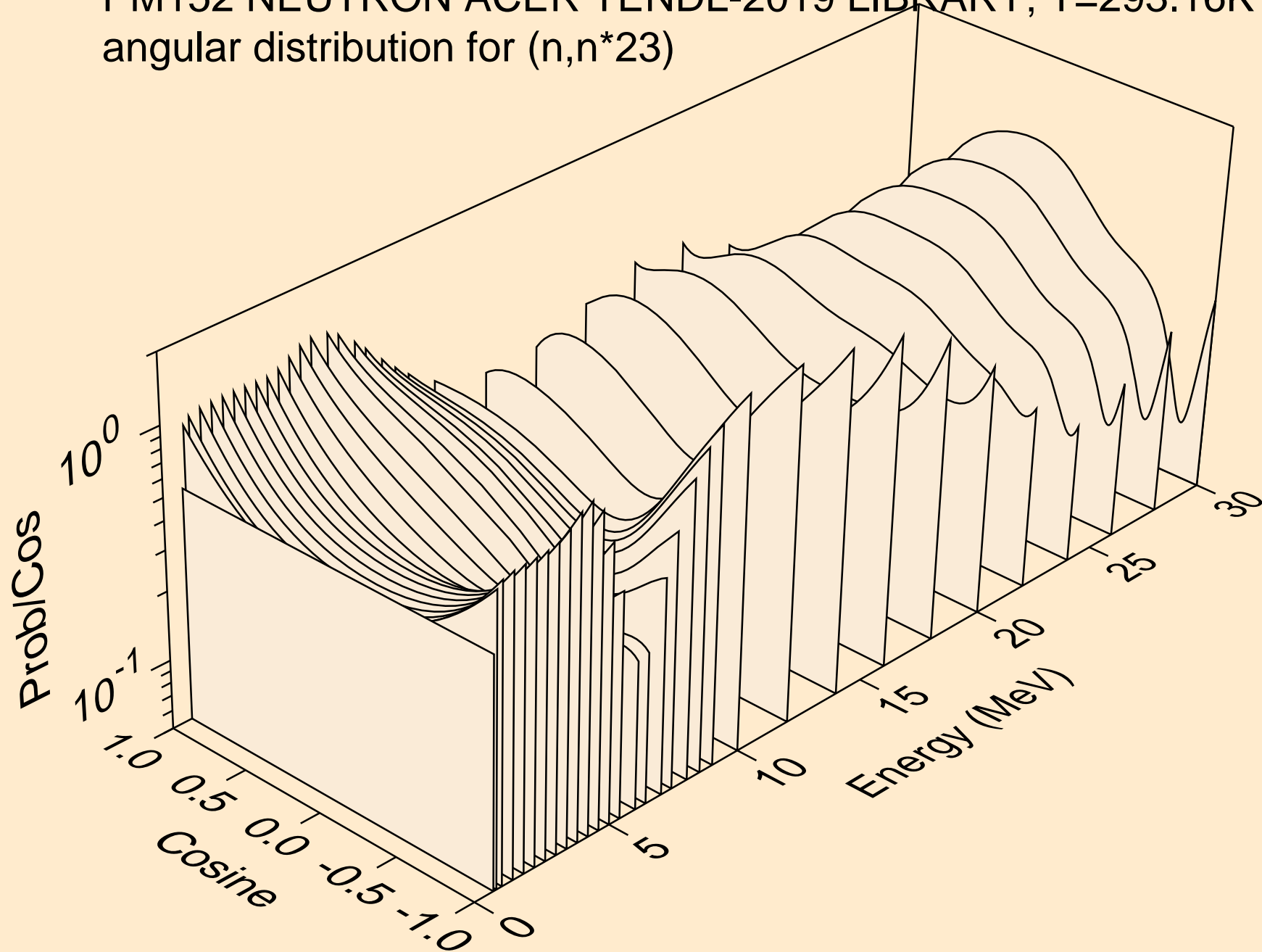

PM152 NEUTRON ACER TENDL-2019 LIBRARY; T=293.16K
angular distribution for (n,n*24)

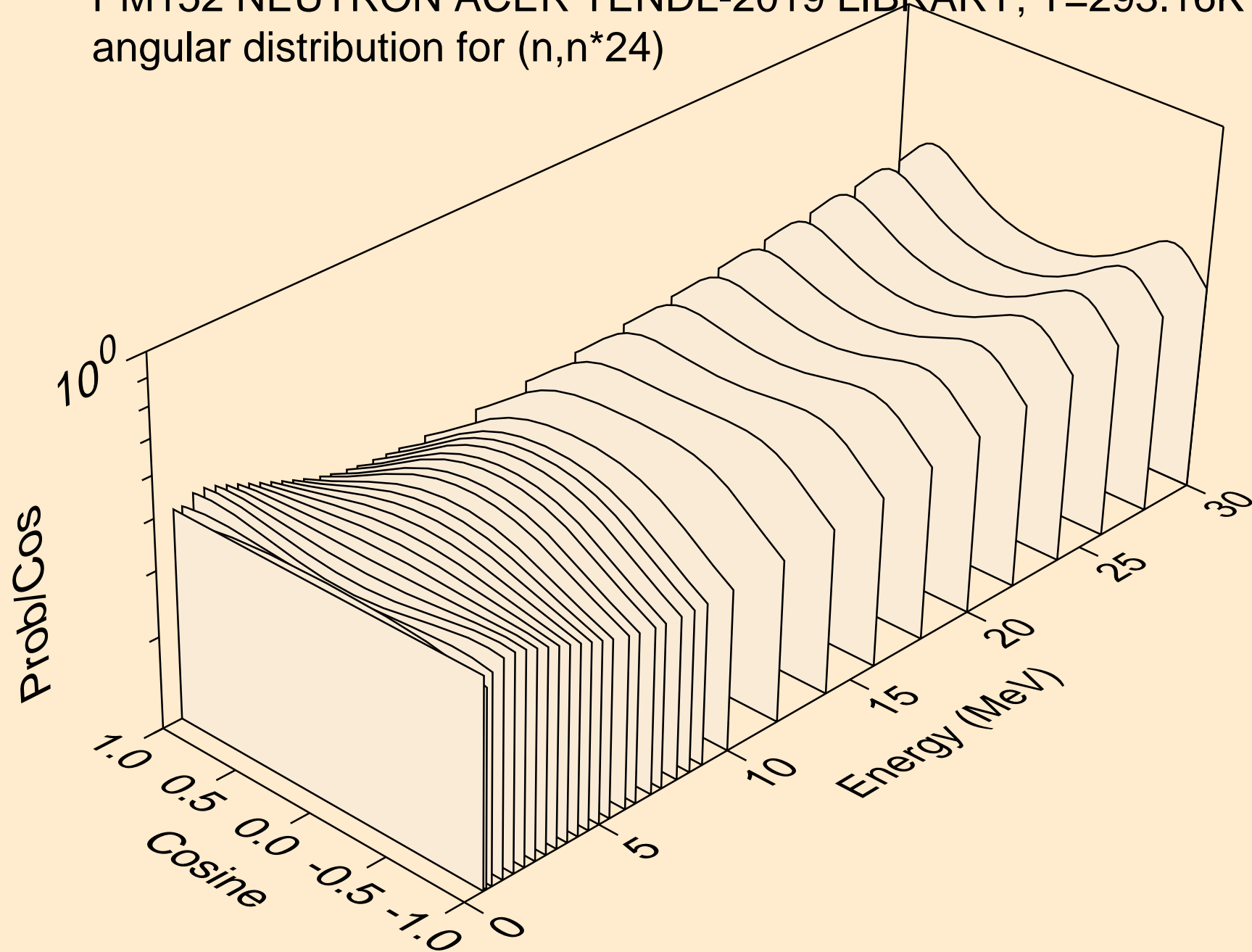

PM152 NEUTRON ACER TENDL-2019 LIBRARY; T=293.16K
angular distribution for (n,n*25)

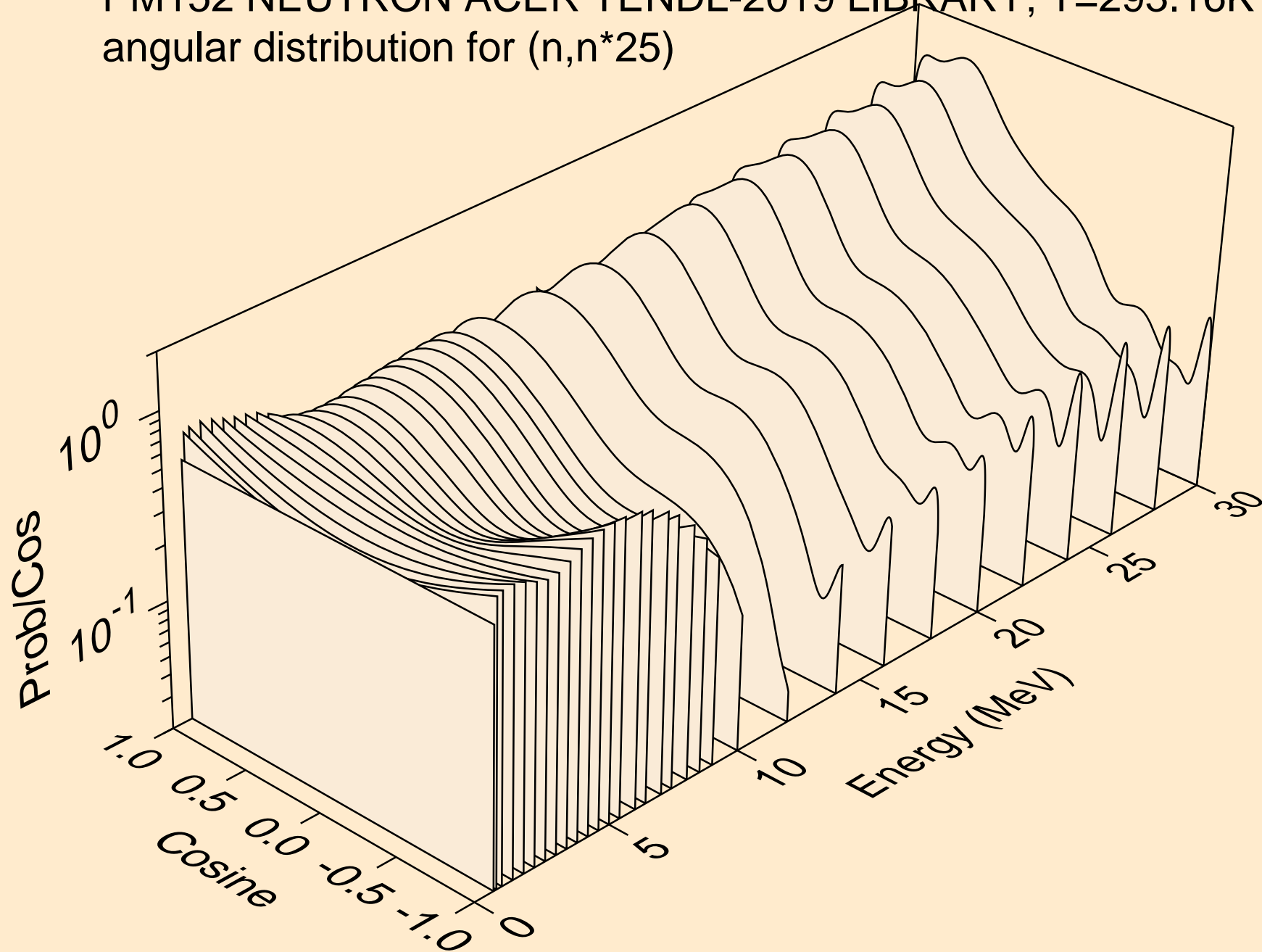

PM152 NEUTRON ACER TENDL-2019 LIBRARY; T=293.16K
angular distribution for (n,n*26)

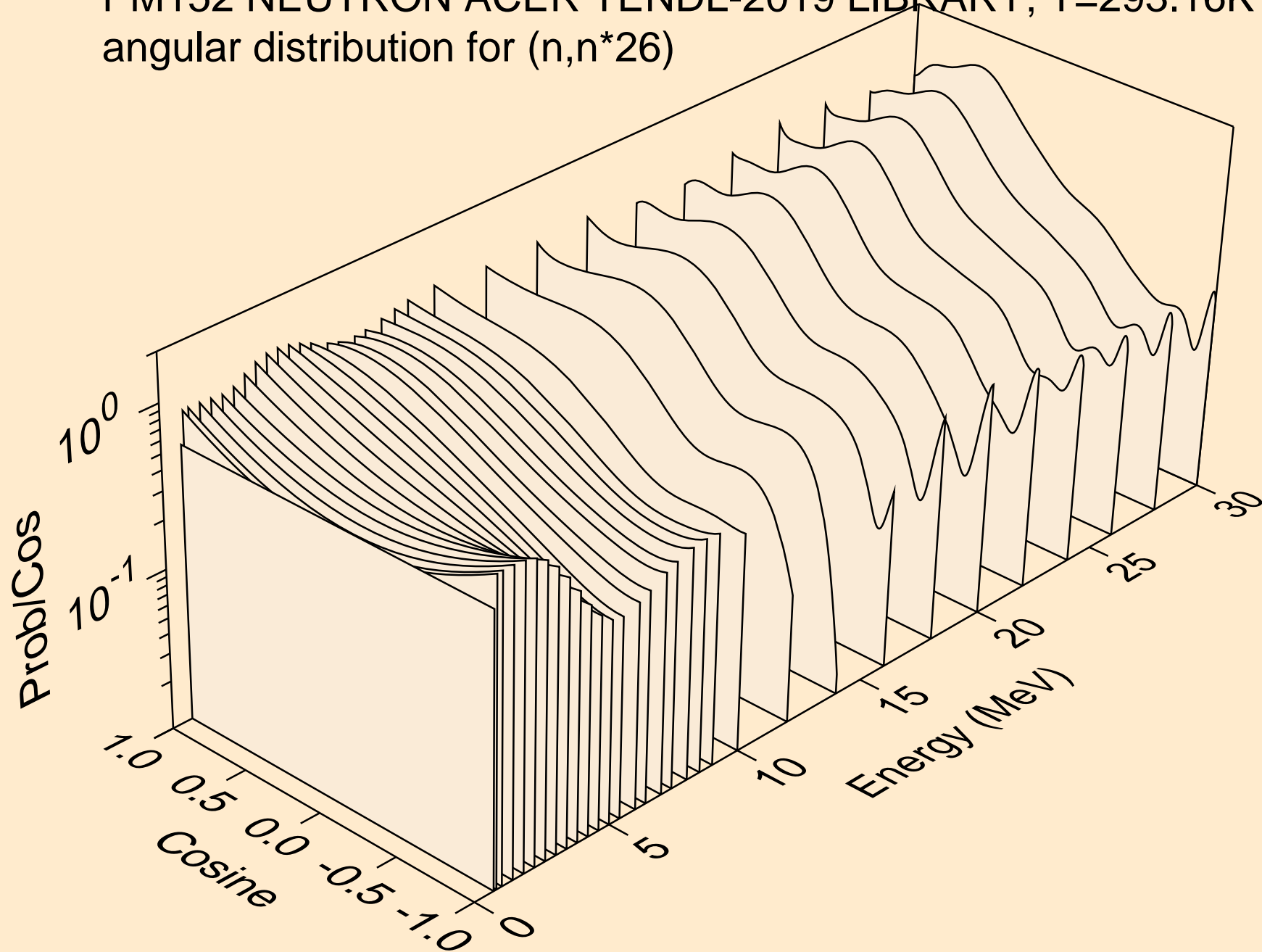

PM152 NEUTRON ACER TENDL-2019 LIBRARY; T=293.16K
angular distribution for (n,n*27)

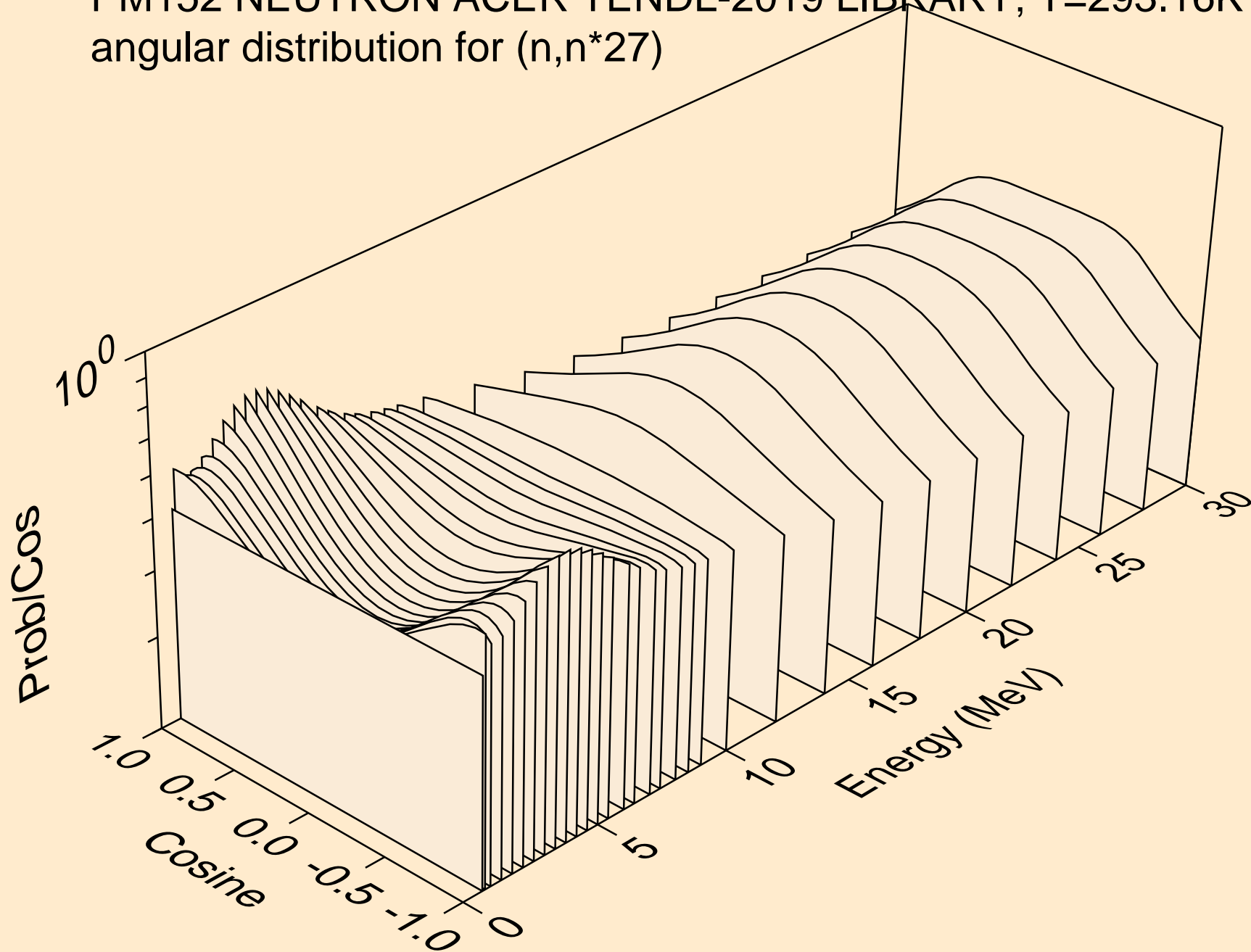

PM152 NEUTRON ACER TENDL-2019 LIBRARY; T=293.16K
angular distribution for (n,n*28)

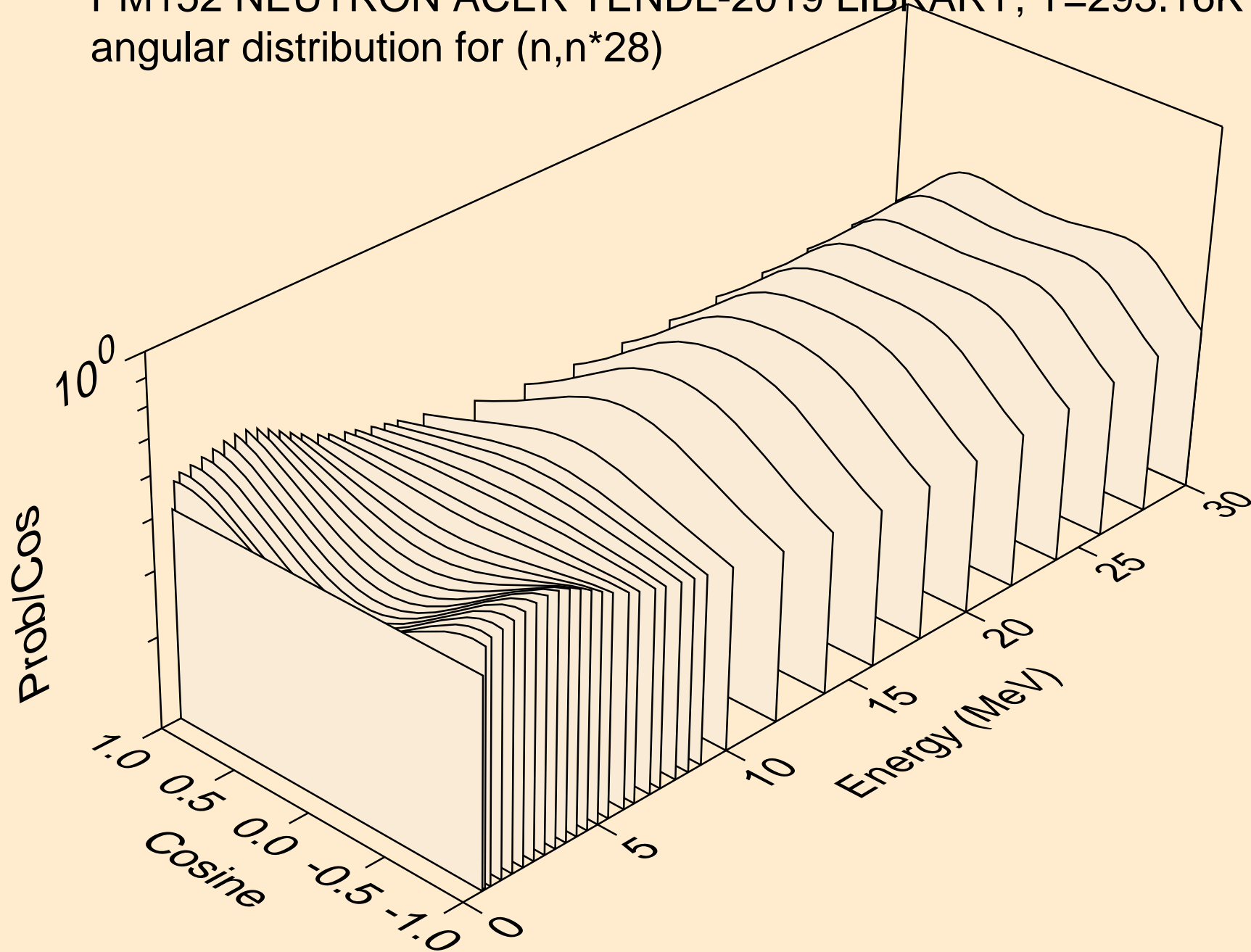

PM152 NEUTRON ACER TENDL-2019 LIBRARY; T=293.16K
angular distribution for (n,n*29)

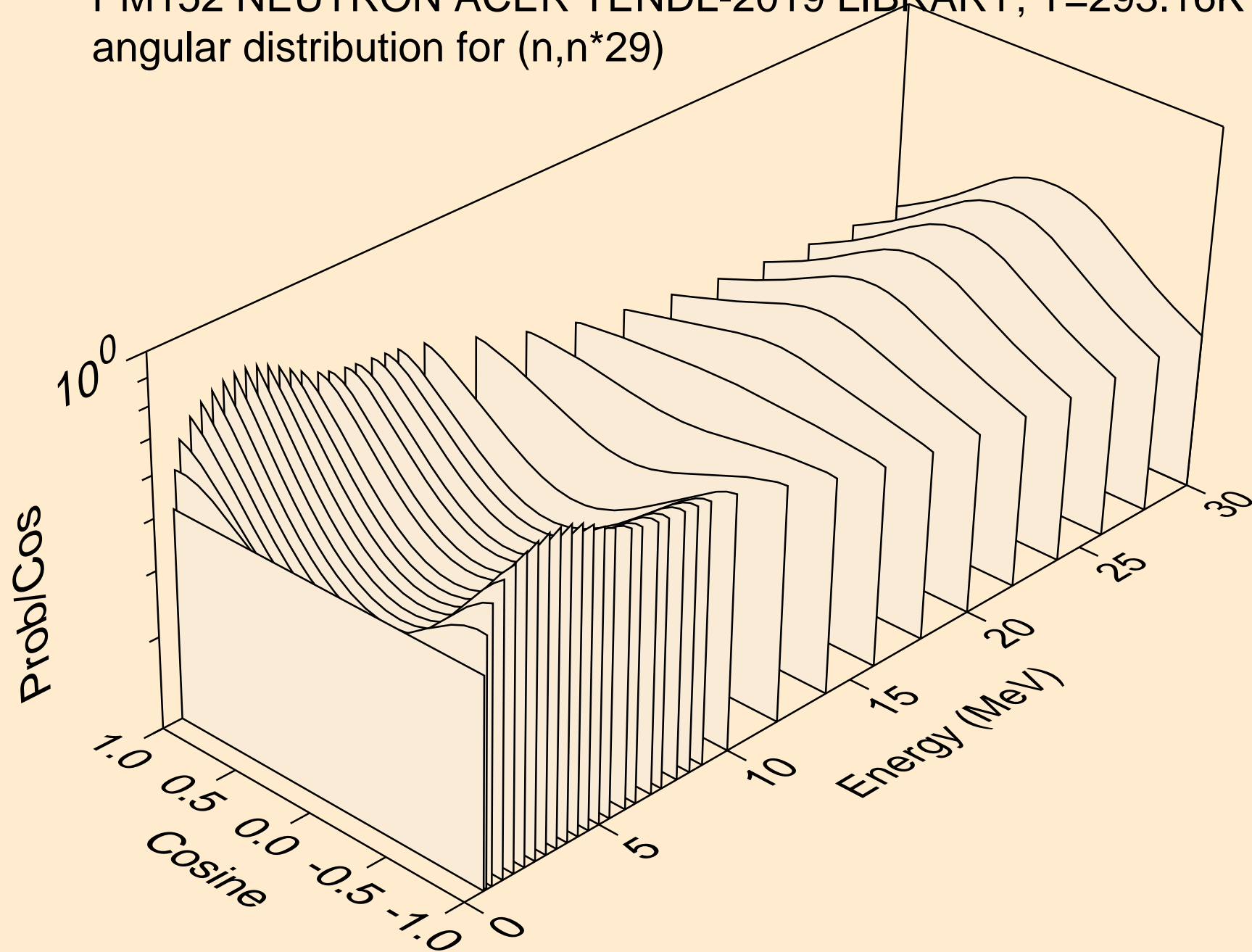

PM152 NEUTRON ACER TENDL-2019 LIBRARY; T=293.16K
angular distribution for (n,n*30)

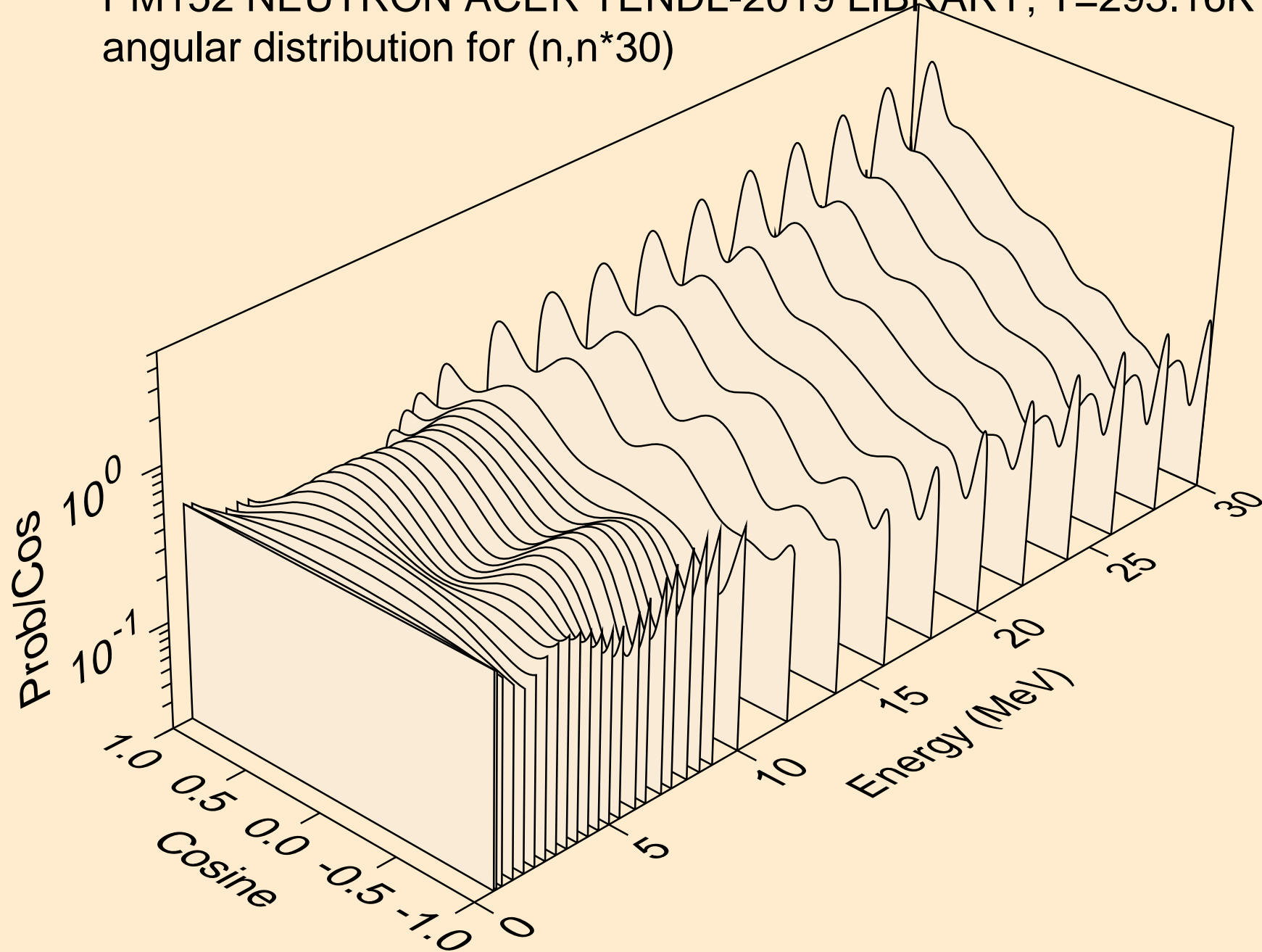

PM152 NEUTRON ACER TENDL-2019 LIBRARY; T=293.16K
Neutron emission for (n,x)

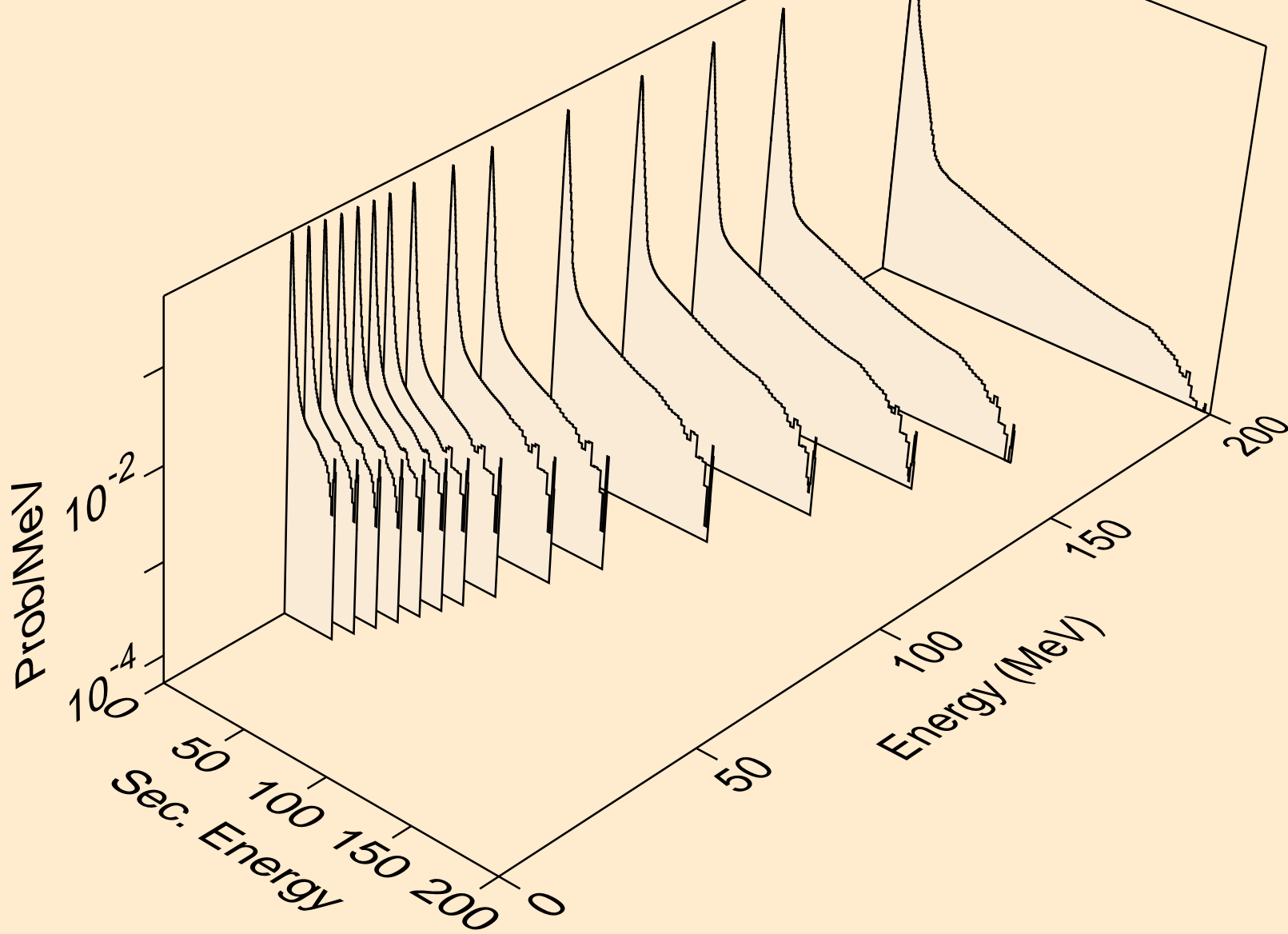

PM152 NEUTRON ACER TENDL-2019 LIBRARY; T=293.16K
Neutron emission for (n,2nd)

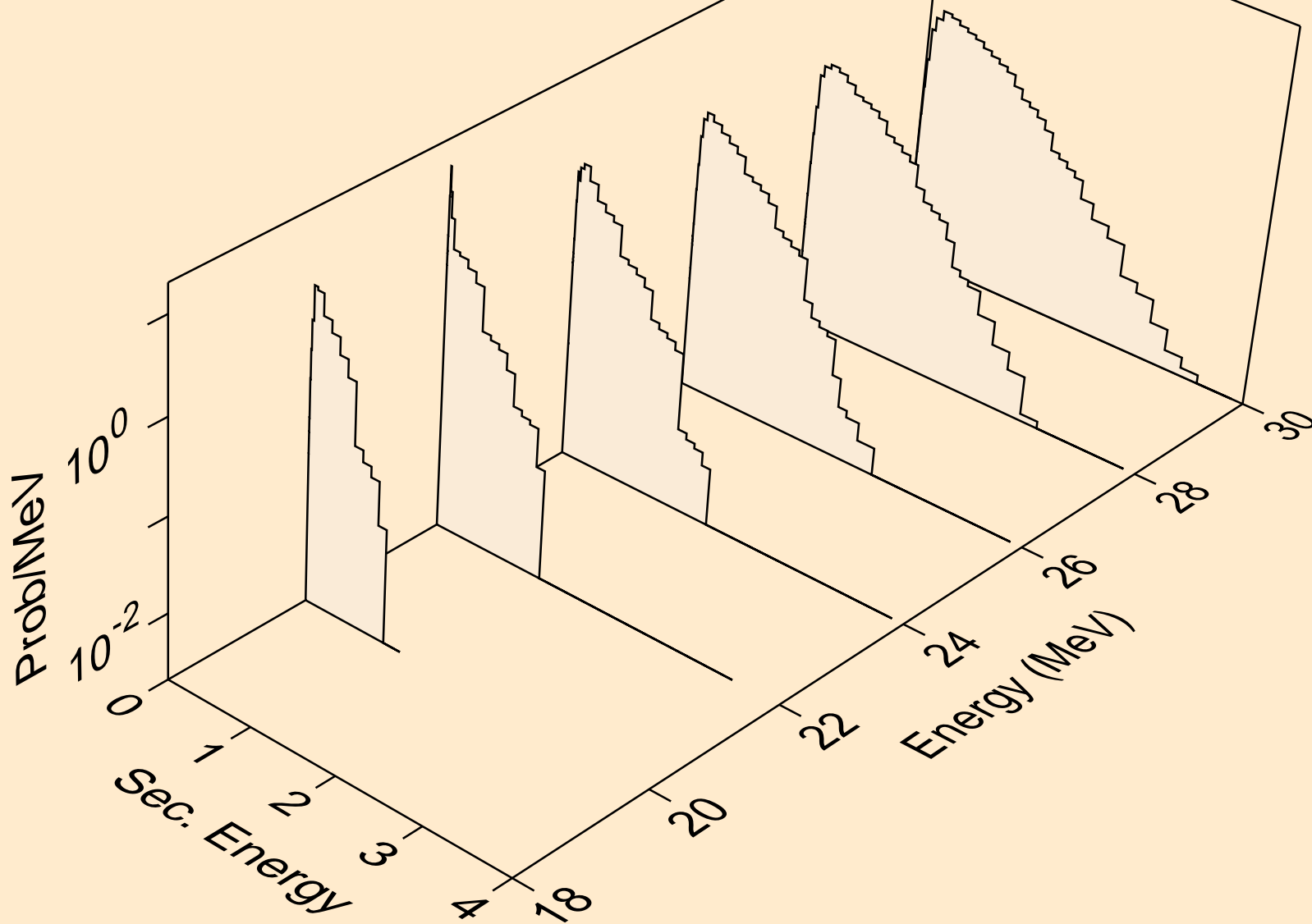

PM152 NEUTRON ACER TENDL-2019 LIBRARY; T=293.16K
Neutron emission for (n,2n)

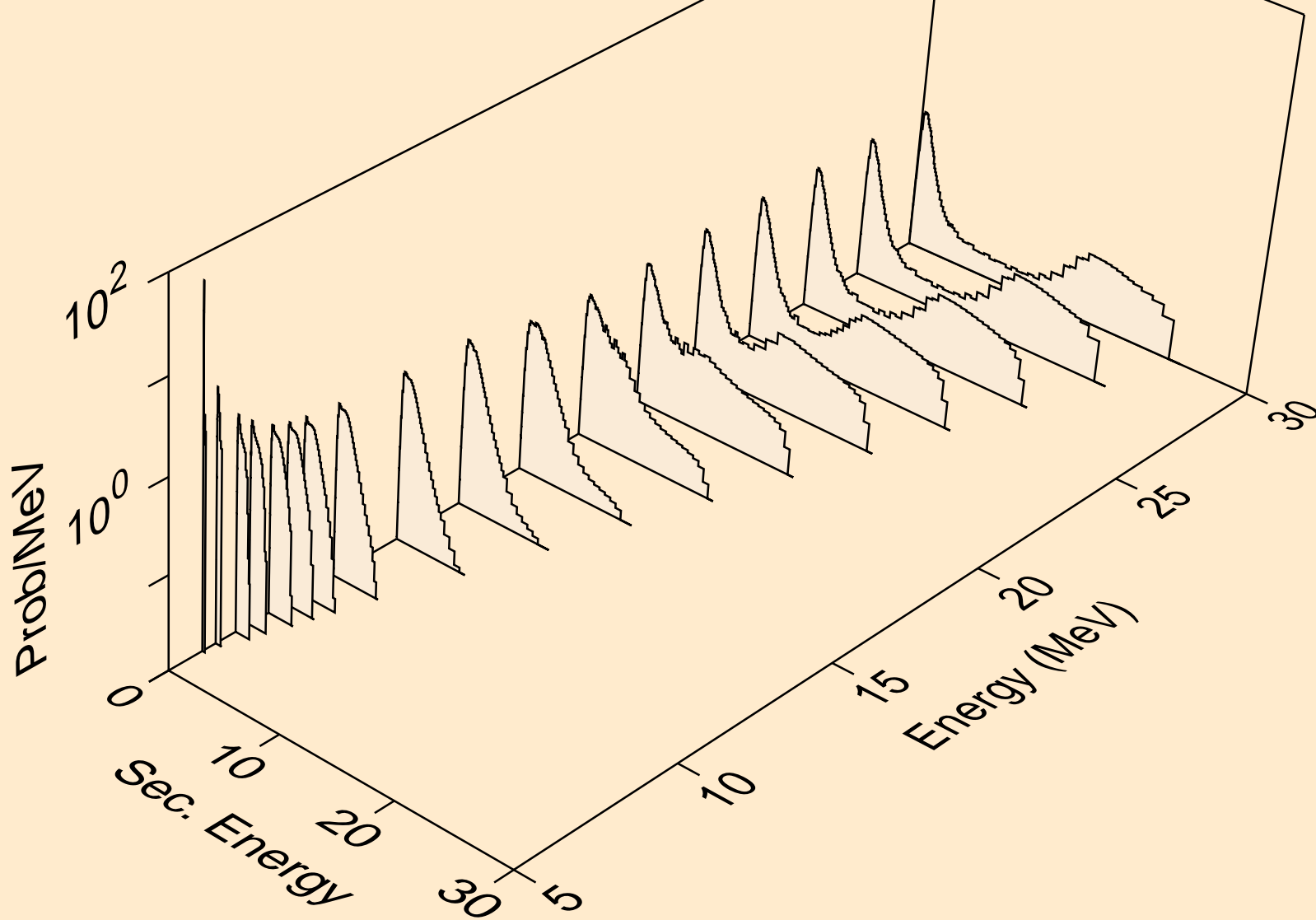

PM152 NEUTRON ACER TENDL-2019 LIBRARY; T=293.16K
Neutron emission for (n,3n)

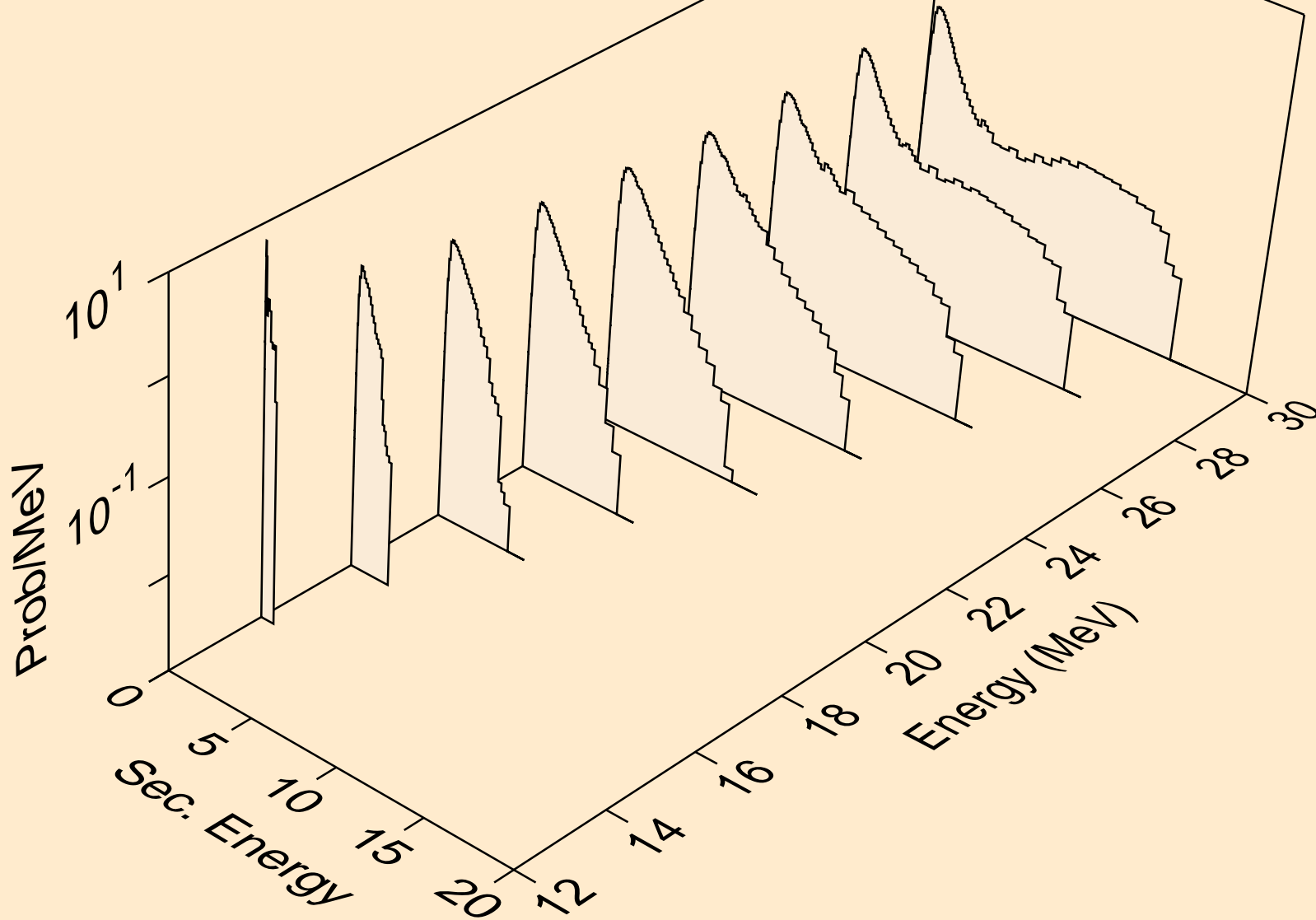

PM152 NEUTRON ACER TENDL-2019 LIBRARY; T=293.16K
Neutron emission for (n,n*)a

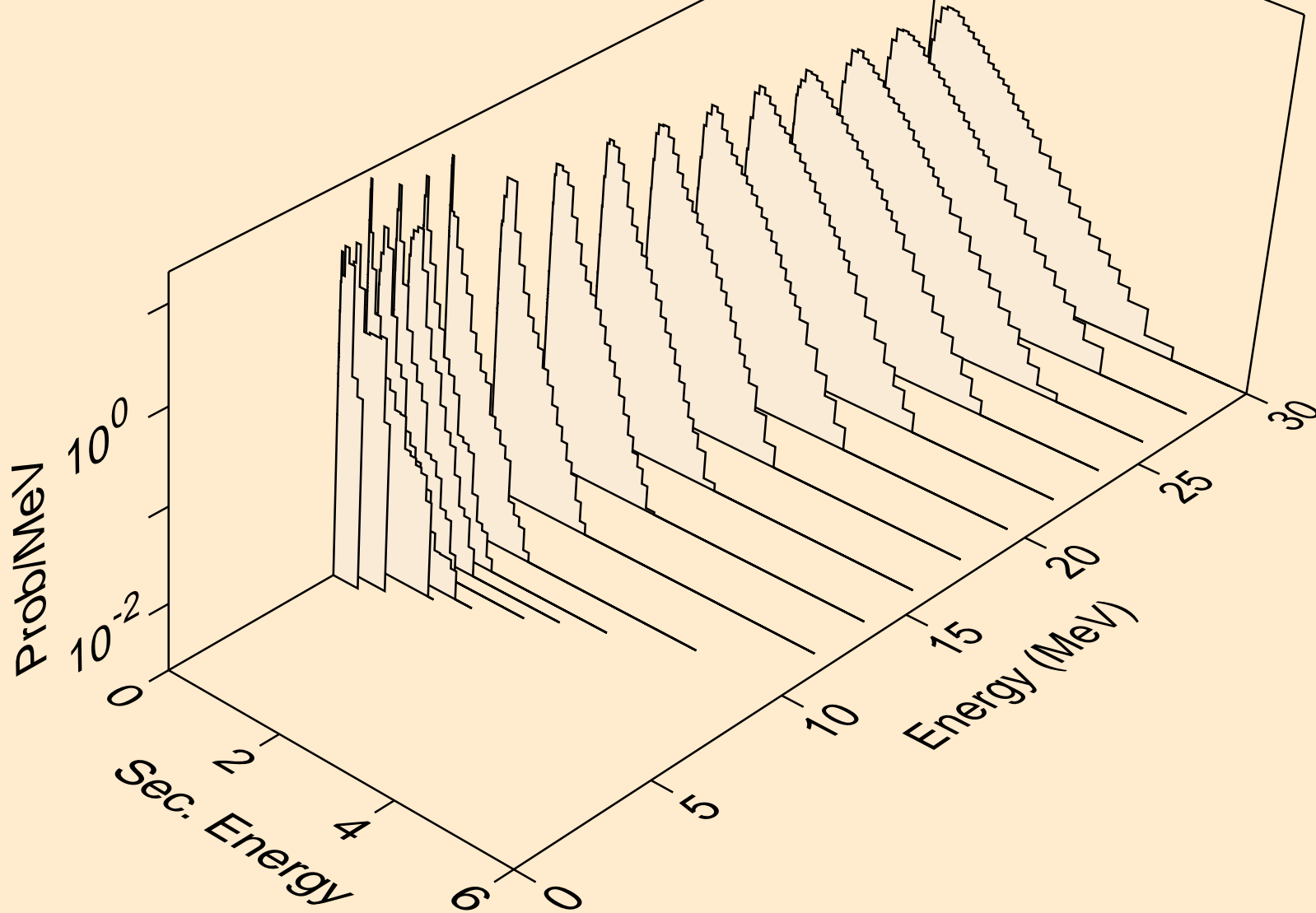

PM152 NEUTRON ACER TENDL-2019 LIBRARY; T=293.16K
Neutron emission for (n,2n)a

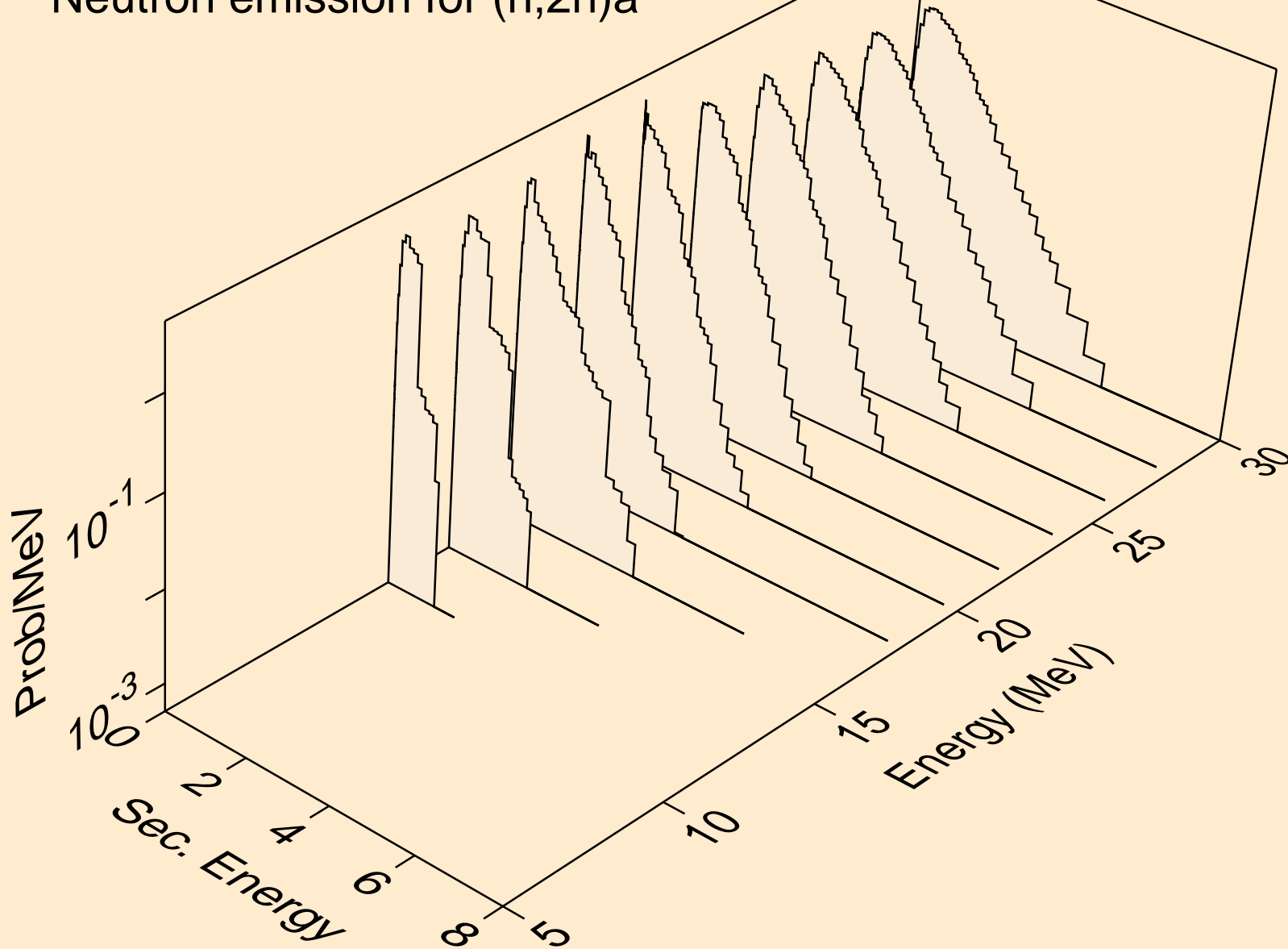

PM152 NEUTRON ACER TENDL-2019 LIBRARY; T=293.16K
Neutron emission for (n,3n)a

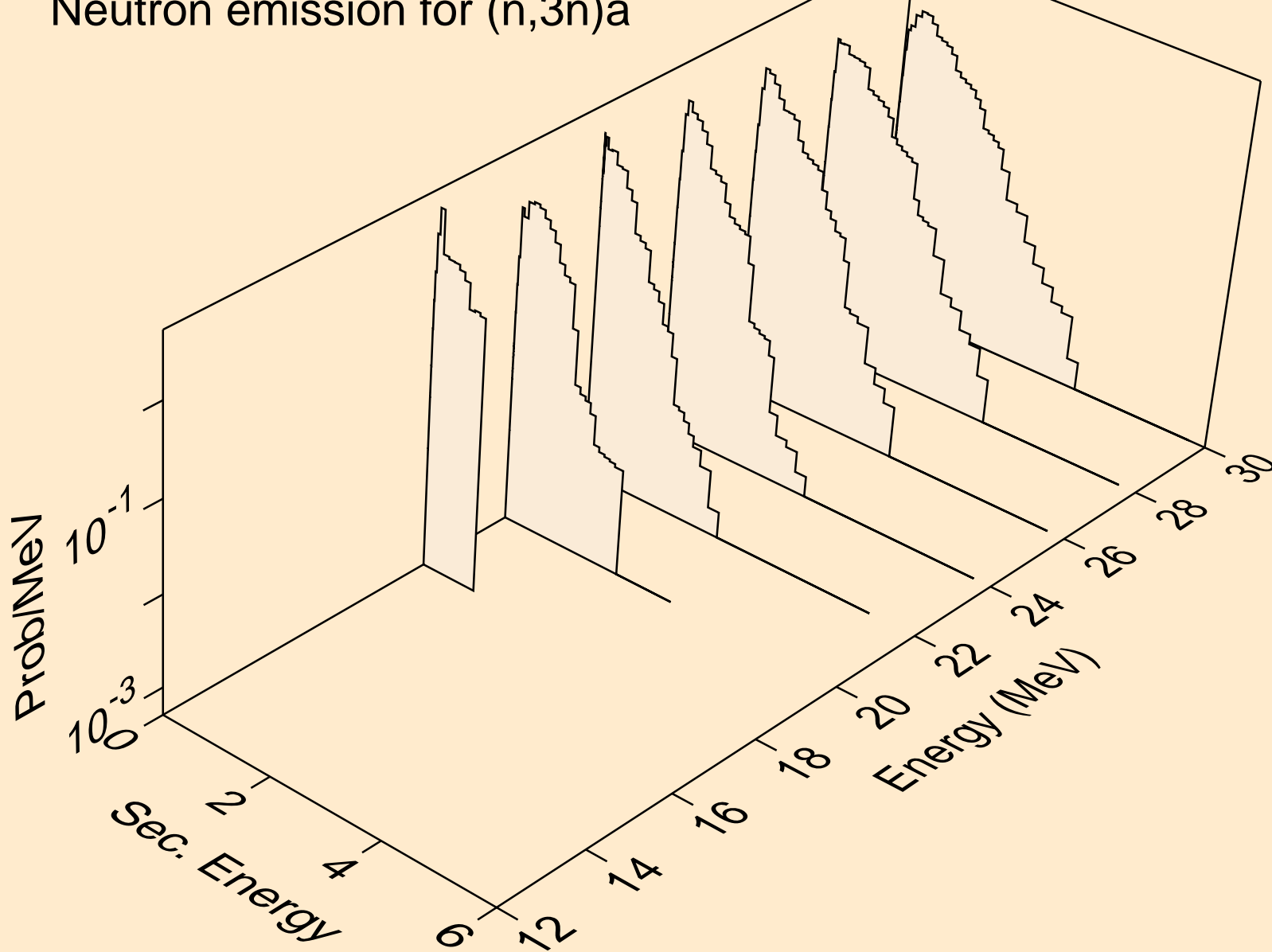

PM152 NEUTRON ACER TENDL-2019 LIBRARY; T=293.16K
Neutron emission for (n,n*)p

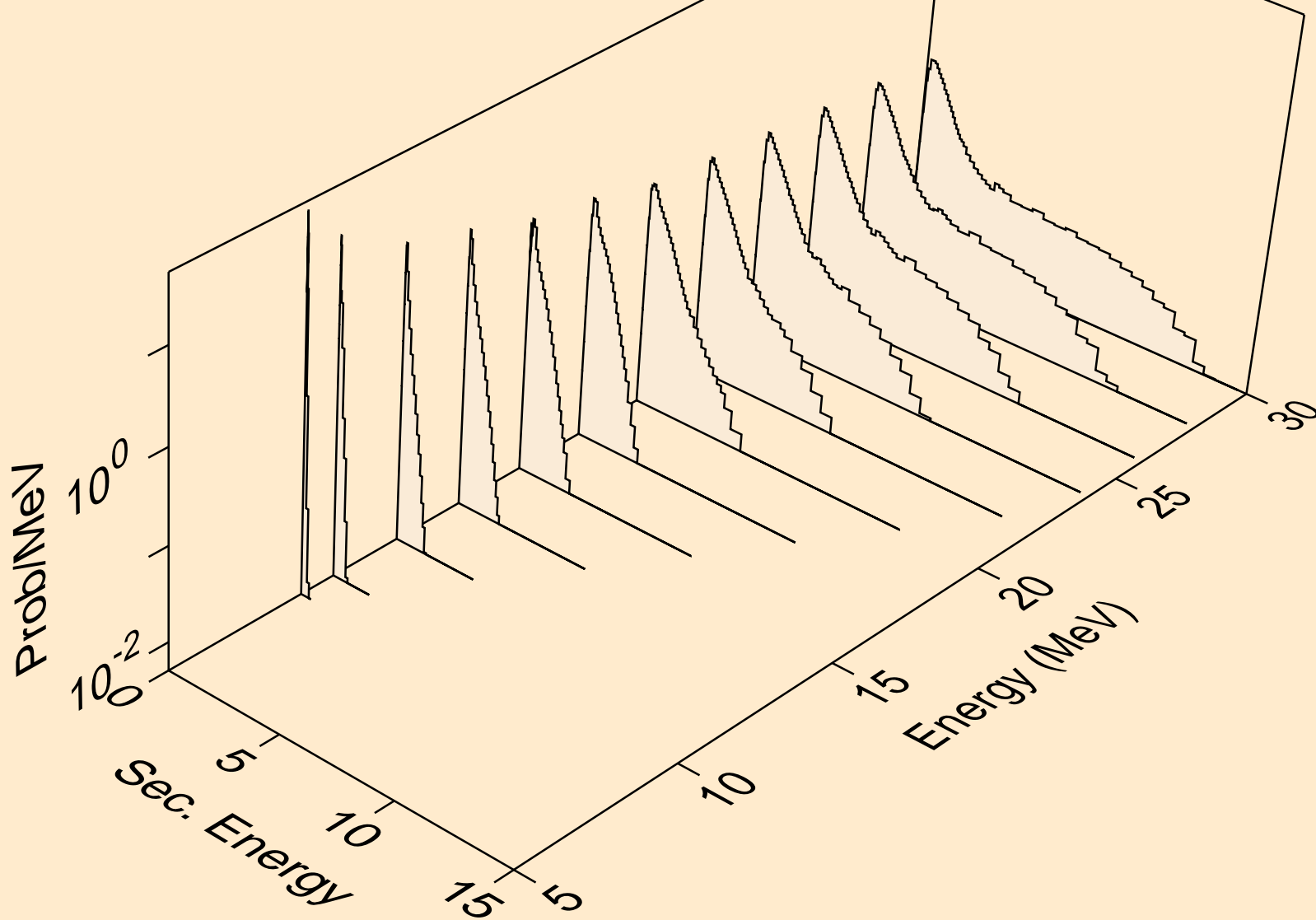

PM152 NEUTRON ACER TENDL-2019 LIBRARY; T=293.16K
Neutron emission for (n,n*)d

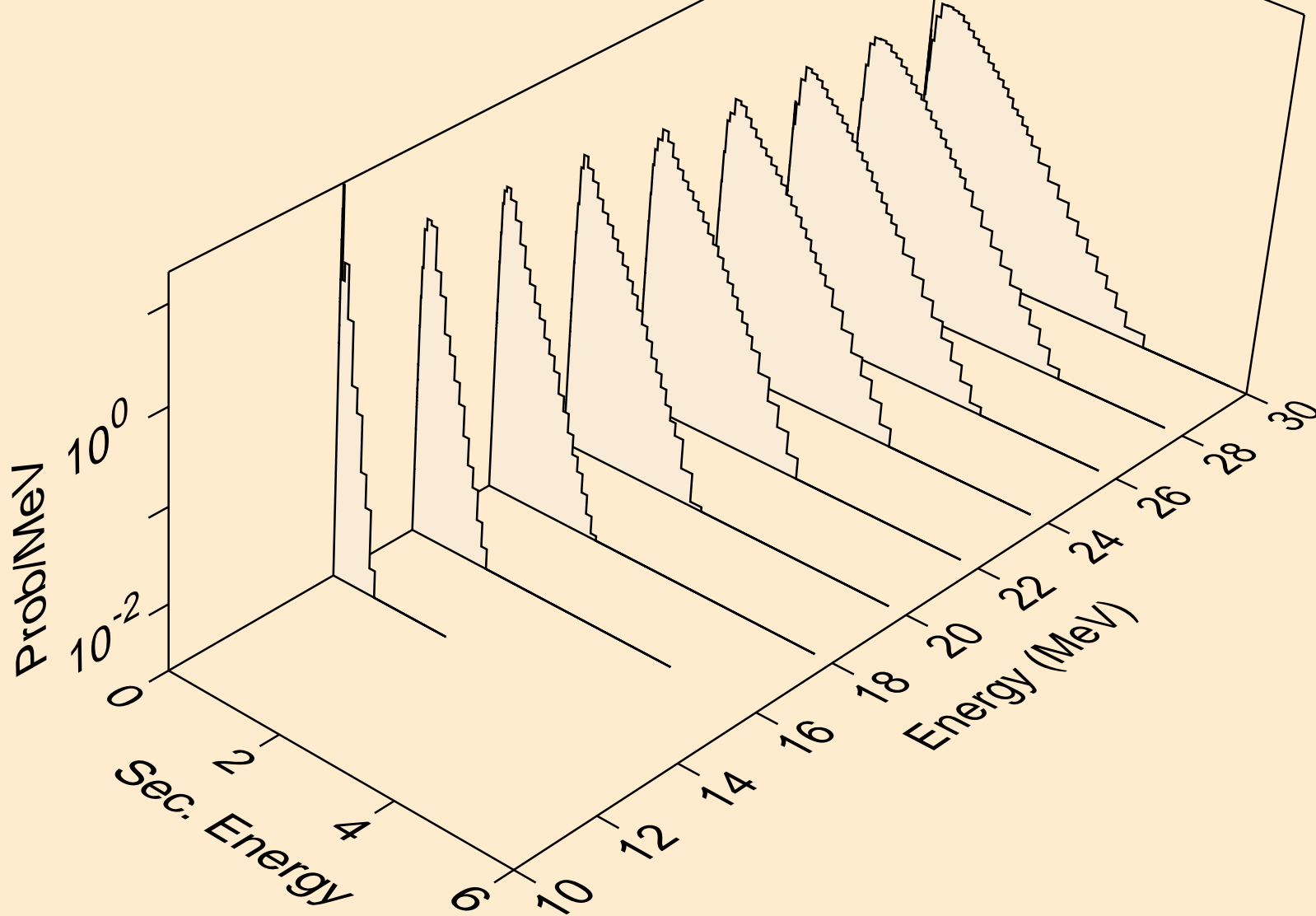

PM152 NEUTRON ACER TENDL-2019 LIBRARY; T=293.16K
Neutron emission for (n,n*)t

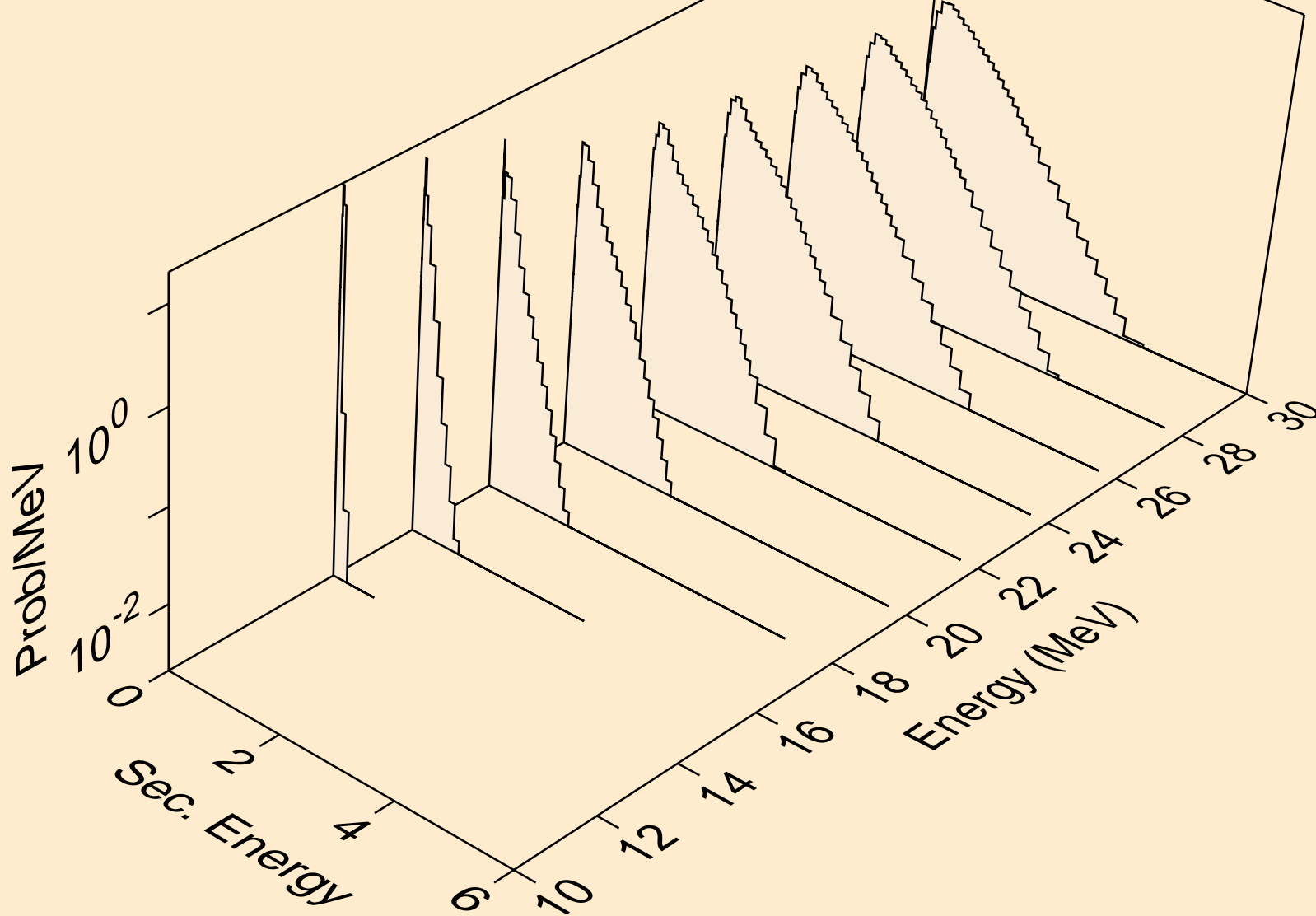

PM152 NEUTRON ACER TENDL-2019 LIBRARY; T=293.16K
Neutron emission for (n,n*)he3

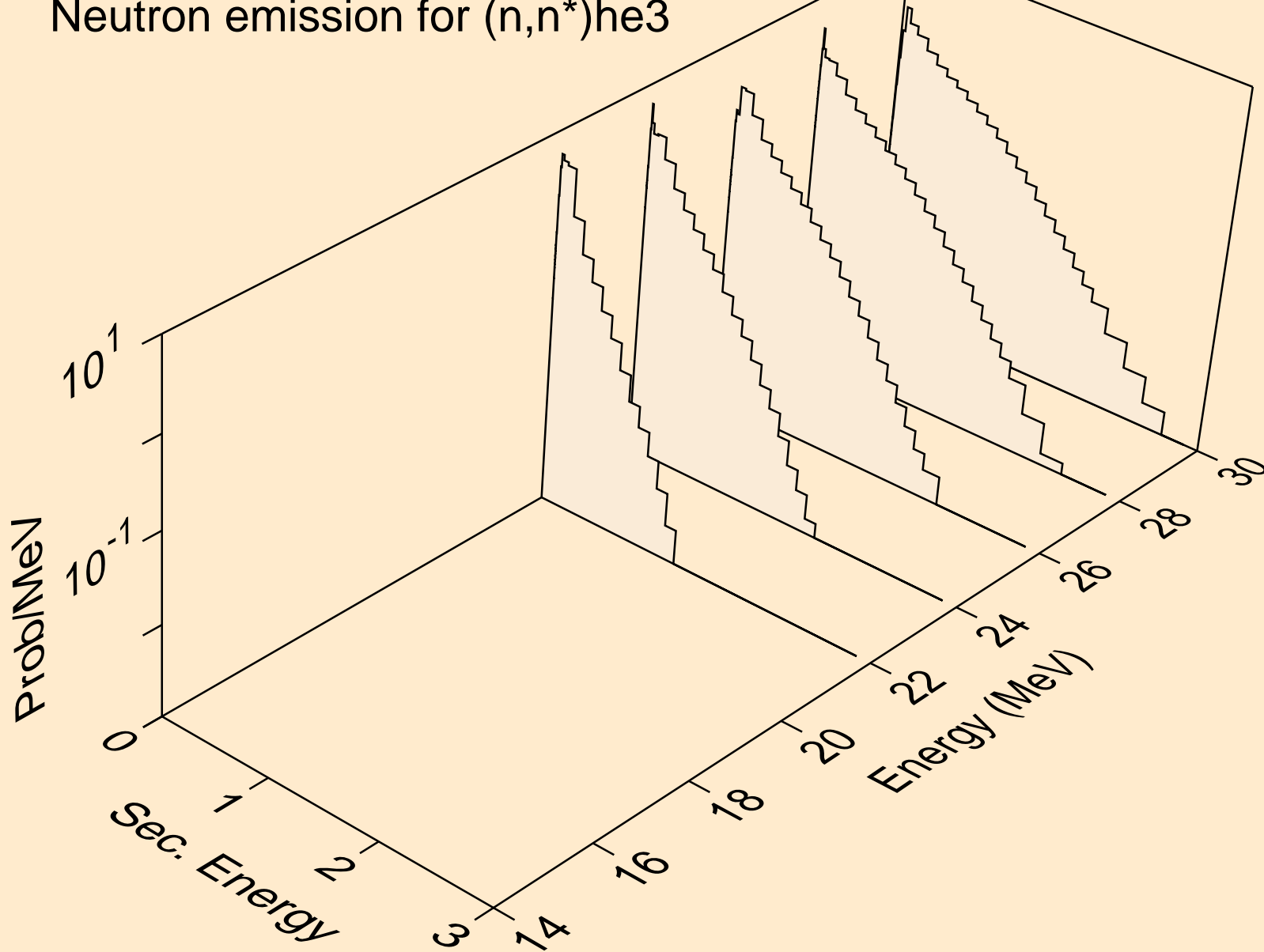

PM152 NEUTRON ACER TENDL-2019 LIBRARY; T=293.16K
Neutron emission for (n,4n)

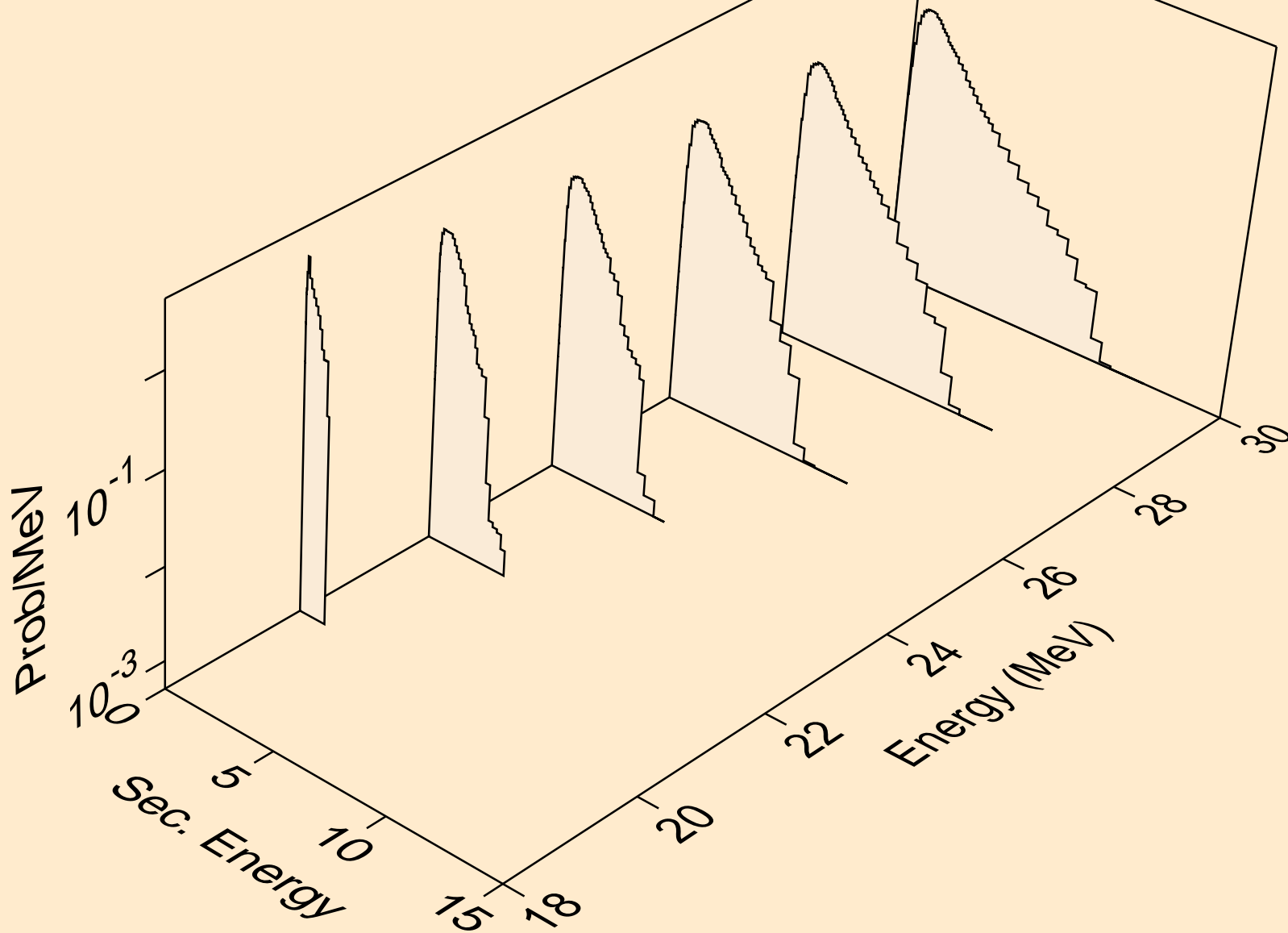

PM152 NEUTRON ACER TENDL-2019 LIBRARY; T=293.16K
Neutron emission for (n,2np)

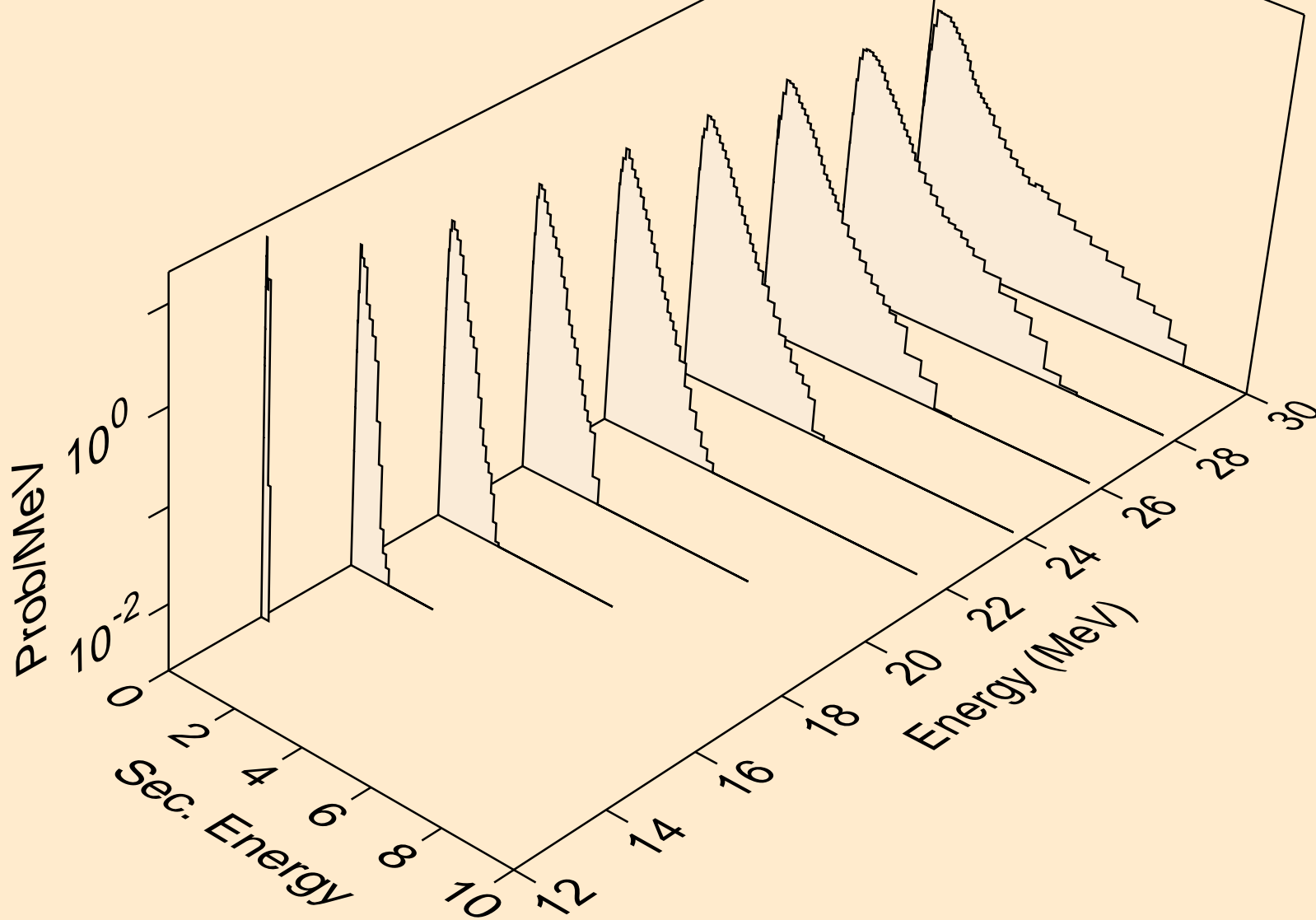

PM152 NEUTRON ACER TENDL-2019 LIBRARY; T=293.16K
Neutron emission for (n,3np)

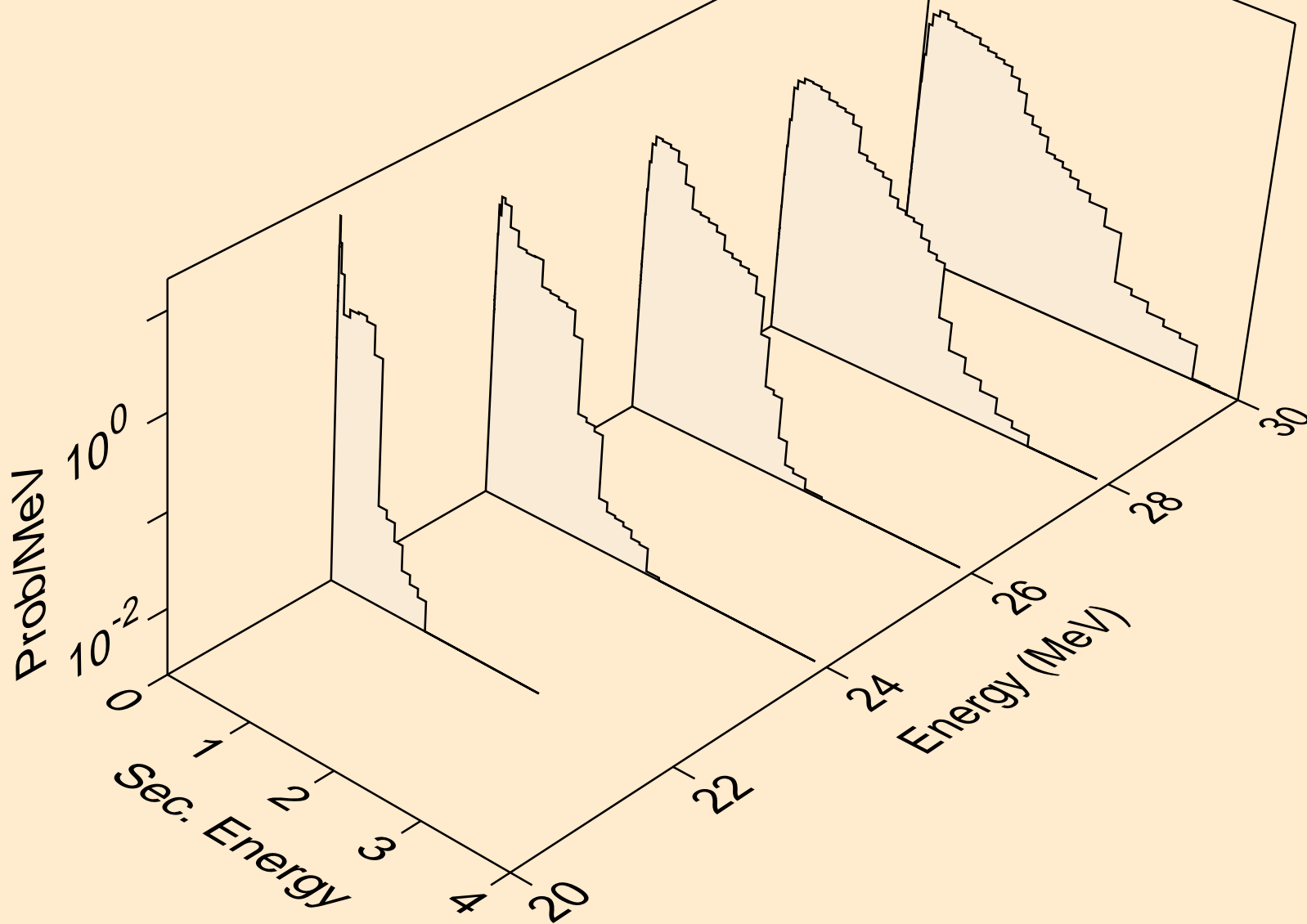

PM152 NEUTRON ACER TENDL-2019 LIBRARY; T=293.16K
Neutron emission for (n,2np)

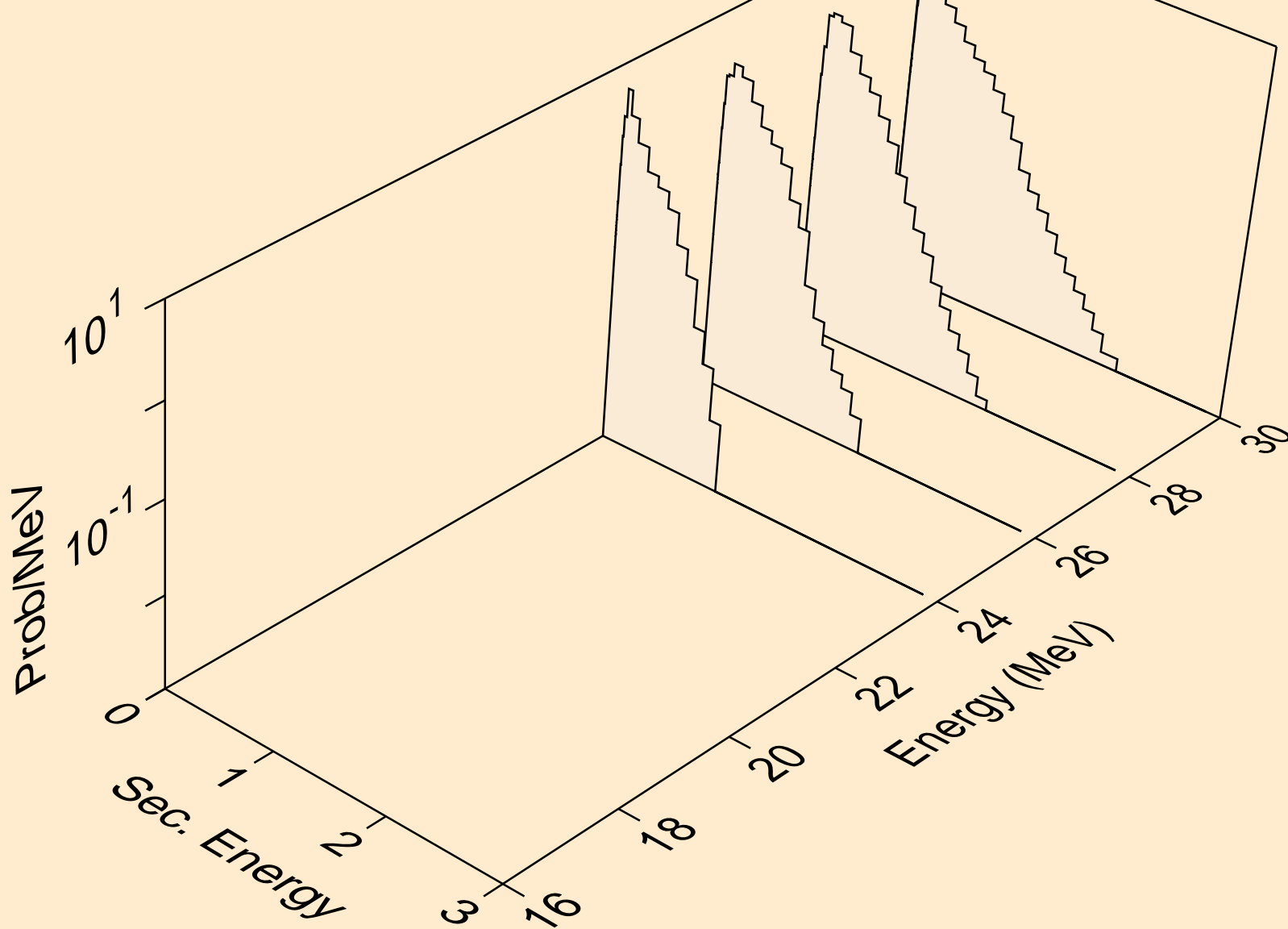

PM152 NEUTRON ACER TENDL-2019 LIBRARY; T=293.16K
Neutron emission for (n,n*c)

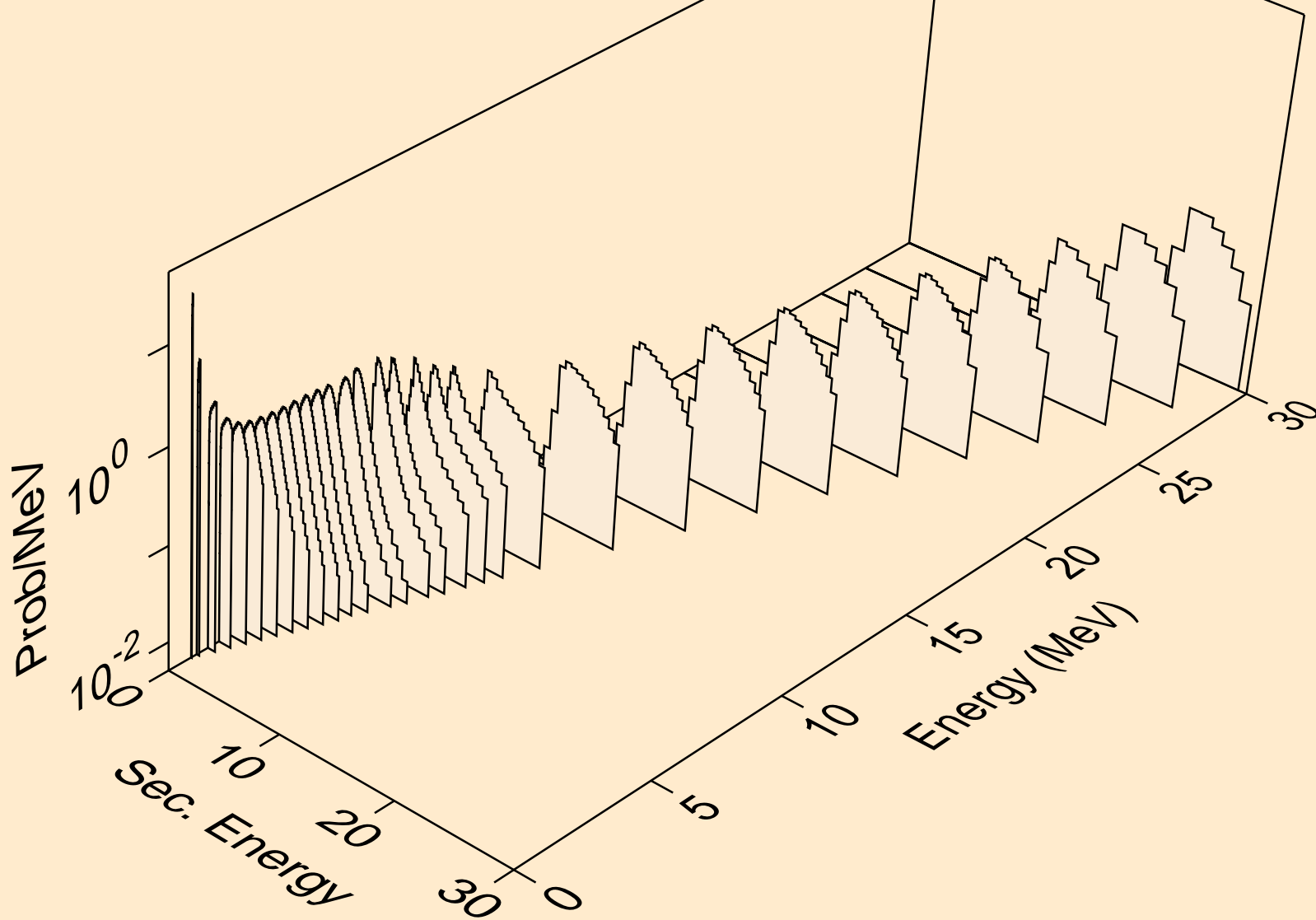

PM152 NEUTRON ACER TENDL-2019 LIBRARY; T=293.16K
Photon emission for (n,x)

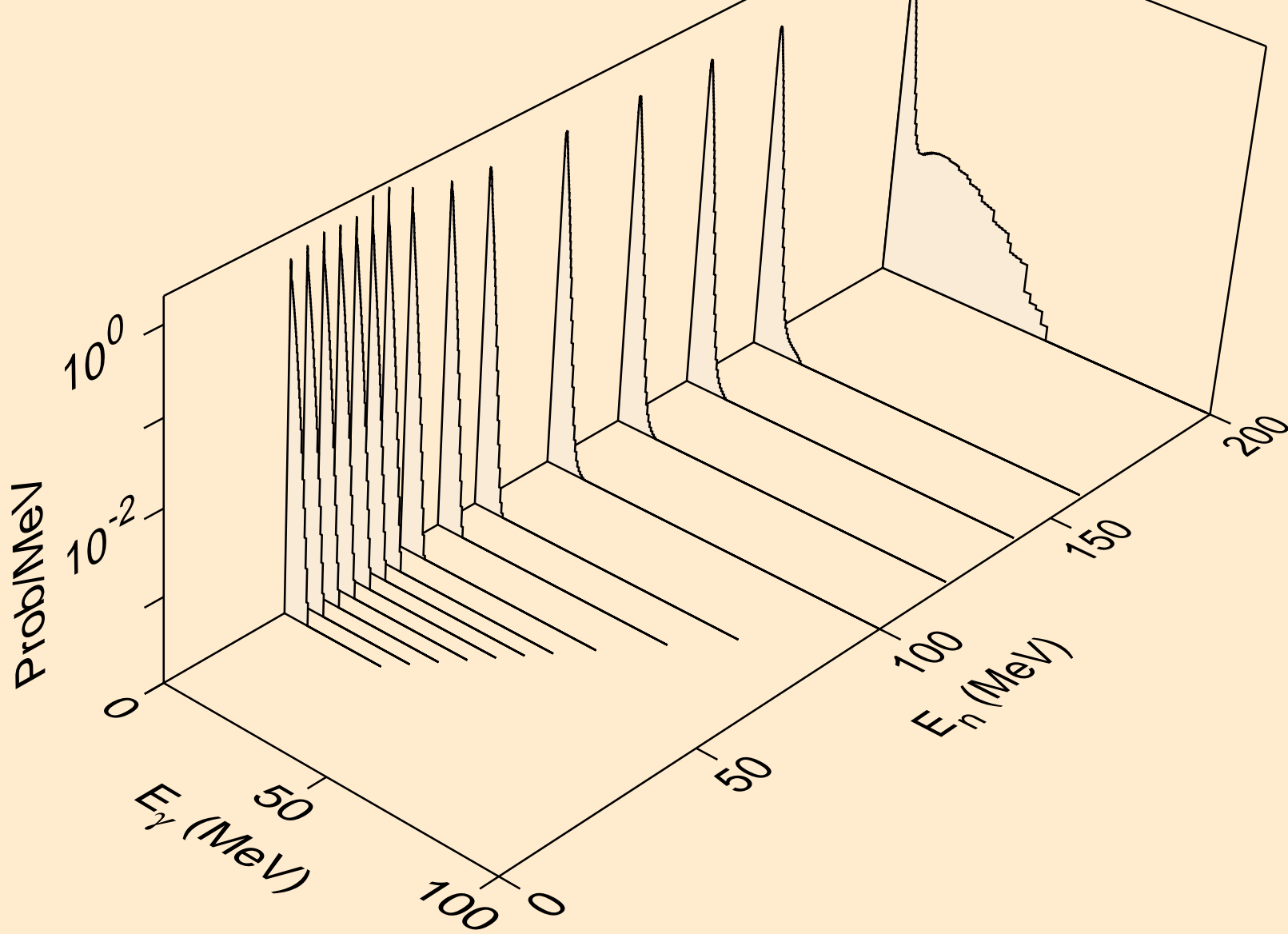

PM152 NEUTRON ACER TENDL-2019 LIBRARY; T=293.16K
Photon emission for (n,2nd)

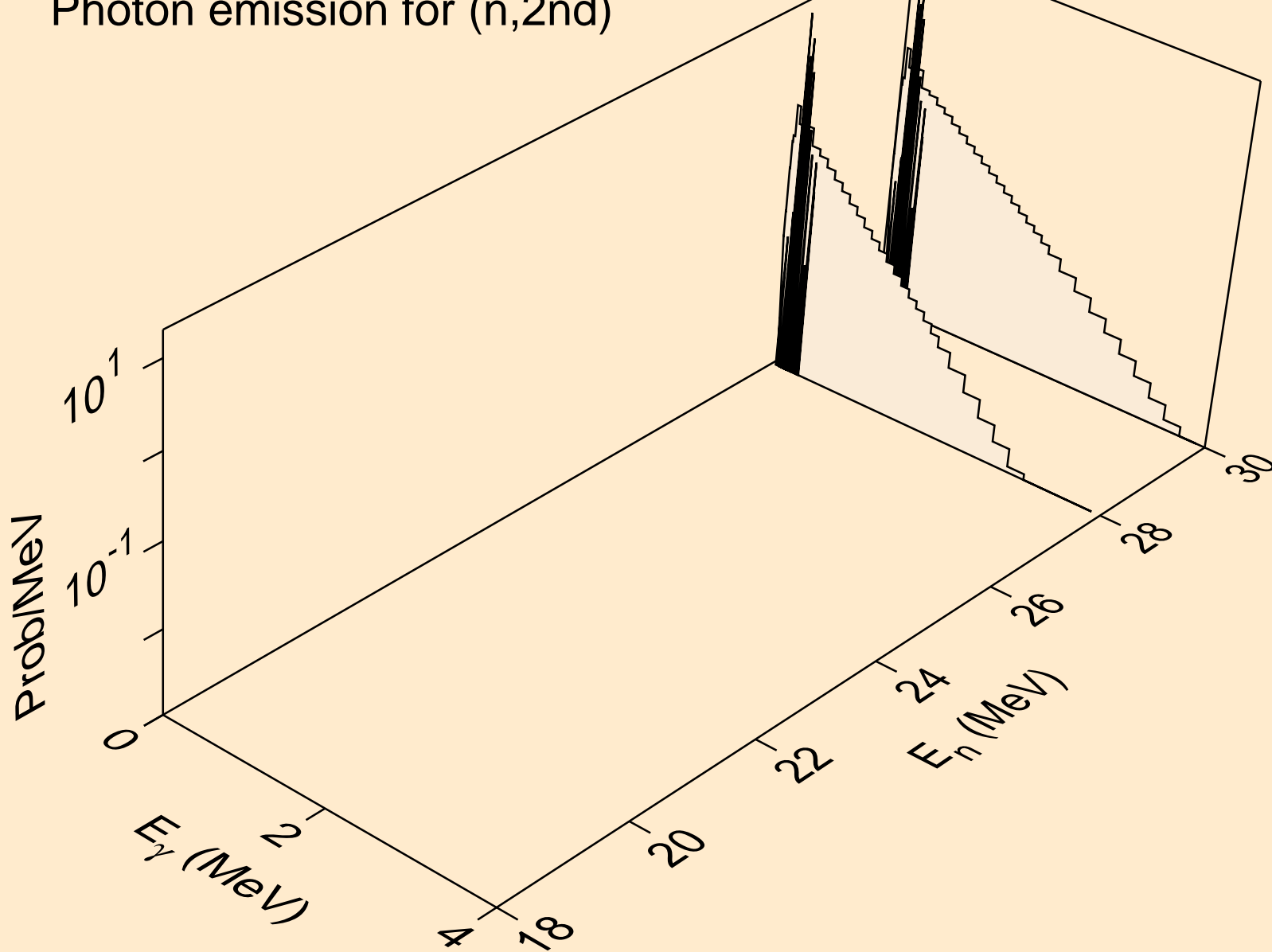

PM152 NEUTRON ACER TENDL-2019 LIBRARY; T=293.16K
Photon emission for (n,2n)

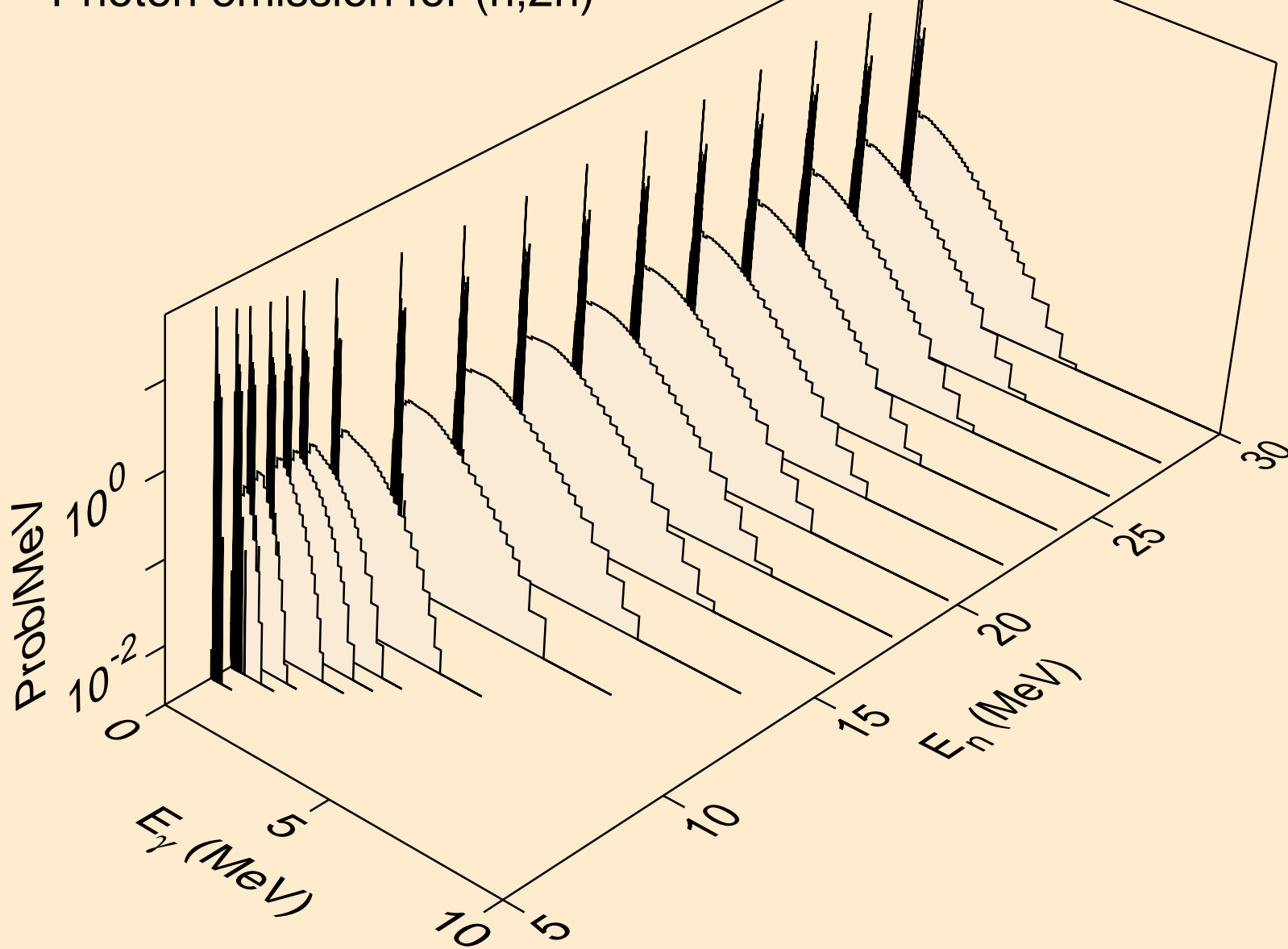

PM152 NEUTRON ACER TENDL-2019 LIBRARY; T=293.16K
Photon emission for (n,3n)

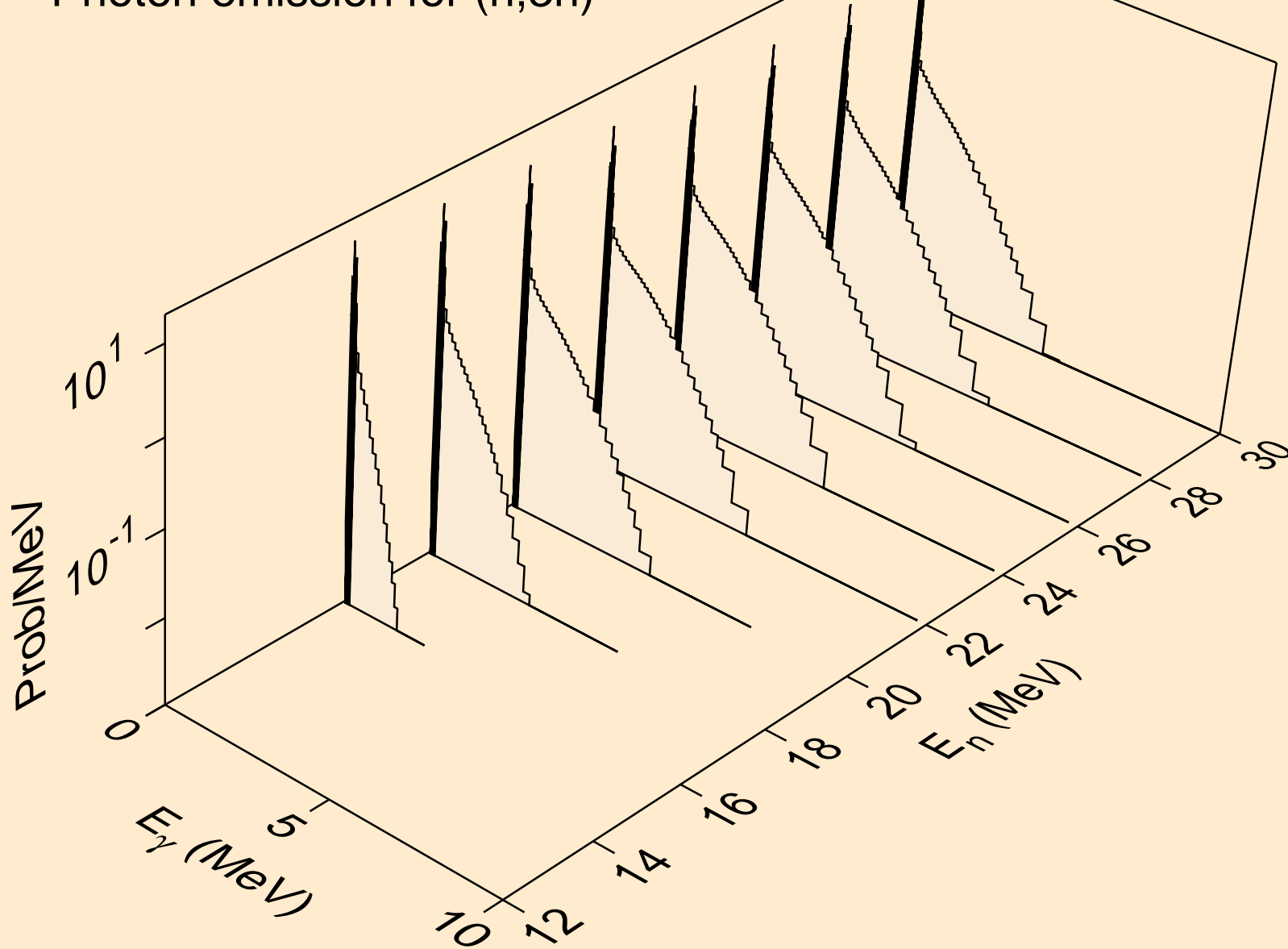

PM152 NEUTRON ACER TENDL-2019 LIBRARY; T=293.16K
Photon emission for (n,n*)a

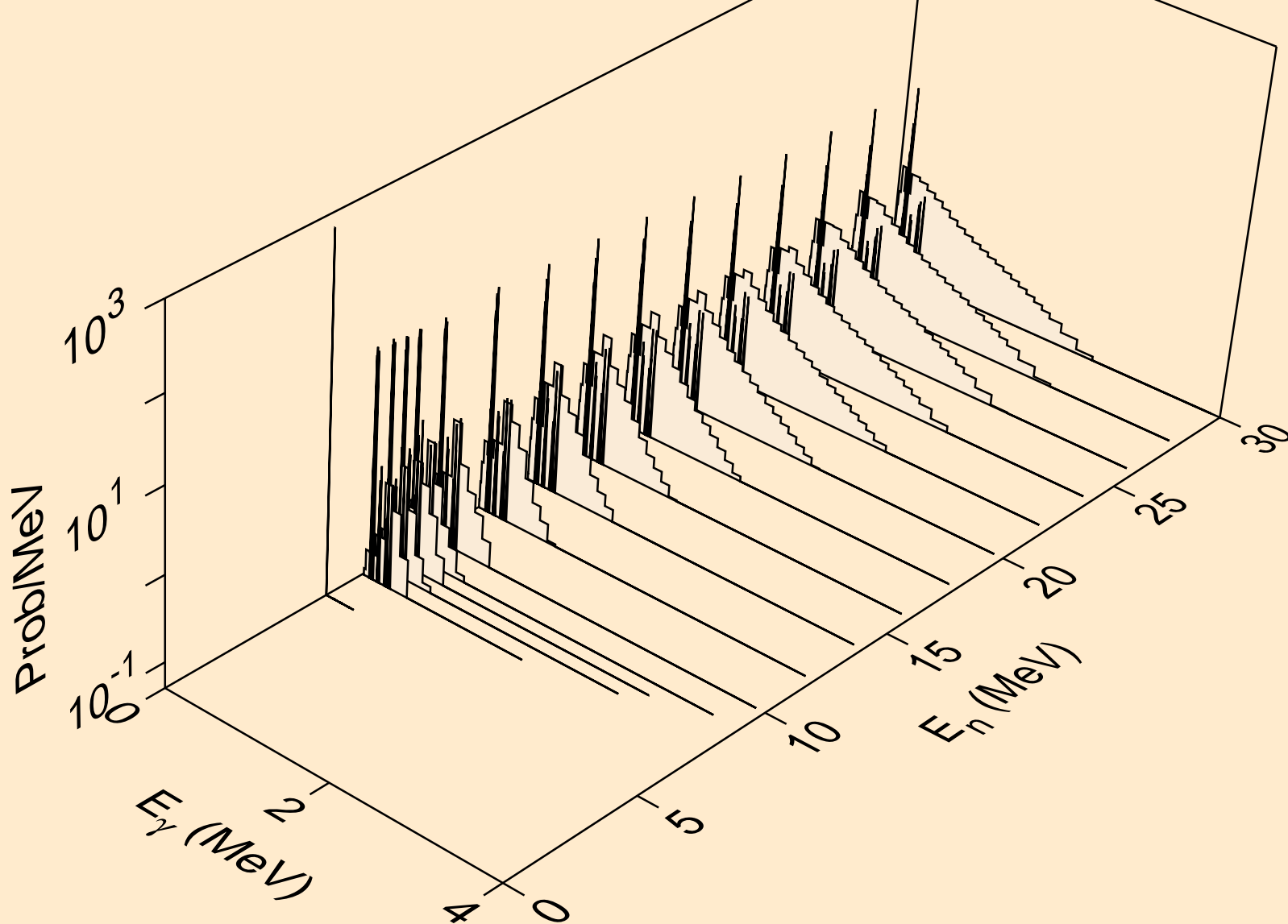

PM152 NEUTRON ACER TENDL-2019 LIBRARY; T=293.16K
Photon emission for (n,2n)a

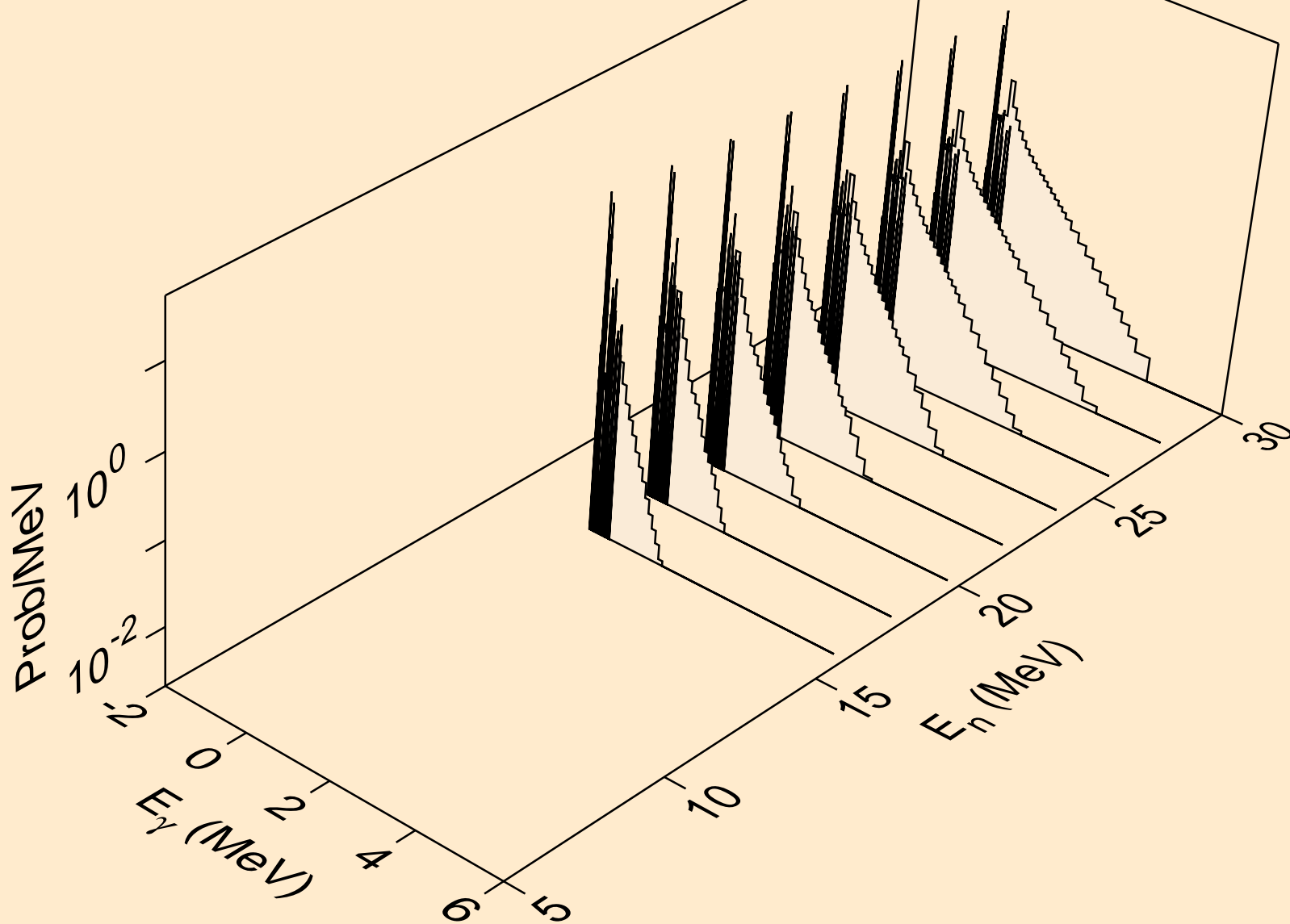

PM152 NEUTRON ACER TENDL-2019 LIBRARY; T=293.16K
Photon emission for (n,3n)a

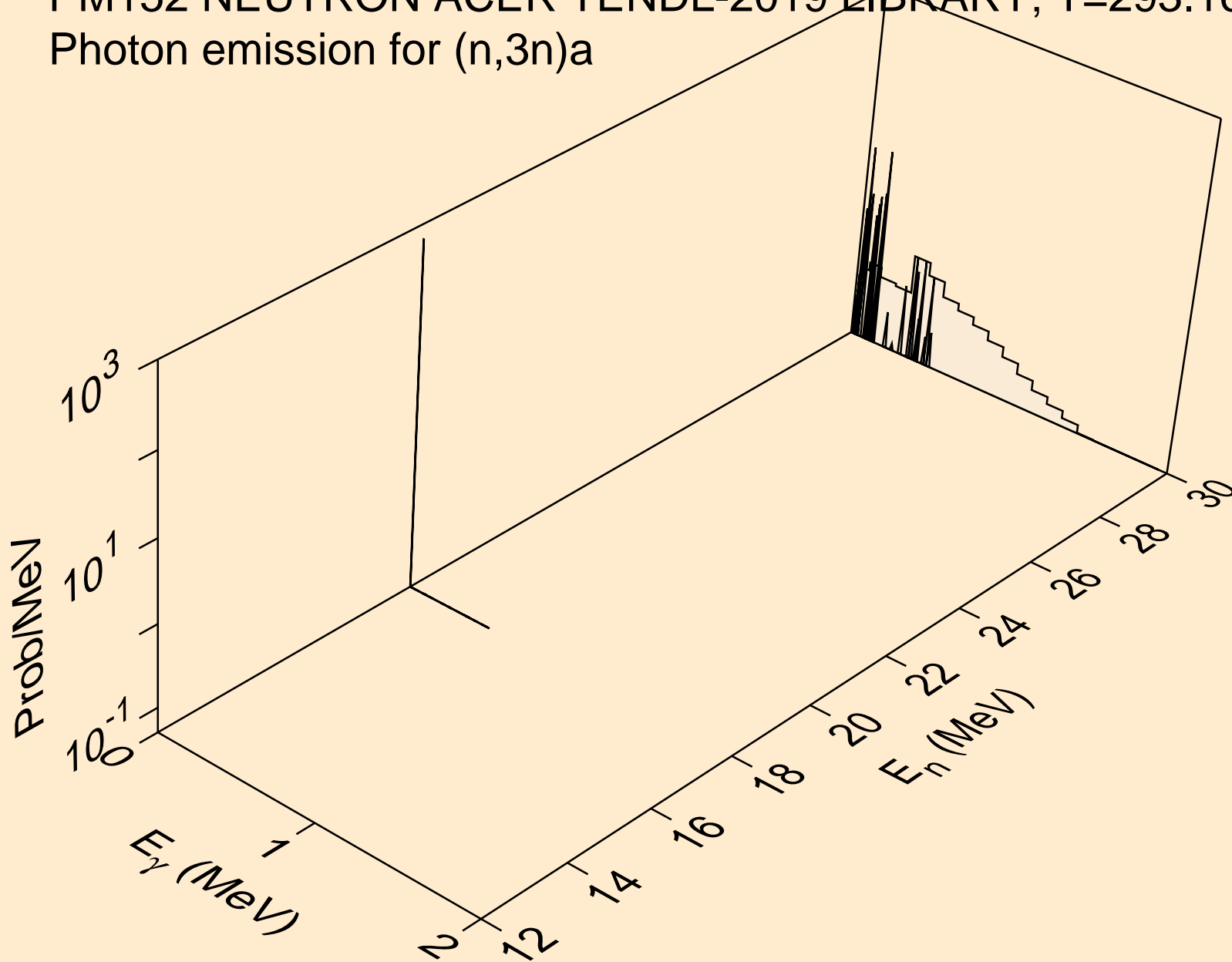

PM152 NEUTRON ACER TENDL-2019 LIBRARY; T=293.16K
Photon emission for (n,n*)p

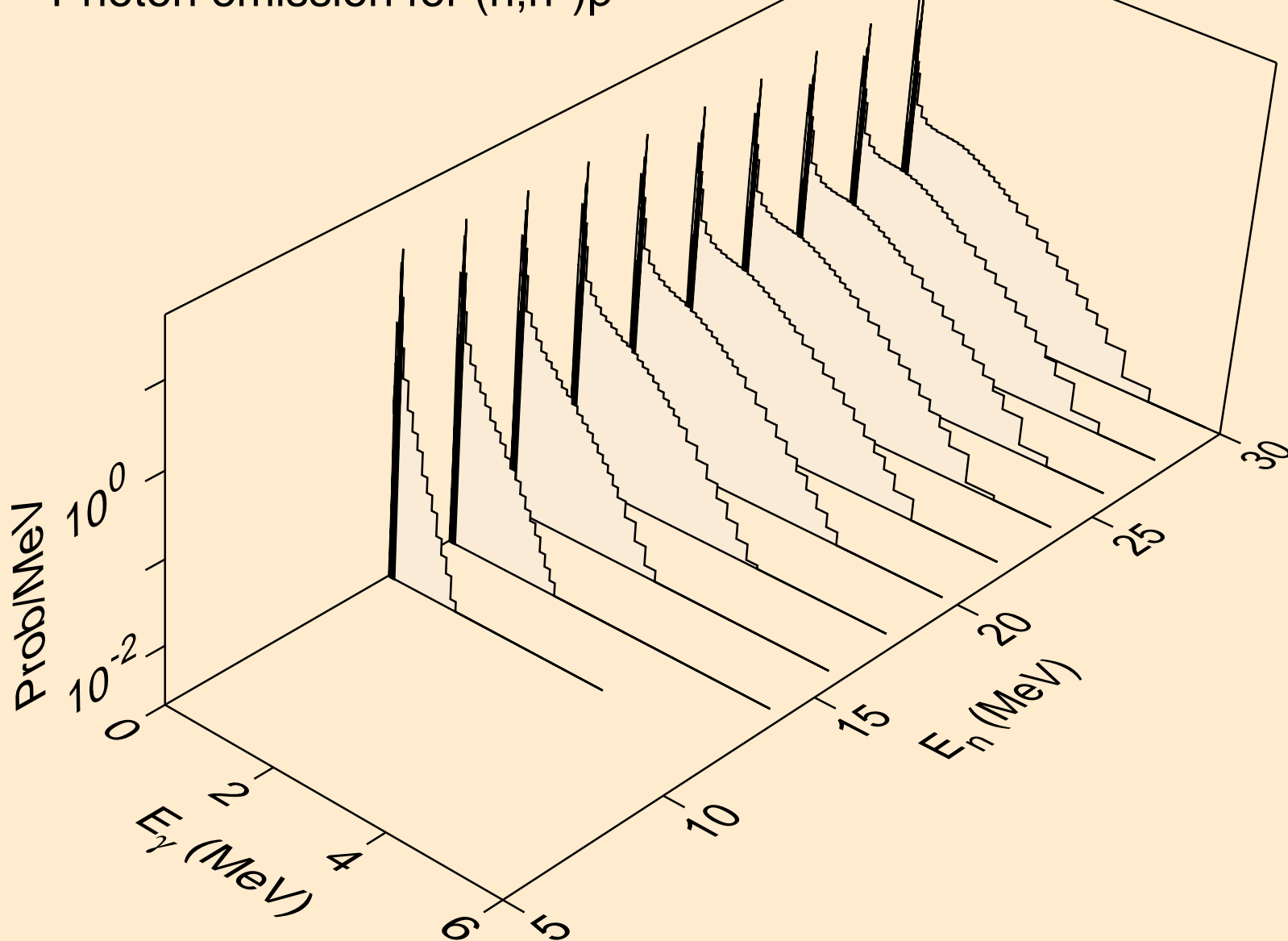

PM152 NEUTRON ACER TENDL-2019 LIBRARY; T=293.16K
Photon emission for (n,n*)d

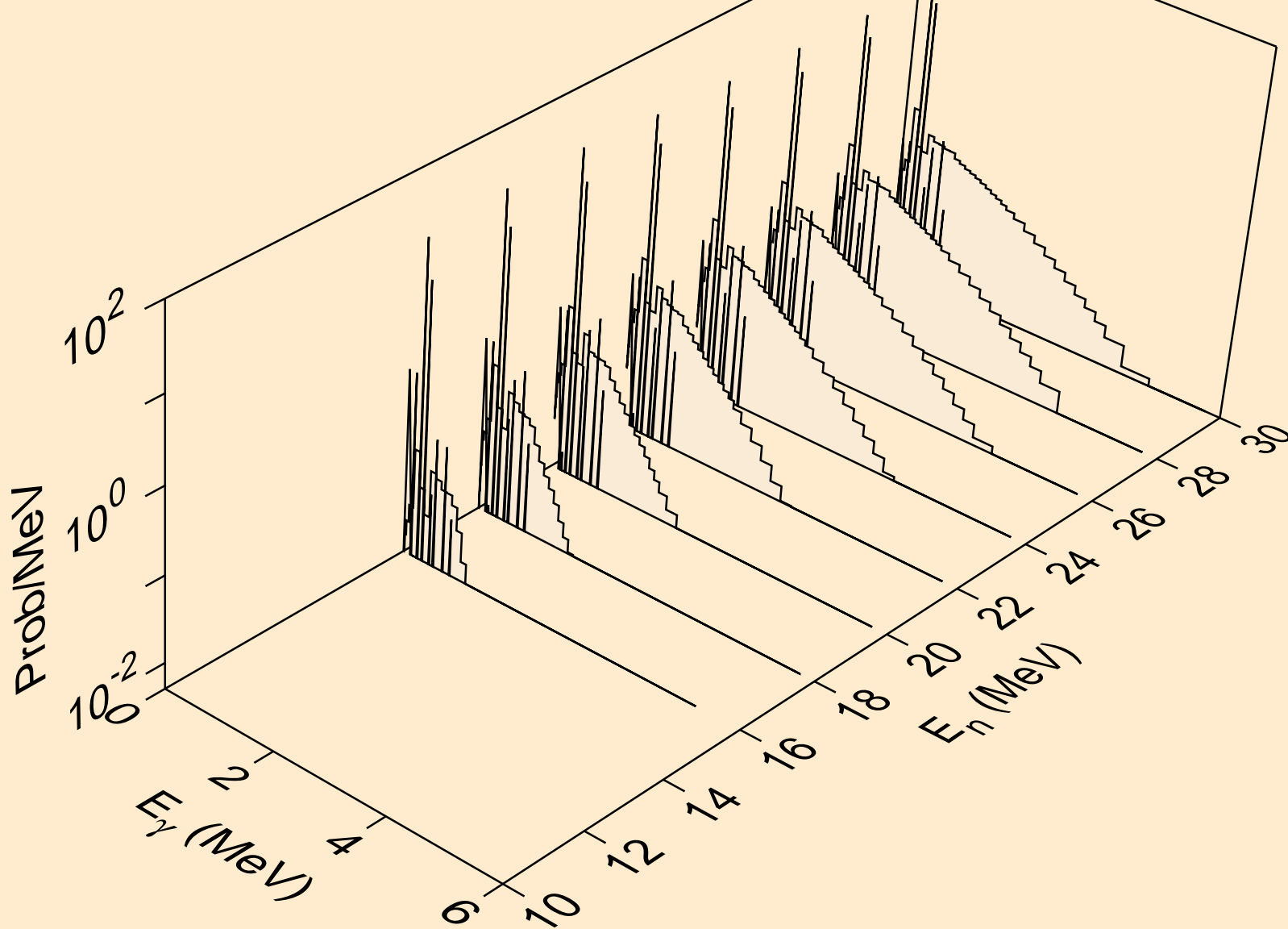

PM152 NEUTRON ACER TENDL-2019 LIBRARY; T=293.16K
Photon emission for (n,n*)t

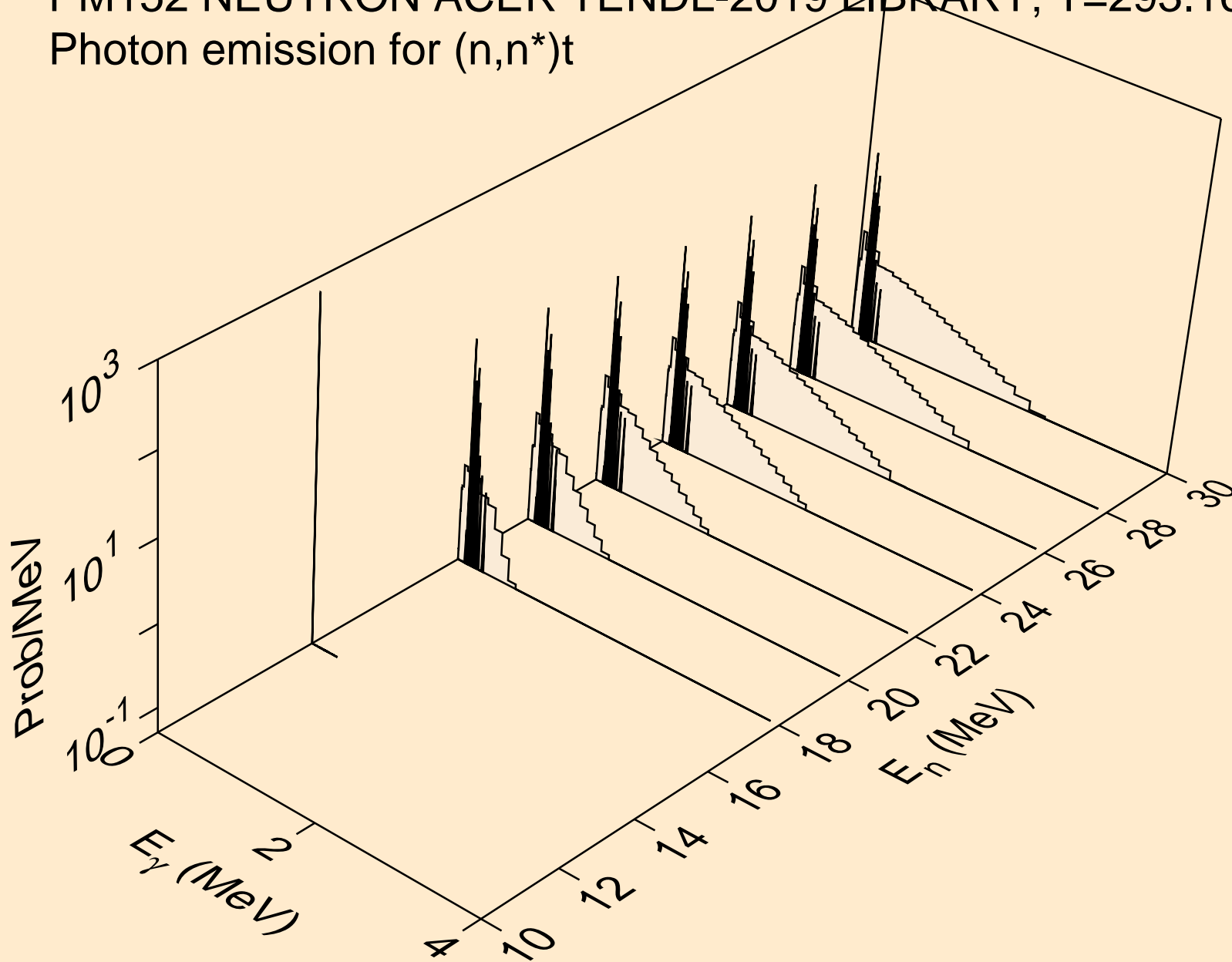

PM152 NEUTRON ACER TENDL-2019 LIBRARY; T=293.16K
Photon emission for (n,n*)he3

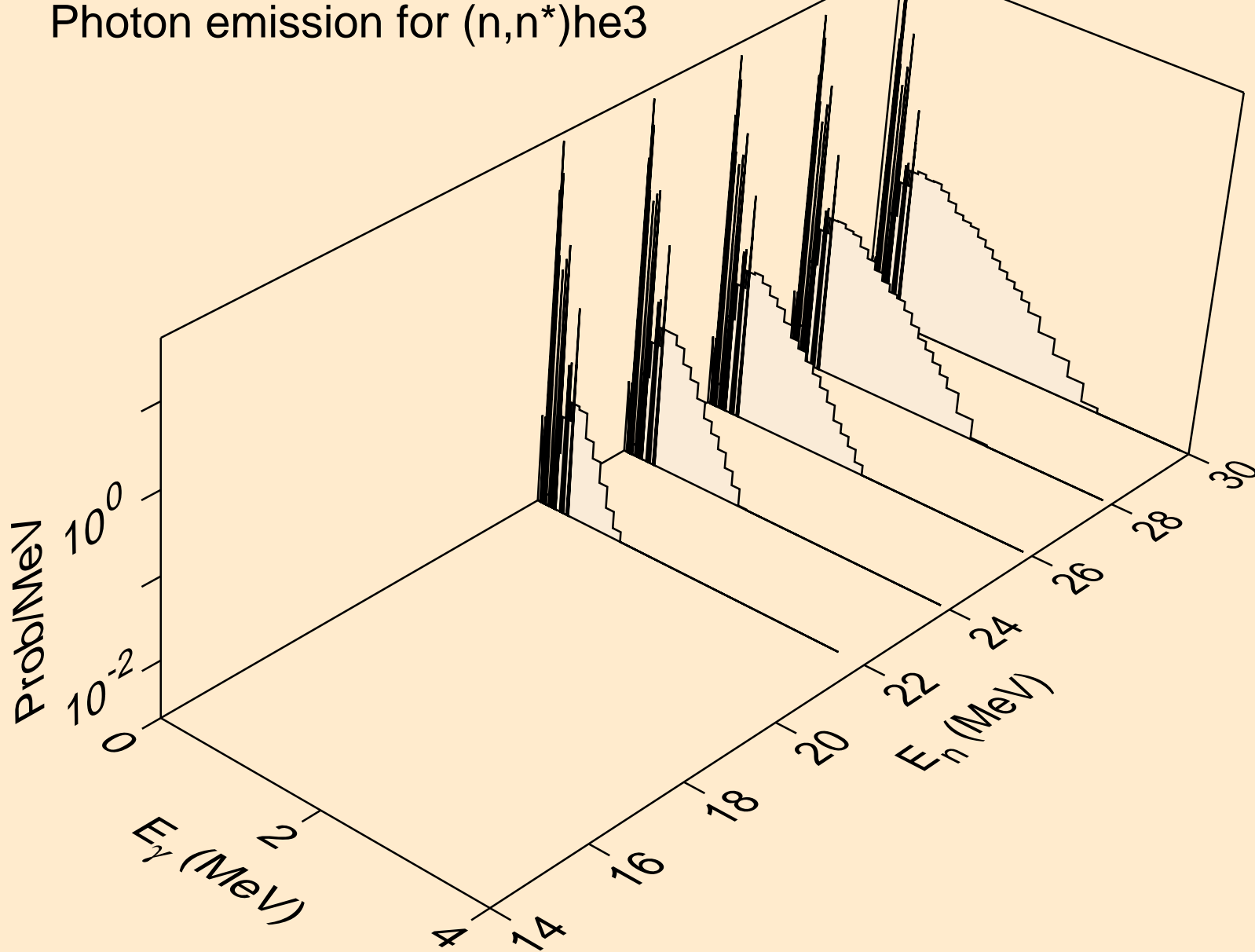

PM152 NEUTRON ACER TENDL-2019 LIBRARY; T=293.16K
Photon emission for (n,4n)

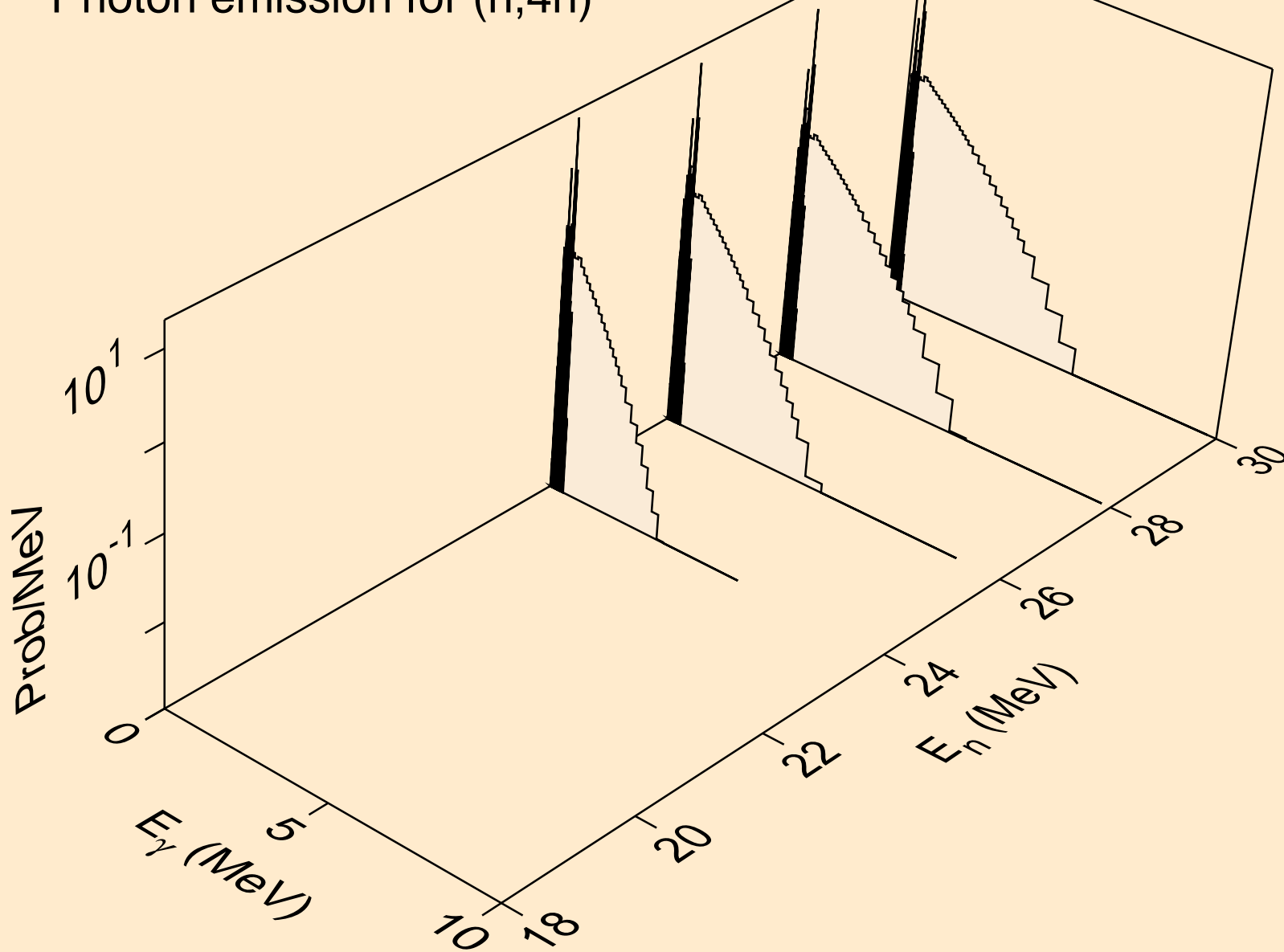

PM152 NEUTRON ACER TENDL-2019 LIBRARY; T=293.16K
Photon emission for (n,2np)

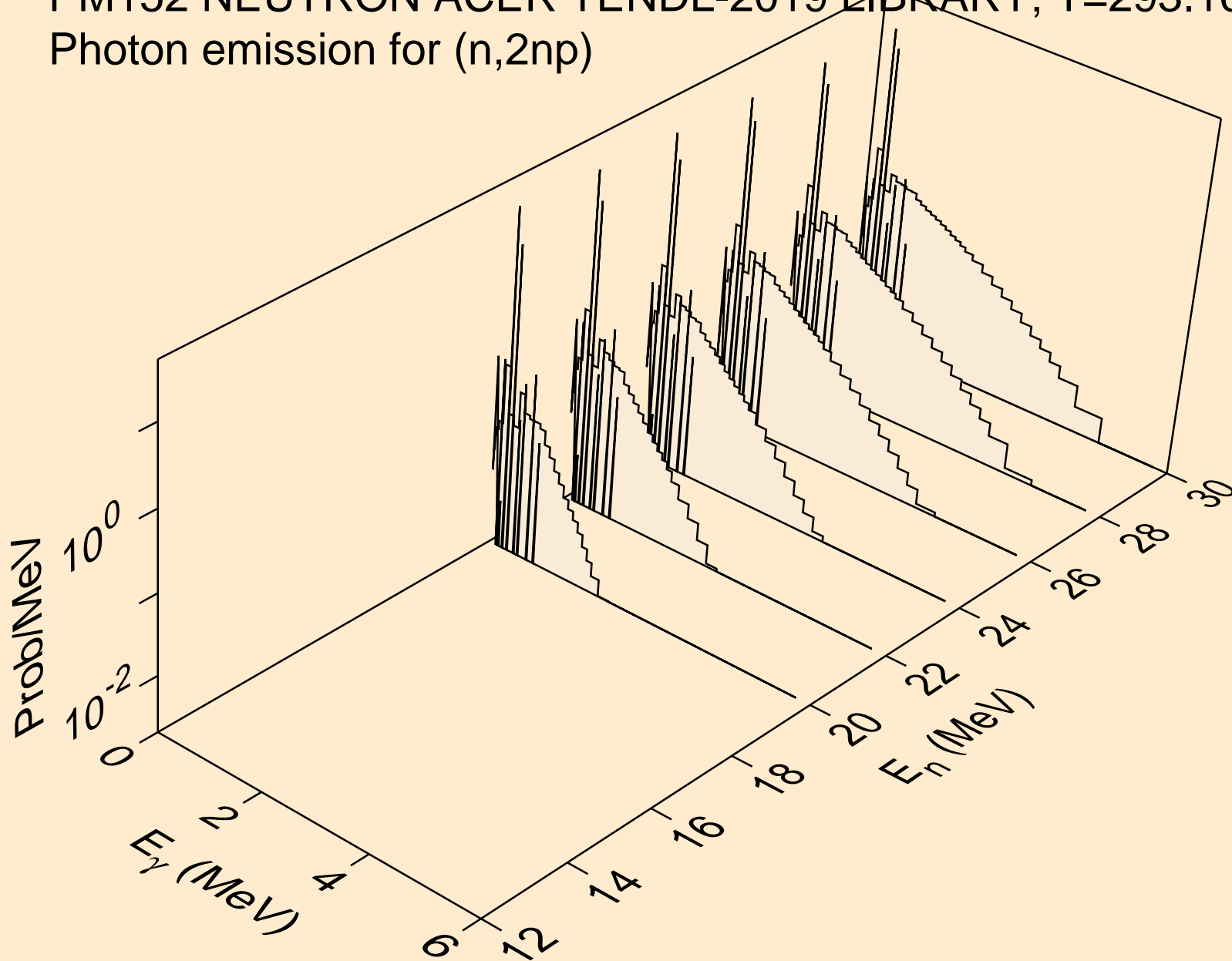

PM152 NEUTRON ACER TENDL-2019 LIBRARY; T=293.16K
Photon emission for (n,3np)

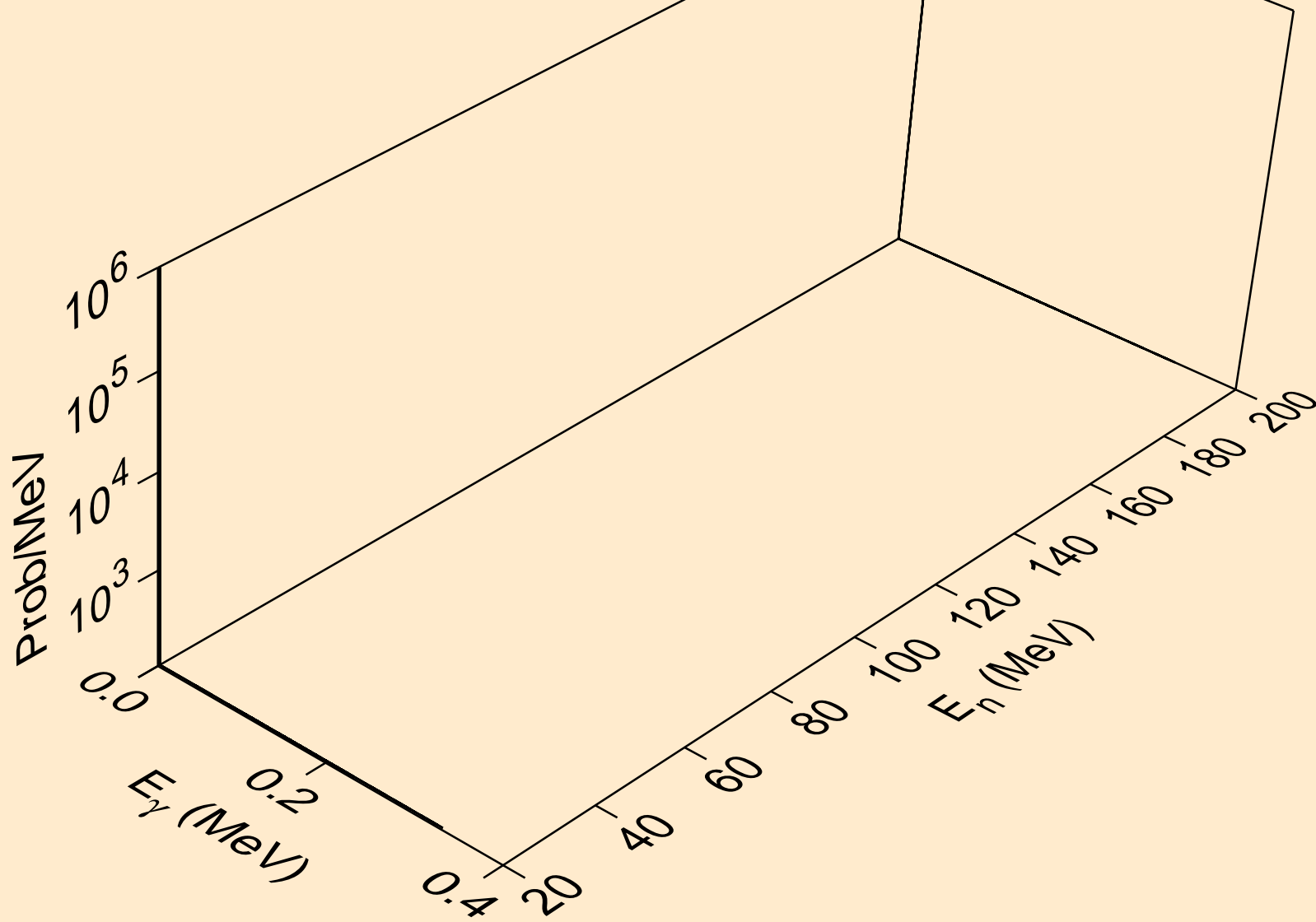

PM152 NEUTRON ACER TENDL-2019 LIBRARY; T=293.16K
Photon emission for (n,2np)

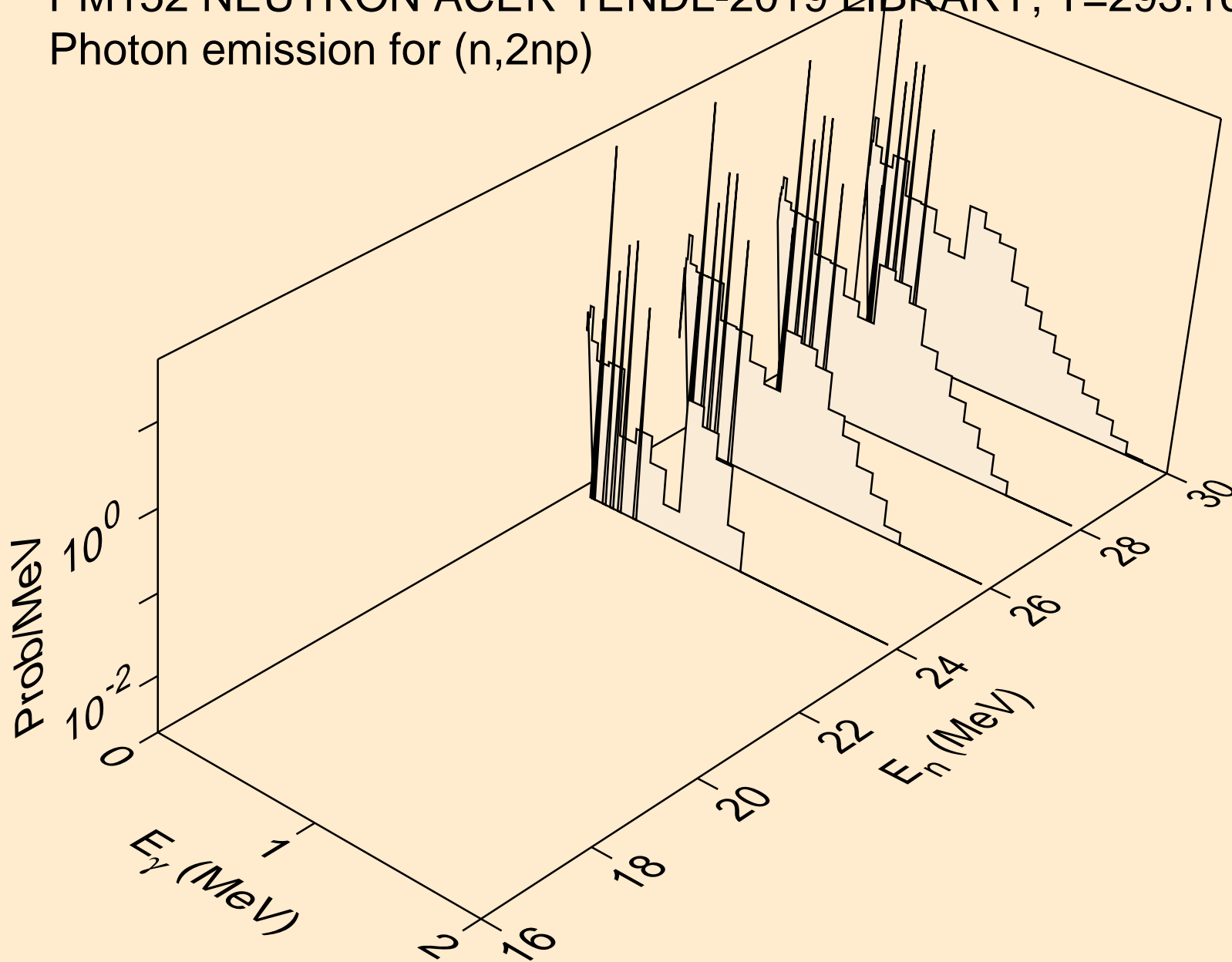

PM152 NEUTRON ACER TENDL-2019 LIBRARY; T=293.16K
Photon emission for (n,n*c)

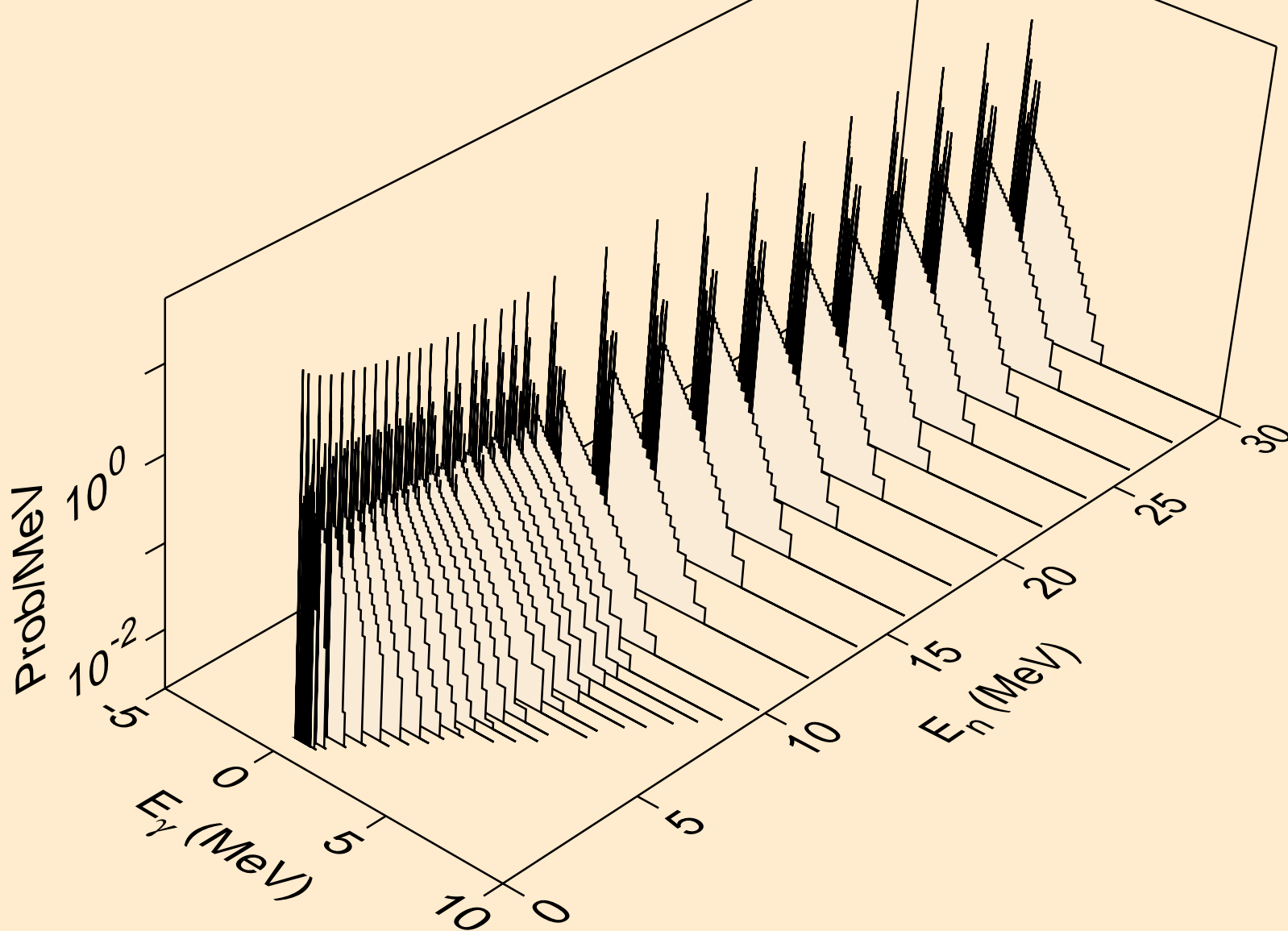

PM152 NEUTRON ACER TENDL-2019 LIBRARY; T=293.16K
Photon emission for (n,gma)

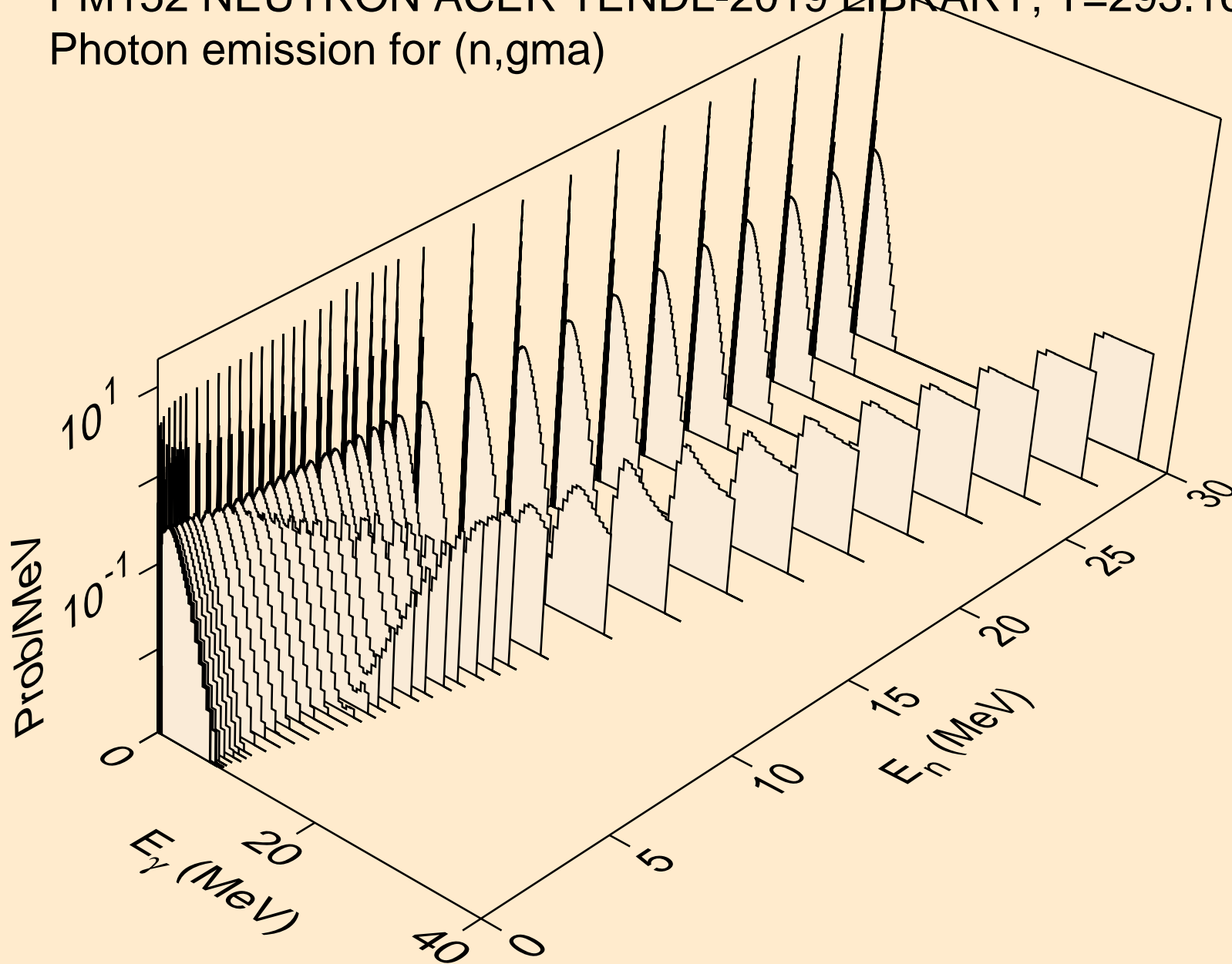

PM152 NEUTRON ACER TENDL-2019 LIBRARY; T=293.16K
Photon emission for (n,p)

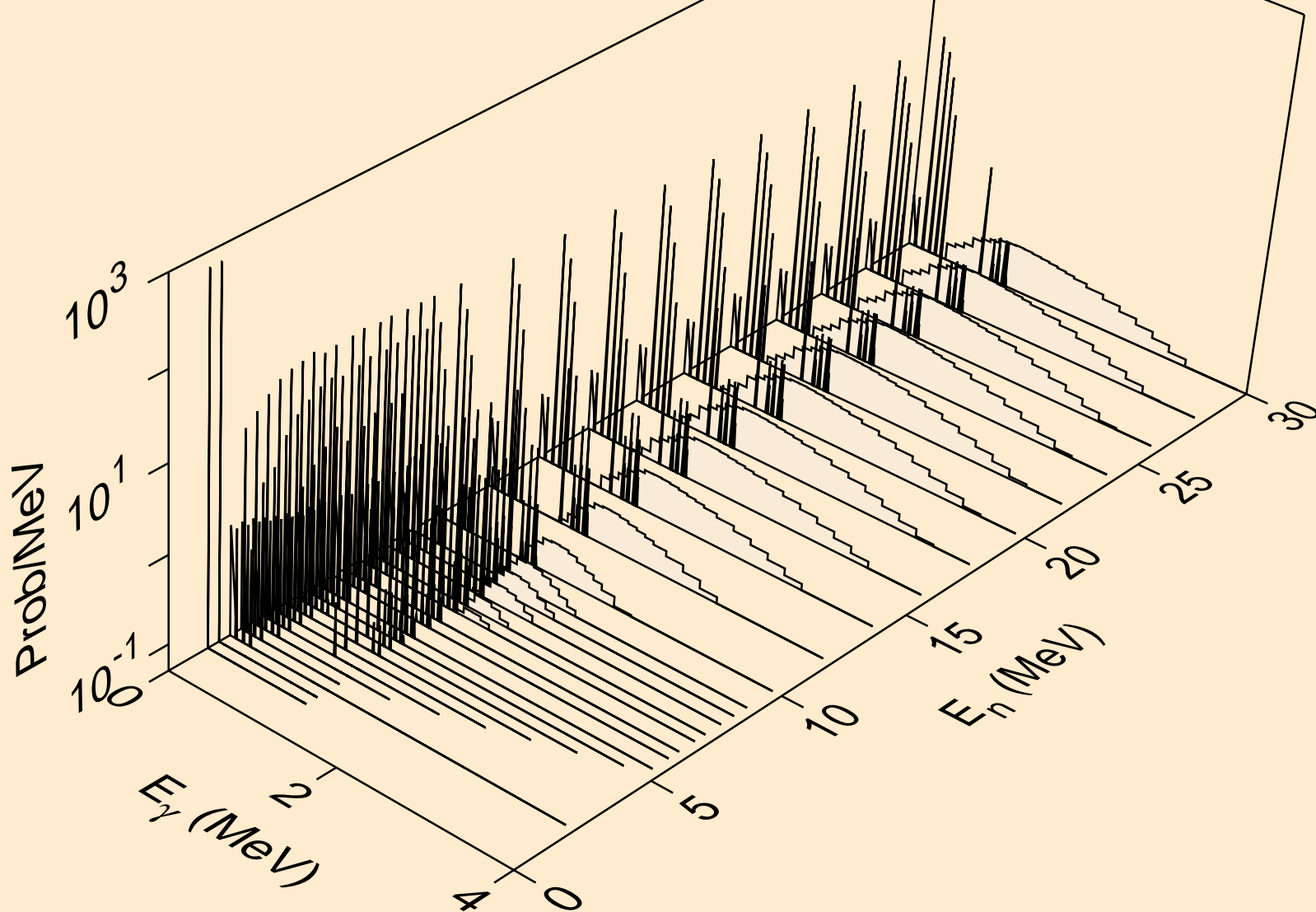

PM152 NEUTRON ACER TENDL-2019 LIBRARY; T=293.16K
Photon emission for (n,d)

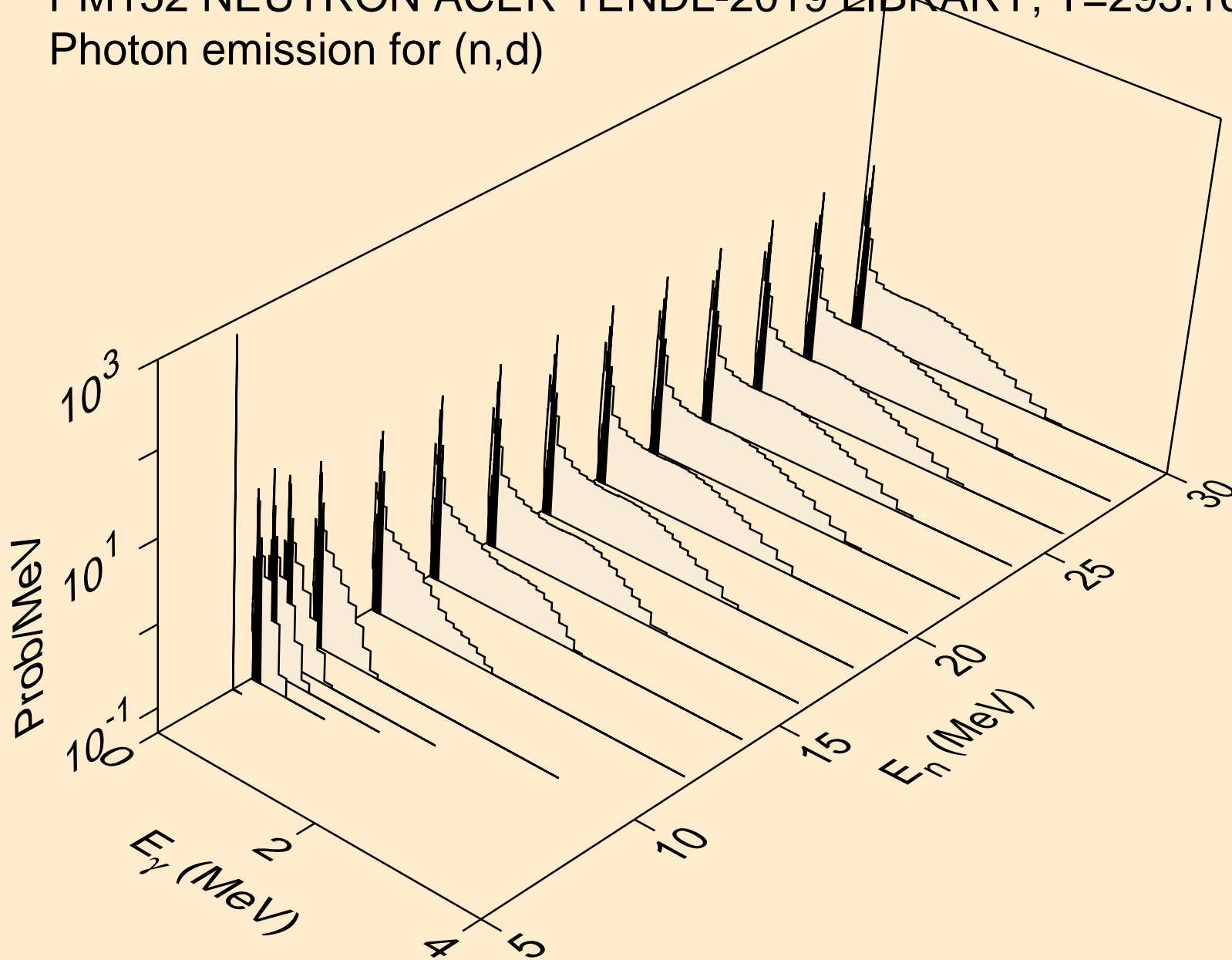

PM152 NEUTRON ACER TENDL-2019 LIBRARY; T=293.16K
Photon emission for (n,t)

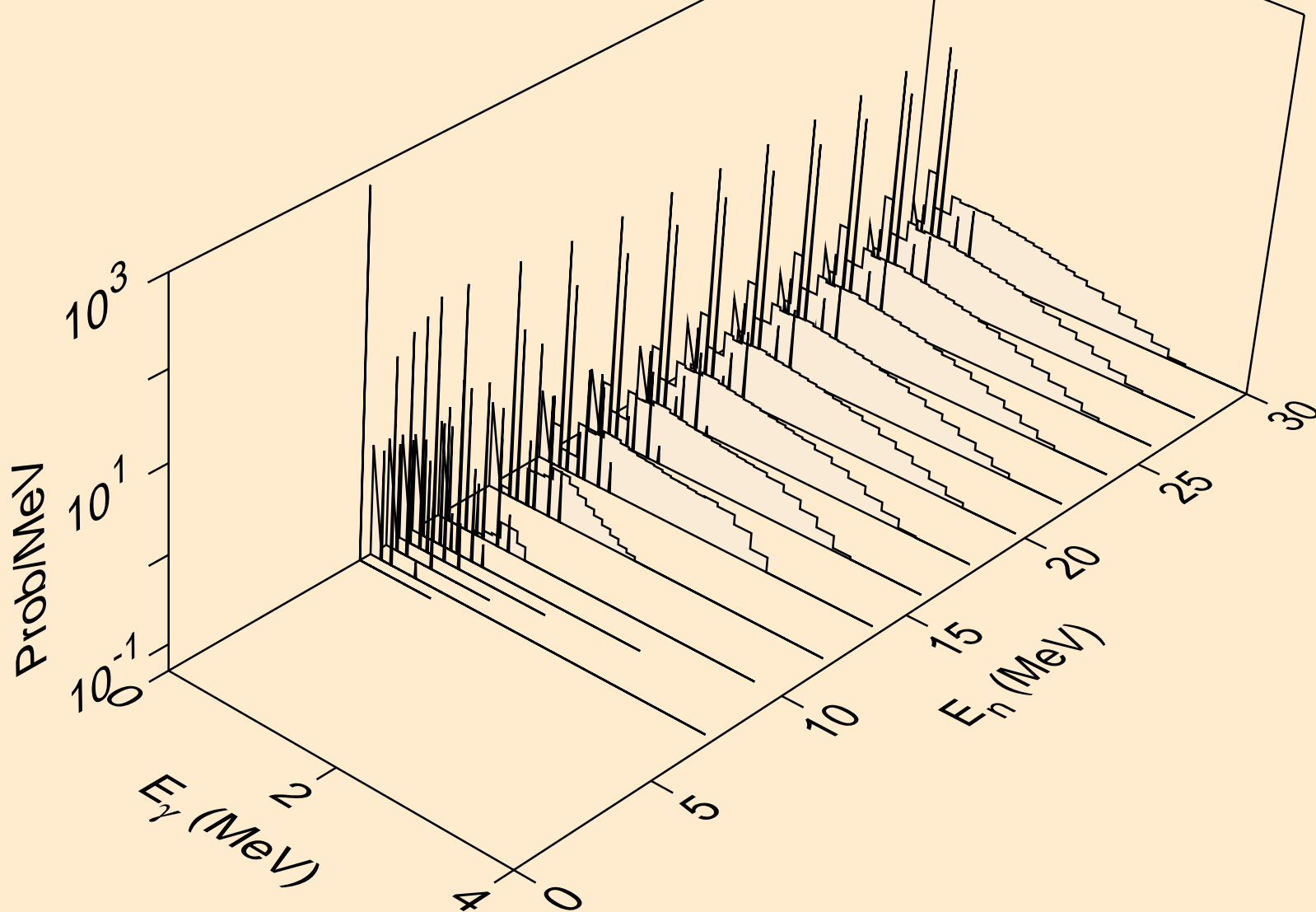

PM152 NEUTRON ACER TENDL-2019 LIBRARY; T=293.16K
Photon emission for (n,he3)

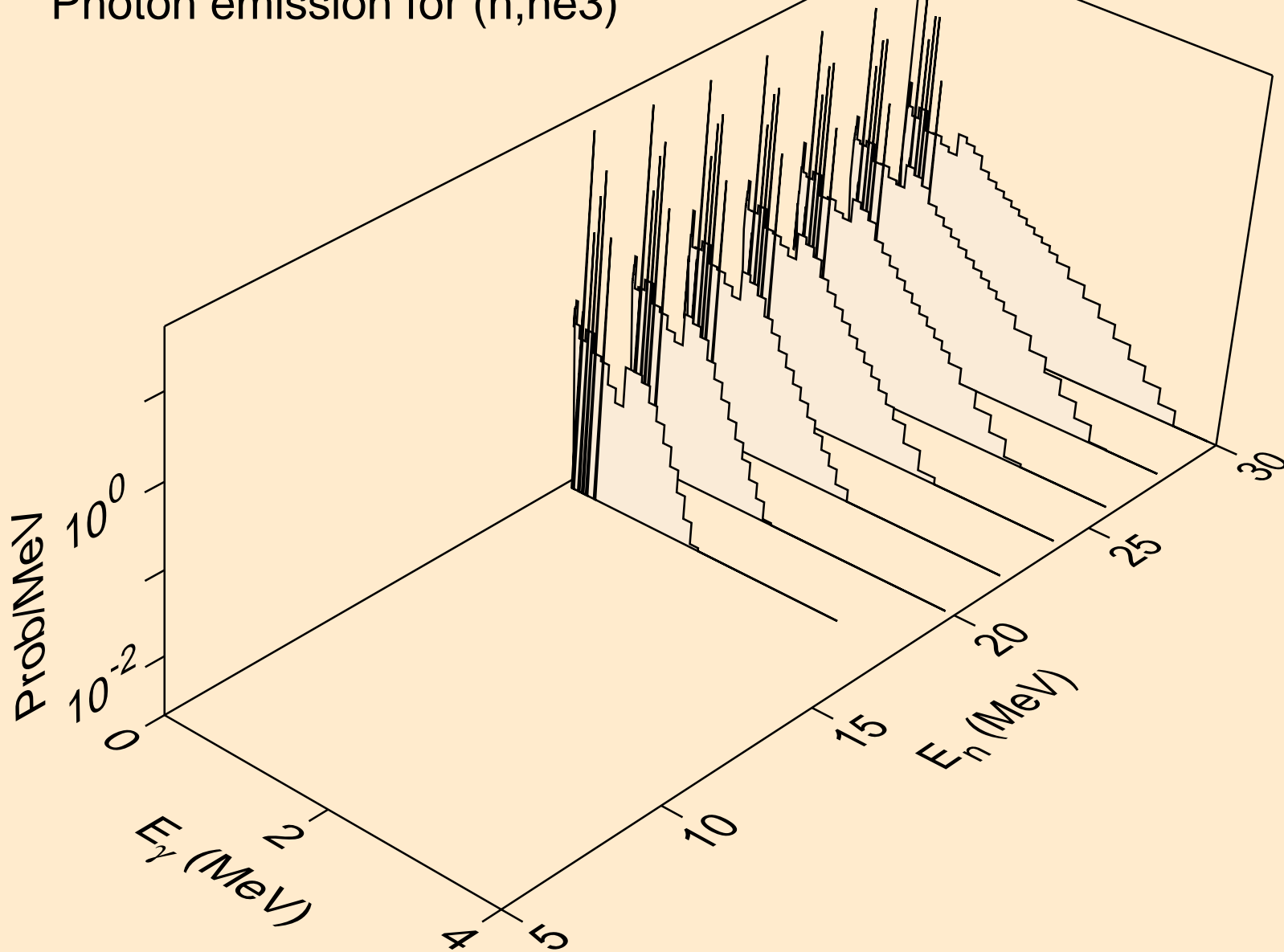

PM152 NEUTRON ACER TENDL-2019 LIBRARY; T=293.16K
Photon emission for (n,a)

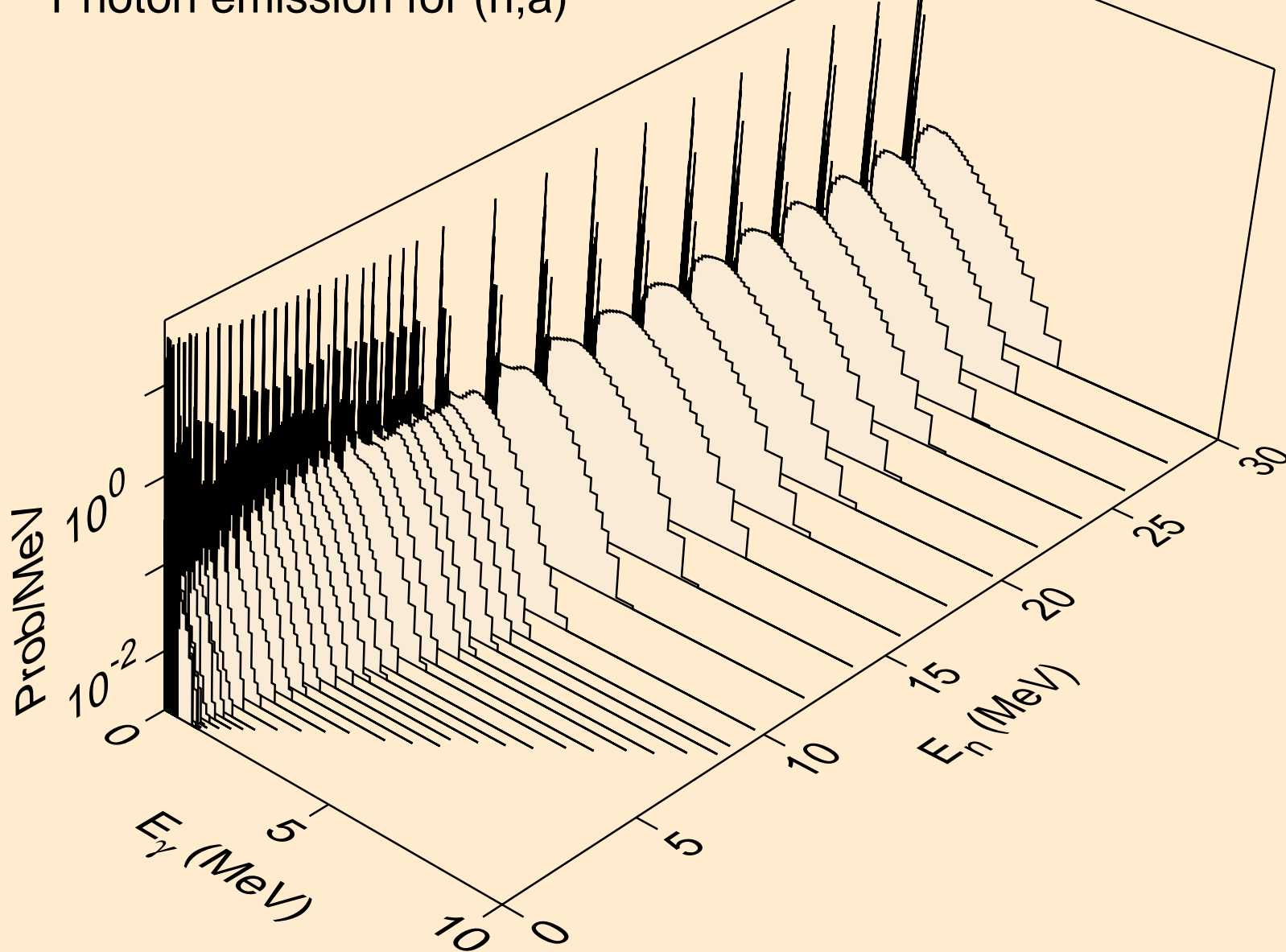

PM152 NEUTRON ACER TENDL-2019 LIBRARY; T=293.16K
Photon emission for (n,2p)

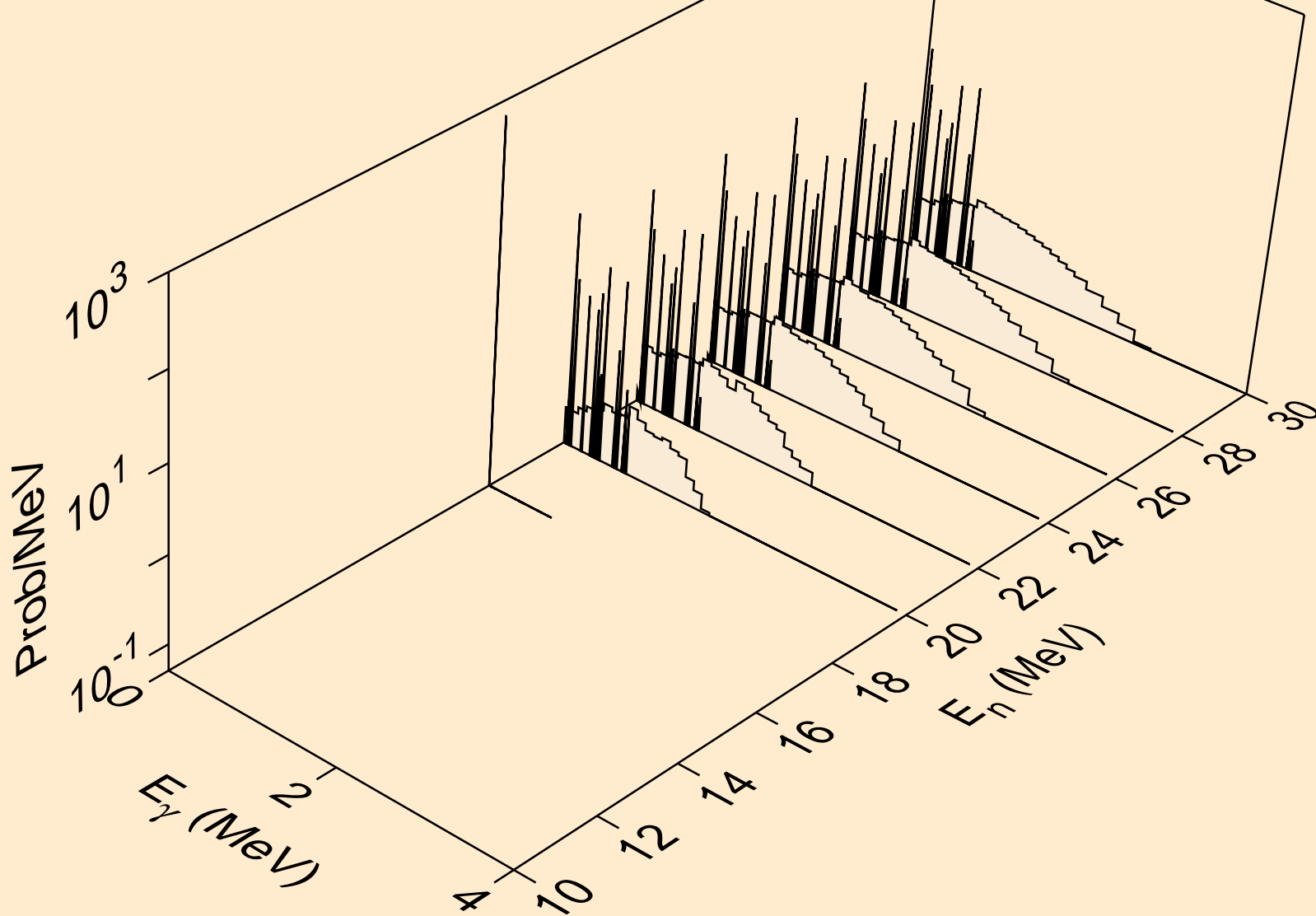

PM152 NEUTRON ACER TENDL-2019 LIBRARY; T=293.16K
thermal capture photon spectrum

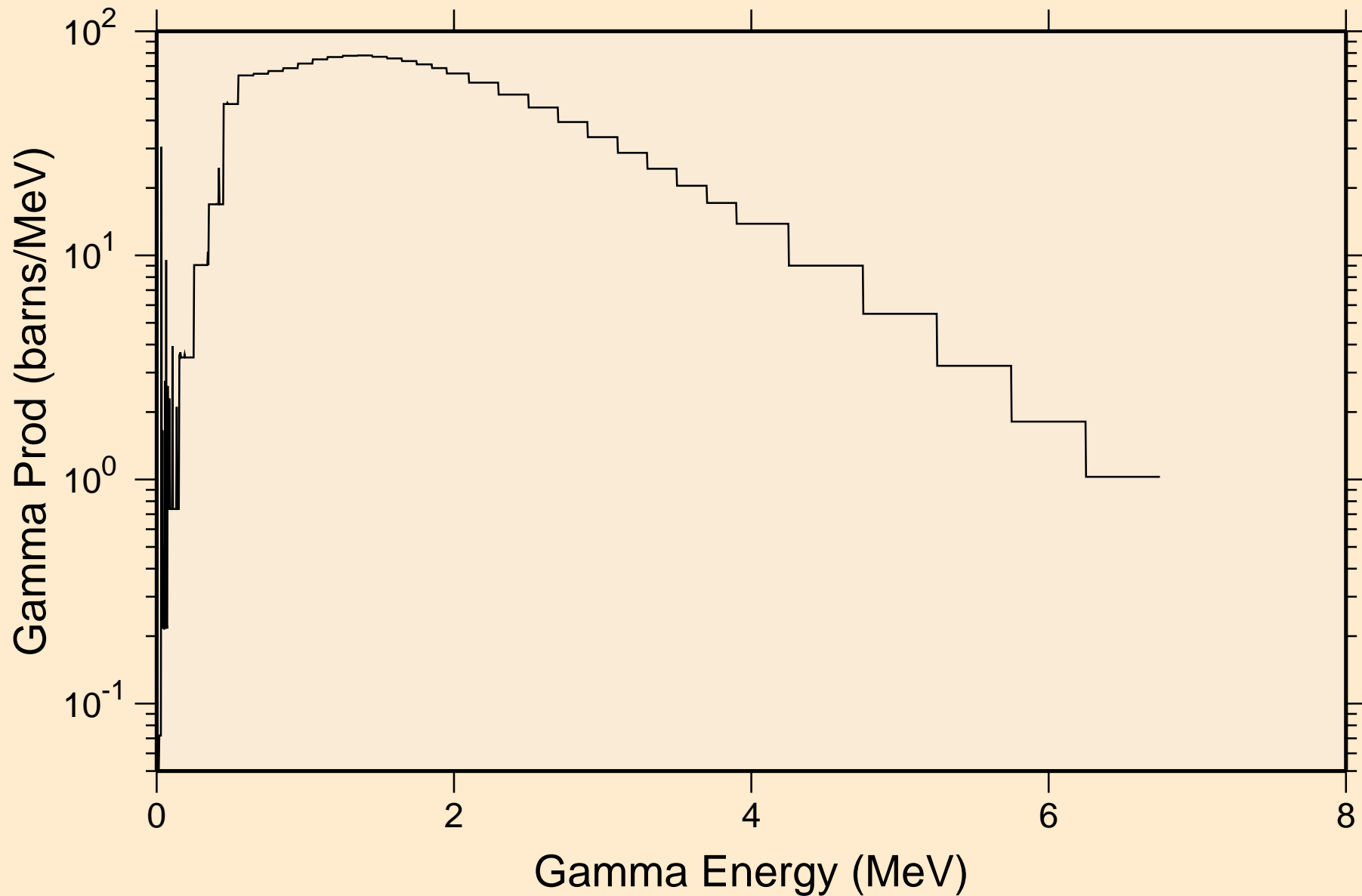

PM152 NEUTRON ACER TENDL-2019 LIBRARY; T=293.16K
14 MeV photon spectrum

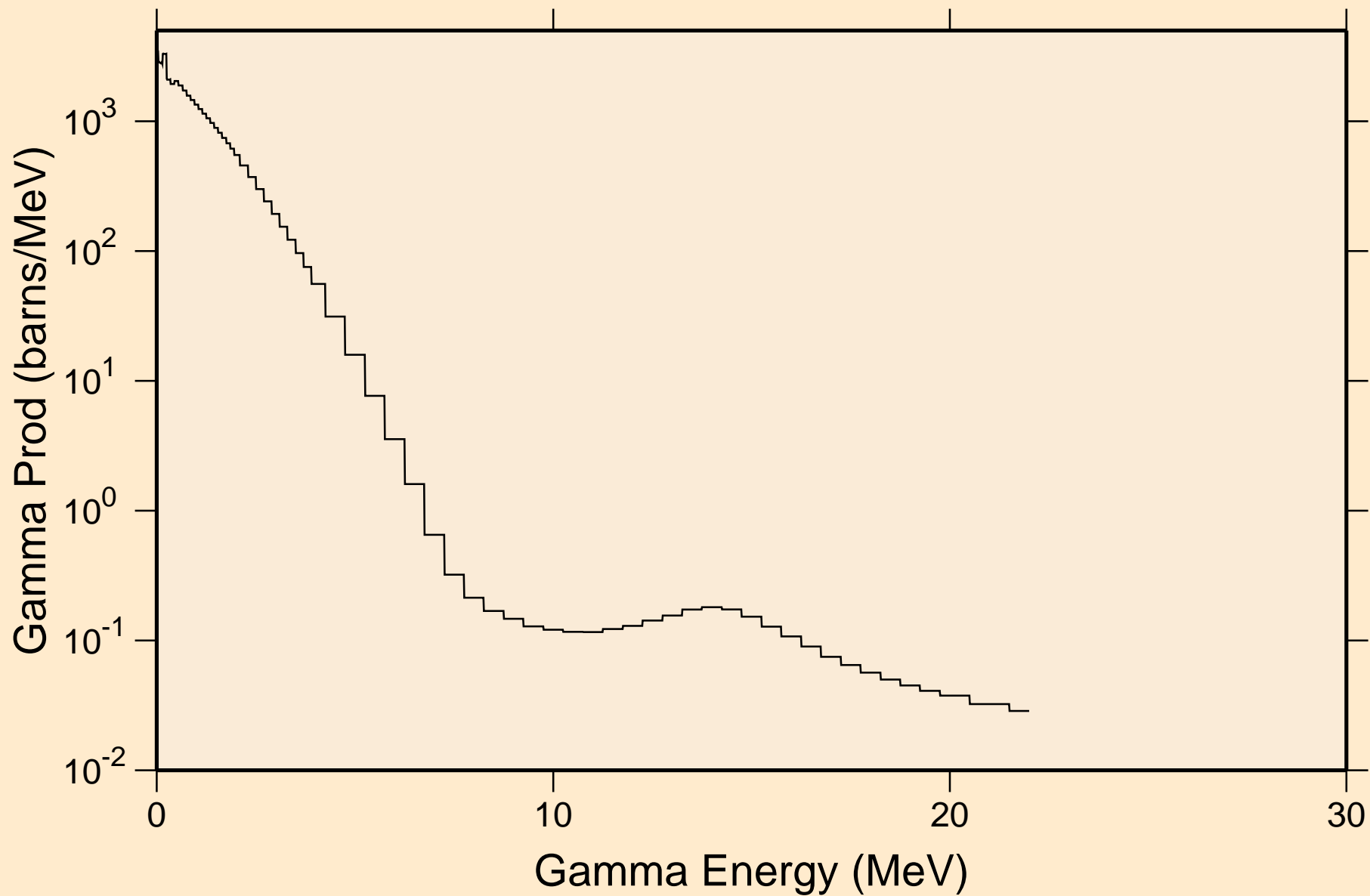

PM152 NEUTRON ACER TENDL-2019 LIBRARY; T=293.16K

Particle heating contributions

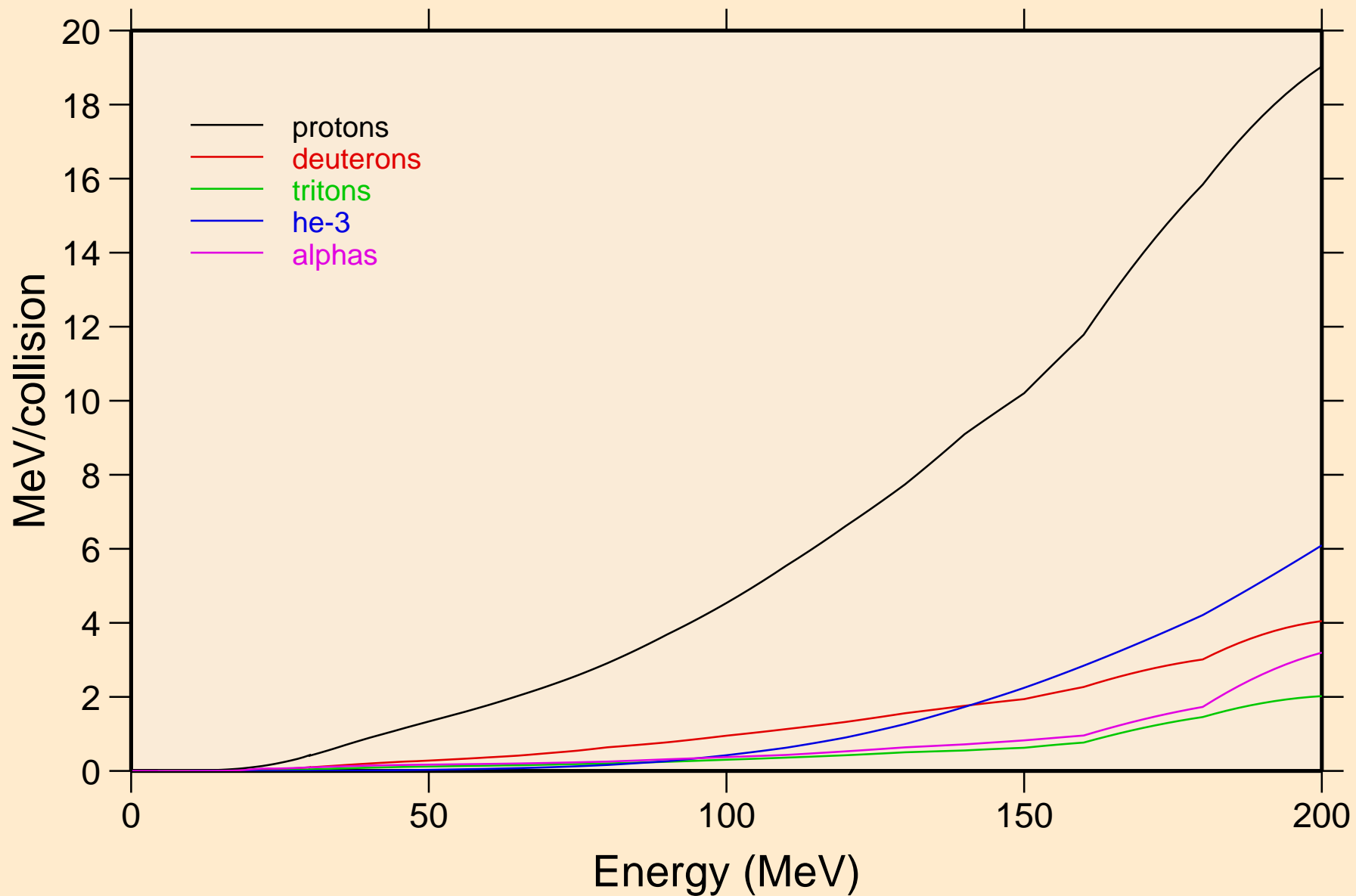

PM152 NEUTRON ACER TENDL-2019 LIBRARY; T=293.16K
Recoil Heating

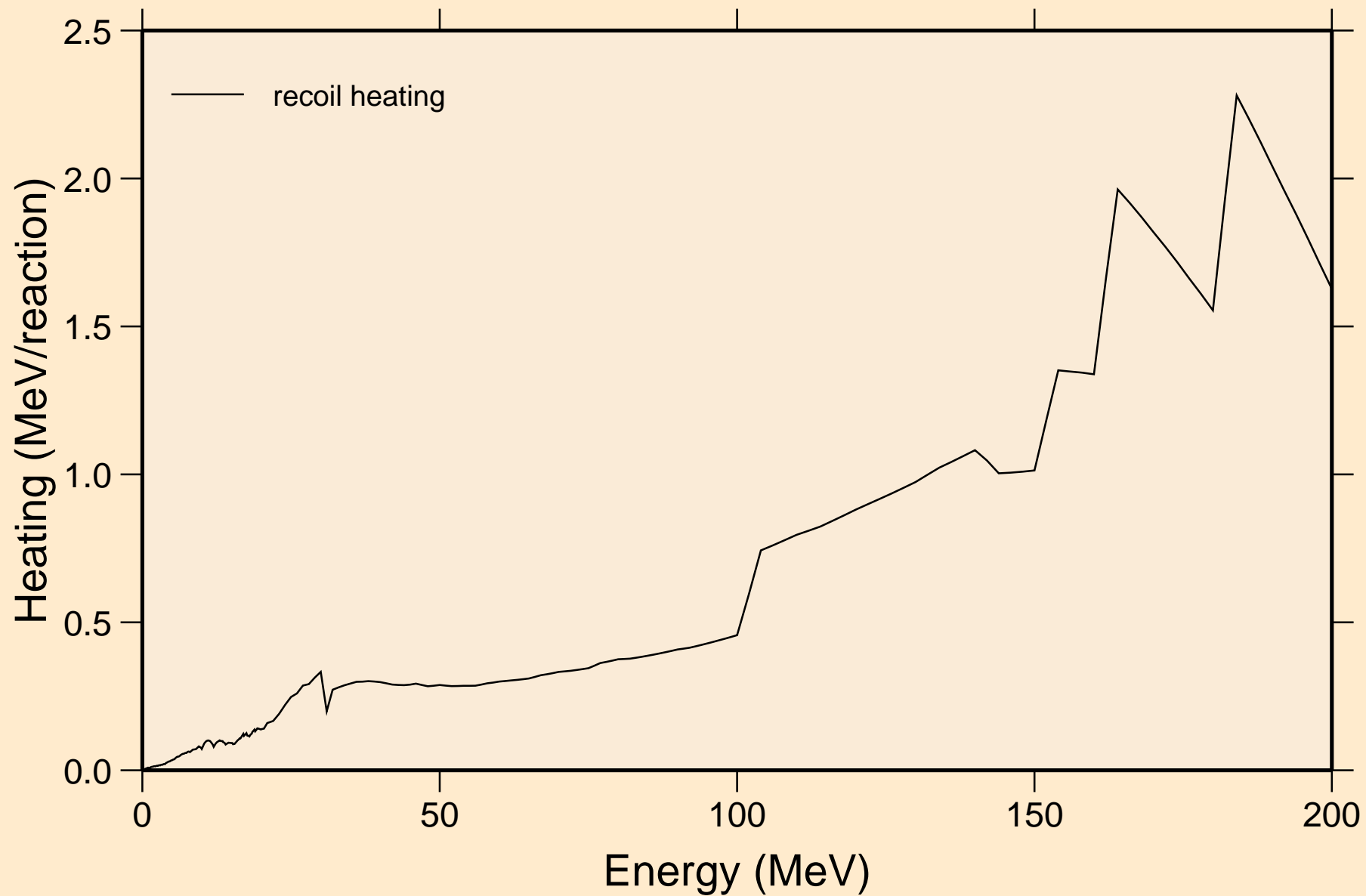

PM152 NEUTRON ACER TENDL-2019 LIBRARY; T=293.16K
Particle production cross sections

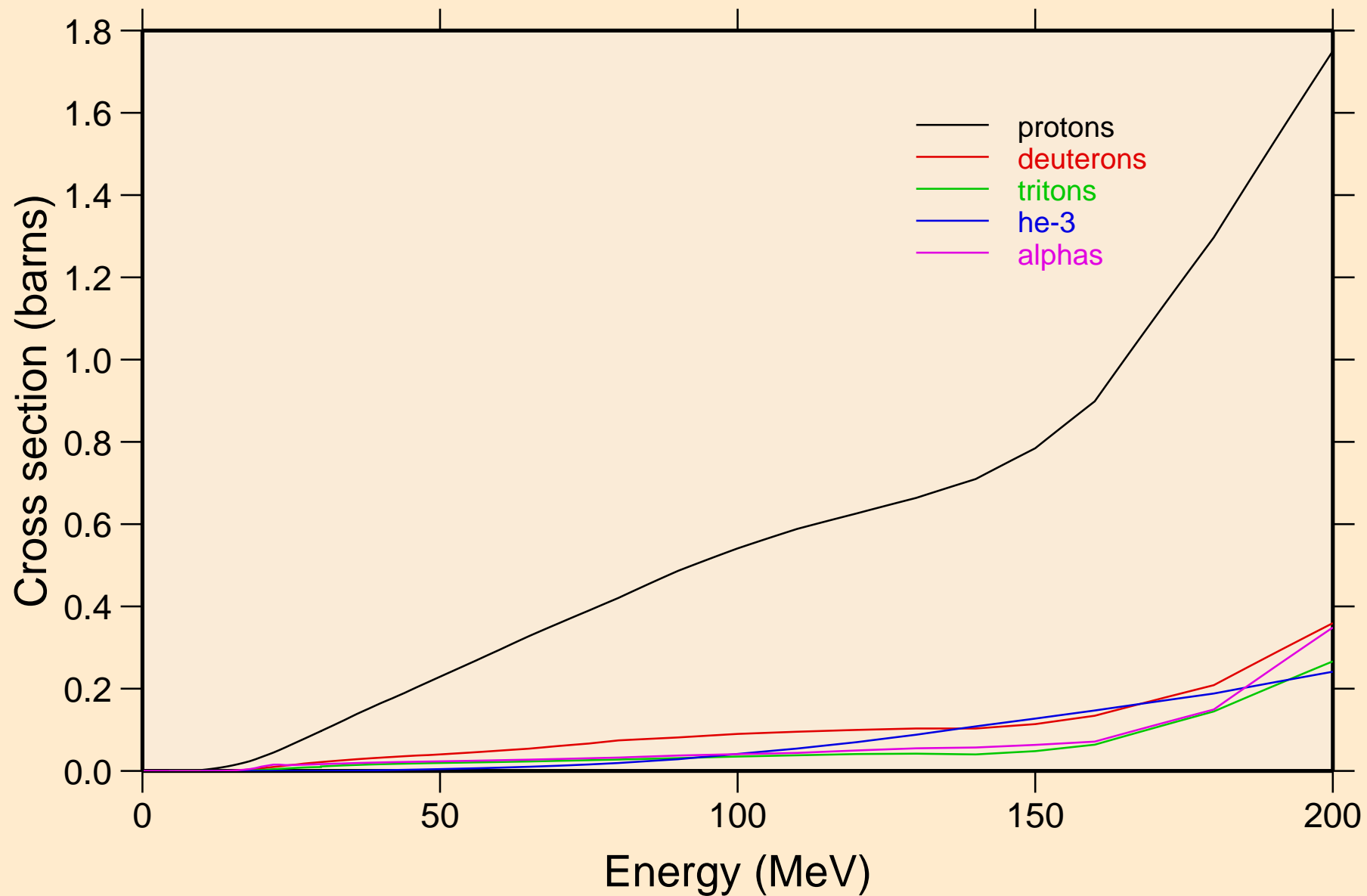

PM152 NEUTRON ACER TENDL-2019 LIBRARY; T=293.16K
protons from (n,x)

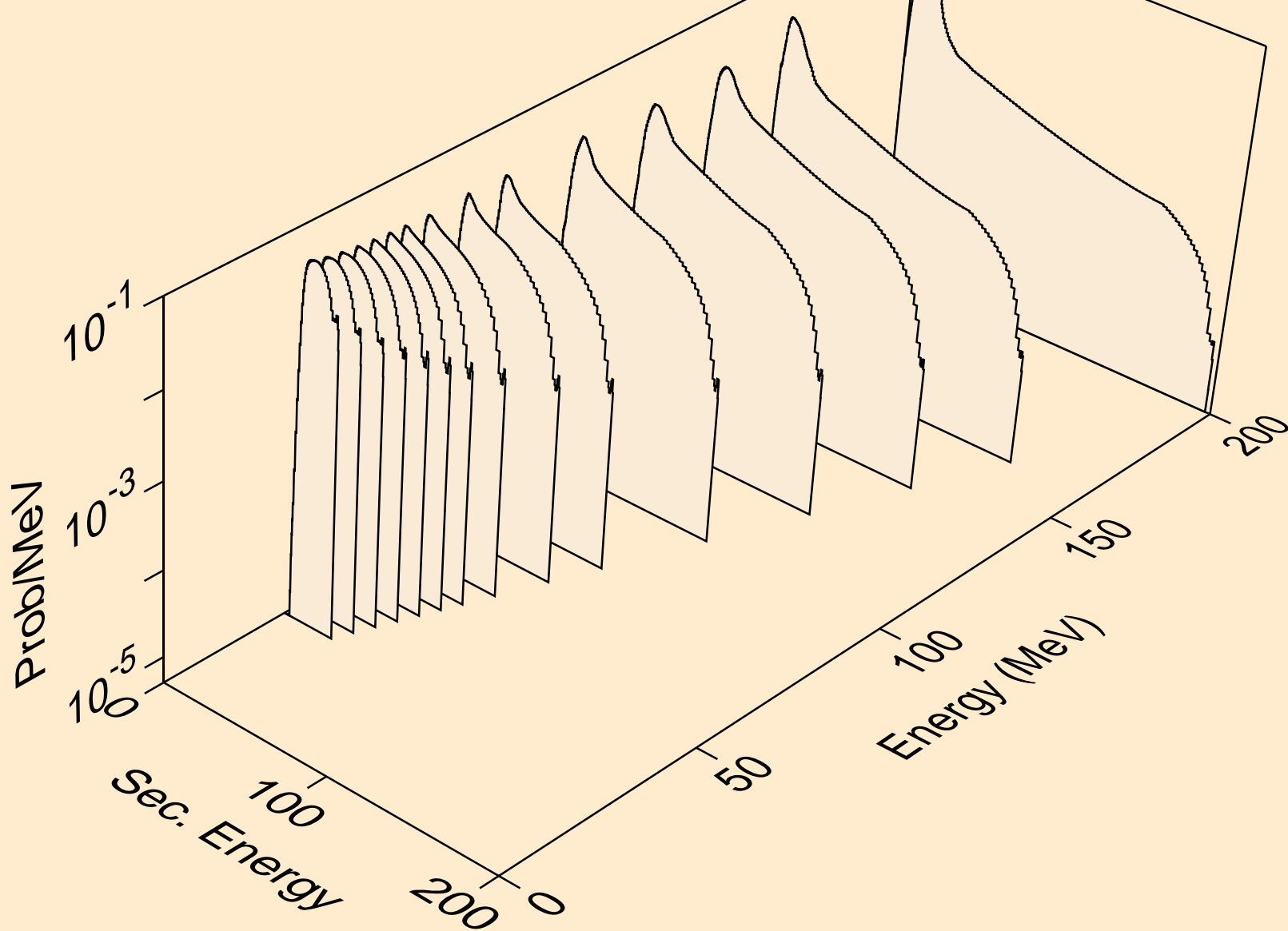

PM152 NEUTRON ACER TENDL-2019 LIBRARY; T=293.16K
protons from (n,n*)p

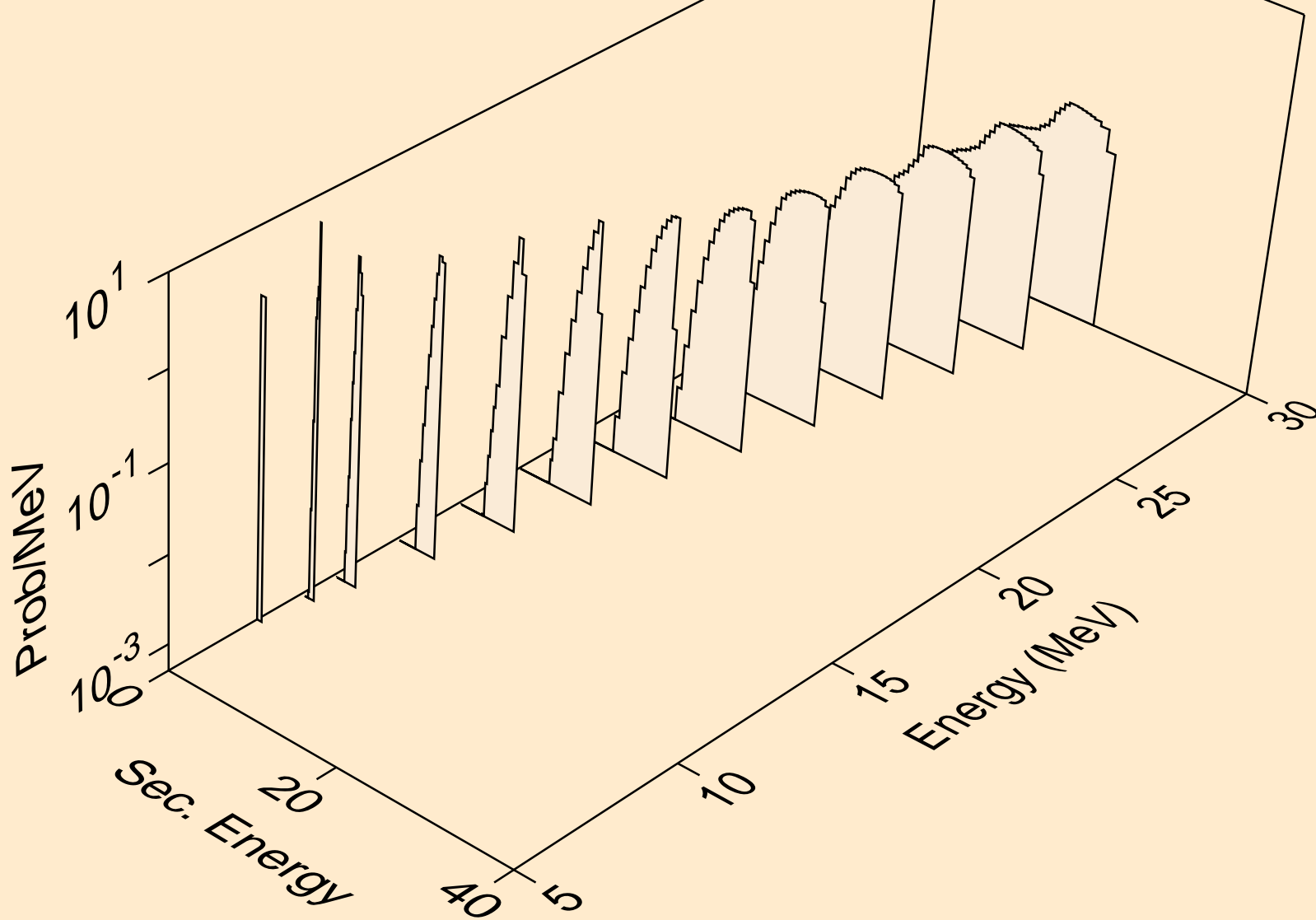

PM152 NEUTRON ACER TENDL-2019 LIBRARY; T=293.16K
protons from (n,2np)

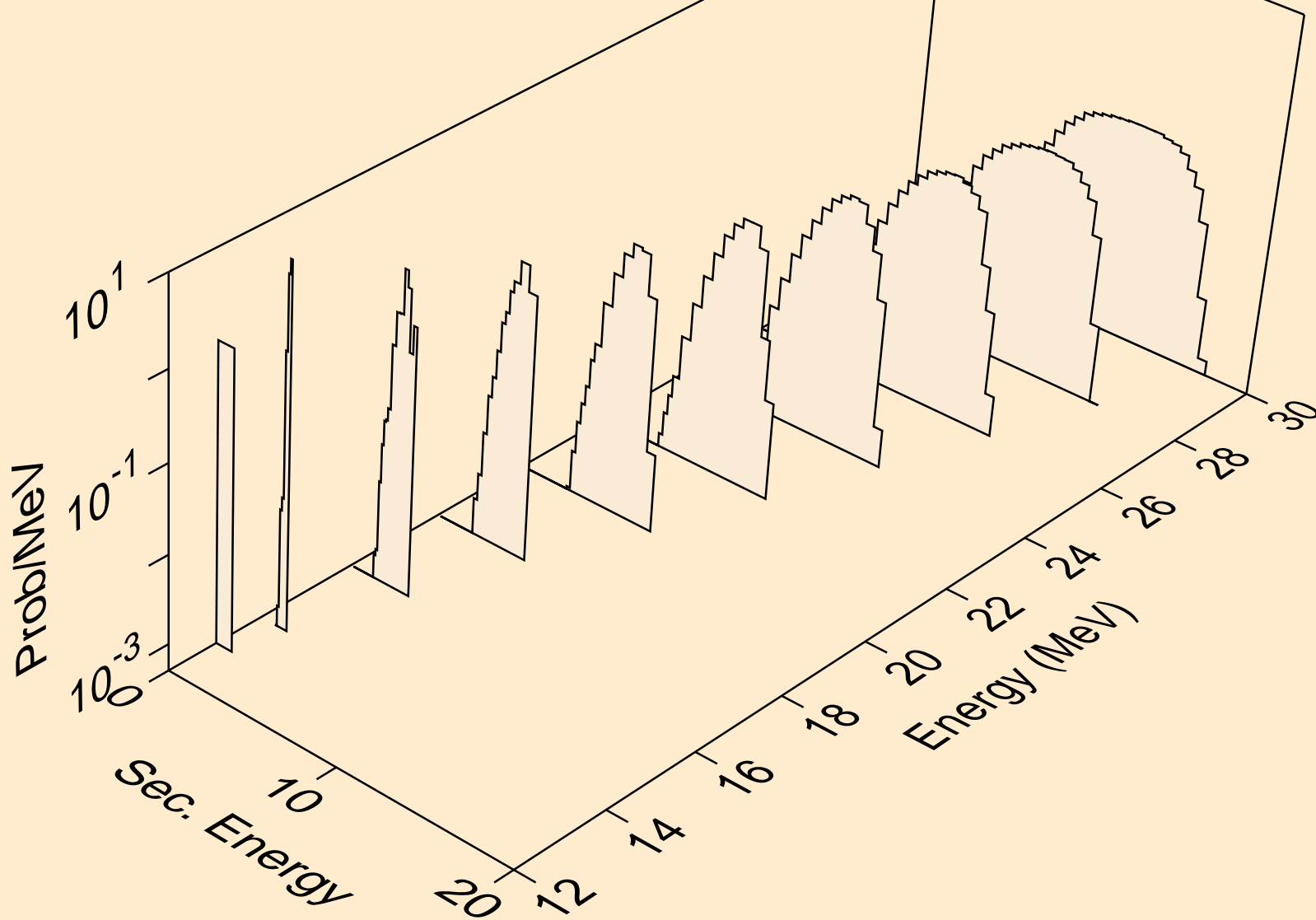

PM152 NEUTRON ACER TENDL-2019 LIBRARY; T=293.16K
protons from (n,3np)

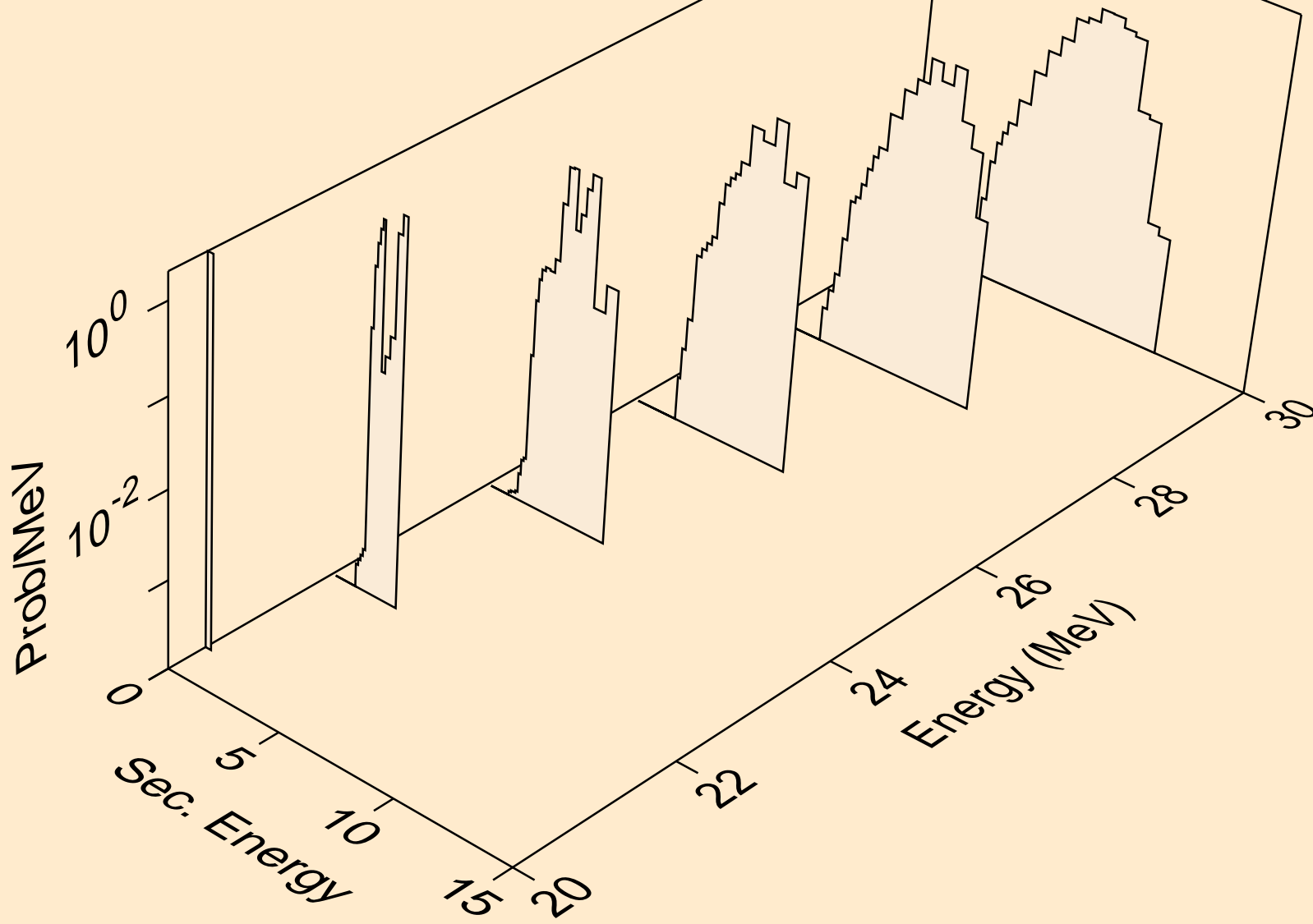

PM152 NEUTRON ACER TENDL-2019 LIBRARY; T=293.16K
protons from (n,2np)

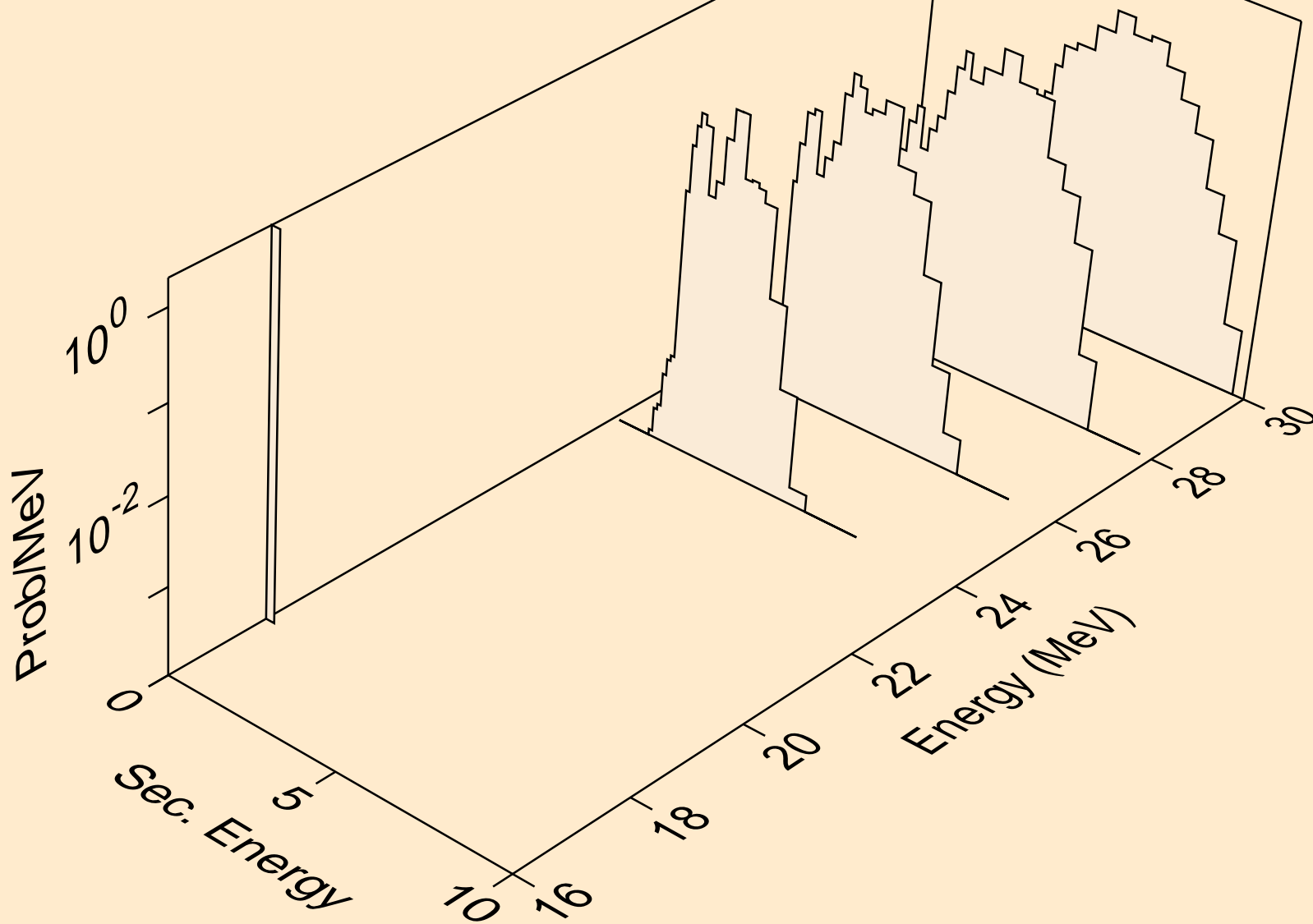

PM152 NEUTRON ACER TENDL-2019 LIBRARY; T=293.16K
protons from (n,p)

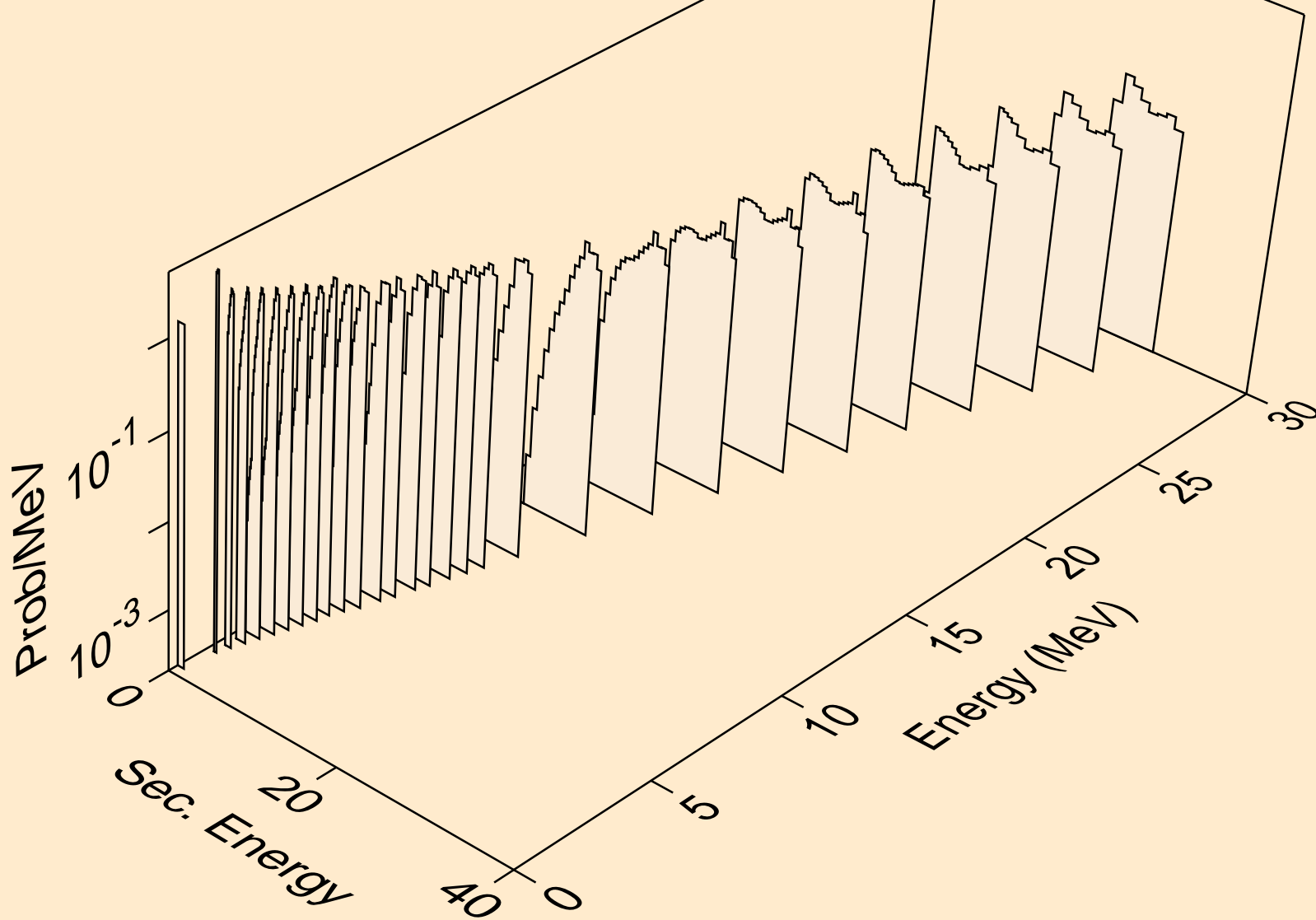

PM152 NEUTRON ACER TENDL-2019 LIBRARY; T=293.16K
protons from (n,2p)

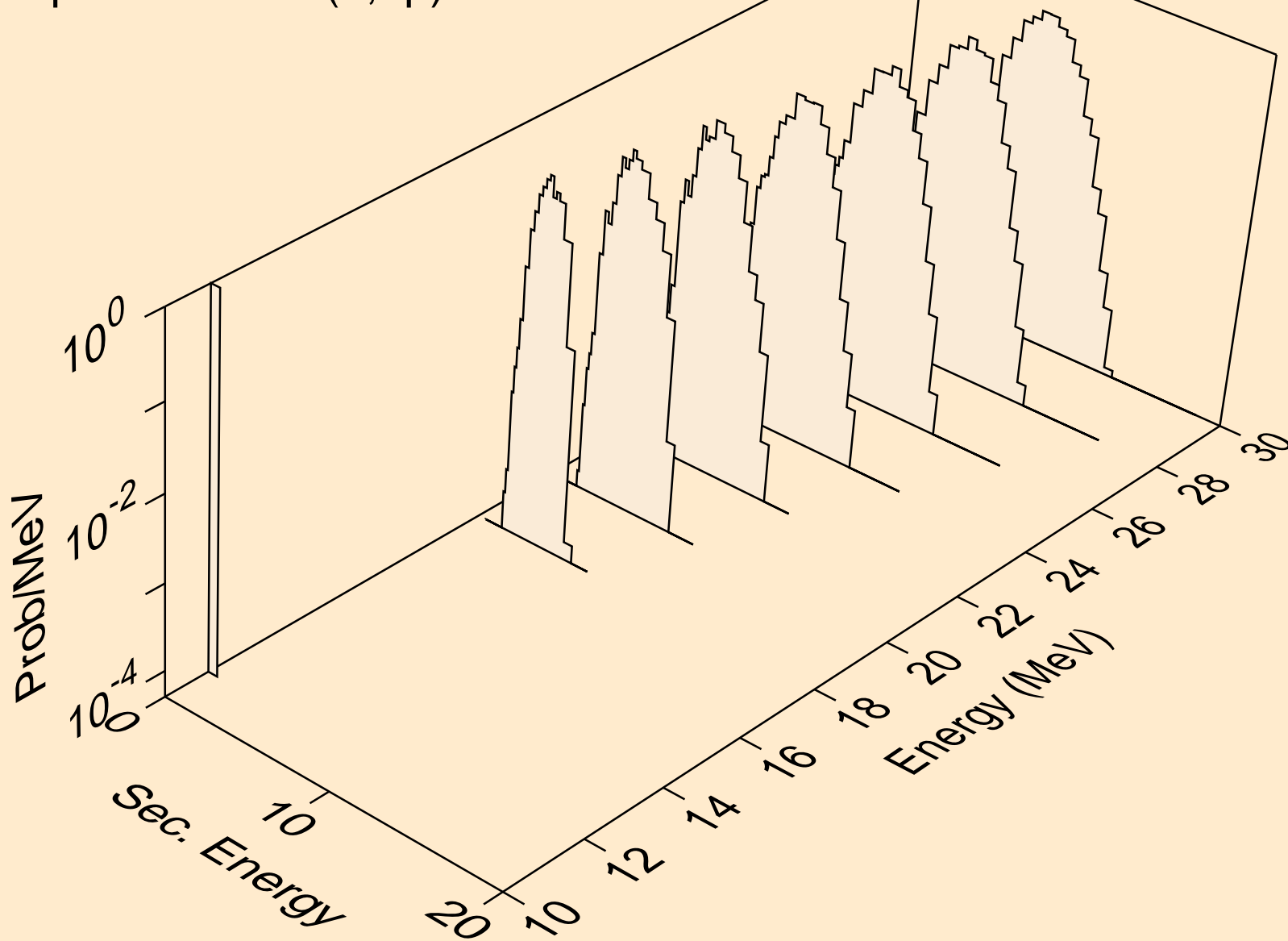

PM152 NEUTRON ACER TENDL-2019 LIBRARY; T=293.16K
deuterons from (n,x)

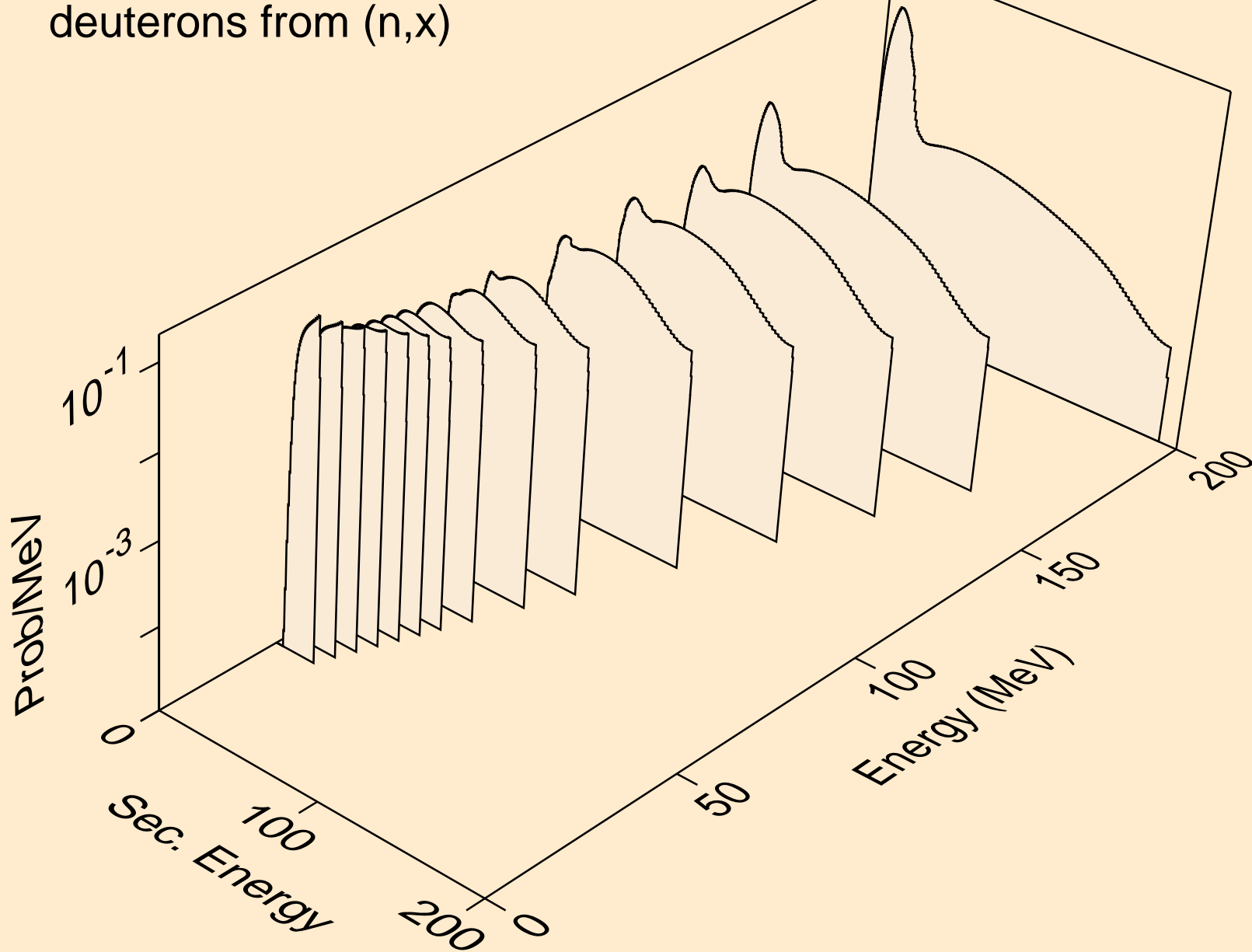

PM152 NEUTRON ACER TENDL-2019 LIBRARY; T=293.16K
deuterons from (n,2nd)

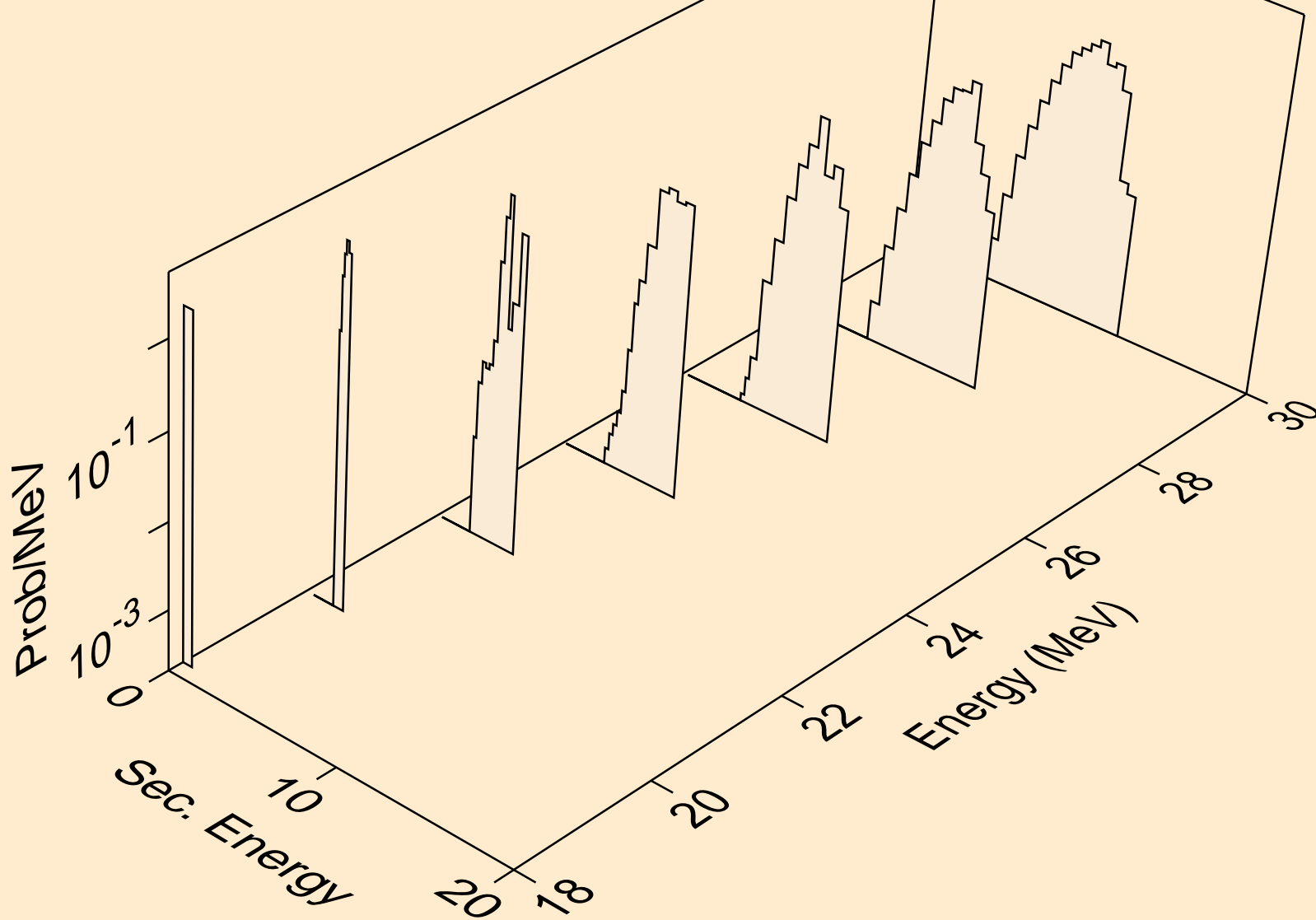

PM152 NEUTRON ACER TENDL-2019 LIBRARY; T=293.16K
deuterons from (n,n*)d

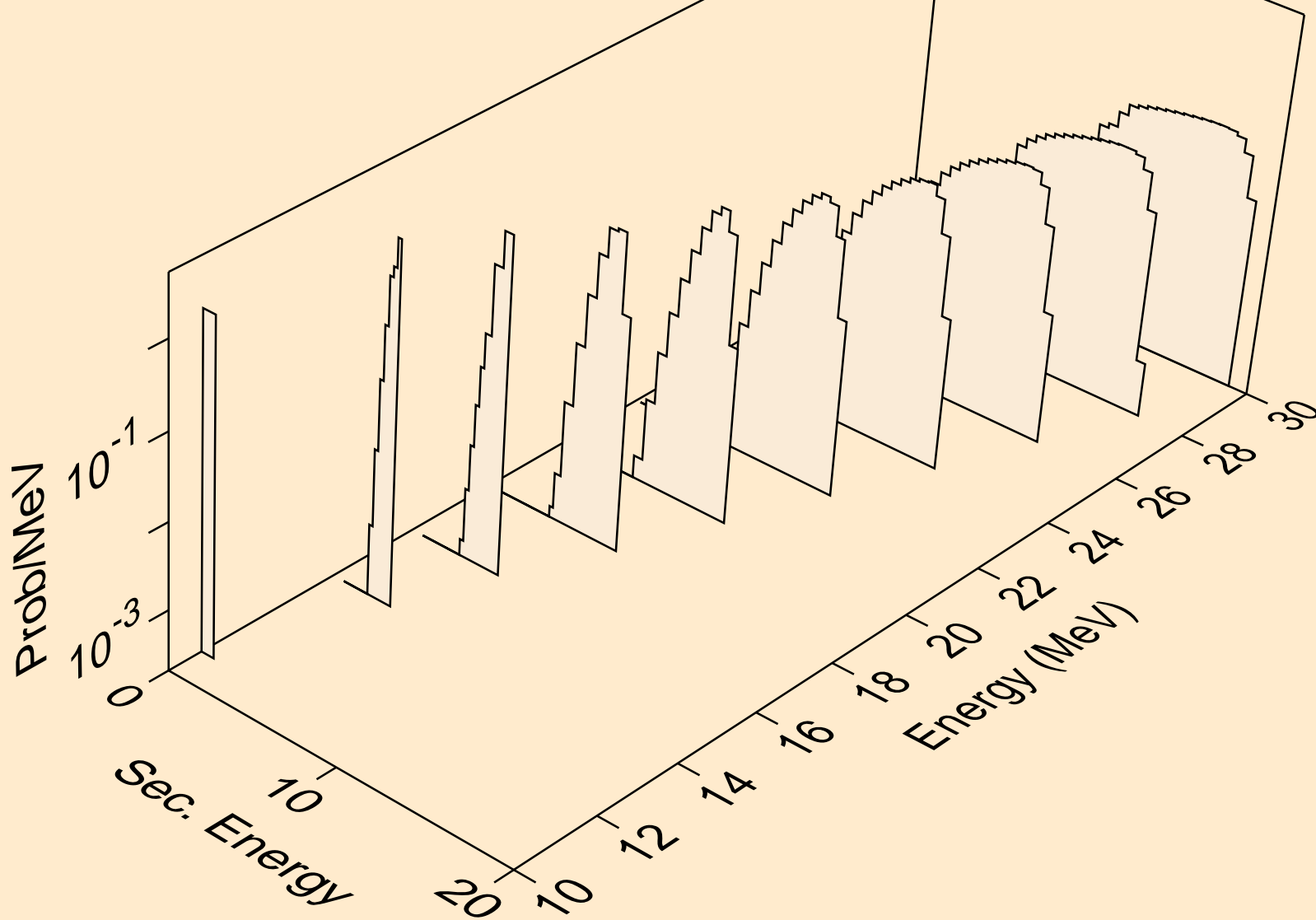

PM152 NEUTRON ACER TENDL-2019 LIBRARY; T=293.16K
deuterons from (n,d)

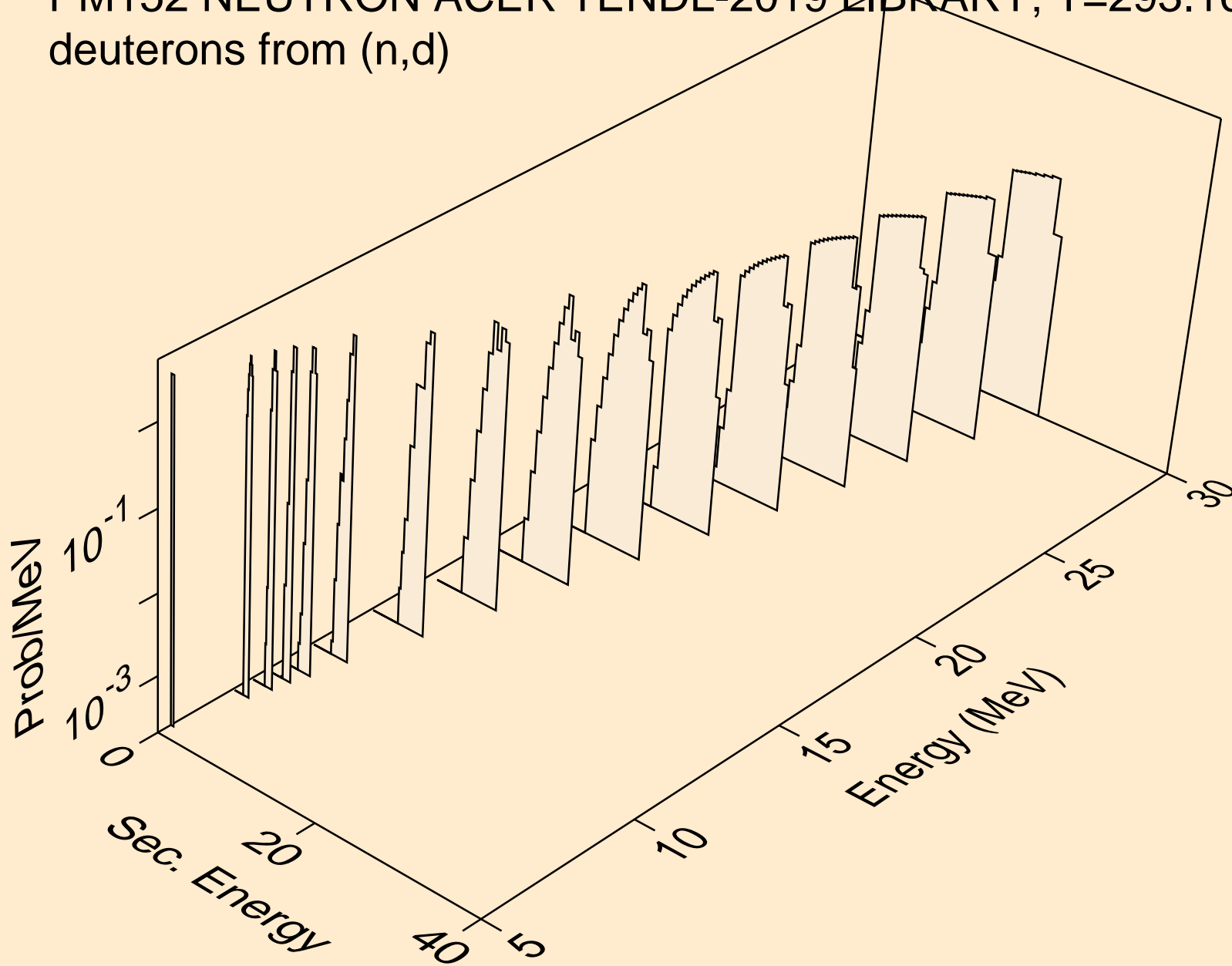

PM152 NEUTRON ACER TENDL-2019 LIBRARY; T=293.16K
tritons from (n,x)

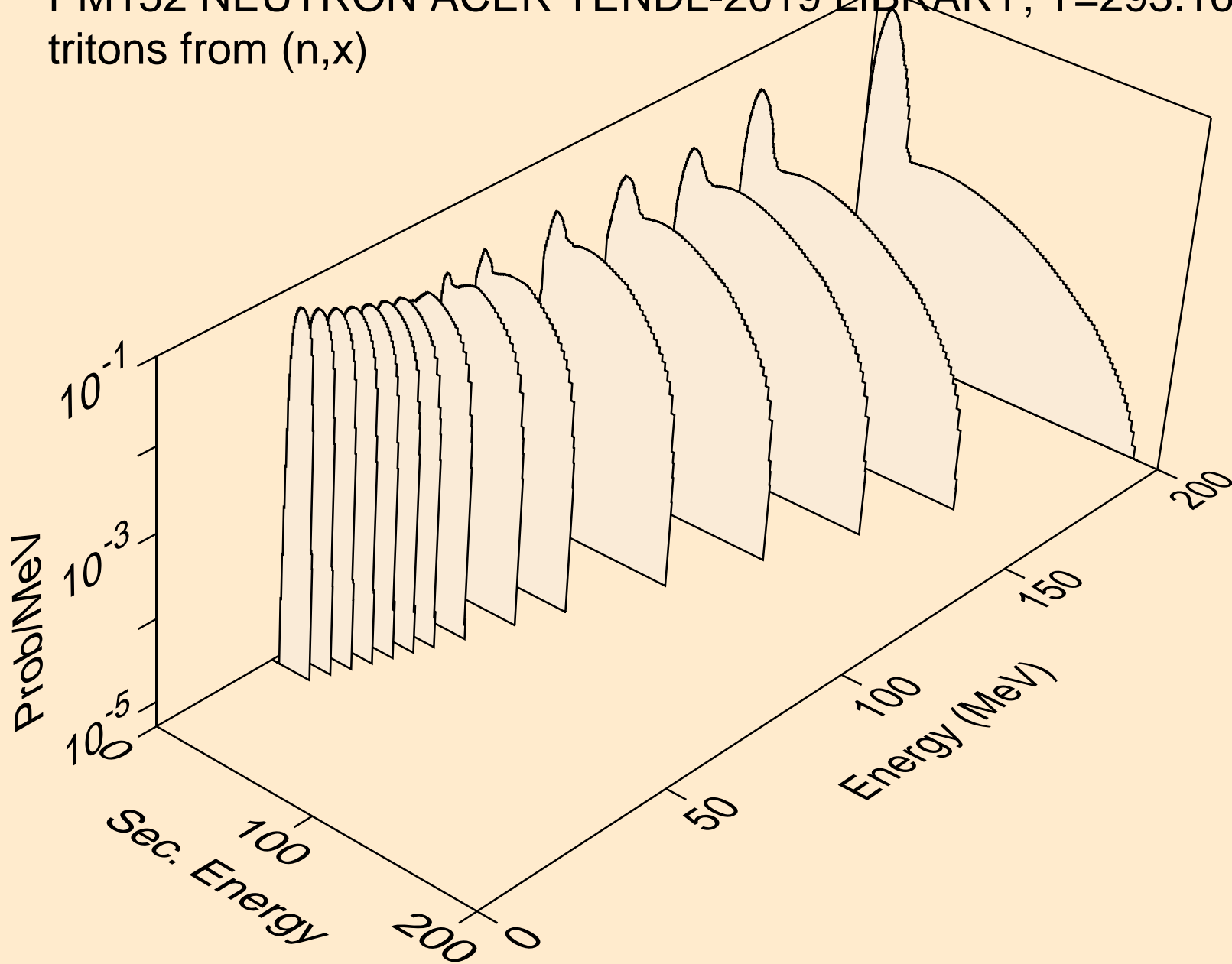

PM152 NEUTRON ACER TENDL-2019 LIBRARY; T=293.16K
tritons from (n,n*)t

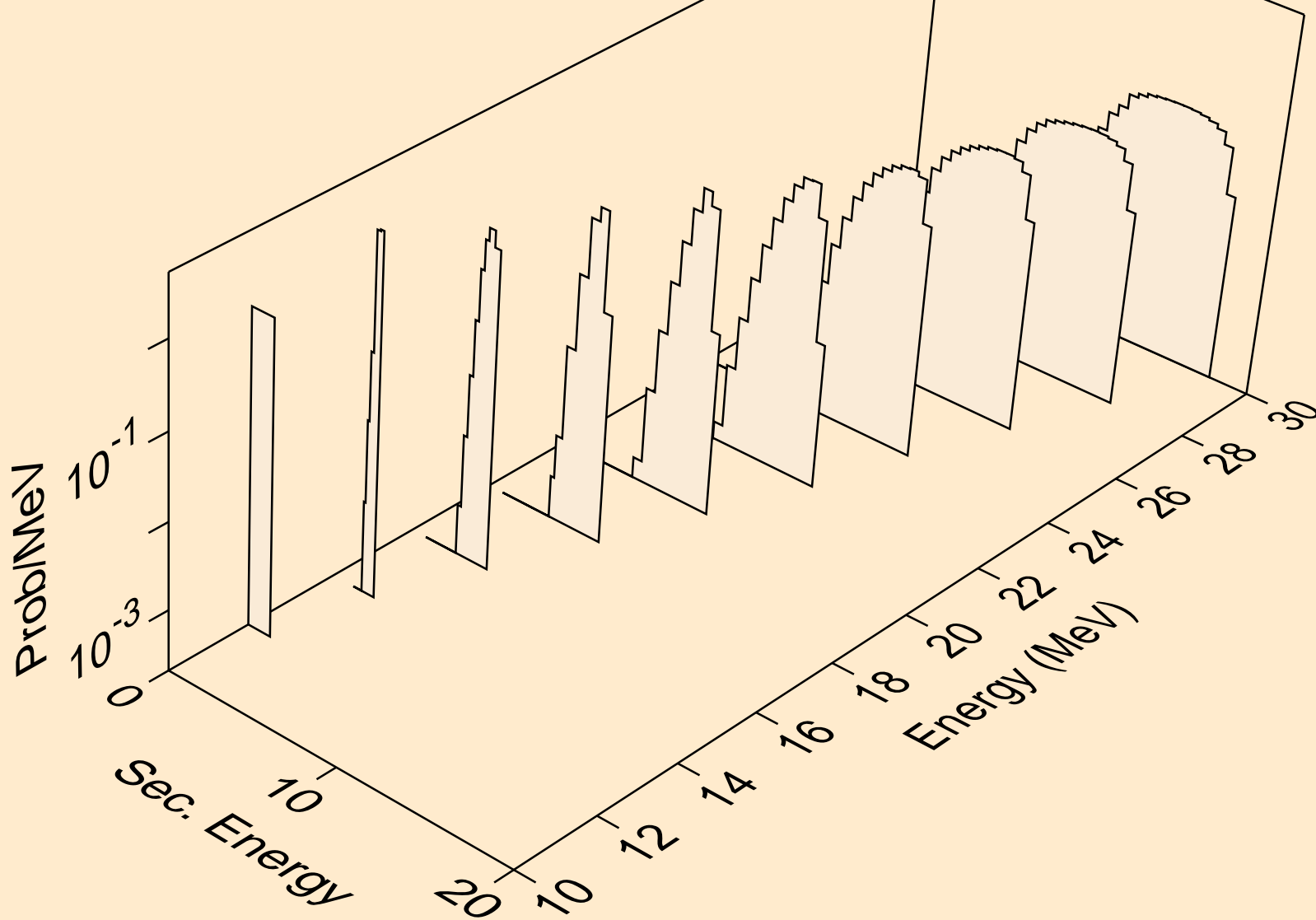

PM152 NEUTRON ACER TENDL-2019 LIBRARY; T=293.16K
tritons from (n,t)

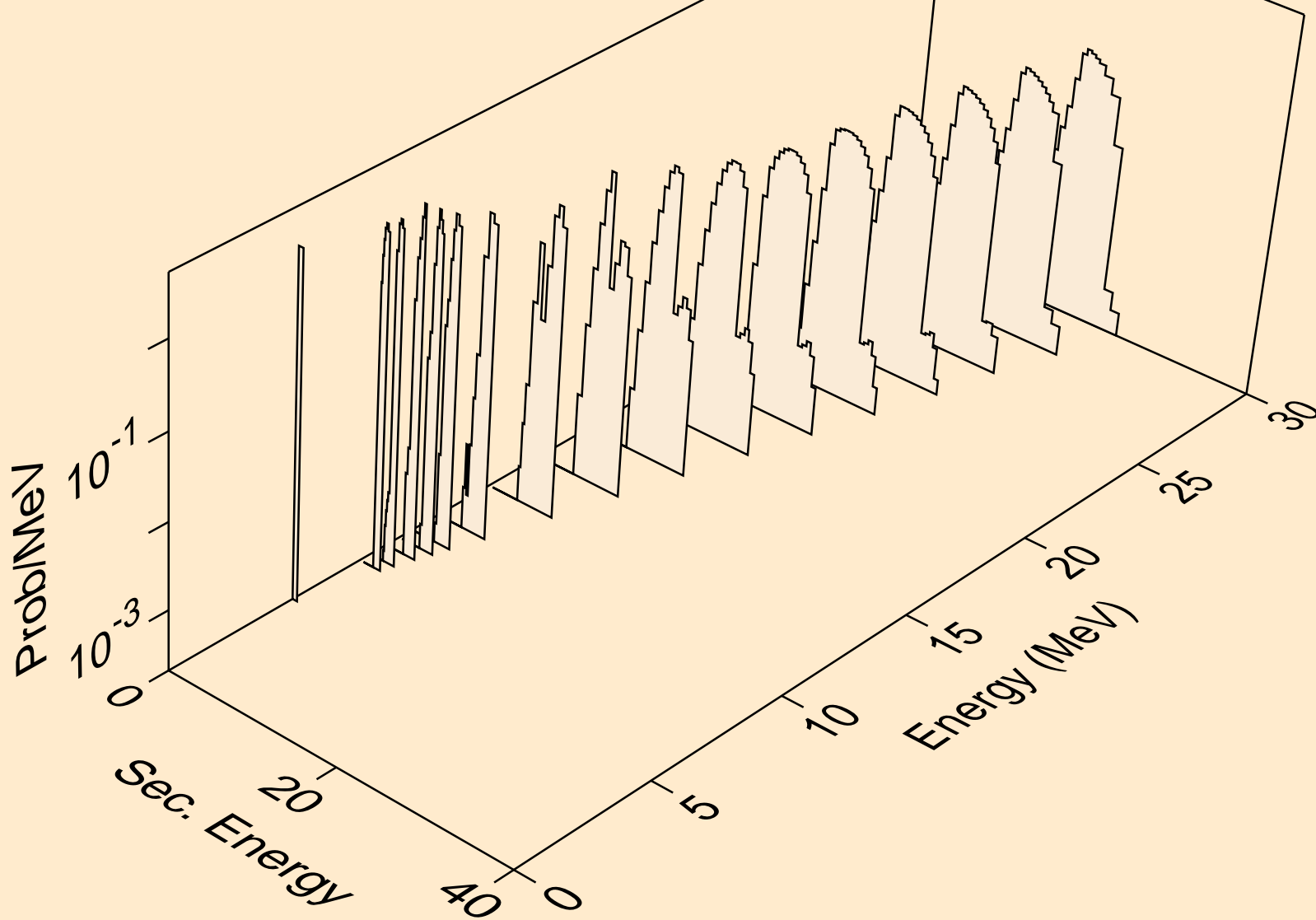

PM152 NEUTRON ACER TENDL-2019 LIBRARY; T=293.16K
he3s from (n,x)

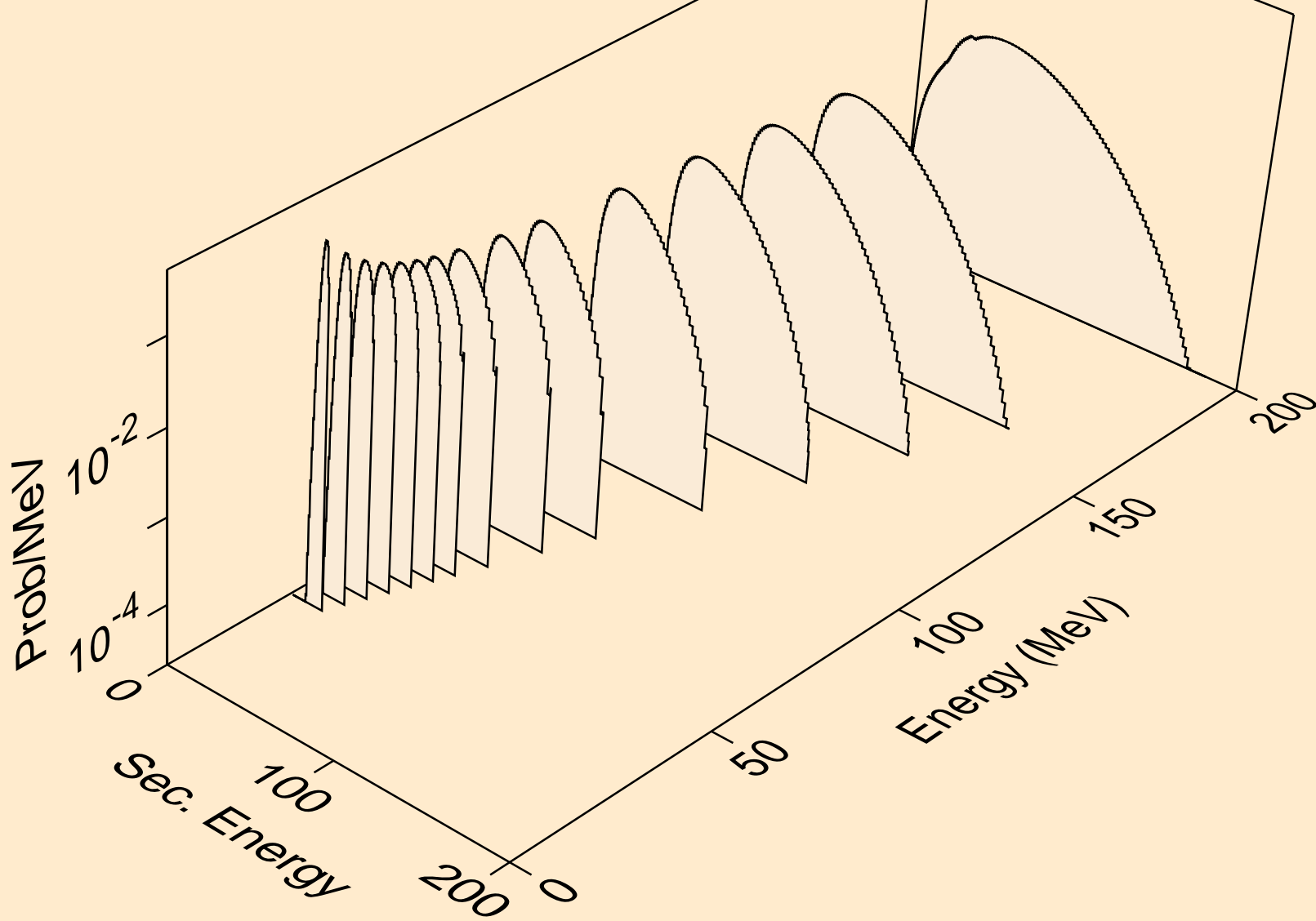

PM152 NEUTRON ACER TENDL-2019 LIBRARY; T=293.16K
he3s from (n,n*)he3

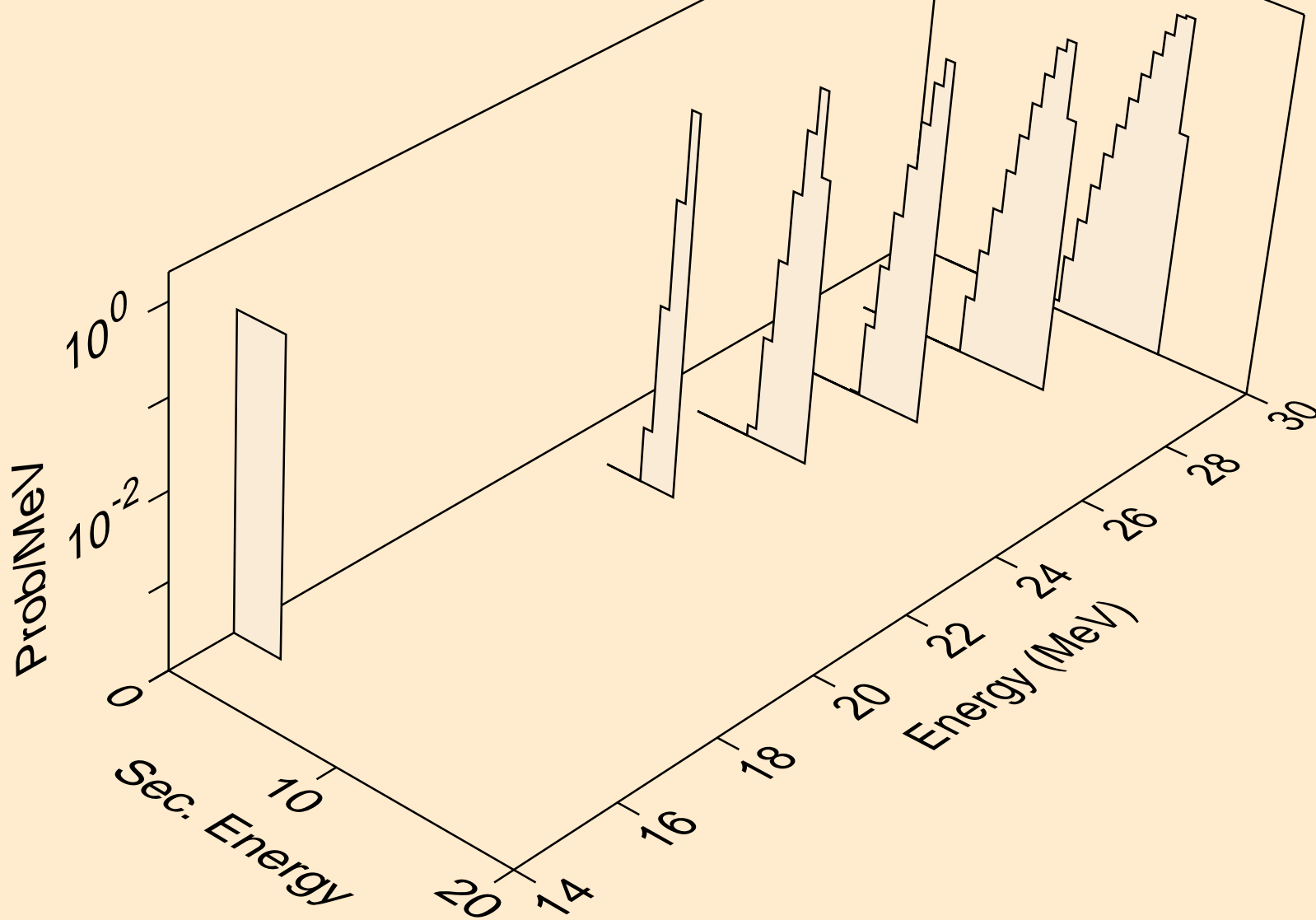

PM152 NEUTRON ACER TENDL-2019 LIBRARY; T=293.16K
he3s from (n,he3)

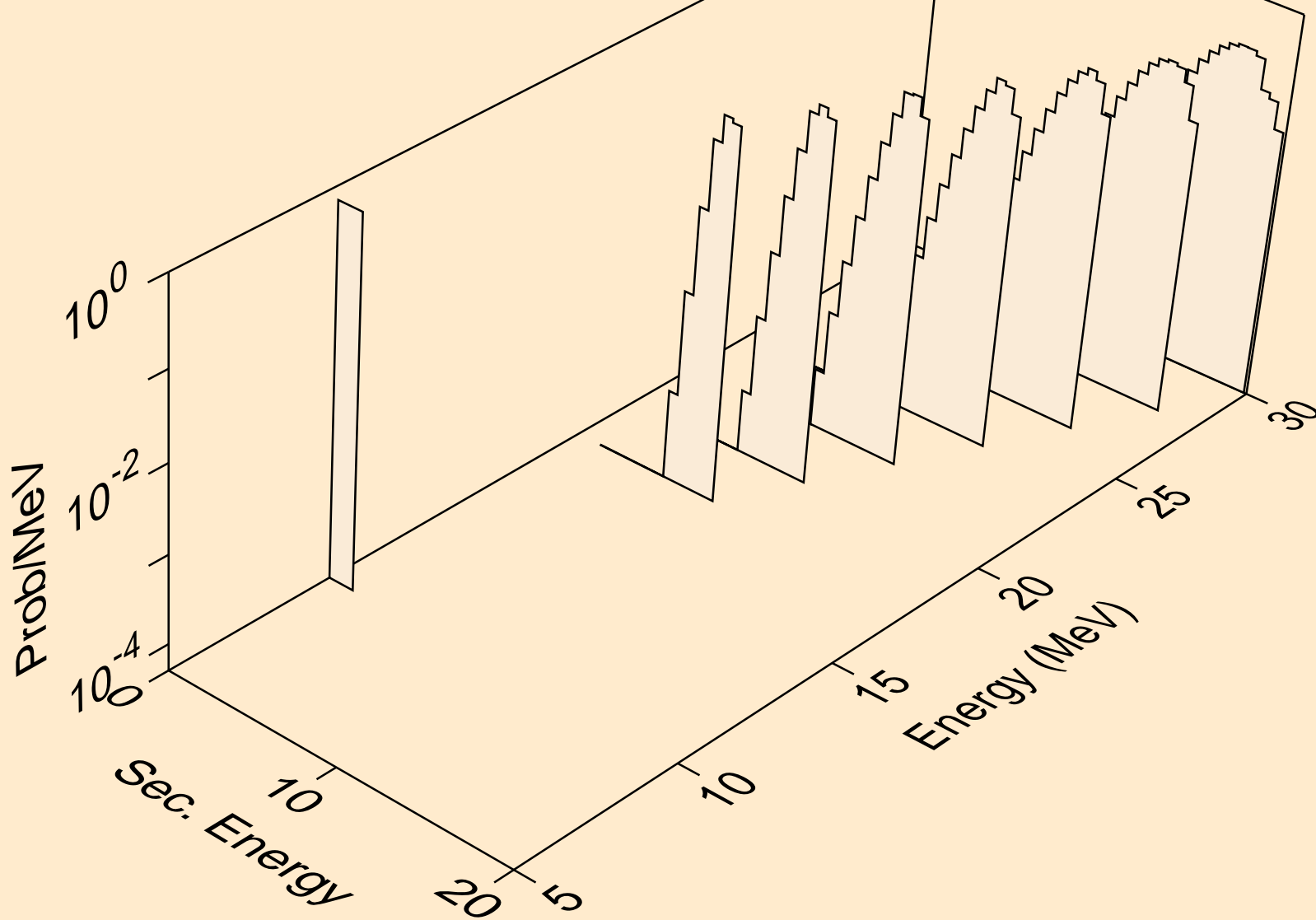

PM152 NEUTRON ACER TENDL-2019 LIBRARY; T=293.16K
alphas from (n,x)

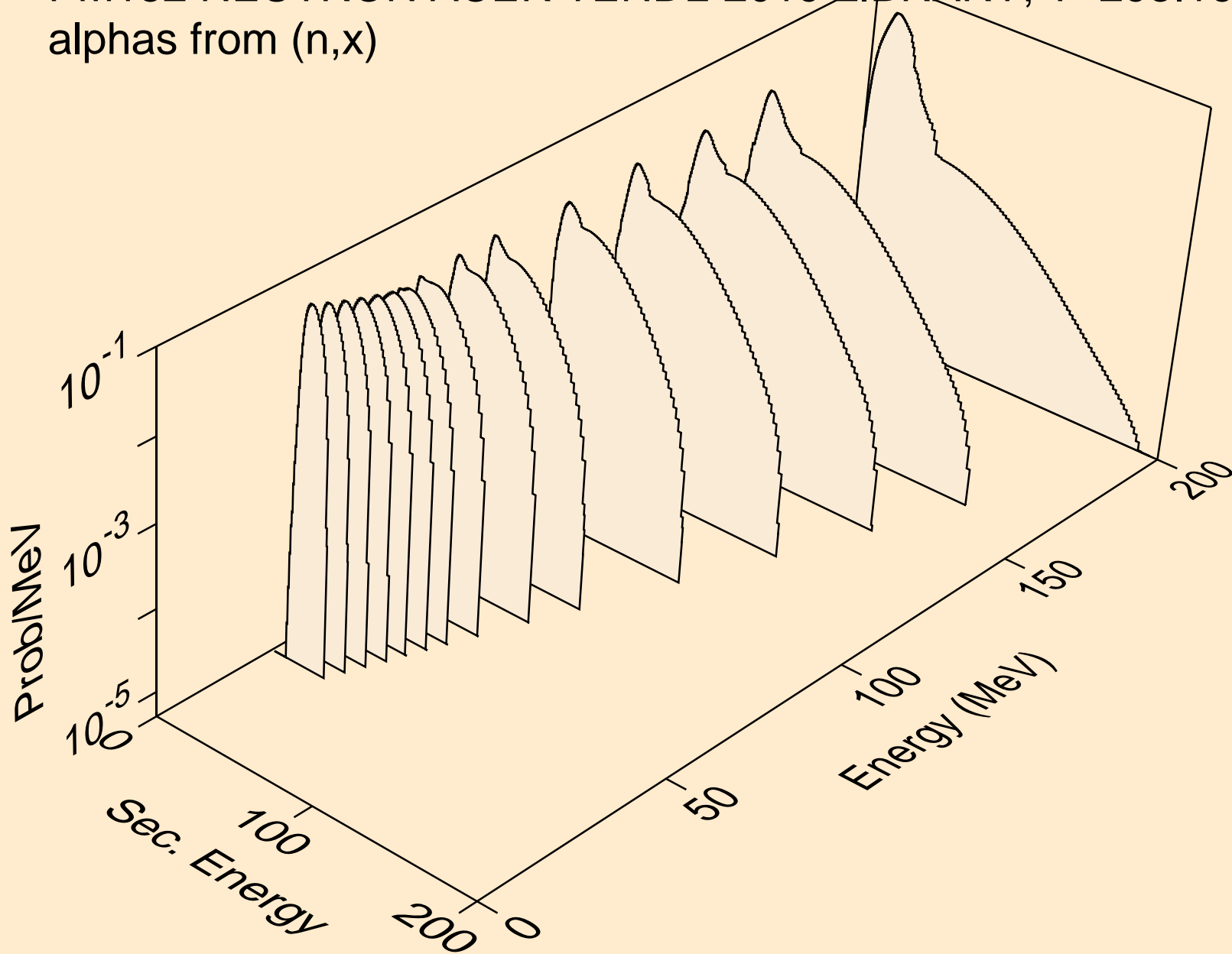

PM152 NEUTRON ACER TENDL-2019 LIBRARY; T=293.16K
alphas from (n,n*)a

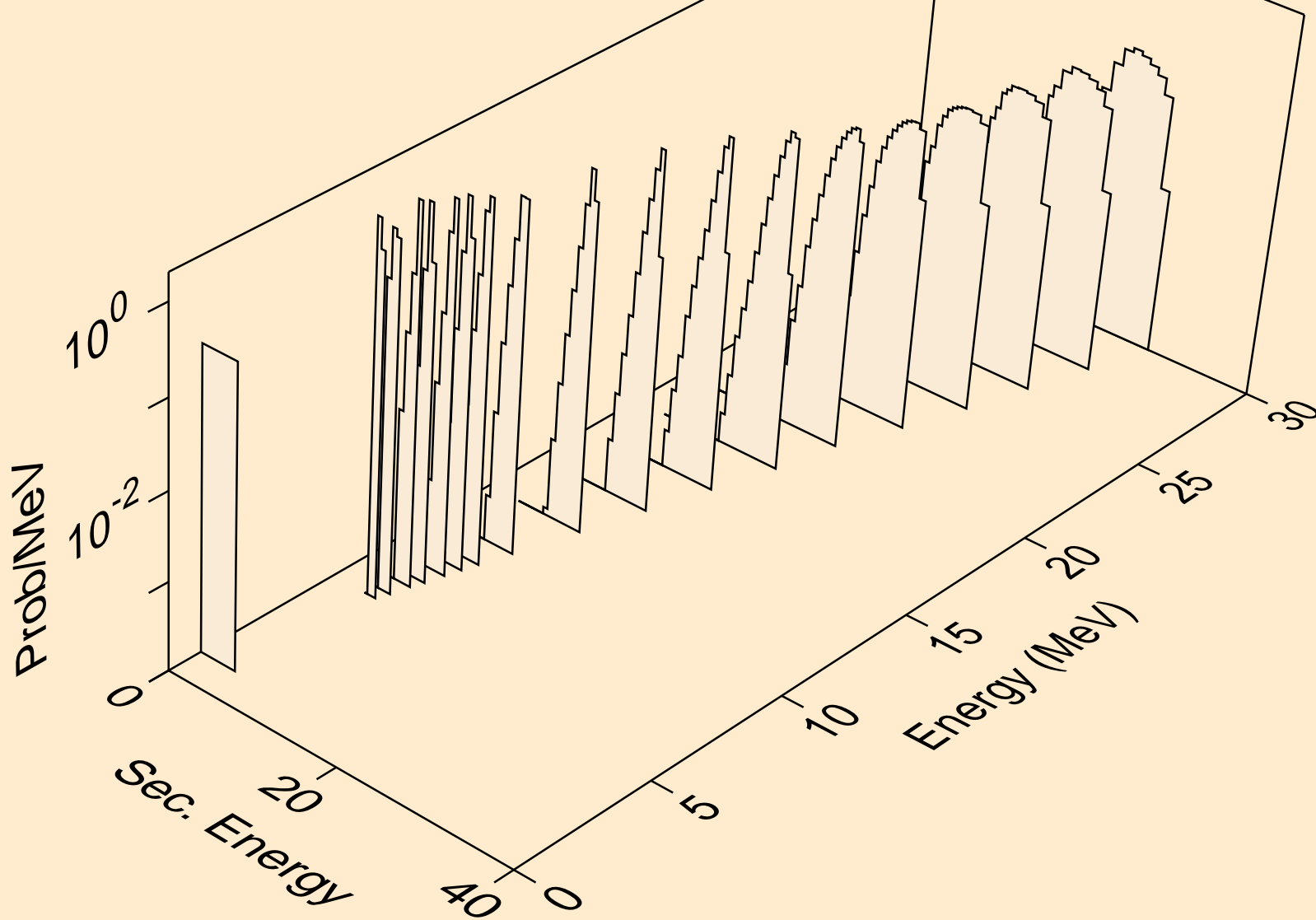

PM152 NEUTRON ACER TENDL-2019 LIBRARY; T=293.16K
alphas from (n,2n)a

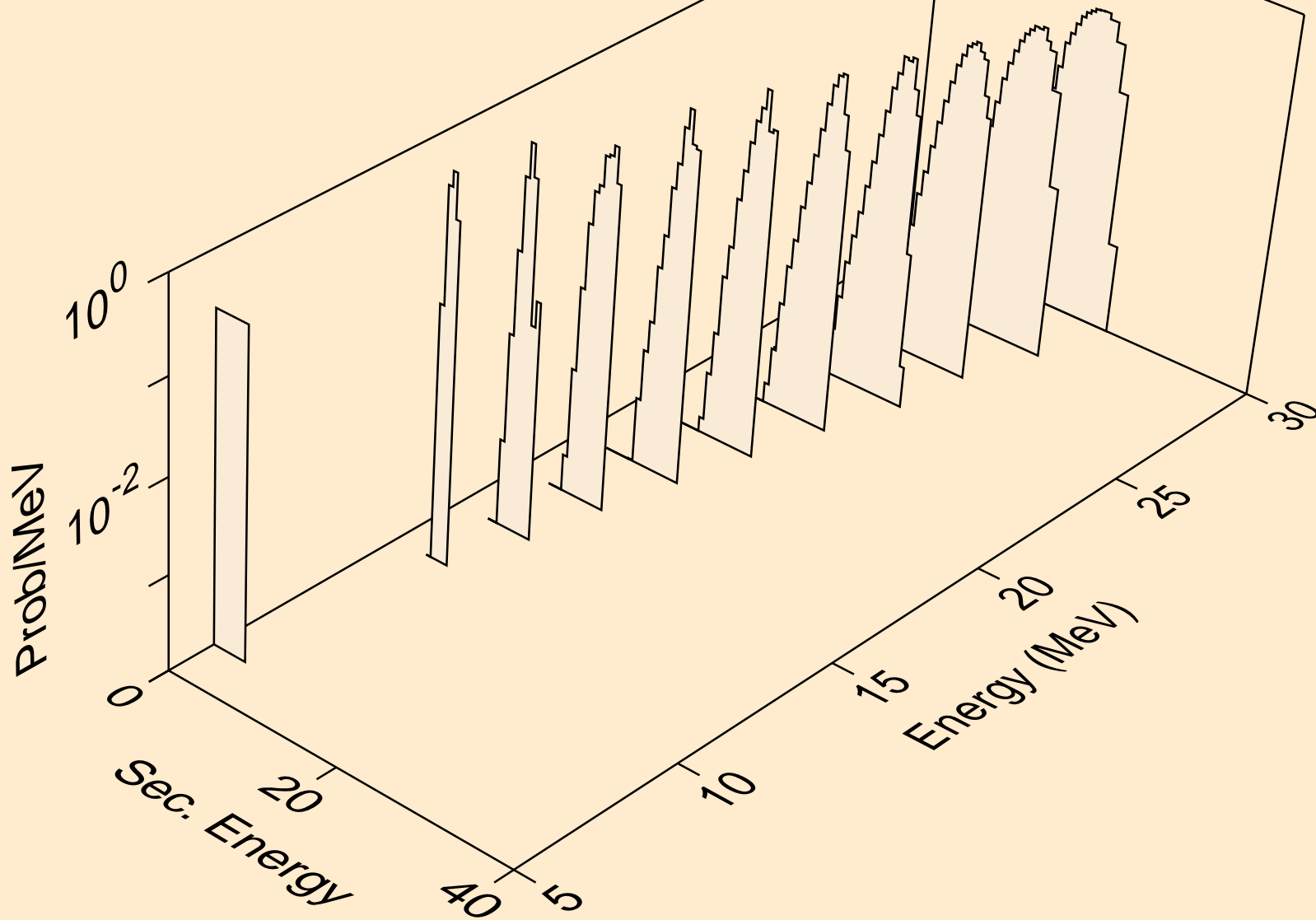

PM152 NEUTRON ACER TENDL-2019 LIBRARY; T=293.16K
alphas from (n,3n)a

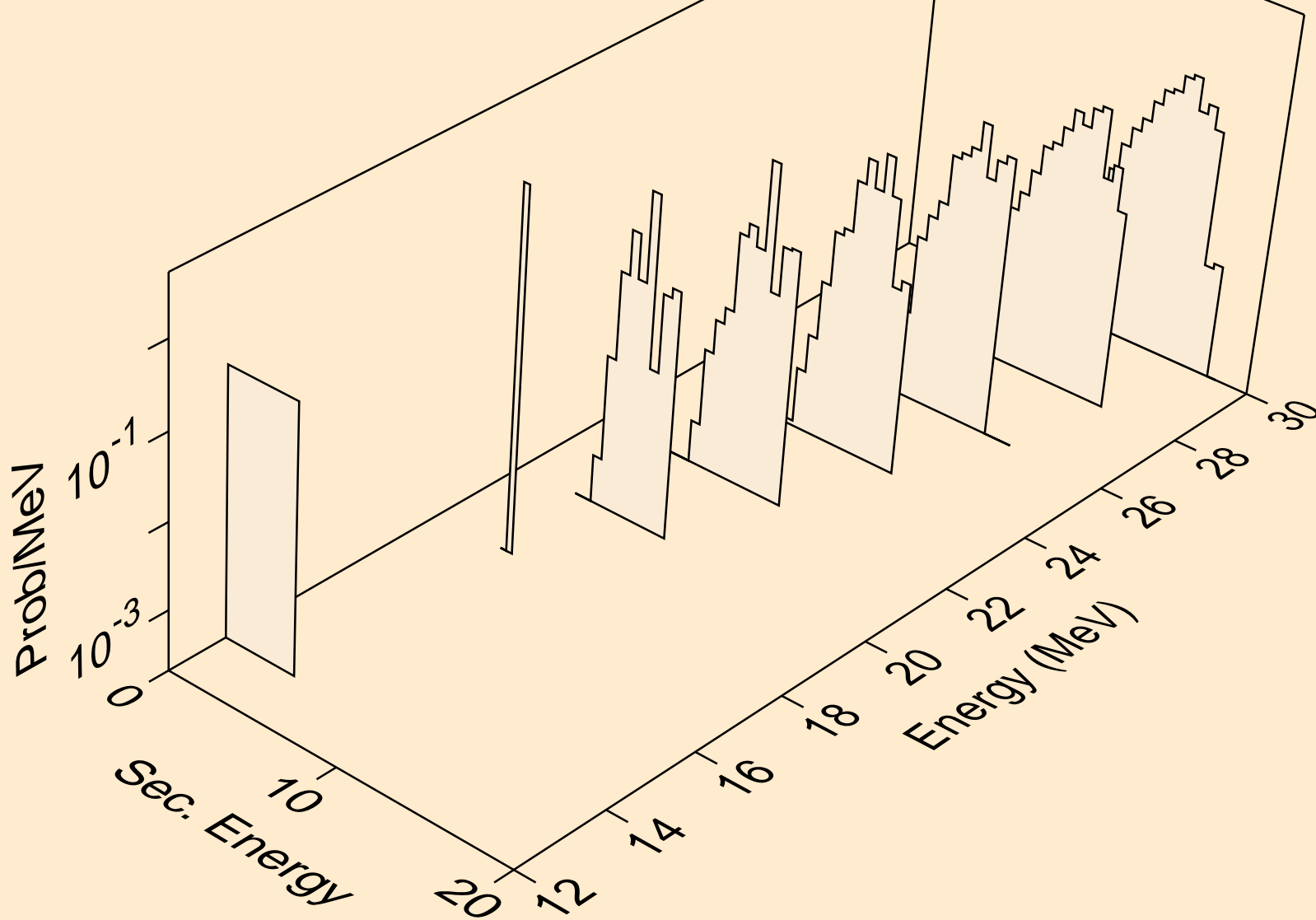

PM152 NEUTRON ACER TENDL-2019 LIBRARY; T=293.16K
alphas from (n,a)

