

PR140 NEUTRON ACER TENDL-2019 LIBRARY; T=293.16K
Principal cross sections

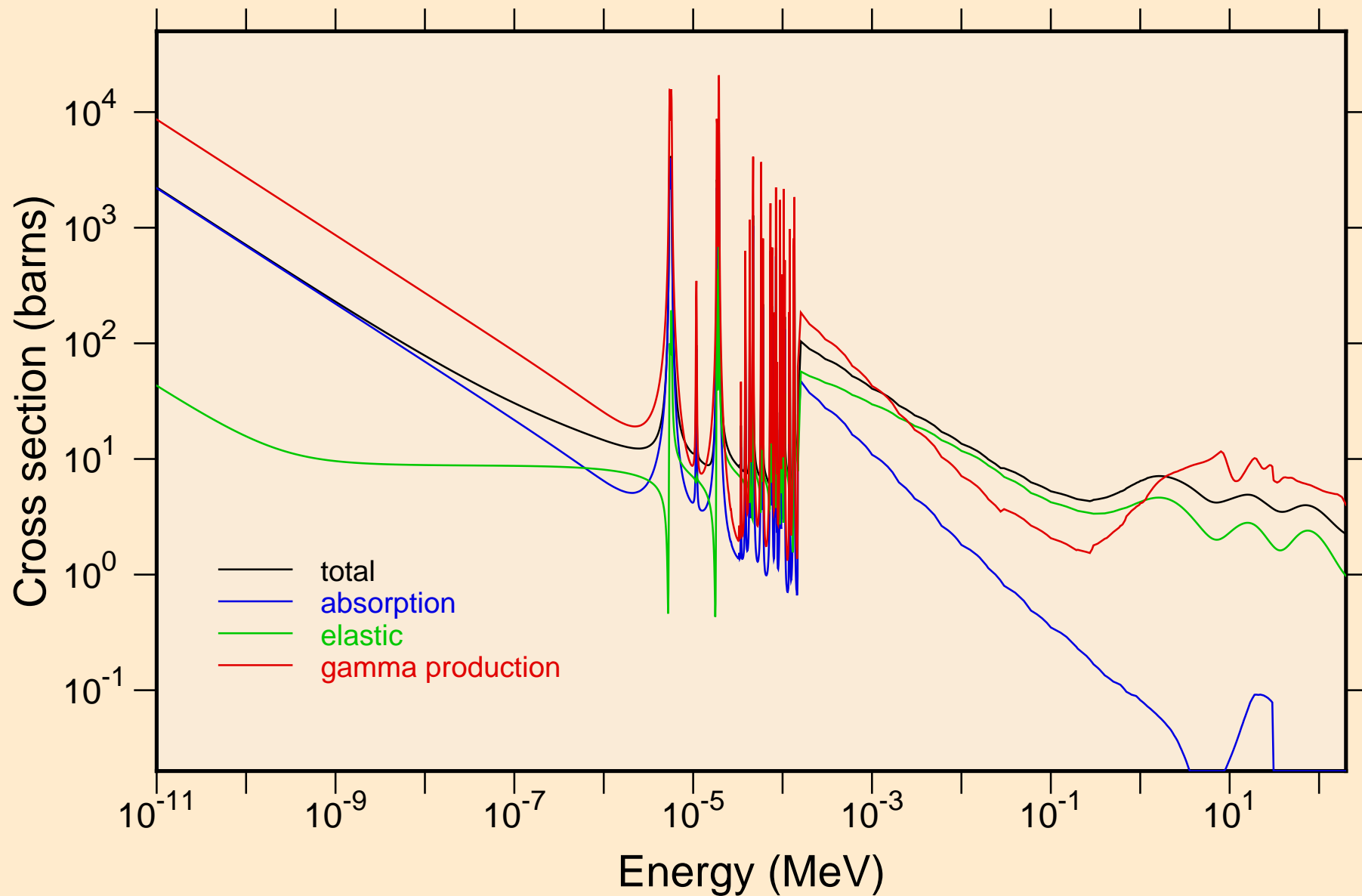

PR140 NEUTRON ACER TENDL-2019 LIBRARY; T=293.16K
resonance total cross section

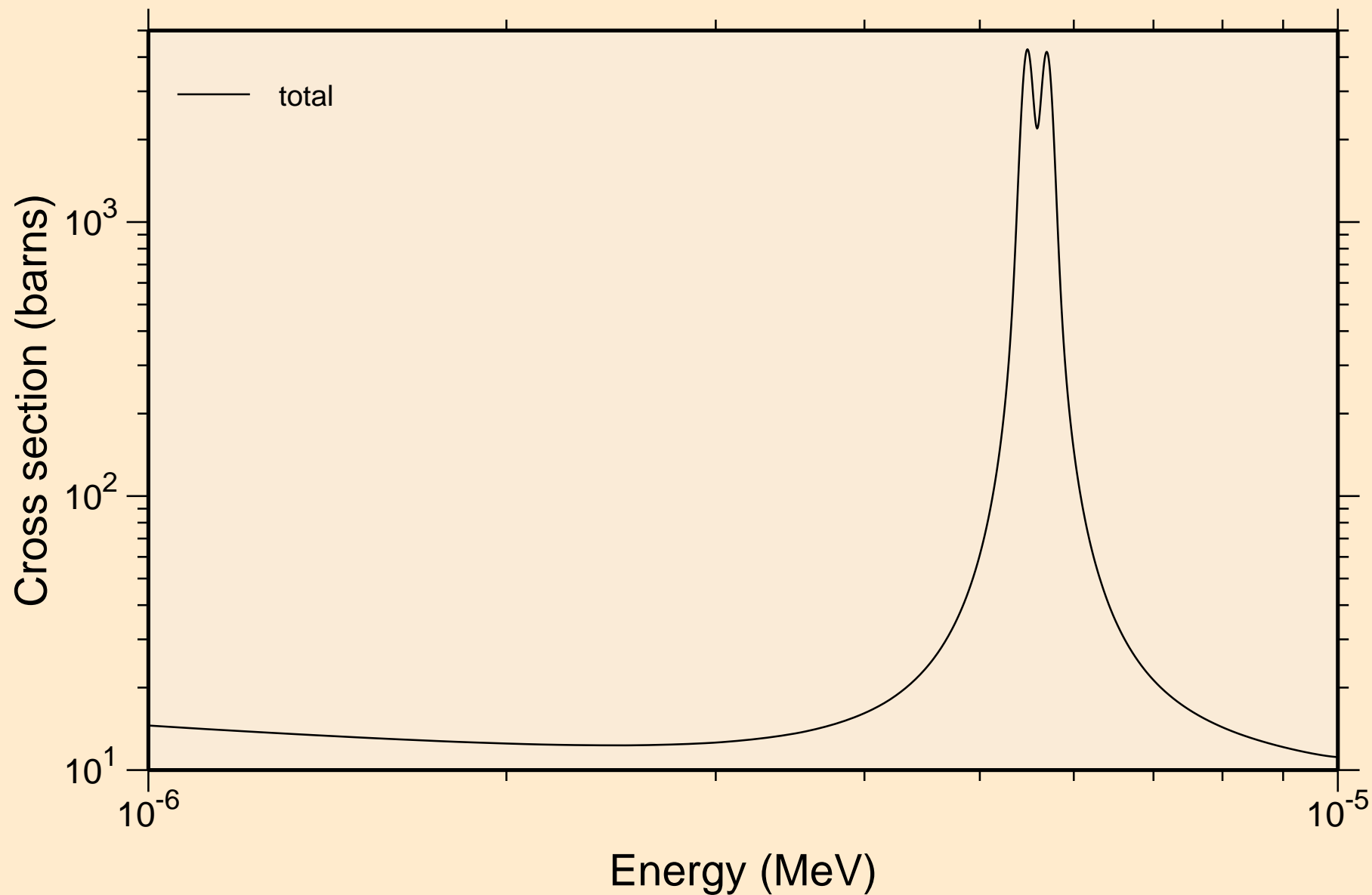

PR140 NEUTRON ACER TENDL-2019 LIBRARY; T=293.16K
resonance total cross section

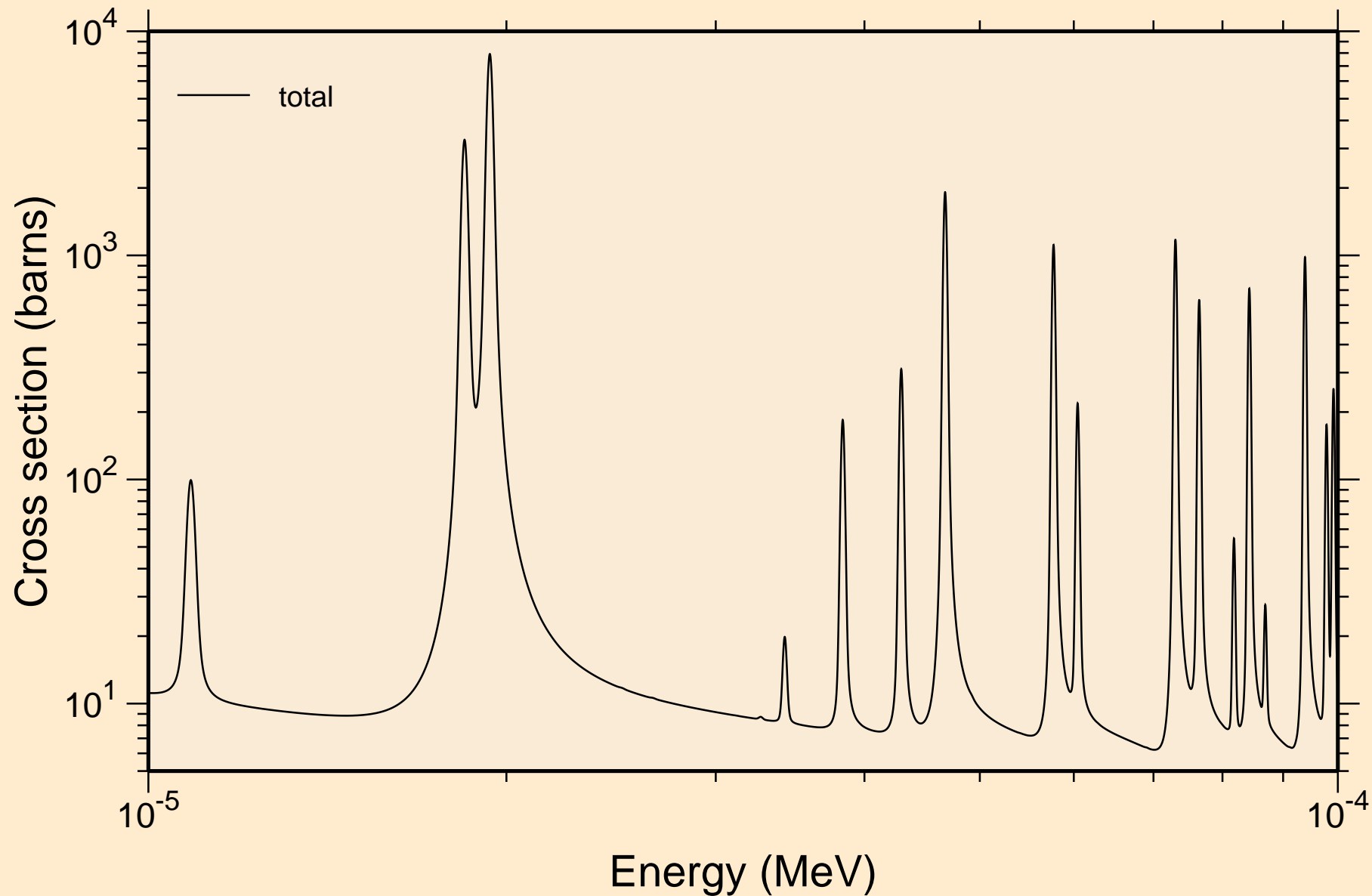

PR140 NEUTRON ACER TENDL-2019 LIBRARY; T=293.16K
resonance total cross section

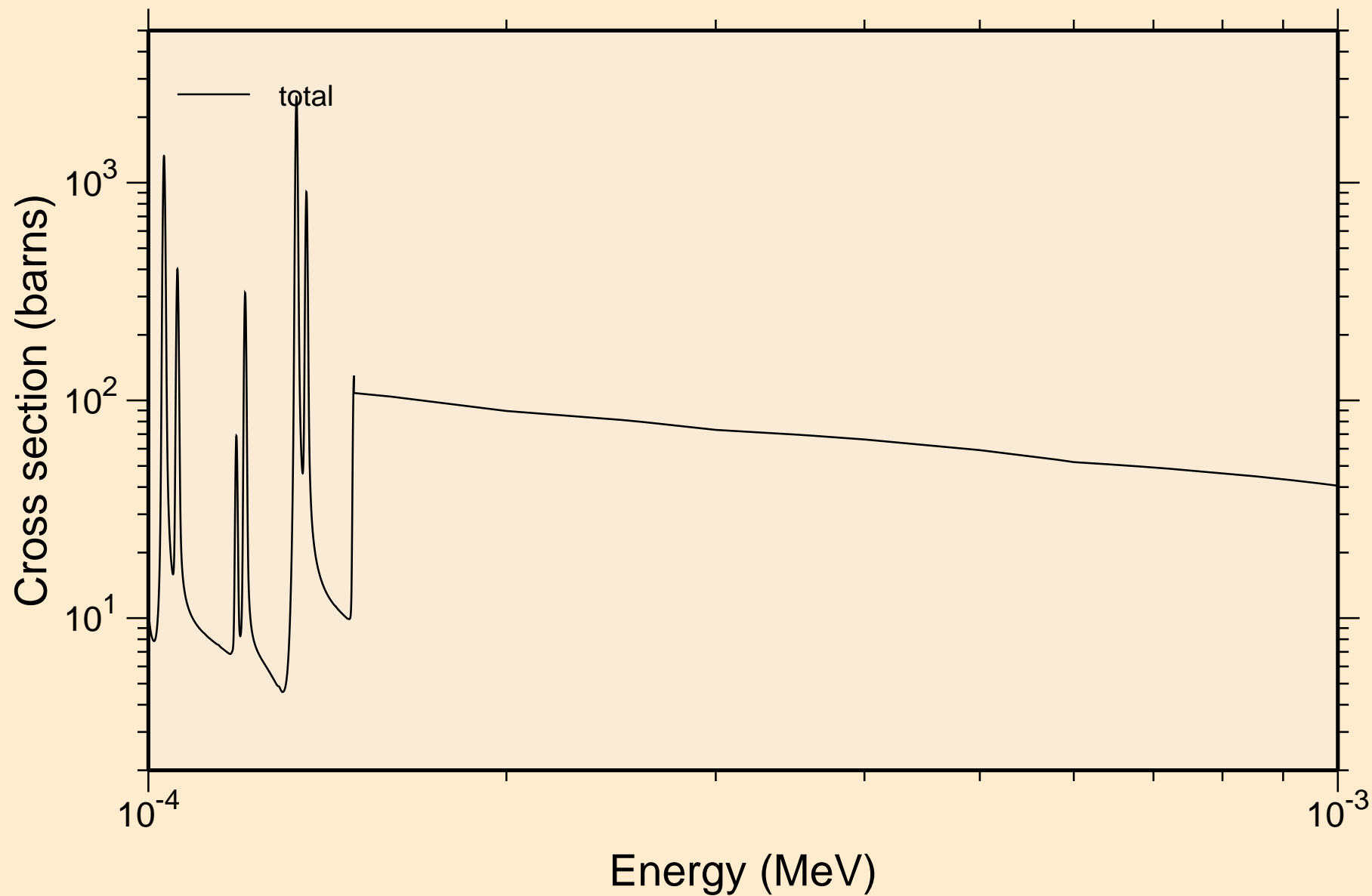

PR140 NEUTRON ACER TENDL-2019 LIBRARY; T=293.16K
resonance total cross section

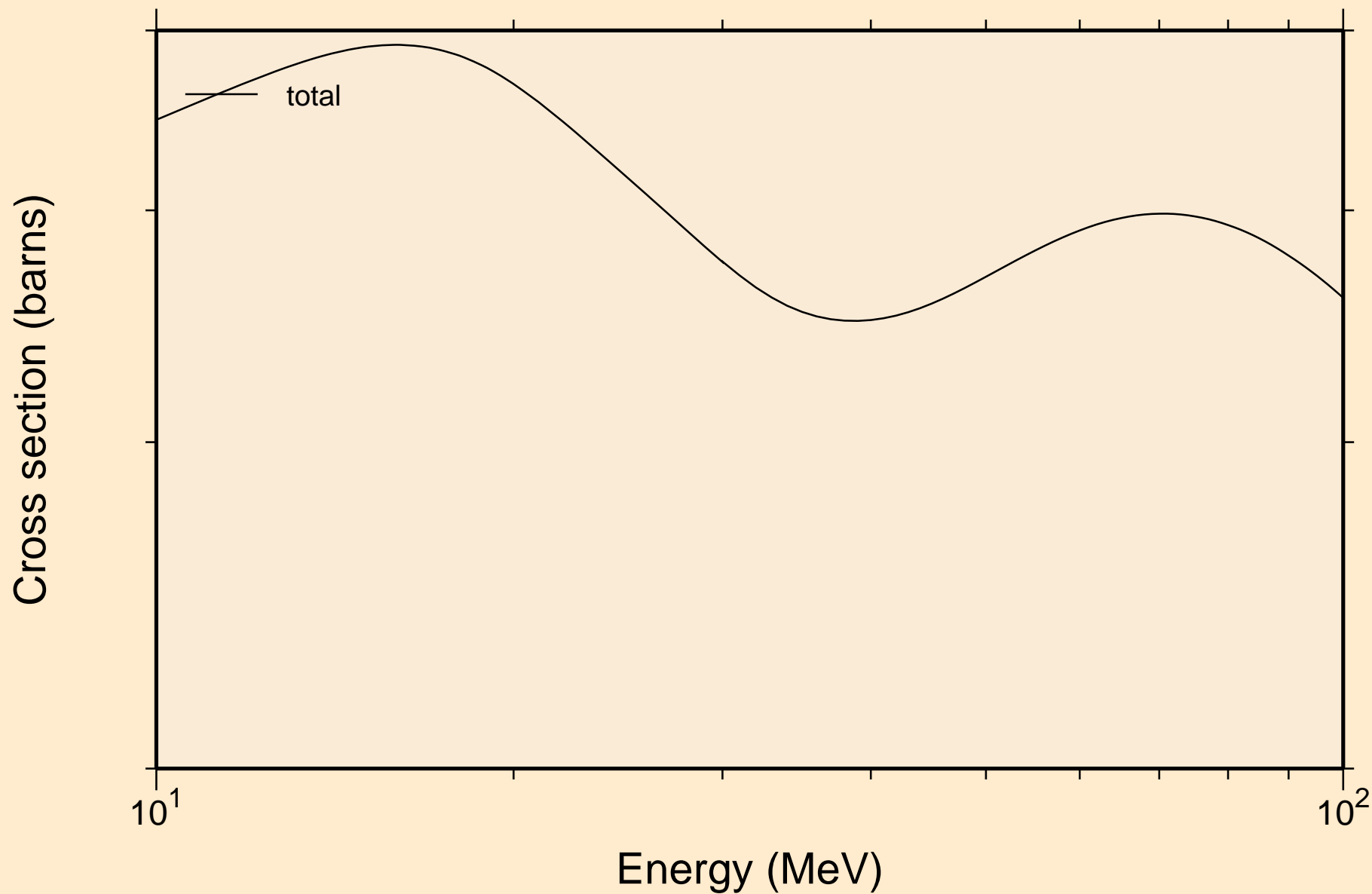

PR140 NEUTRON ACER TENDL-2019 LIBRARY; T=293.16K
resonance absorption cross sections

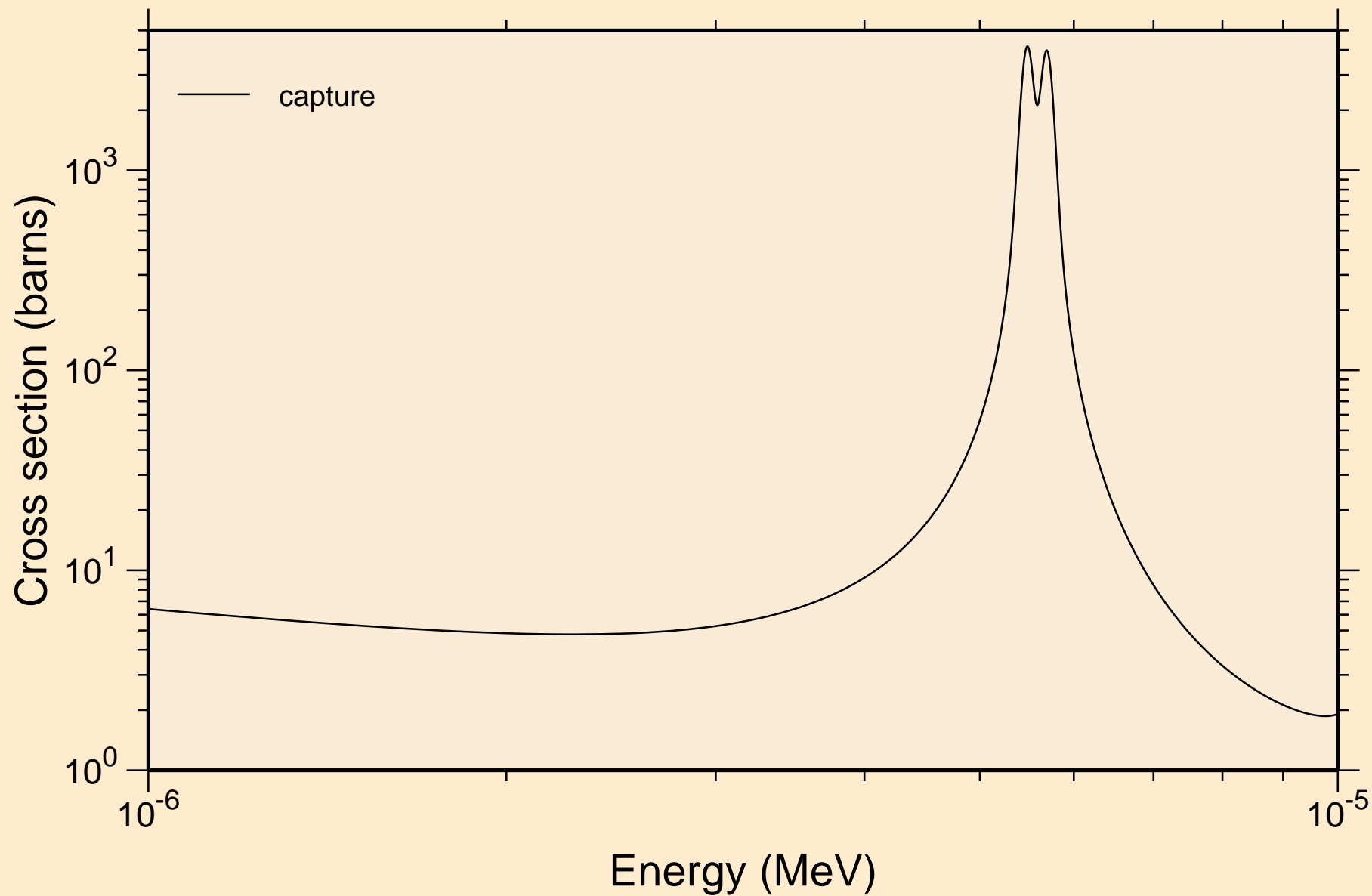

PR140 NEUTRON ACER TENDL-2019 LIBRARY; T=293.16K
resonance absorption cross sections

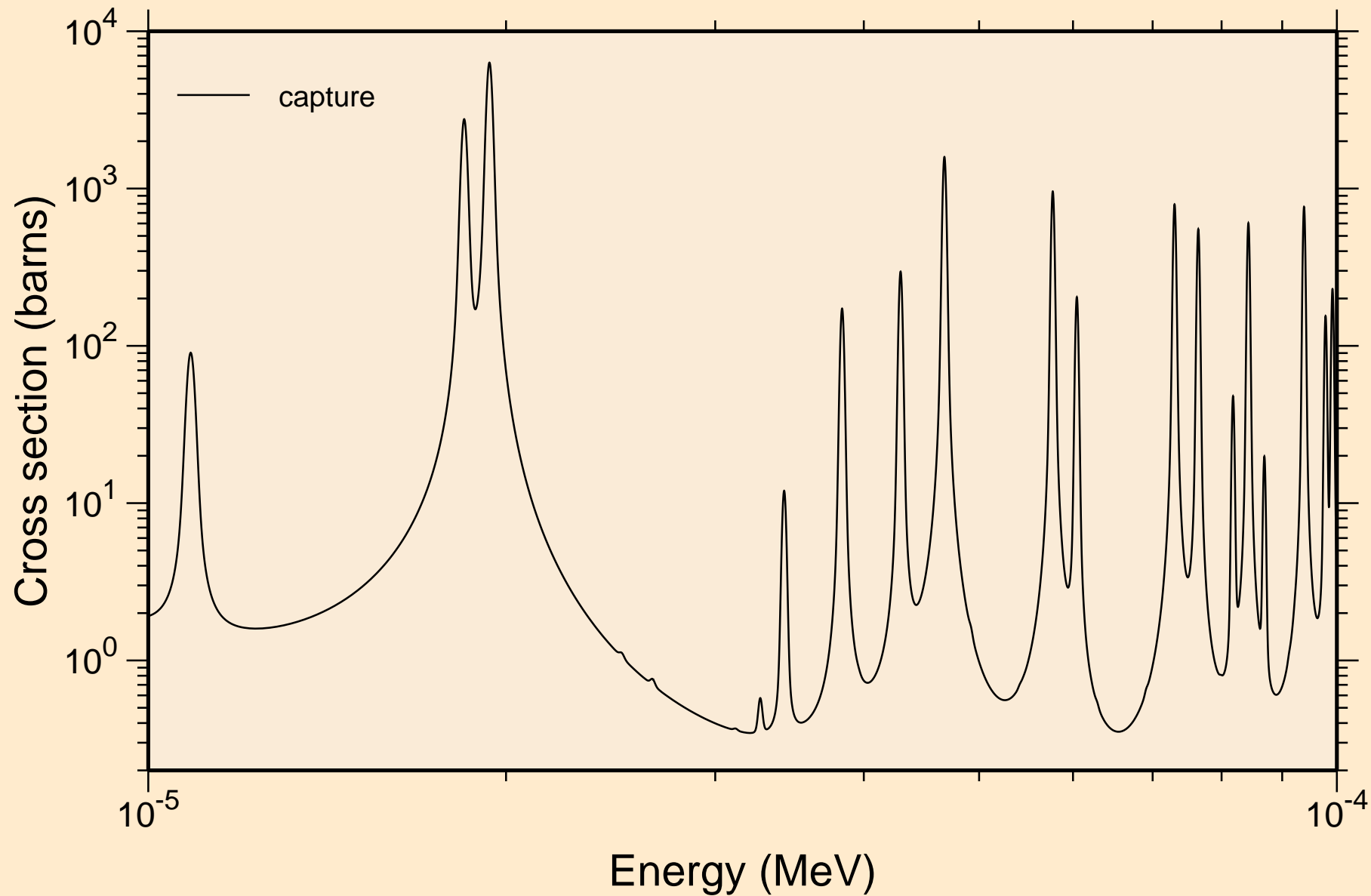

PR140 NEUTRON ACER TENDL-2019 LIBRARY; T=293.16K
resonance absorption cross sections

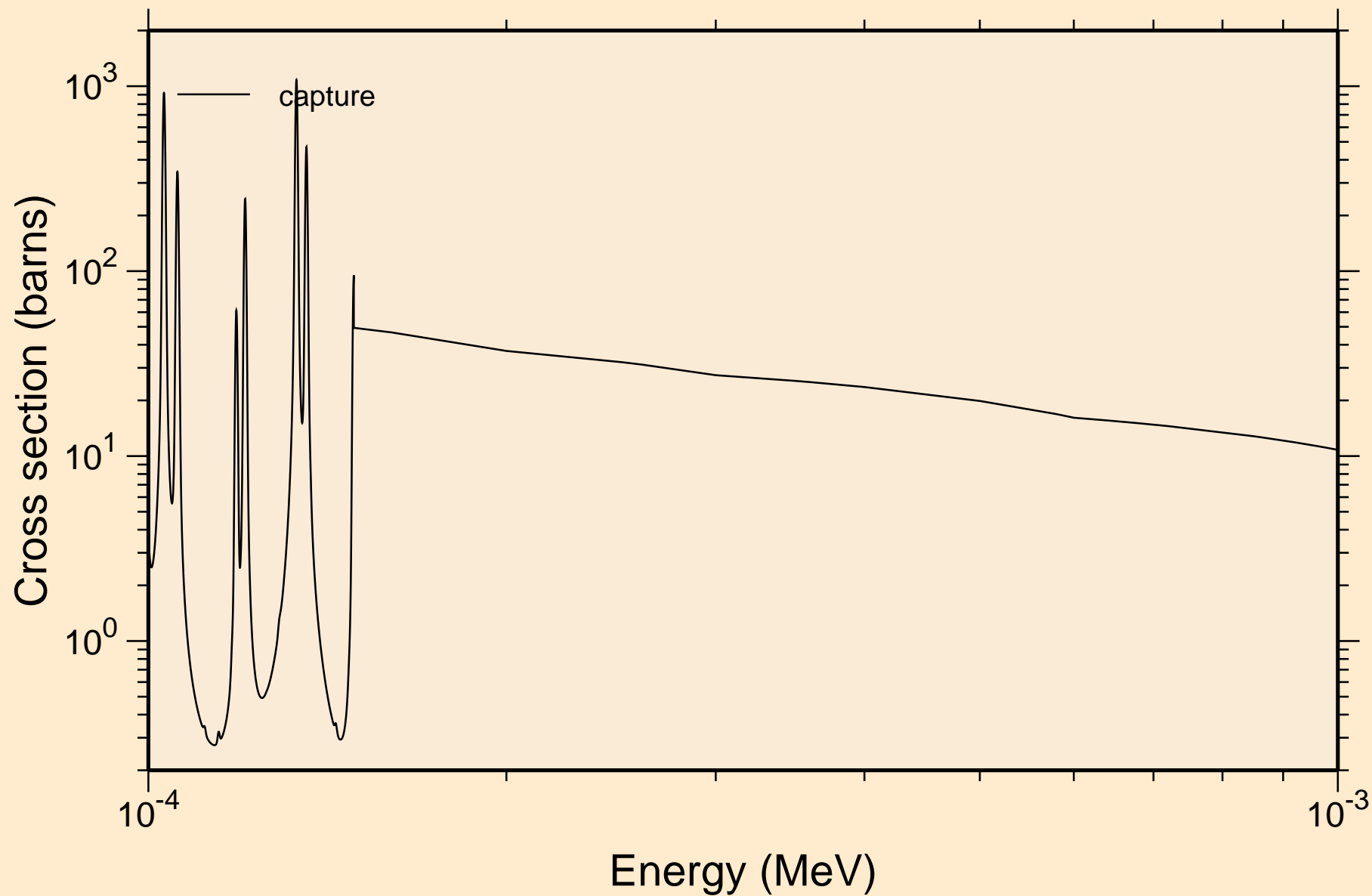

PR140 NEUTRON ACER TENDL-2019 LIBRARY; T=293.16K
resonance absorption cross sections

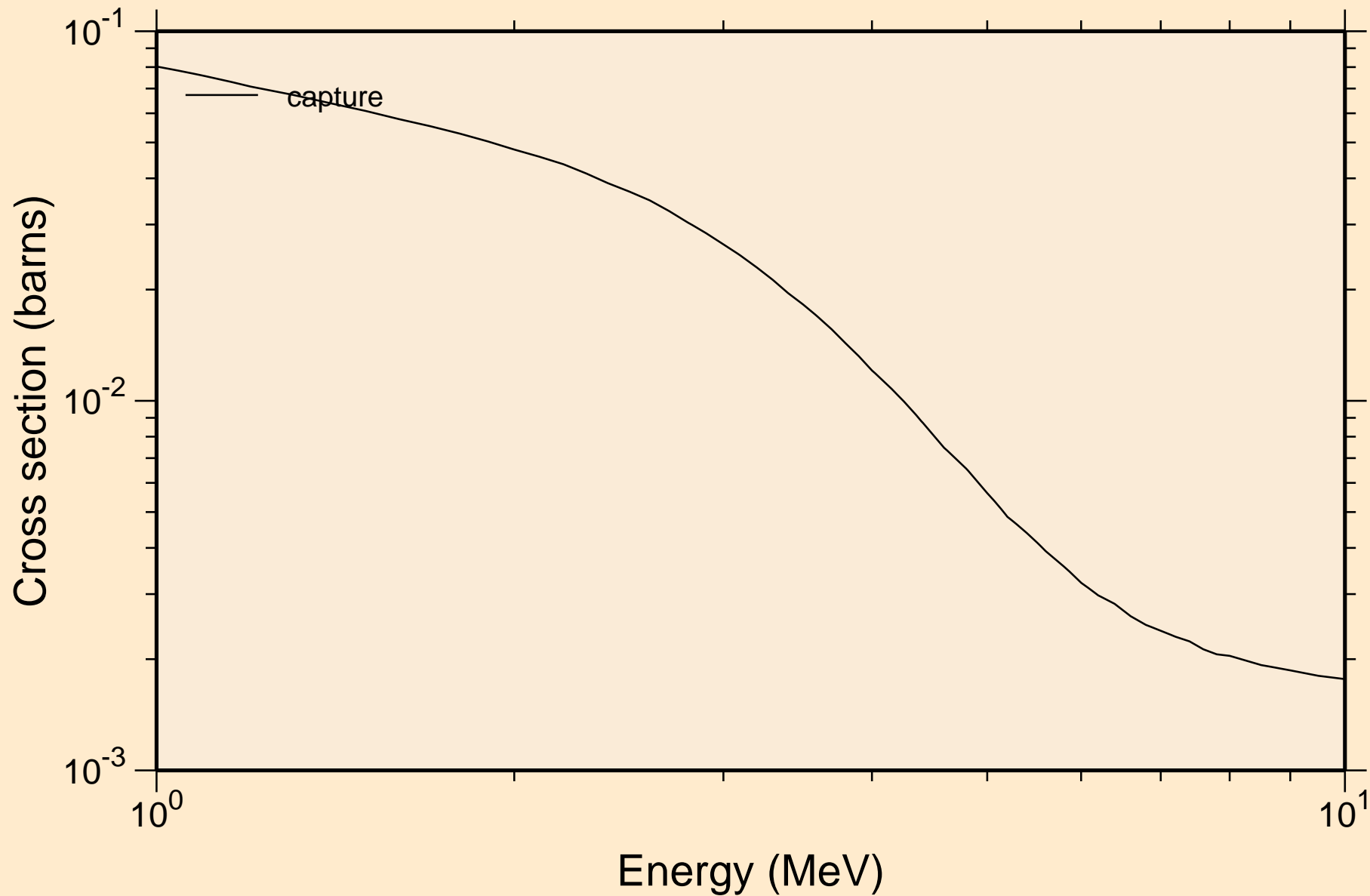

PR140 NEUTRON ACER TENDL-2019 LIBRARY; T=293.16K
Heating

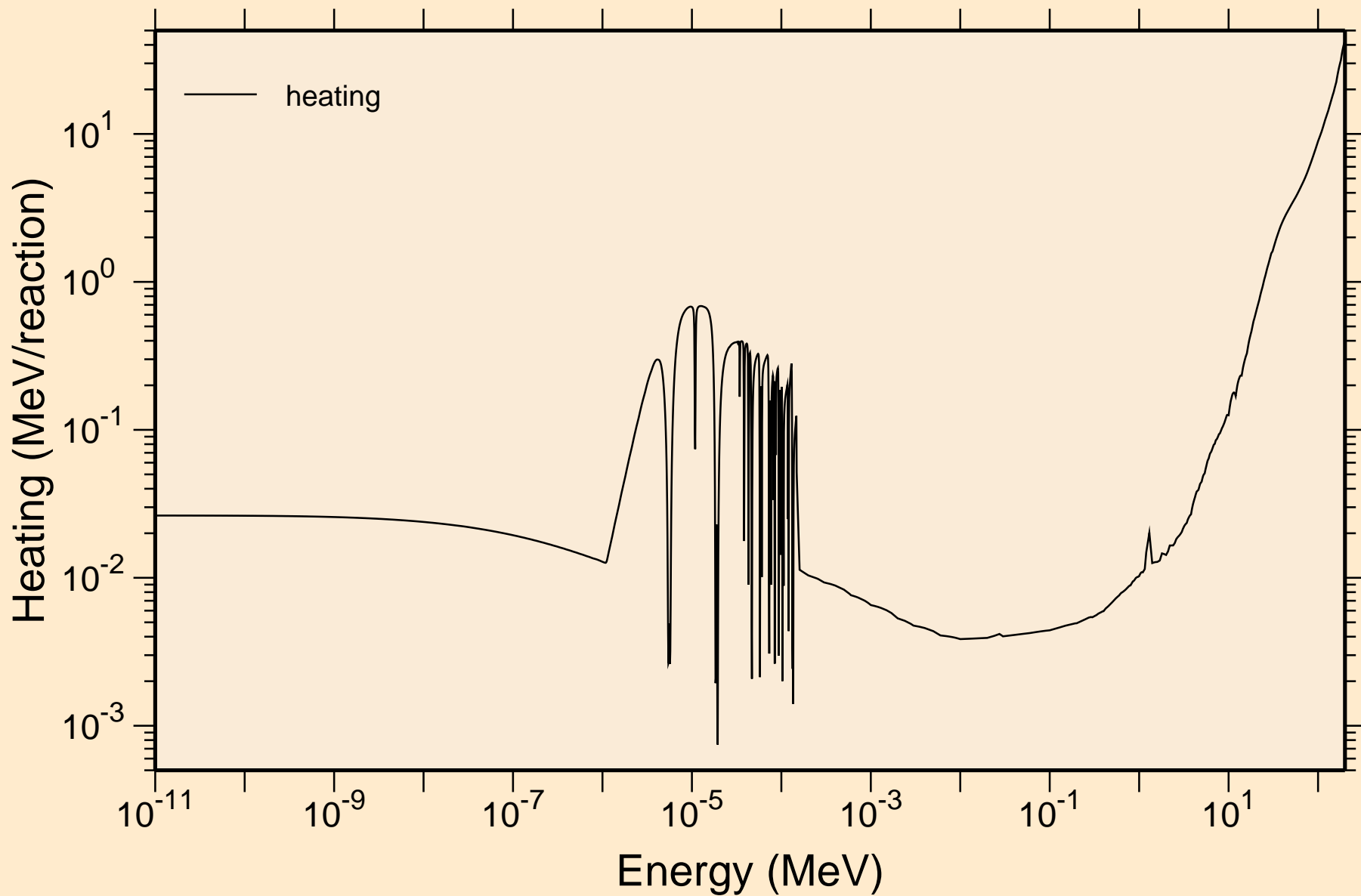

PR140 NEUTRON ACER TENDL-2019 LIBRARY; T=293.16K
Damage

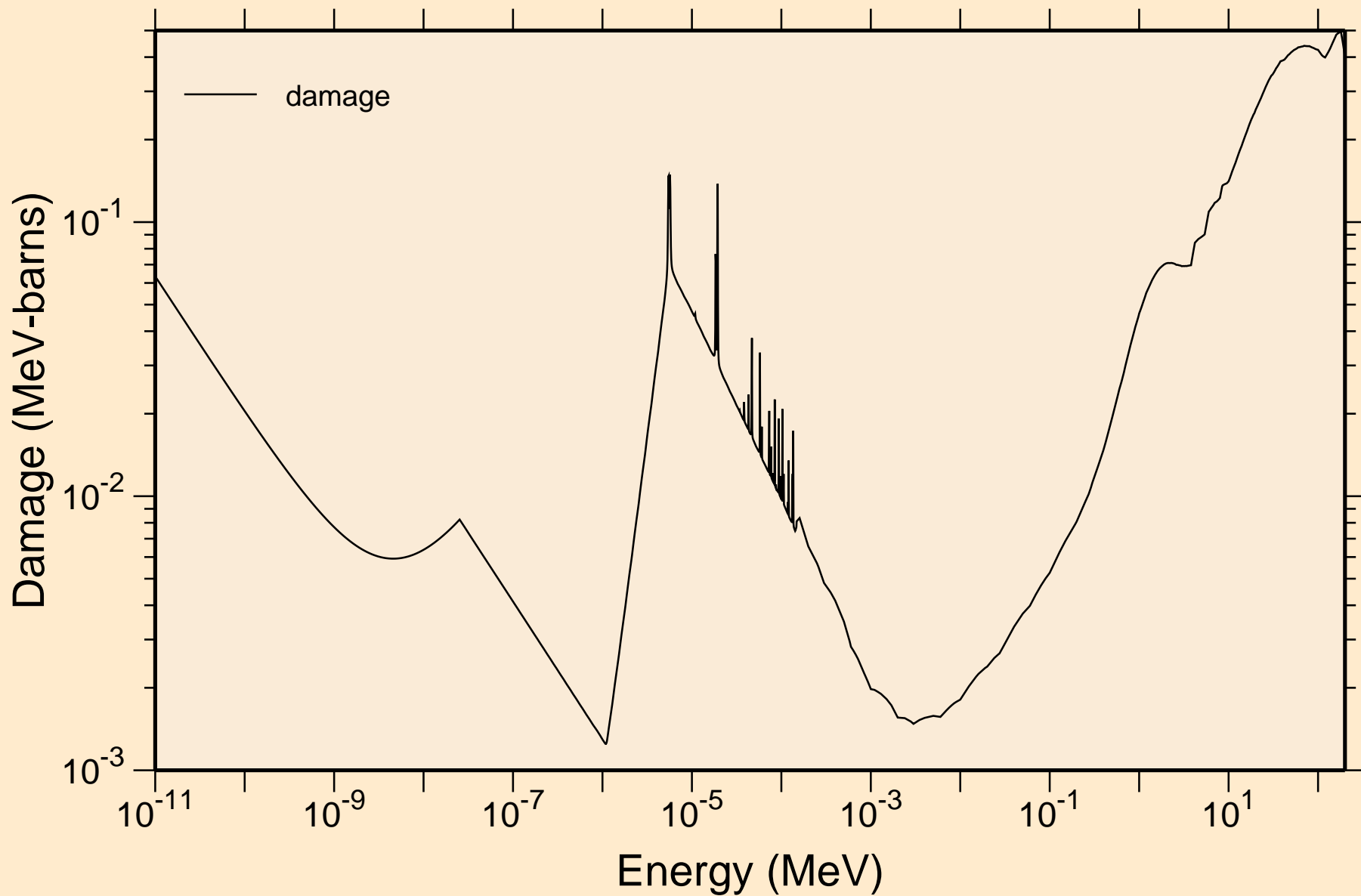

PR140 NEUTRON ACER TENDL-2019 LIBRARY; T=293.16K
Non-threshold reactions

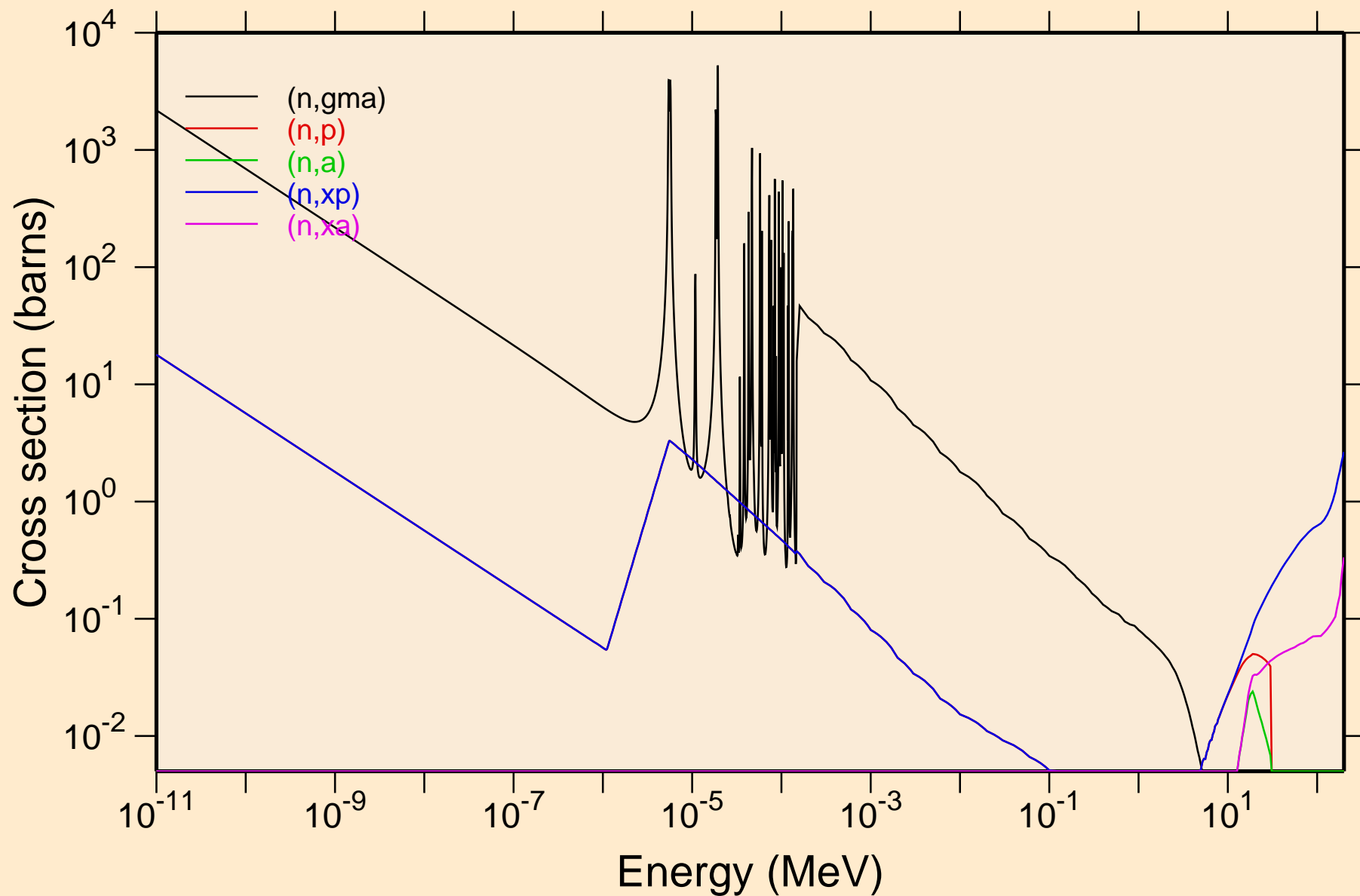

PR140 NEUTRON ACER TENDL-2019 LIBRARY; T=293.16K
Principal cross sections

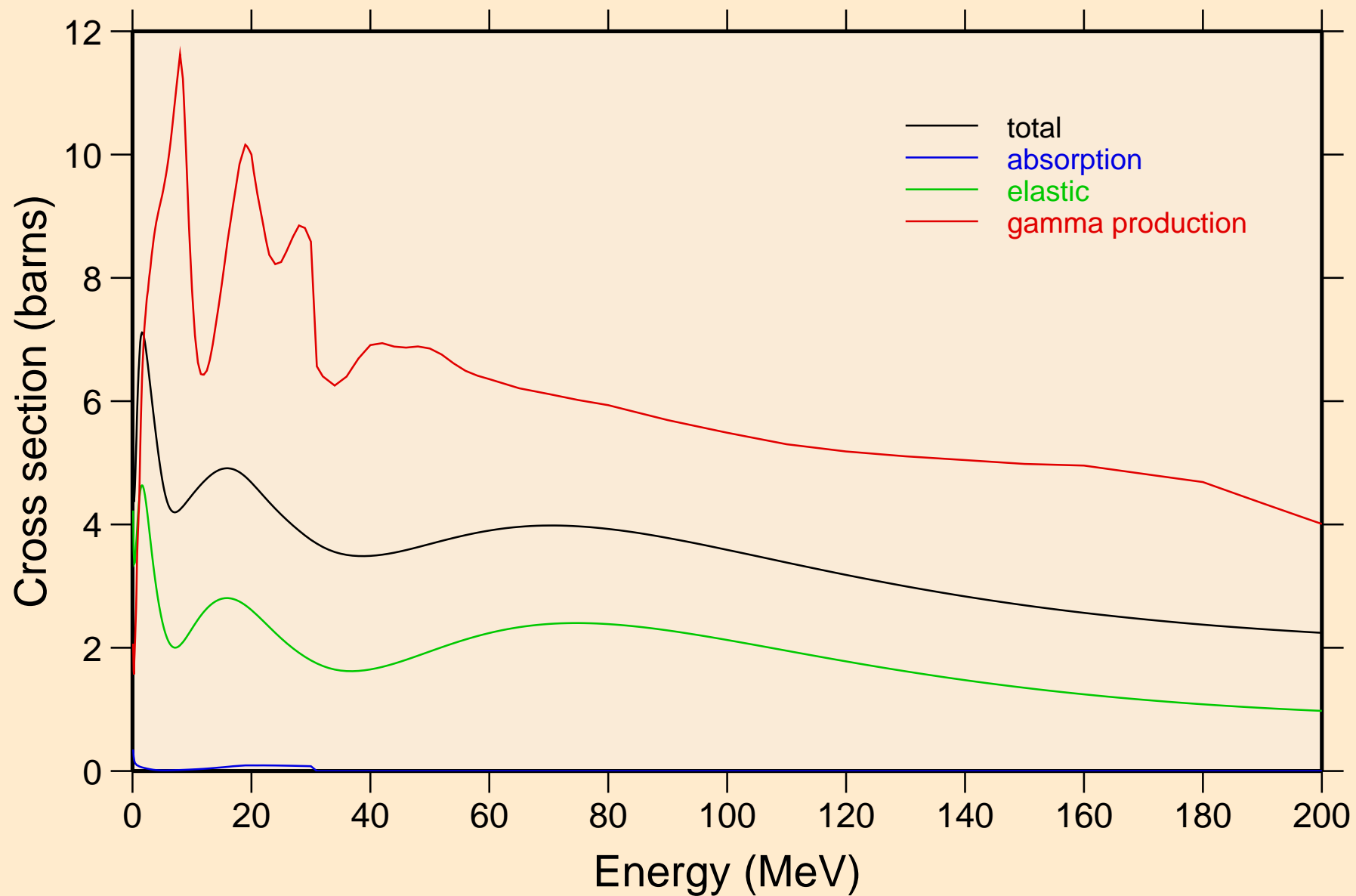

PR140 NEUTRON ACER TENDL-2019 LIBRARY; T=293.16K
Heating

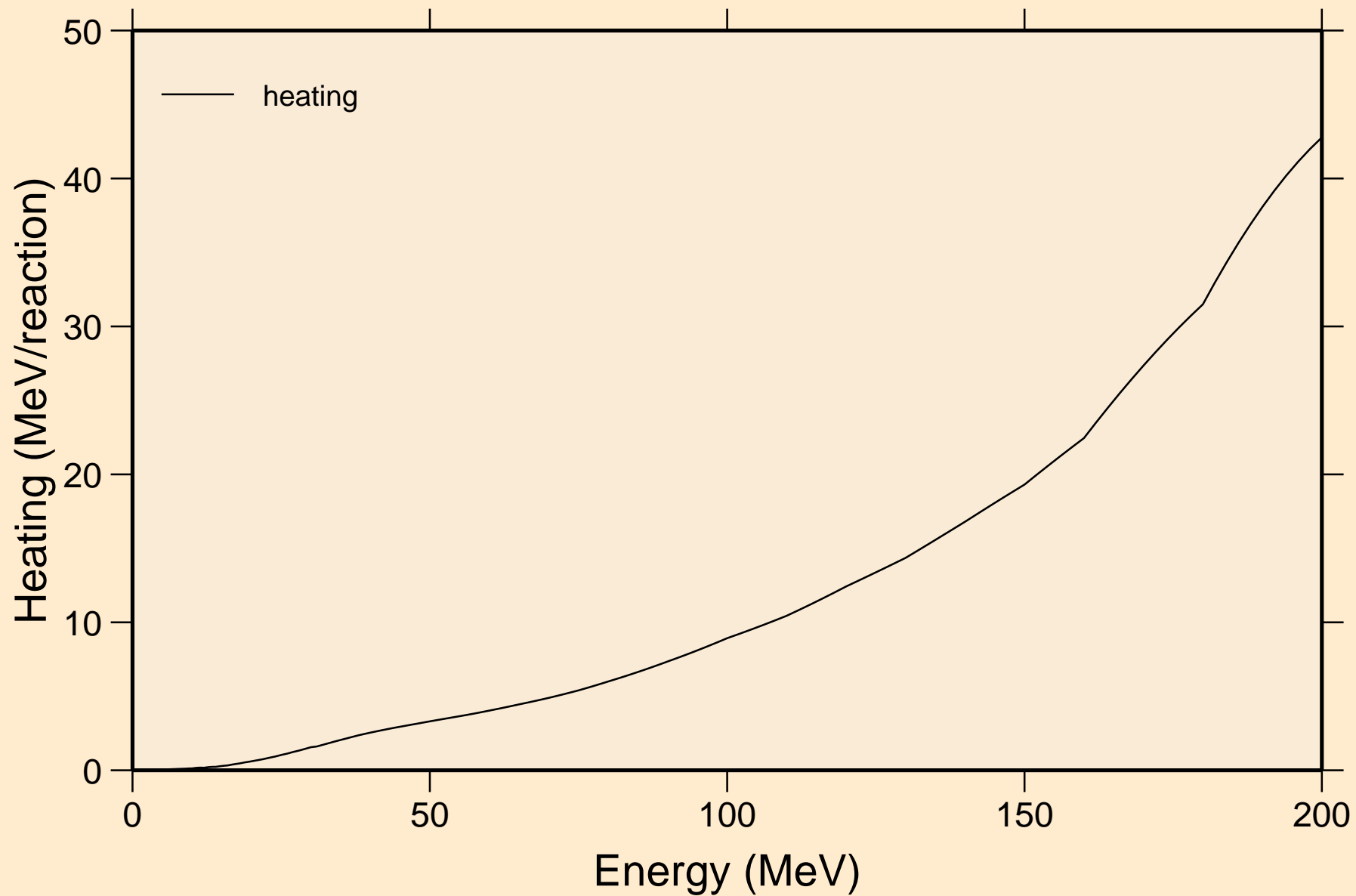

PR140 NEUTRON ACER TENDL-2019 LIBRARY; T=293.16K
Damage

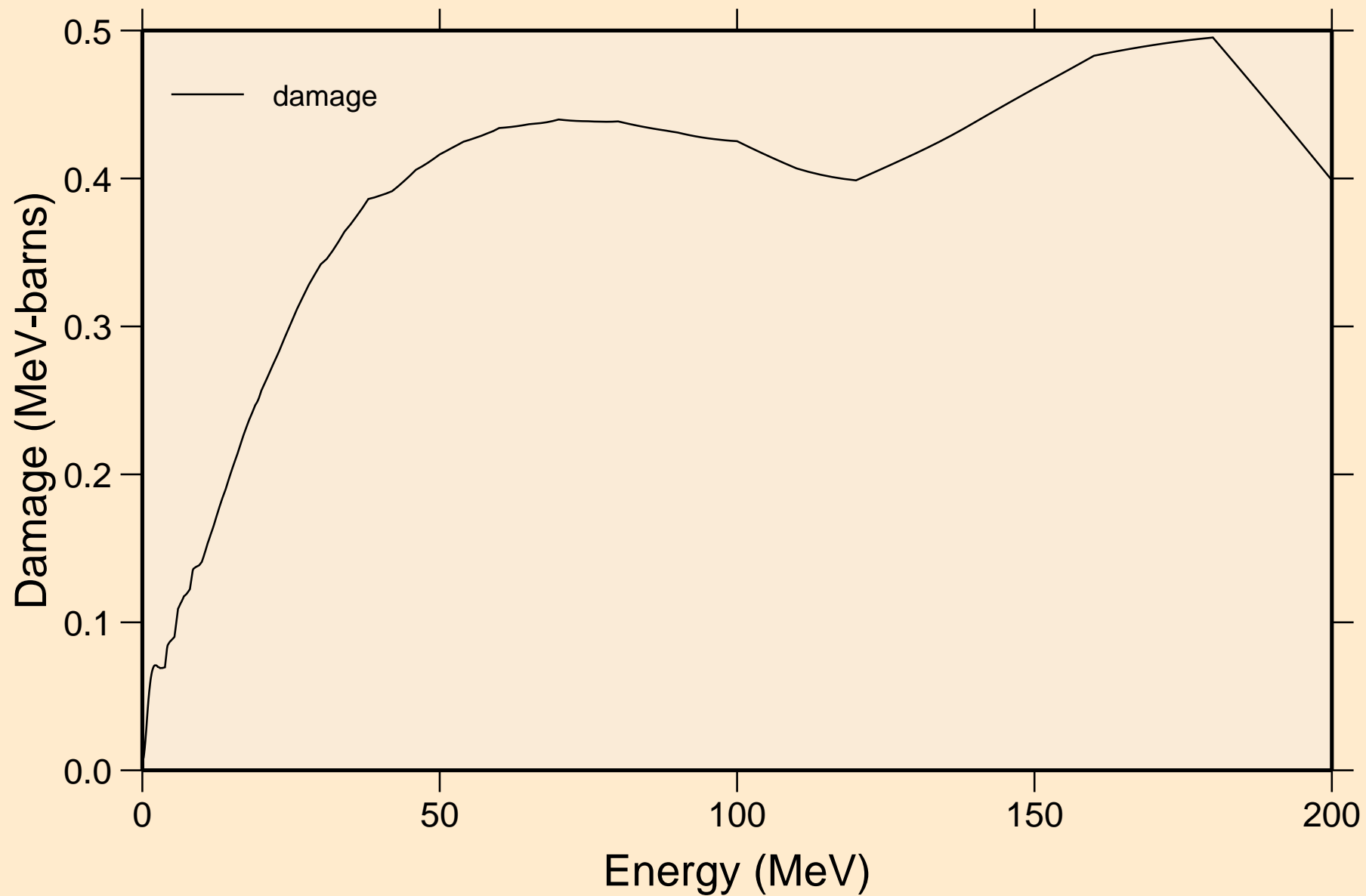

PR140 NEUTRON ACER TENDL-2019 LIBRARY; T=293.16K
Non-threshold reactions

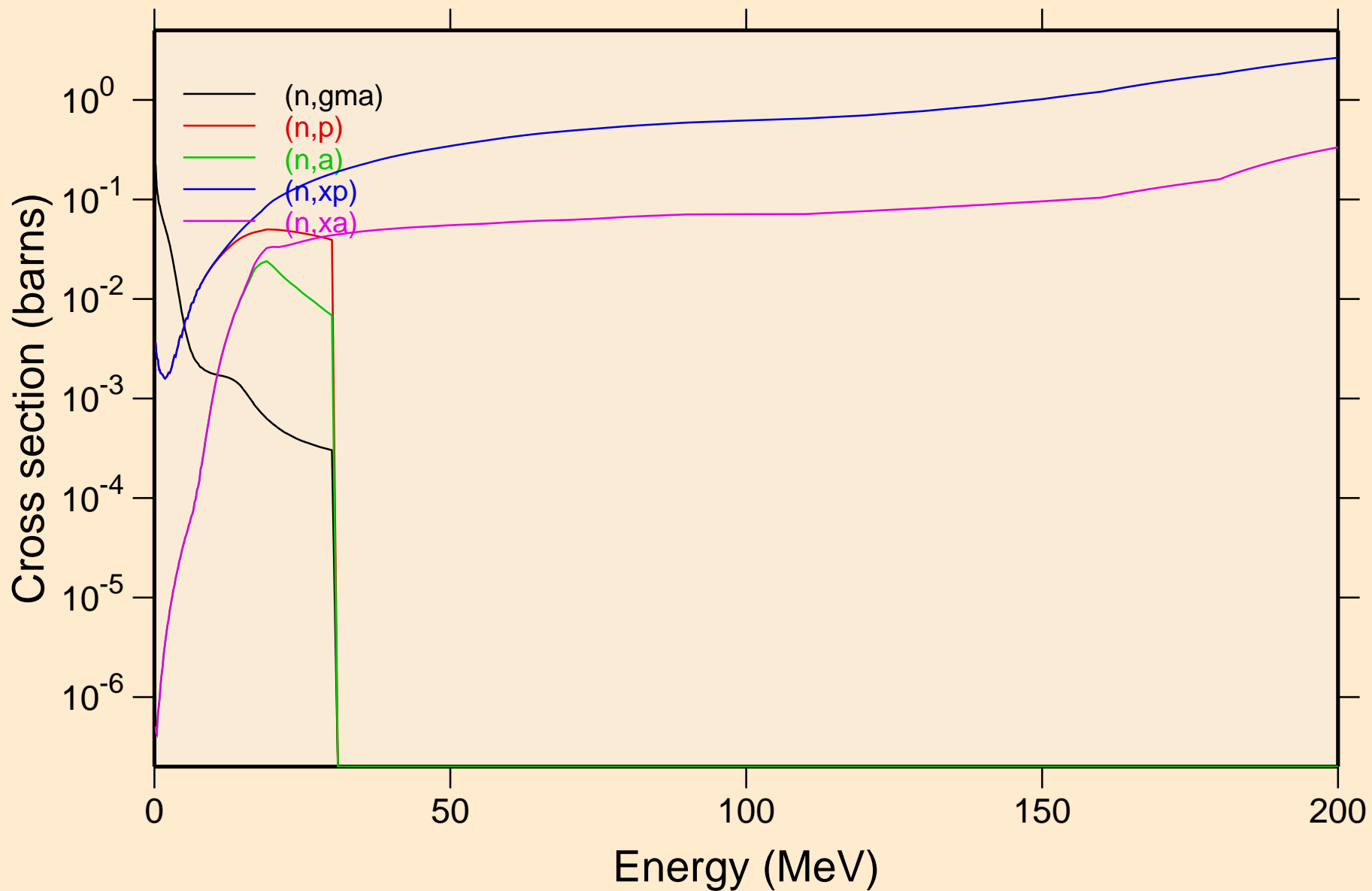

PR140 NEUTRON ACER TENDL-2019 LIBRARY; T=293.16K
Inelastic levels

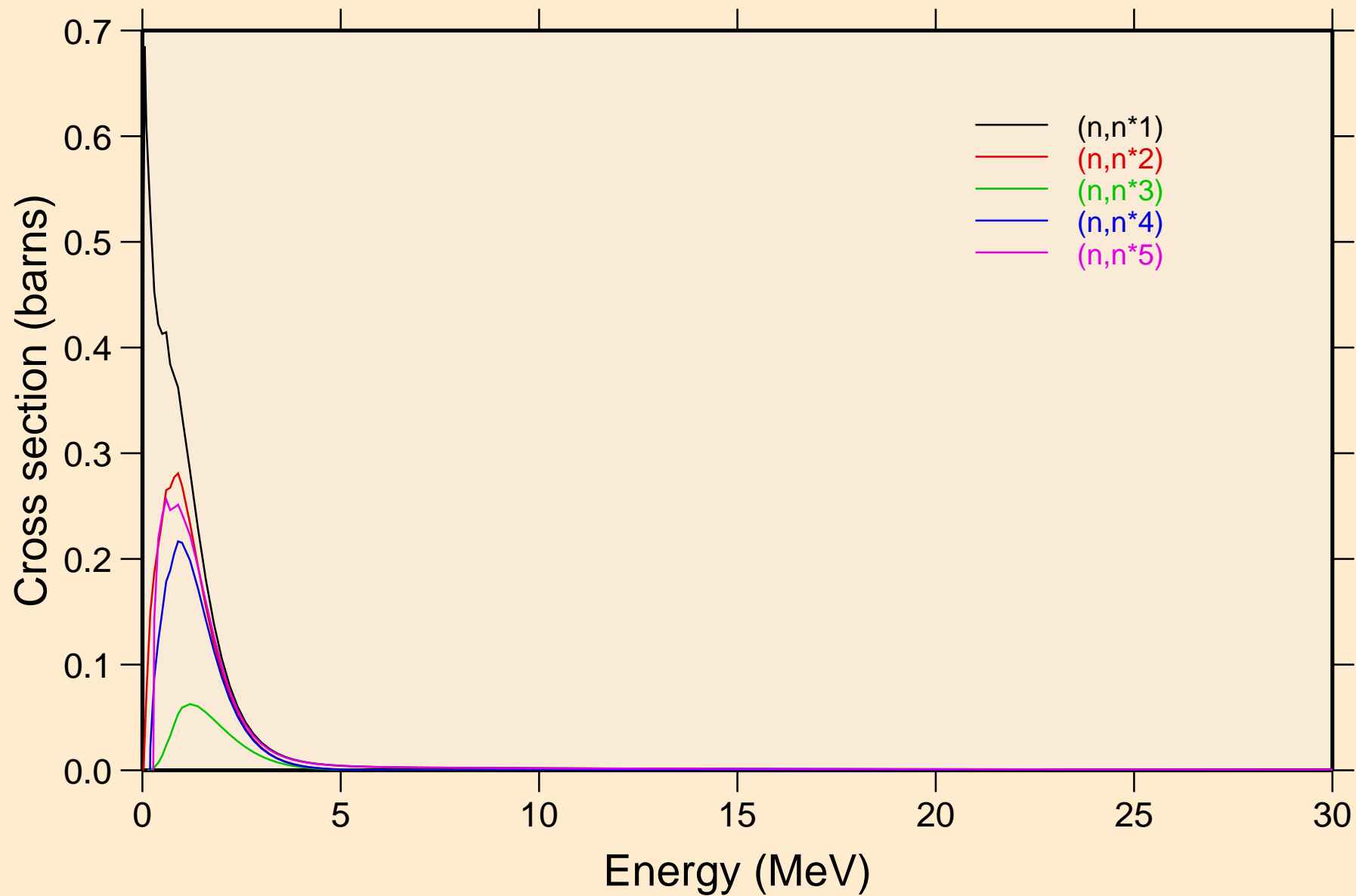

PR140 NEUTRON ACER TENDL-2019 LIBRARY; T=293.16K
Inelastic levels

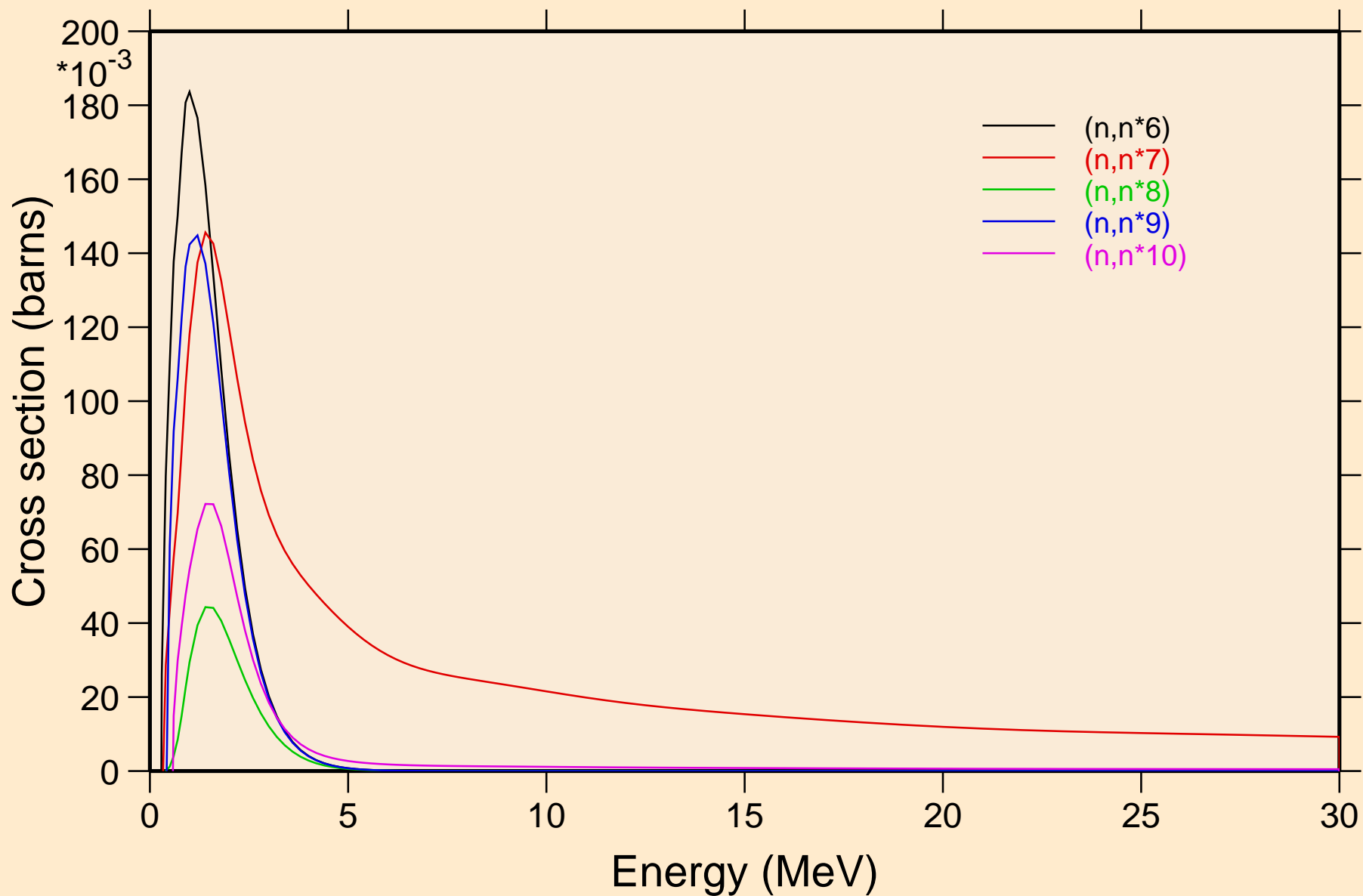

PR140 NEUTRON ACER TENDL-2019 LIBRARY; T=293.16K
Inelastic levels

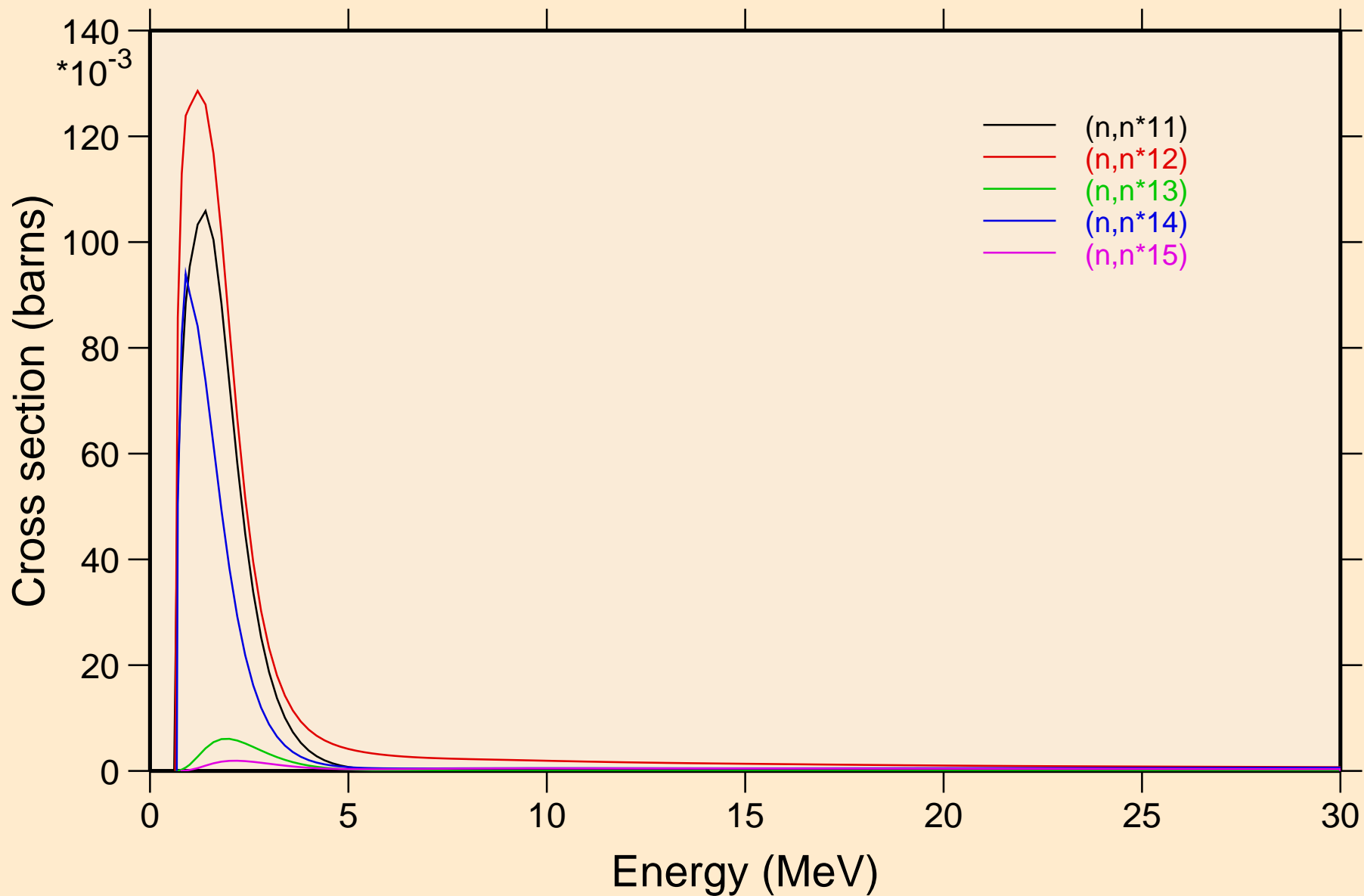

PR140 NEUTRON ACER TENDL-2019 LIBRARY; T=293.16K
Inelastic levels

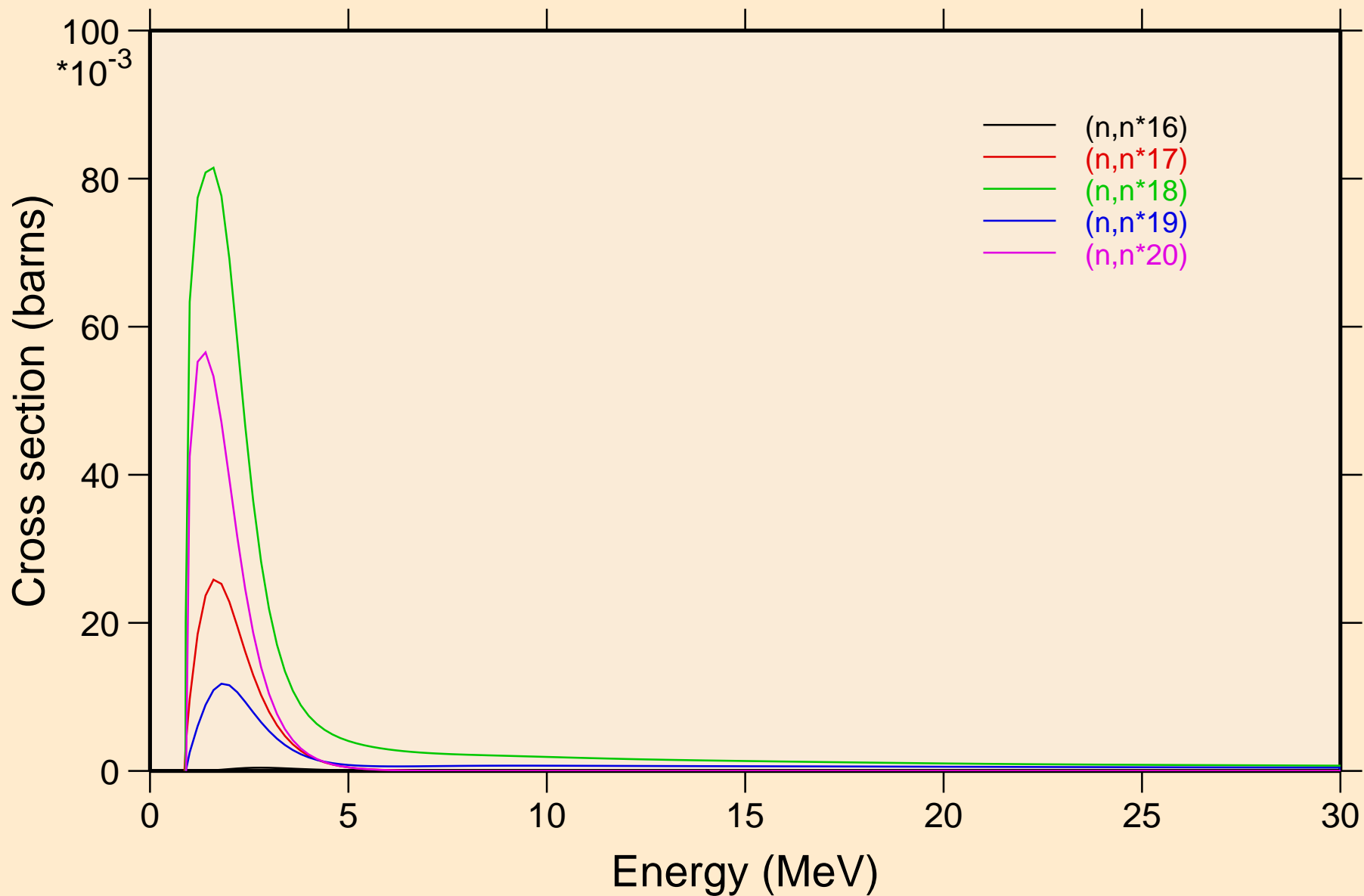

PR140 NEUTRON ACER TENDL-2019 LIBRARY; T=293.16K
Inelastic levels

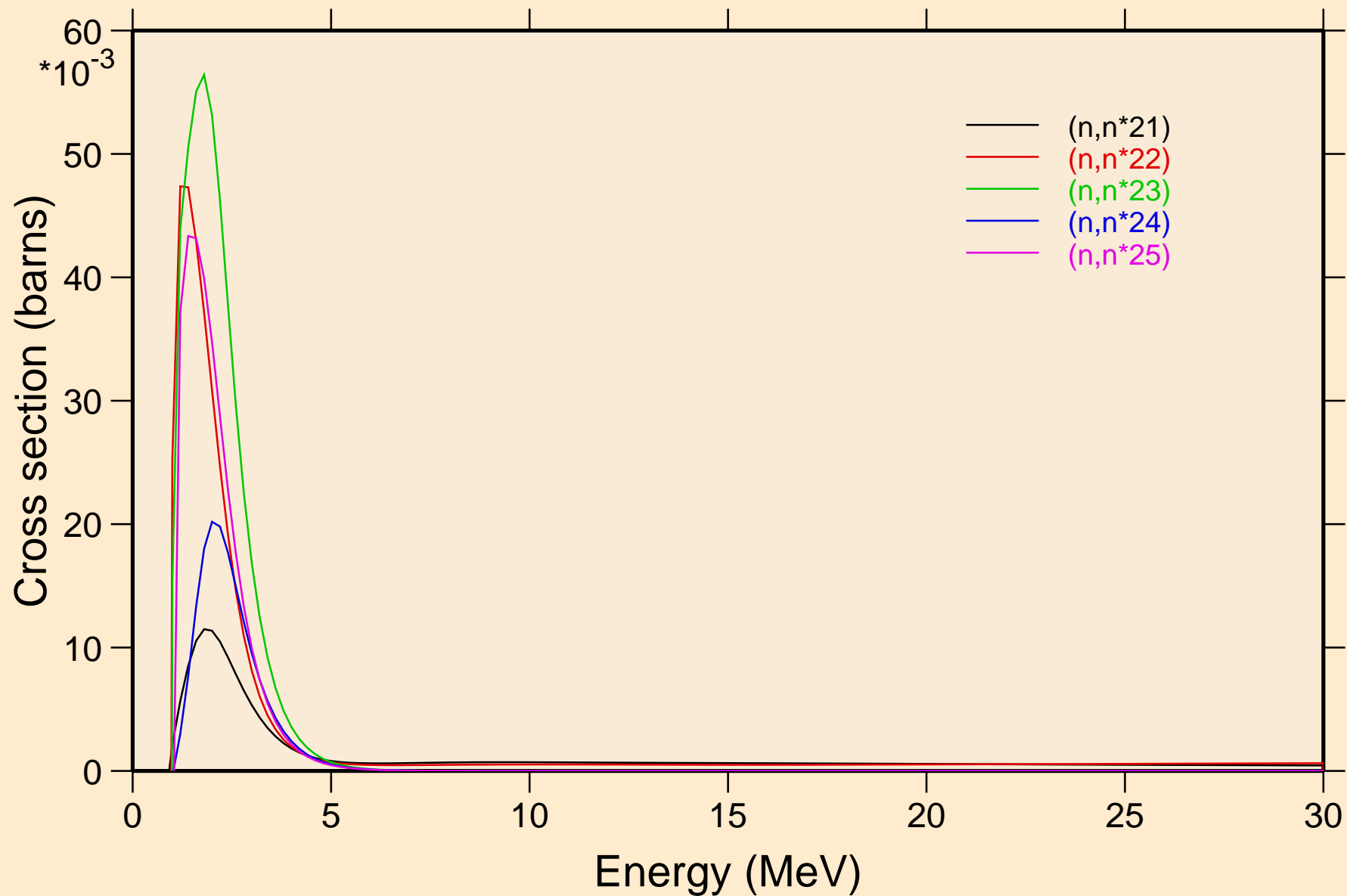

PR140 NEUTRON ACER TENDL-2019 LIBRARY; T=293.16K
Inelastic levels

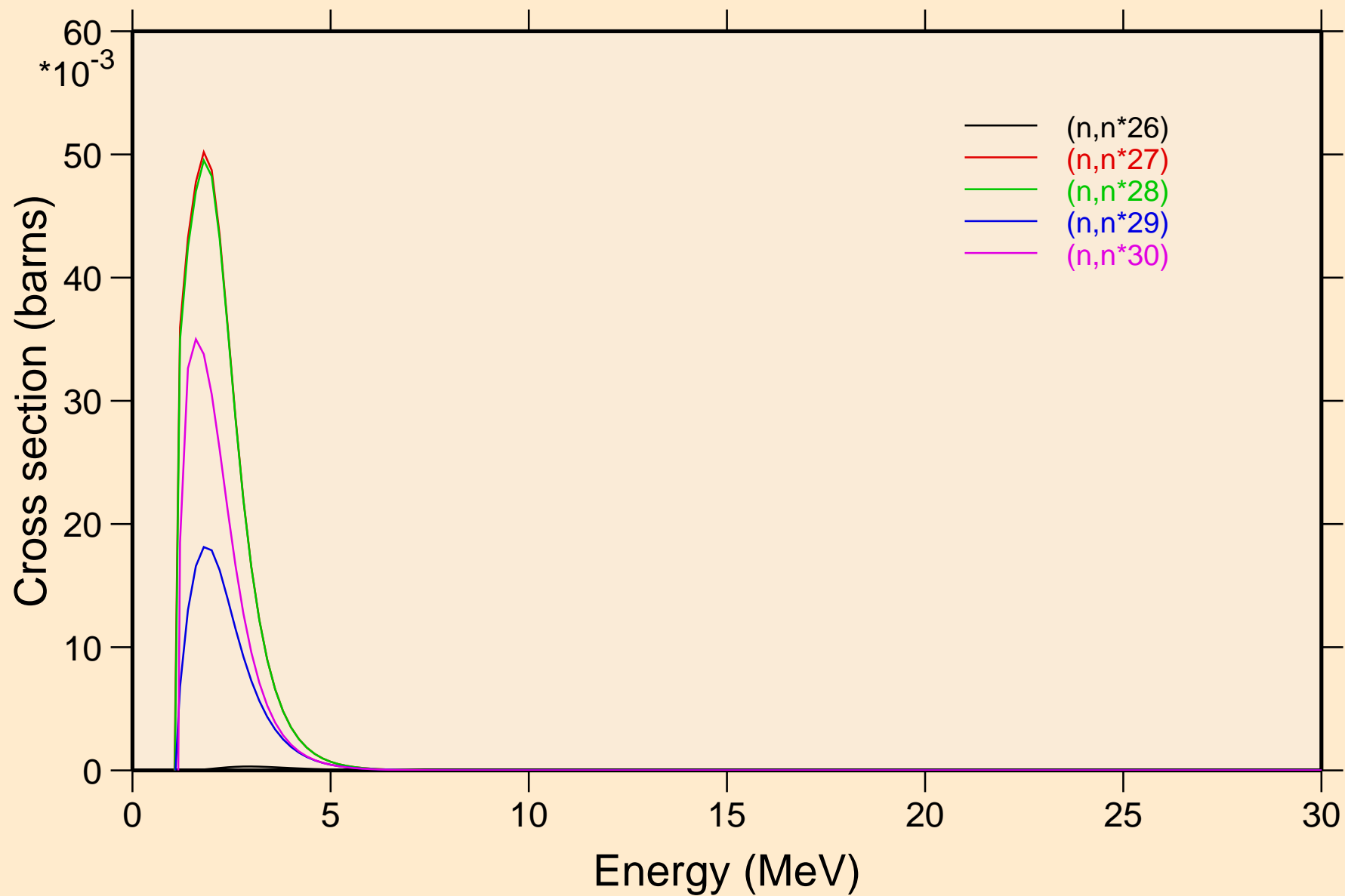

PR140 NEUTRON ACER TENDL-2019 LIBRARY; T=293.16K
Threshold reactions

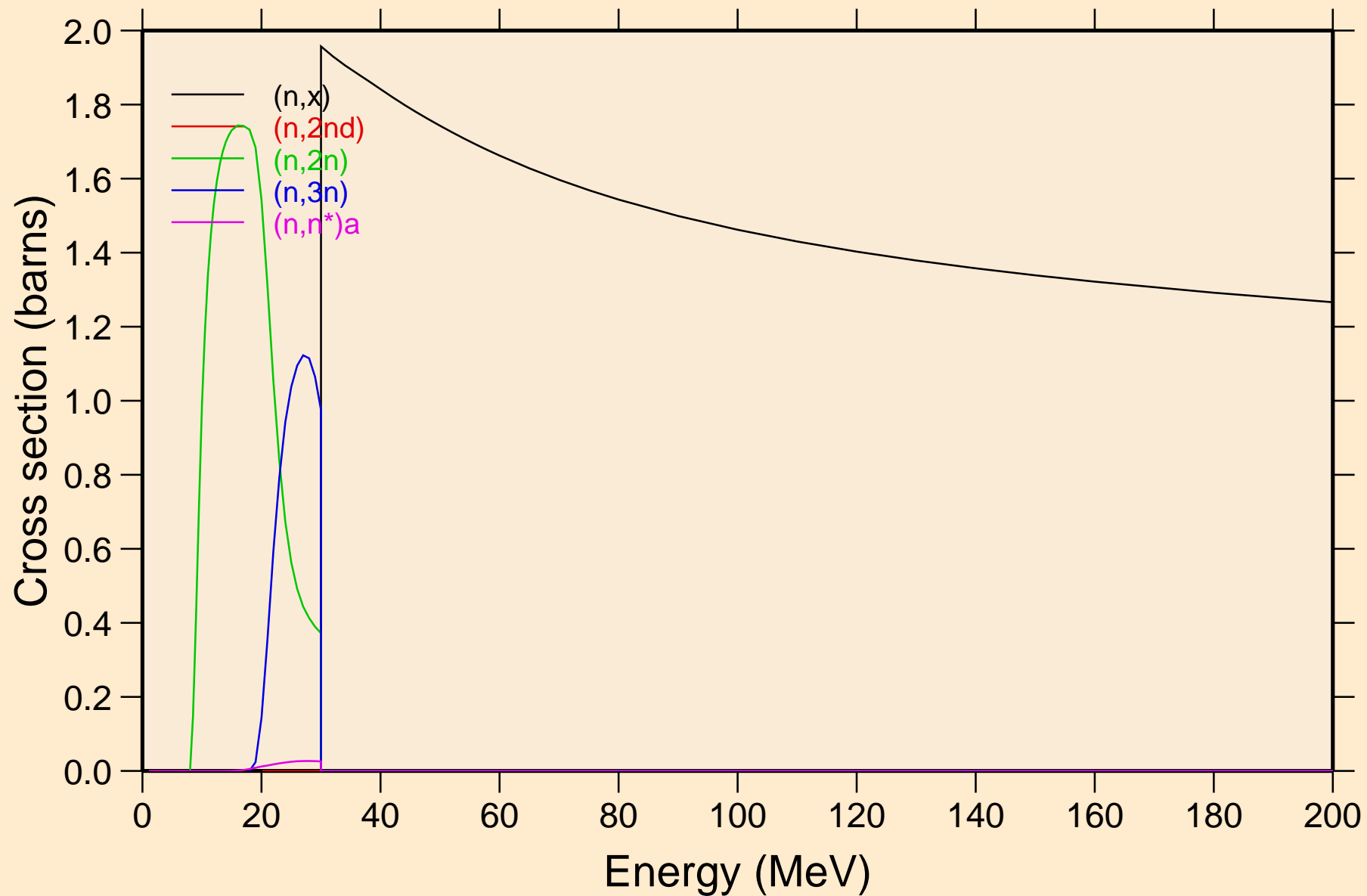

PR140 NEUTRON ACER TENDL-2019 LIBRARY; T=293.16K
Threshold reactions

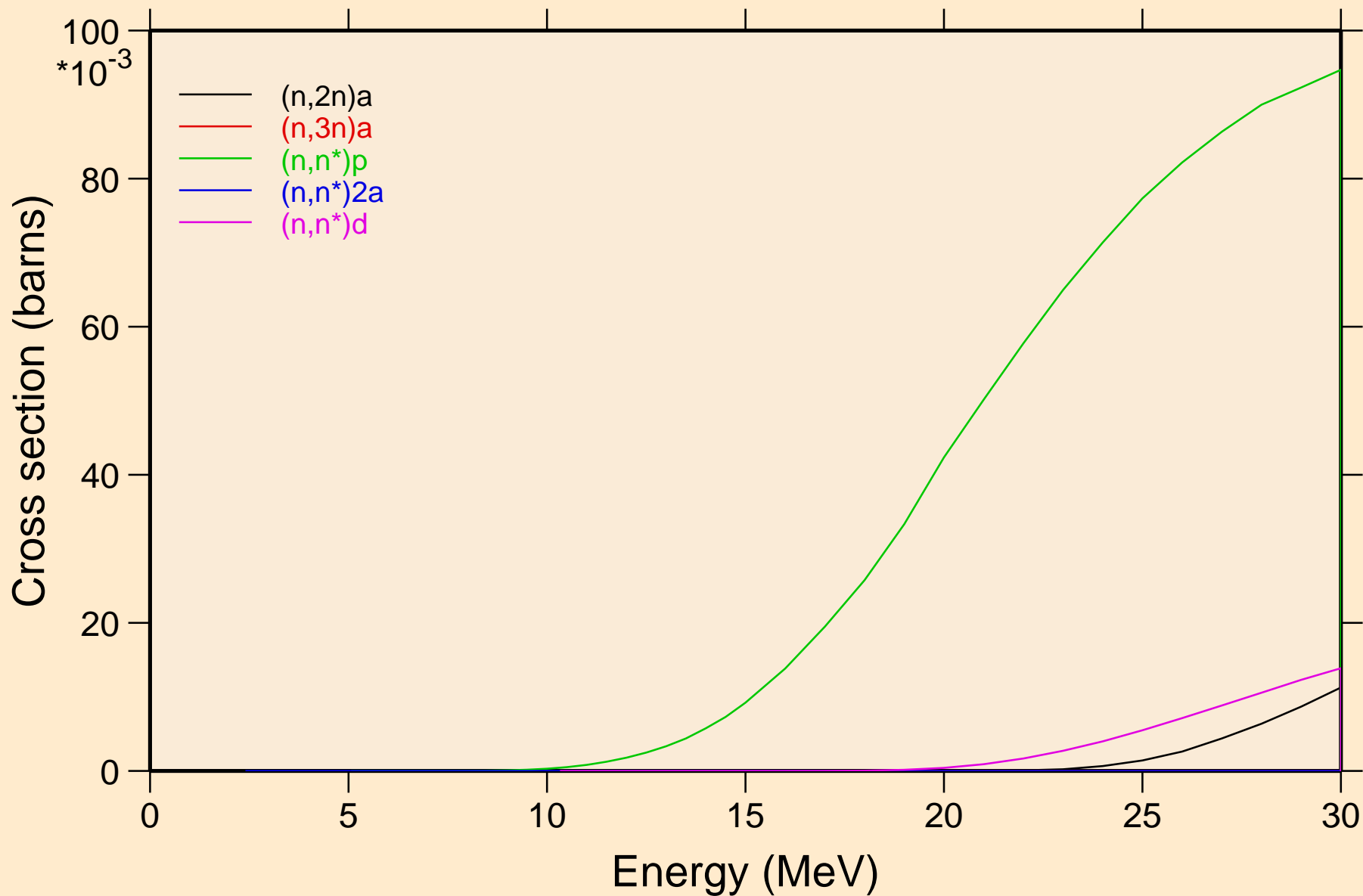

PR140 NEUTRON ACER TENDL-2019 LIBRARY; T=293.16K
Threshold reactions

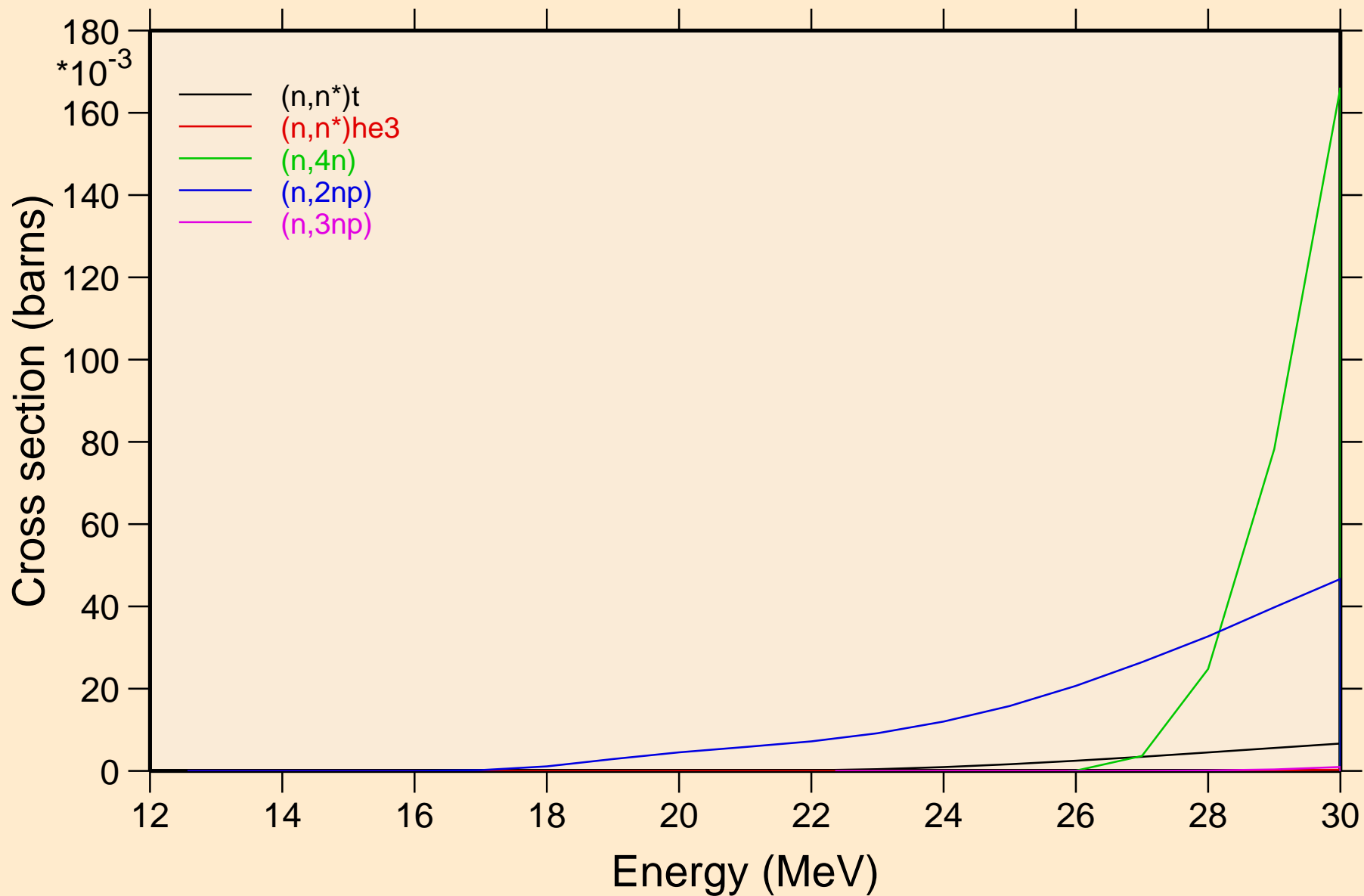

PR140 NEUTRON ACER TENDL-2019 LIBRARY; T=293.16K
Threshold reactions

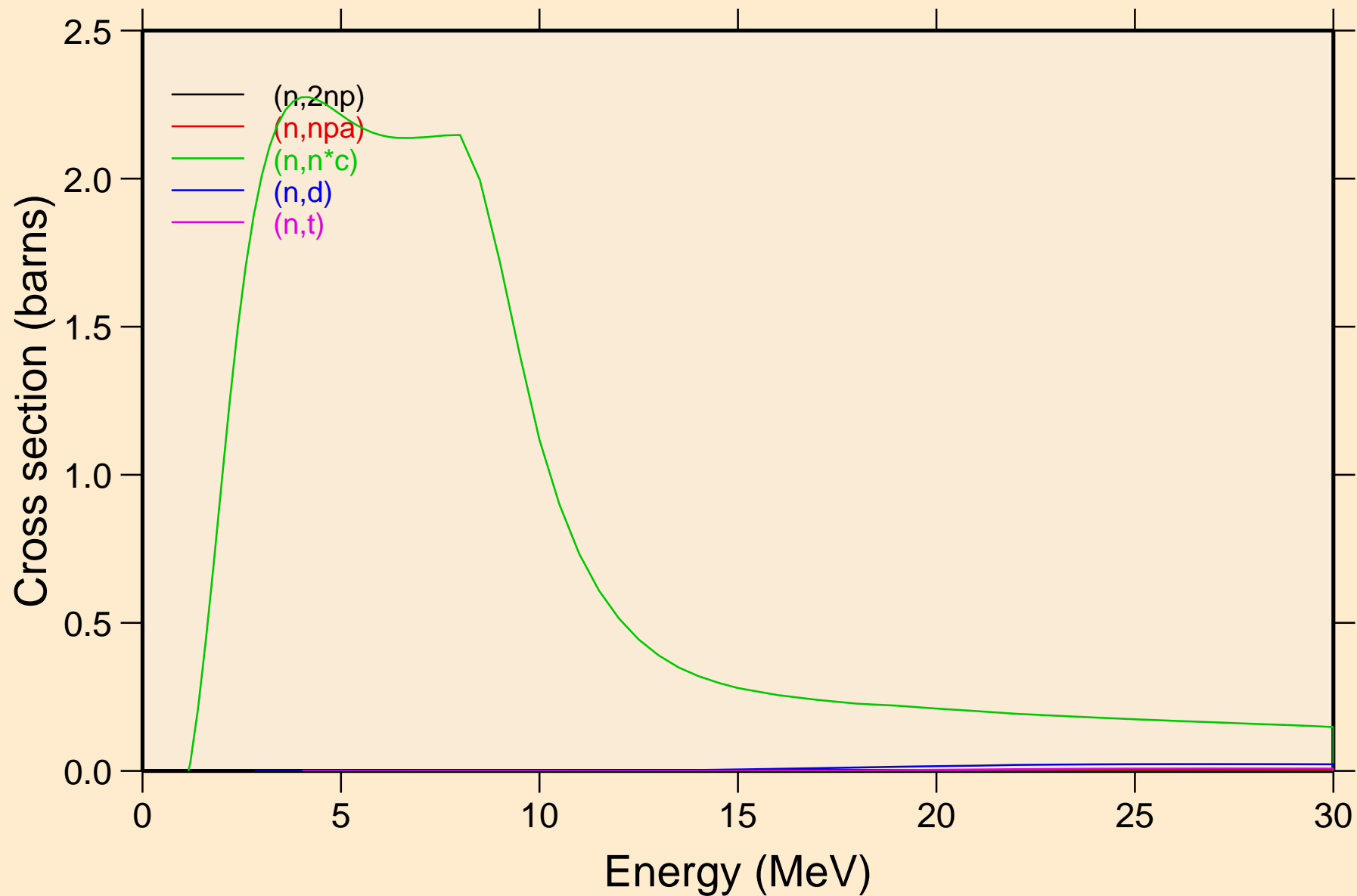

PR140 NEUTRON ACER TENDL-2019 LIBRARY; T=293.16K
Threshold reactions

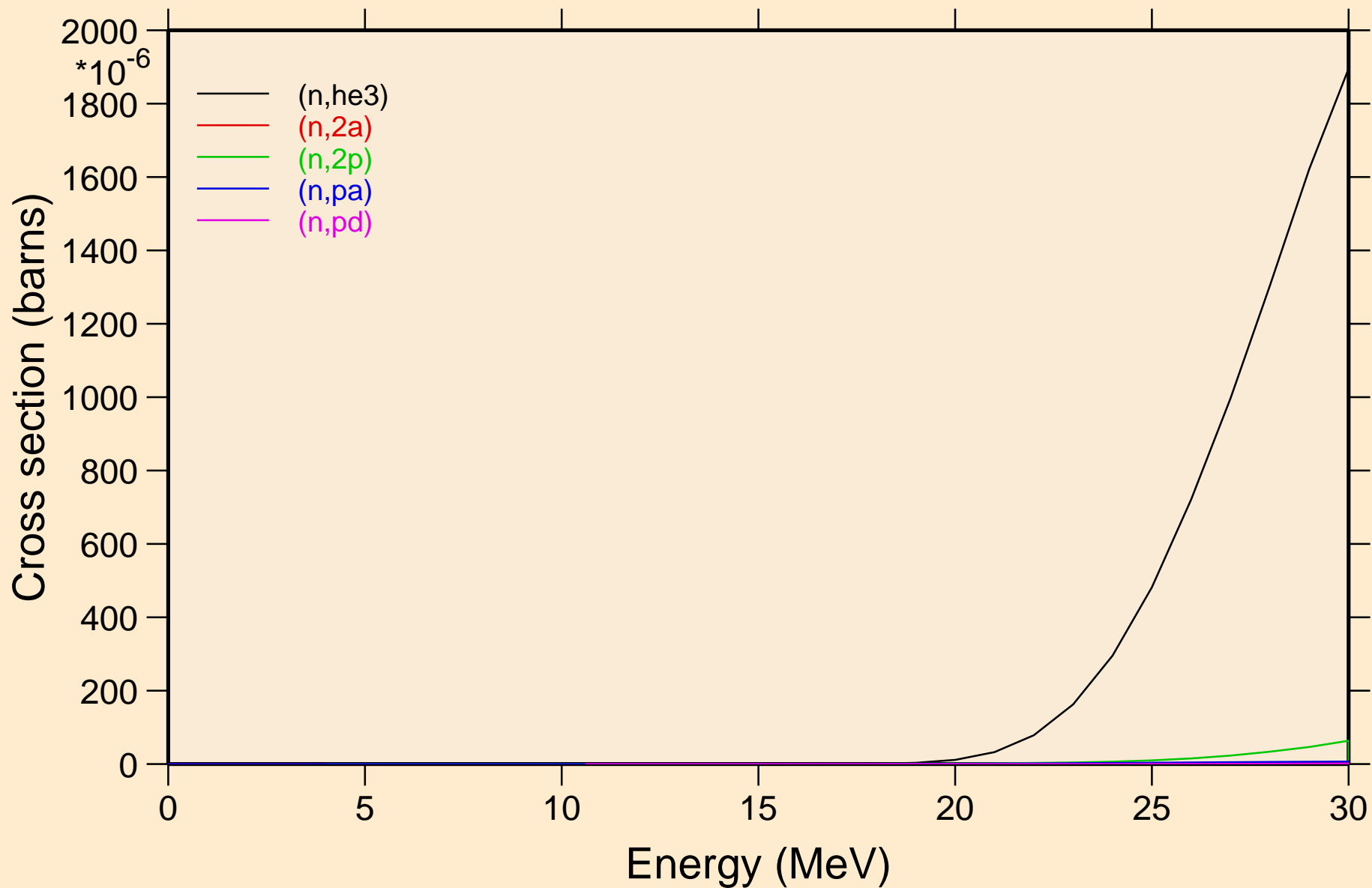

PR140 NEUTRON ACER TENDL-2019 LIBRARY; T=293.16K
Threshold reactions

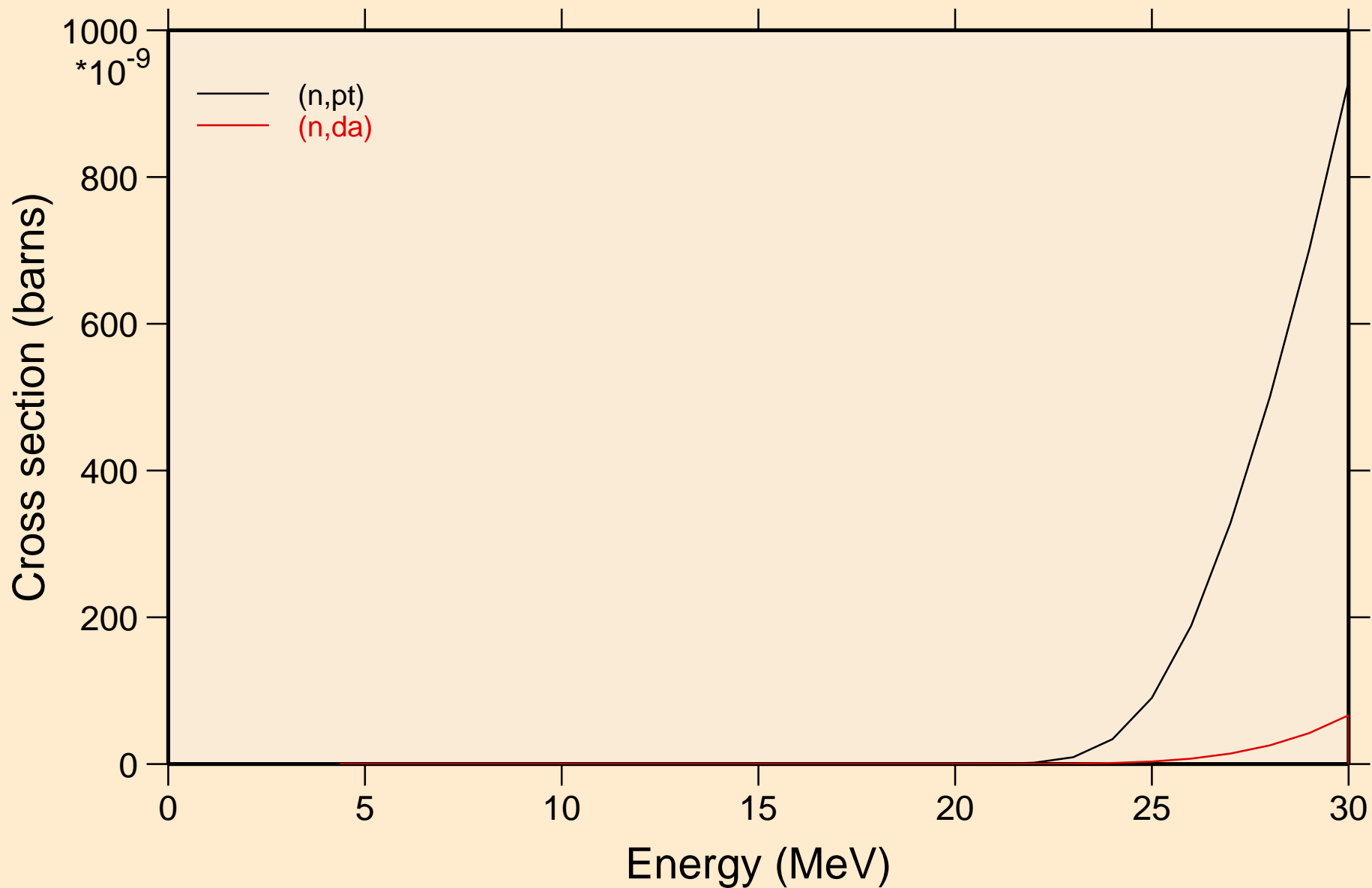

PR140 NEUTRON ACER TENDL-2019 LIBRARY; T=293.16K
Threshold reactions

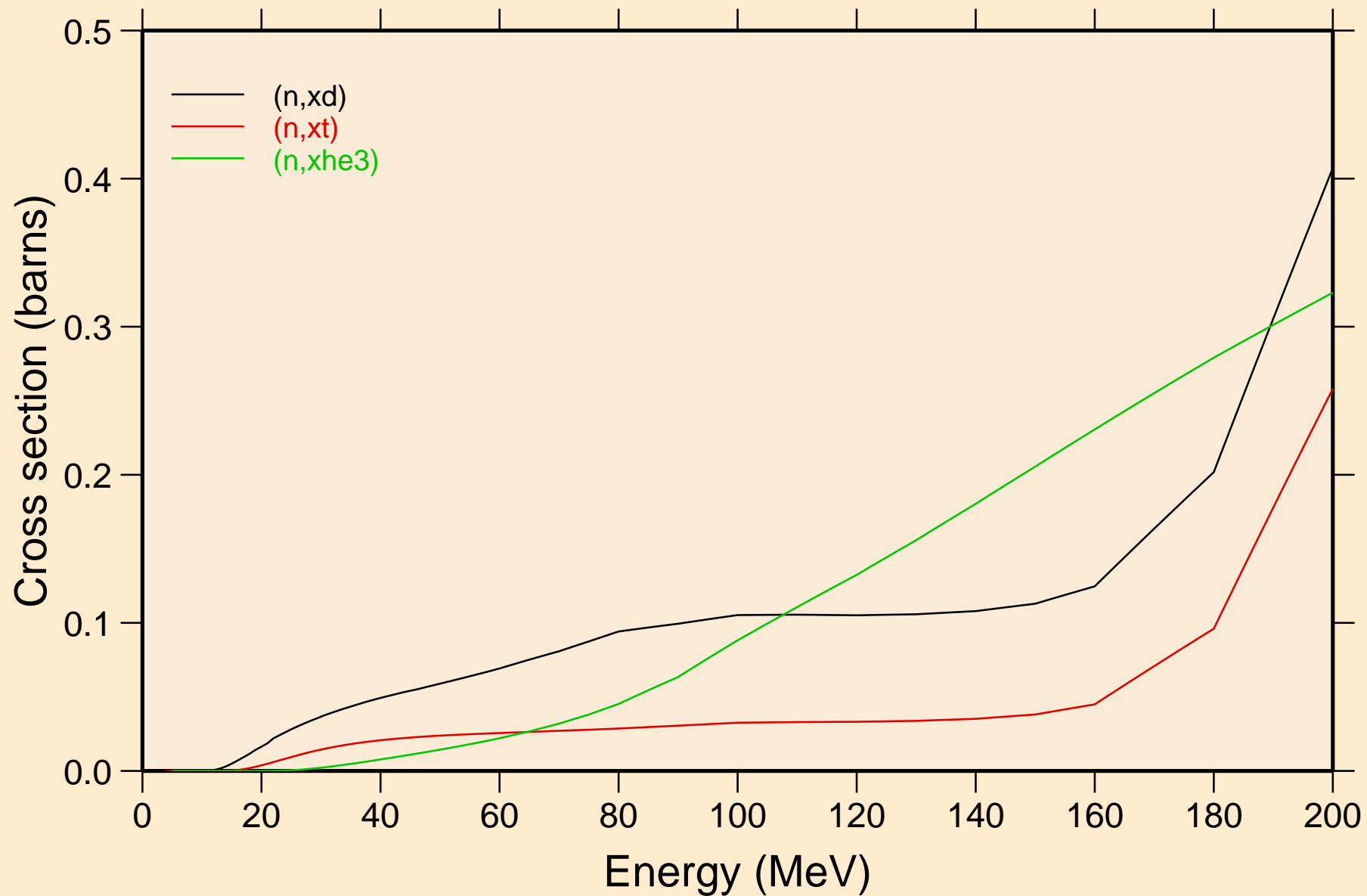

PR140 NEUTRON ACER TENDL-2019 LIBRARY; T=293.16K
angular distribution for elastic

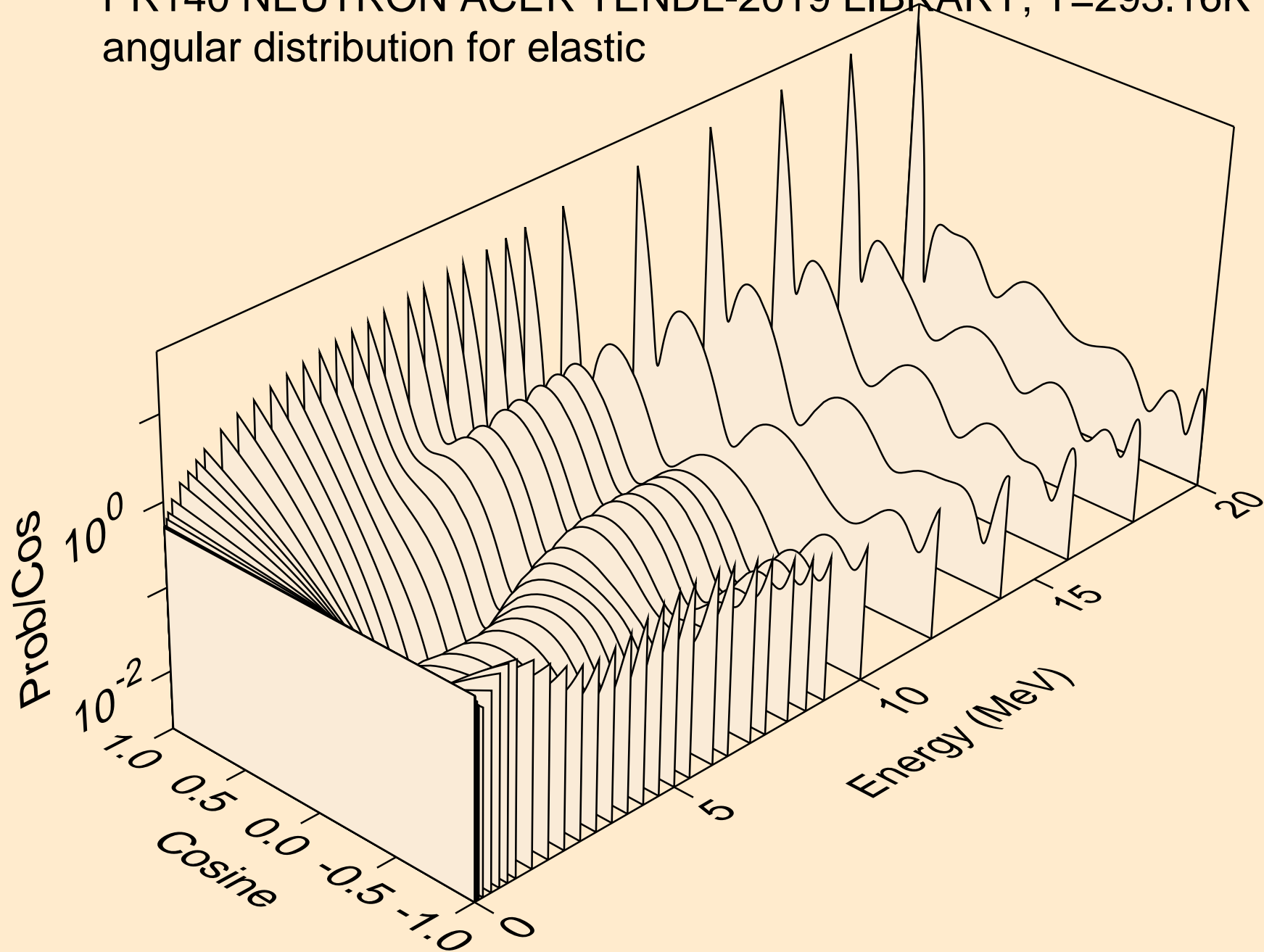

PR140 NEUTRON ACER TENDL-2019 LIBRARY; T=293.16K
angular distribution for elastic

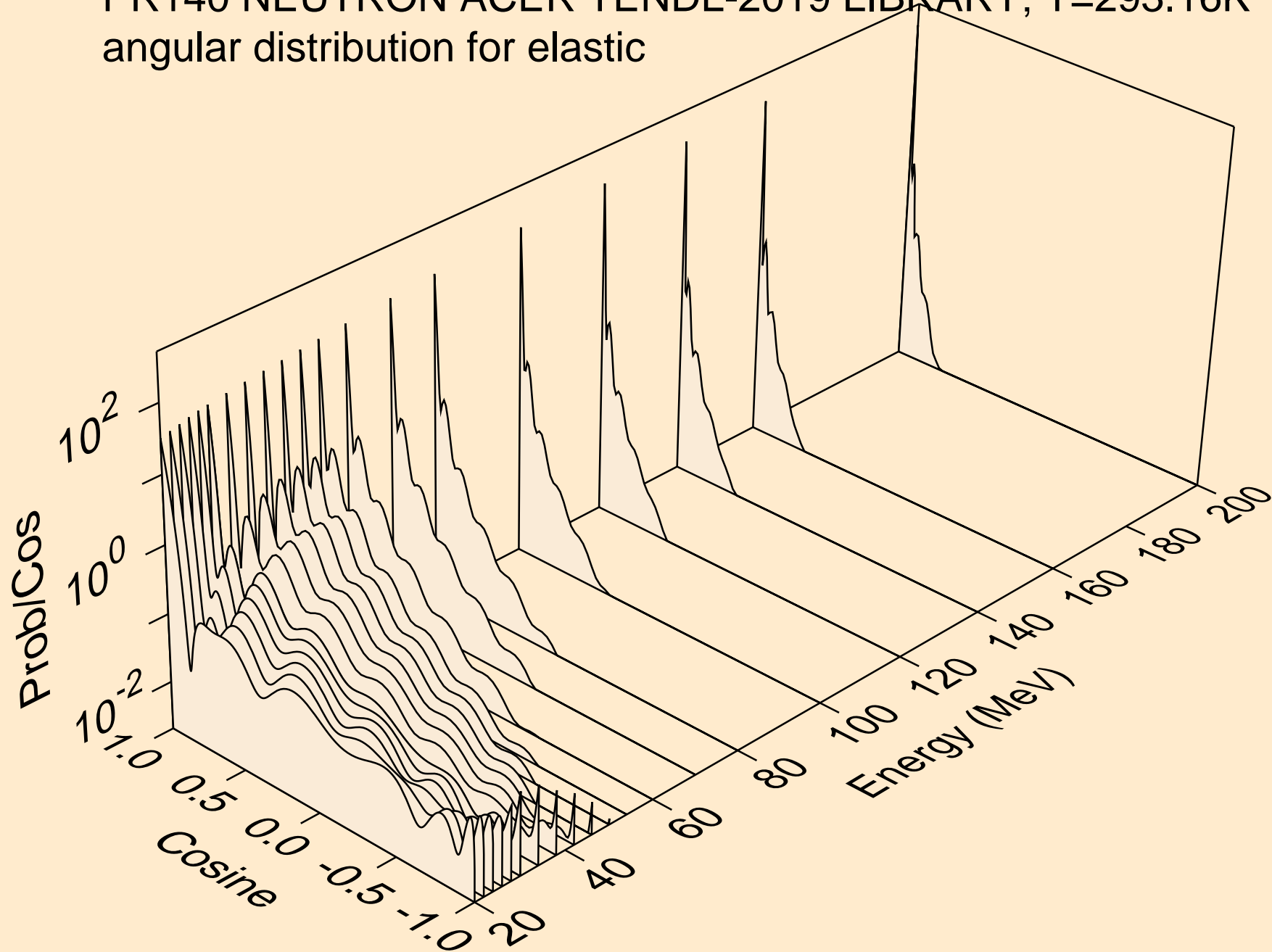

PR140 NEUTRON ACER TENDL-2019 LIBRARY; T=293.16K
angular distribution for (n,n*1)

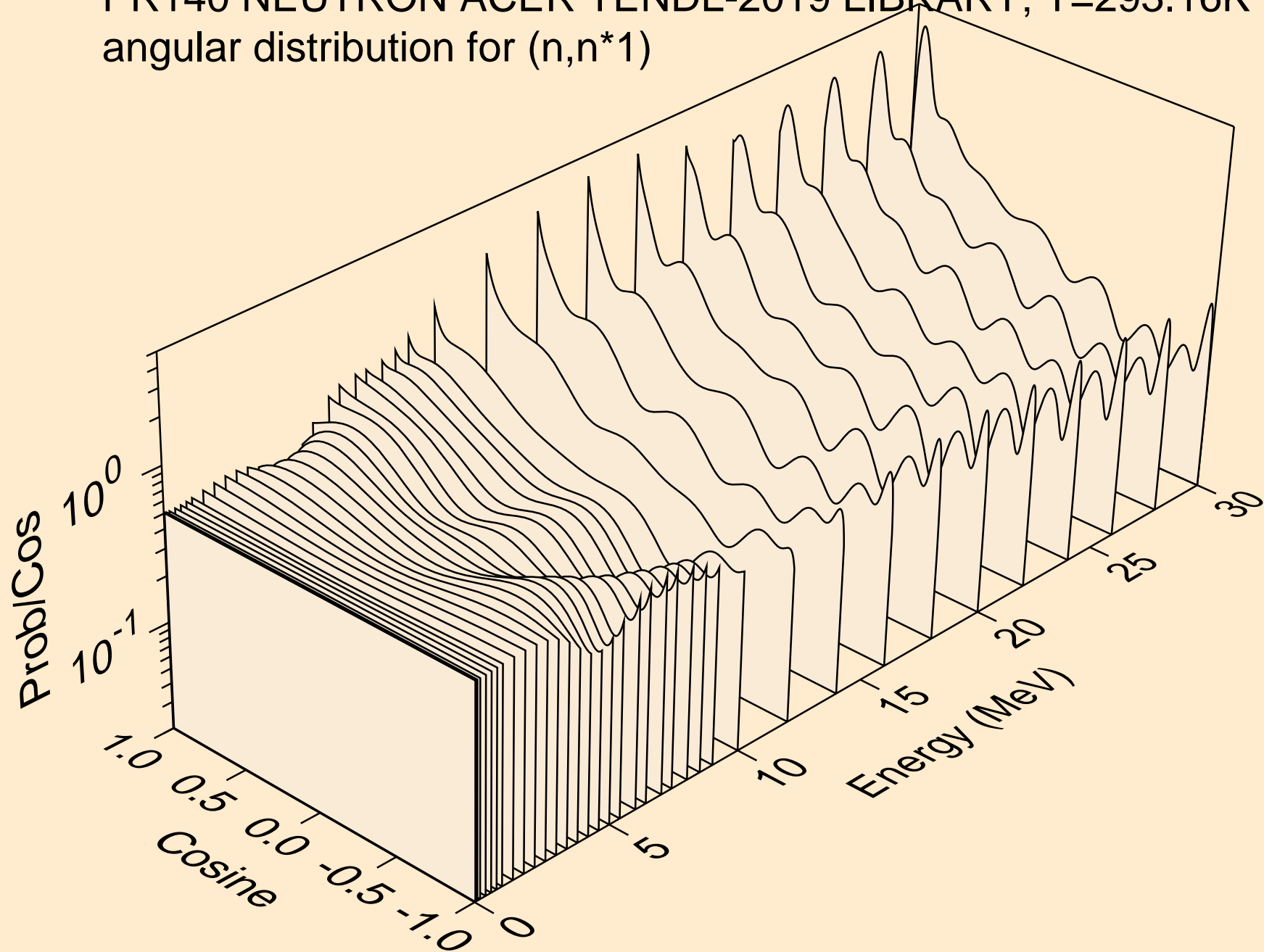

PR140 NEUTRON ACER TENDL-2019 LIBRARY; T=293.16K
angular distribution for (n,n*2)

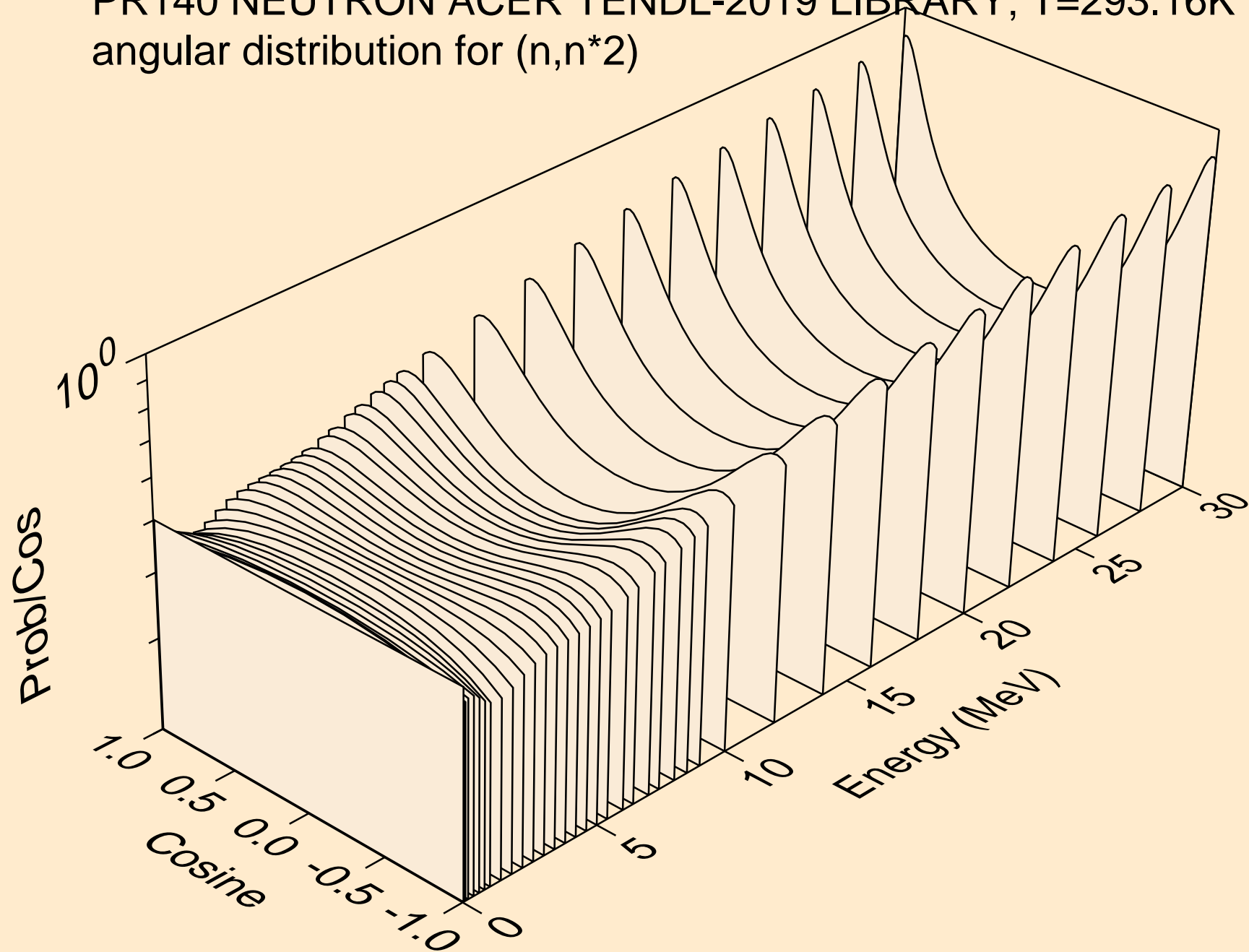

PR140 NEUTRON ACER TENDL-2019 LIBRARY; T=293.16K
angular distribution for (n,n*3)

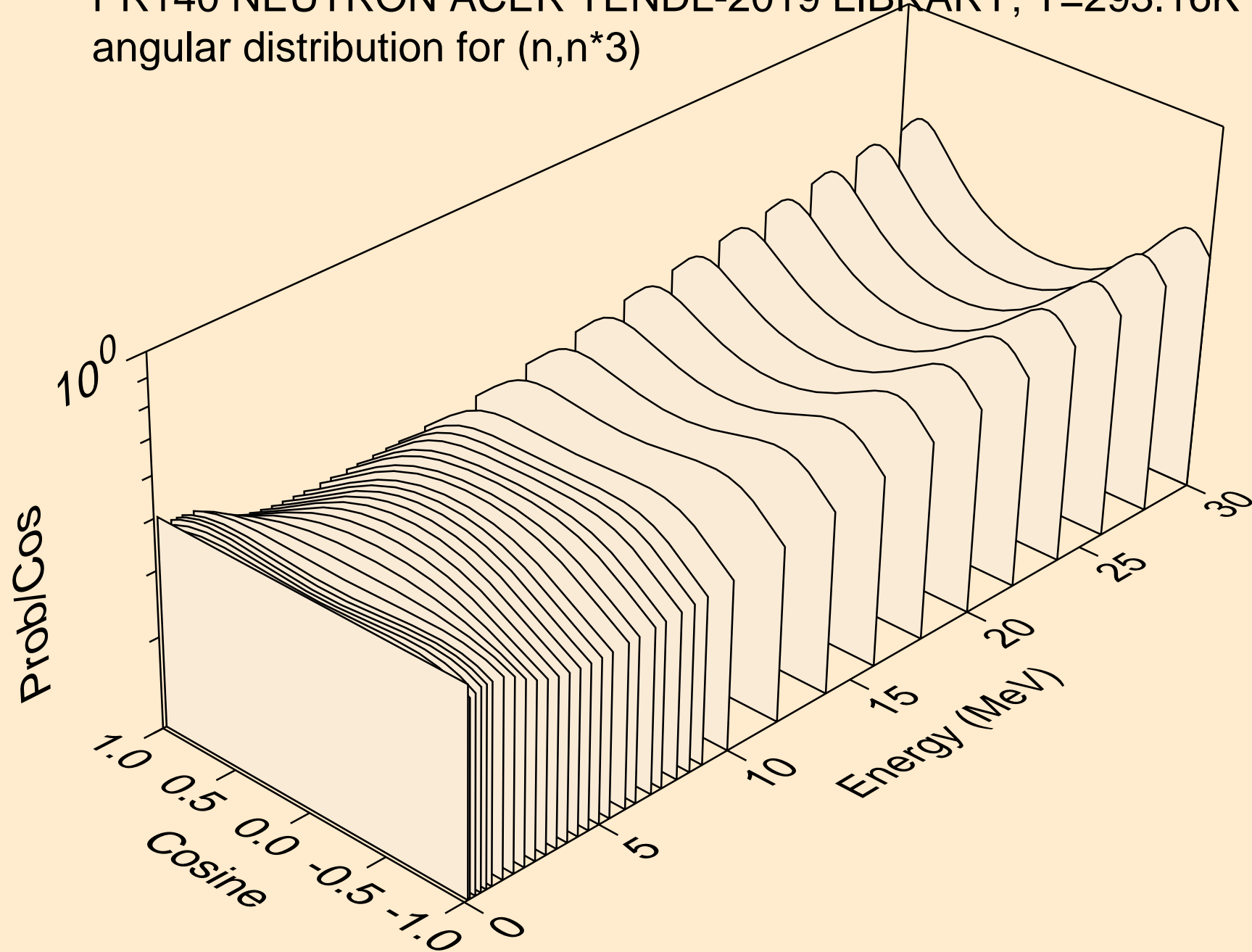

PR140 NEUTRON ACER TENDL-2019 LIBRARY; T=293.16K
angular distribution for (n,n*4)

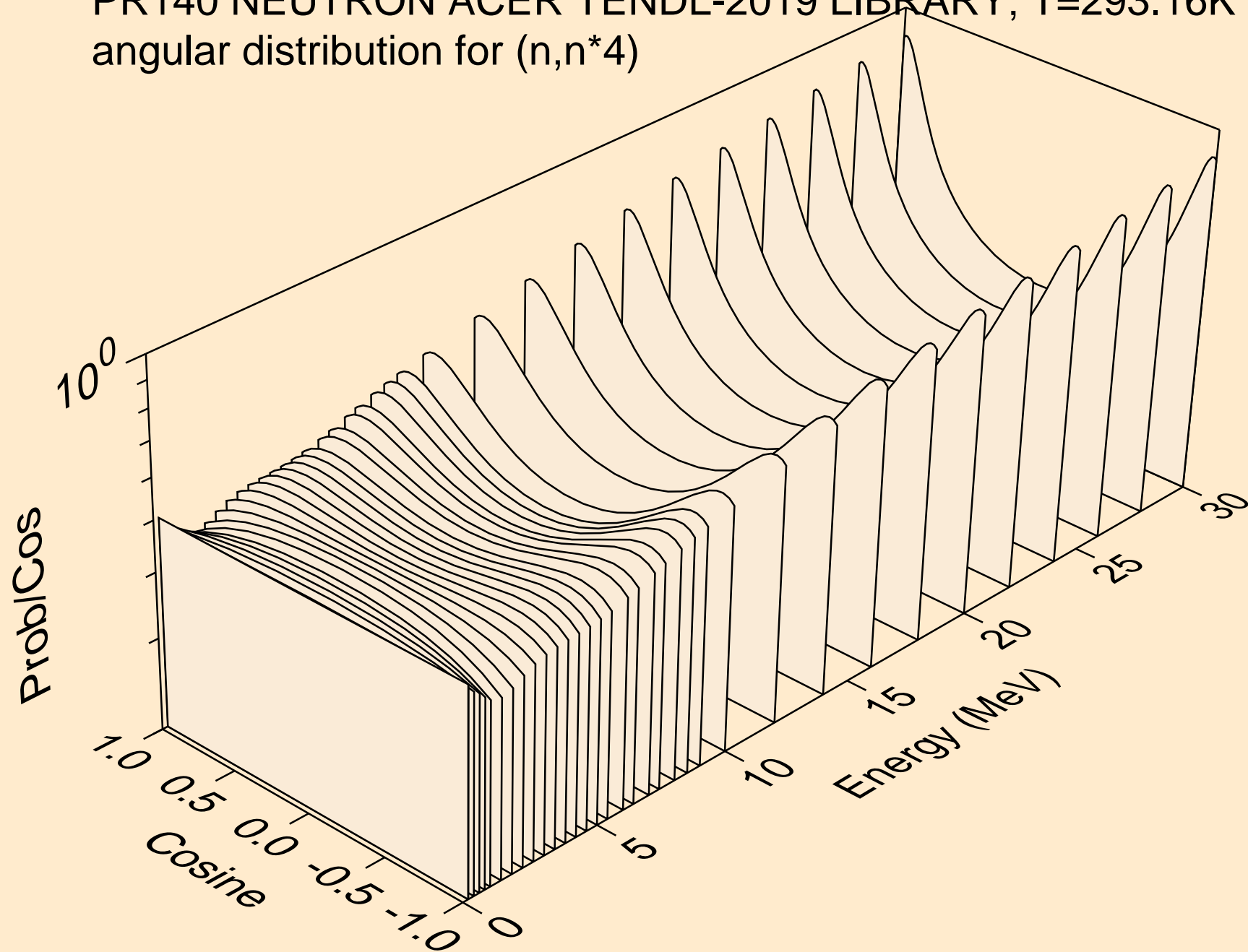

PR140 NEUTRON ACER TENDL-2019 LIBRARY; T=293.16K
angular distribution for (n,n*5)

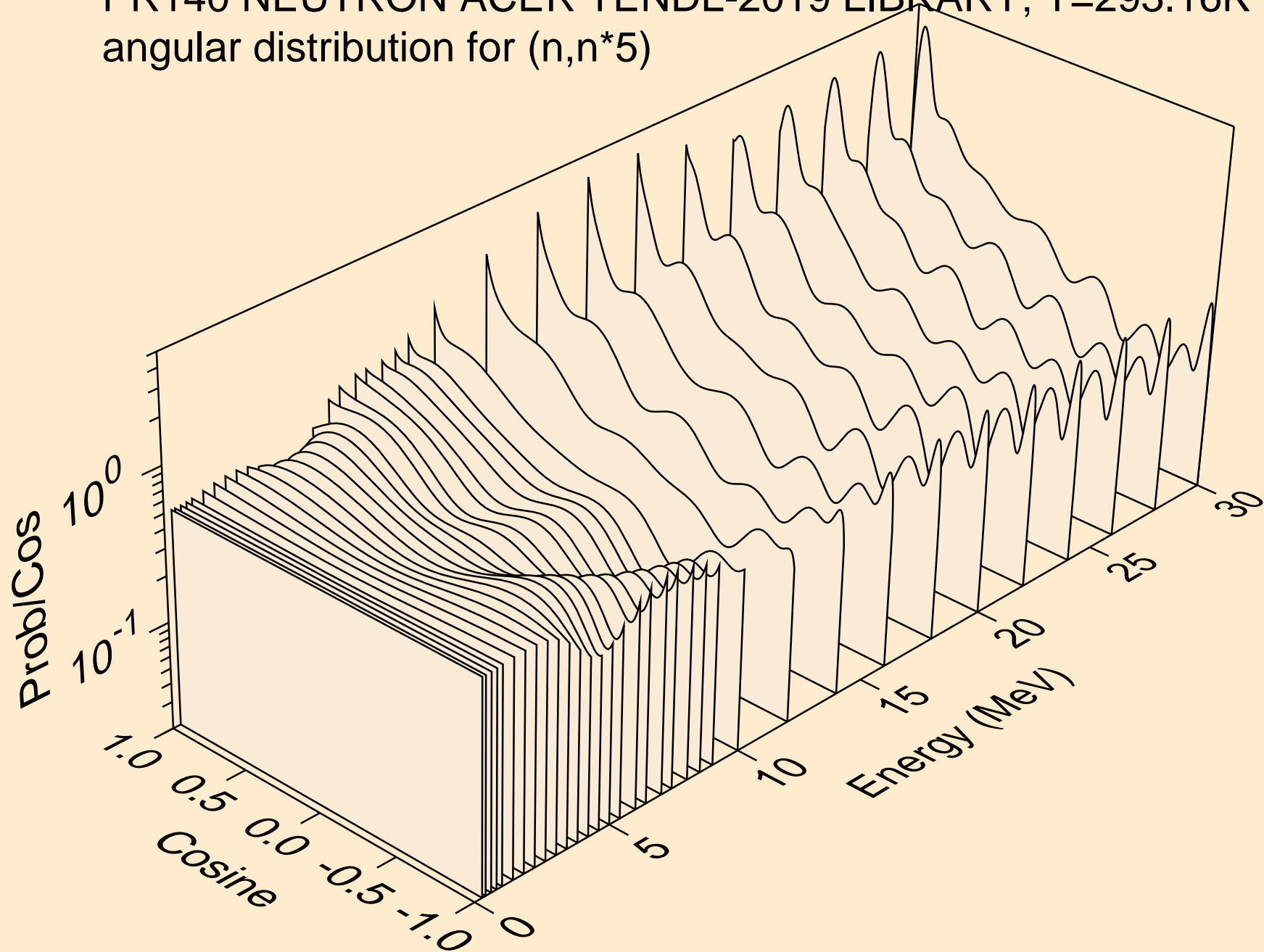

PR140 NEUTRON ACER TENDL-2019 LIBRARY; T=293.16K
angular distribution for (n,n*6)

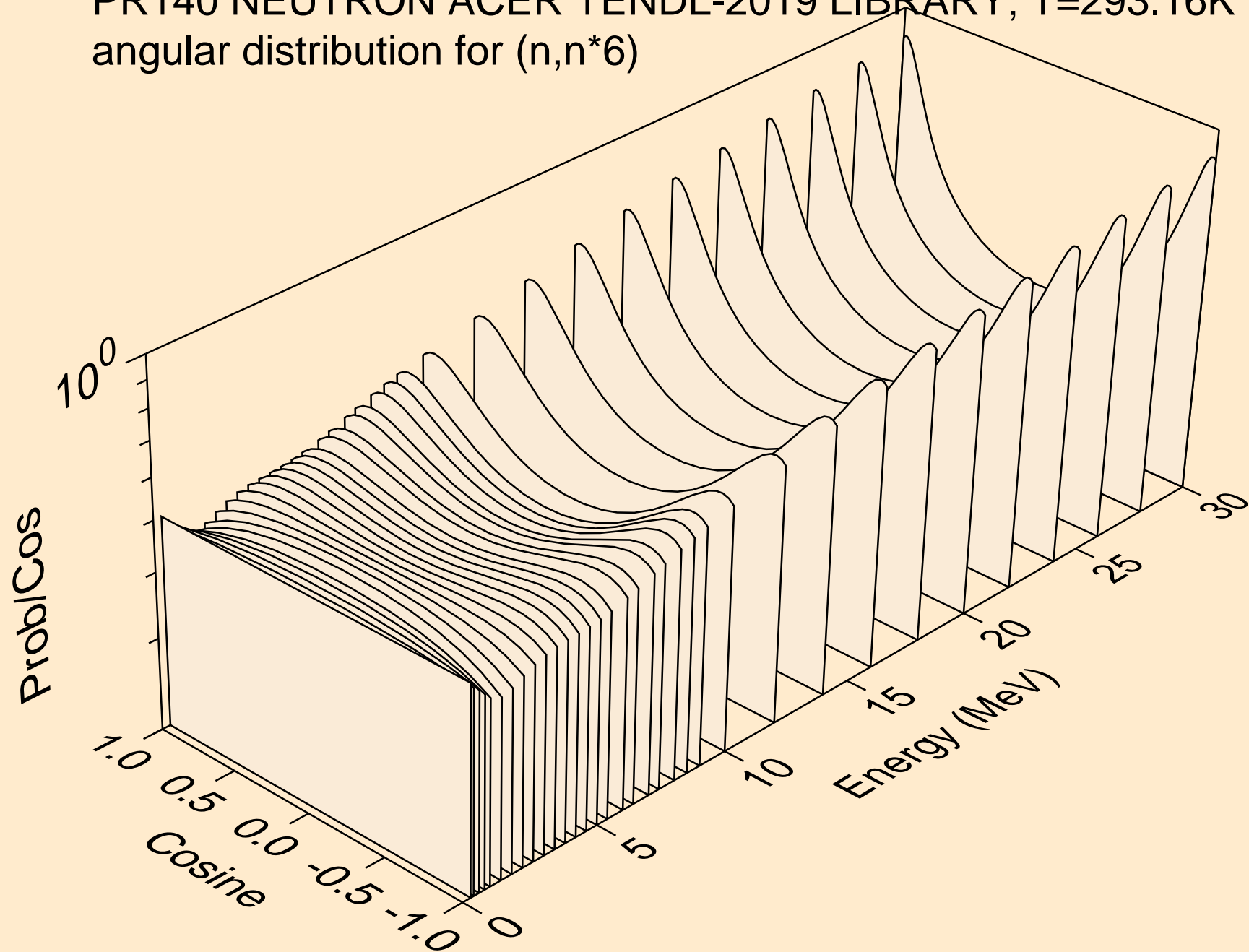

PR140 NEUTRON ACER TENDL-2019 LIBRARY; T=293.16K
angular distribution for (n,n*7)

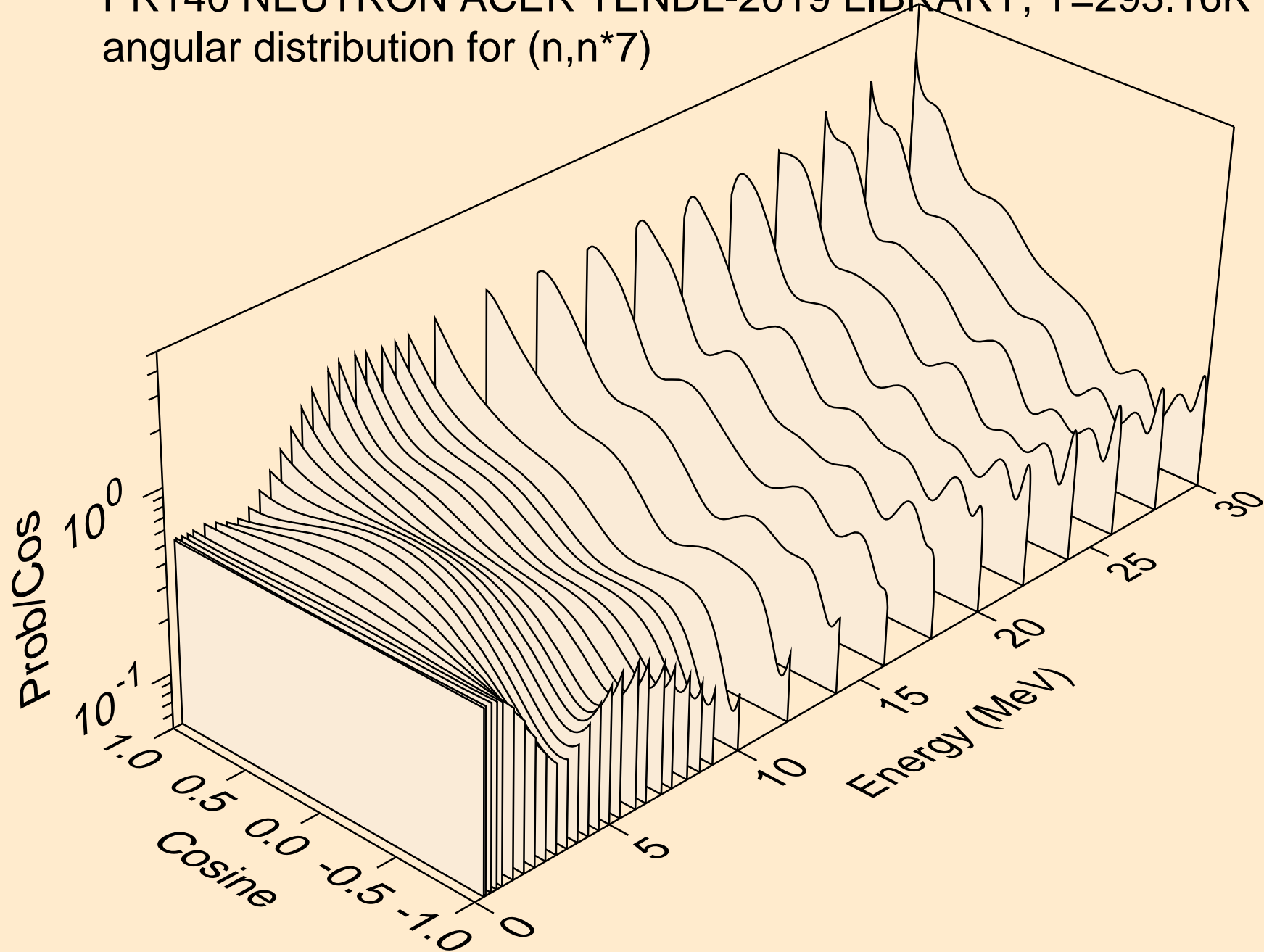

PR140 NEUTRON ACER TENDL-2019 LIBRARY; T=293.16K
angular distribution for (n,n*8)

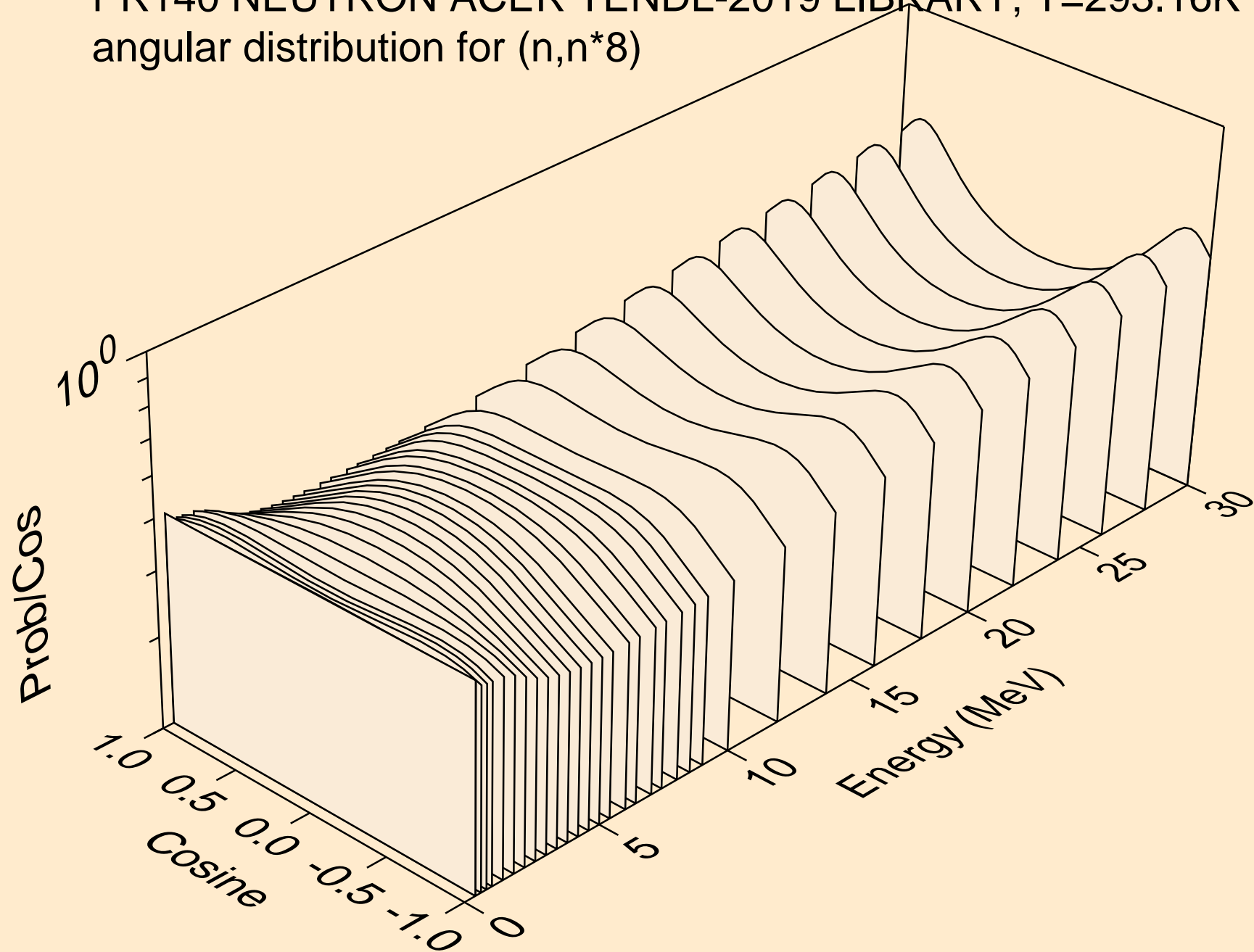

PR140 NEUTRON ACER TENDL-2019 LIBRARY; T=293.16K
angular distribution for (n,n*9)

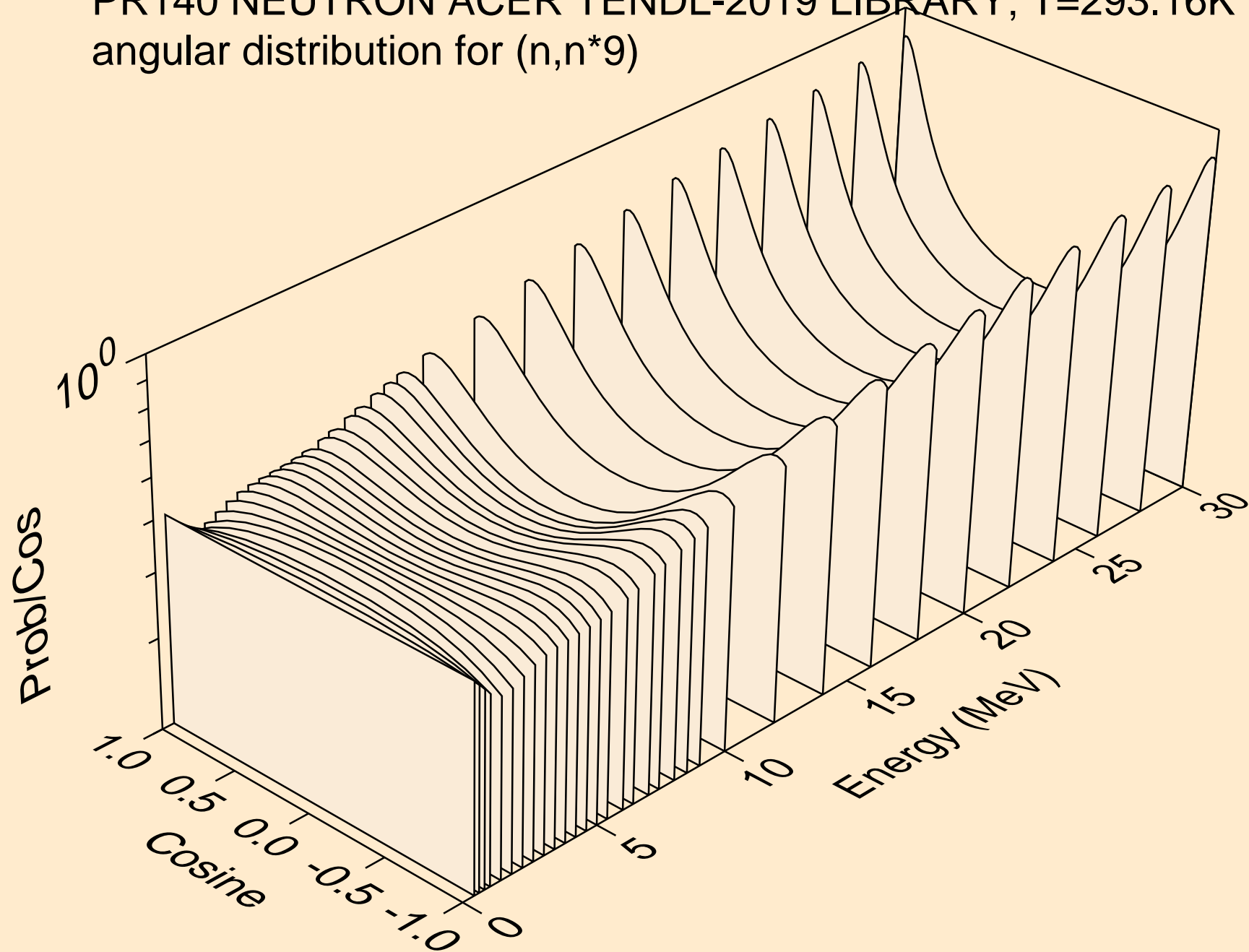

PR140 NEUTRON ACER TENDL-2019 LIBRARY; T=293.16K
angular distribution for (n,n*10)

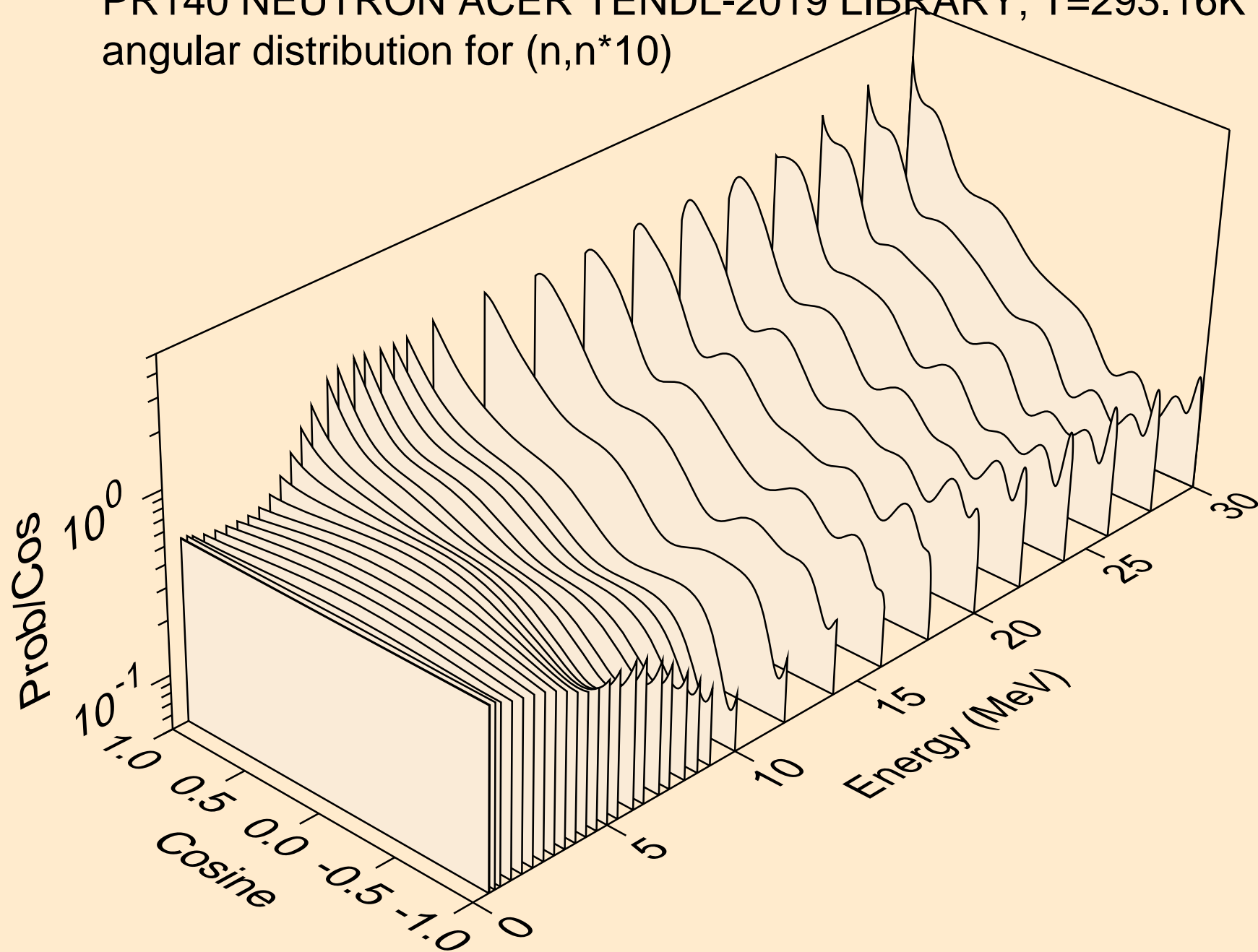

PR140 NEUTRON ACER TENDL-2019 LIBRARY; T=293.16K
angular distribution for (n,n*11)

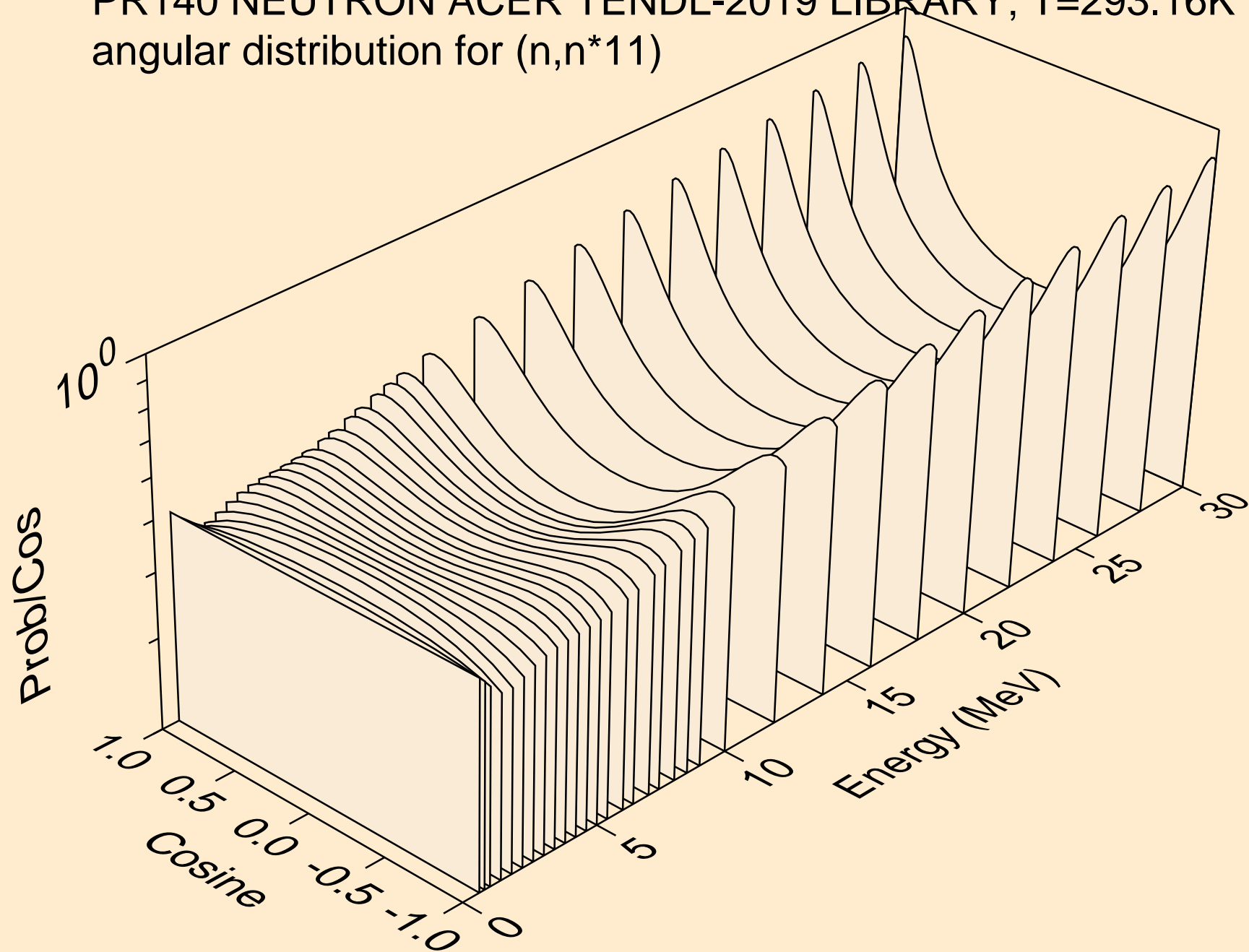

PR140 NEUTRON ACER TENDL-2019 LIBRARY; T=293.16K
angular distribution for (n,n*12)

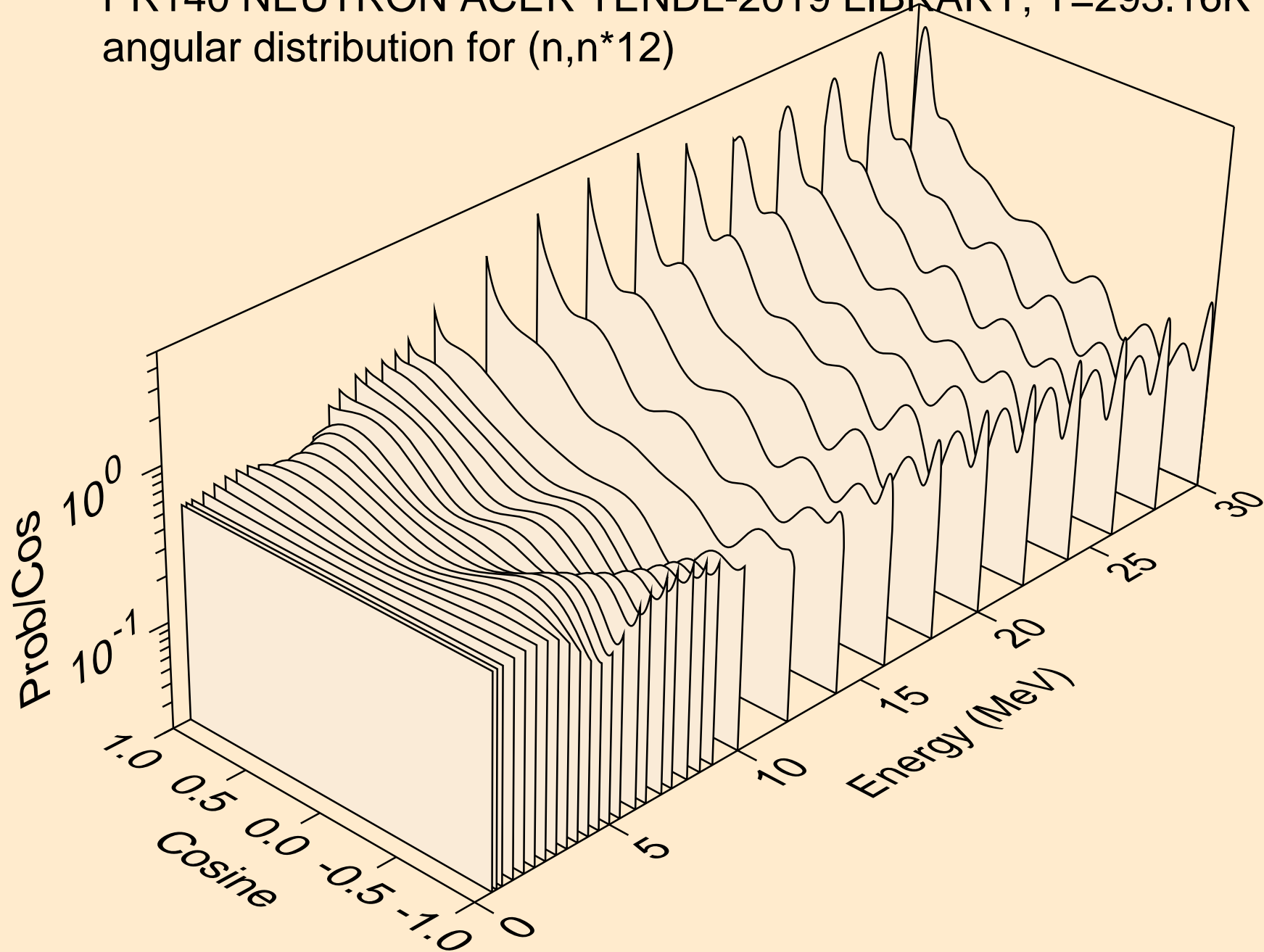

PR140 NEUTRON ACER TENDL-2019 LIBRARY; T=293.16K
angular distribution for (n,n*13)

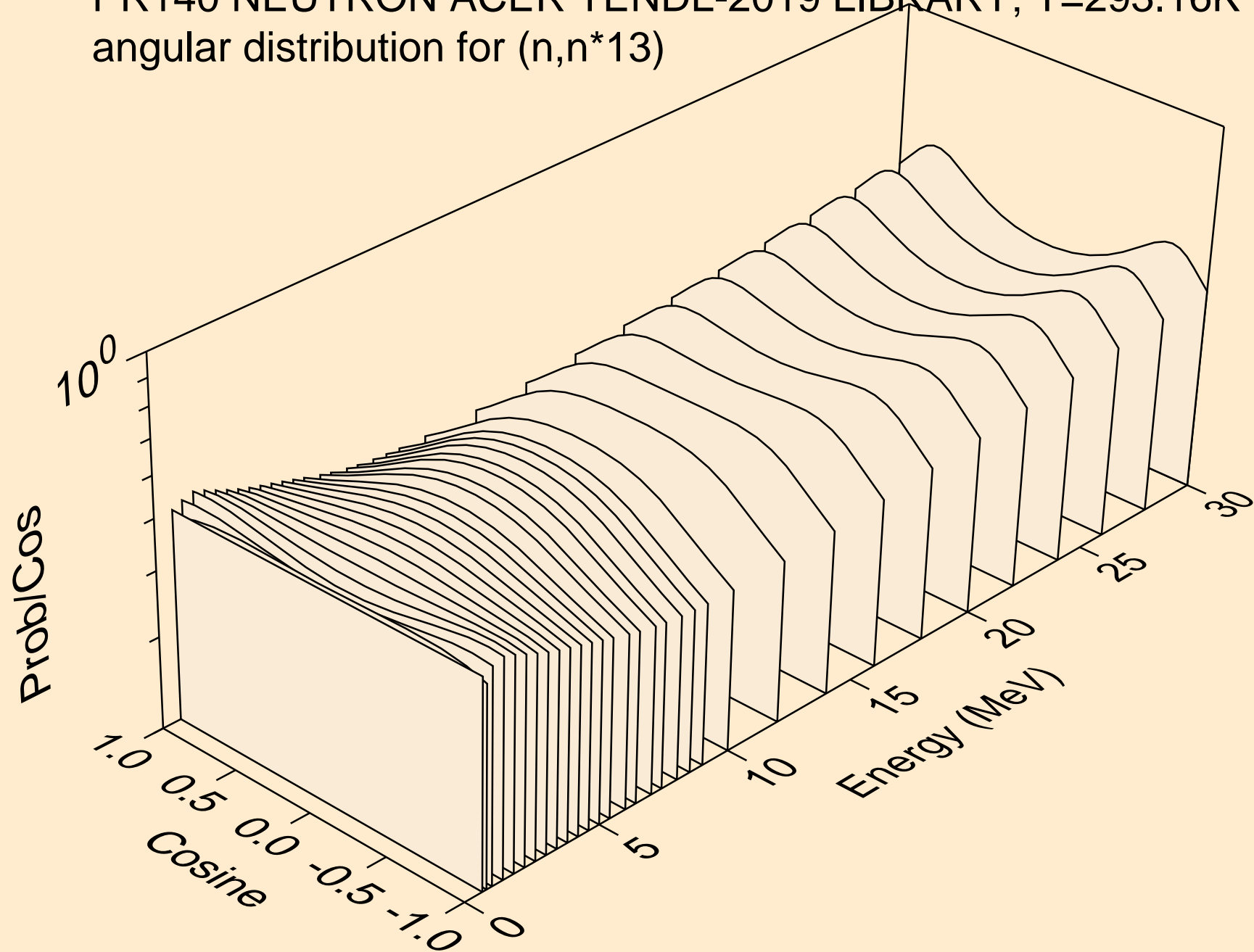

PR140 NEUTRON ACER TENDL-2019 LIBRARY; T=293.16K
angular distribution for (n,n*14)

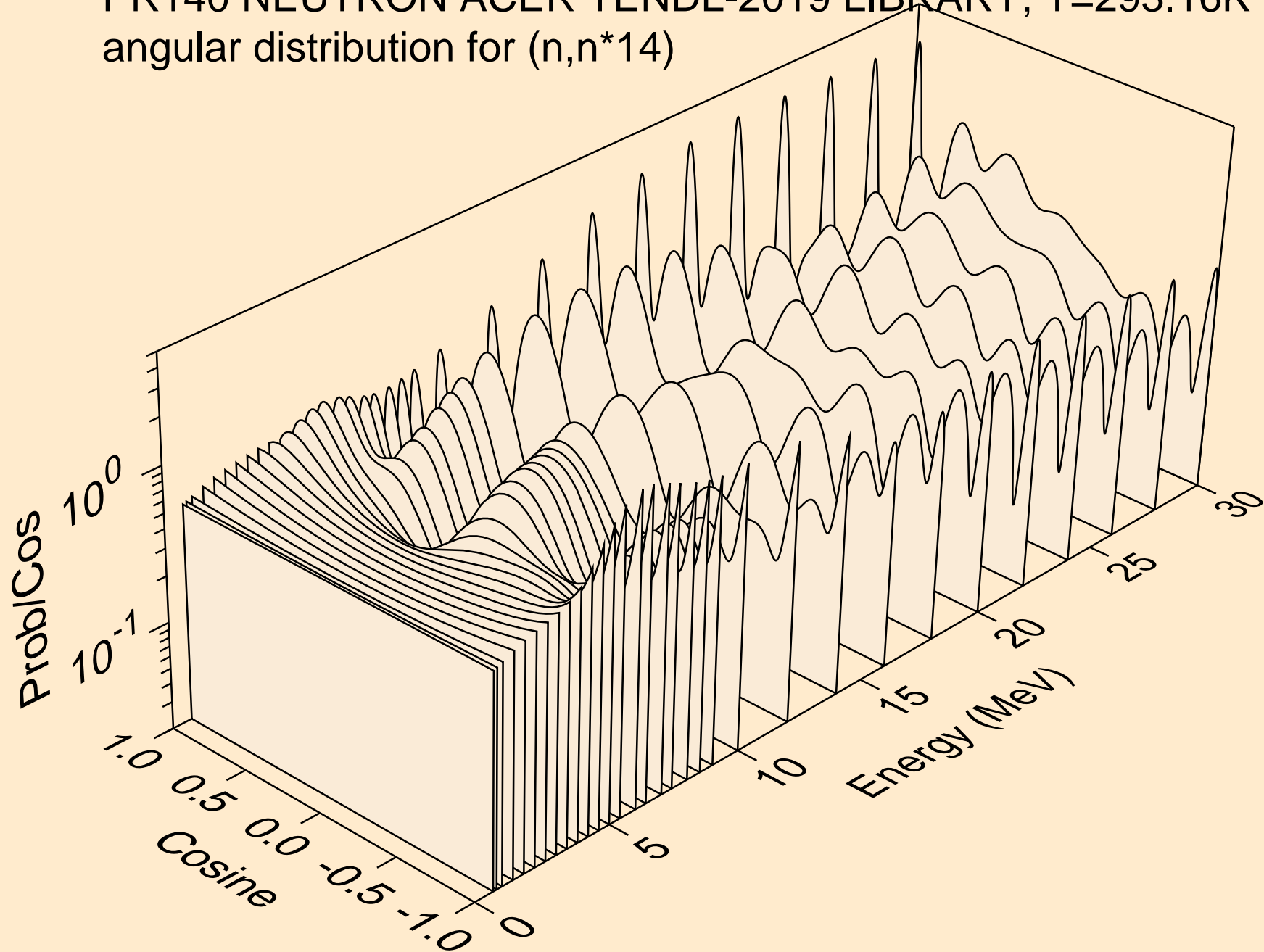

PR140 NEUTRON ACER TENDL-2019 LIBRARY; T=293.16K
angular distribution for (n,n*15)

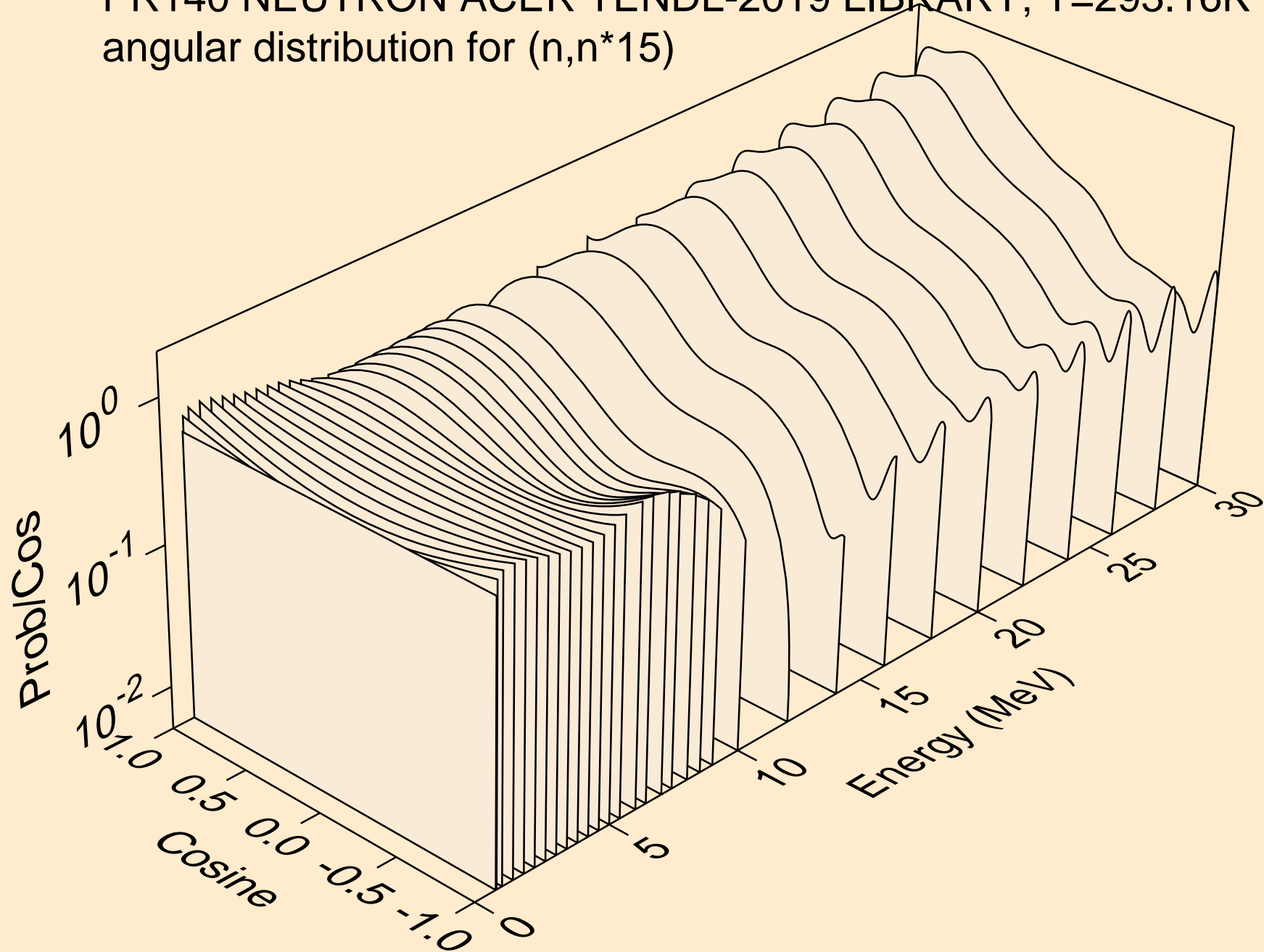

PR140 NEUTRON ACER TENDL-2019 LIBRARY; T=293.16K
angular distribution for (n,n*16)

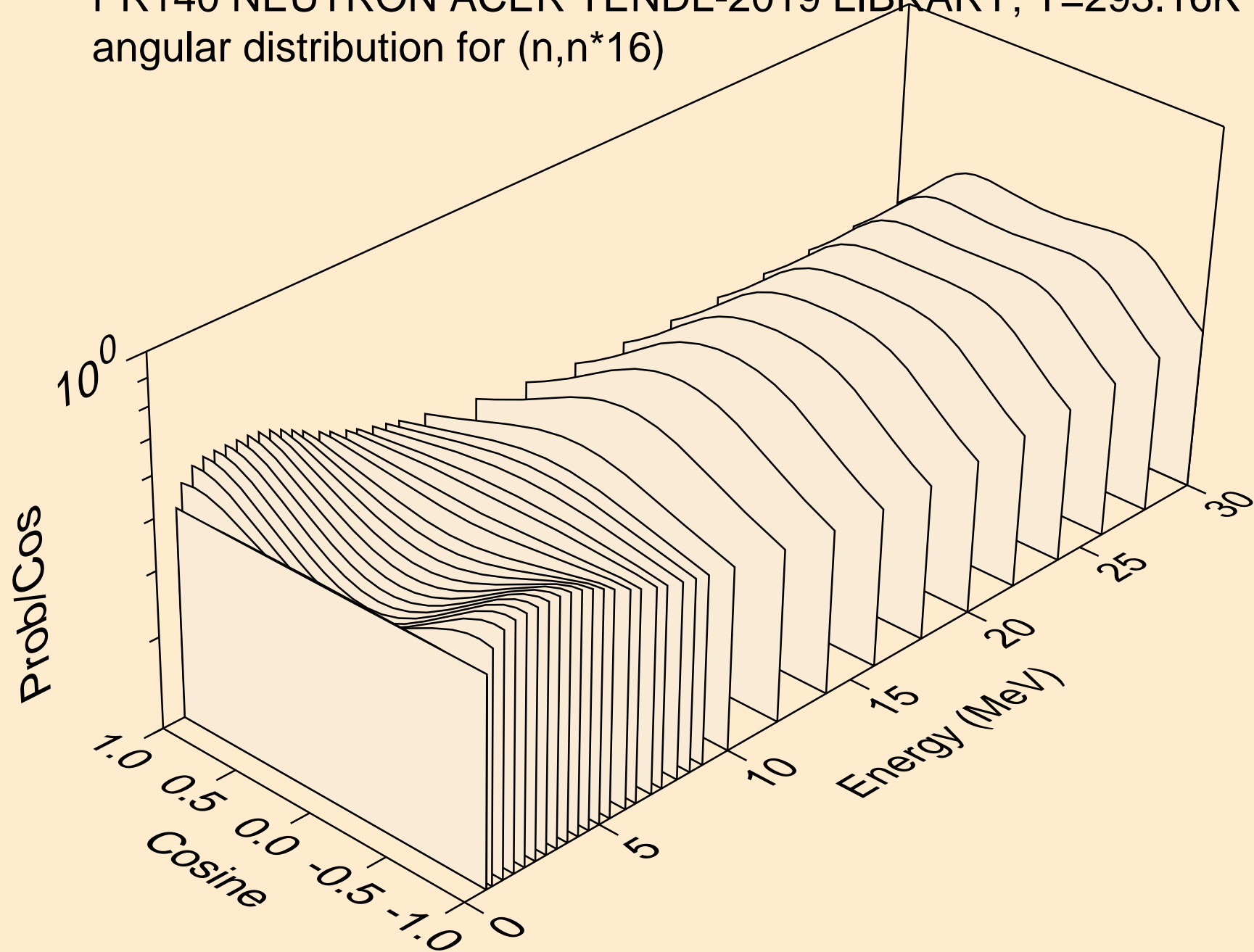

PR140 NEUTRON ACER TENDL-2019 LIBRARY; T=293.16K
angular distribution for (n,n*17)

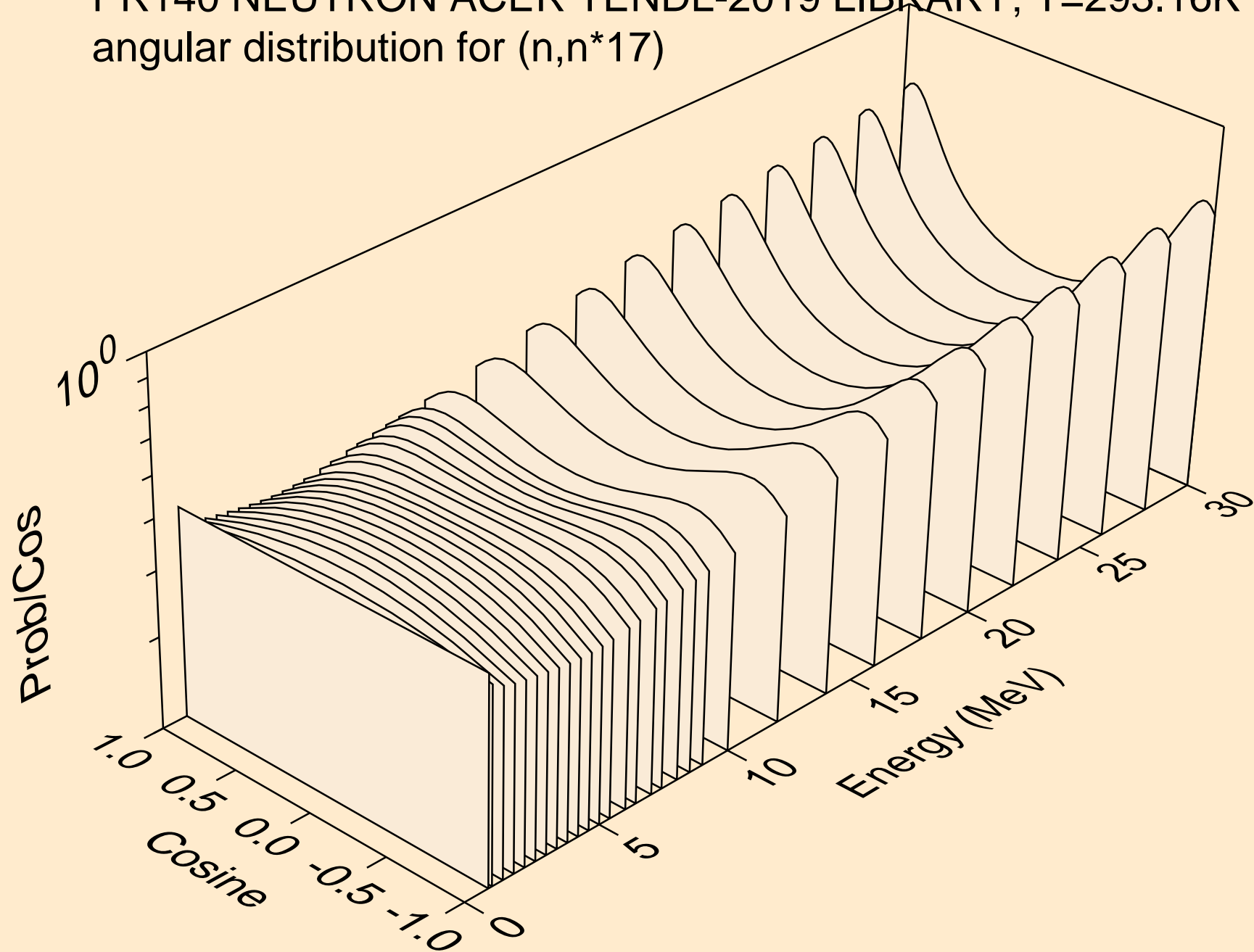

PR140 NEUTRON ACER TENDL-2019 LIBRARY; T=293.16K
angular distribution for (n,n*18)

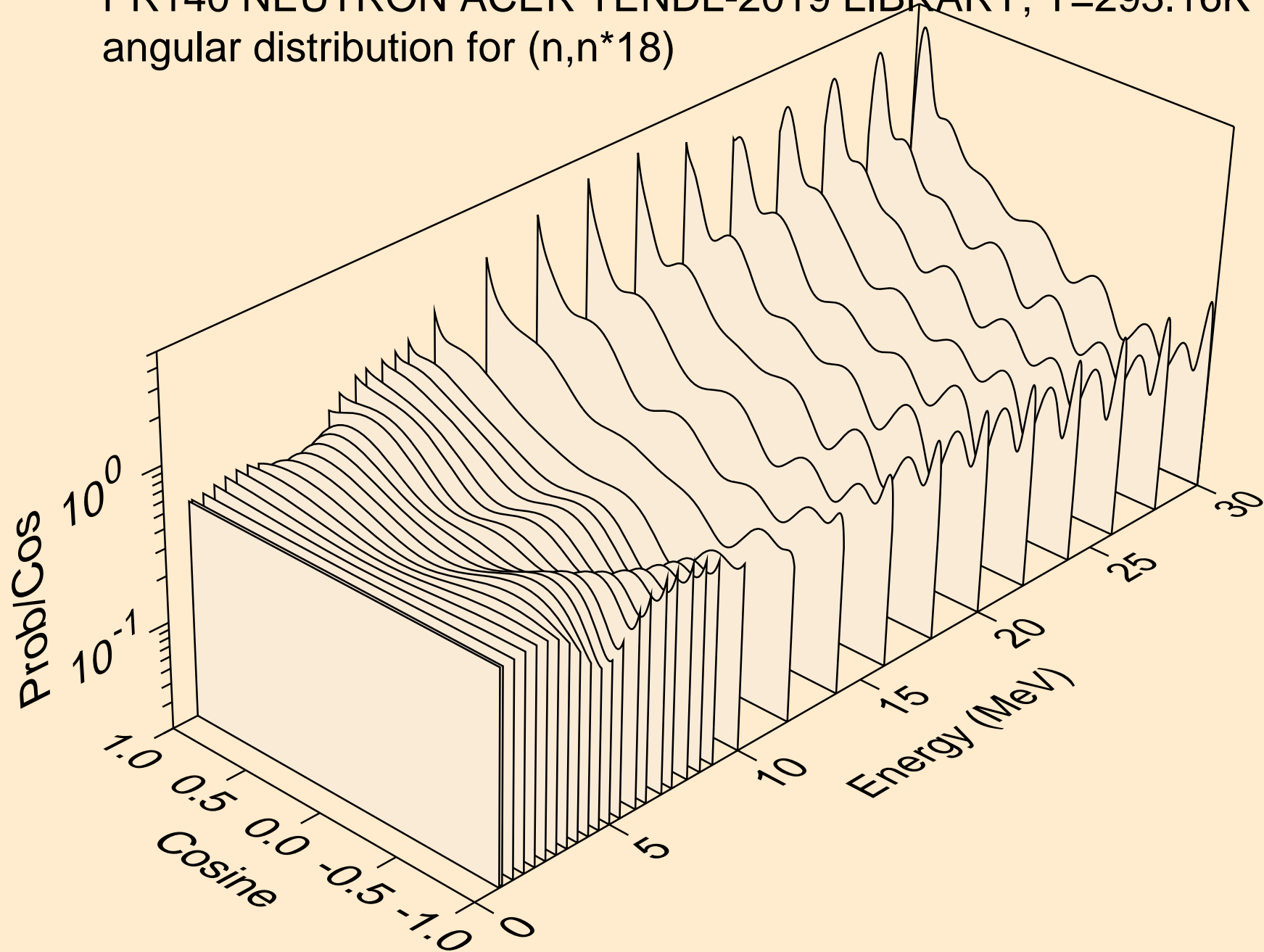

PR140 NEUTRON ACER TENDL-2019 LIBRARY; T=293.16K
angular distribution for (n,n*19)

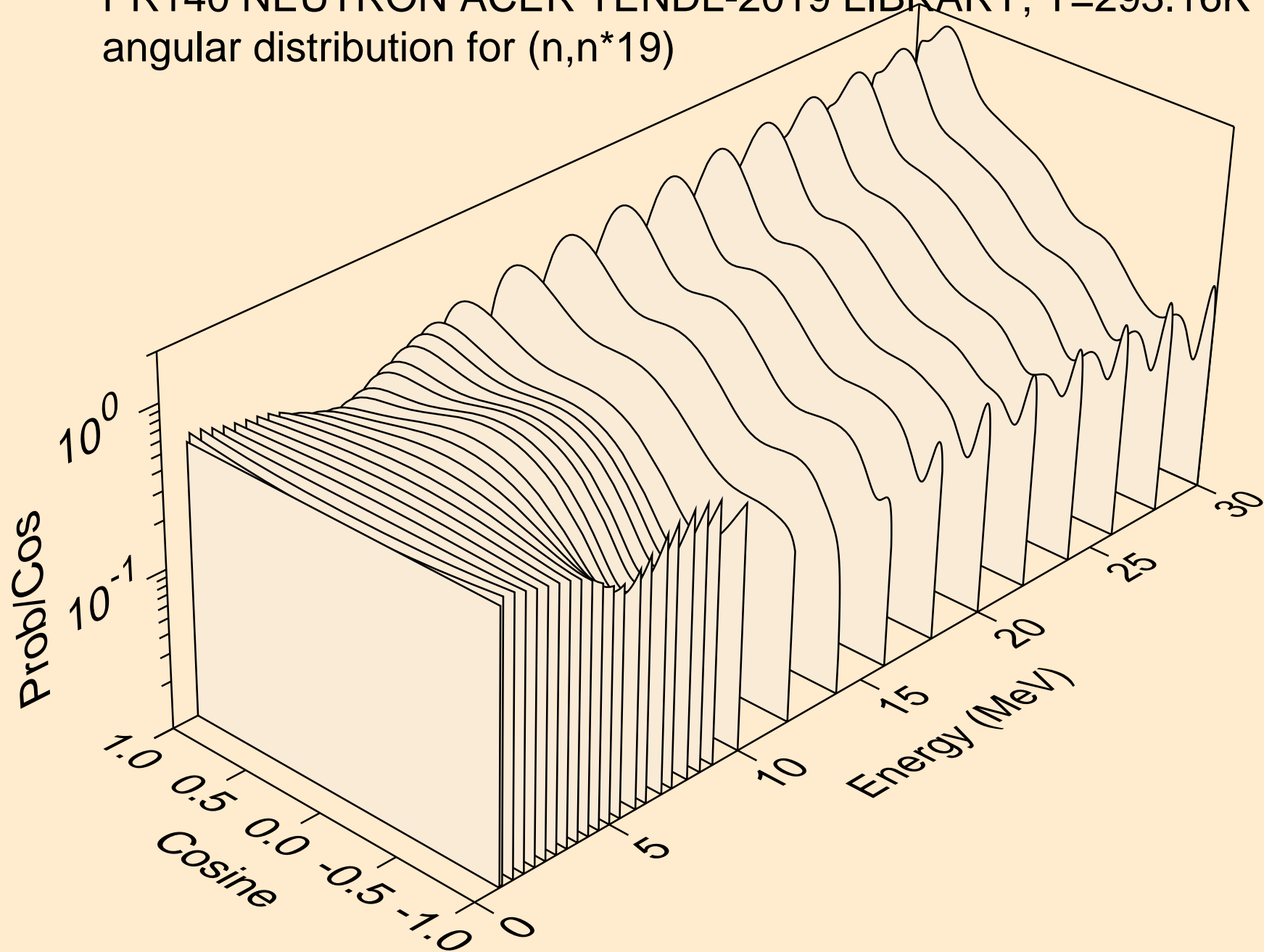

PR140 NEUTRON ACER TENDL-2019 LIBRARY; T=293.16K
angular distribution for (n,n*20)

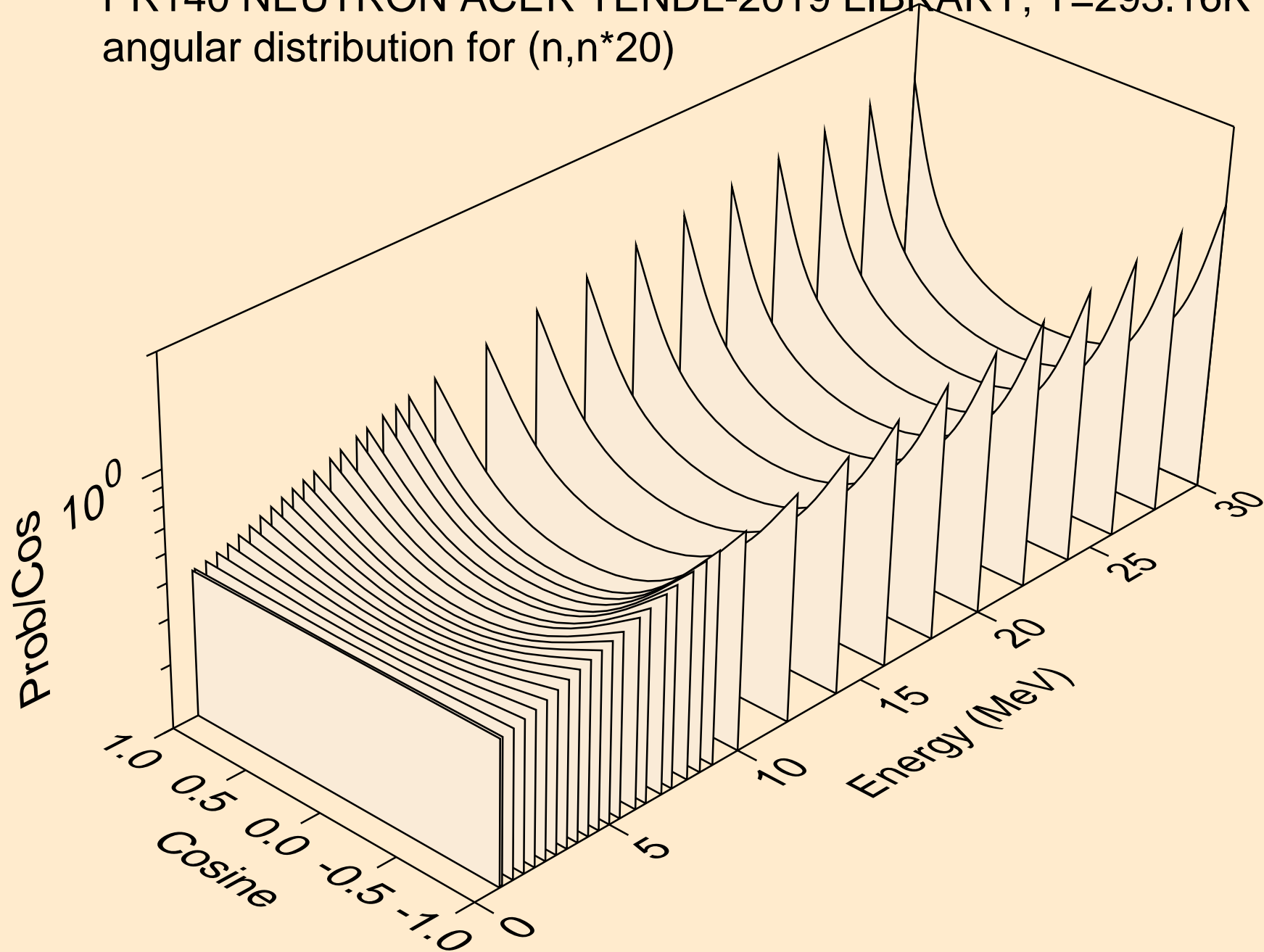

PR140 NEUTRON ACER TENDL-2019 LIBRARY; T=293.16K
angular distribution for (n,n*21)

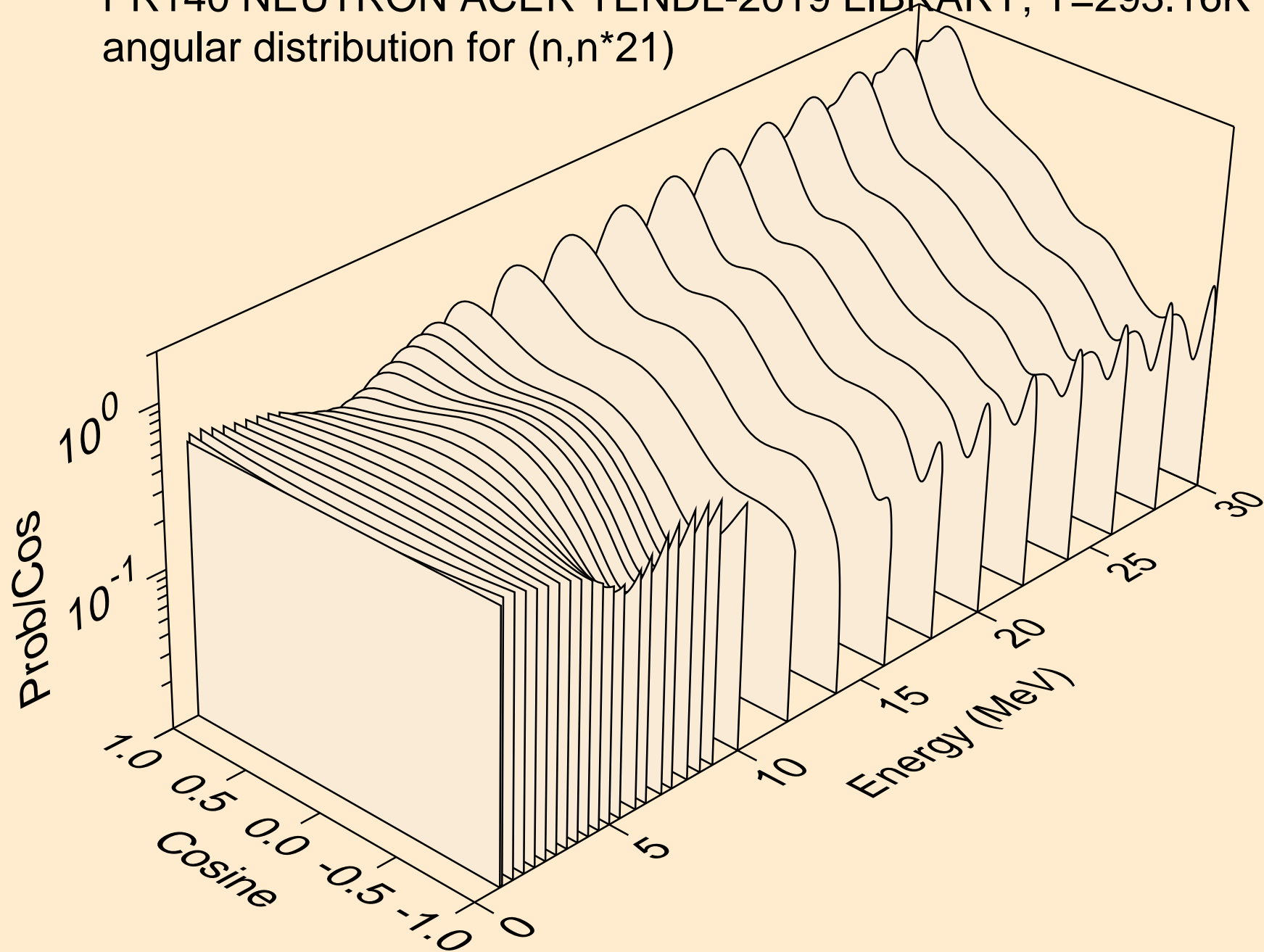

PR140 NEUTRON ACER TENDL-2019 LIBRARY; T=293.16K
angular distribution for (n,n*22)

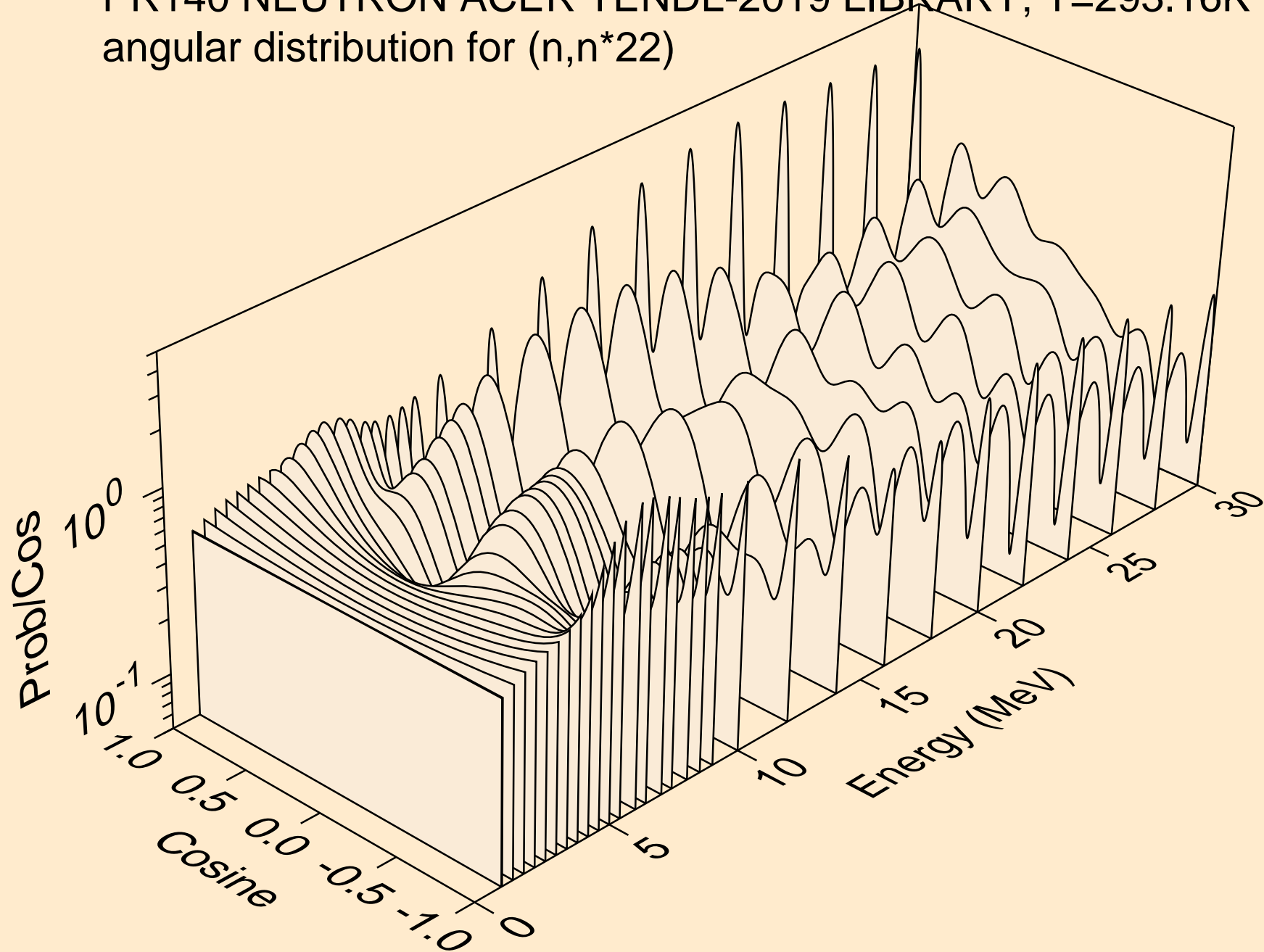

PR140 NEUTRON ACER TENDL-2019 LIBRARY; T=293.16K
angular distribution for (n,n*23)

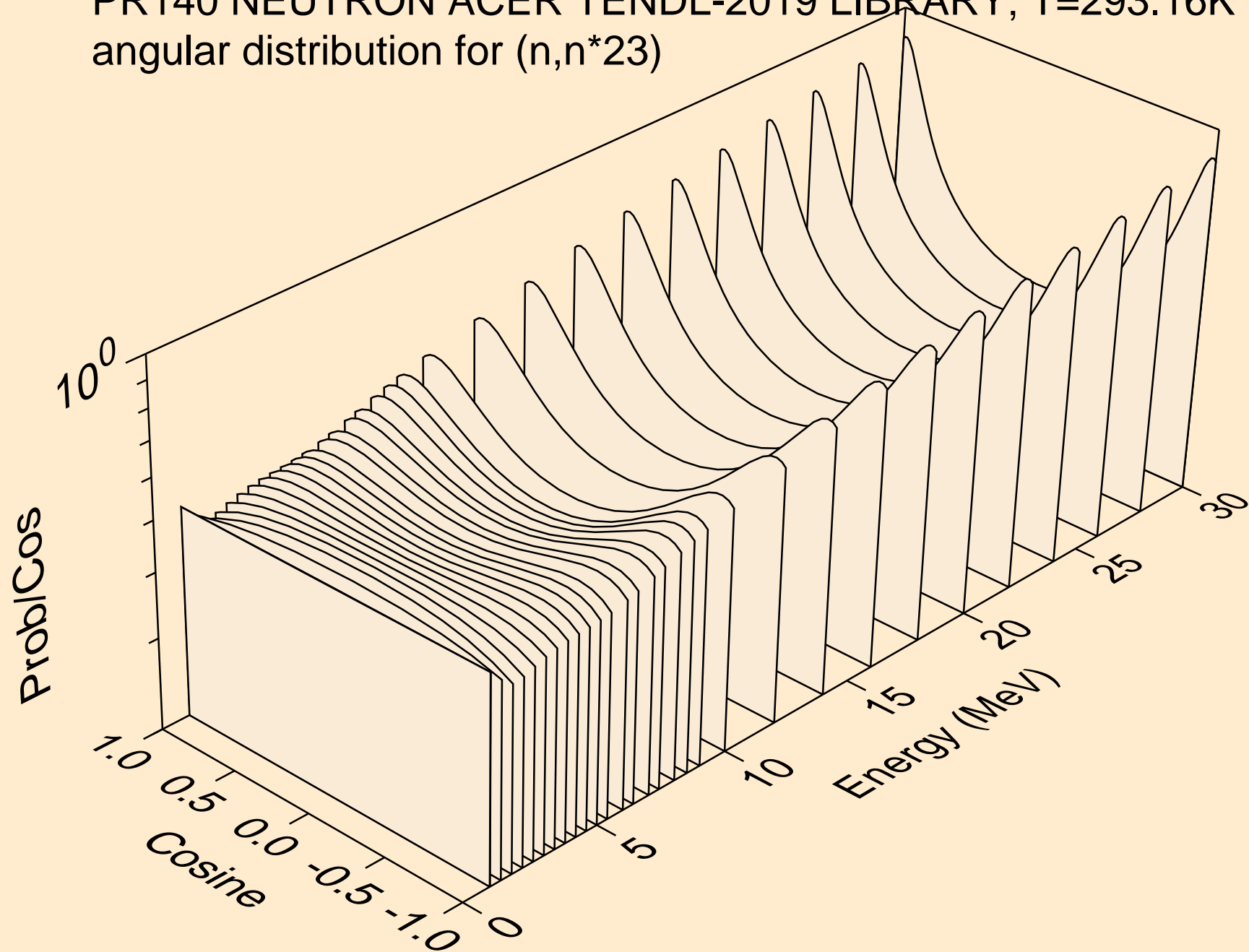

PR140 NEUTRON ACER TENDL-2019 LIBRARY; T=293.16K
angular distribution for (n,n*24)

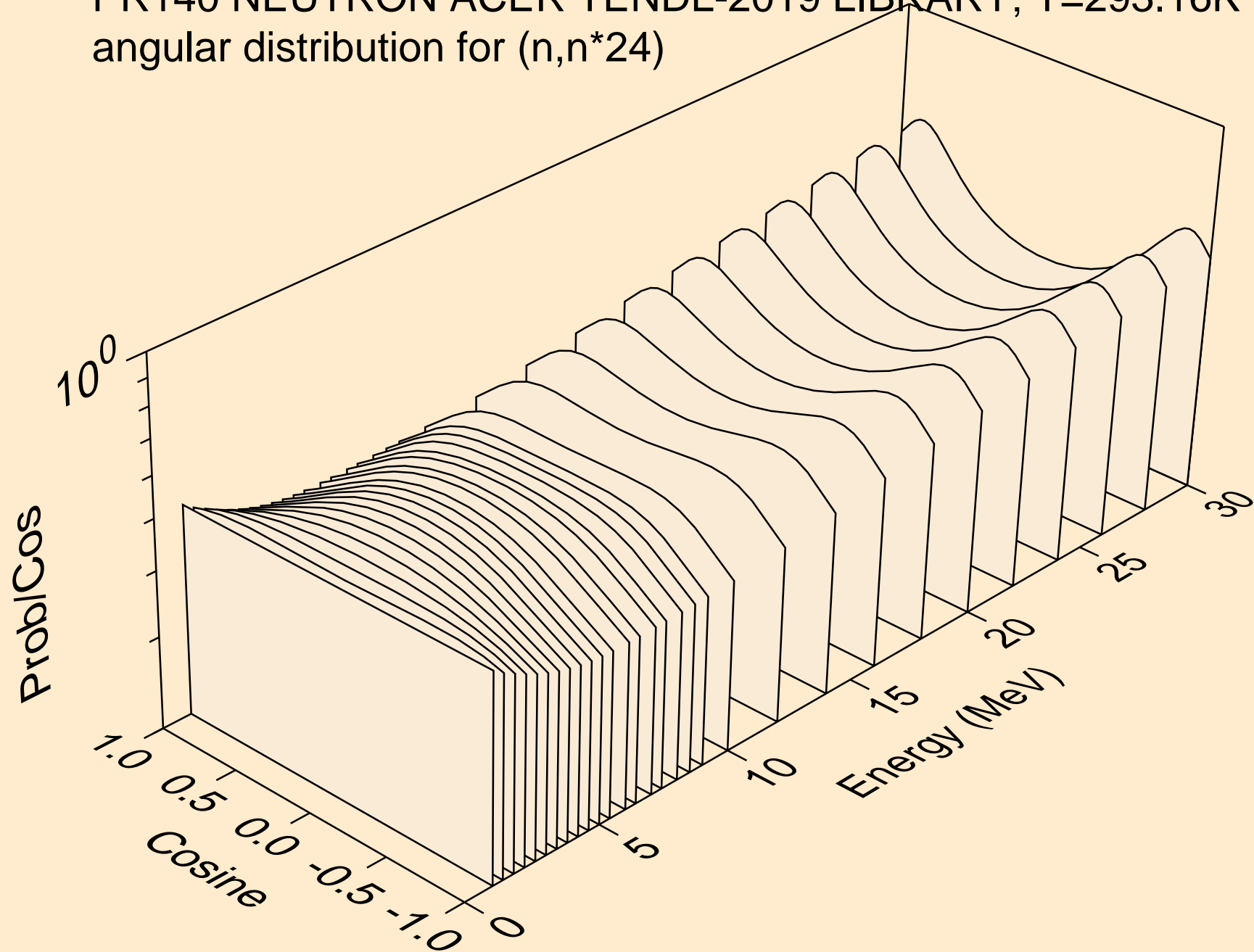

PR140 NEUTRON ACER TENDL-2019 LIBRARY; T=293.16K
angular distribution for (n,n*25)

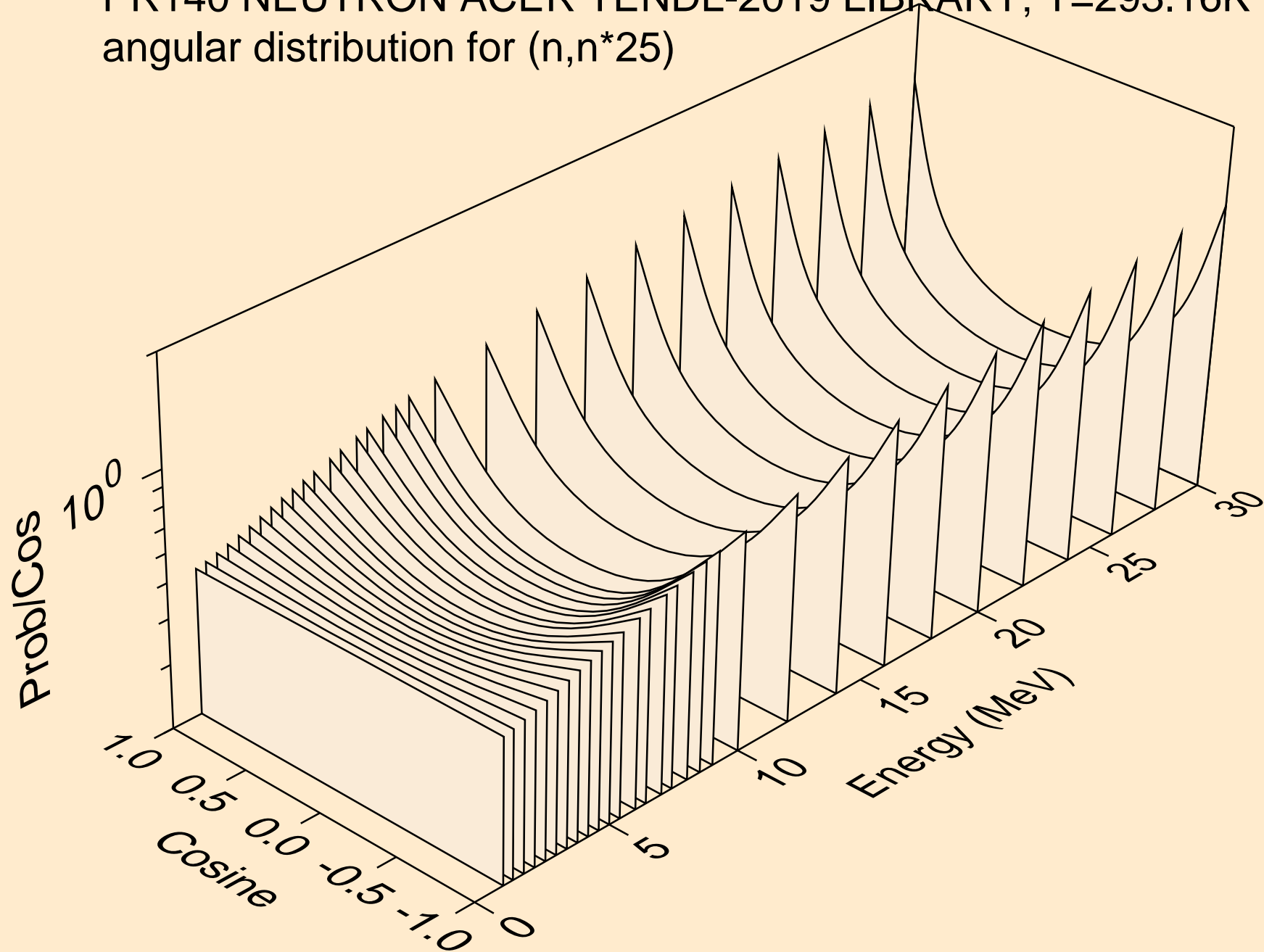

PR140 NEUTRON ACER TENDL-2019 LIBRARY; T=293.16K
angular distribution for (n,n*26)

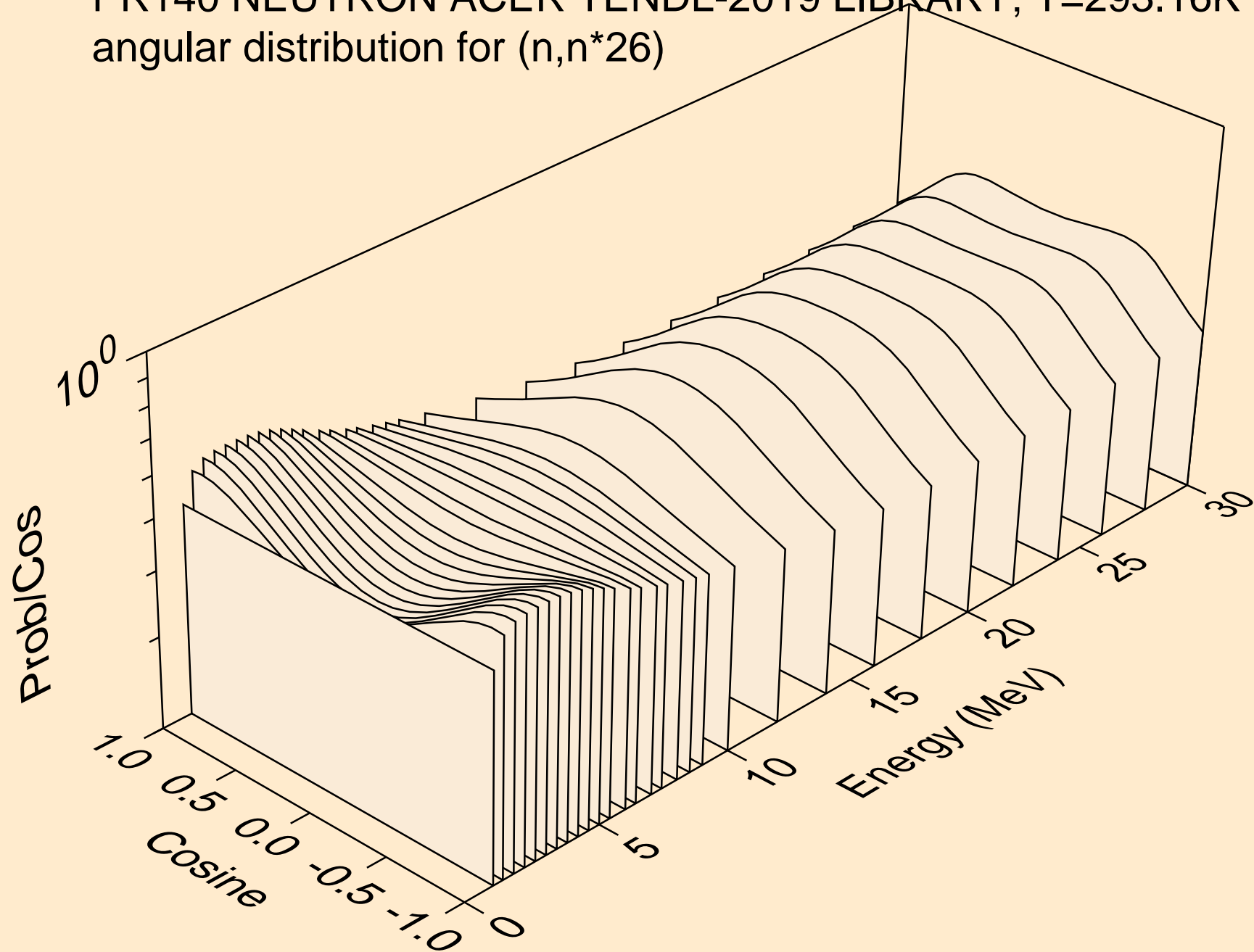

PR140 NEUTRON ACER TENDL-2019 LIBRARY; T=293.16K
angular distribution for (n,n*27)

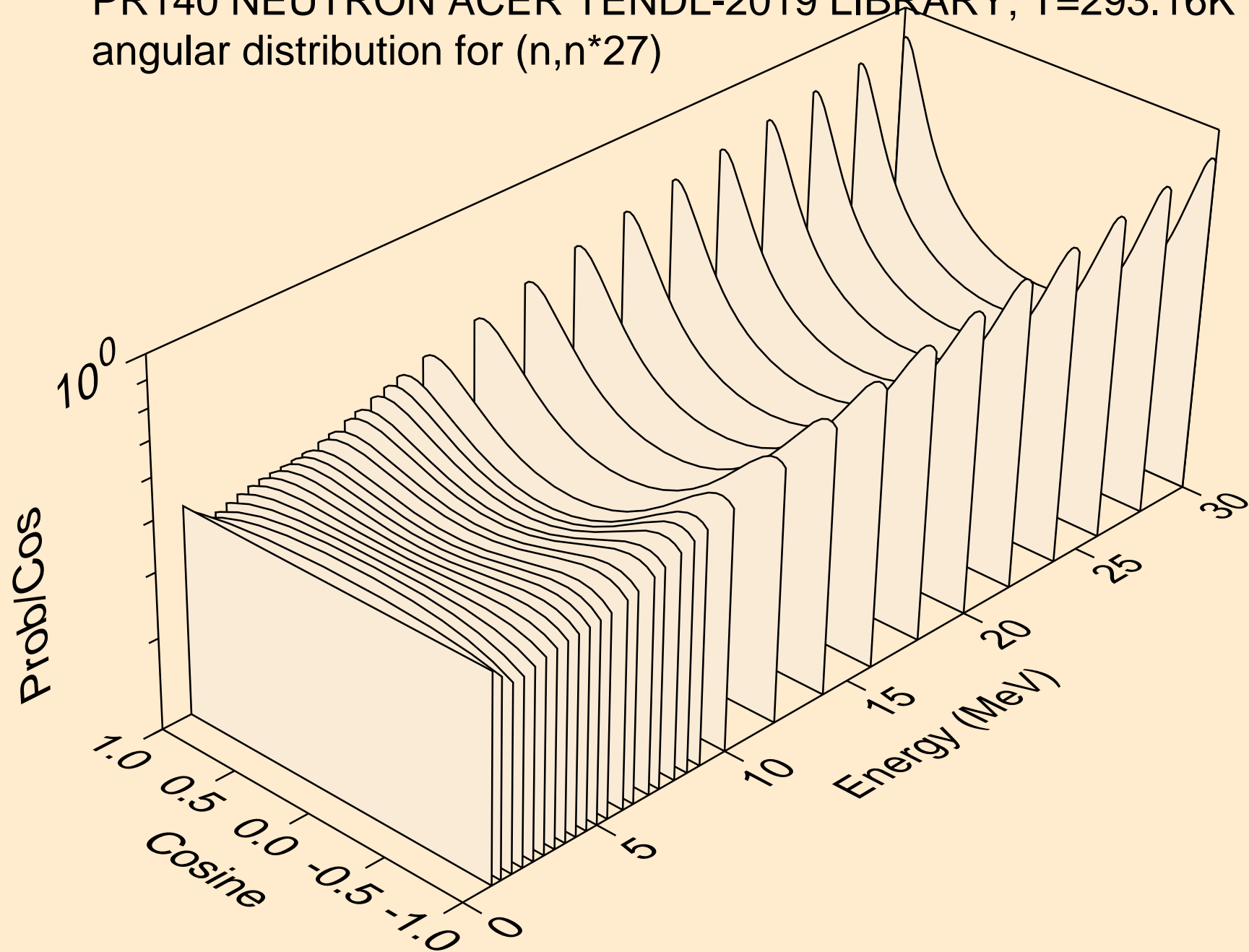

PR140 NEUTRON ACER TENDL-2019 LIBRARY; T=293.16K
angular distribution for (n,n*28)

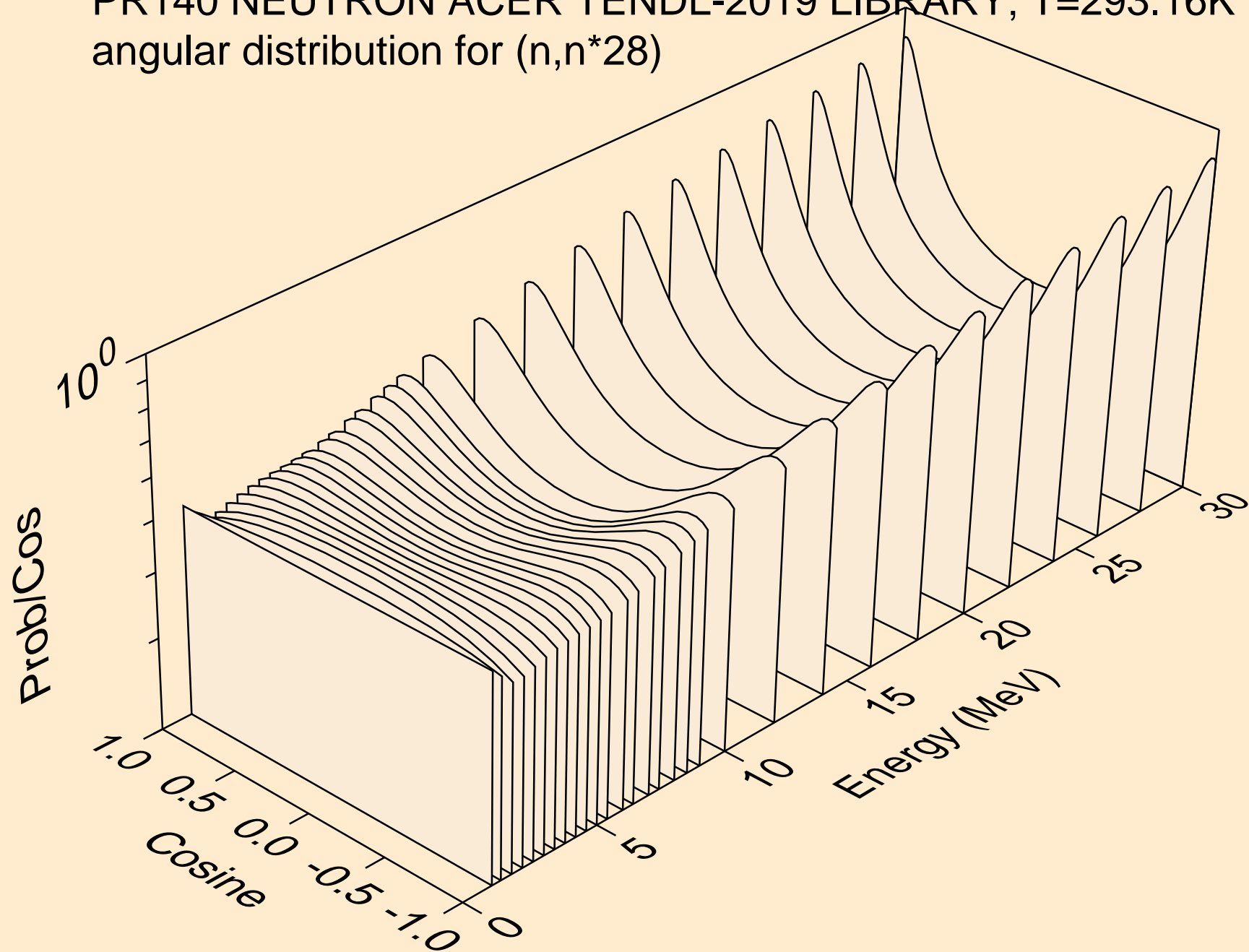

PR140 NEUTRON ACER TENDL-2019 LIBRARY; T=293.16K
angular distribution for (n,n*29)

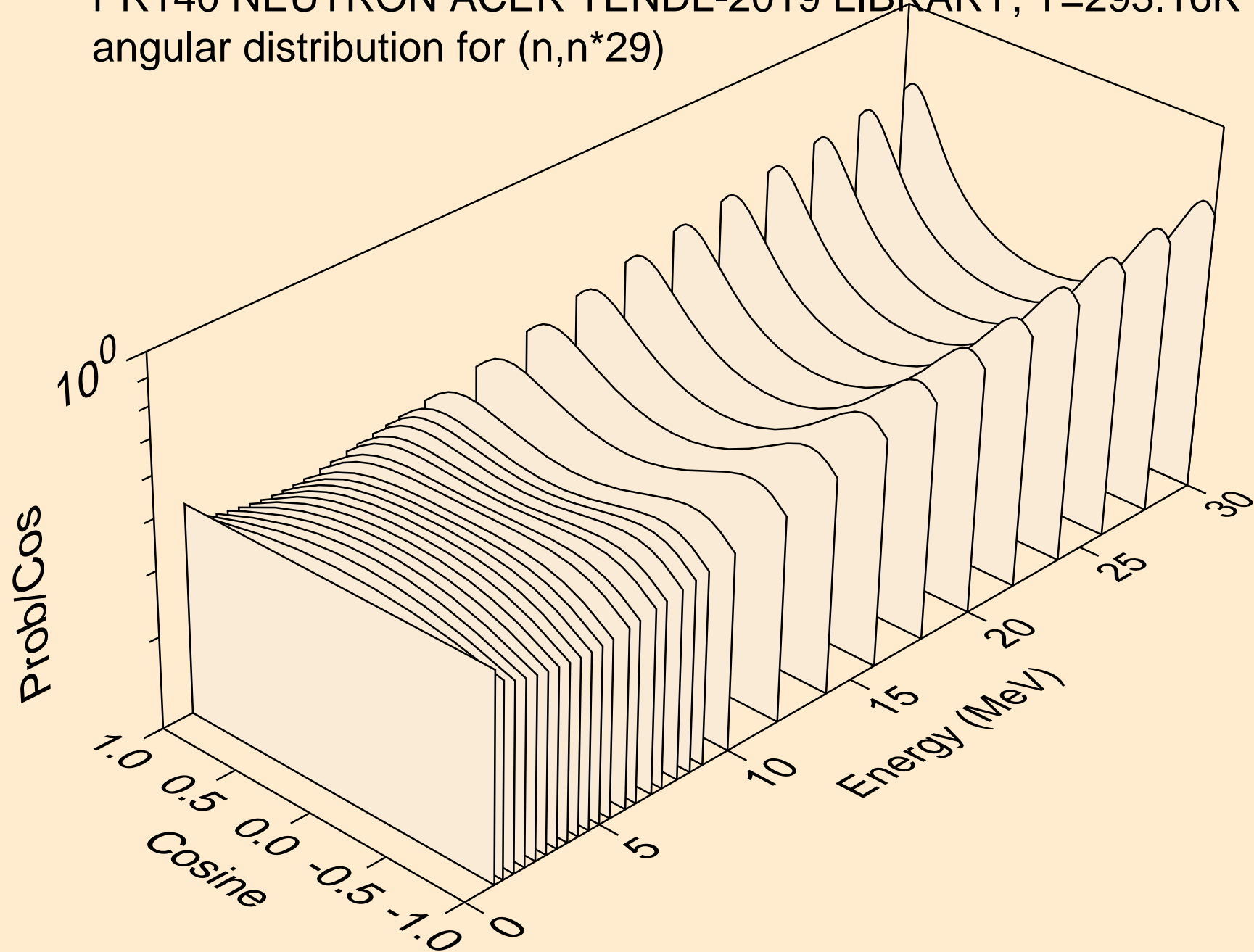

PR140 NEUTRON ACER TENDL-2019 LIBRARY; T=293.16K
angular distribution for (n,n*30)

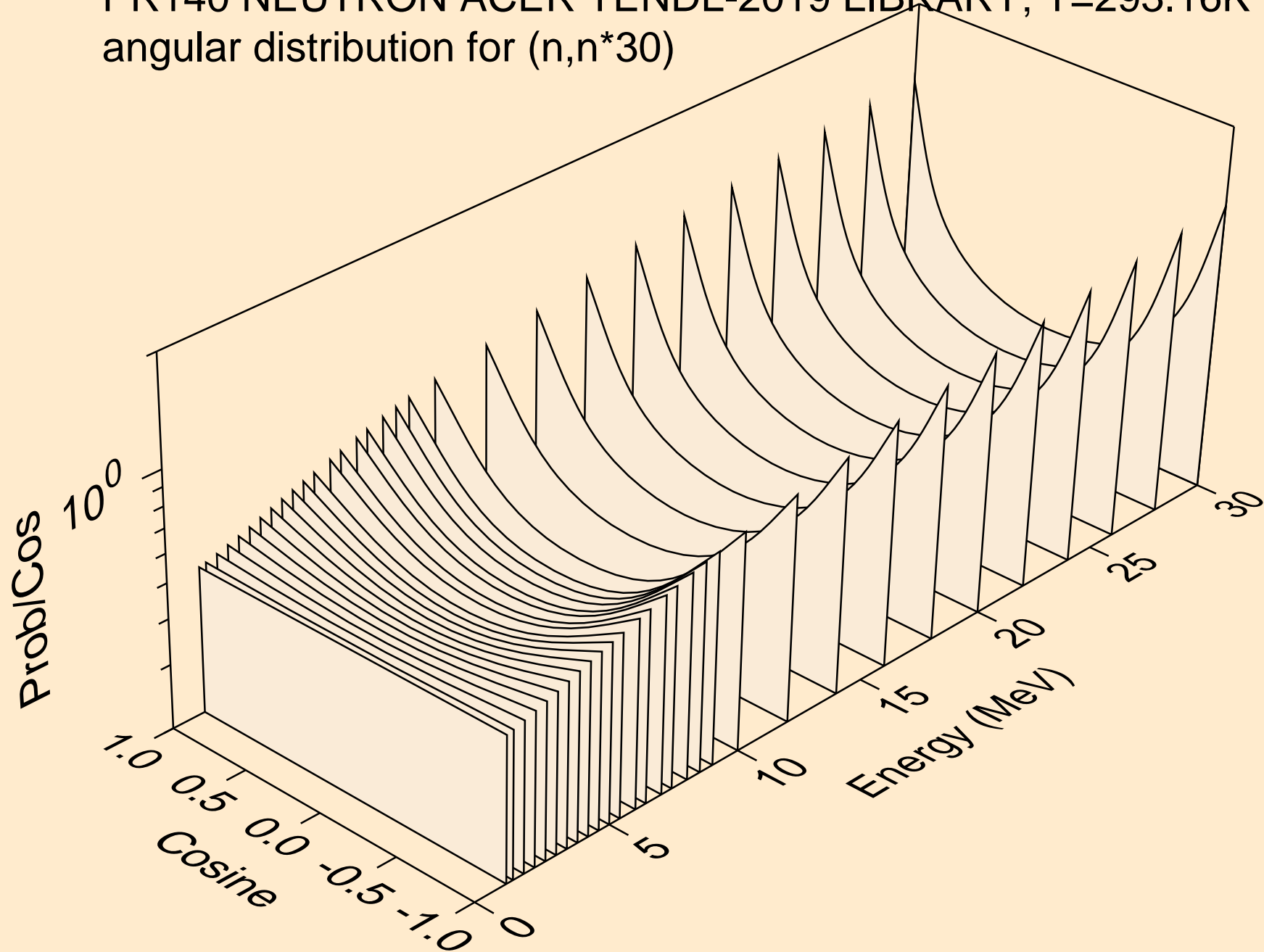

PR140 NEUTRON ACER TENDL-2019 LIBRARY; T=293.16K
Neutron emission for (n,x)

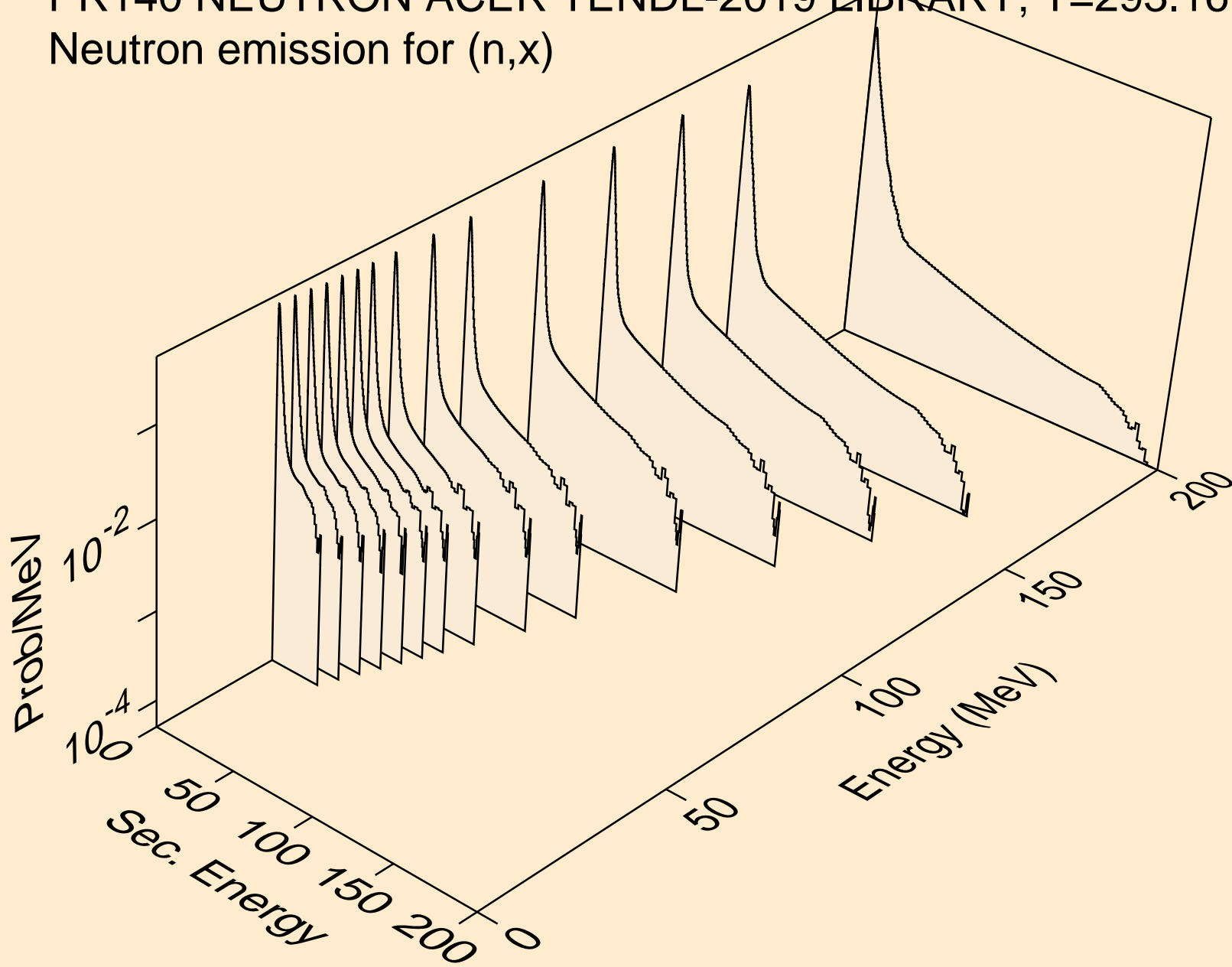

PR140 NEUTRON ACER TENDL-2019 LIBRARY; T=293.16K
Neutron emission for (n,2nd)

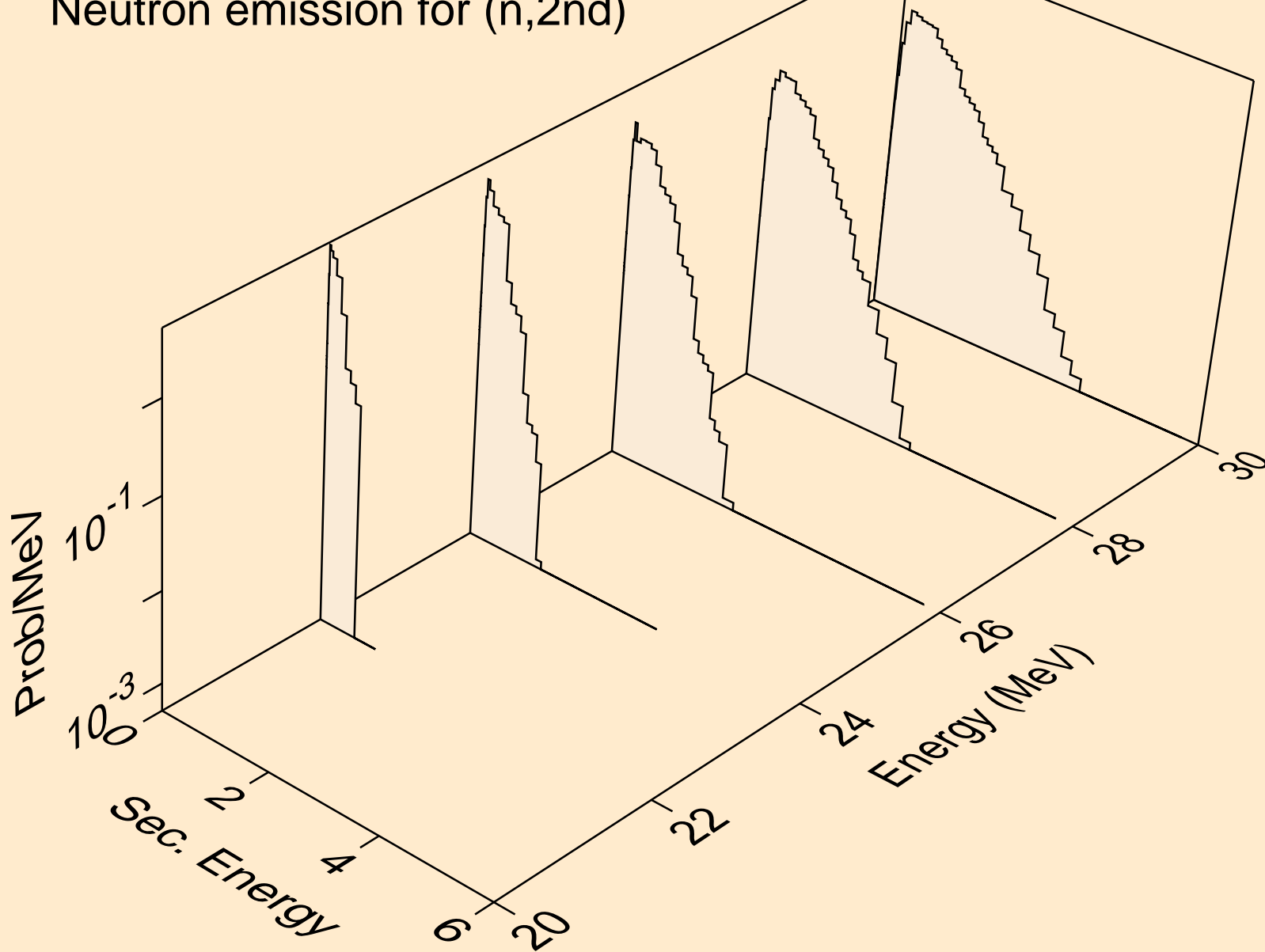

PR140 NEUTRON ACER TENDL-2019 LIBRARY; T=293.16K
Neutron emission for (n,2n)

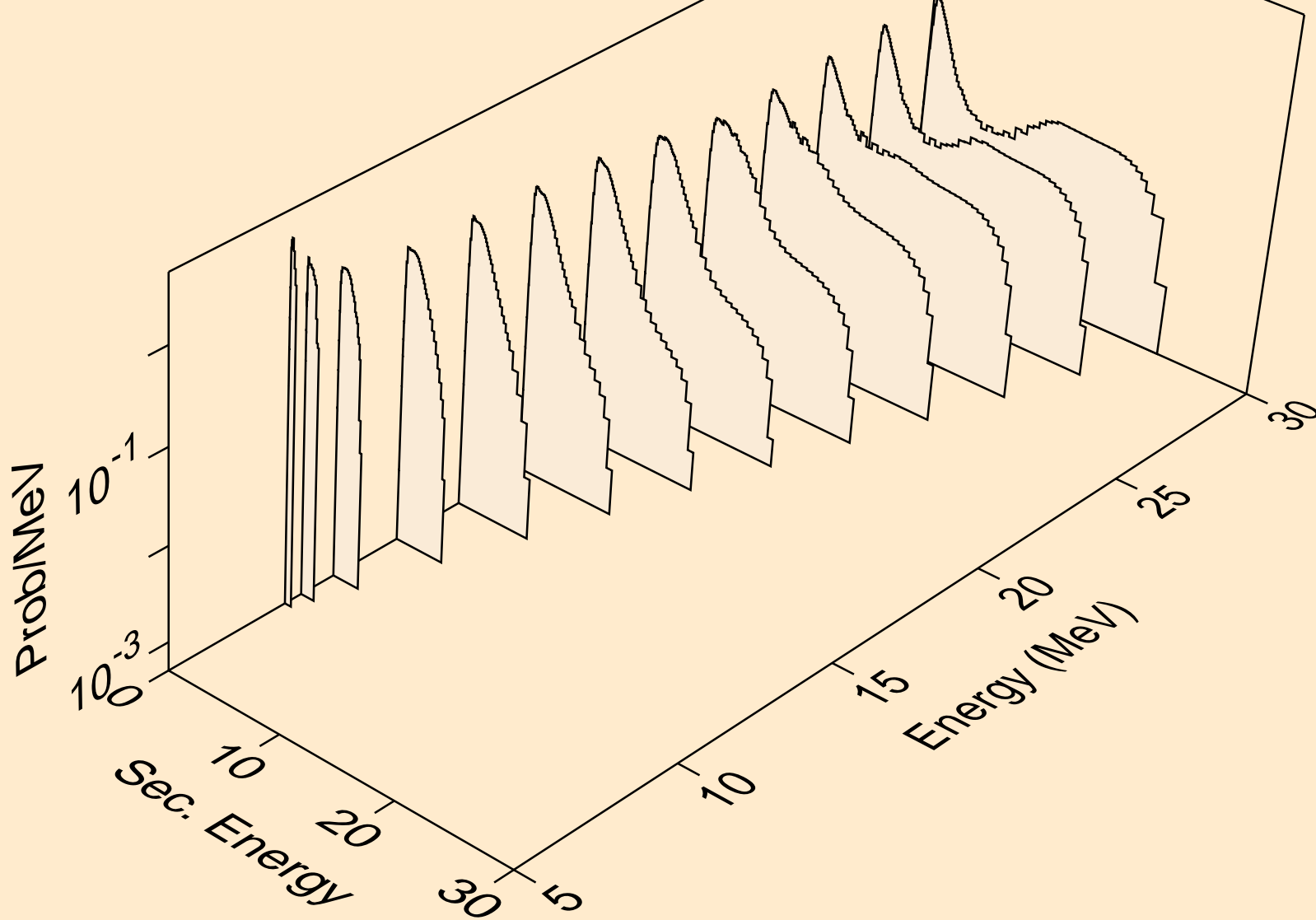

PR140 NEUTRON ACER TENDL-2019 LIBRARY; T=293.16K
Neutron emission for (n,3n)

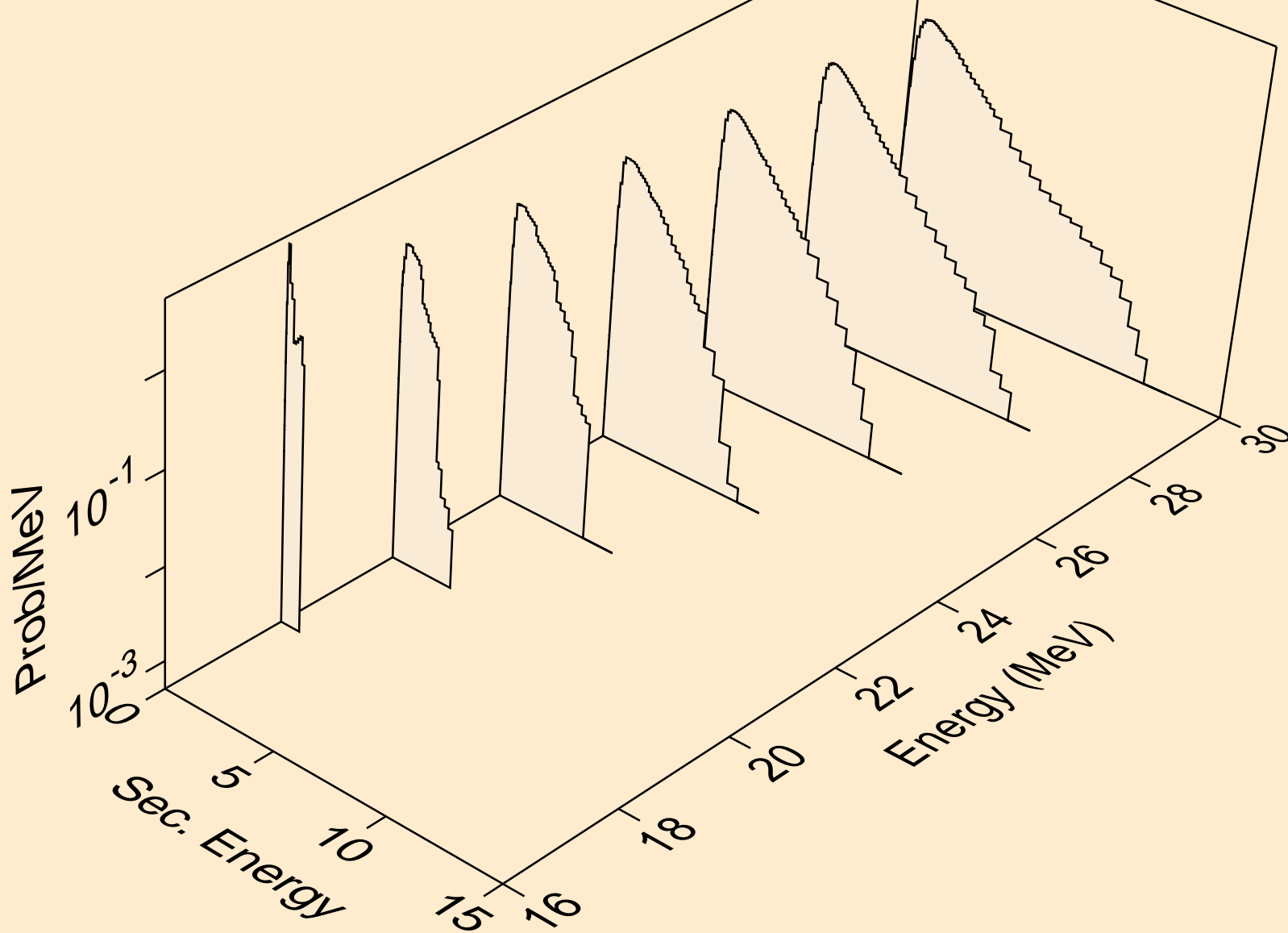

PR140 NEUTRON ACER TENDL-2019 LIBRARY; T=293.16K
Neutron emission for (n,n*)a

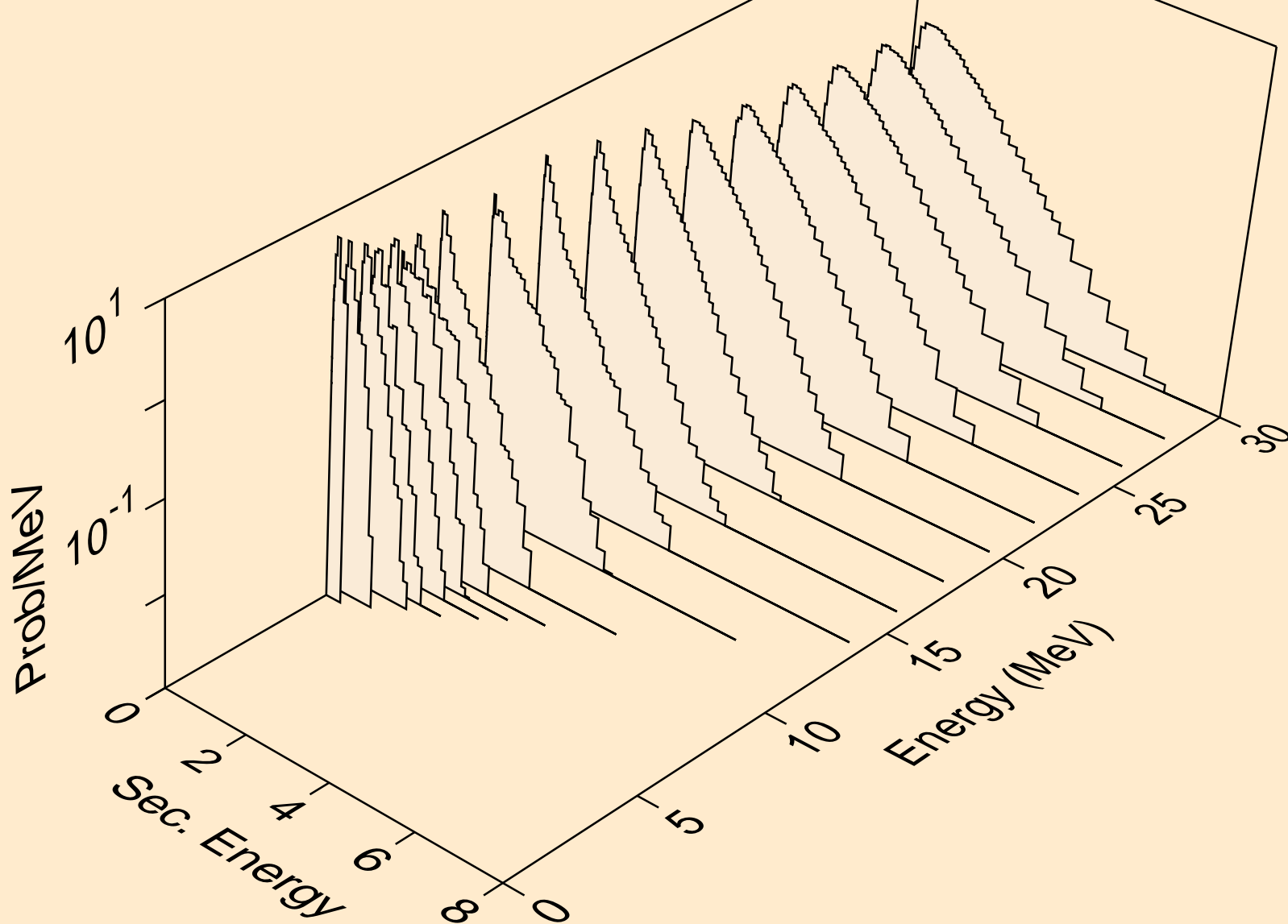

PR140 NEUTRON ACER TENDL-2019 LIBRARY; T=293.16K
Neutron emission for (n,2n)a

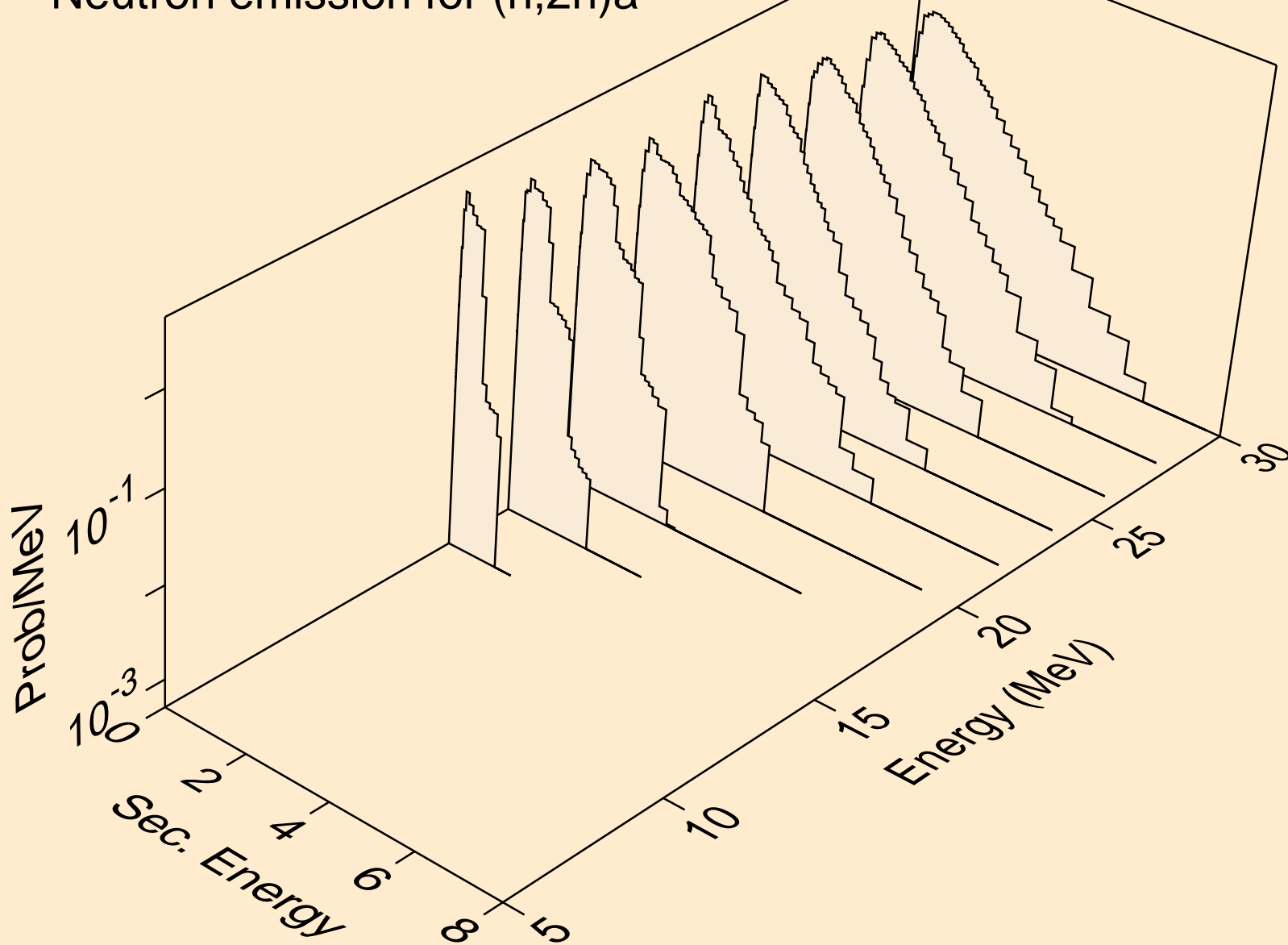

PR140 NEUTRON ACER TENDL-2019 LIBRARY; T=293.16K
Neutron emission for (n,3n)a

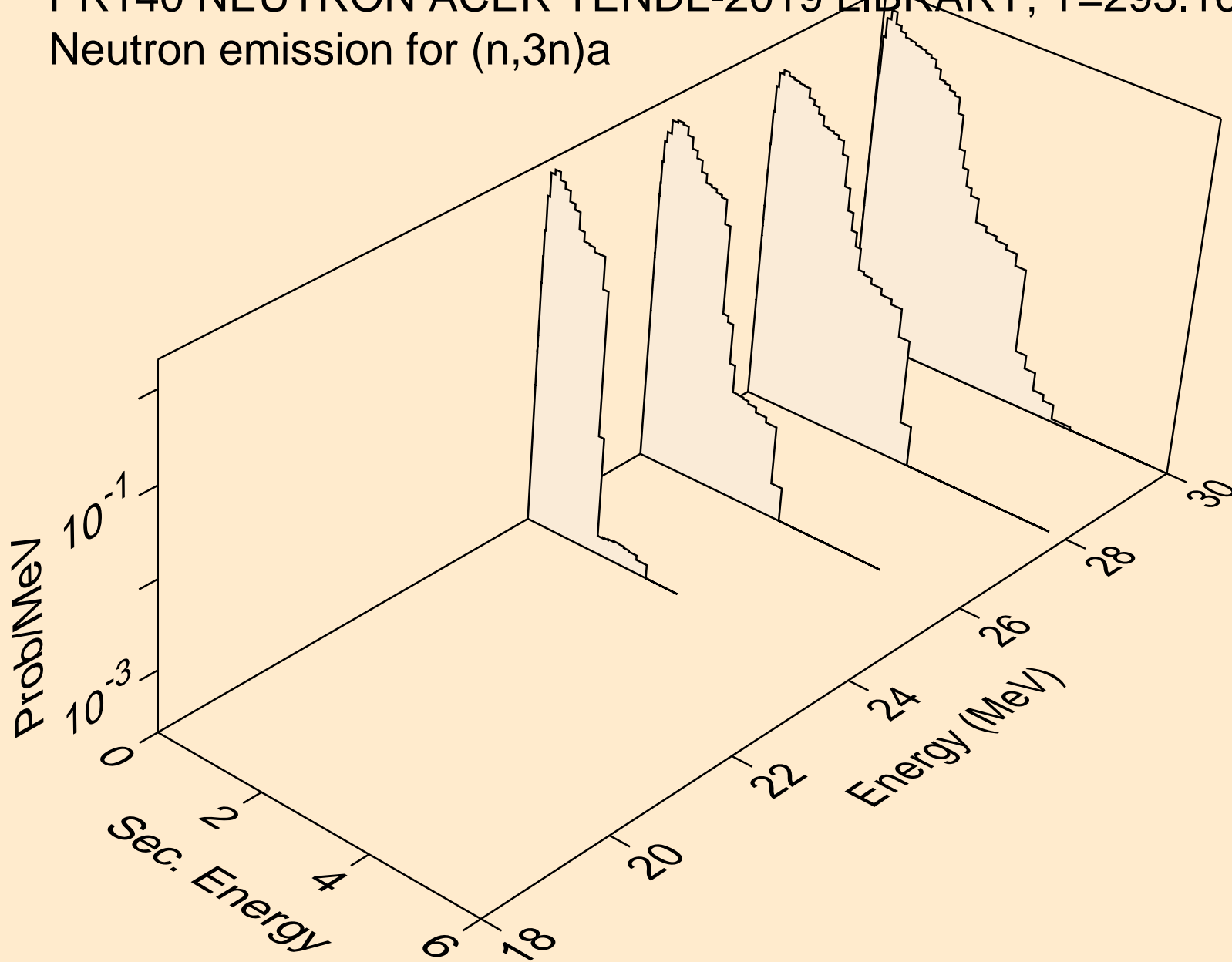

PR140 NEUTRON ACER TENDL-2019 LIBRARY; T=293.16K
Neutron emission for (n,n*)p

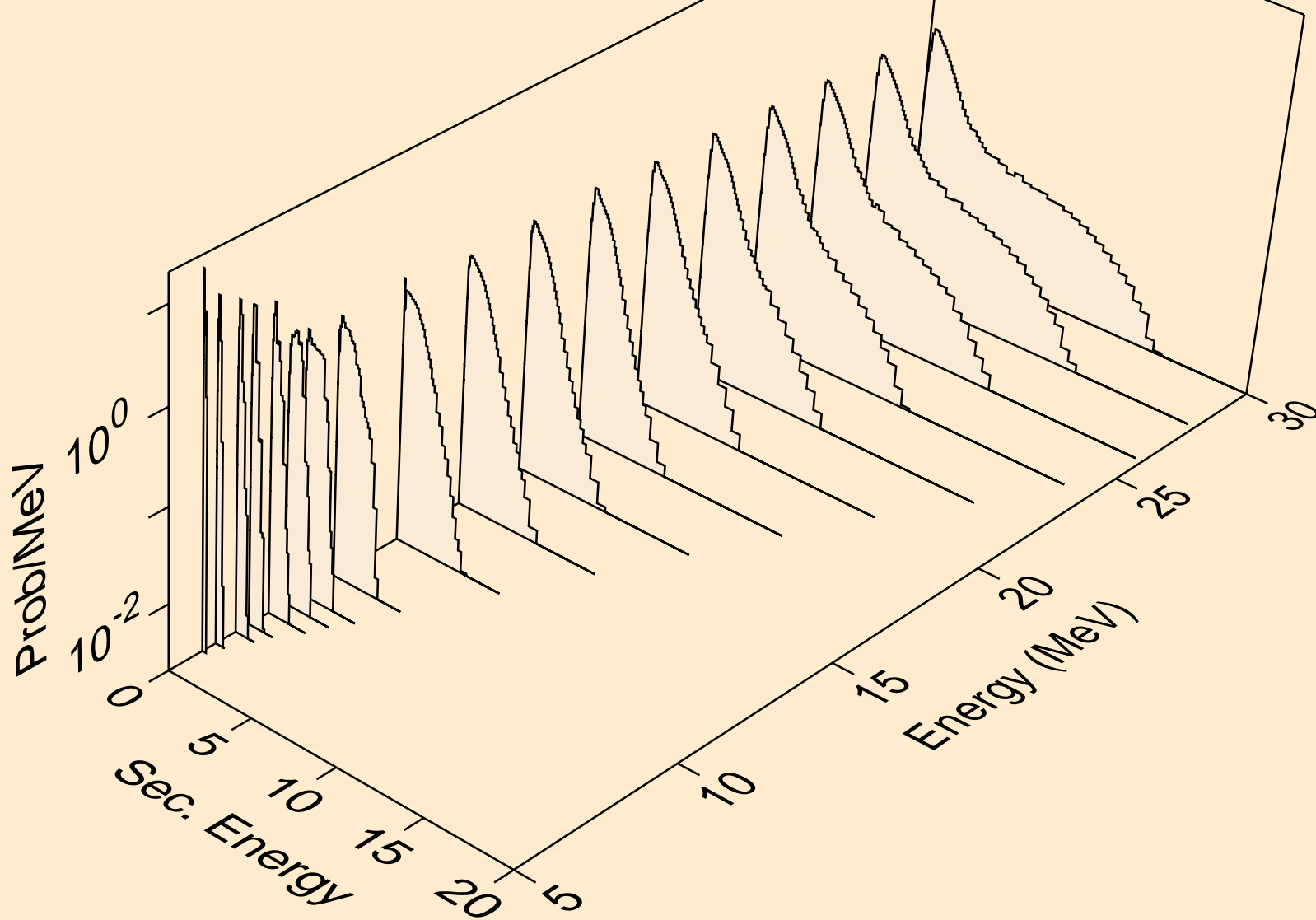

PR140 NEUTRON ACER TENDL-2019 LIBRARY; T=293.16K
Neutron emission for (n,n*)2a

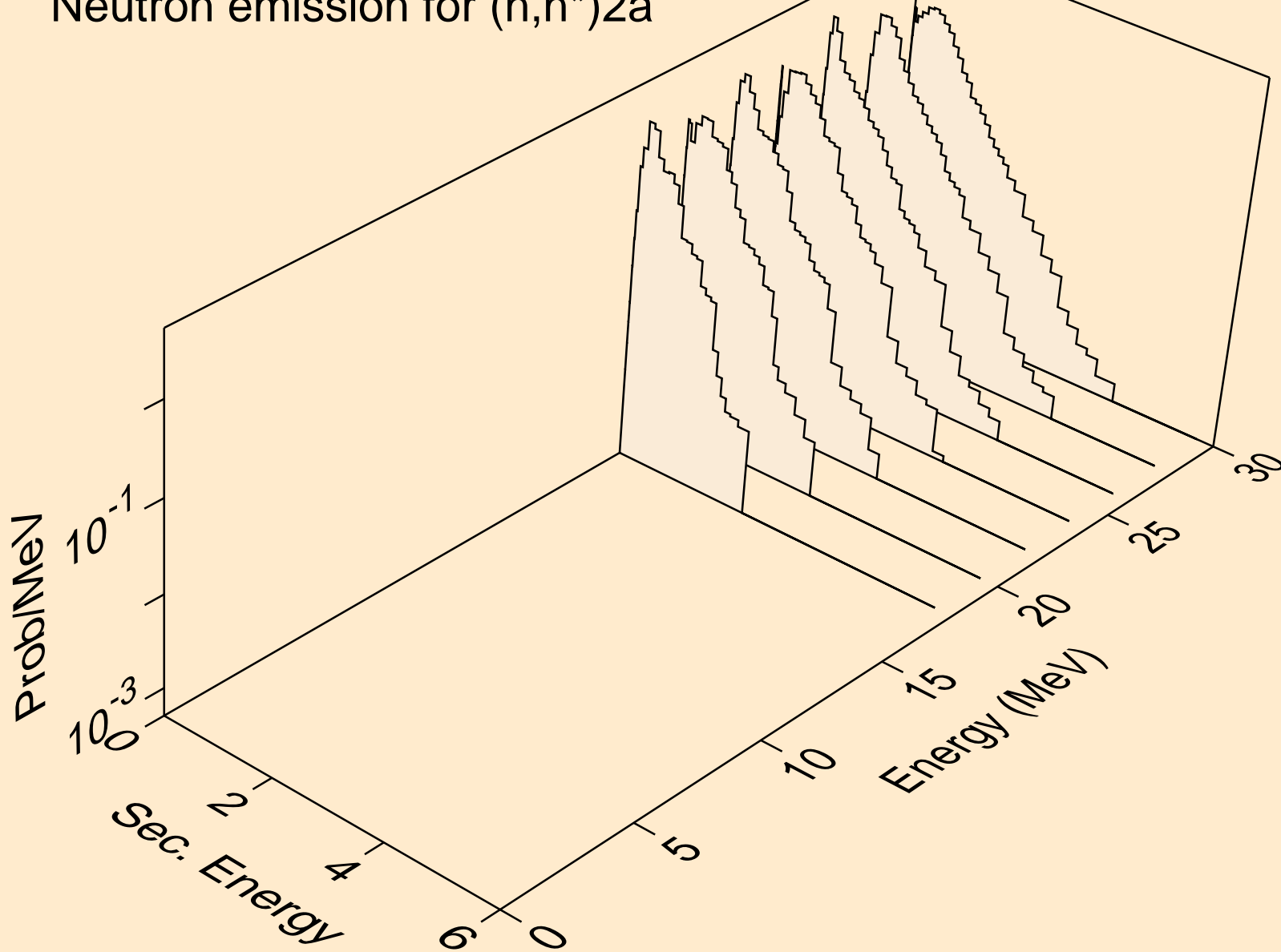

PR140 NEUTRON ACER TENDL-2019 LIBRARY; T=293.16K
Neutron emission for (n,n*)d

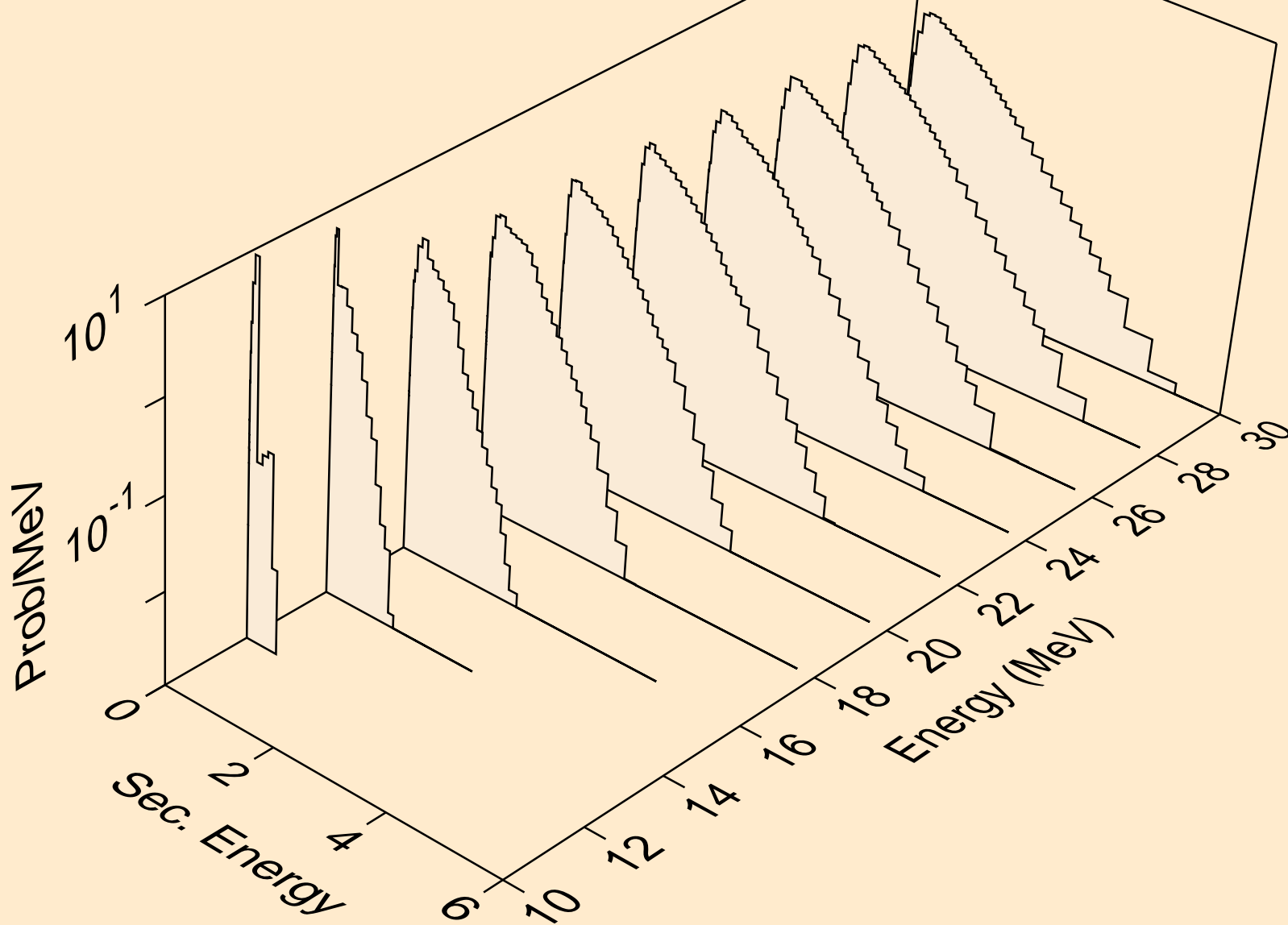

PR140 NEUTRON ACER TENDL-2019 LIBRARY; T=293.16K
Neutron emission for (n,n*)t

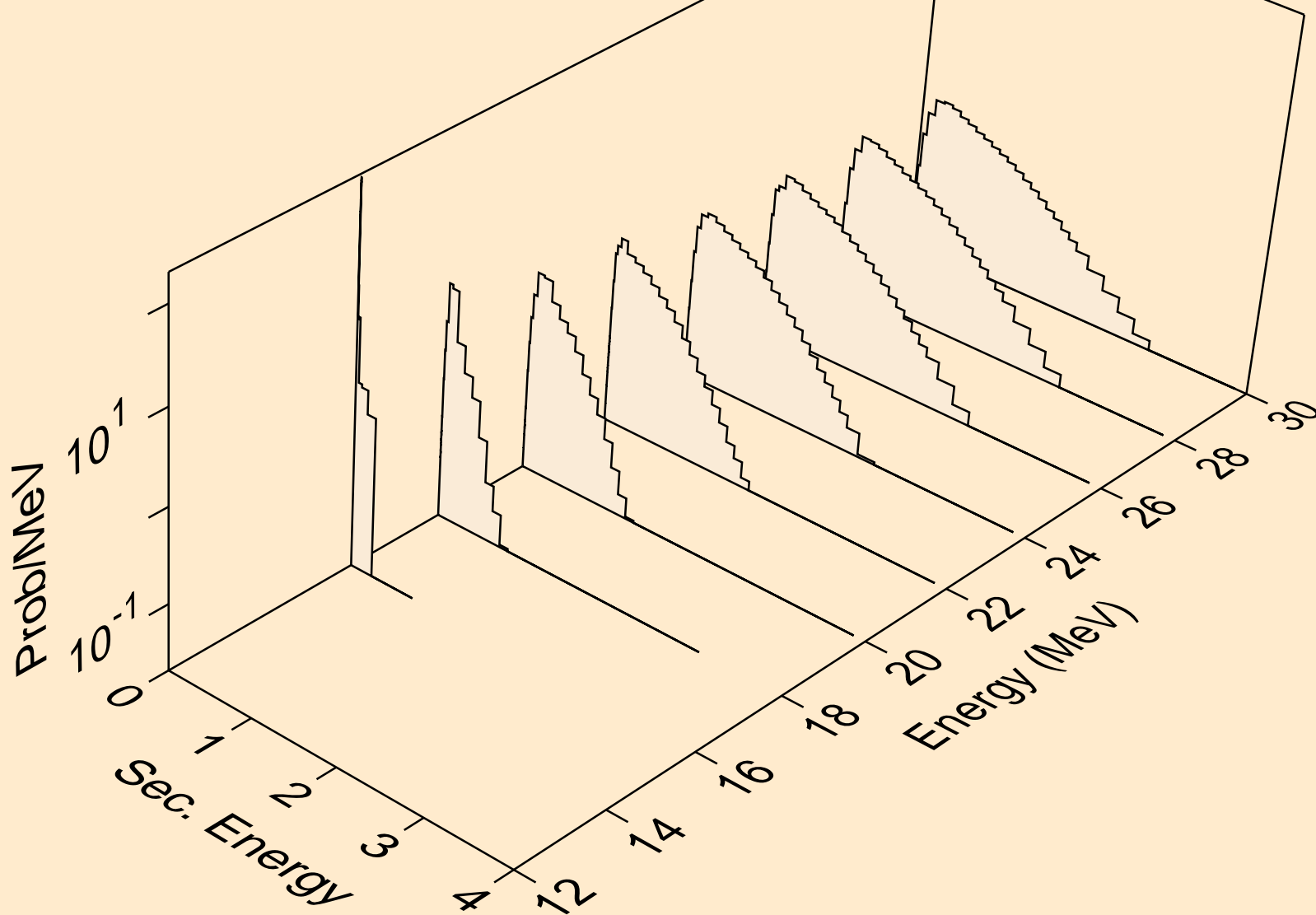

PR140 NEUTRON ACER TENDL-2019 LIBRARY; T=293.16K
Neutron emission for (n,n*)he3

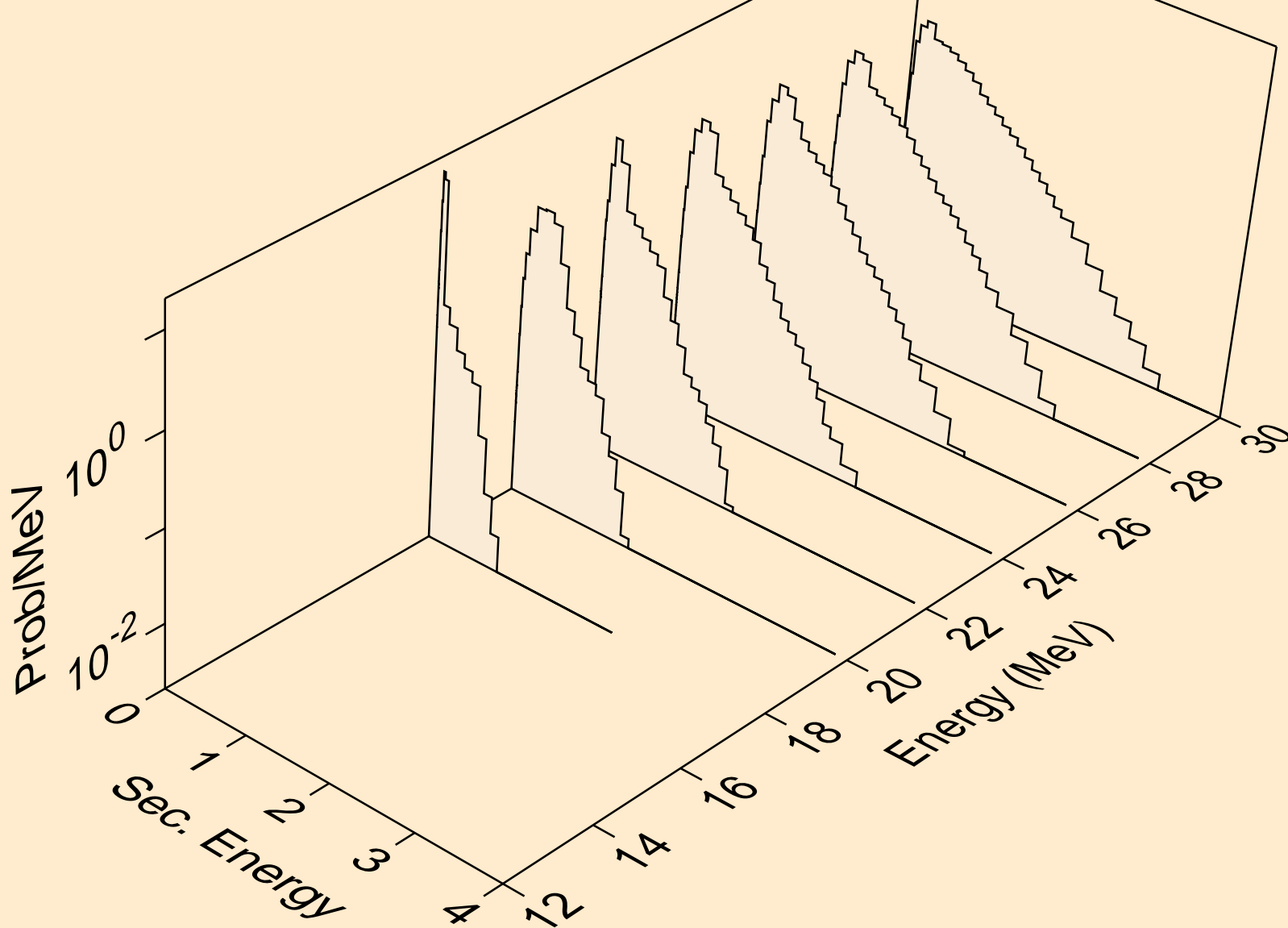

PR140 NEUTRON ACER TENDL-2019 LIBRARY; T=293.16K
Neutron emission for (n,4n)

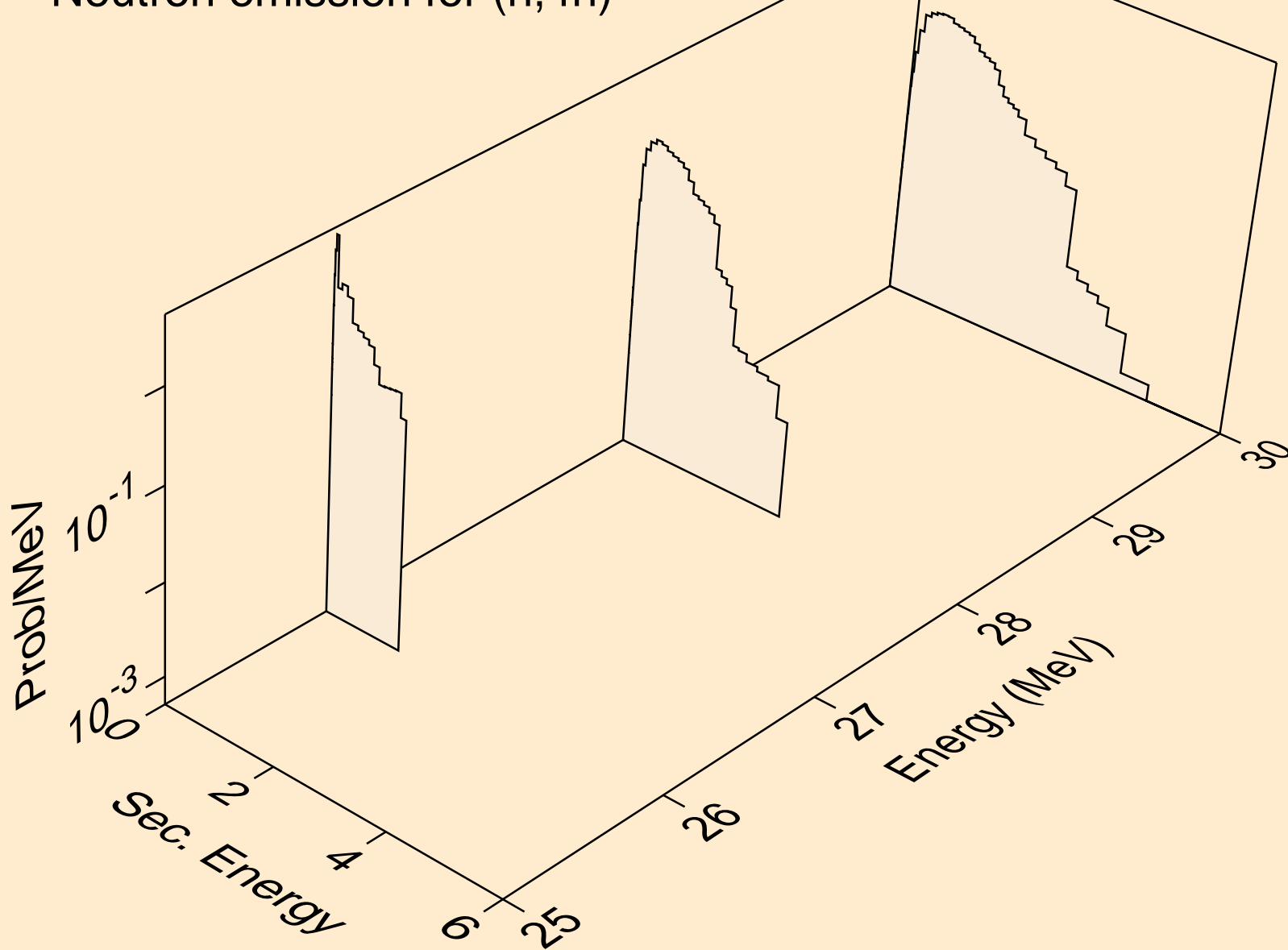

PR140 NEUTRON ACER TENDL-2019 LIBRARY; T=293.16K
Neutron emission for (n,2np)

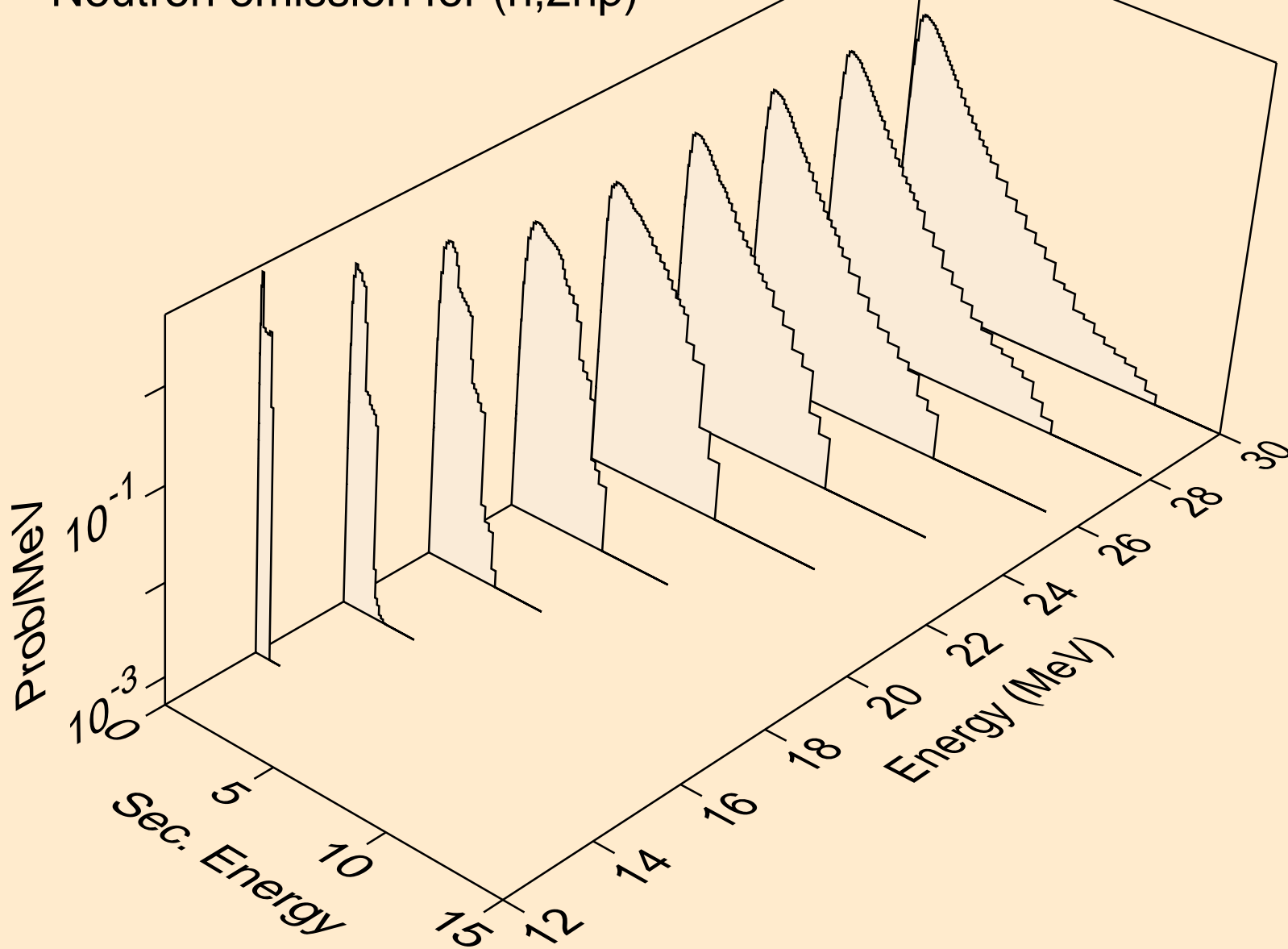

PR140 NEUTRON ACER TENDL-2019 LIBRARY; T=293.16K
Neutron emission for (n,3np)

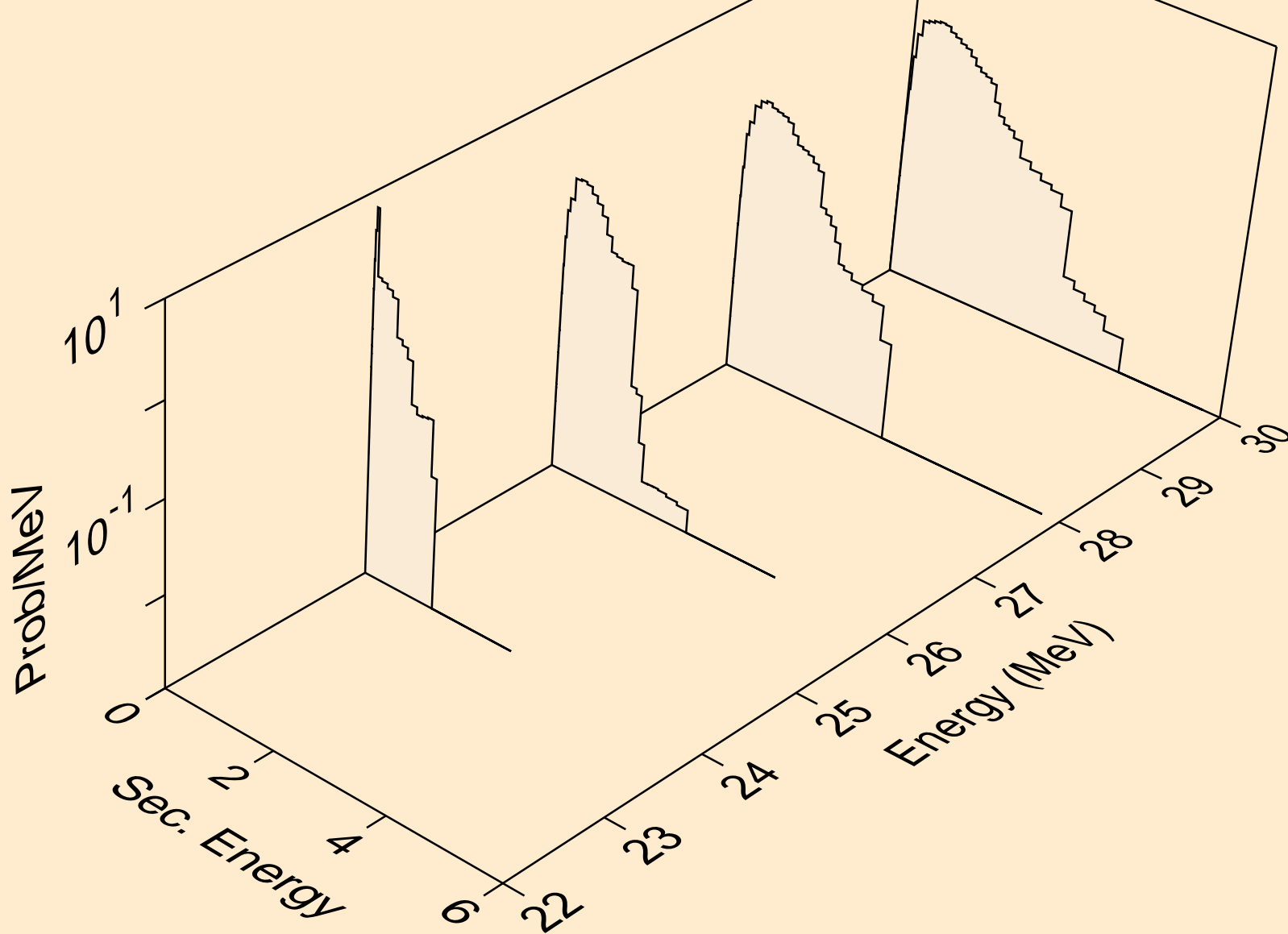

PR140 NEUTRON ACER TENDL-2019 LIBRARY; T=293.16K
Neutron emission for (n,2np)

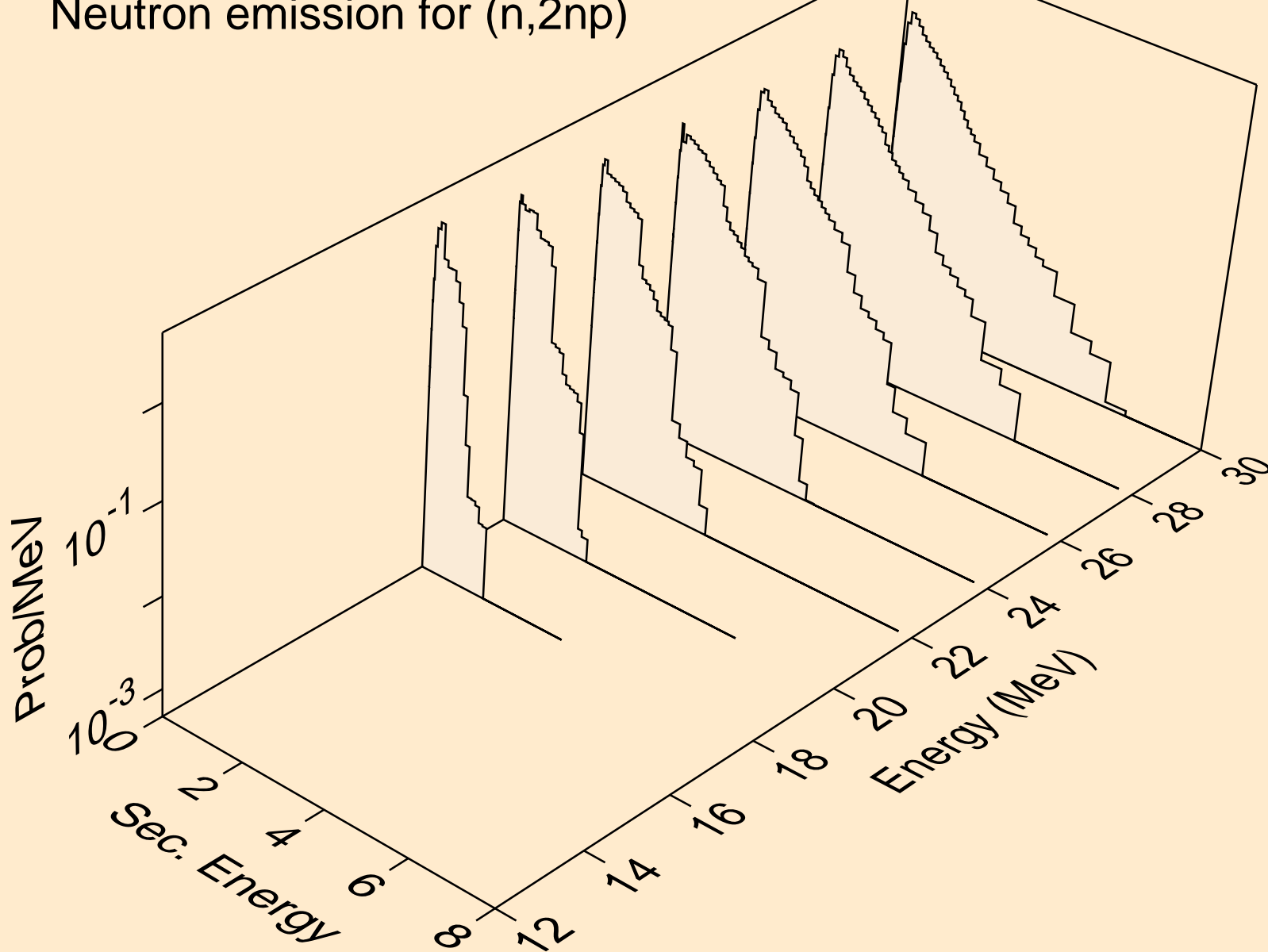

PR140 NEUTRON ACER TENDL-2019 LIBRARY; T=293.16K
Neutron emission for (n,npa)

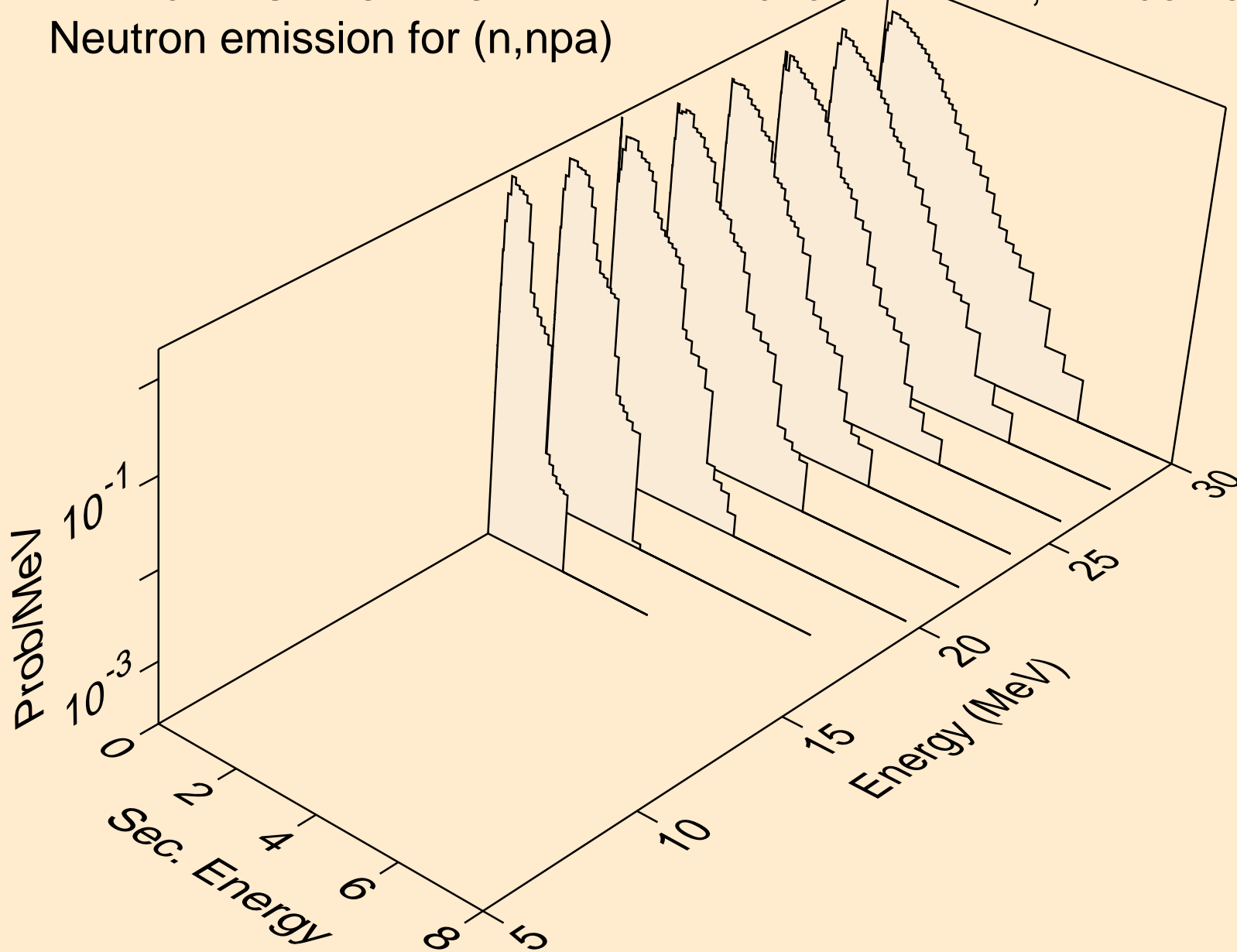

PR140 NEUTRON ACER TENDL-2019 LIBRARY; T=293.16K
Neutron emission for (n,n*c)

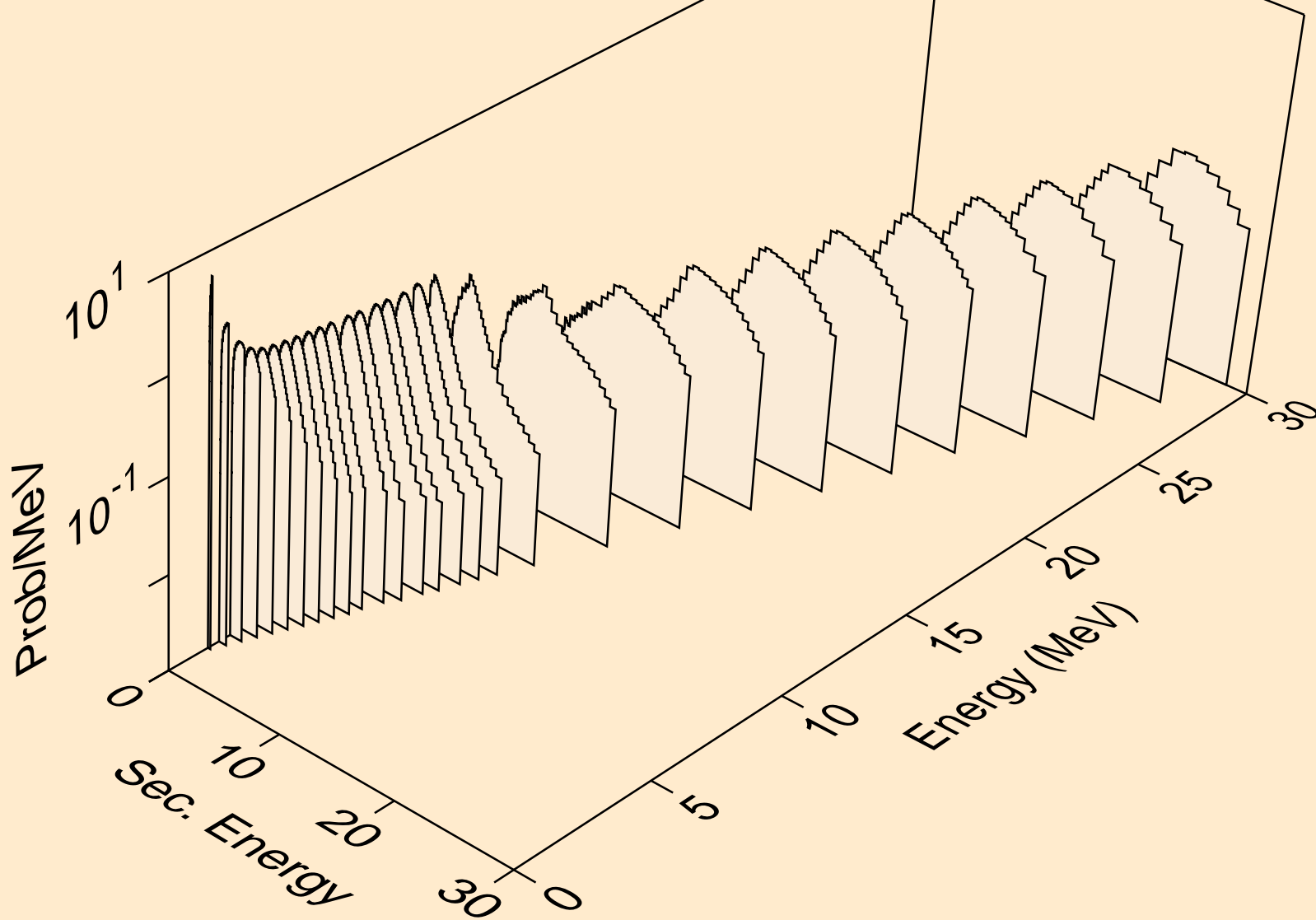

PR140 NEUTRON ACER TENDL-2019 LIBRARY; T=293.16K
Photon emission for (n,x)

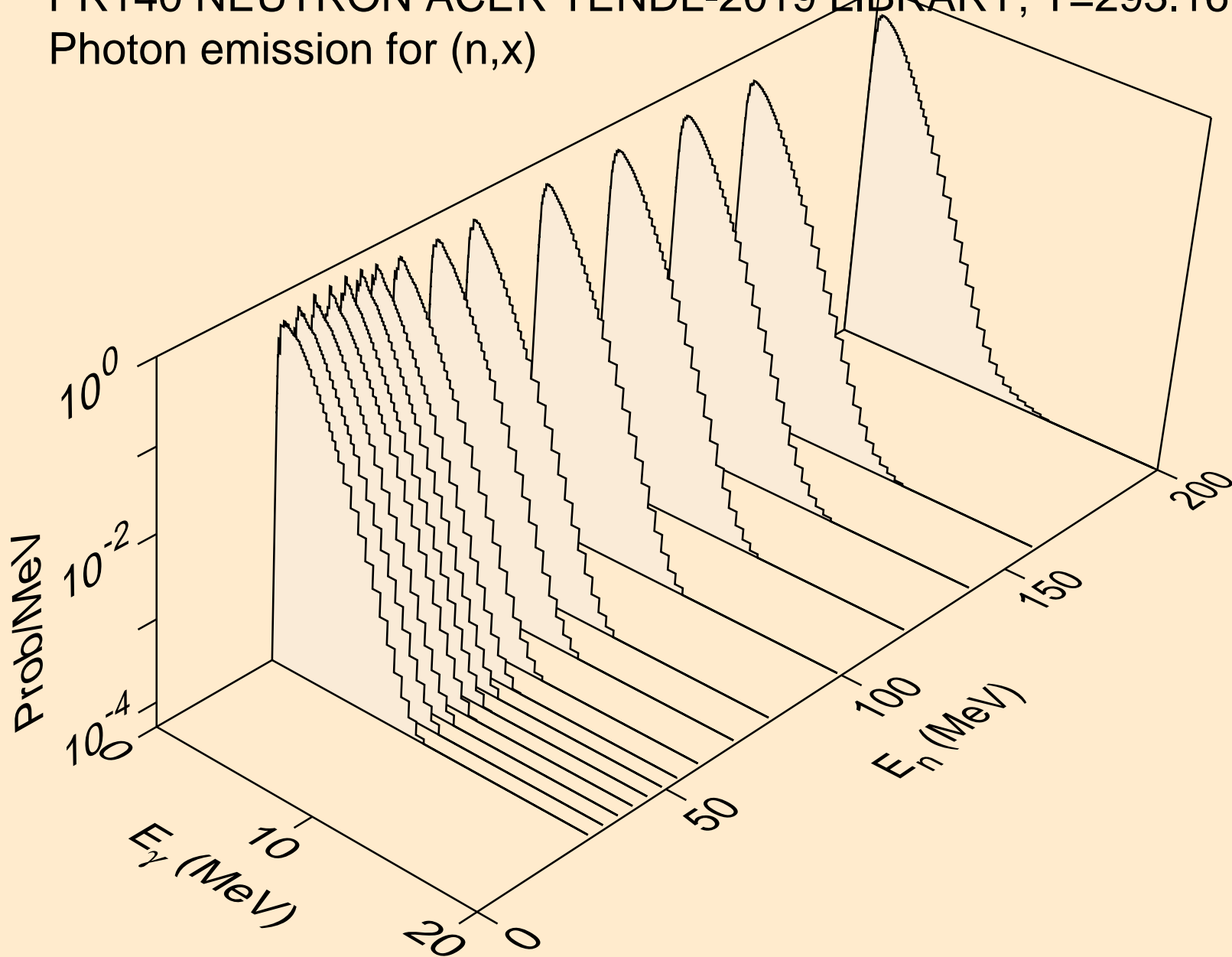

PR140 NEUTRON ACER TENDL-2019 LIBRARY; T=293.16K
Photon emission for (n,2nd)

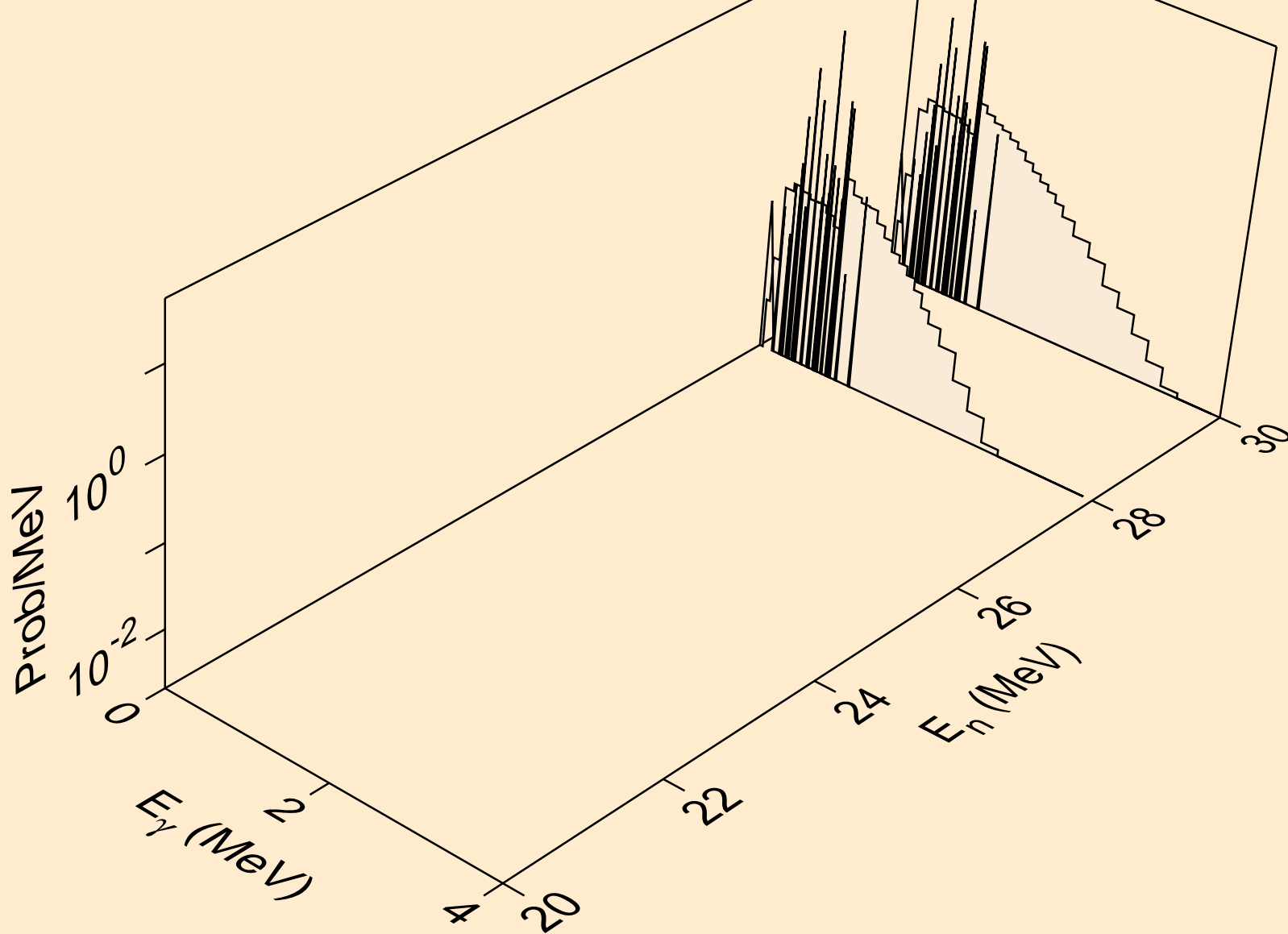

PR140 NEUTRON ACER TENDL-2019 LIBRARY; T=293.16K
Photon emission for (n,2n)

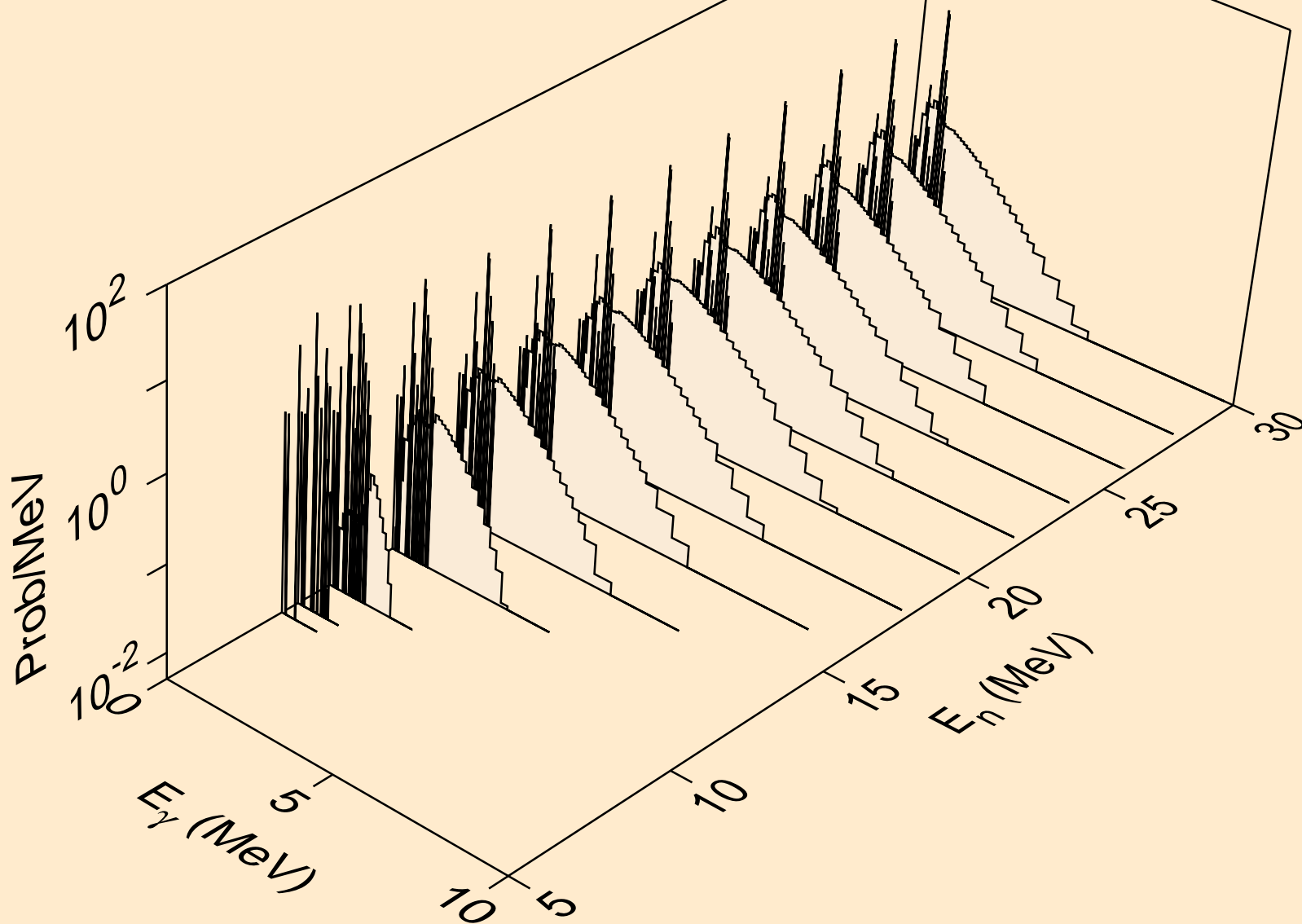

PR140 NEUTRON ACER TENDL-2019 LIBRARY; T=293.16K
Photon emission for (n,3n)

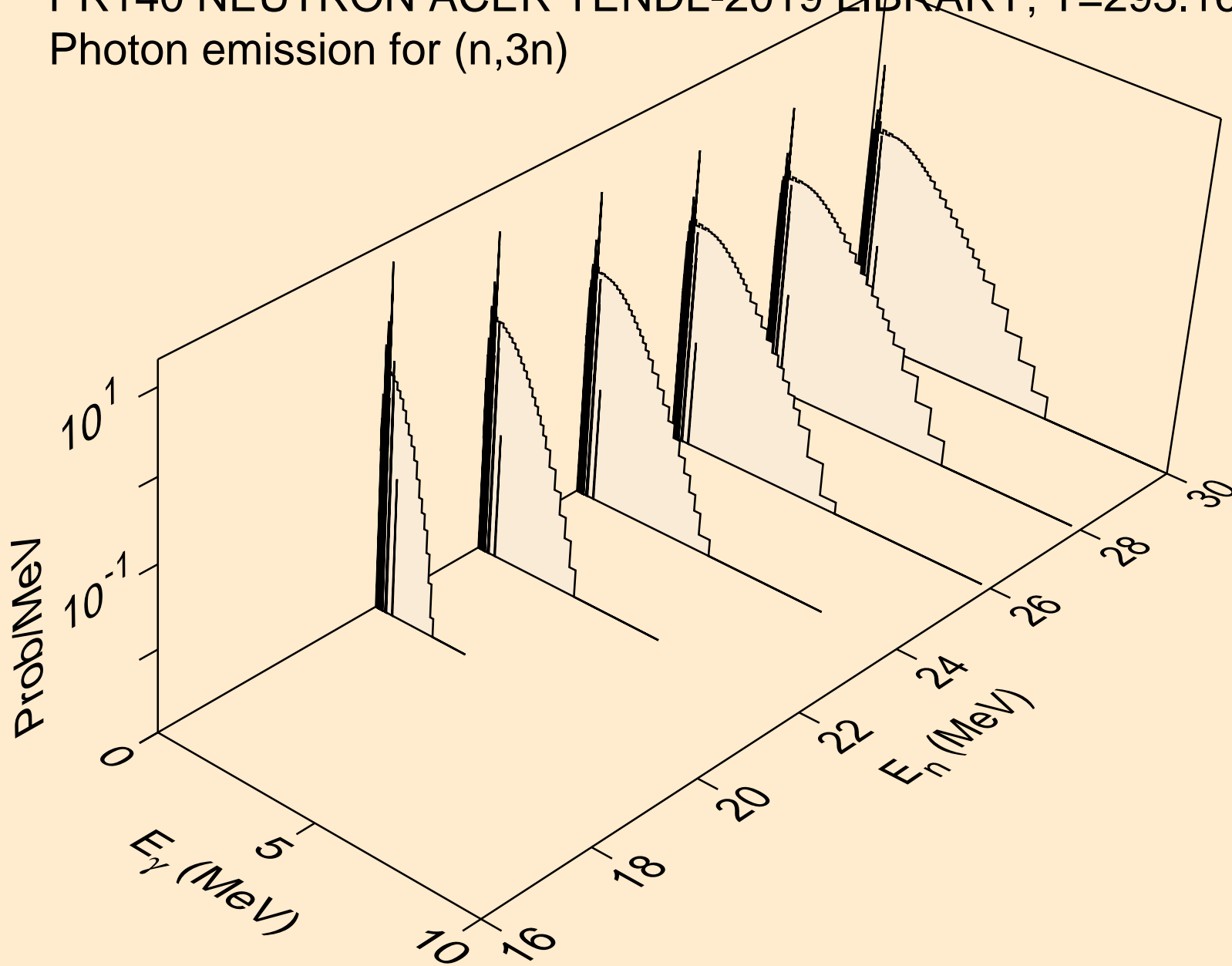

PR140 NEUTRON ACER TENDL-2019 LIBRARY; T=293.16K
Photon emission for (n,n*)a

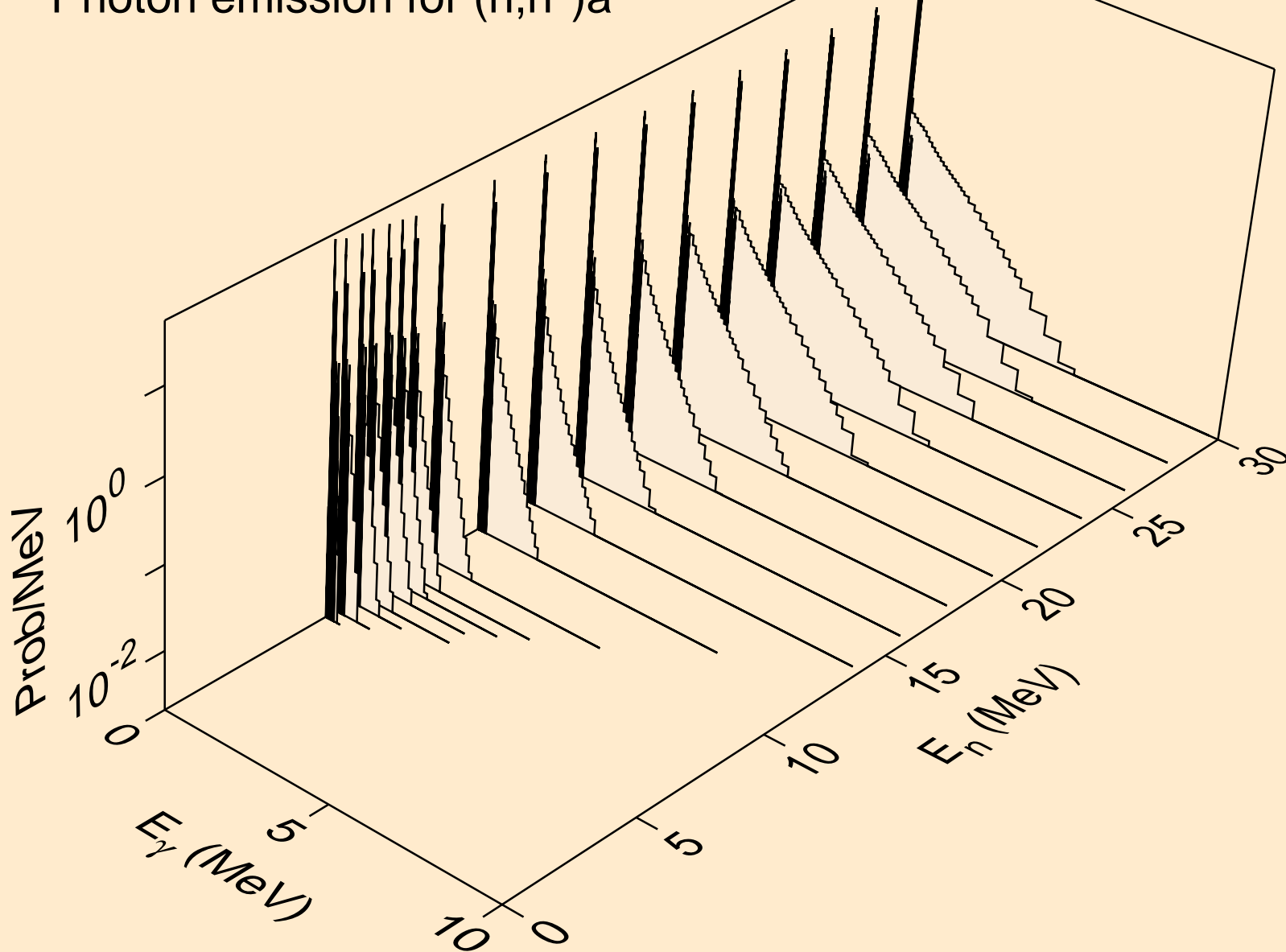

PR140 NEUTRON ACER TENDL-2019 LIBRARY; T=293.16K
Photon emission for (n,2n)a

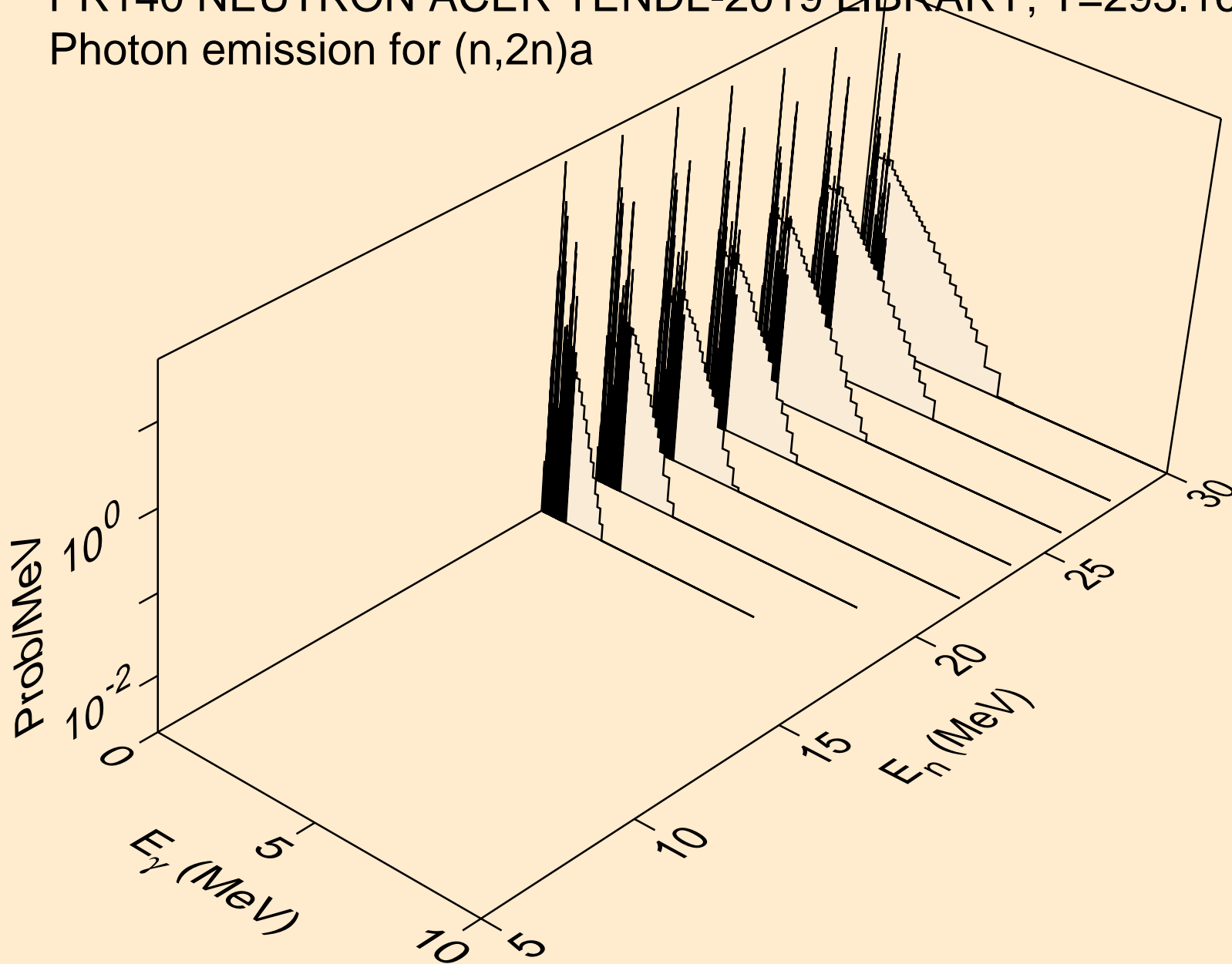

PR140 NEUTRON ACER TENDL-2019 LIBRARY; T=293.16K
Photon emission for (n,3n)a

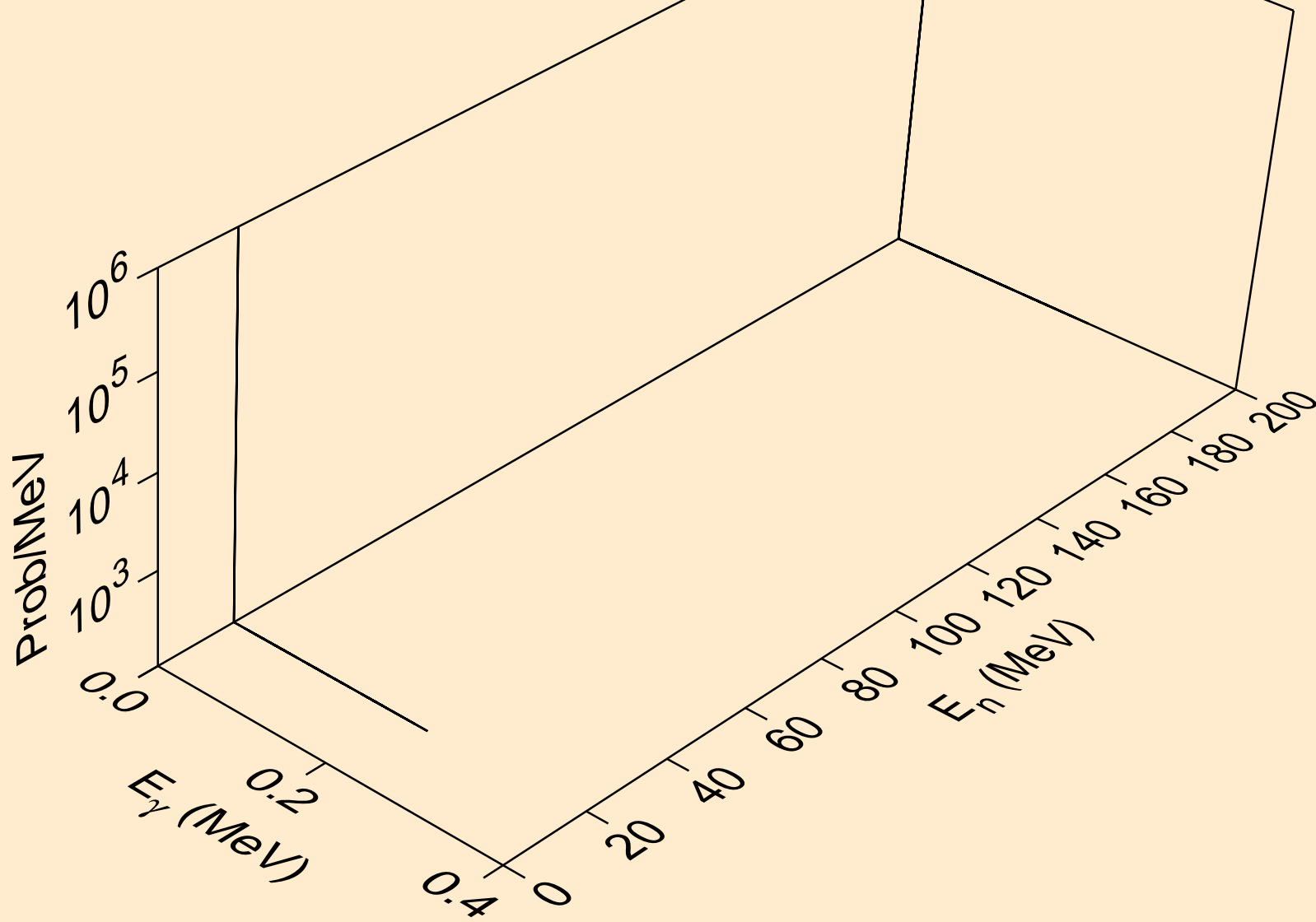

PR140 NEUTRON ACER TENDL-2019 LIBRARY; T=293.16K
Photon emission for (n,n*)p

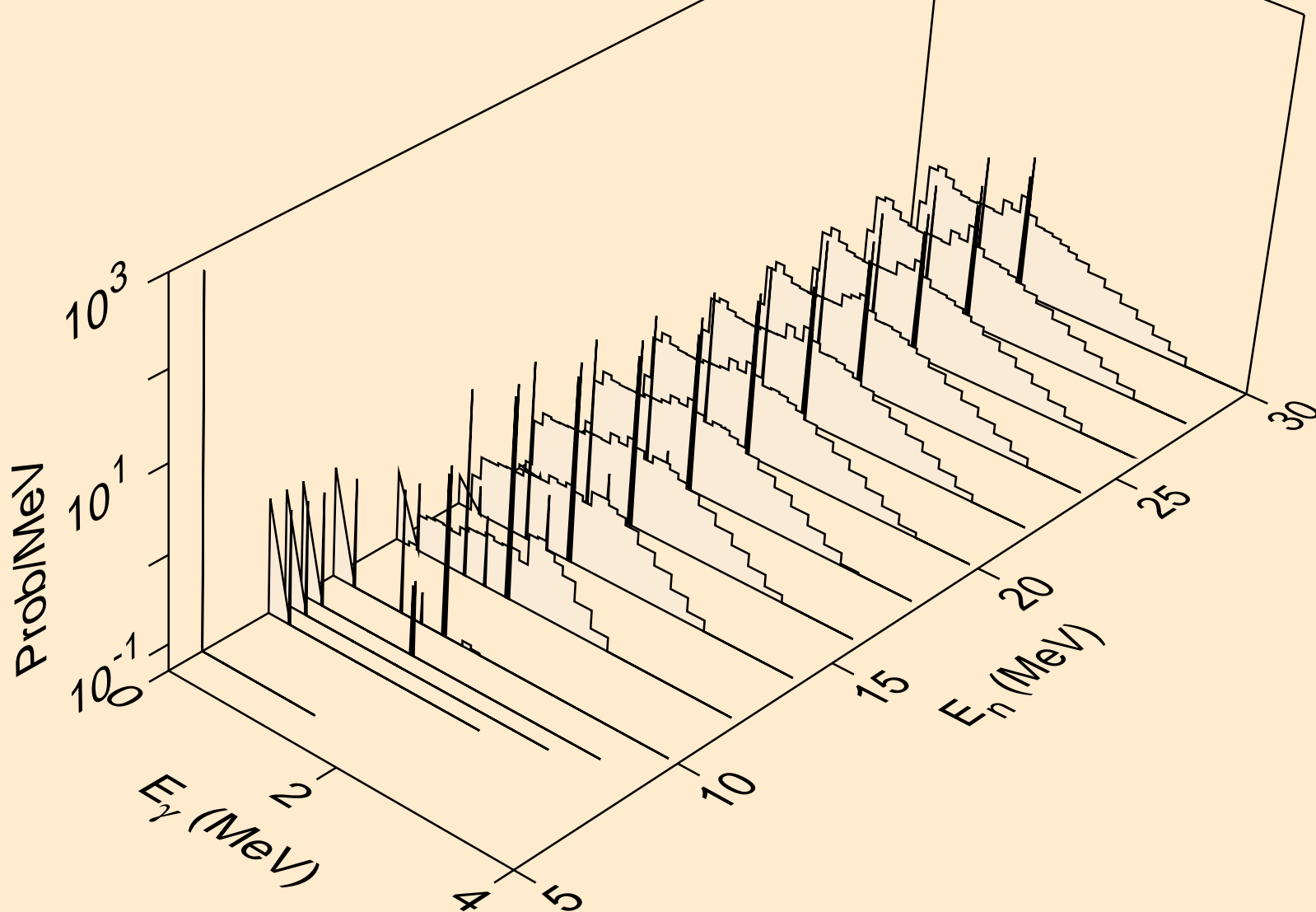

PR140 NEUTRON ACER TENDL-2019 LIBRARY; T=293.16K
Photon emission for (n,n*)2a

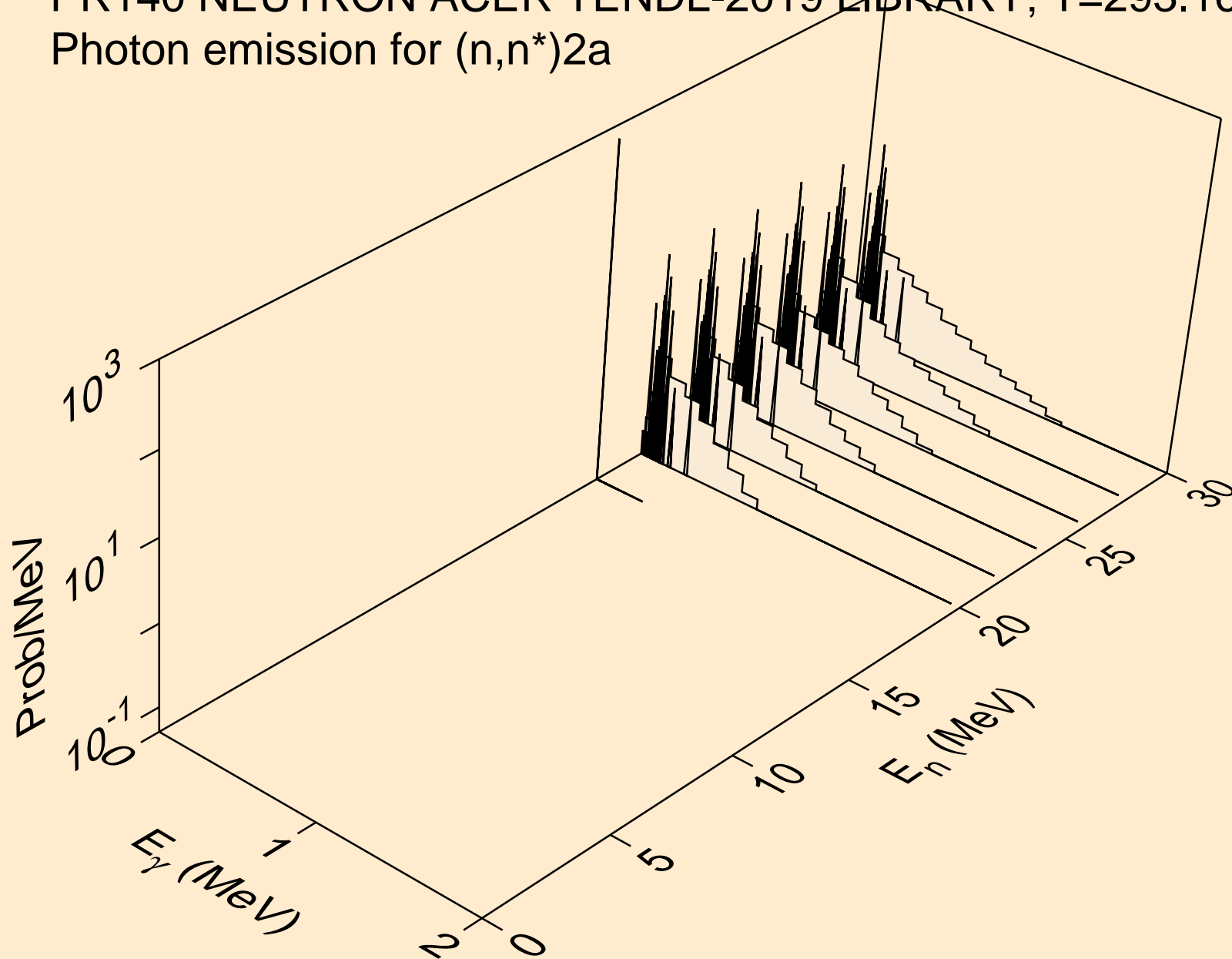

PR140 NEUTRON ACER TENDL-2019 LIBRARY; T=293.16K
Photon emission for (n,n*)d

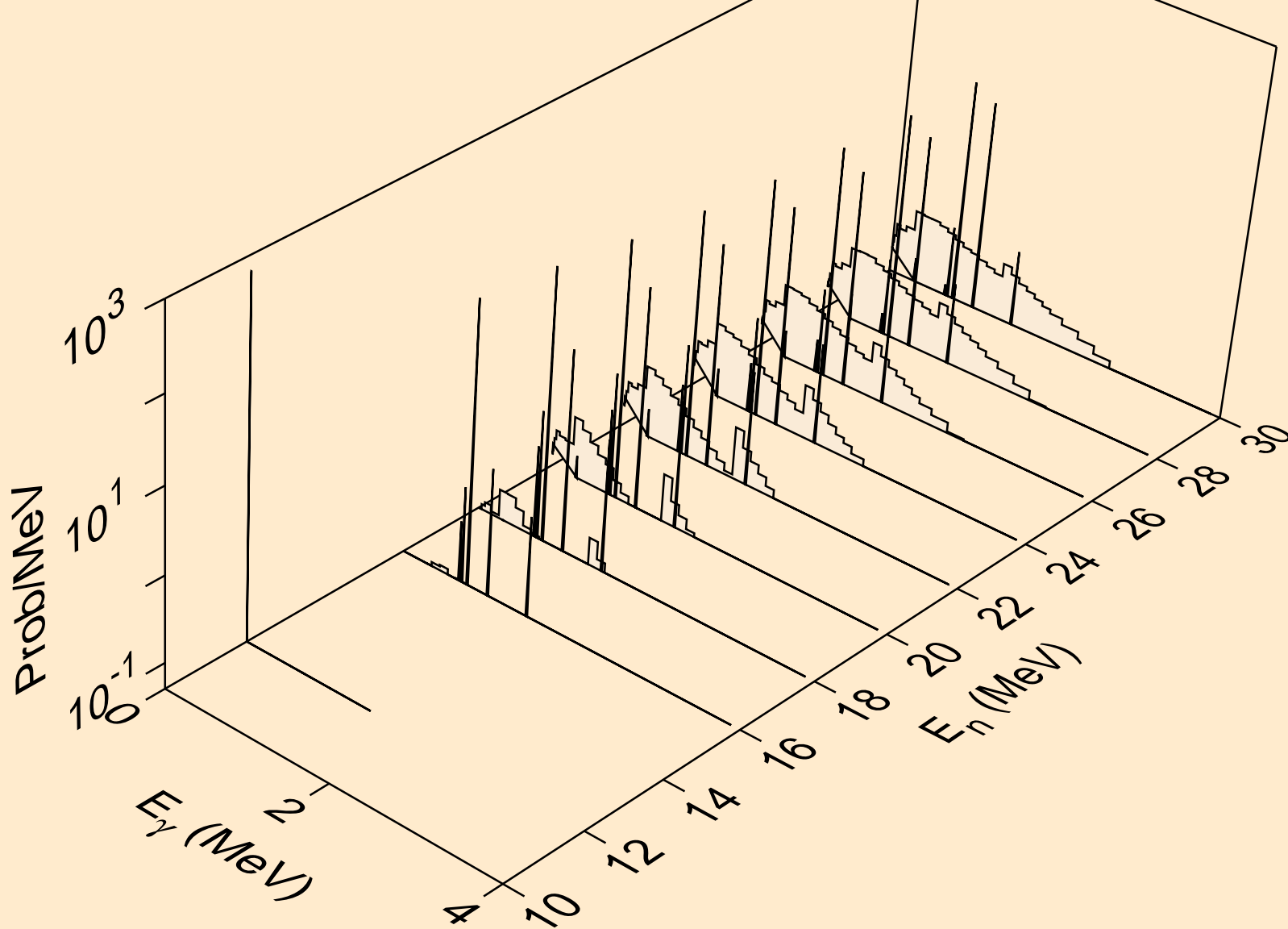

PR140 NEUTRON ACER TENDL-2019 LIBRARY; T=293.16K
Photon emission for (n,n*)t

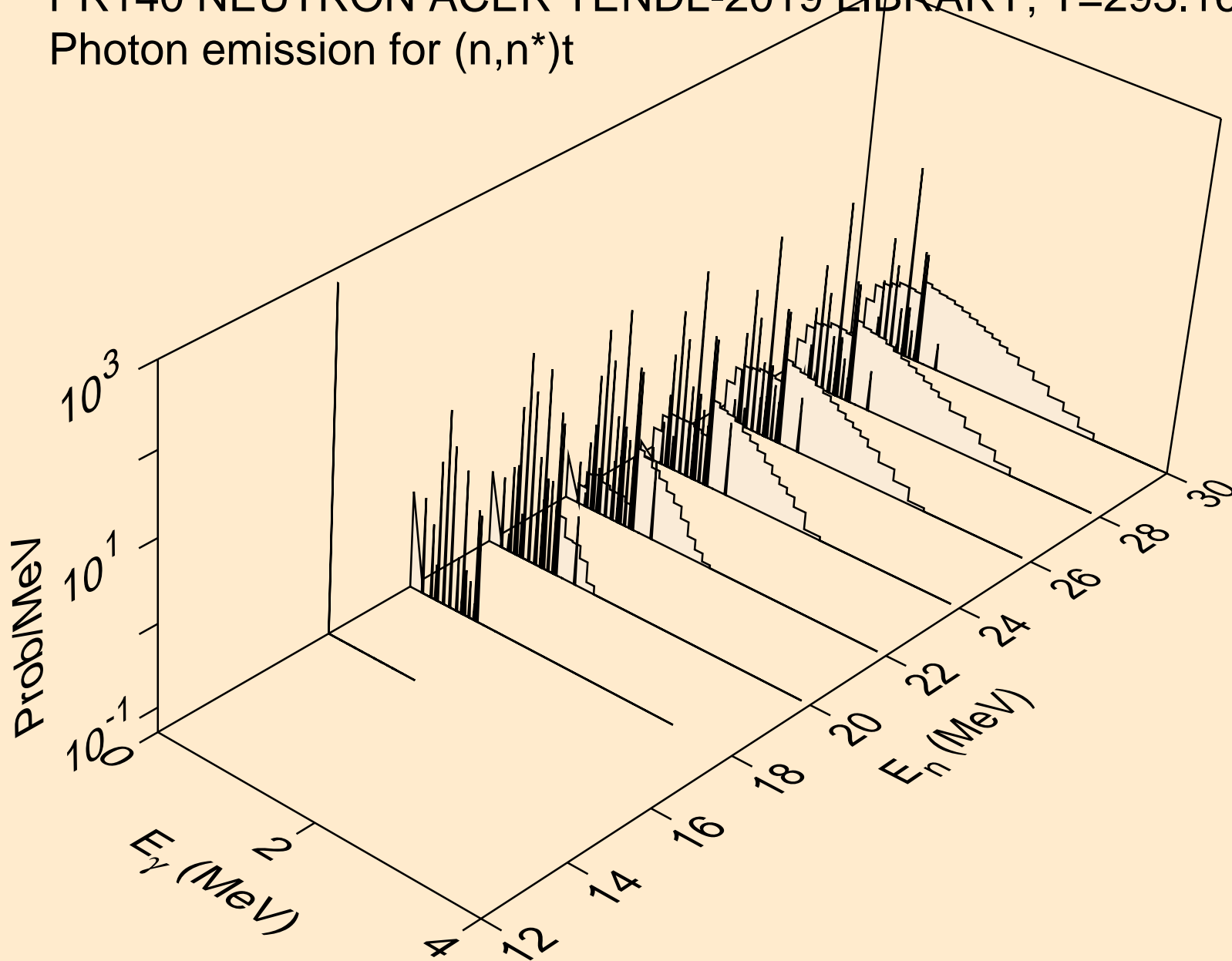

PR140 NEUTRON ACER TENDL-2019 LIBRARY; T=293.16K
Photon emission for (n,n*)he3

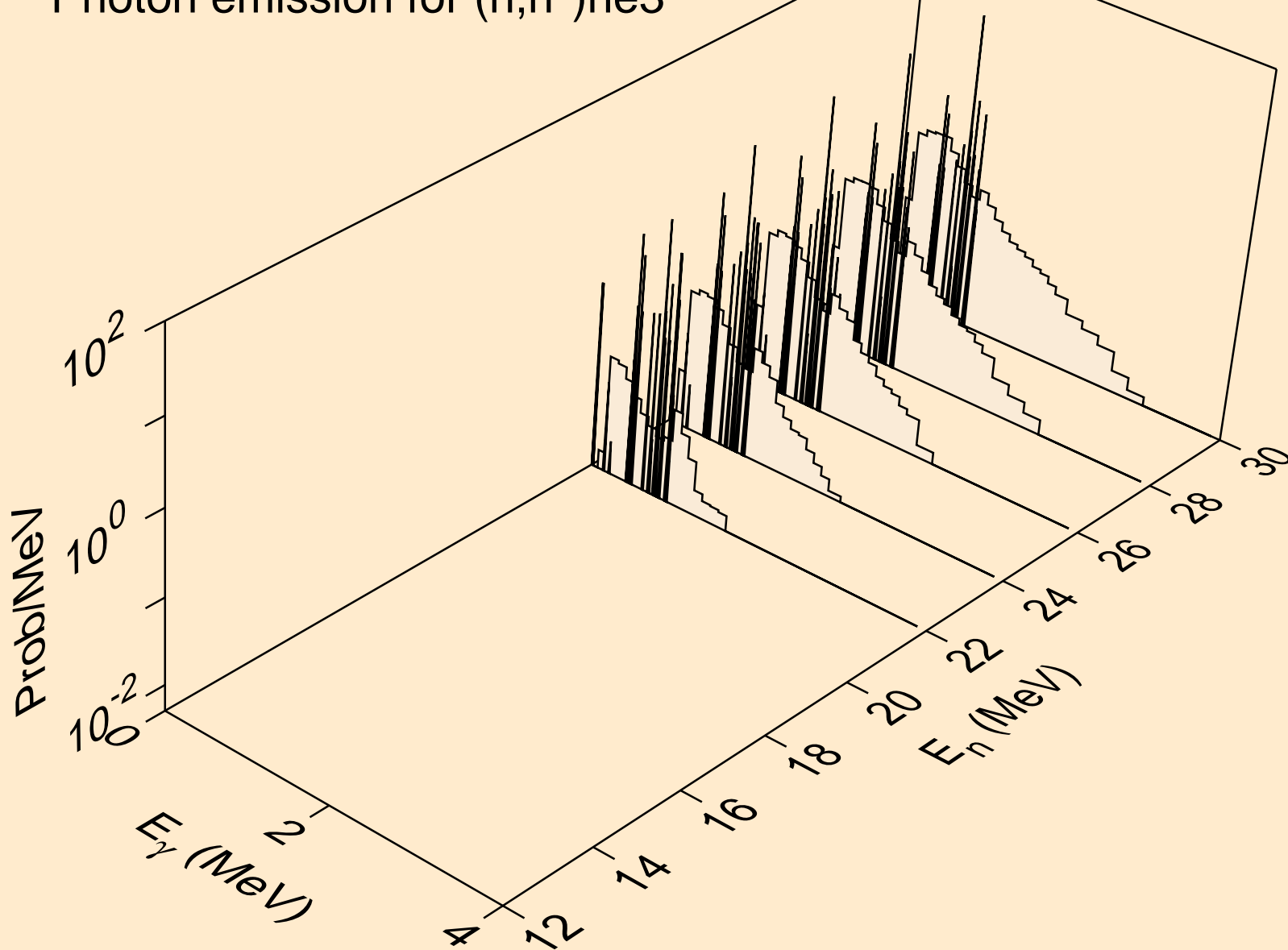

PR140 NEUTRON ACER TENDL-2019 LIBRARY; T=293.16K
Photon emission for (n,4n)

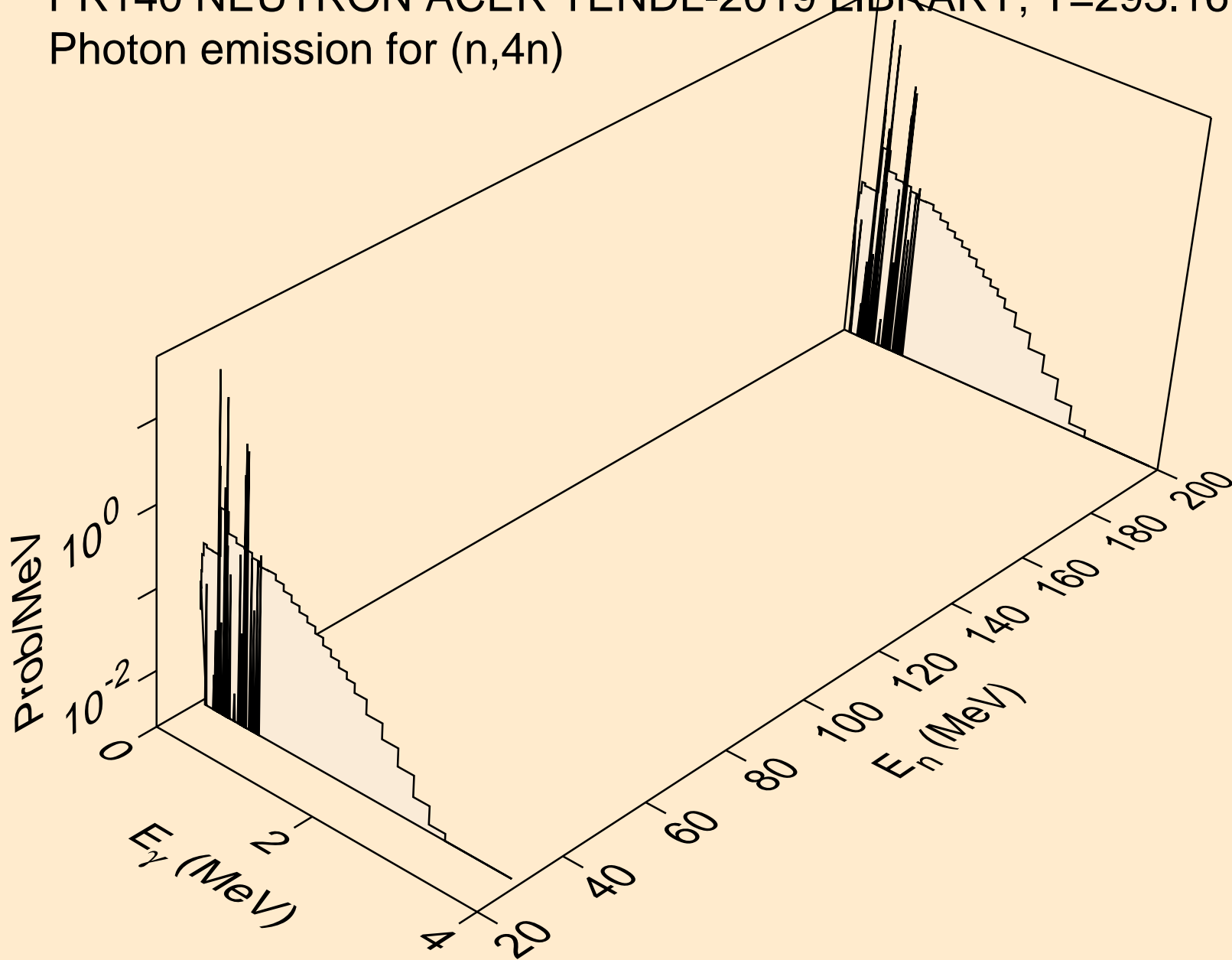

PR140 NEUTRON ACER TENDL-2019 LIBRARY; T=293.16K
Photon emission for (n,2np)

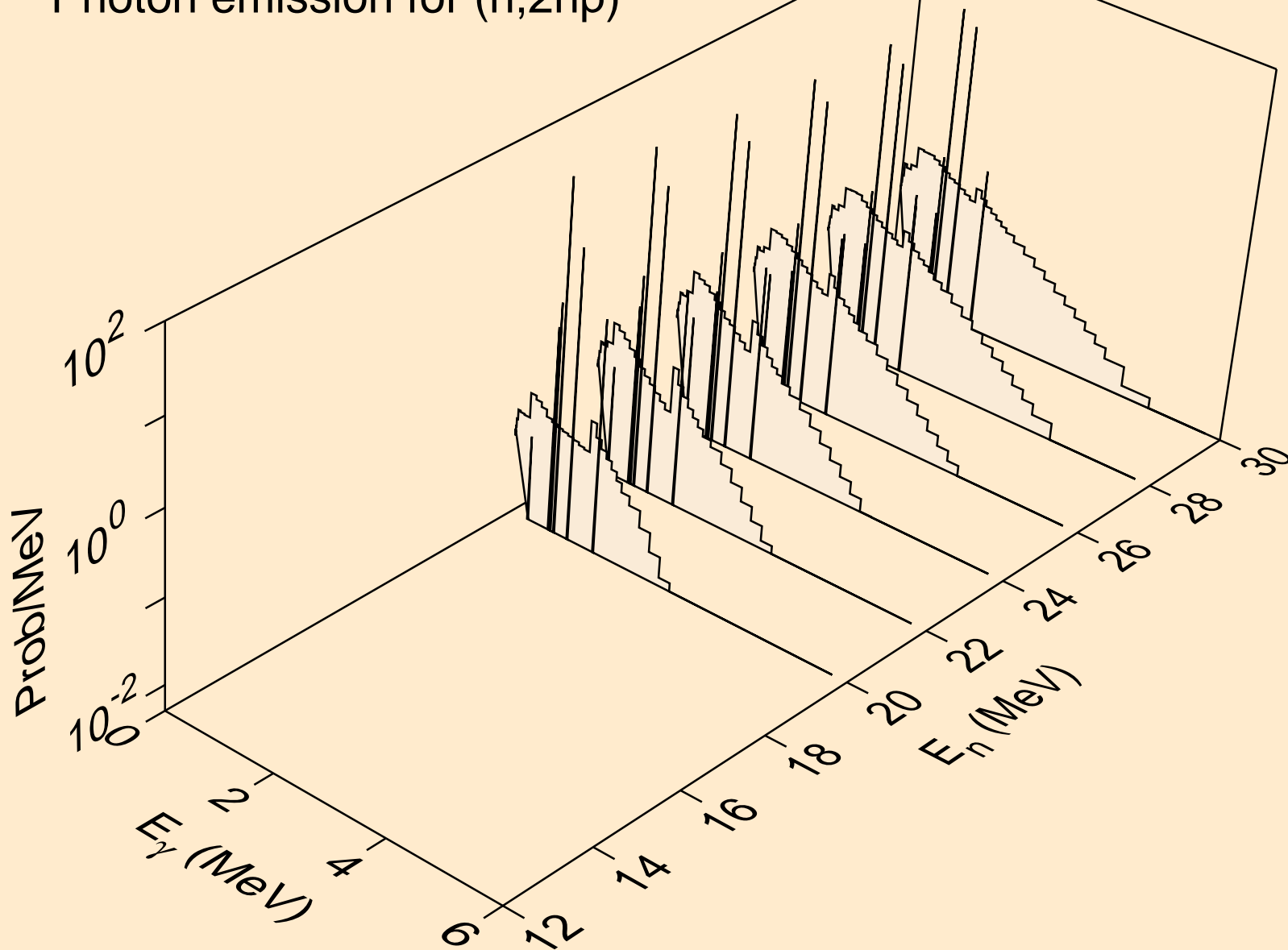

PR140 NEUTRON ACER TENDL-2019 LIBRARY; T=293.16K
Photon emission for (n,3np)

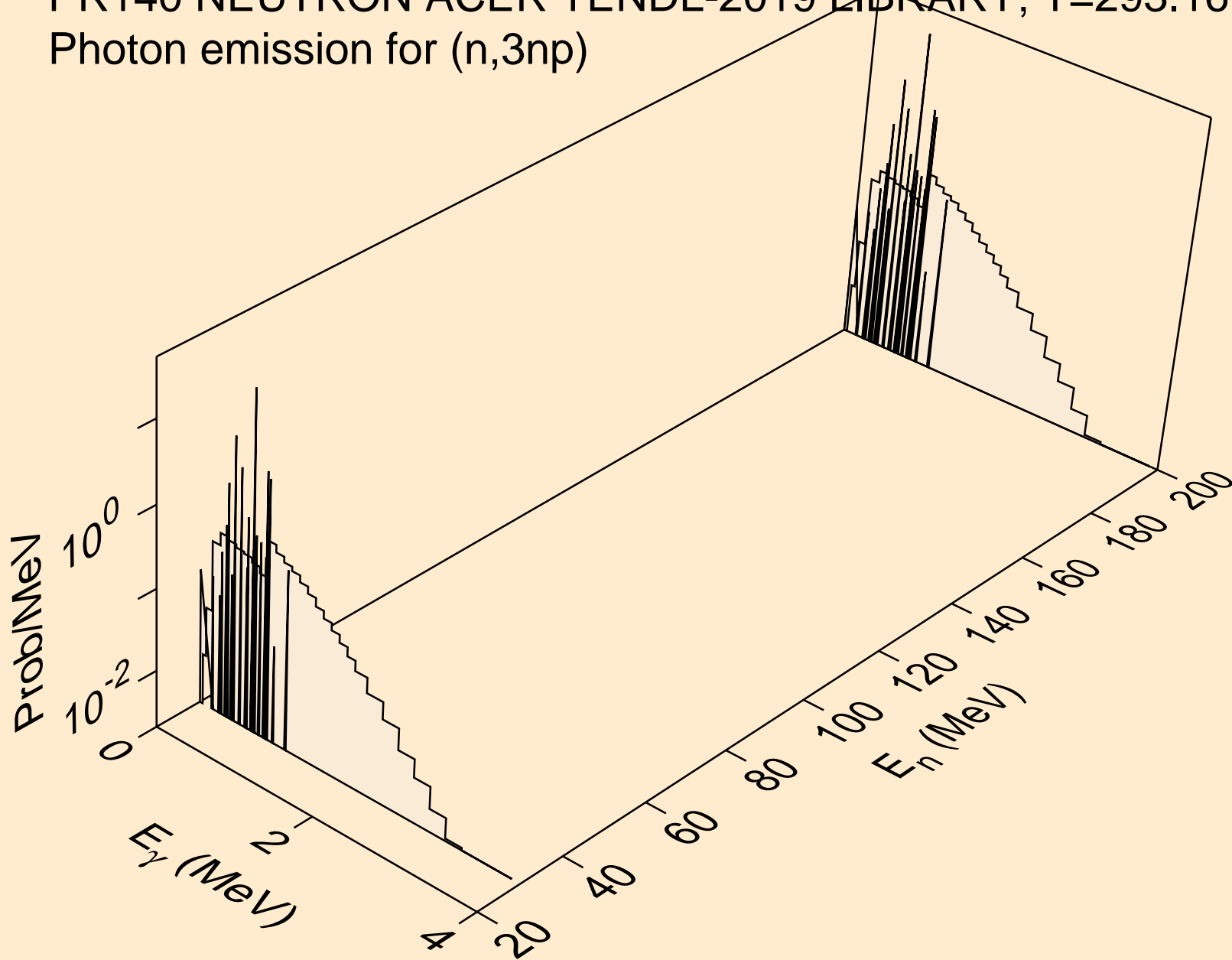

PR140 NEUTRON ACER TENDL-2019 LIBRARY; T=293.16K
Photon emission for (n,2np)

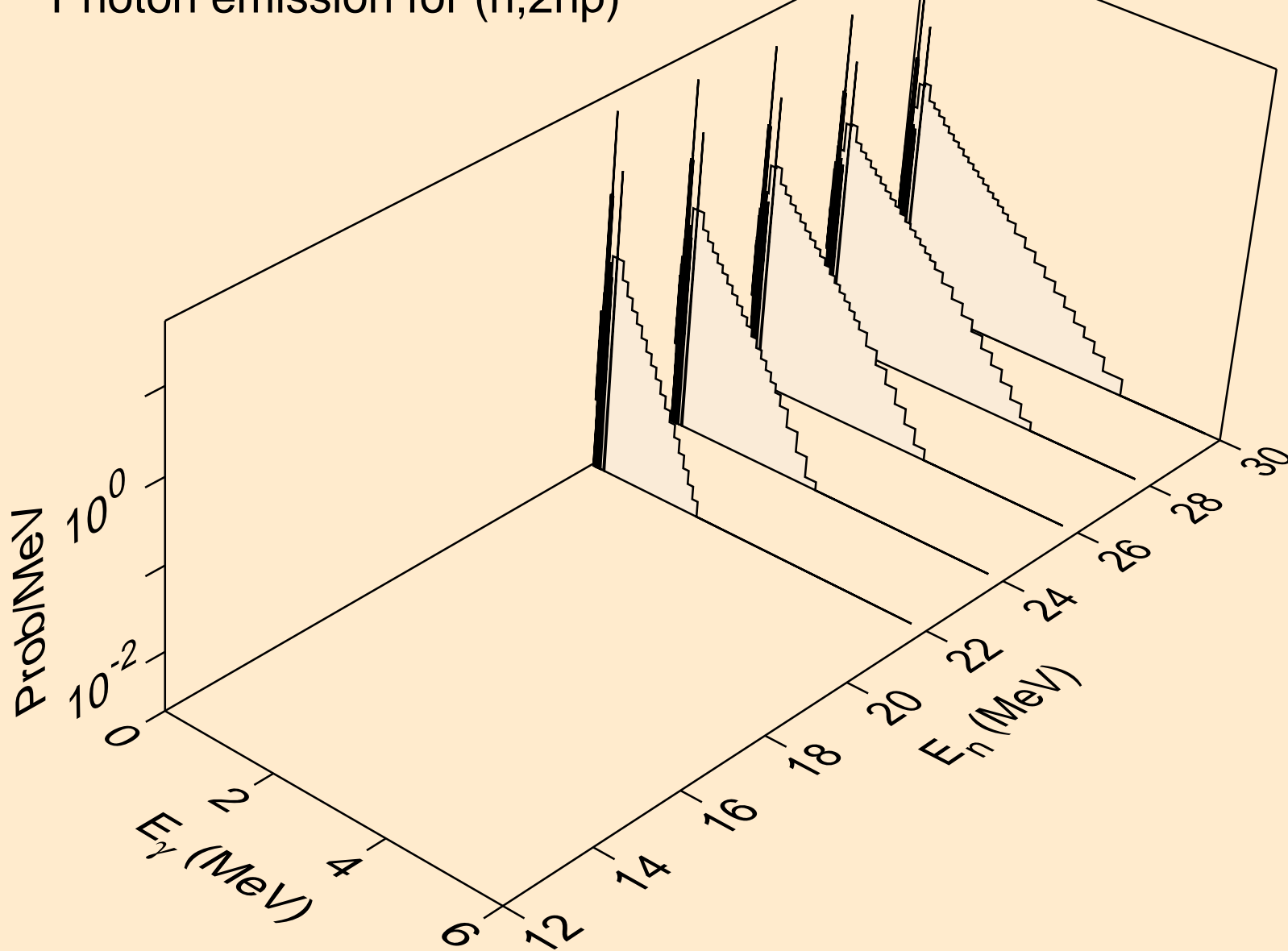

PR140 NEUTRON ACER TENDL-2019 LIBRARY; T=293.16K
Photon emission for (n,npa)

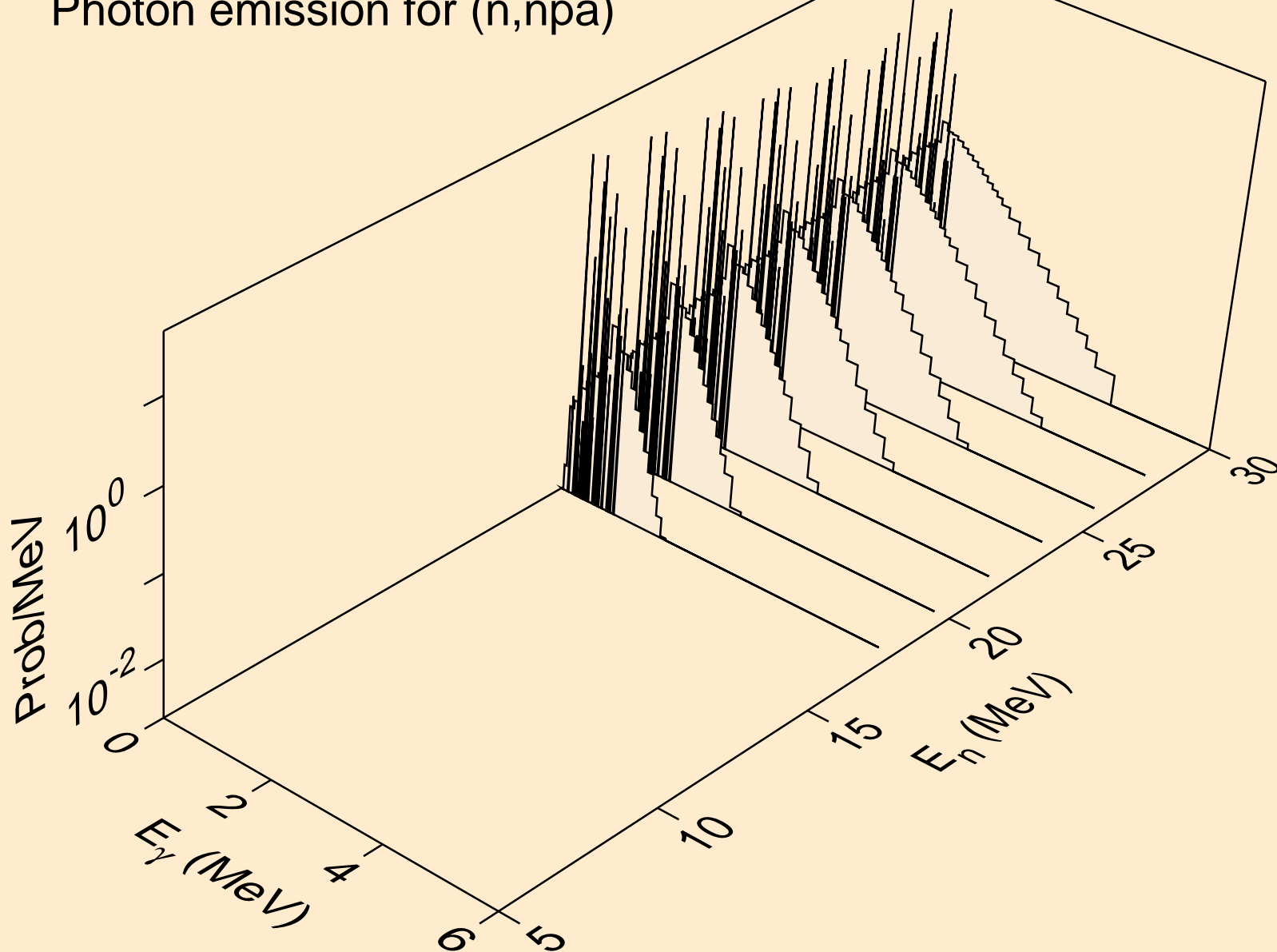

PR140 NEUTRON ACER TENDL-2019 LIBRARY; T=293.16K
Photon emission for (n,n*c)

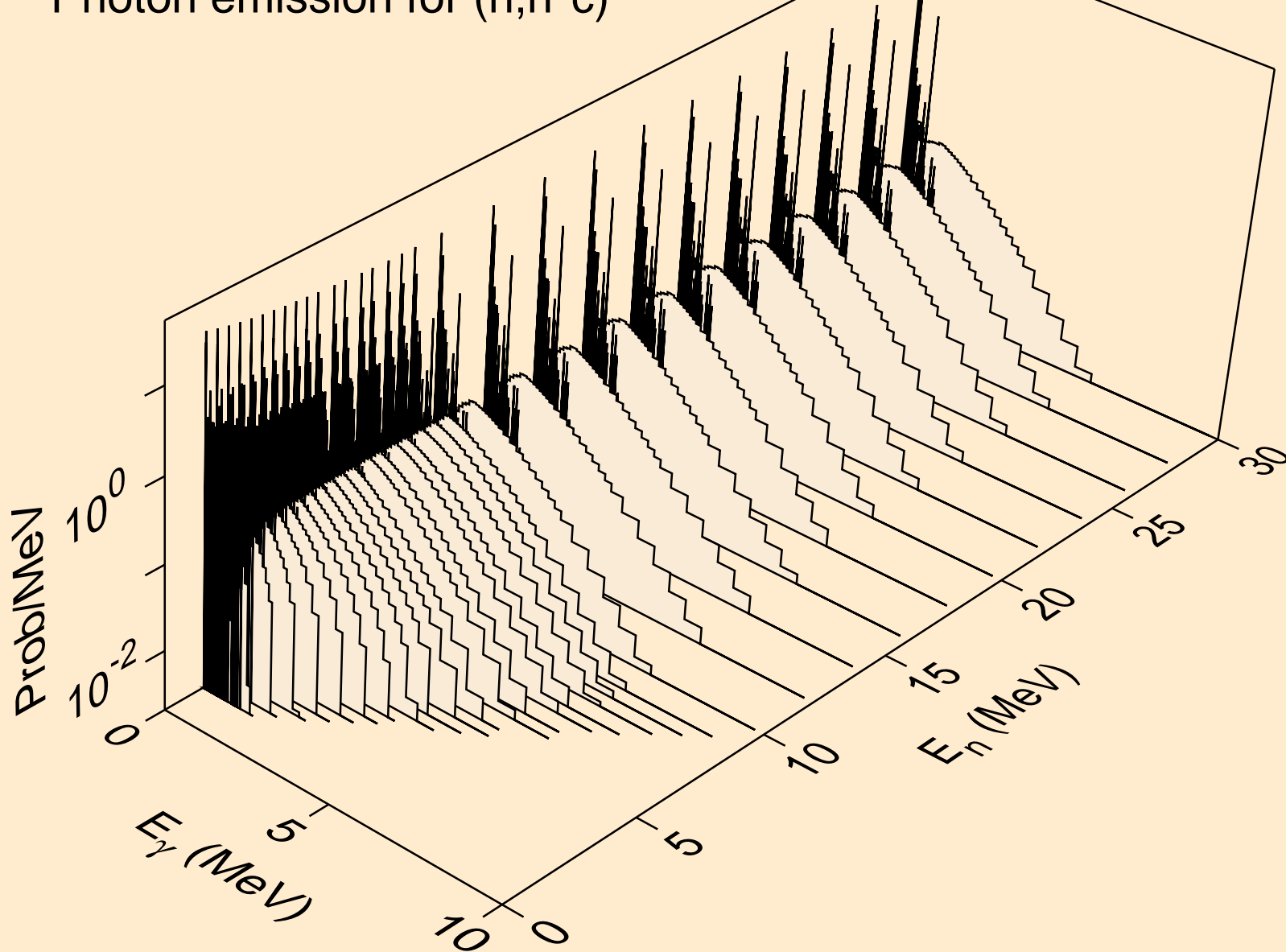

PR140 NEUTRON ACER TENDL-2019 LIBRARY; T=293.16K
Photon emission for (n,gma)

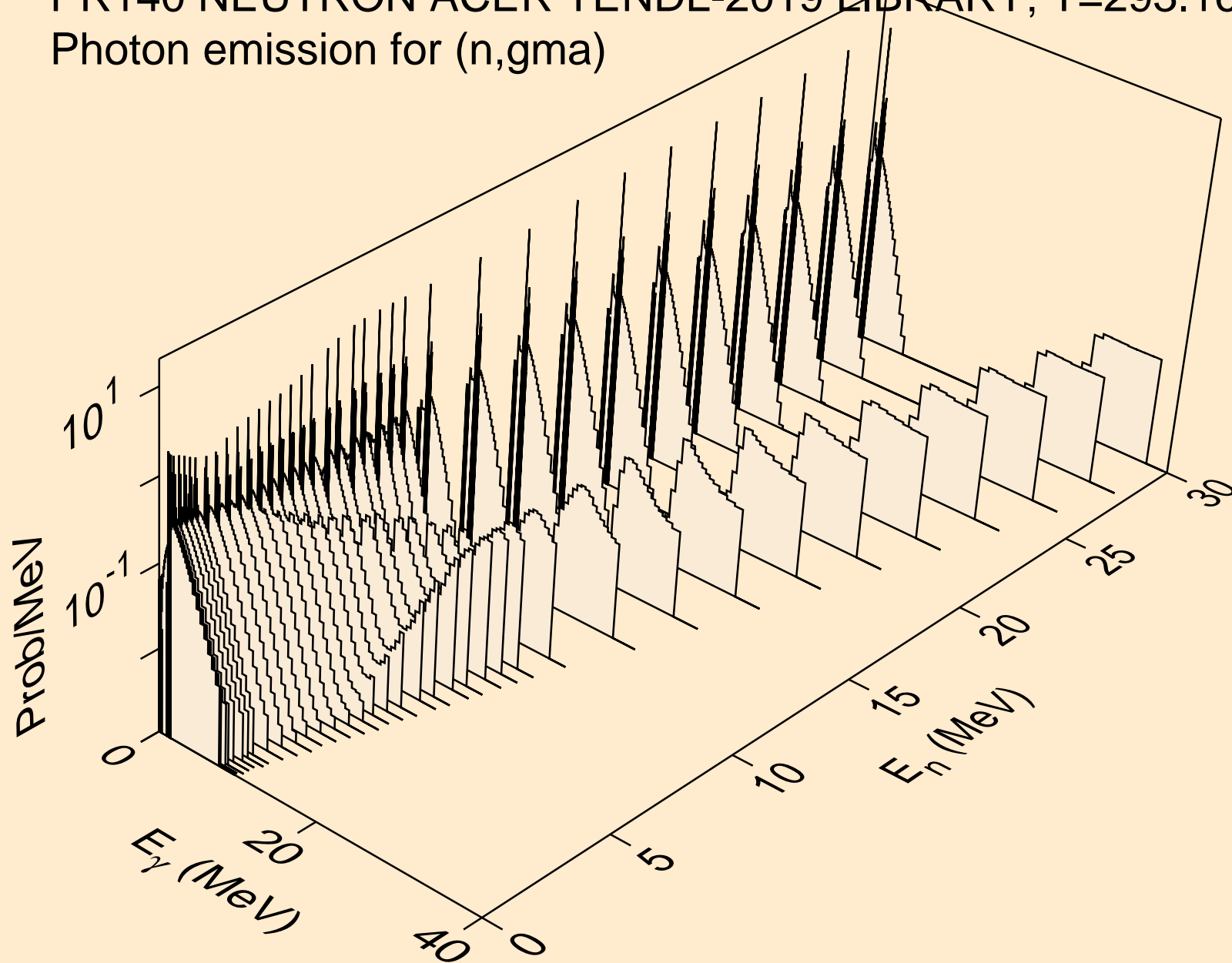

PR140 NEUTRON ACER TENDL-2019 LIBRARY; T=293.16K
Photon emission for (n,p)

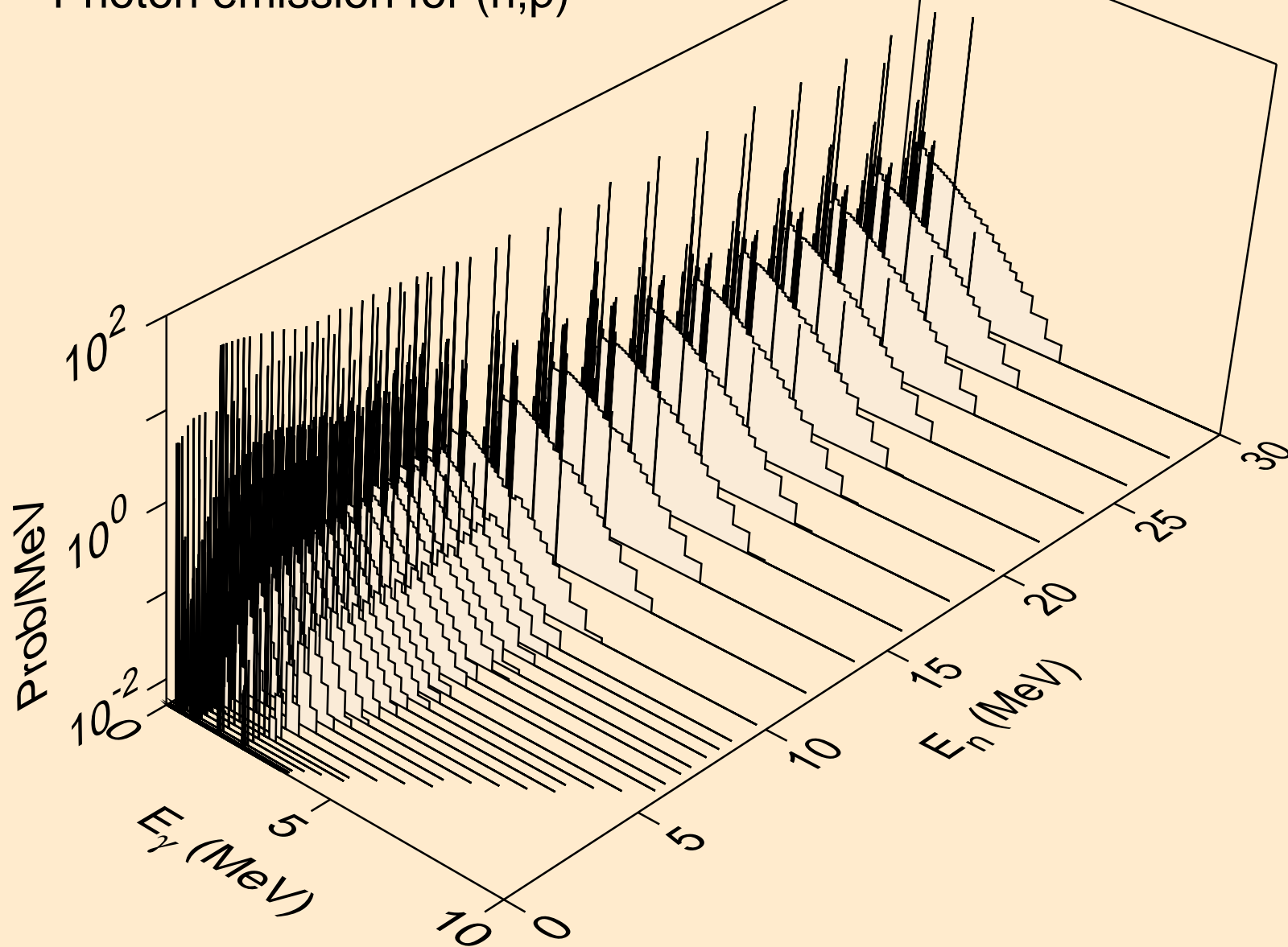

PR140 NEUTRON ACER TENDL-2019 LIBRARY; T=293.16K
Photon emission for (n,d)

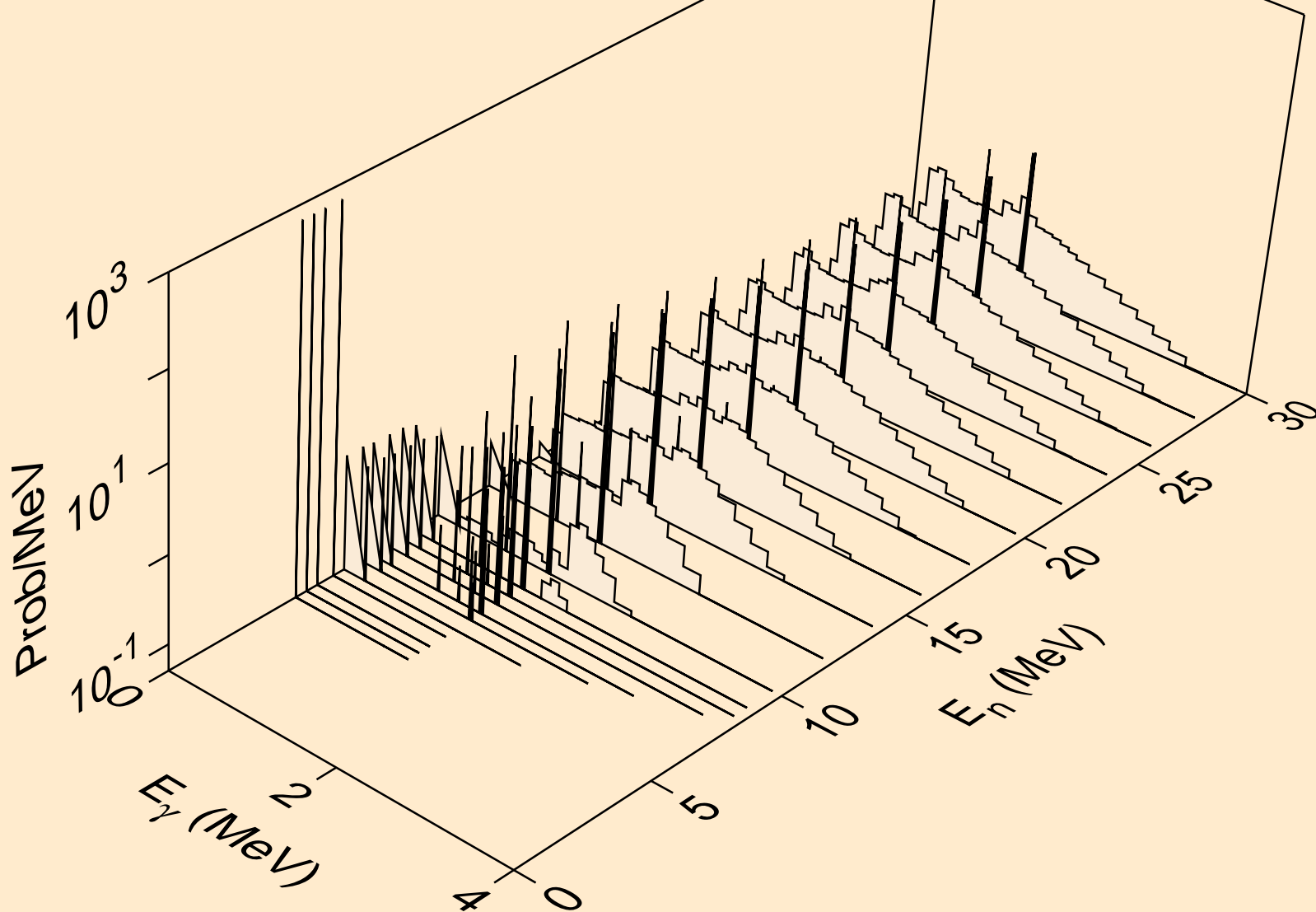

PR140 NEUTRON ACER TENDL-2019 LIBRARY; T=293.16K
Photon emission for (n,t)

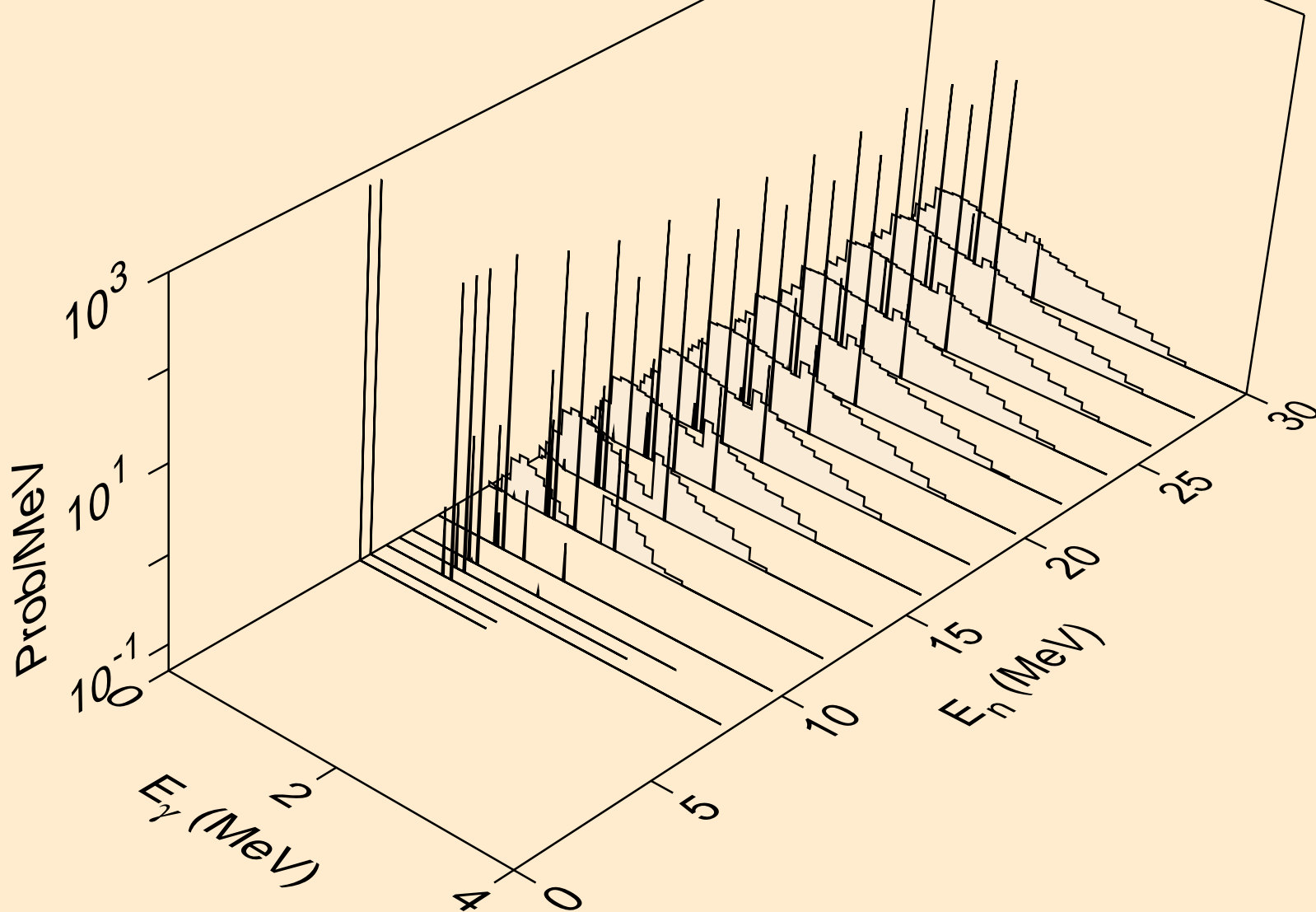

PR140 NEUTRON ACER TENDL-2019 LIBRARY; T=293.16K
Photon emission for (n,he3)

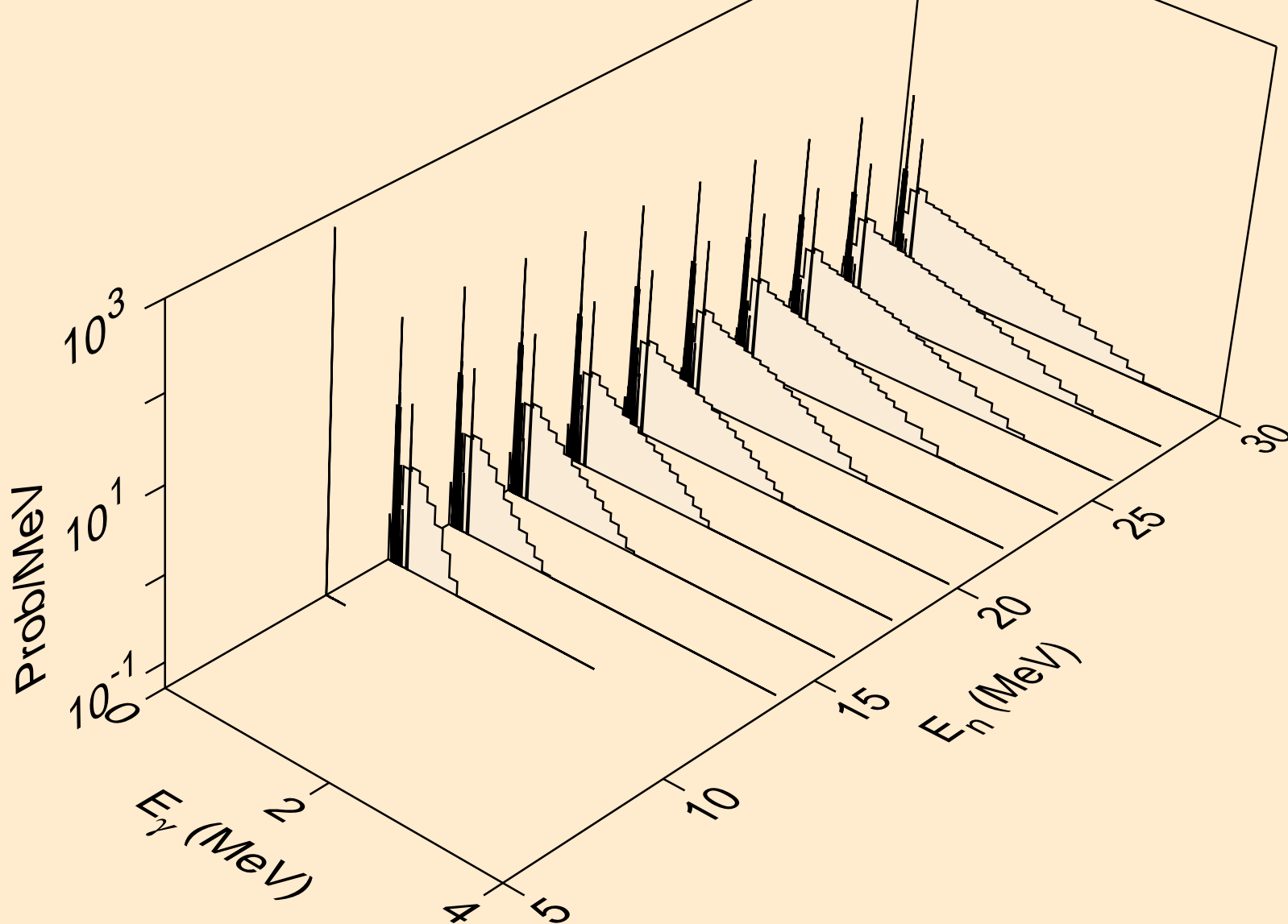

PR140 NEUTRON ACER TENDL-2019 LIBRARY; T=293.16K
Photon emission for (n,a)

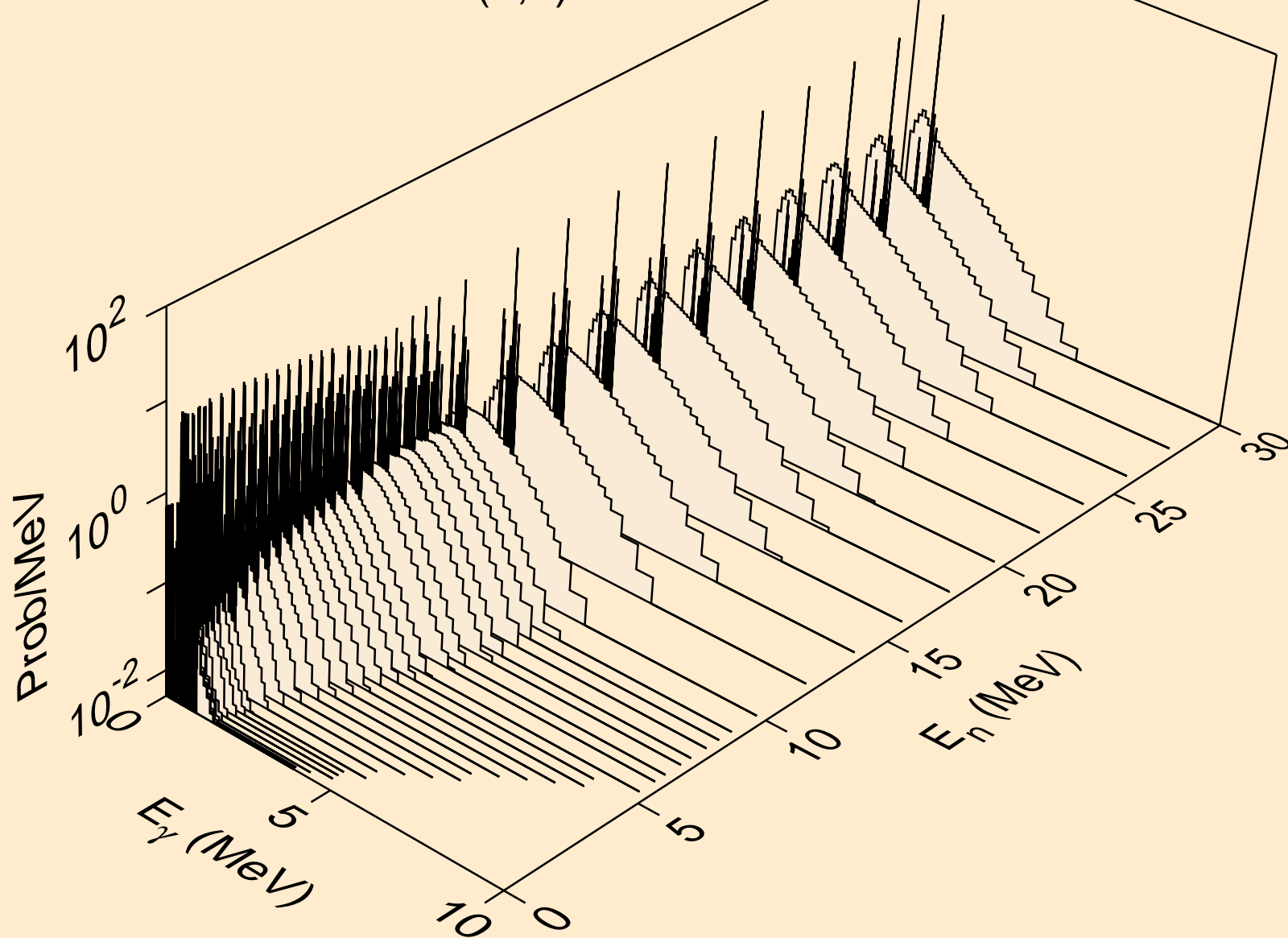

PR140 NEUTRON ACER TENDL-2019 LIBRARY; T=293.16K
Photon emission for (n,2a)

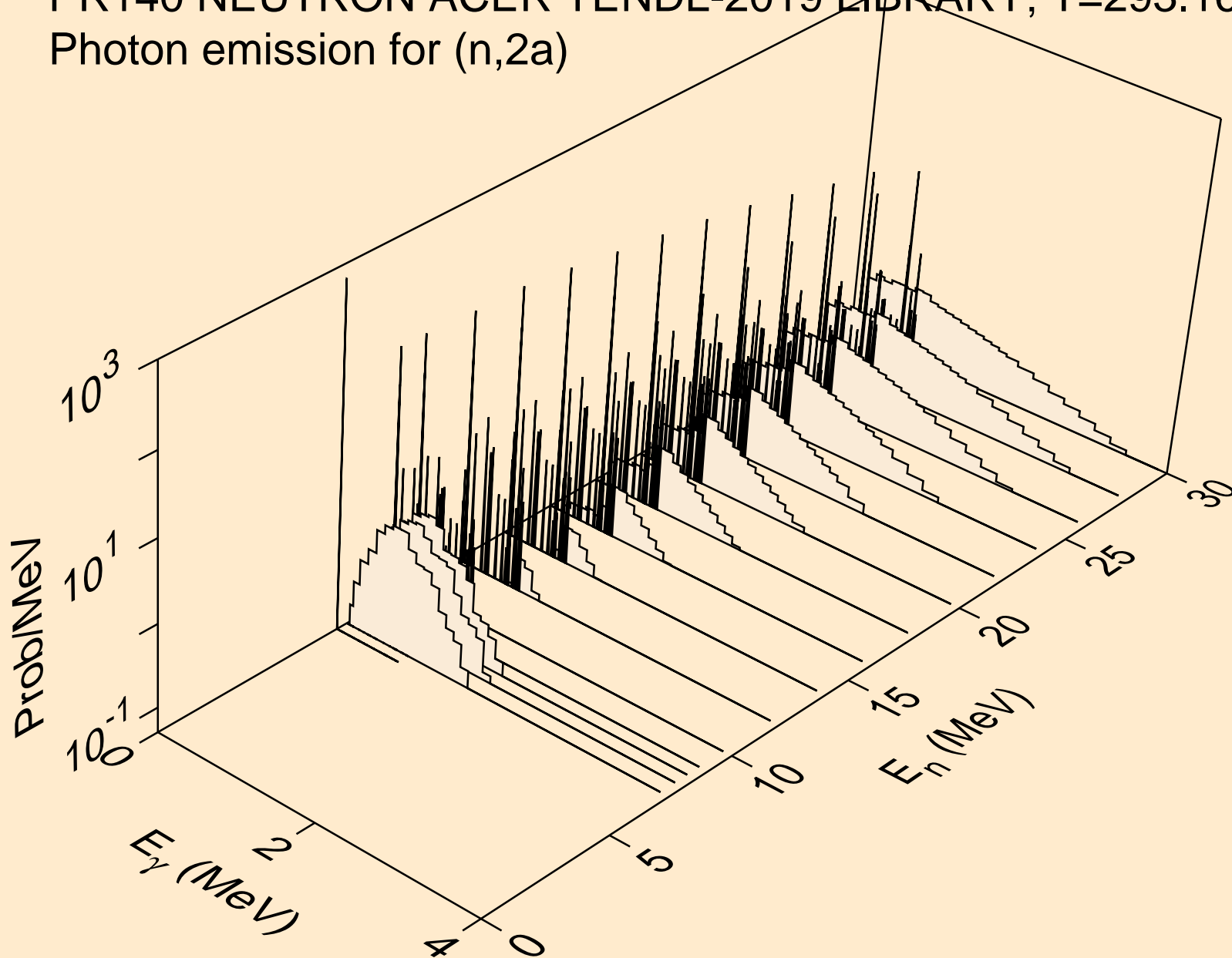

PR140 NEUTRON ACER TENDL-2019 LIBRARY; T=293.16K
Photon emission for (n,2p)

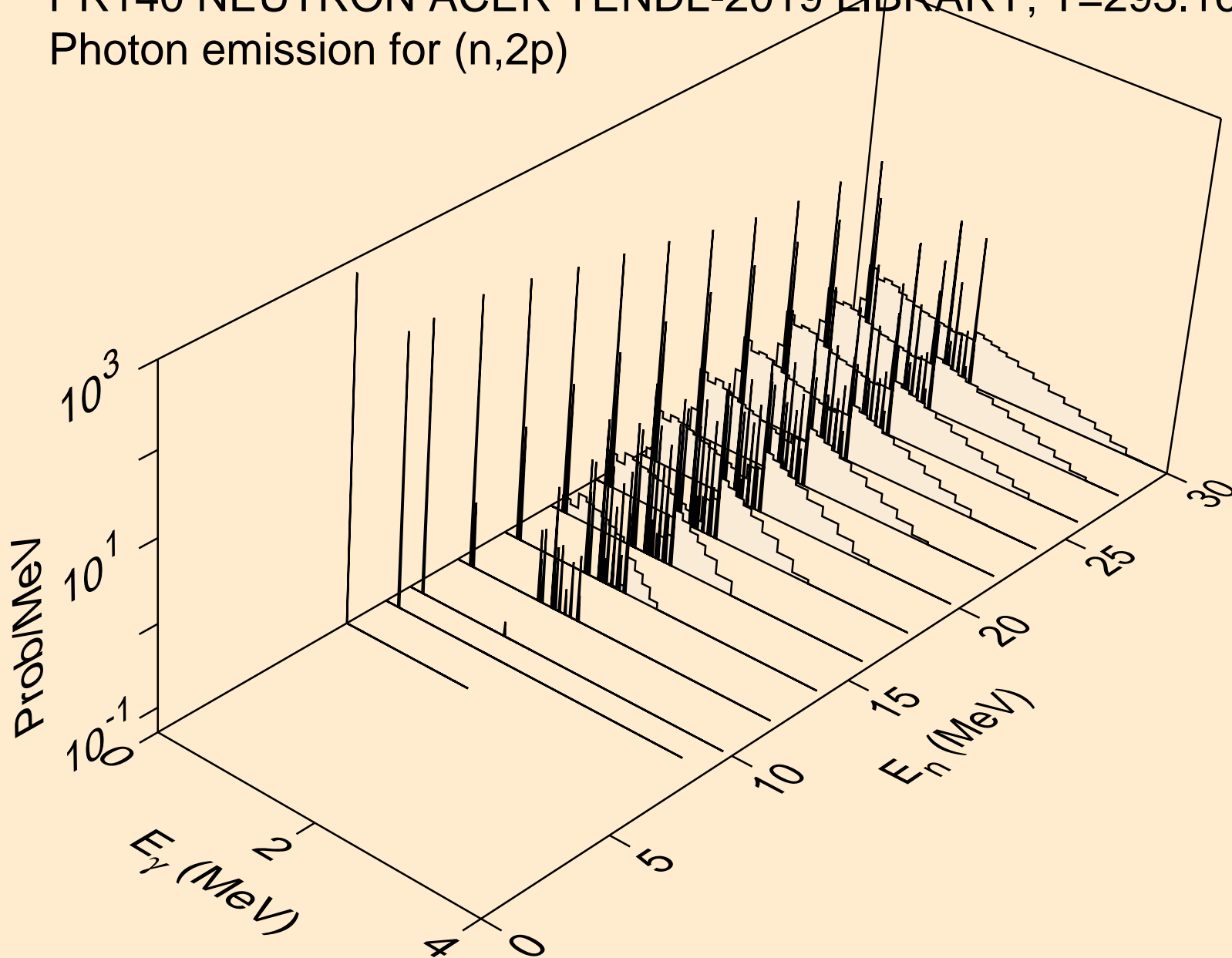

PR140 NEUTRON ACER TENDL-2019 LIBRARY; T=293.16K
Photon emission for (n,p)

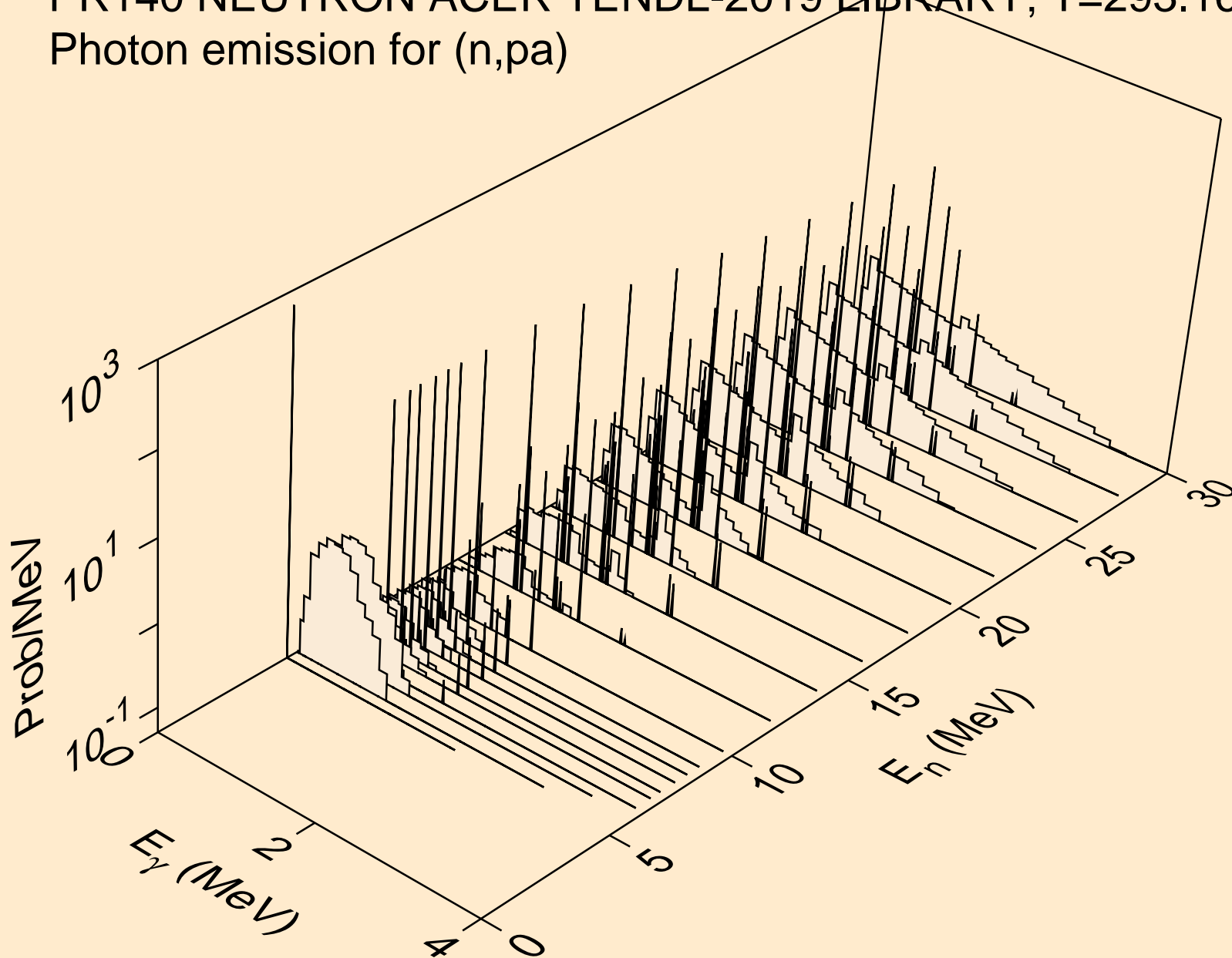

PR140 NEUTRON ACER TENDL-2019 LIBRARY; T=293.16K
Photon emission for (n,pd)

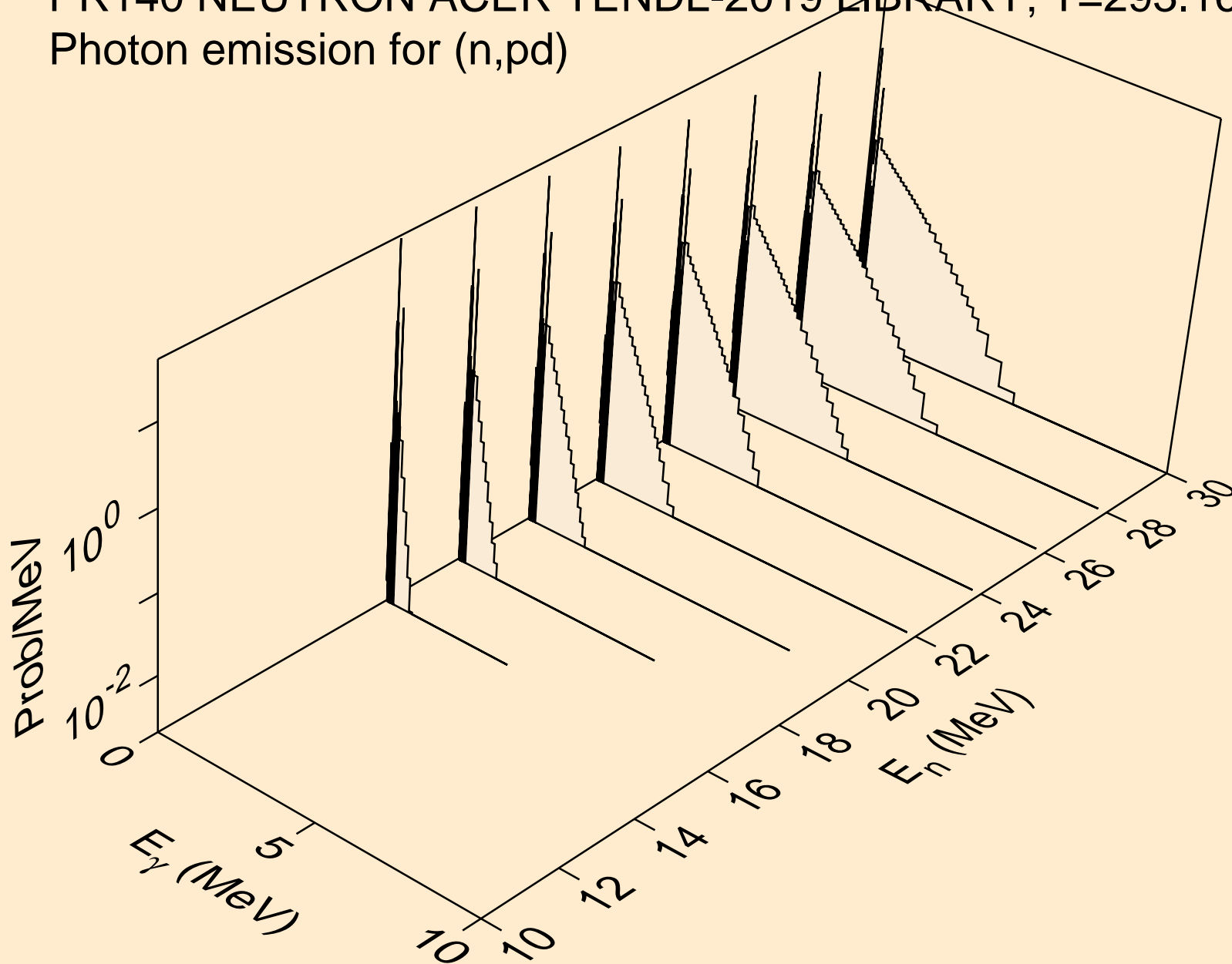

PR140 NEUTRON ACER TENDL-2019 LIBRARY; T=293.16K
Photon emission for (n,pt)

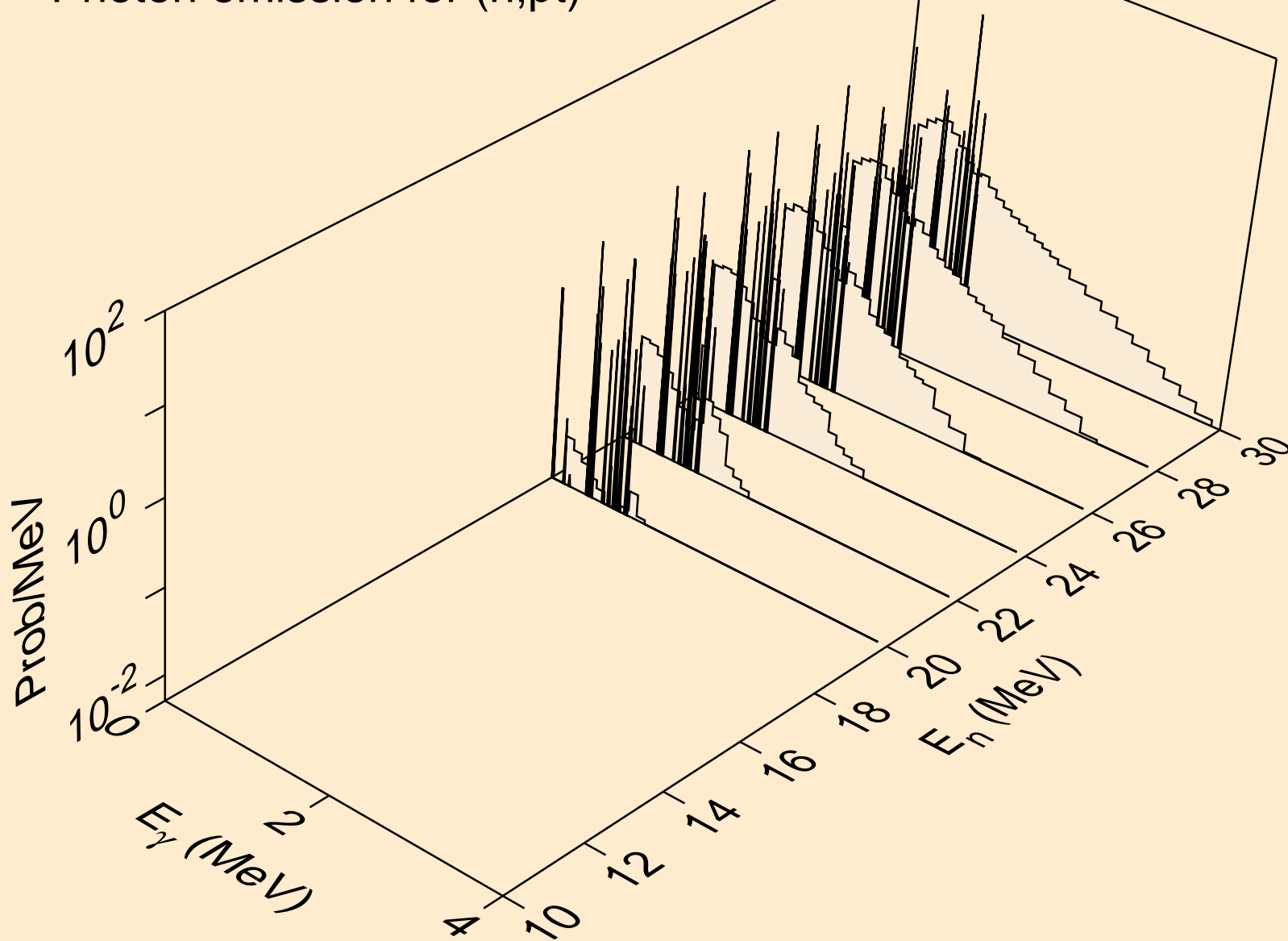

PR140 NEUTRON ACER TENDL-2019 LIBRARY; T=293.16K
Photon emission for (n,da)

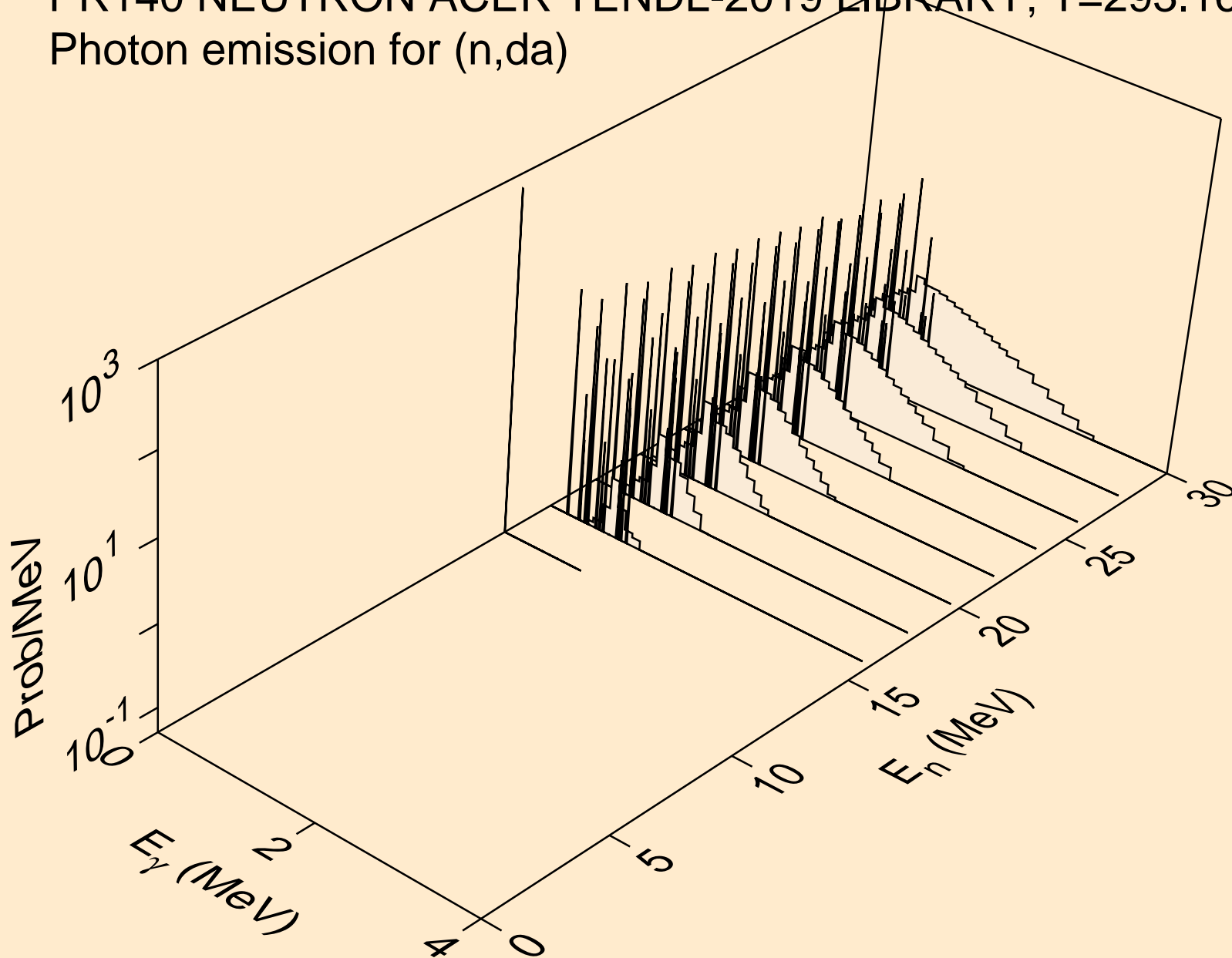

PR140 NEUTRON ACER TENDL-2019 LIBRARY; T=293.16K
thermal capture photon spectrum

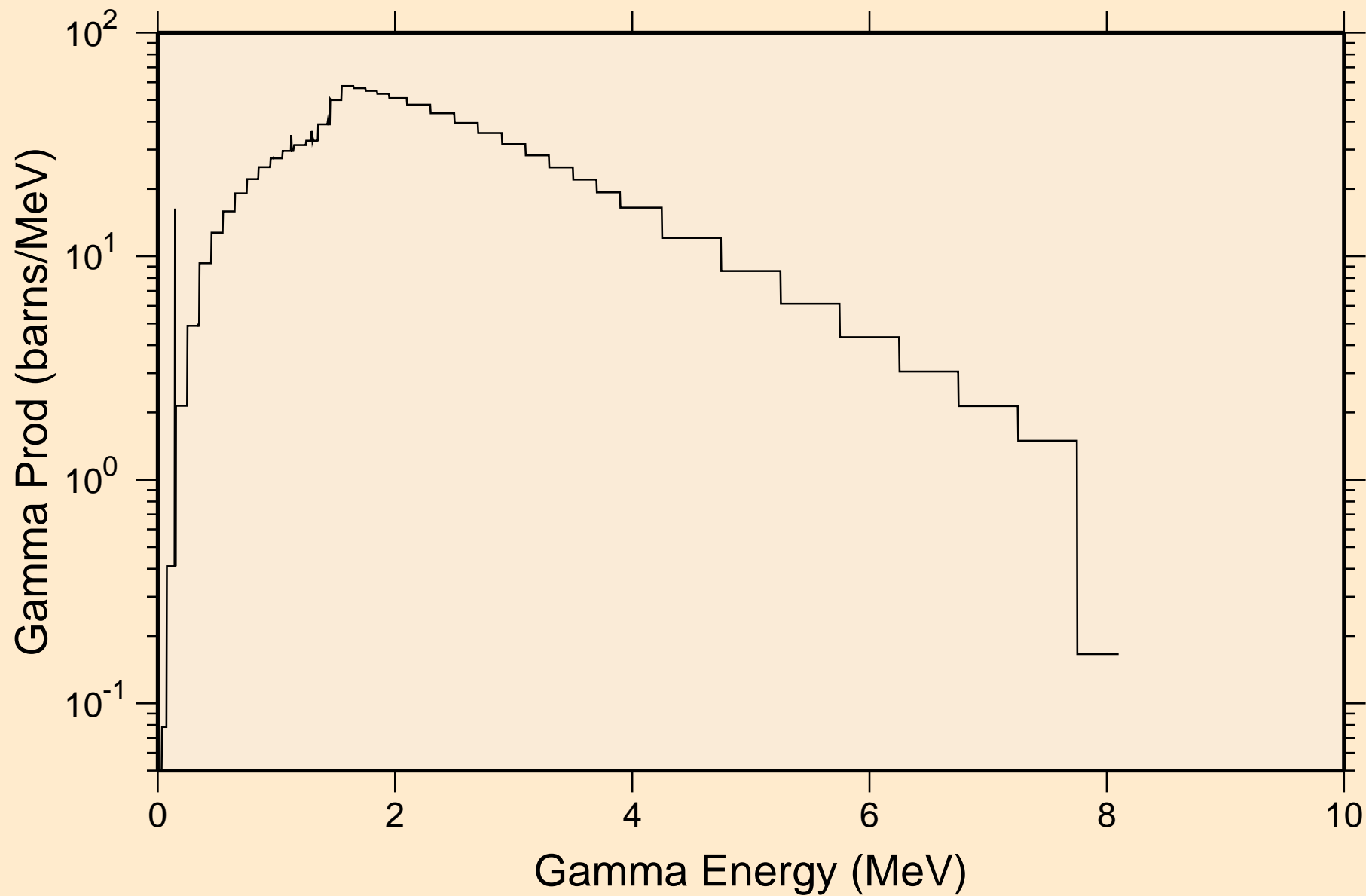

PR140 NEUTRON ACER TENDL-2019 LIBRARY; T=293.16K
14 MeV photon spectrum

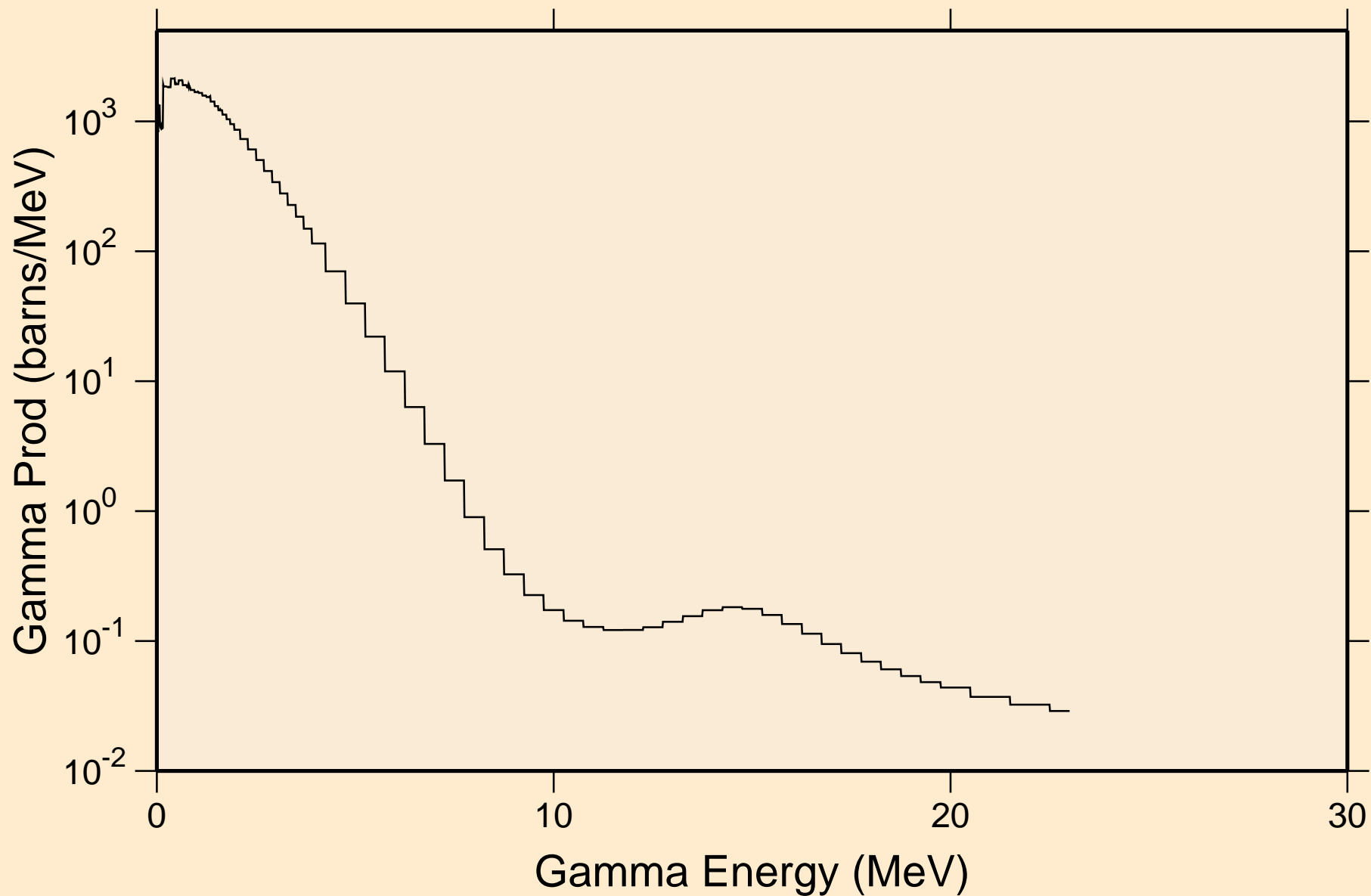

PR140 NEUTRON ACER TENDL-2019 LIBRARY; T=293.16K
Particle heating contributions

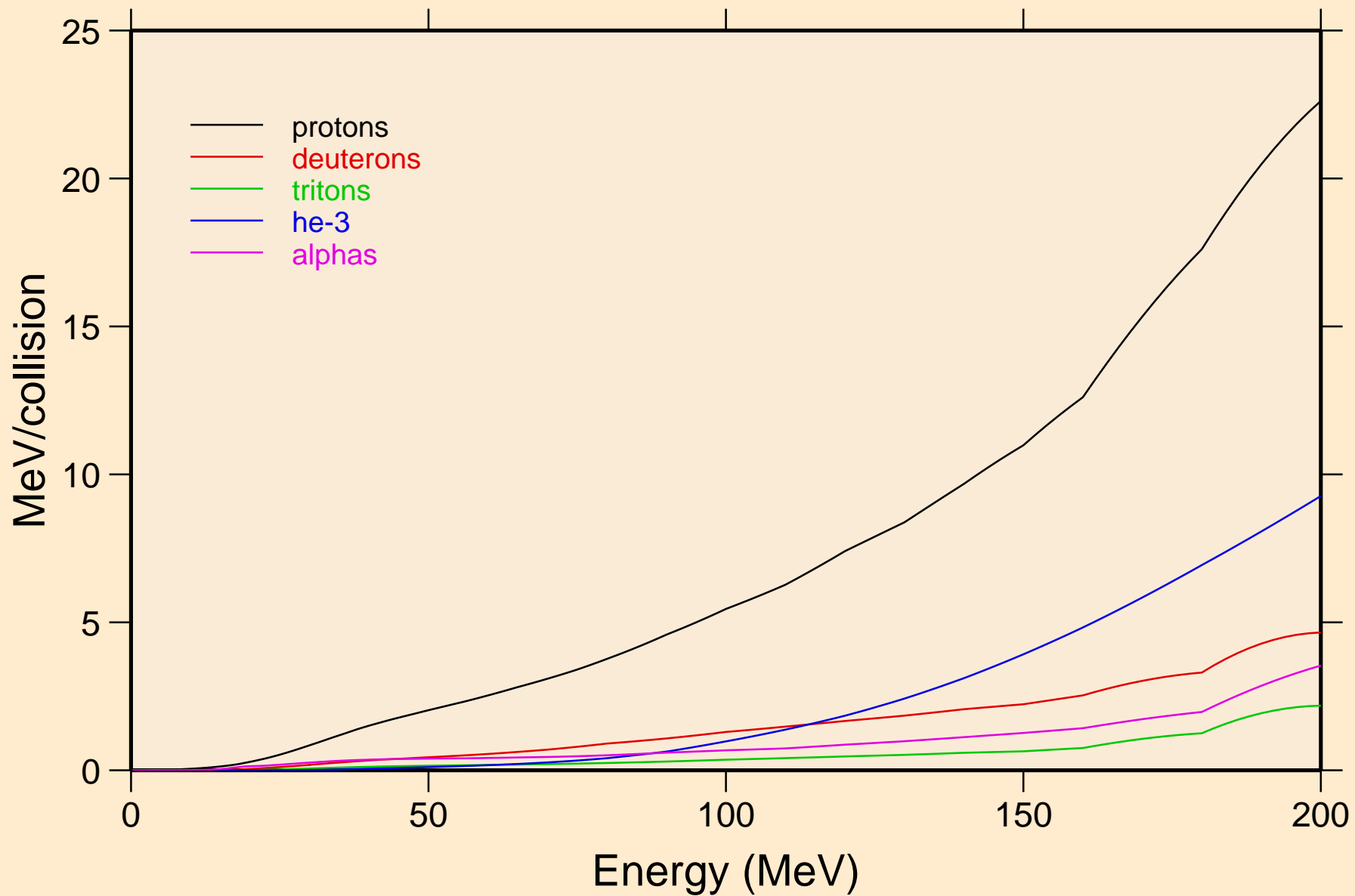

PR140 NEUTRON ACER TENDL-2019 LIBRARY; T=293.16K
Recoil Heating

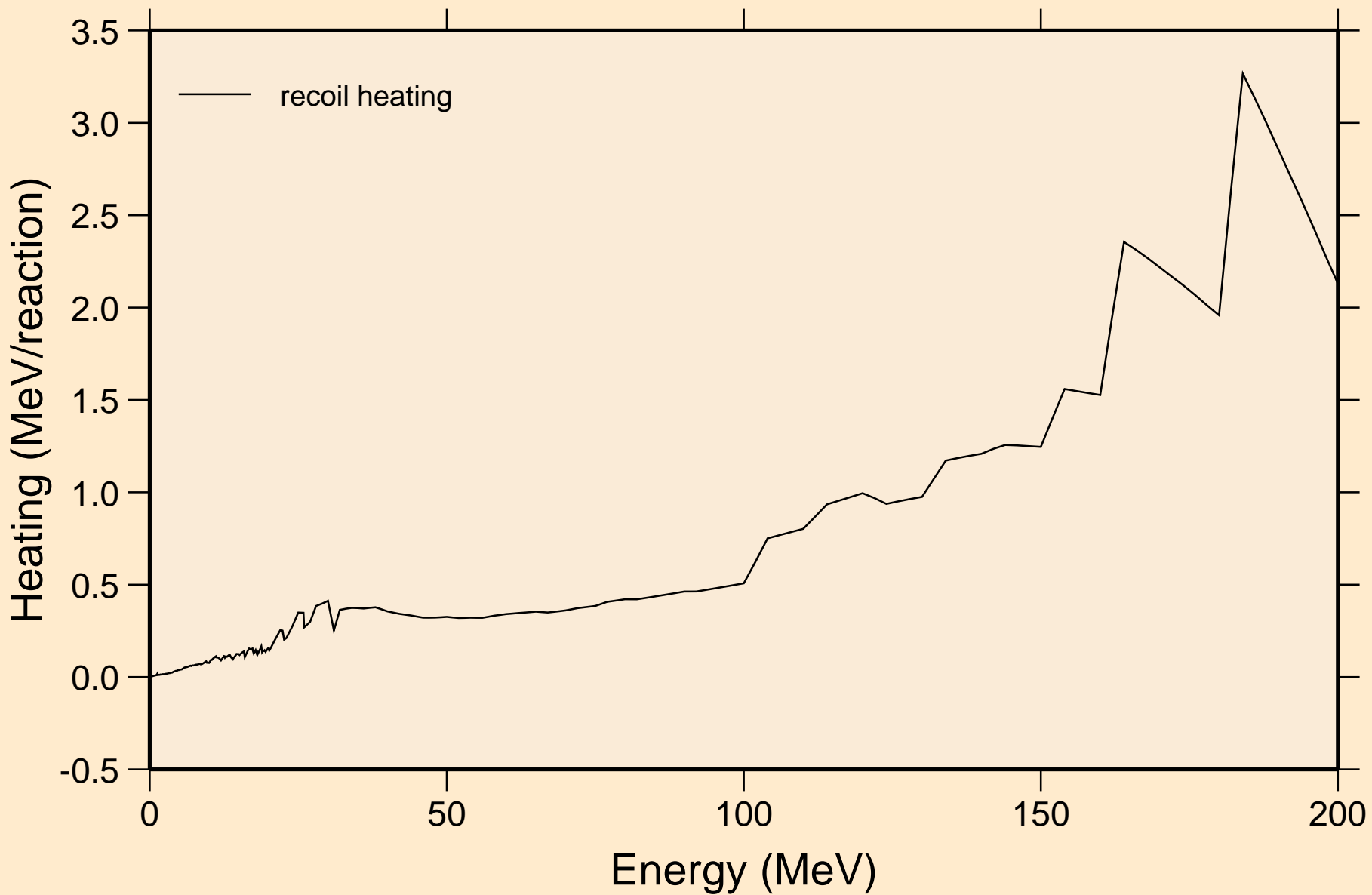

PR140 NEUTRON ACER TENDL-2019 LIBRARY; T=293.16K
Particle production cross sections

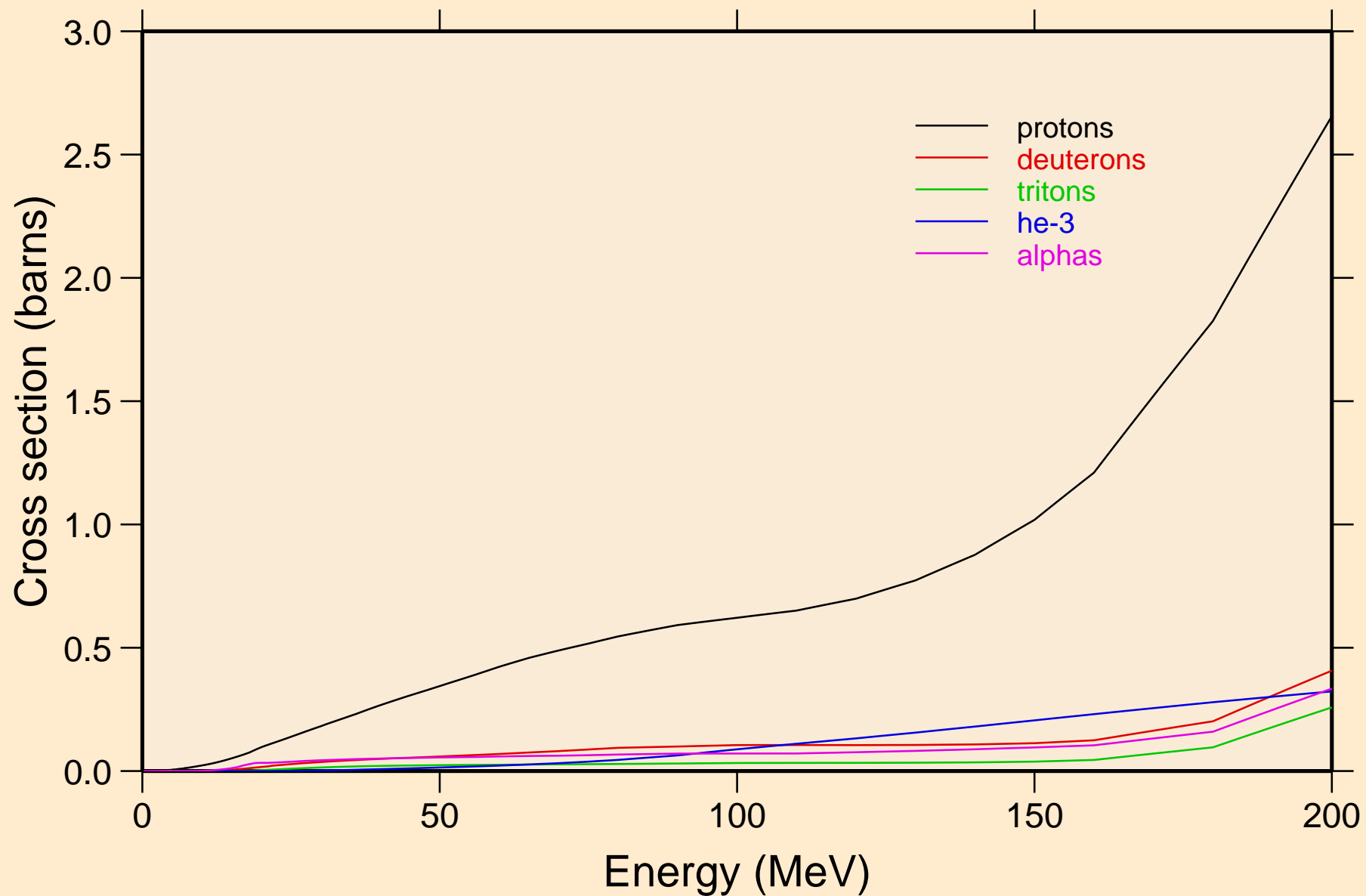

PR140 NEUTRON ACER TENDL-2019 LIBRARY; T=293.16K
protons from (n,x)

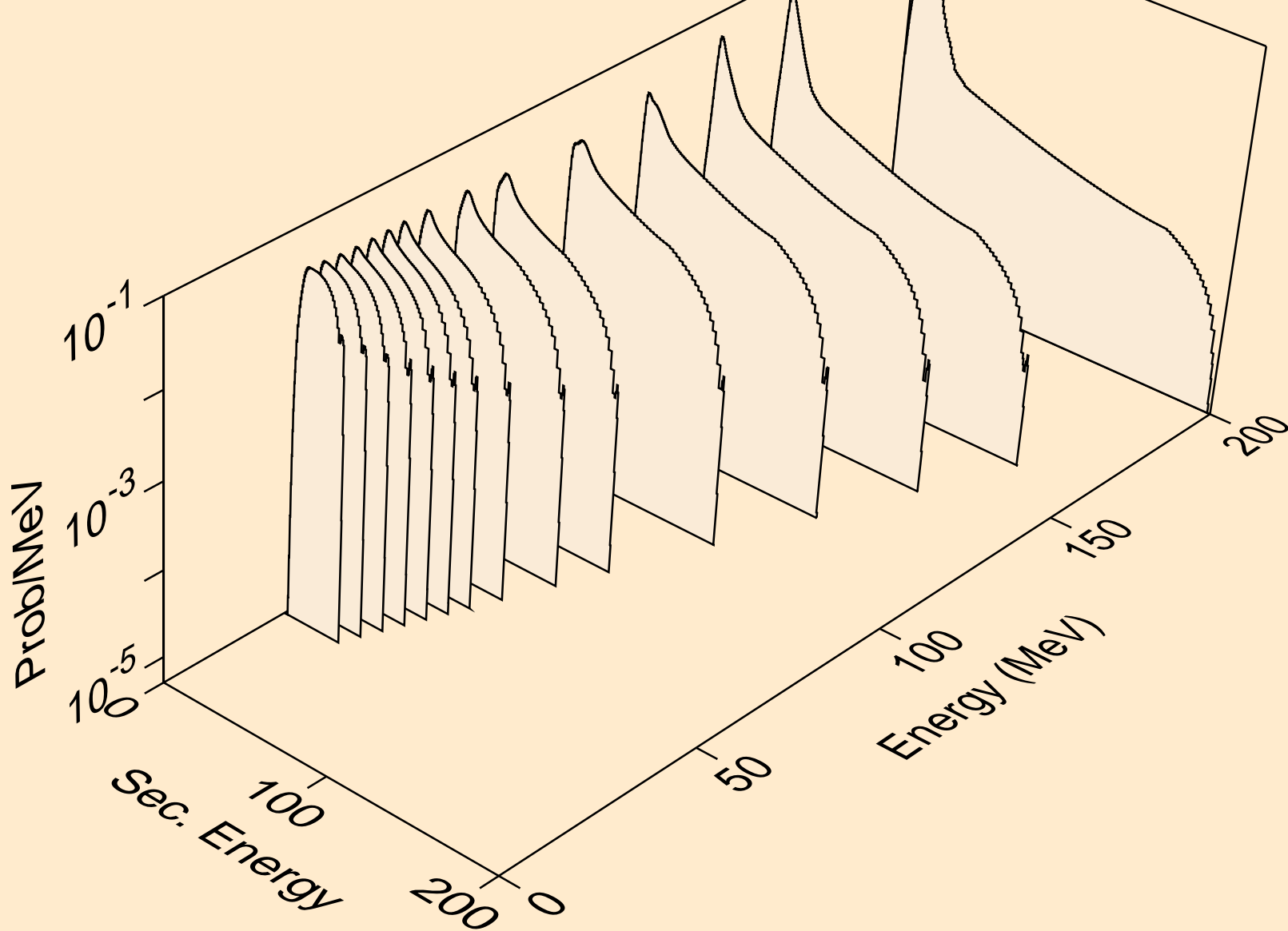

PR140 NEUTRON ACER TENDL-2019 LIBRARY; T=293.16K
protons from (n,n*)p

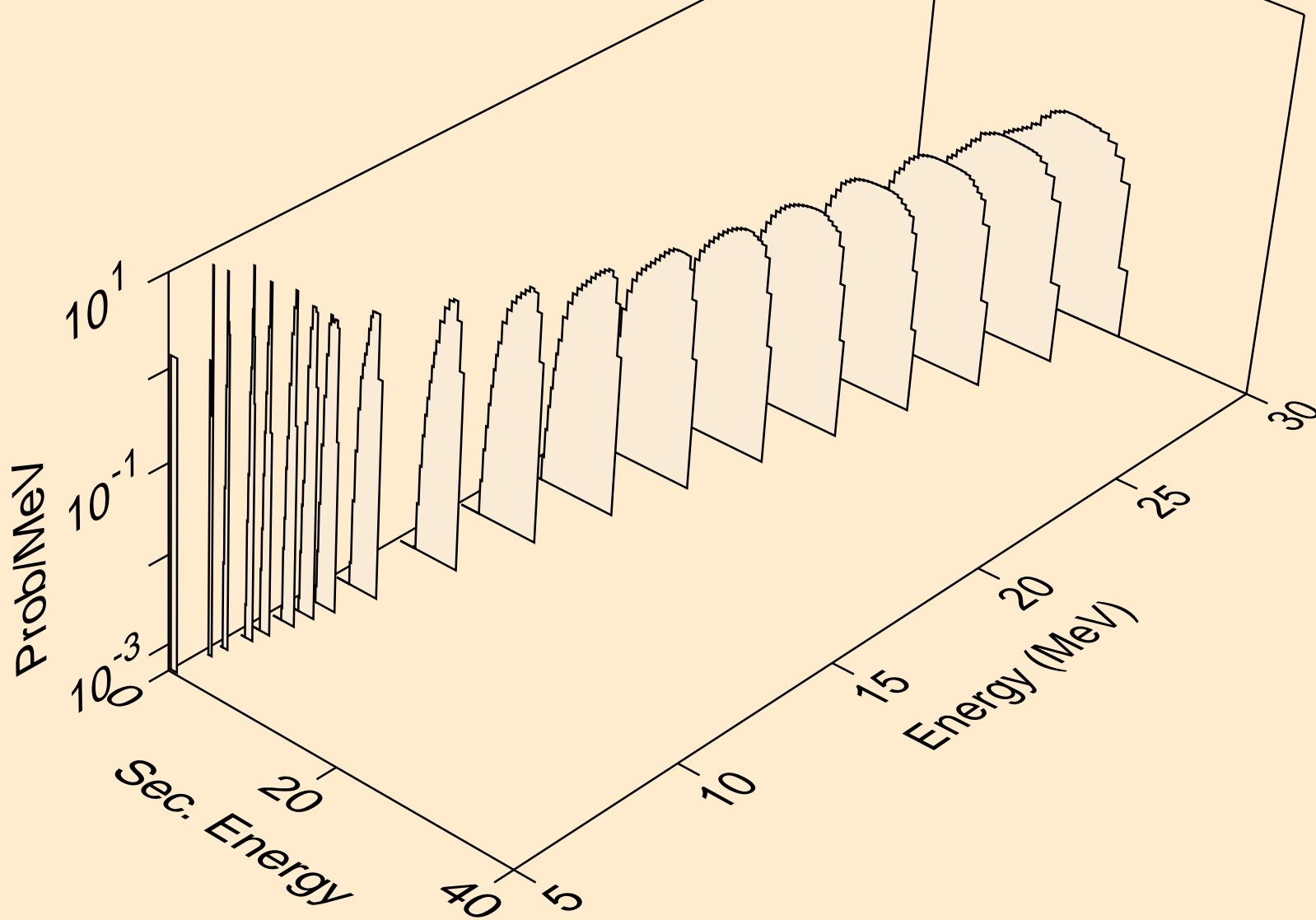

PR140 NEUTRON ACER TENDL-2019 LIBRARY; T=293.16K
protons from (n,2np)

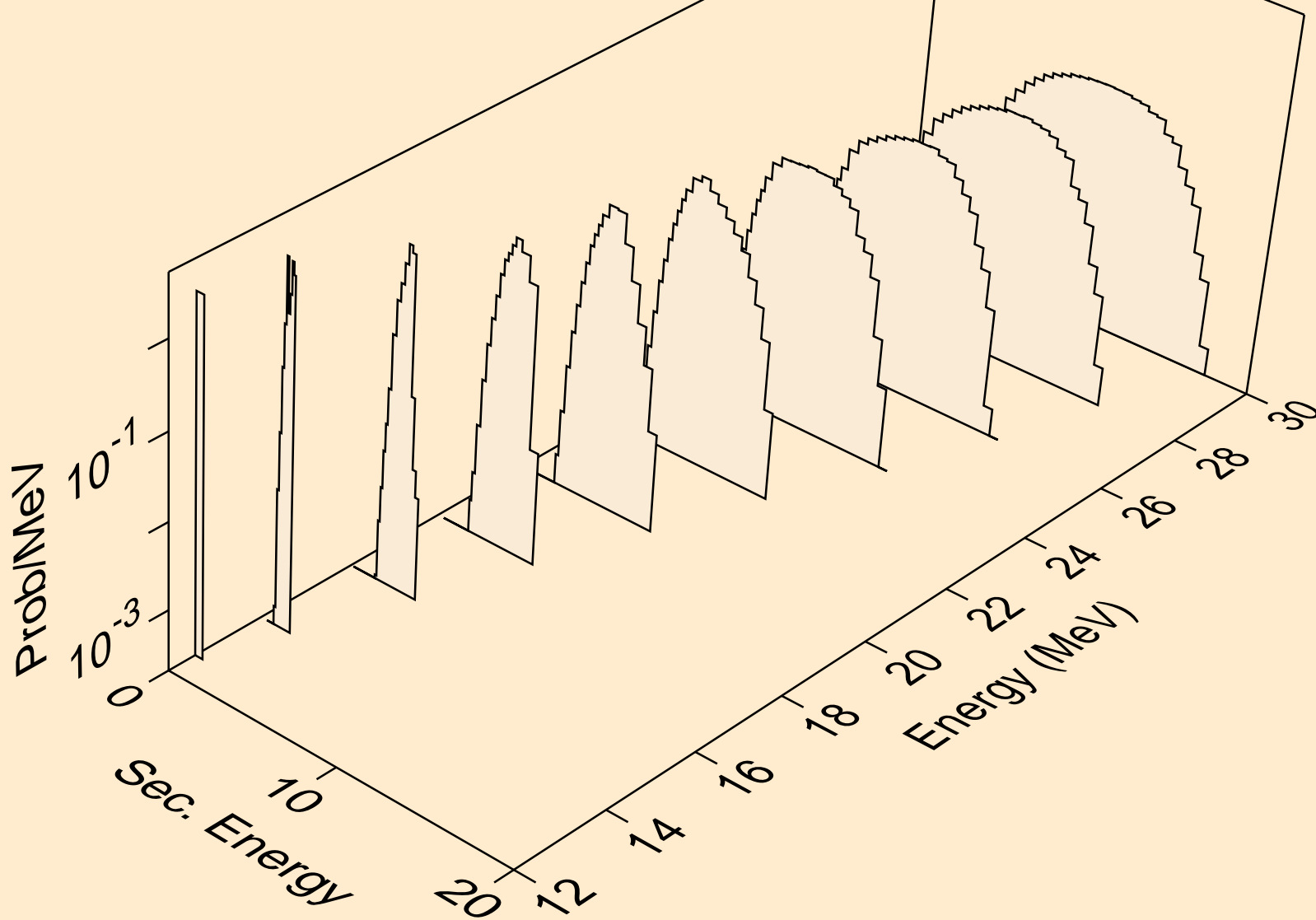

PR140 NEUTRON ACER TENDL-2019 LIBRARY; T=293.16K
protons from (n,3np)

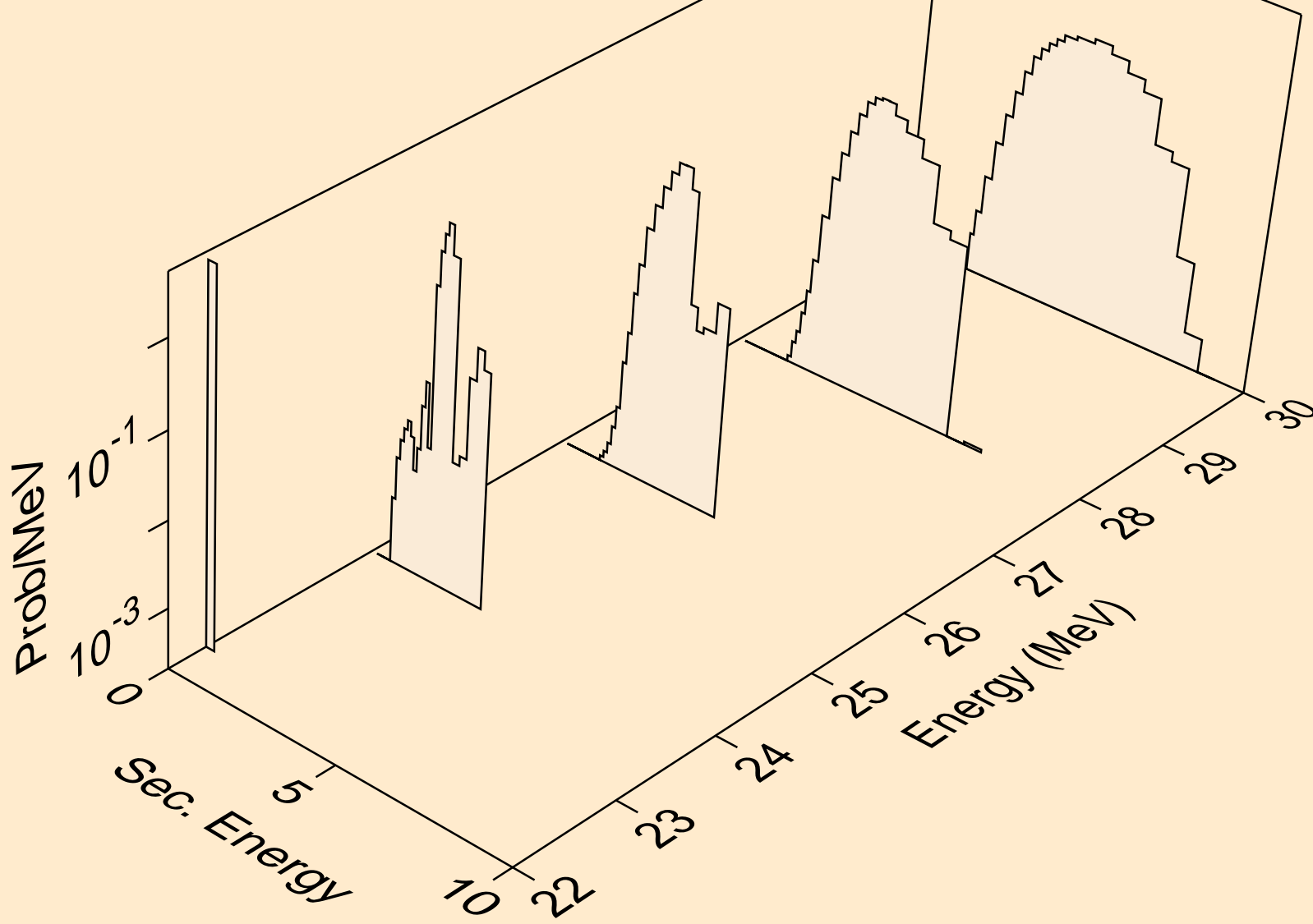

PR140 NEUTRON ACER TENDL-2019 LIBRARY; T=293.16K
protons from (n,2np)

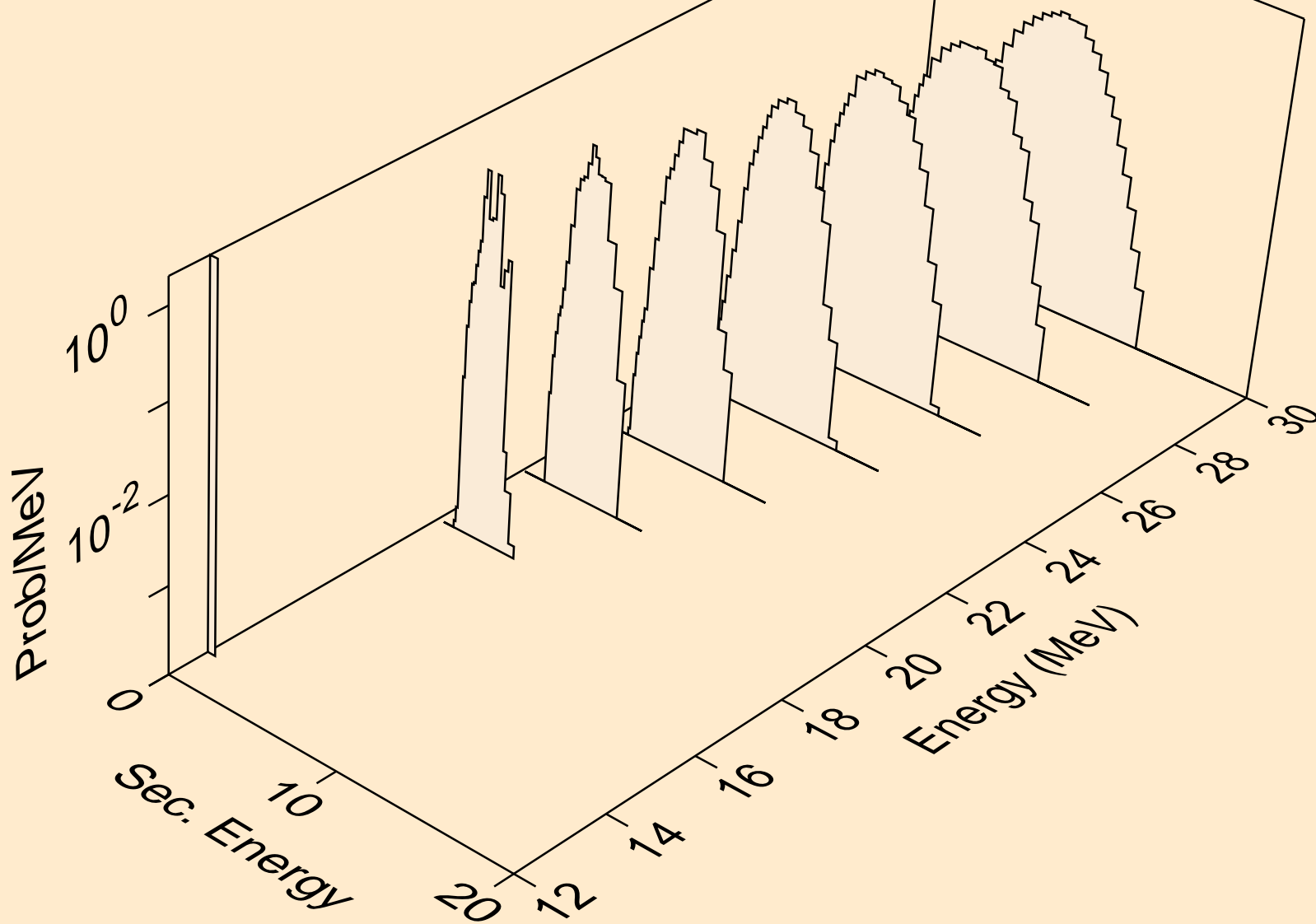

PR140 NEUTRON ACER TENDL-2019 LIBRARY; T=293.16K
protons from (n,npa)

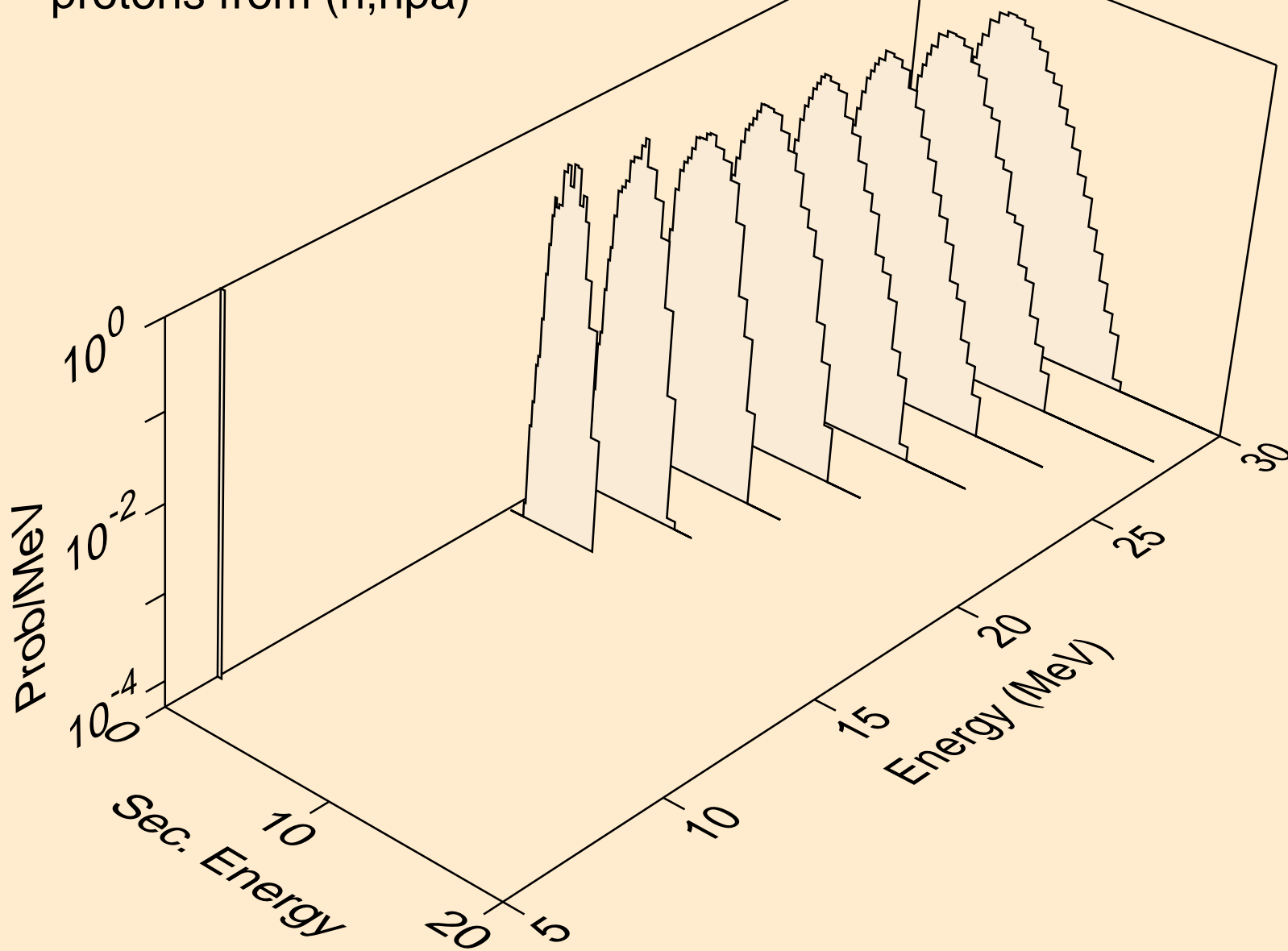

PR140 NEUTRON ACER TENDL-2019 LIBRARY; T=293.16K
protons from (n,p)

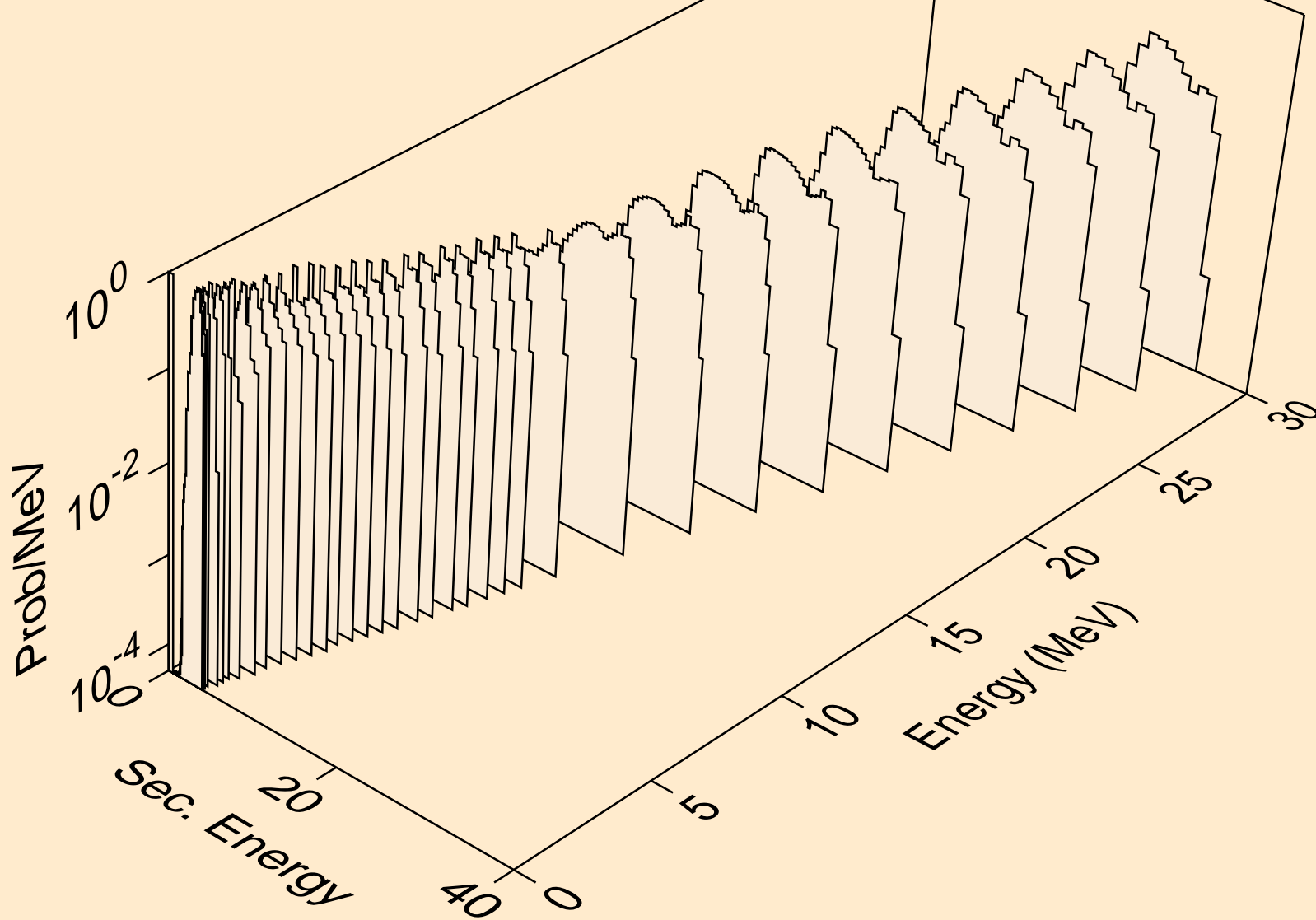

PR140 NEUTRON ACER TENDL-2019 LIBRARY; T=293.16K
protons from (n,2p)

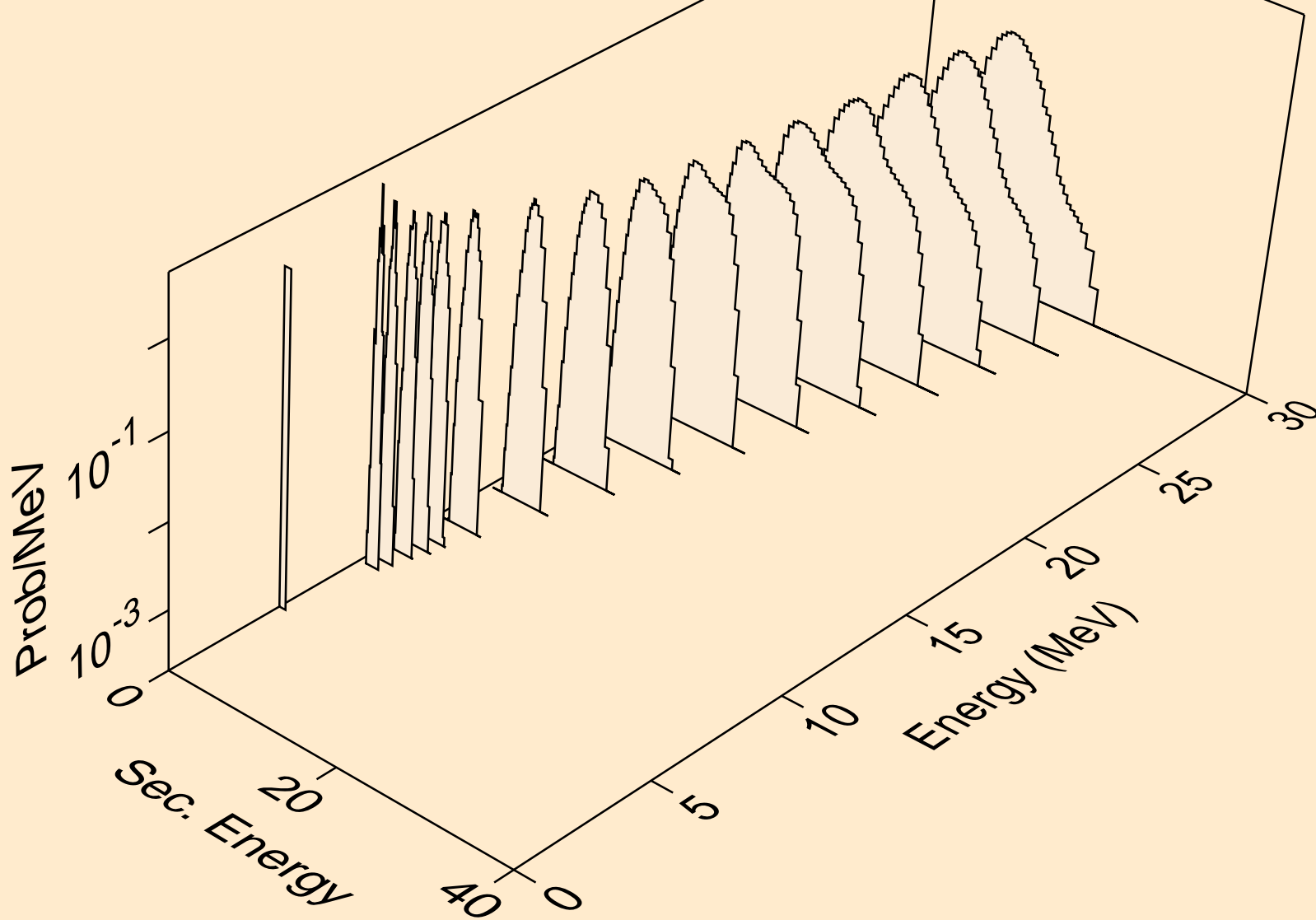

PR140 NEUTRON ACER TENDL-2019 LIBRARY; T=293.16K
protons from (n,p)

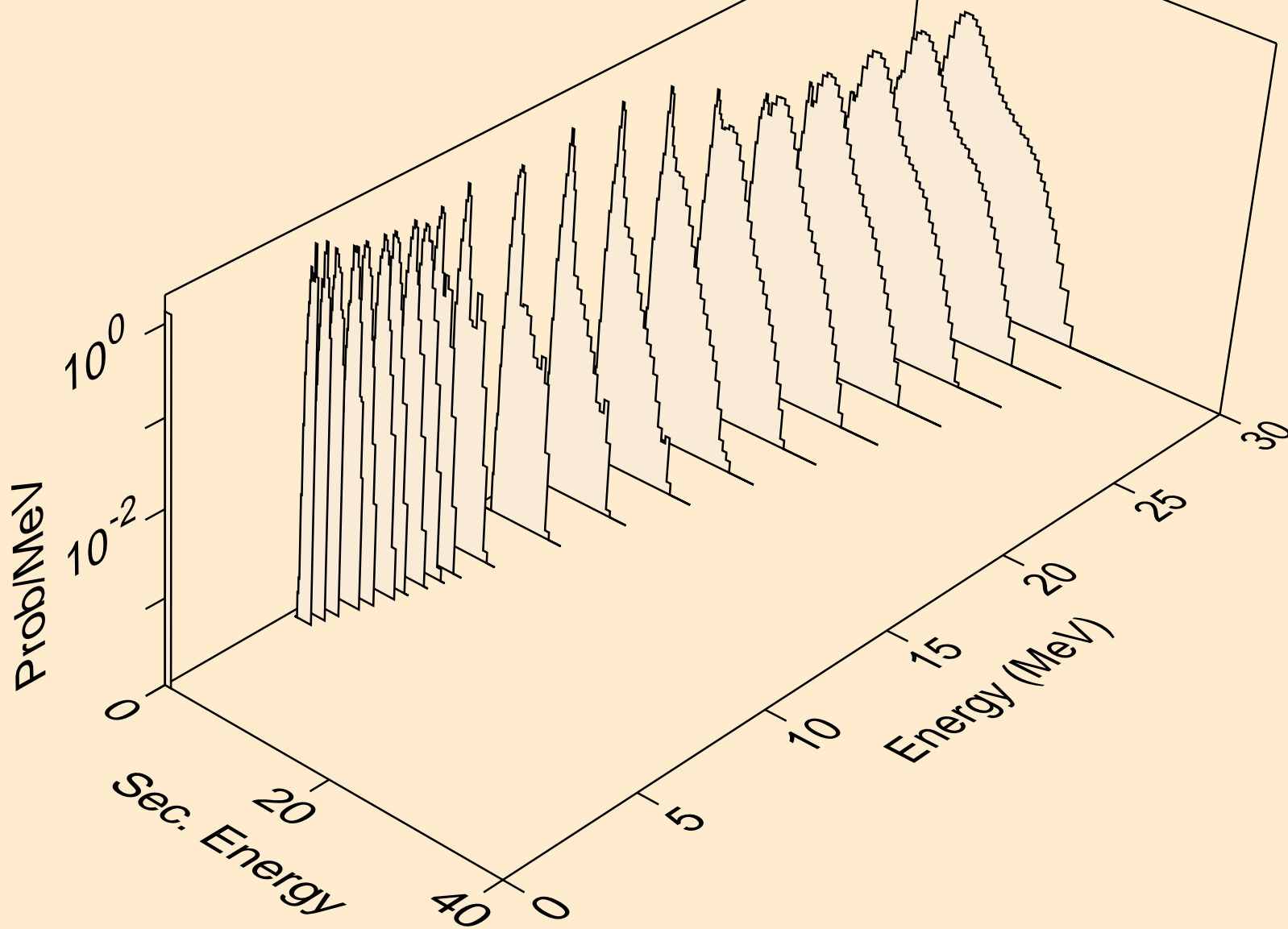

PR140 NEUTRON ACER TENDL-2019 LIBRARY; T=293.16K
protons from (n,pd)

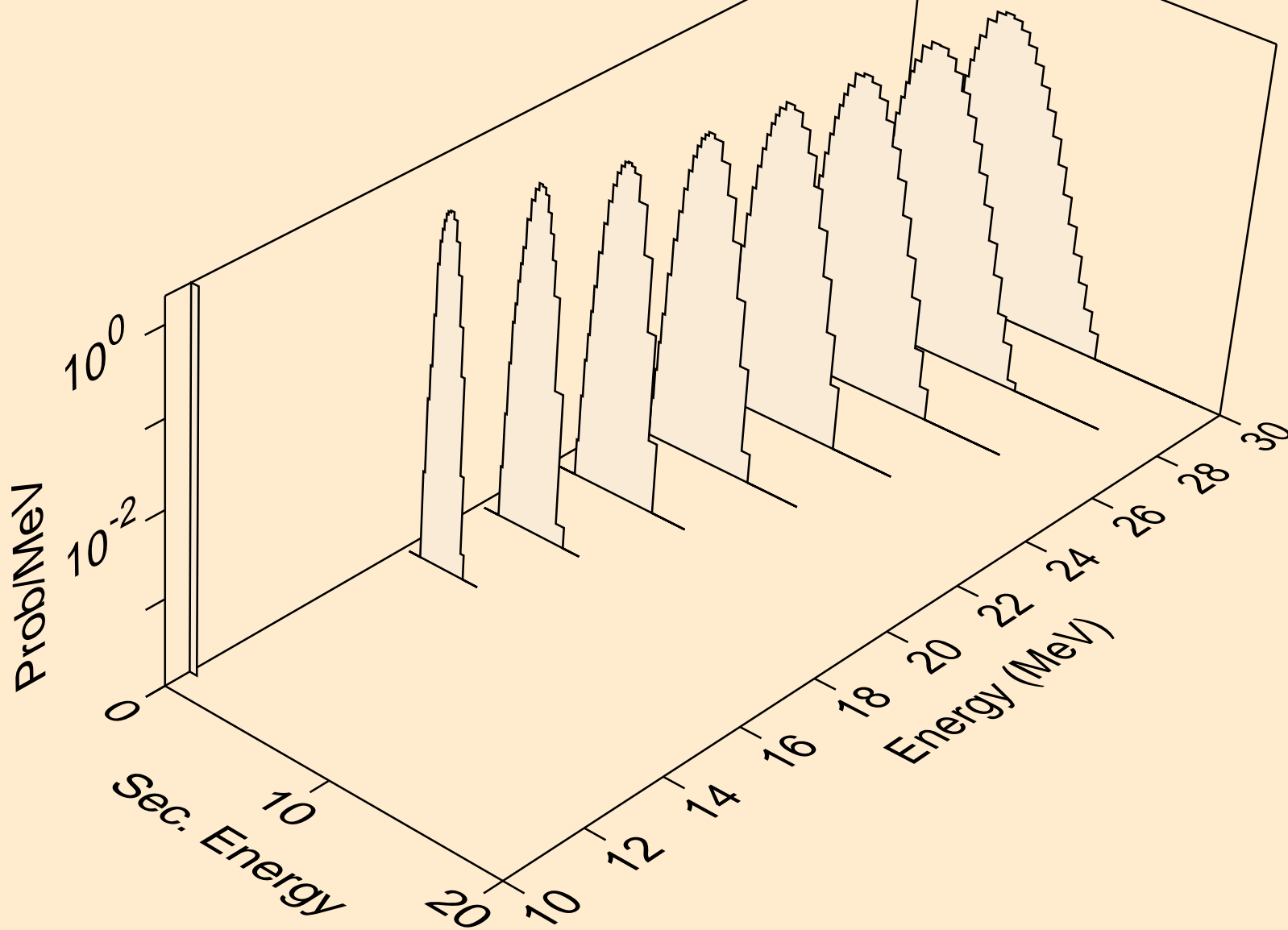

PR140 NEUTRON ACER TENDL-2019 LIBRARY; T=293.16K
protons from (n,pt)

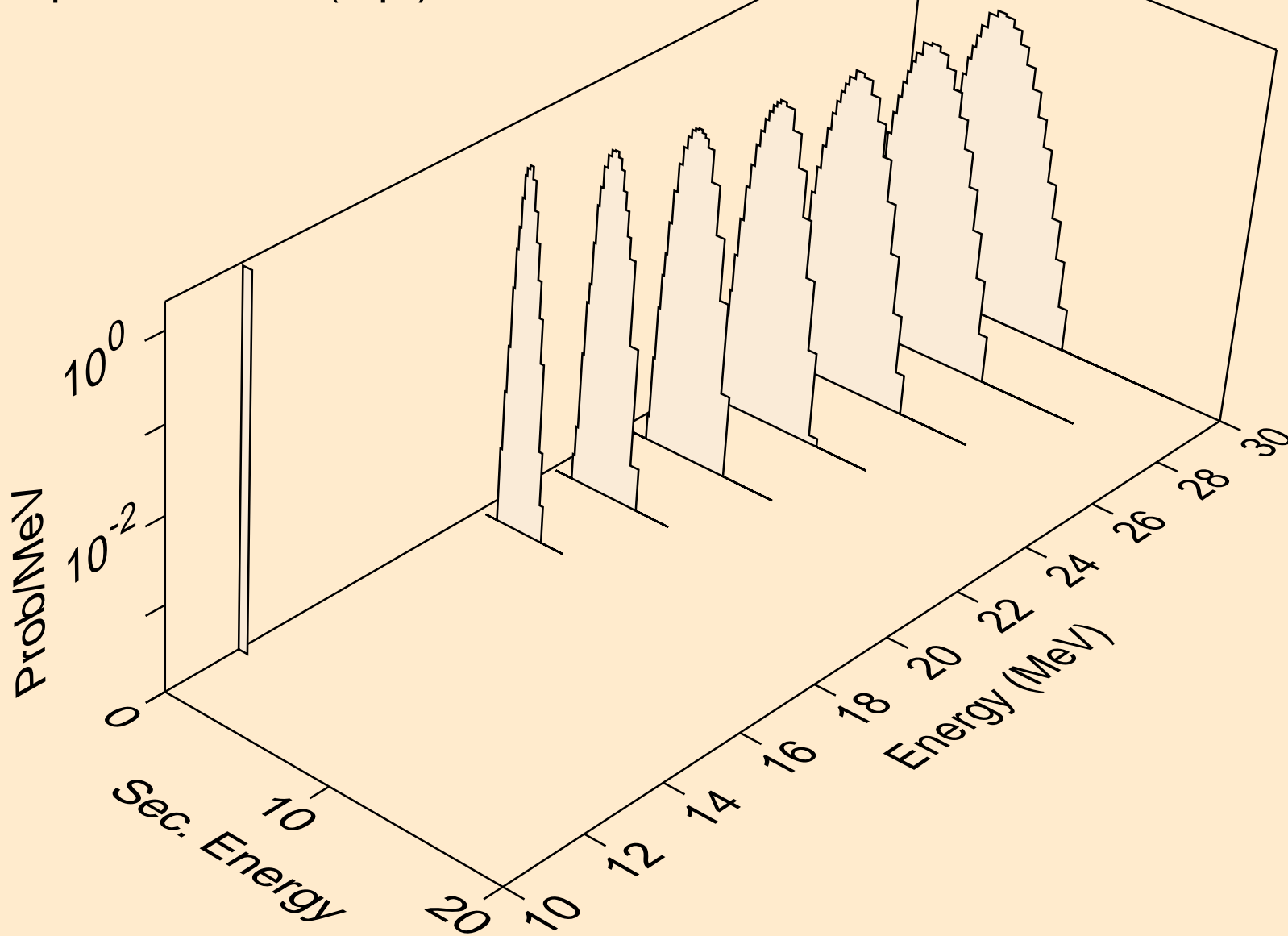

PR140 NEUTRON ACER TENDL-2019 LIBRARY; T=293.16K
deuterons from (n,x)

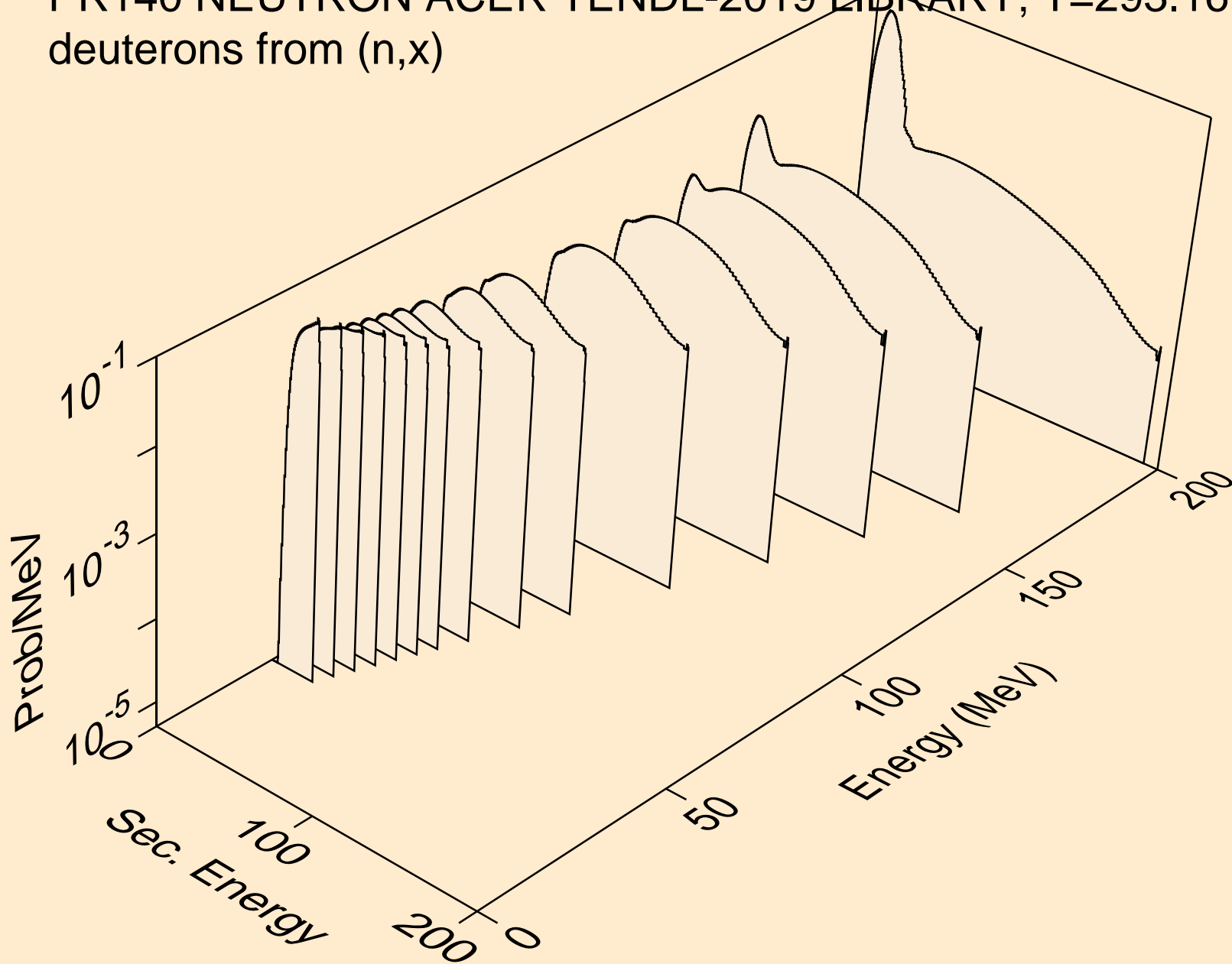

PR140 NEUTRON ACER TENDL-2019 LIBRARY; T=293.16K
deuterons from (n,2nd)

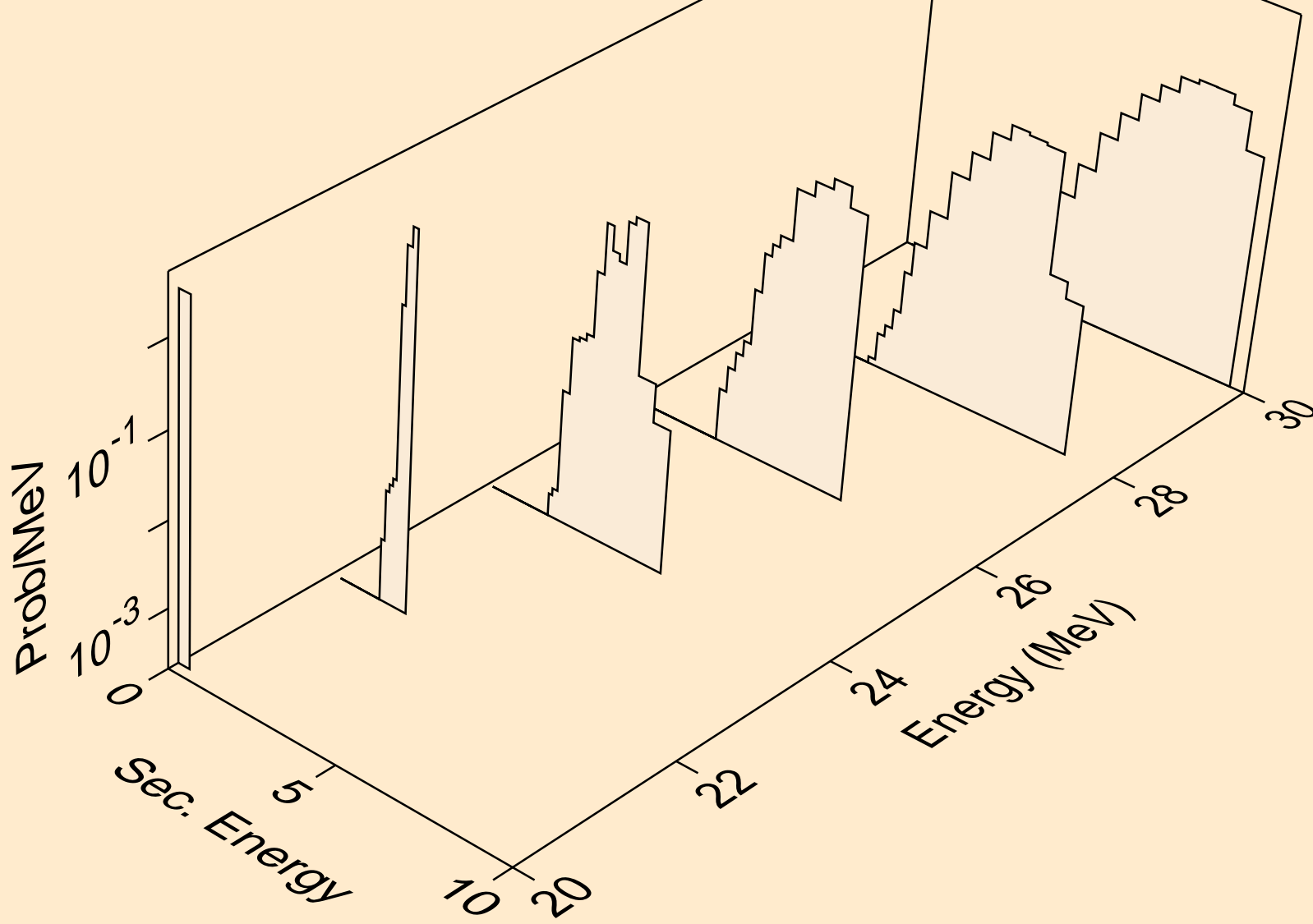

PR140 NEUTRON ACER TENDL-2019 LIBRARY; T=293.16K
deuterons from (n,n*)d

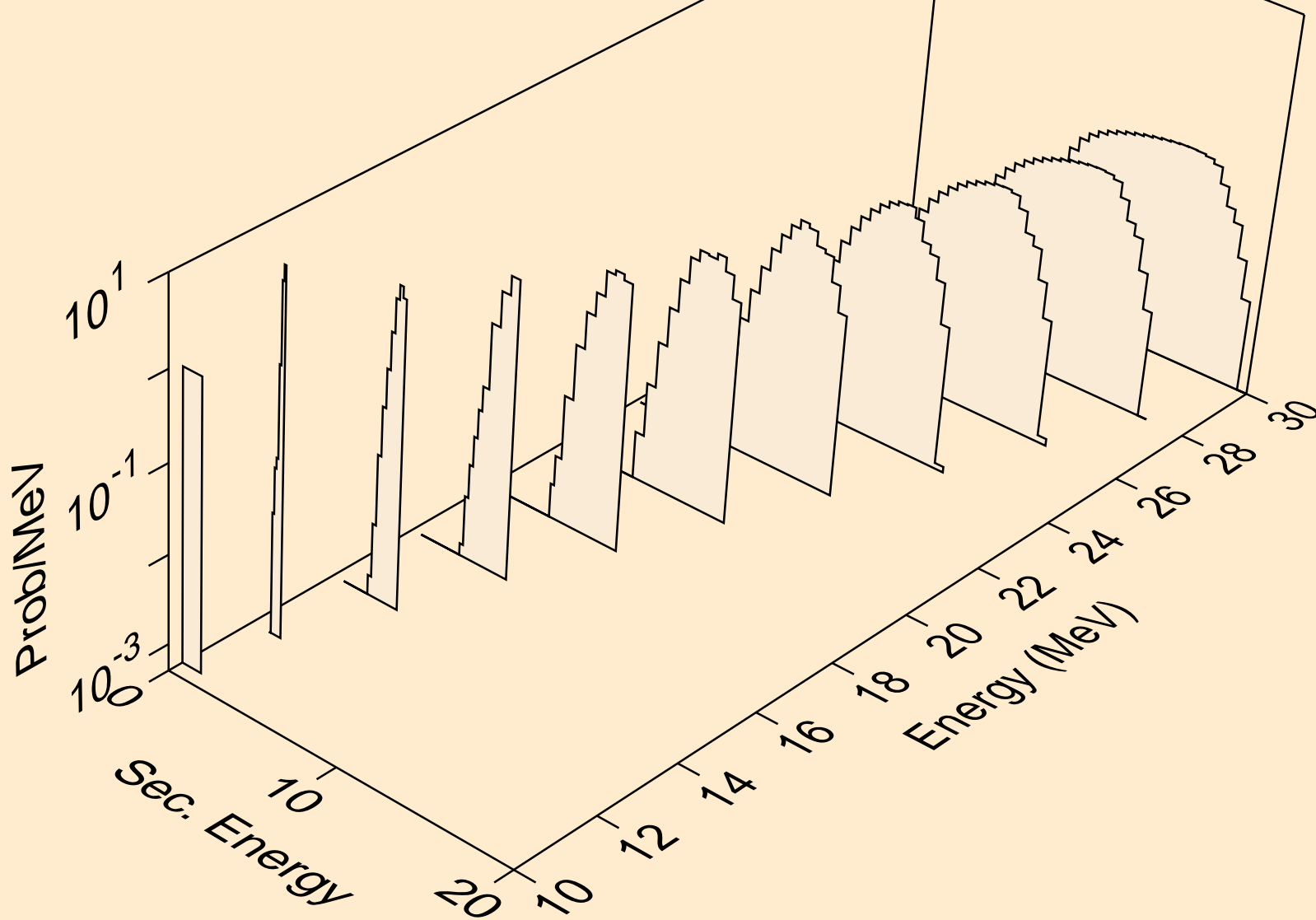

PR140 NEUTRON ACER TENDL-2019 LIBRARY; T=293.16K
deuterons from (n,d)

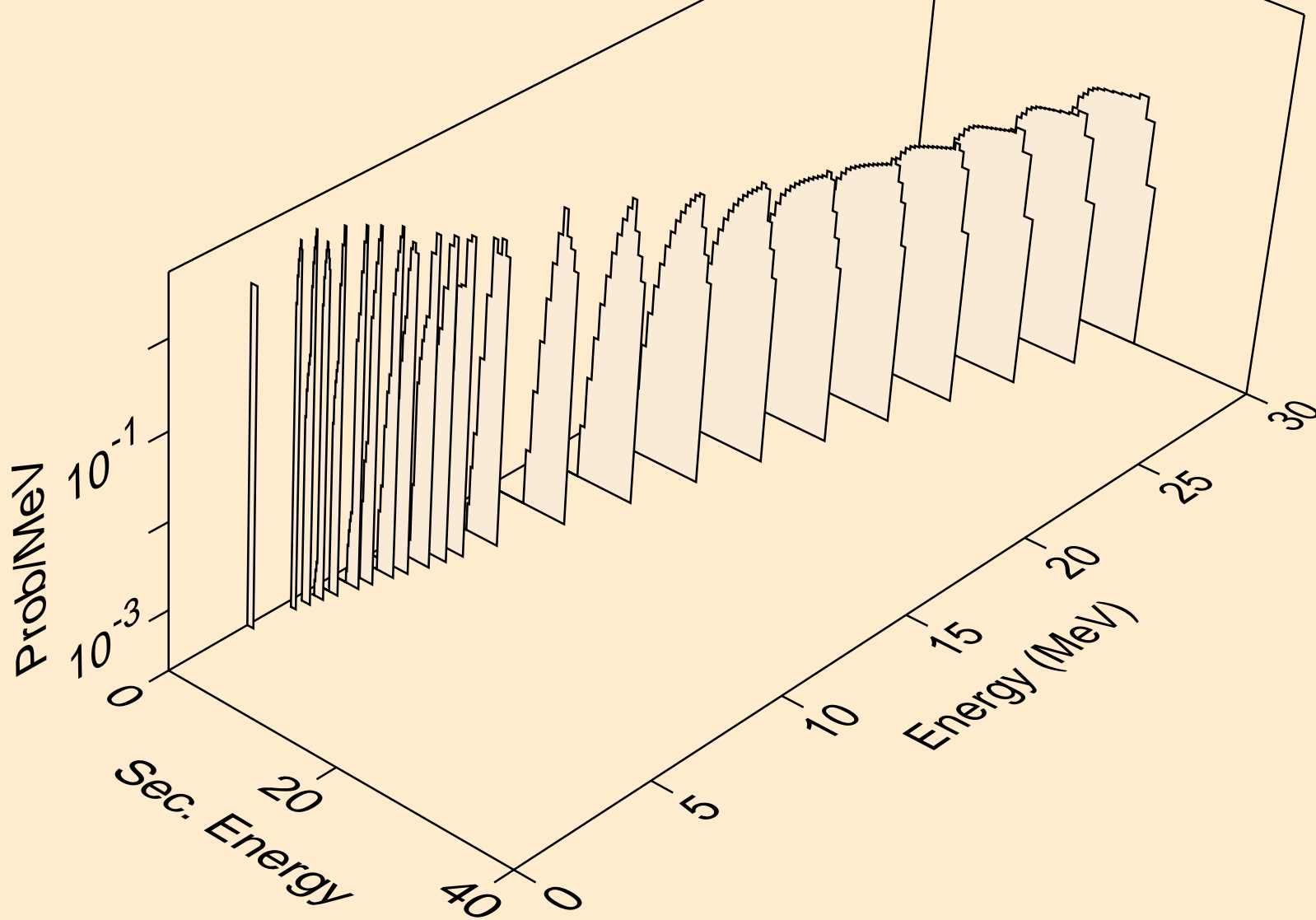

PR140 NEUTRON ACER TENDL-2019 LIBRARY; T=293.16K
deuterons from (n,pd)

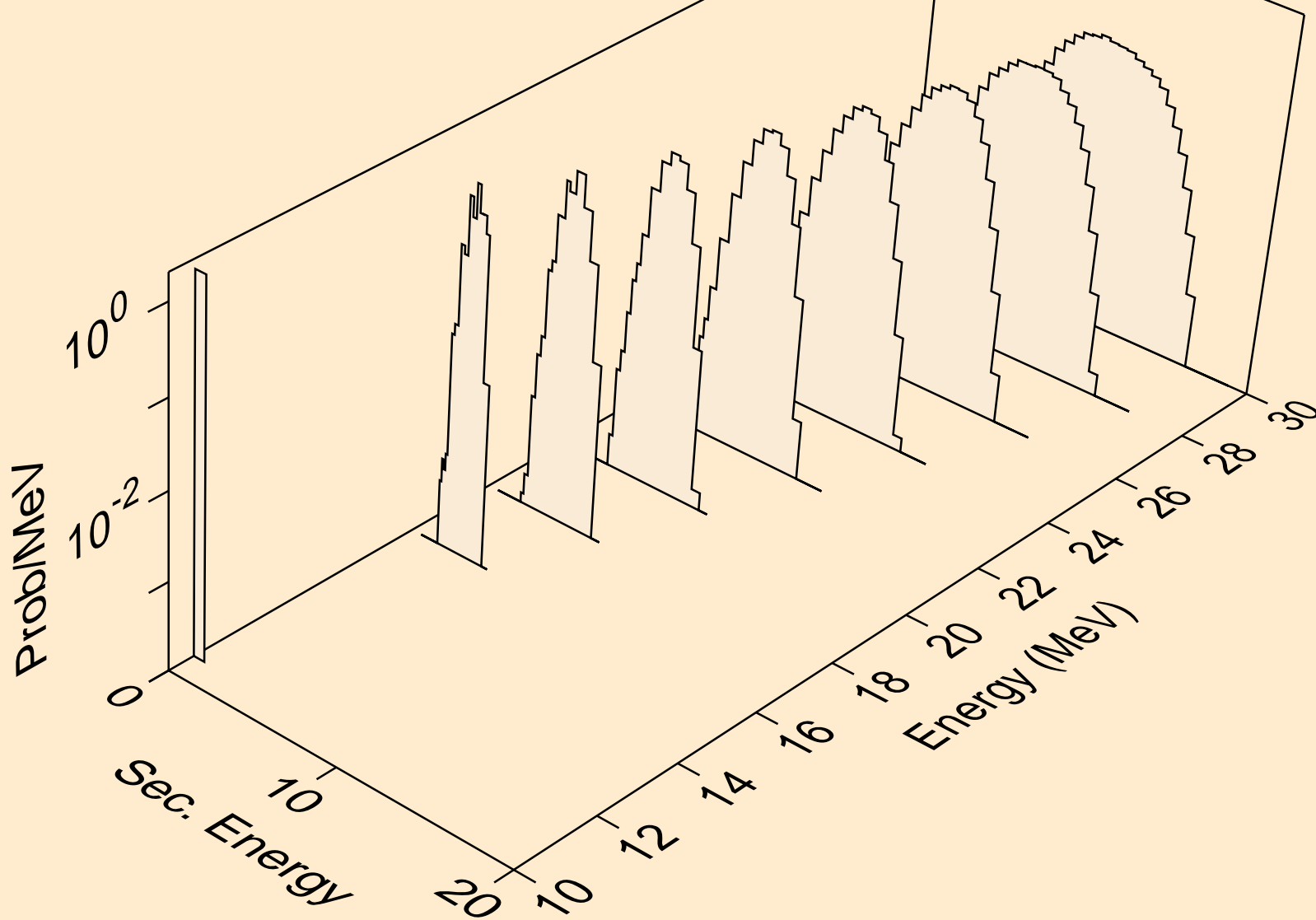

PR140 NEUTRON ACER TENDL-2019 LIBRARY; T=293.16K
deuterons from (n,da)

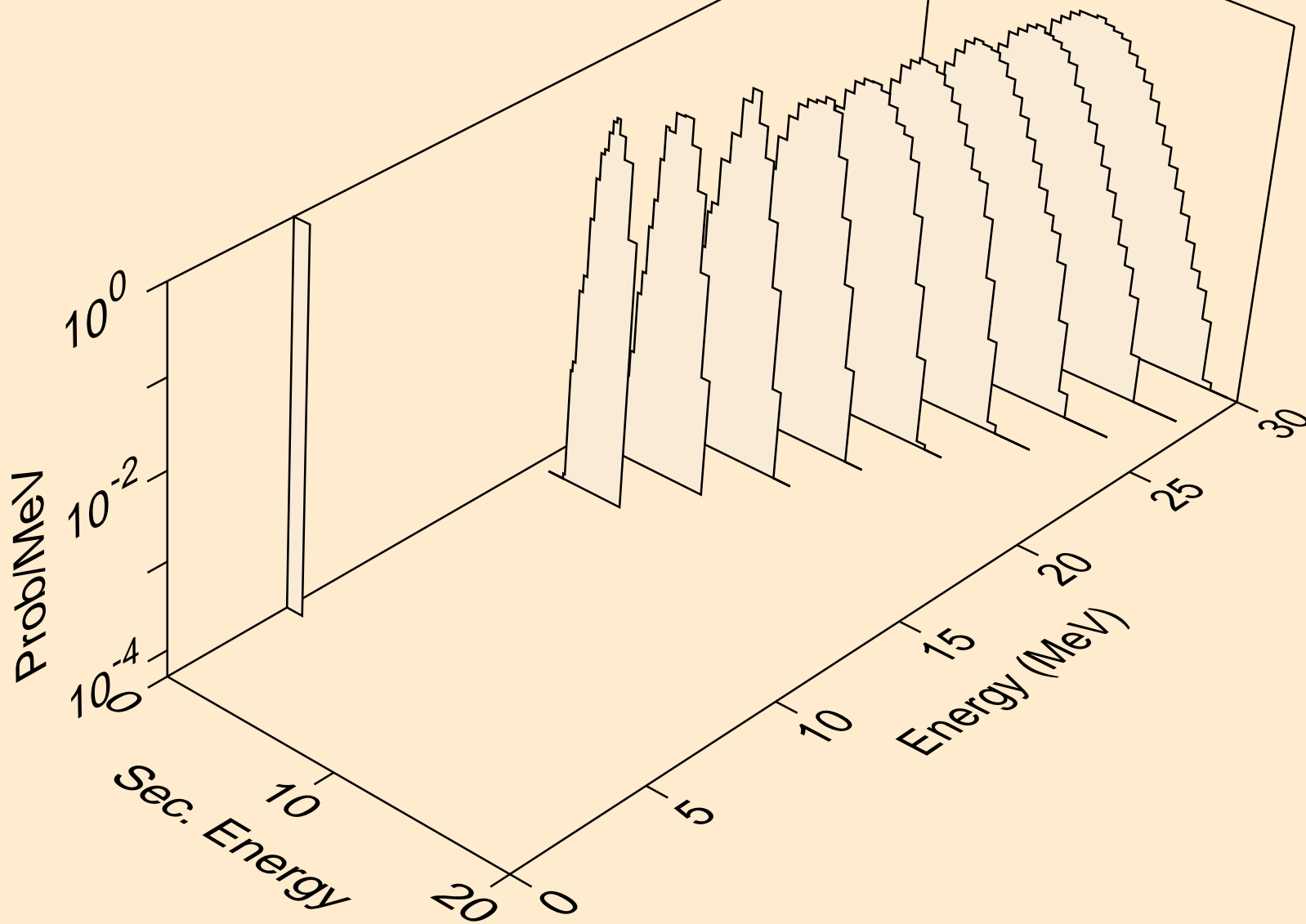

PR140 NEUTRON ACER TENDL-2019 LIBRARY; T=293.16K
tritons from (n,x)

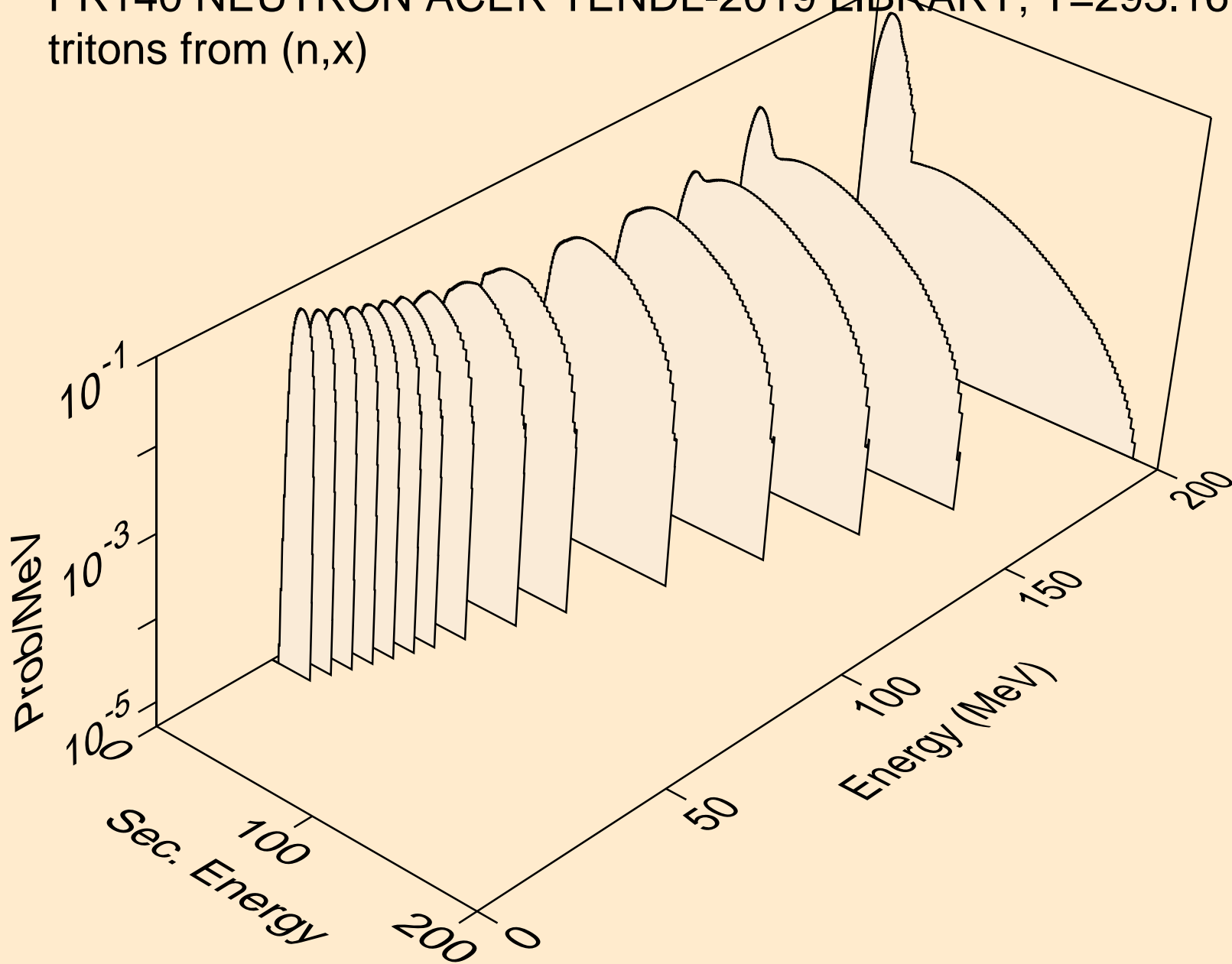

PR140 NEUTRON ACER TENDL-2019 LIBRARY; T=293.16K
tritons from (n,n*)t

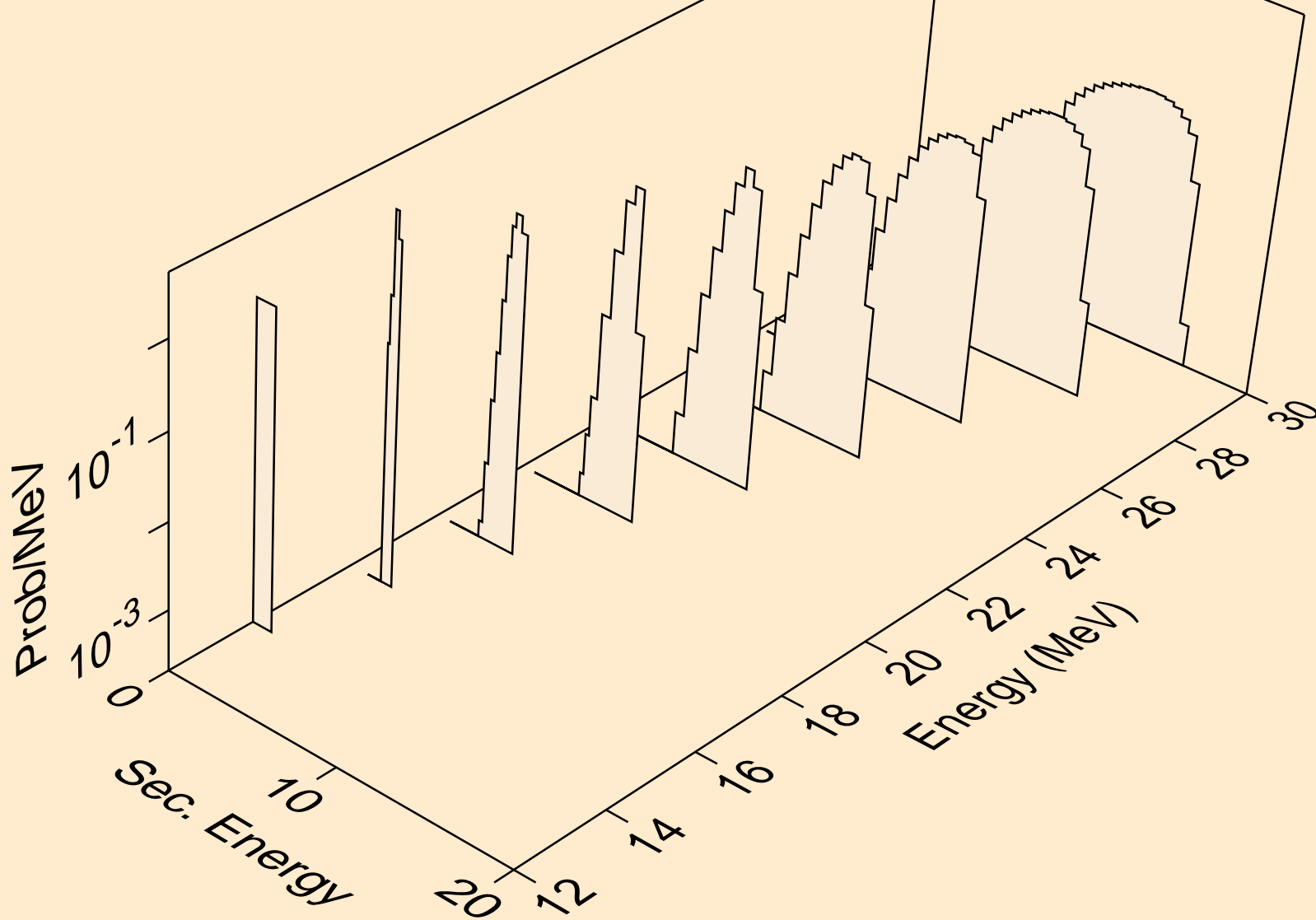

PR140 NEUTRON ACER TENDL-2019 LIBRARY; T=293.16K
tritons from (n,t)

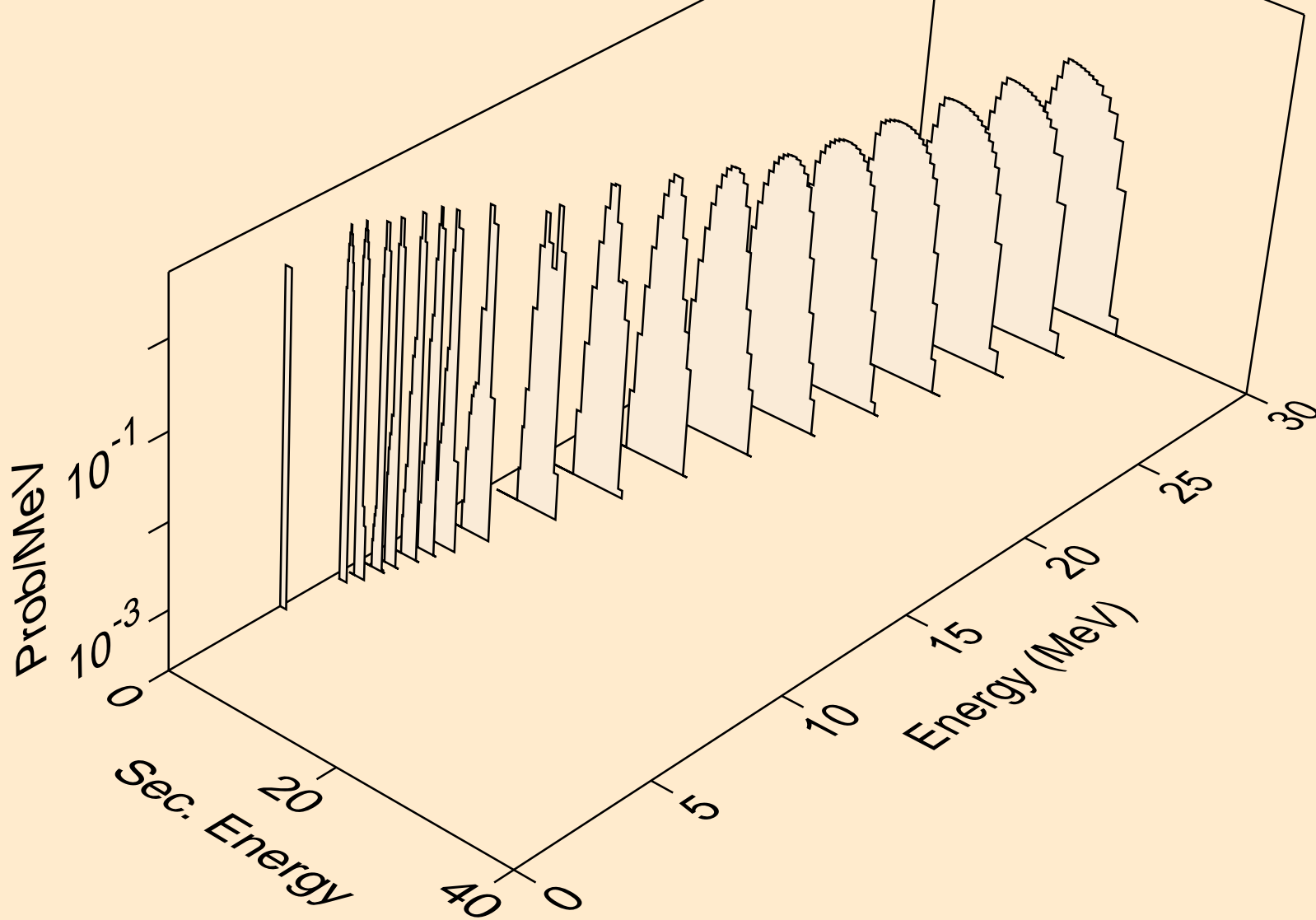

PR140 NEUTRON ACER TENDL-2019 LIBRARY; T=293.16K
tritons from (n,pt)

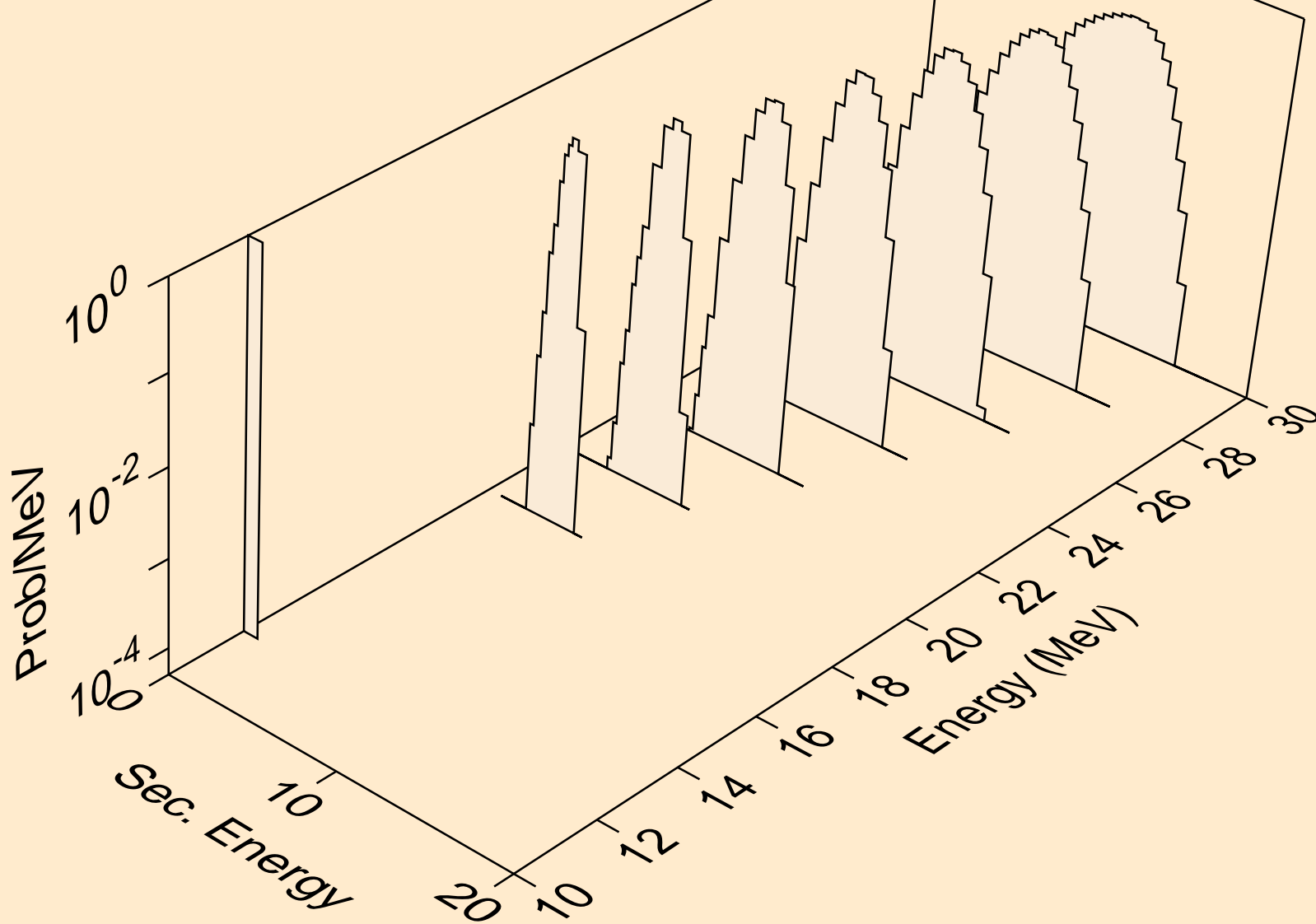

PR140 NEUTRON ACER TENDL-2019 LIBRARY; T=293.16K
he3s from (n,x)

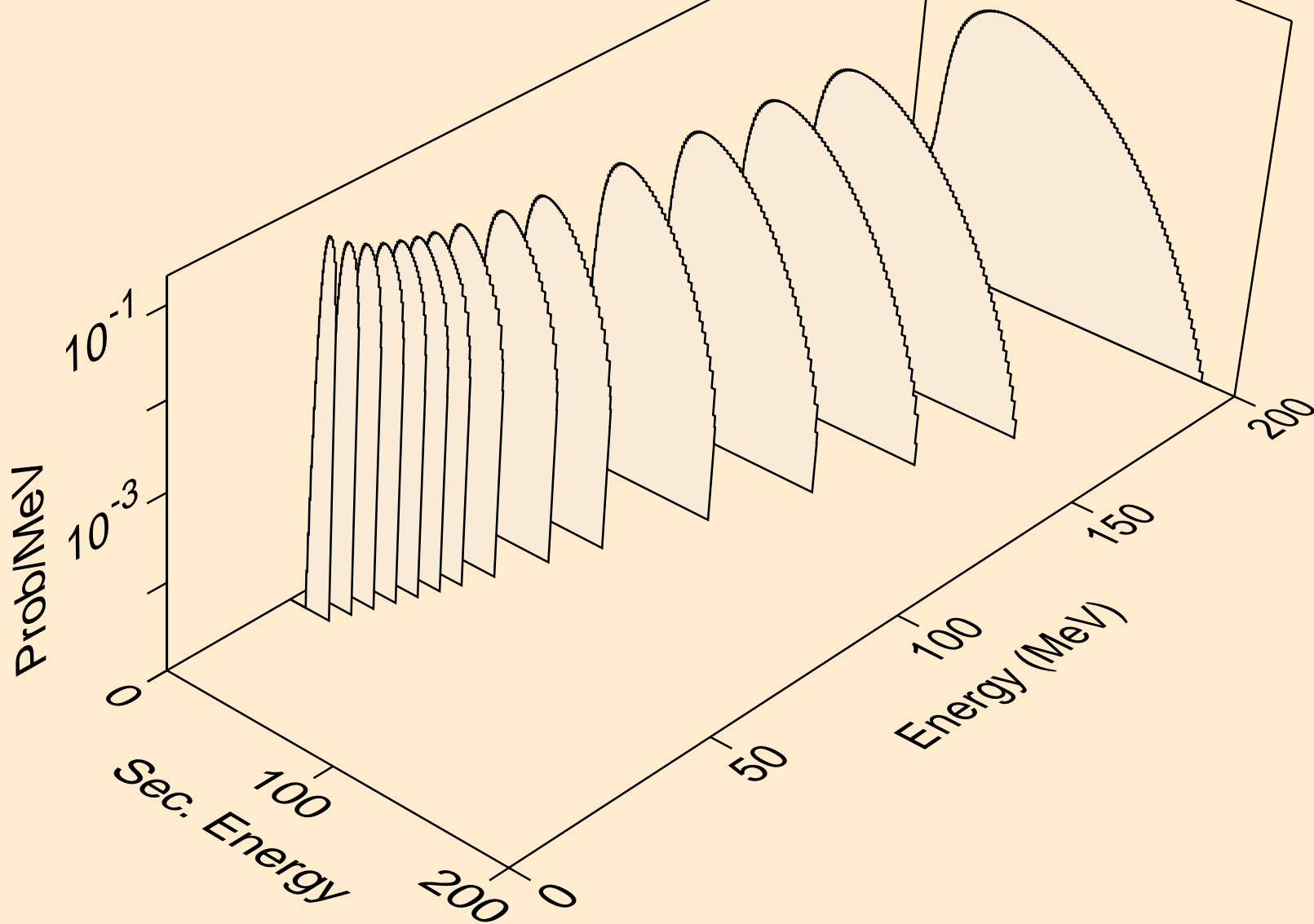

PR140 NEUTRON ACER TENDL-2019 LIBRARY; T=293.16K
he3s from (n,n*)he3

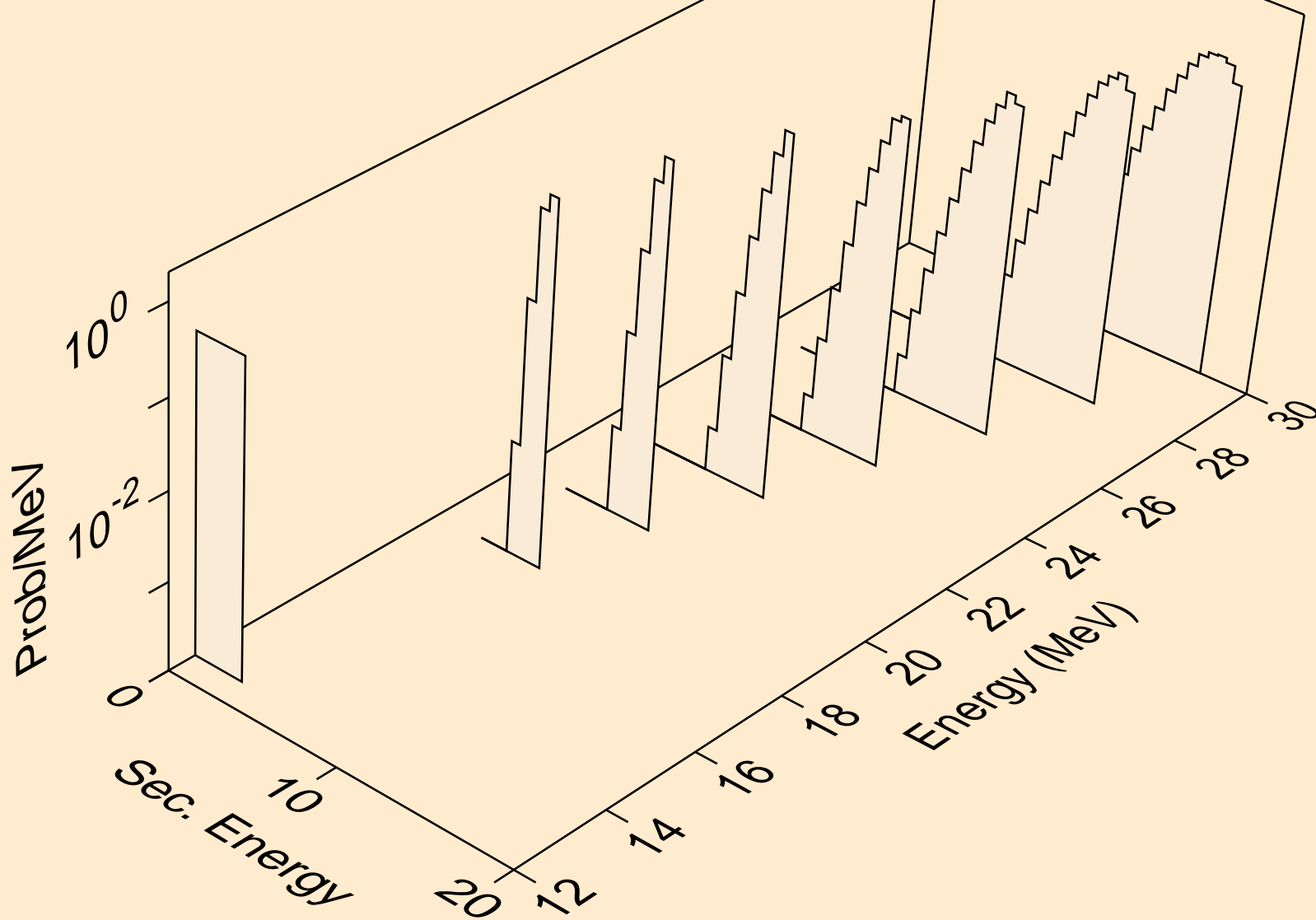

PR140 NEUTRON ACER TENDL-2019 LIBRARY; T=293.16K
he3s from (n,he3)

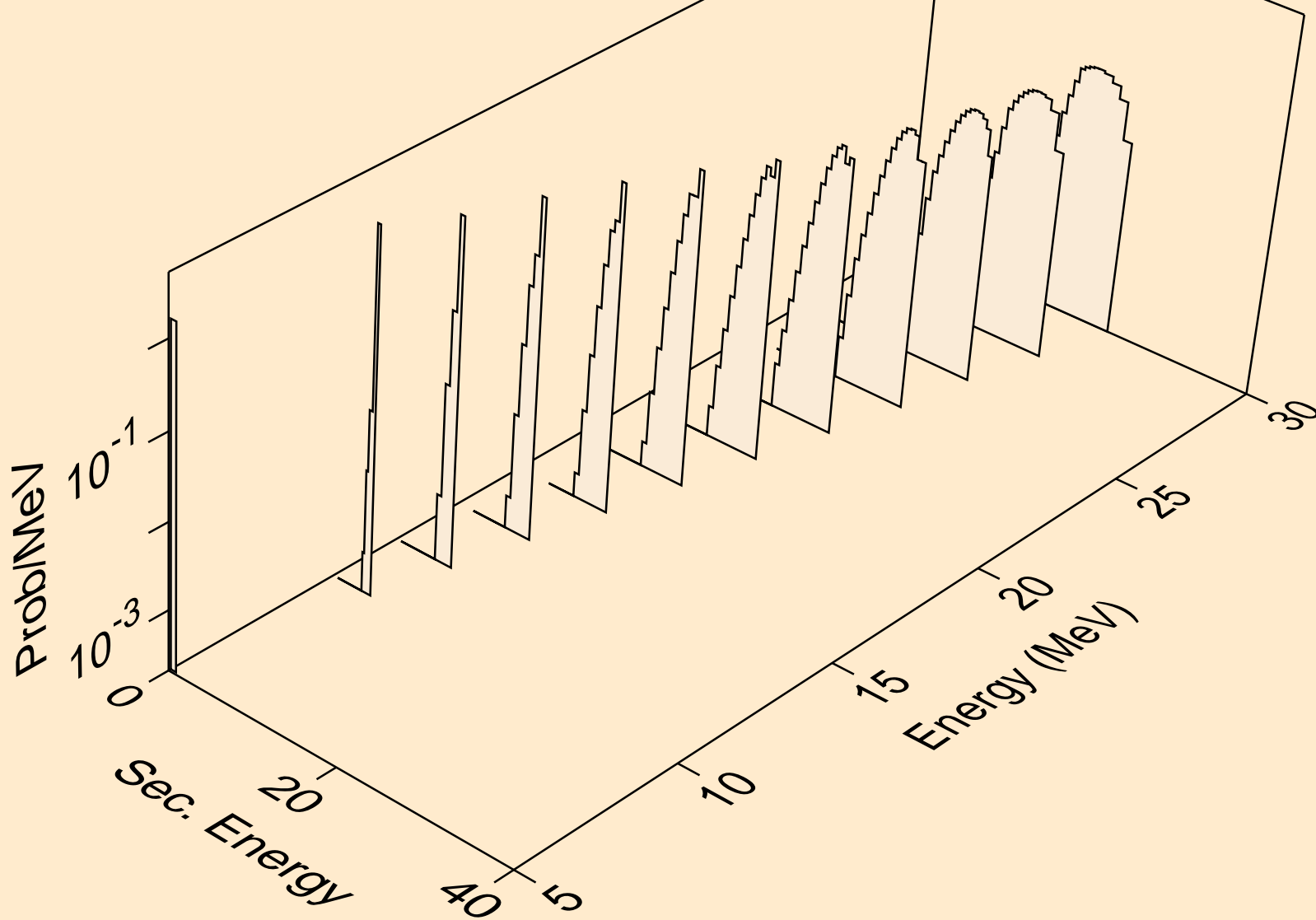

PR140 NEUTRON ACER TENDL-2019 LIBRARY; T=293.16K
alphas from (n,x)

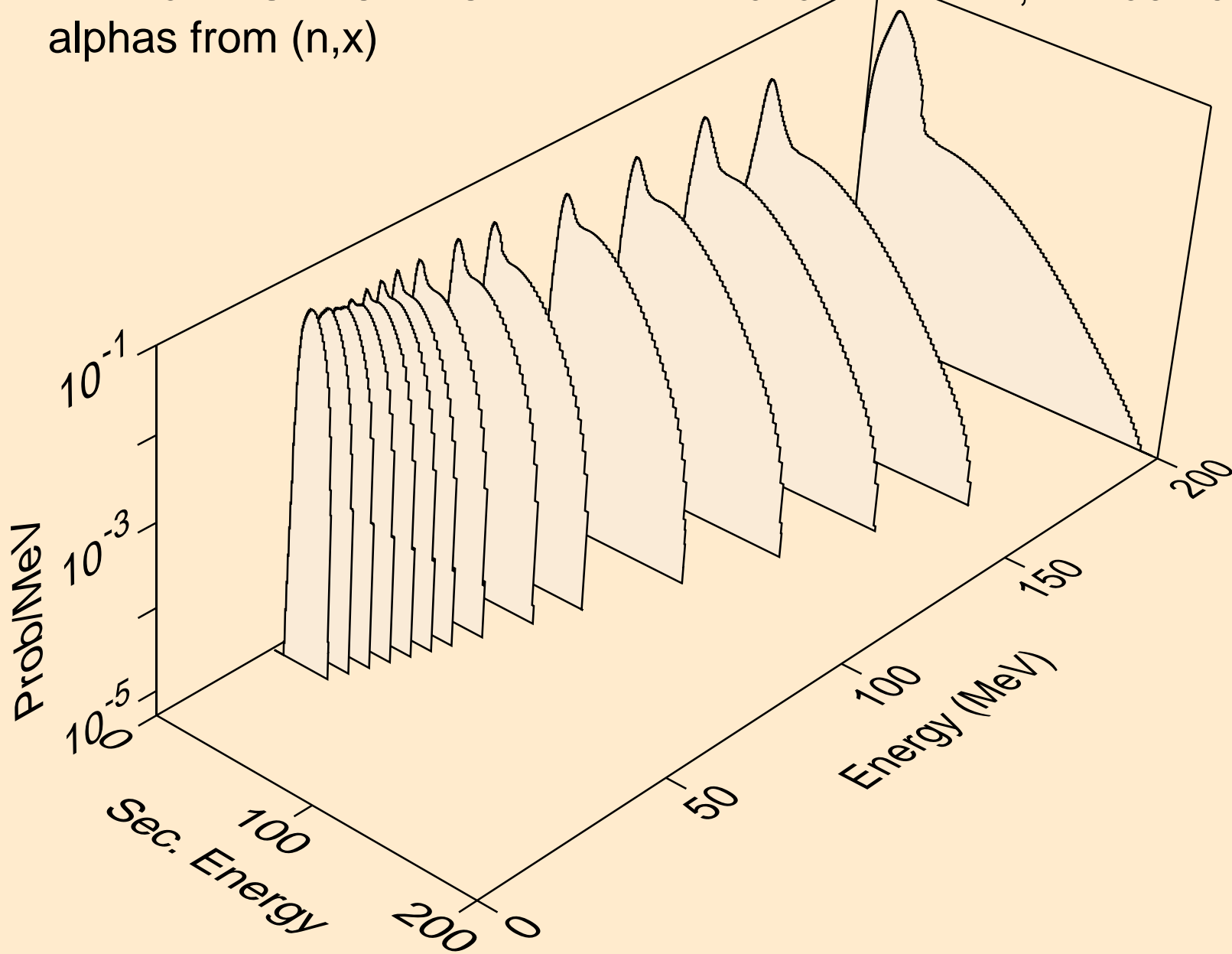

PR140 NEUTRON ACER TENDL-2019 LIBRARY; T=293.16K
alphas from (n,n*)a

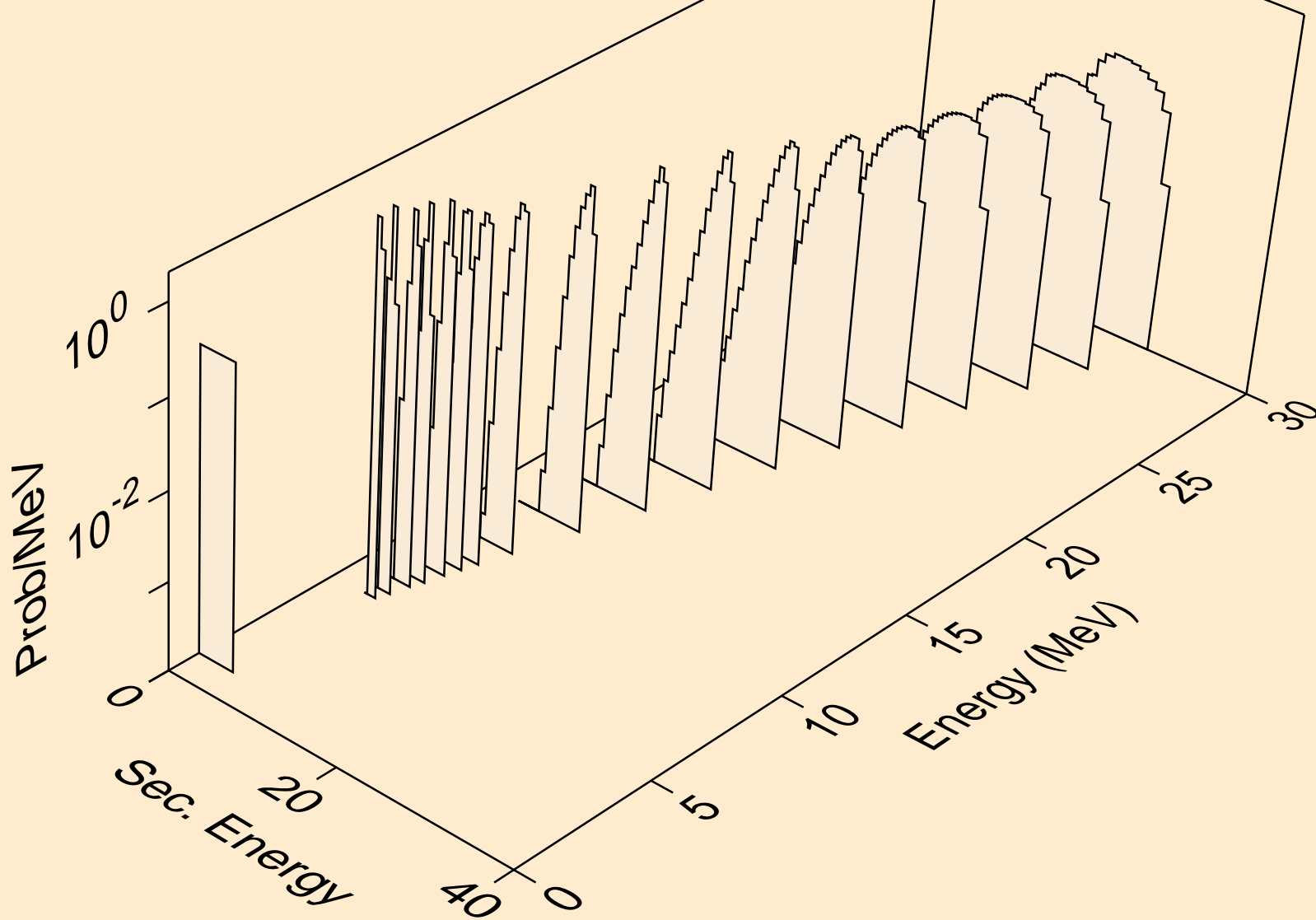

PR140 NEUTRON ACER TENDL-2019 LIBRARY; T=293.16K
alphas from (n,2n)a

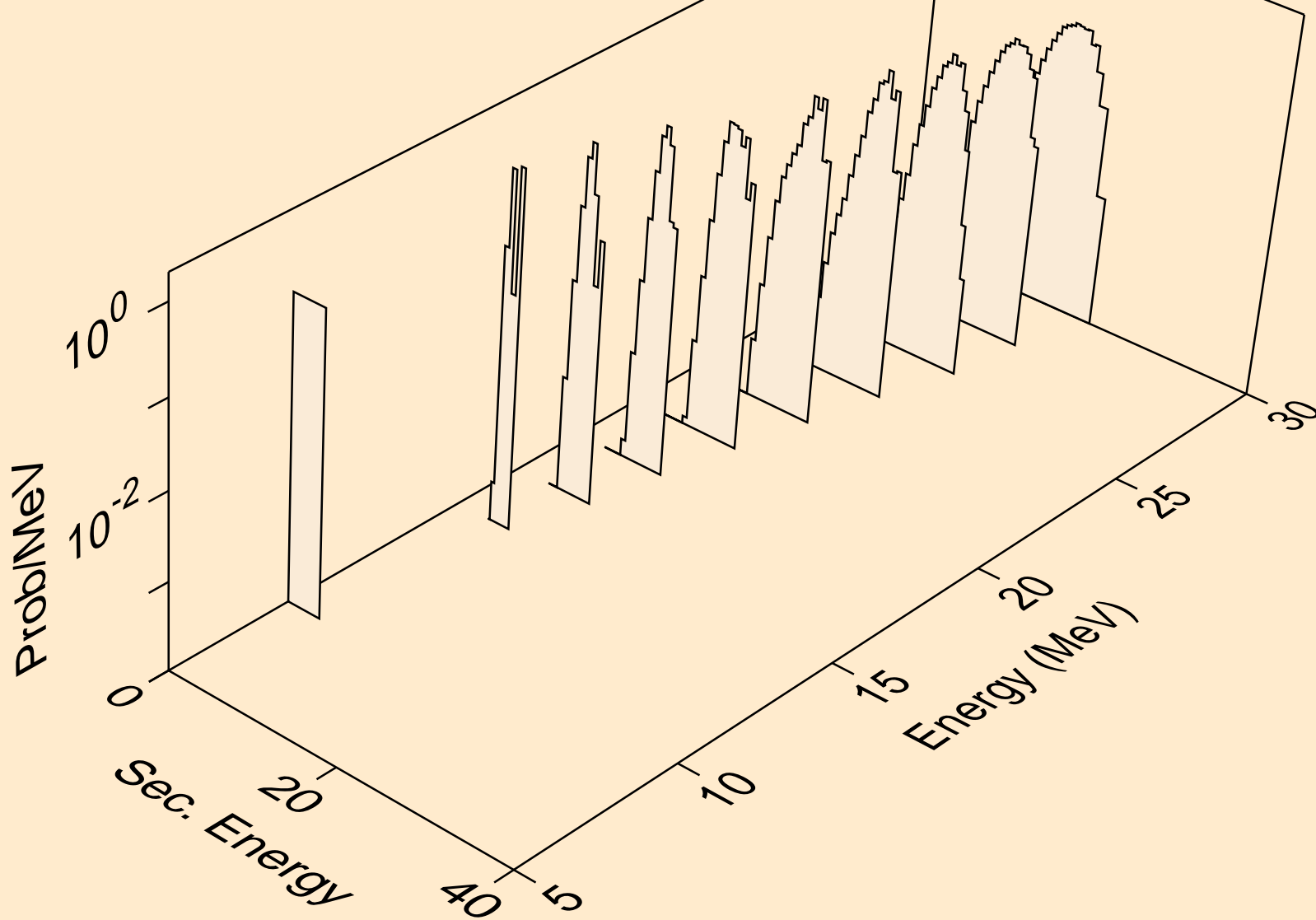

PR140 NEUTRON ACER TENDL-2019 LIBRARY; T=293.16K
alphas from (n,3n)a

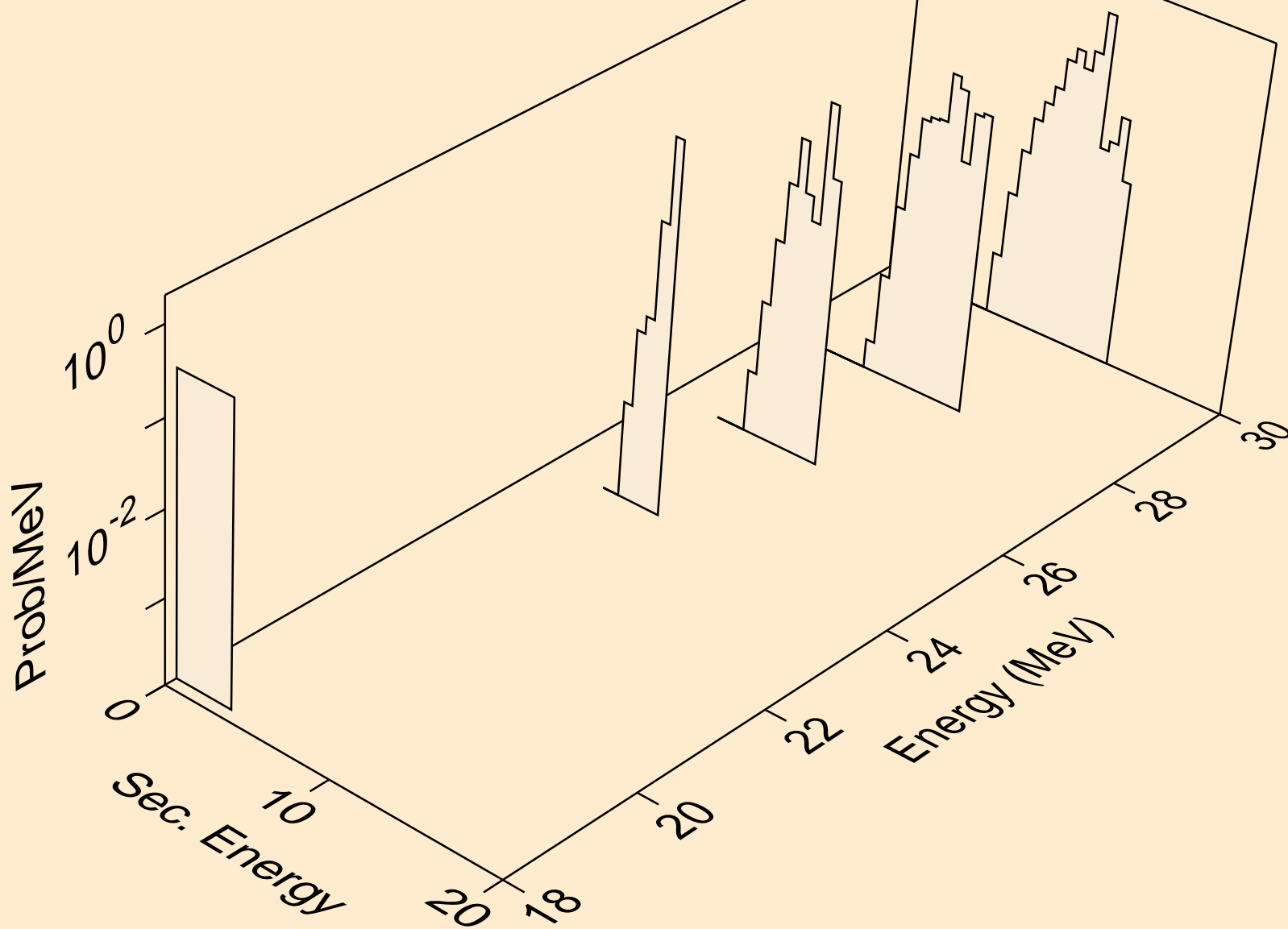

PR140 NEUTRON ACER TENDL-2019 LIBRARY; T=293.16K
alphas from (n,n*)2a

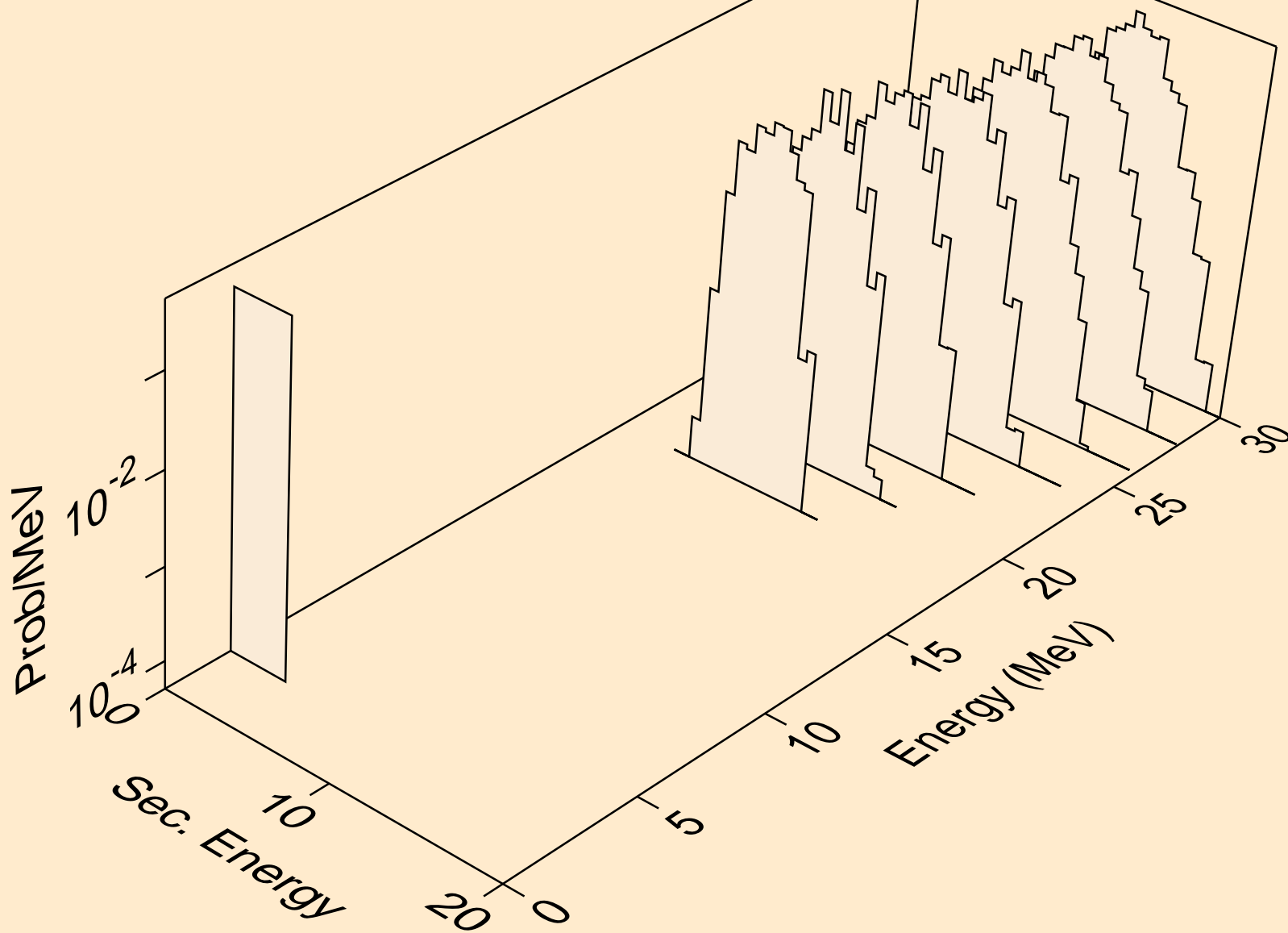

PR140 NEUTRON ACER TENDL-2019 LIBRARY; T=293.16K
alphas from (n,npa)

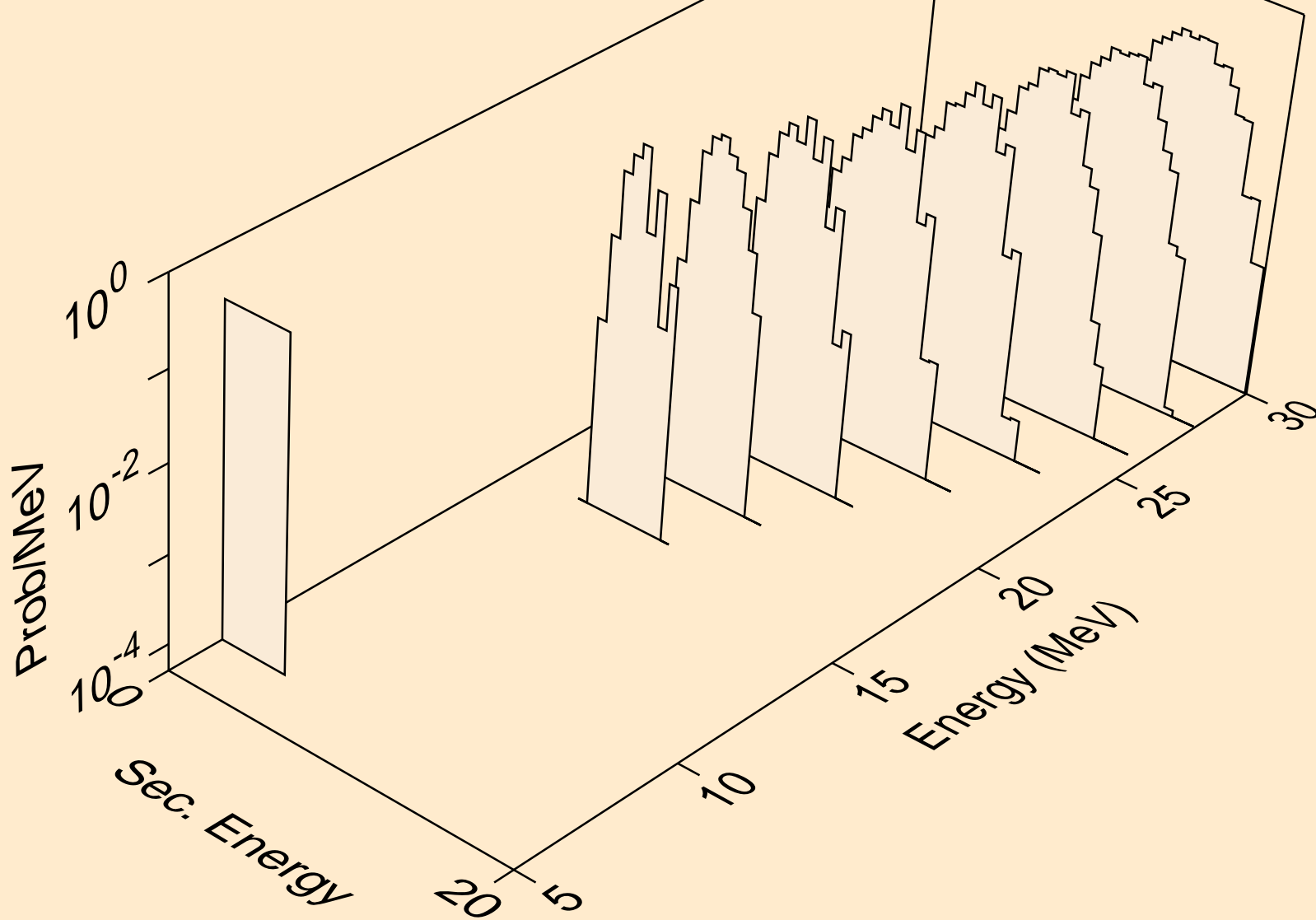

PR140 NEUTRON ACER TENDL-2019 LIBRARY; T=293.16K
alphas from (n,a)

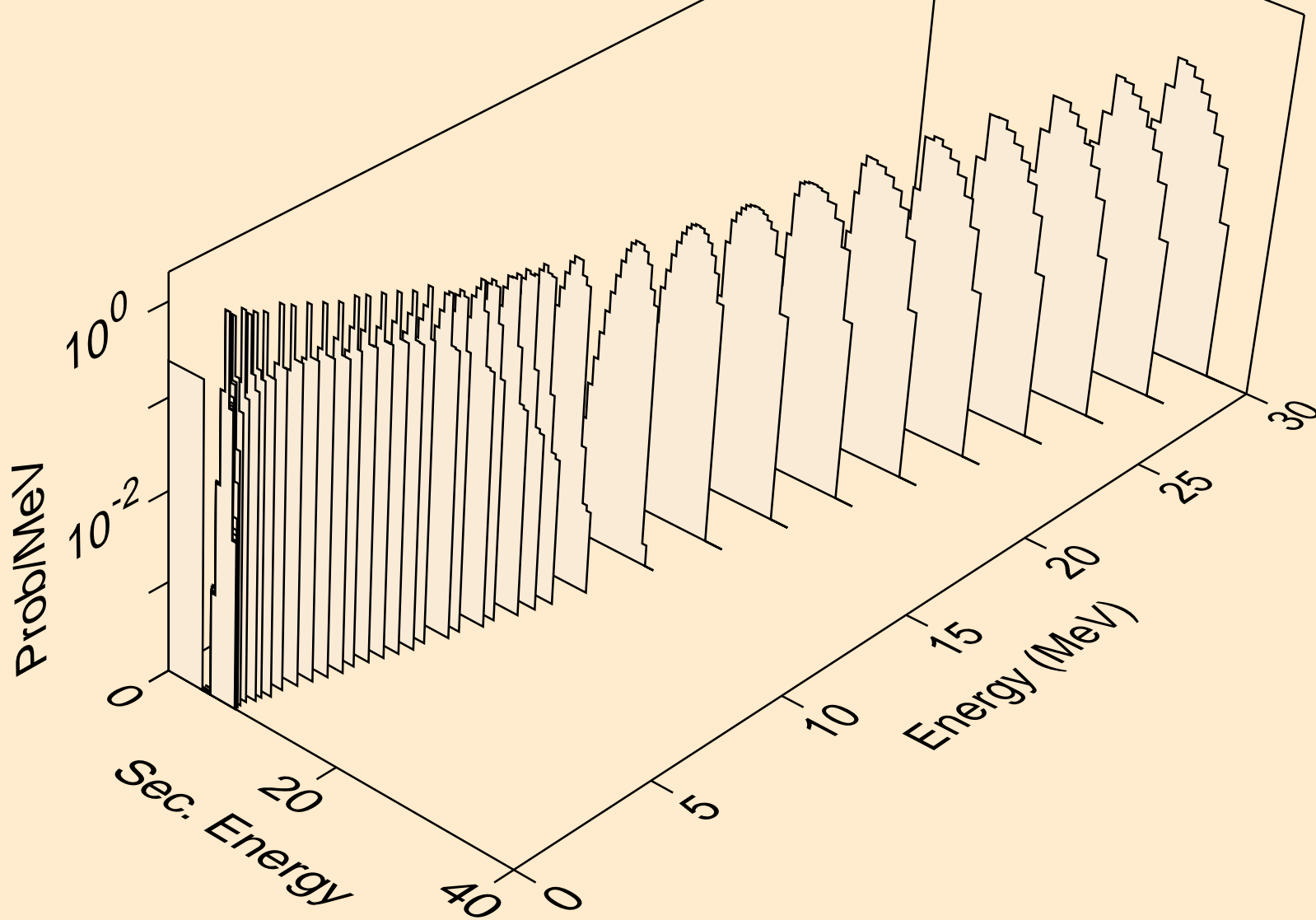

PR140 NEUTRON ACER TENDL-2019 LIBRARY; T=293.16K
alphas from (n,2a)

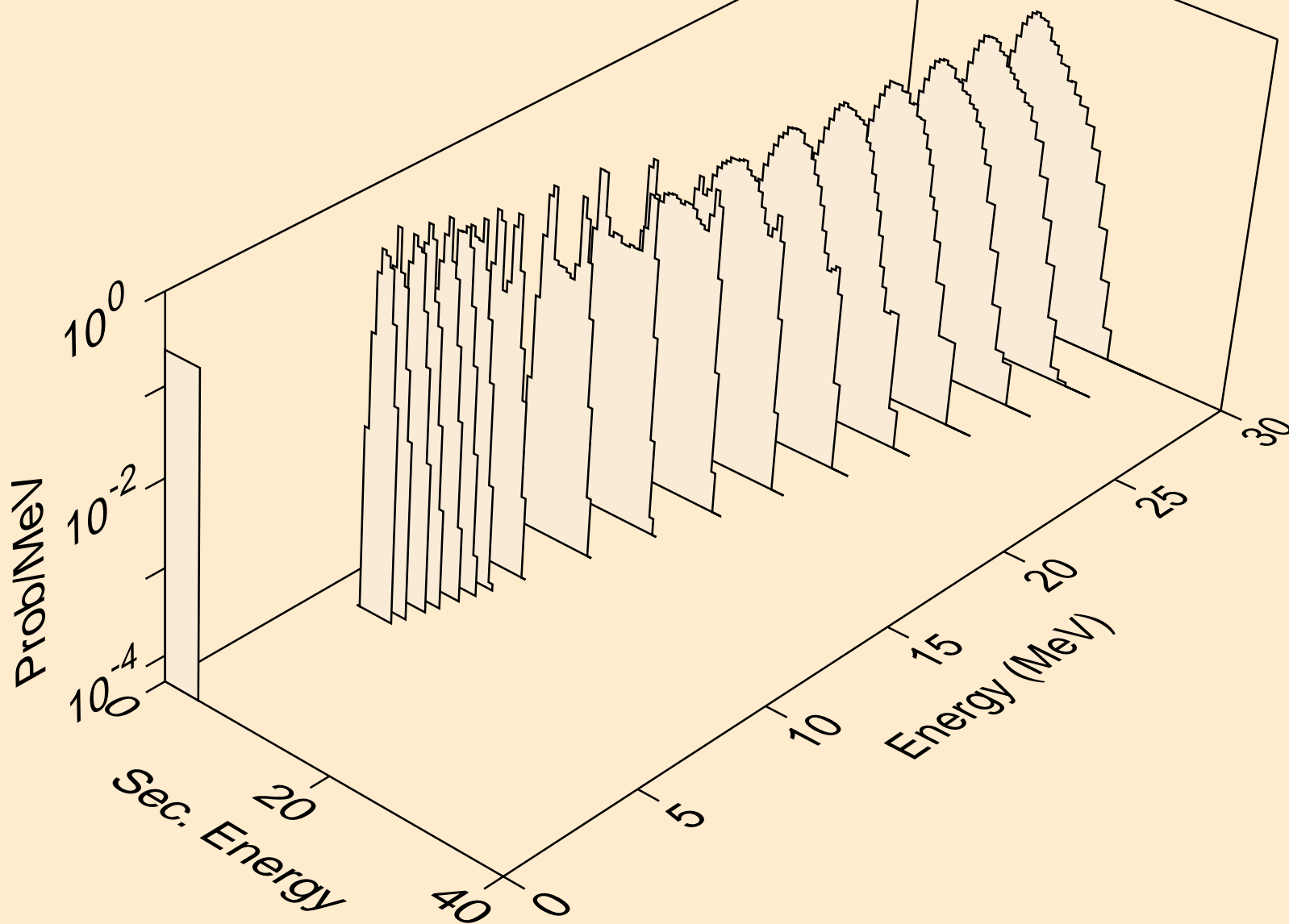

PR140 NEUTRON ACER TENDL-2019 LIBRARY; T=293.16K
alphas from (n,pa)

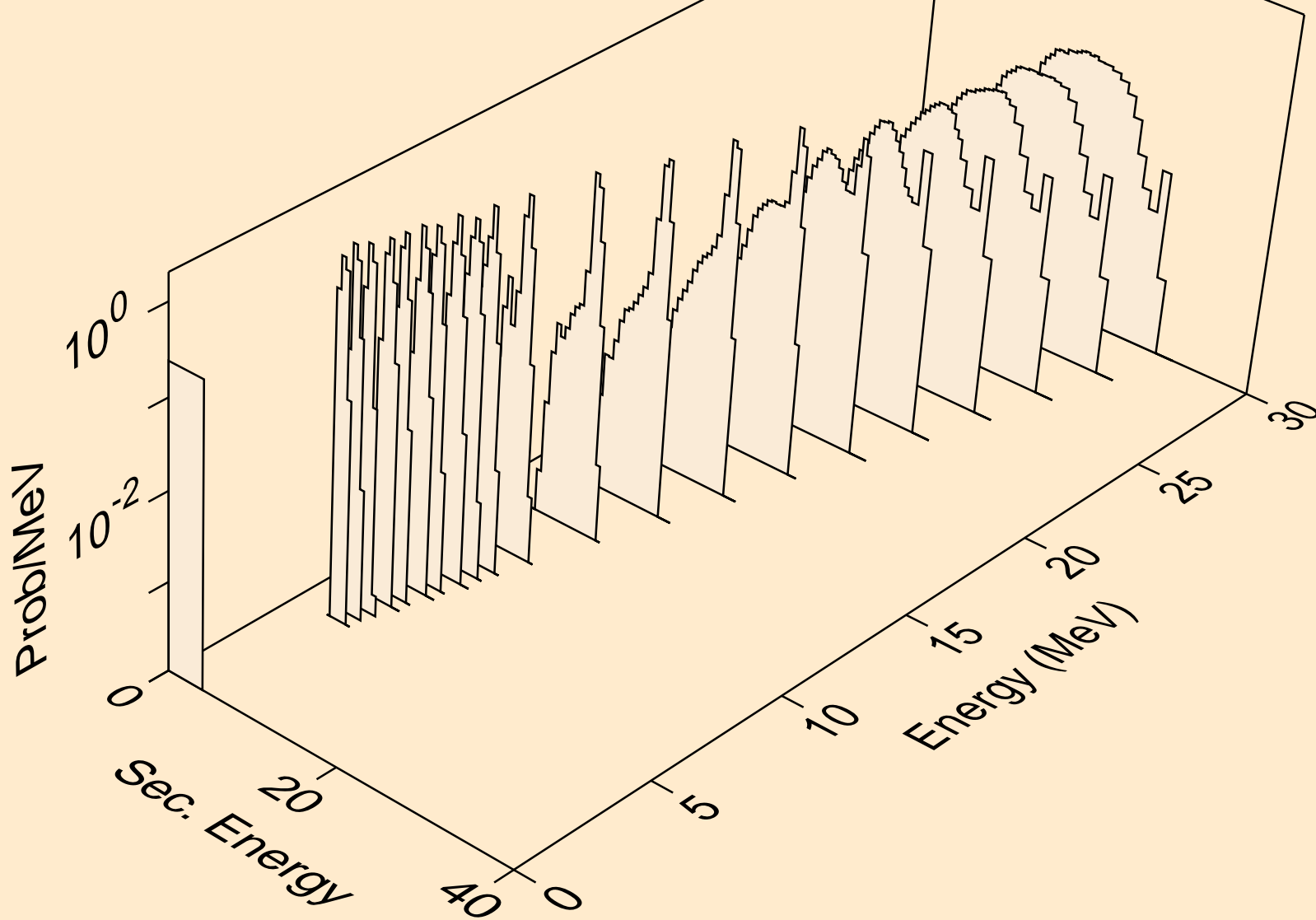

PR140 NEUTRON ACER TENDL-2019 LIBRARY; T=293.16K
alphas from (n,da)

