

PR146 NEUTRON ACER TENDL-2019 LIBRARY; T=293.16K  
Principal cross sections

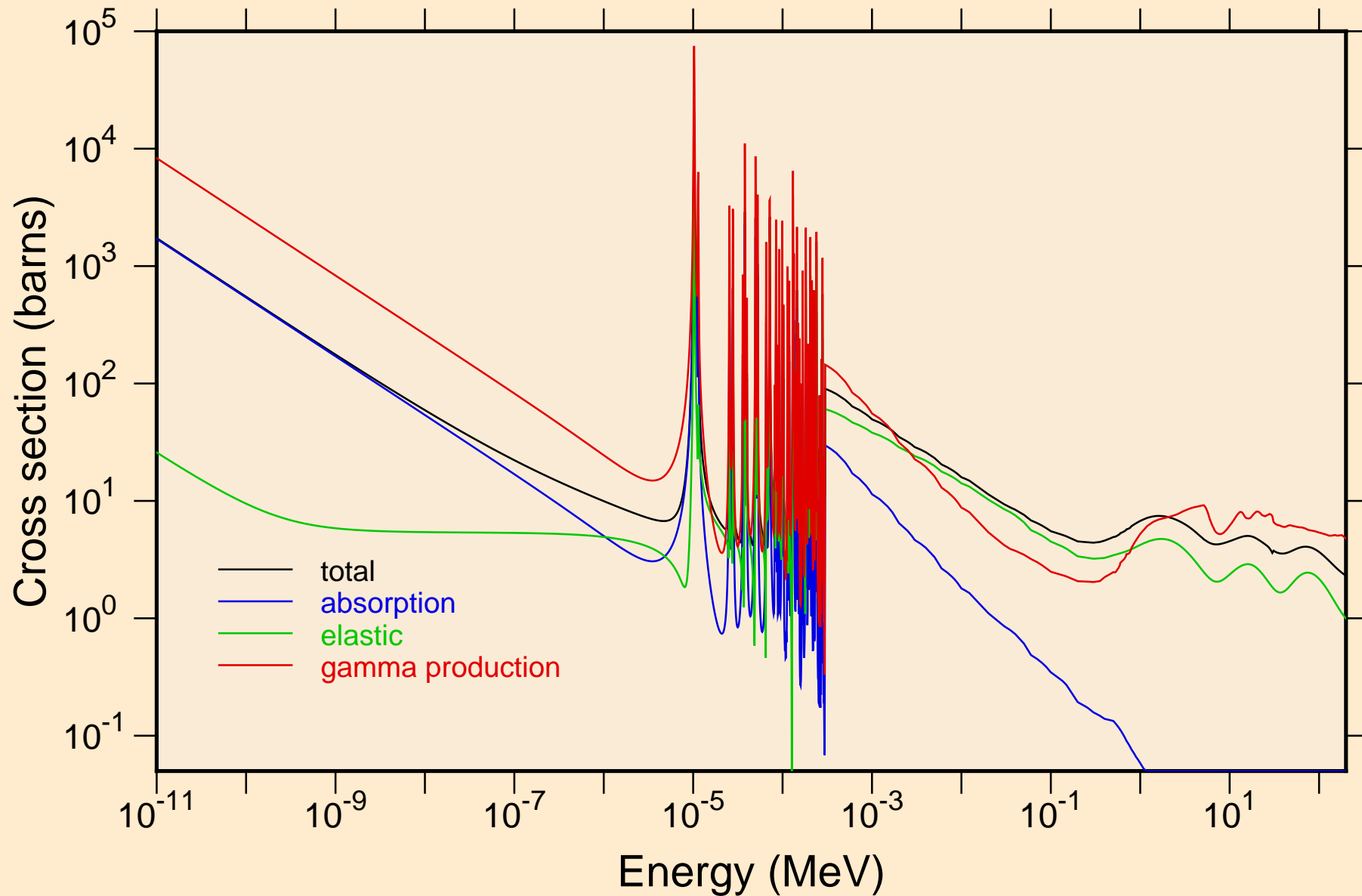

PR146 NEUTRON ACER TENDL-2019 LIBRARY; T=293.16K  
resonance total cross section

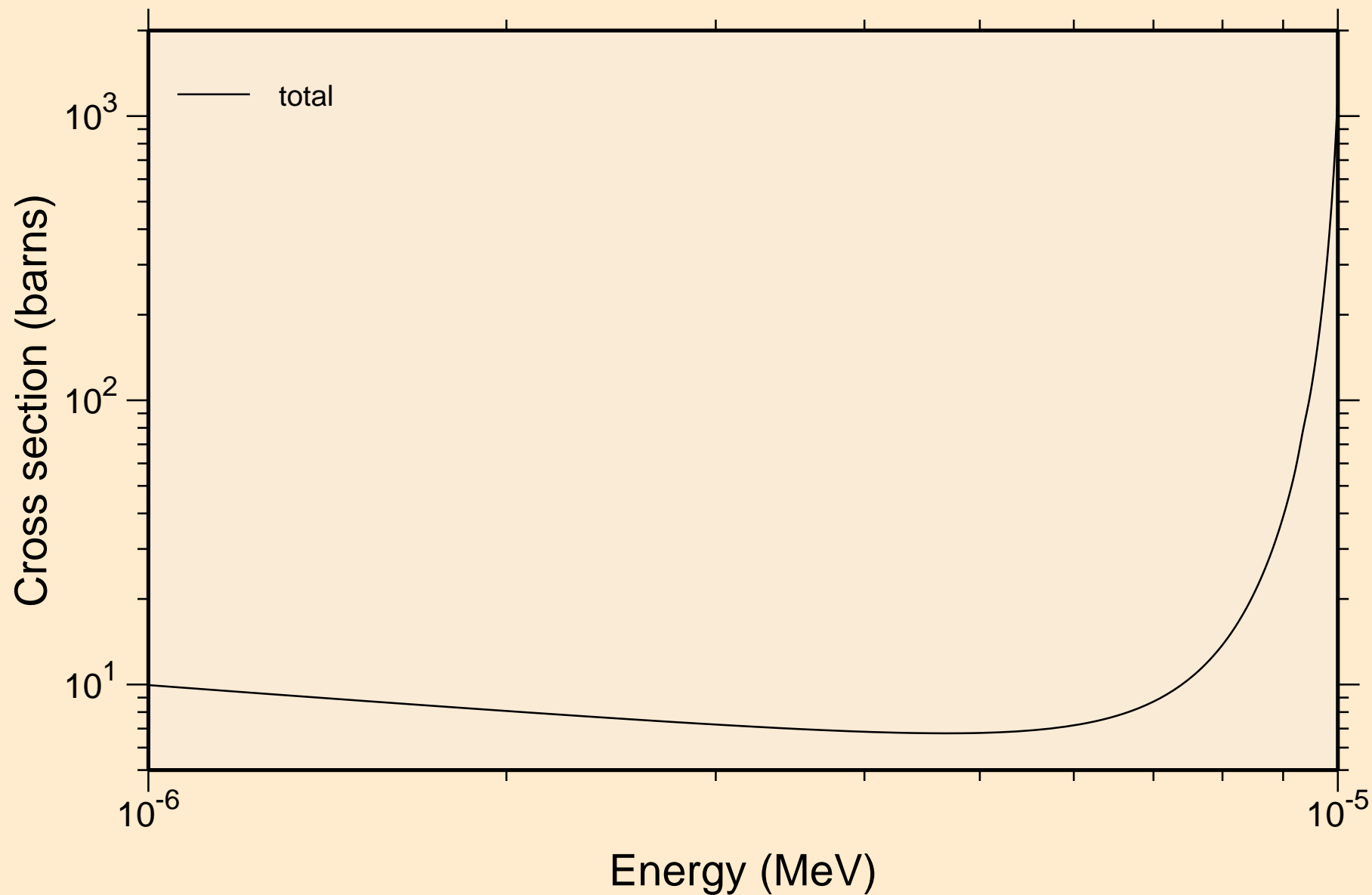

PR146 NEUTRON ACER TENDL-2019 LIBRARY; T=293.16K  
resonance total cross section

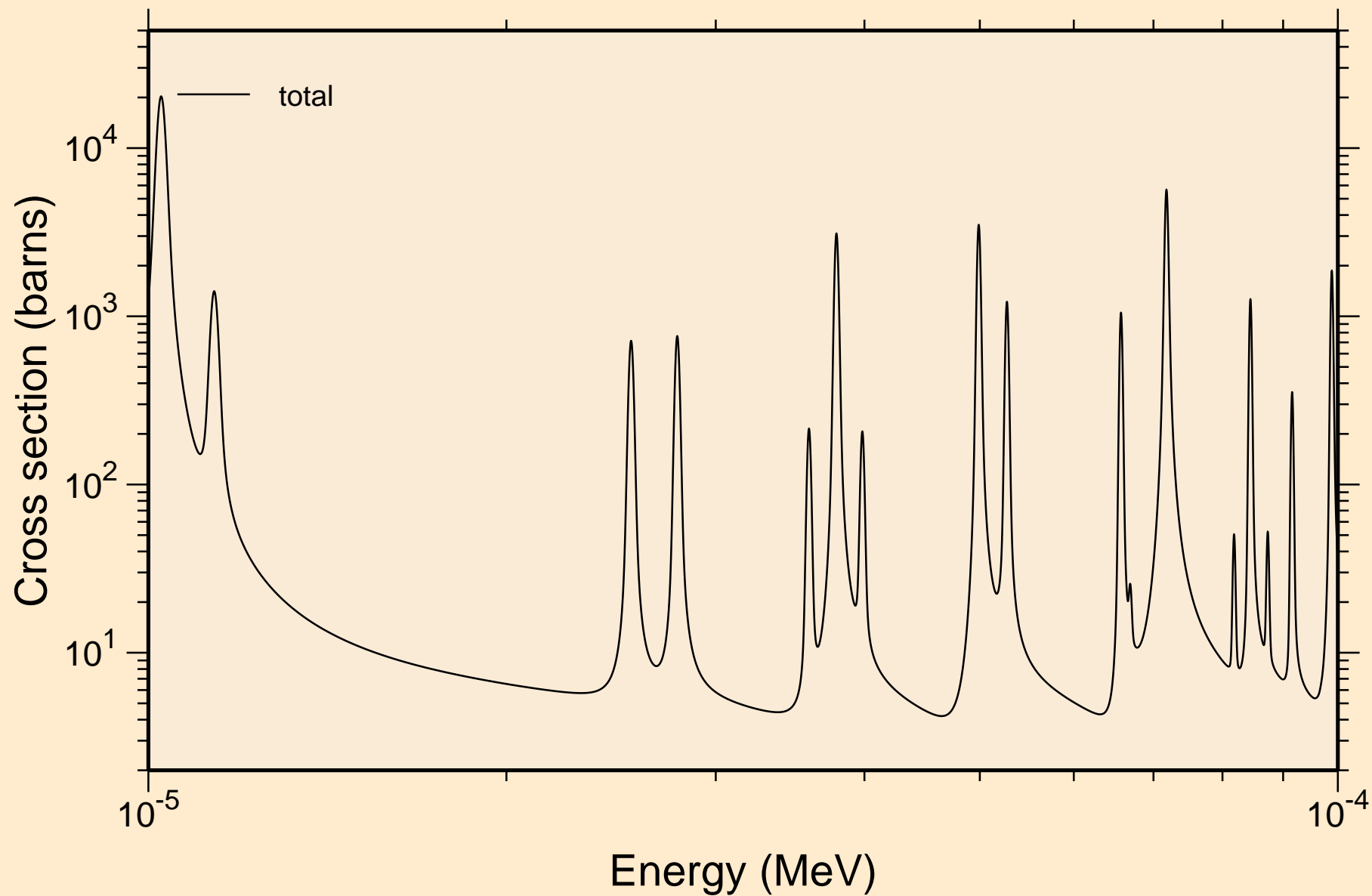

PR146 NEUTRON ACER TENDL-2019 LIBRARY; T=293.16K  
resonance total cross section

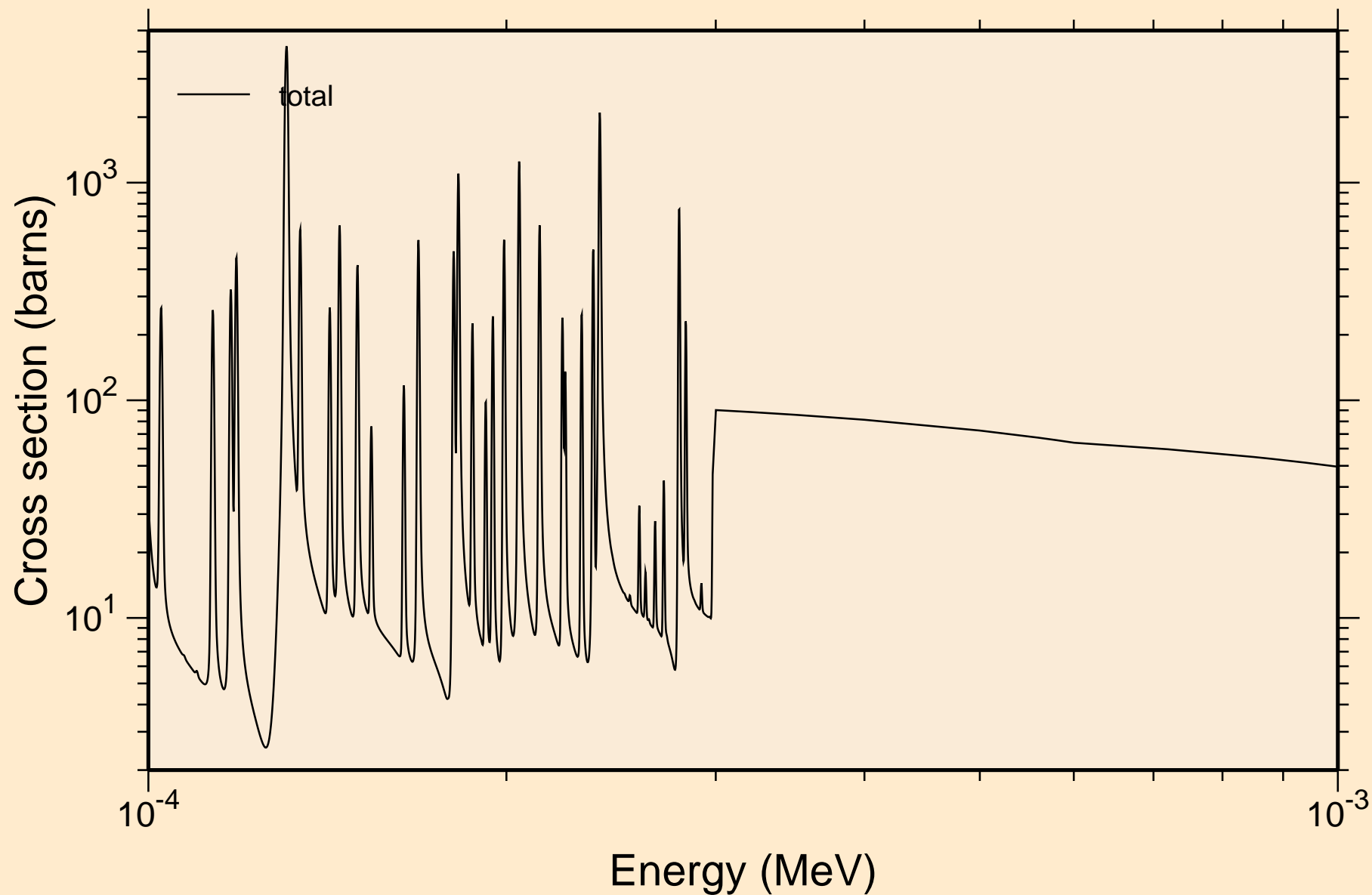

PR146 NEUTRON ACER TENDL-2019 LIBRARY; T=293.16K  
resonance total cross section

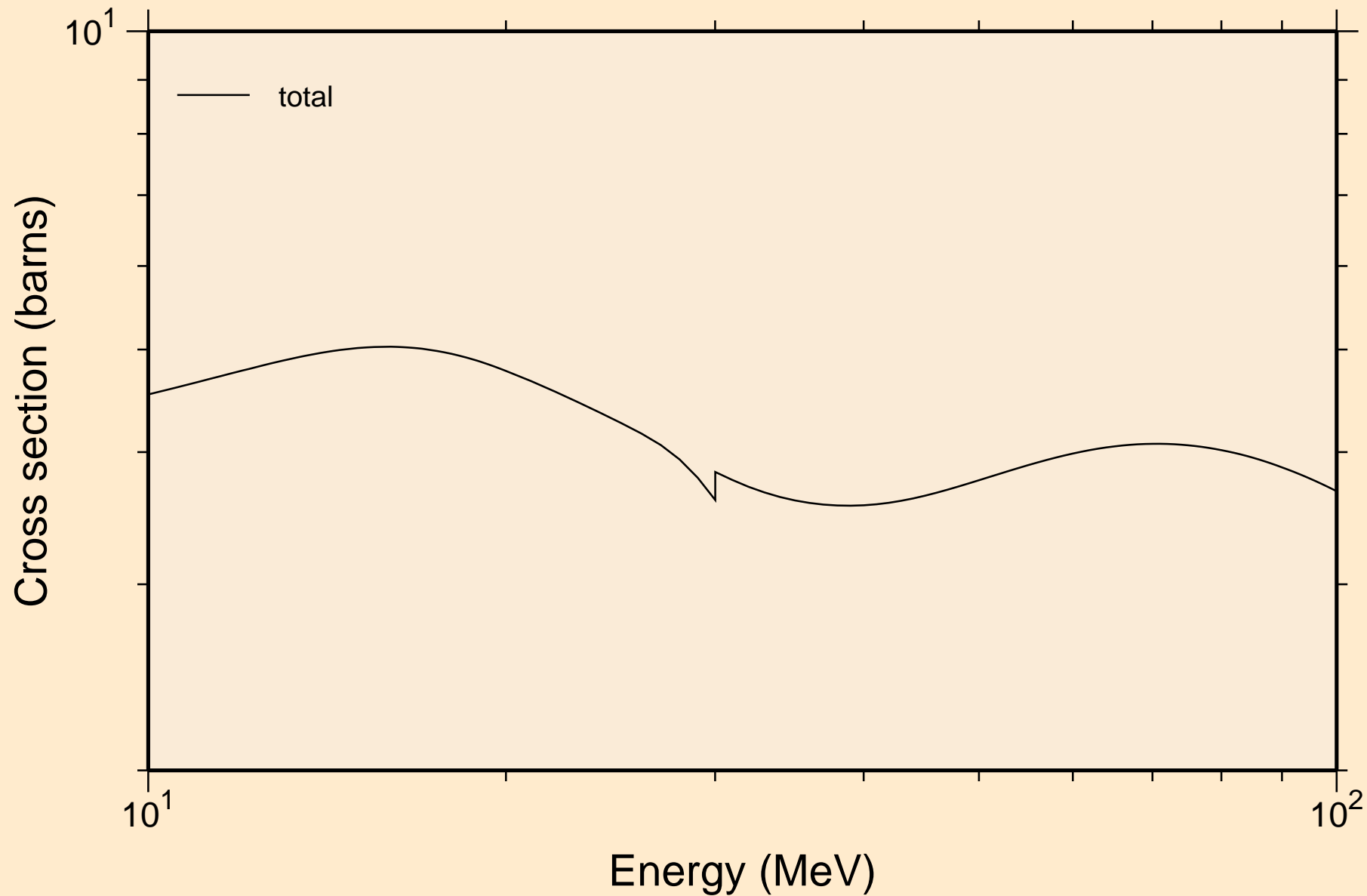

PR146 NEUTRON ACER TENDL-2019 LIBRARY; T=293.16K  
resonance absorption cross sections

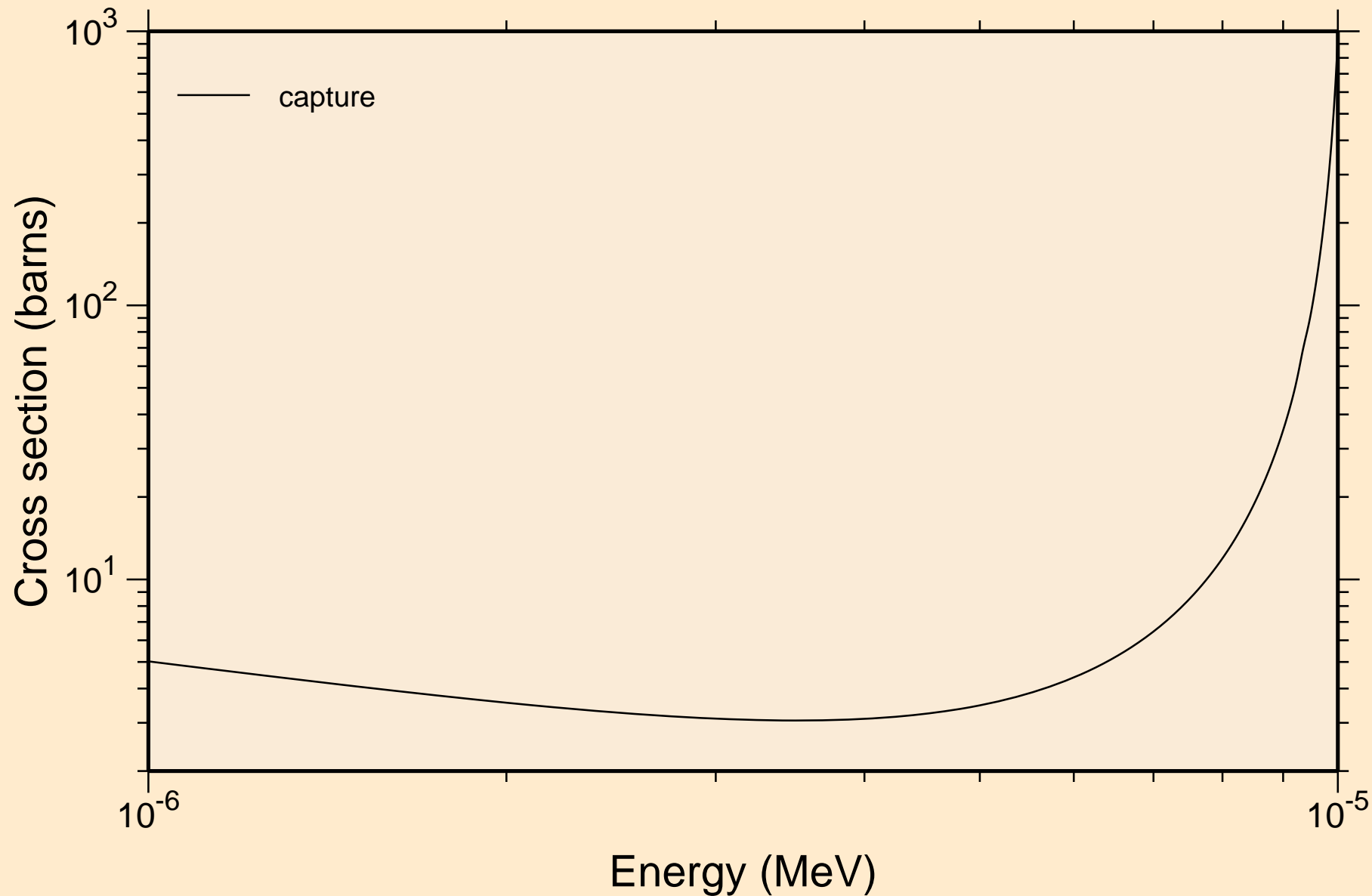

PR146 NEUTRON ACER TENDL-2019 LIBRARY; T=293.16K  
resonance absorption cross sections

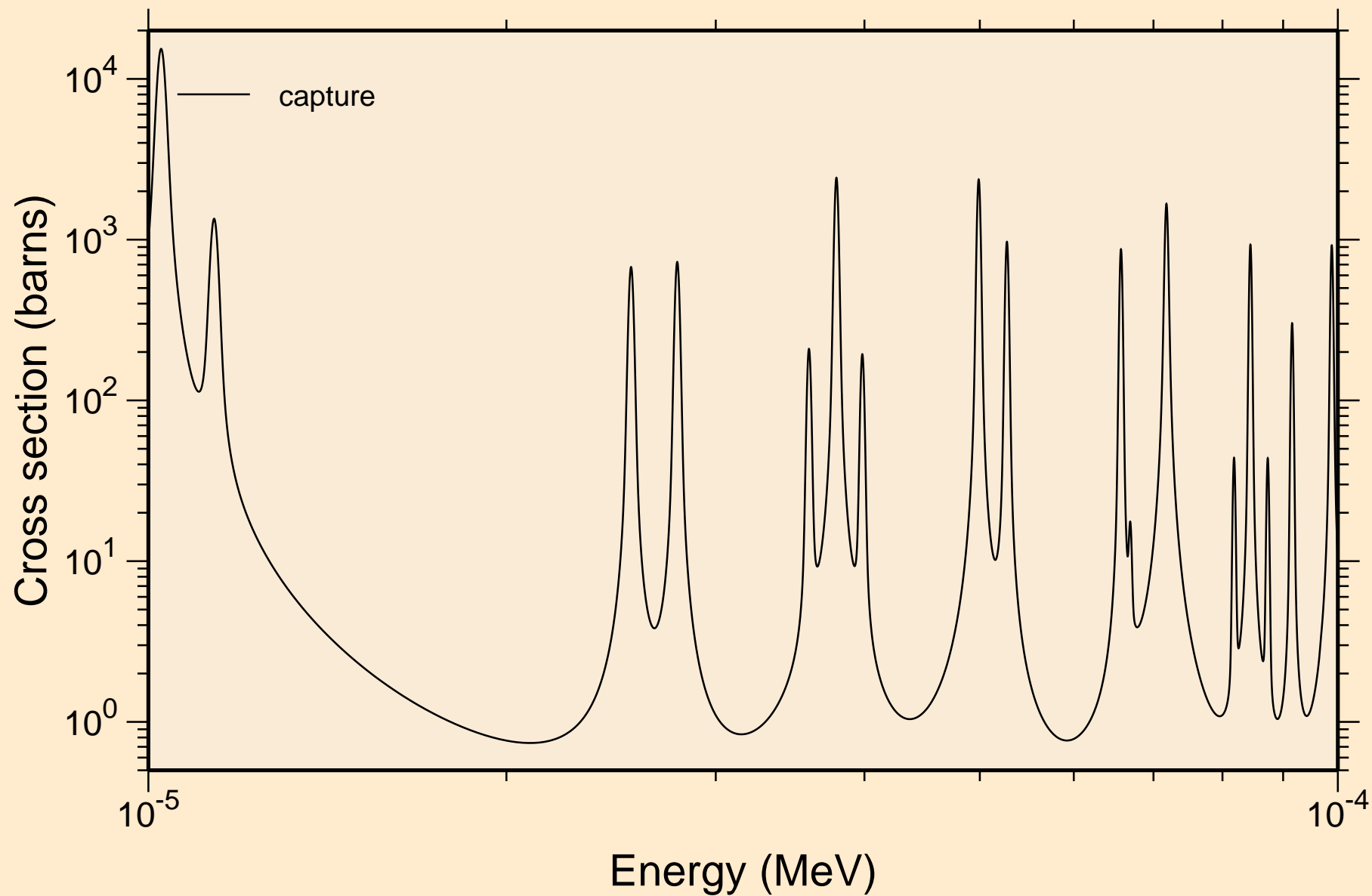

PR146 NEUTRON ACER TENDL-2019 LIBRARY; T=293.16K  
resonance absorption cross sections

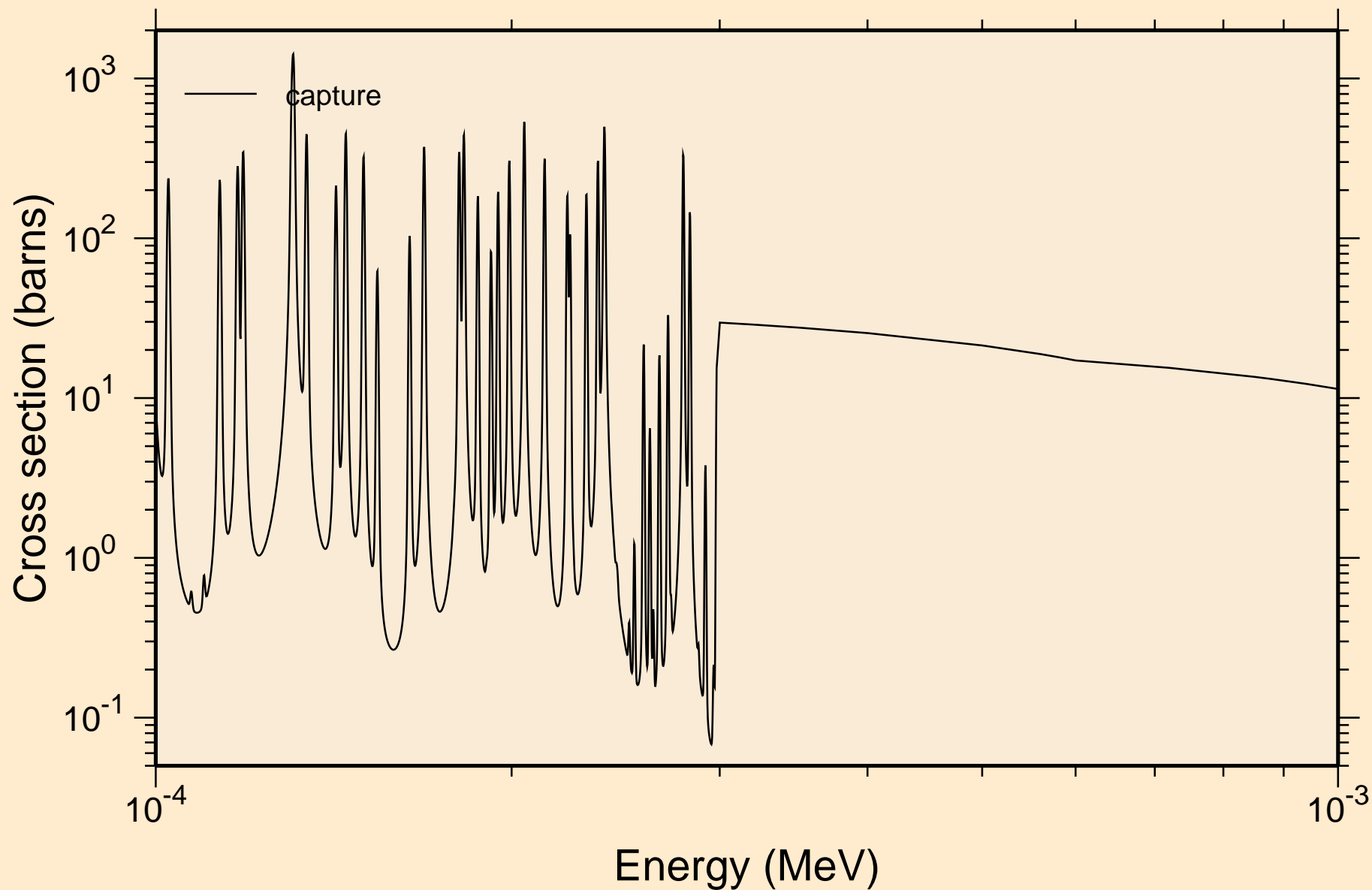



PR146 NEUTRON ACER TENDL-2019 LIBRARY; T=293.16K  
resonance absorption cross sections

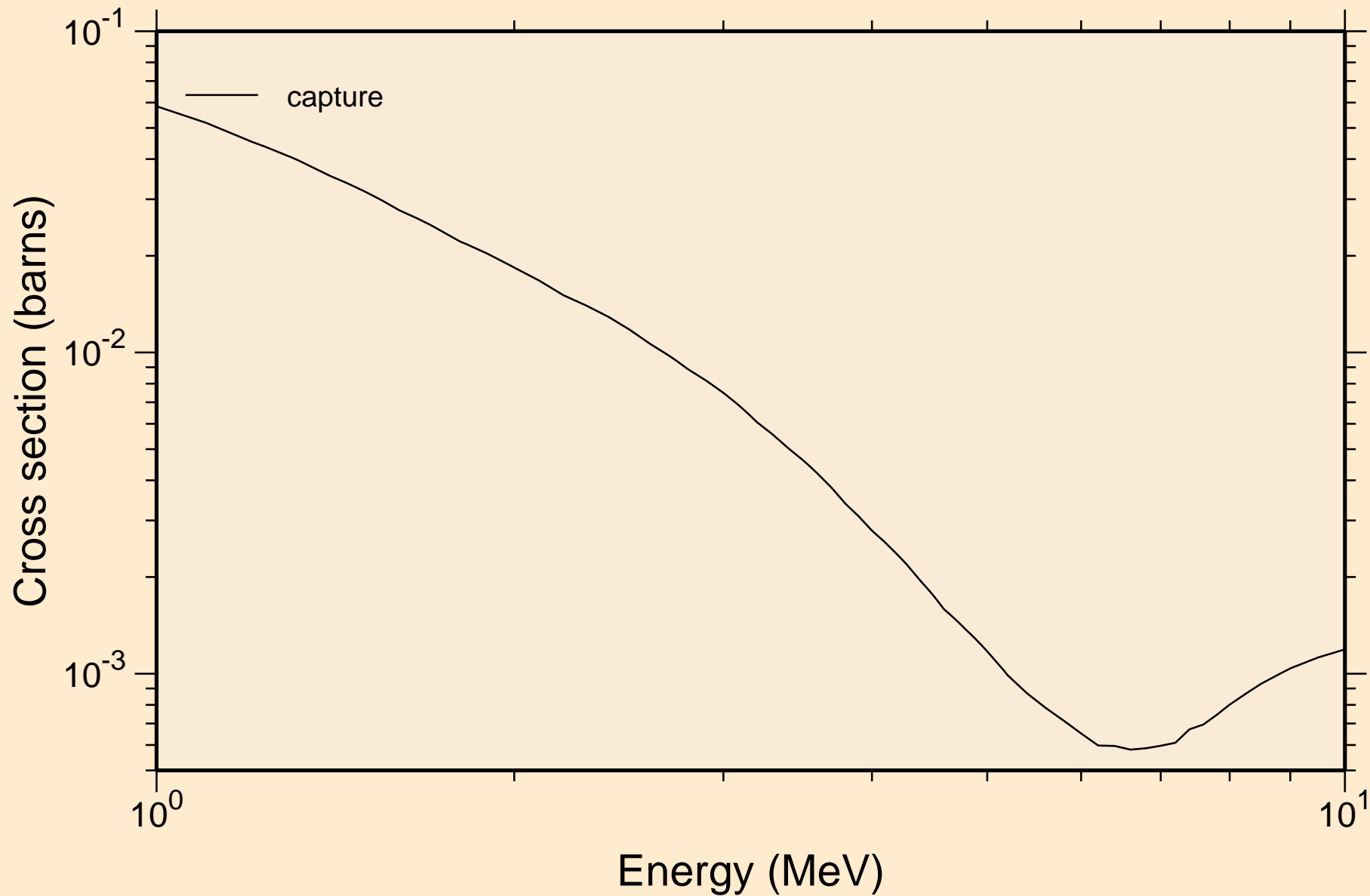

PR146 NEUTRON ACER TENDL-2019 LIBRARY; T=293.16K  
Heating

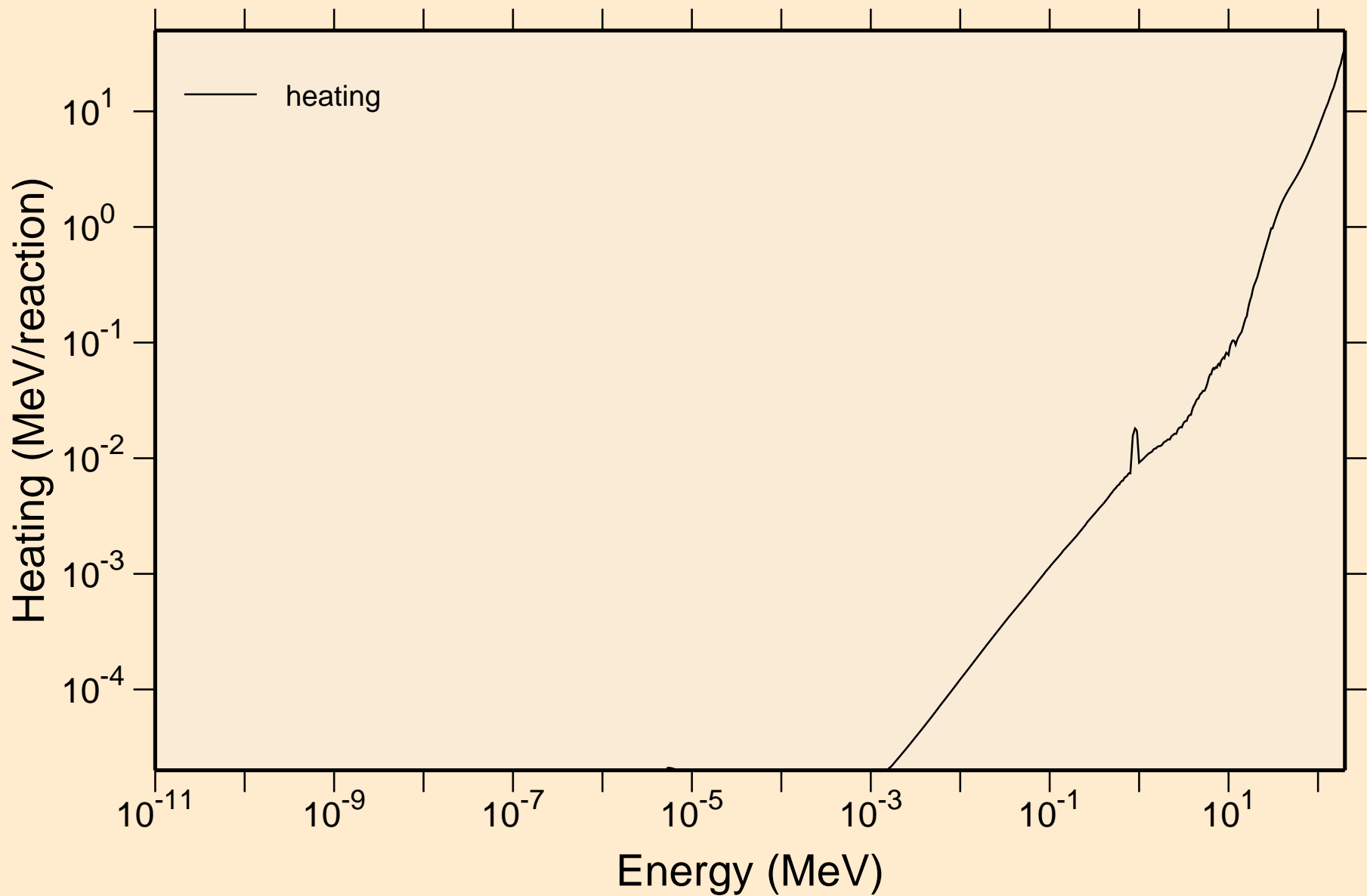

PR146 NEUTRON ACER TENDL-2019 LIBRARY; T=293.16K  
Damage

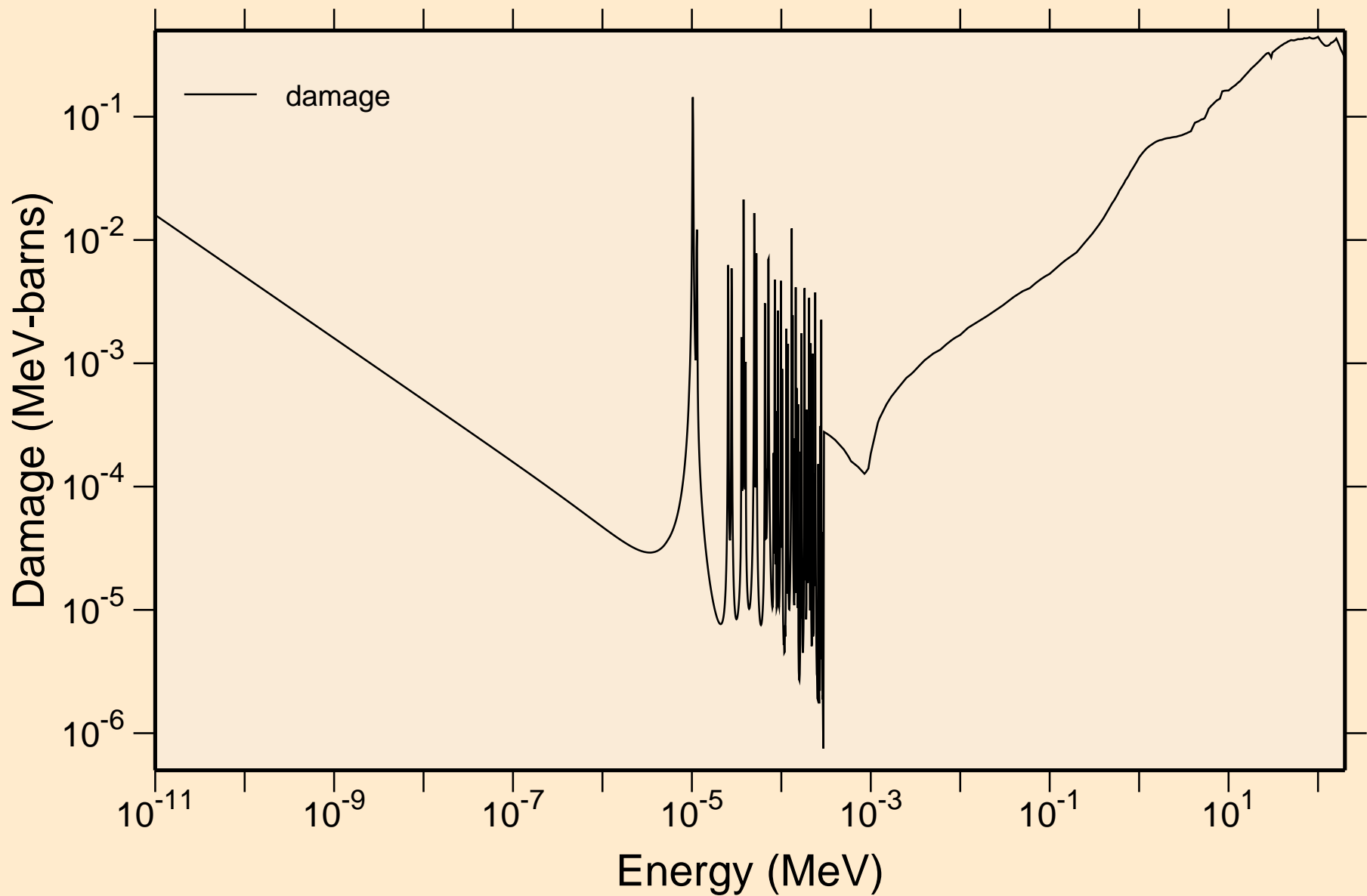

PR146 NEUTRON ACER TENDL-2019 LIBRARY; T=293.16K  
Non-threshold reactions

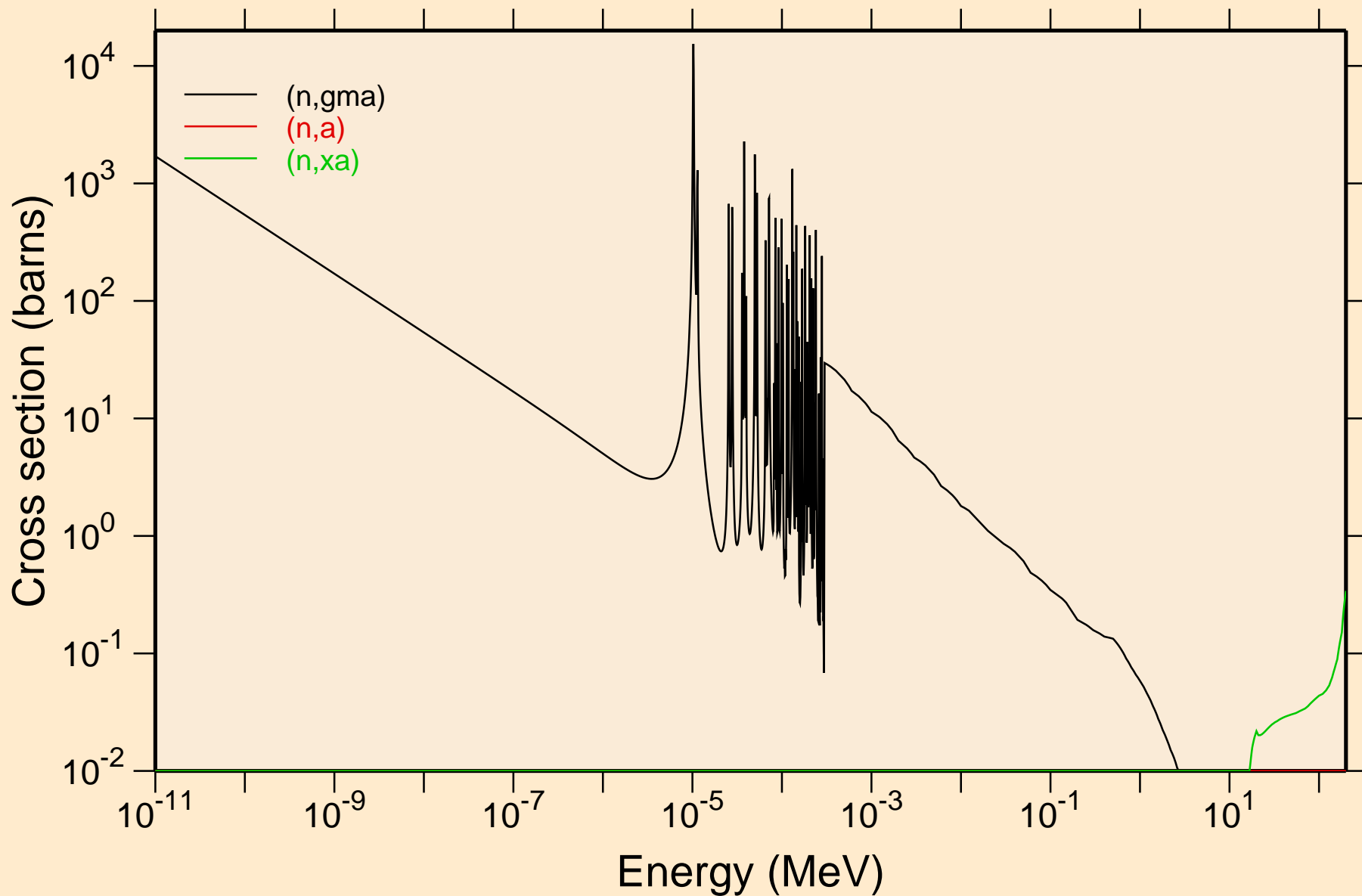

PR146 NEUTRON ACER TENDL-2019 LIBRARY; T=293.16K  
Principal cross sections

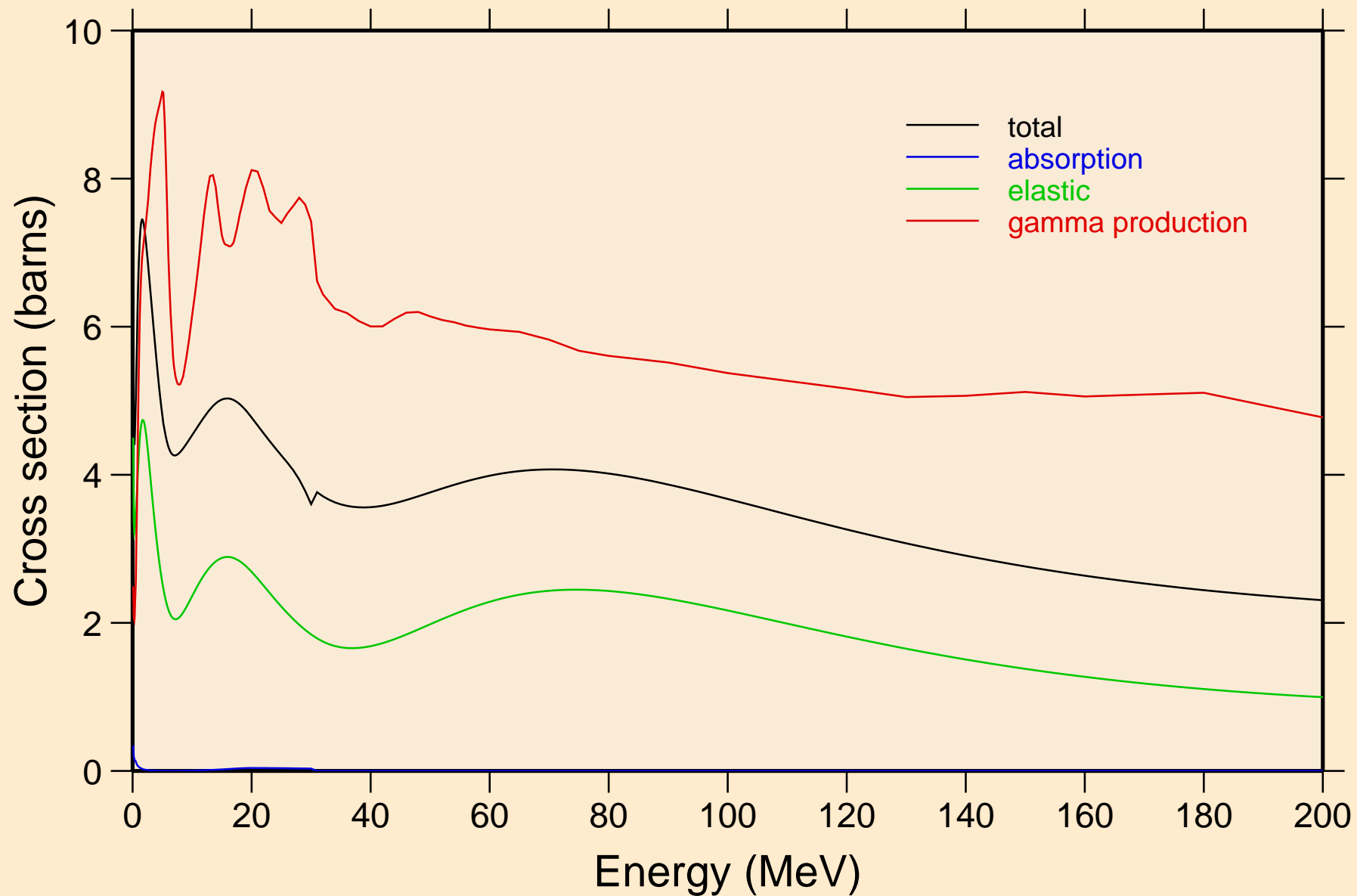

PR146 NEUTRON ACER TENDL-2019 LIBRARY; T=293.16K  
Heating

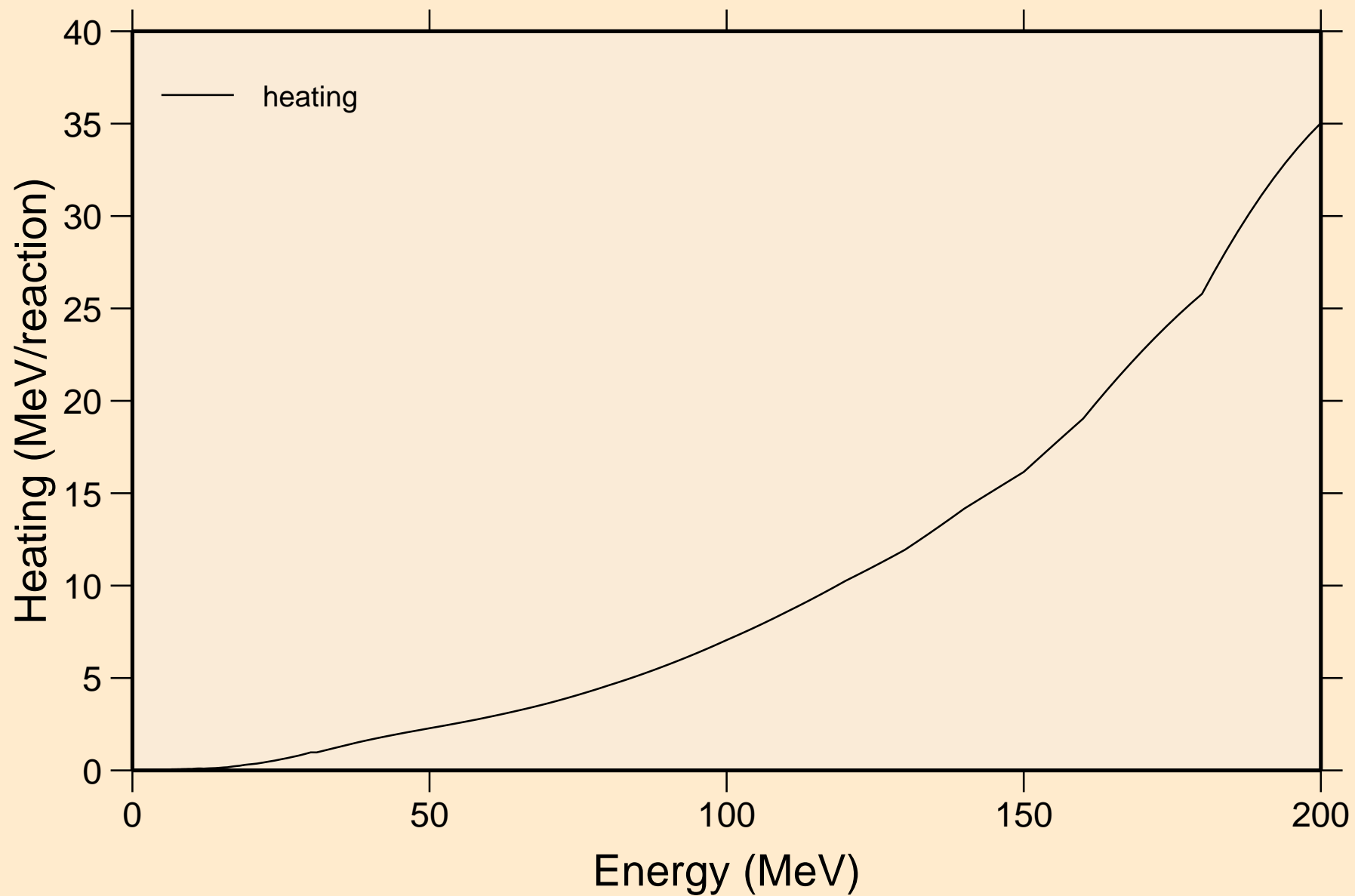

PR146 NEUTRON ACER TENDL-2019 LIBRARY; T=293.16K  
Damage

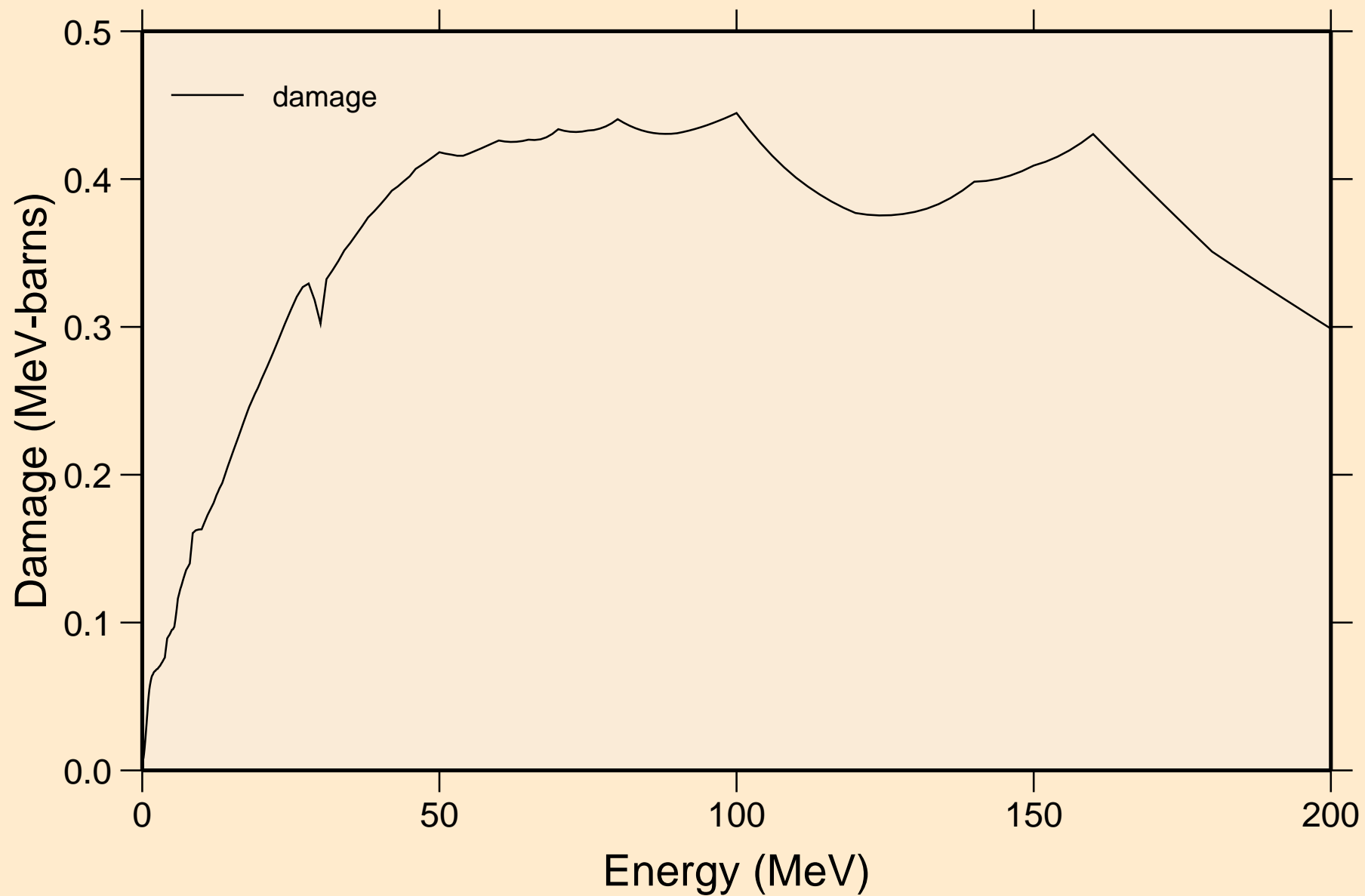

PR146 NEUTRON ACER TENDL-2019 LIBRARY; T=293.16K  
Non-threshold reactions

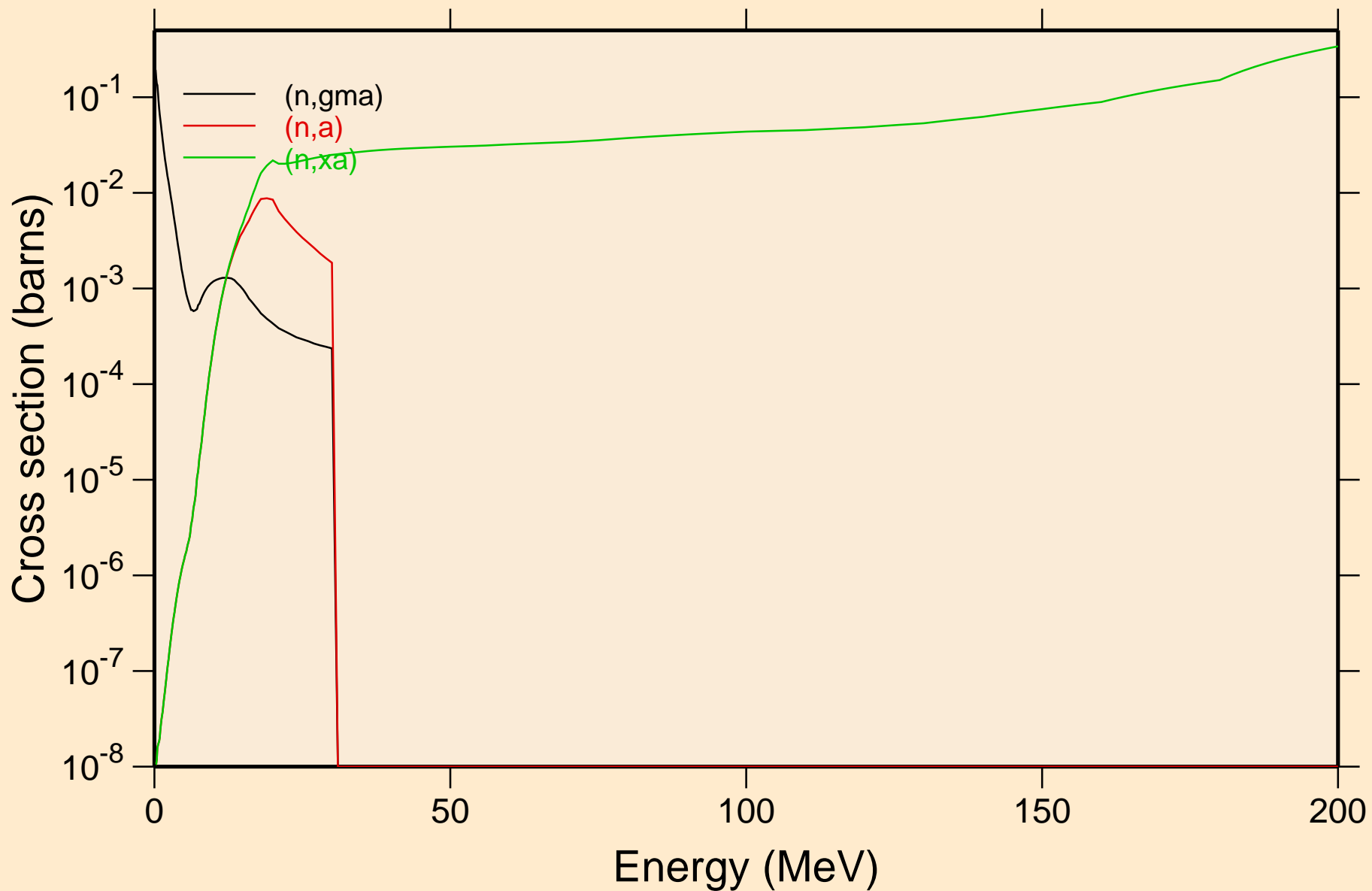



PR146 NEUTRON ACER TENDL-2019 LIBRARY; T=293.16K  
Inelastic levels

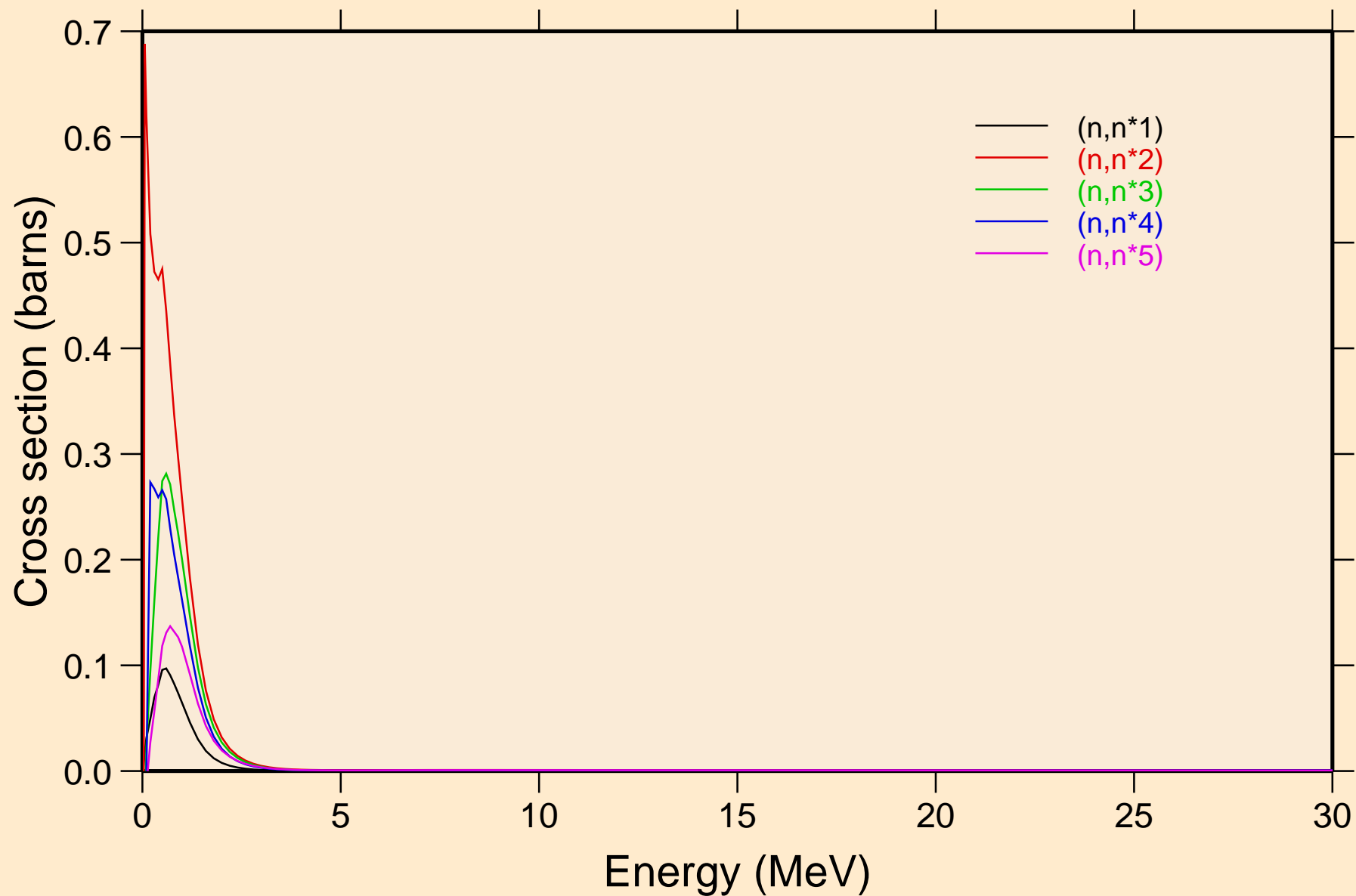

PR146 NEUTRON ACER TENDL-2019 LIBRARY; T=293.16K  
Inelastic levels

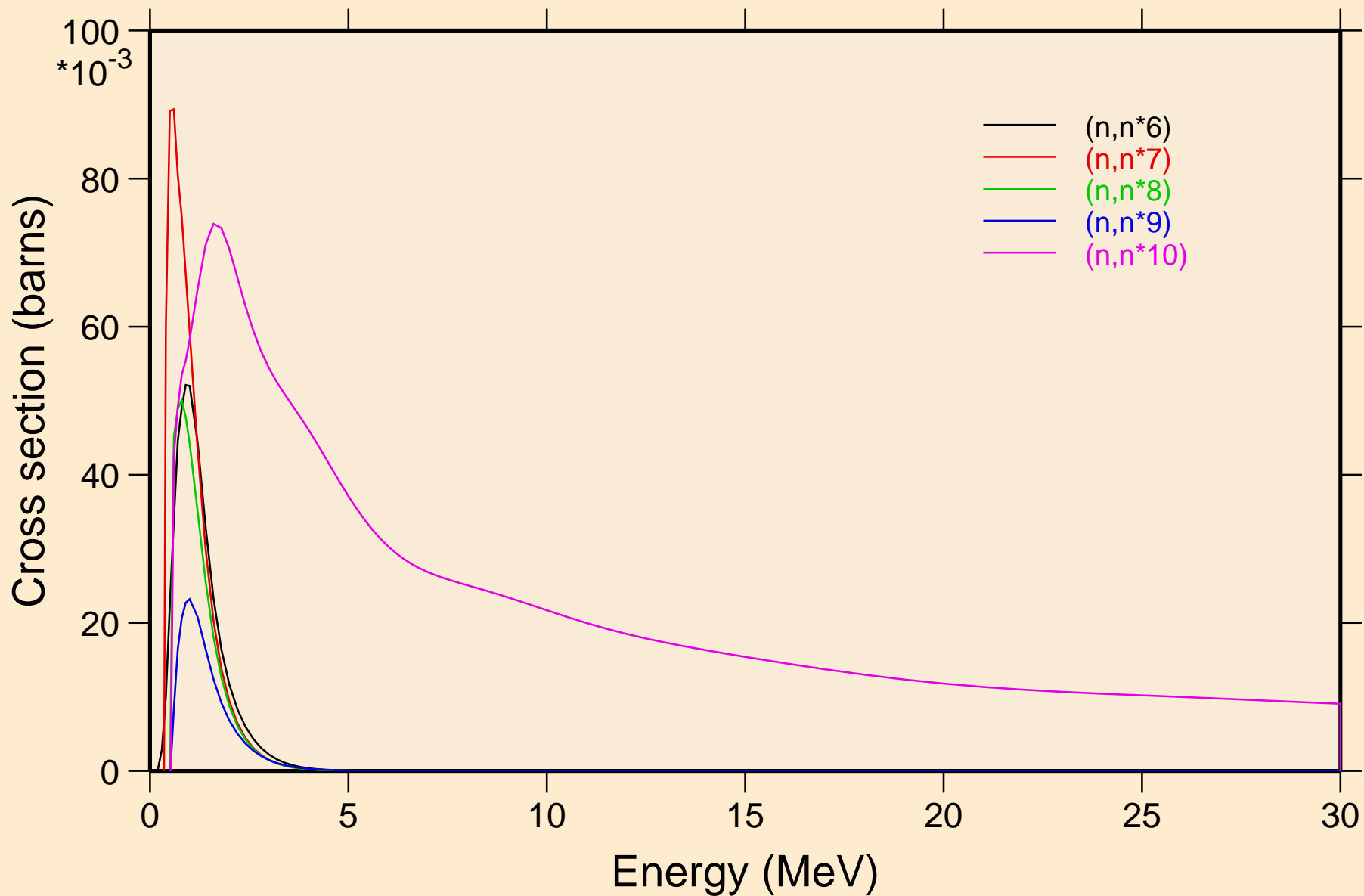

PR146 NEUTRON ACER TENDL-2019 LIBRARY; T=293.16K  
Inelastic levels

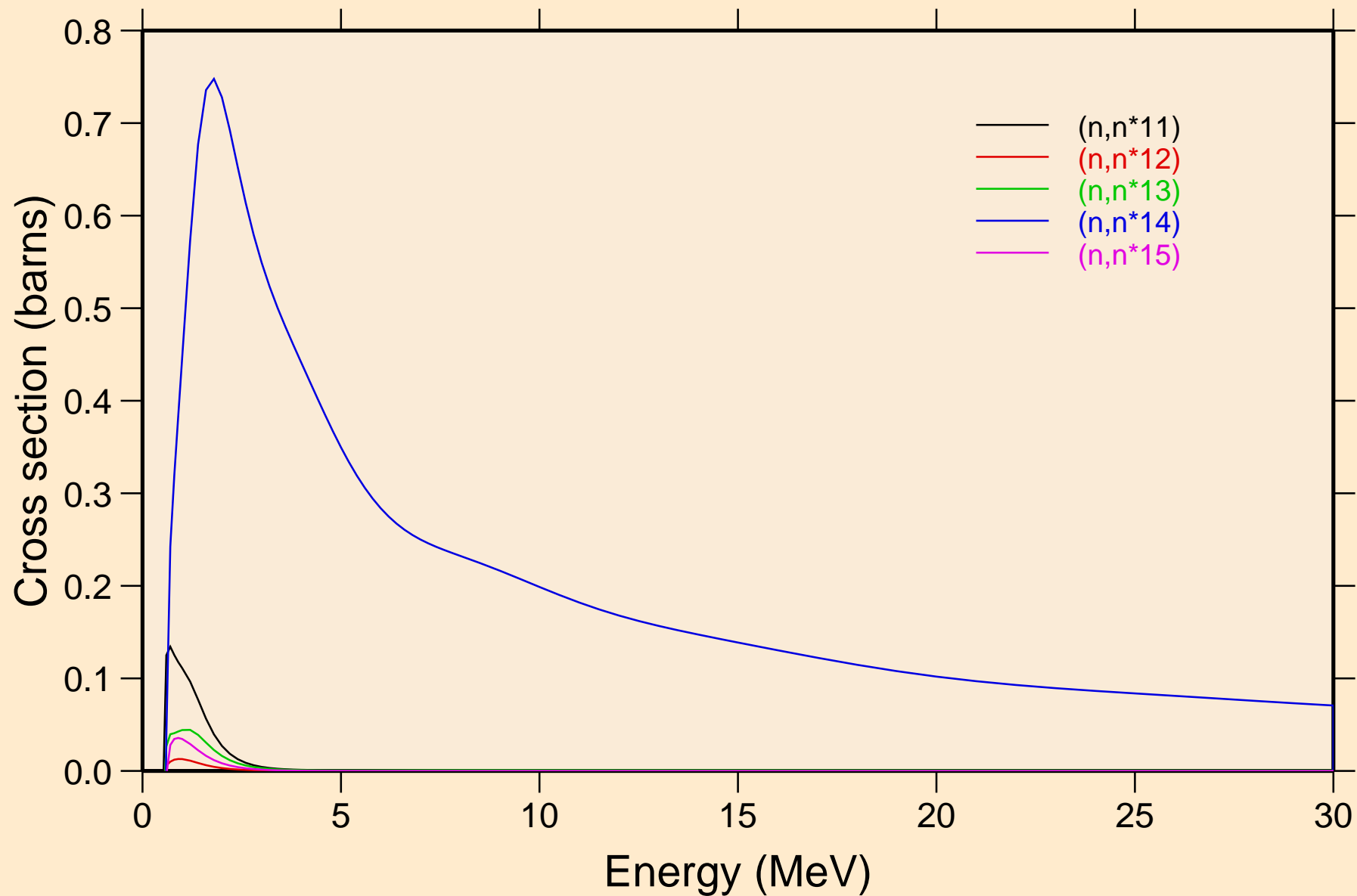

PR146 NEUTRON ACER TENDL-2019 LIBRARY; T=293.16K  
Inelastic levels

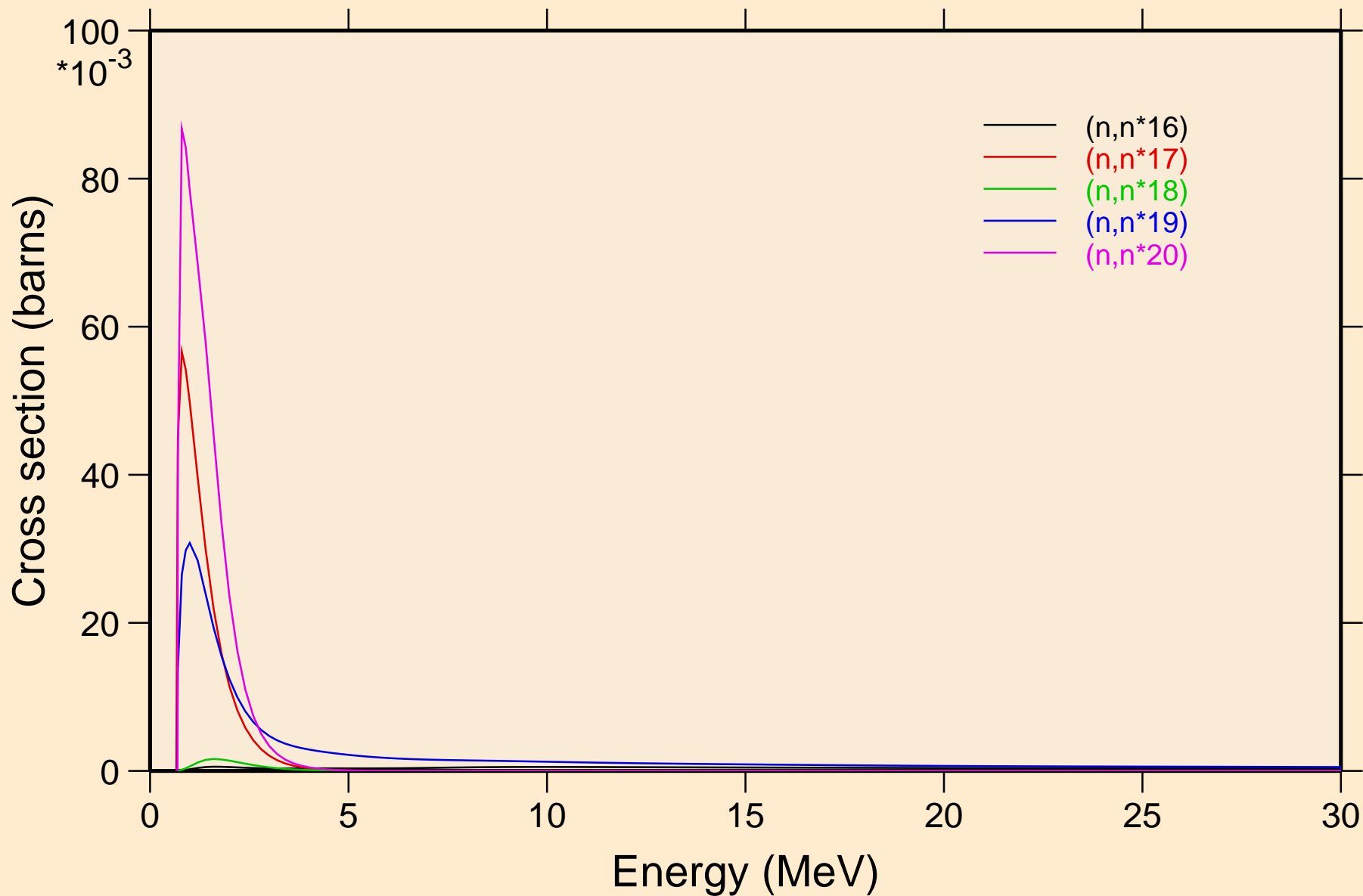

PR146 NEUTRON ACER TENDL-2019 LIBRARY; T=293.16K  
Inelastic levels

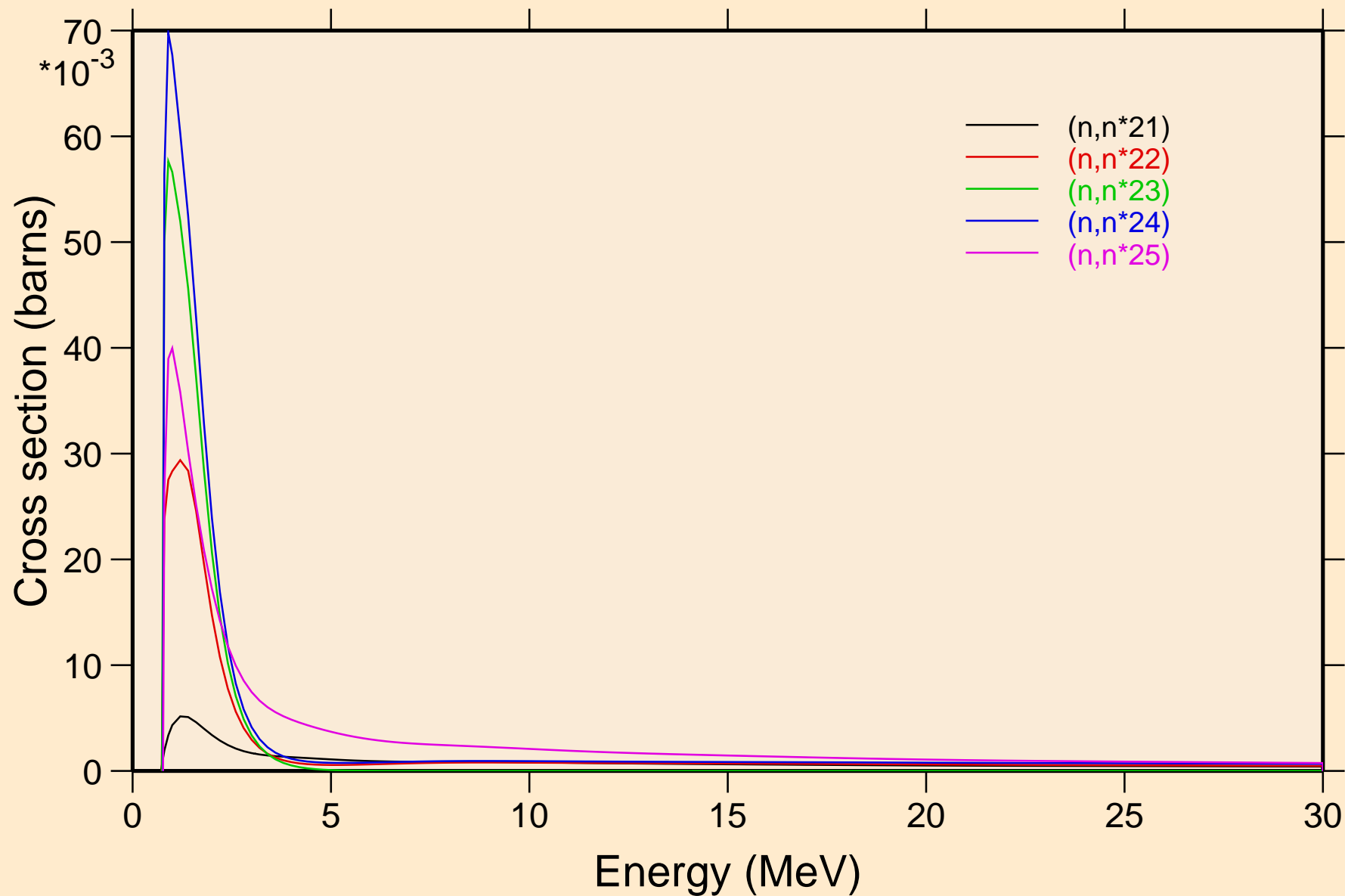

PR146 NEUTRON ACER TENDL-2019 LIBRARY; T=293.16K  
Inelastic levels

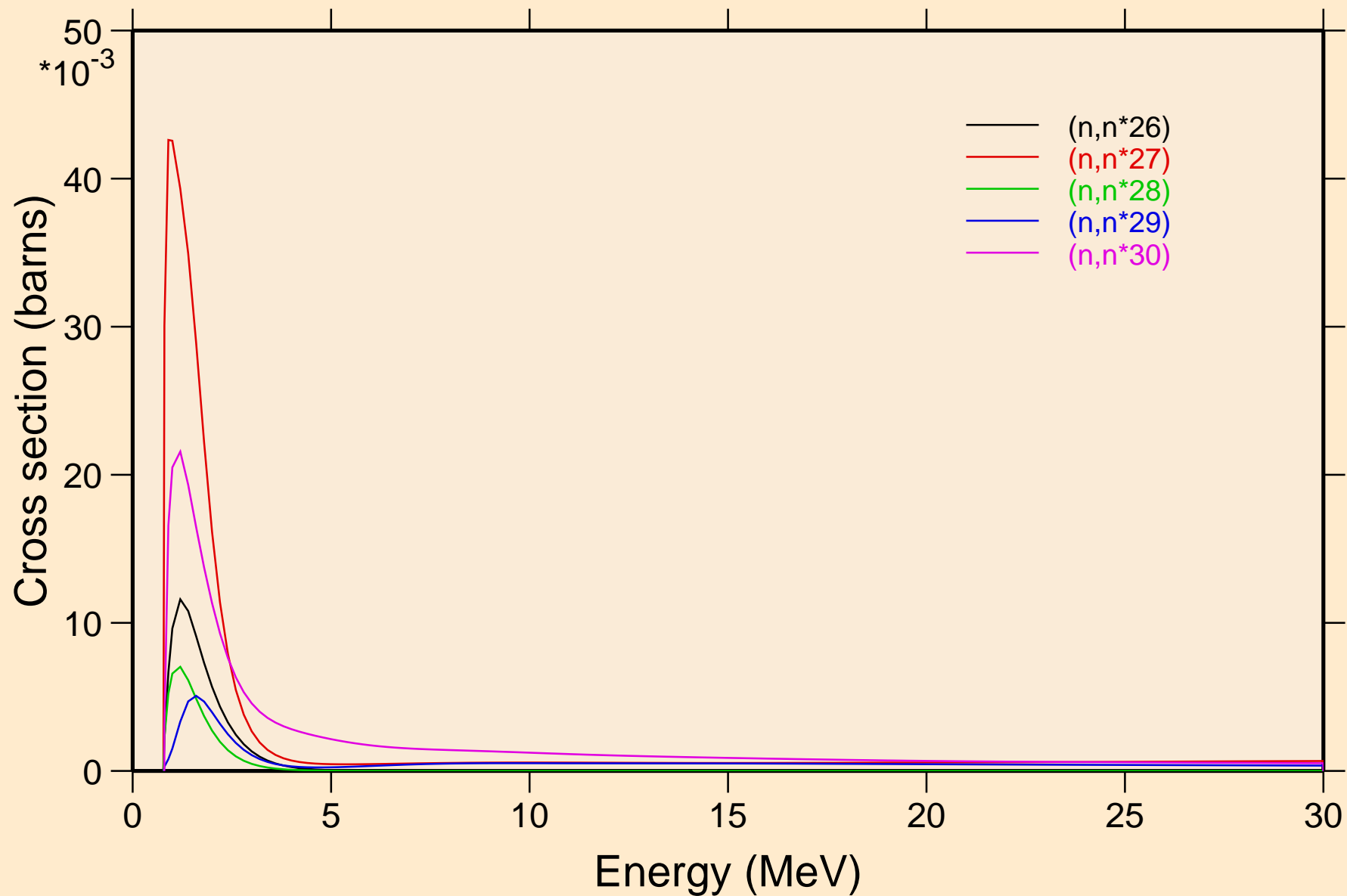

PR146 NEUTRON ACER TENDL-2019 LIBRARY; T=293.16K  
Threshold reactions

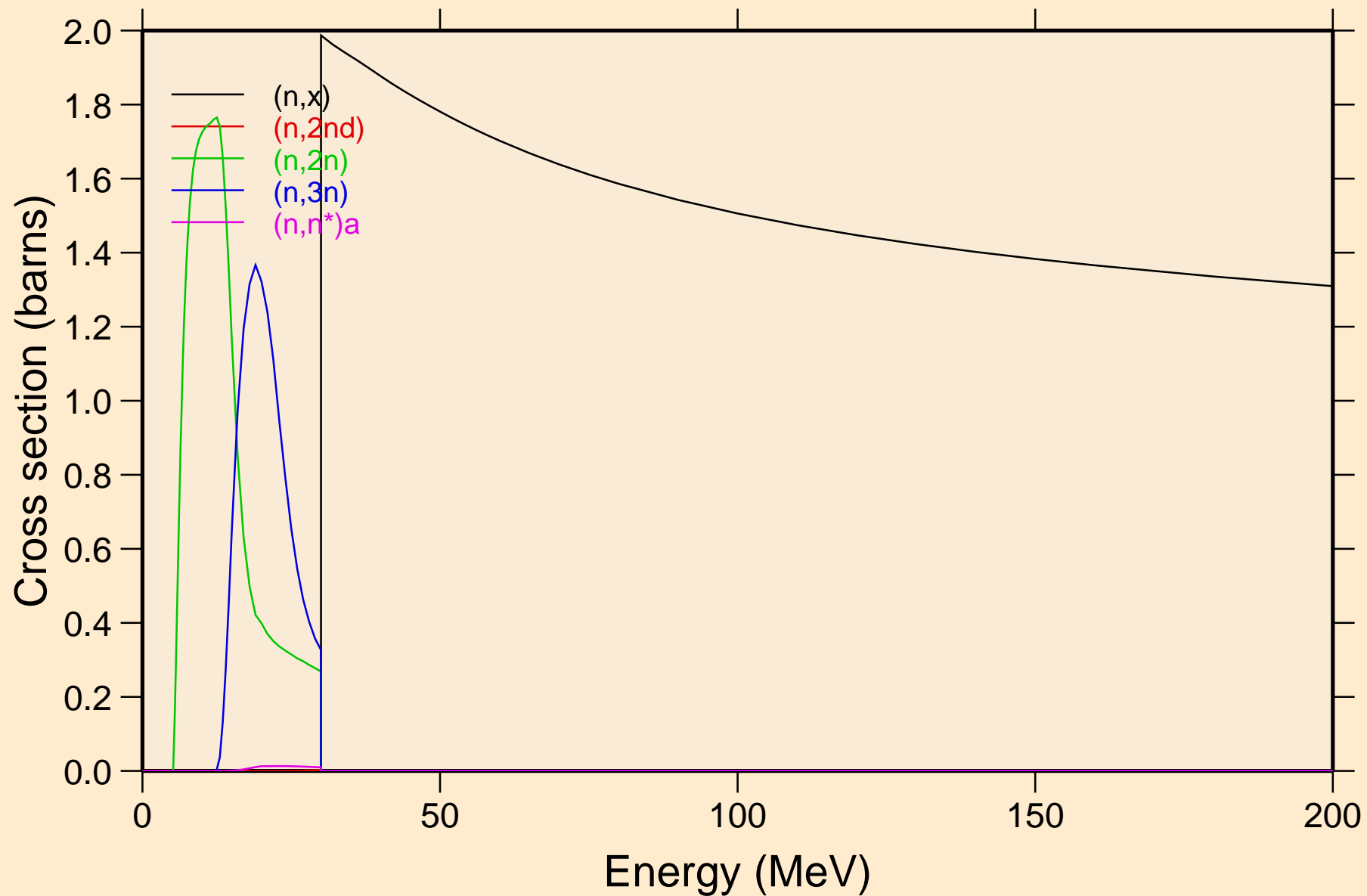

PR146 NEUTRON ACER TENDL-2019 LIBRARY; T=293.16K  
Threshold reactions

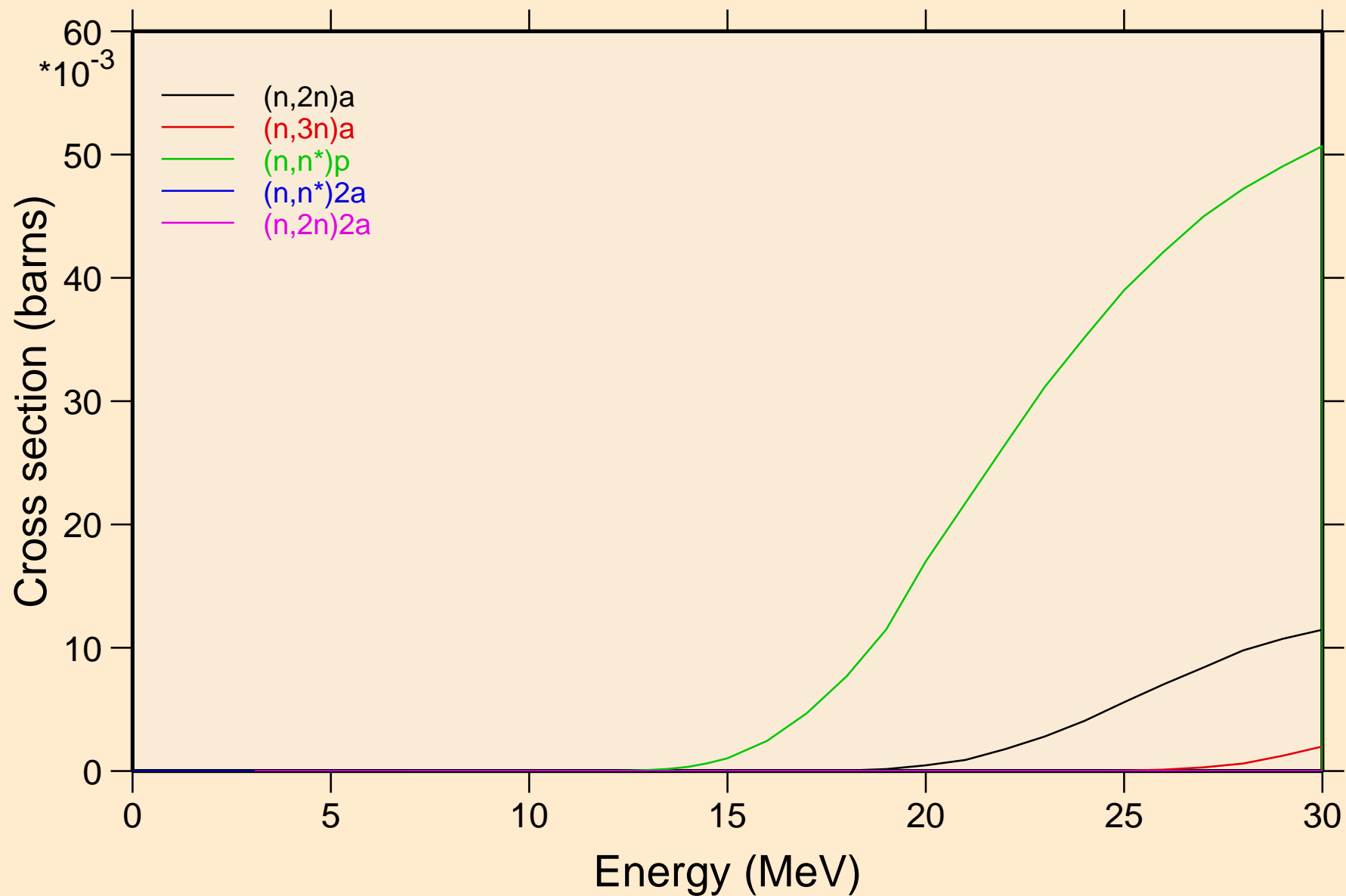



PR146 NEUTRON ACER TENDL-2019 LIBRARY; T=293.16K  
Threshold reactions

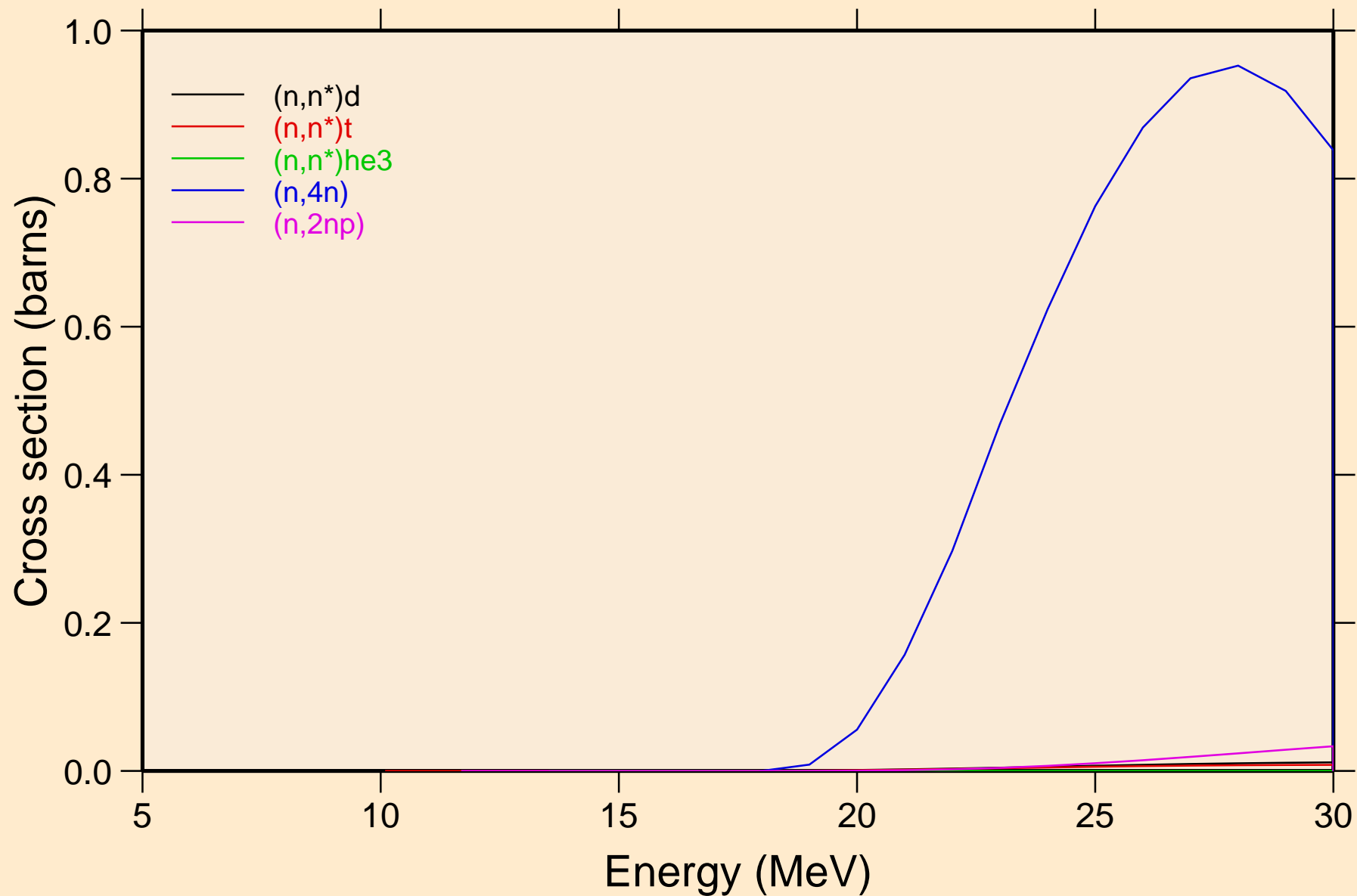

PR146 NEUTRON ACER TENDL-2019 LIBRARY; T=293.16K  
Threshold reactions

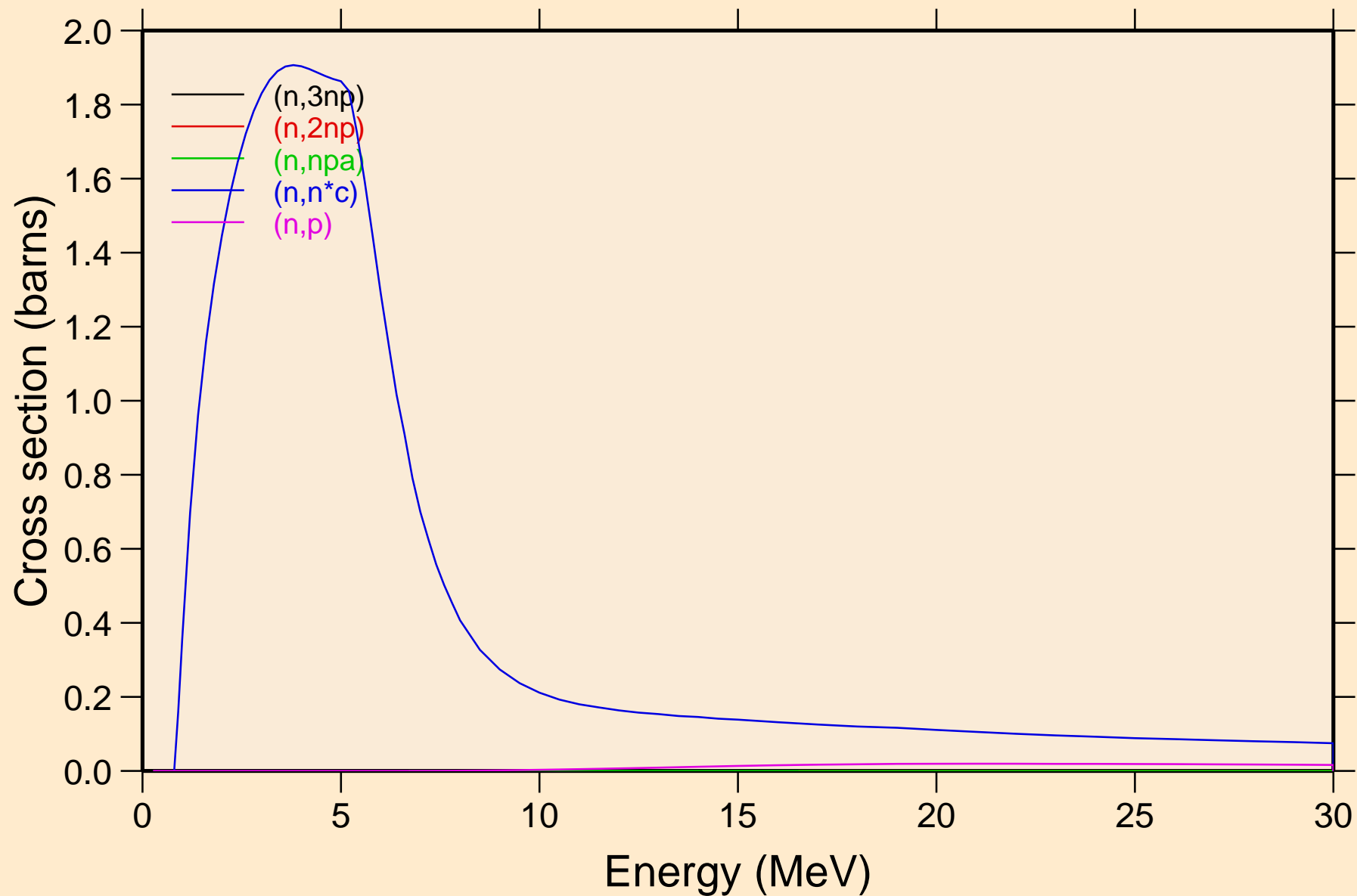

PR146 NEUTRON ACER TENDL-2019 LIBRARY; T=293.16K  
Threshold reactions

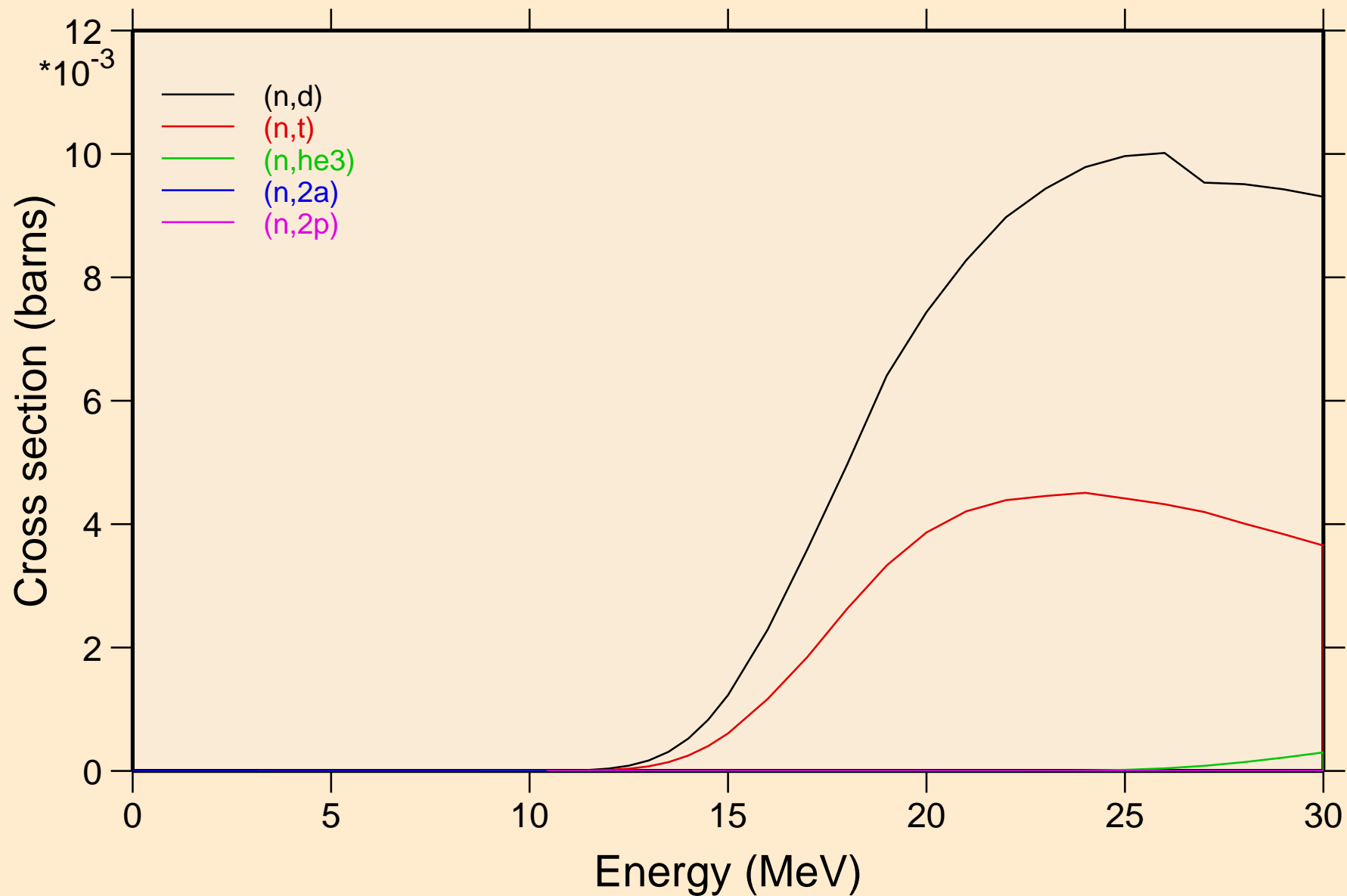

PR146 NEUTRON ACER TENDL-2019 LIBRARY; T=293.16K  
Threshold reactions

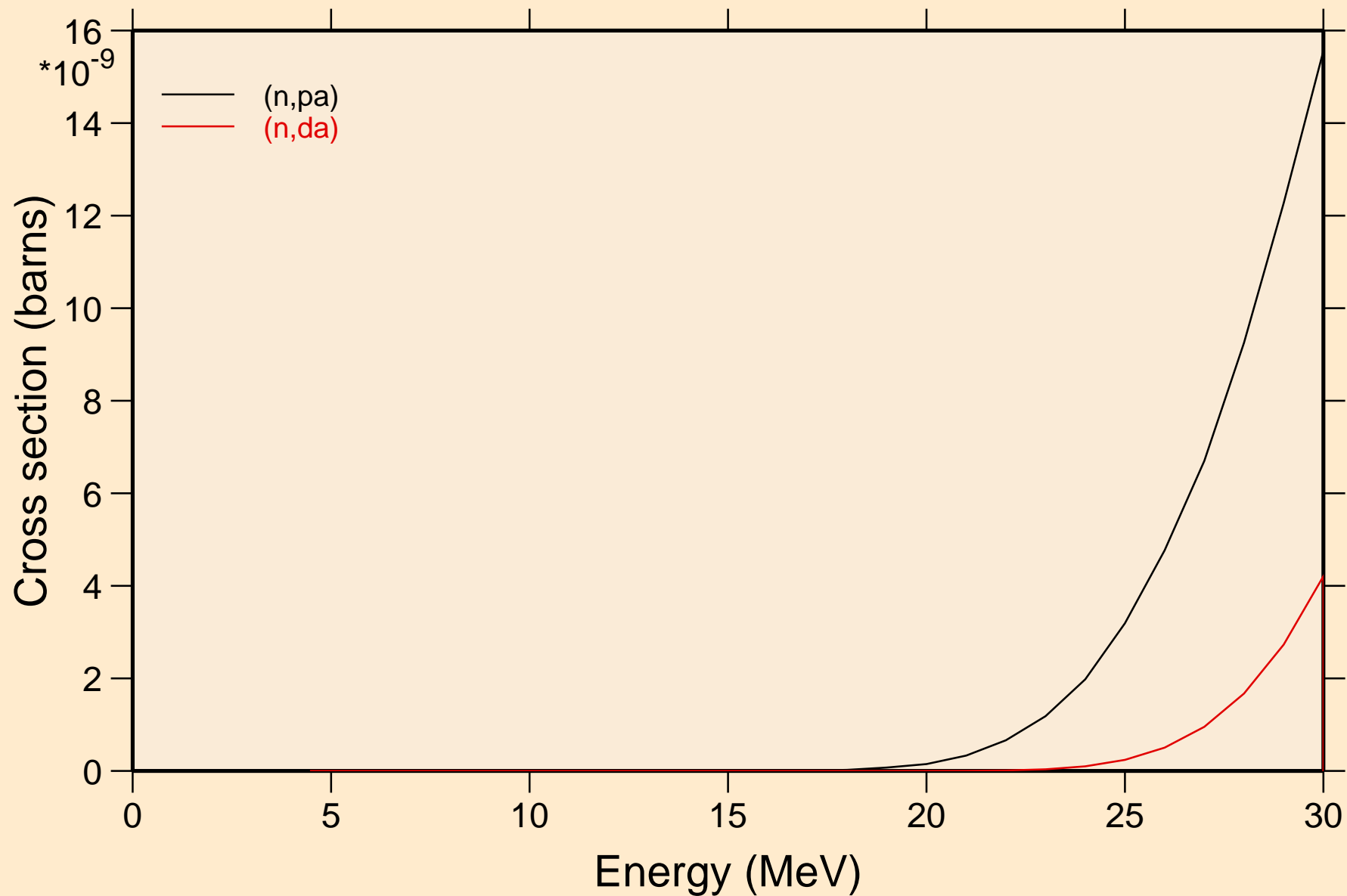

PR146 NEUTRON ACER TENDL-2019 LIBRARY; T=293.16K  
Threshold reactions

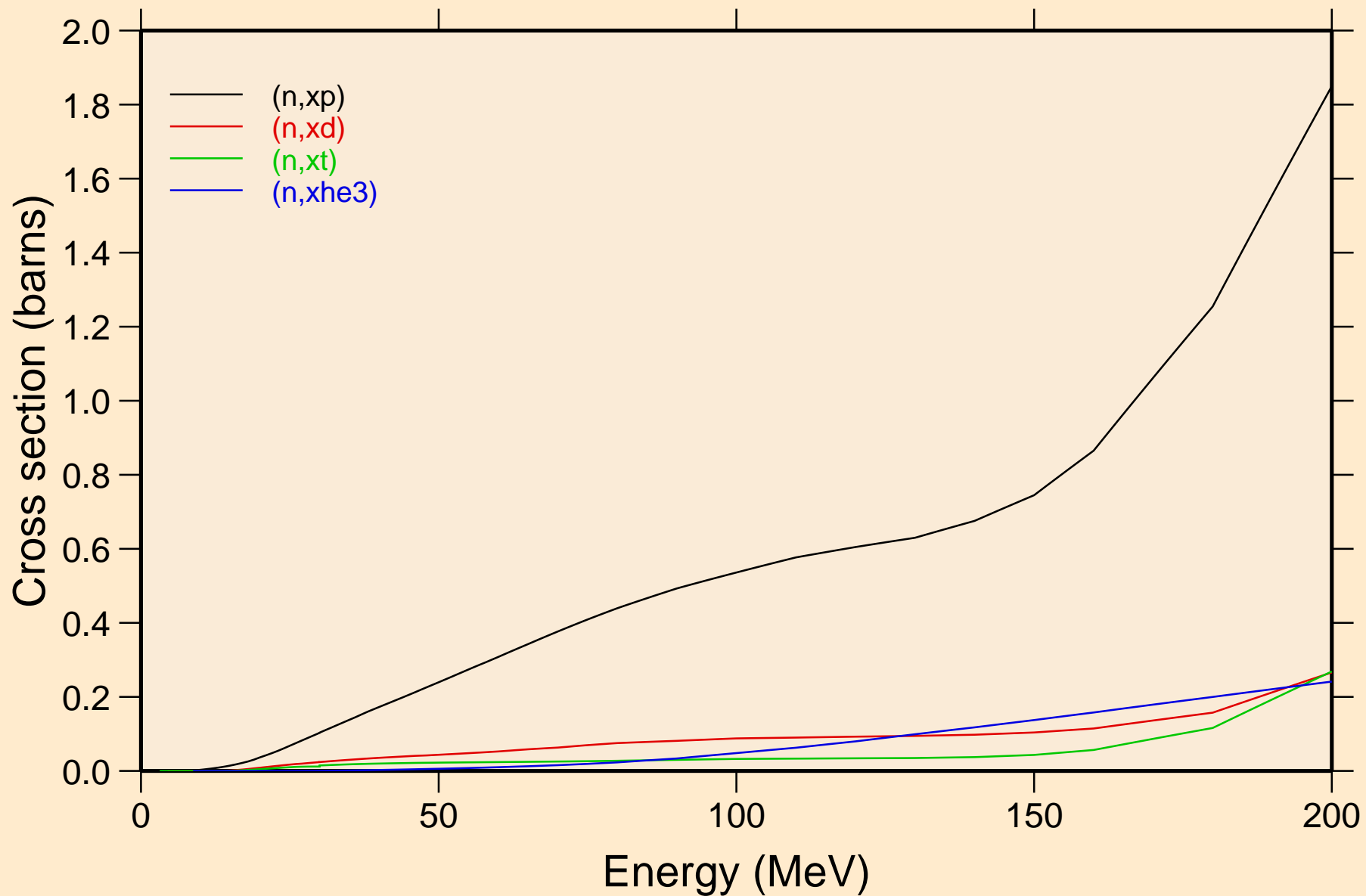

PR146 NEUTRON ACER TENDL-2019 LIBRARY; T=293.16K  
angular distribution for elastic

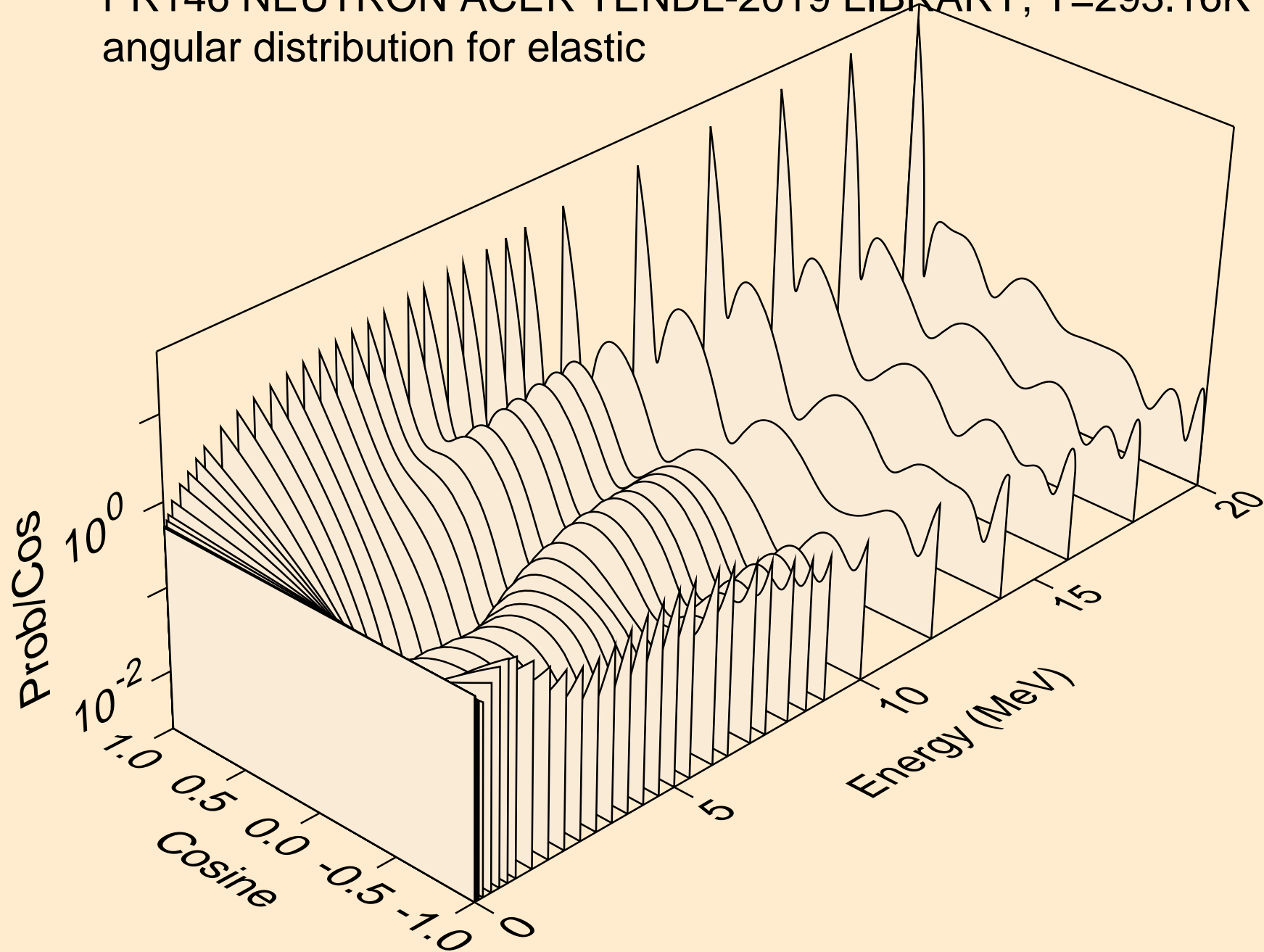

PR146 NEUTRON ACER TENDL-2019 LIBRARY; T=293.16K  
angular distribution for elastic

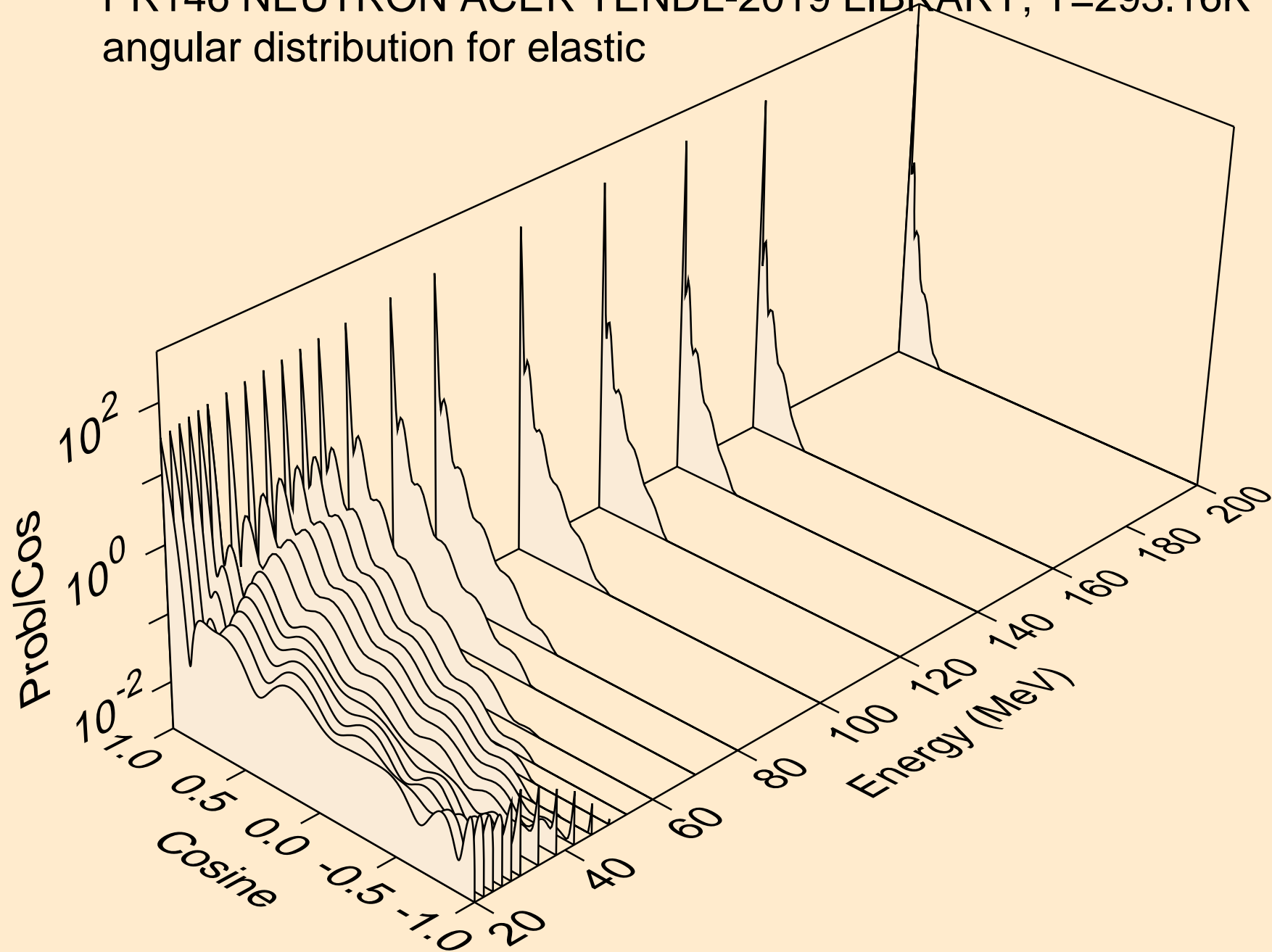

PR146 NEUTRON ACER TENDL-2019 LIBRARY; T=293.16K  
angular distribution for (n,n\*1)

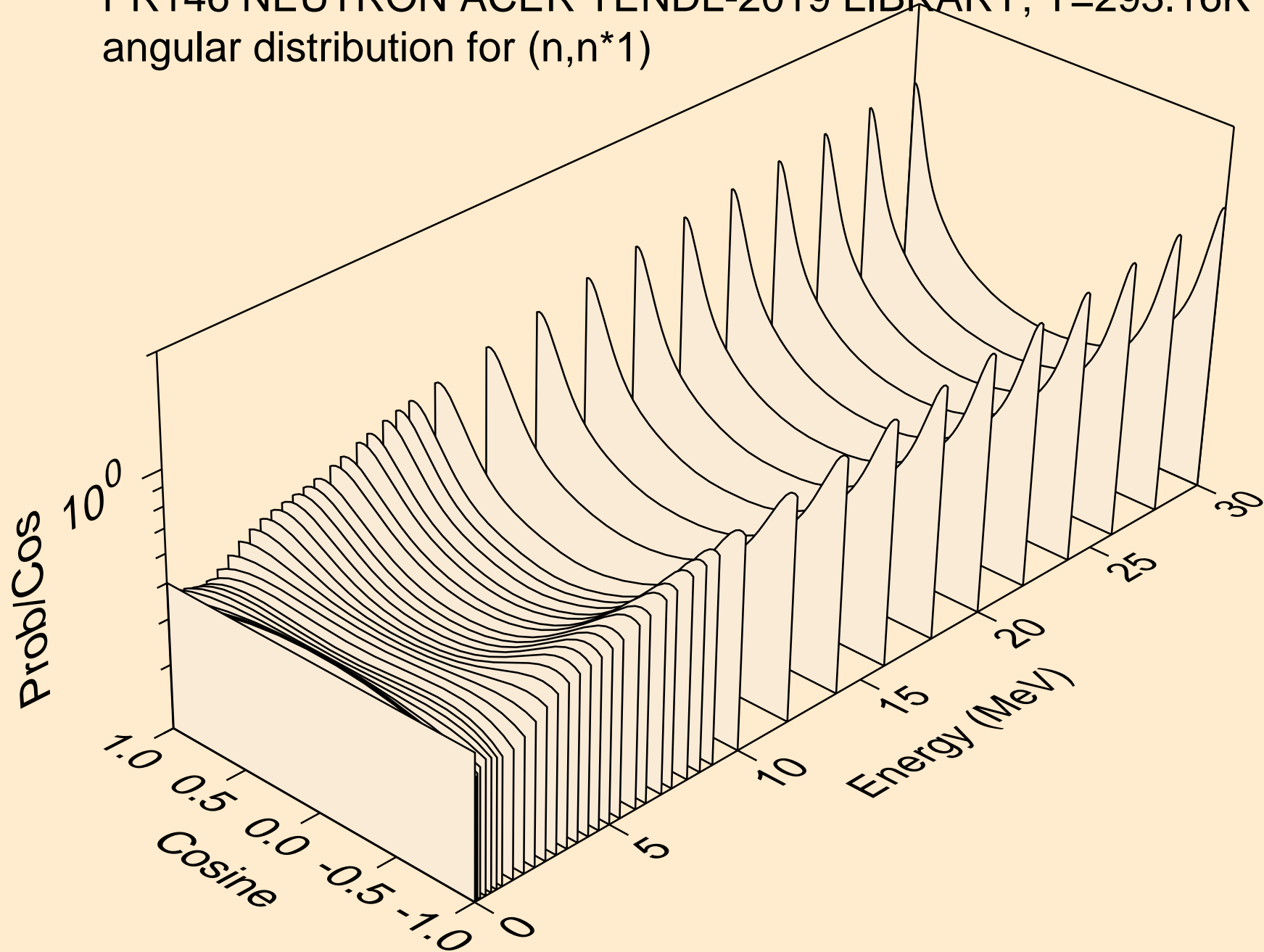



PR146 NEUTRON ACER TENDL-2019 LIBRARY; T=293.16K  
angular distribution for (n,n\*2)

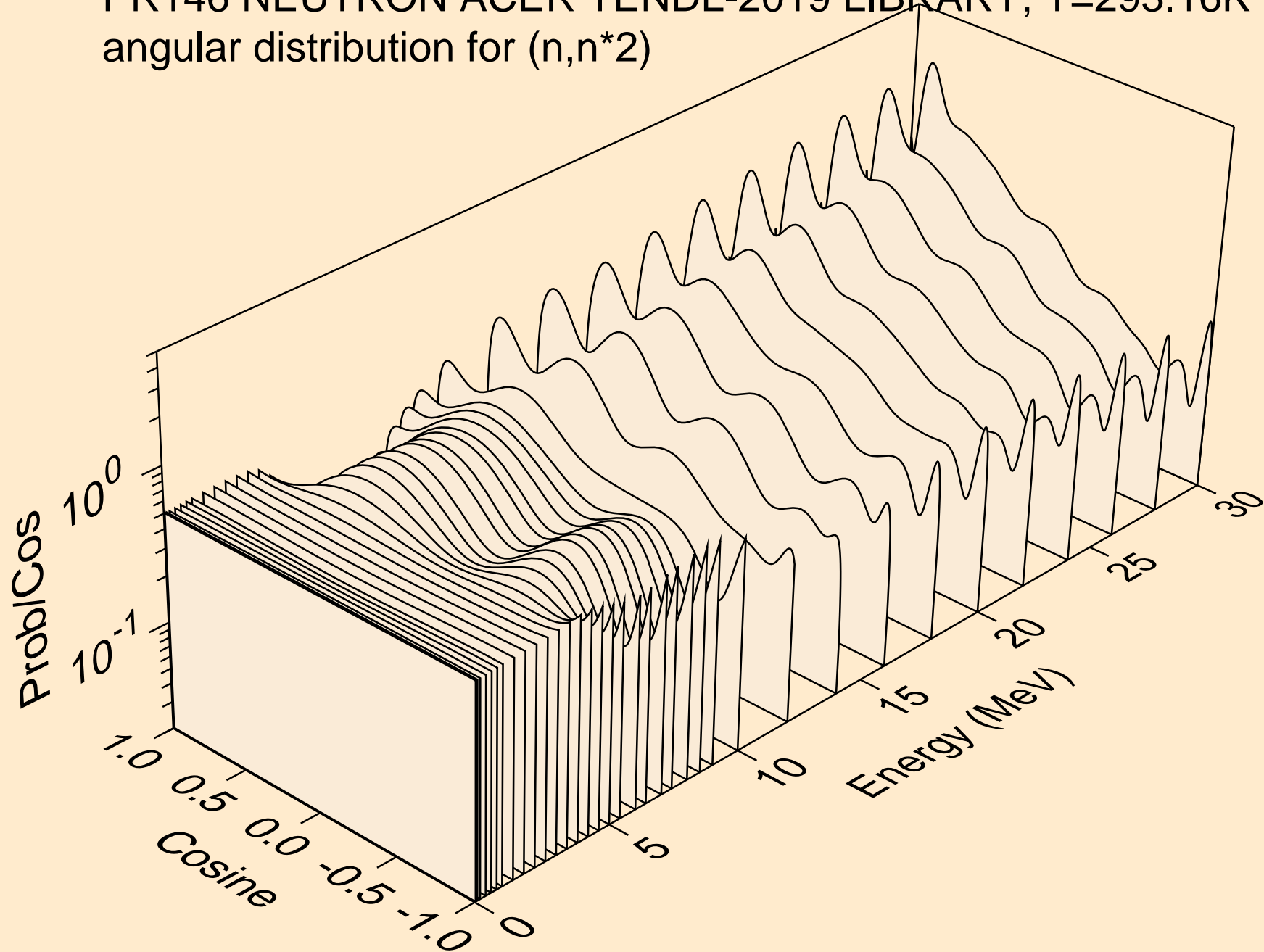

PR146 NEUTRON ACER TENDL-2019 LIBRARY; T=293.16K  
angular distribution for (n,n\*3)

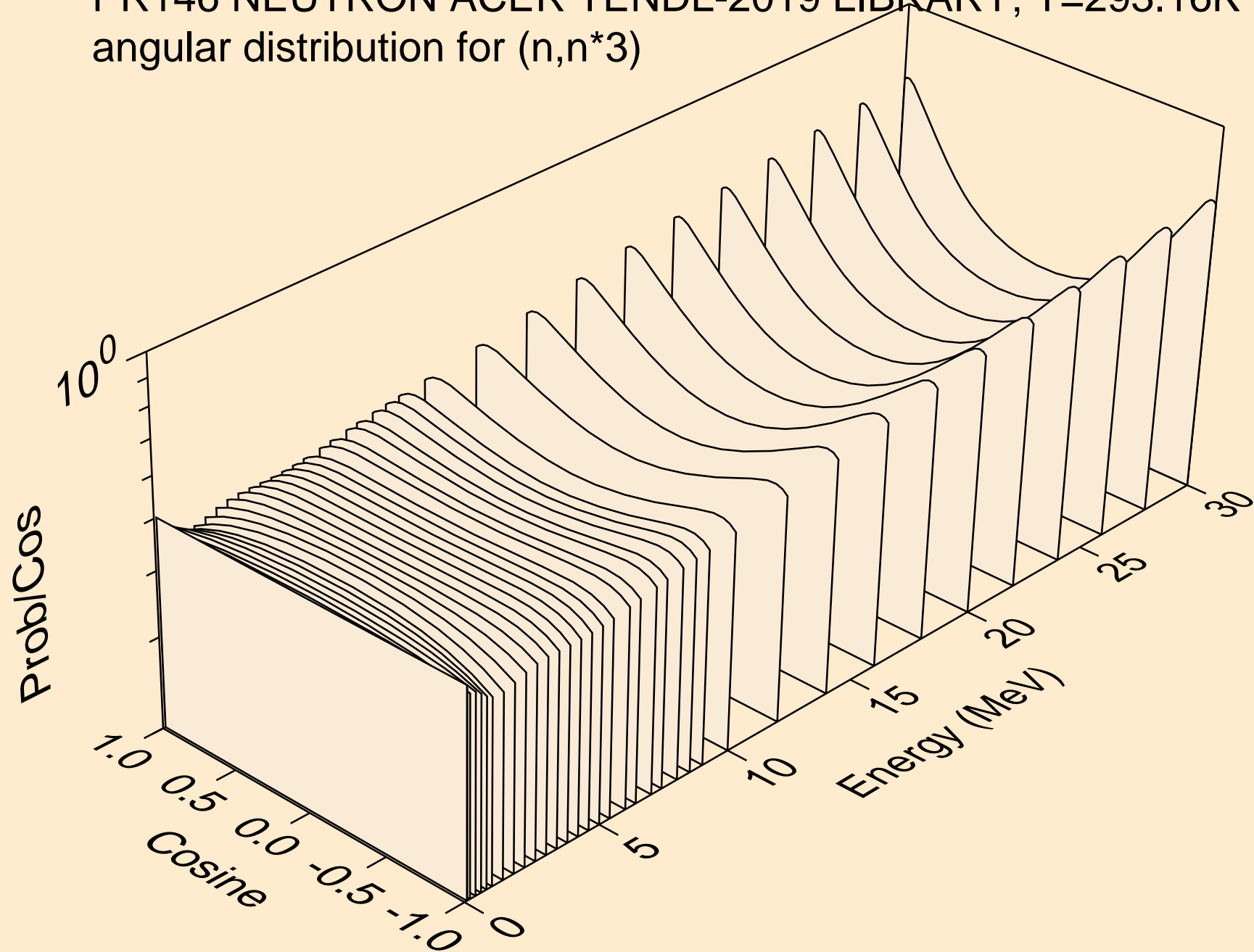

PR146 NEUTRON ACER TENDL-2019 LIBRARY; T=293.16K  
angular distribution for (n,n\*4)

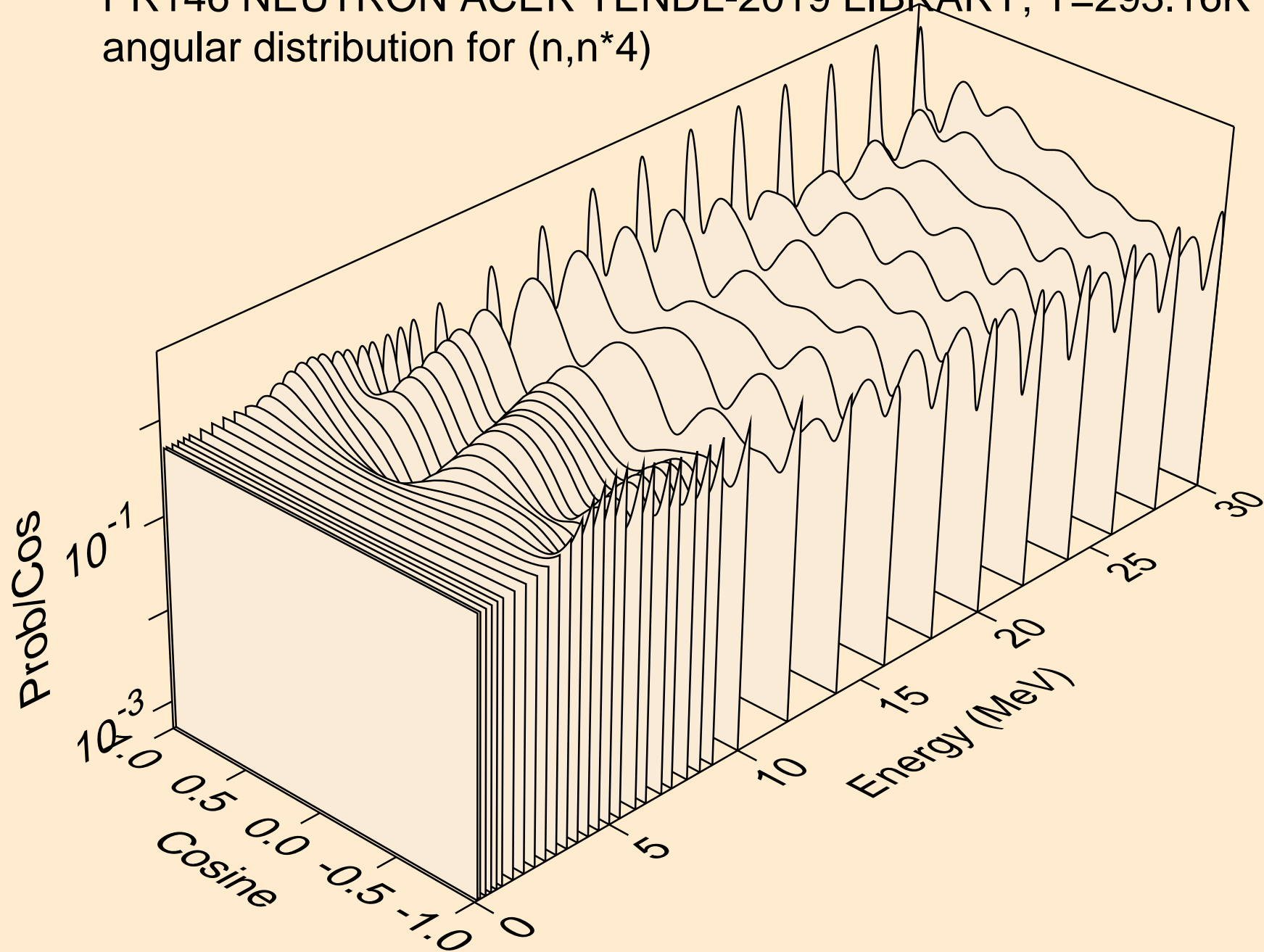

PR146 NEUTRON ACER TENDL-2019 LIBRARY; T=293.16K  
angular distribution for (n,n\*5)

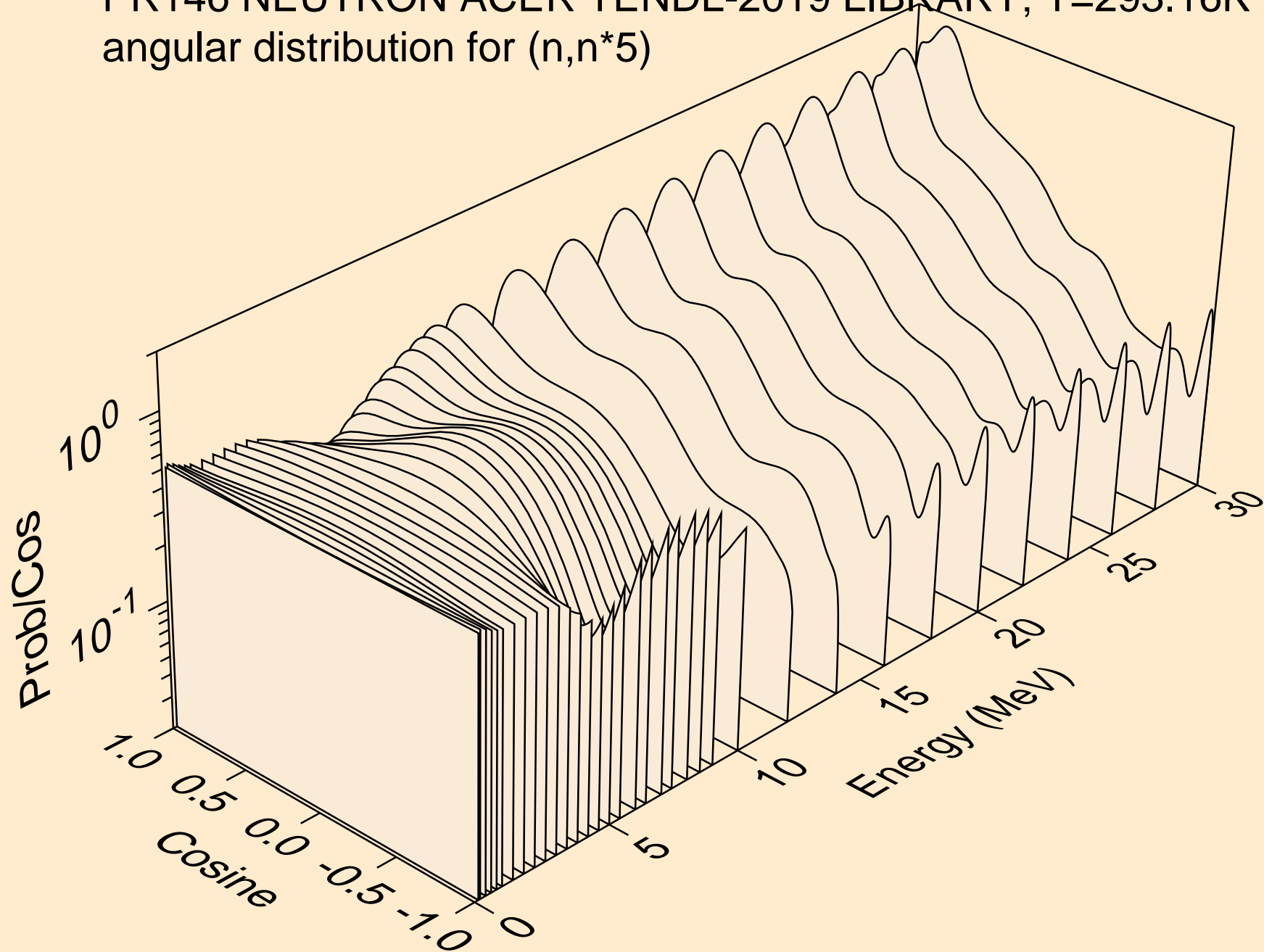

PR146 NEUTRON ACER TENDL-2019 LIBRARY; T=293.16K  
angular distribution for (n,n\*6)

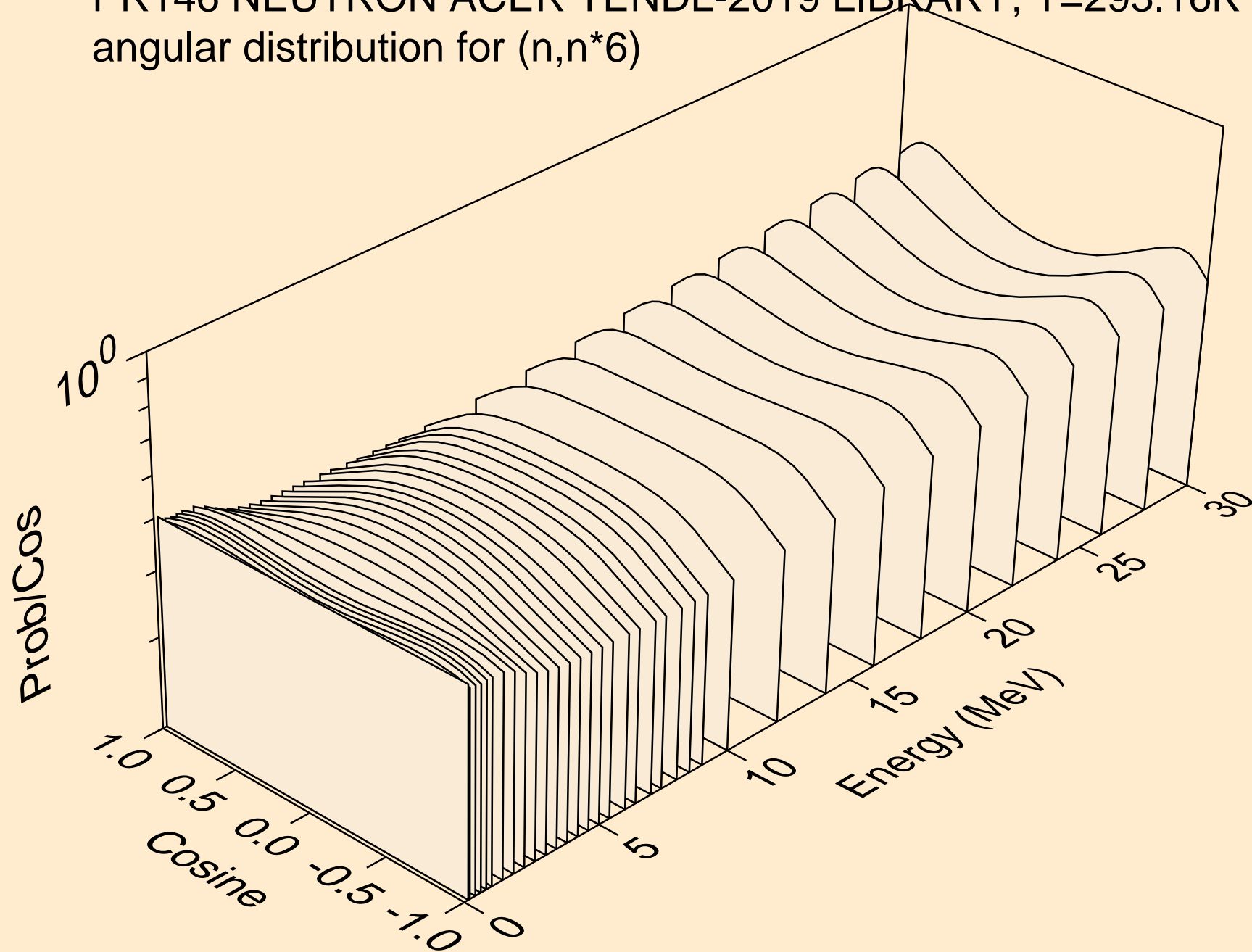

PR146 NEUTRON ACER TENDL-2019 LIBRARY; T=293.16K  
angular distribution for (n,n\*7)

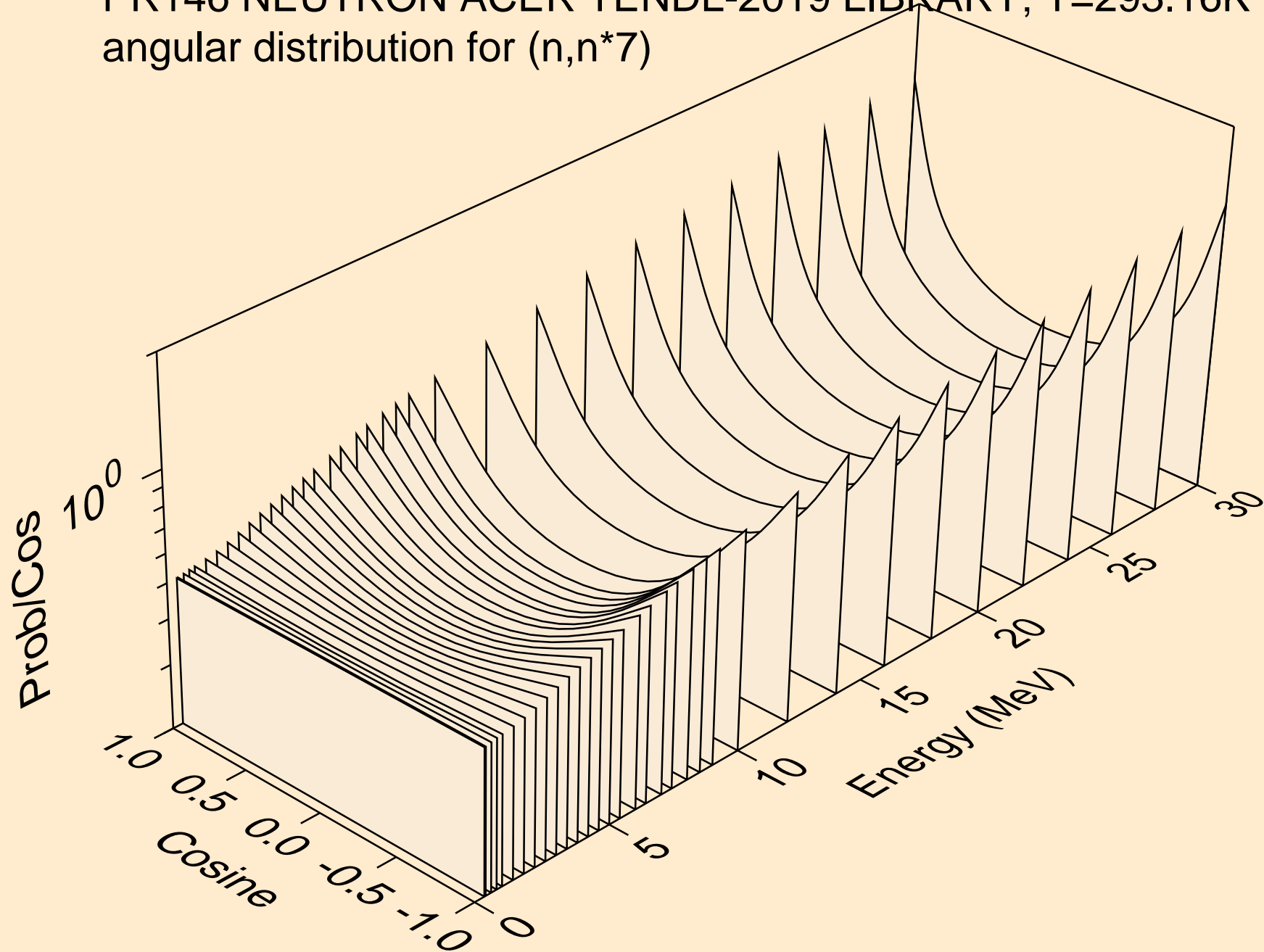

PR146 NEUTRON ACER TENDL-2019 LIBRARY; T=293.16K  
angular distribution for (n,n\*8)

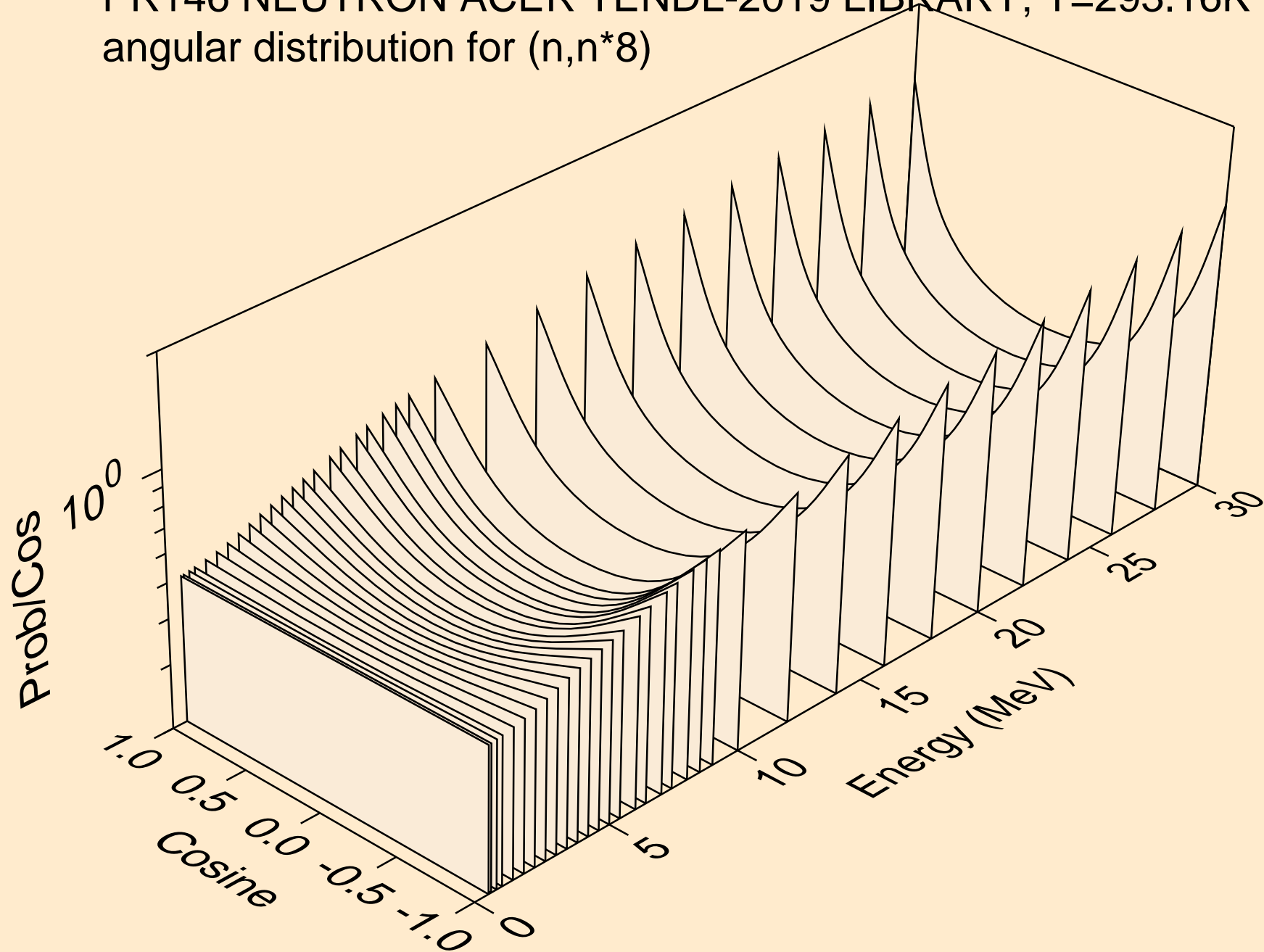

PR146 NEUTRON ACER TENDL-2019 LIBRARY; T=293.16K  
angular distribution for (n,n\*9)

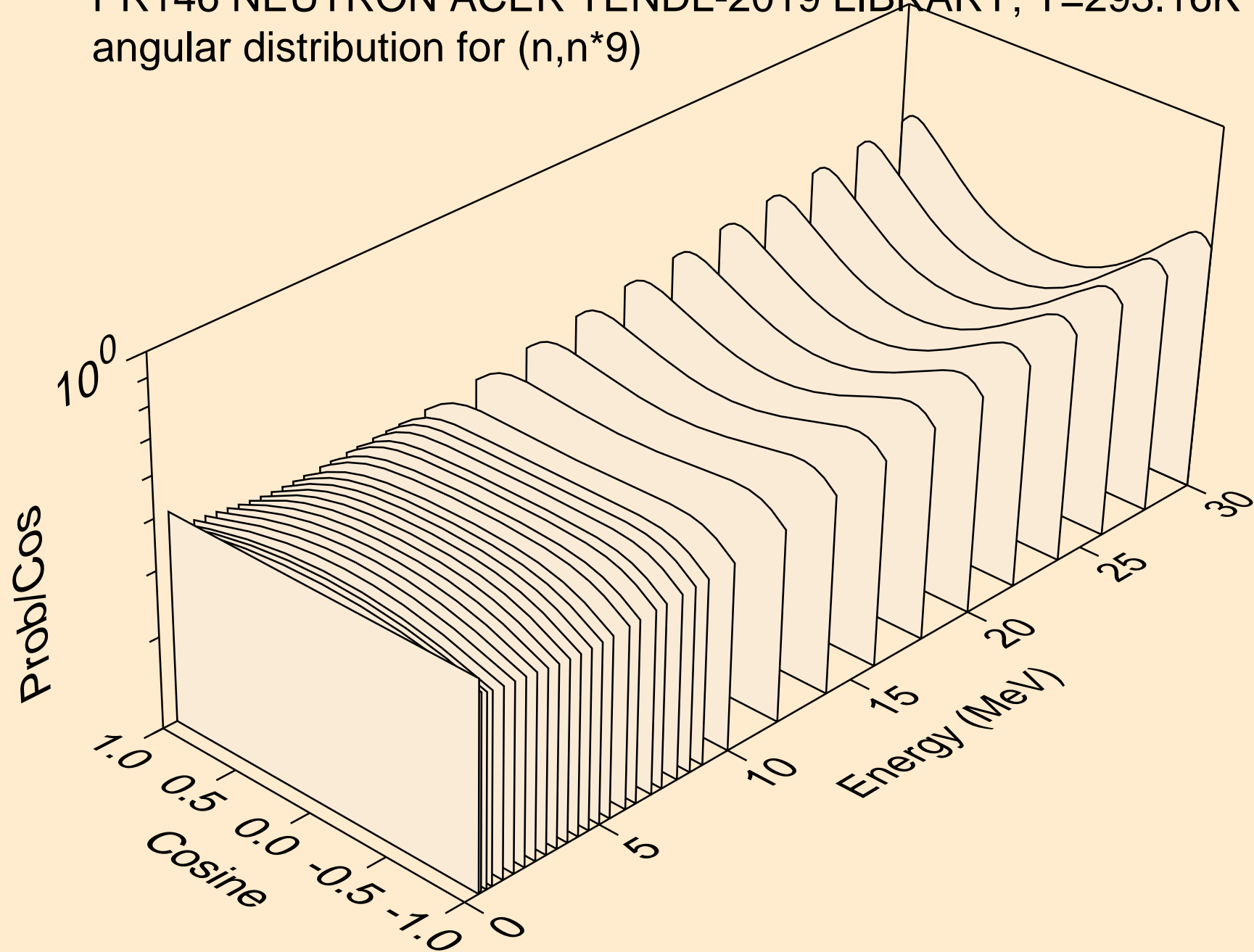



PR146 NEUTRON ACER TENDL-2019 LIBRARY; T=293.16K  
angular distribution for (n,n\*10)

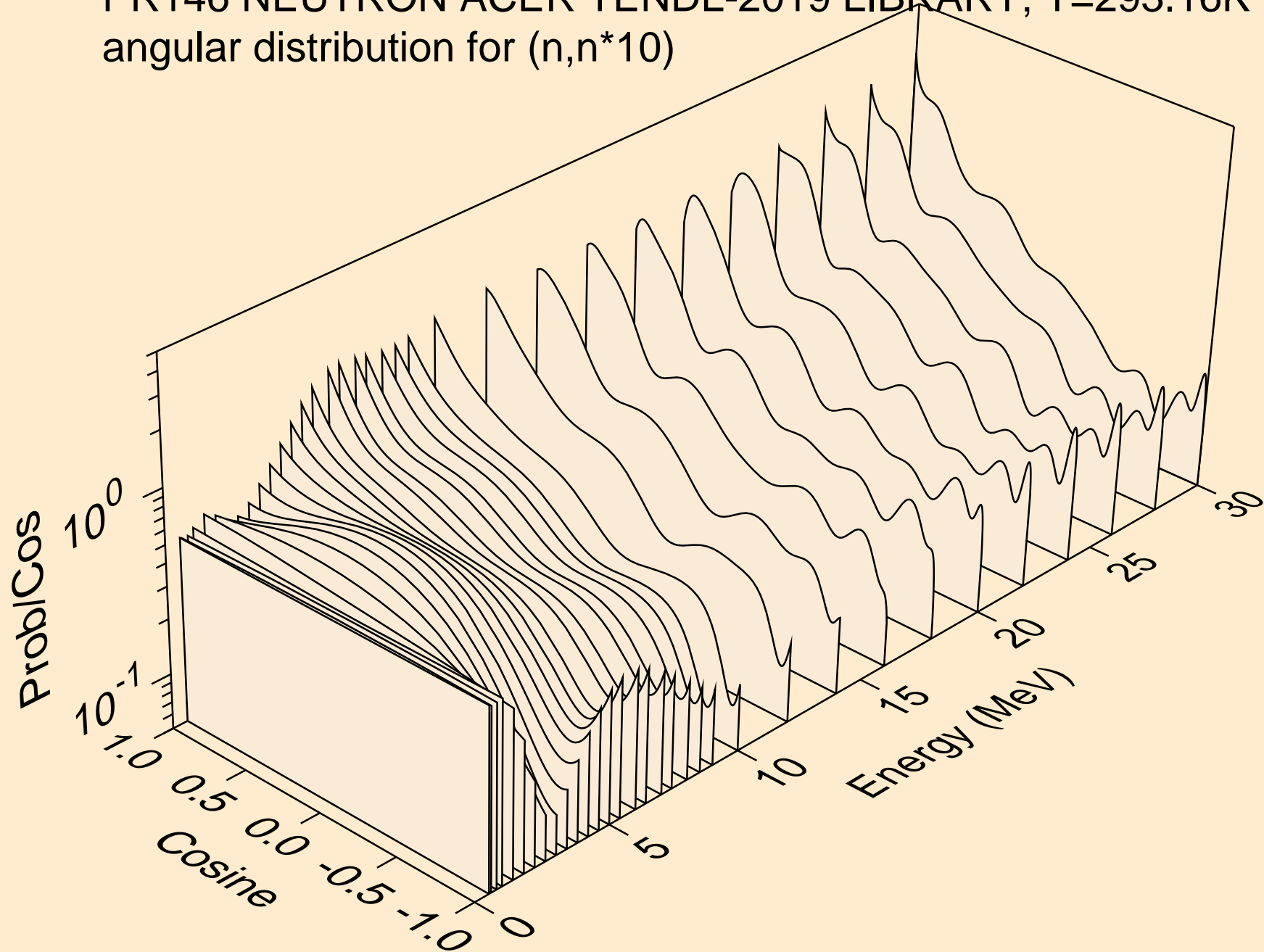

PR146 NEUTRON ACER TENDL-2019 LIBRARY; T=293.16K  
angular distribution for (n,n\*11)

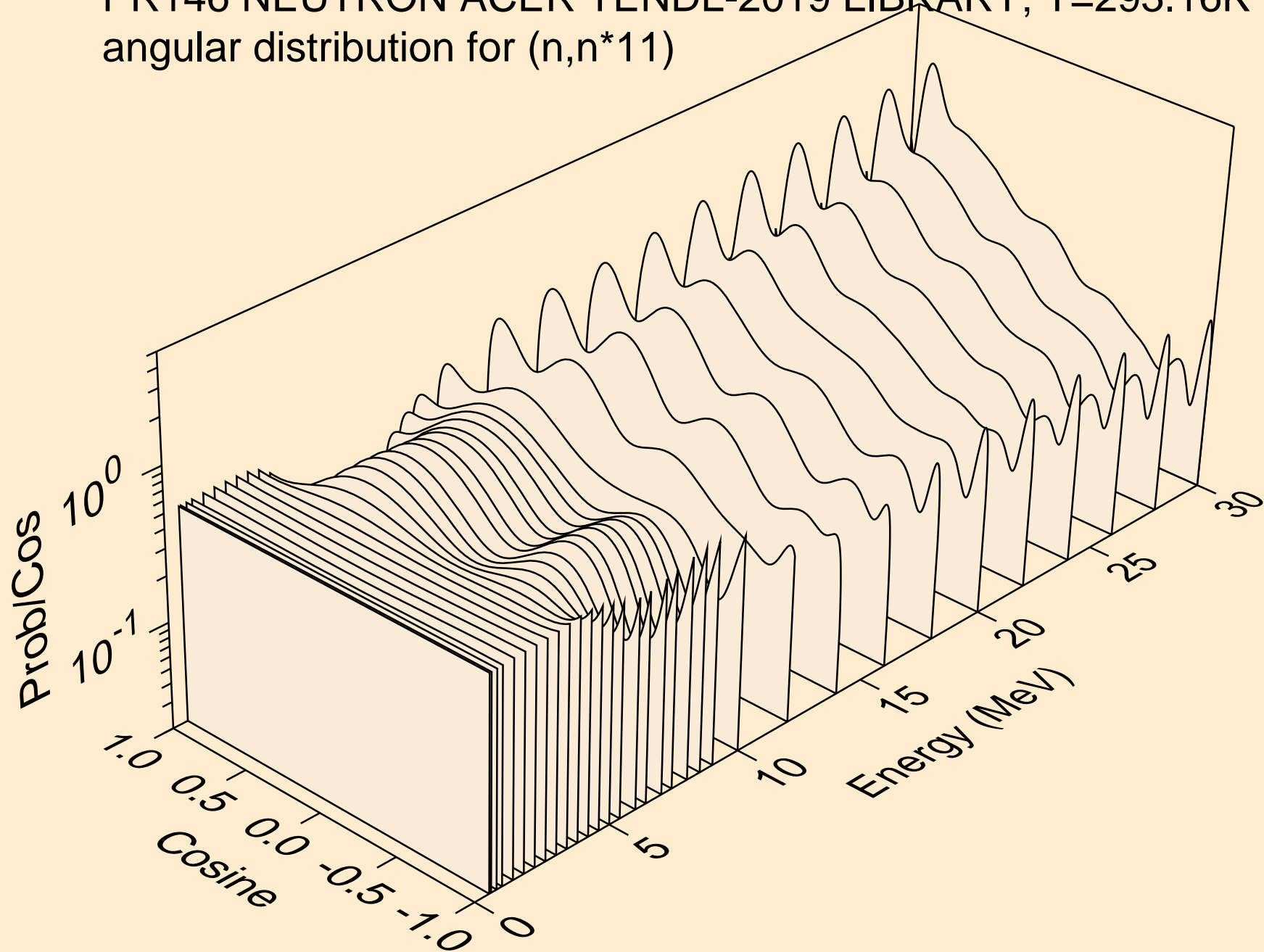

PR146 NEUTRON ACER TENDL-2019 LIBRARY; T=293.16K  
angular distribution for (n,n\*12)

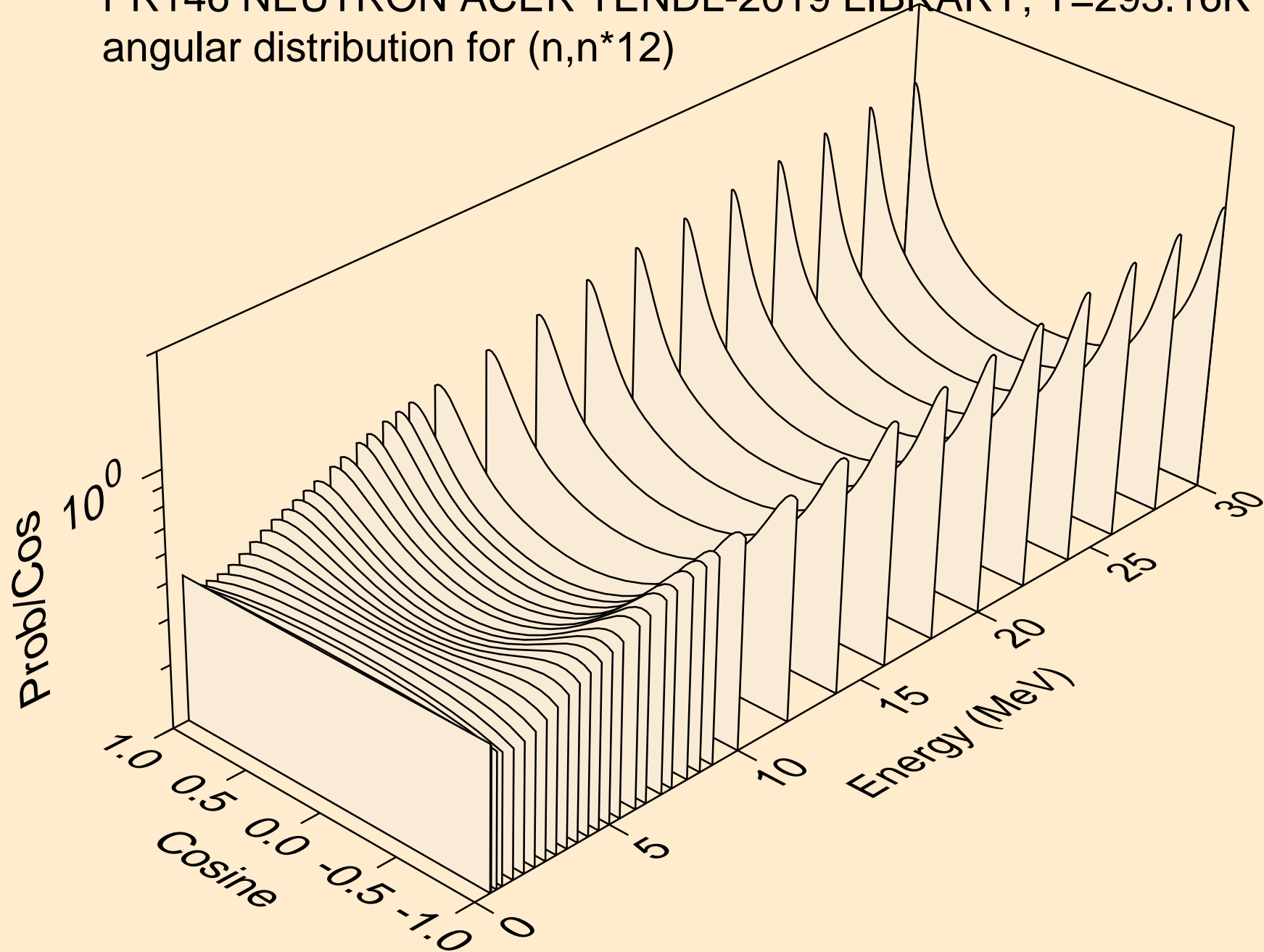

PR146 NEUTRON ACER TENDL-2019 LIBRARY; T=293.16K  
angular distribution for (n,n\*13)

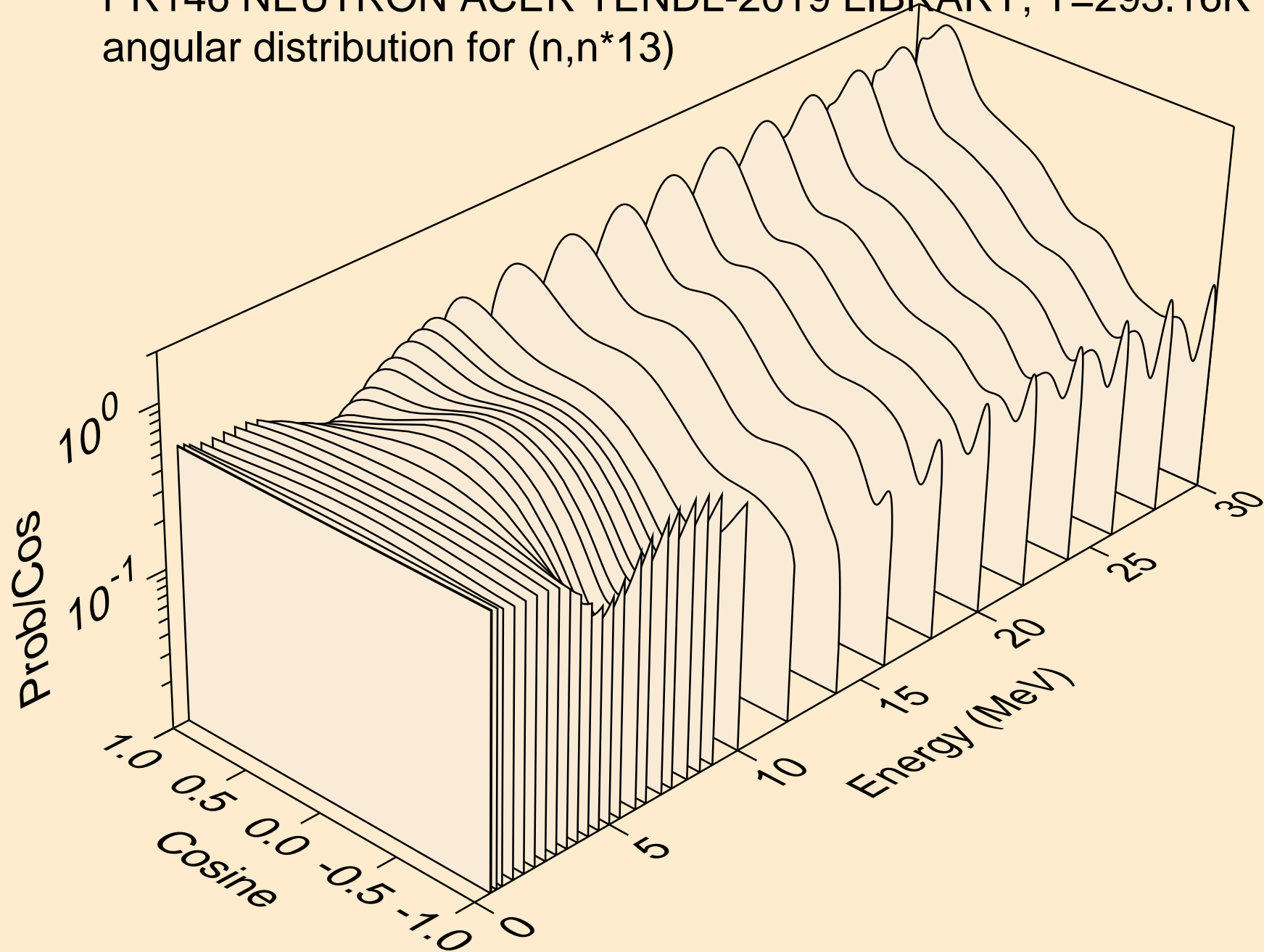

PR146 NEUTRON ACER TENDL-2019 LIBRARY; T=293.16K  
angular distribution for (n,n\*14)

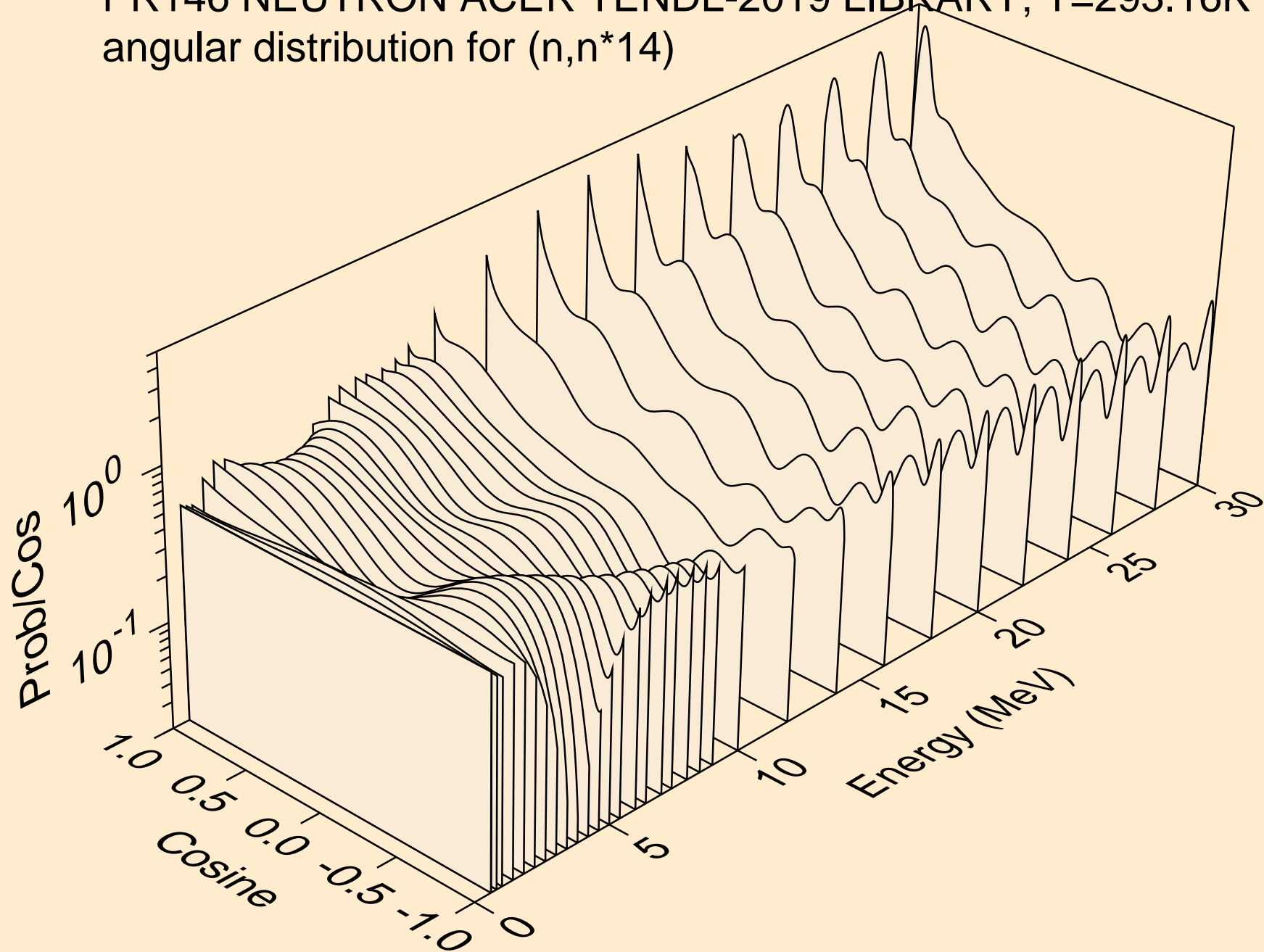

PR146 NEUTRON ACER TENDL-2019 LIBRARY; T=293.16K  
angular distribution for (n,n\*15)

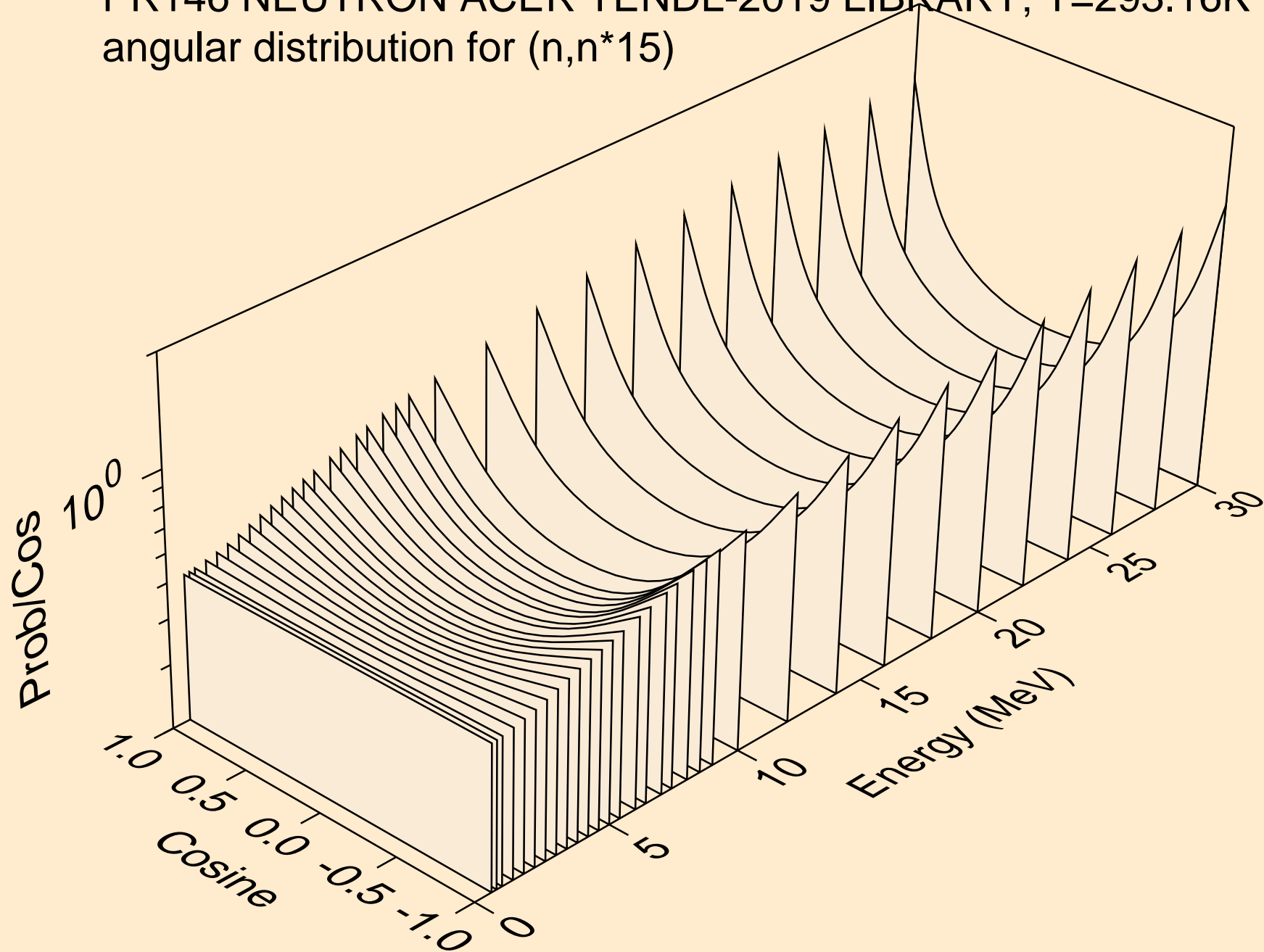

PR146 NEUTRON ACER TENDL-2019 LIBRARY; T=293.16K  
angular distribution for (n,n\*16)

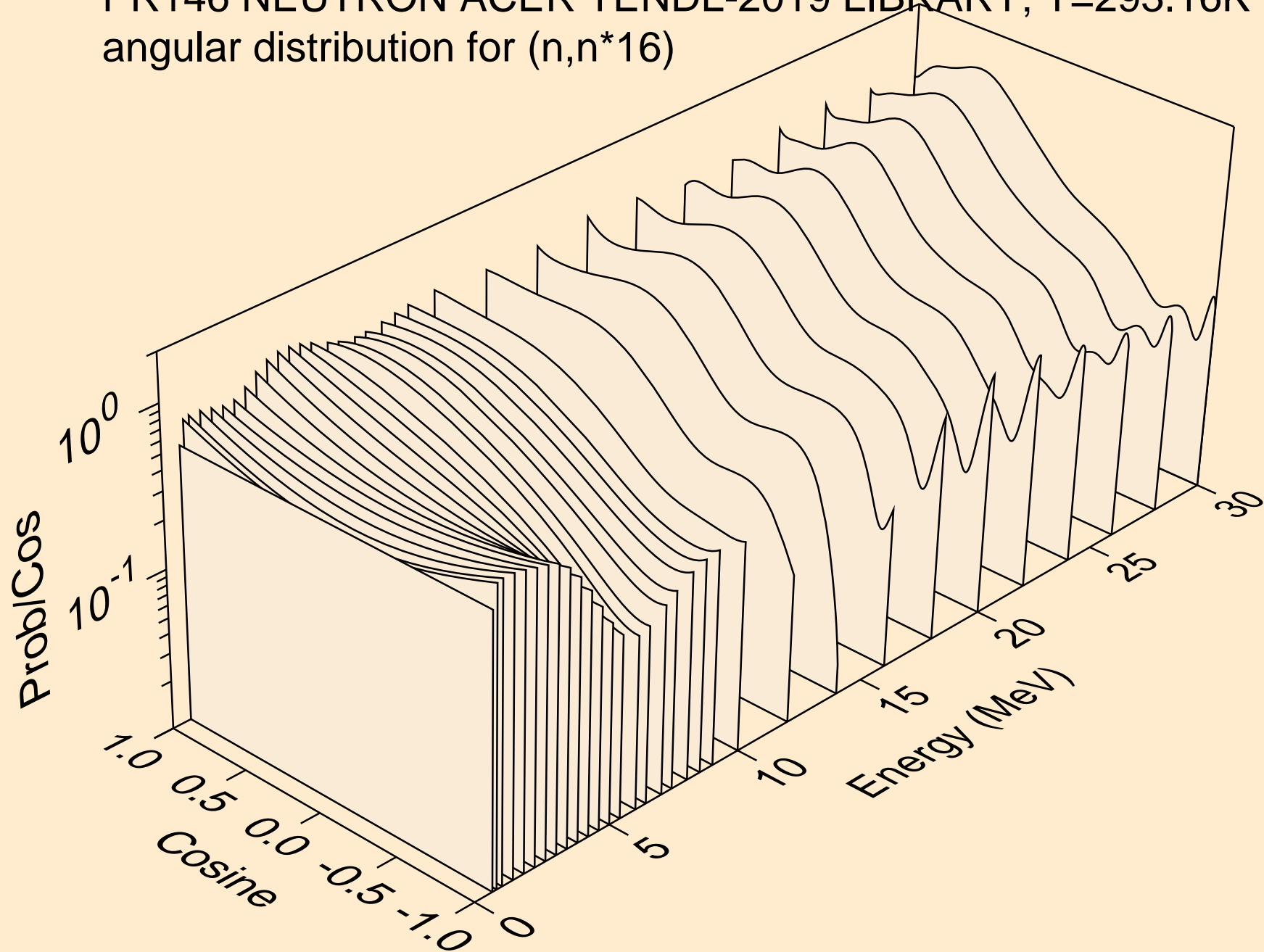

PR146 NEUTRON ACER TENDL-2019 LIBRARY; T=293.16K  
angular distribution for (n,n\*17)

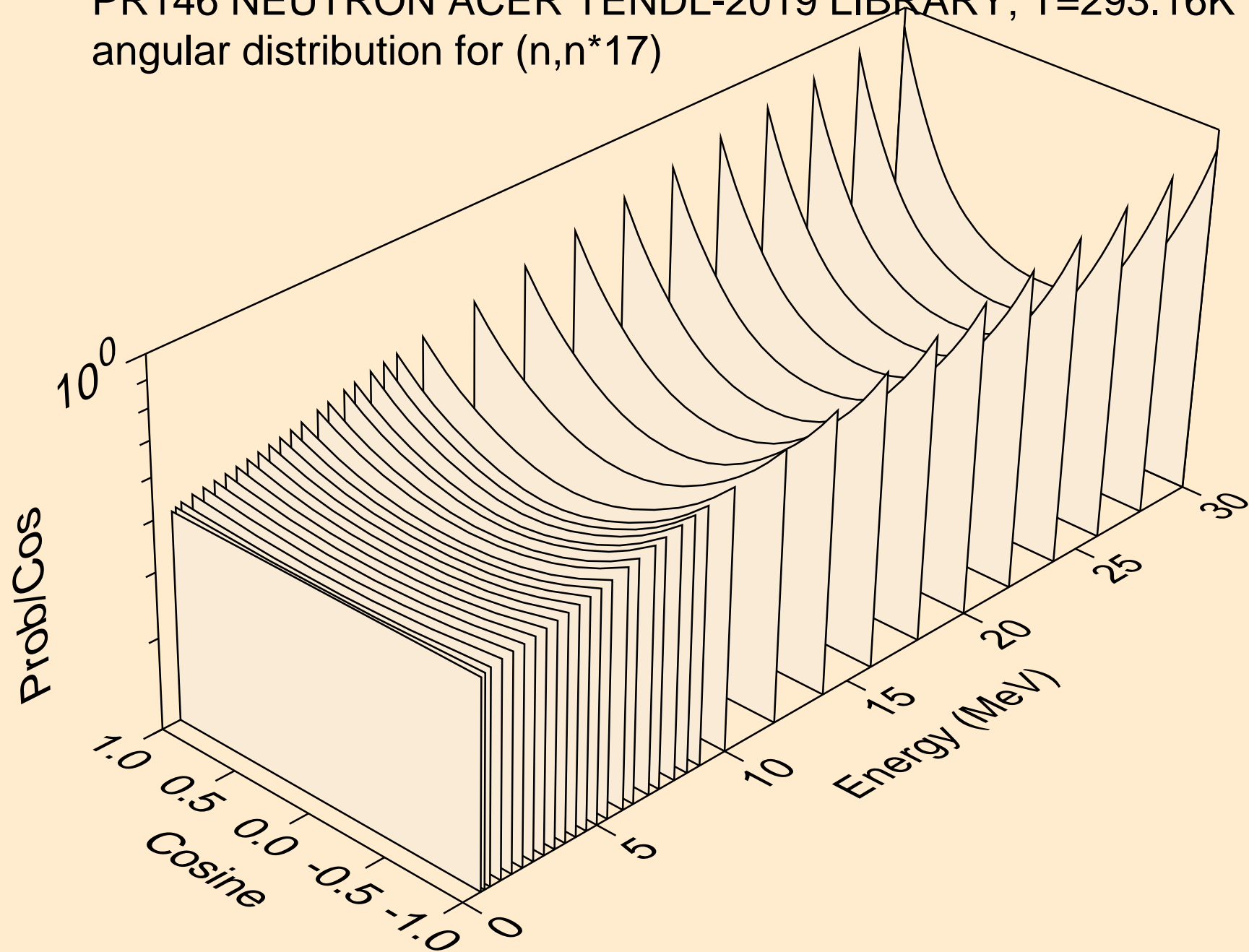



PR146 NEUTRON ACER TENDL-2019 LIBRARY; T=293.16K  
angular distribution for (n,n\*18)

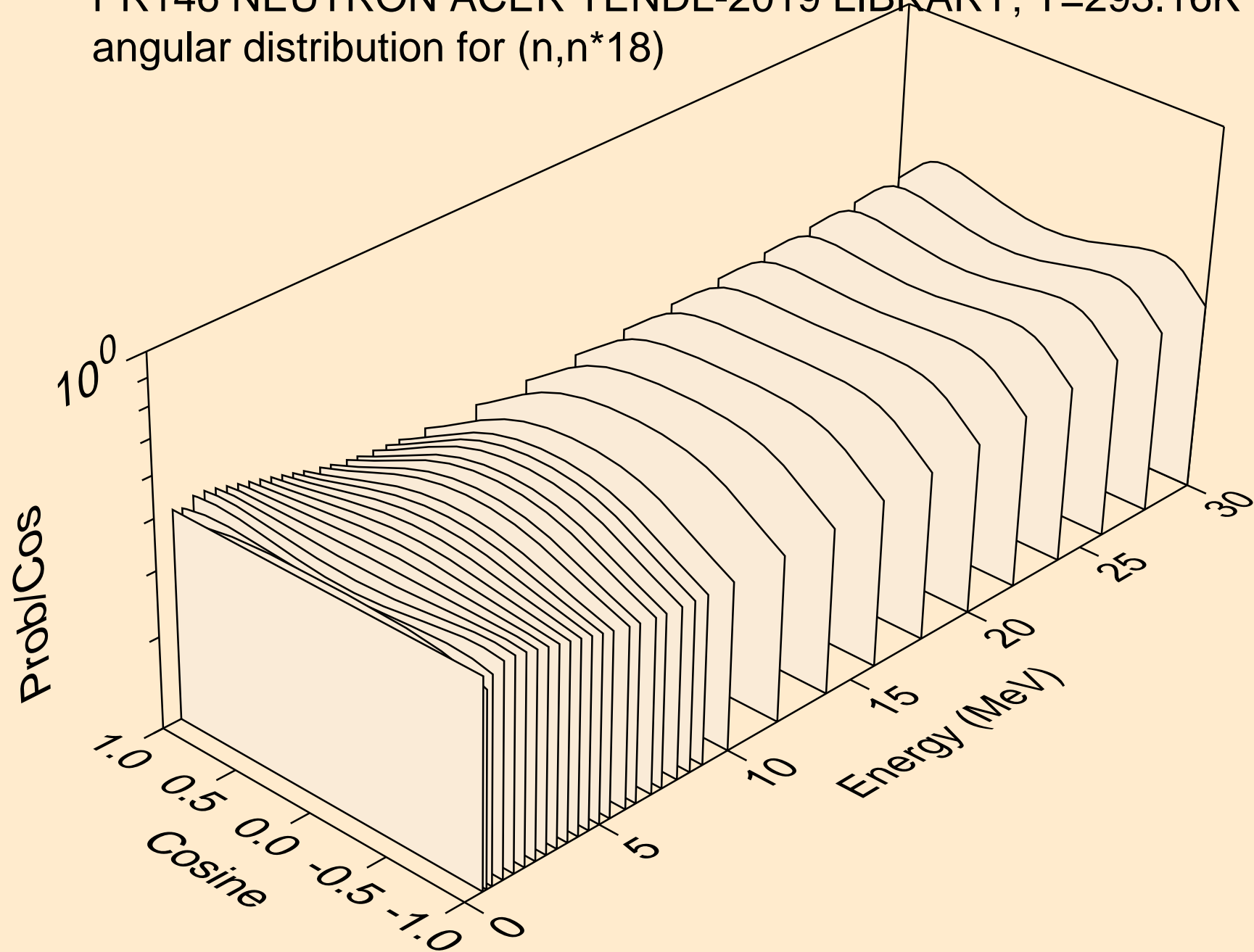

PR146 NEUTRON ACER TENDL-2019 LIBRARY; T=293.16K  
angular distribution for (n,n\*19)

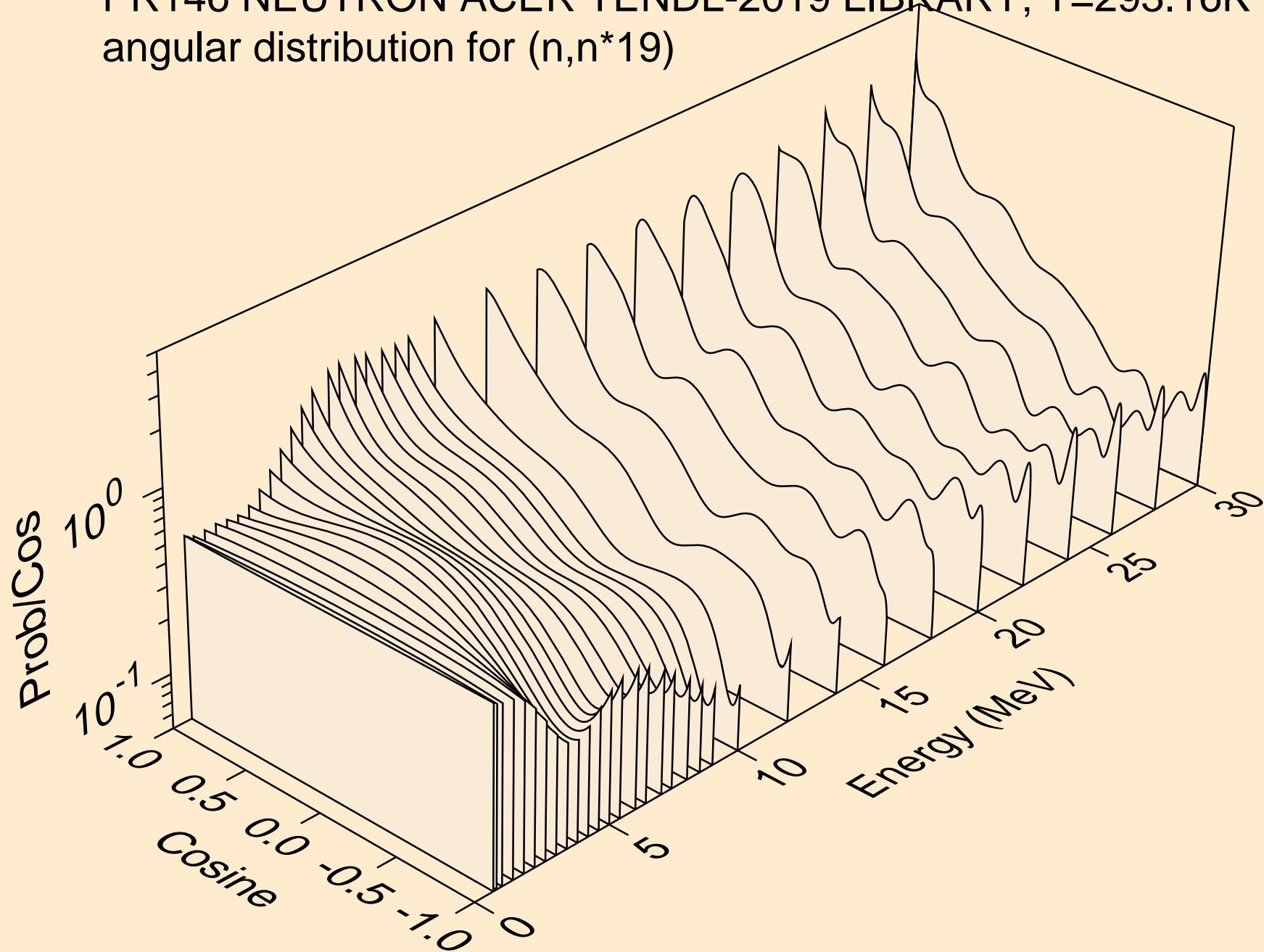

PR146 NEUTRON ACER TENDL-2019 LIBRARY; T=293.16K  
angular distribution for (n,n\*20)

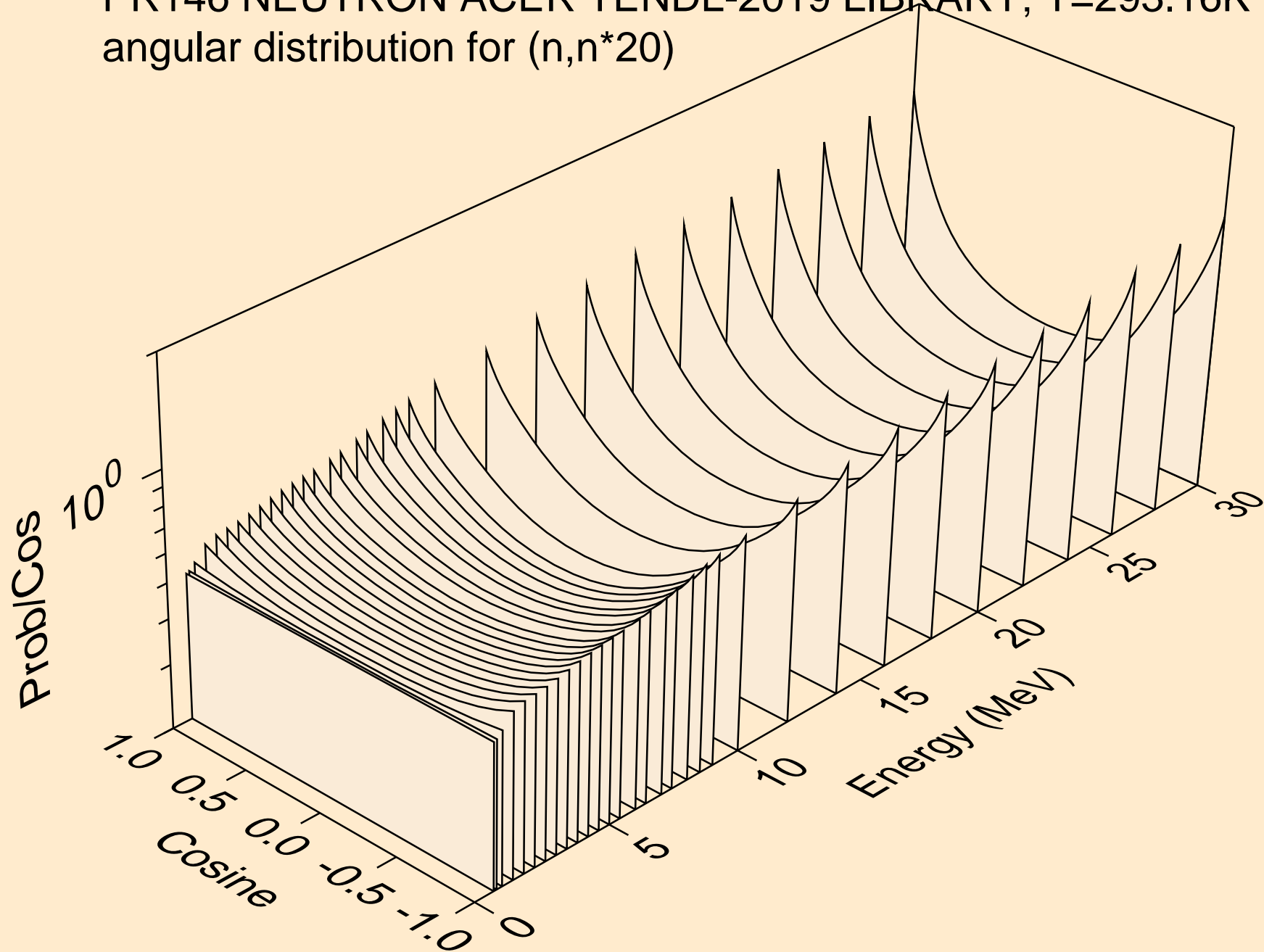

PR146 NEUTRON ACER TENDL-2019 LIBRARY; T=293.16K  
angular distribution for (n,n\*21)

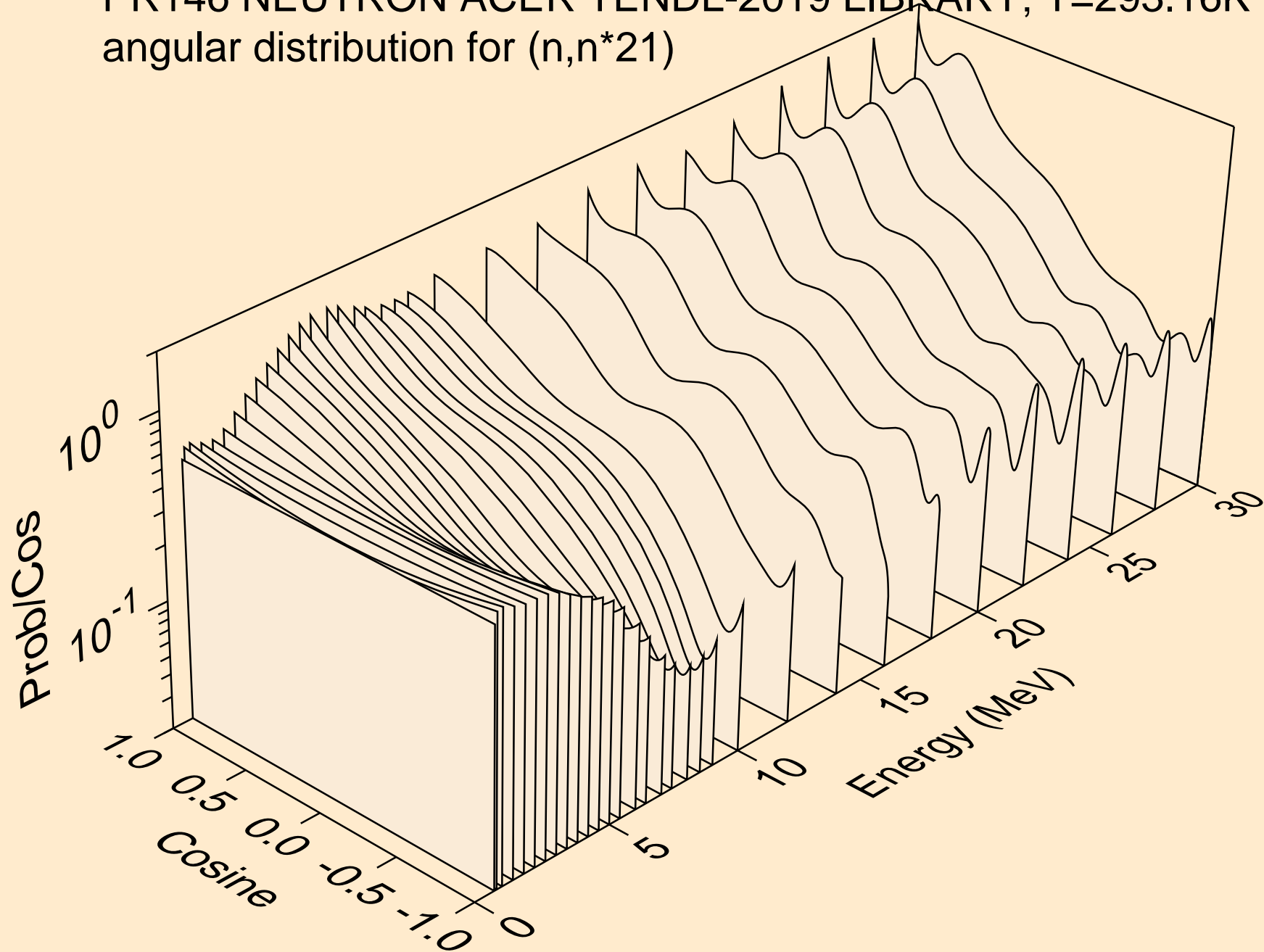

PR146 NEUTRON ACER TENDL-2019 LIBRARY; T=293.16K  
angular distribution for (n,n\*22)

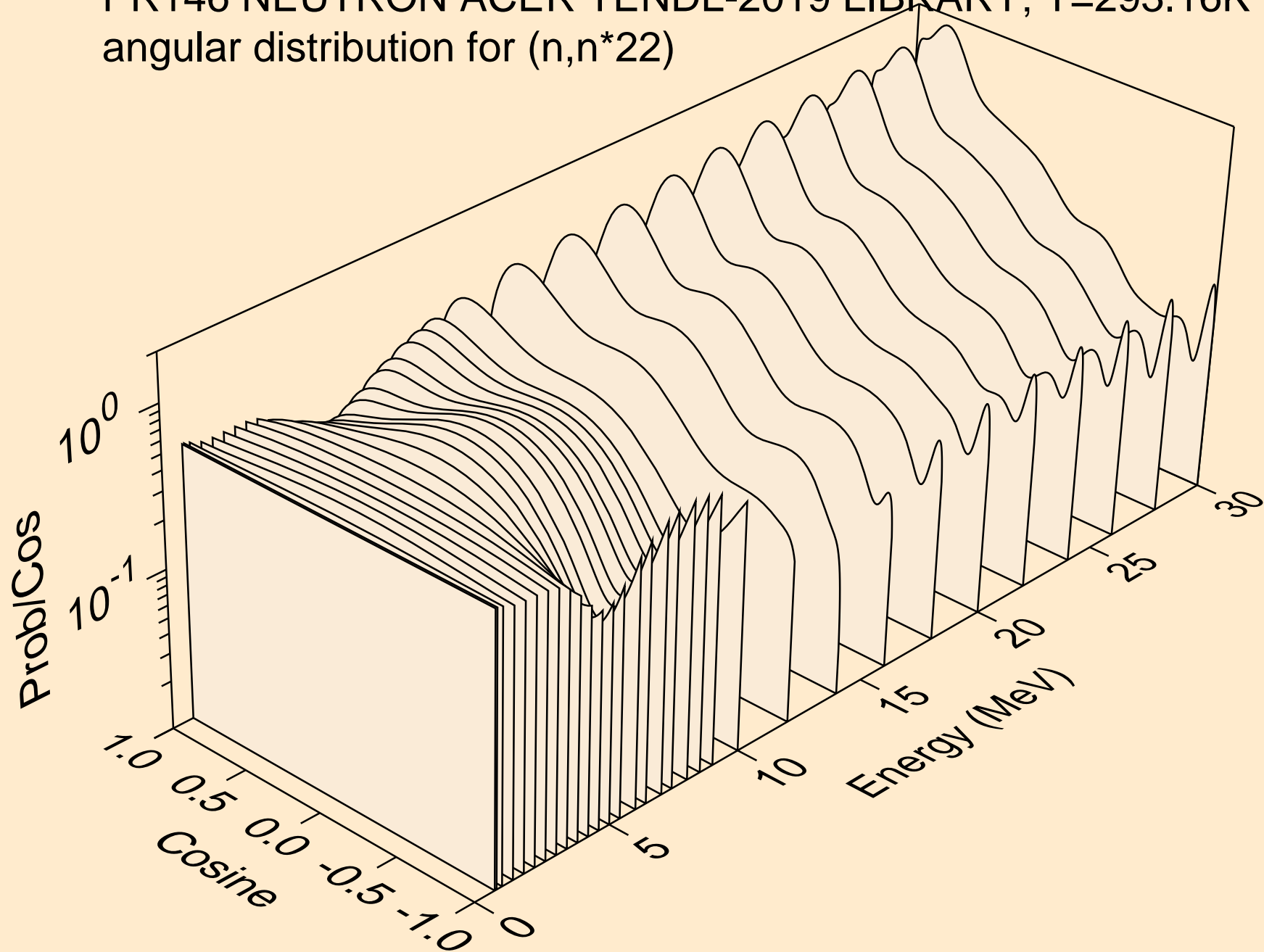

PR146 NEUTRON ACER TENDL-2019 LIBRARY; T=293.16K  
angular distribution for (n,n\*23)

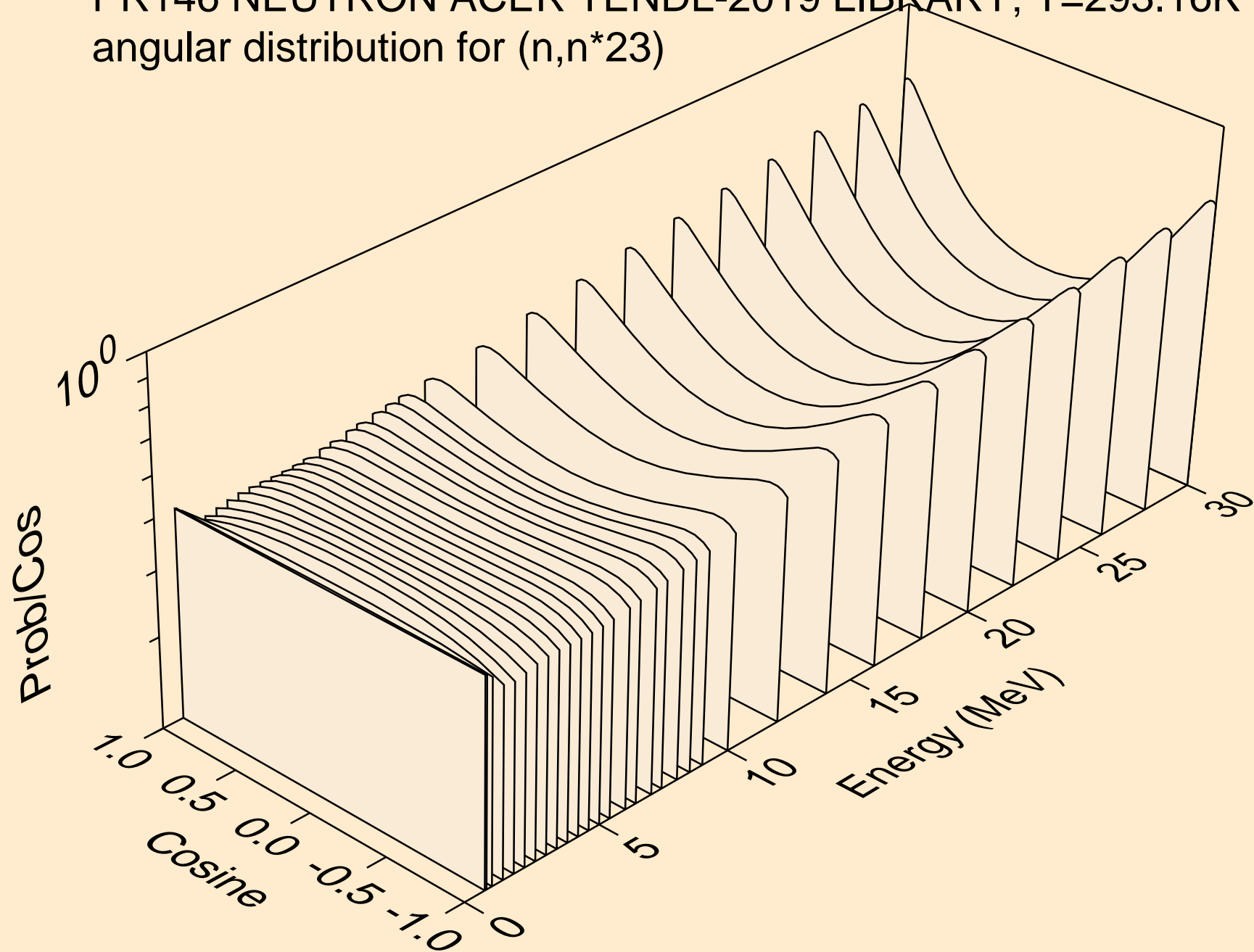

PR146 NEUTRON ACER TENDL-2019 LIBRARY; T=293.16K  
angular distribution for (n,n\*24)

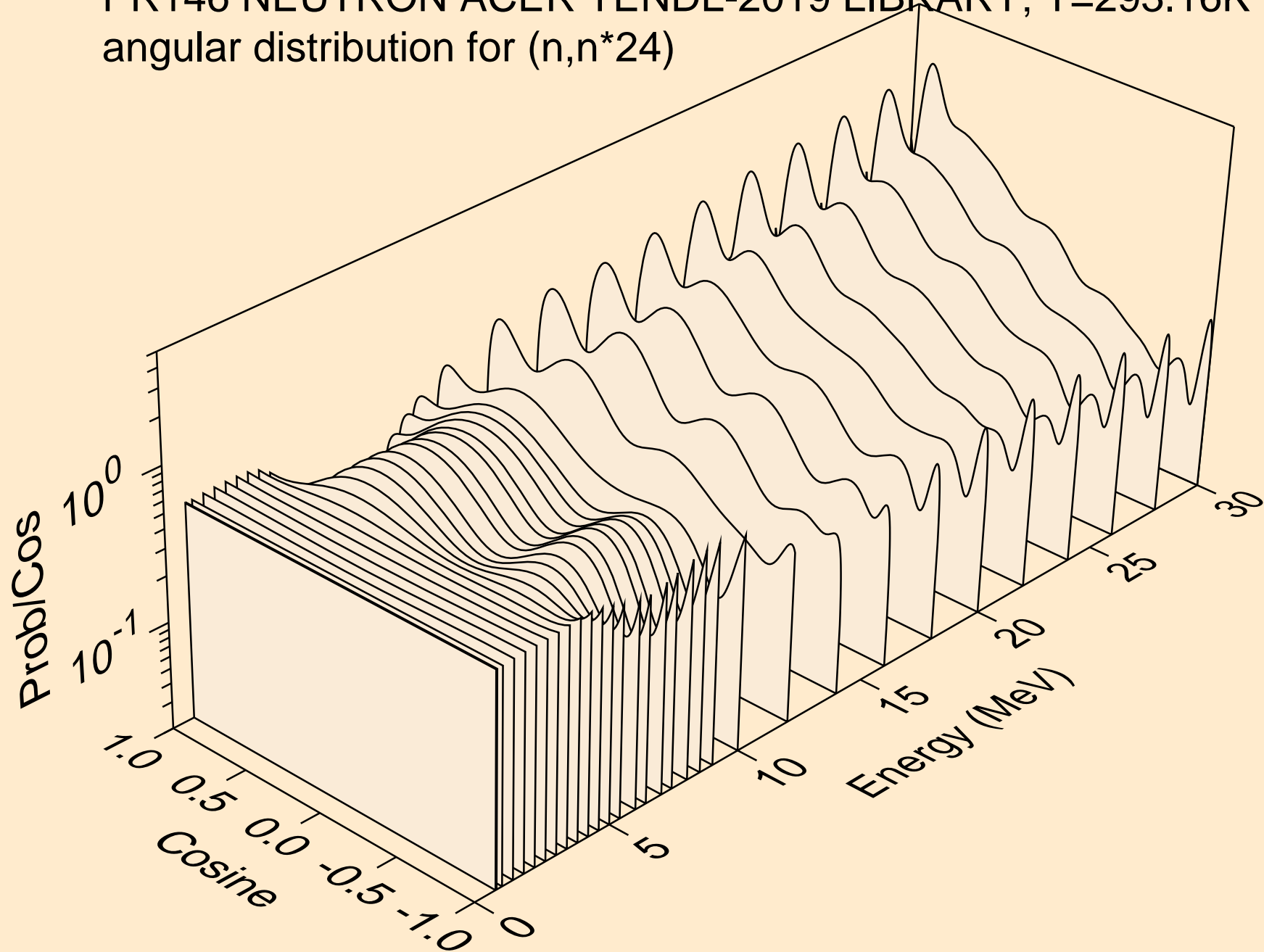

PR146 NEUTRON ACER TENDL-2019 LIBRARY; T=293.16K  
angular distribution for (n,n\*25)

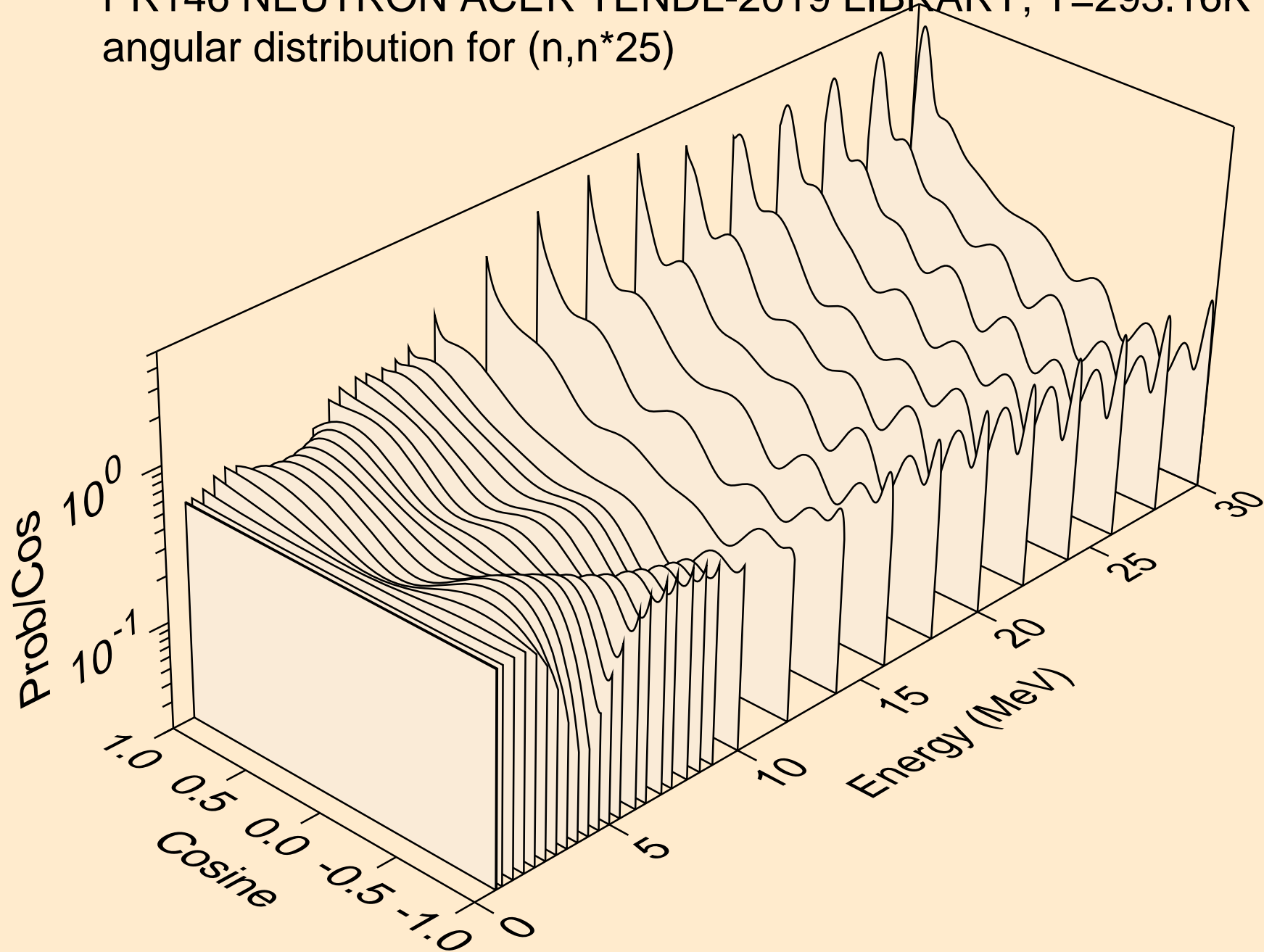



PR146 NEUTRON ACER TENDL-2019 LIBRARY; T=293.16K  
angular distribution for (n,n\*26)

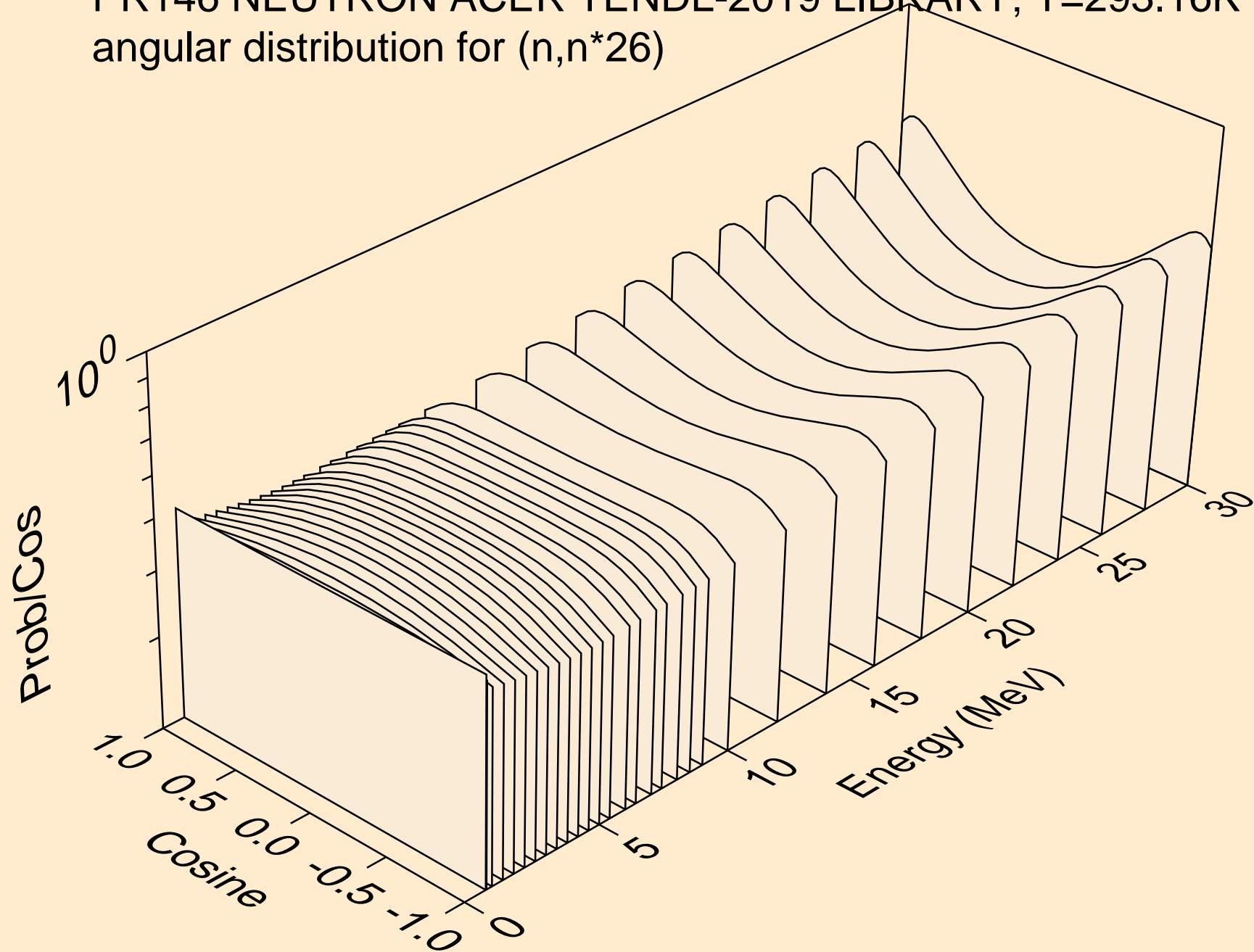

PR146 NEUTRON ACER TENDL-2019 LIBRARY; T=293.16K  
angular distribution for (n,n\*27)

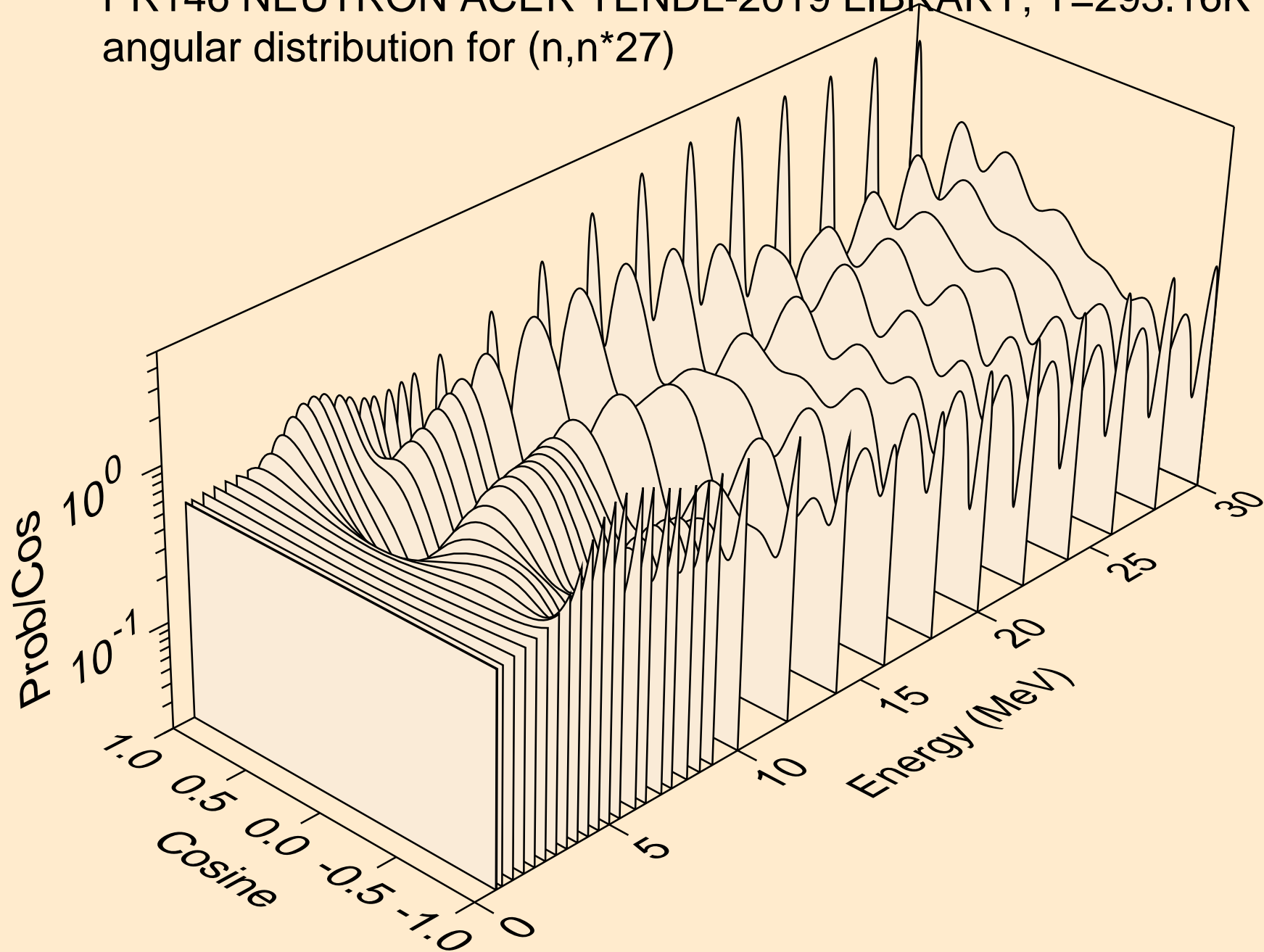

PR146 NEUTRON ACER TENDL-2019 LIBRARY; T=293.16K  
angular distribution for (n,n\*28)

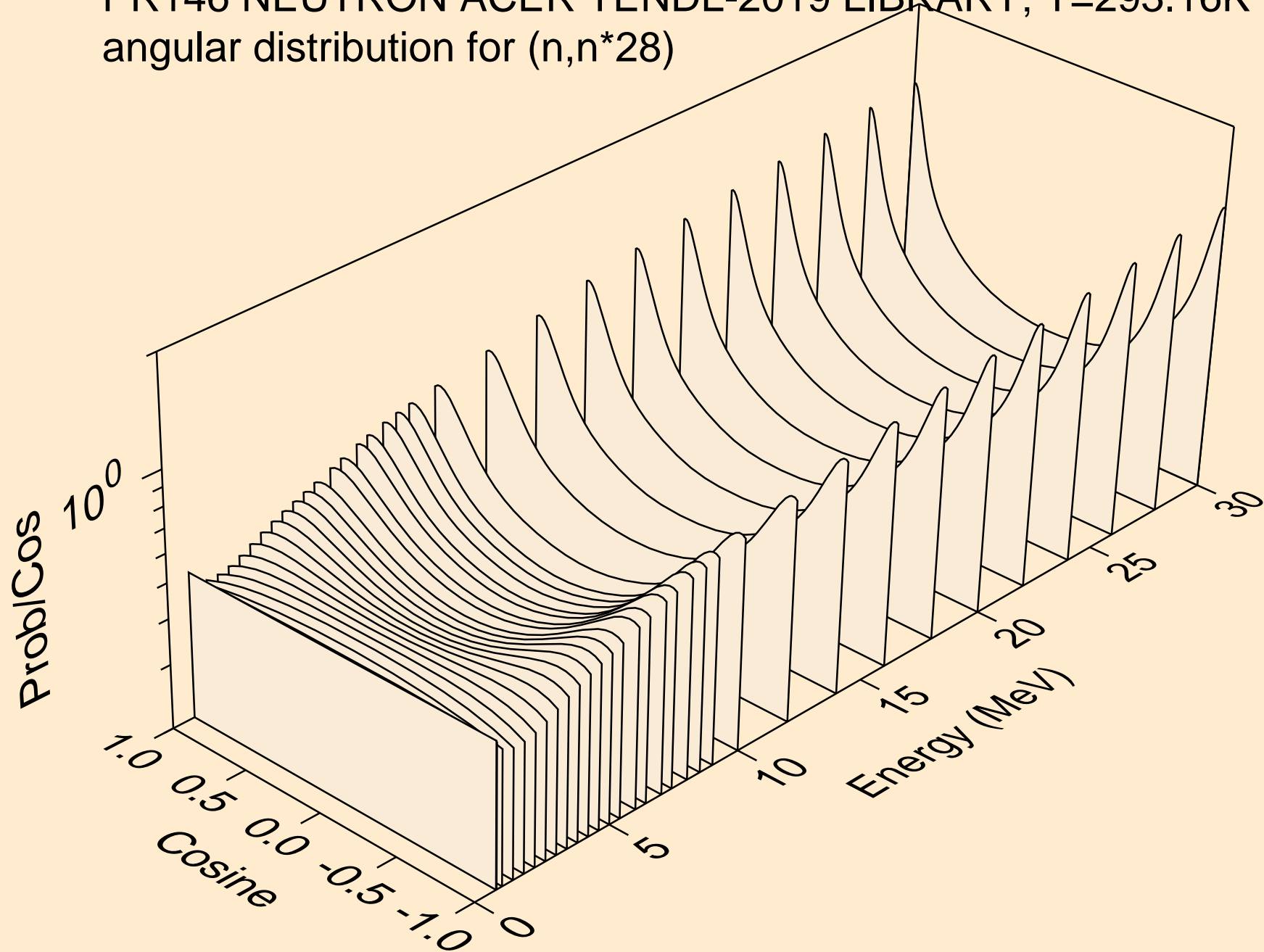

PR146 NEUTRON ACER TENDL-2019 LIBRARY; T=293.16K  
angular distribution for (n,n\*29)

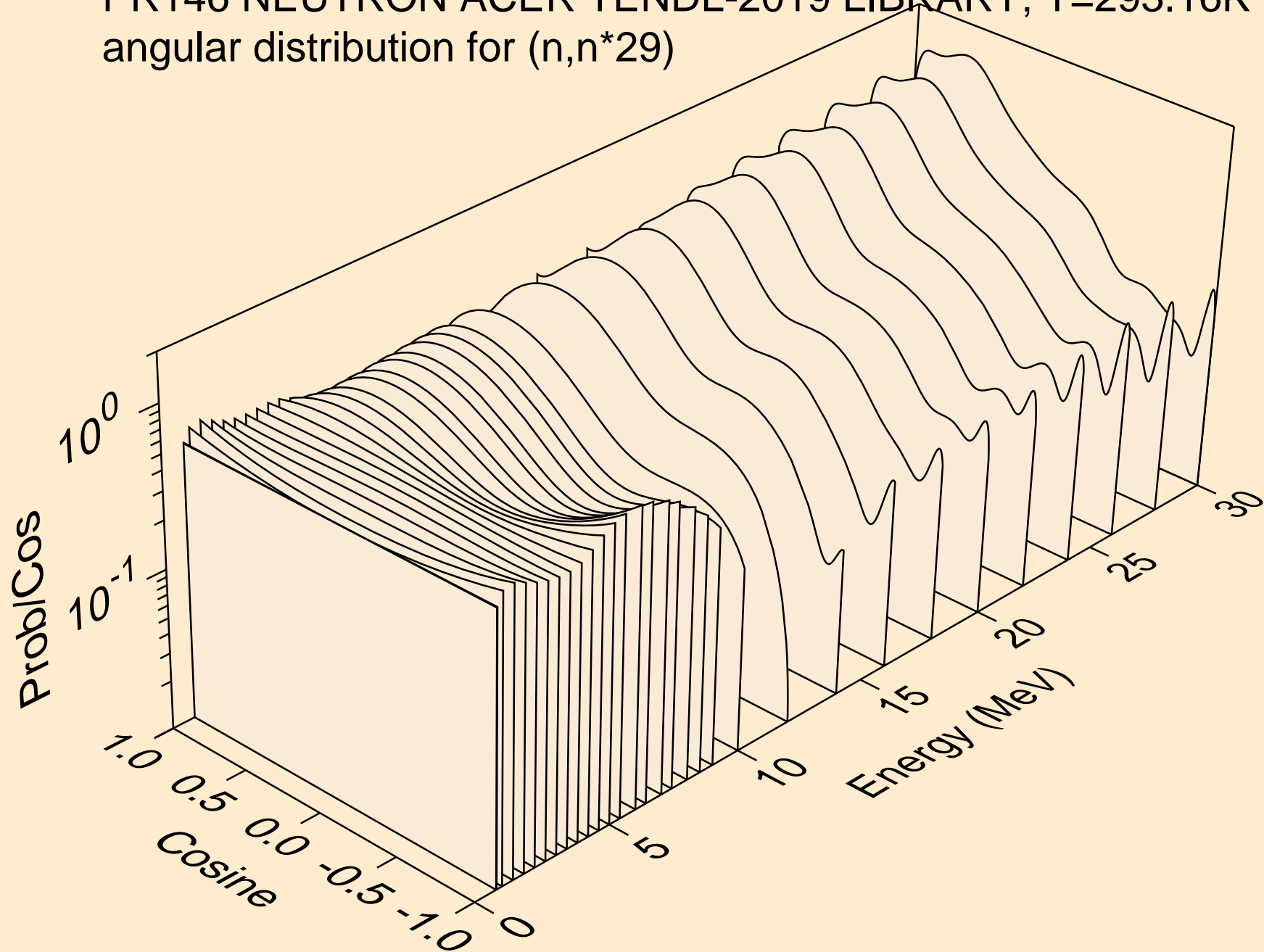

PR146 NEUTRON ACER TENDL-2019 LIBRARY; T=293.16K  
angular distribution for (n,n\*30)

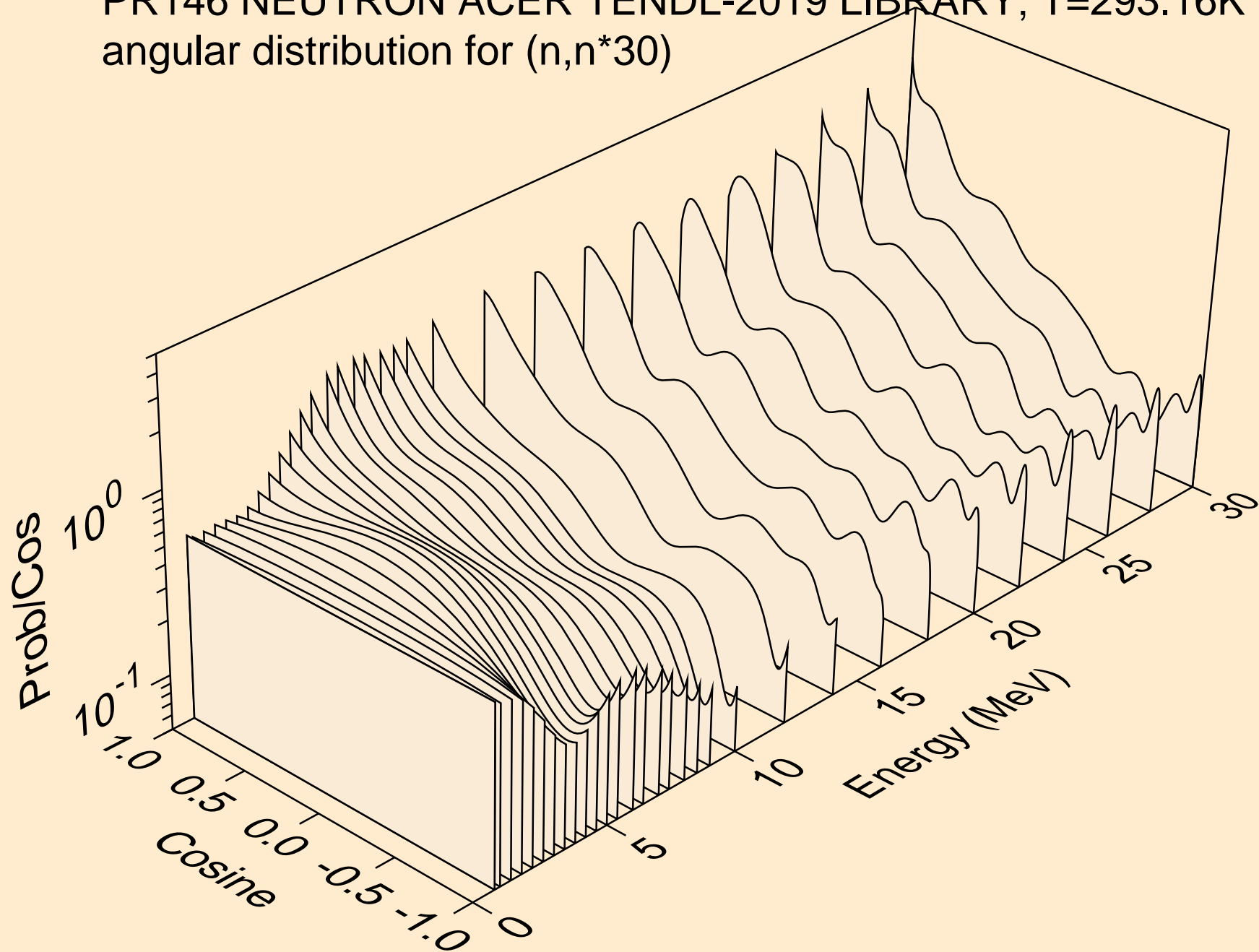

PR146 NEUTRON ACER TENDL-2019 LIBRARY; T=293.16K  
Neutron emission for (n,x)

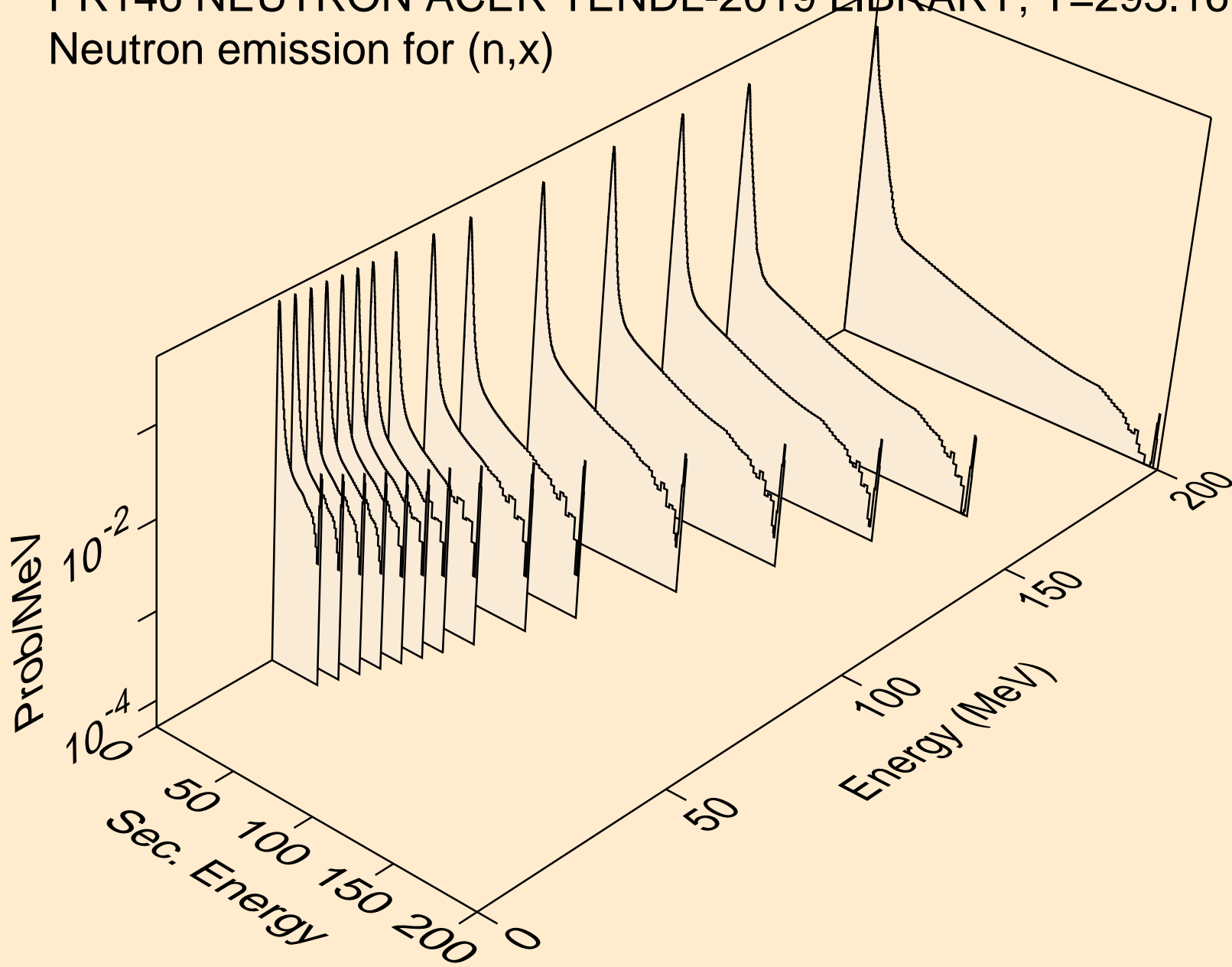

PR146 NEUTRON ACER TENDL-2019 LIBRARY; T=293.16K  
Neutron emission for (n,2nd)

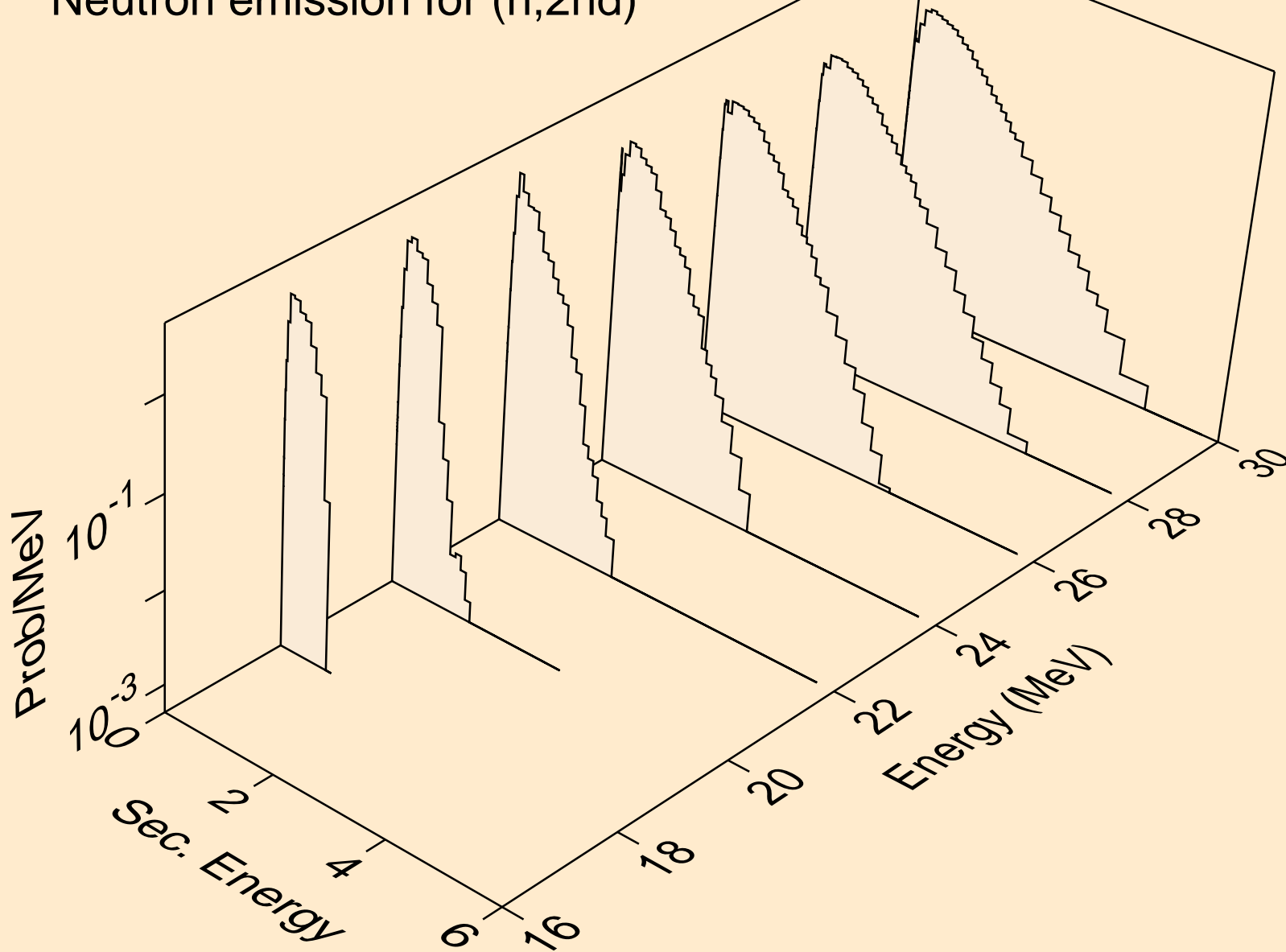

PR146 NEUTRON ACER TENDL-2019 LIBRARY; T=293.16K  
Neutron emission for (n,2n)

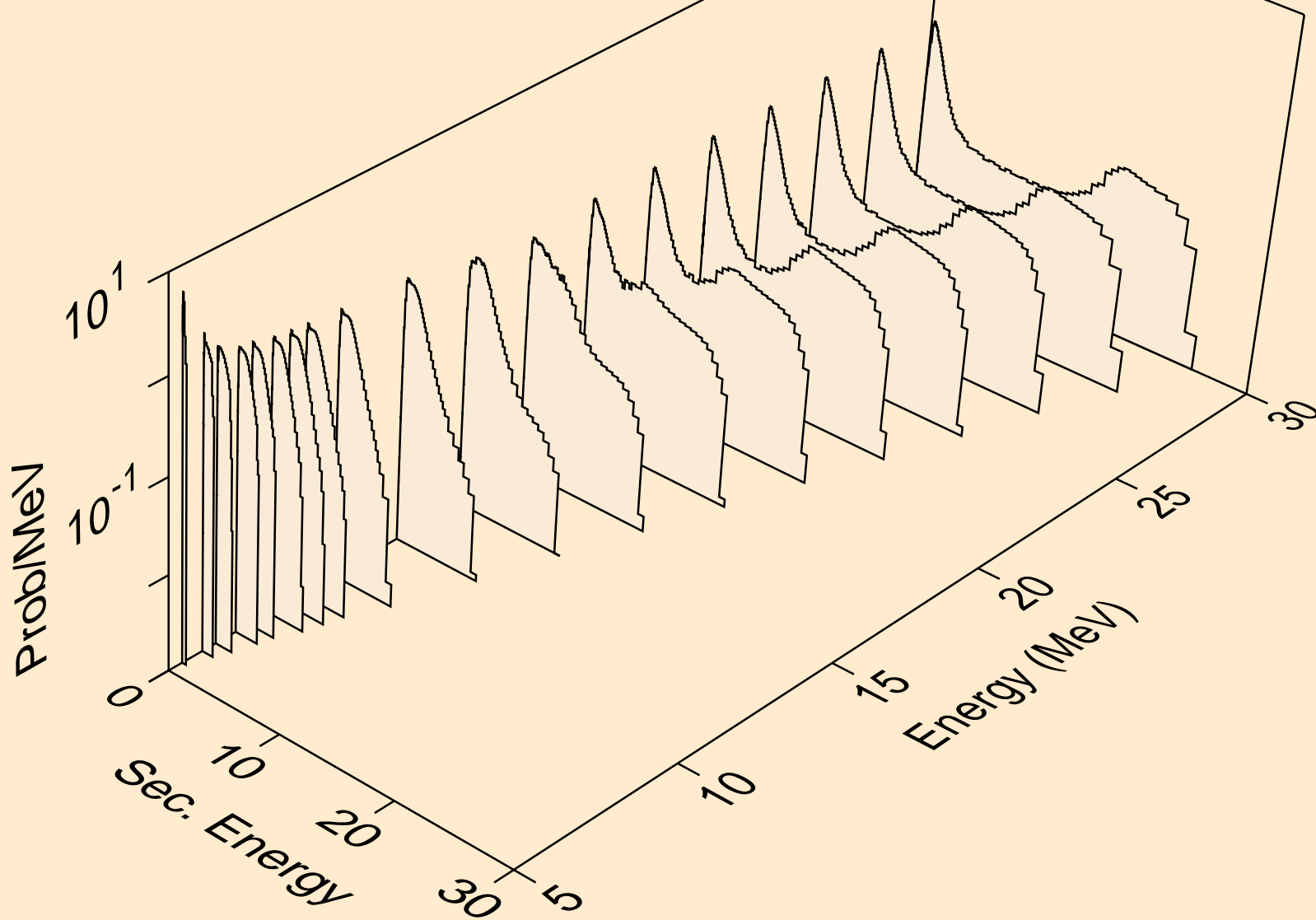



PR146 NEUTRON ACER TENDL-2019 LIBRARY; T=293.16K  
Neutron emission for (n,3n)

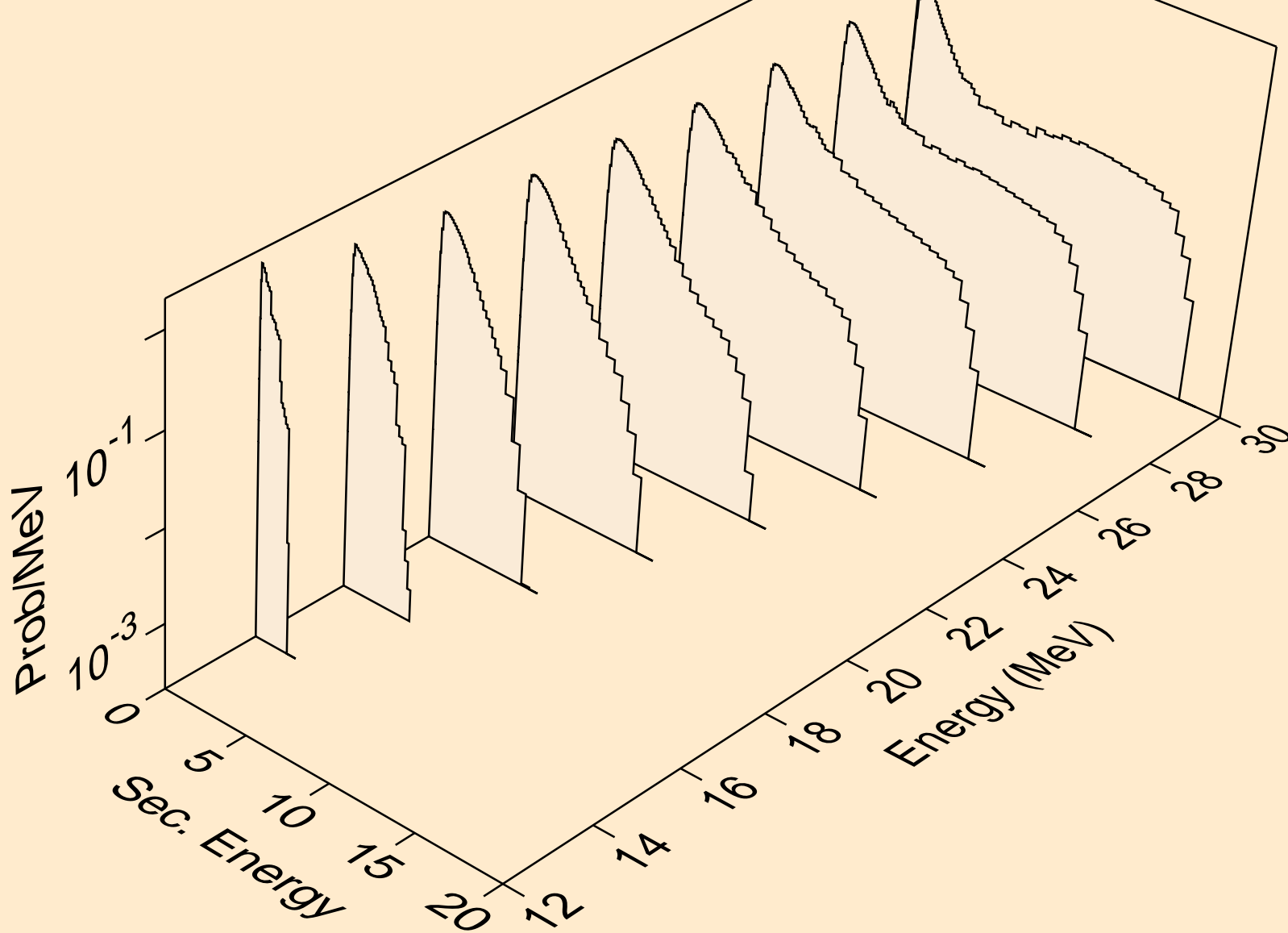

PR146 NEUTRON ACER TENDL-2019 LIBRARY; T=293.16K  
Neutron emission for (n,n\*)a

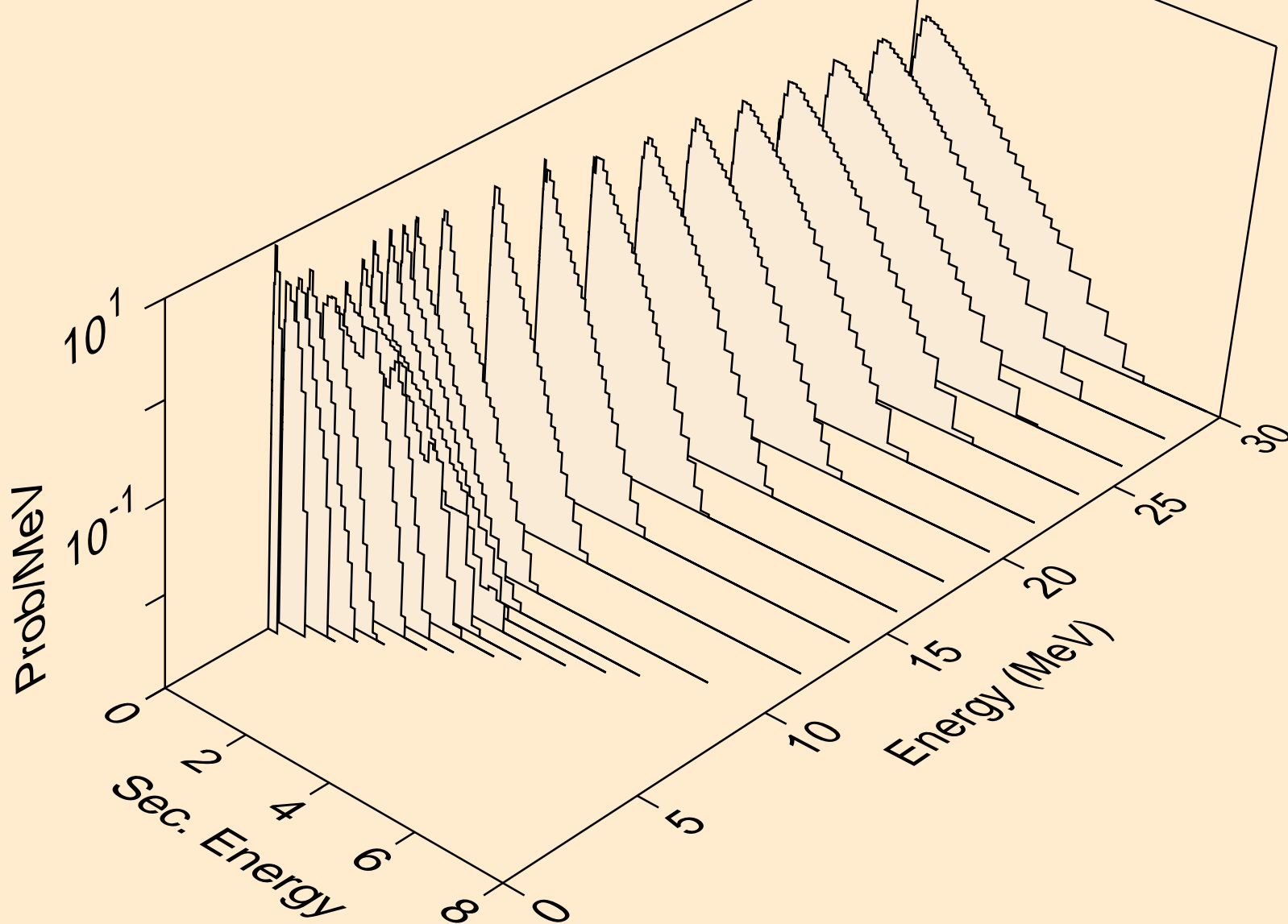

PR146 NEUTRON ACER TENDL-2019 LIBRARY; T=293.16K  
Neutron emission for (n,2n)a

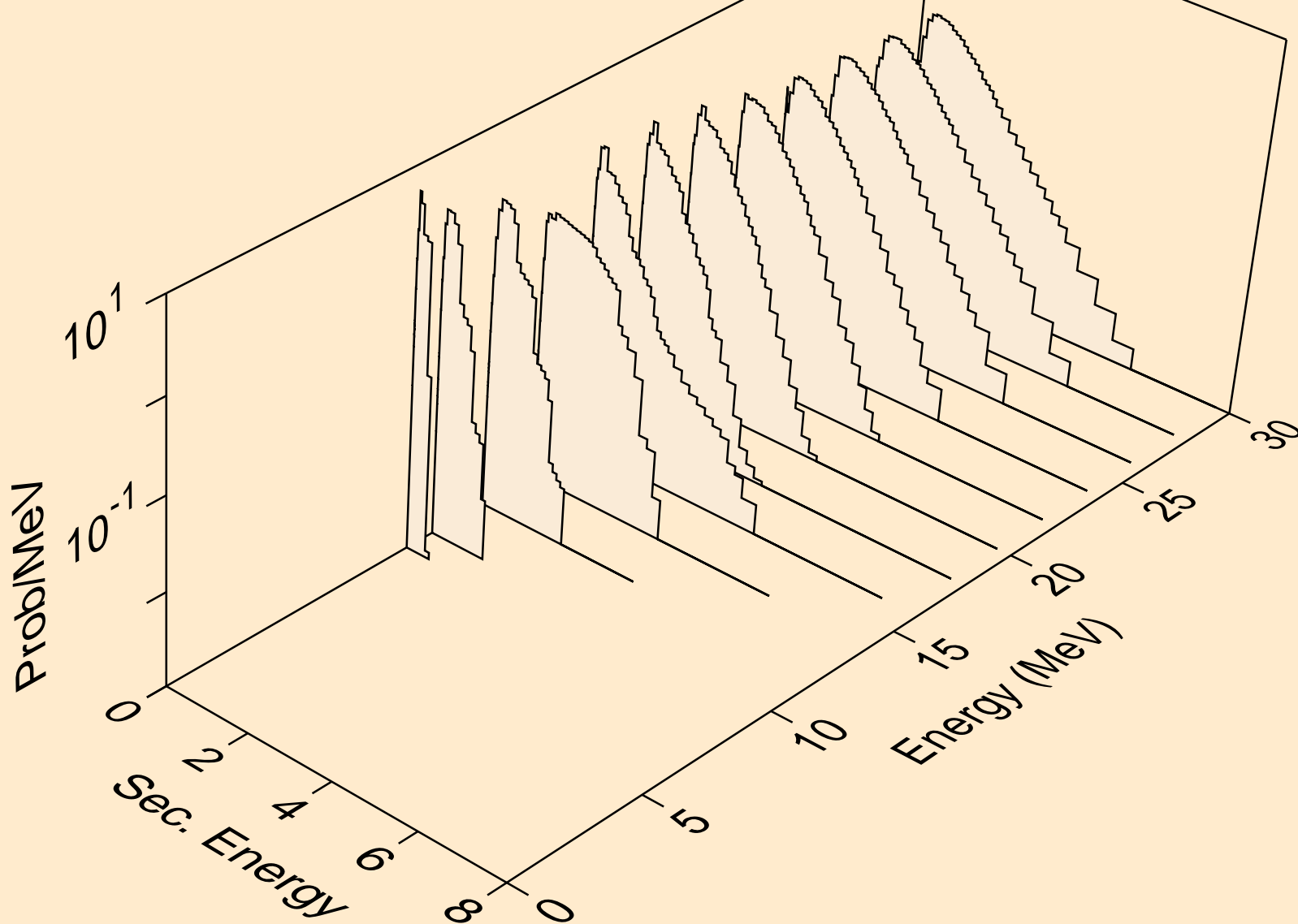

PR146 NEUTRON ACER TENDL-2019 LIBRARY; T=293.16K  
Neutron emission for (n,3n)a

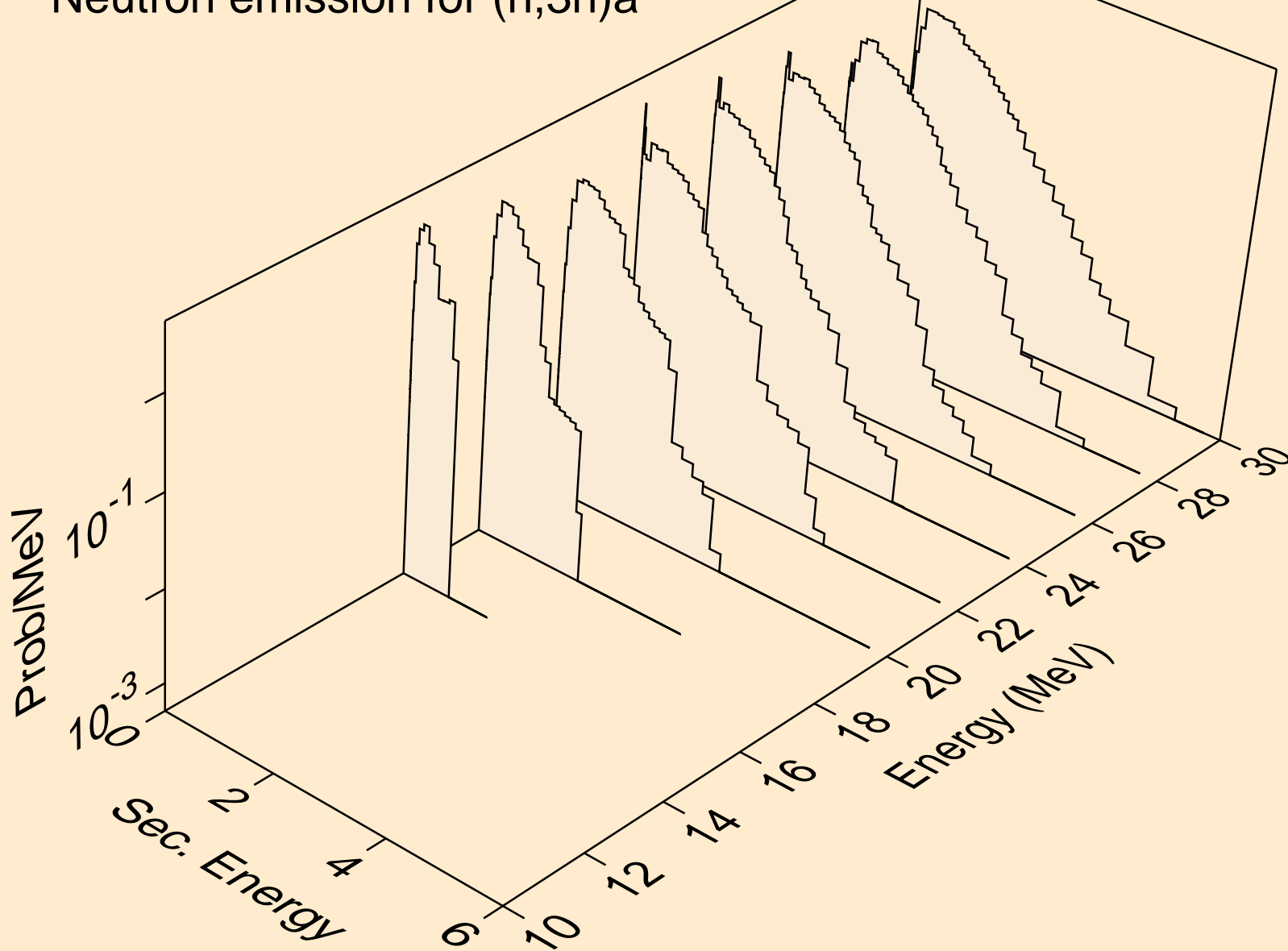

PR146 NEUTRON ACER TENDL-2019 LIBRARY; T=293.16K  
Neutron emission for (n,n\*)p

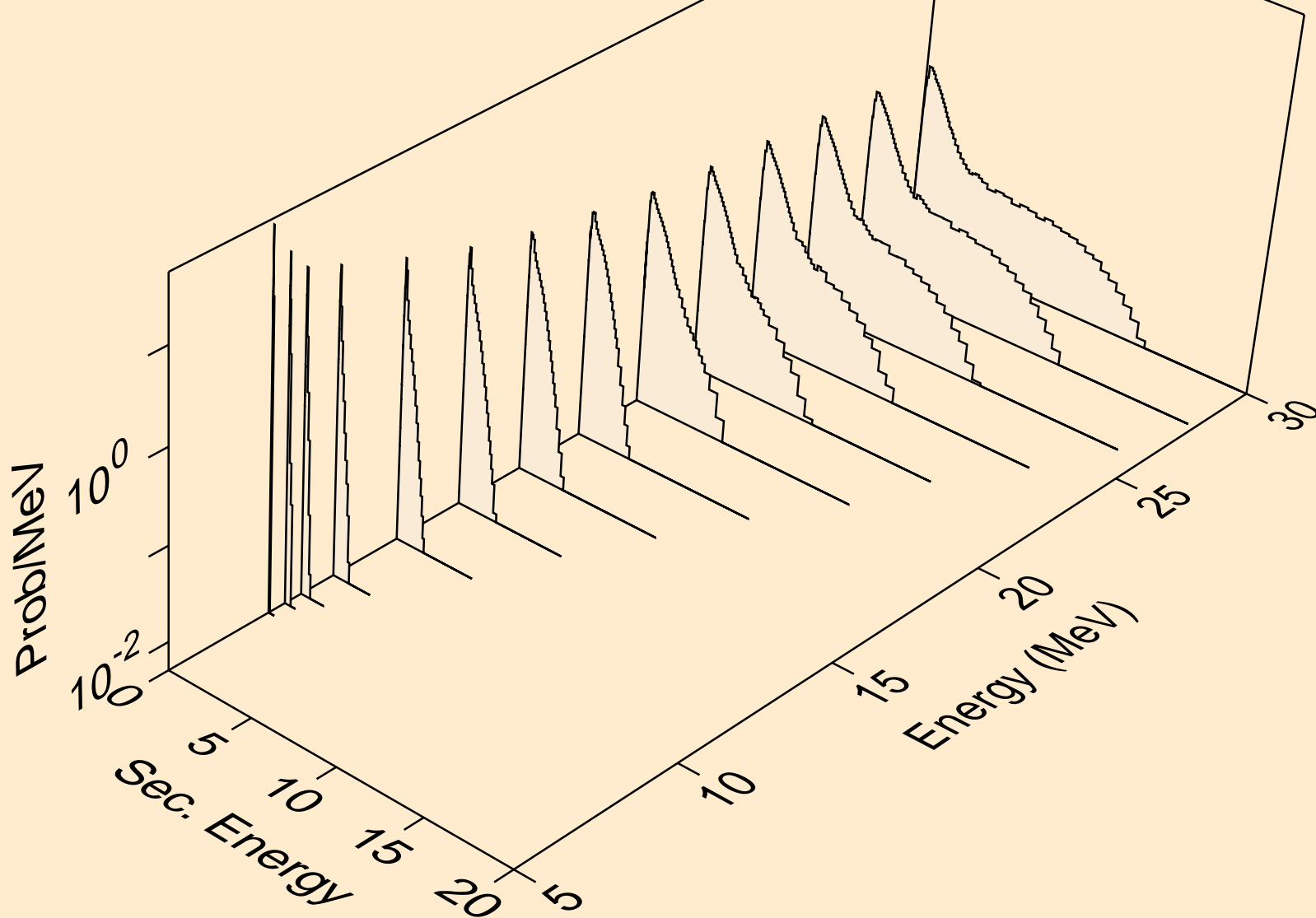

PR146 NEUTRON ACER TENDL-2019 LIBRARY; T=293.16K  
Neutron emission for (n,n\*)2a

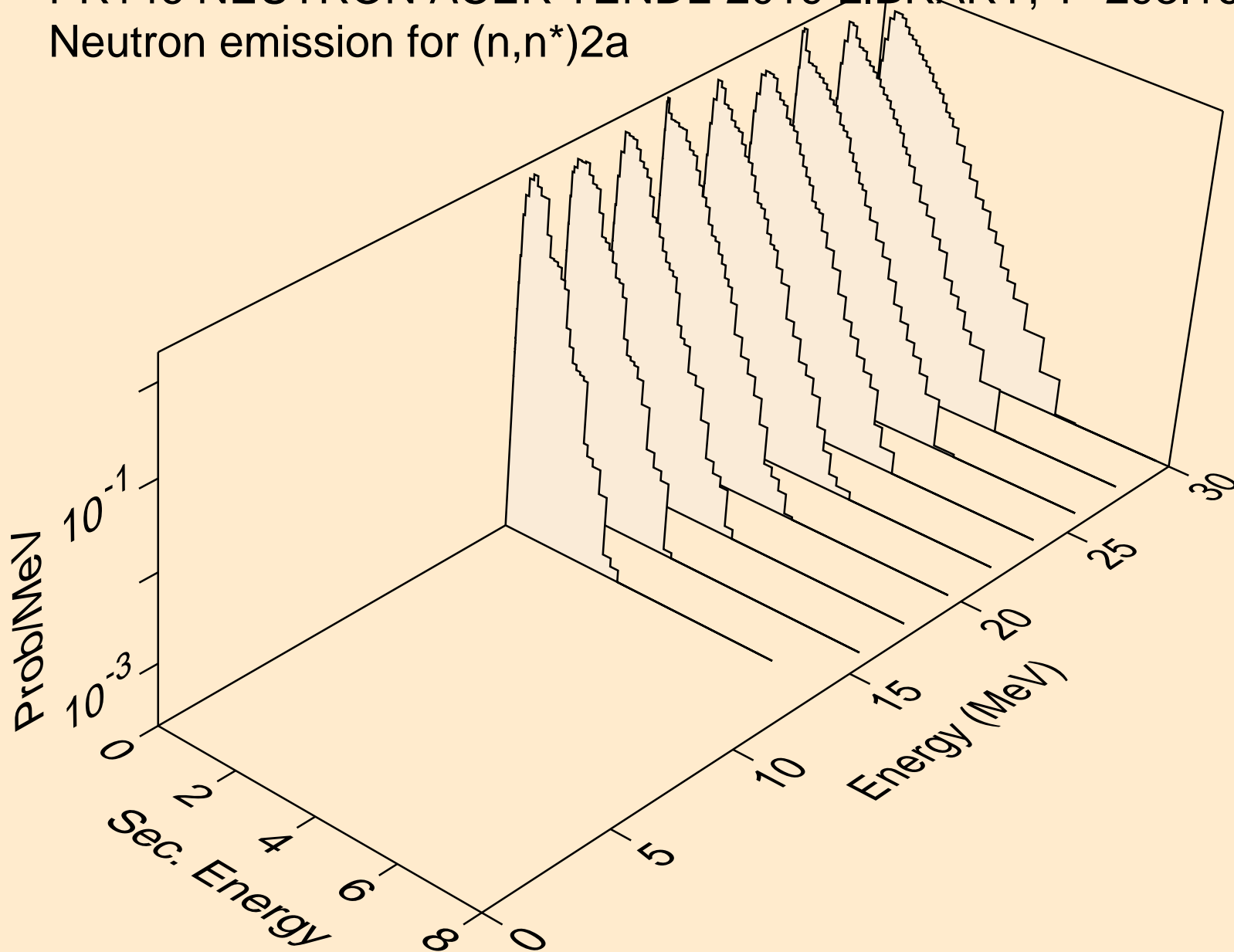

PR146 NEUTRON ACER TENDL-2019 LIBRARY; T=293.16K  
Neutron emission for (n,2n)2a

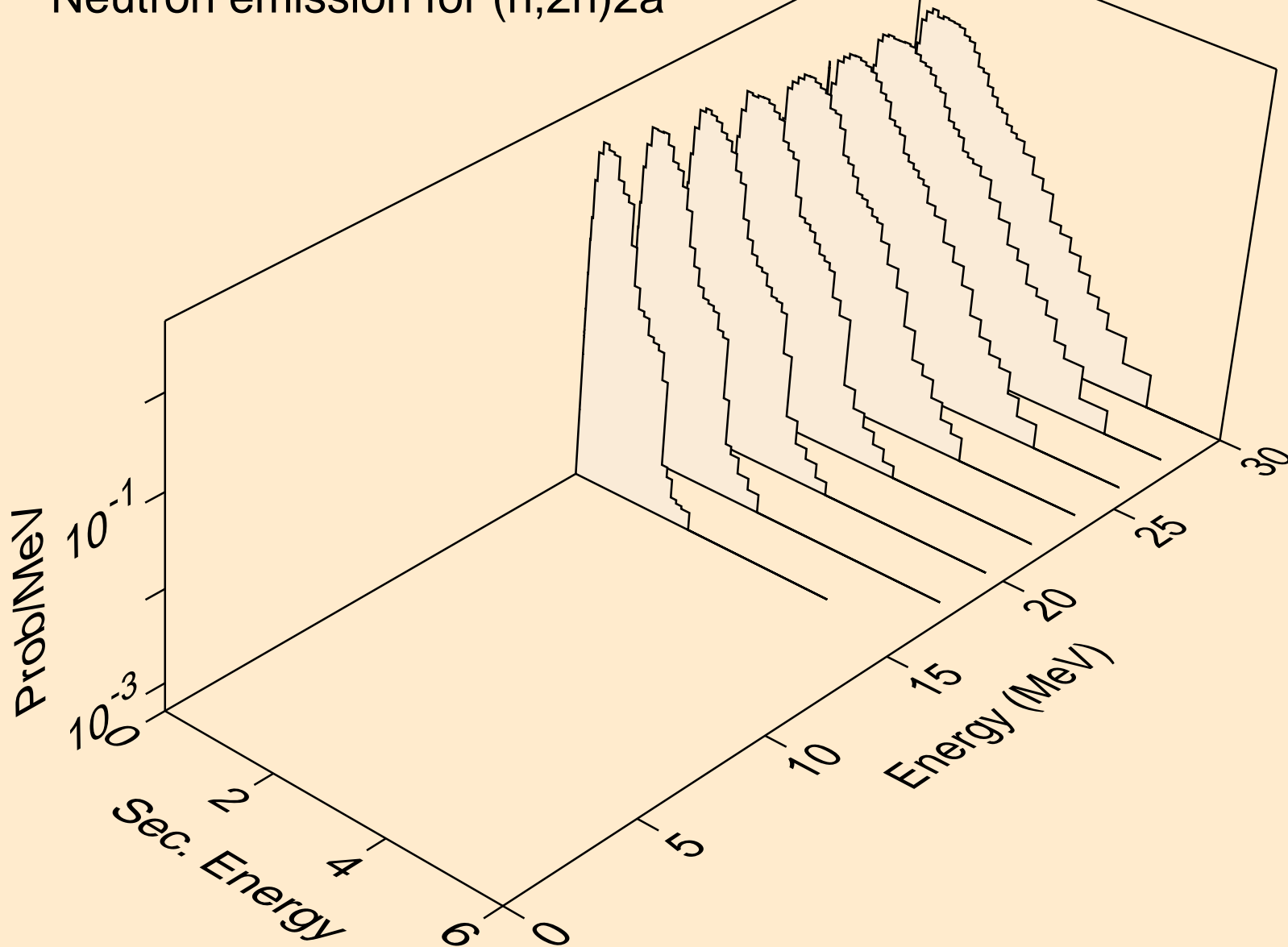

PR146 NEUTRON ACER TENDL-2019 LIBRARY; T=293.16K  
Neutron emission for (n,n\*)d

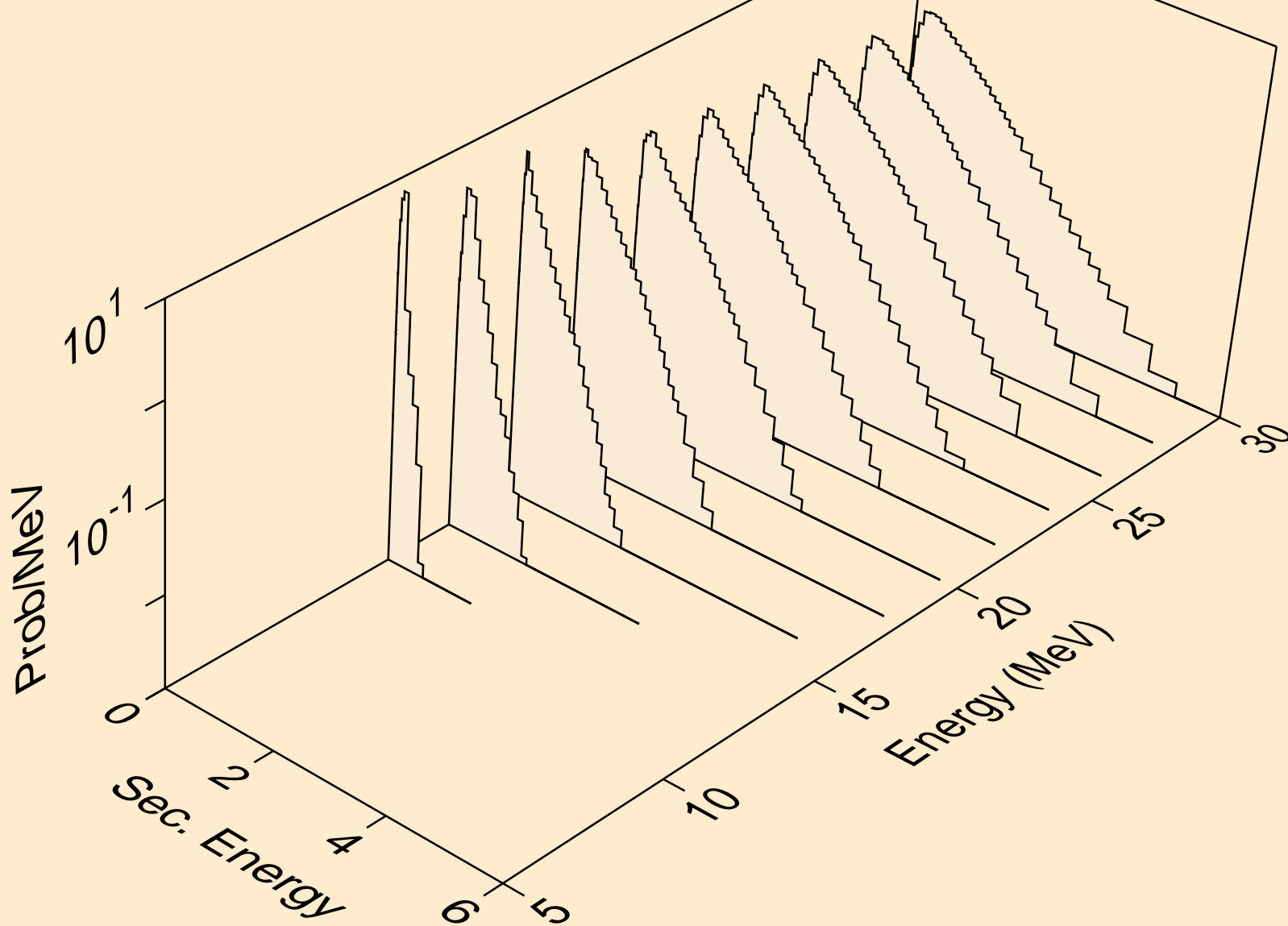



PR146 NEUTRON ACER TENDL-2019 LIBRARY; T=293.16K  
Neutron emission for (n,n\*)t

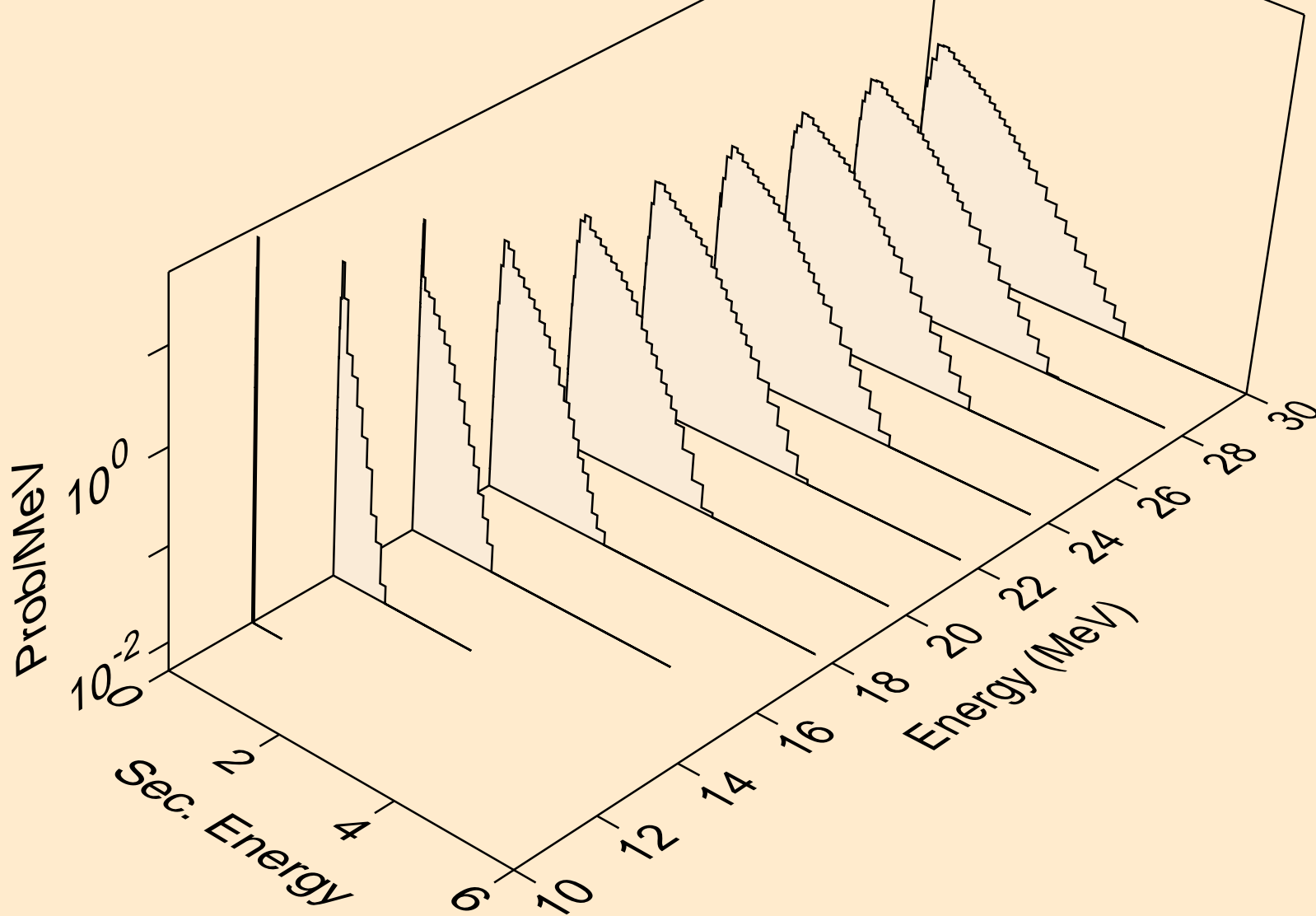

PR146 NEUTRON ACER TENDL-2019 LIBRARY; T=293.16K  
Neutron emission for (n,n\*)he3

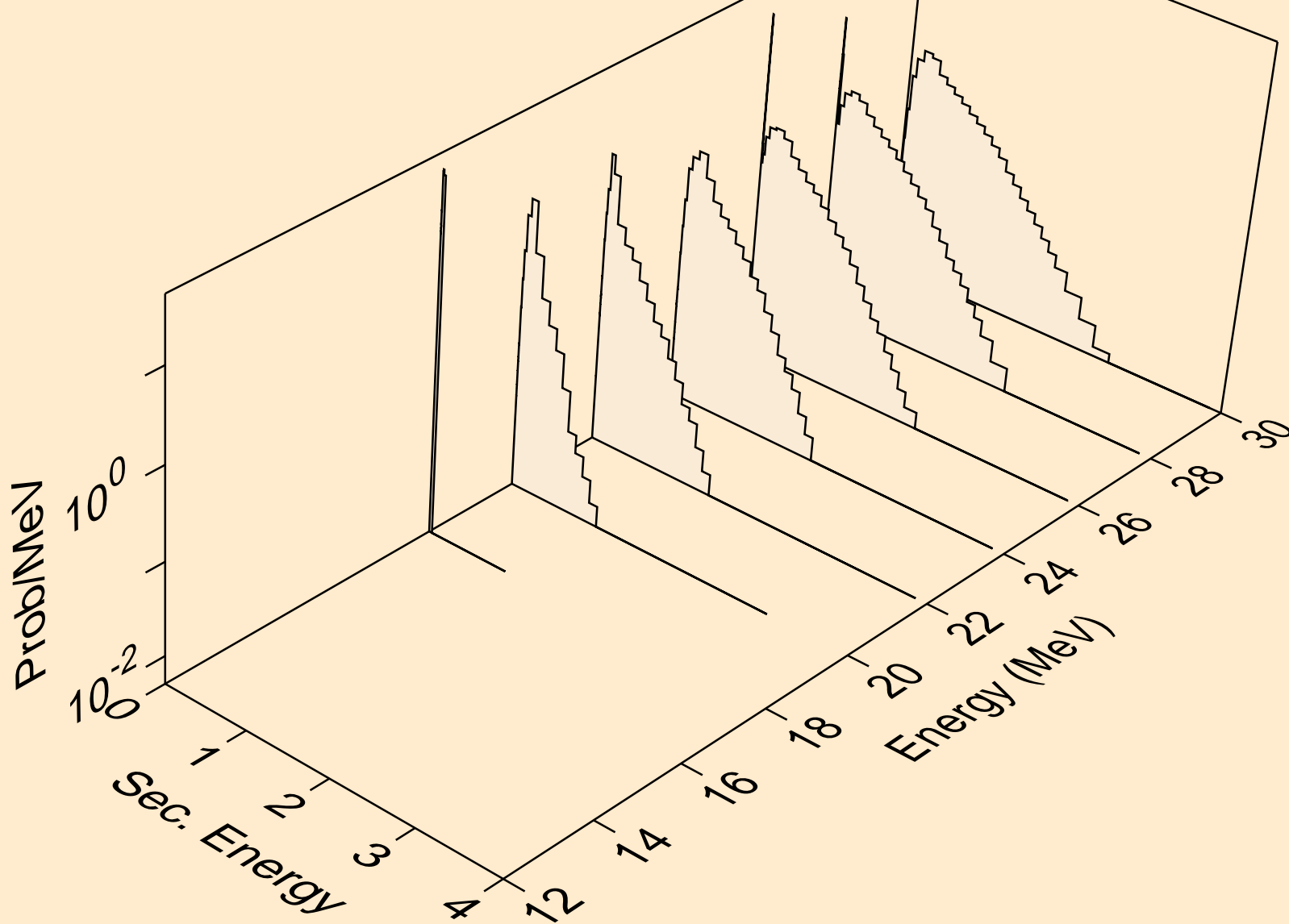

PR146 NEUTRON ACER TENDL-2019 LIBRARY; T=293.16K  
Neutron emission for (n,4n)

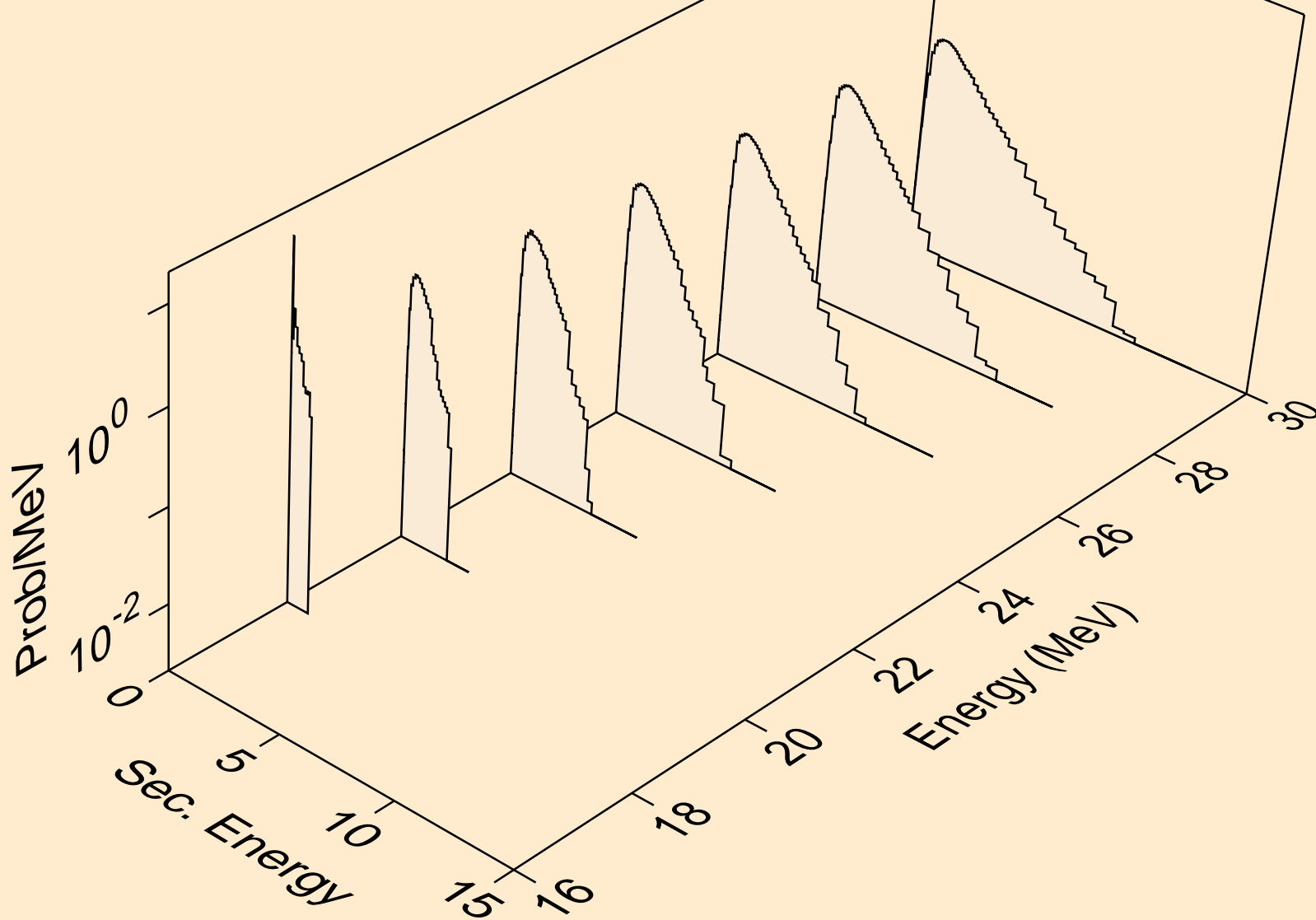

PR146 NEUTRON ACER TENDL-2019 LIBRARY; T=293.16K  
Neutron emission for (n,2np)

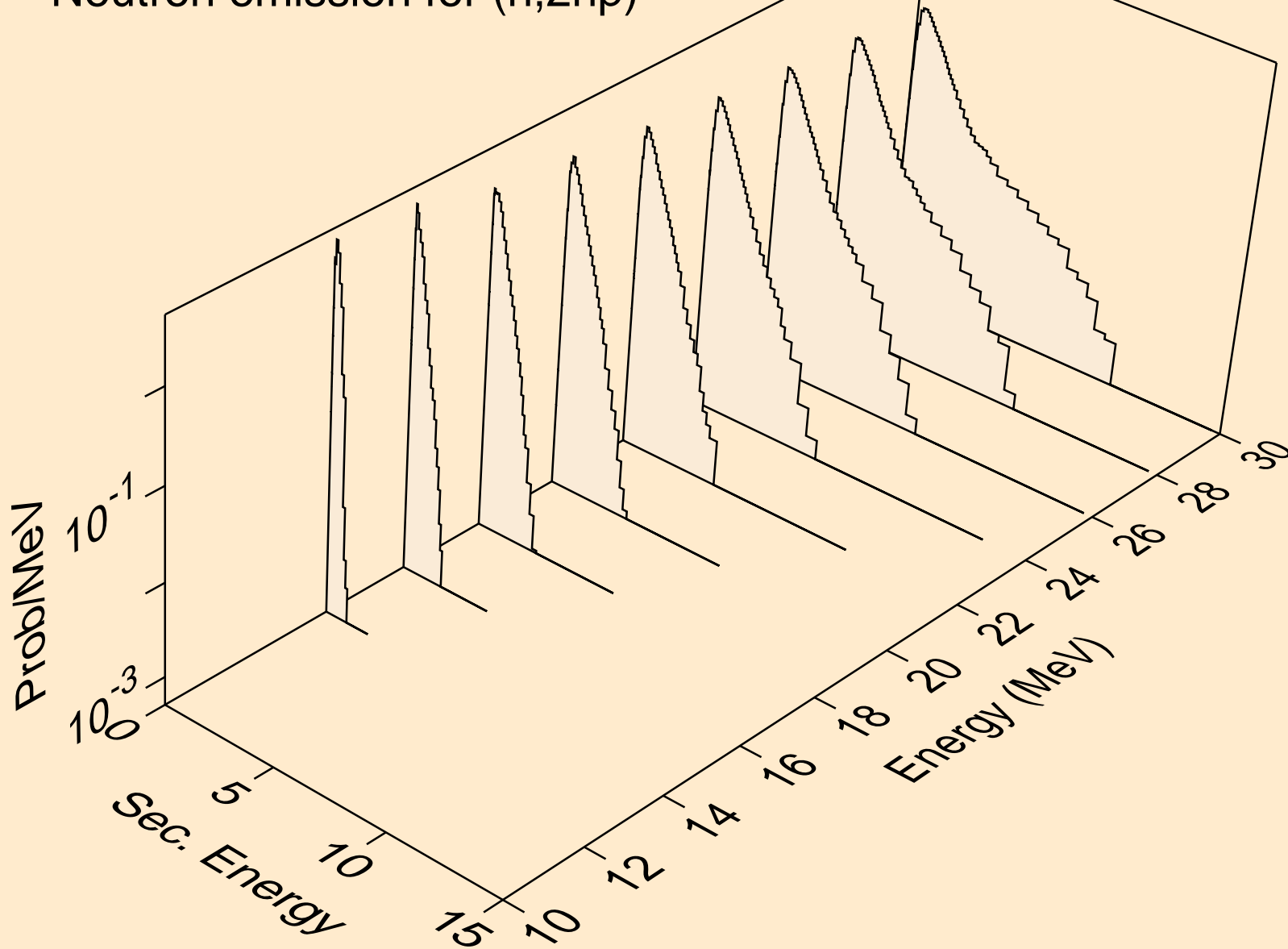

PR146 NEUTRON ACER TENDL-2019 LIBRARY; T=293.16K  
Neutron emission for (n,3np)

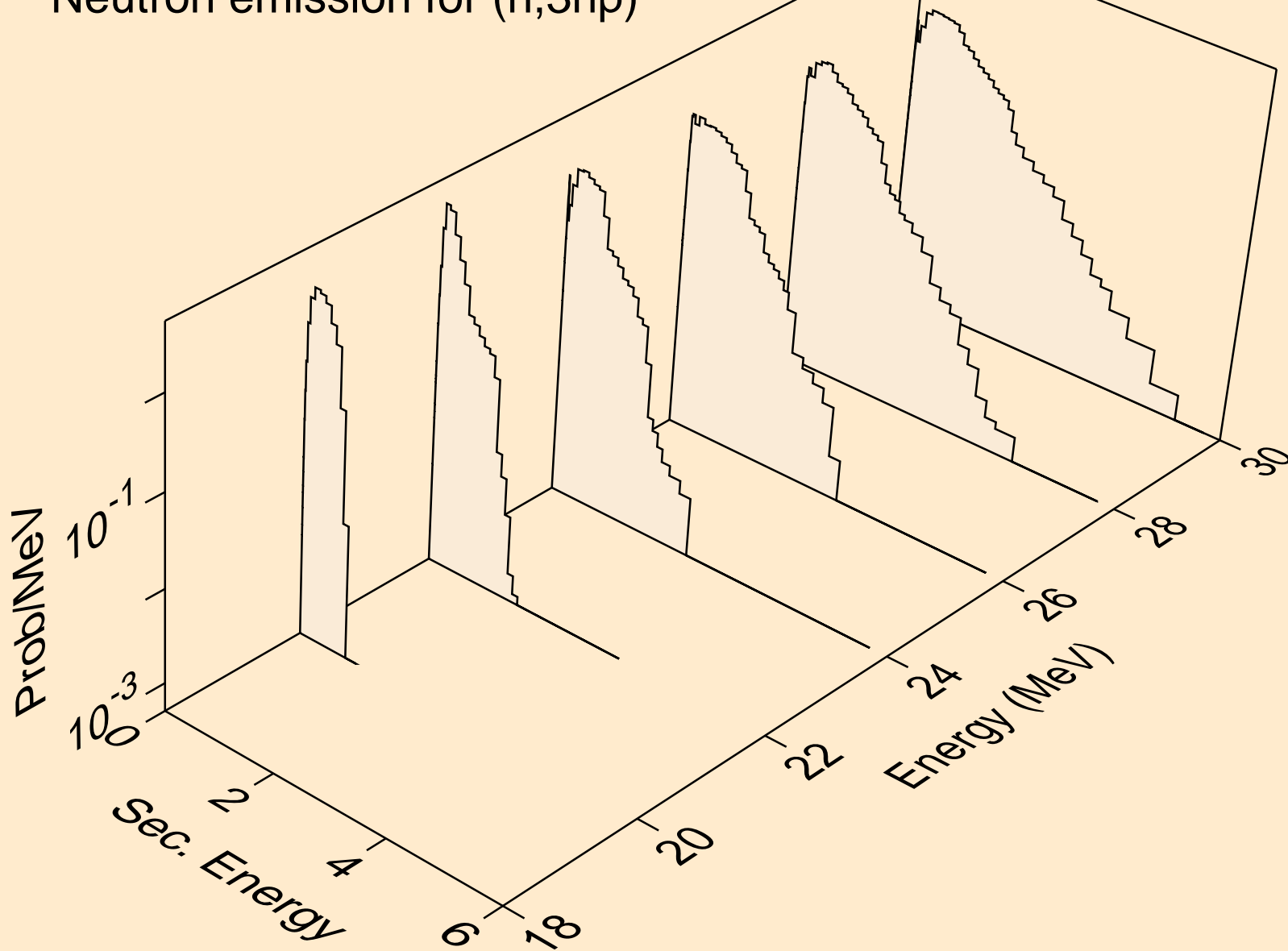

PR146 NEUTRON ACER TENDL-2019 LIBRARY; T=293.16K  
Neutron emission for (n,2np)

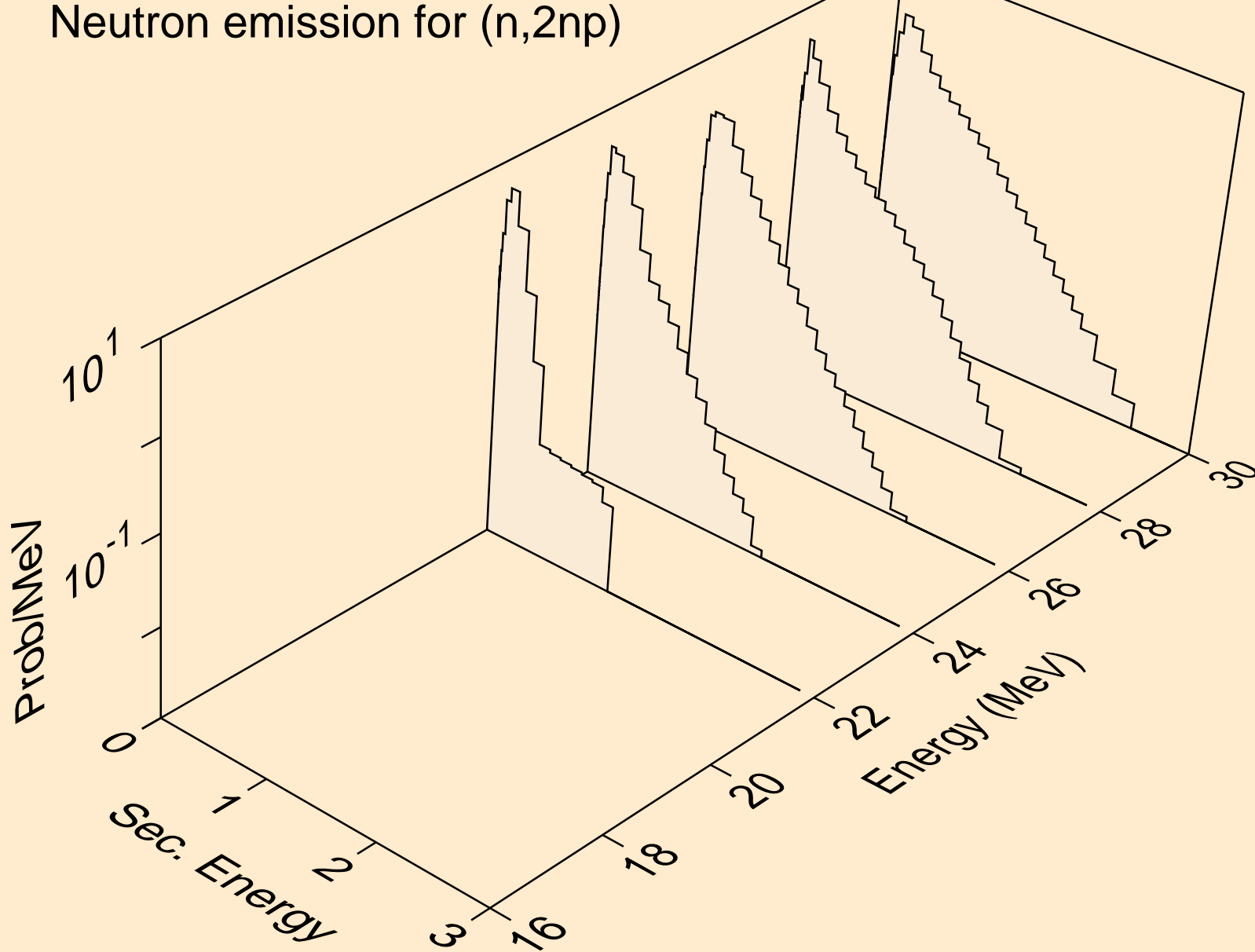

PR146 NEUTRON ACER TENDL-2019 LIBRARY; T=293.16K  
Neutron emission for (n,npa)

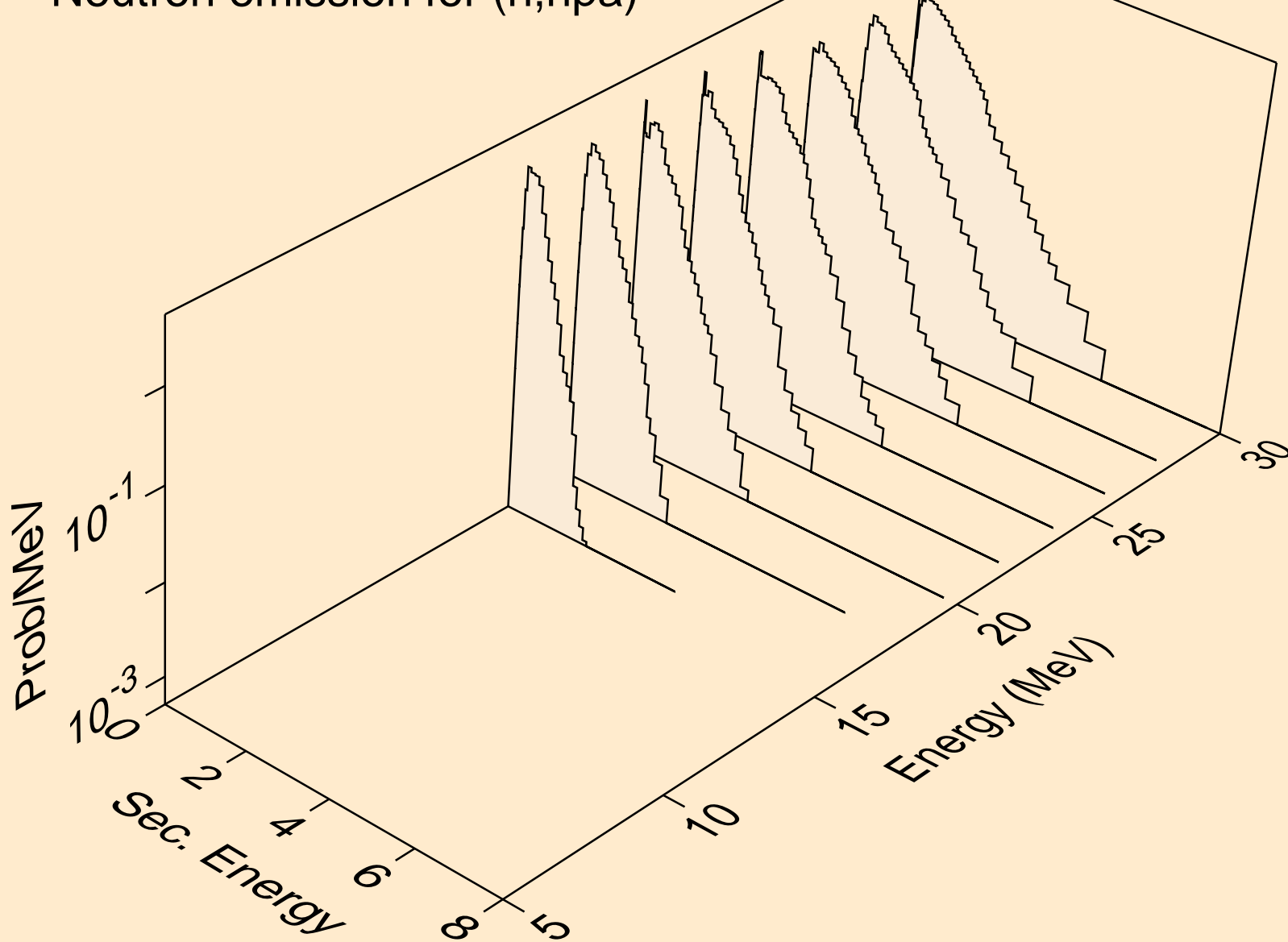

PR146 NEUTRON ACER TENDL-2019 LIBRARY; T=293.16K  
Neutron emission for (n,n\*c)

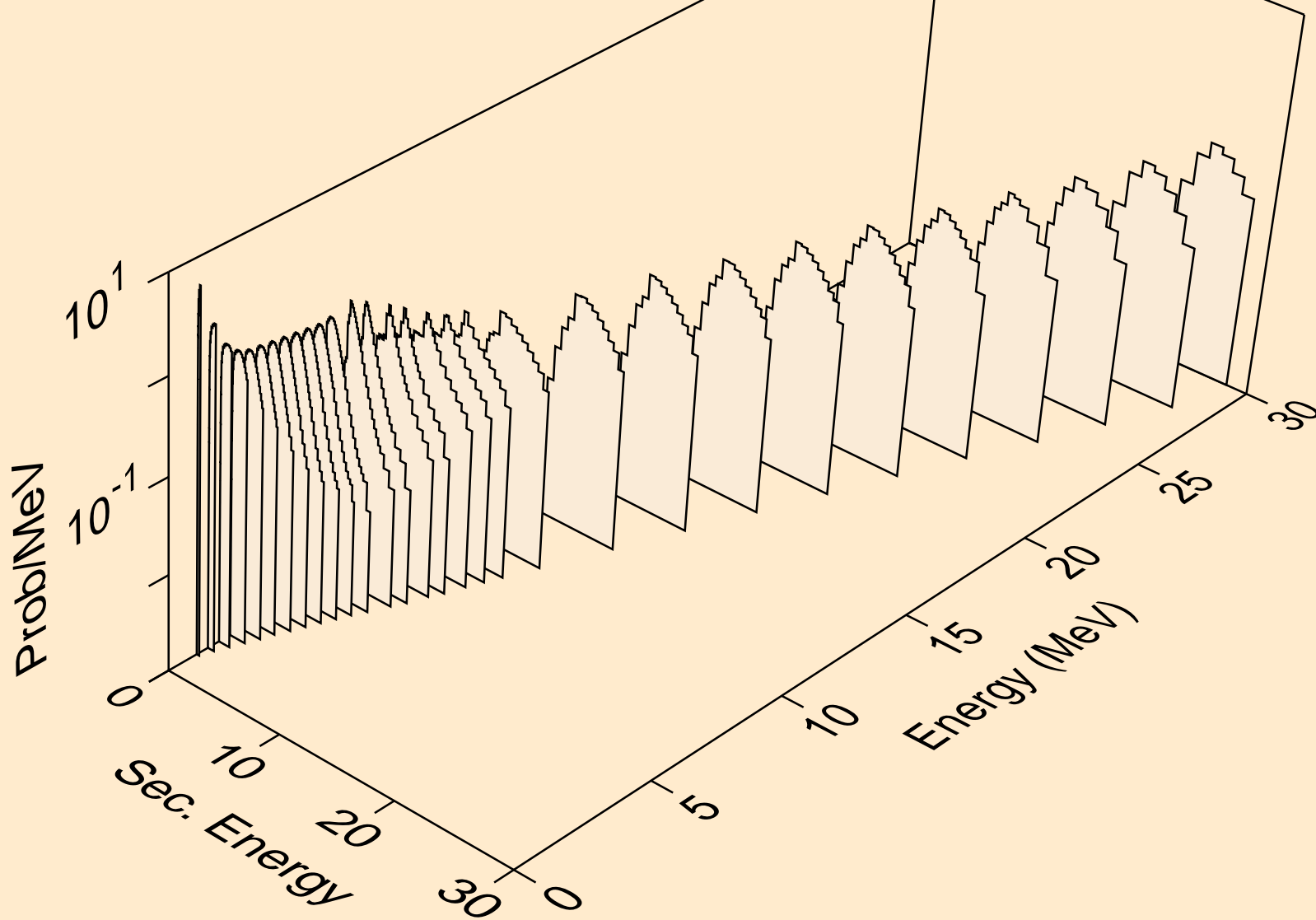



PR146 NEUTRON ACER TENDL-2019 LIBRARY; T=293.16K  
Photon emission for (n,x)

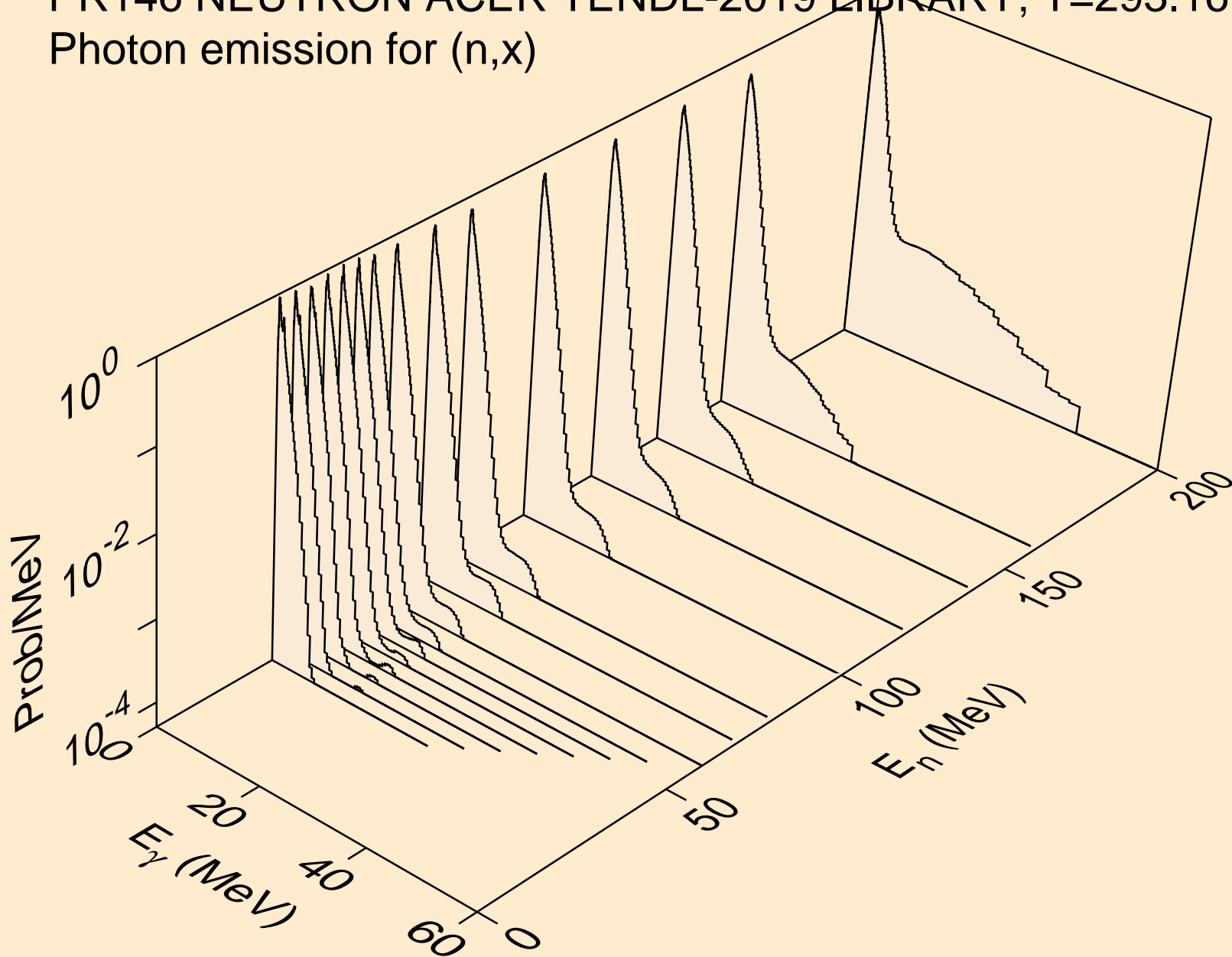

PR146 NEUTRON ACER TENDL-2019 LIBRARY; T=293.16K  
Photon emission for (n,2nd)

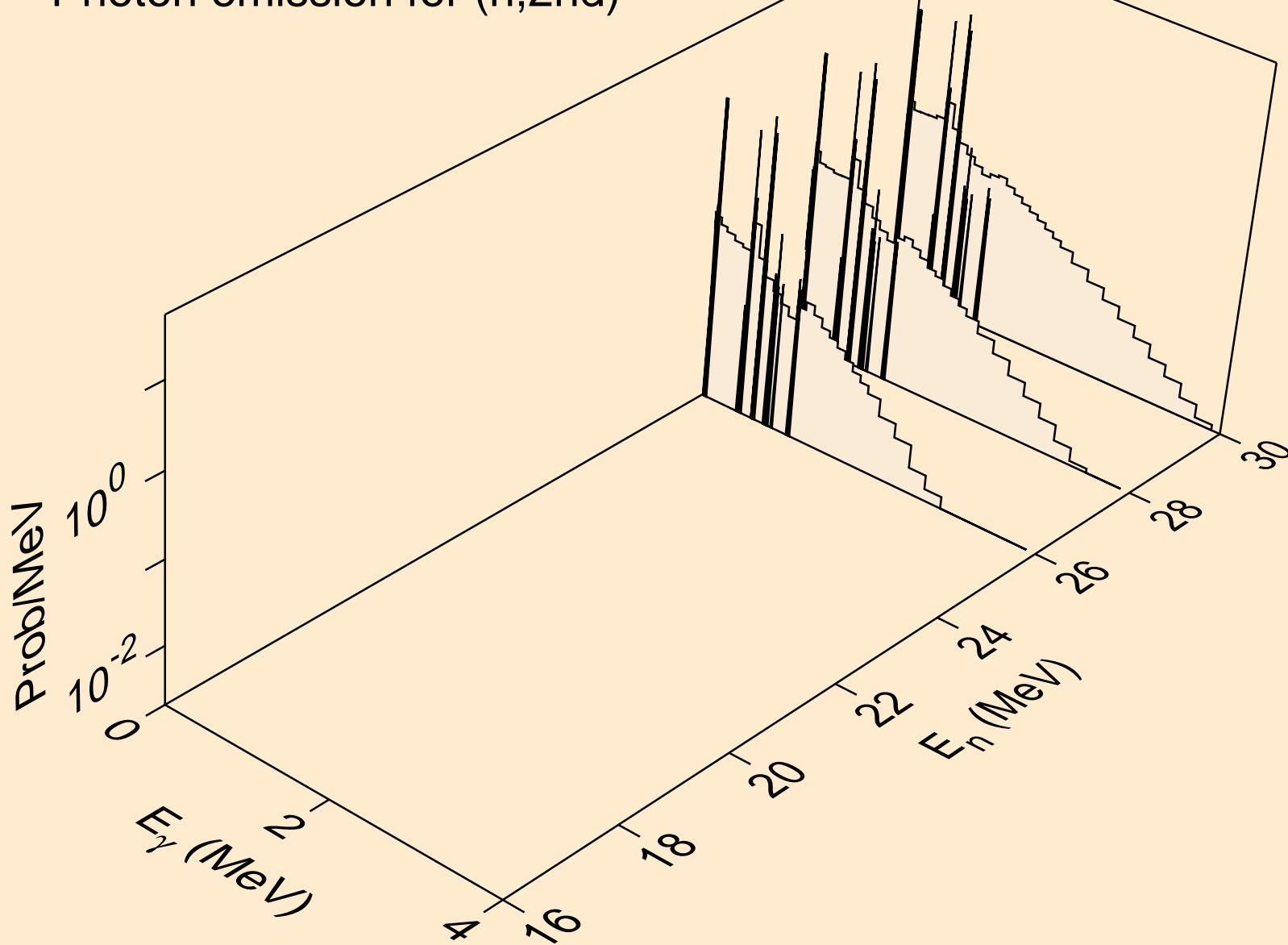

PR146 NEUTRON ACER TENDL-2019 LIBRARY; T=293.16K  
Photon emission for (n,2n)

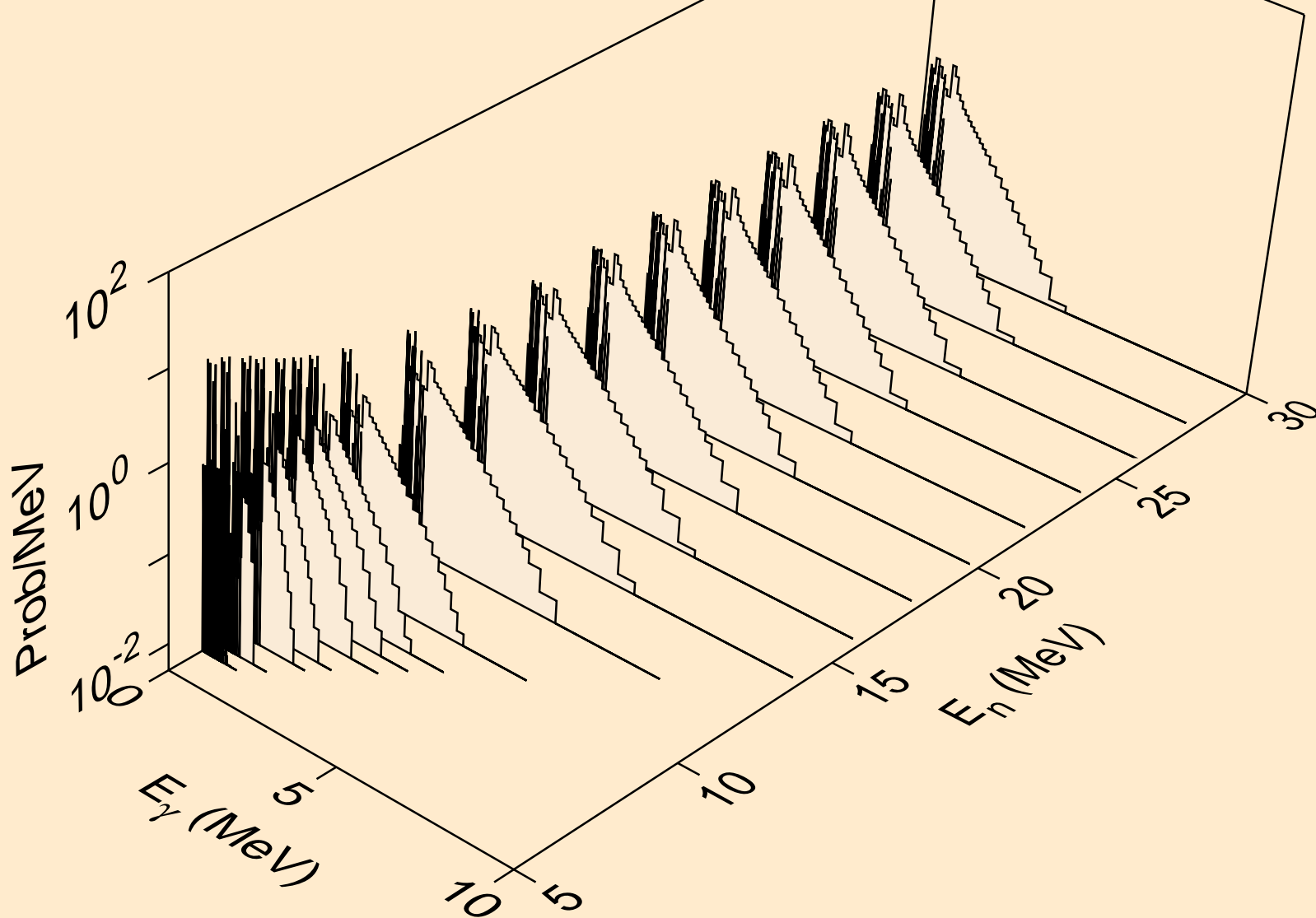

PR146 NEUTRON ACER TENDL-2019 LIBRARY; T=293.16K  
Photon emission for (n,3n)

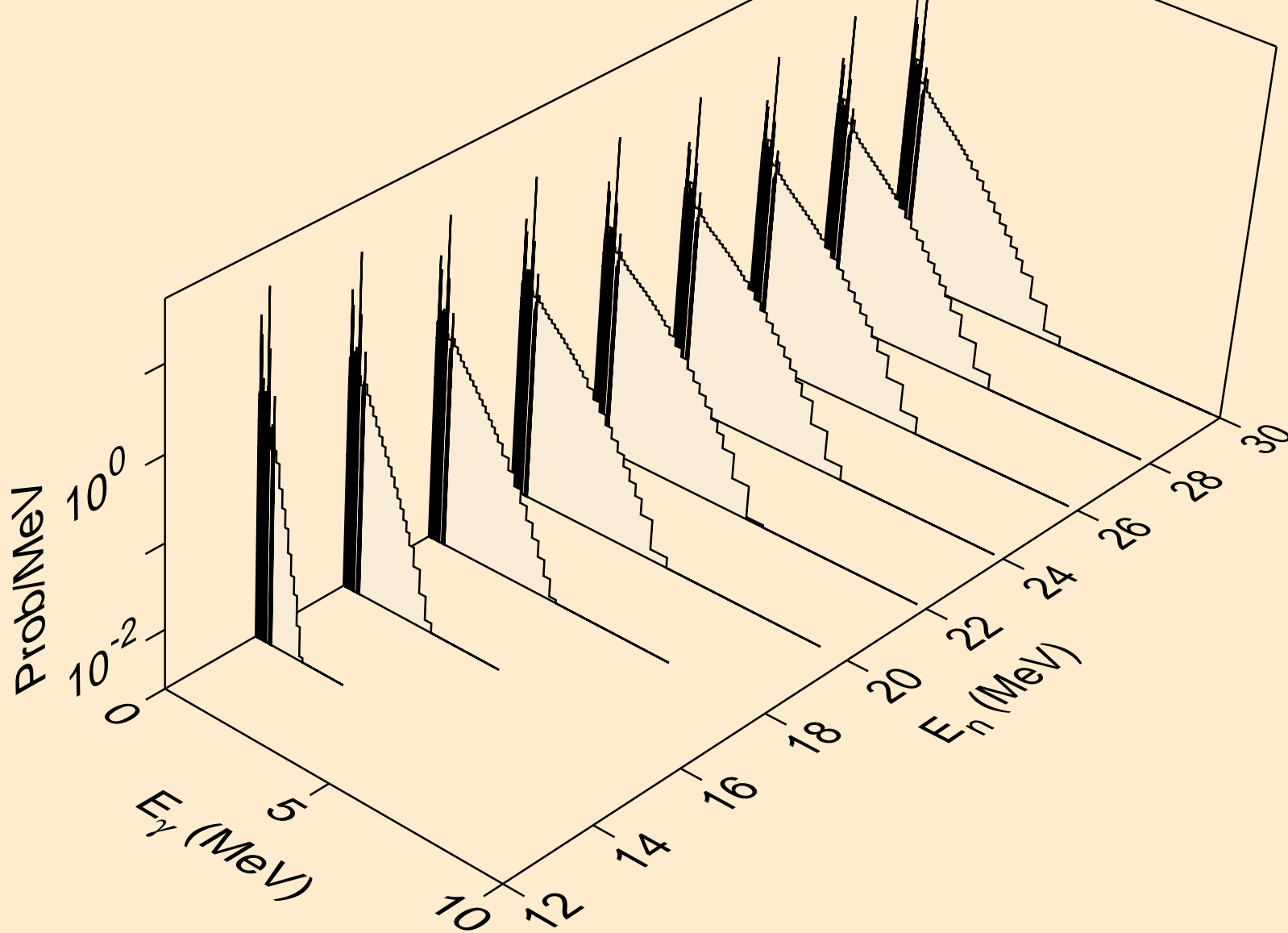

PR146 NEUTRON ACER TENDL-2019 LIBRARY; T=293.16K  
Photon emission for (n,n\*)a

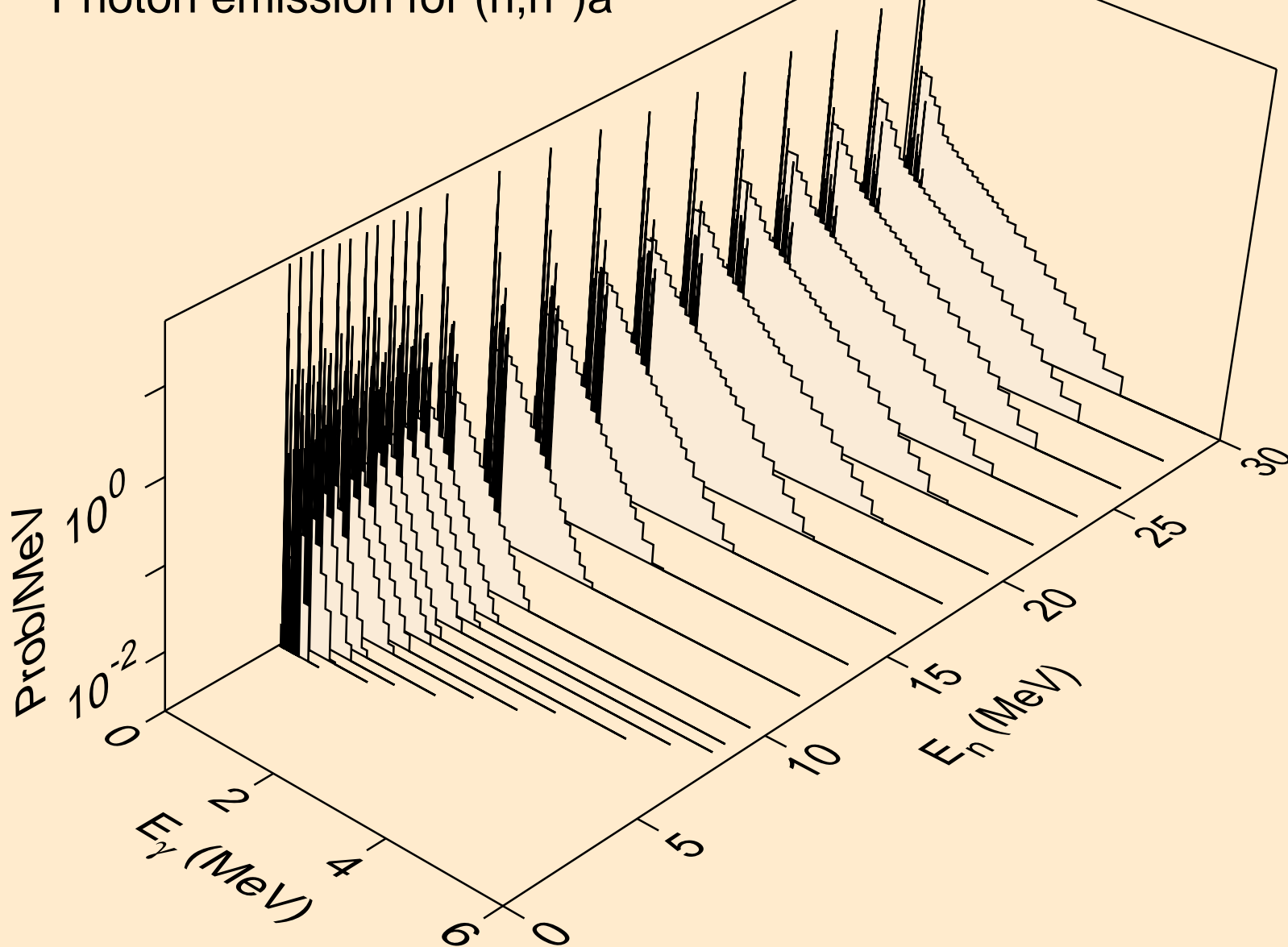

PR146 NEUTRON ACER TENDL-2019 LIBRARY; T=293.16K  
Photon emission for (n,2n)a

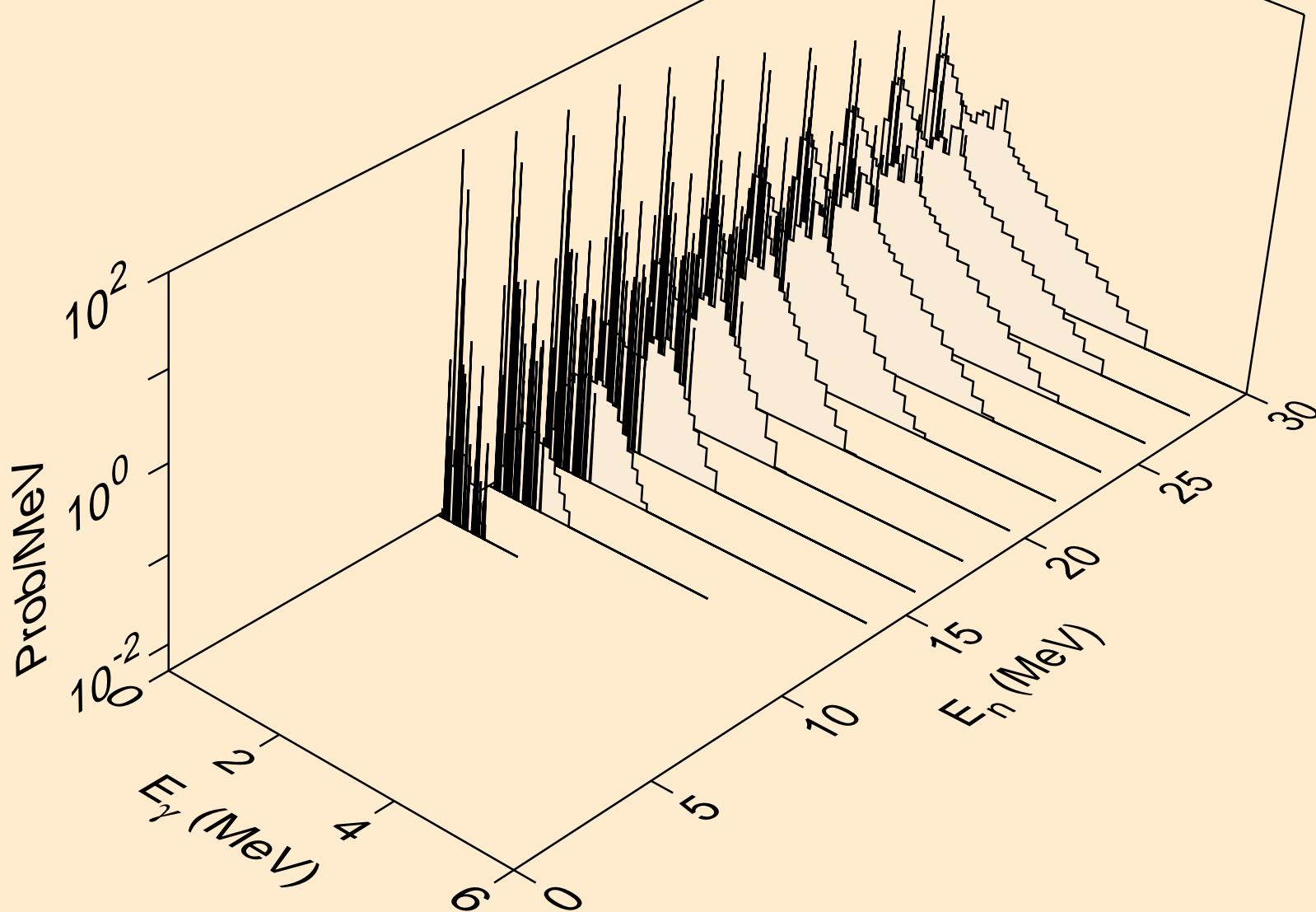

PR146 NEUTRON ACER TENDL-2019 LIBRARY; T=293.16K  
Photon emission for (n,3n)a

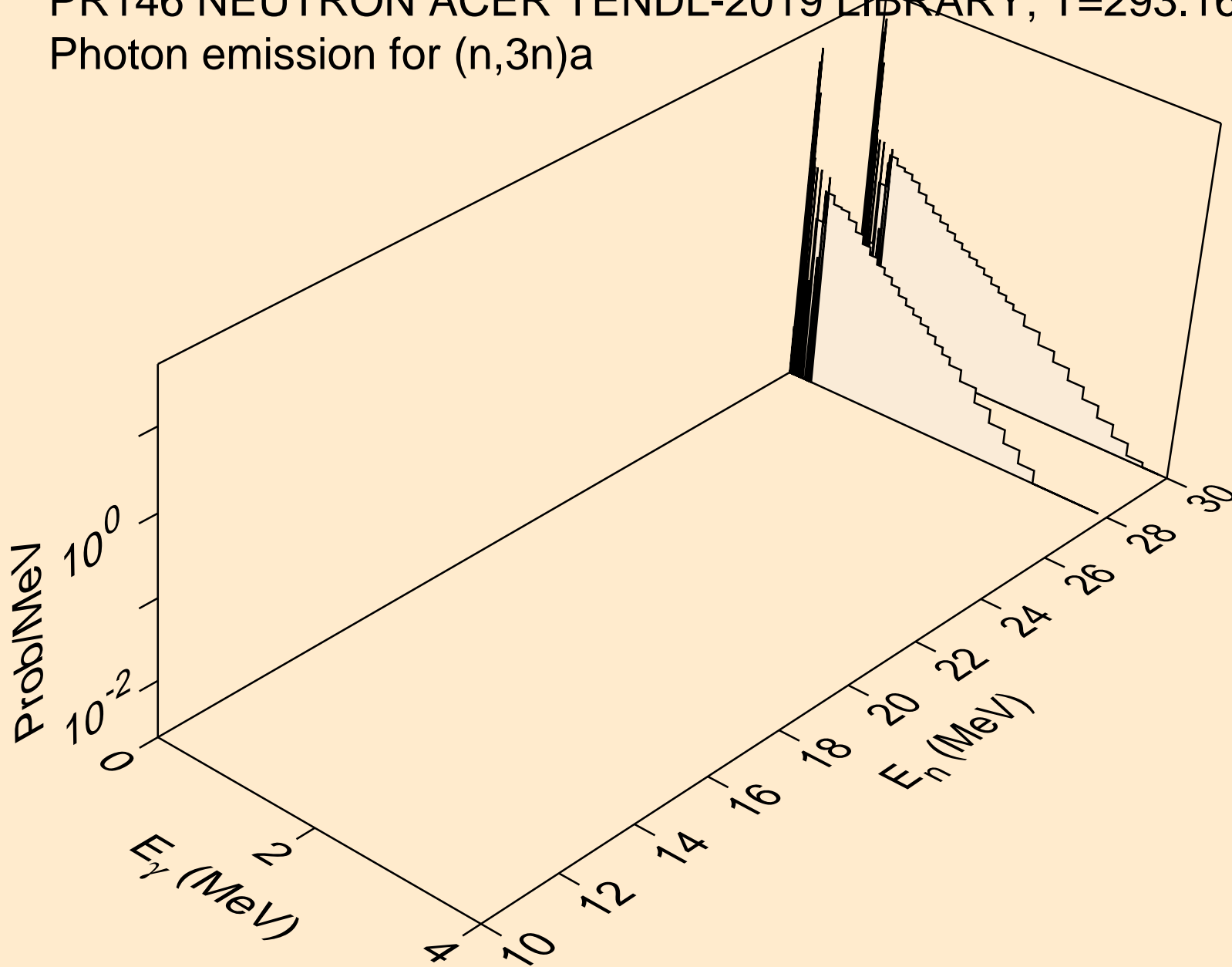

PR146 NEUTRON ACER TENDL-2019 LIBRARY; T=293.16K  
Photon emission for (n,n\*)p

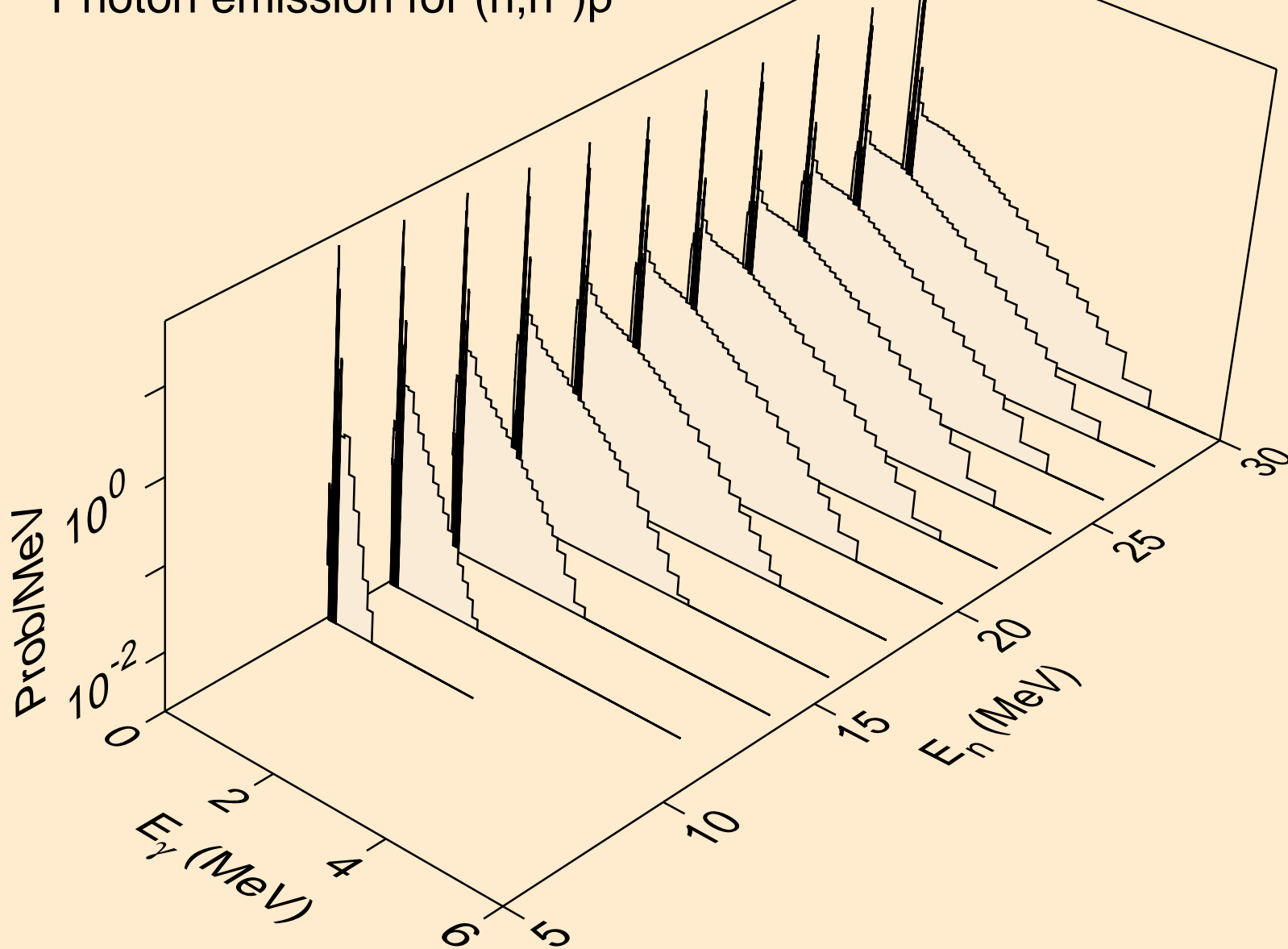



PR146 NEUTRON ACER TENDL-2019 LIBRARY; T=293.16K  
Photon emission for (n,n\*)2a

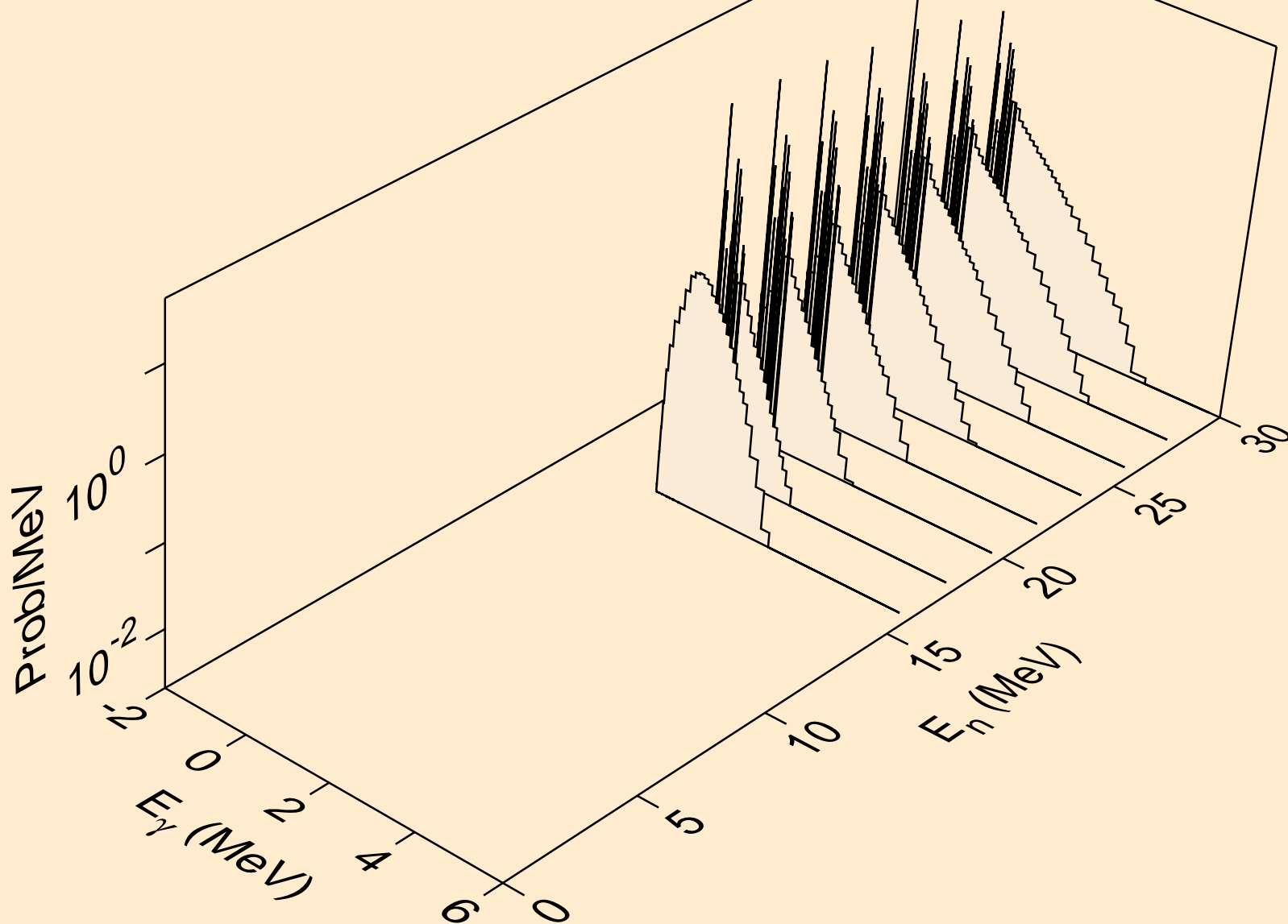

PR146 NEUTRON ACER TENDL-2019 LIBRARY; T=293.16K  
Photon emission for (n,2n)2a

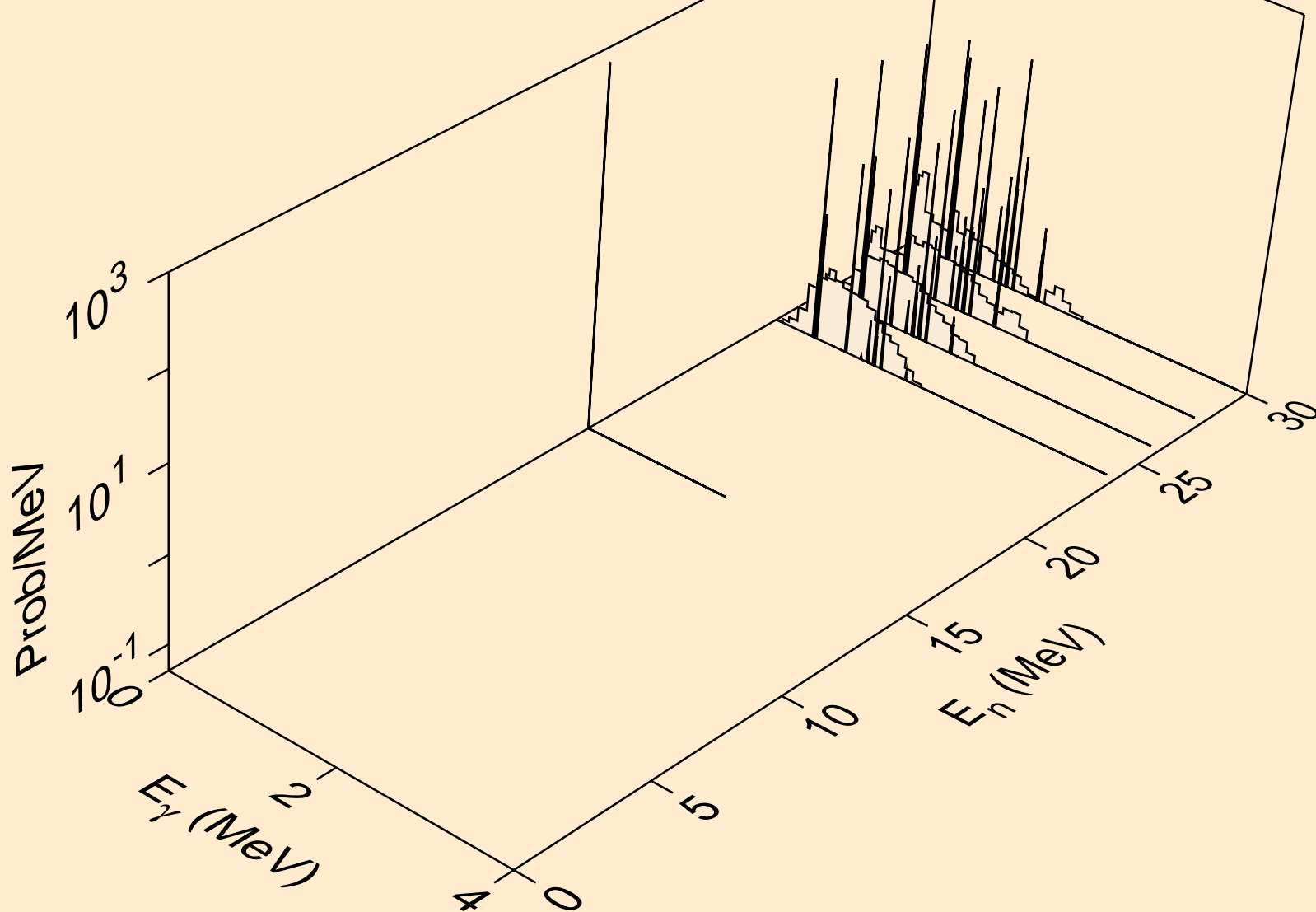

PR146 NEUTRON ACER TENDL-2019 LIBRARY; T=293.16K  
Photon emission for (n,n\*)d

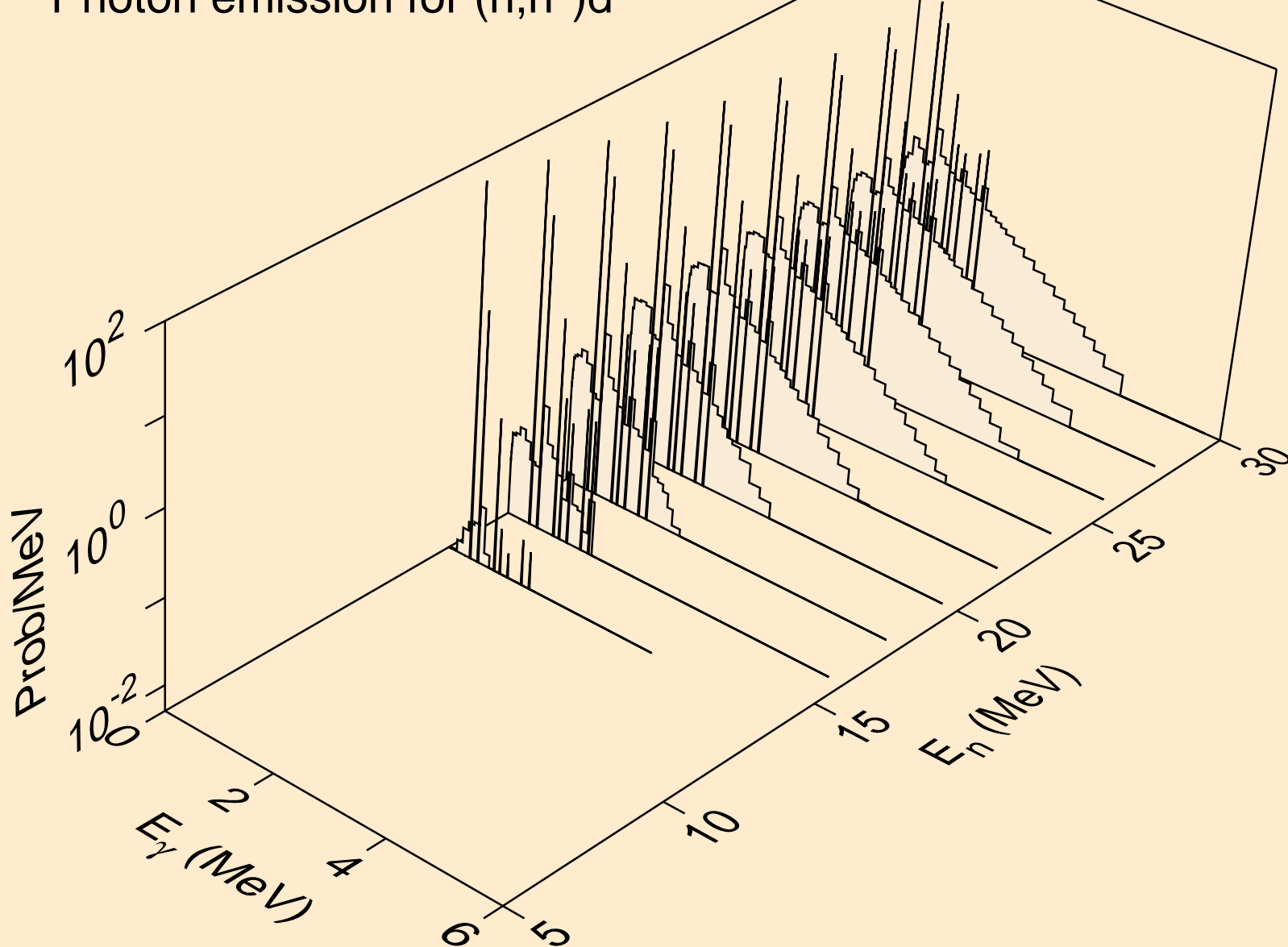

PR146 NEUTRON ACER TENDL-2019 LIBRARY; T=293.16K  
Photon emission for (n,n\*)t

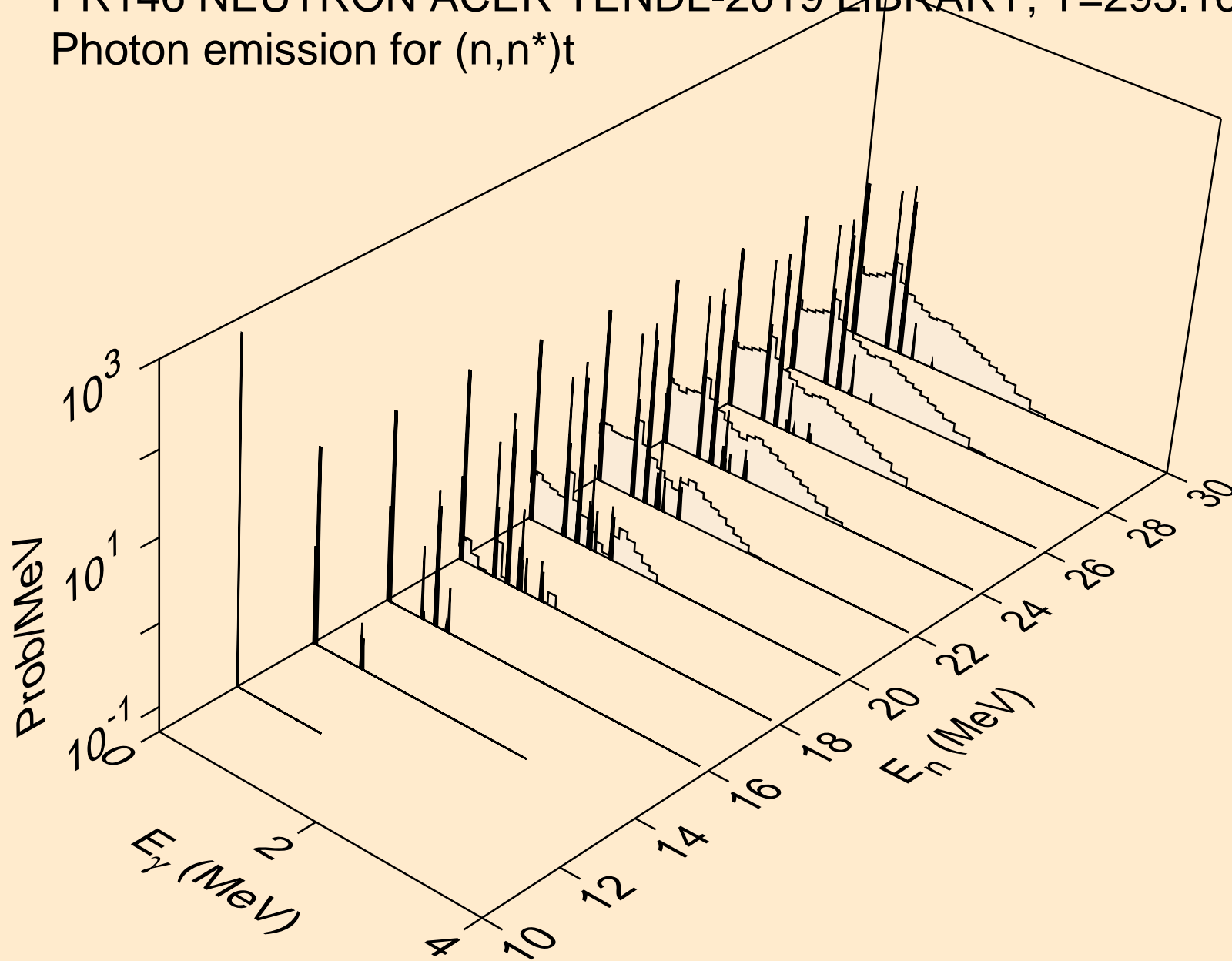

PR146 NEUTRON ACER TENDL-2019 LIBRARY; T=293.16K  
Photon emission for (n,n\*)he3

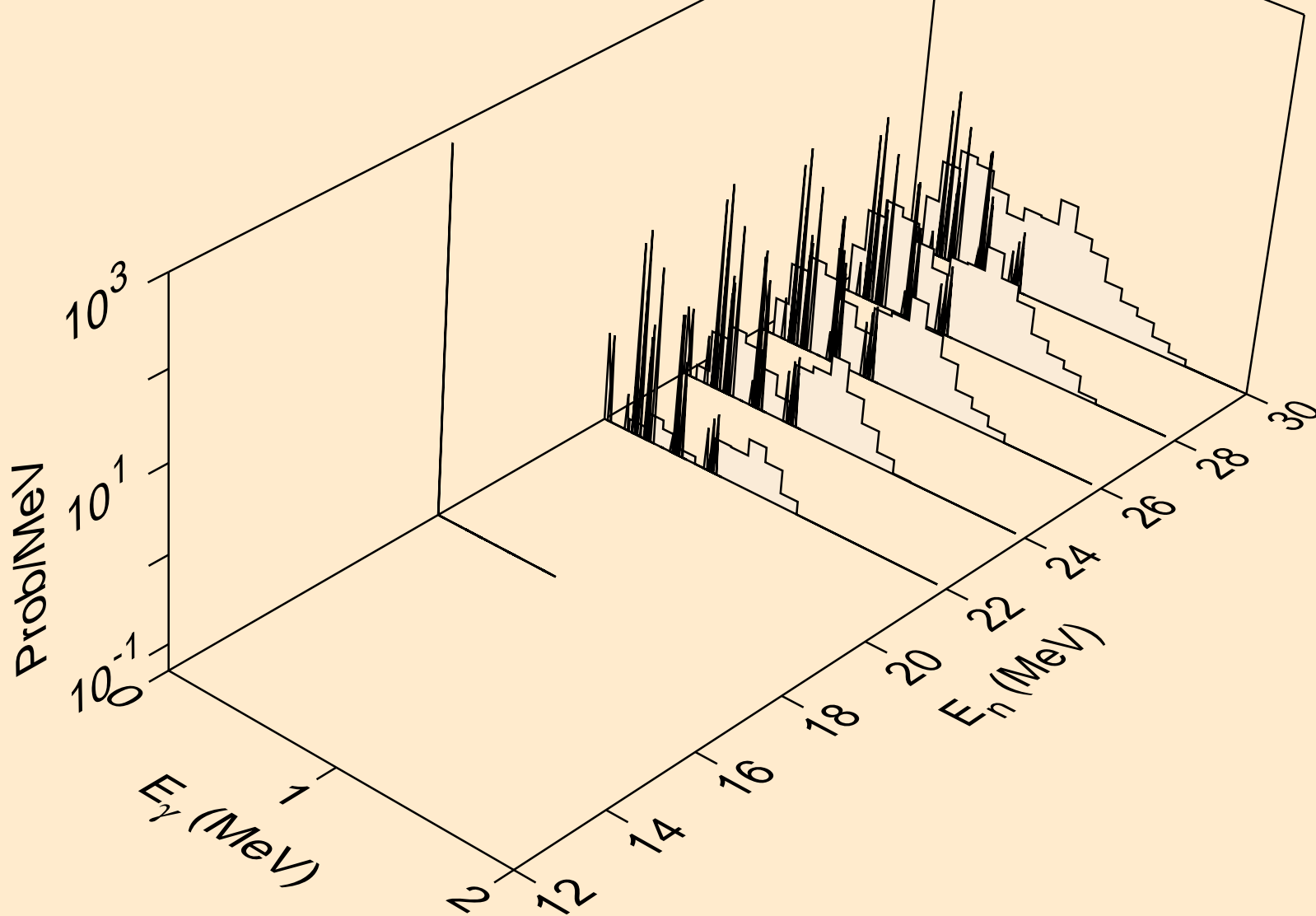

PR146 NEUTRON ACER TENDL-2019 LIBRARY; T=293.16K  
Photon emission for (n,4n)

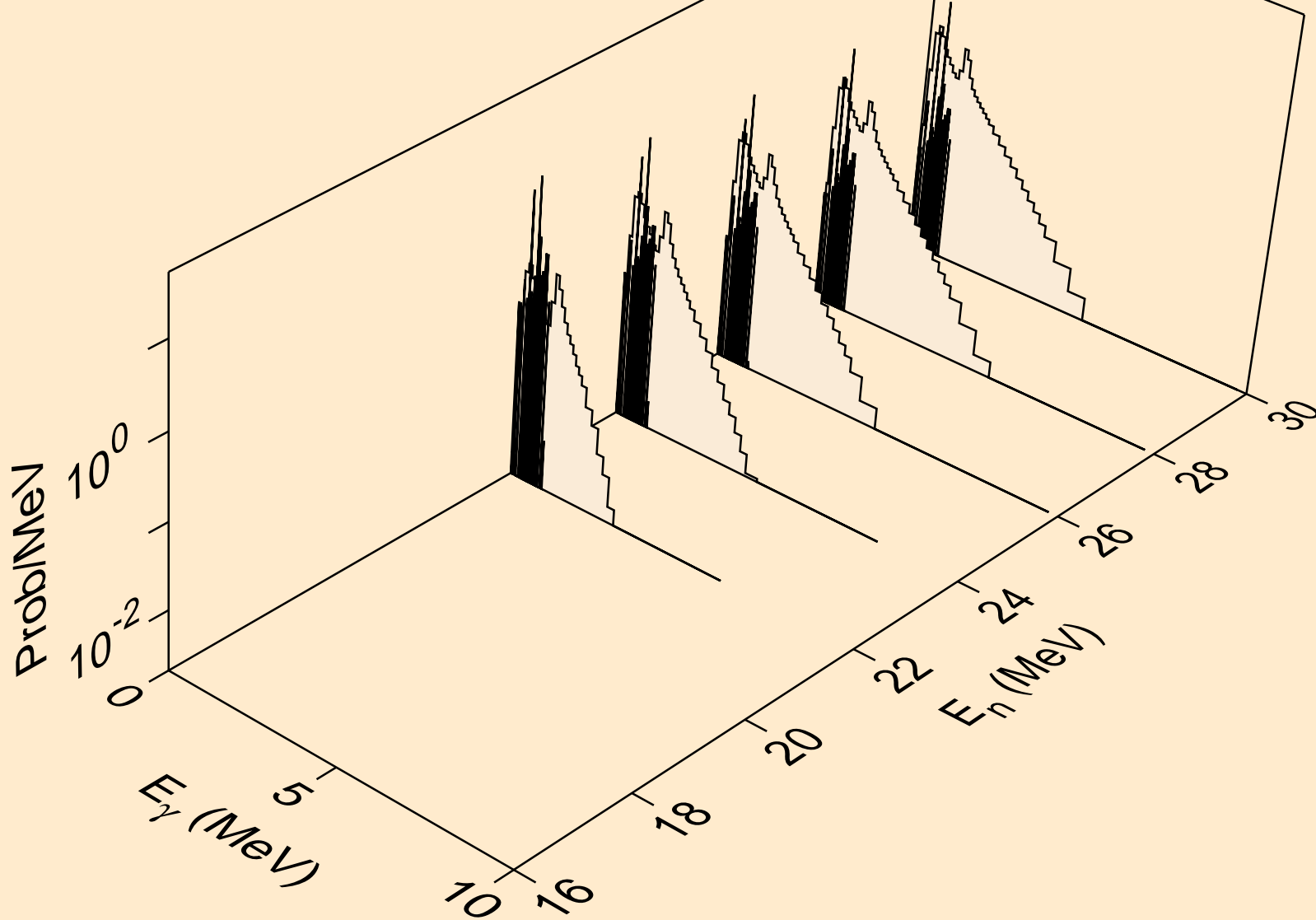

PR146 NEUTRON ACER TENDL-2019 LIBRARY; T=293.16K  
Photon emission for (n,2np)

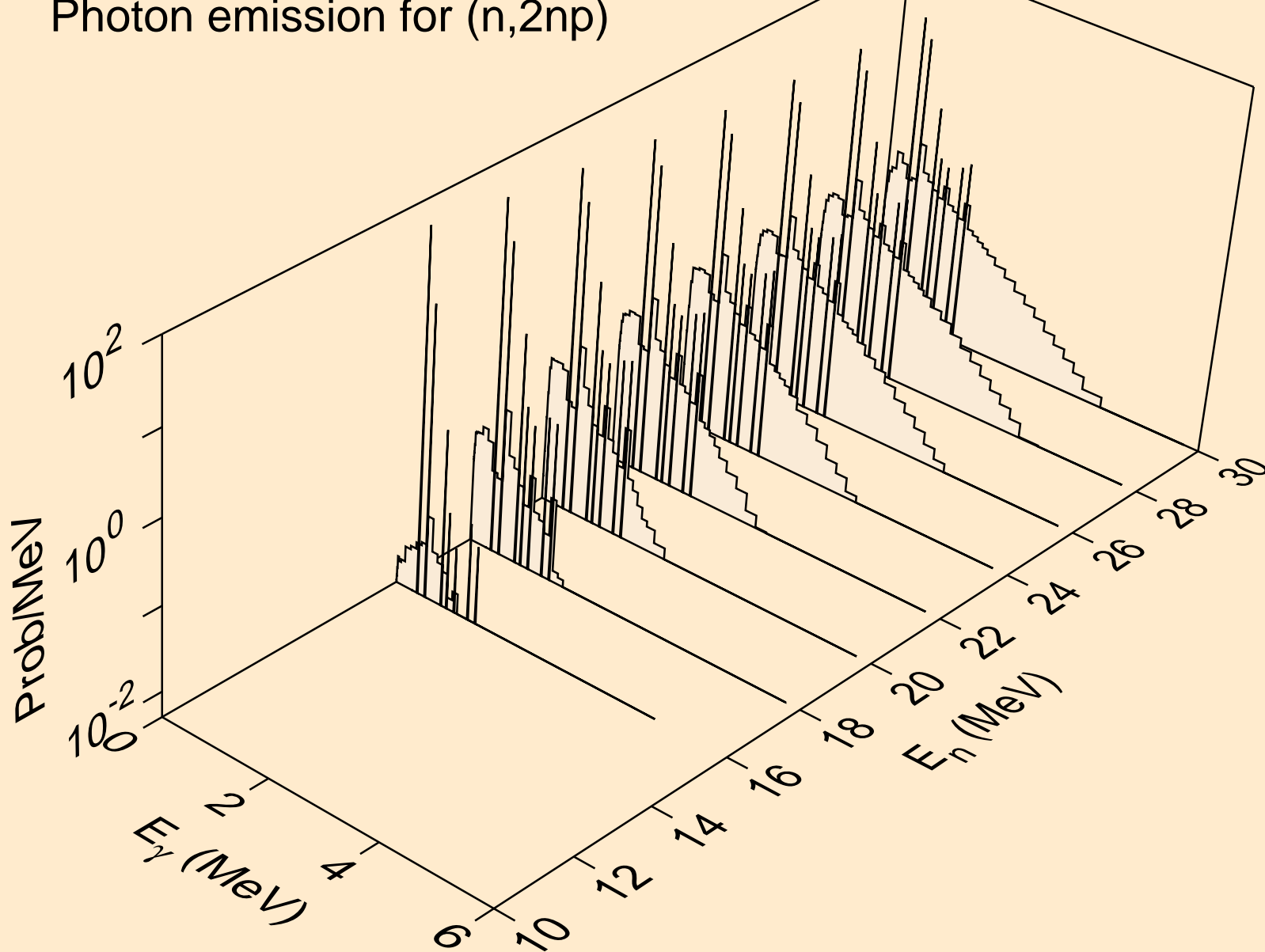

PR146 NEUTRON ACER TENDL-2019 LIBRARY; T=293.16K  
Photon emission for (n,3np)

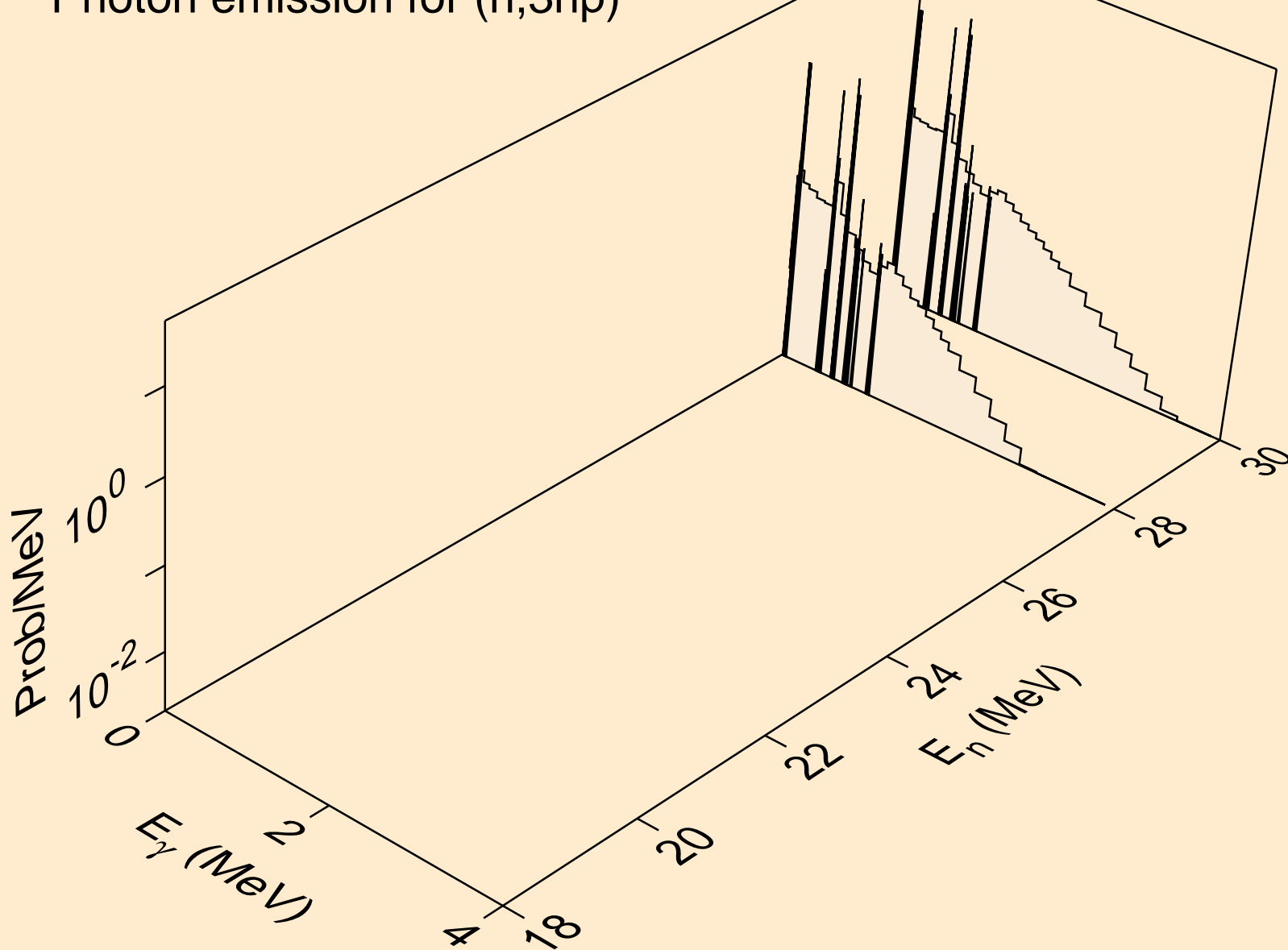



PR146 NEUTRON ACER TENDL-2019 LIBRARY; T=293.16K  
Photon emission for (n,2np)

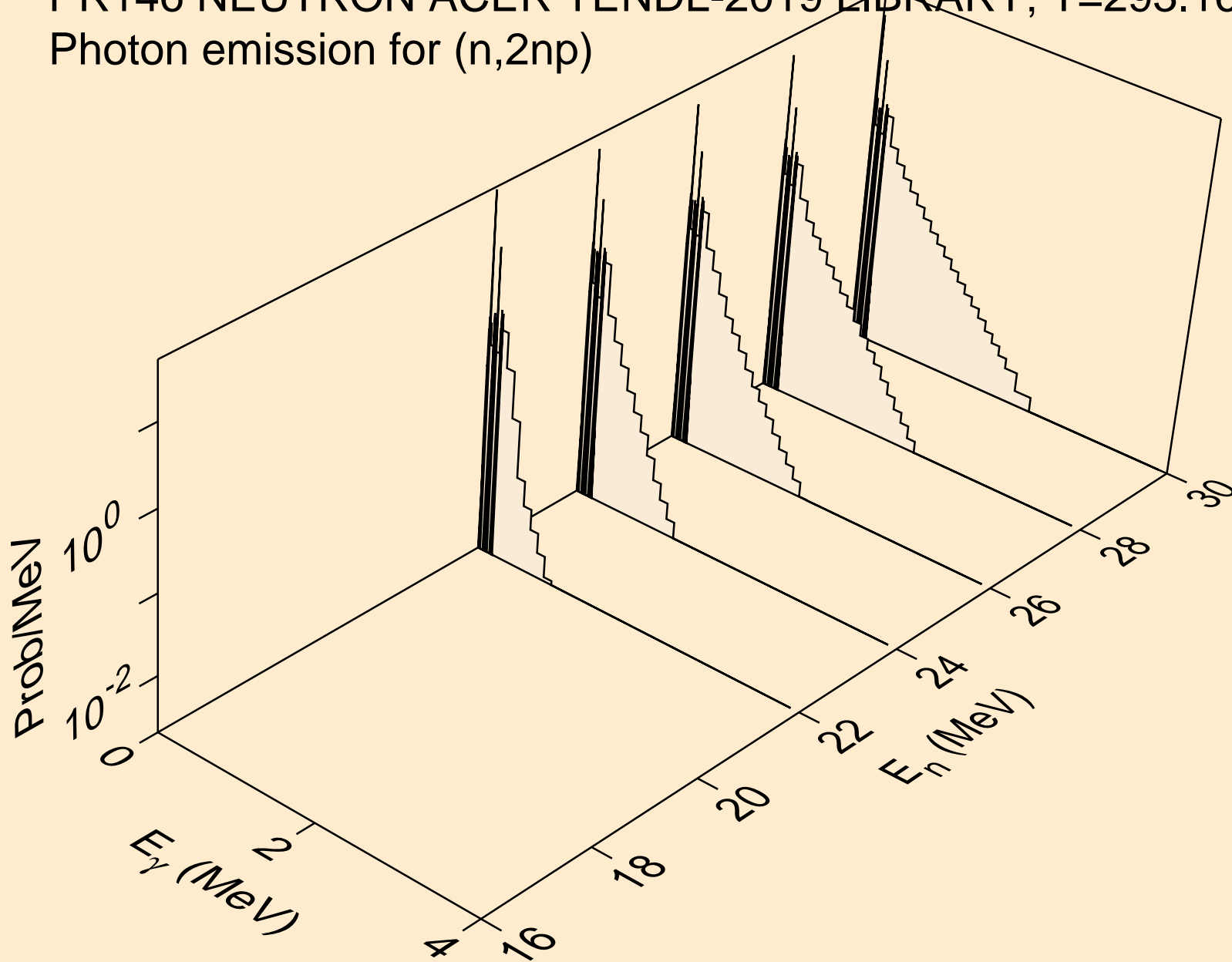

PR146 NEUTRON ACER TENDL-2019 LIBRARY; T=293.16K  
Photon emission for (n,npa)

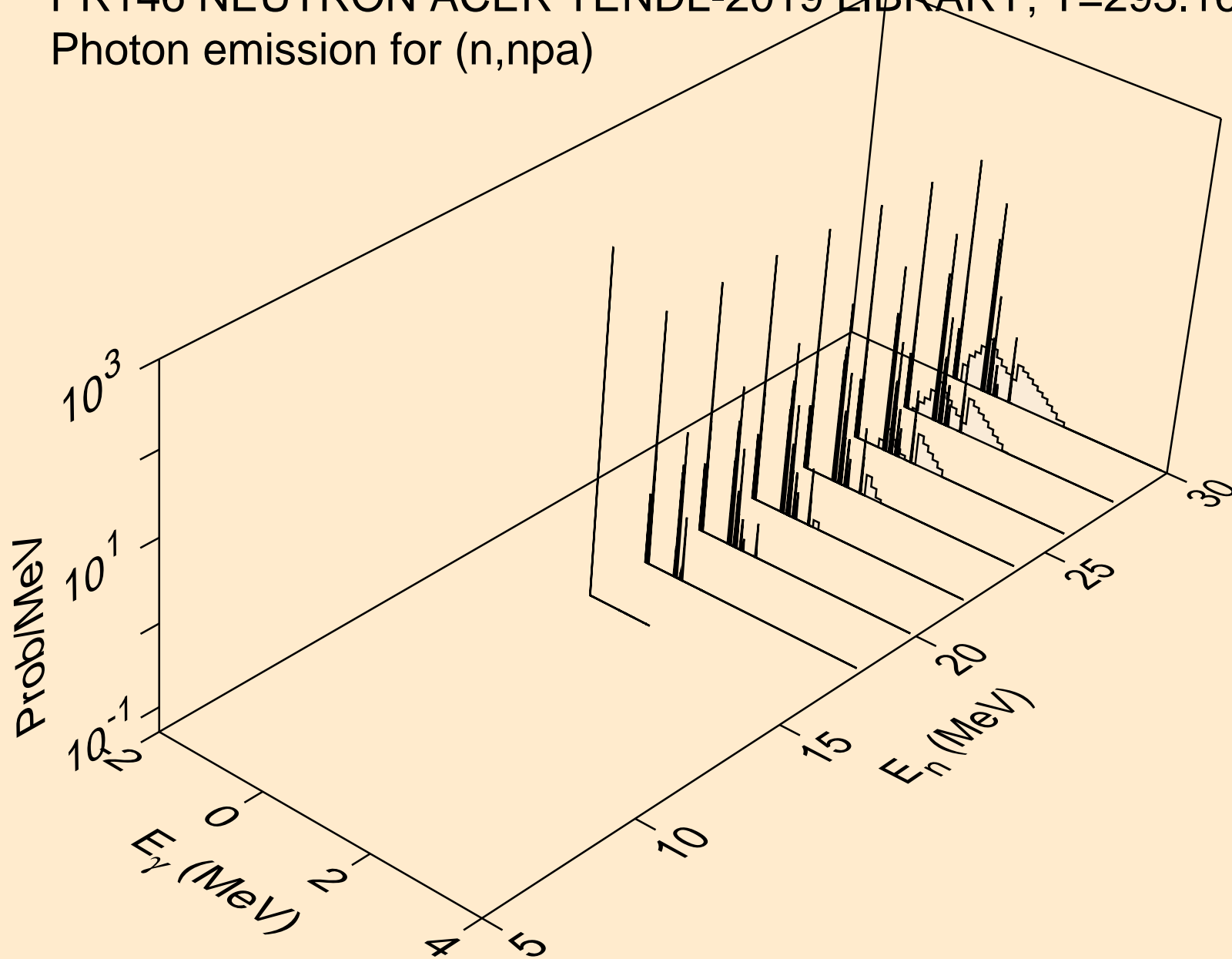

PR146 NEUTRON ACER TENDL-2019 LIBRARY; T=293.16K  
Photon emission for (n,n\*c)

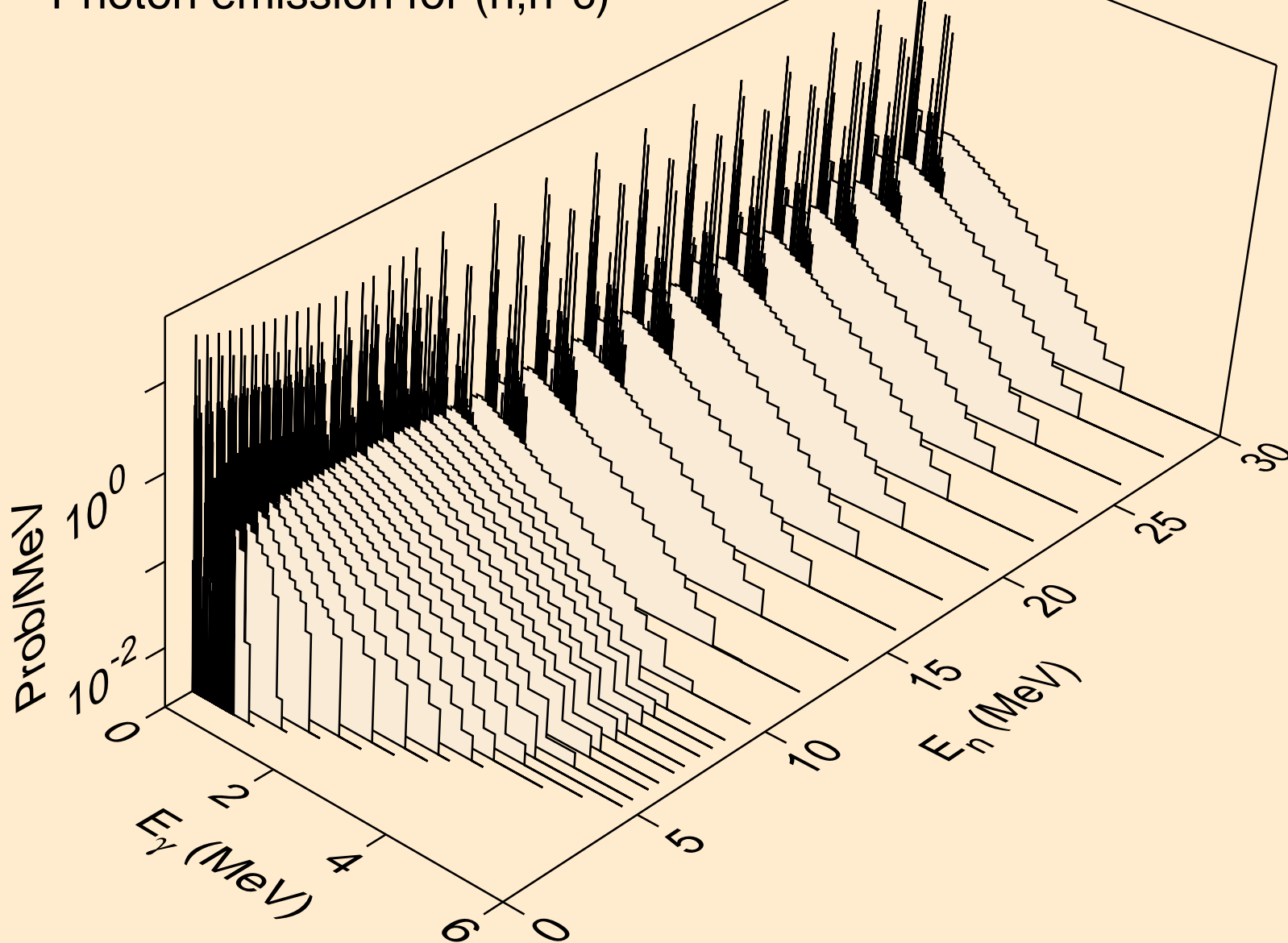

PR146 NEUTRON ACER TENDL-2019 LIBRARY; T=293.16K  
Photon emission for (n,gma)

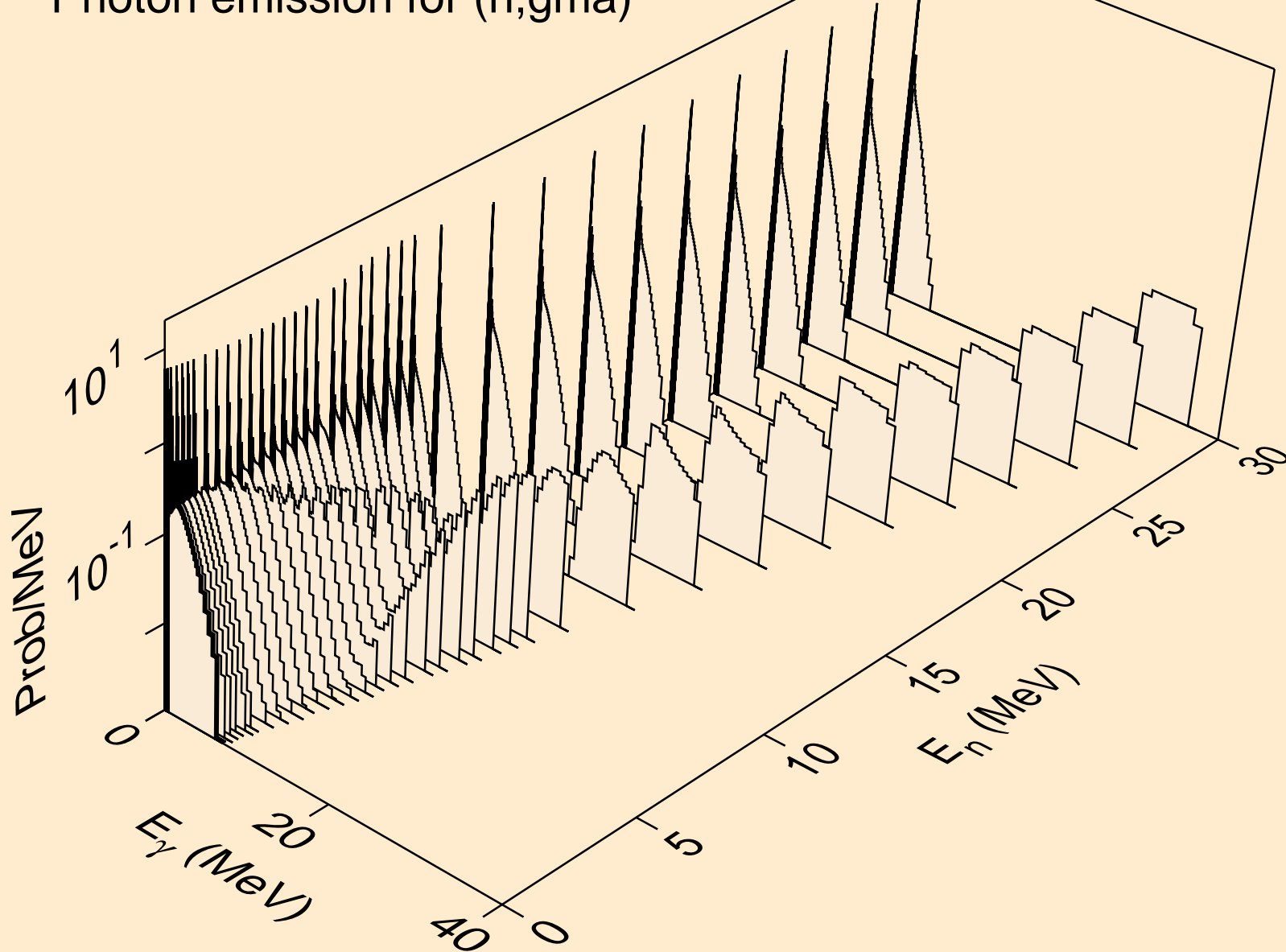

PR146 NEUTRON ACER TENDL-2019 LIBRARY; T=293.16K  
Photon emission for (n,p)

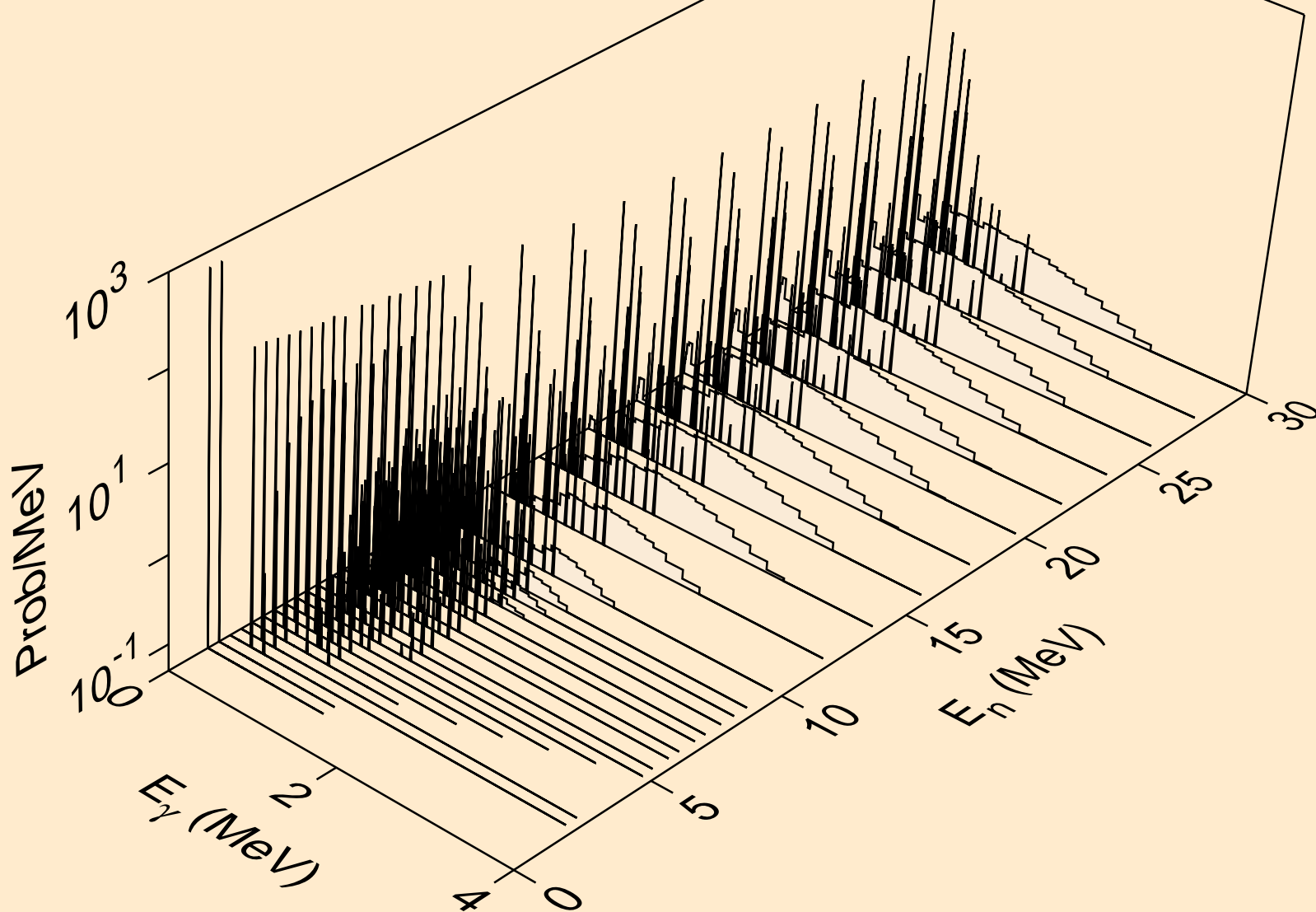

PR146 NEUTRON ACER TENDL-2019 LIBRARY; T=293.16K  
Photon emission for (n,d)

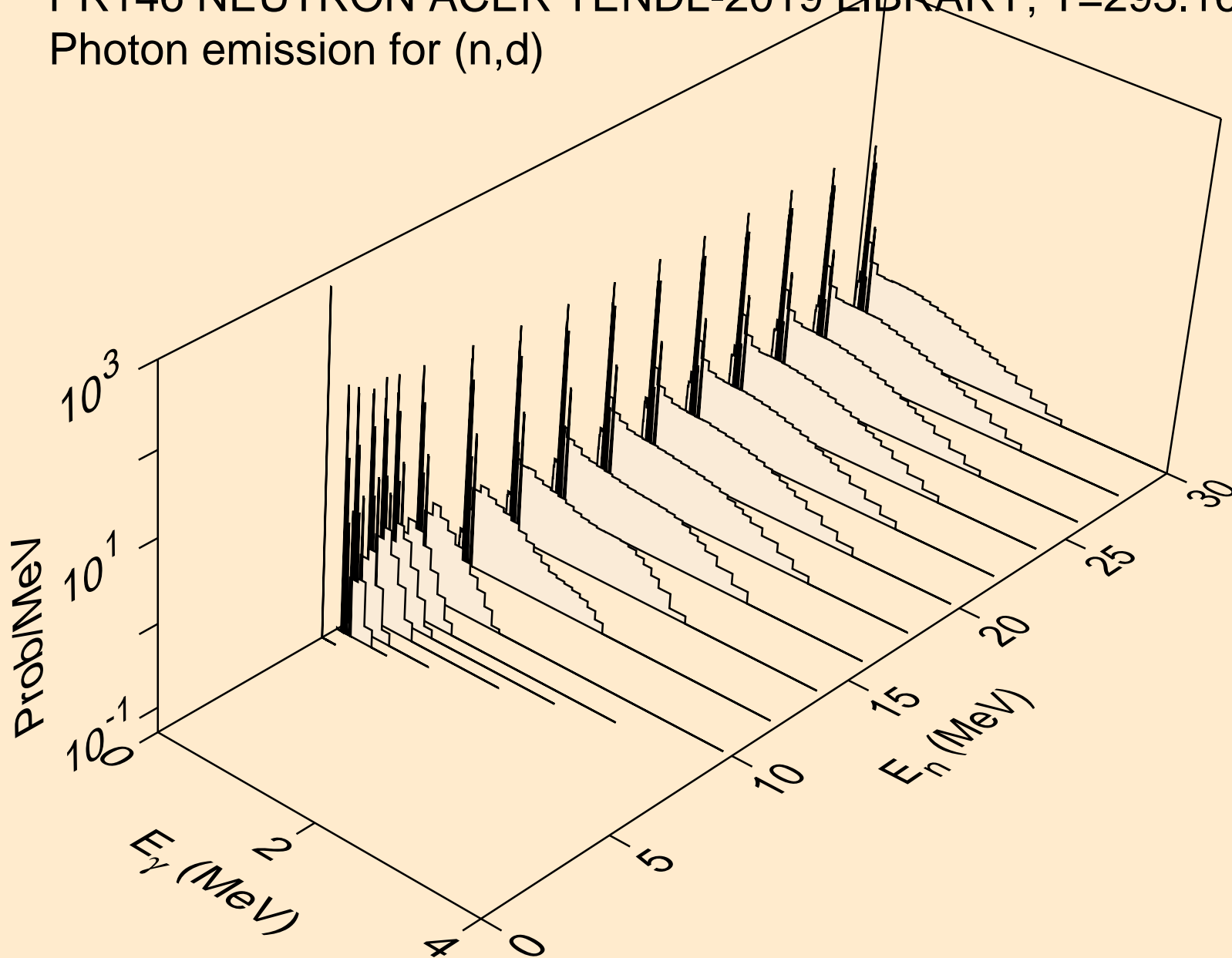

PR146 NEUTRON ACER TENDL-2019 LIBRARY; T=293.16K  
Photon emission for (n,t)

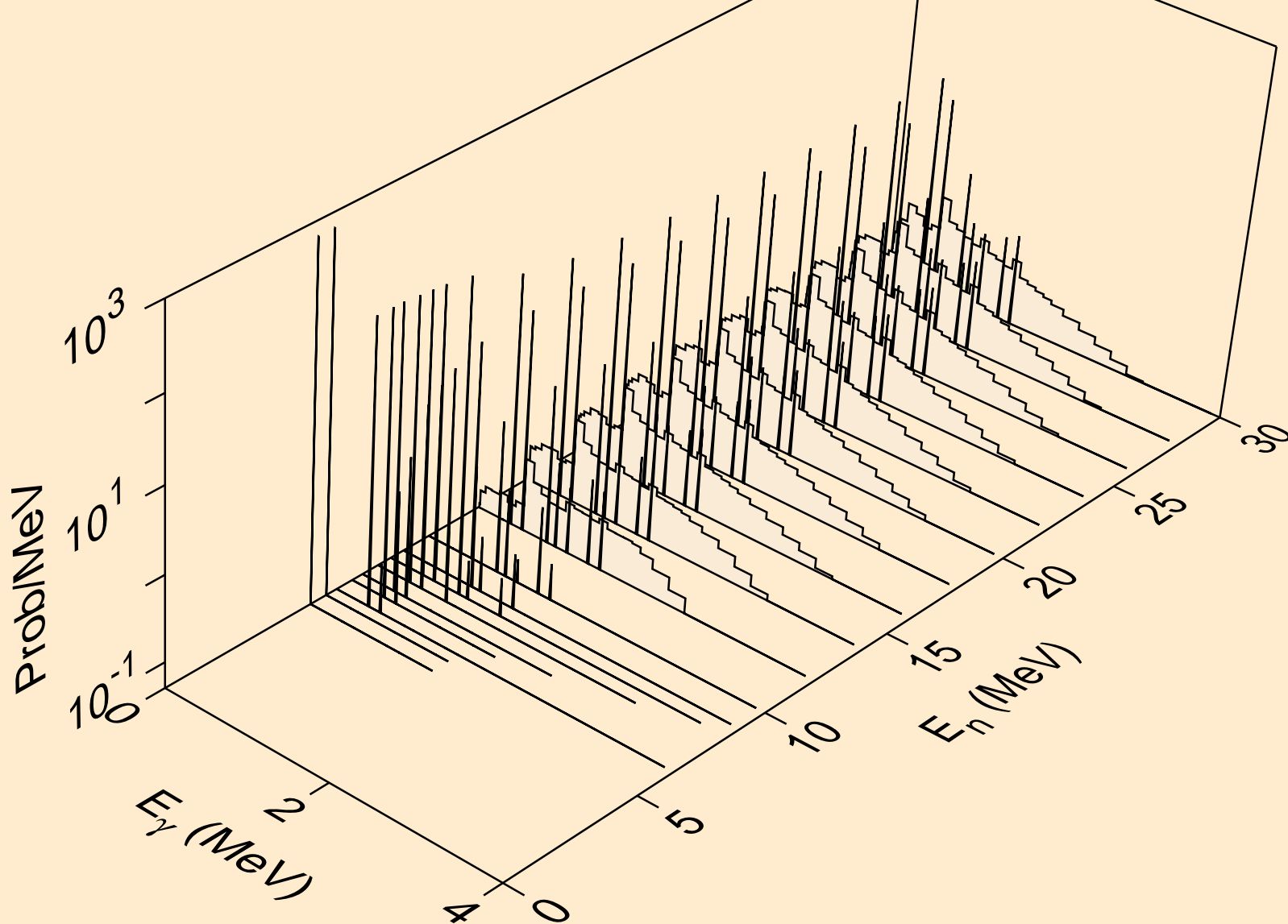

PR146 NEUTRON ACER TENDL-2019 LIBRARY; T=293.16K  
Photon emission for (n,he3)

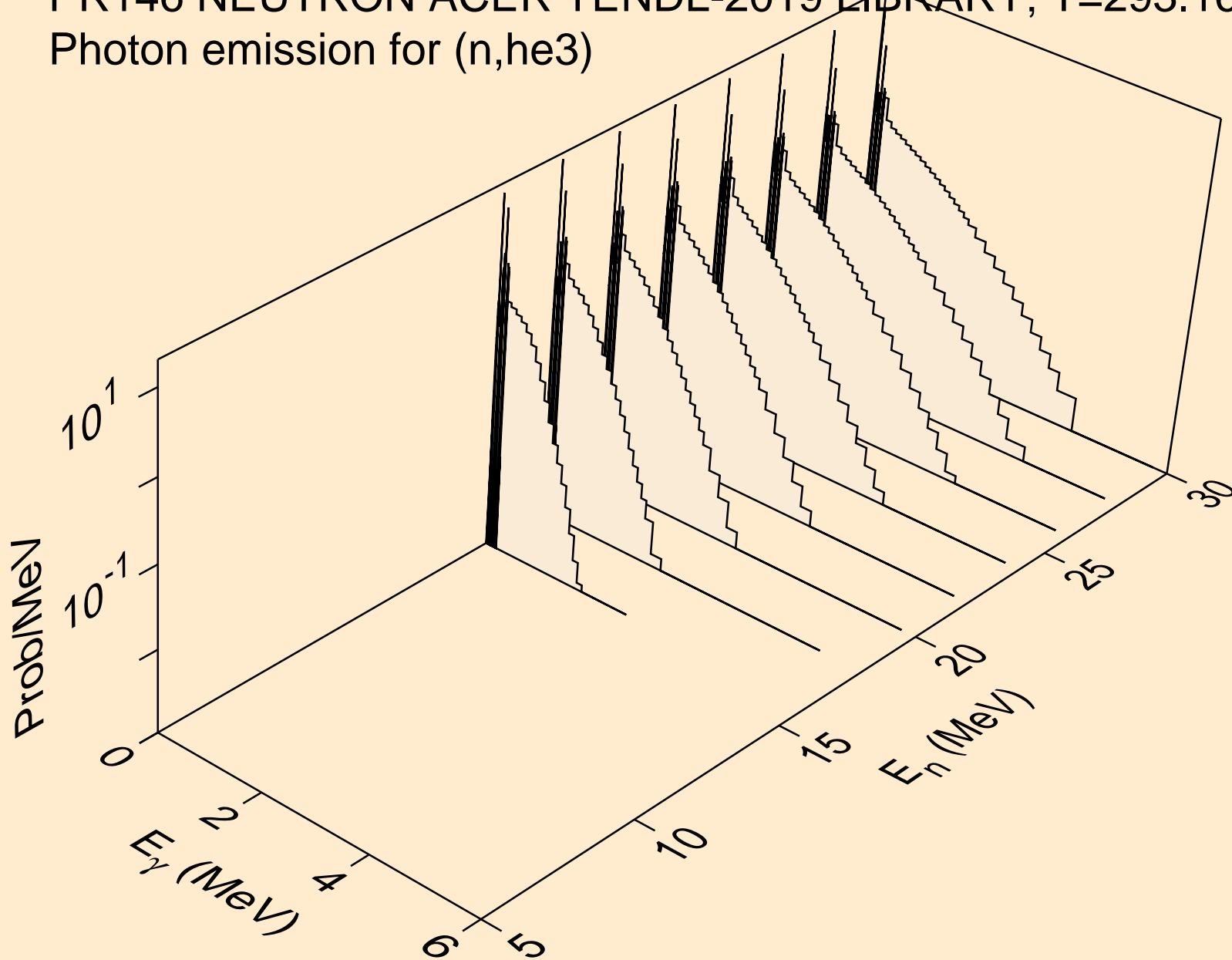



PR146 NEUTRON ACER TENDL-2019 LIBRARY; T=293.16K  
Photon emission for (n,a)

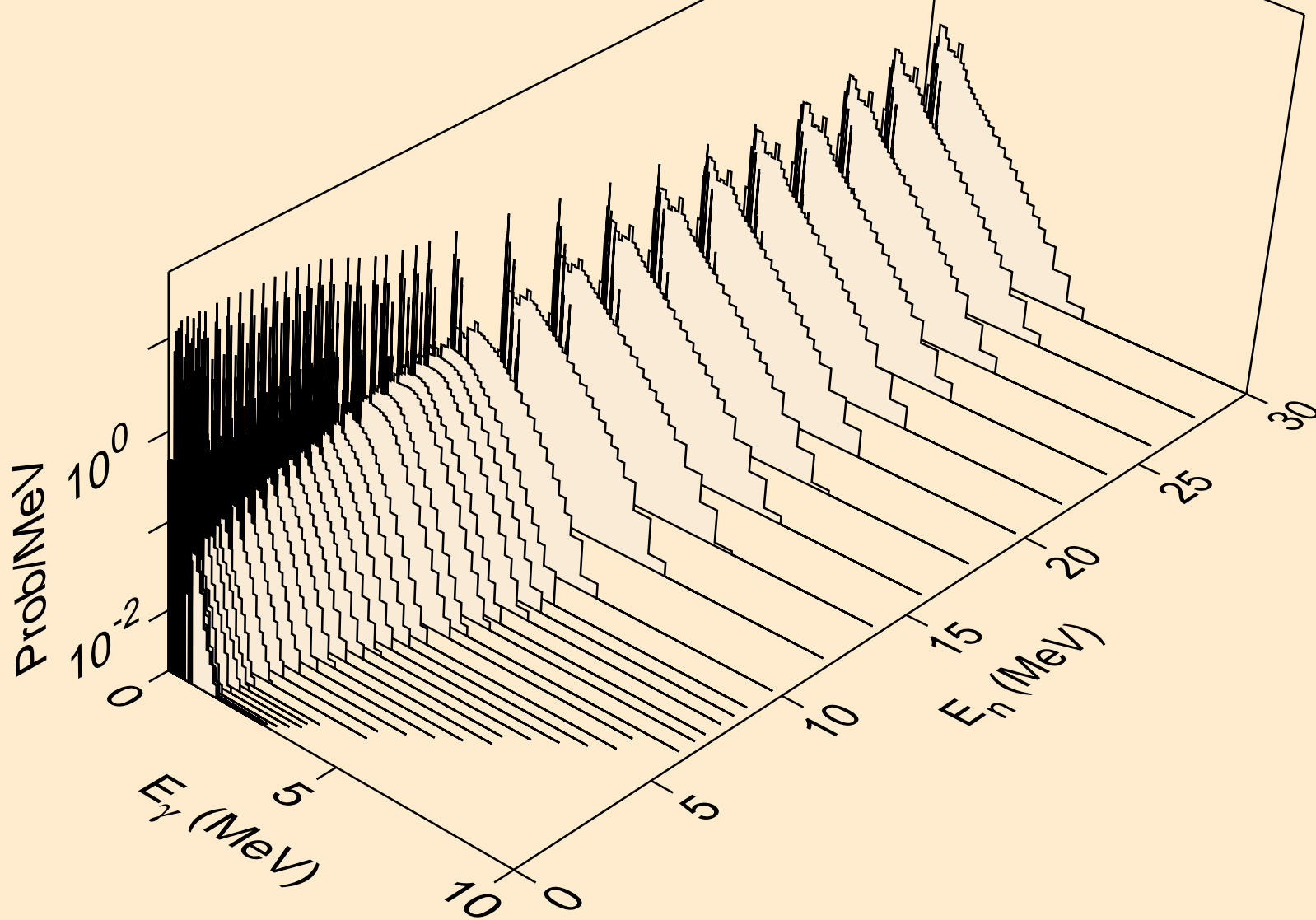

PR146 NEUTRON ACER TENDL-2019 LIBRARY; T=293.16K  
Photon emission for (n,2a)

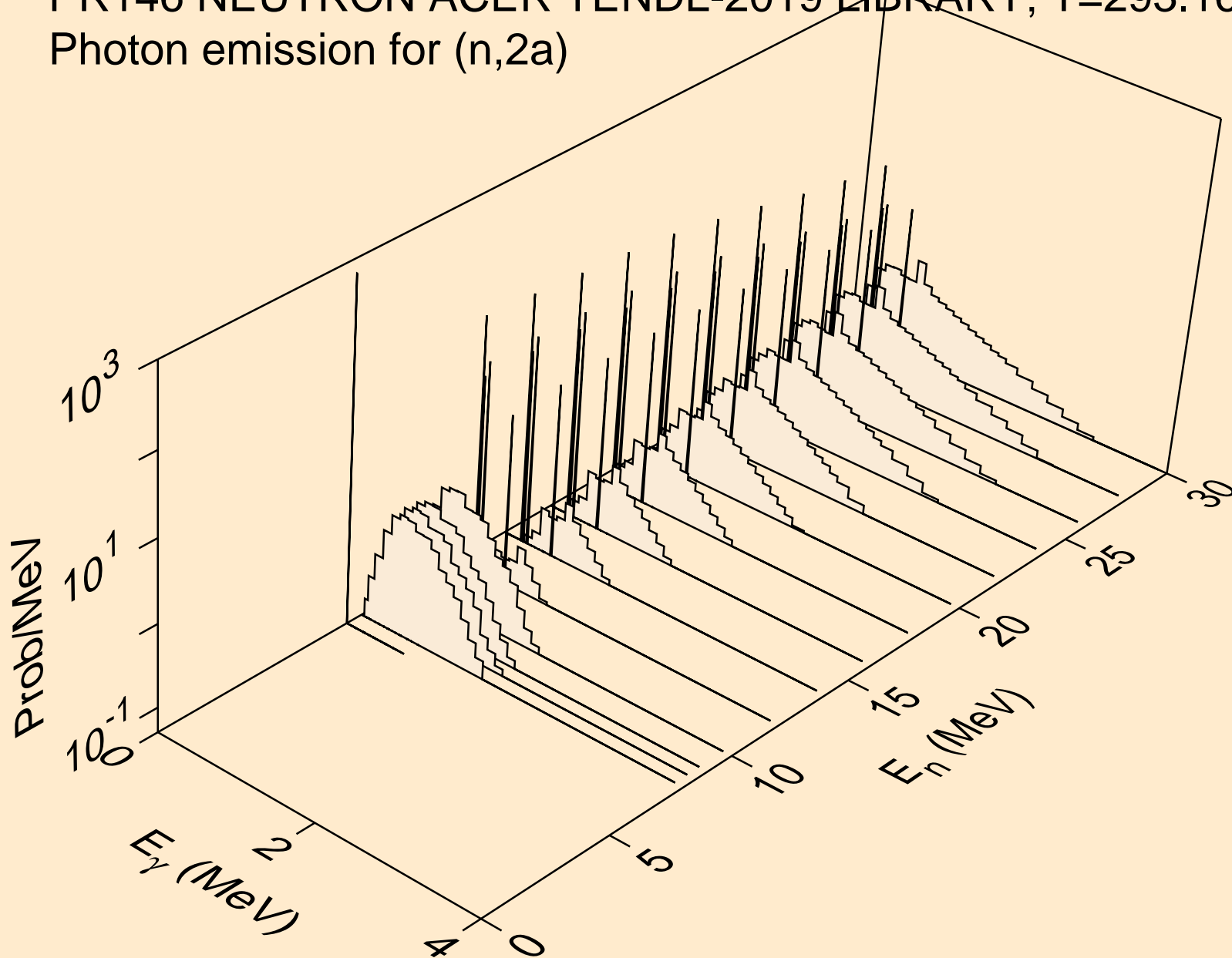

PR146 NEUTRON ACER TENDL-2019 LIBRARY; T=293.16K  
Photon emission for (n,2p)

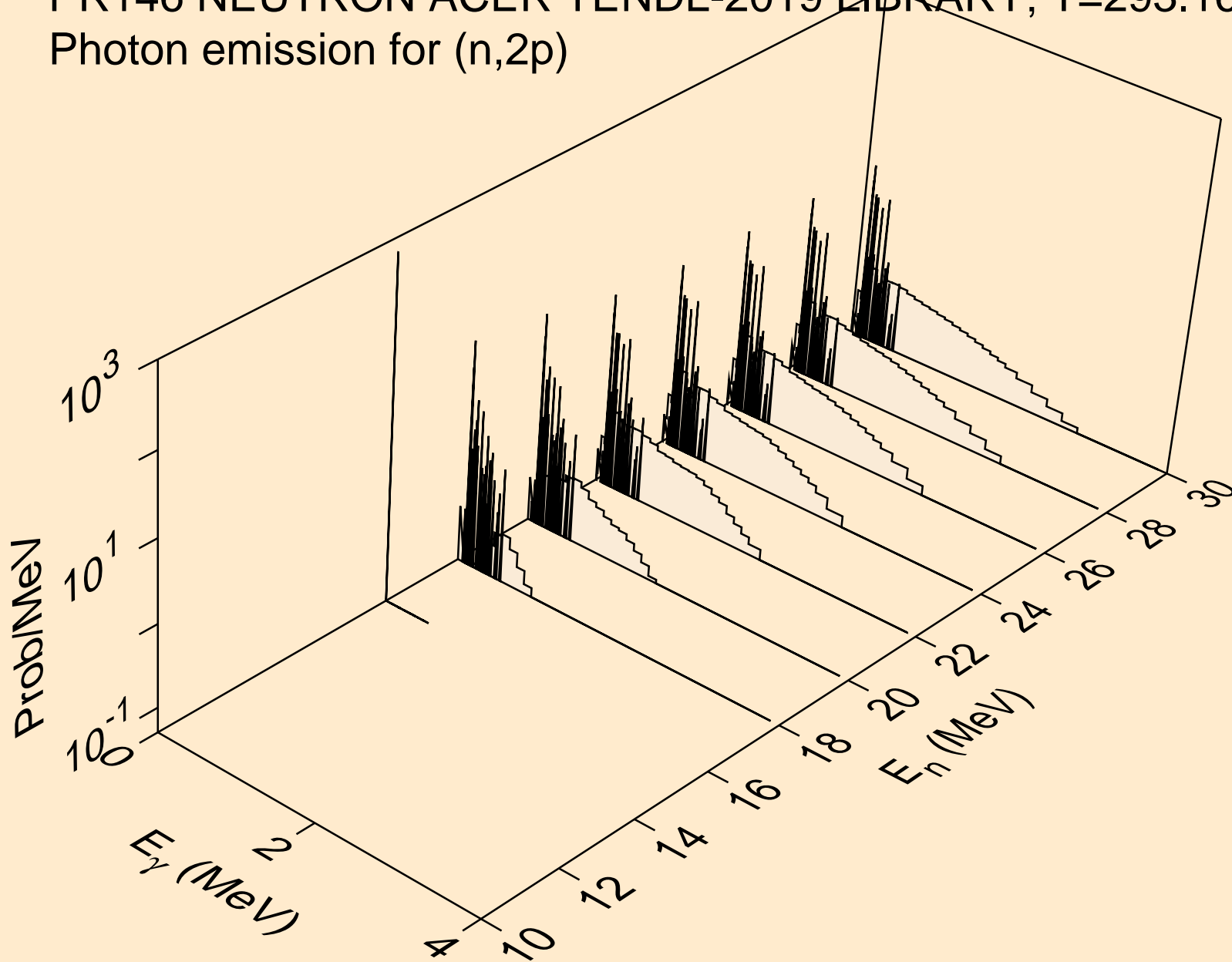

PR146 NEUTRON ACER TENDL-2019 LIBRARY; T=293.16K  
Photon emission for (n,p)

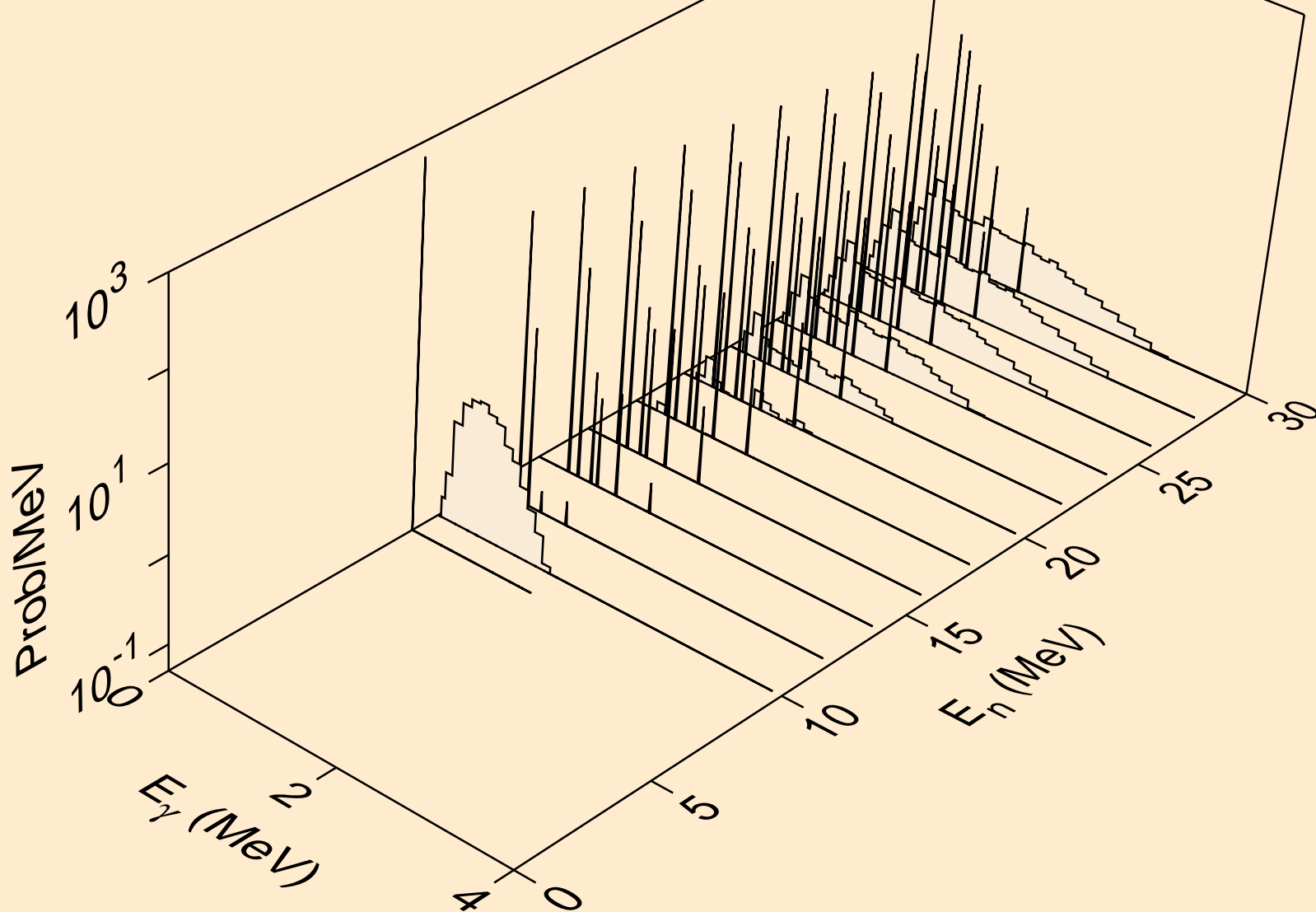

PR146 NEUTRON ACER TENDL-2019 LIBRARY; T=293.16K  
Photon emission for (n,da)

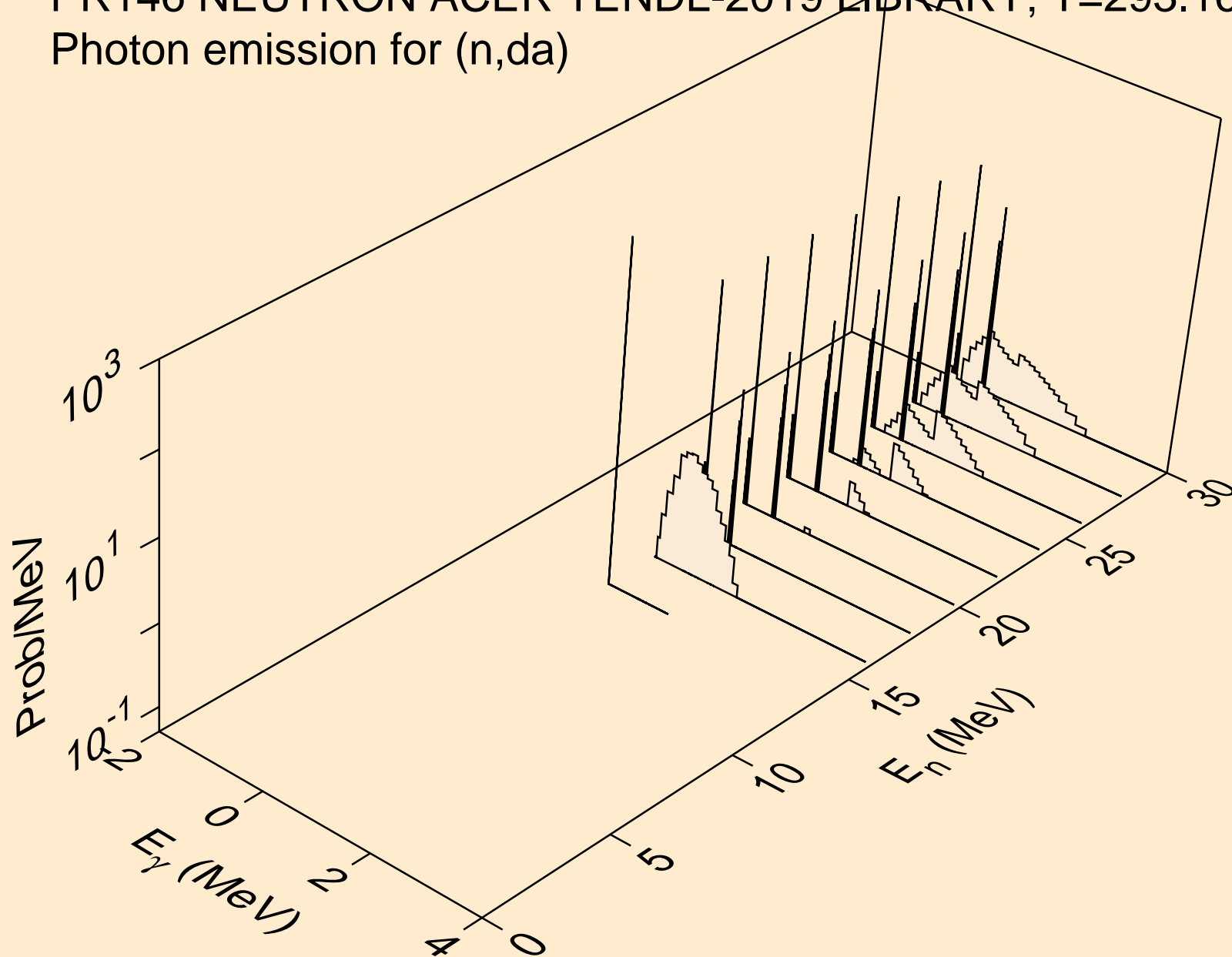

PR146 NEUTRON ACER TENDL-2019 LIBRARY; T=293.16K  
thermal capture photon spectrum

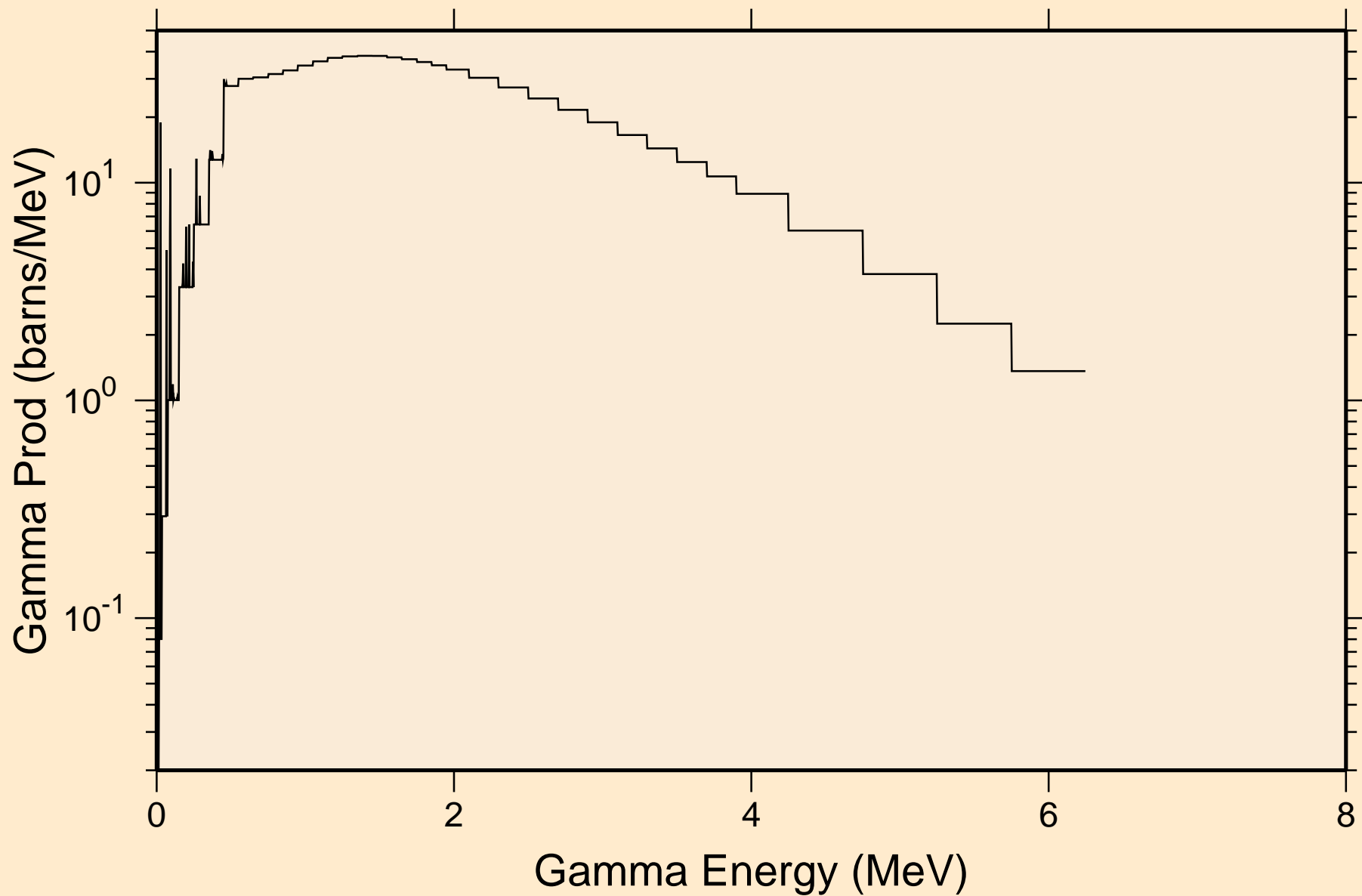

PR146 NEUTRON ACER TENDL-2019 LIBRARY; T=293.16K  
14 MeV photon spectrum

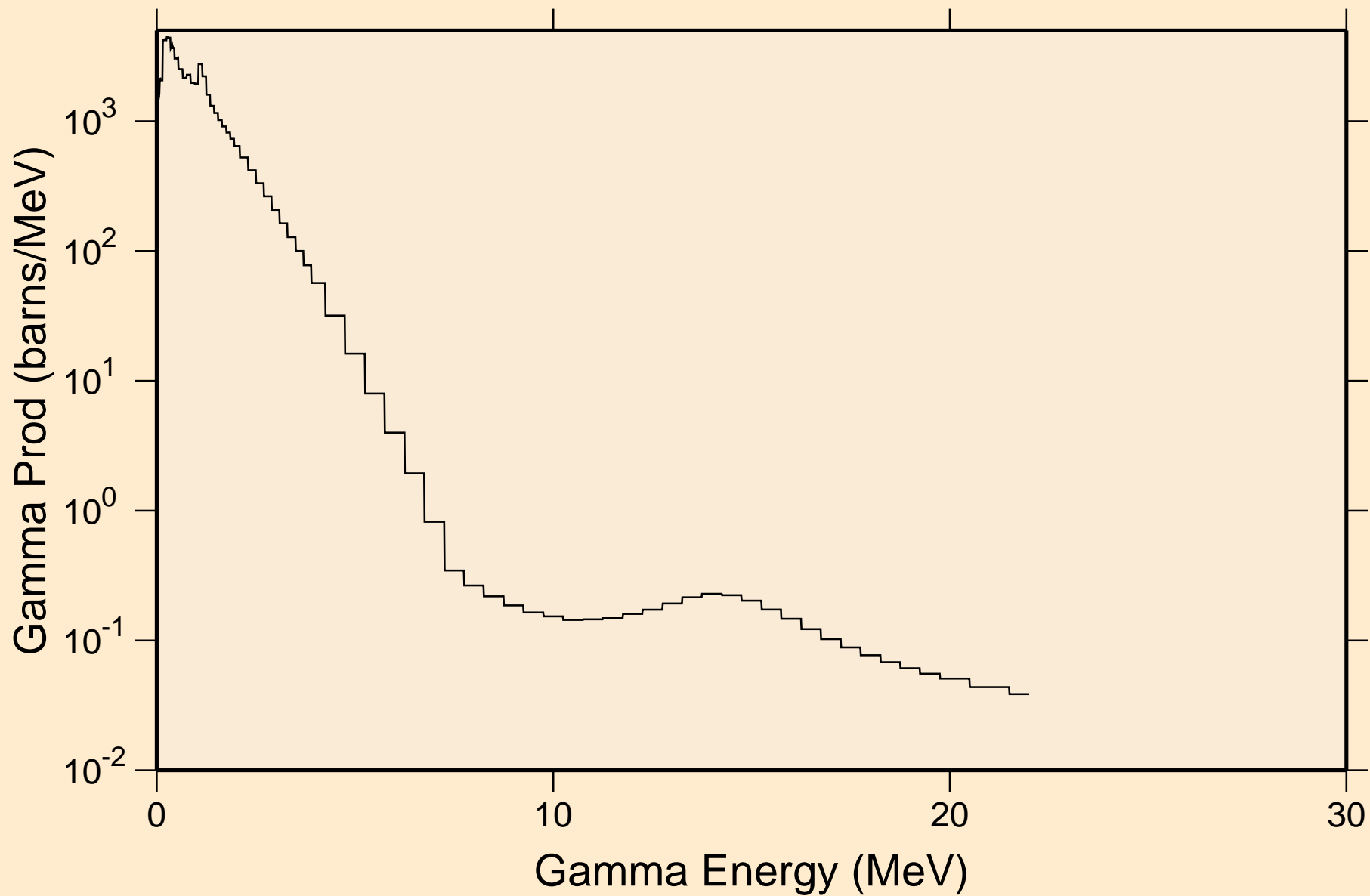

PR146 NEUTRON ACER TENDL-2019 LIBRARY; T=293.16K  
Particle heating contributions

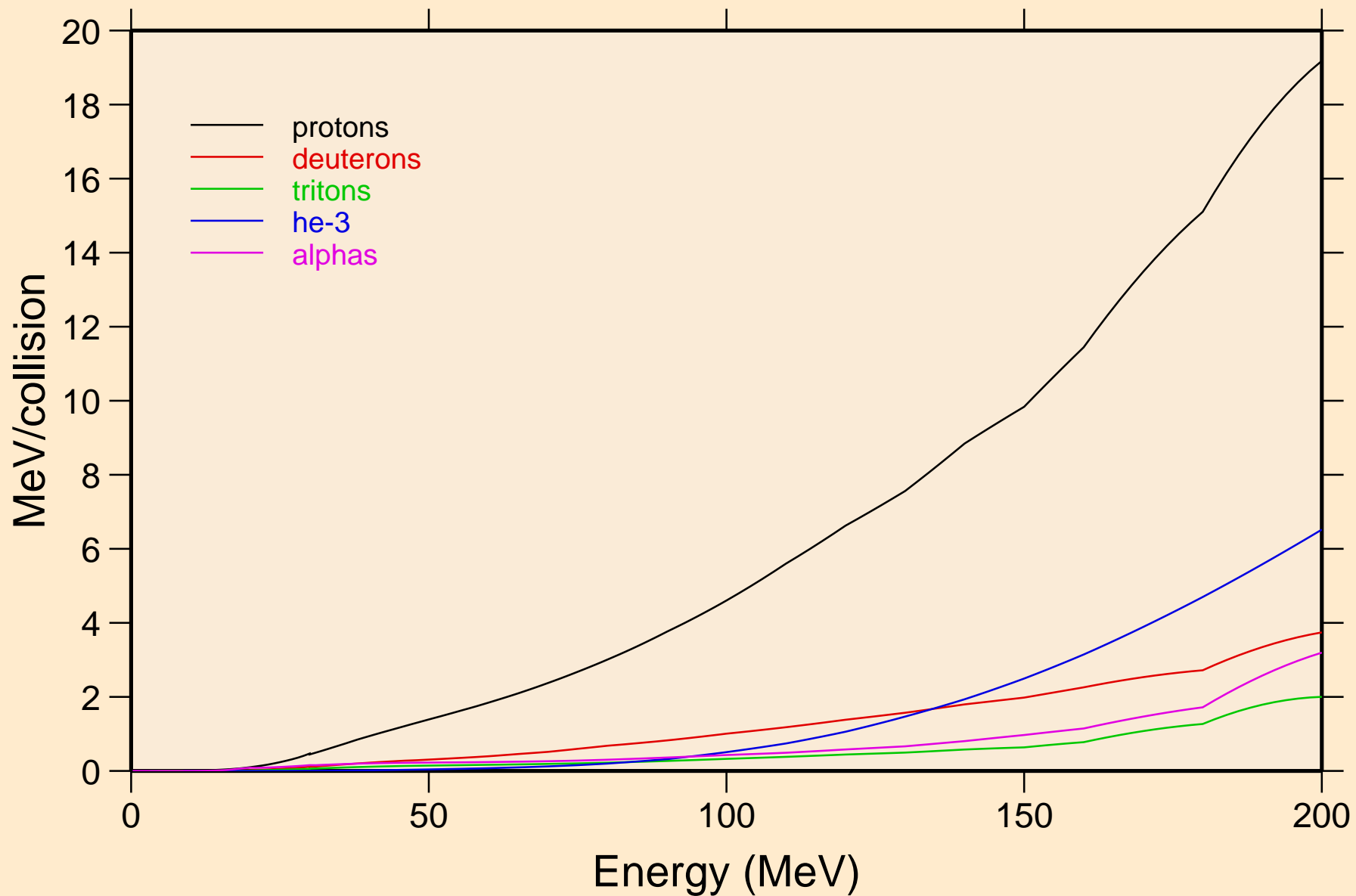



PR146 NEUTRON ACER TENDL-2019 LIBRARY; T=293.16K  
Recoil Heating

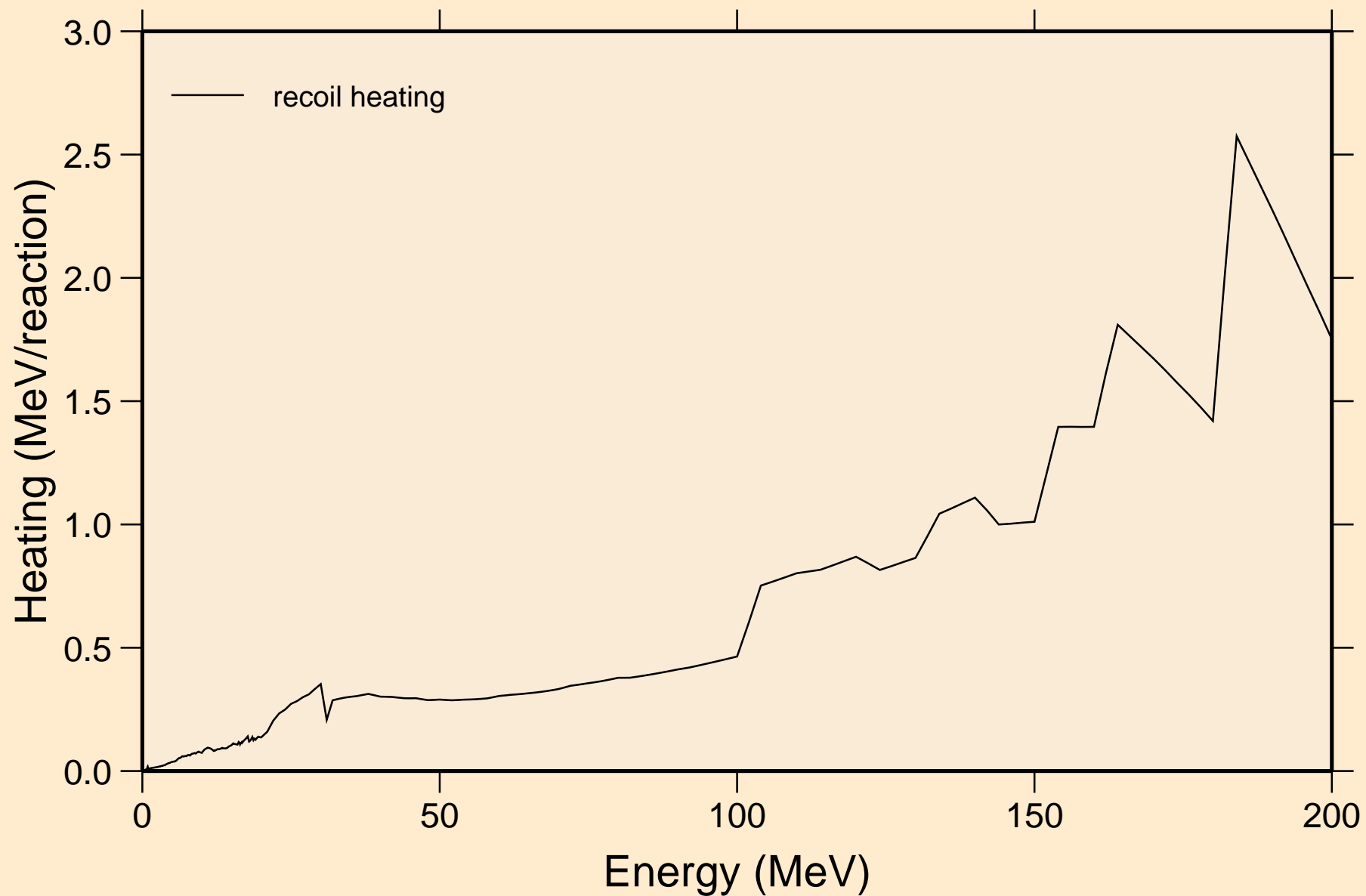

PR146 NEUTRON ACER TENDL-2019 LIBRARY; T=293.16K  
Particle production cross sections

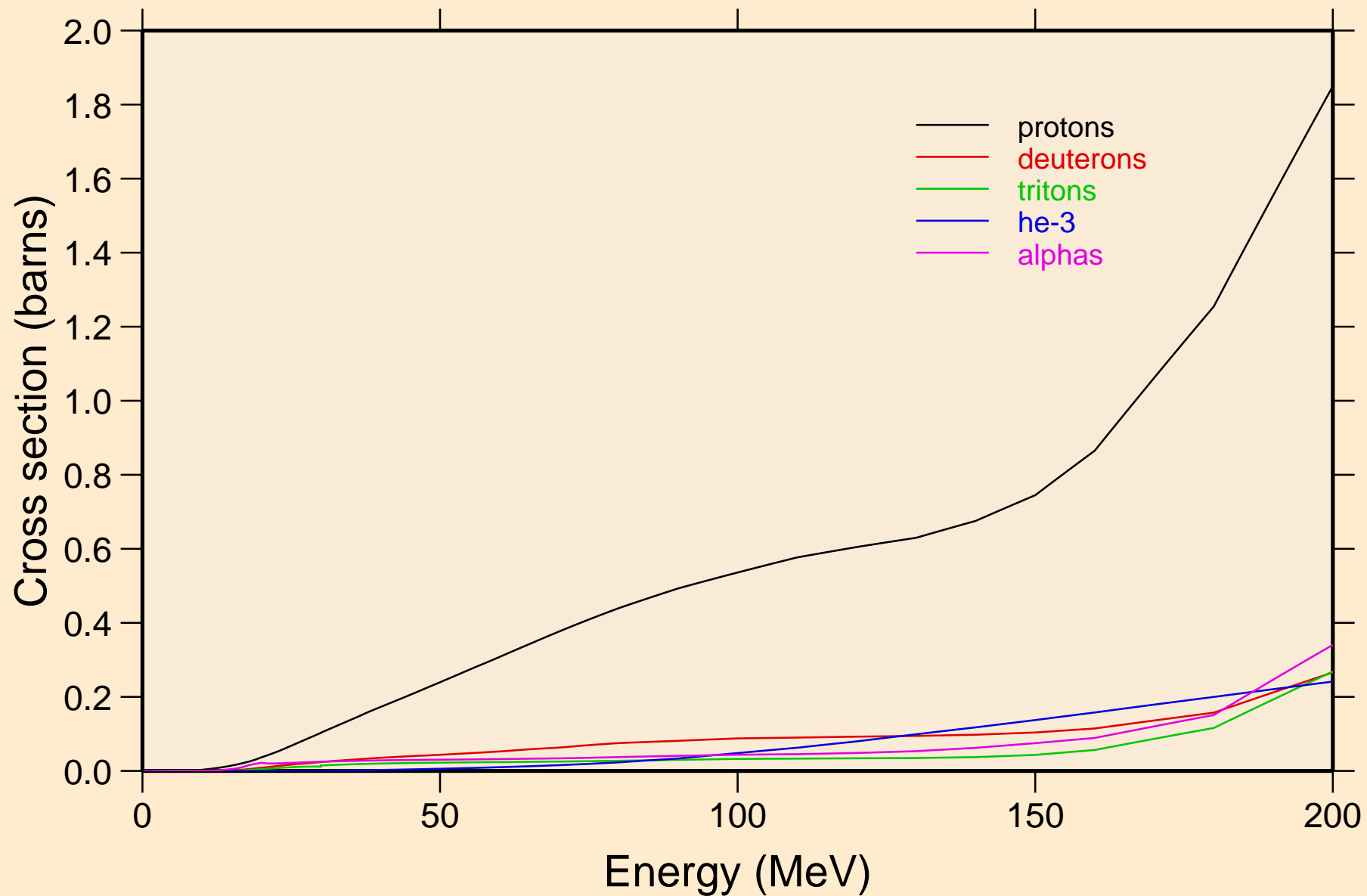

PR146 NEUTRON ACER TENDL-2019 LIBRARY; T=293.16K  
protons from (n,x)

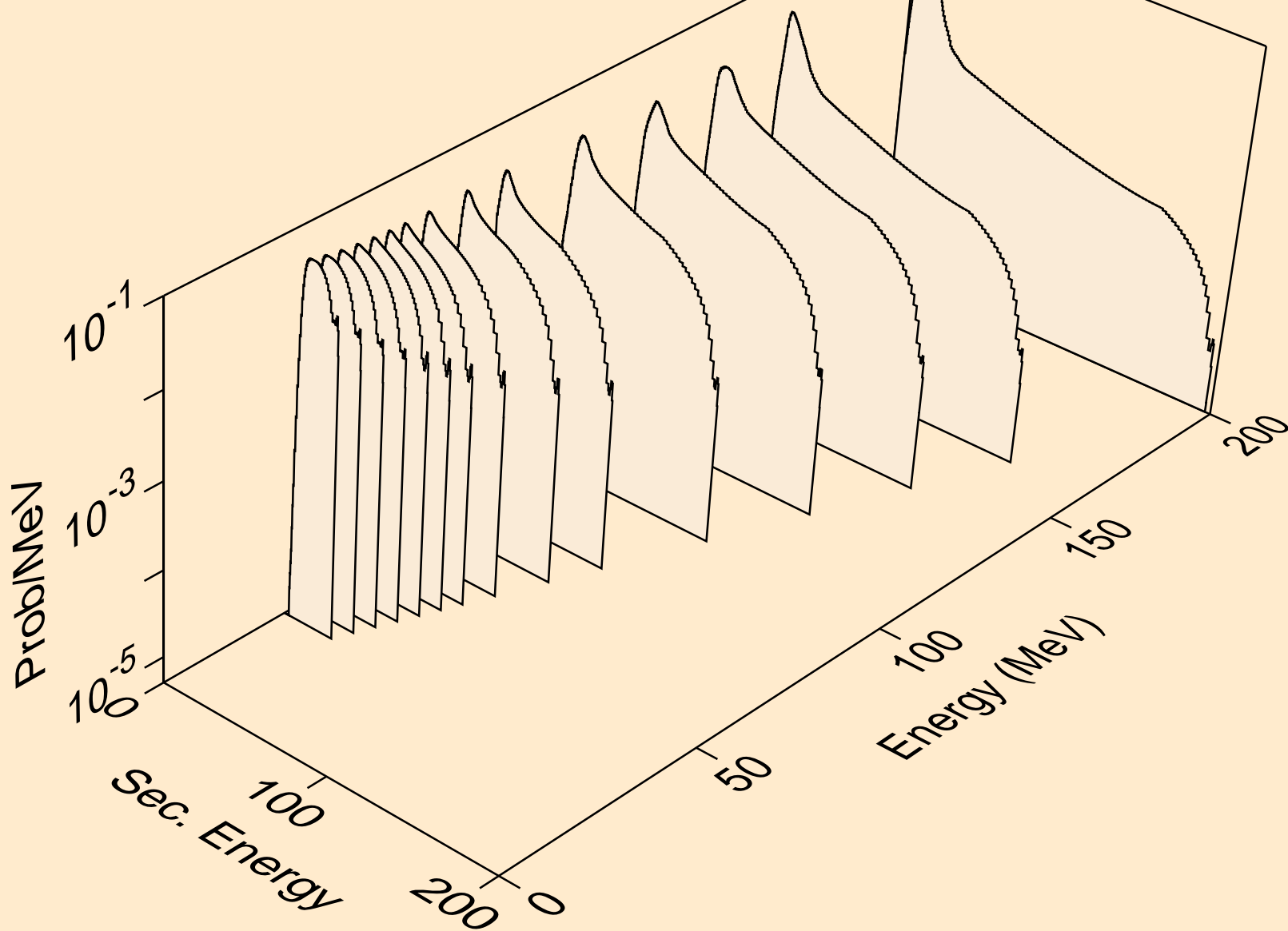

PR146 NEUTRON ACER TENDL-2019 LIBRARY; T=293.16K  
protons from (n,n\*)p

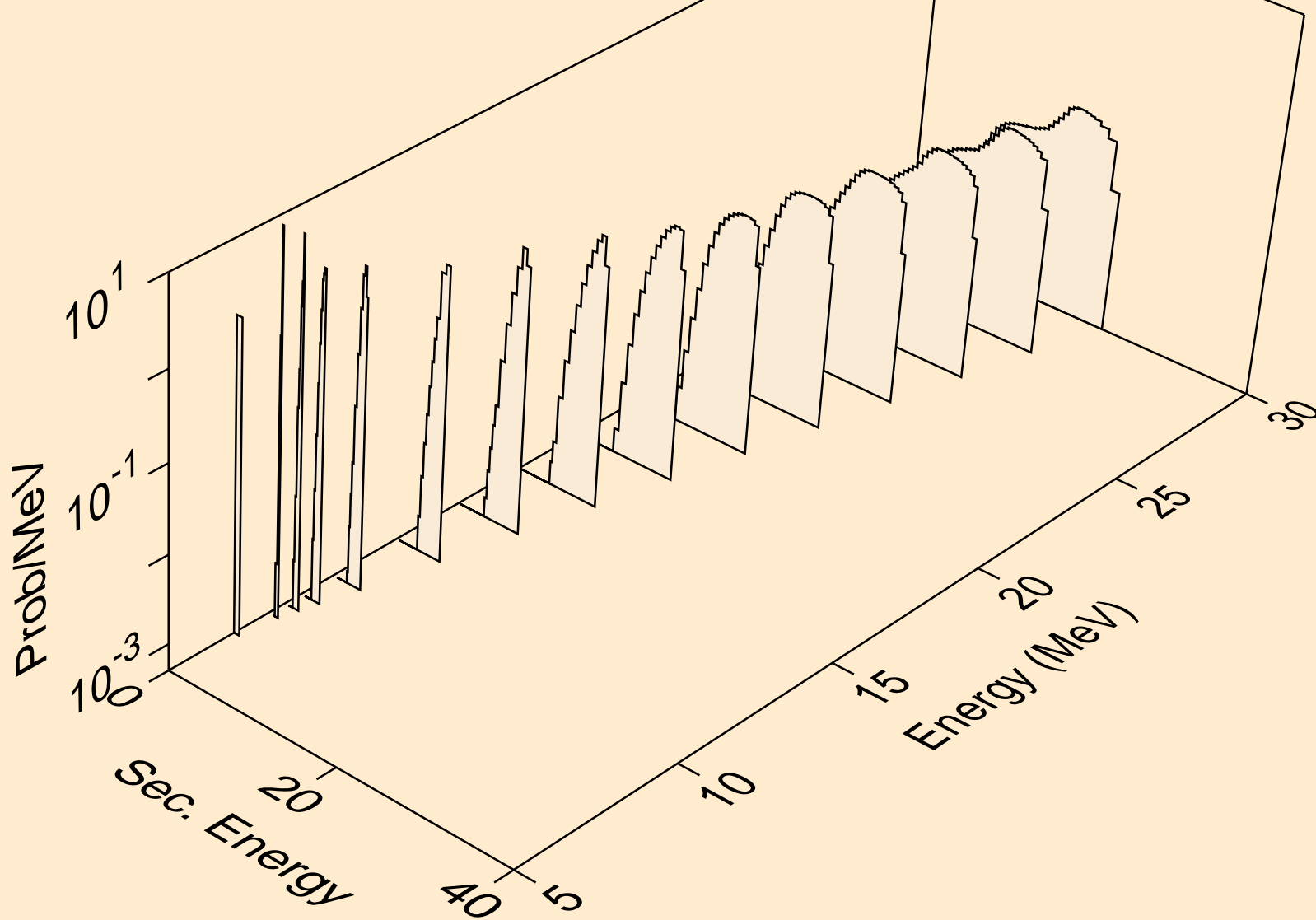

PR146 NEUTRON ACER TENDL-2019 LIBRARY; T=293.16K  
protons from (n,2np)

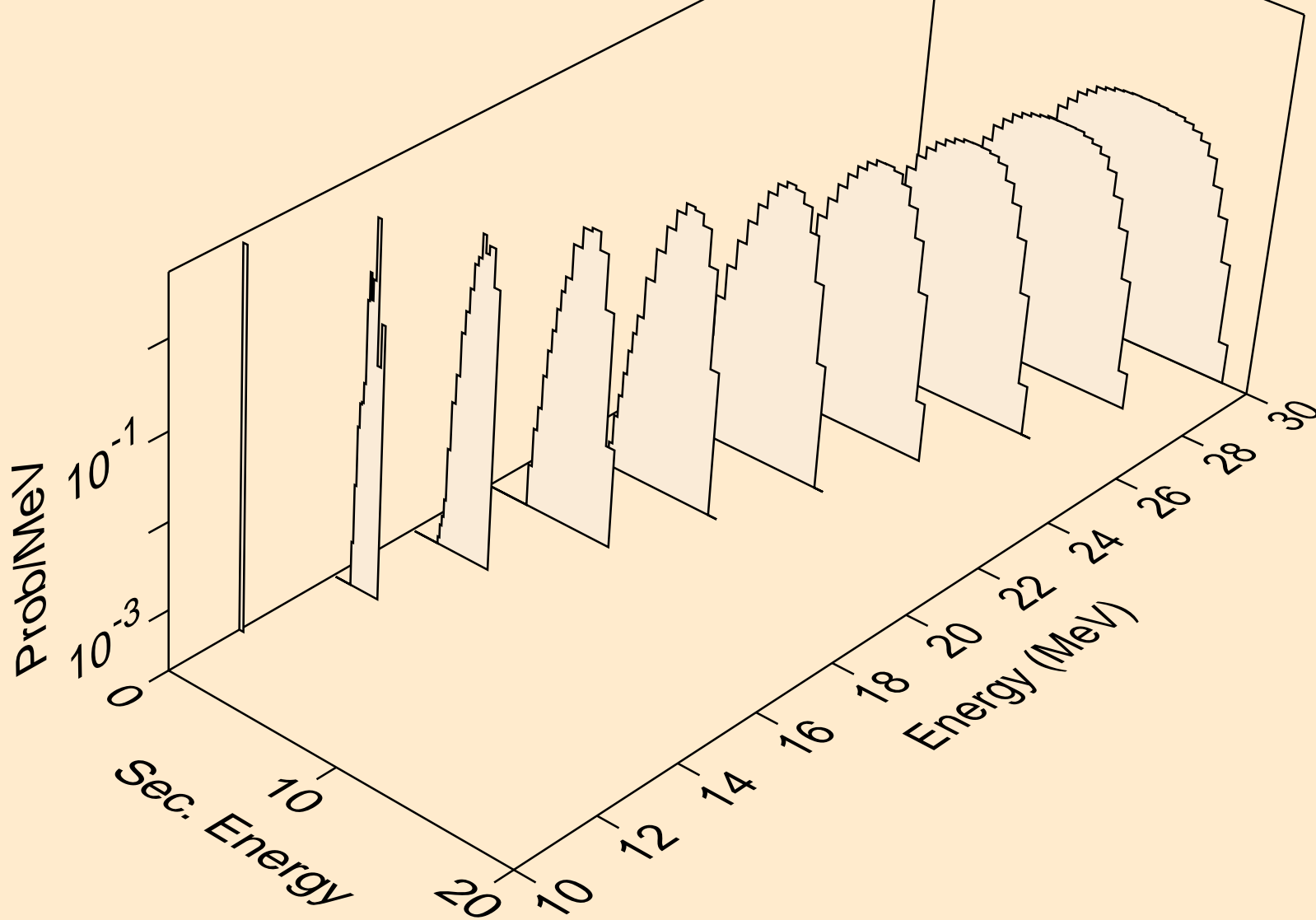

PR146 NEUTRON ACER TENDL-2019 LIBRARY; T=293.16K  
protons from (n,3np)

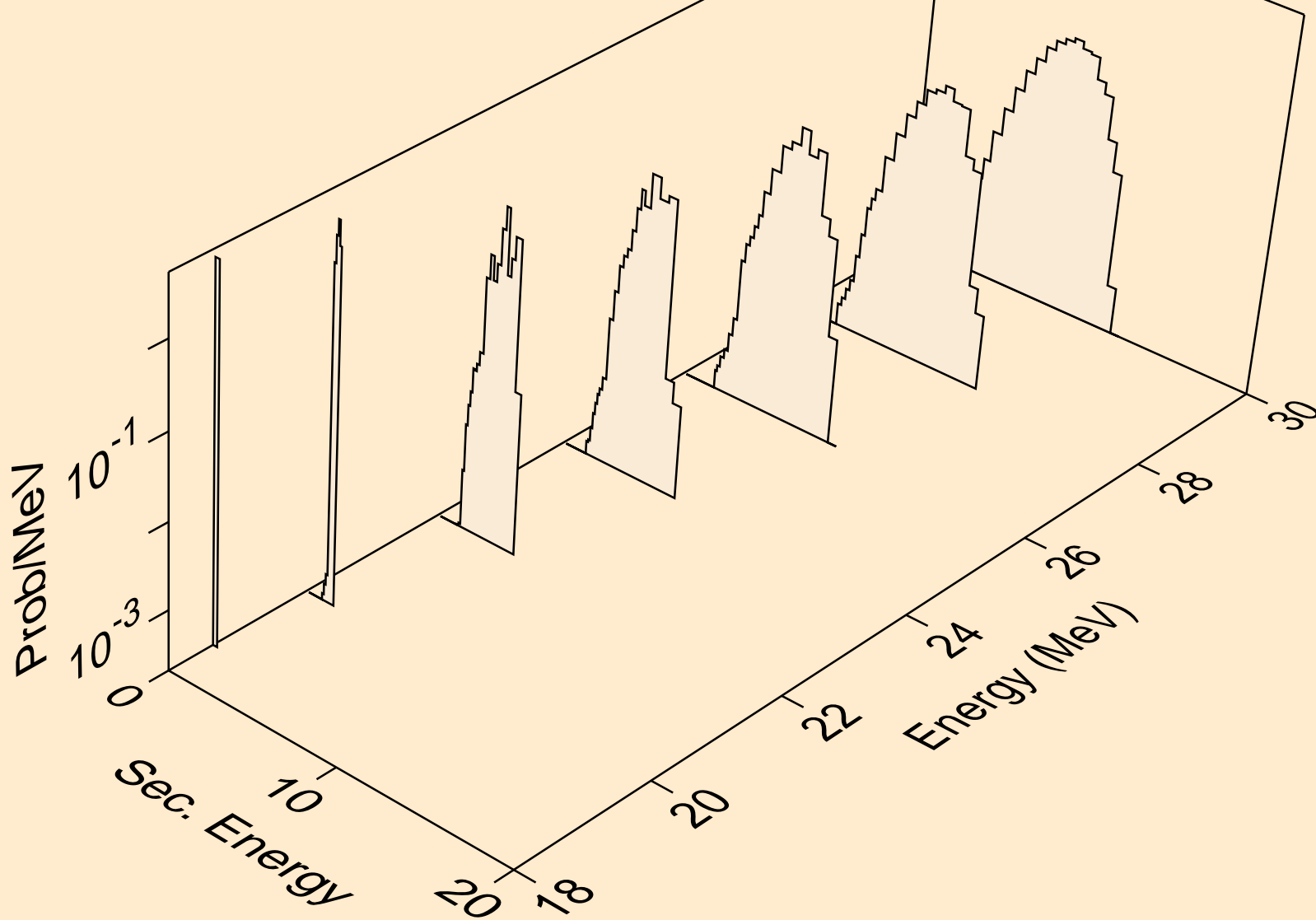

PR146 NEUTRON ACER TENDL-2019 LIBRARY; T=293.16K  
protons from (n,2np)

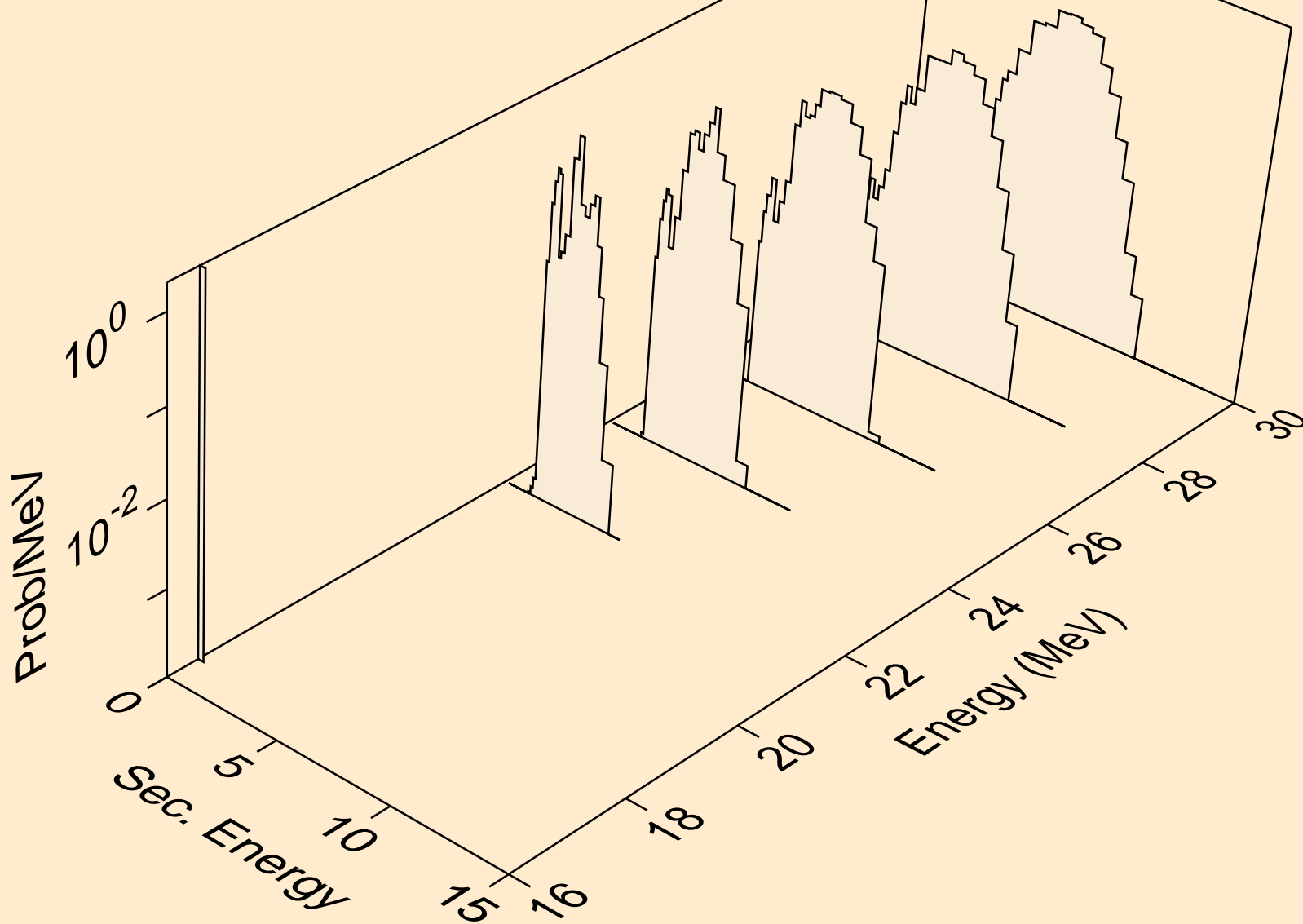

PR146 NEUTRON ACER TENDL-2019 LIBRARY; T=293.16K  
protons from (n,npa)

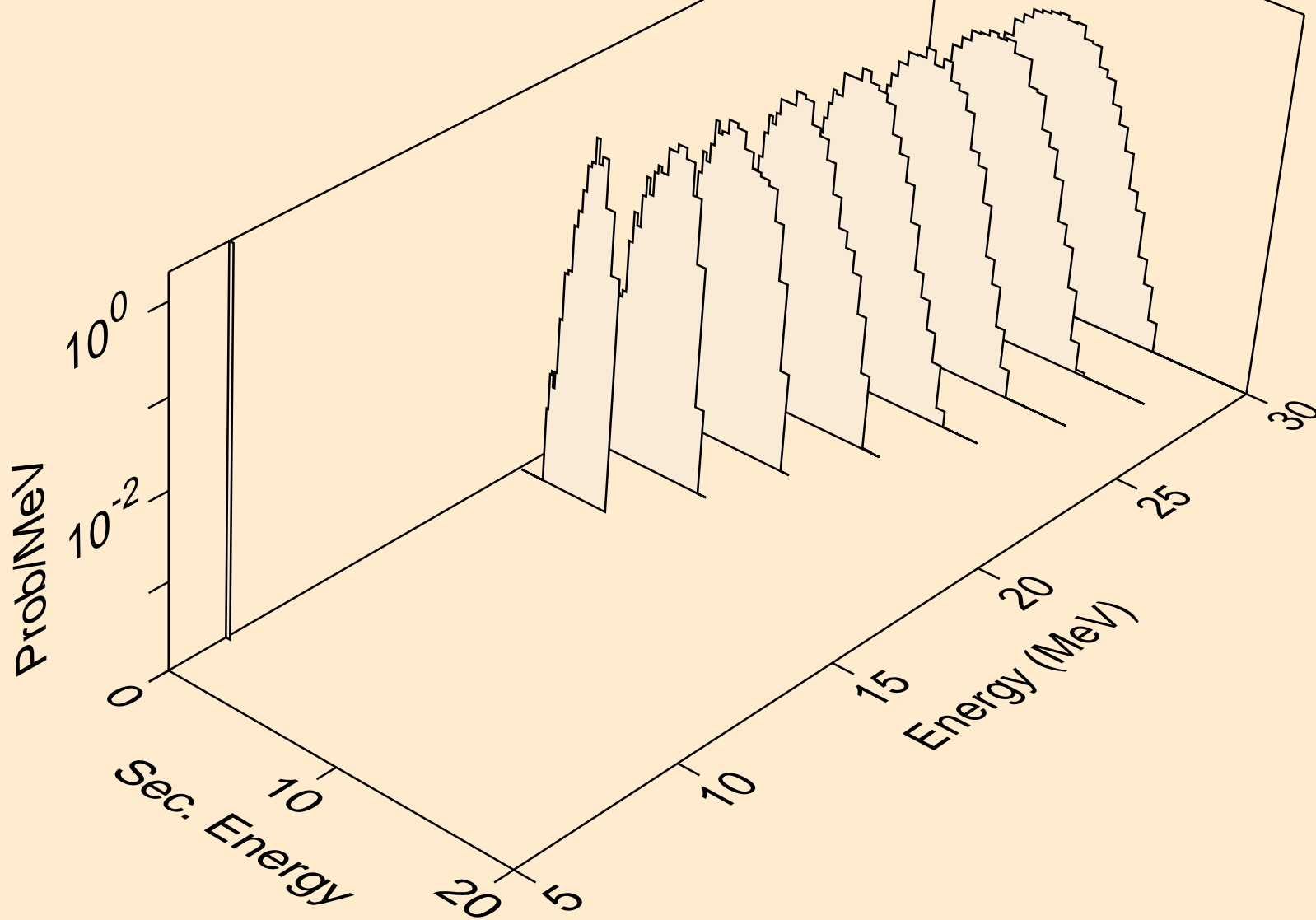



PR146 NEUTRON ACER TENDL-2019 LIBRARY; T=293.16K  
protons from (n,p)

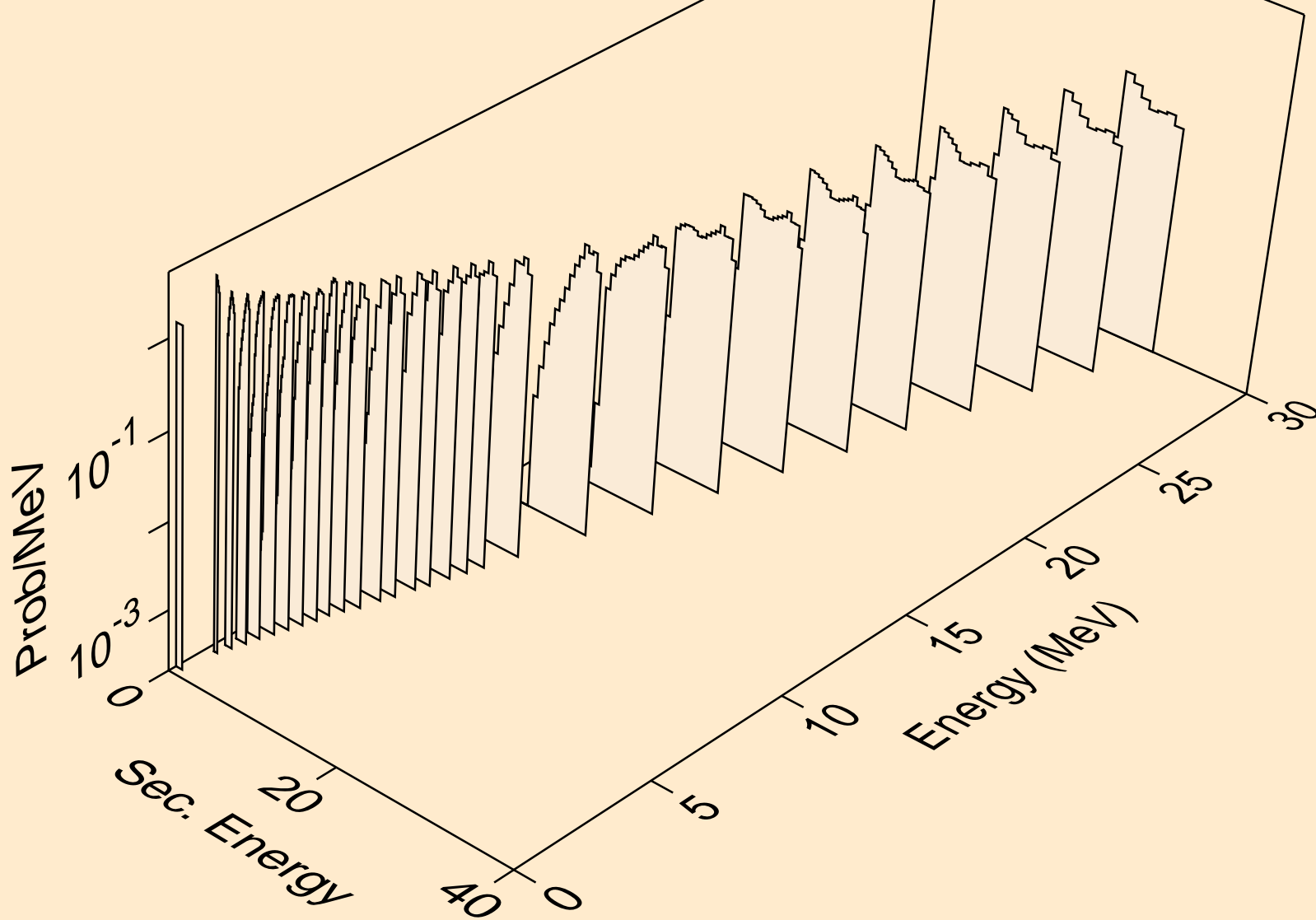

PR146 NEUTRON ACER TENDL-2019 LIBRARY; T=293.16K  
protons from (n,2p)

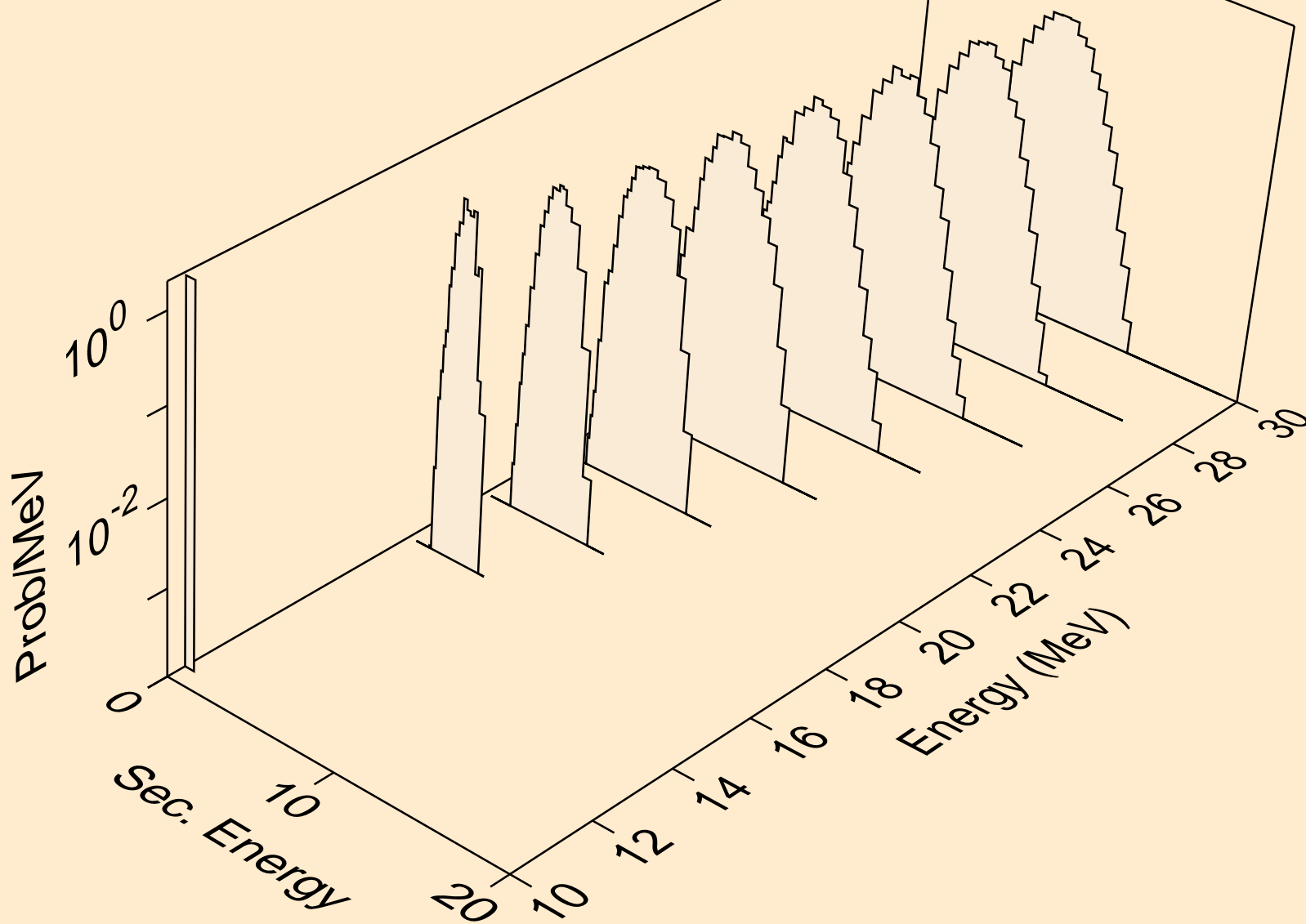

PR146 NEUTRON ACER TENDL-2019 LIBRARY; T=293.16K  
protons from (n,p)

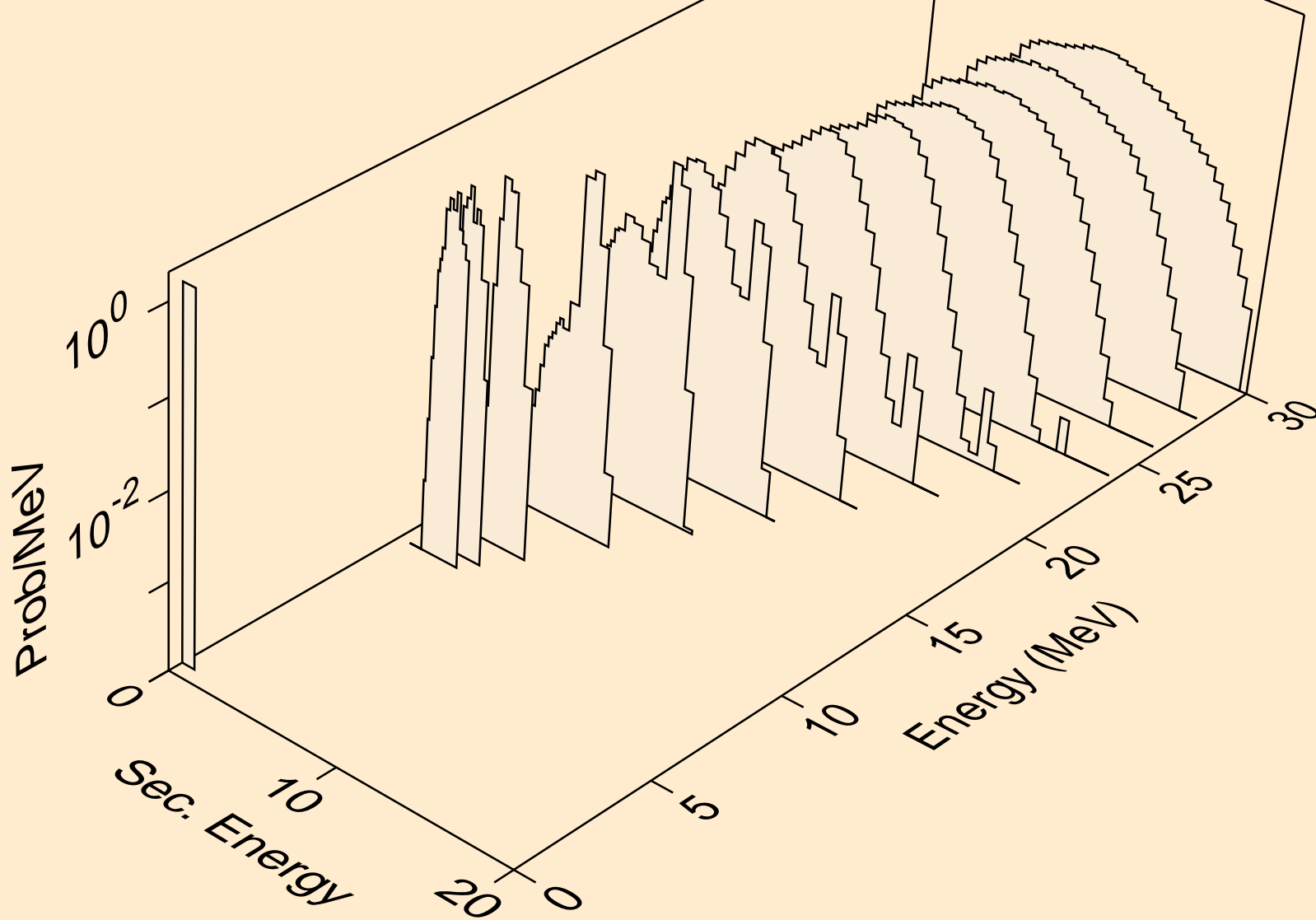

PR146 NEUTRON ACER TENDL-2019 LIBRARY; T=293.16K  
deuterons from (n,x)

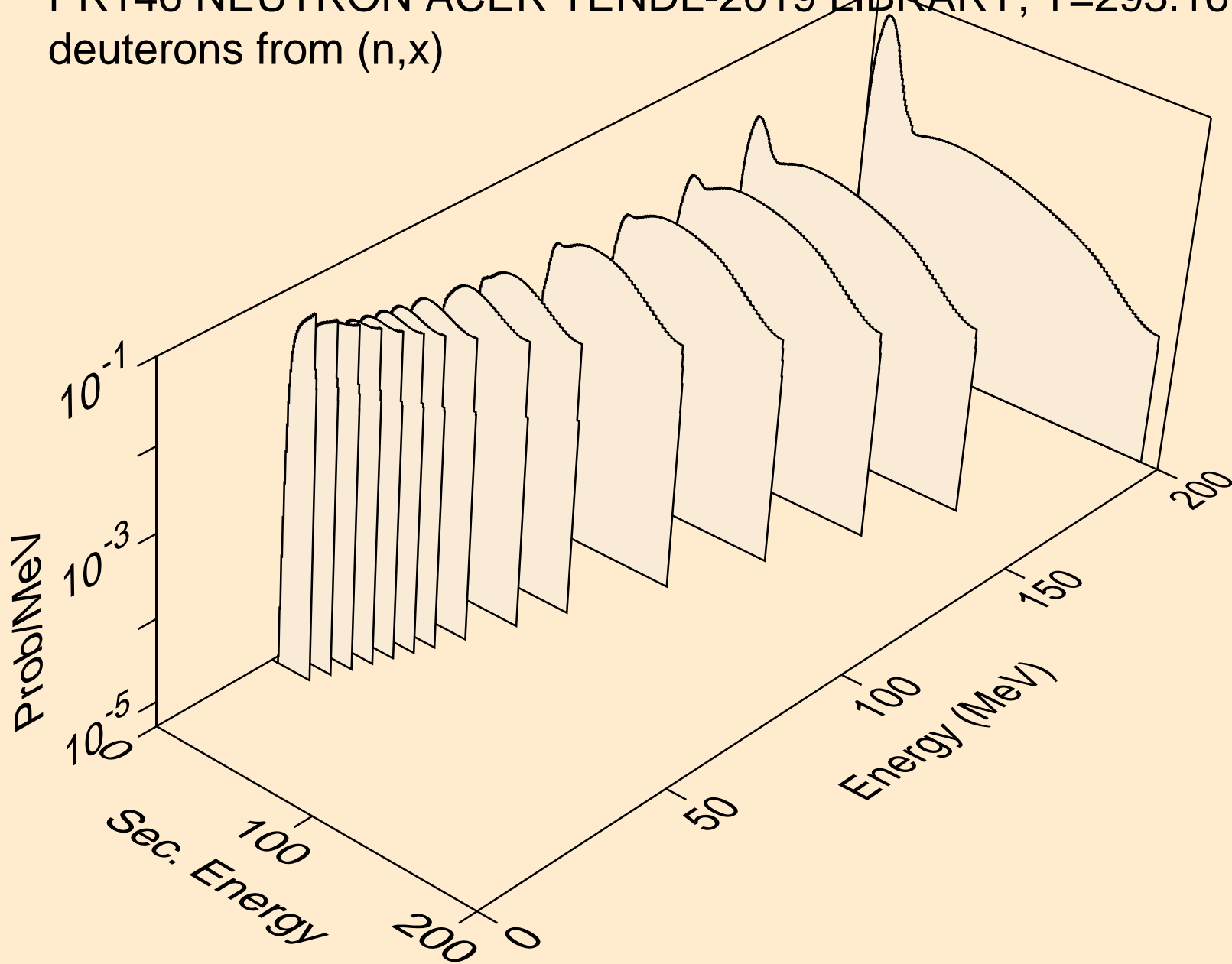

PR146 NEUTRON ACER TENDL-2019 LIBRARY; T=293.16K  
deuterons from (n,2nd)

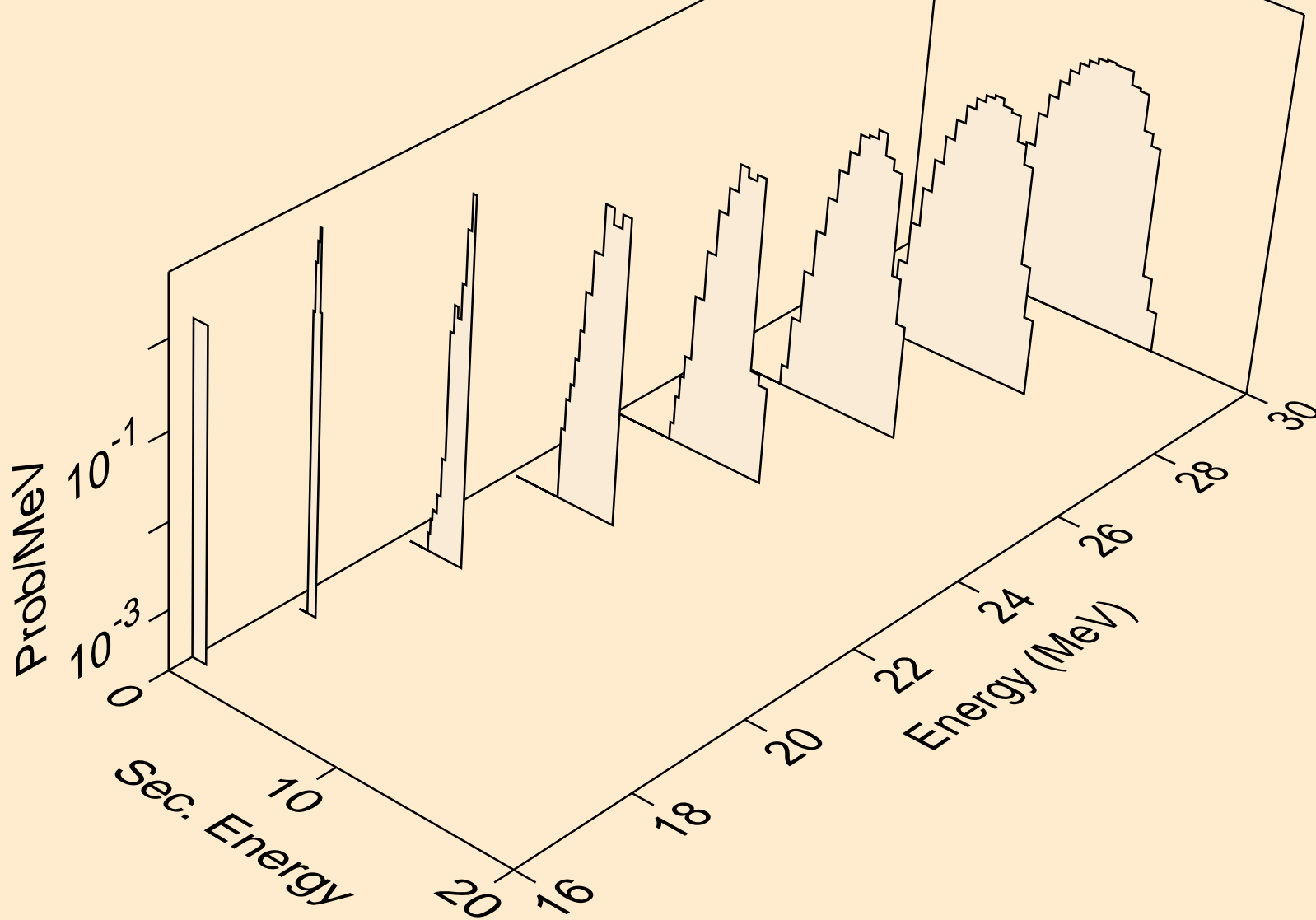

PR146 NEUTRON ACER TENDL-2019 LIBRARY; T=293.16K  
deuterons from (n,n\*)d

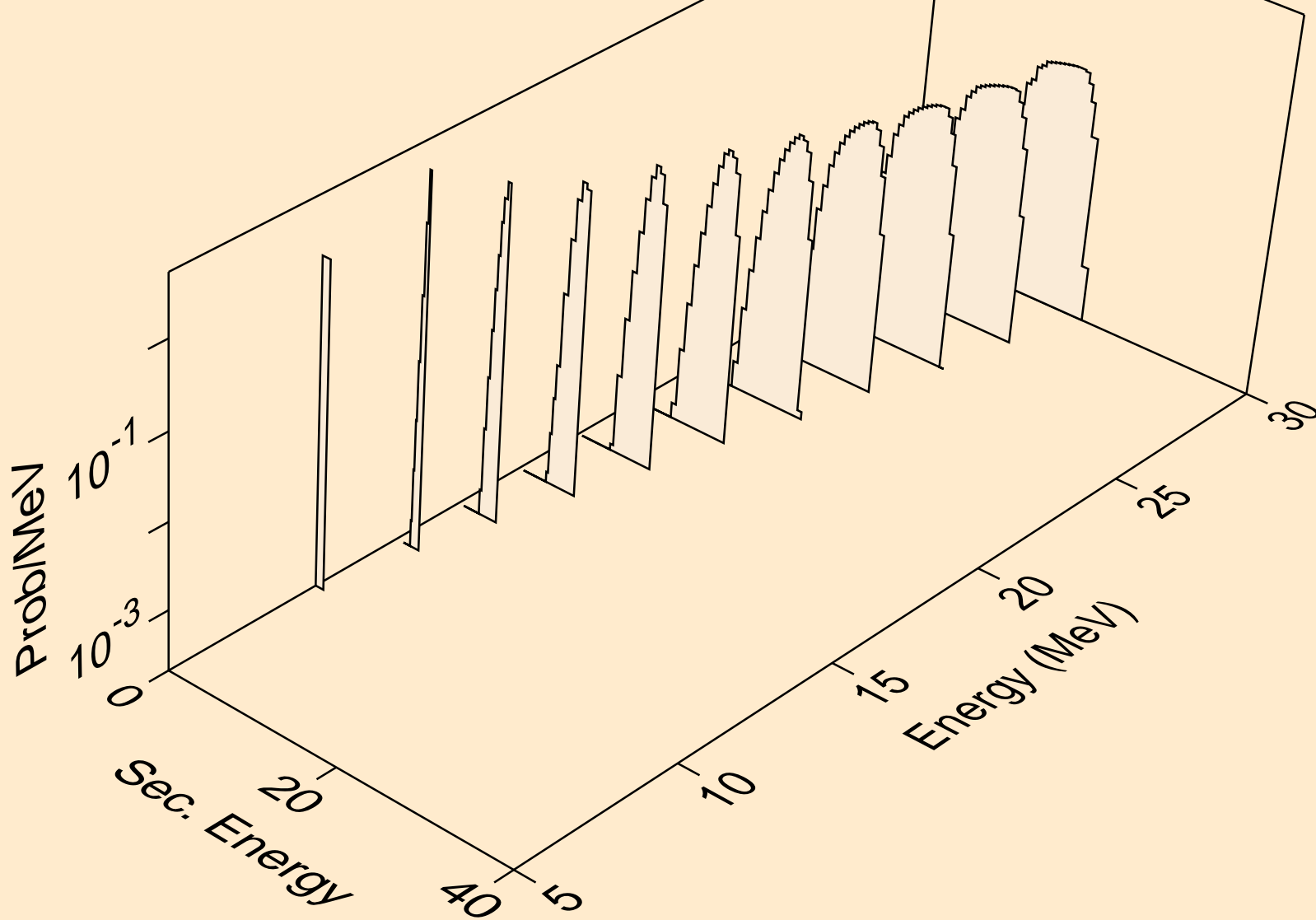

PR146 NEUTRON ACER TENDL-2019 LIBRARY; T=293.16K  
deuterons from (n,d)

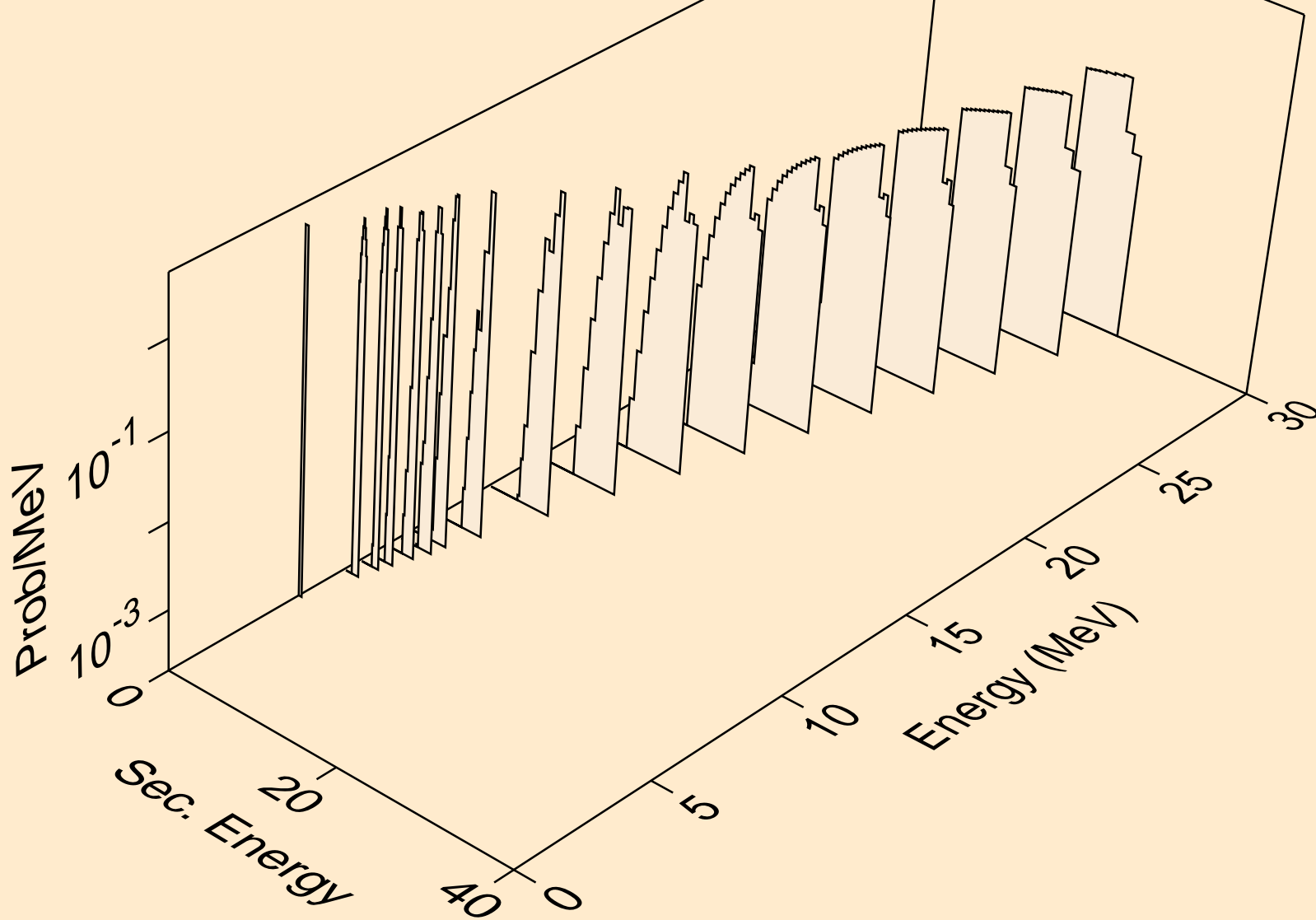

PR146 NEUTRON ACER TENDL-2019 LIBRARY; T=293.16K  
deuterons from (n,da)

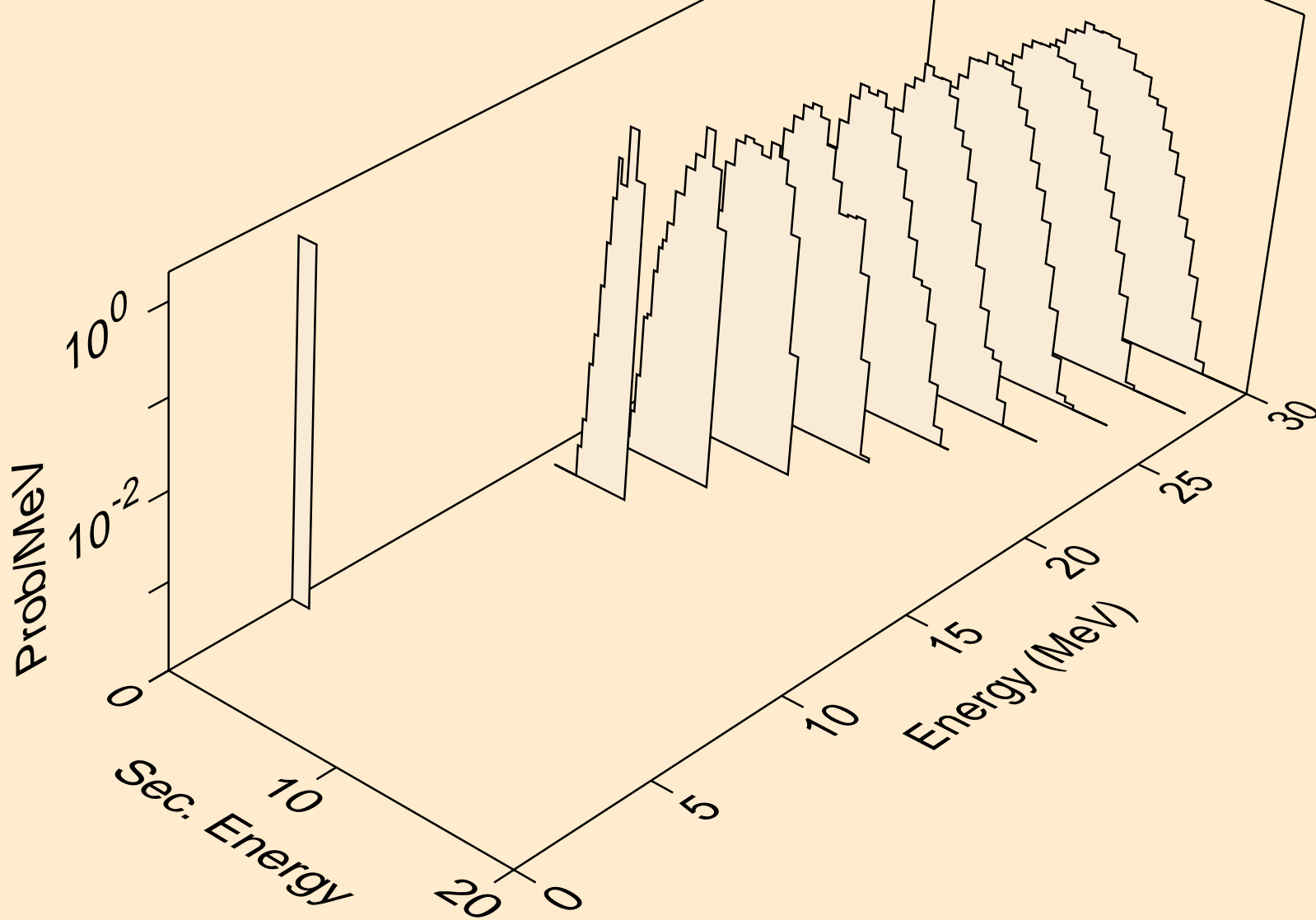



PR146 NEUTRON ACER TENDL-2019 LIBRARY; T=293.16K  
tritons from (n,x)

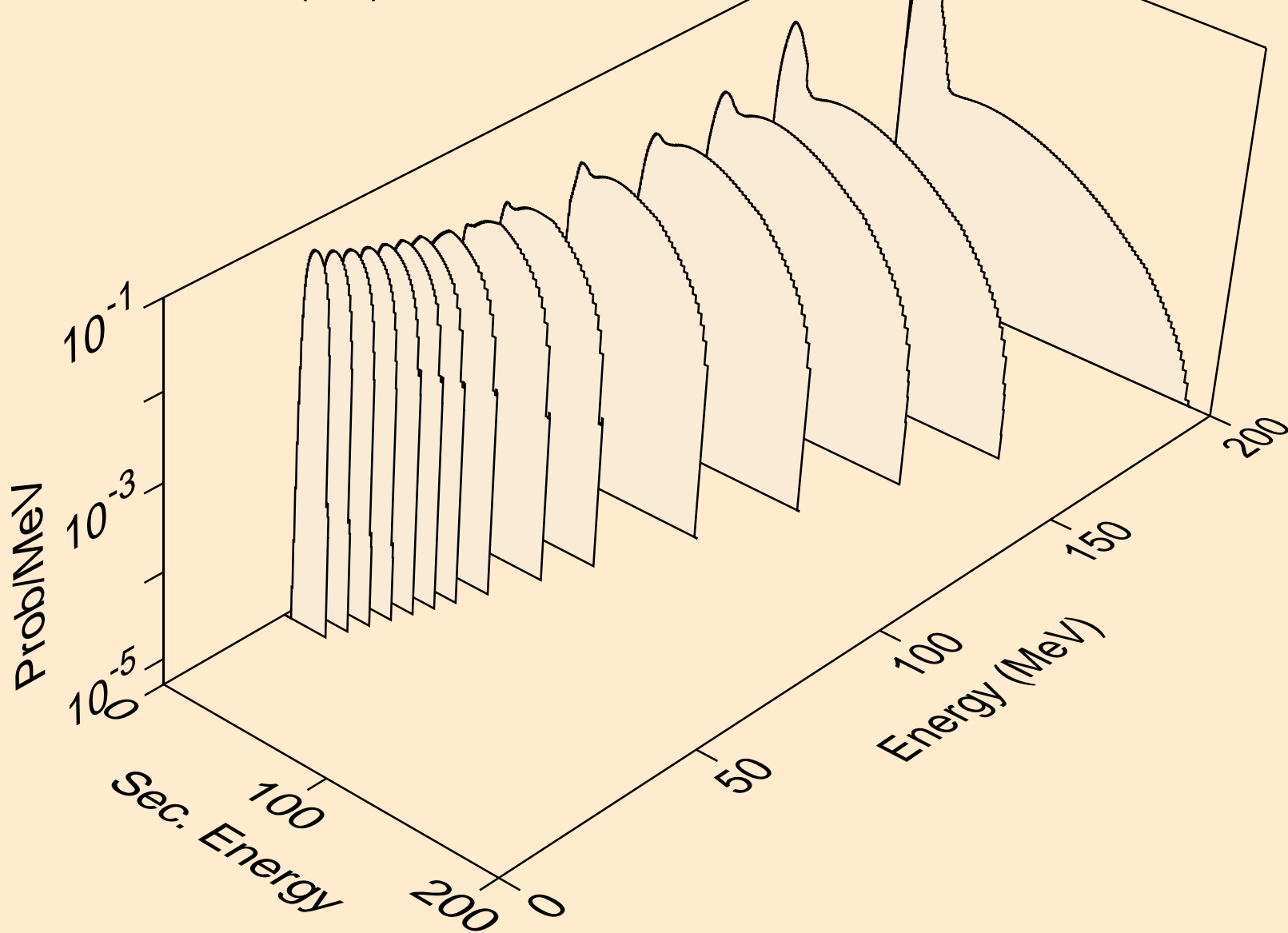

PR146 NEUTRON ACER TENDL-2019 LIBRARY; T=293.16K  
tritons from (n,n\*)t

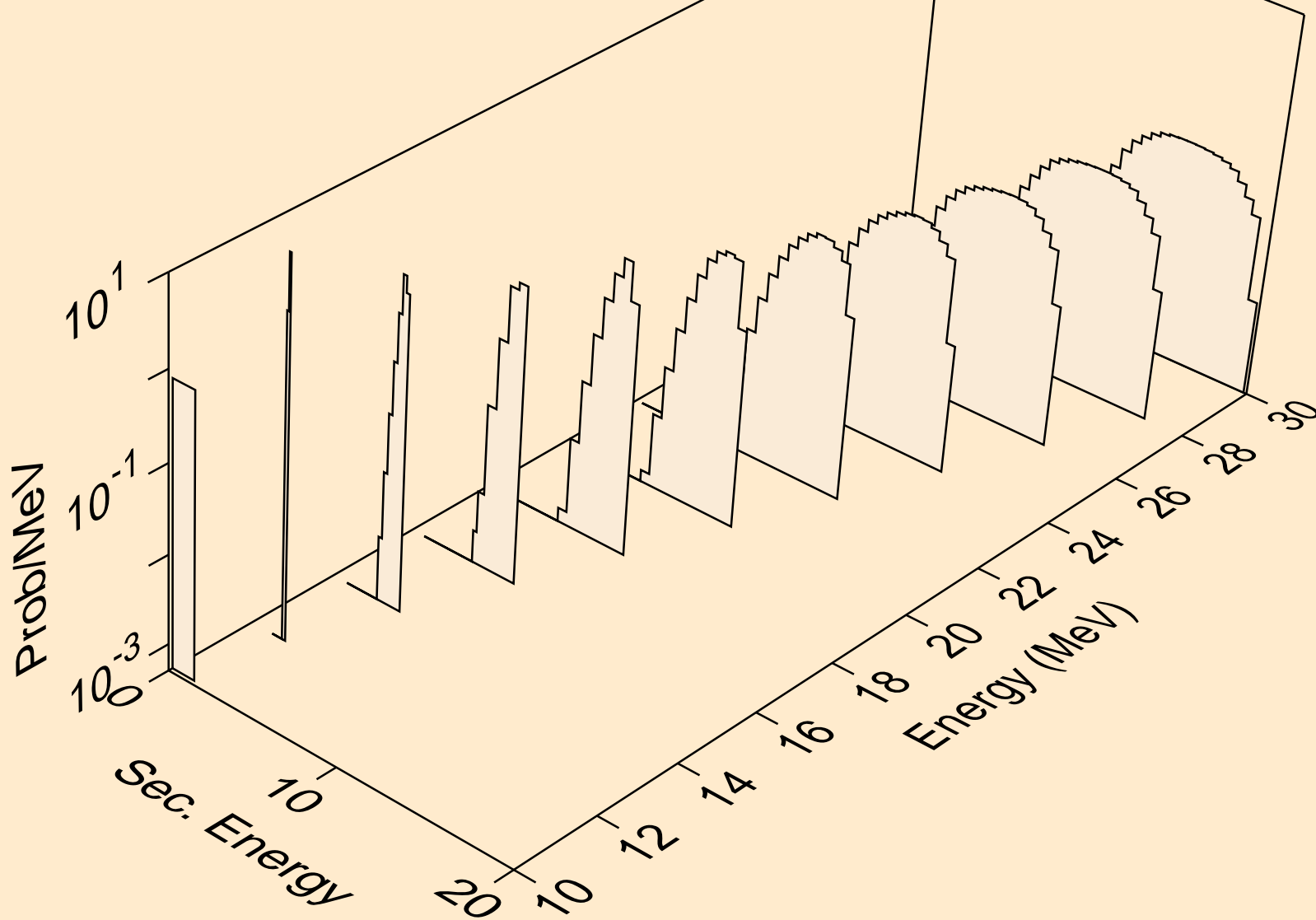

PR146 NEUTRON ACER TENDL-2019 LIBRARY; T=293.16K  
tritons from (n,t)

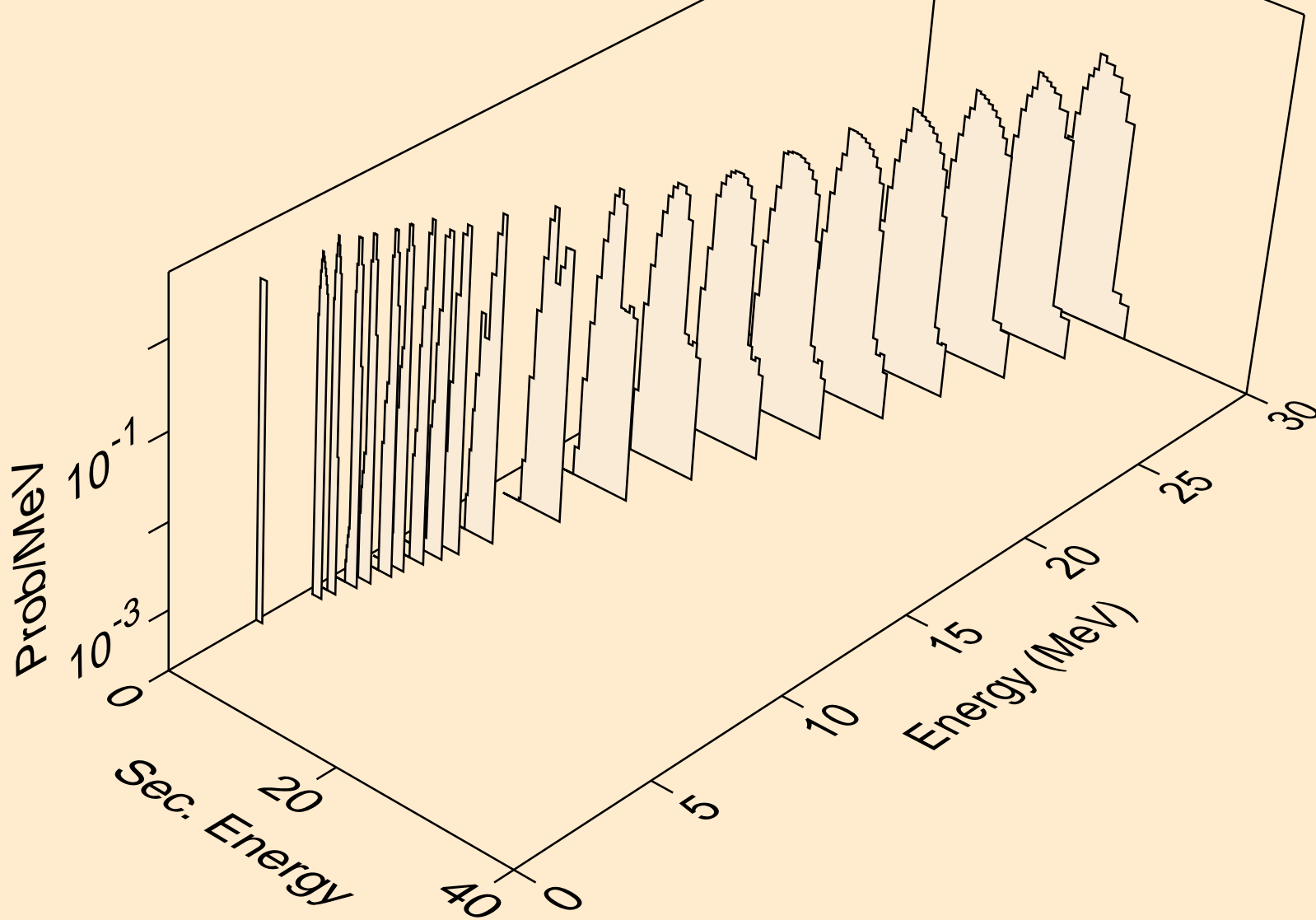

PR146 NEUTRON ACER TENDL-2019 LIBRARY; T=293.16K  
he3s from (n,x)

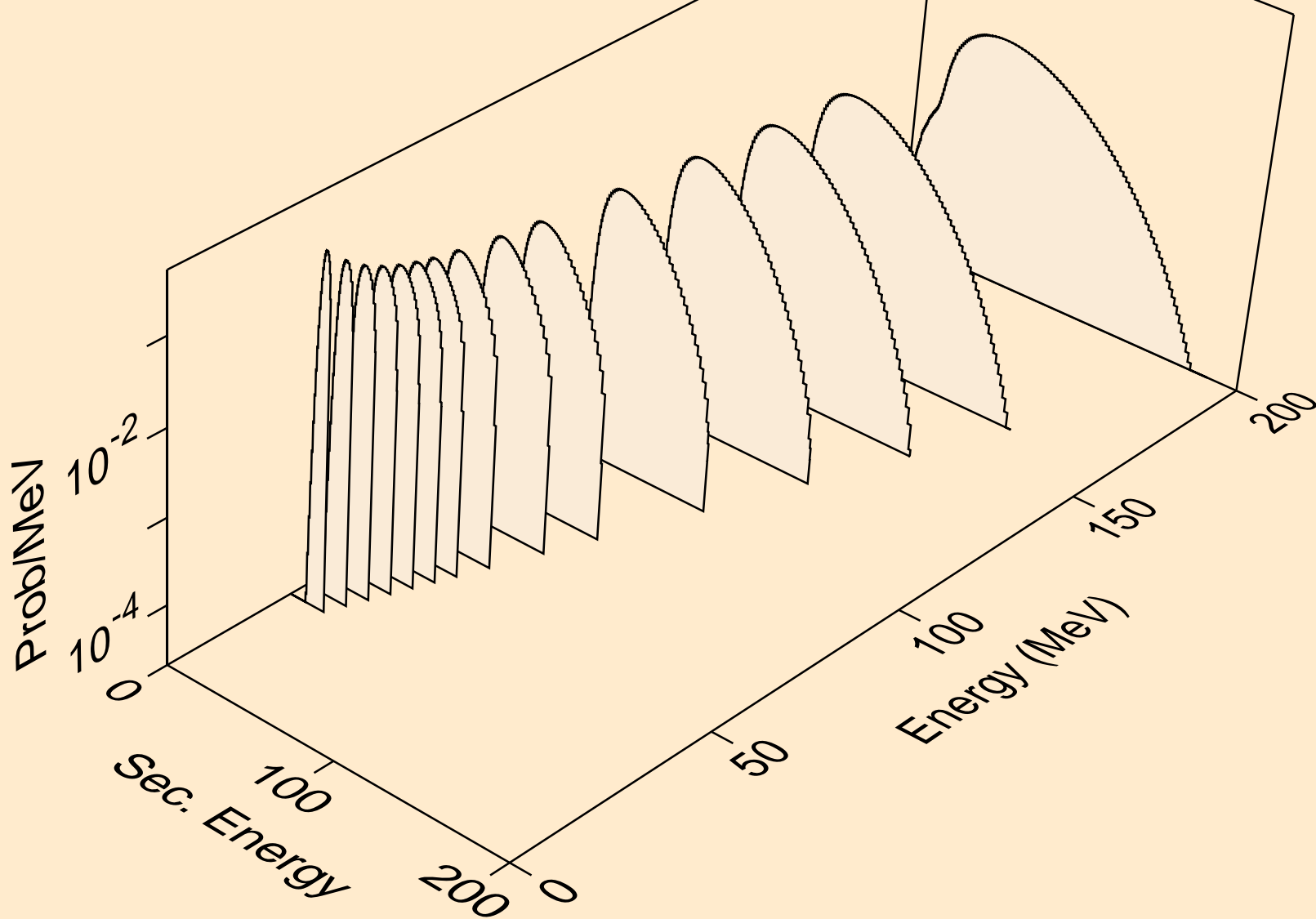

PR146 NEUTRON ACER TENDL-2019 LIBRARY; T=293.16K  
he3s from (n,n\*)he3

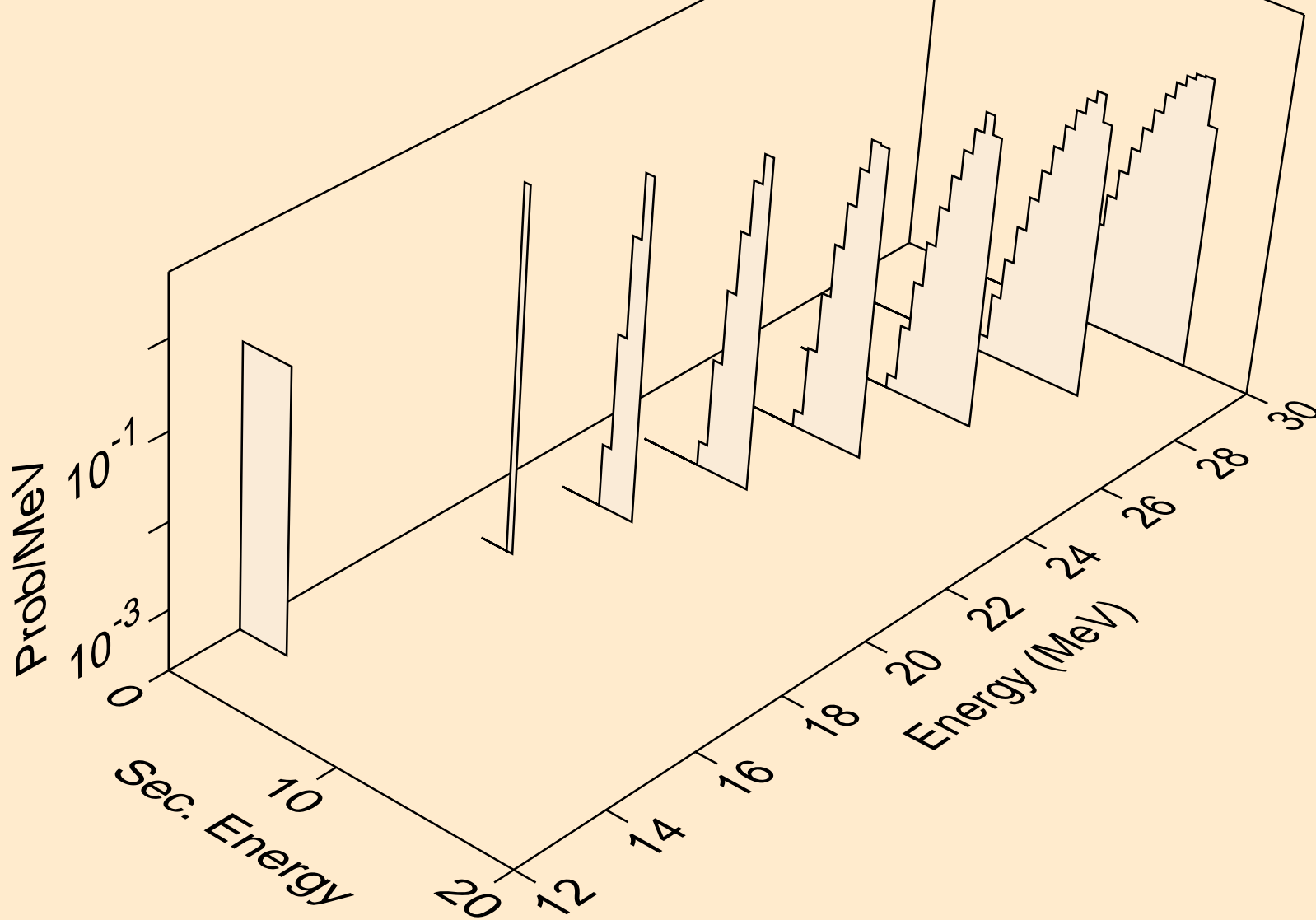

PR146 NEUTRON ACER TENDL-2019 LIBRARY; T=293.16K  
he3s from (n,he3)

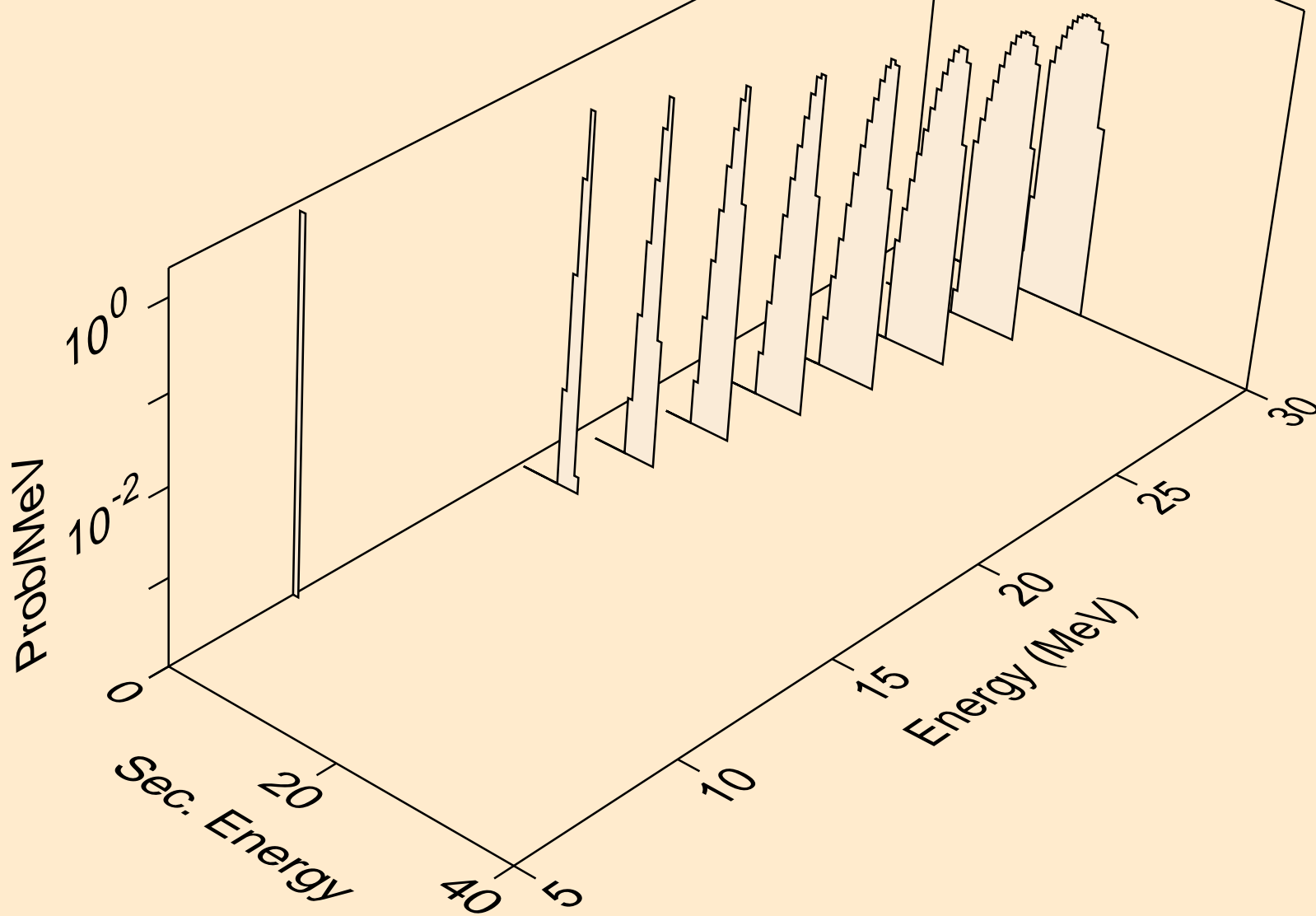

PR146 NEUTRON ACER TENDL-2019 LIBRARY; T=293.16K  
alphas from (n,x)

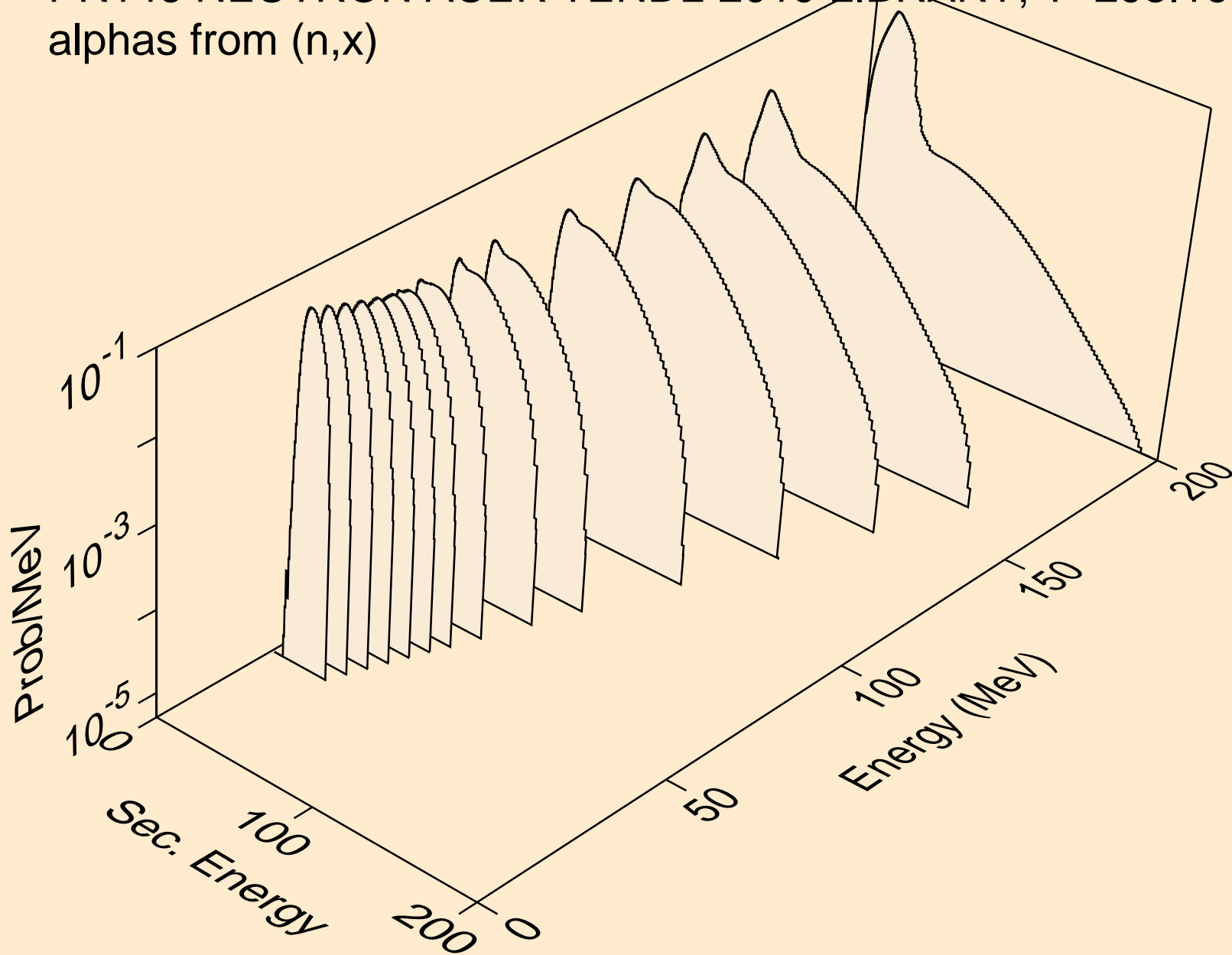

PR146 NEUTRON ACER TENDL-2019 LIBRARY; T=293.16K  
alphas from (n,n\*)a

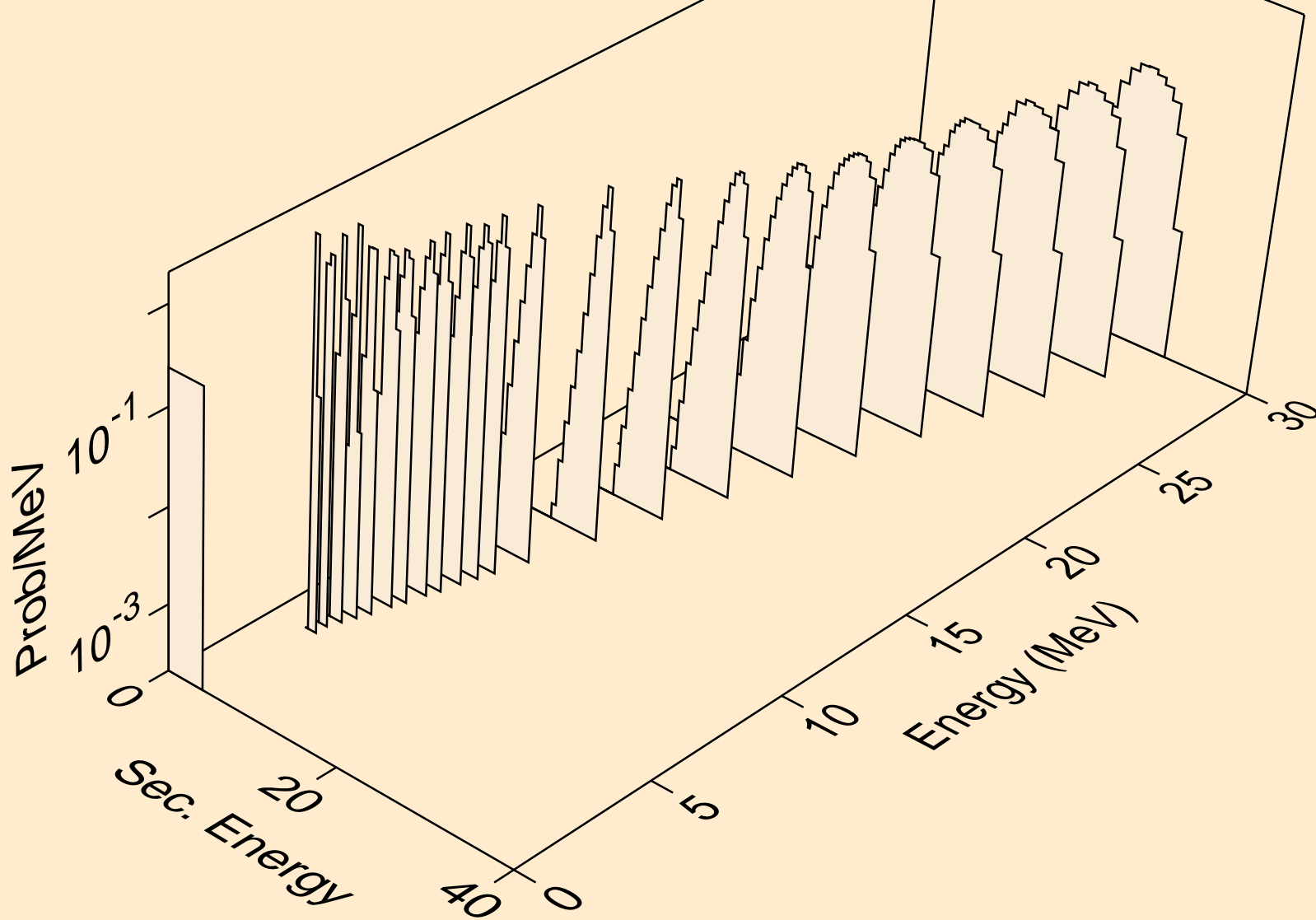



PR146 NEUTRON ACER TENDL-2019 LIBRARY; T=293.16K  
alphas from (n,2n)a

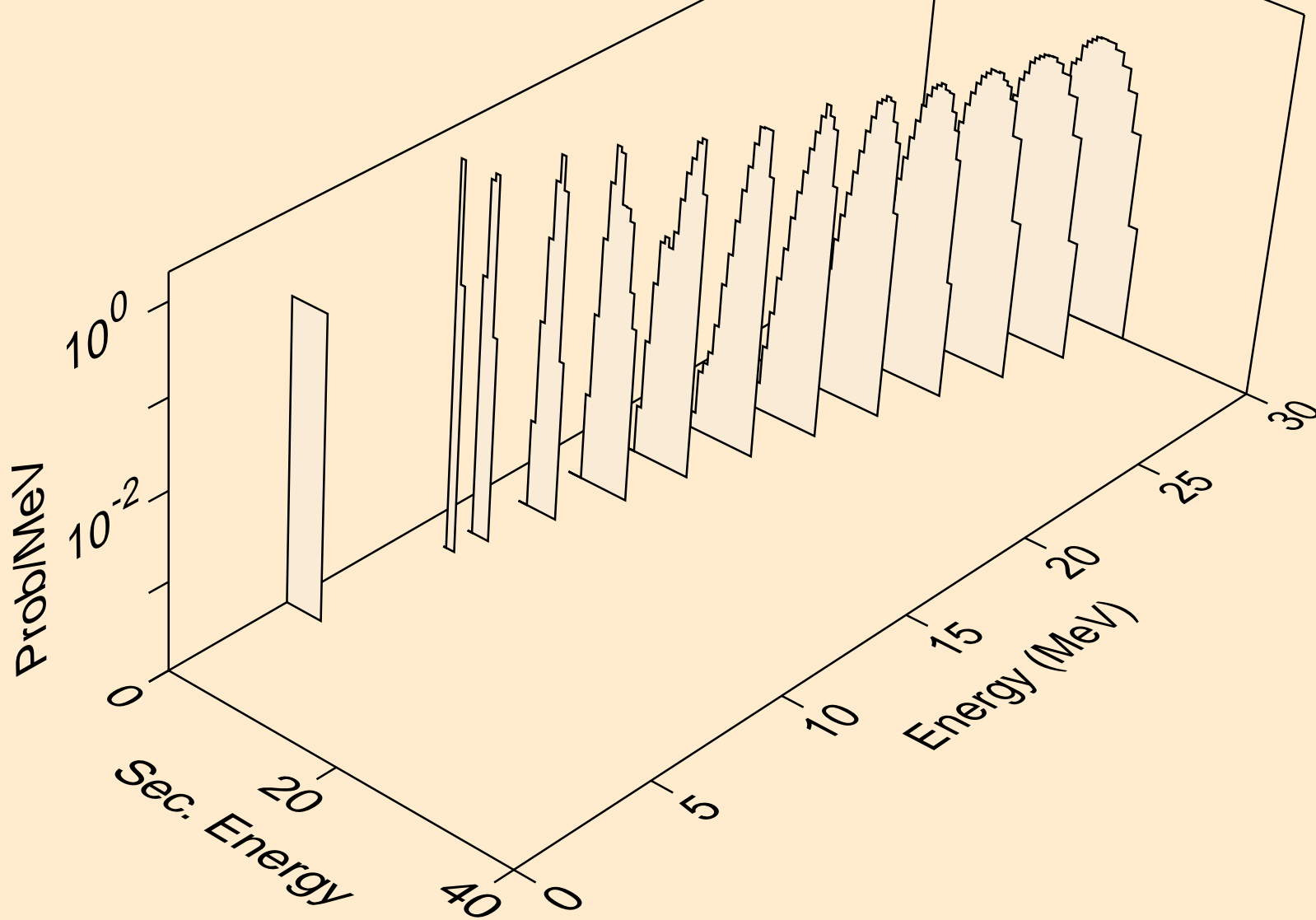

PR146 NEUTRON ACER TENDL-2019 LIBRARY; T=293.16K  
alphas from (n,3n)a

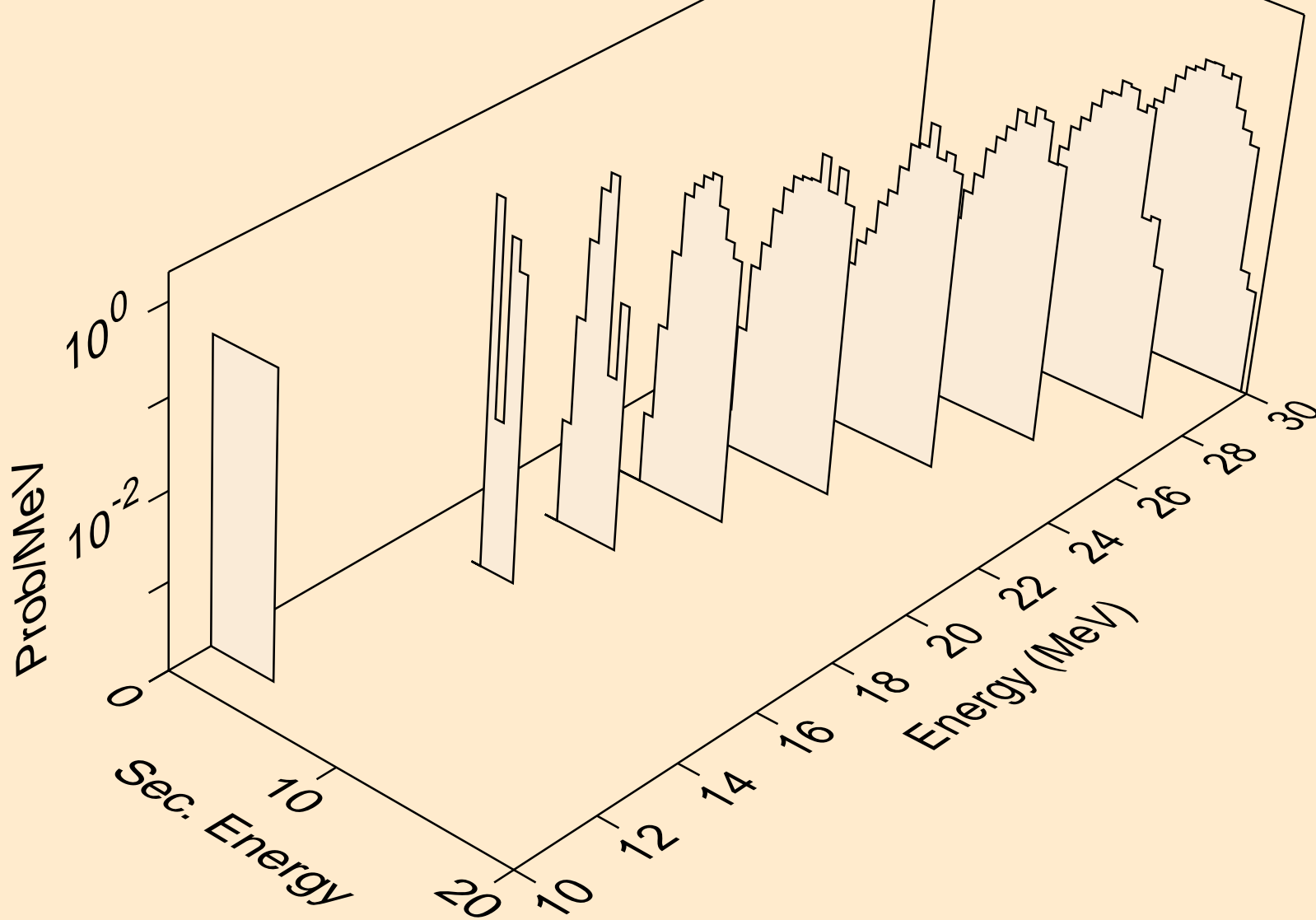

PR146 NEUTRON ACER TENDL-2019 LIBRARY; T=293.16K  
alphas from (n,n\*)2a

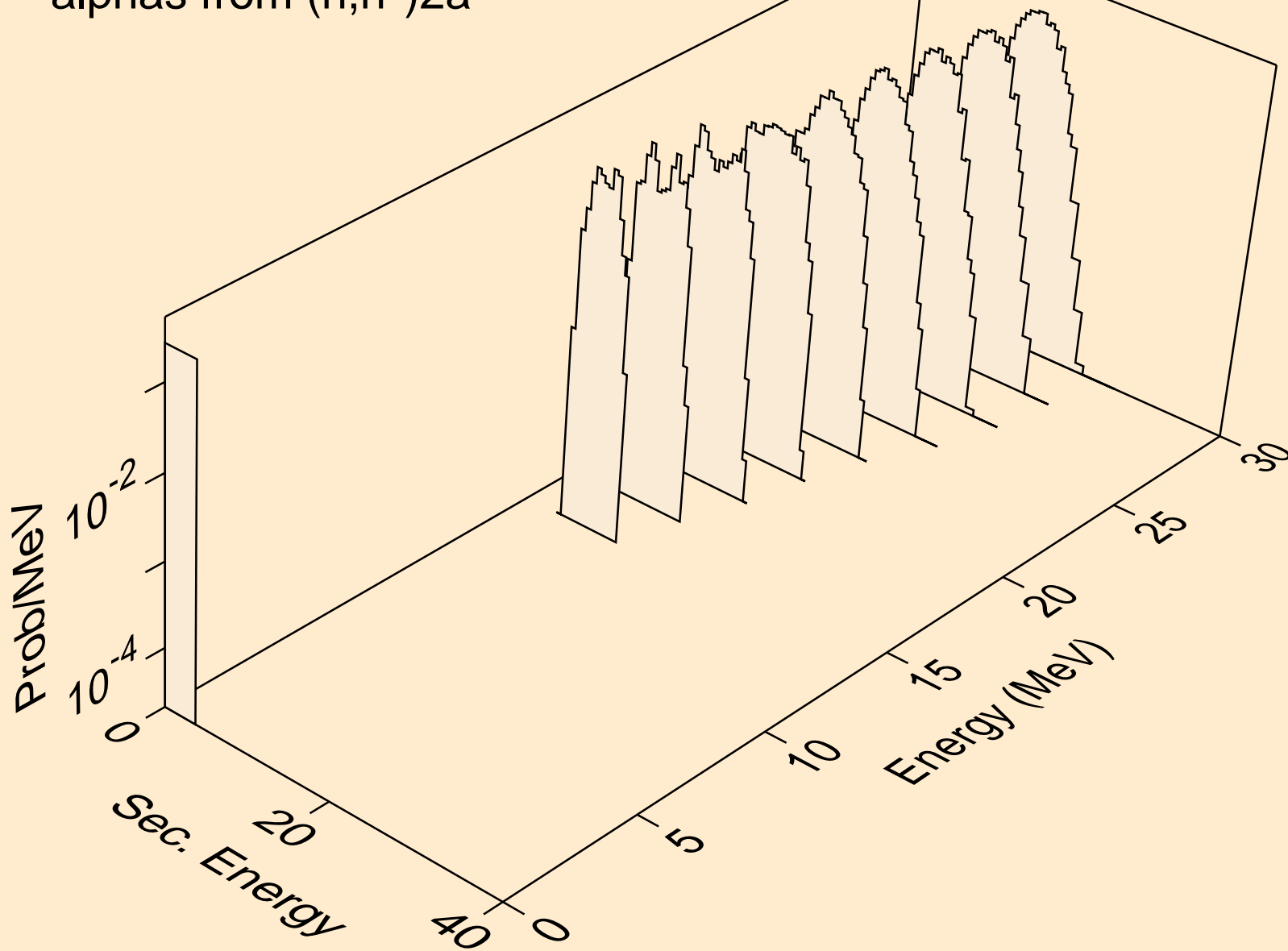

PR146 NEUTRON ACER TENDL-2019 LIBRARY; T=293.16K  
alphas from (n,2n)2a

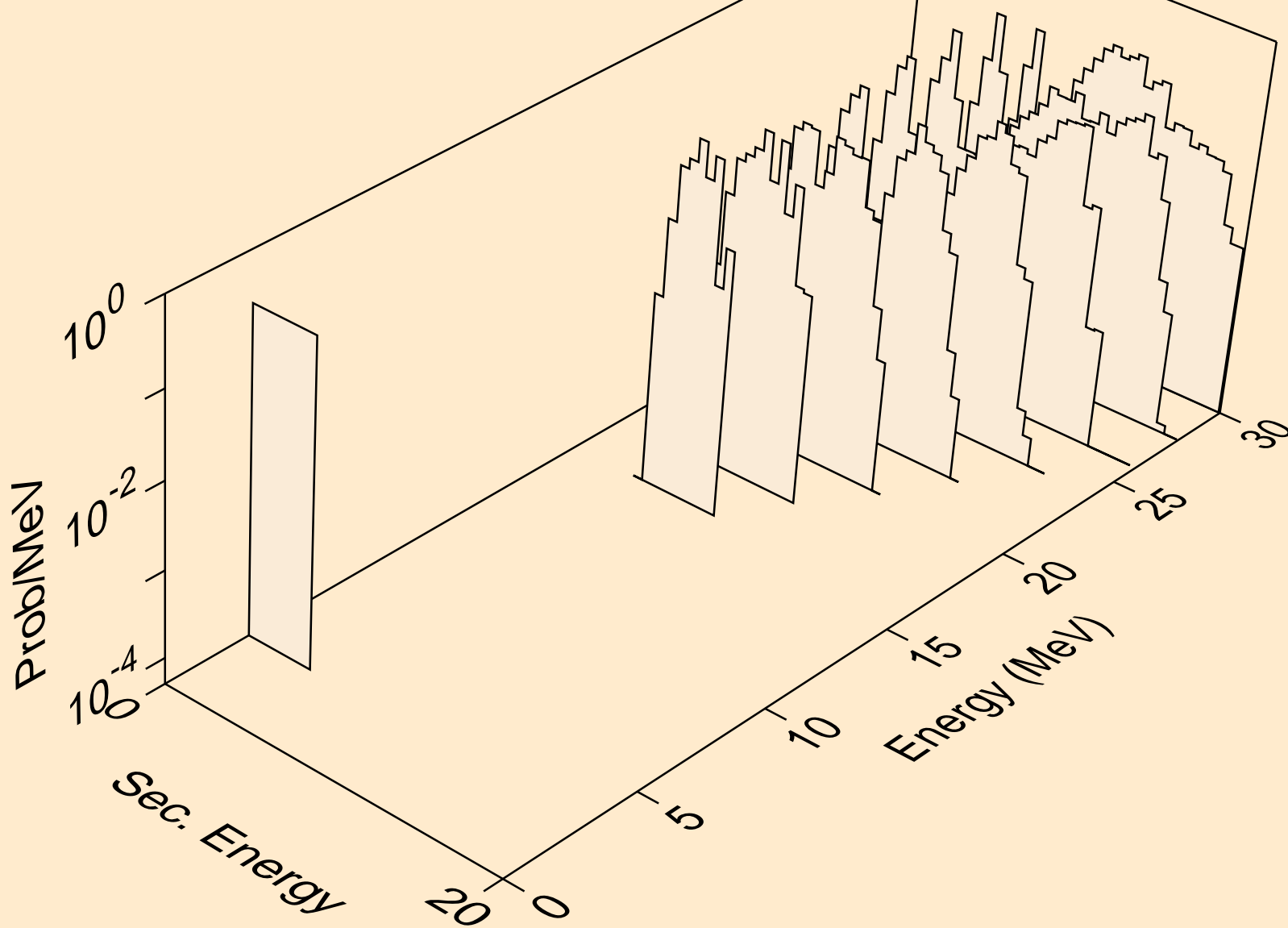

PR146 NEUTRON ACER TENDL-2019 LIBRARY; T=293.16K  
alphas from (n,npa)

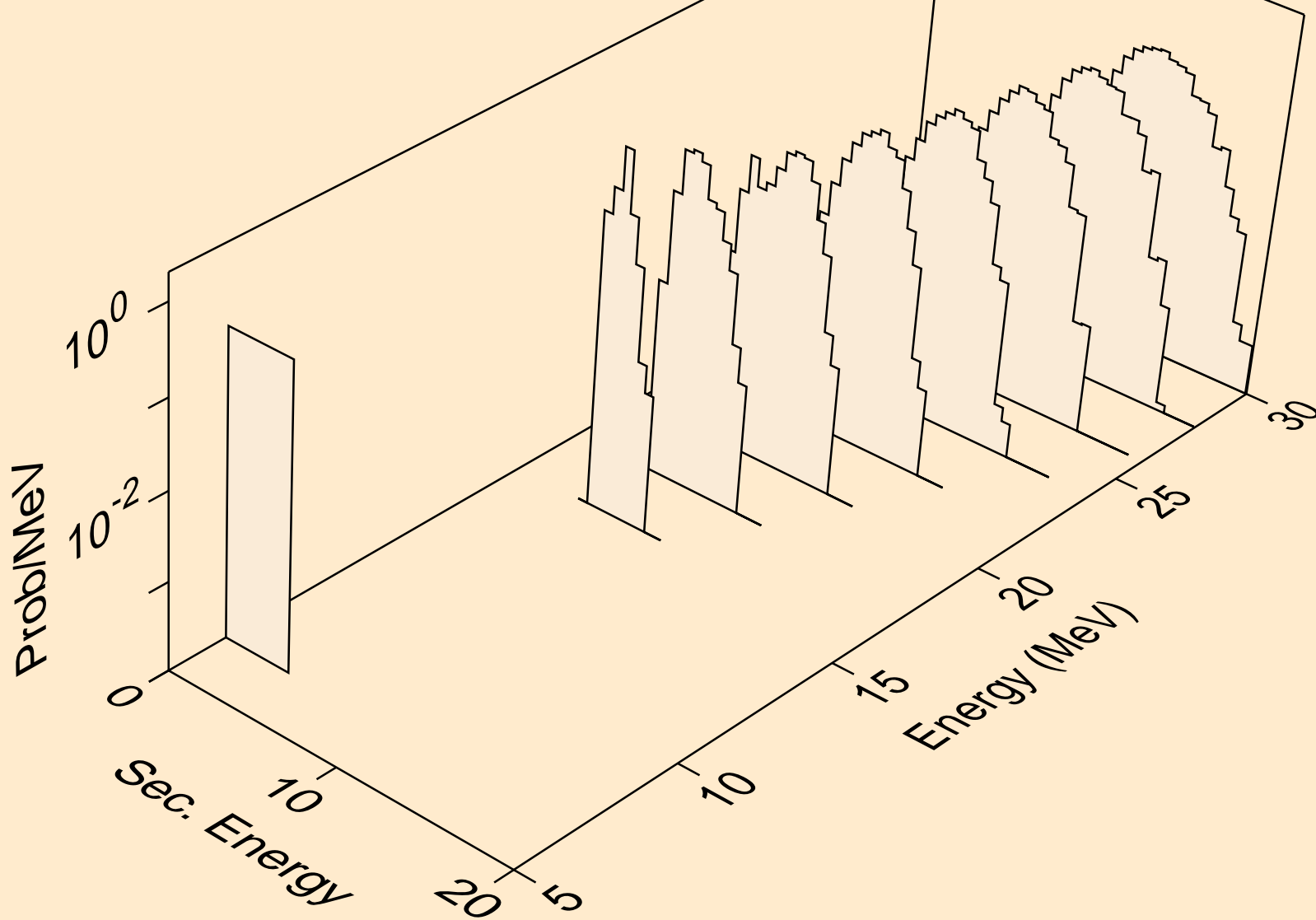

PR146 NEUTRON ACER TENDL-2019 LIBRARY; T=293.16K  
alphas from (n,a)

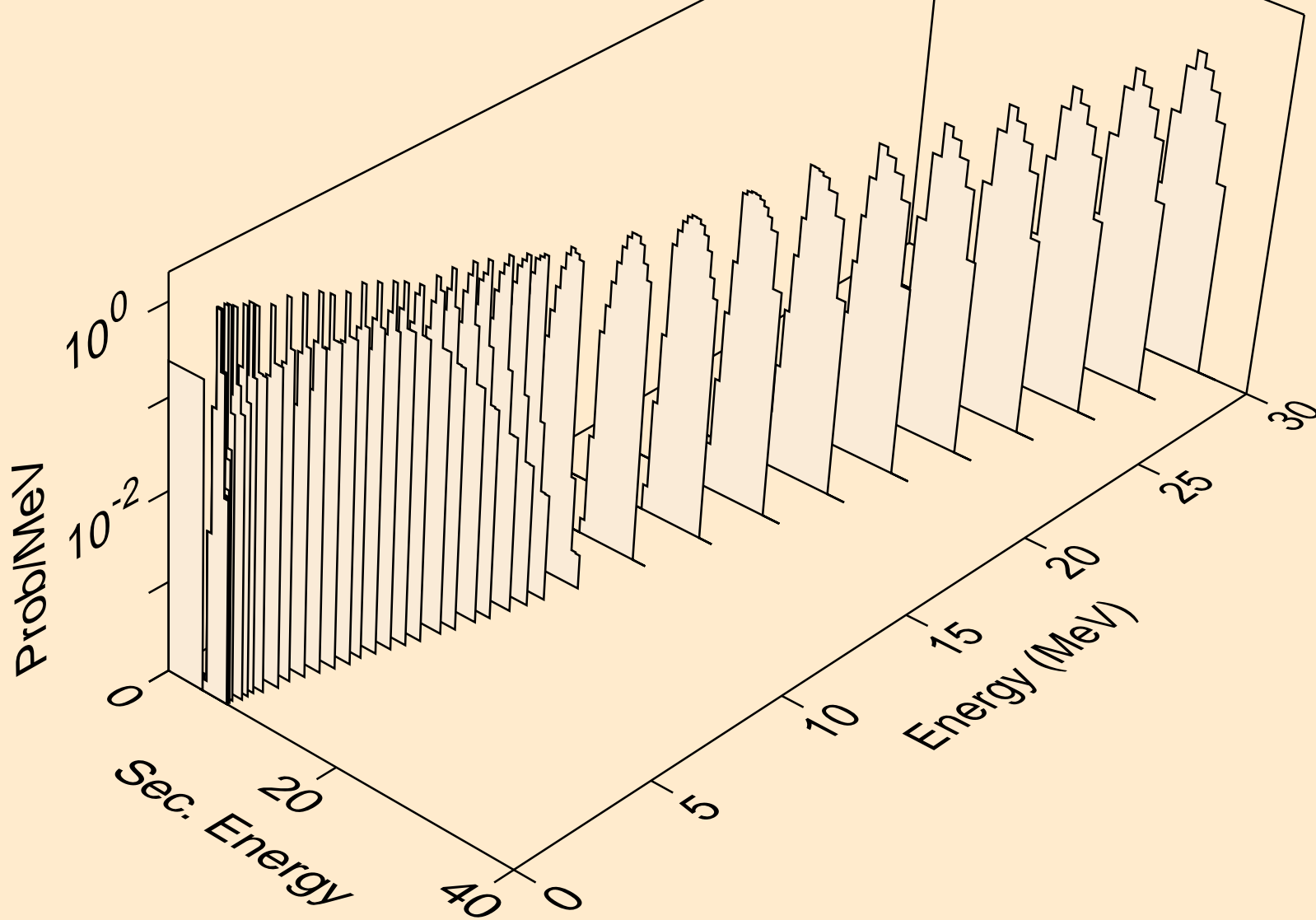

PR146 NEUTRON ACER TENDL-2019 LIBRARY; T=293.16K  
alphas from (n,2a)

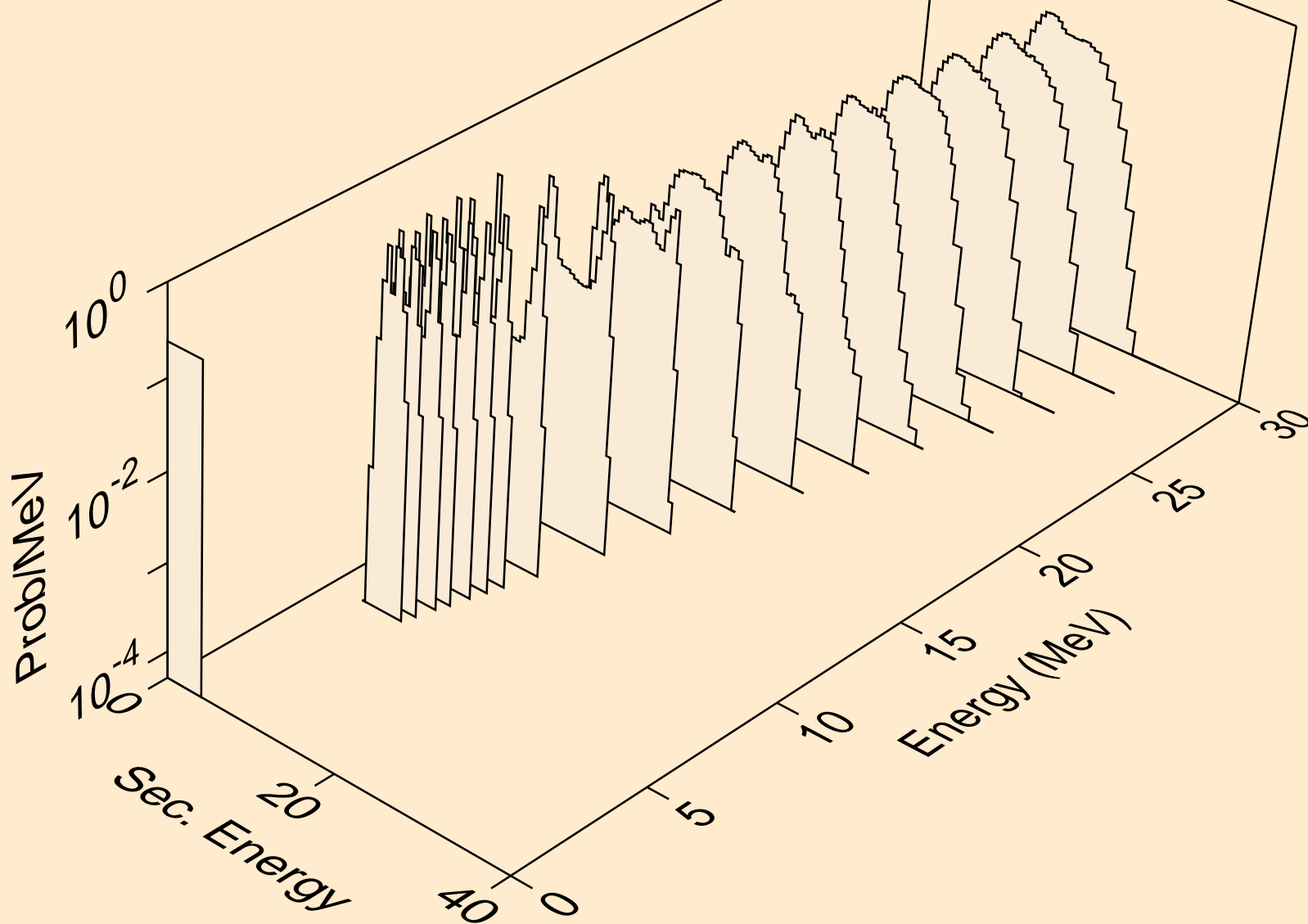

PR146 NEUTRON ACER TENDL-2019 LIBRARY; T=293.16K  
alphas from (n,pa)

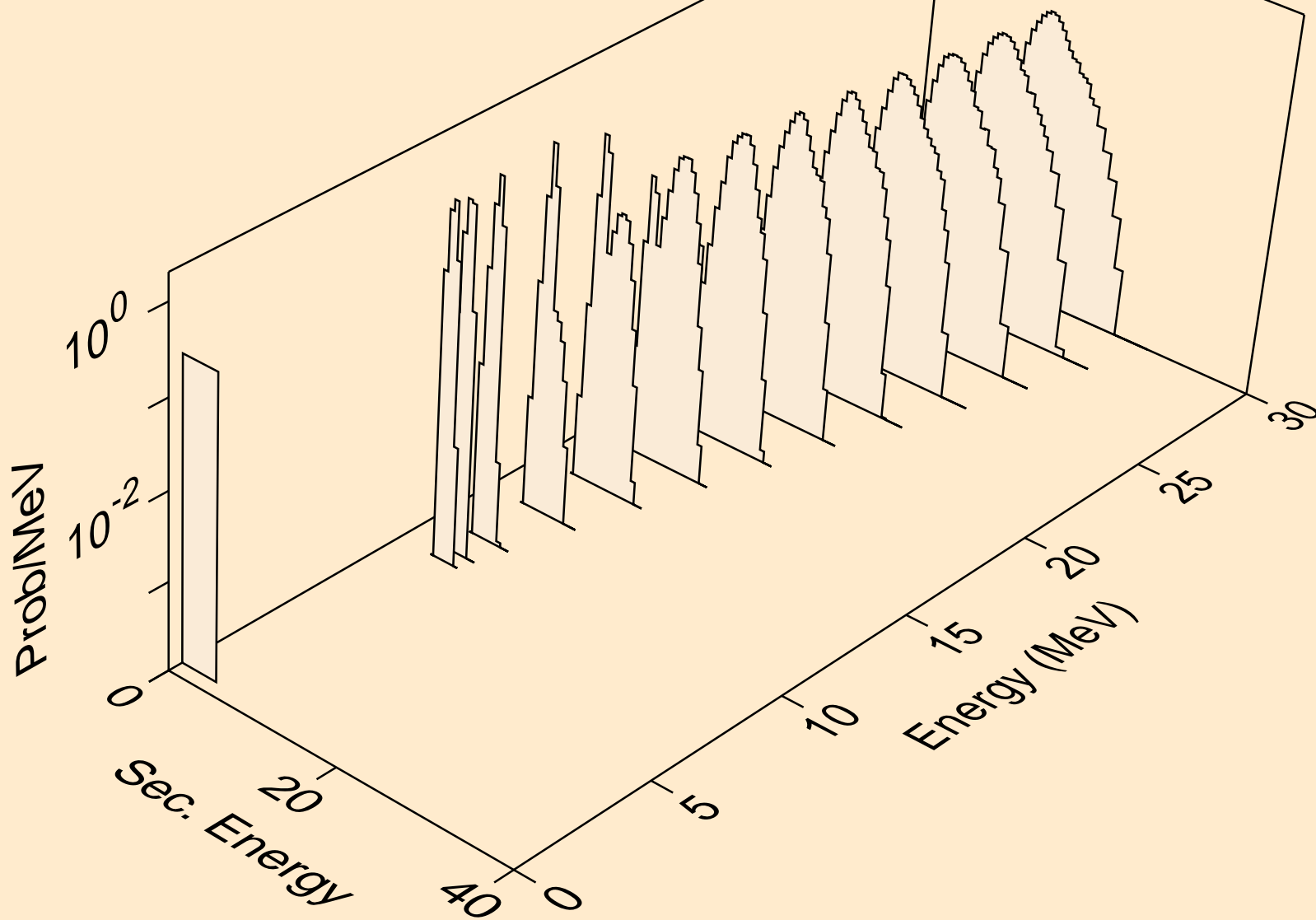



PR146 NEUTRON ACER TENDL-2019 LIBRARY; T=293.16K  
alphas from (n,da)

