

PR155 NEUTRON ACER TENDL-2019 LIBRARY; T=293.16K
Principal cross sections

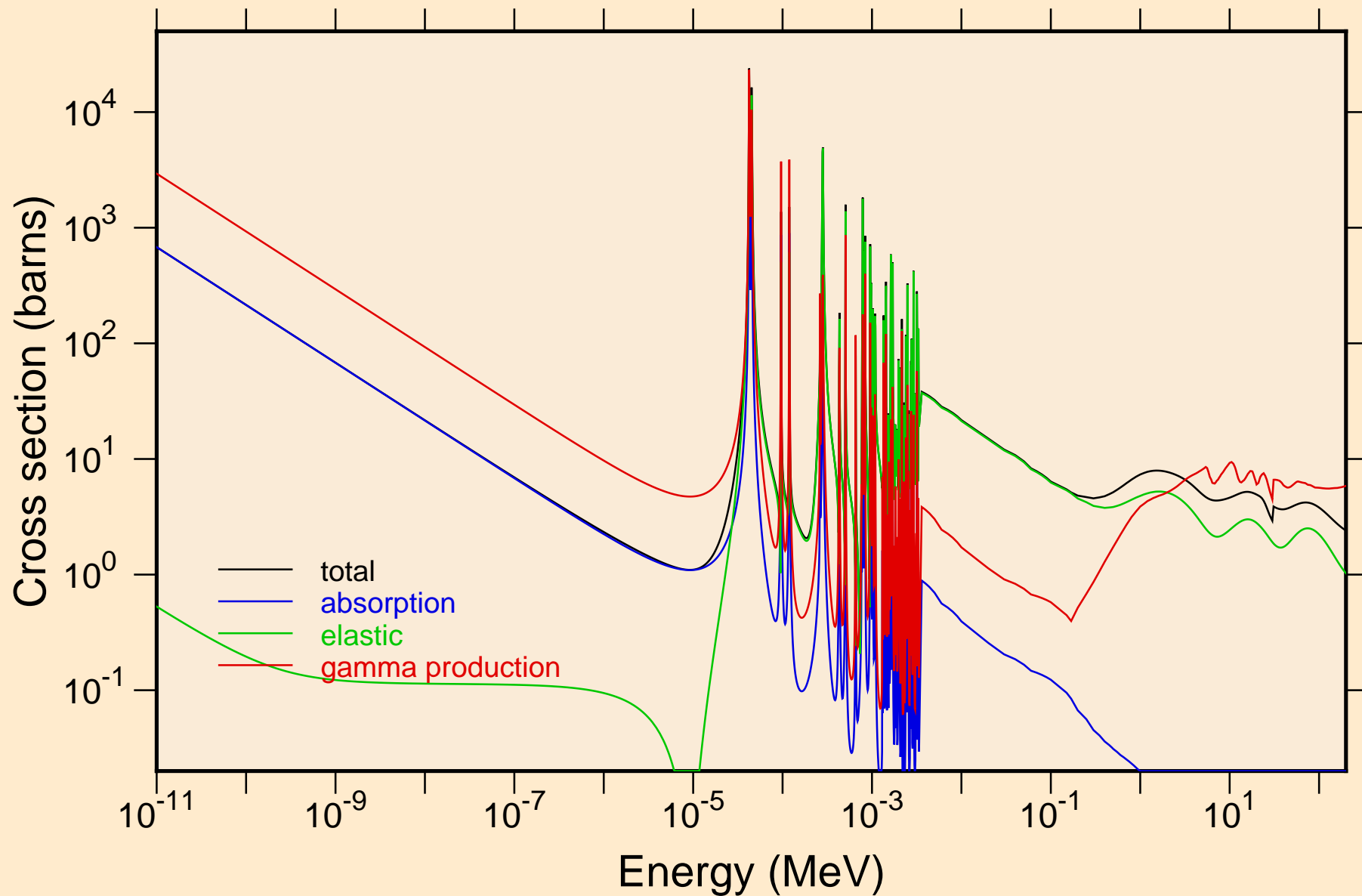

PR155 NEUTRON ACER TENDL-2019 LIBRARY; T=293.16K
resonance total cross section

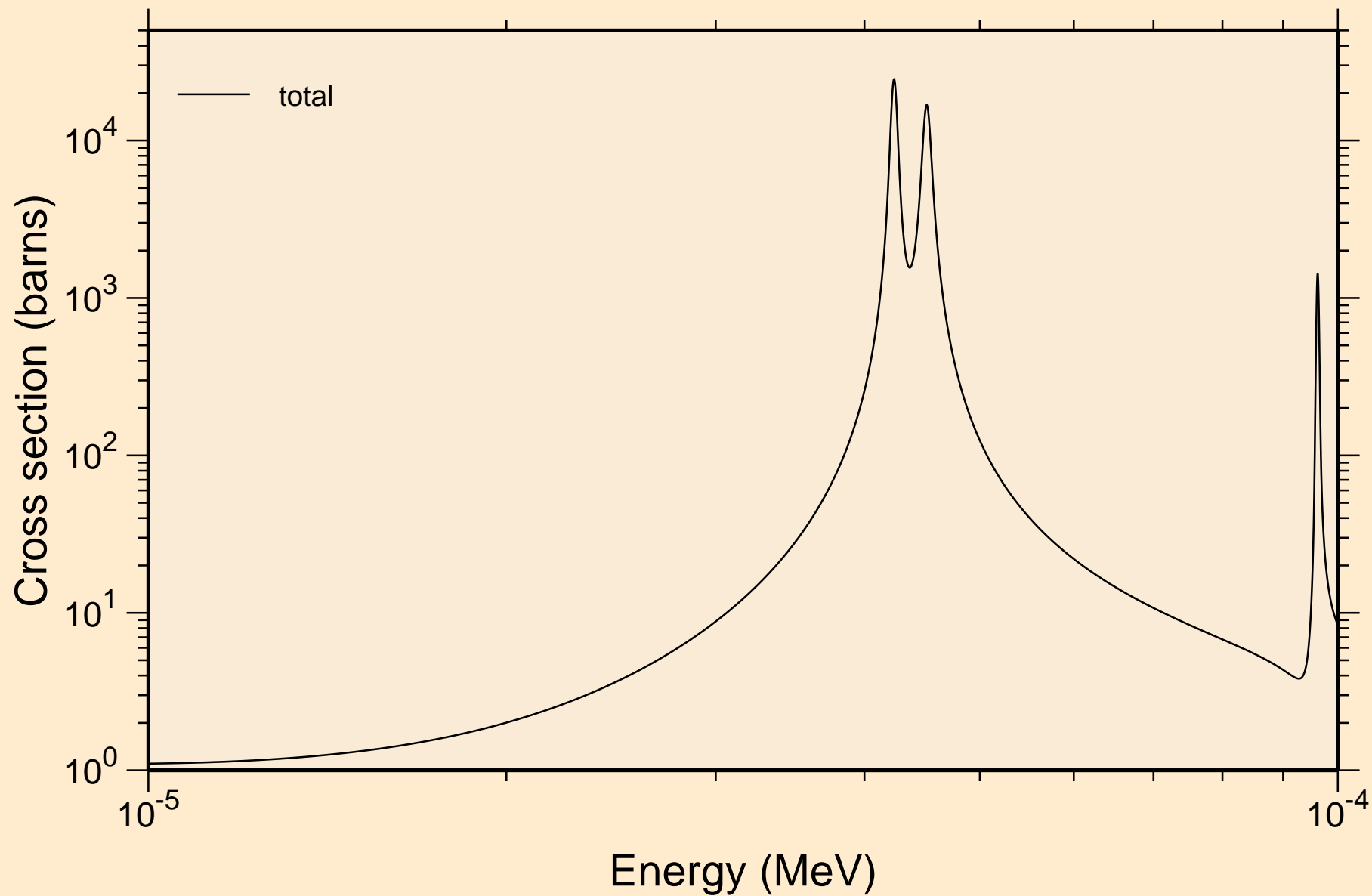

PR155 NEUTRON ACER TENDL-2019 LIBRARY; T=293.16K
resonance total cross section

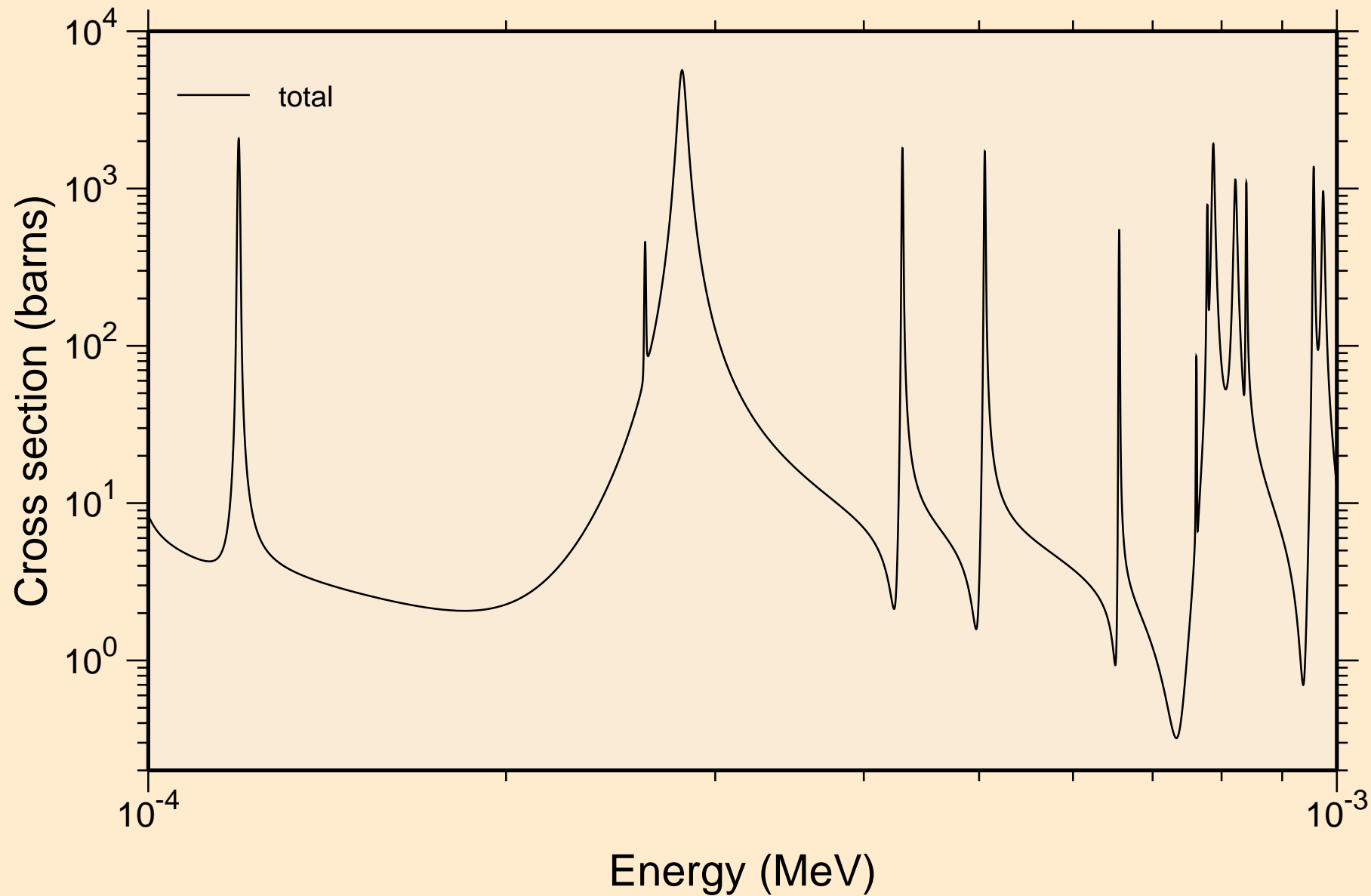

PR155 NEUTRON ACER TENDL-2019 LIBRARY; T=293.16K
resonance total cross section

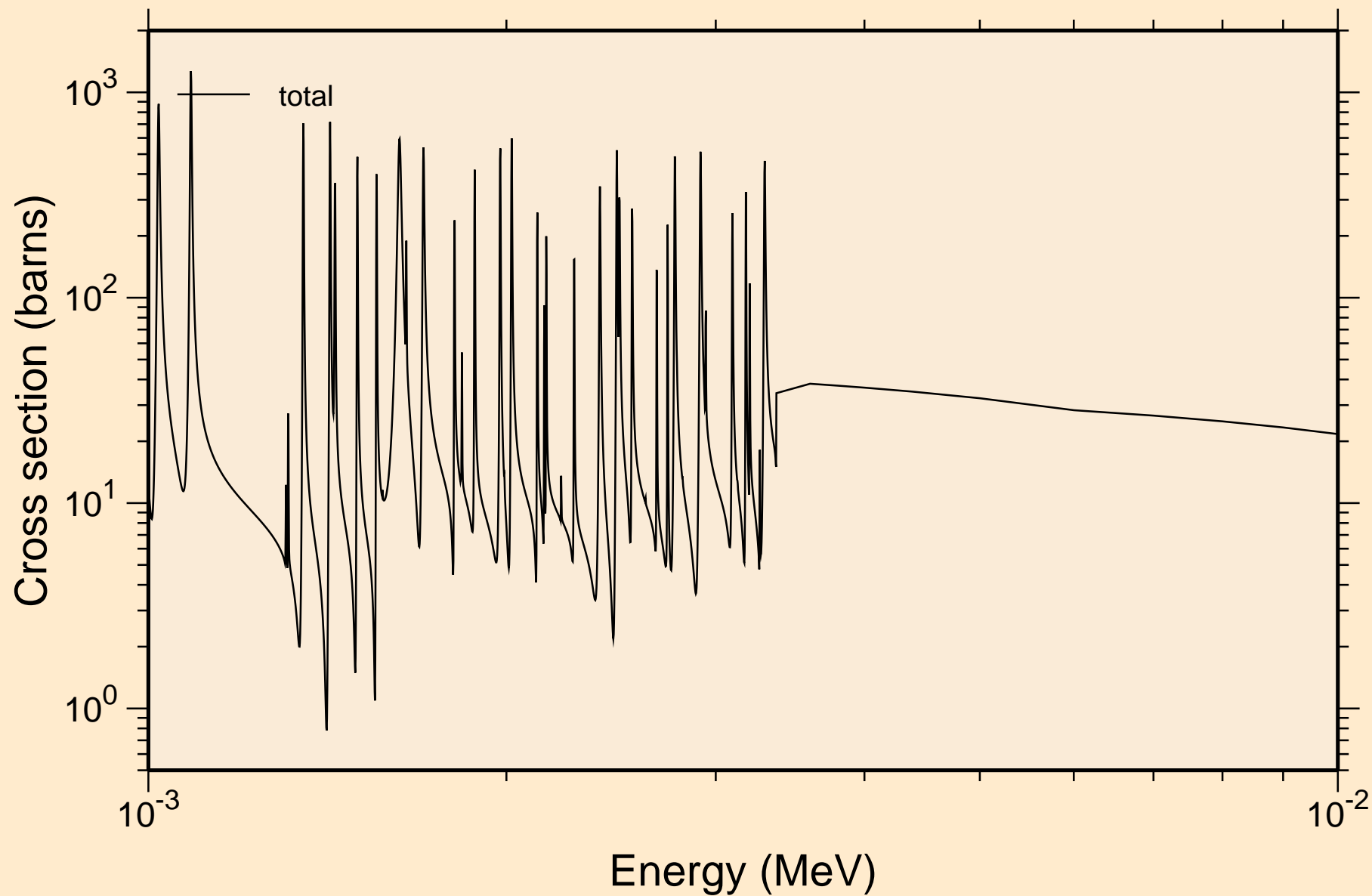

PR155 NEUTRON ACER TENDL-2019 LIBRARY; T=293.16K
resonance total cross section

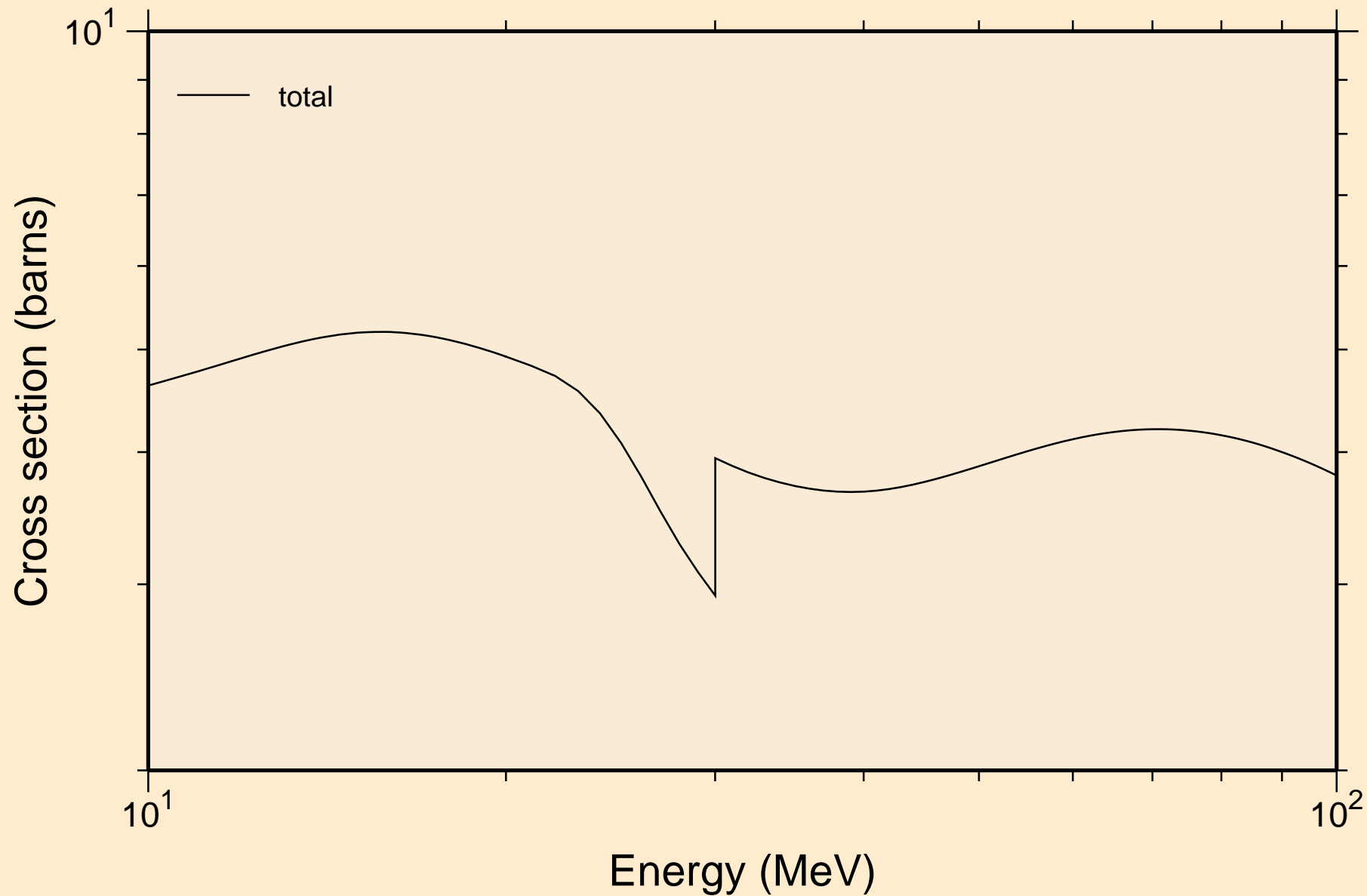

PR155 NEUTRON ACER TENDL-2019 LIBRARY; T=293.16K
resonance absorption cross sections

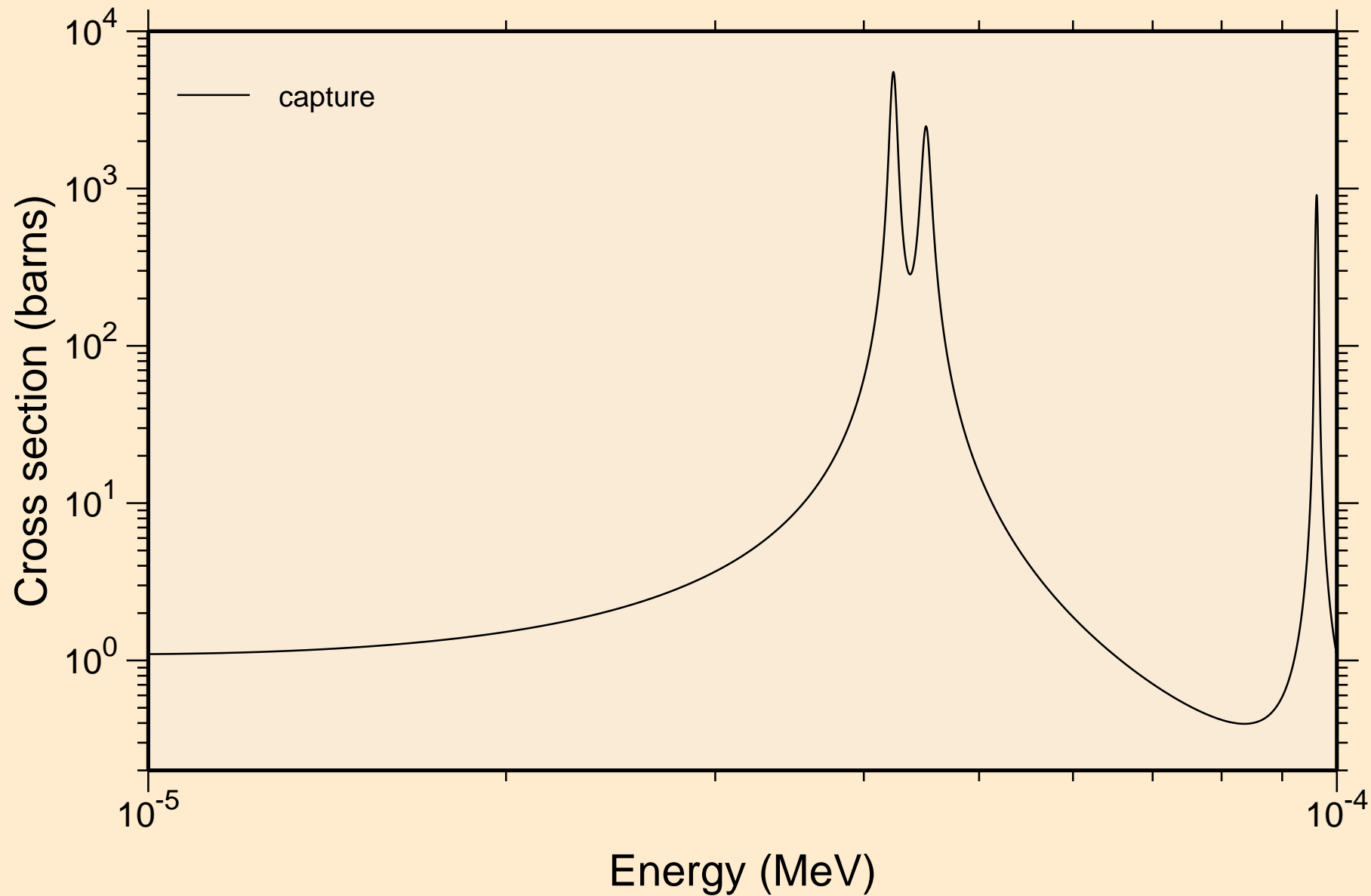

PR155 NEUTRON ACER TENDL-2019 LIBRARY; T=293.16K
resonance absorption cross sections

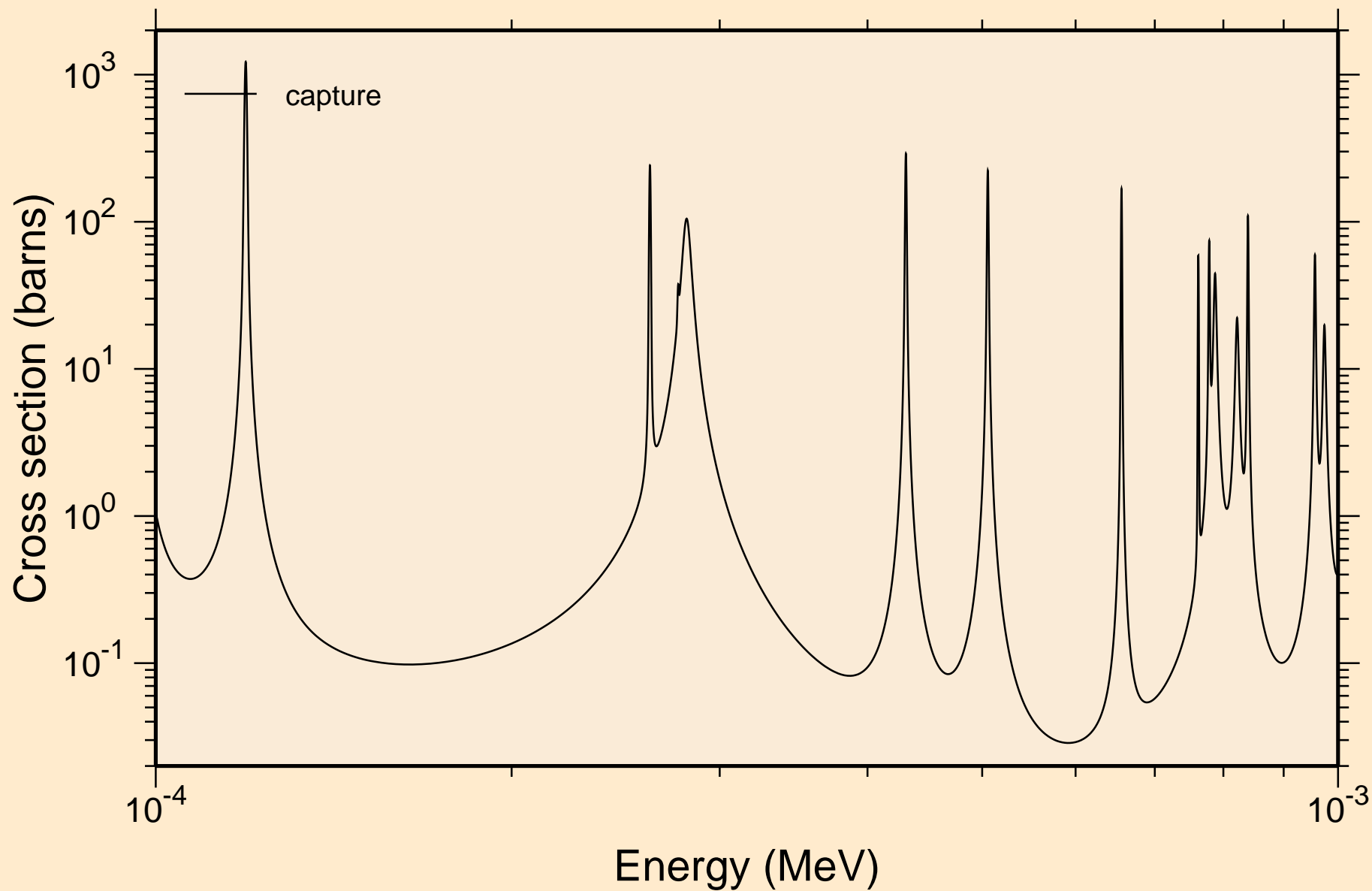

PR155 NEUTRON ACER TENDL-2019 LIBRARY; T=293.16K
resonance absorption cross sections

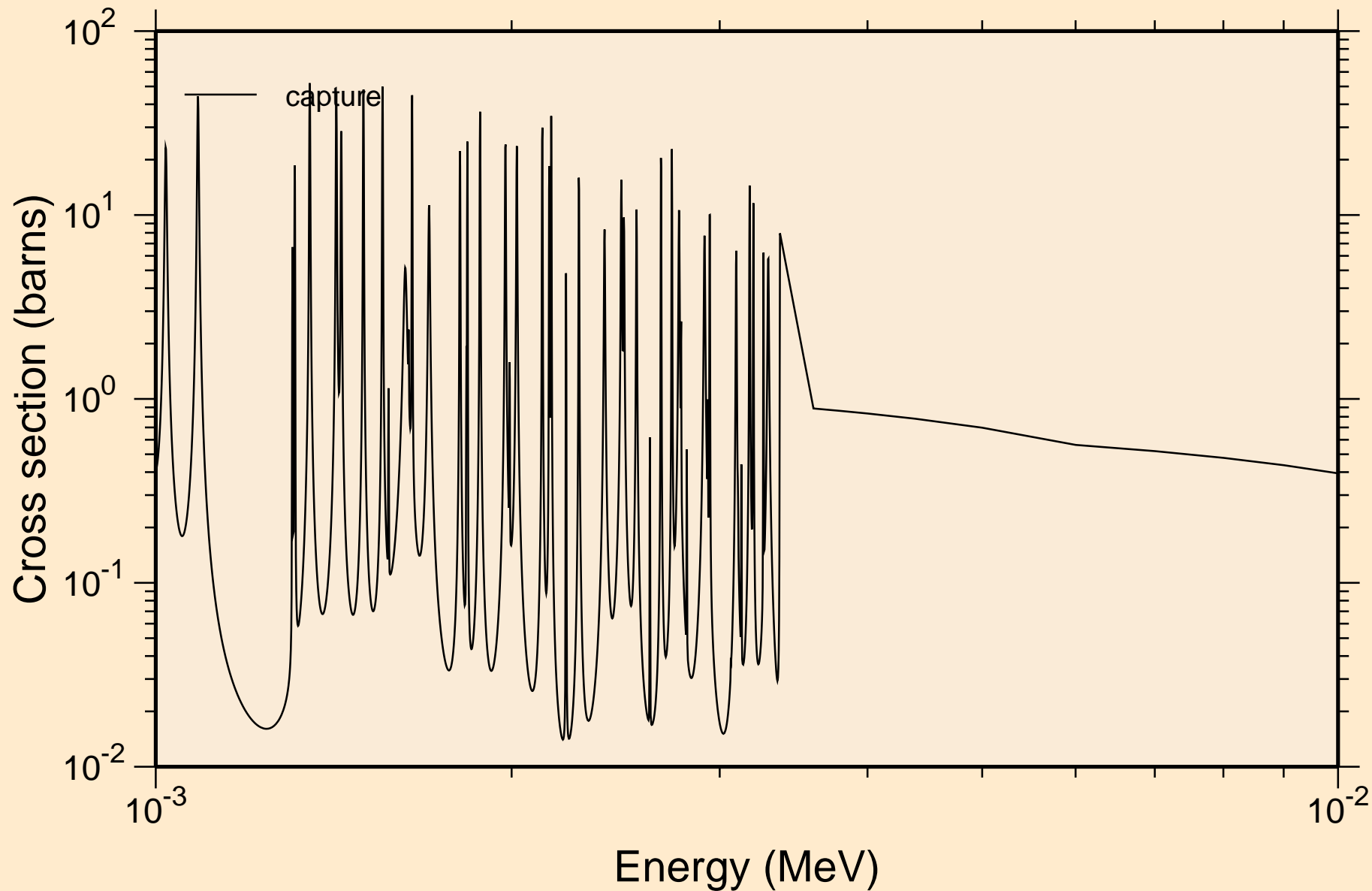

PR155 NEUTRON ACER TENDL-2019 LIBRARY; T=293.16K
resonance absorption cross sections

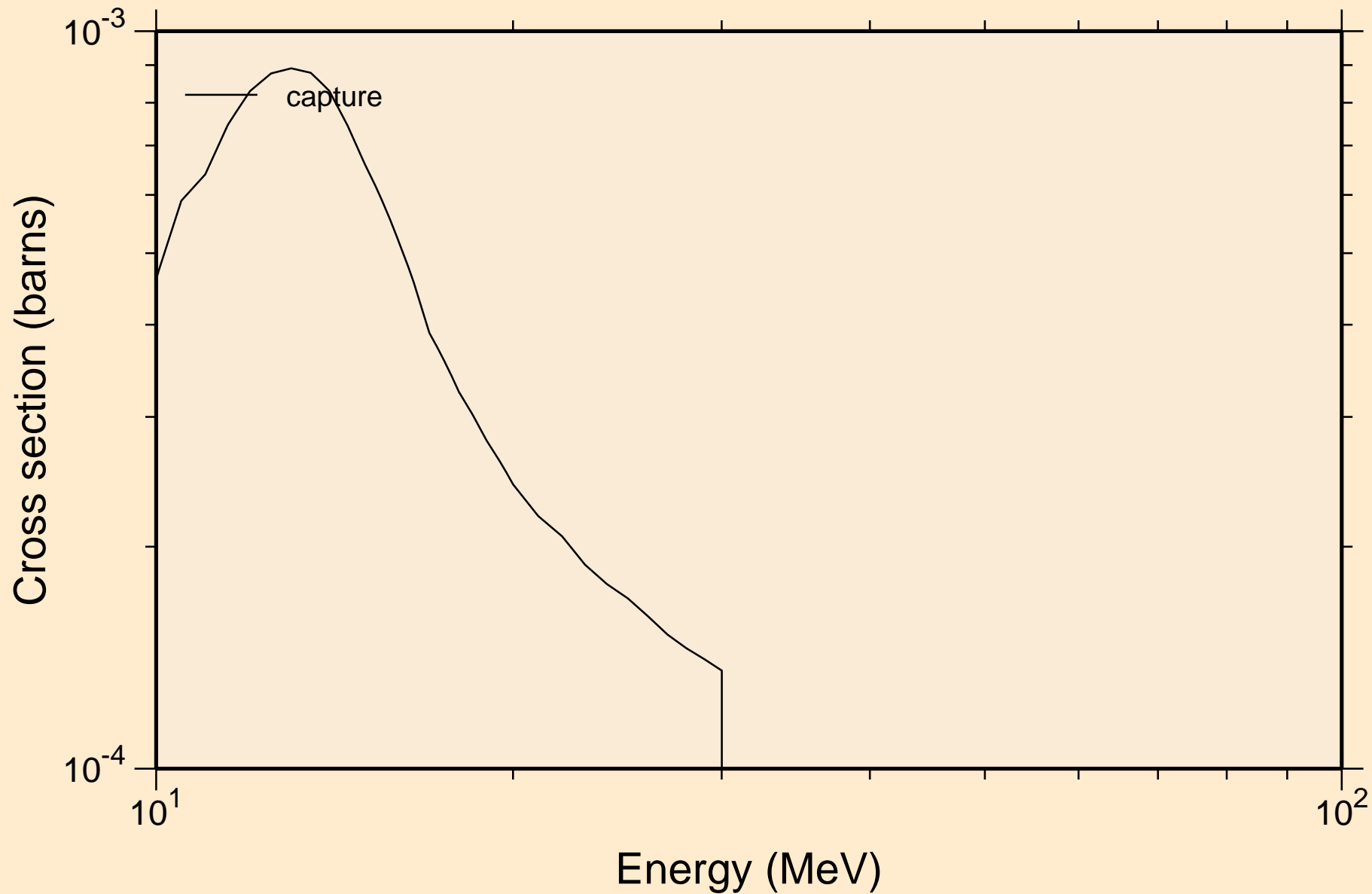

PR155 NEUTRON ACER TENDL-2019 LIBRARY; T=293.16K
Heating

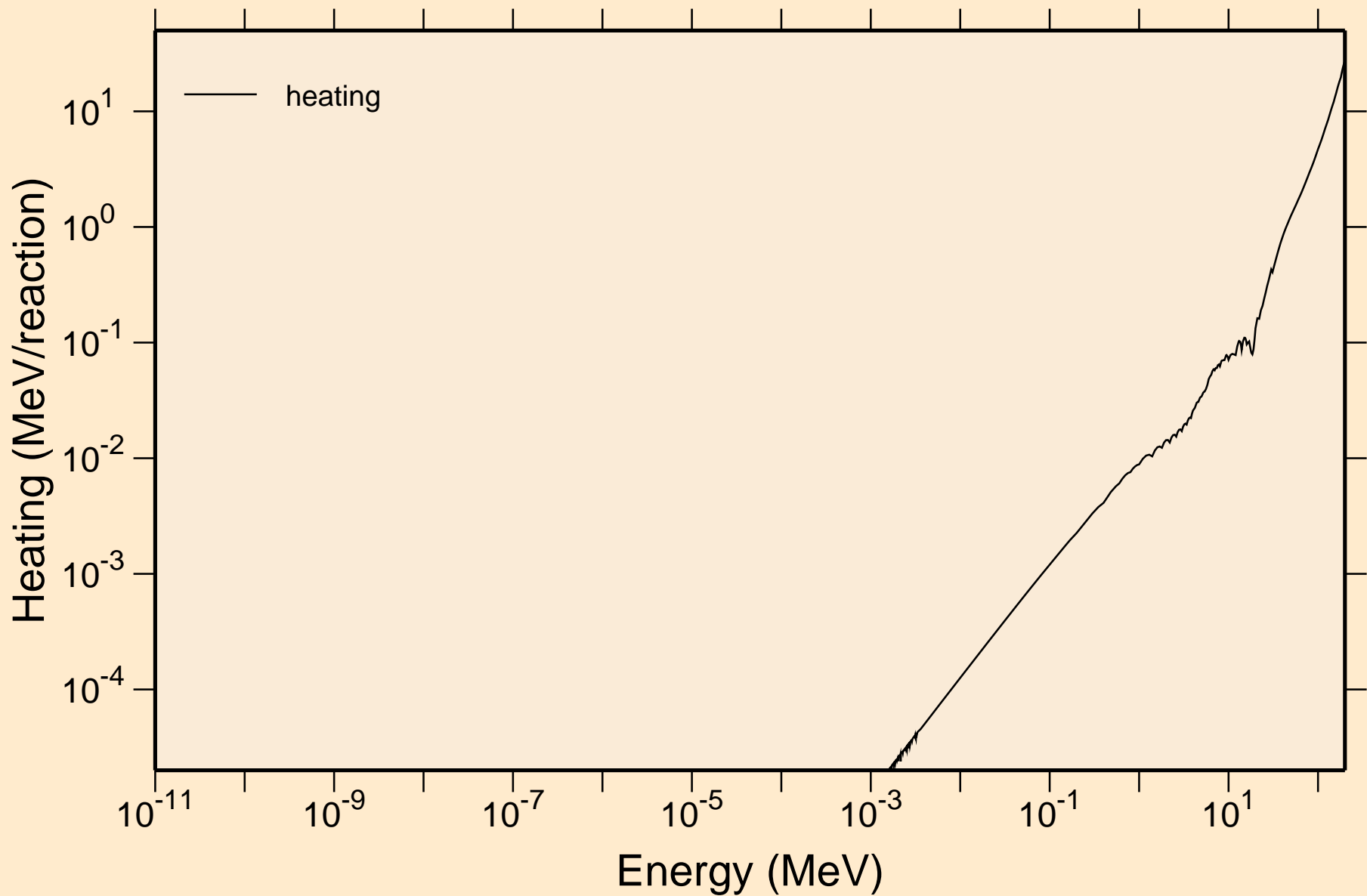

PR155 NEUTRON ACER TENDL-2019 LIBRARY; T=293.16K
Damage

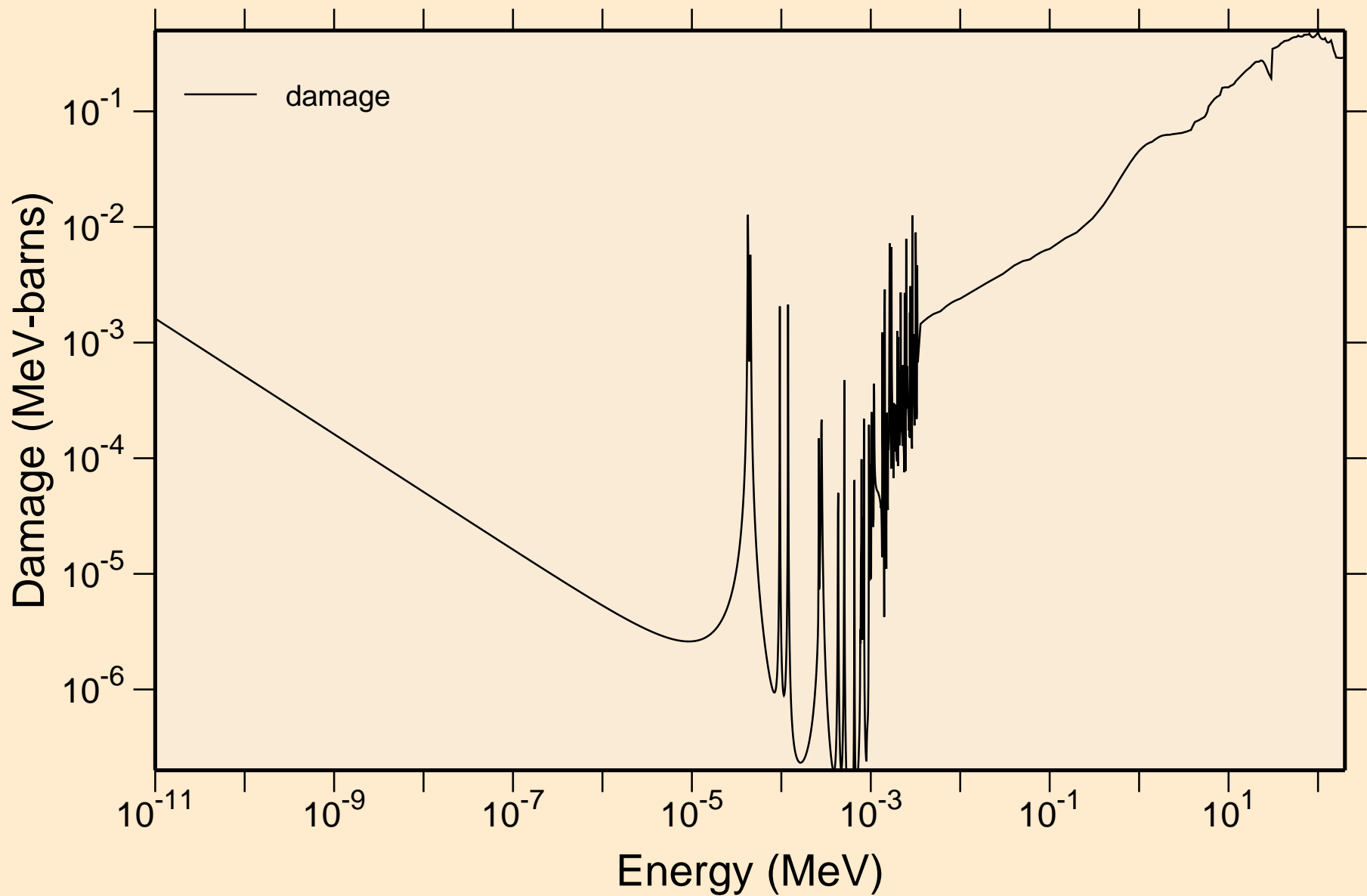

PR155 NEUTRON ACER TENDL-2019 LIBRARY; T=293.16K
Non-threshold reactions

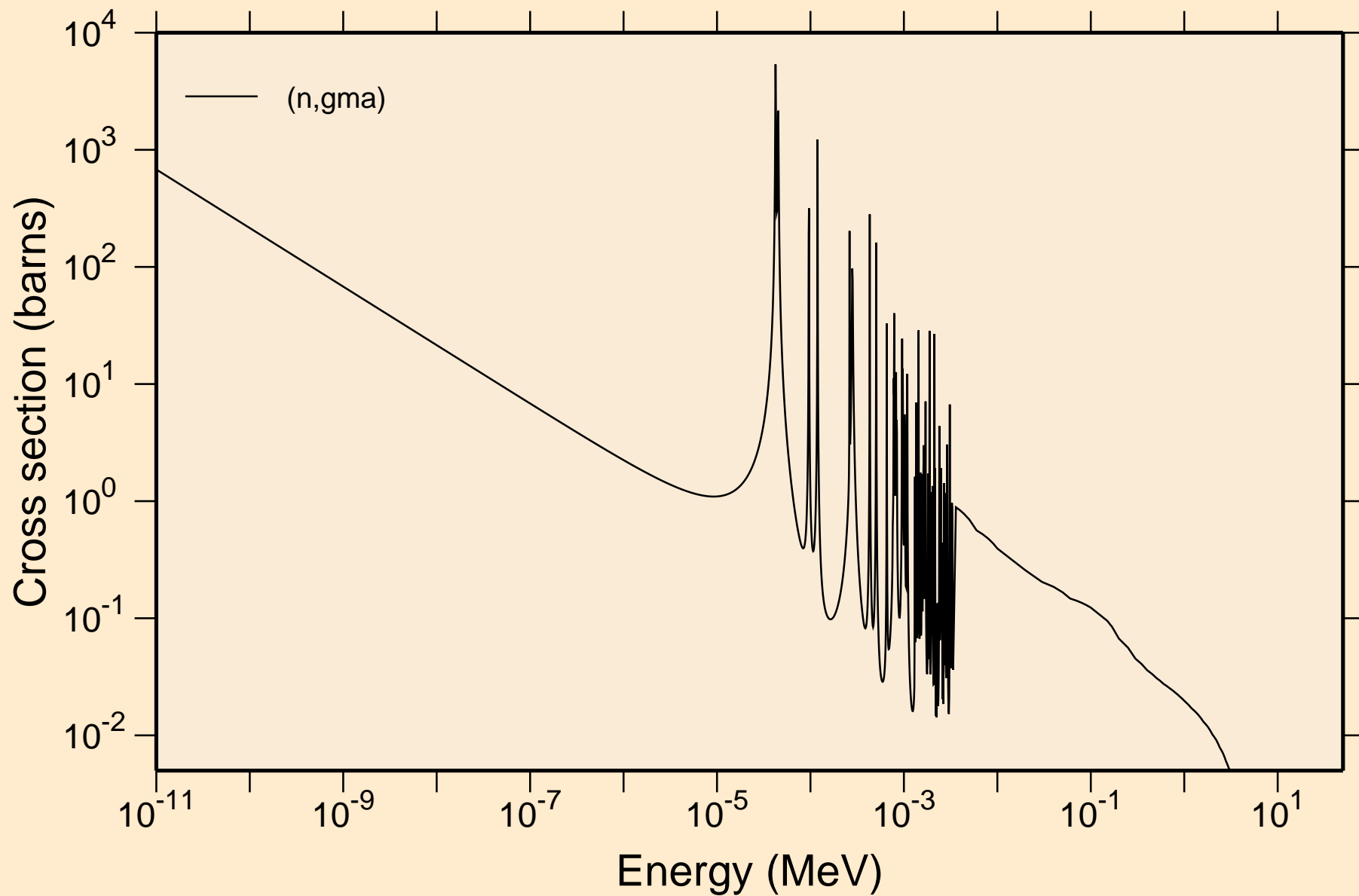

PR155 NEUTRON ACER TENDL-2019 LIBRARY; T=293.16K
Principal cross sections

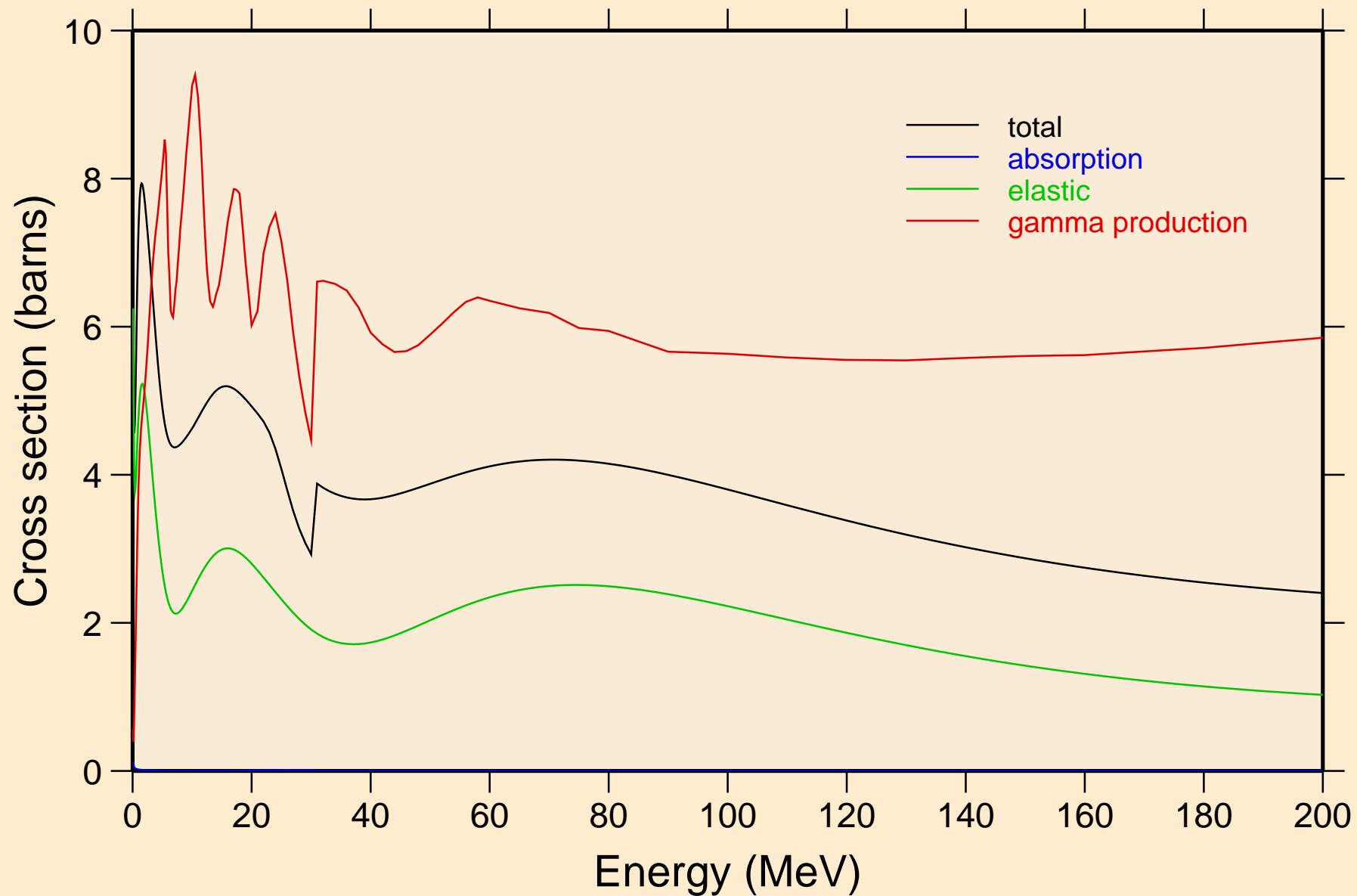

PR155 NEUTRON ACER TENDL-2019 LIBRARY; T=293.16K
Heating

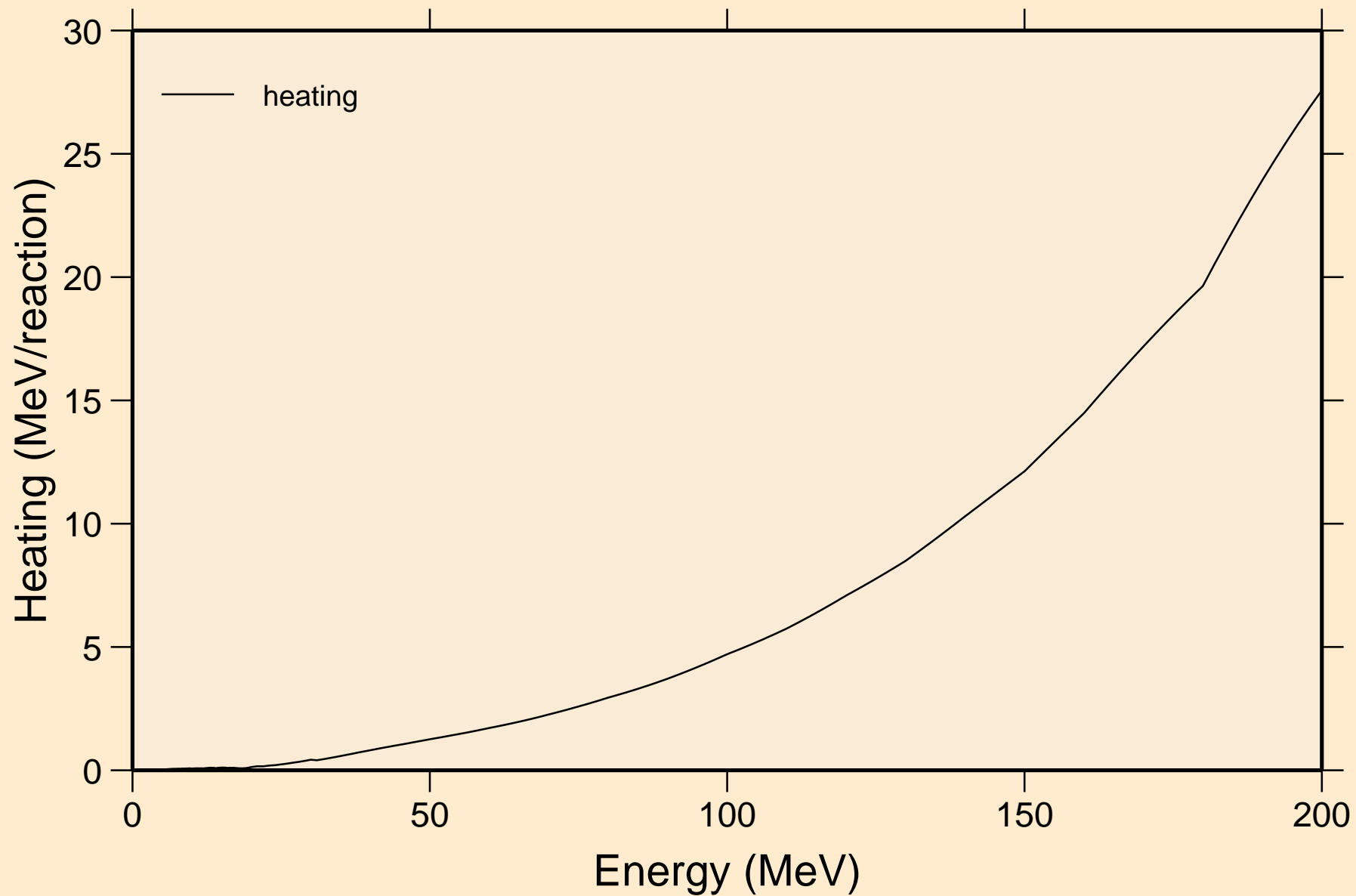

PR155 NEUTRON ACER TENDL-2019 LIBRARY; T=293.16K
Damage

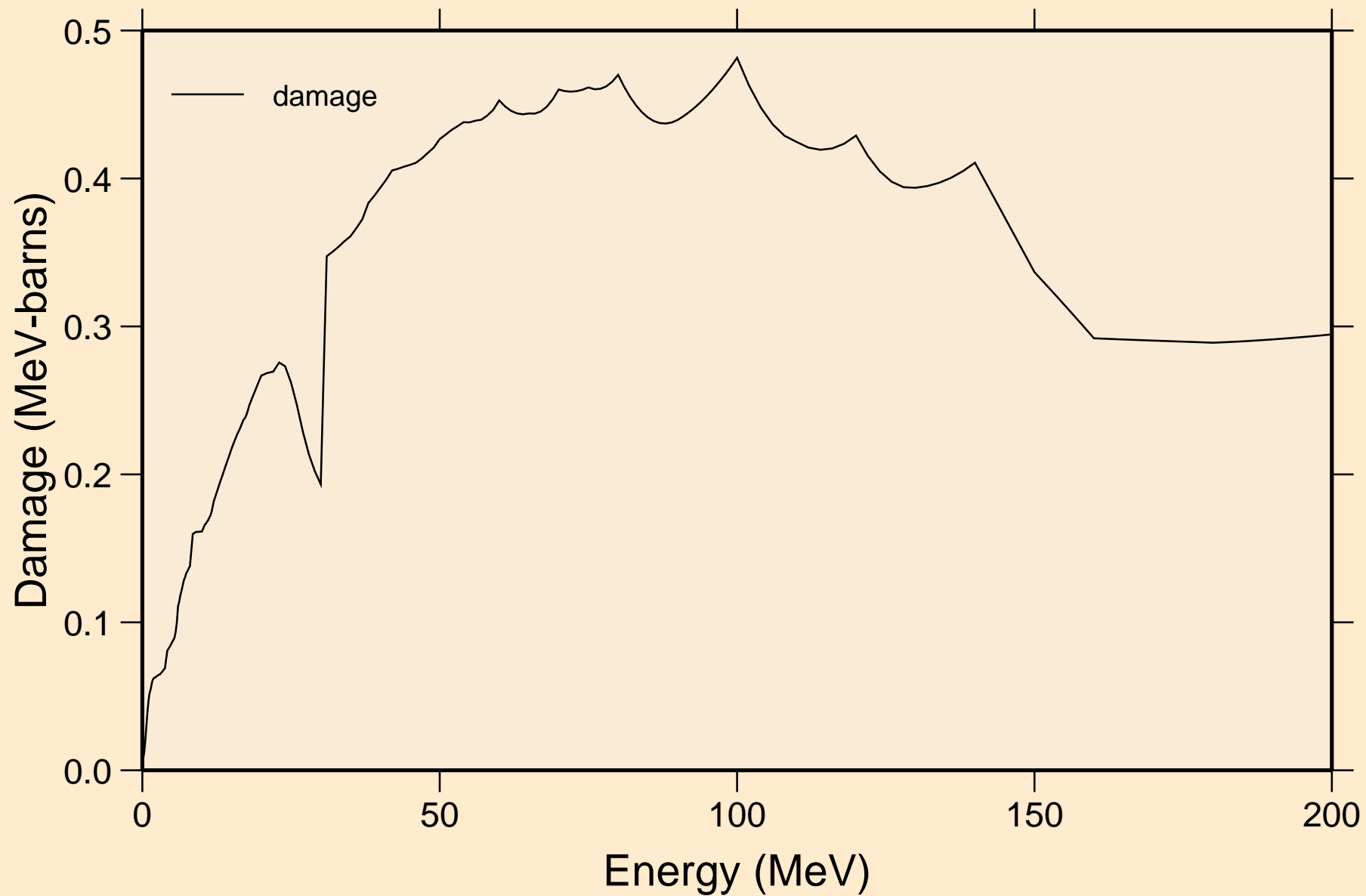

PR155 NEUTRON ACER TENDL-2019 LIBRARY; T=293.16K
Non-threshold reactions

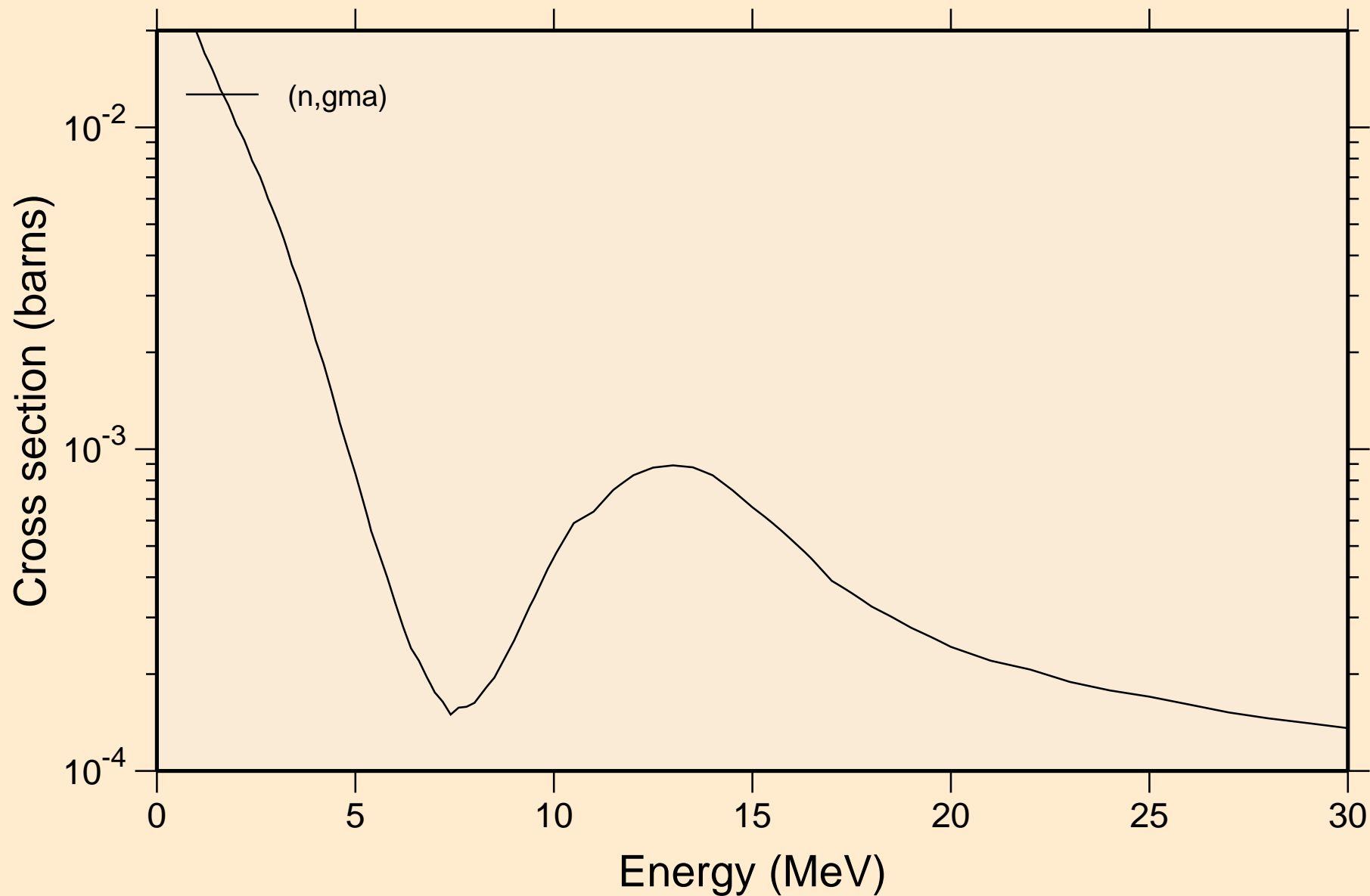

PR155 NEUTRON ACER TENDL-2019 LIBRARY; T=293.16K
Inelastic levels

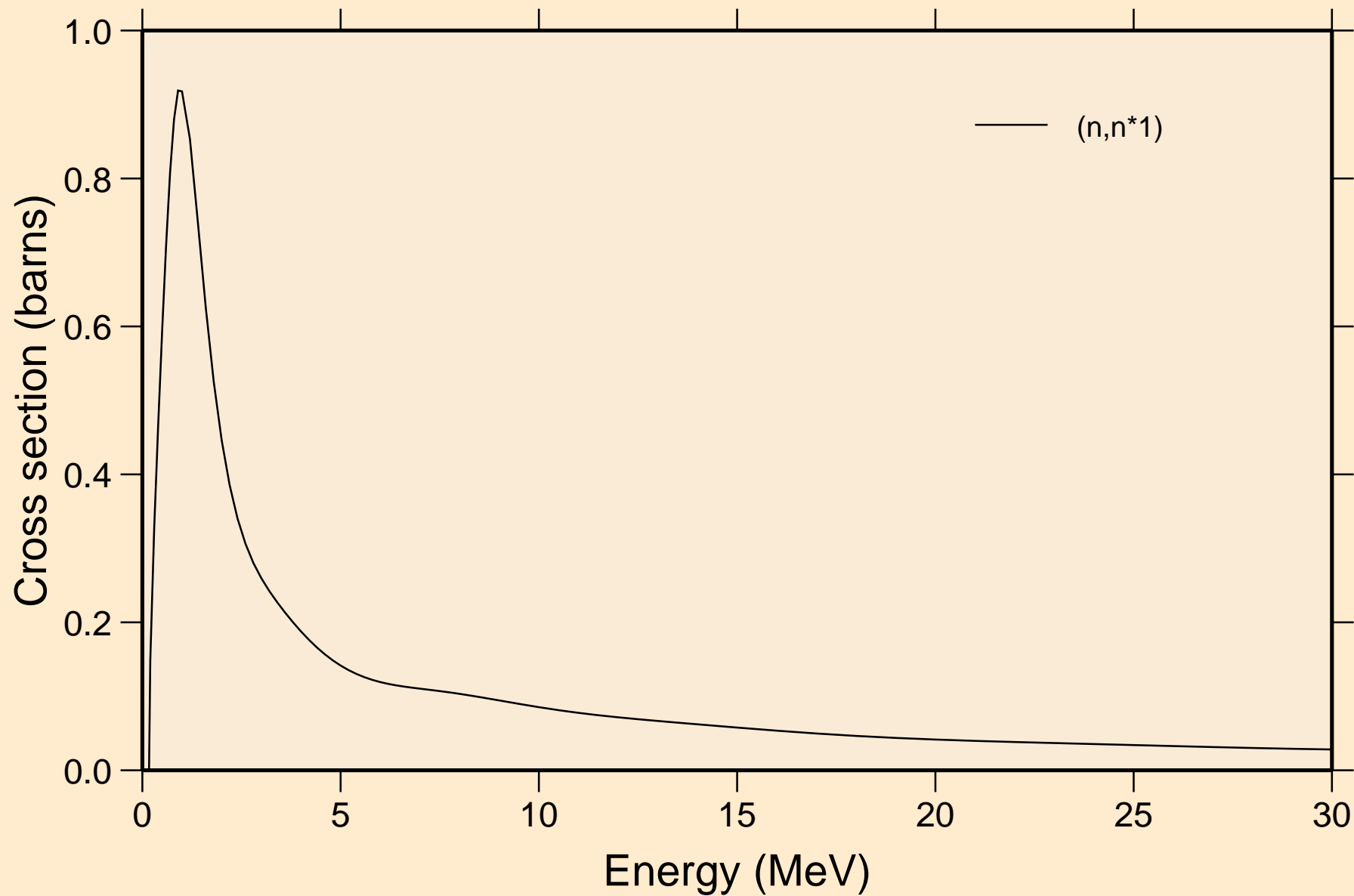

PR155 NEUTRON ACER TENDL-2019 LIBRARY; T=293.16K
Threshold reactions

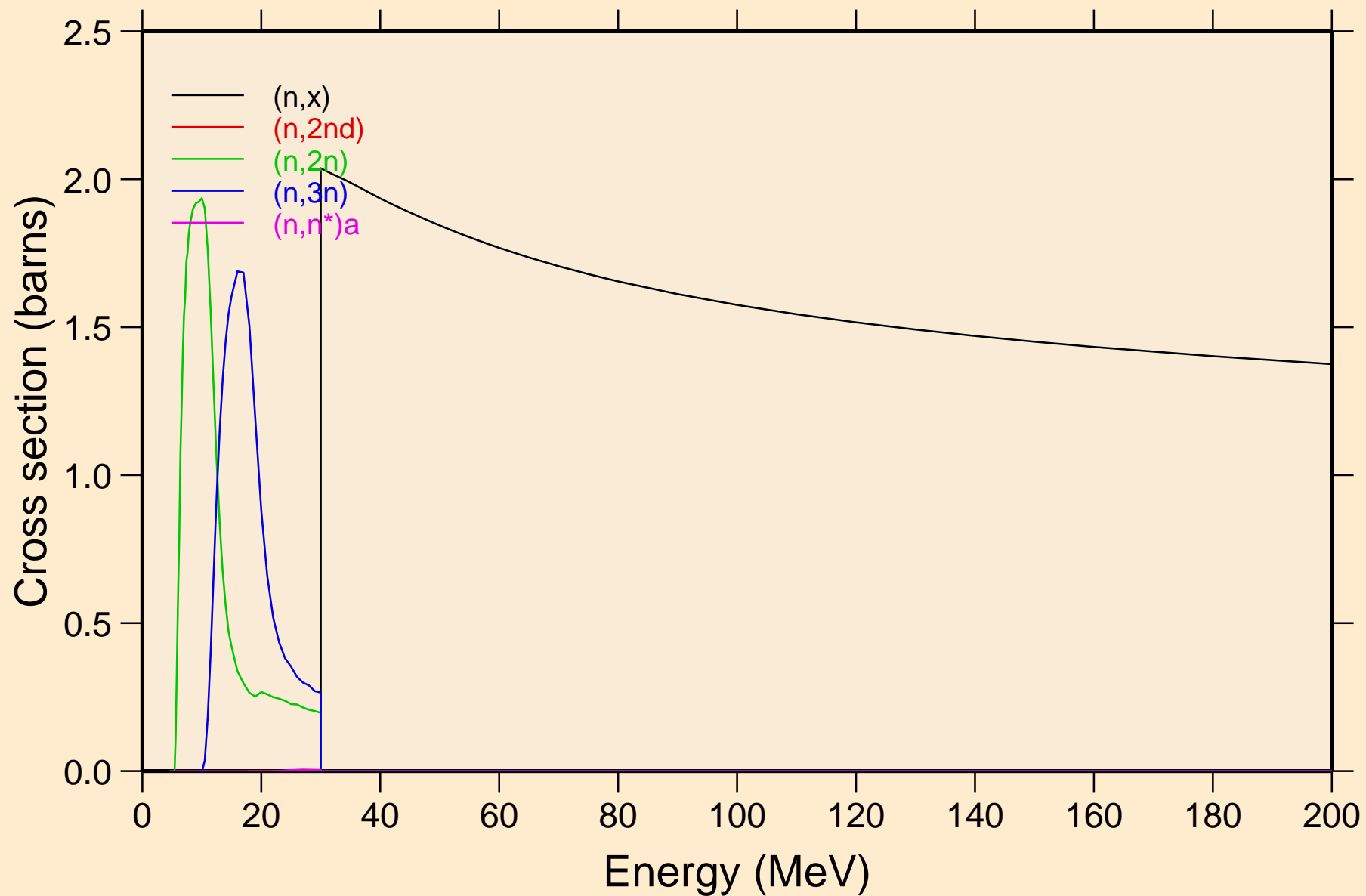

PR155 NEUTRON ACER TENDL-2019 LIBRARY; T=293.16K
Threshold reactions

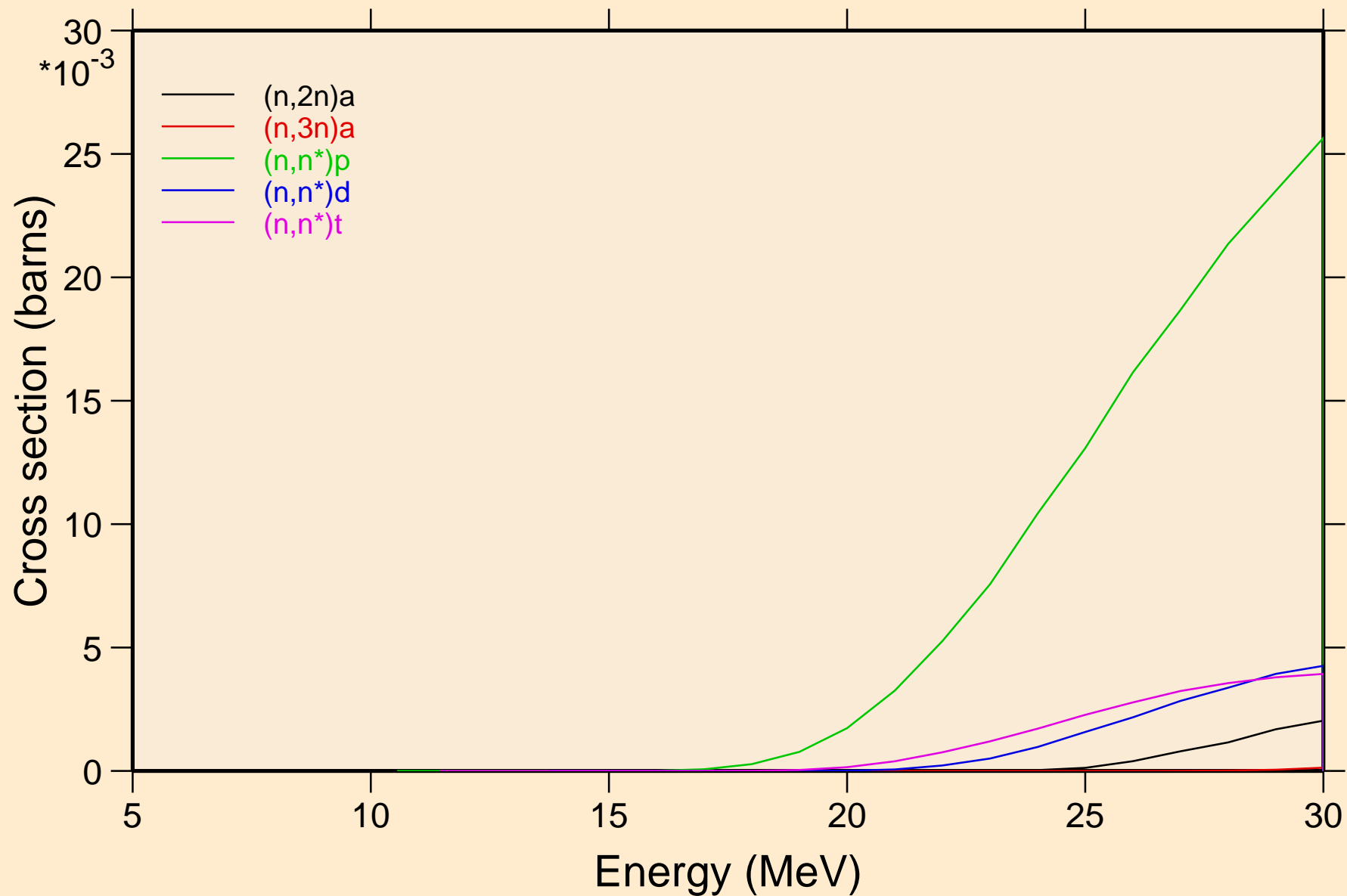

PR155 NEUTRON ACER TENDL-2019 LIBRARY; T=293.16K
Threshold reactions

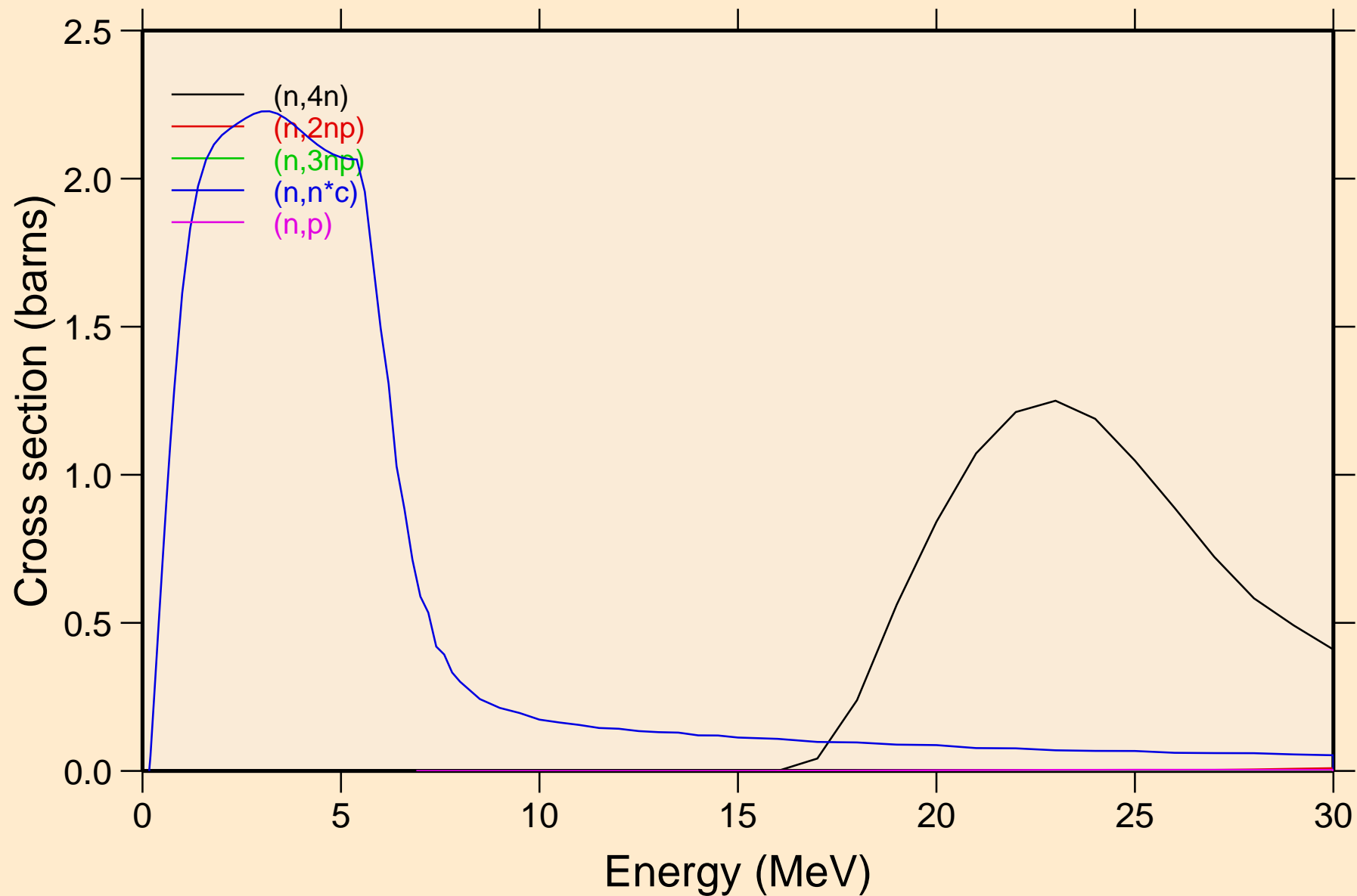

PR155 NEUTRON ACER TENDL-2019 LIBRARY; T=293.16K
Threshold reactions

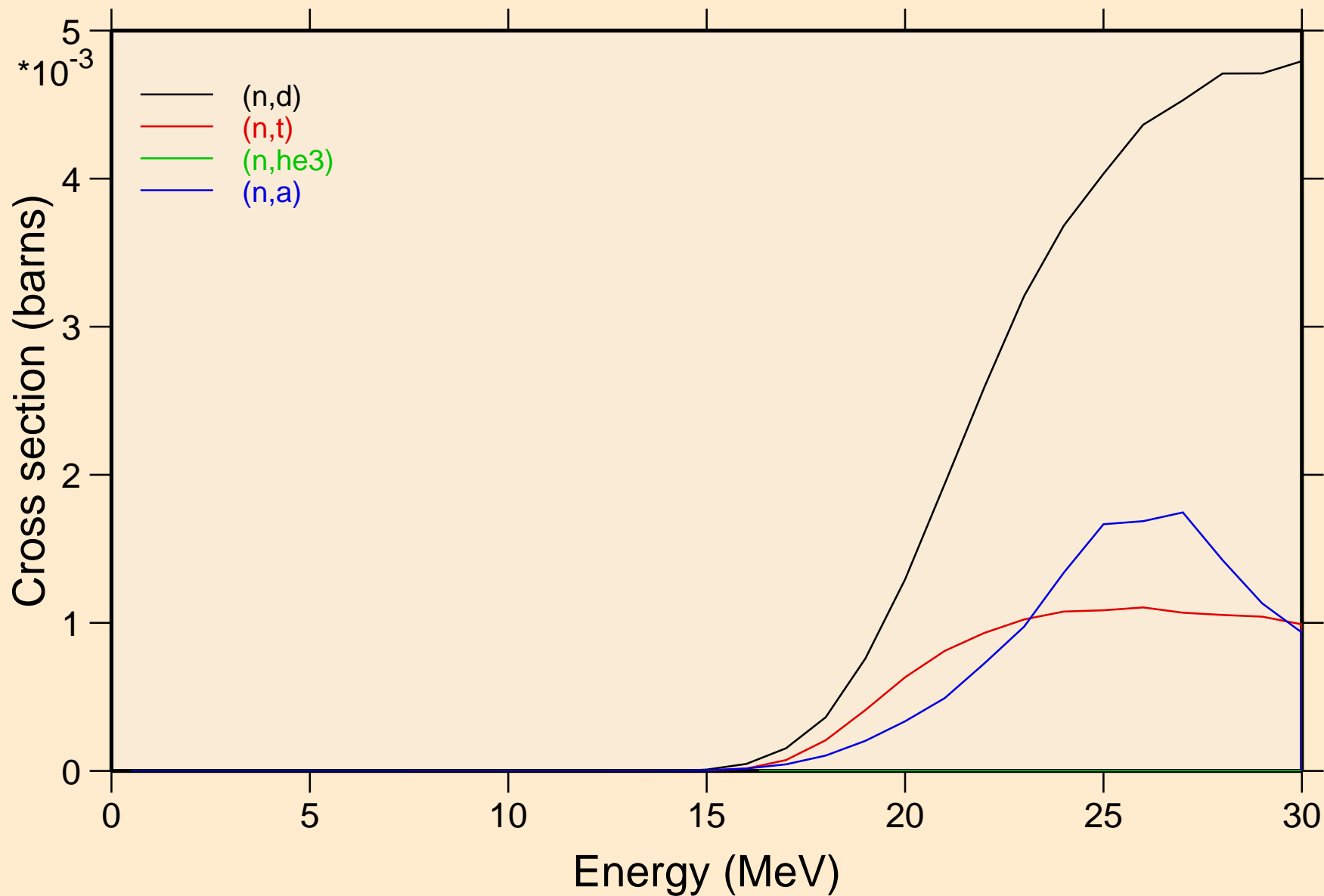

PR155 NEUTRON ACER TENDL-2019 LIBRARY; T=293.16K
Threshold reactions

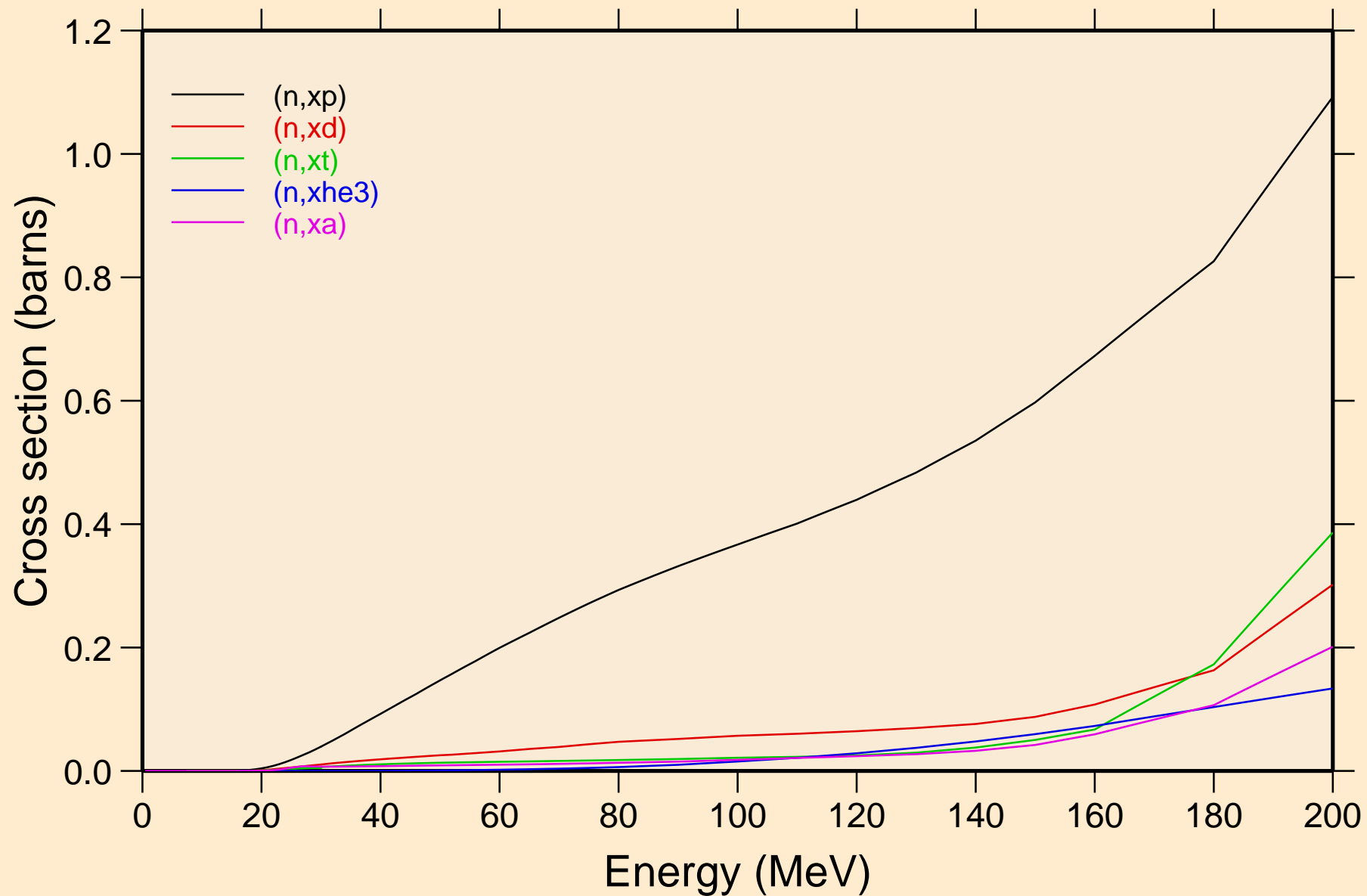

PR155 NEUTRON ACER TENDL-2019 LIBRARY; T=293.16K
angular distribution for elastic

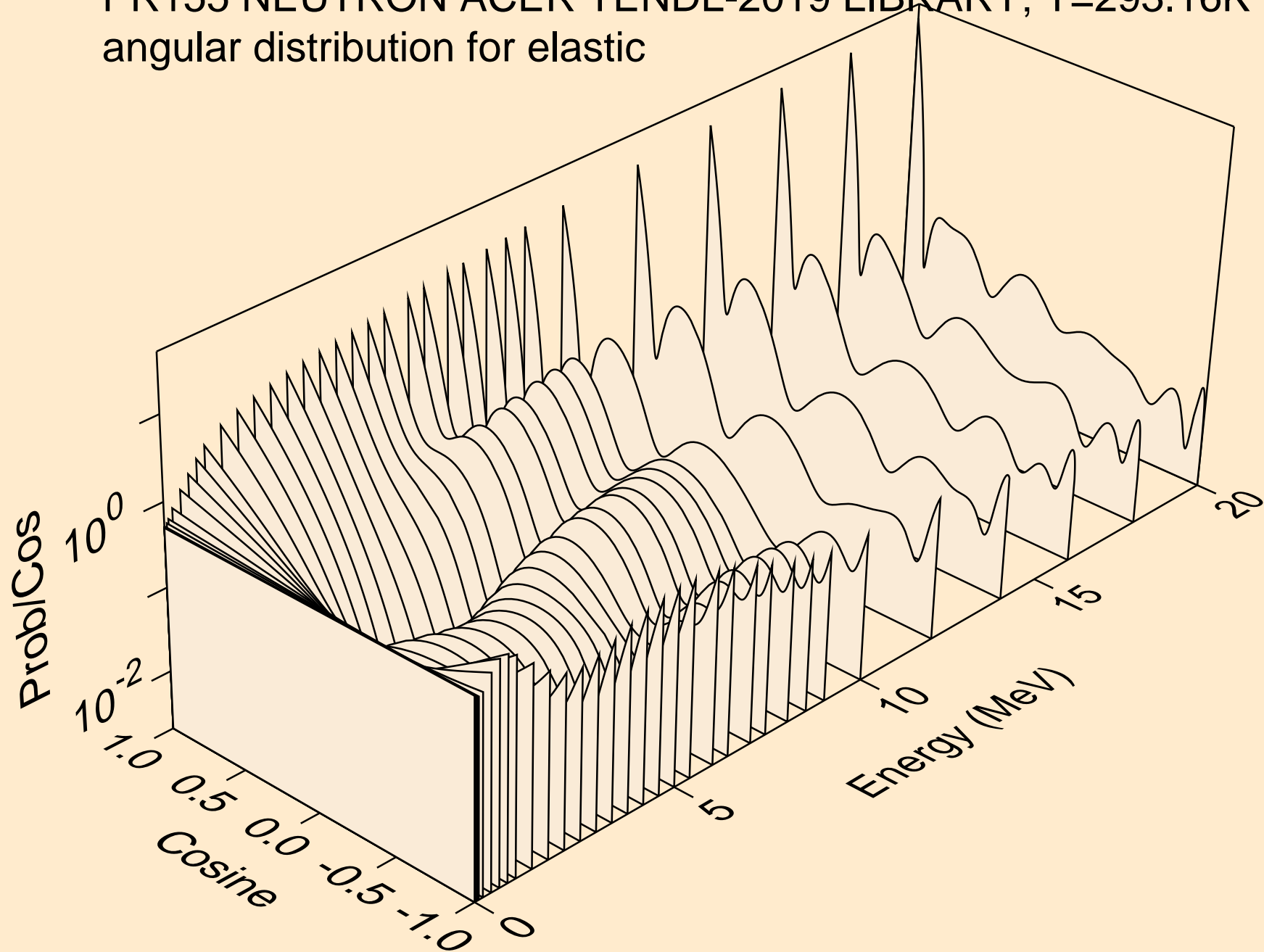

PR155 NEUTRON ACER TENDL-2019 LIBRARY; T=293.16K
angular distribution for elastic

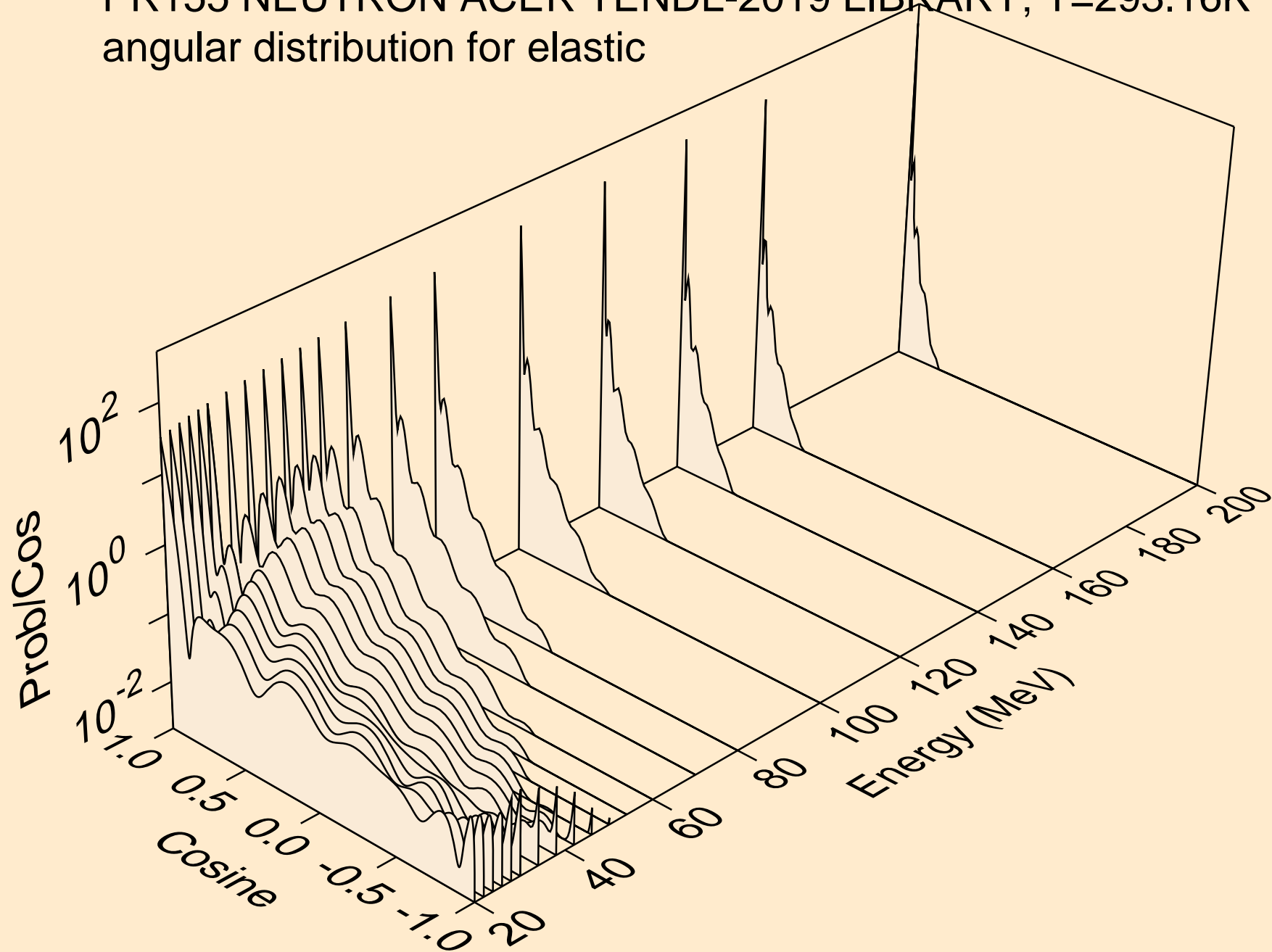

PR155 NEUTRON ACER TENDL-2019 LIBRARY; T=293.16K
angular distribution for (n,n*1)

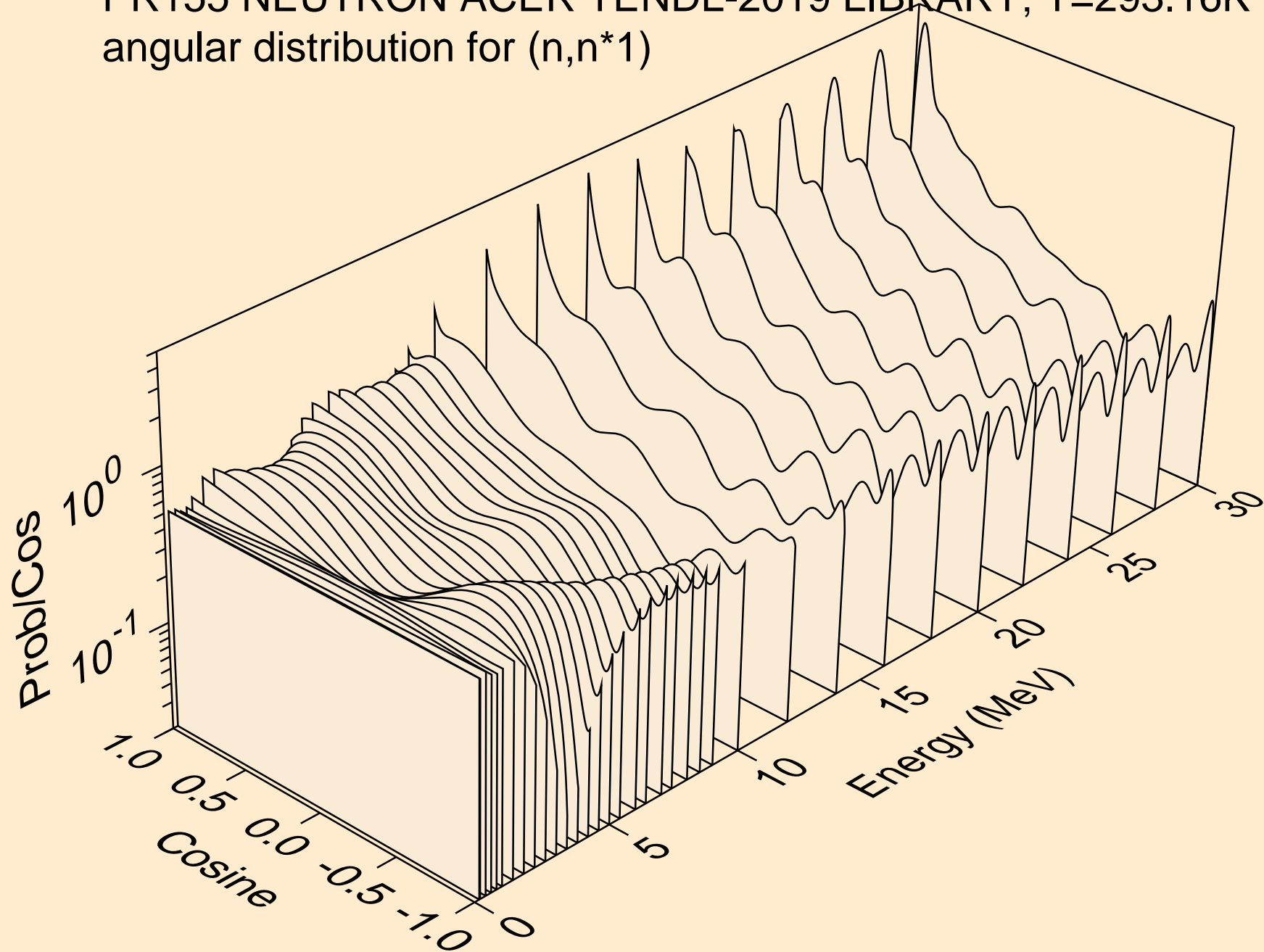

PR155 NEUTRON ACER TENDL-2019 LIBRARY; T=293.16K
Neutron emission for (n,x)

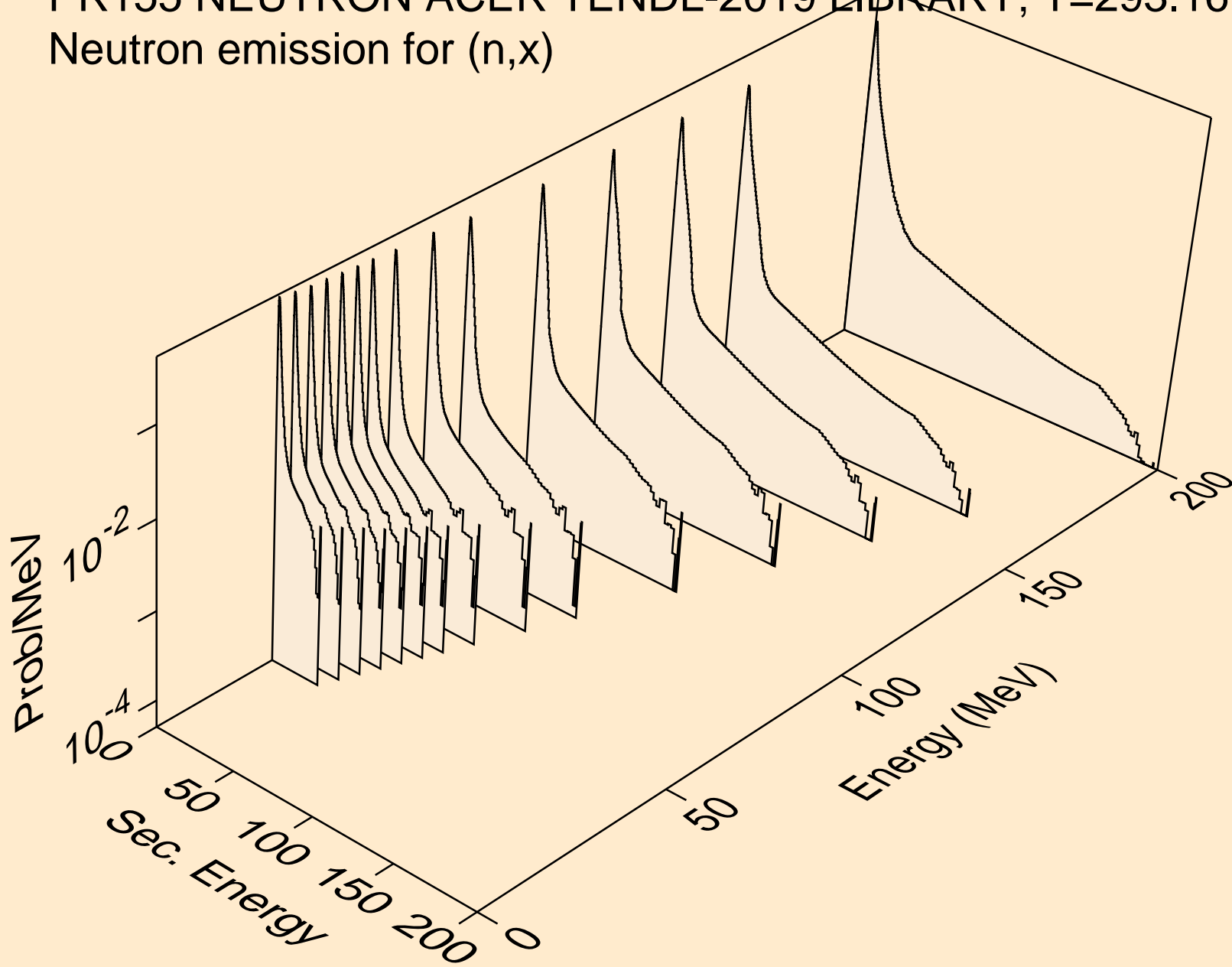

PR155 NEUTRON ACER TENDL-2019 LIBRARY; T=293.16K
Neutron emission for (n,2nd)

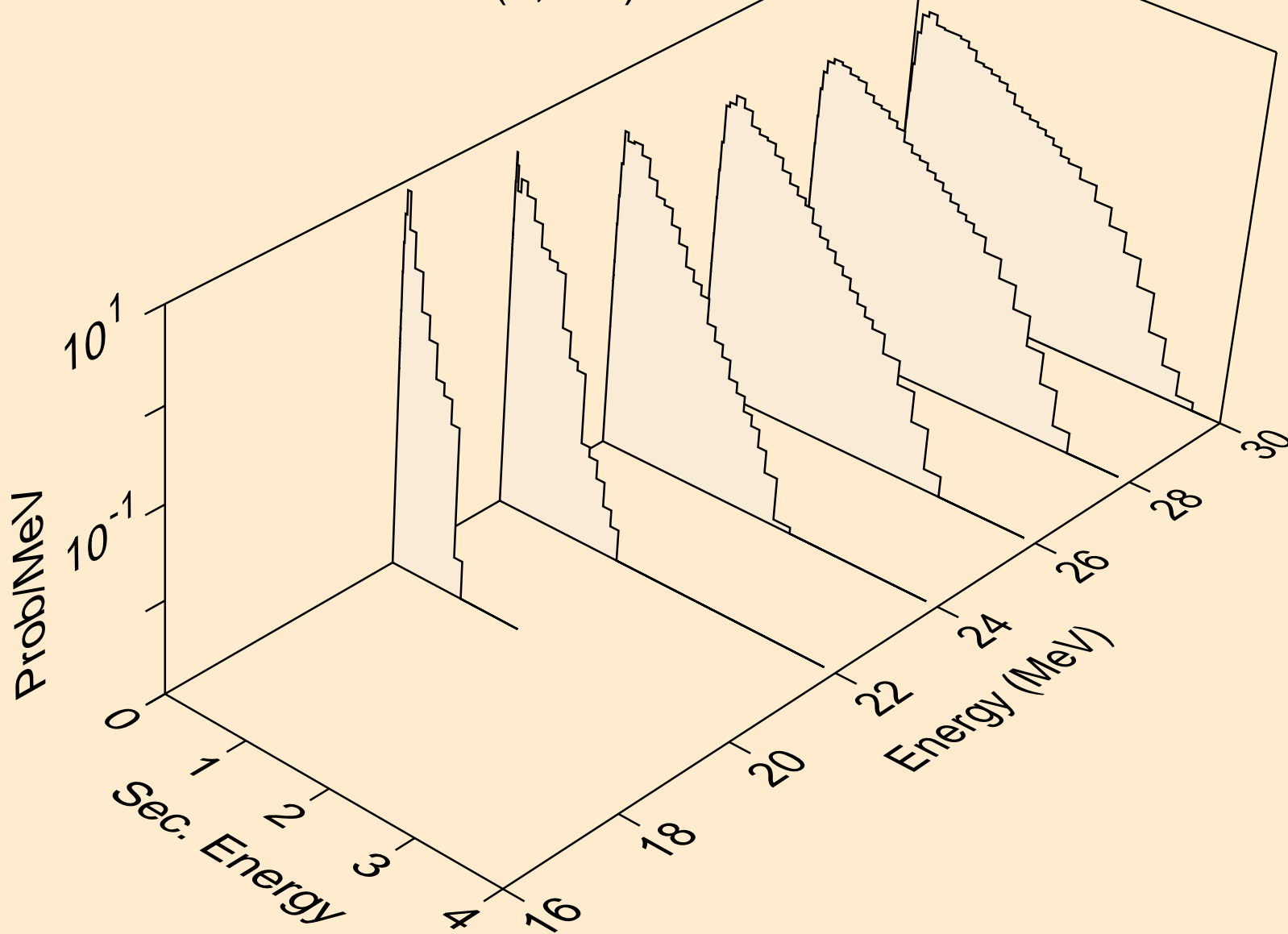

PR155 NEUTRON ACER TENDL-2019 LIBRARY; T=293.16K
Neutron emission for (n,2n)

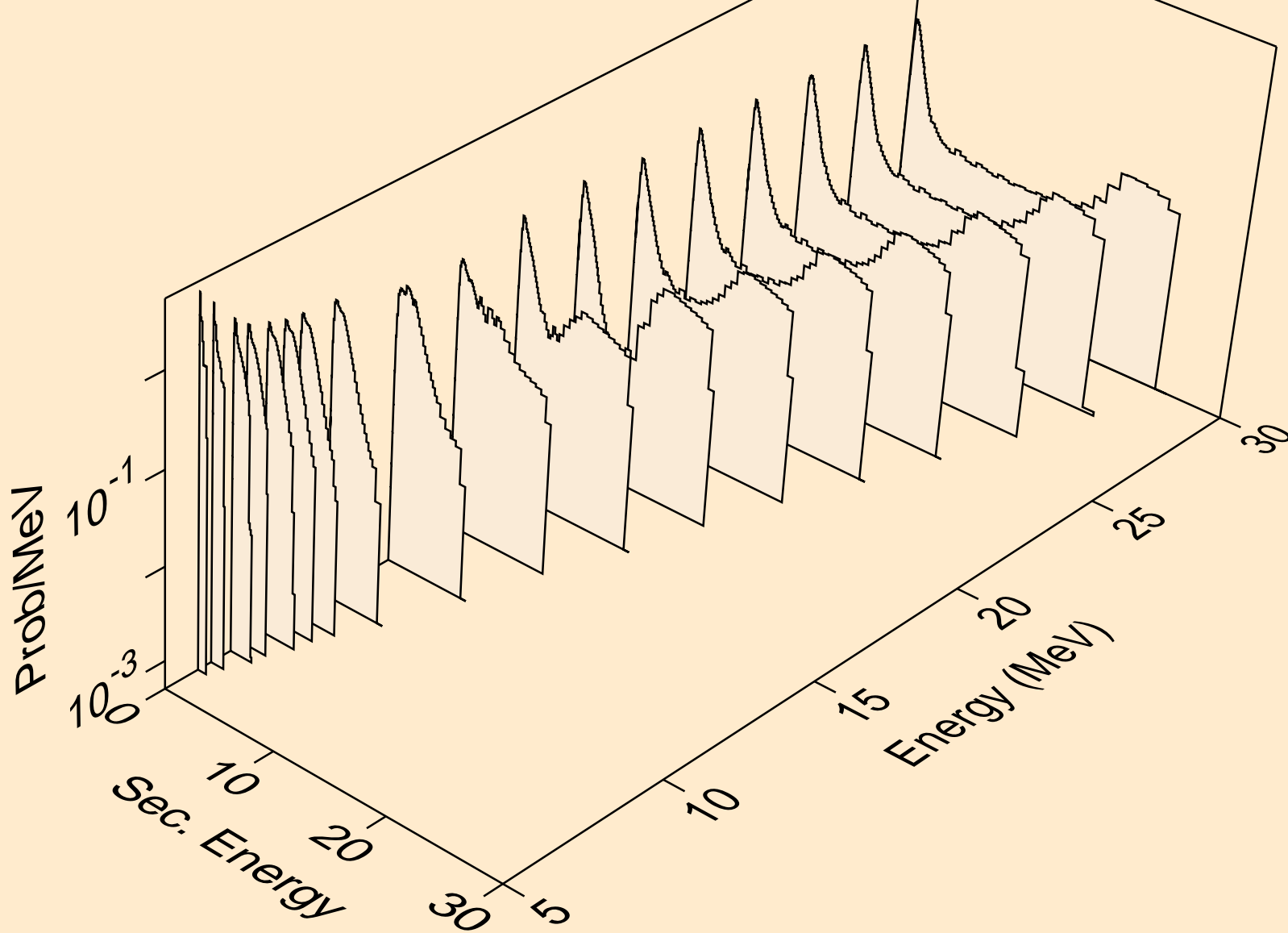

PR155 NEUTRON ACER TENDL-2019 LIBRARY; T=293.16K
Neutron emission for (n,3n)

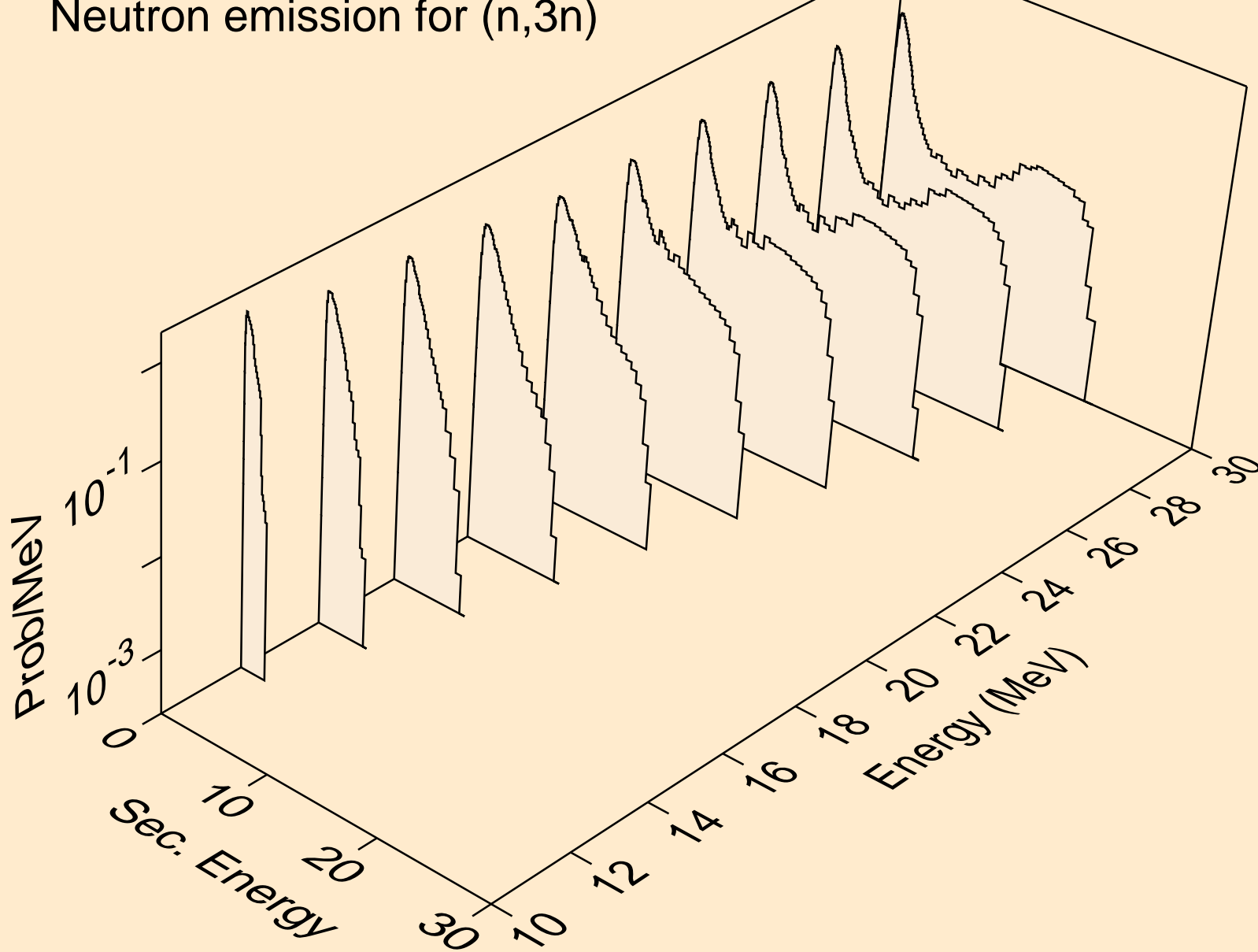

PR155 NEUTRON ACER TENDL-2019 LIBRARY; T=293.16K
Neutron emission for (n,n*)a

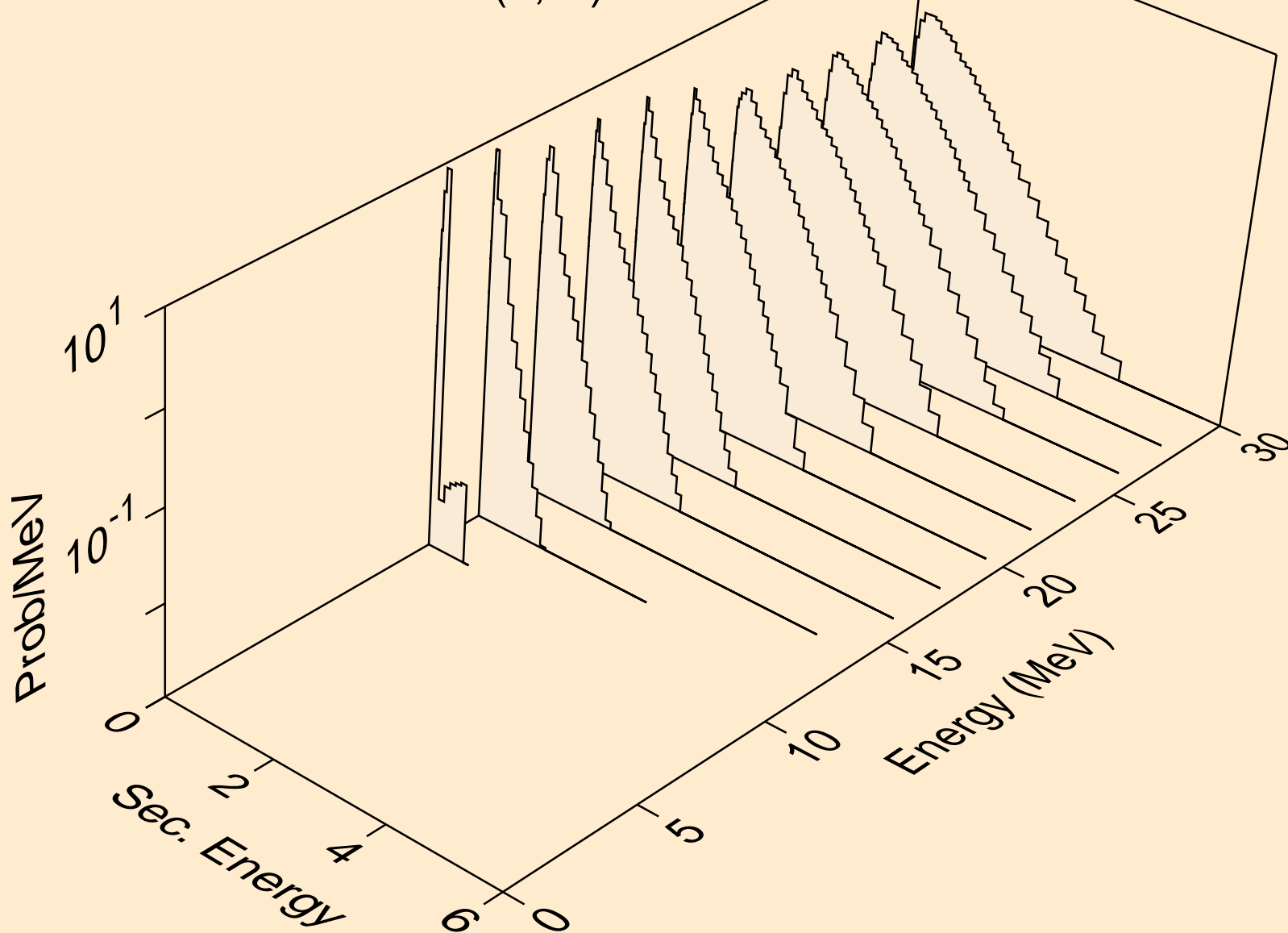

PR155 NEUTRON ACER TENDL-2019 LIBRARY; T=293.16K
Neutron emission for (n,2n)a

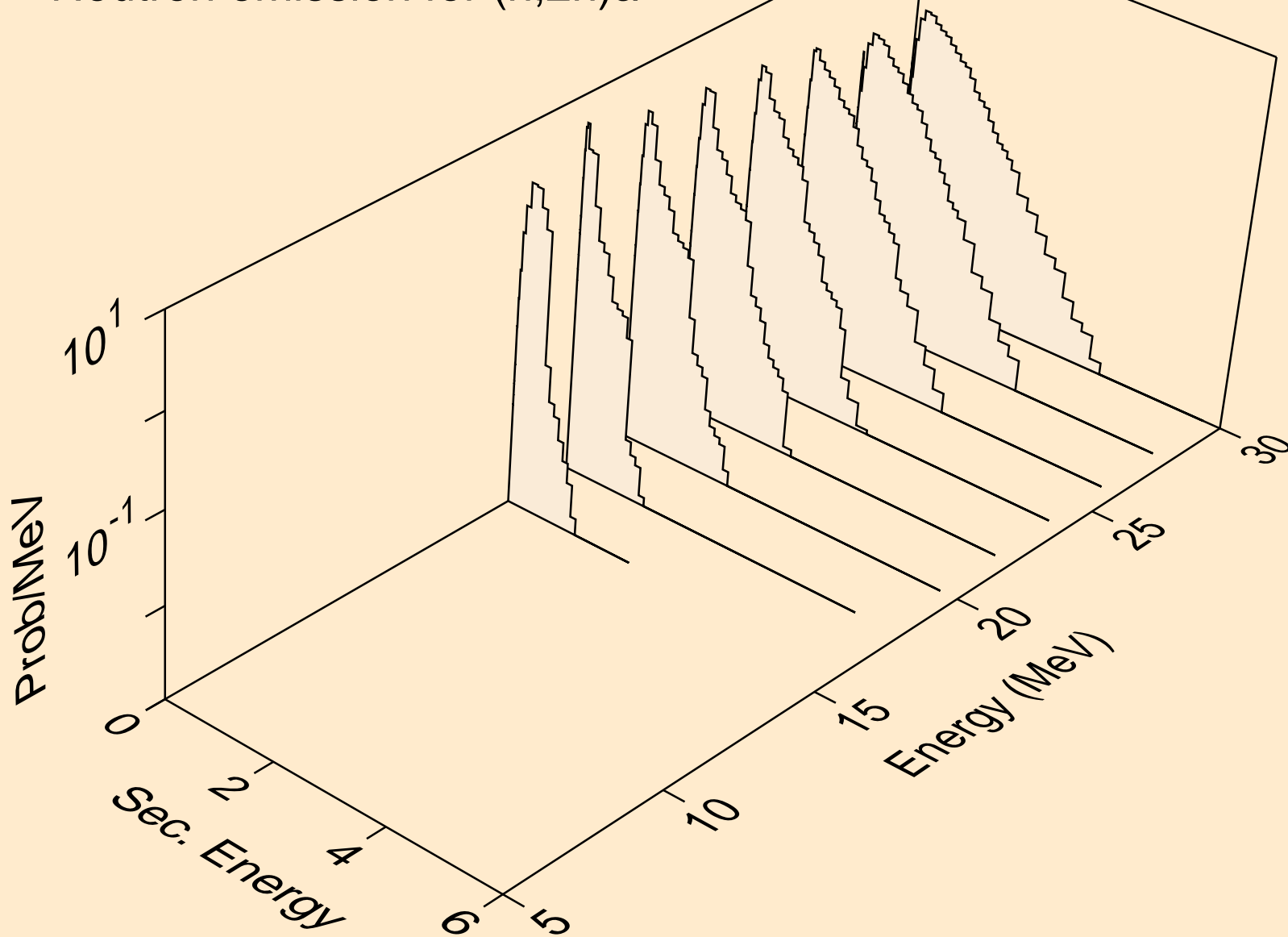

PR155 NEUTRON ACER TENDL-2019 LIBRARY; T=293.16K
Neutron emission for (n,3n)a

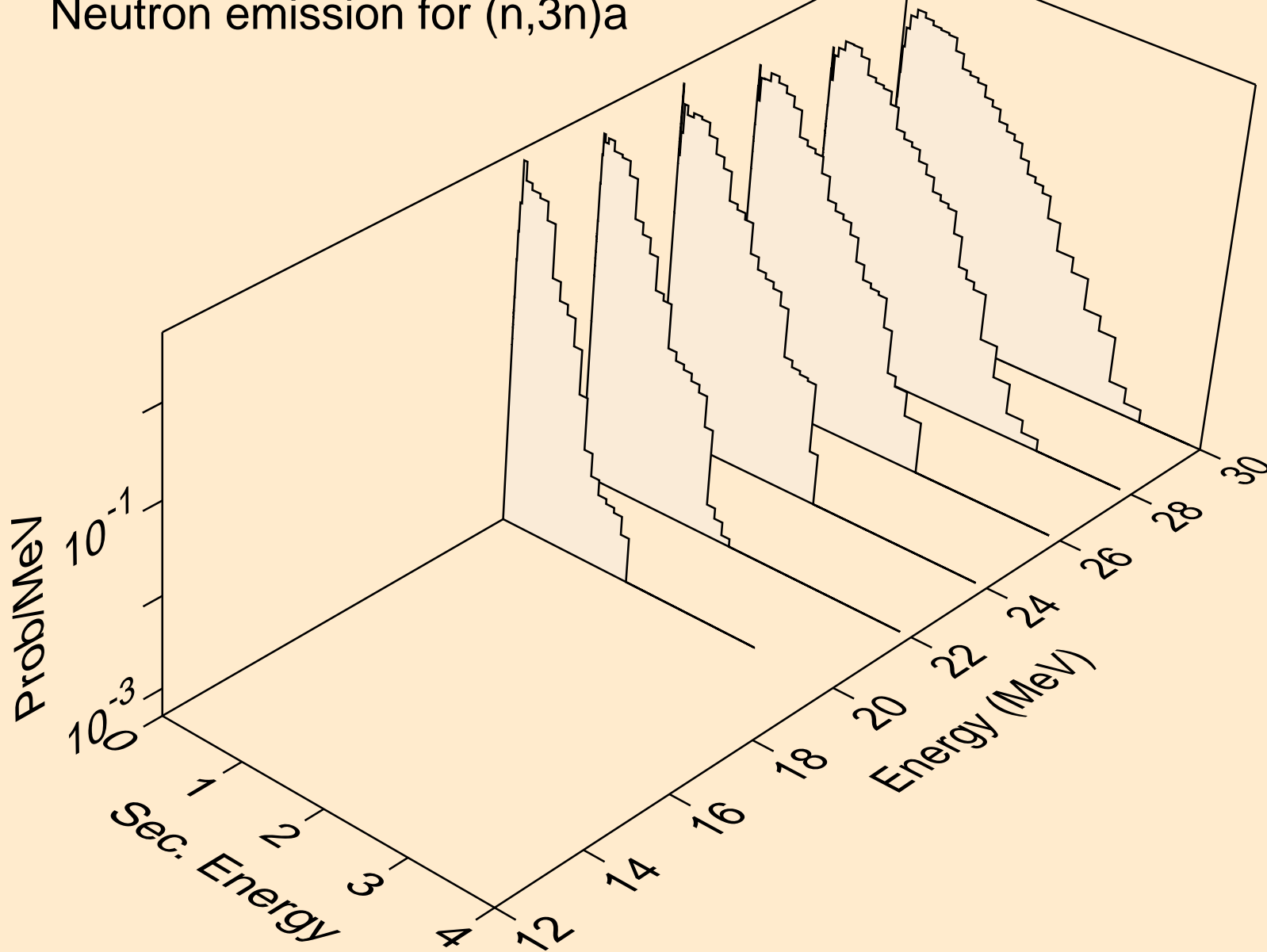

PR155 NEUTRON ACER TENDL-2019 LIBRARY; T=293.16K
Neutron emission for (n,n*)p

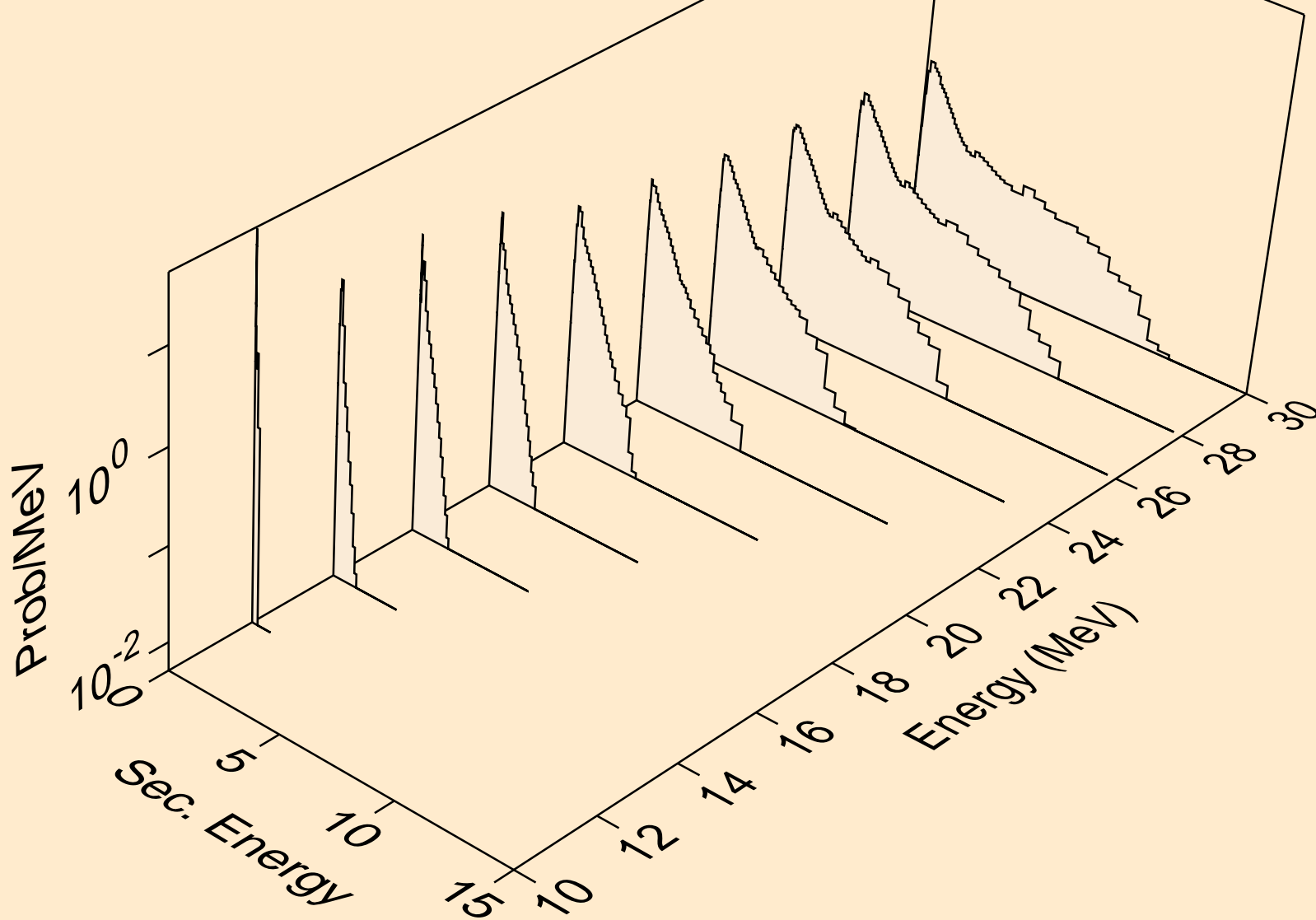

PR155 NEUTRON ACER TENDL-2019 LIBRARY; T=293.16K
Neutron emission for (n,n*)d

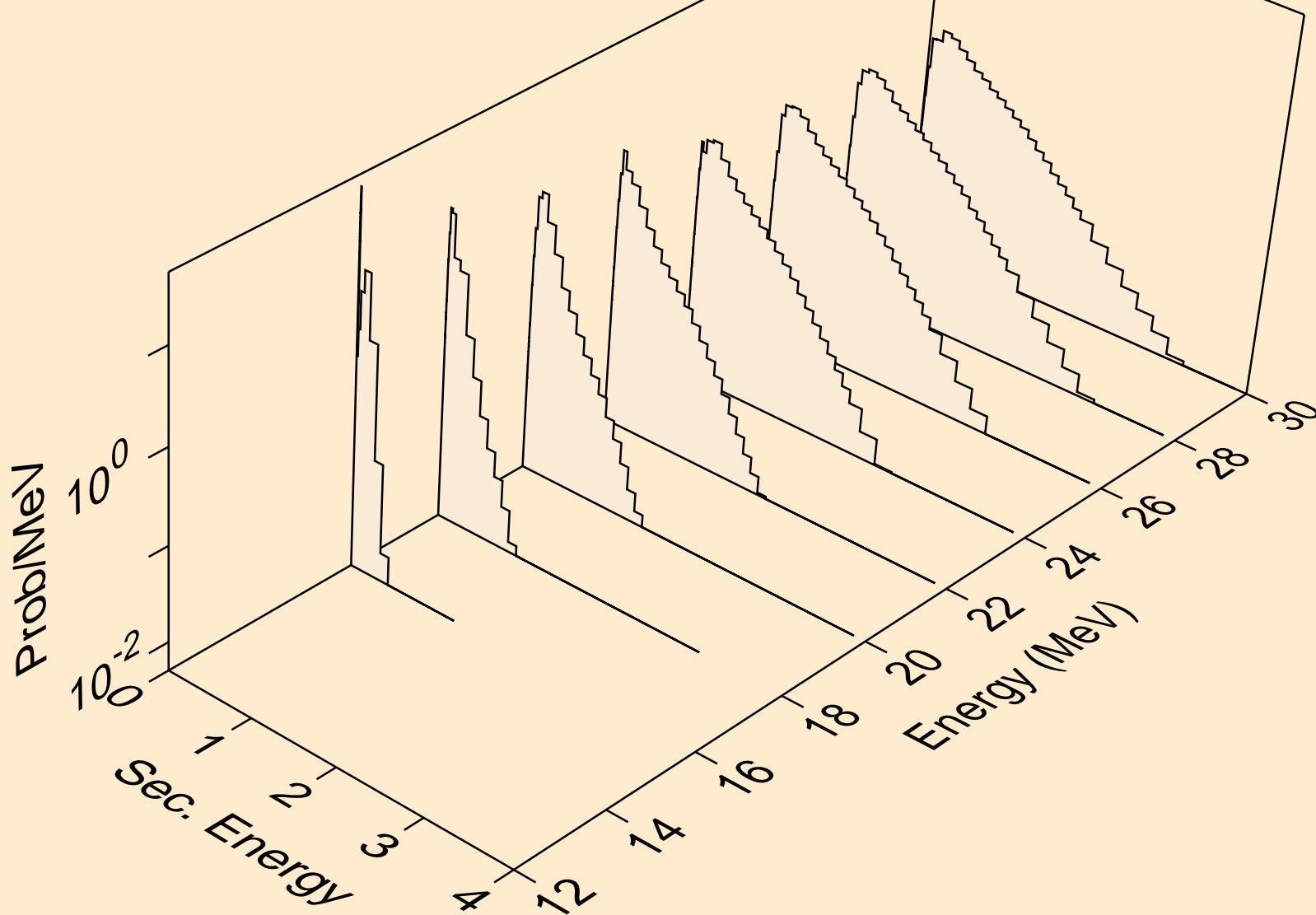

PR155 NEUTRON ACER TENDL-2019 LIBRARY; T=293.16K
Neutron emission for (n,n*)t

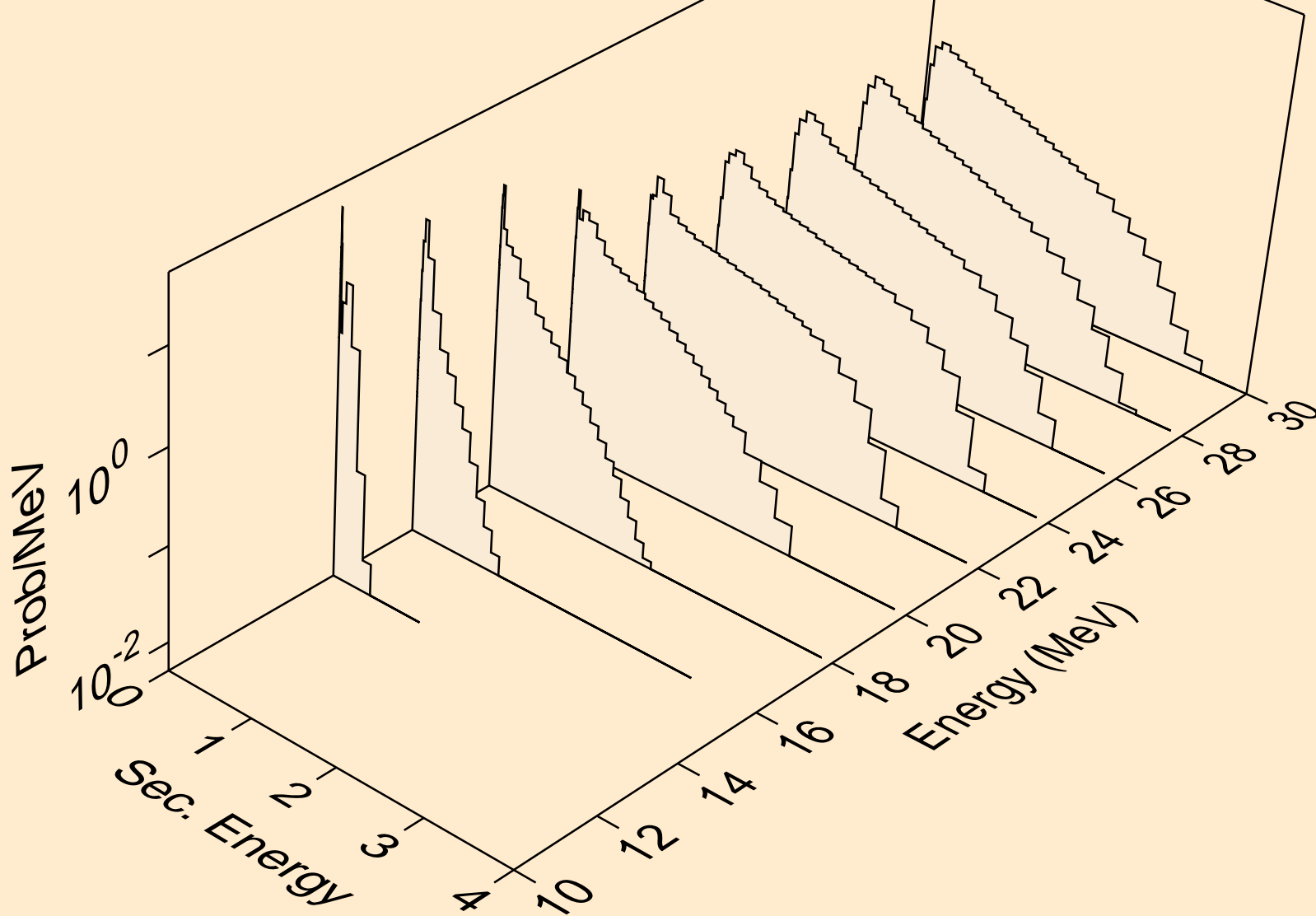

PR155 NEUTRON ACER TENDL-2019 LIBRARY; T=293.16K
Neutron emission for (n,4n)

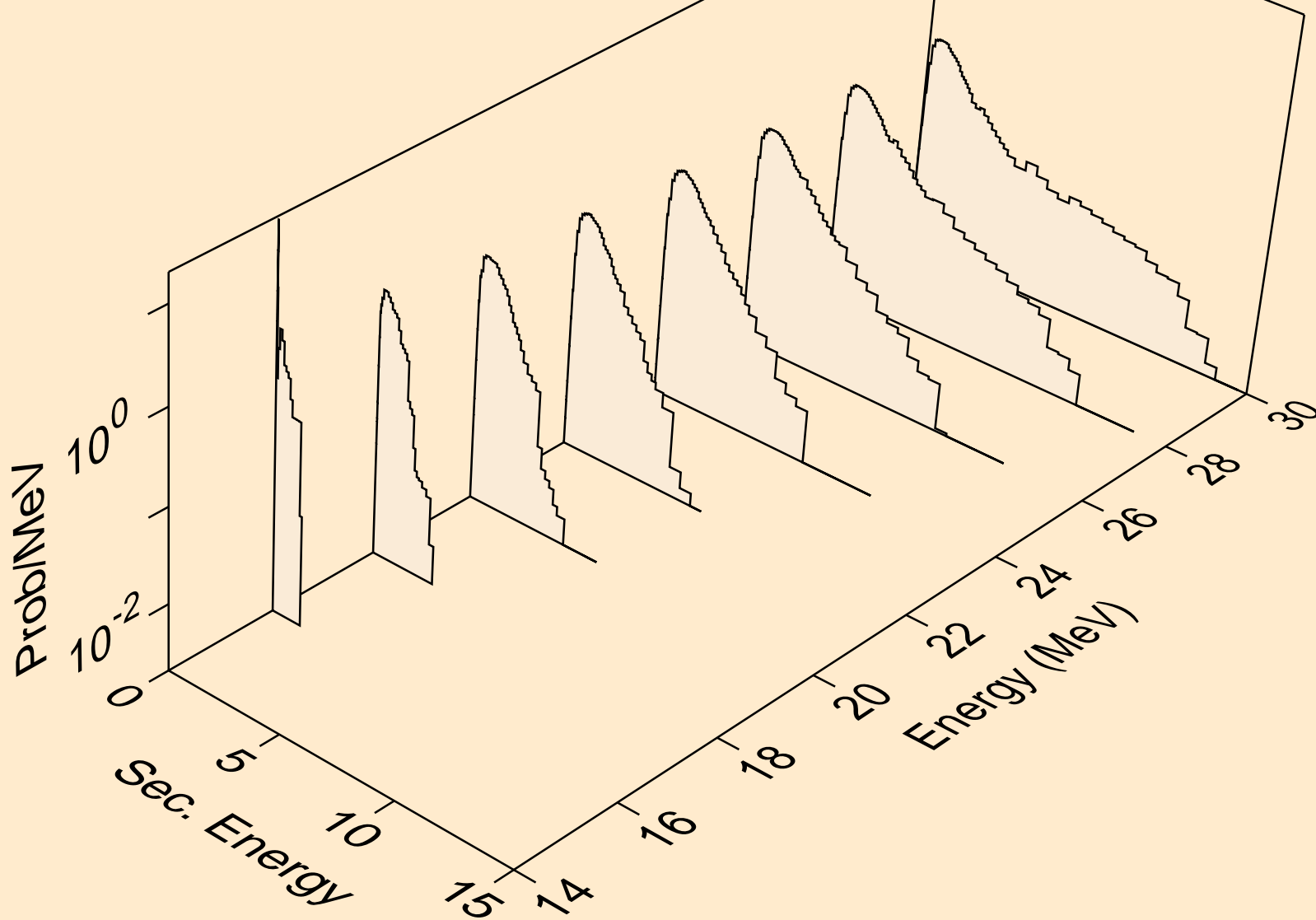

PR155 NEUTRON ACER TENDL-2019 LIBRARY; T=293.16K
Neutron emission for (n,2np)

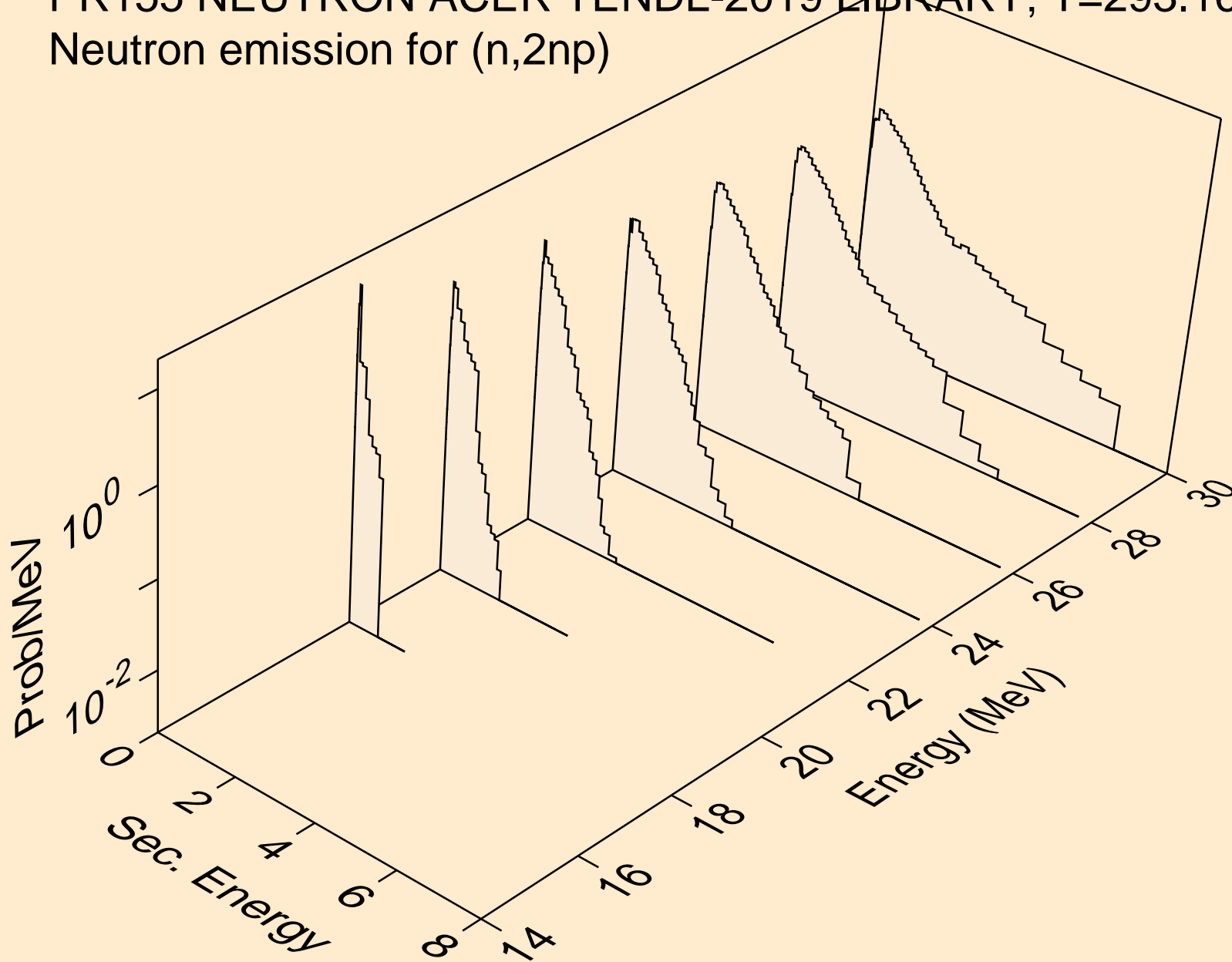

PR155 NEUTRON ACER TENDL-2019 LIBRARY; T=293.16K
Neutron emission for (n,3np)

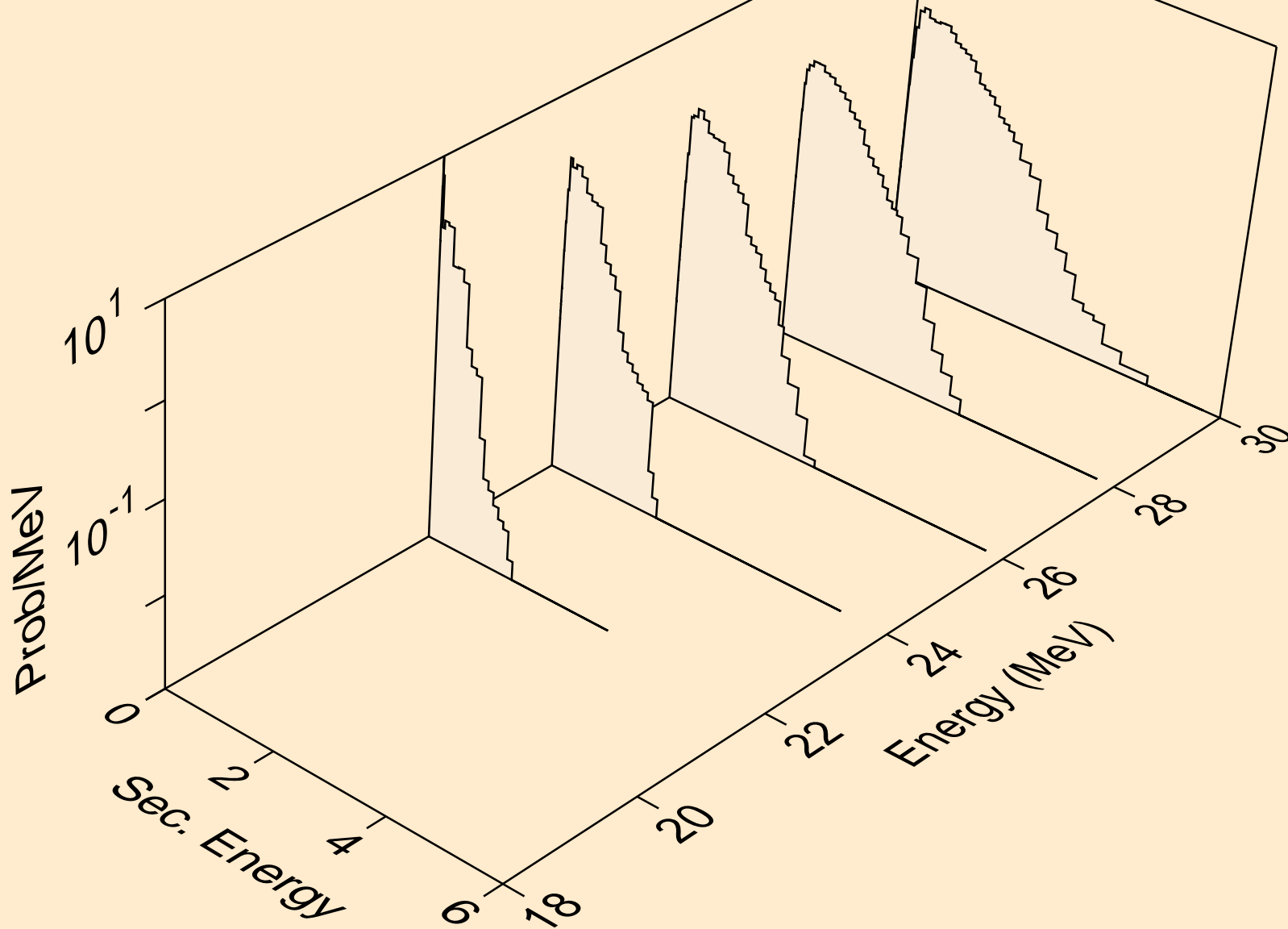

PR155 NEUTRON ACER TENDL-2019 LIBRARY; T=293.16K
Neutron emission for (n,n*c)

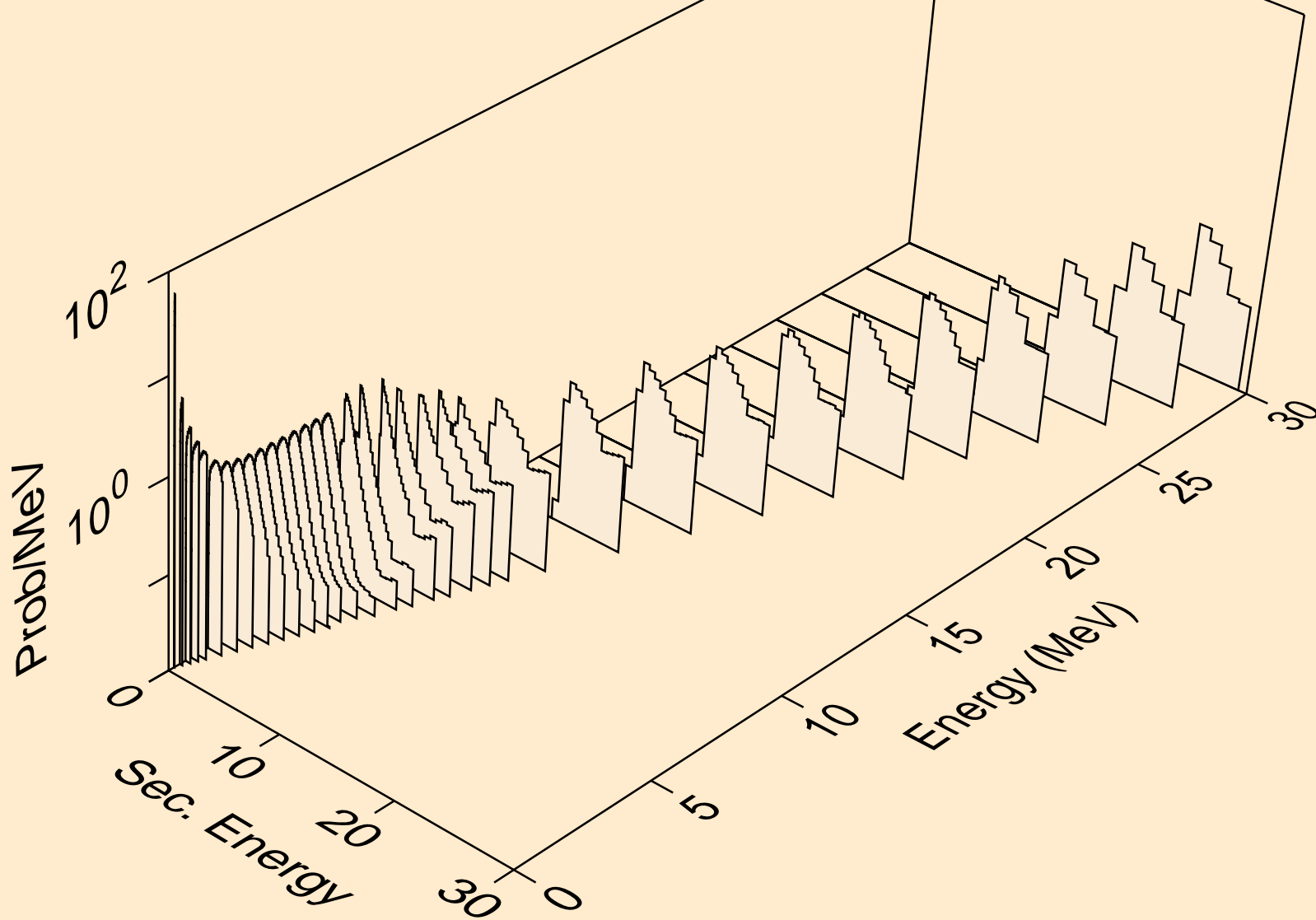

PR155 NEUTRON ACER TENDL-2019 LIBRARY; T=293.16K
Photon emission for (n,x)

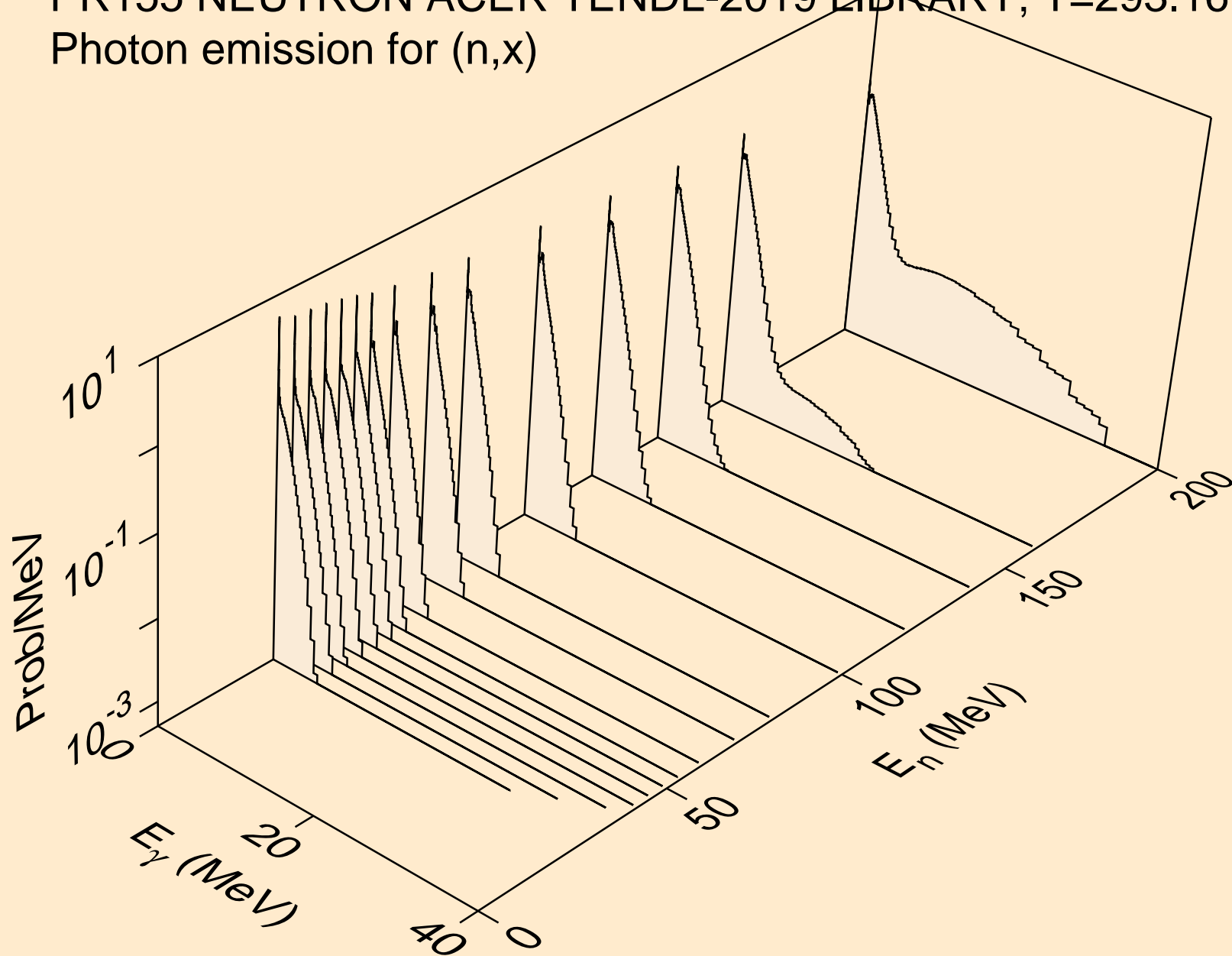

PR155 NEUTRON ACER TENDL-2019 LIBRARY; T=293.16K
Photon emission for (n,2nd)

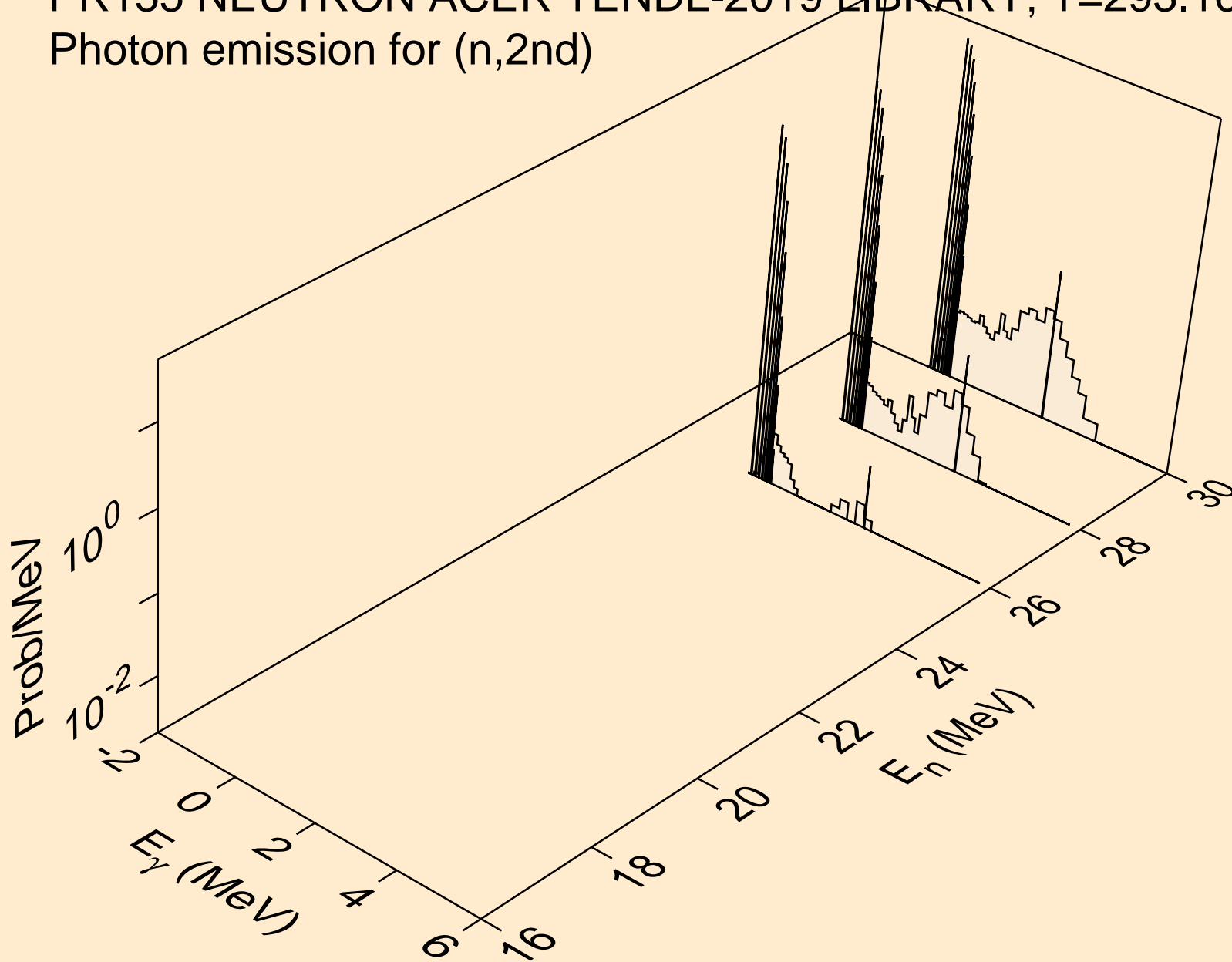

PR155 NEUTRON ACER TENDL-2019 LIBRARY; T=293.16K
Photon emission for (n,2n)

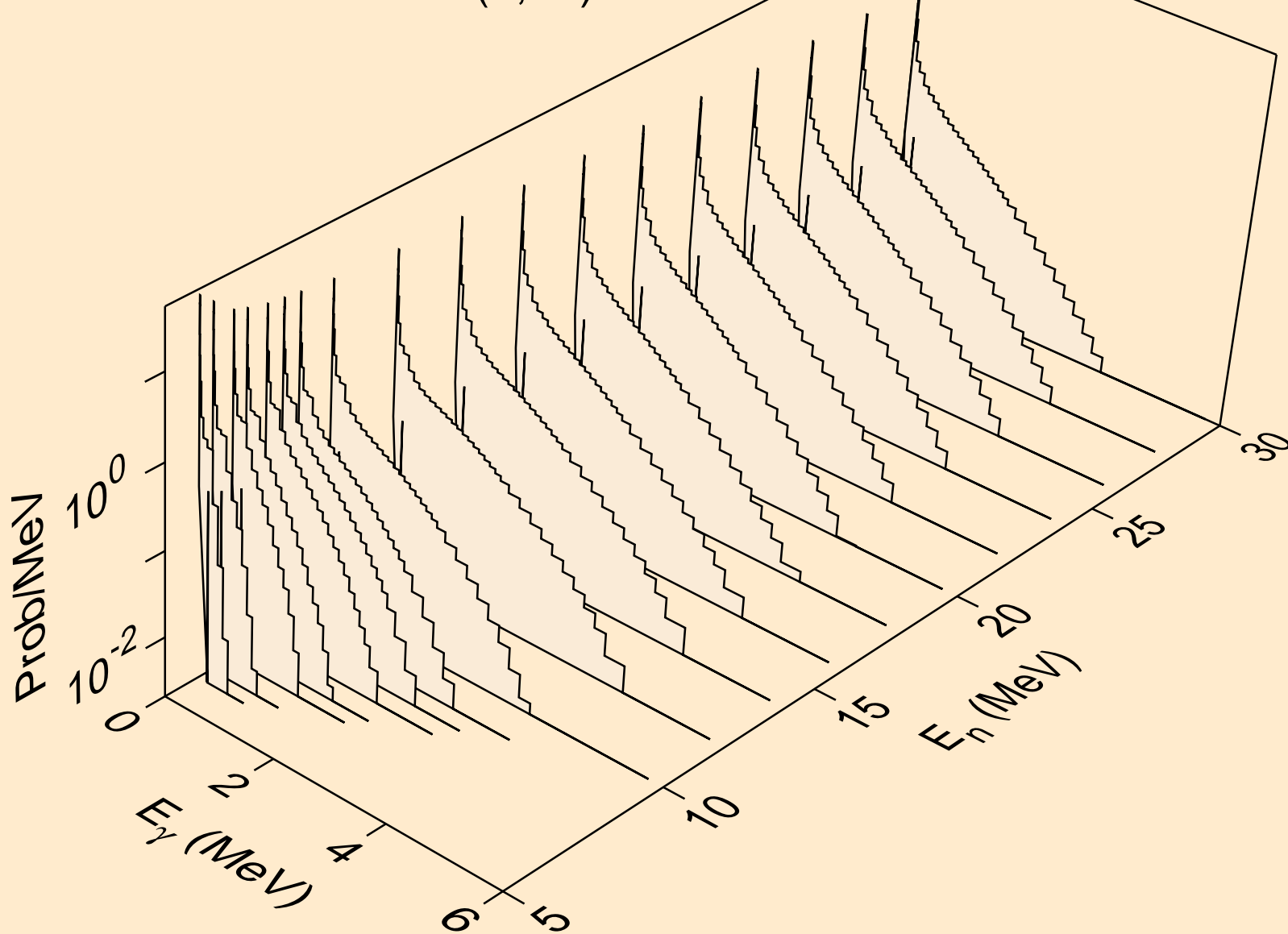

PR155 NEUTRON ACER TENDL-2019 LIBRARY; T=293.16K
Photon emission for (n,3n)

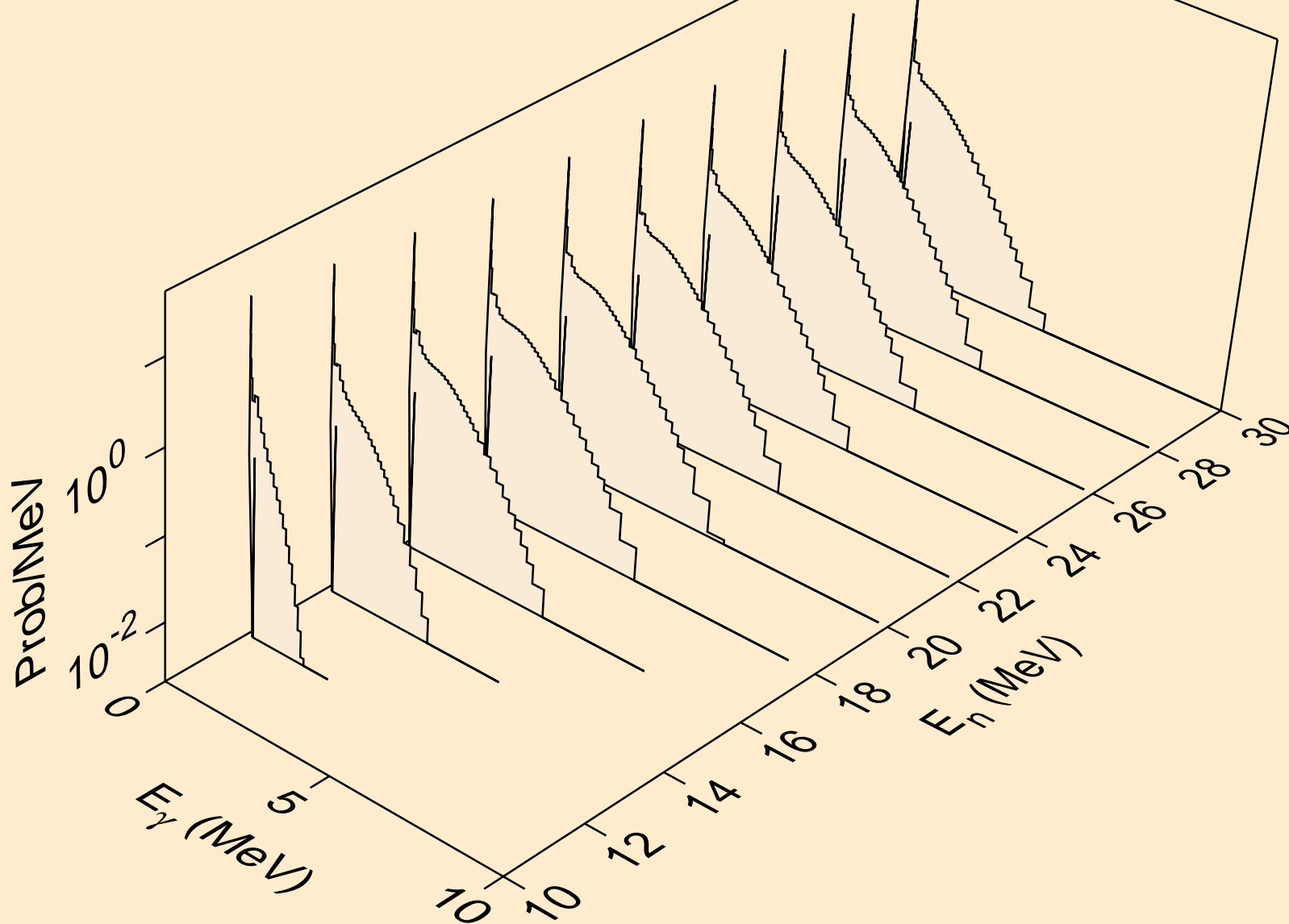

PR155 NEUTRON ACER TENDL-2019 LIBRARY; T=293.16K
Photon emission for (n,n*)a

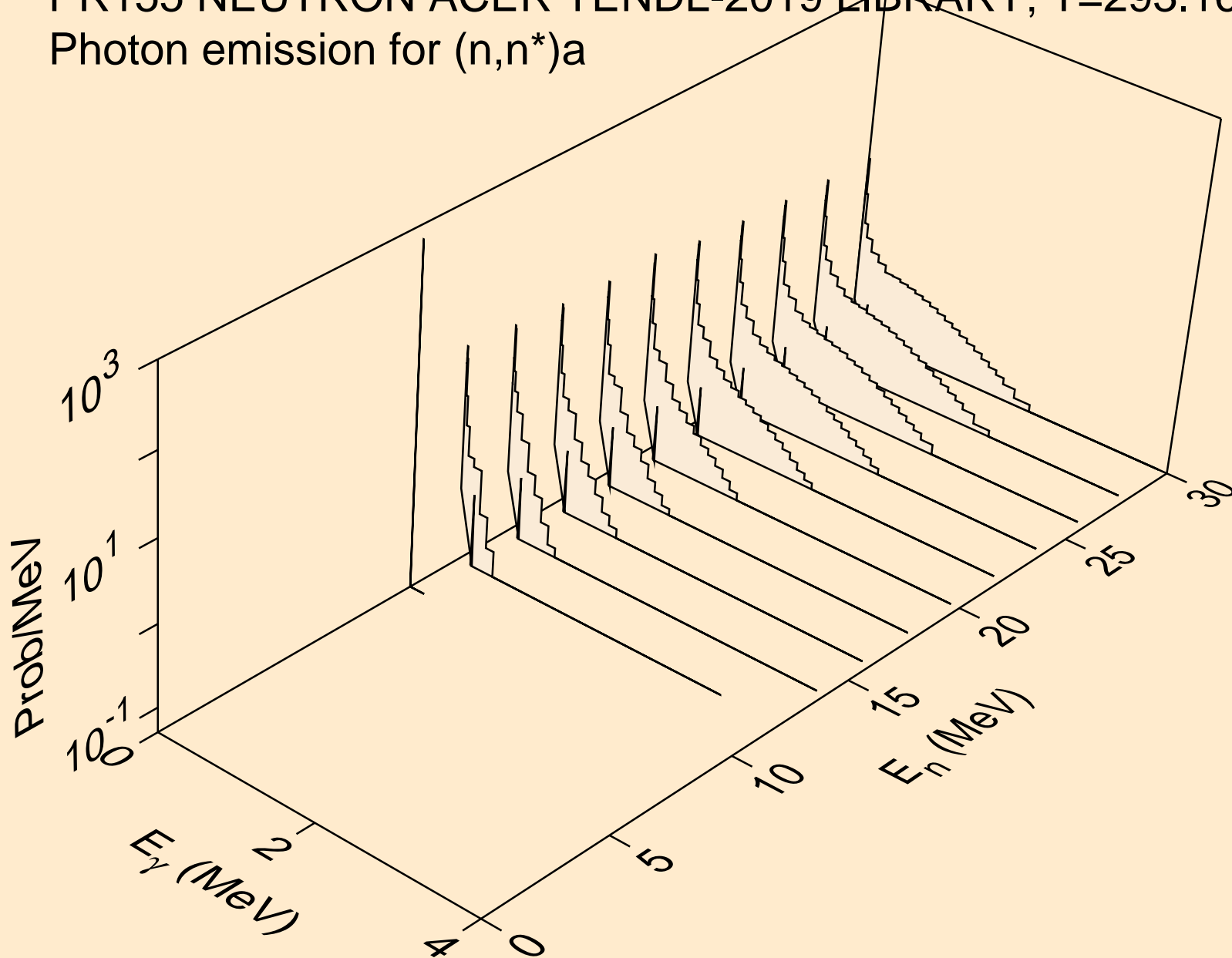

PR155 NEUTRON ACER TENDL-2019 LIBRARY; T=293.16K
Photon emission for (n,2n)a

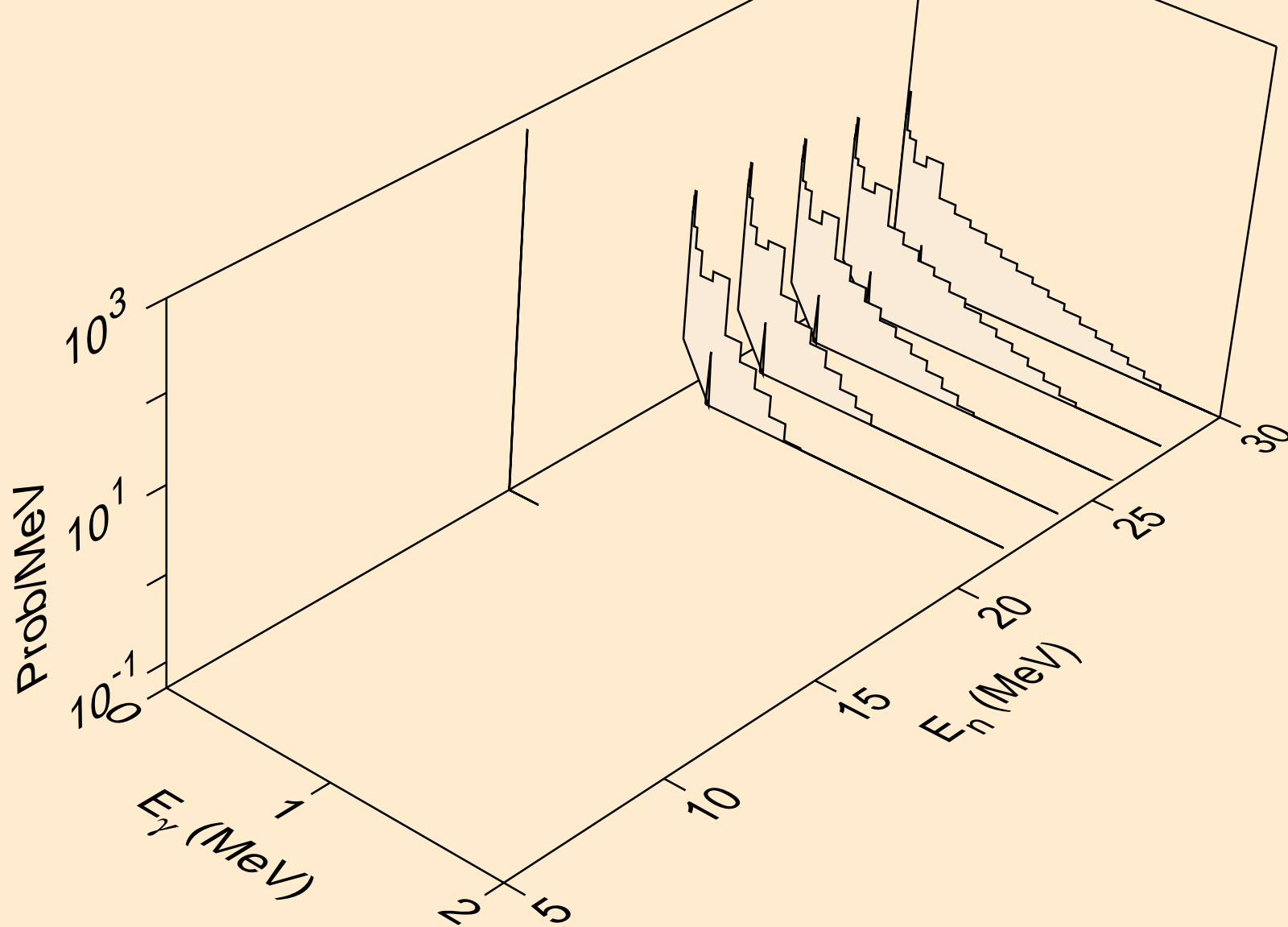

PR155 NEUTRON ACER TENDL-2019 LIBRARY; T=293.16K
Photon emission for (n,3n)a

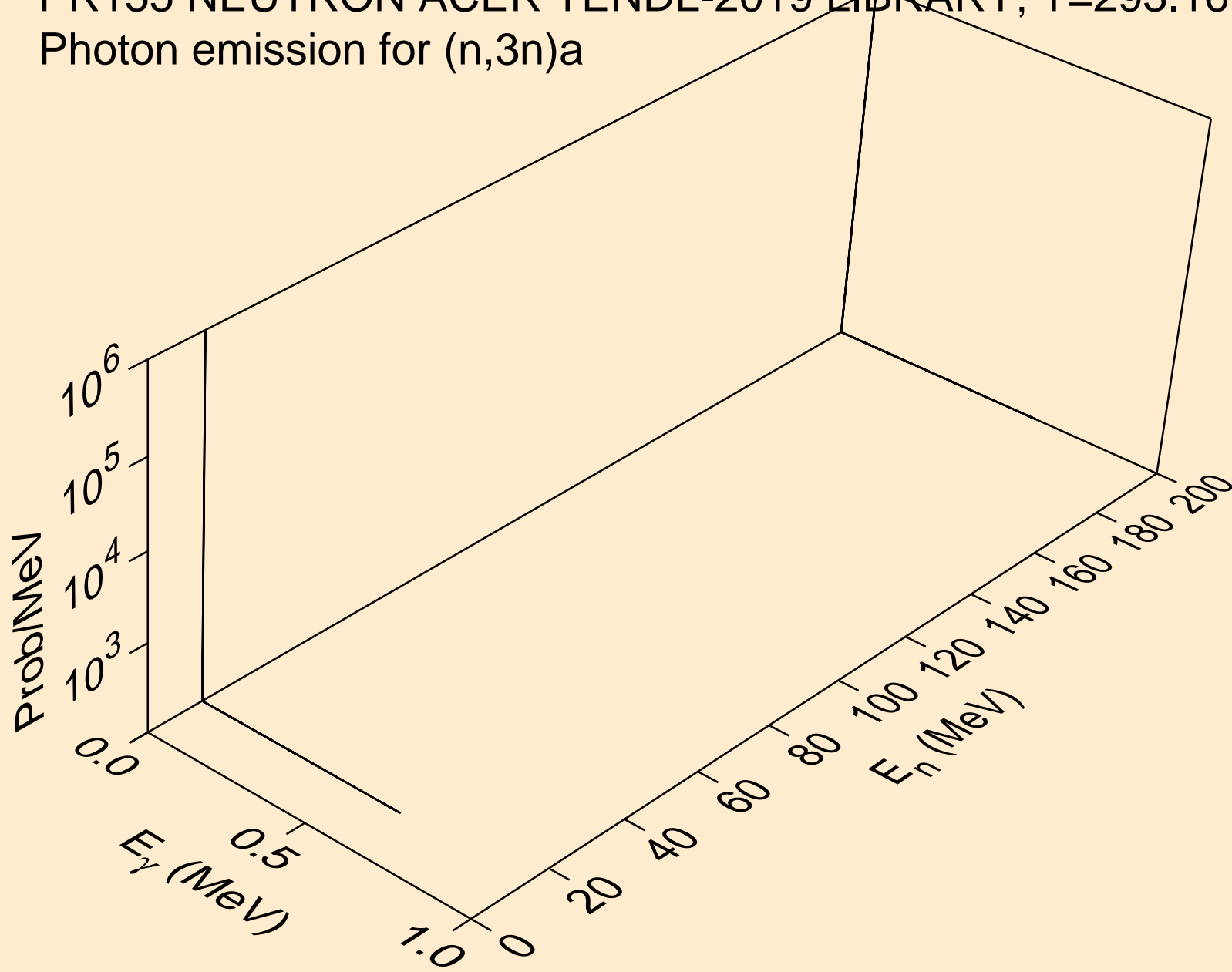

PR155 NEUTRON ACER TENDL-2019 LIBRARY; T=293.16K
Photon emission for (n,n*)p

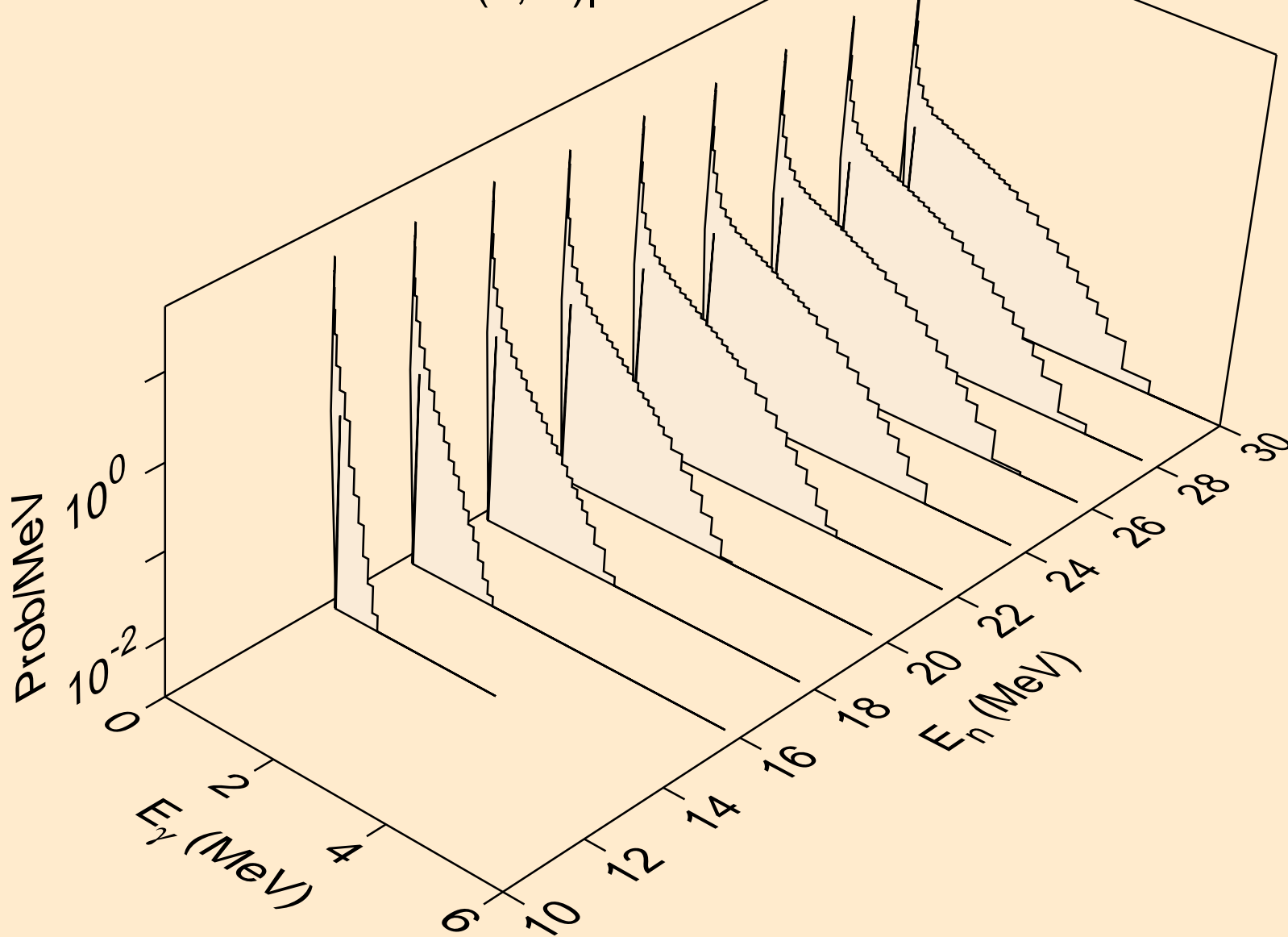

PR155 NEUTRON ACER TENDL-2019 LIBRARY; T=293.16K
Photon emission for (n,n*)d

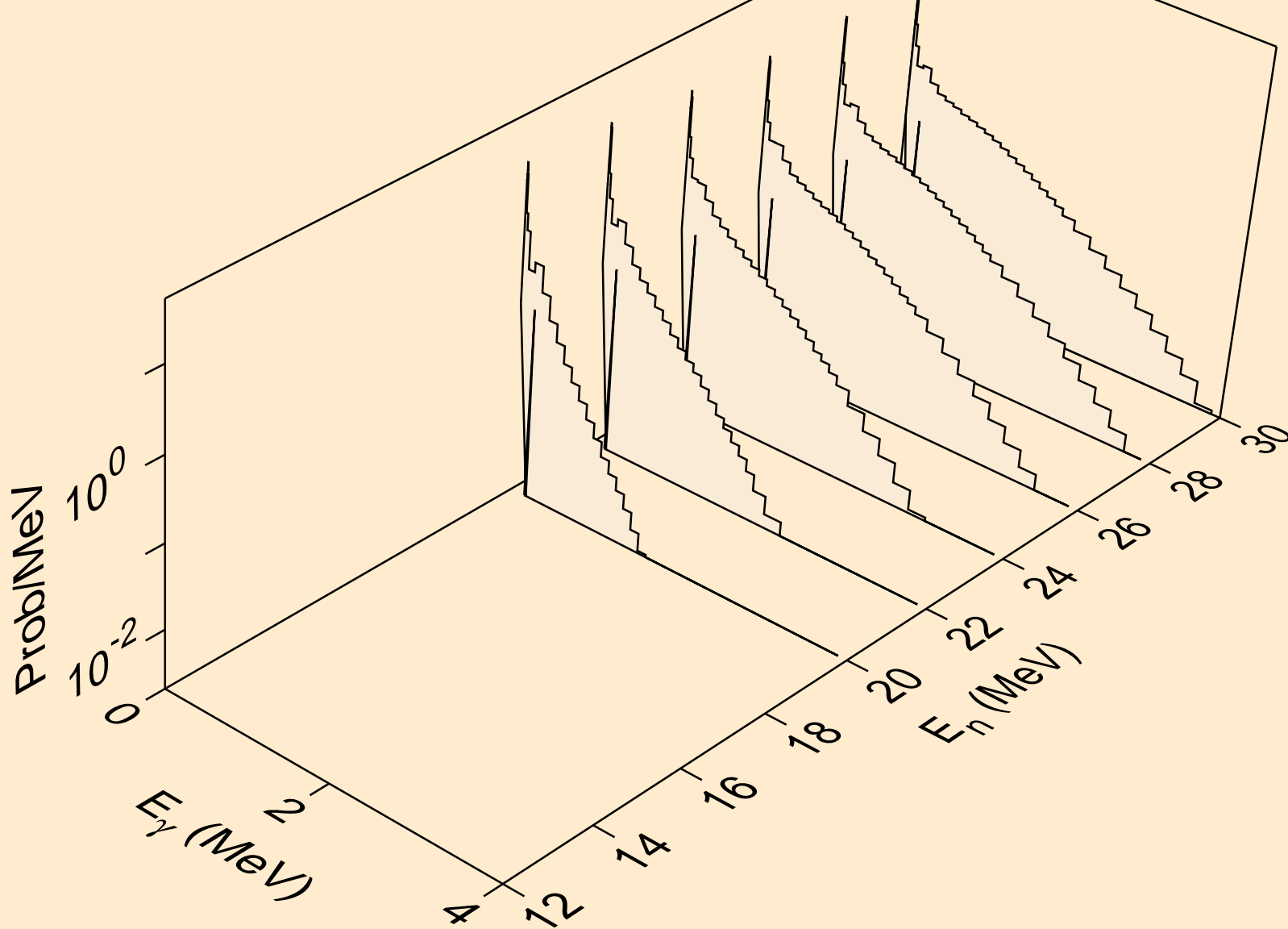

PR155 NEUTRON ACER TENDL-2019 LIBRARY; T=293.16K
Photon emission for (n,n*)t

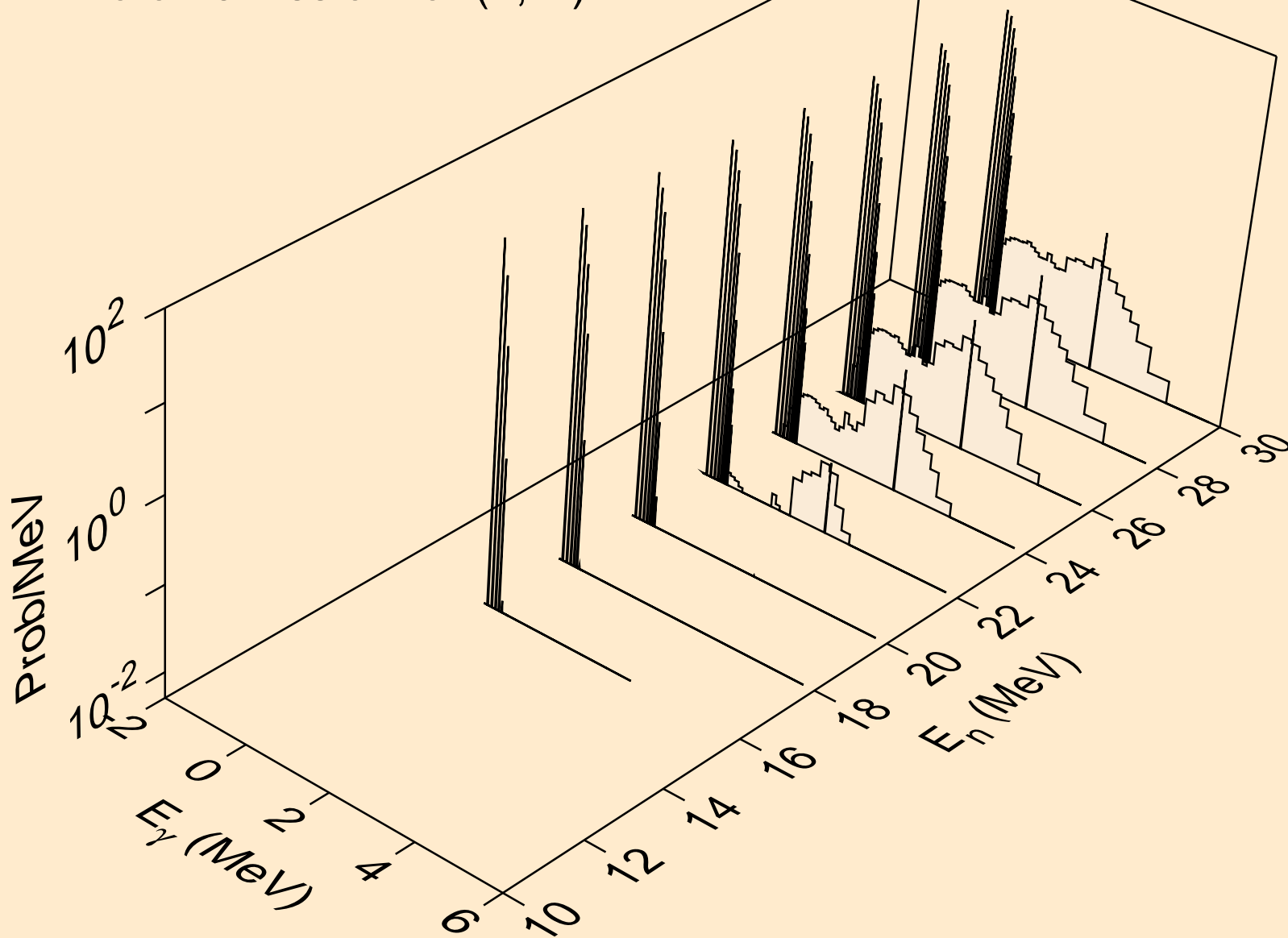

PR155 NEUTRON ACER TENDL-2019 LIBRARY; T=293.16K
Photon emission for (n,4n)

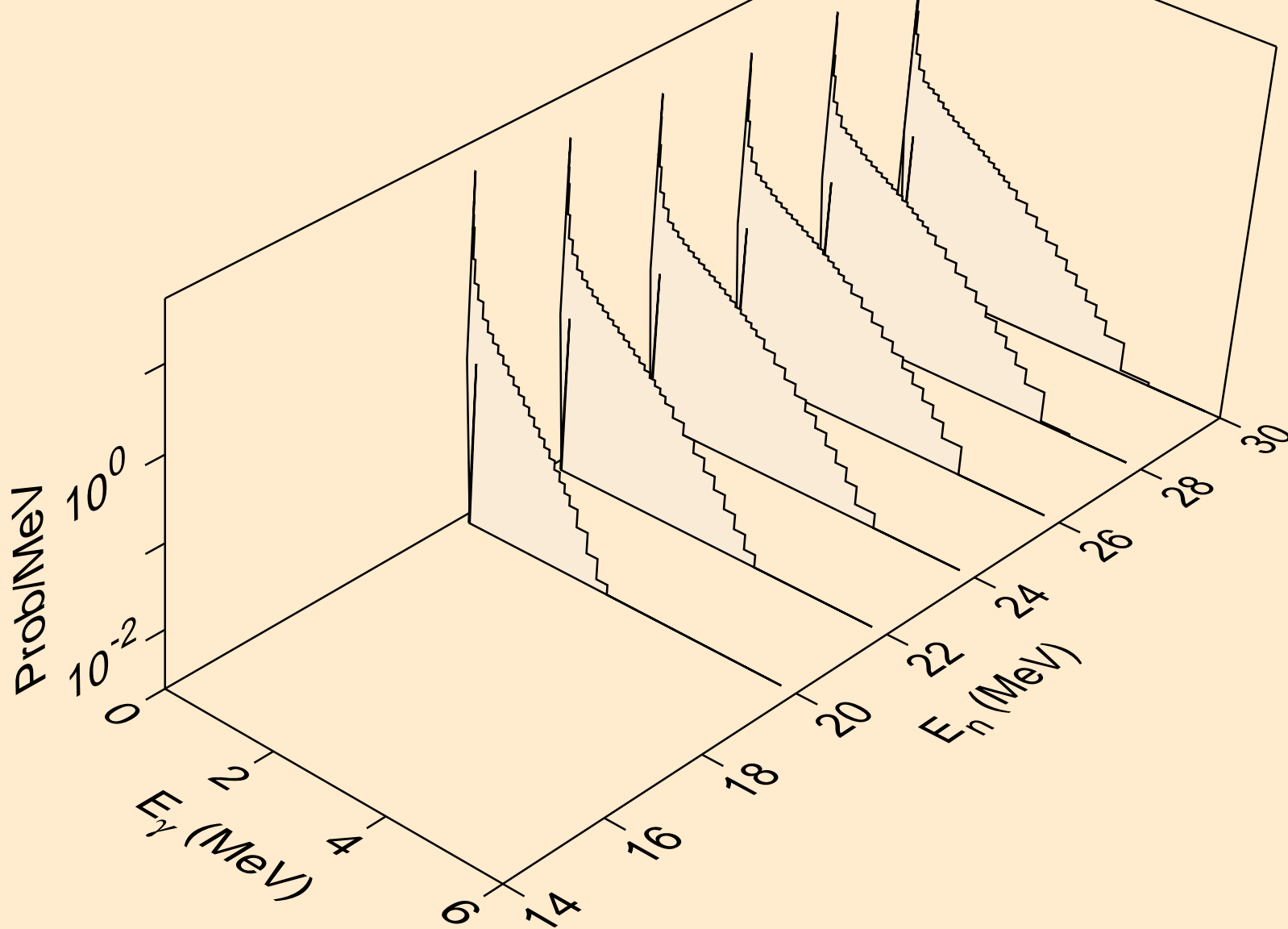

PR155 NEUTRON ACER TENDL-2019 LIBRARY; T=293.16K
Photon emission for (n,2np)

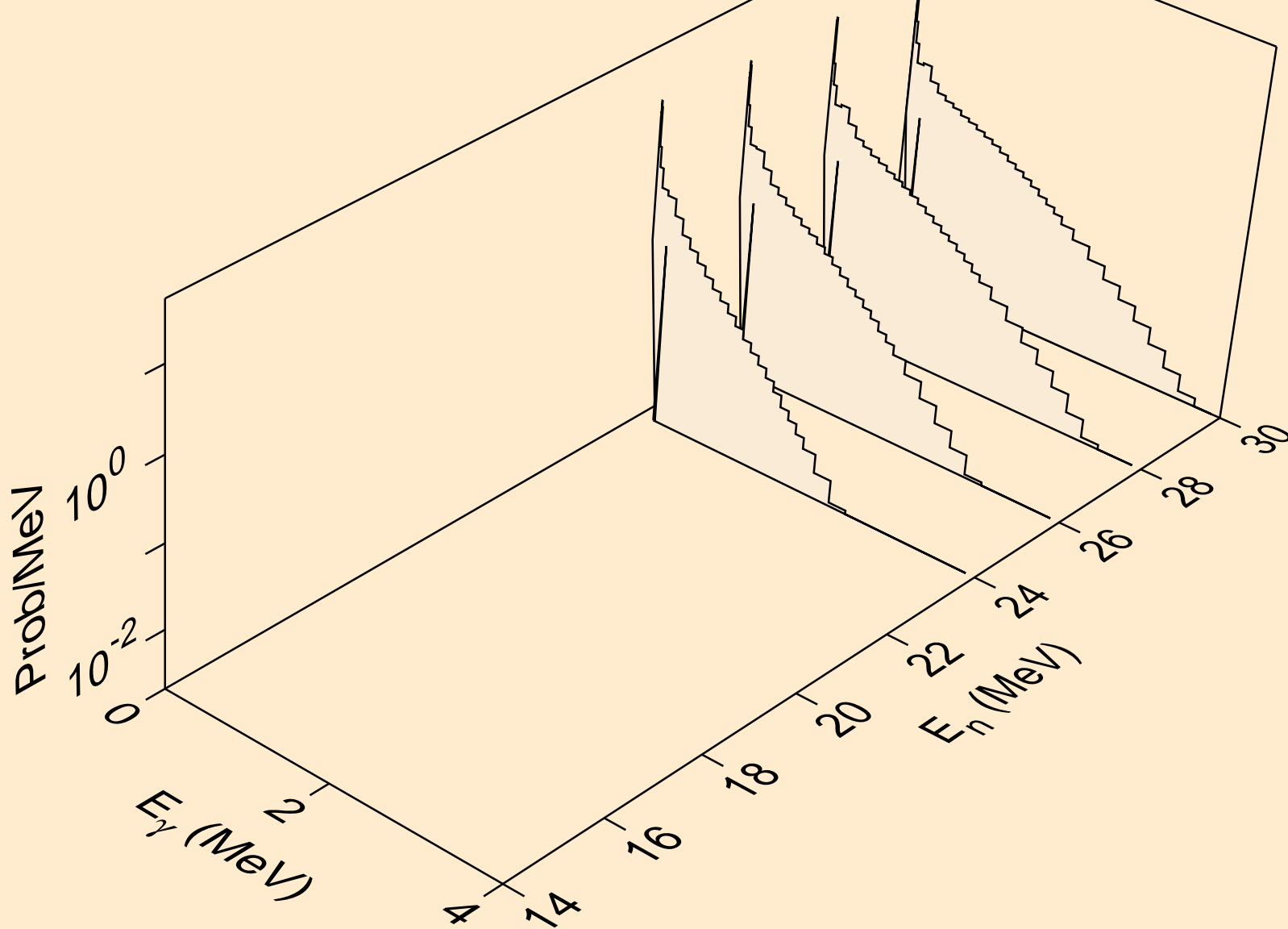

PR155 NEUTRON ACER TENDL-2019 LIBRARY; T=293.16K
Photon emission for (n,3np)

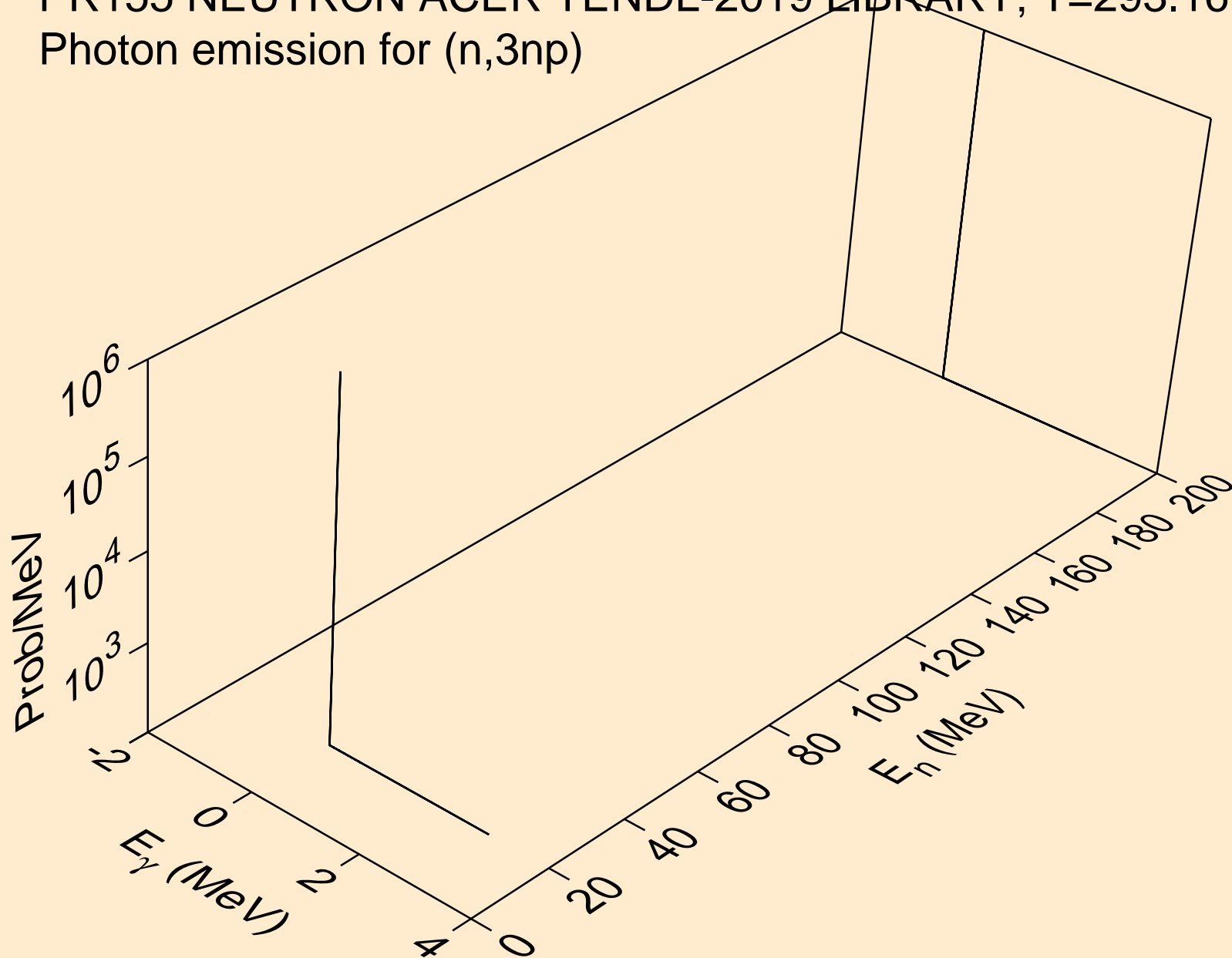

PR155 NEUTRON ACER TENDL-2019 LIBRARY; T=293.16K
Photon emission for (n,n*c)

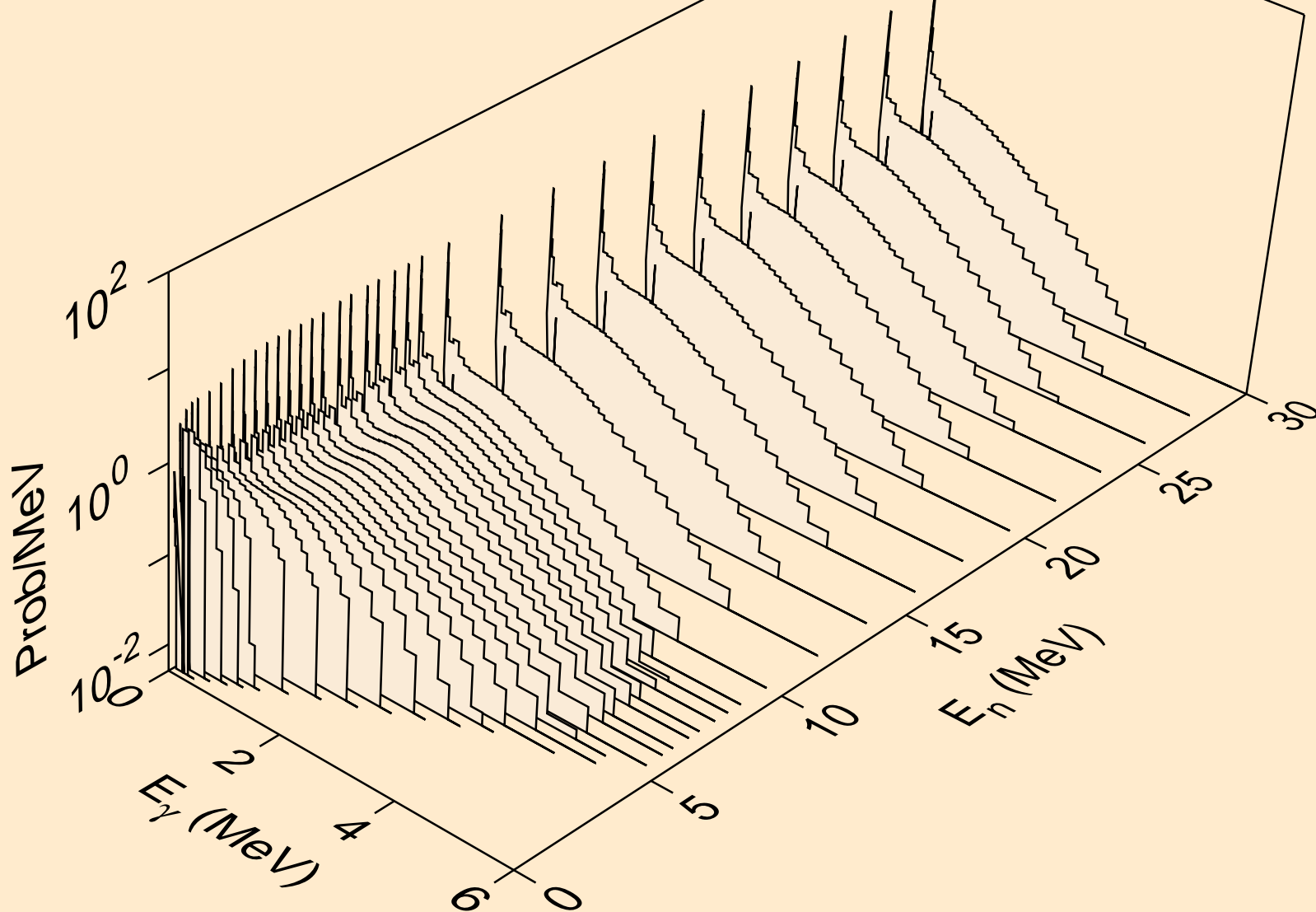

PR155 NEUTRON ACER TENDL-2019 LIBRARY; T=293.16K
Photon emission for (n,gma)

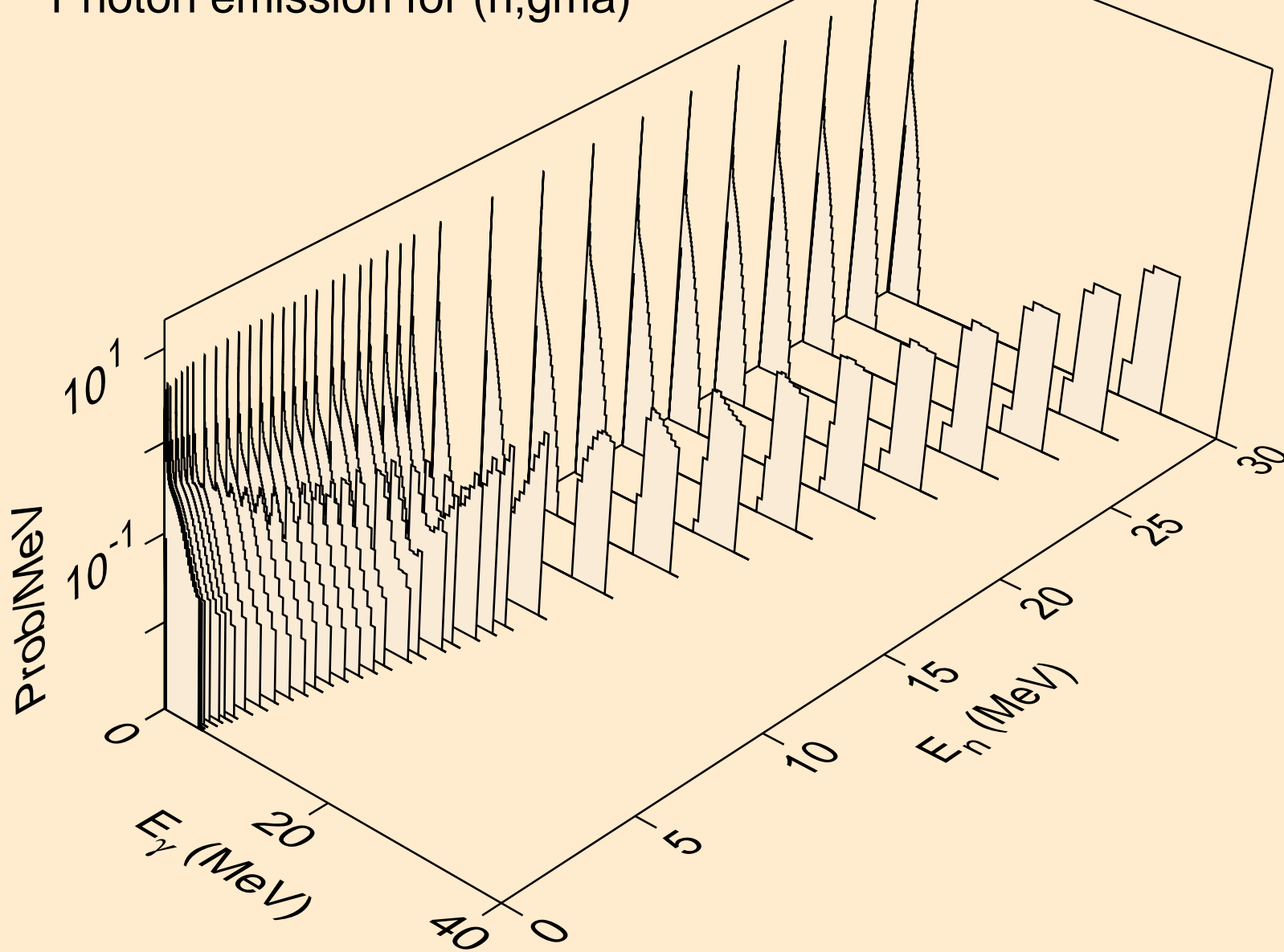

PR155 NEUTRON ACER TENDL-2019 LIBRARY; T=293.16K
Photon emission for (n,p)

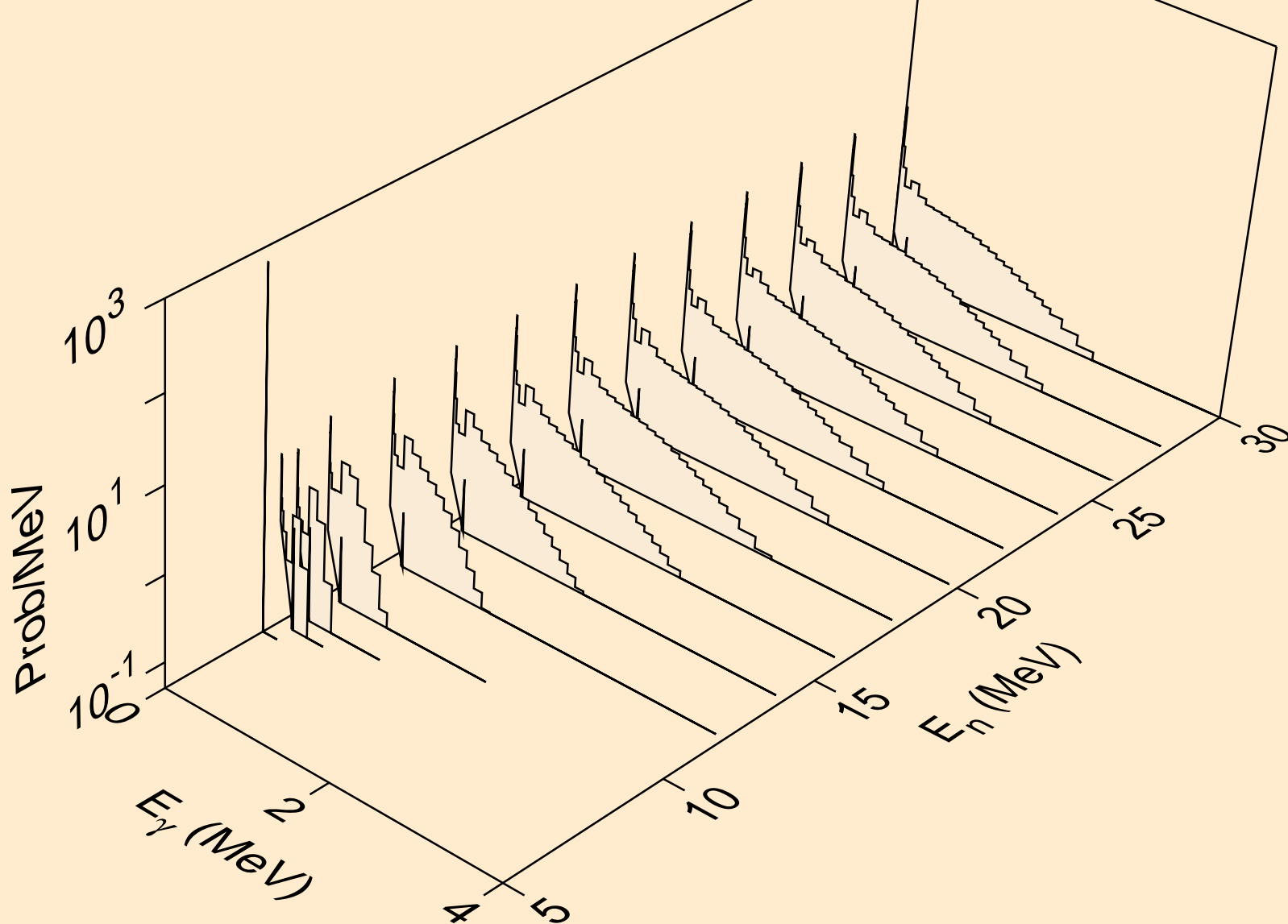

PR155 NEUTRON ACER TENDL-2019 LIBRARY; T=293.16K
Photon emission for (n,d)

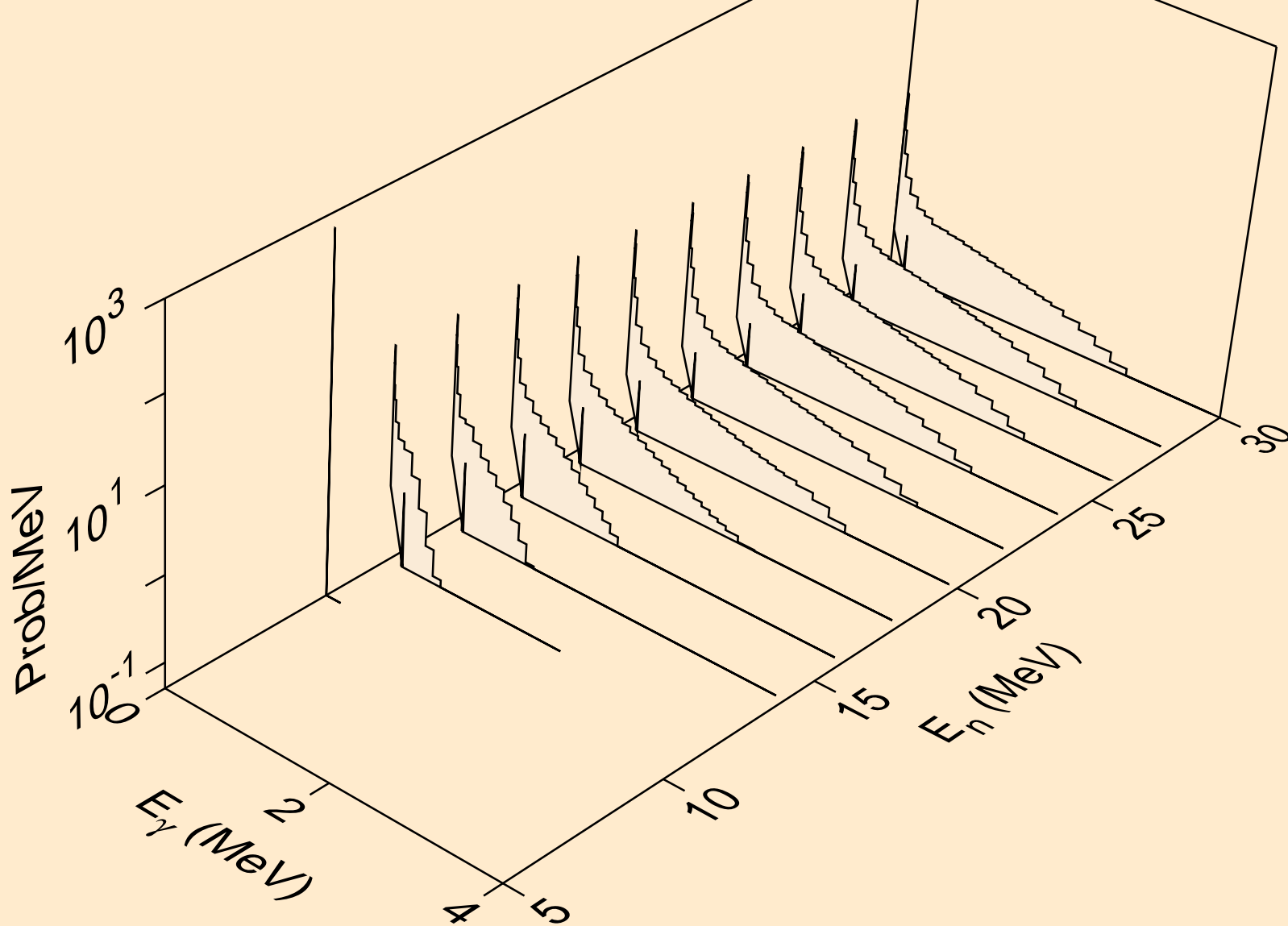

PR155 NEUTRON ACER TENDL-2019 LIBRARY; T=293.16K
Photon emission for (n,t)

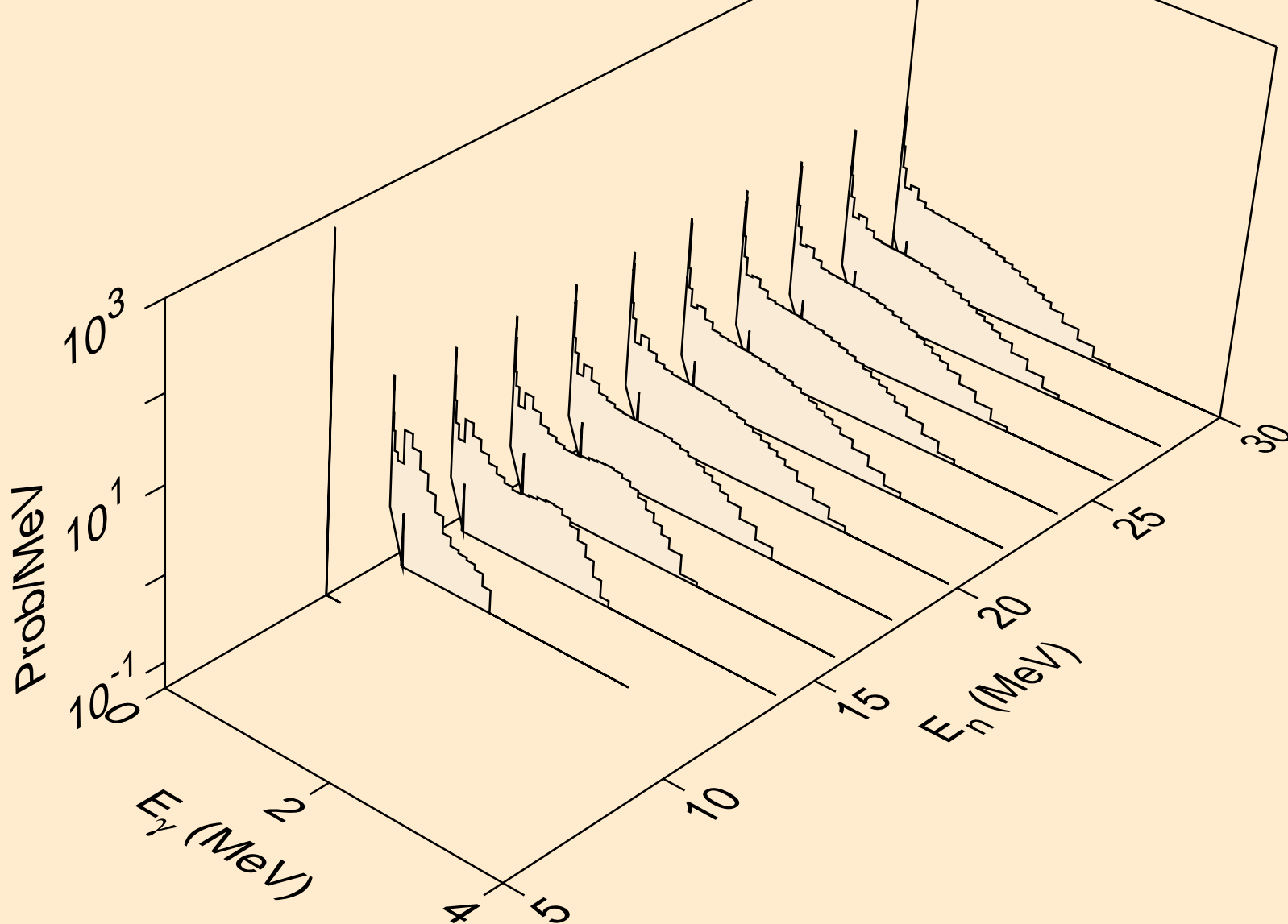

PR155 NEUTRON ACER TENDL-2019 LIBRARY; T=293.16K
Photon emission for (n,he3)

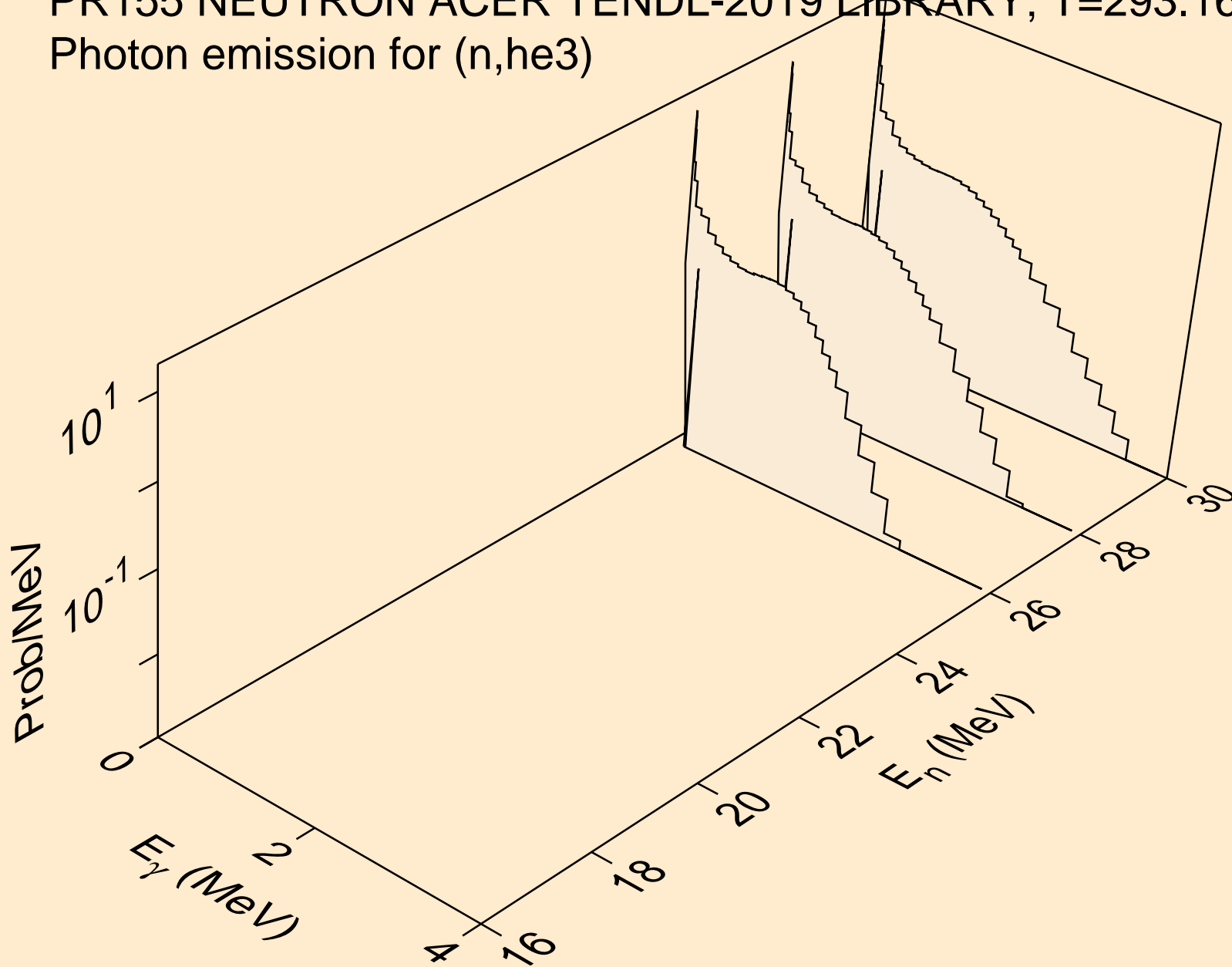

PR155 NEUTRON ACER TENDL-2019 LIBRARY; T=293.16K
Photon emission for (n,a)

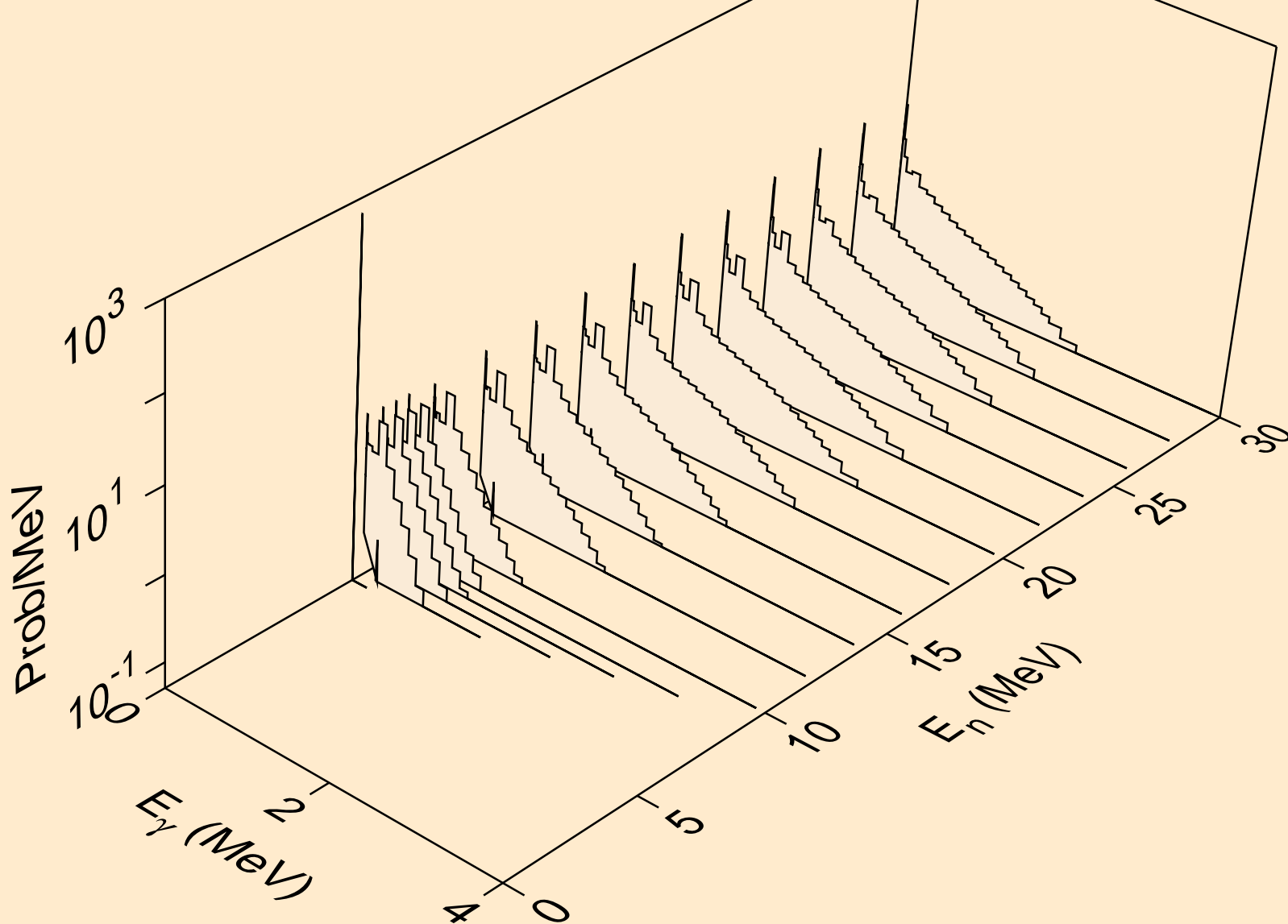

PR155 NEUTRON ACER TENDL-2019 LIBRARY; T=293.16K
thermal capture photon spectrum

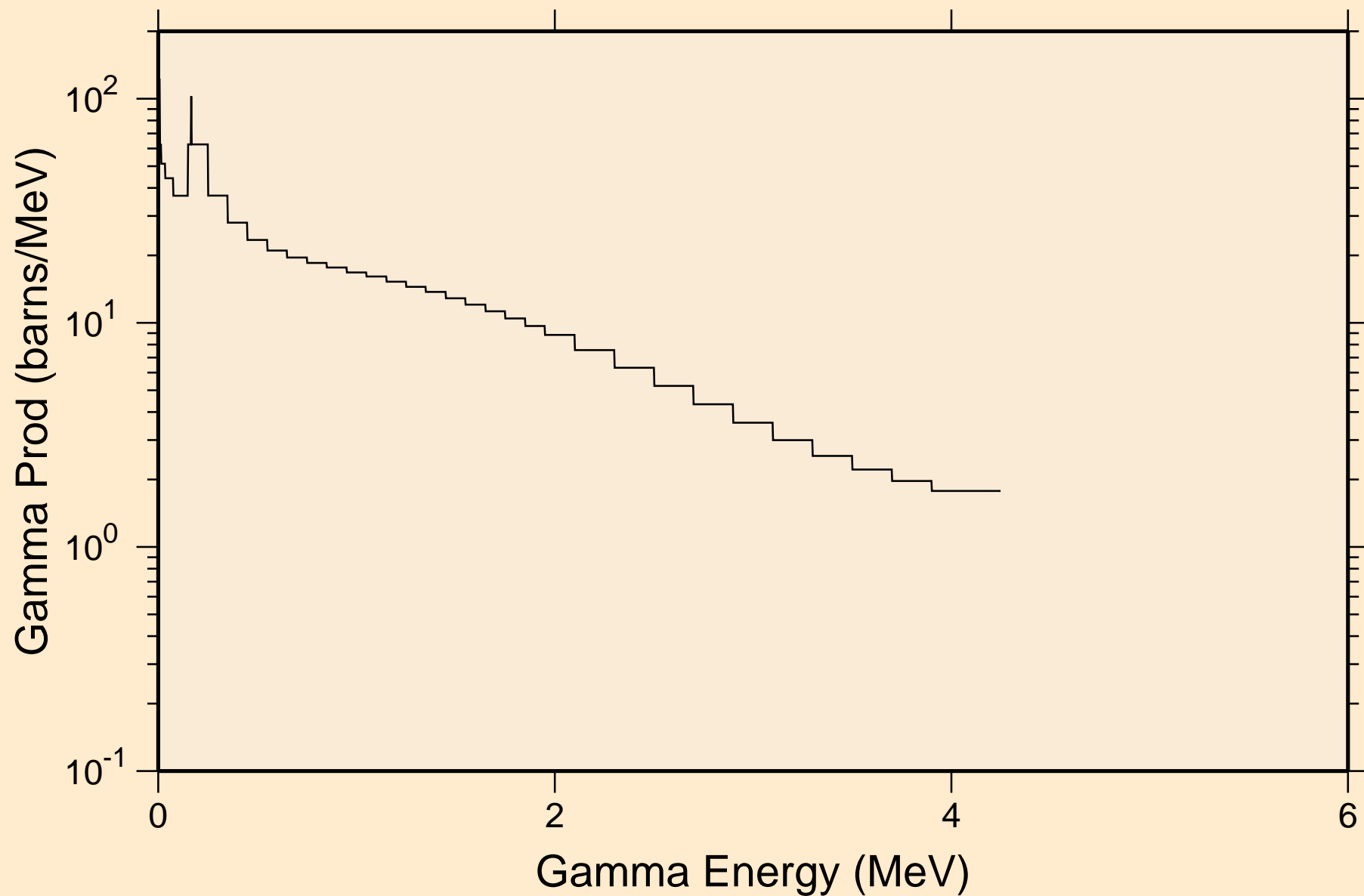

PR155 NEUTRON ACER TENDL-2019 LIBRARY; T=293.16K
14 MeV photon spectrum

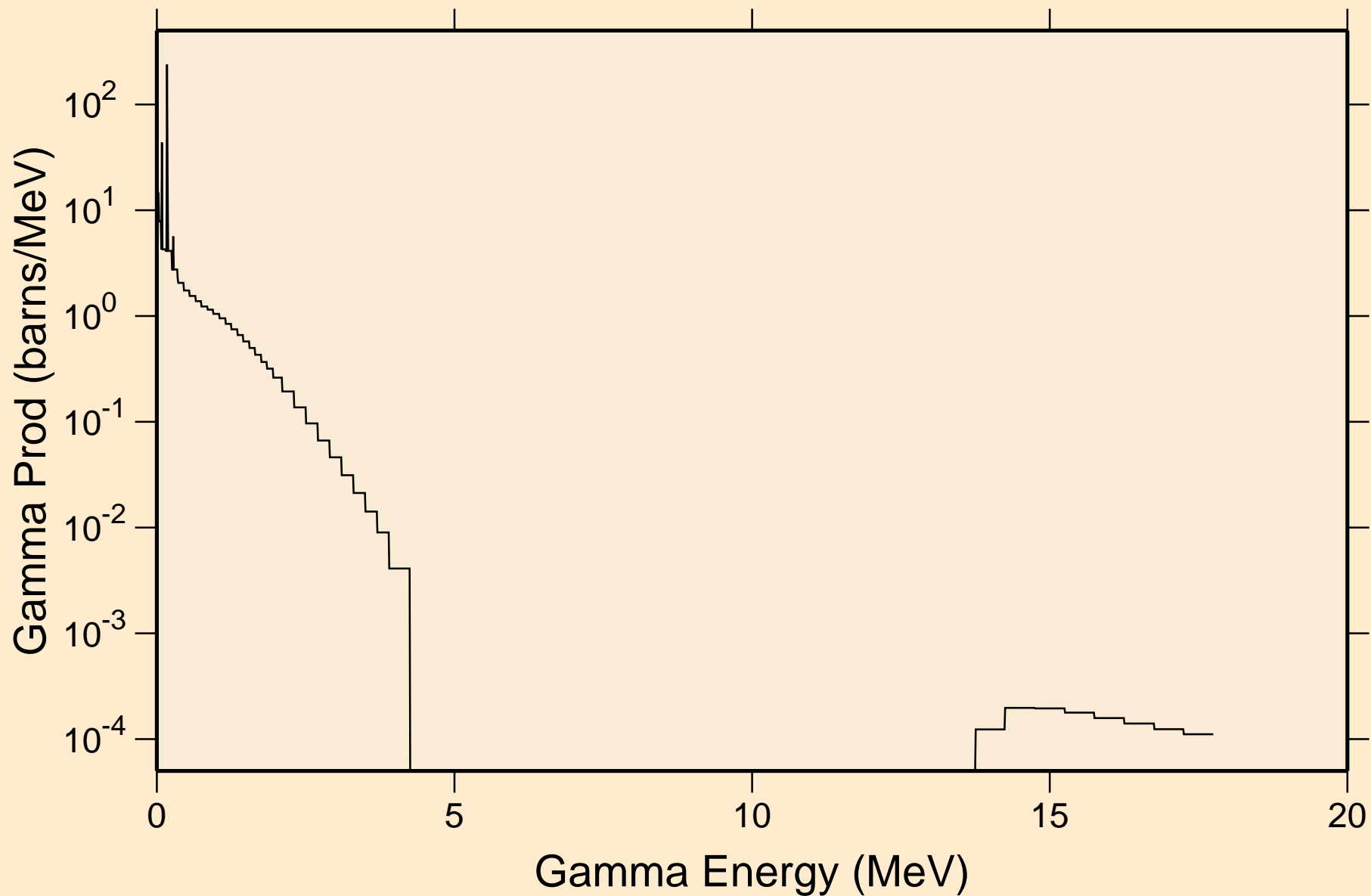

PR155 NEUTRON ACER TENDL-2019 LIBRARY; T=293.16K
Particle heating contributions

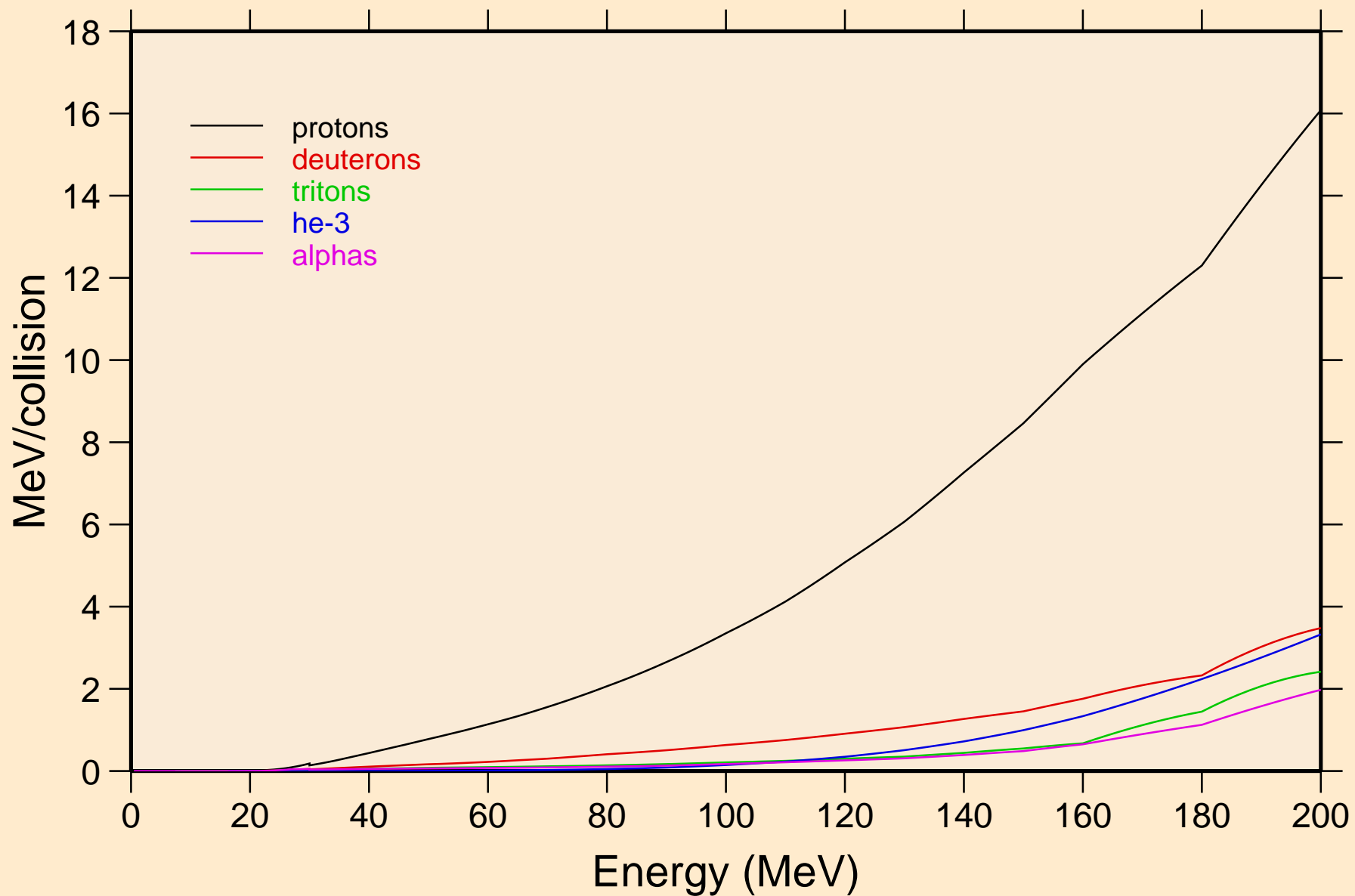

PR155 NEUTRON ACER TENDL-2019 LIBRARY; T=293.16K
Recoil Heating

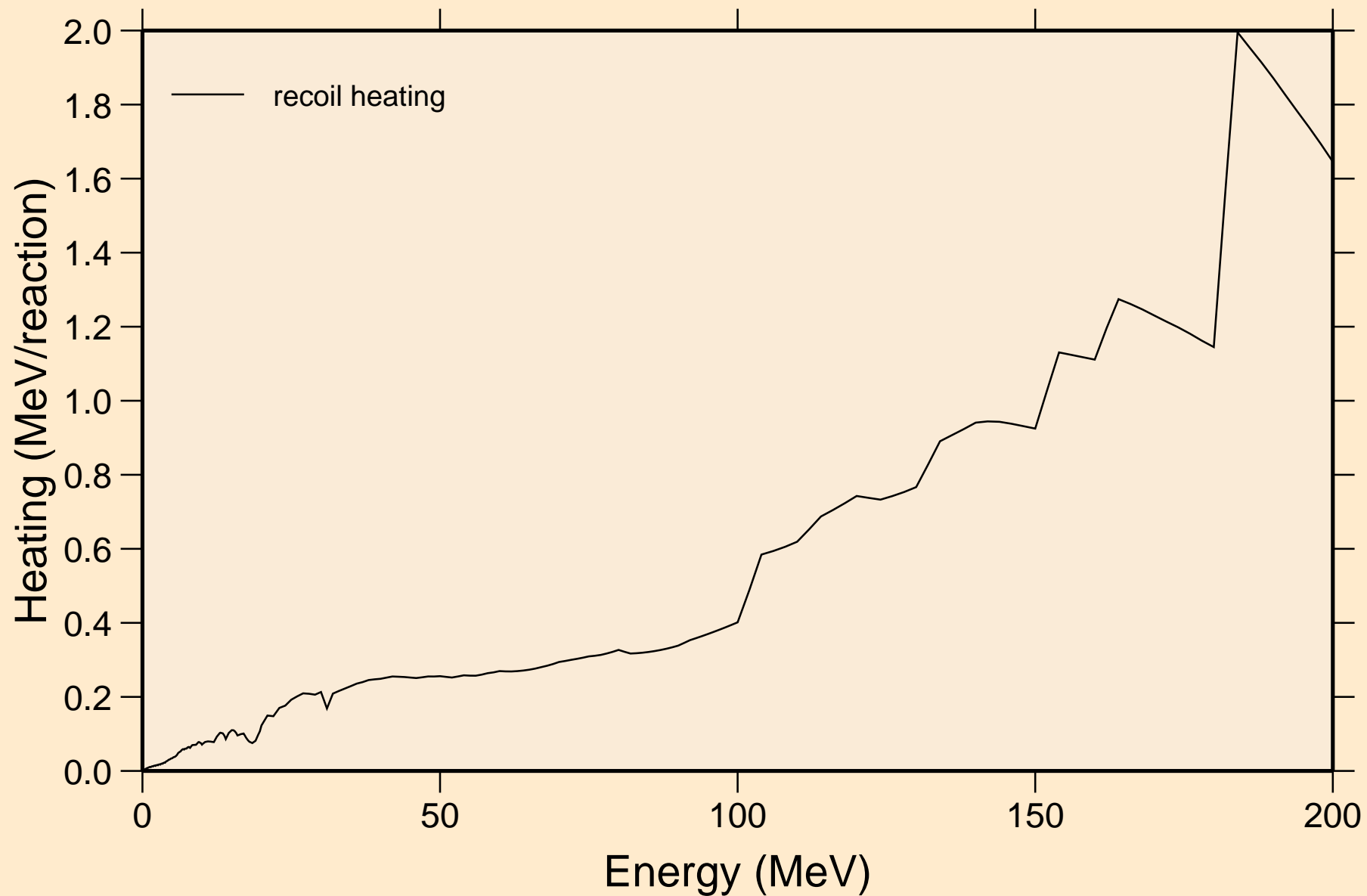

PR155 NEUTRON ACER TENDL-2019 LIBRARY; T=293.16K
Particle production cross sections

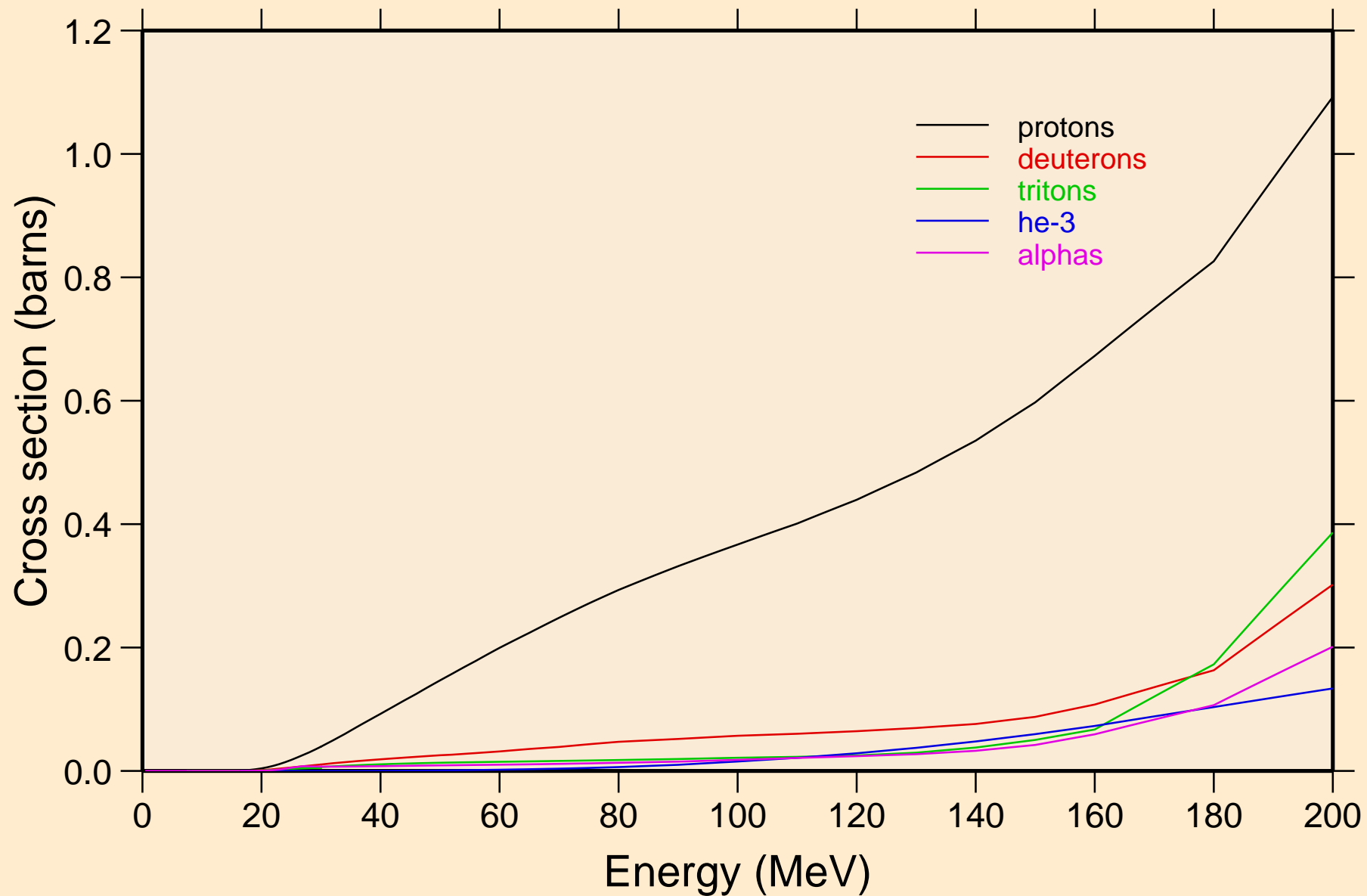

PR155 NEUTRON ACER TENDL-2019 LIBRARY; T=293.16K
protons from (n,x)

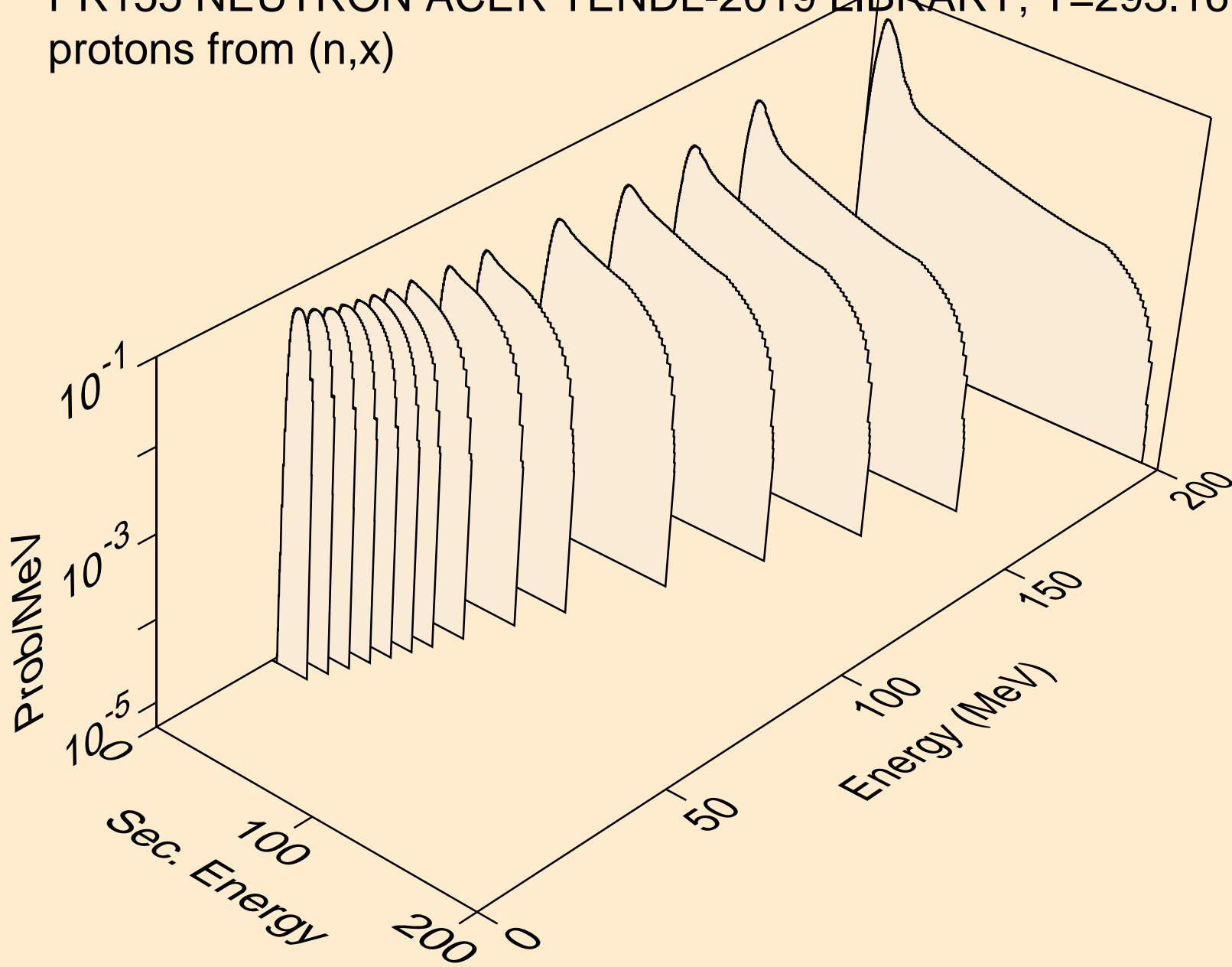

PR155 NEUTRON ACER TENDL-2019 LIBRARY; T=293.16K
protons from (n,n*)p

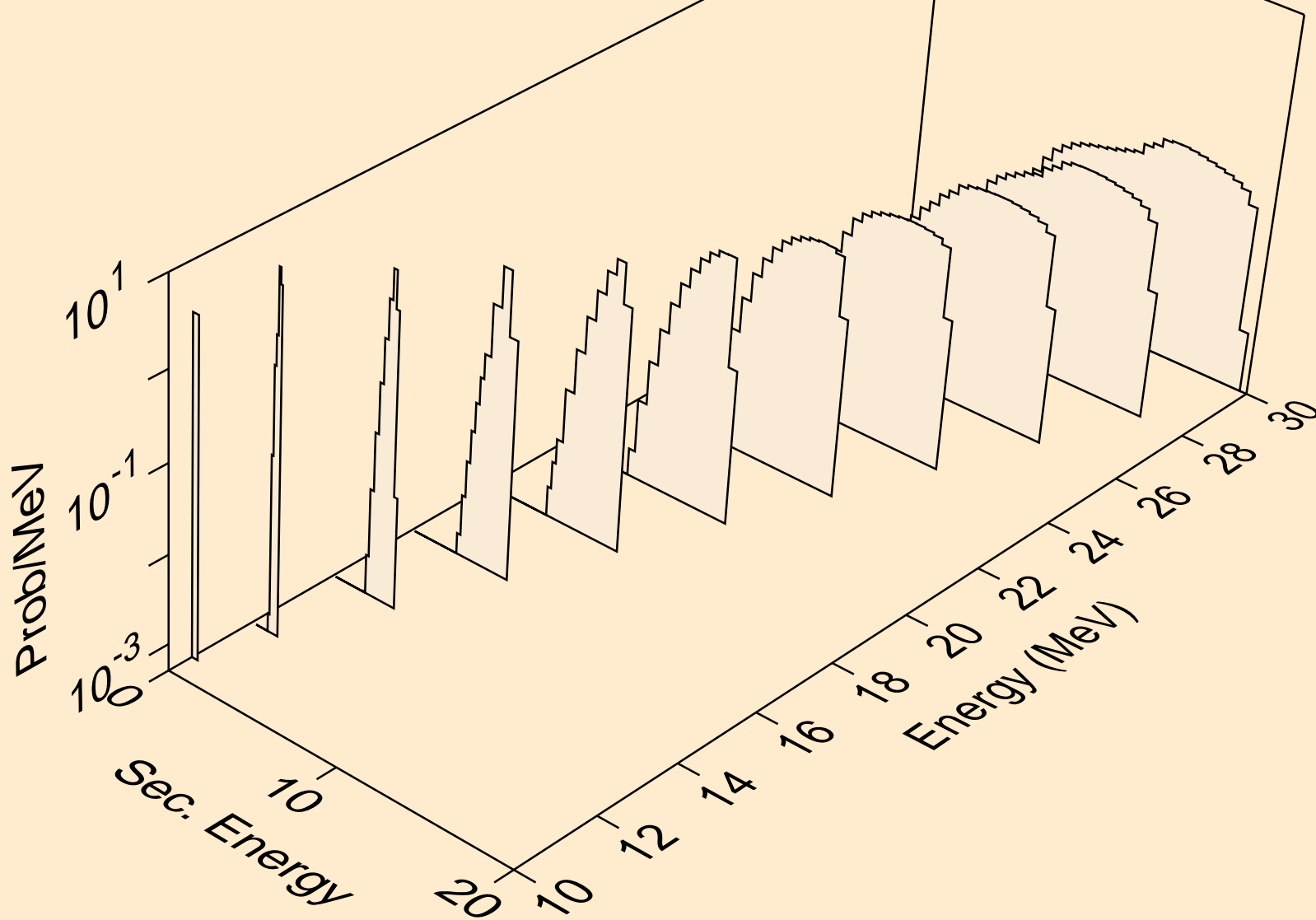

PR155 NEUTRON ACER TENDL-2019 LIBRARY; T=293.16K
protons from (n,2np)

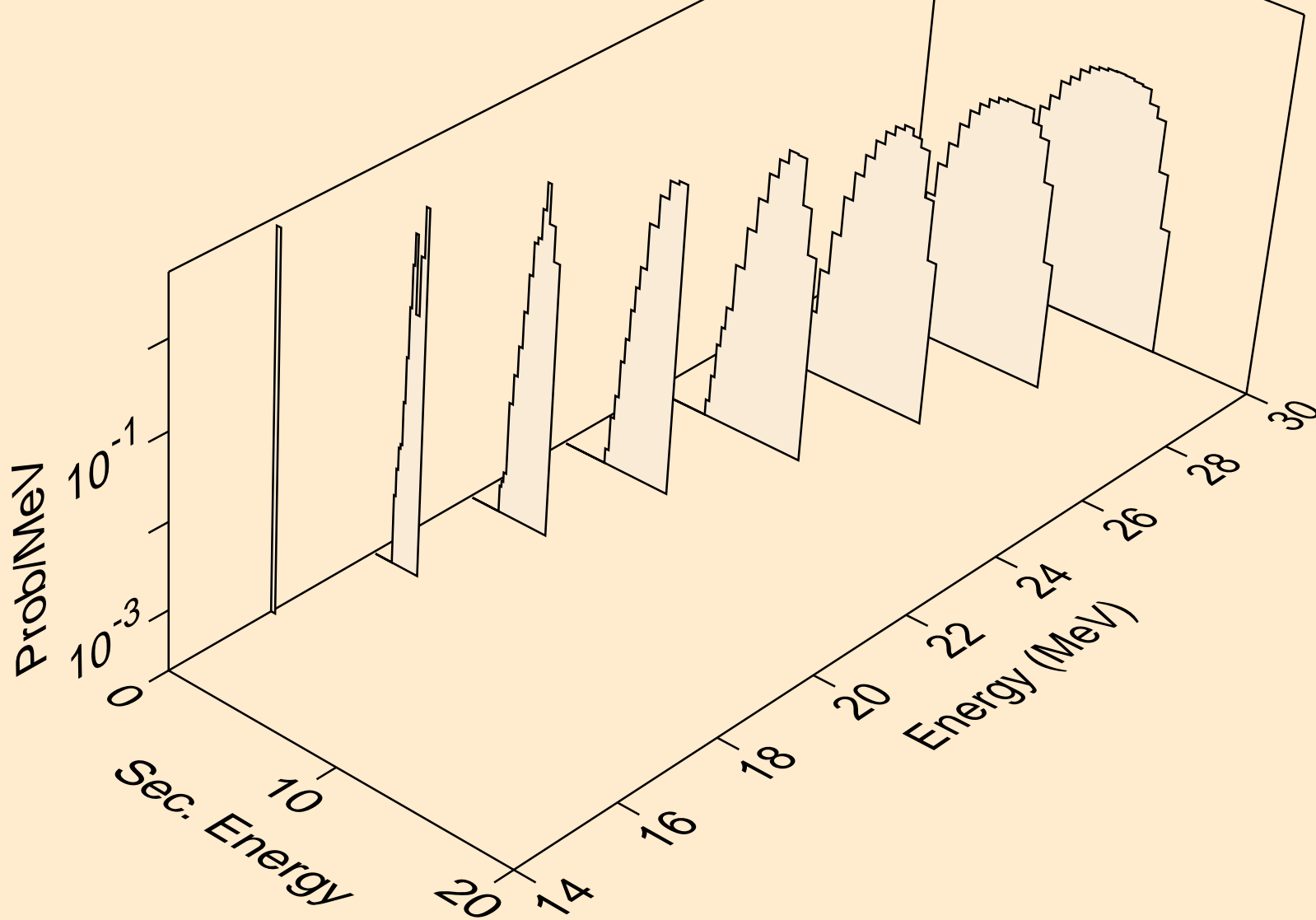

PR155 NEUTRON ACER TENDL-2019 LIBRARY; T=293.16K
protons from (n,3np)

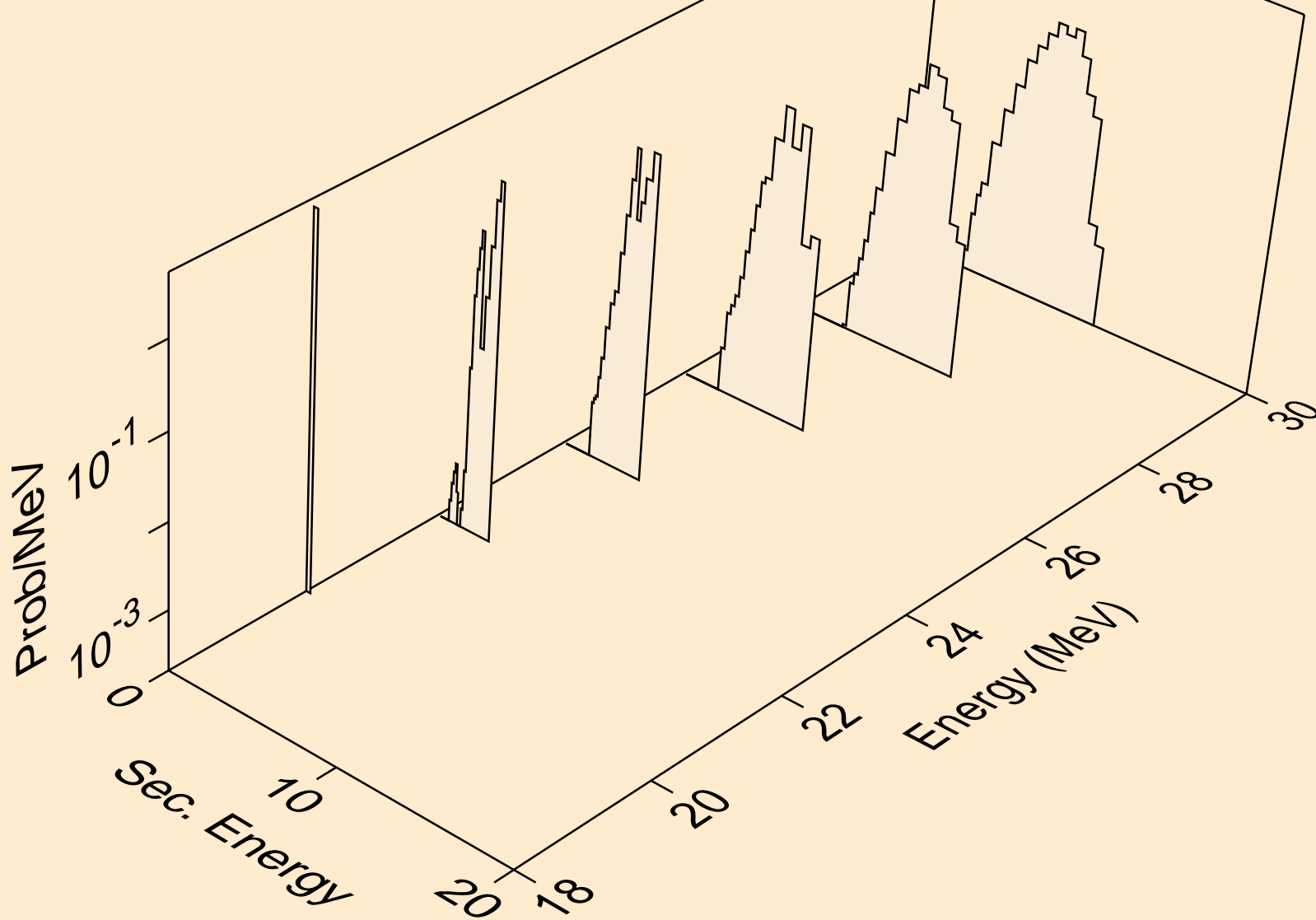

PR155 NEUTRON ACER TENDL-2019 LIBRARY; T=293.16K
protons from (n,p)

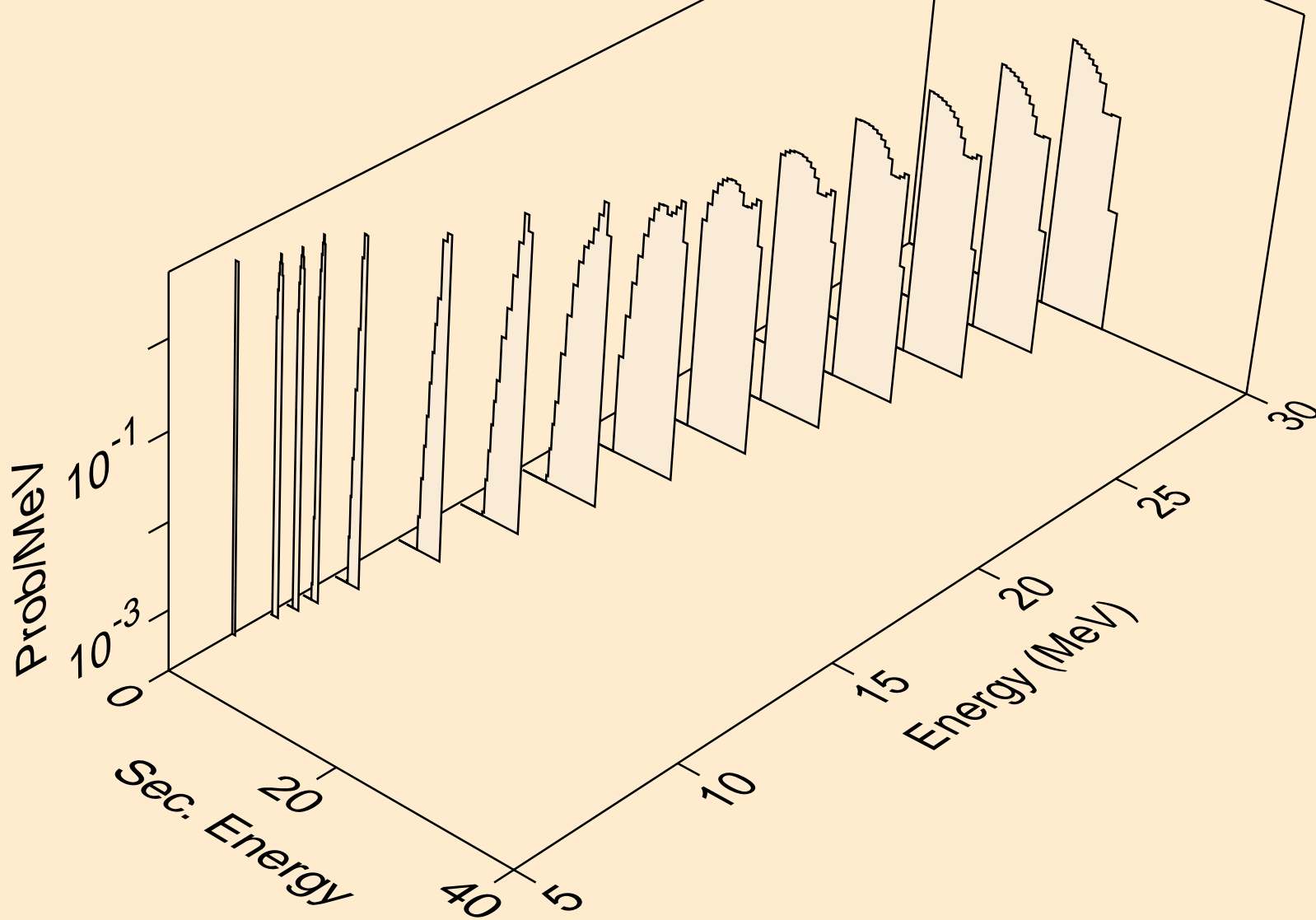

PR155 NEUTRON ACER TENDL-2019 LIBRARY; T=293.16K
deuterons from (n,x)

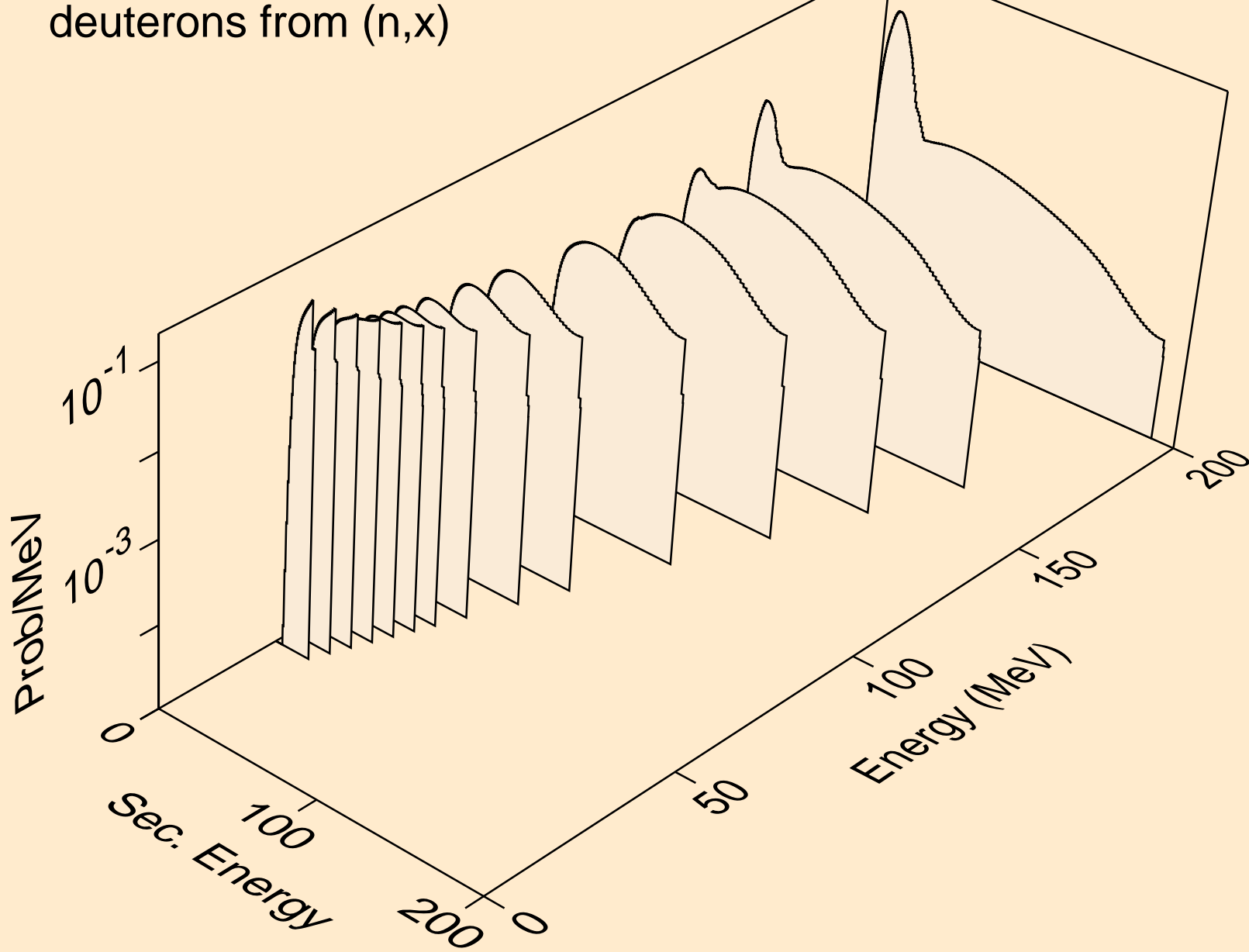

PR155 NEUTRON ACER TENDL-2019 LIBRARY; T=293.16K
deuterons from (n,2nd)

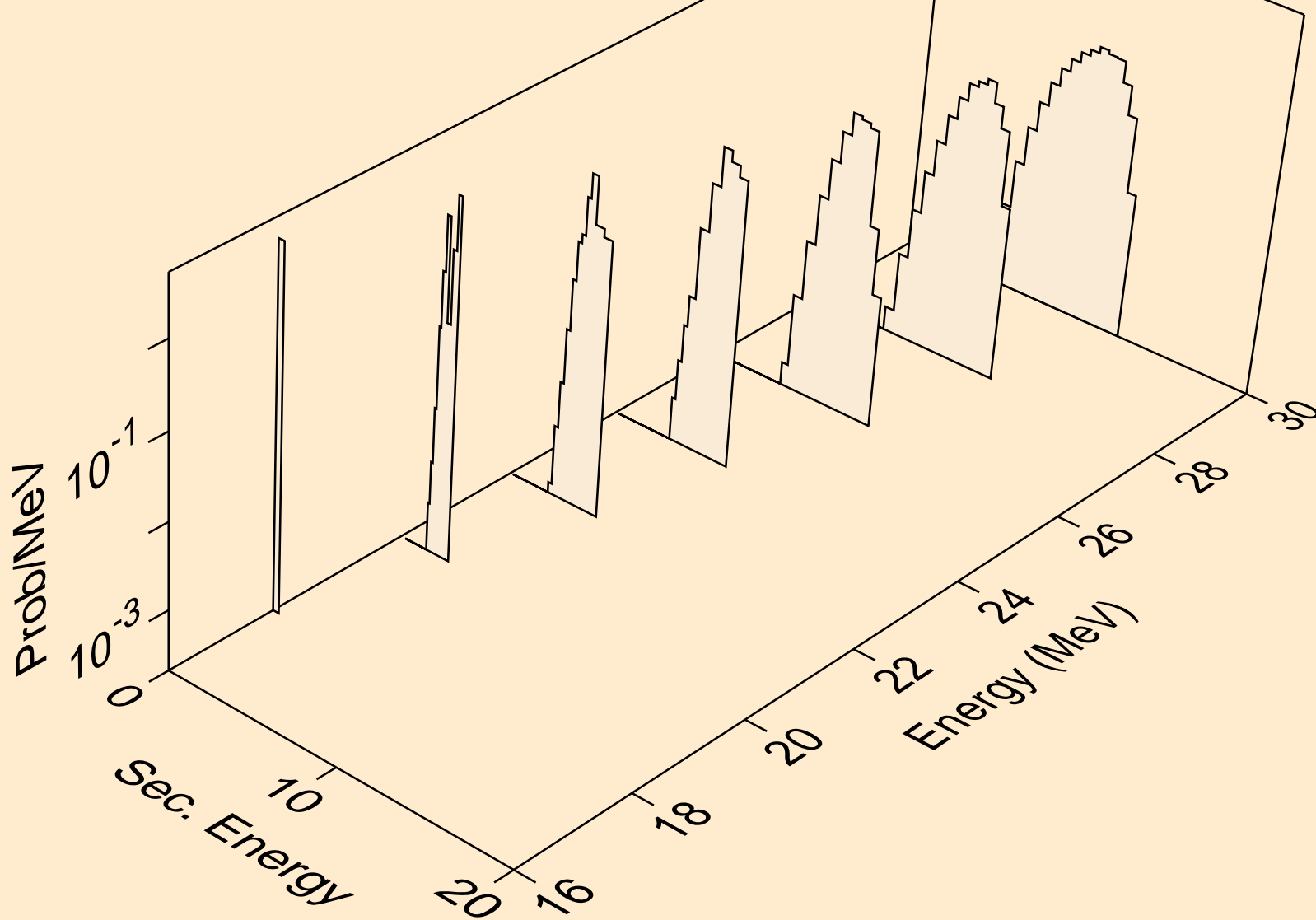

PR155 NEUTRON ACER TENDL-2019 LIBRARY; T=293.16K
deuterons from (n,n*)d

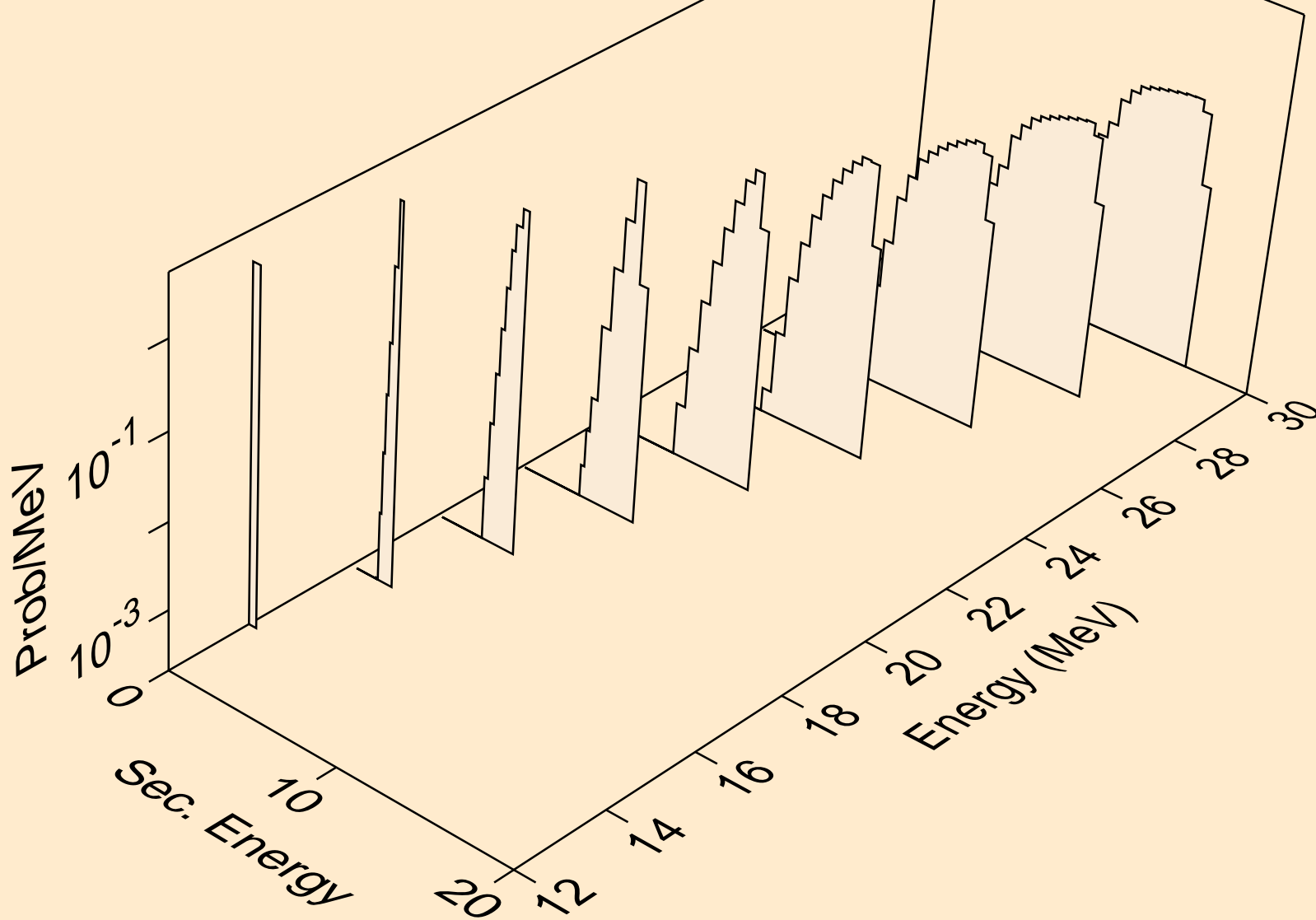

PR155 NEUTRON ACER TENDL-2019 LIBRARY; T=293.16K
deuterons from (n,d)

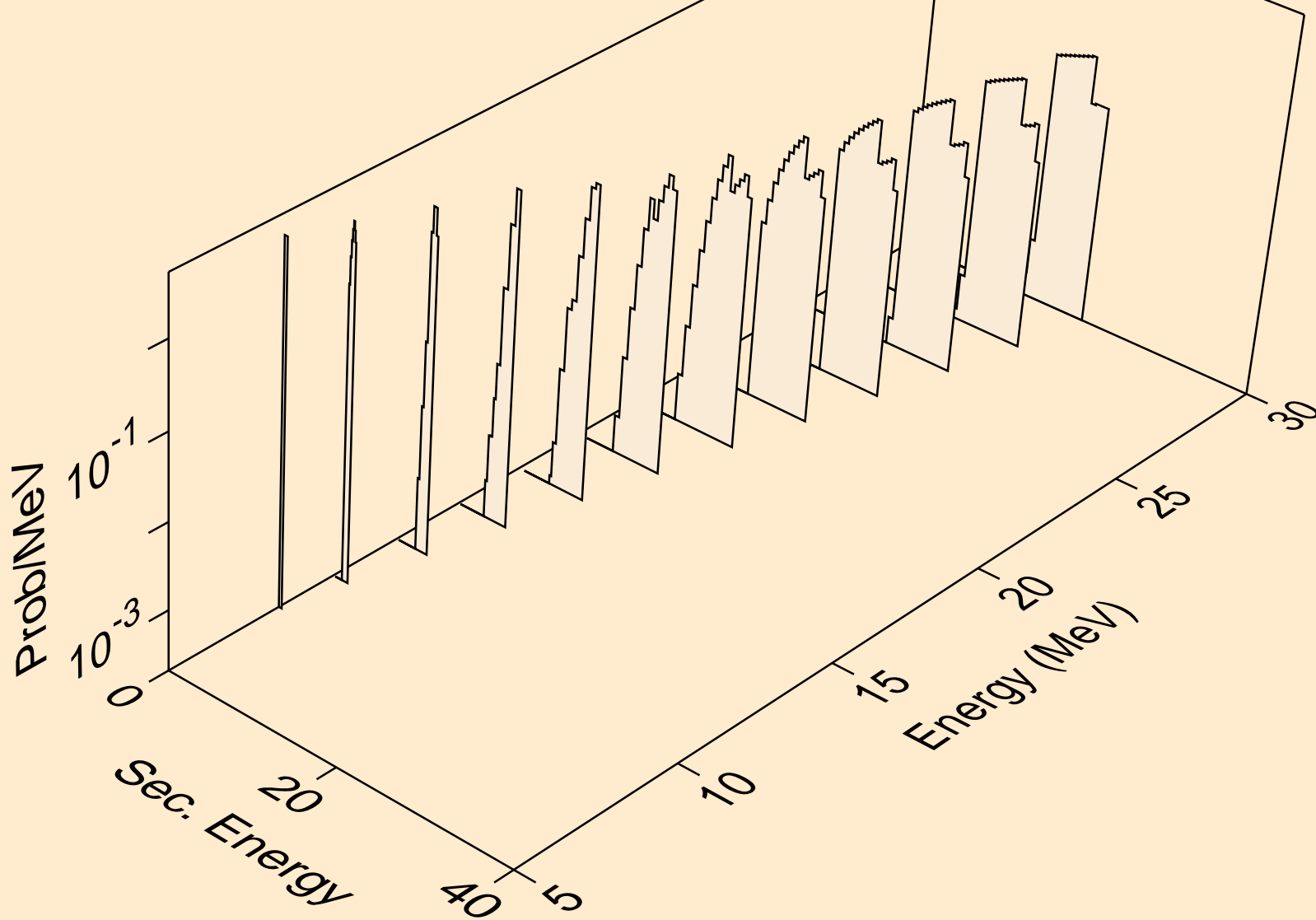

PR155 NEUTRON ACER TENDL-2019 LIBRARY; T=293.16K
tritons from (n,x)

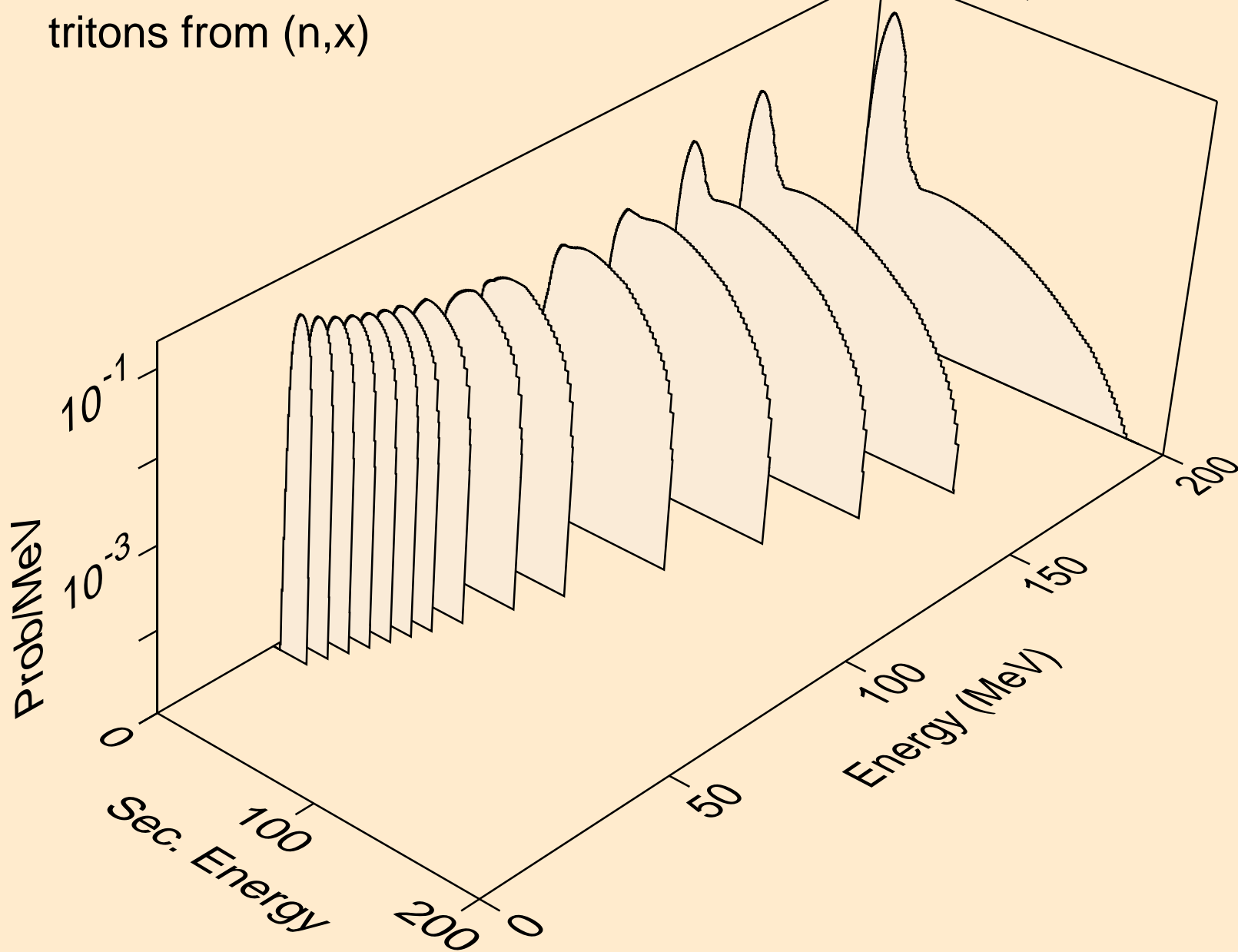

PR155 NEUTRON ACER TENDL-2019 LIBRARY; T=293.16K
tritons from (n,n*)t

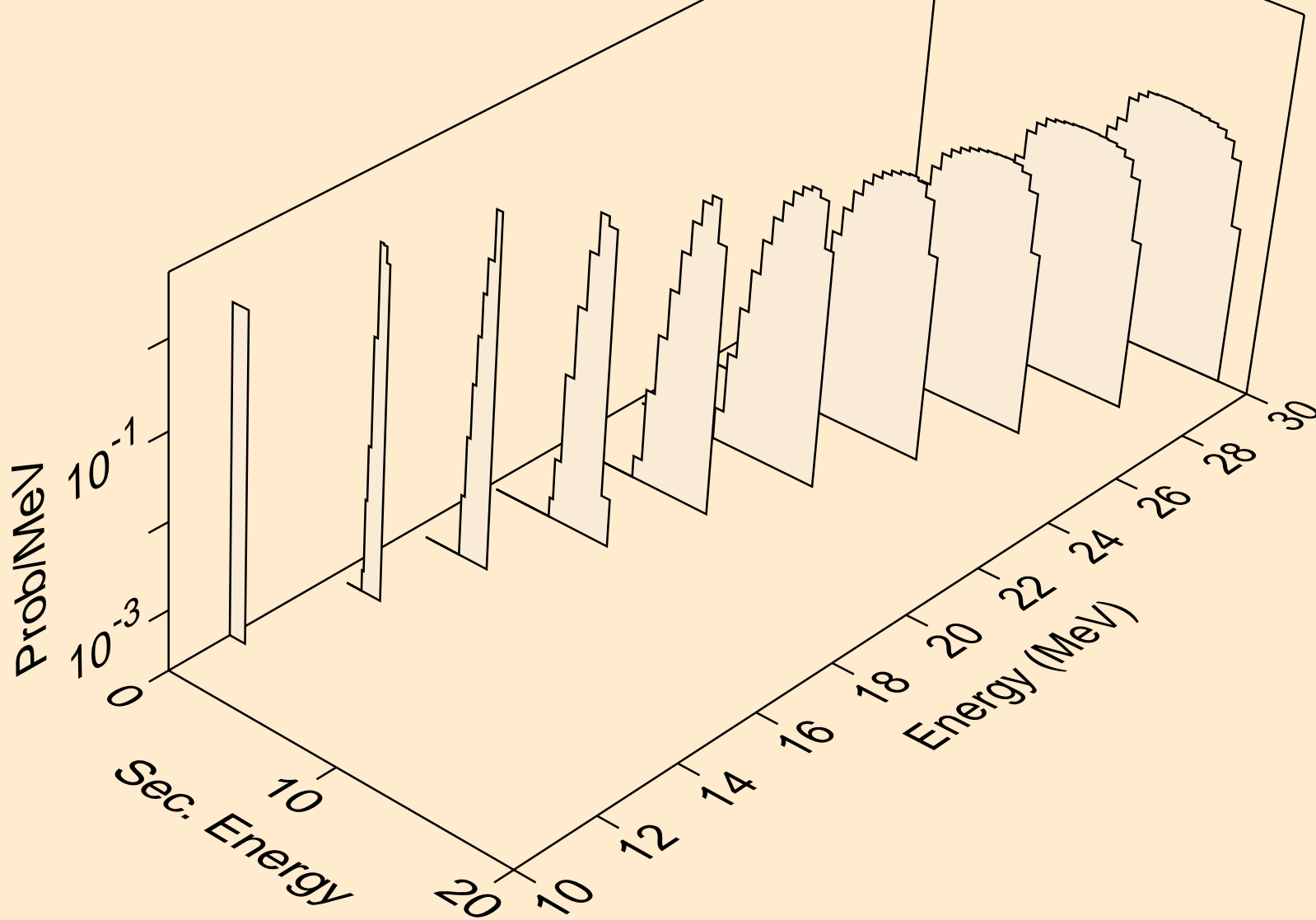

PR155 NEUTRON ACER TENDL-2019 LIBRARY; T=293.16K
tritons from (n,t)

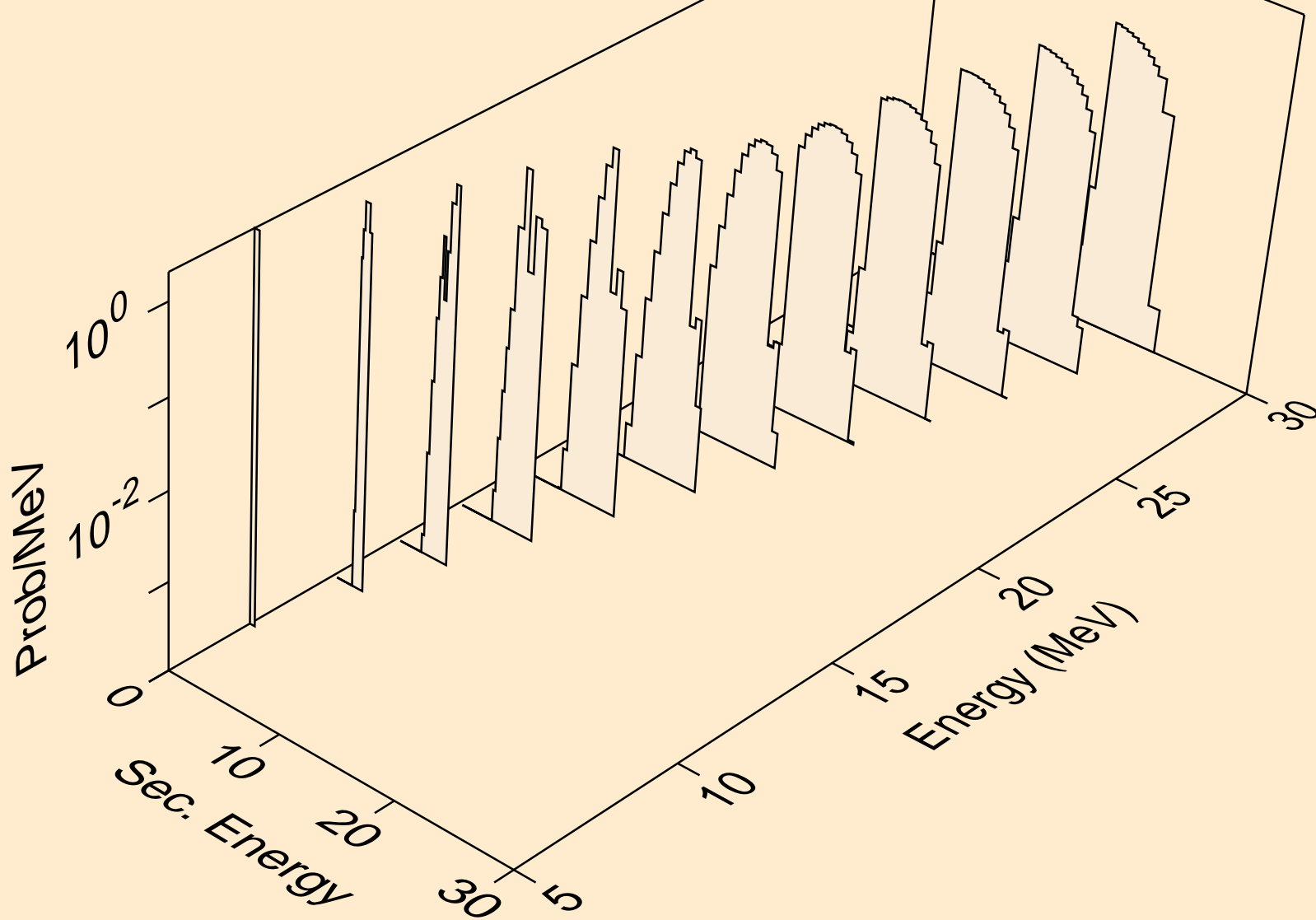

PR155 NEUTRON ACER TENDL-2019 LIBRARY; T=293.16K
he3s from (n,x)

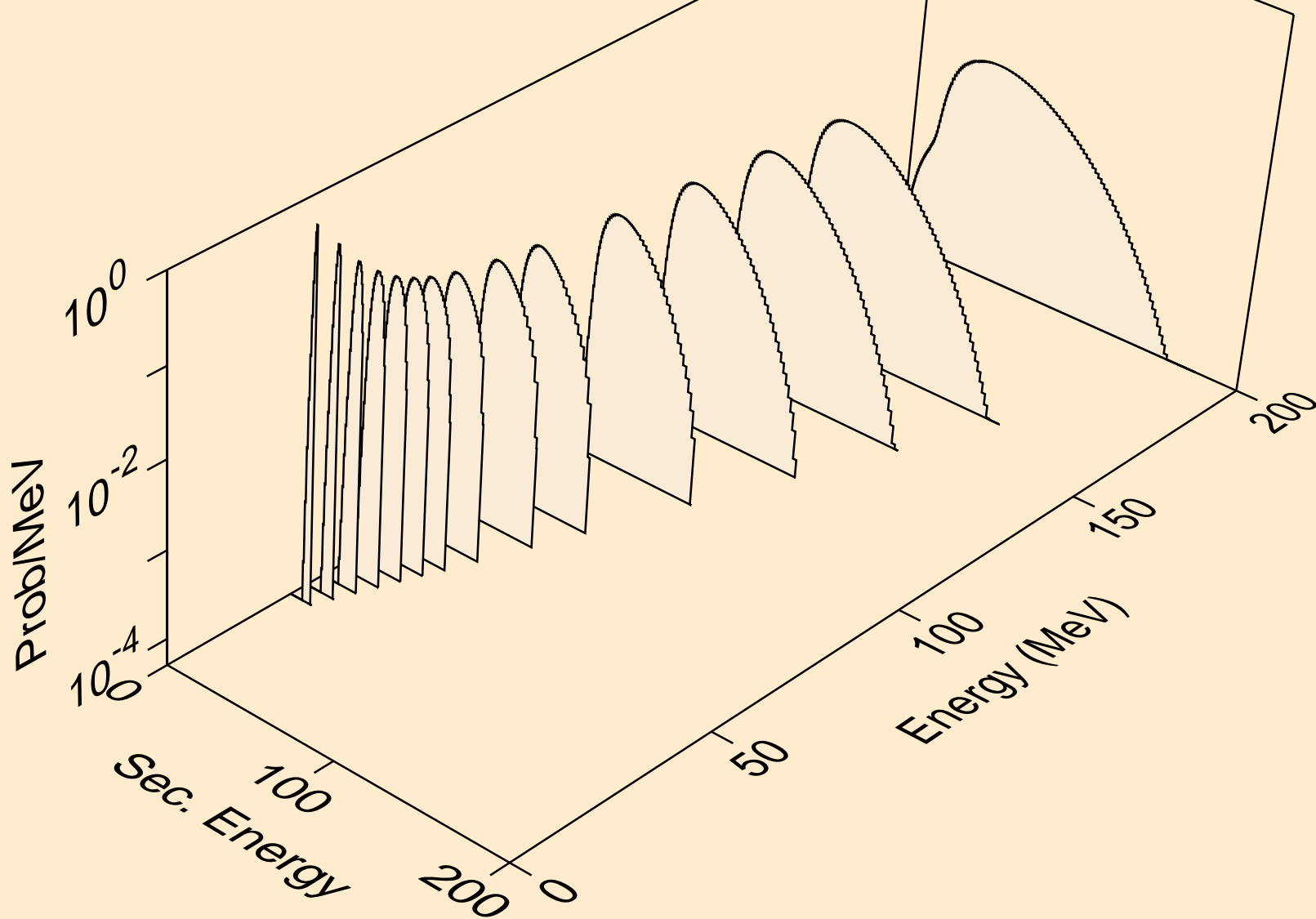

PR155 NEUTRON ACER TENDL-2019 LIBRARY; T=293.16K
he3s from (n,he3)

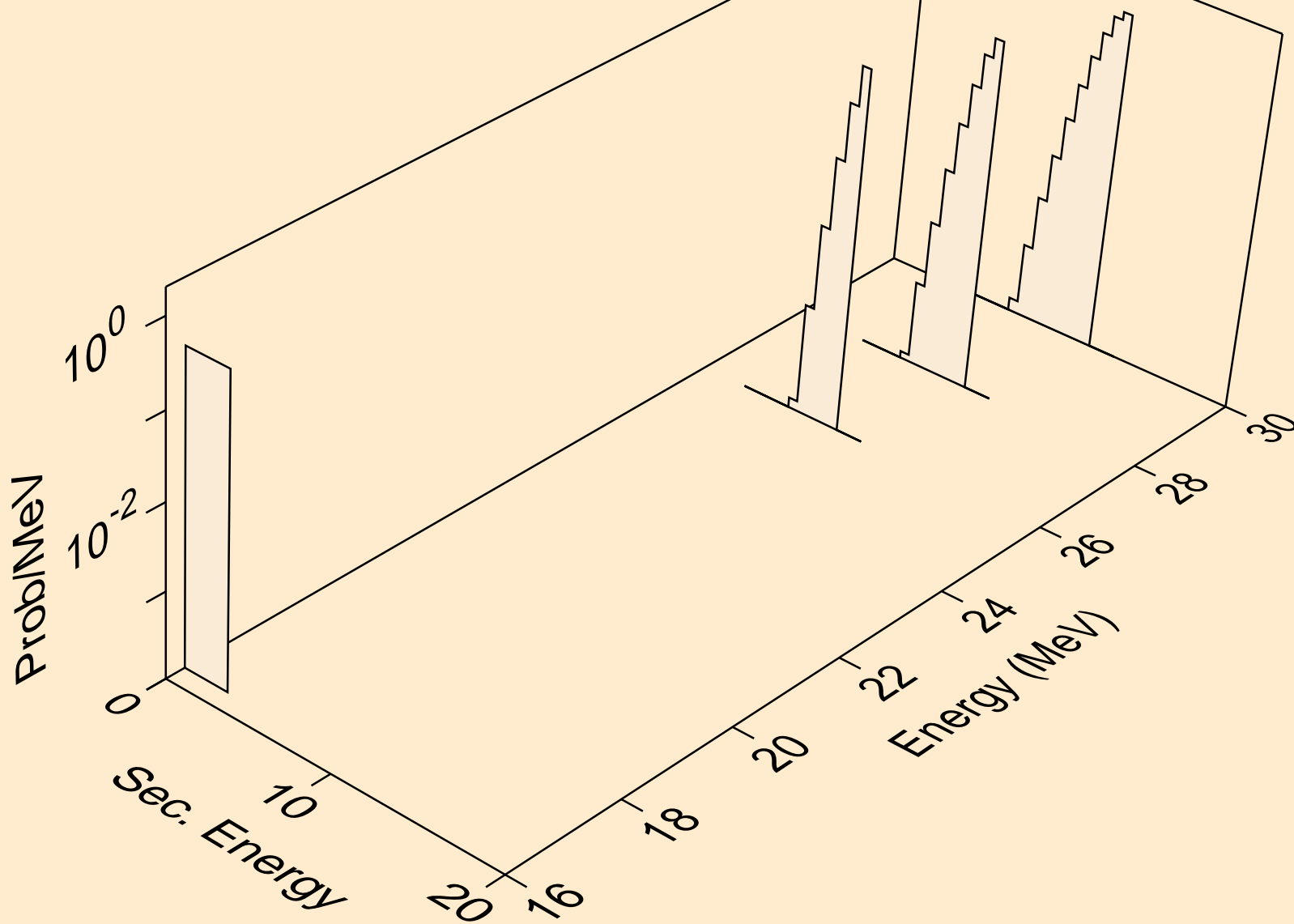

PR155 NEUTRON ACER TENDL-2019 LIBRARY; T=293.16K
alphas from (n,x)

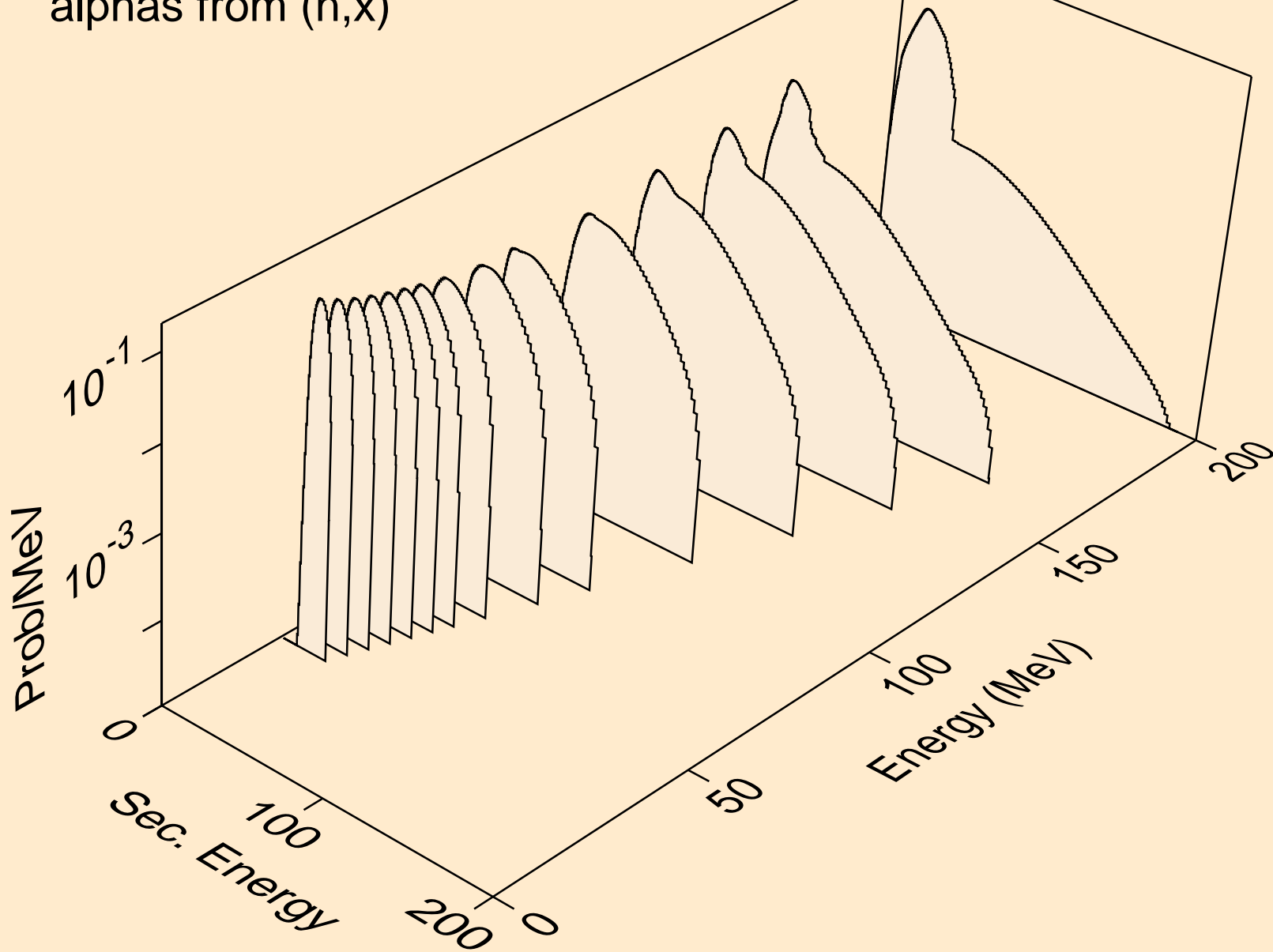

PR155 NEUTRON ACER TENDL-2019 LIBRARY; T=293.16K
alphas from (n,n*)a

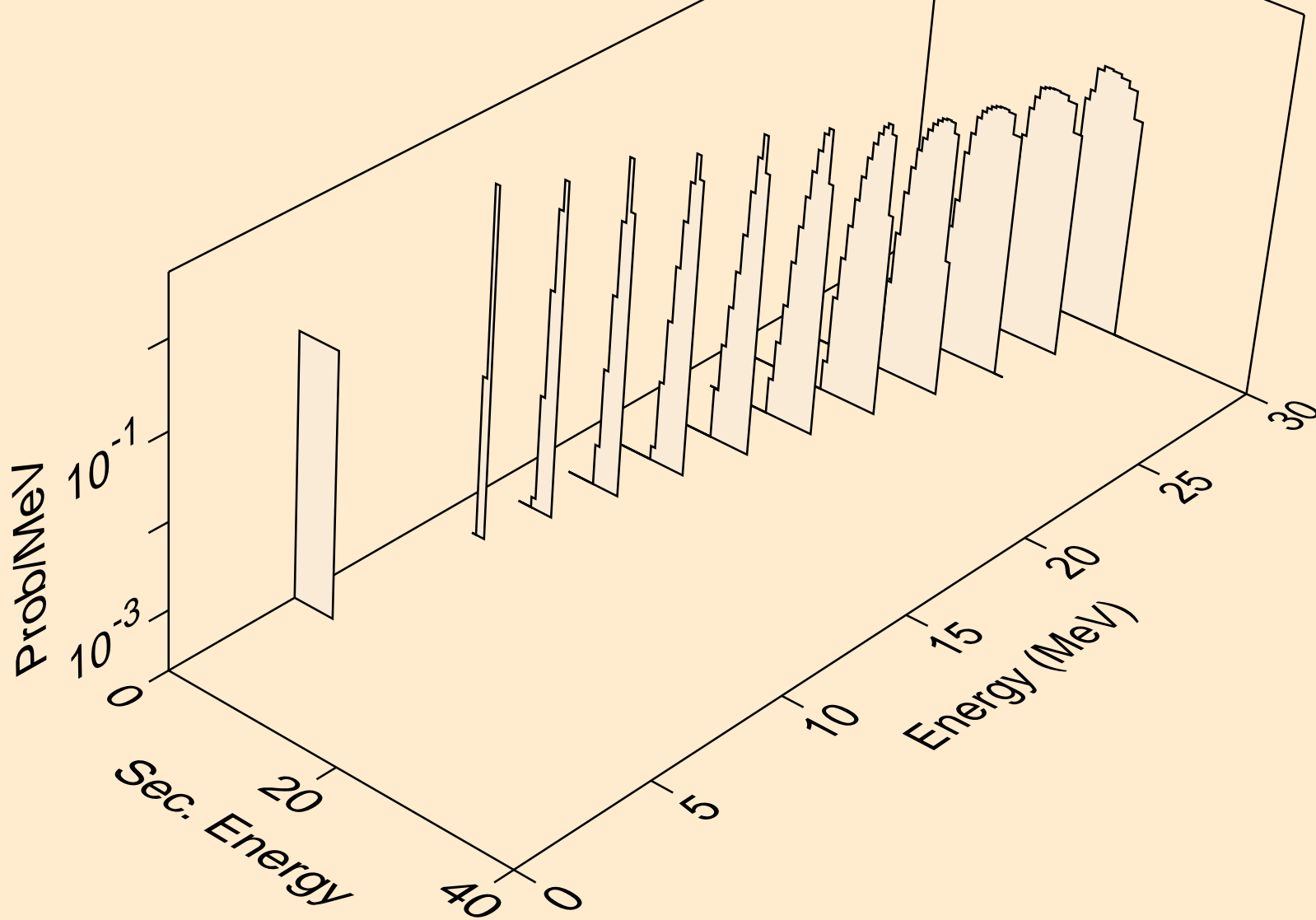

PR155 NEUTRON ACER TENDL-2019 LIBRARY; T=293.16K
alphas from (n,2n)a

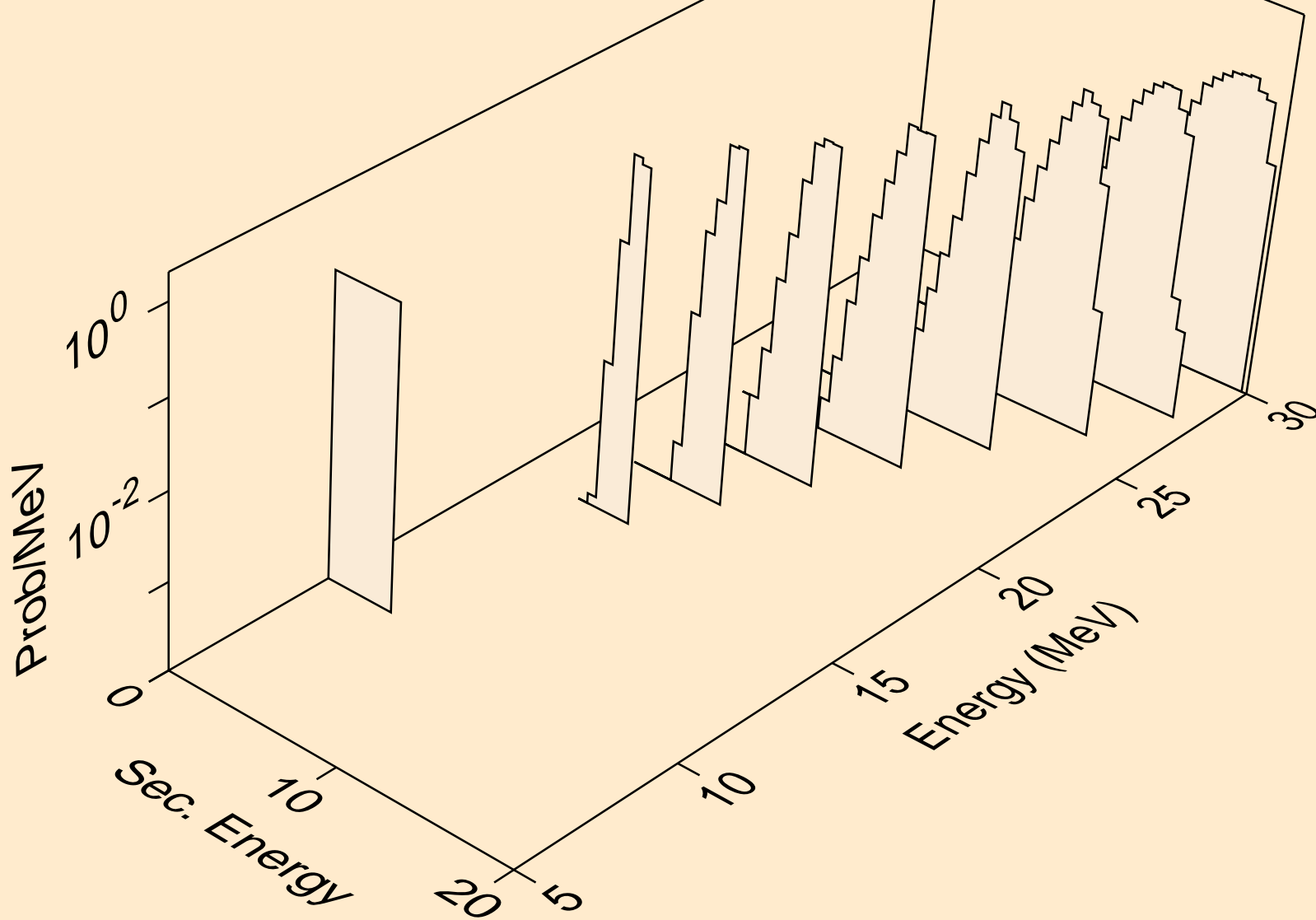

PR155 NEUTRON ACER TENDL-2019 LIBRARY; T=293.16K
alphas from (n,3n)_a

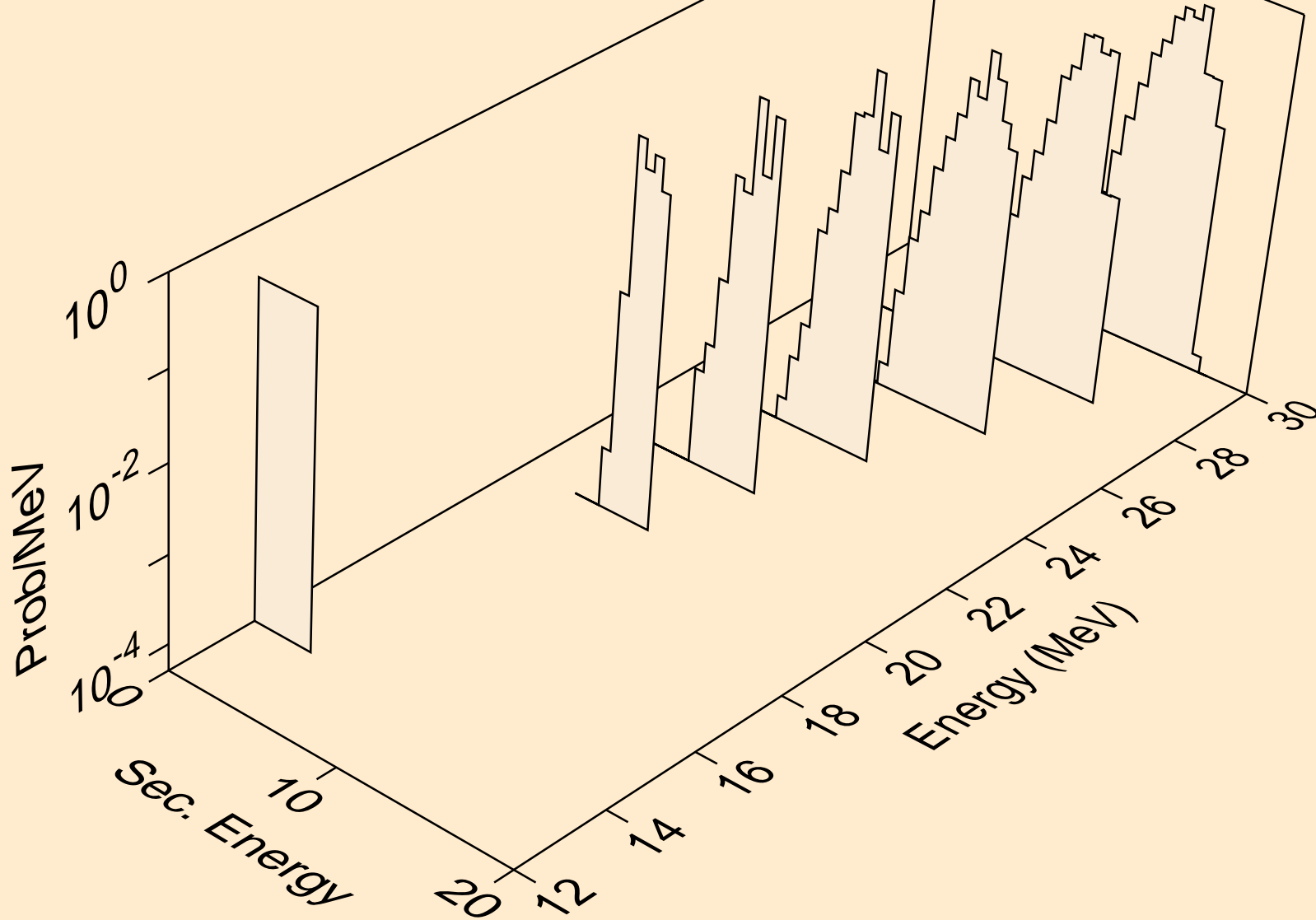

PR155 NEUTRON ACER TENDL-2019 LIBRARY; T=293.16K
alphas from (n,a)

