

PU230 NEUTRON ACER TENDL-2019 LIBRARY; T=293.16K
Principal cross sections

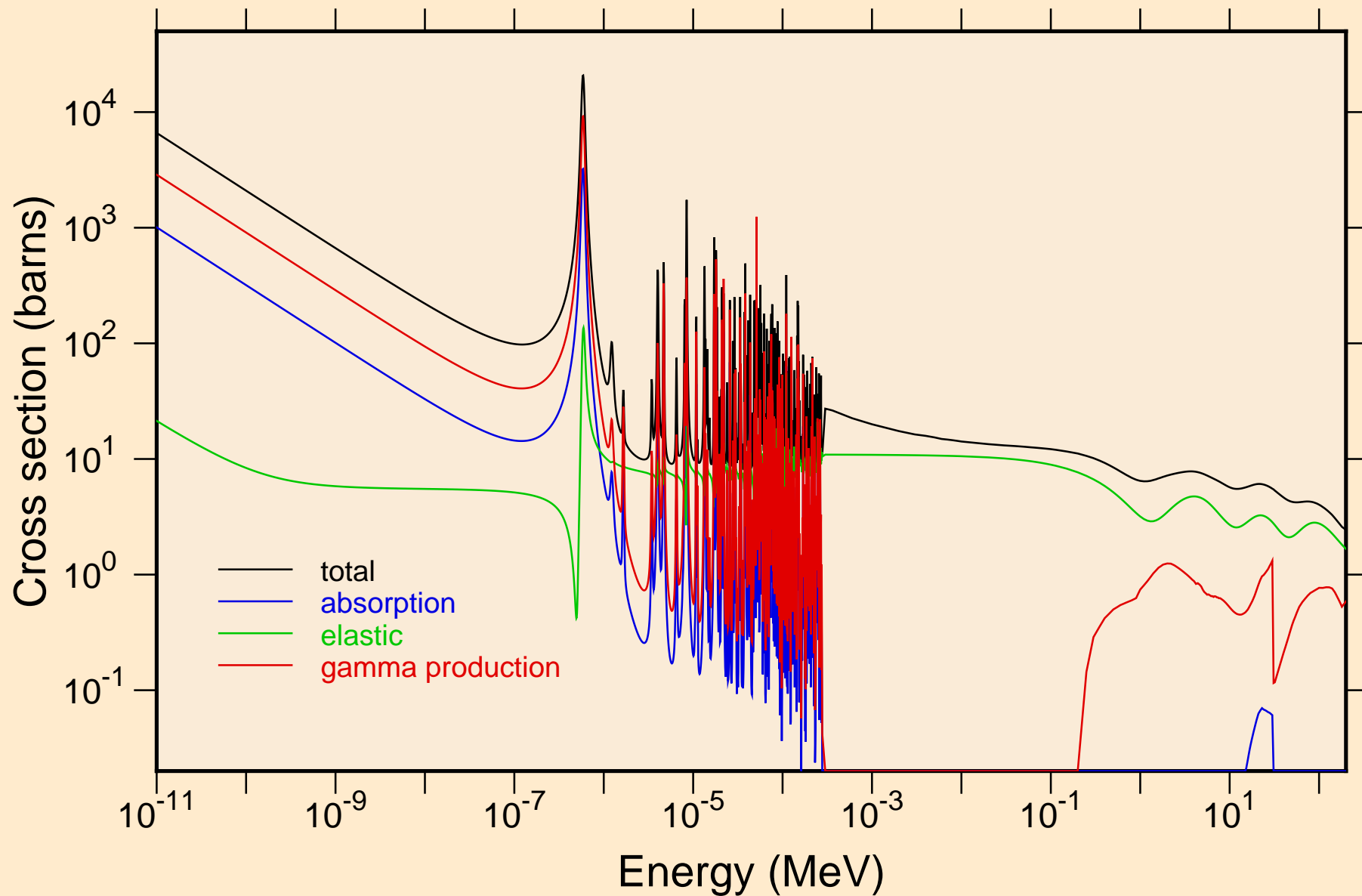

PU230 NEUTRON ACER TENDL-2019 LIBRARY; T=293.16K
resonance total cross section

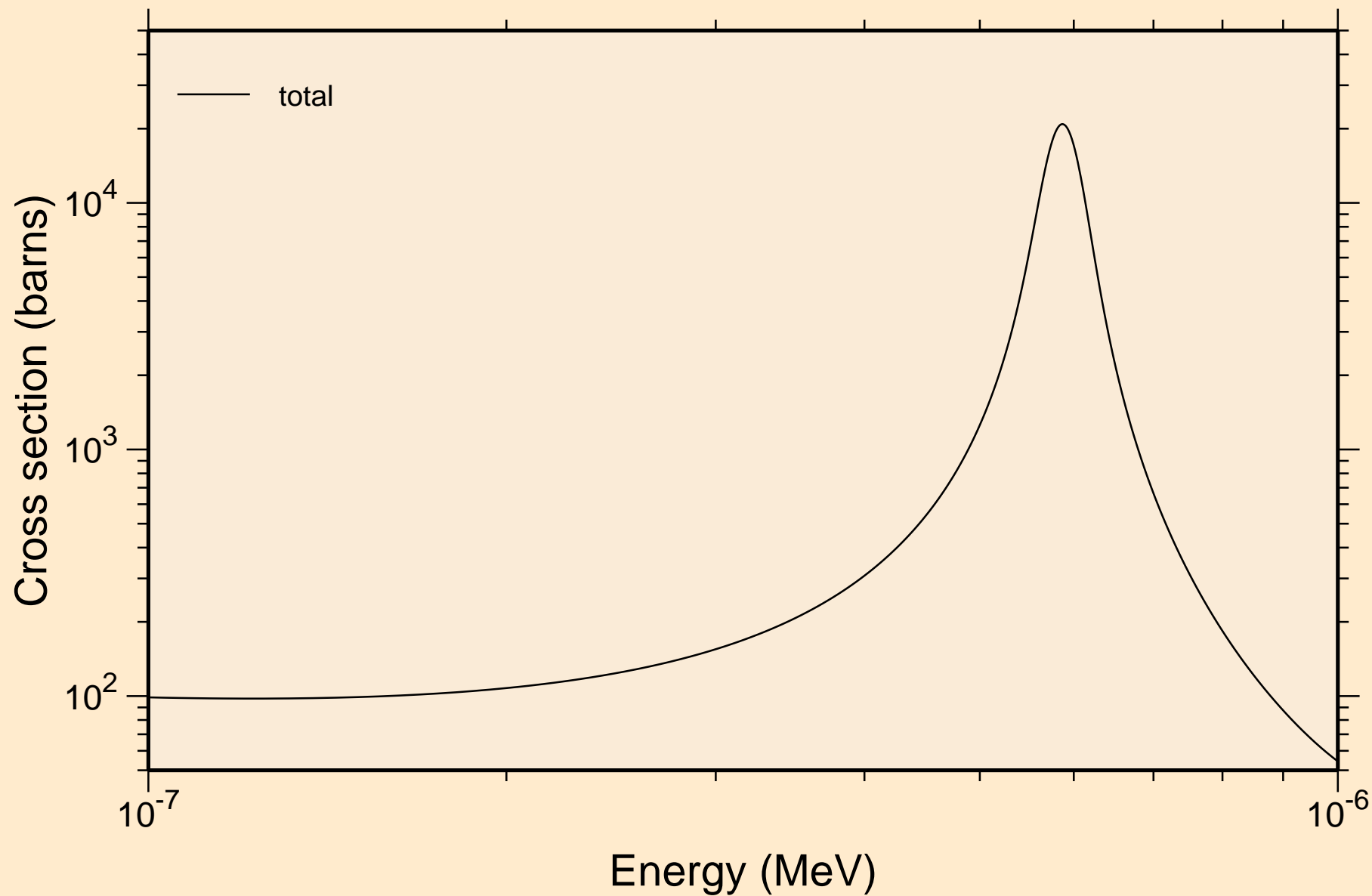

PU230 NEUTRON ACER TENDL-2019 LIBRARY; T=293.16K
resonance total cross section

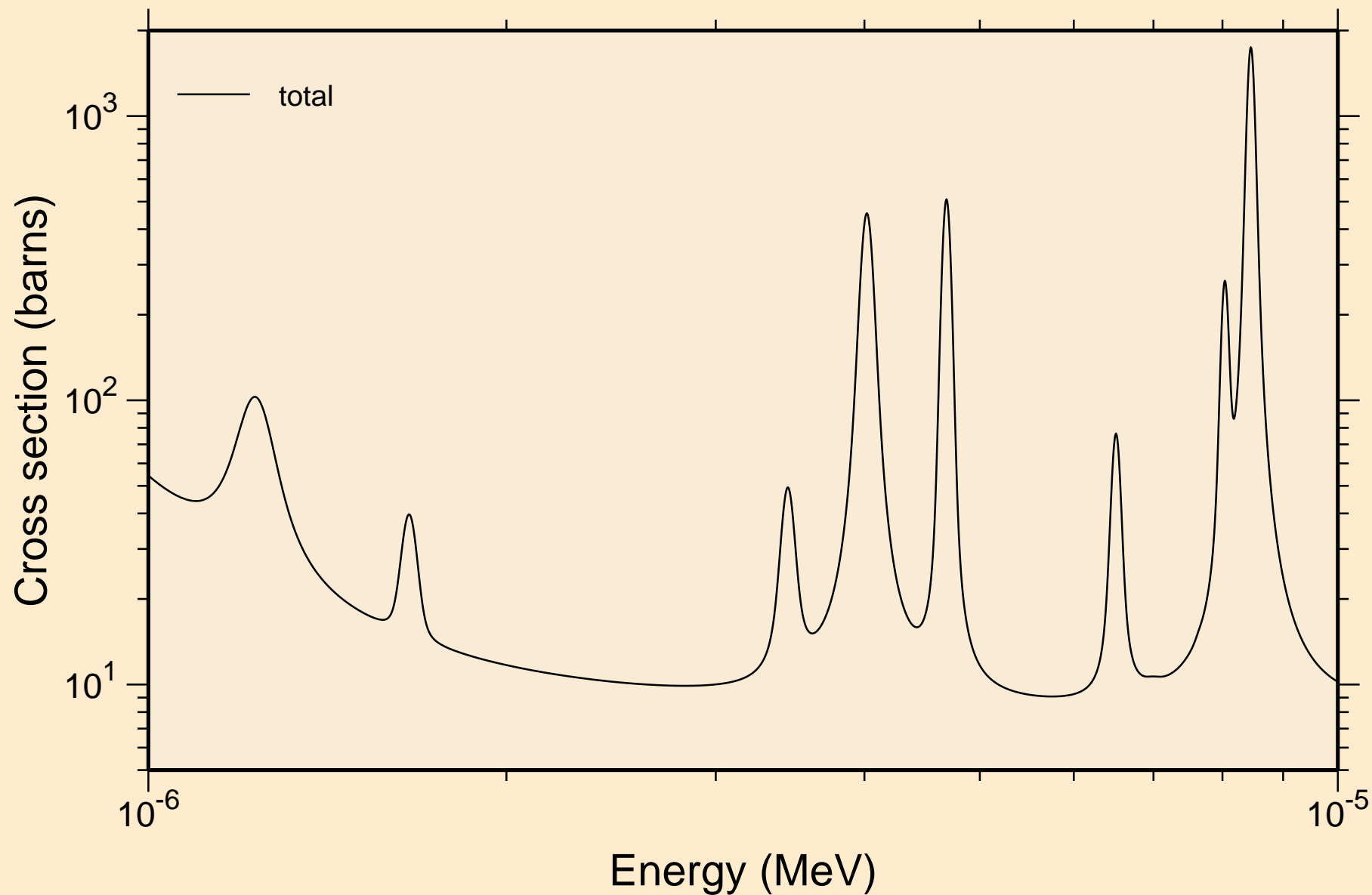

PU230 NEUTRON ACER TENDL-2019 LIBRARY; T=293.16K
resonance total cross section

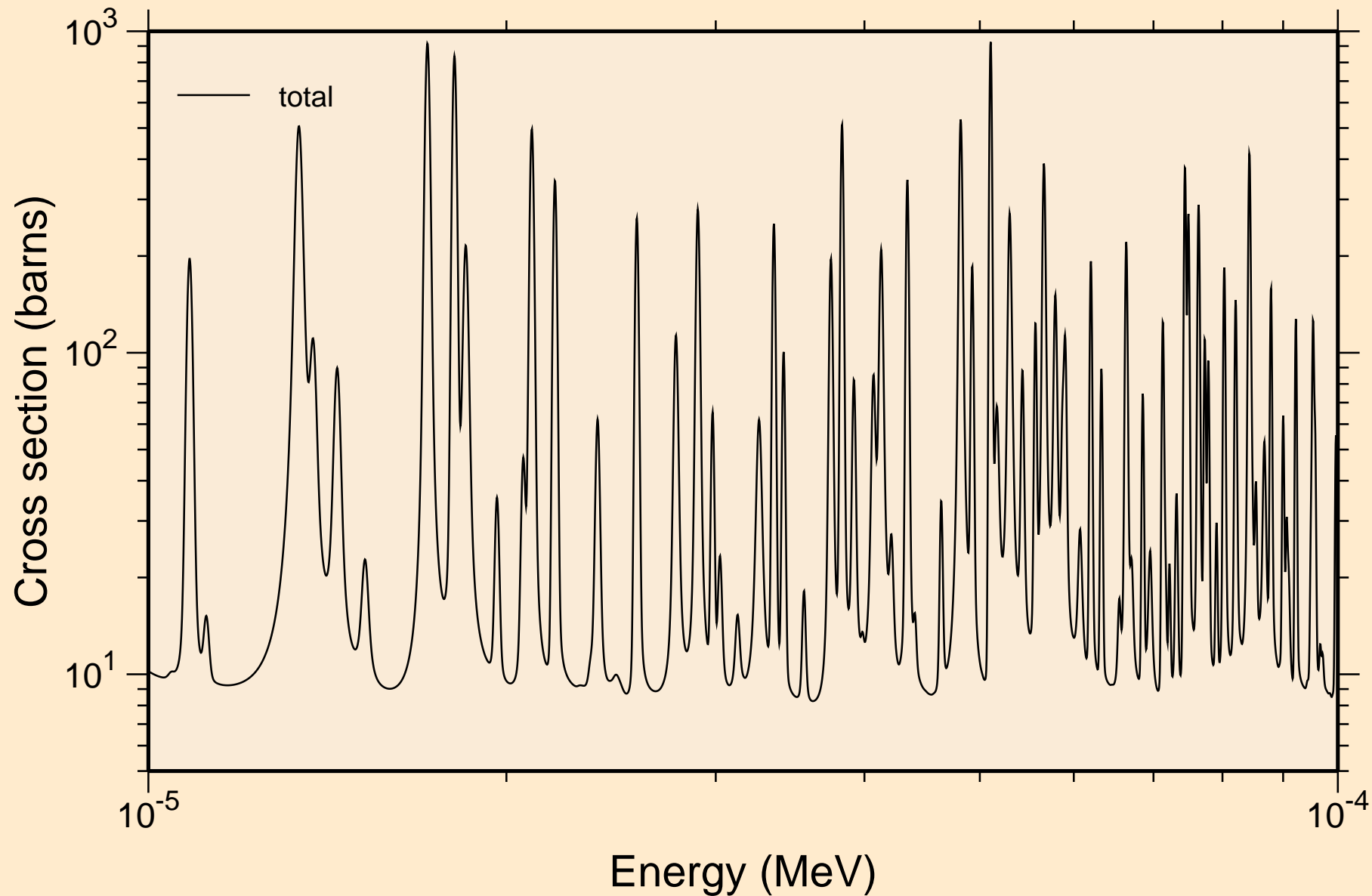

PU230 NEUTRON ACER TENDL-2019 LIBRARY; T=293.16K
resonance total cross section

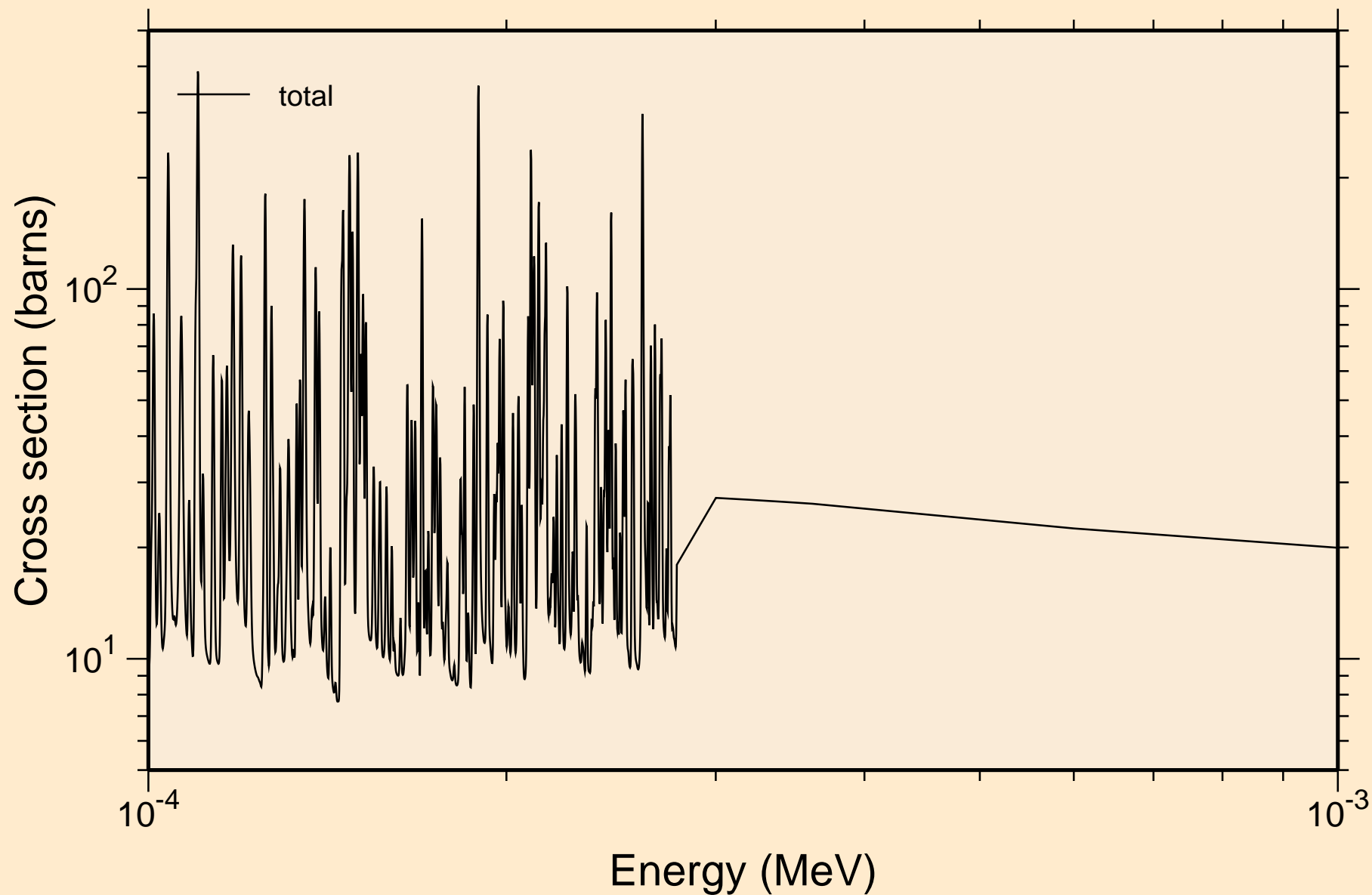

PU230 NEUTRON ACER TENDL-2019 LIBRARY; T=293.16K
resonance total cross section

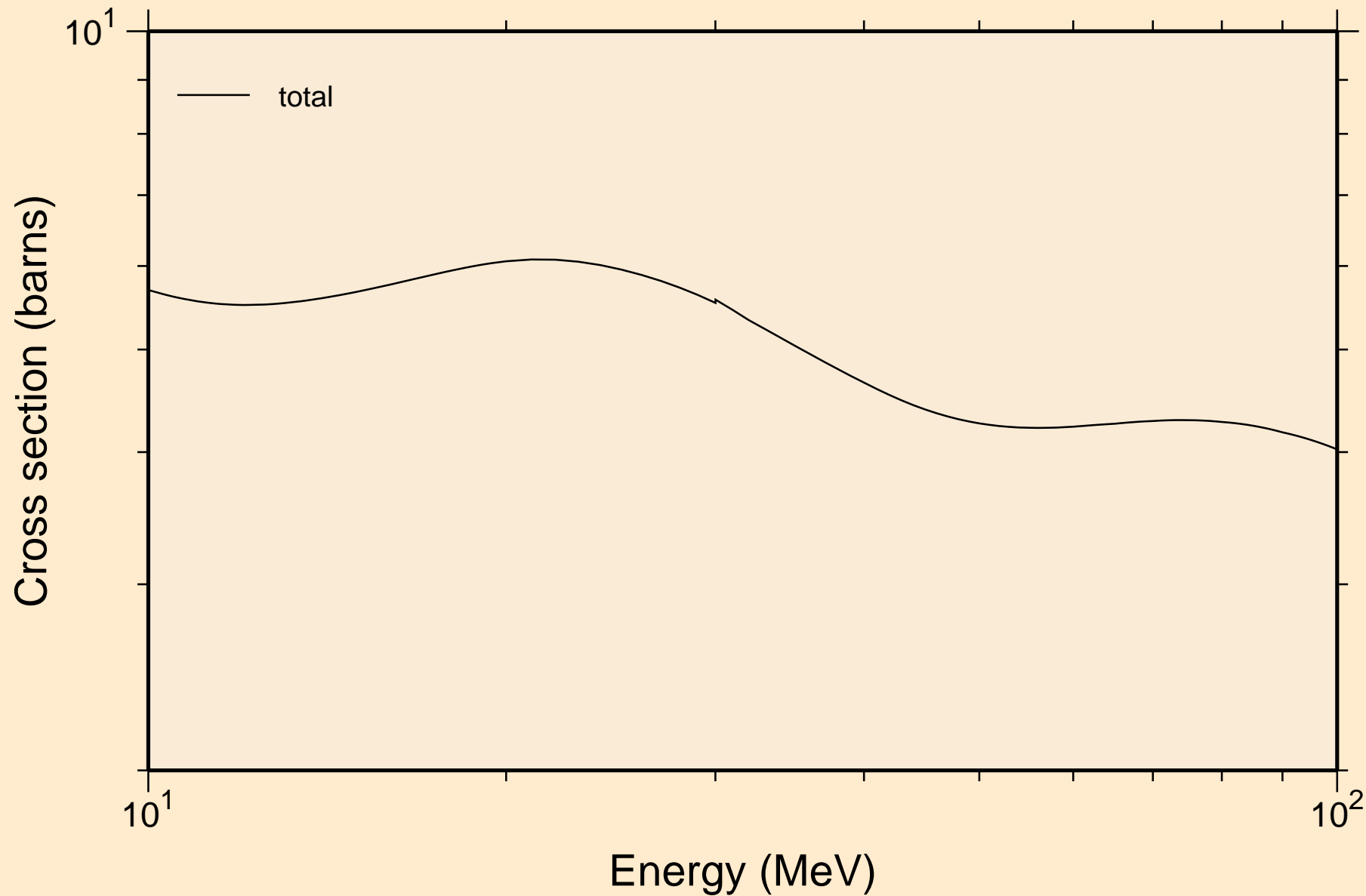

PU230 NEUTRON ACER TENDL-2019 LIBRARY; T=293.16K
resonance absorption cross sections

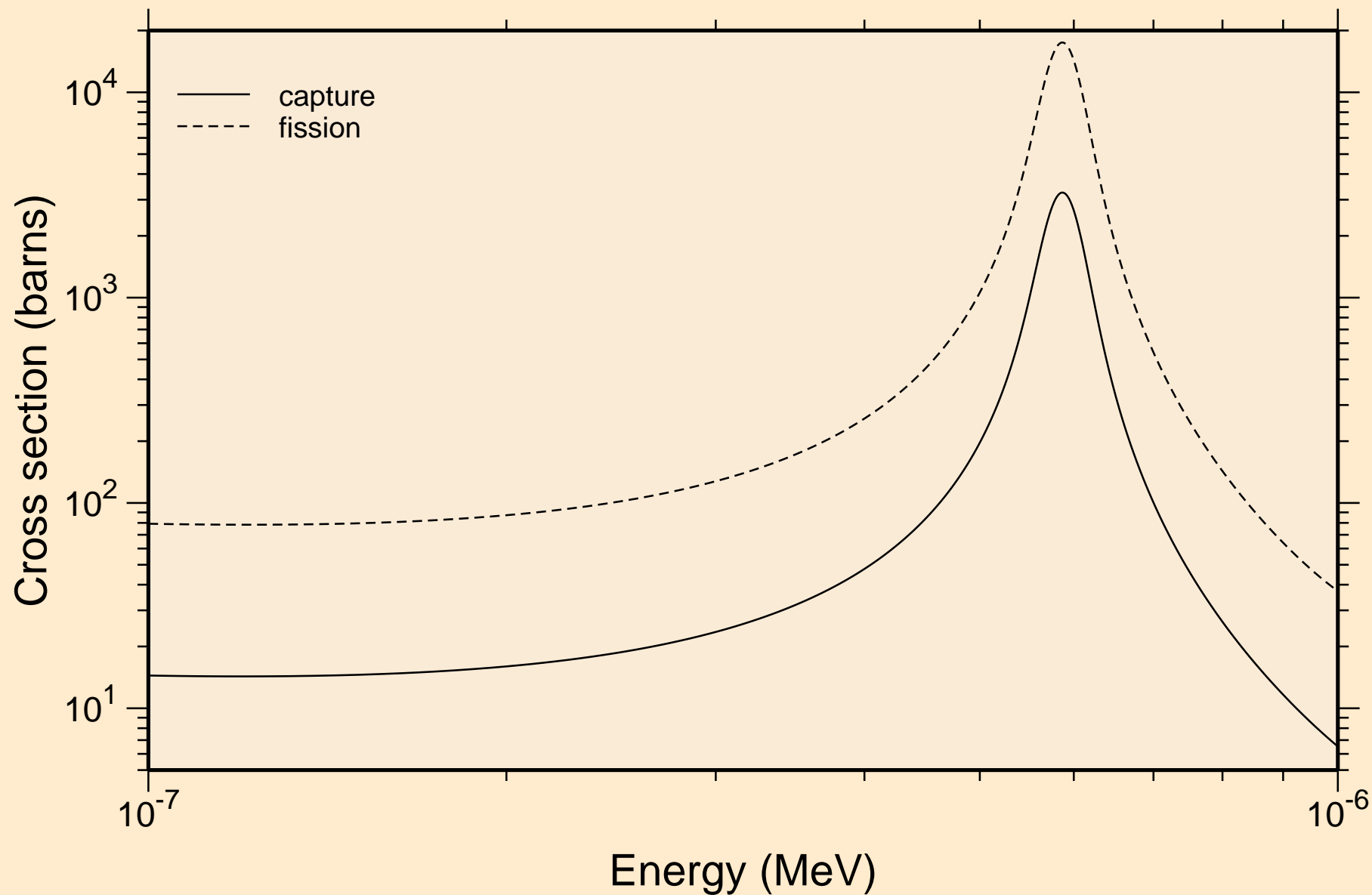

PU230 NEUTRON ACER TENDL-2019 LIBRARY; T=293.16K
resonance absorption cross sections

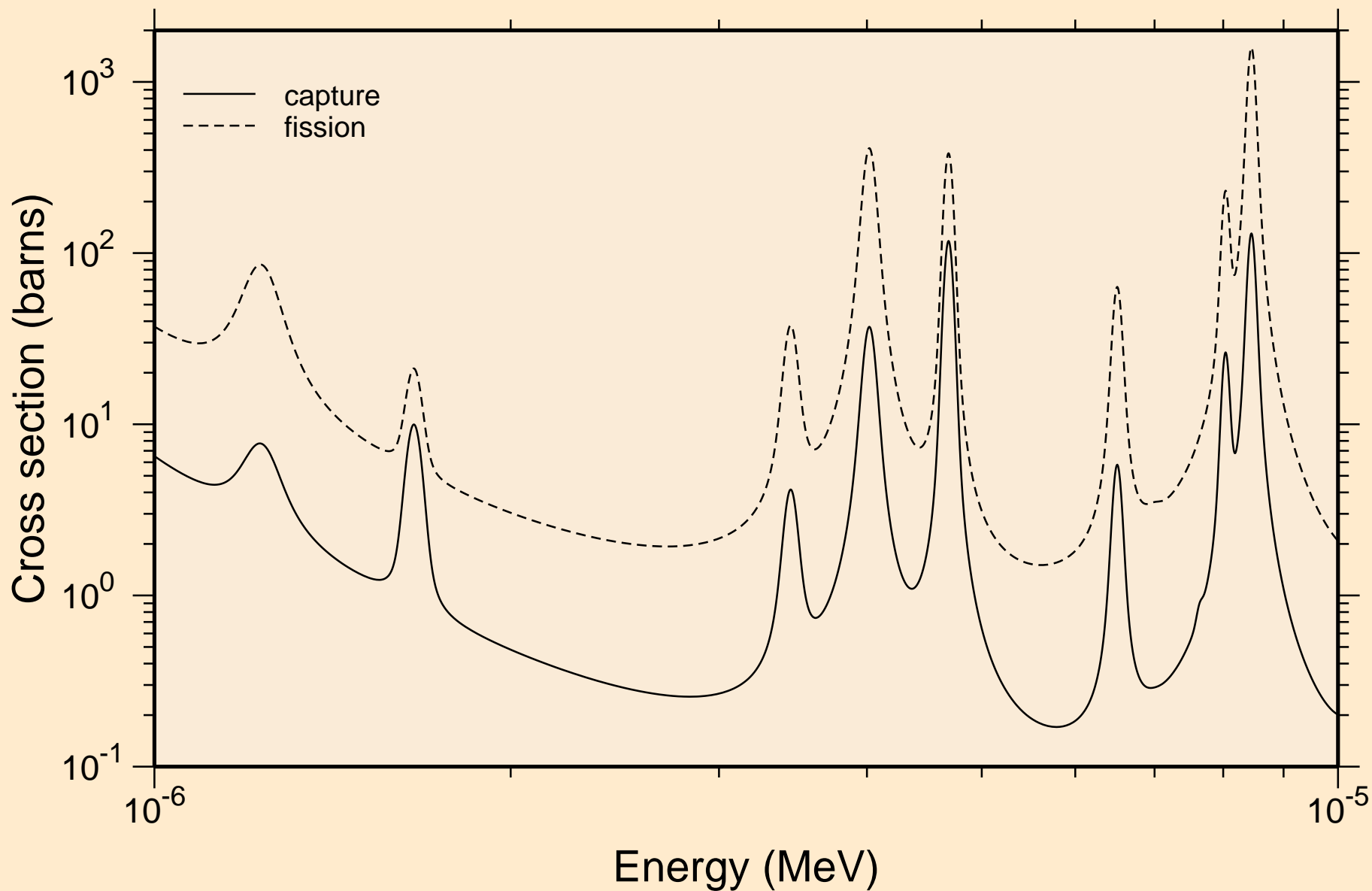

PU230 NEUTRON ACER TENDL-2019 LIBRARY; T=293.16K
resonance absorption cross sections

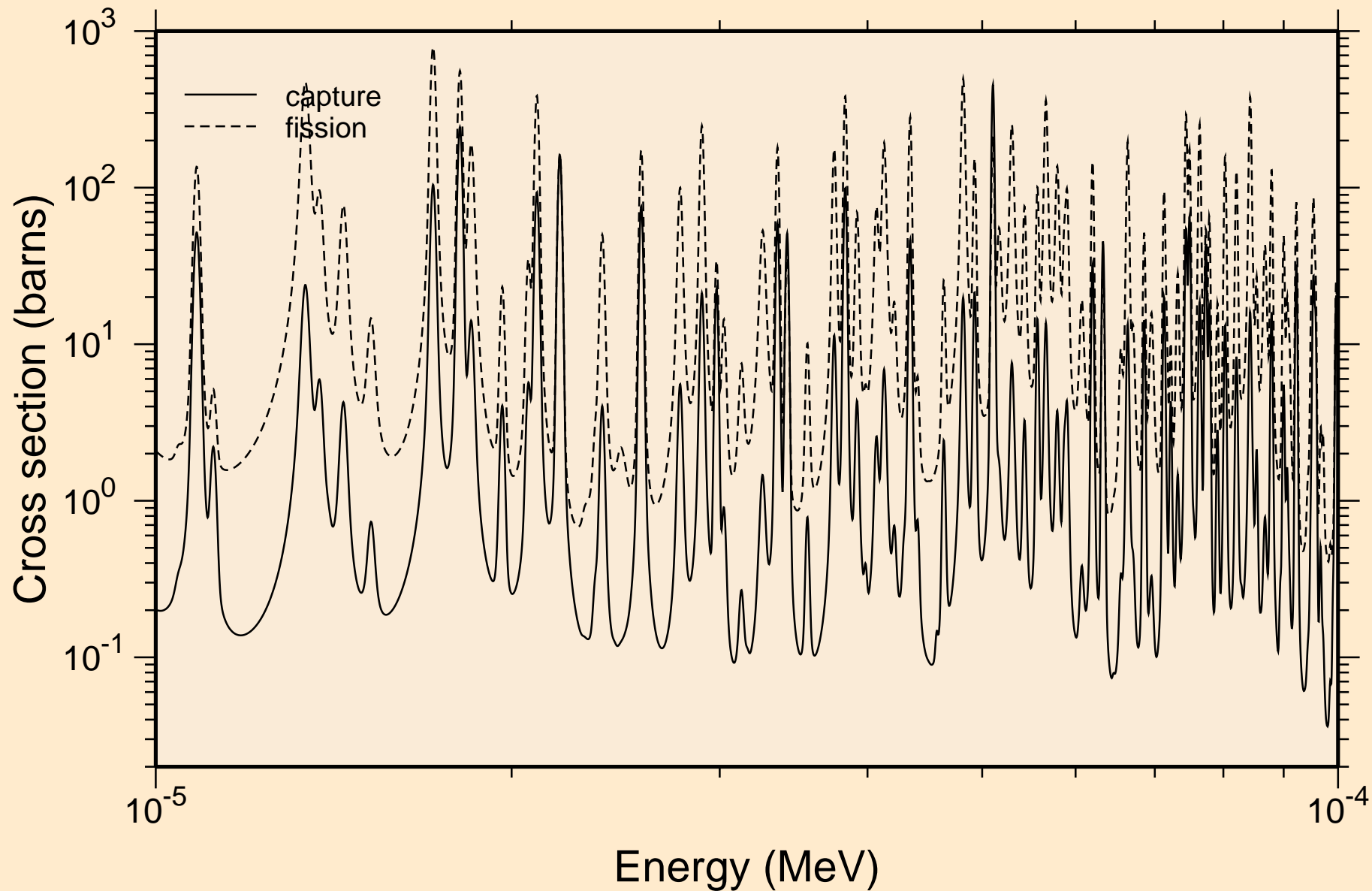

PU230 NEUTRON ACER TENDL-2019 LIBRARY; T=293.16K
resonance absorption cross sections

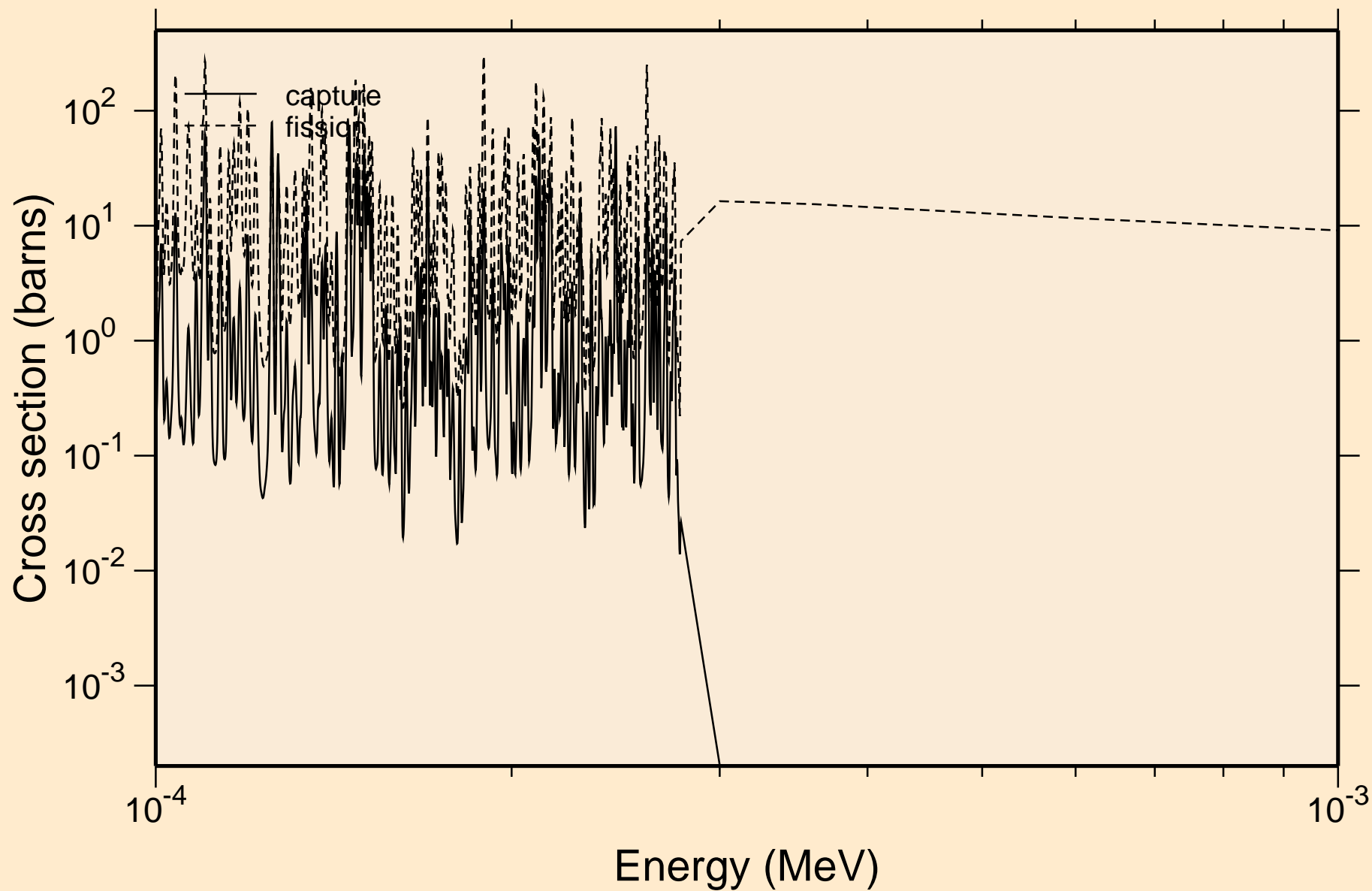

PU230 NEUTRON ACER TENDL-2019 LIBRARY; T=293.16K
resonance absorption cross sections

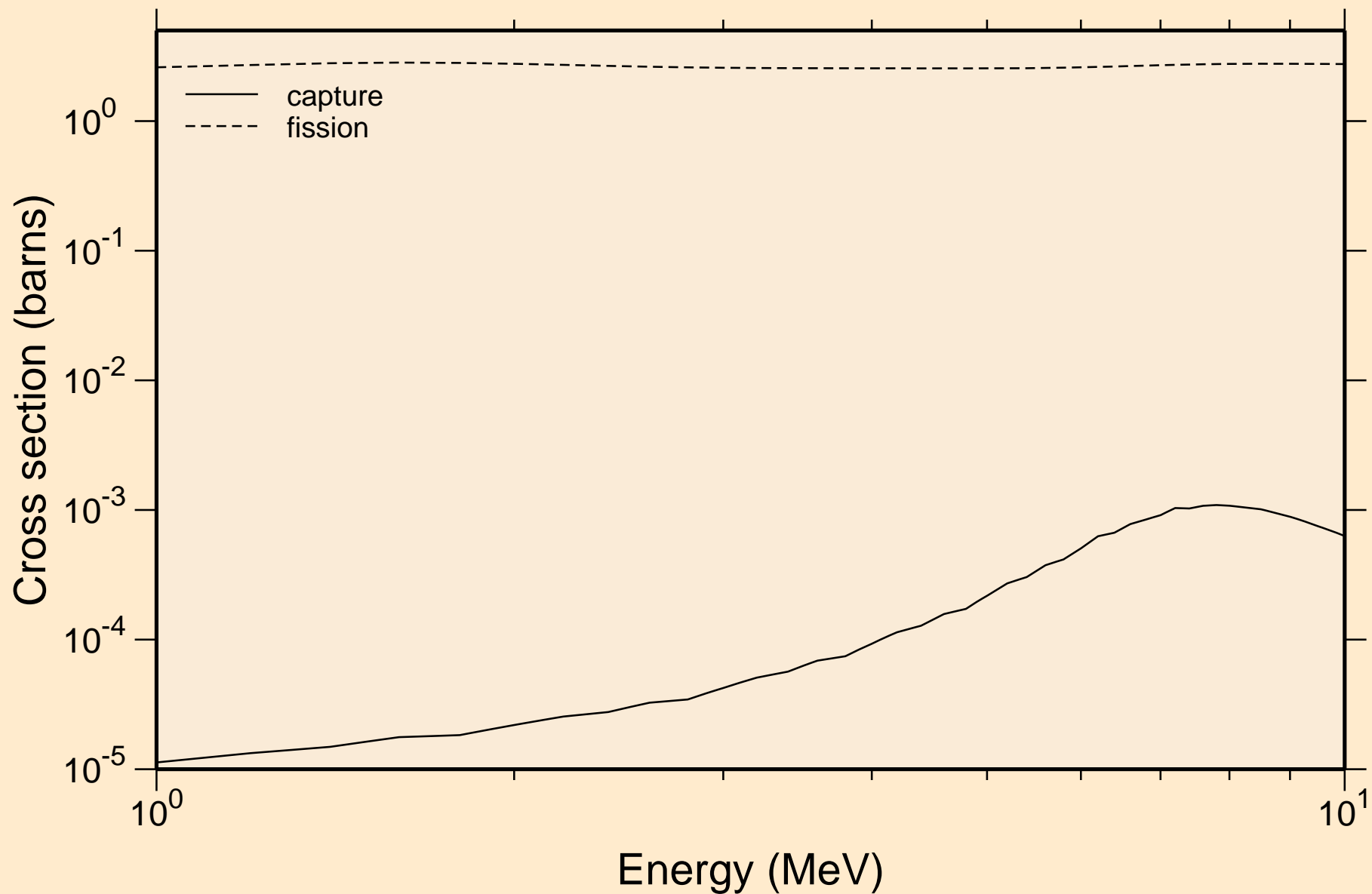

PU230 NEUTRON ACER TENDL-2019 LIBRARY; T=293.16K
Heating

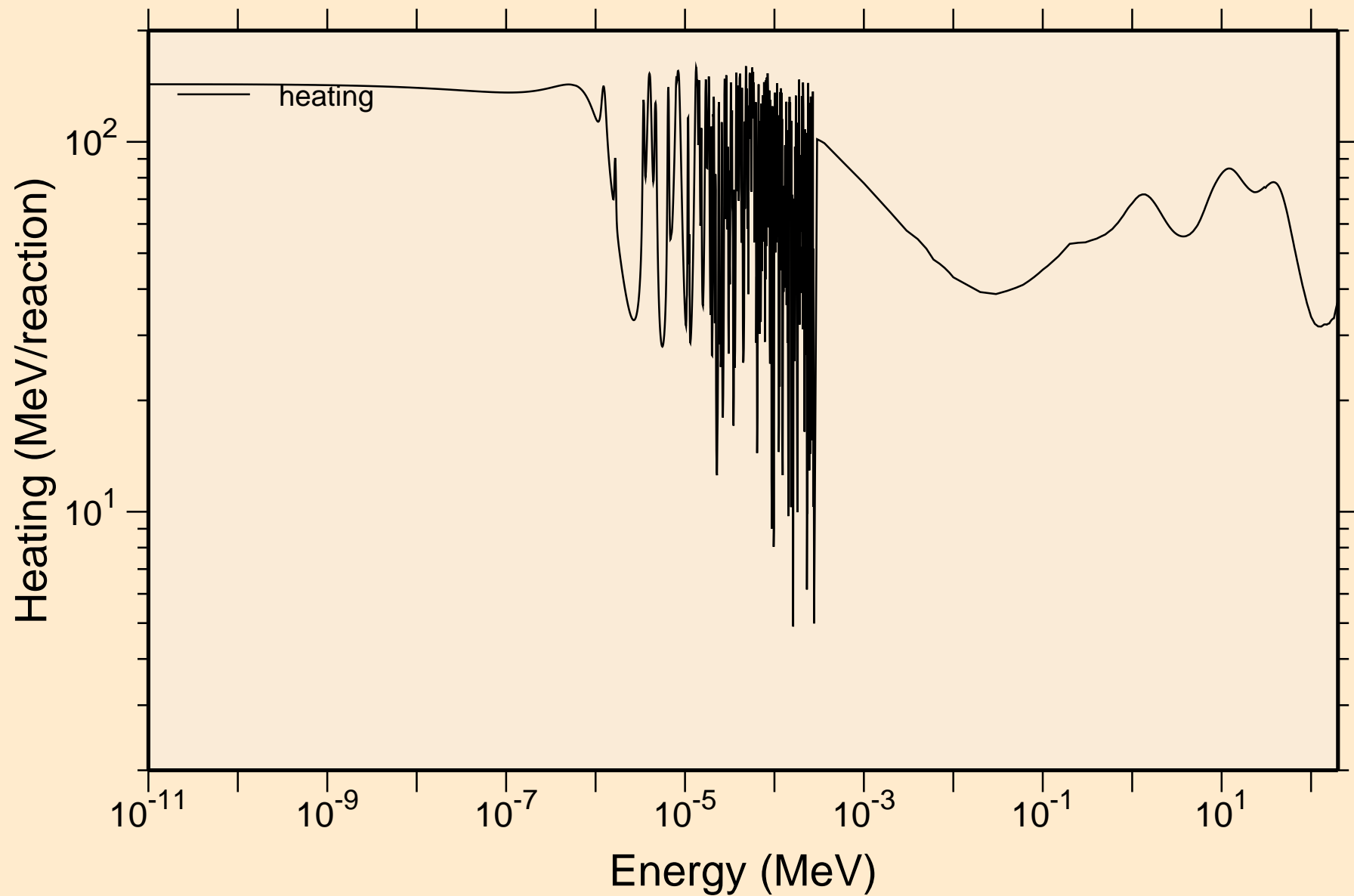

PU230 NEUTRON ACER TENDL-2019 LIBRARY; T=293.16K
Damage

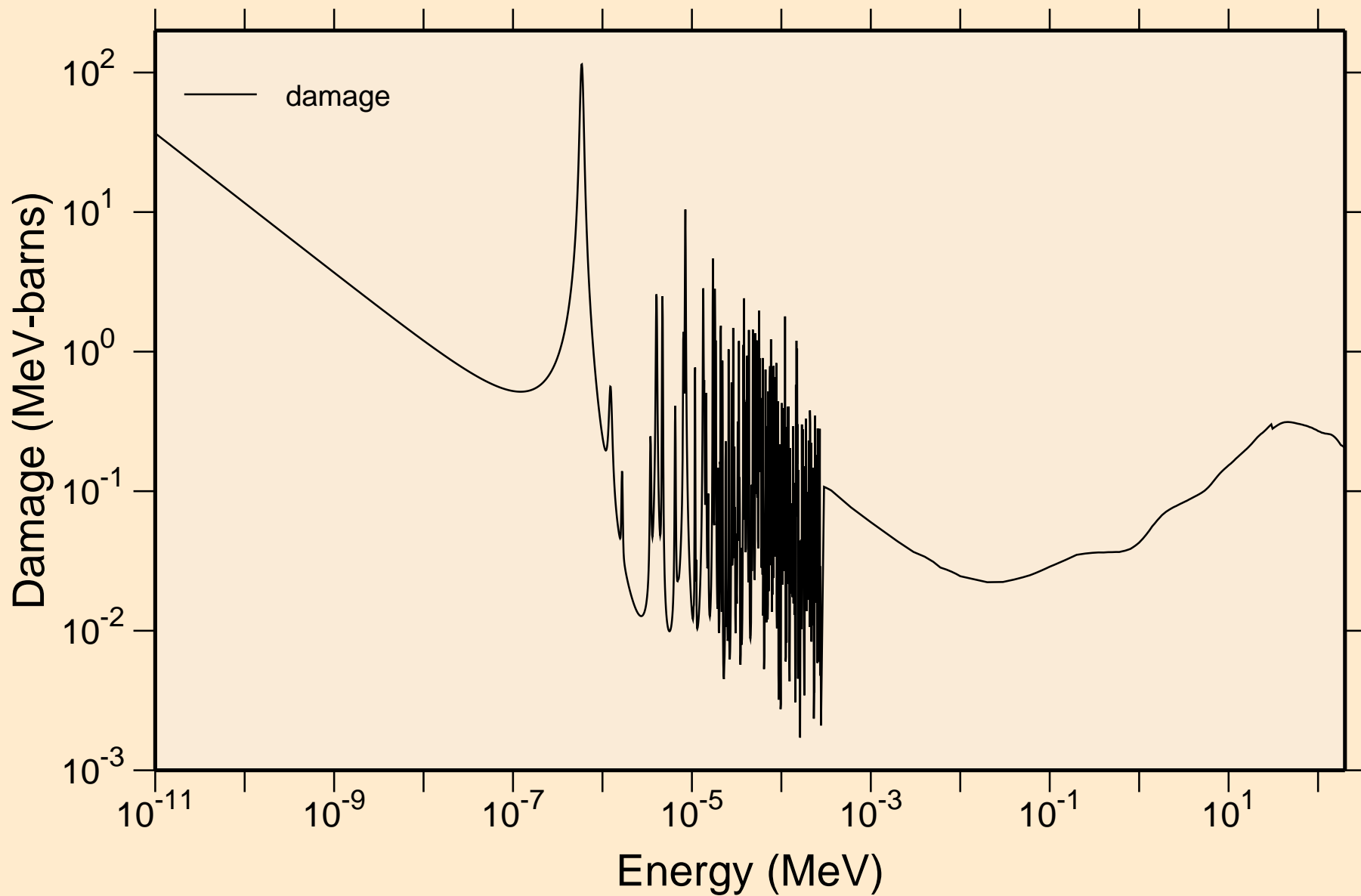

PU230 NEUTRON ACER TENDL-2019 LIBRARY; T=293.16K
Non-threshold reactions

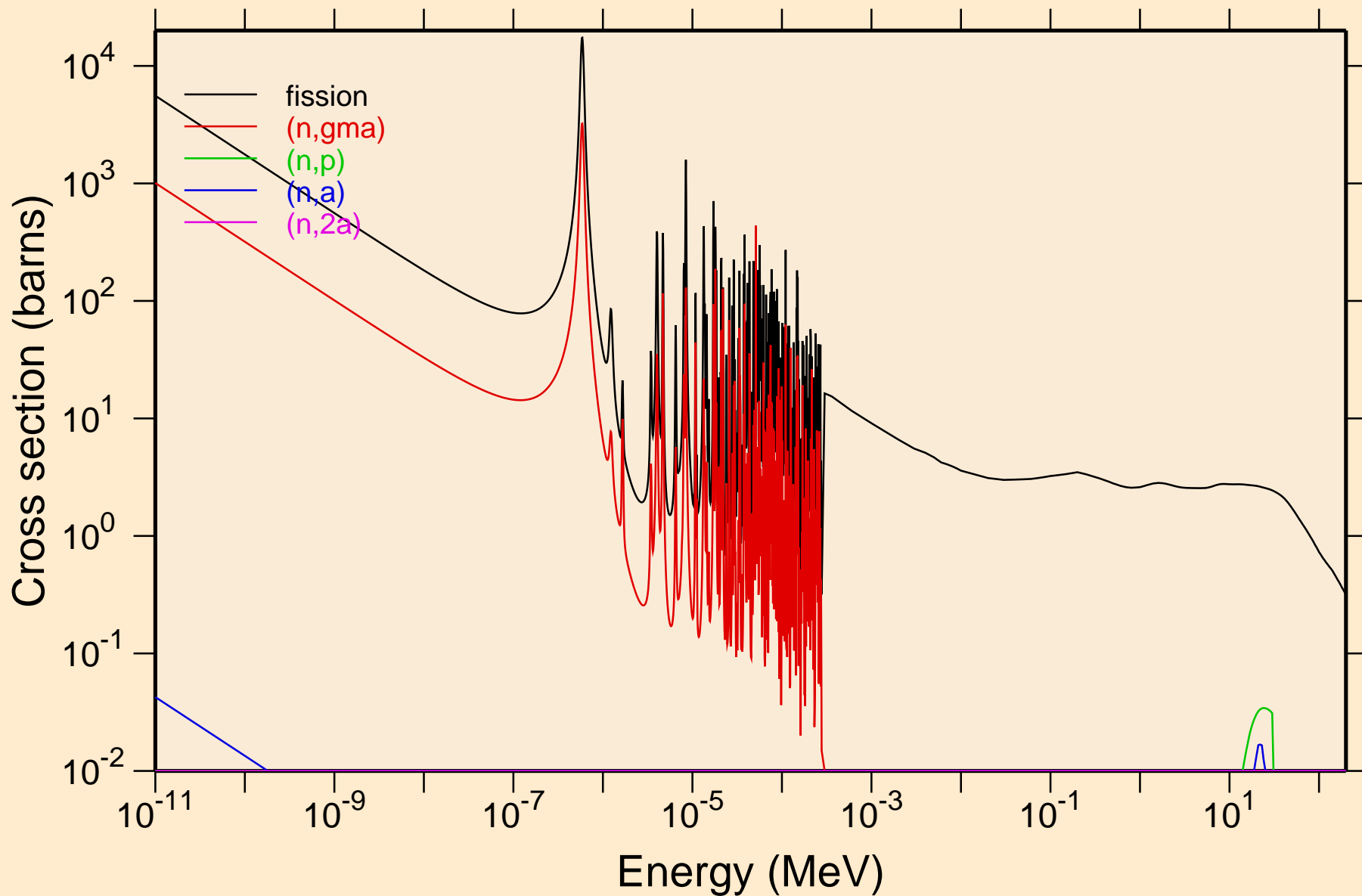

PU230 NEUTRON ACER TENDL-2019 LIBRARY; T=293.16K
Non-threshold reactions

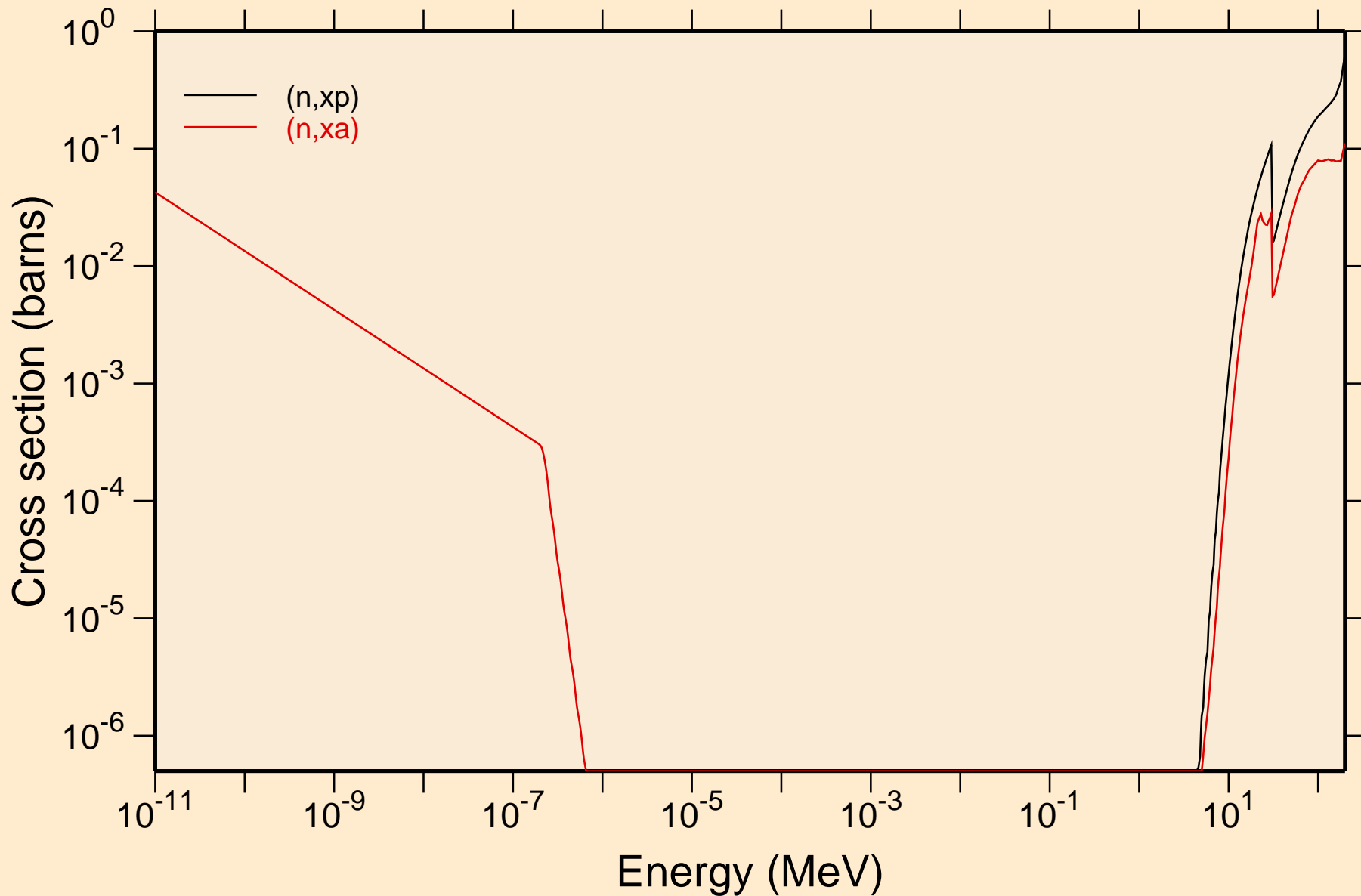

PU230 NEUTRON ACER TENDL-2019 LIBRARY; T=293.16K
Principal cross sections

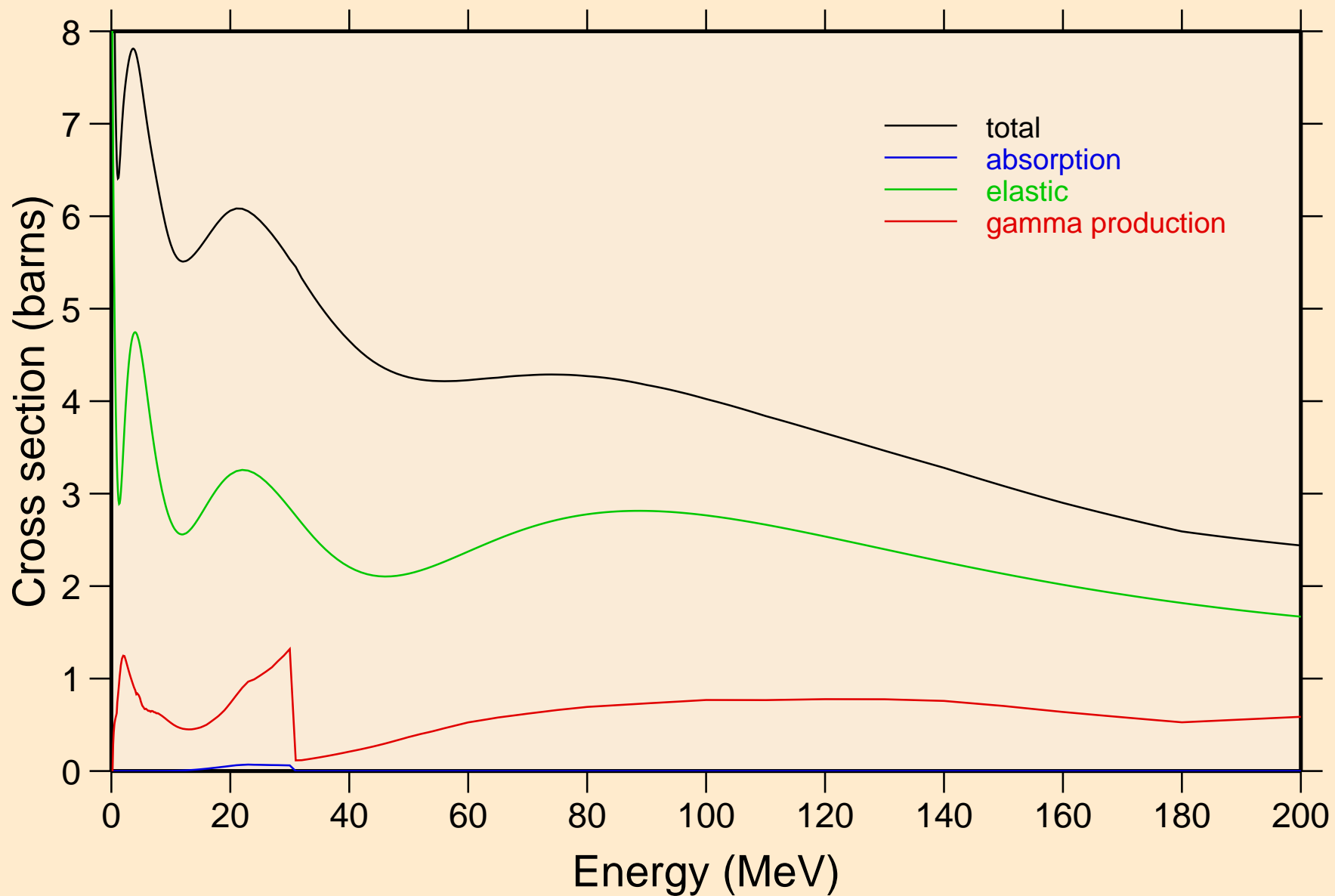

PU230 NEUTRON ACER TENDL-2019 LIBRARY; T=293.16K
Heating

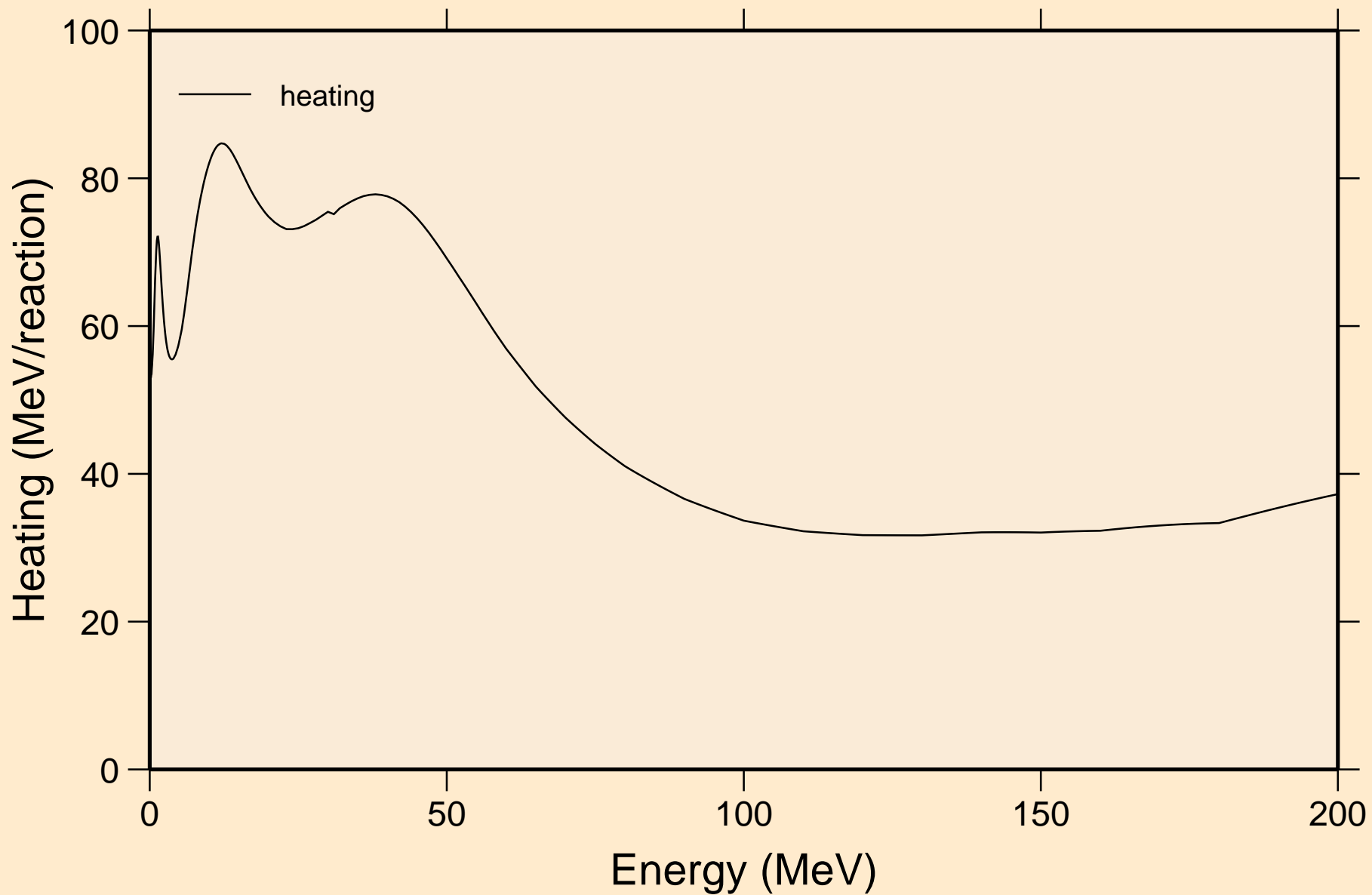

PU230 NEUTRON ACER TENDL-2019 LIBRARY; T=293.16K
Damage

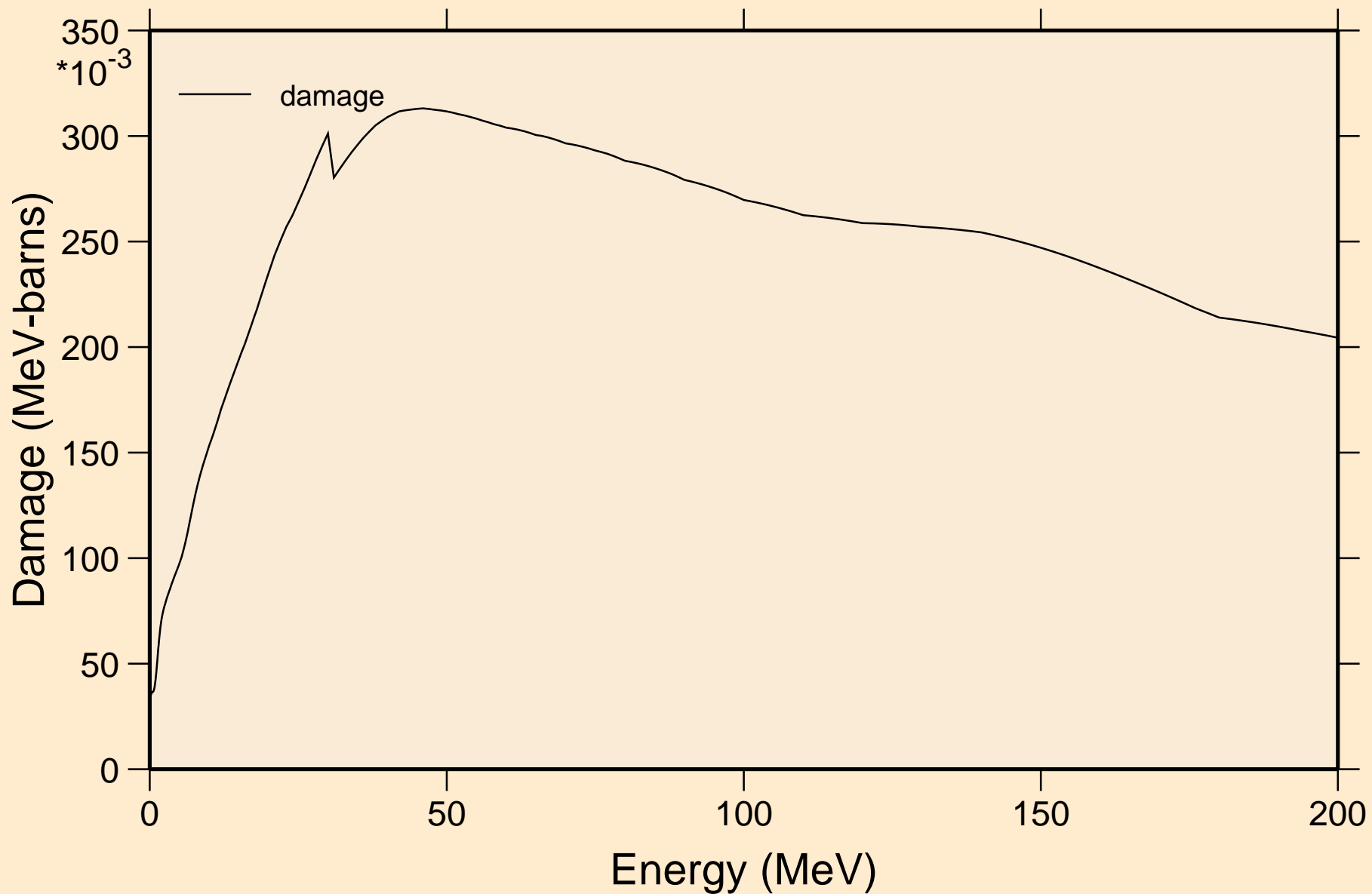

PU230 NEUTRON ACER TENDL-2019 LIBRARY; T=293.16K
Non-threshold reactions

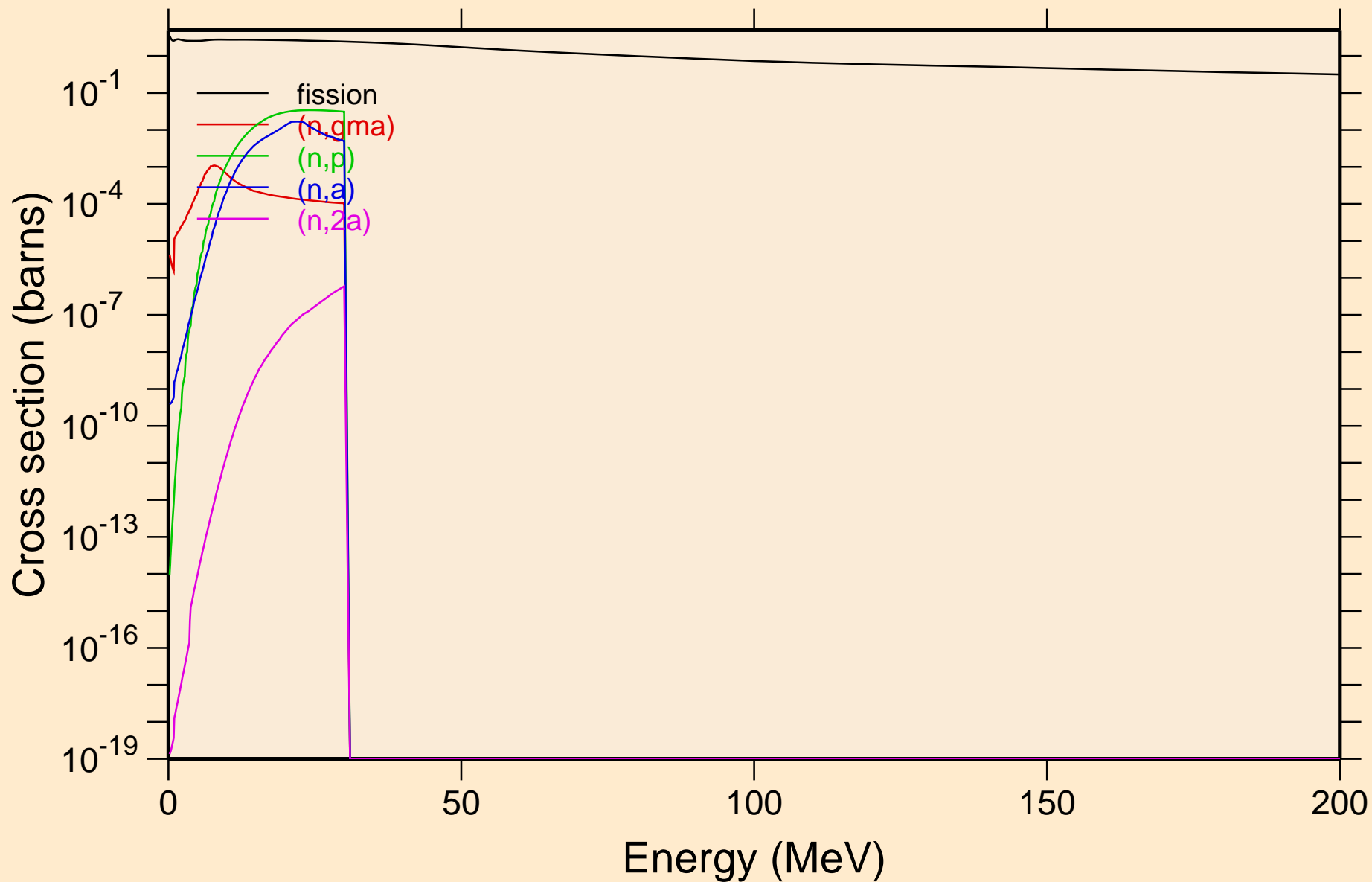

PU230 NEUTRON ACER TENDL-2019 LIBRARY; T=293.16K
Non-threshold reactions

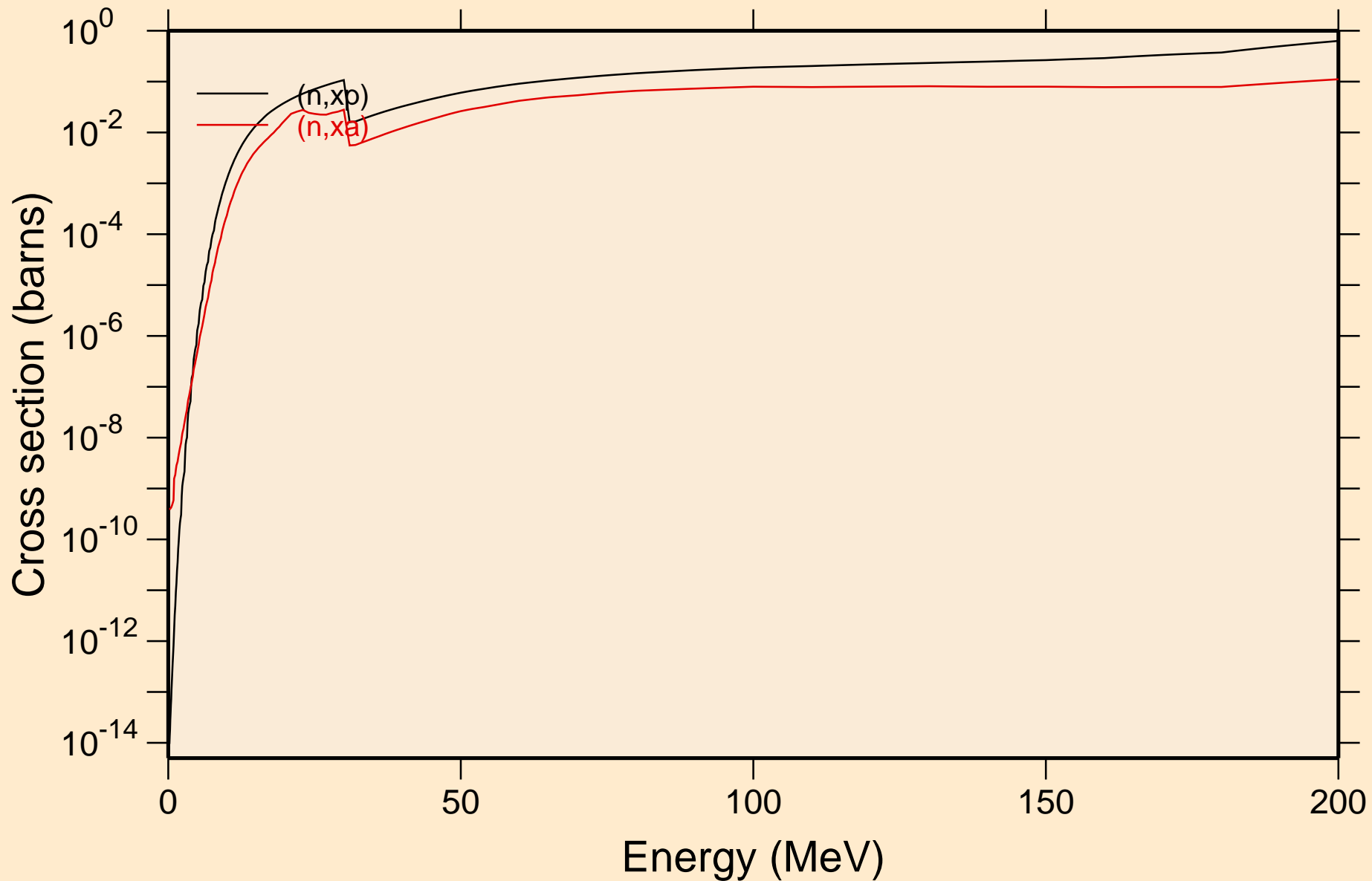

PU230 NEUTRON ACER TENDL-2019 LIBRARY; T=293.16K
Inelastic levels

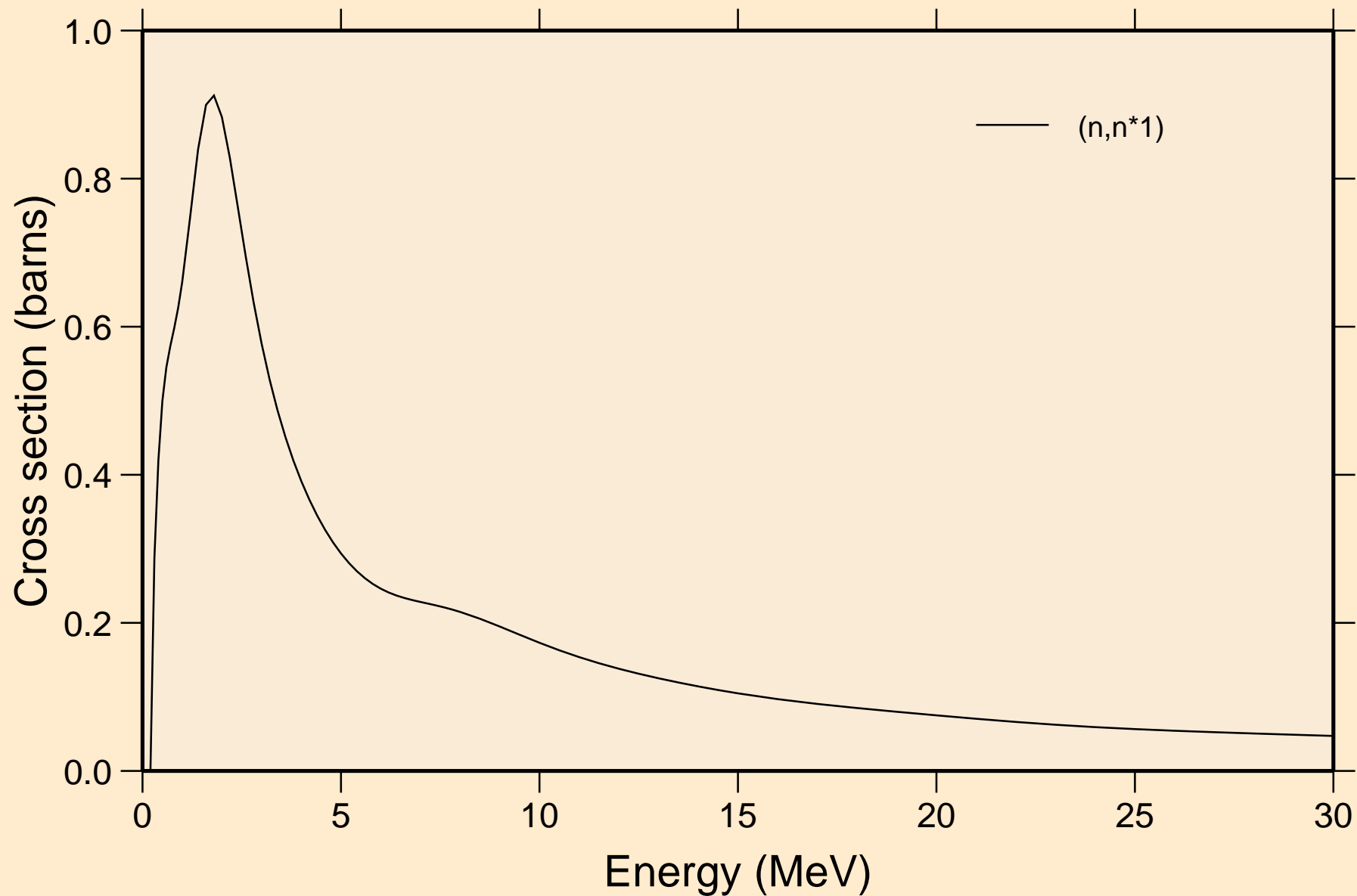

PU230 NEUTRON ACER TENDL-2019 LIBRARY; T=293.16K
Threshold reactions

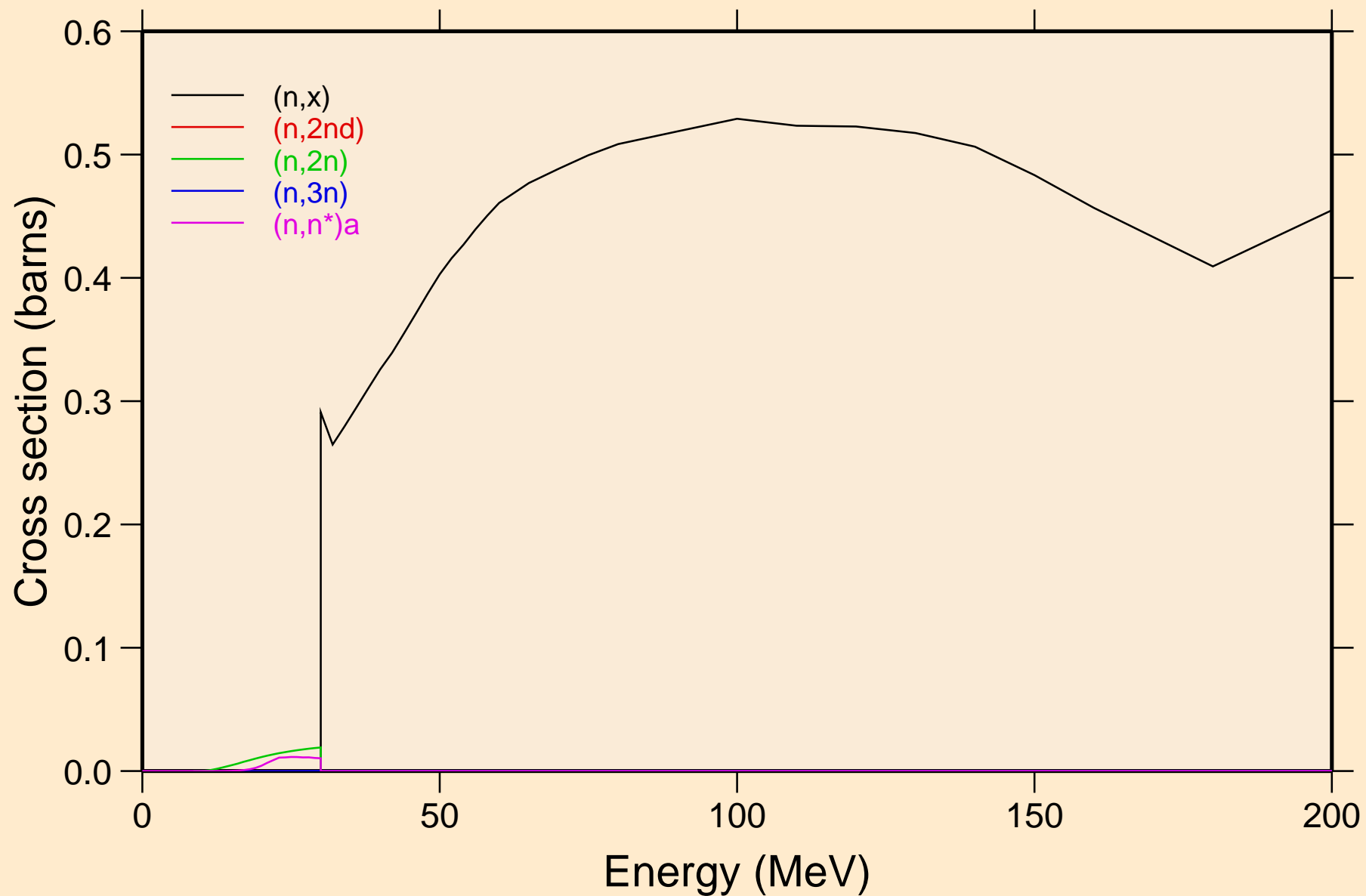

PU230 NEUTRON ACER TENDL-2019 LIBRARY; T=293.16K
Threshold reactions

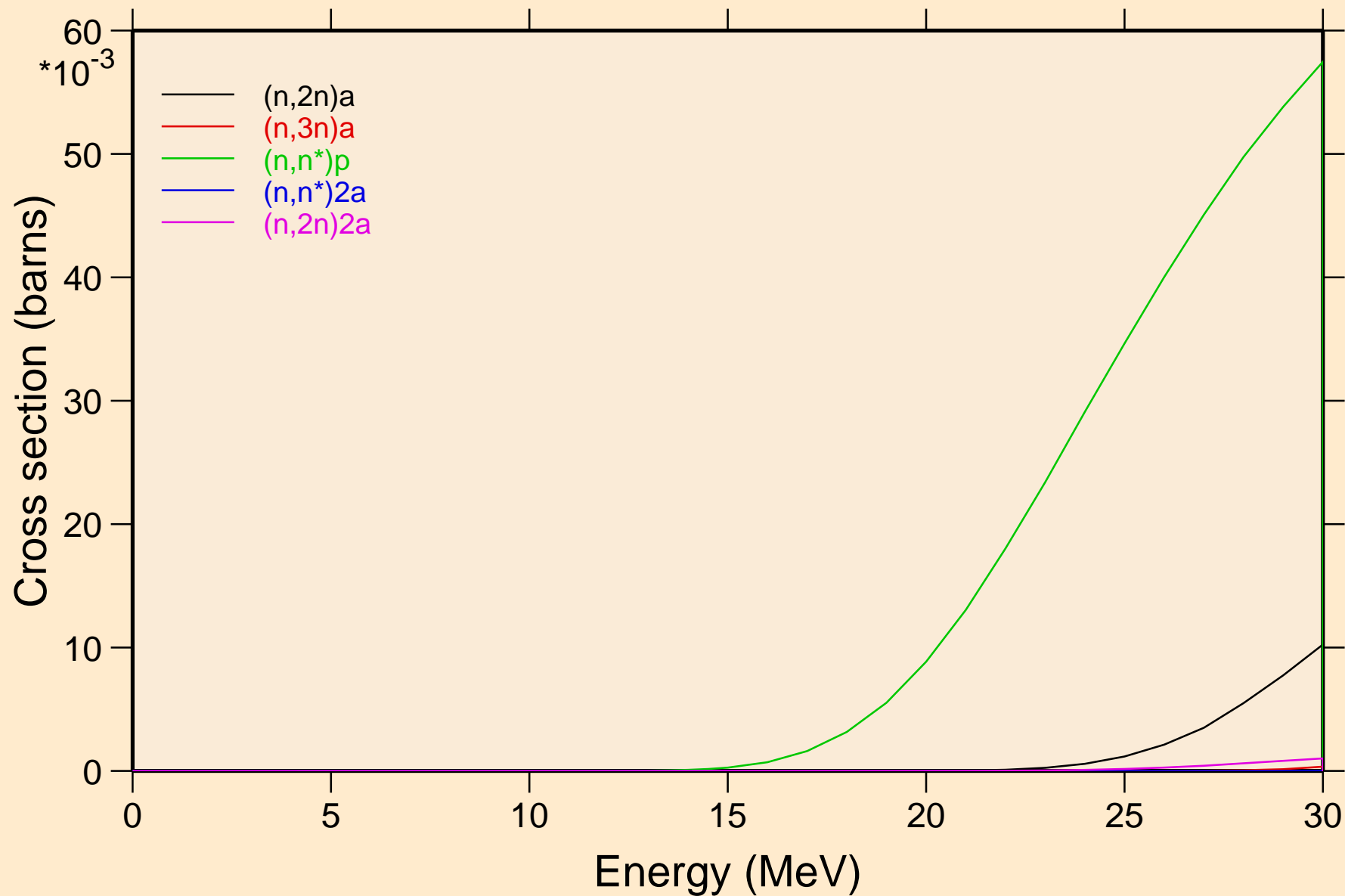

PU230 NEUTRON ACER TENDL-2019 LIBRARY; T=293.16K
Threshold reactions

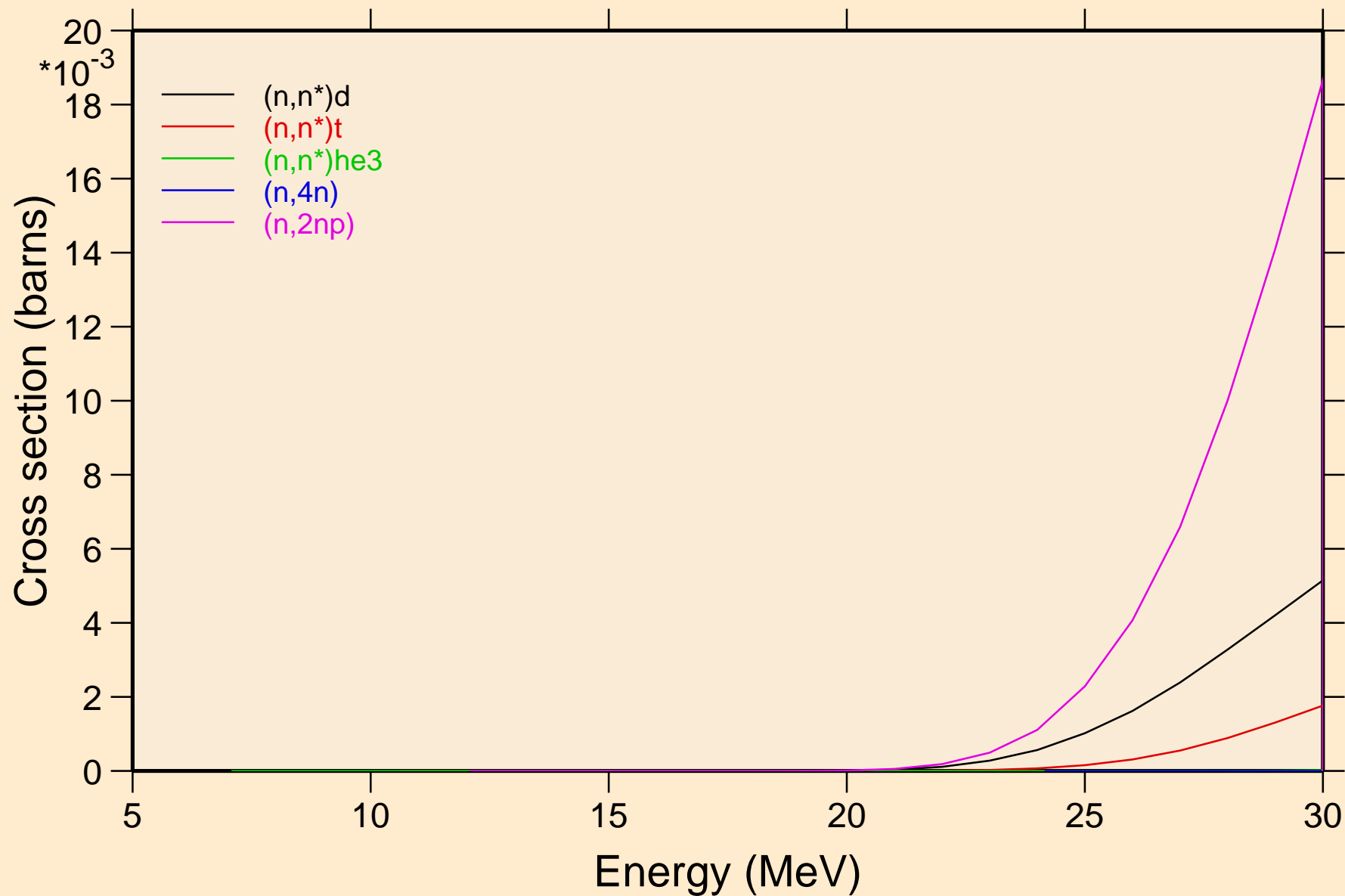

PU230 NEUTRON ACER TENDL-2019 LIBRARY; T=293.16K
Threshold reactions

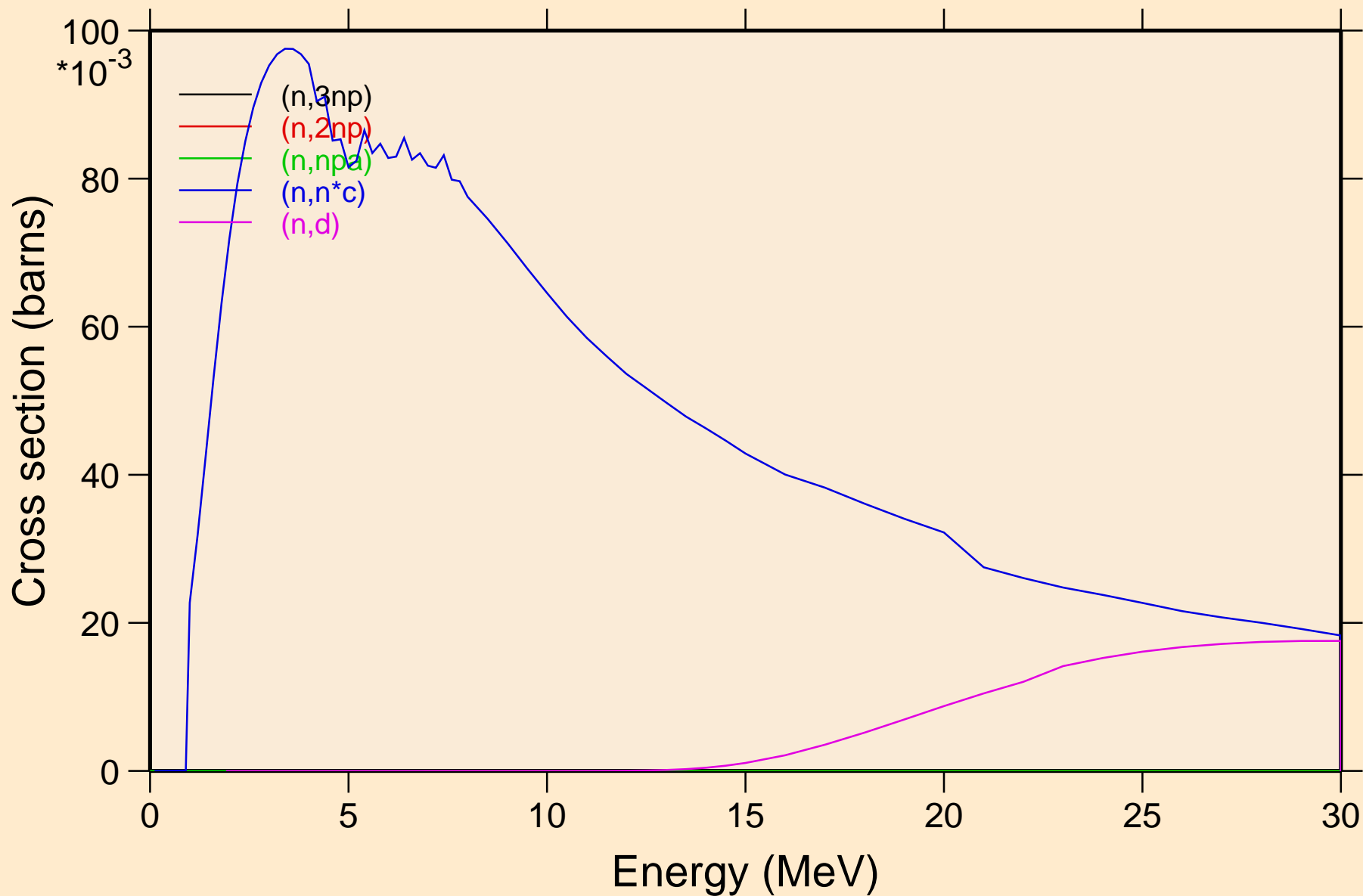

PU230 NEUTRON ACER TENDL-2019 LIBRARY; T=293.16K
Threshold reactions

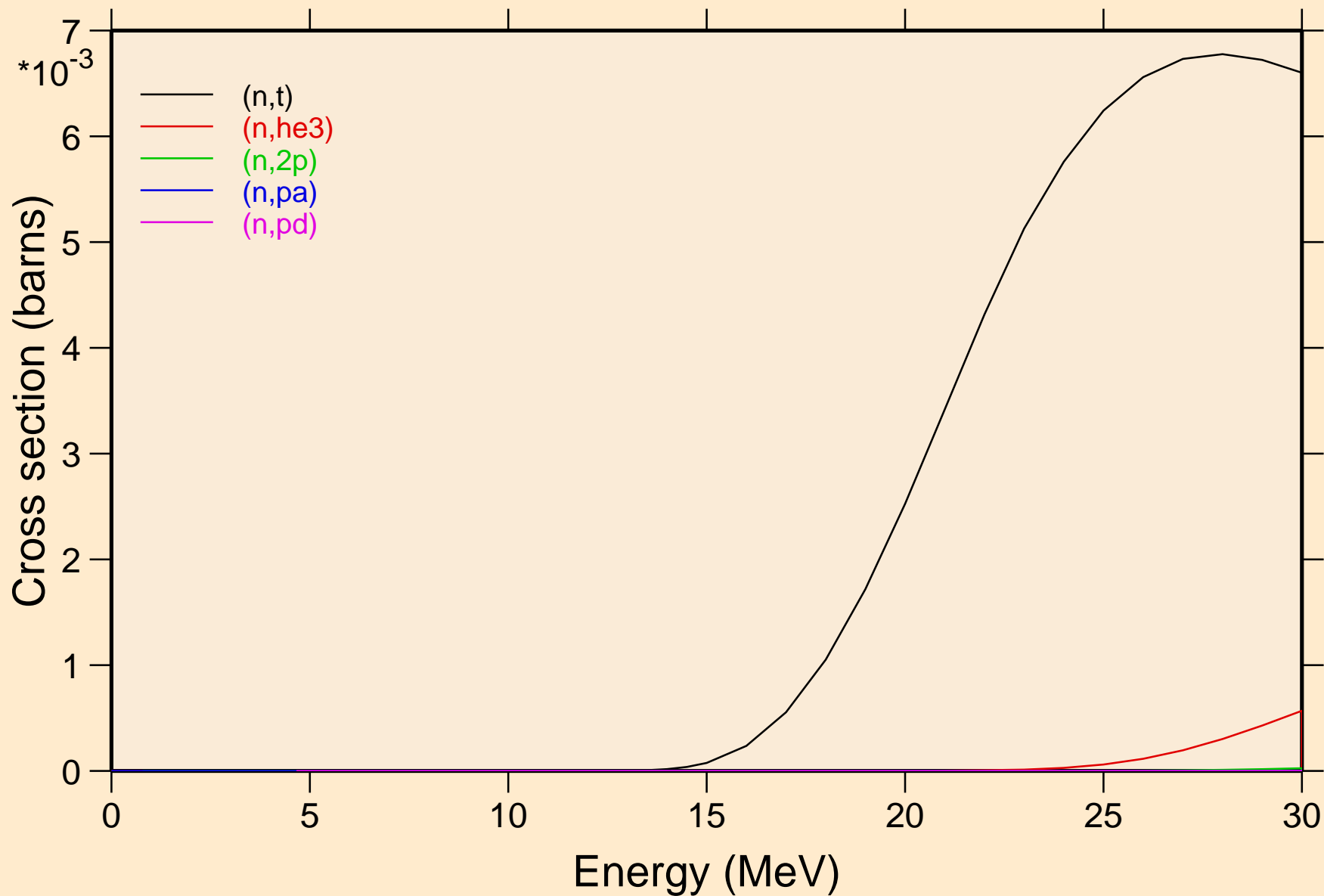

PU230 NEUTRON ACER TENDL-2019 LIBRARY; T=293.16K
Threshold reactions

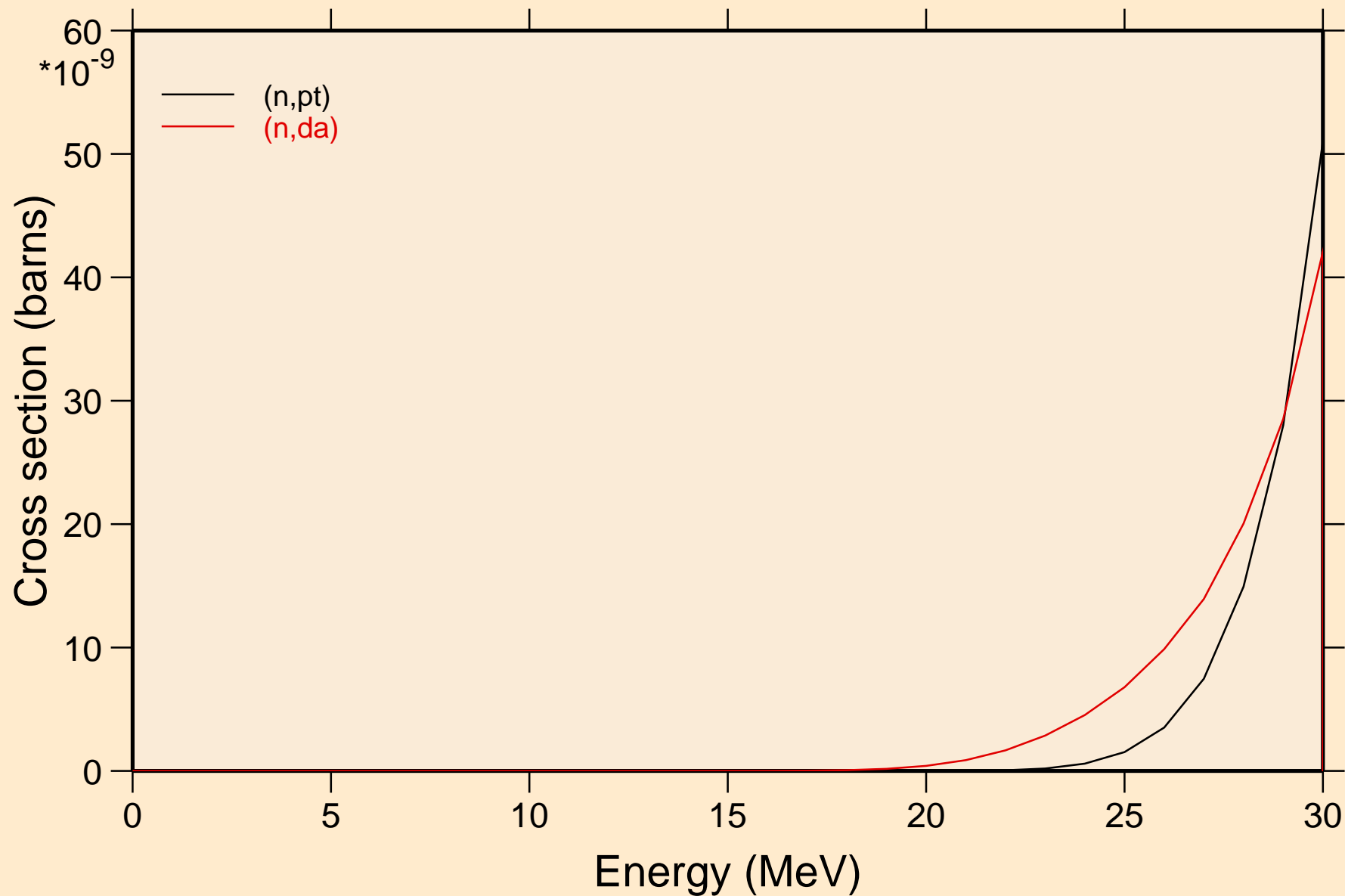

PU230 NEUTRON ACER TENDL-2019 LIBRARY; T=293.16K
Threshold reactions

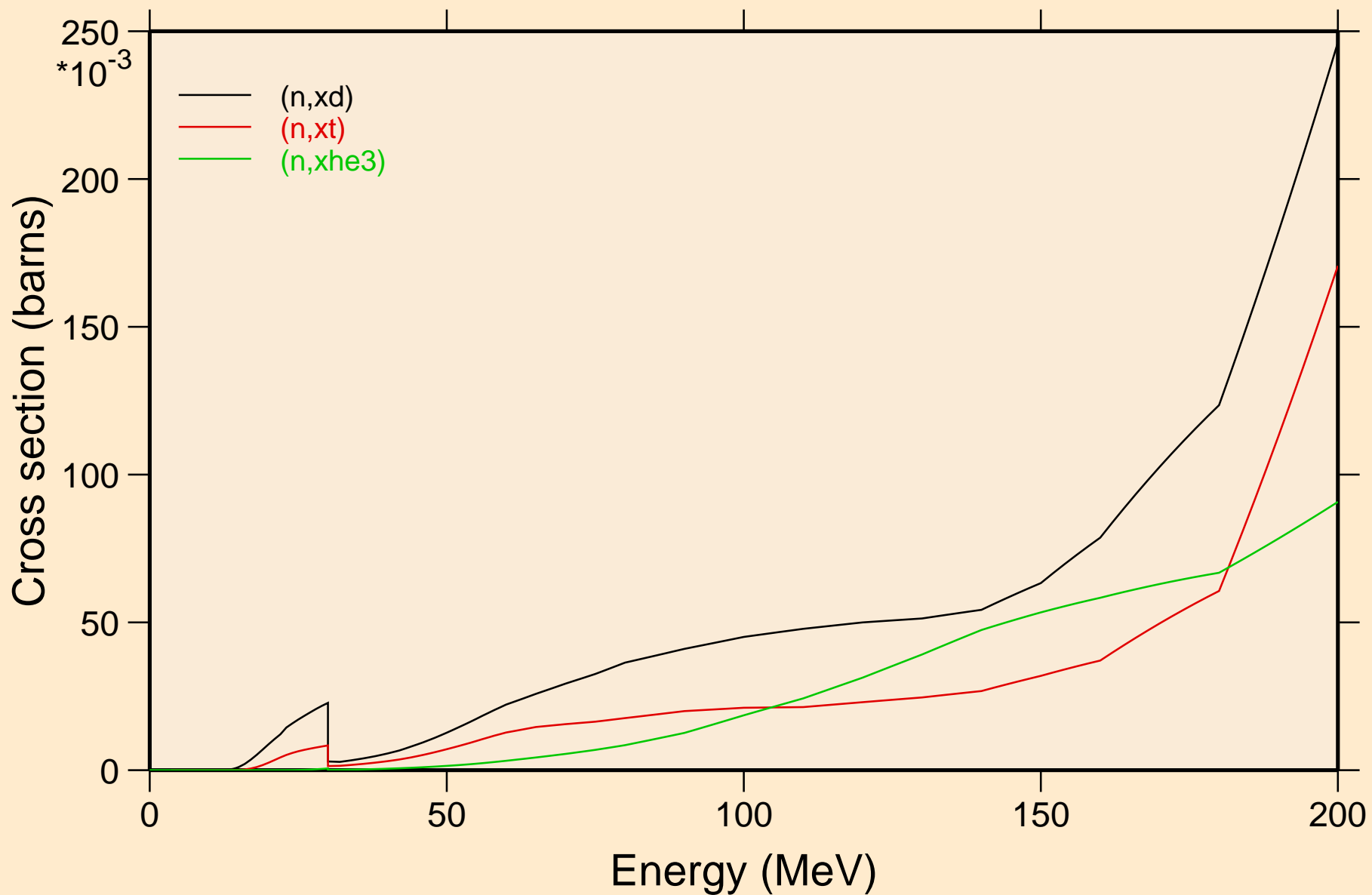

PU230 NEUTRON ACER TENDL-2019 LIBRARY; T=293.16K
angular distribution for elastic

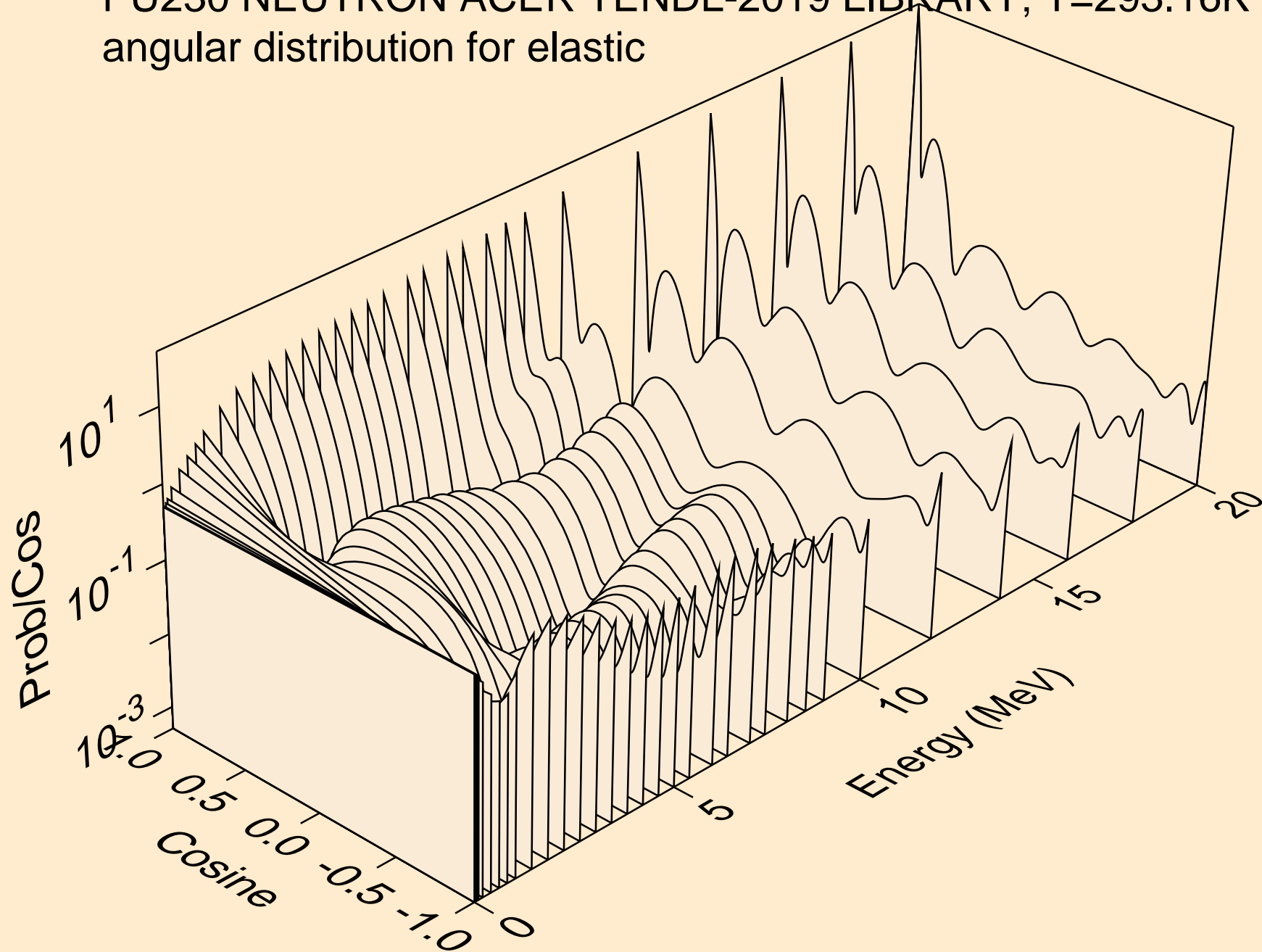

PU230 NEUTRON ACER TENDL-2019 LIBRARY; T=293.16K
angular distribution for elastic

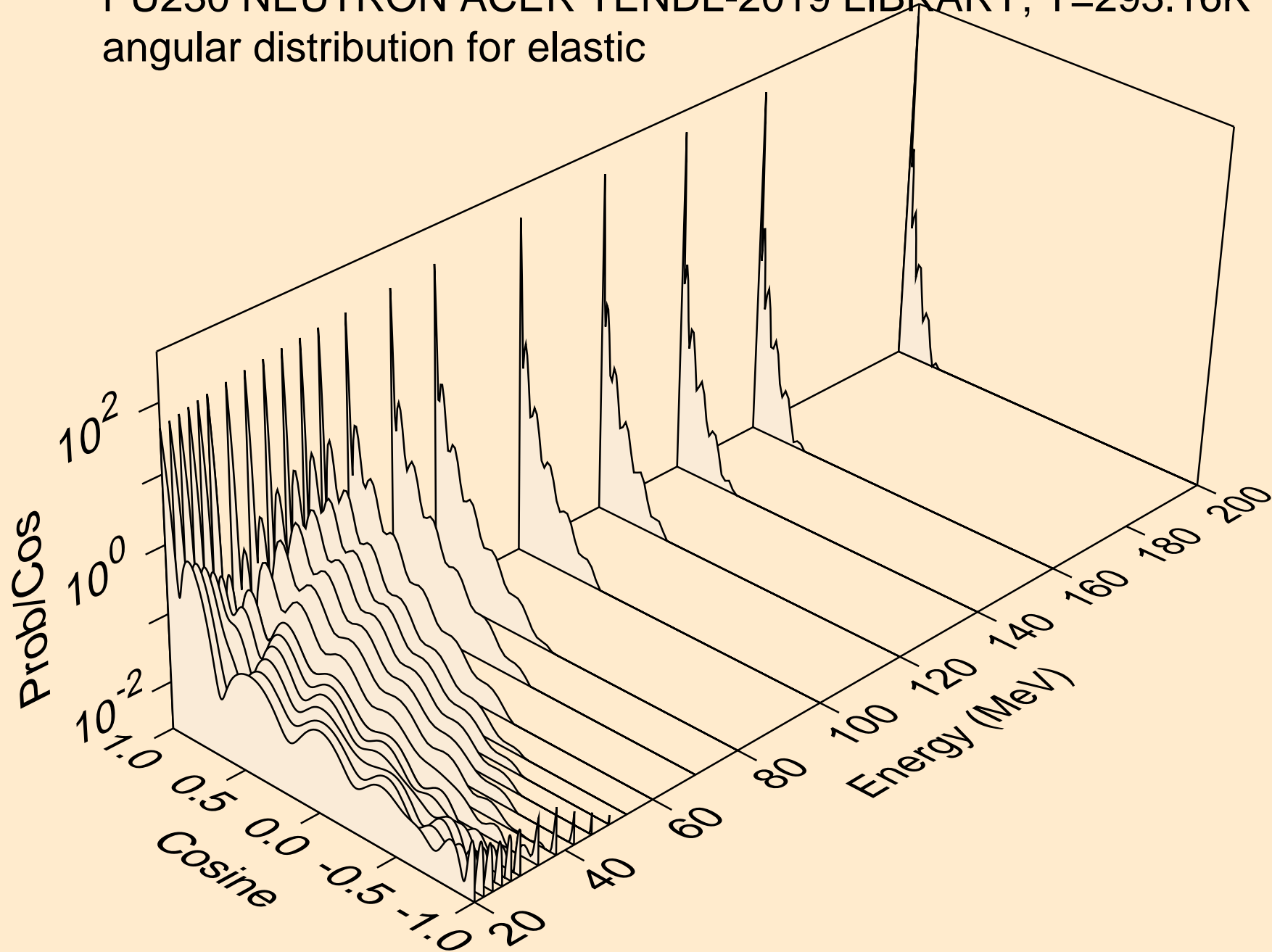

PU230 NEUTRON ACER TENDL-2019 LIBRARY; T=293.16K
angular distribution for (n,n*1)

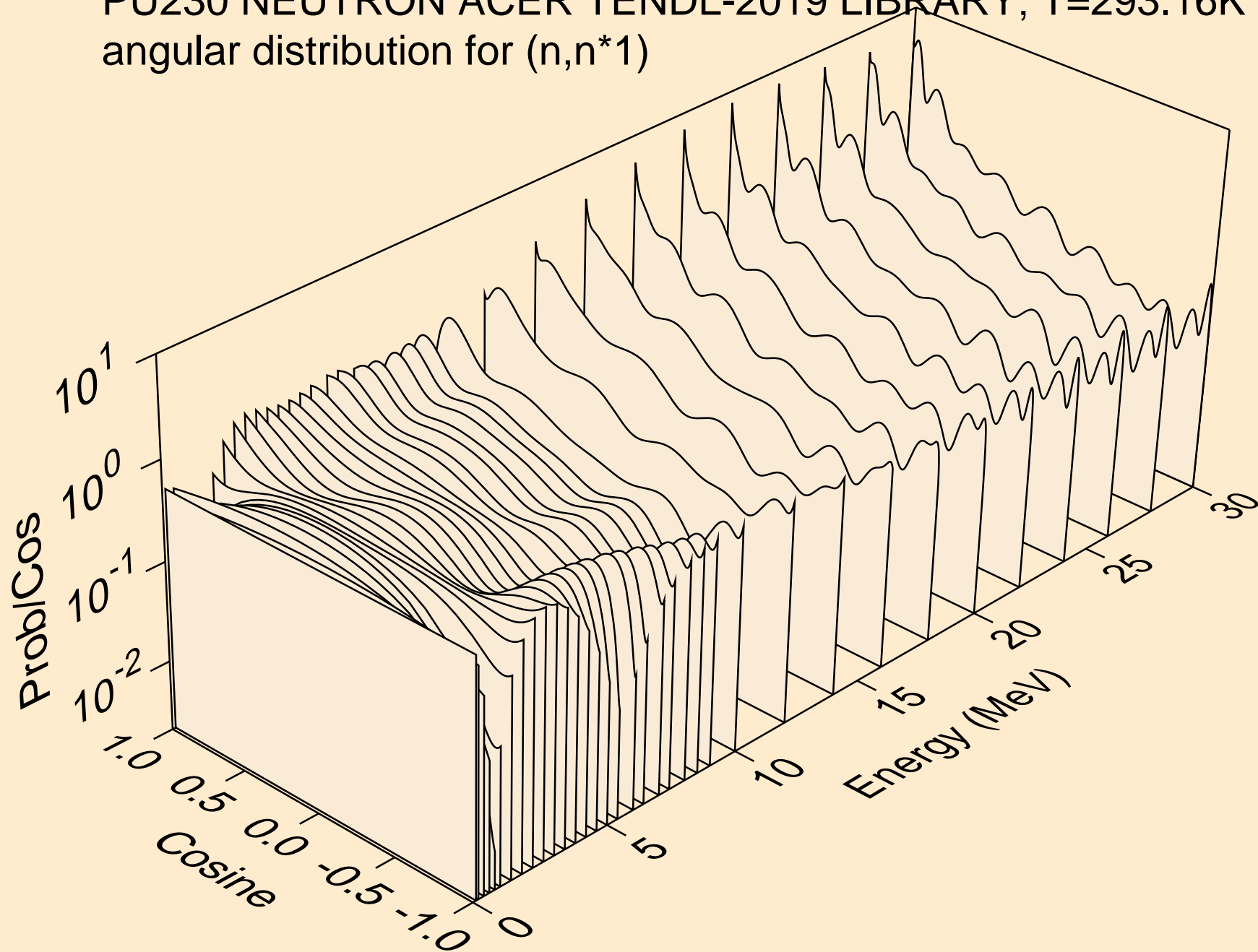

PU230 NEUTRON ACER TENDL-2019 LIBRARY; T=293.16K
Total fission nubar

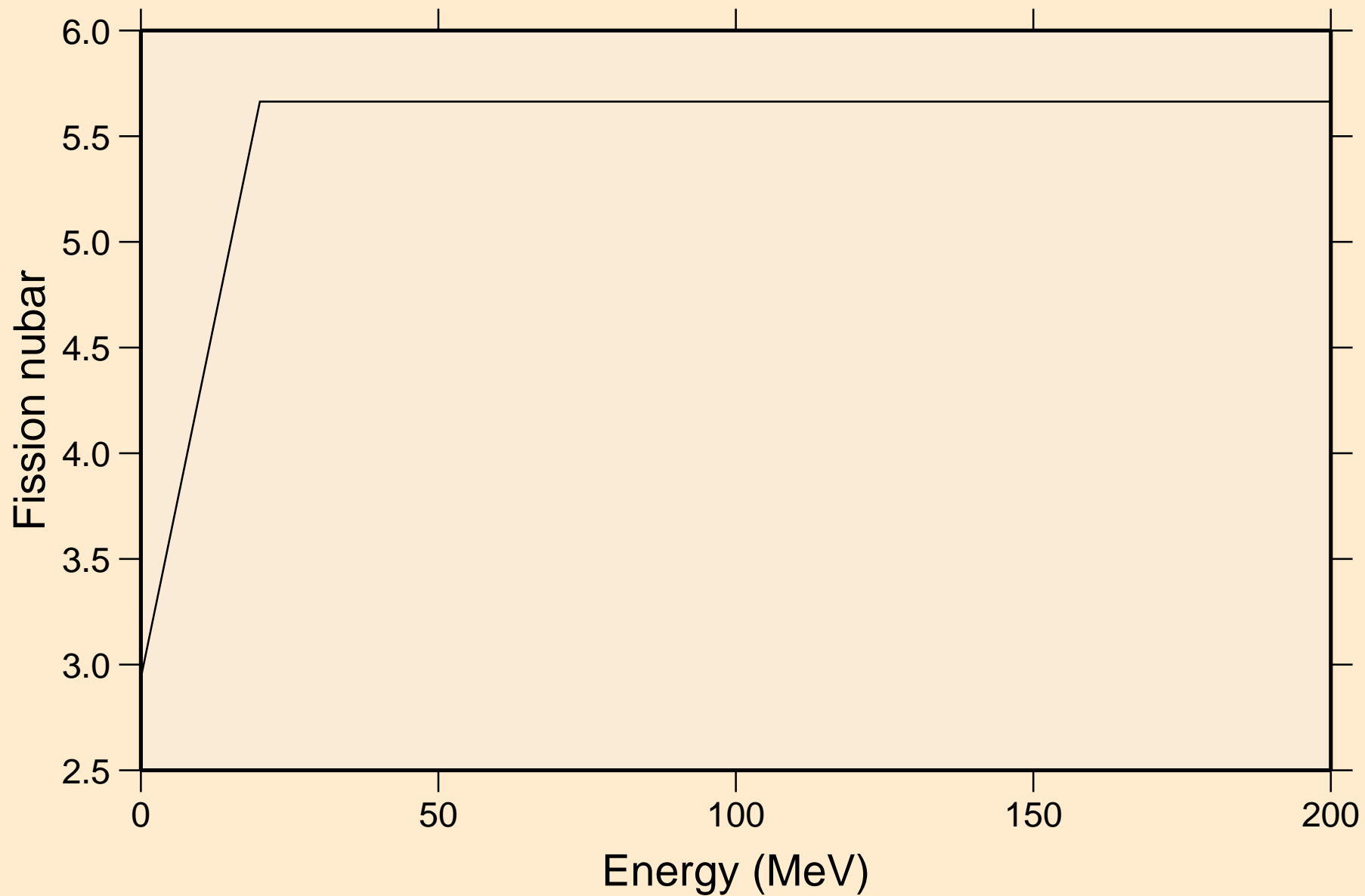

PU230 NEUTRON ACER TENDL-2019 LIBRARY; T=293.16K
Neutron emission for (n,x)

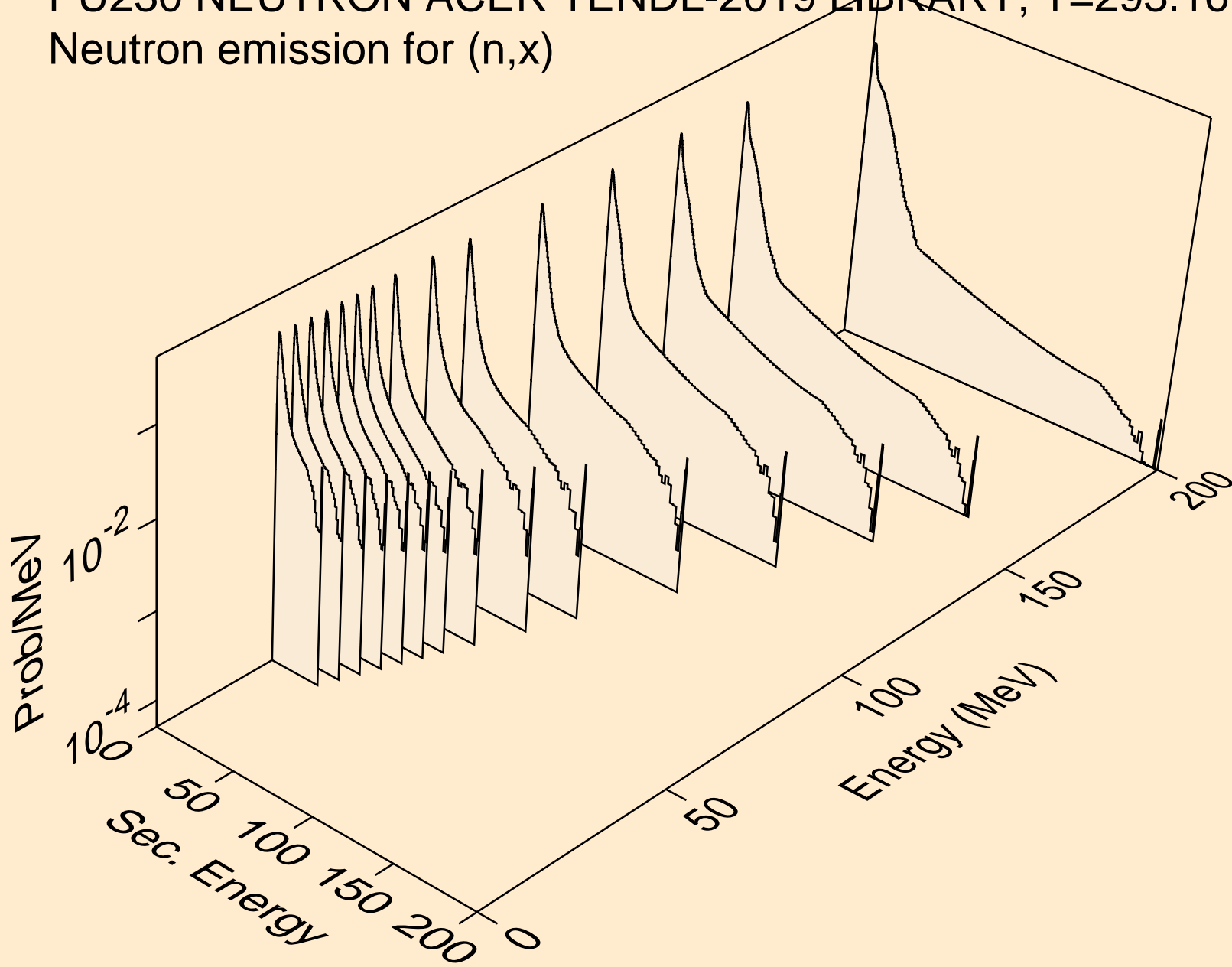

PU230 NEUTRON ACER TENDL-2019 LIBRARY; T=293.16K
Neutron emission for (n,2nd)

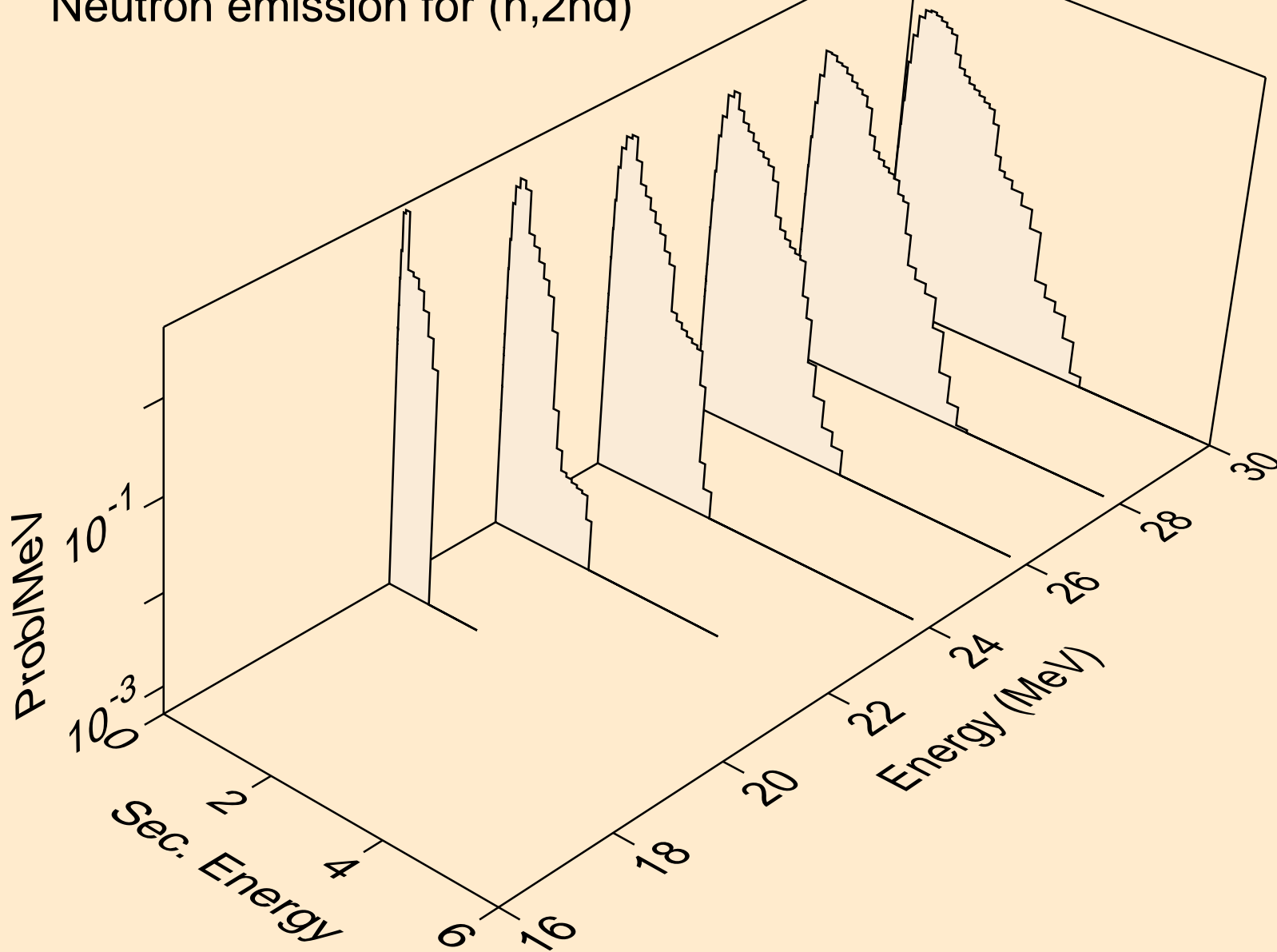

PU230 NEUTRON ACER TENDL-2019 LIBRARY; T=293.16K
Neutron emission for (n,2n)

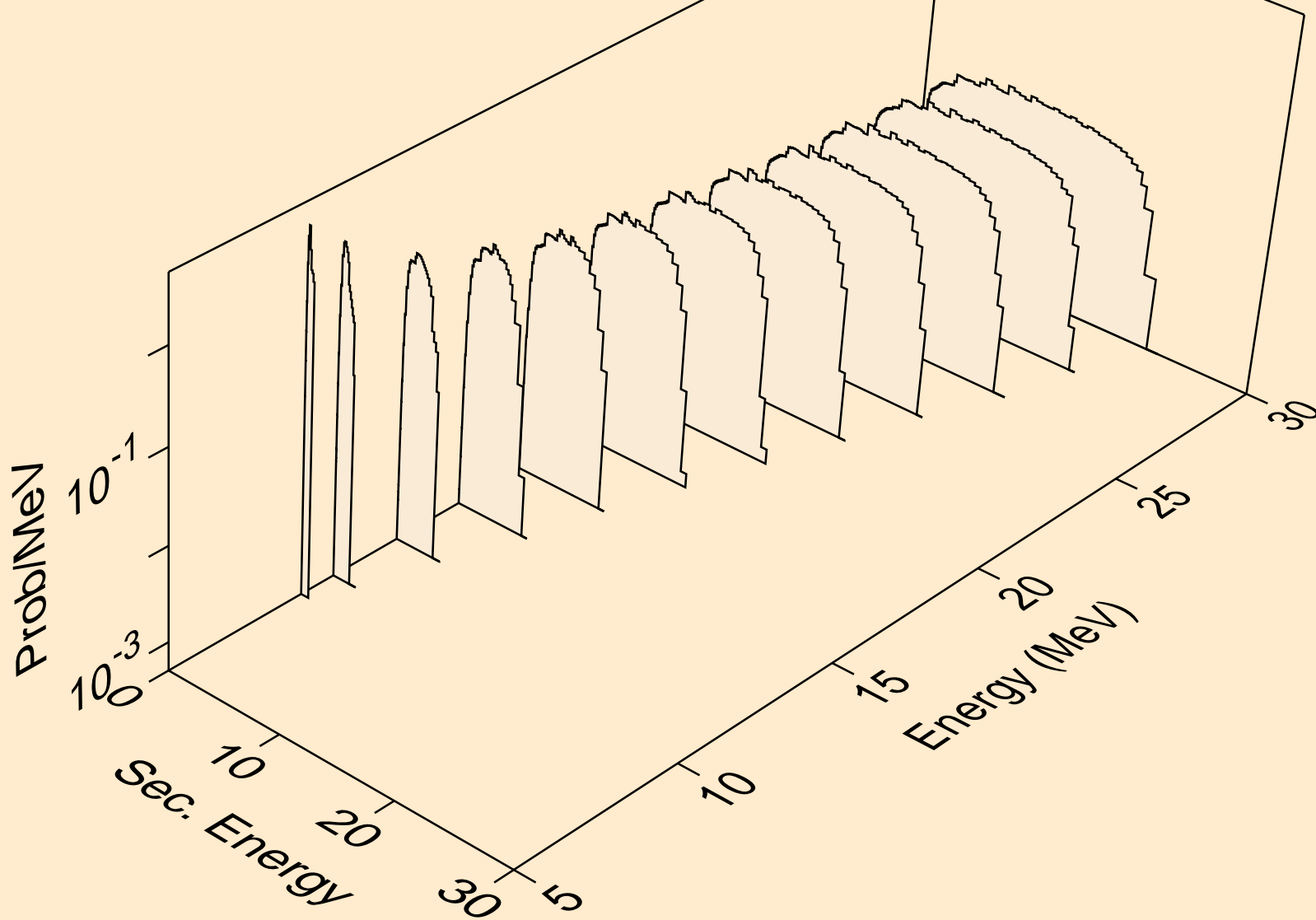

PU230 NEUTRON ACER TENDL-2019 LIBRARY; T=293.16K
Neutron emission for (n,3n)

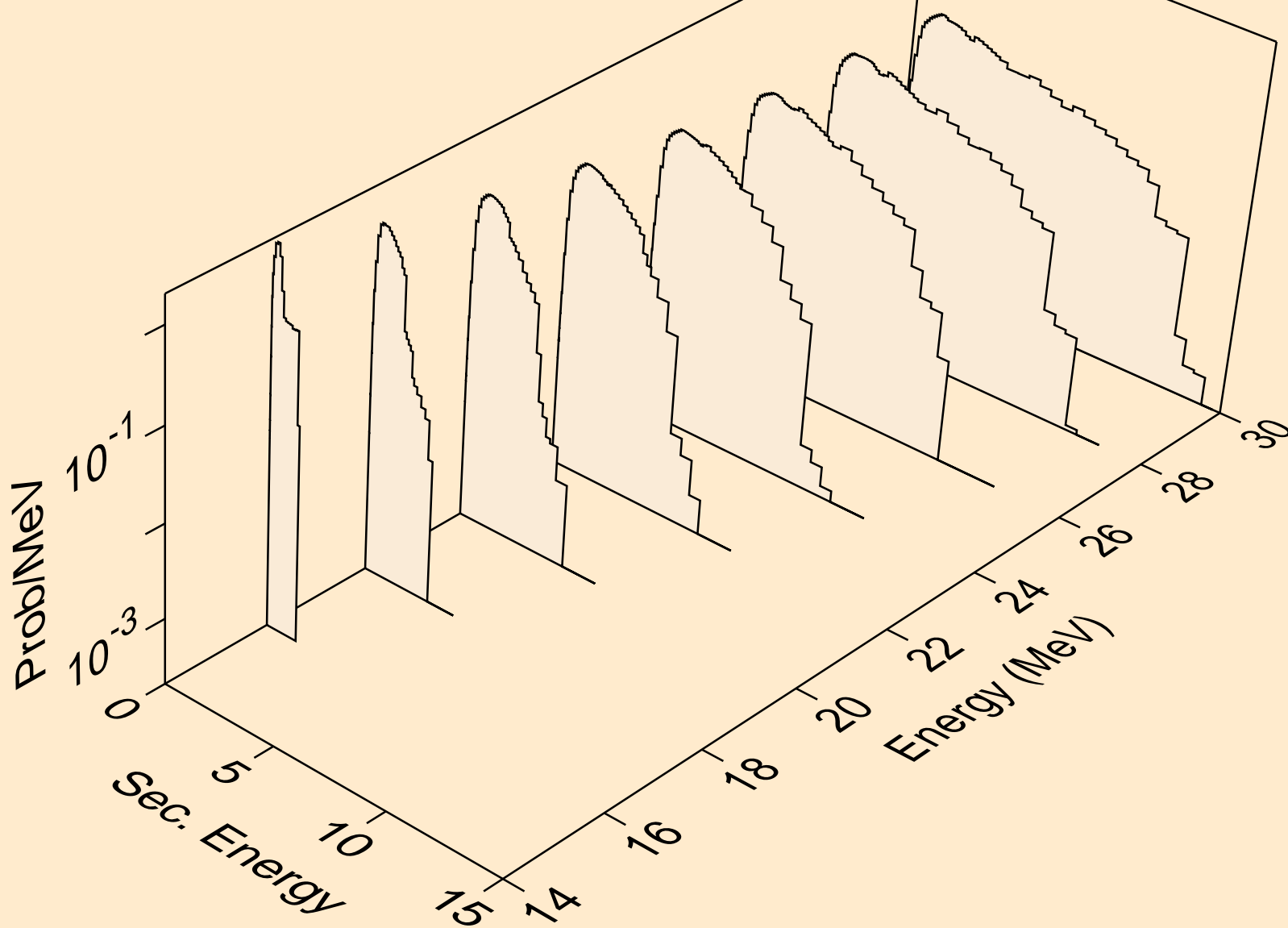

PU230 NEUTRON ACER TENDL-2019 LIBRARY; T=293.16K
Neutron emission for fission

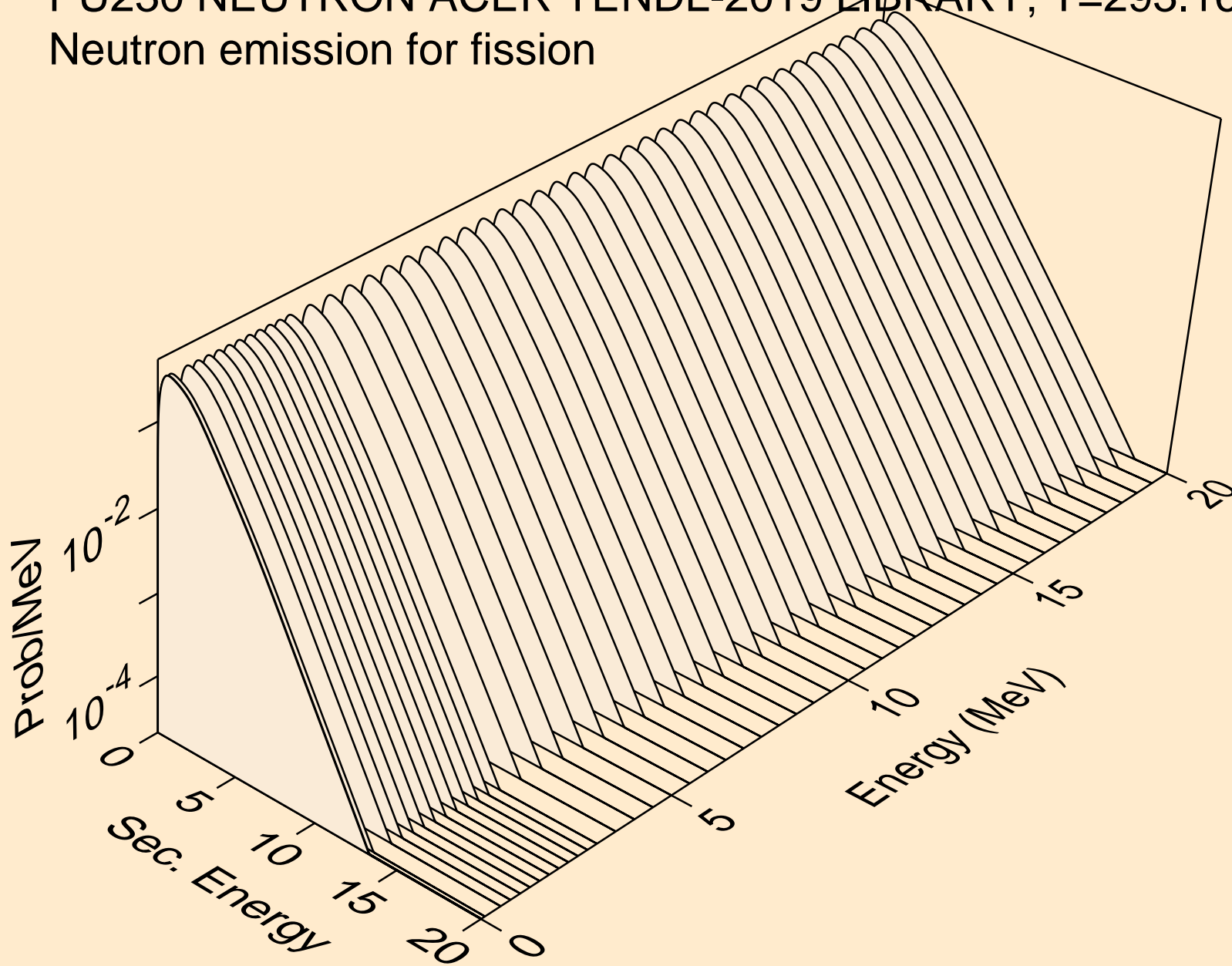

PU230 NEUTRON ACER TENDL-2019 LIBRARY; T=293.16K
Neutron emission for (n,n*)a

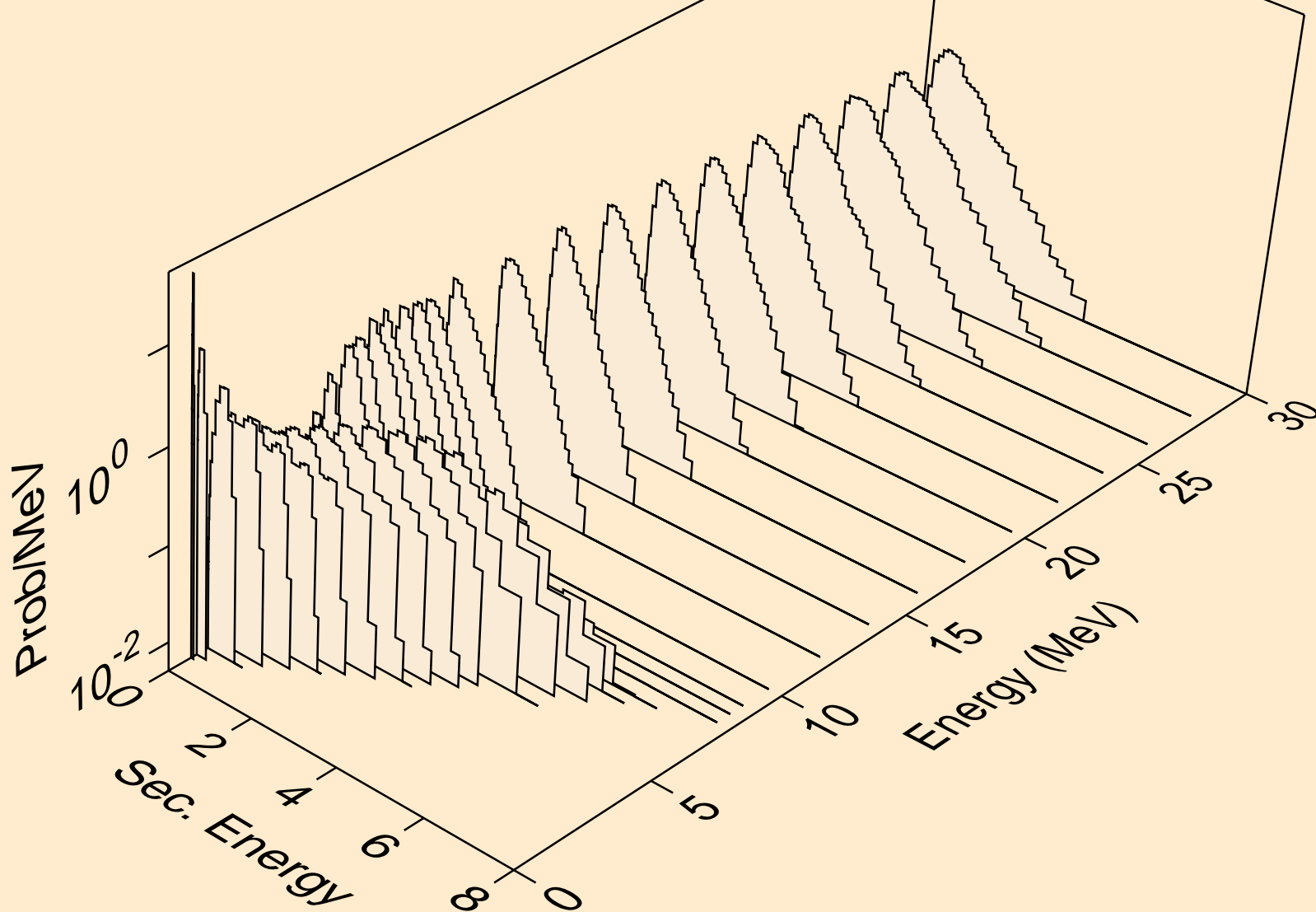

PU230 NEUTRON ACER TENDL-2019 LIBRARY; T=293.16K
Neutron emission for (n,2n)a

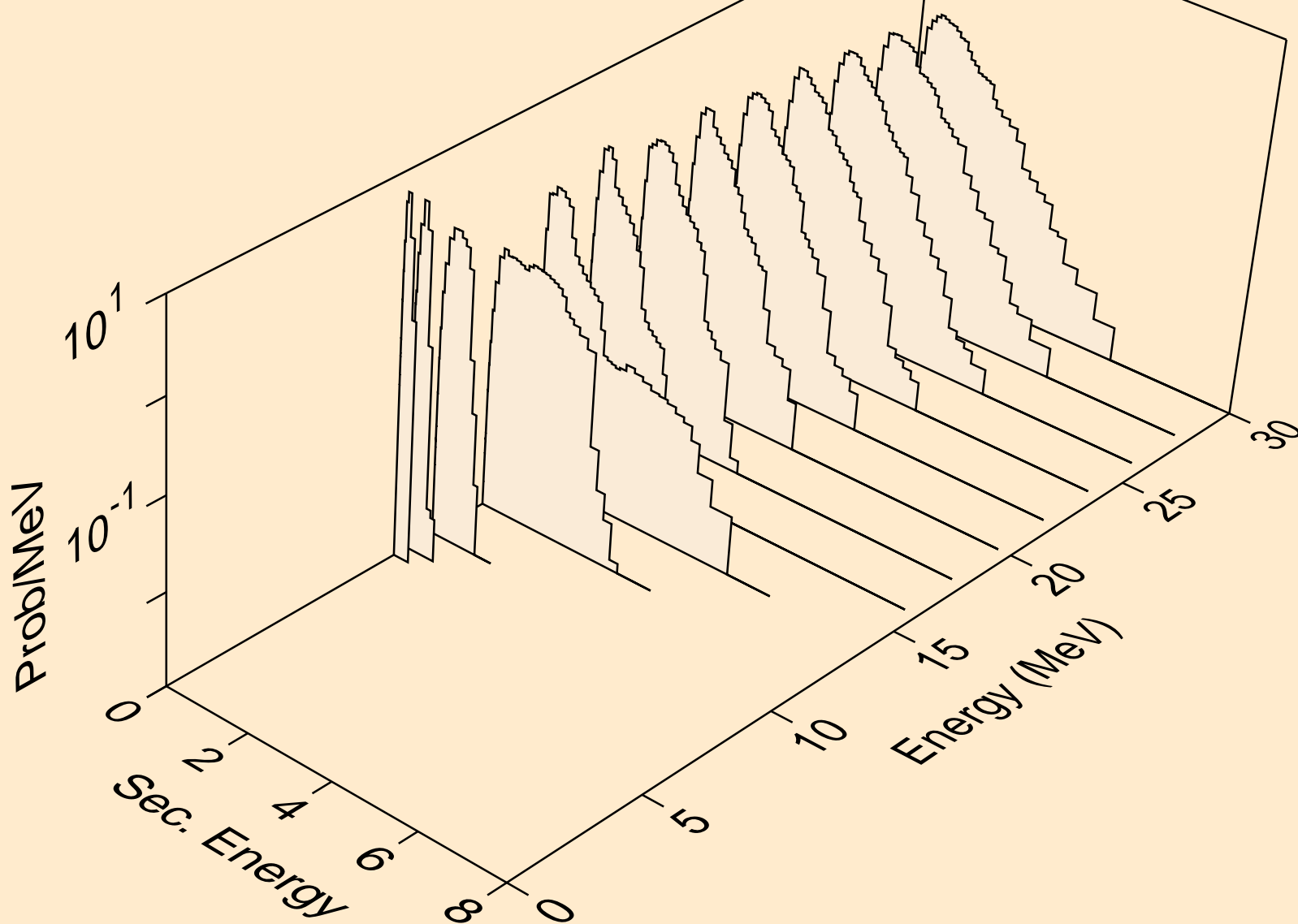

PU230 NEUTRON ACER TENDL-2019 LIBRARY; T=293.16K
Neutron emission for (n,3n)a

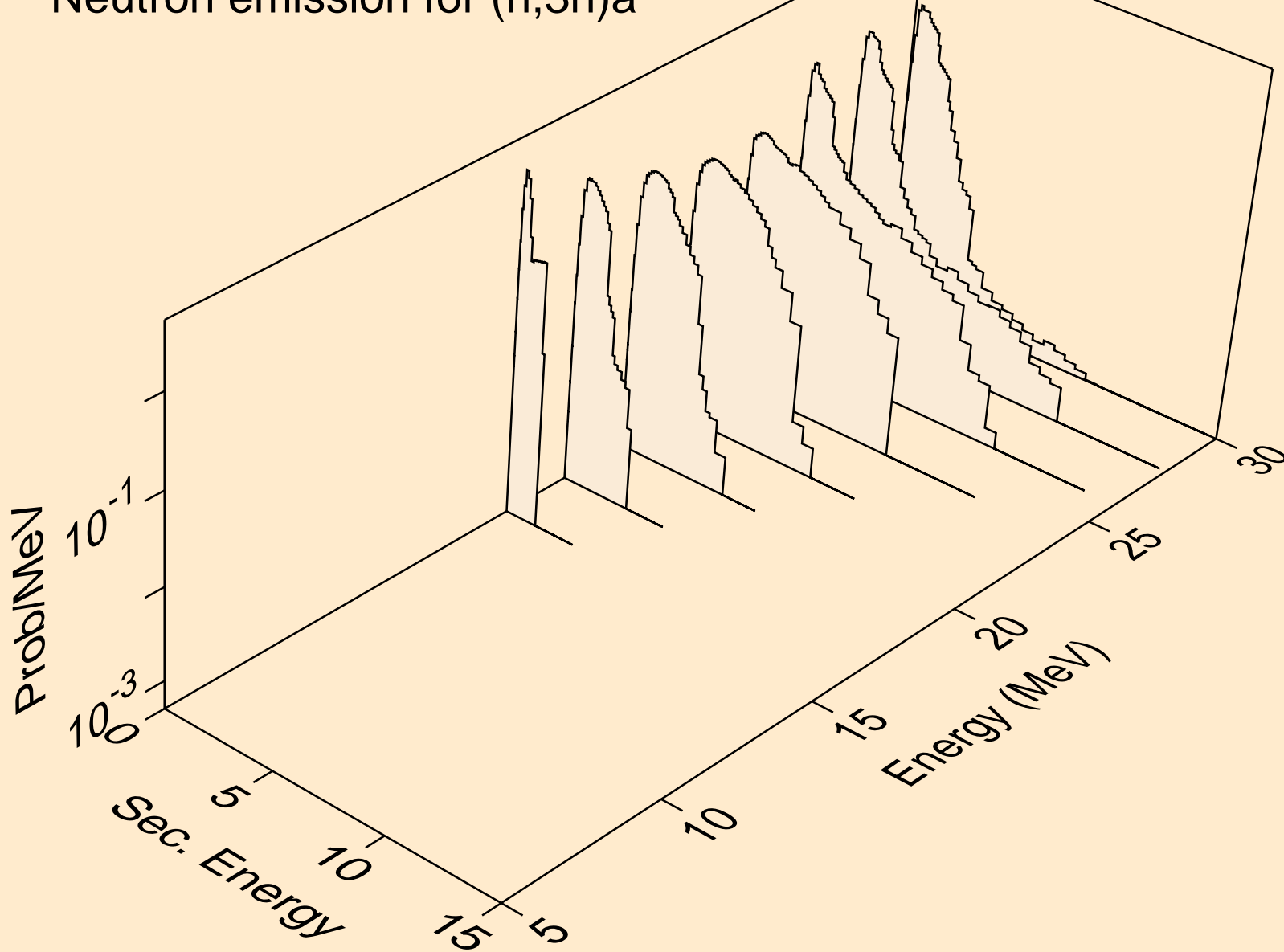

PU230 NEUTRON ACER TENDL-2019 LIBRARY; T=293.16K
Neutron emission for (n,n*)p

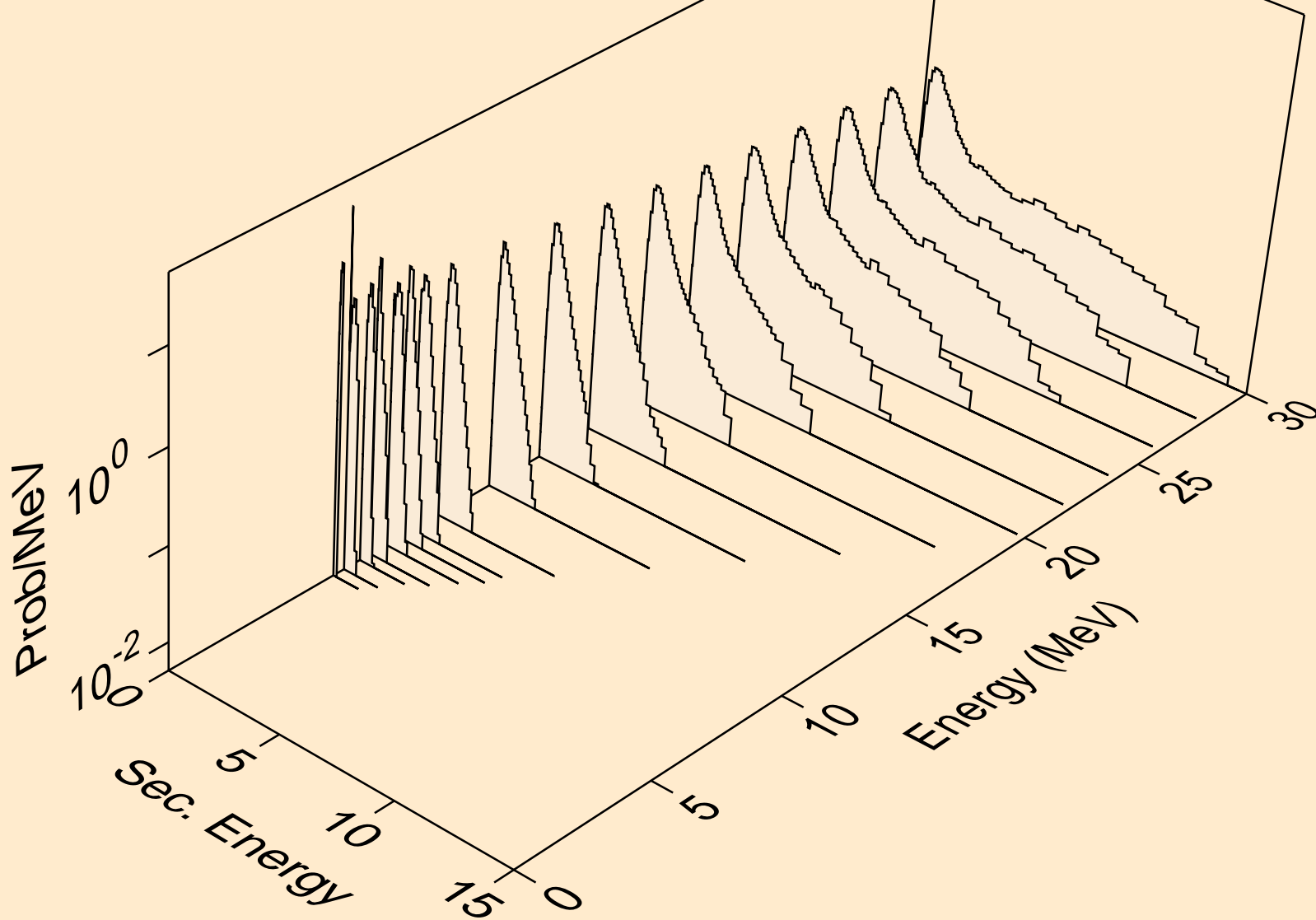

PU230 NEUTRON ACER TENDL-2019 LIBRARY; T=293.16K
Neutron emission for (n,n*)2a

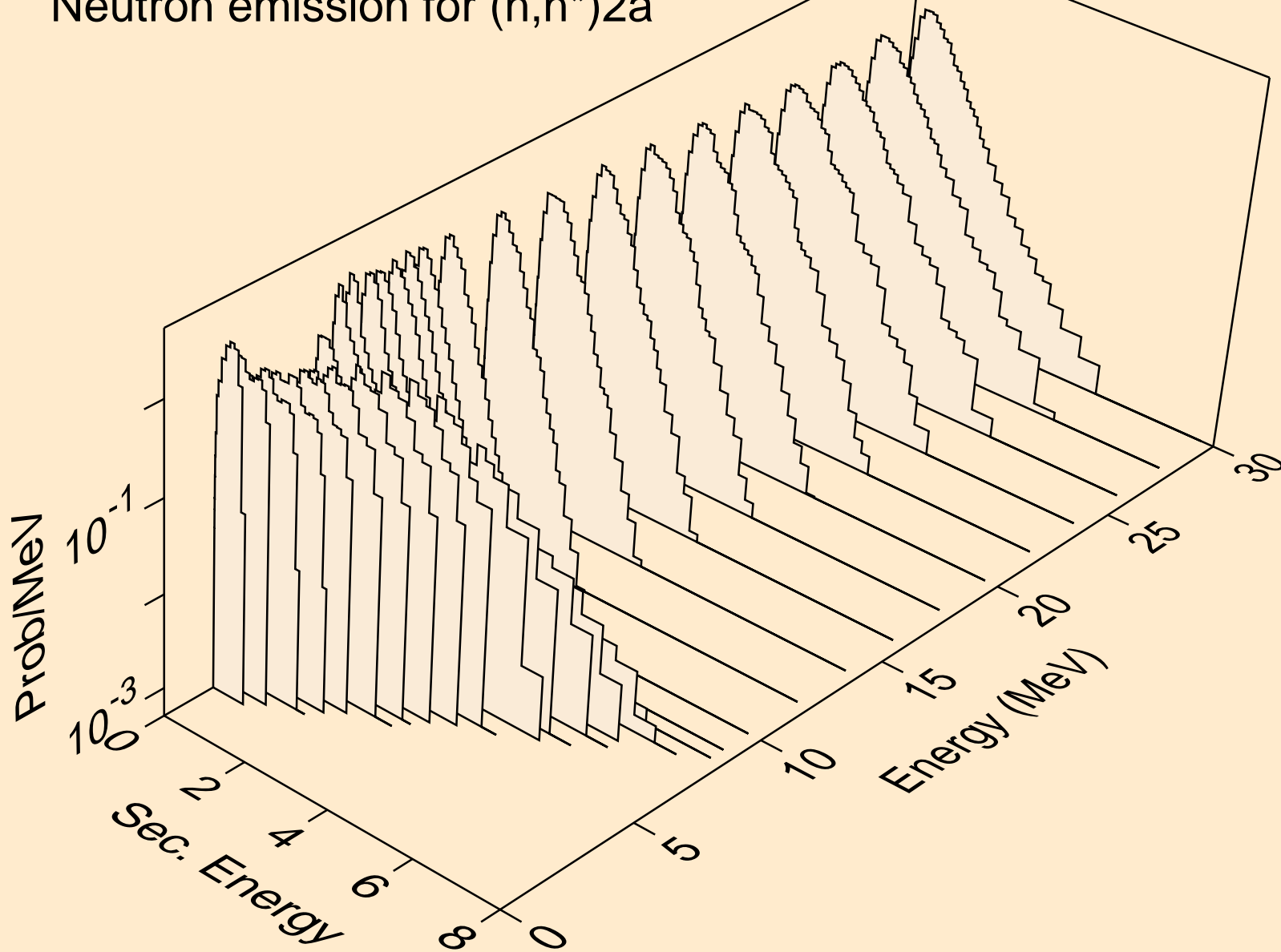

PU230 NEUTRON ACER TENDL-2019 LIBRARY; T=293.16K
Neutron emission for (n,2n)2a

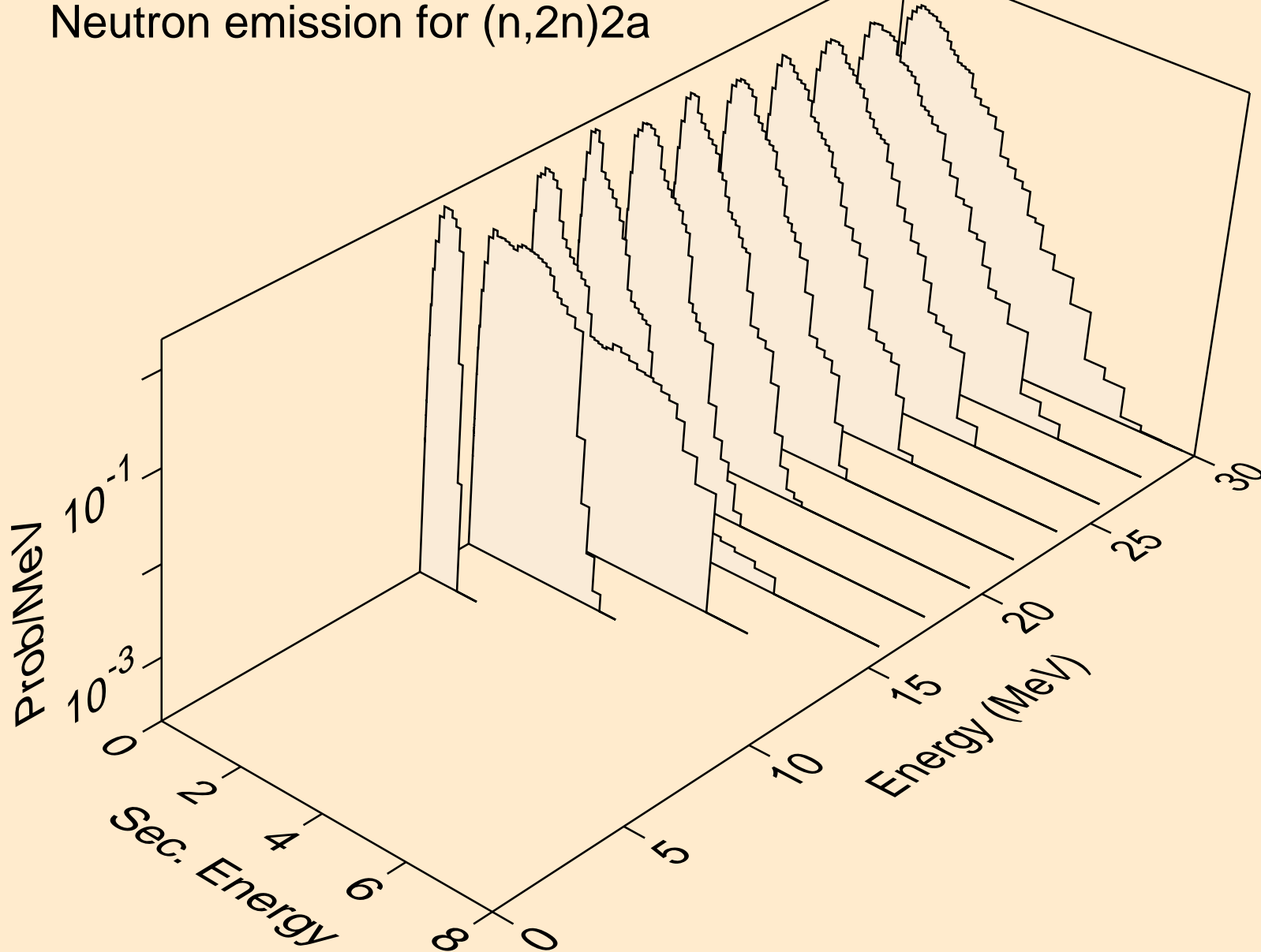

PU230 NEUTRON ACER TENDL-2019 LIBRARY; T=293.16K
Neutron emission for (n,n*)d

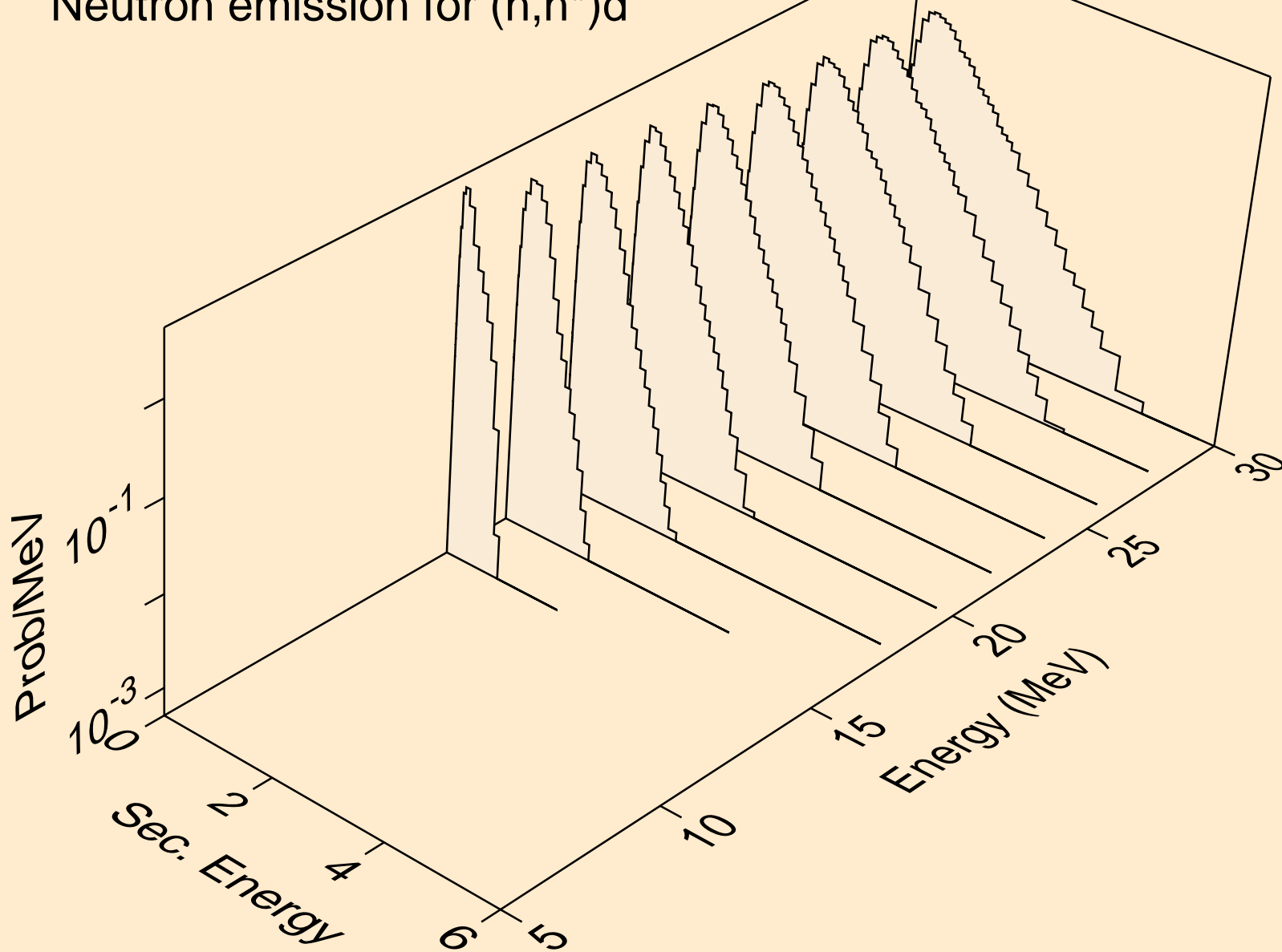

PU230 NEUTRON ACER TENDL-2019 LIBRARY; T=293.16K
Neutron emission for (n,n*)t

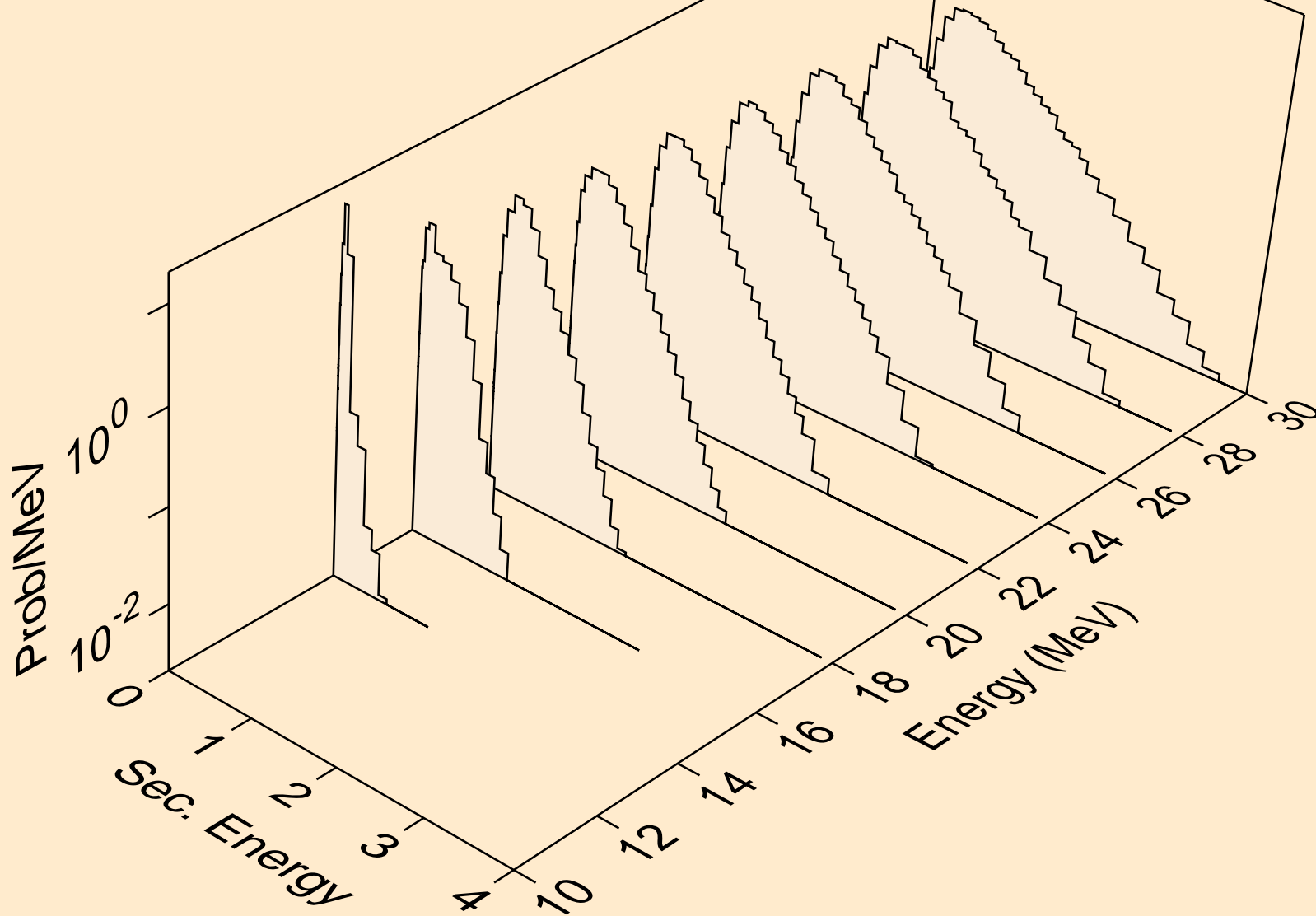

PU230 NEUTRON ACER TENDL-2019 LIBRARY; T=293.16K
Neutron emission for (n,n*)he3

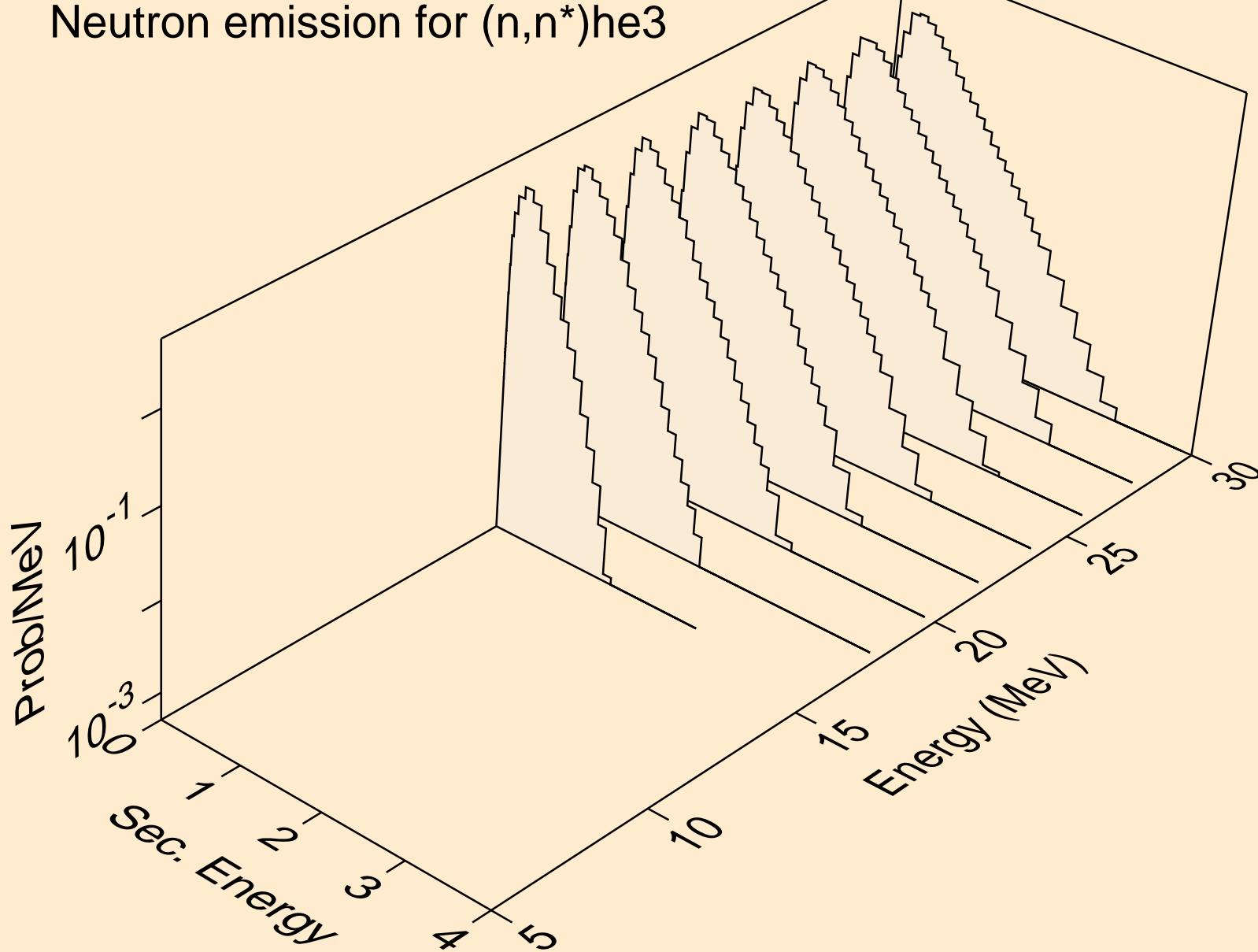

PU230 NEUTRON ACER TENDL-2019 LIBRARY; T=293.16K
Neutron emission for (n,4n)

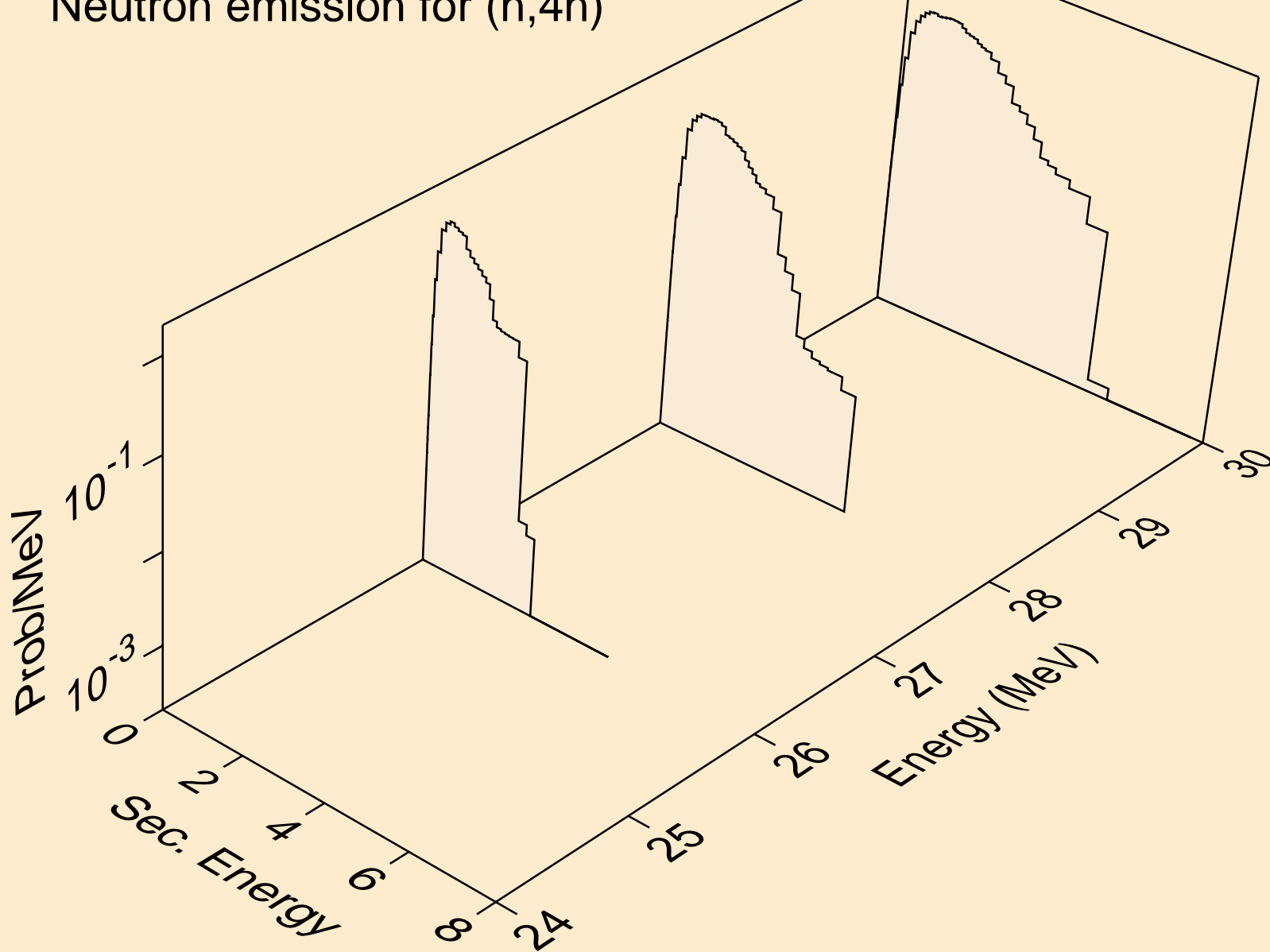

PU230 NEUTRON ACER TENDL-2019 LIBRARY; T=293.16K
Neutron emission for (n,2np)

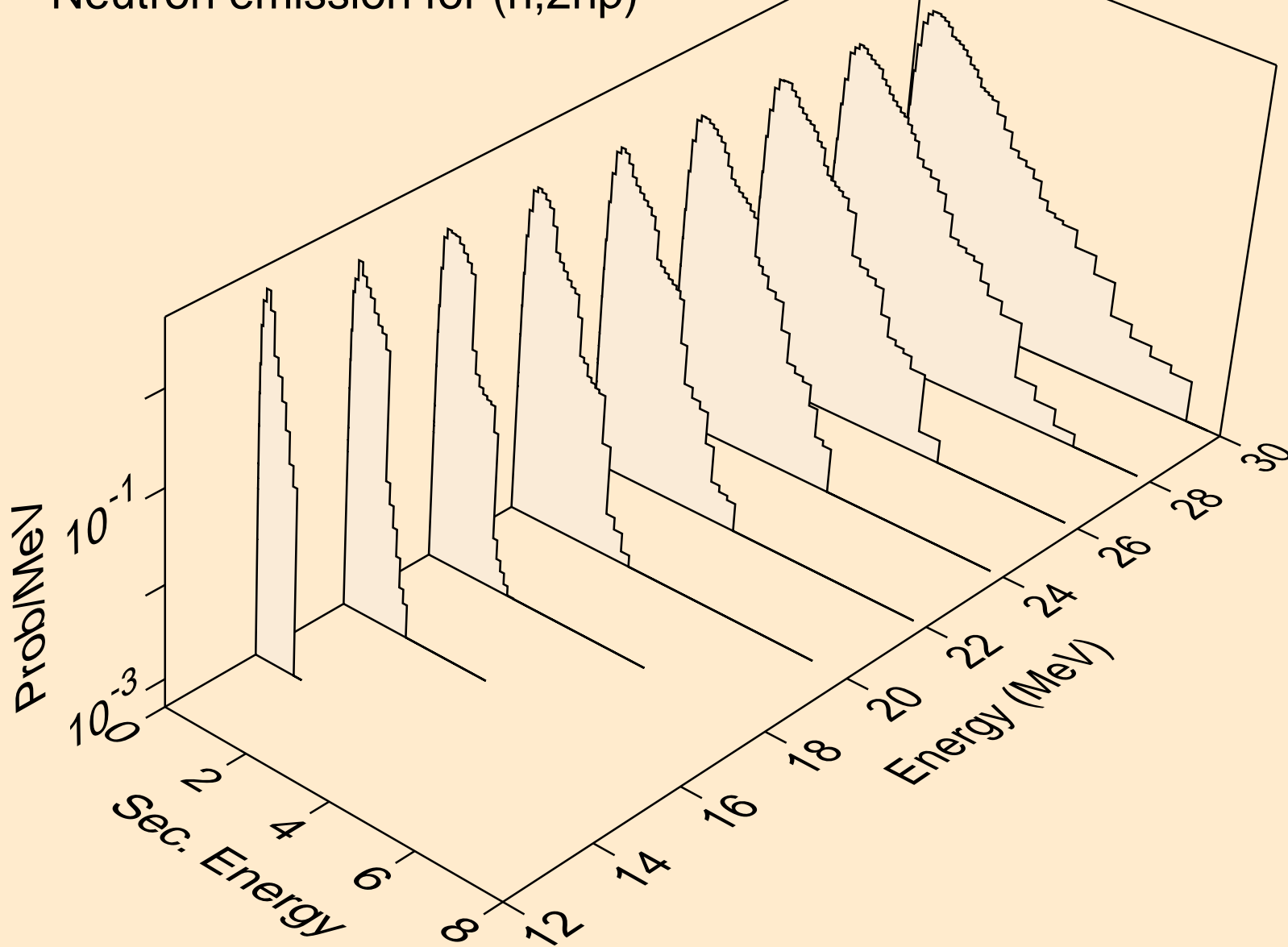

PU230 NEUTRON ACER TENDL-2019 LIBRARY; T=293.16K
Neutron emission for (n,3np)

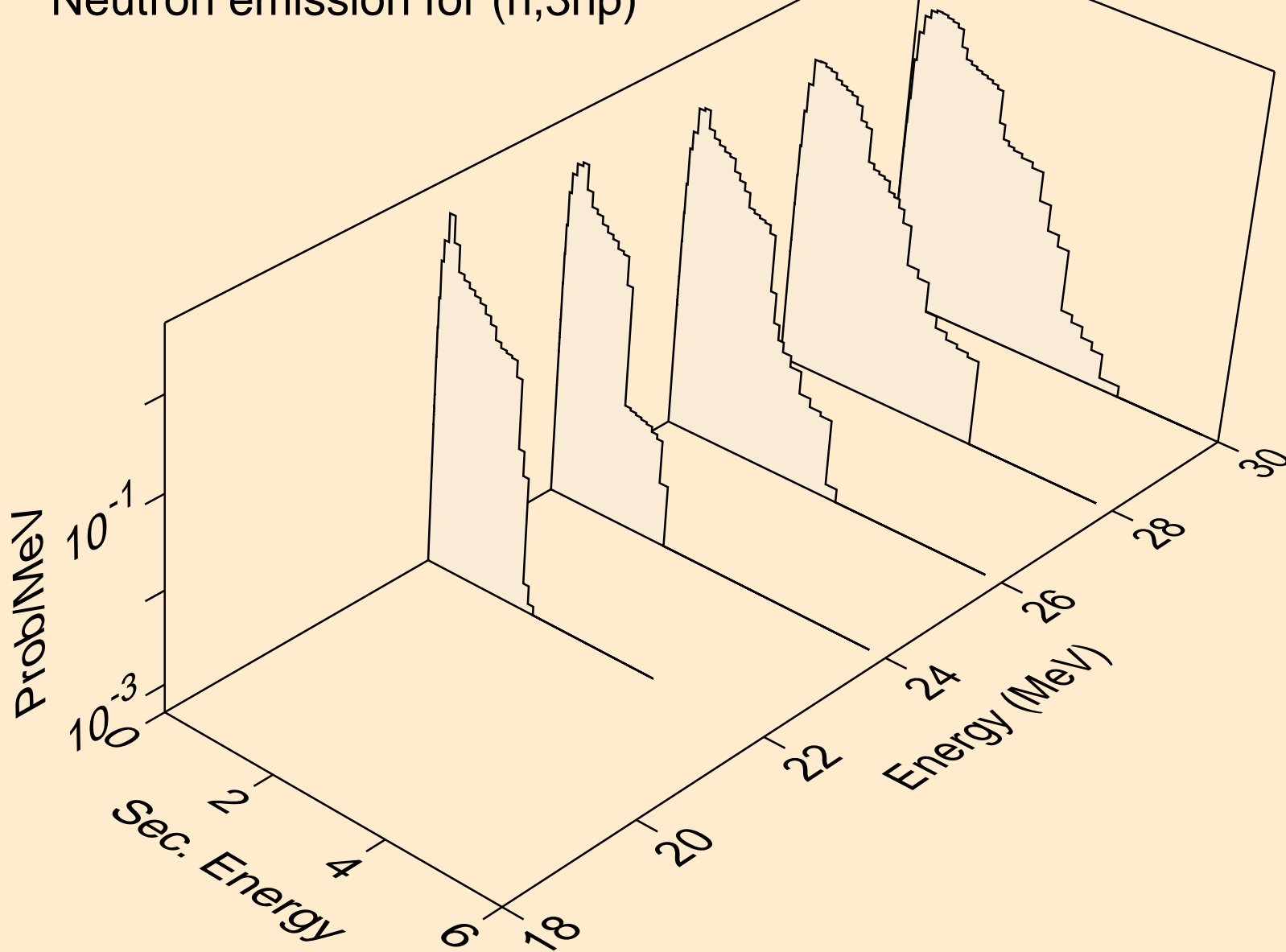

PU230 NEUTRON ACER TENDL-2019 LIBRARY; T=293.16K
Neutron emission for (n,2np)

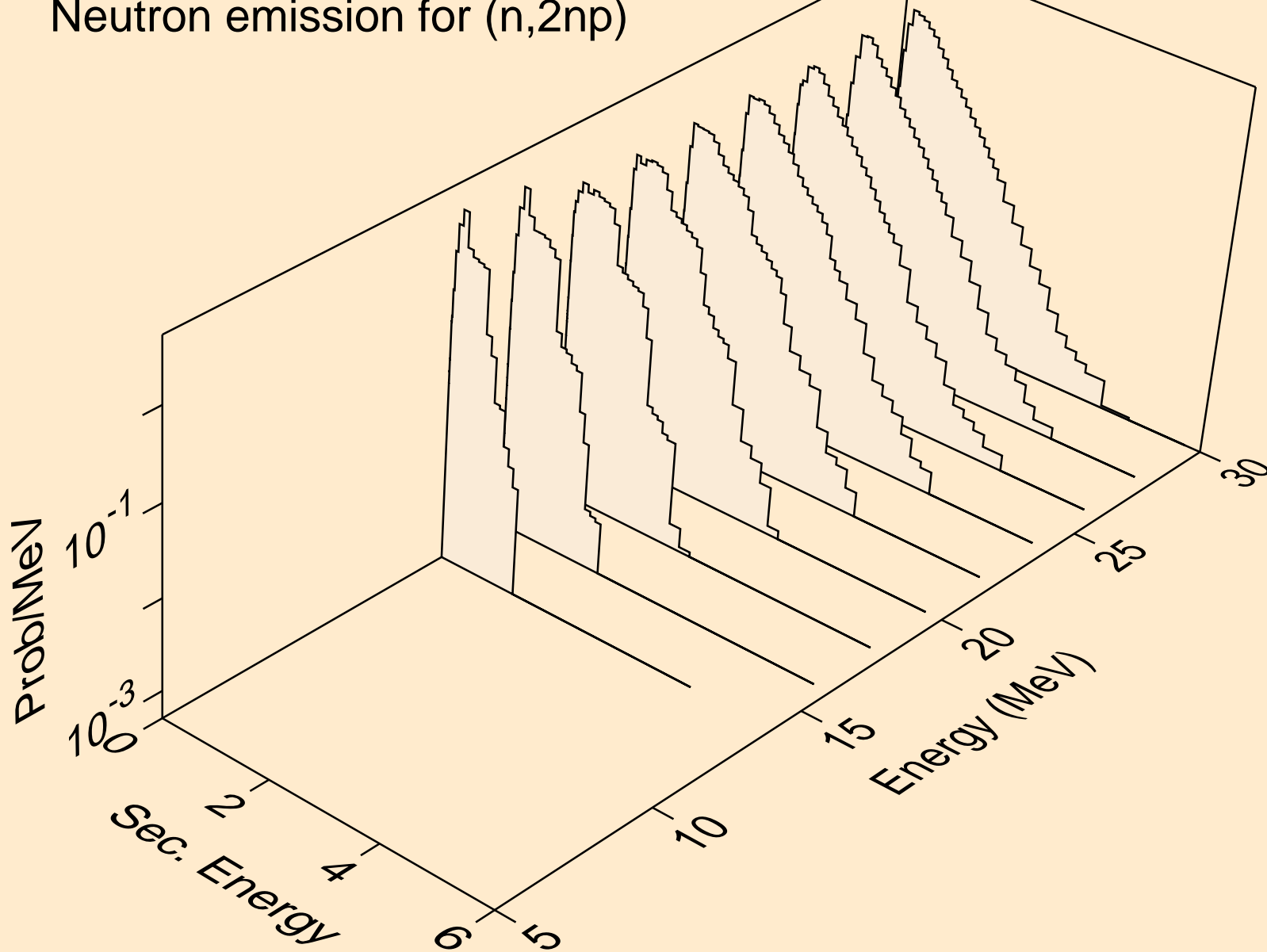

PU230 NEUTRON ACER TENDL-2019 LIBRARY; T=293.16K
Neutron emission for (n,npa)

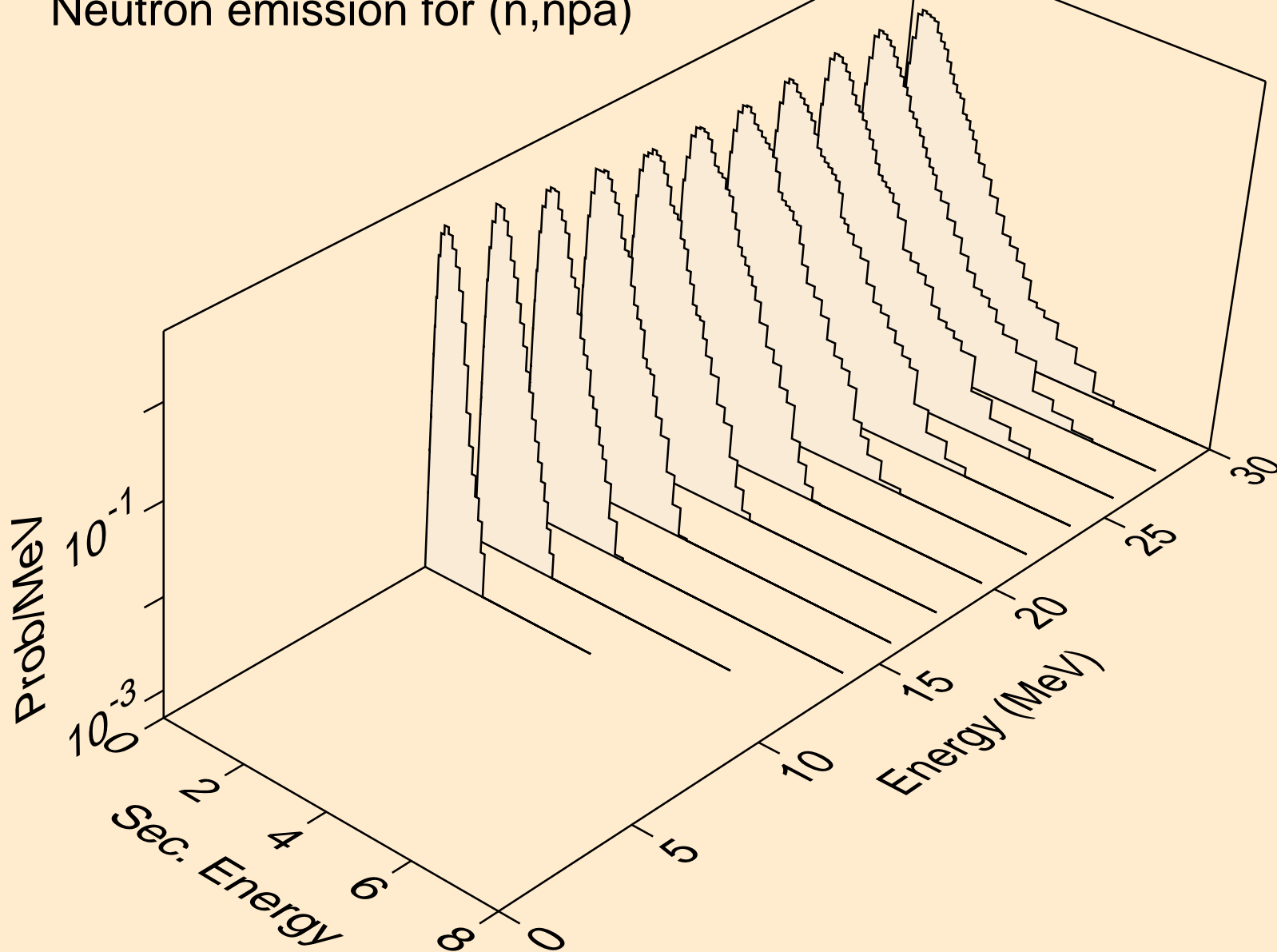

PU230 NEUTRON ACER TENDL-2019 LIBRARY; T=293.16K
Neutron emission for (n,n*c)

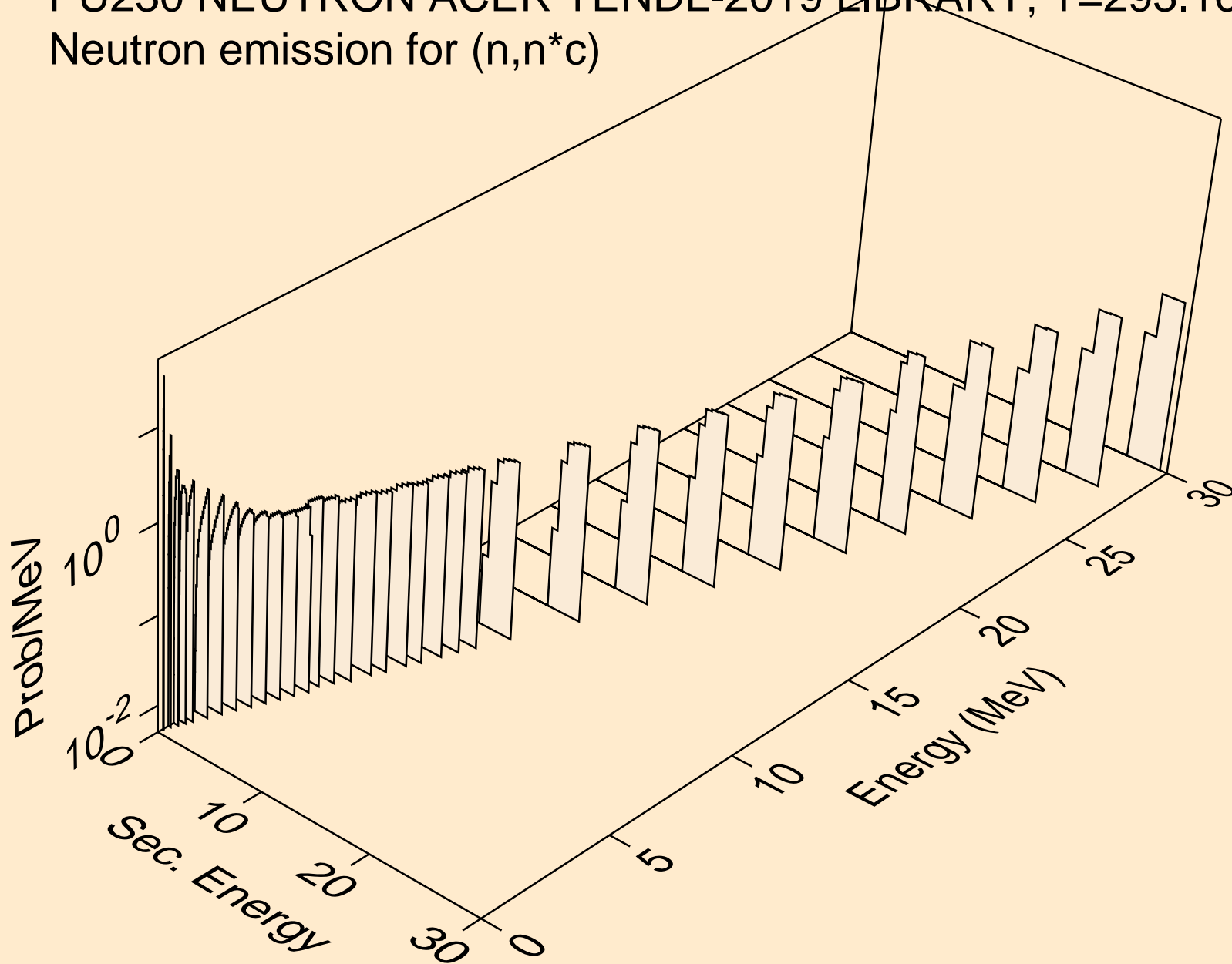

PU230 NEUTRON ACER TENDL-2019 LIBRARY; T=293.16K
Delayed nubar

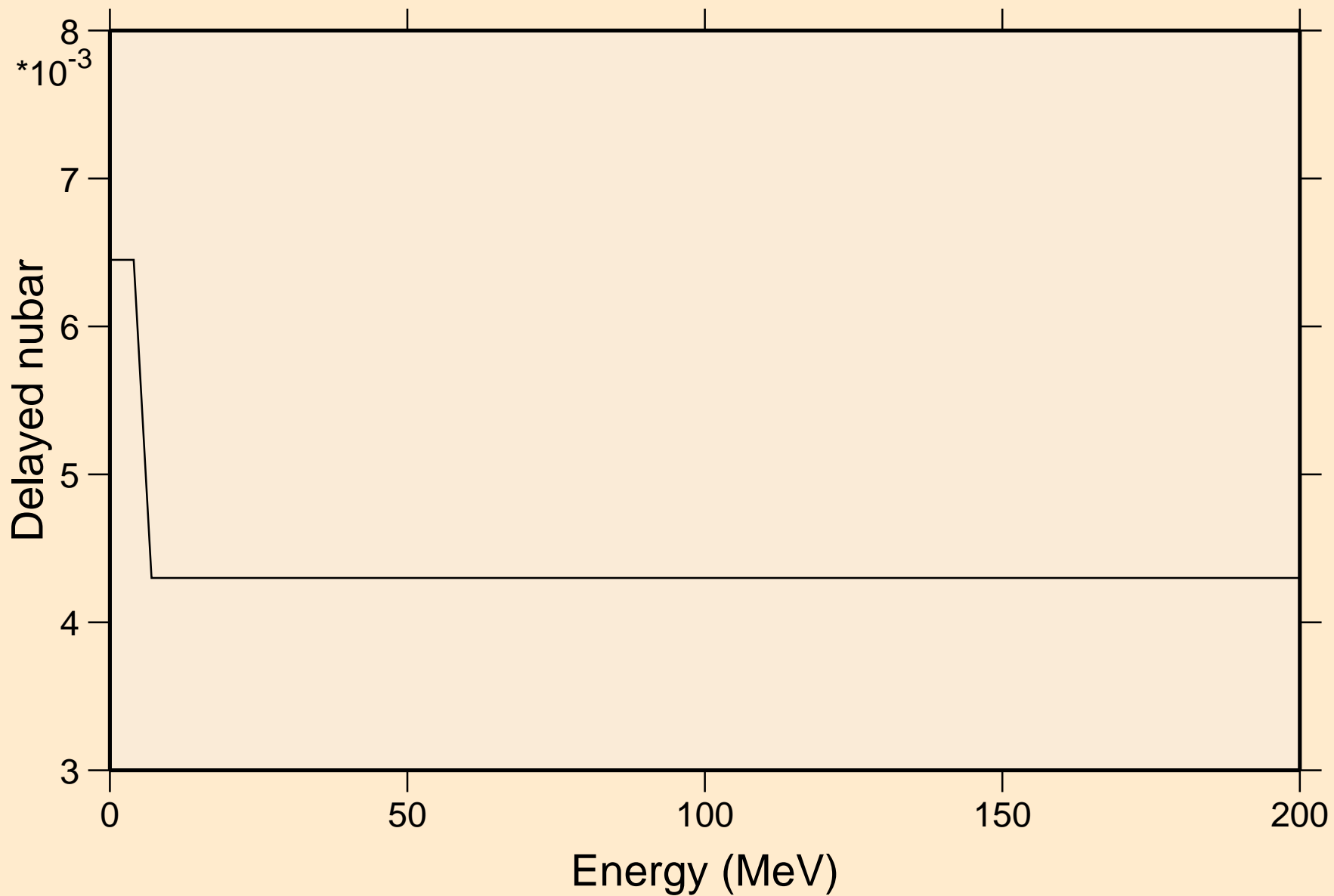

PU230 NEUTRON ACER TENDL-2019 LIBRARY; T=293.16K
Delayed neutron spectra

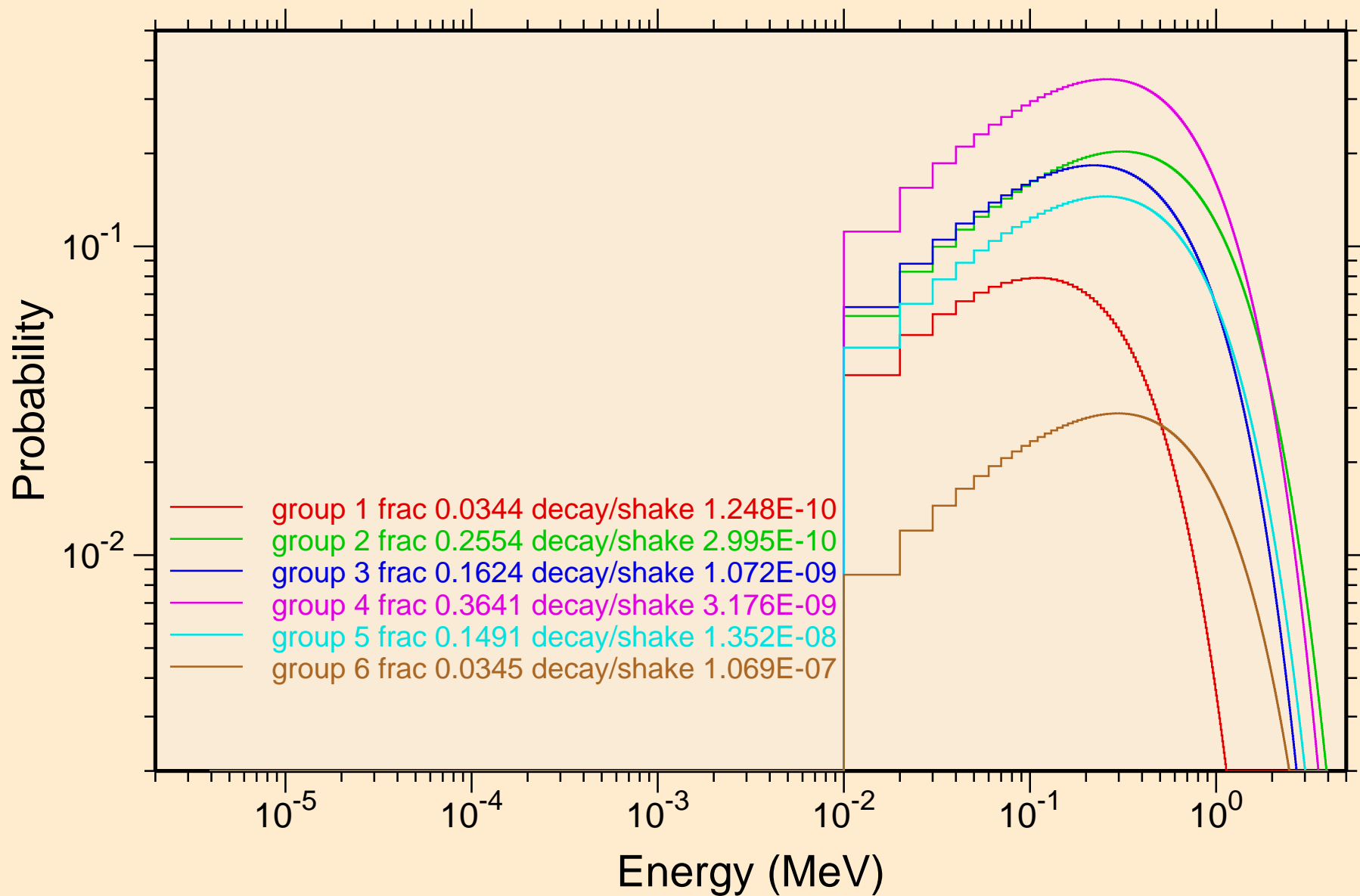

PU230 NEUTRON ACER TENDL-2019 LIBRARY; T=293.16K
Photon emission for (n,x)

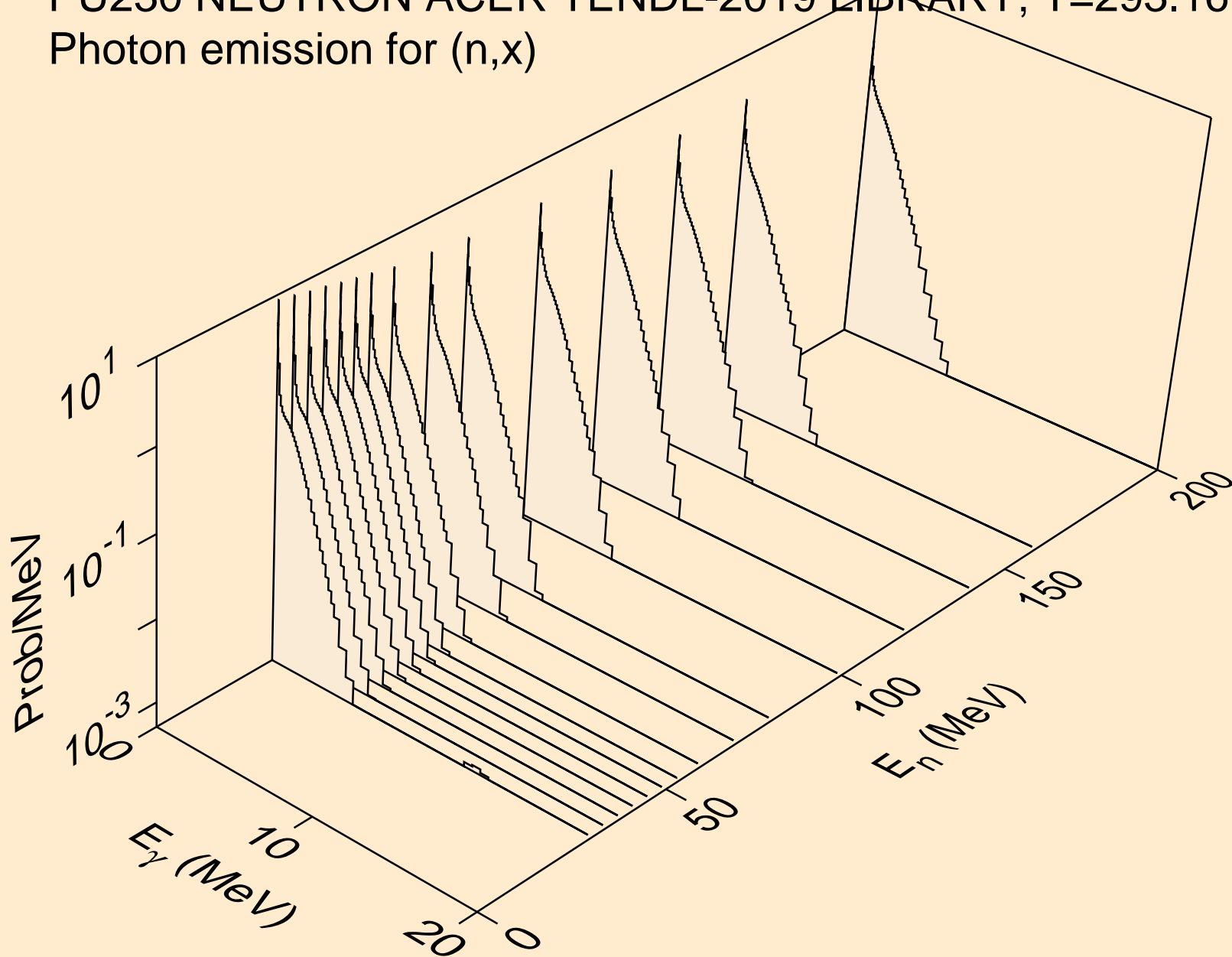

PU230 NEUTRON ACER TENDL-2019 LIBRARY; T=293.16K
Photon emission for (n,2nd)

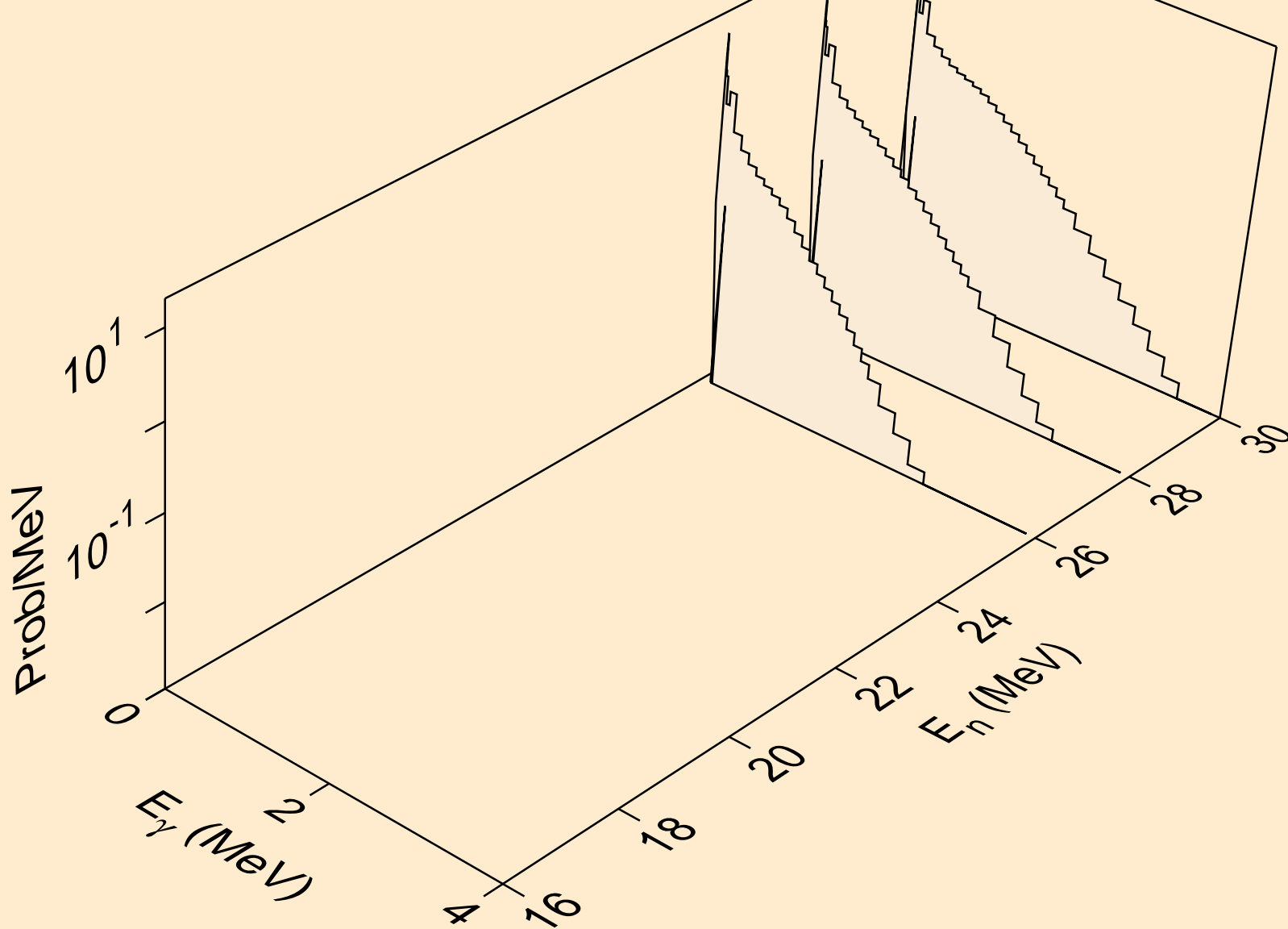

PU230 NEUTRON ACER TENDL-2019 LIBRARY; T=293.16K
Photon emission for (n,2n)

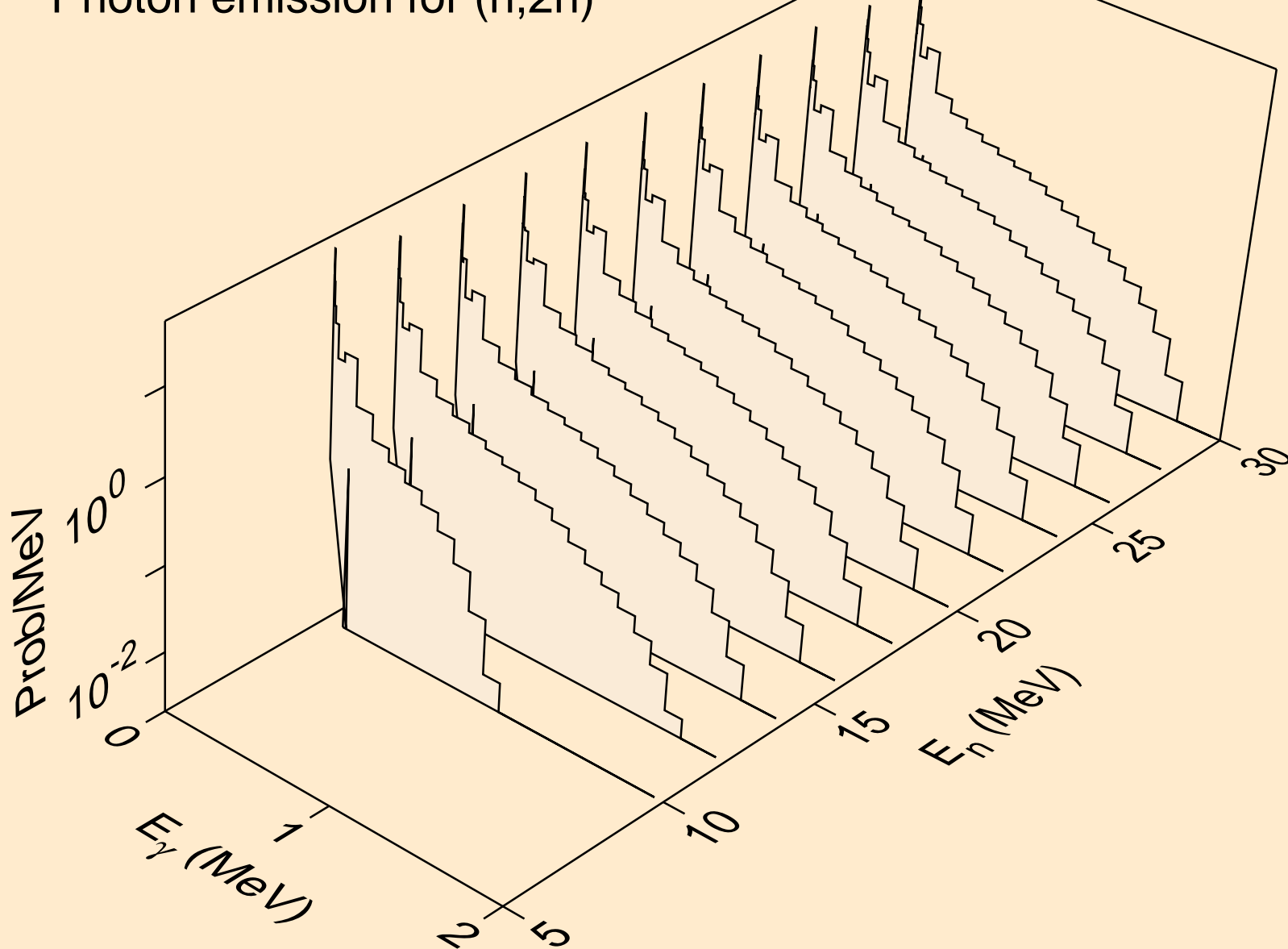

PU230 NEUTRON ACER TENDL-2019 LIBRARY; T=293.16K
Photon emission for (n,3n)

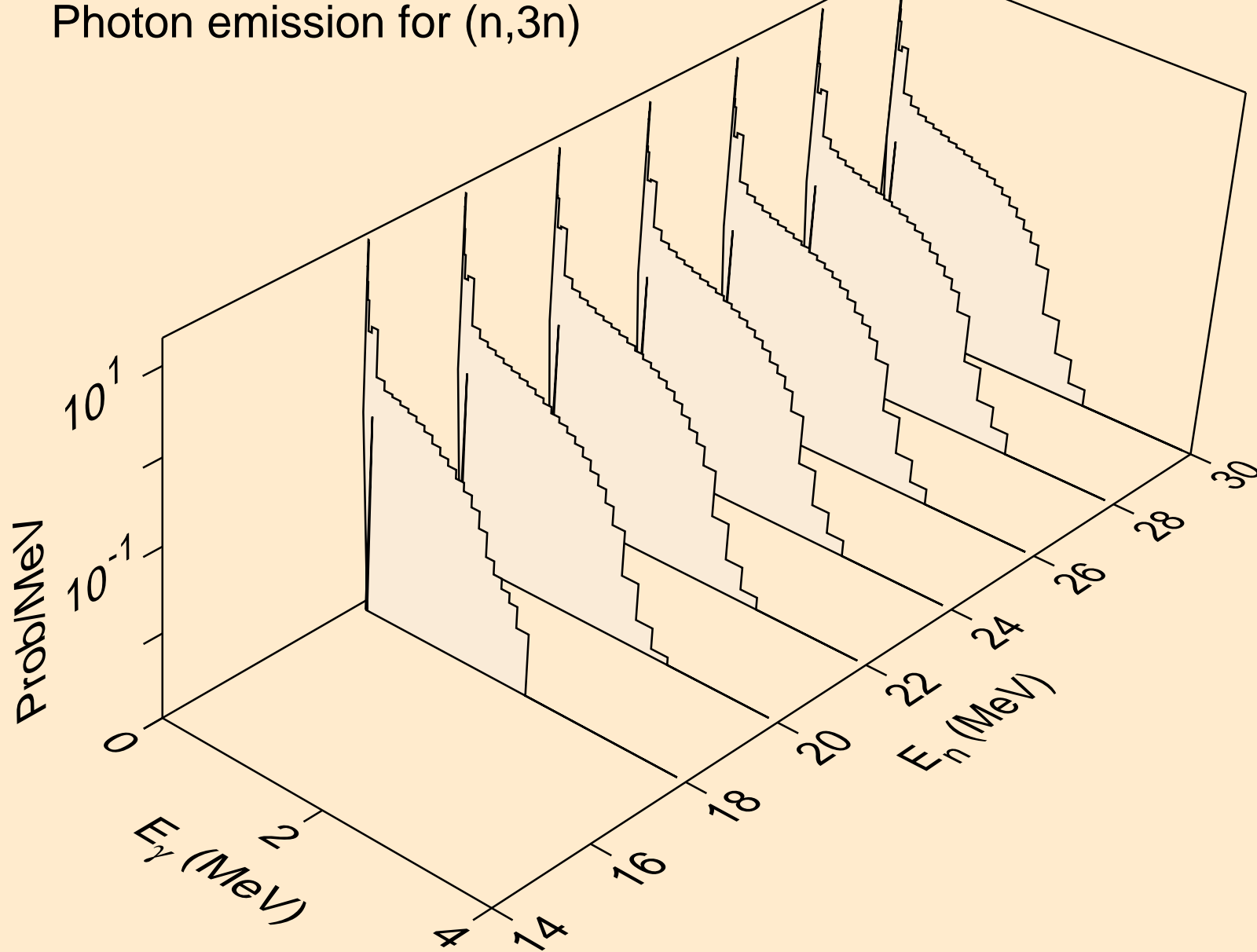

PU230 NEUTRON ACER TENDL-2019 LIBRARY; T=293.16K
Photon emission for (n,n*)a

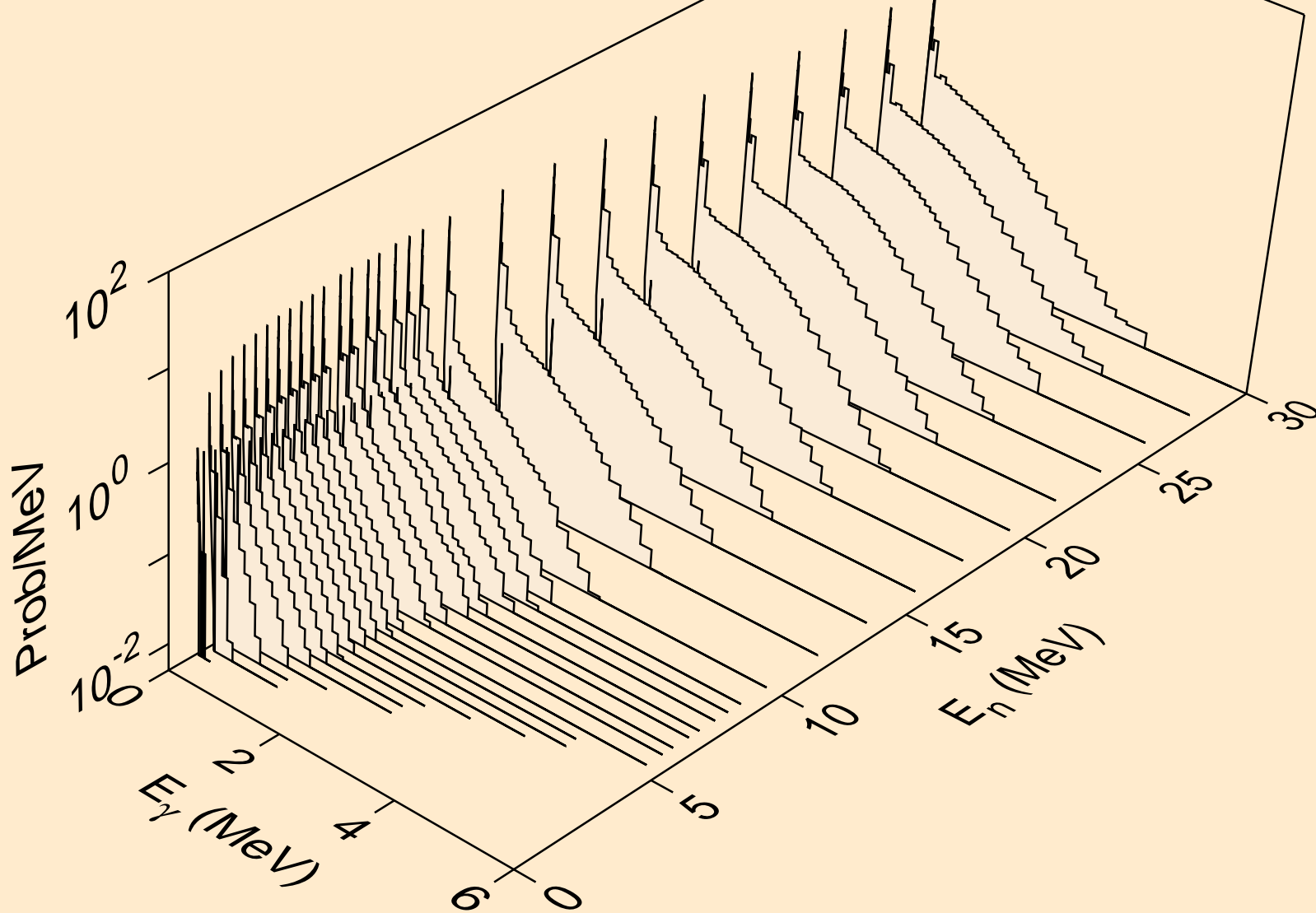

PU230 NEUTRON ACER TENDL-2019 LIBRARY; T=293.16K
Photon emission for (n,2n)a

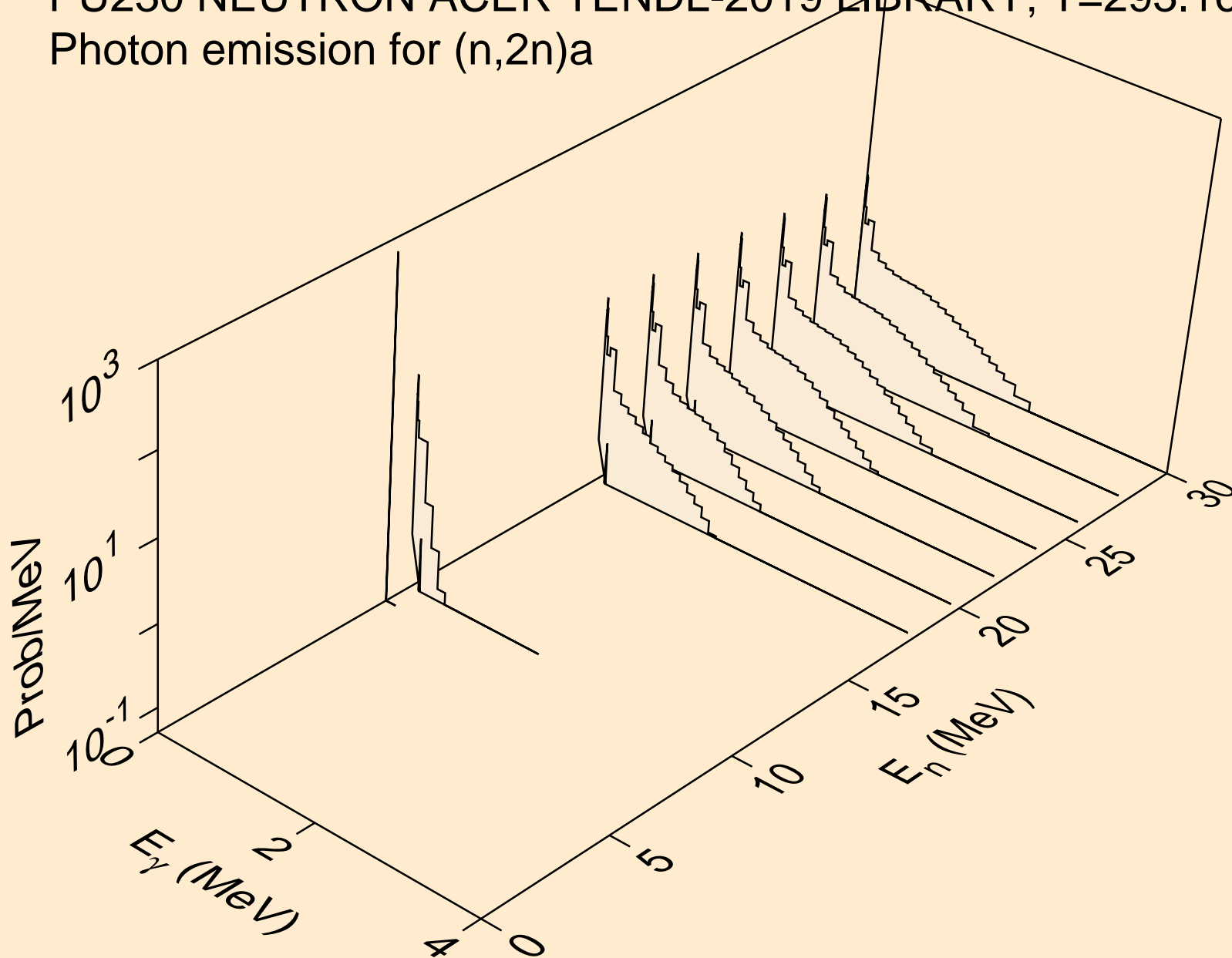

PU230 NEUTRON ACER TENDL-2019 LIBRARY; T=293.16K
Photon emission for (n,3n)a

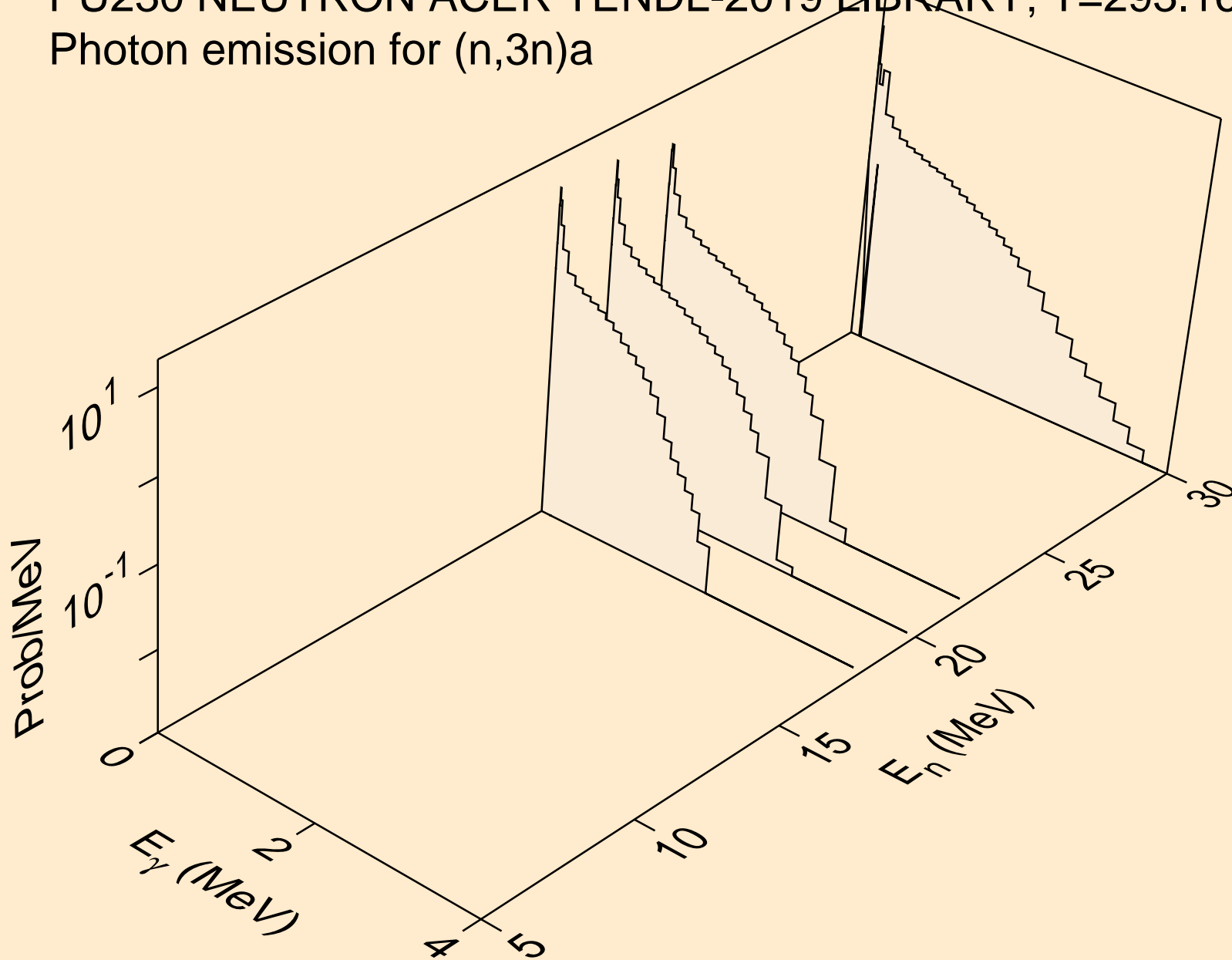

PU230 NEUTRON ACER TENDL-2019 LIBRARY; T=293.16K
Photon emission for (n,n*)p

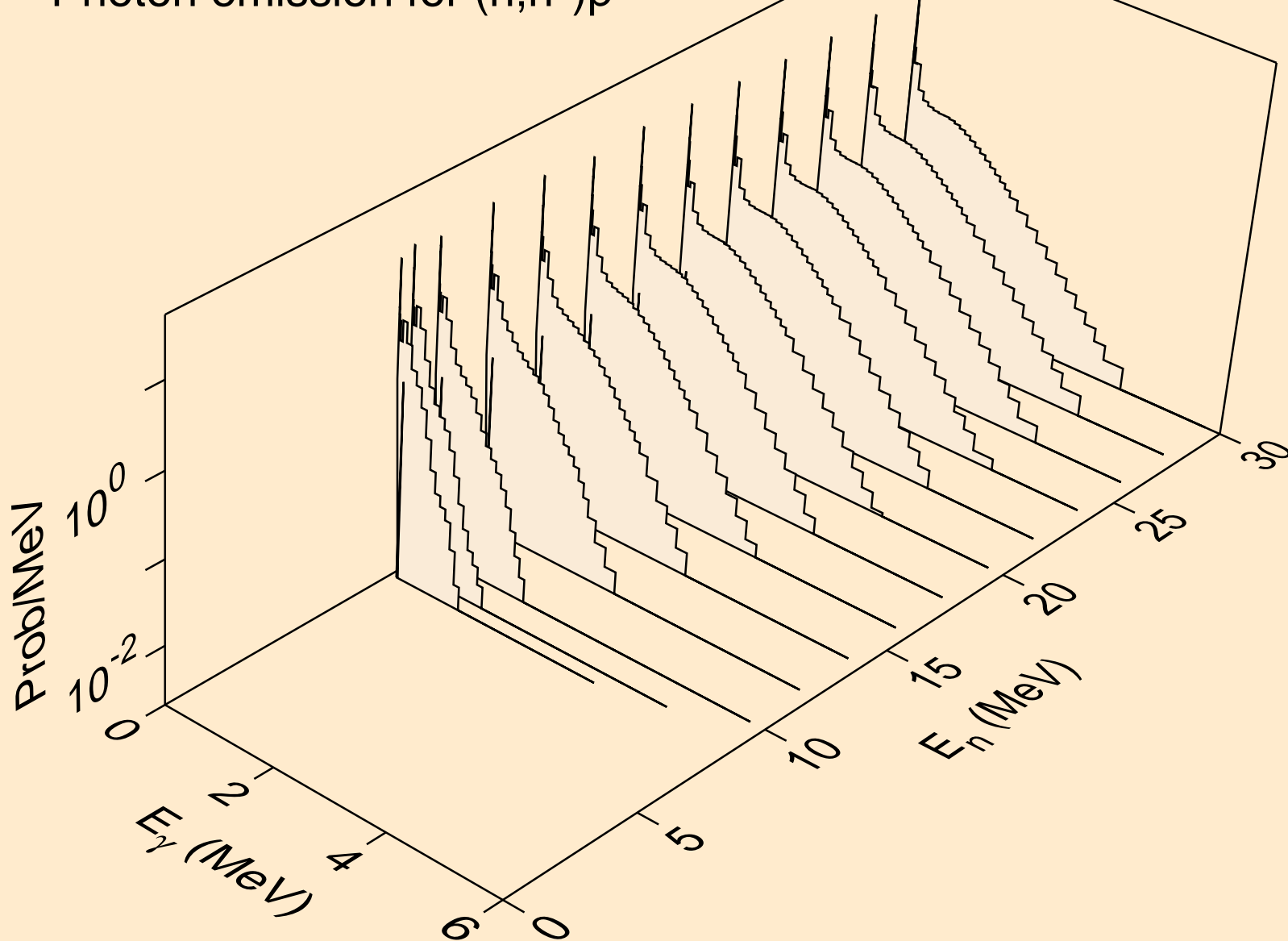

PU230 NEUTRON ACER TENDL-2019 LIBRARY; T=293.16K
Photon emission for (n,n*)2a

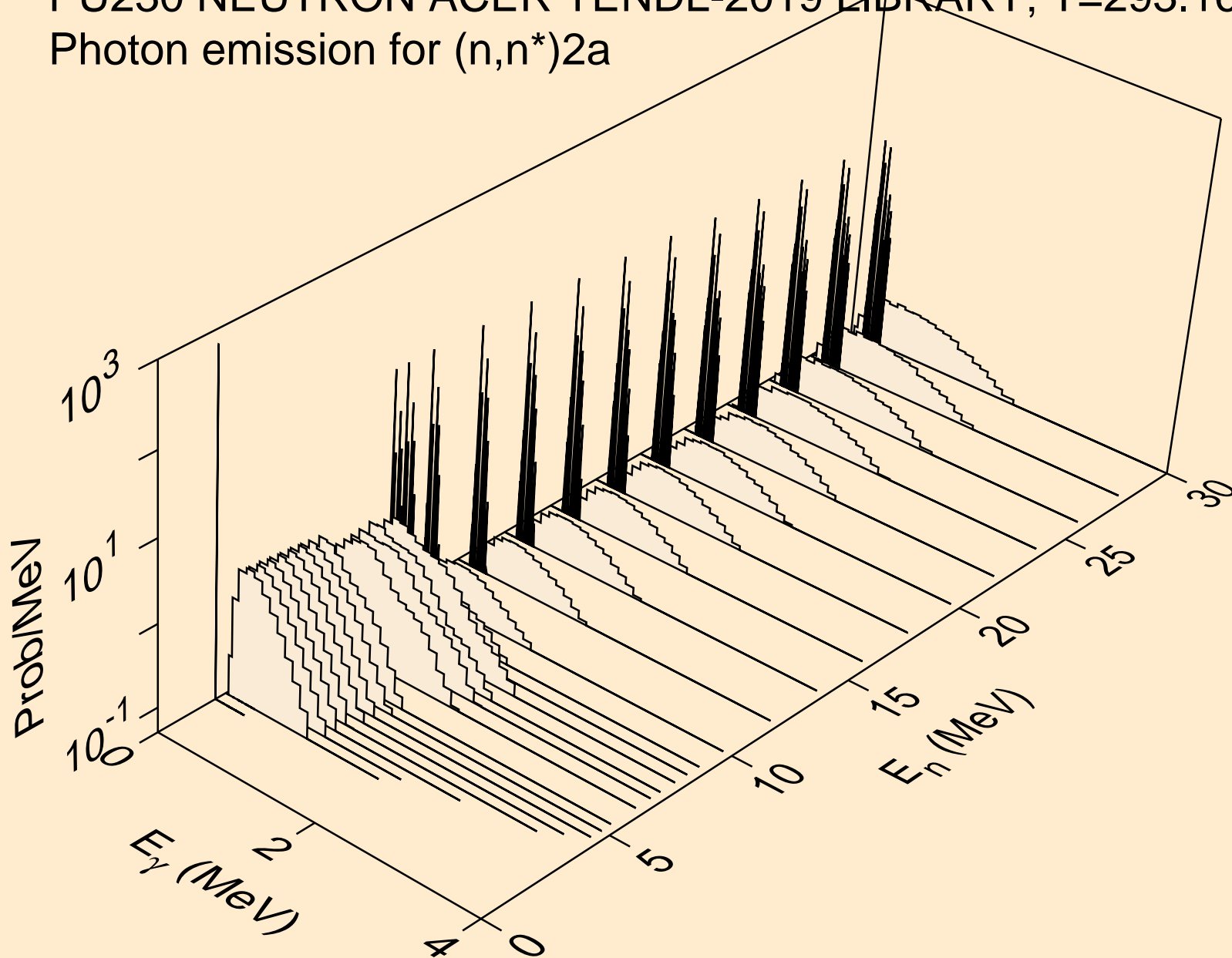

PU230 NEUTRON ACER TENDL-2019 LIBRARY; T=293.16K
Photon emission for (n,2n)2a

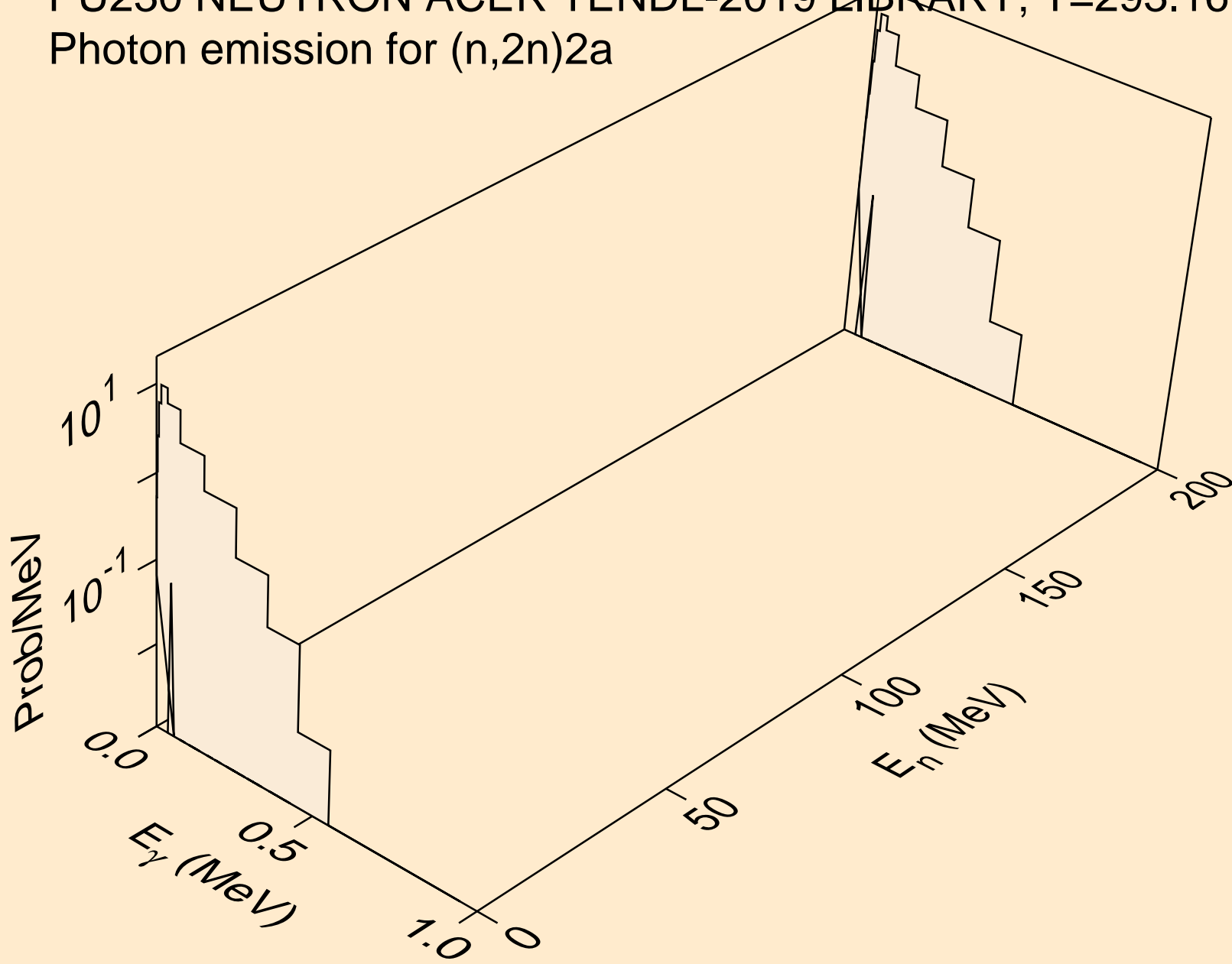

PU230 NEUTRON ACER TENDL-2019 LIBRARY; T=293.16K
Photon emission for (n,n*)d

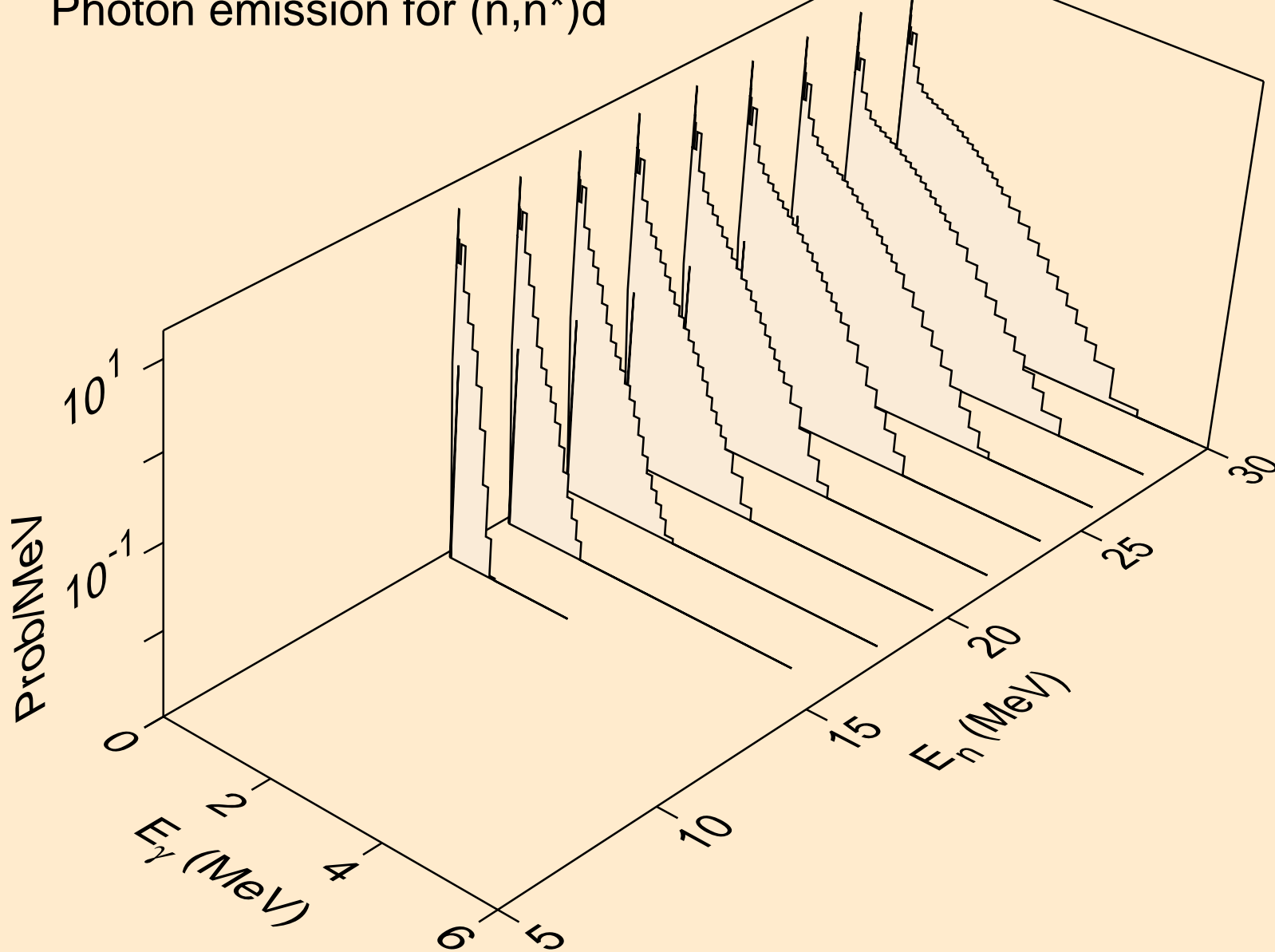

PU230 NEUTRON ACER TENDL-2019 LIBRARY; T=293.16K
Photon emission for (n,n*)t

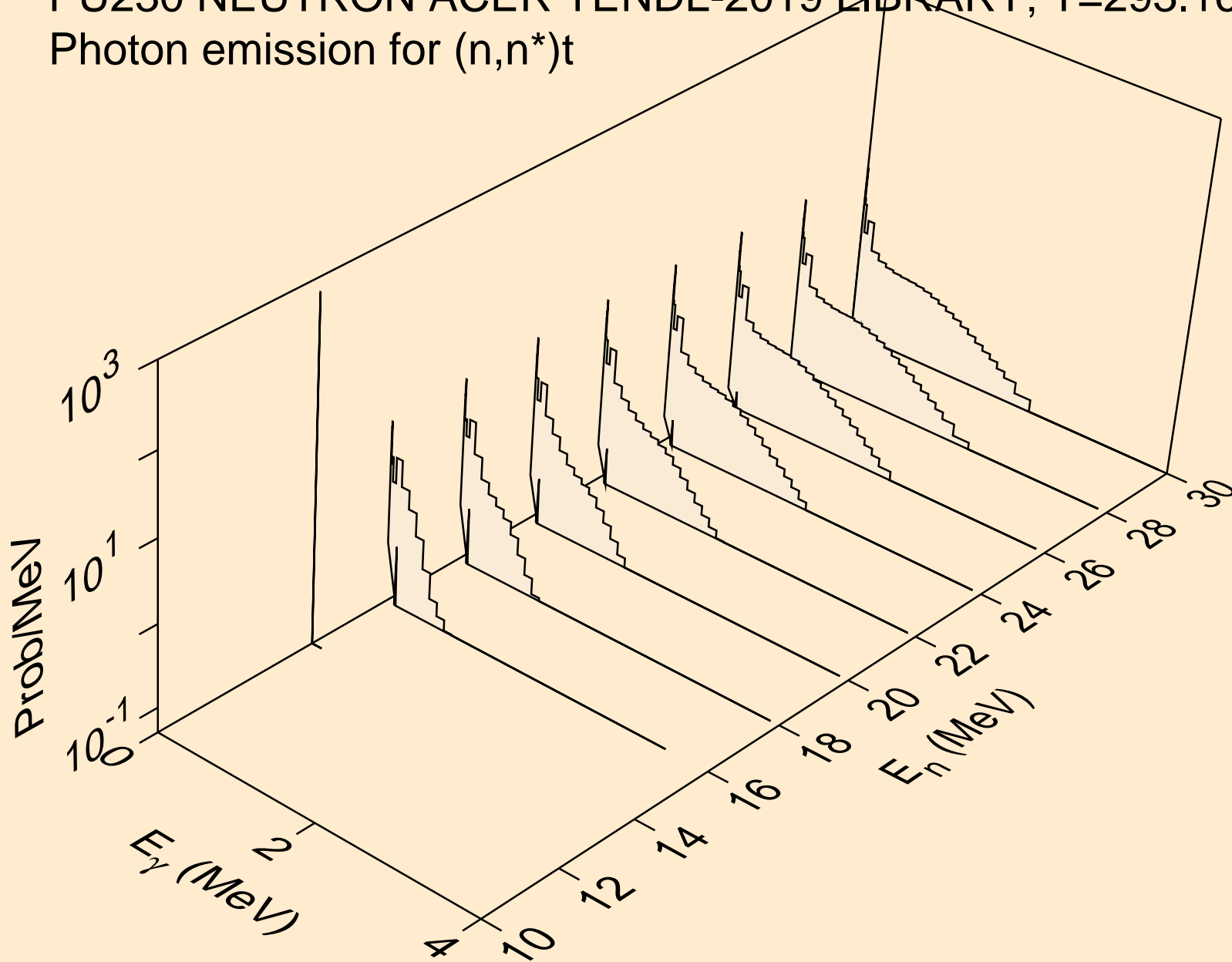

PU230 NEUTRON ACER TENDL-2019 LIBRARY; T=293.16K
Photon emission for (n,n*)he3

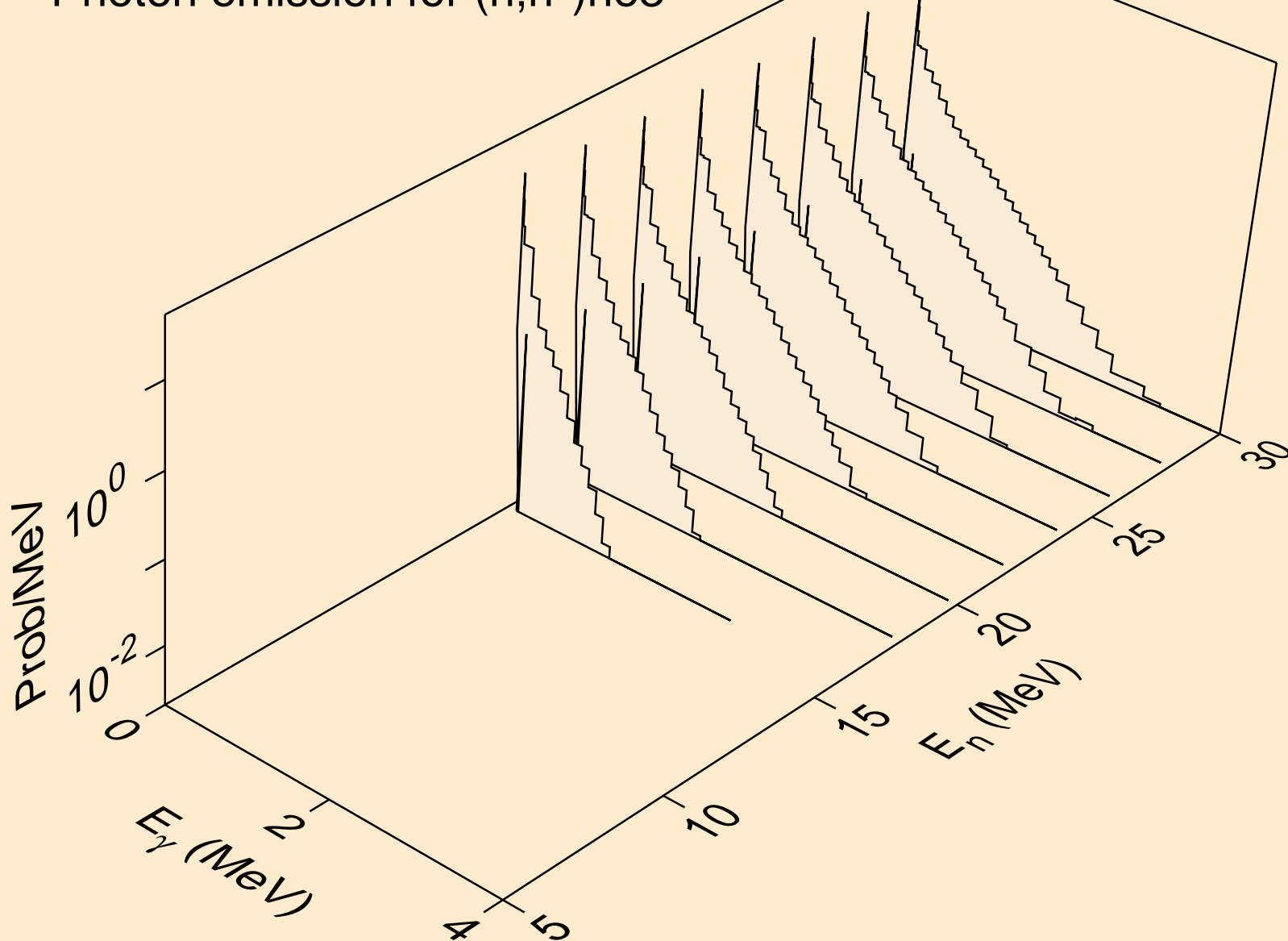

PU230 NEUTRON ACER TENDL-2019 LIBRARY; T=293.16K
Photon emission for (n,4n)

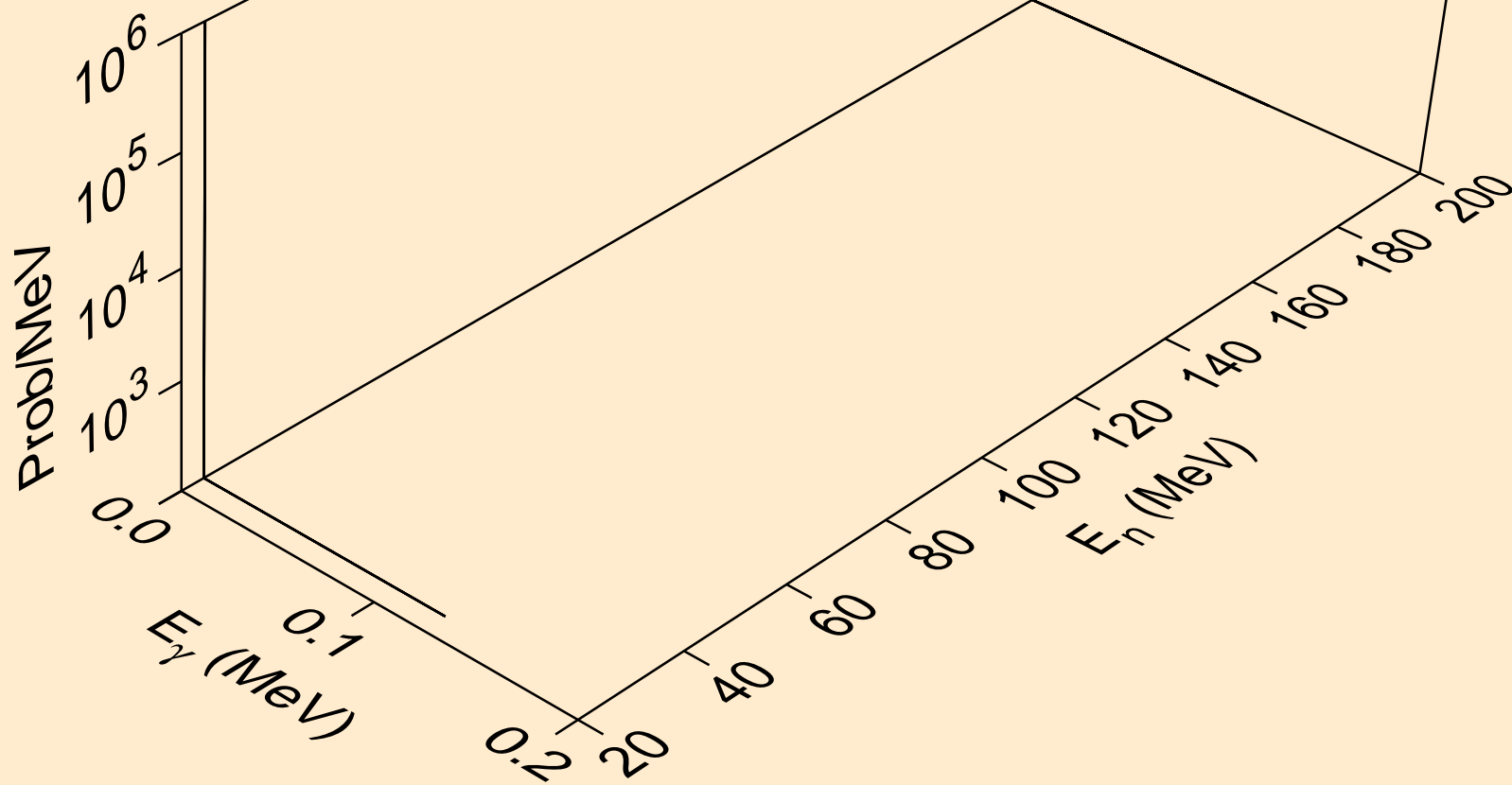

PU230 NEUTRON ACER TENDL-2019 LIBRARY; T=293.16K
Photon emission for (n,2np)

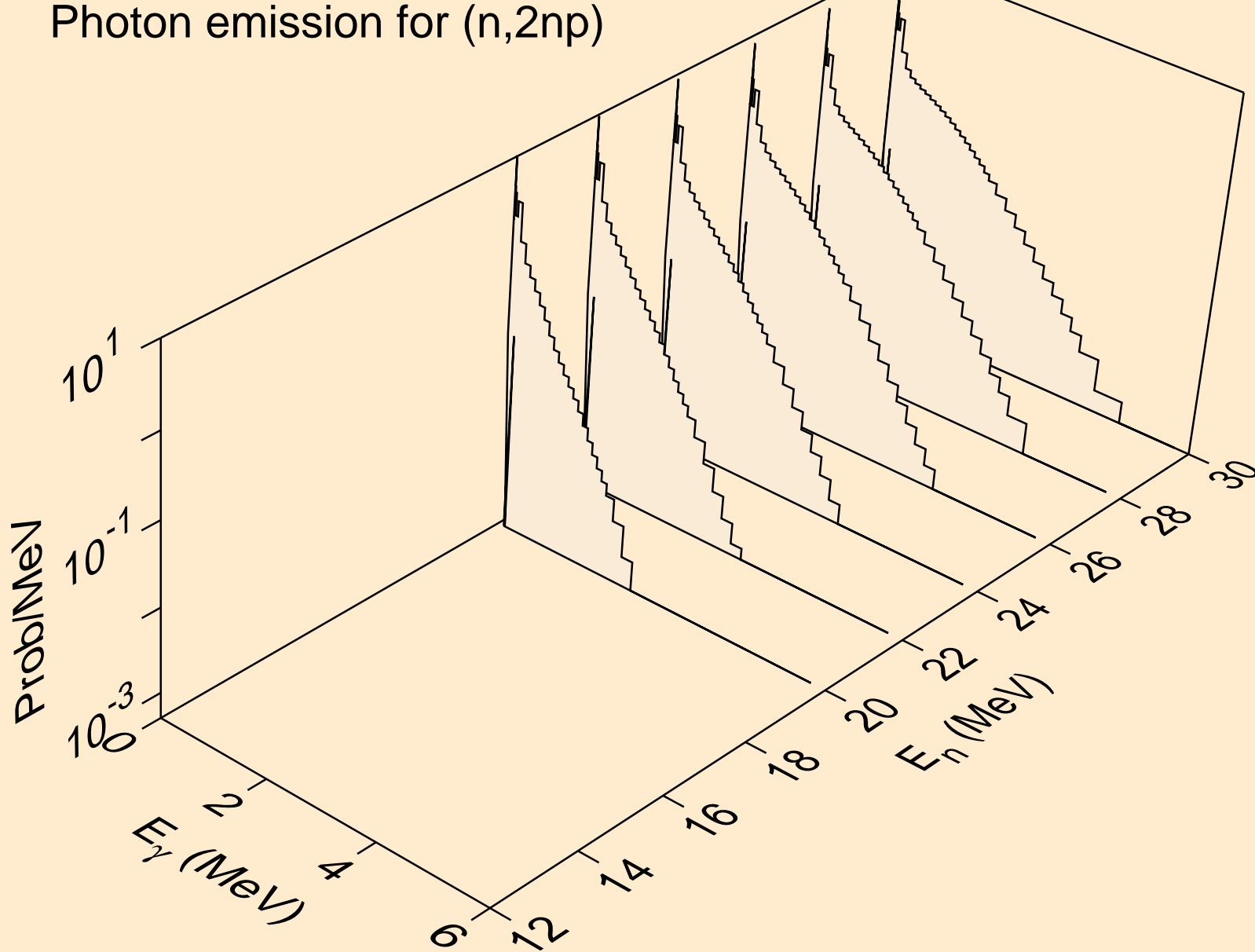

PU230 NEUTRON ACER TENDL-2019 LIBRARY; T=293.16K
Photon emission for (n,3np)

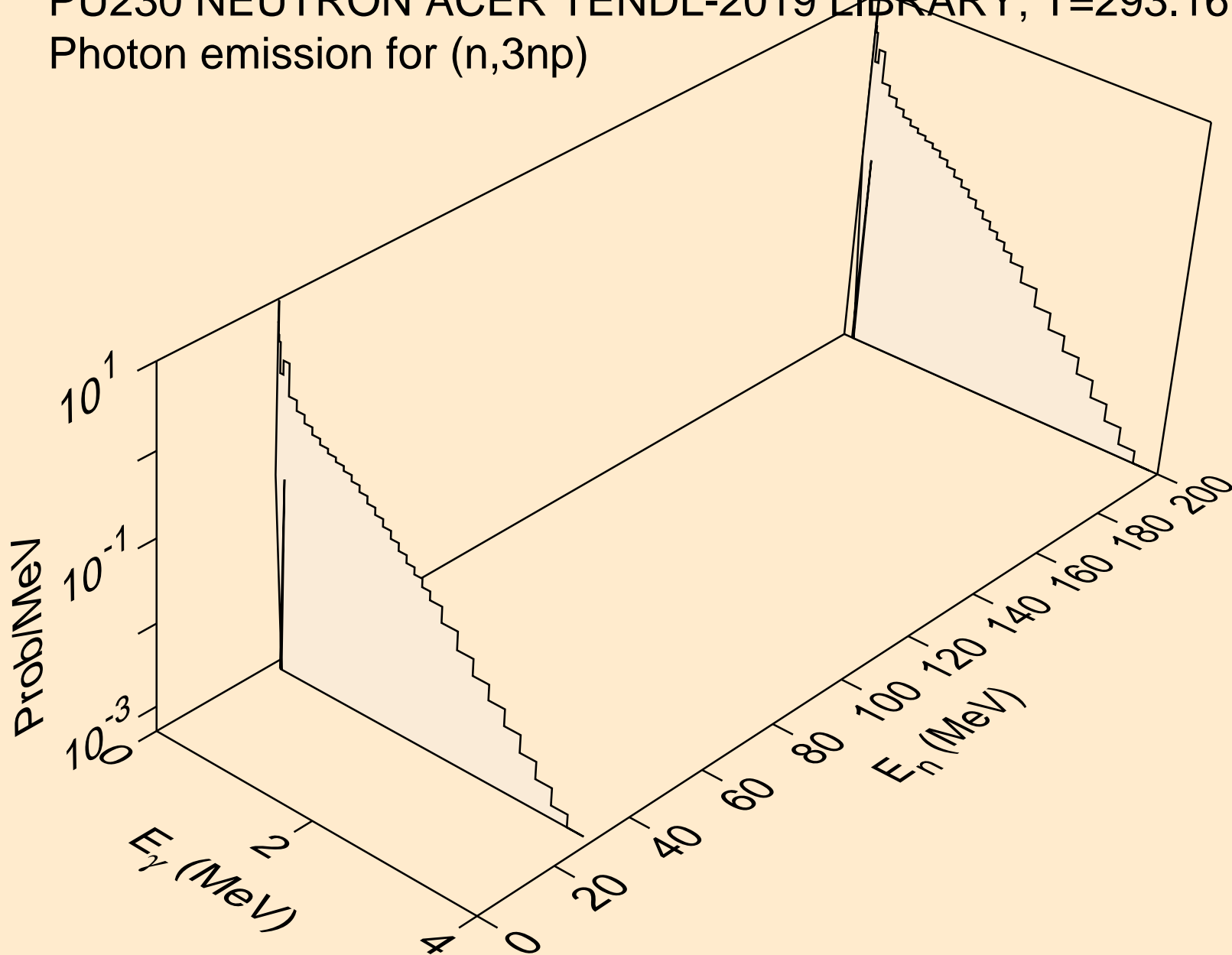

PU230 NEUTRON ACER TENDL-2019 LIBRARY; T=293.16K
Photon emission for (n,2np)

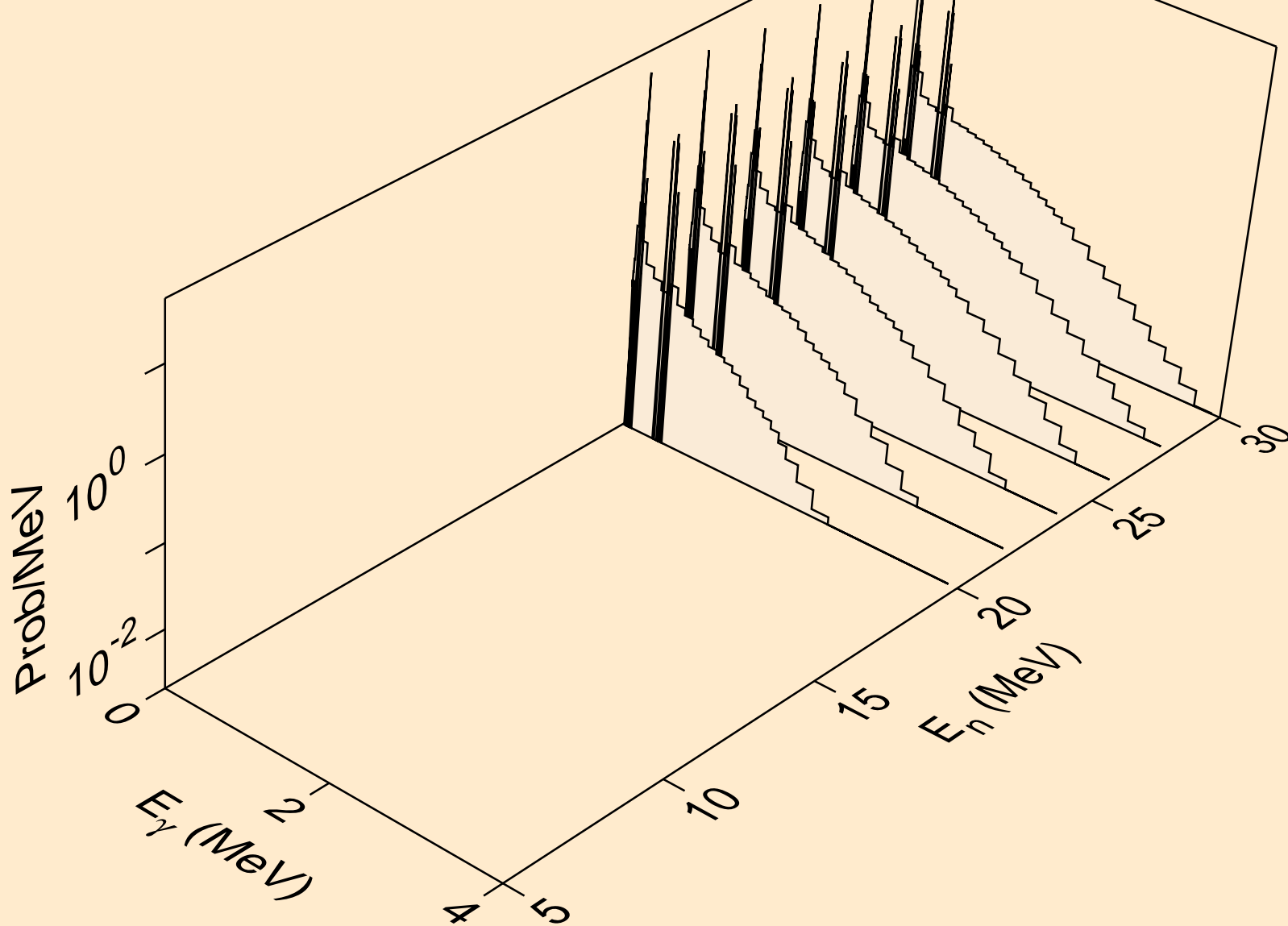

PU230 NEUTRON ACER TENDL-2019 LIBRARY; T=293.16K
Photon emission for (n,npa)

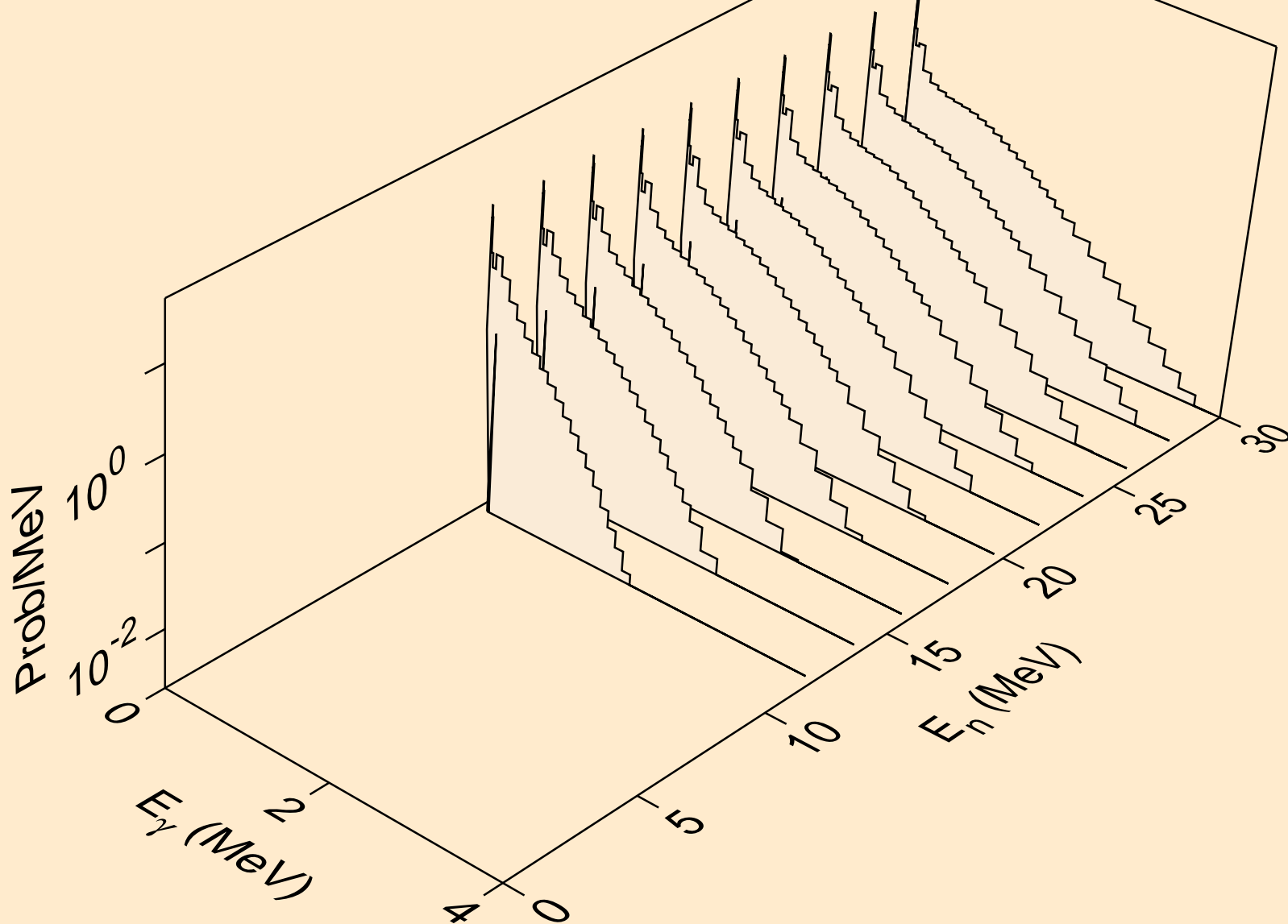

PU230 NEUTRON ACER TENDL-2019 LIBRARY; T=293.16K
Photon emission for (n,n*c)

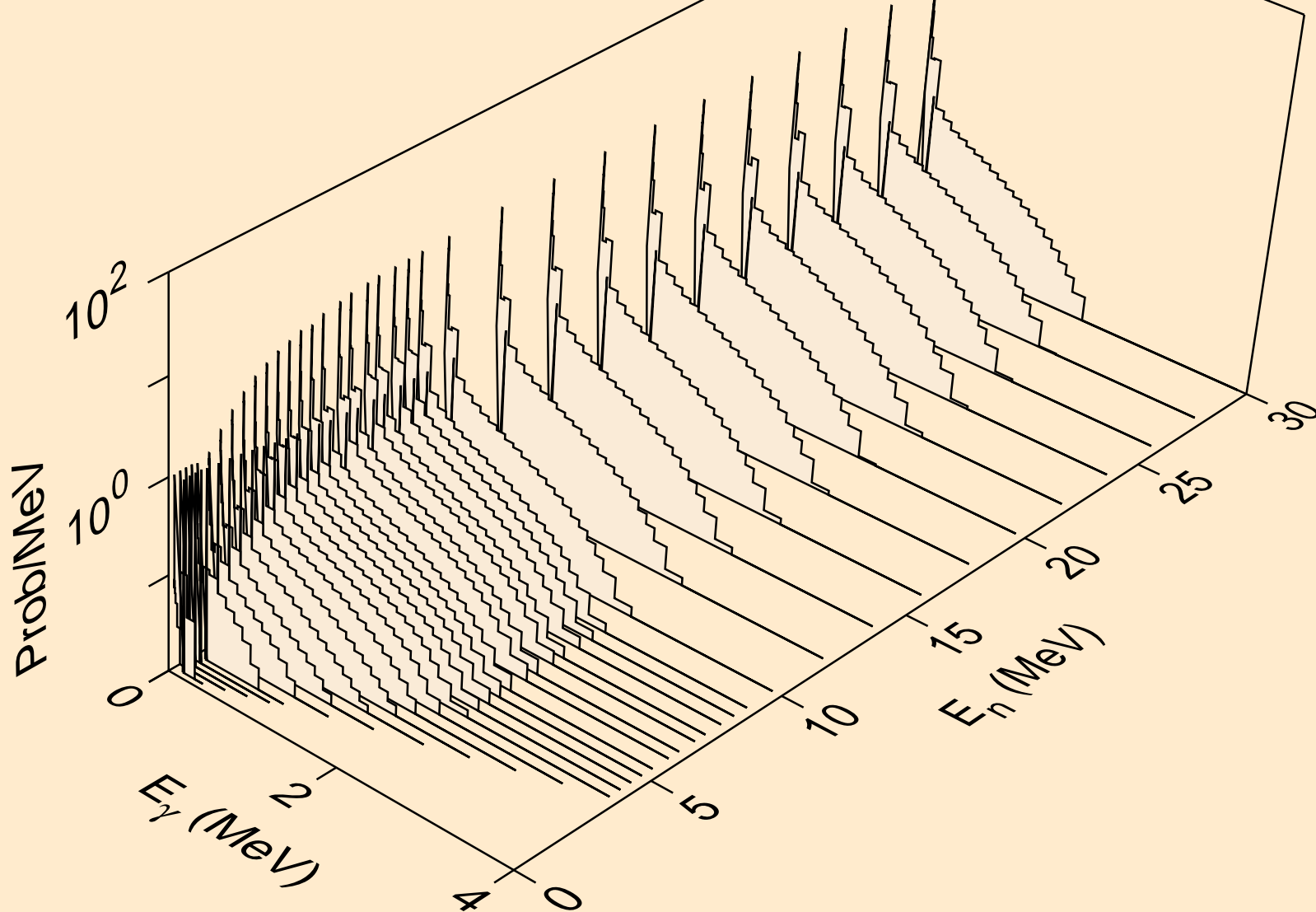

PU230 NEUTRON ACER TENDL-2019 LIBRARY; T=293.16K
Photon emission for (n,gma)

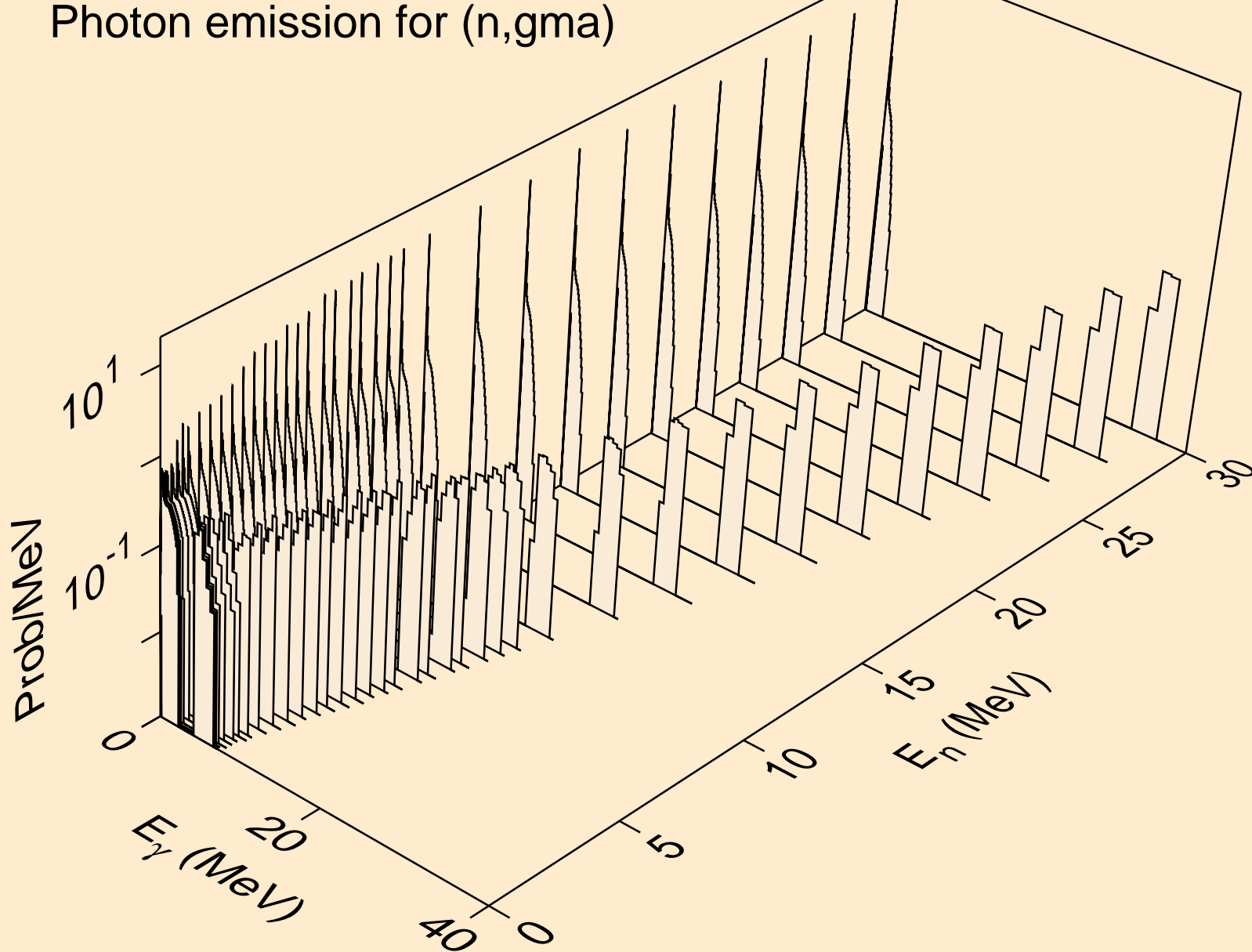

PU230 NEUTRON ACER TENDL-2019 LIBRARY; T=293.16K
Photon emission for (n,p)

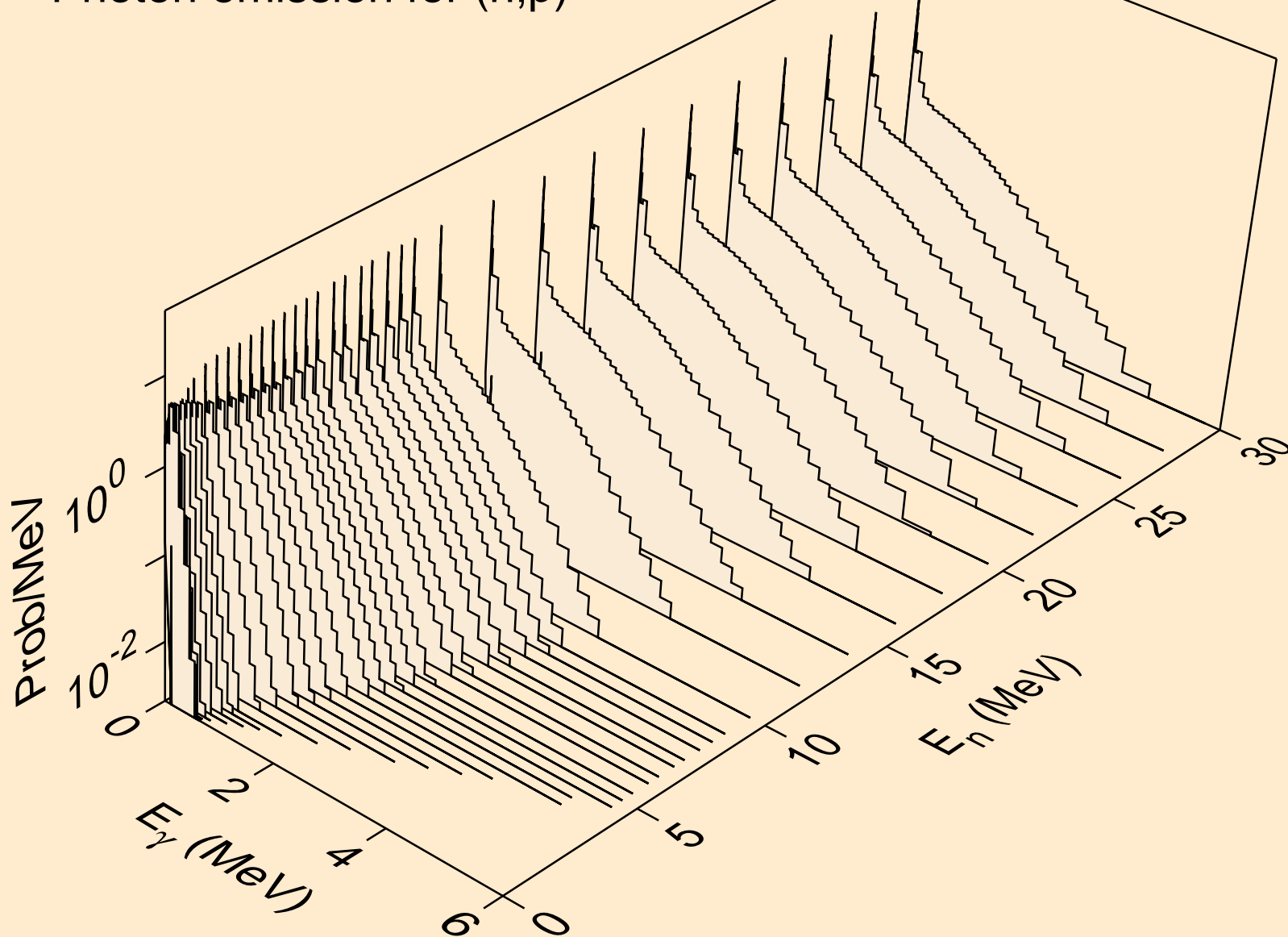

PU230 NEUTRON ACER TENDL-2019 LIBRARY; T=293.16K
Photon emission for (n,d)

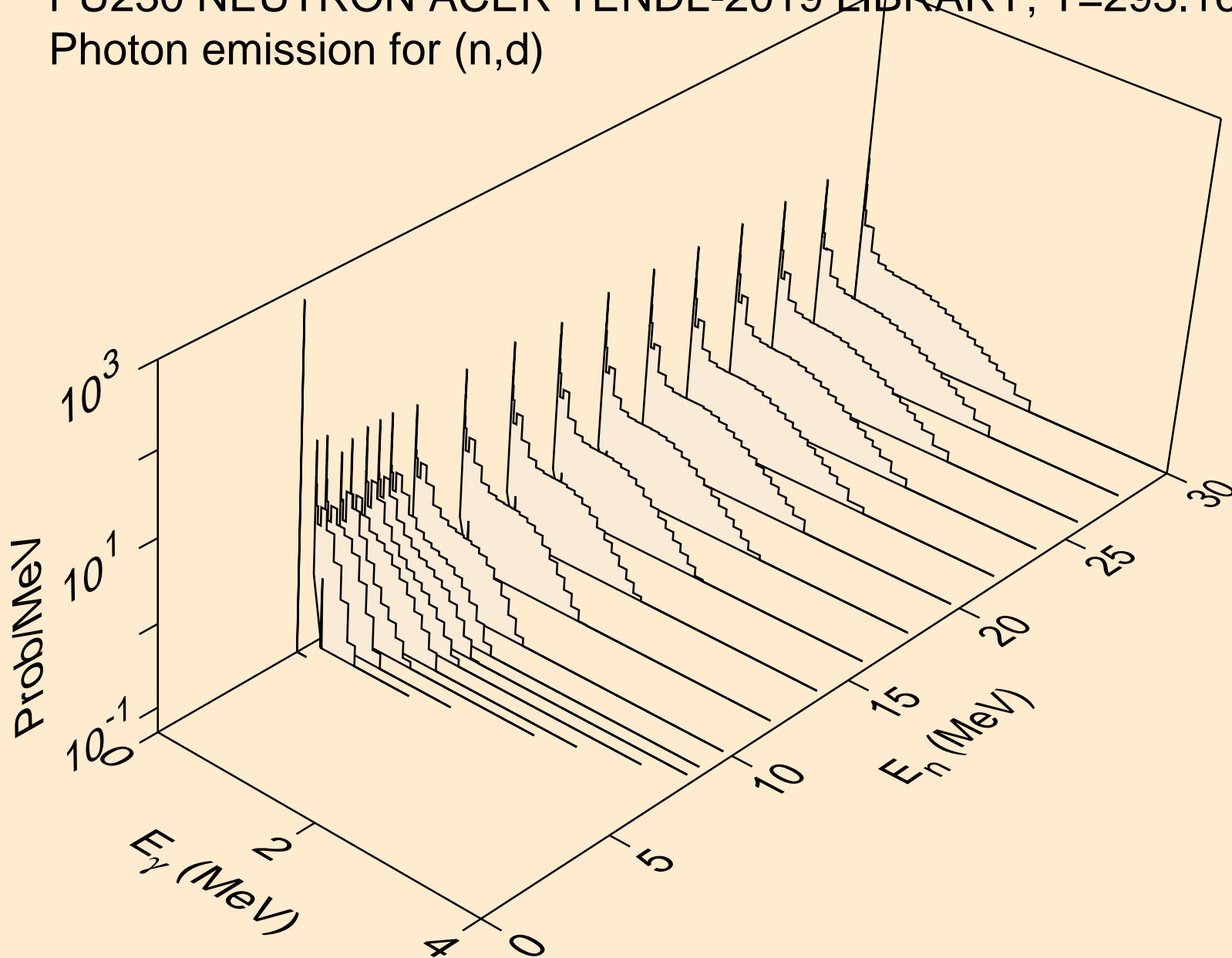

PU230 NEUTRON ACER TENDL-2019 LIBRARY; T=293.16K
Photon emission for (n,t)

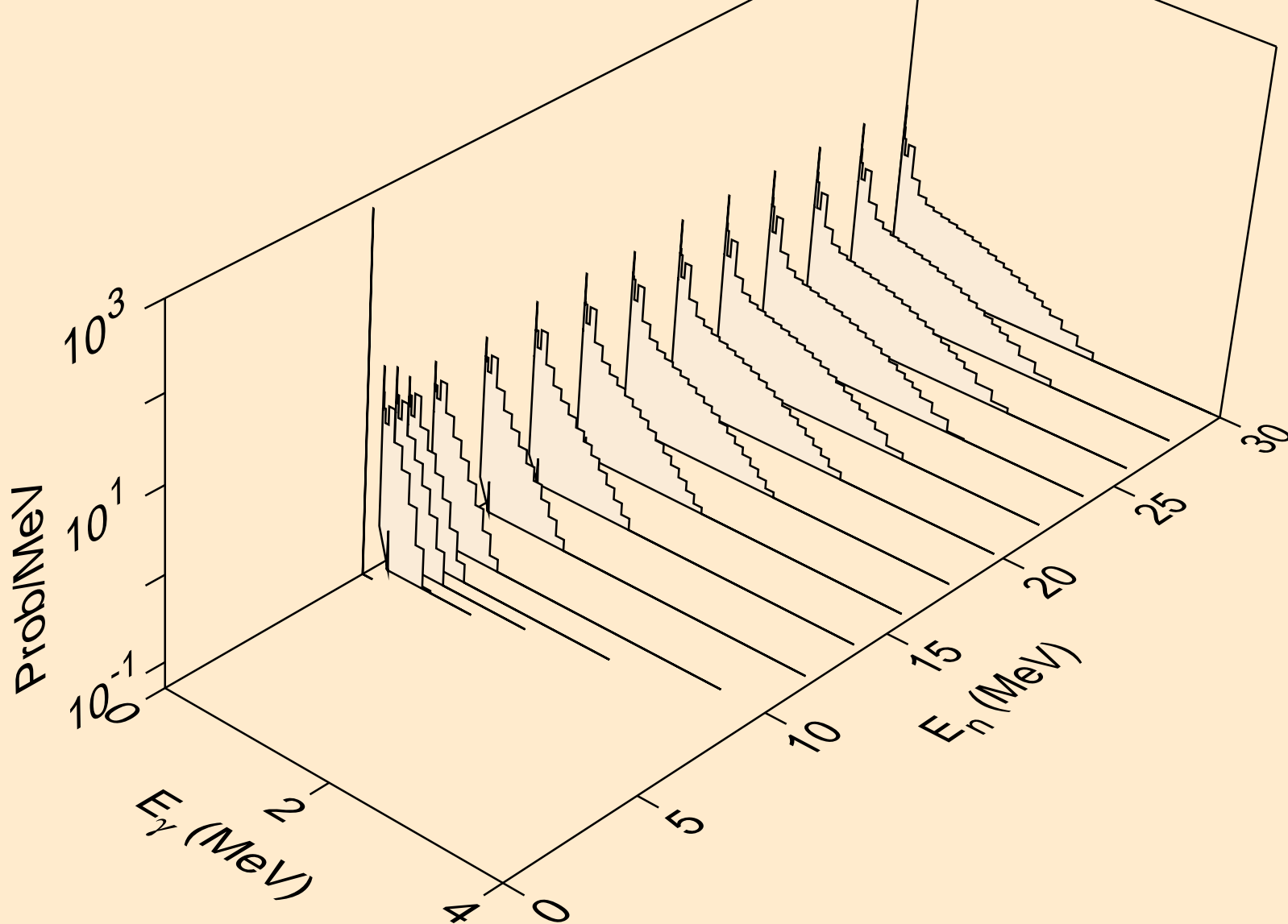

PU230 NEUTRON ACER TENDL-2019 LIBRARY; T=293.16K
Photon emission for (n,he3)

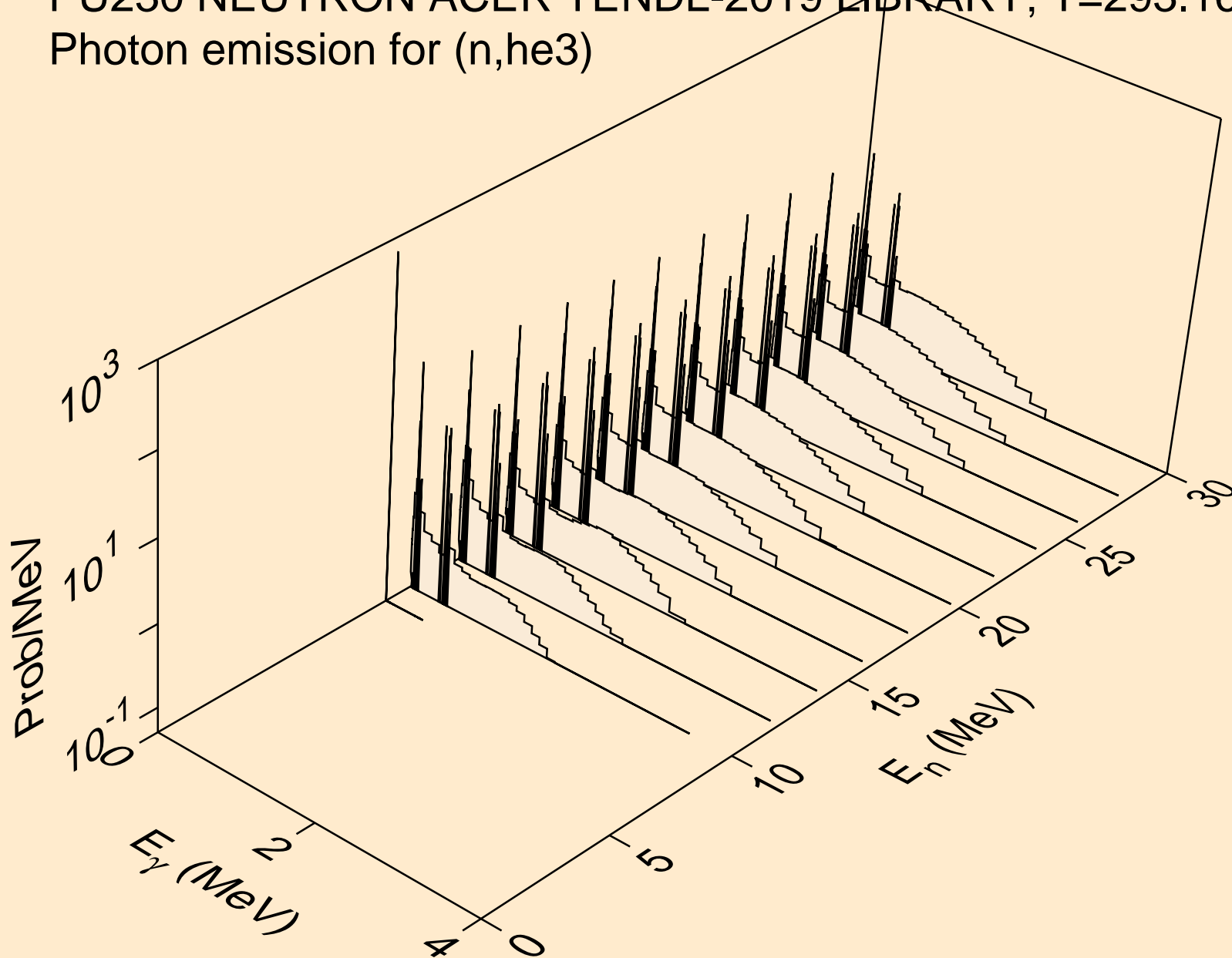

PU230 NEUTRON ACER TENDL-2019 LIBRARY; T=293.16K
Photon emission for (n,a)

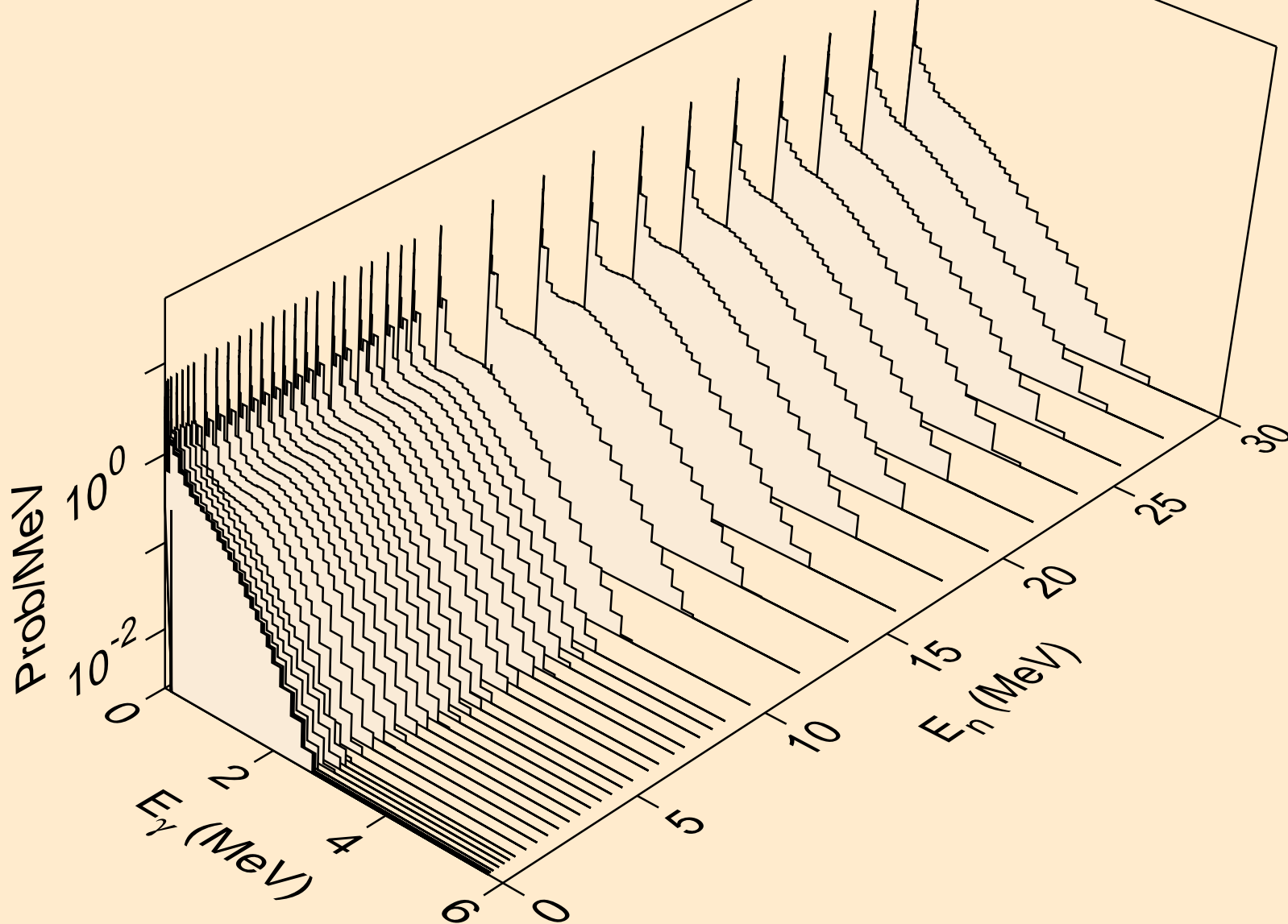

PU230 NEUTRON ACER TENDL-2019 LIBRARY; T=293.16K
Photon emission for (n,2a)

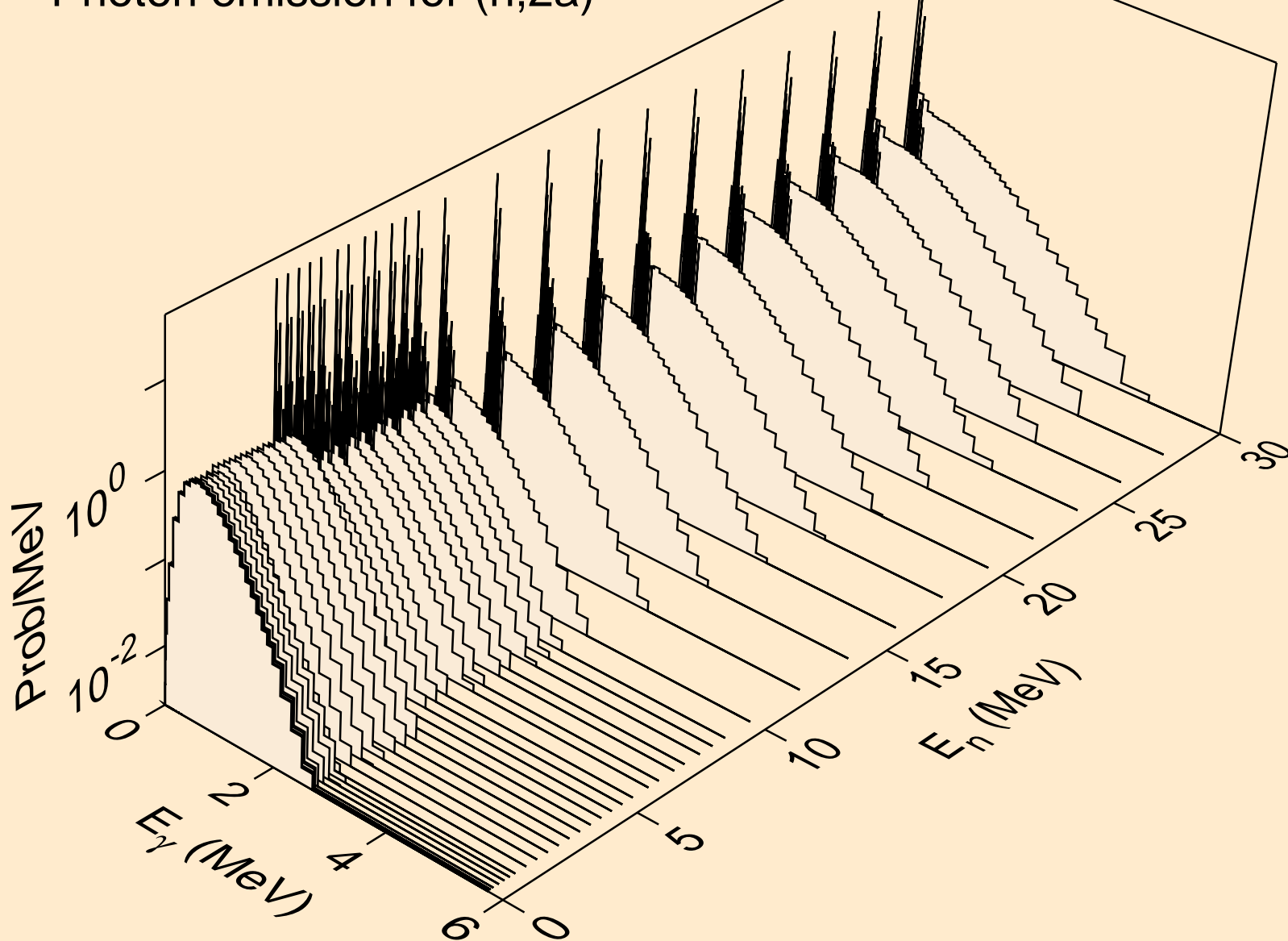

PU230 NEUTRON ACER TENDL-2019 LIBRARY; T=293.16K
Photon emission for (n,2p)

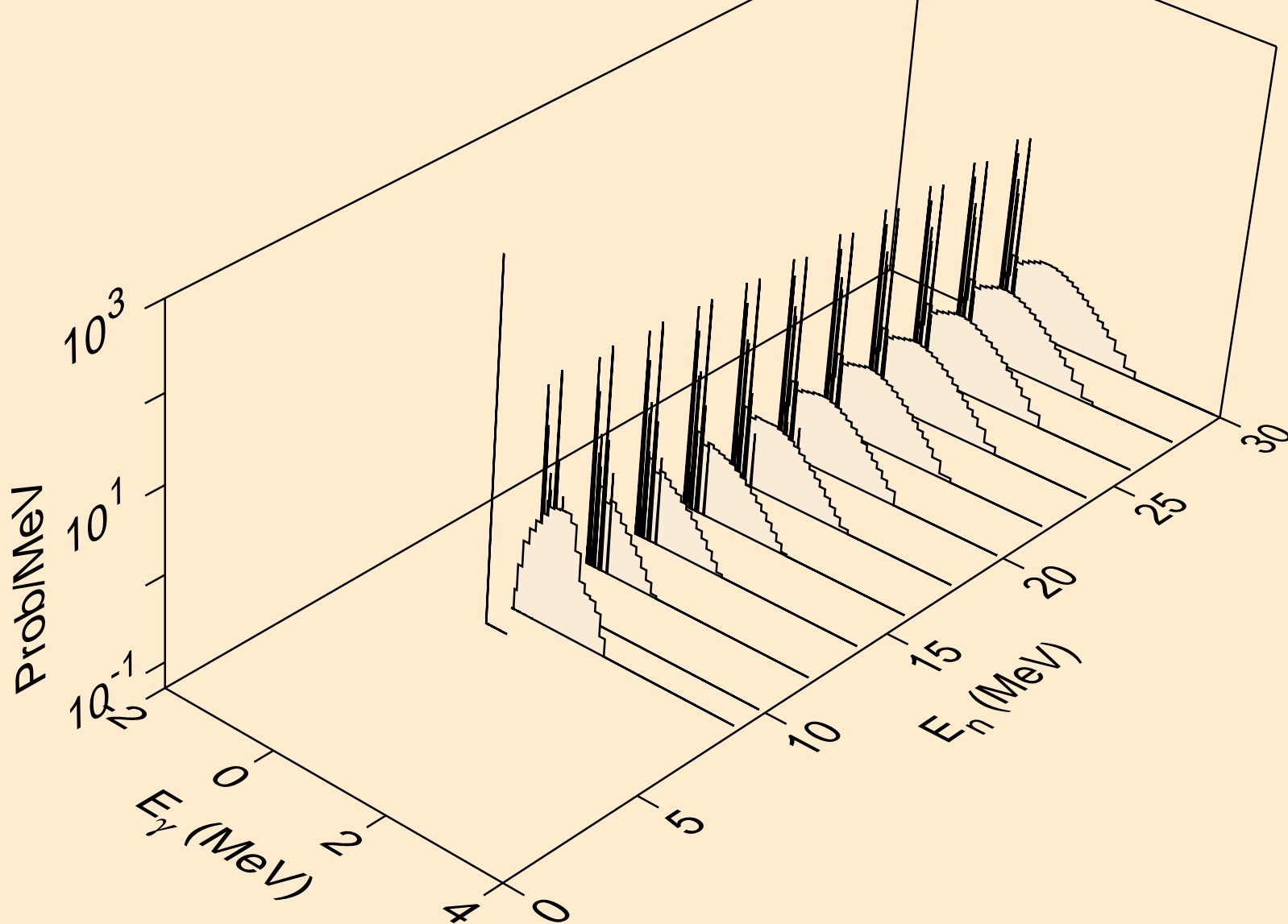

PU230 NEUTRON ACER TENDL-2019 LIBRARY; T=293.16K
Photon emission for (n,p α)

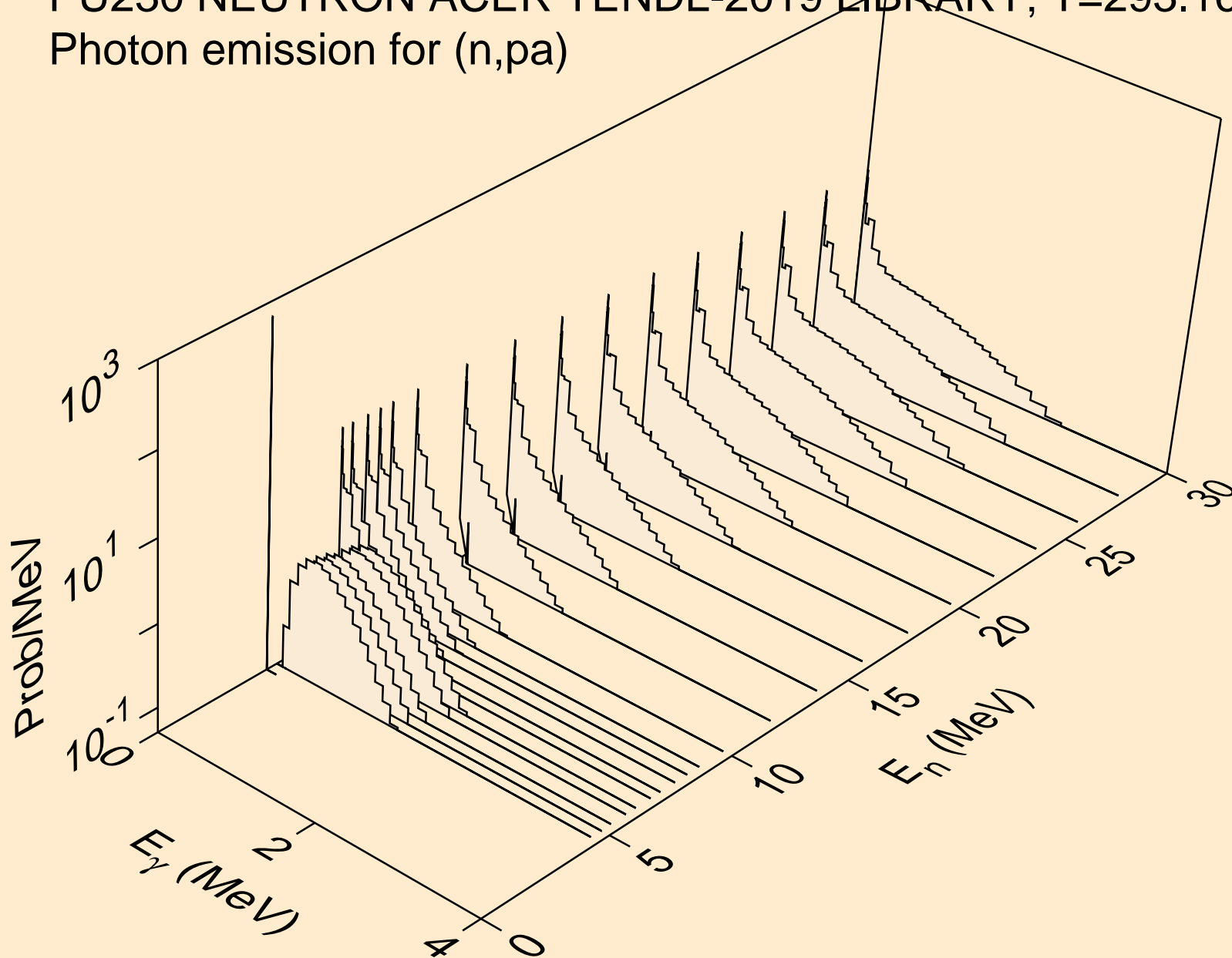

PU230 NEUTRON ACER TENDL-2019 LIBRARY; T=293.16K
Photon emission for (n,pd)

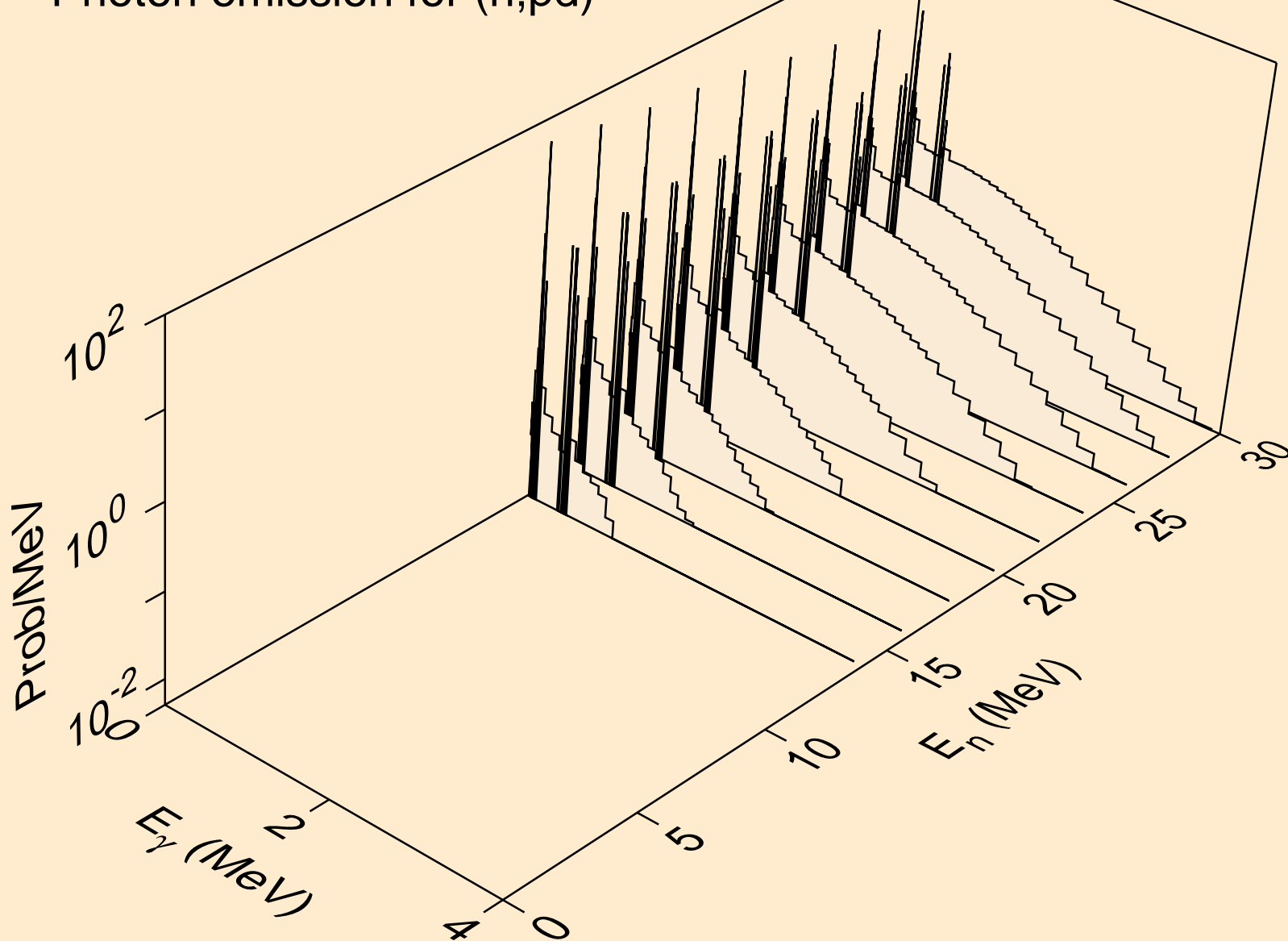

PU230 NEUTRON ACER TENDL-2019 LIBRARY; T=293.16K
Photon emission for (n,pt)

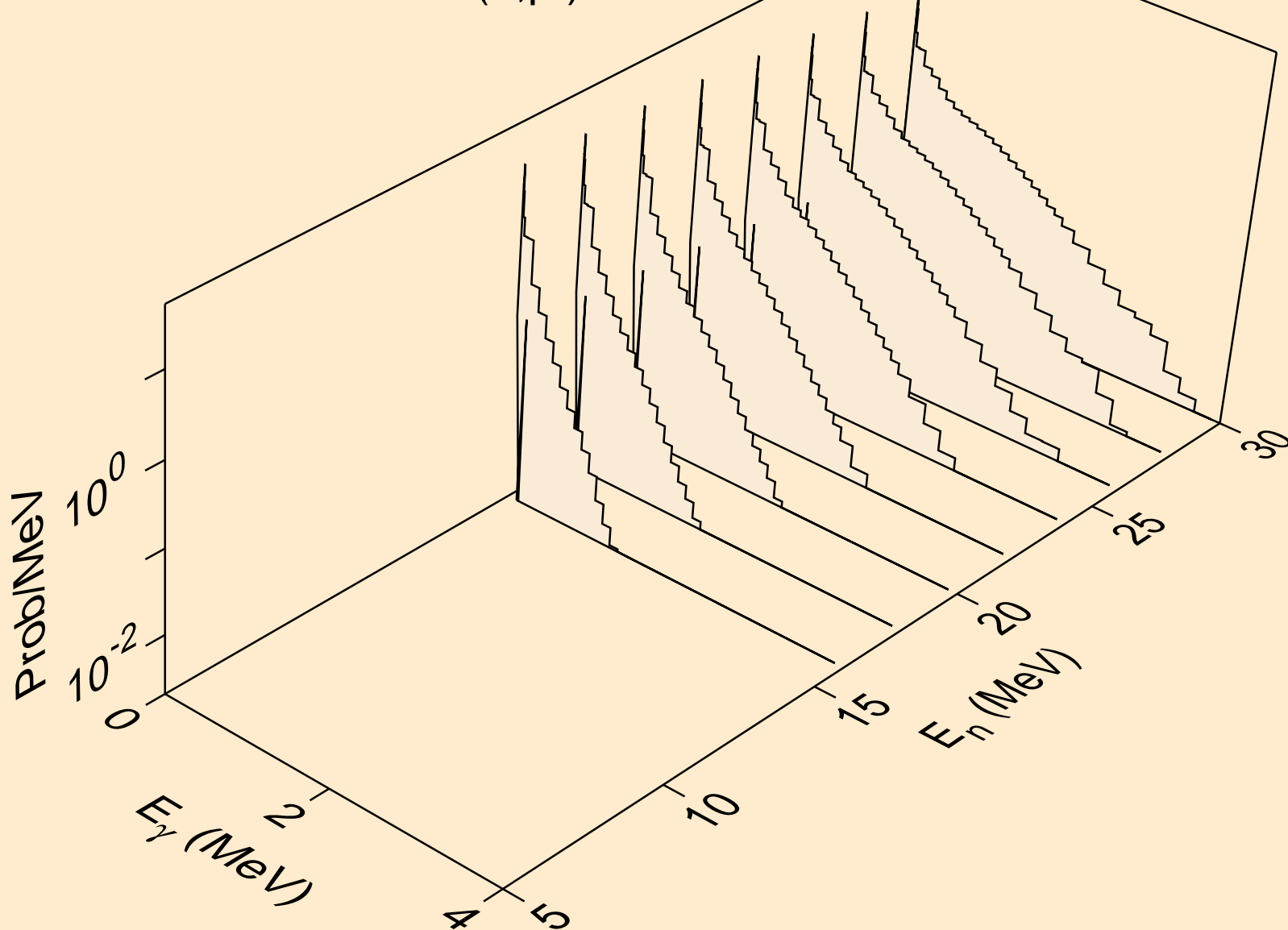

PU230 NEUTRON ACER TENDL-2019 LIBRARY; T=293.16K
Photon emission for (n,da)

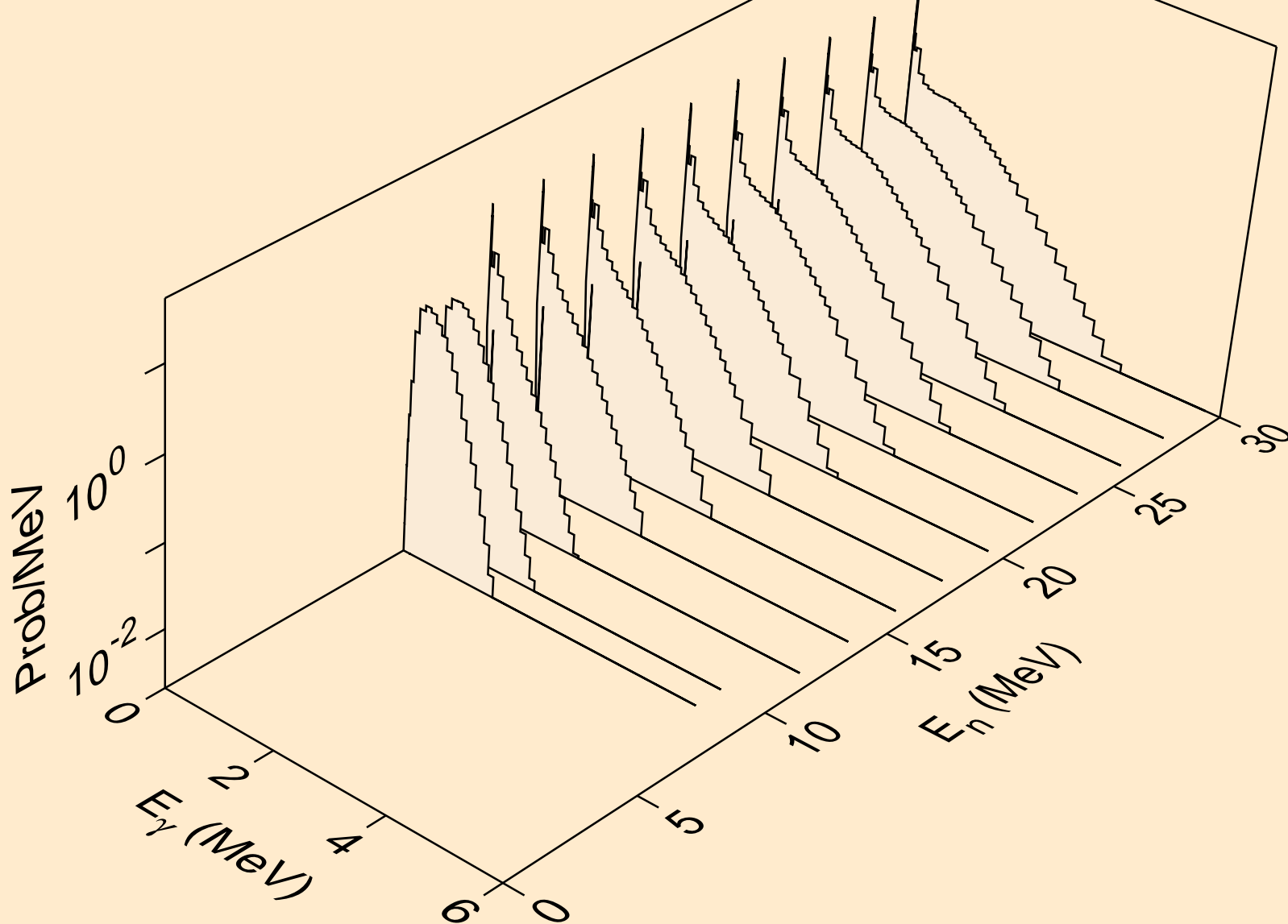

PU230 NEUTRON ACER TENDL-2019 LIBRARY; T=293.16K
thermal capture photon spectrum

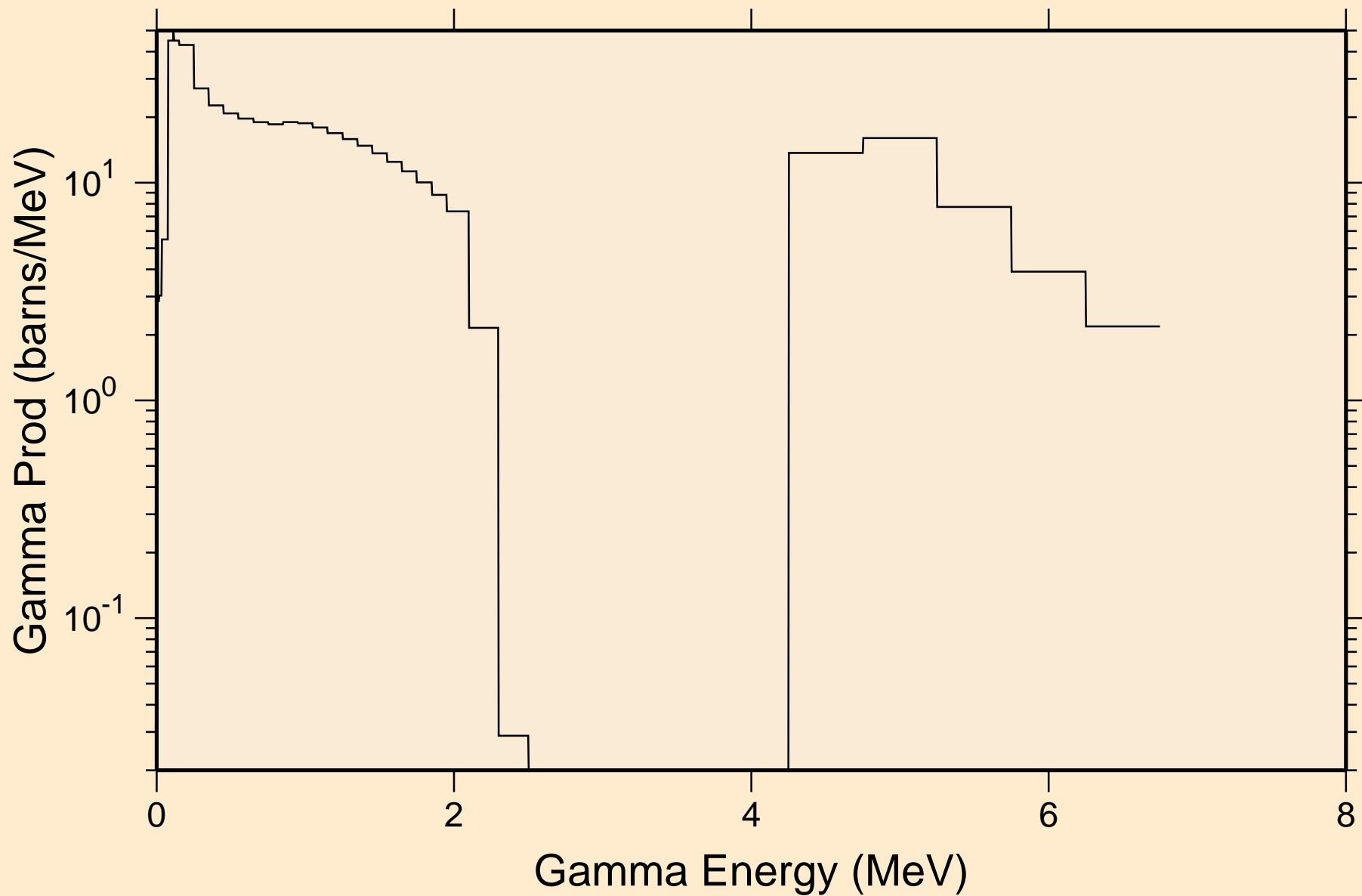

PU230 NEUTRON ACER TENDL-2019 LIBRARY; T=293.16K
14 MeV photon spectrum

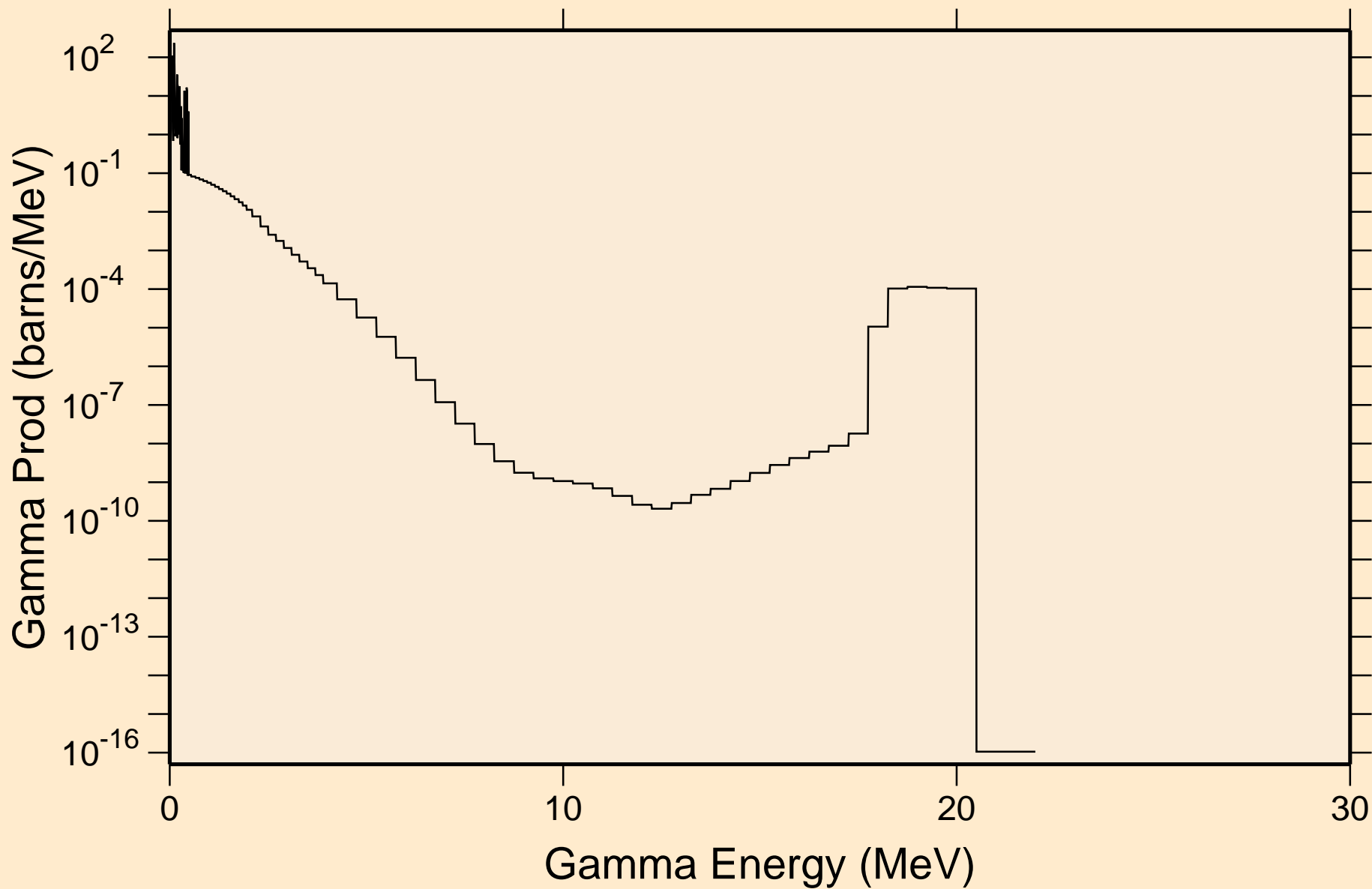

PU230 NEUTRON ACER TENDL-2019 LIBRARY; T=293.16K
Particle heating contributions

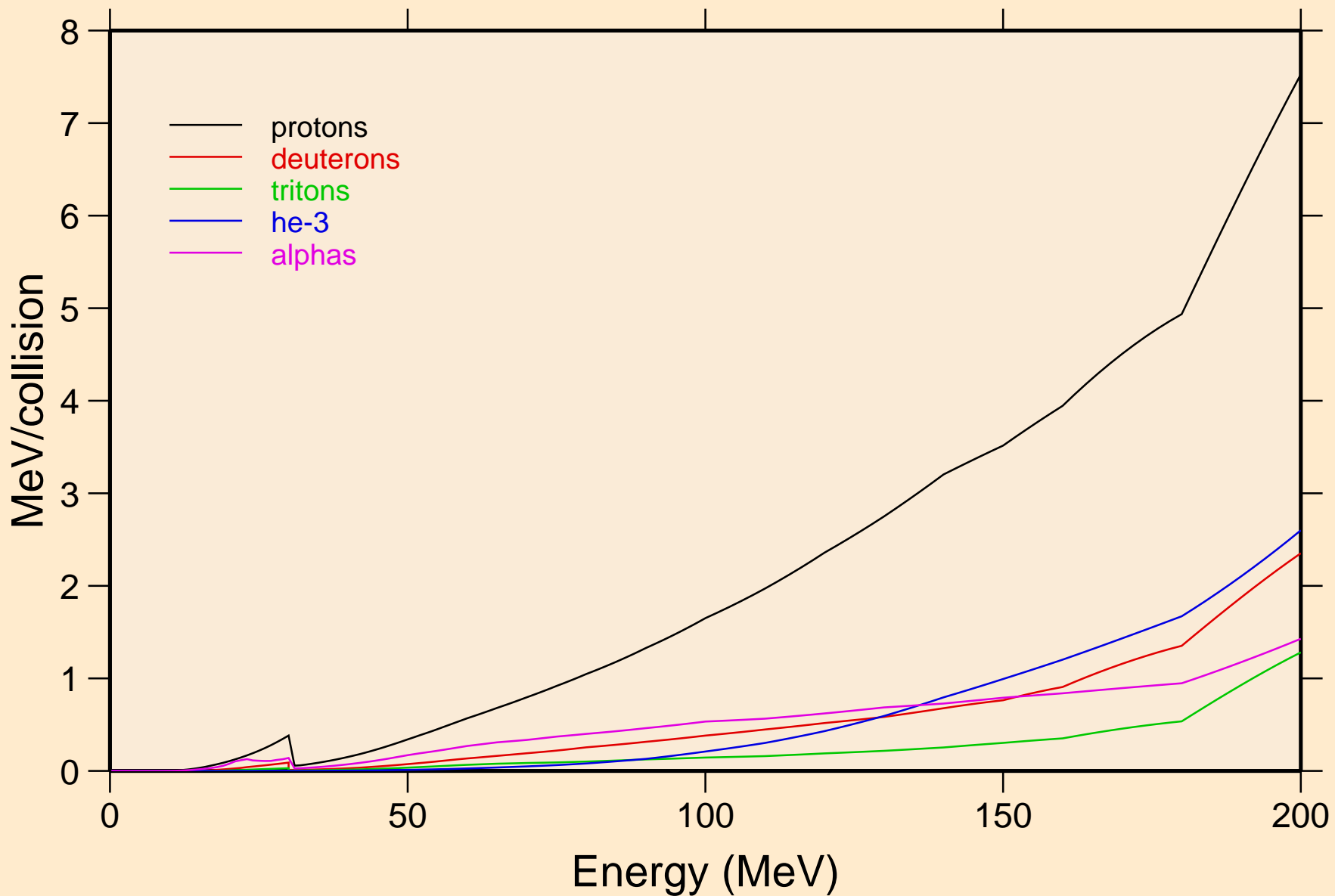

PU230 NEUTRON ACER TENDL-2019 LIBRARY; T=293.16K
Recoil Heating

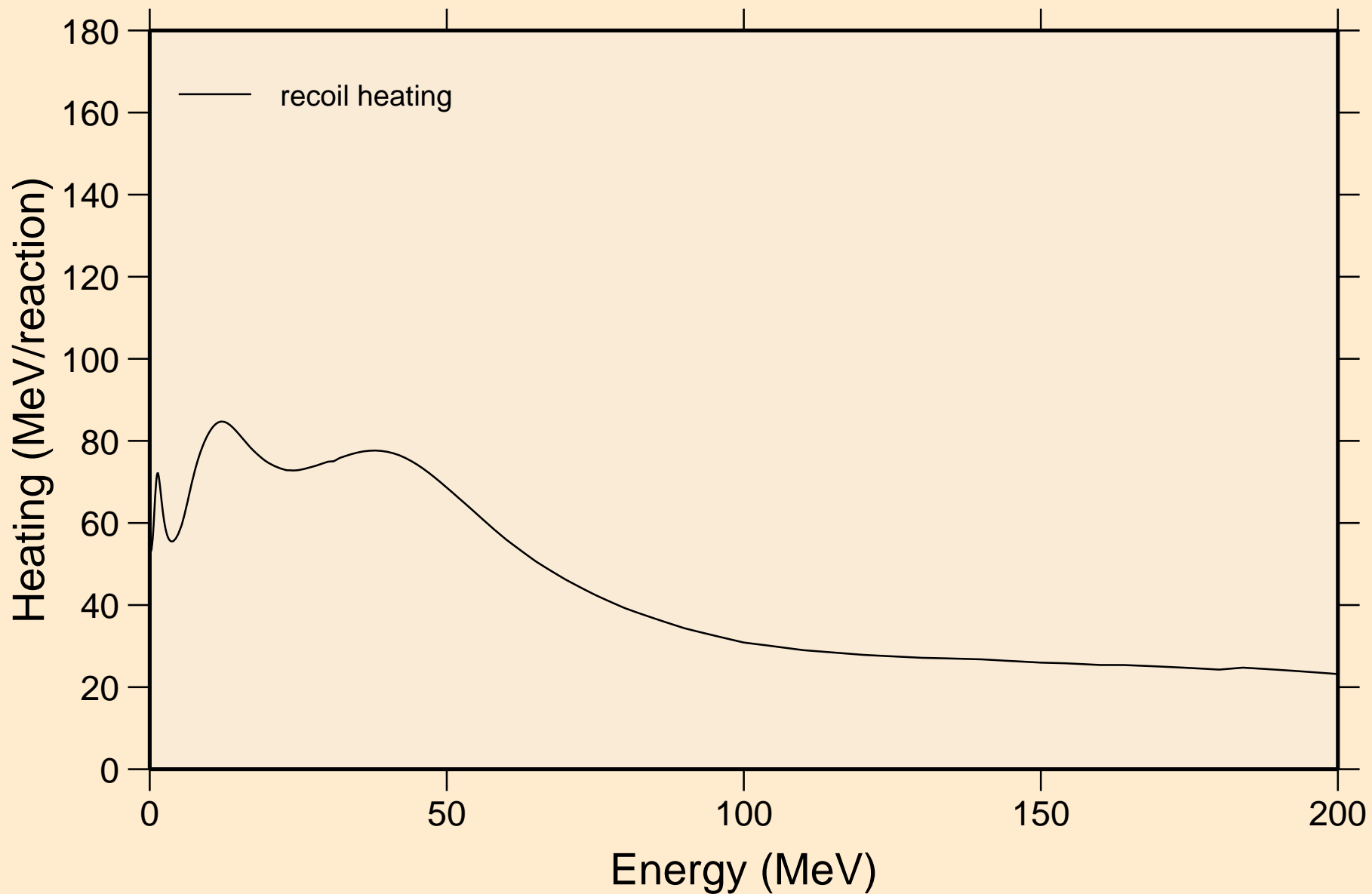

PU230 NEUTRON ACER TENDL-2019 LIBRARY; T=293.16K
Particle production cross sections

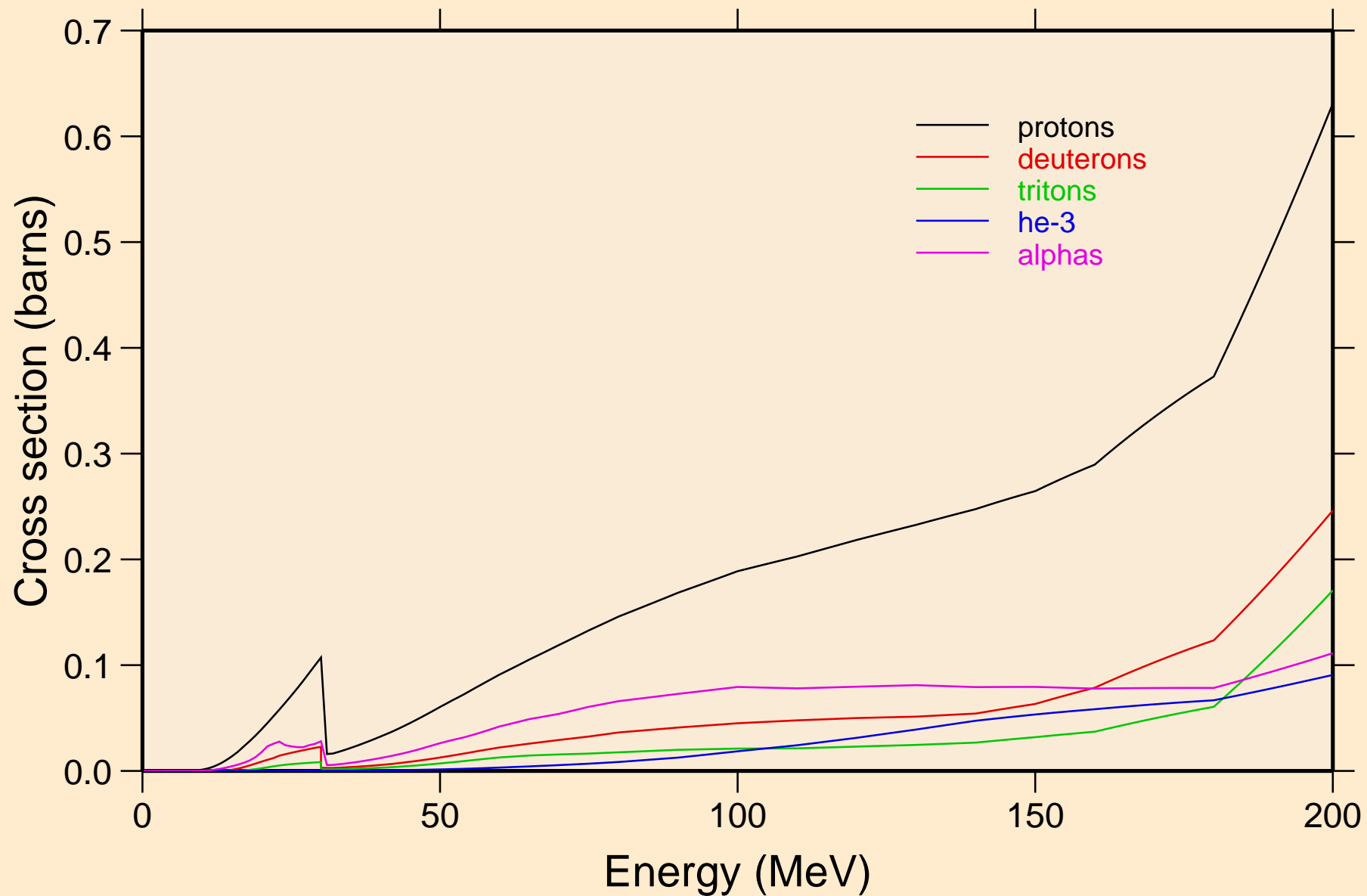

PU230 NEUTRON ACER TENDL-2019 LIBRARY; T=293.16K
protons from (n,x)

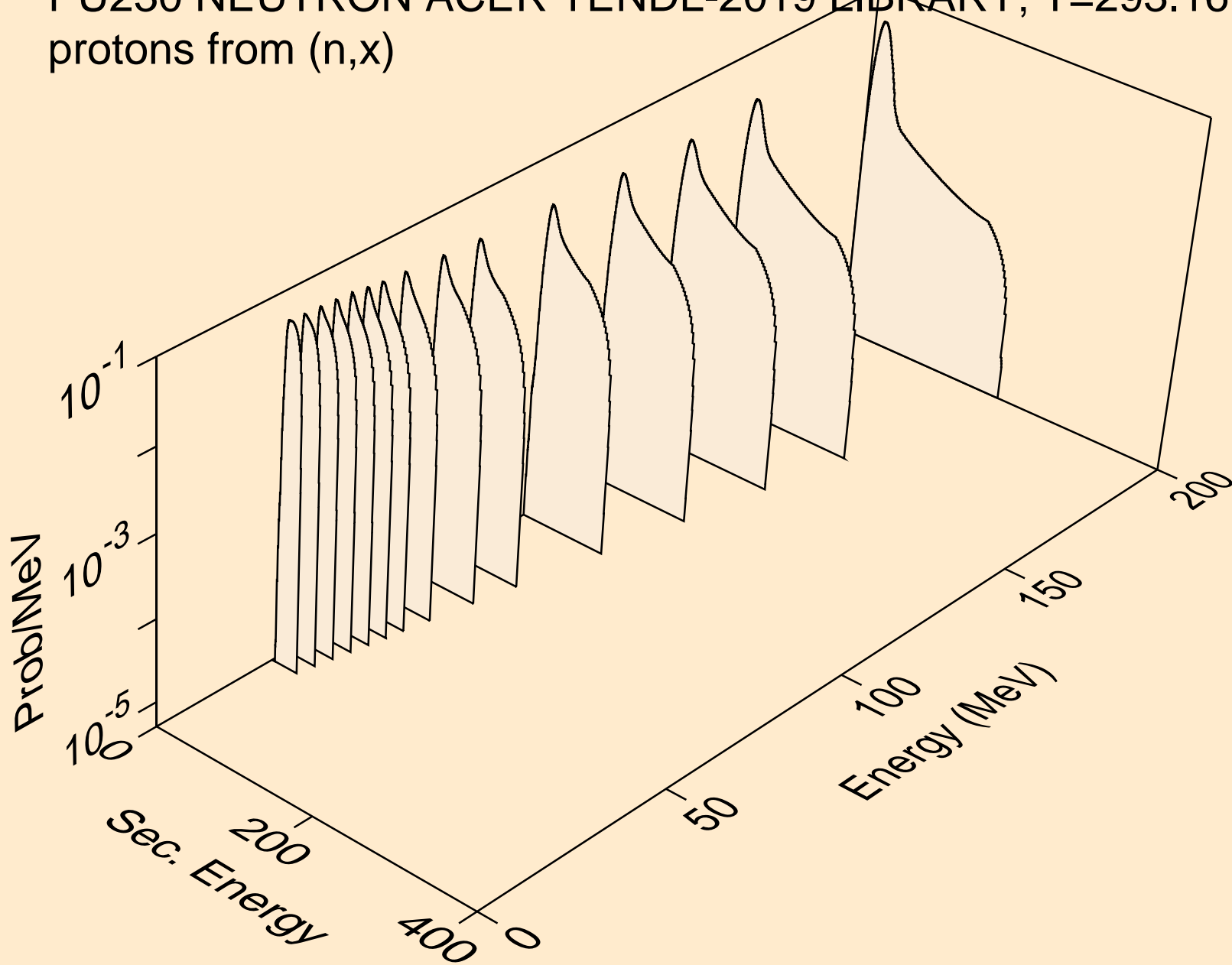

PU230 NEUTRON ACER TENDL-2019 LIBRARY; T=293.16K
protons from (n,n*)p

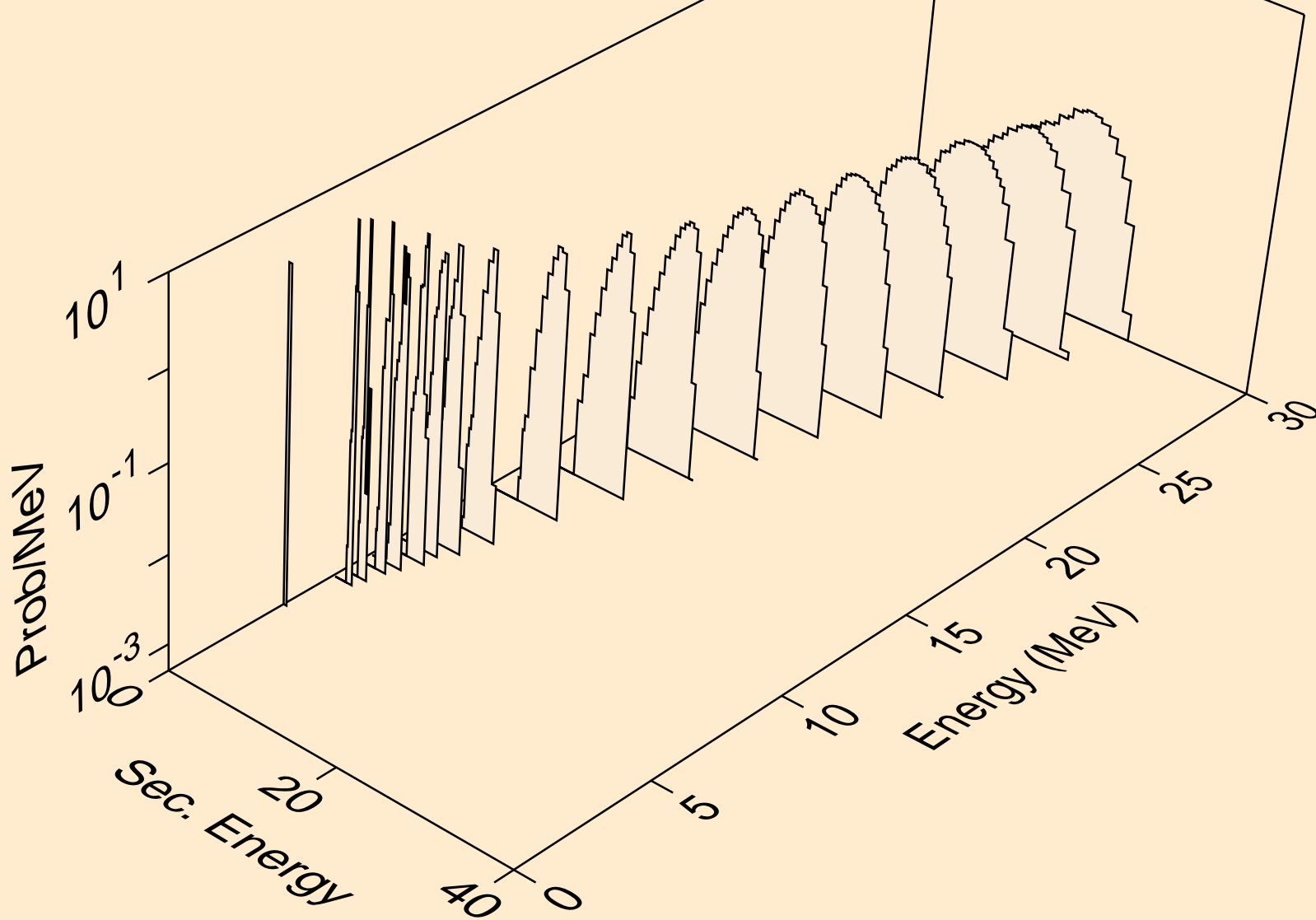

PU230 NEUTRON ACER TENDL-2019 LIBRARY; T=293.16K
protons from (n,2np)

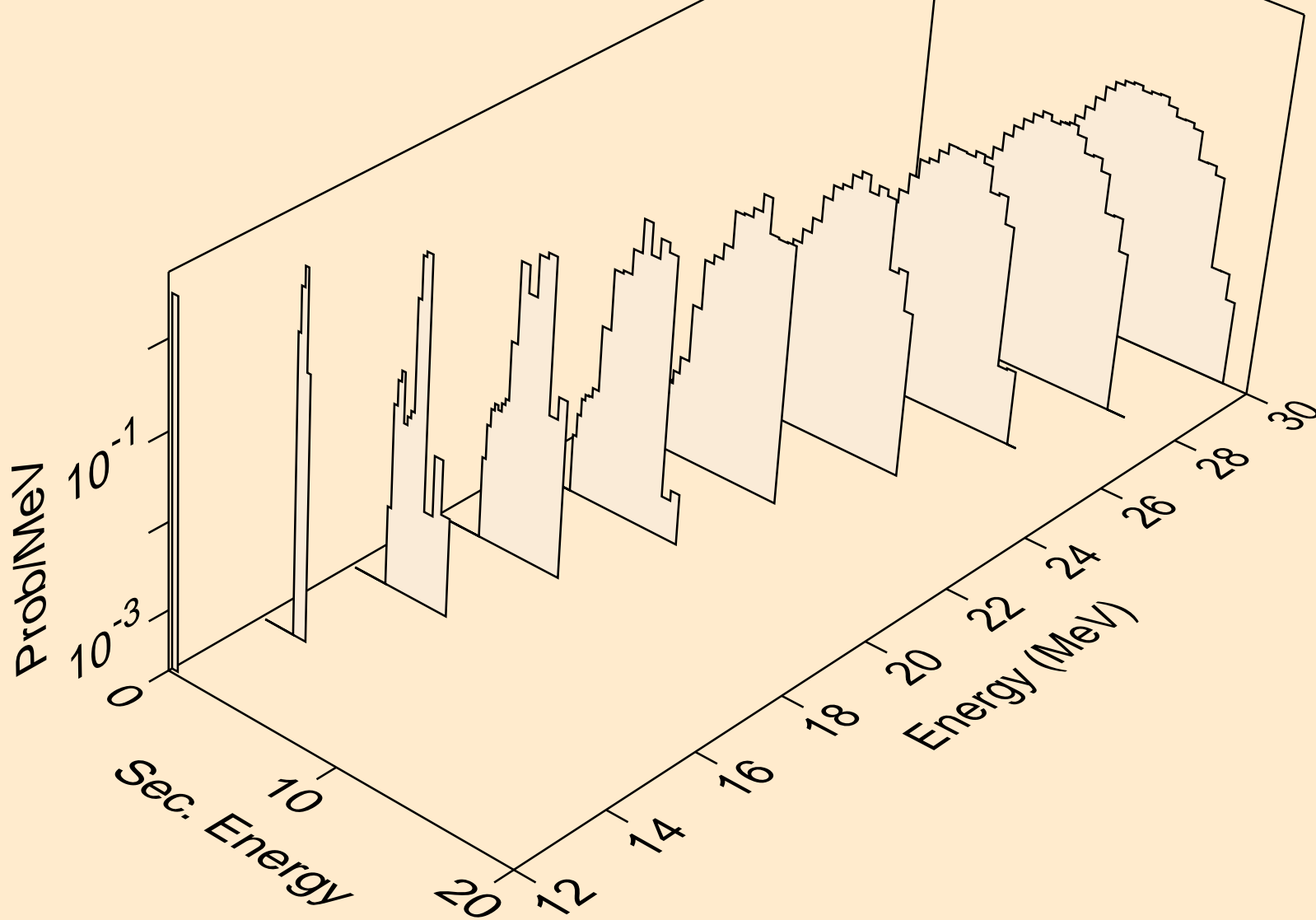

PU230 NEUTRON ACER TENDL-2019 LIBRARY; T=293.16K
protons from (n,3np)

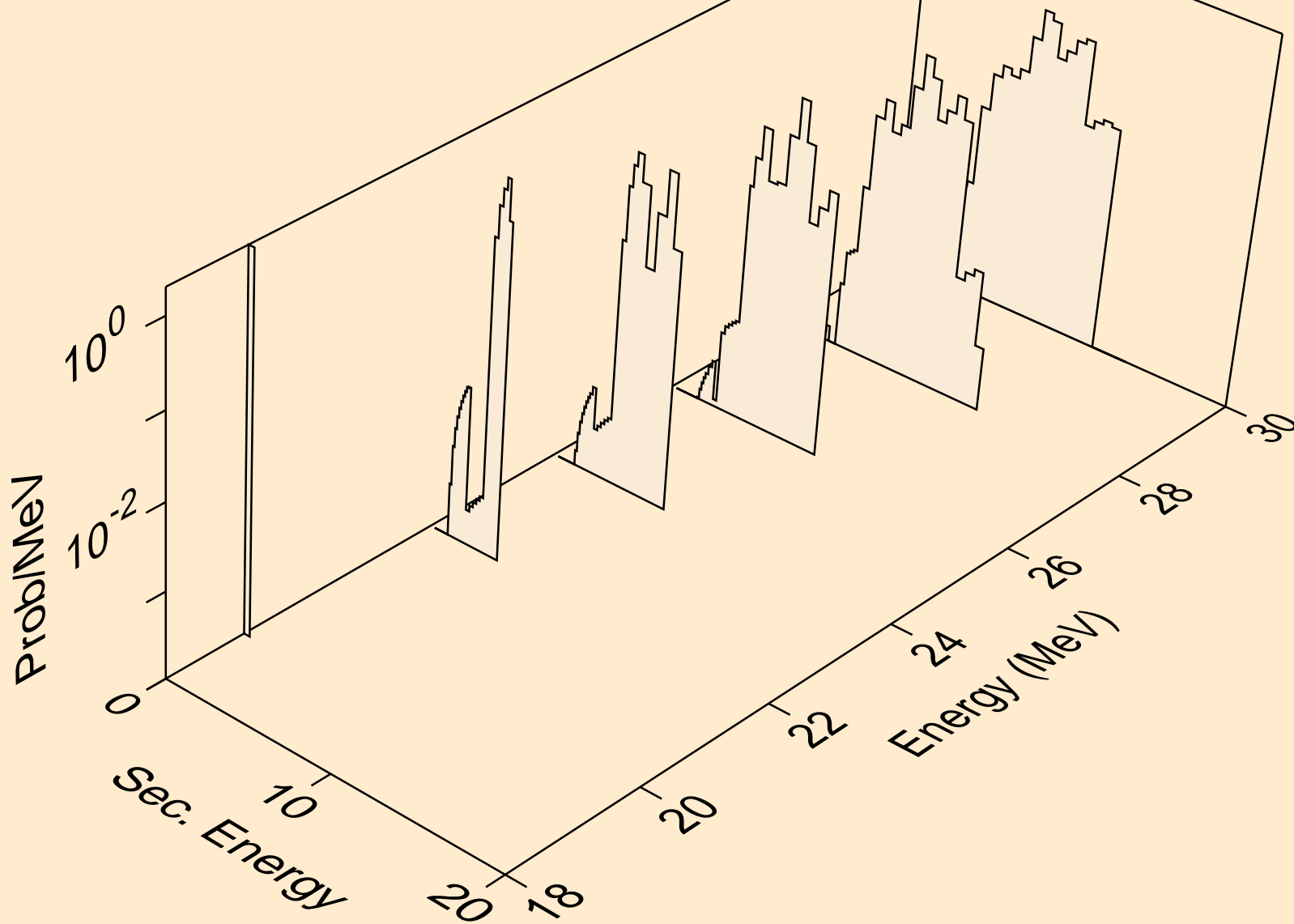

PU230 NEUTRON ACER TENDL-2019 LIBRARY; T=293.16K
protons from (n,2np)

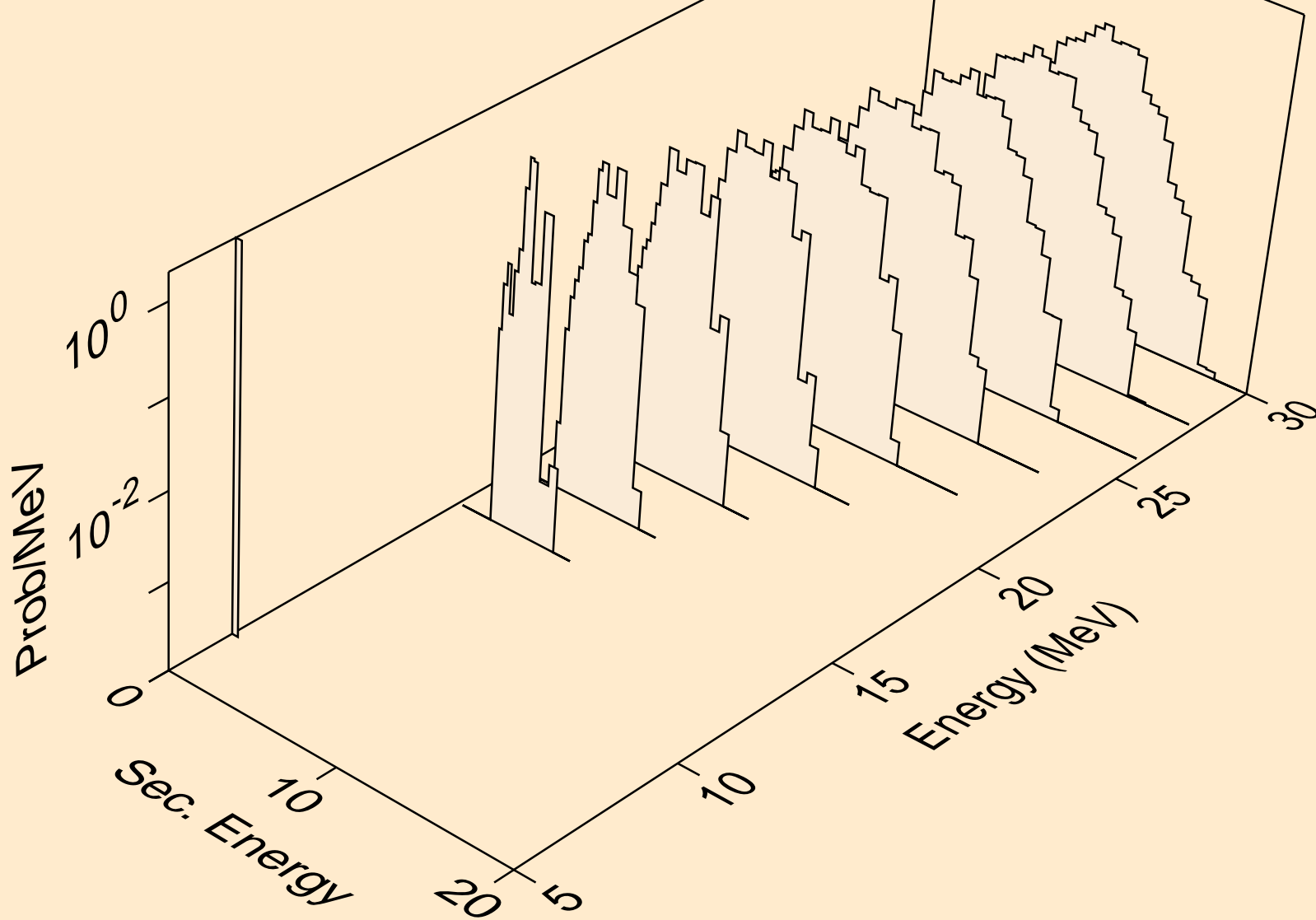

PU230 NEUTRON ACER TENDL-2019 LIBRARY; T=293.16K
protons from (n,npa)

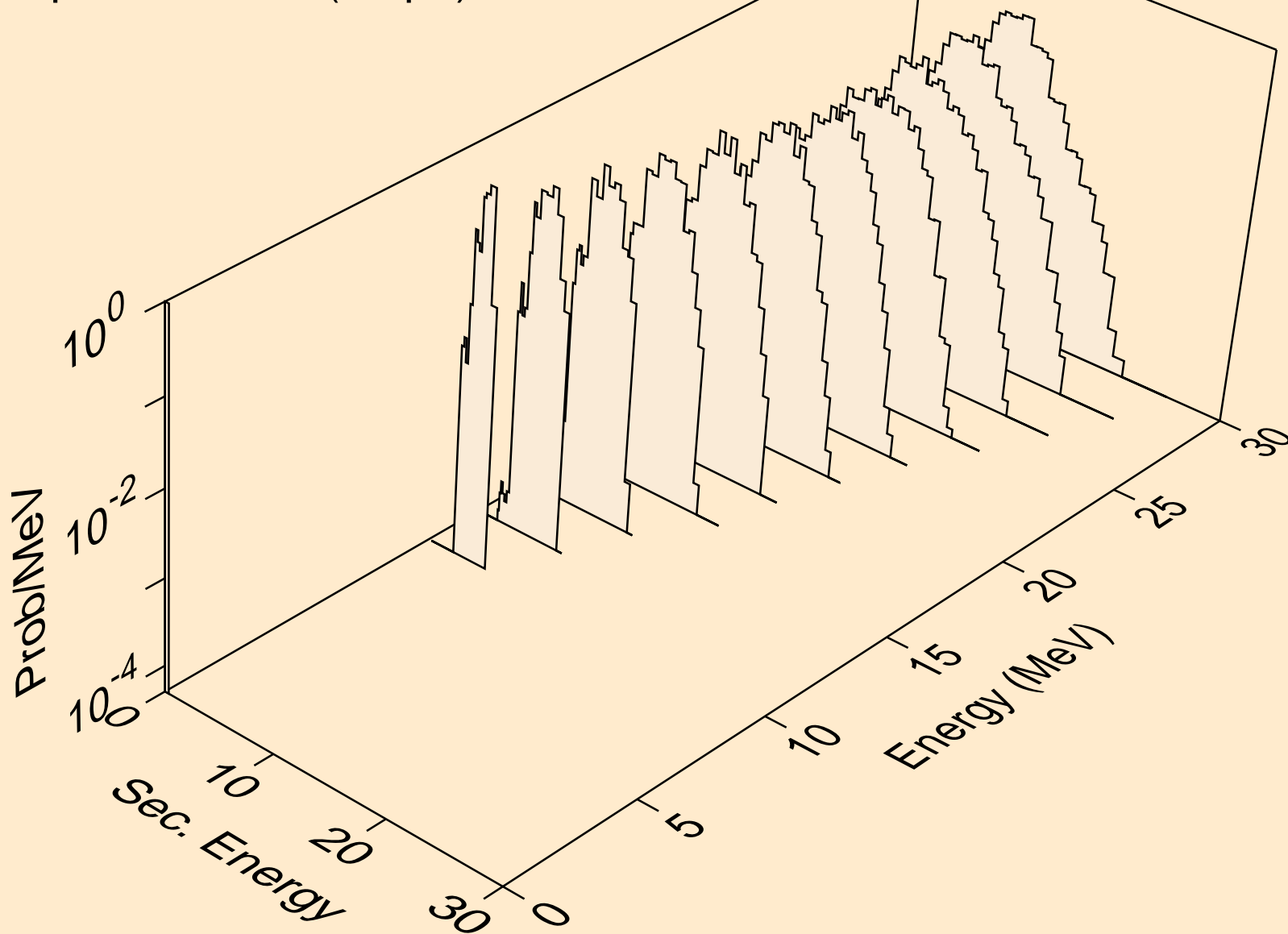

PU230 NEUTRON ACER TENDL-2019 LIBRARY; T=293.16K
protons from (n,p)

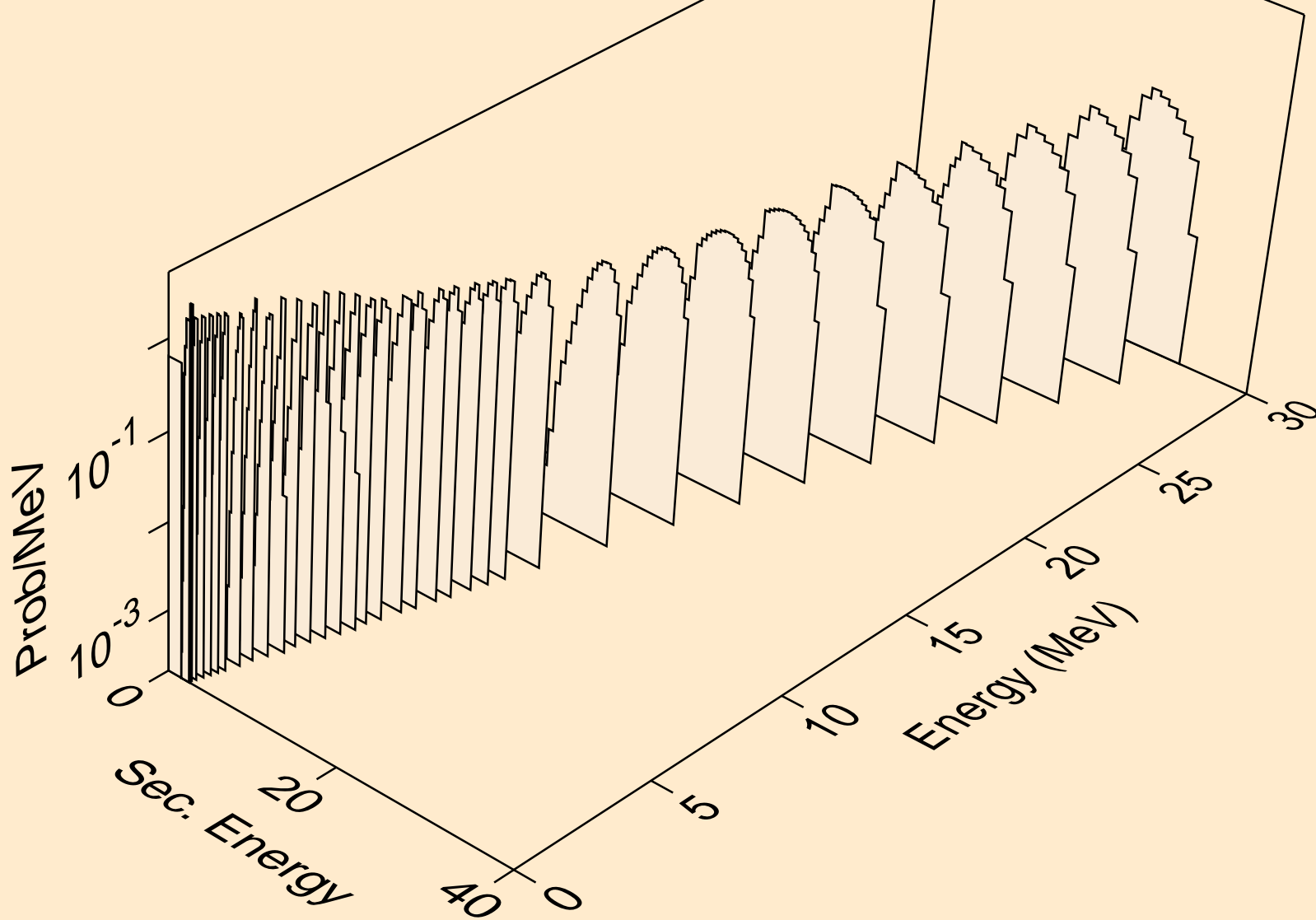

PU230 NEUTRON ACER TENDL-2019 LIBRARY; T=293.16K
protons from (n,2p)

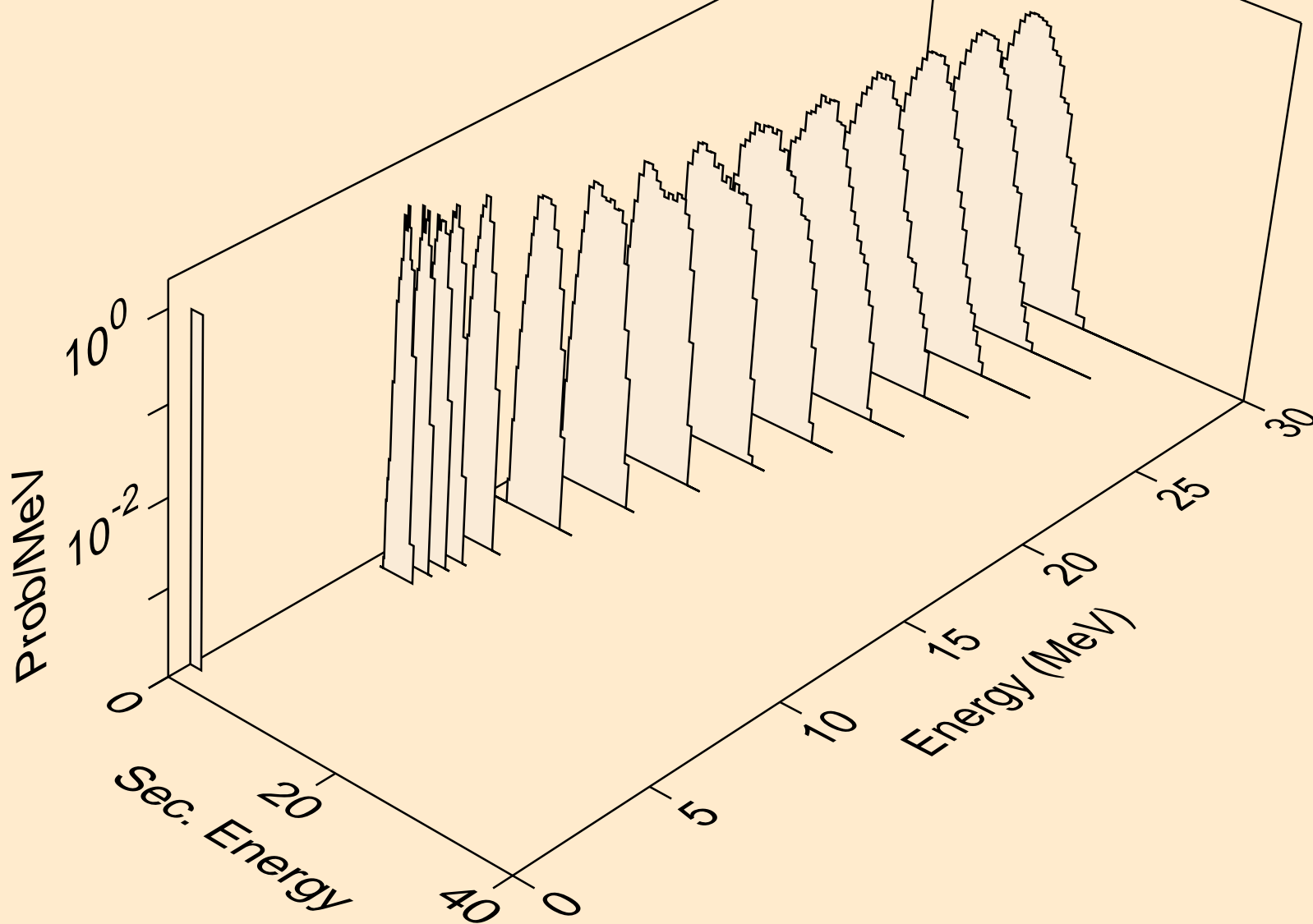

PU230 NEUTRON ACER TENDL-2019 LIBRARY; T=293.16K
protons from (n,p)

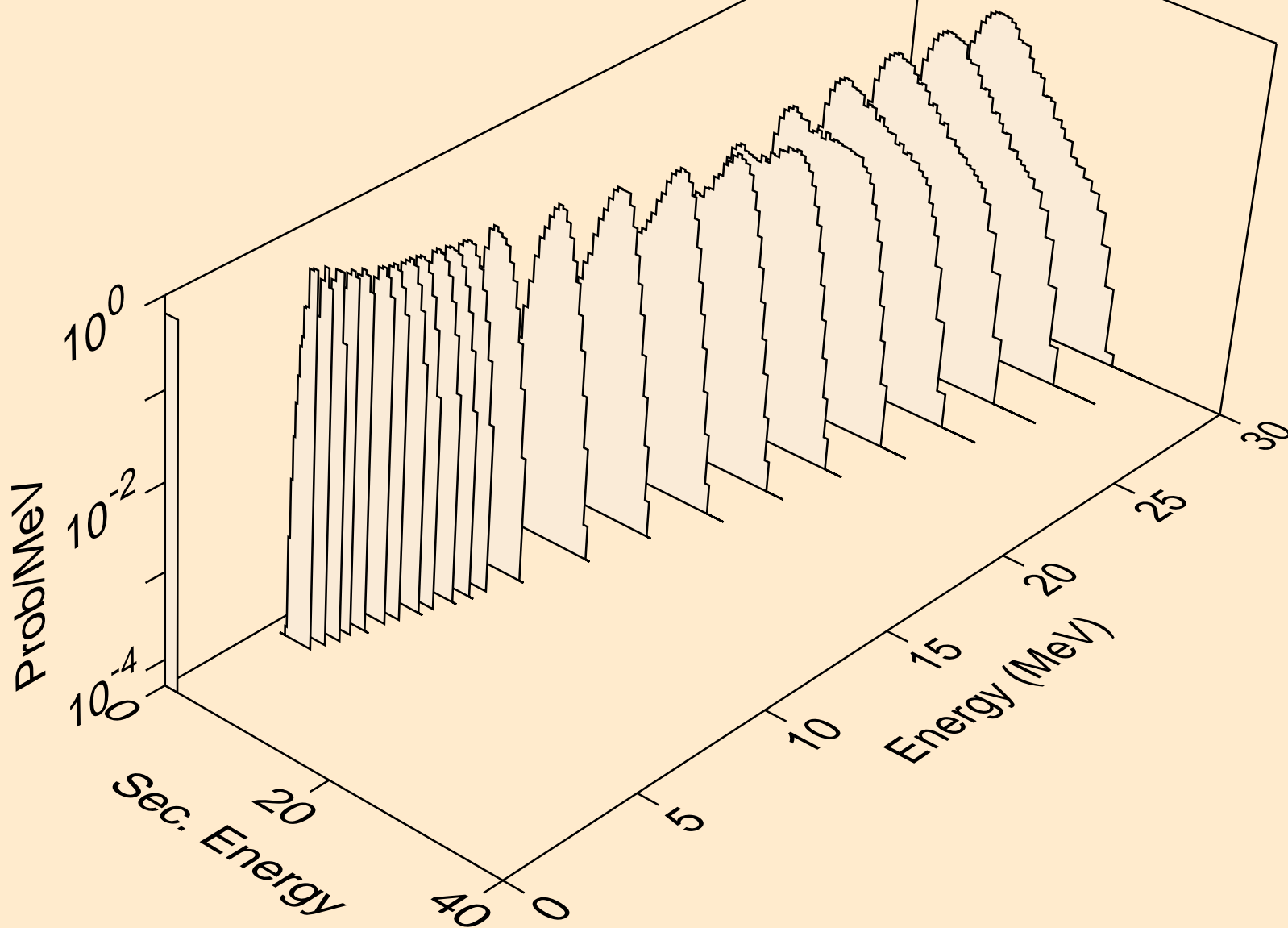

PU230 NEUTRON ACER TENDL-2019 LIBRARY; T=293.16K
protons from (n,pd)

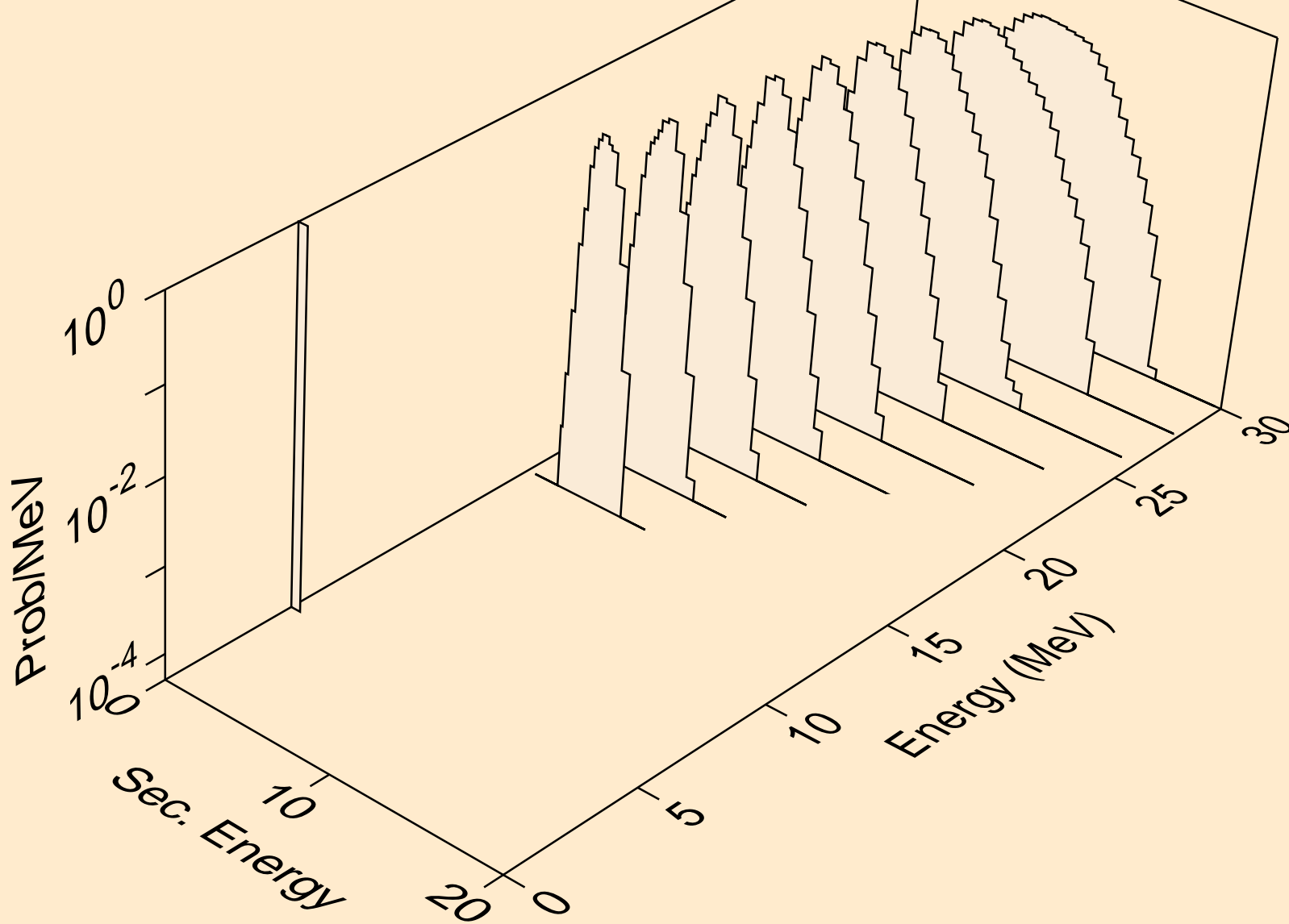

PU230 NEUTRON ACER TENDL-2019 LIBRARY; T=293.16K
protons from (n,pt)

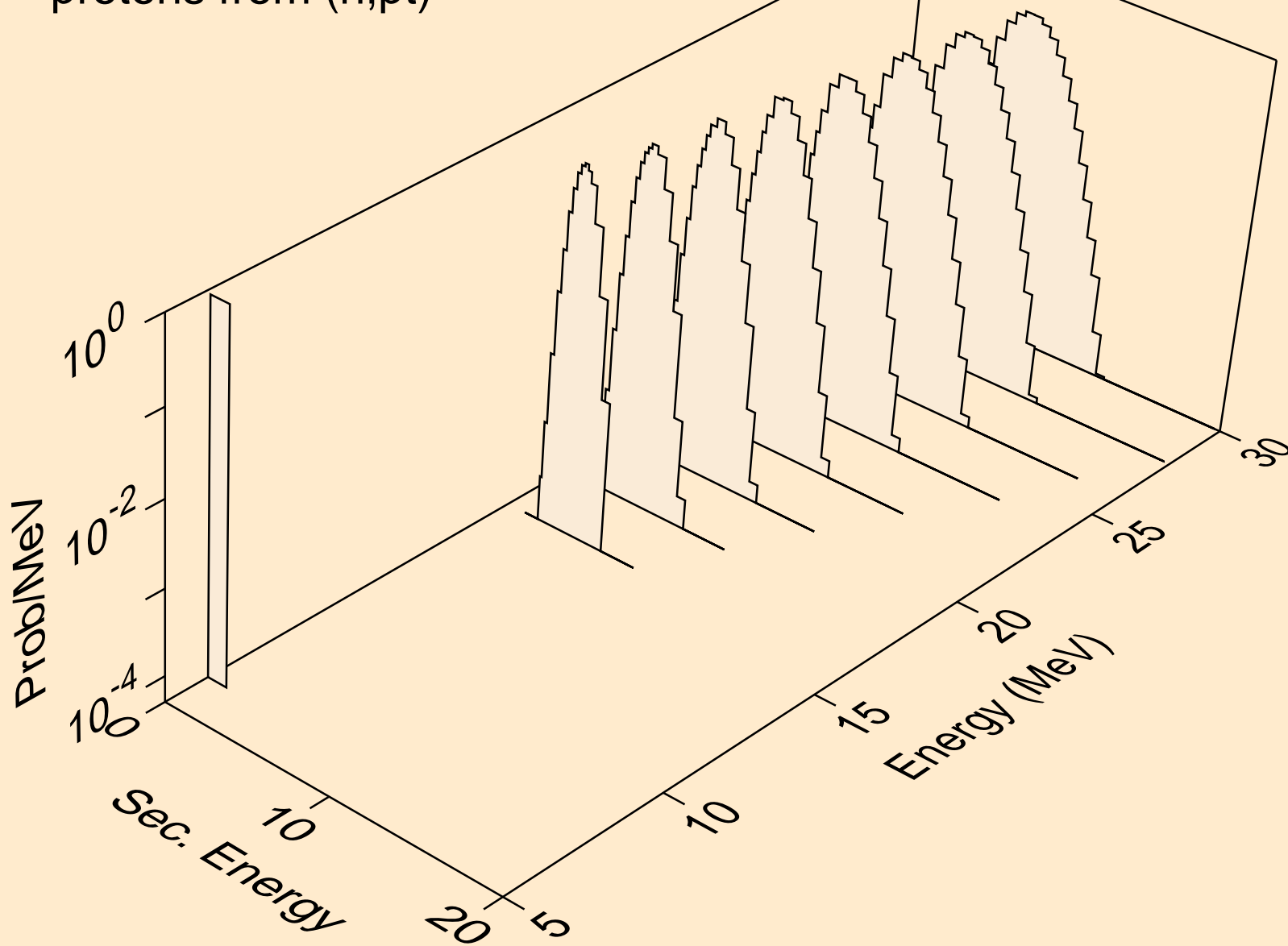

PU230 NEUTRON ACER TENDL-2019 LIBRARY; T=293.16K
deuterons from (n,x)

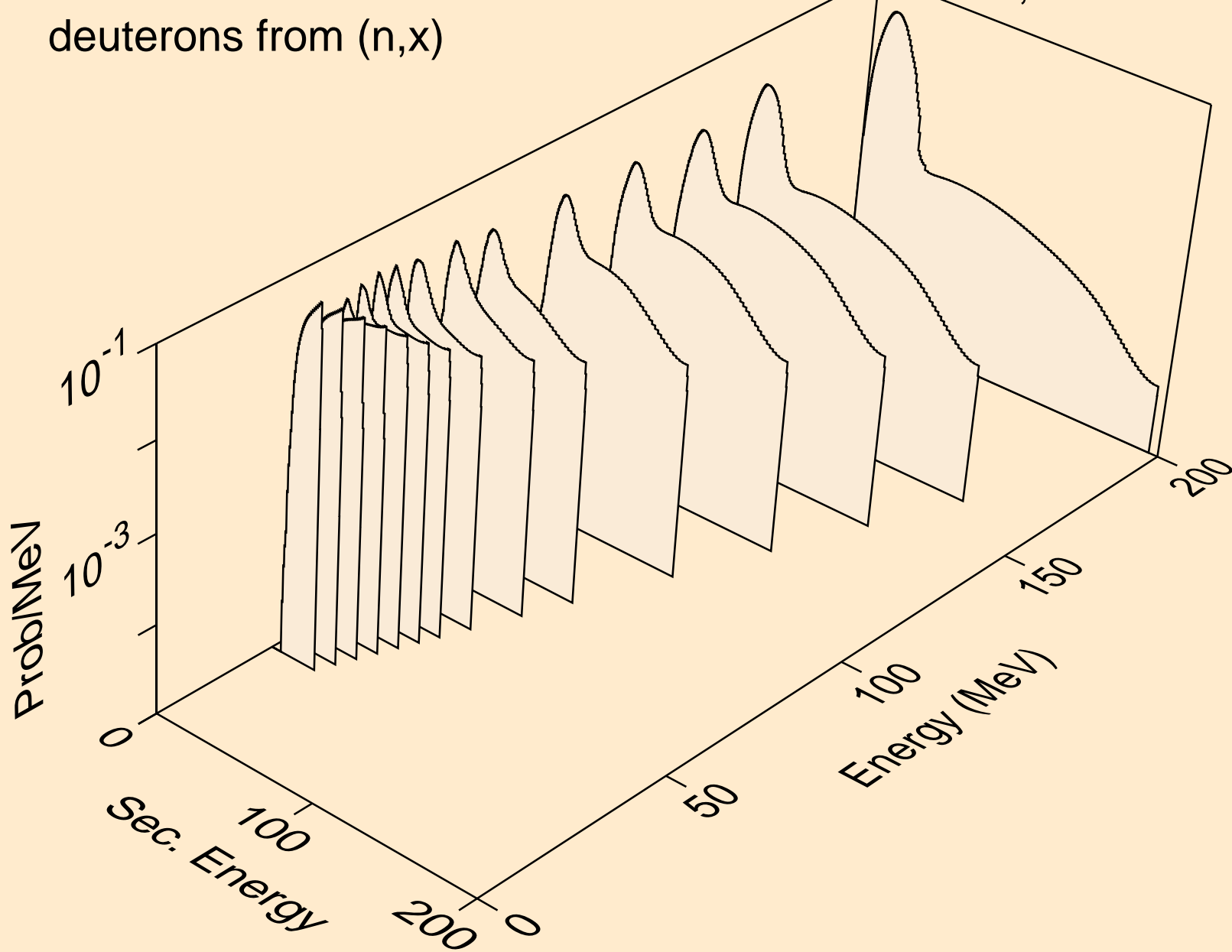

PU230 NEUTRON ACER TENDL-2019 LIBRARY; T=293.16K
deuterons from (n,2nd)

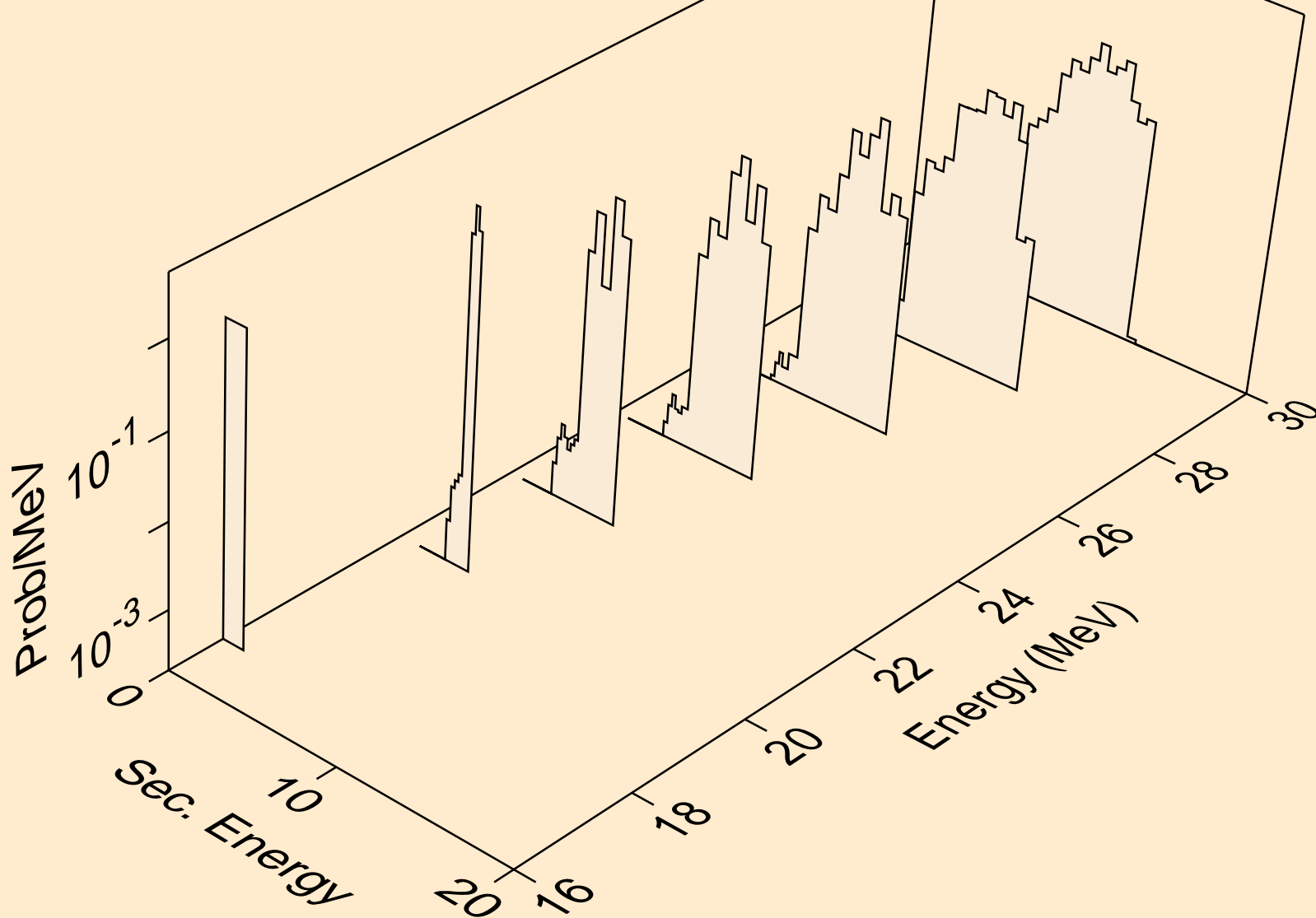

PU230 NEUTRON ACER TENDL-2019 LIBRARY; T=293.16K
deuterons from (n,n*)d

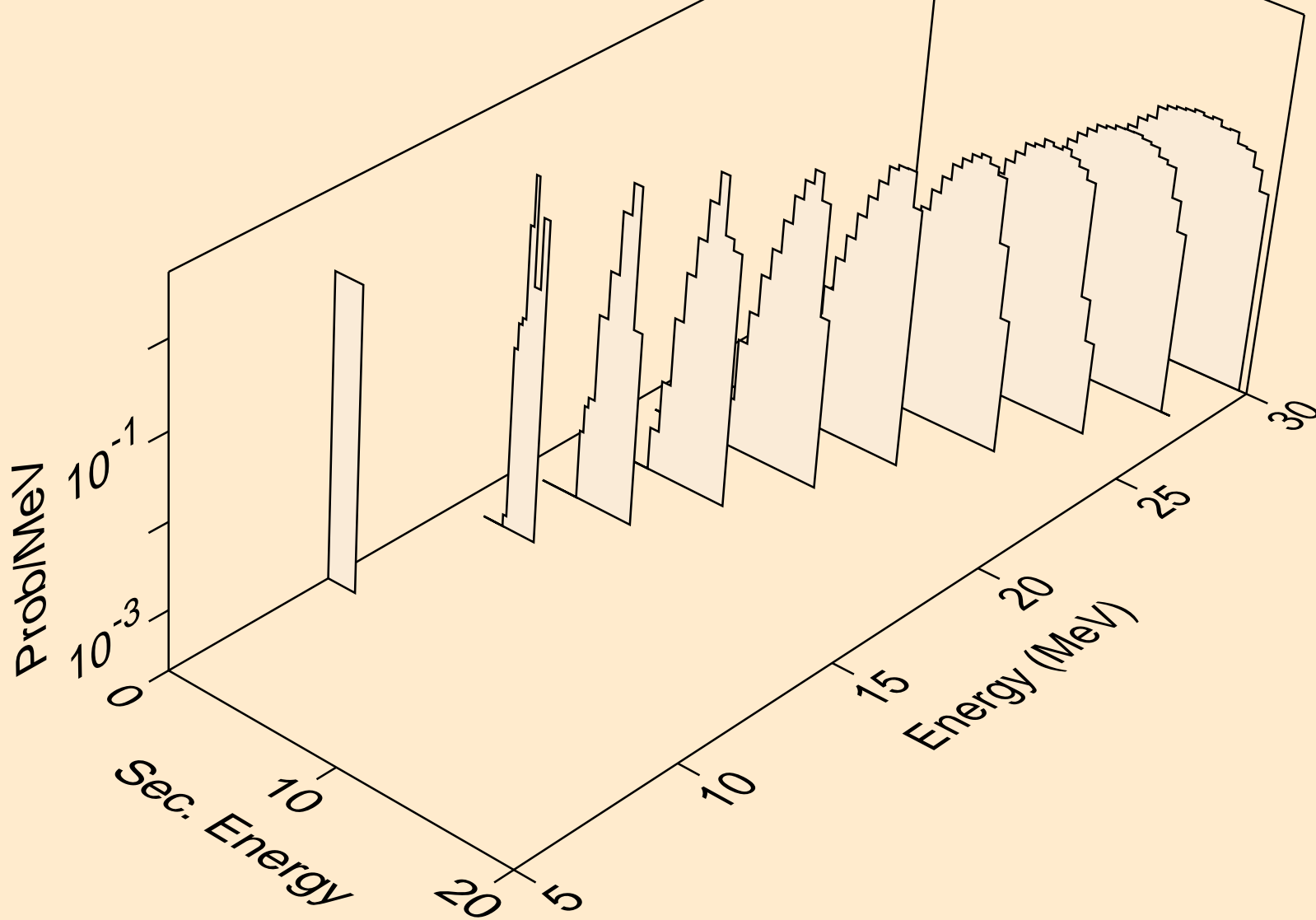

PU230 NEUTRON ACER TENDL-2019 LIBRARY; T=293.16K
deuterons from (n,d)

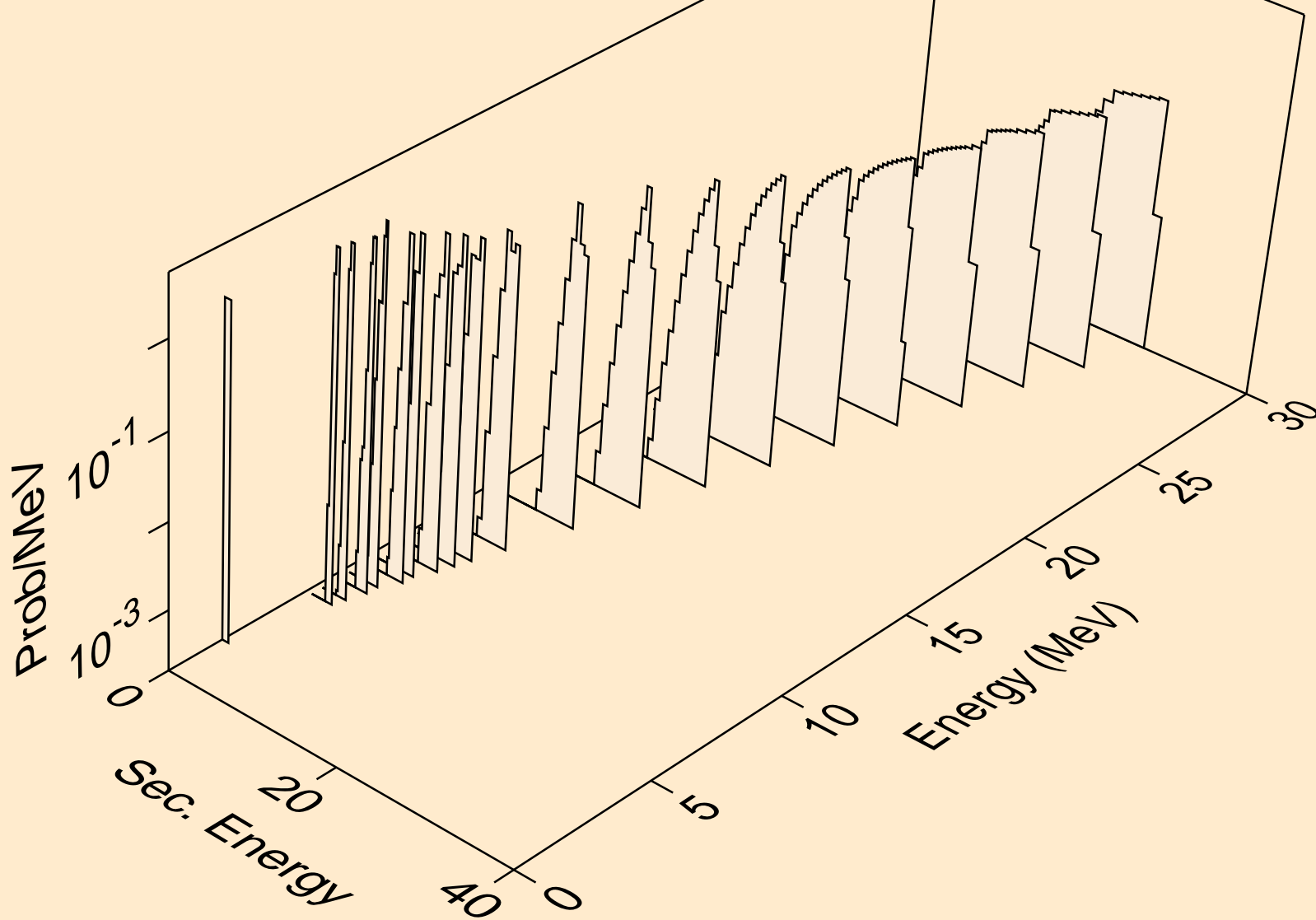

PU230 NEUTRON ACER TENDL-2019 LIBRARY; T=293.16K
deuterons from (n,pd)

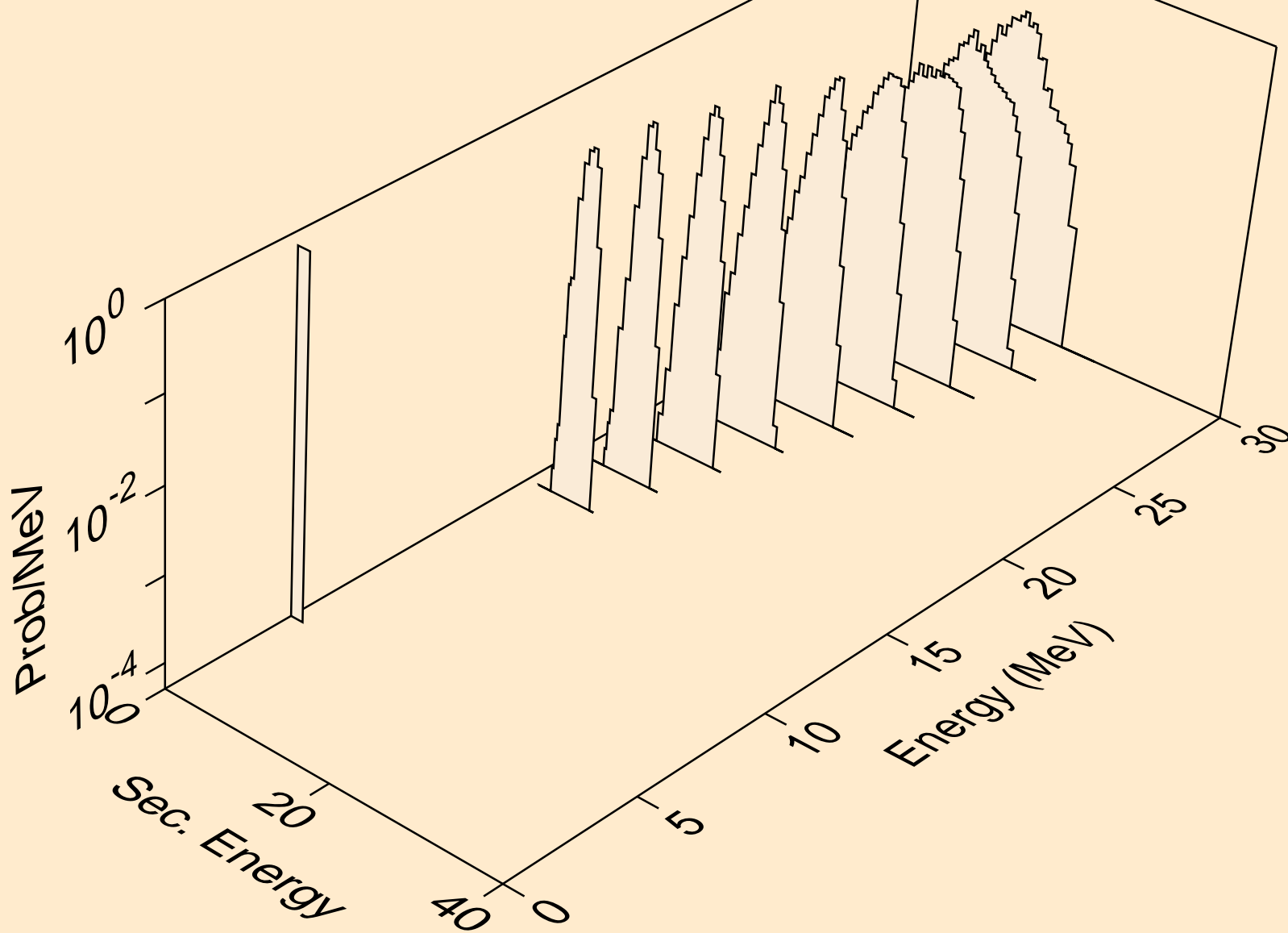

PU230 NEUTRON ACER TENDL-2019 LIBRARY; T=293.16K
deuterons from (n,da)

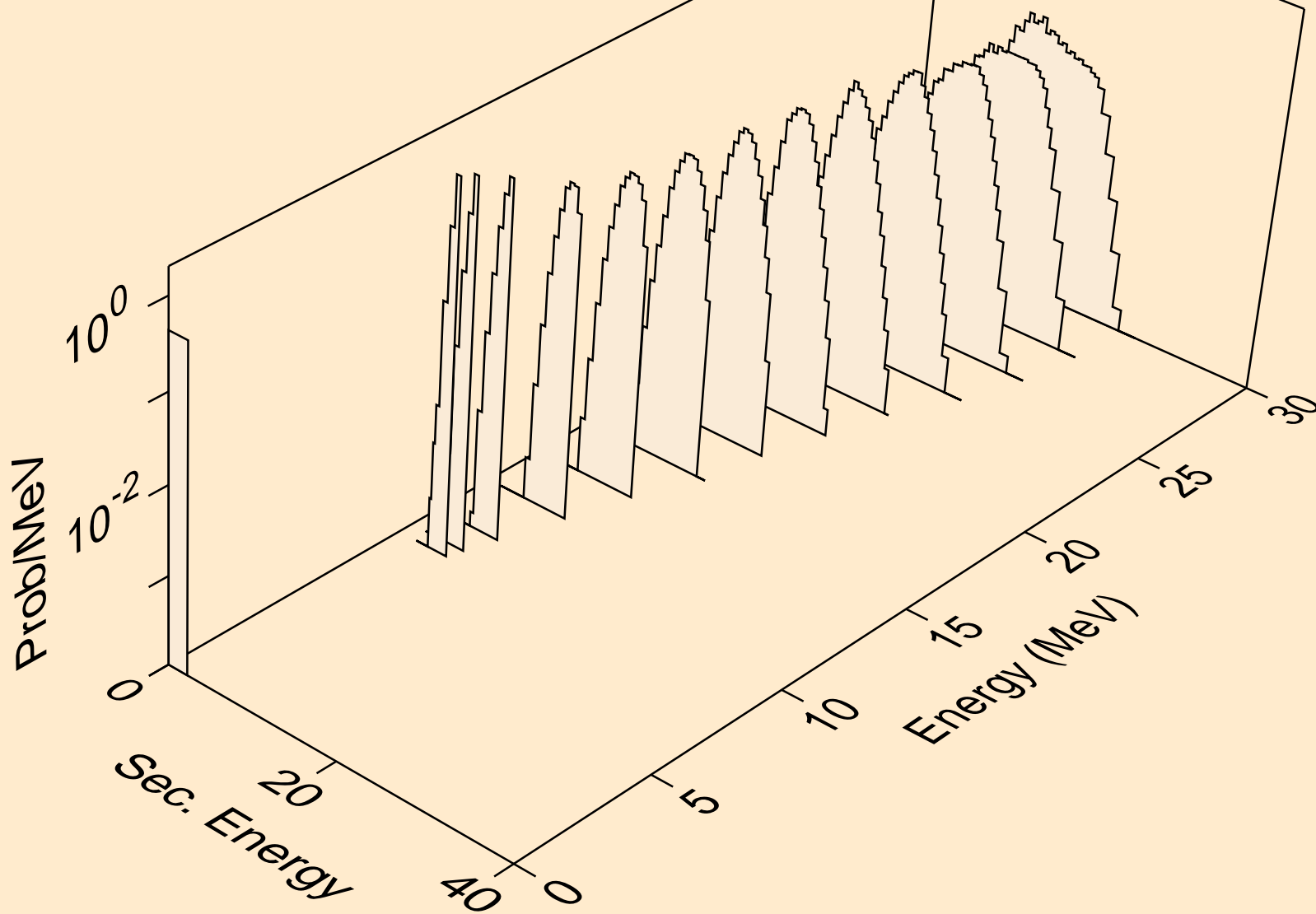

PU230 NEUTRON ACER TENDL-2019 LIBRARY; T=293.16K
tritons from (n,x)

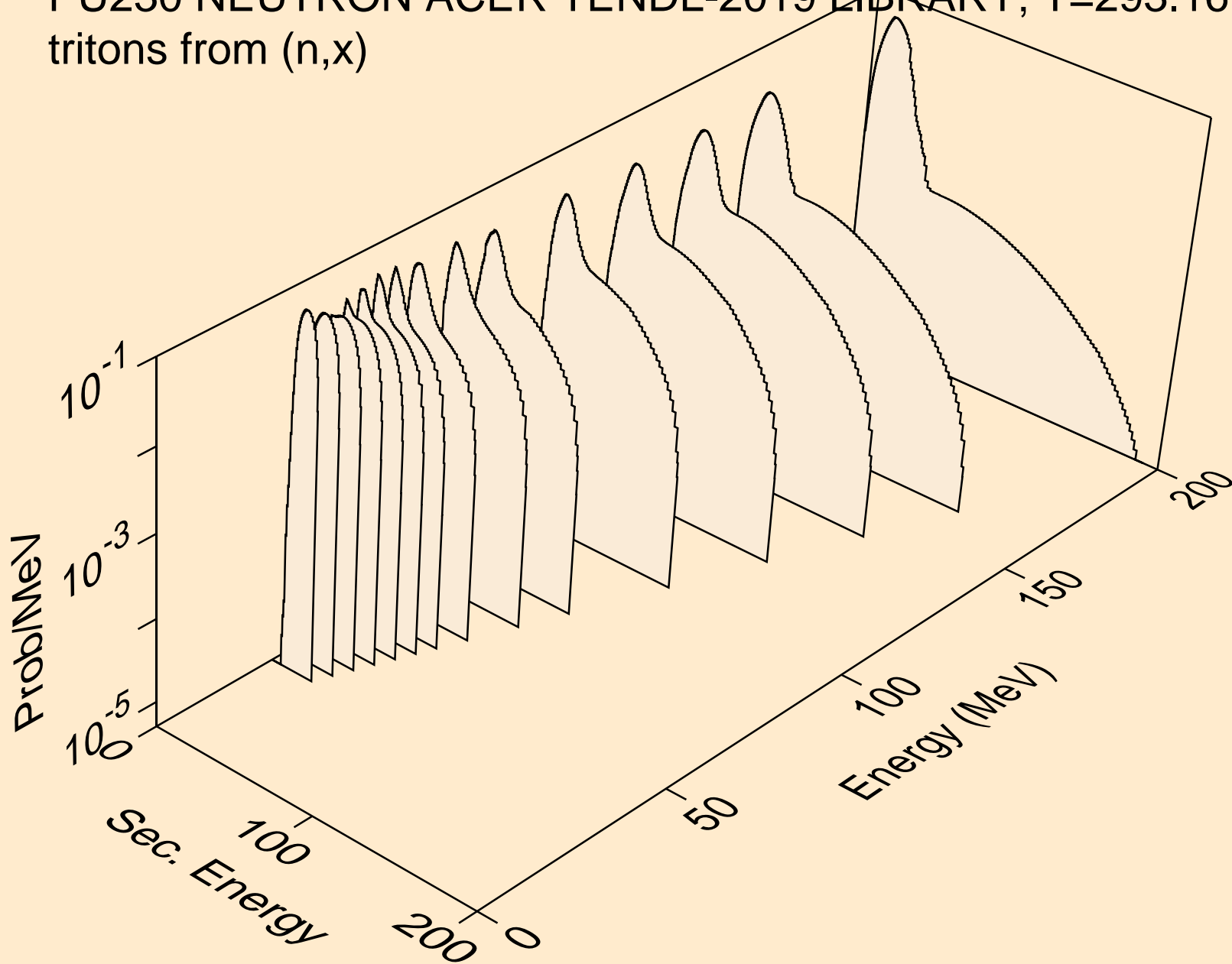

PU230 NEUTRON ACER TENDL-2019 LIBRARY; T=293.16K
tritons from (n,n*)t

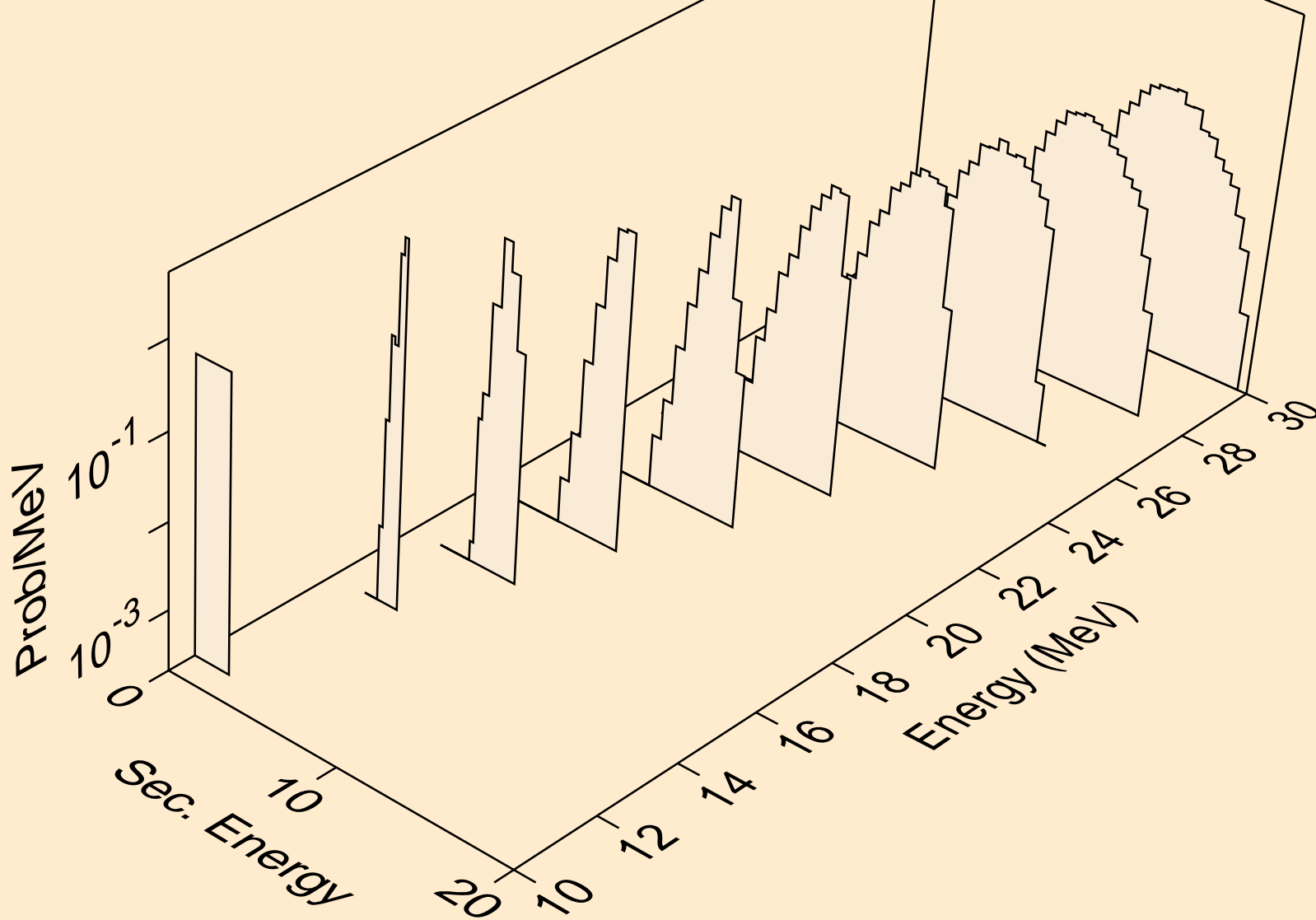

PU230 NEUTRON ACER TENDL-2019 LIBRARY; T=293.16K
tritons from (n,t)

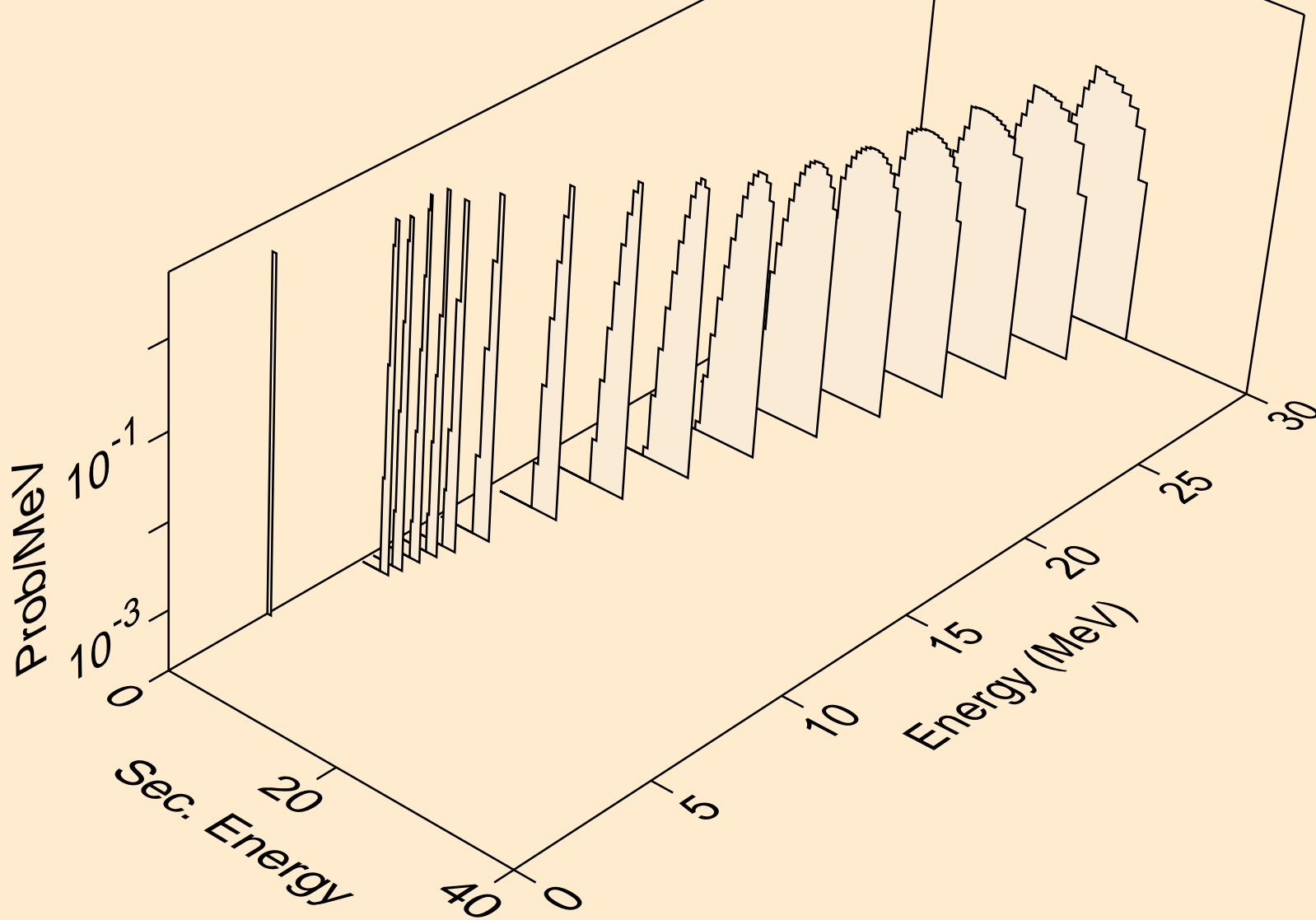

PU230 NEUTRON ACER TENDL-2019 LIBRARY; T=293.16K
tritons from (n,pt)

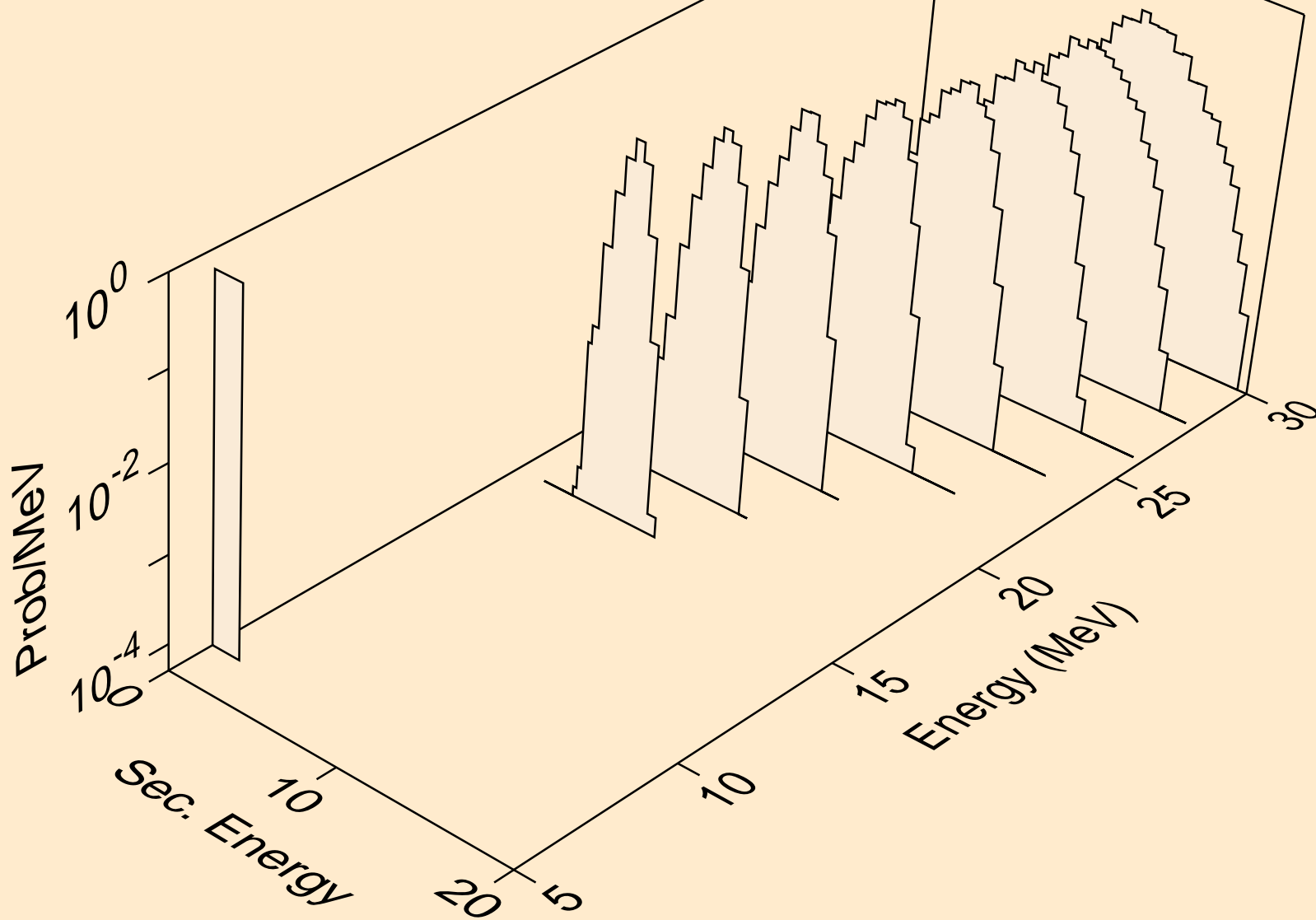

PU230 NEUTRON ACER TENDL-2019 LIBRARY; T=293.16K
he3s from (n,x)

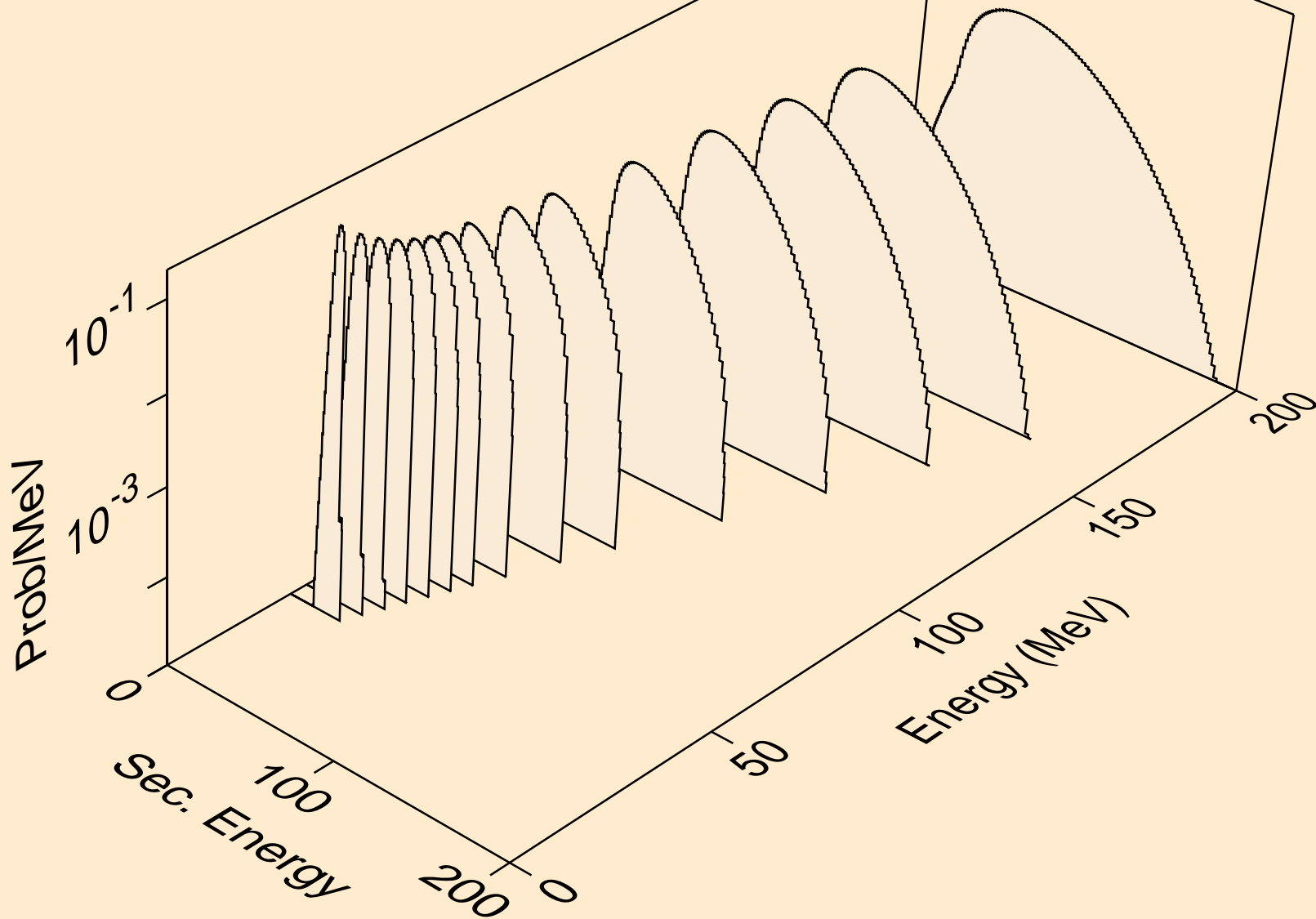

PU230 NEUTRON ACER TENDL-2019 LIBRARY; T=293.16K
he3s from (n,n*)he3

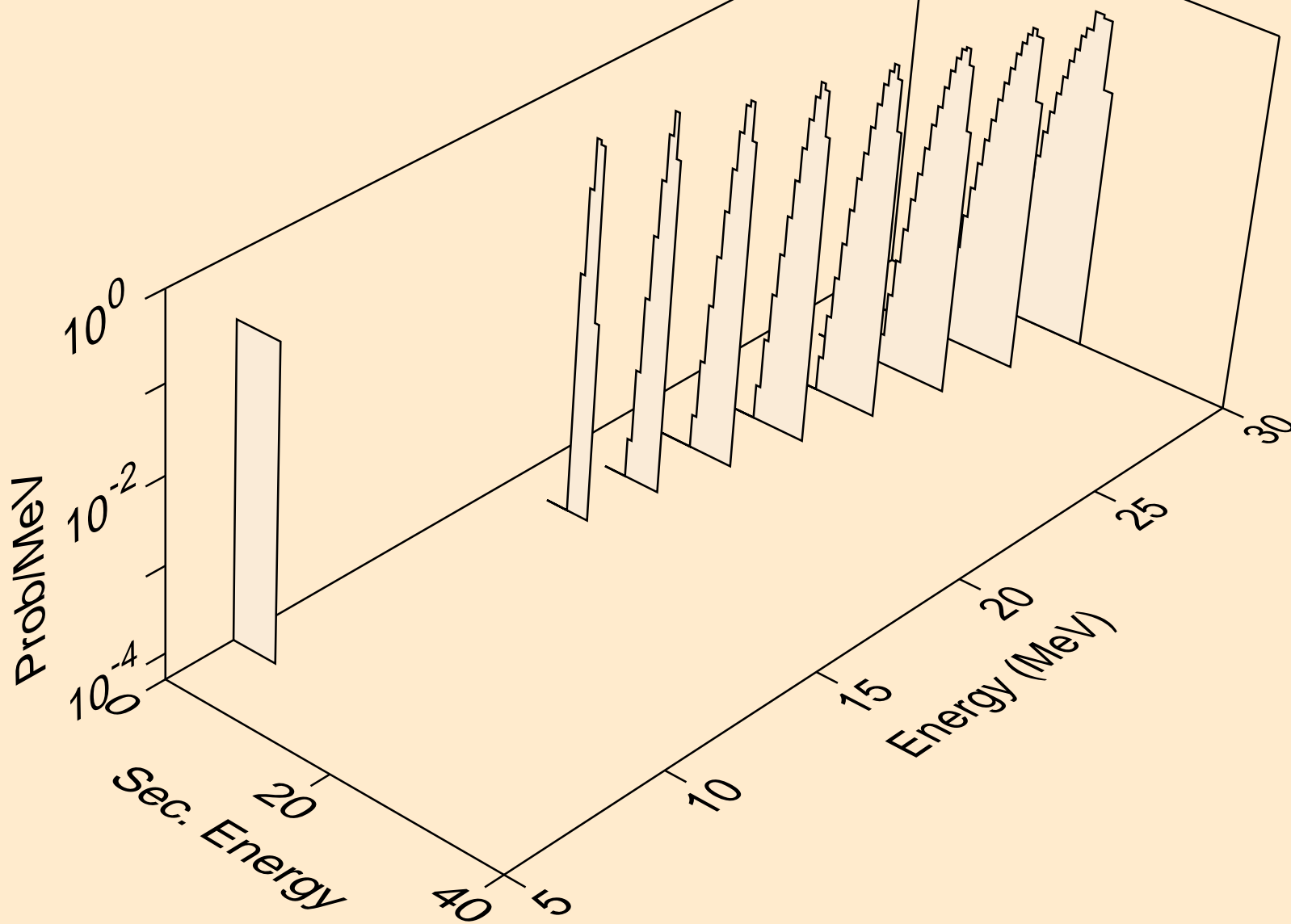

PU230 NEUTRON ACER TENDL-2019 LIBRARY; T=293.16K
he3s from (n,he3)

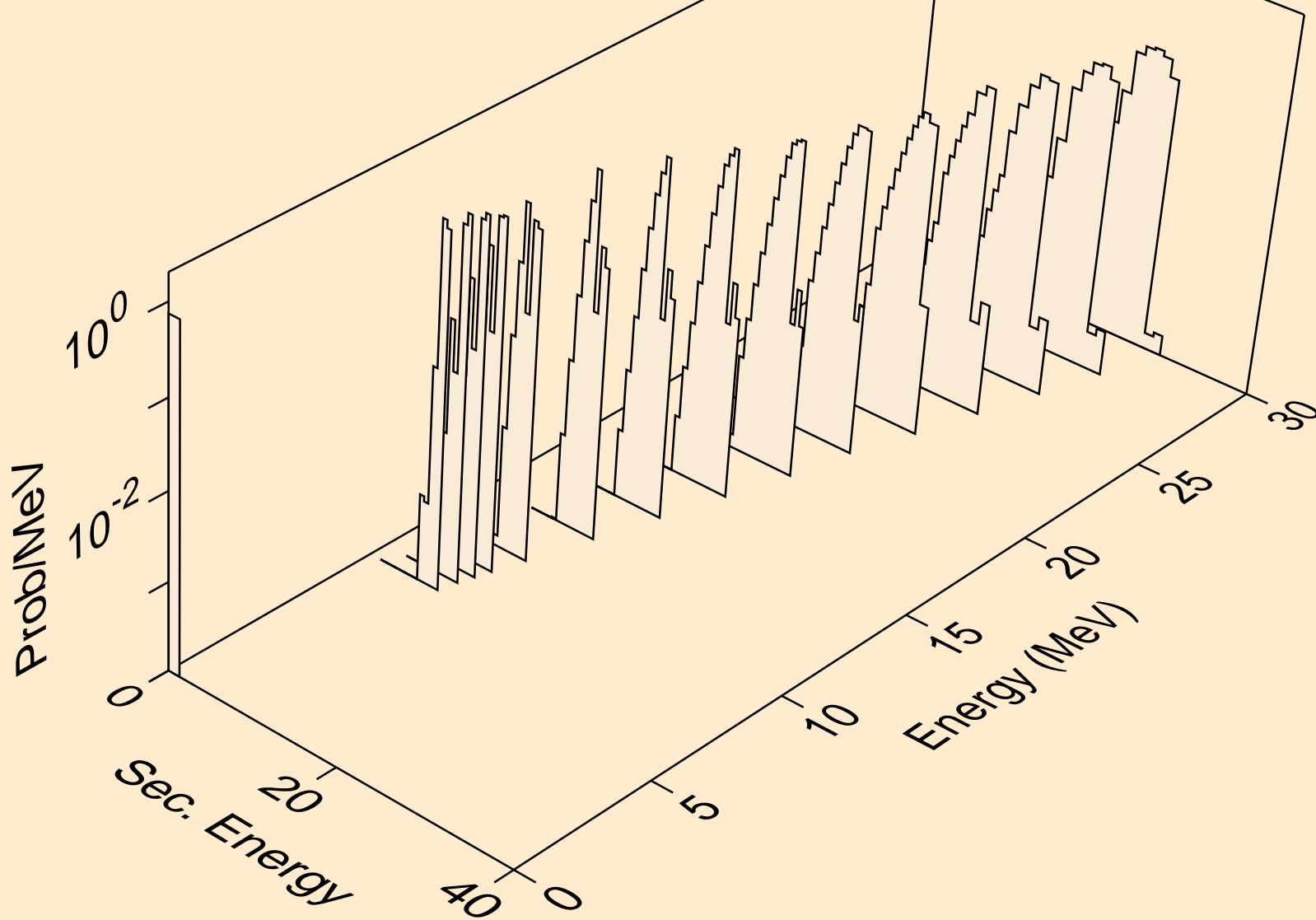

PU230 NEUTRON ACER TENDL-2019 LIBRARY; T=293.16K
alphas from (n,x)

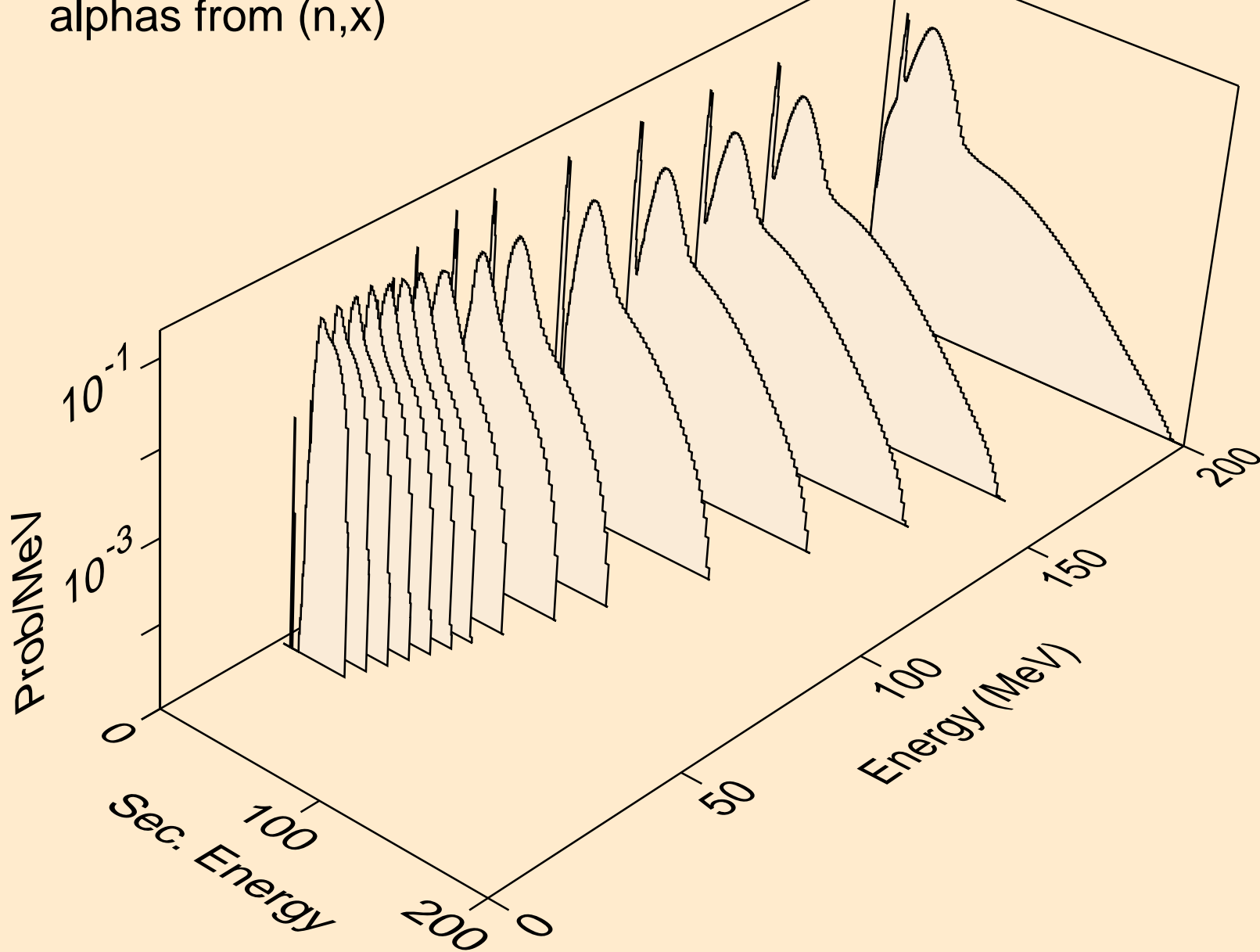

PU230 NEUTRON ACER TENDL-2019 LIBRARY; T=293.16K
alphas from (n,n*)a

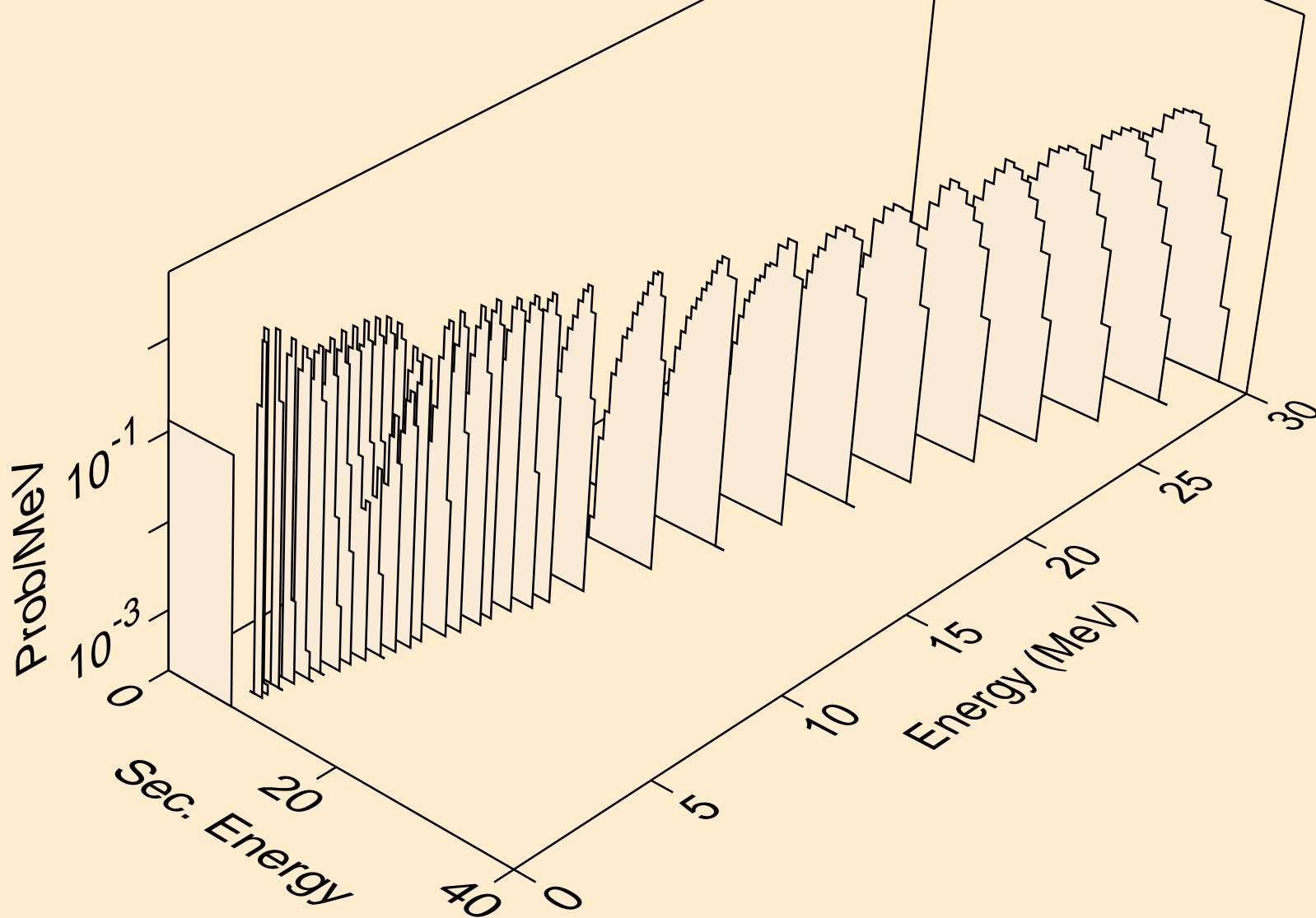

PU230 NEUTRON ACER TENDL-2019 LIBRARY; T=293.16K
alphas from (n,2n)a

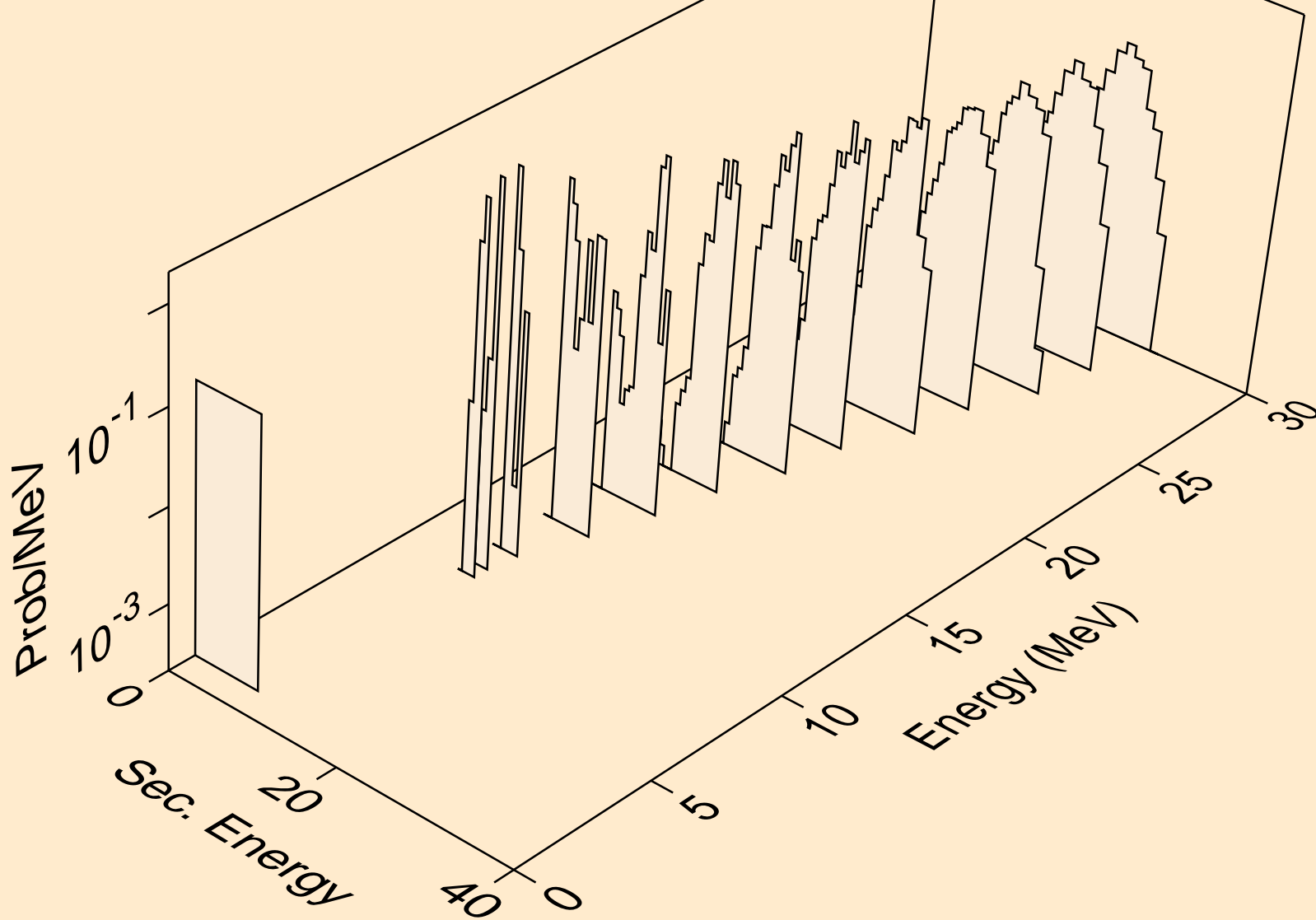

PU230 NEUTRON ACER TENDL-2019 LIBRARY; T=293.16K
alphas from (n,3n)a

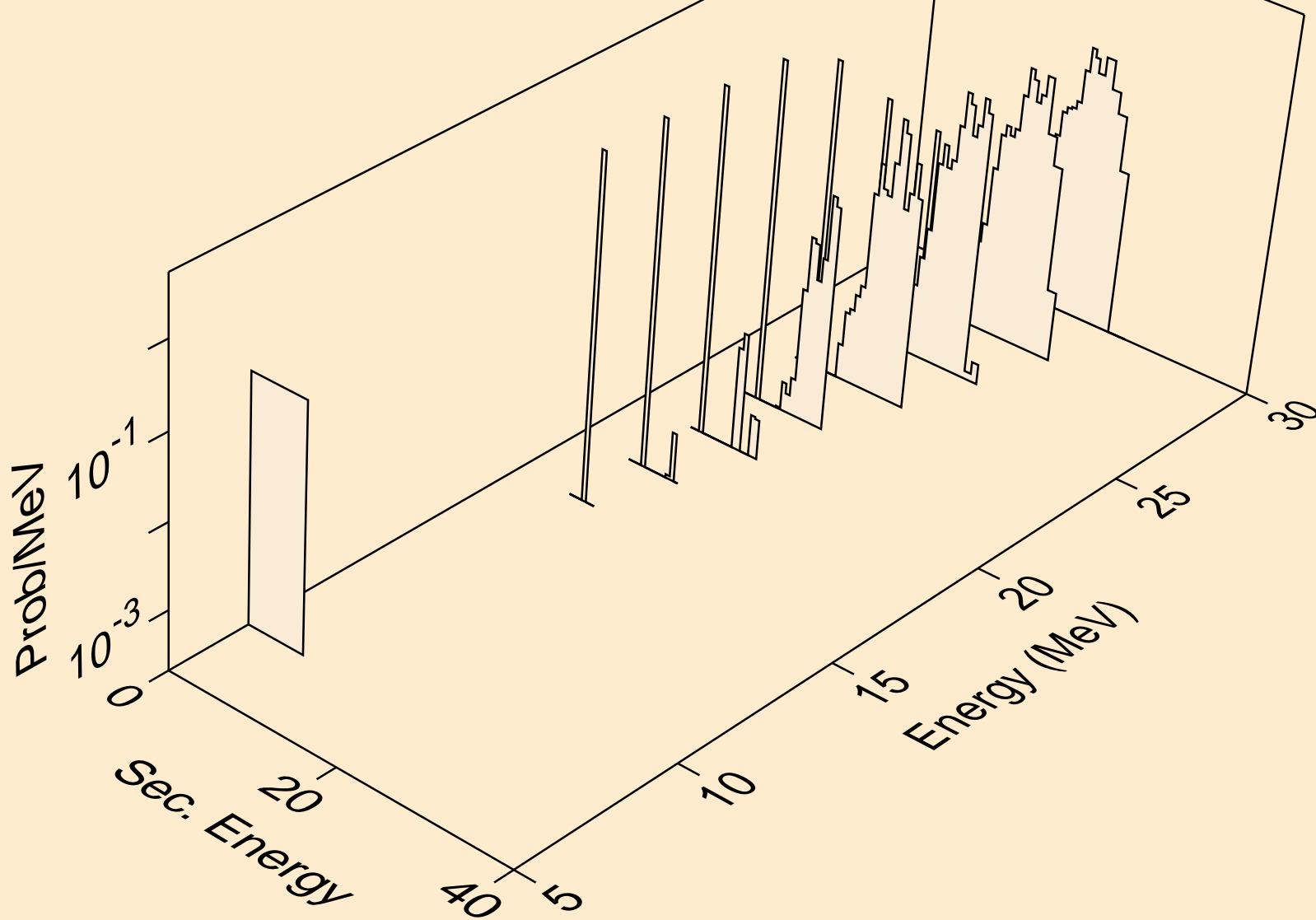

PU230 NEUTRON ACER TENDL-2019 LIBRARY; T=293.16K
alphas from (n,n*)2a

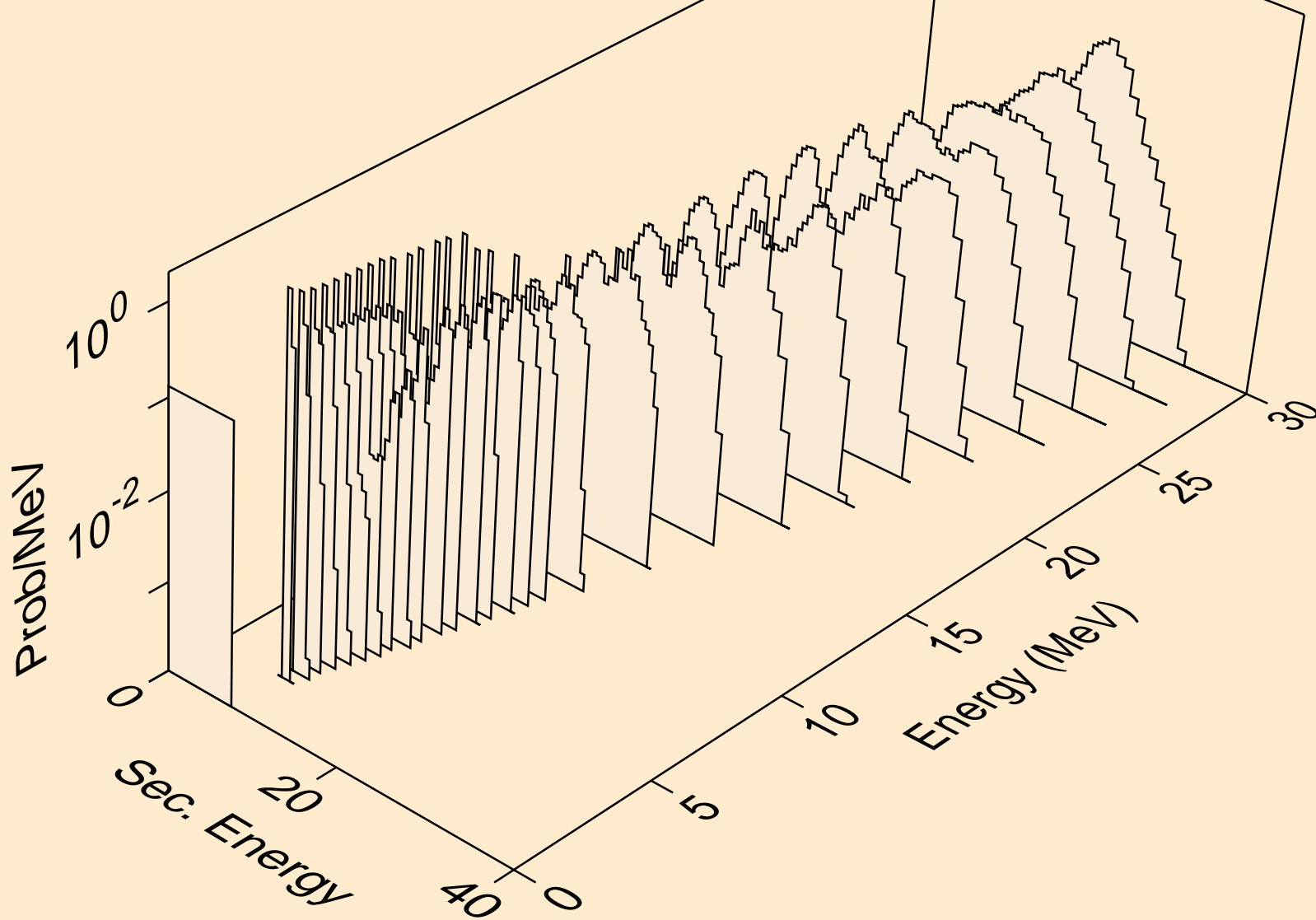

PU230 NEUTRON ACER TENDL-2019 LIBRARY; T=293.16K
alphas from (n,2n)2a

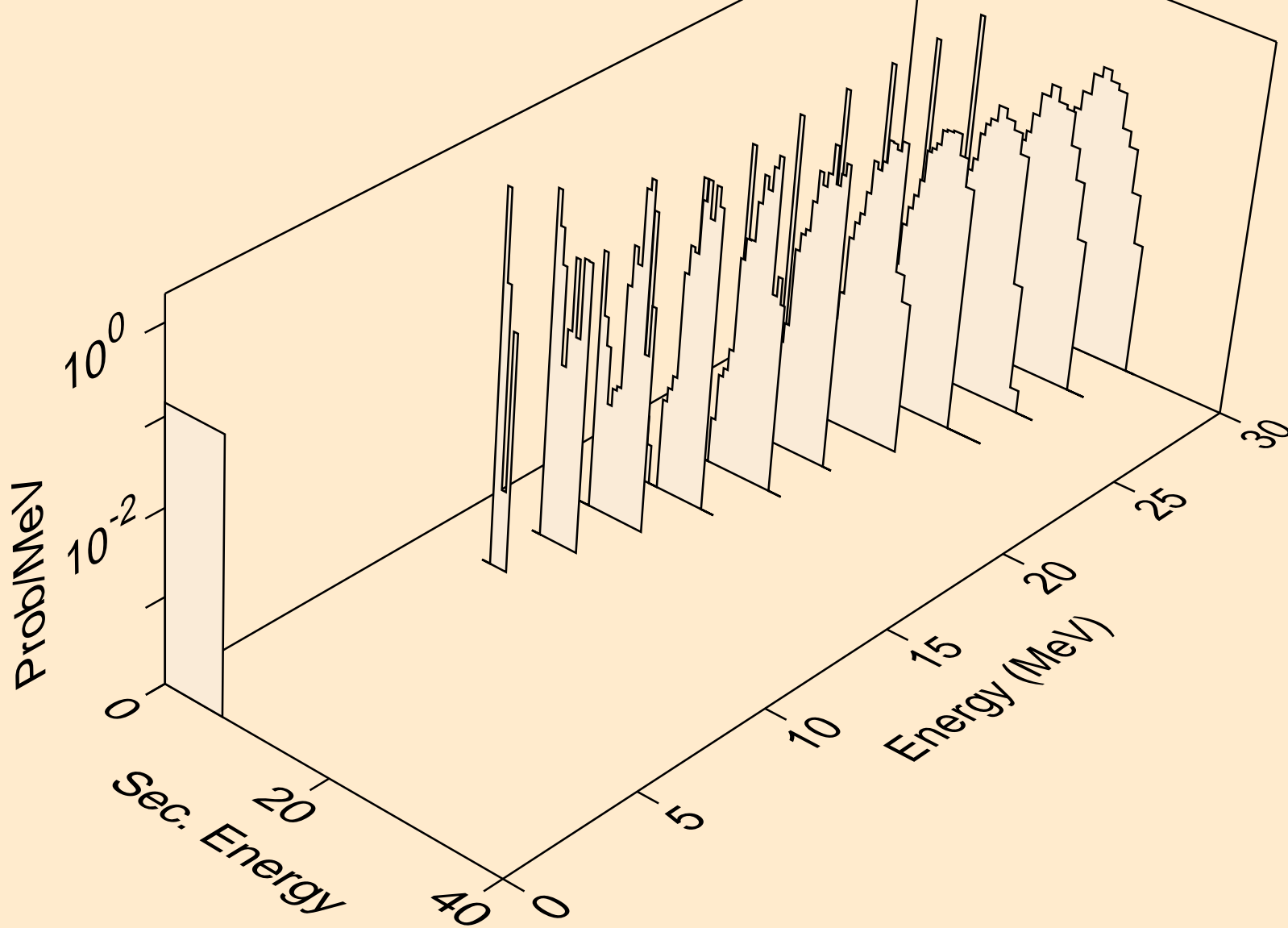

PU230 NEUTRON ACER TENDL-2019 LIBRARY; T=293.16K
alphas from (n,npa)

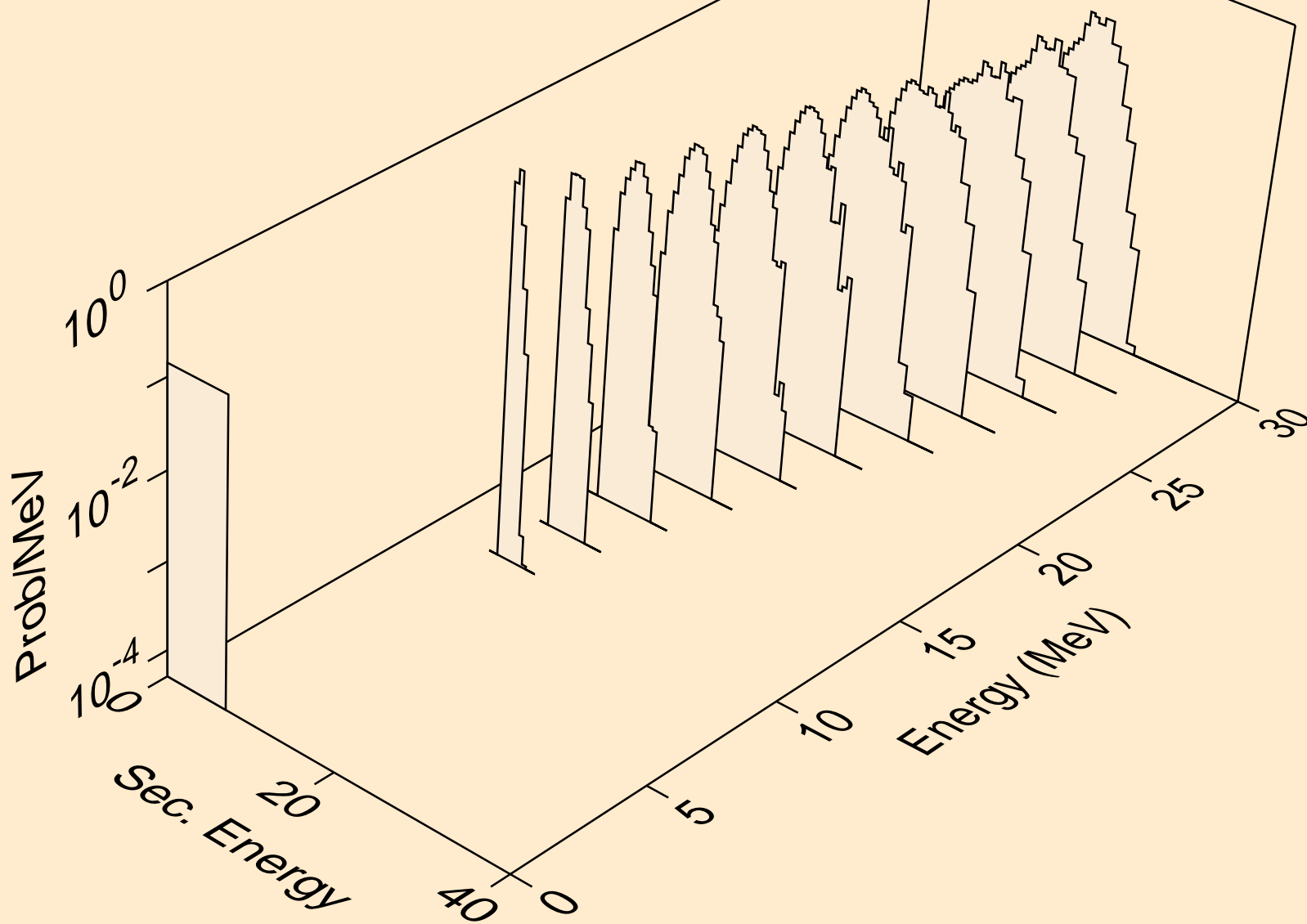

PU230 NEUTRON ACER TENDL-2019 LIBRARY; T=293.16K
alphas from (n,a)

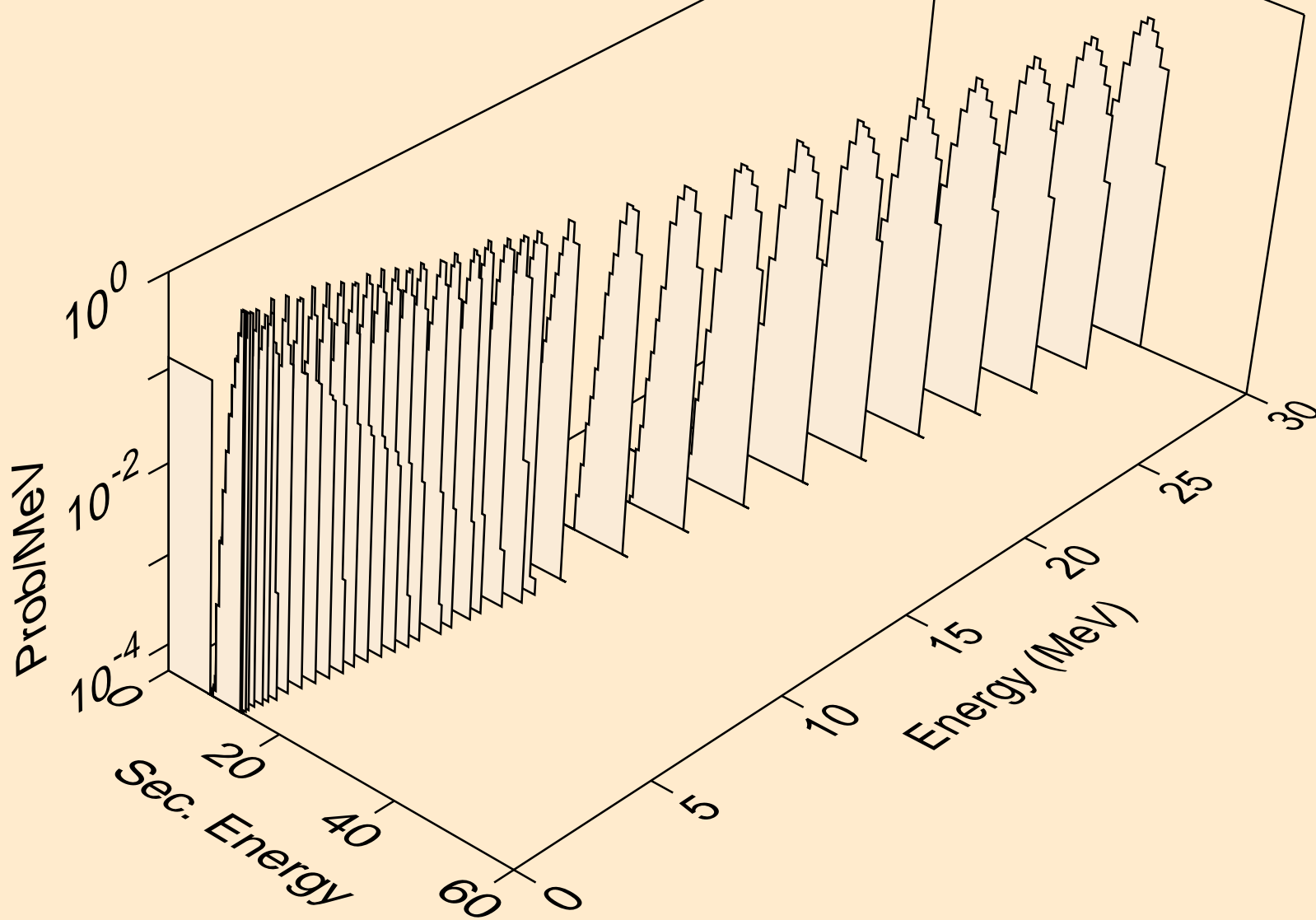

PU230 NEUTRON ACER TENDL-2019 LIBRARY; T=293.16K
alphas from (n,2a)

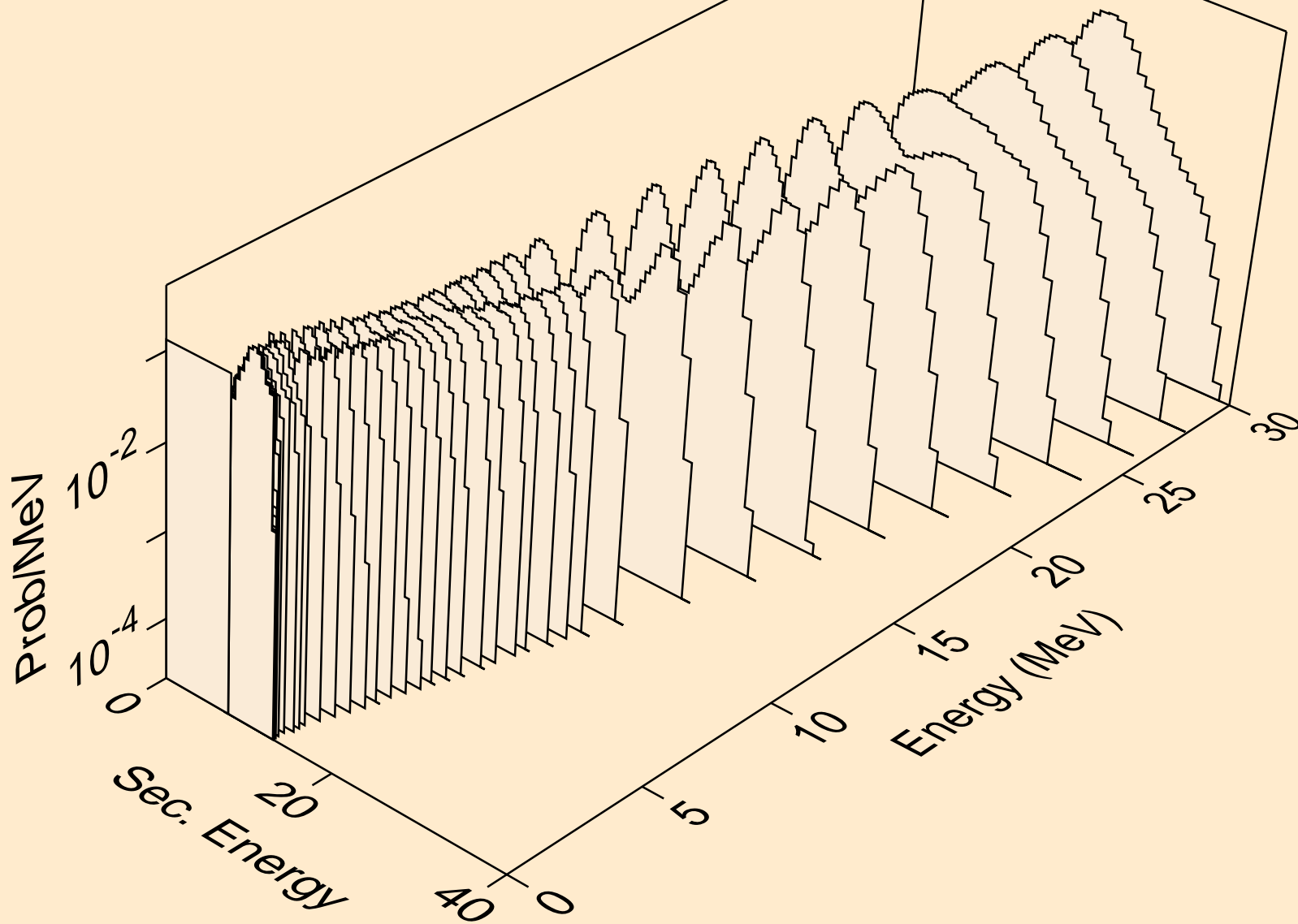

PU230 NEUTRON ACER TENDL-2019 LIBRARY; T=293.16K
alphas from (n,pa)

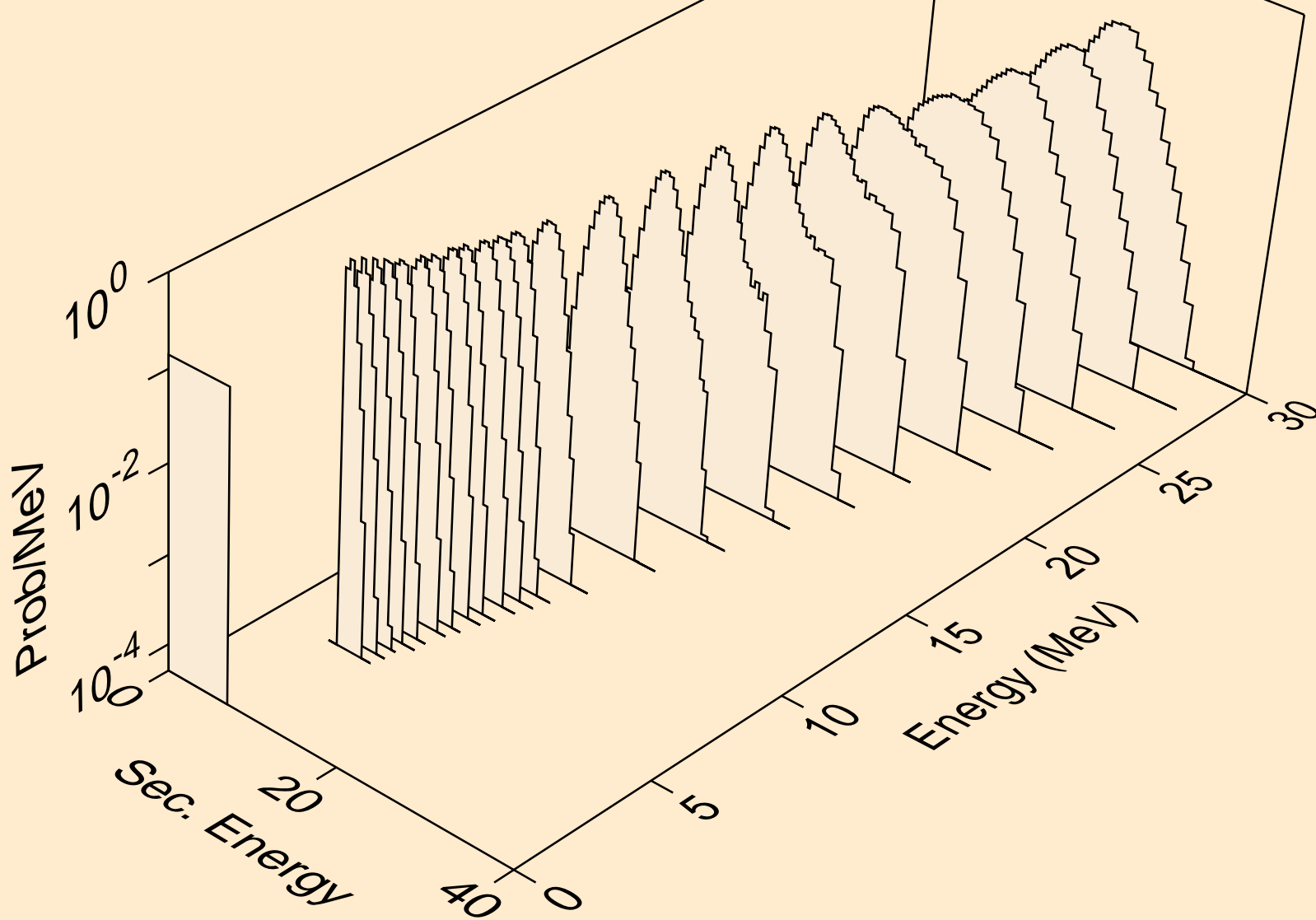

PU230 NEUTRON ACER TENDL-2019 LIBRARY; T=293.16K
alphas from (n,da)

