

SM133 NEUTRON ACER TENDL-2019 LIBRARY; T=293.16K

Principal cross sections

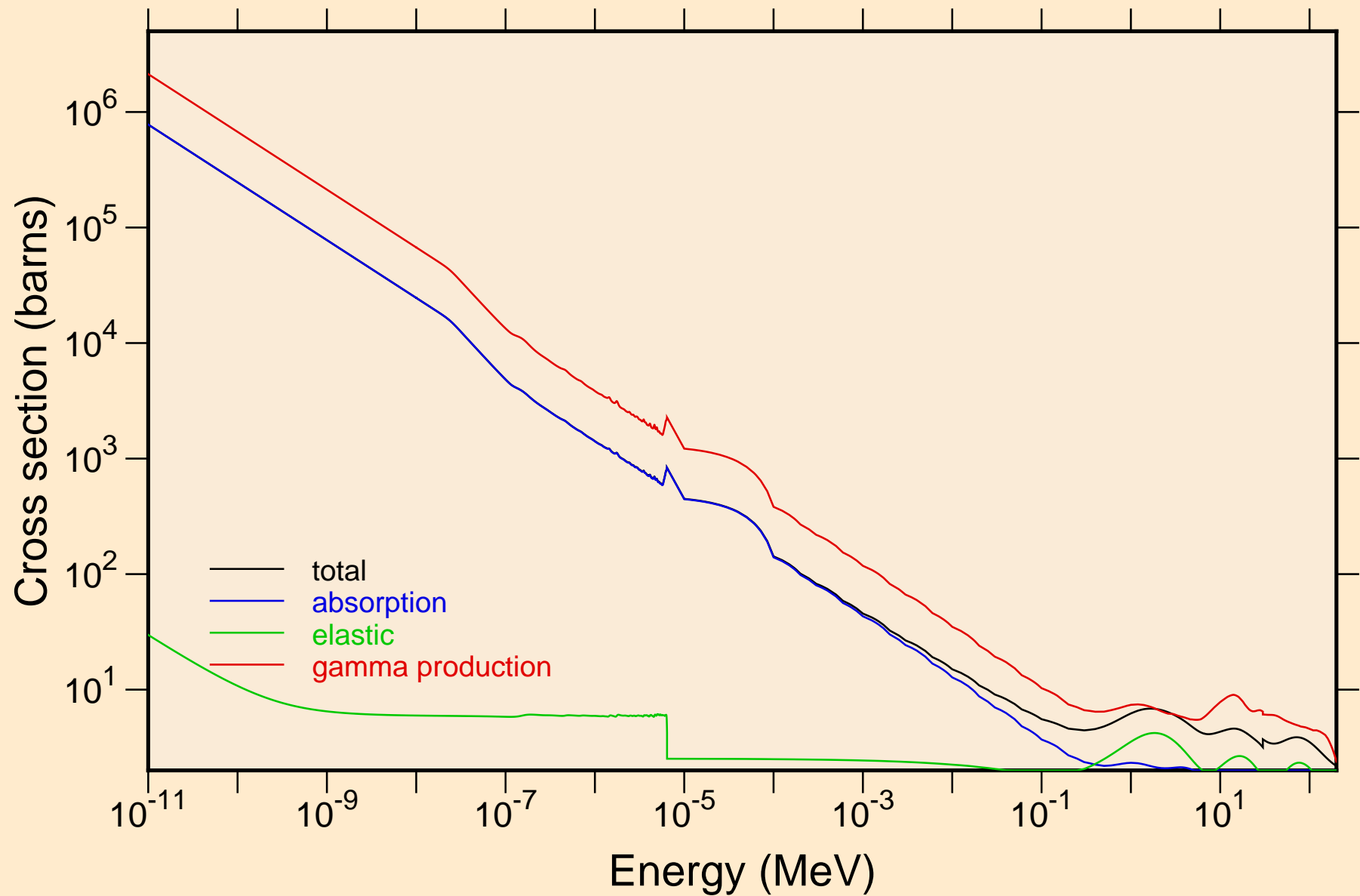

SM133 NEUTRON ACER TENDL-2019 LIBRARY; T=293.16K
resonance total cross section

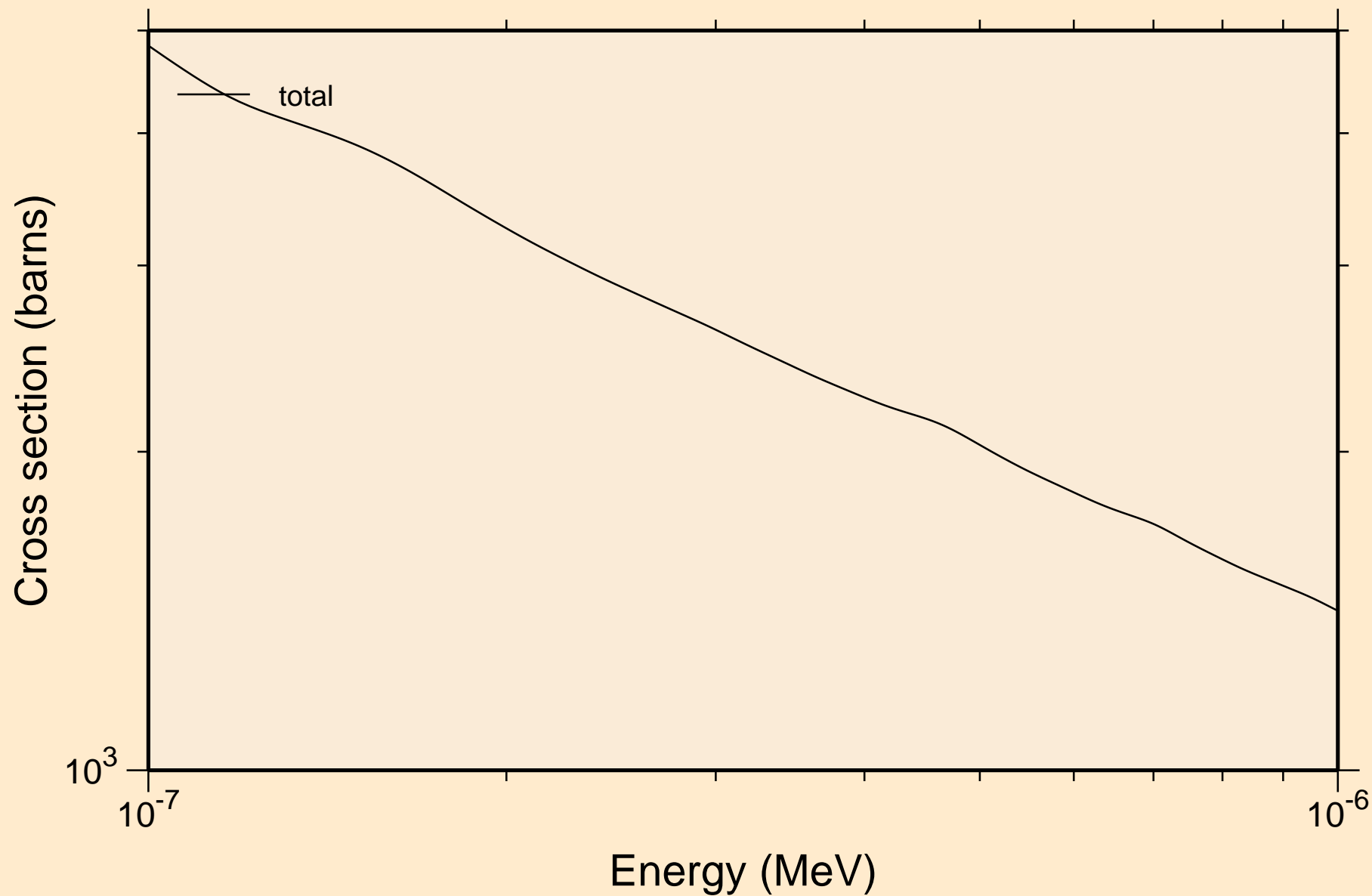

SM133 NEUTRON ACER TENDL-2019 LIBRARY; T=293.16K
resonance total cross section

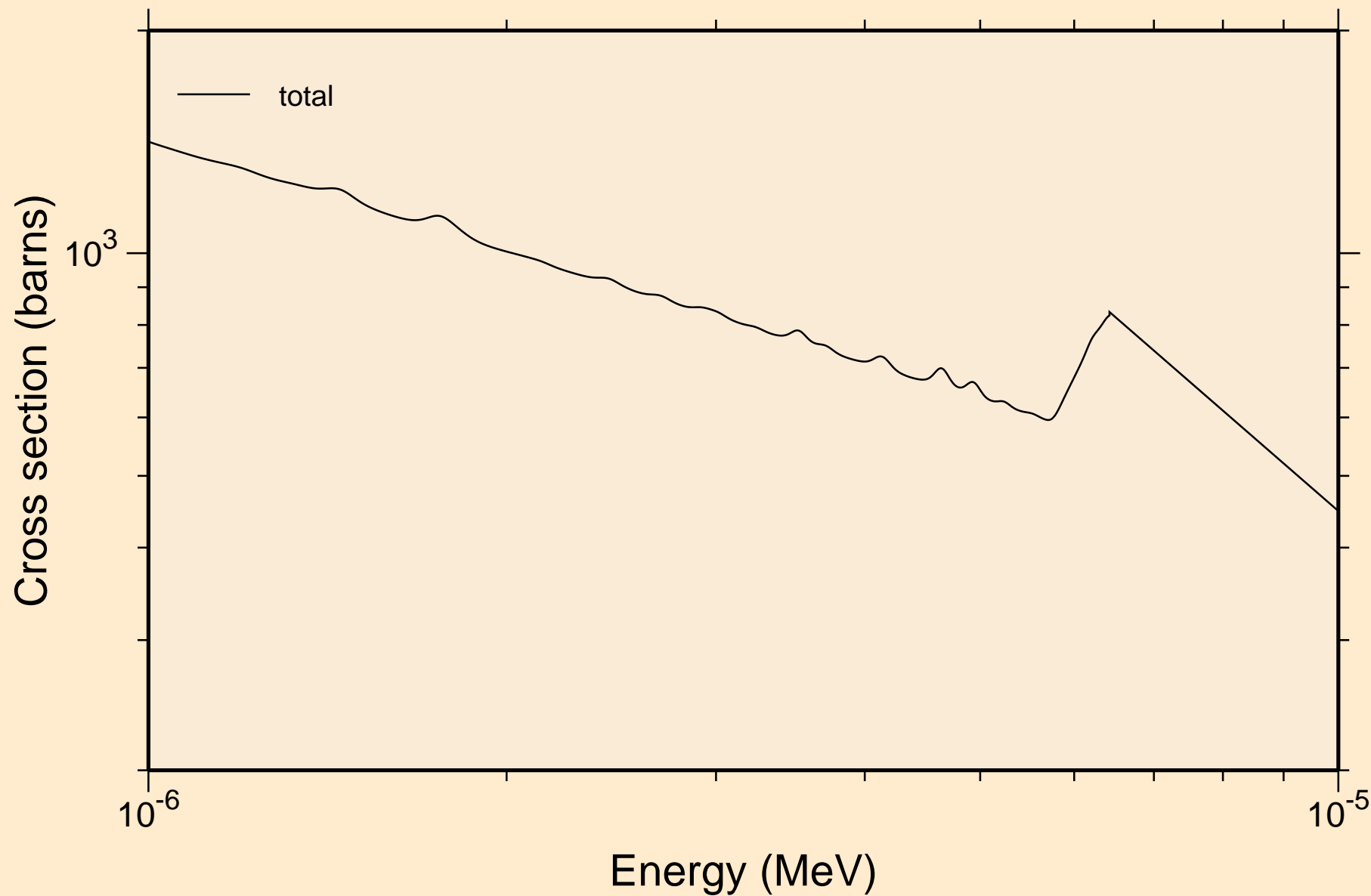

SM133 NEUTRON ACER TENDL-2019 LIBRARY; T=293.16K
resonance total cross section

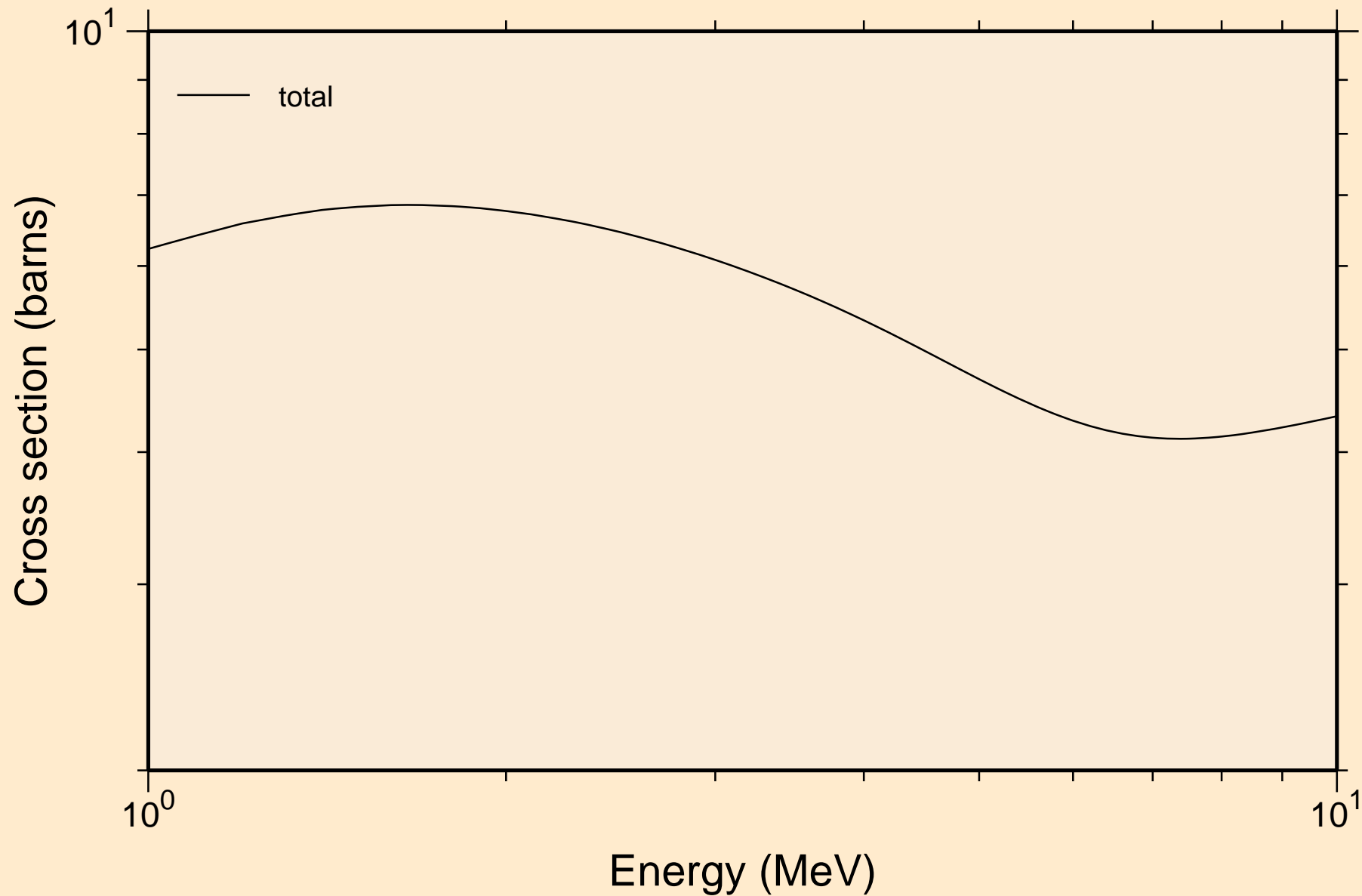

SM133 NEUTRON ACER TENDL-2019 LIBRARY; T=293.16K
resonance absorption cross sections

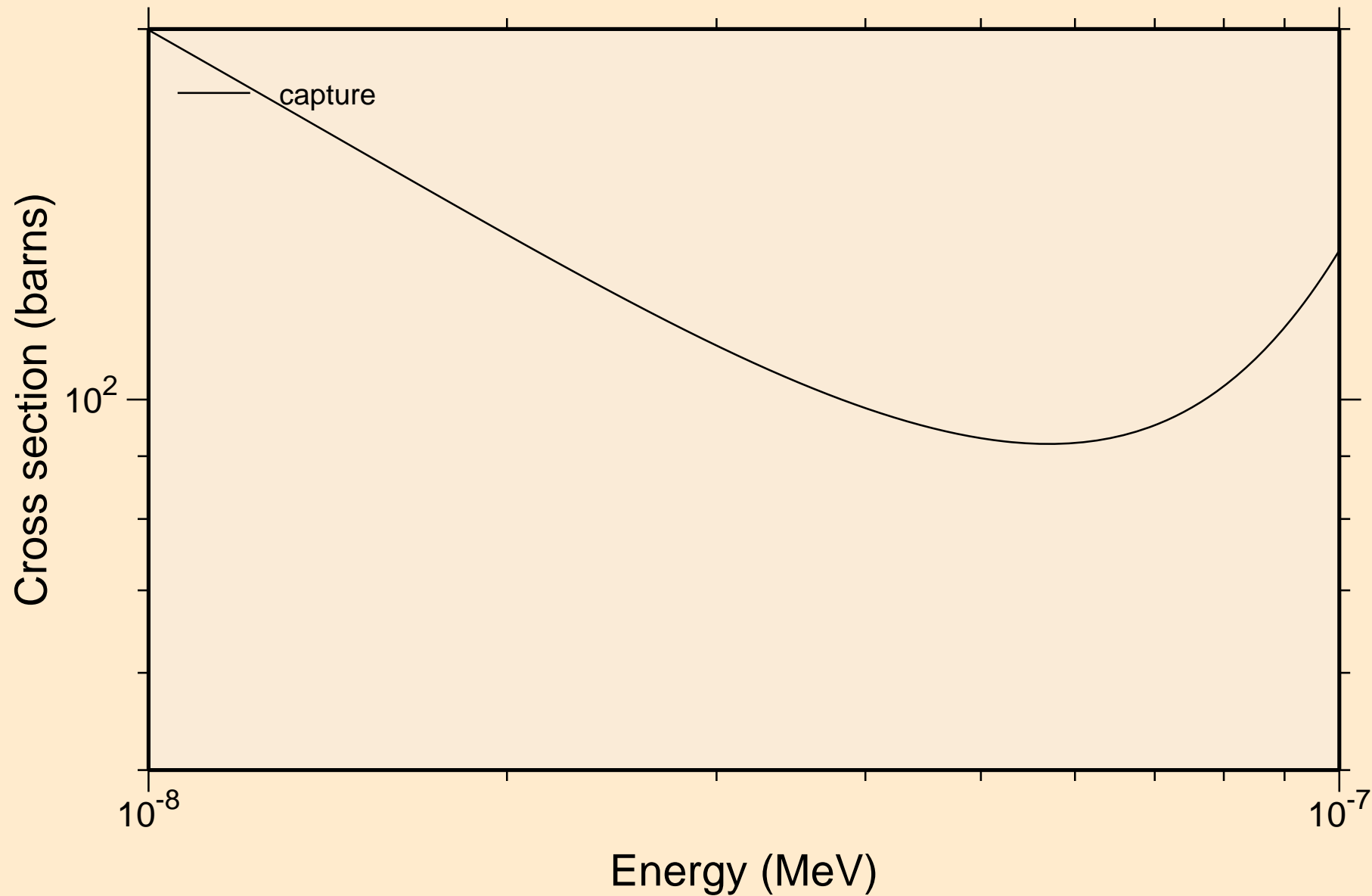

SM133 NEUTRON ACER TENDL-2019 LIBRARY; T=293.16K
resonance absorption cross sections

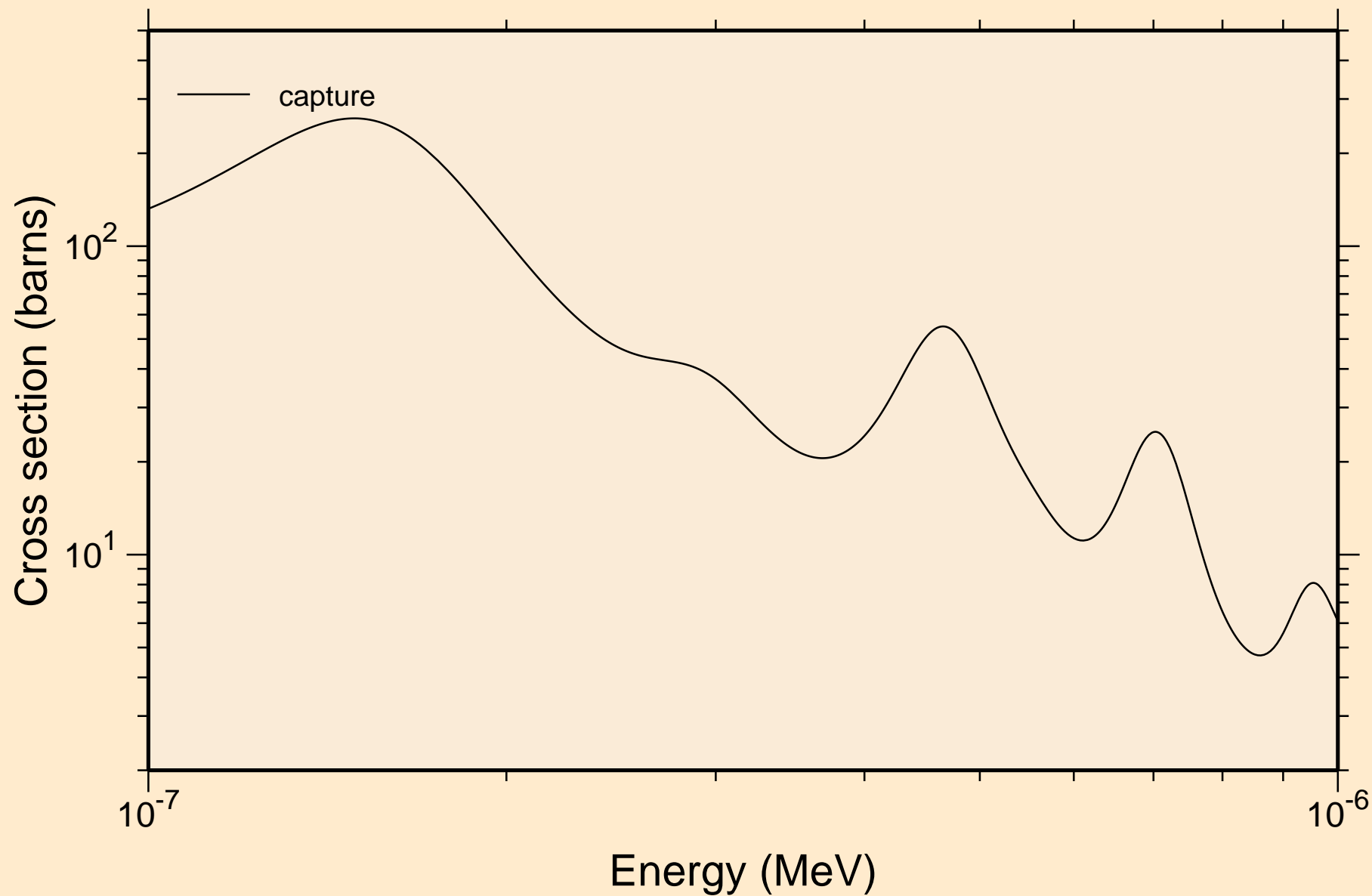

SM133 NEUTRON ACER TENDL-2019 LIBRARY; T=293.16K
resonance absorption cross sections

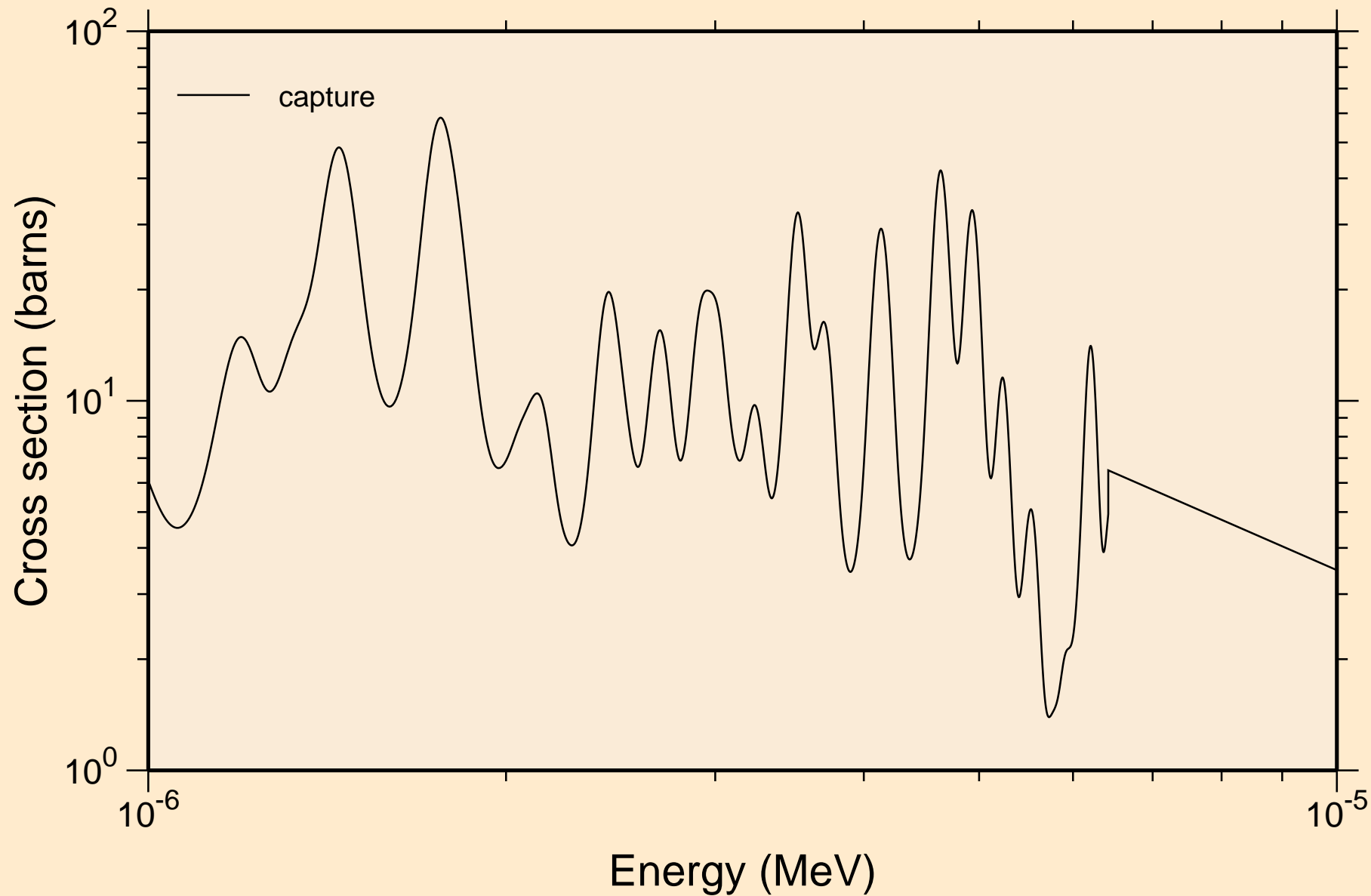

SM133 NEUTRON ACER TENDL-2019 LIBRARY; T=293.16K
resonance absorption cross sections

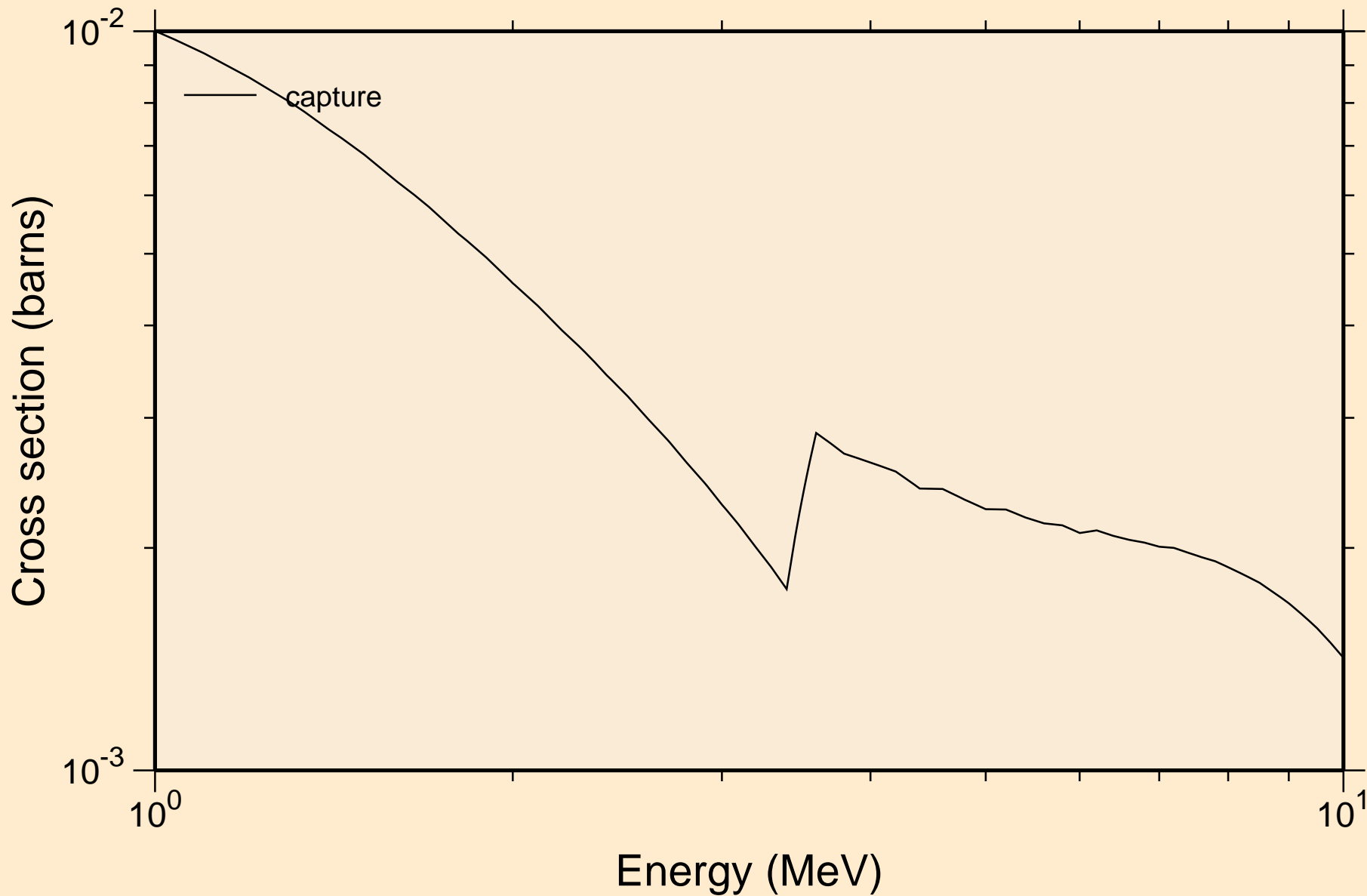

SM133 NEUTRON ACER TENDL-2019 LIBRARY; T=293.16K
Heating

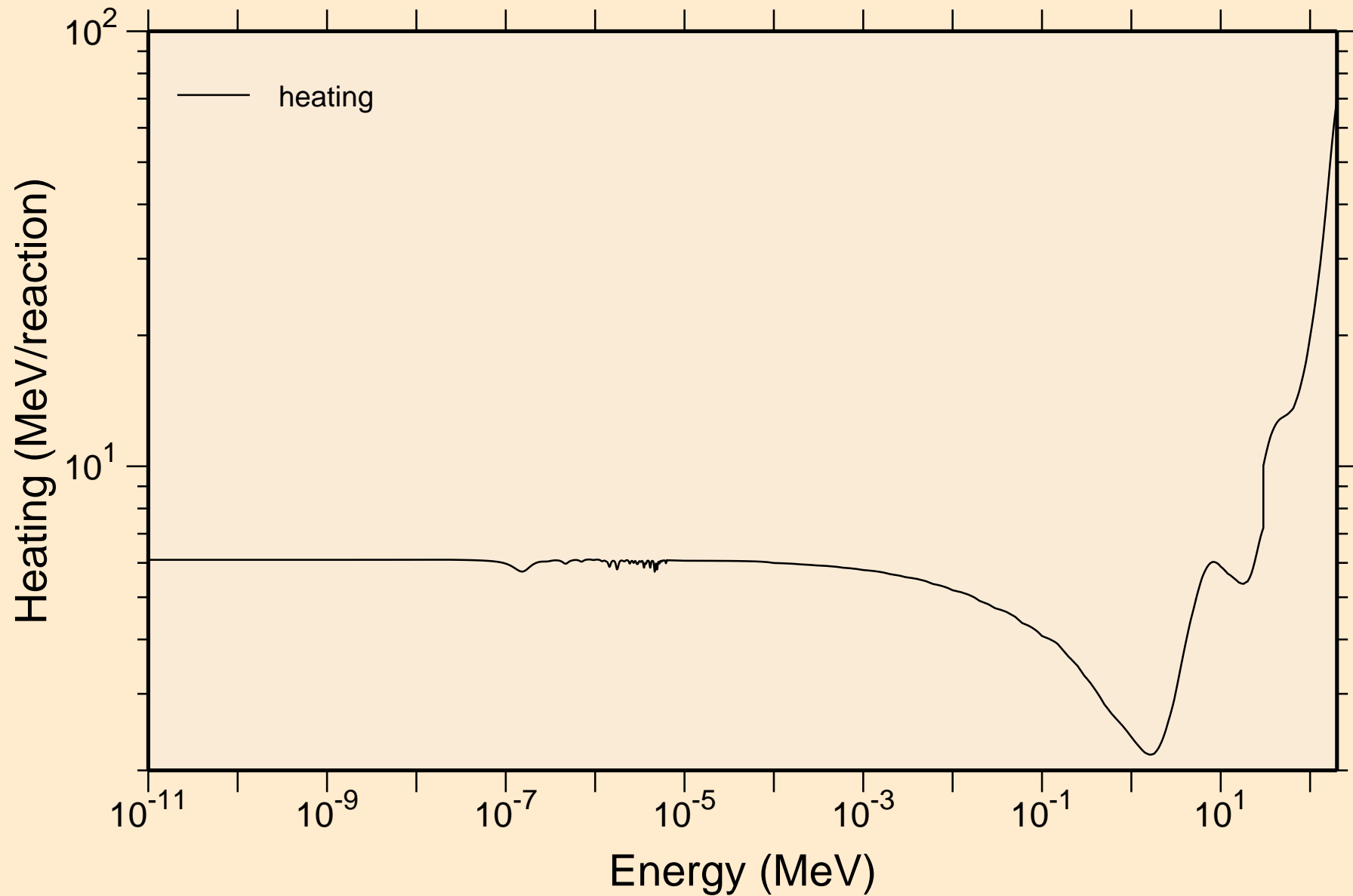

SM133 NEUTRON ACER TENDL-2019 LIBRARY; T=293.16K Damage

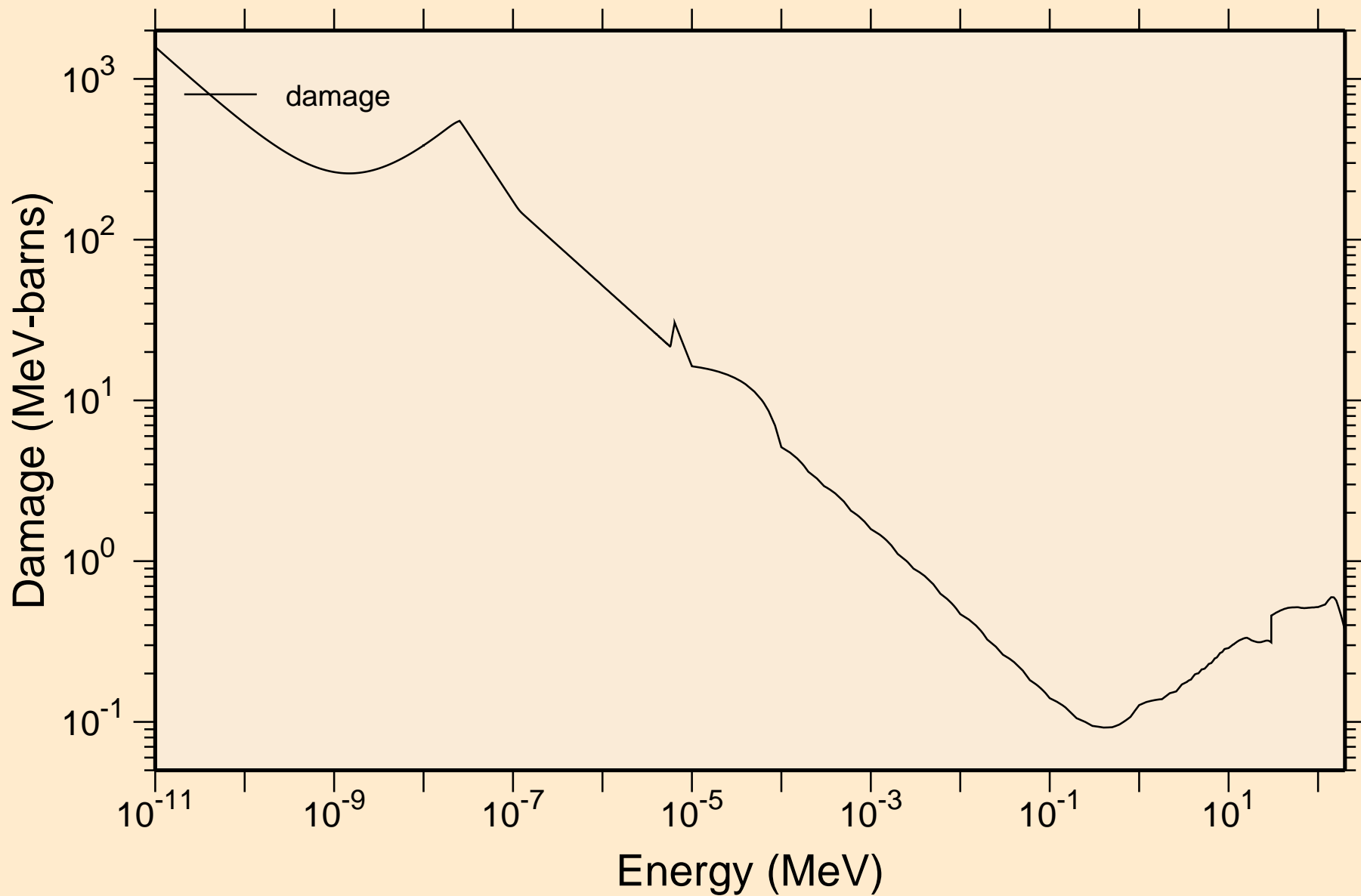

SM133 NEUTRON ACER TENDL-2019 LIBRARY; T=293.16K
Non-threshold reactions

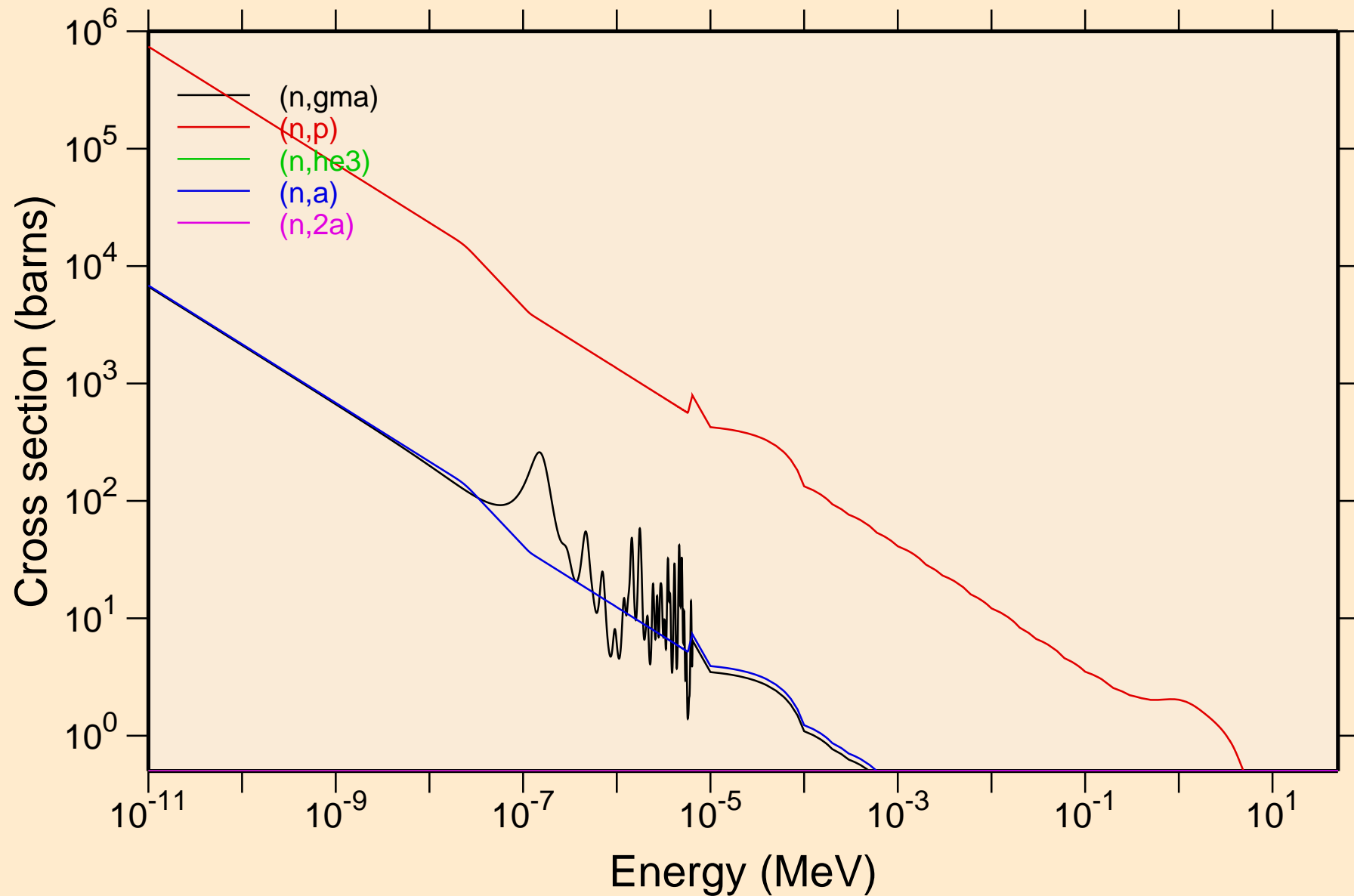

SM133 NEUTRON ACER TENDL-2019 LIBRARY; T=293.16K
Non-threshold reactions

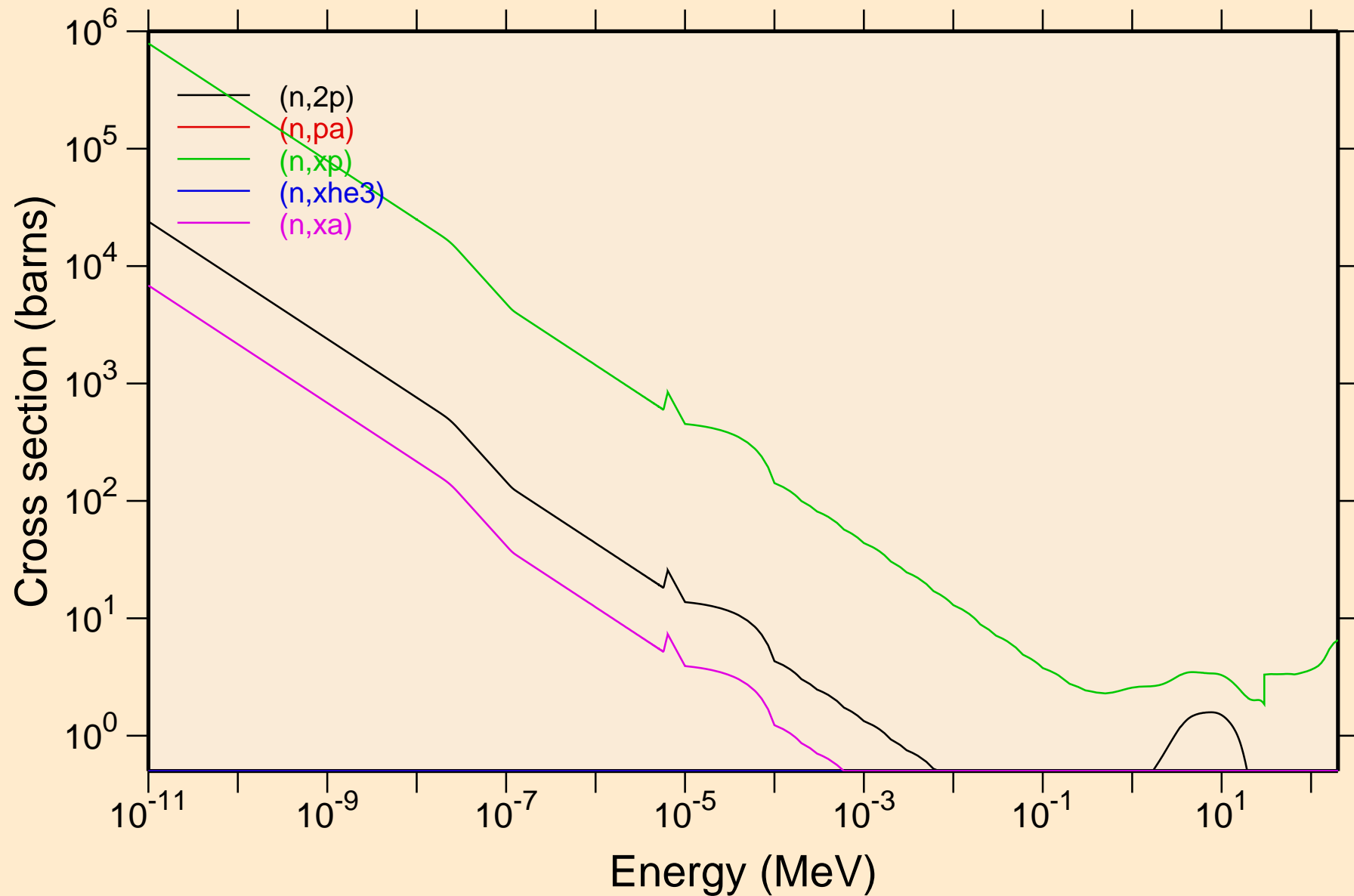

SM133 NEUTRON ACER TENDL-2019 LIBRARY; T=293.16K
Principal cross sections

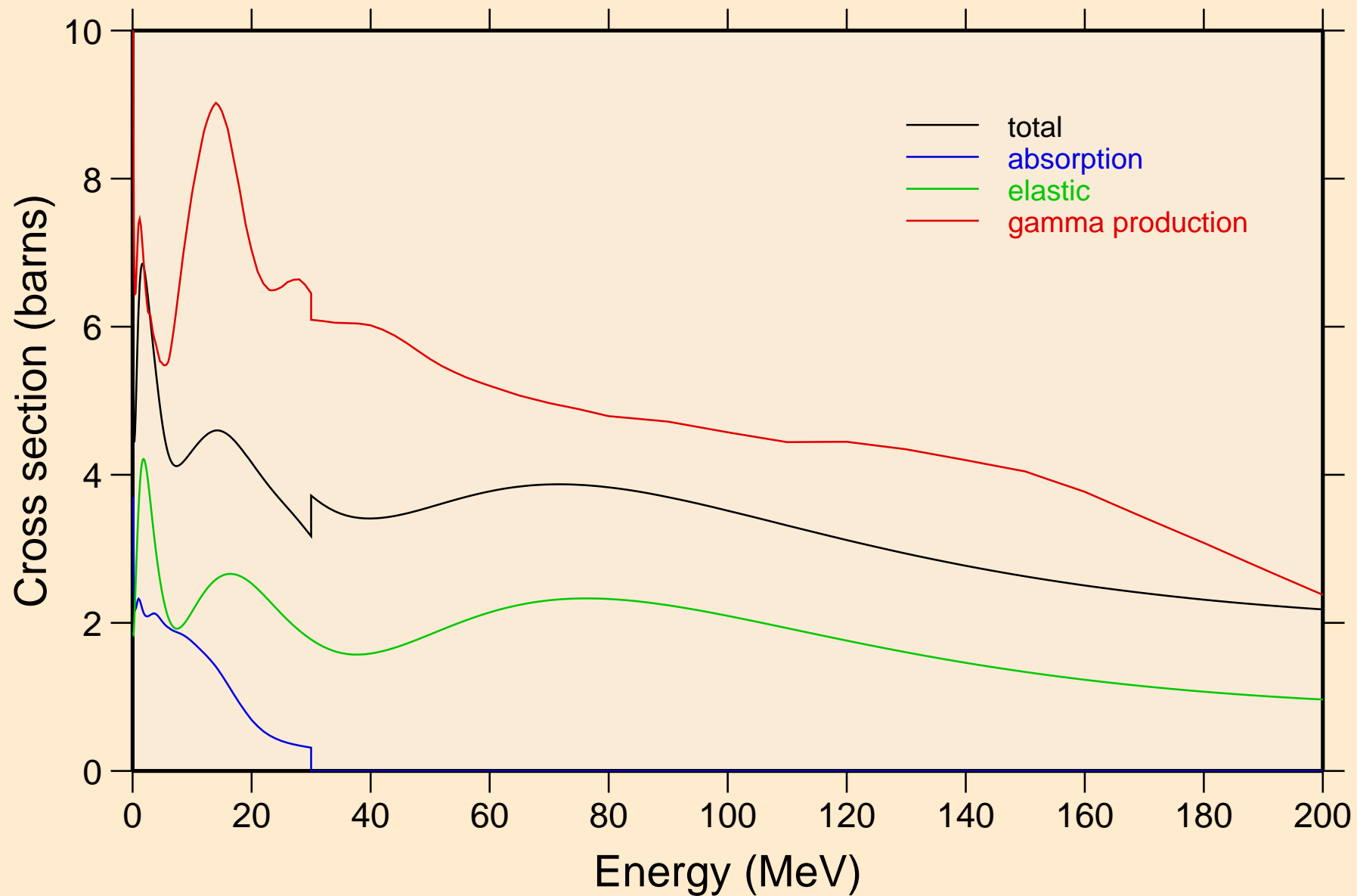

SM133 NEUTRON ACER TENDL-2019 LIBRARY; T=293.16K
Heating

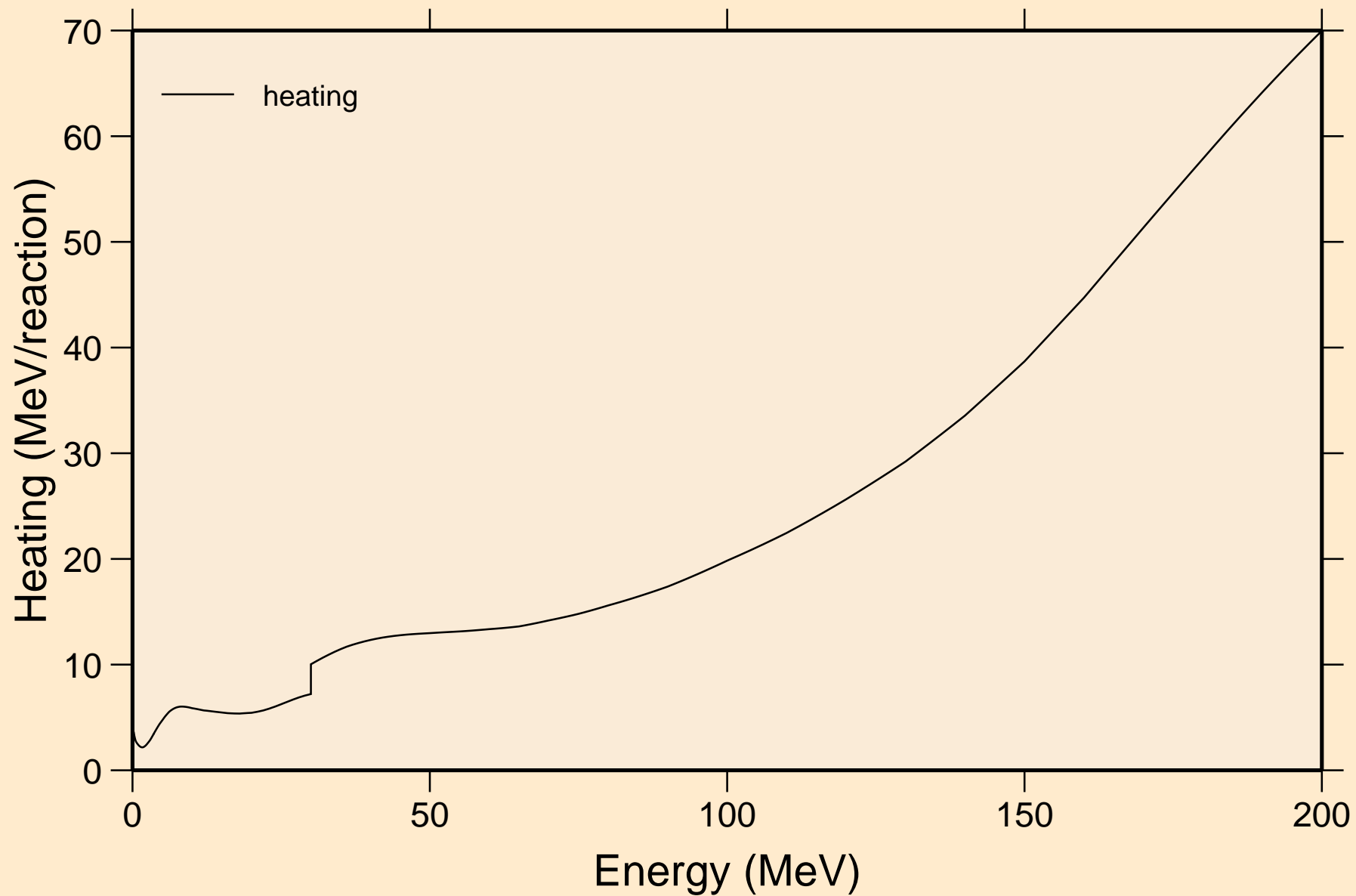

SM133 NEUTRON ACER TENDL-2019 LIBRARY; T=293.16K
Damage

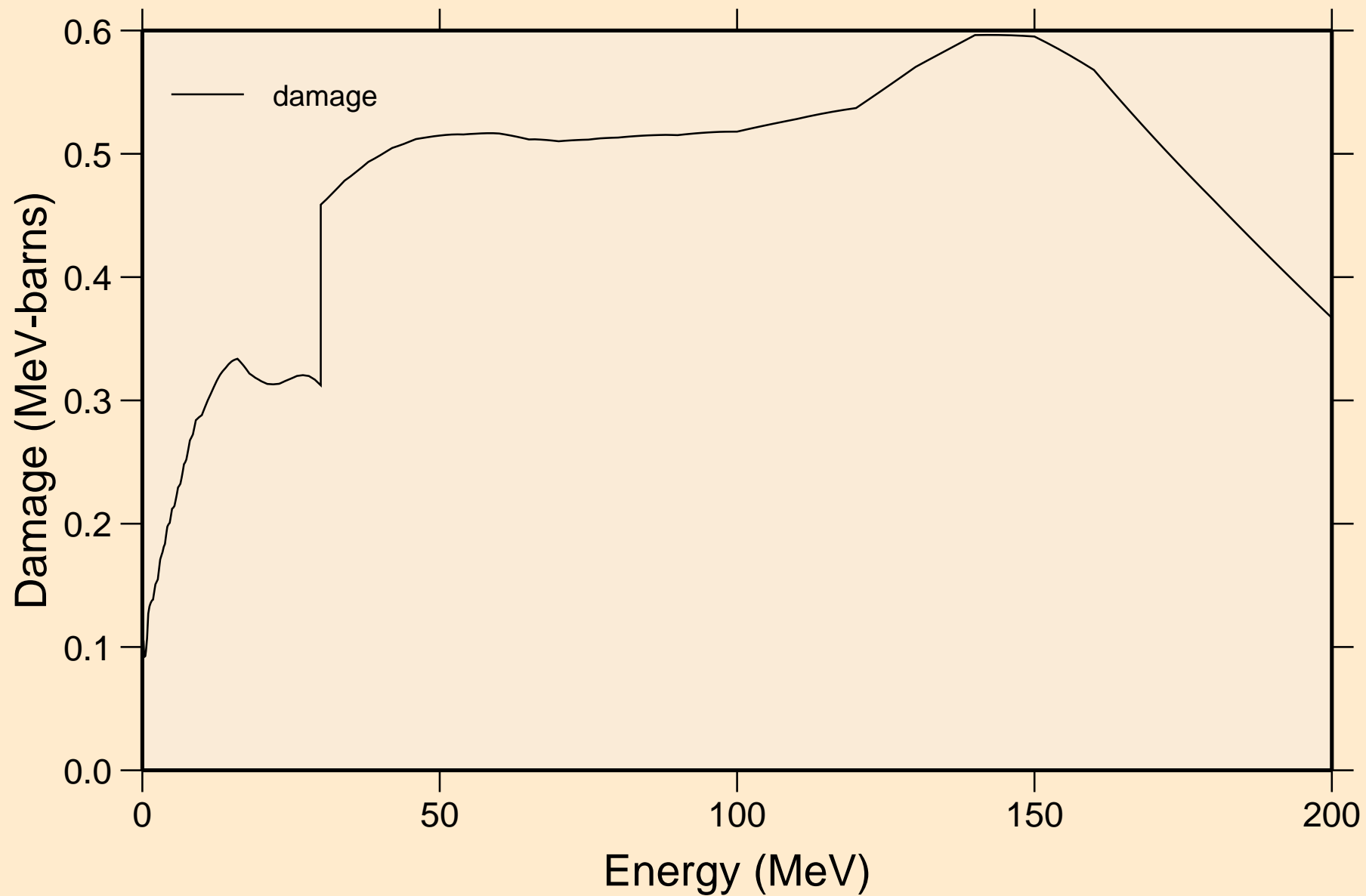

SM133 NEUTRON ACER TENDL-2019 LIBRARY; T=293.16K
Non-threshold reactions

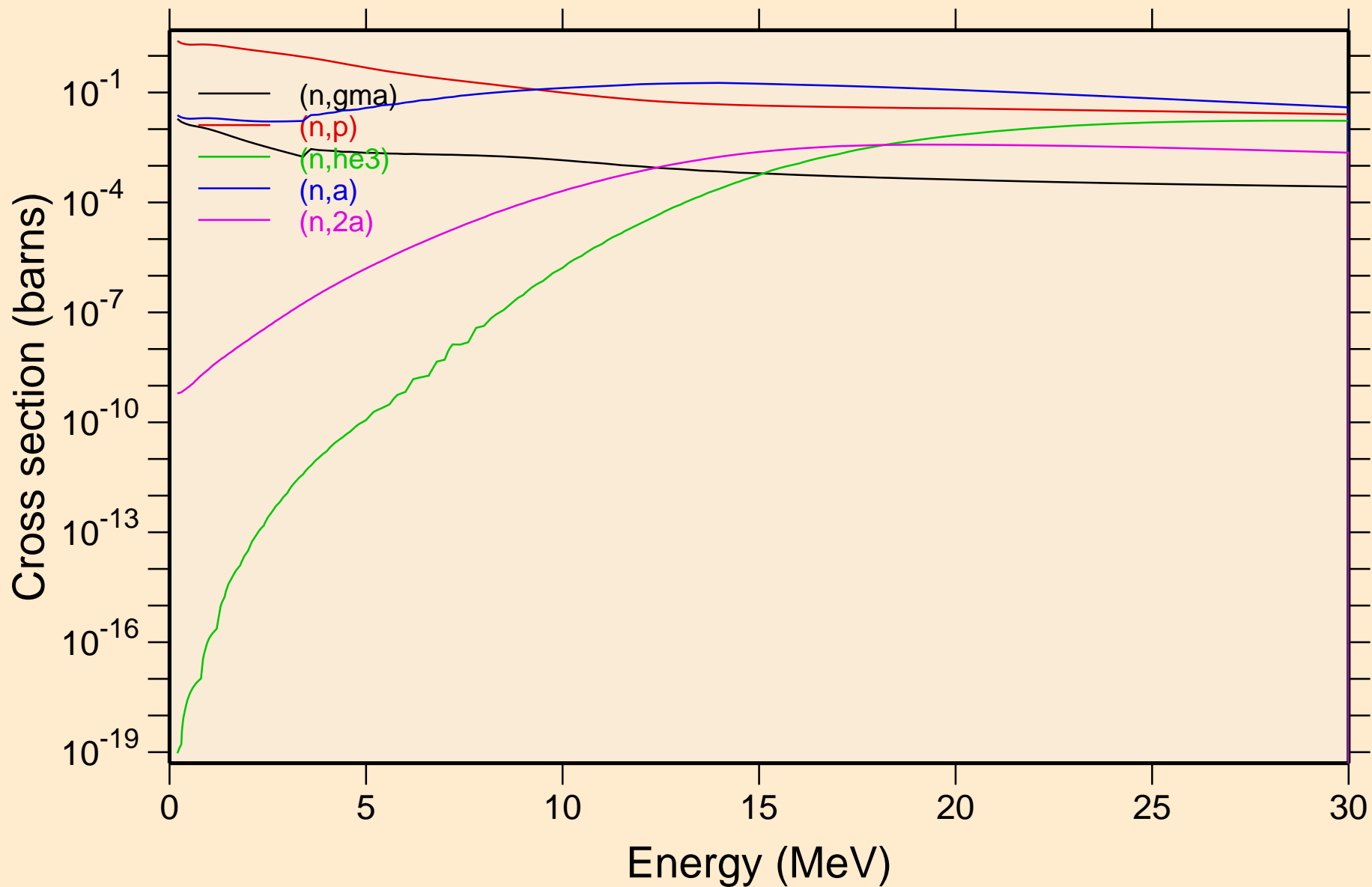

SM133 NEUTRON ACER TENDL-2019 LIBRARY; T=293.16K
Non-threshold reactions

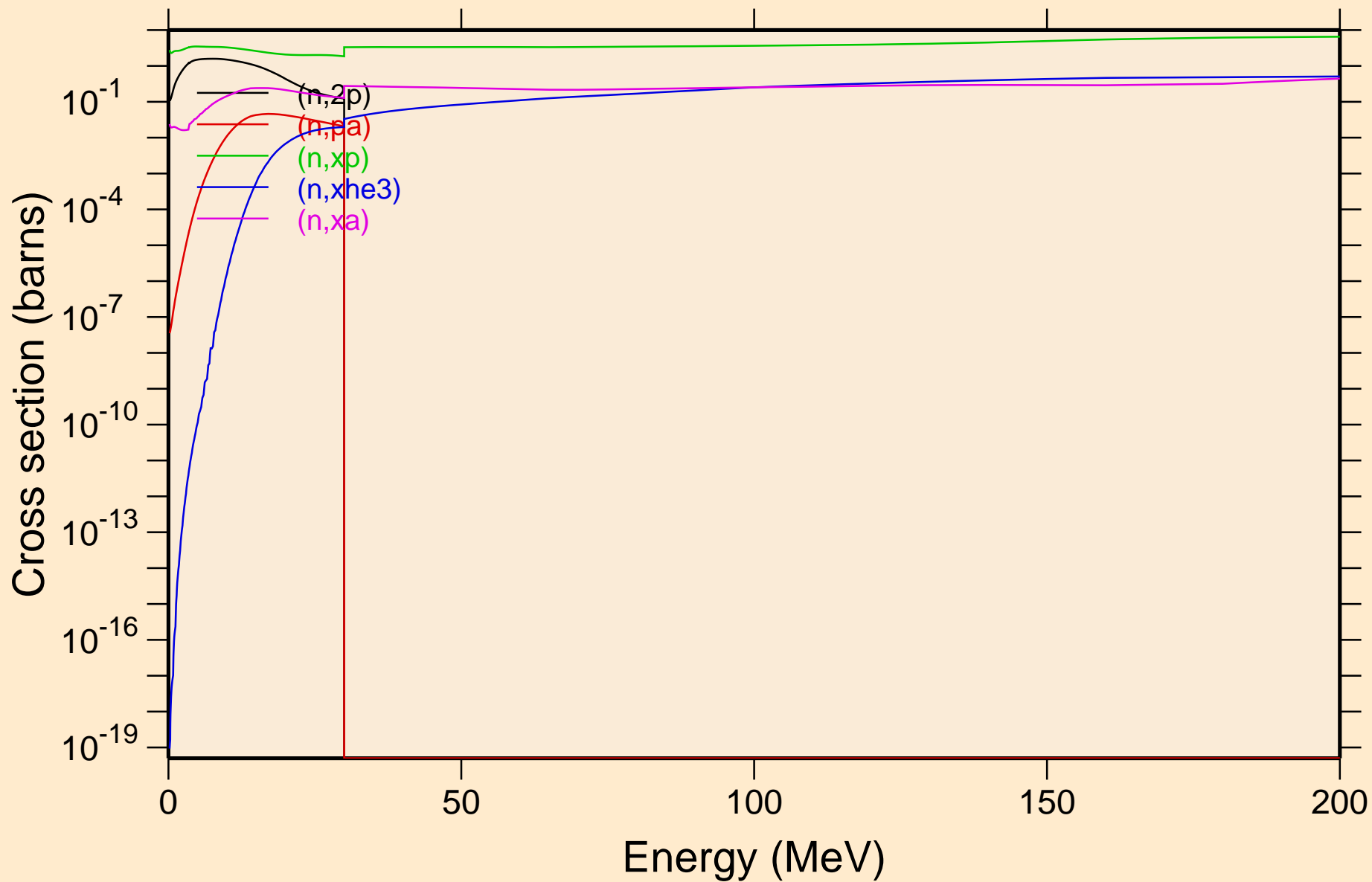

SM133 NEUTRON ACER TENDL-2019 LIBRARY; T=293.16K
Inelastic levels

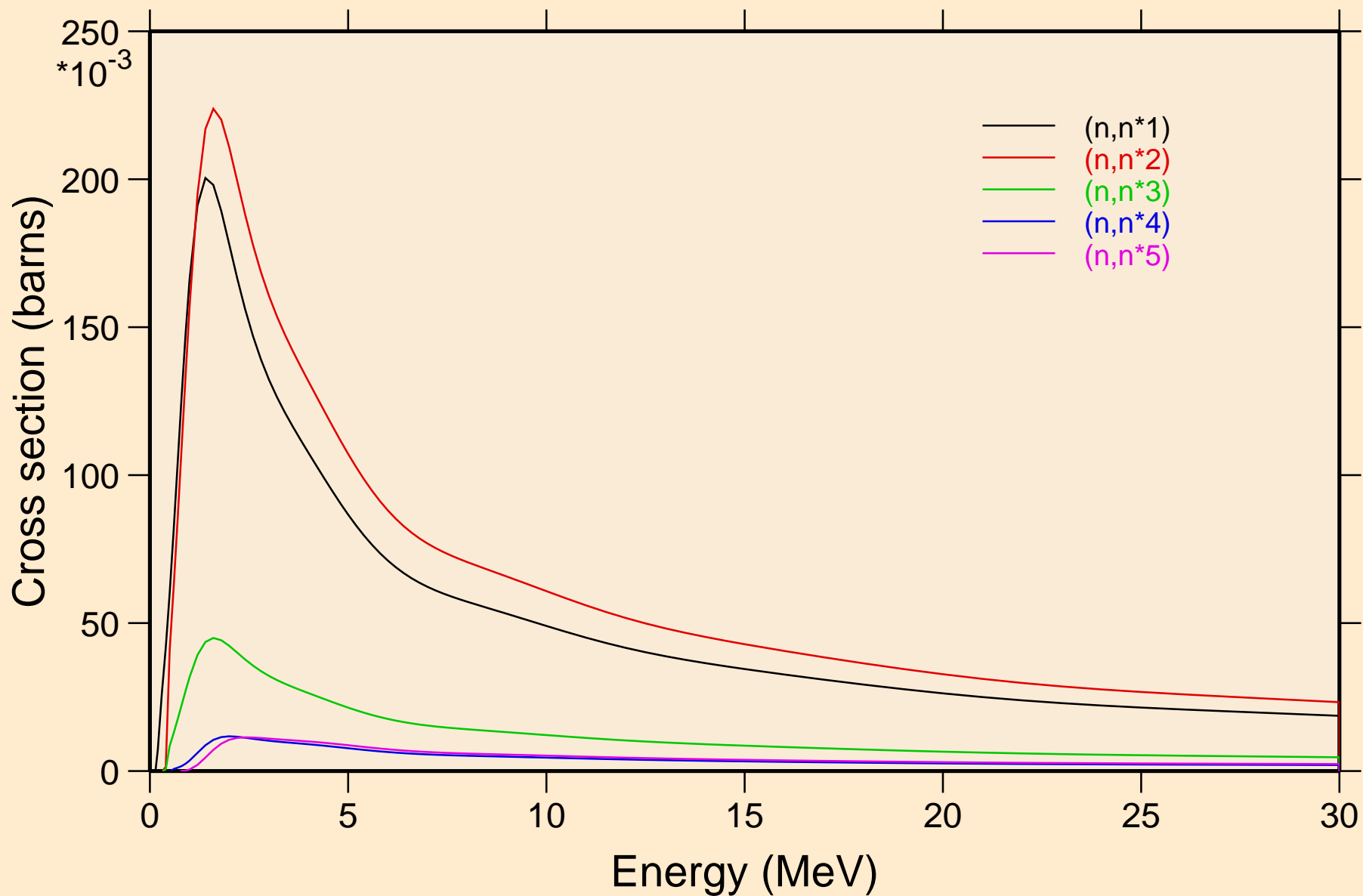

SM133 NEUTRON ACER TENDL-2019 LIBRARY; T=293.16K
Threshold reactions

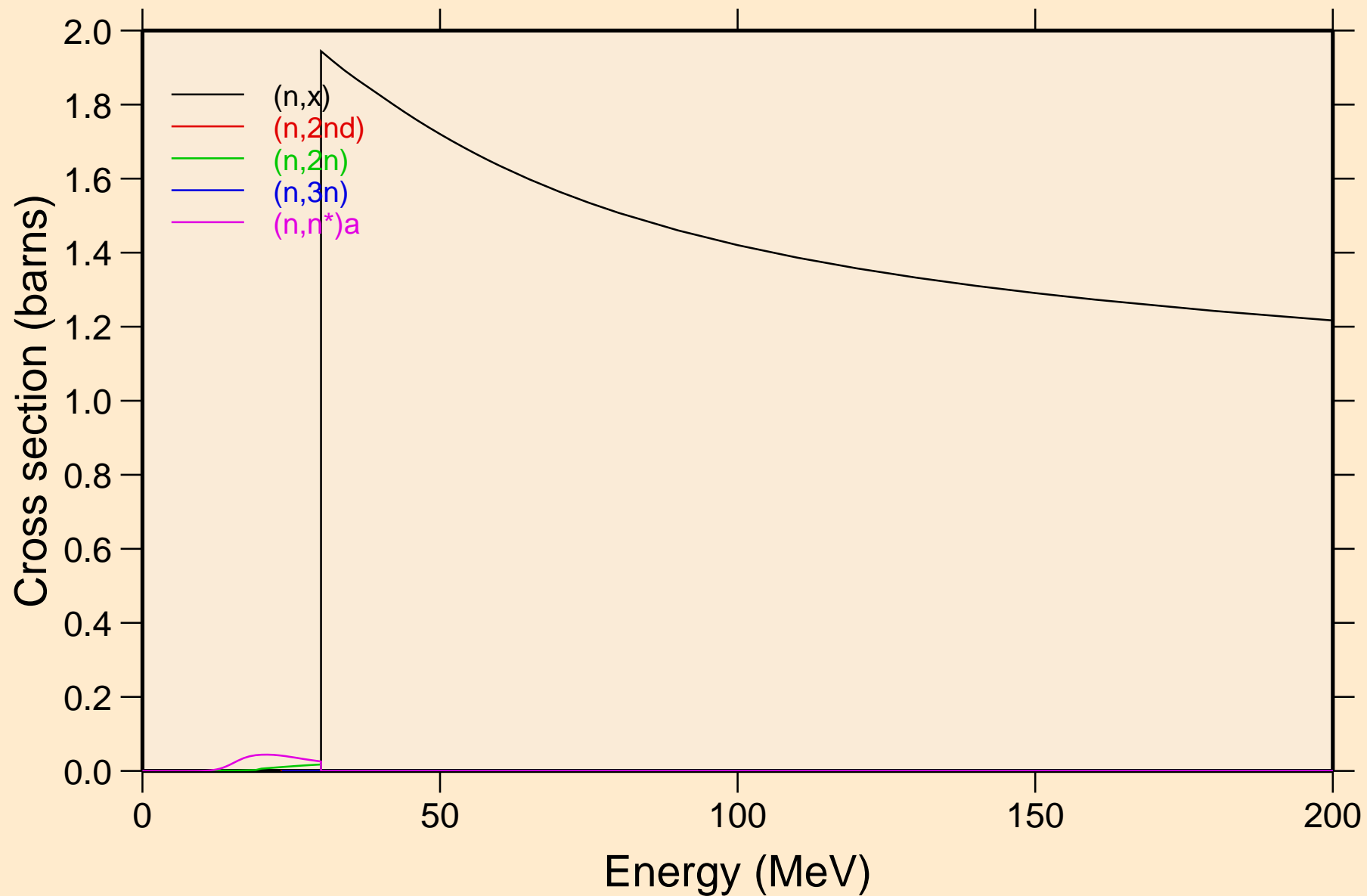

SM133 NEUTRON ACER TENDL-2019 LIBRARY; T=293.16K
Threshold reactions

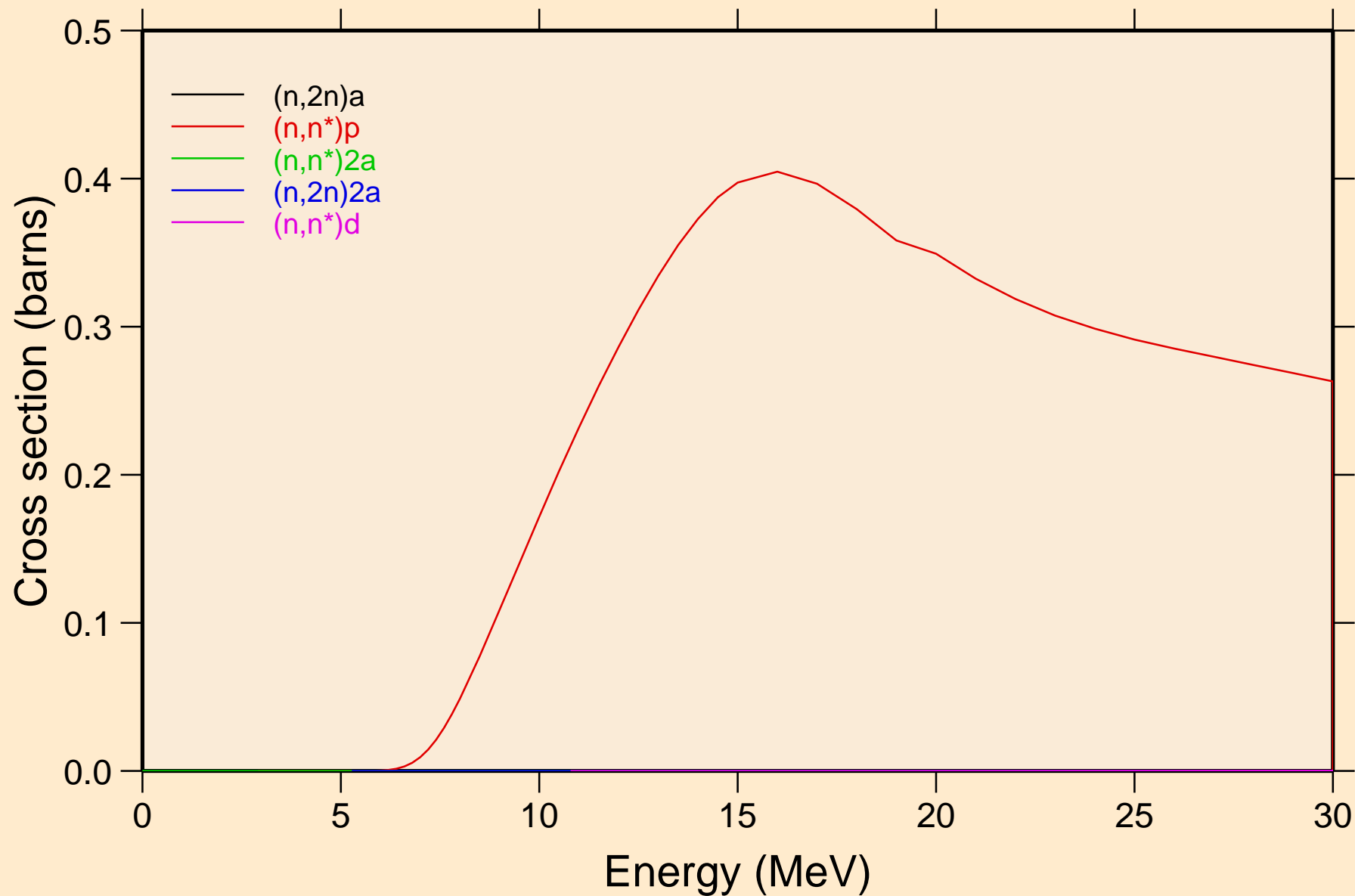

SM133 NEUTRON ACER TENDL-2019 LIBRARY; T=293.16K
Threshold reactions

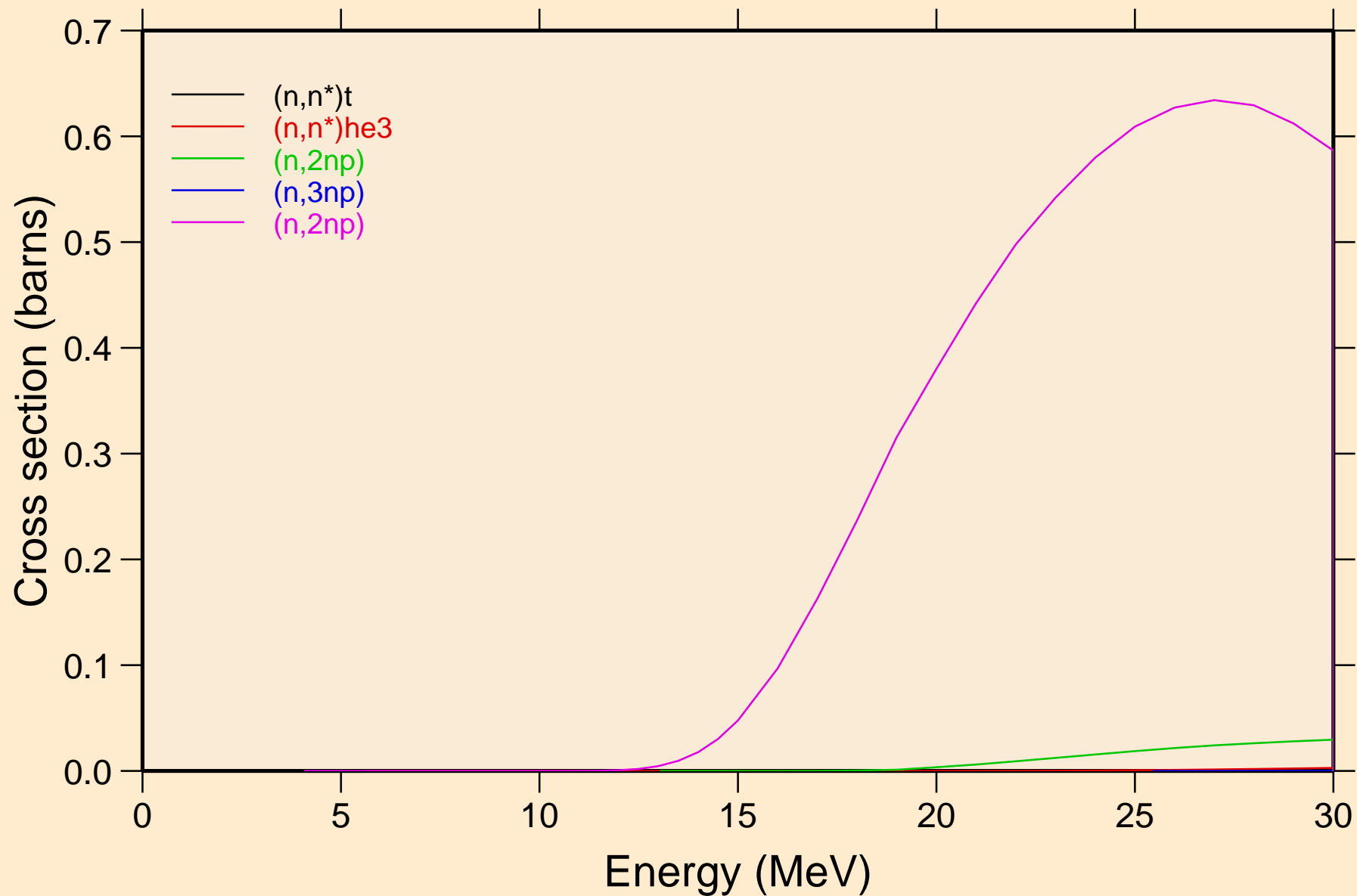

SM133 NEUTRON ACER TENDL-2019 LIBRARY; T=293.16K

Threshold reactions

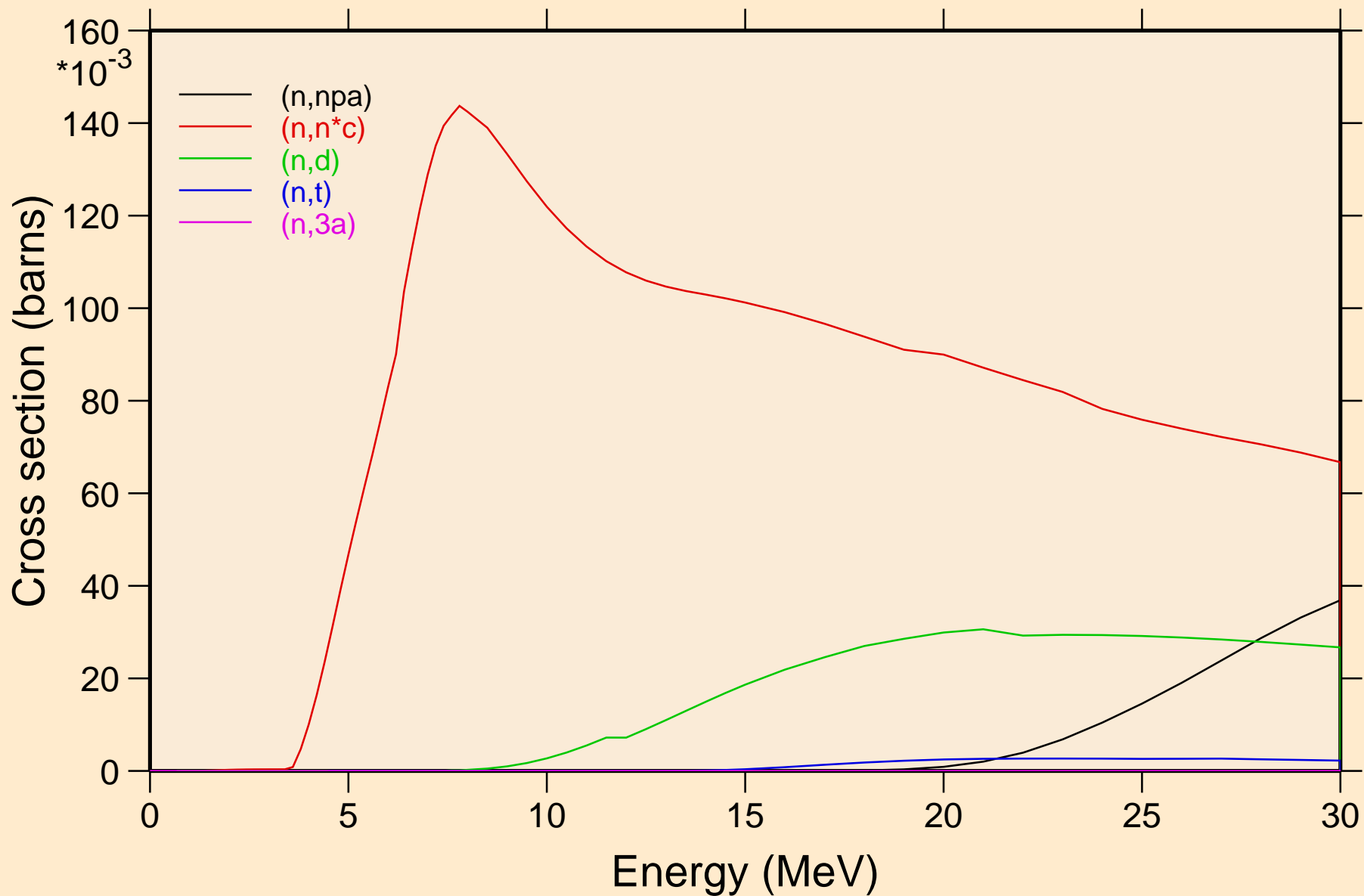

SM133 NEUTRON ACER TENDL-2019 LIBRARY; T=293.16K
Threshold reactions

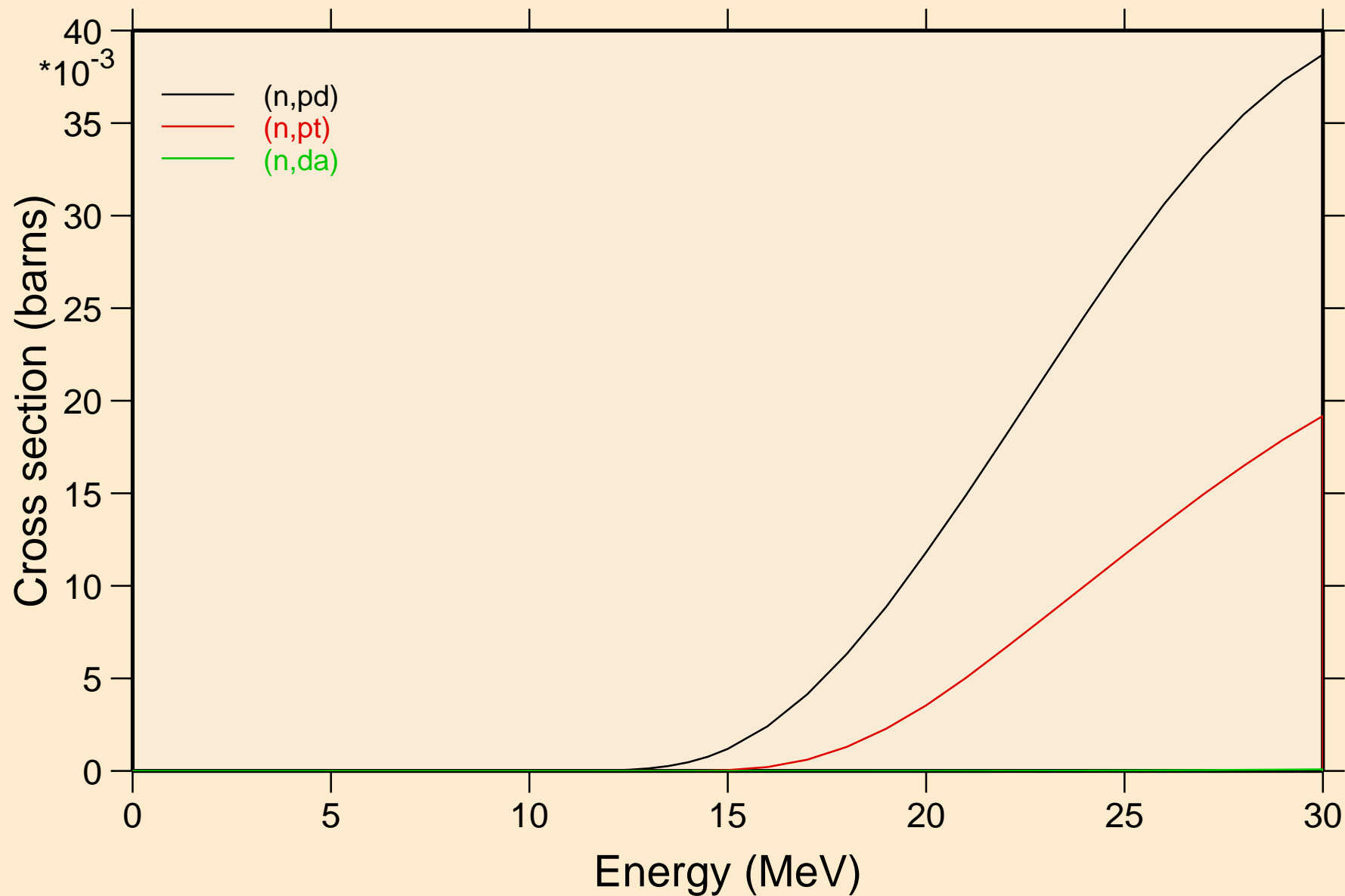

SM133 NEUTRON ACER TENDL-2019 LIBRARY; T=293.16K
Threshold reactions

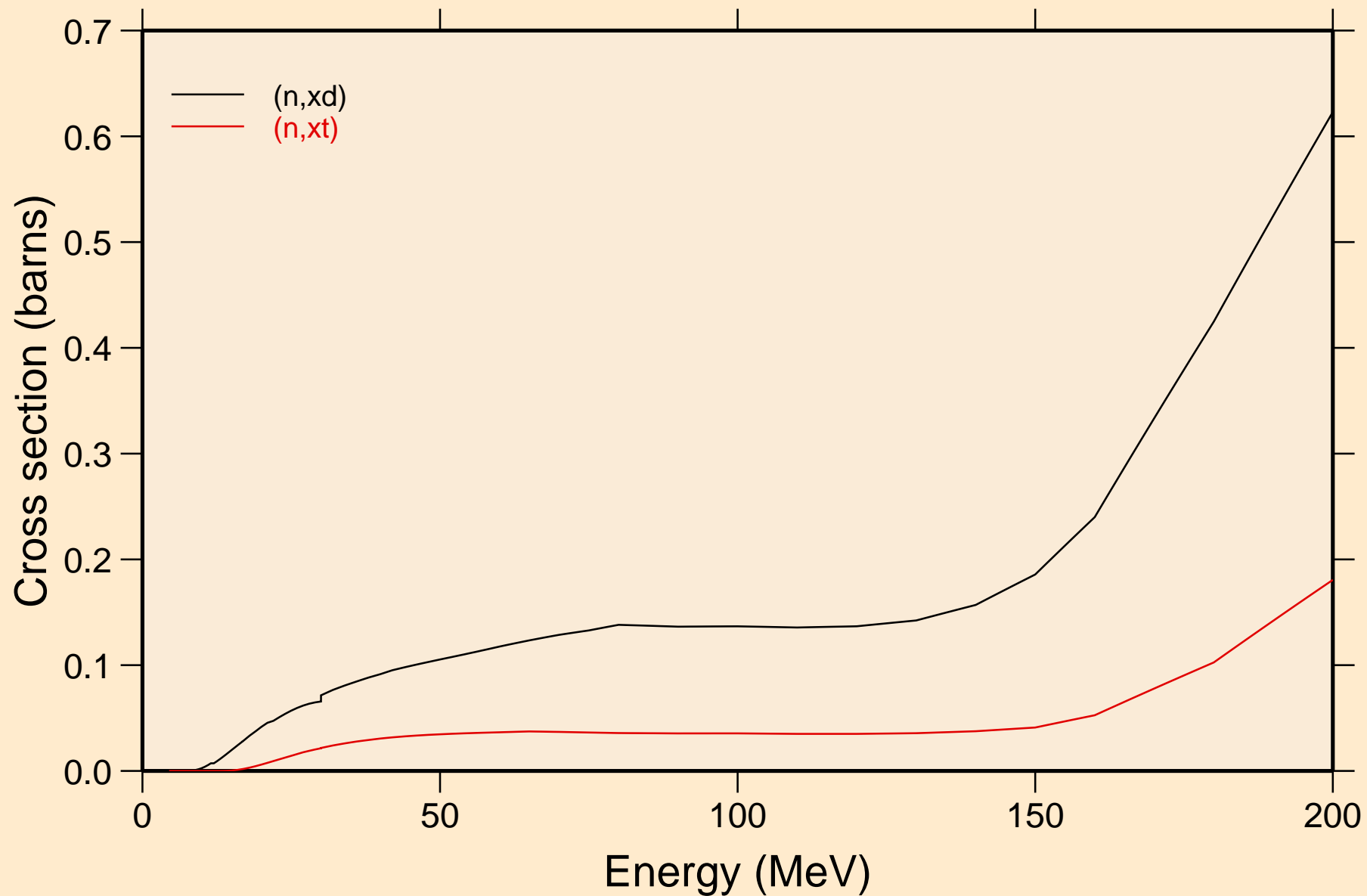

SM133 NEUTRON ACER TENDL-2019 LIBRARY; T=293.16K
angular distribution for elastic

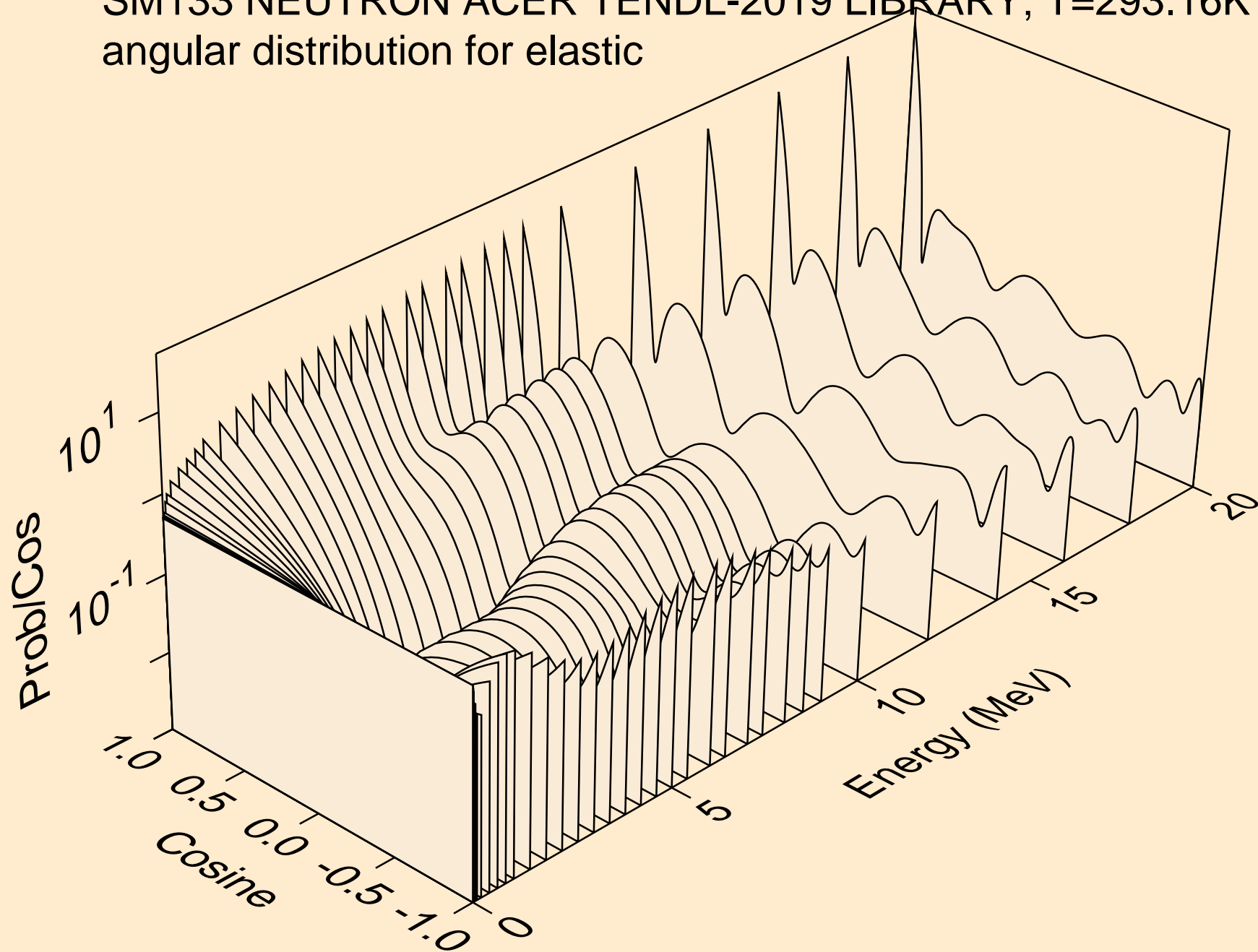

SM133 NEUTRON ACER TENDL-2019 LIBRARY; T=293.16K
angular distribution for elastic

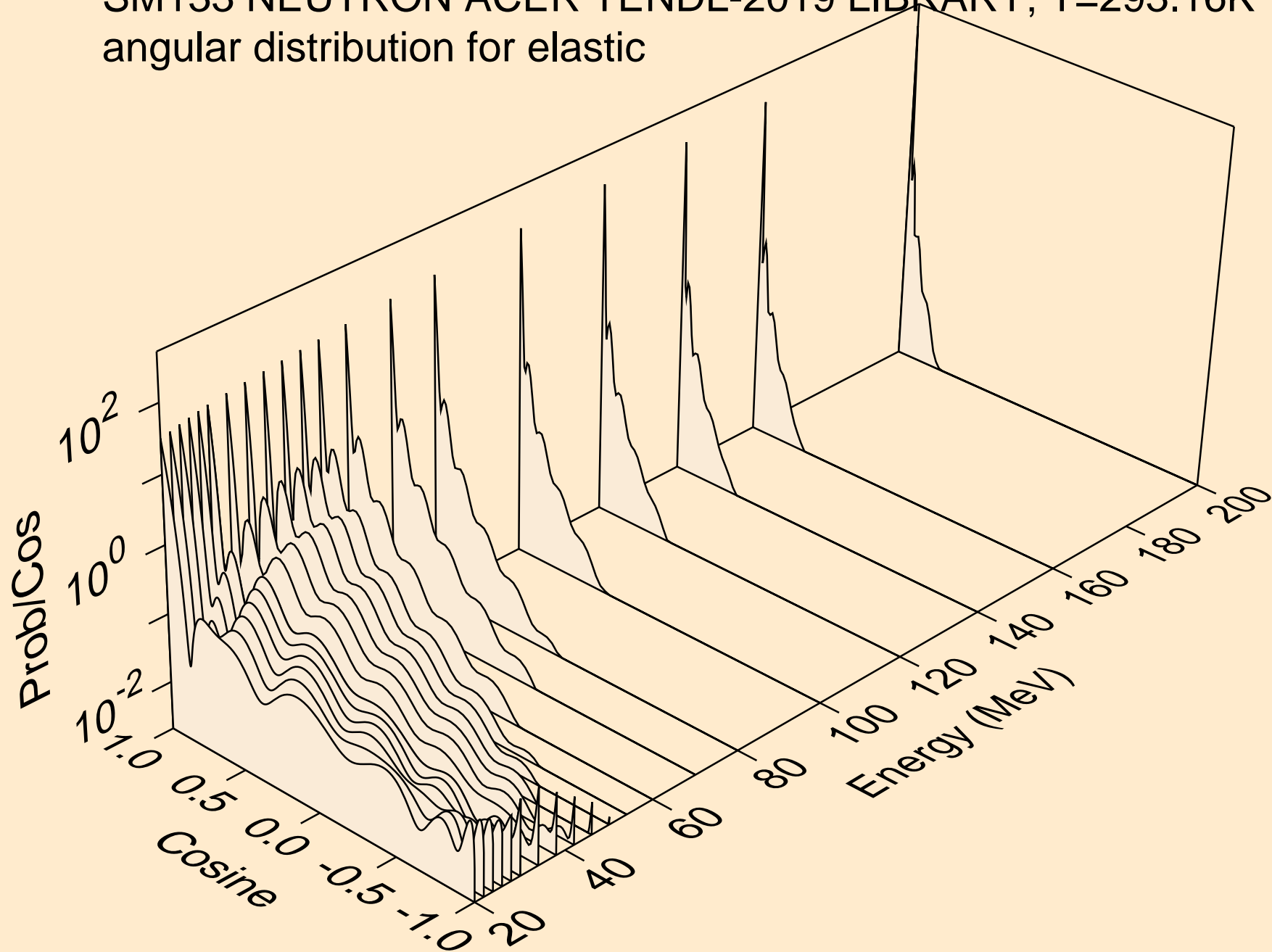

SM133 NEUTRON ACER TENDL-2019 LIBRARY; T=293.16K
angular distribution for (n,n*1)

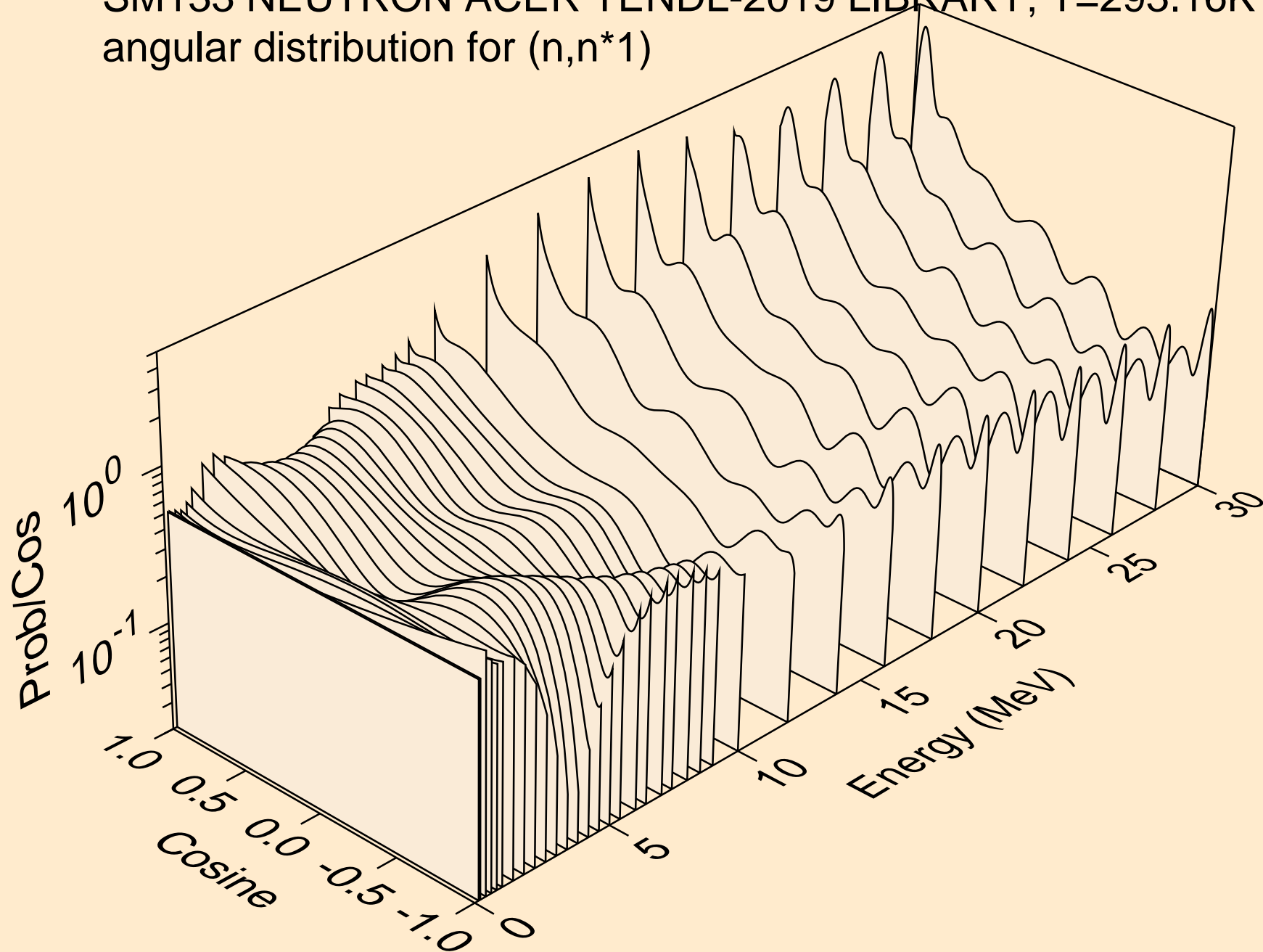

SM133 NEUTRON ACER TENDL-2019 LIBRARY; T=293.16K
angular distribution for (n,n*2)

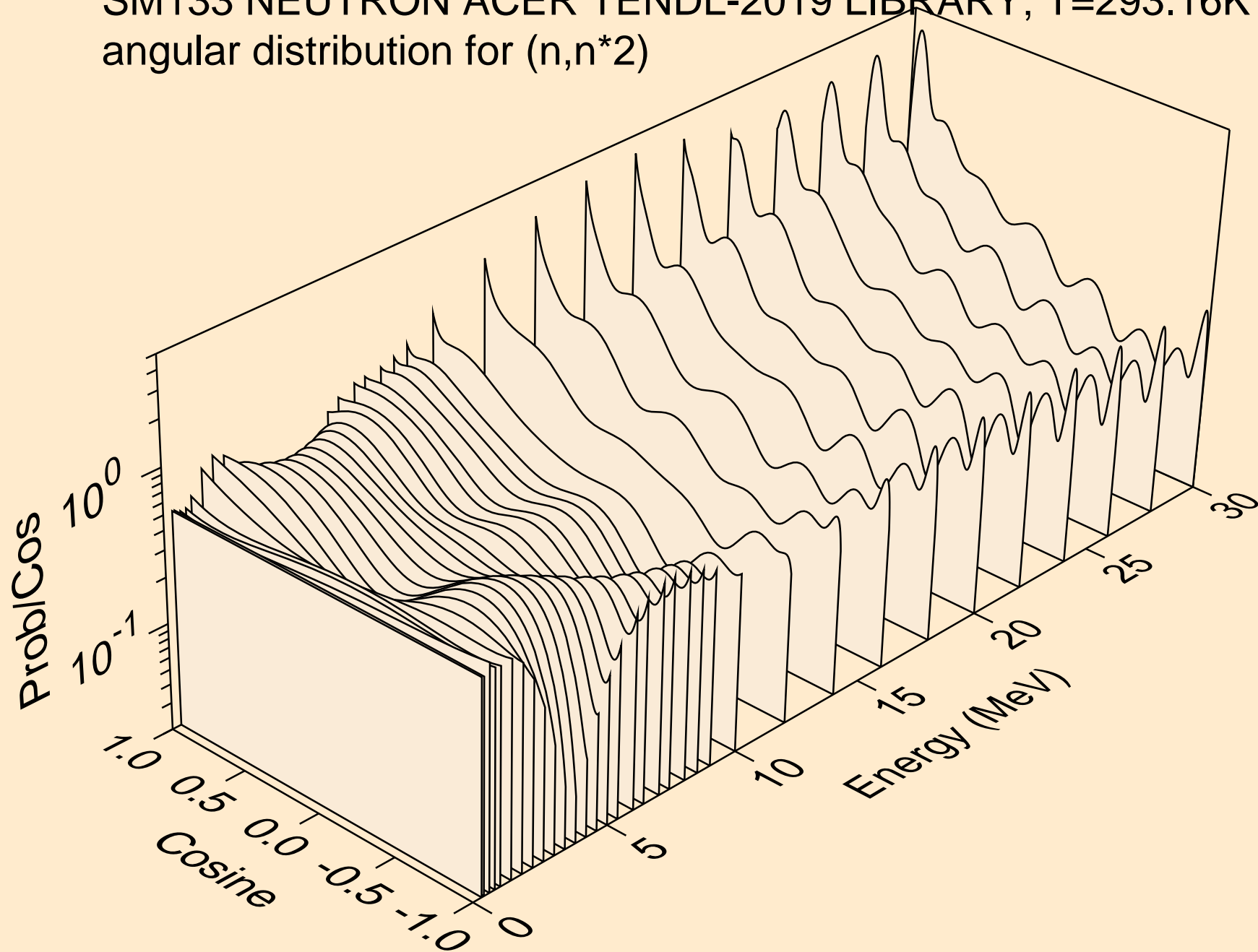

SM133 NEUTRON ACER TENDL-2019 LIBRARY; T=293.16K
angular distribution for (n,n*3)

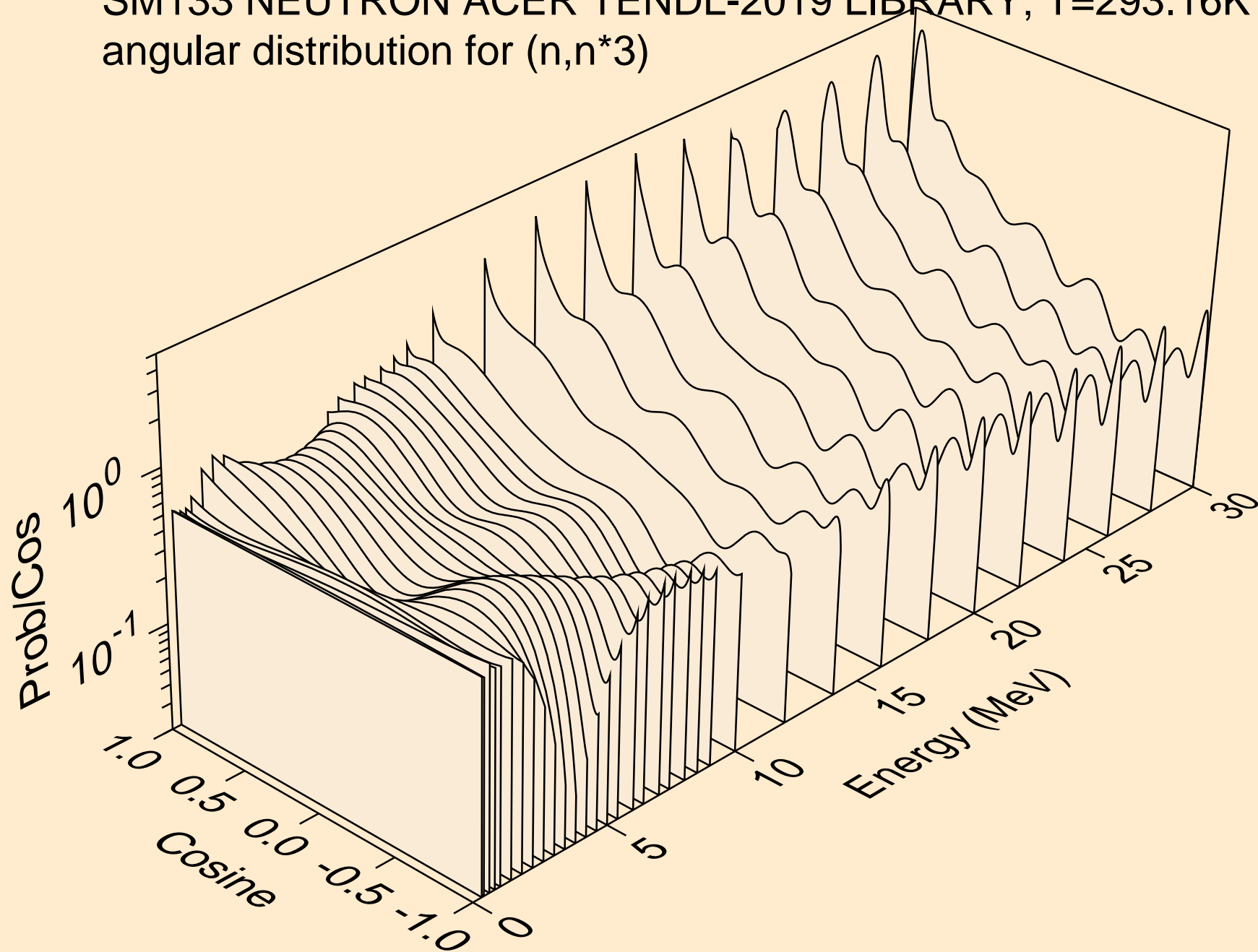

SM133 NEUTRON ACER TENDL-2019 LIBRARY; T=293.16K
angular distribution for (n,n*4)

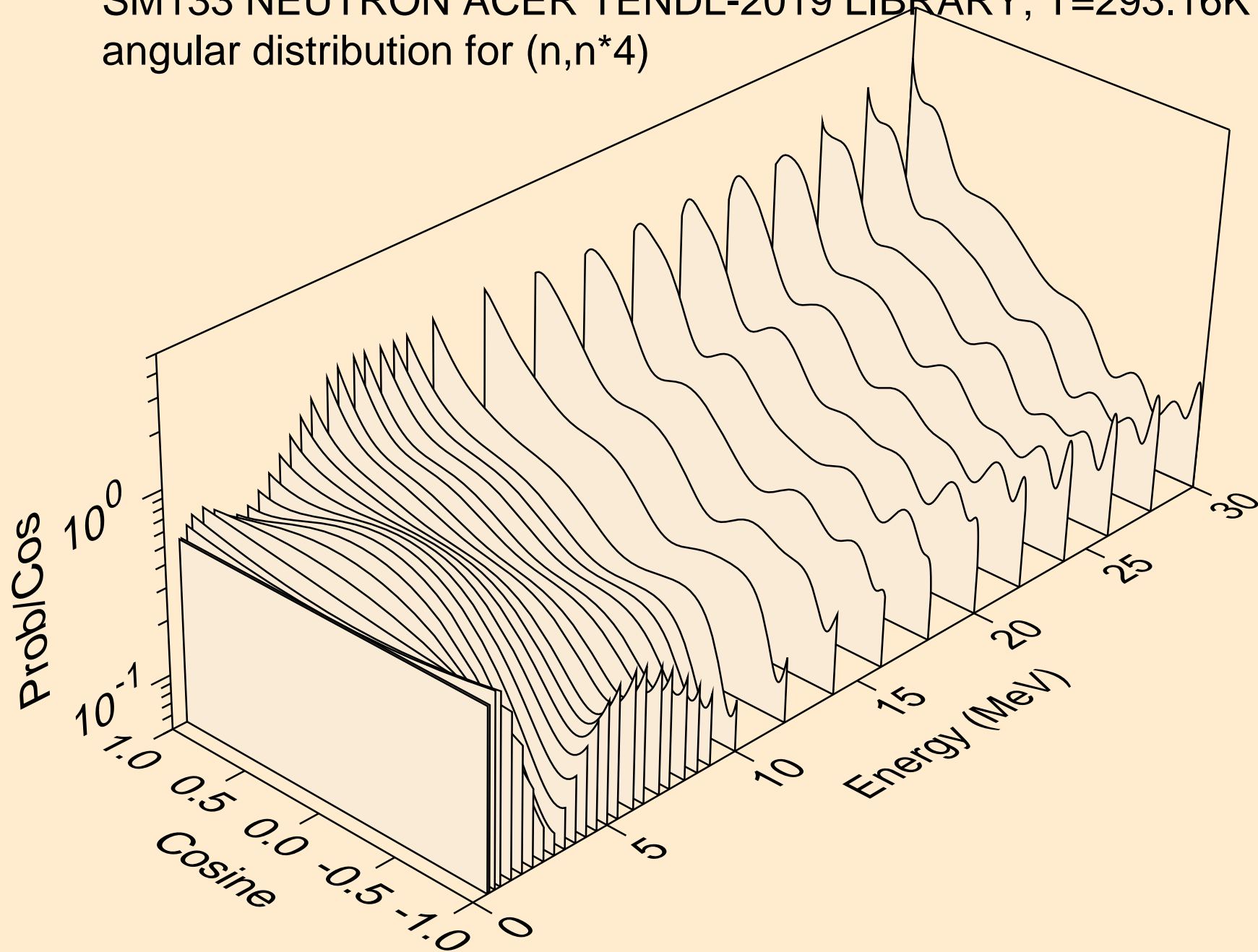

SM133 NEUTRON ACER TENDL-2019 LIBRARY; T=293.16K
angular distribution for (n,n*5)

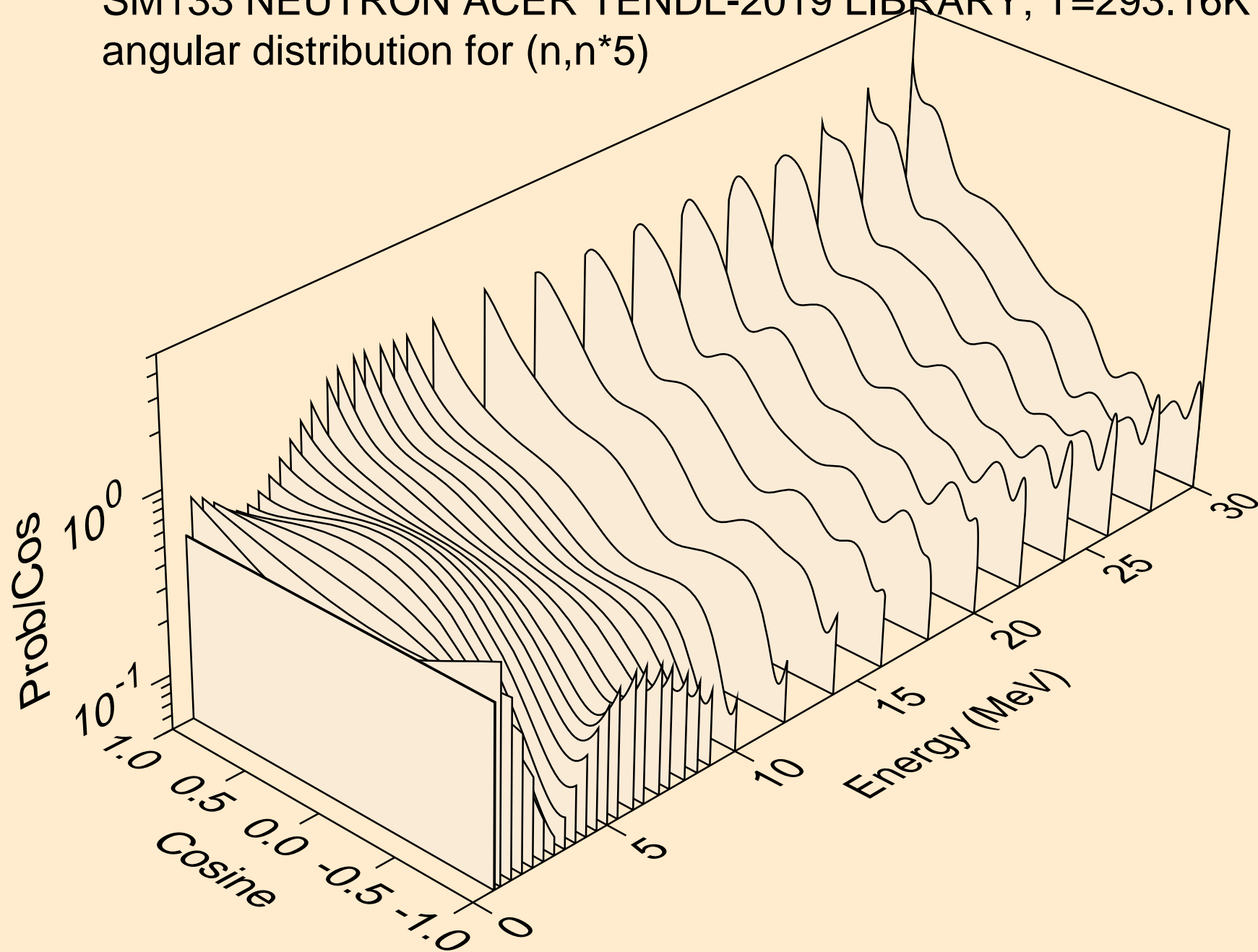

SM133 NEUTRON ACER TENDL-2019 LIBRARY; T=293.16K
Neutron emission for (n,x)

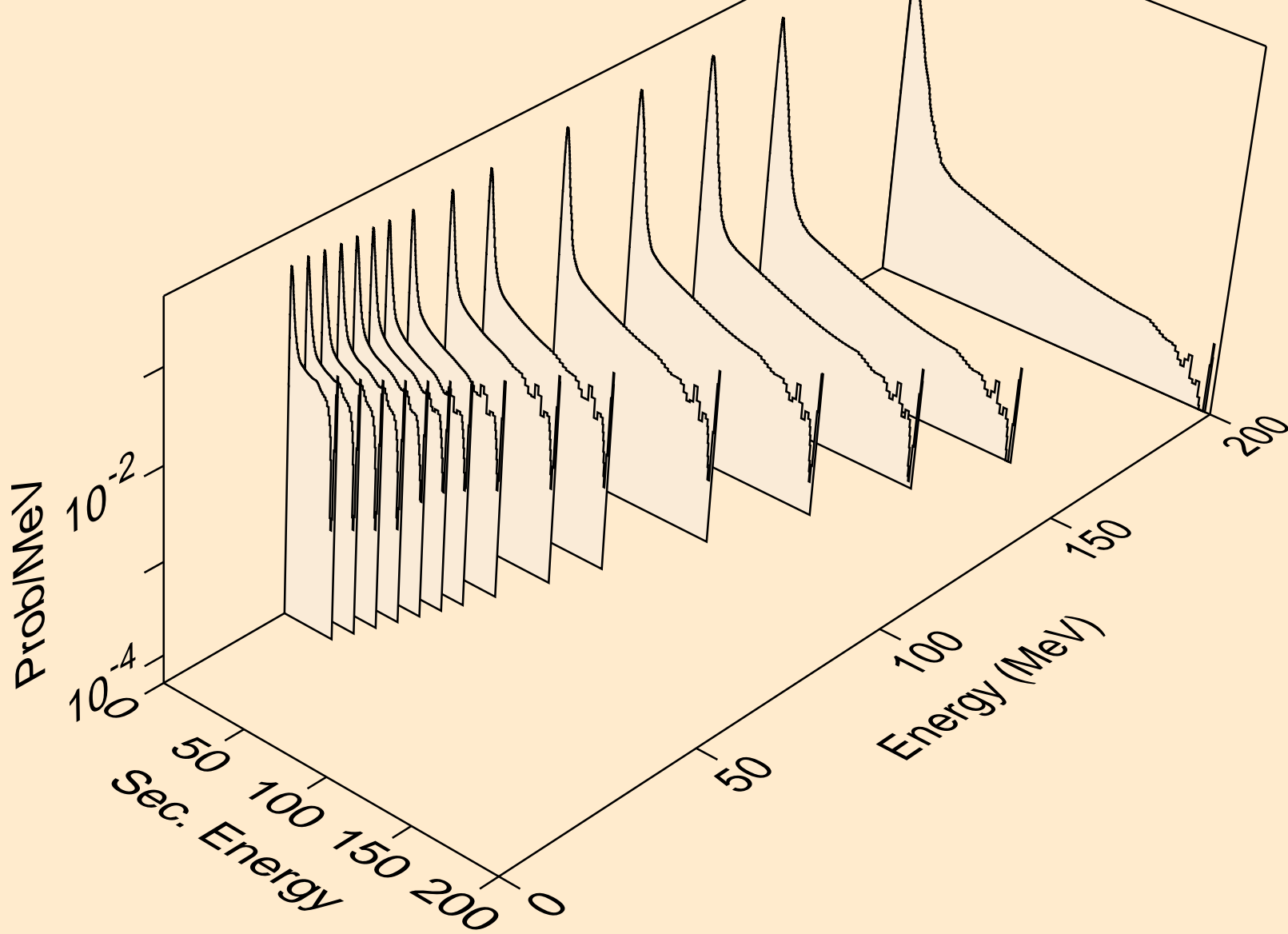

SM133 NEUTRON ACER TENDL-2019 LIBRARY; T=293.16K
Neutron emission for (n,2nd)

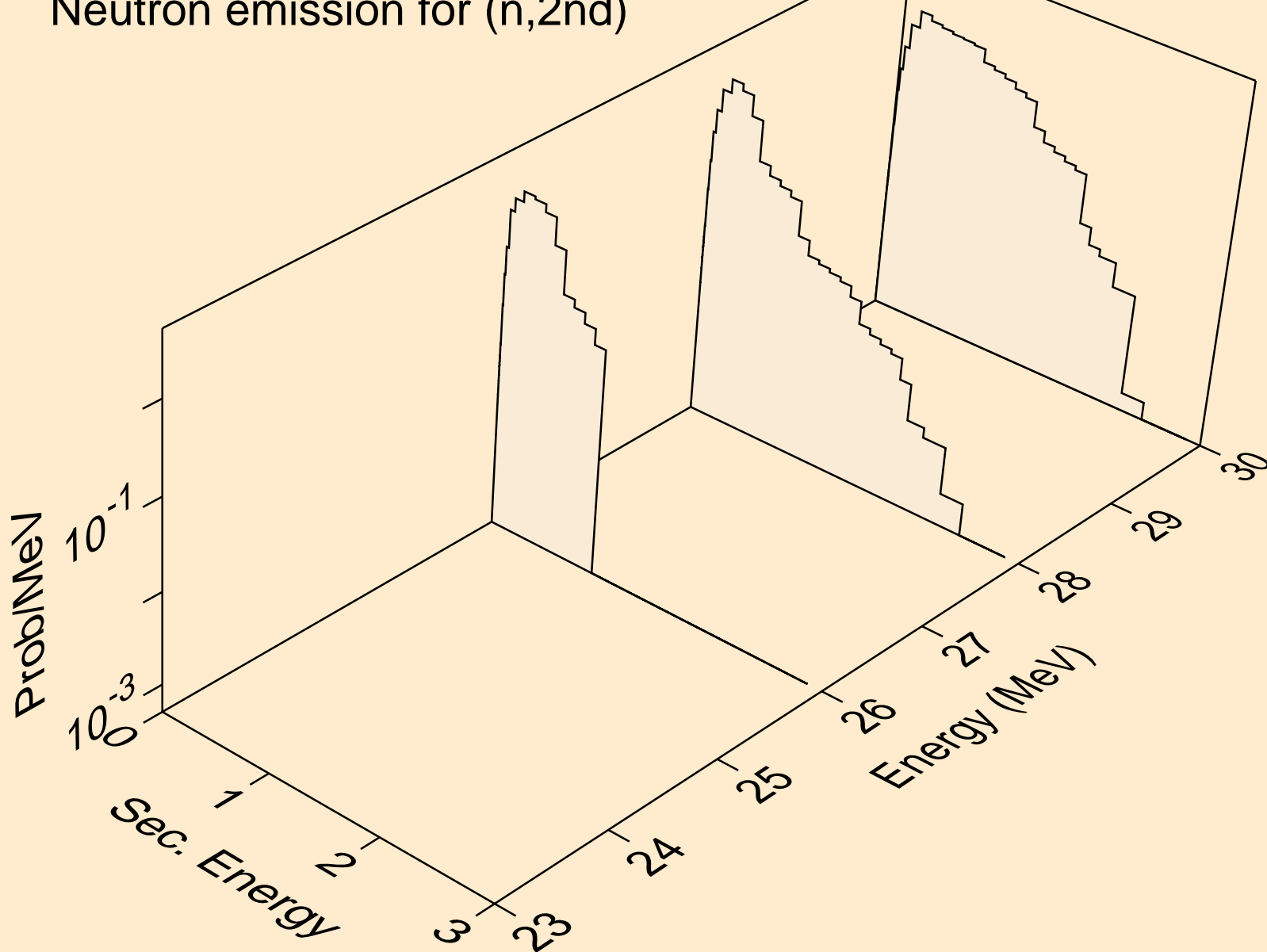

SM133 NEUTRON ACER TENDL-2019 LIBRARY; T=293.16K
Neutron emission for (n,2n)

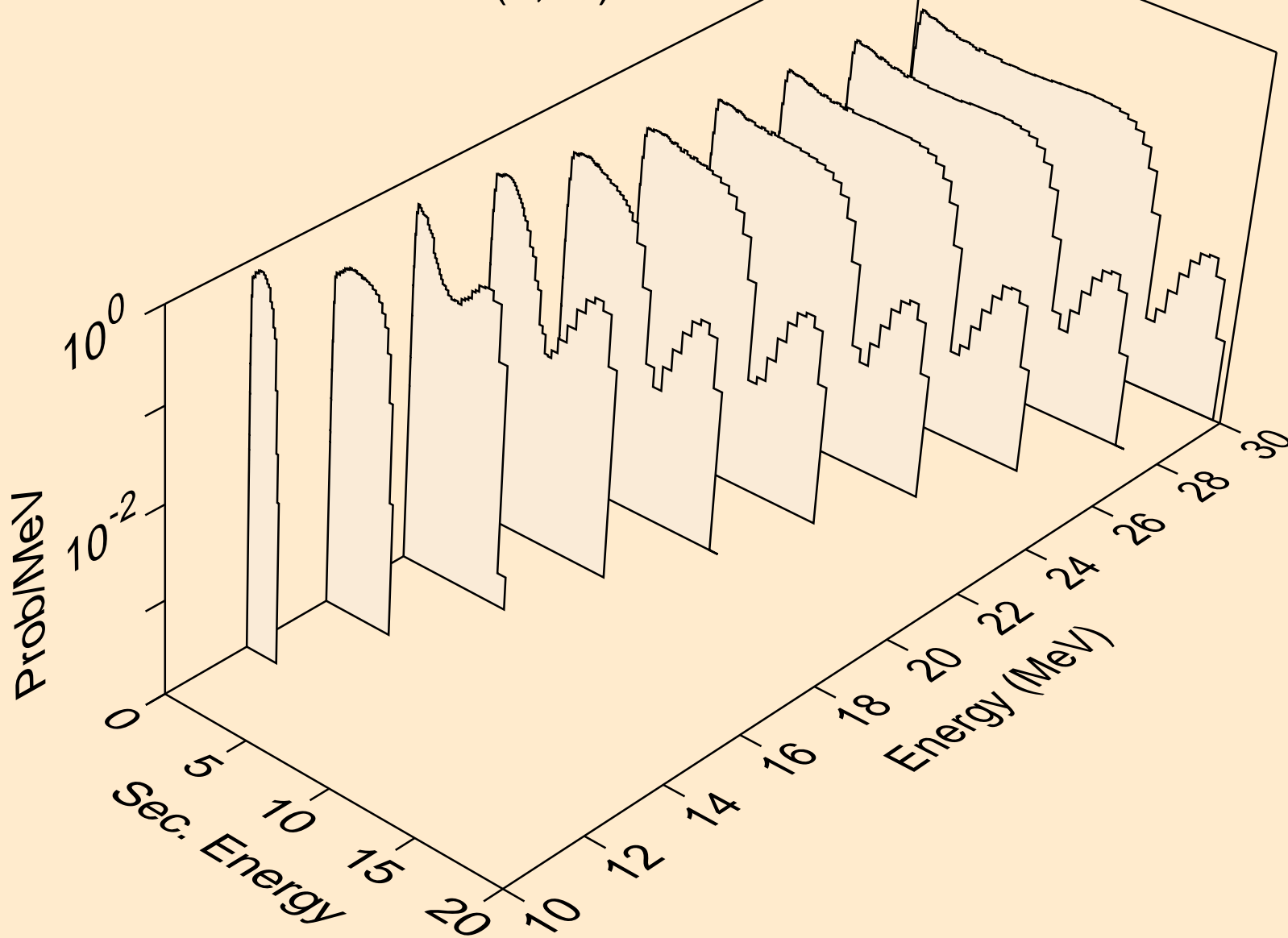

SM133 NEUTRON ACER TENDL-2019 LIBRARY; T=293.16K
Neutron emission for (n,3n)

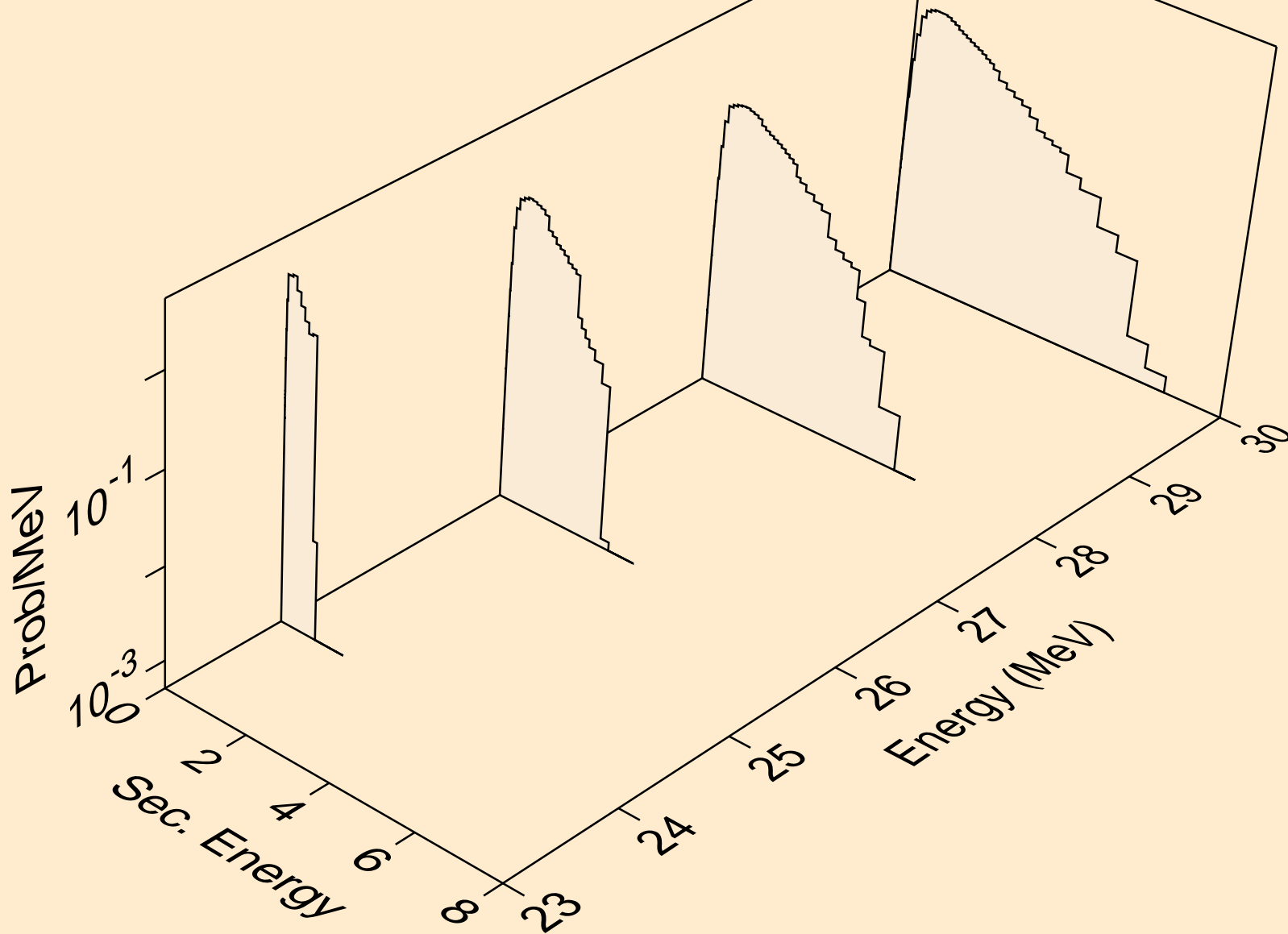

SM133 NEUTRON ACER TENDL-2019 LIBRARY; T=293.16K
Neutron emission for (n,n*)a

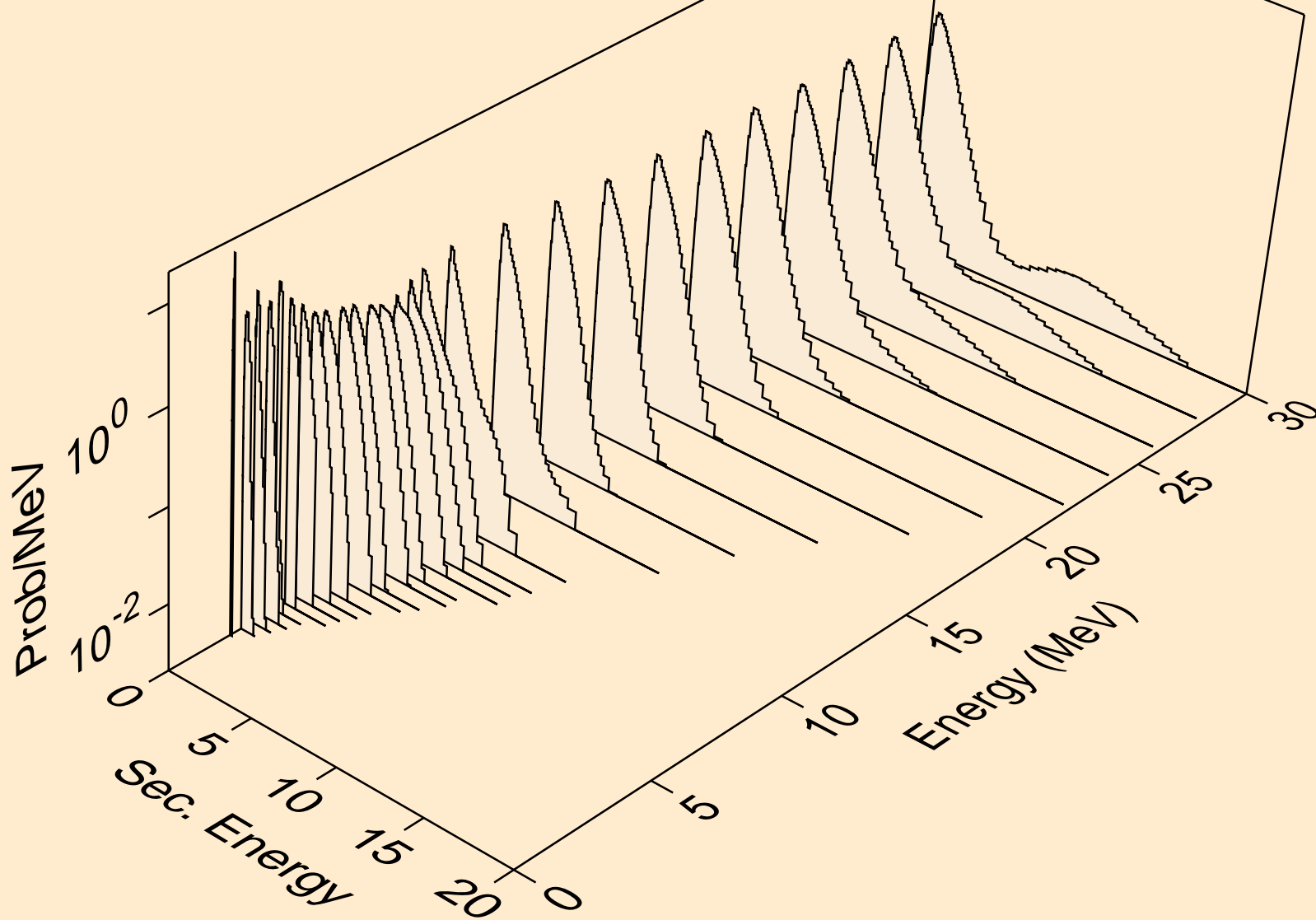

SM133 NEUTRON ACER TENDL-2019 LIBRARY; T=293.16K
Neutron emission for (n,2n)a

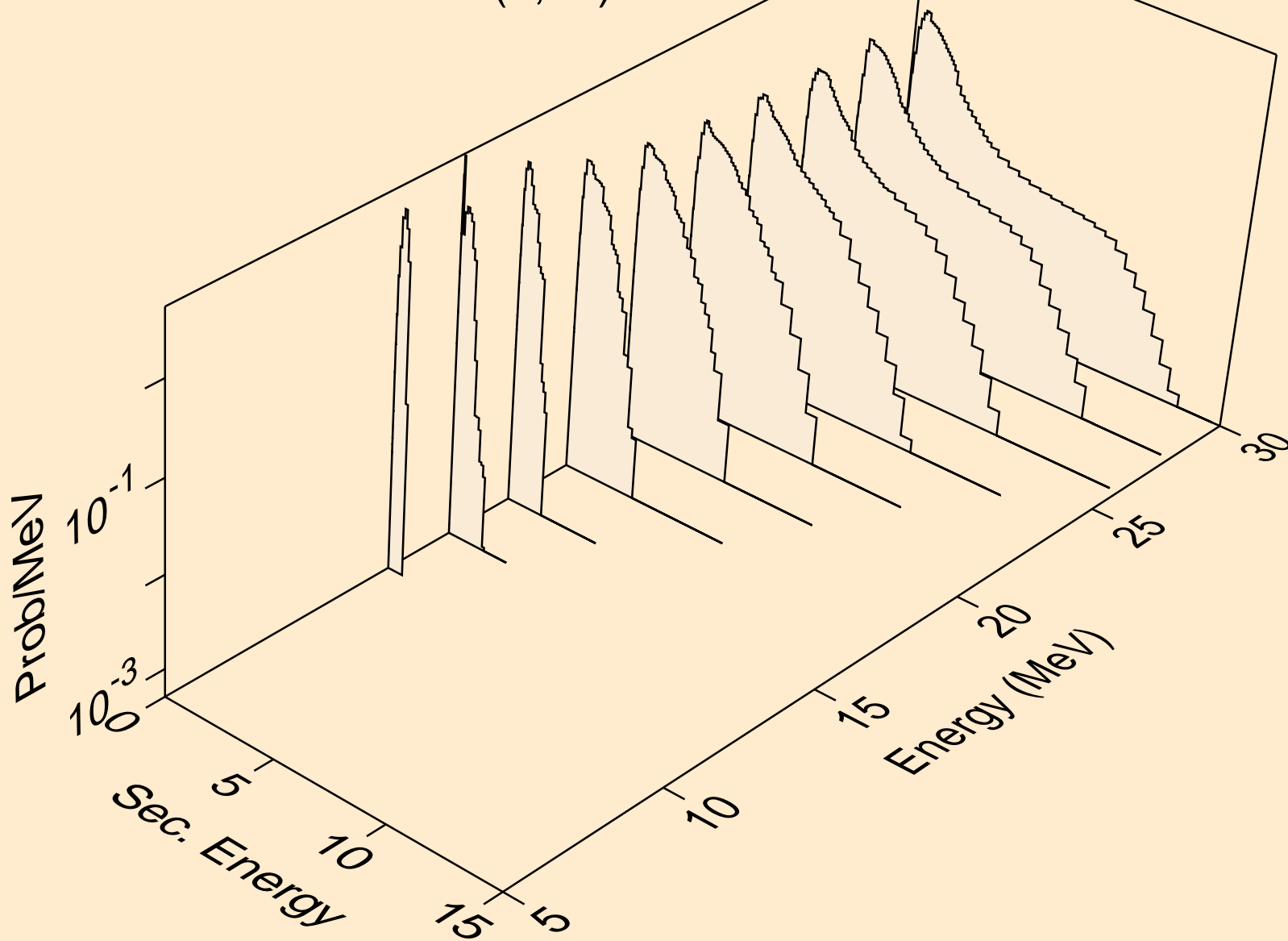

SM133 NEUTRON ACER TENDL-2019 LIBRARY; T=293.16K
Neutron emission for (n,n*)p

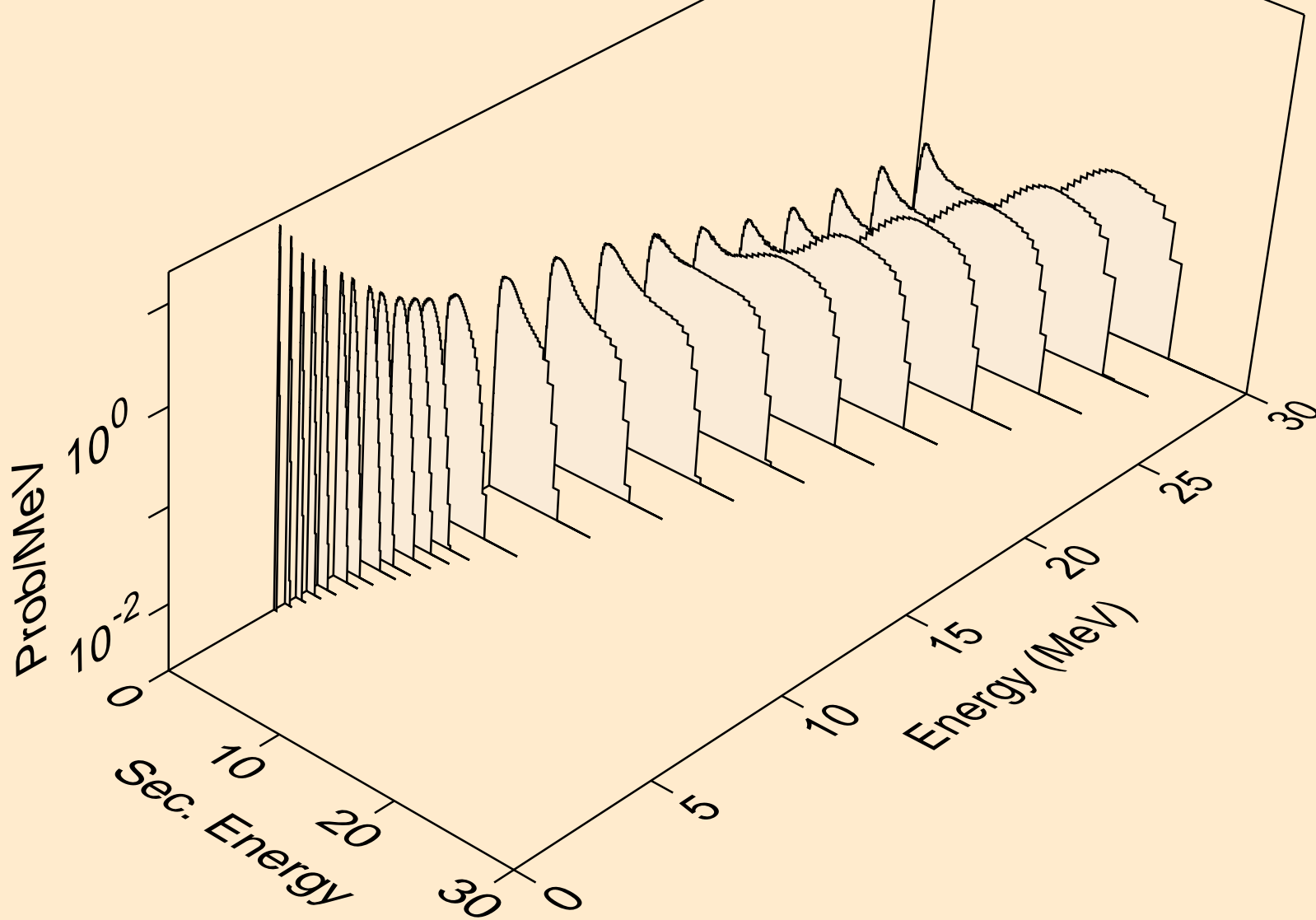

SM133 NEUTRON ACER TENDL-2019 LIBRARY; T=293.16K
Neutron emission for (n,n*)2a

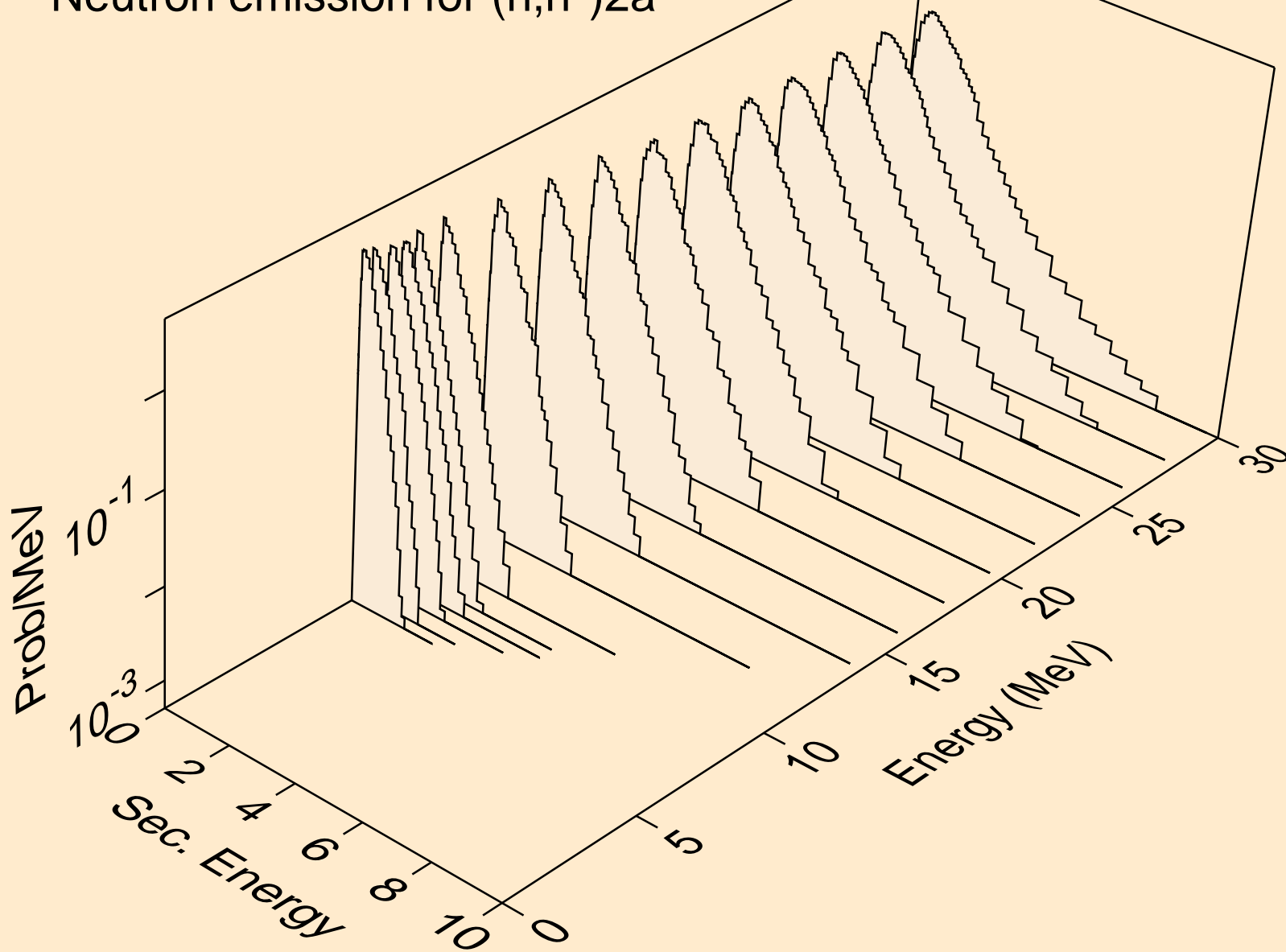

SM133 NEUTRON ACER TENDL-2019 LIBRARY; T=293.16K
Neutron emission for (n,2n)2a

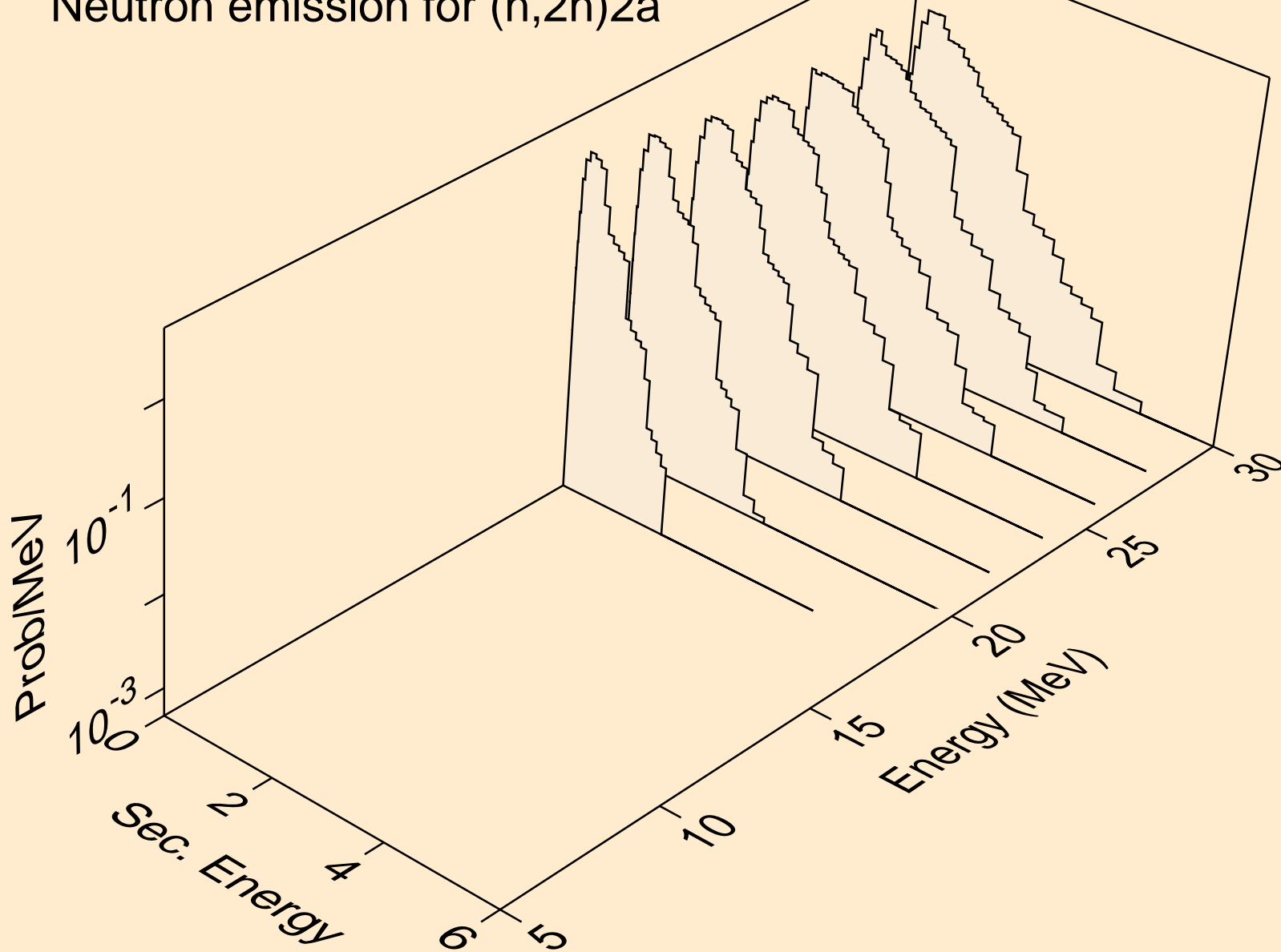

SM133 NEUTRON ACER TENDL-2019 LIBRARY; T=293.16K
Neutron emission for (n,n*)d

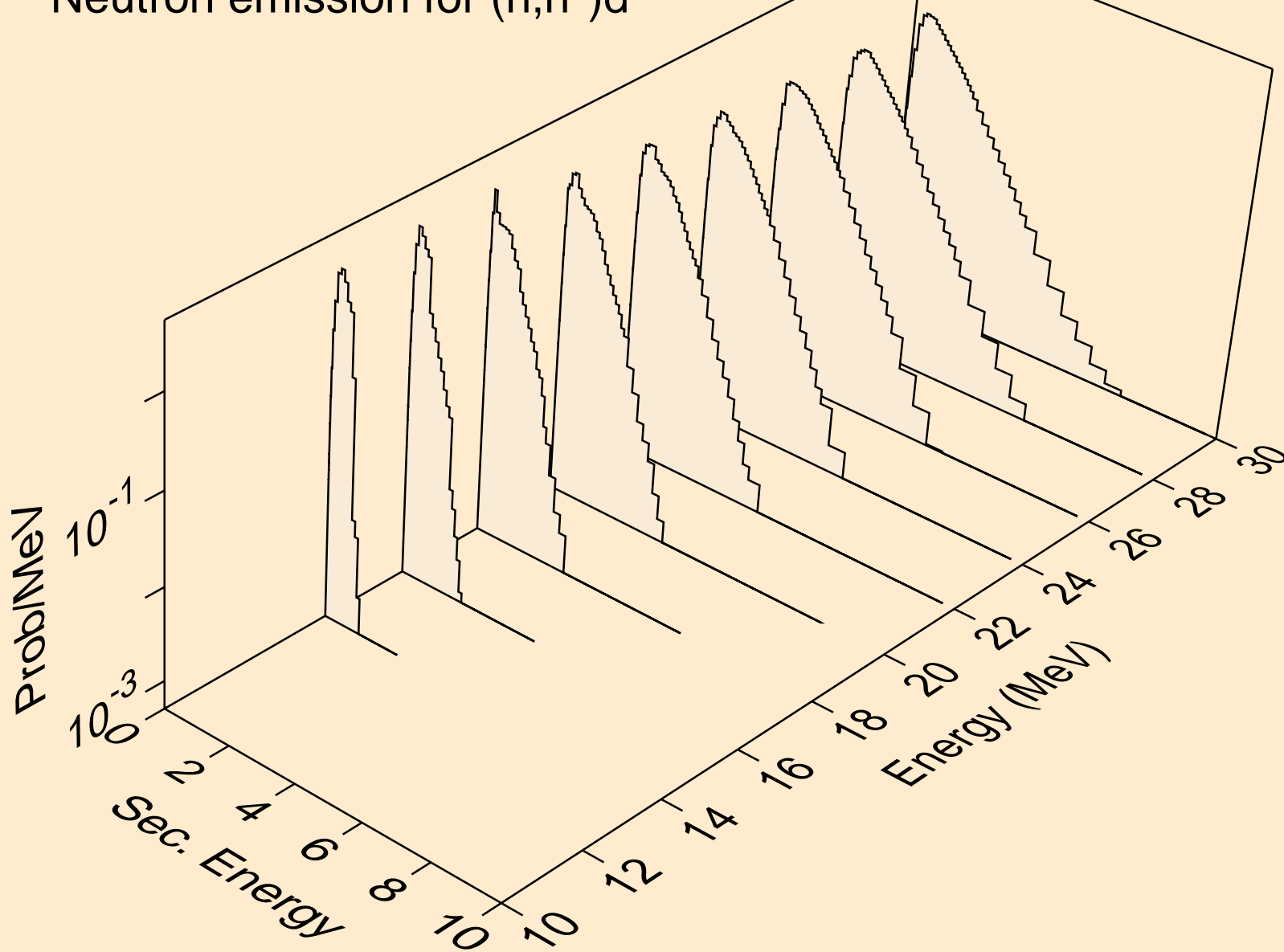

SM133 NEUTRON ACER TENDL-2019 LIBRARY; T=293.16K
Neutron emission for (n,n*)t

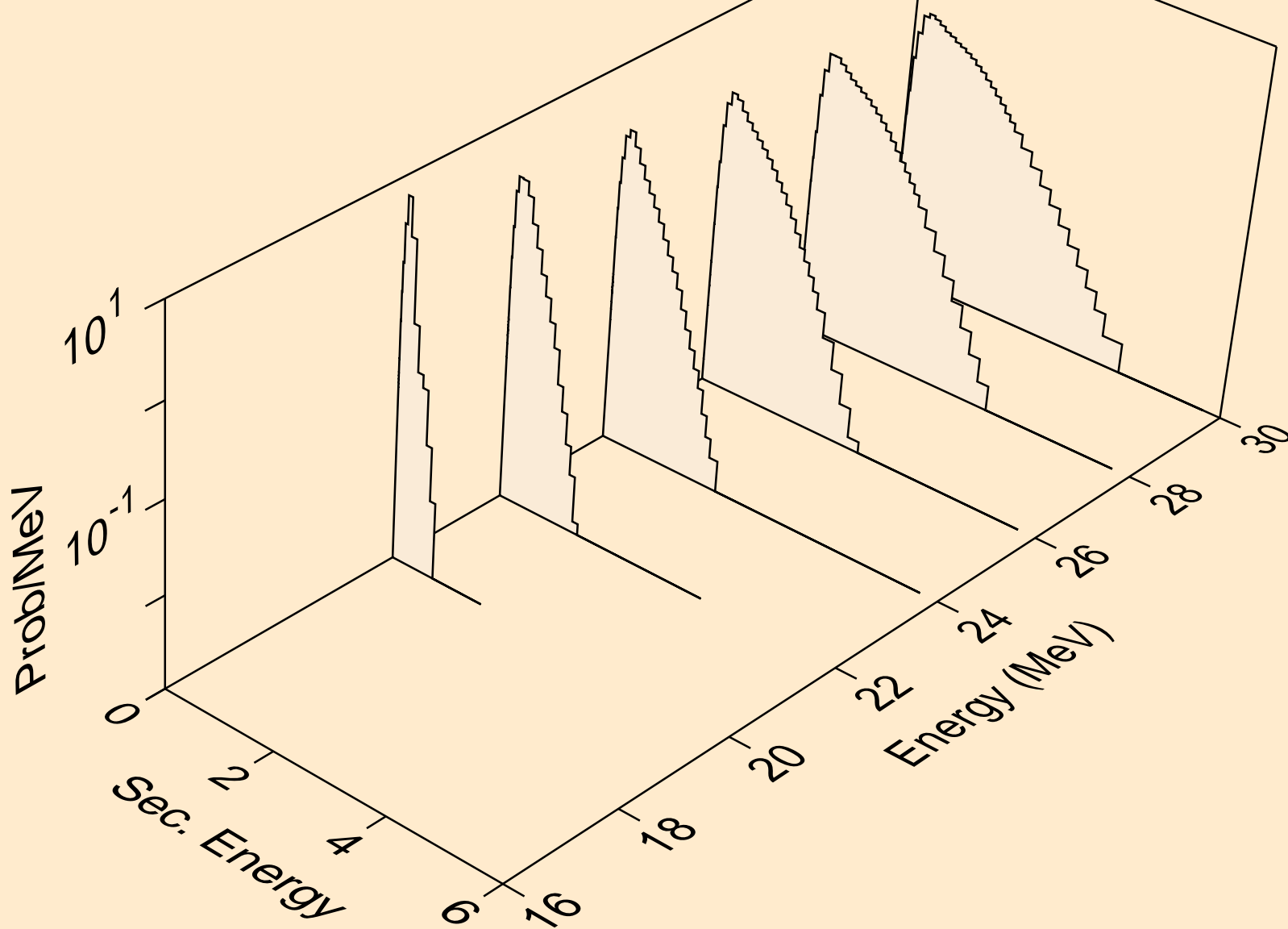

SM133 NEUTRON ACER TENDL-2019 LIBRARY; T=293.16K
Neutron emission for (n,n*)he3

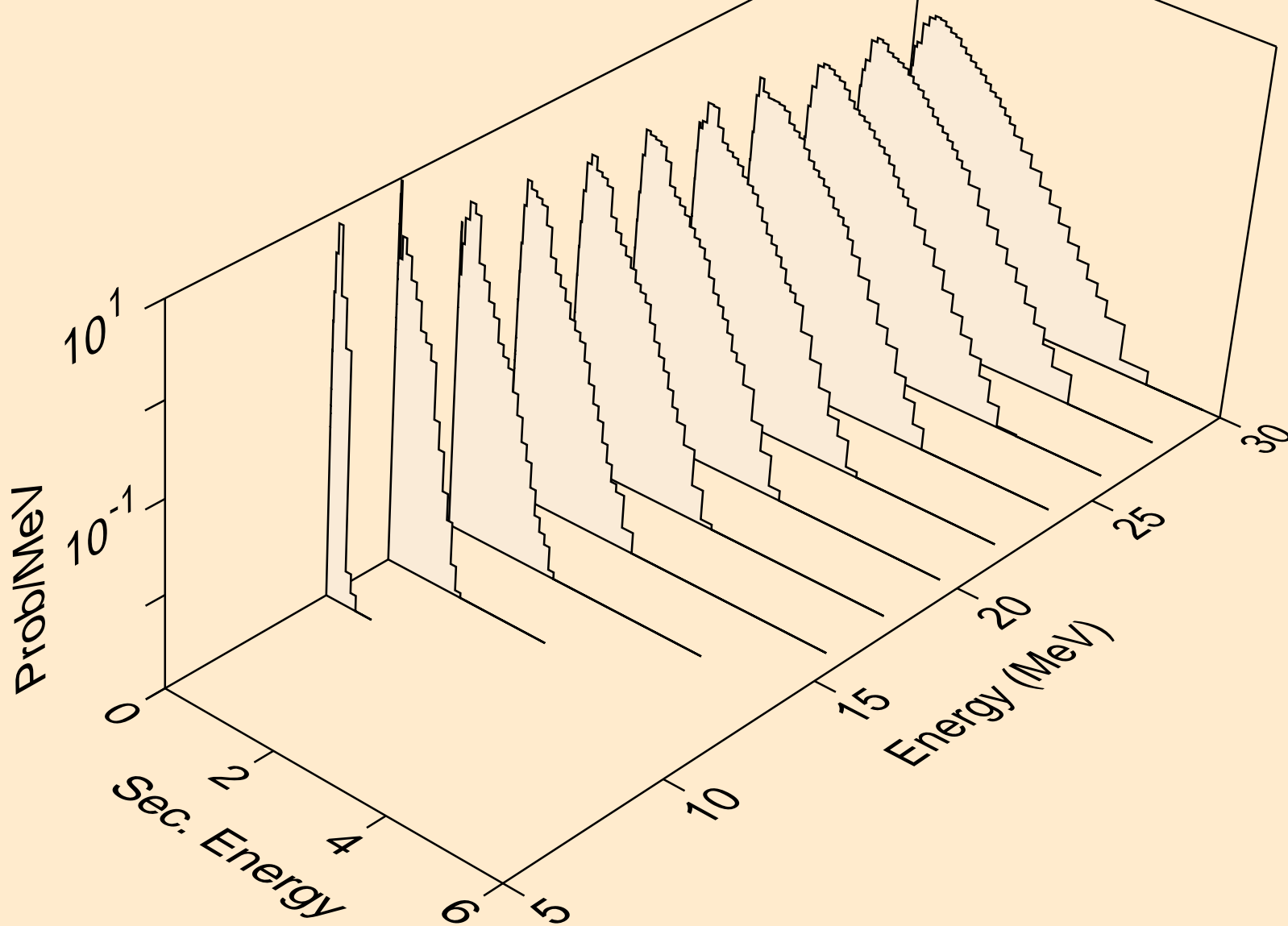

SM133 NEUTRON ACER TENDL-2019 LIBRARY; T=293.16K
Neutron emission for (n,2np)

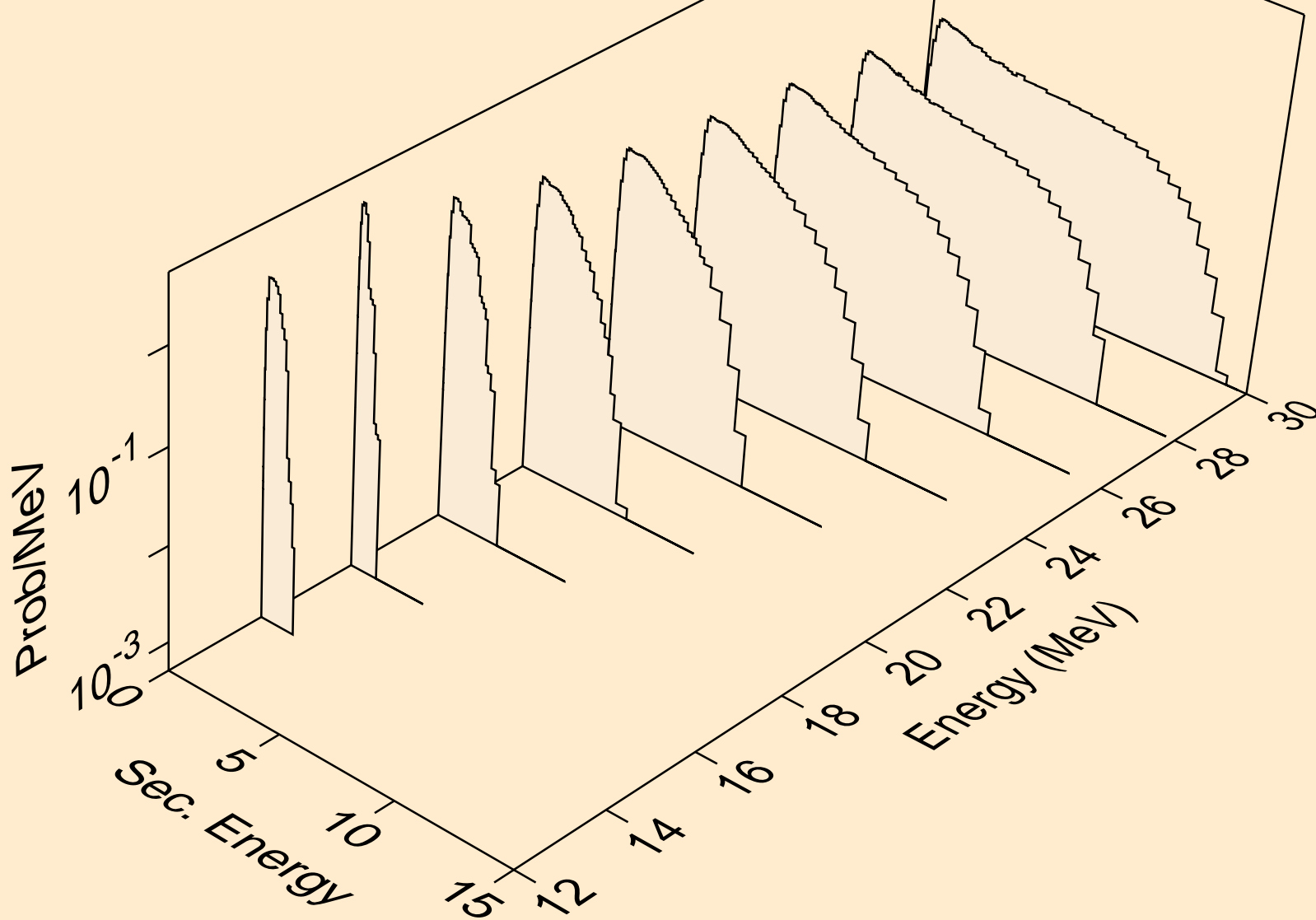

SM133 NEUTRON ACER TENDL-2019 LIBRARY; T=293.16K
Neutron emission for (n,3np)

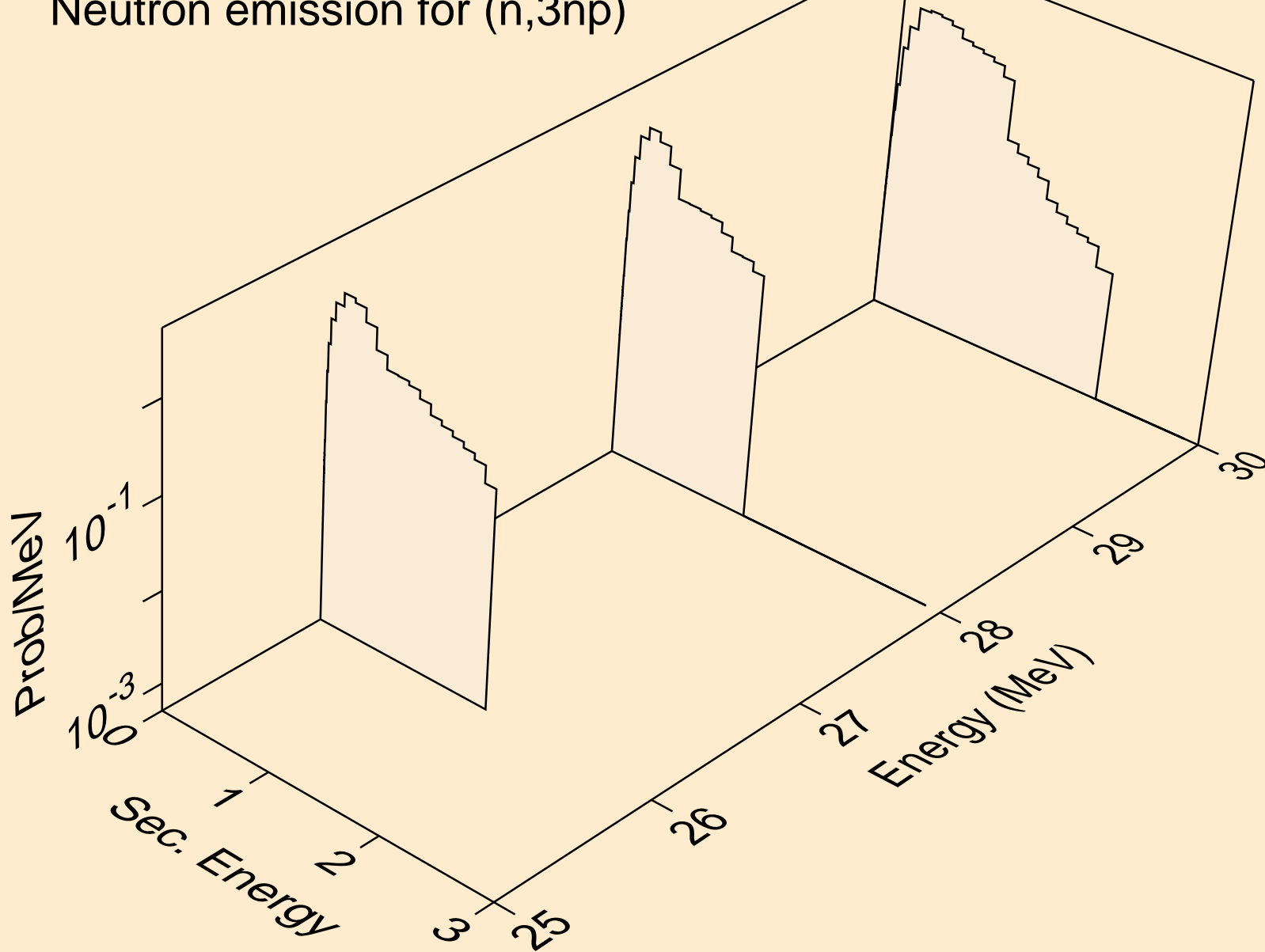

SM133 NEUTRON ACER TENDL-2019 LIBRARY; T=293.16K
Neutron emission for (n,2np)

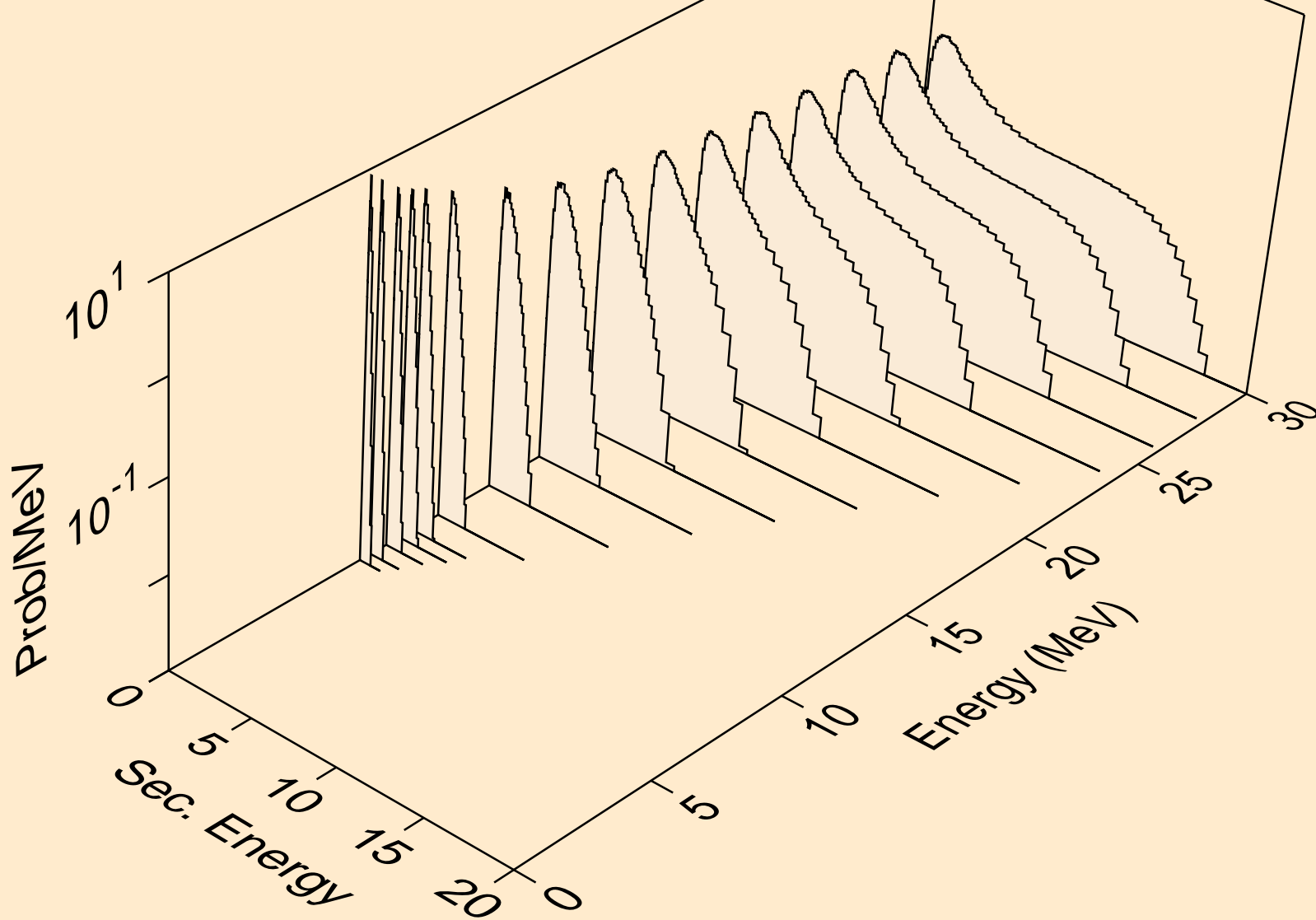

SM133 NEUTRON ACER TENDL-2019 LIBRARY; T=293.16K
Neutron emission for (n,npa)

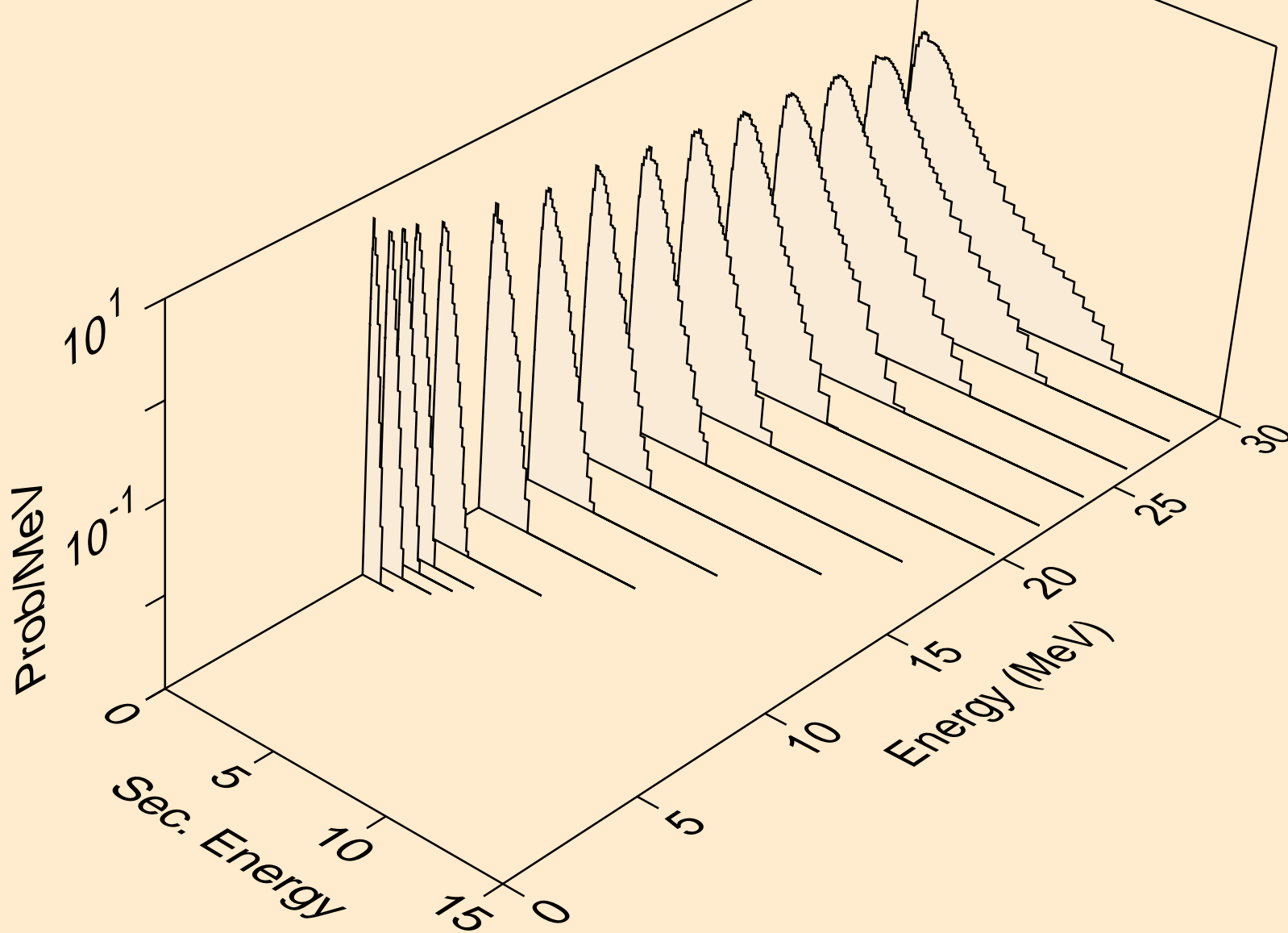

SM133 NEUTRON ACER TENDL-2019 LIBRARY; T=293.16K
Neutron emission for (n,n*c)

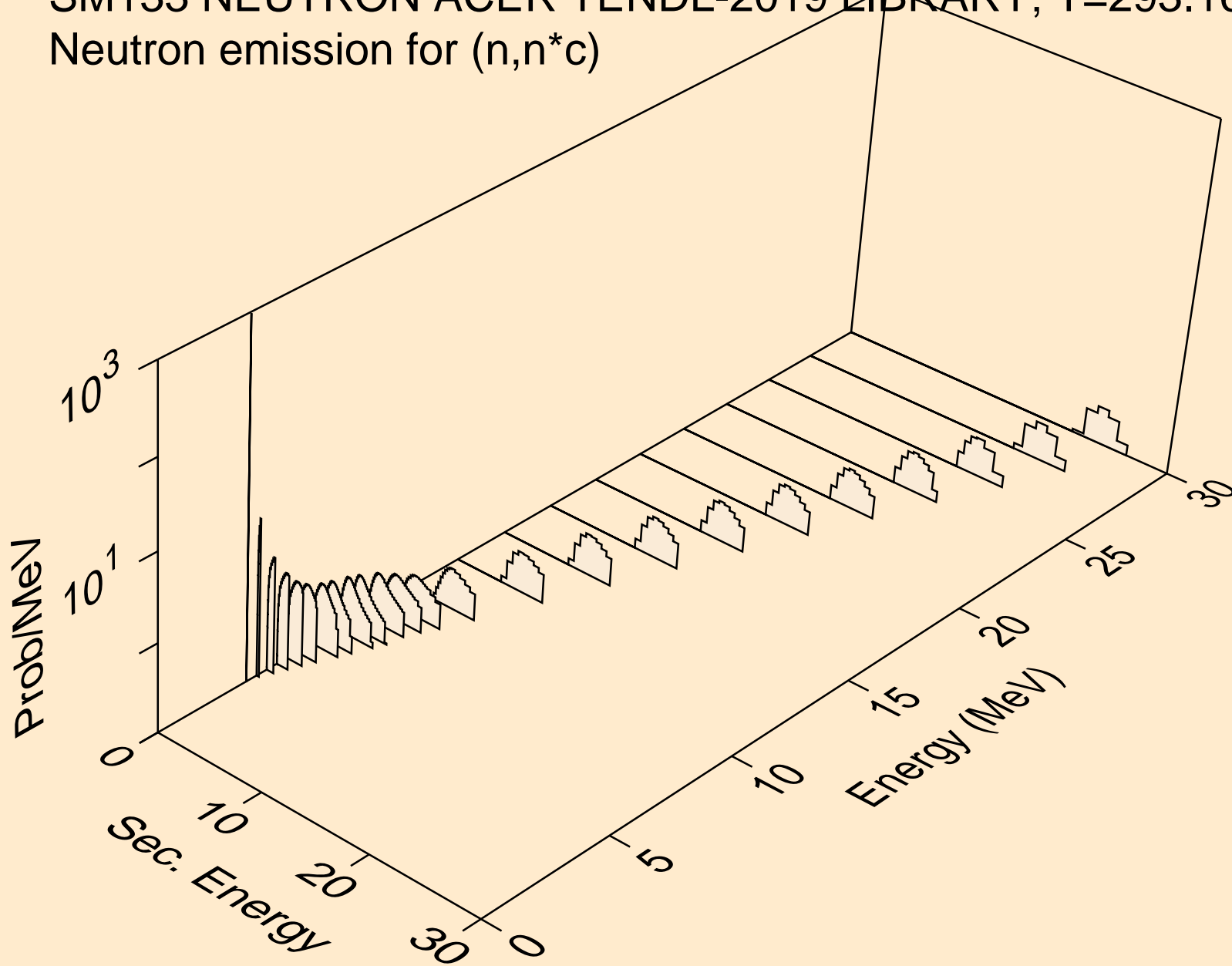

SM133 NEUTRON ACER TENDL-2019 LIBRARY; T=293.16K
Photon emission for (n,x)

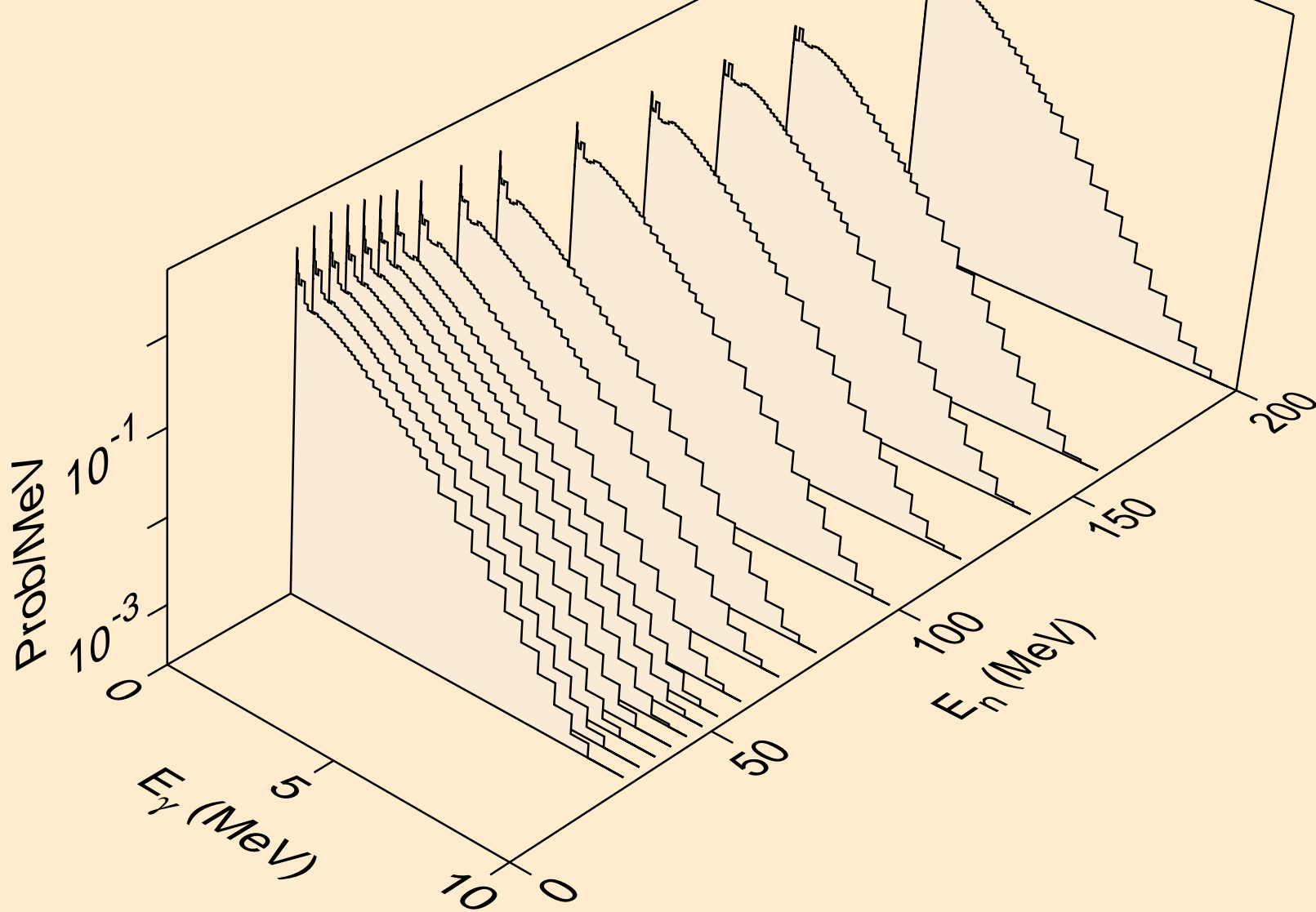

SM133 NEUTRON ACER TENDL-2019 LIBRARY; T=293.16K
Photon emission for (n,2nd)

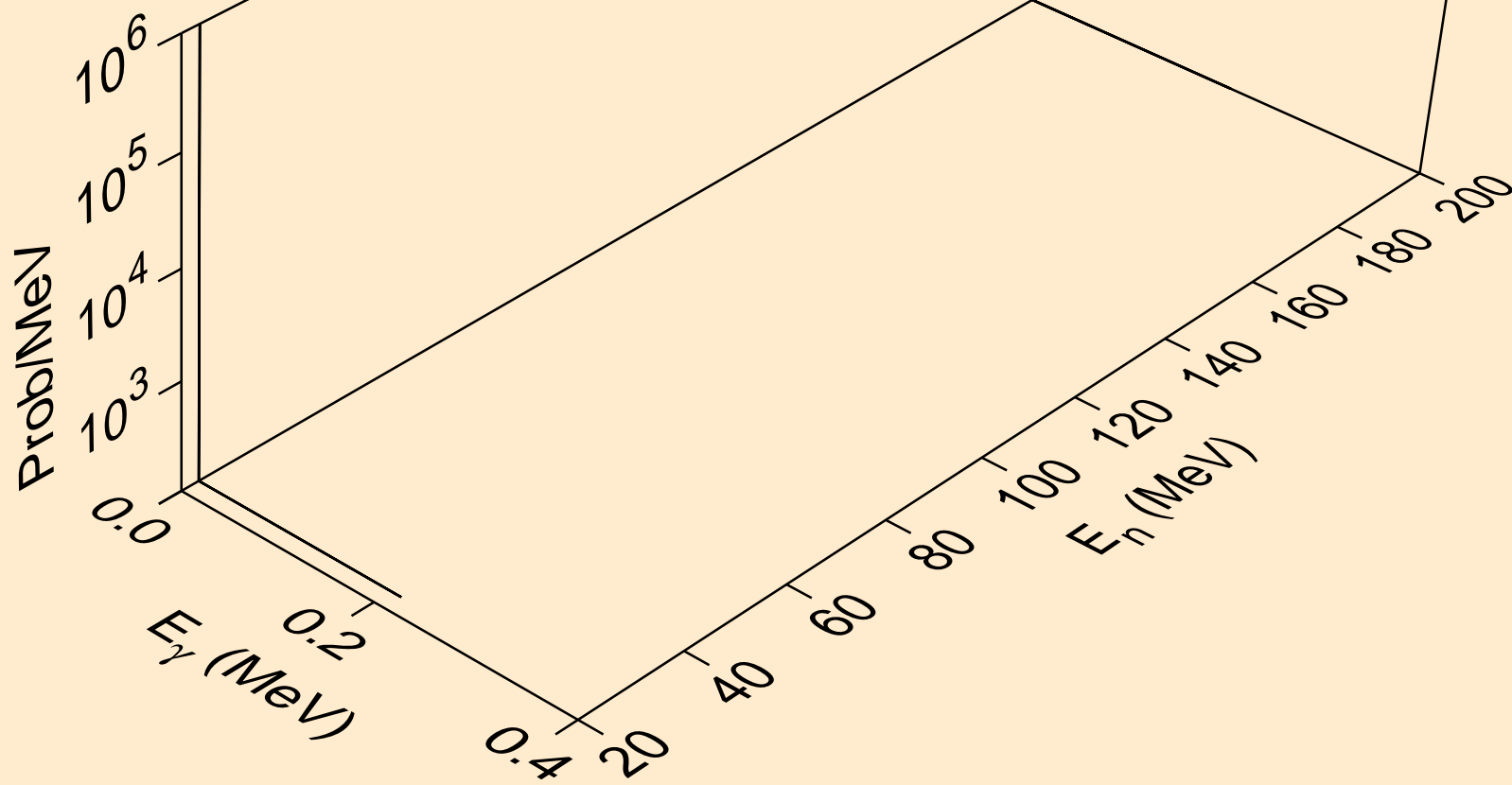

SM133 NEUTRON ACER TENDL-2019 LIBRARY; T=293.16K
Photon emission for (n,2n)

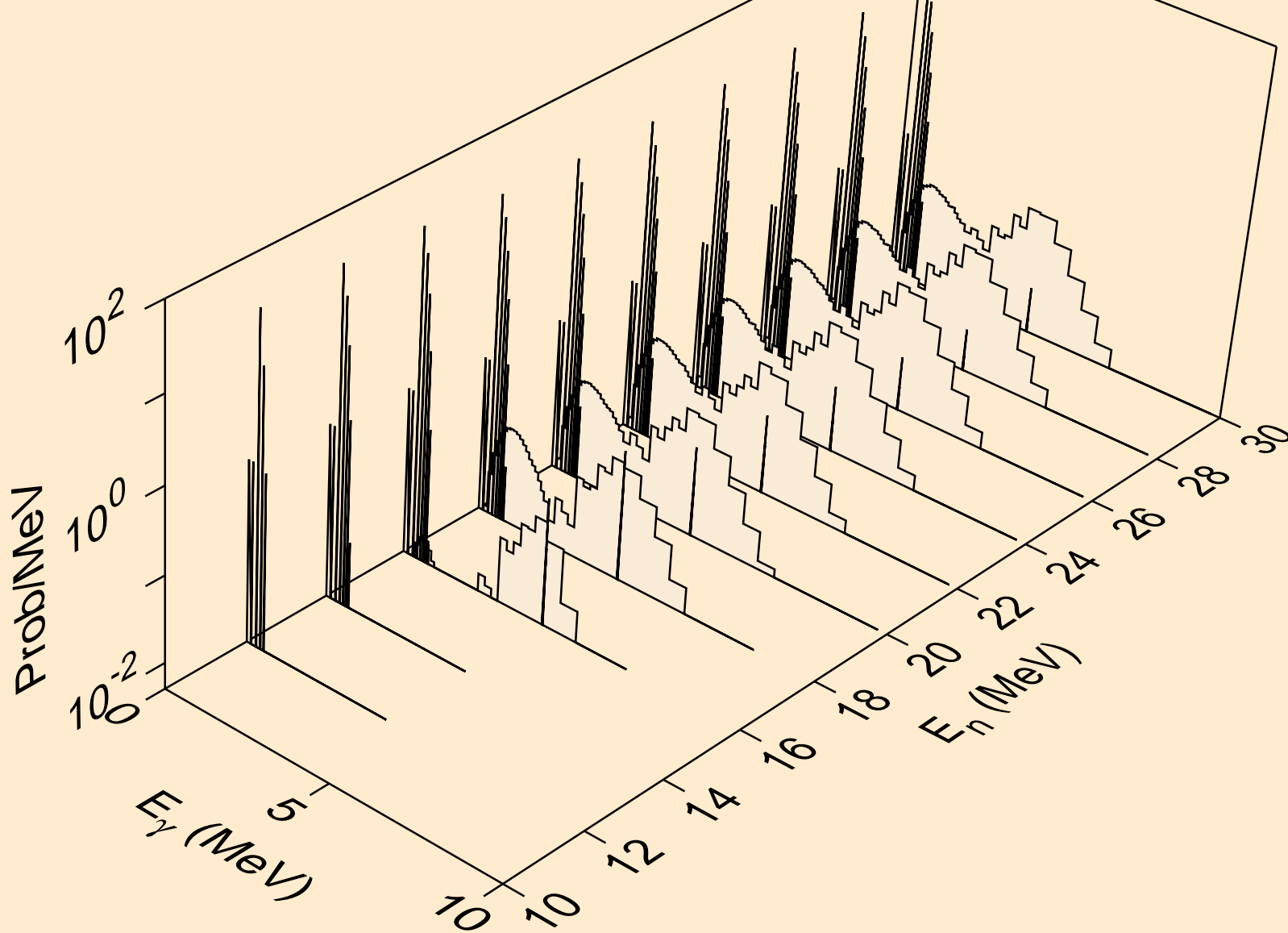

SM133 NEUTRON ACER TENDL-2019 LIBRARY; T=293.16K
Photon emission for (n,3n)

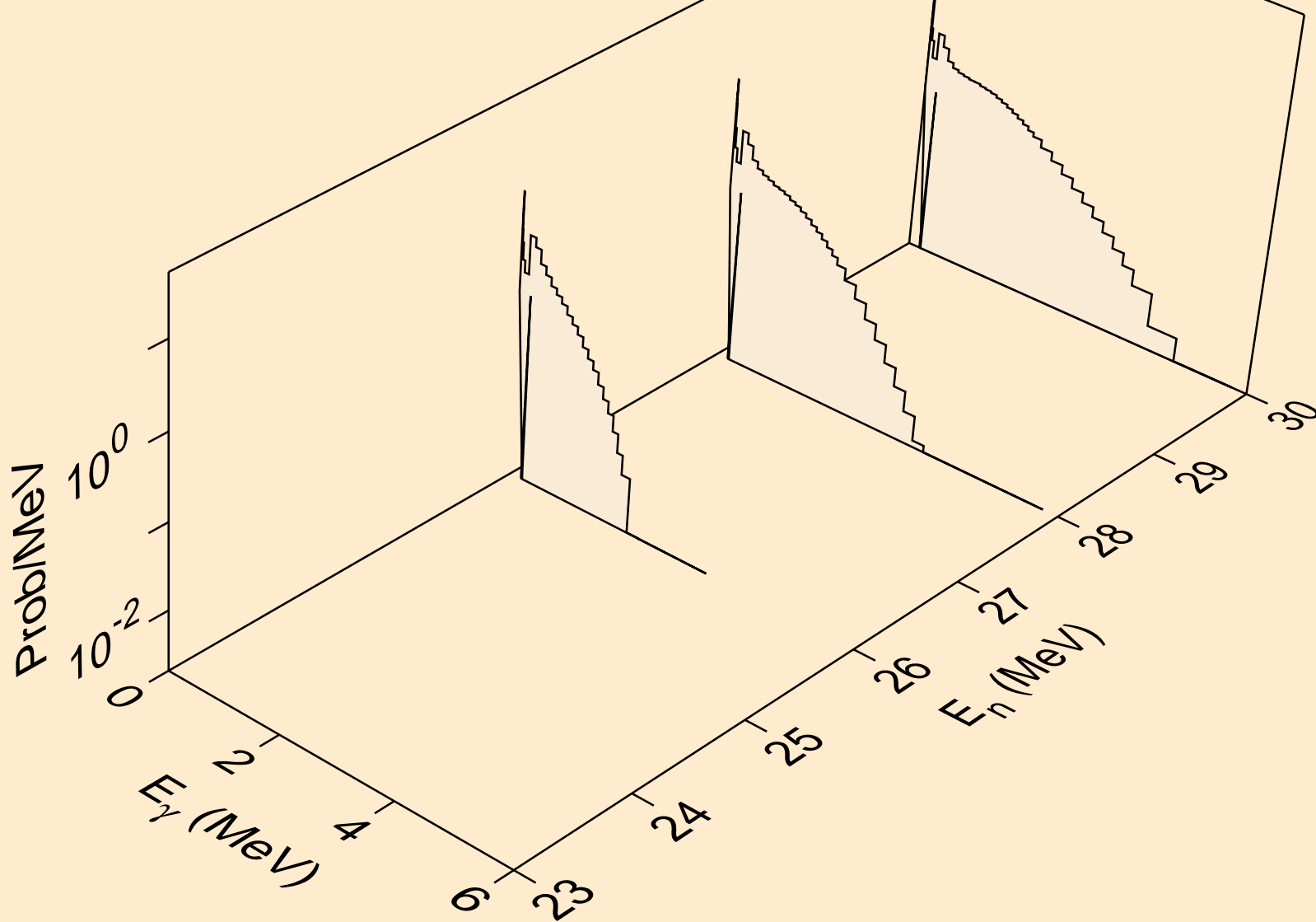

SM133 NEUTRON ACER TENDL-2019 LIBRARY; T=293.16K
Photon emission for (n,n*)a

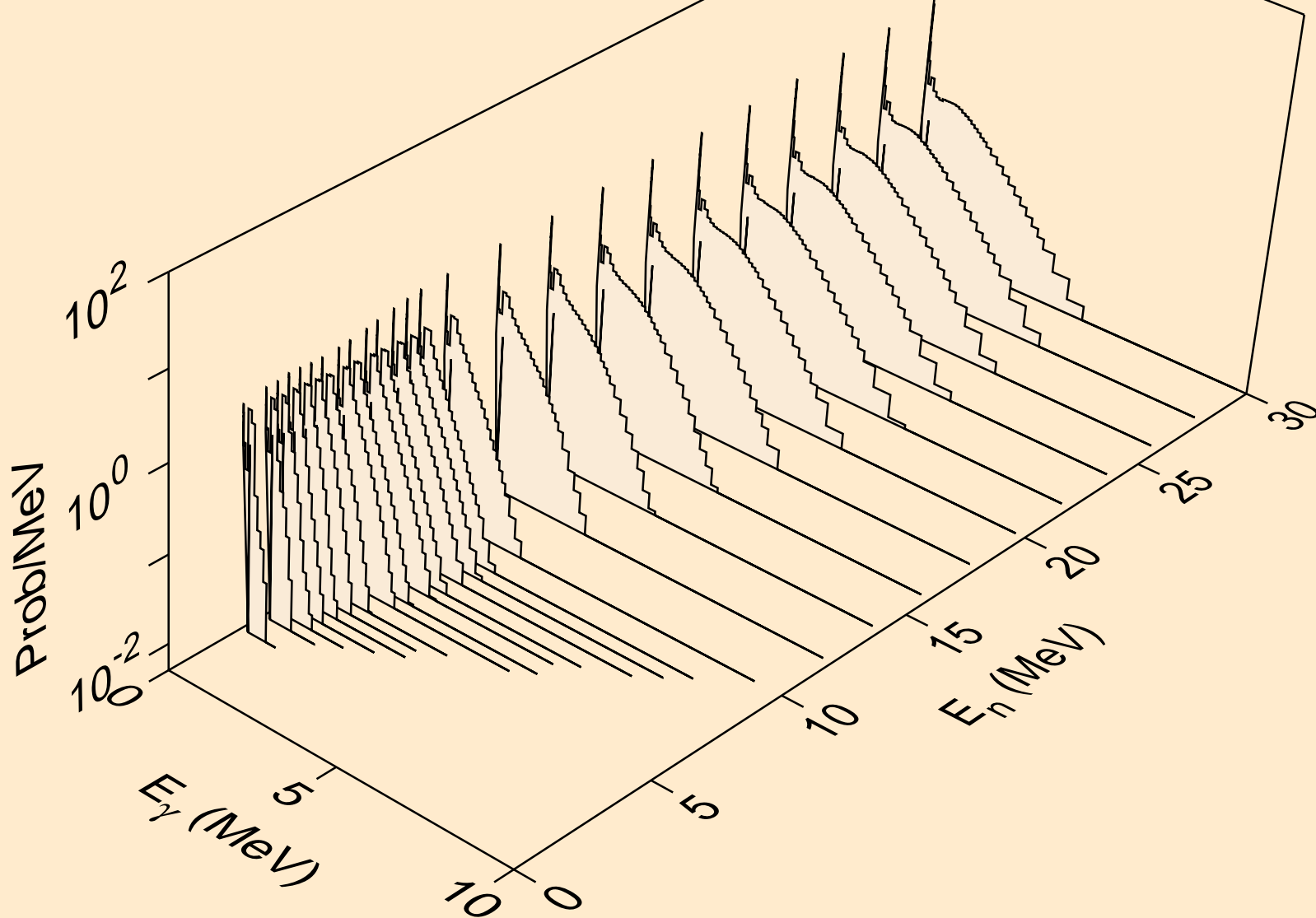

SM133 NEUTRON ACER TENDL-2019 LIBRARY; T=293.16K
Photon emission for (n,2n)a

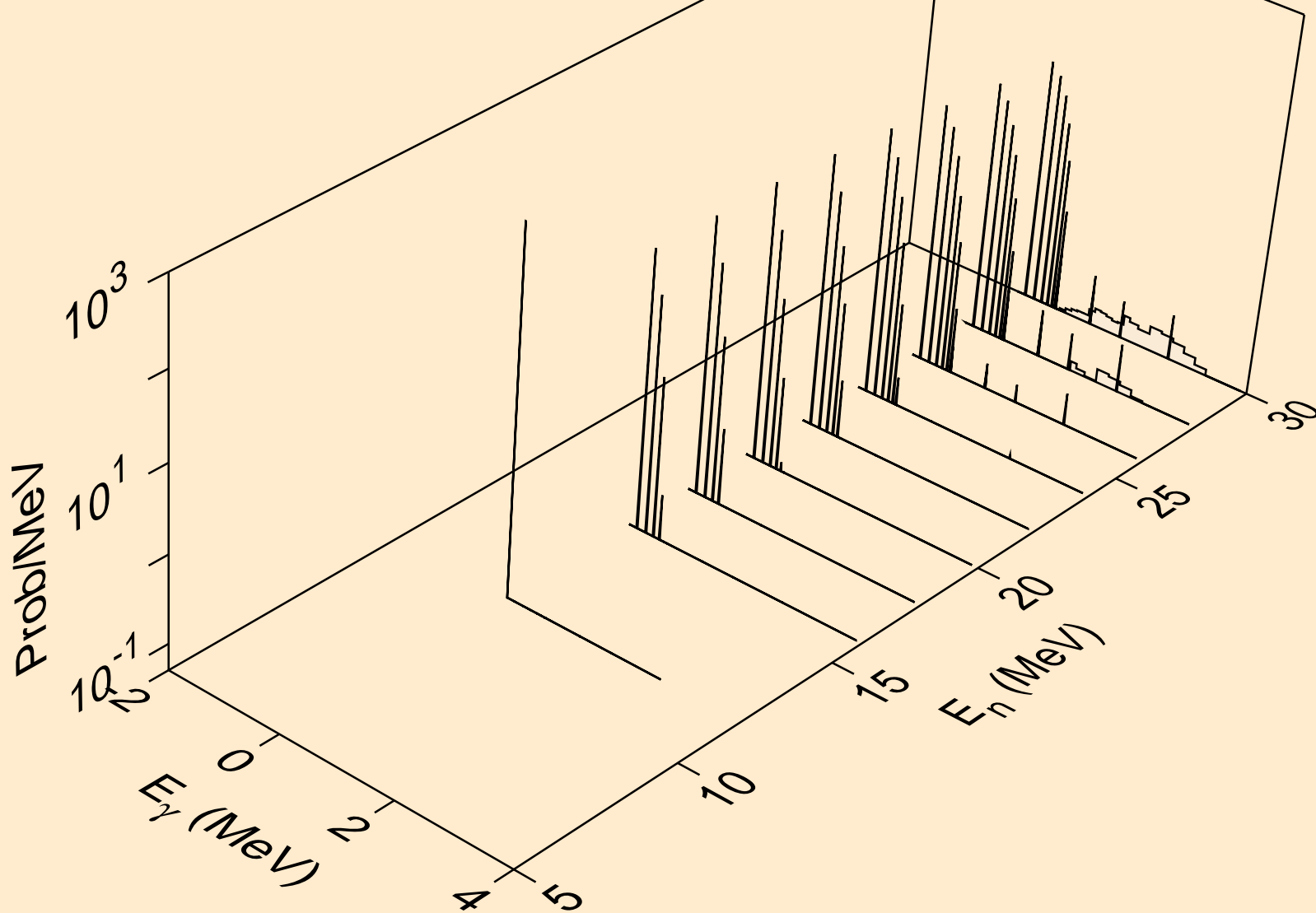

SM133 NEUTRON ACER TENDL-2019 LIBRARY; T=293.16K
Photon emission for (n,n*)p

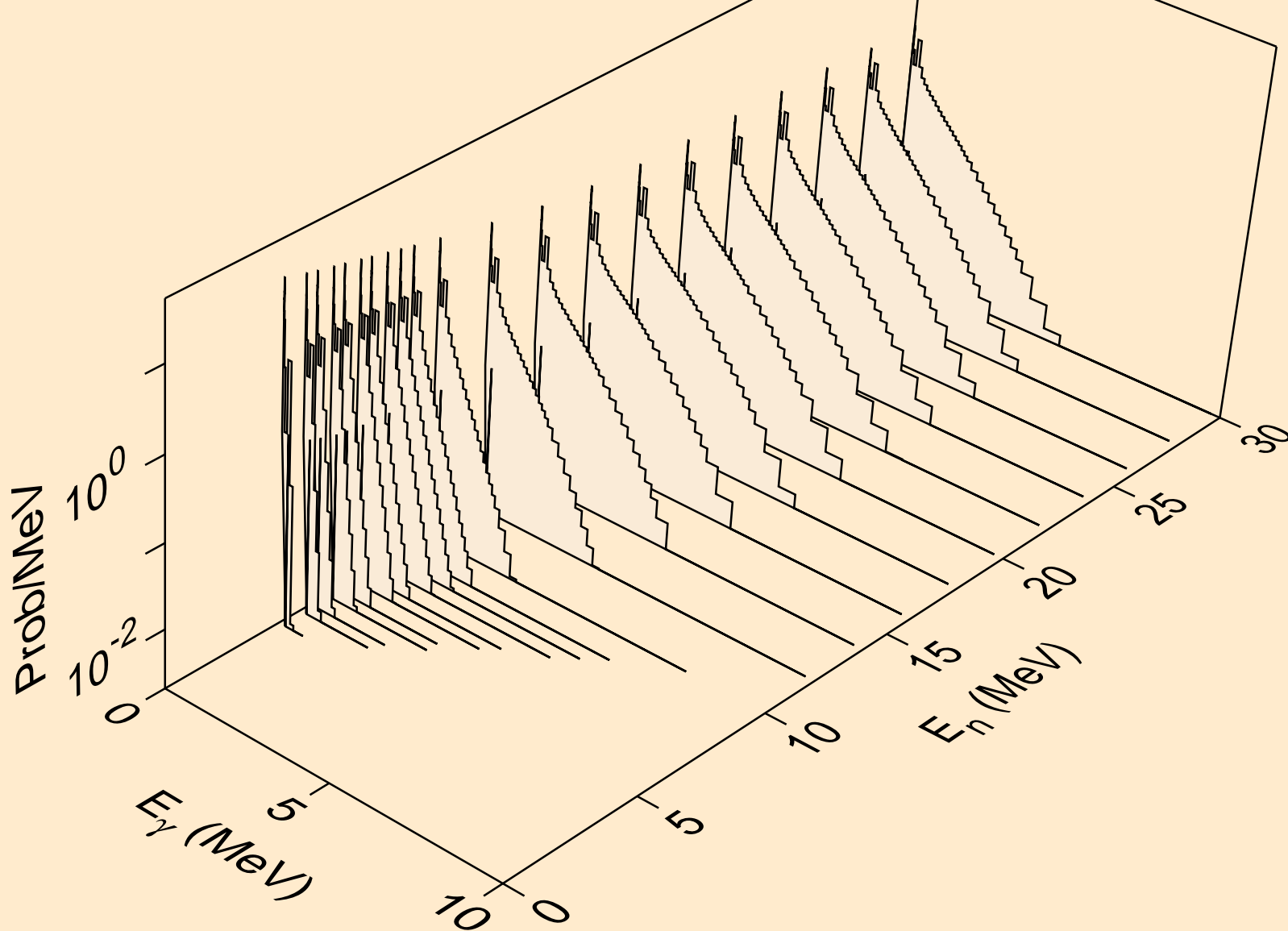

SM133 NEUTRON ACER TENDL-2019 LIBRARY; T=293.16K
Photon emission for (n,n*)2a

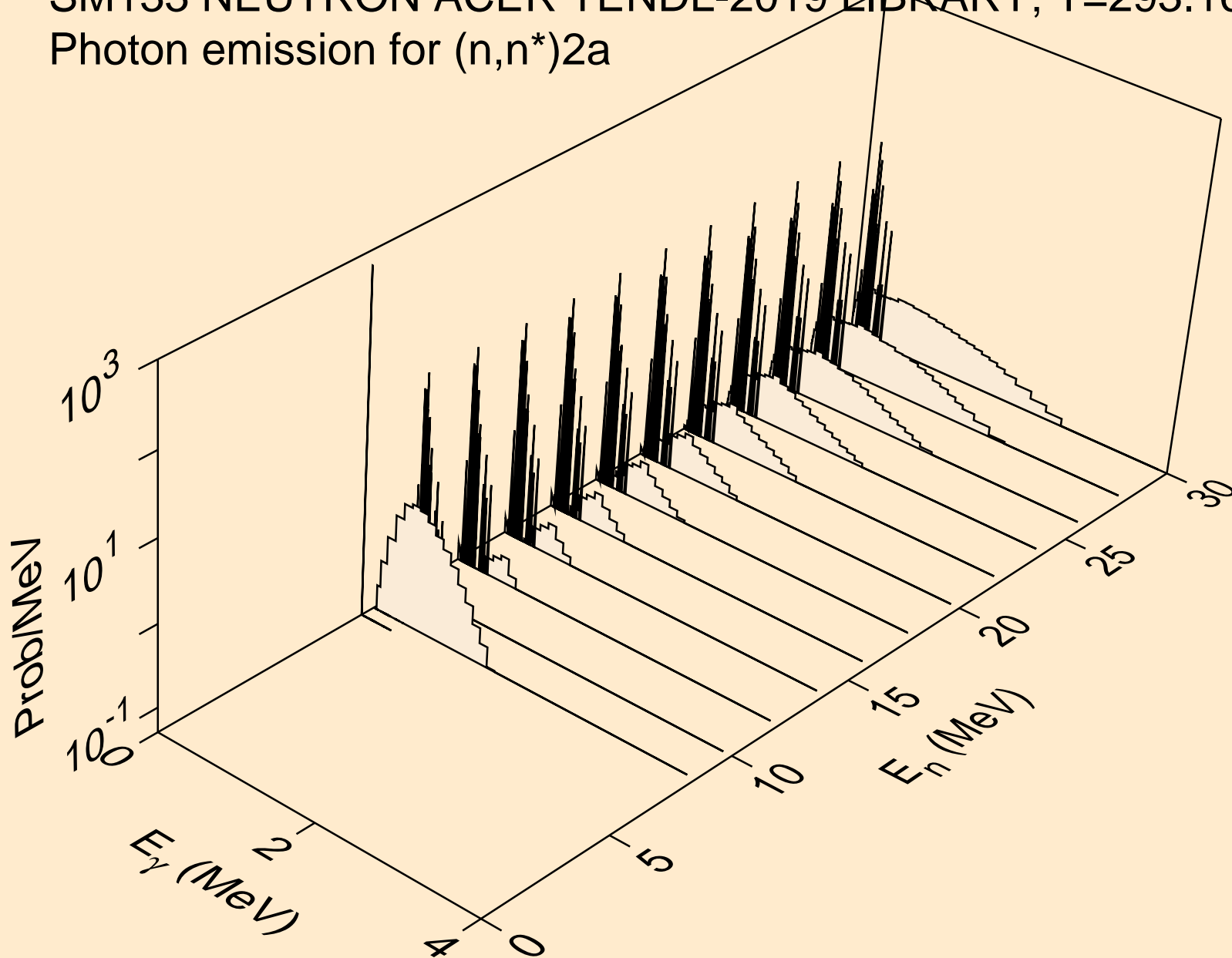

SM133 NEUTRON ACER TENDL-2019 LIBRARY; T=293.16K
Photon emission for (n,2n)2a

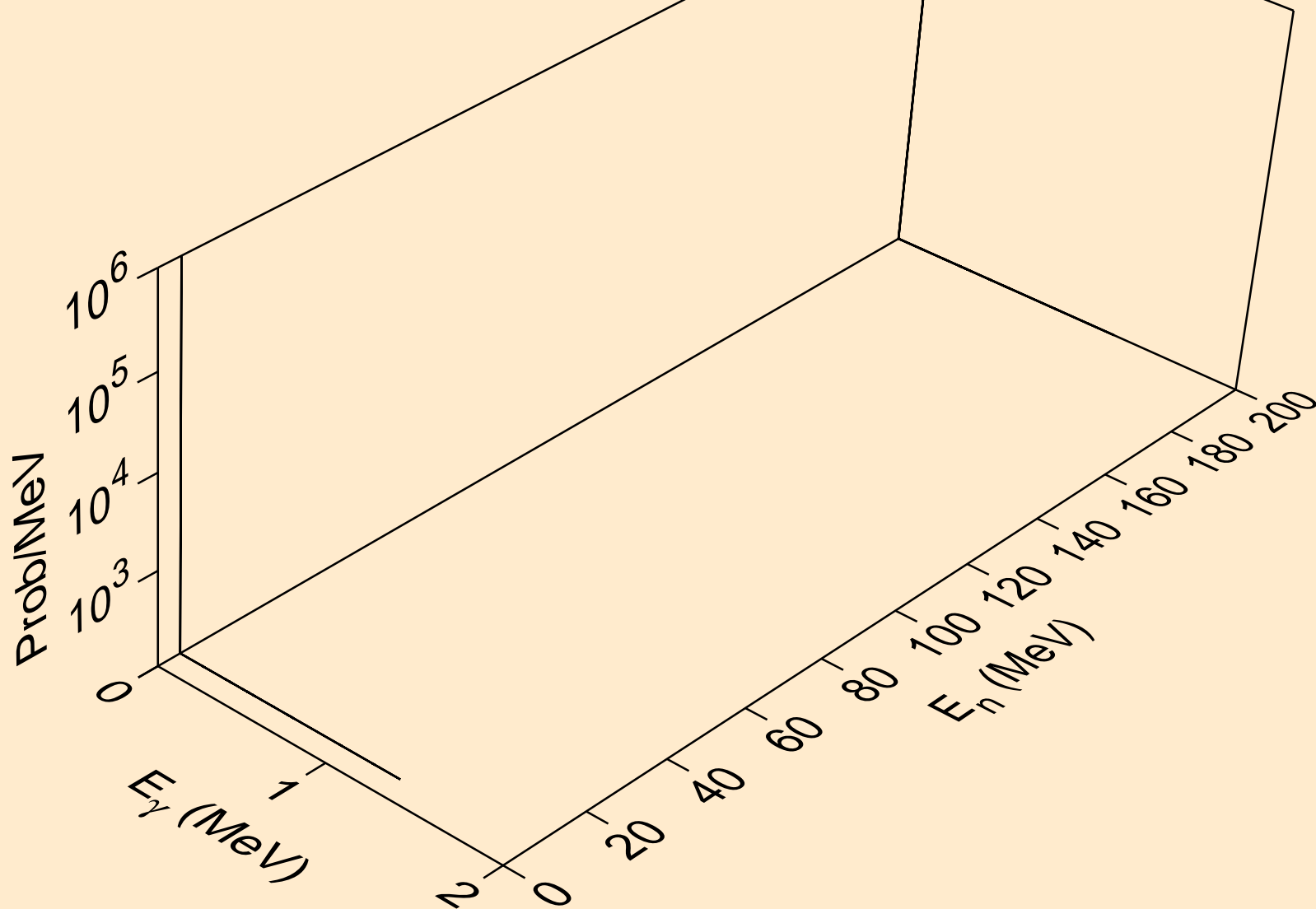

SM133 NEUTRON ACER TENDL-2019 LIBRARY; T=293.16K
Photon emission for (n,n*)d

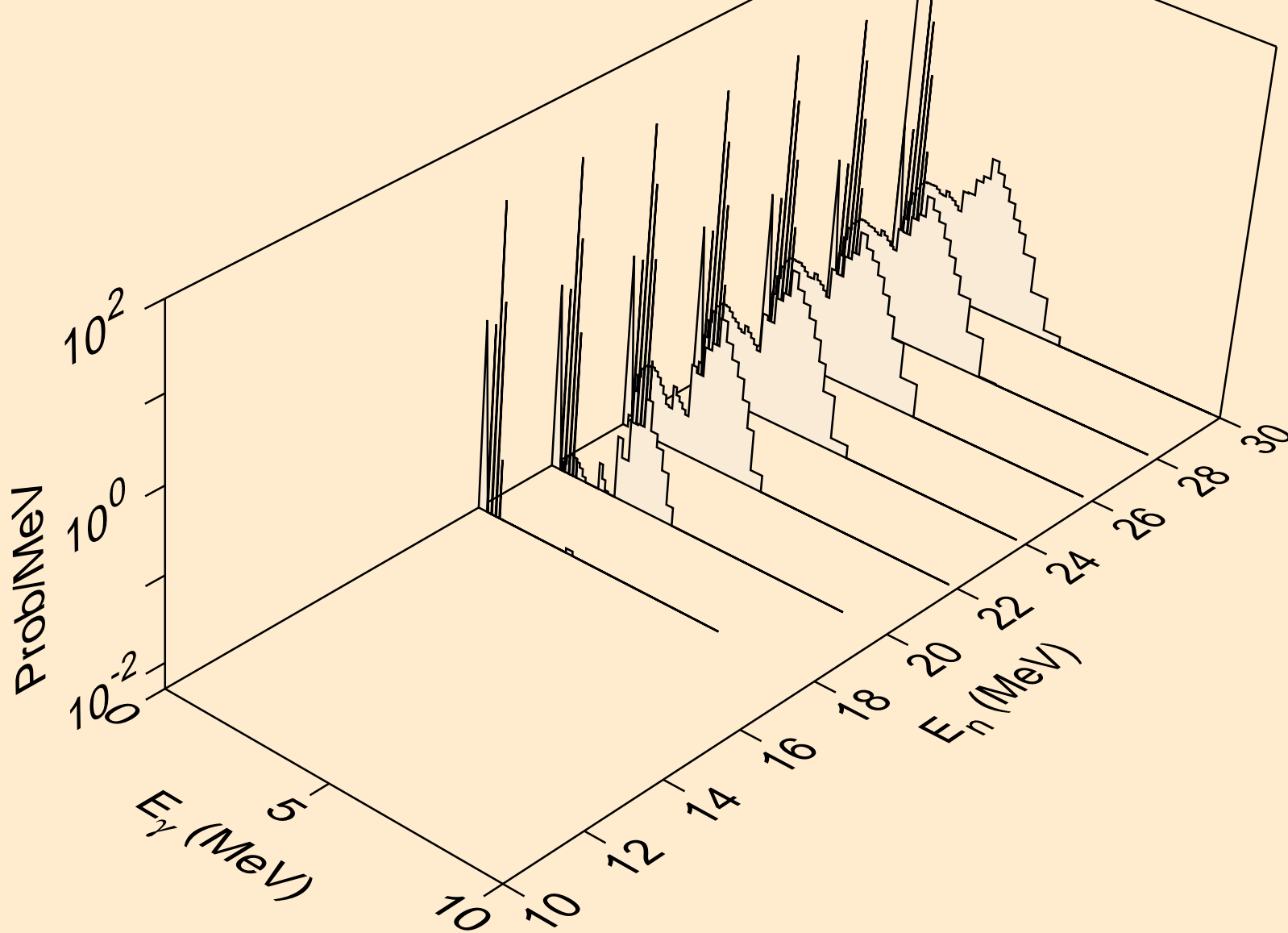

SM133 NEUTRON ACER TENDL-2019 LIBRARY; T=293.16K
Photon emission for (n,n*)t

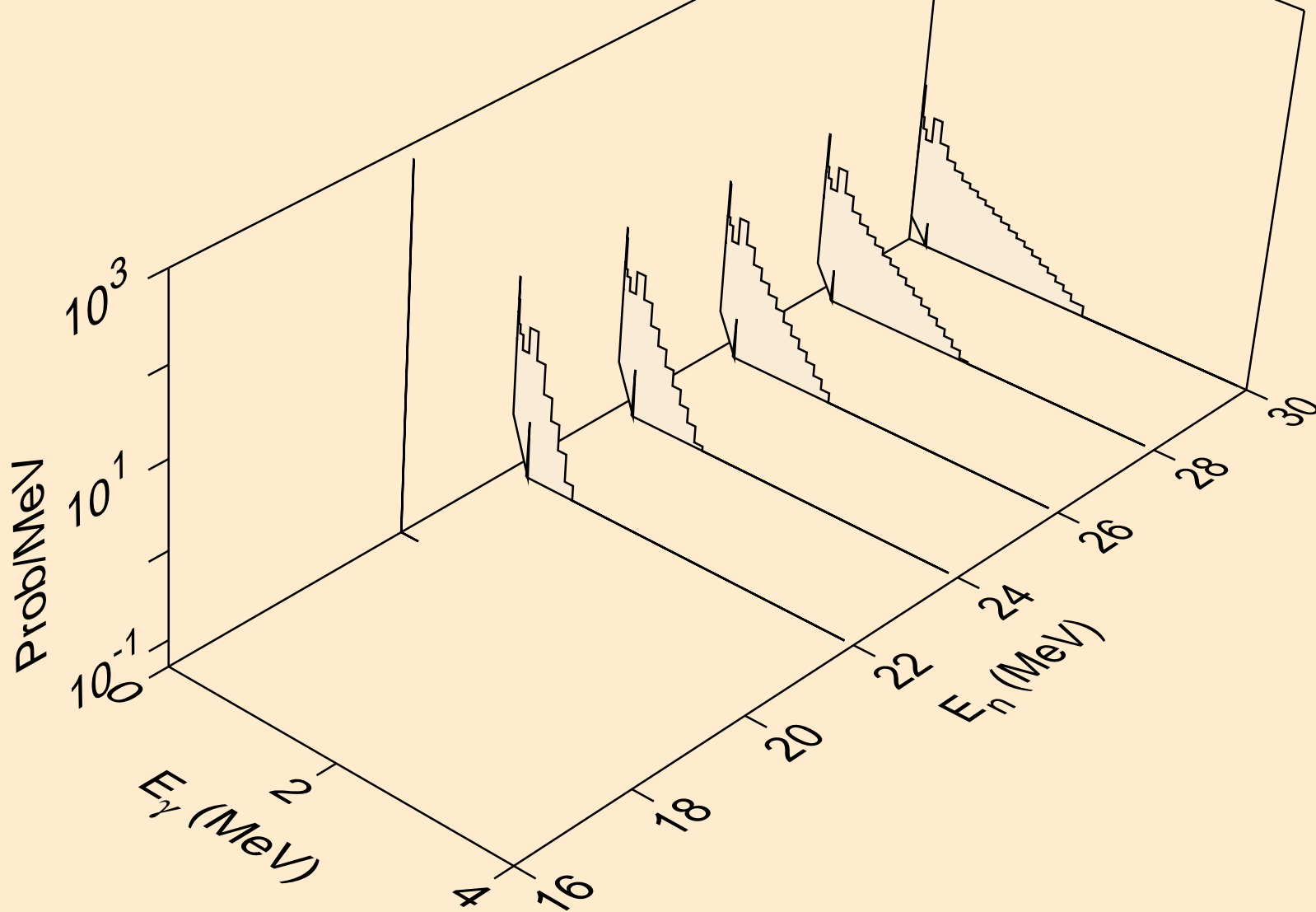

SM133 NEUTRON ACER TENDL-2019 LIBRARY; T=293.16K
Photon emission for (n,n*)he3

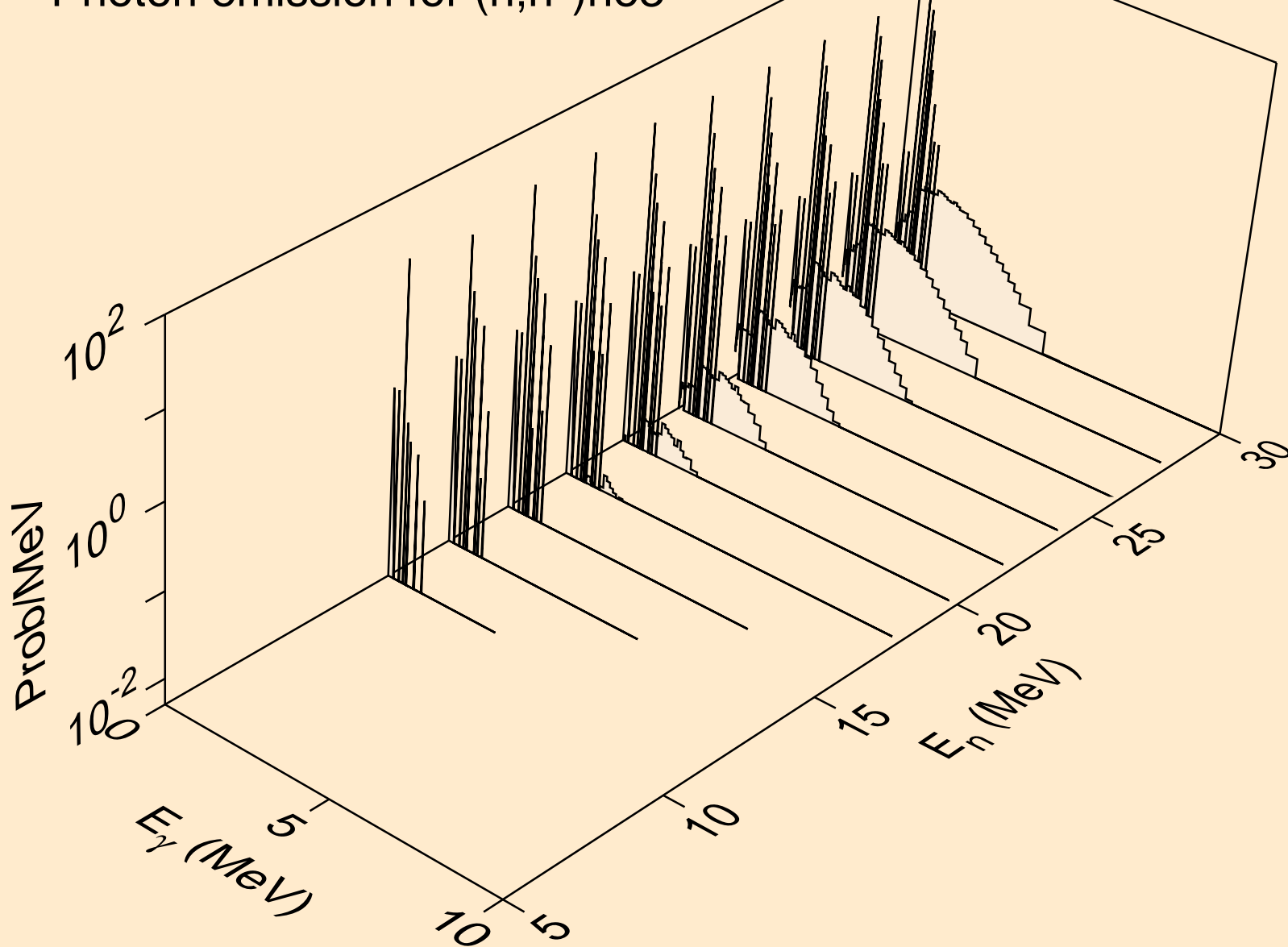

SM133 NEUTRON ACER TENDL-2019 LIBRARY; T=293.16K
Photon emission for (n,2np)

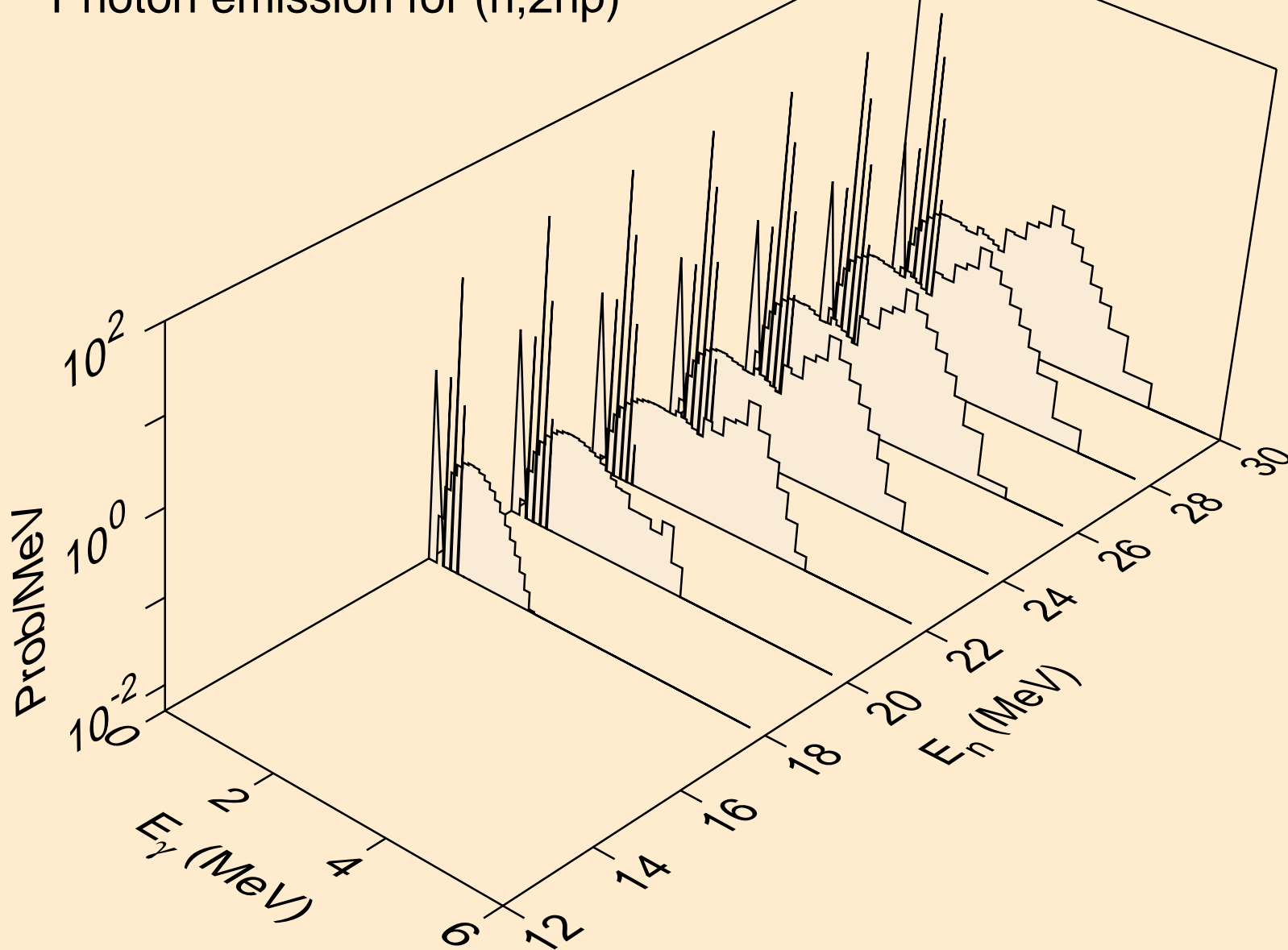

SM133 NEUTRON ACER TENDL-2019 LIBRARY; T=293.16K
Photon emission for (n,3np)

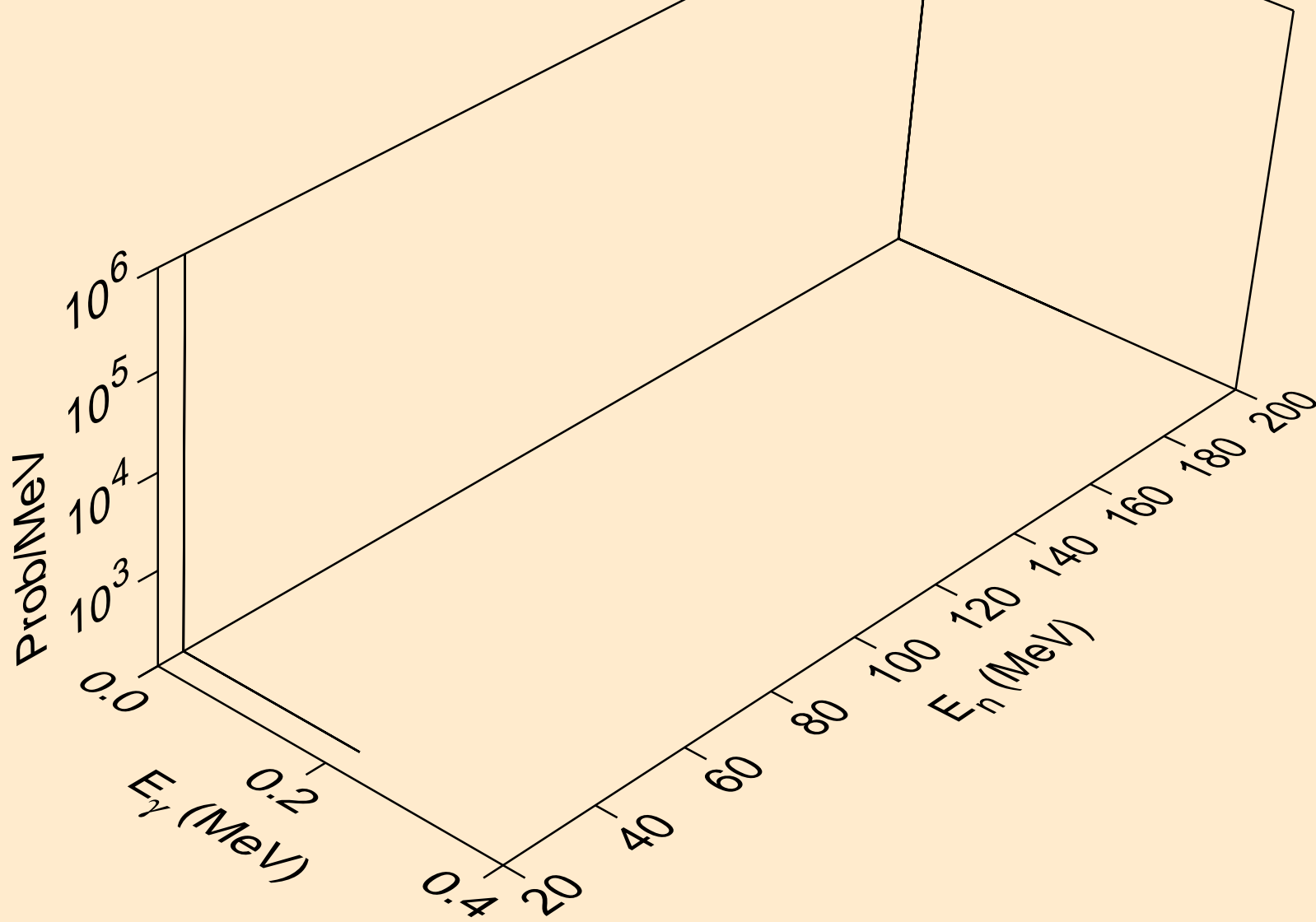

SM133 NEUTRON ACER TENDL-2019 LIBRARY; T=293.16K
Photon emission for (n,2np)

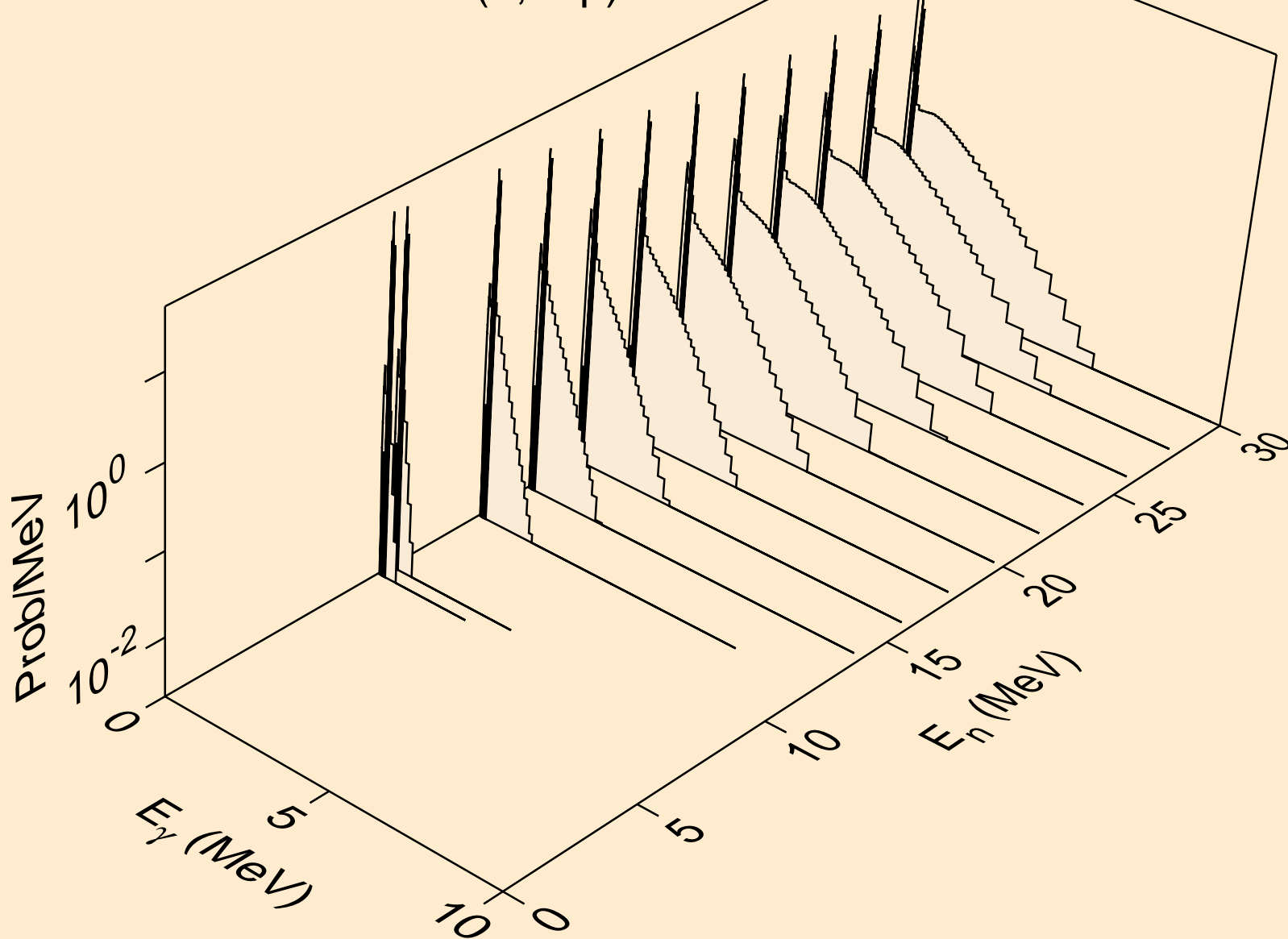

SM133 NEUTRON ACER TENDL-2019 LIBRARY; T=293.16K
Photon emission for (n,npa)

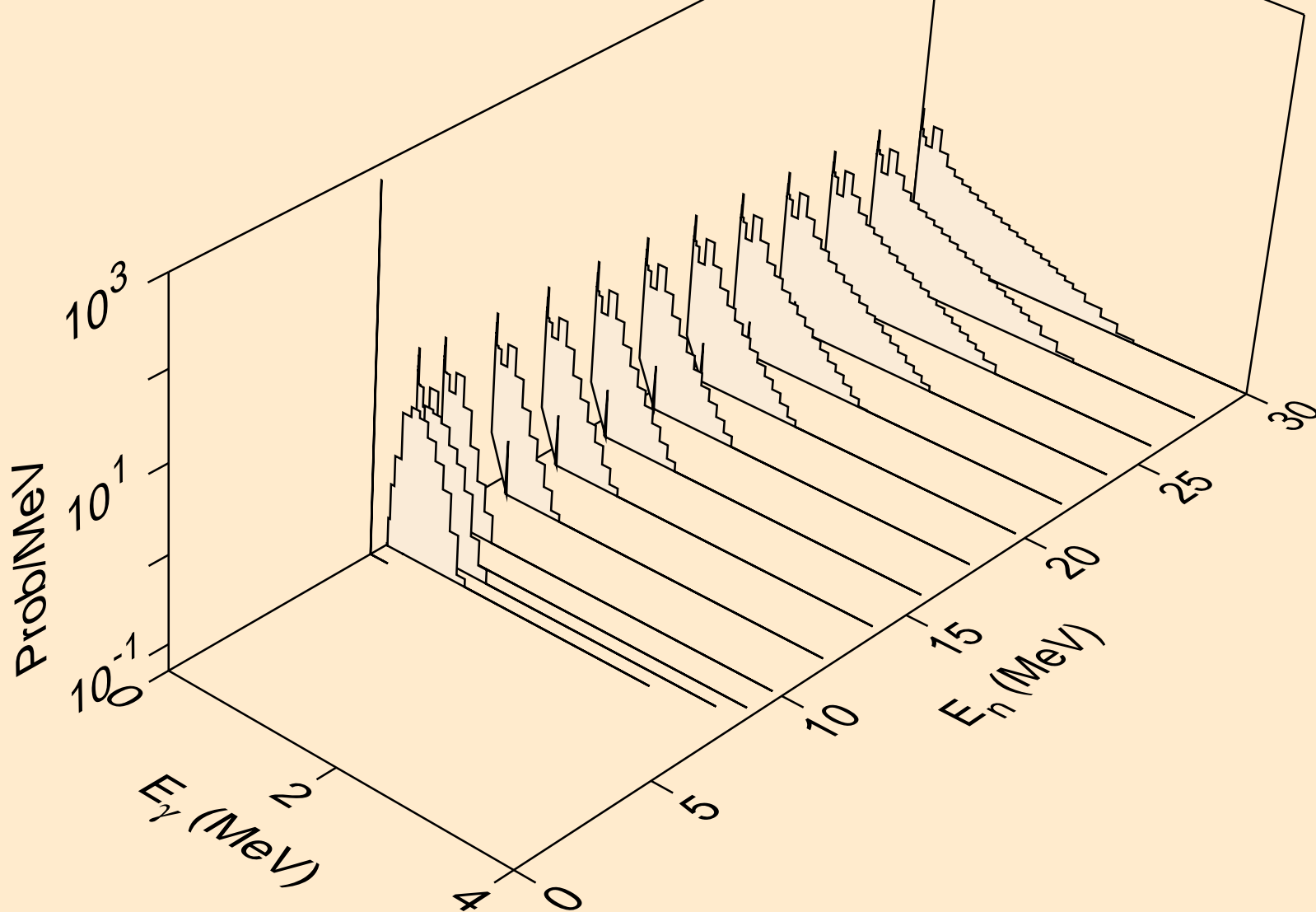

SM133 NEUTRON ACER TENDL-2019 LIBRARY; T=293.16K
Photon emission for (n,n*c)

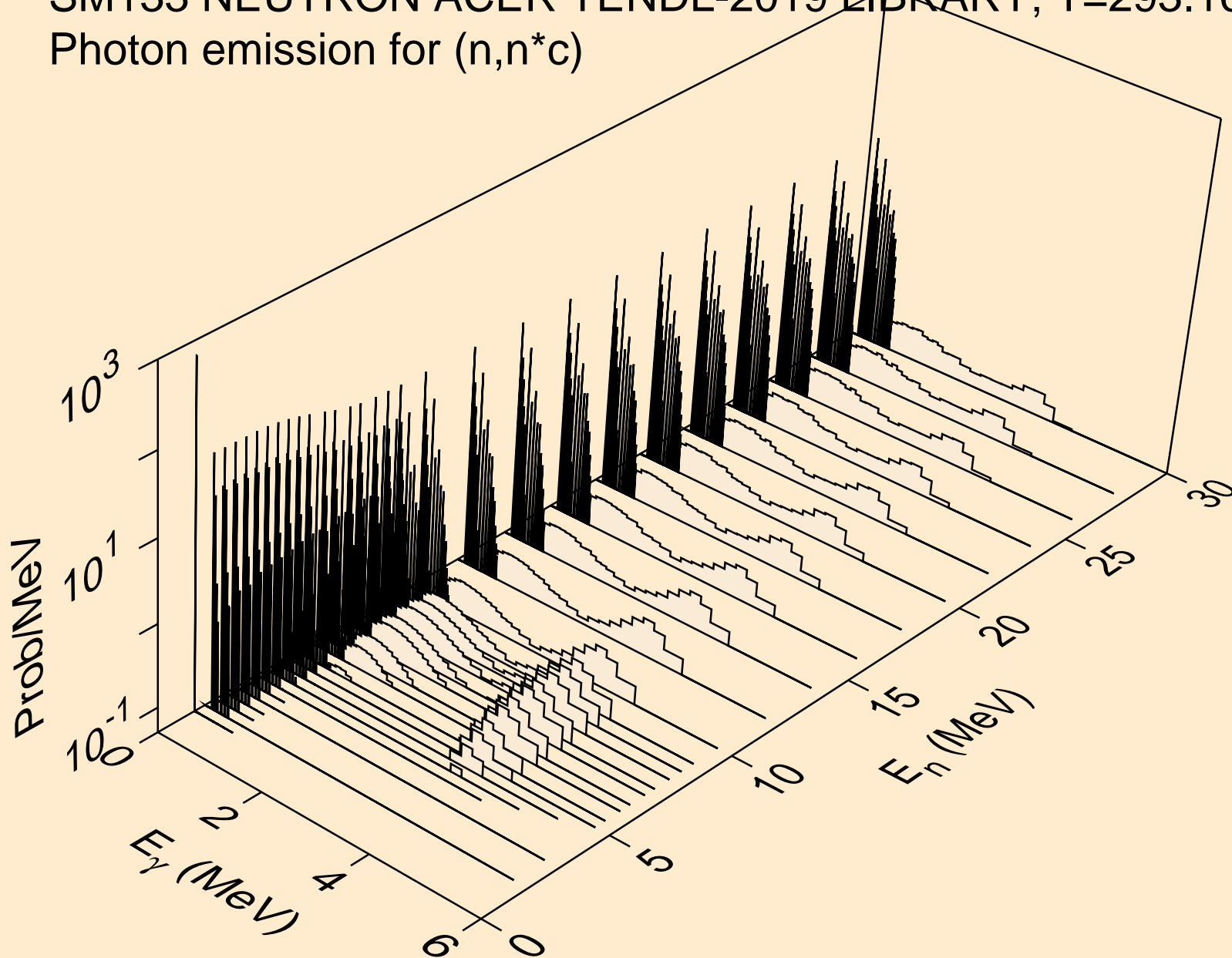

SM133 NEUTRON ACER TENDL-2019 LIBRARY; T=293.16K
Photon emission for (n,gma)

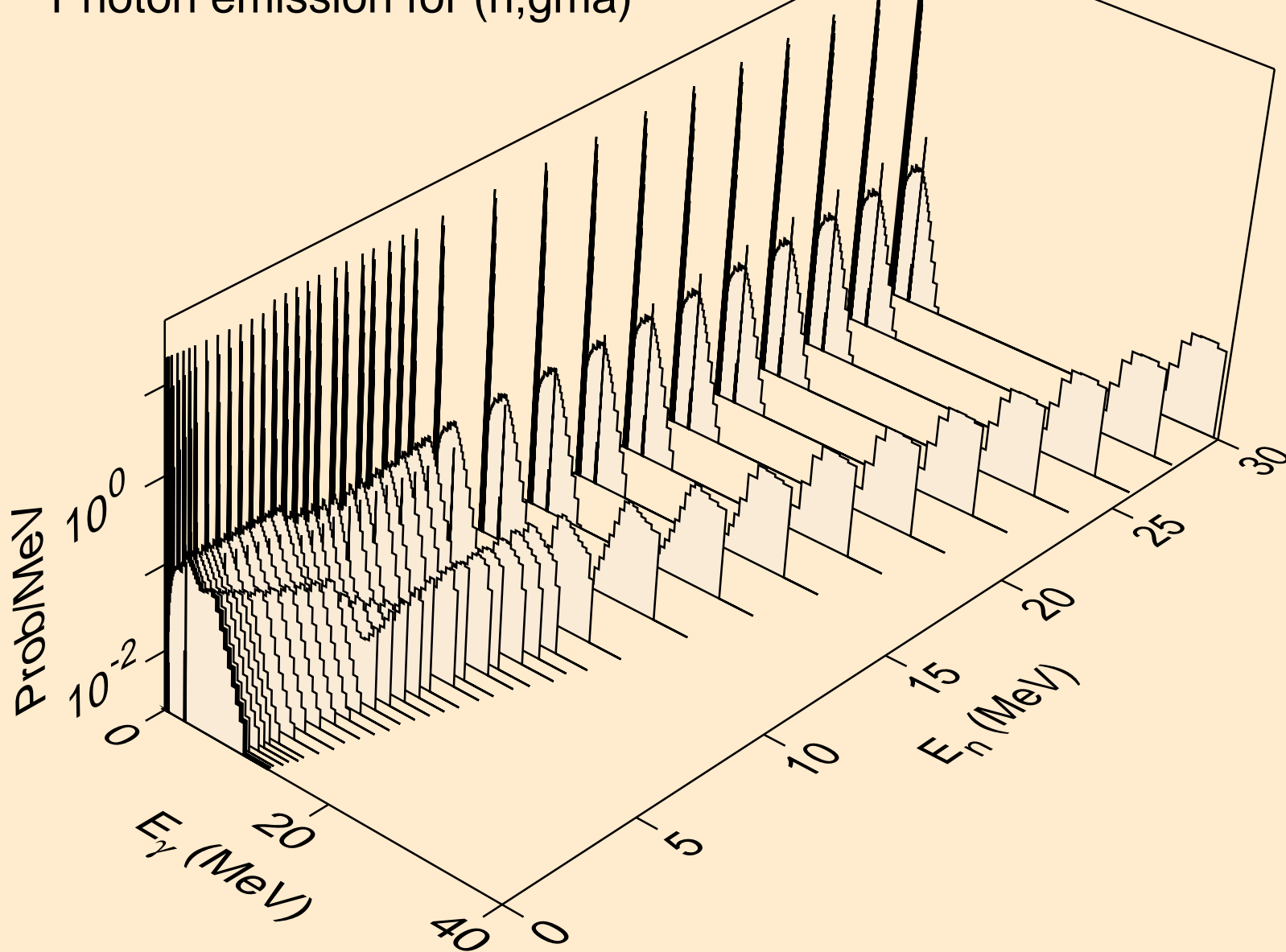

SM133 NEUTRON ACER TENDL-2019 LIBRARY; T=293.16K
Photon emission for (n,p)

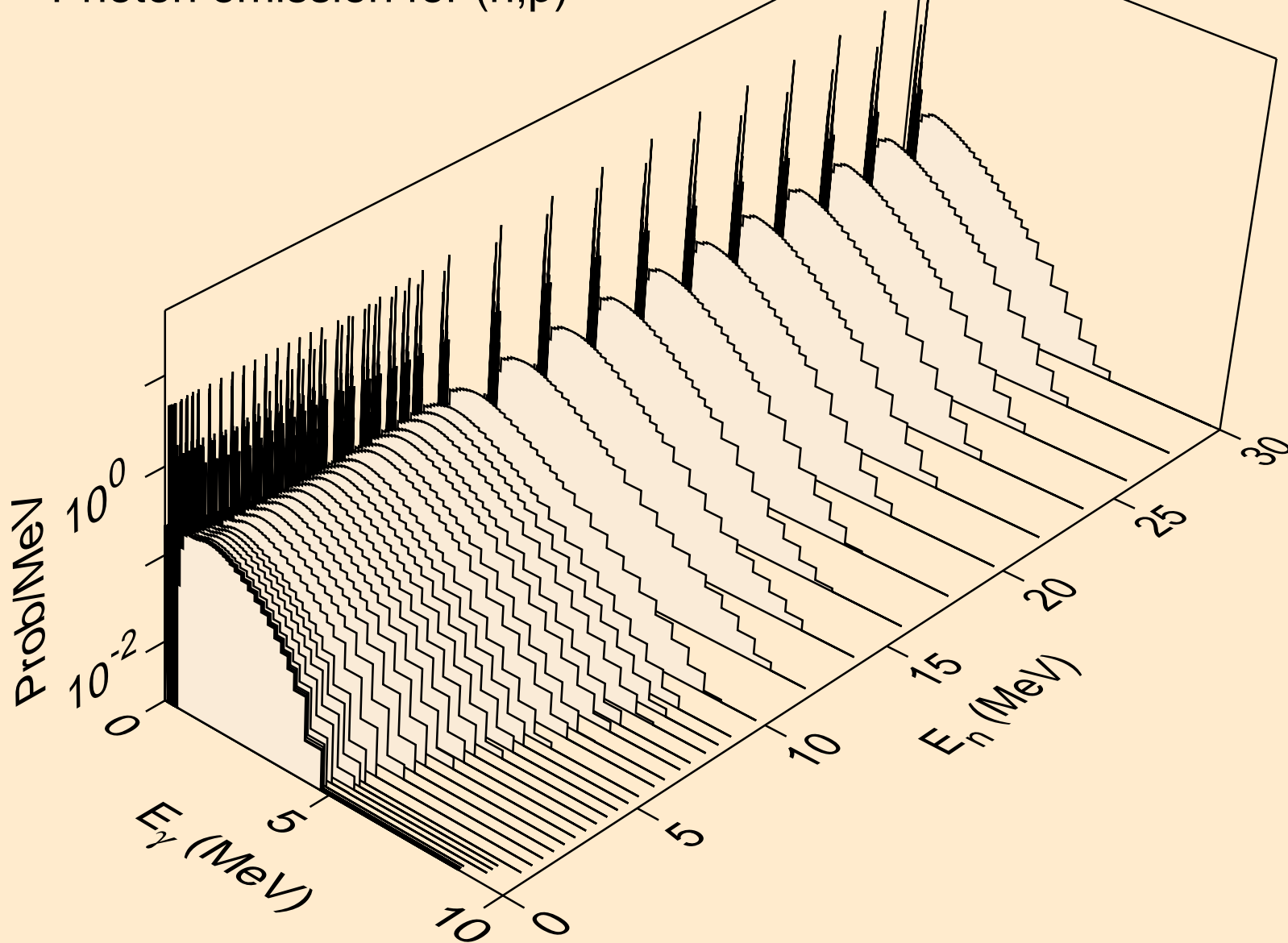

SM133 NEUTRON ACER TENDL-2019 LIBRARY; T=293.16K
Photon emission for (n,d)

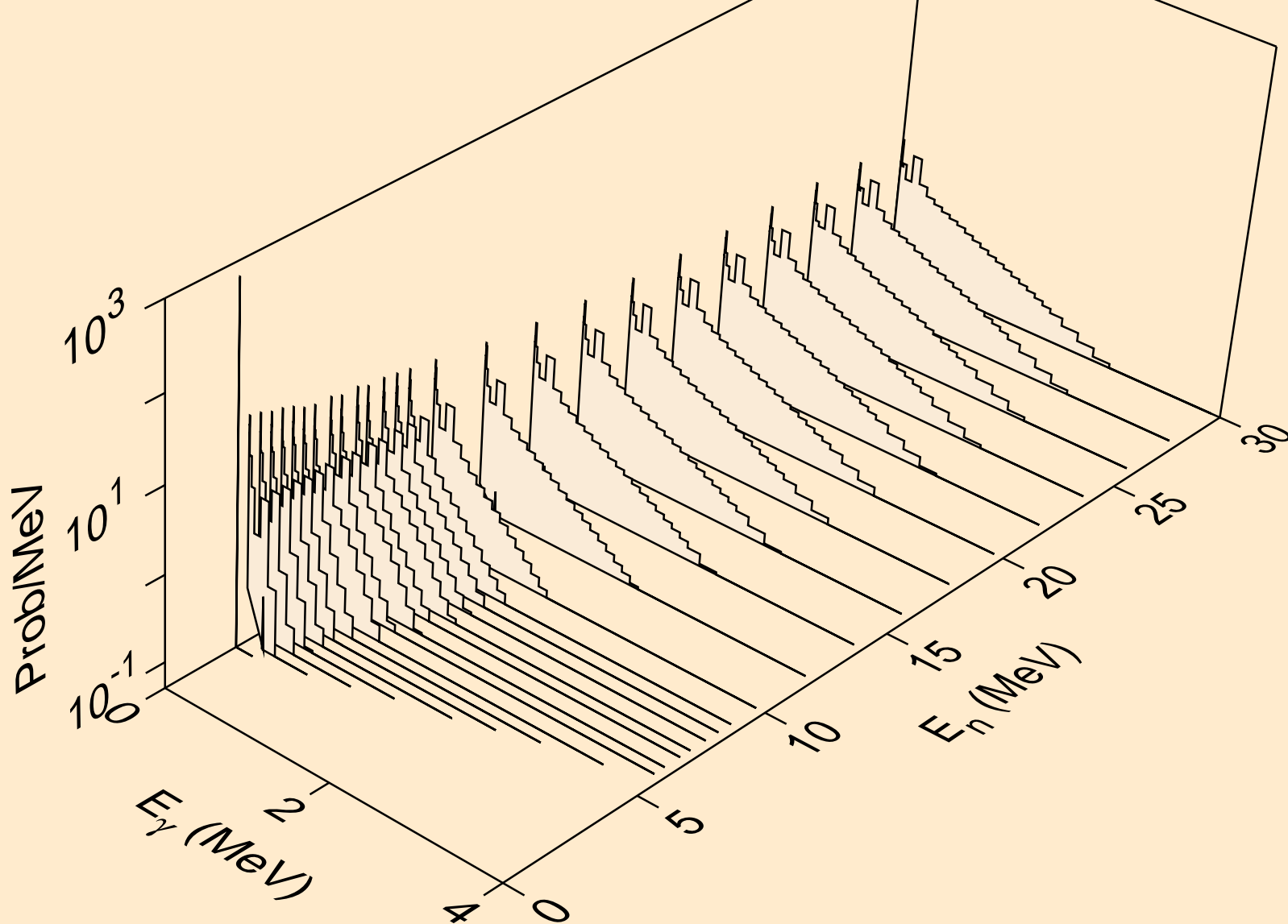

SM133 NEUTRON ACER TENDL-2019 LIBRARY; T=293.16K
Photon emission for (n,t)

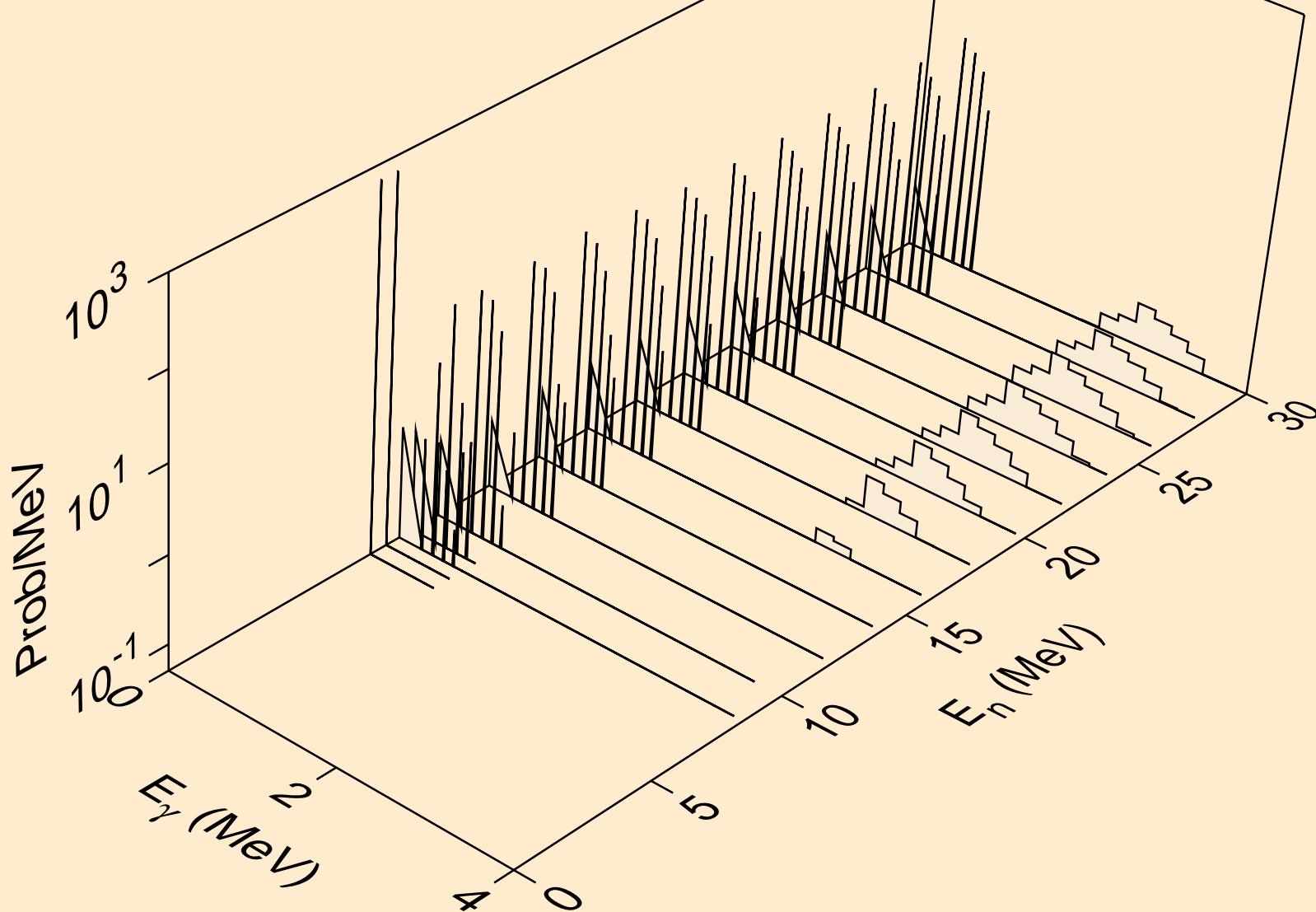

SM133 NEUTRON ACER TENDL-2019 LIBRARY; T=293.16K
Photon emission for (n,he3)

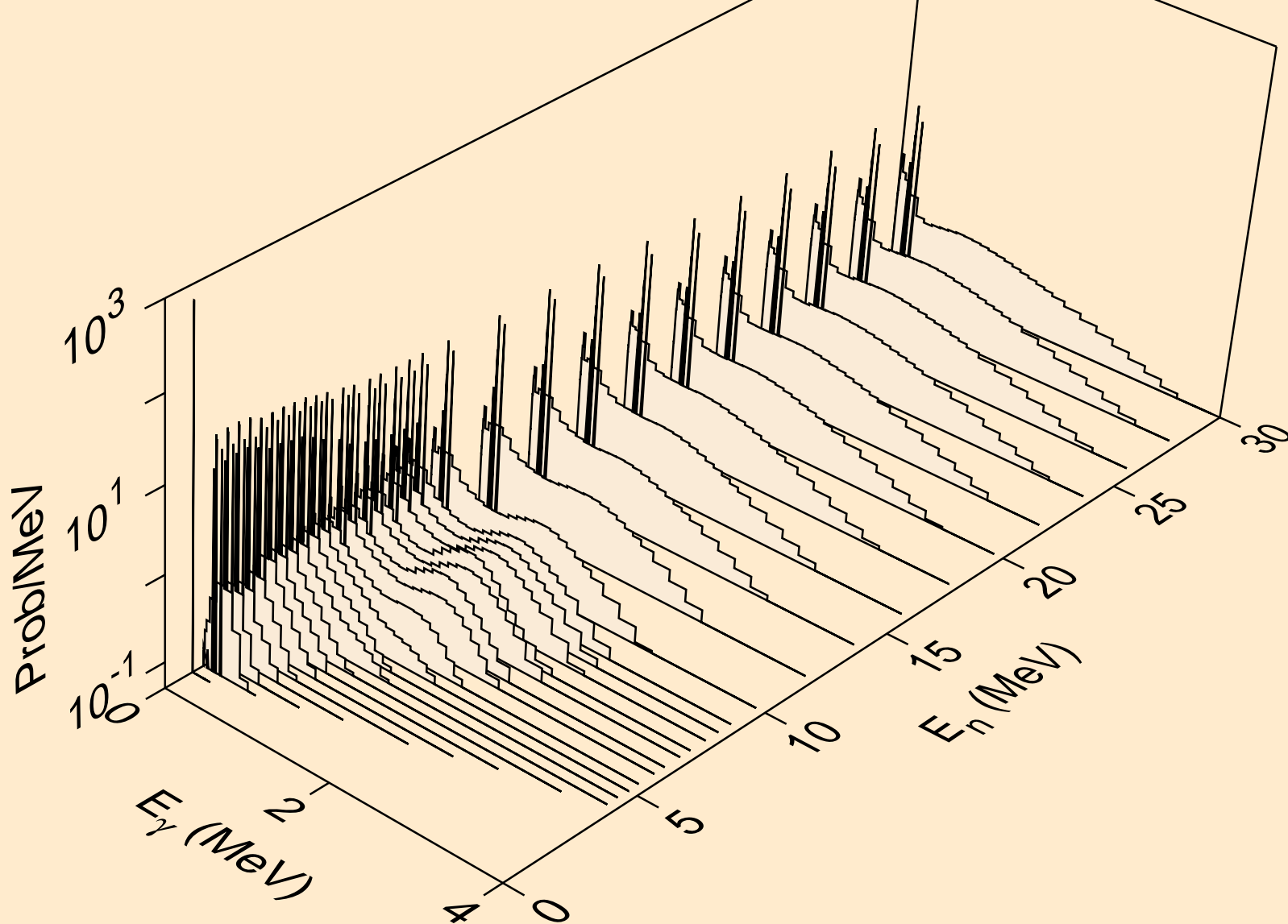

SM133 NEUTRON ACER TENDL-2019 LIBRARY; T=293.16K
Photon emission for (n,a)

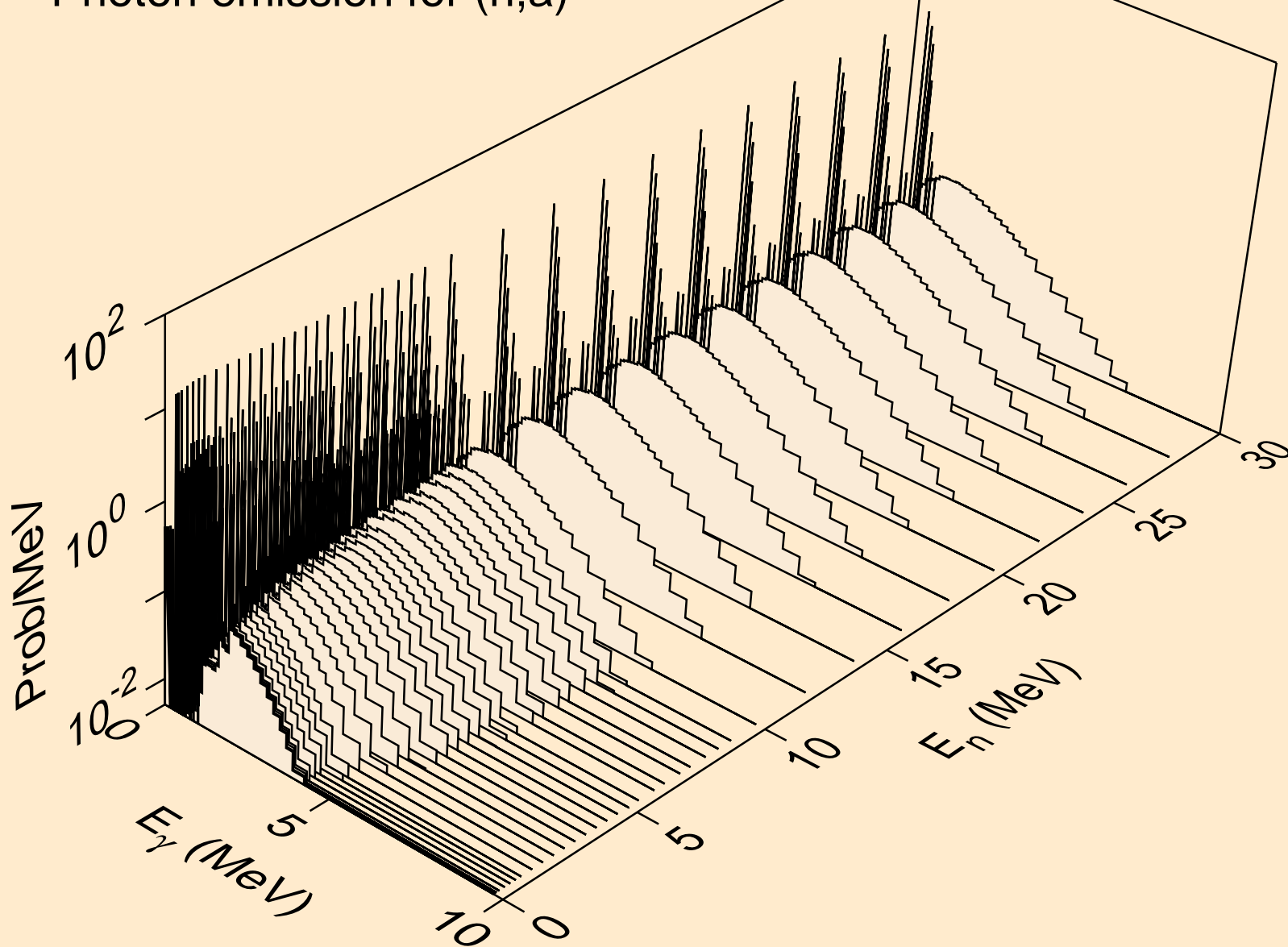

SM133 NEUTRON ACER TENDL-2019 LIBRARY; T=293.16K
Photon emission for (n,2a)

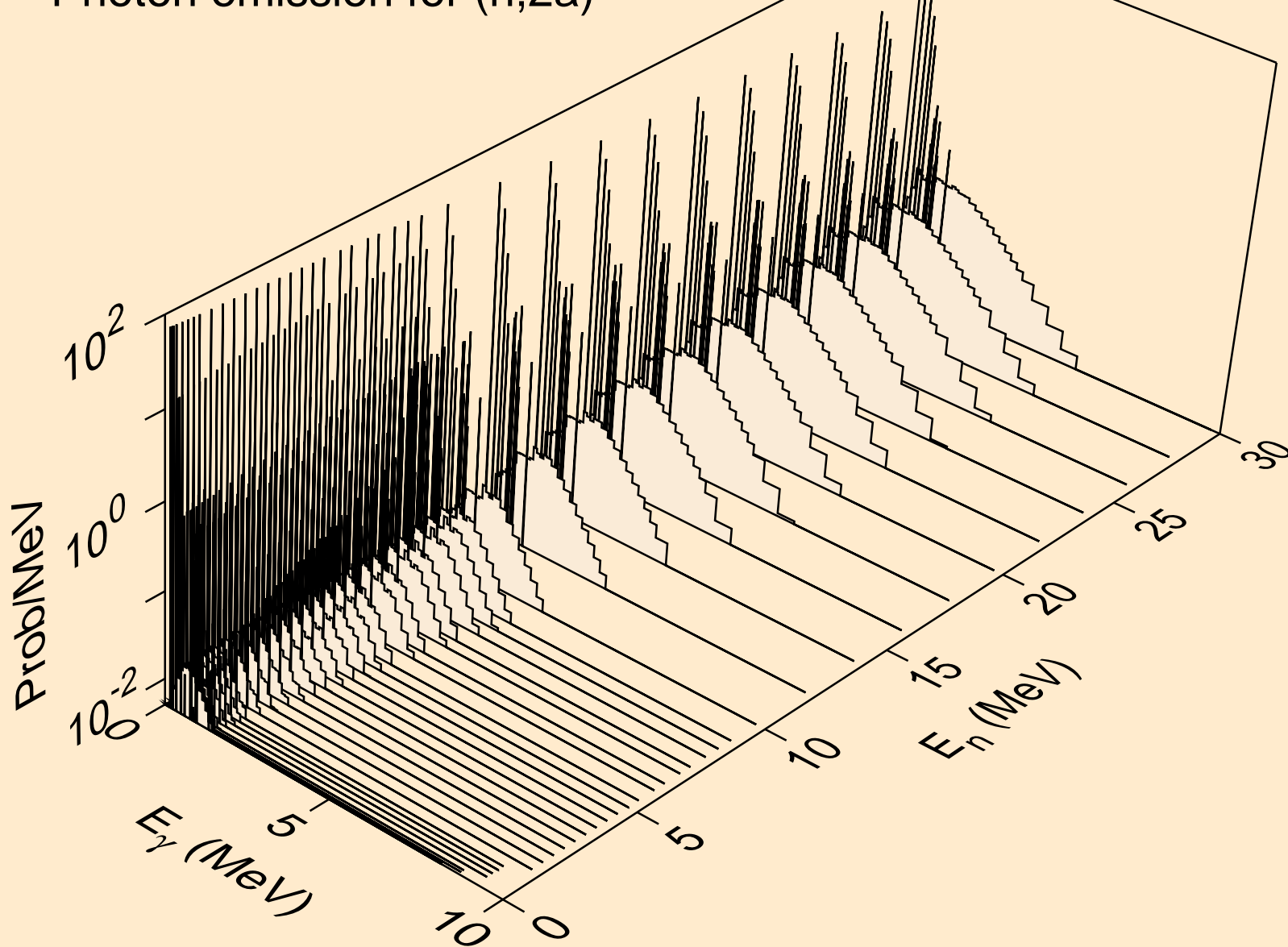

SM133 NEUTRON ACER TENDL-2019 LIBRARY; T=293.16K
Photon emission for (n,3a)

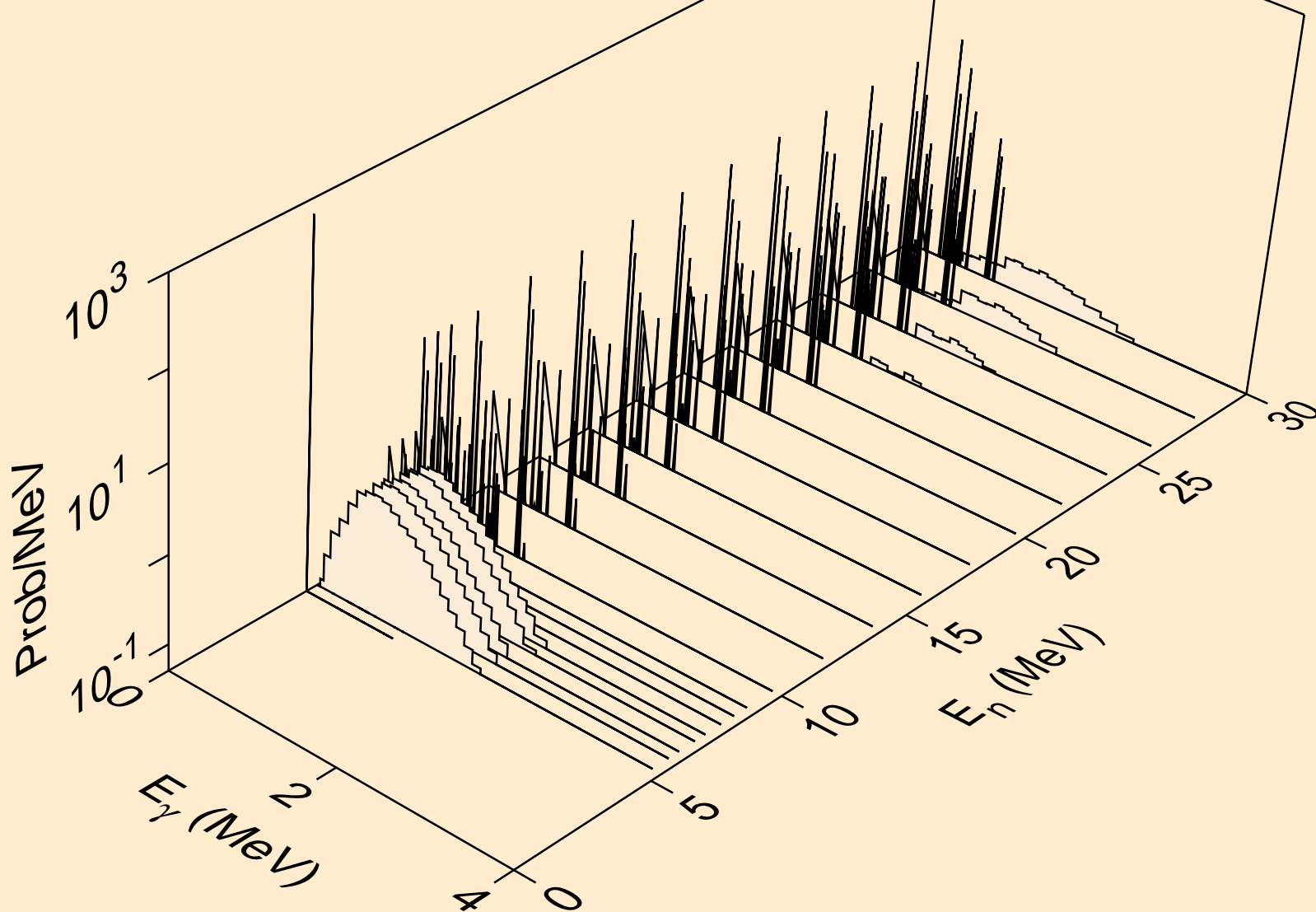

SM133 NEUTRON ACER TENDL-2019 LIBRARY; T=293.16K
Photon emission for (n,2p)

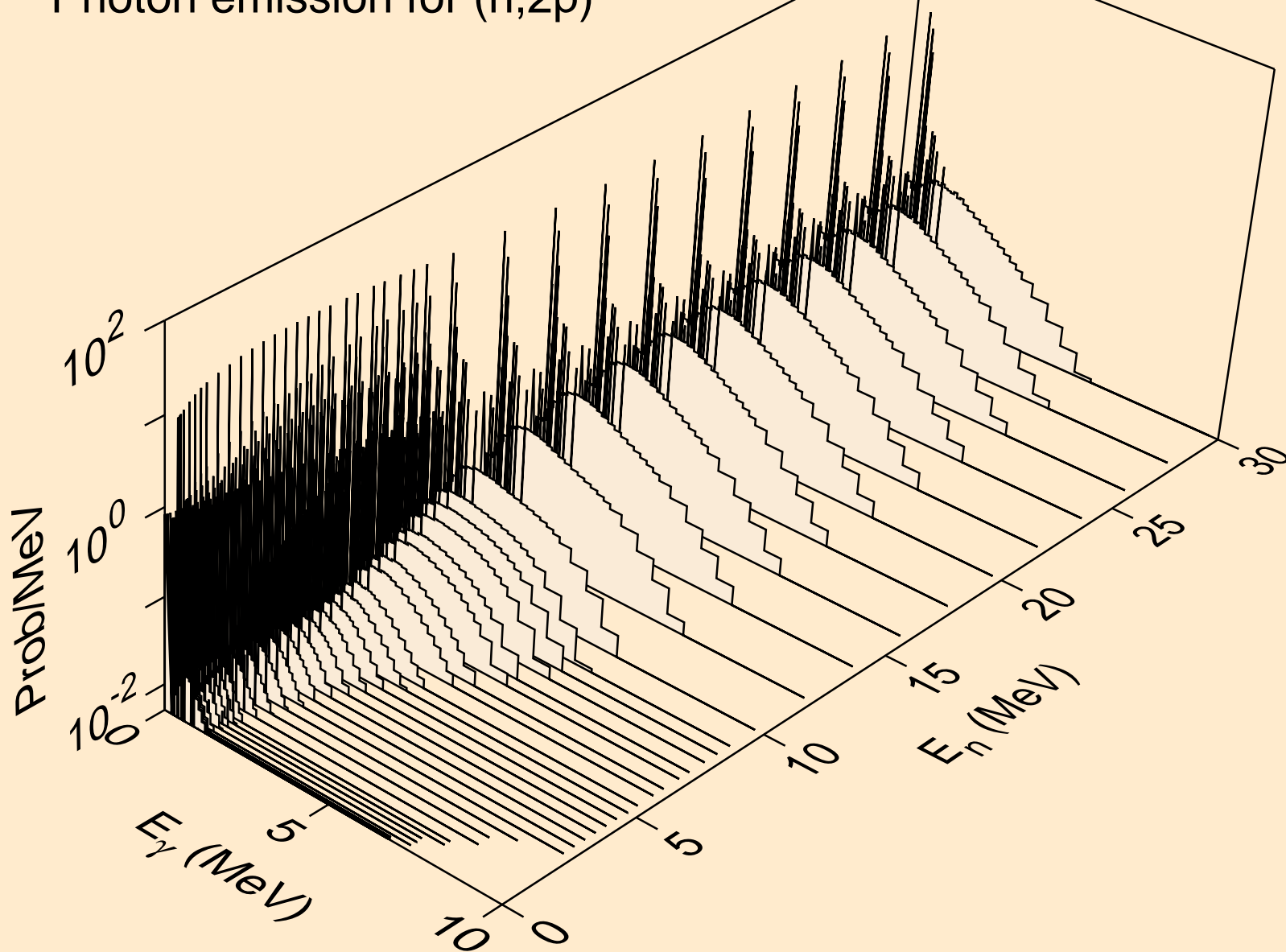

SM133 NEUTRON ACER TENDL-2019 LIBRARY; T=293.16K
Photon emission for (n,p)

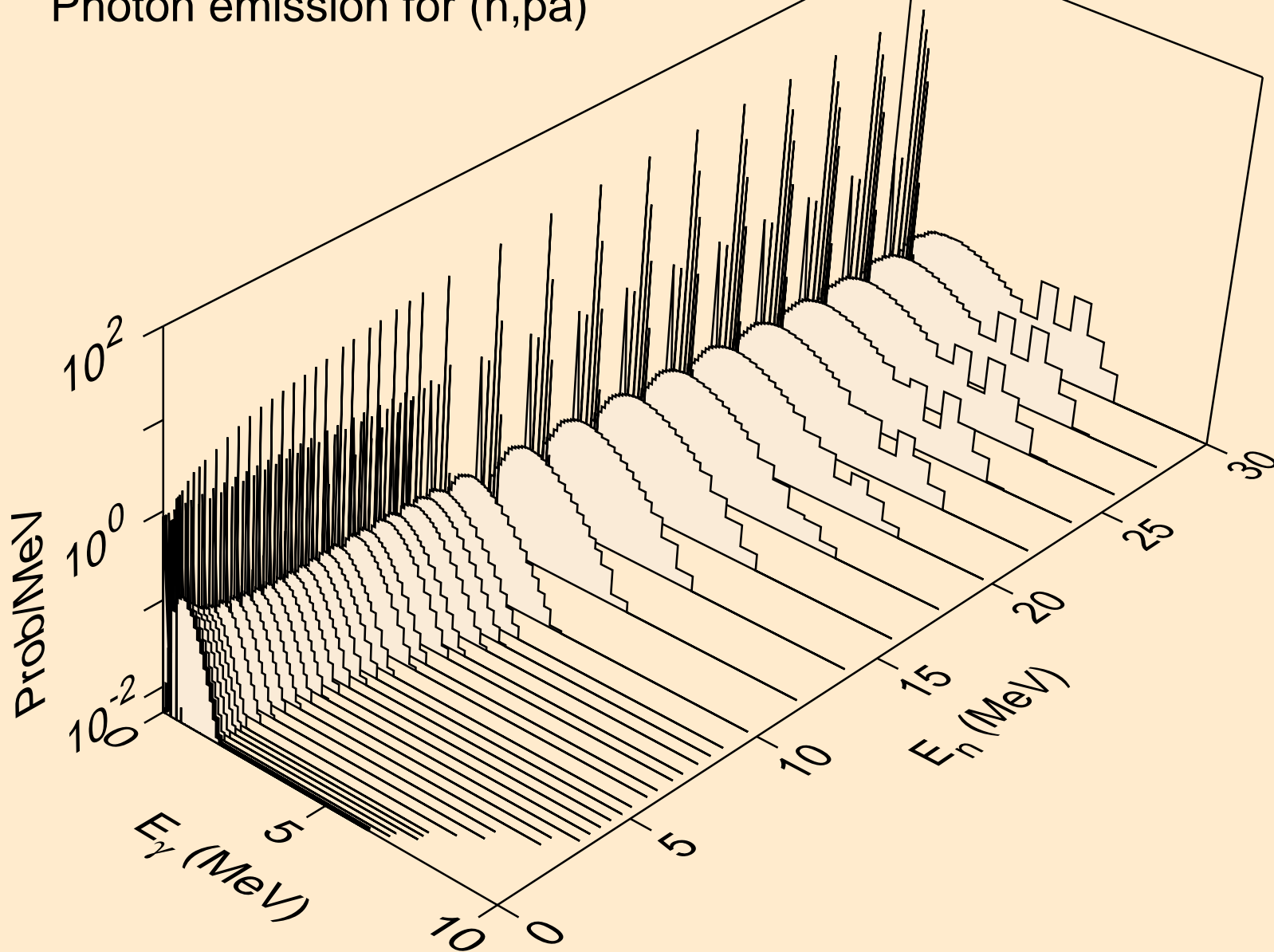

SM133 NEUTRON ACER TENDL-2019 LIBRARY; T=293.16K
Photon emission for (n,pd)

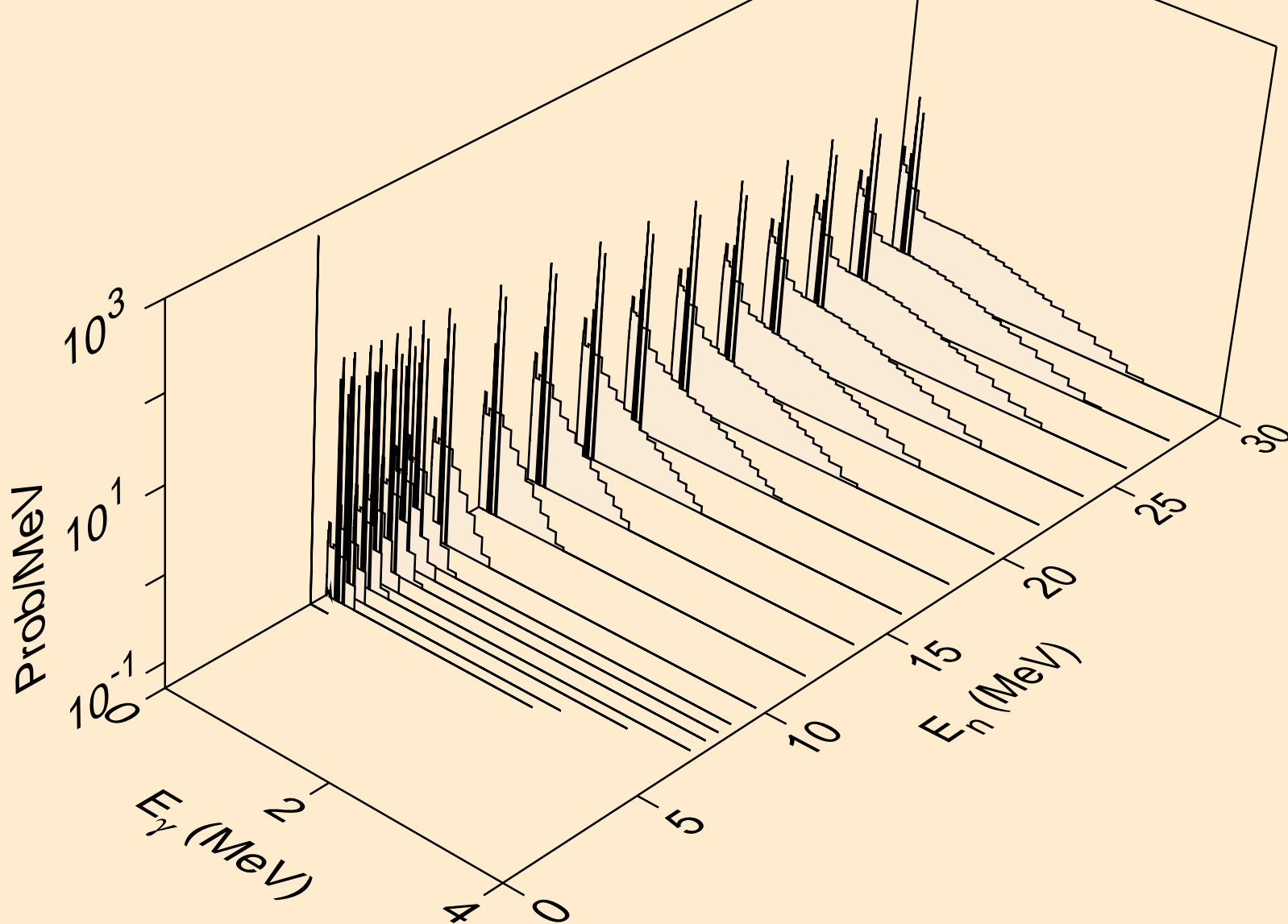

SM133 NEUTRON ACER TENDL-2019 LIBRARY; T=293.16K
Photon emission for (n,pt)

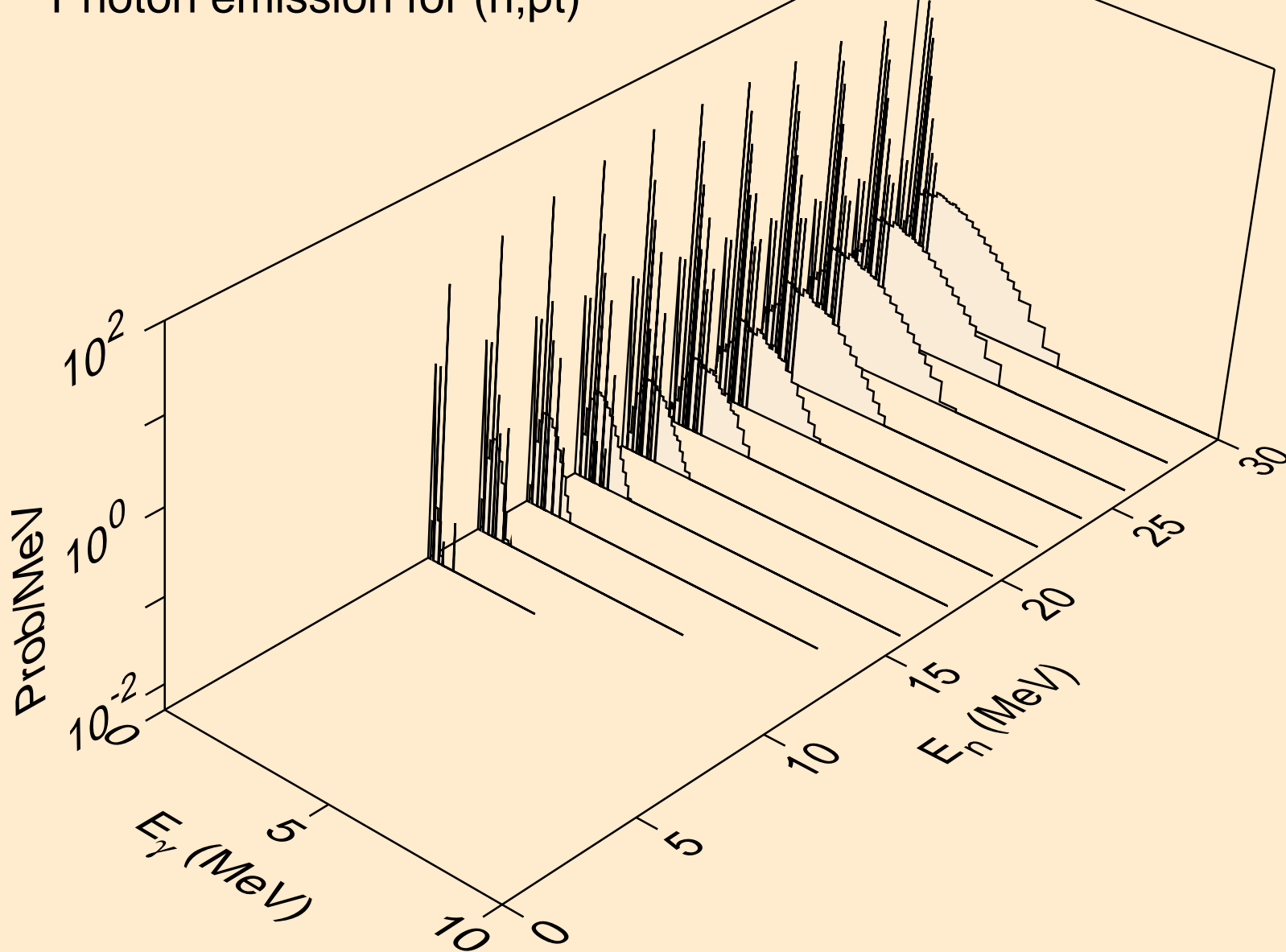

SM133 NEUTRON ACER TENDL-2019 LIBRARY; T=293.16K
Photon emission for (n,da)

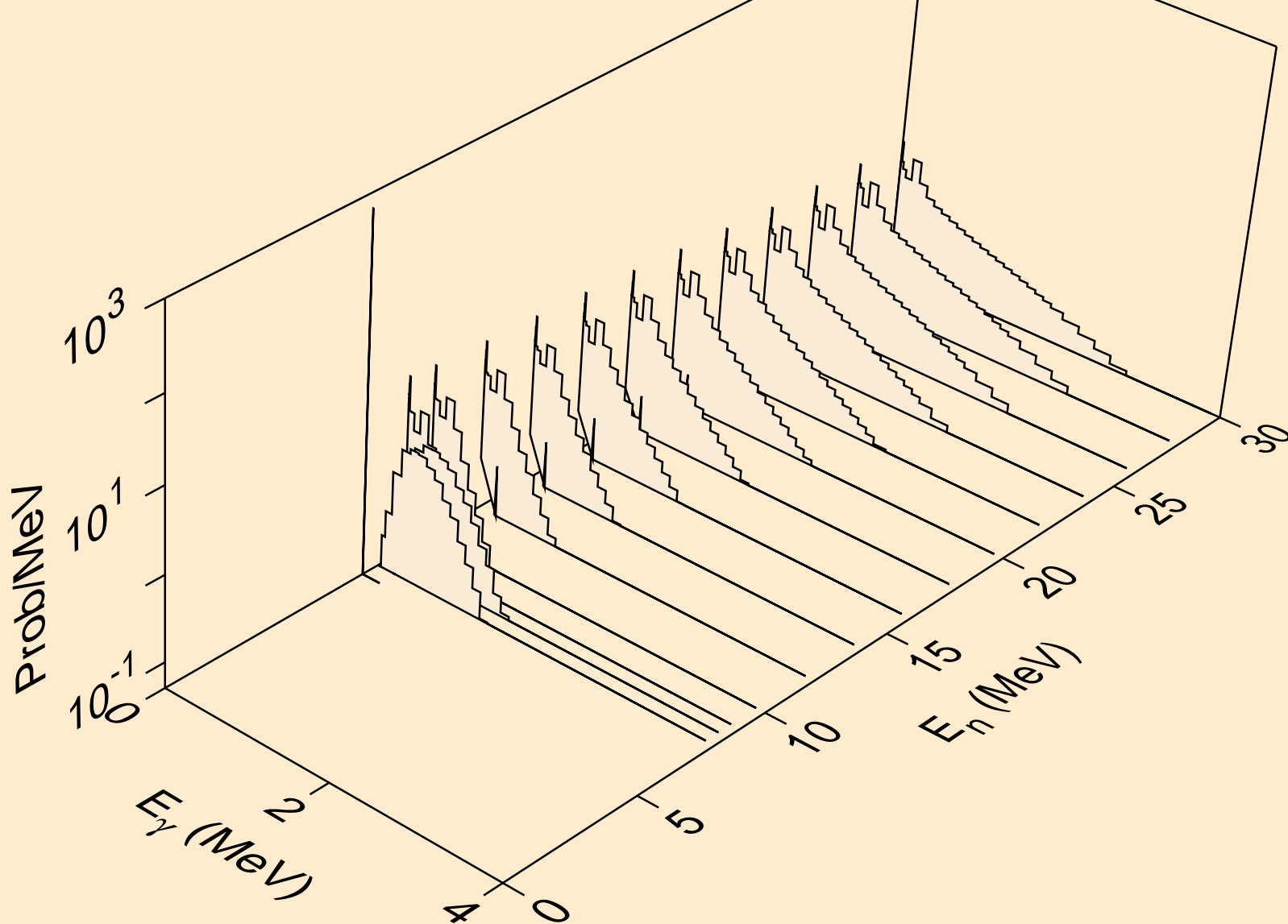

SM133 NEUTRON ACER TENDL-2019 LIBRARY; T=293.16K
thermal capture photon spectrum

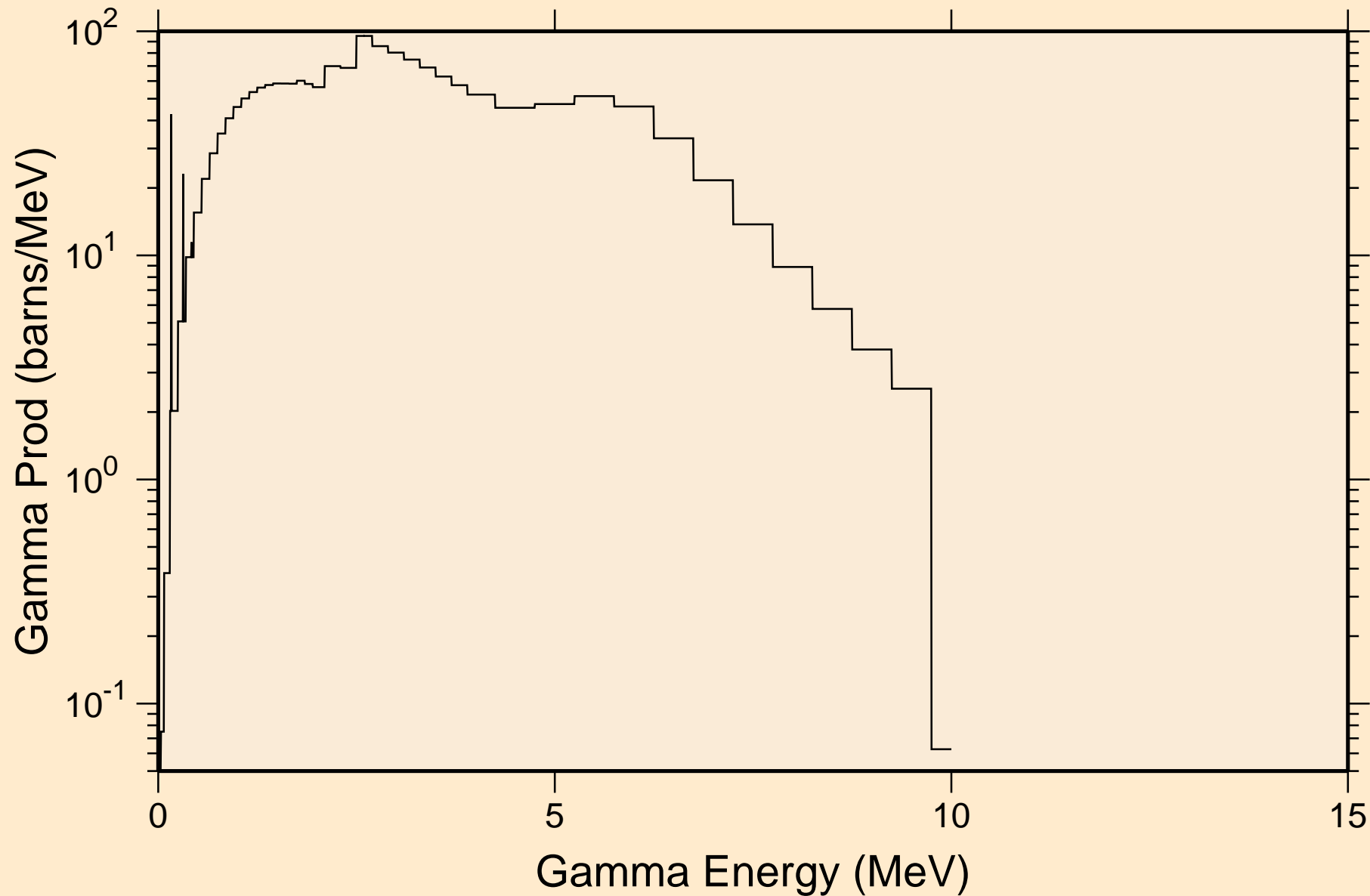

SM133 NEUTRON ACER TENDL-2019 LIBRARY; T=293.16K
14 MeV photon spectrum

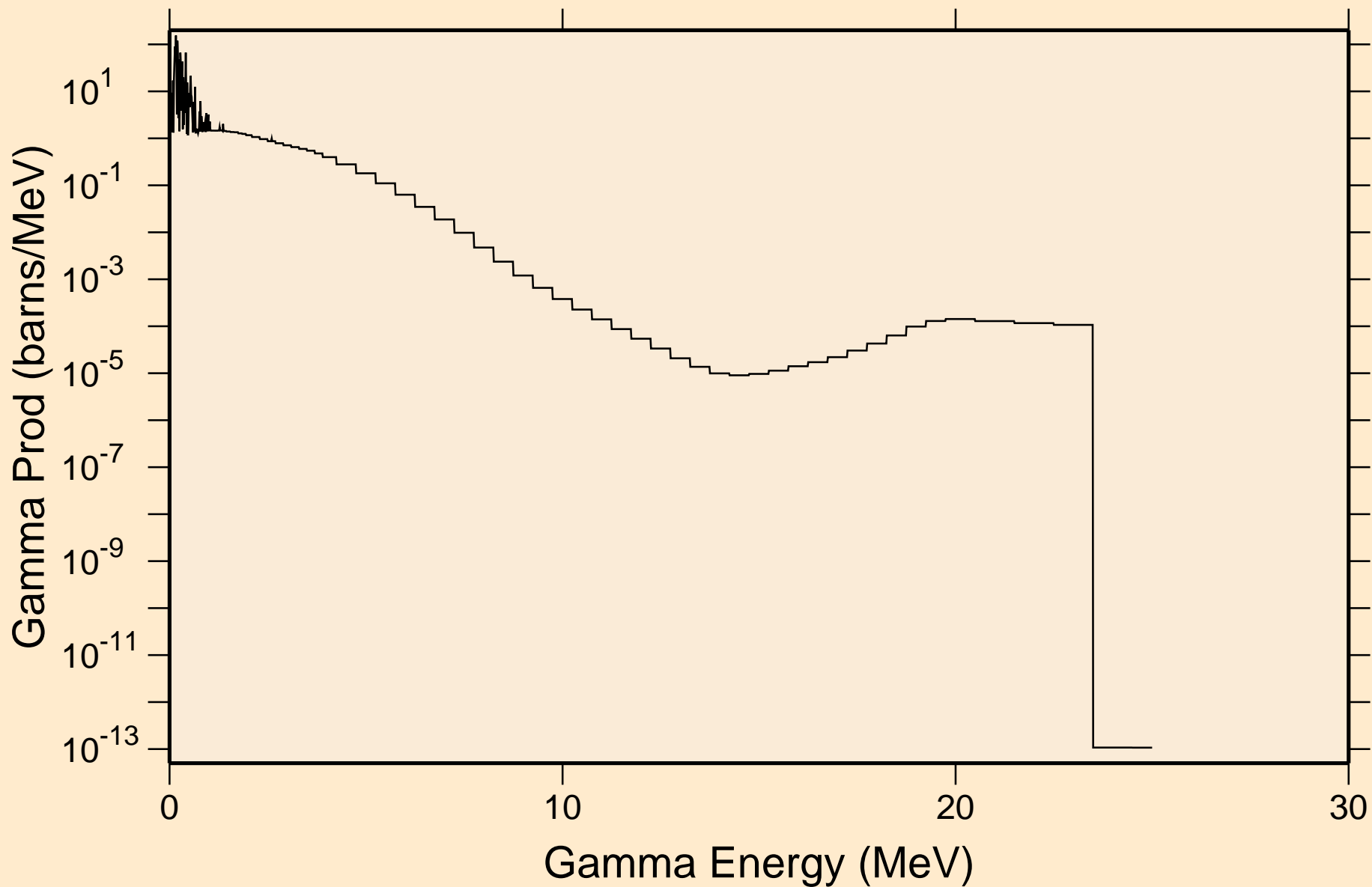

SM133 NEUTRON ACER TENDL-2019 LIBRARY; T=293.16K

Particle heating contributions

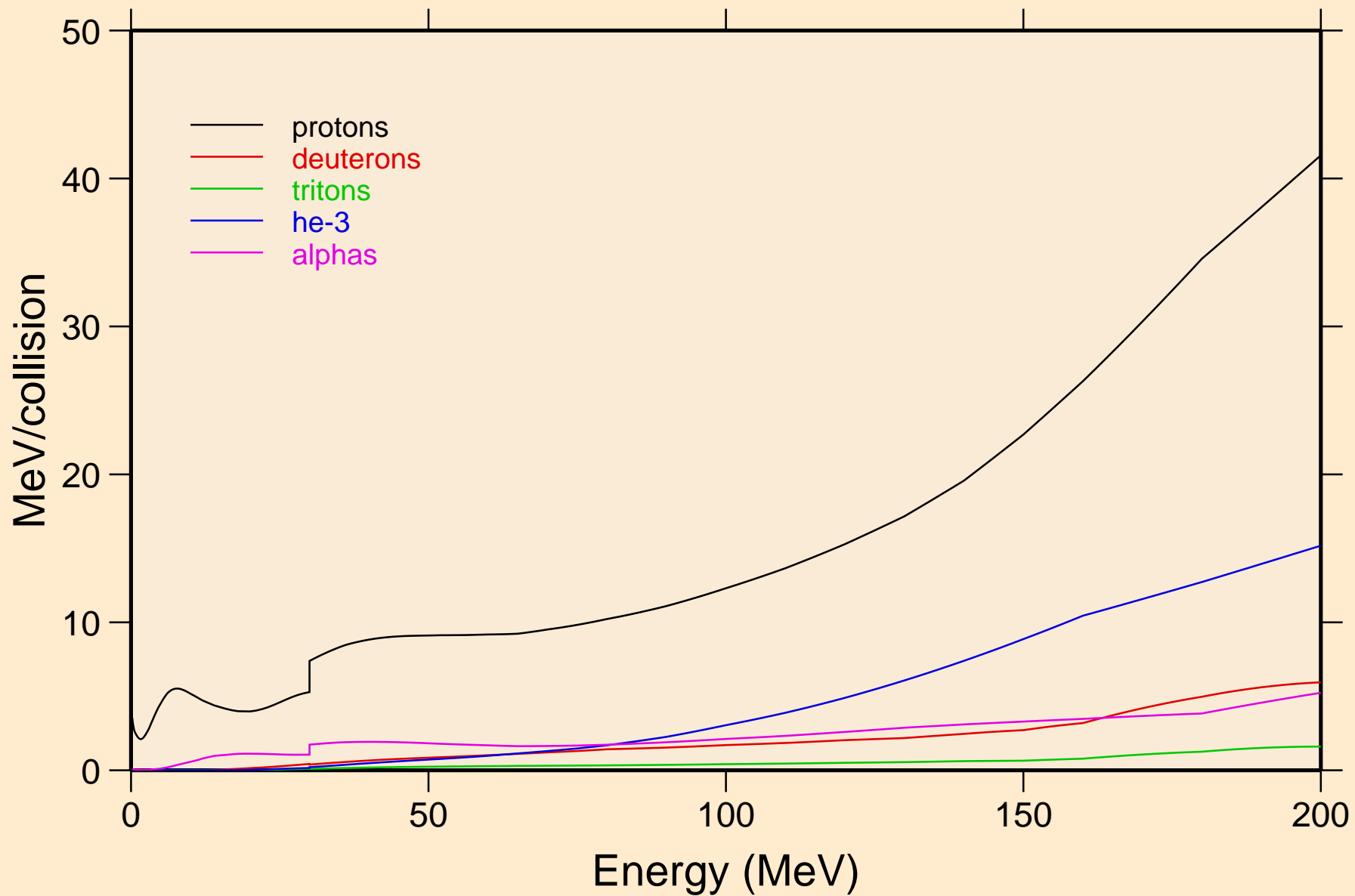

SM133 NEUTRON ACER TENDL-2019 LIBRARY; T=293.16K
Recoil Heating

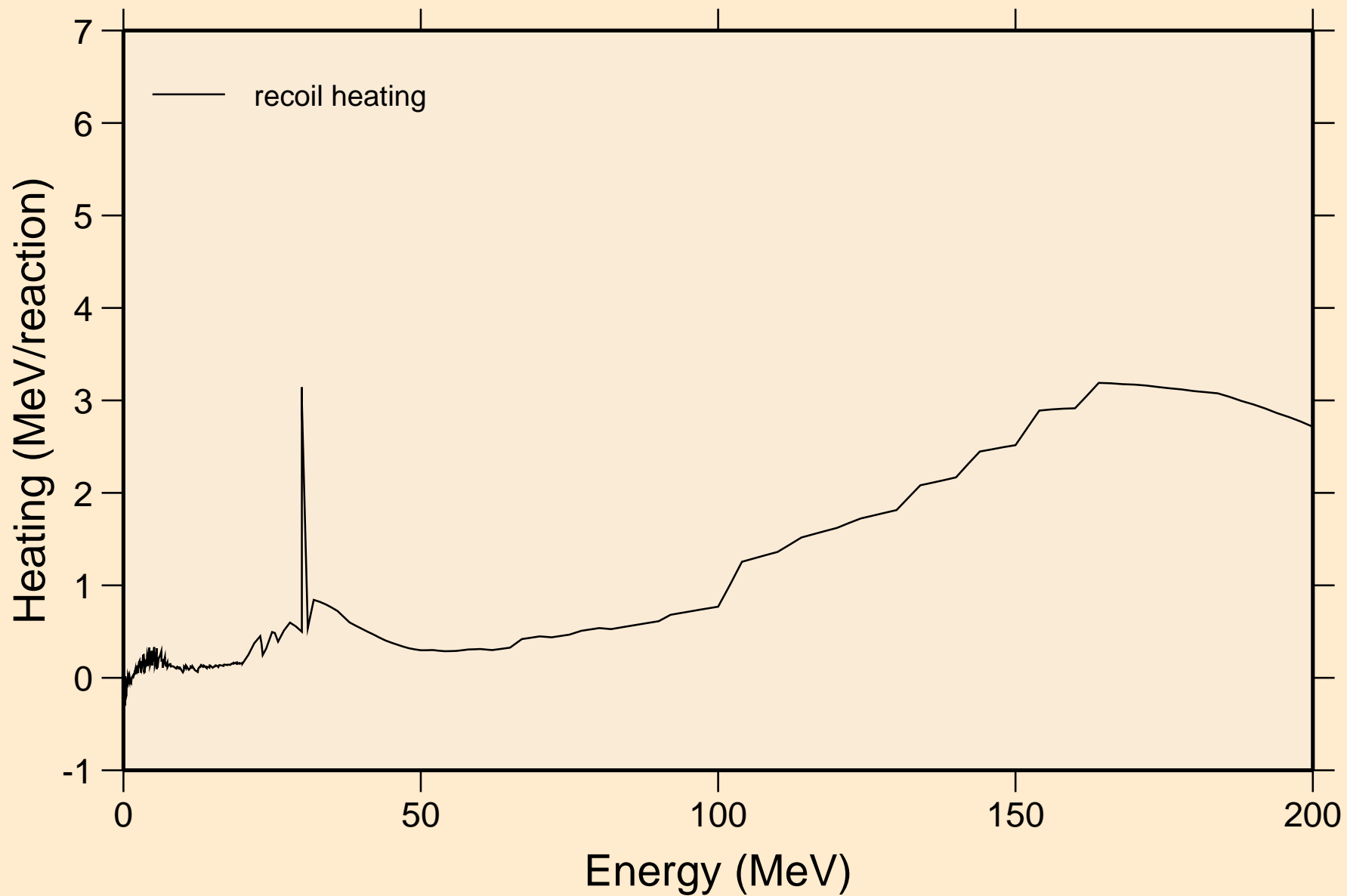

SM133 NEUTRON ACER TENDL-2019 LIBRARY; T=293.16K
Particle production cross sections

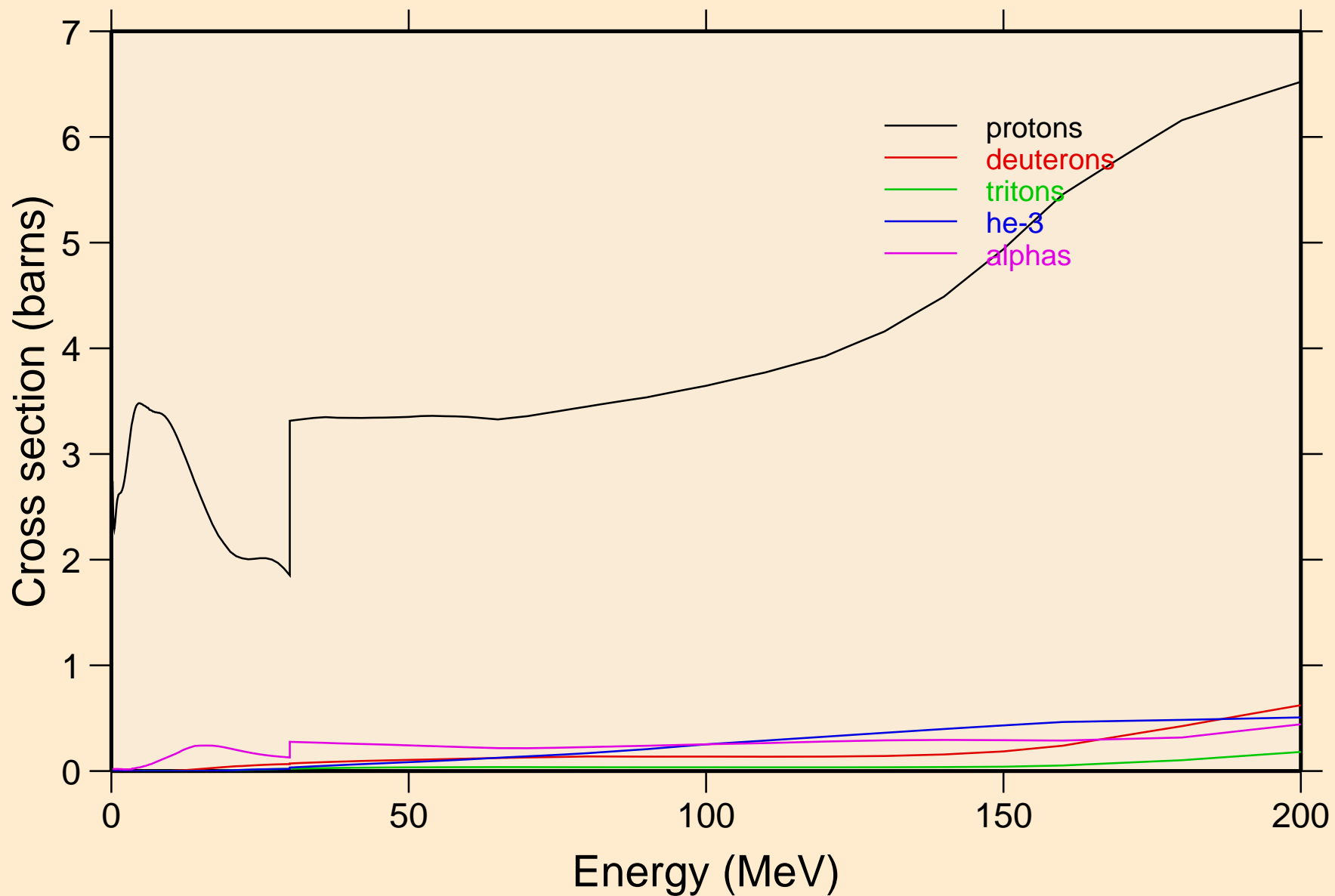

SM133 NEUTRON ACER TENDL-2019 LIBRARY; T=293.16K
protons from (n,x)

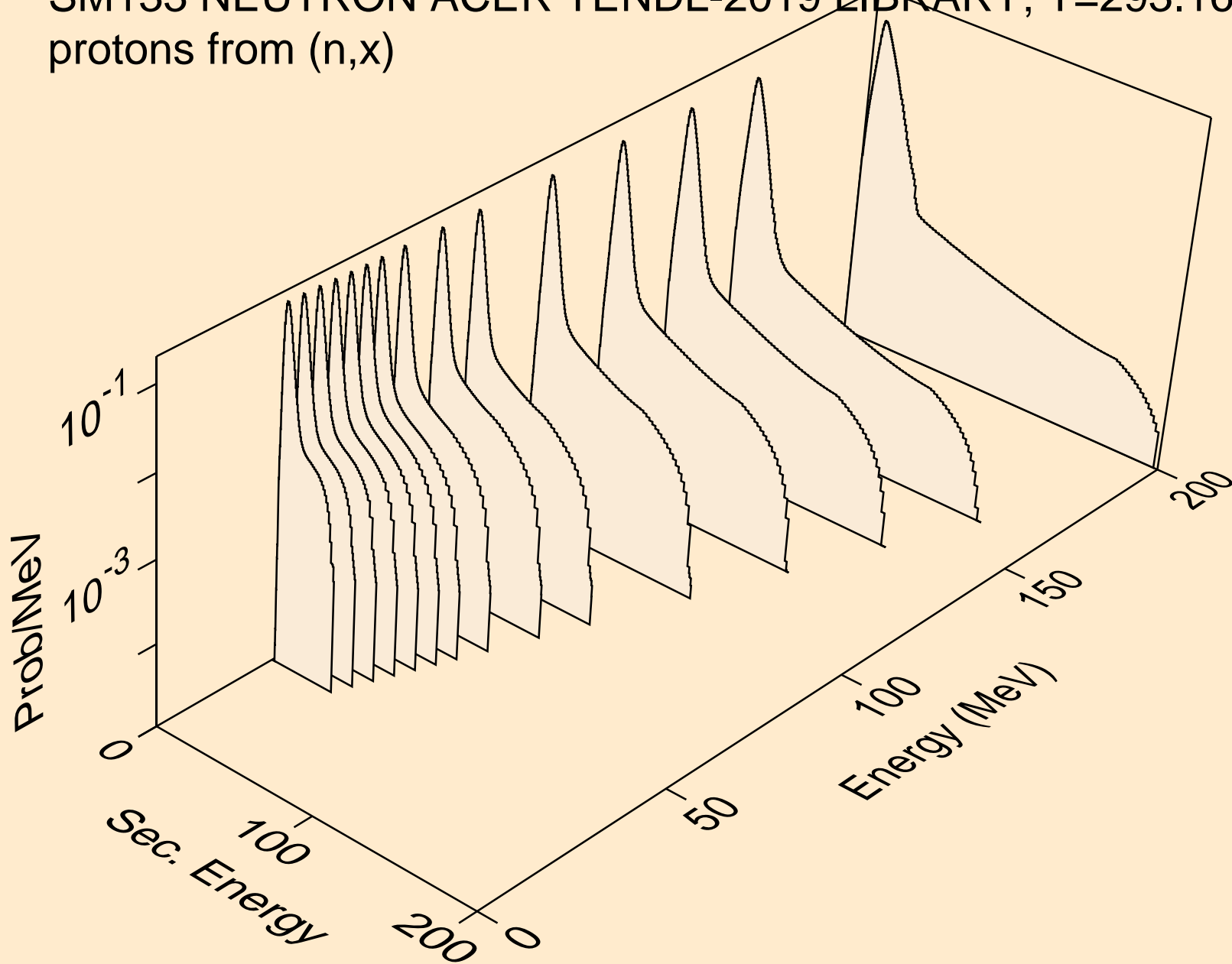

SM133 NEUTRON ACER TENDL-2019 LIBRARY; T=293.16K
protons from (n,n*)p

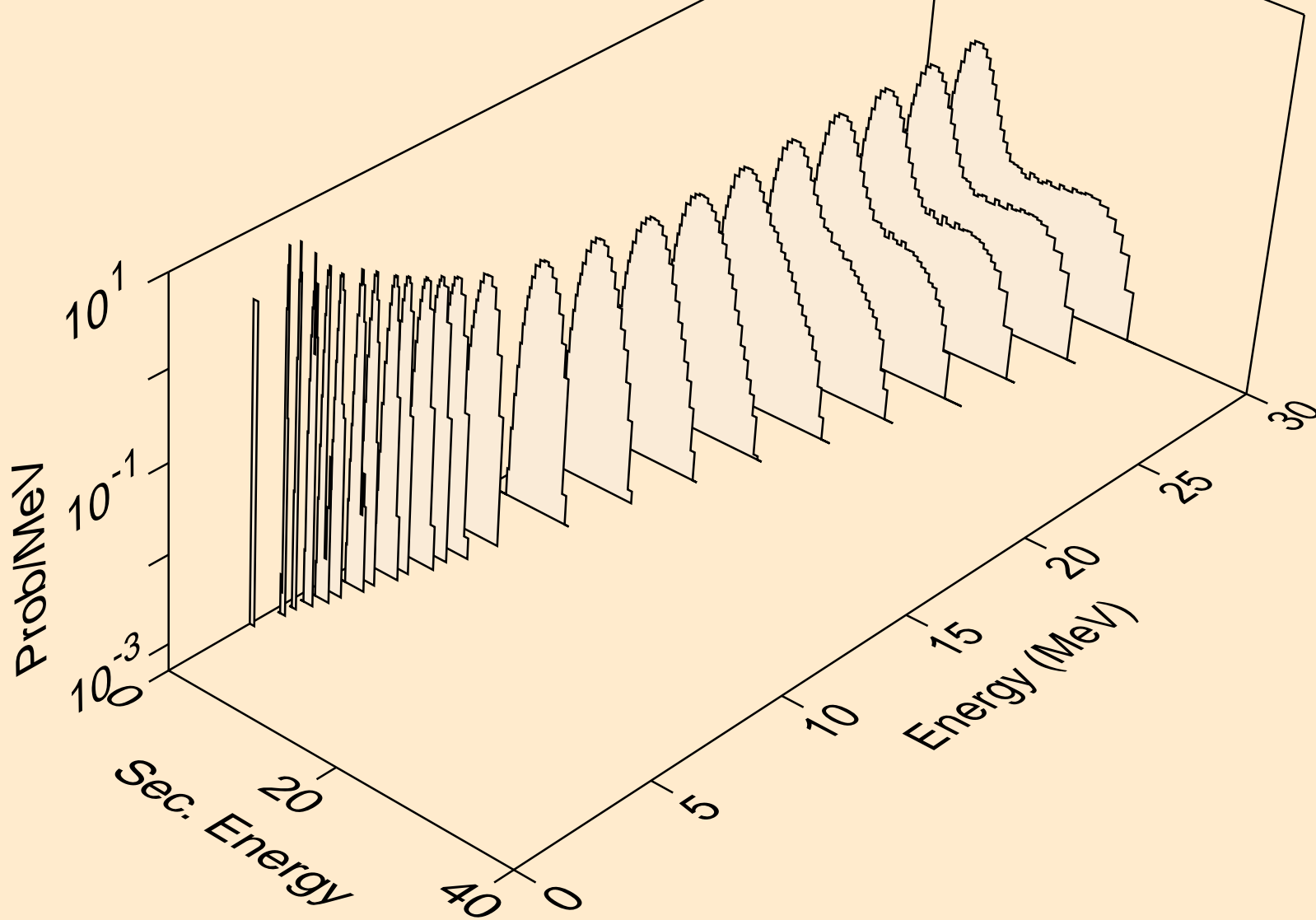

SM133 NEUTRON ACER TENDL-2019 LIBRARY; T=293.16K
protons from (n,2np)

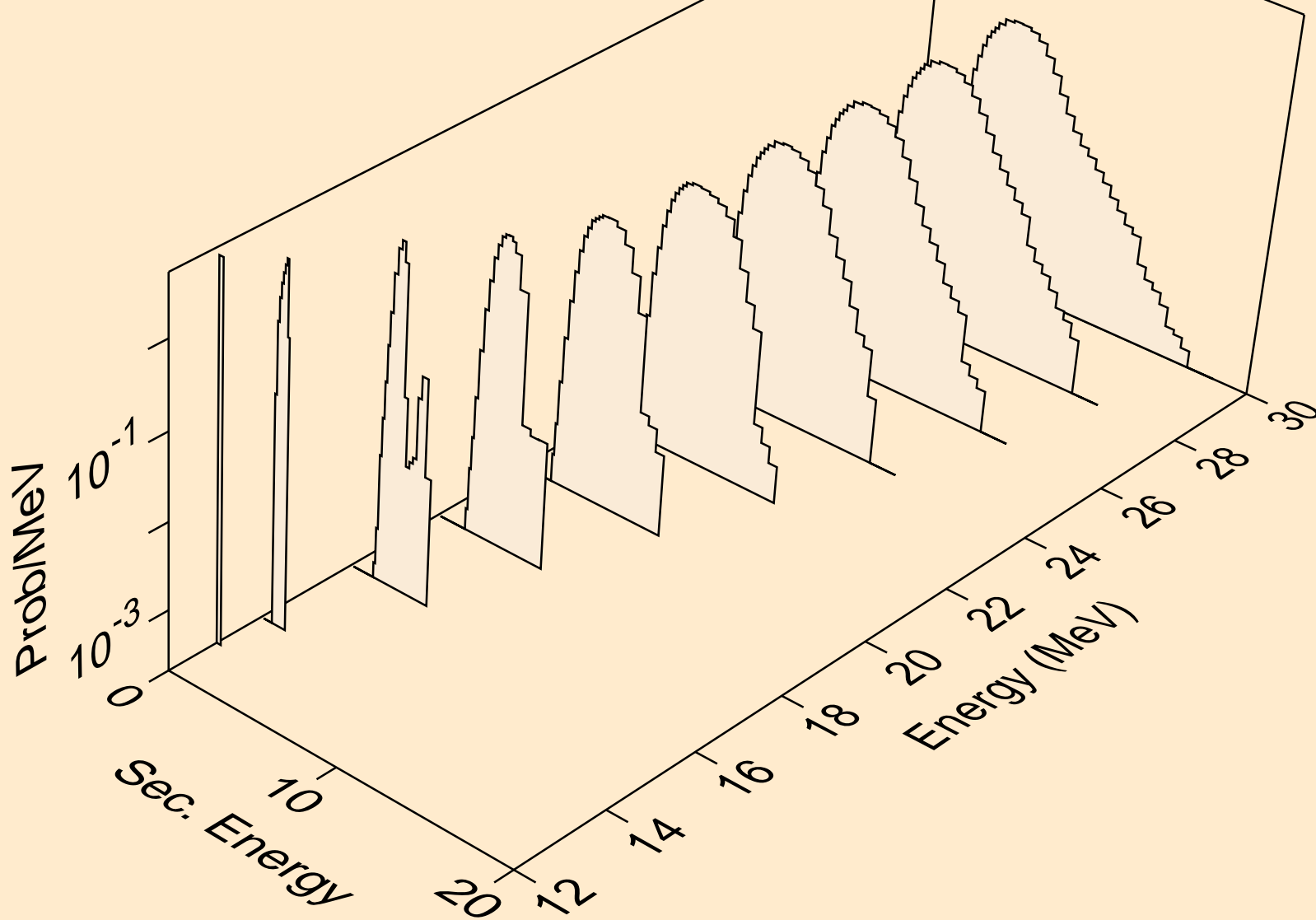

SM133 NEUTRON ACER TENDL-2019 LIBRARY; T=293.16K
protons from (n,3np)

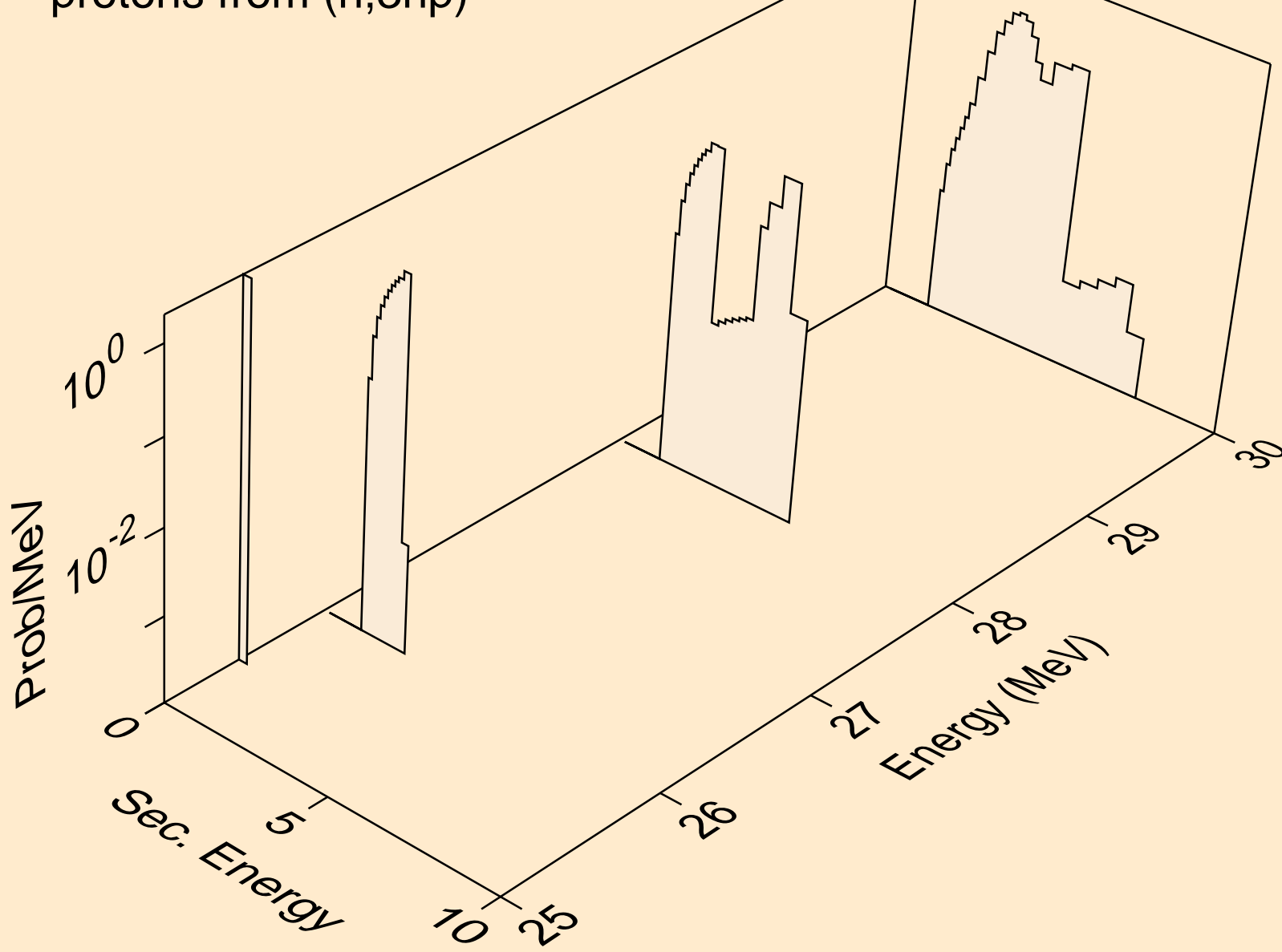

SM133 NEUTRON ACER TENDL-2019 LIBRARY; T=293.16K
protons from (n,2np)

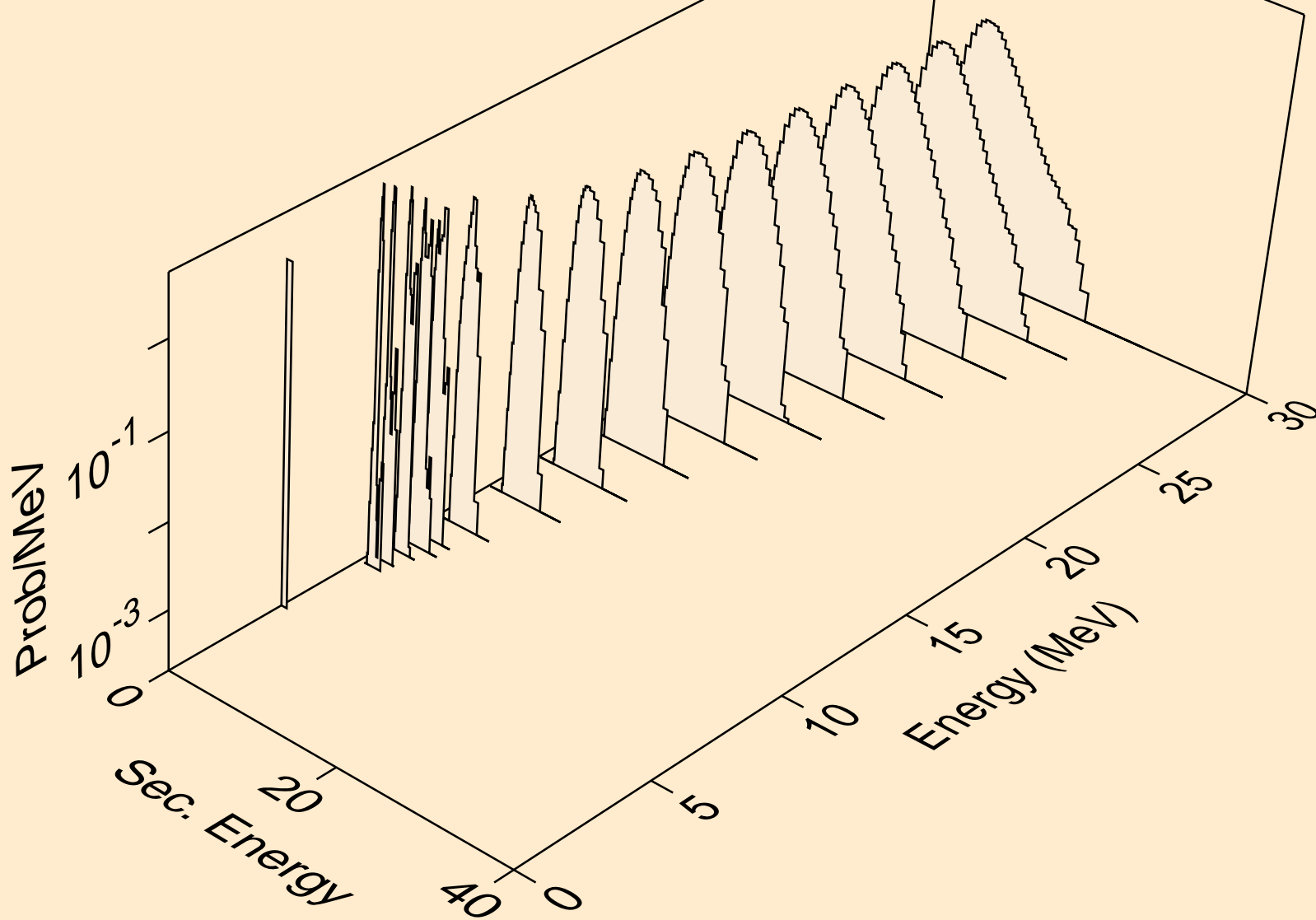

SM133 NEUTRON ACER TENDL-2019 LIBRARY; T=293.16K
protons from (n,npa)

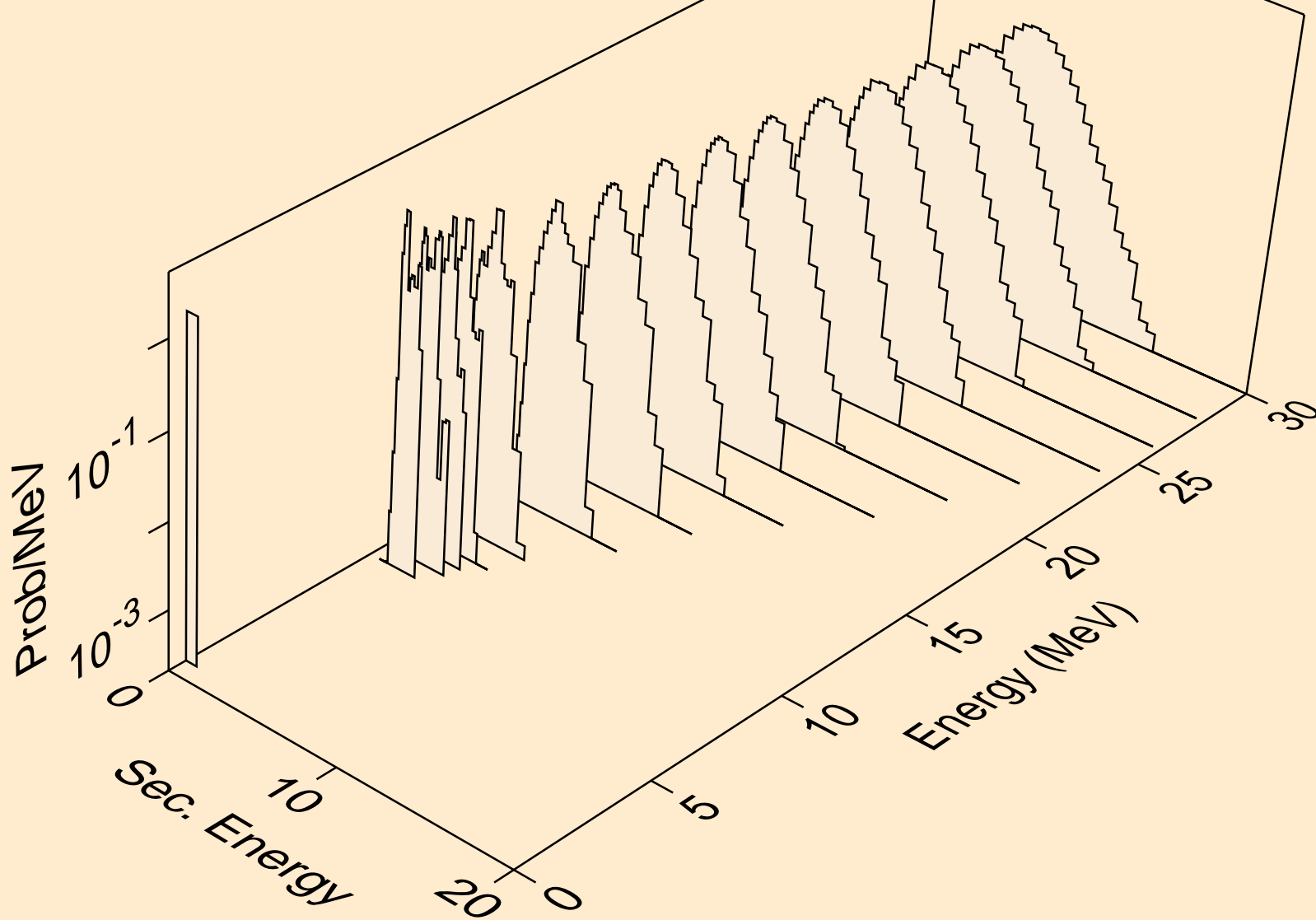

SM133 NEUTRON ACER TENDL-2019 LIBRARY; T=293.16K
protons from (n,p)

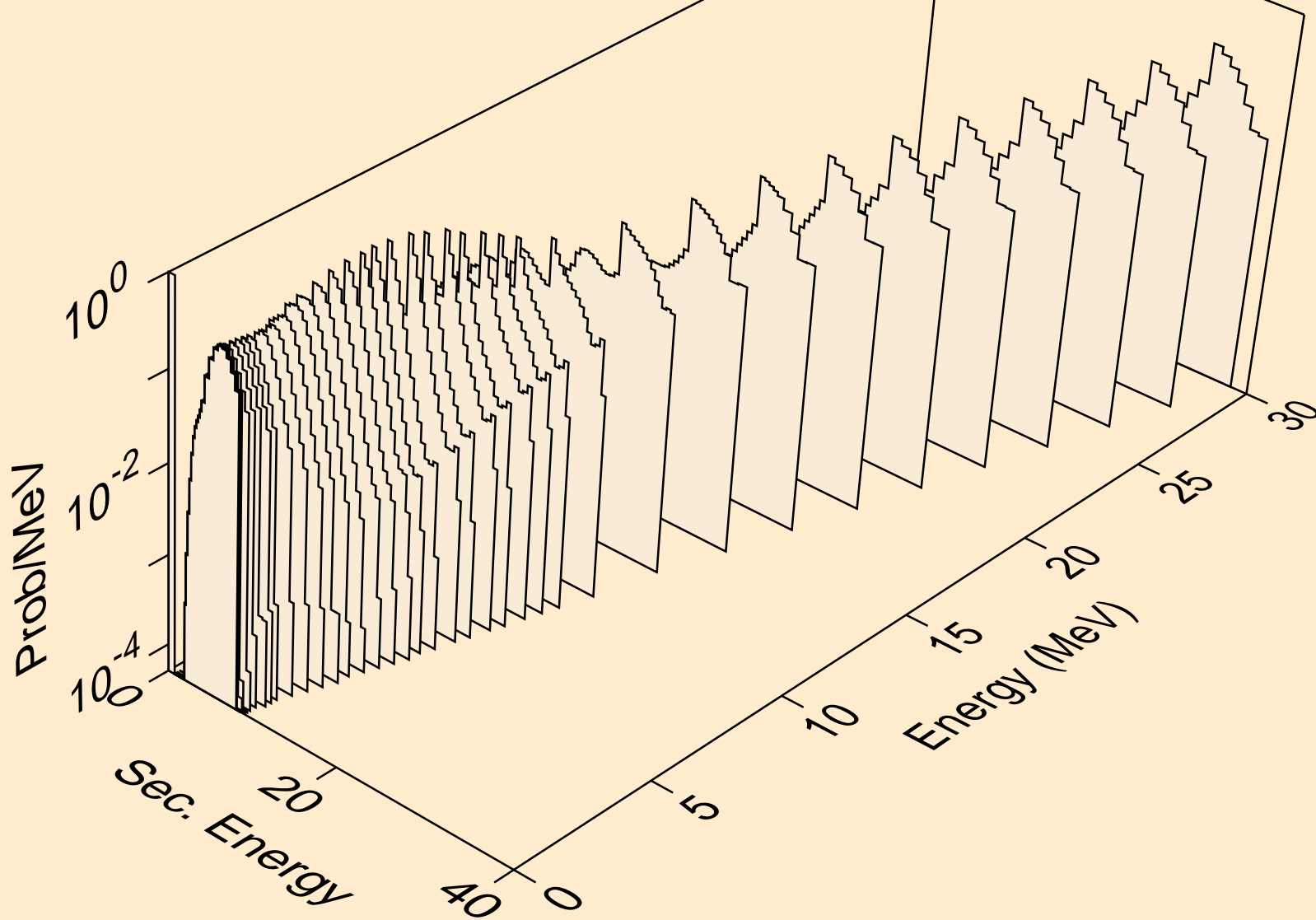

SM133 NEUTRON ACER TENDL-2019 LIBRARY; T=293.16K
protons from (n,2p)

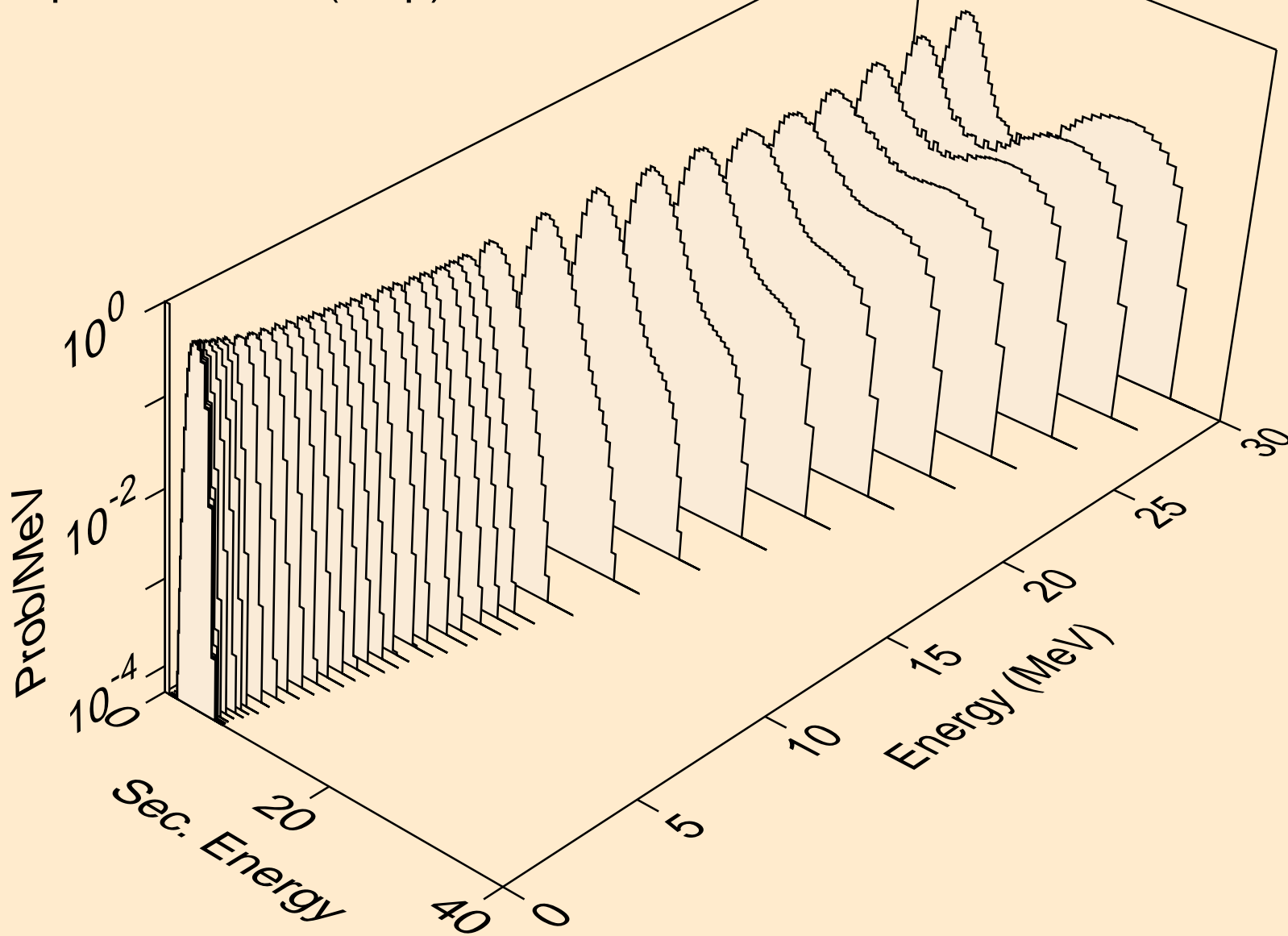

SM133 NEUTRON ACER TENDL-2019 LIBRARY; T=293.16K
protons from (n,p)

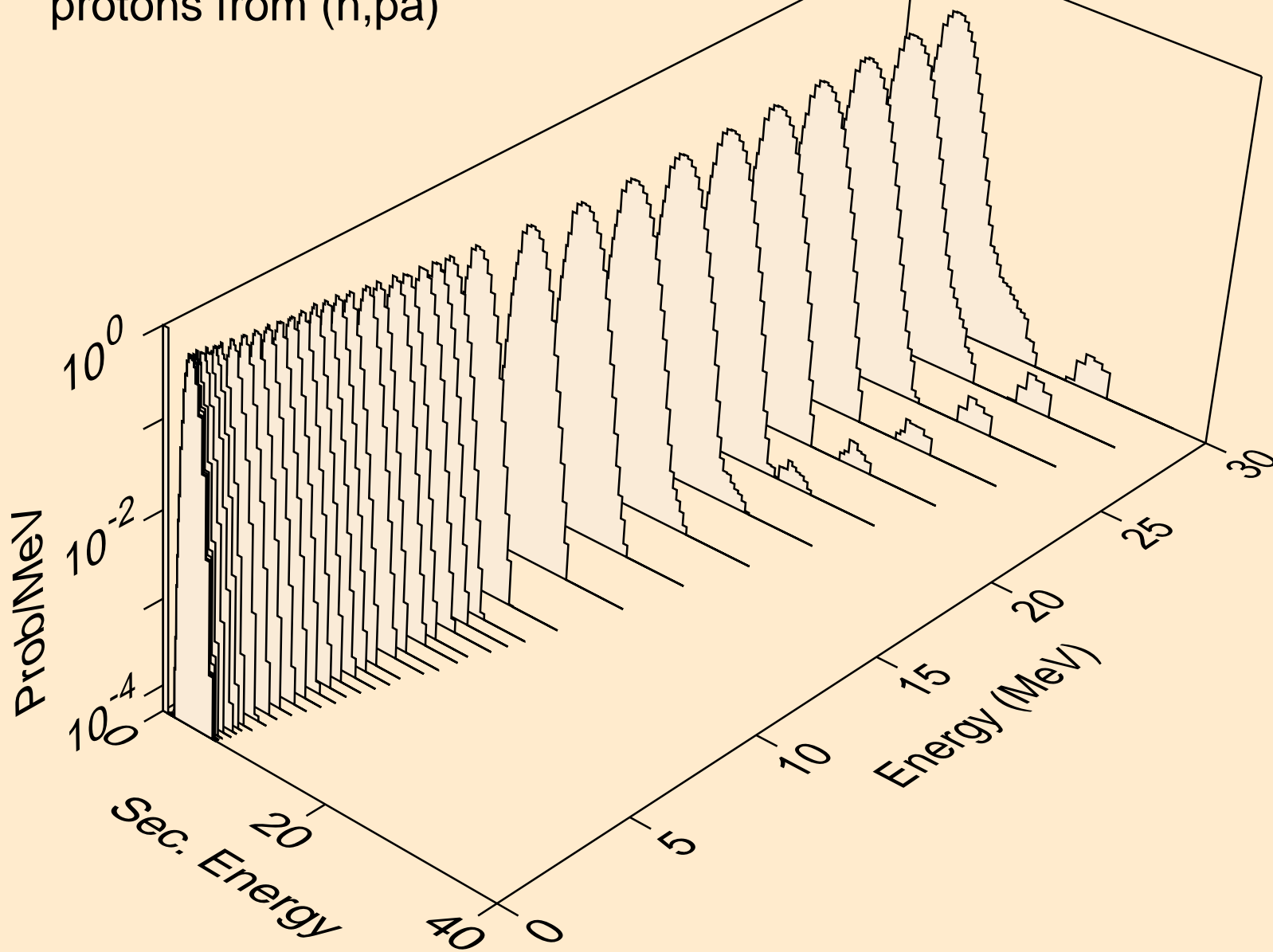

SM133 NEUTRON ACER TENDL-2019 LIBRARY; T=293.16K
protons from (n,pd)

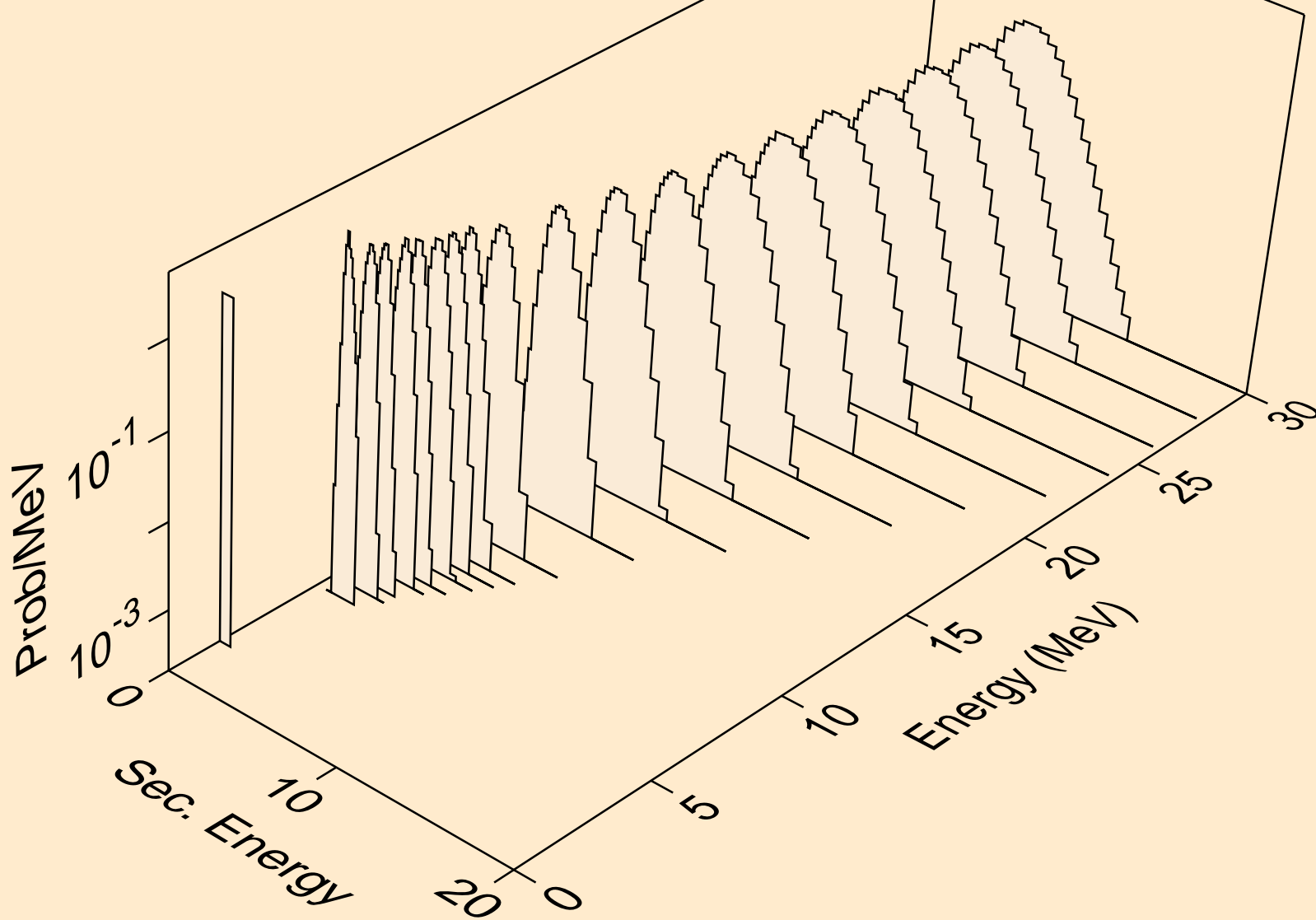

SM133 NEUTRON ACER TENDL-2019 LIBRARY; T=293.16K
protons from (n,pt)

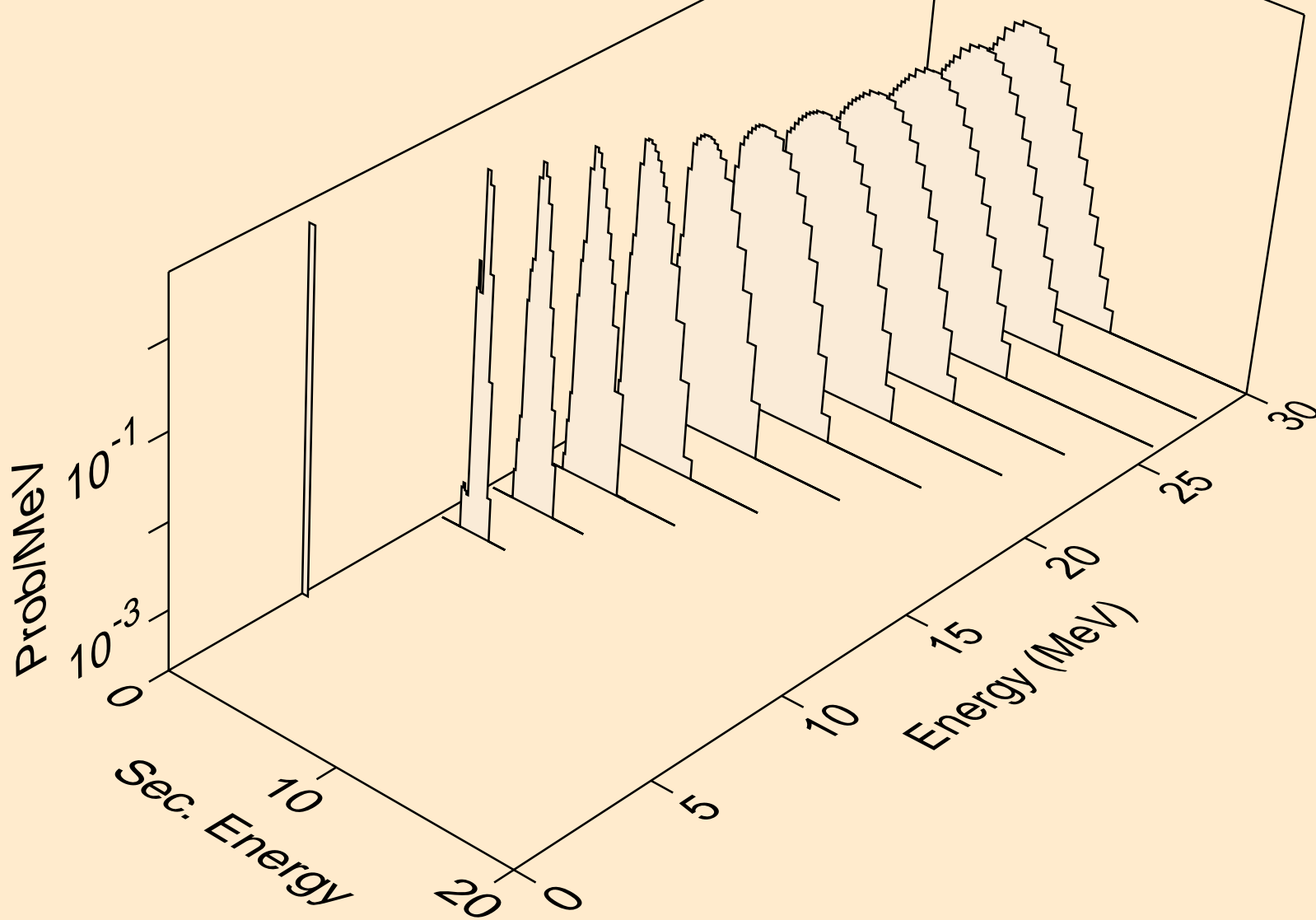

SM133 NEUTRON ACER TENDL-2019 LIBRARY; T=293.16K
deuterons from (n,x)

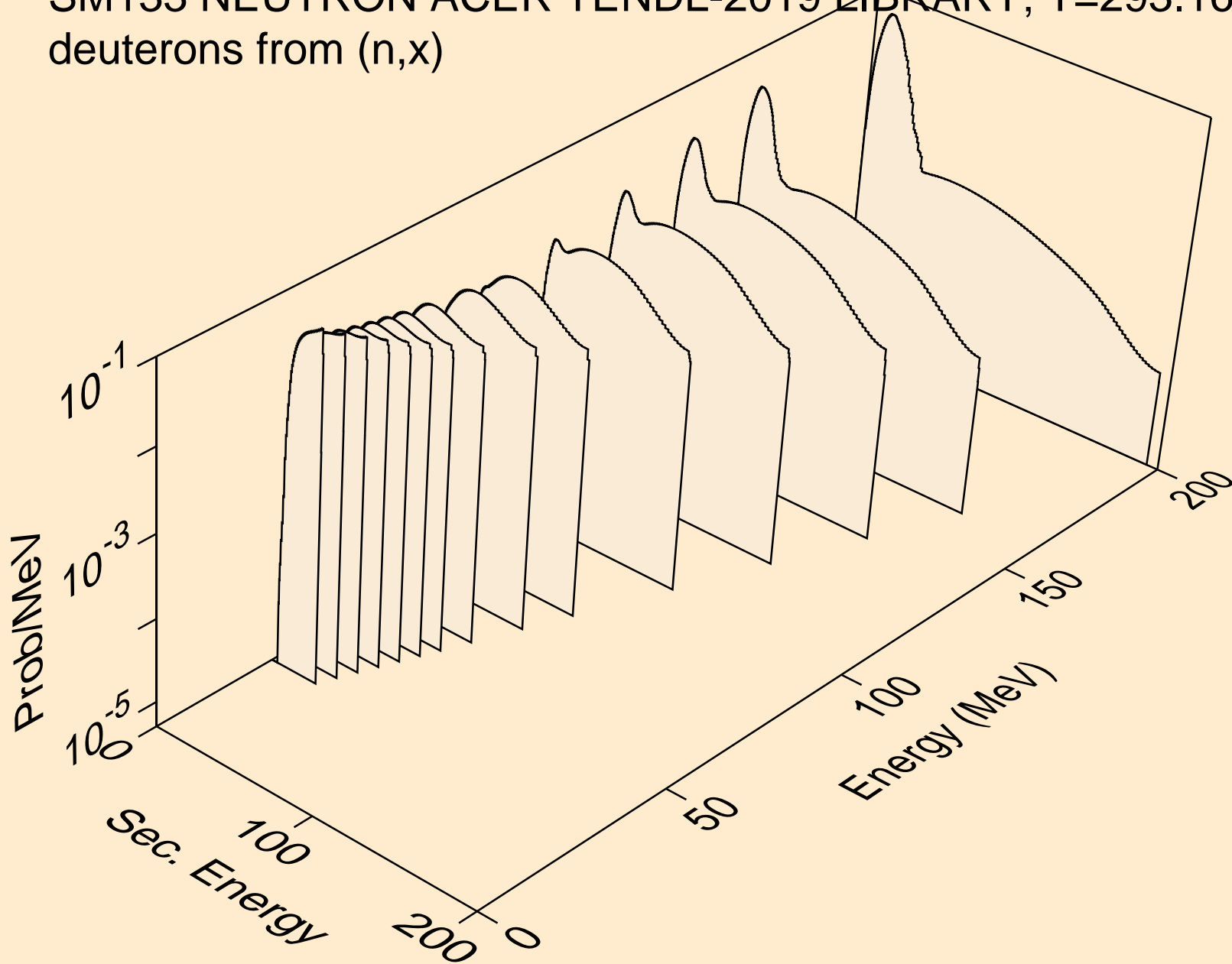

SM133 NEUTRON ACER TENDL-2019 LIBRARY; T=293.16K
deuterons from (n,2nd)

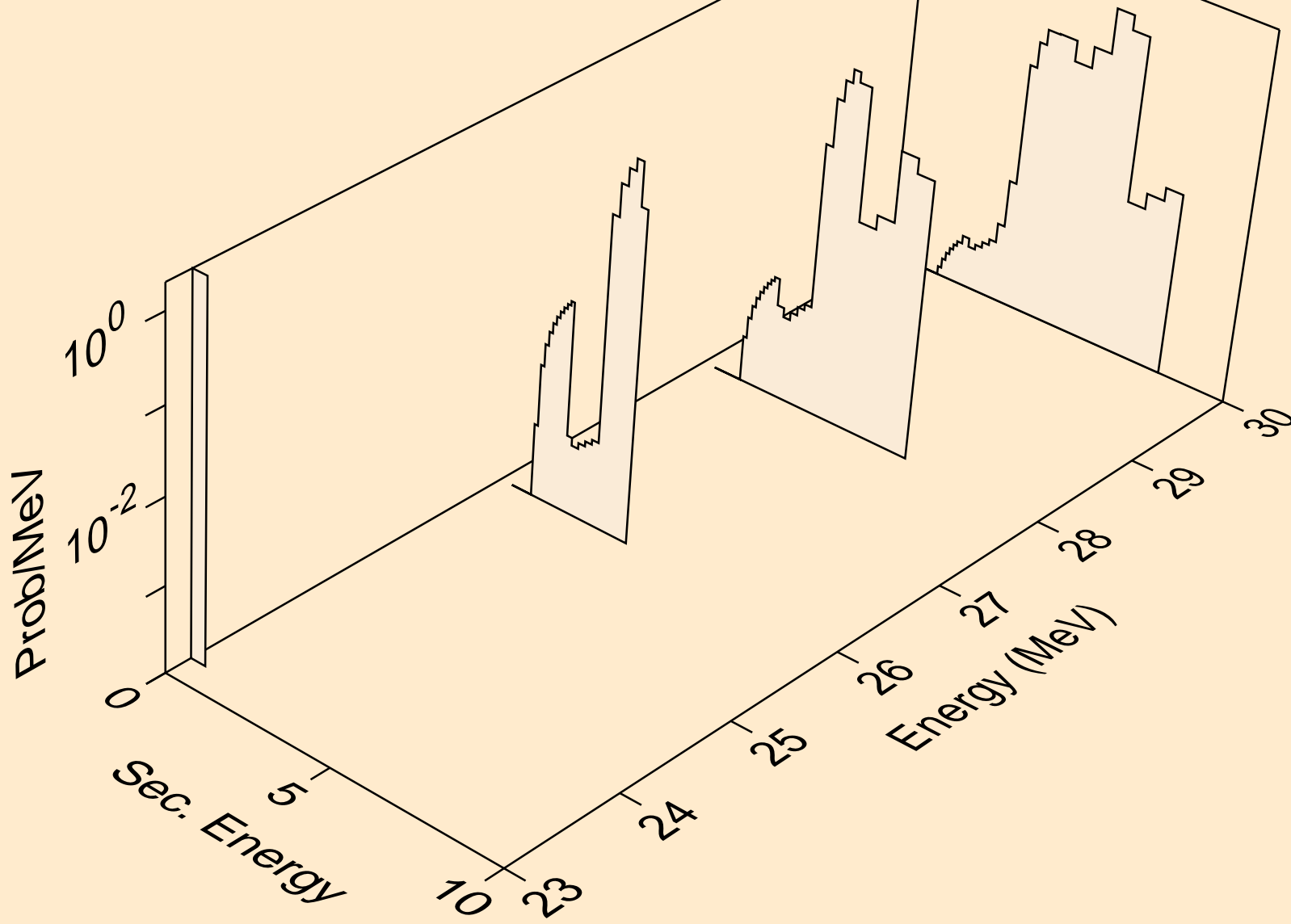

SM133 NEUTRON ACER TENDL-2019 LIBRARY; T=293.16K
deuterons from (n,n*)d

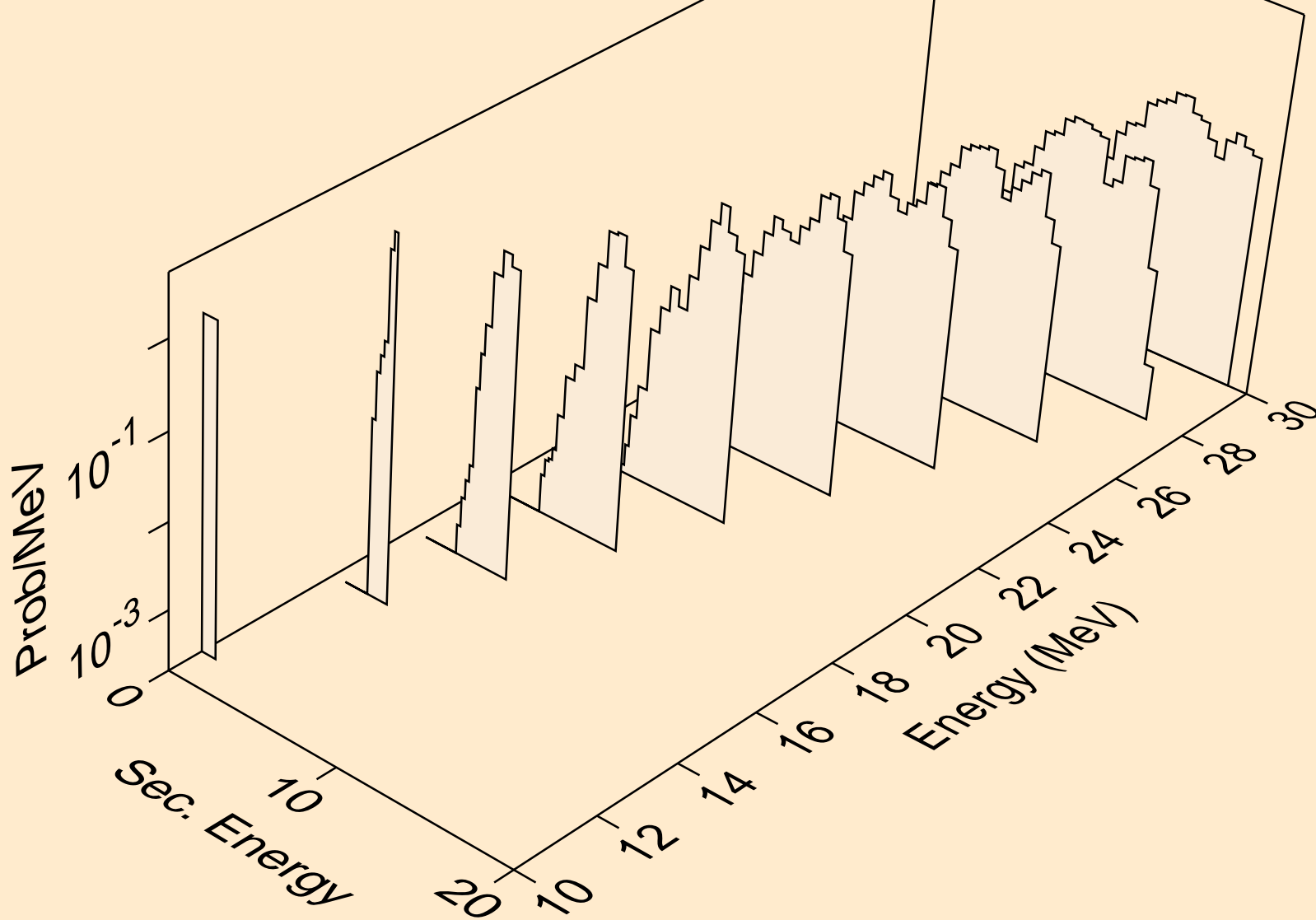

SM133 NEUTRON ACER TENDL-2019 LIBRARY; T=293.16K
deuterons from (n,d)

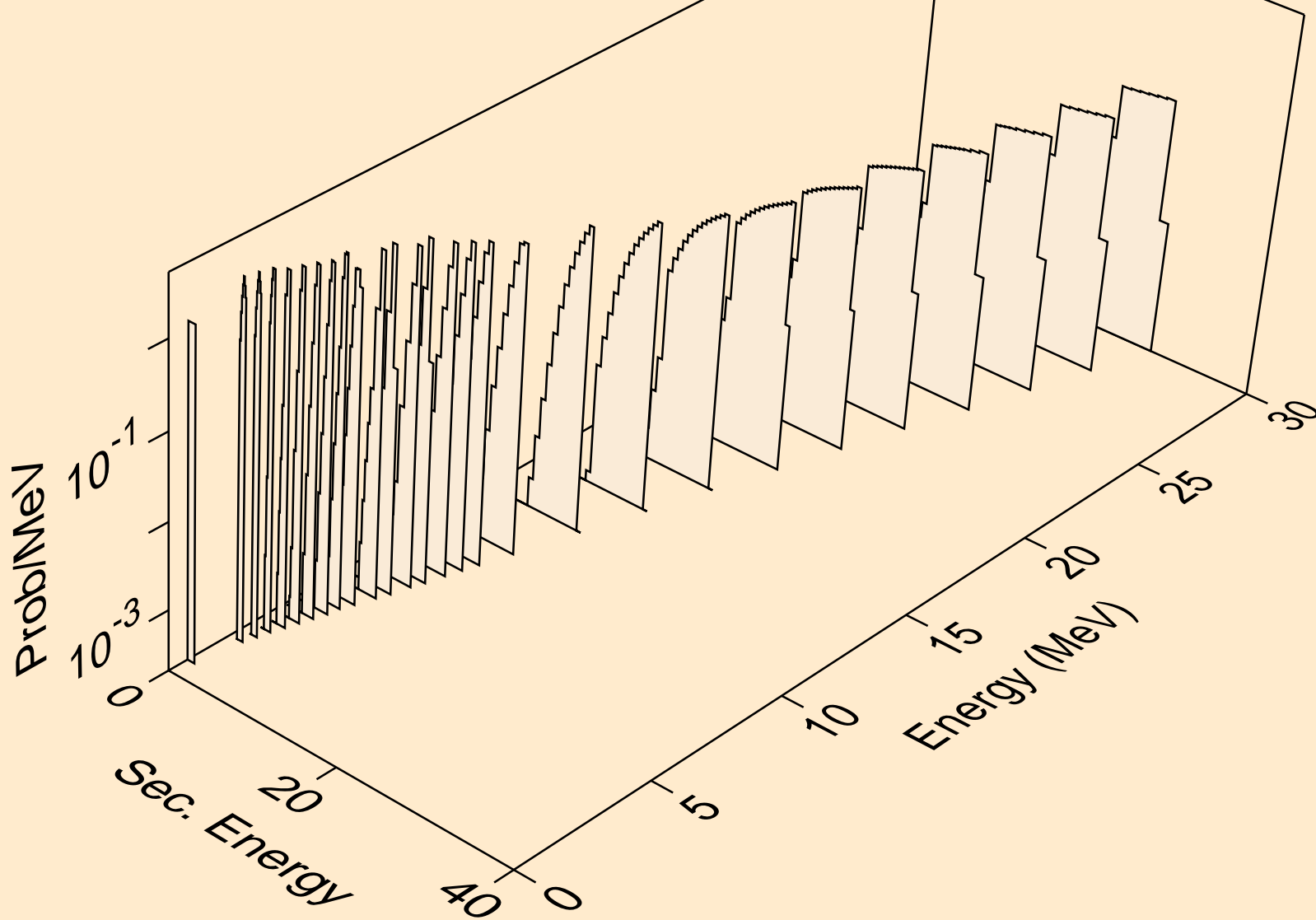

SM133 NEUTRON ACER TENDL-2019 LIBRARY; T=293.16K
deuterons from (n,pd)

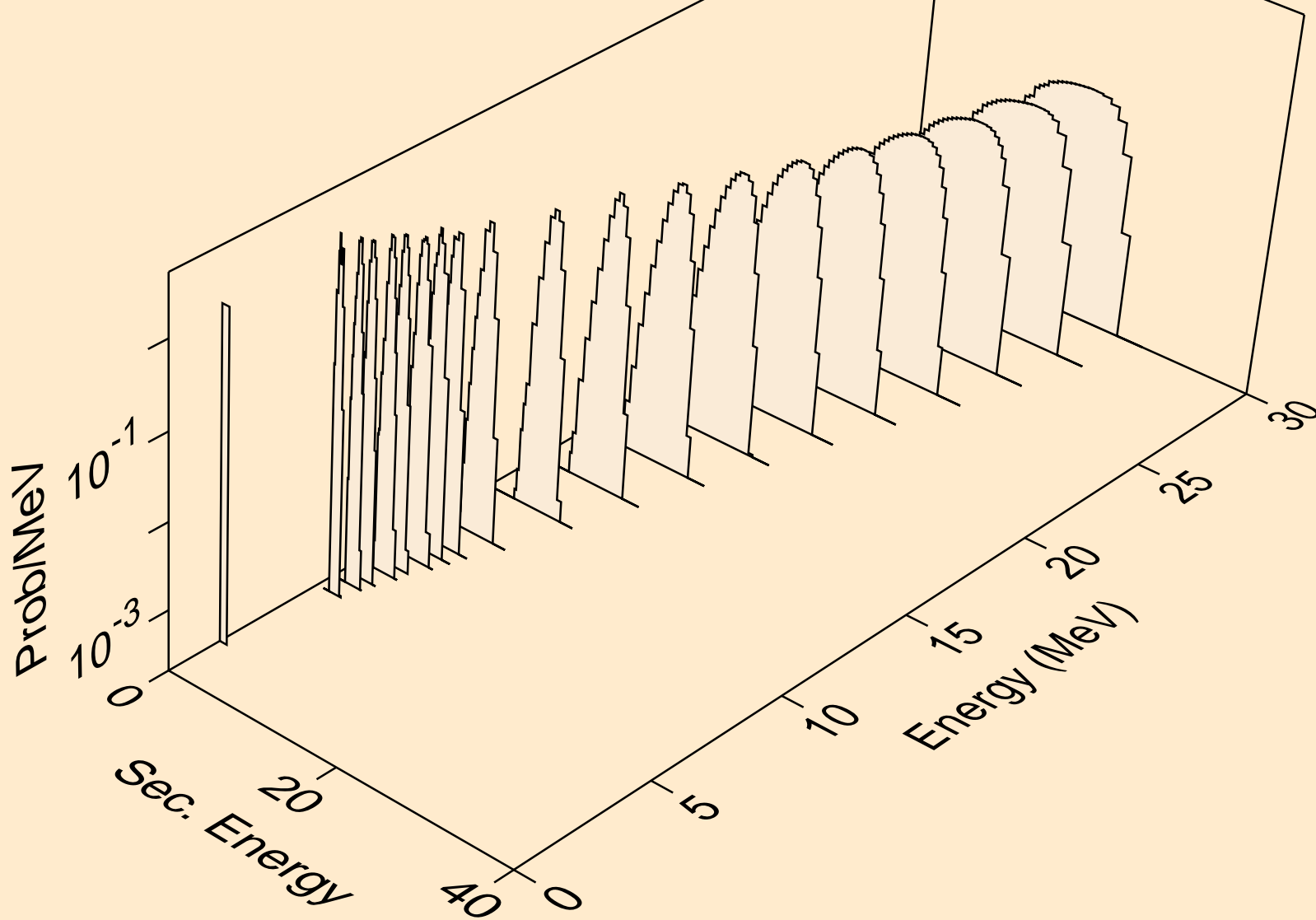

SM133 NEUTRON ACER TENDL-2019 LIBRARY; T=293.16K
deuterons from (n,da)

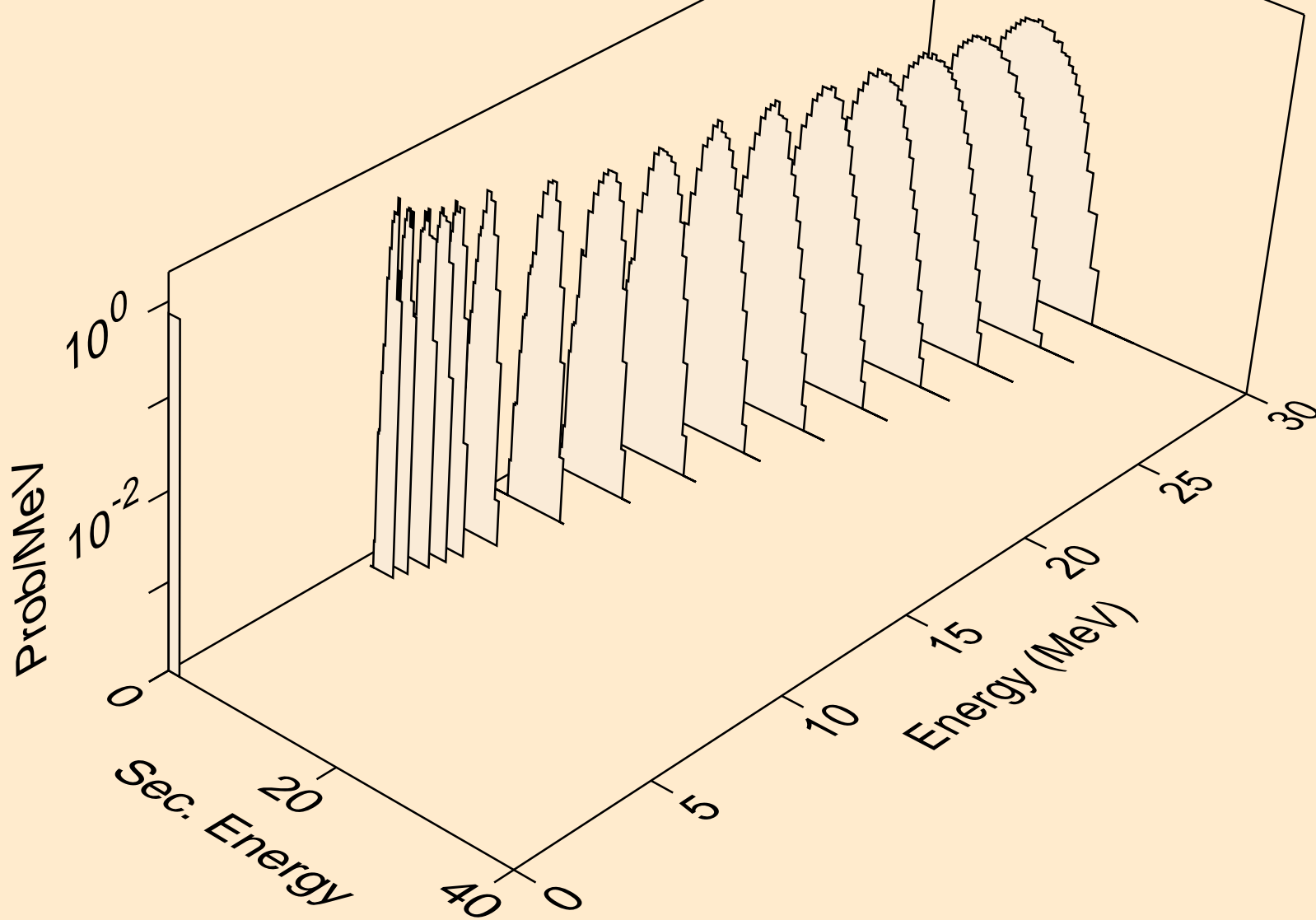

SM133 NEUTRON ACER TENDL-2019 LIBRARY; T=293.16K
tritons from (n,x)

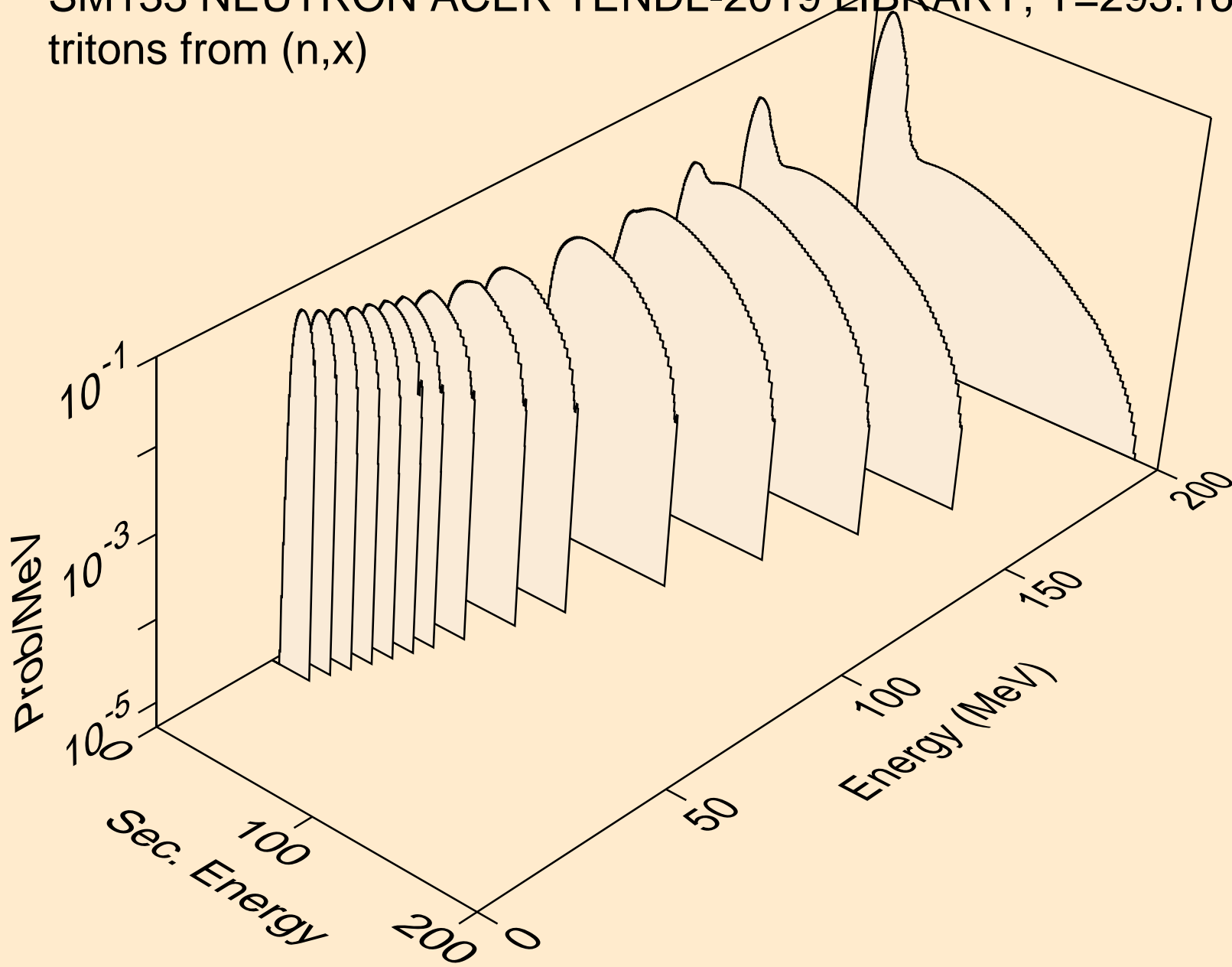

SM133 NEUTRON ACER TENDL-2019 LIBRARY; T=293.16K
tritons from (n,n*)t

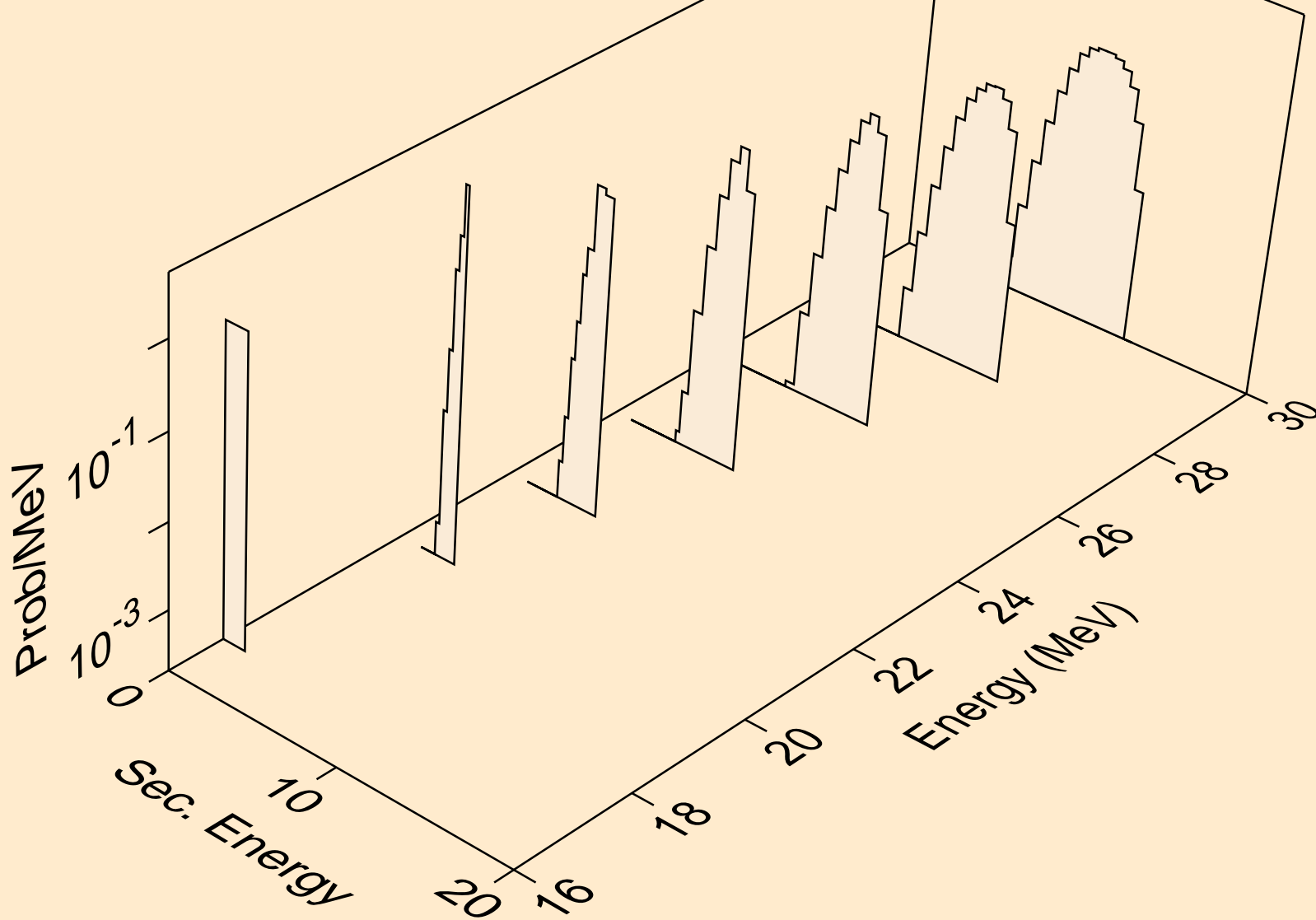

SM133 NEUTRON ACER TENDL-2019 LIBRARY; T=293.16K
tritons from (n,t)

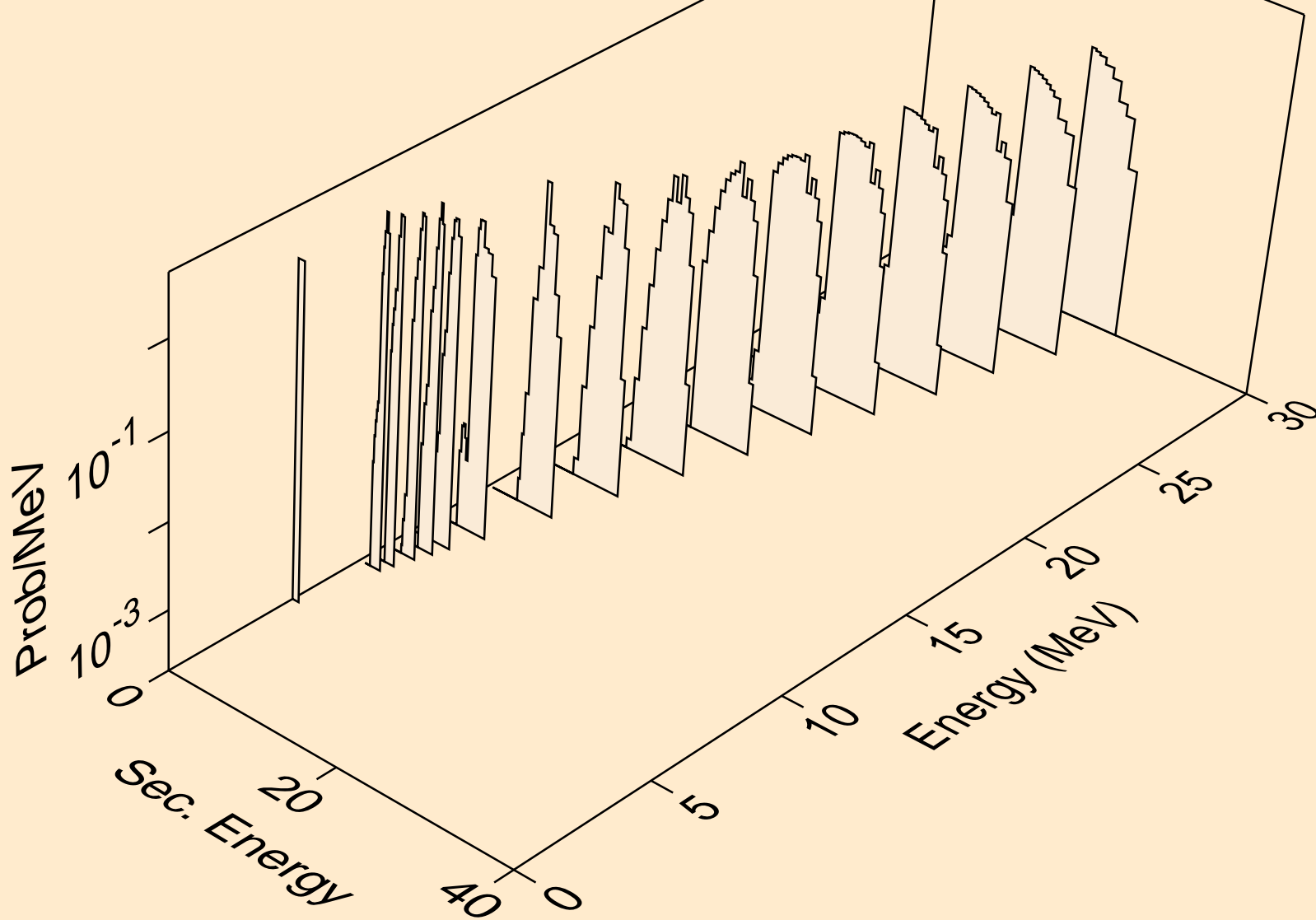

SM133 NEUTRON ACER TENDL-2019 LIBRARY; T=293.16K
tritons from (n,pt)

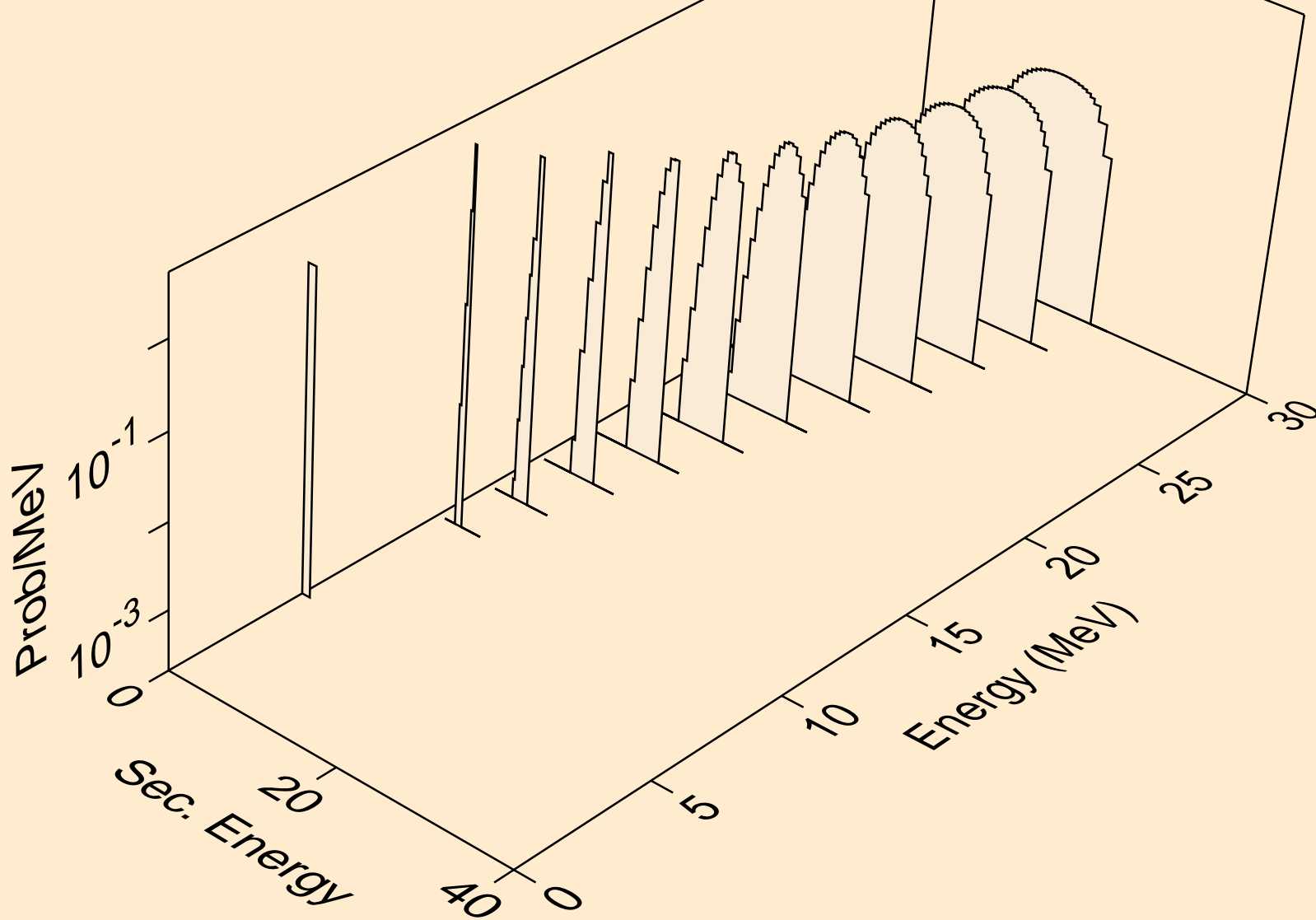

SM133 NEUTRON ACER TENDL-2019 LIBRARY; T=293.16K
he3s from (n,x)

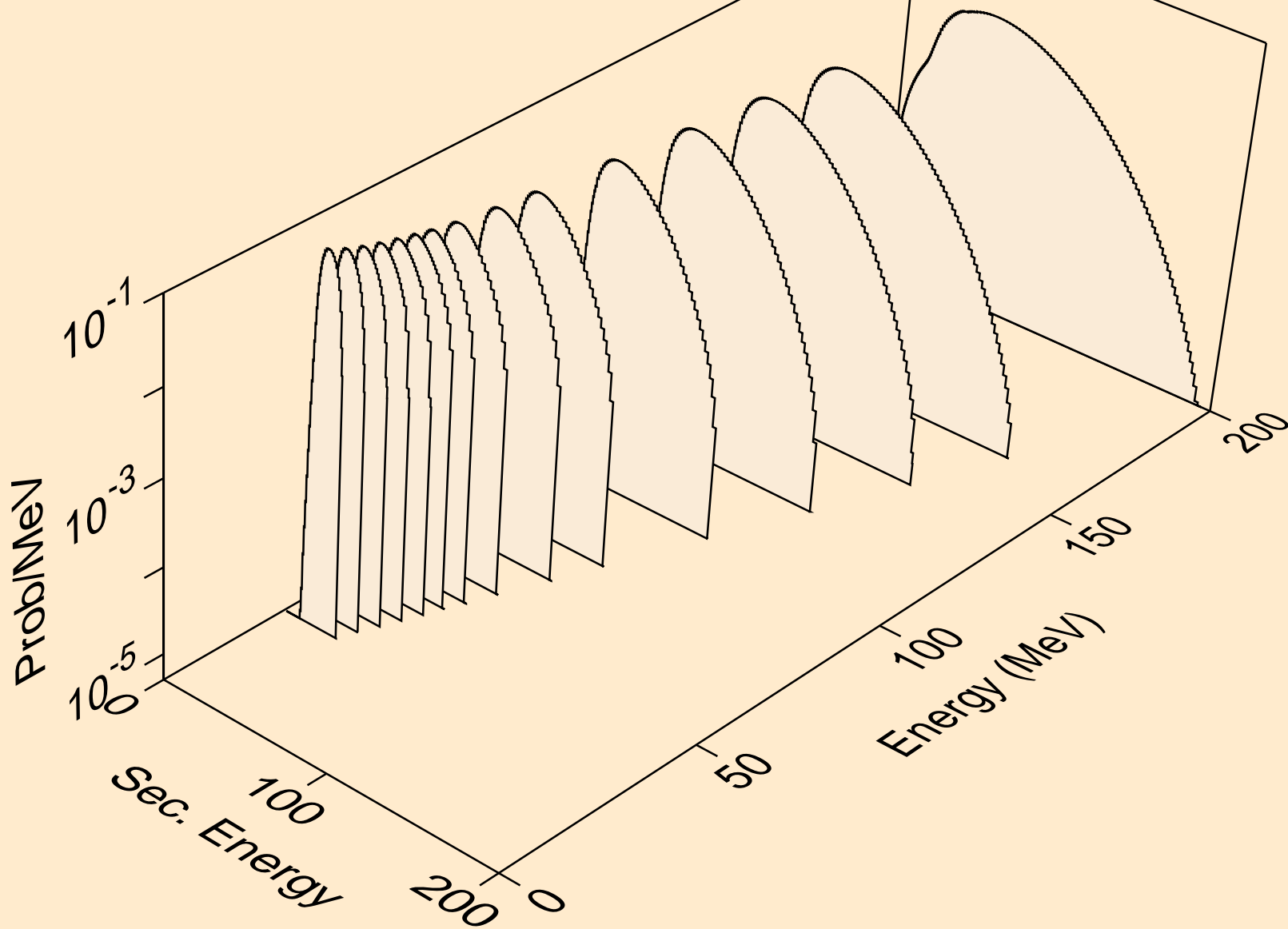

SM133 NEUTRON ACER TENDL-2019 LIBRARY; T=293.16K
he3s from (n,n*)he3

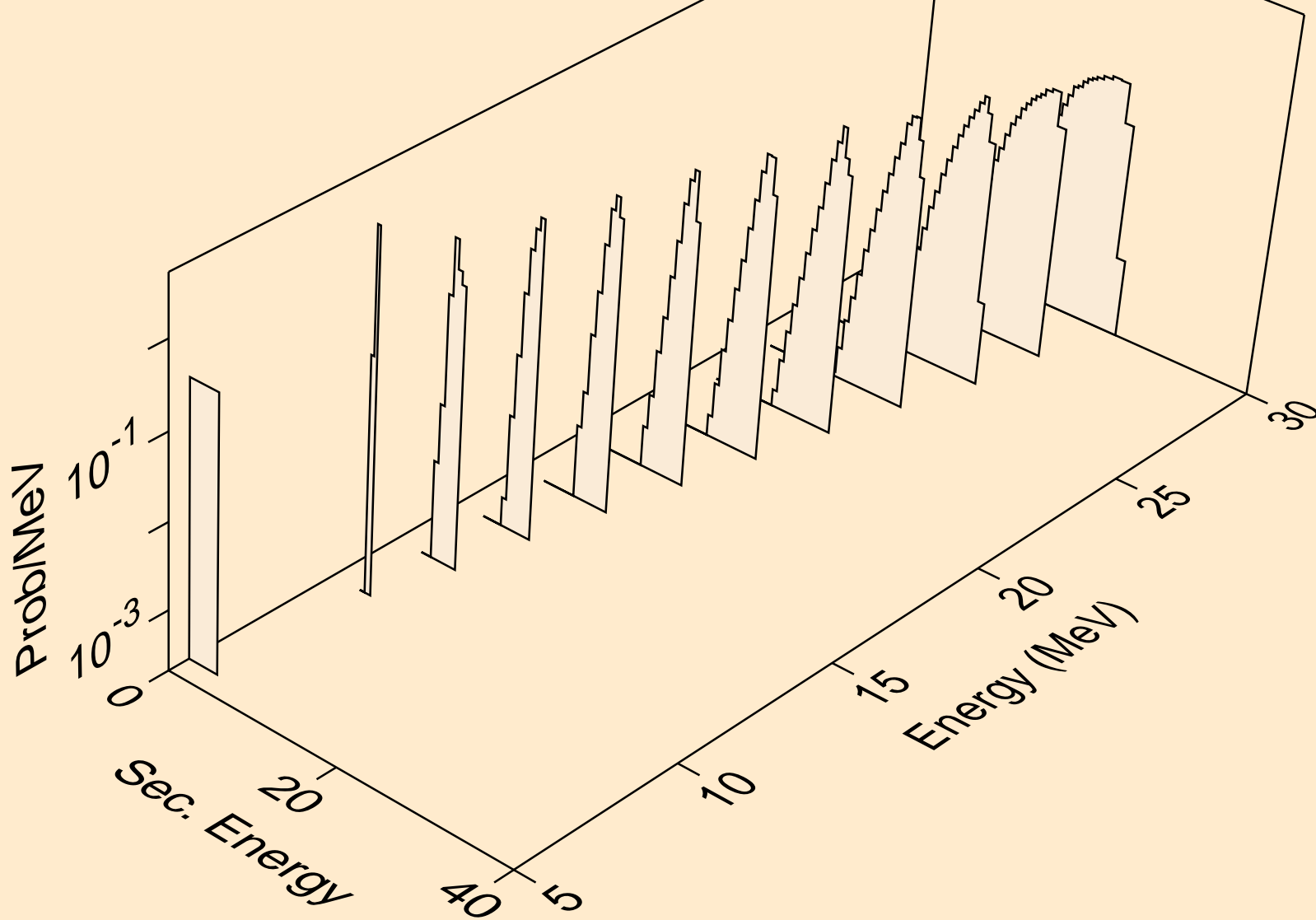

SM133 NEUTRON ACER TENDL-2019 LIBRARY; T=293.16K
he3s from (n,he3)

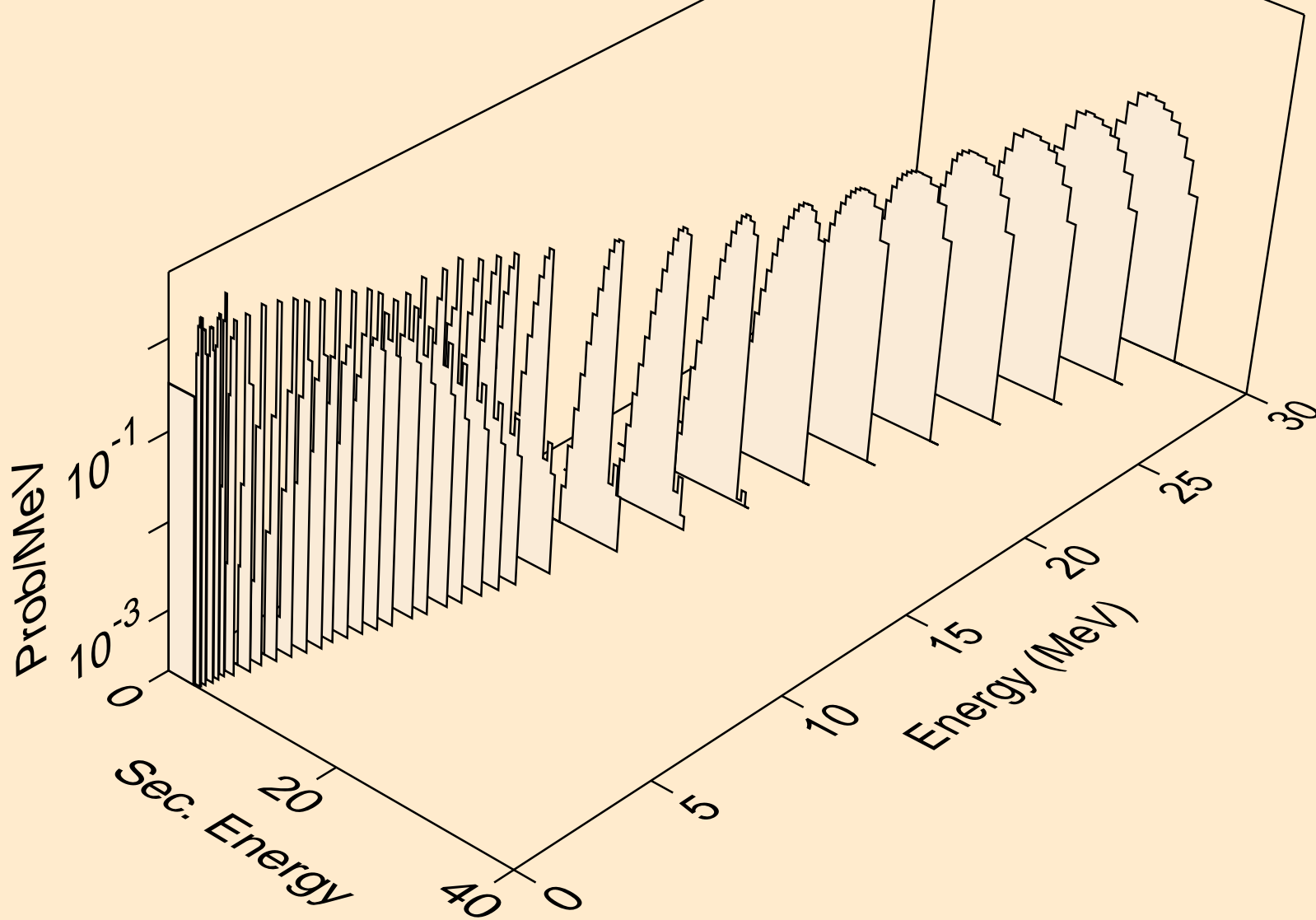

SM133 NEUTRON ACER TENDL-2019 LIBRARY; T=293.16K
alphas from (n,x)

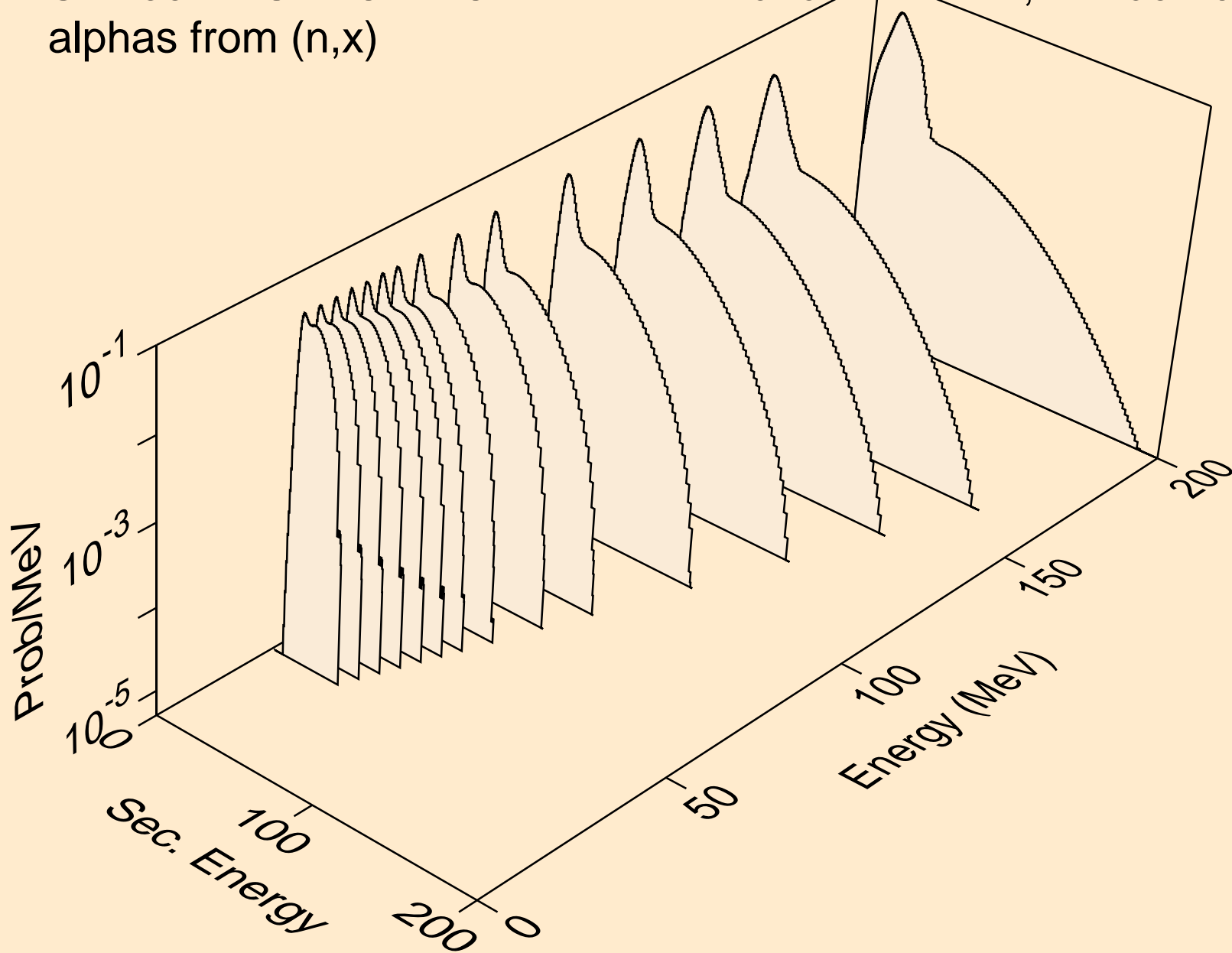

SM133 NEUTRON ACER TENDL-2019 LIBRARY; T=293.16K
alphas from (n,n*)a

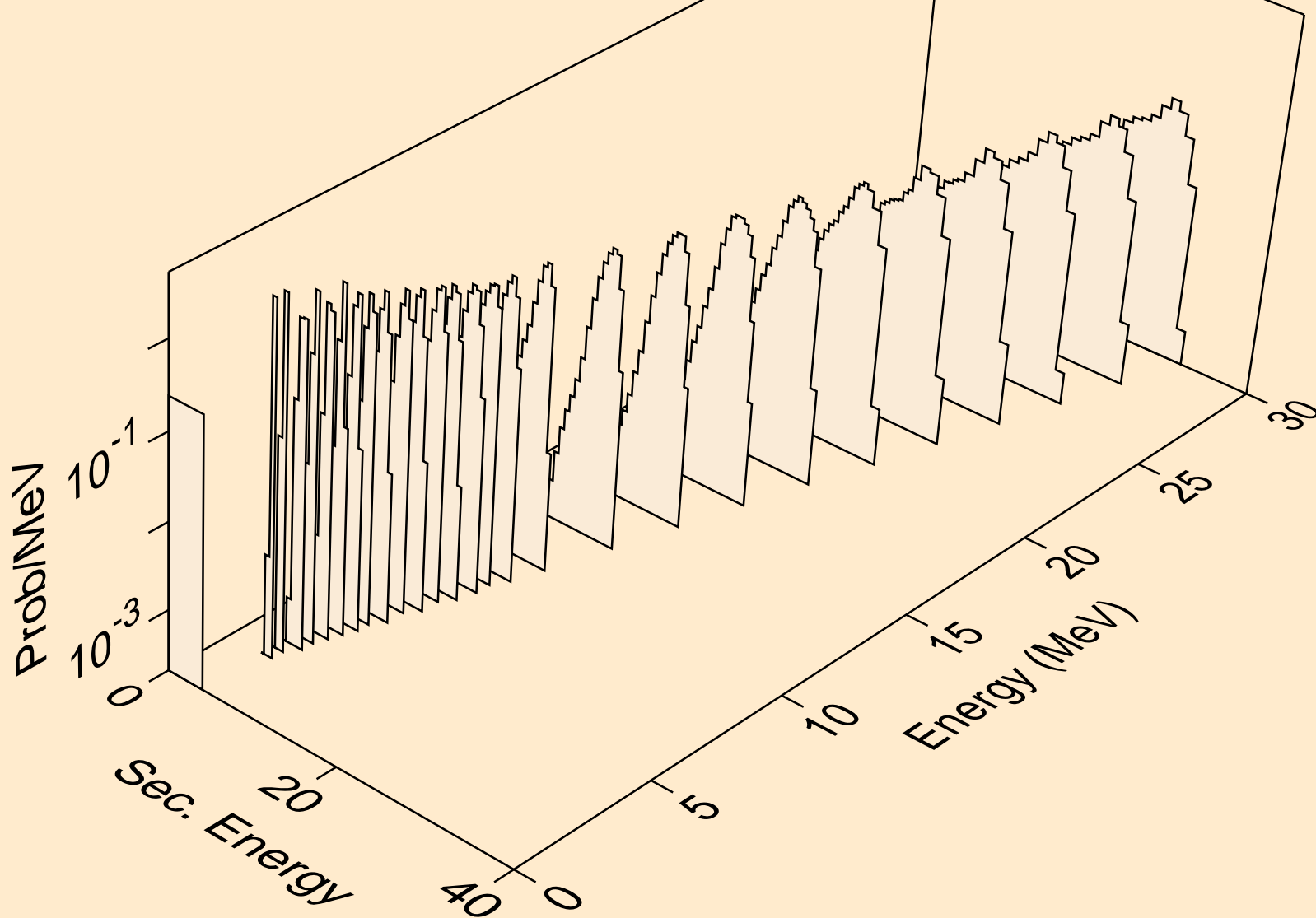

SM133 NEUTRON ACER TENDL-2019 LIBRARY; T=293.16K
alphas from (n,2n)a

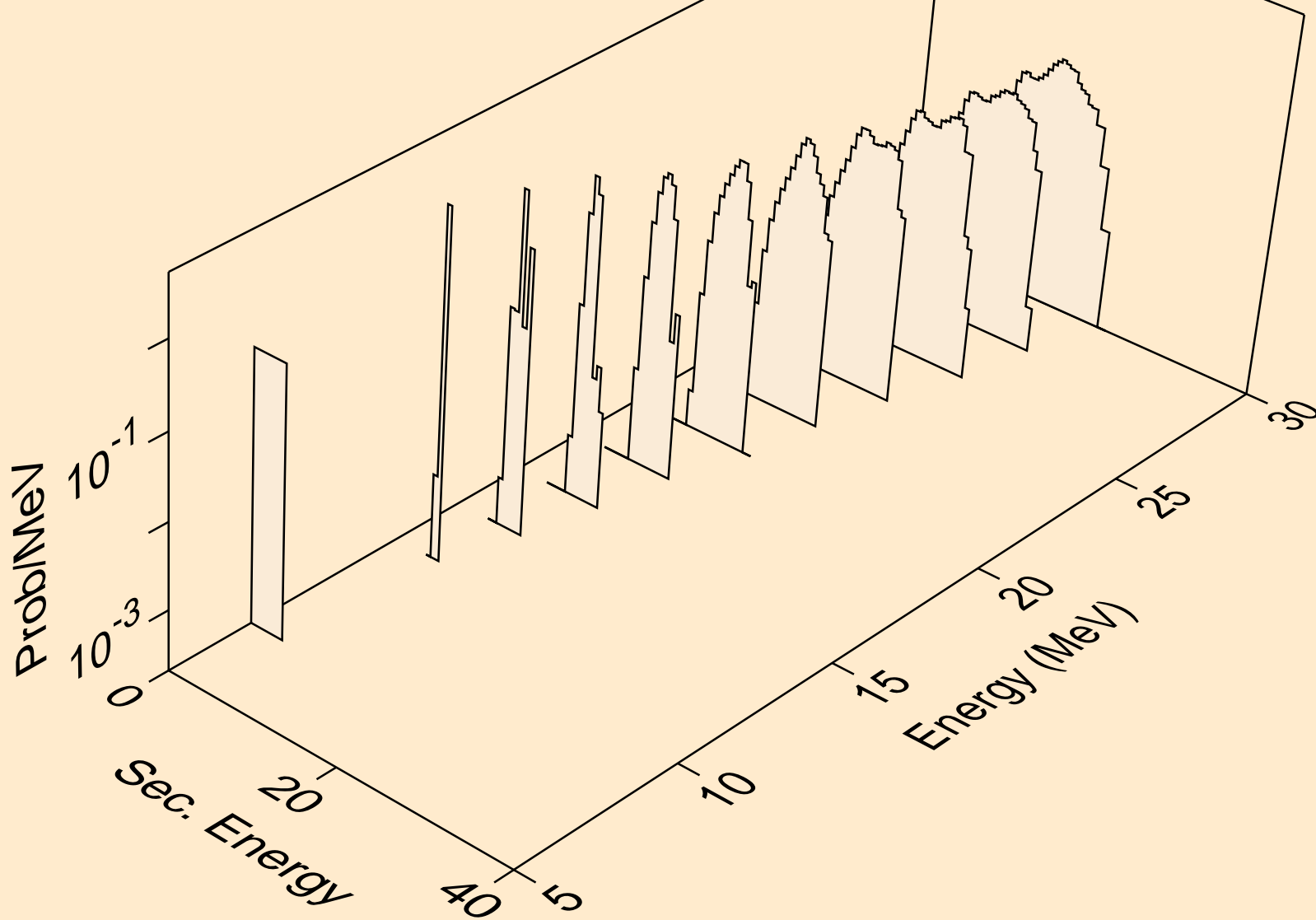

SM133 NEUTRON ACER TENDL-2019 LIBRARY; T=293.16K
alphas from (n,n*)2a

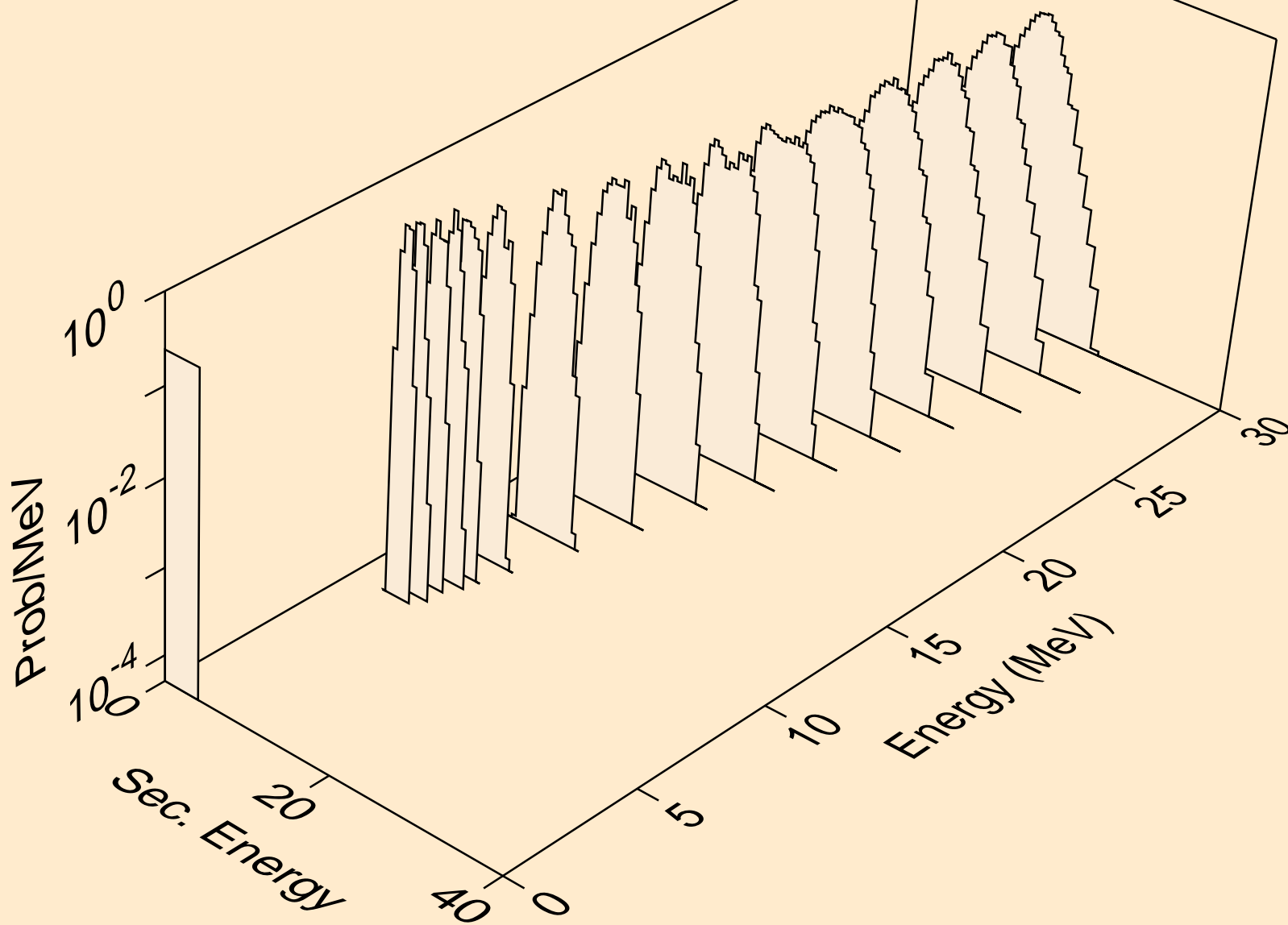

SM133 NEUTRON ACER TENDL-2019 LIBRARY; T=293.16K
alphas from (n,2n)2a

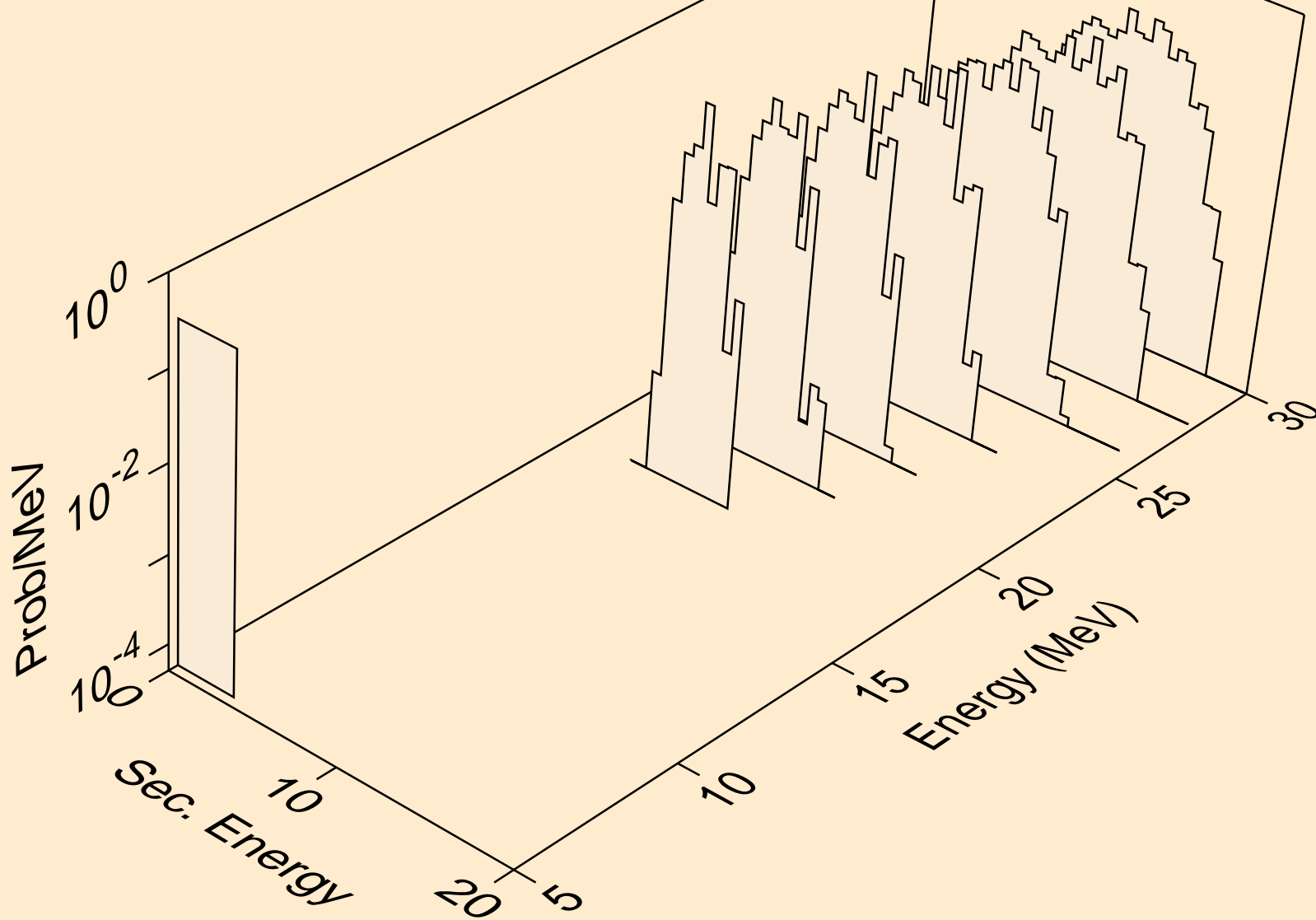

SM133 NEUTRON ACER TENDL-2019 LIBRARY; T=293.16K
alphas from (n,npa)

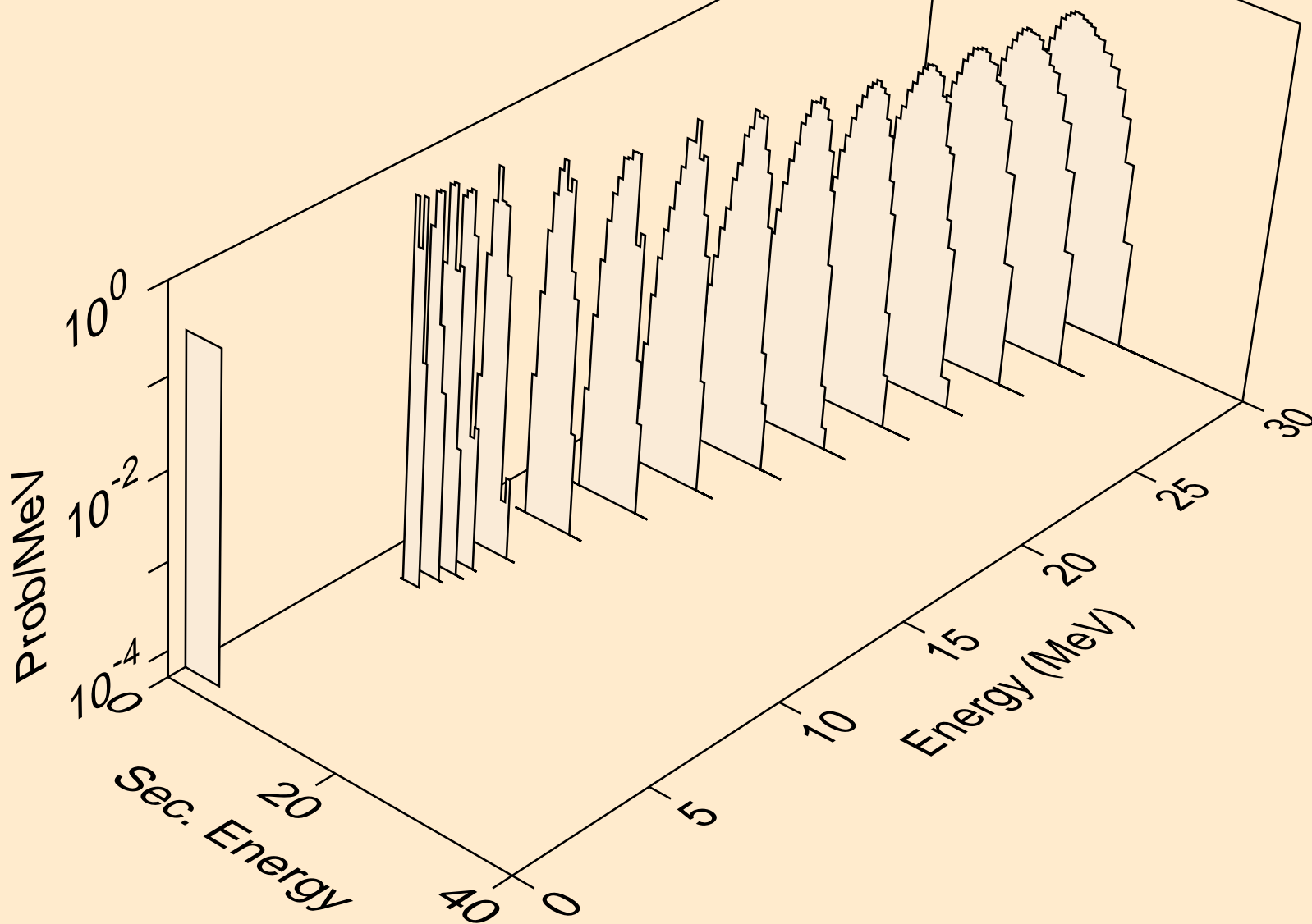

SM133 NEUTRON ACER TENDL-2019 LIBRARY; T=293.16K
alphas from (n,a)

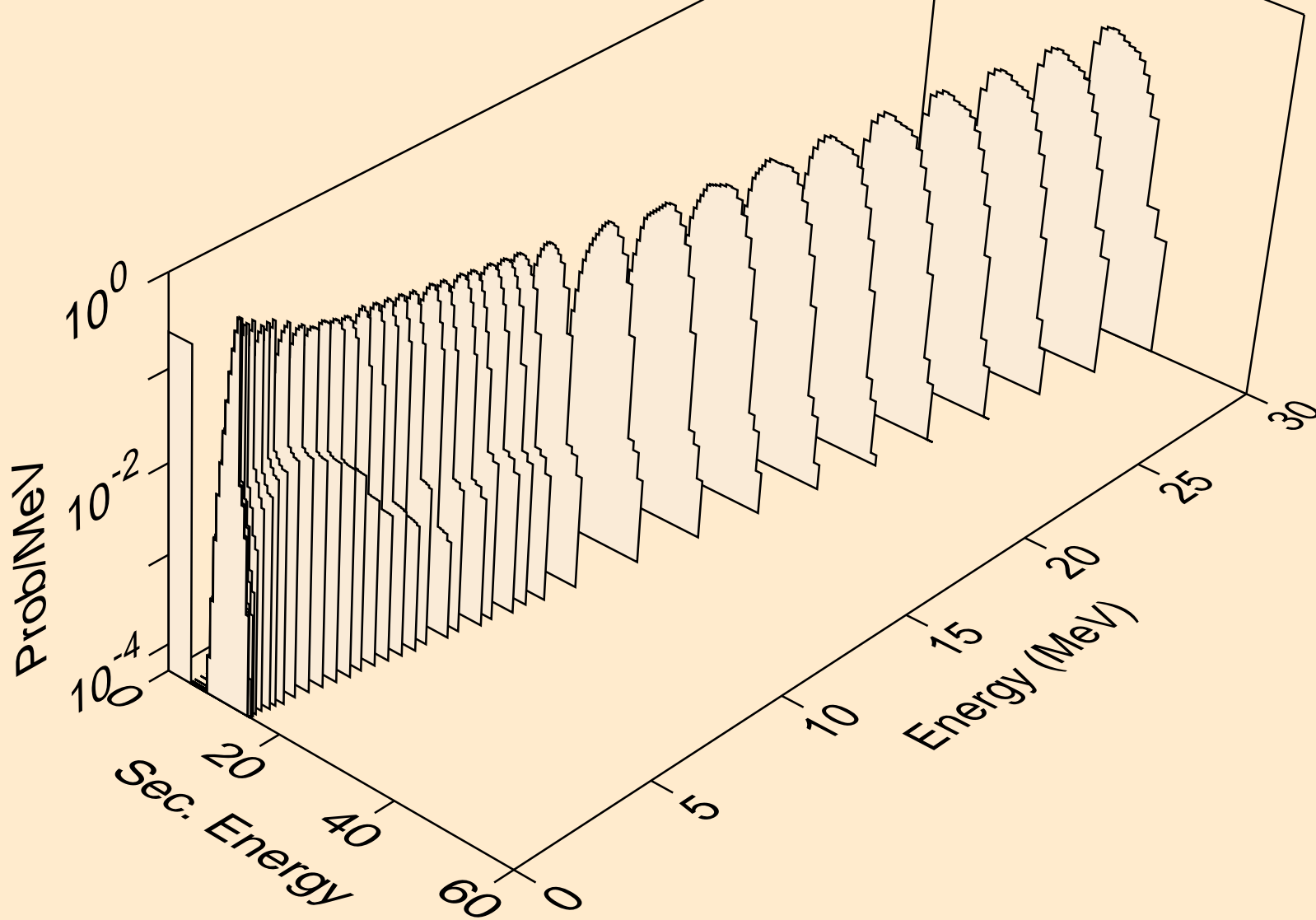

SM133 NEUTRON ACER TENDL-2019 LIBRARY; T=293.16K
alphas from (n,2a)

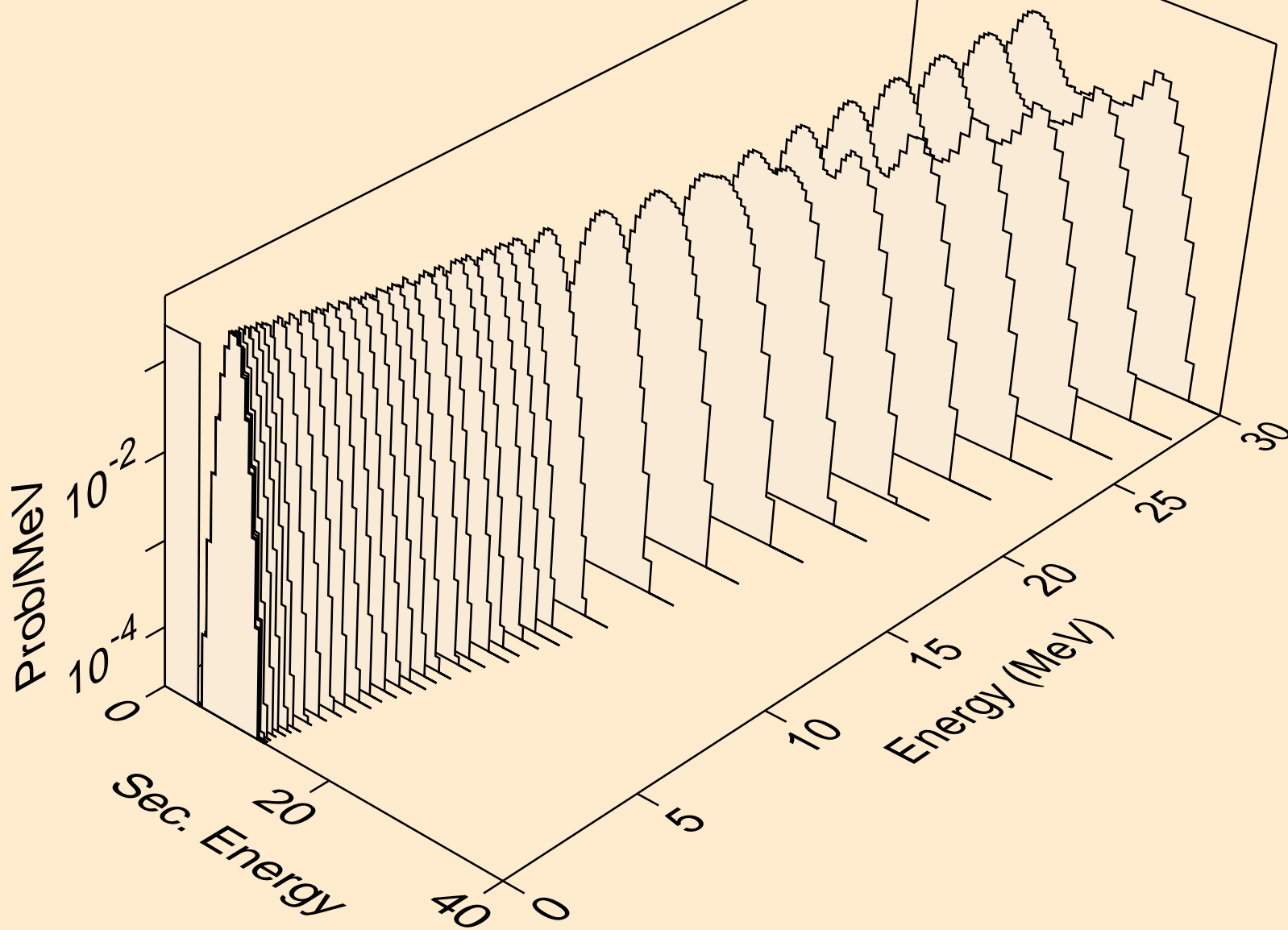

SM133 NEUTRON ACER TENDL-2019 LIBRARY; T=293.16K
alphas from (n,3a)

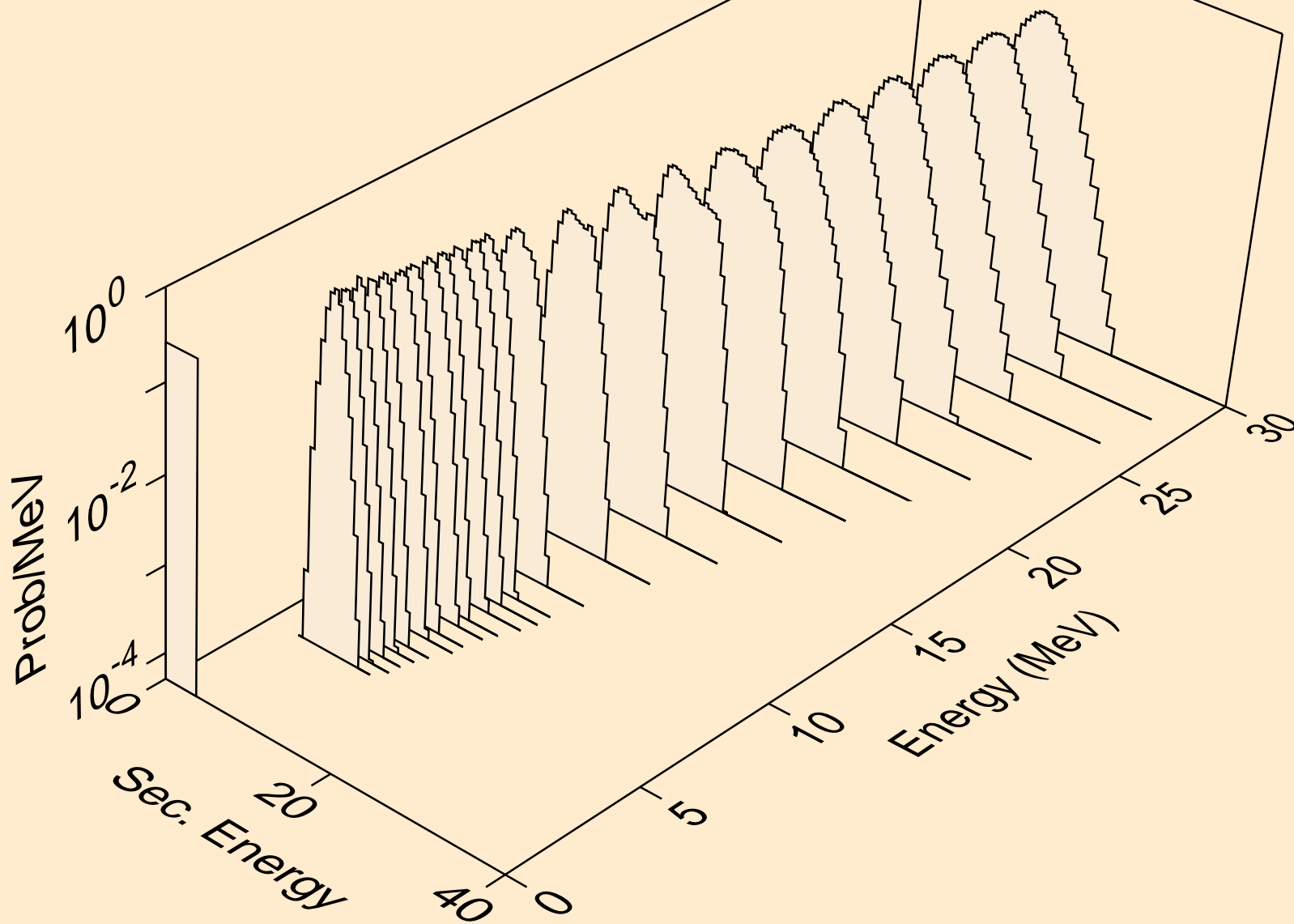

SM133 NEUTRON ACER TENDL-2019 LIBRARY; T=293.16K
alphas from (n,pa)

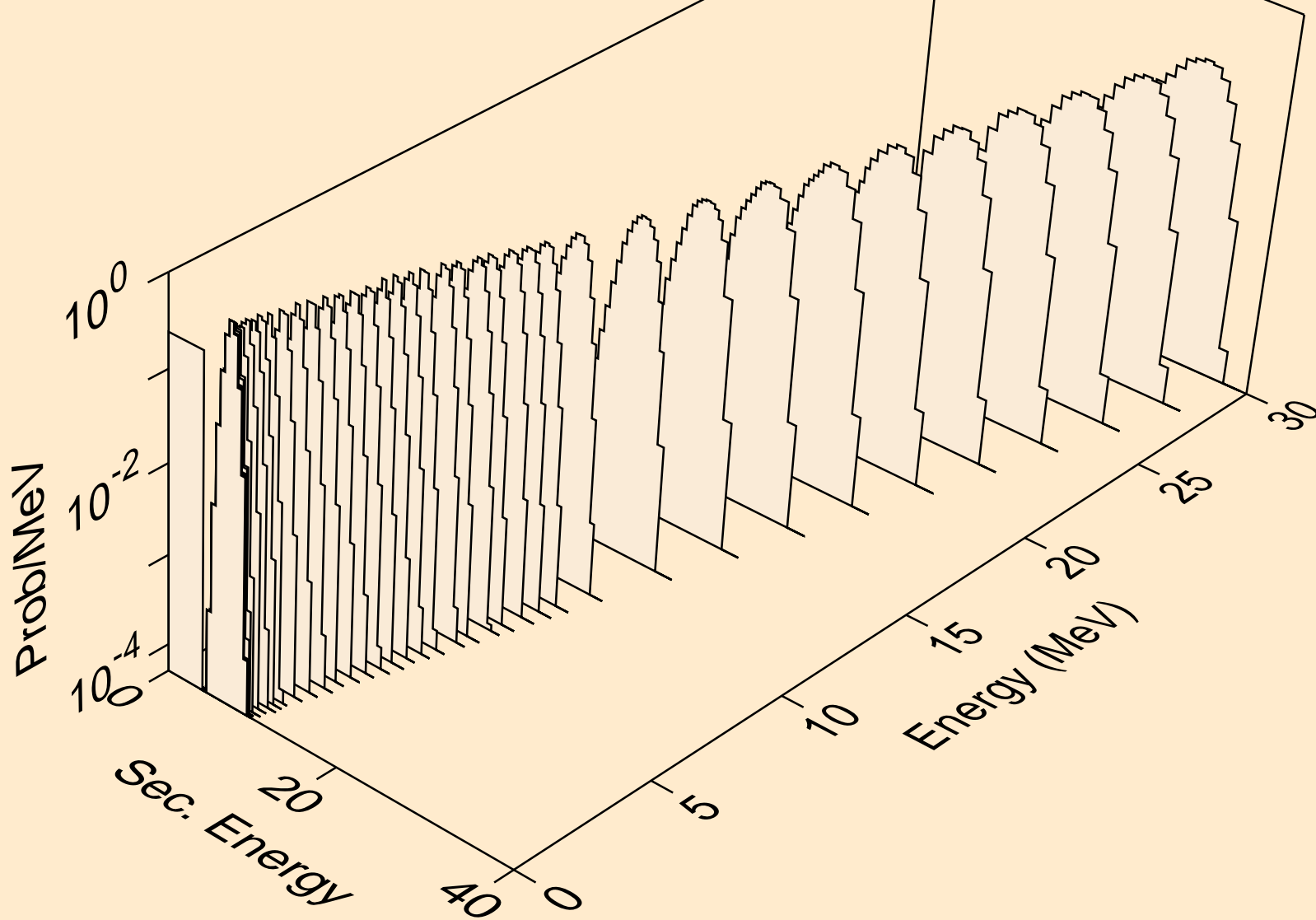

SM133 NEUTRON ACER TENDL-2019 LIBRARY; T=293.16K
alphas from (n,da)

