

SM142 NEUTRON ACER TENDL-2019 LIBRARY; T=293.16K  
Principal cross sections

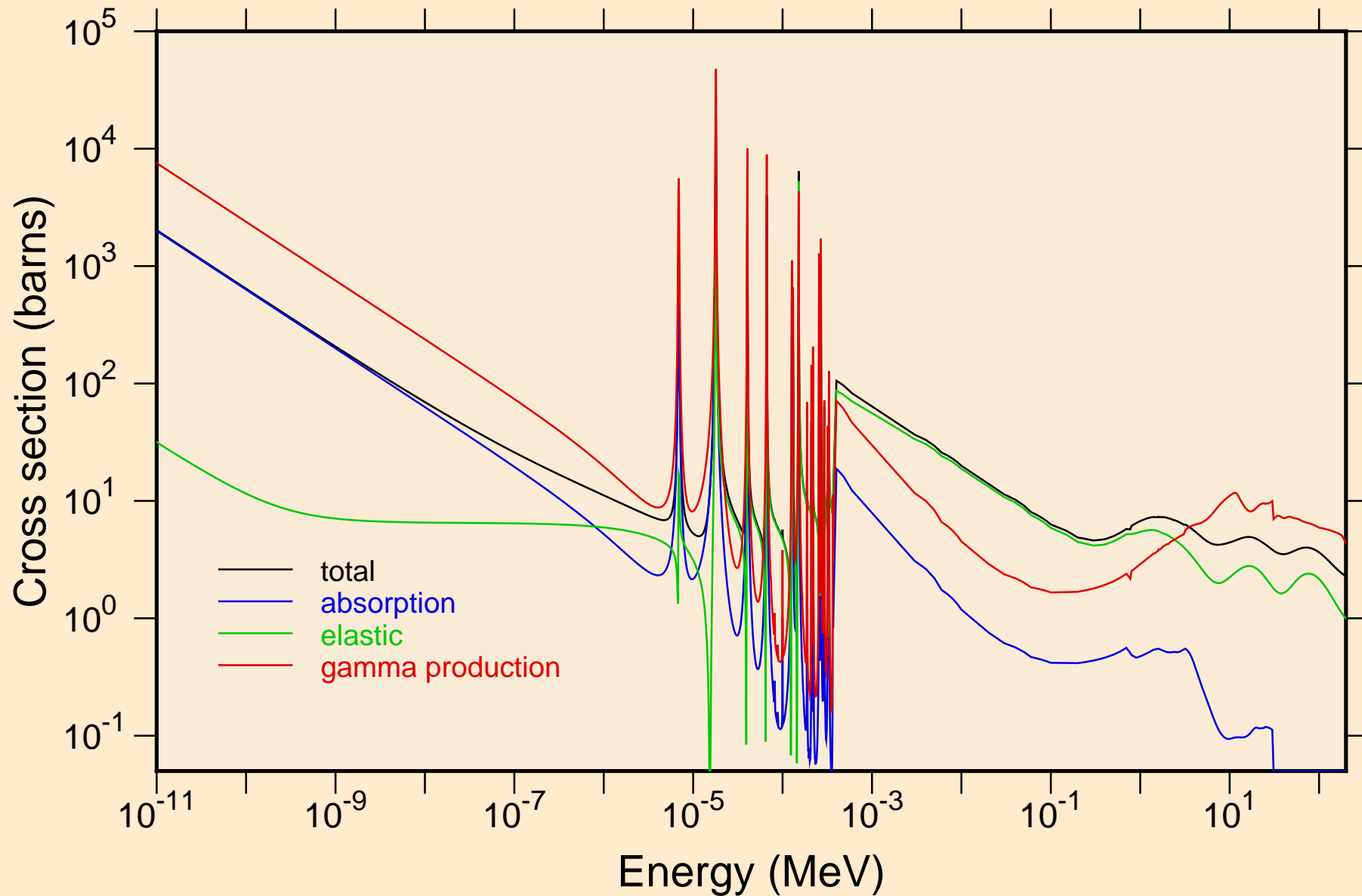

SM142 NEUTRON ACER TENDL-2019 LIBRARY; T=293.16K  
resonance total cross section

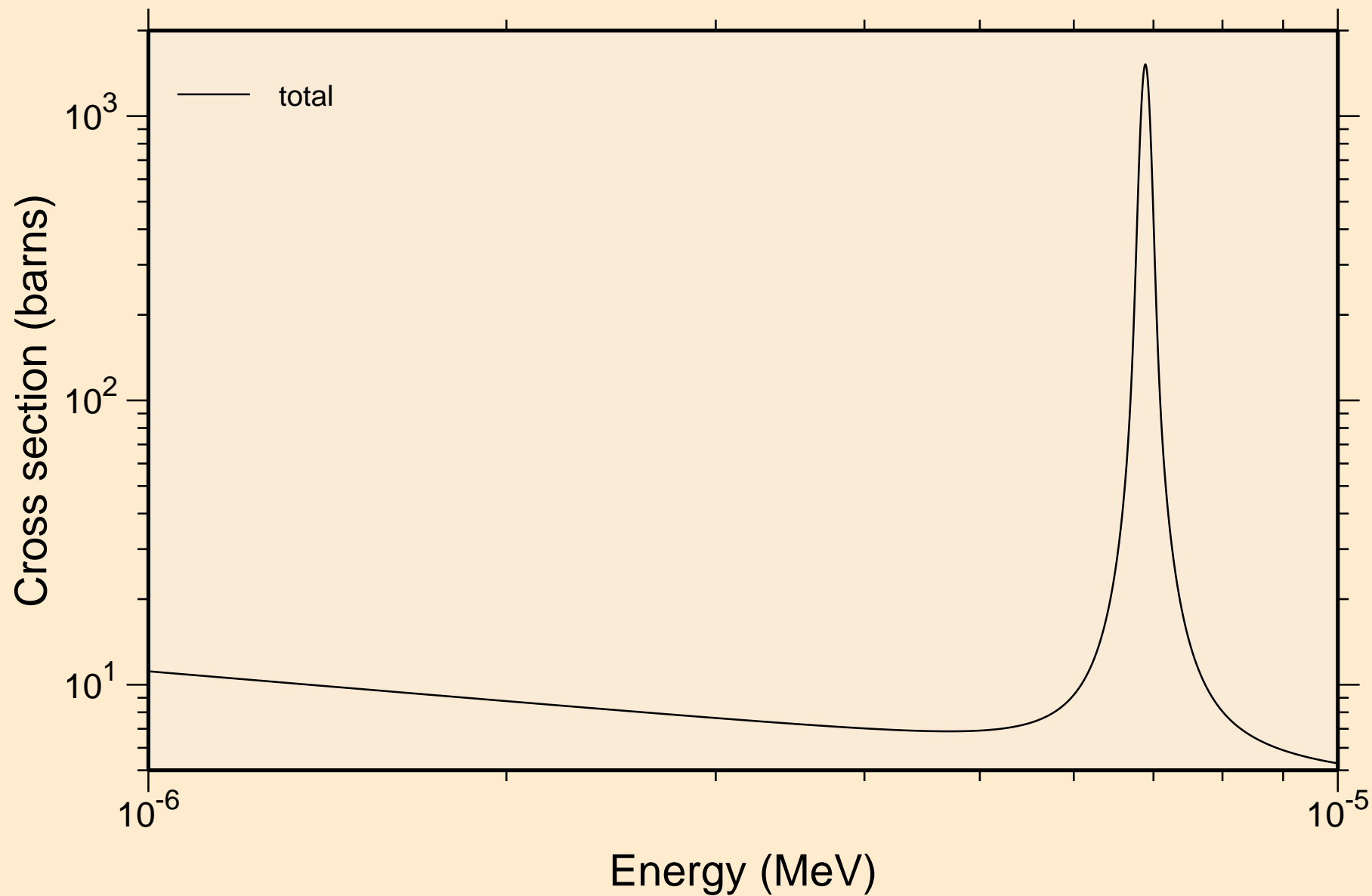

SM142 NEUTRON ACER TENDL-2019 LIBRARY; T=293.16K  
resonance total cross section

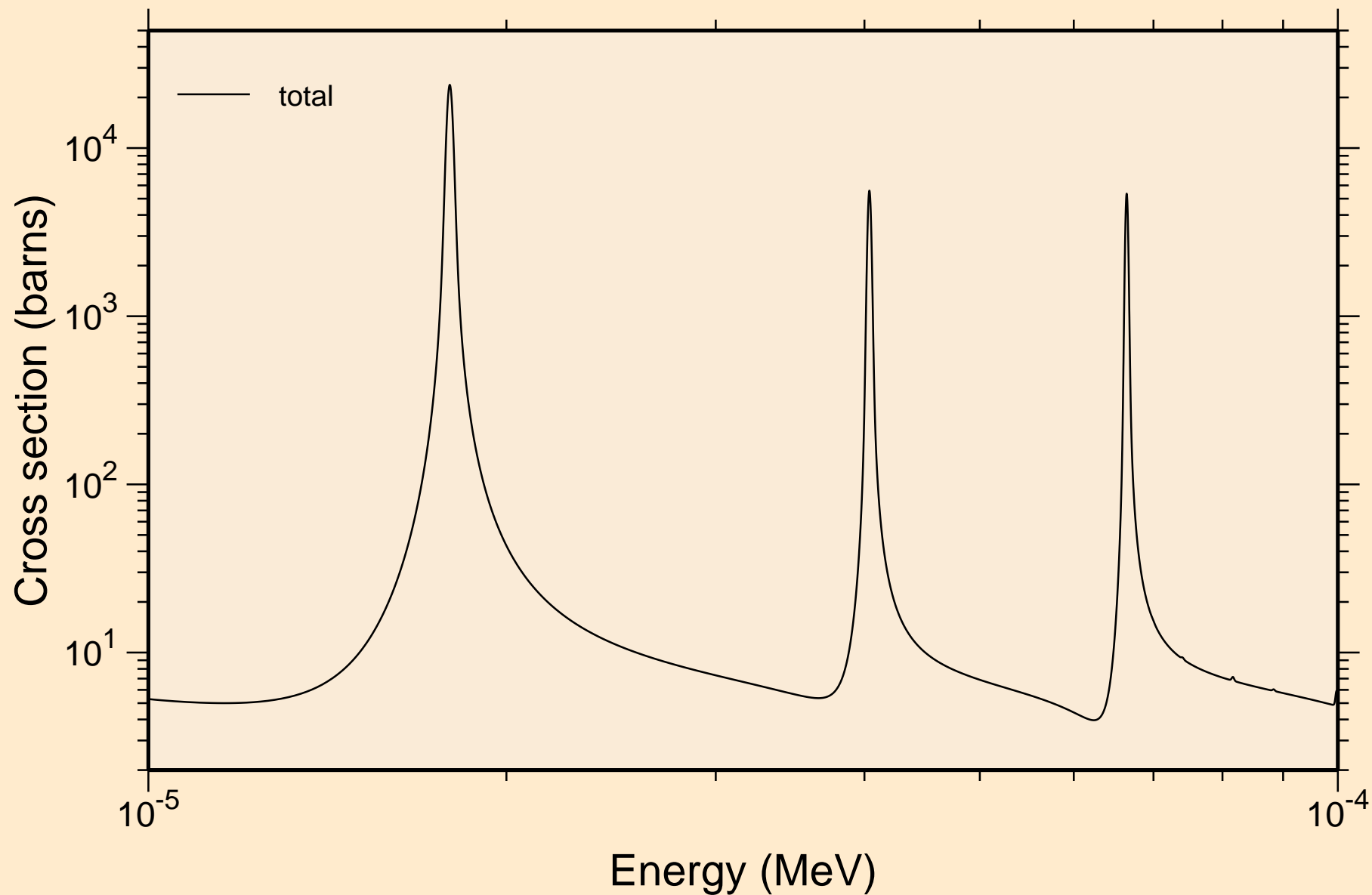

SM142 NEUTRON ACER TENDL-2019 LIBRARY; T=293.16K  
resonance total cross section

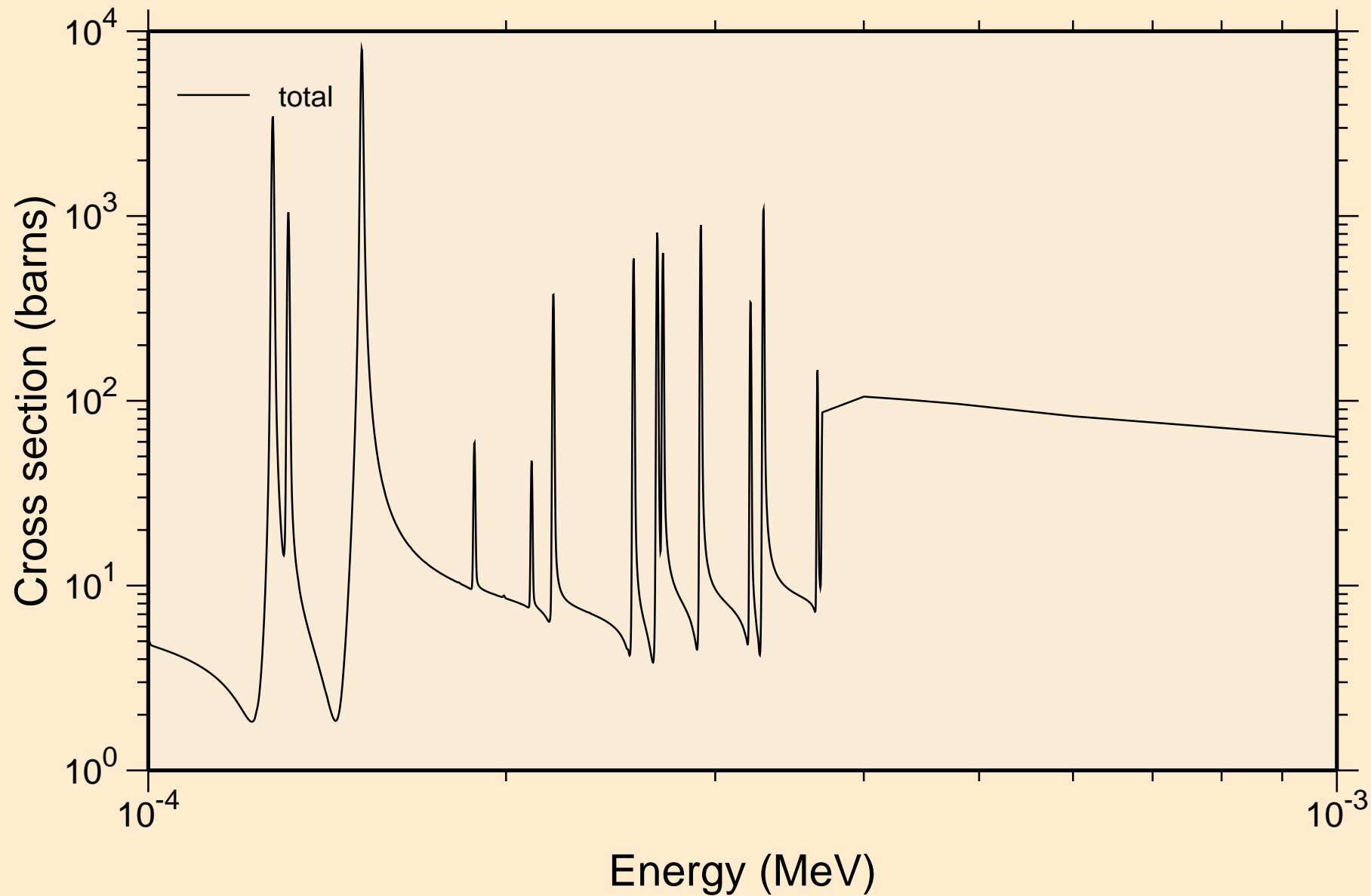

SM142 NEUTRON ACER TENDL-2019 LIBRARY; T=293.16K  
resonance total cross section

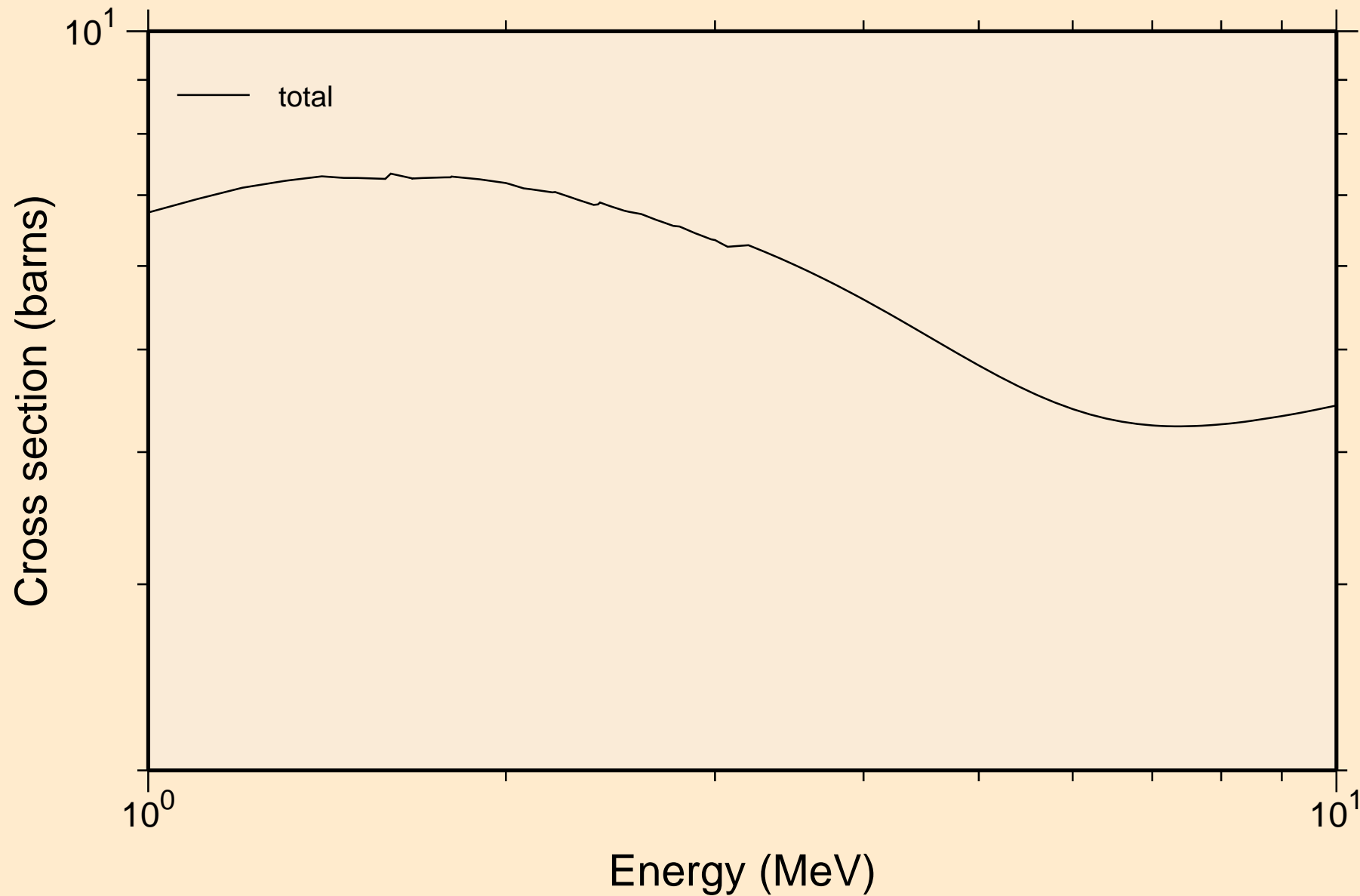

SM142 NEUTRON ACER TENDL-2019 LIBRARY; T=293.16K  
resonance absorption cross sections

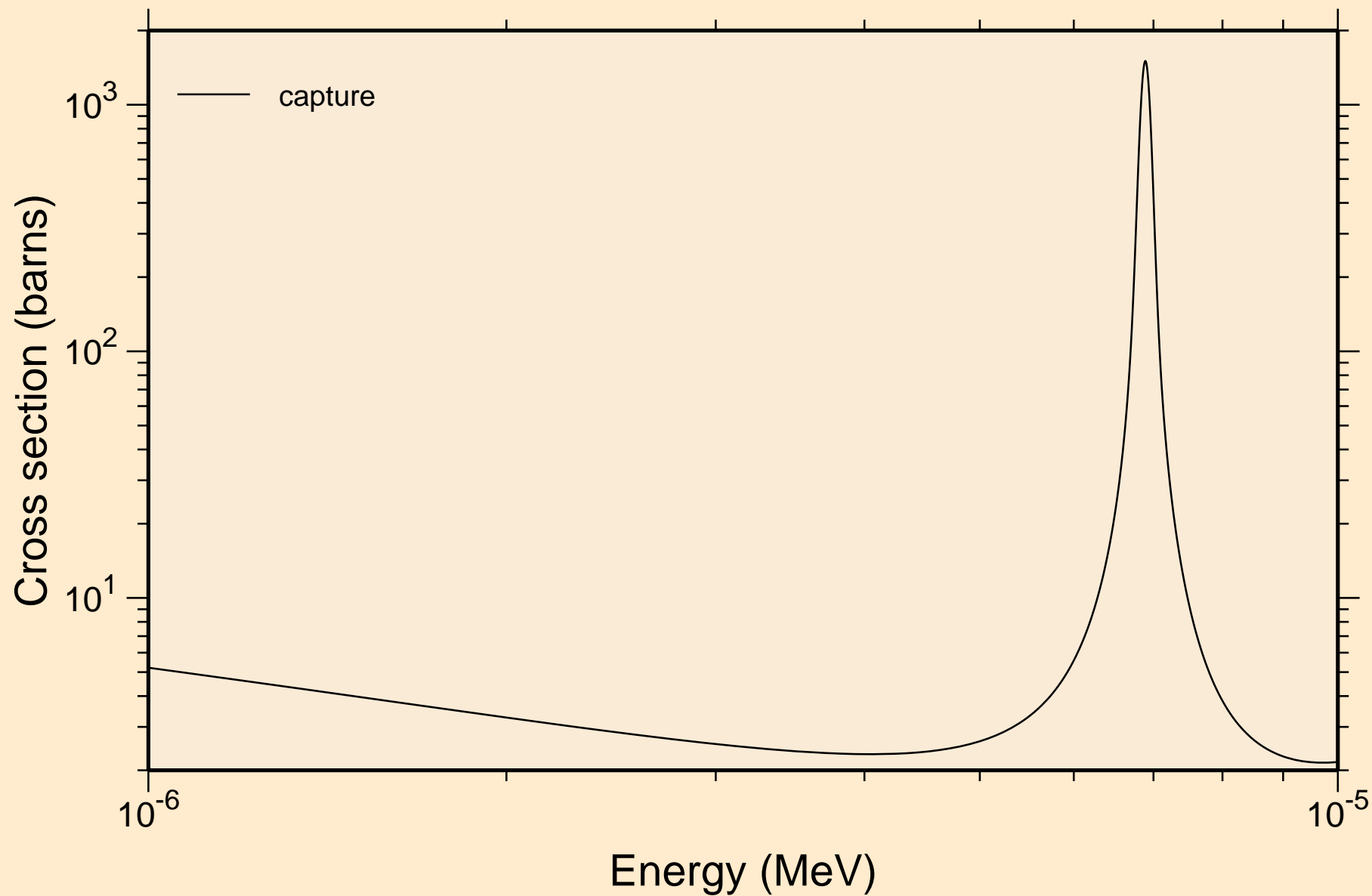

SM142 NEUTRON ACER TENDL-2019 LIBRARY; T=293.16K  
resonance absorption cross sections

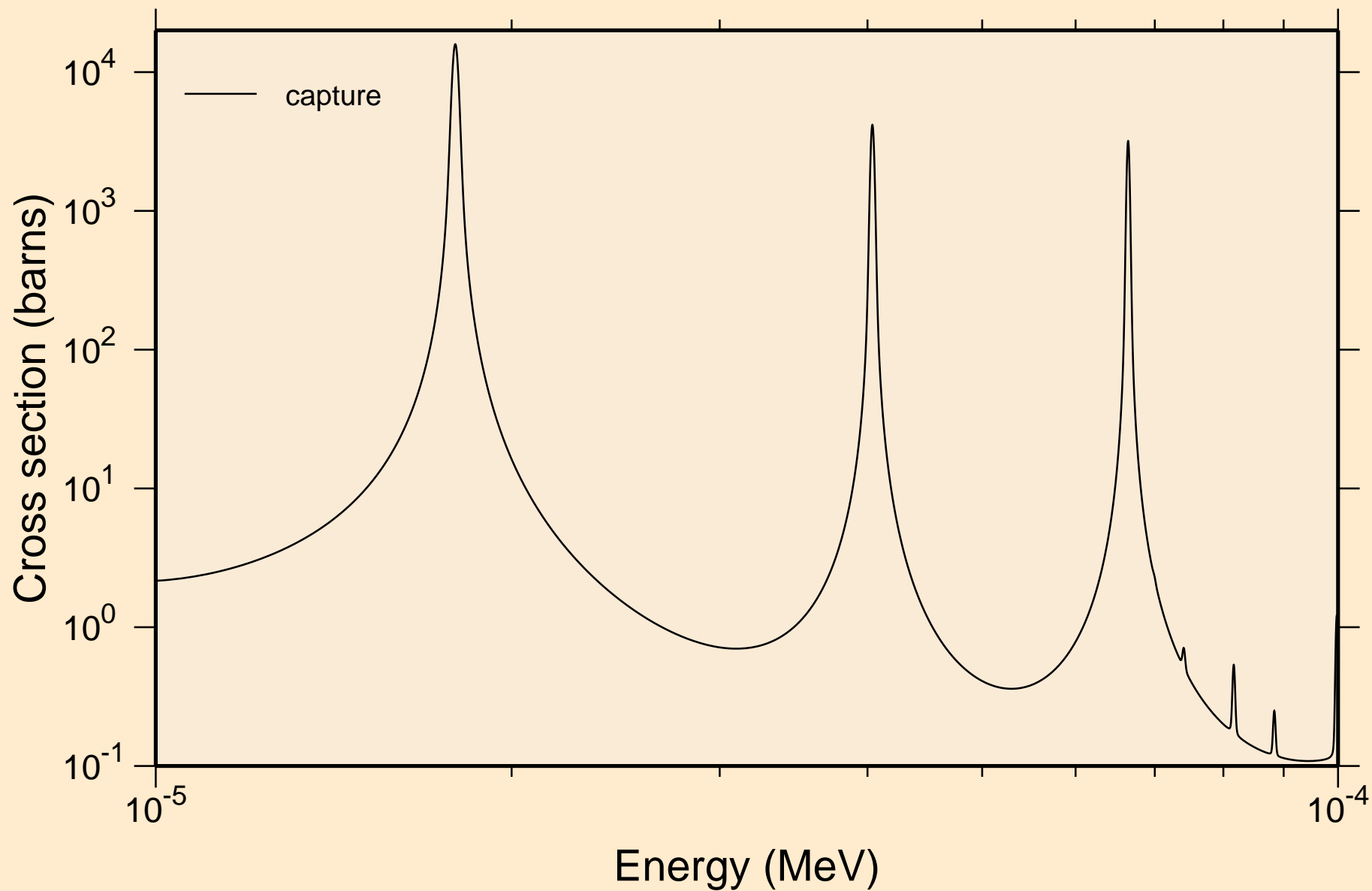

SM142 NEUTRON ACER TENDL-2019 LIBRARY; T=293.16K  
resonance absorption cross sections

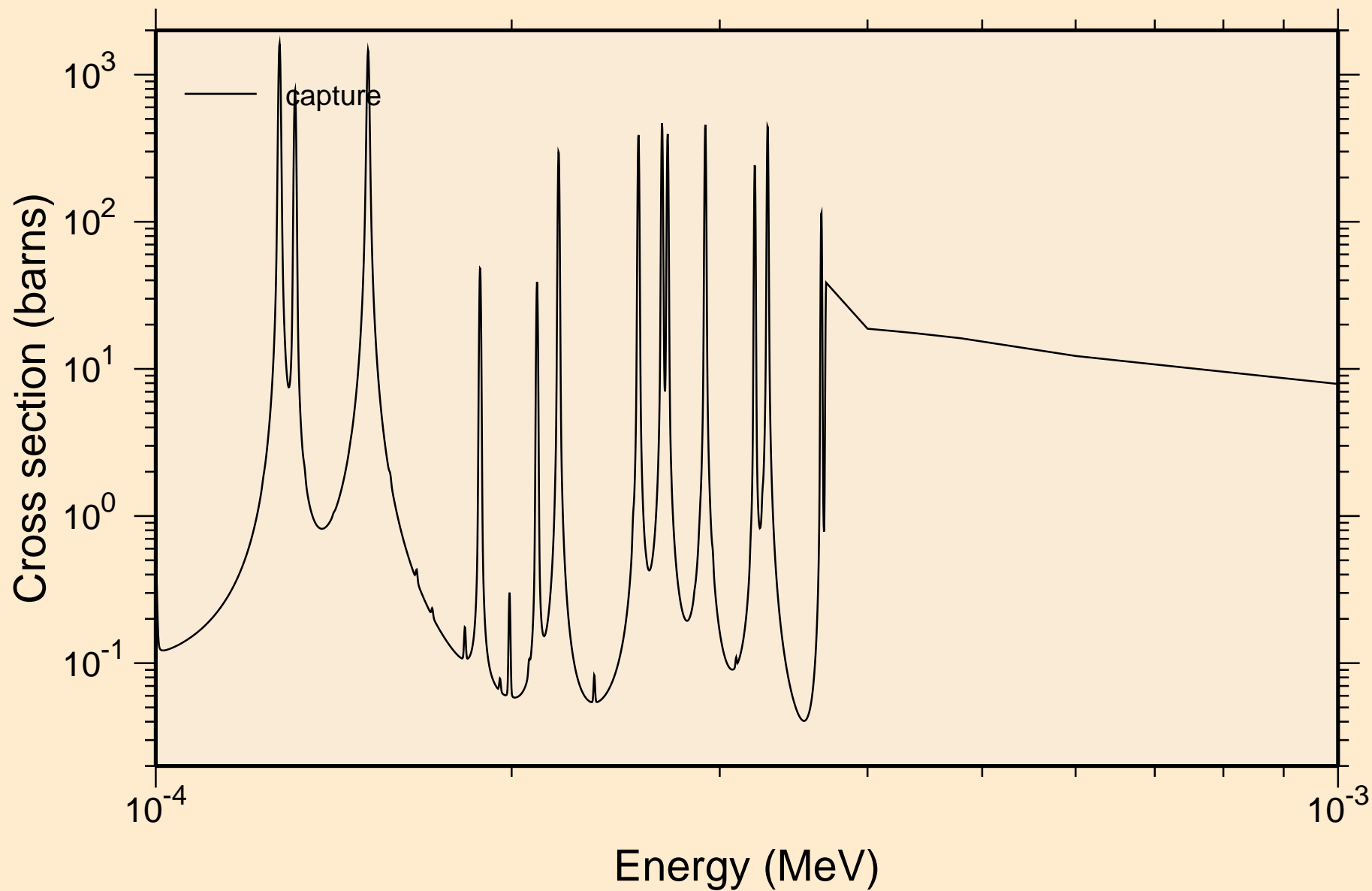



SM142 NEUTRON ACER TENDL-2019 LIBRARY; T=293.16K  
resonance absorption cross sections

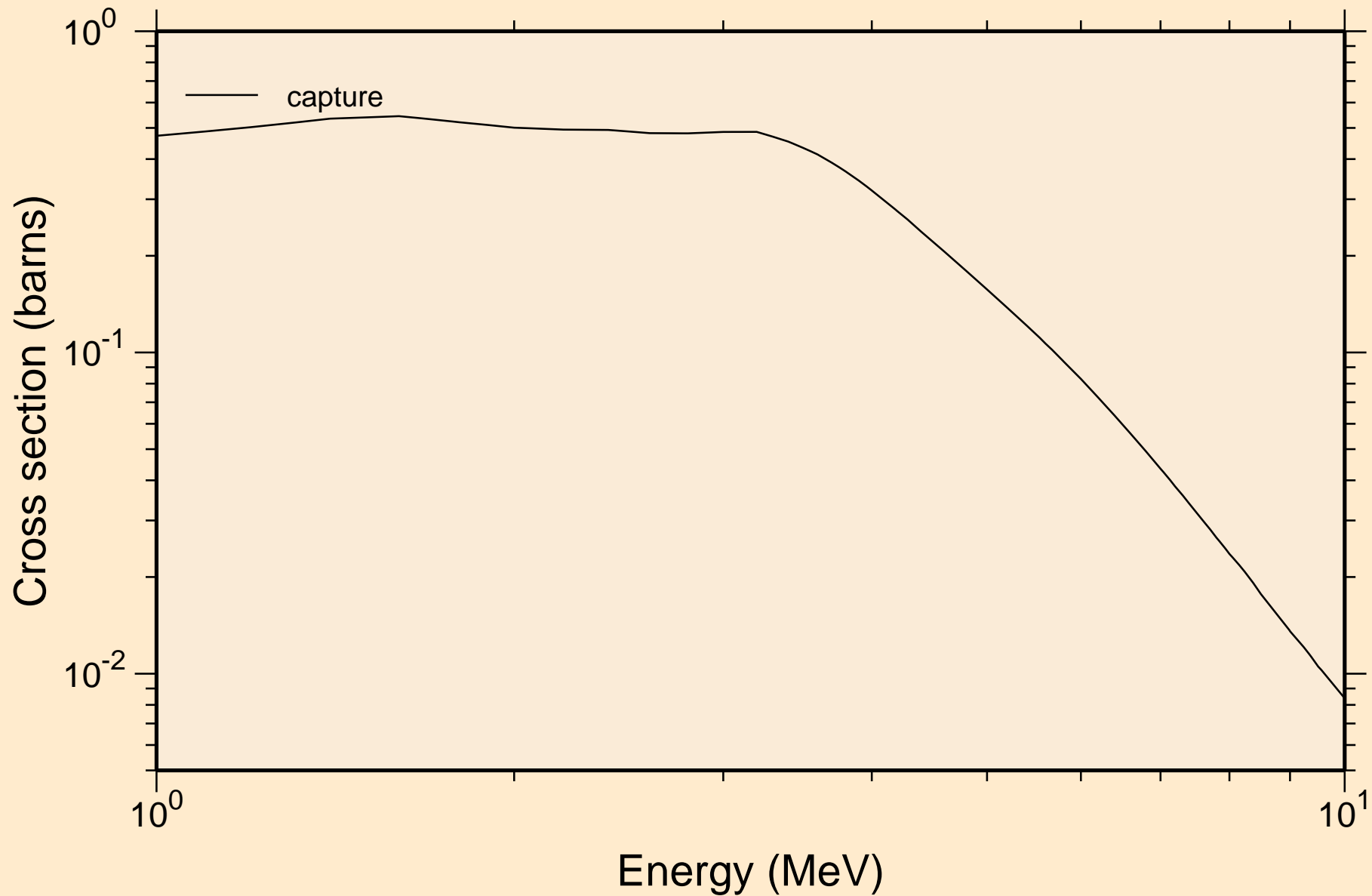

SM142 NEUTRON ACER TENDL-2019 LIBRARY; T=293.16K  
Heating

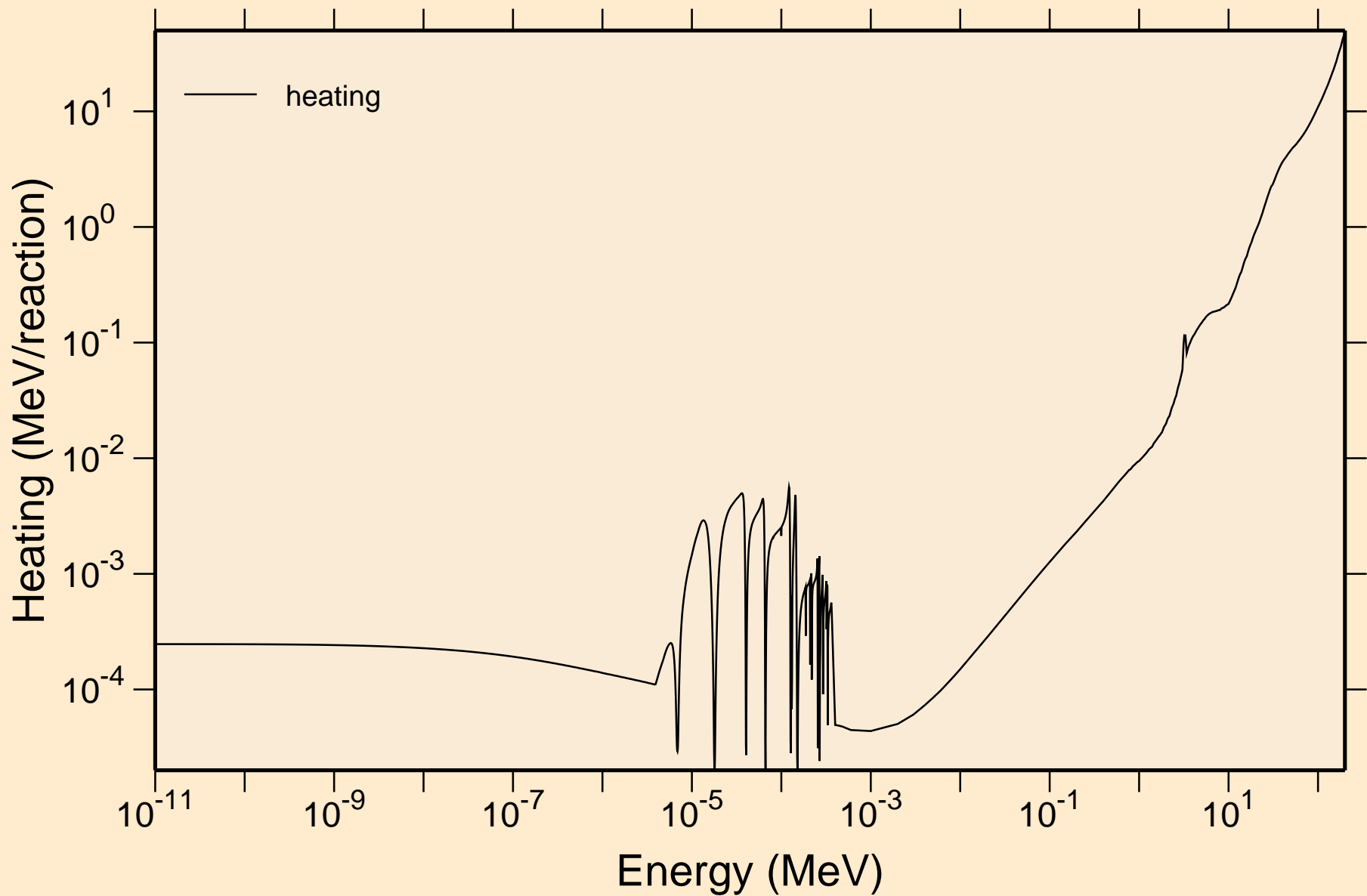

# SM142 NEUTRON ACER TENDL-2019 LIBRARY; T=293.16K Damage

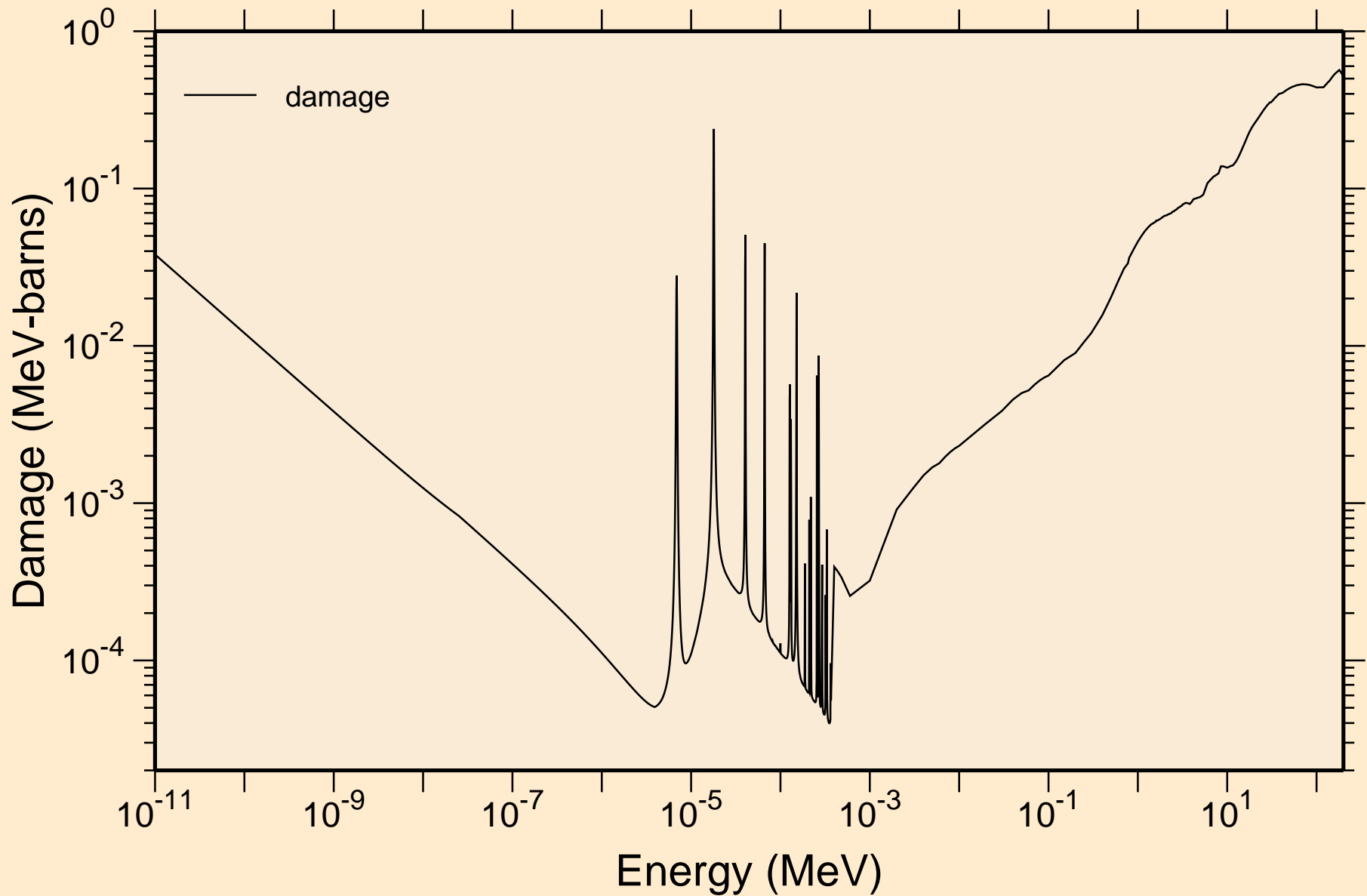

# SM142 NEUTRON ACER TENDL-2019 LIBRARY; T=293.16K

## Non-threshold reactions

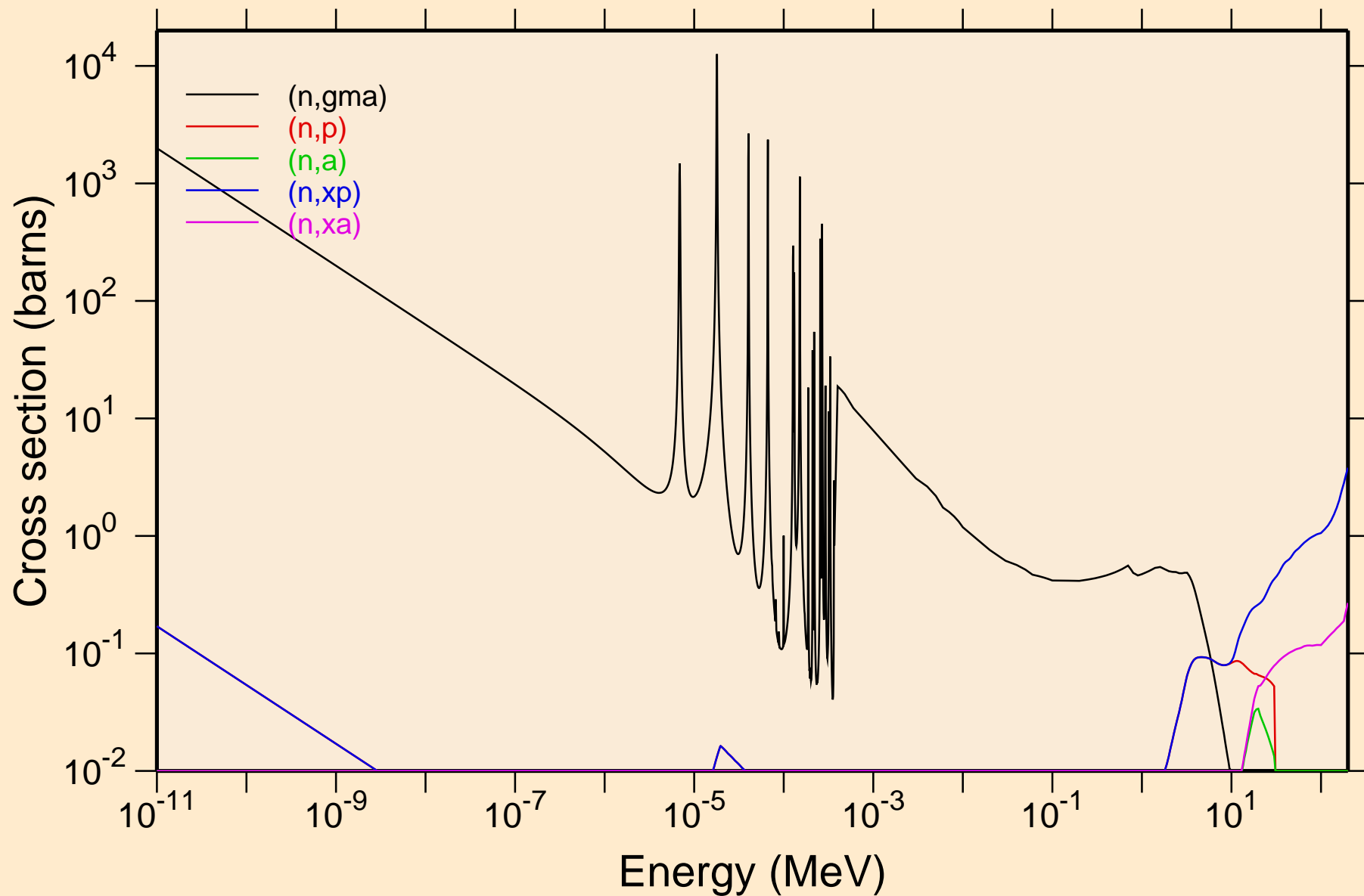

SM142 NEUTRON ACER TENDL-2019 LIBRARY; T=293.16K  
Principal cross sections

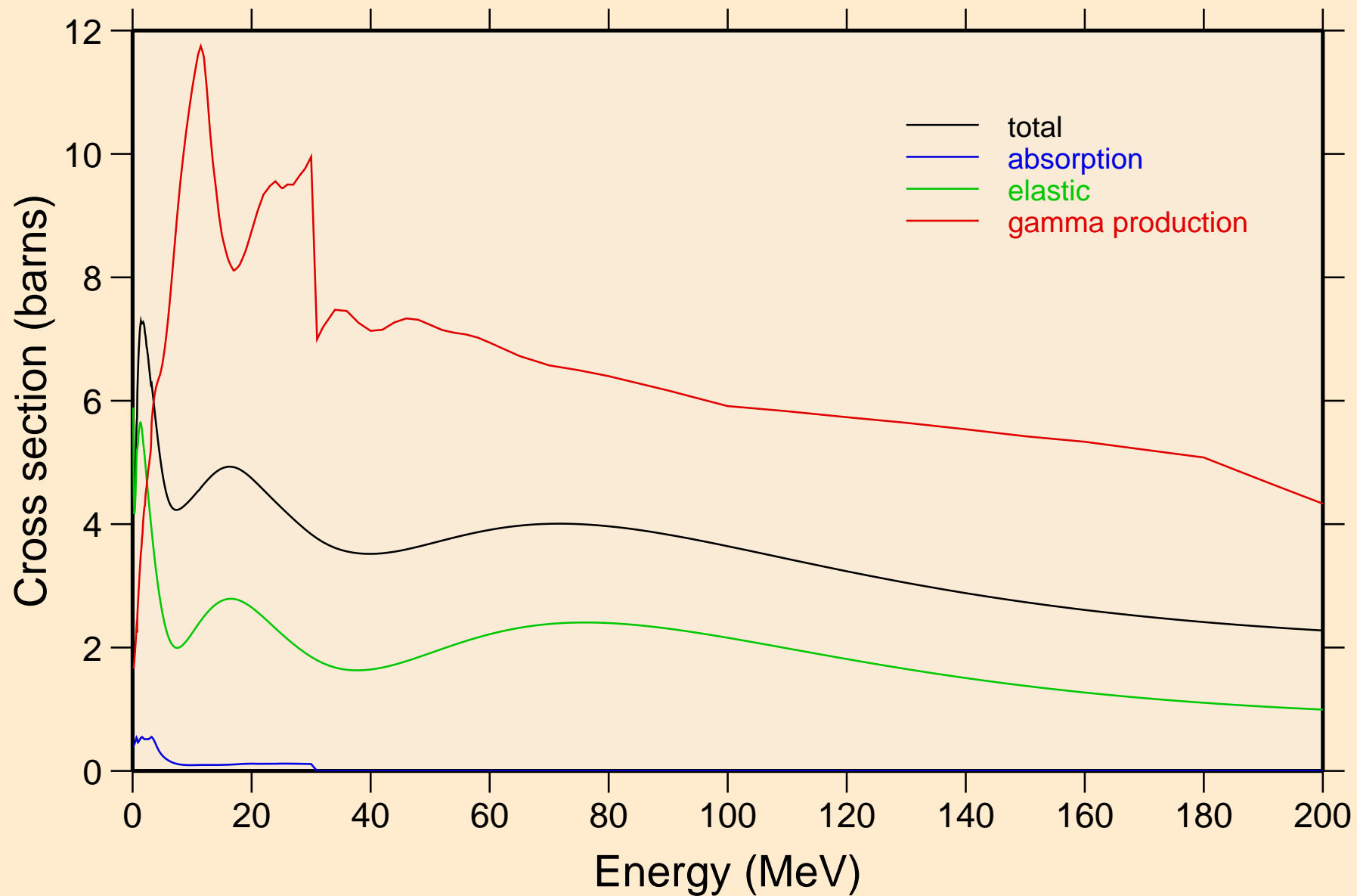

SM142 NEUTRON ACER TENDL-2019 LIBRARY; T=293.16K  
Heating

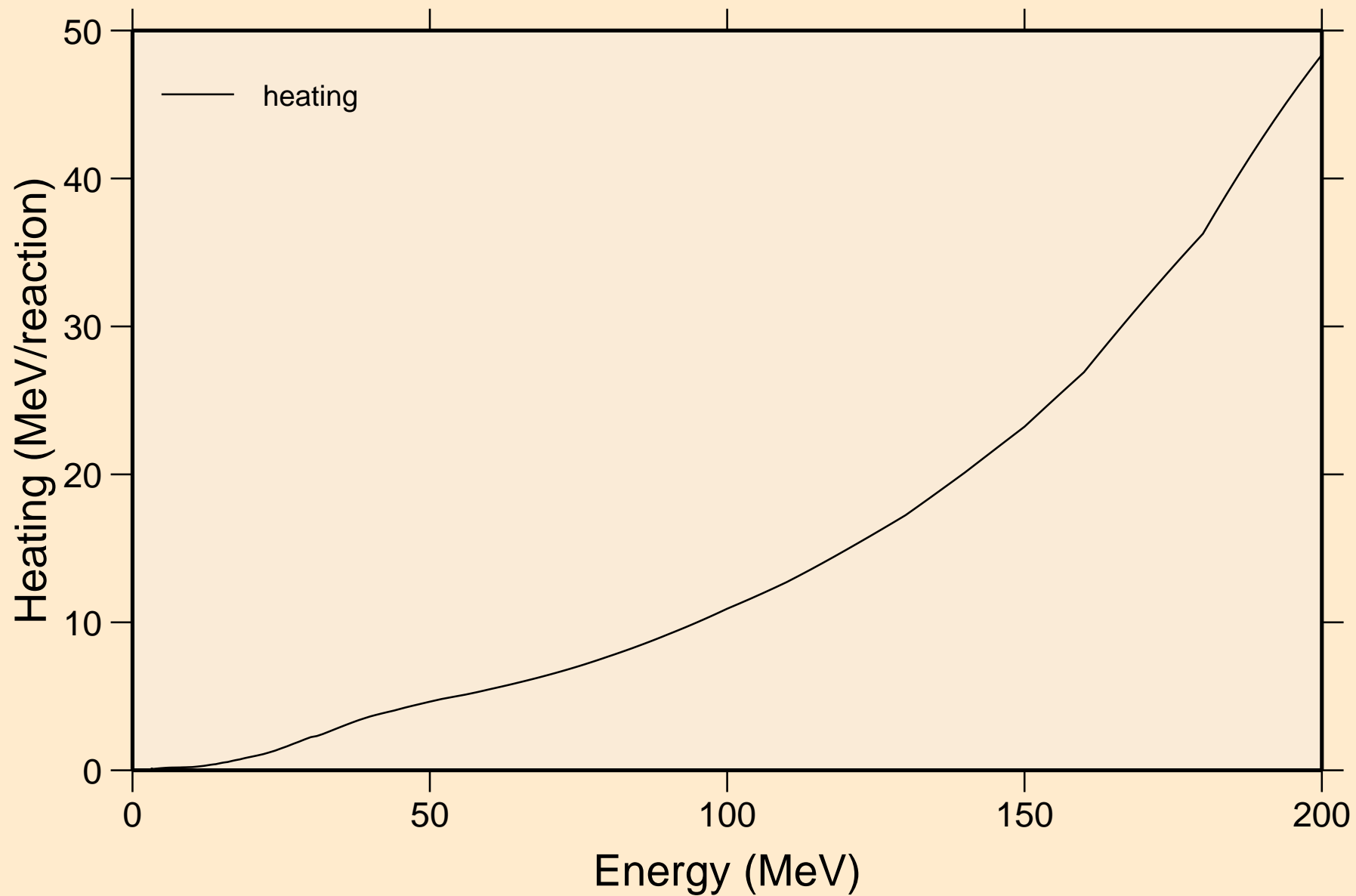

SM142 NEUTRON ACER TENDL-2019 LIBRARY; T=293.16K  
Damage

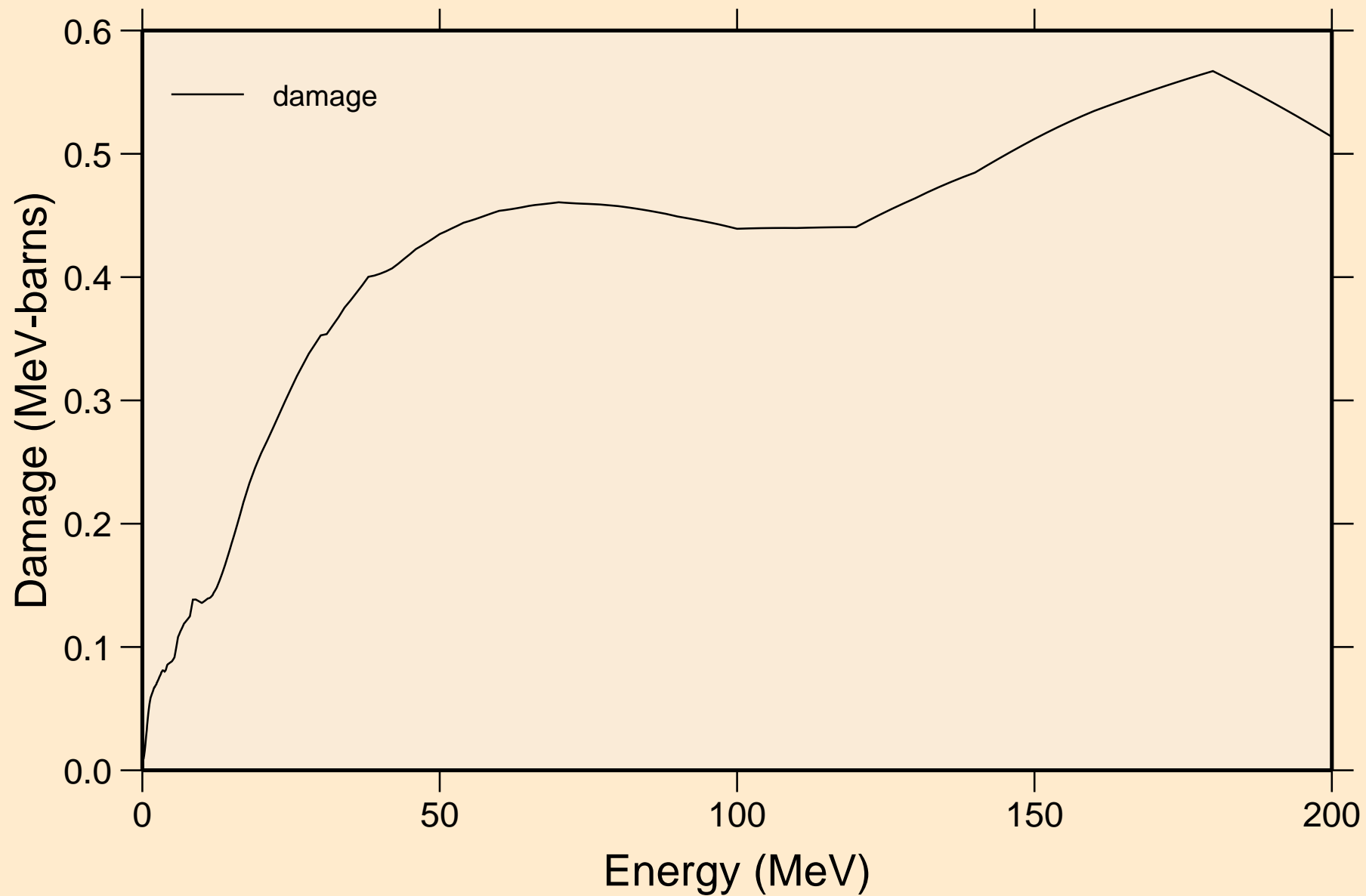

# SM142 NEUTRON ACER TENDL-2019 LIBRARY; T=293.16K

## Non-threshold reactions

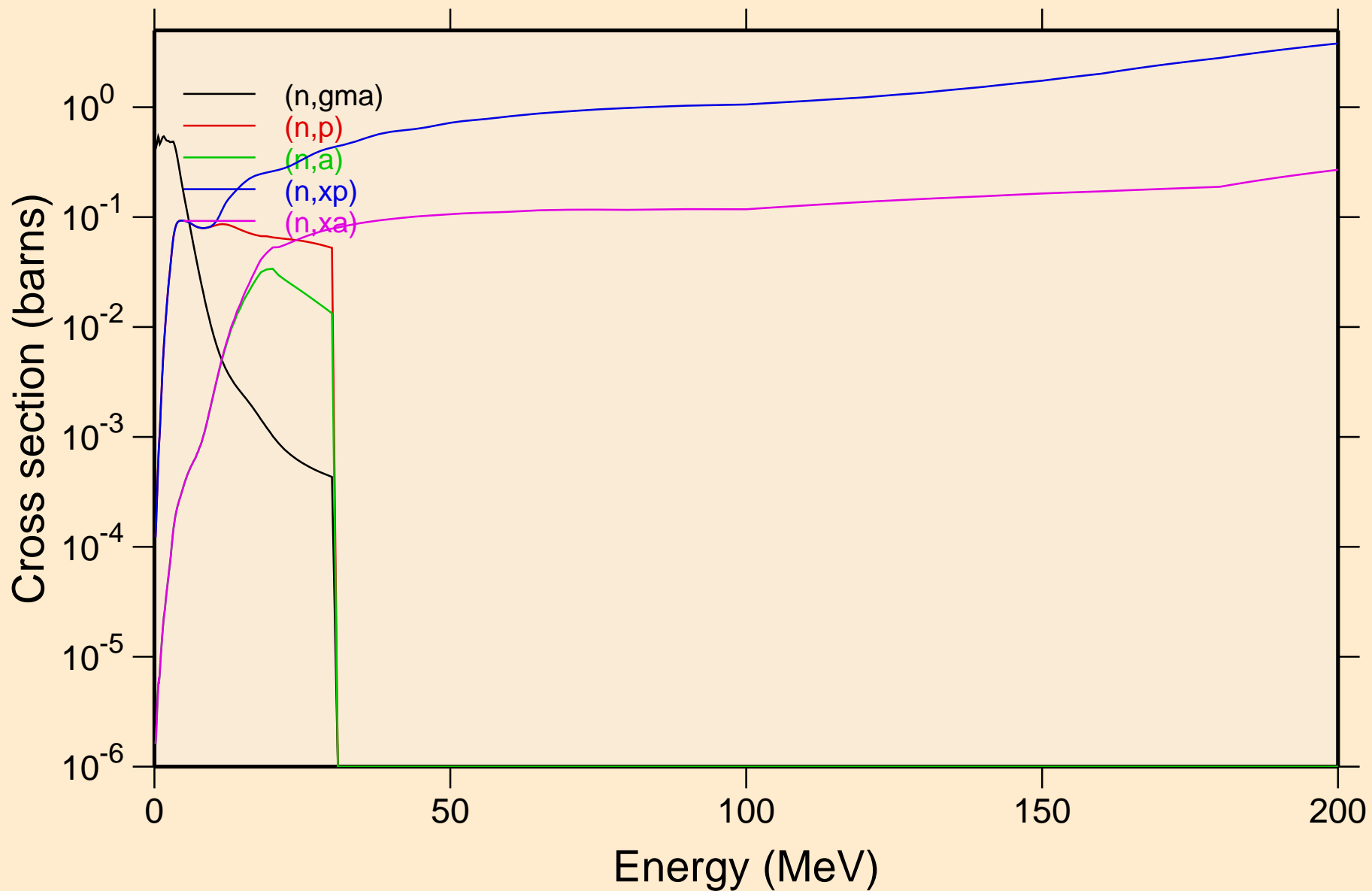



SM142 NEUTRON ACER TENDL-2019 LIBRARY; T=293.16K  
Inelastic levels

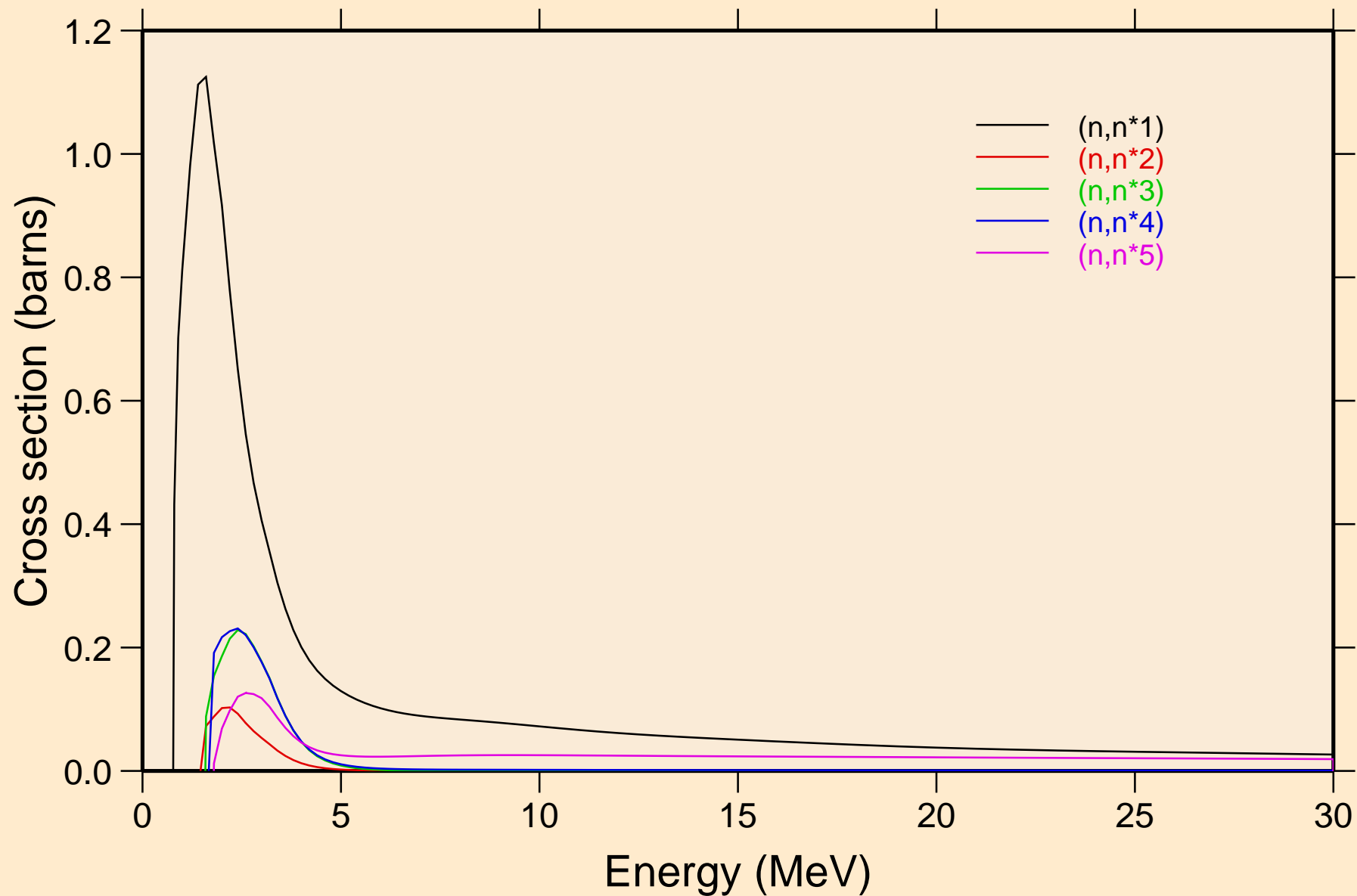

SM142 NEUTRON ACER TENDL-2019 LIBRARY; T=293.16K  
Inelastic levels

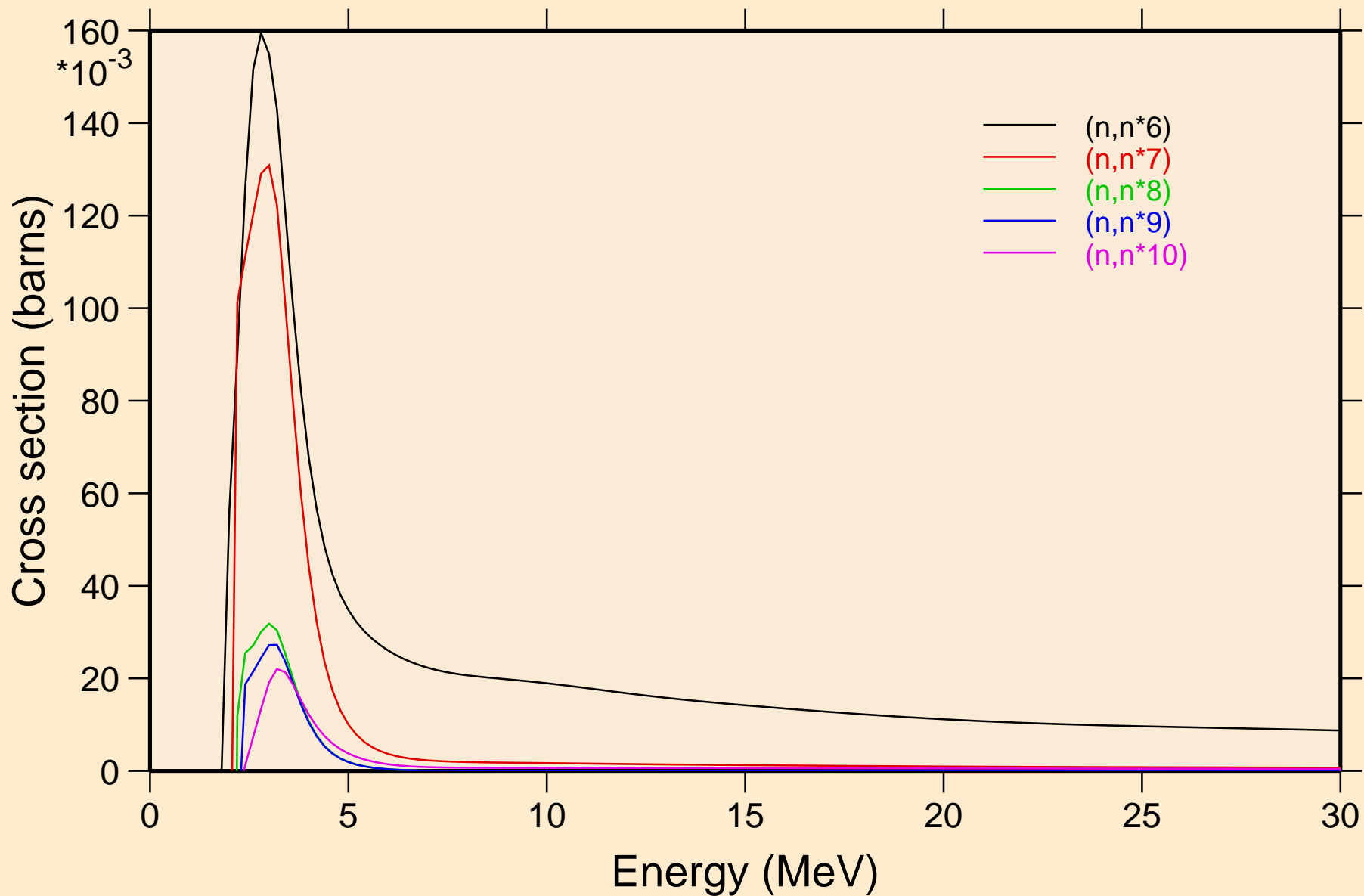

SM142 NEUTRON ACER TENDL-2019 LIBRARY; T=293.16K  
Inelastic levels

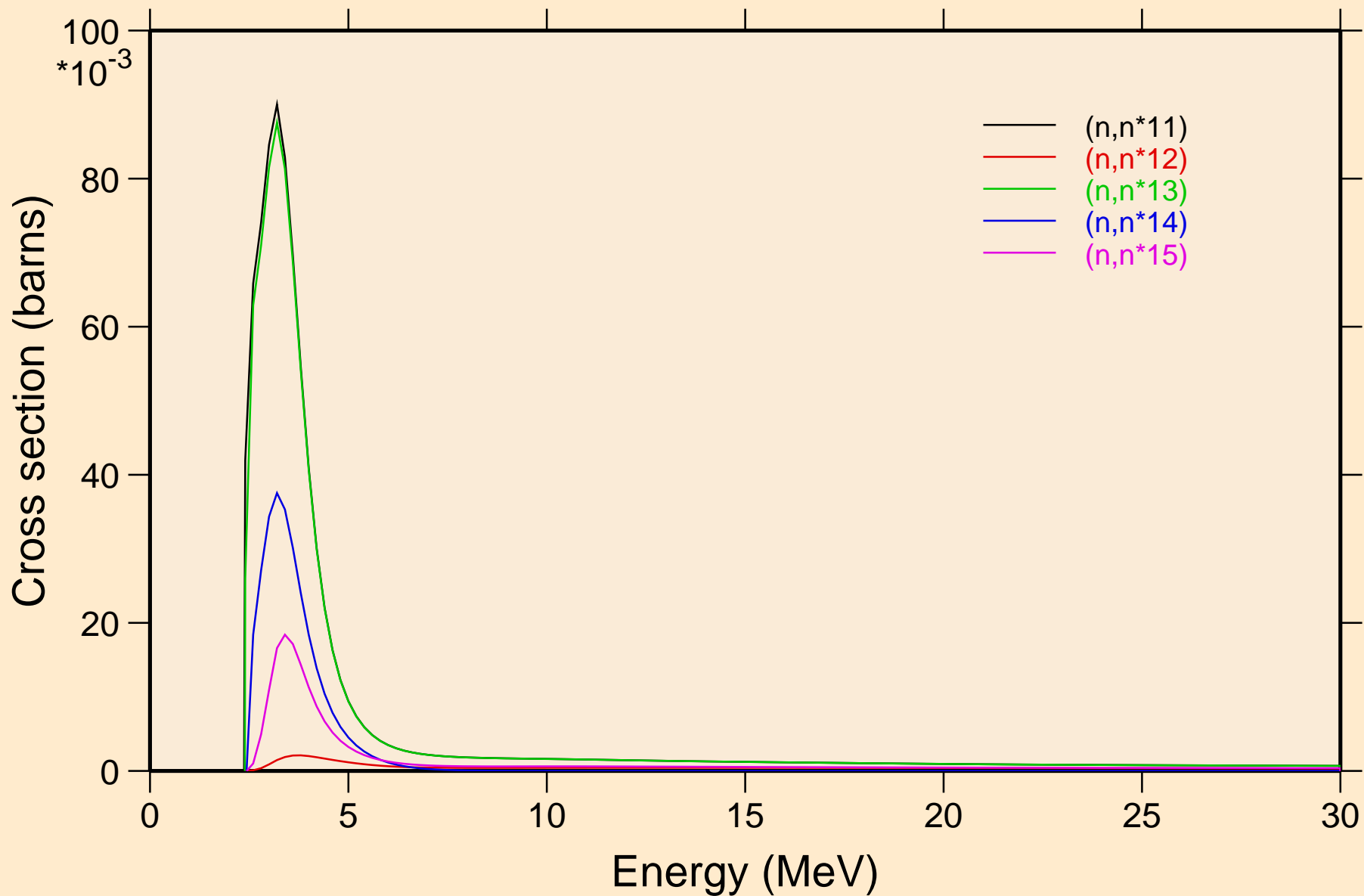

SM142 NEUTRON ACER TENDL-2019 LIBRARY; T=293.16K  
Inelastic levels

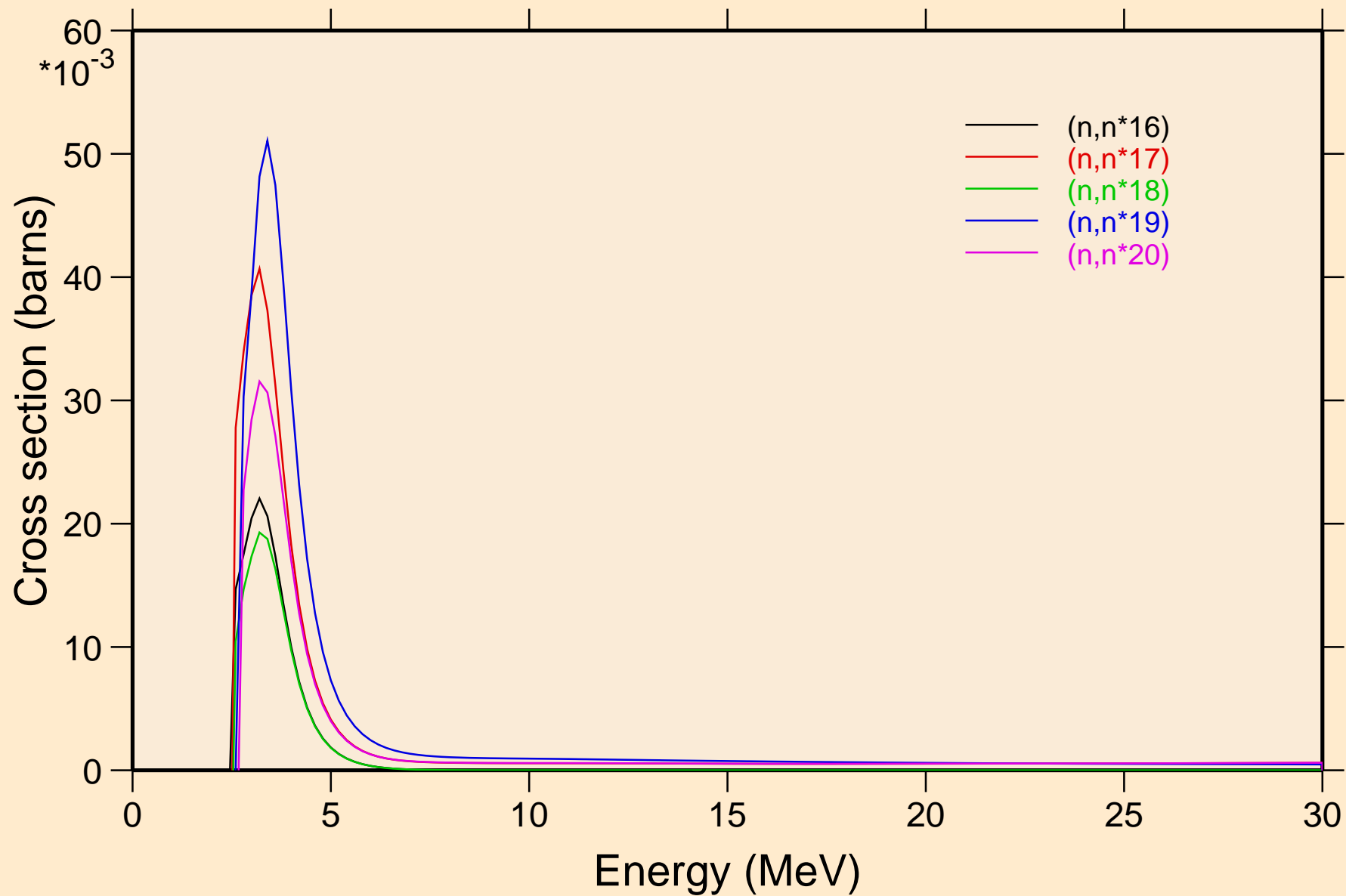

SM142 NEUTRON ACER TENDL-2019 LIBRARY; T=293.16K  
Inelastic levels

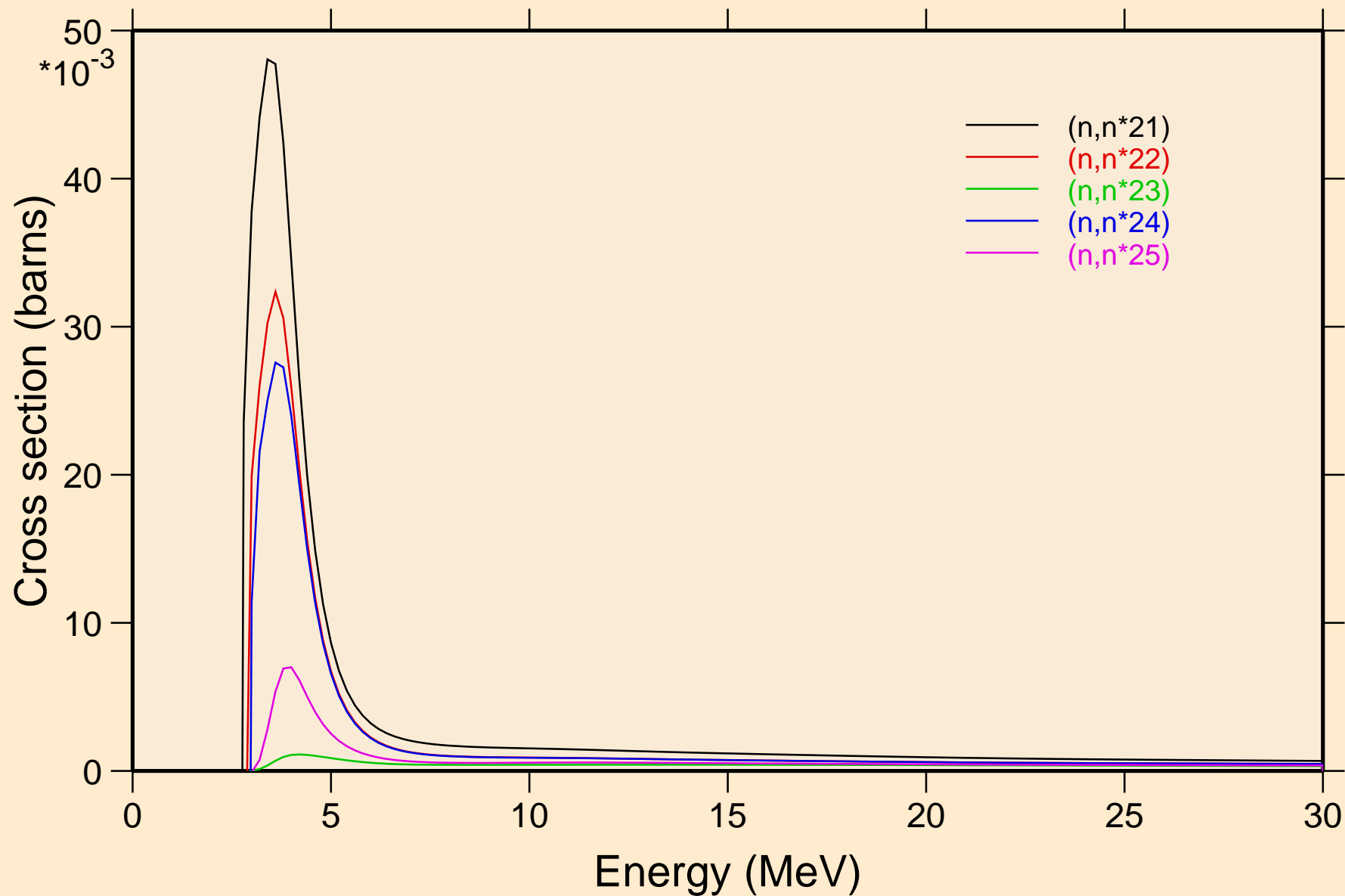

SM142 NEUTRON ACER TENDL-2019 LIBRARY; T=293.16K  
Inelastic levels

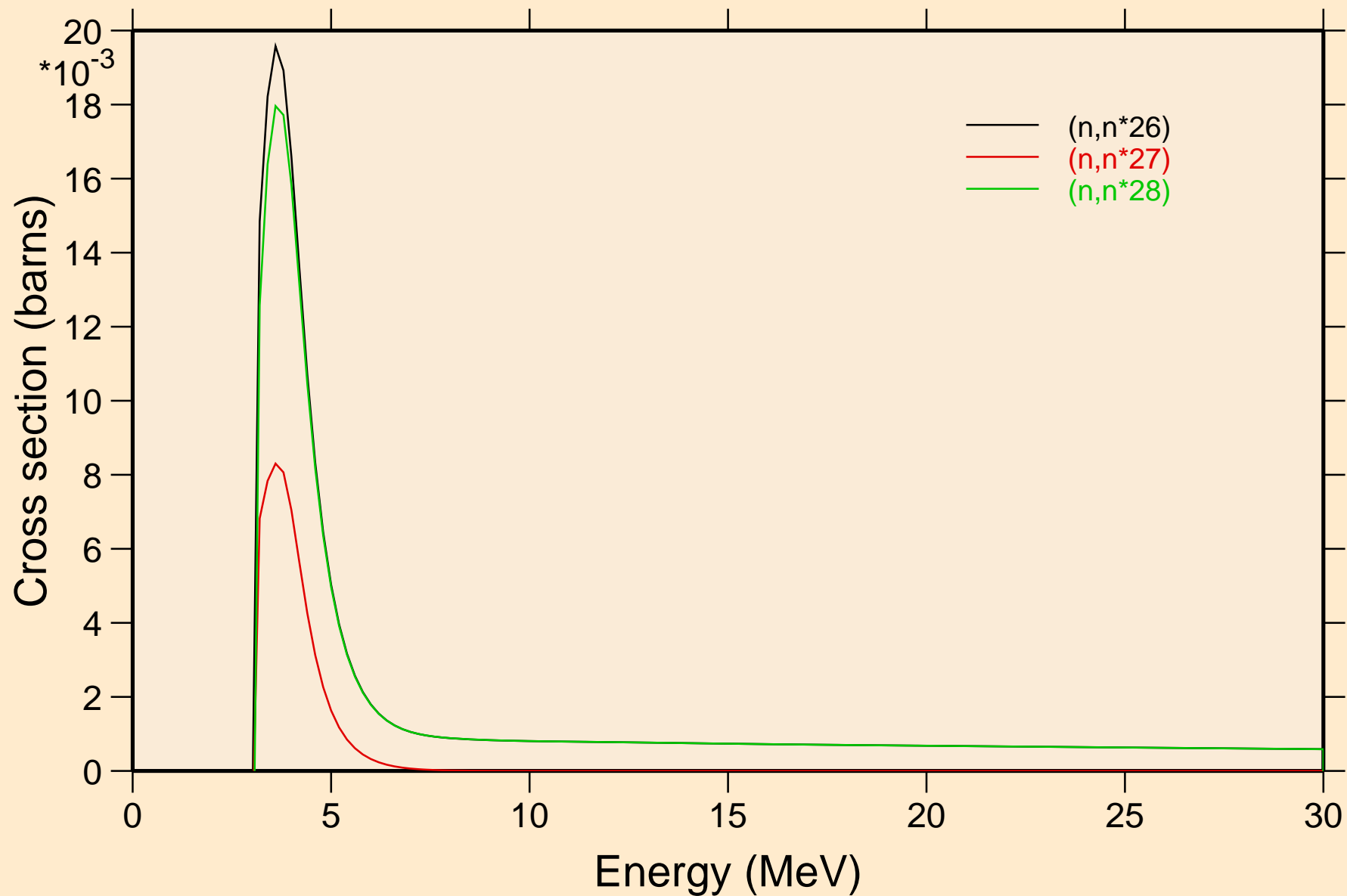

SM142 NEUTRON ACER TENDL-2019 LIBRARY; T=293.16K  
Threshold reactions

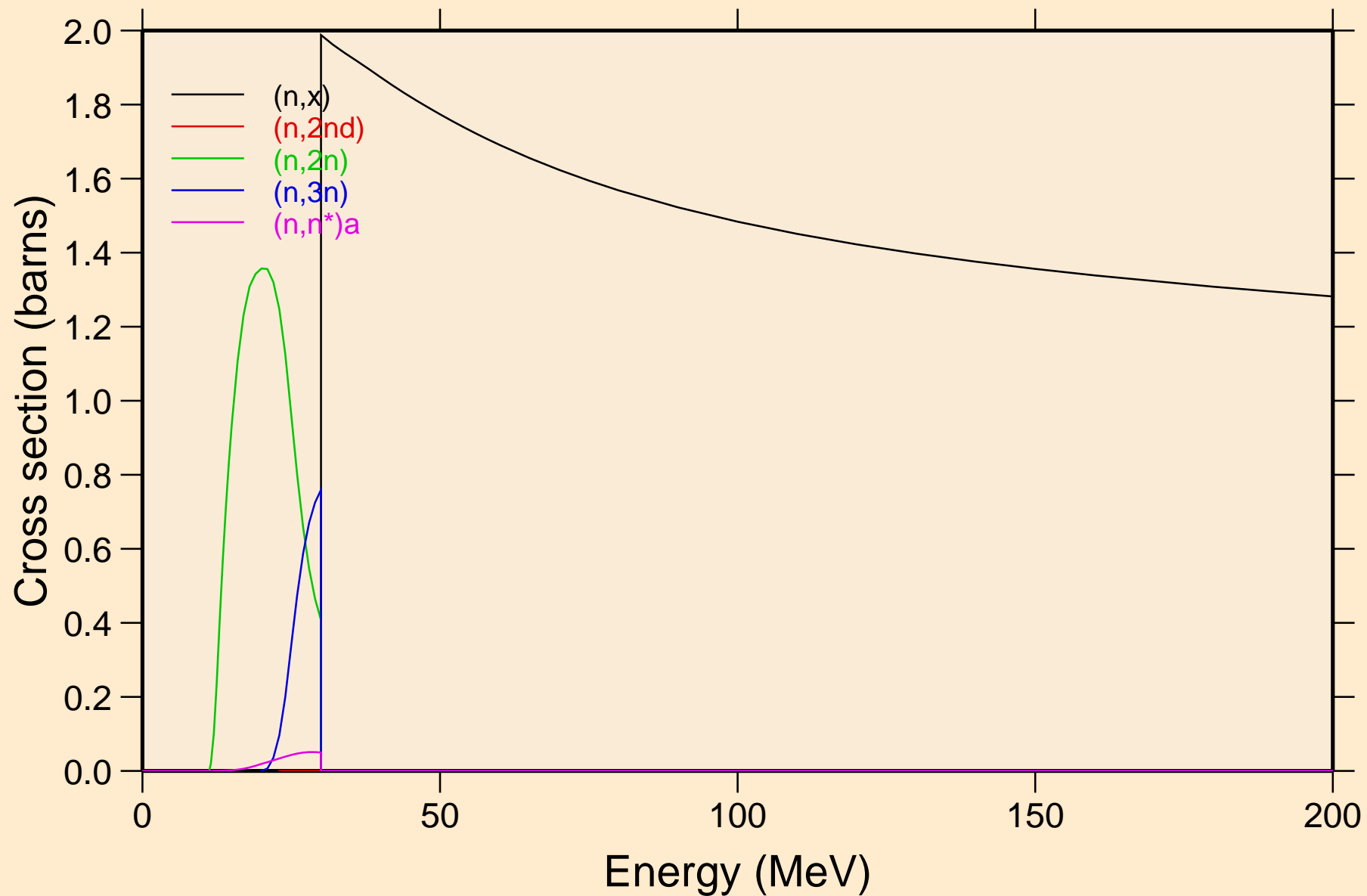

SM142 NEUTRON ACER TENDL-2019 LIBRARY; T=293.16K  
Threshold reactions

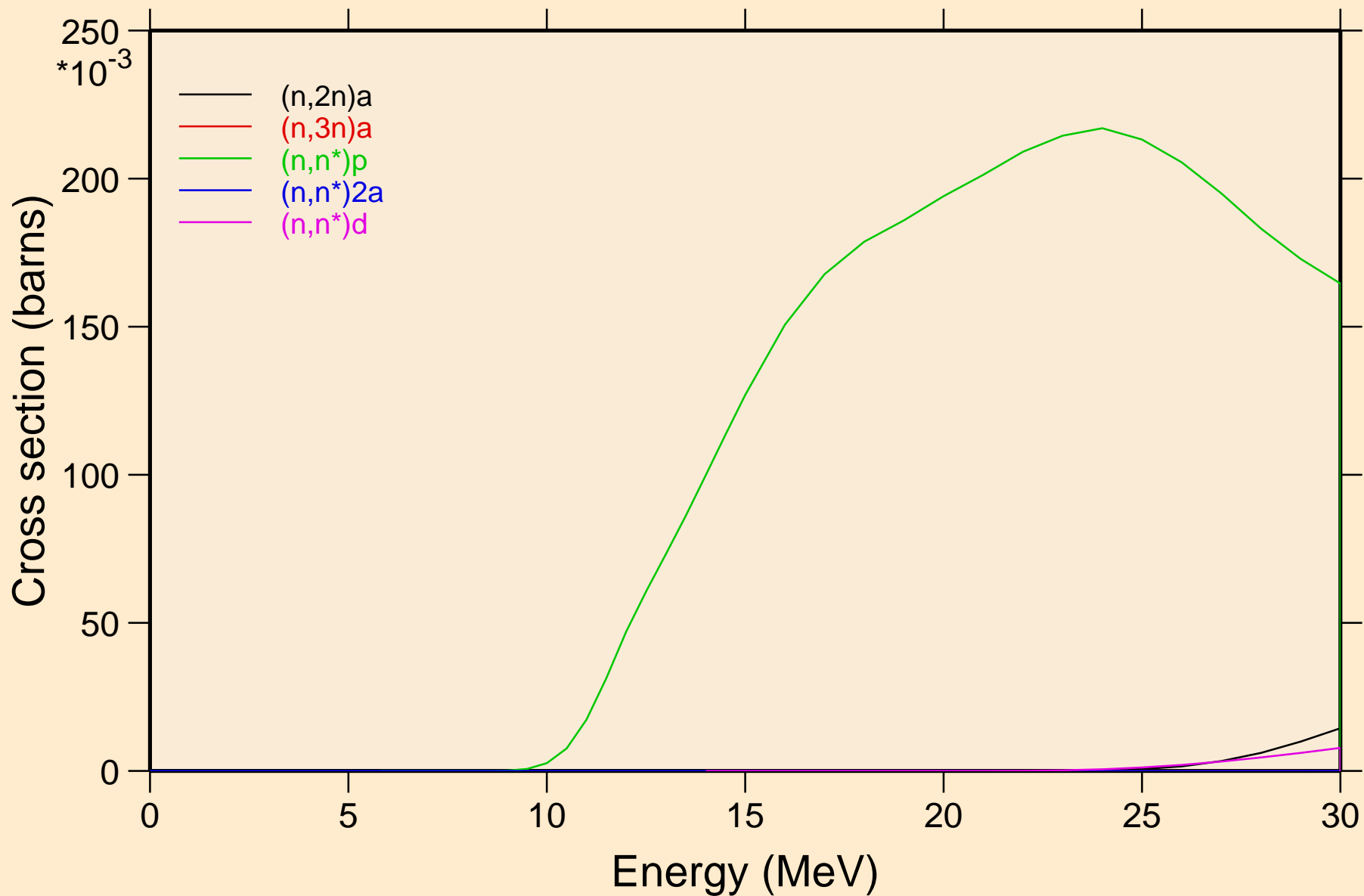



SM142 NEUTRON ACER TENDL-2019 LIBRARY; T=293.16K  
Threshold reactions

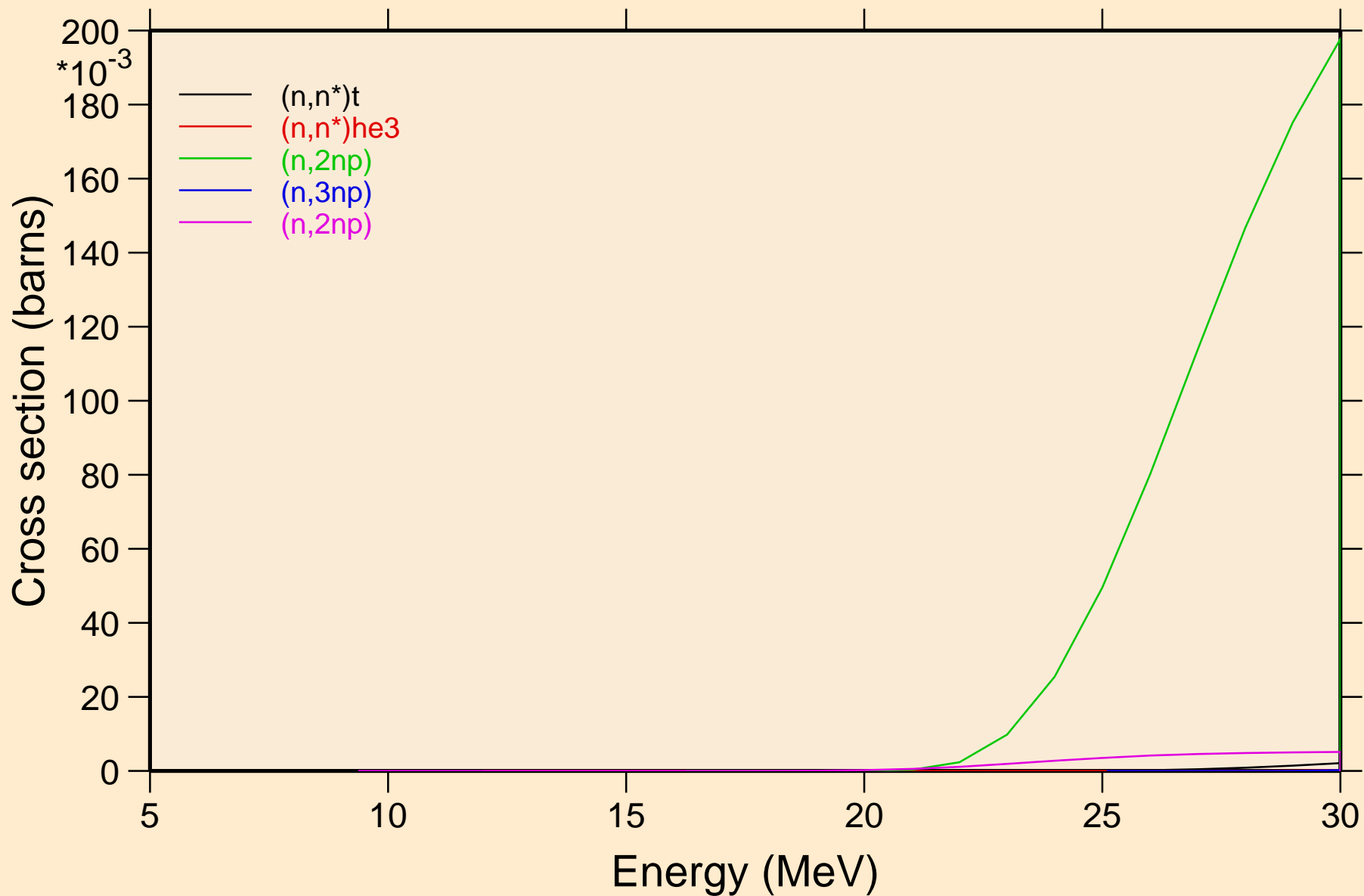

SM142 NEUTRON ACER TENDL-2019 LIBRARY; T=293.16K  
Threshold reactions

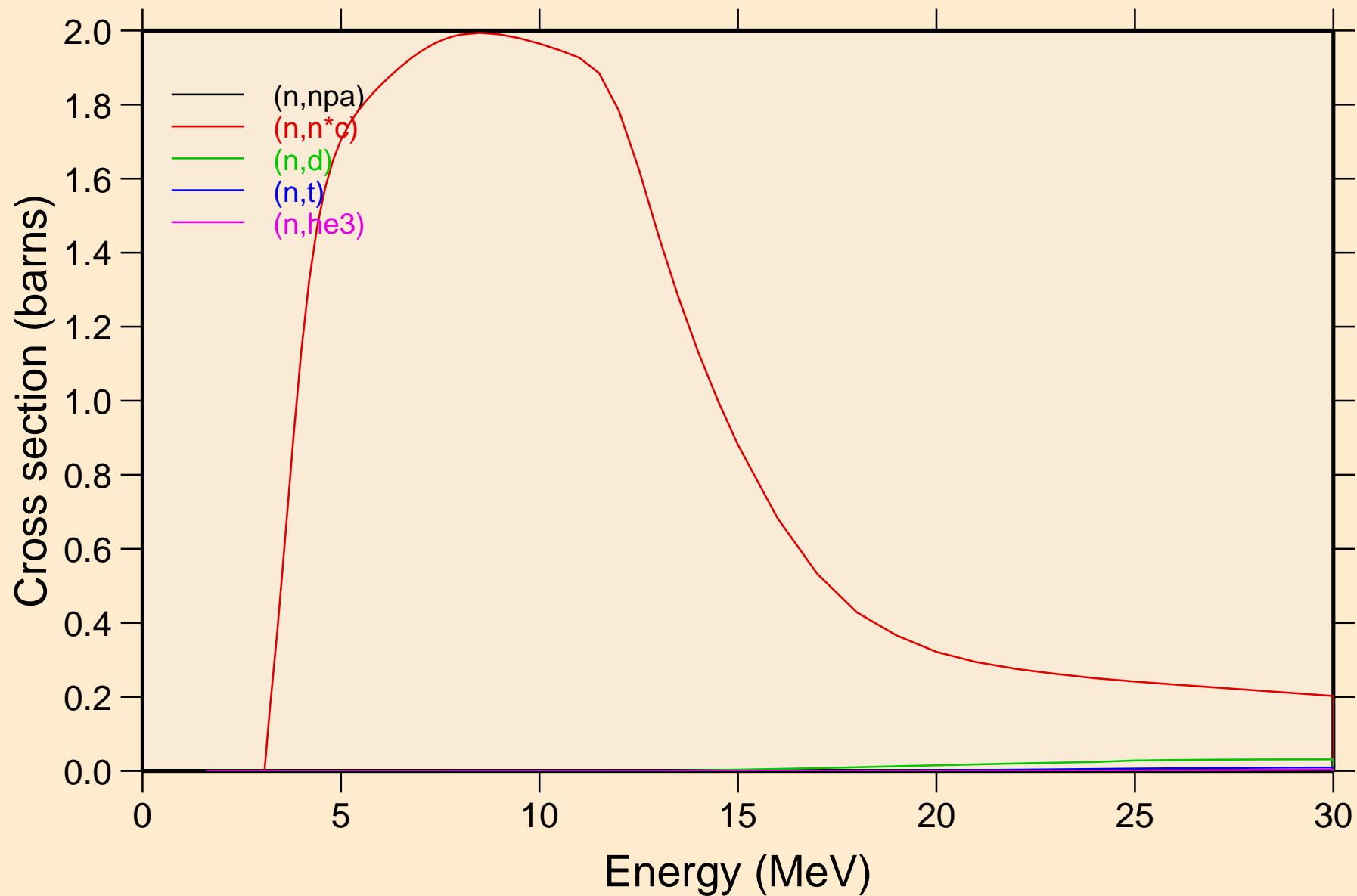

SM142 NEUTRON ACER TENDL-2019 LIBRARY; T=293.16K  
Threshold reactions

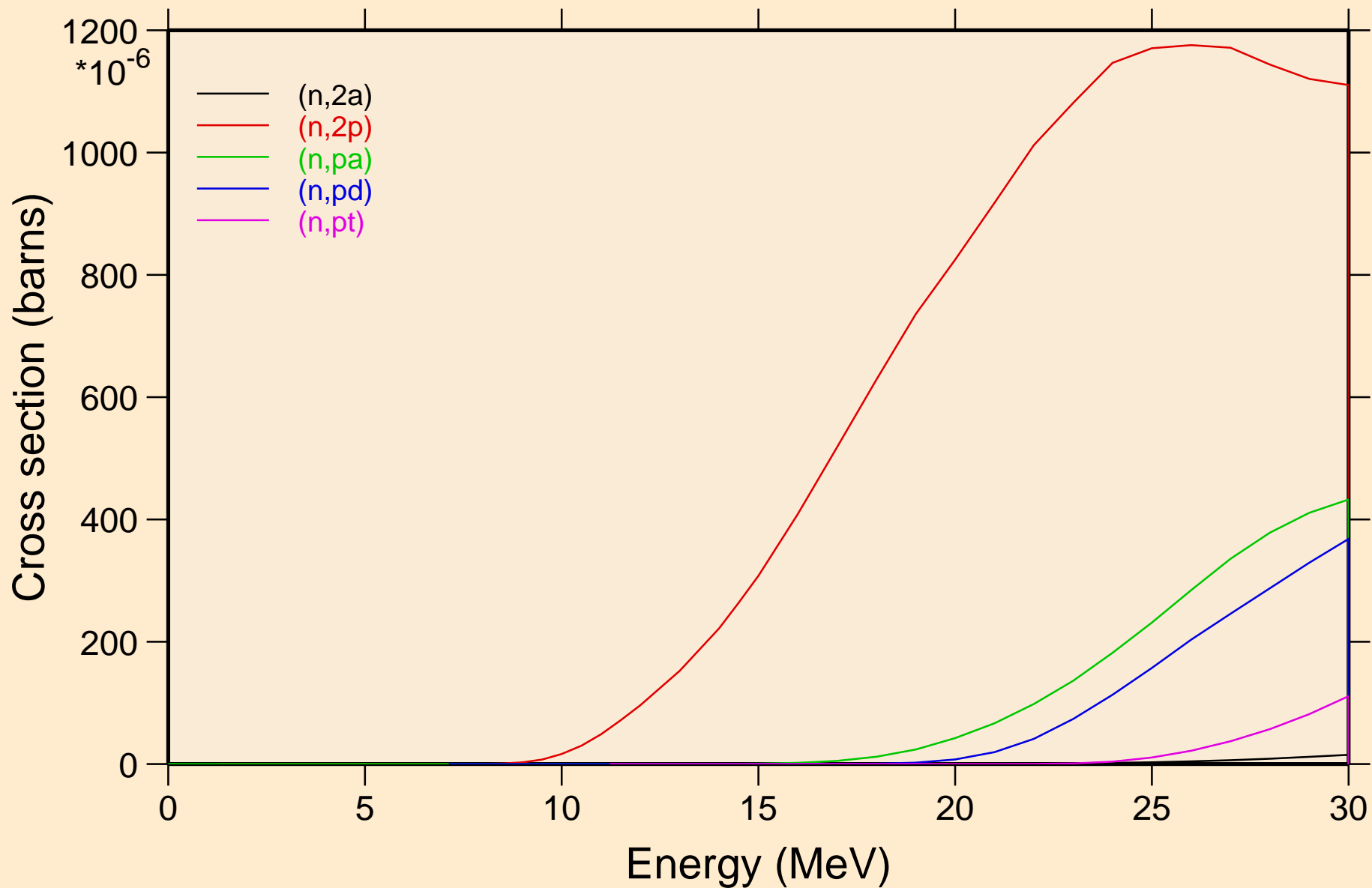

SM142 NEUTRON ACER TENDL-2019 LIBRARY; T=293.16K  
Threshold reactions

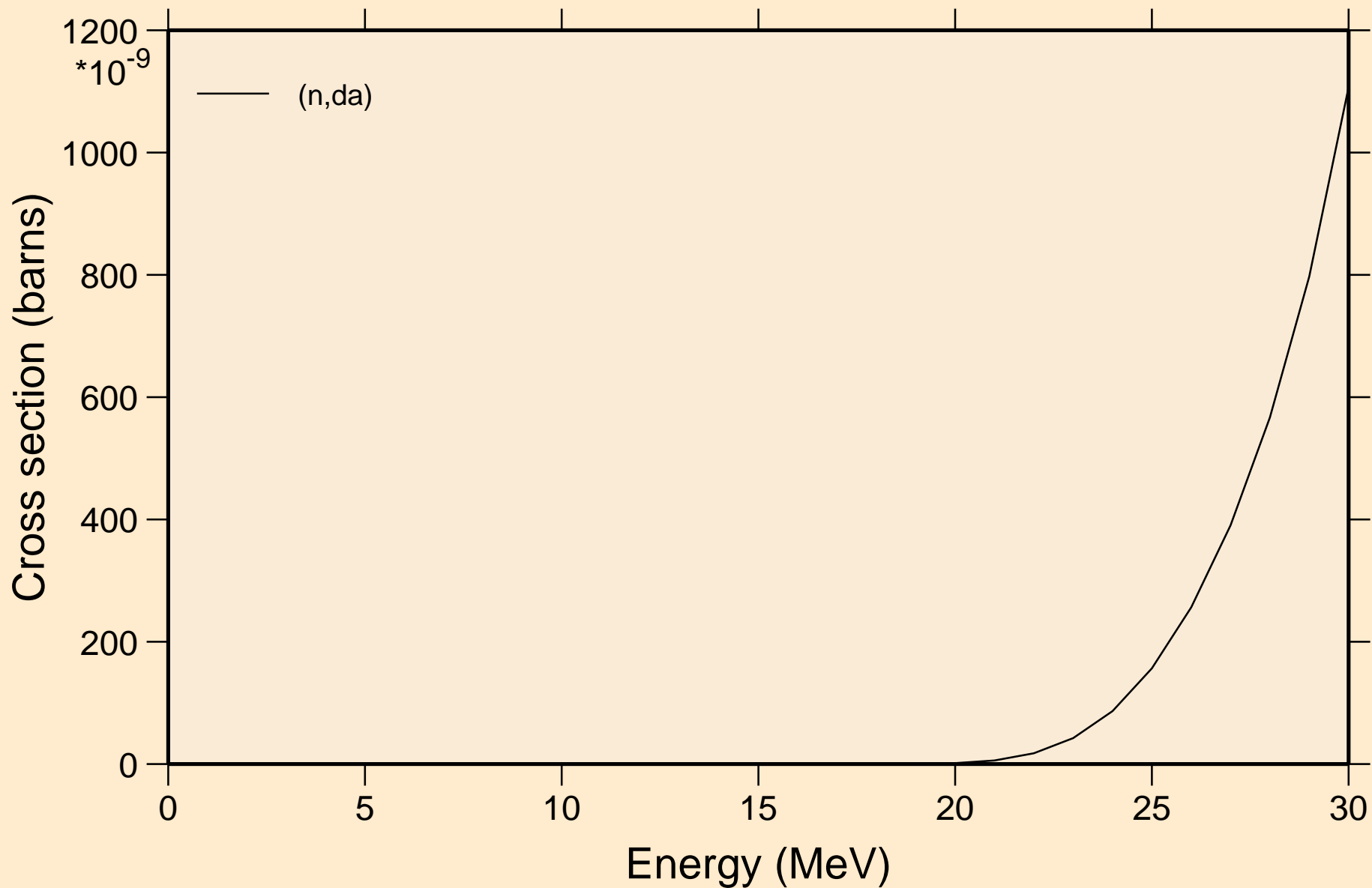

SM142 NEUTRON ACER TENDL-2019 LIBRARY; T=293.16K  
Threshold reactions

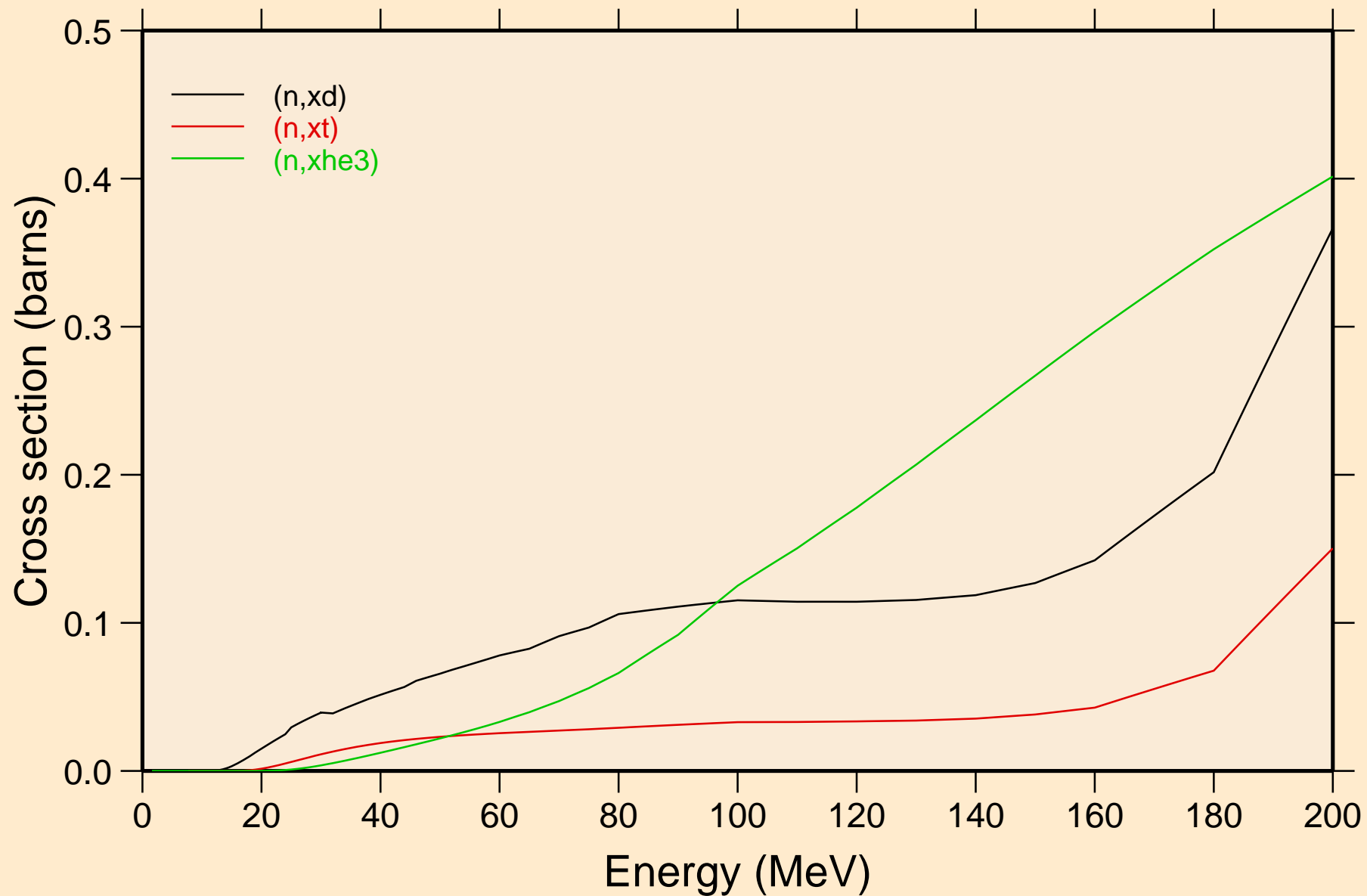

SM142 NEUTRON ACER TENDL-2019 LIBRARY; T=293.16K  
angular distribution for elastic

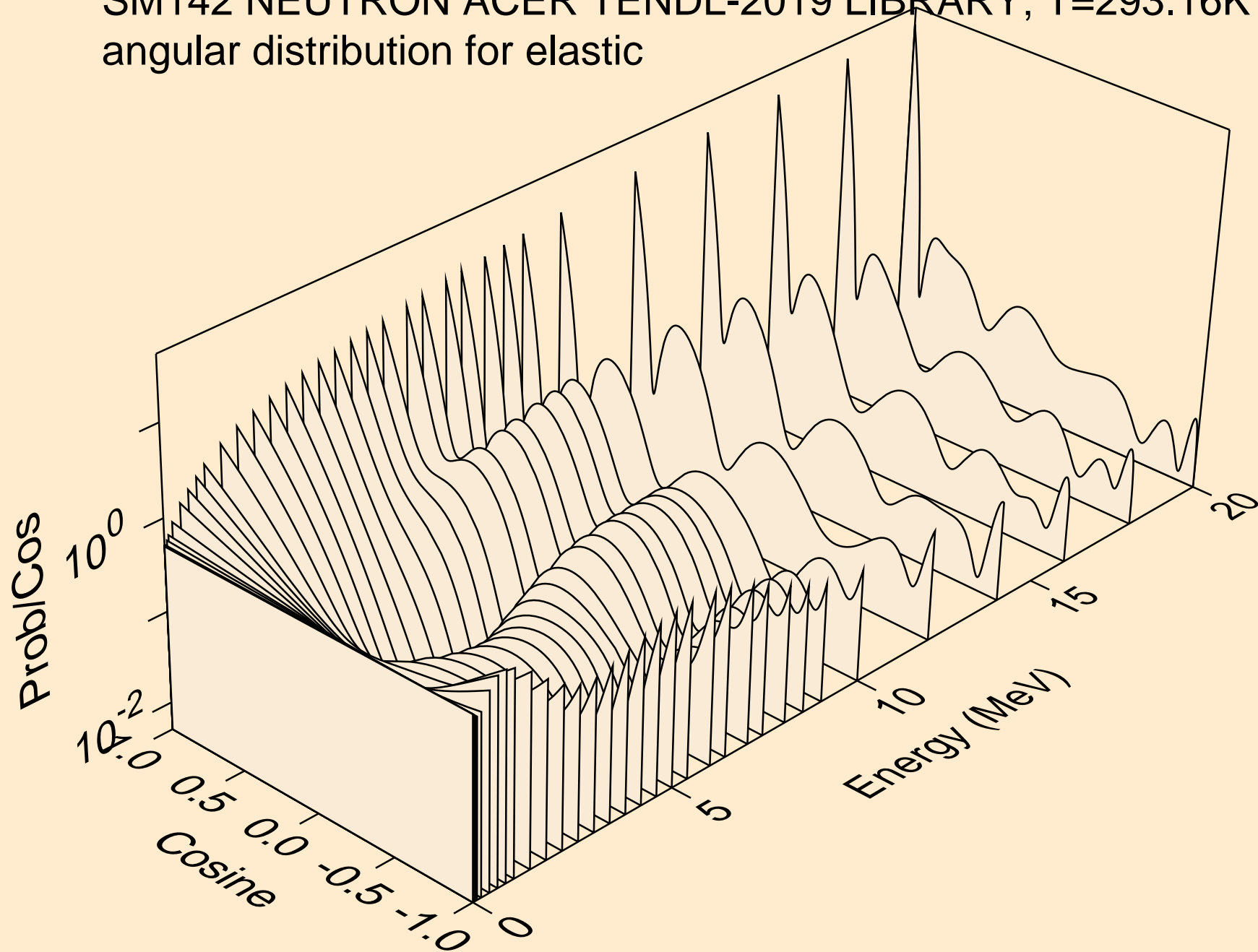

SM142 NEUTRON ACER TENDL-2019 LIBRARY; T=293.16K  
angular distribution for elastic

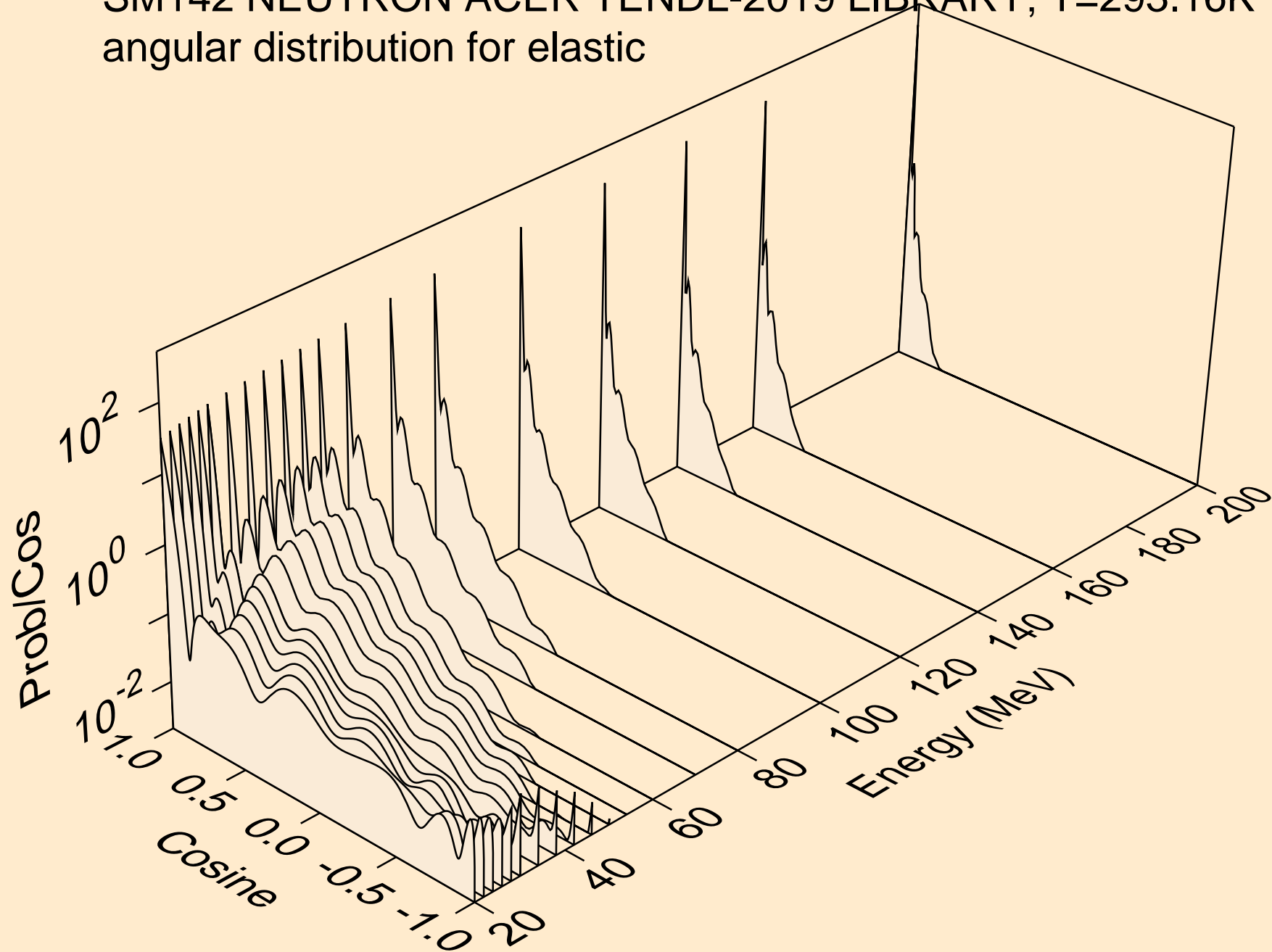

SM142 NEUTRON ACER TENDL-2019 LIBRARY; T=293.16K  
angular distribution for (n,n\*1)

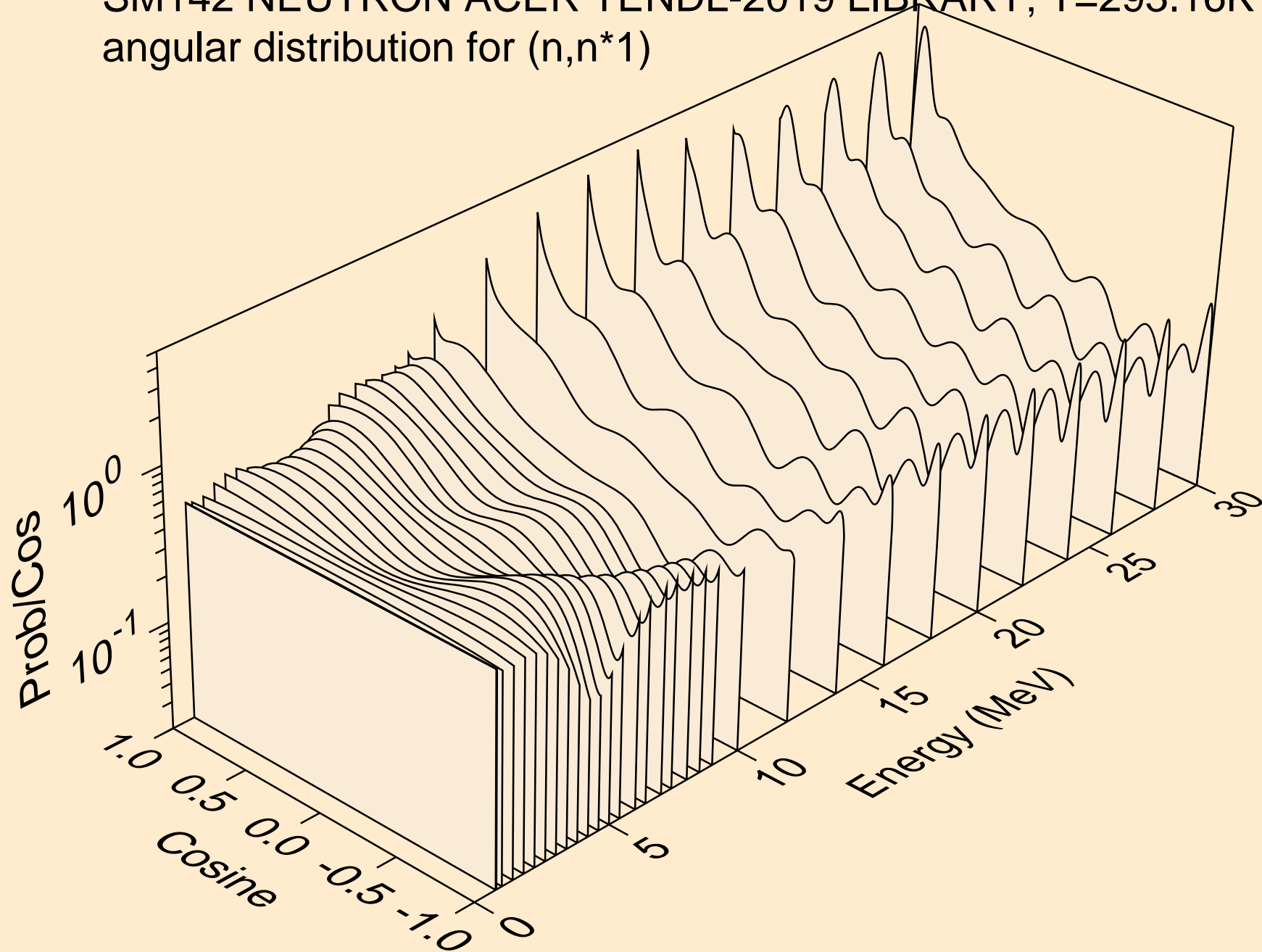



SM142 NEUTRON ACER TENDL-2019 LIBRARY; T=293.16K  
angular distribution for (n,n\*2)

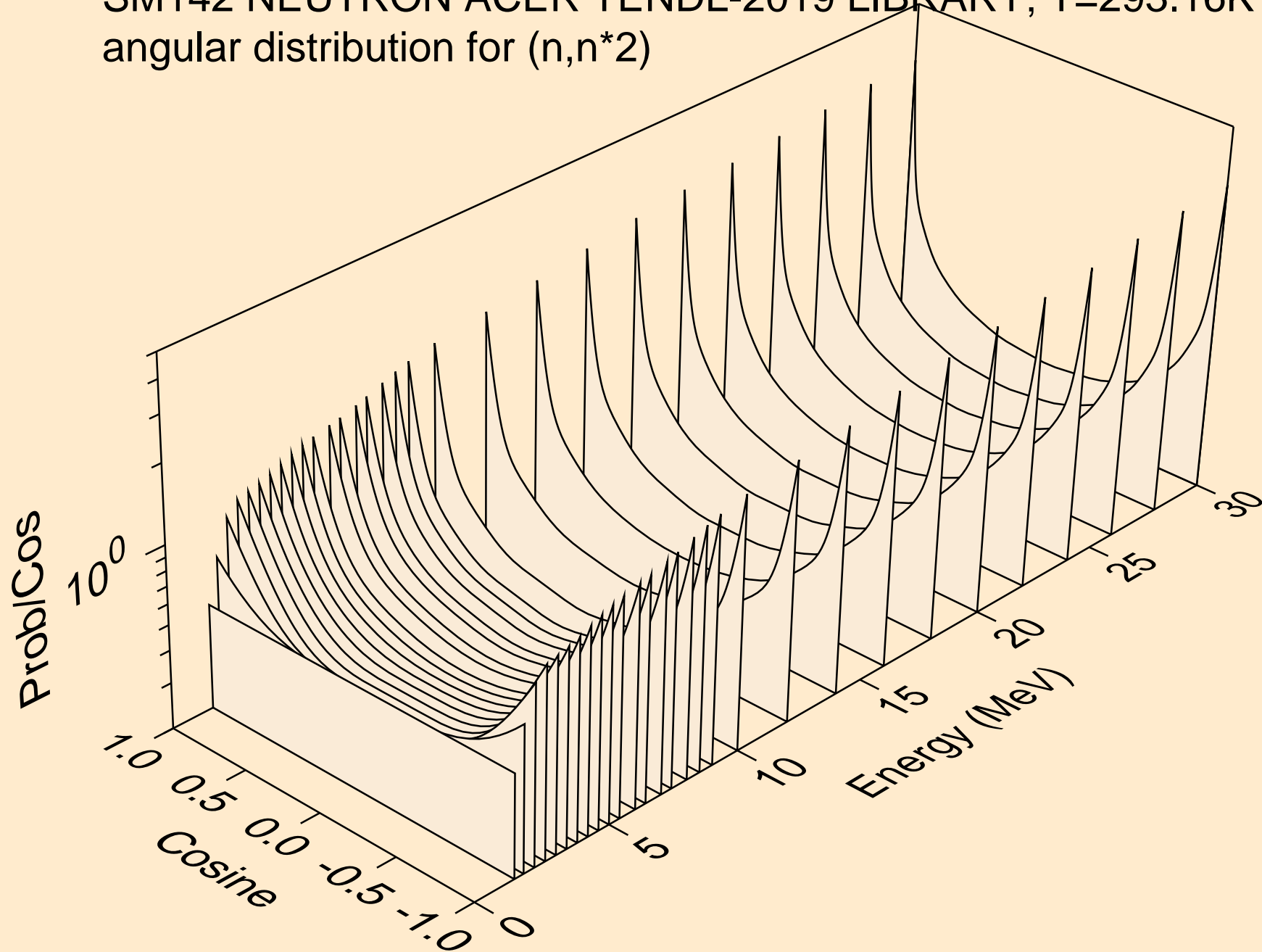

SM142 NEUTRON ACER TENDL-2019 LIBRARY; T=293.16K  
angular distribution for (n,n\*3)

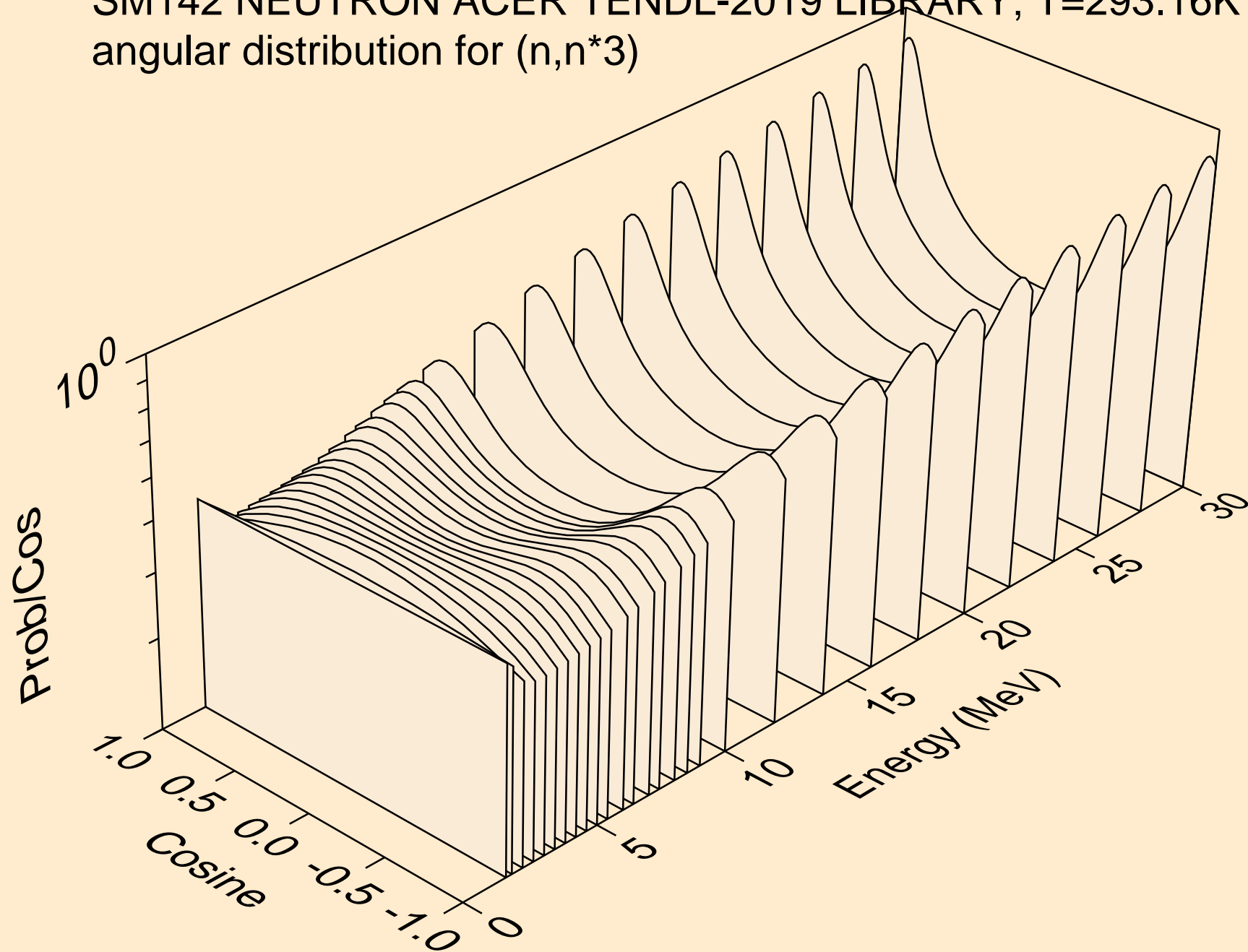

SM142 NEUTRON ACER TENDL-2019 LIBRARY; T=293.16K  
angular distribution for (n,n\*4)

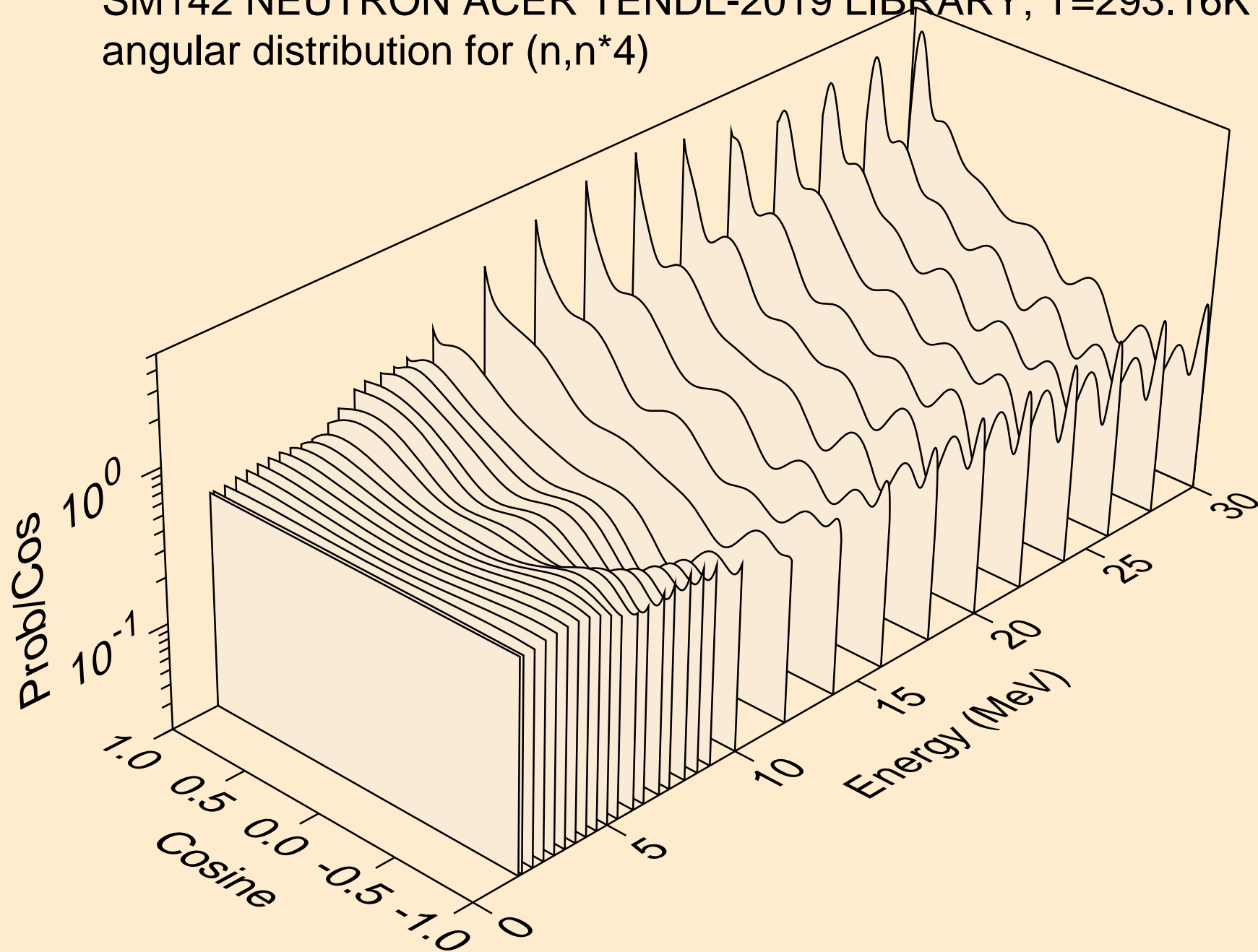

SM142 NEUTRON ACER TENDL-2019 LIBRARY; T=293.16K  
angular distribution for (n,n\*5)

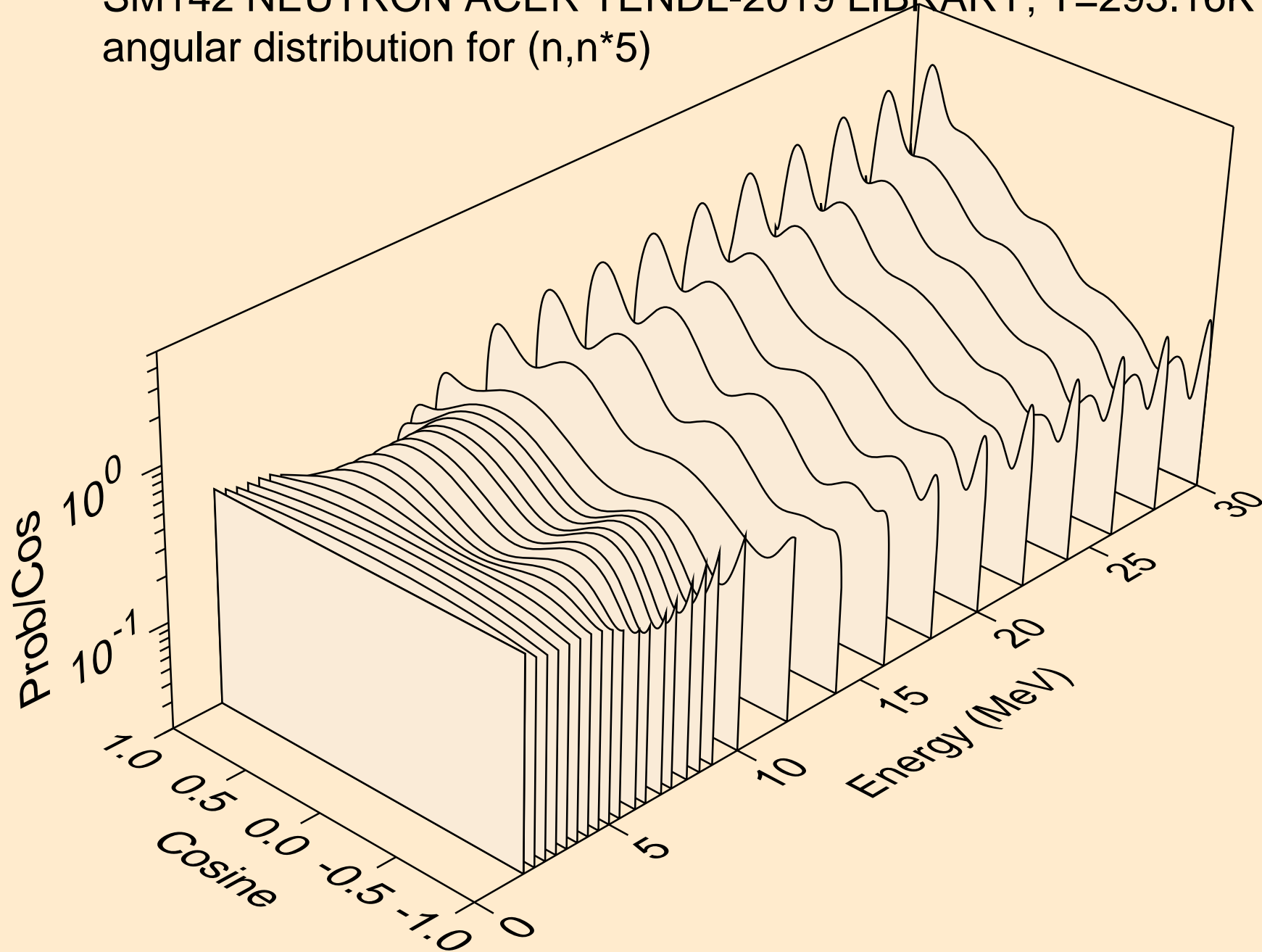

SM142 NEUTRON ACER TENDL-2019 LIBRARY; T=293.16K  
angular distribution for (n,n\*6)

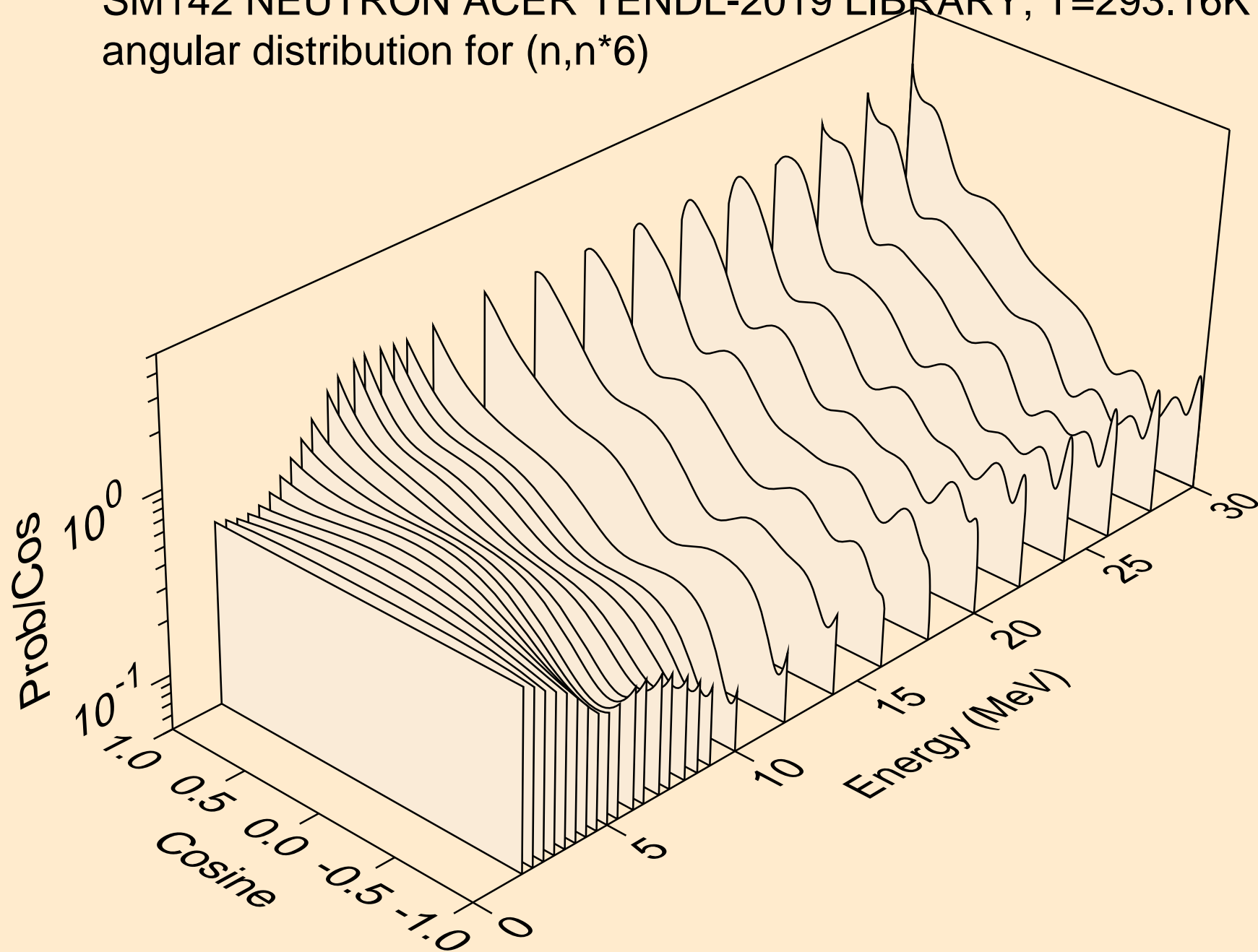

SM142 NEUTRON ACER TENDL-2019 LIBRARY; T=293.16K  
angular distribution for (n,n\*7)

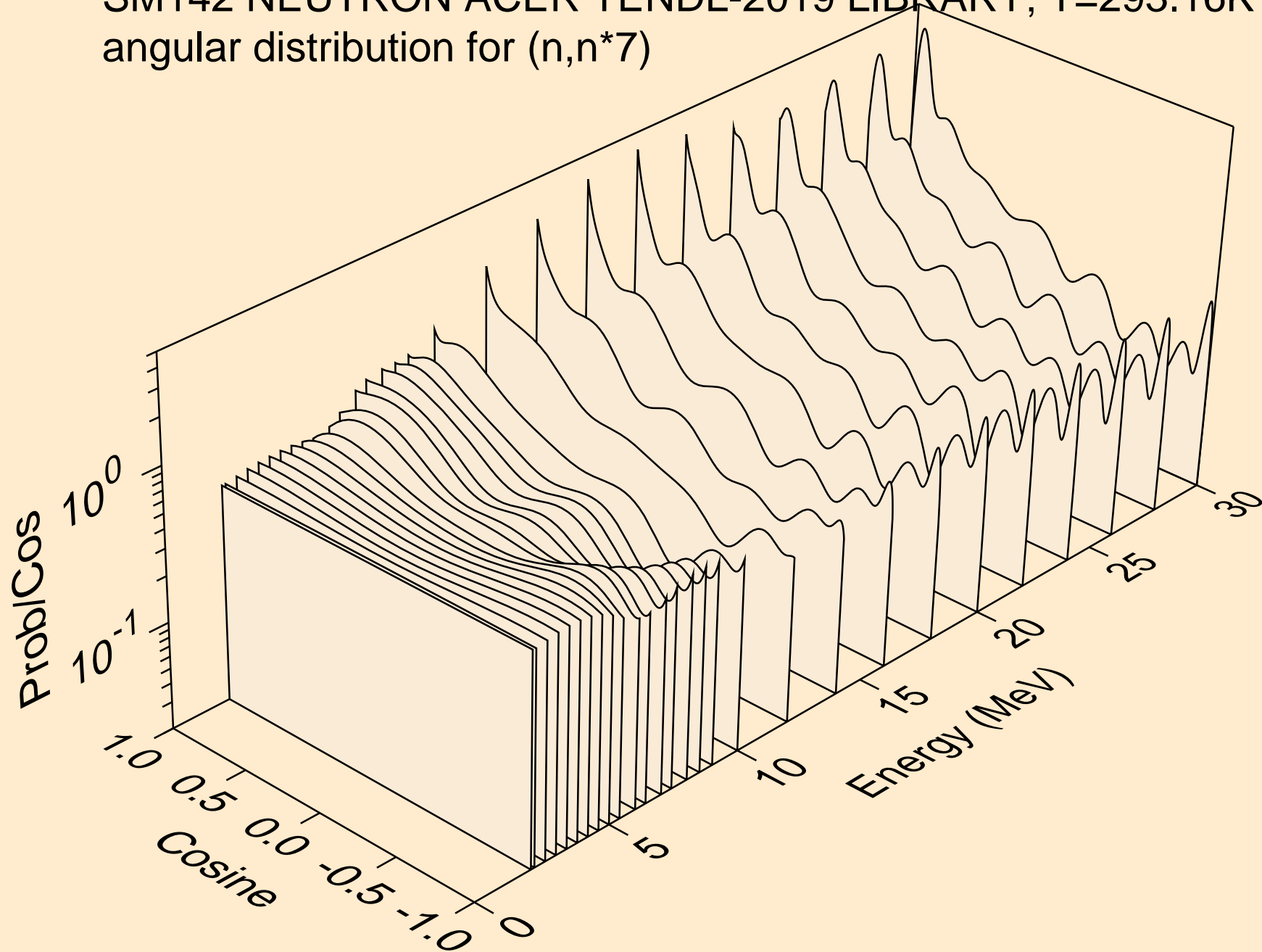

SM142 NEUTRON ACER TENDL-2019 LIBRARY; T=293.16K  
angular distribution for (n,n\*8)

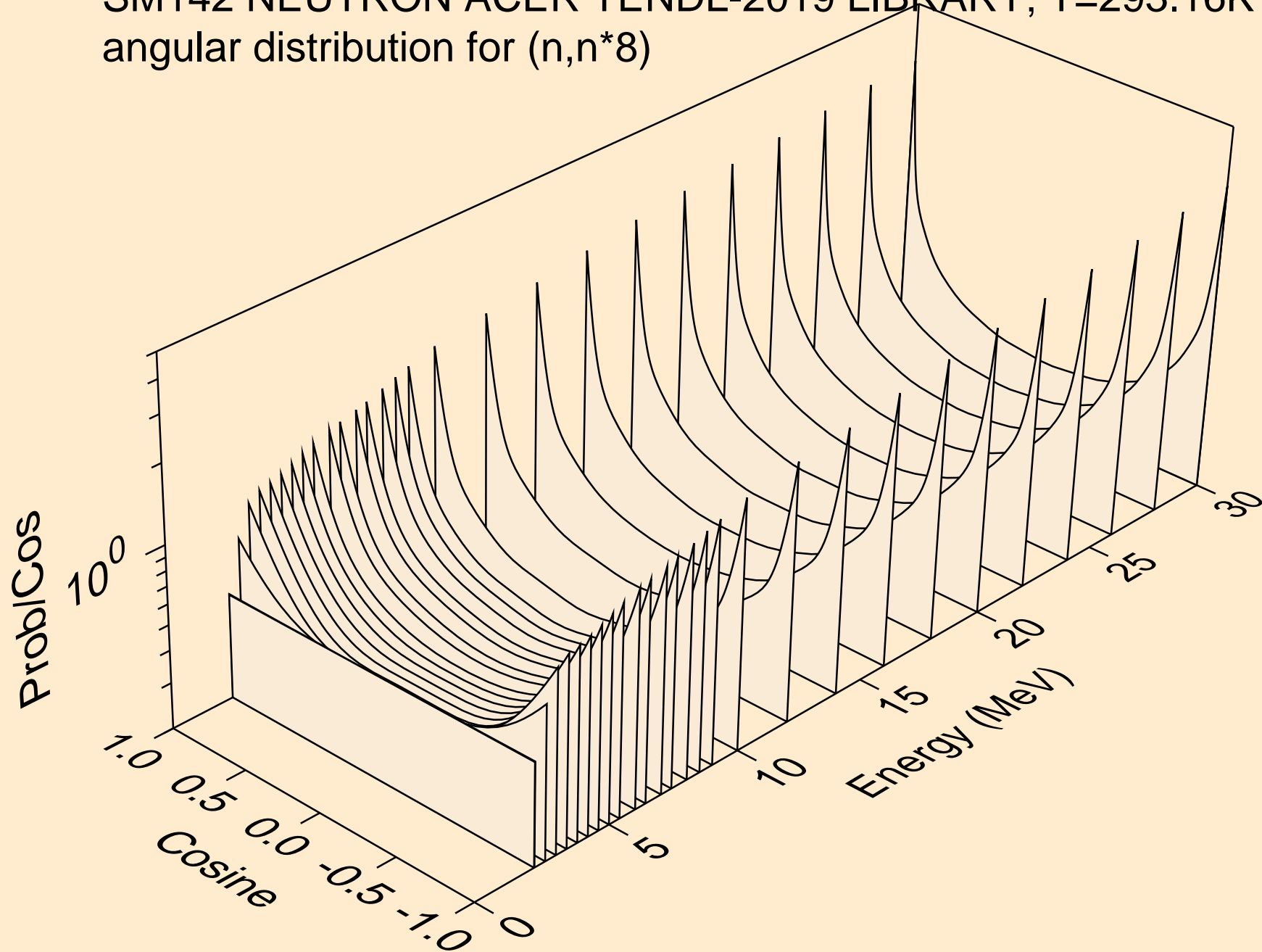

SM142 NEUTRON ACER TENDL-2019 LIBRARY; T=293.16K  
angular distribution for (n,n\*9)

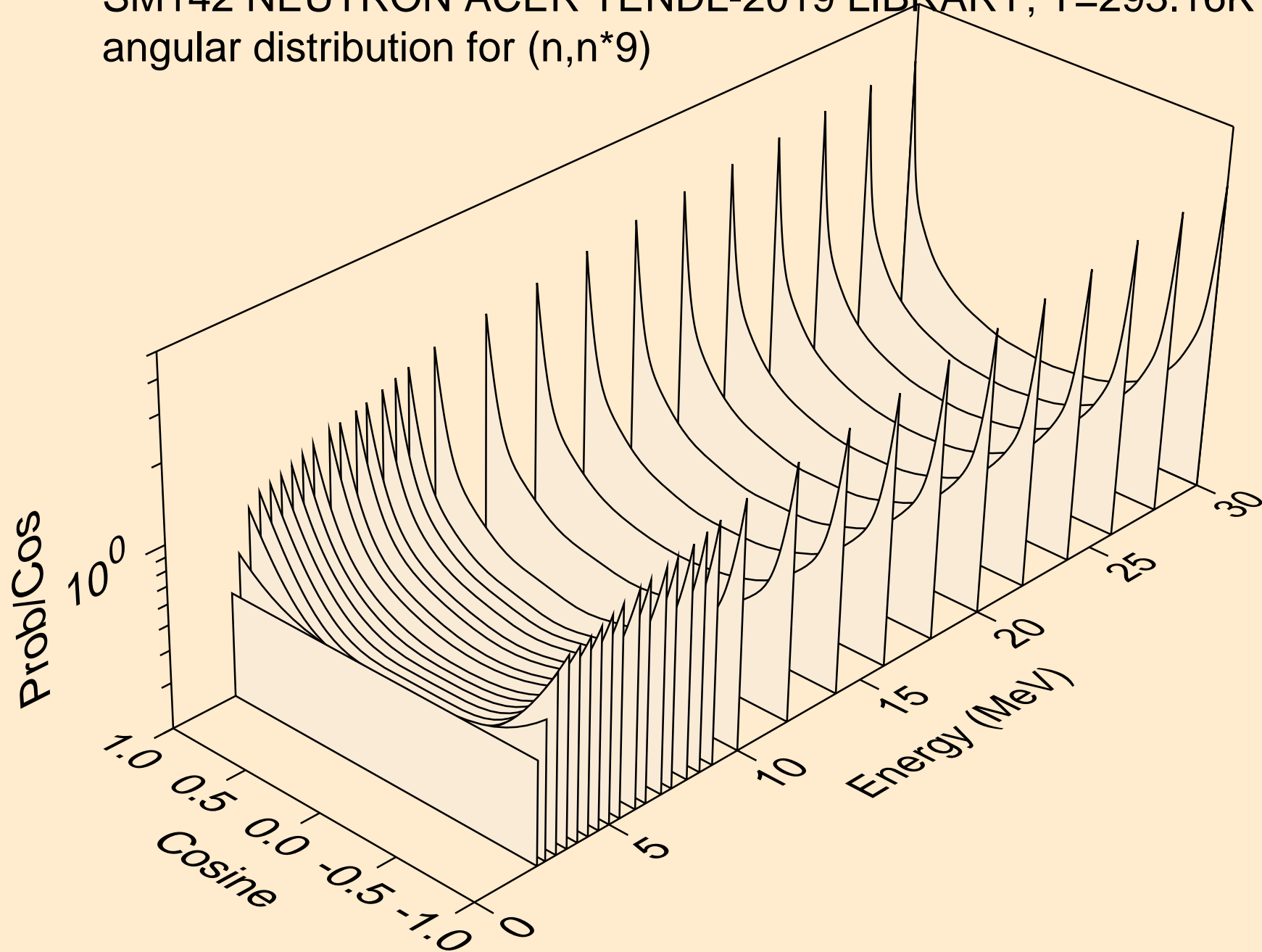



SM142 NEUTRON ACER TENDL-2019 LIBRARY; T=293.16K  
angular distribution for (n,n\*10)

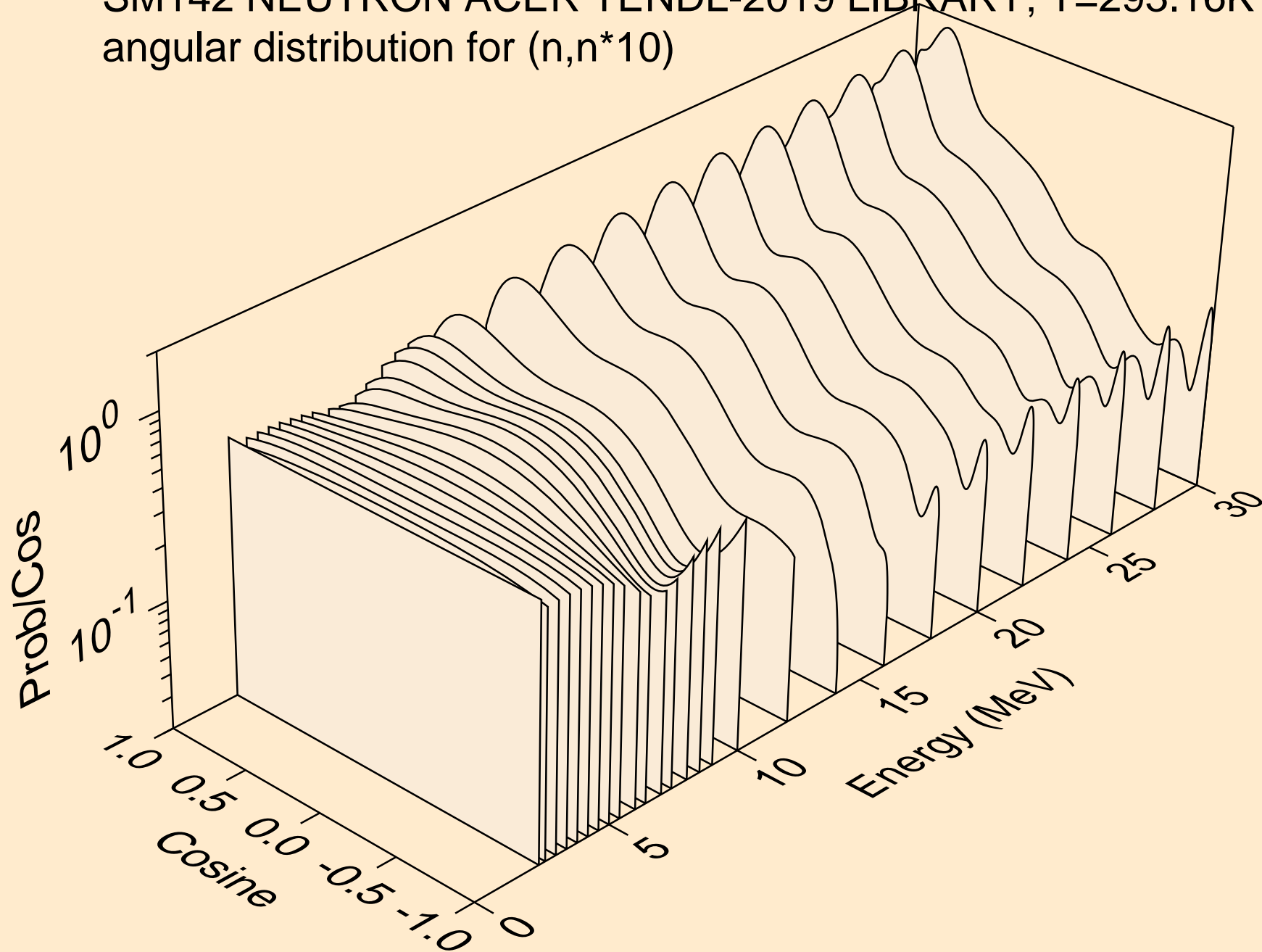

SM142 NEUTRON ACER TENDL-2019 LIBRARY; T=293.16K  
angular distribution for (n,n\*11)

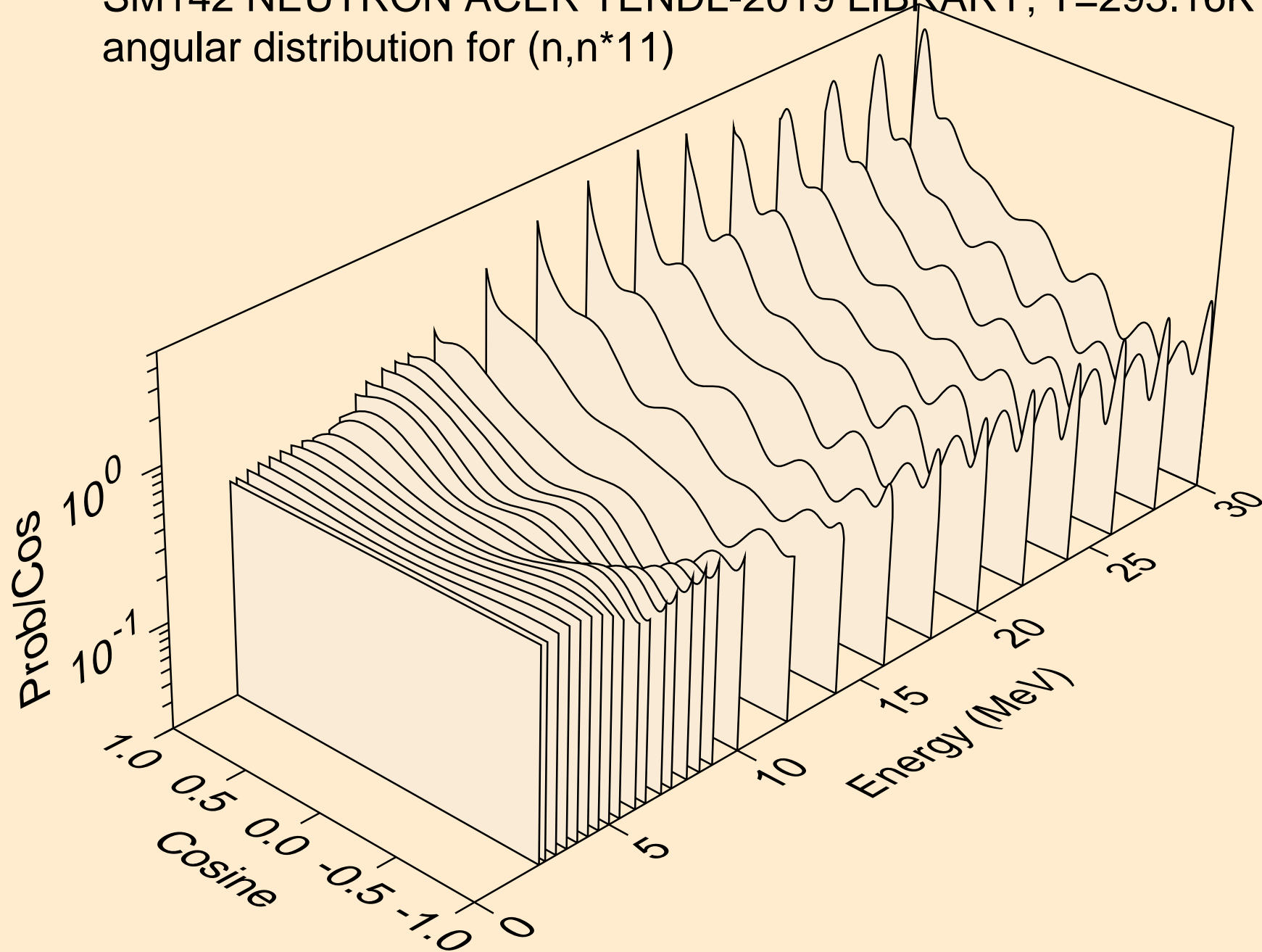

SM142 NEUTRON ACER TENDL-2019 LIBRARY; T=293.16K  
angular distribution for (n,n\*12)

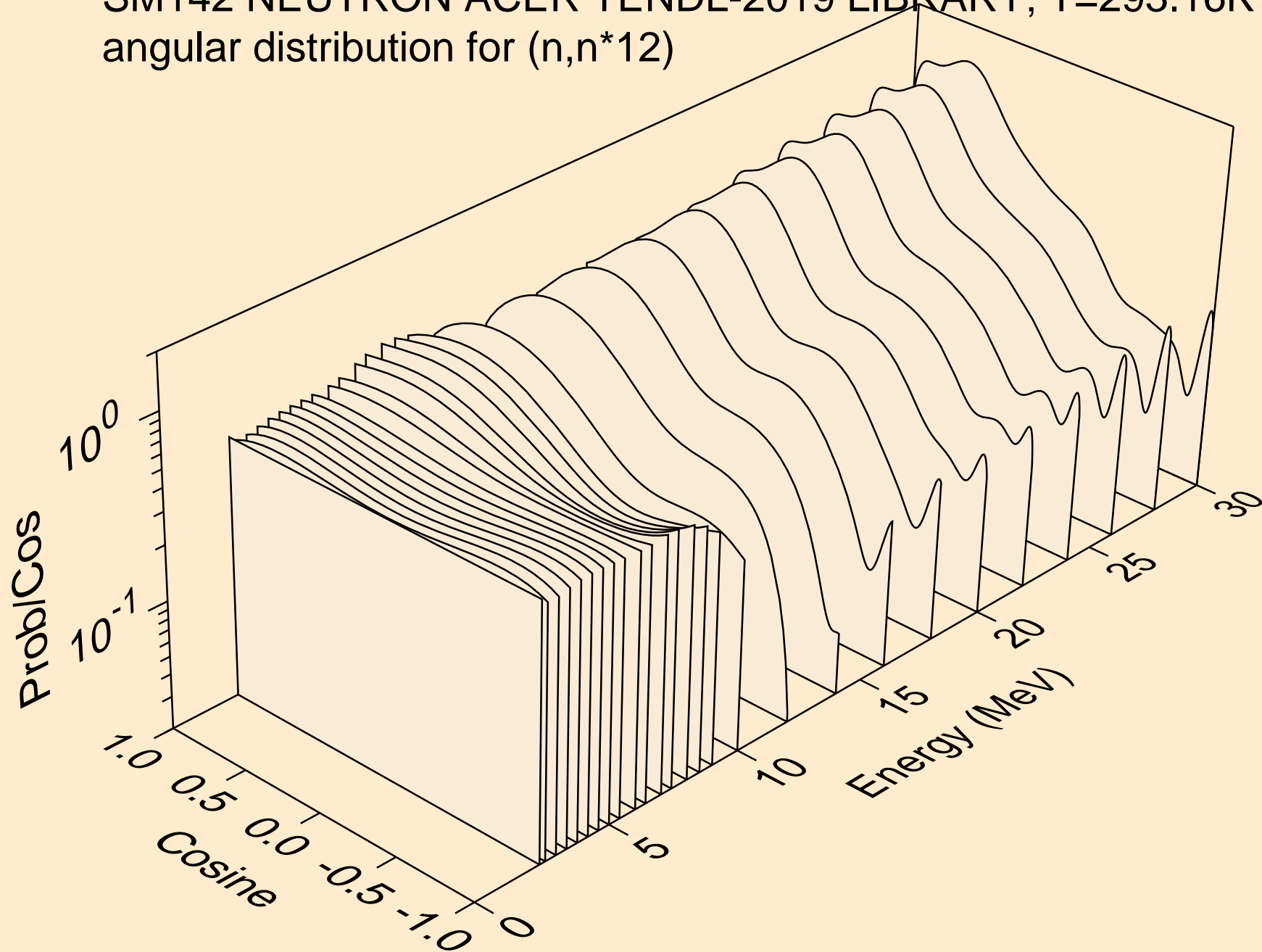

SM142 NEUTRON ACER TENDL-2019 LIBRARY; T=293.16K  
angular distribution for (n,n\*13)

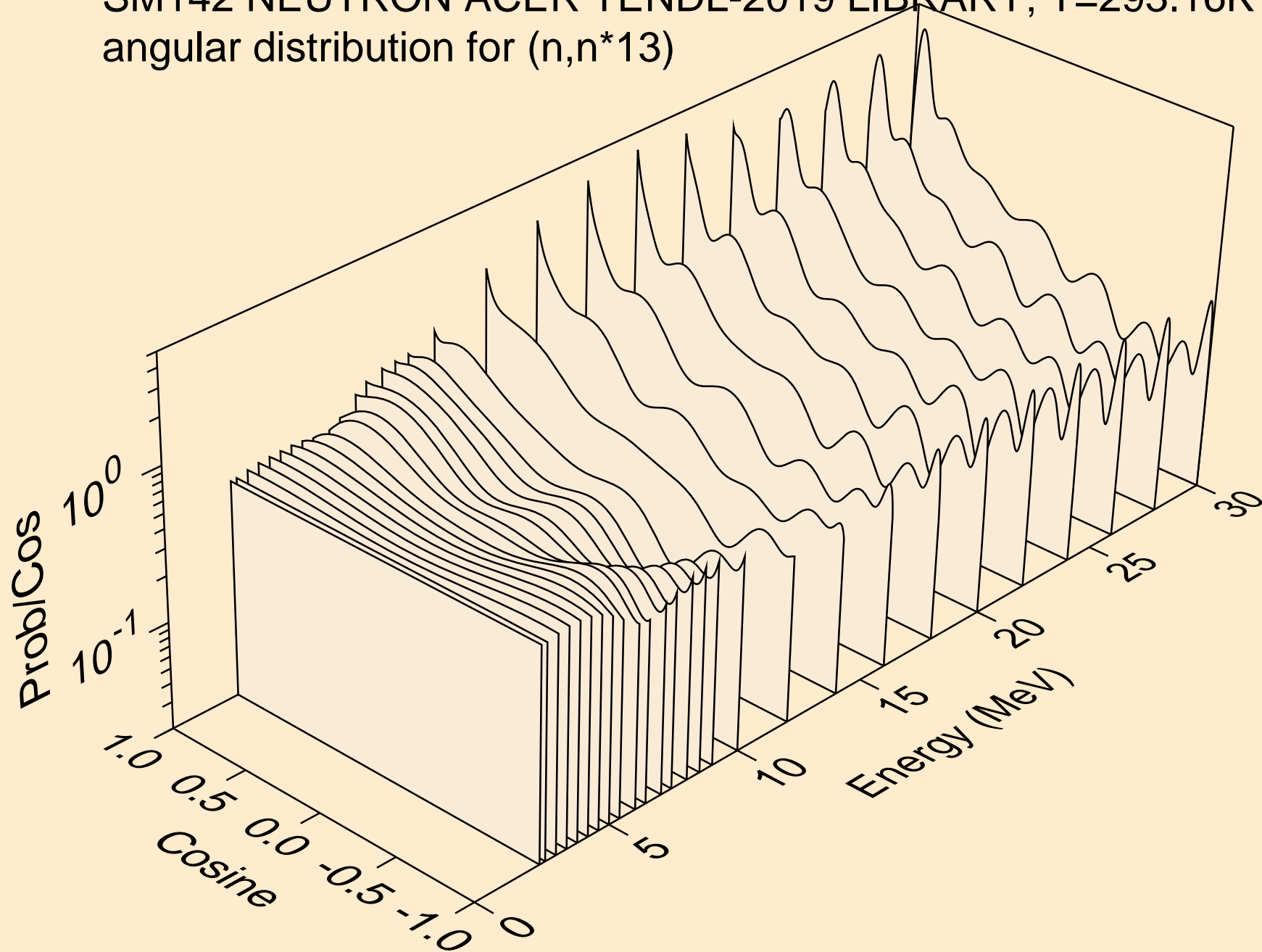

SM142 NEUTRON ACER TENDL-2019 LIBRARY; T=293.16K  
angular distribution for (n,n\*14)

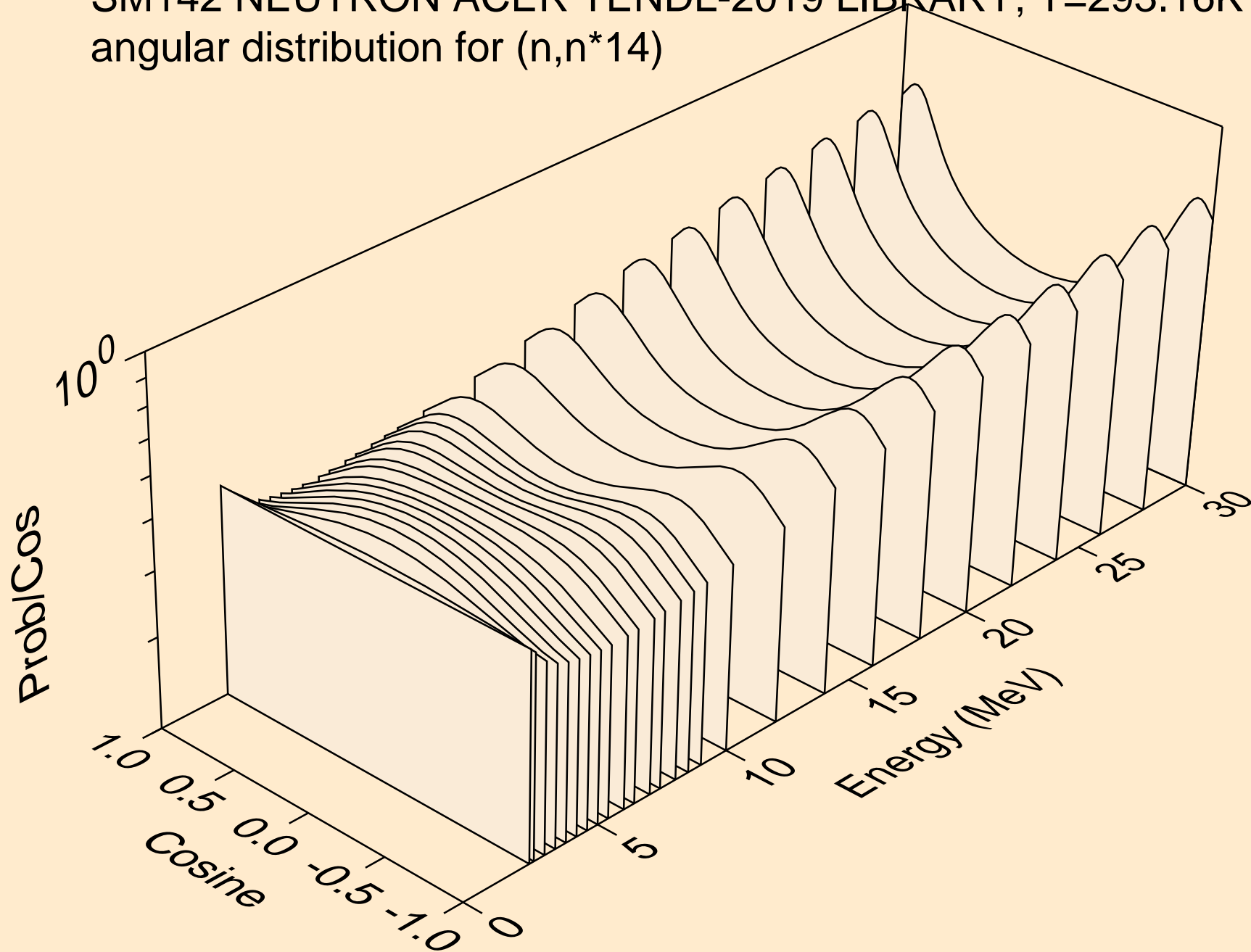

SM142 NEUTRON ACER TENDL-2019 LIBRARY; T=293.16K  
angular distribution for (n,n\*15)

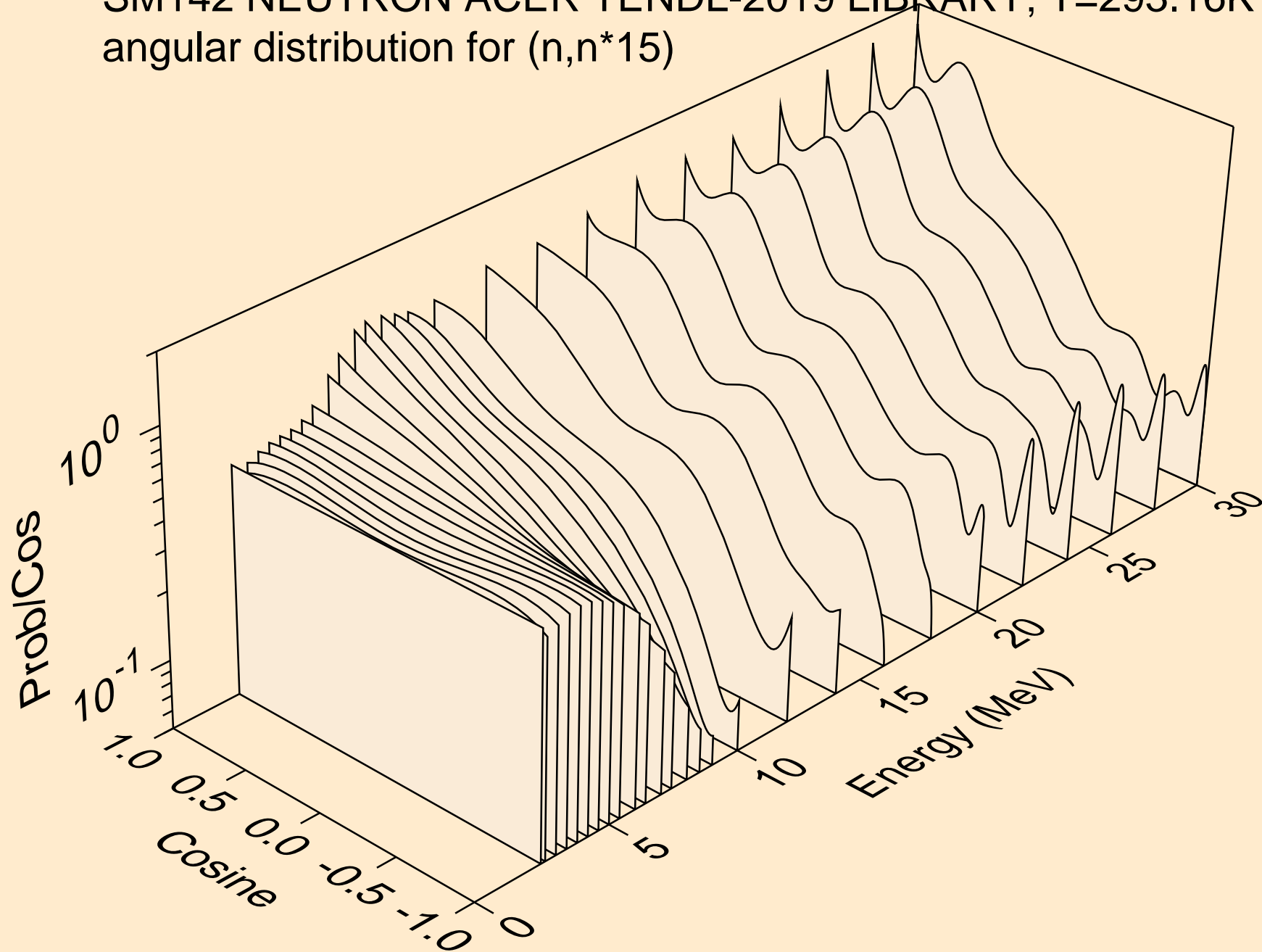

SM142 NEUTRON ACER TENDL-2019 LIBRARY; T=293.16K  
angular distribution for (n,n\*16)

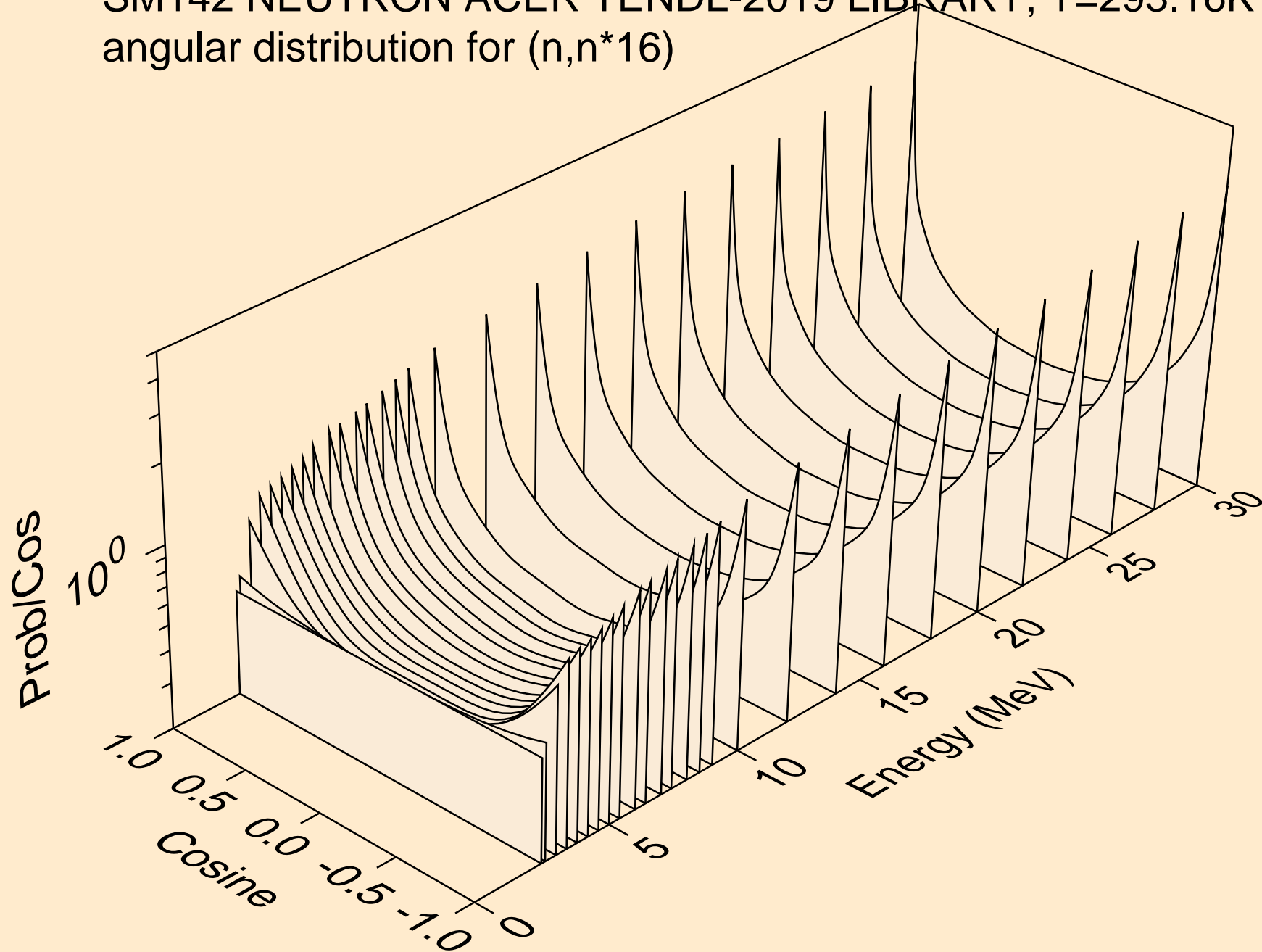

SM142 NEUTRON ACER TENDL-2019 LIBRARY; T=293.16K  
angular distribution for (n,n\*17)

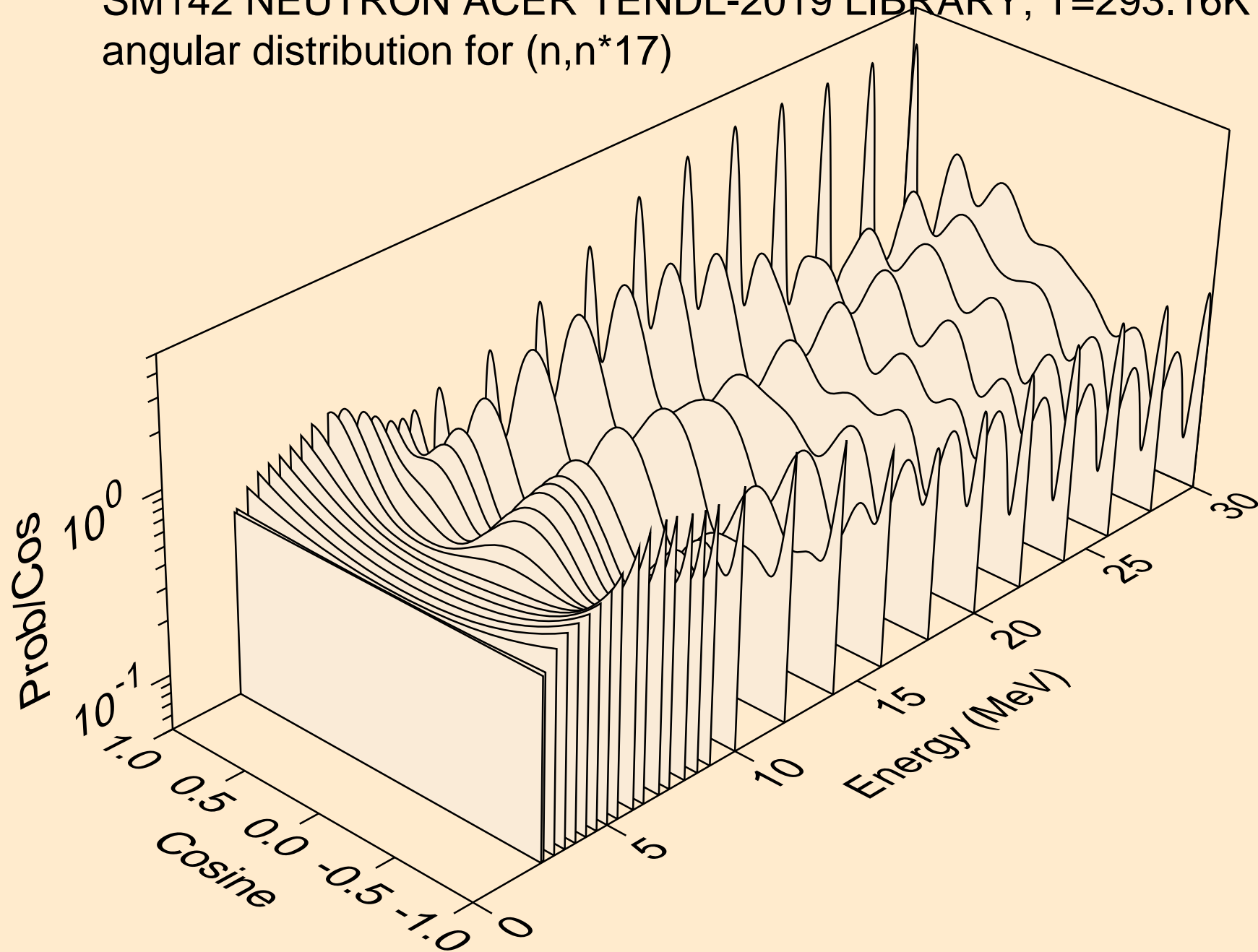



SM142 NEUTRON ACER TENDL-2019 LIBRARY; T=293.16K  
angular distribution for (n,n\*18)

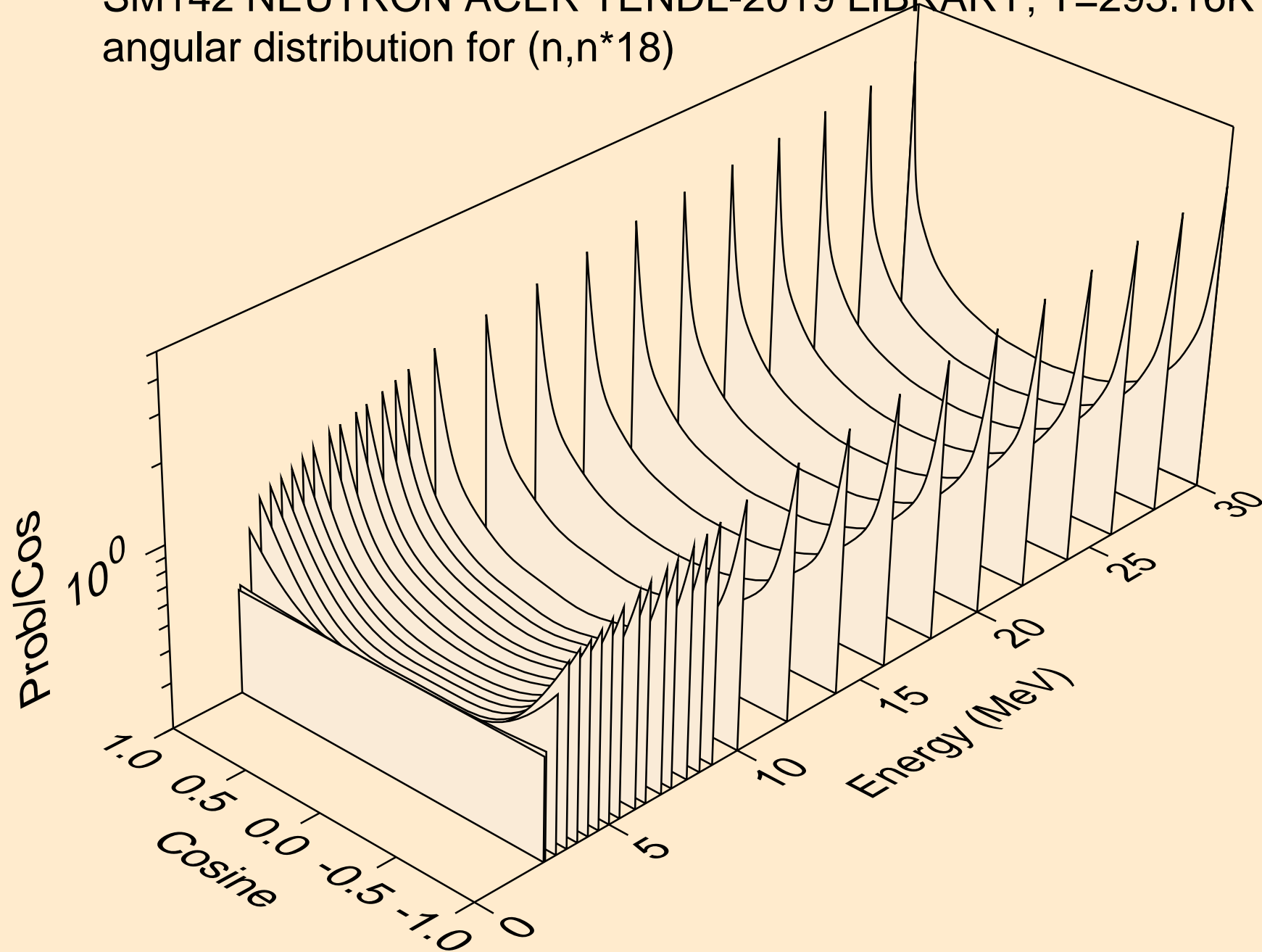

SM142 NEUTRON ACER TENDL-2019 LIBRARY; T=293.16K  
angular distribution for (n,n\*19)

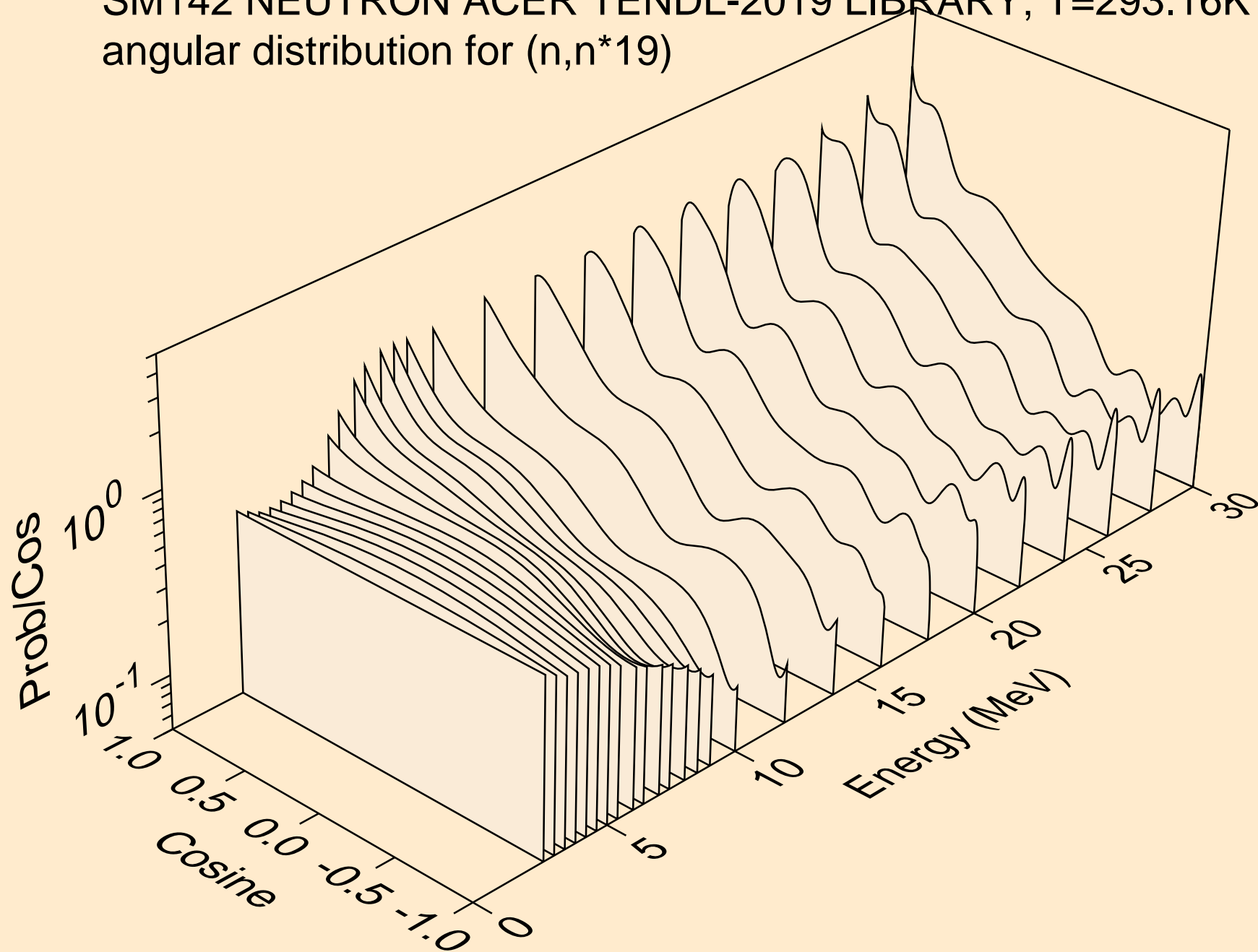

SM142 NEUTRON ACER TENDL-2019 LIBRARY; T=293.16K  
angular distribution for (n,n\*20)

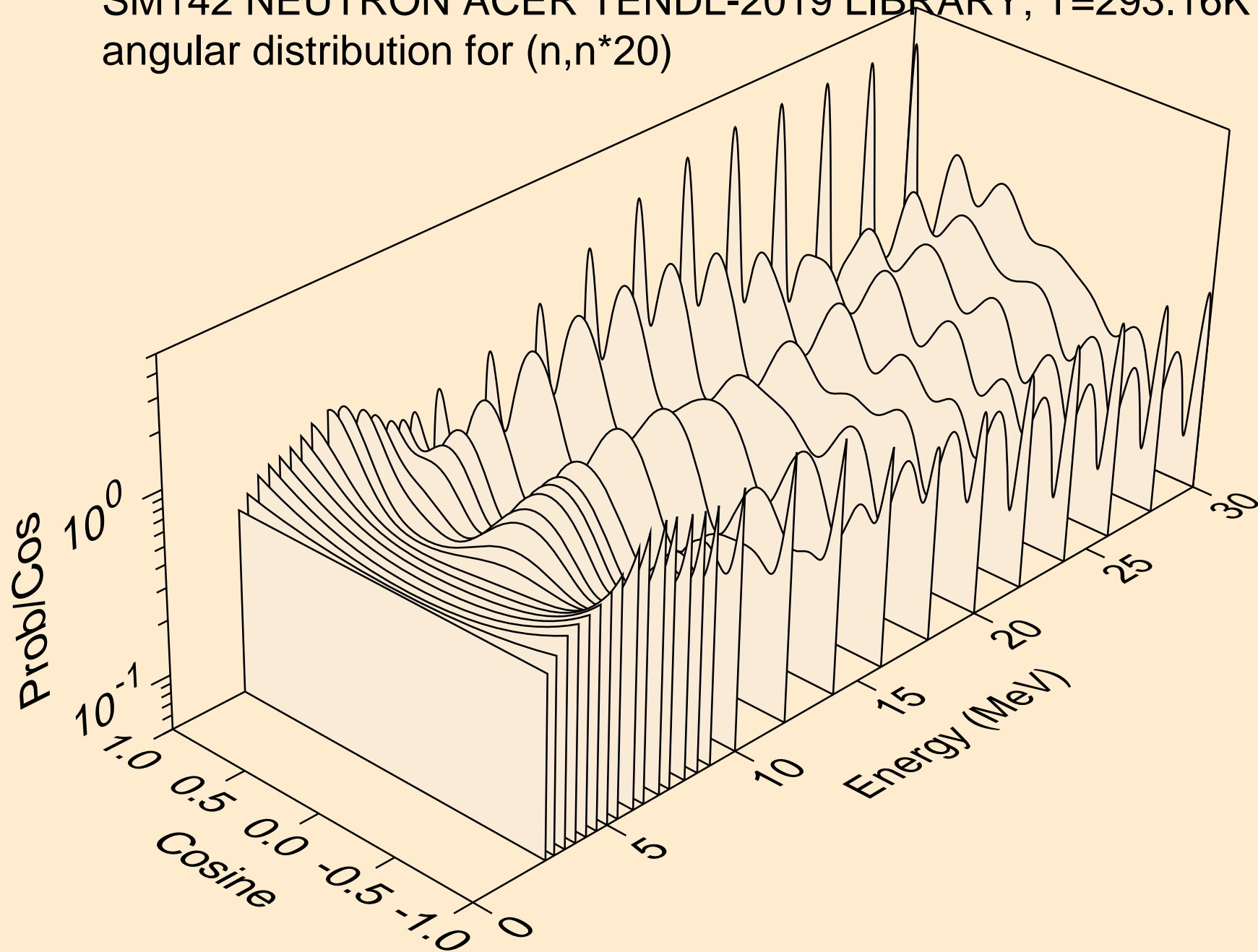

SM142 NEUTRON ACER TENDL-2019 LIBRARY; T=293.16K  
angular distribution for (n,n\*21)

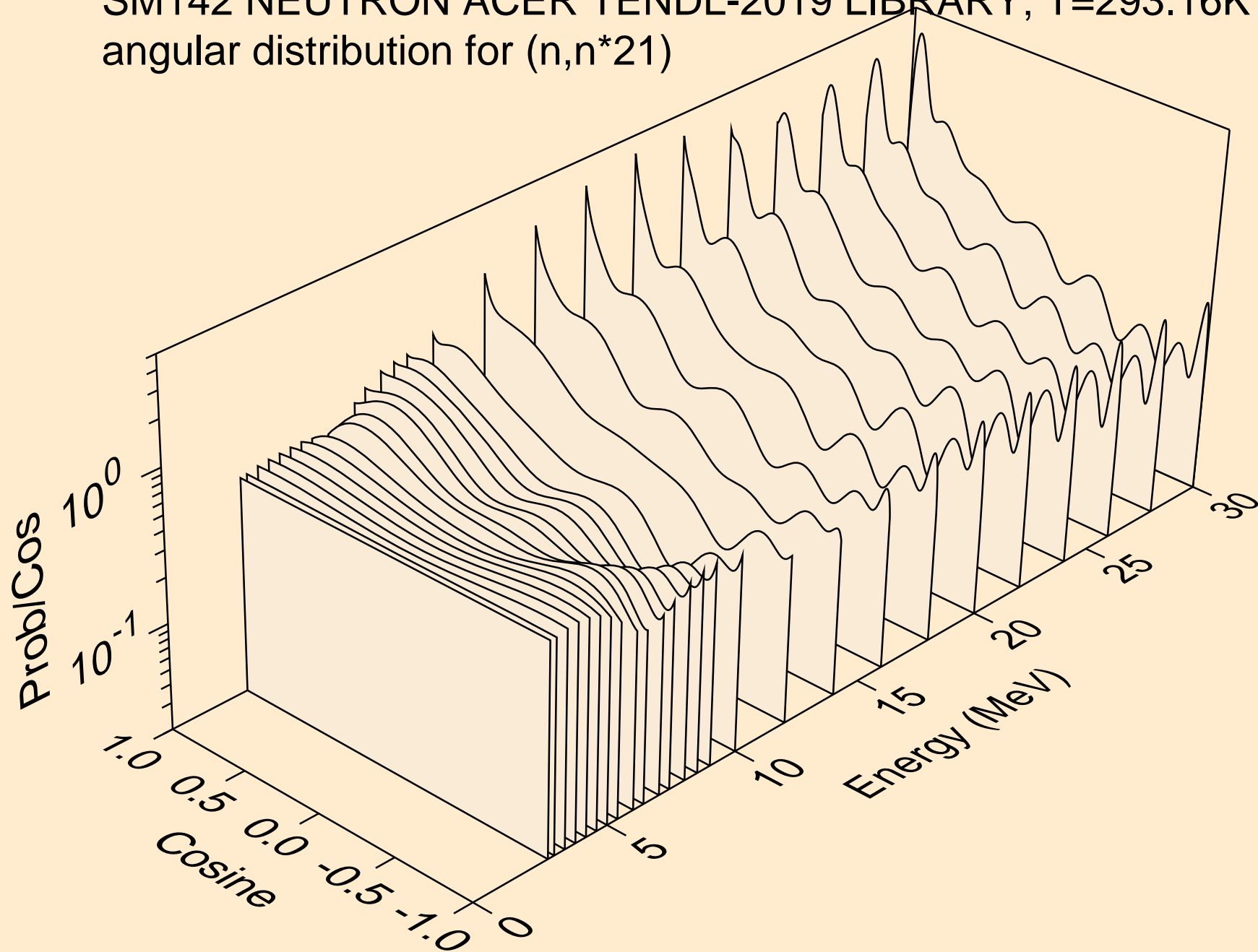

SM142 NEUTRON ACER TENDL-2019 LIBRARY; T=293.16K  
angular distribution for (n,n\*22)

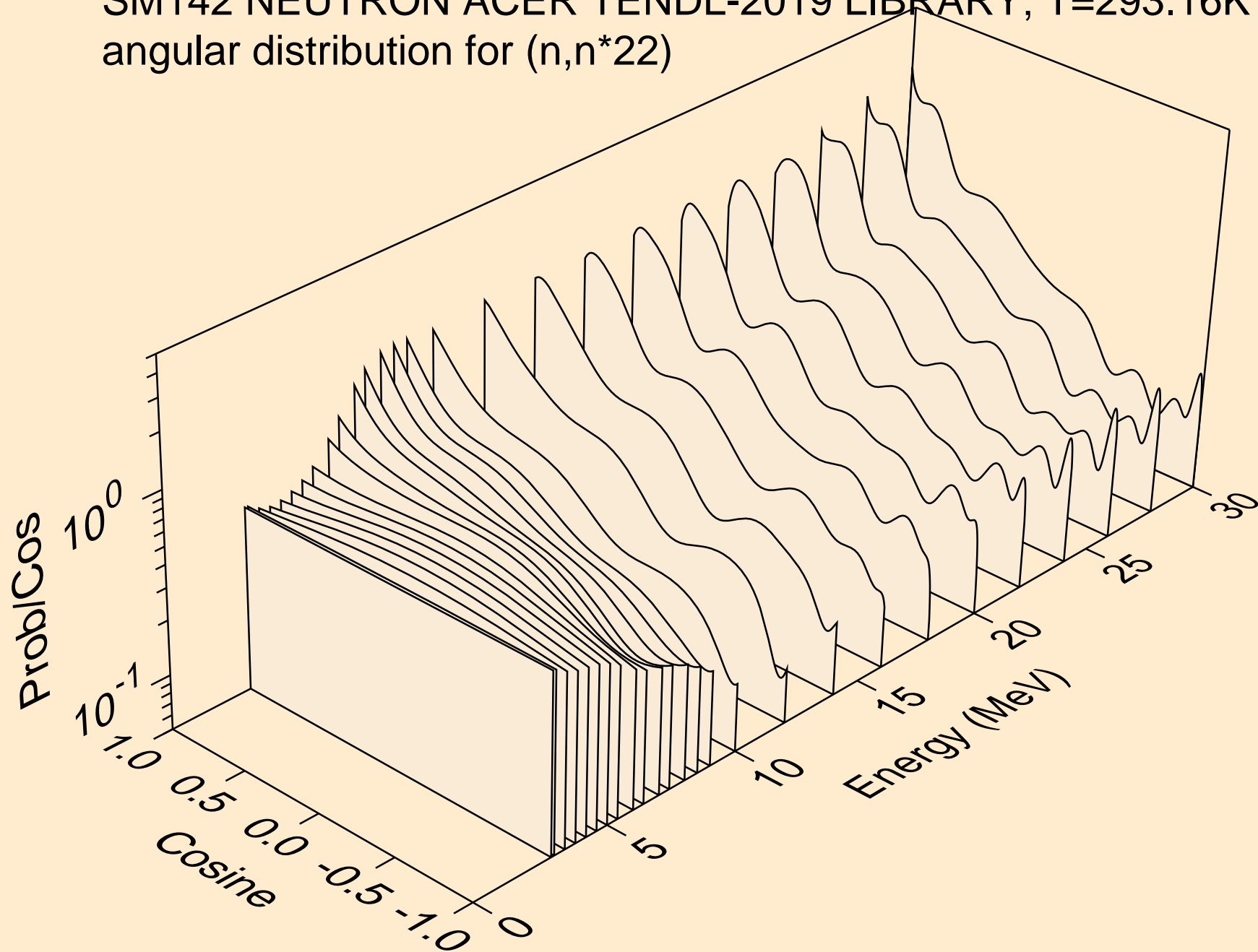

SM142 NEUTRON ACER TENDL-2019 LIBRARY; T=293.16K  
angular distribution for (n,n\*23)

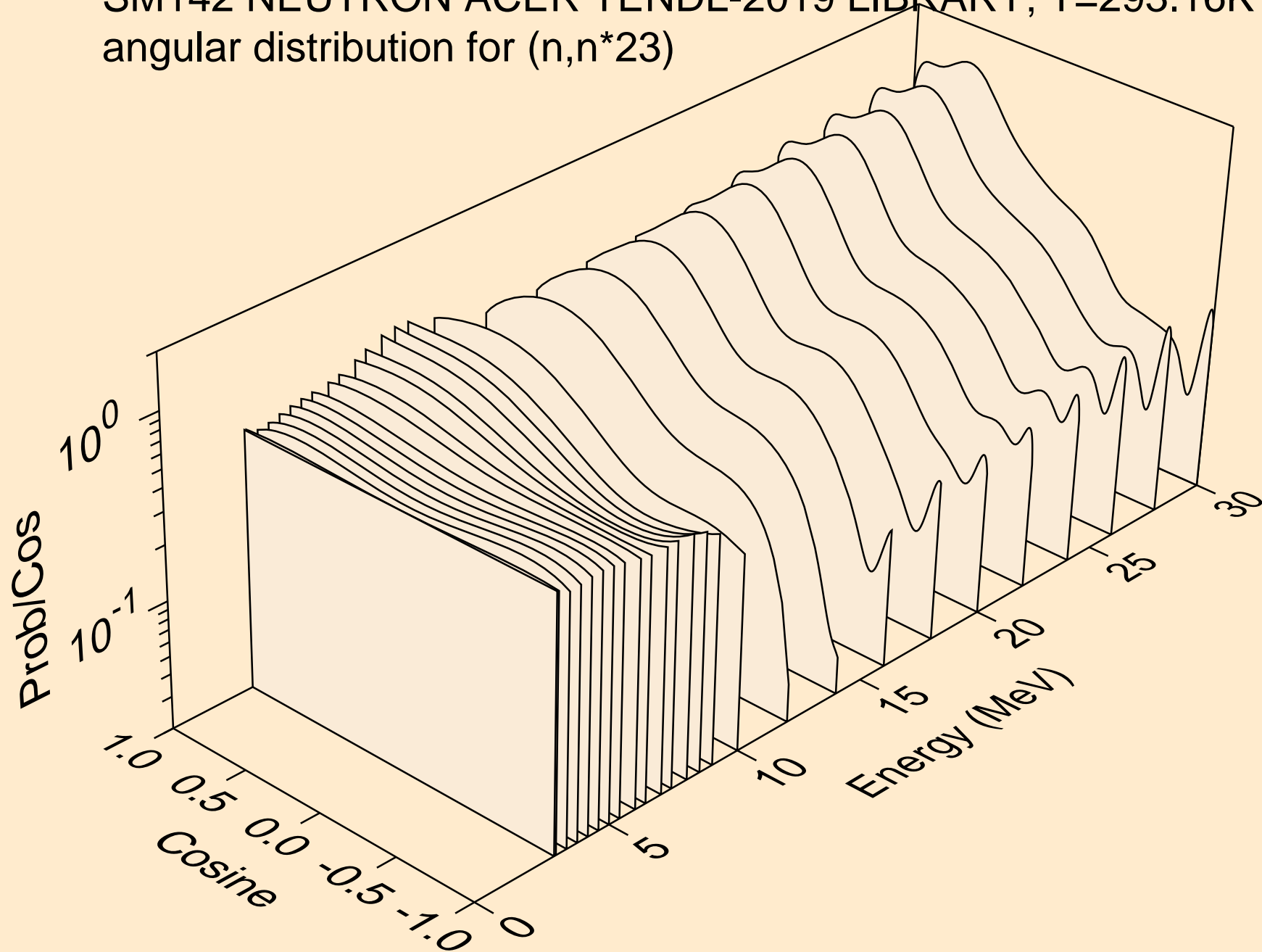

SM142 NEUTRON ACER TENDL-2019 LIBRARY; T=293.16K  
angular distribution for (n,n\*24)

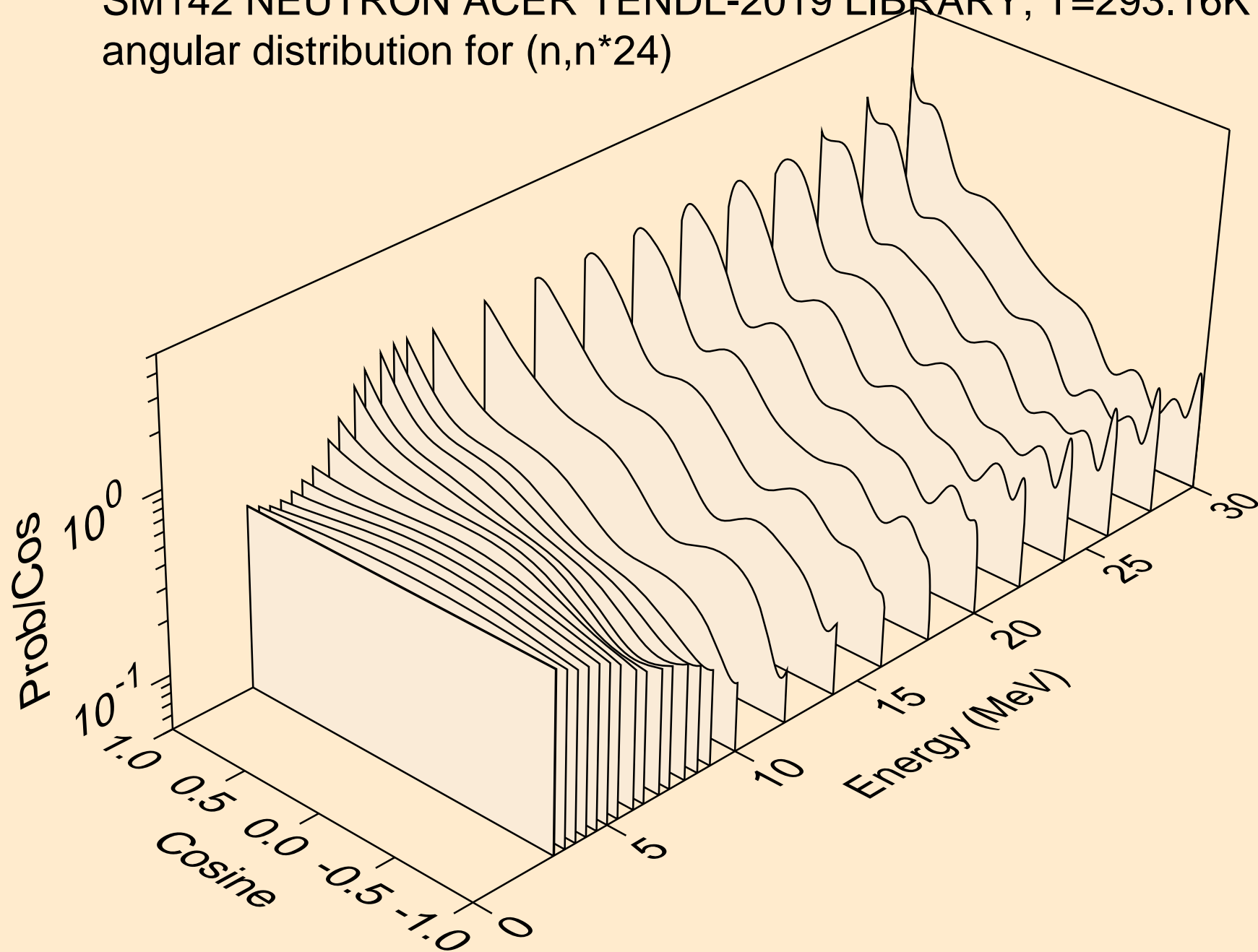

SM142 NEUTRON ACER TENDL-2019 LIBRARY; T=293.16K  
angular distribution for (n,n\*25)

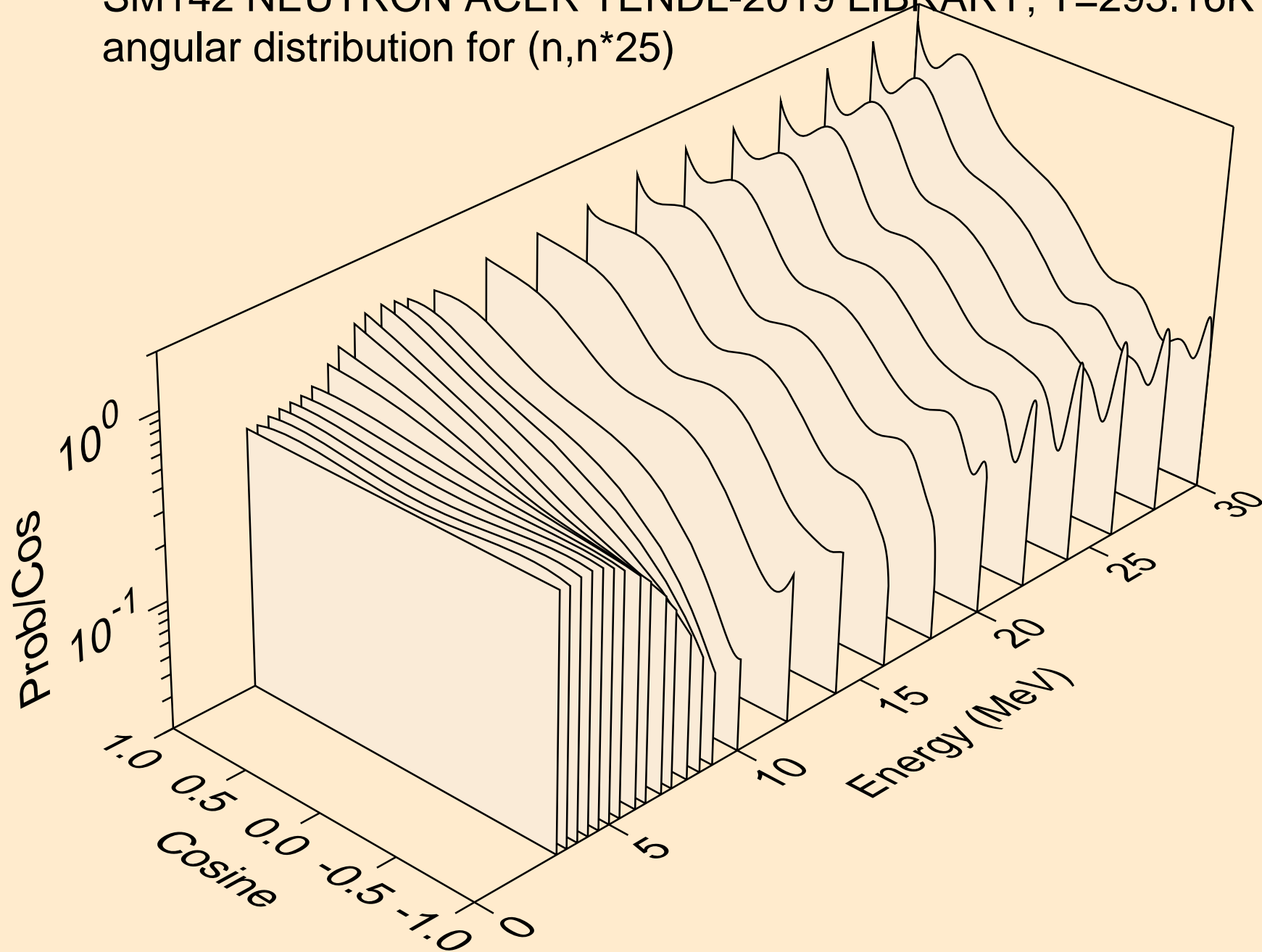



SM142 NEUTRON ACER TENDL-2019 LIBRARY; T=293.16K  
angular distribution for (n,n\*26)

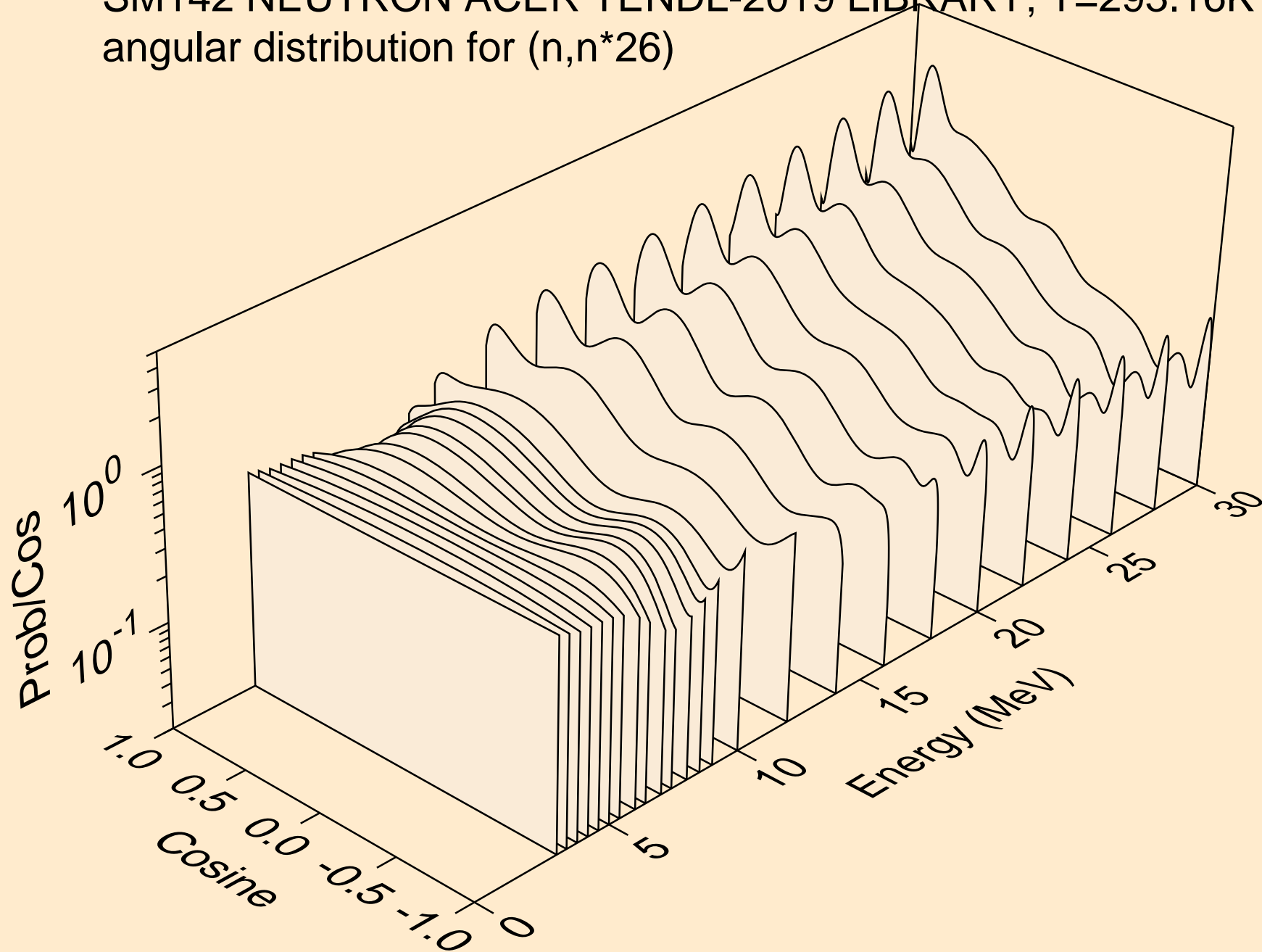

SM142 NEUTRON ACER TENDL-2019 LIBRARY; T=293.16K  
angular distribution for (n,n\*27)

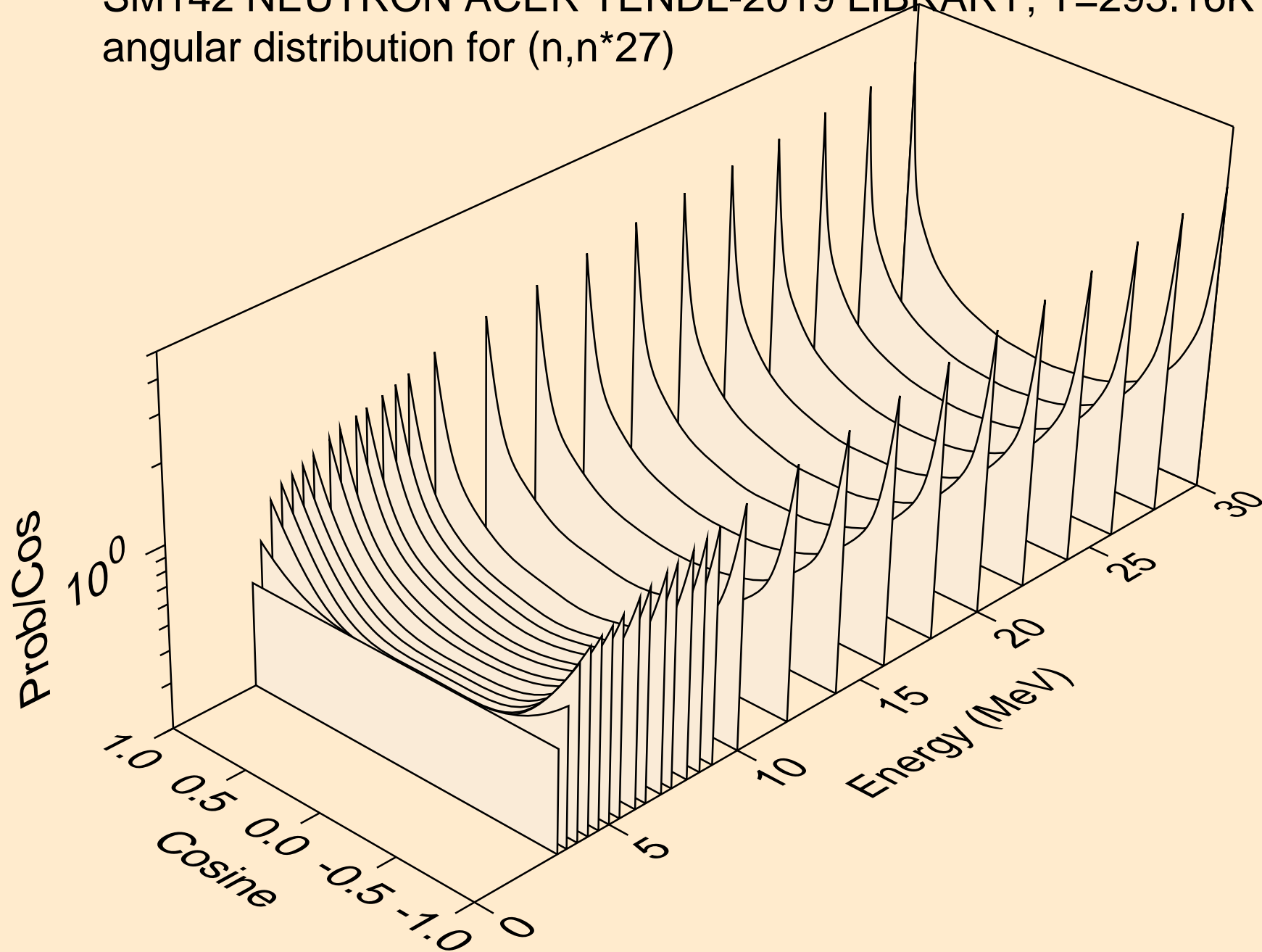

SM142 NEUTRON ACER TENDL-2019 LIBRARY; T=293.16K  
angular distribution for (n,n\*28)

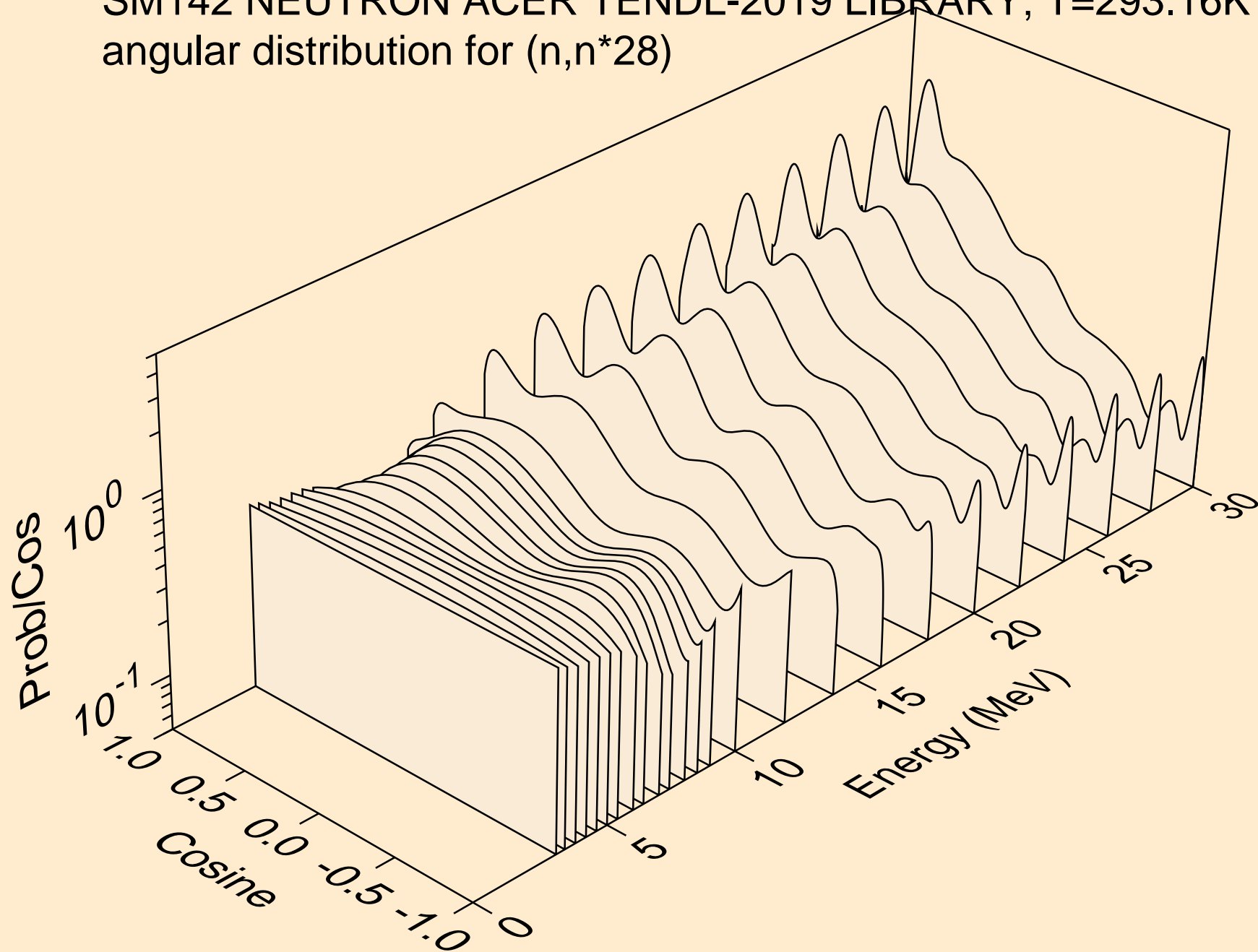

SM142 NEUTRON ACER TENDL-2019 LIBRARY; T=293.16K  
Neutron emission for (n,x)

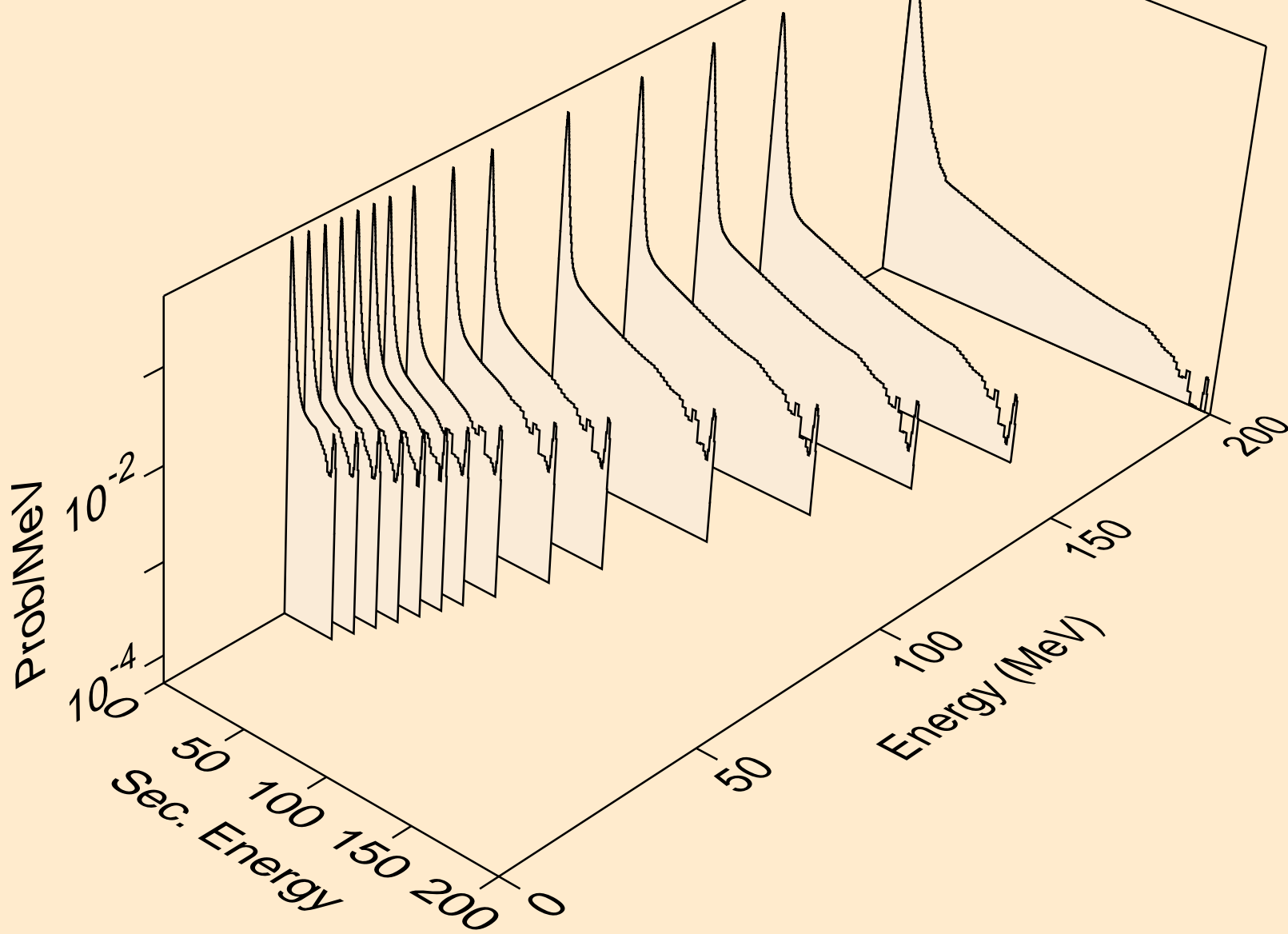

SM142 NEUTRON ACER TENDL-2019 LIBRARY; T=293.16K  
Neutron emission for (n,2nd)

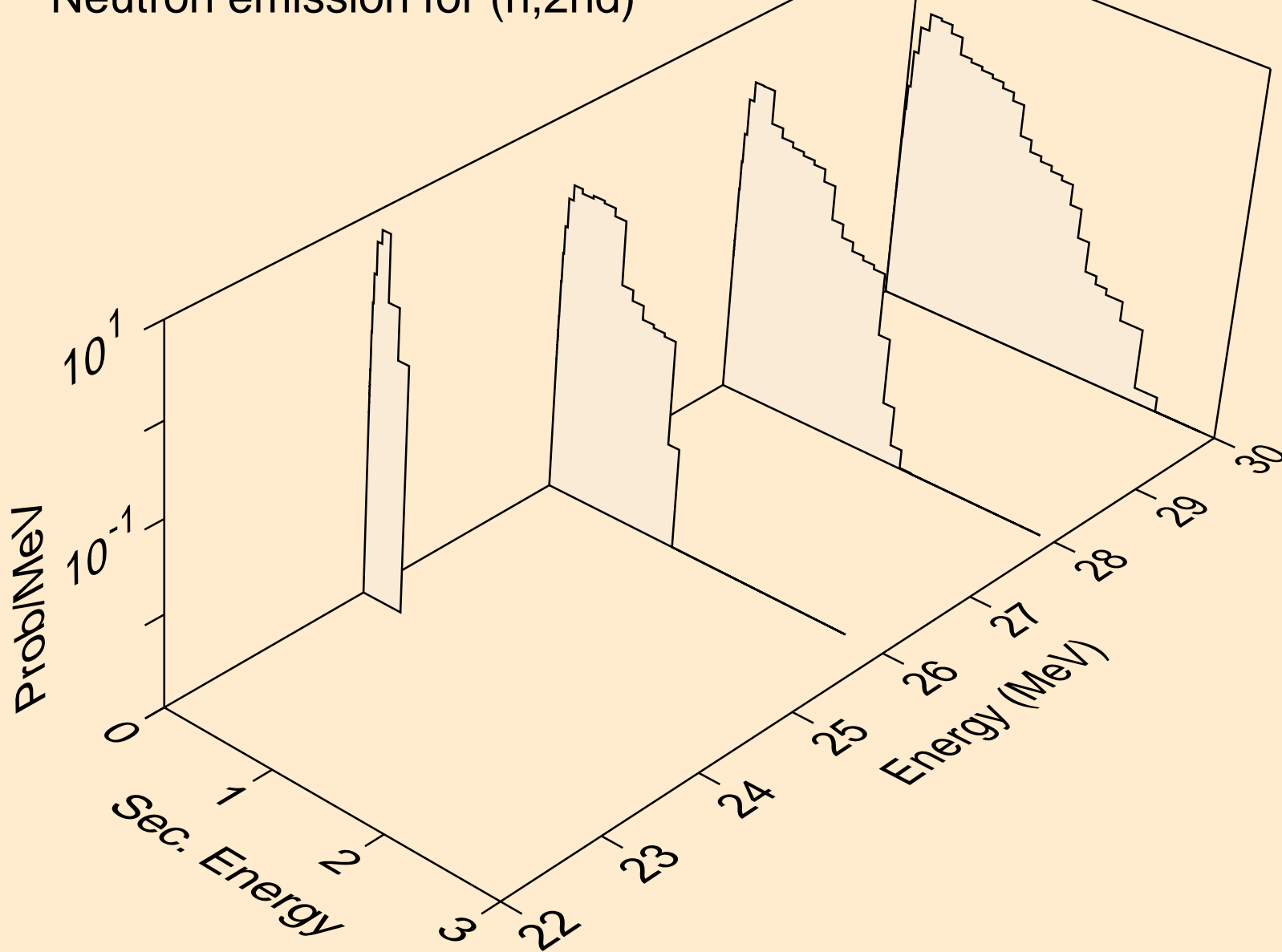

SM142 NEUTRON ACER TENDL-2019 LIBRARY; T=293.16K  
Neutron emission for (n,2n)

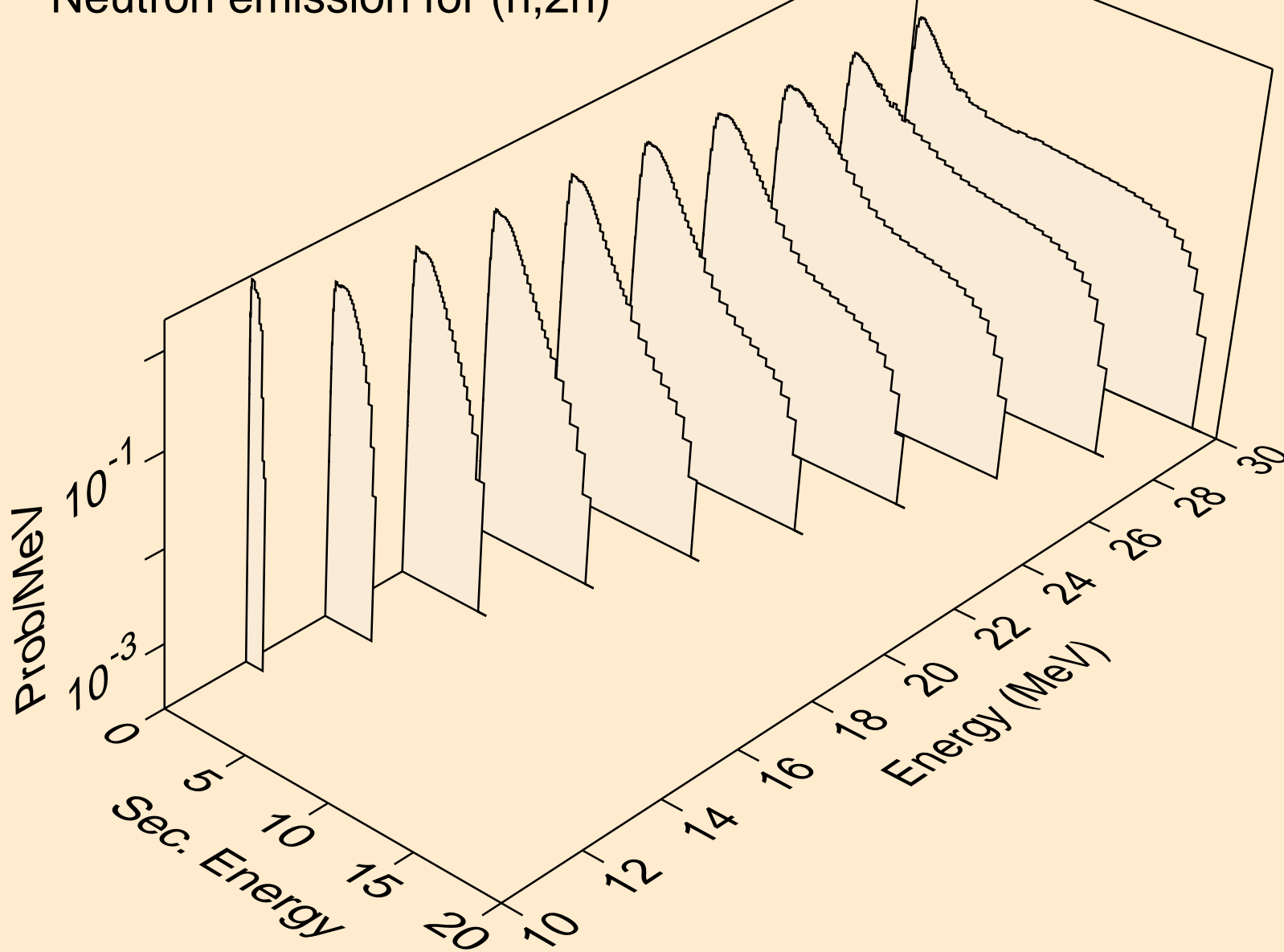

SM142 NEUTRON ACER TENDL-2019 LIBRARY; T=293.16K  
Neutron emission for (n,3n)

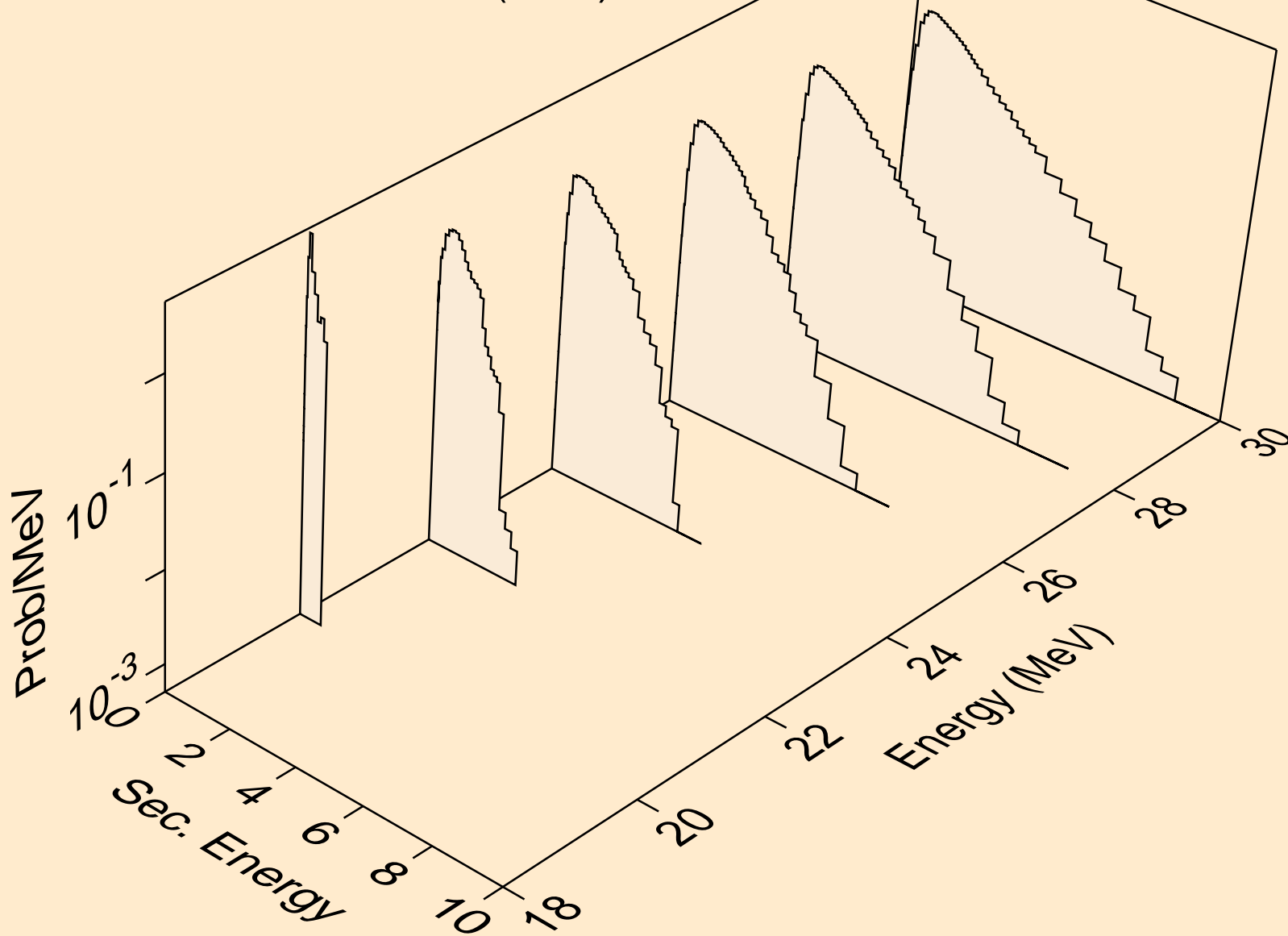

SM142 NEUTRON ACER TENDL-2019 LIBRARY; T=293.16K  
Neutron emission for (n,n\*)a

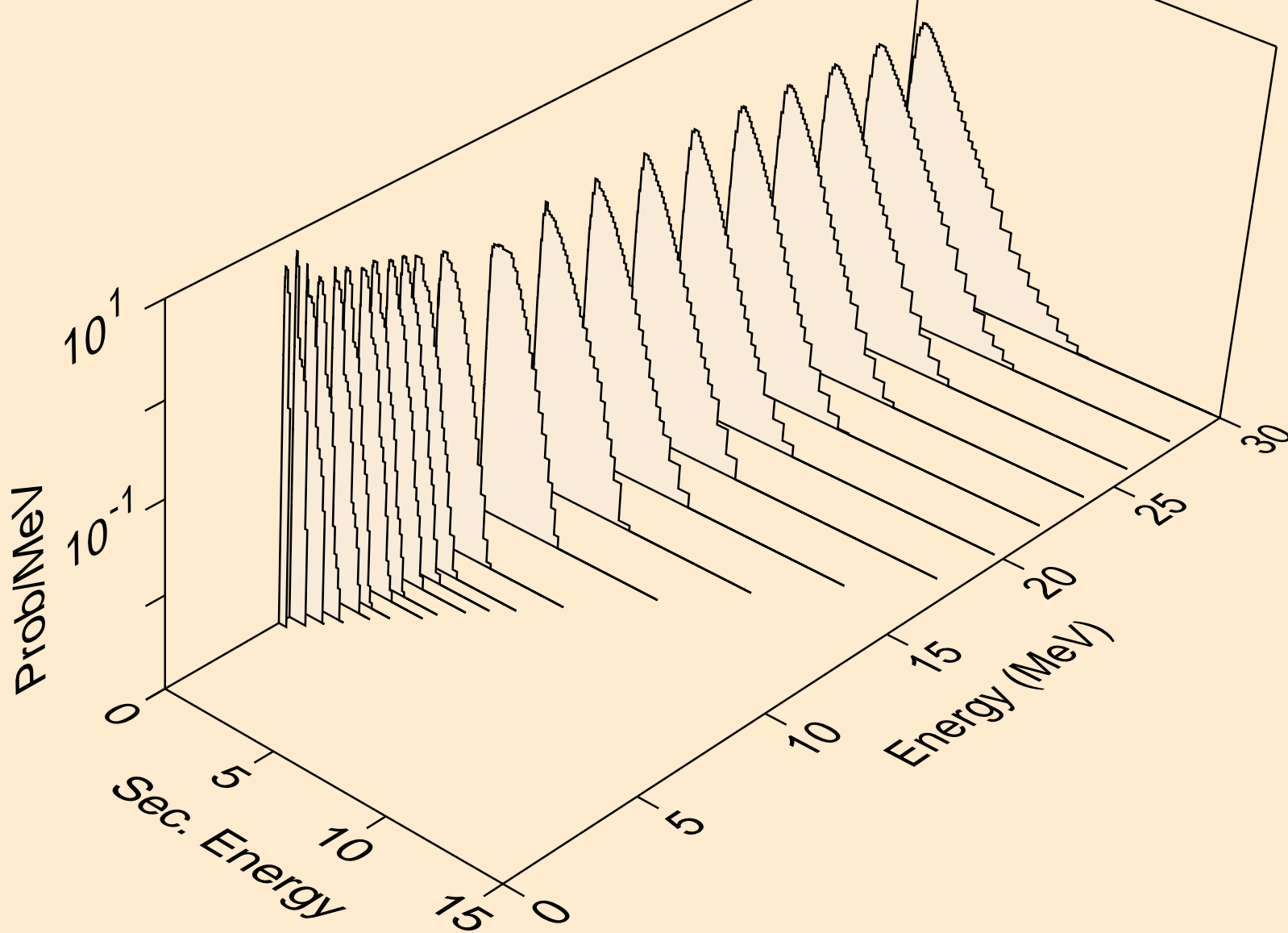



SM142 NEUTRON ACER TENDL-2019 LIBRARY; T=293.16K  
Neutron emission for (n,2n)a

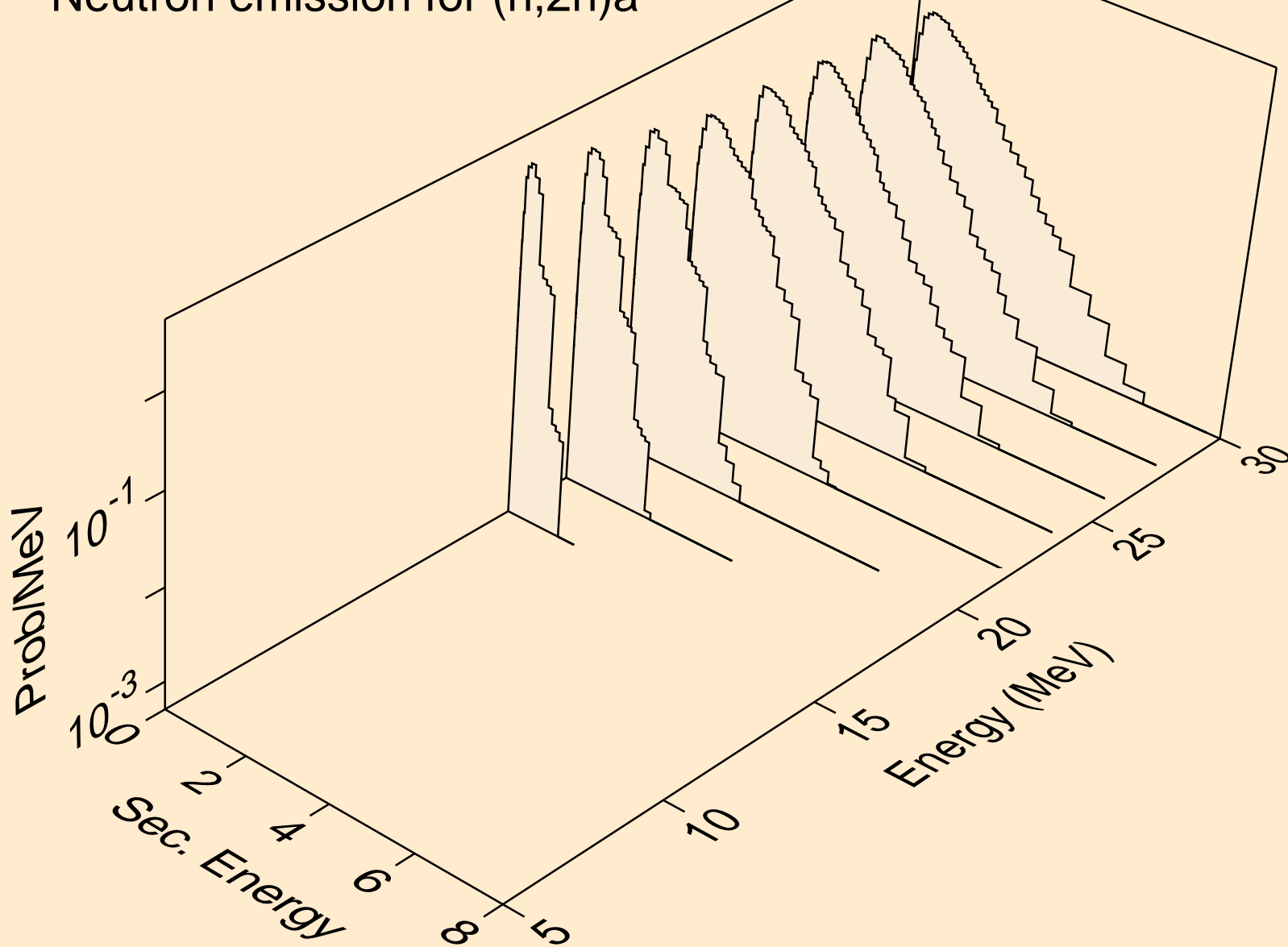

SM142 NEUTRON ACER TENDL-2019 LIBRARY; T=293.16K  
Neutron emission for (n,3n)a

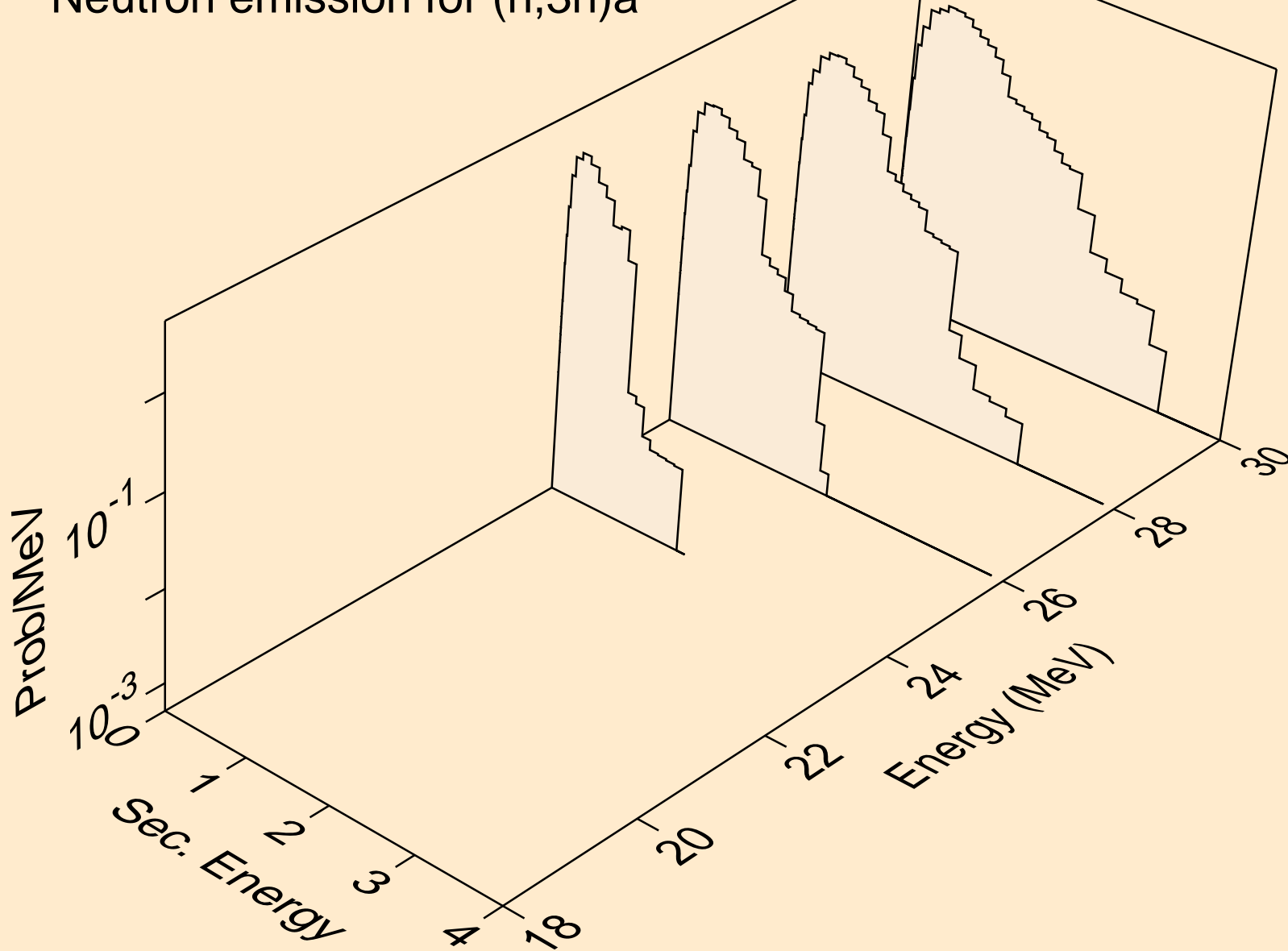

SM142 NEUTRON ACER TENDL-2019 LIBRARY; T=293.16K  
Neutron emission for (n,n\*)p

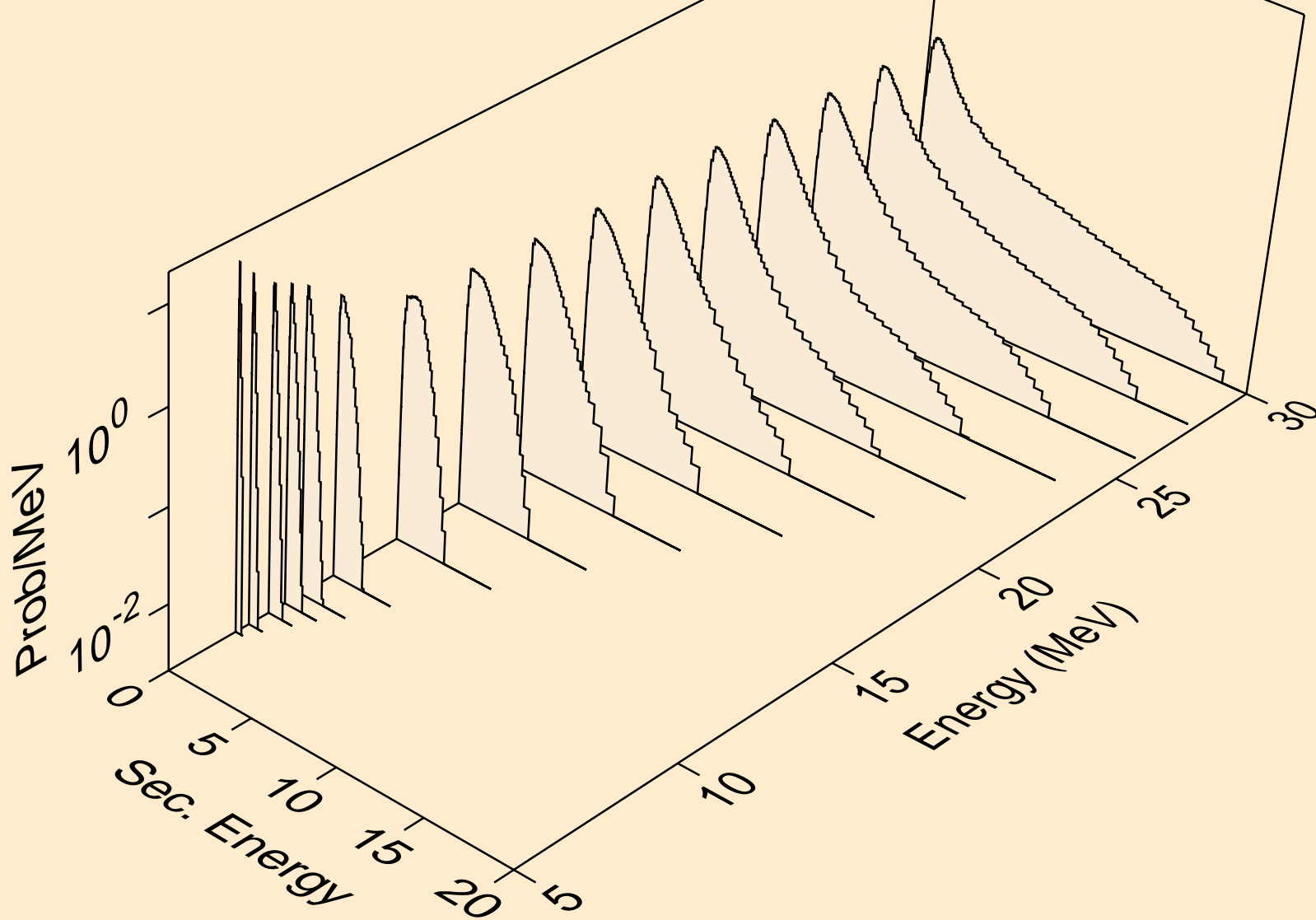

SM142 NEUTRON ACER TENDL-2019 LIBRARY; T=293.16K  
Neutron emission for (n,n\*)2a

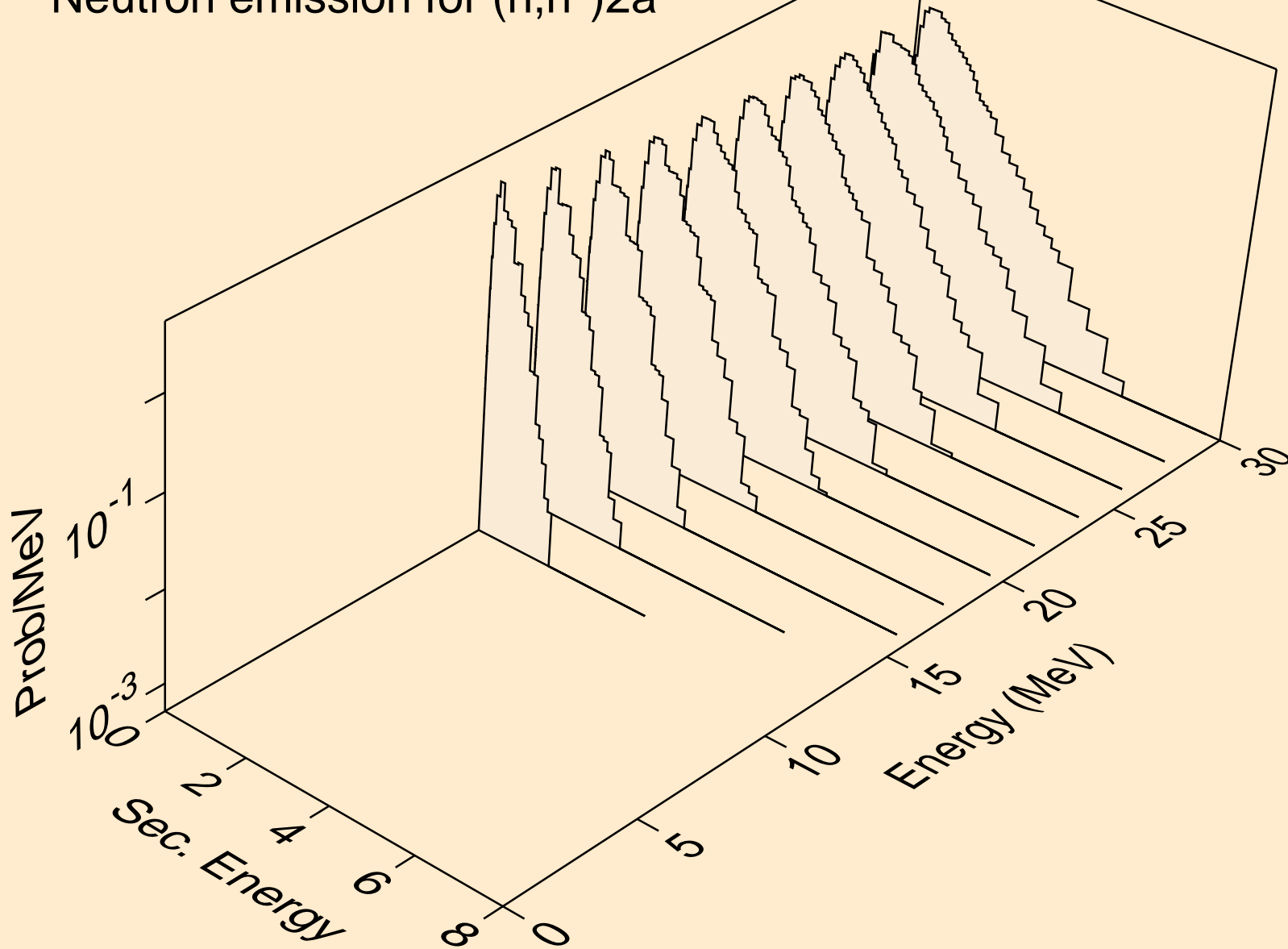

SM142 NEUTRON ACER TENDL-2019 LIBRARY; T=293.16K  
Neutron emission for (n,n\*)d

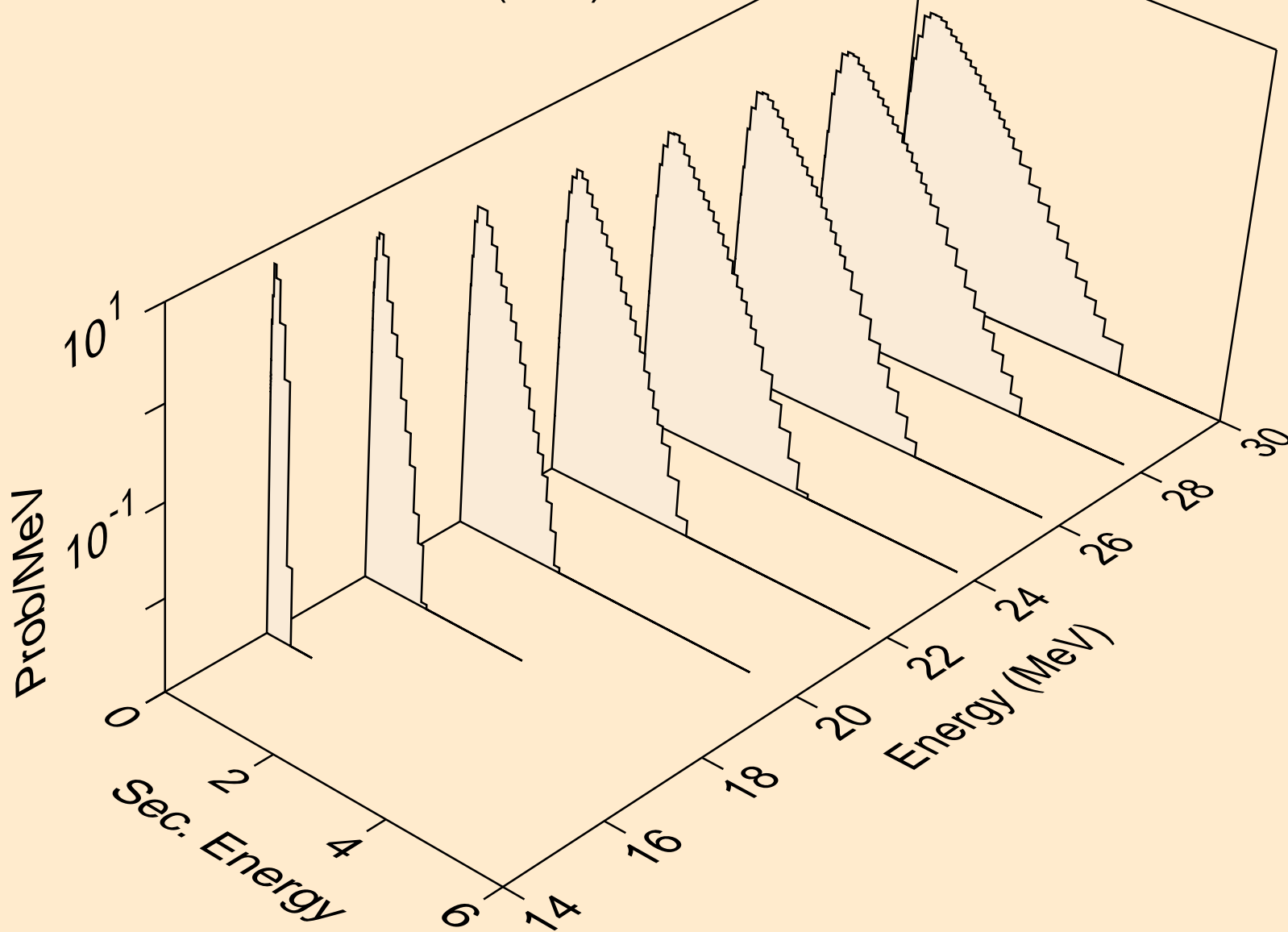

SM142 NEUTRON ACER TENDL-2019 LIBRARY; T=293.16K  
Neutron emission for (n,n\*)t

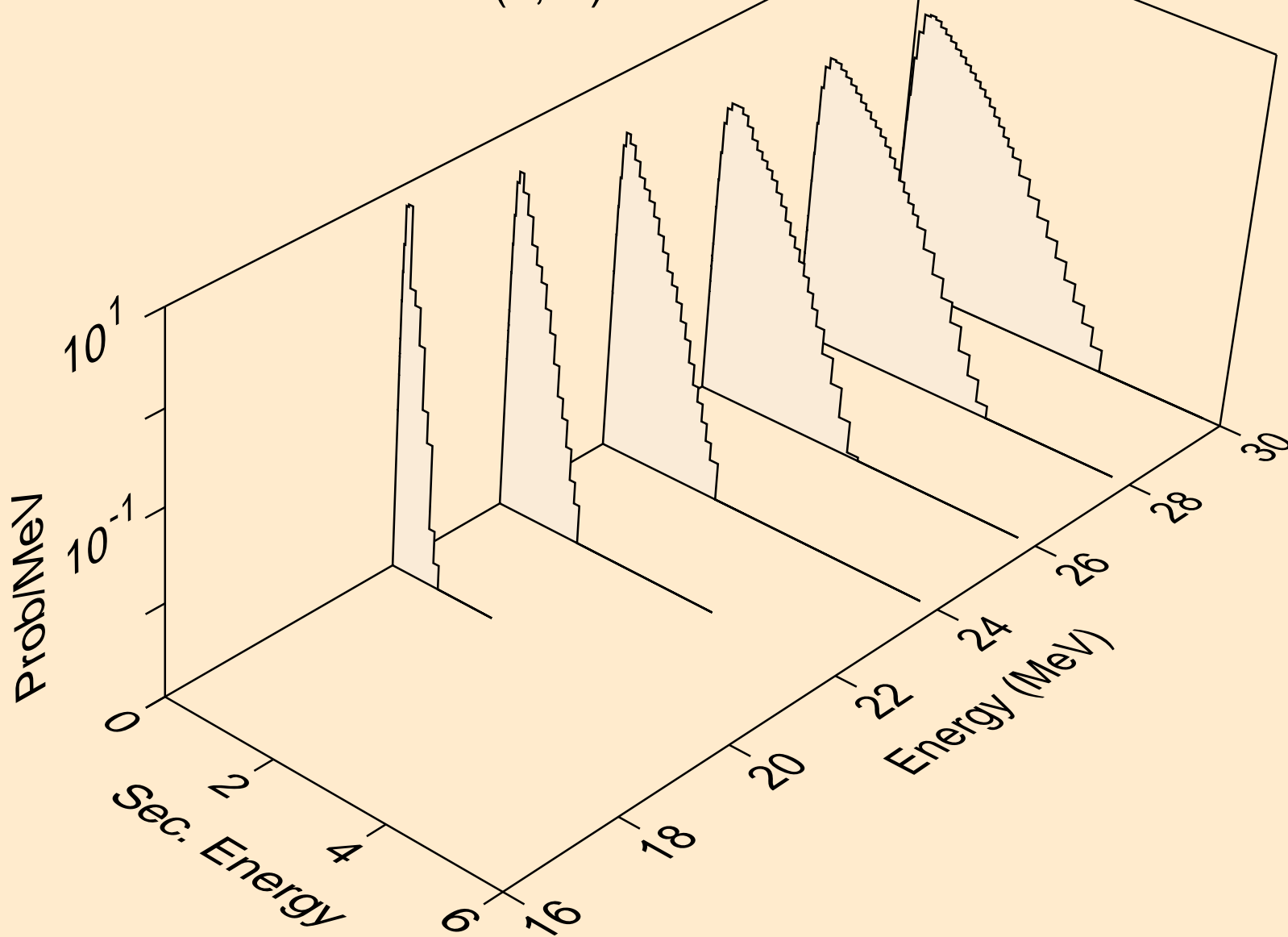

SM142 NEUTRON ACER TENDL-2019 LIBRARY; T=293.16K  
Neutron emission for (n,n\*)he3

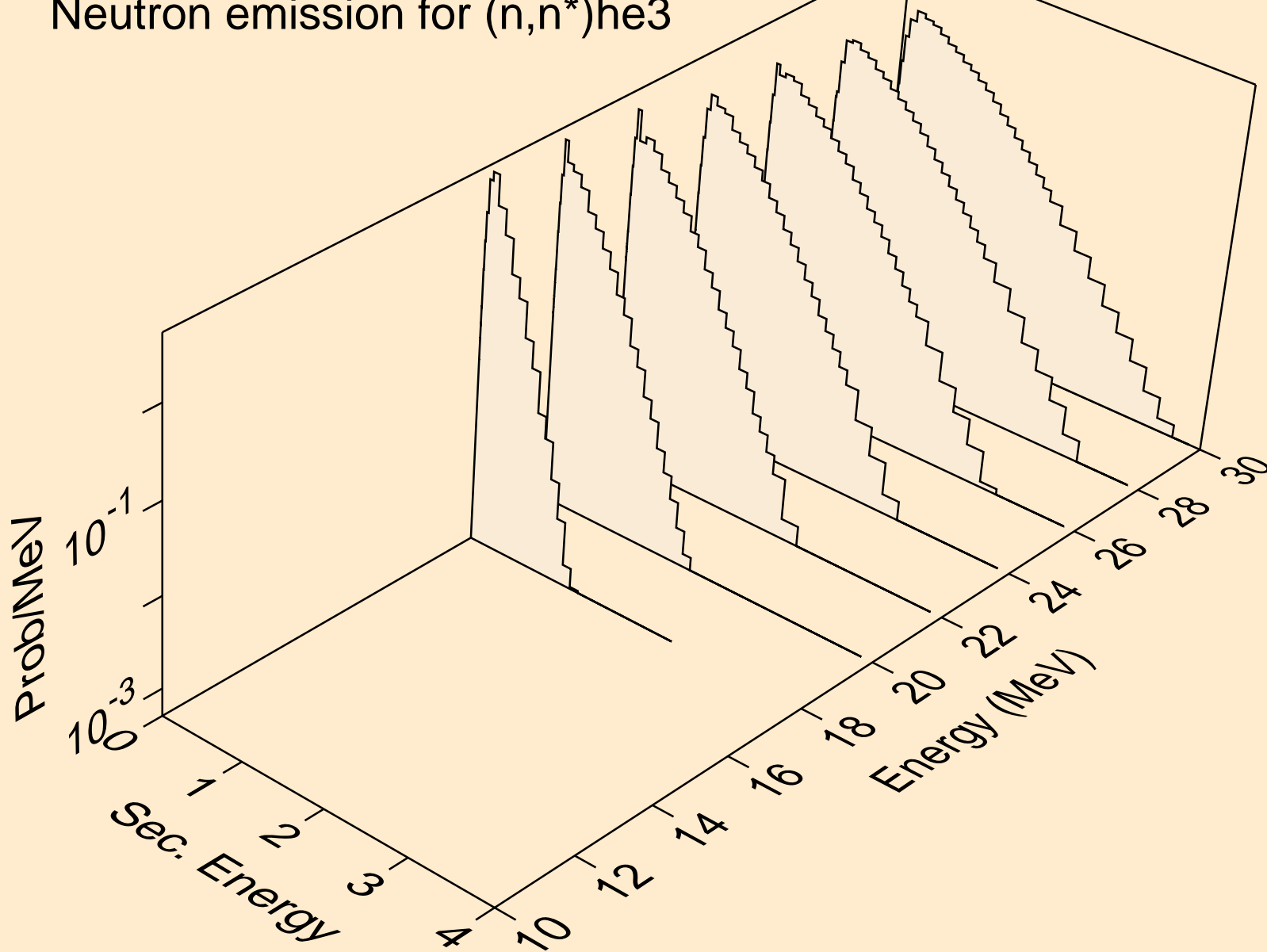

SM142 NEUTRON ACER TENDL-2019 LIBRARY; T=293.16K  
Neutron emission for (n,2np)

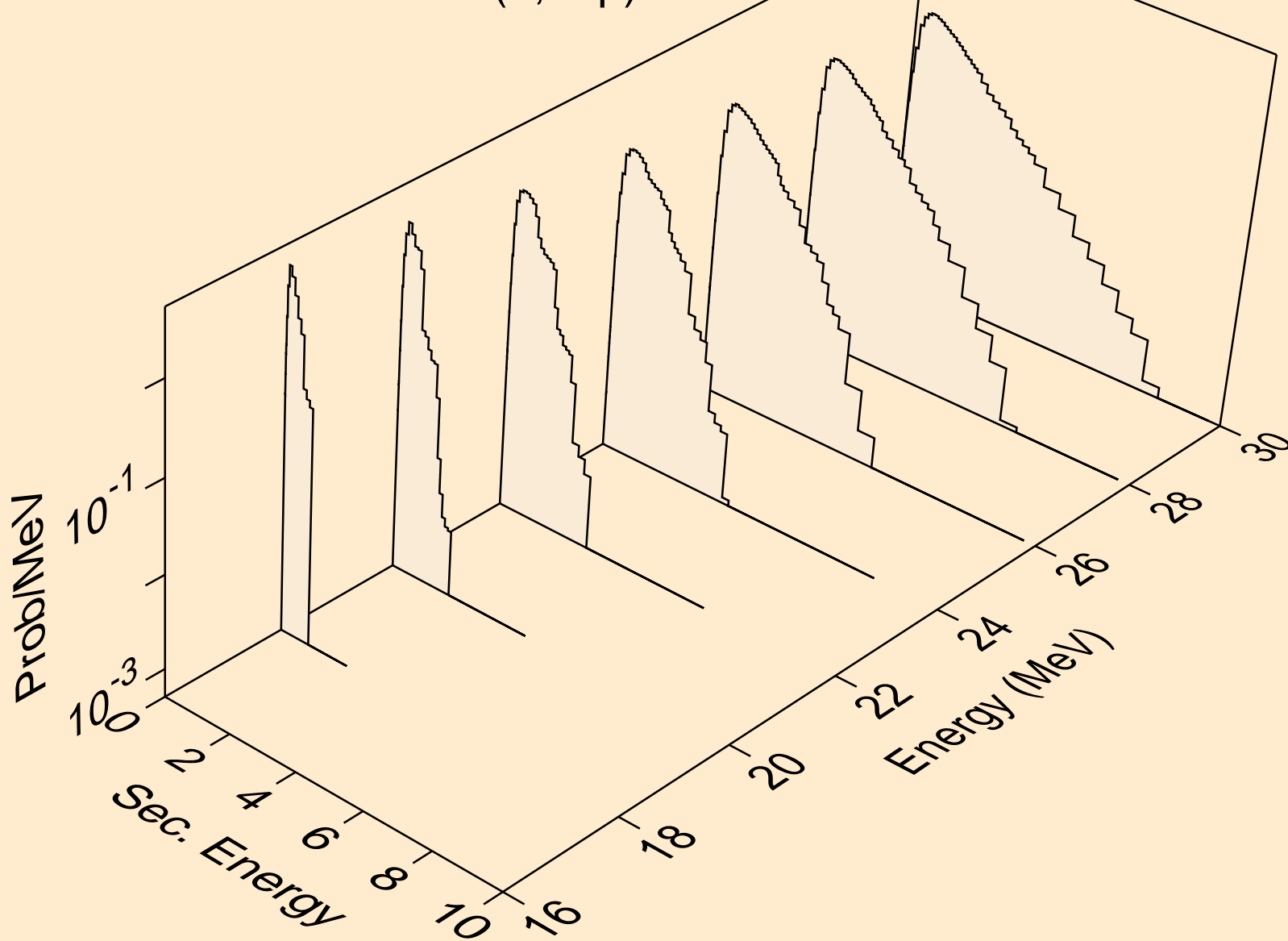



SM142 NEUTRON ACER TENDL-2019 LIBRARY; T=293.16K  
Neutron emission for (n,3np)

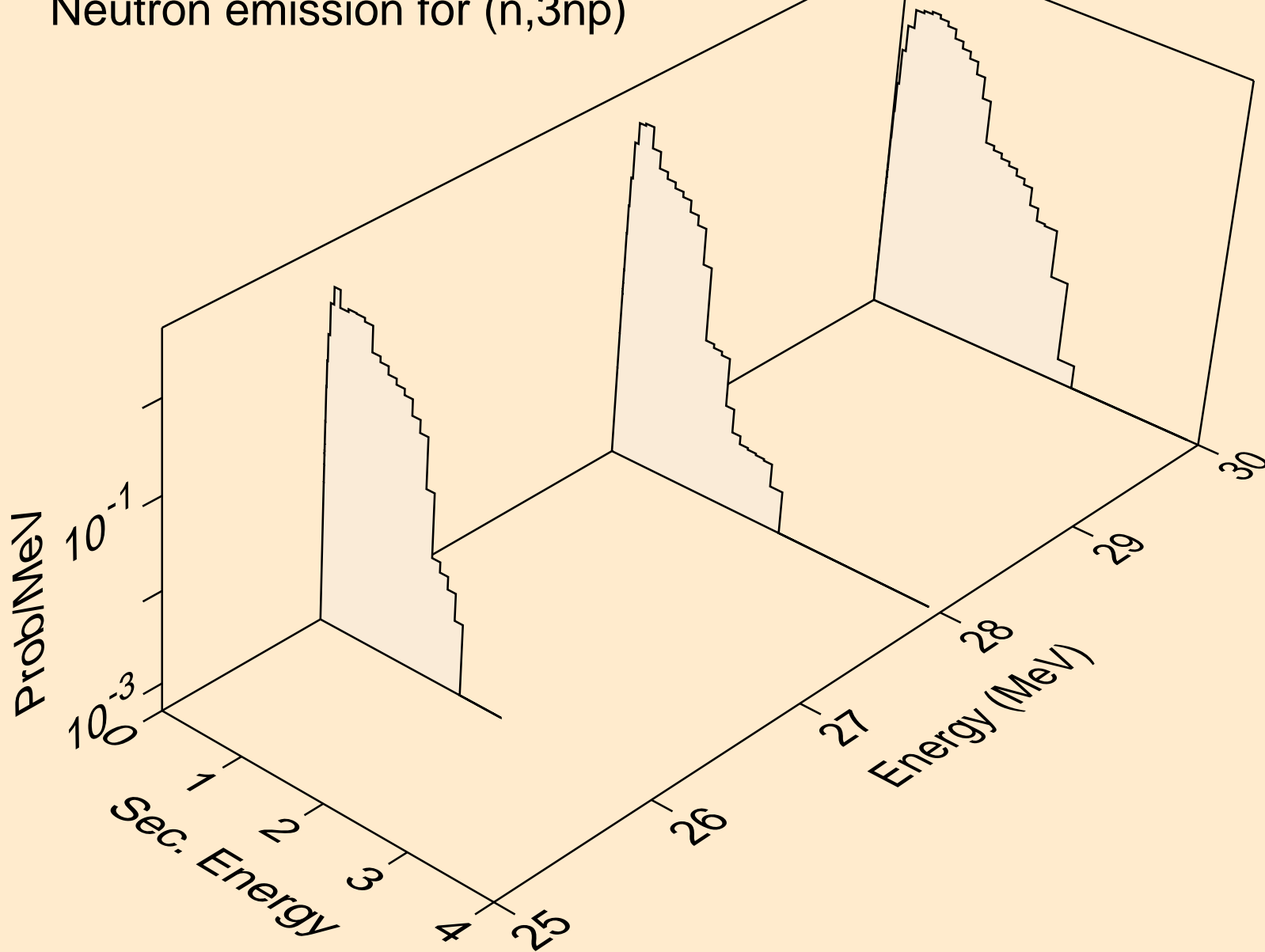

SM142 NEUTRON ACER TENDL-2019 LIBRARY; T=293.16K  
Neutron emission for (n,2np)

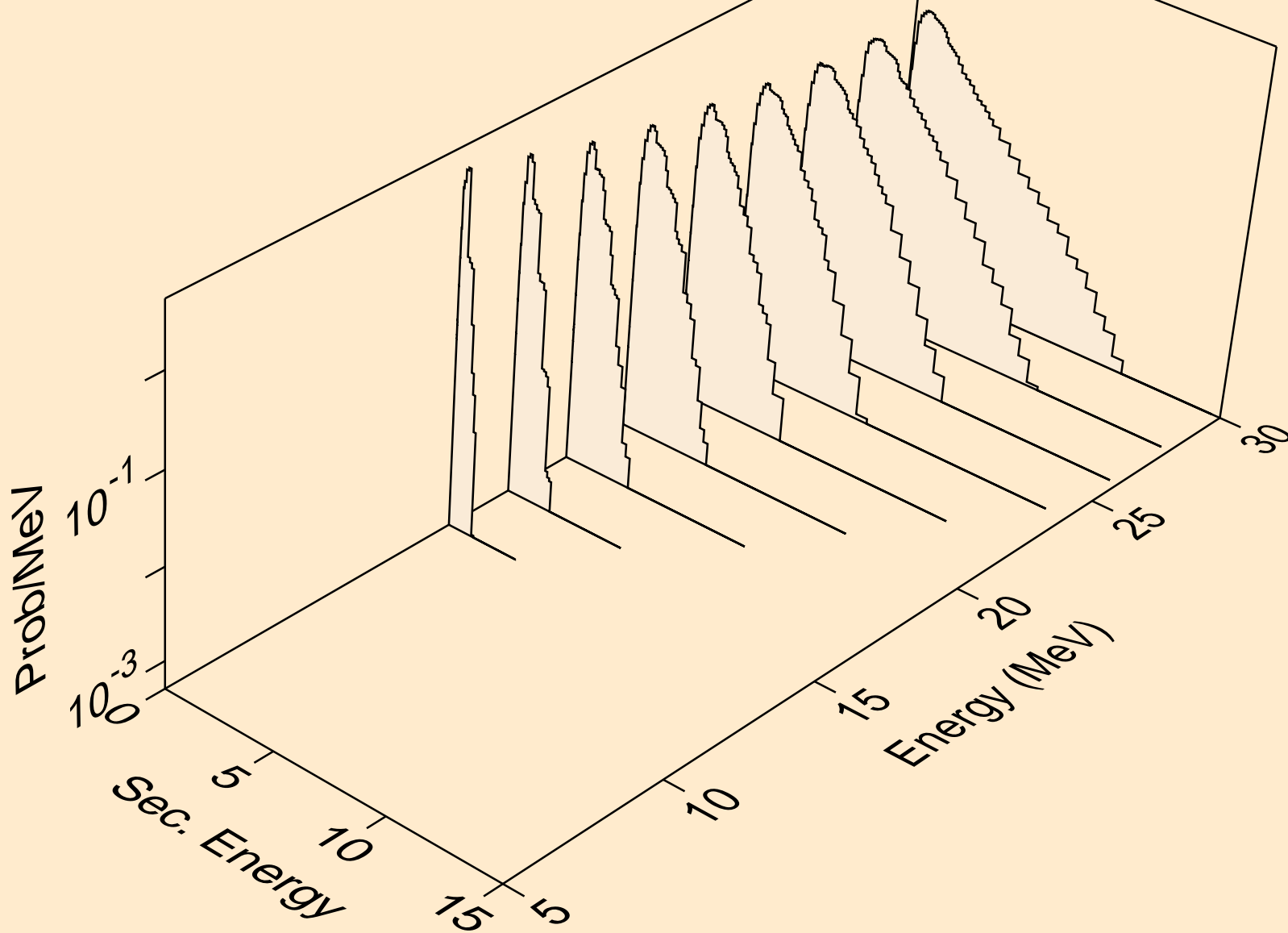

SM142 NEUTRON ACER TENDL-2019 LIBRARY; T=293.16K  
Neutron emission for (n,npa)

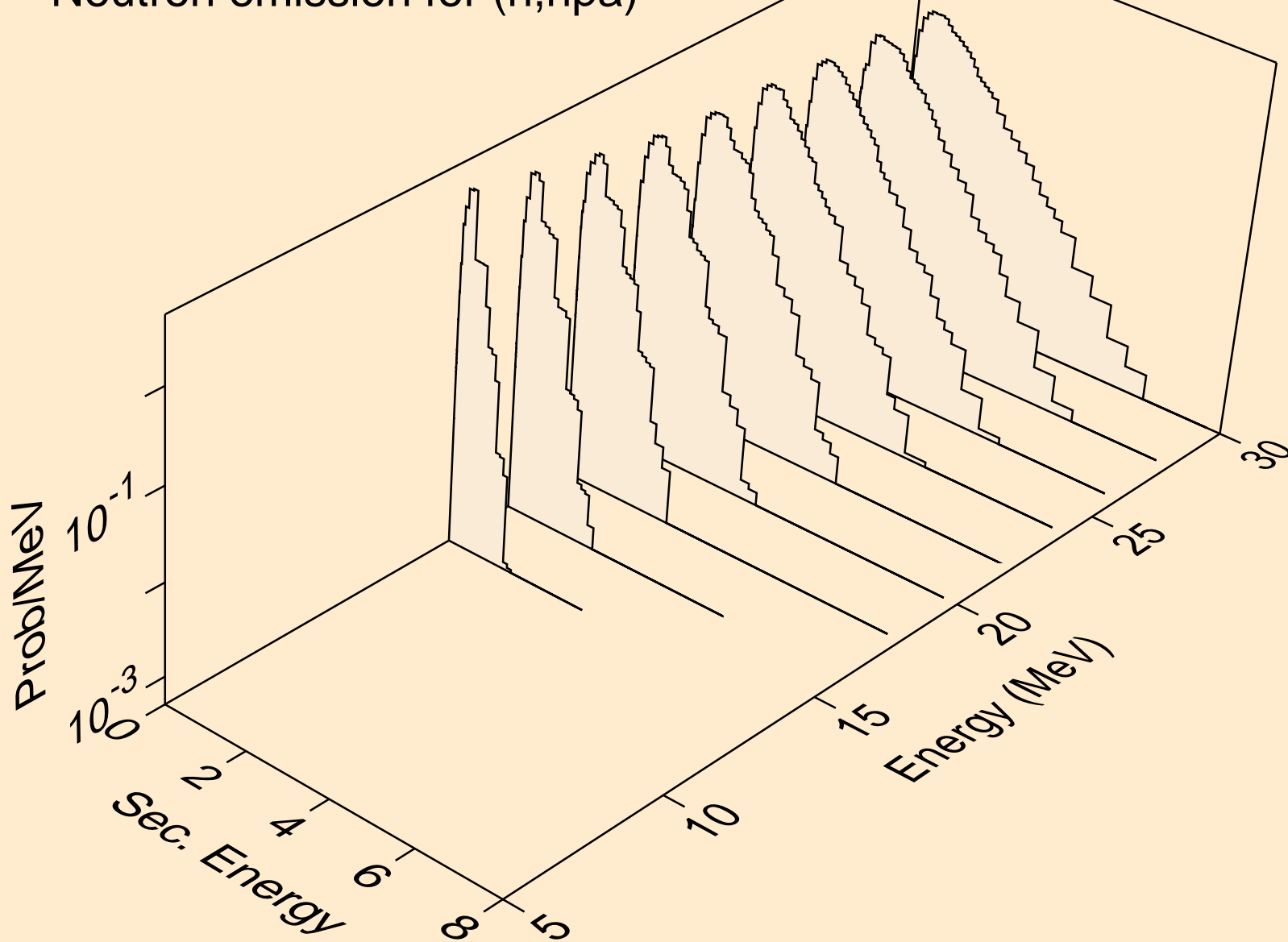

SM142 NEUTRON ACER TENDL-2019 LIBRARY; T=293.16K  
Neutron emission for (n,n\*c)

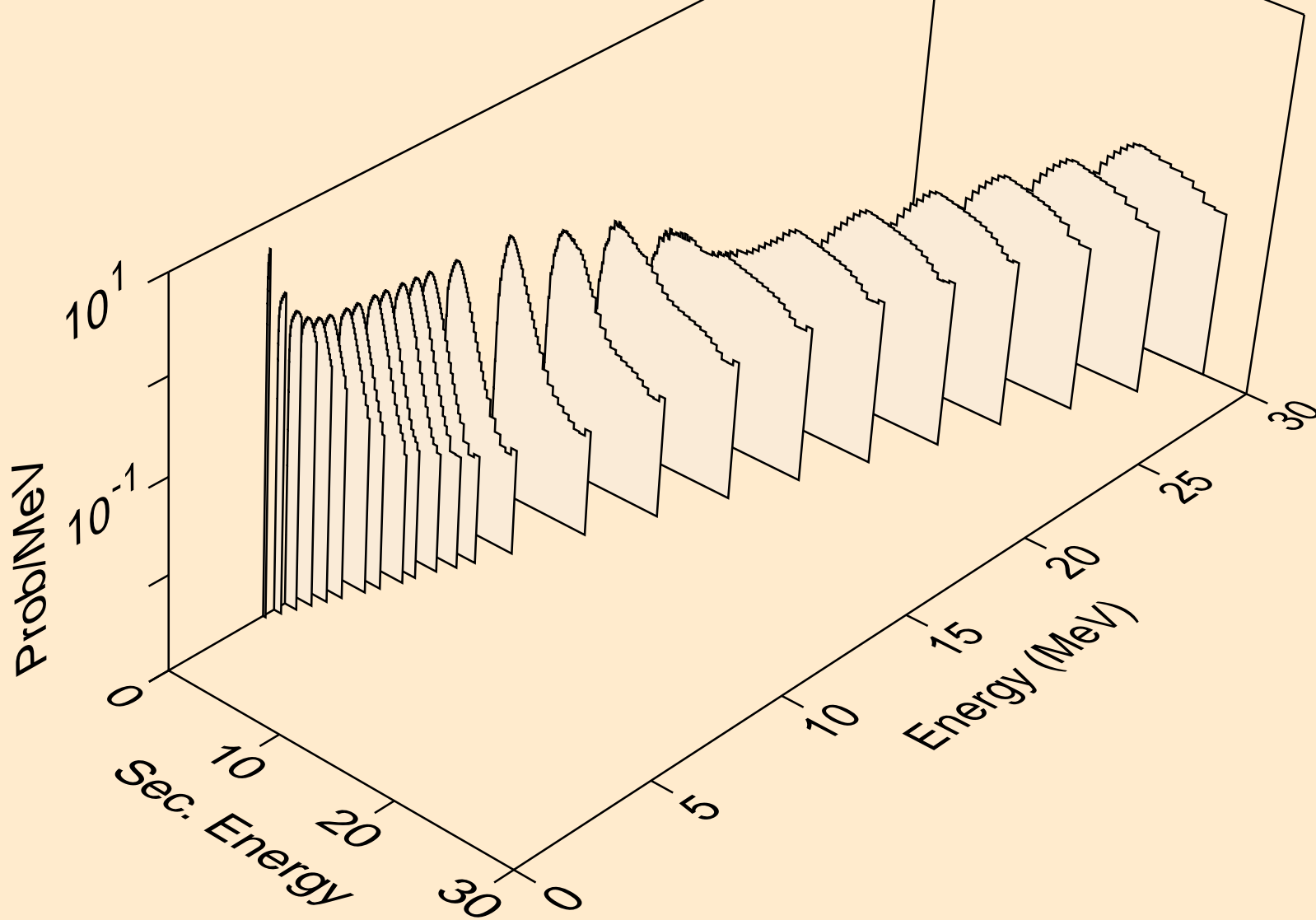

SM142 NEUTRON ACER TENDL-2019 LIBRARY; T=293.16K  
Photon emission for (n,x)

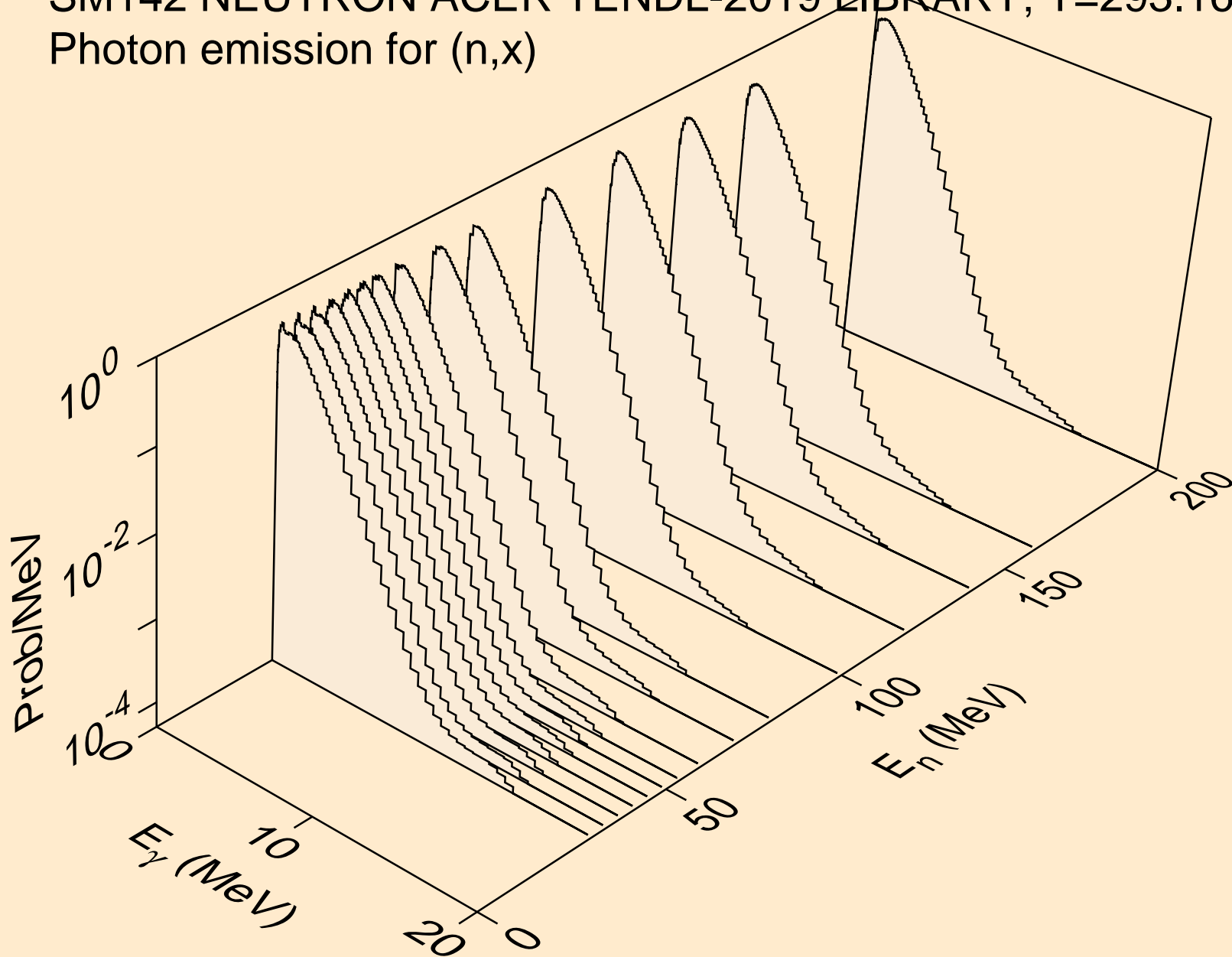

SM142 NEUTRON ACER TENDL-2019 LIBRARY; T=293.16K  
Photon emission for (n,2nd)

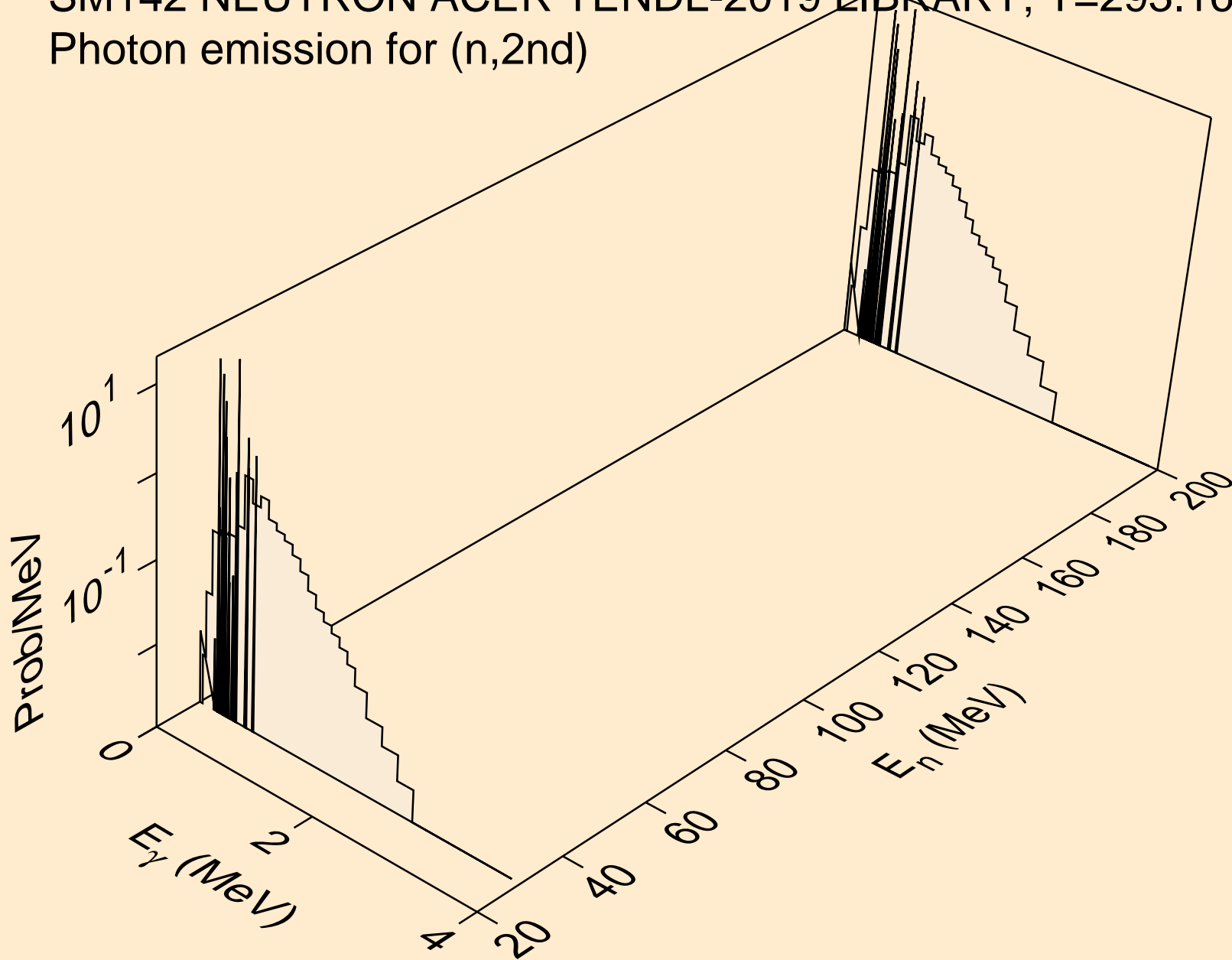

SM142 NEUTRON ACER TENDL-2019 LIBRARY; T=293.16K  
Photon emission for (n,2n)

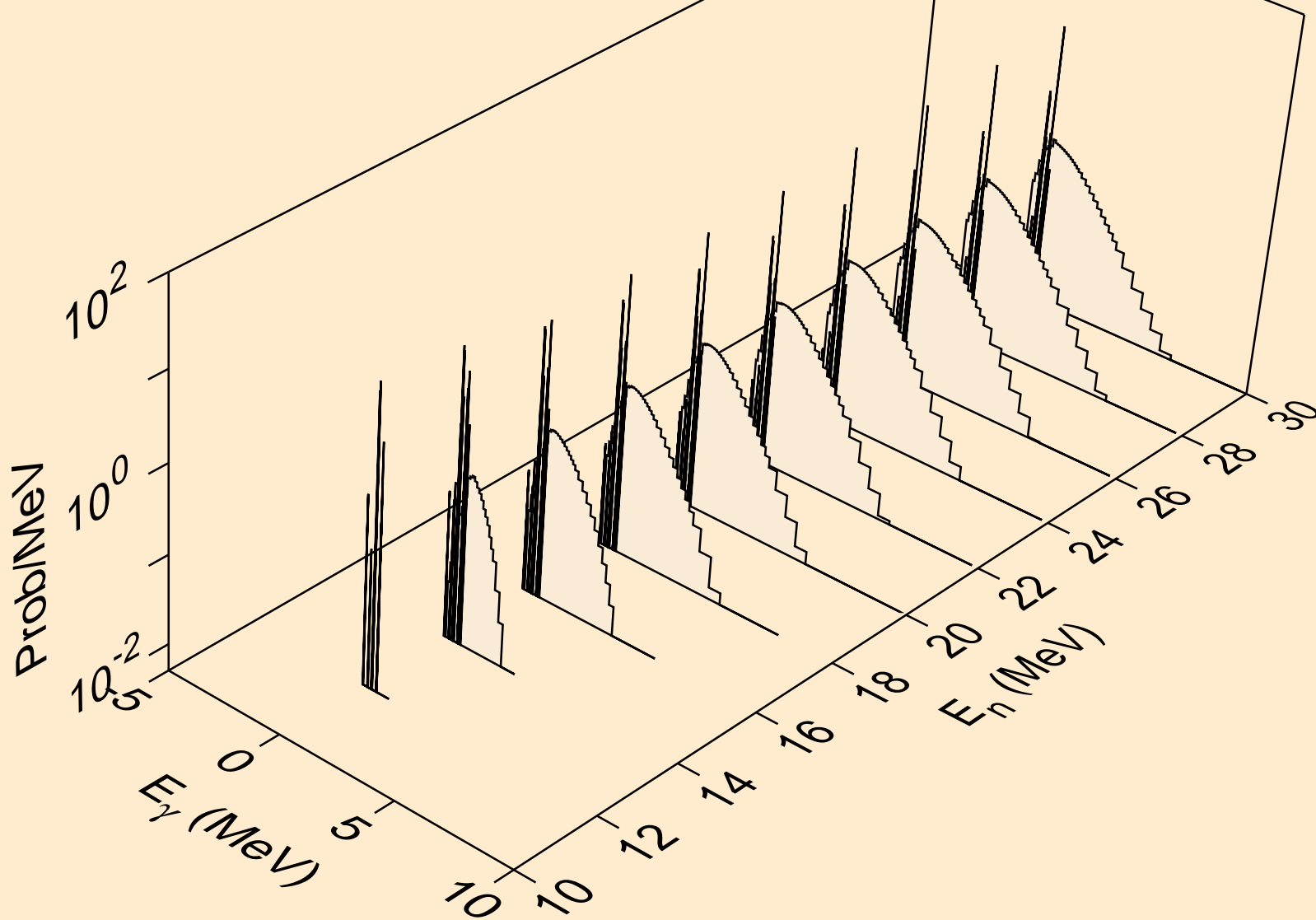

SM142 NEUTRON ACER TENDL-2019 LIBRARY; T=293.16K  
Photon emission for (n,3n)

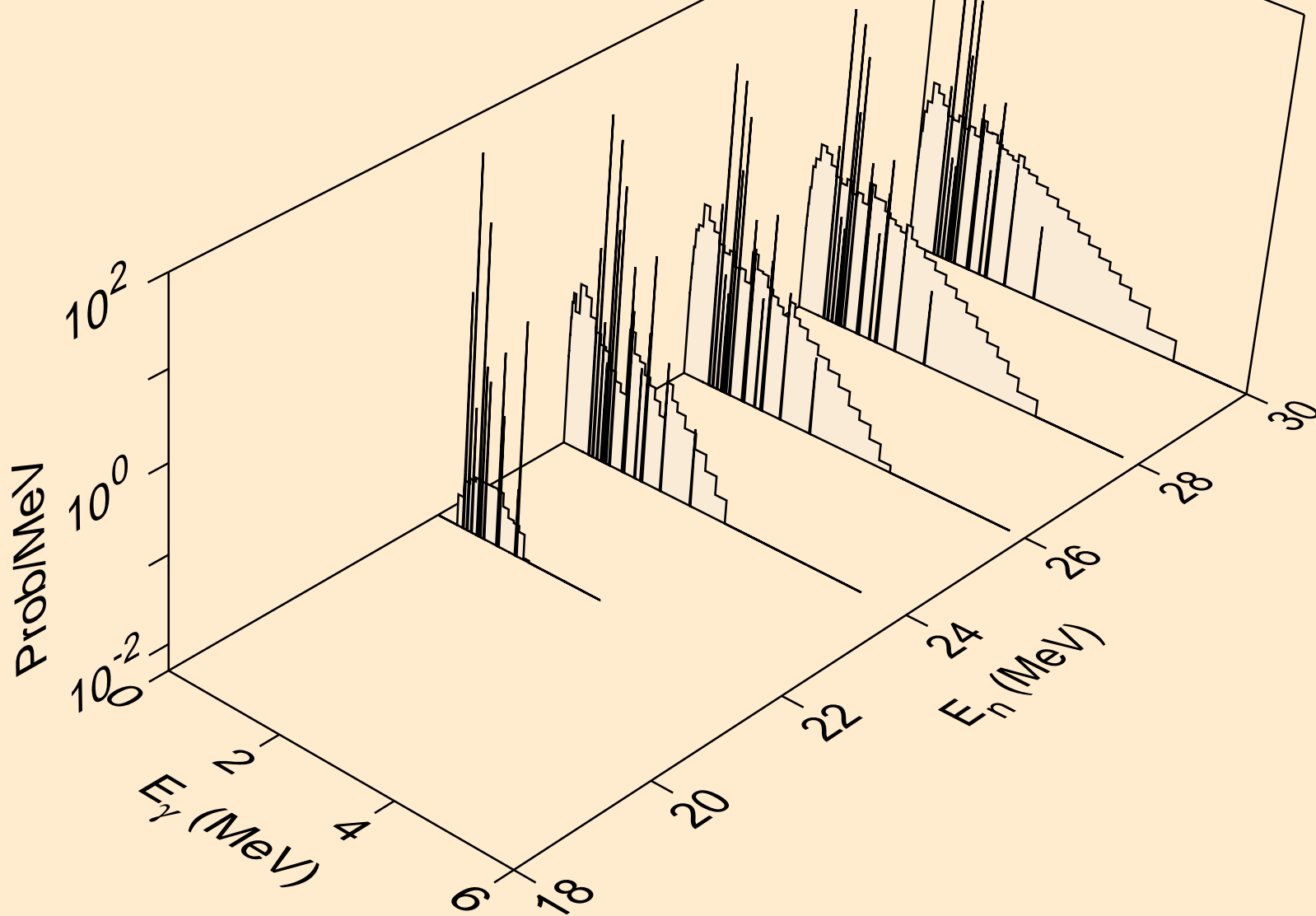



SM142 NEUTRON ACER TENDL-2019 LIBRARY; T=293.16K  
Photon emission for (n,n\*)a

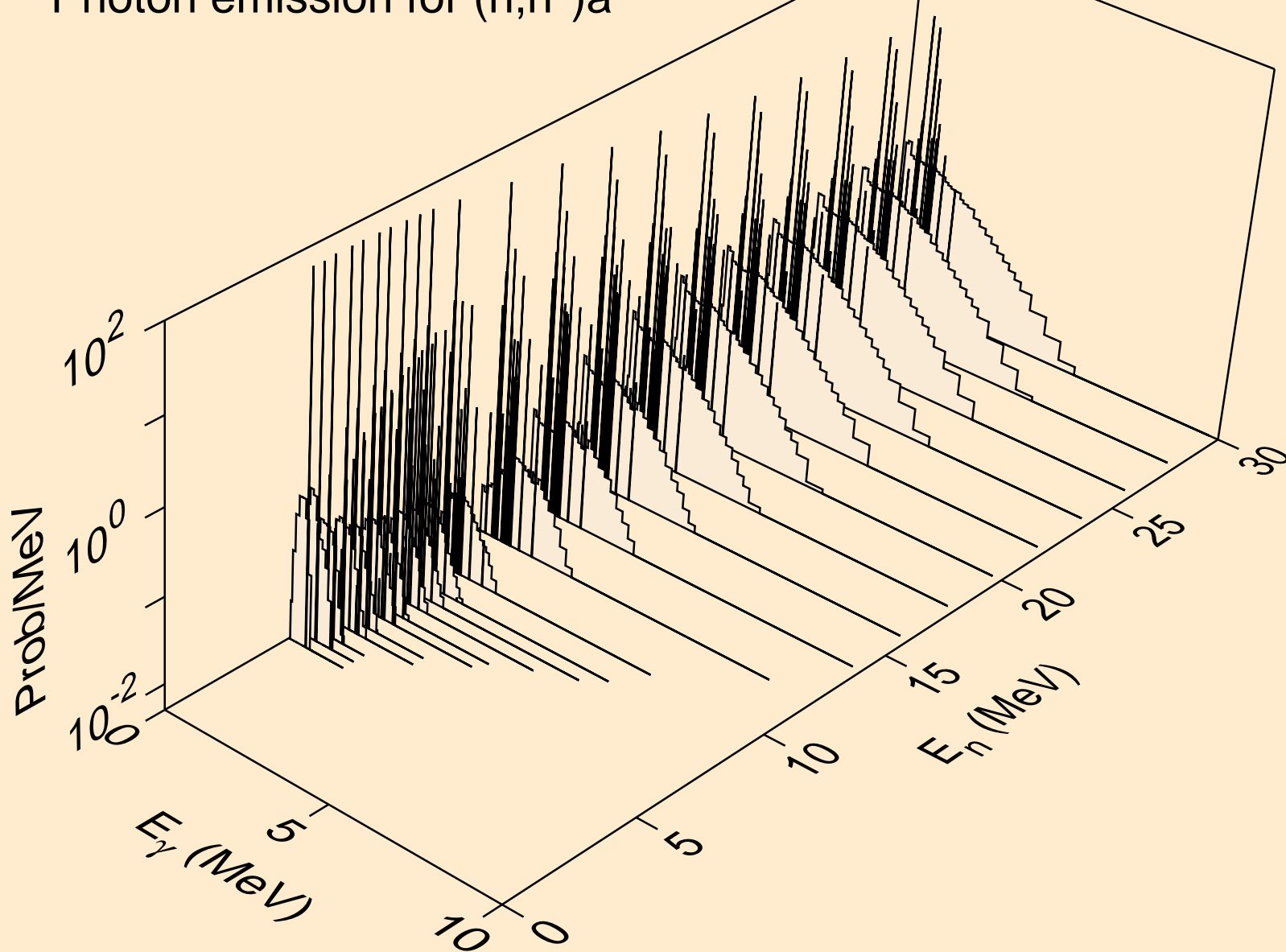

SM142 NEUTRON ACER TENDL-2019 LIBRARY; T=293.16K  
Photon emission for (n,2n)a

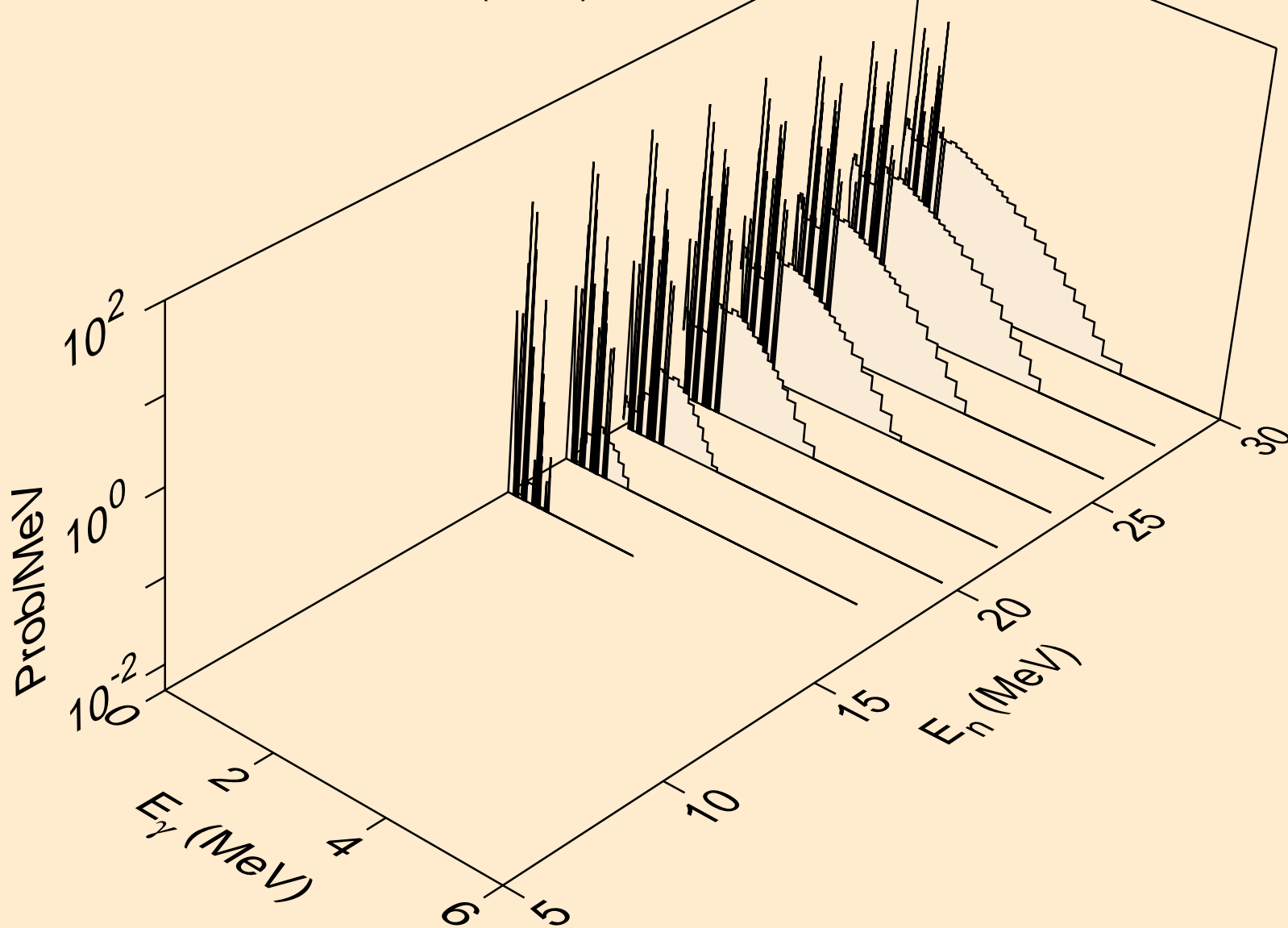

SM142 NEUTRON ACER TENDL-2019 LIBRARY; T=293.16K  
Photon emission for (n,3n)a

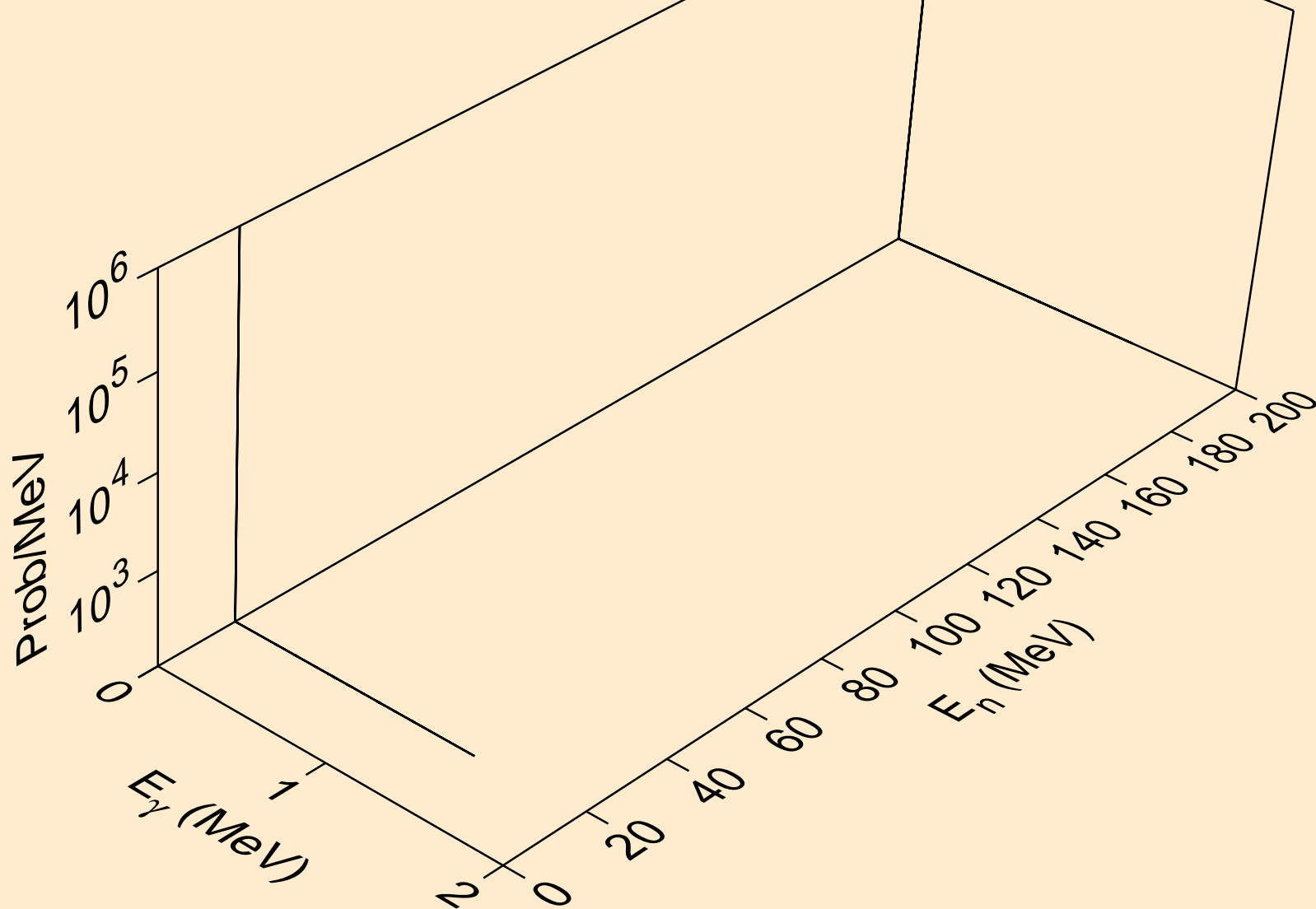

SM142 NEUTRON ACER TENDL-2019 LIBRARY; T=293.16K  
Photon emission for (n,n\*)p

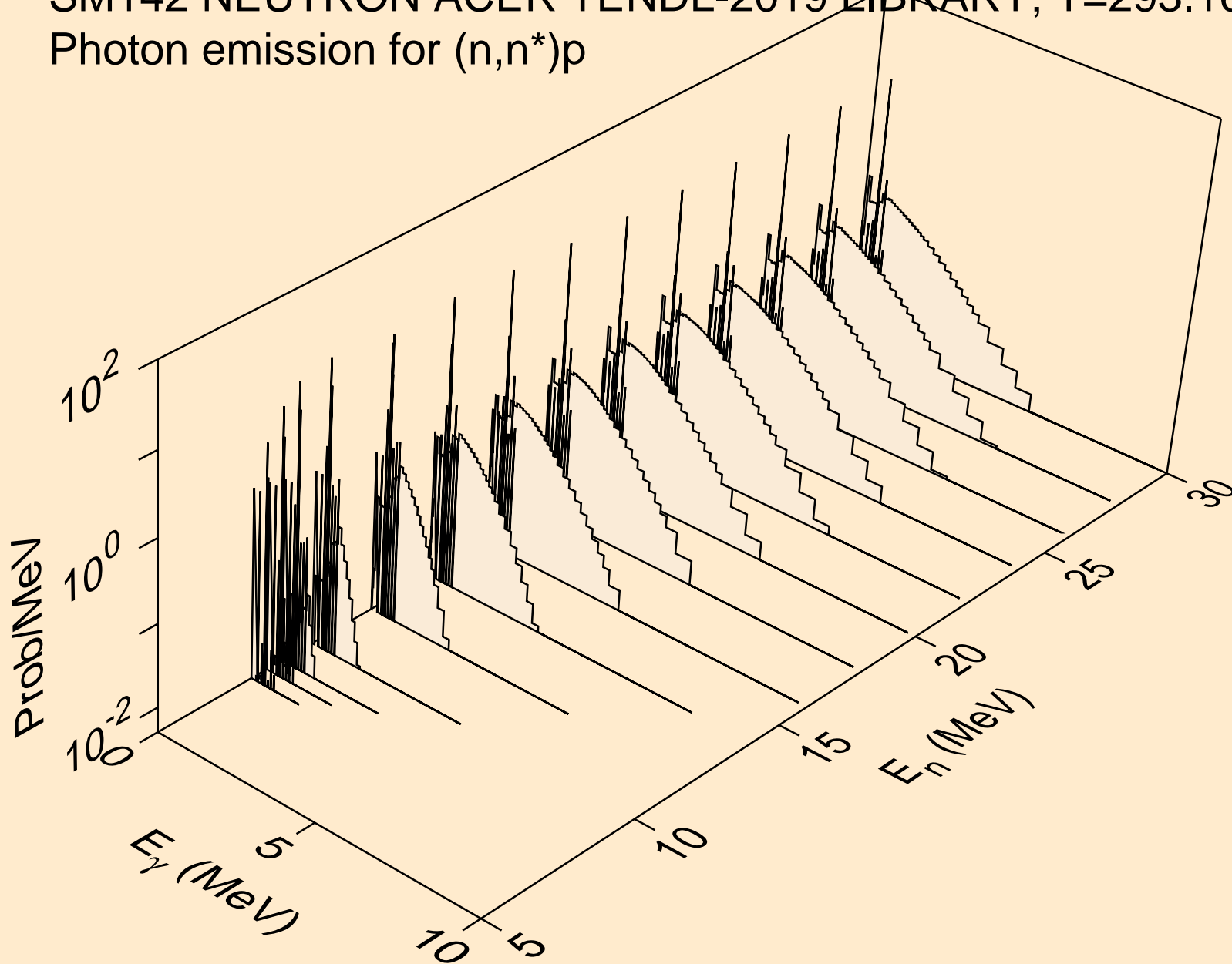

SM142 NEUTRON ACER TENDL-2019 LIBRARY; T=293.16K  
Photon emission for (n,n\*)2a

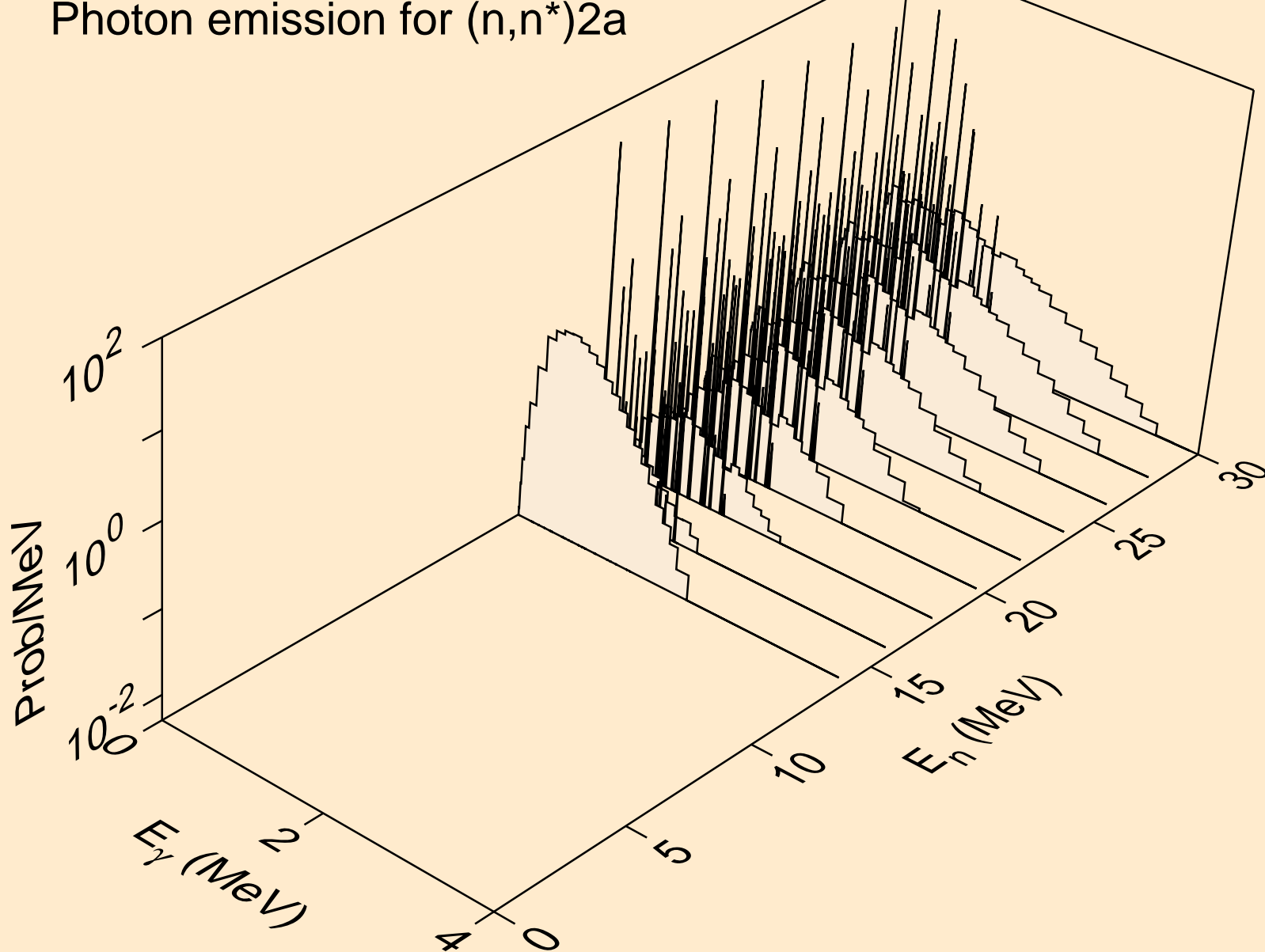

SM142 NEUTRON ACER TENDL-2019 LIBRARY; T=293.16K  
Photon emission for (n,n\*)d

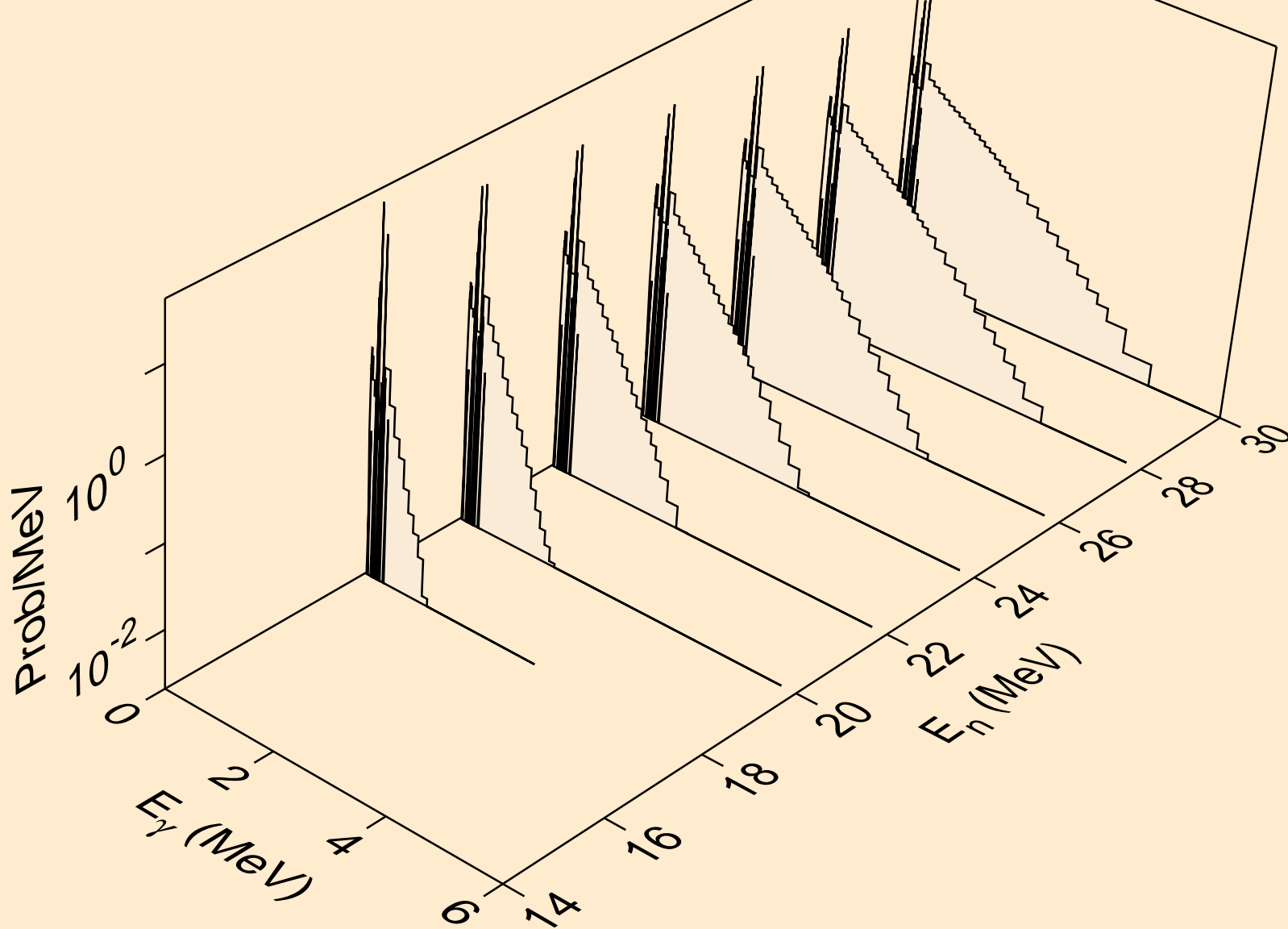

SM142 NEUTRON ACER TENDL-2019 LIBRARY; T=293.16K  
Photon emission for (n,n\*)t

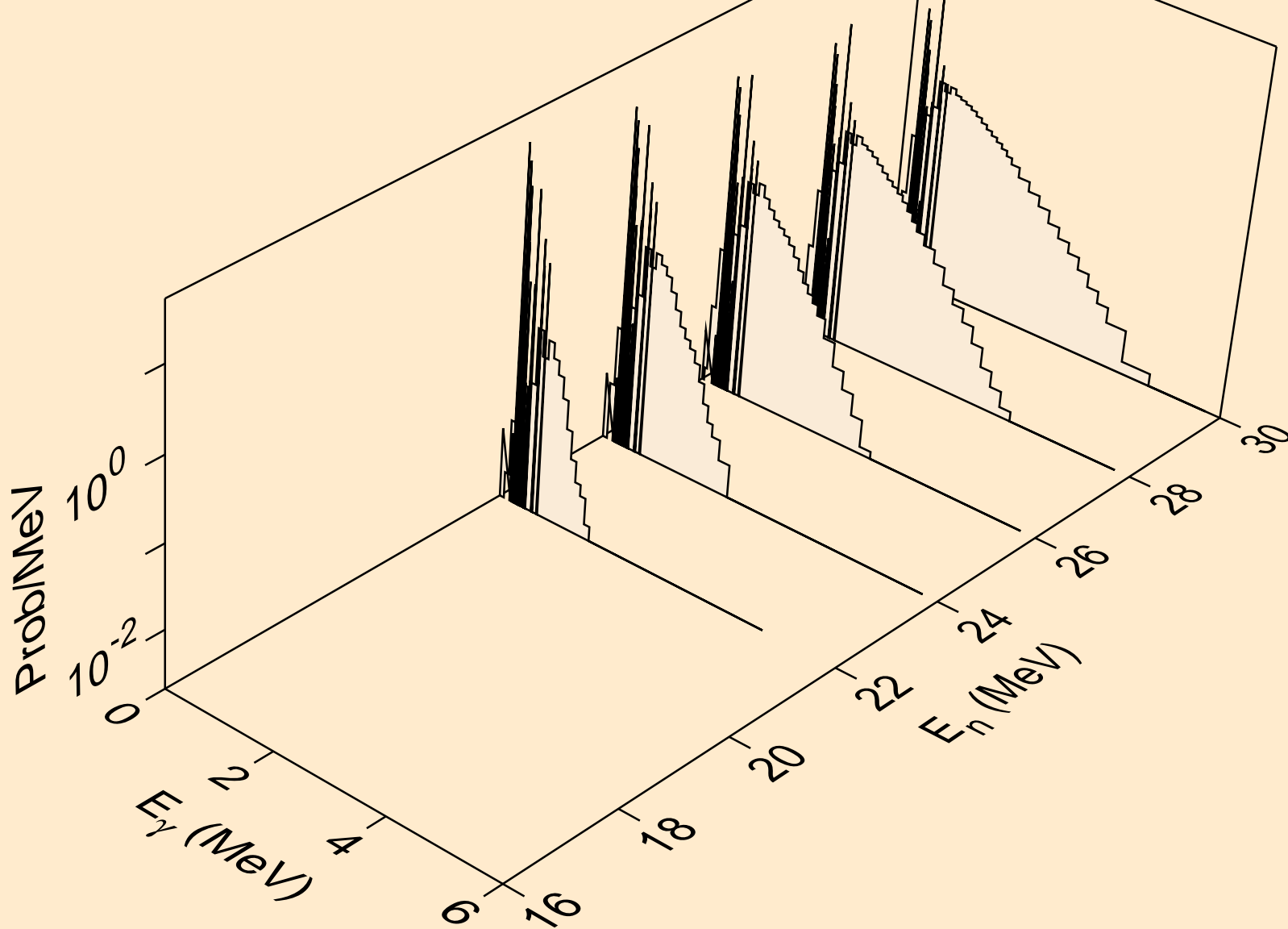

SM142 NEUTRON ACER TENDL-2019 LIBRARY; T=293.16K  
Photon emission for (n,n\*)he3

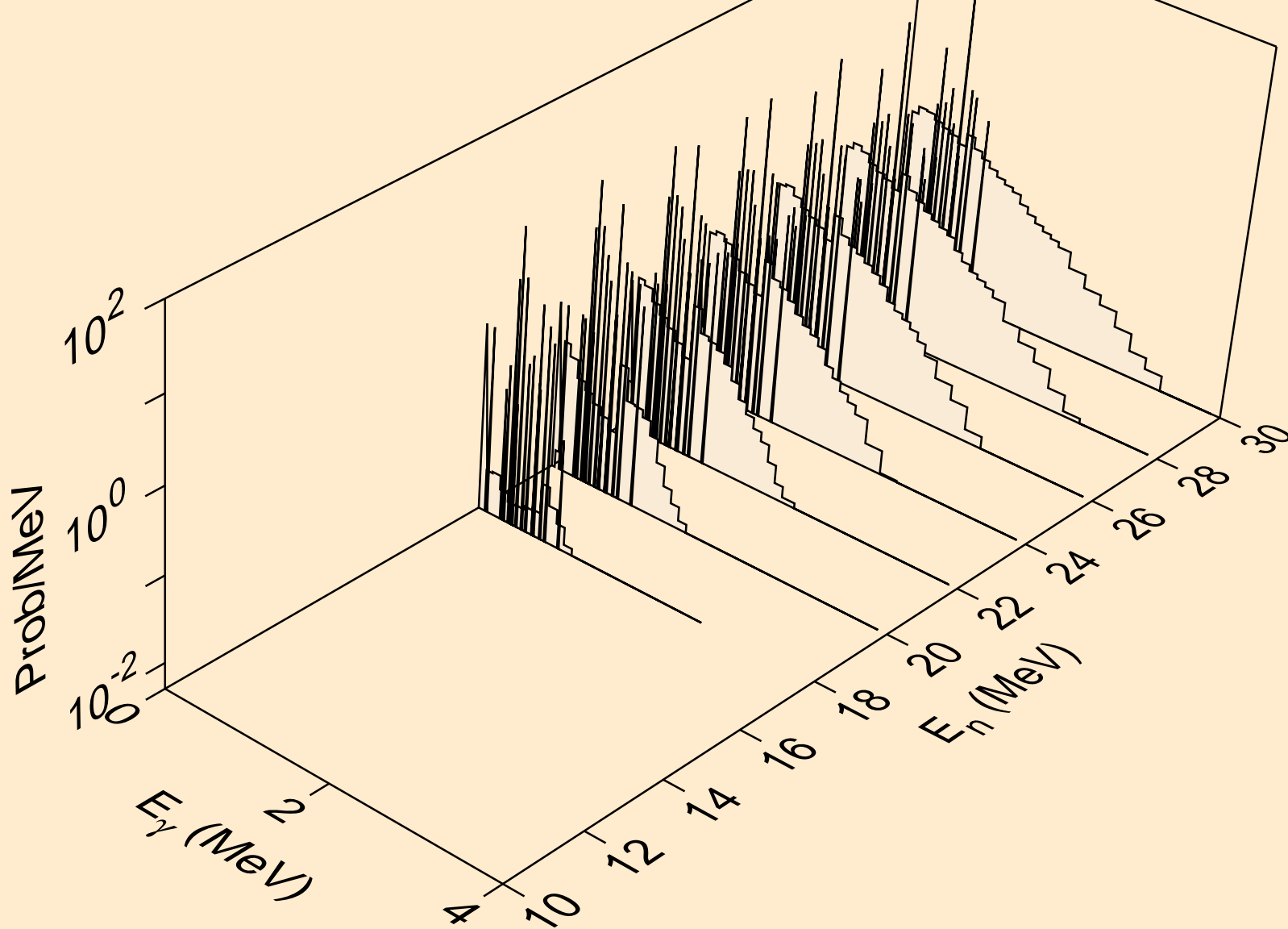



SM142 NEUTRON ACER TENDL-2019 LIBRARY; T=293.16K  
Photon emission for (n,2np)

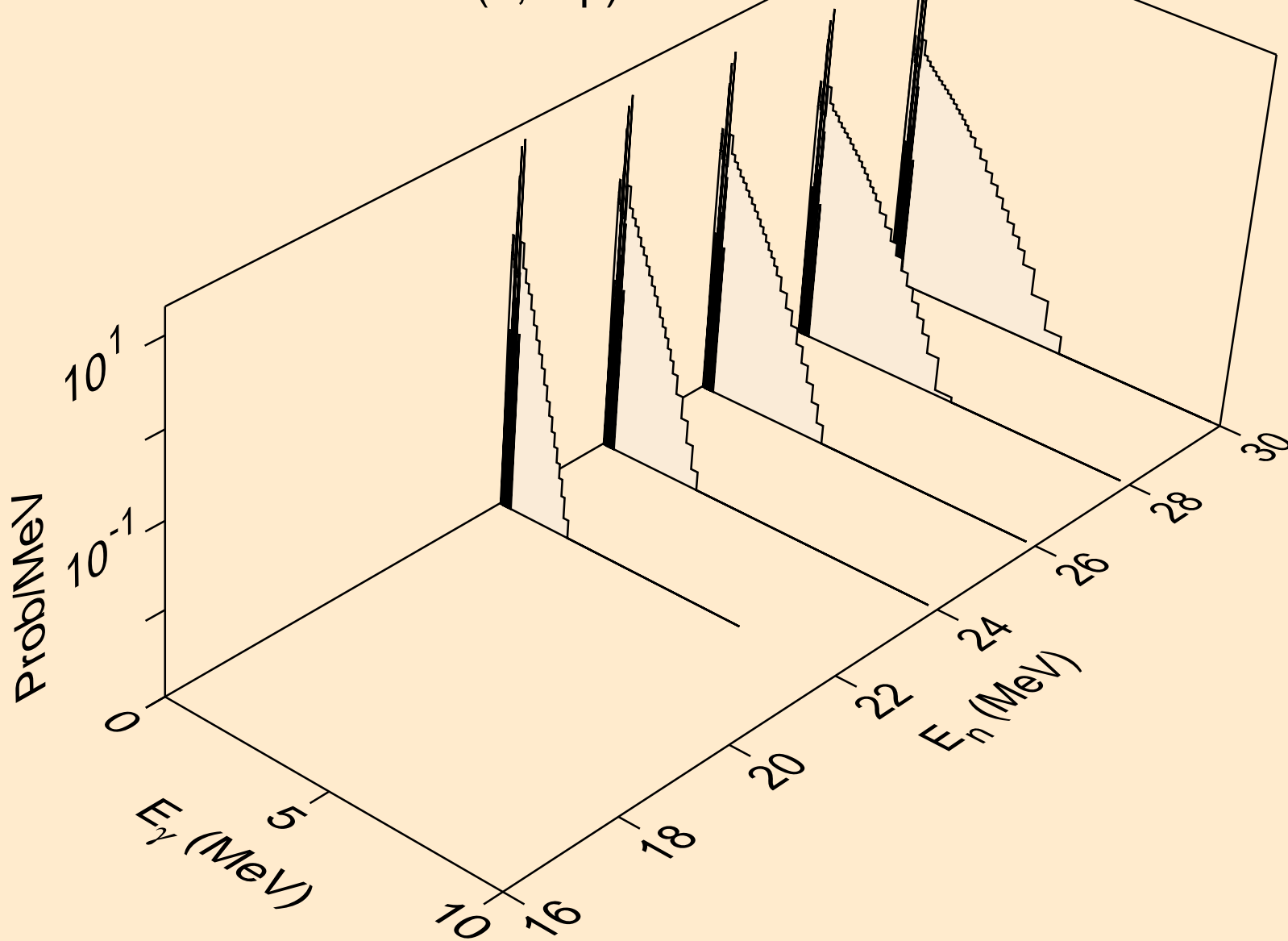

SM142 NEUTRON ACER TENDL-2019 LIBRARY; T=293.16K  
Photon emission for (n,3np)

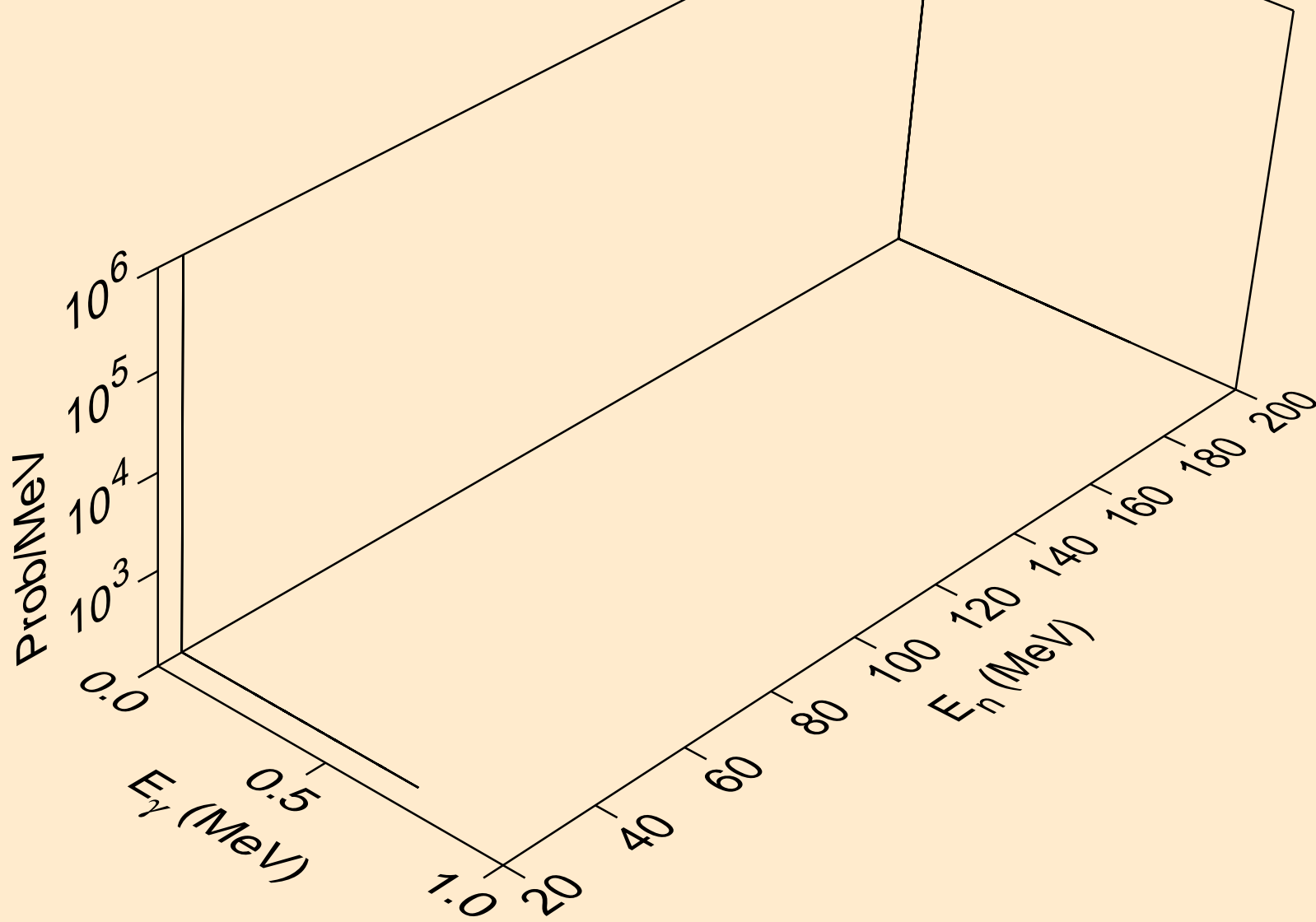

SM142 NEUTRON ACER TENDL-2019 LIBRARY; T=293.16K  
Photon emission for (n,2np)

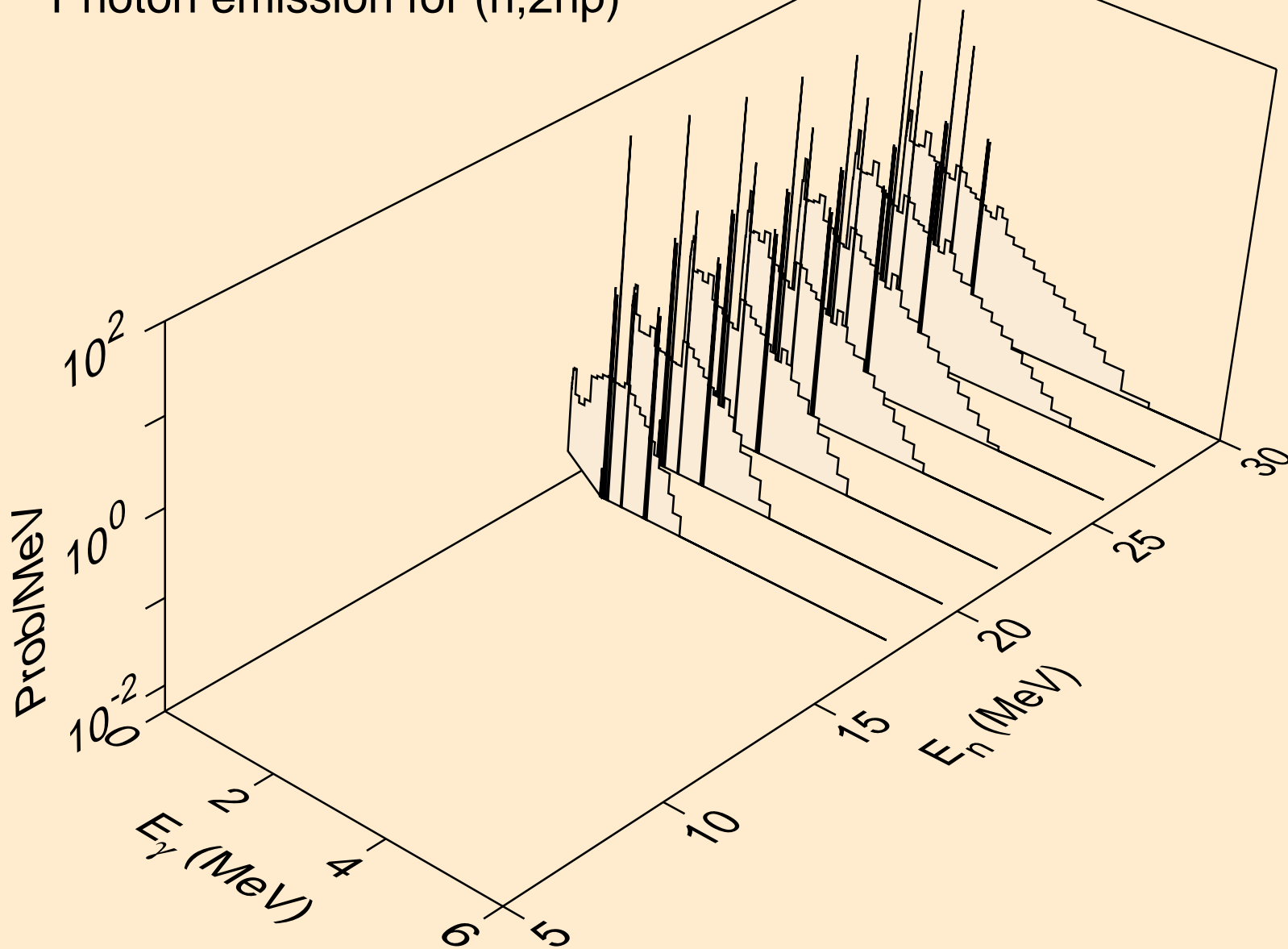

SM142 NEUTRON ACER TENDL-2019 LIBRARY; T=293.16K  
Photon emission for (n,npa)

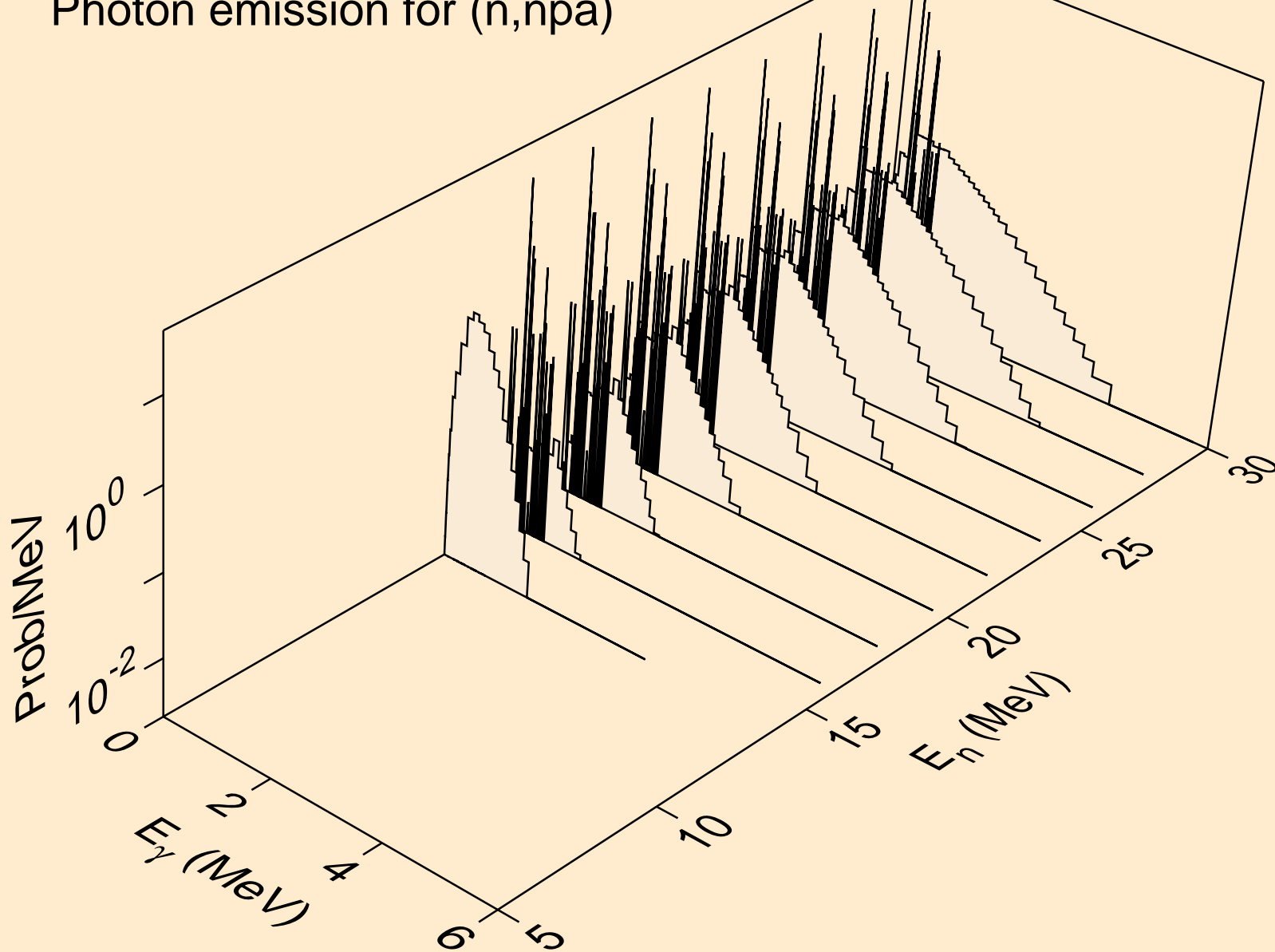

SM142 NEUTRON ACER TENDL-2019 LIBRARY; T=293.16K  
Photon emission for (n,n\*c)

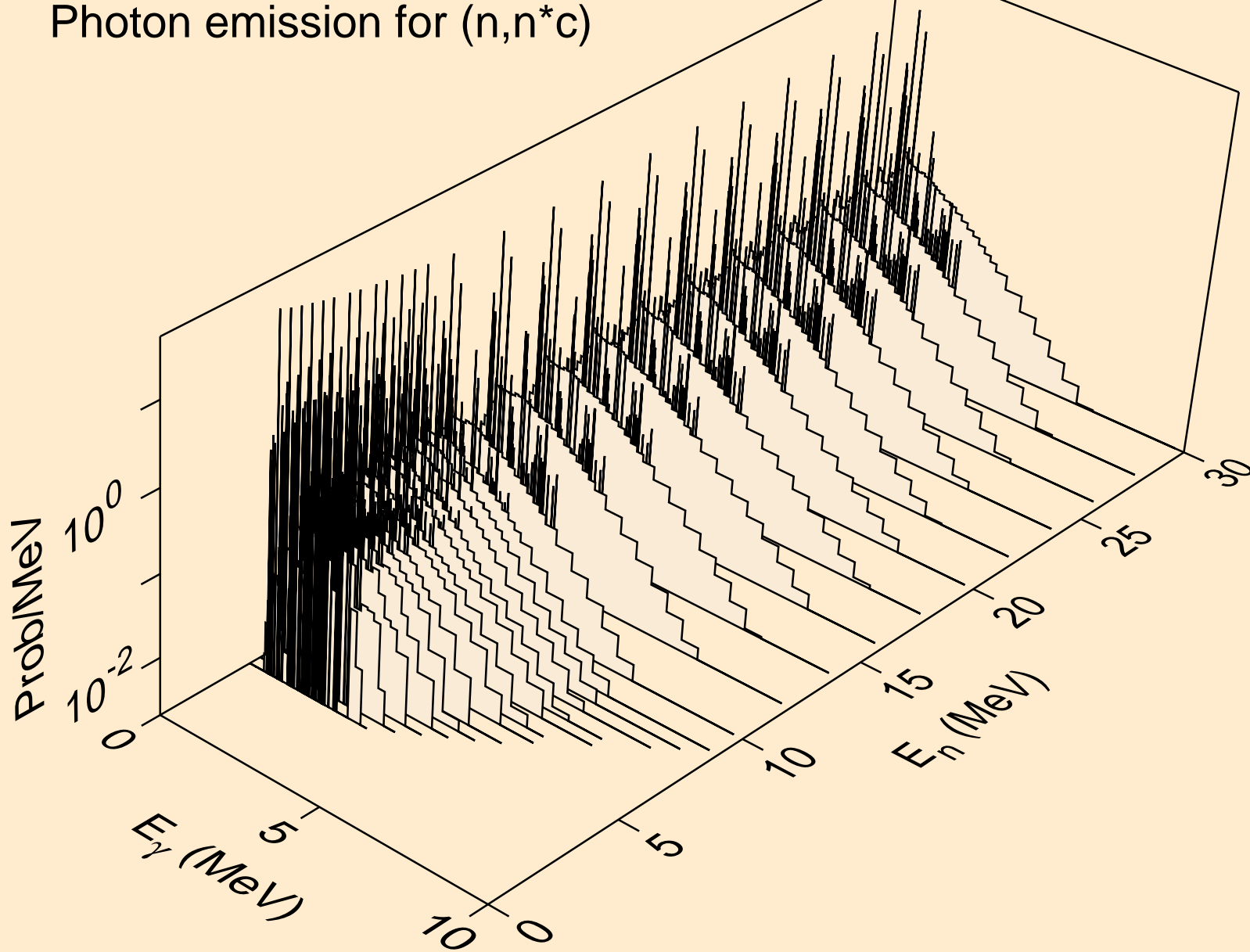

SM142 NEUTRON ACER TENDL-2019 LIBRARY; T=293.16K  
Photon emission for (n,gma)

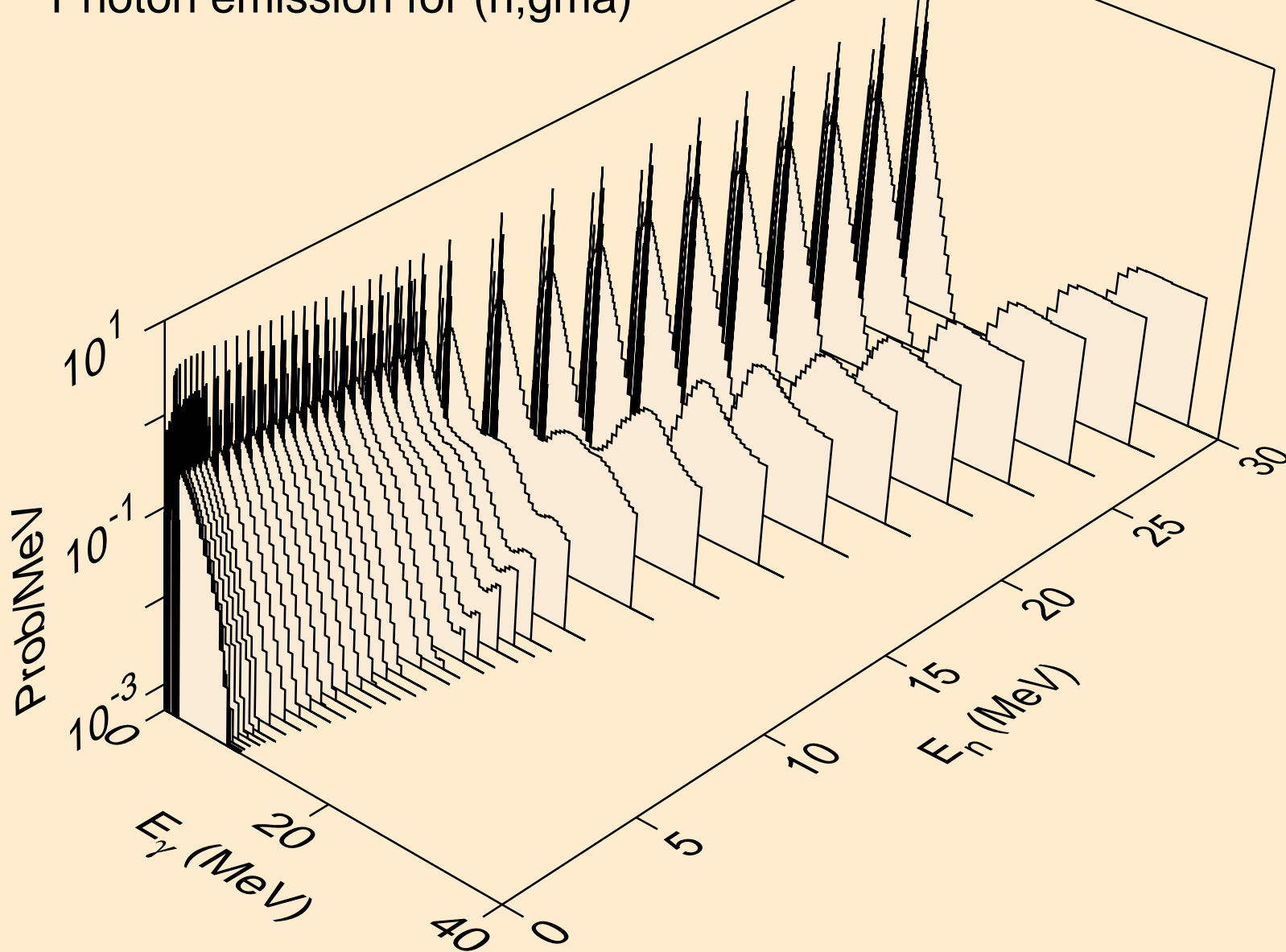

SM142 NEUTRON ACER TENDL-2019 LIBRARY; T=293.16K  
Photon emission for (n,p)

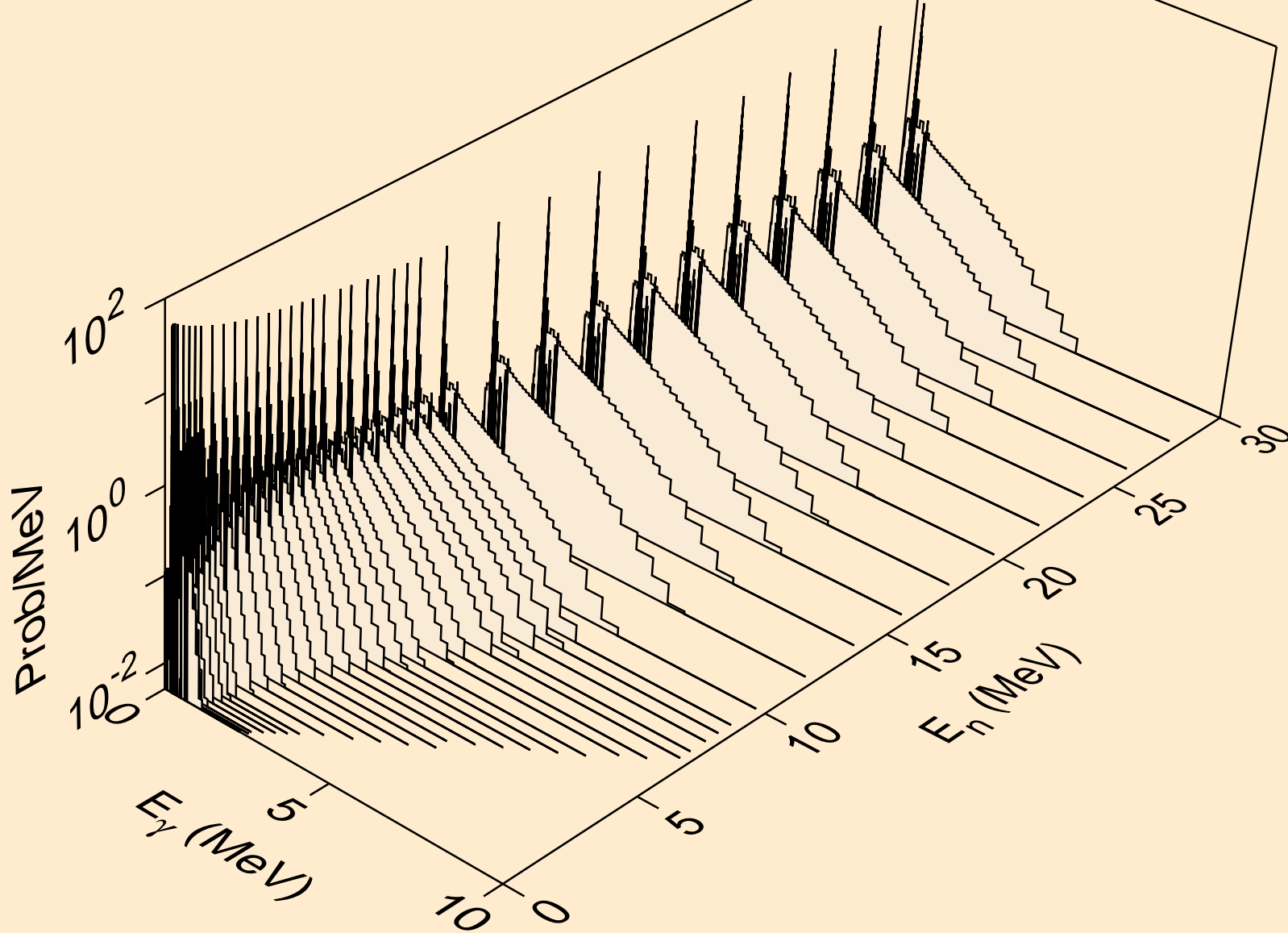

SM142 NEUTRON ACER TENDL-2019 LIBRARY; T=293.16K  
Photon emission for (n,d)

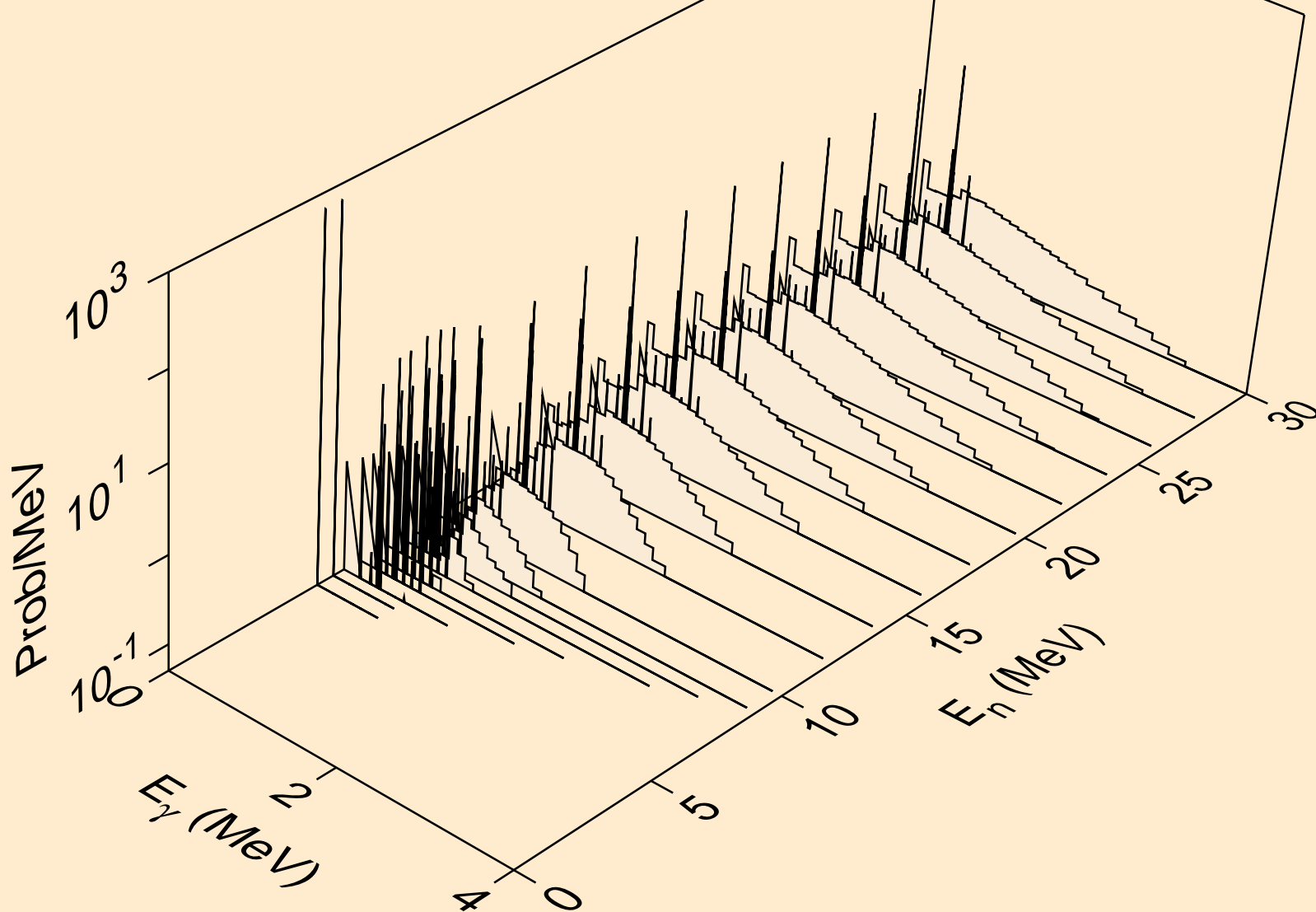



SM142 NEUTRON ACER TENDL-2019 LIBRARY; T=293.16K  
Photon emission for (n,t)

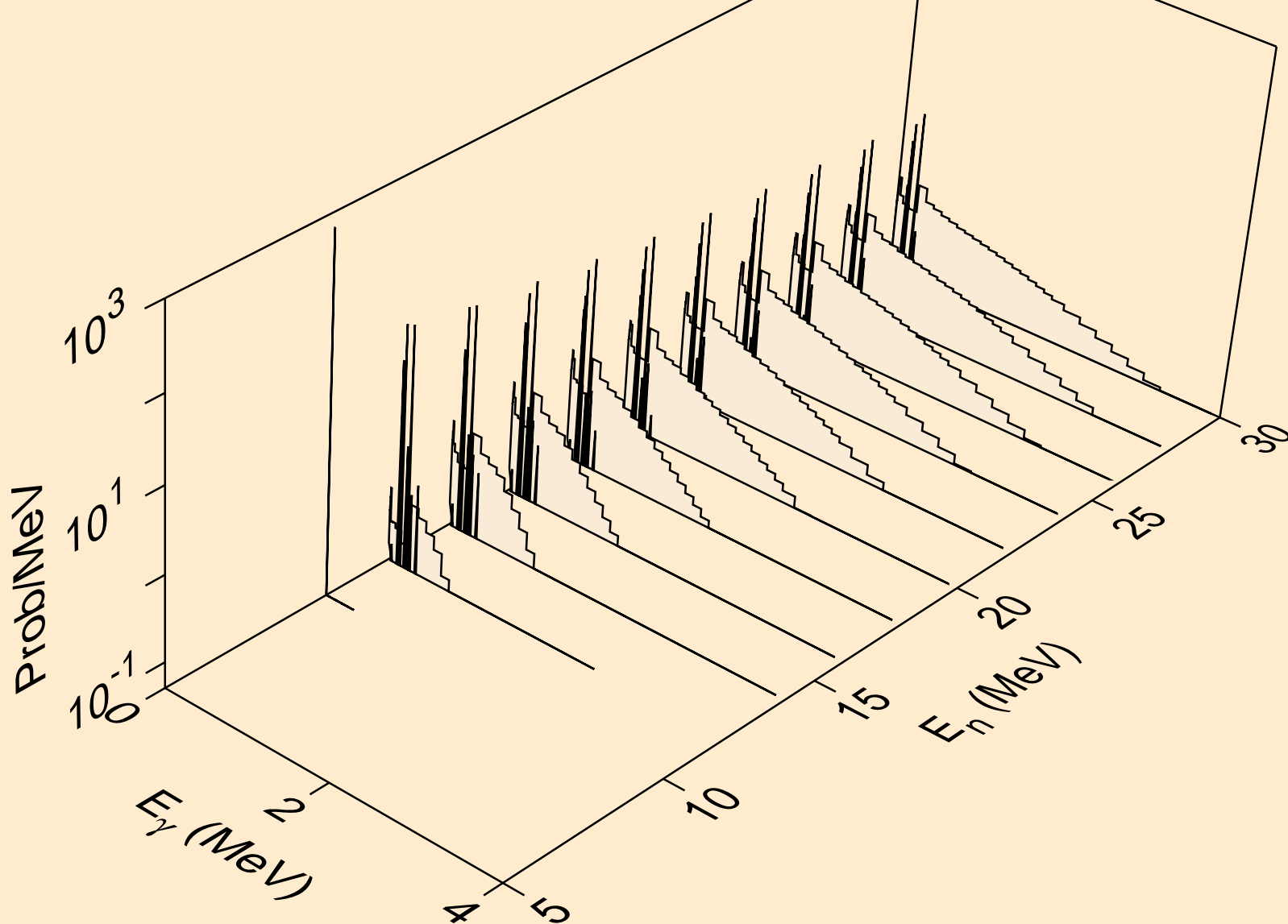

SM142 NEUTRON ACER TENDL-2019 LIBRARY; T=293.16K  
Photon emission for (n,he3)

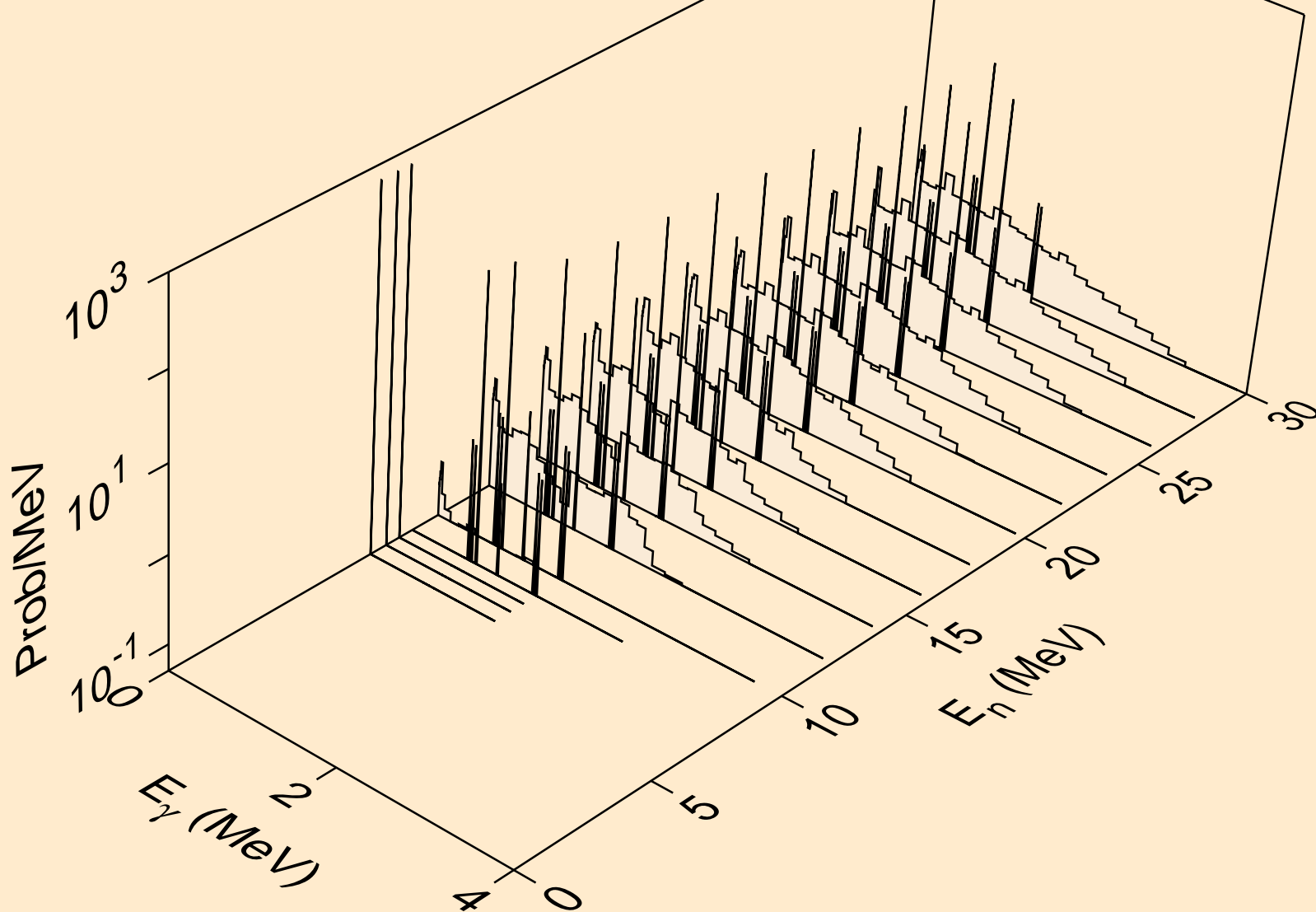

SM142 NEUTRON ACER TENDL-2019 LIBRARY; T=293.16K  
Photon emission for (n,a)

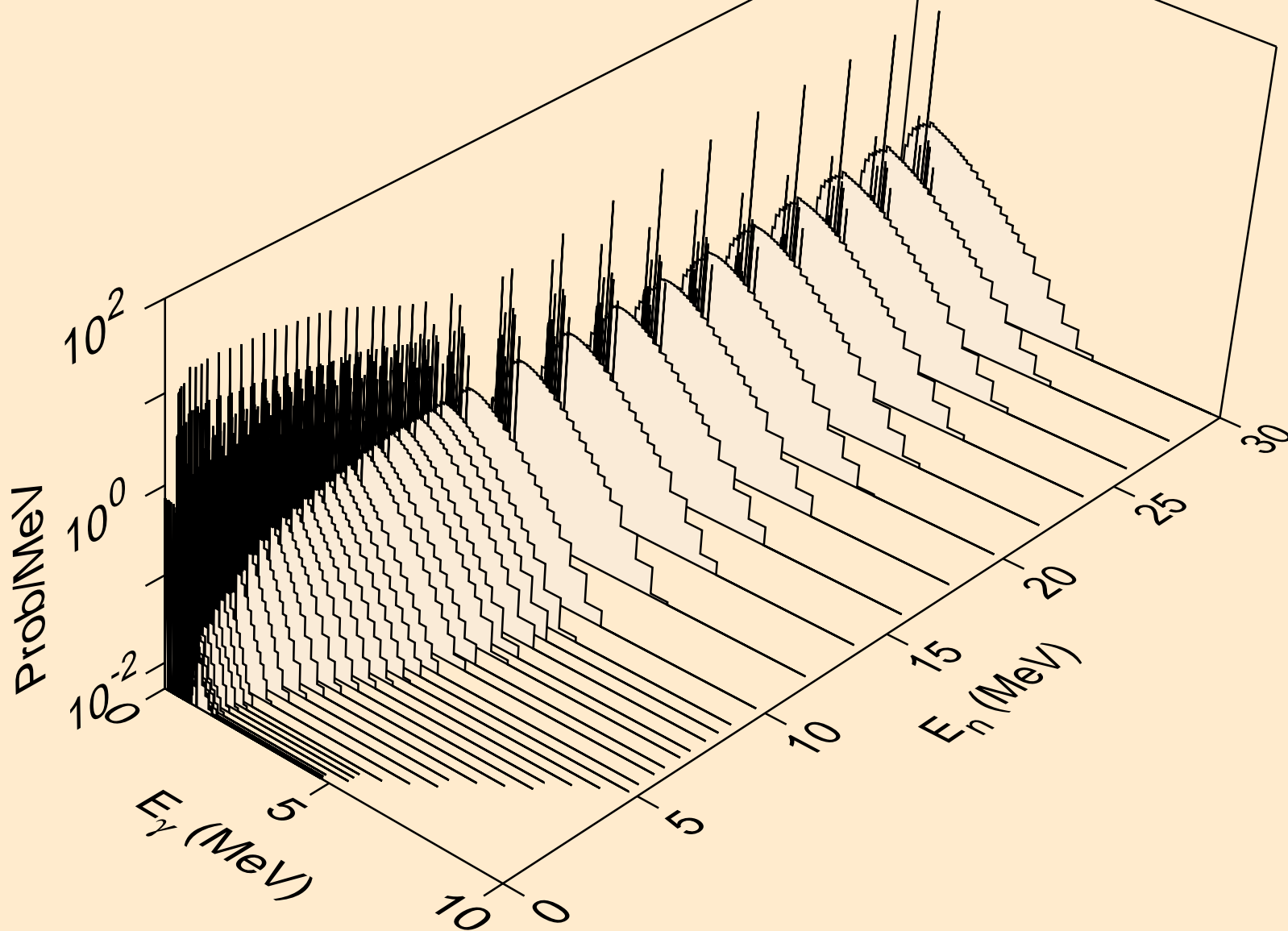

SM142 NEUTRON ACER TENDL-2019 LIBRARY; T=293.16K  
Photon emission for (n,2a)

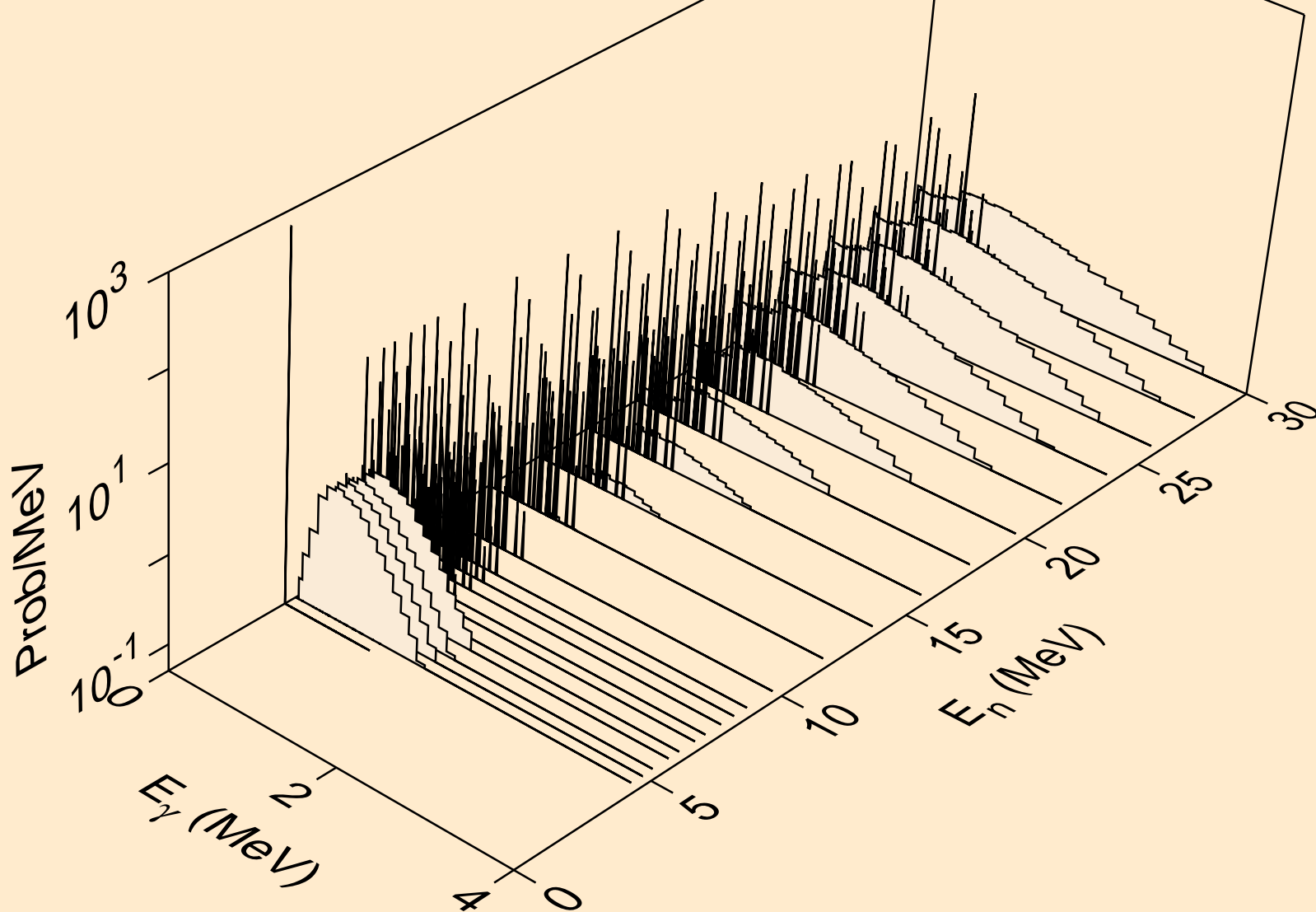

SM142 NEUTRON ACER TENDL-2019 LIBRARY; T=293.16K  
Photon emission for (n,2p)

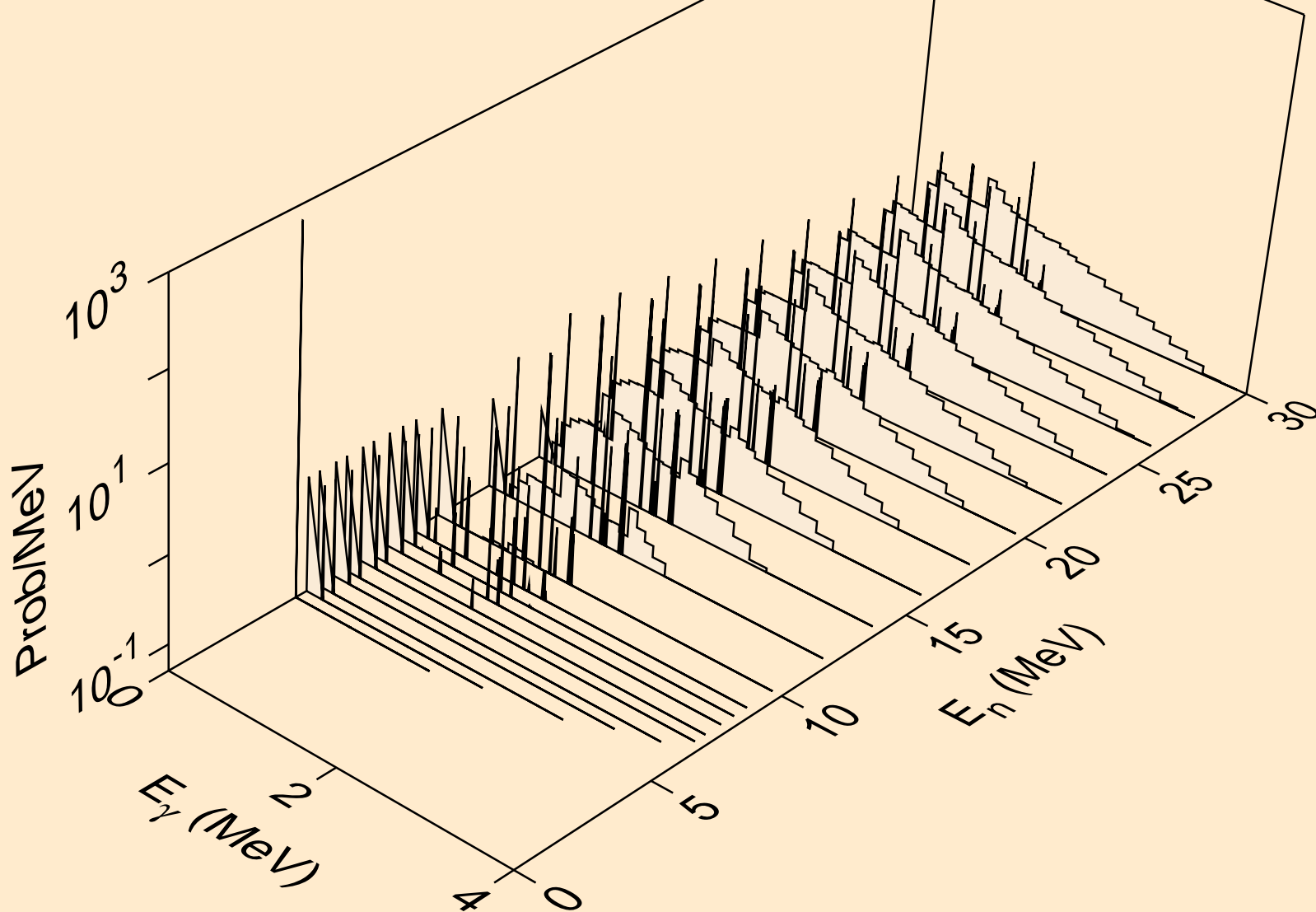

SM142 NEUTRON ACER TENDL-2019 LIBRARY; T=293.16K  
Photon emission for (n,p)

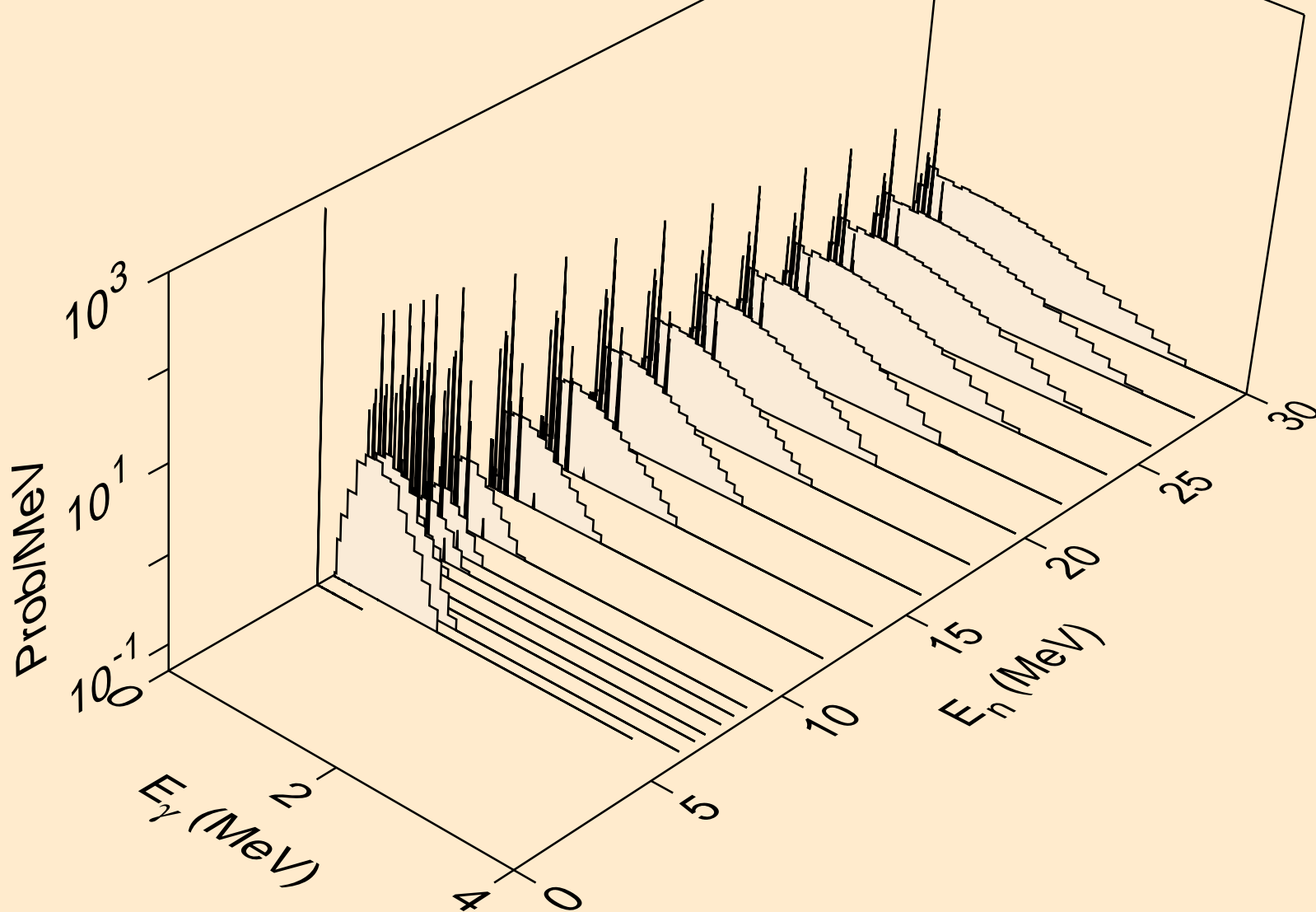

SM142 NEUTRON ACER TENDL-2019 LIBRARY; T=293.16K  
Photon emission for (n,pd)

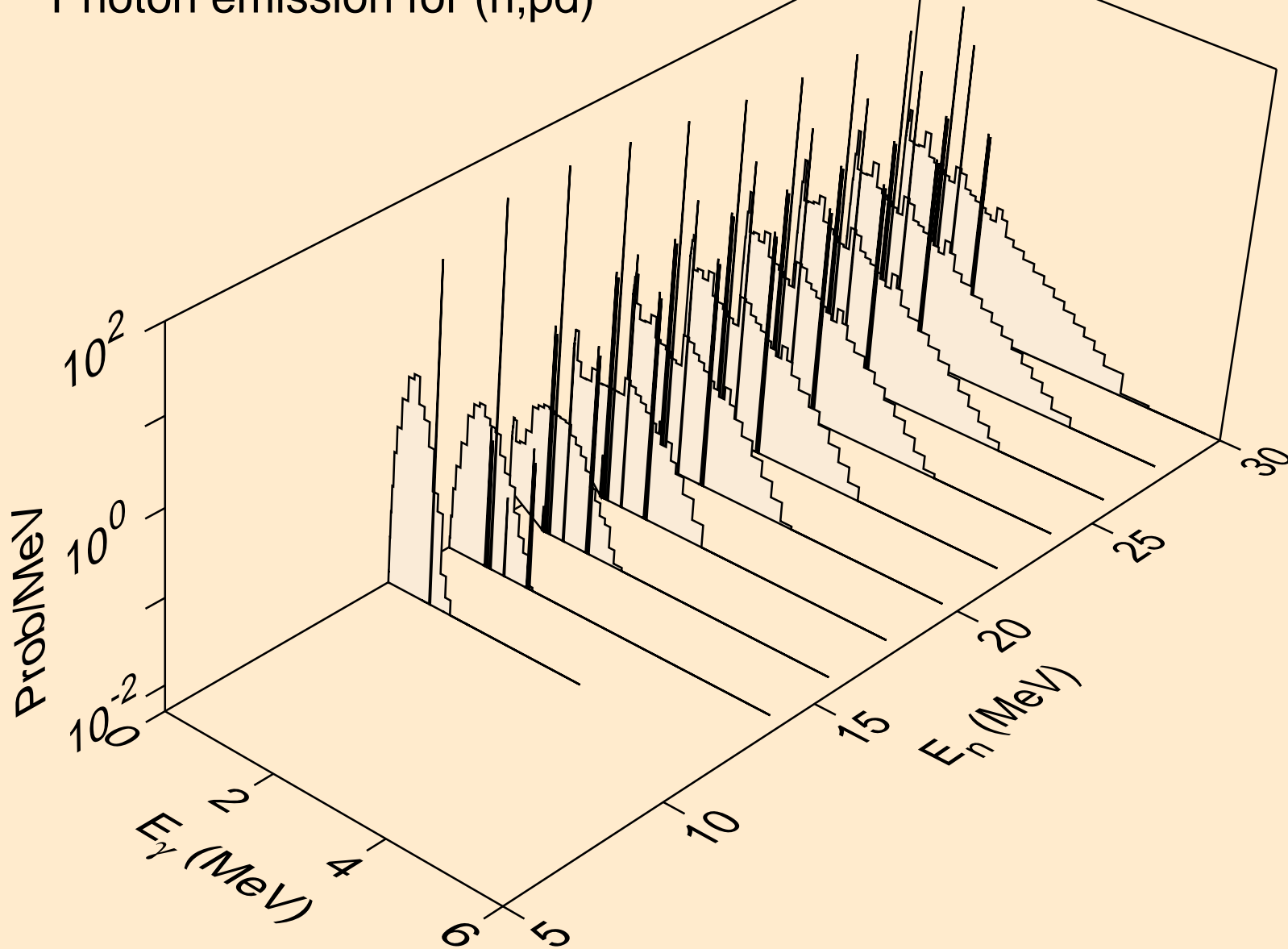

SM142 NEUTRON ACER TENDL-2019 LIBRARY; T=293.16K  
Photon emission for (n,pt)

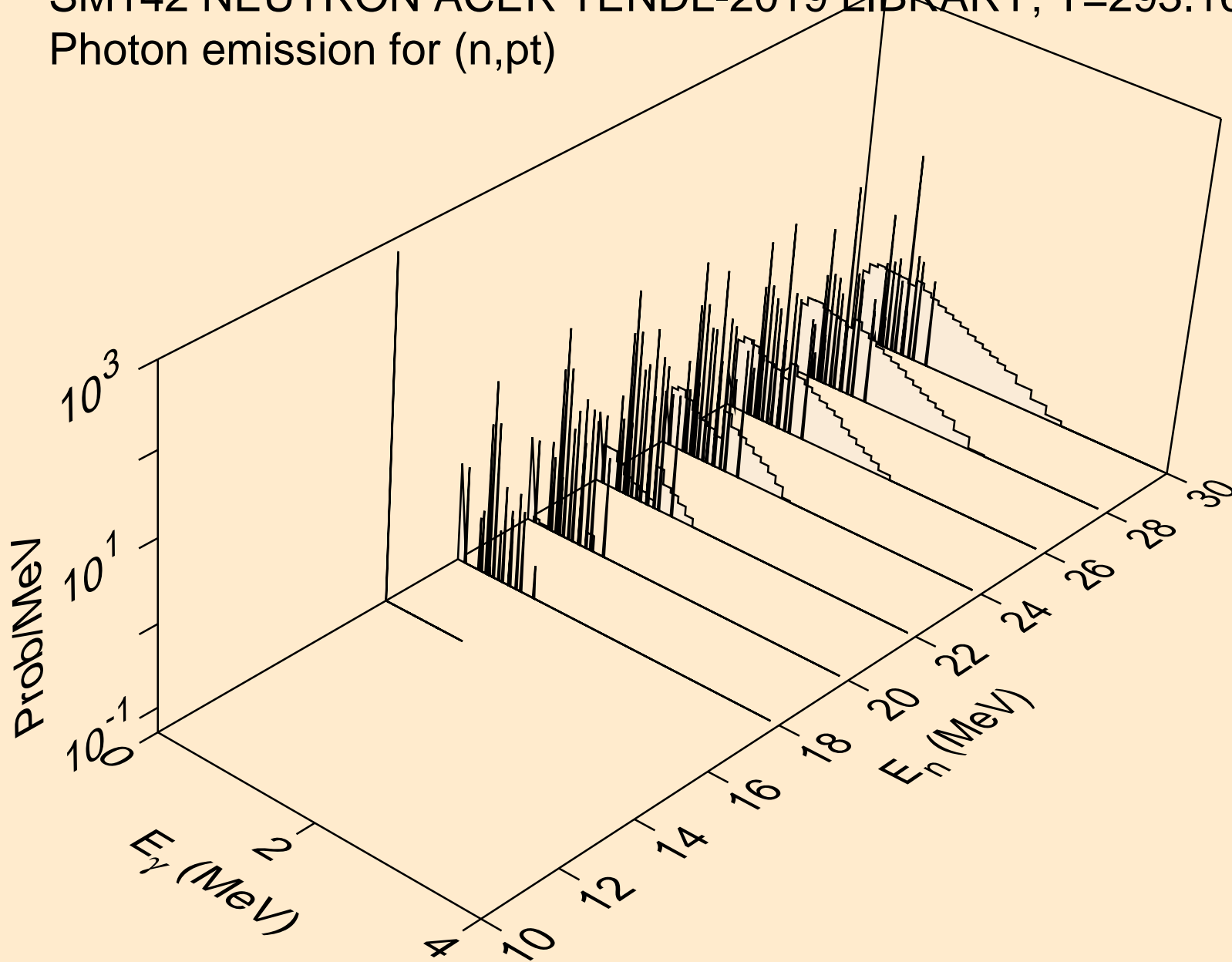



SM142 NEUTRON ACER TENDL-2019 LIBRARY; T=293.16K  
Photon emission for (n,da)

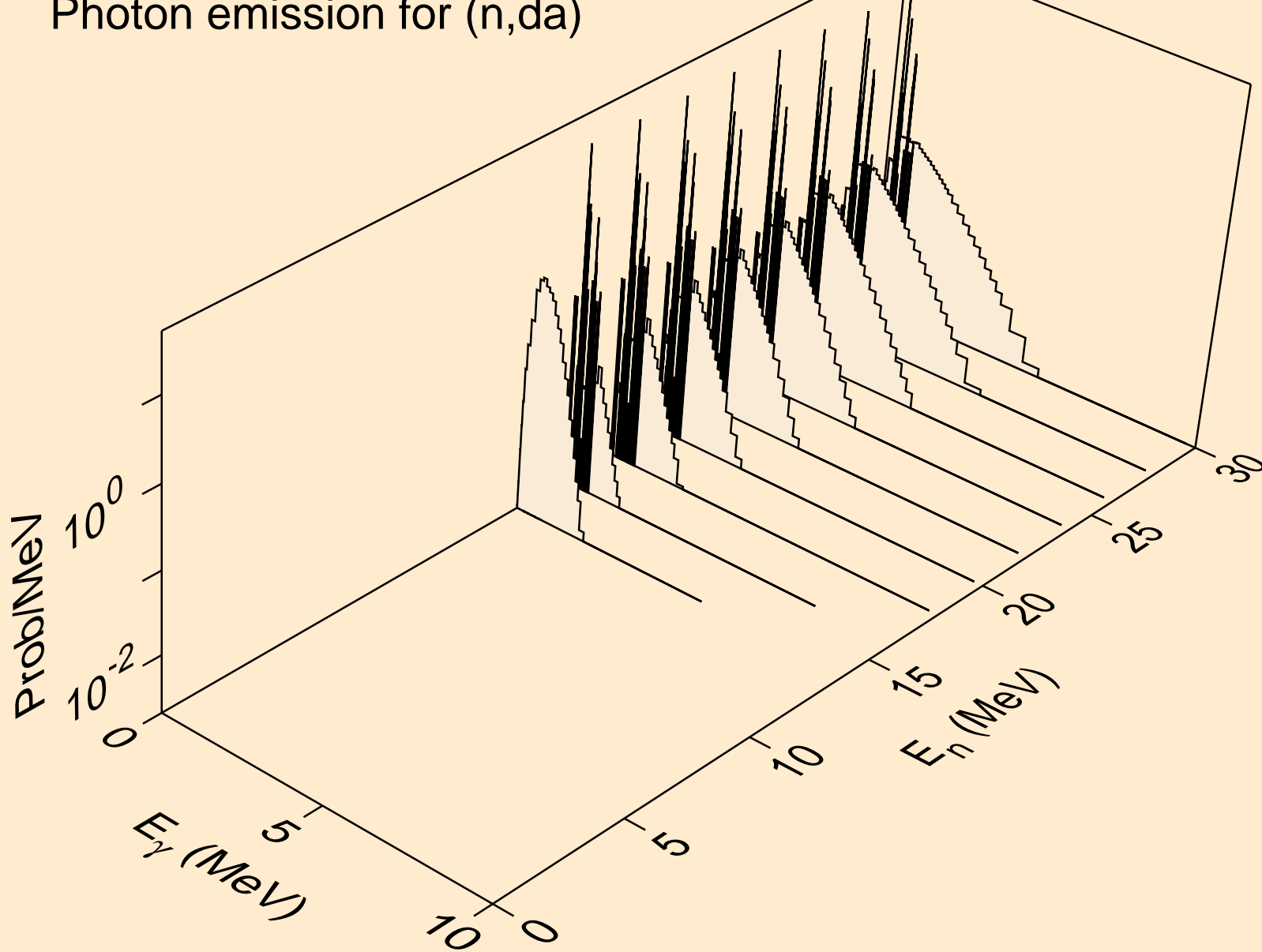

SM142 NEUTRON ACER TENDL-2019 LIBRARY; T=293.16K  
thermal capture photon spectrum

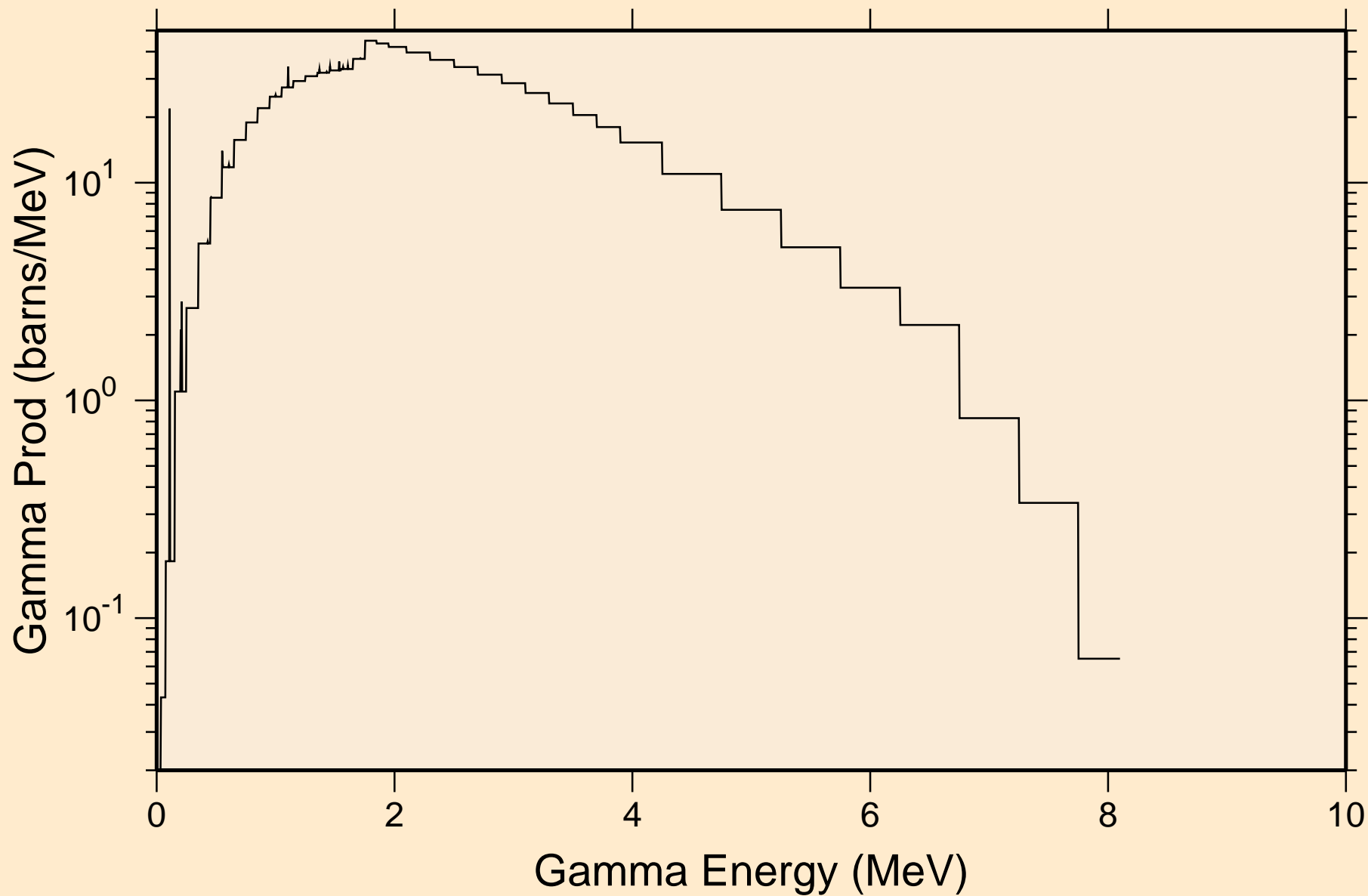

SM142 NEUTRON ACER TENDL-2019 LIBRARY; T=293.16K  
14 MeV photon spectrum

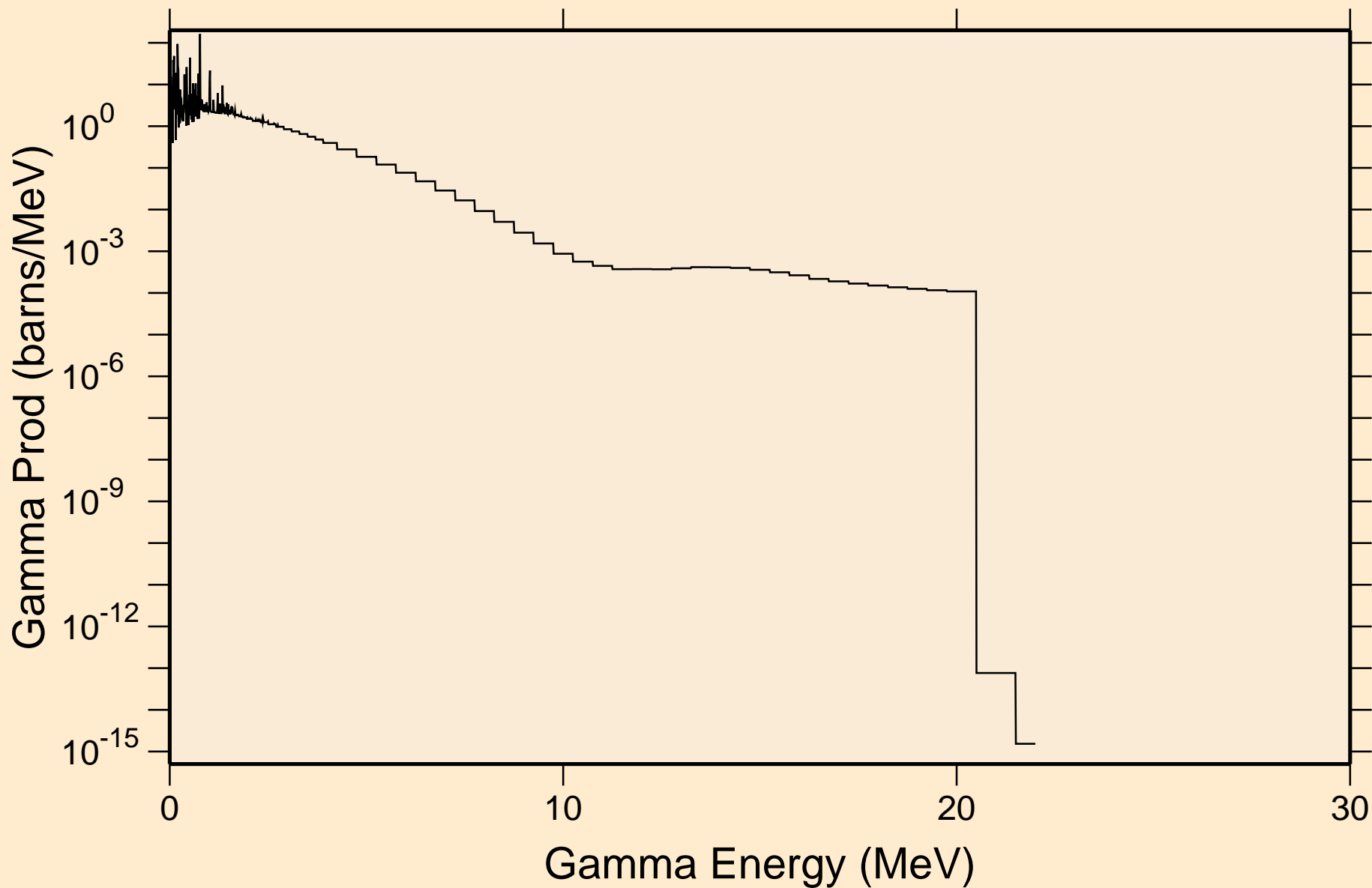

# SM142 NEUTRON ACER TENDL-2019 LIBRARY; T=293.16K

## Particle heating contributions

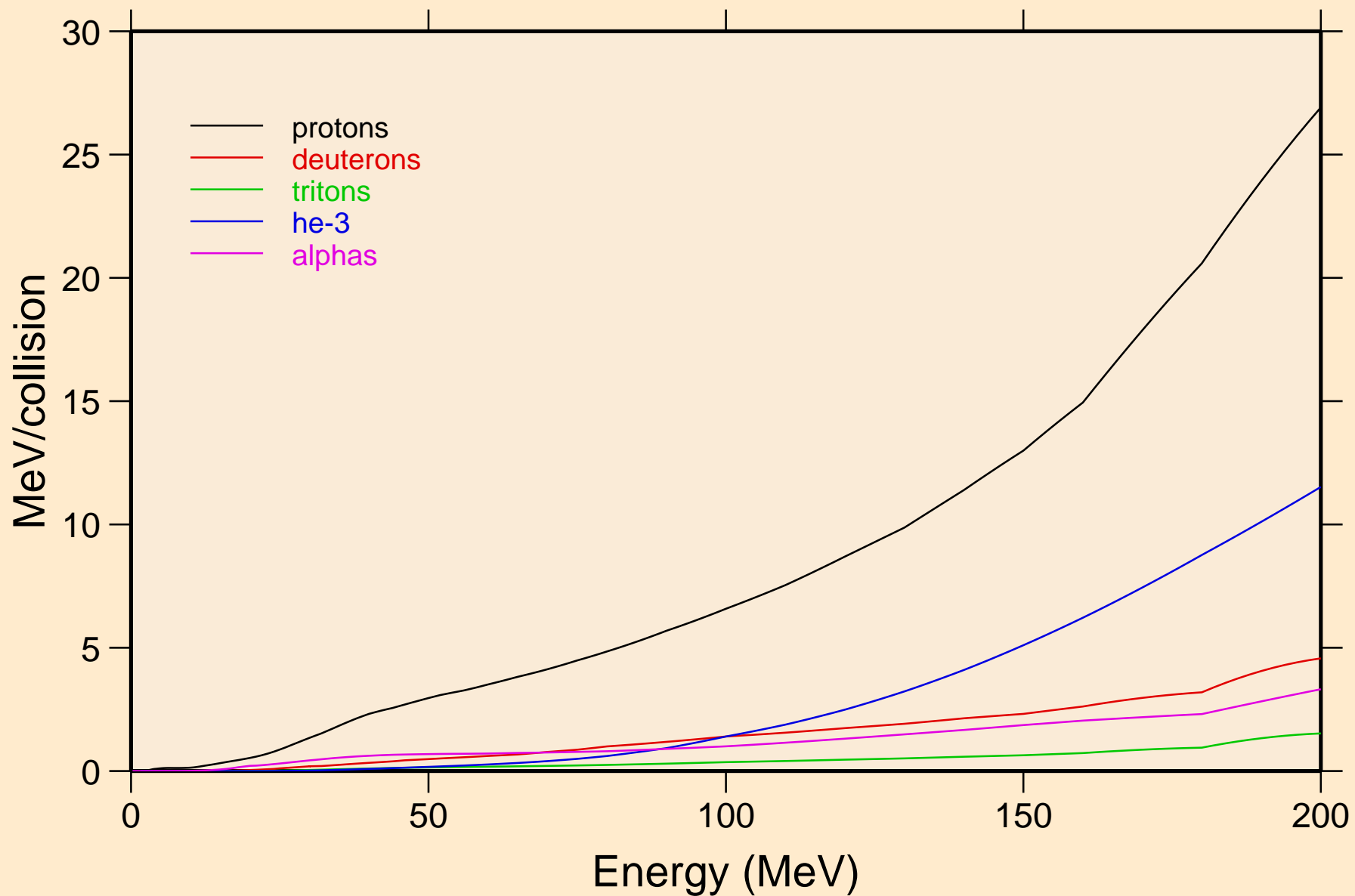

SM142 NEUTRON ACER TENDL-2019 LIBRARY; T=293.16K  
Recoil Heating

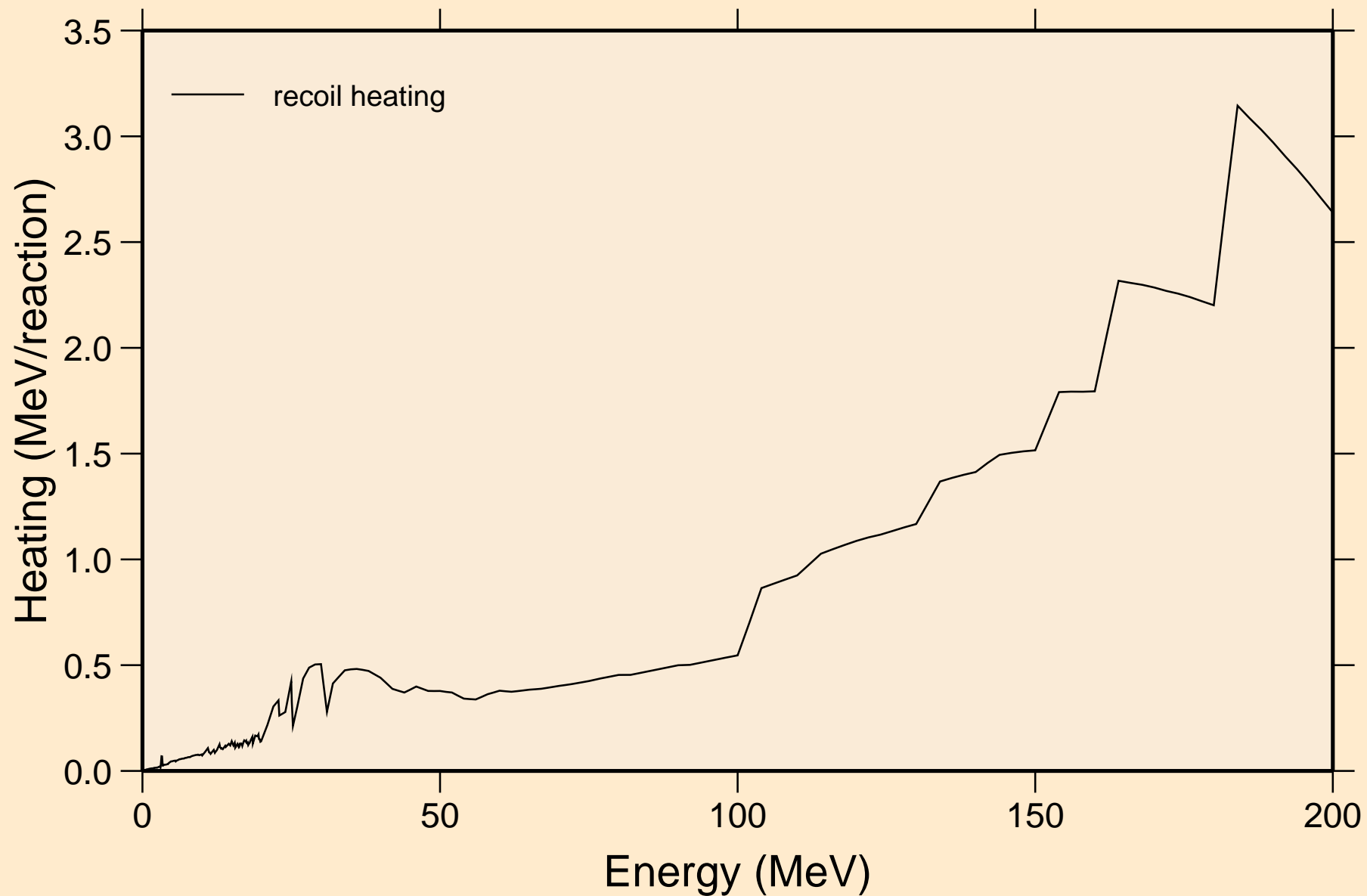

SM142 NEUTRON ACER TENDL-2019 LIBRARY; T=293.16K  
Particle production cross sections

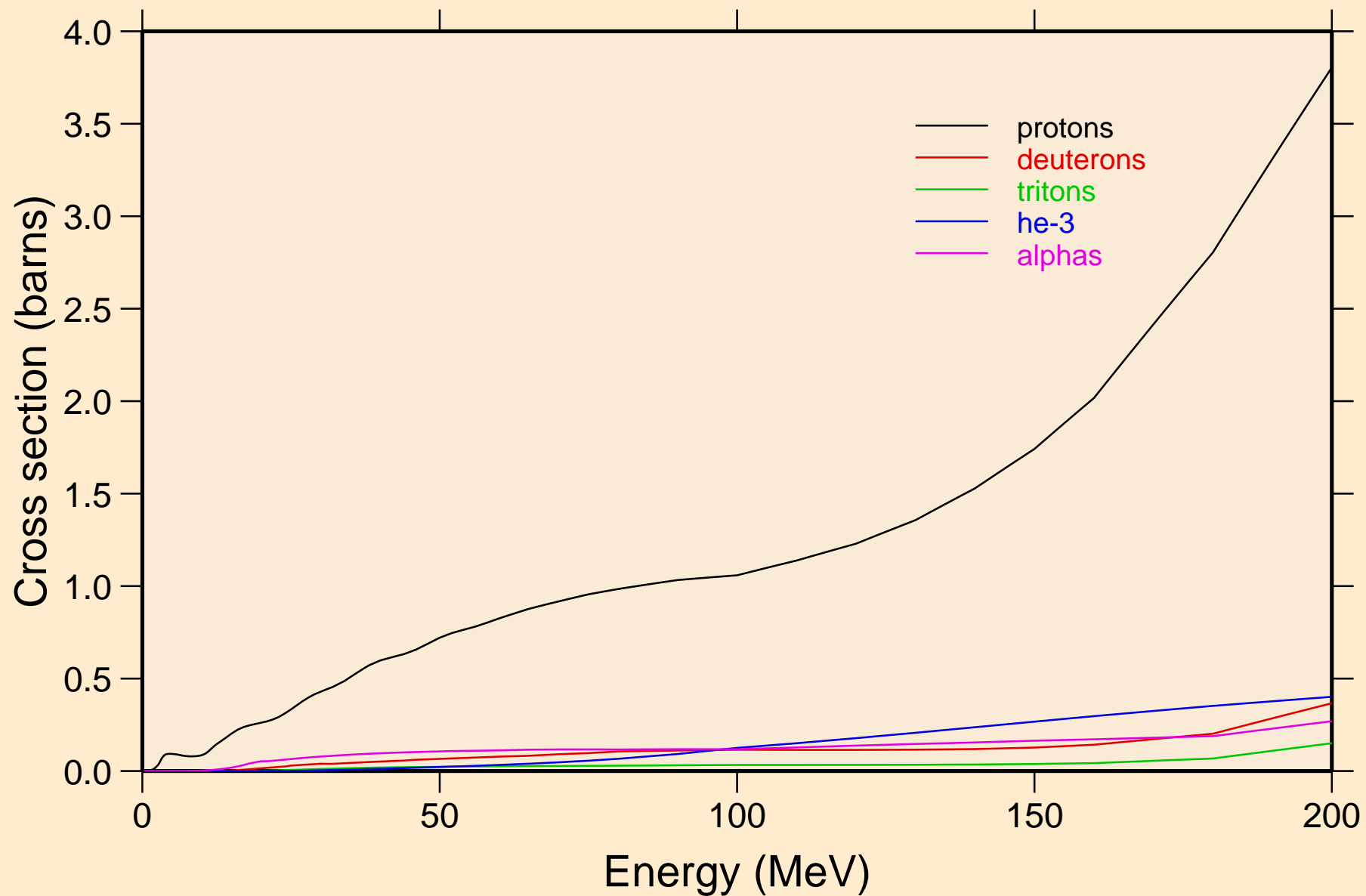

SM142 NEUTRON ACER TENDL-2019 LIBRARY; T=293.16K  
protons from (n,x)

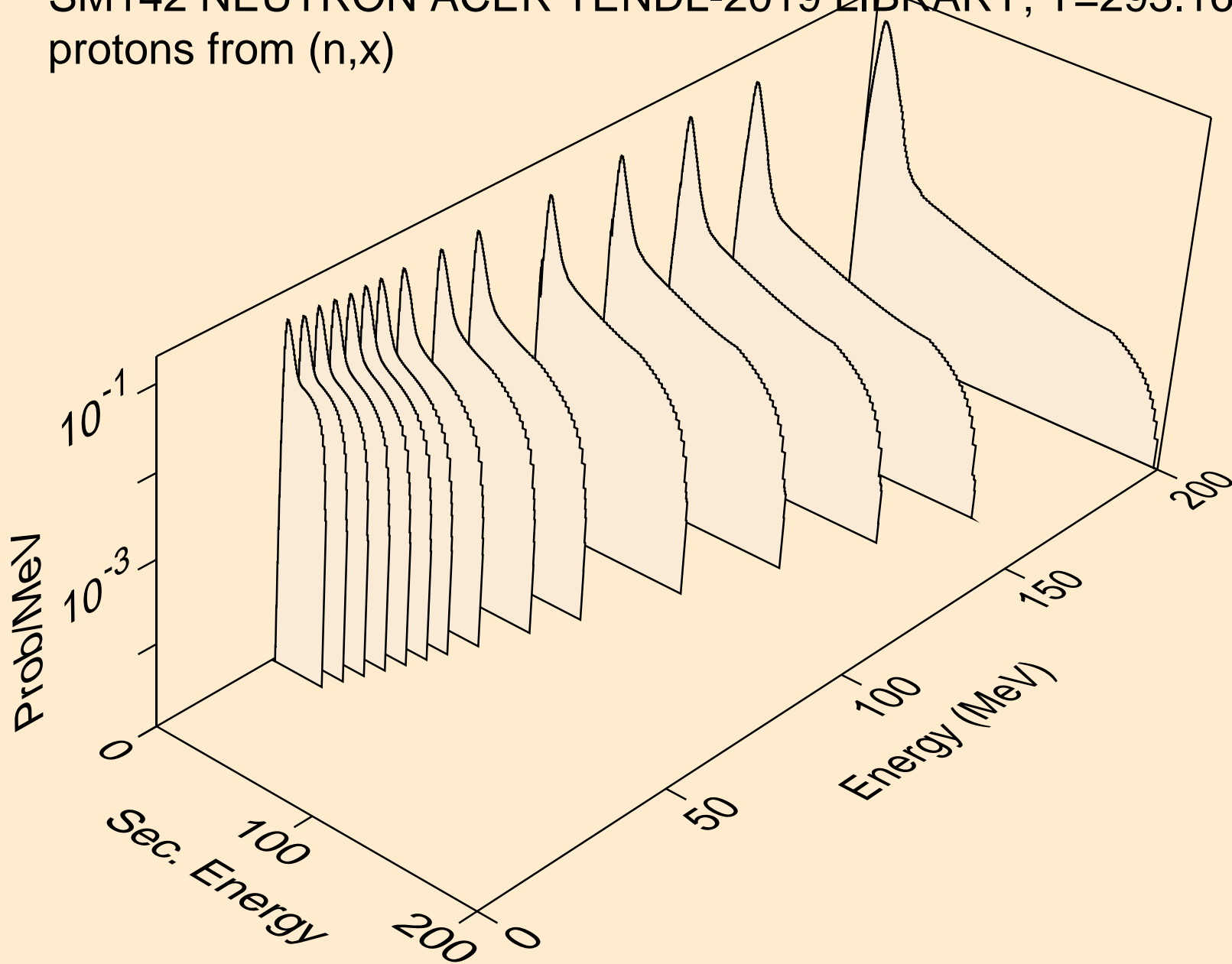

SM142 NEUTRON ACER TENDL-2019 LIBRARY; T=293.16K  
protons from (n,n\*)p

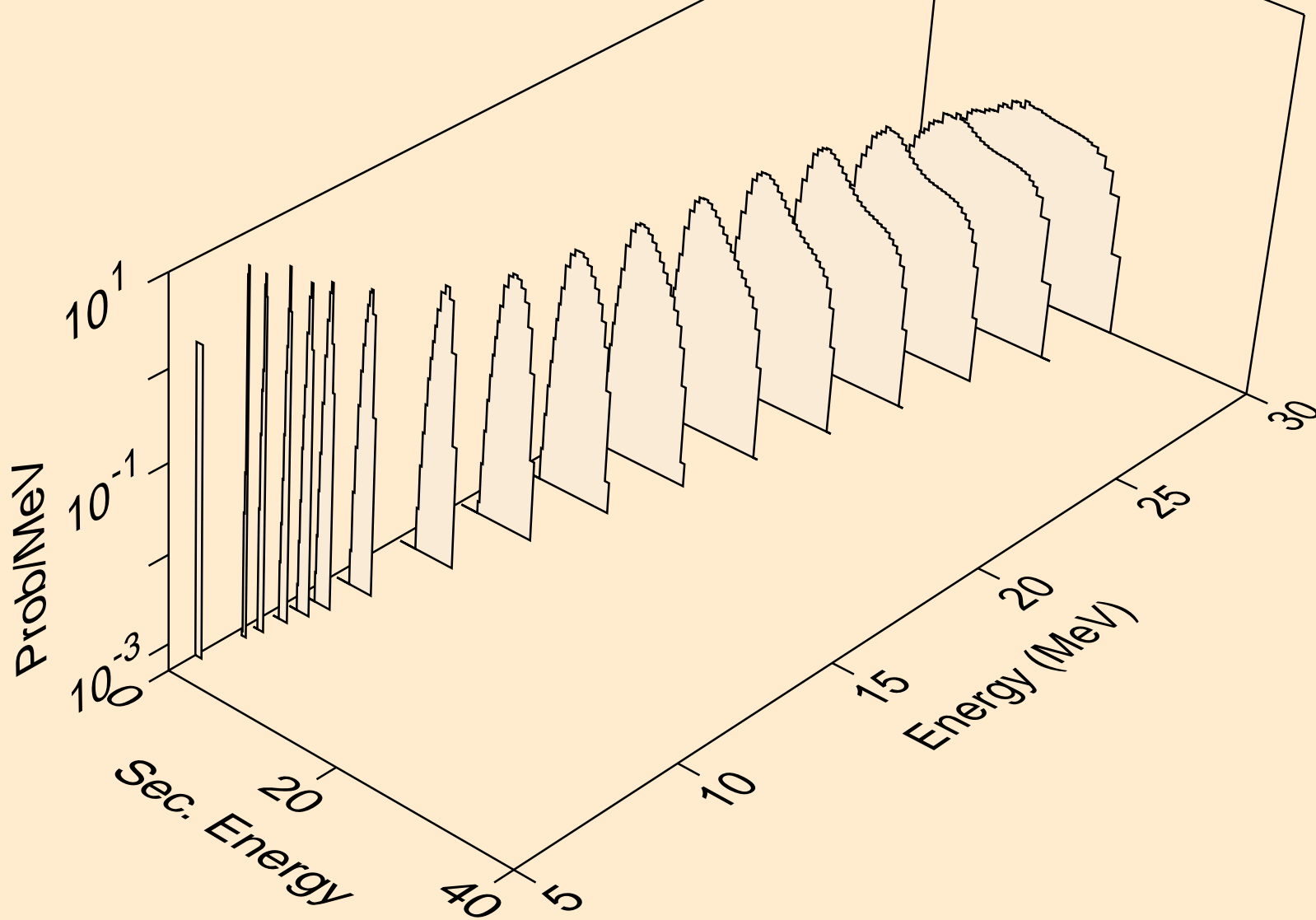



SM142 NEUTRON ACER TENDL-2019 LIBRARY; T=293.16K  
protons from (n,2np)

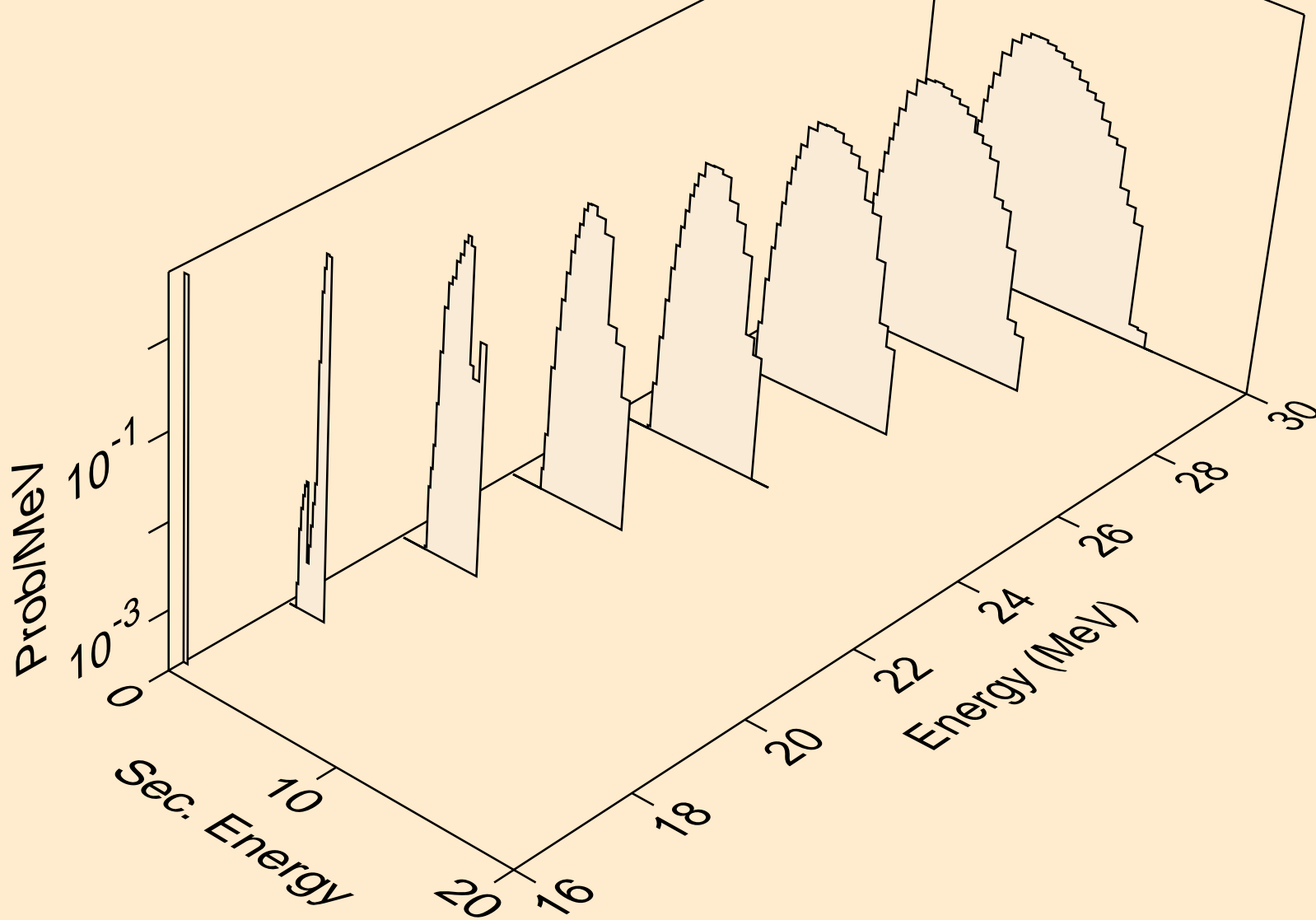

SM142 NEUTRON ACER TENDL-2019 LIBRARY; T=293.16K  
protons from (n,3np)

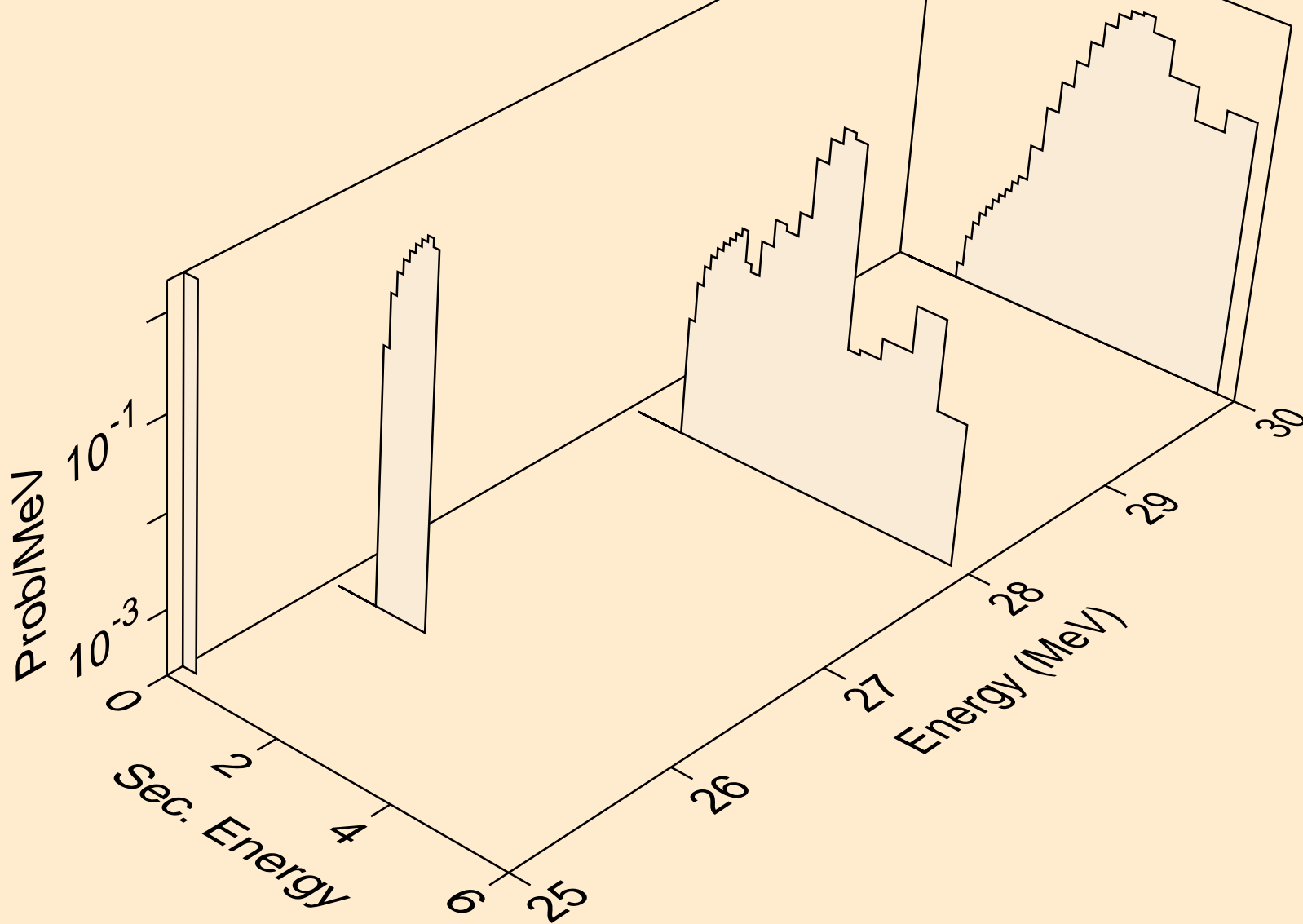

SM142 NEUTRON ACER TENDL-2019 LIBRARY; T=293.16K  
protons from (n,2np)

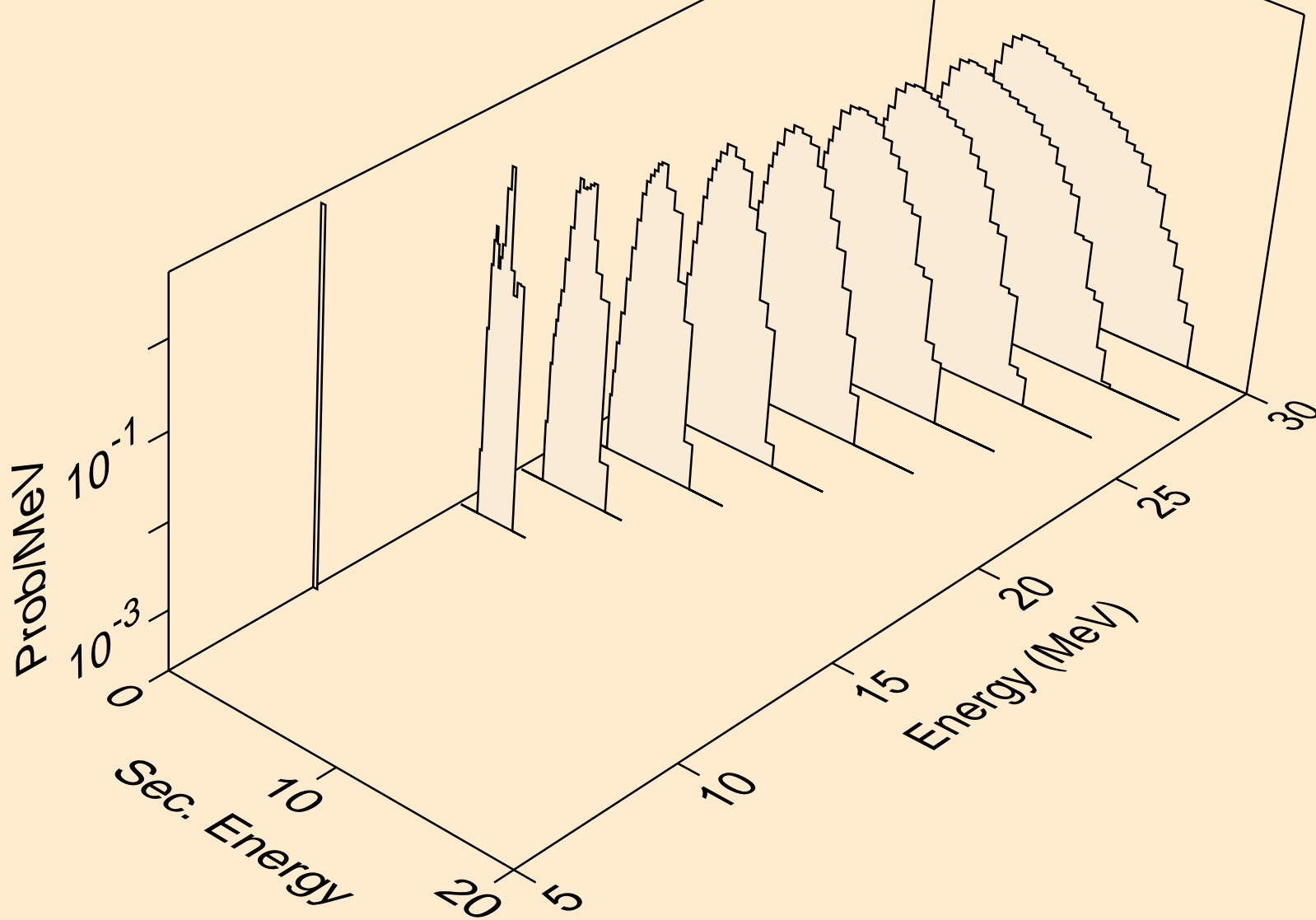

SM142 NEUTRON ACER TENDL-2019 LIBRARY; T=293.16K  
protons from (n,npa)

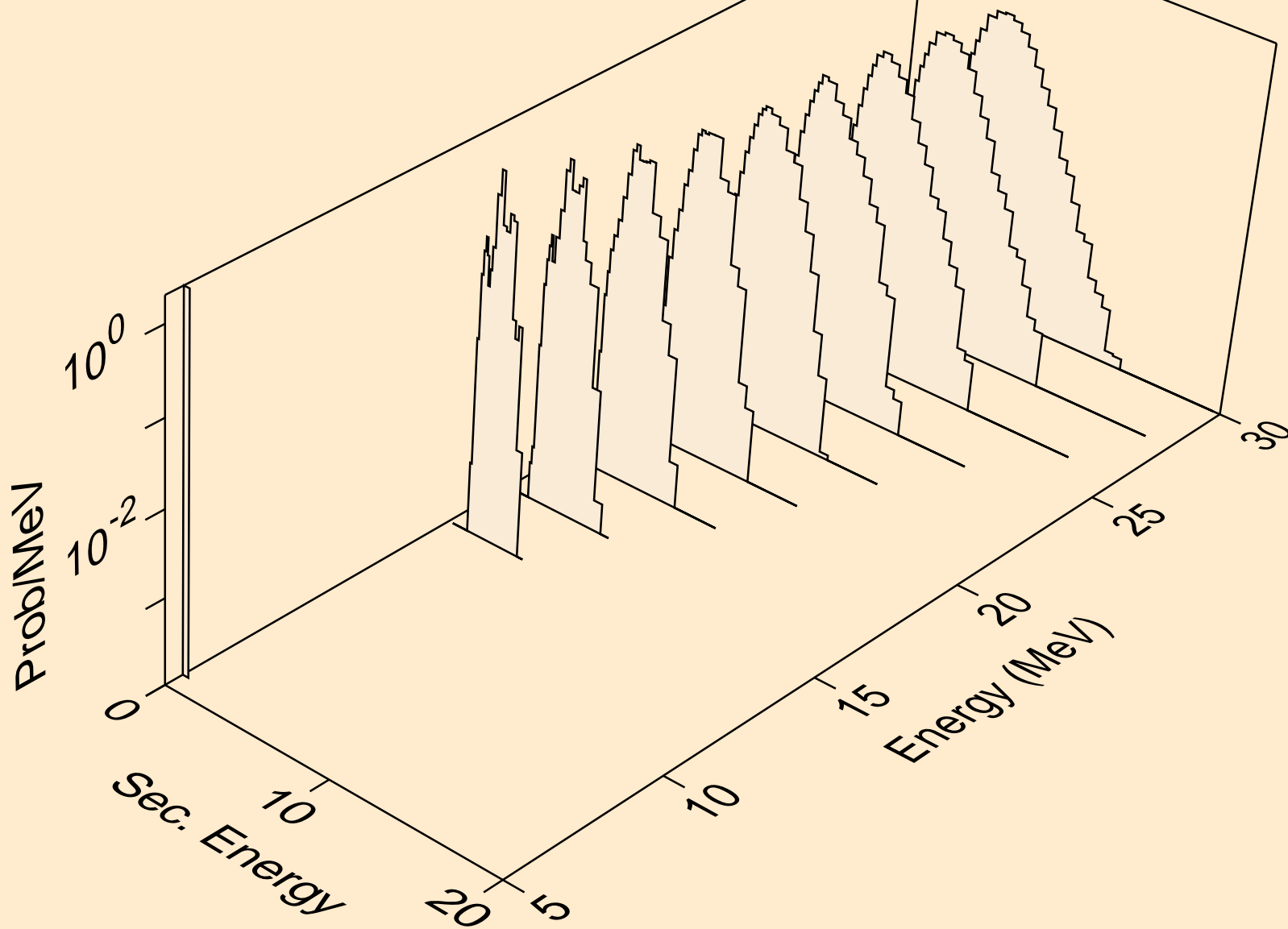

SM142 NEUTRON ACER TENDL-2019 LIBRARY; T=293.16K  
protons from (n,p)

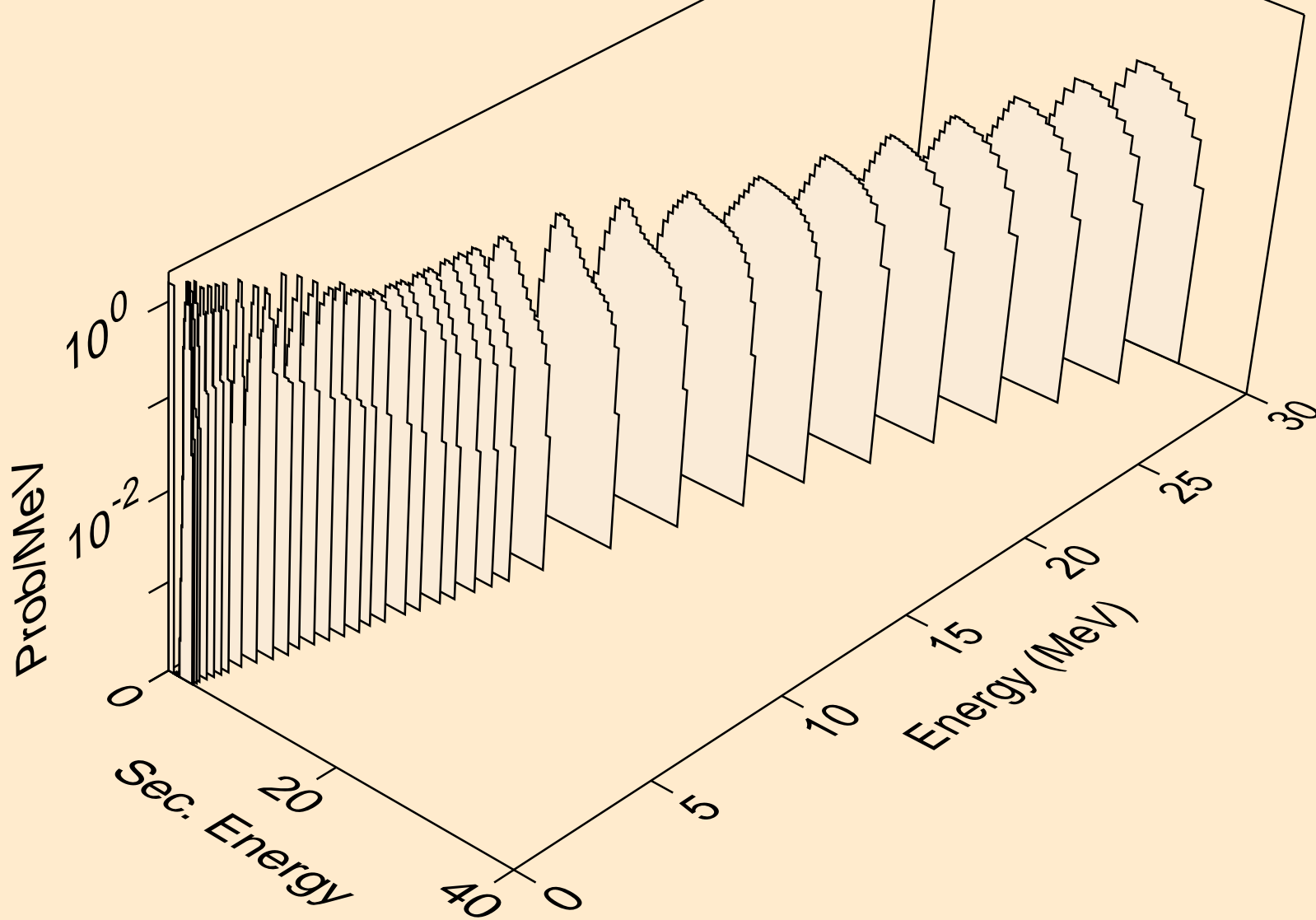

SM142 NEUTRON ACER TENDL-2019 LIBRARY; T=293.16K  
protons from (n,2p)

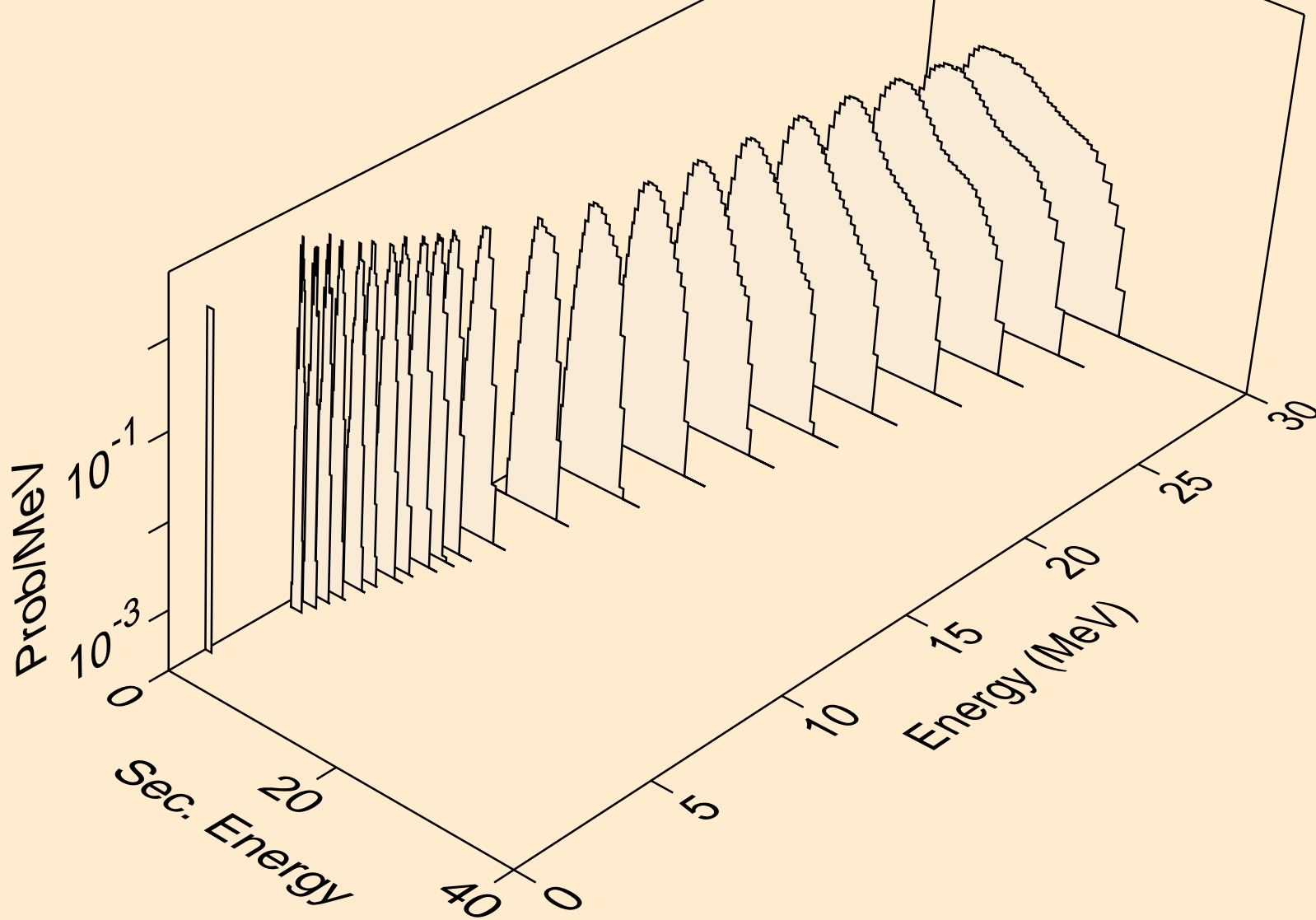

SM142 NEUTRON ACER TENDL-2019 LIBRARY; T=293.16K  
protons from (n,p)

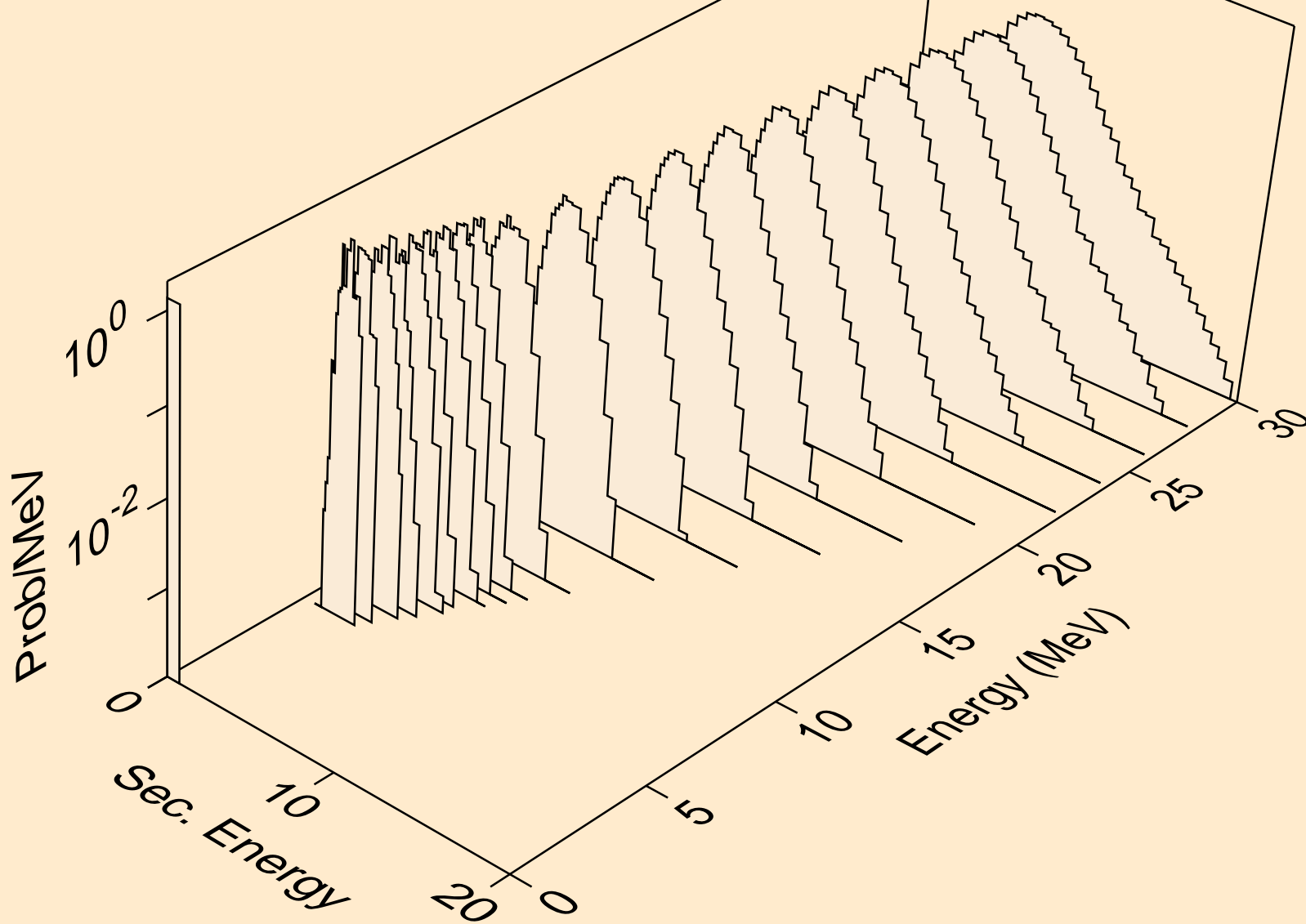

SM142 NEUTRON ACER TENDL-2019 LIBRARY; T=293.16K  
protons from (n,pd)

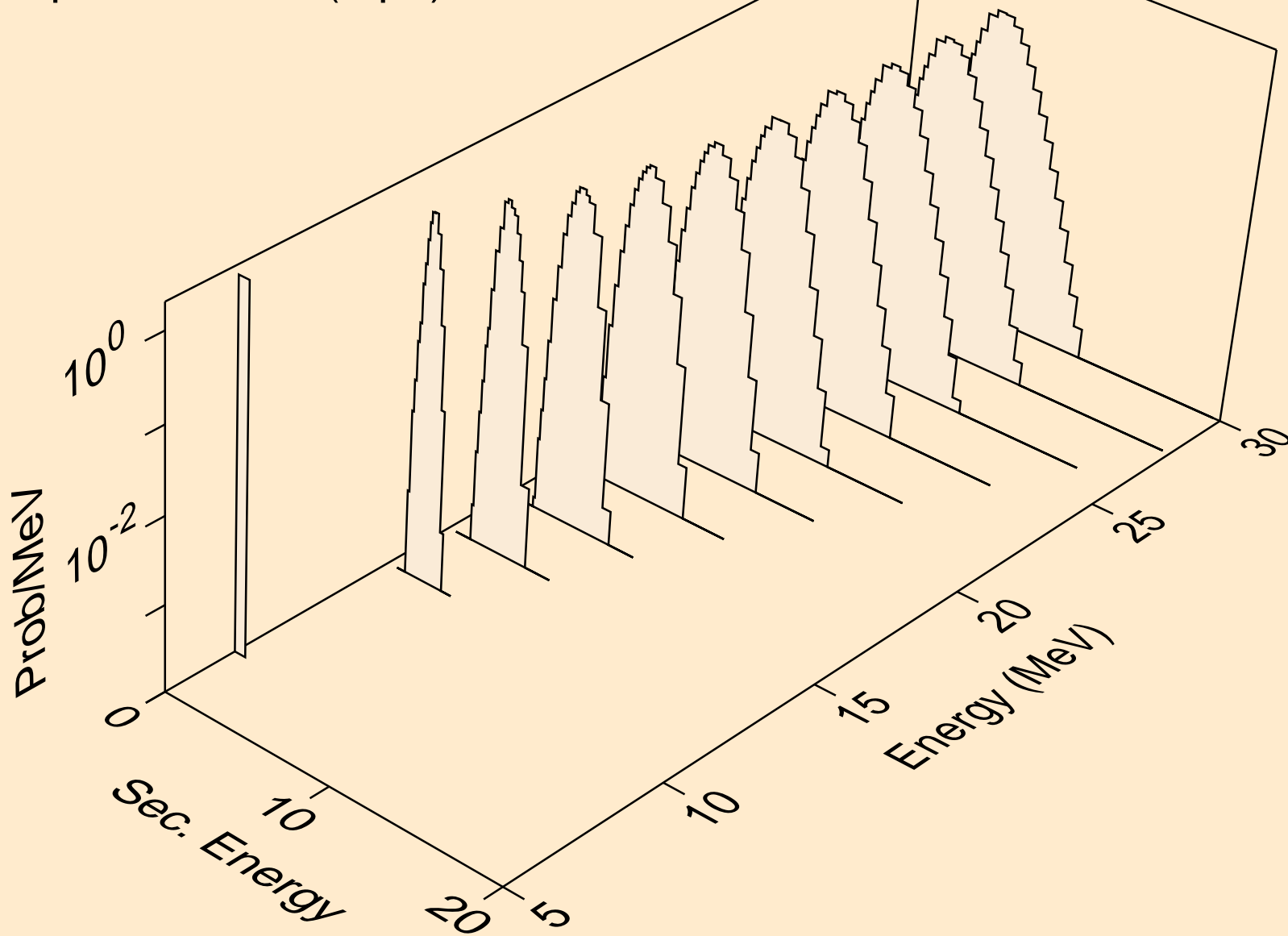



SM142 NEUTRON ACER TENDL-2019 LIBRARY; T=293.16K  
protons from (n,pt)

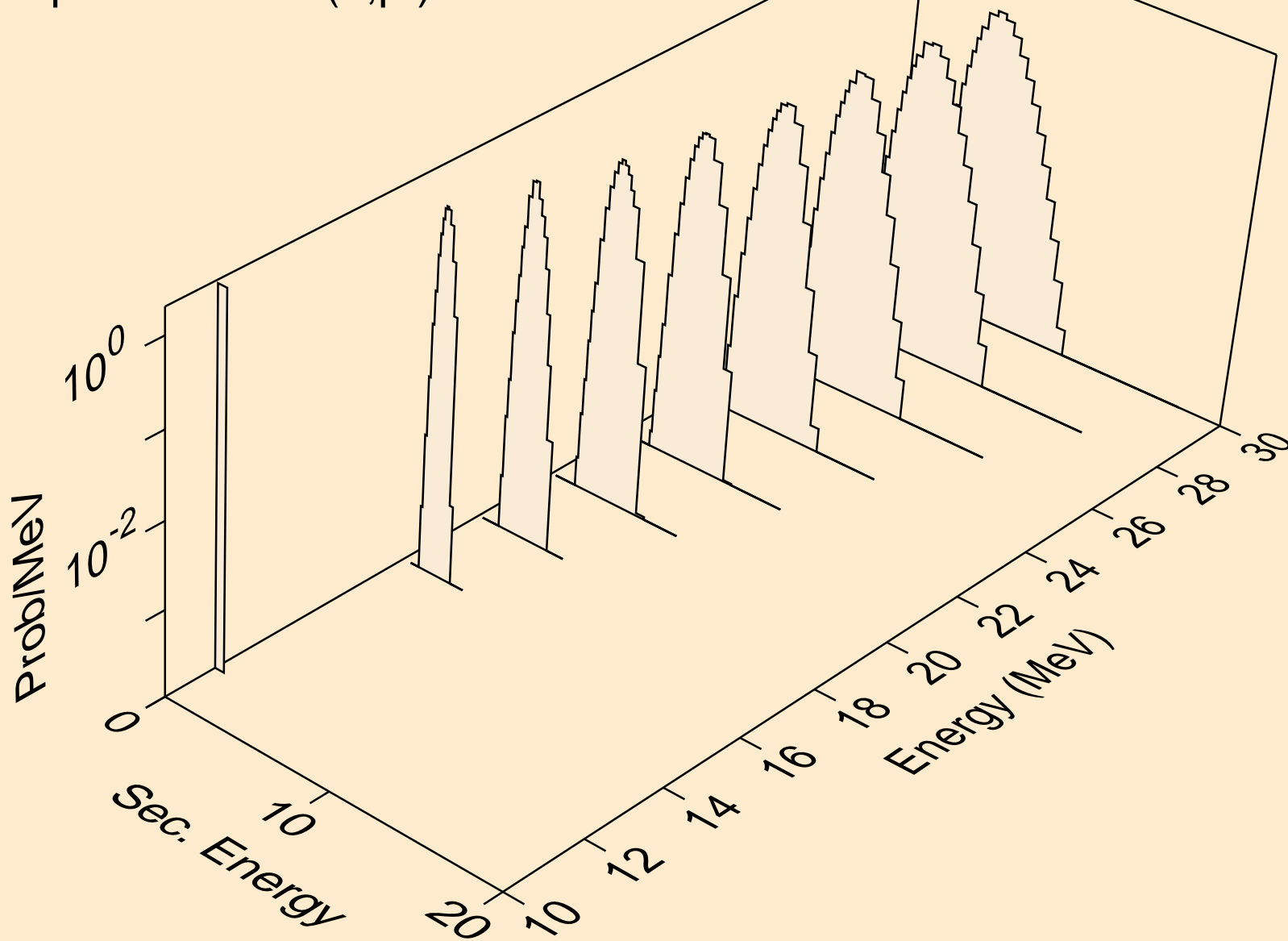

SM142 NEUTRON ACER TENDL-2019 LIBRARY; T=293.16K  
deuterons from (n,x)

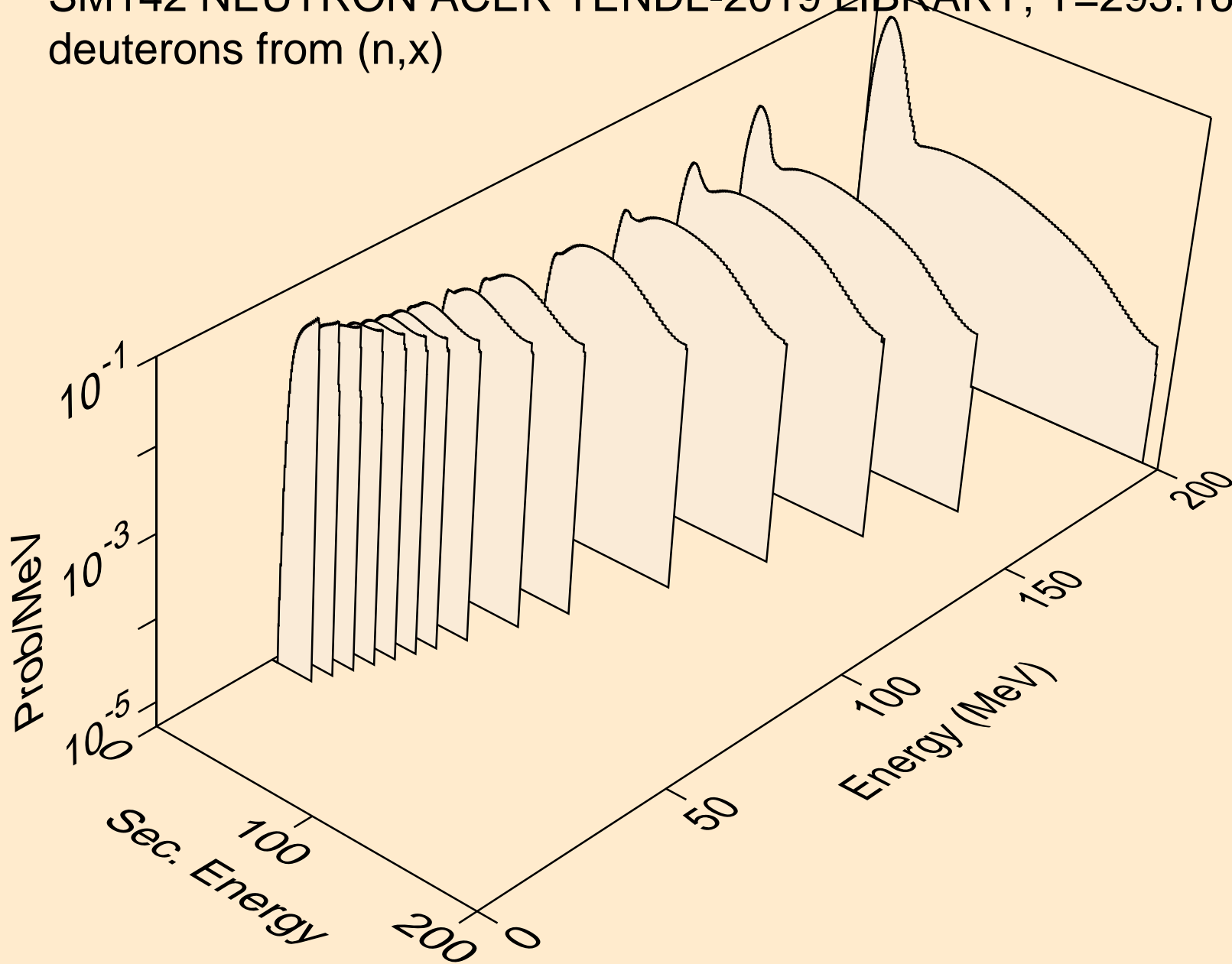

SM142 NEUTRON ACER TENDL-2019 LIBRARY; T=293.16K  
deuterons from (n,2nd)

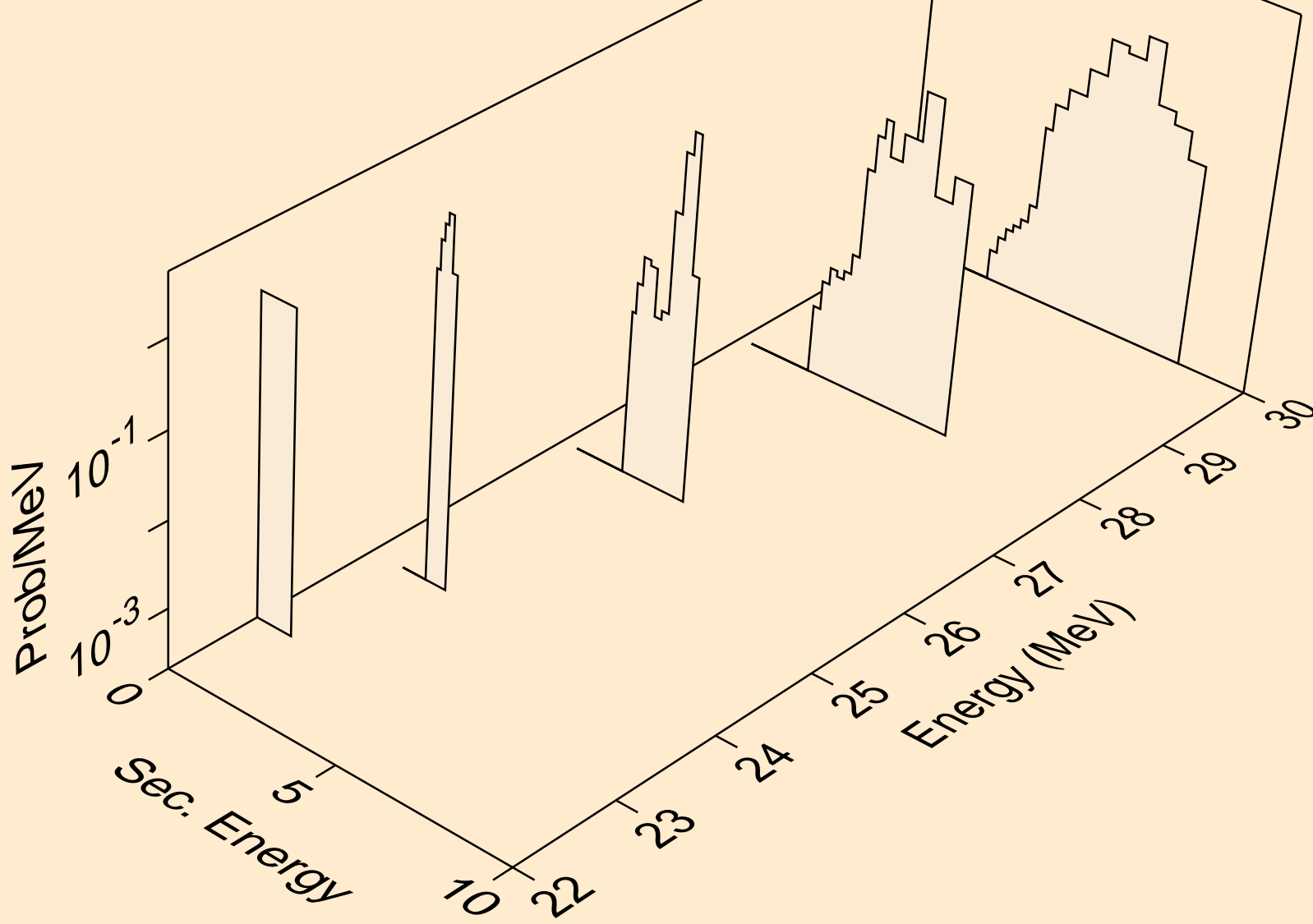

SM142 NEUTRON ACER TENDL-2019 LIBRARY; T=293.16K  
deuterons from (n,n\*)d

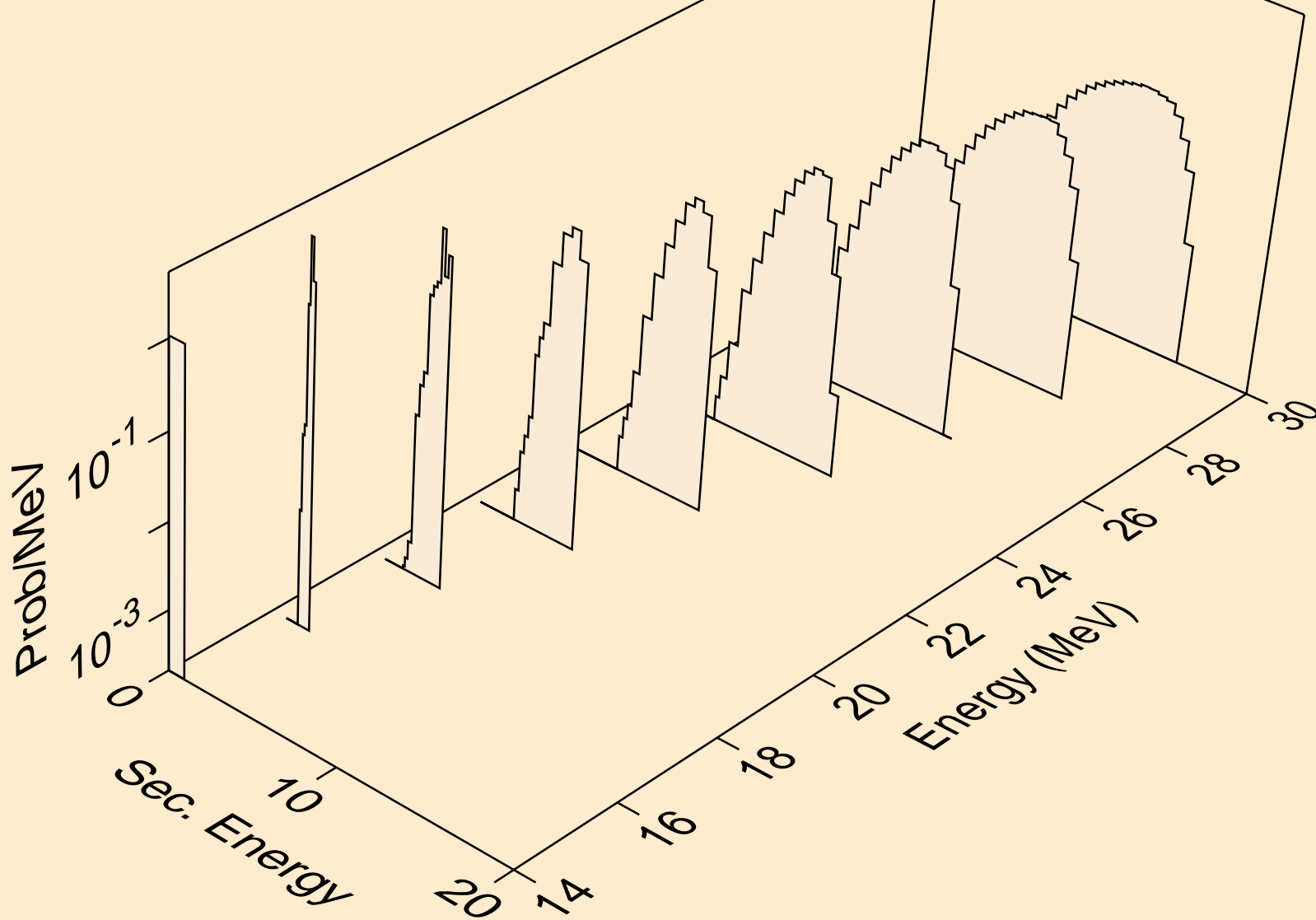

SM142 NEUTRON ACER TENDL-2019 LIBRARY; T=293.16K  
deuterons from (n,d)

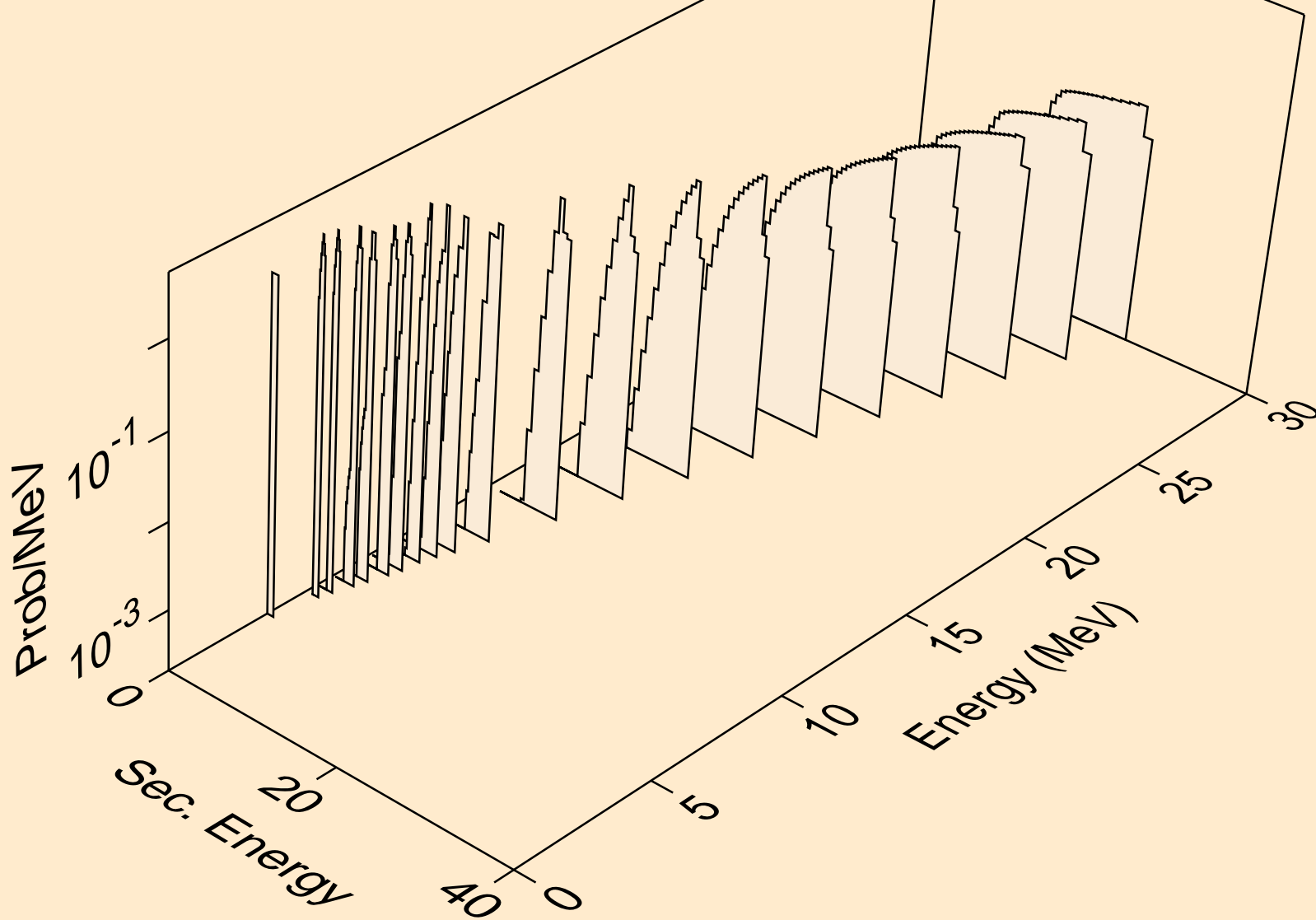

SM142 NEUTRON ACER TENDL-2019 LIBRARY; T=293.16K  
deuterons from (n,pd)

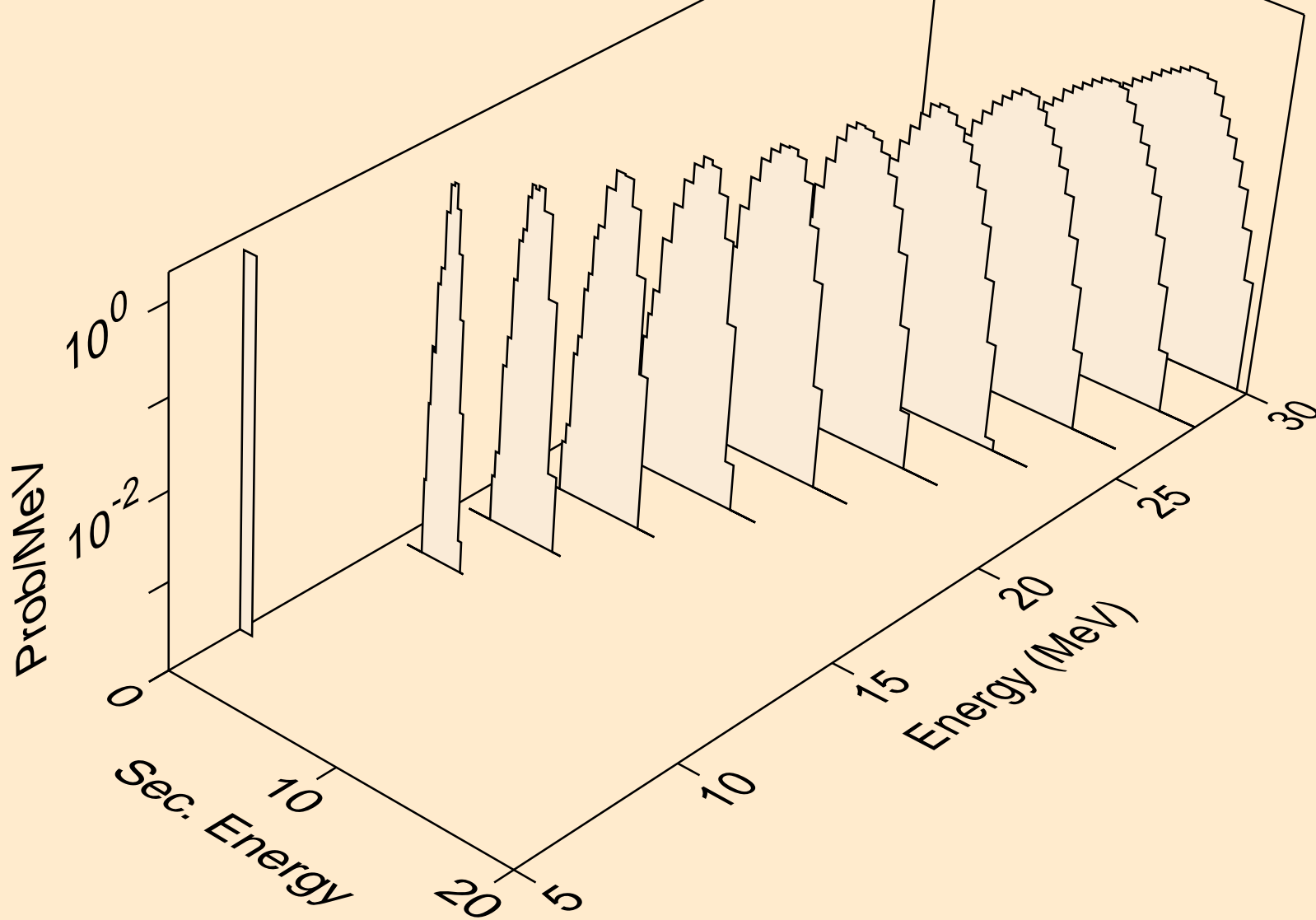

SM142 NEUTRON ACER TENDL-2019 LIBRARY; T=293.16K  
deuterons from (n,da)

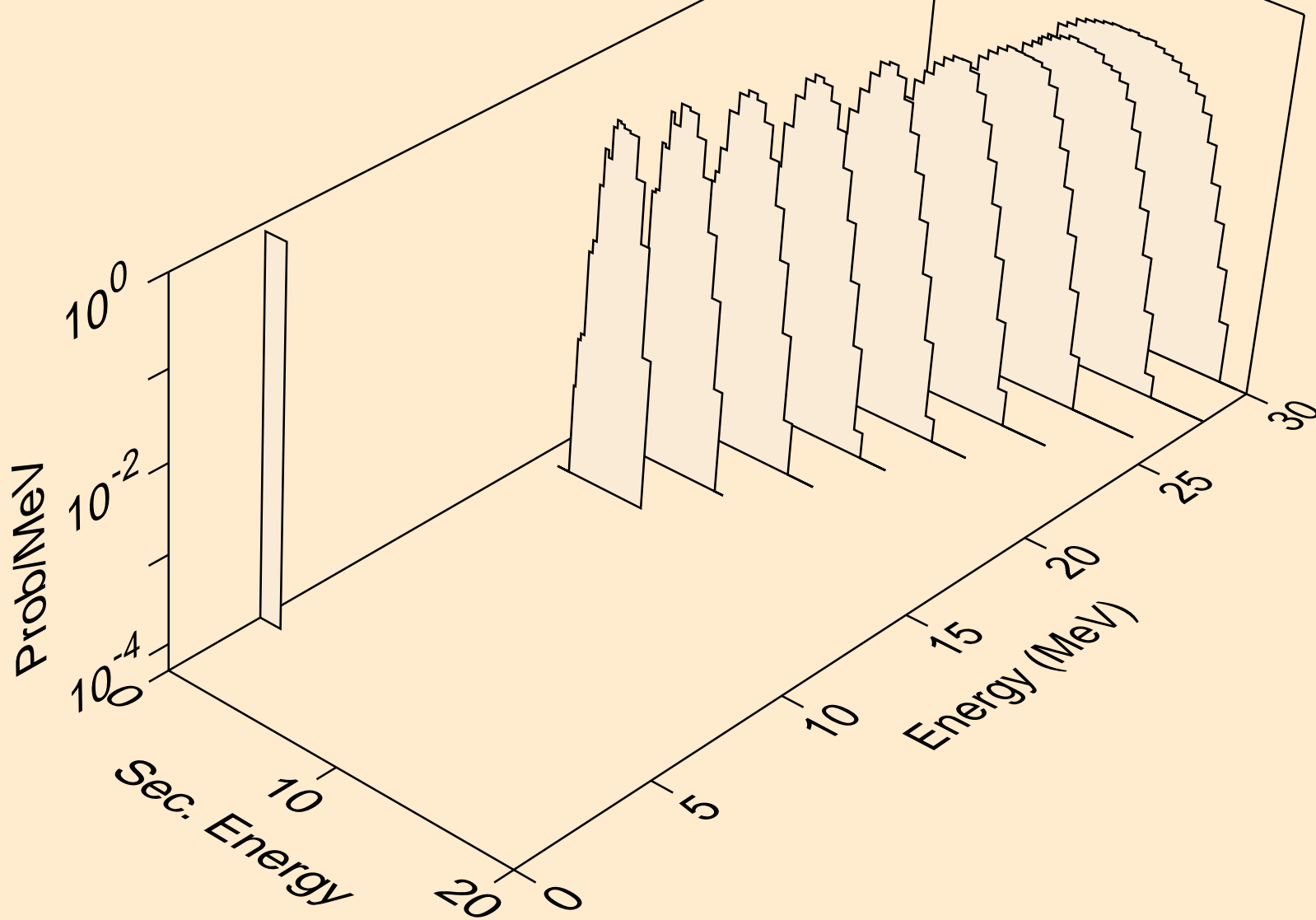

SM142 NEUTRON ACER TENDL-2019 LIBRARY; T=293.16K  
tritons from (n,x)

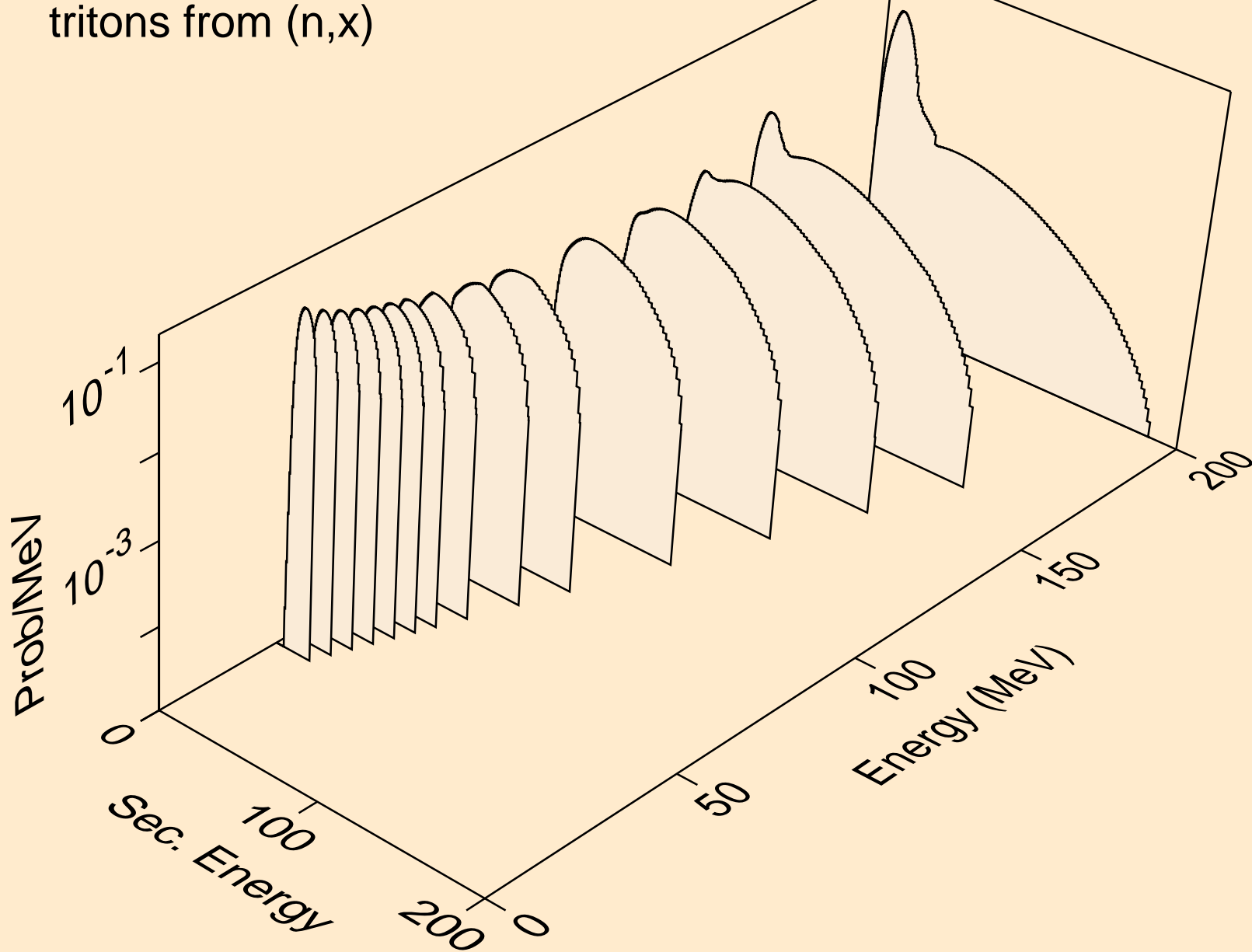



SM142 NEUTRON ACER TENDL-2019 LIBRARY; T=293.16K  
tritons from (n,n\*)t

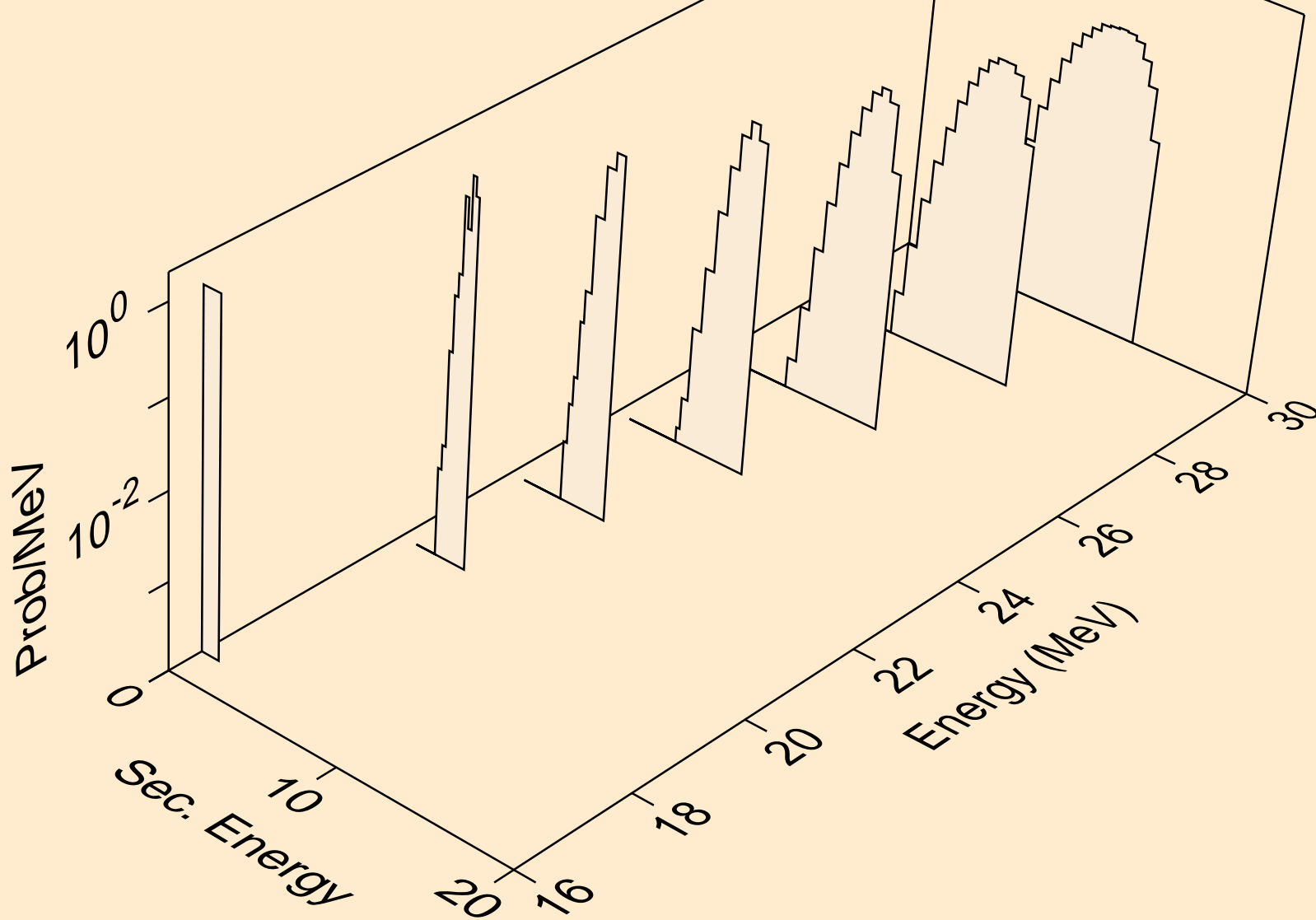

SM142 NEUTRON ACER TENDL-2019 LIBRARY; T=293.16K  
tritons from (n,t)

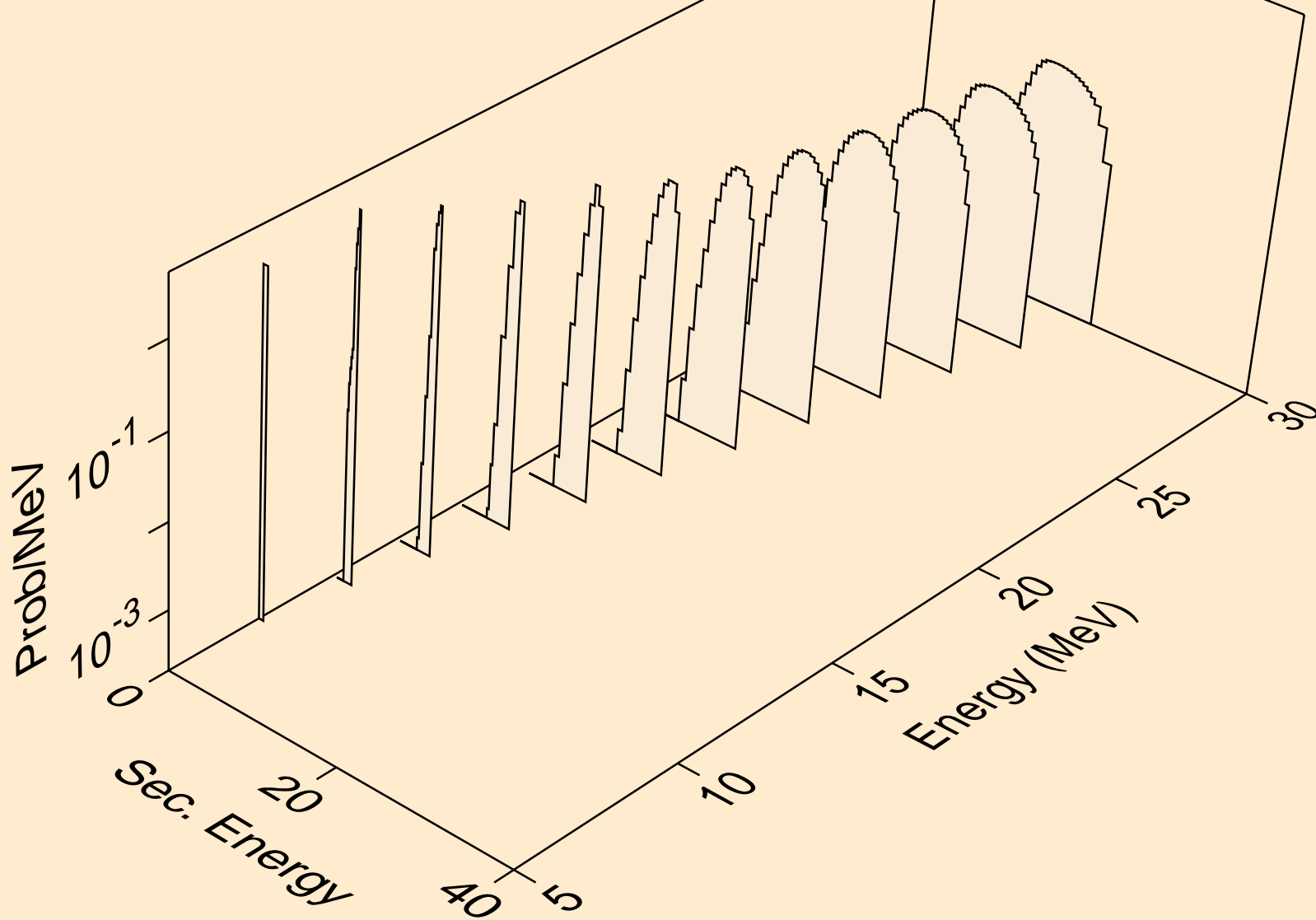

SM142 NEUTRON ACER TENDL-2019 LIBRARY; T=293.16K  
tritons from (n,pt)

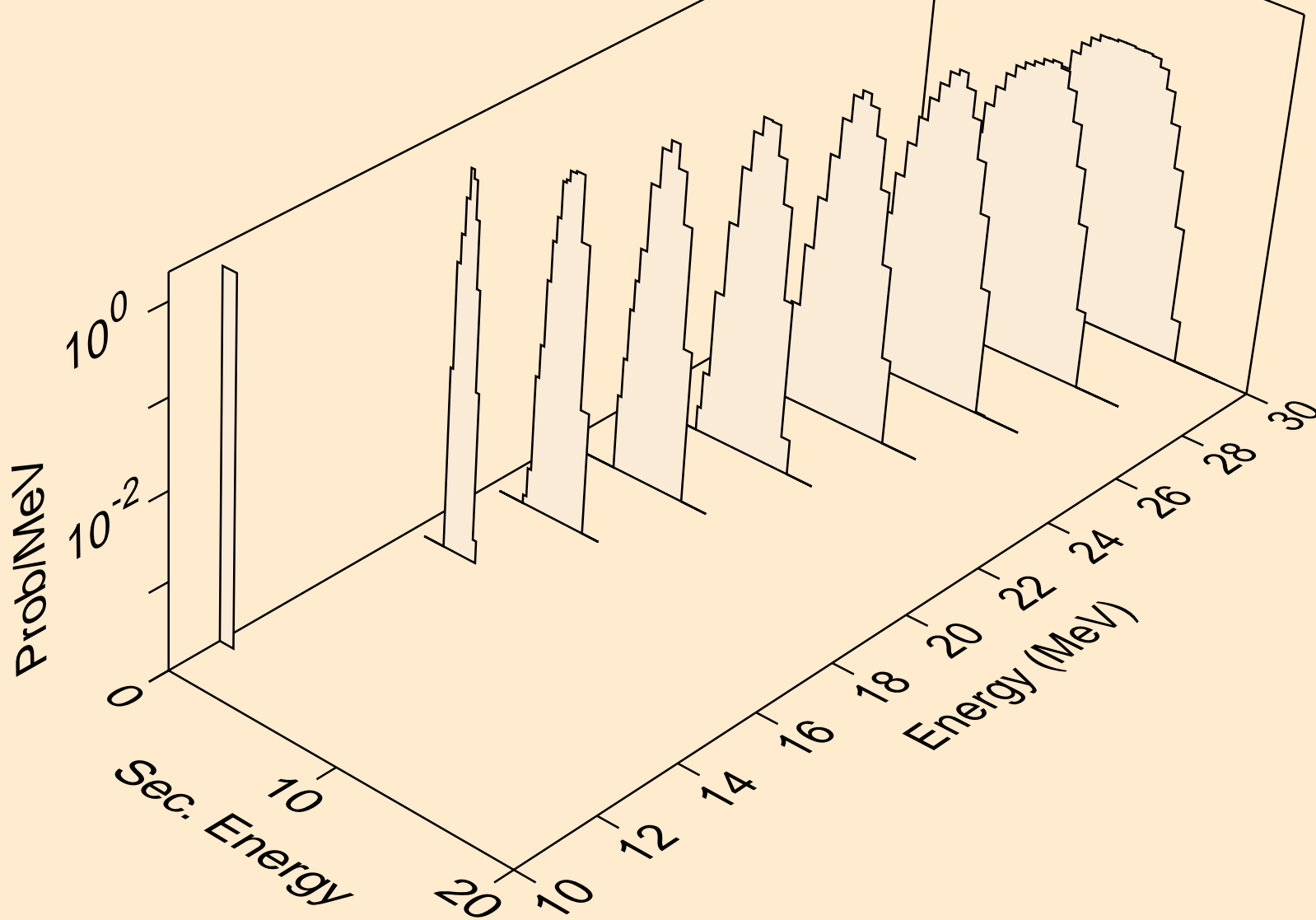

SM142 NEUTRON ACER TENDL-2019 LIBRARY; T=293.16K  
he3s from (n,x)

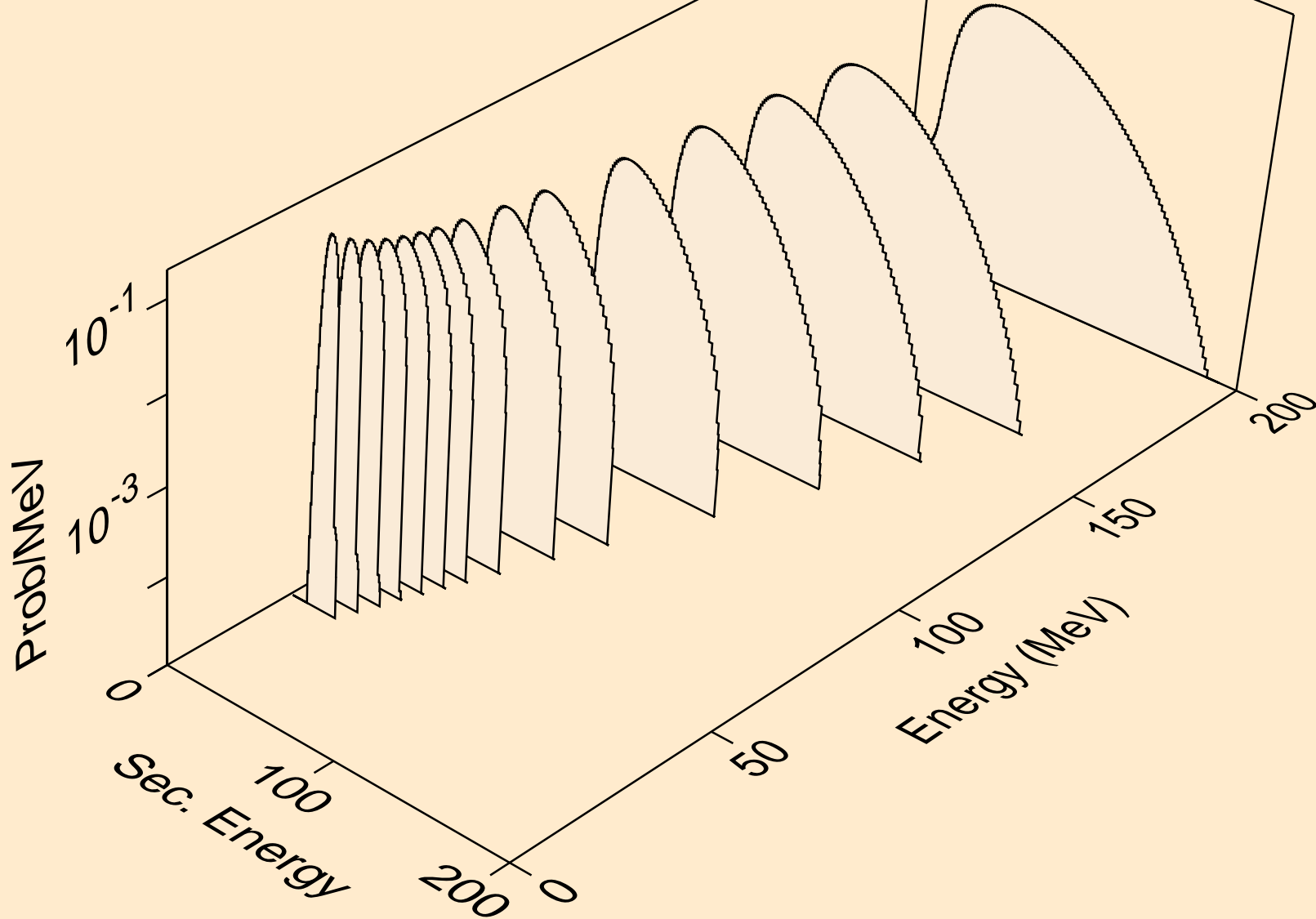

SM142 NEUTRON ACER TENDL-2019 LIBRARY; T=293.16K  
he3s from (n,n\*)he3

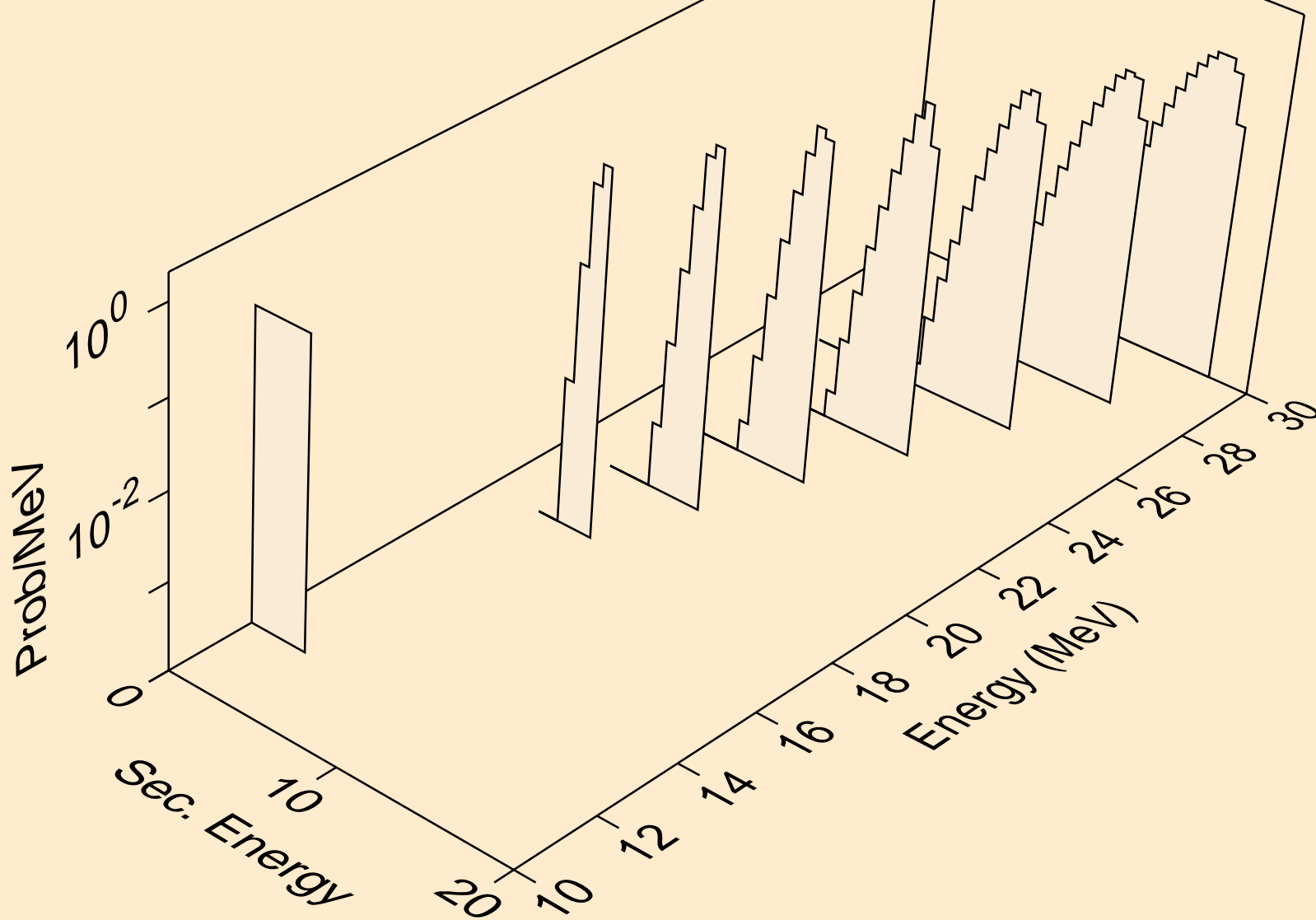

SM142 NEUTRON ACER TENDL-2019 LIBRARY; T=293.16K  
he3s from (n,he3)

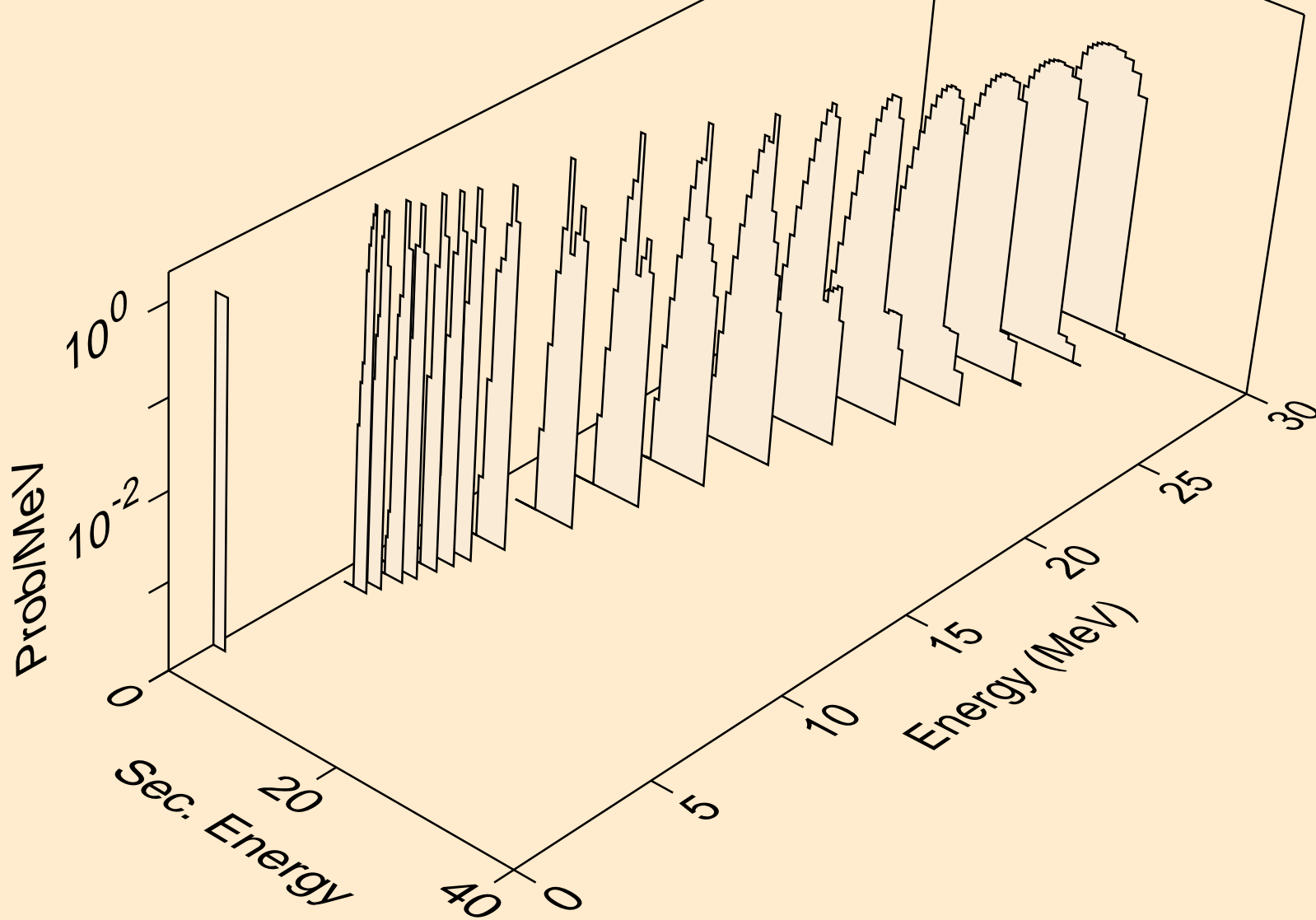

SM142 NEUTRON ACER TENDL-2019 LIBRARY; T=293.16K  
alphas from (n,x)

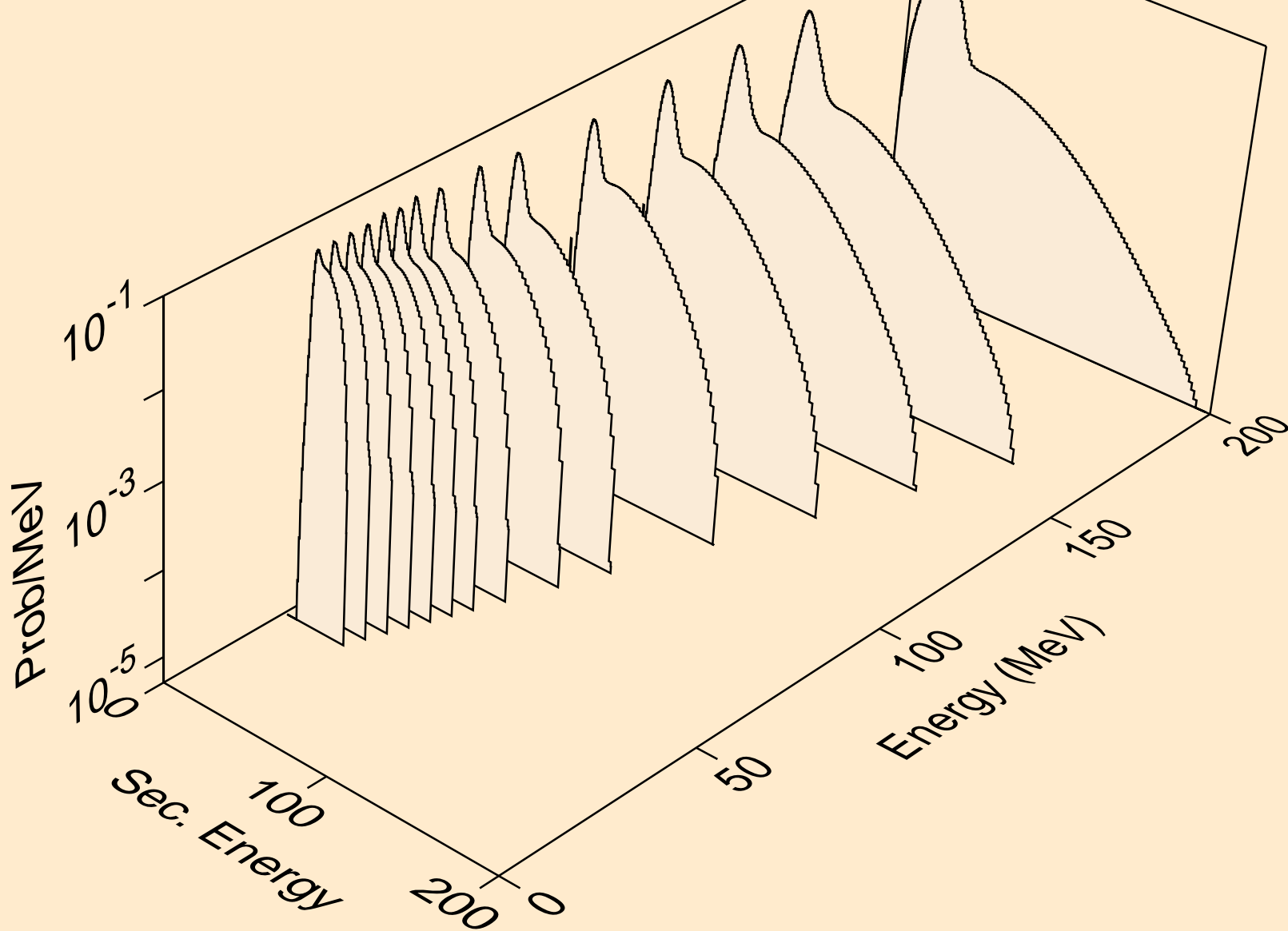

SM142 NEUTRON ACER TENDL-2019 LIBRARY; T=293.16K  
alphas from (n,n\*)a

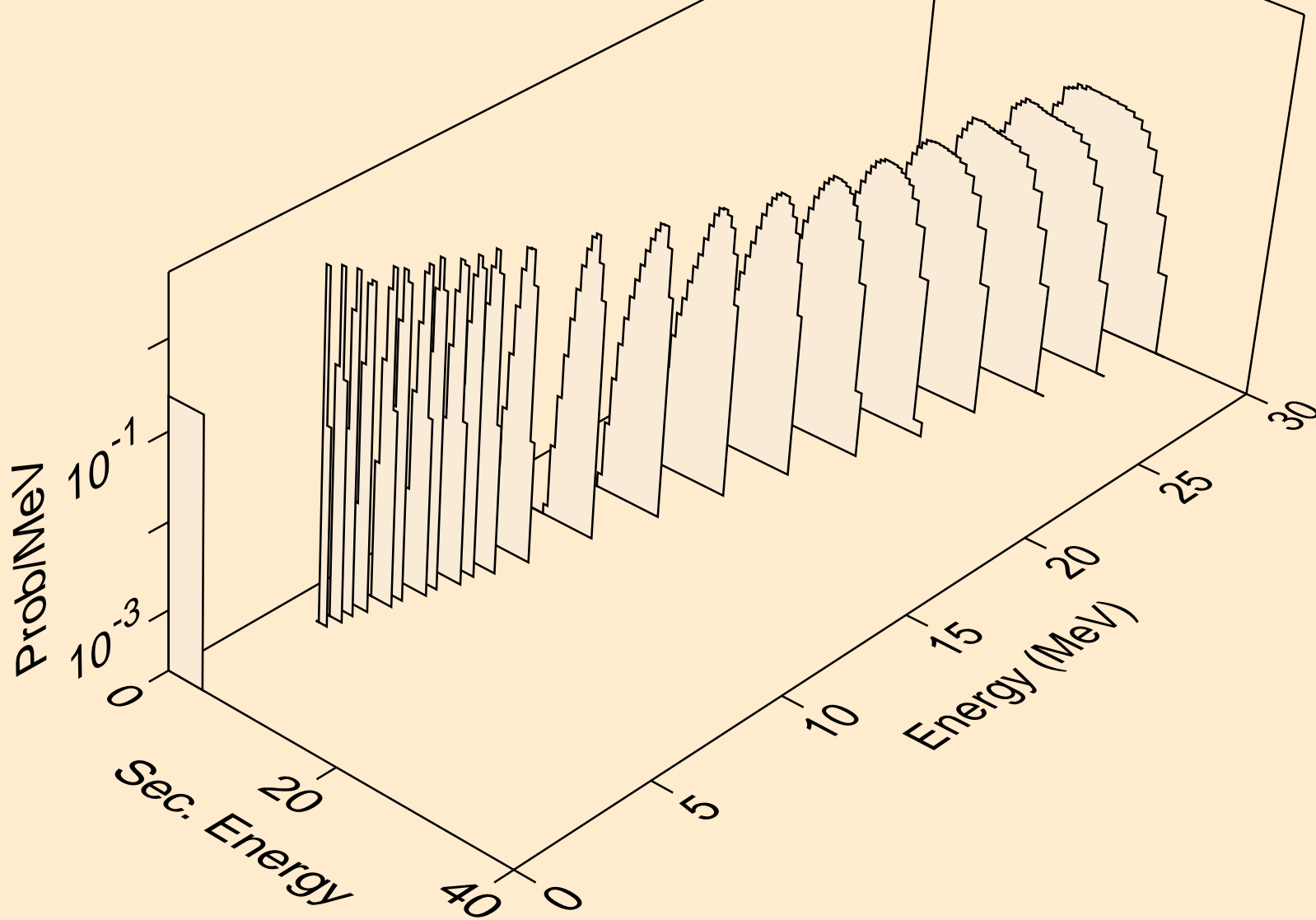



SM142 NEUTRON ACER TENDL-2019 LIBRARY; T=293.16K  
alphas from (n,2n)a

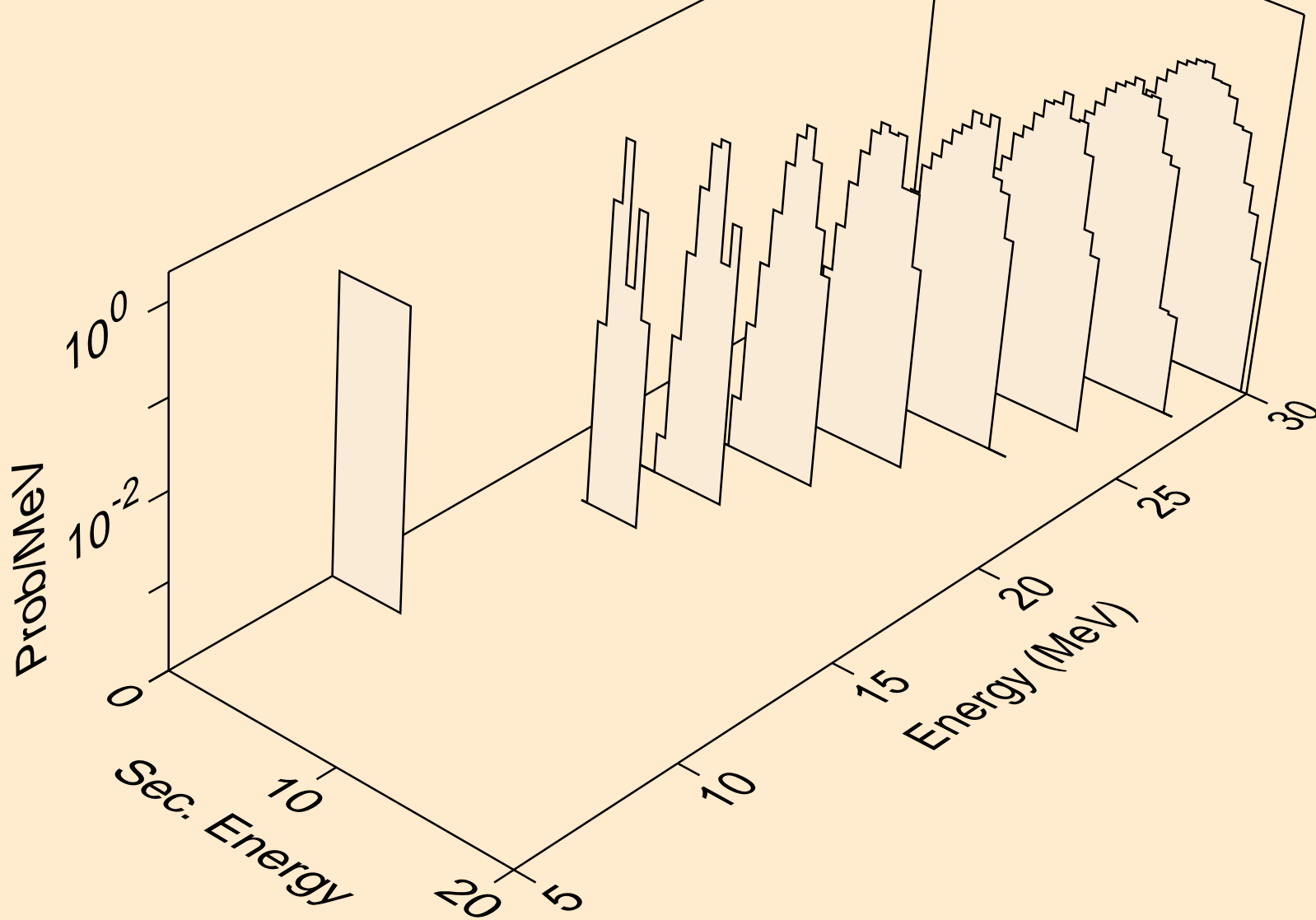

SM142 NEUTRON ACER TENDL-2019 LIBRARY; T=293.16K  
alphas from (n,3n)a

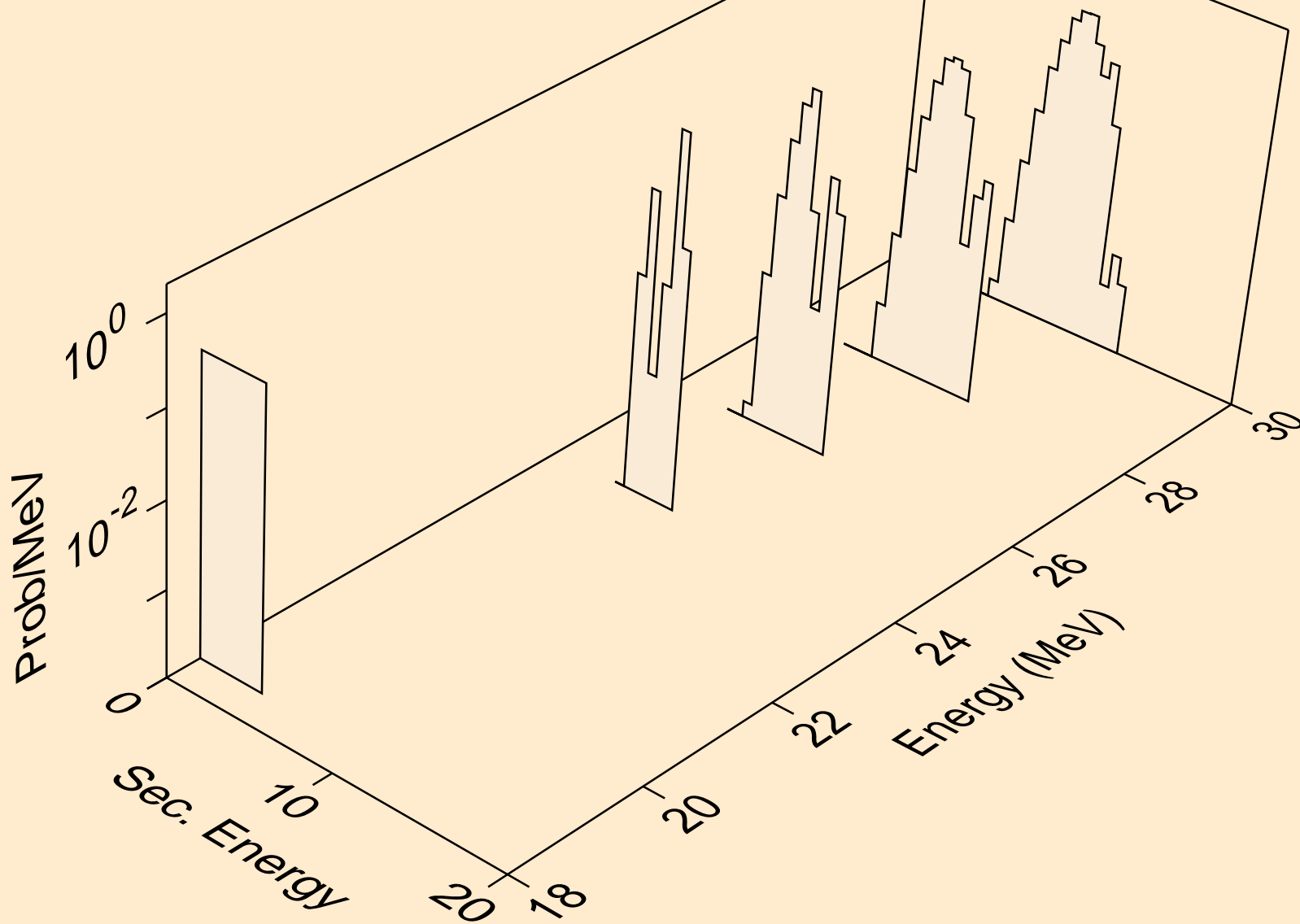

SM142 NEUTRON ACER TENDL-2019 LIBRARY; T=293.16K  
alphas from (n,n\*)2a

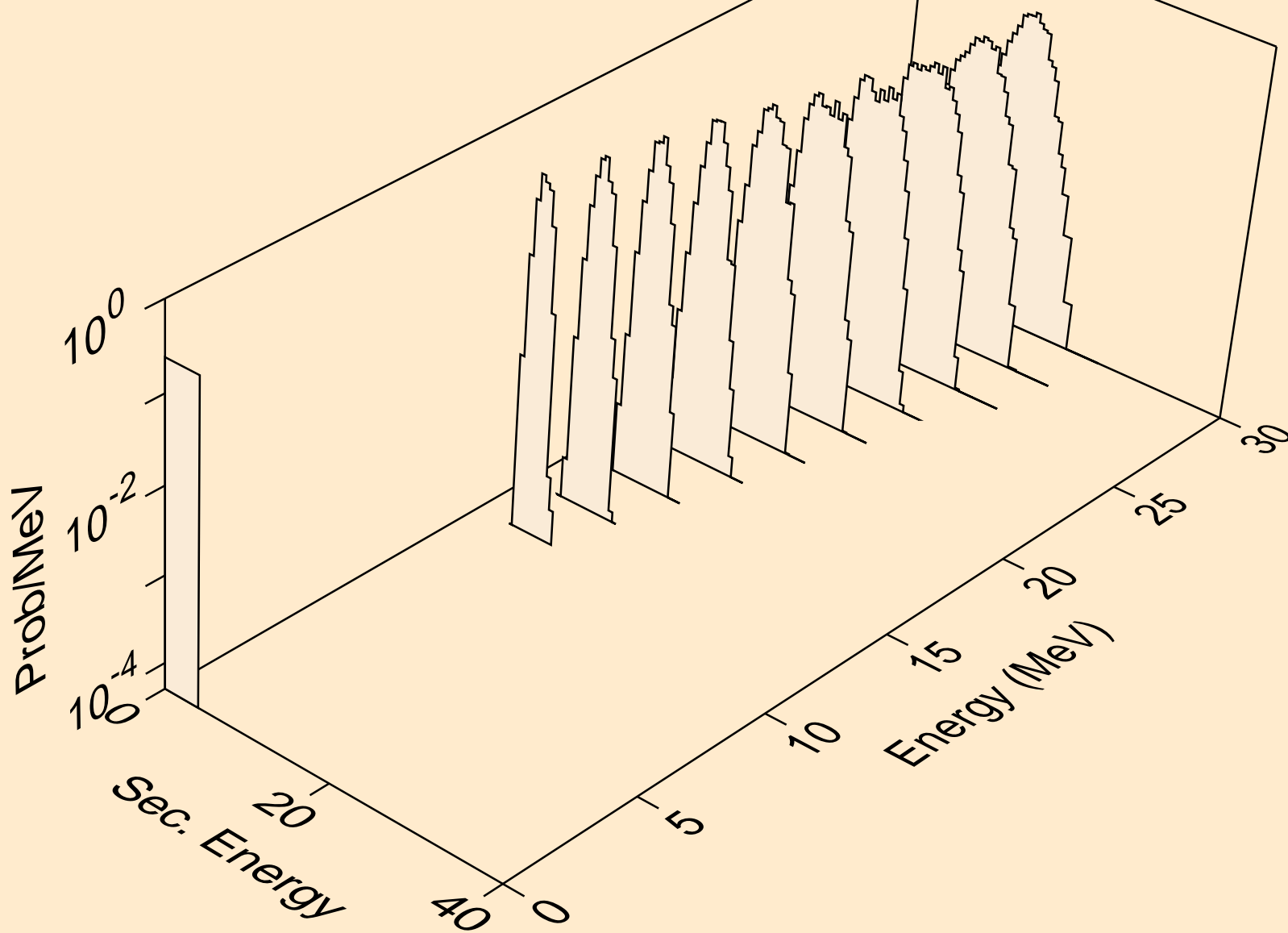

SM142 NEUTRON ACER TENDL-2019 LIBRARY; T=293.16K  
alphas from (n,npa)

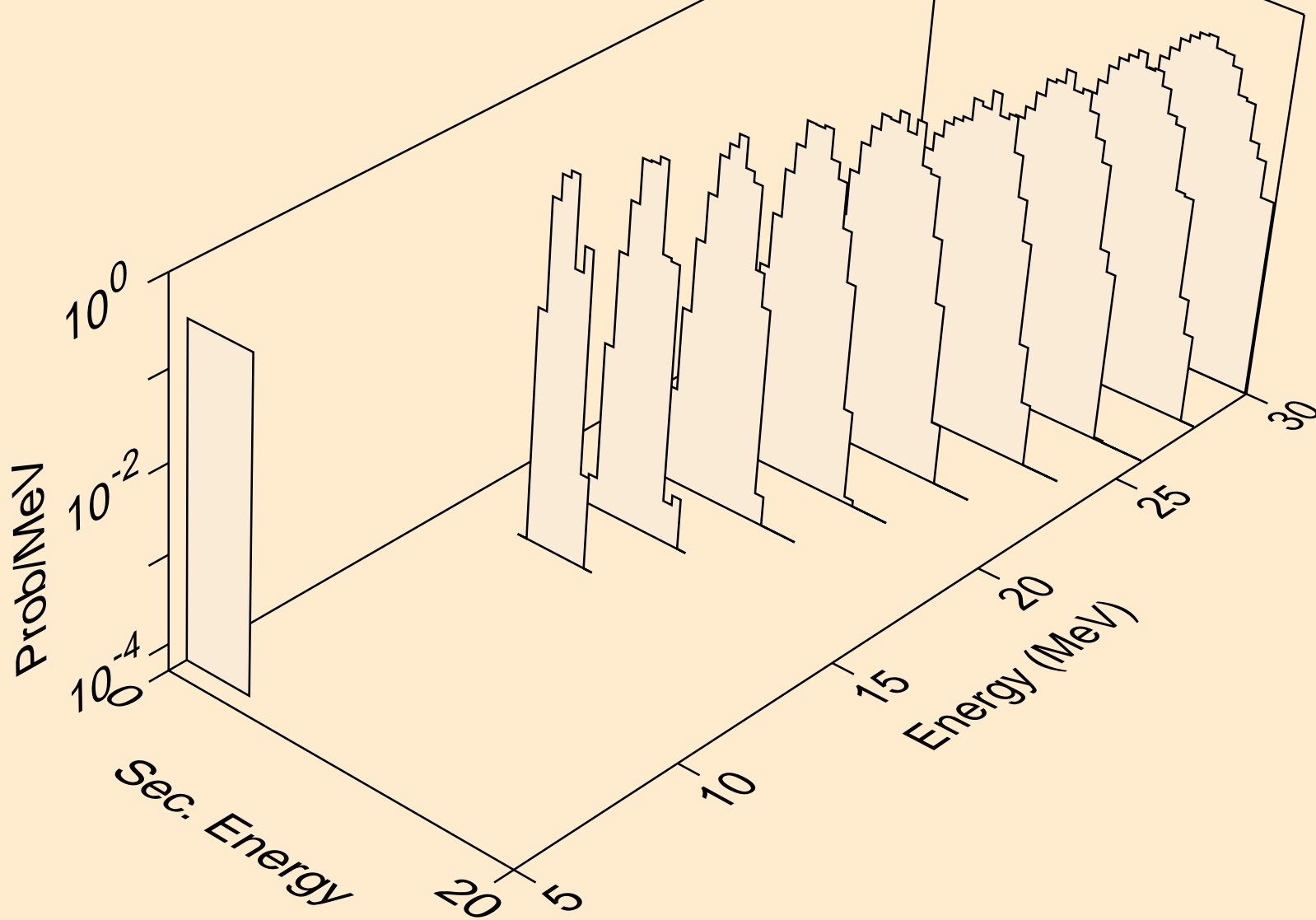

SM142 NEUTRON ACER TENDL-2019 LIBRARY; T=293.16K  
alphas from (n,a)

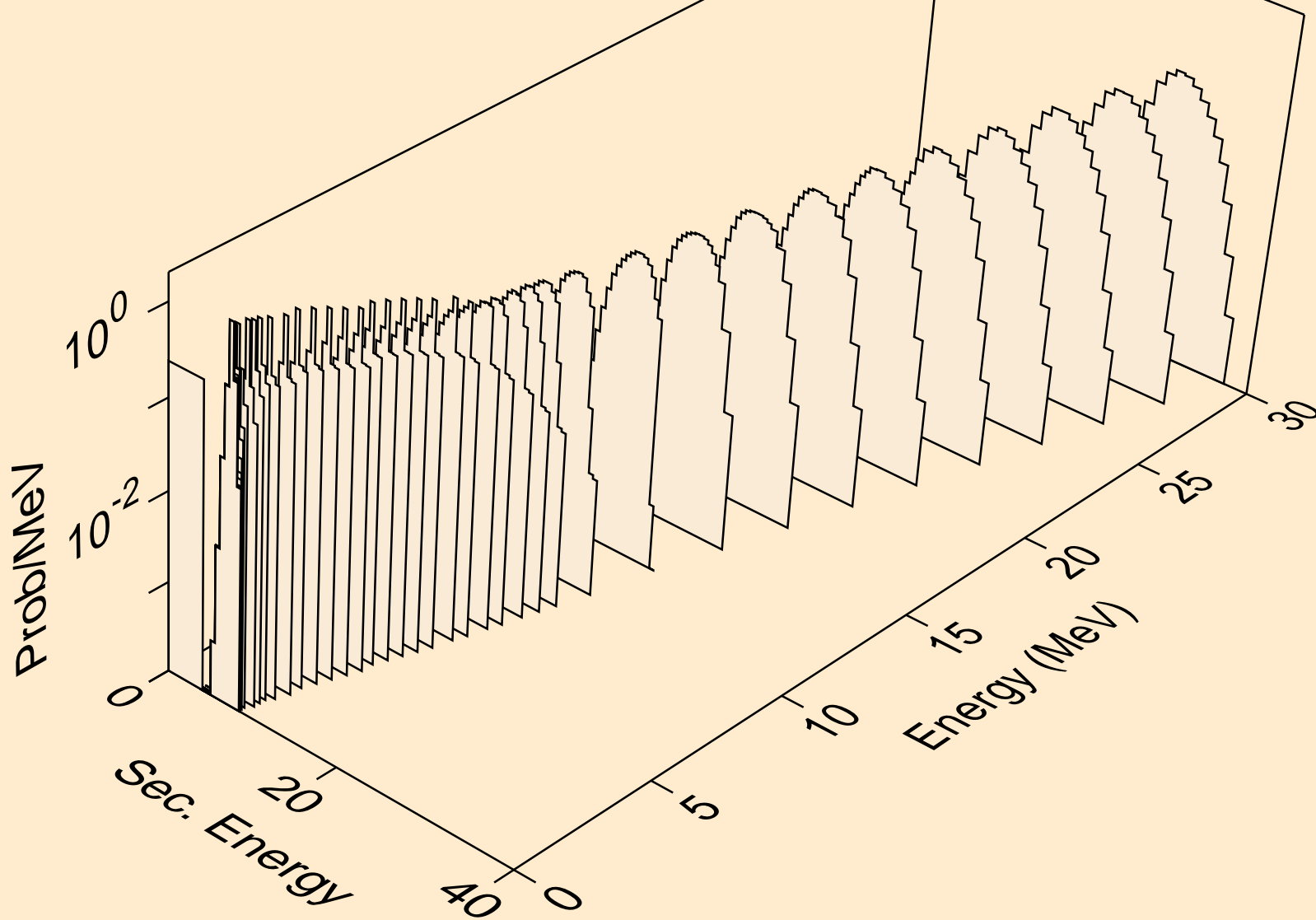

SM142 NEUTRON ACER TENDL-2019 LIBRARY; T=293.16K  
alphas from (n,2a)

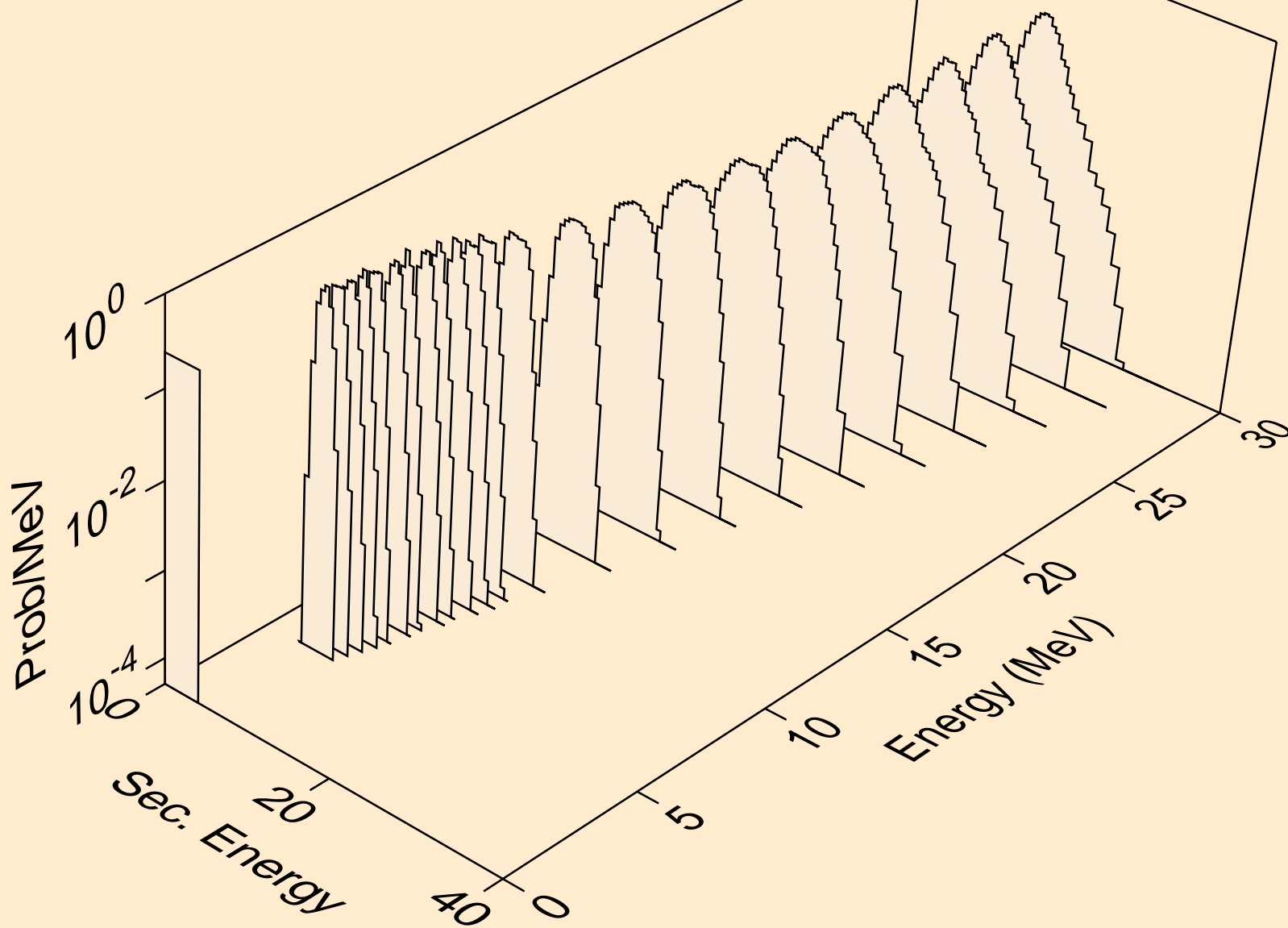

SM142 NEUTRON ACER TENDL-2019 LIBRARY; T=293.16K  
alphas from (n,pa)

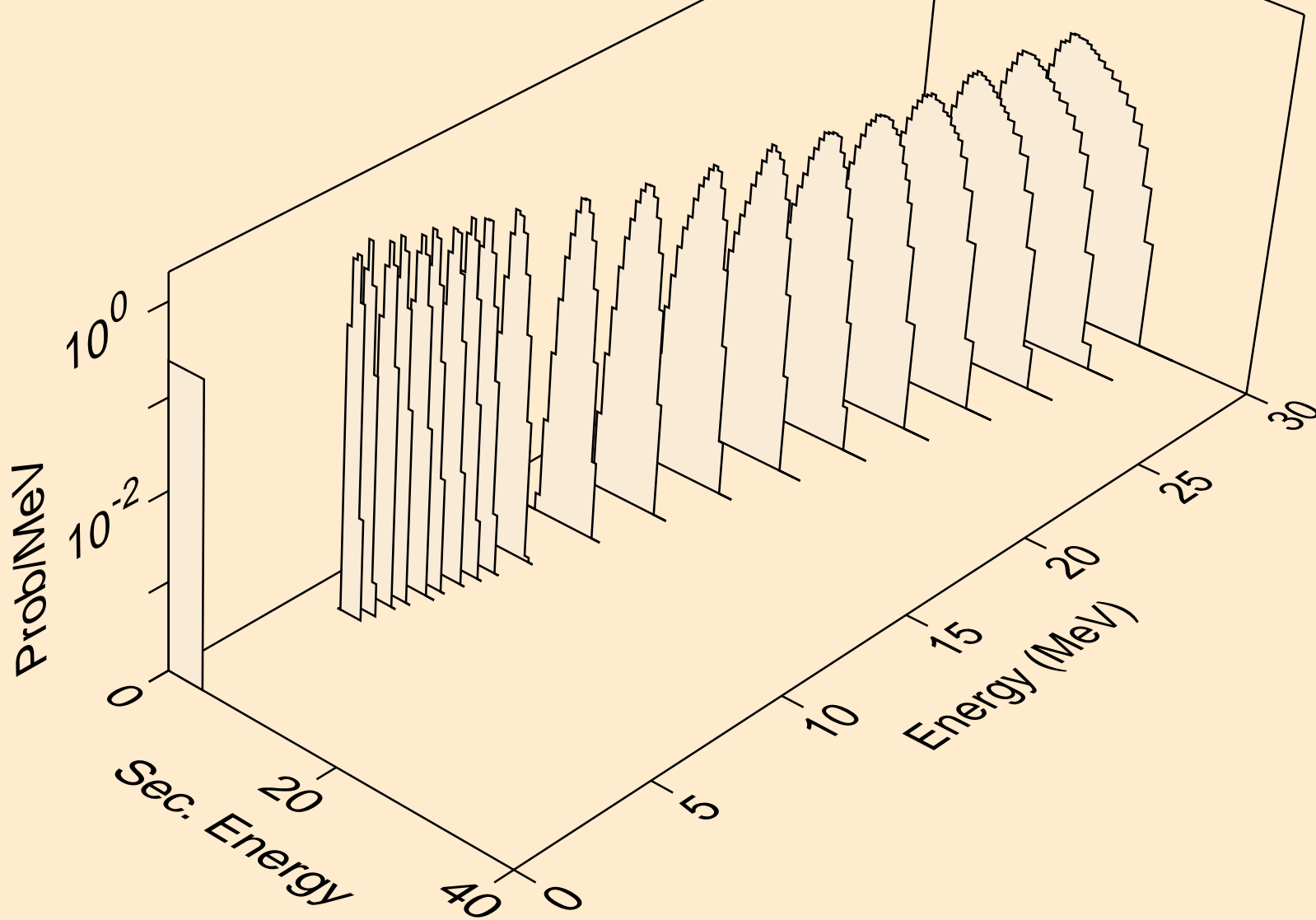

SM142 NEUTRON ACER TENDL-2019 LIBRARY; T=293.16K  
alphas from (n,da)

