

SM145 NEUTRON ACER TENDL-2019 LIBRARY; T=293.16K
Principal cross sections

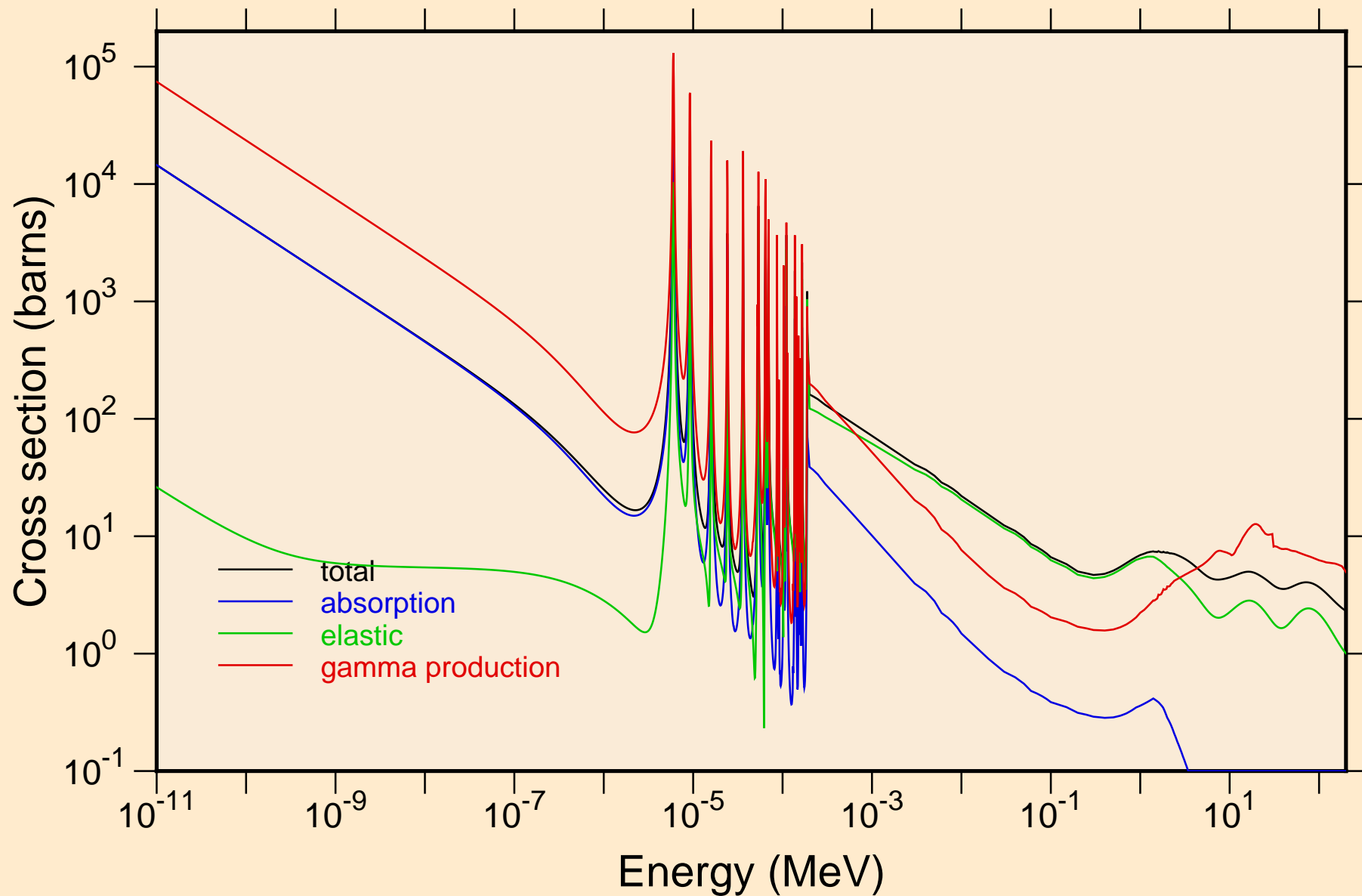

SM145 NEUTRON ACER TENDL-2019 LIBRARY; T=293.16K
resonance total cross section

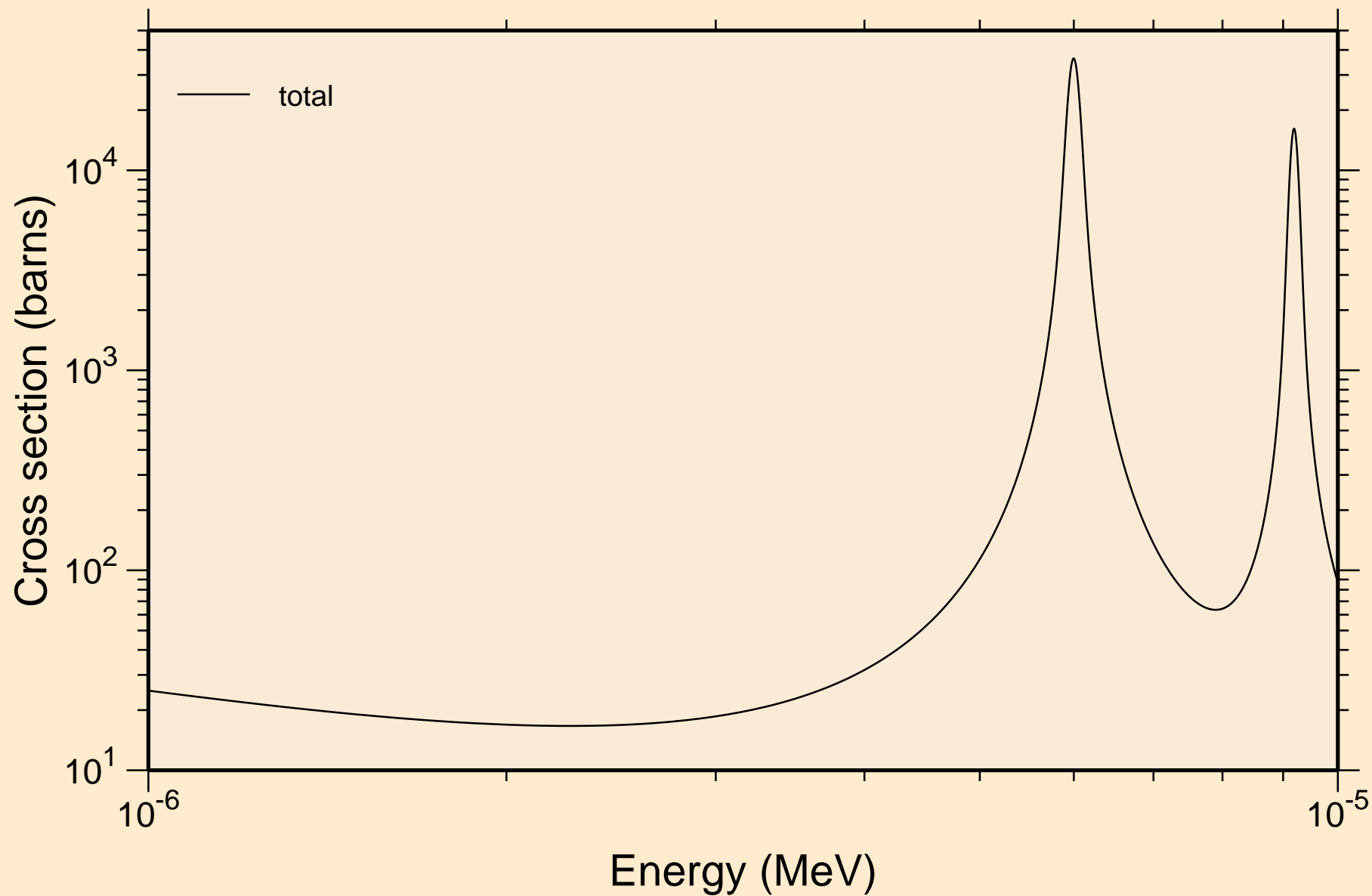

SM145 NEUTRON ACER TENDL-2019 LIBRARY; T=293.16K
resonance total cross section

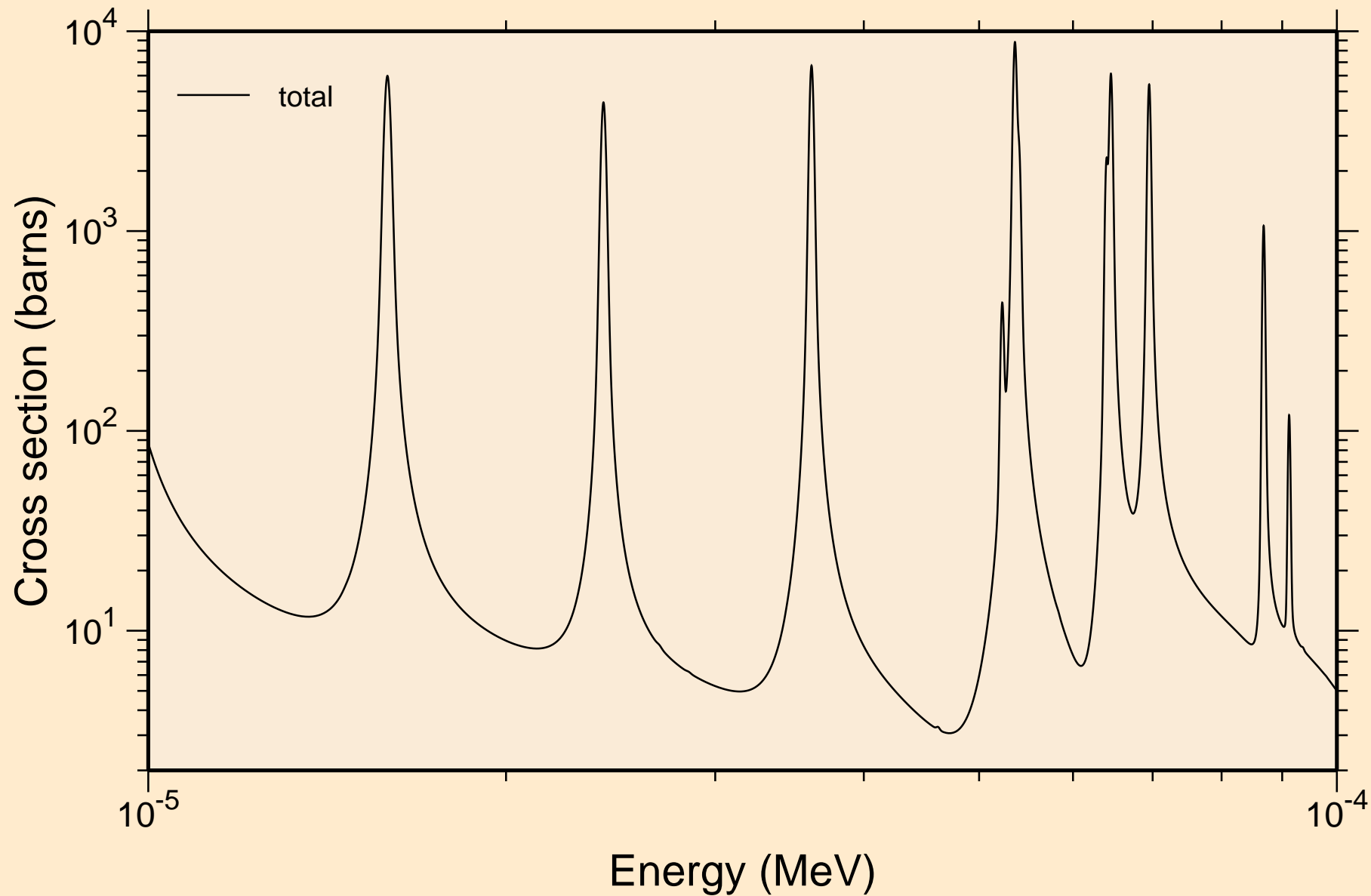

SM145 NEUTRON ACER TENDL-2019 LIBRARY; T=293.16K
resonance total cross section

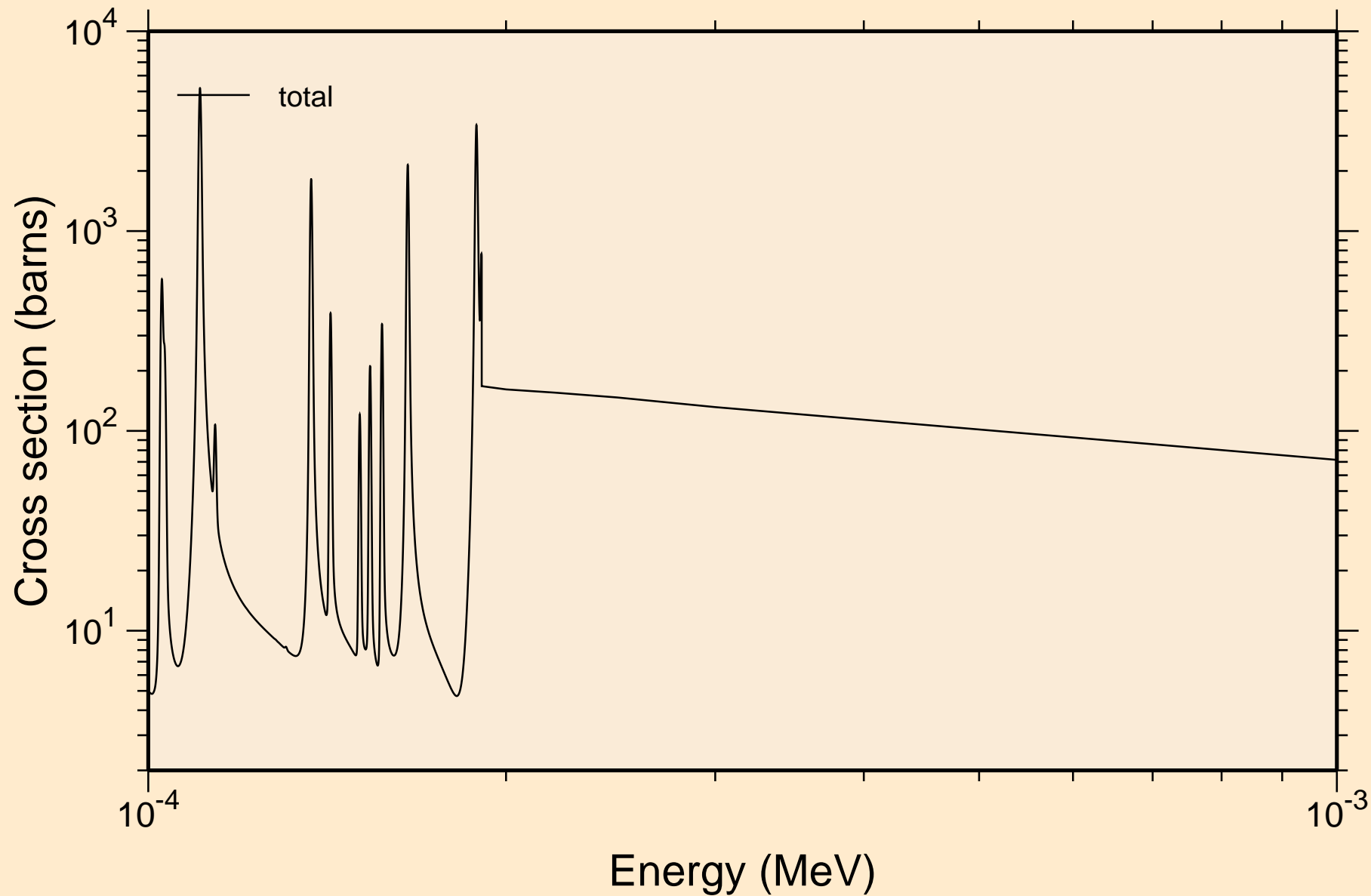

SM145 NEUTRON ACER TENDL-2019 LIBRARY; T=293.16K
resonance total cross section

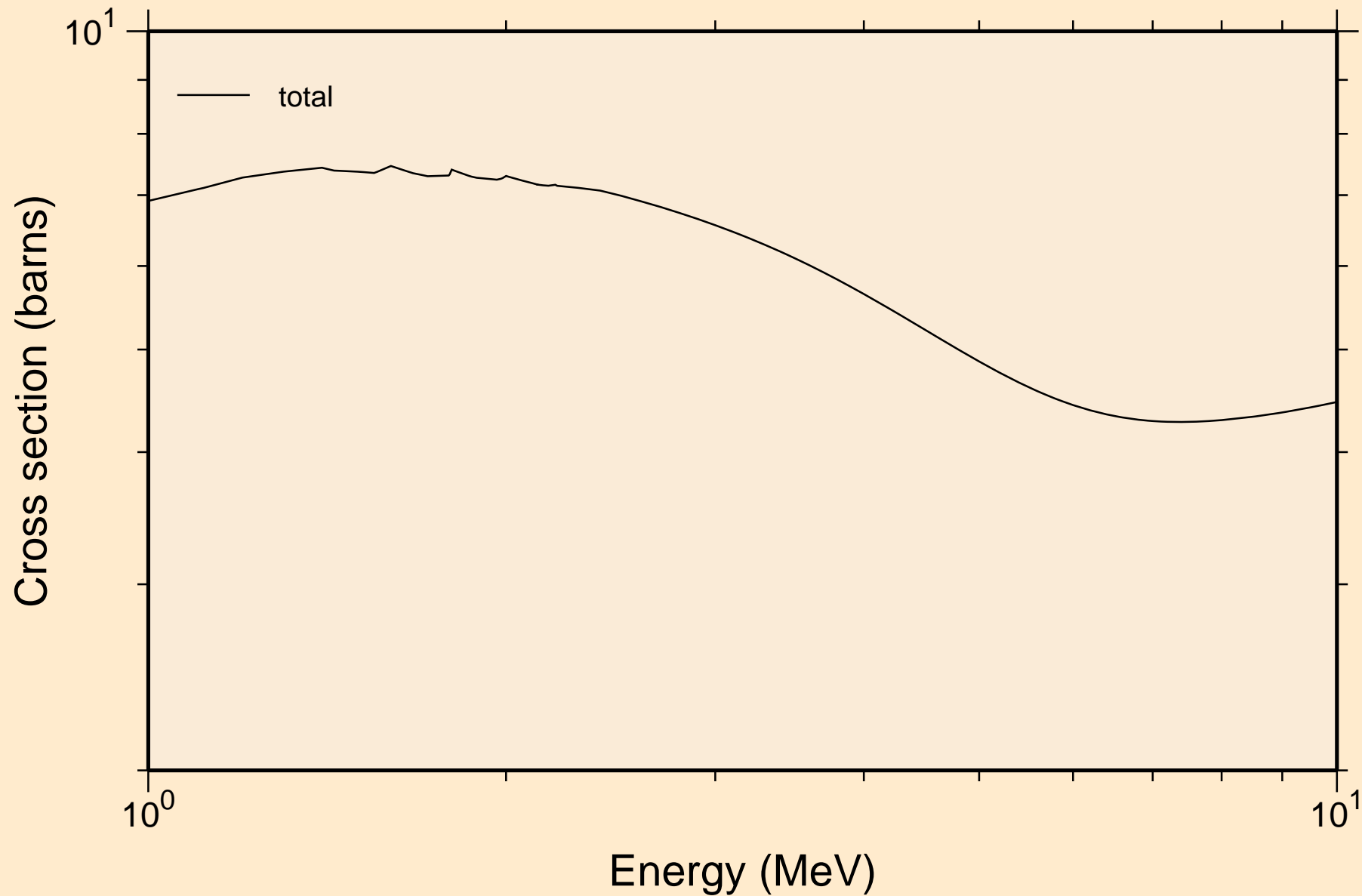

SM145 NEUTRON ACER TENDL-2019 LIBRARY; T=293.16K
resonance absorption cross sections

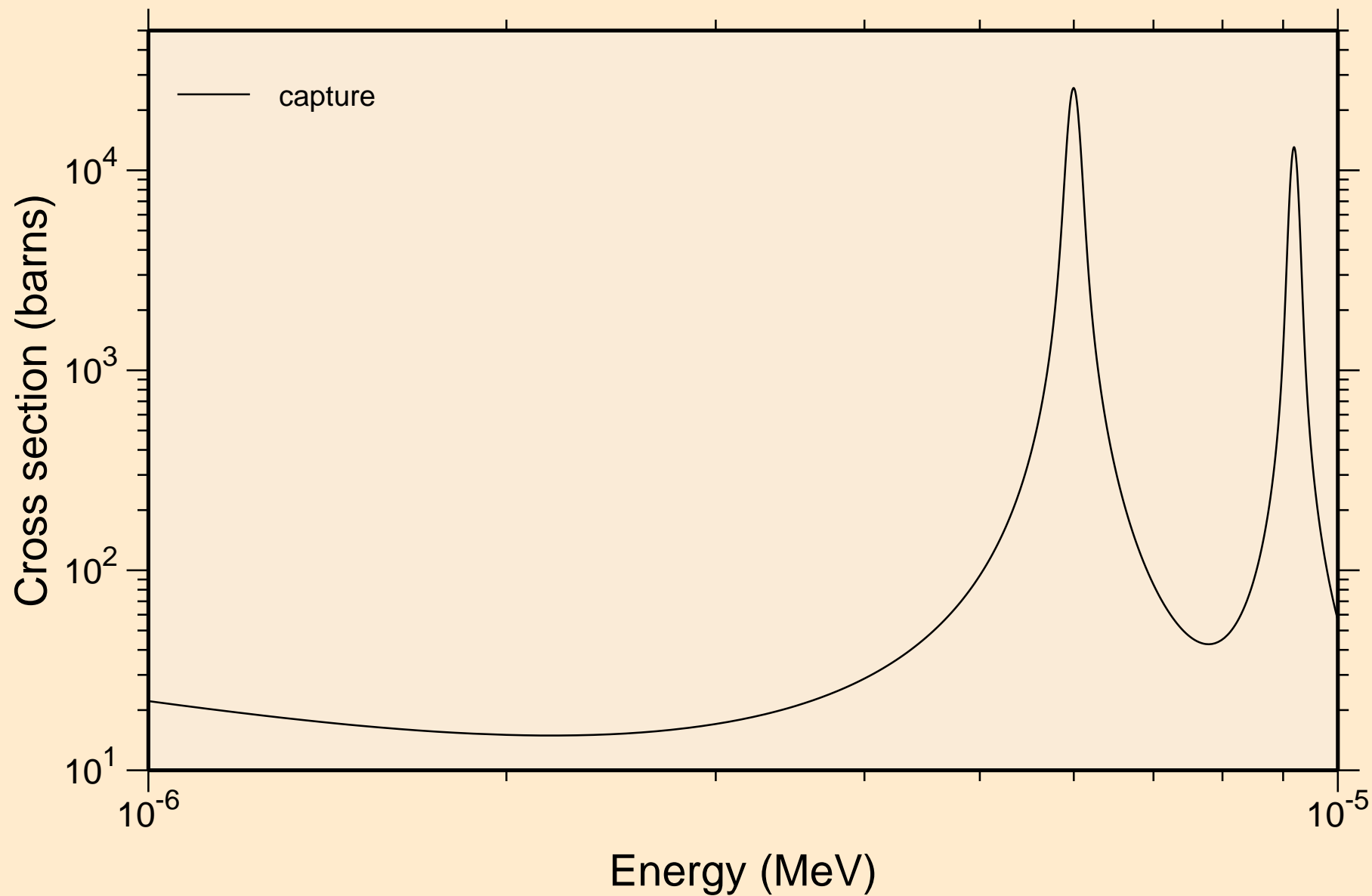

SM145 NEUTRON ACER TENDL-2019 LIBRARY; T=293.16K
resonance absorption cross sections

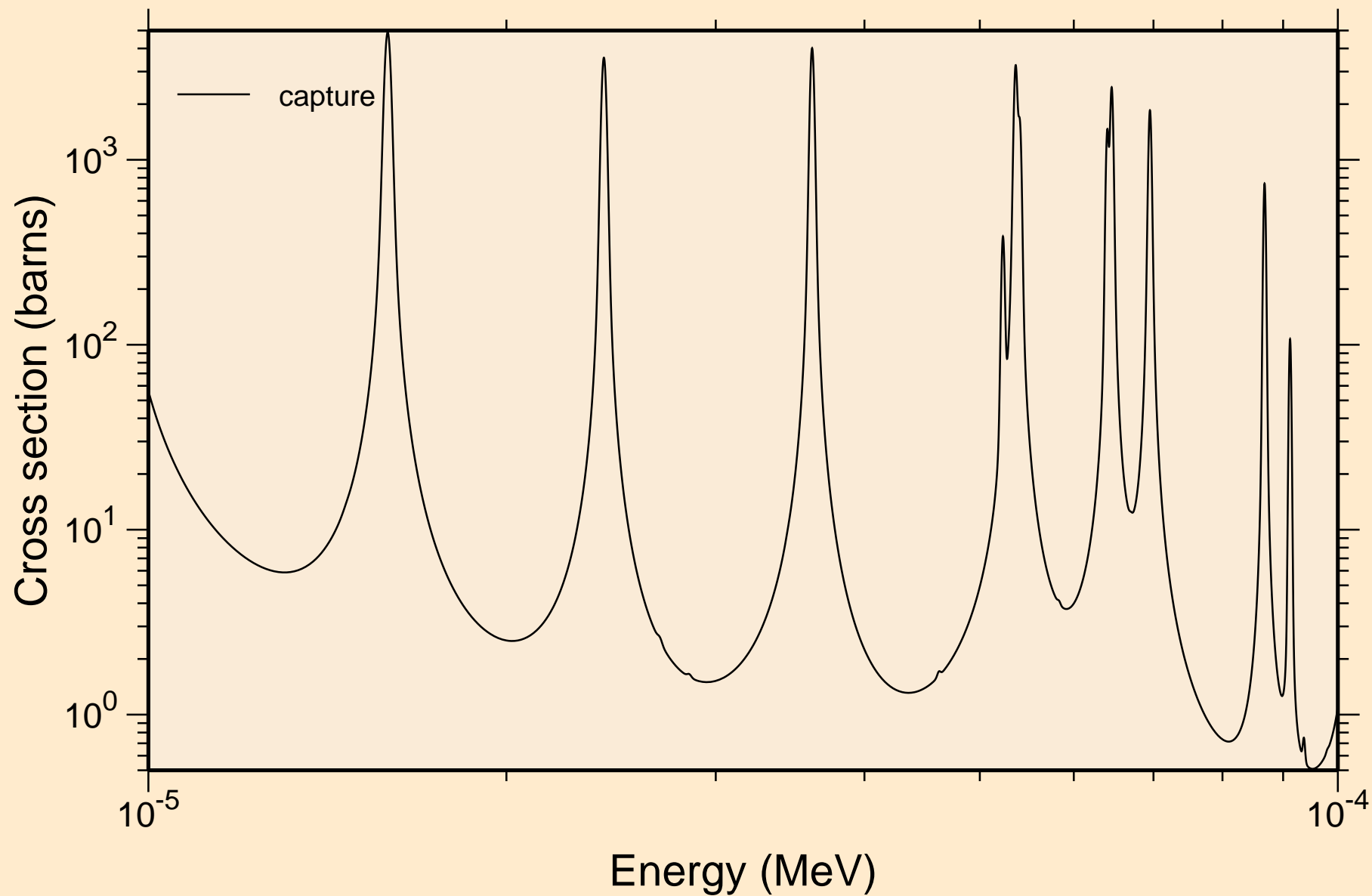

SM145 NEUTRON ACER TENDL-2019 LIBRARY; T=293.16K
resonance absorption cross sections

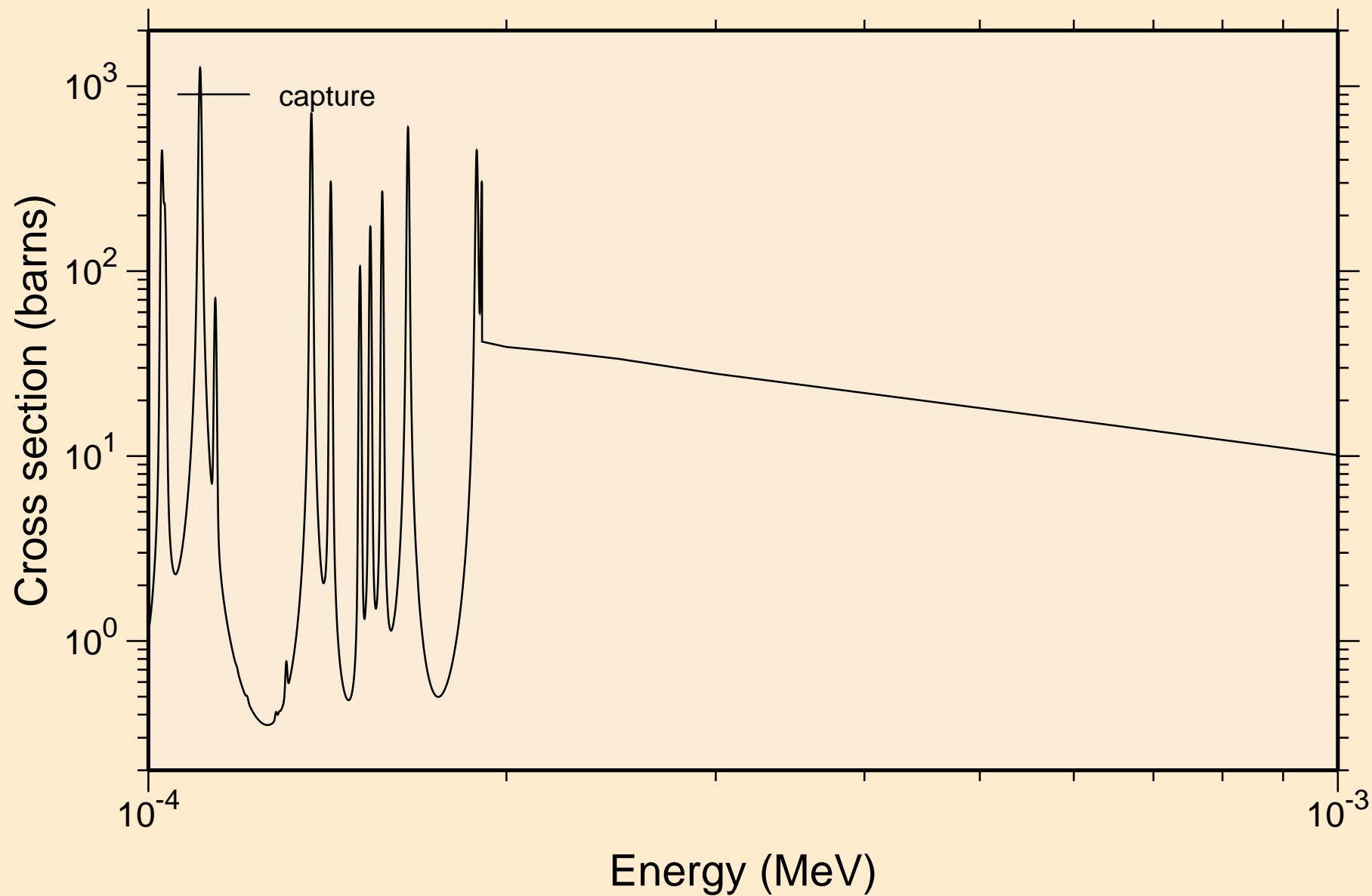

SM145 NEUTRON ACER TENDL-2019 LIBRARY; T=293.16K
resonance absorption cross sections

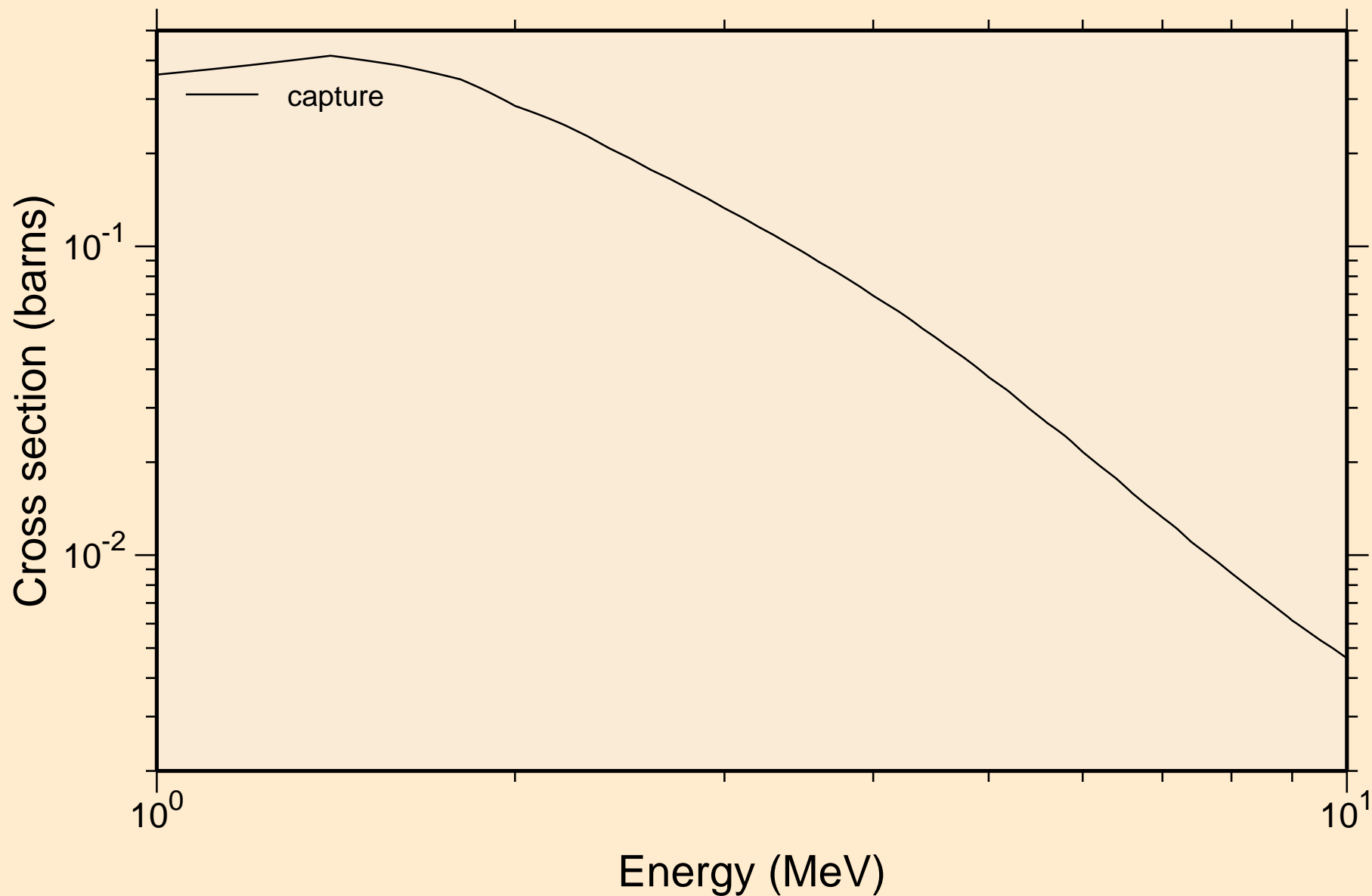

SM145 NEUTRON ACER TENDL-2019 LIBRARY; T=293.16K
Heating

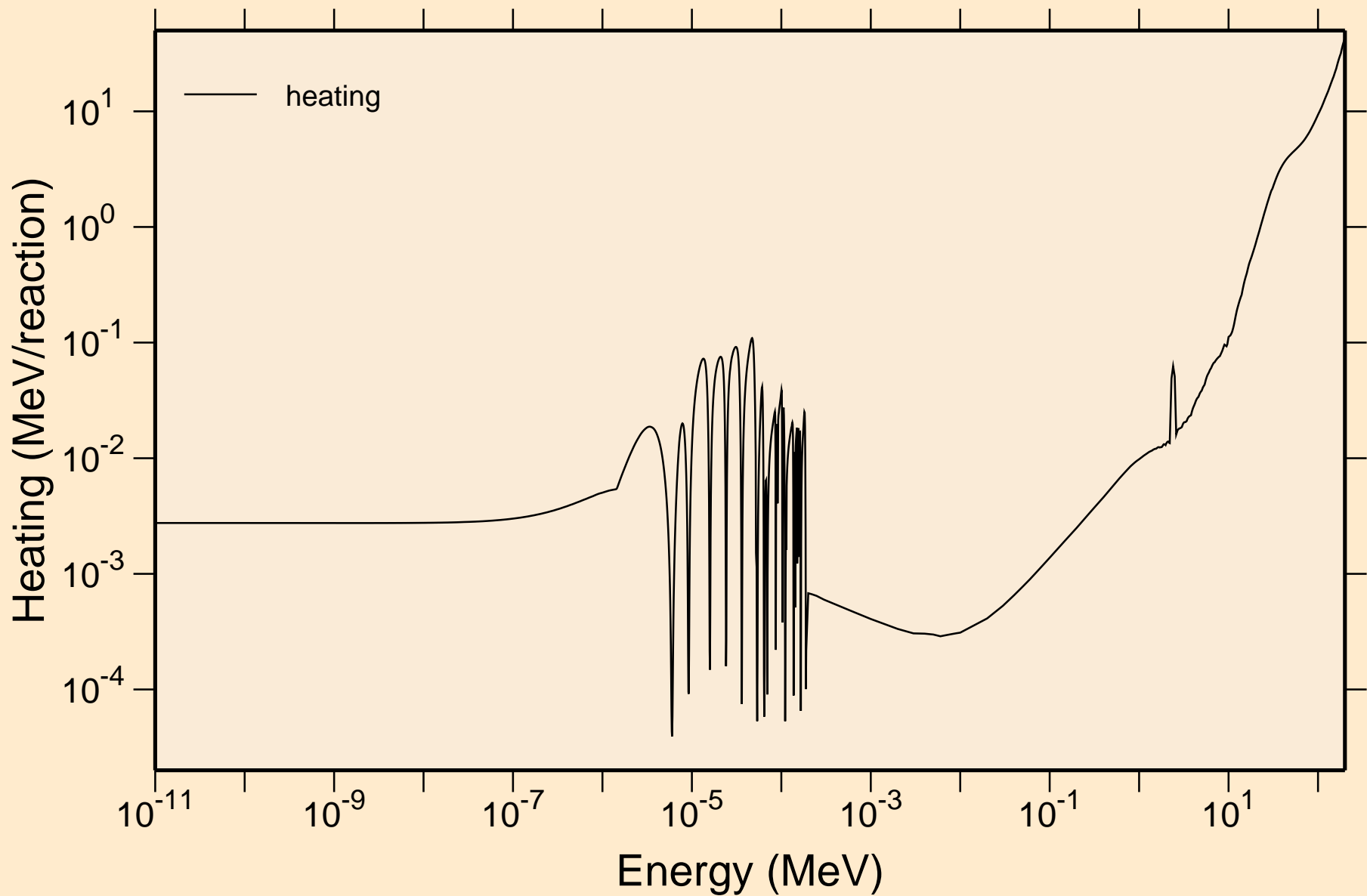

SM145 NEUTRON ACER TENDL-2019 LIBRARY; T=293.16K
Damage

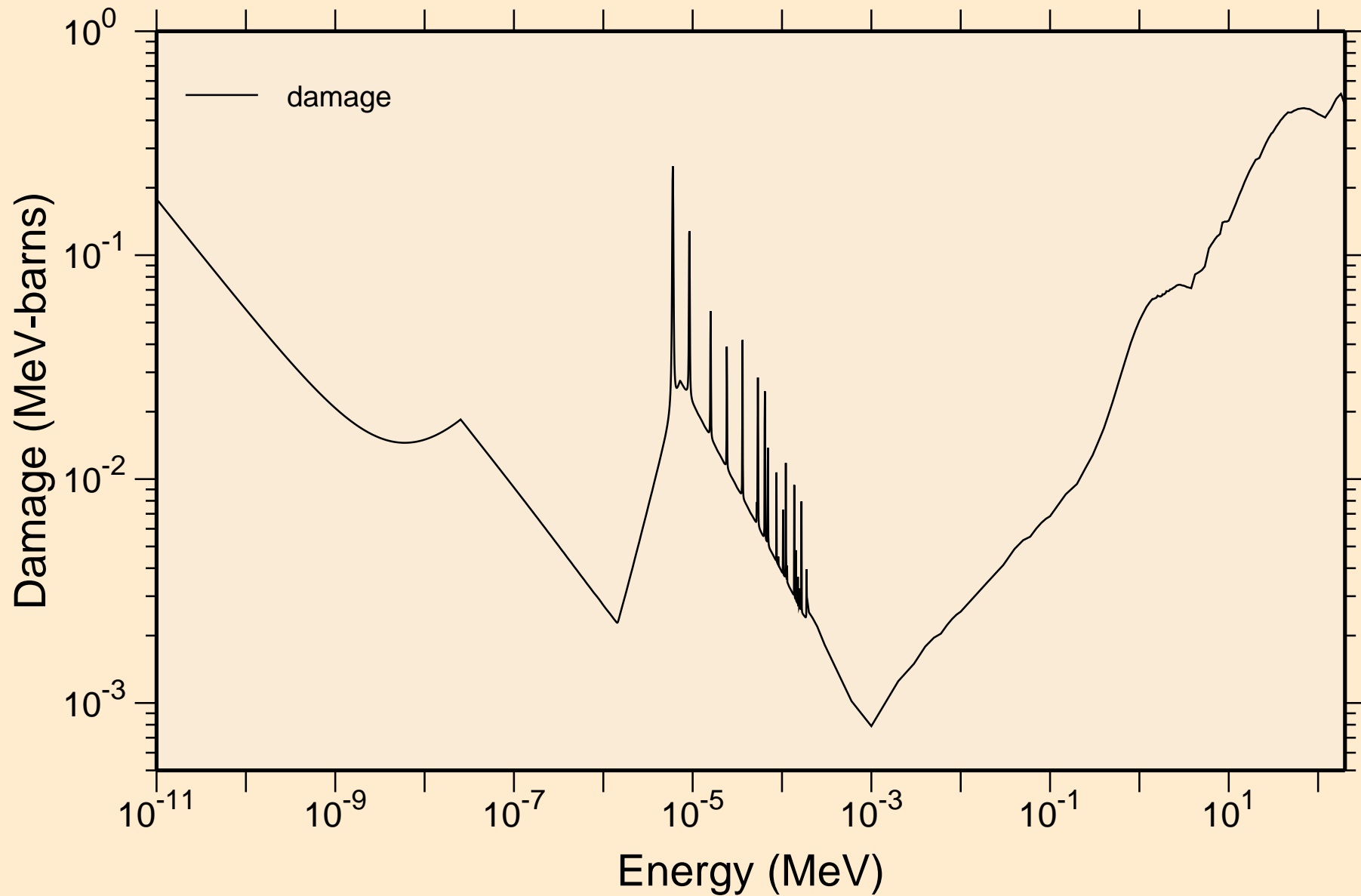

SM145 NEUTRON ACER TENDL-2019 LIBRARY; T=293.16K
Non-threshold reactions

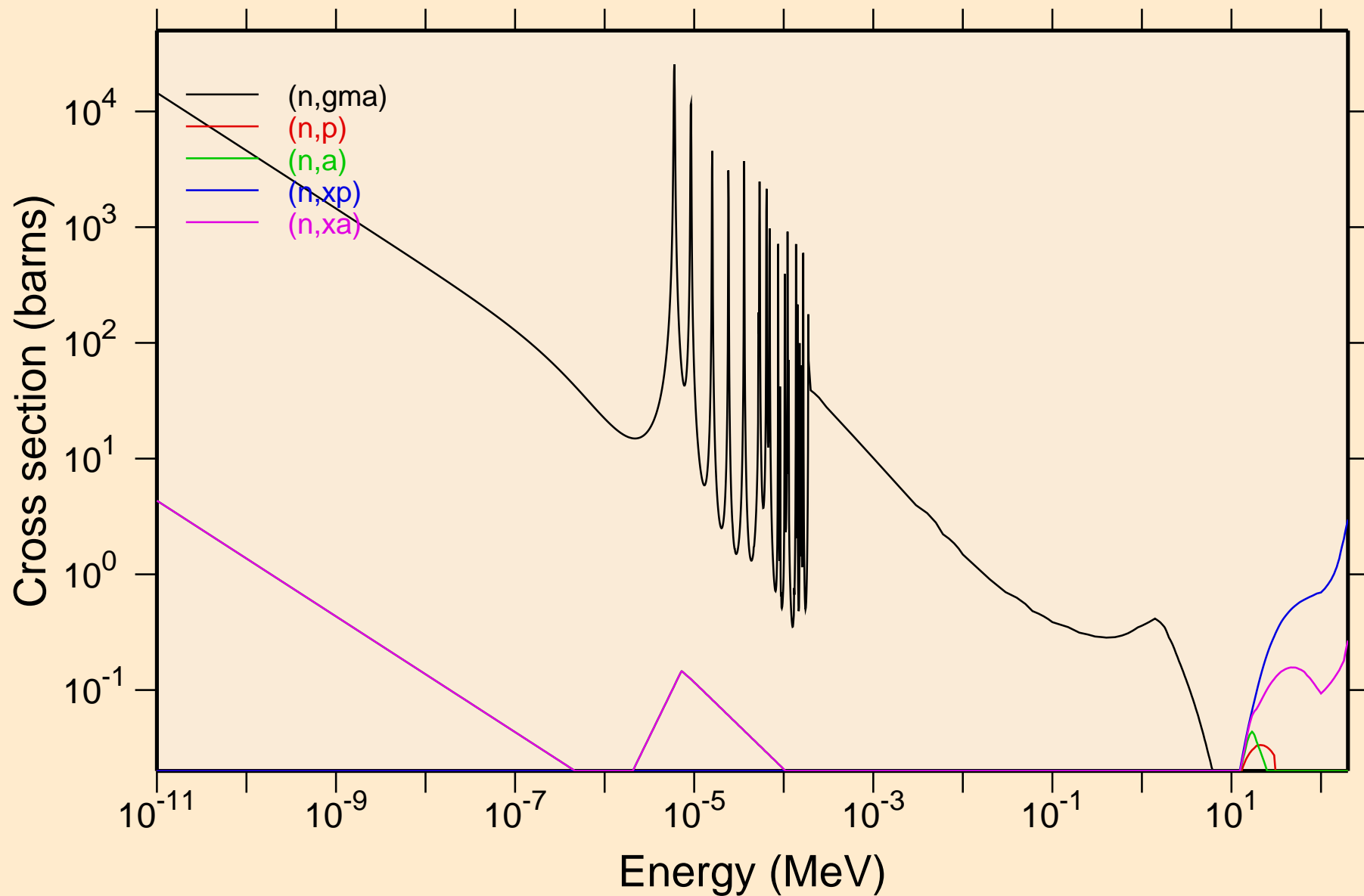

SM145 NEUTRON ACER TENDL-2019 LIBRARY; T=293.16K
Principal cross sections

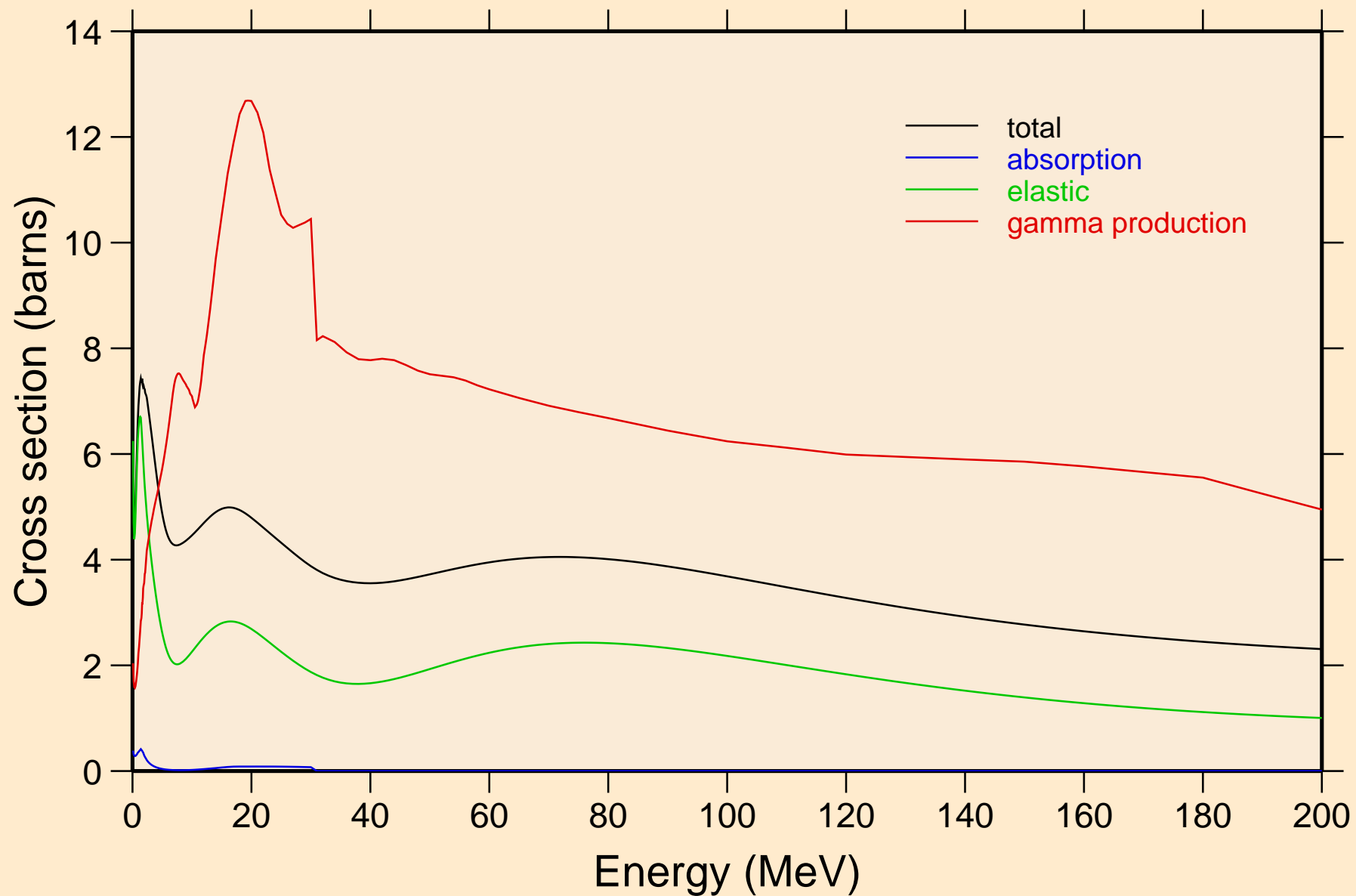

SM145 NEUTRON ACER TENDL-2019 LIBRARY; T=293.16K
Heating

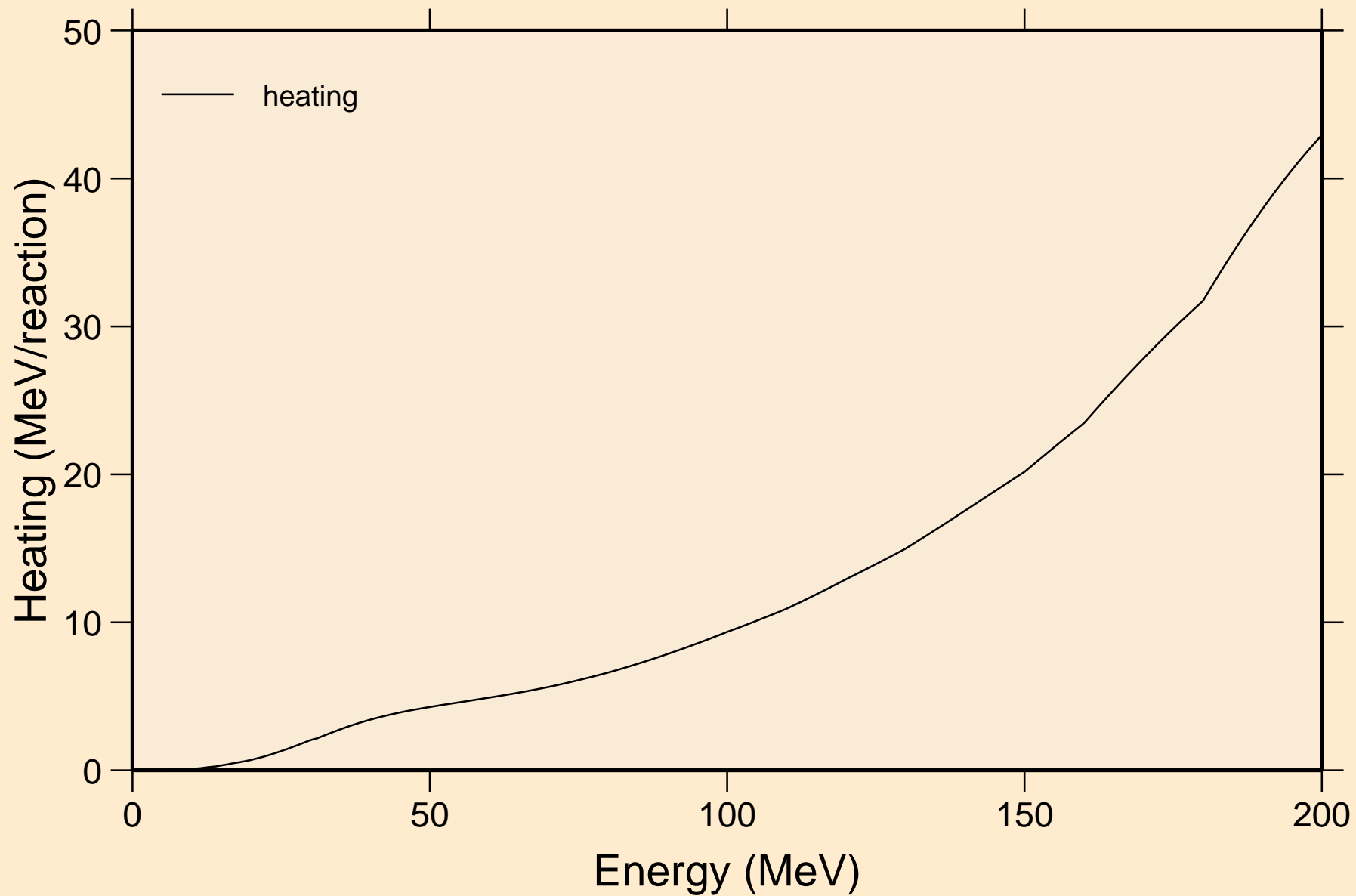

SM145 NEUTRON ACER TENDL-2019 LIBRARY; T=293.16K
Damage

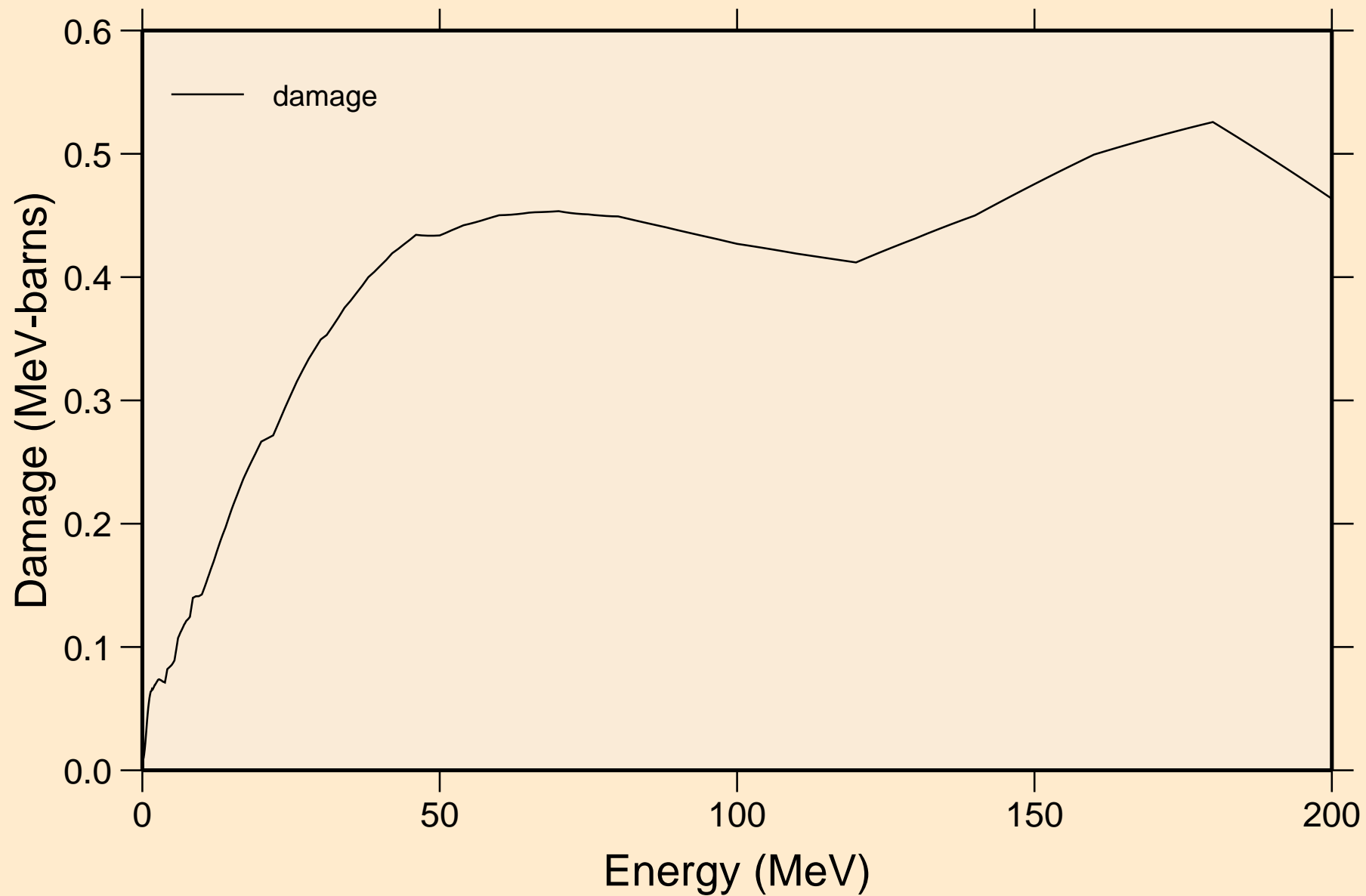

SM145 NEUTRON ACER TENDL-2019 LIBRARY; T=293.16K
Non-threshold reactions

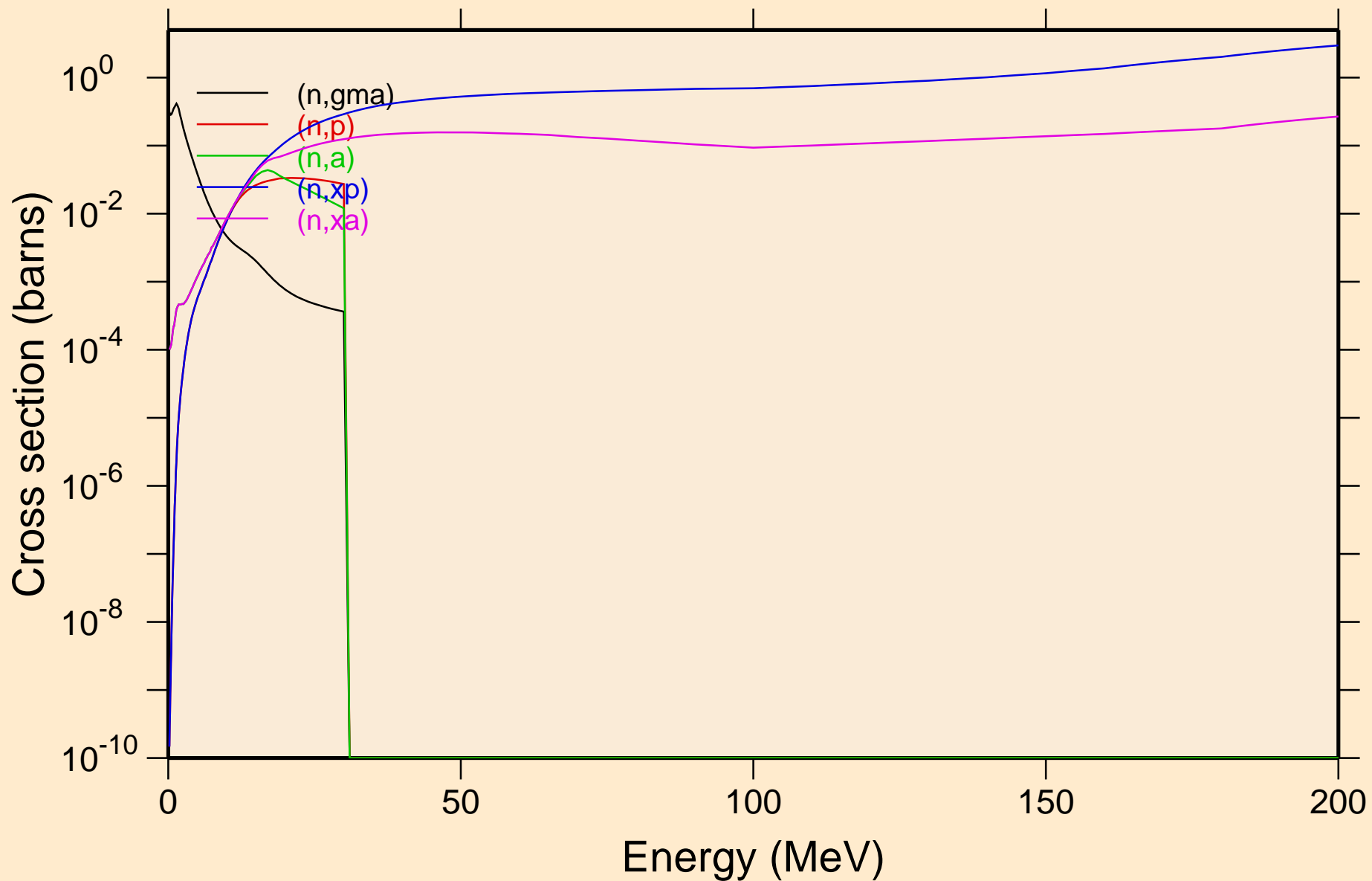

SM145 NEUTRON ACER TENDL-2019 LIBRARY; T=293.16K
Inelastic levels

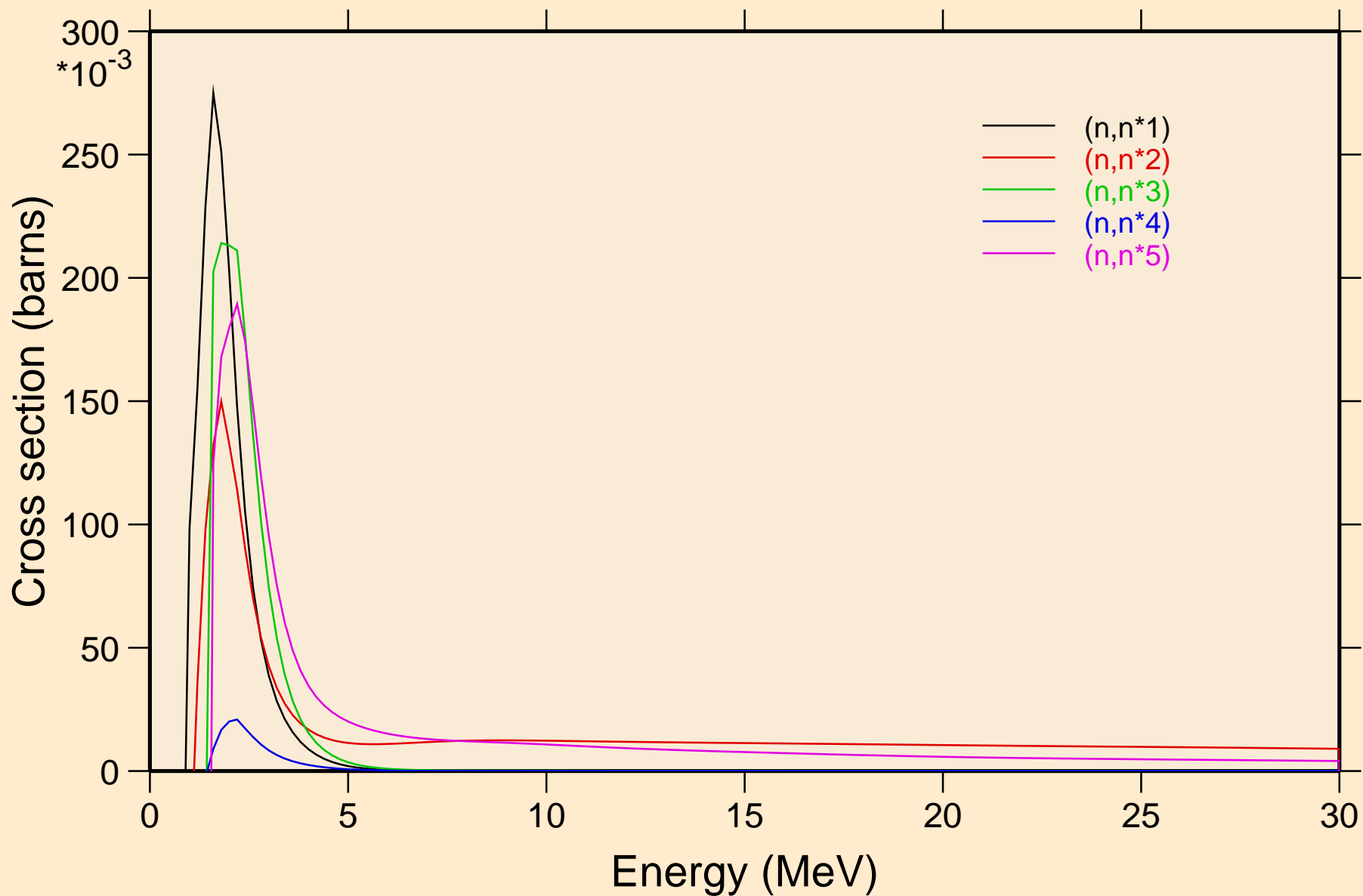

SM145 NEUTRON ACER TENDL-2019 LIBRARY; T=293.16K
Inelastic levels

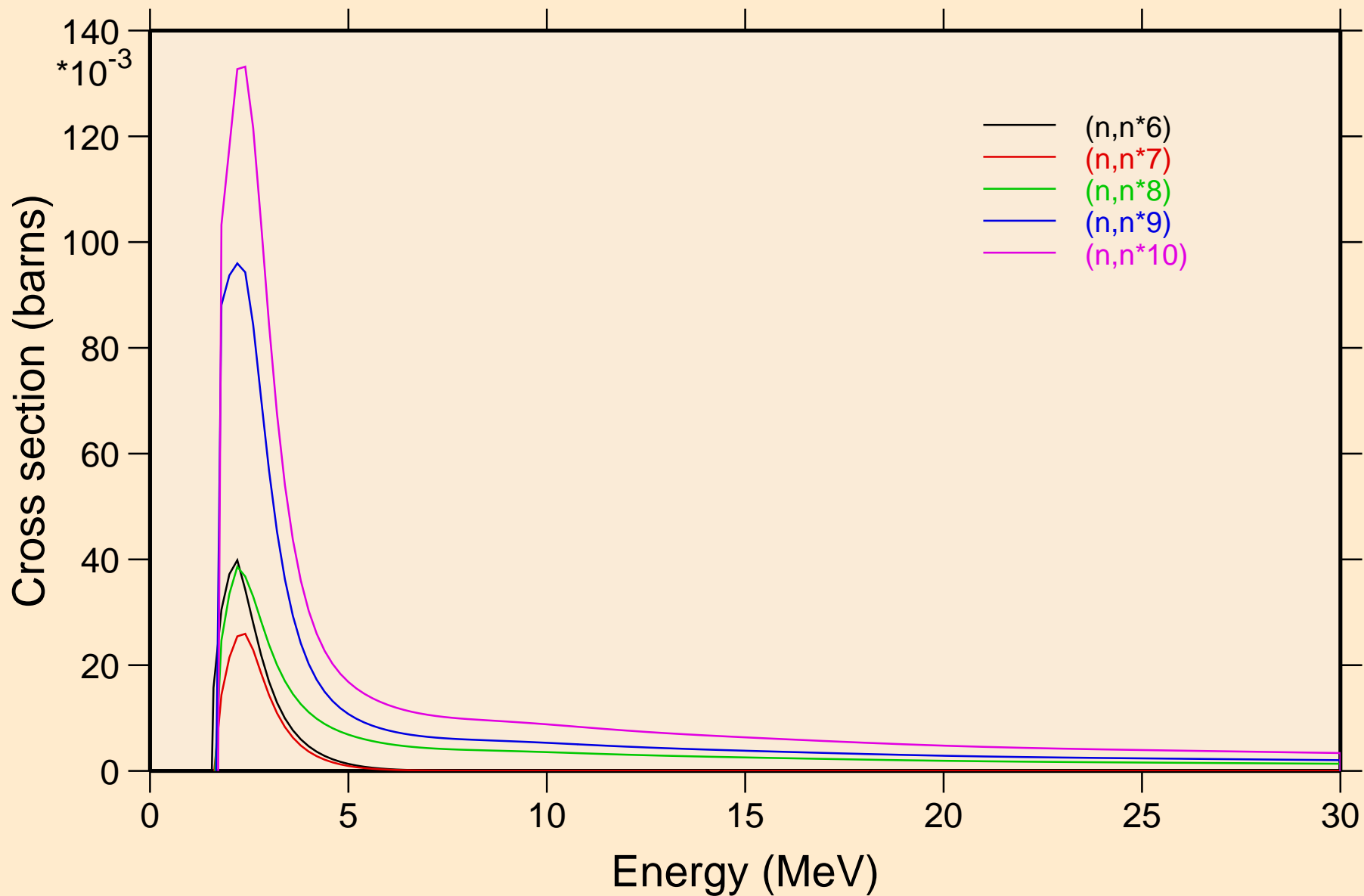

SM145 NEUTRON ACER TENDL-2019 LIBRARY; T=293.16K
Inelastic levels

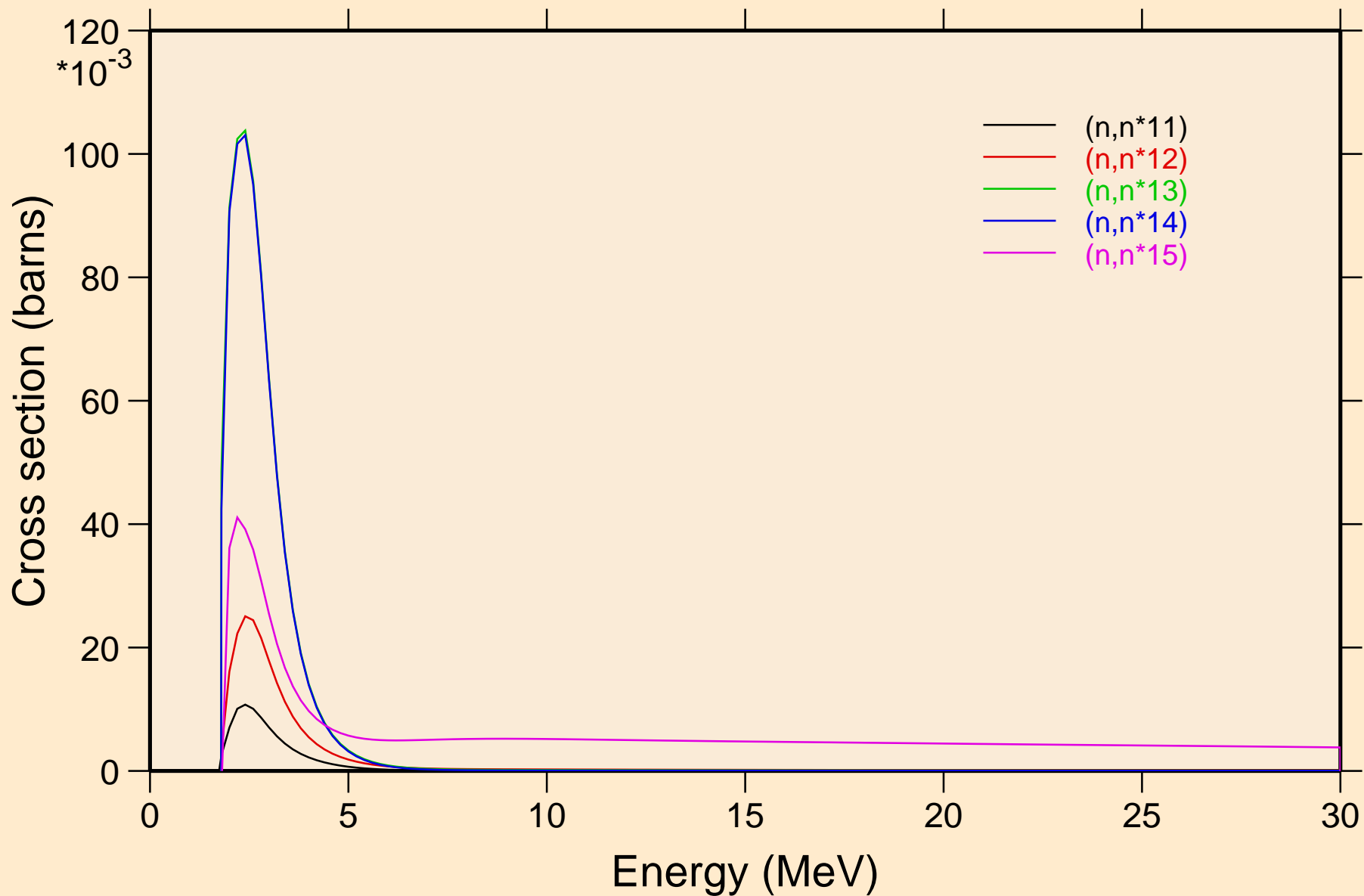

SM145 NEUTRON ACER TENDL-2019 LIBRARY; T=293.16K
Inelastic levels

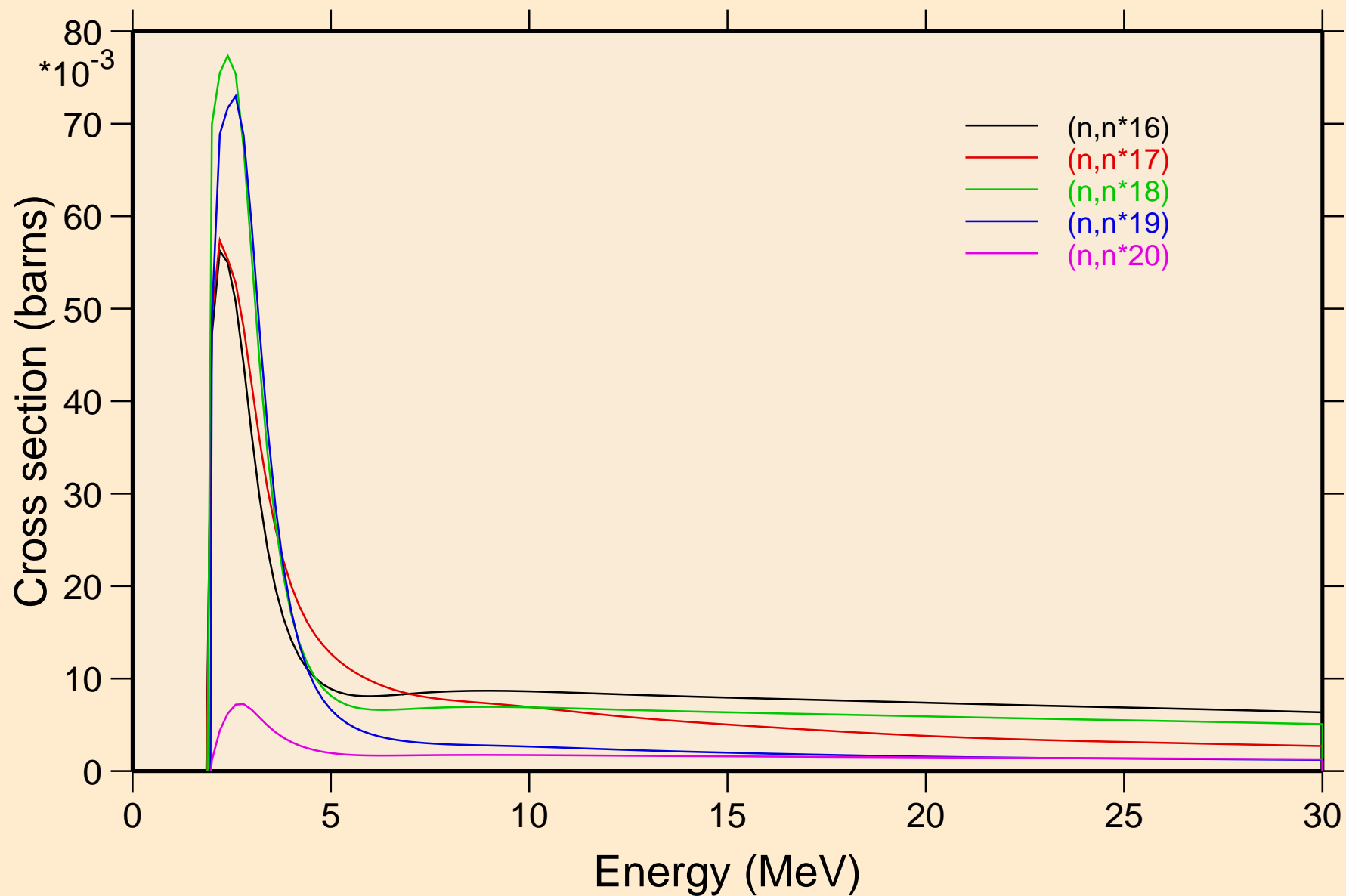

SM145 NEUTRON ACER TENDL-2019 LIBRARY; T=293.16K
Inelastic levels

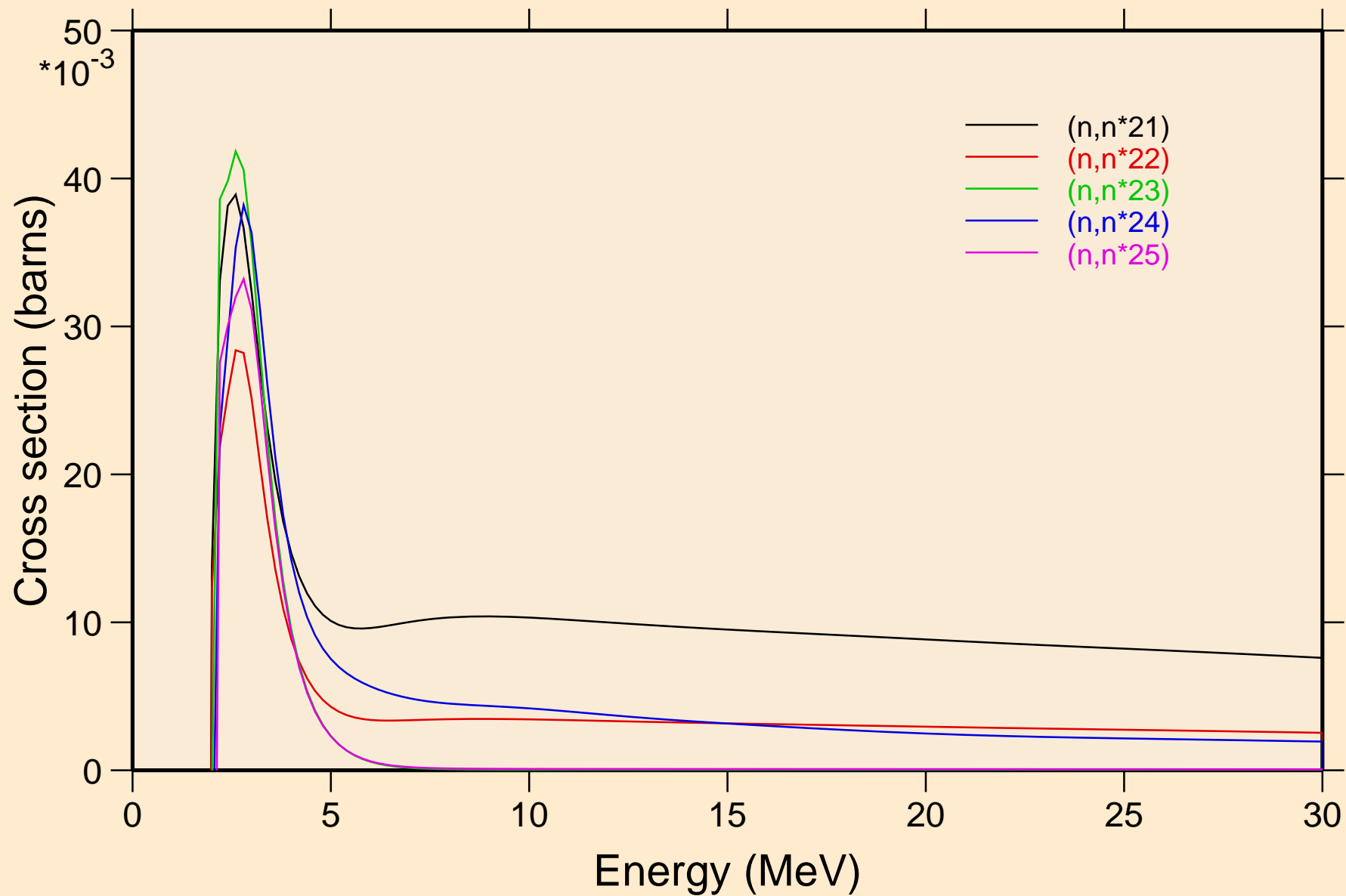

SM145 NEUTRON ACER TENDL-2019 LIBRARY; T=293.16K
Inelastic levels

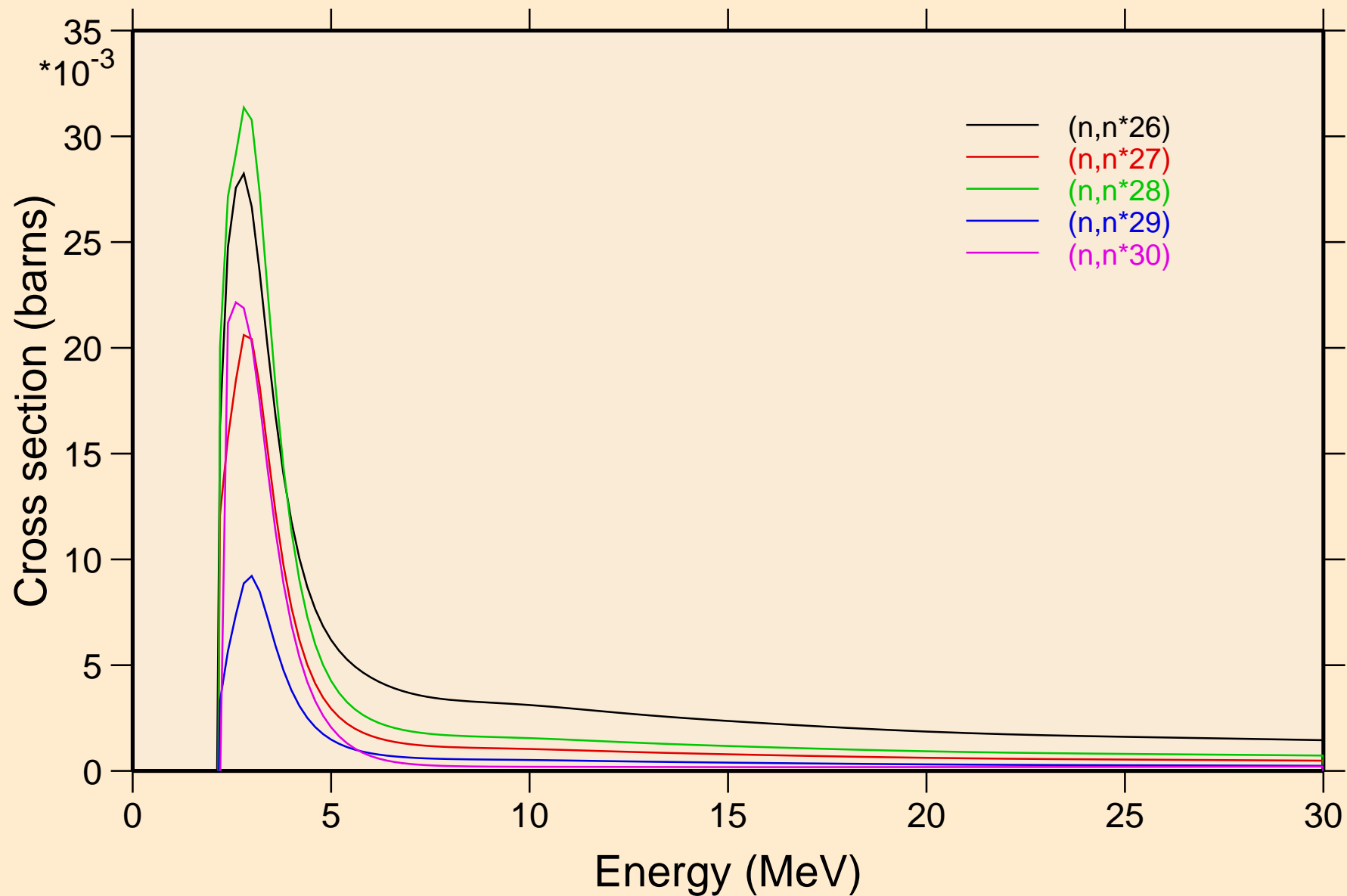

SM145 NEUTRON ACER TENDL-2019 LIBRARY; T=293.16K
Threshold reactions

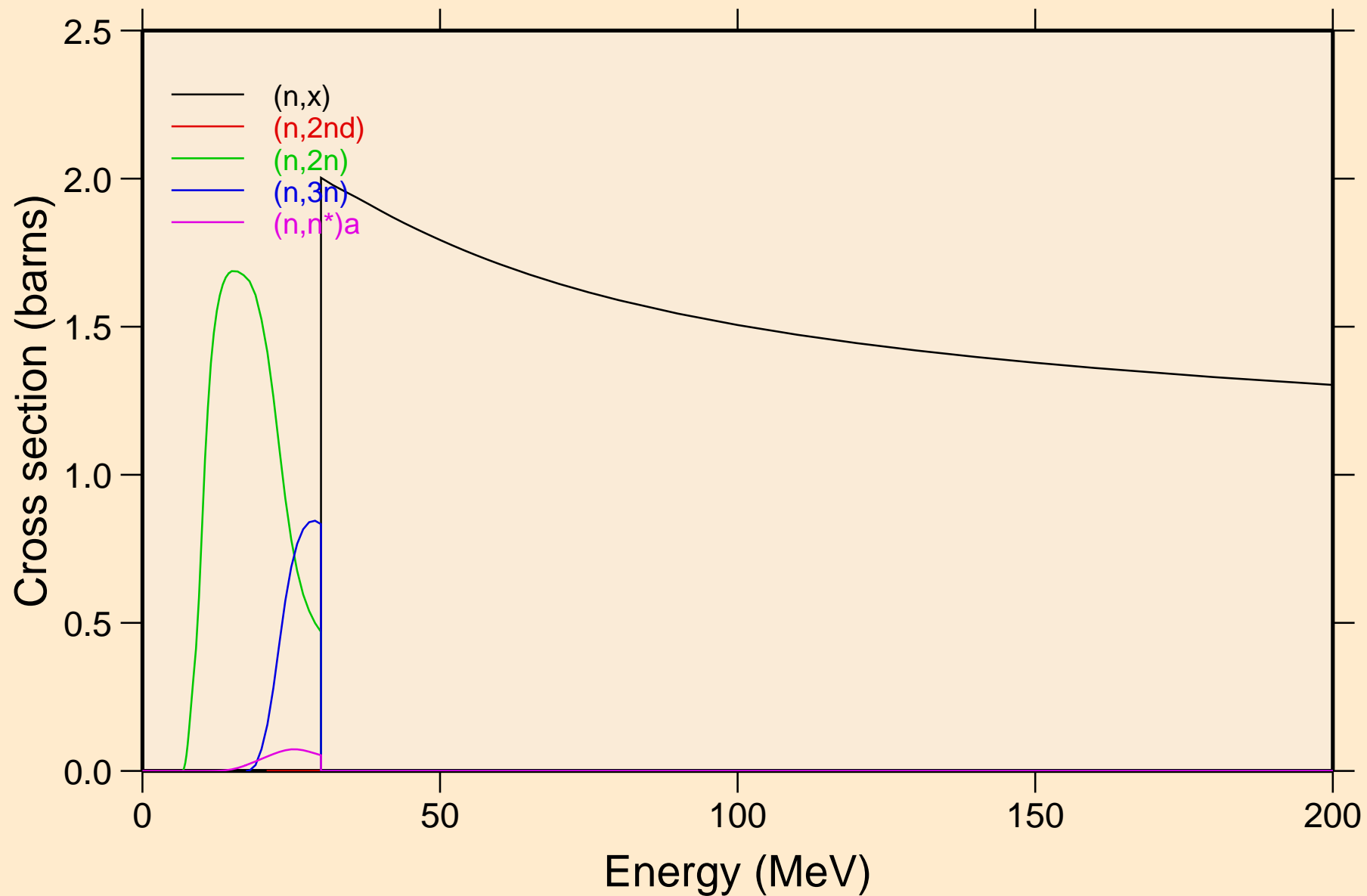

SM145 NEUTRON ACER TENDL-2019 LIBRARY; T=293.16K
Threshold reactions

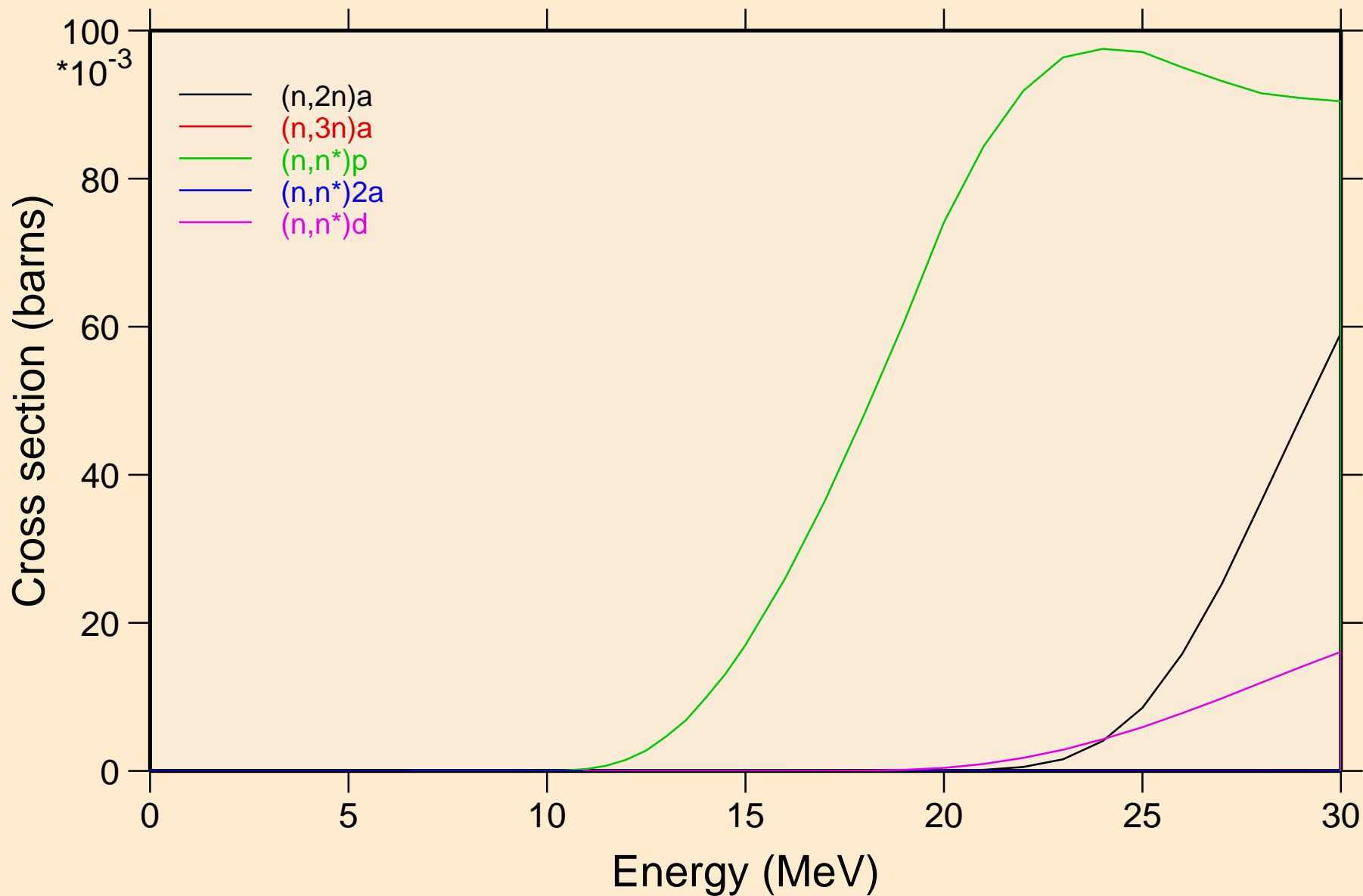

SM145 NEUTRON ACER TENDL-2019 LIBRARY; T=293.16K
Threshold reactions

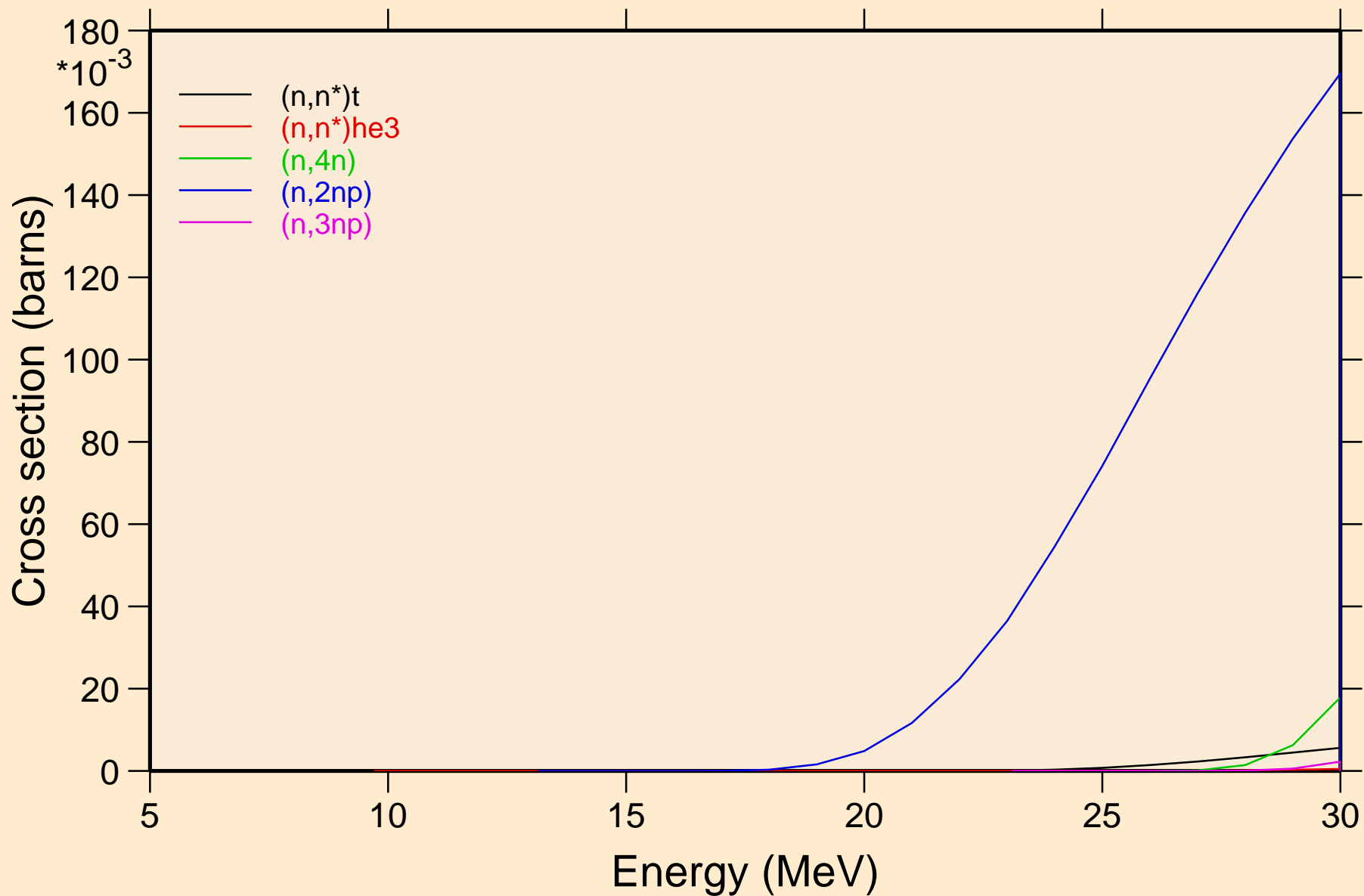

SM145 NEUTRON ACER TENDL-2019 LIBRARY; T=293.16K
Threshold reactions

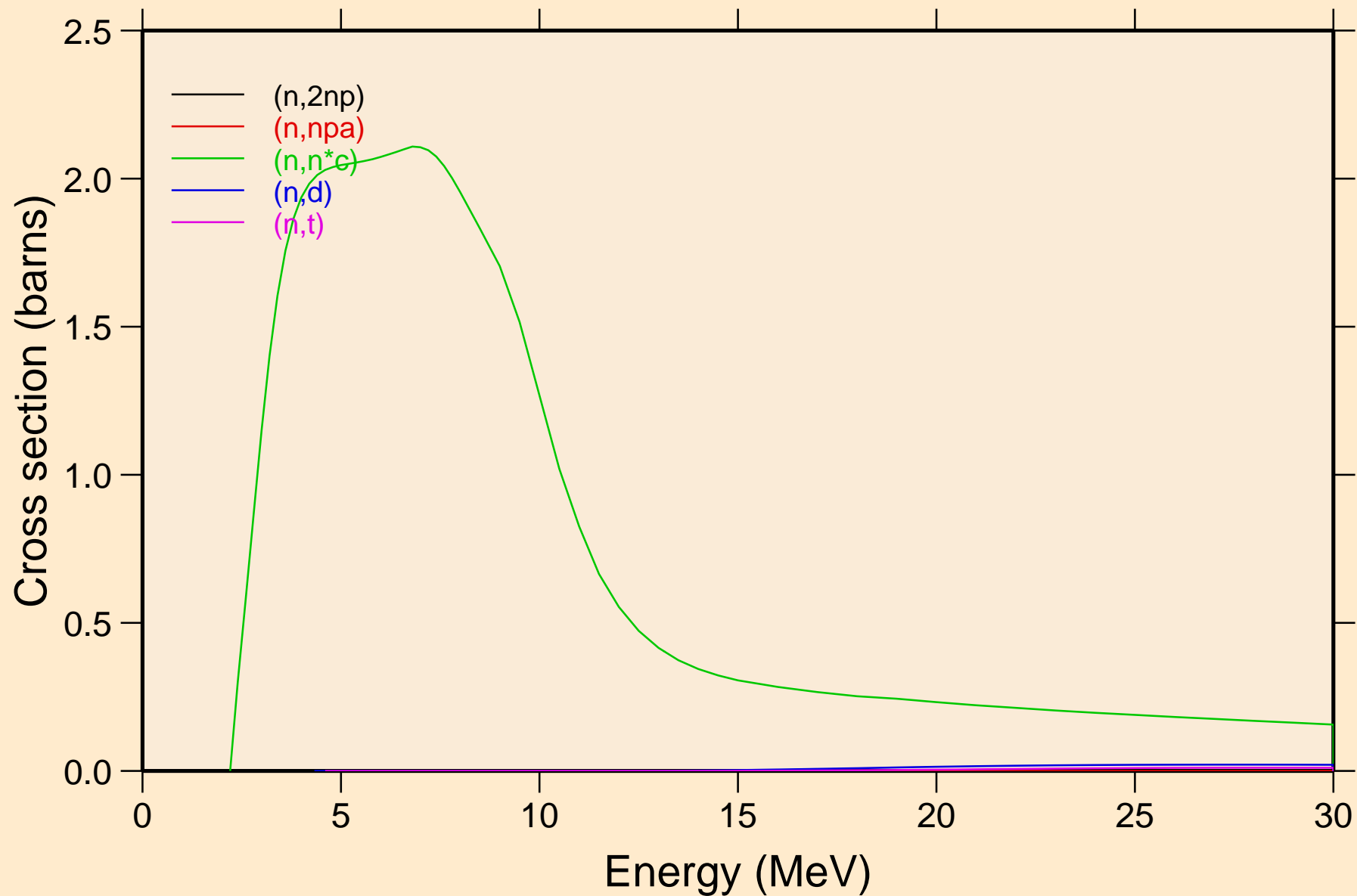

SM145 NEUTRON ACER TENDL-2019 LIBRARY; T=293.16K
Threshold reactions

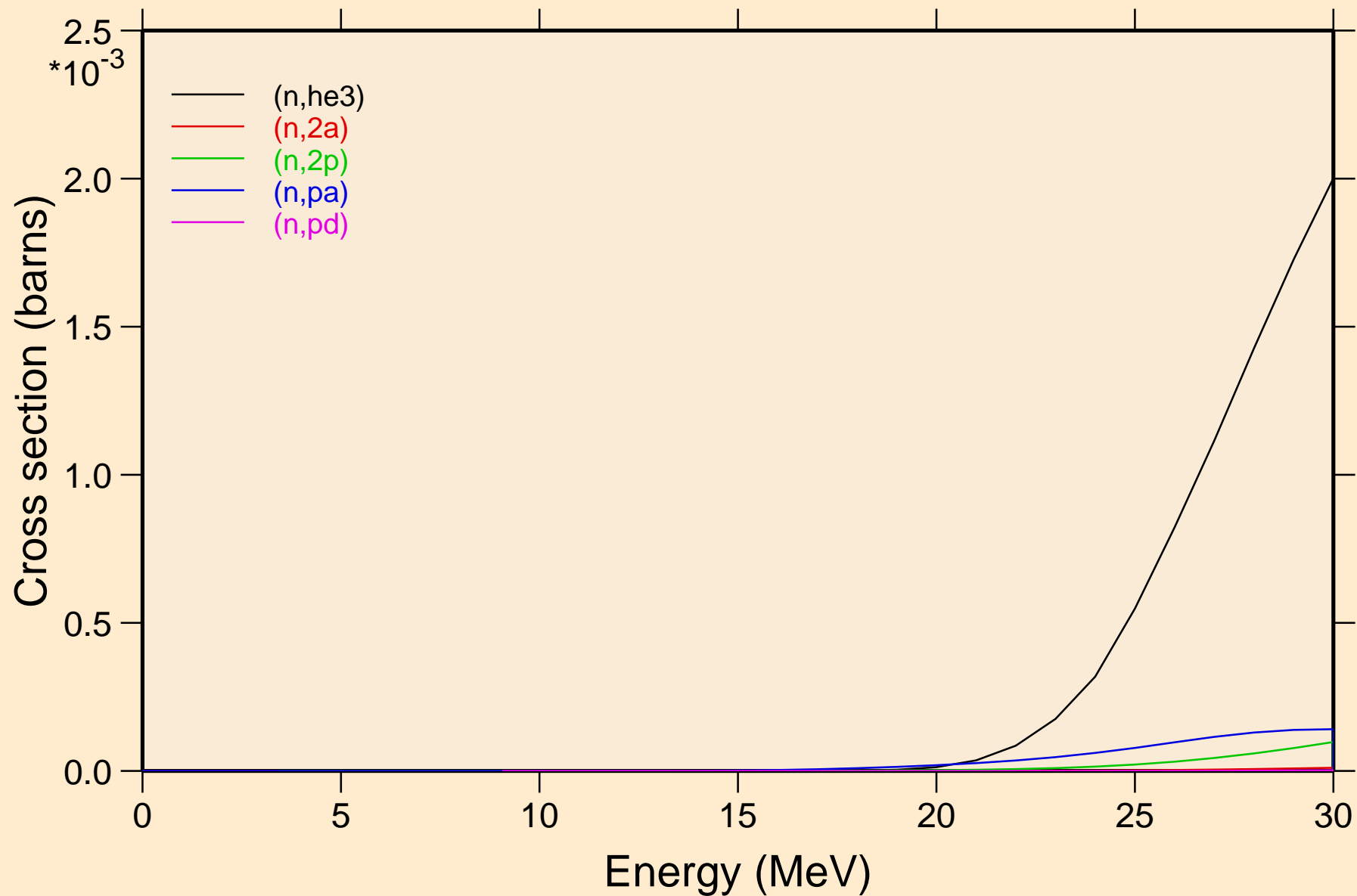

SM145 NEUTRON ACER TENDL-2019 LIBRARY; T=293.16K
Threshold reactions

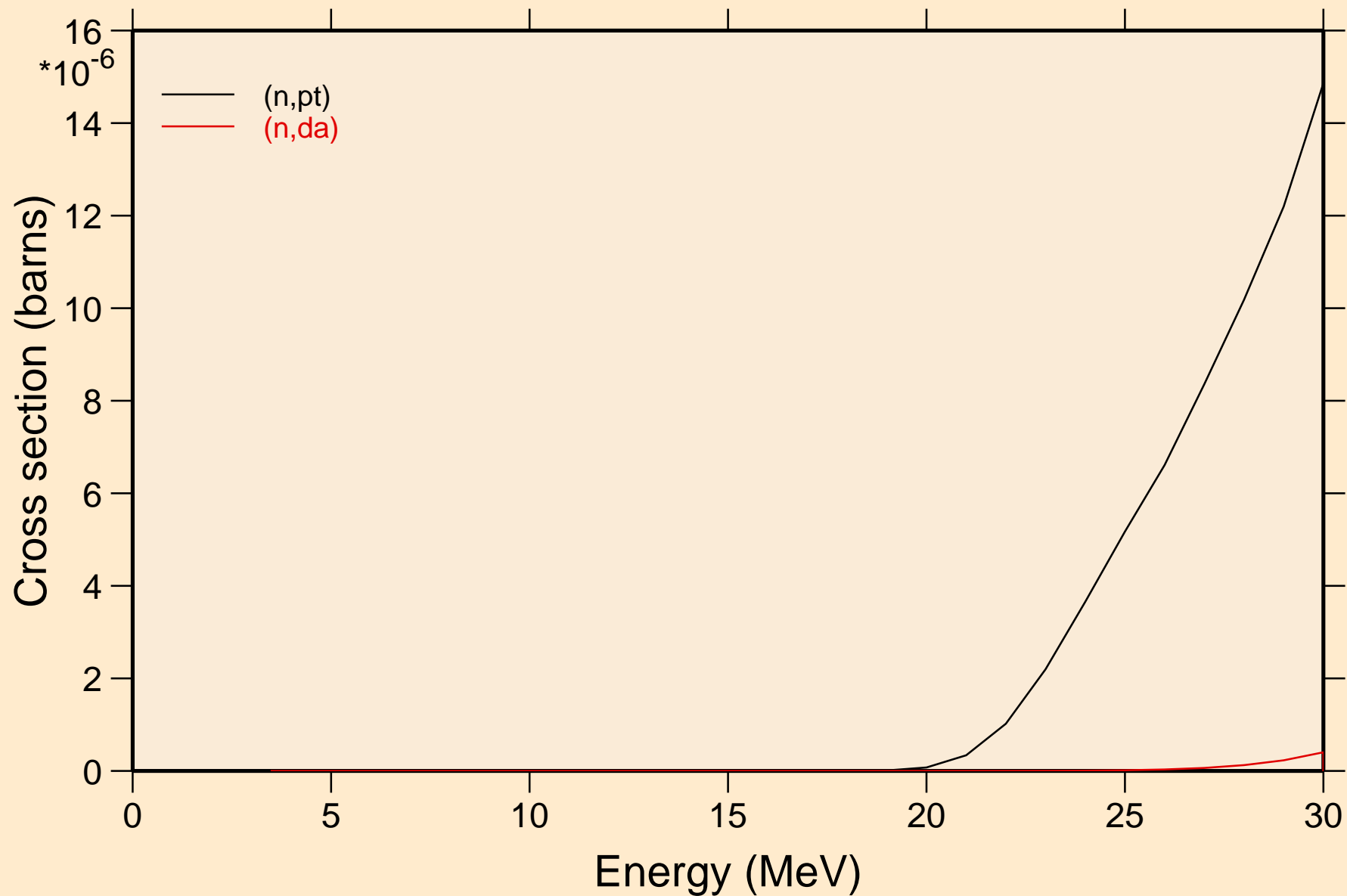

SM145 NEUTRON ACER TENDL-2019 LIBRARY; T=293.16K

Threshold reactions

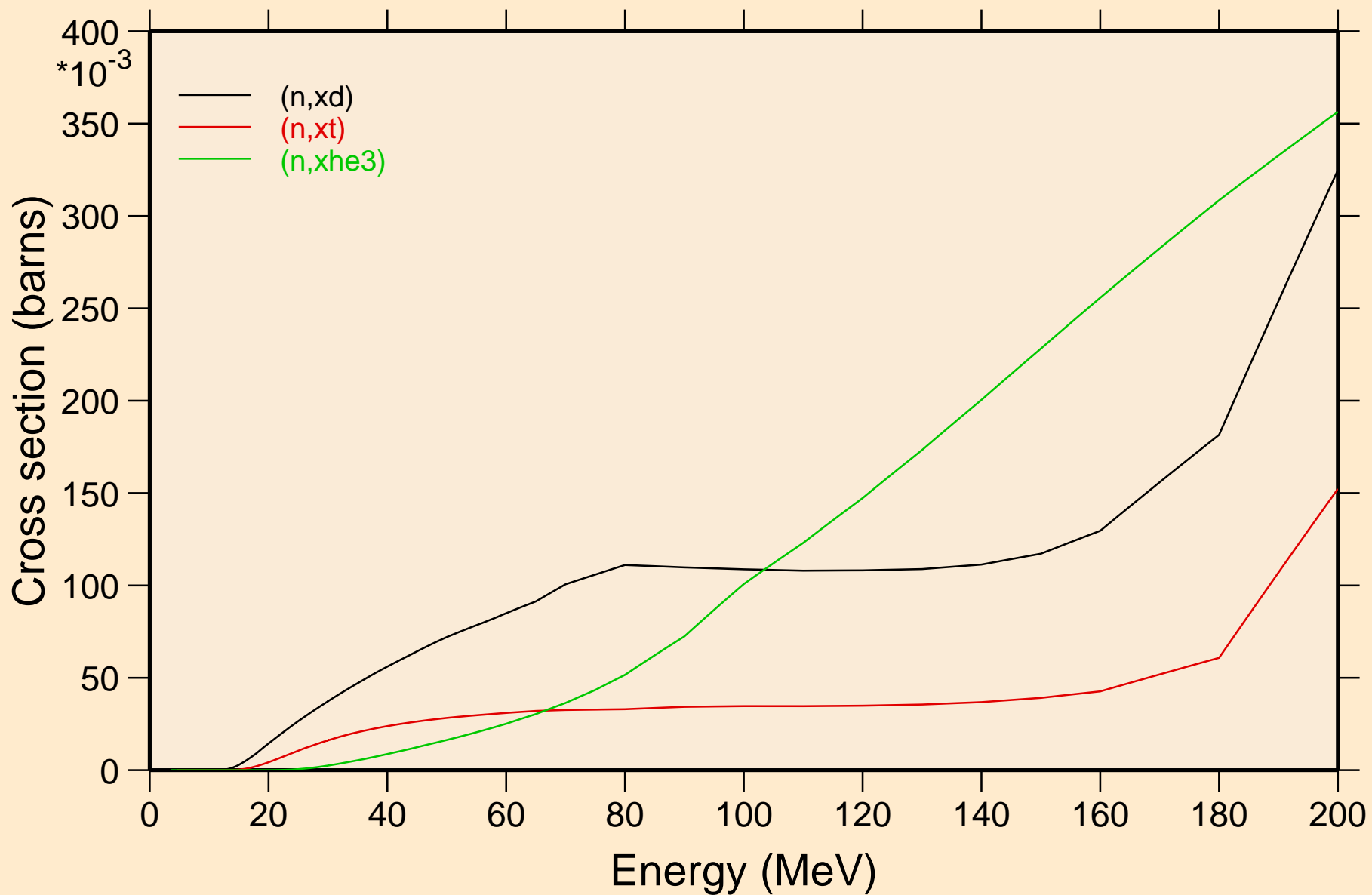

SM145 NEUTRON ACER TENDL-2019 LIBRARY; T=293.16K
angular distribution for elastic

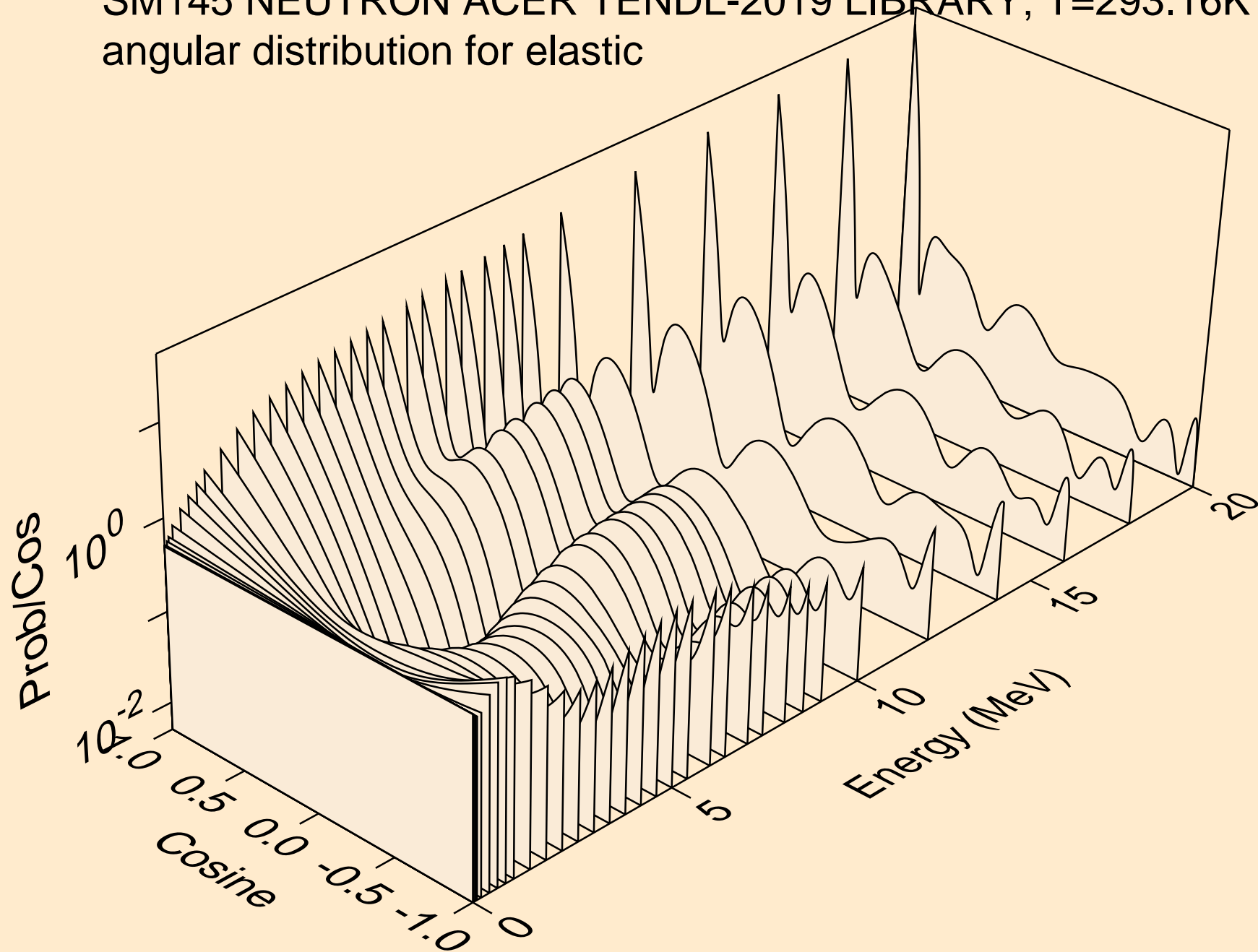

SM145 NEUTRON ACER TENDL-2019 LIBRARY; T=293.16K
angular distribution for elastic

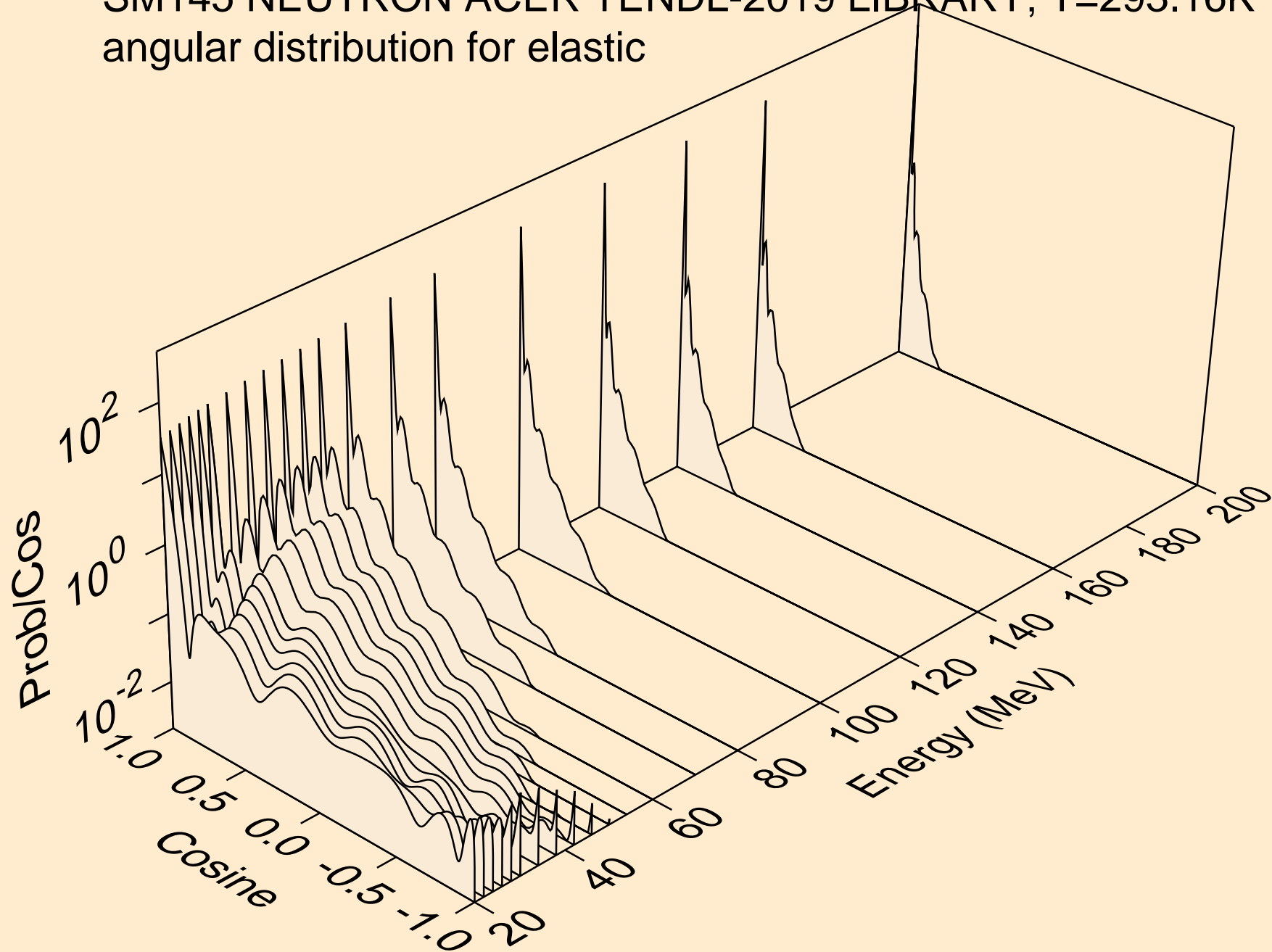

SM145 NEUTRON ACER TENDL-2019 LIBRARY; T=293.16K
angular distribution for (n,n*1)

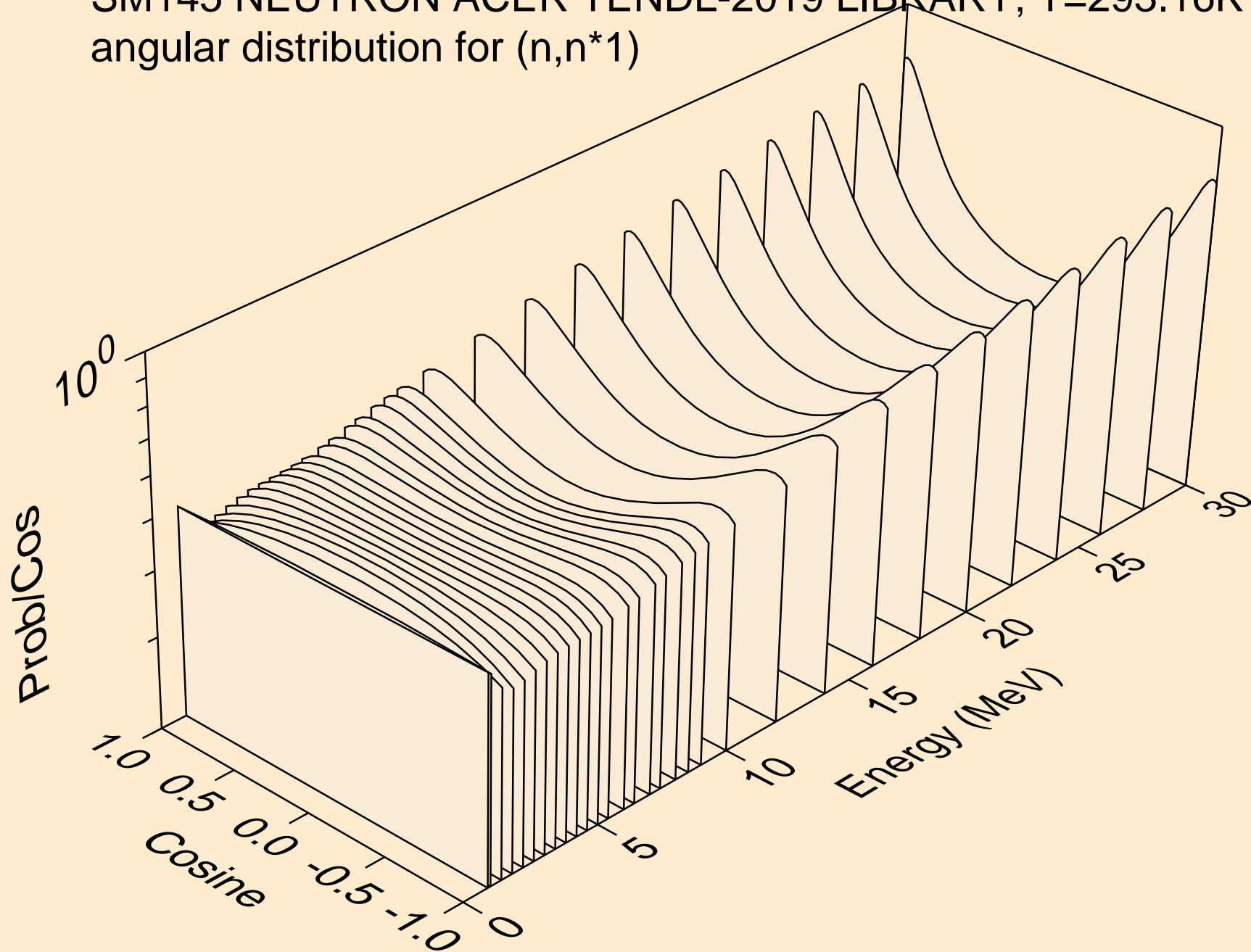

SM145 NEUTRON ACER TENDL-2019 LIBRARY; T=293.16K
angular distribution for (n,n*2)

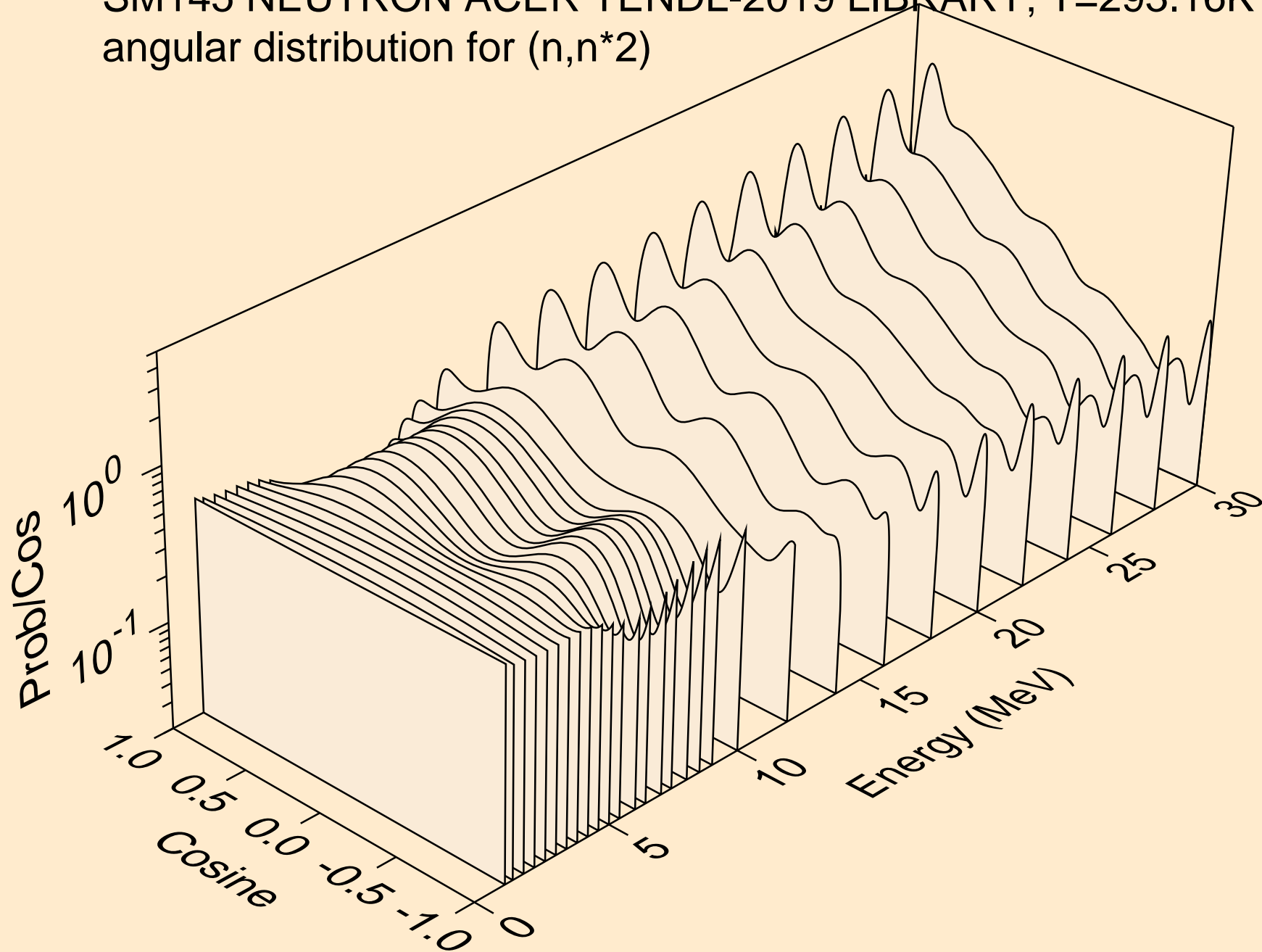

SM145 NEUTRON ACER TENDL-2019 LIBRARY; T=293.16K
angular distribution for (n,n*3)

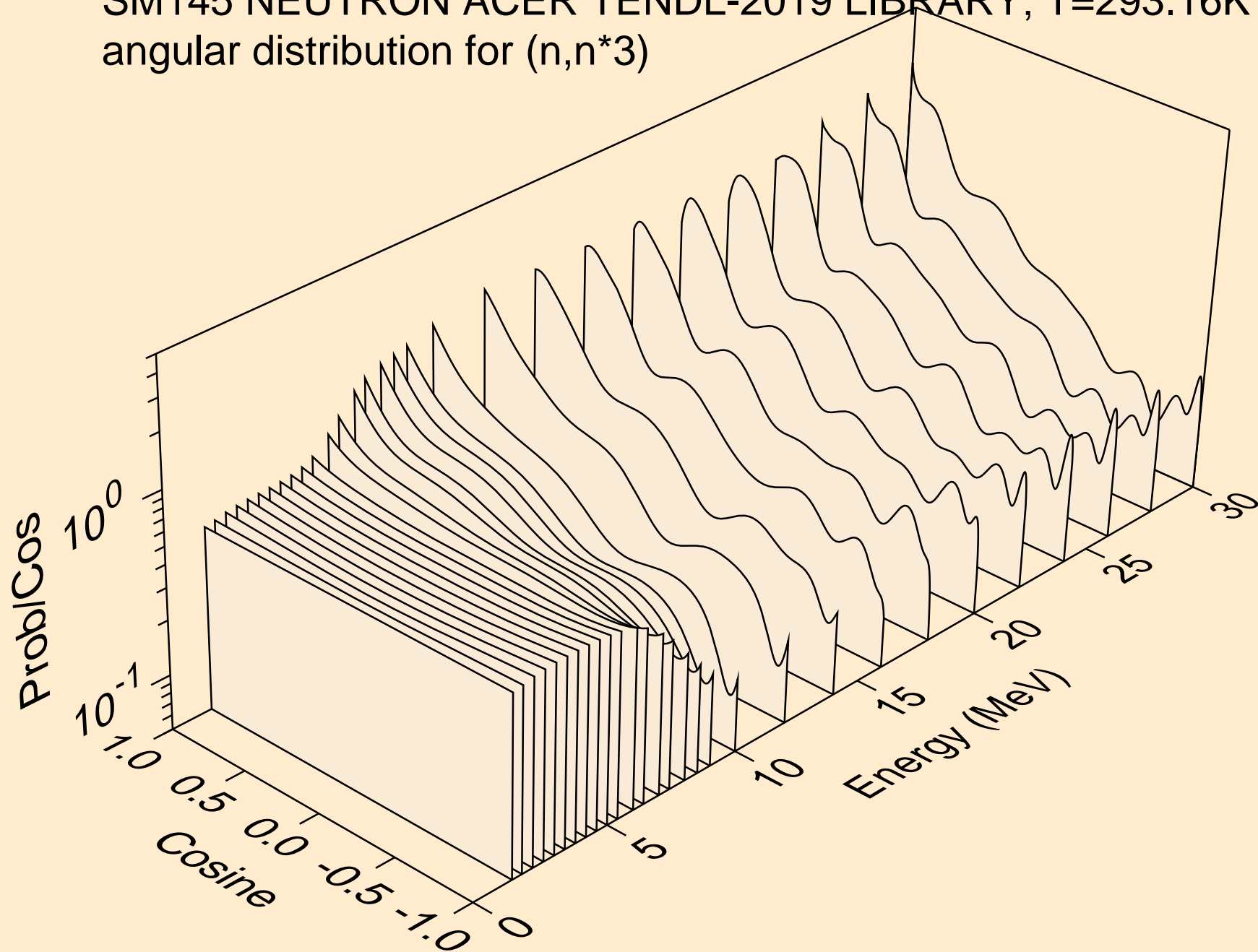

SM145 NEUTRON ACER TENDL-2019 LIBRARY; T=293.16K
angular distribution for (n,n*4)

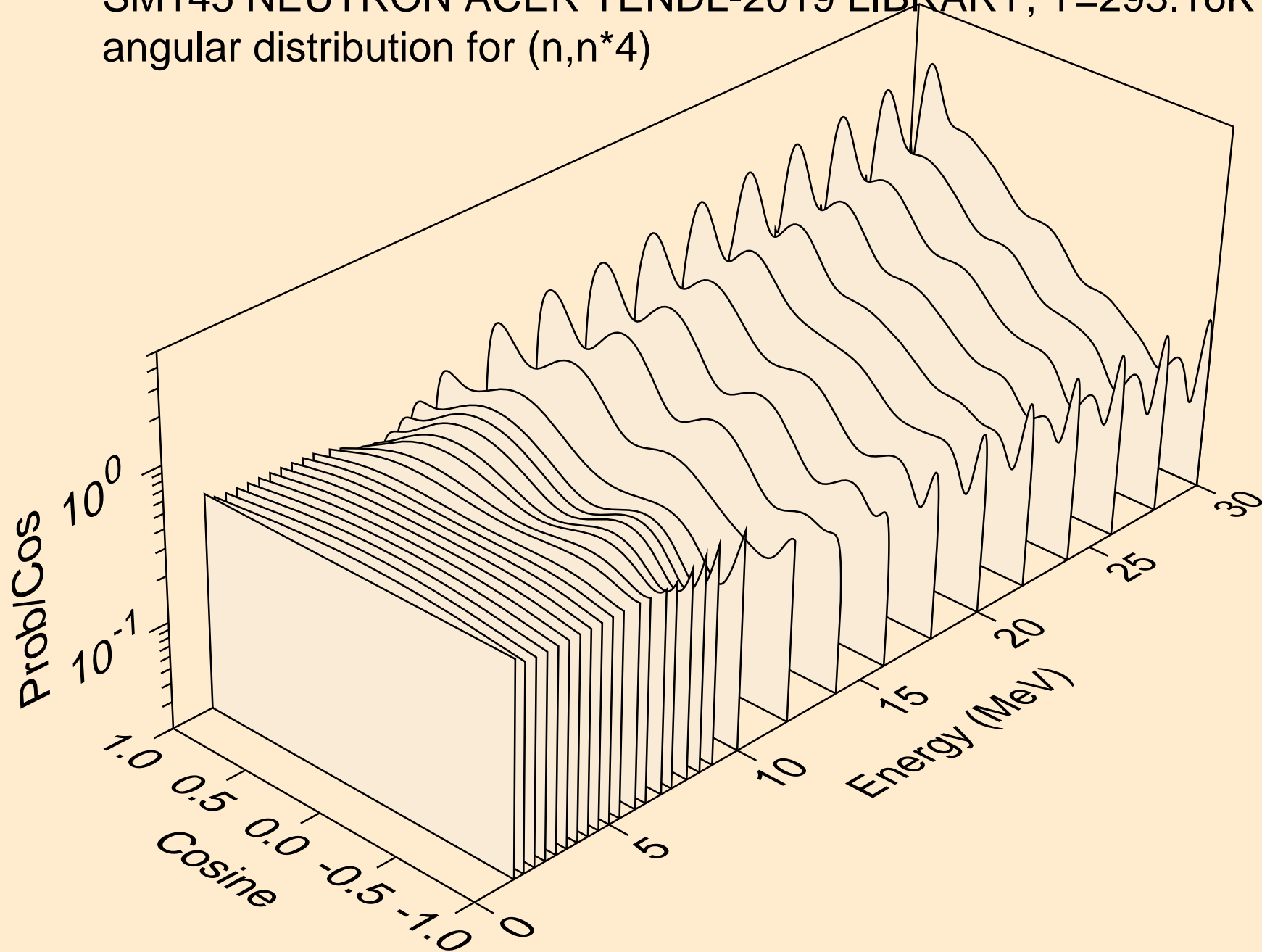

SM145 NEUTRON ACER TENDL-2019 LIBRARY; T=293.16K
angular distribution for (n,n*5)

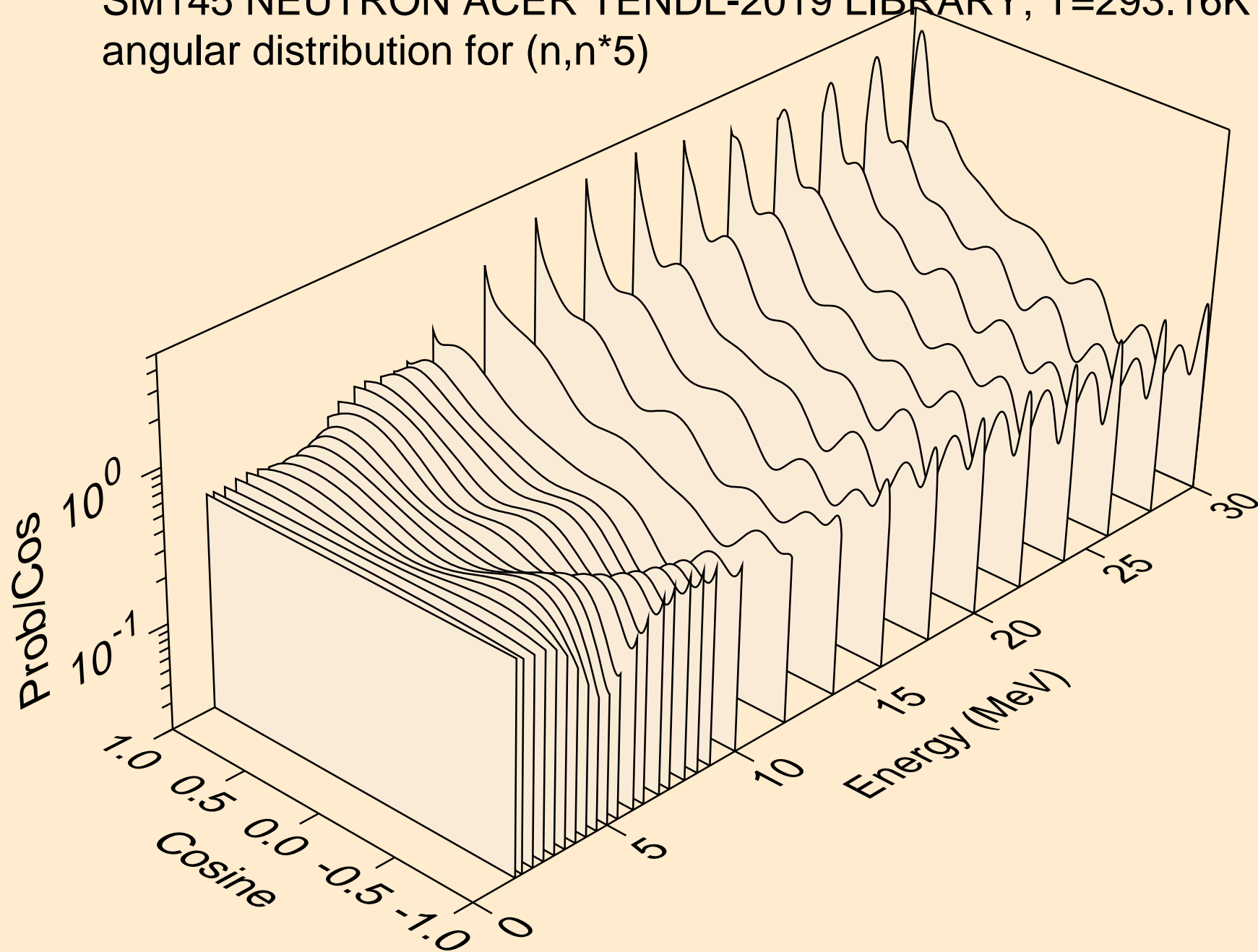

SM145 NEUTRON ACER TENDL-2019 LIBRARY; T=293.16K
angular distribution for (n,n*6)

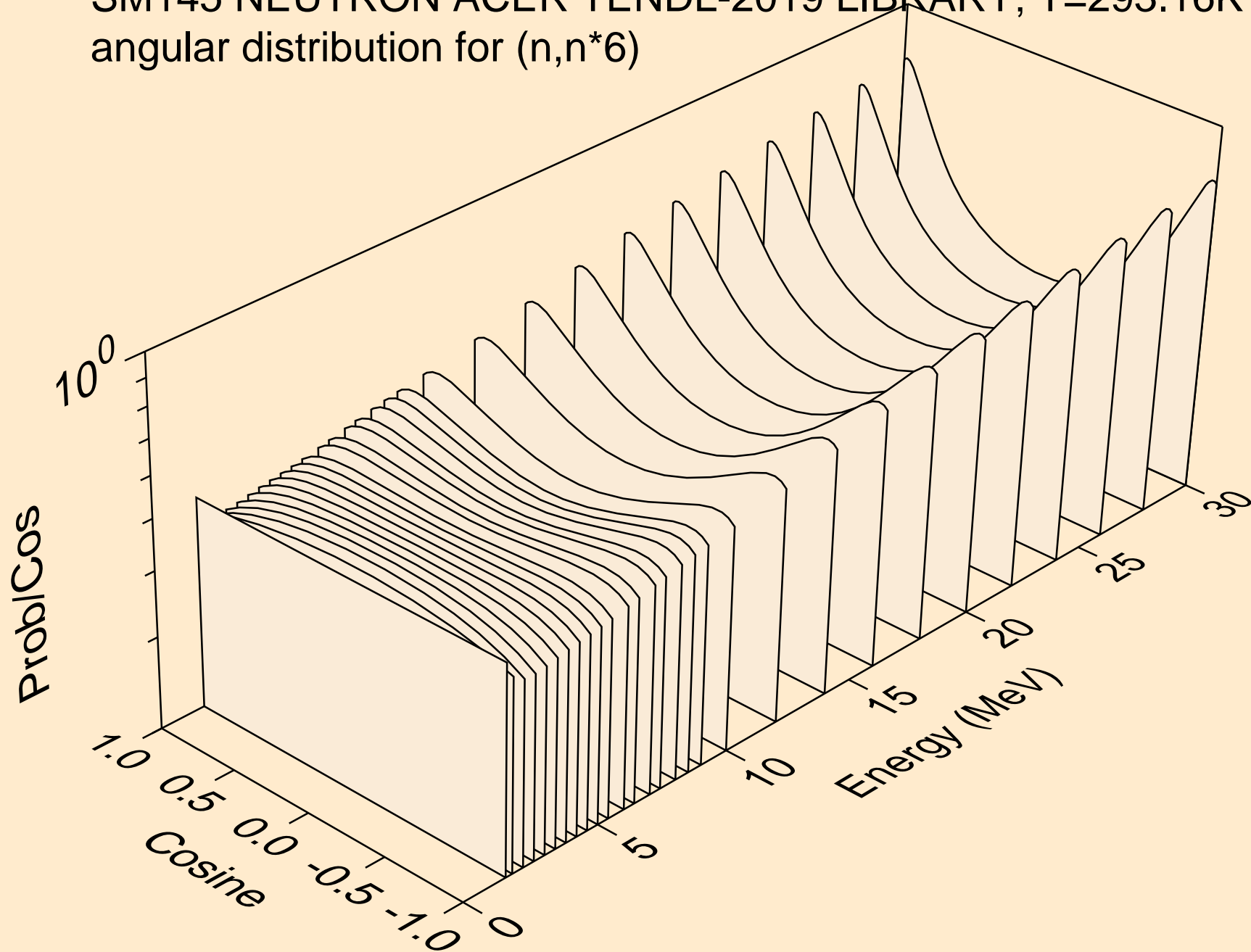

SM145 NEUTRON ACER TENDL-2019 LIBRARY; T=293.16K
angular distribution for (n,n*7)

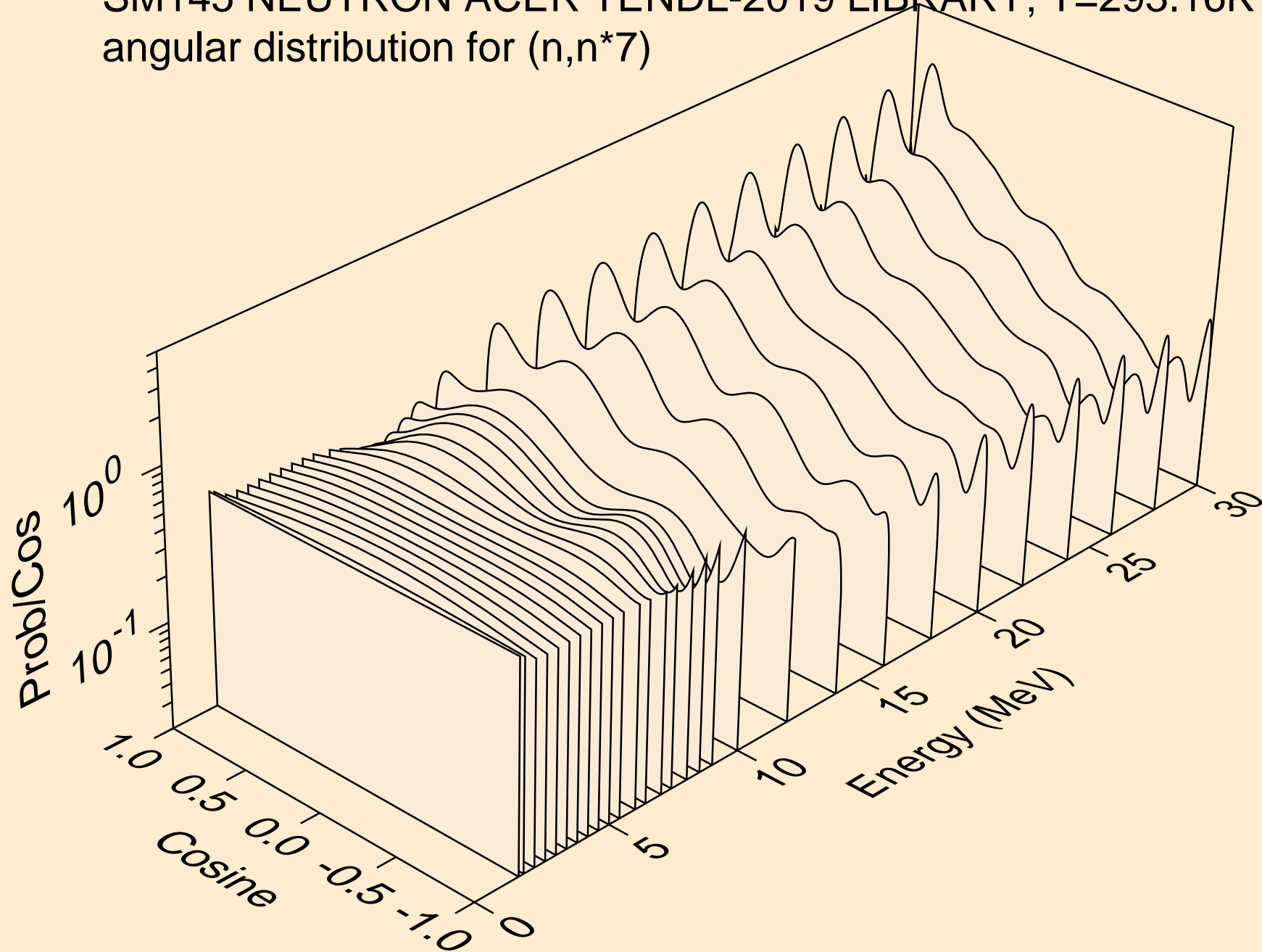

SM145 NEUTRON ACER TENDL-2019 LIBRARY; T=293.16K
angular distribution for (n,n*8)

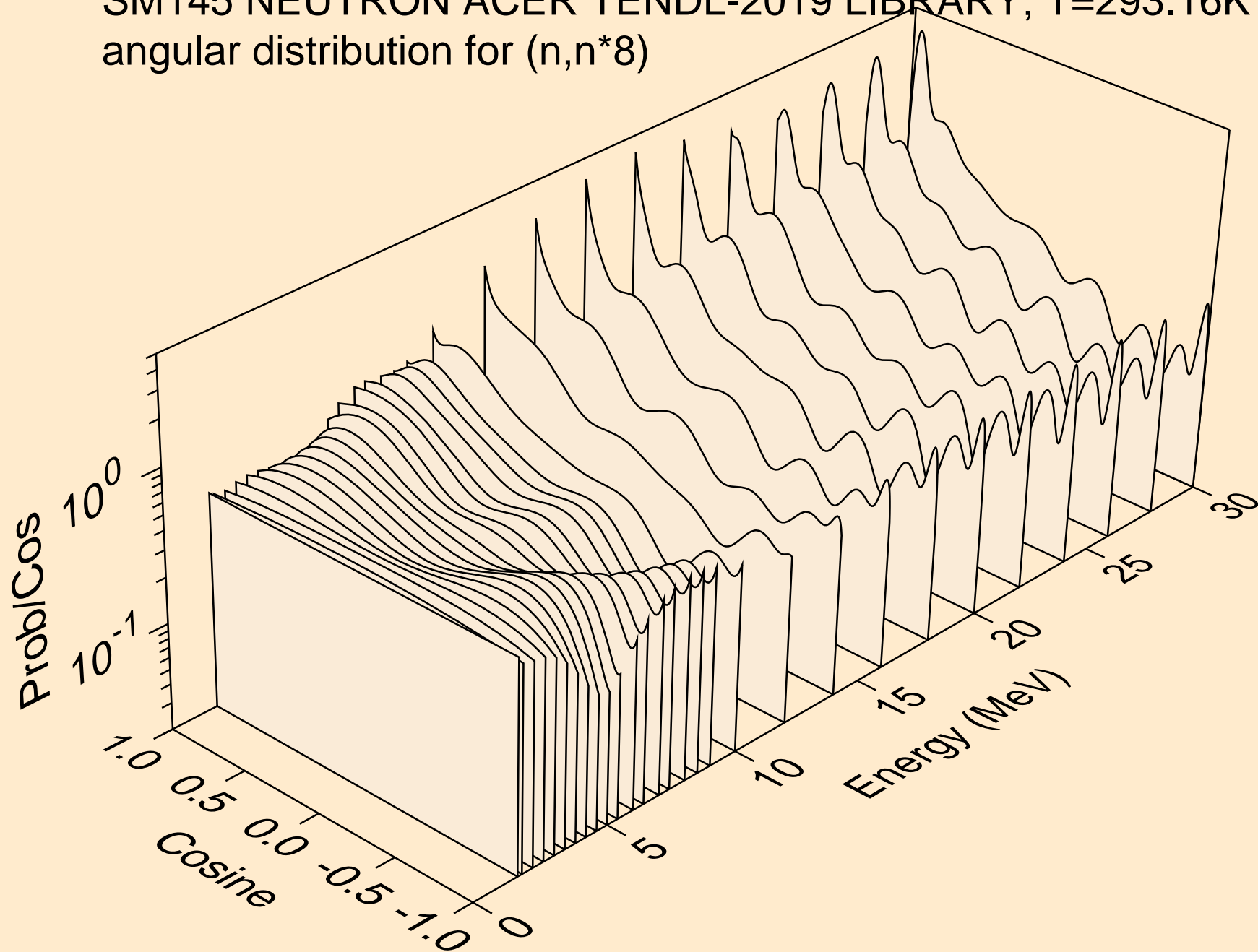

SM145 NEUTRON ACER TENDL-2019 LIBRARY; T=293.16K
angular distribution for (n,n*9)

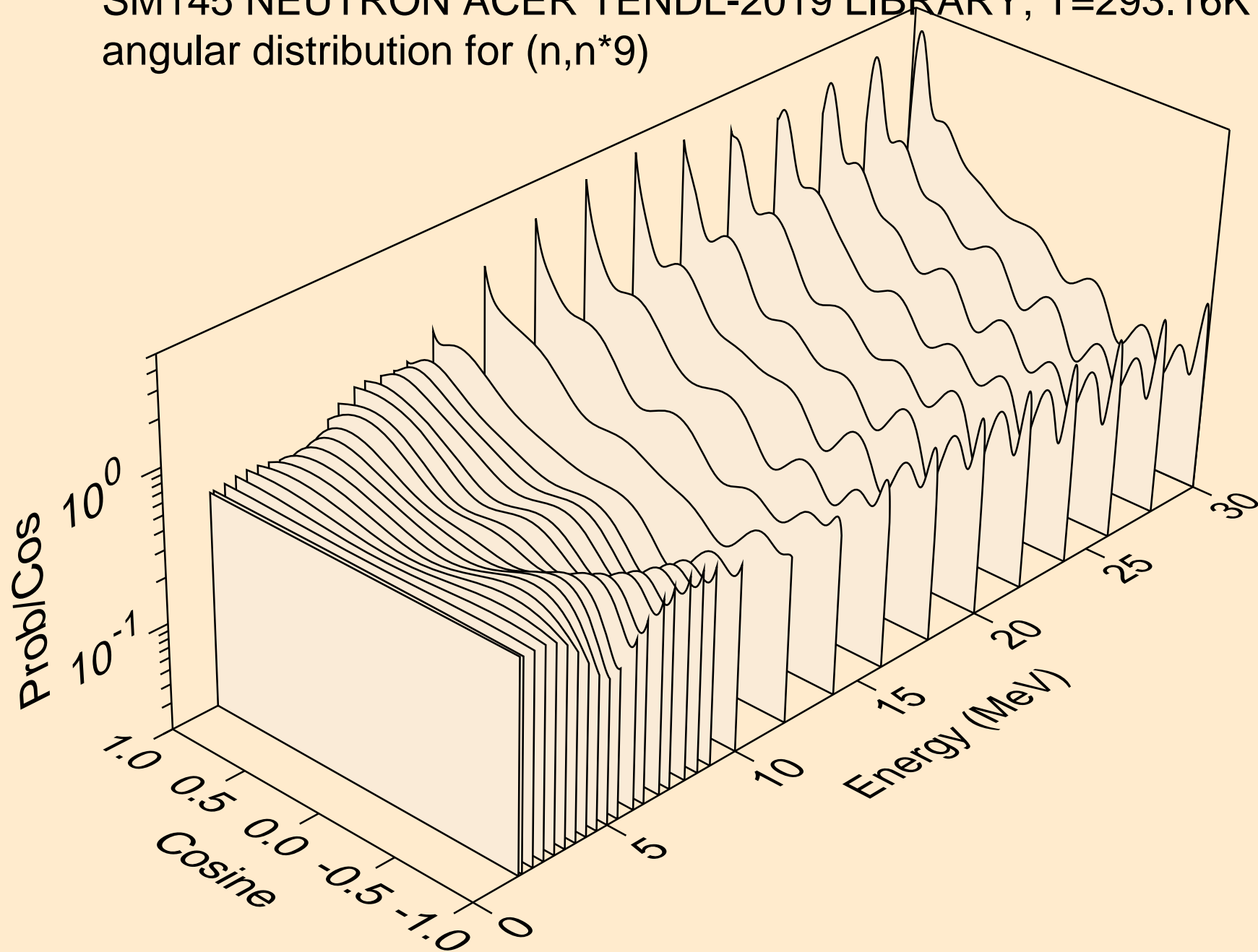

SM145 NEUTRON ACER TENDL-2019 LIBRARY; T=293.16K
angular distribution for (n,n*10)

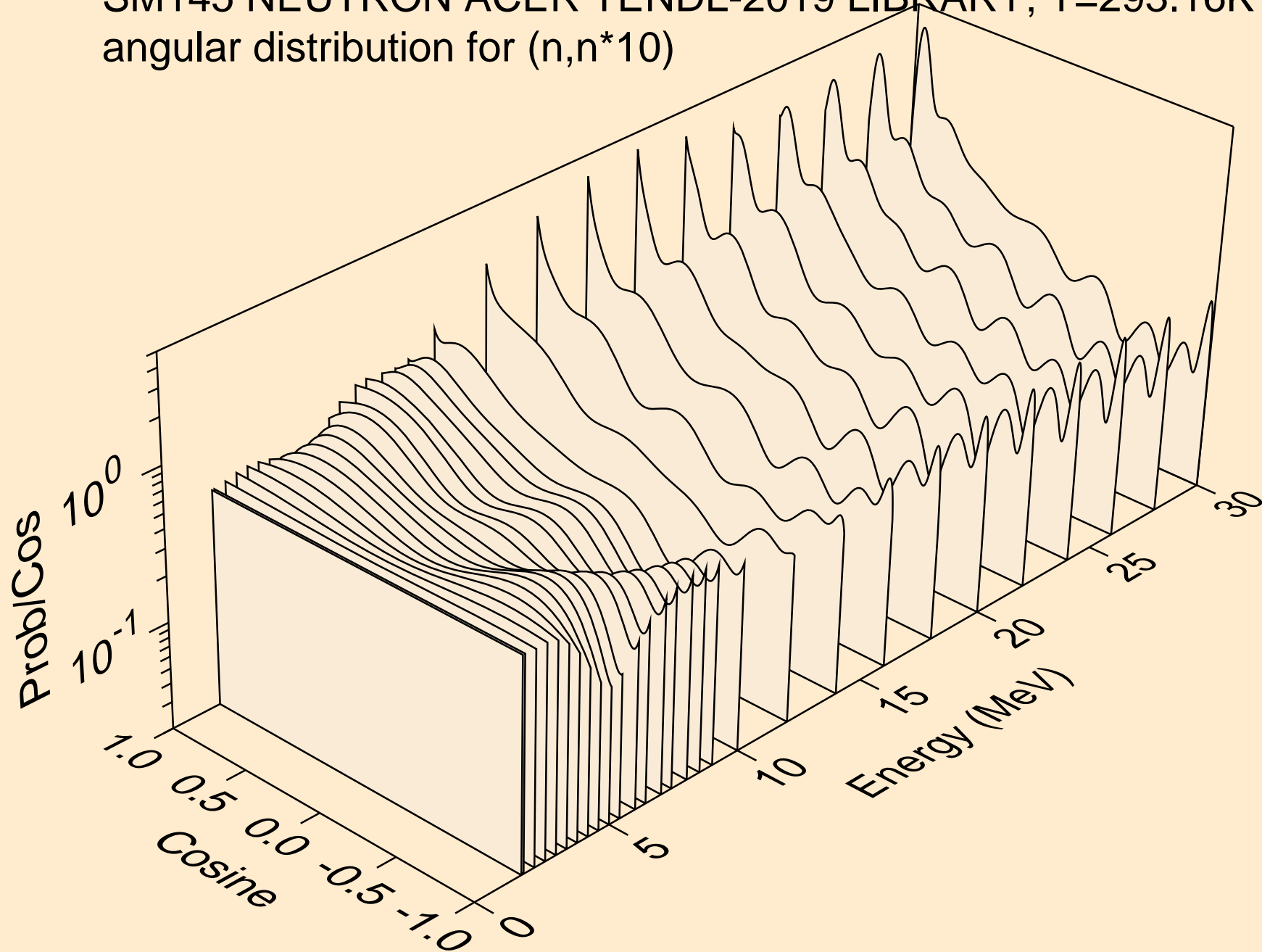

SM145 NEUTRON ACER TENDL-2019 LIBRARY; T=293.16K
angular distribution for (n,n*11)

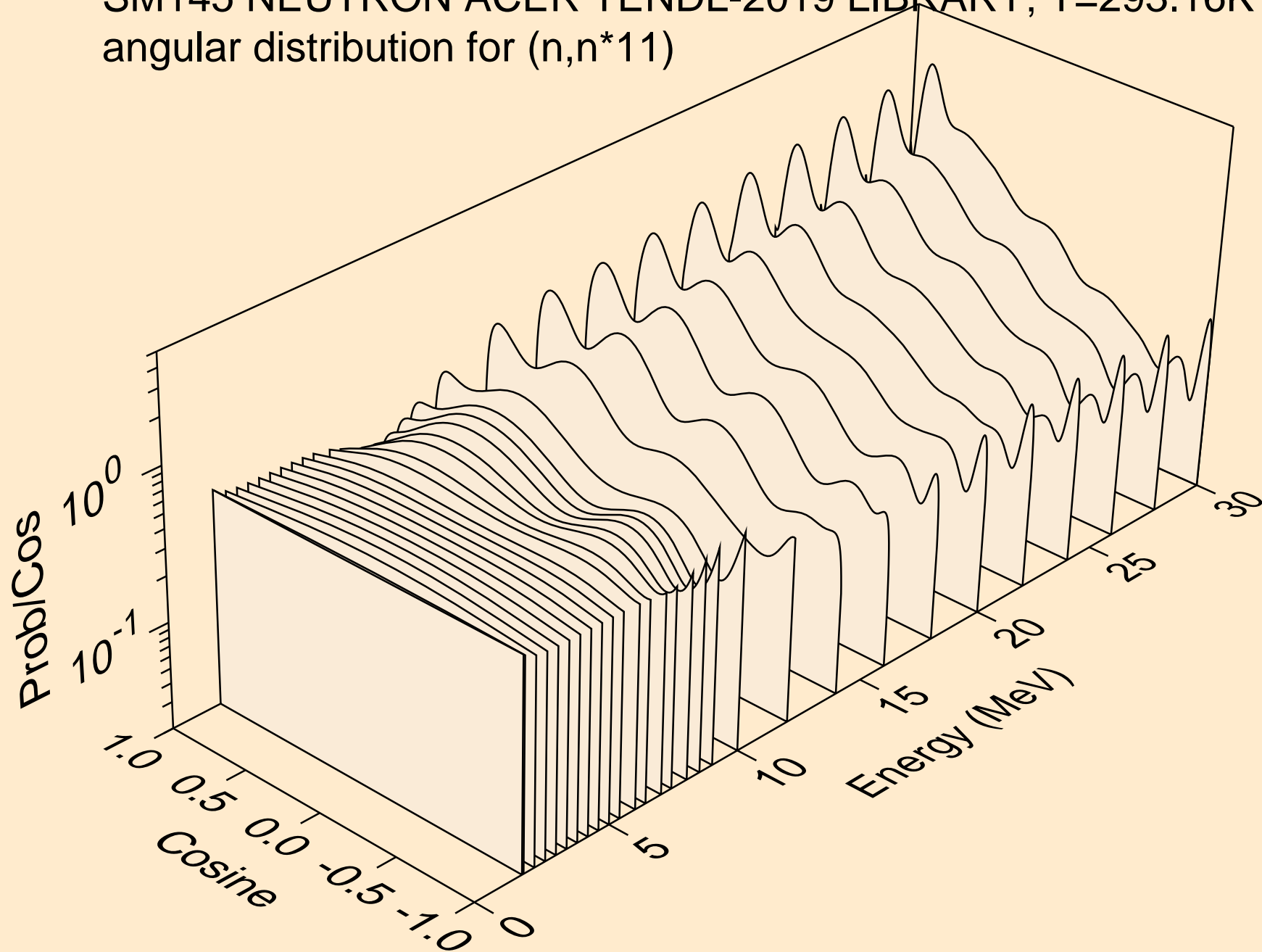

SM145 NEUTRON ACER TENDL-2019 LIBRARY; T=293.16K
angular distribution for (n,n*12)

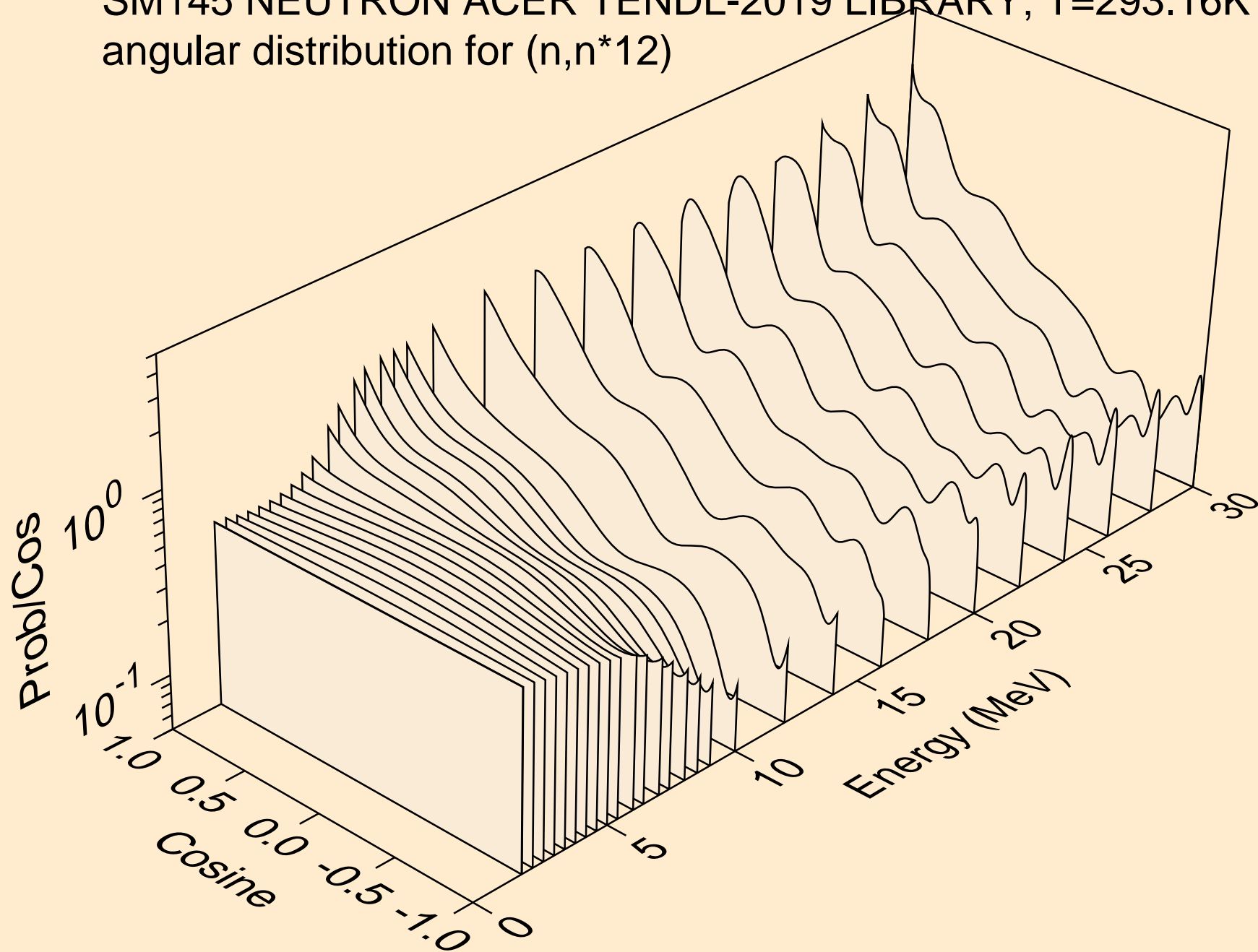

SM145 NEUTRON ACER TENDL-2019 LIBRARY; T=293.16K
angular distribution for (n,n*13)

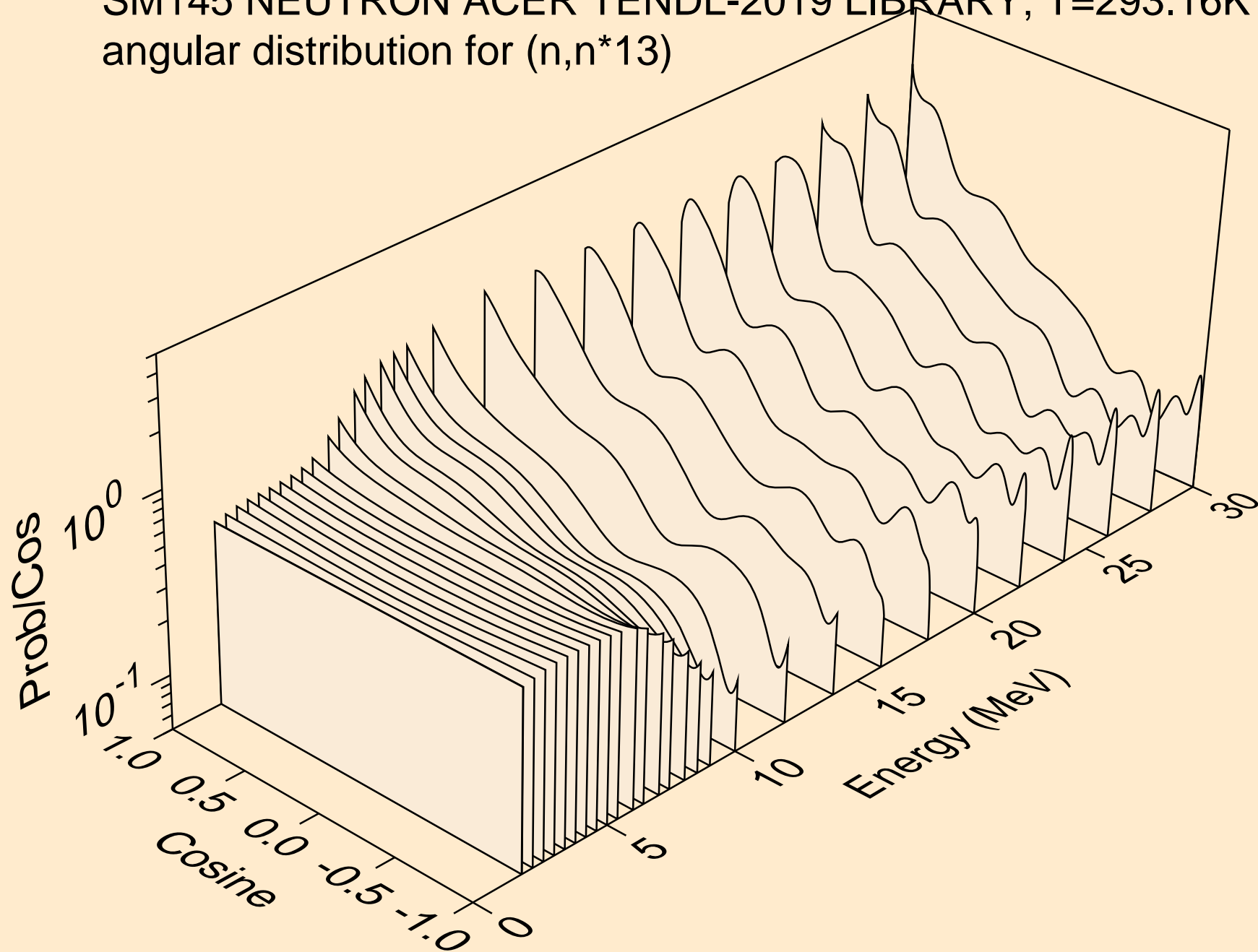

SM145 NEUTRON ACER TENDL-2019 LIBRARY; T=293.16K
angular distribution for (n,n*14)

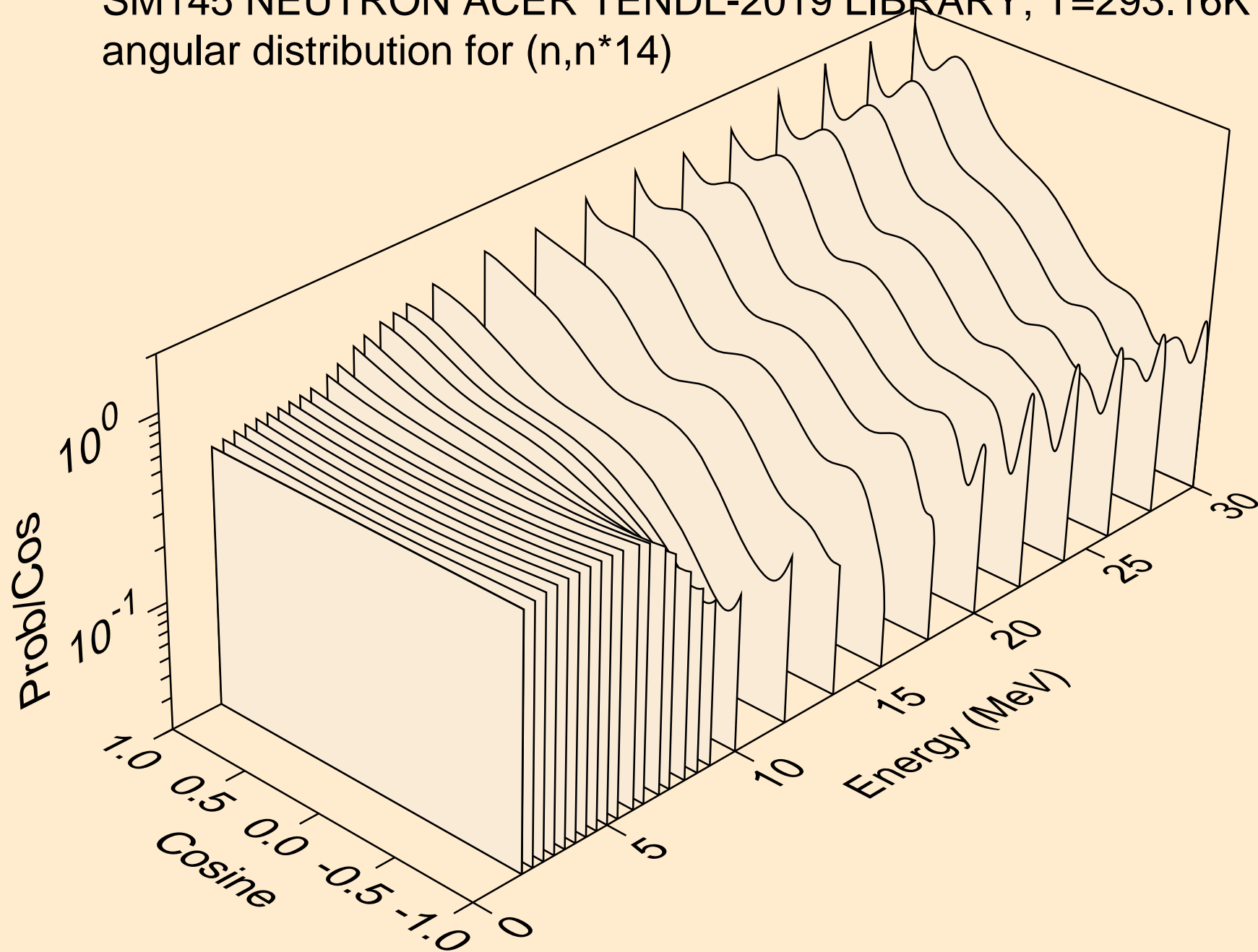

SM145 NEUTRON ACER TENDL-2019 LIBRARY; T=293.16K
angular distribution for (n,n*15)

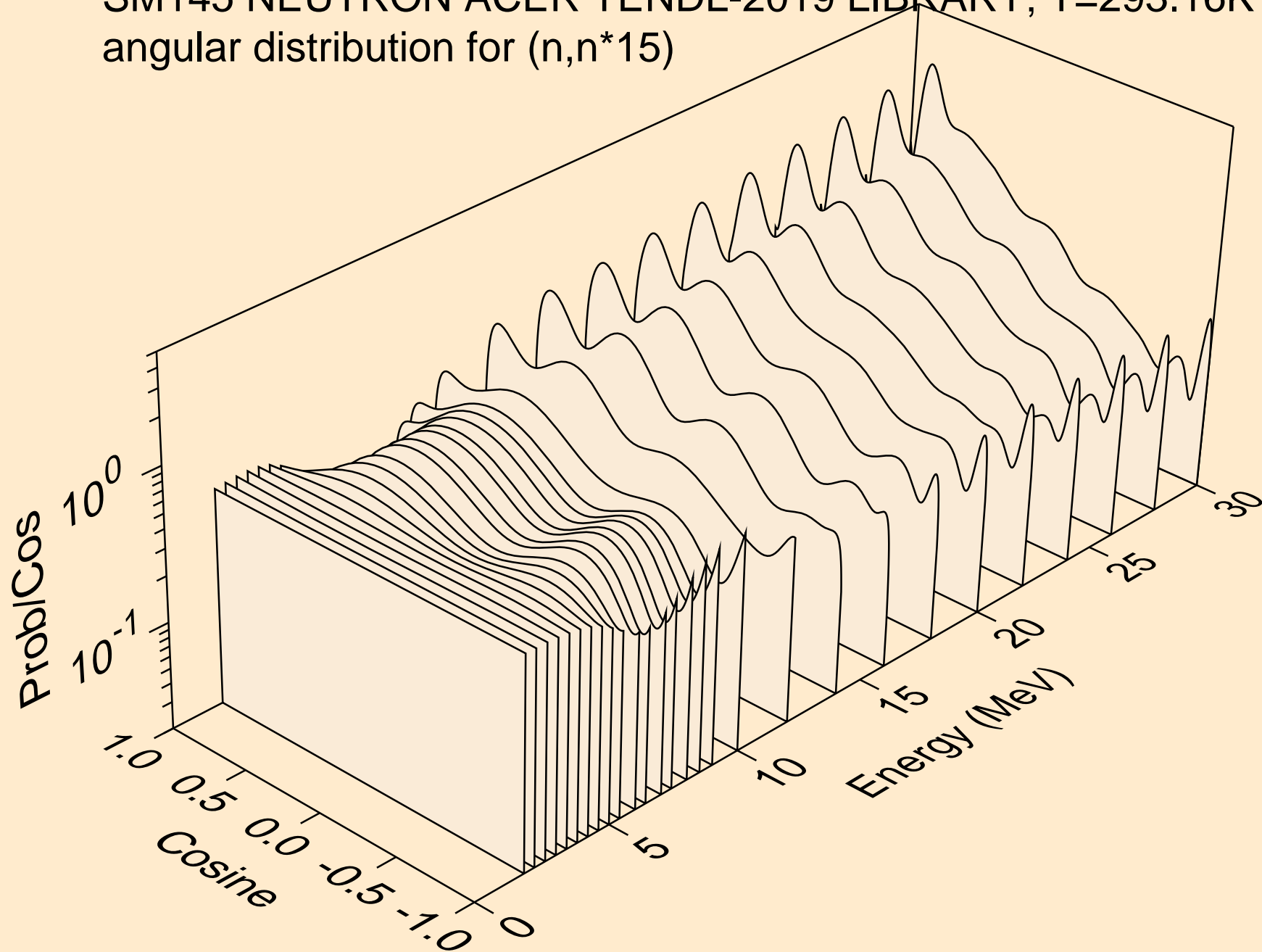

SM145 NEUTRON ACER TENDL-2019 LIBRARY; T=293.16K
angular distribution for (n,n*16)

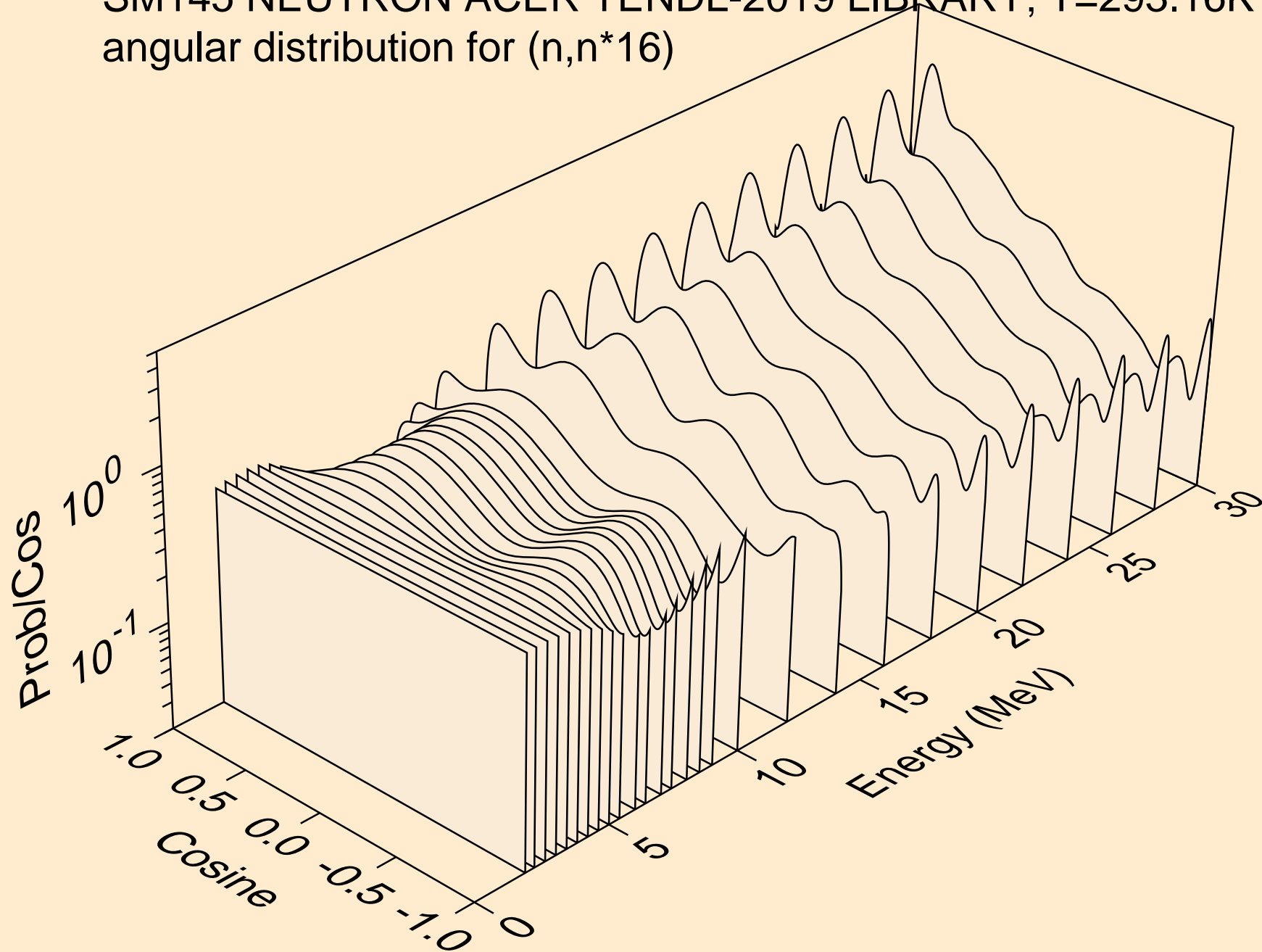

SM145 NEUTRON ACER TENDL-2019 LIBRARY; T=293.16K
angular distribution for (n,n*17)

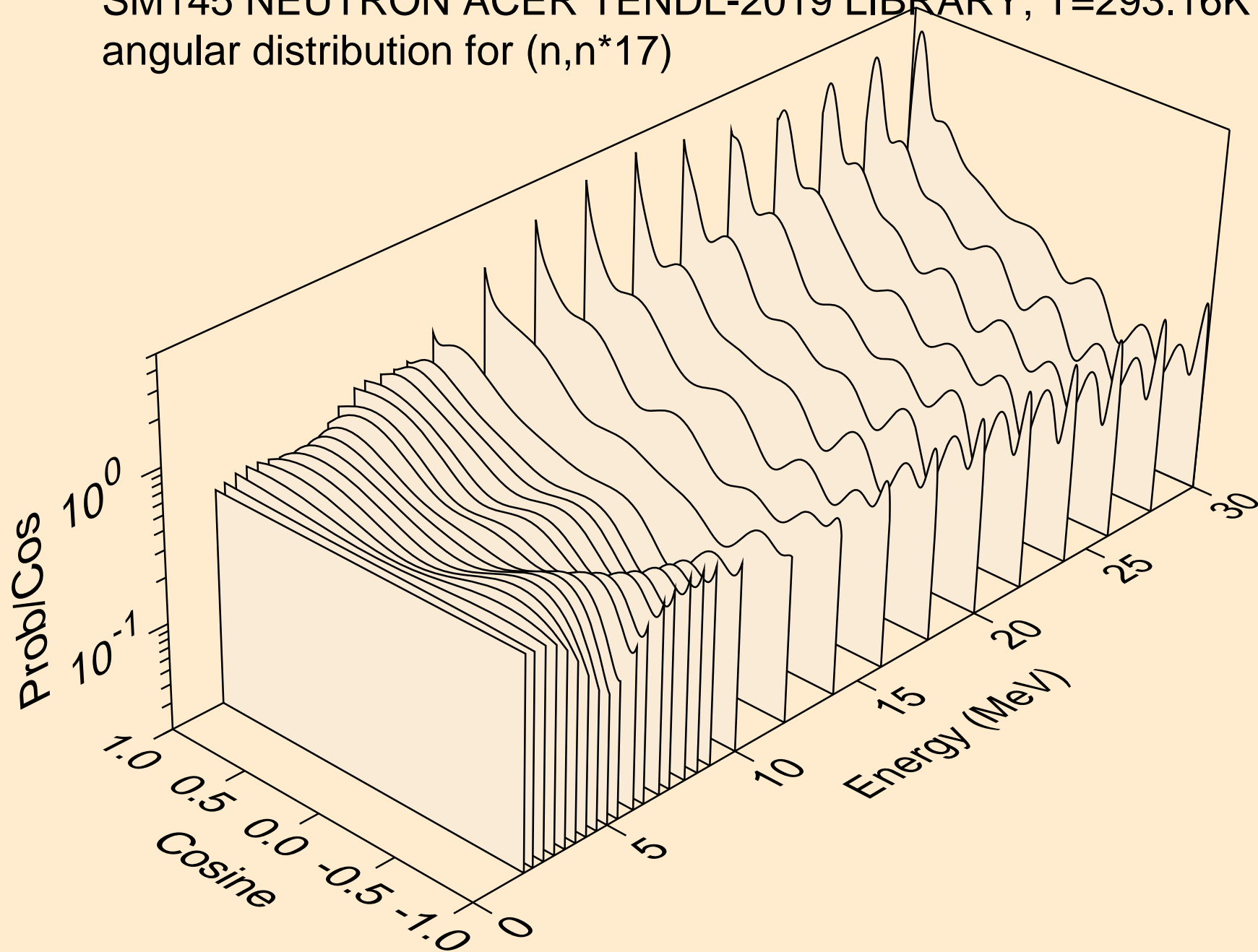

SM145 NEUTRON ACER TENDL-2019 LIBRARY; T=293.16K
angular distribution for (n,n*18)

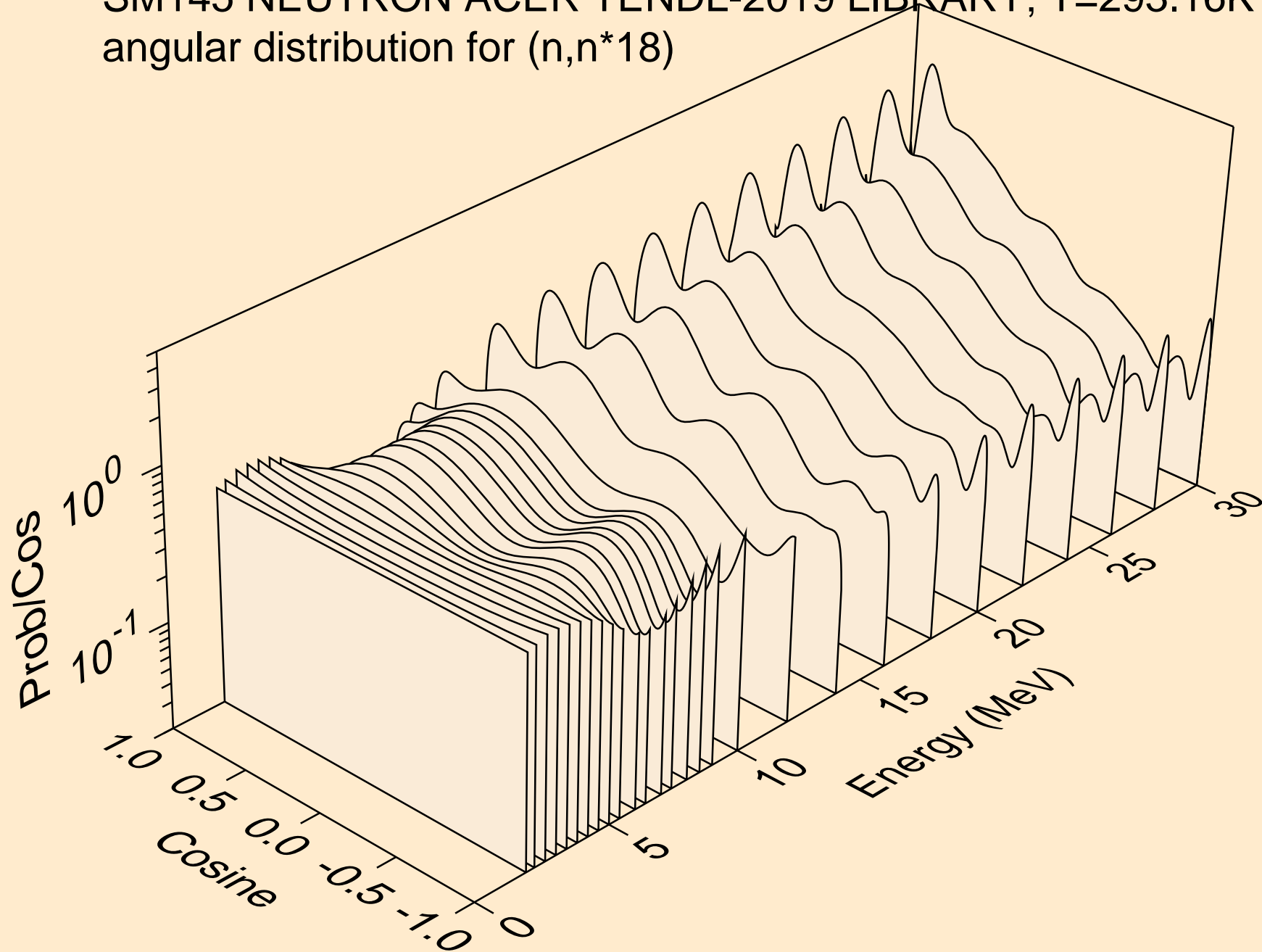

SM145 NEUTRON ACER TENDL-2019 LIBRARY; T=293.16K
angular distribution for (n,n*19)

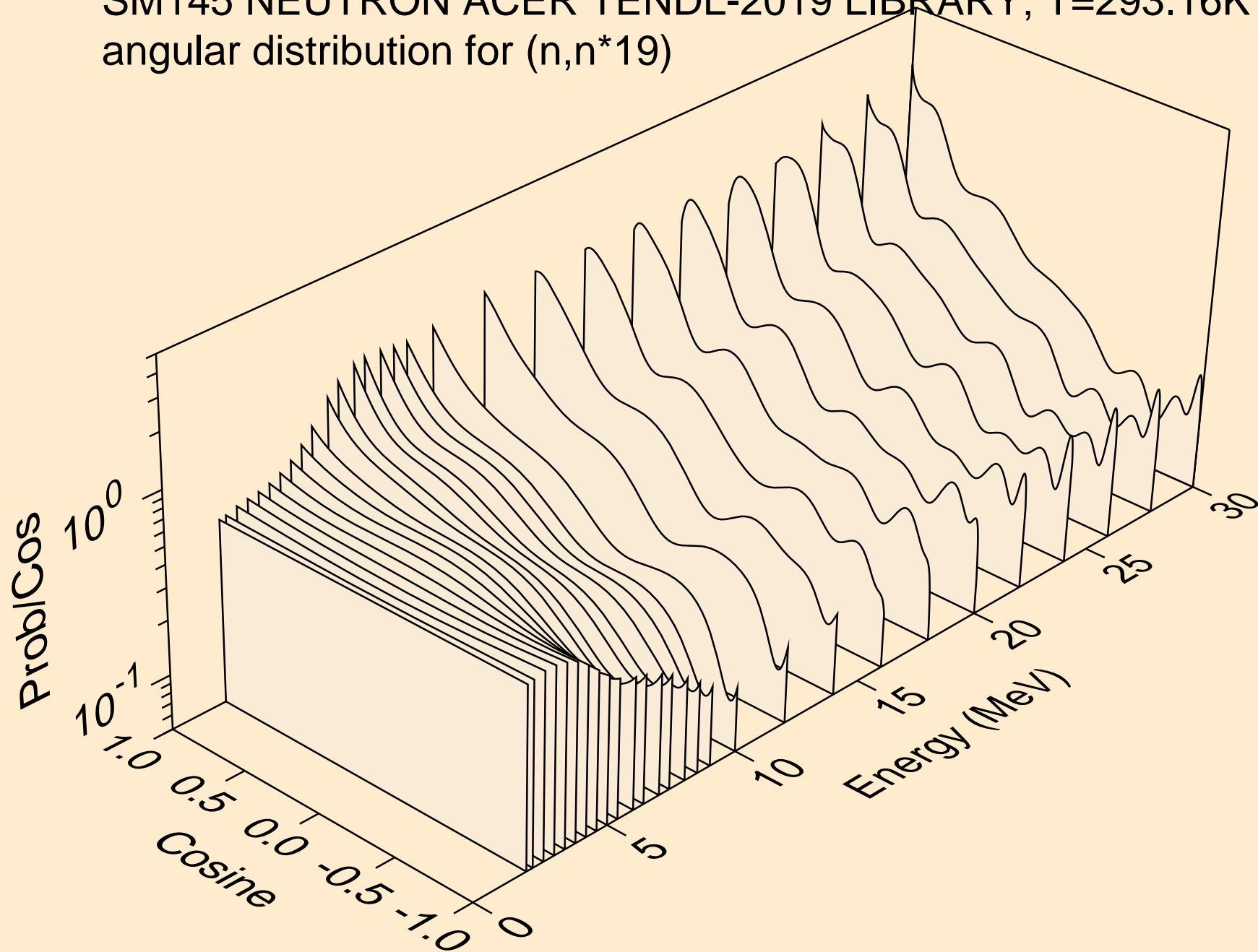

SM145 NEUTRON ACER TENDL-2019 LIBRARY; T=293.16K
angular distribution for (n,n*20)

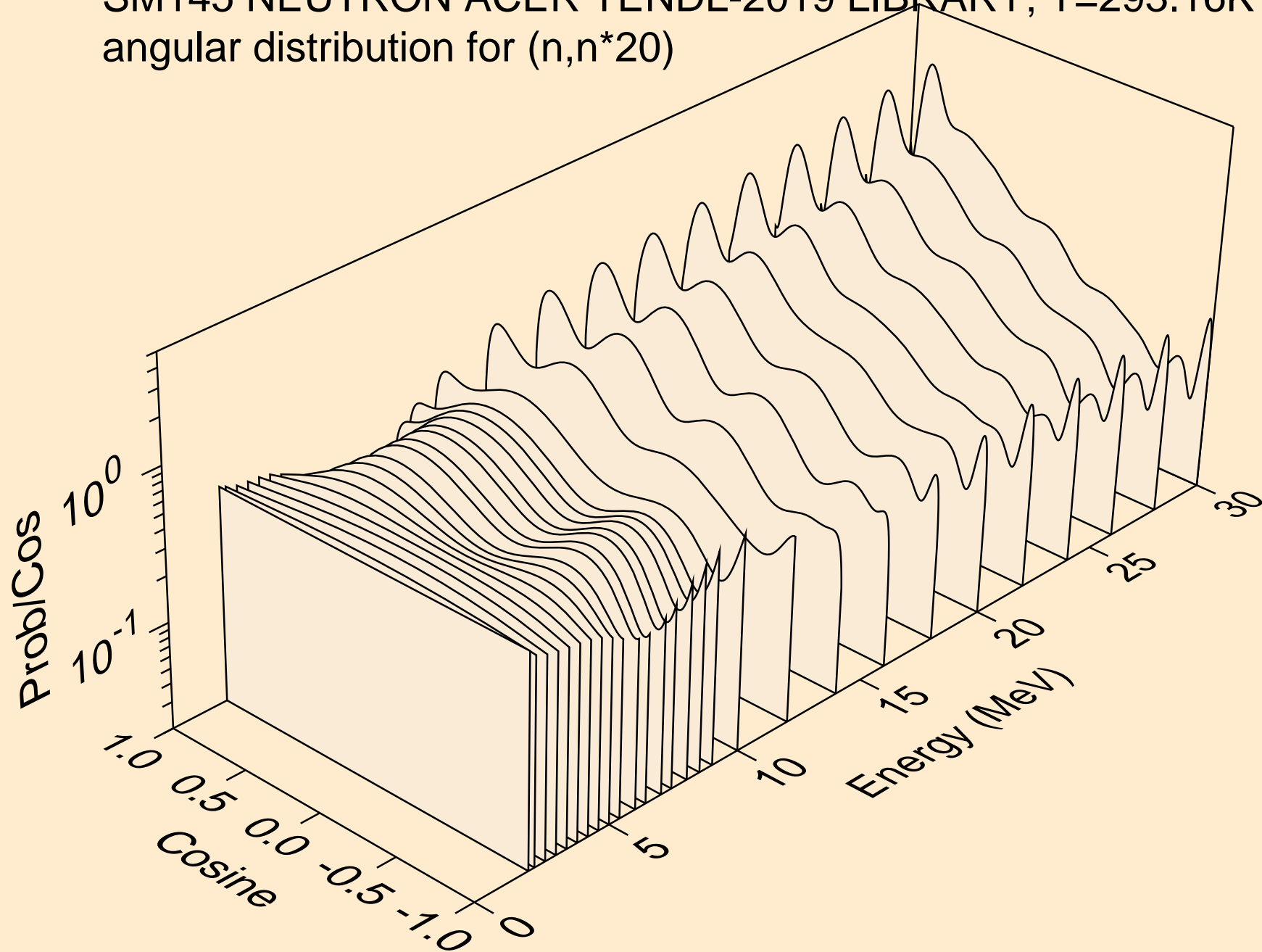

SM145 NEUTRON ACER TENDL-2019 LIBRARY; T=293.16K
angular distribution for (n,n*21)

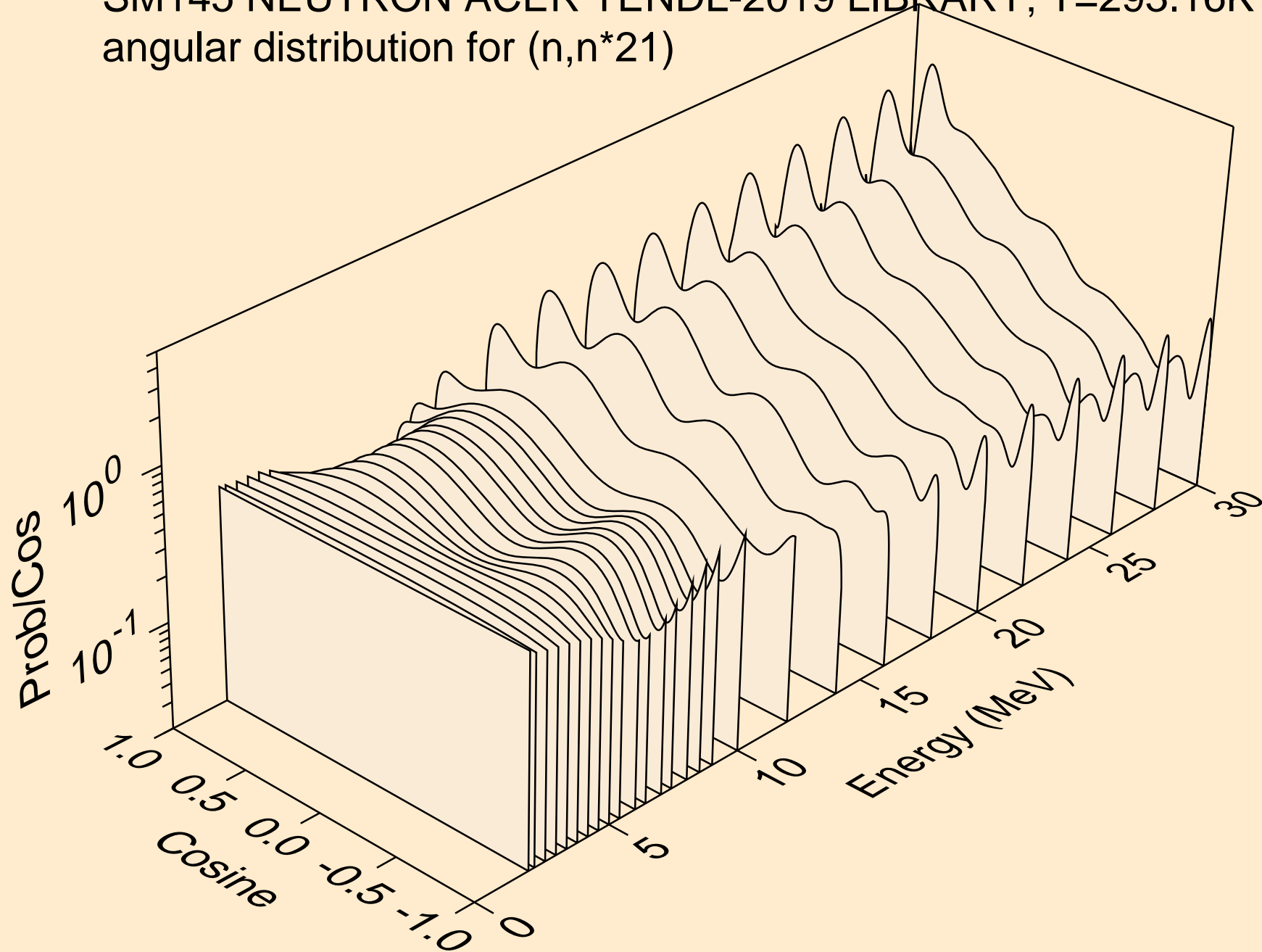

SM145 NEUTRON ACER TENDL-2019 LIBRARY; T=293.16K
angular distribution for (n,n*22)

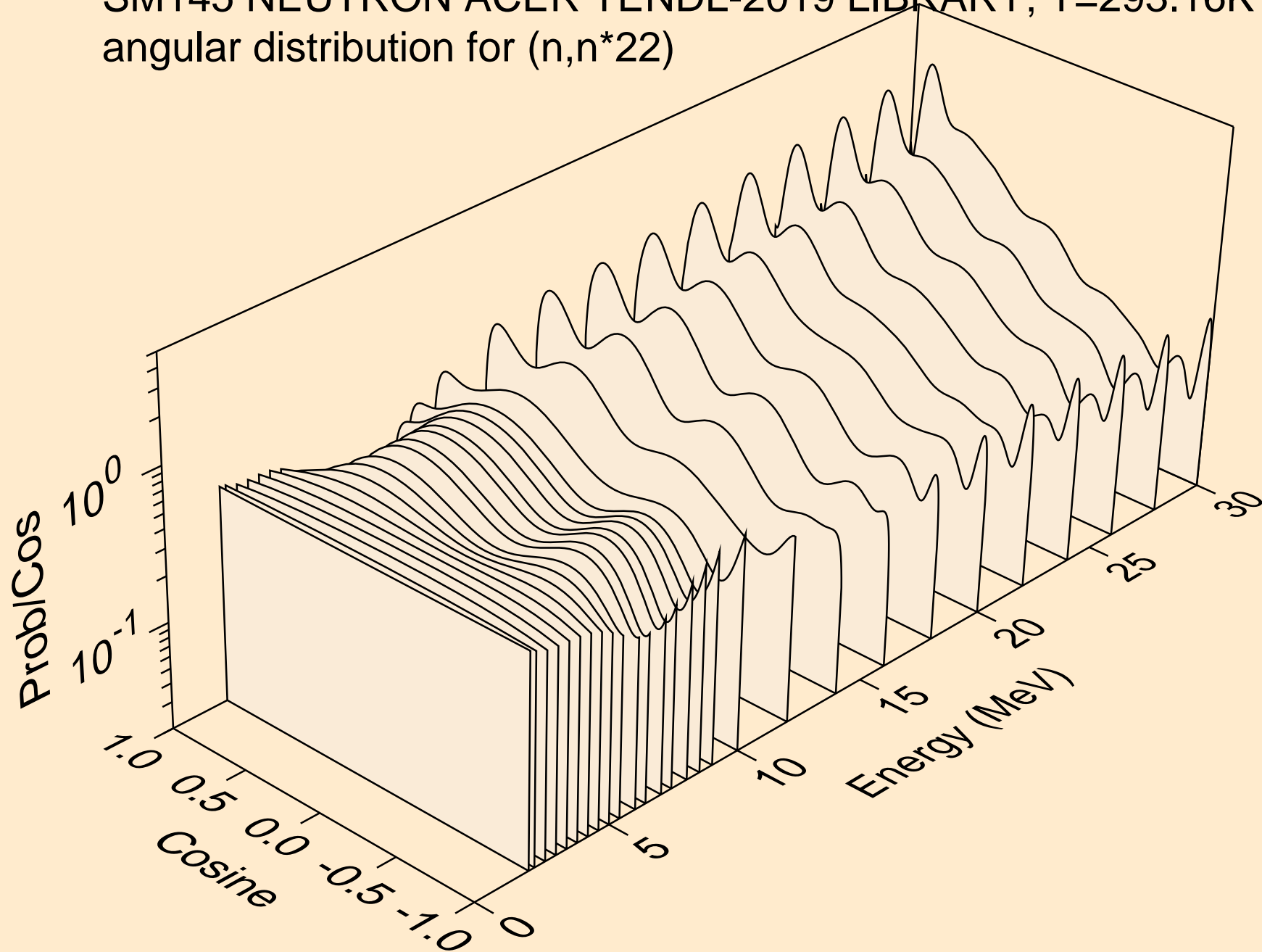

SM145 NEUTRON ACER TENDL-2019 LIBRARY; T=293.16K
angular distribution for (n,n*23)

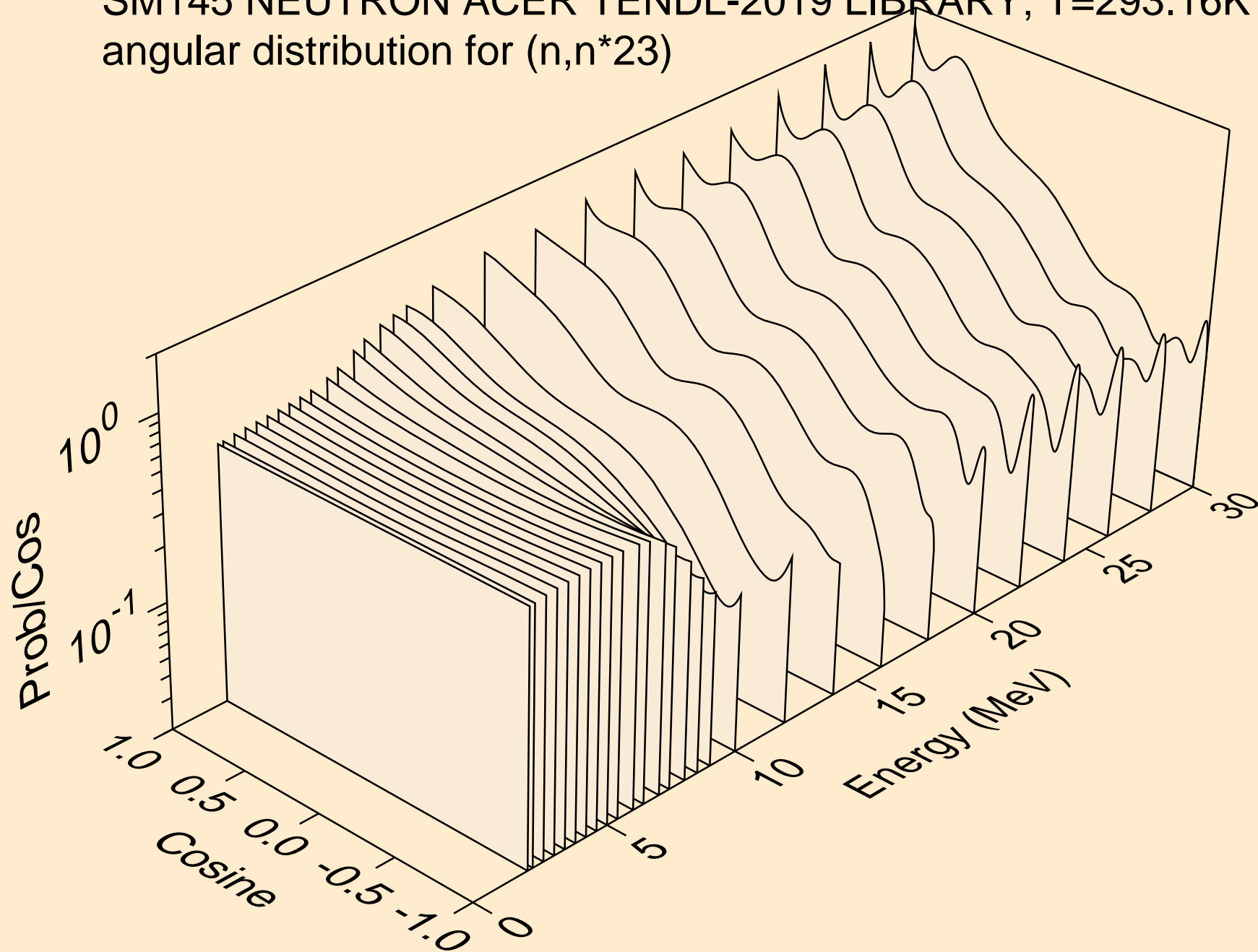

SM145 NEUTRON ACER TENDL-2019 LIBRARY; T=293.16K
angular distribution for (n,n*24)

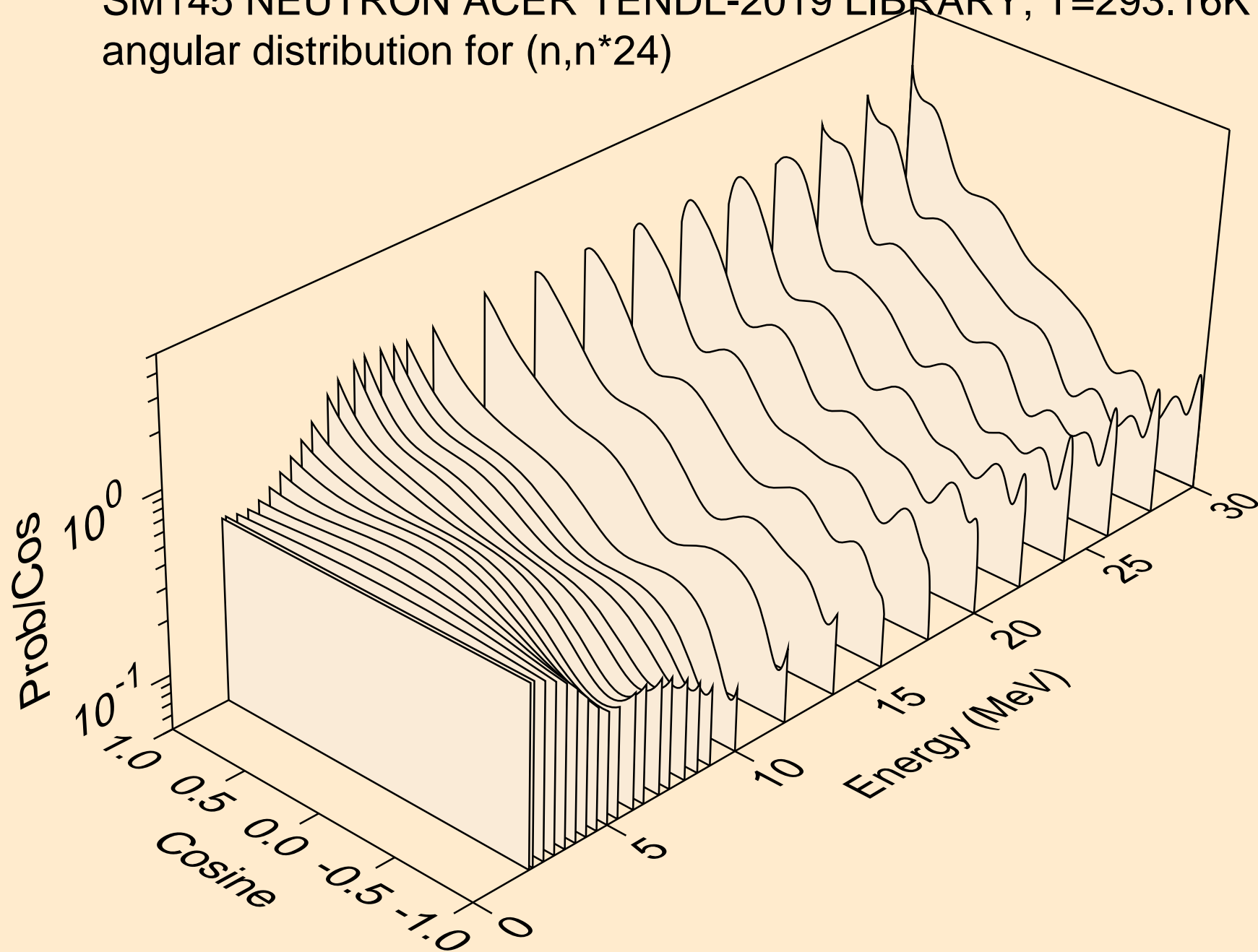

SM145 NEUTRON ACER TENDL-2019 LIBRARY; T=293.16K
angular distribution for (n,n*25)

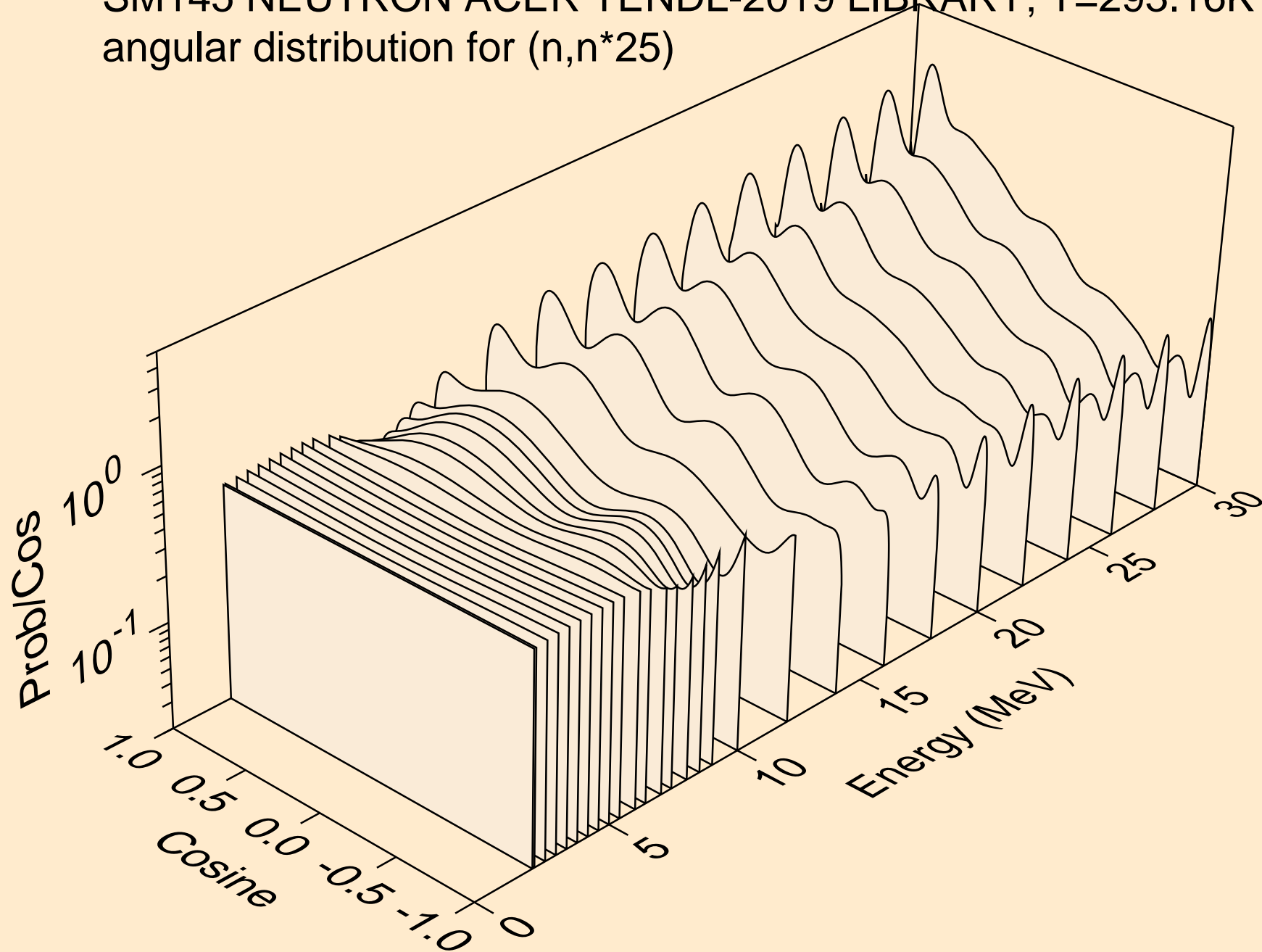

SM145 NEUTRON ACER TENDL-2019 LIBRARY; T=293.16K
angular distribution for (n,n*26)

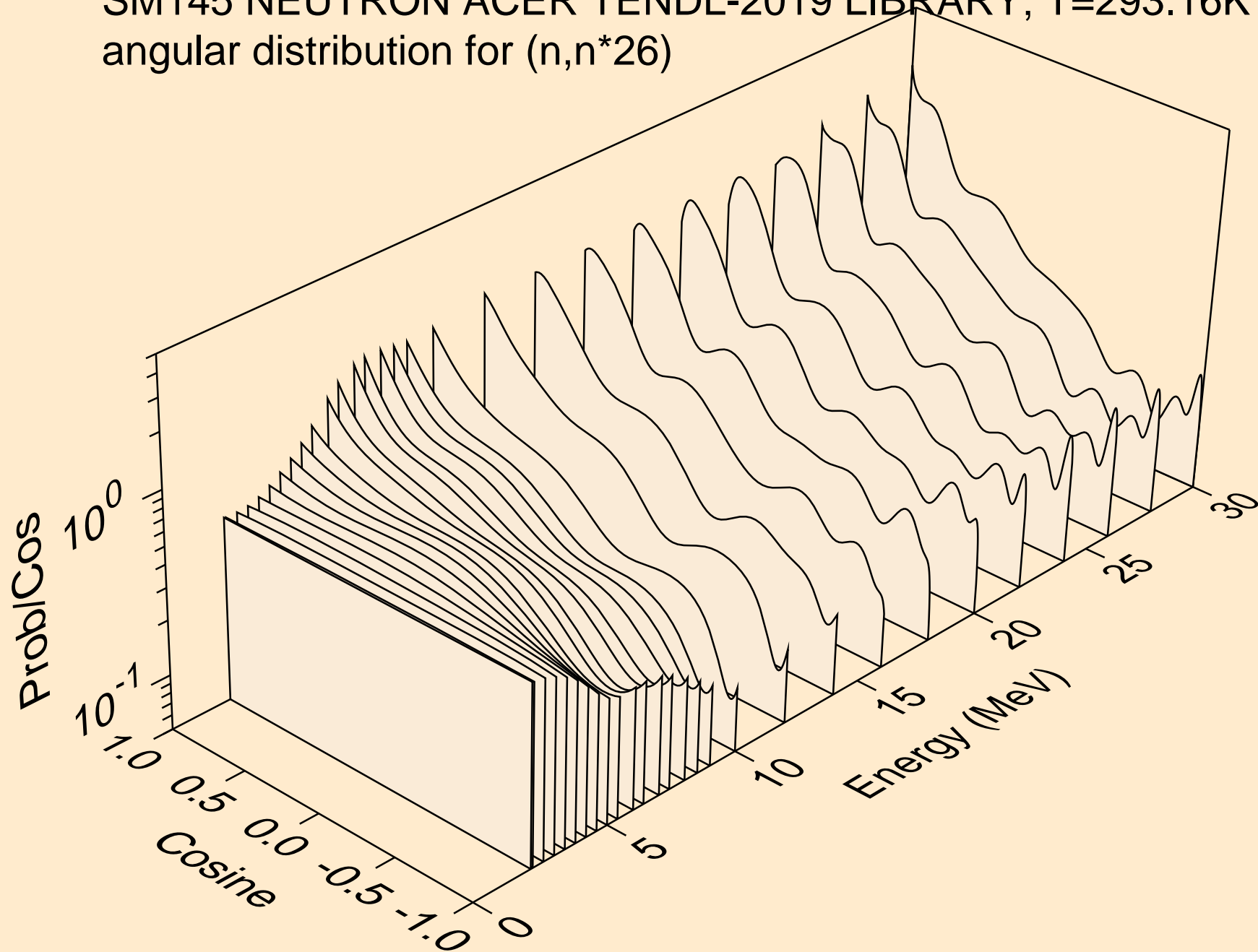

SM145 NEUTRON ACER TENDL-2019 LIBRARY; T=293.16K
angular distribution for (n,n*27)

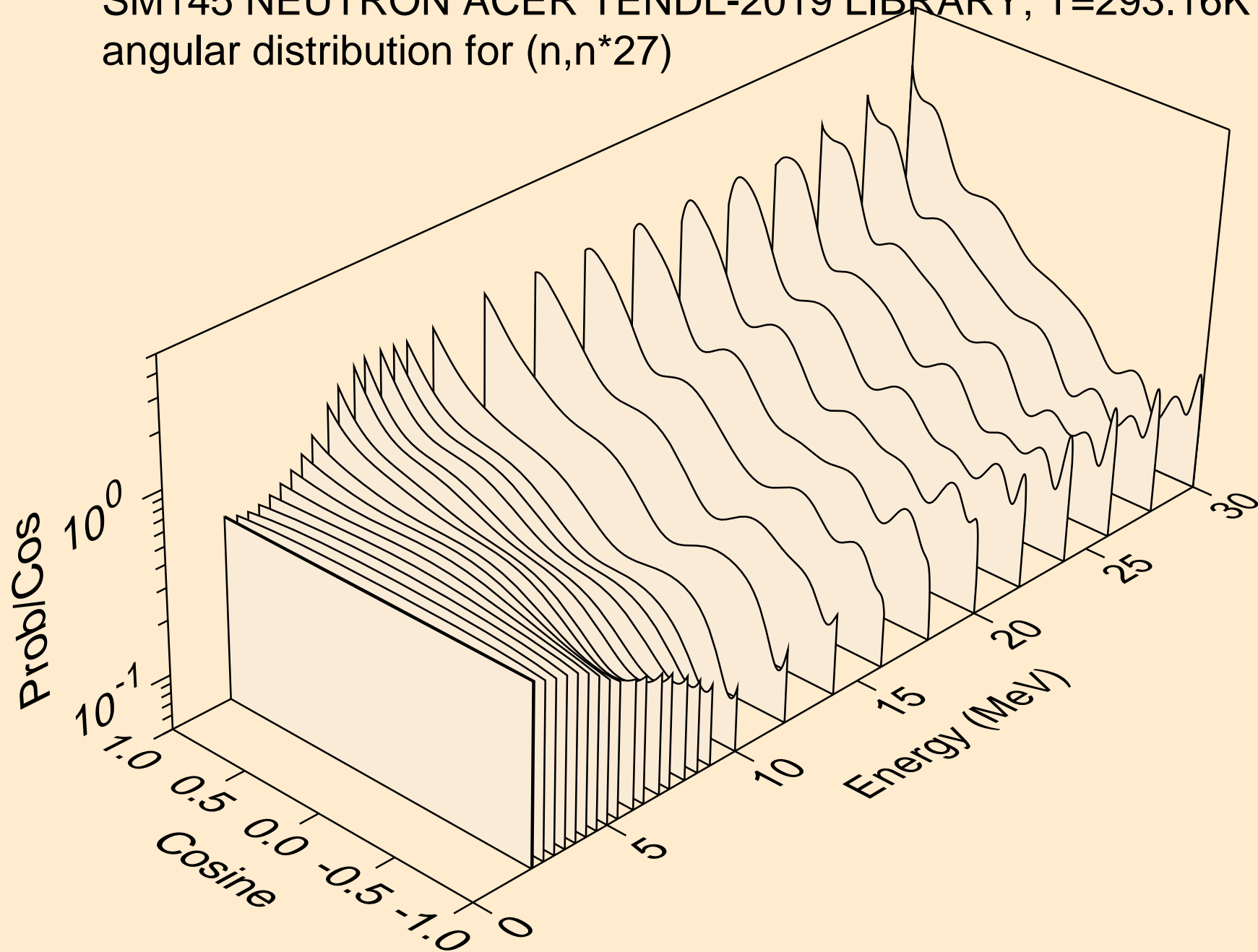

SM145 NEUTRON ACER TENDL-2019 LIBRARY; T=293.16K
angular distribution for (n,n*28)

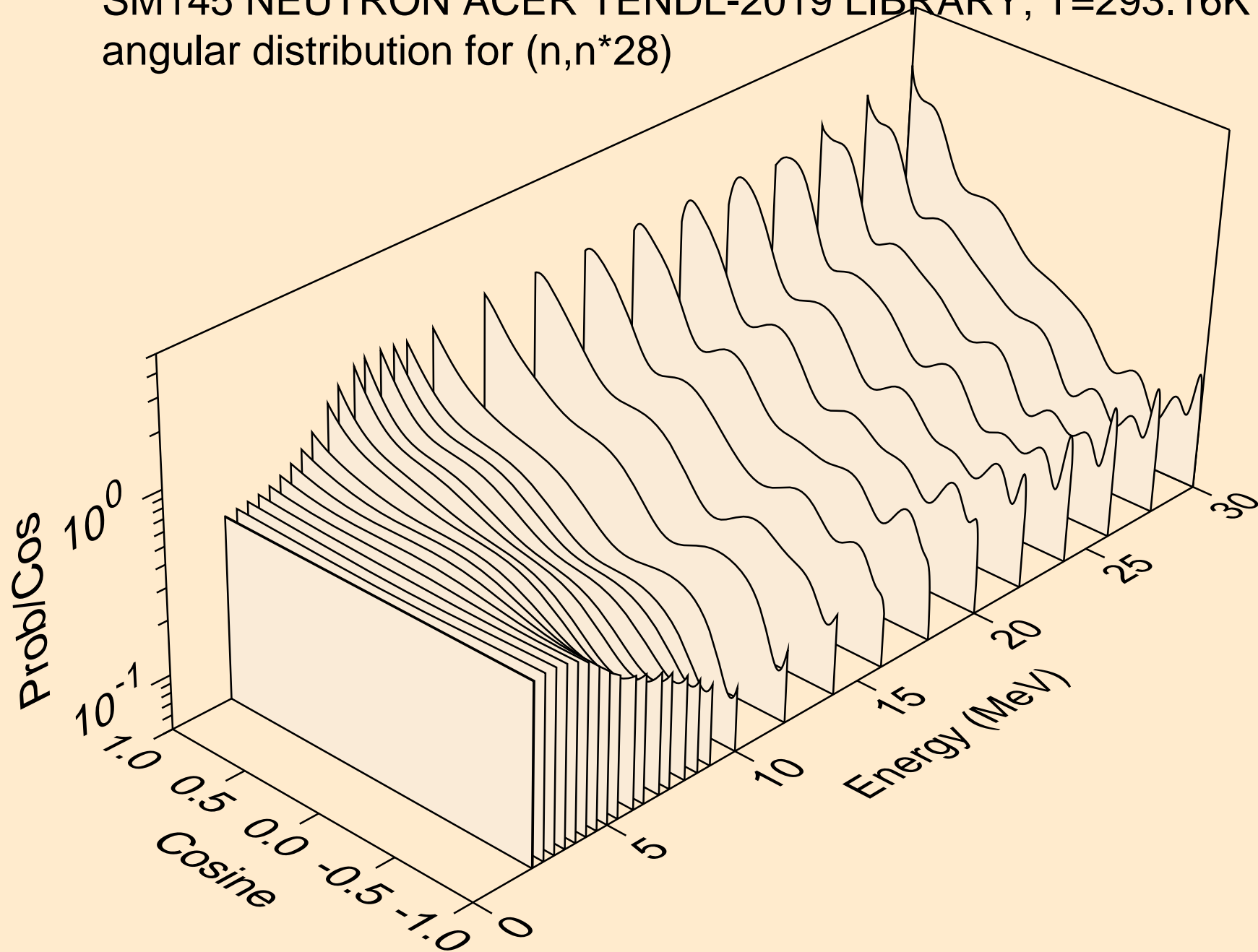

SM145 NEUTRON ACER TENDL-2019 LIBRARY; T=293.16K
angular distribution for (n,n*29)

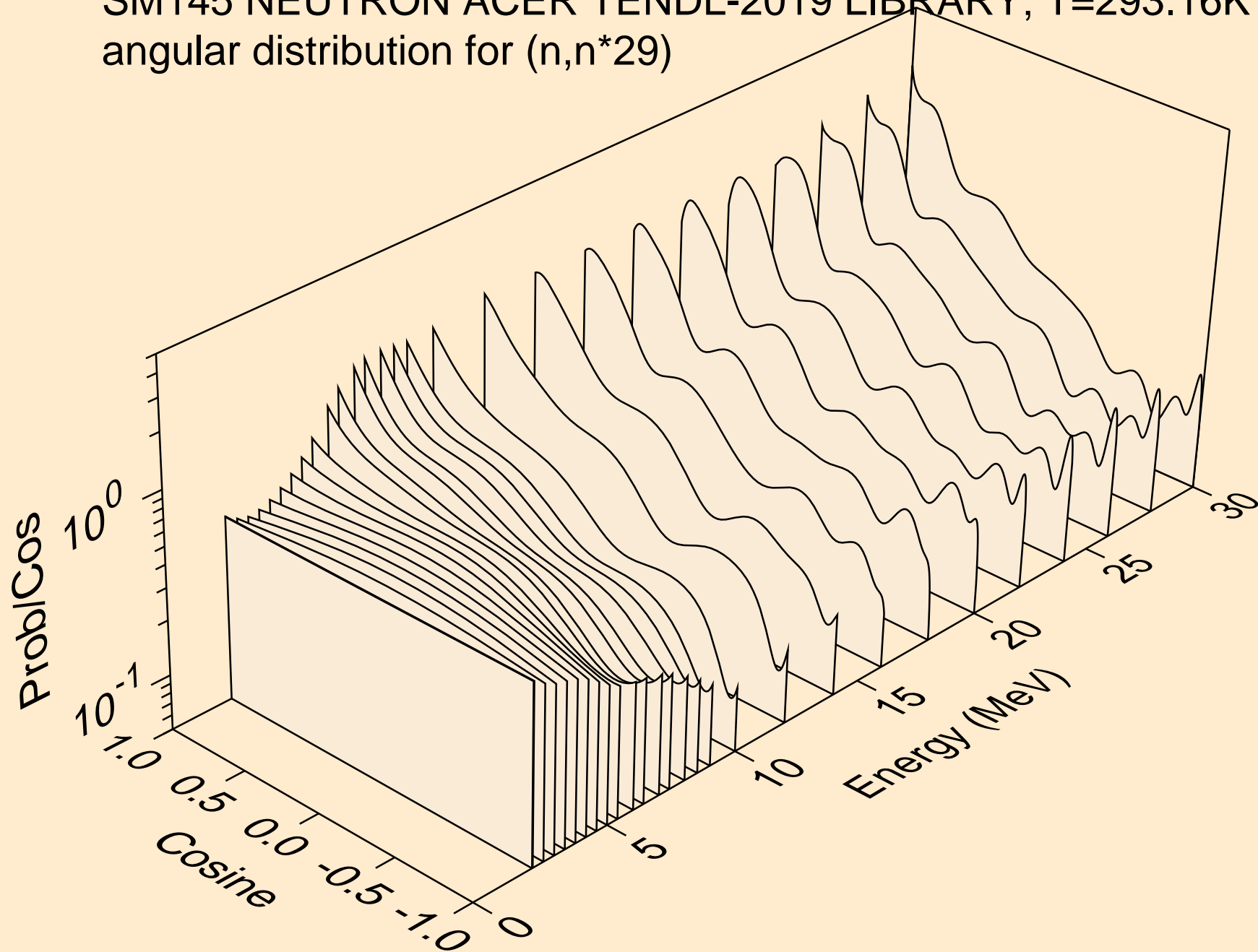

SM145 NEUTRON ACER TENDL-2019 LIBRARY; T=293.16K
angular distribution for (n,n*30)

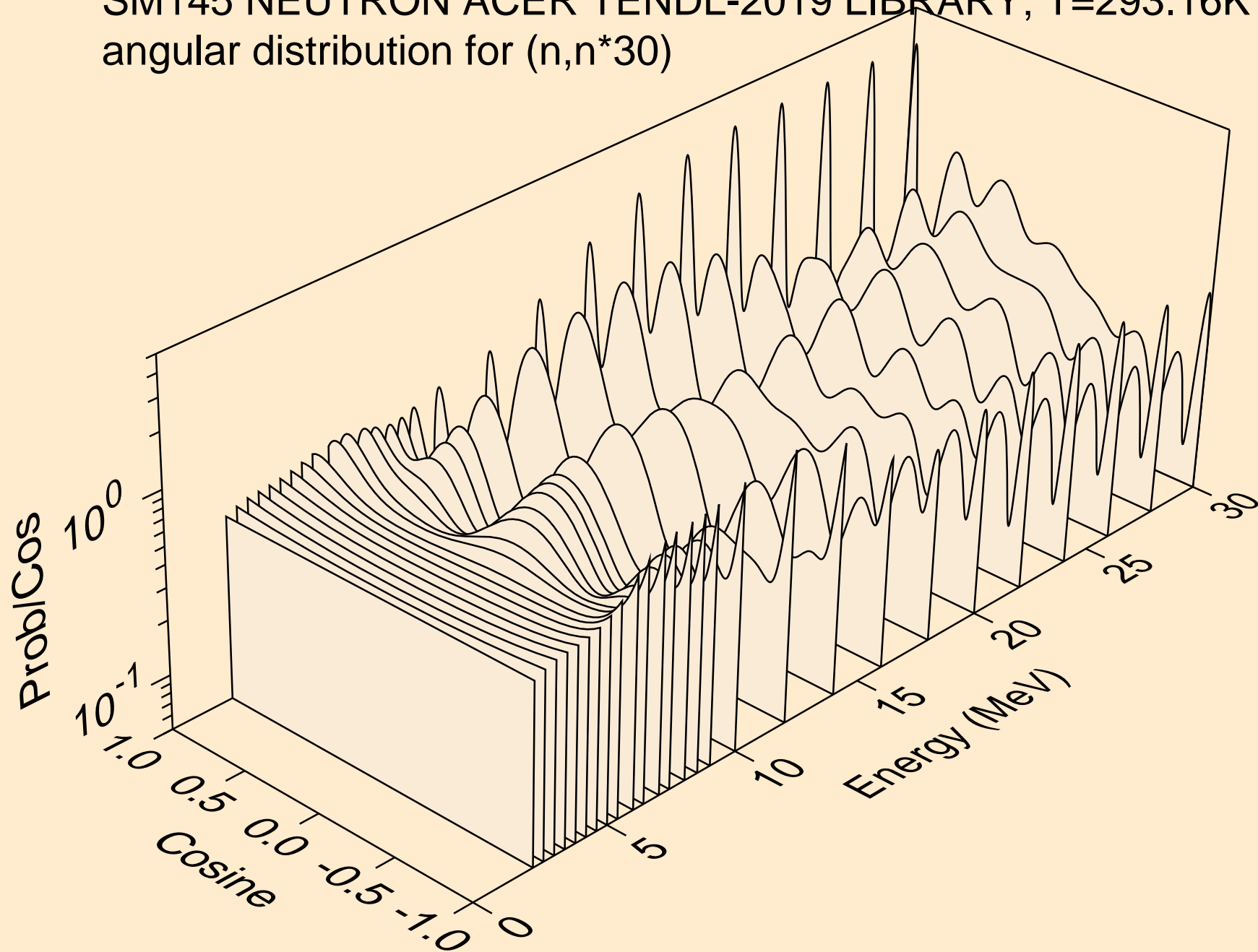

SM145 NEUTRON ACER TENDL-2019 LIBRARY; T=293.16K
Neutron emission for (n,x)

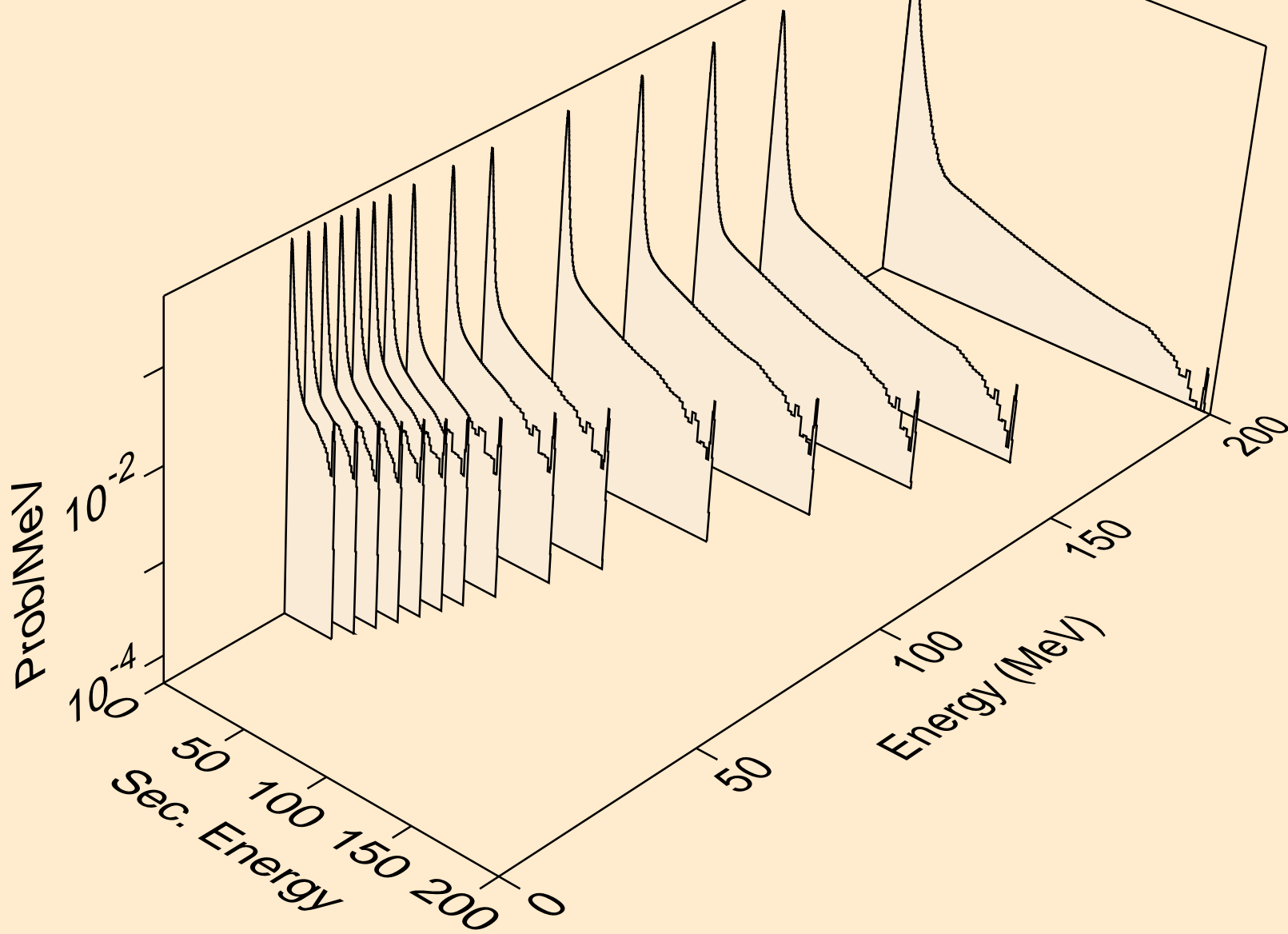

SM145 NEUTRON ACER TENDL-2019 LIBRARY; T=293.16K
Neutron emission for (n,2nd)

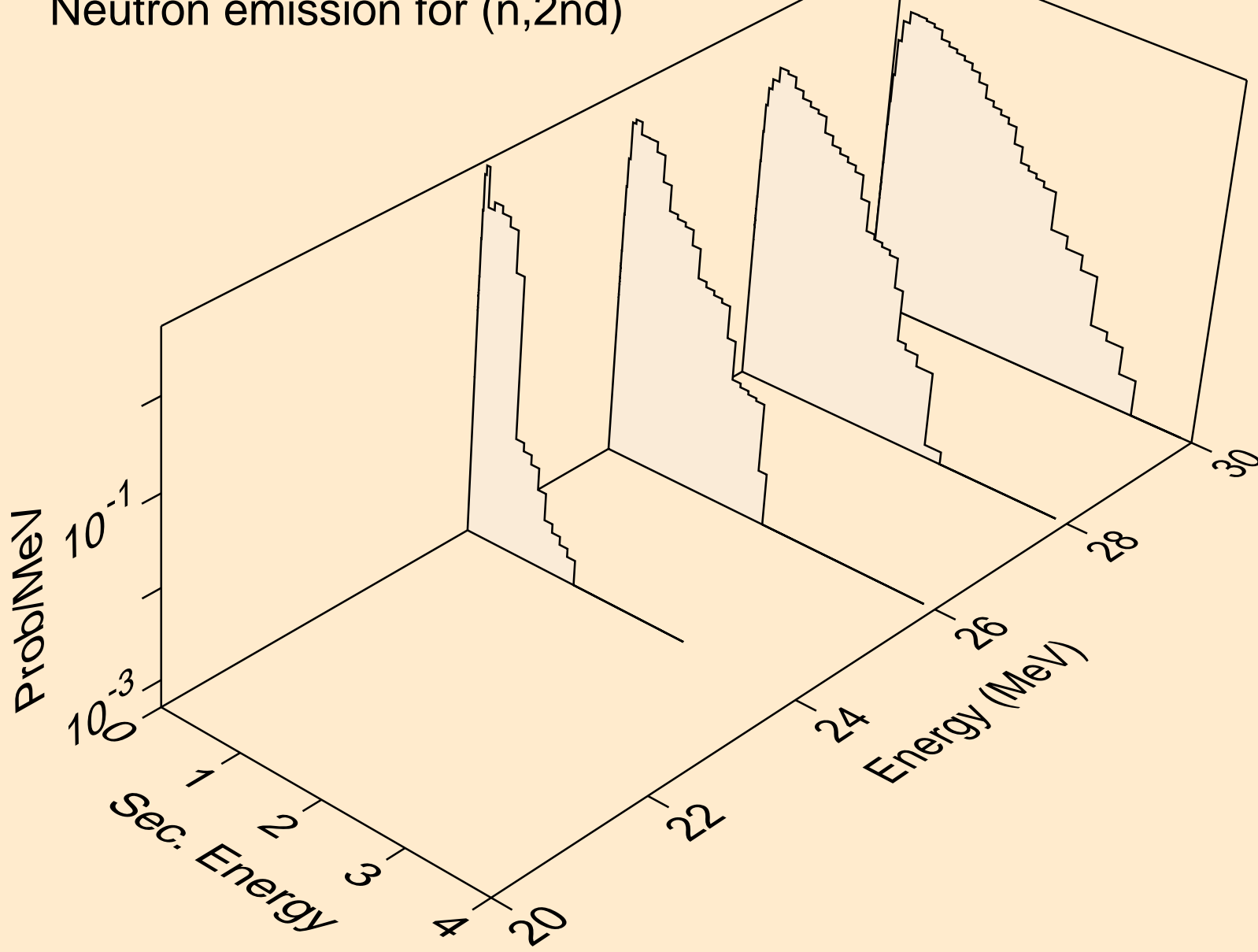

SM145 NEUTRON ACER TENDL-2019 LIBRARY; T=293.16K
Neutron emission for (n,2n)

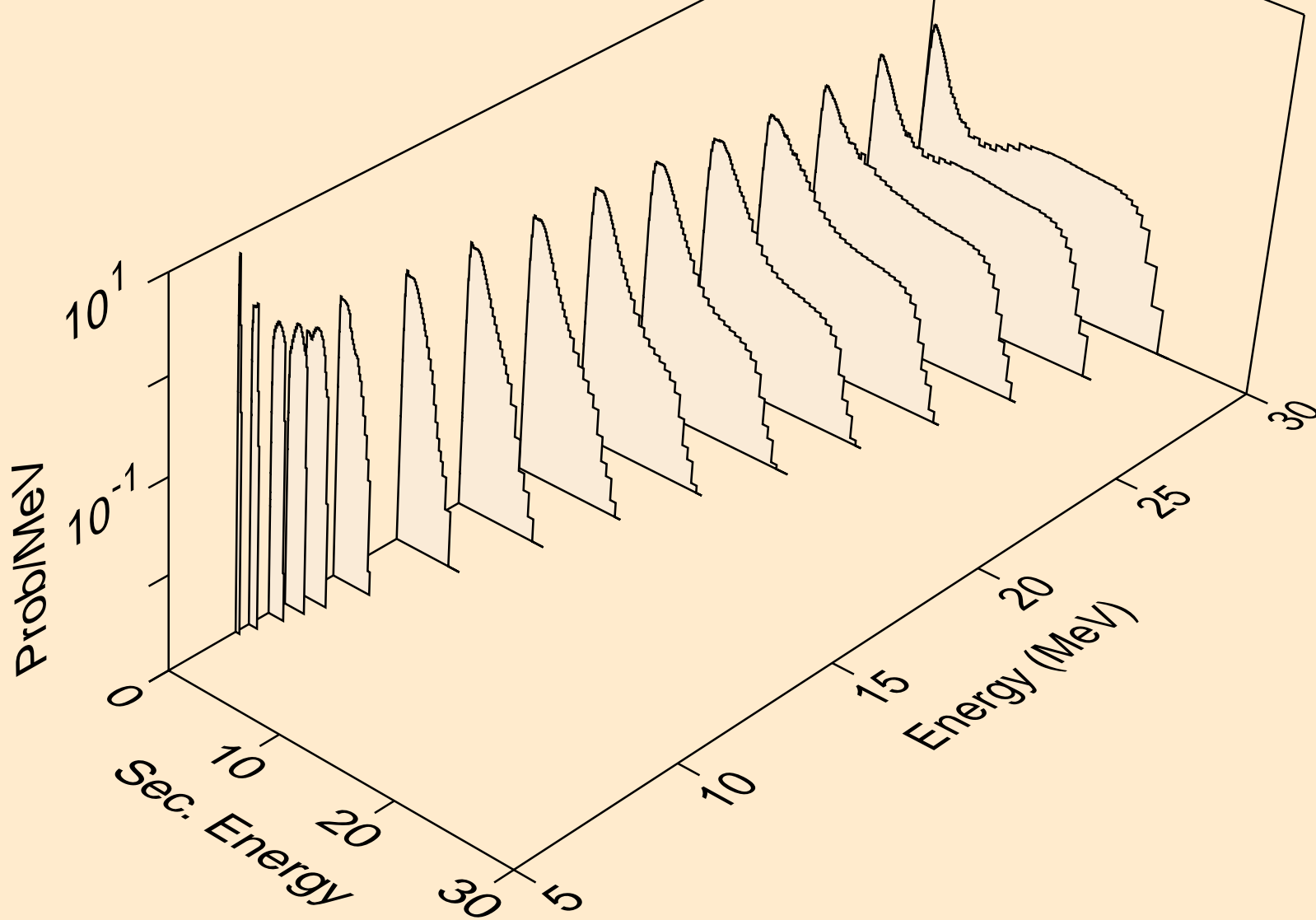

SM145 NEUTRON ACER TENDL-2019 LIBRARY; T=293.16K
Neutron emission for (n,3n)

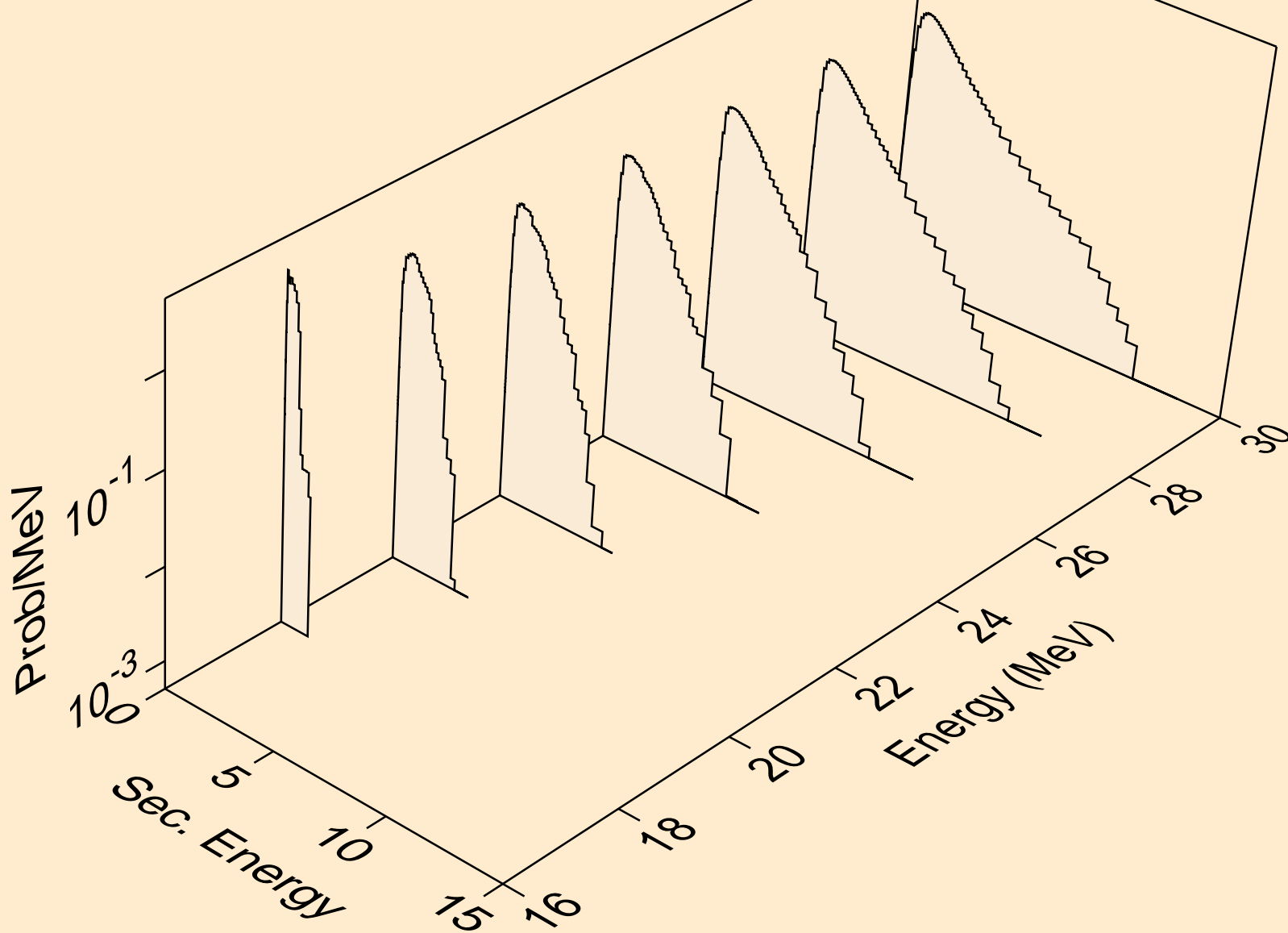

SM145 NEUTRON ACER TENDL-2019 LIBRARY; T=293.16K
Neutron emission for (n,n*)a

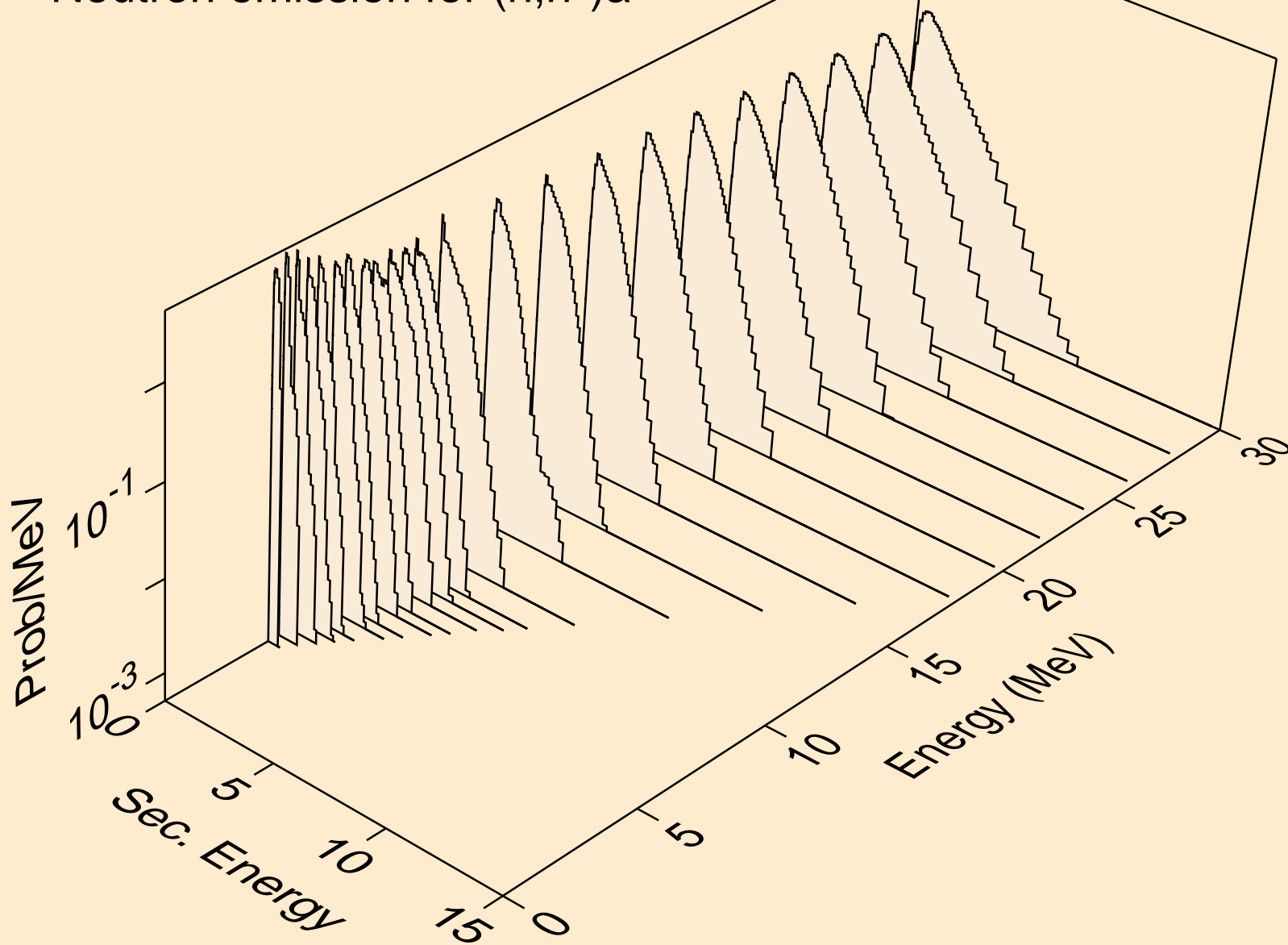

SM145 NEUTRON ACER TENDL-2019 LIBRARY; T=293.16K
Neutron emission for (n,2n)a

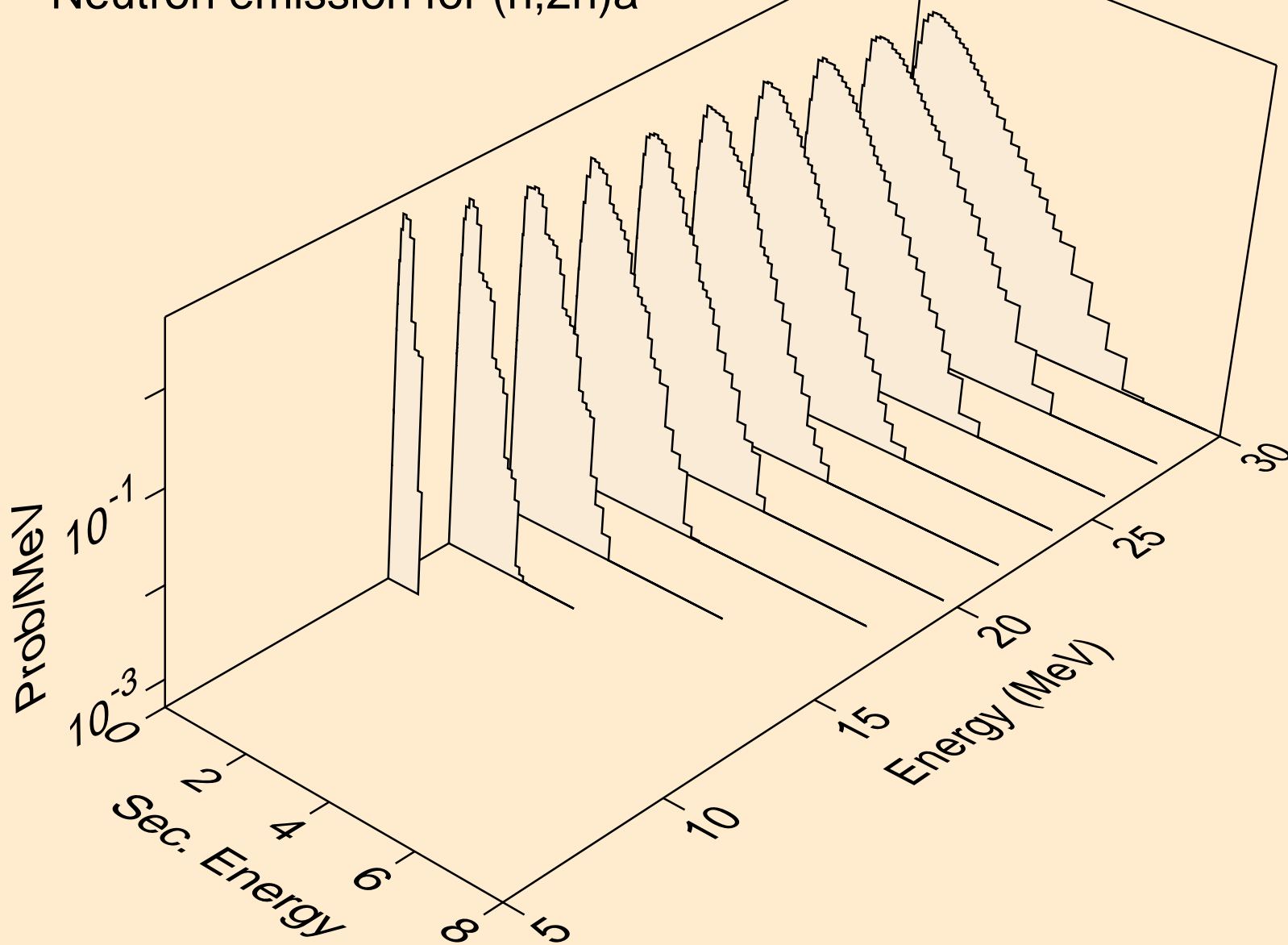

SM145 NEUTRON ACER TENDL-2019 LIBRARY; T=293.16K
Neutron emission for (n,3n)a

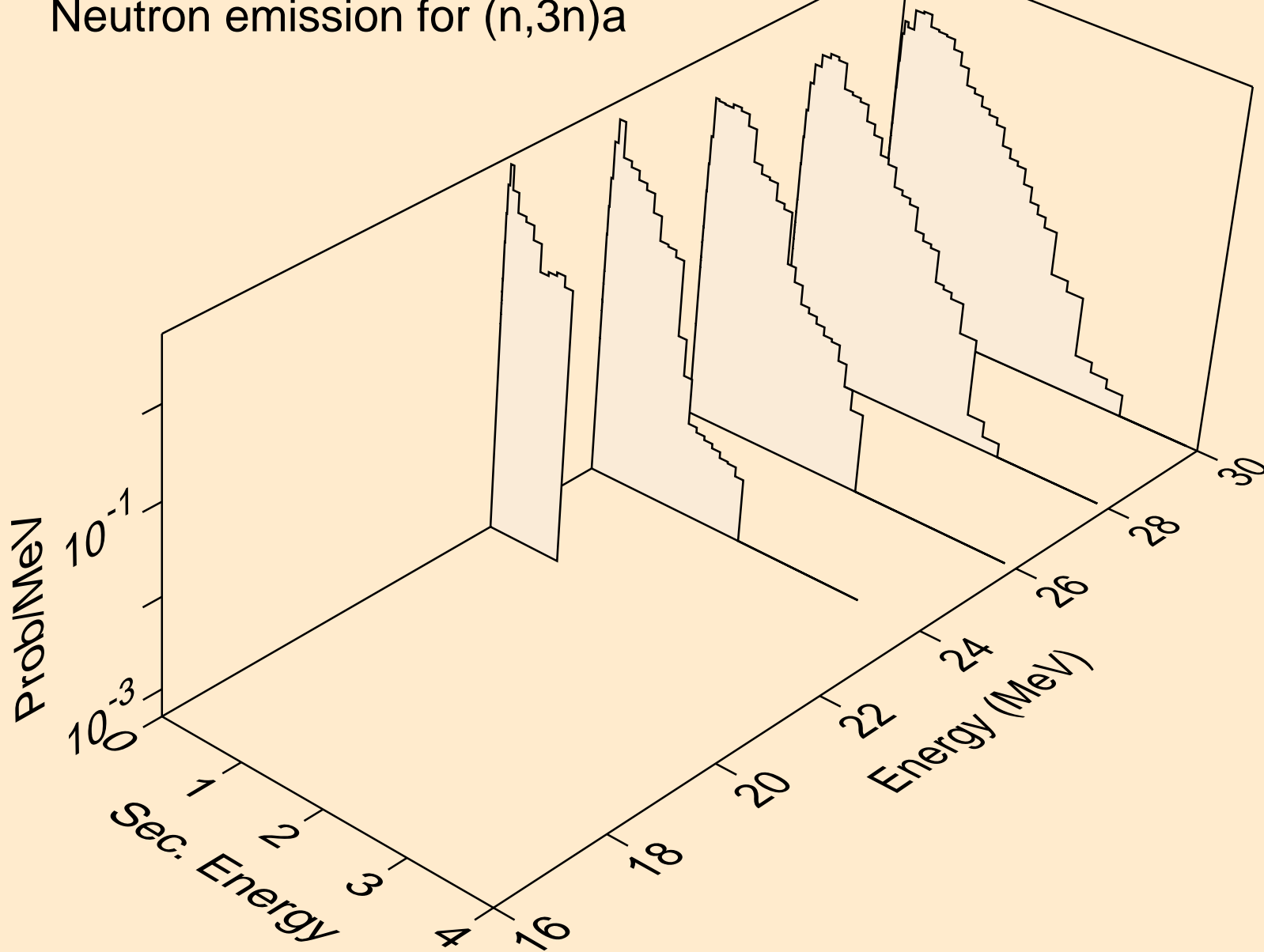

SM145 NEUTRON ACER TENDL-2019 LIBRARY; T=293.16K
Neutron emission for (n,n*)p

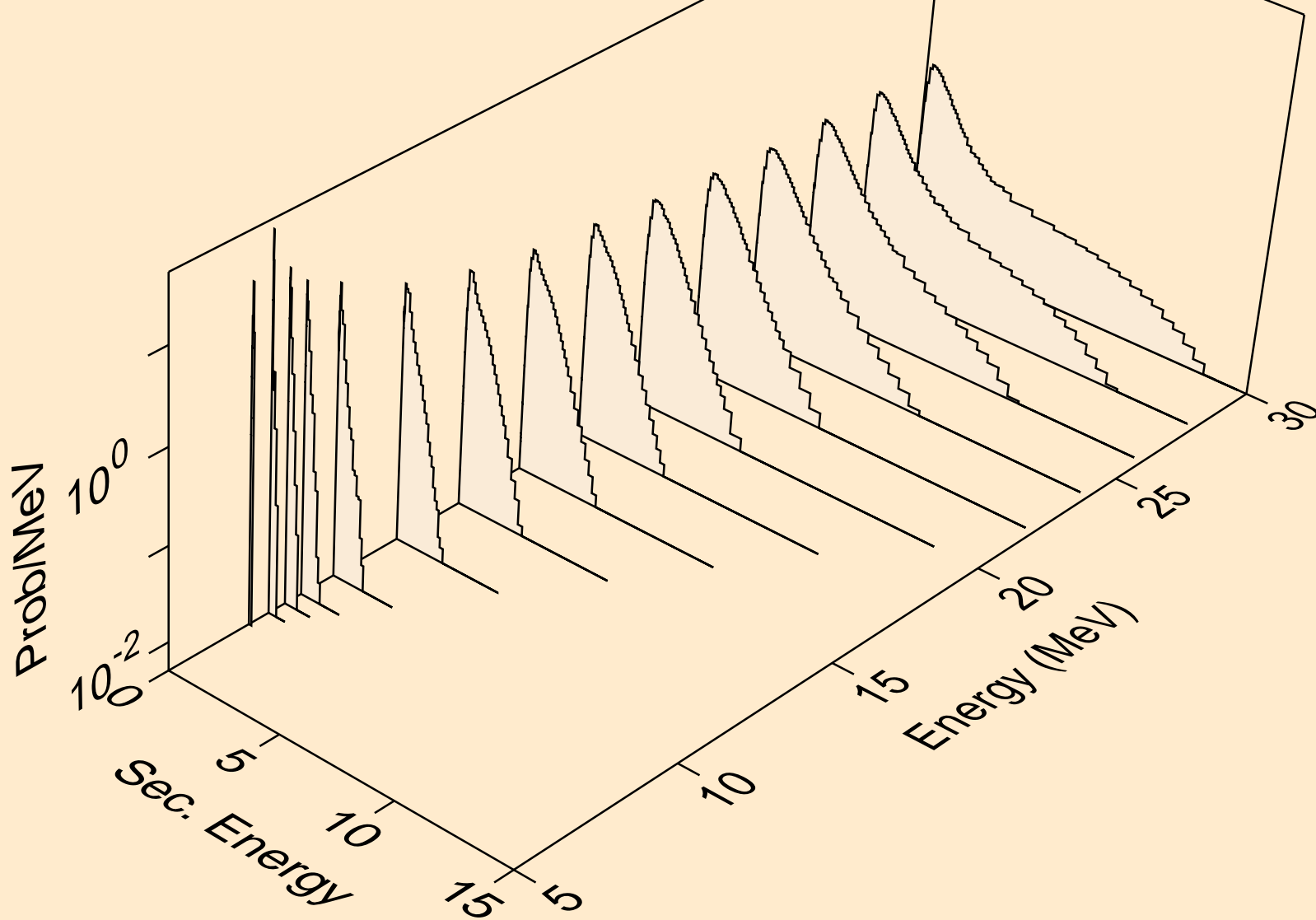

SM145 NEUTRON ACER TENDL-2019 LIBRARY; T=293.16K
Neutron emission for (n,n*)2a

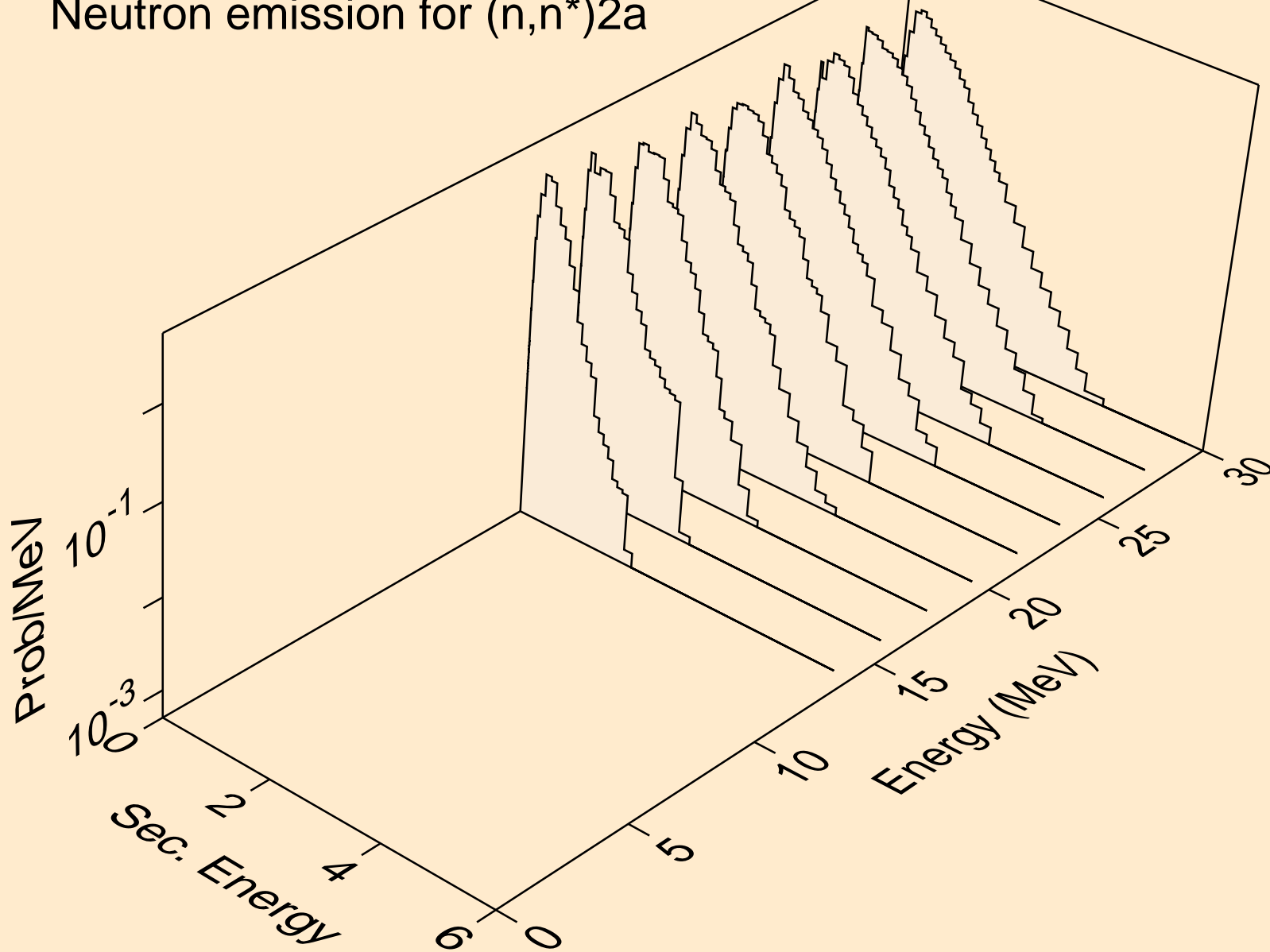

SM145 NEUTRON ACER TENDL-2019 LIBRARY; T=293.16K
Neutron emission for (n,n*)d

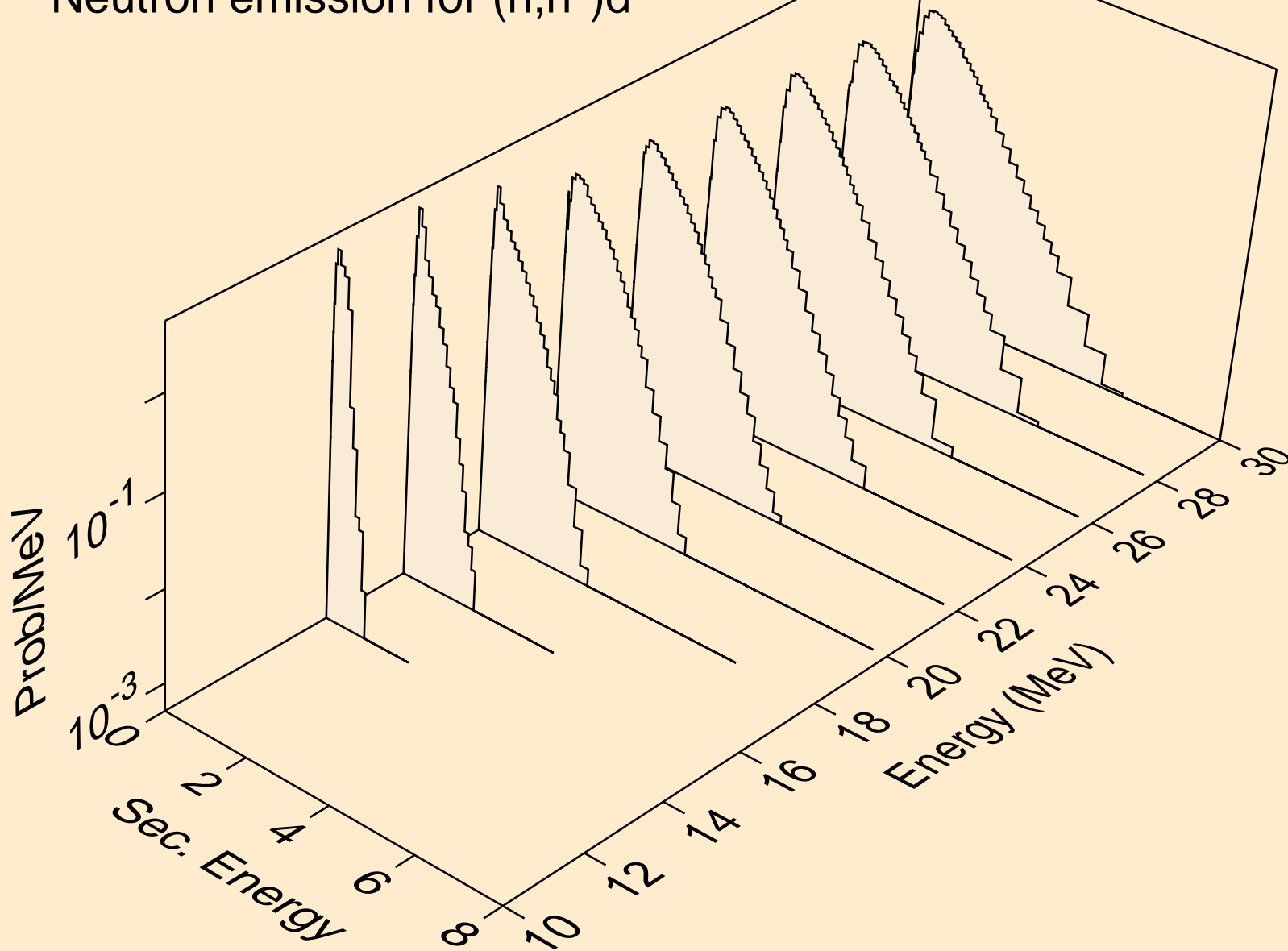

SM145 NEUTRON ACER TENDL-2019 LIBRARY; T=293.16K
Neutron emission for (n,n*)t

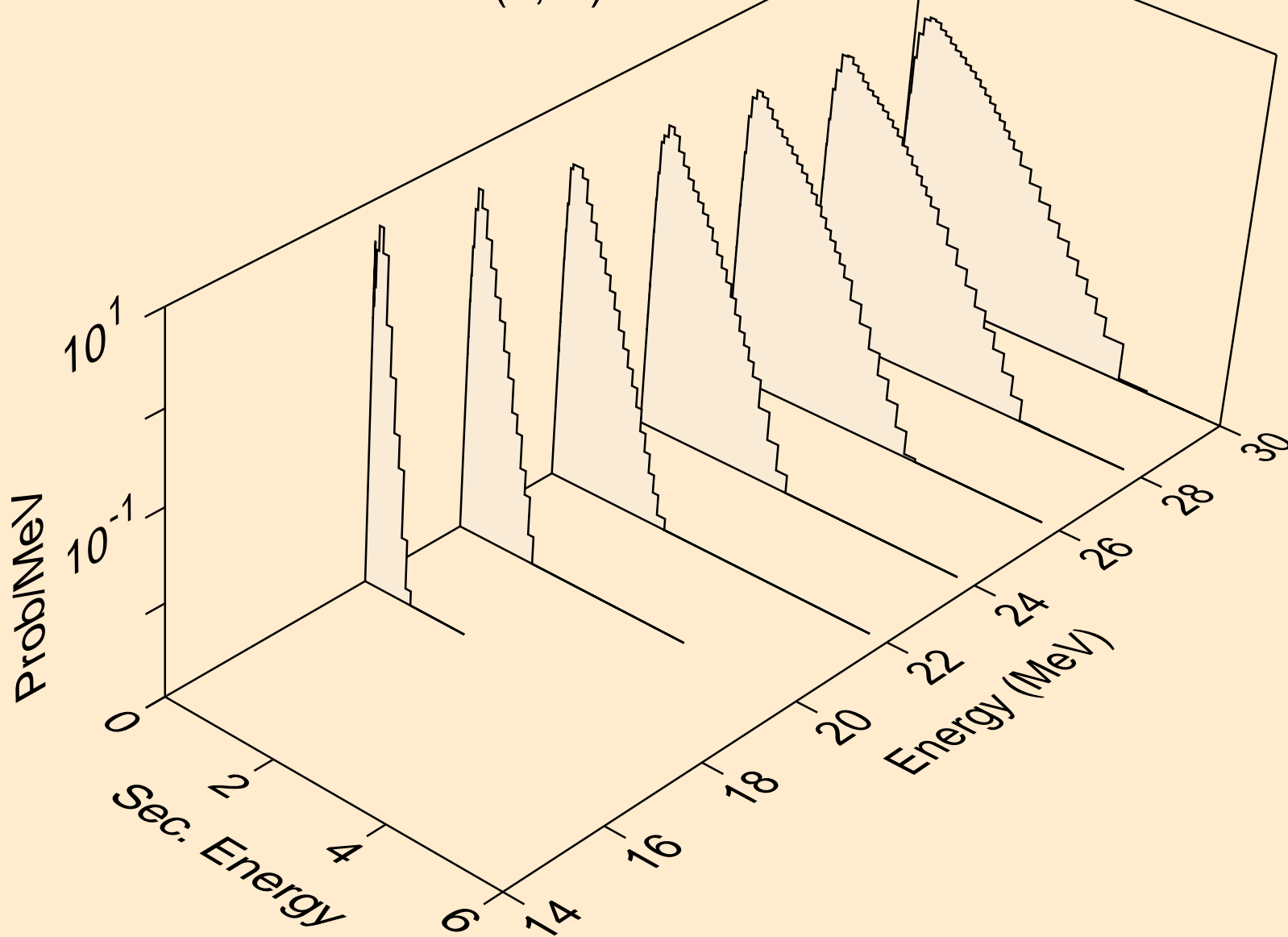

SM145 NEUTRON ACER TENDL-2019 LIBRARY; T=293.16K
Neutron emission for (n,n*)he3

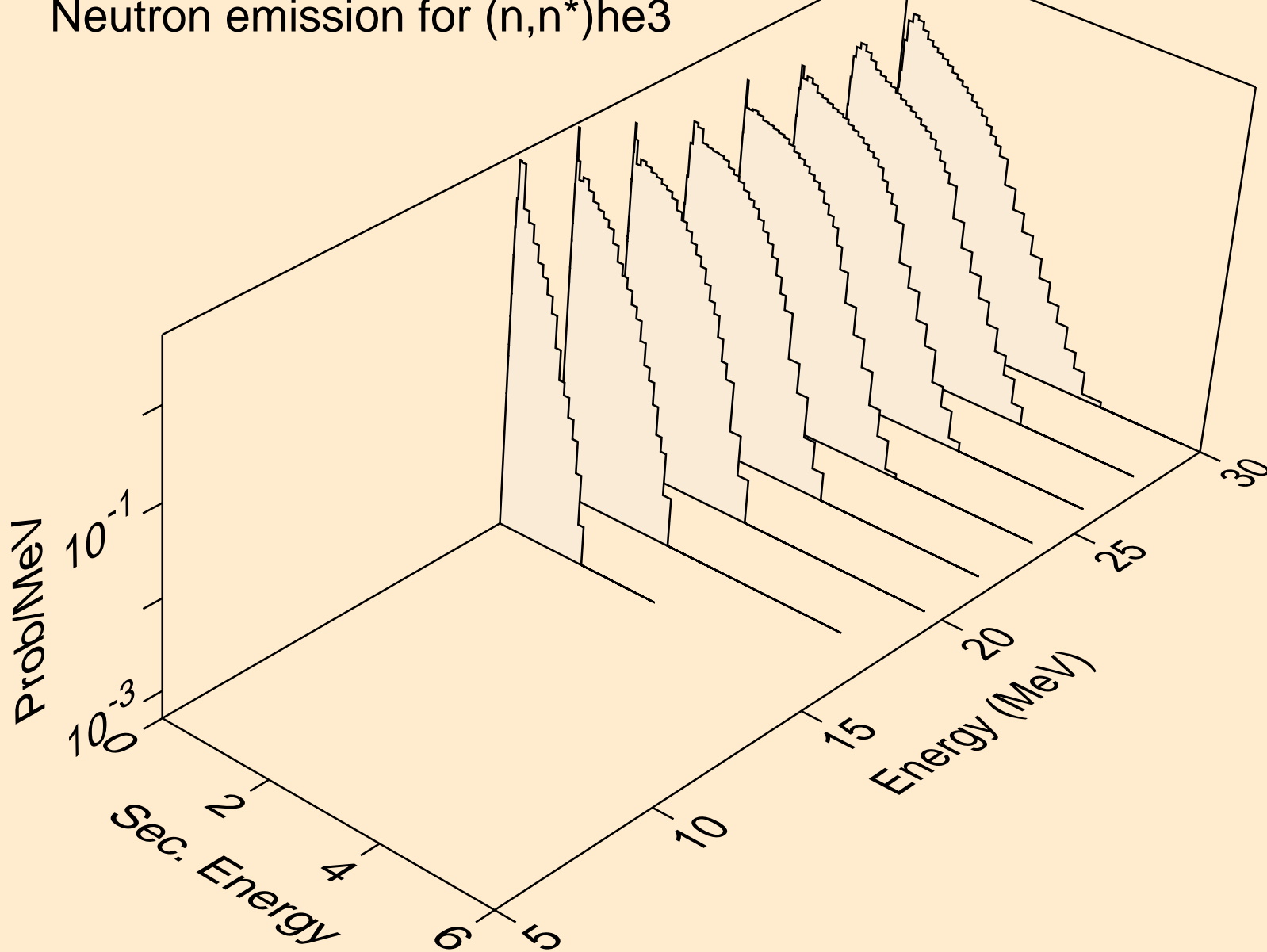

SM145 NEUTRON ACER TENDL-2019 LIBRARY; T=293.16K
Neutron emission for (n,4n)

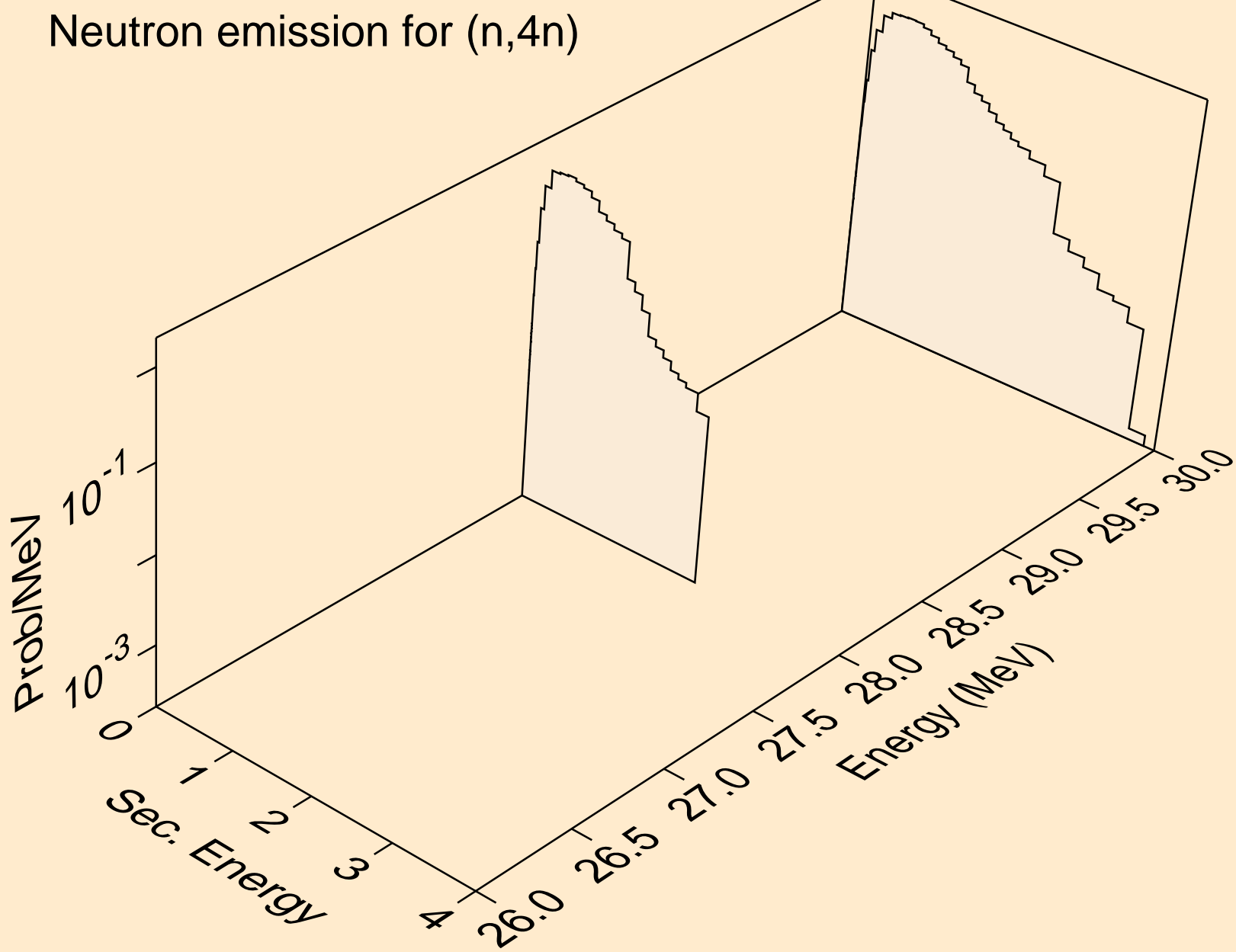

SM145 NEUTRON ACER TENDL-2019 LIBRARY; T=293.16K
Neutron emission for (n,2np)

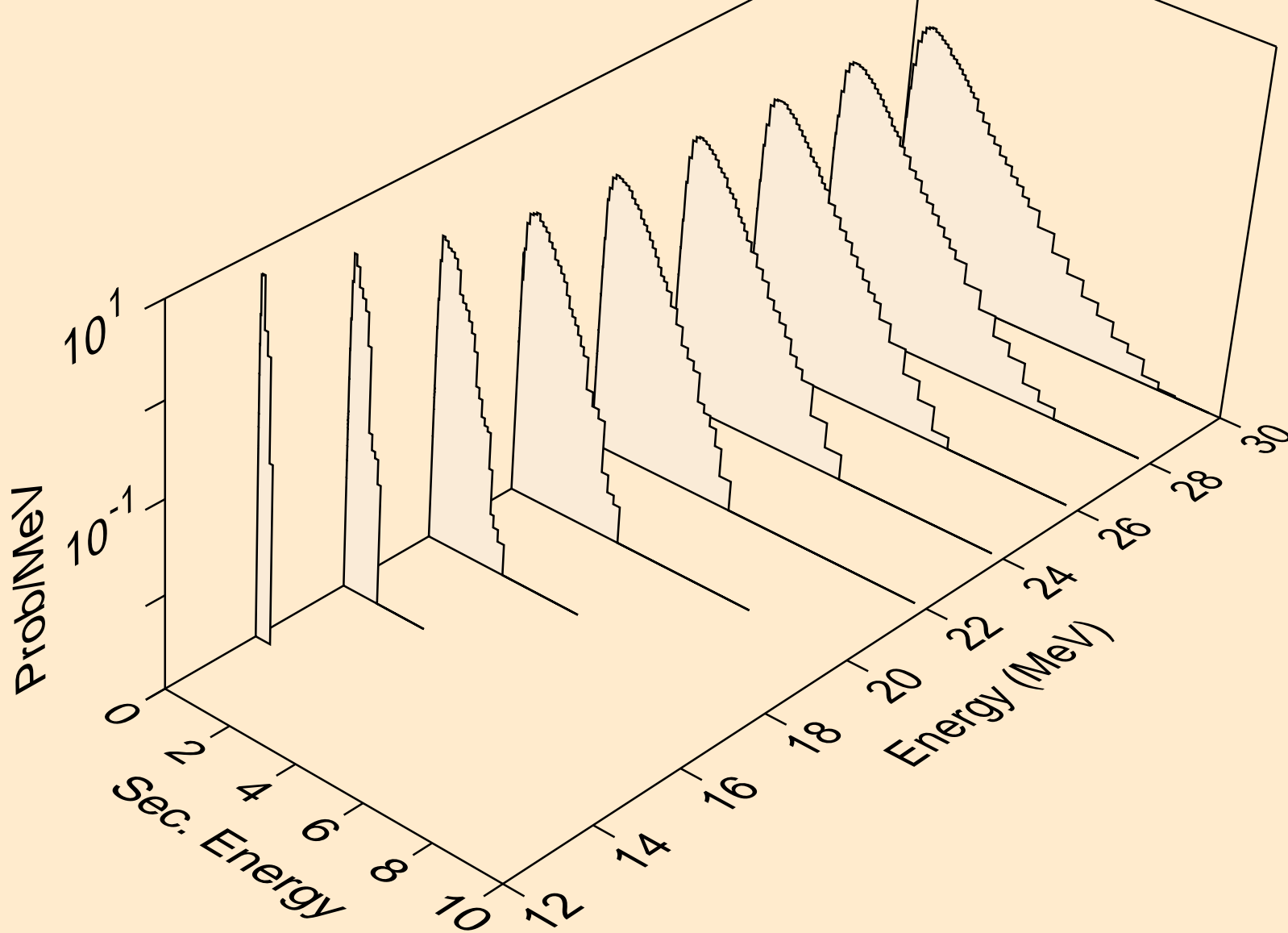

SM145 NEUTRON ACER TENDL-2019 LIBRARY; T=293.16K
Neutron emission for (n,3np)

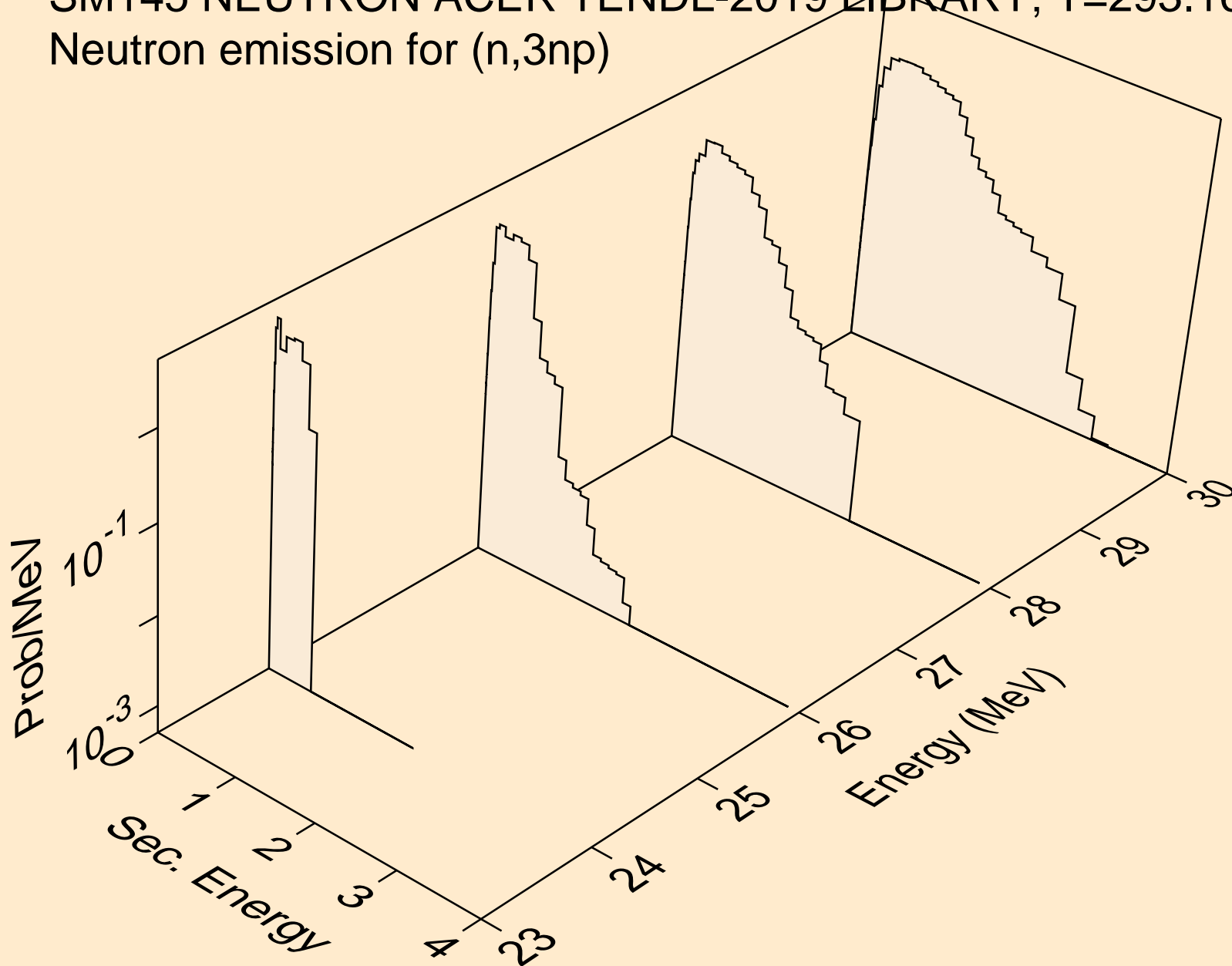

SM145 NEUTRON ACER TENDL-2019 LIBRARY; T=293.16K
Neutron emission for (n,2np)

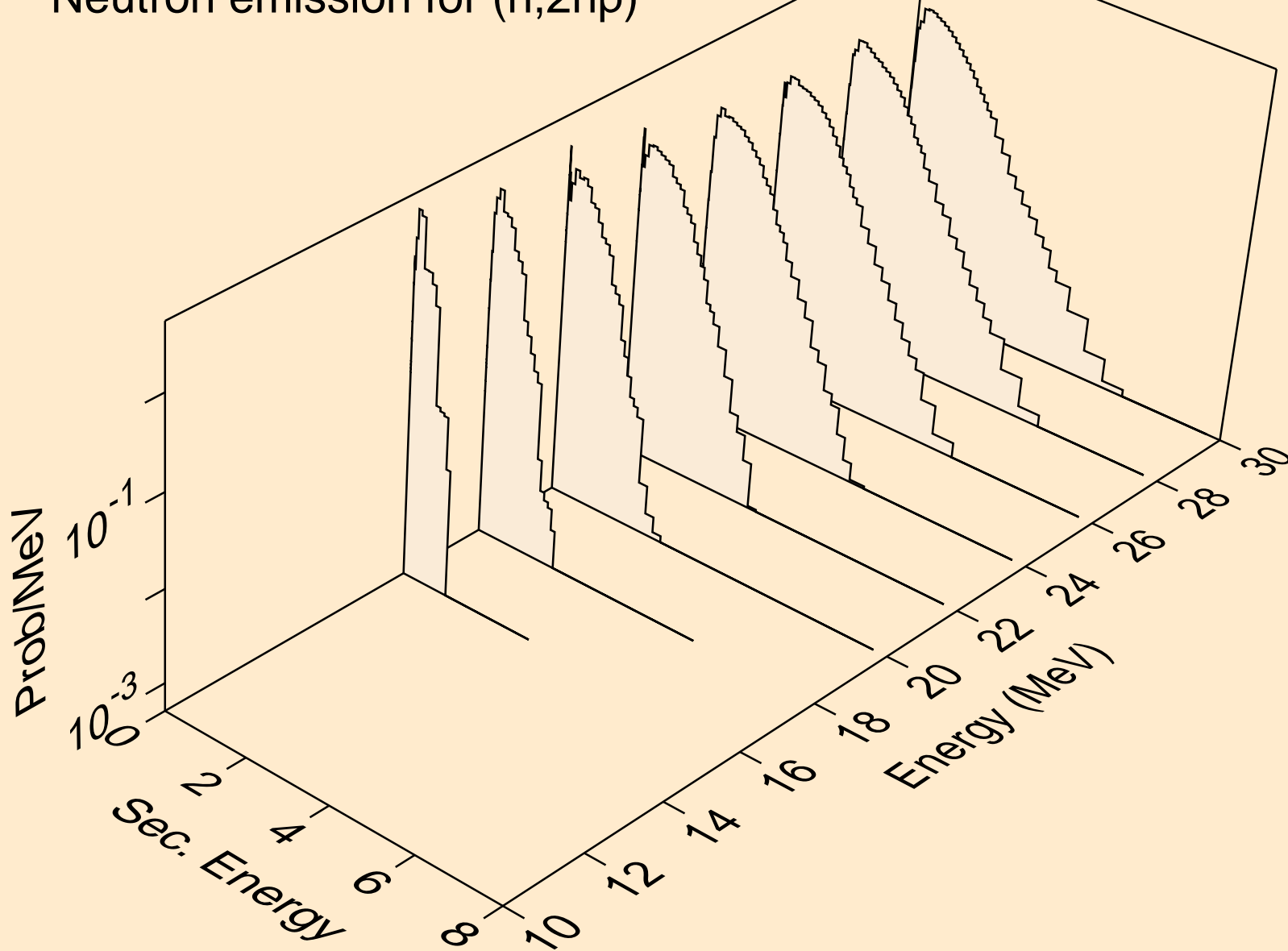

SM145 NEUTRON ACER TENDL-2019 LIBRARY; T=293.16K
Neutron emission for (n,npa)

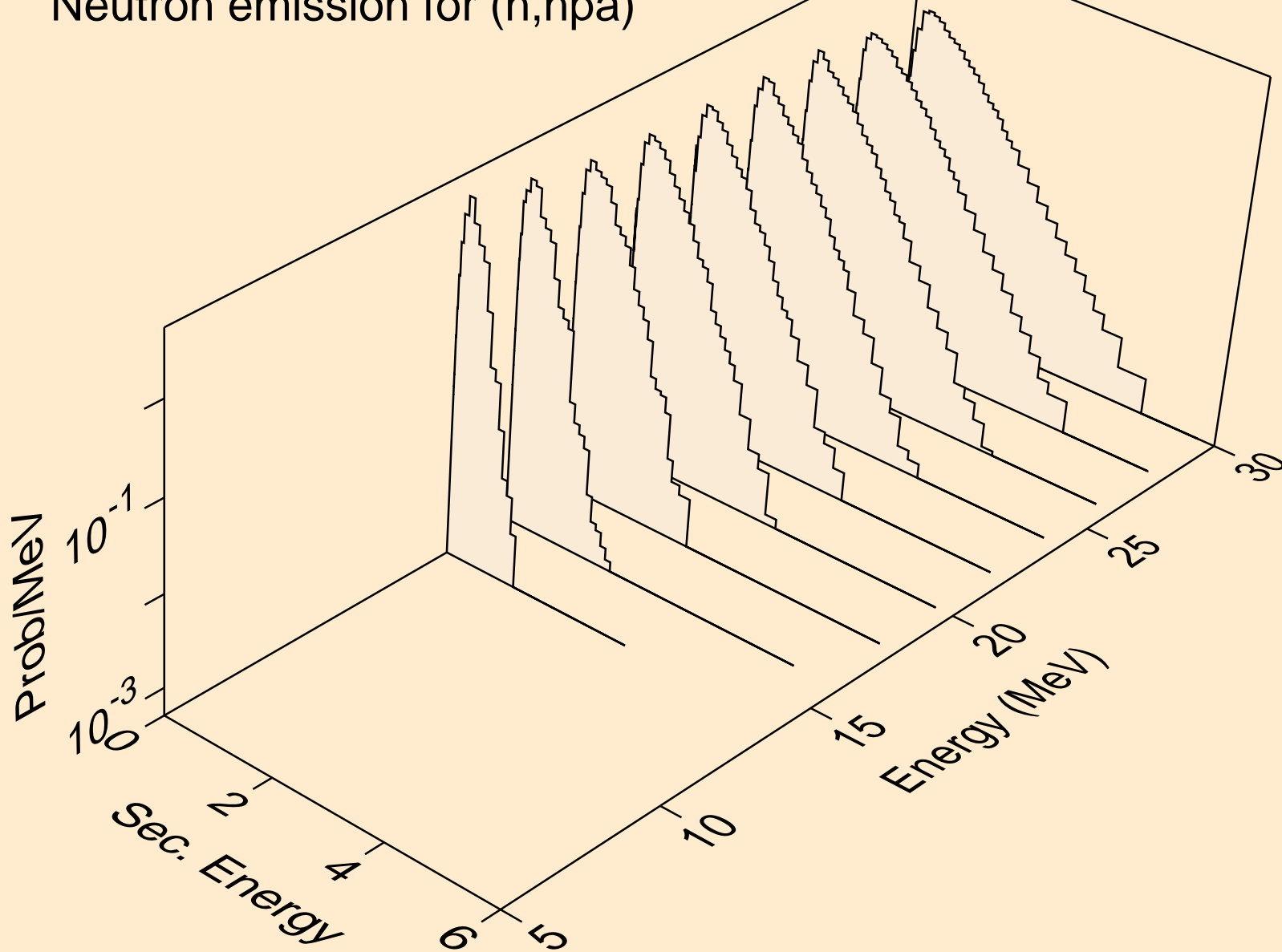

SM145 NEUTRON ACER TENDL-2019 LIBRARY; T=293.16K
Neutron emission for (n,n*c)

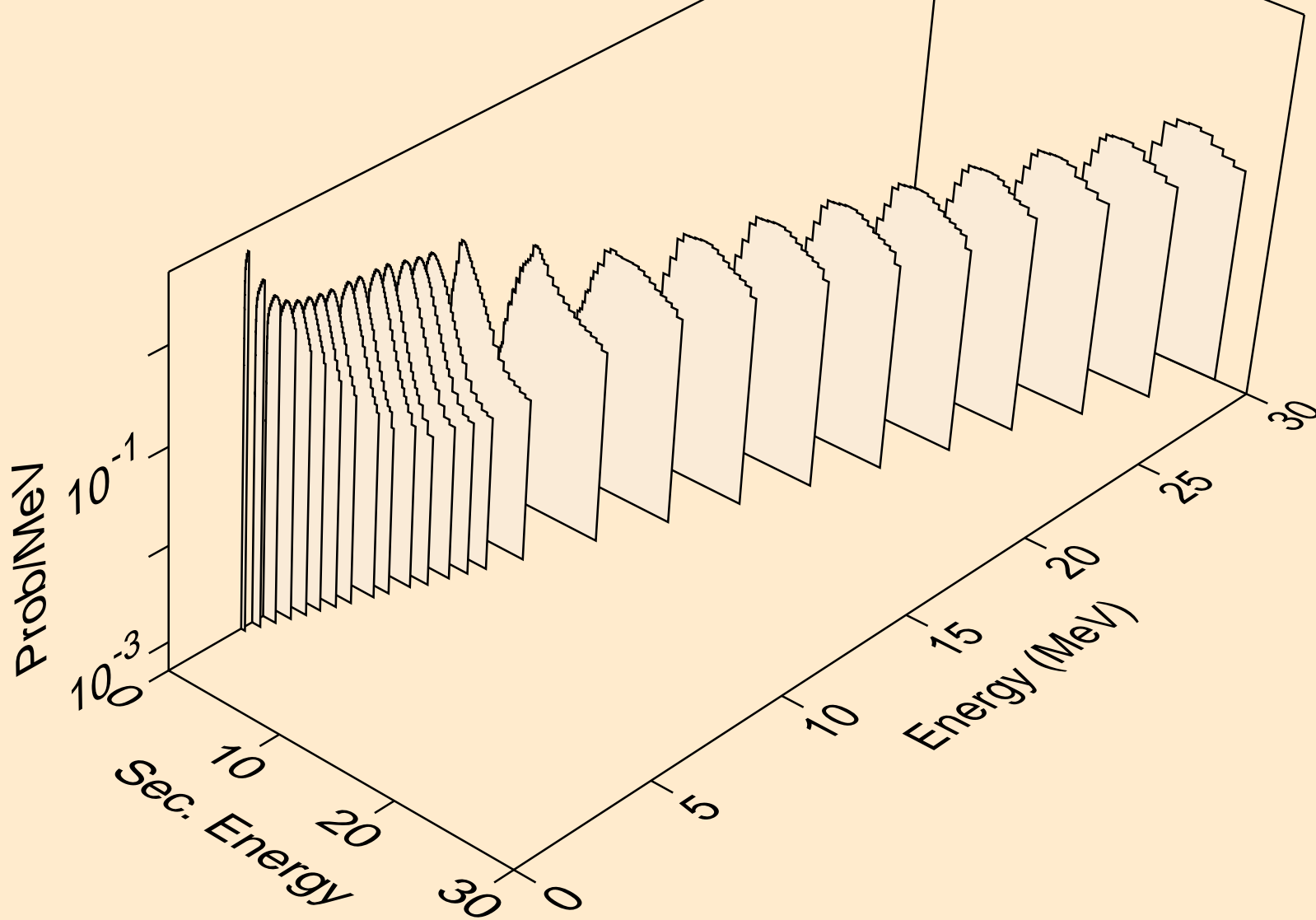

SM145 NEUTRON ACER TENDL-2019 LIBRARY; T=293.16K
Photon emission for (n,x)

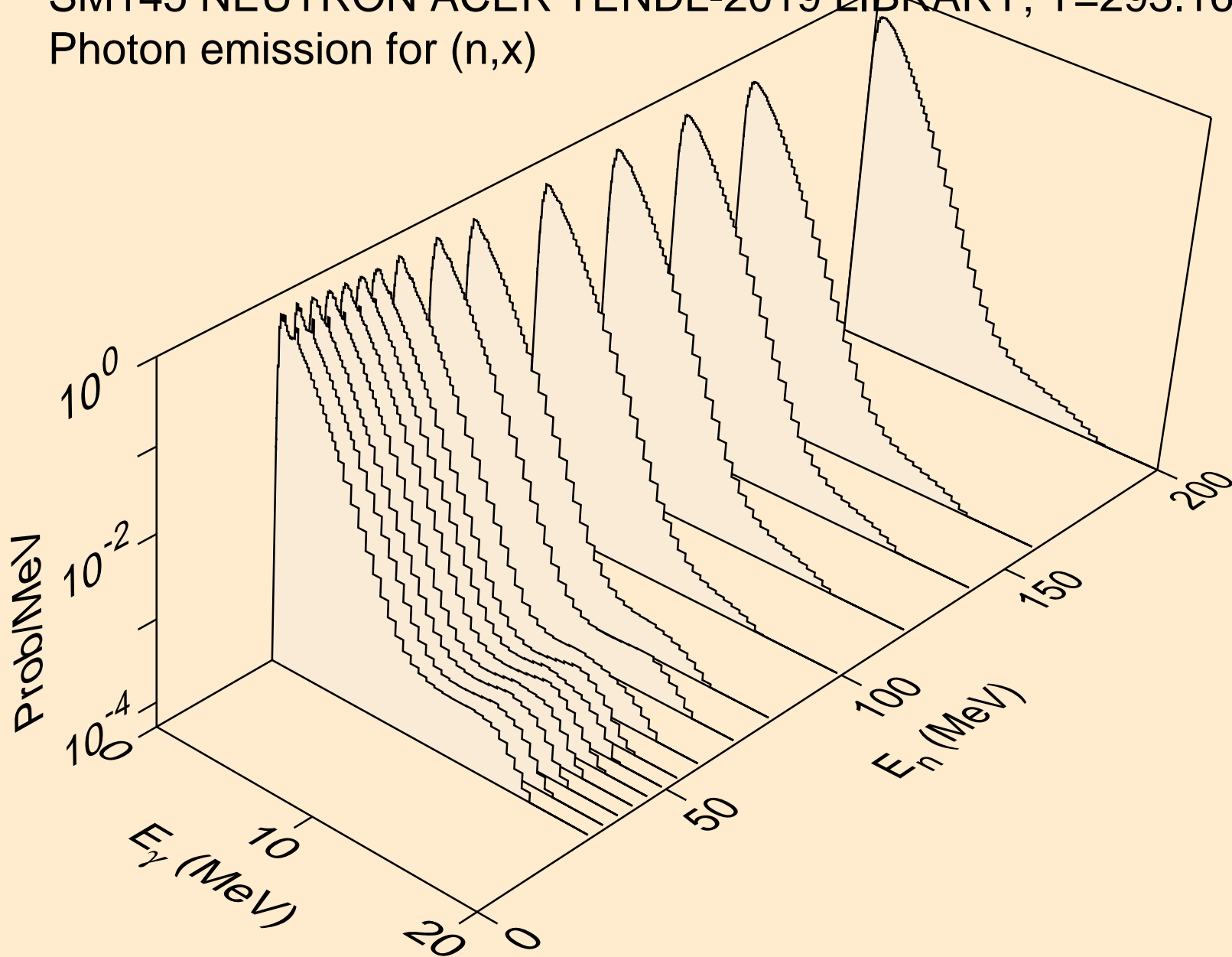

SM145 NEUTRON ACER TENDL-2019 LIBRARY; T=293.16K
Photon emission for (n,2nd)

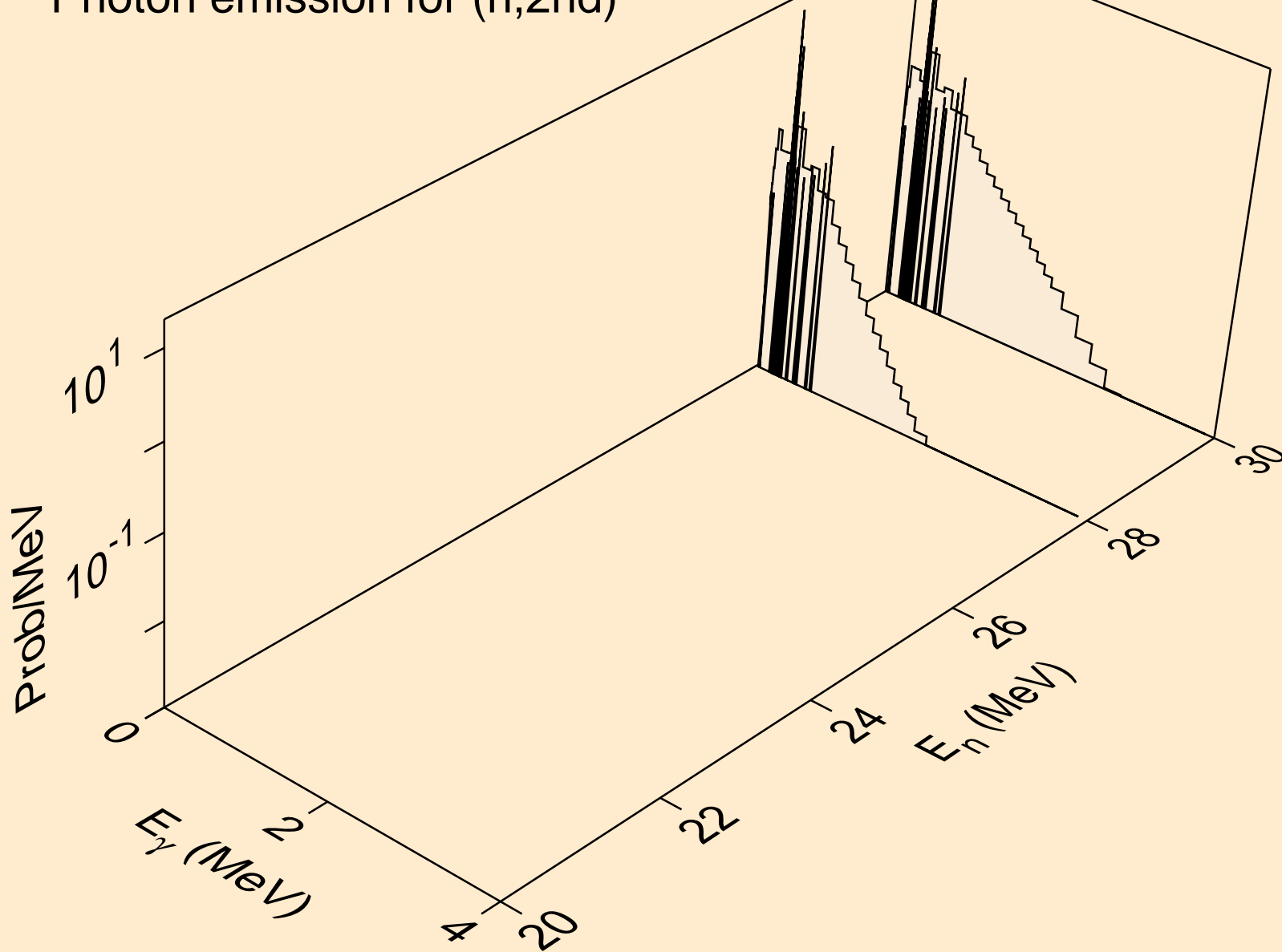

SM145 NEUTRON ACER TENDL-2019 LIBRARY; T=293.16K
Photon emission for (n,2n)

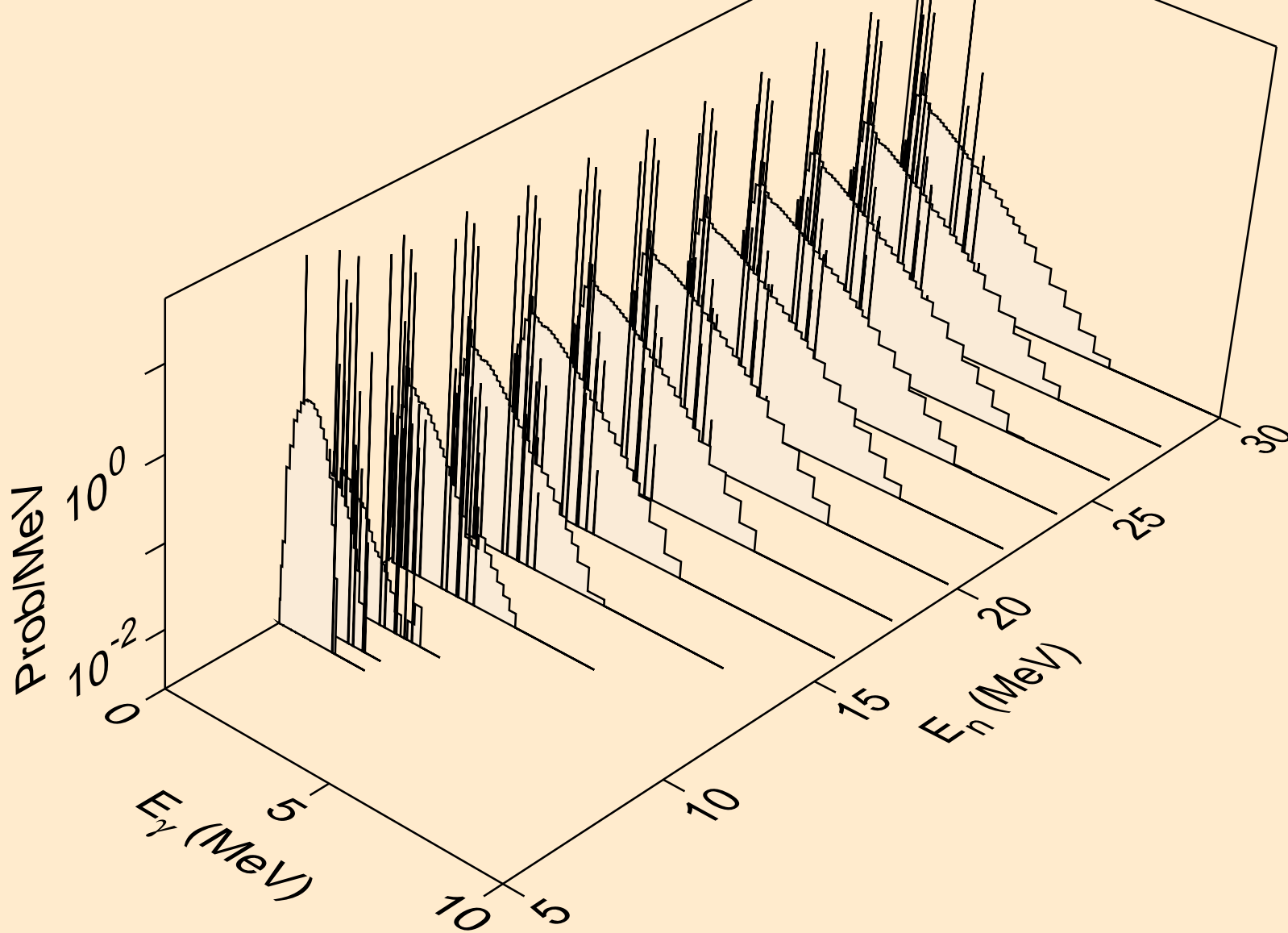

SM145 NEUTRON ACER TENDL-2019 LIBRARY; T=293.16K
Photon emission for (n,3n)

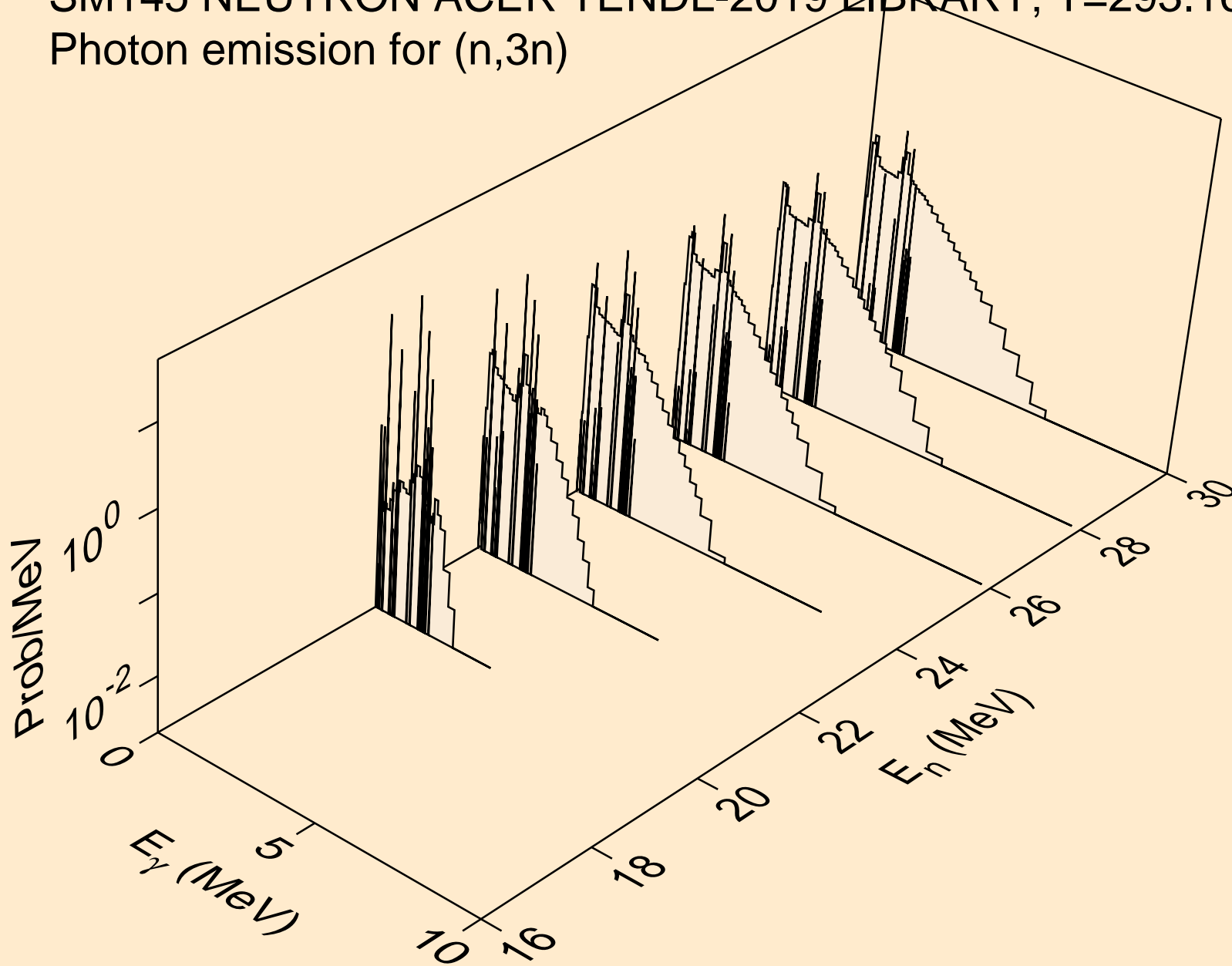

SM145 NEUTRON ACER TENDL-2019 LIBRARY; T=293.16K
Photon emission for (n,n*)a

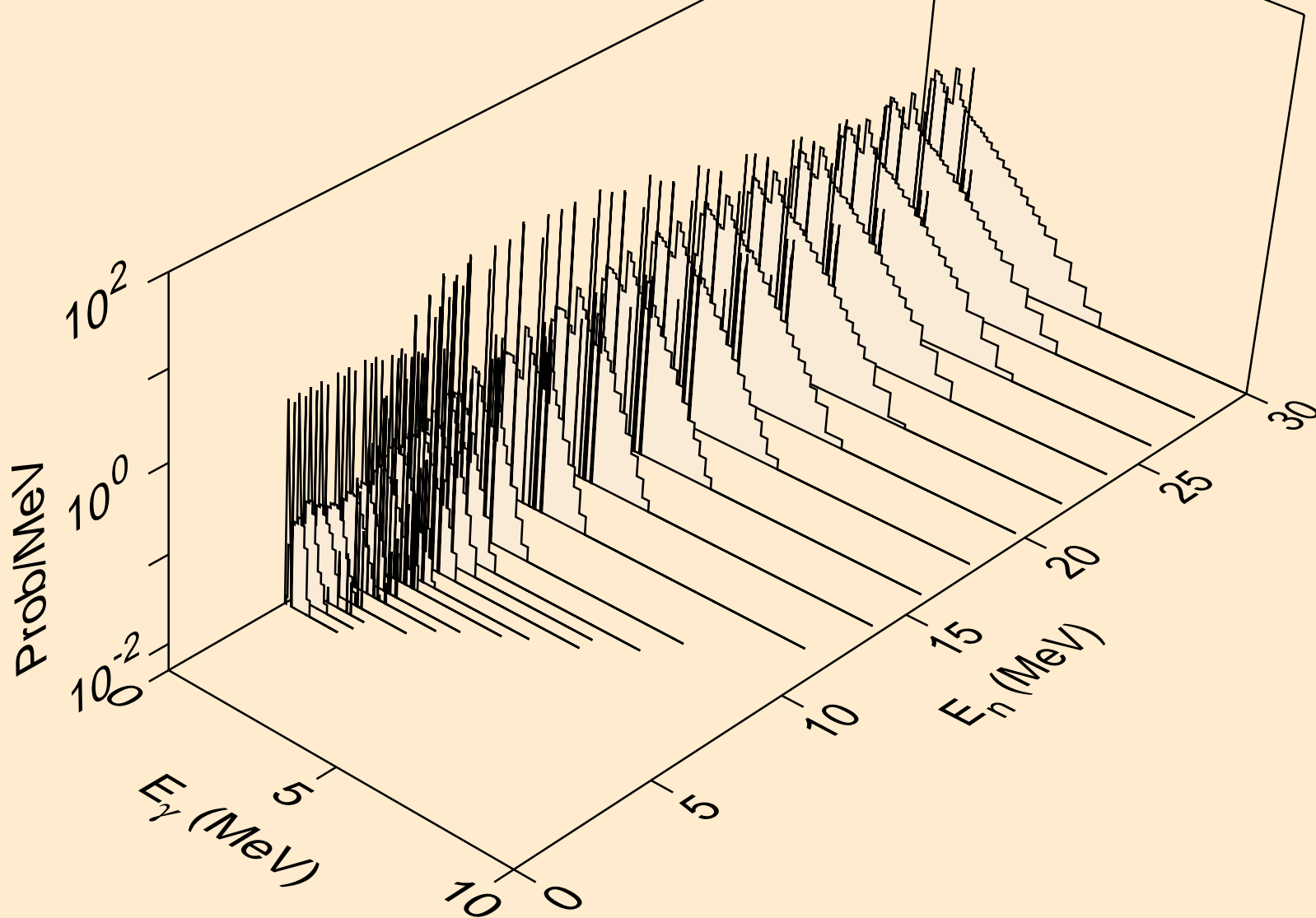

SM145 NEUTRON ACER TENDL-2019 LIBRARY; T=293.16K
Photon emission for (n,2n)a

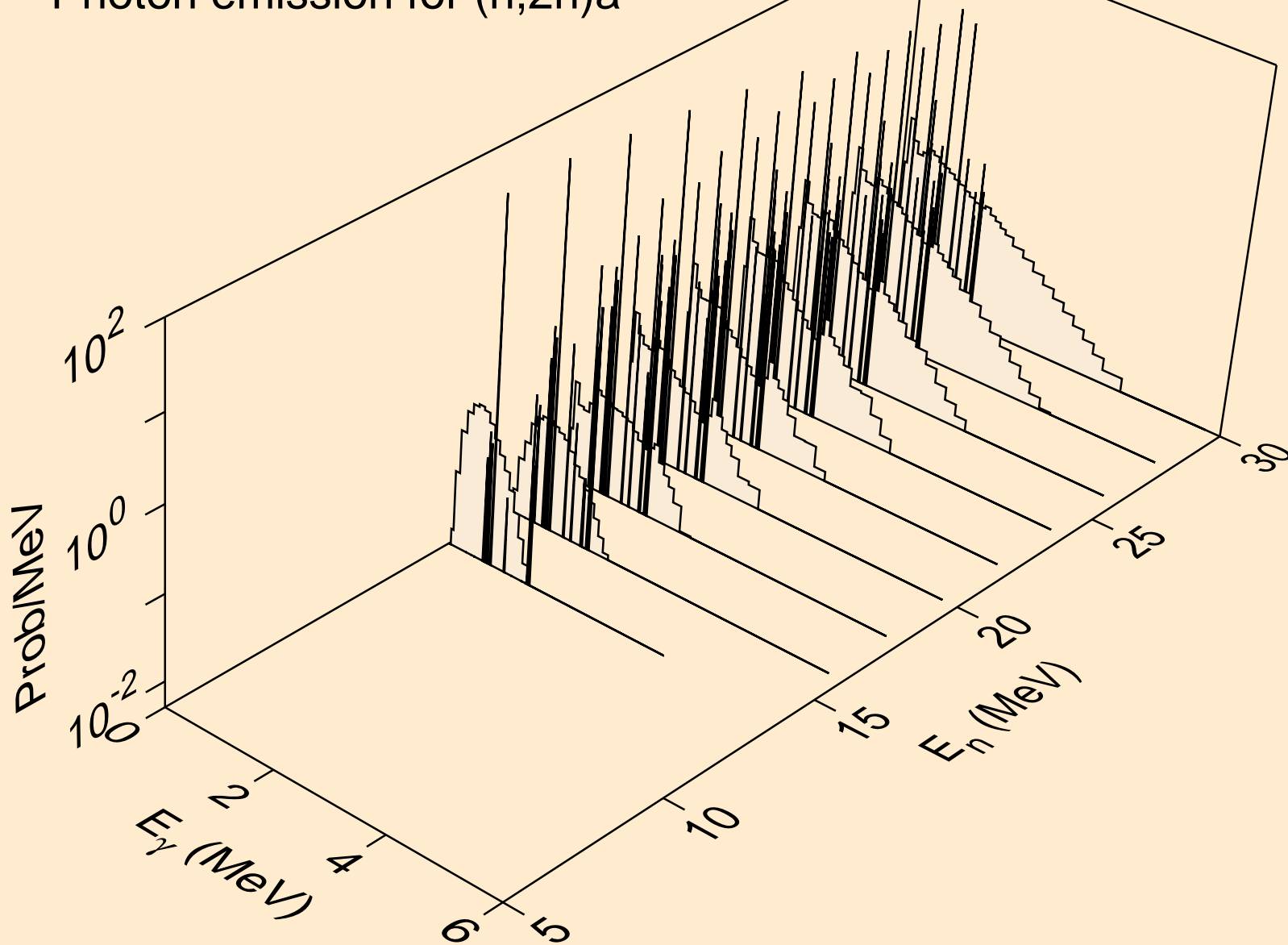

SM145 NEUTRON ACER TENDL-2019 LIBRARY; T=293.16K
Photon emission for (n,3n)a

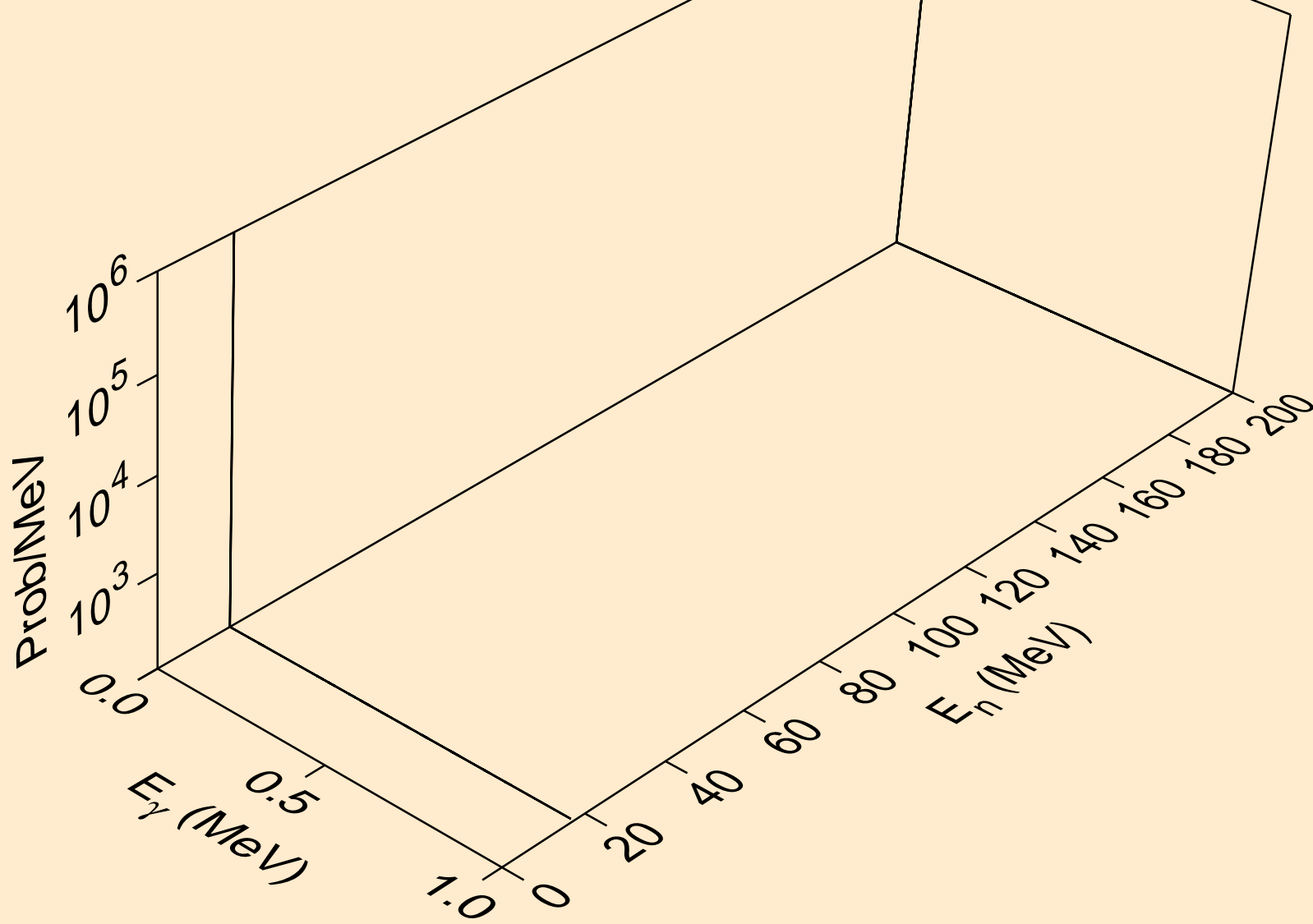

SM145 NEUTRON ACER TENDL-2019 LIBRARY; T=293.16K
Photon emission for (n,n*)p

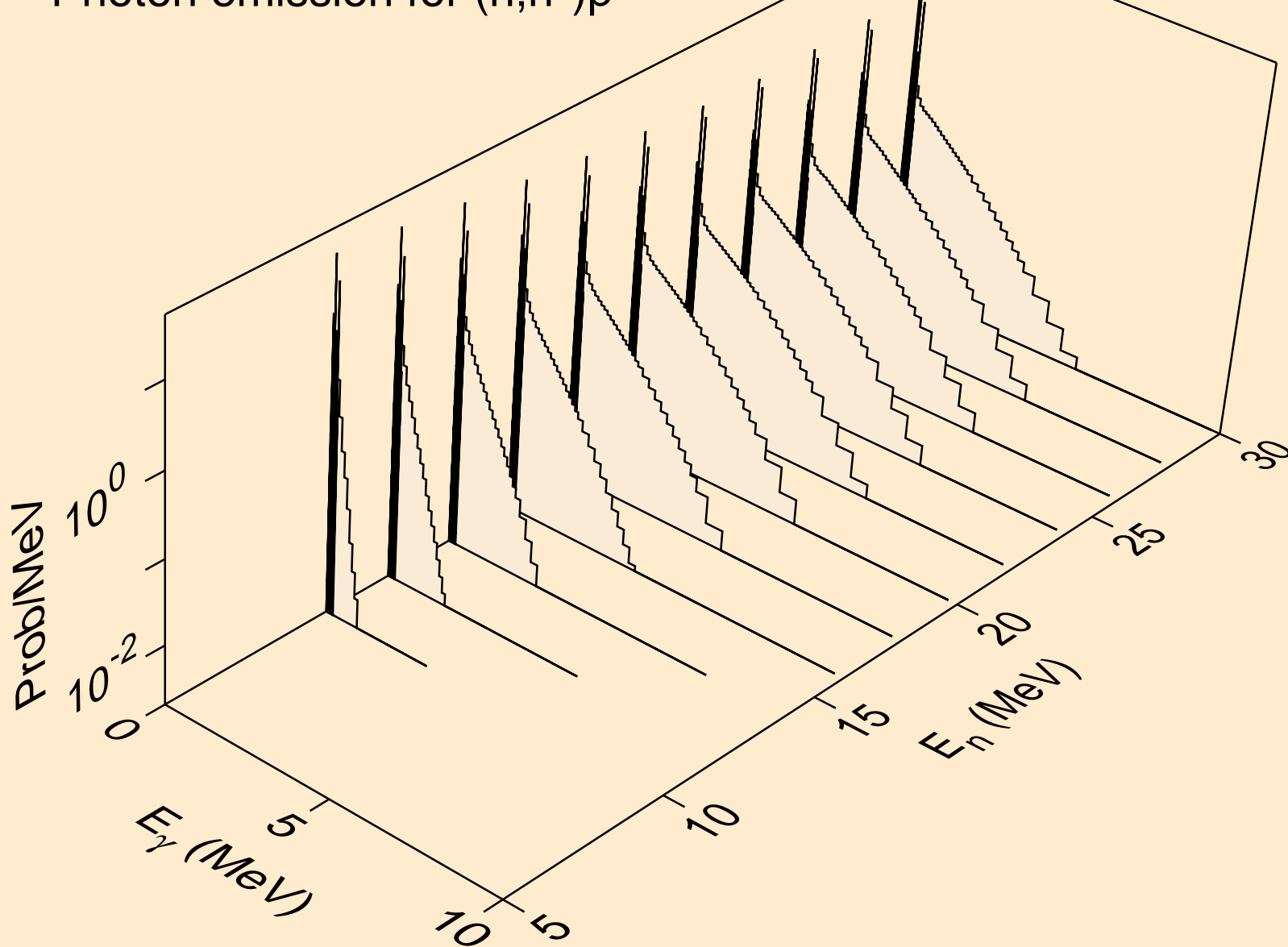

SM145 NEUTRON ACER TENDL-2019 LIBRARY; T=293.16K
Photon emission for (n,n*)2a

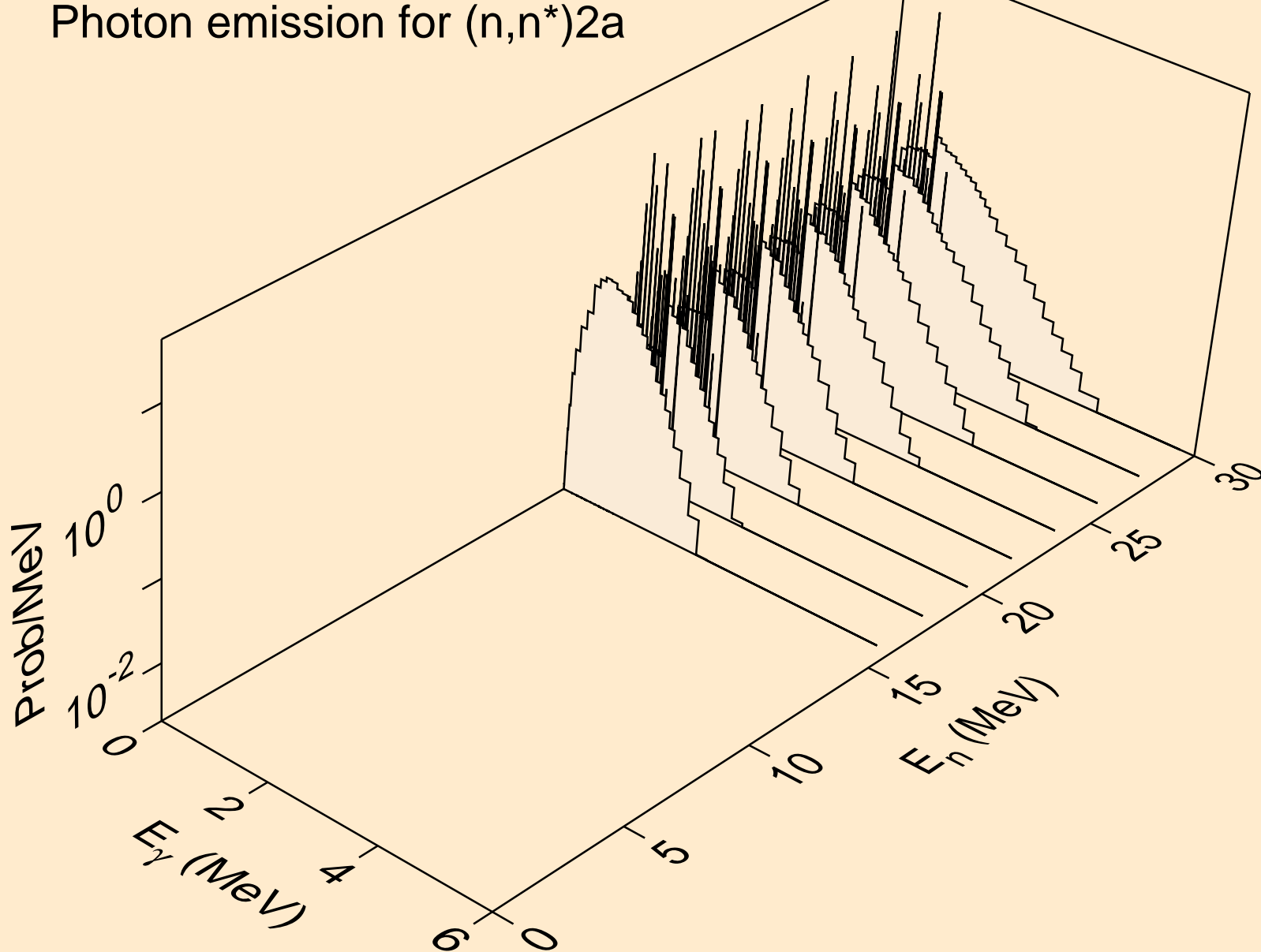

SM145 NEUTRON ACER TENDL-2019 LIBRARY; T=293.16K
Photon emission for (n,n*)d

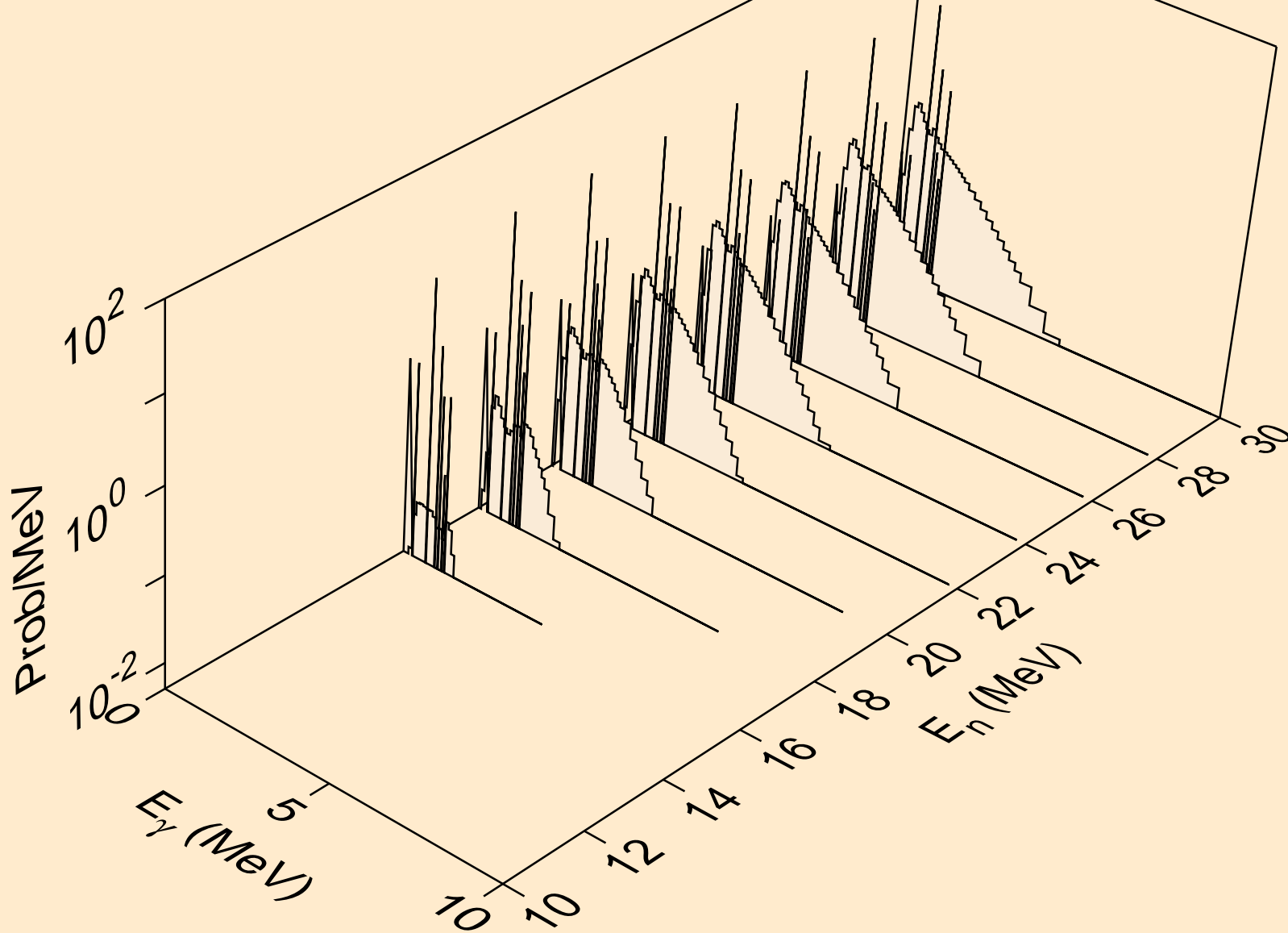

SM145 NEUTRON ACER TENDL-2019 LIBRARY; T=293.16K
Photon emission for (n,n*)t

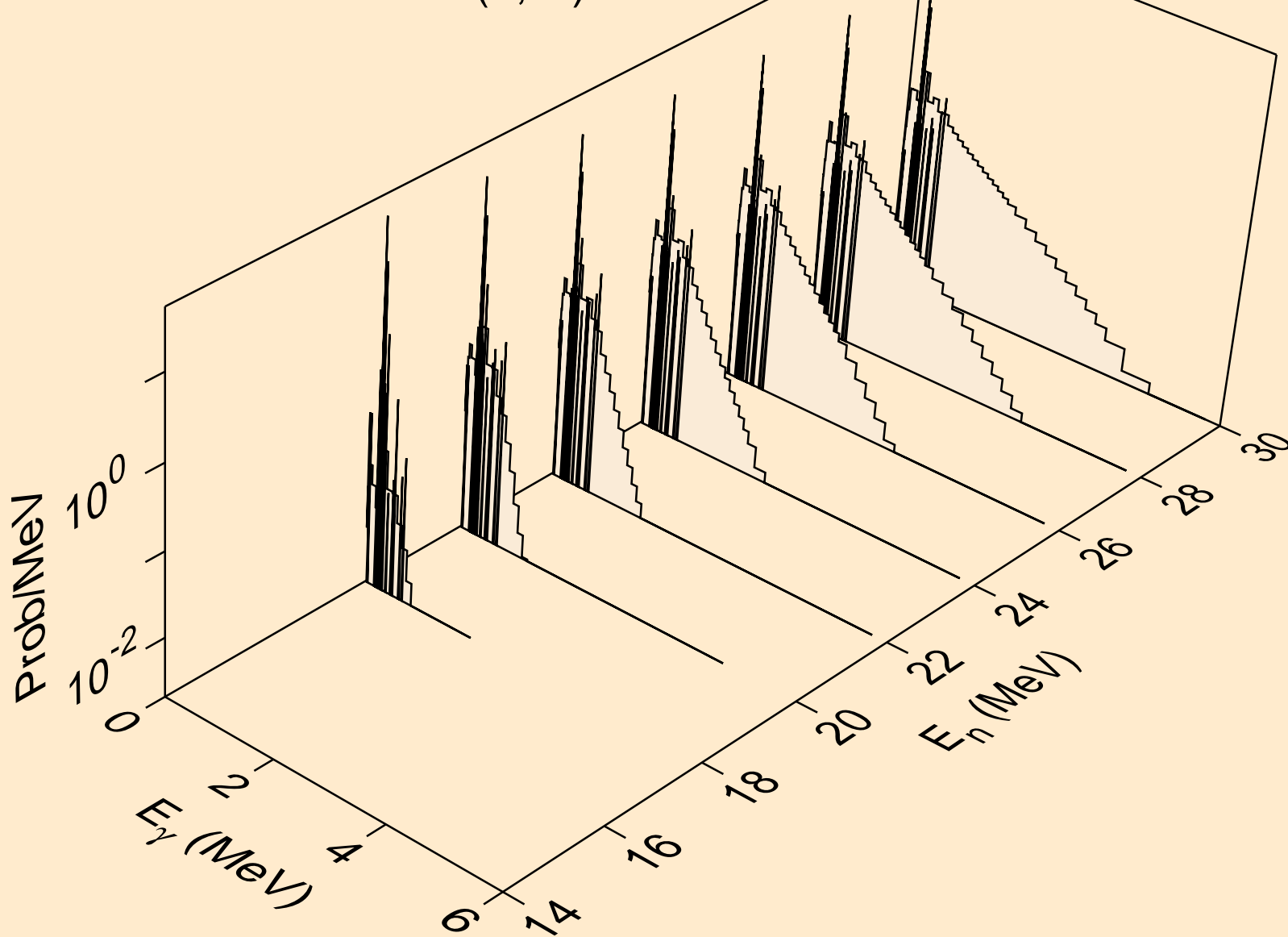

SM145 NEUTRON ACER TENDL-2019 LIBRARY; T=293.16K
Photon emission for (n,n*)he3

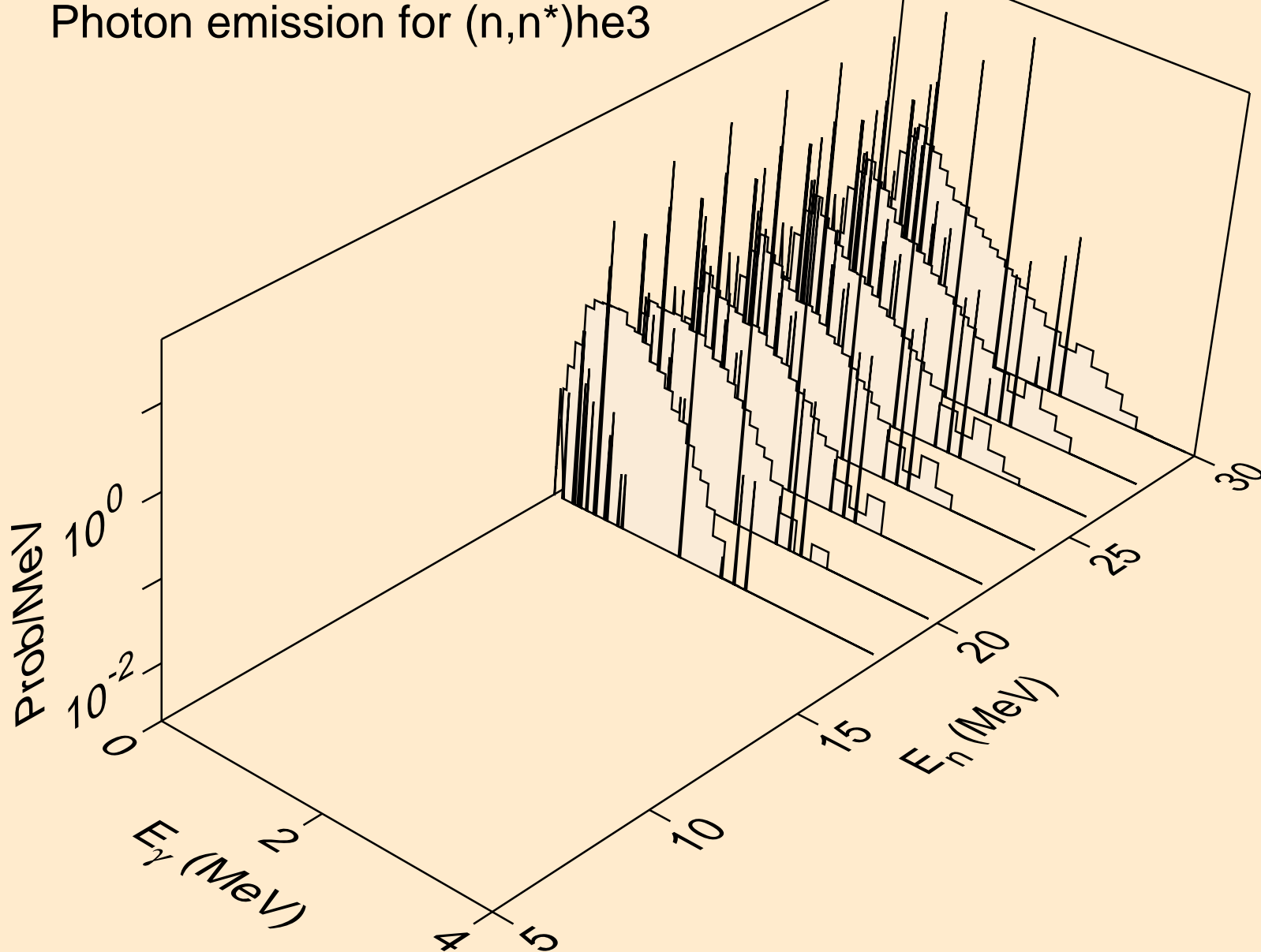

SM145 NEUTRON ACER TENDL-2019 LIBRARY; T=293.16K
Photon emission for (n,4n)

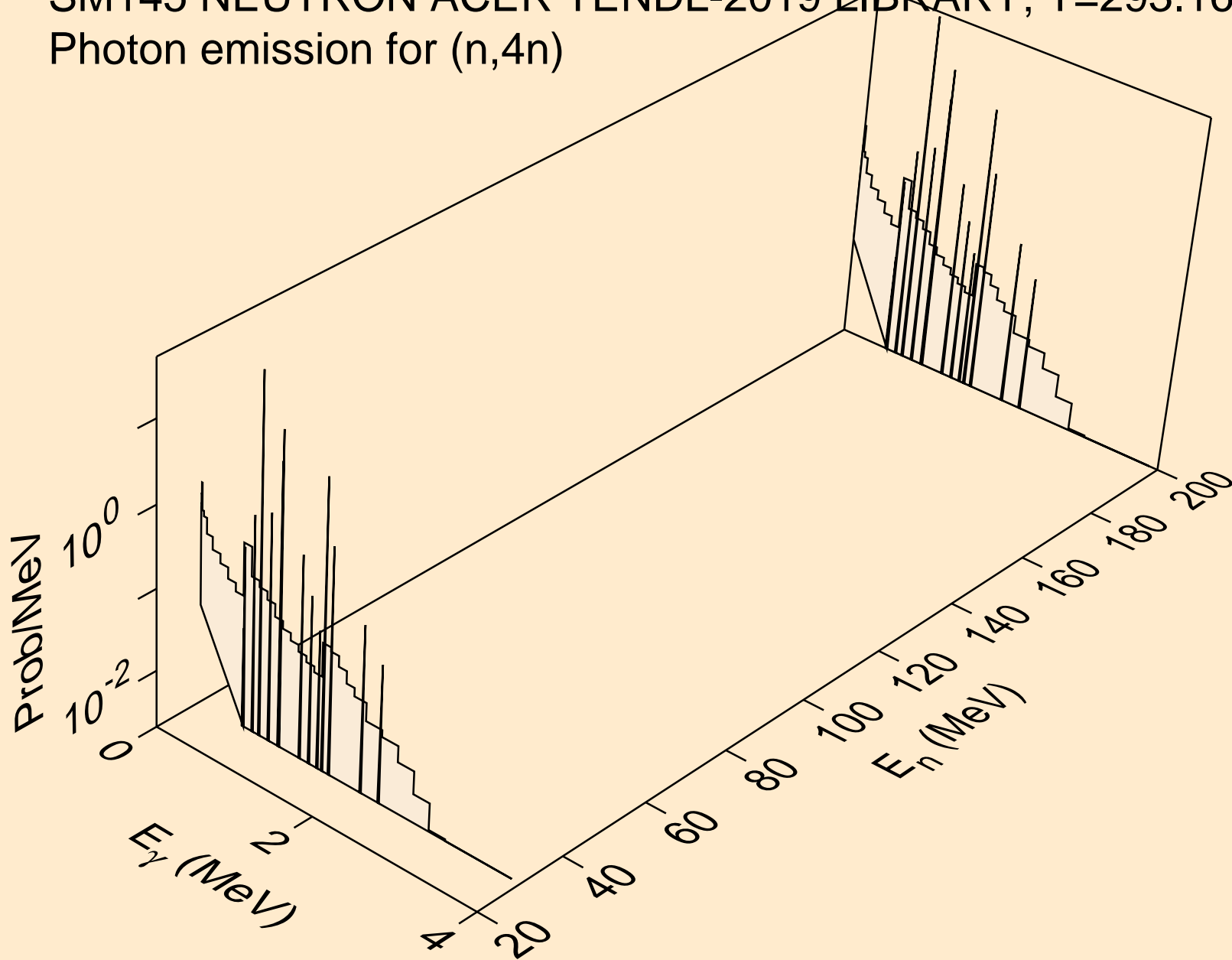

SM145 NEUTRON ACER TENDL-2019 LIBRARY; T=293.16K
Photon emission for (n,2np)

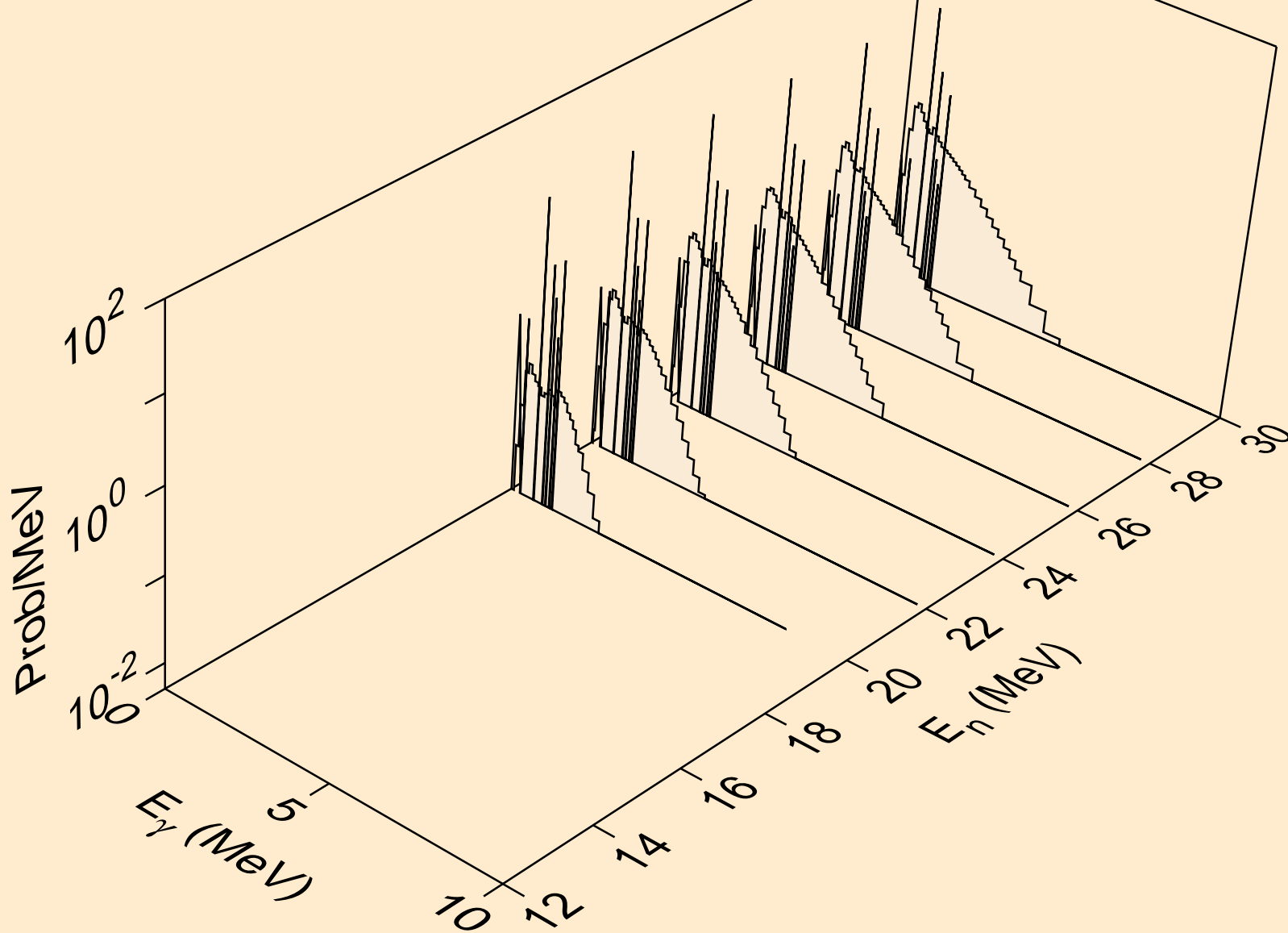

SM145 NEUTRON ACER TENDL-2019 LIBRARY; T=293.16K
Photon emission for (n,3np)

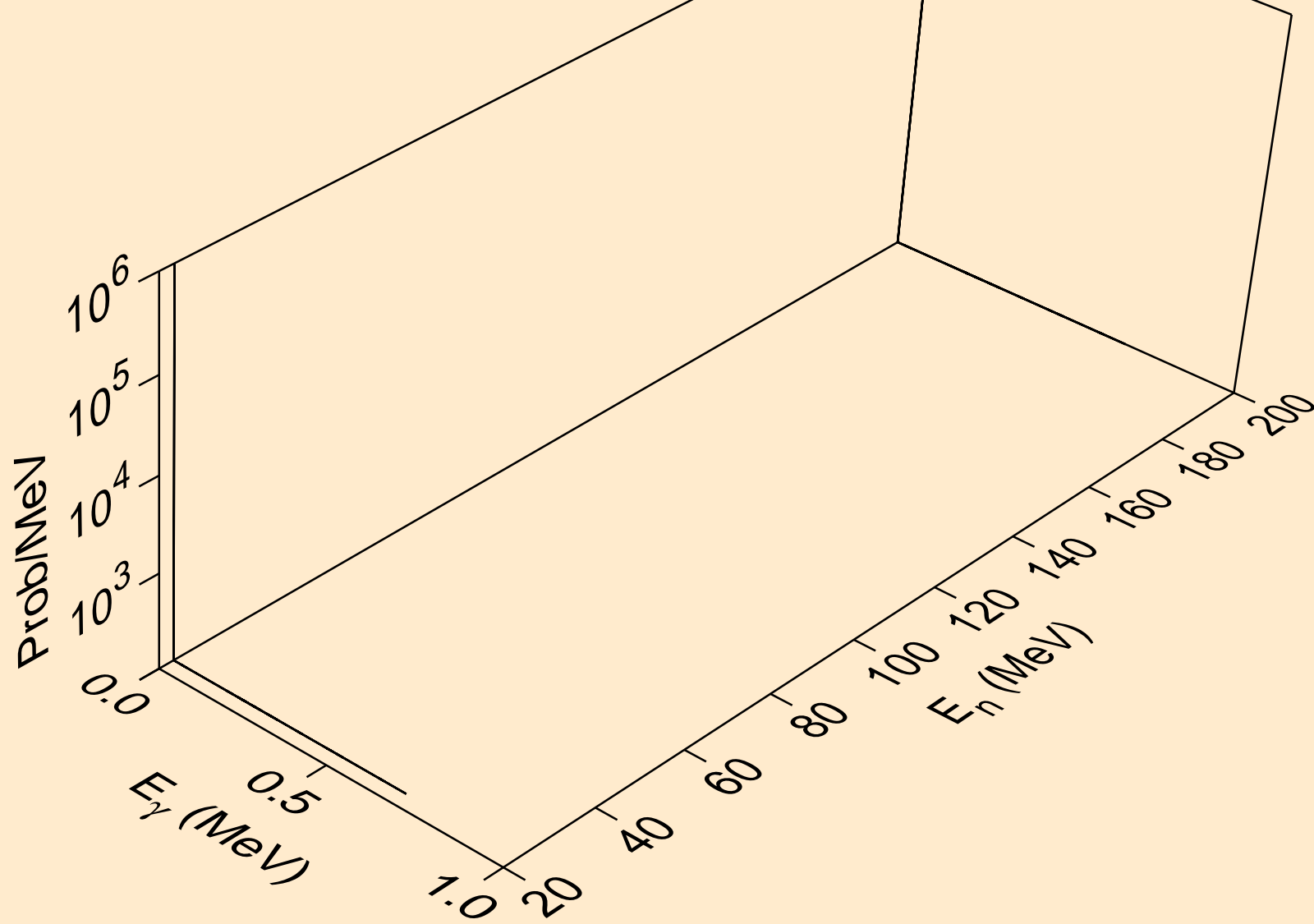

SM145 NEUTRON ACER TENDL-2019 LIBRARY; T=293.16K
Photon emission for (n,2np)

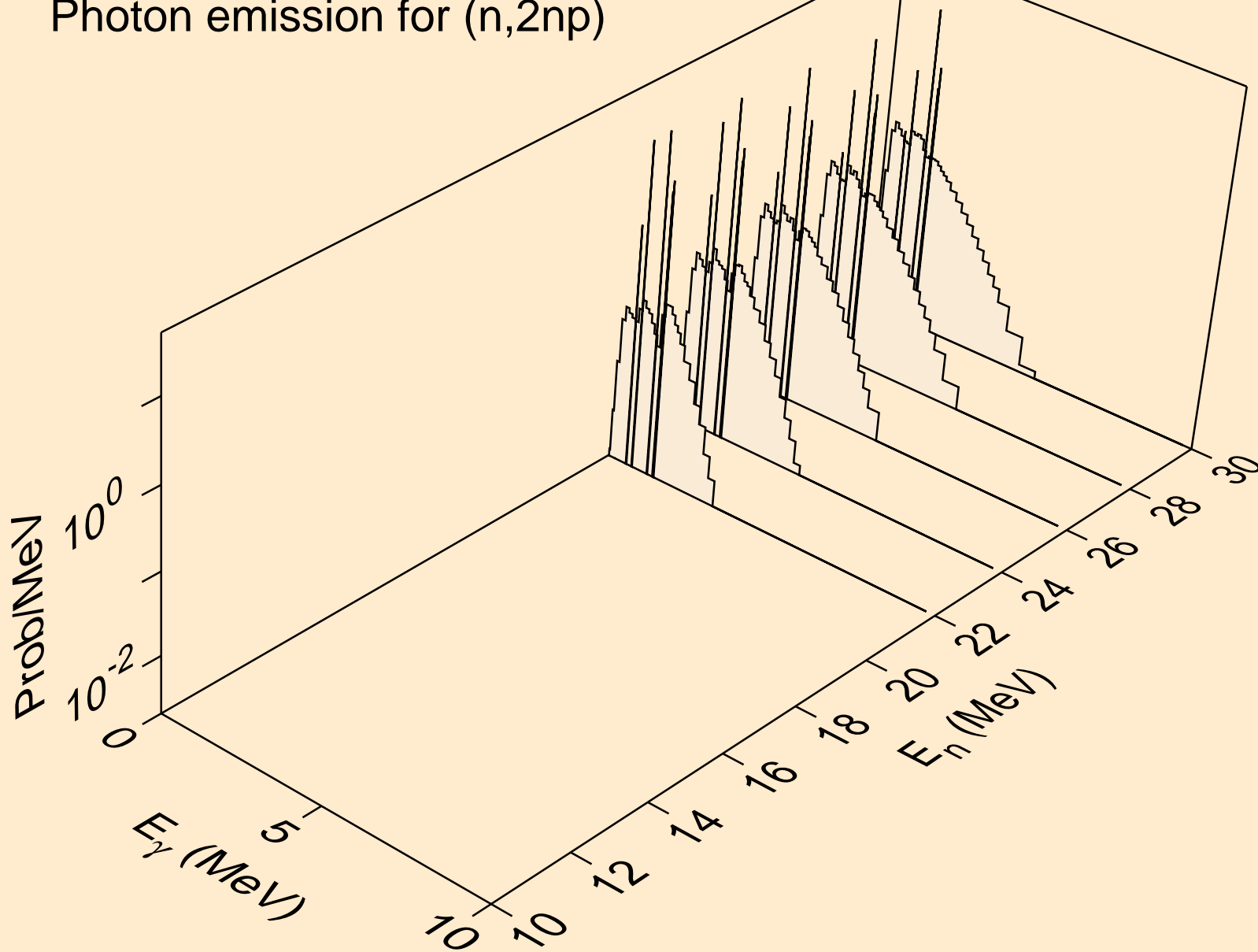

SM145 NEUTRON ACER TENDL-2019 LIBRARY; T=293.16K
Photon emission for (n,npa)

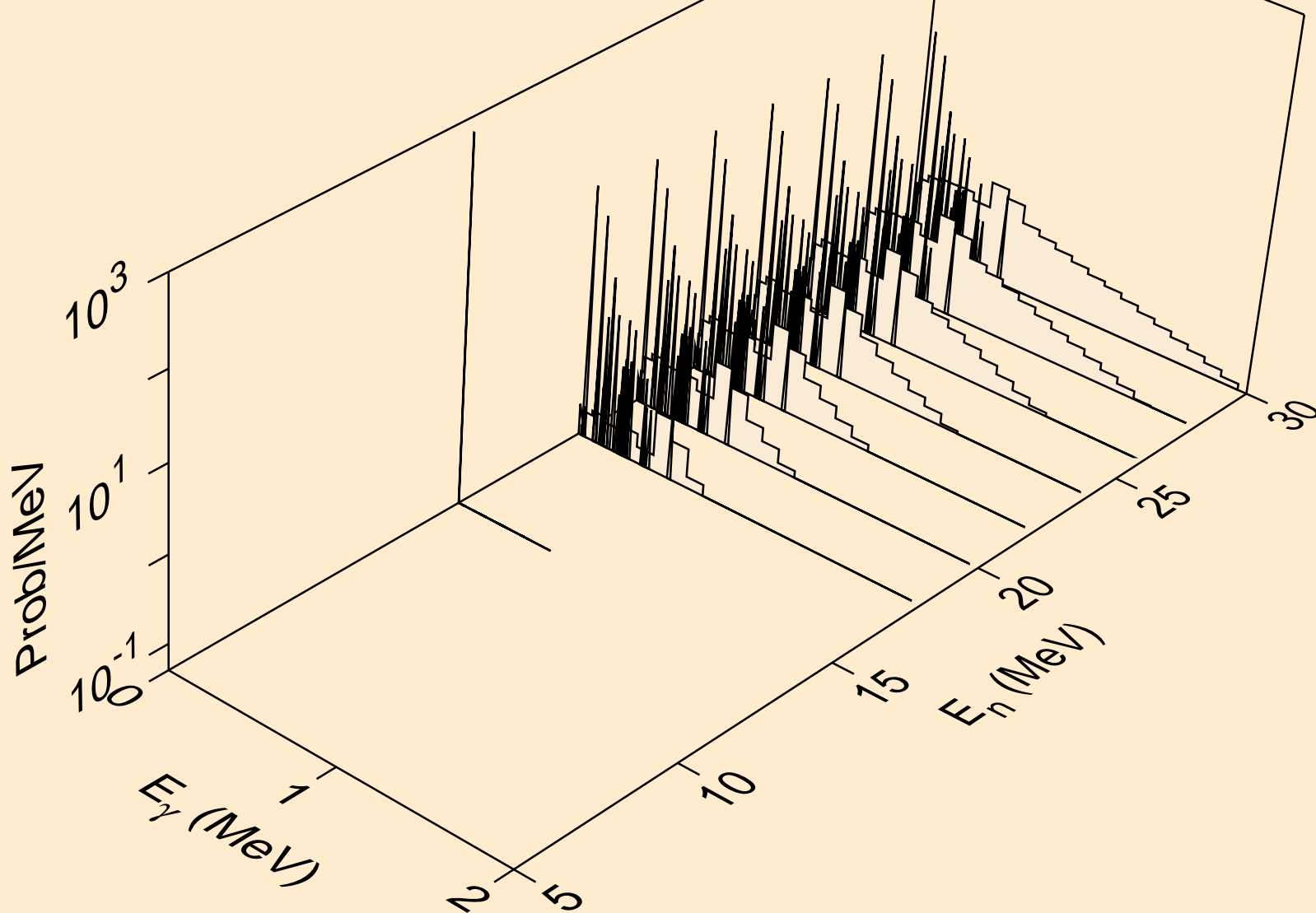

SM145 NEUTRON ACER TENDL-2019 LIBRARY; T=293.16K
Photon emission for (n,n*c)

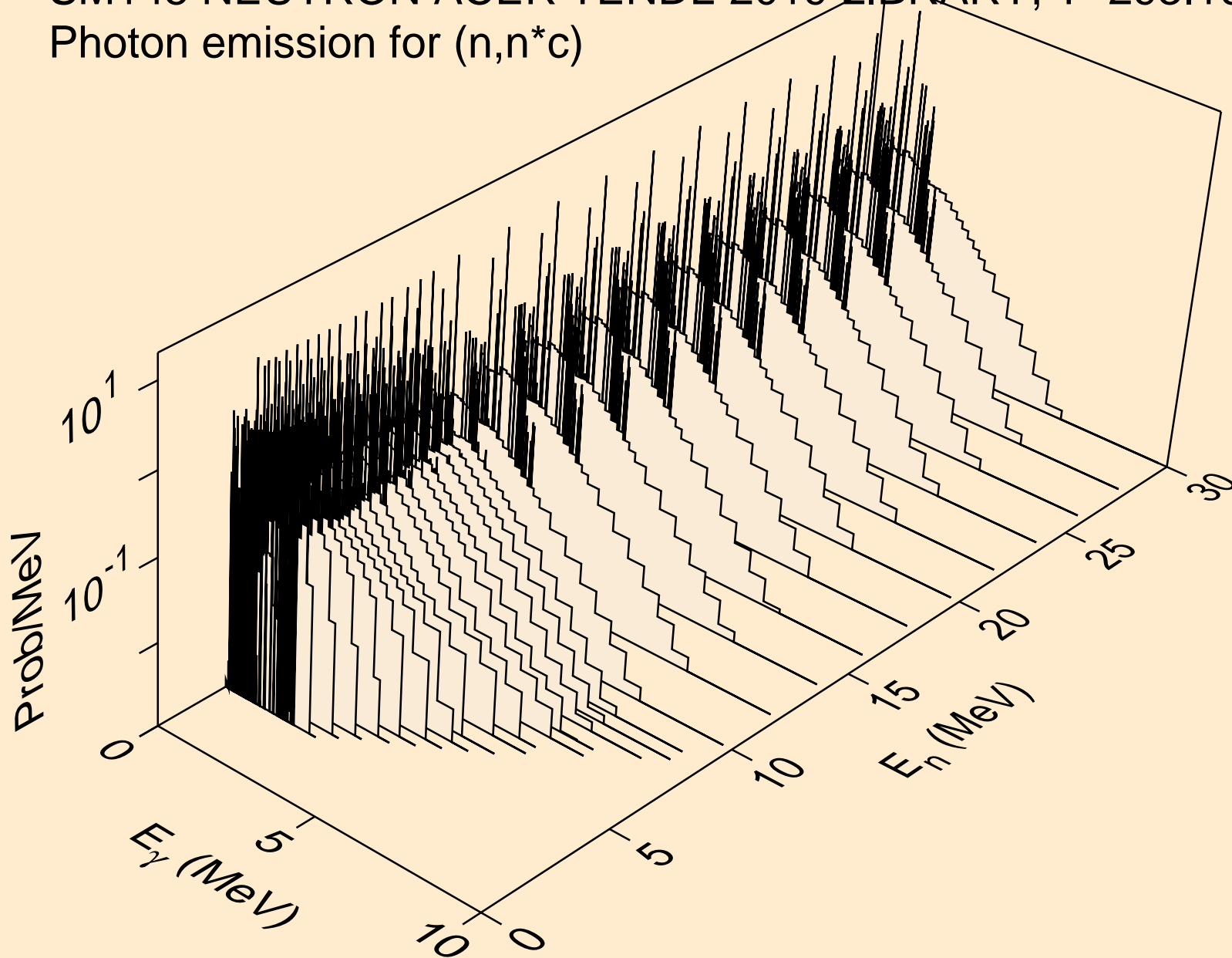

SM145 NEUTRON ACER TENDL-2019 LIBRARY; T=293.16K
Photon emission for (n,gma)

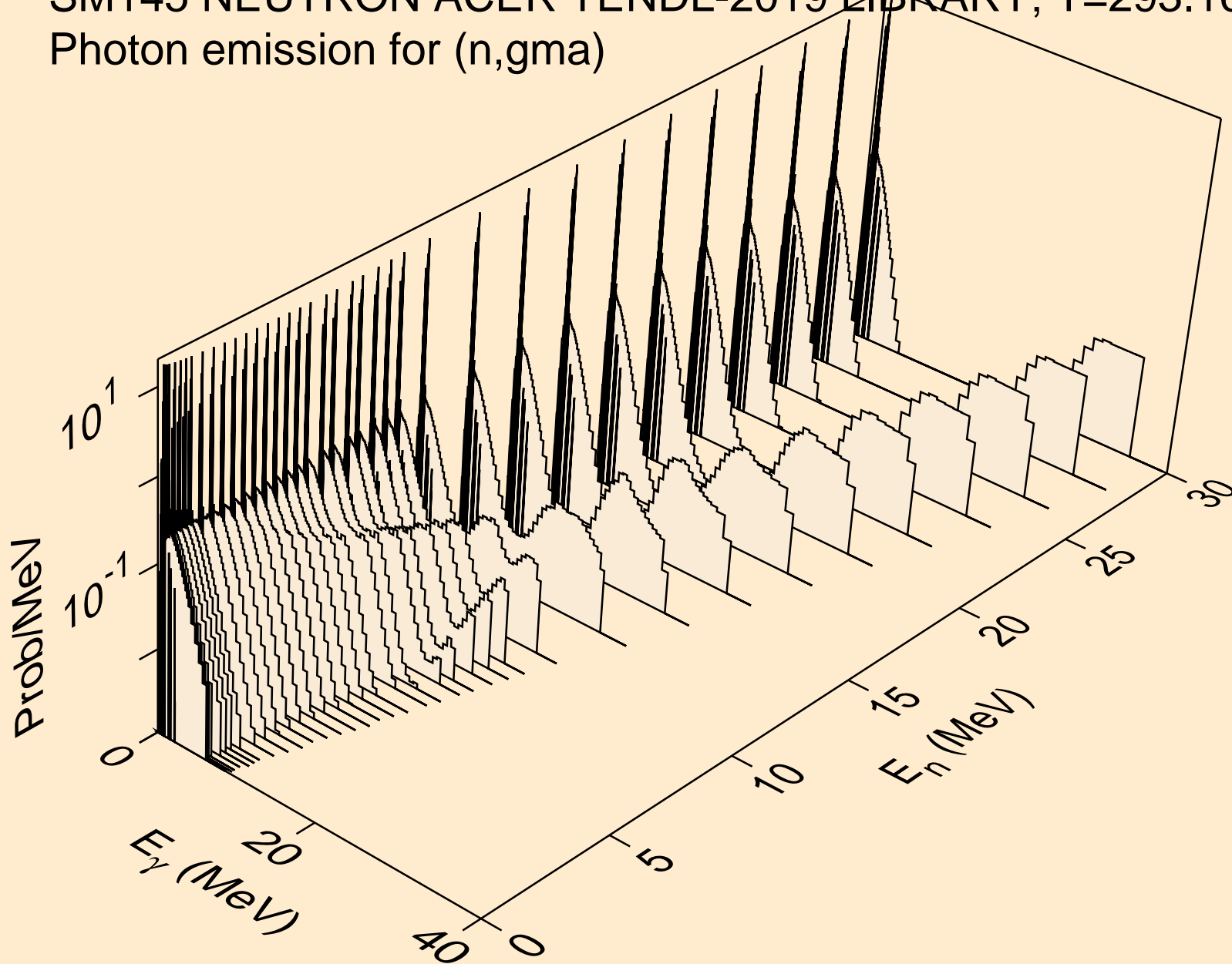

SM145 NEUTRON ACER TENDL-2019 LIBRARY; T=293.16K
Photon emission for (n,p)

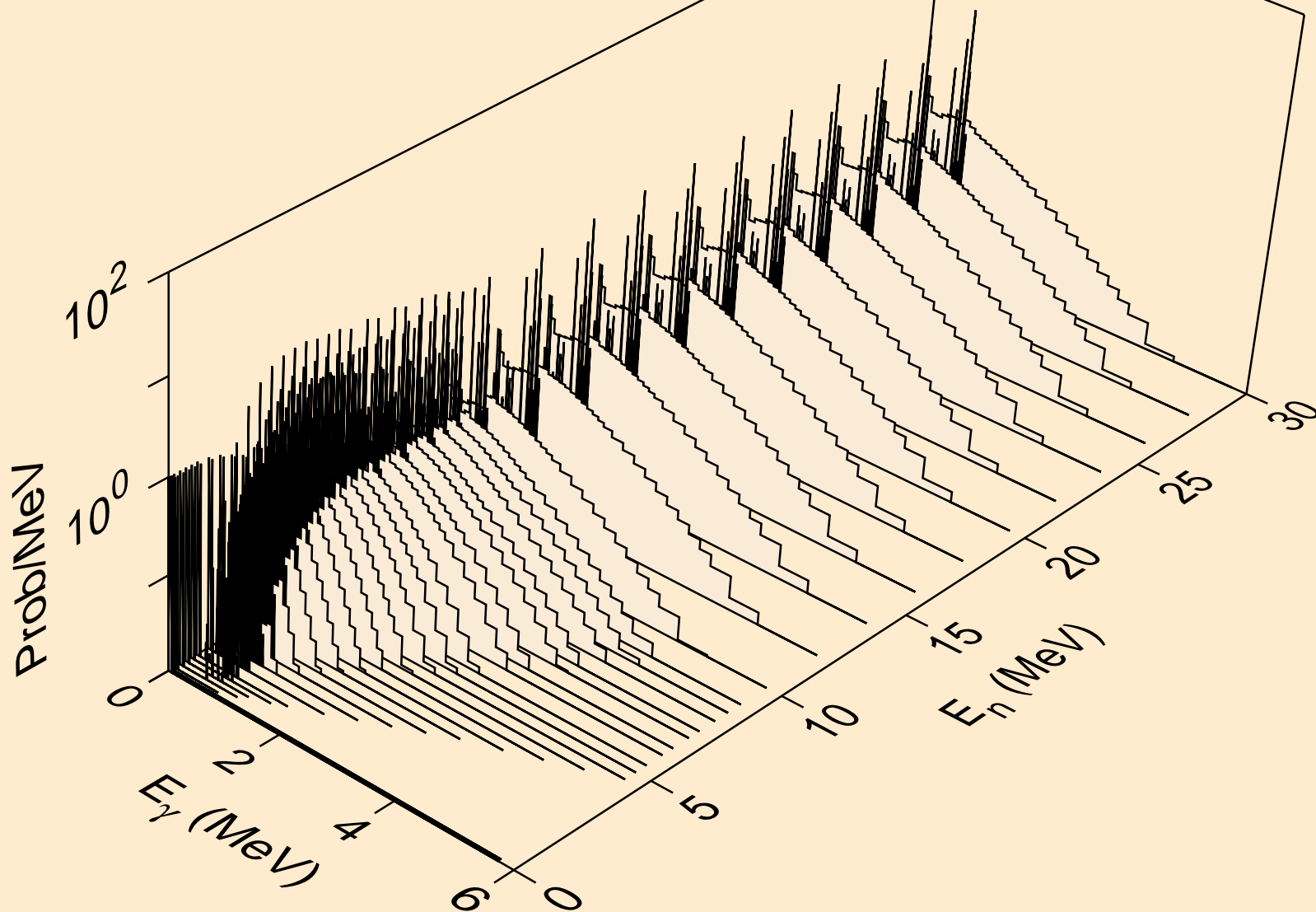

SM145 NEUTRON ACER TENDL-2019 LIBRARY; T=293.16K
Photon emission for (n,d)

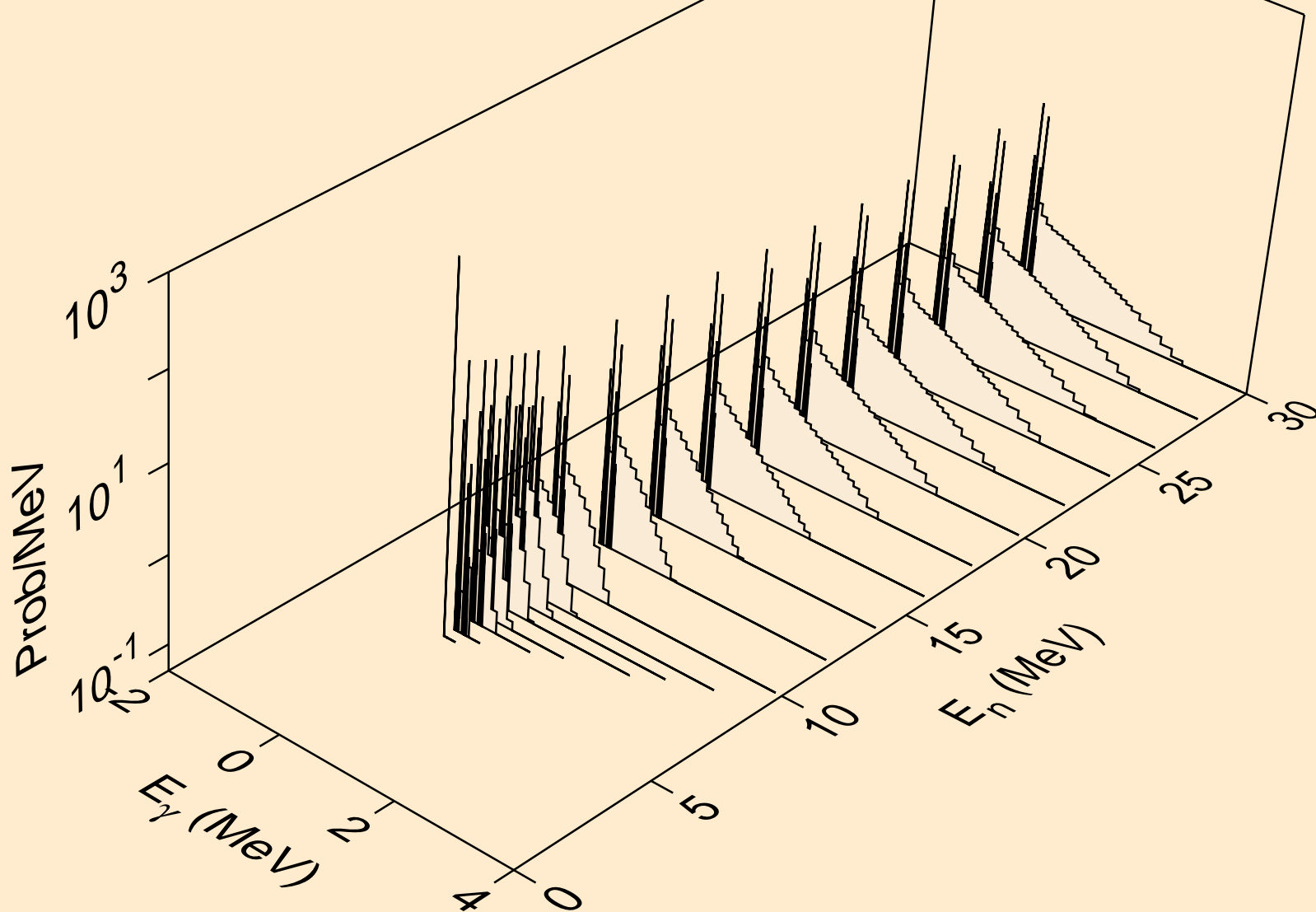

SM145 NEUTRON ACER TENDL-2019 LIBRARY; T=293.16K
Photon emission for (n,t)

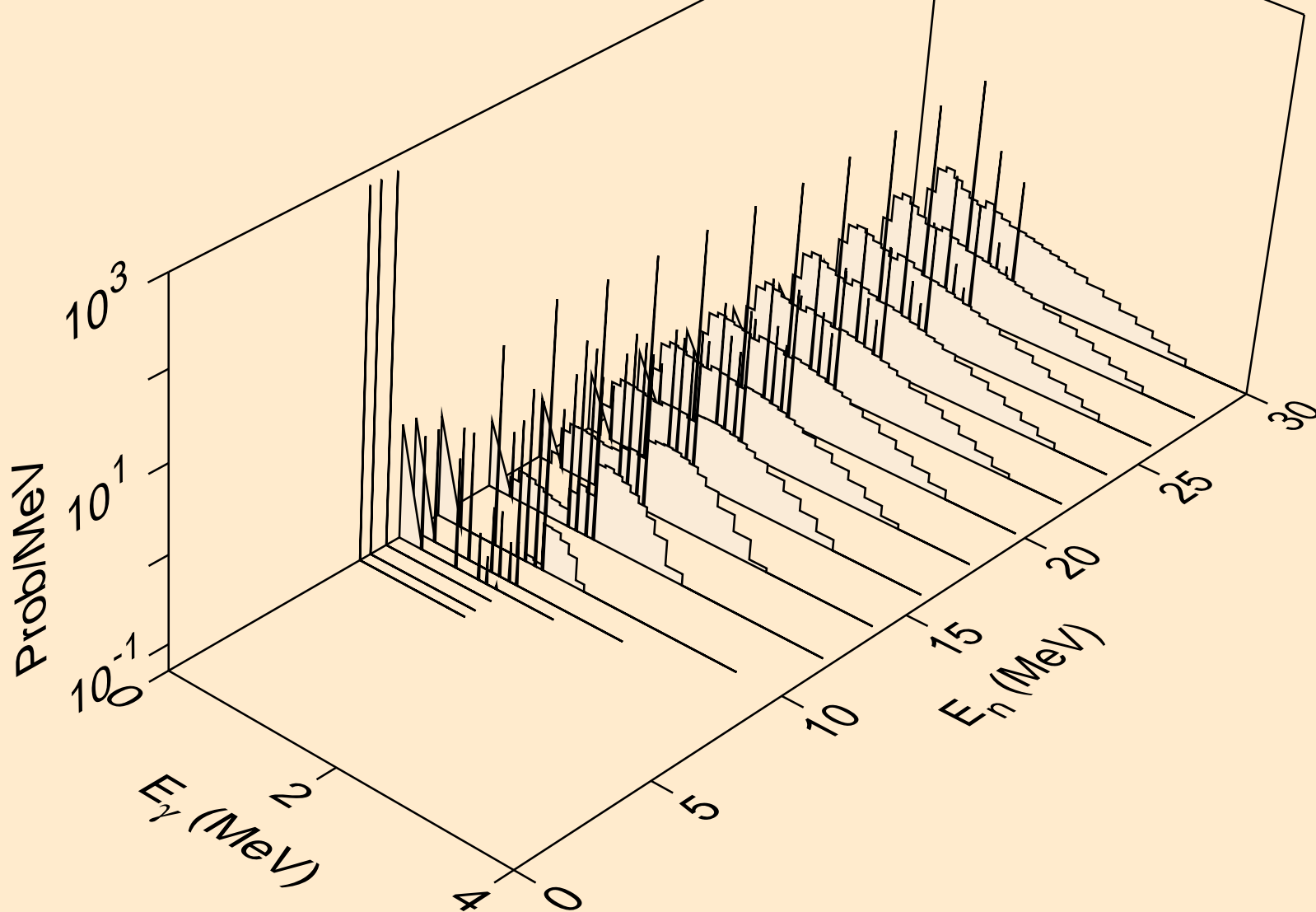

SM145 NEUTRON ACER TENDL-2019 LIBRARY; T=293.16K
Photon emission for (n,he3)

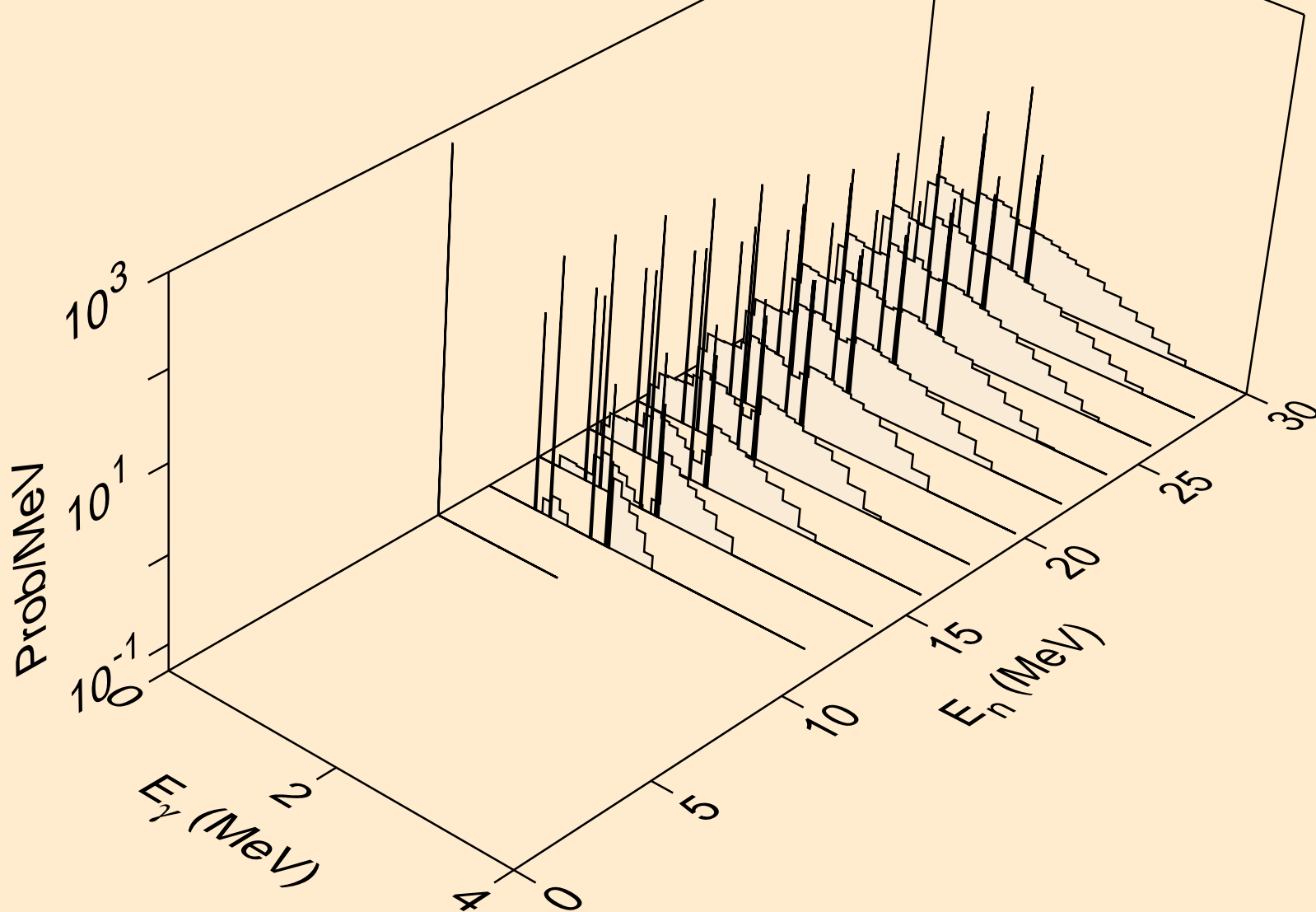

SM145 NEUTRON ACER TENDL-2019 LIBRARY; T=293.16K
Photon emission for (n,a)

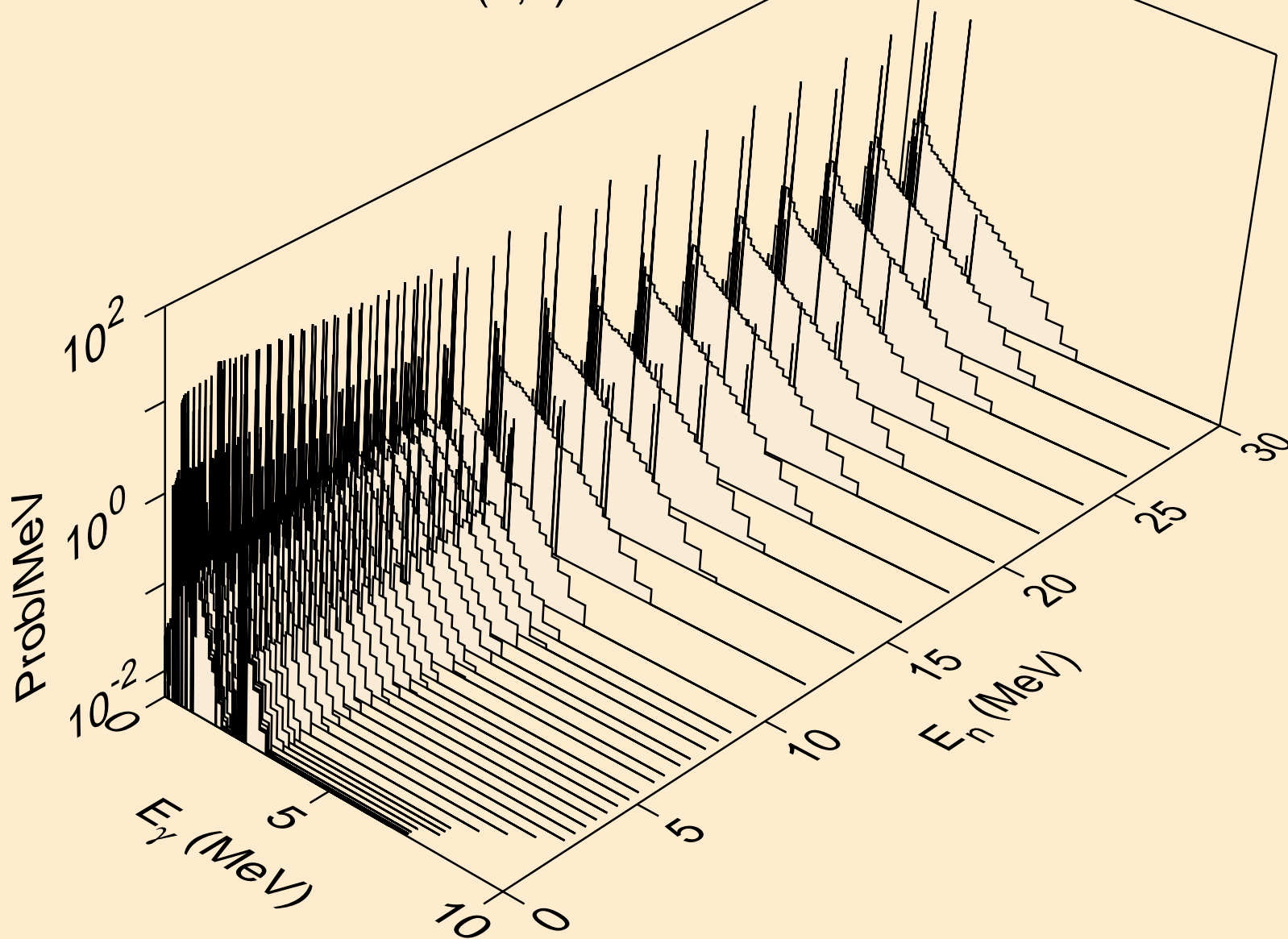

SM145 NEUTRON ACER TENDL-2019 LIBRARY; T=293.16K
Photon emission for (n,2a)

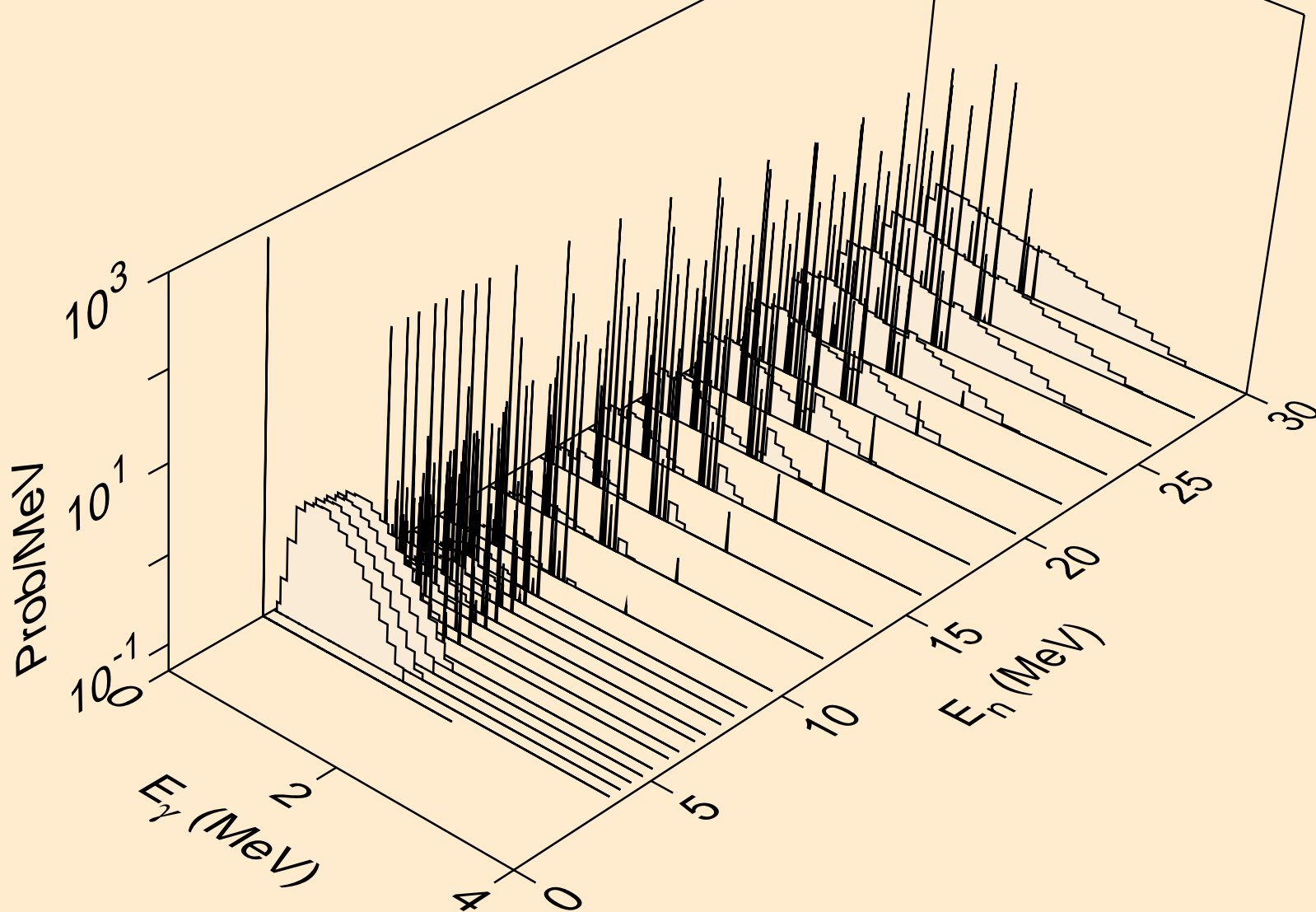

SM145 NEUTRON ACER TENDL-2019 LIBRARY; T=293.16K
Photon emission for (n,2p)

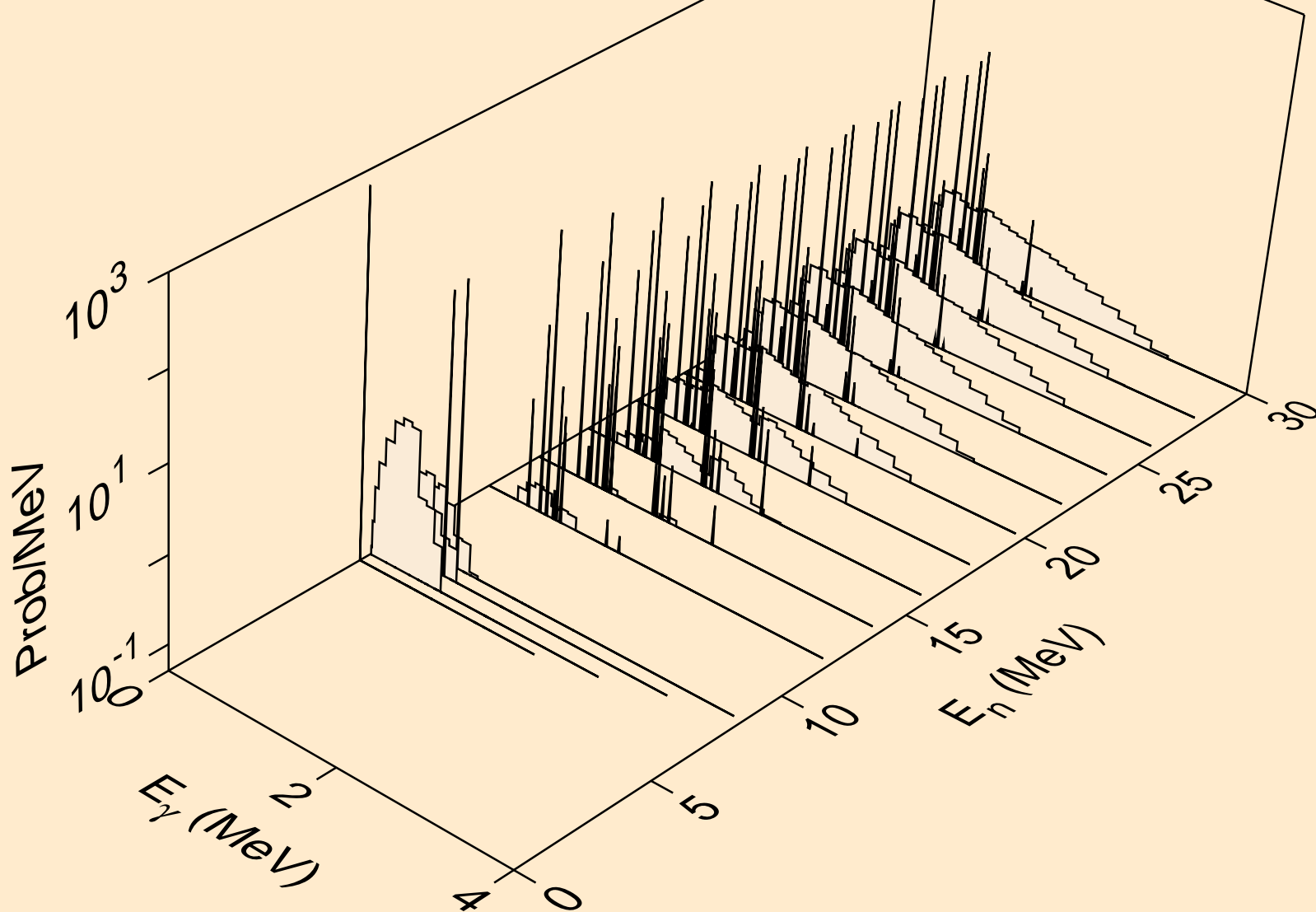

SM145 NEUTRON ACER TENDL-2019 LIBRARY; T=293.16K
Photon emission for (n,p)

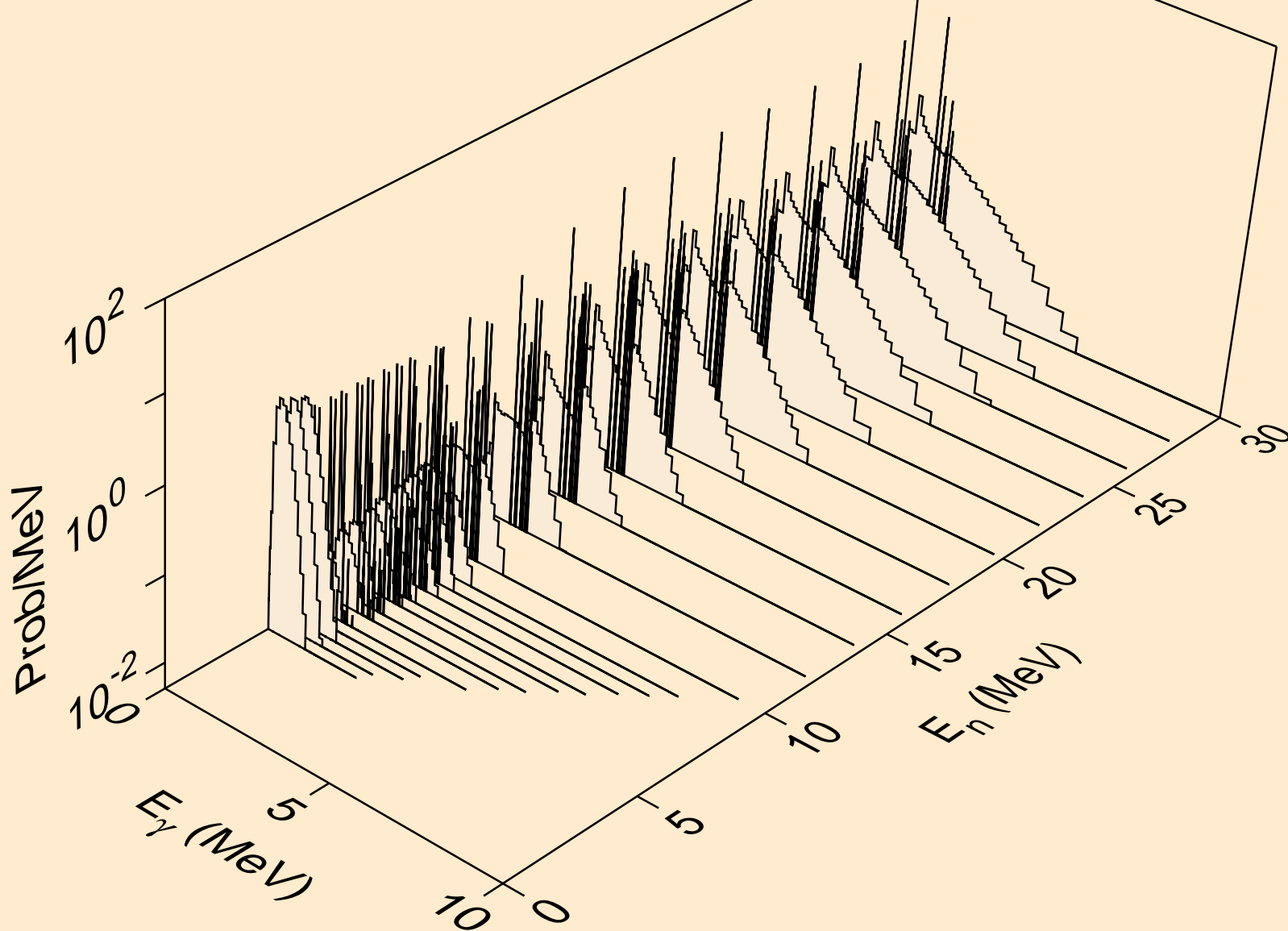

SM145 NEUTRON ACER TENDL-2019 LIBRARY; T=293.16K
Photon emission for (n,pd)

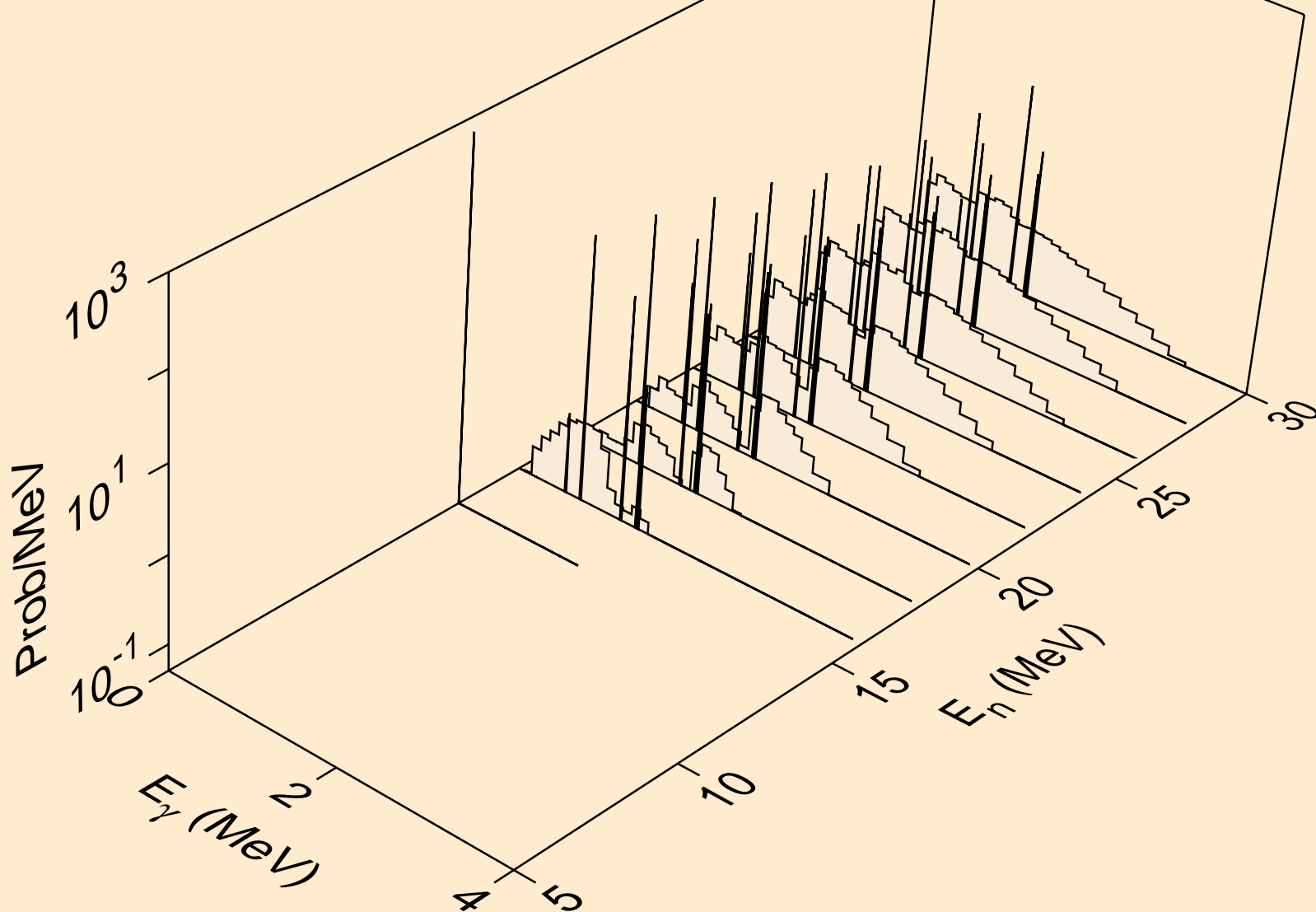

SM145 NEUTRON ACER TENDL-2019 LIBRARY; T=293.16K
Photon emission for (n,pt)

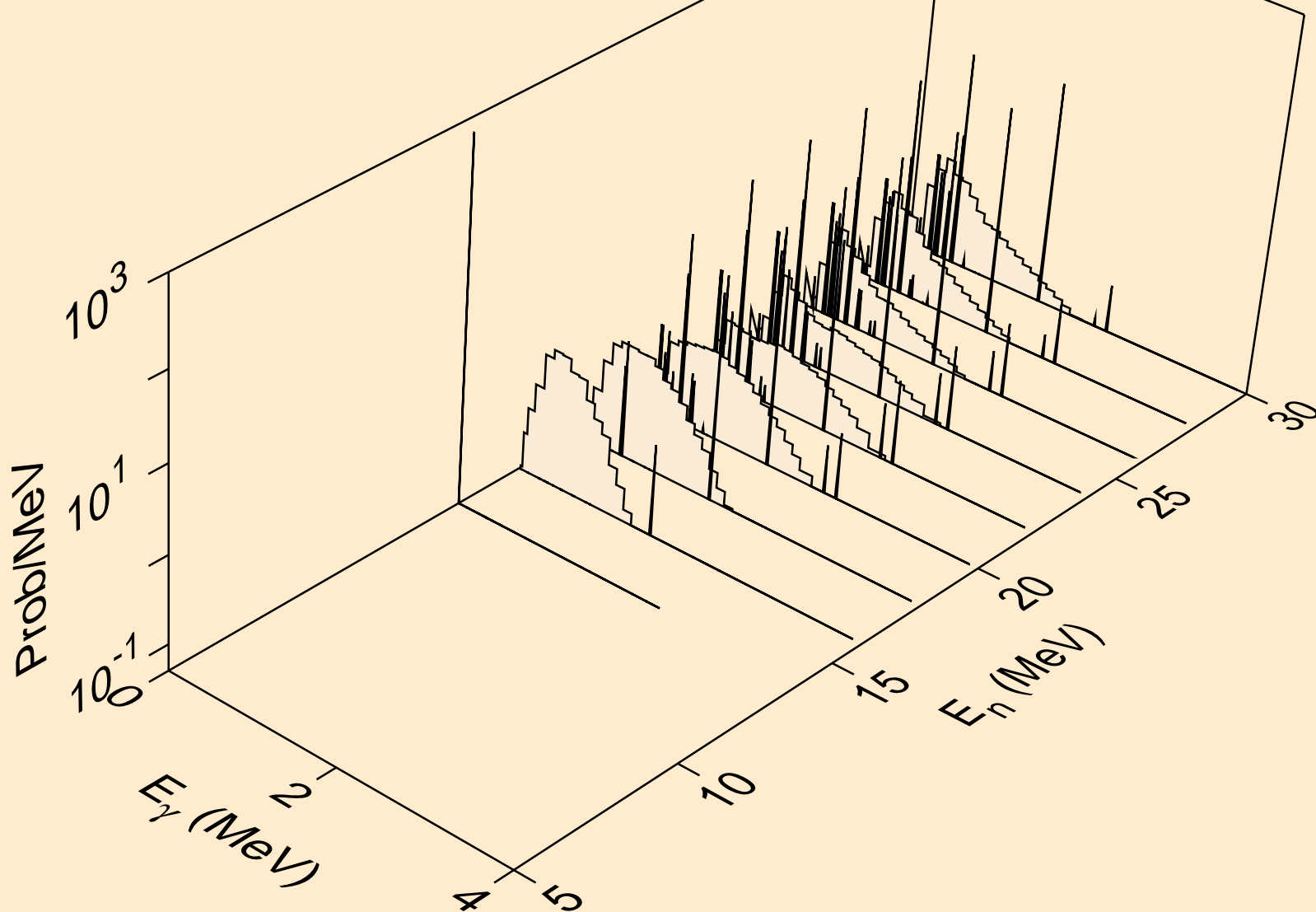

SM145 NEUTRON ACER TENDL-2019 LIBRARY; T=293.16K
Photon emission for (n,da)

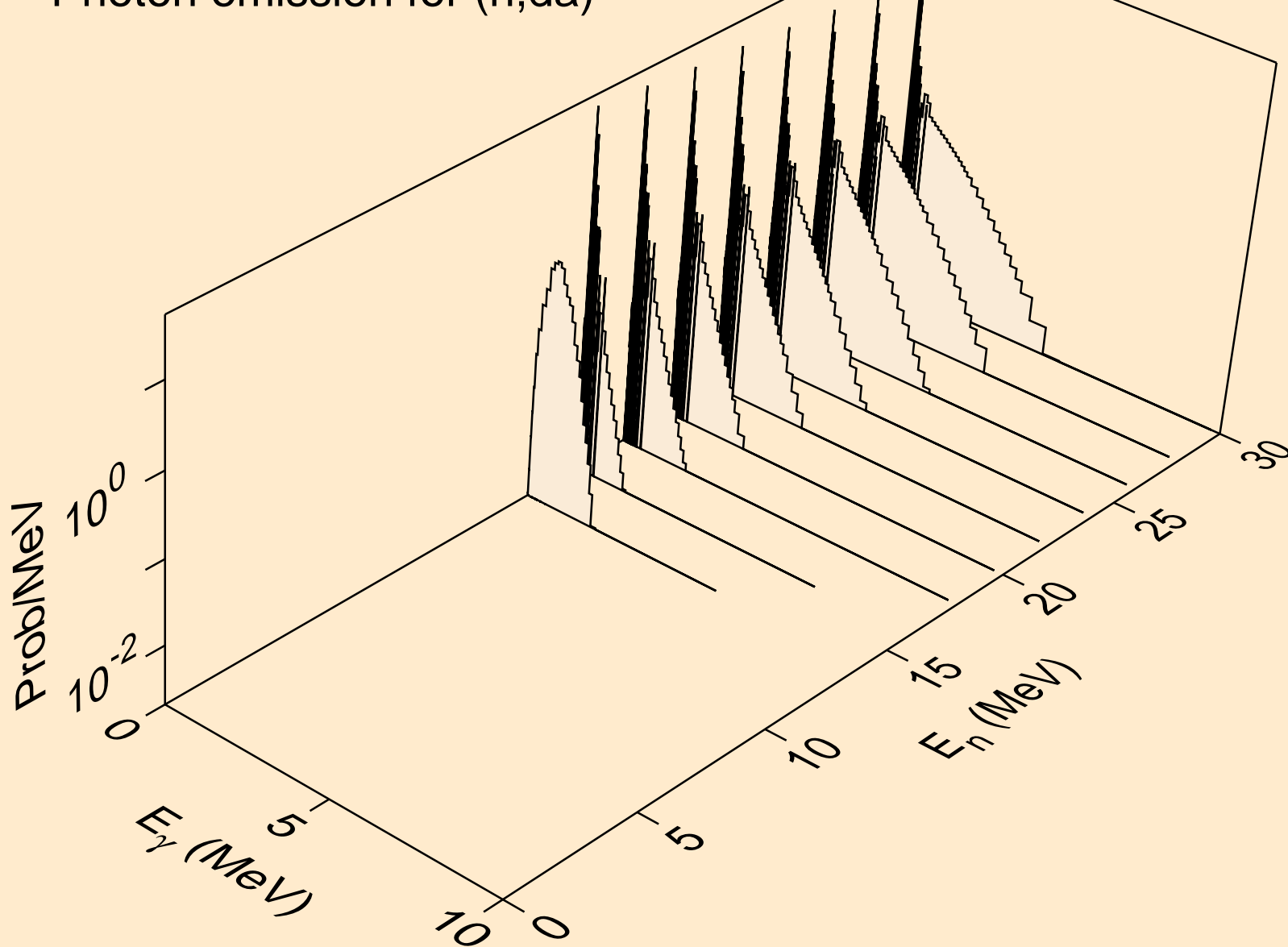

SM145 NEUTRON ACER TENDL-2019 LIBRARY; T=293.16K
thermal capture photon spectrum

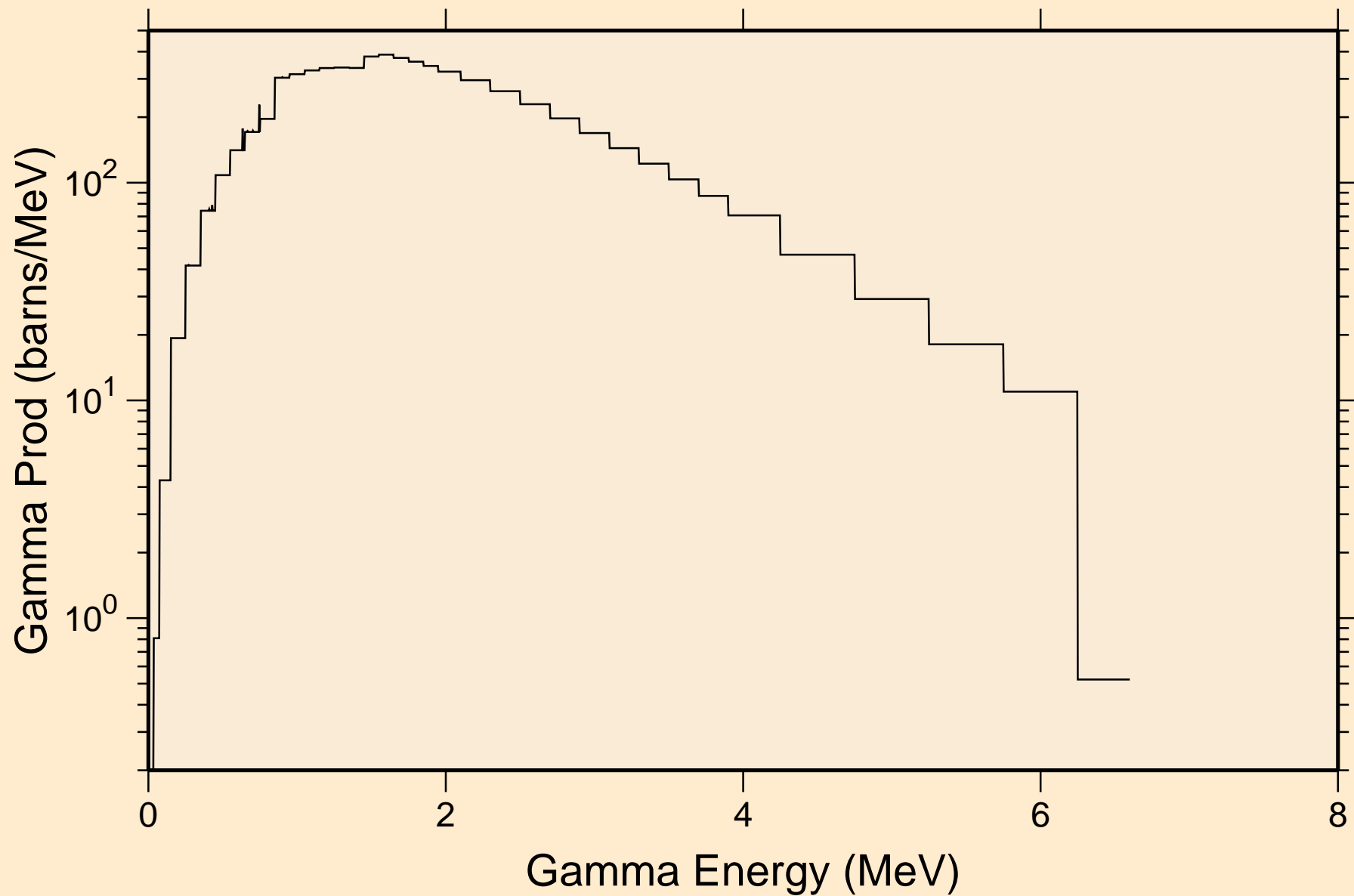

SM145 NEUTRON ACER TENDL-2019 LIBRARY; T=293.16K
14 MeV photon spectrum

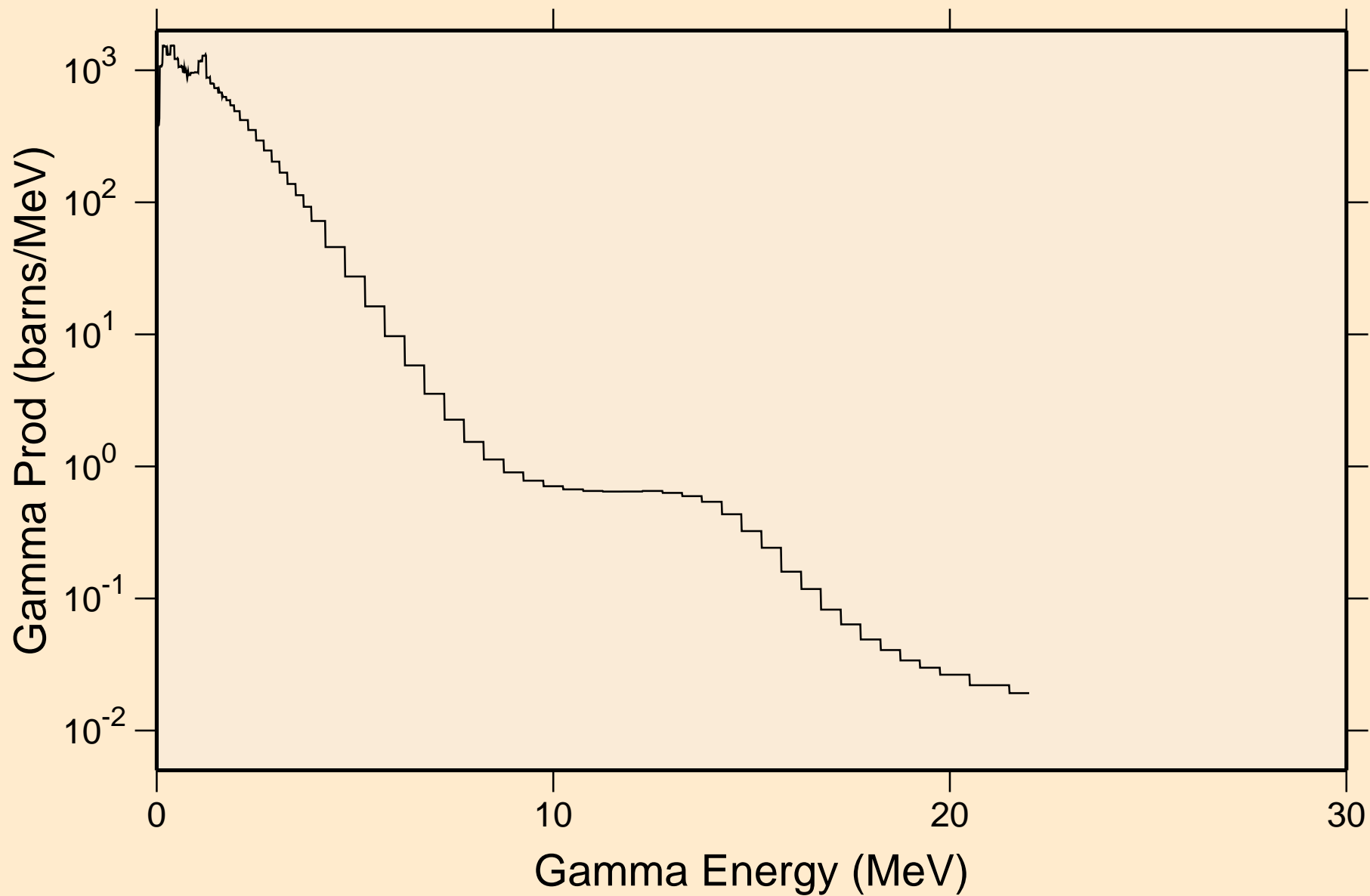

SM145 NEUTRON ACER TENDL-2019 LIBRARY; T=293.16K

Particle heating contributions

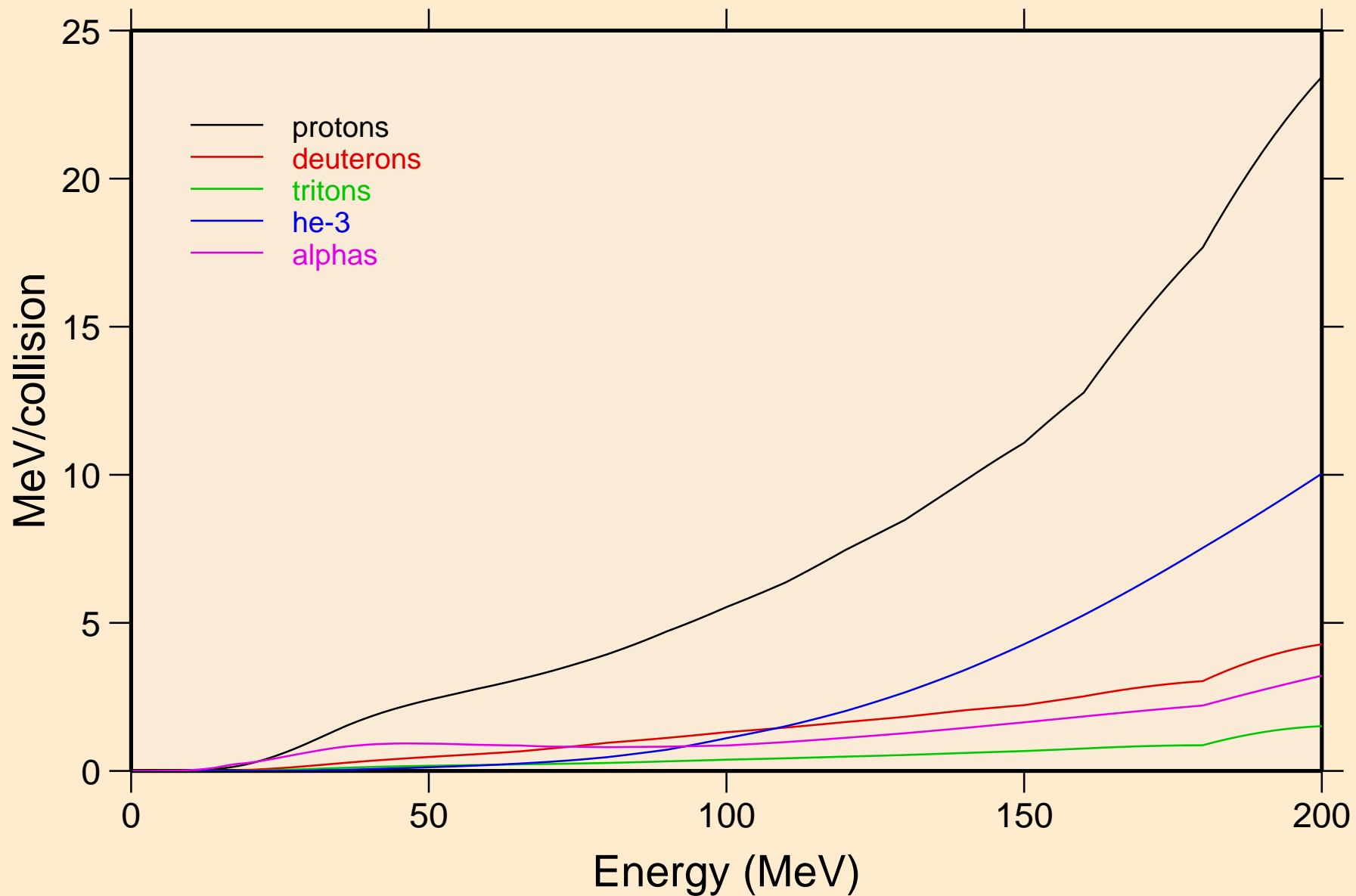

SM145 NEUTRON ACER TENDL-2019 LIBRARY; T=293.16K
Recoil Heating

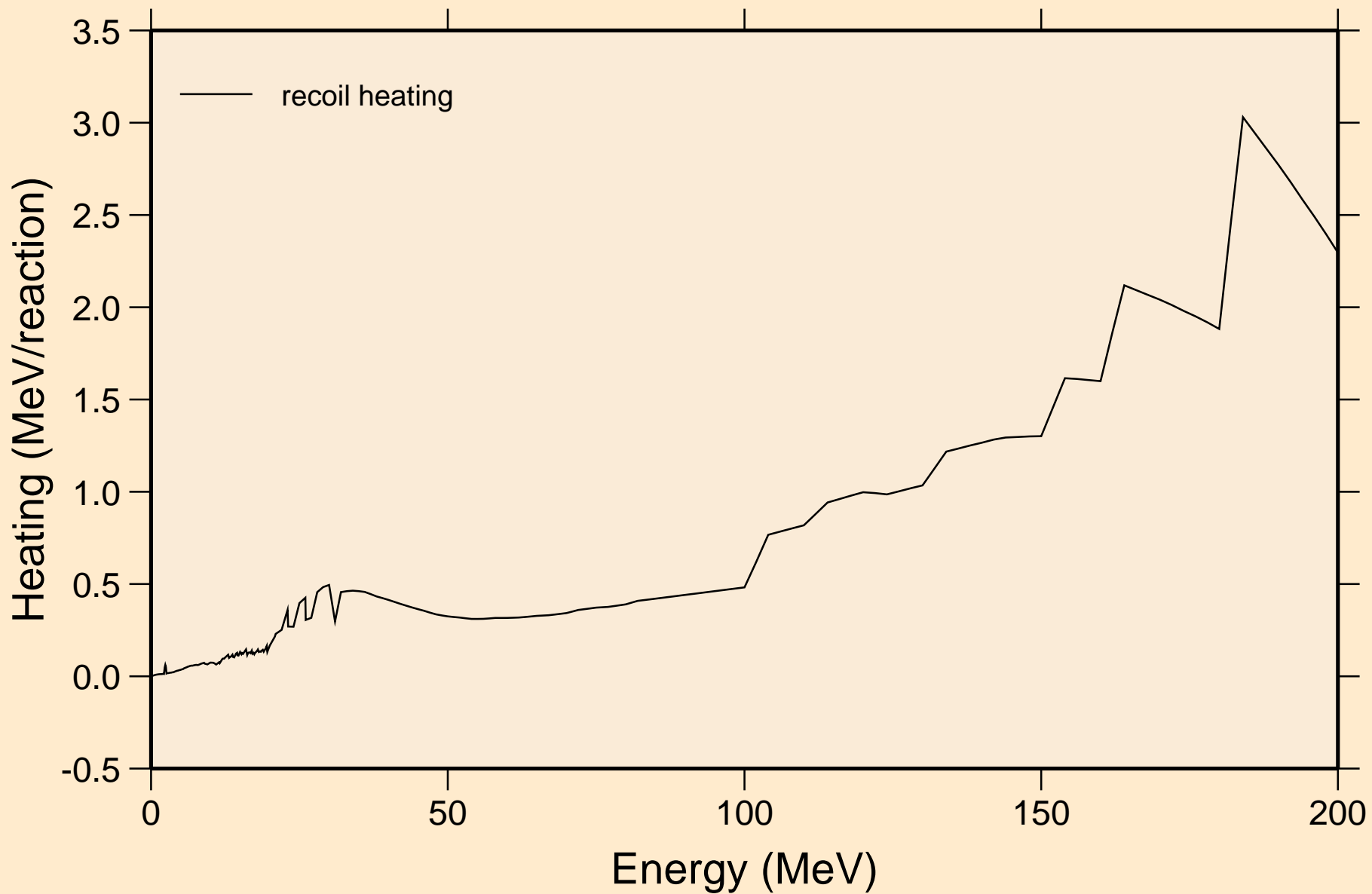

SM145 NEUTRON ACER TENDL-2019 LIBRARY; T=293.16K
Particle production cross sections

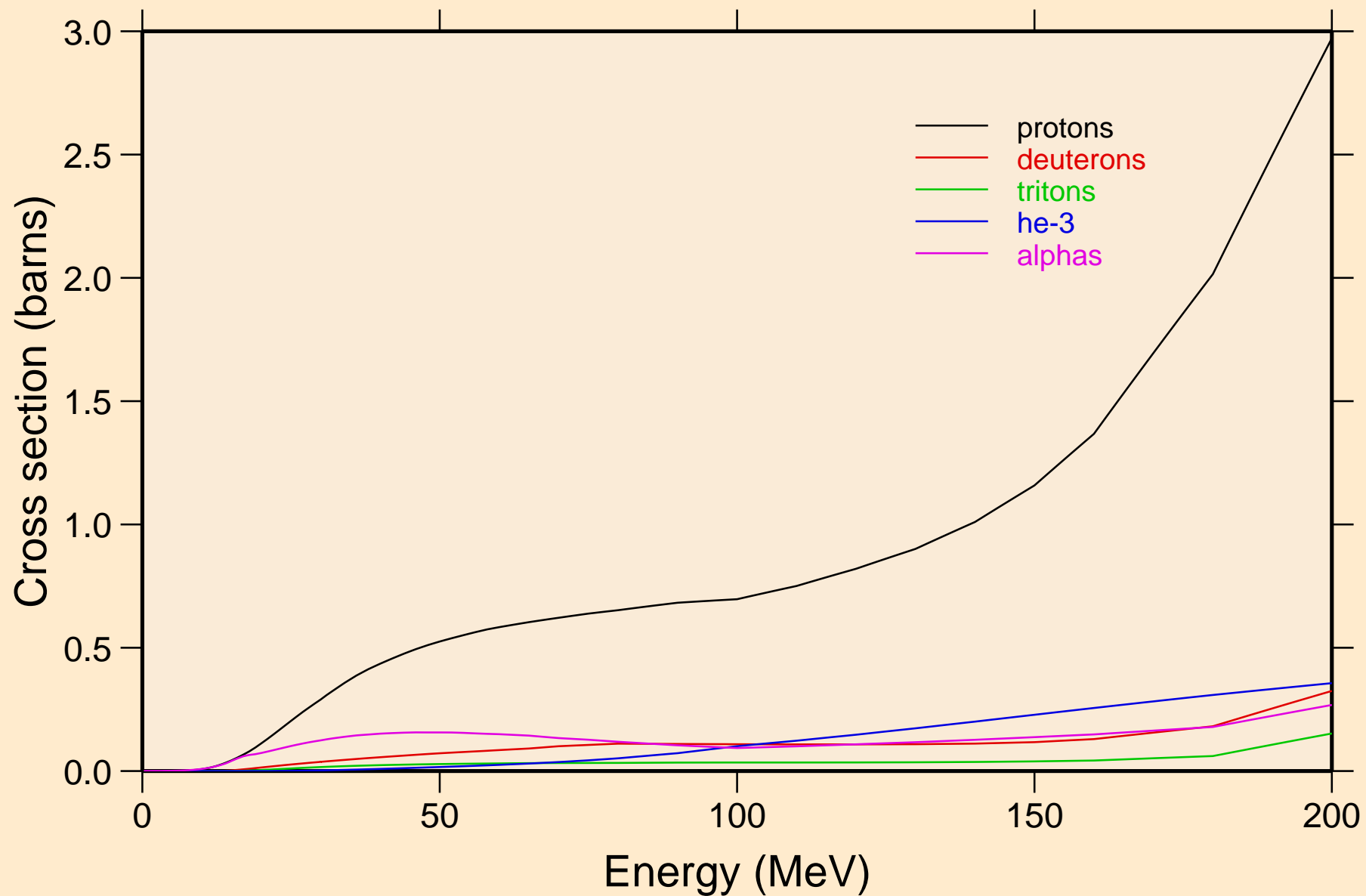

SM145 NEUTRON ACER TENDL-2019 LIBRARY; T=293.16K
protons from (n,x)

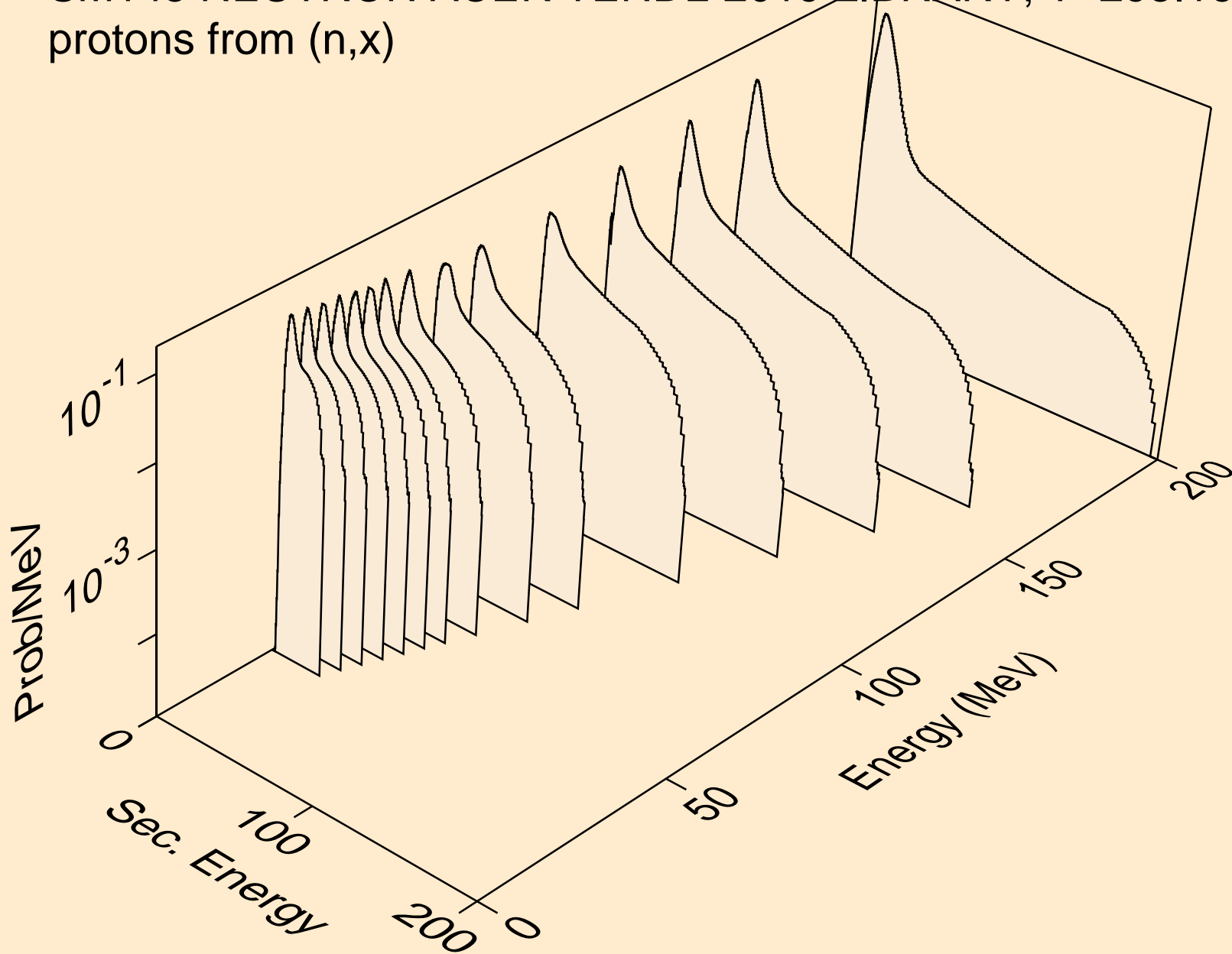

SM145 NEUTRON ACER TENDL-2019 LIBRARY; T=293.16K
protons from (n,n*)p

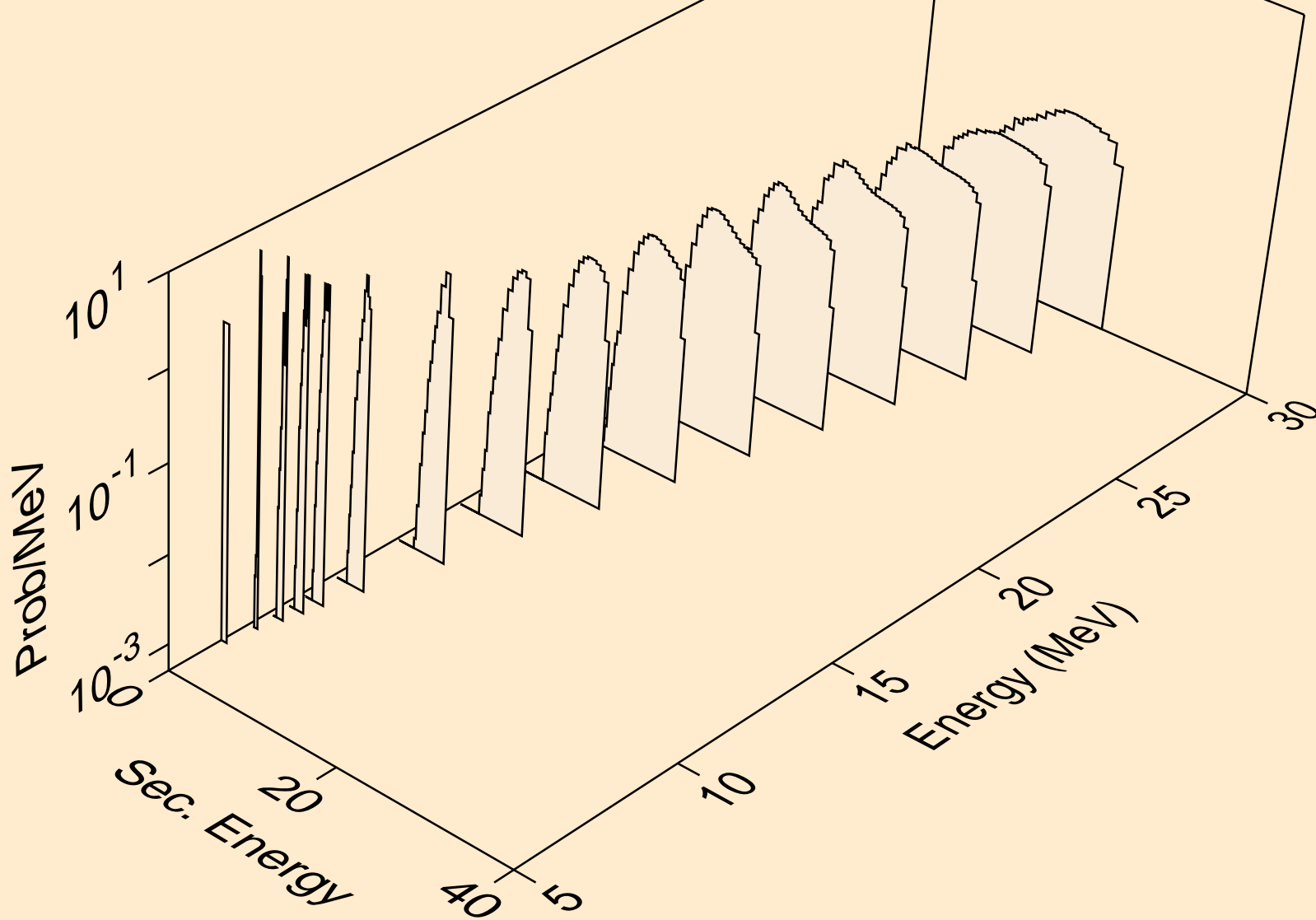

SM145 NEUTRON ACER TENDL-2019 LIBRARY; T=293.16K
protons from (n,2np)

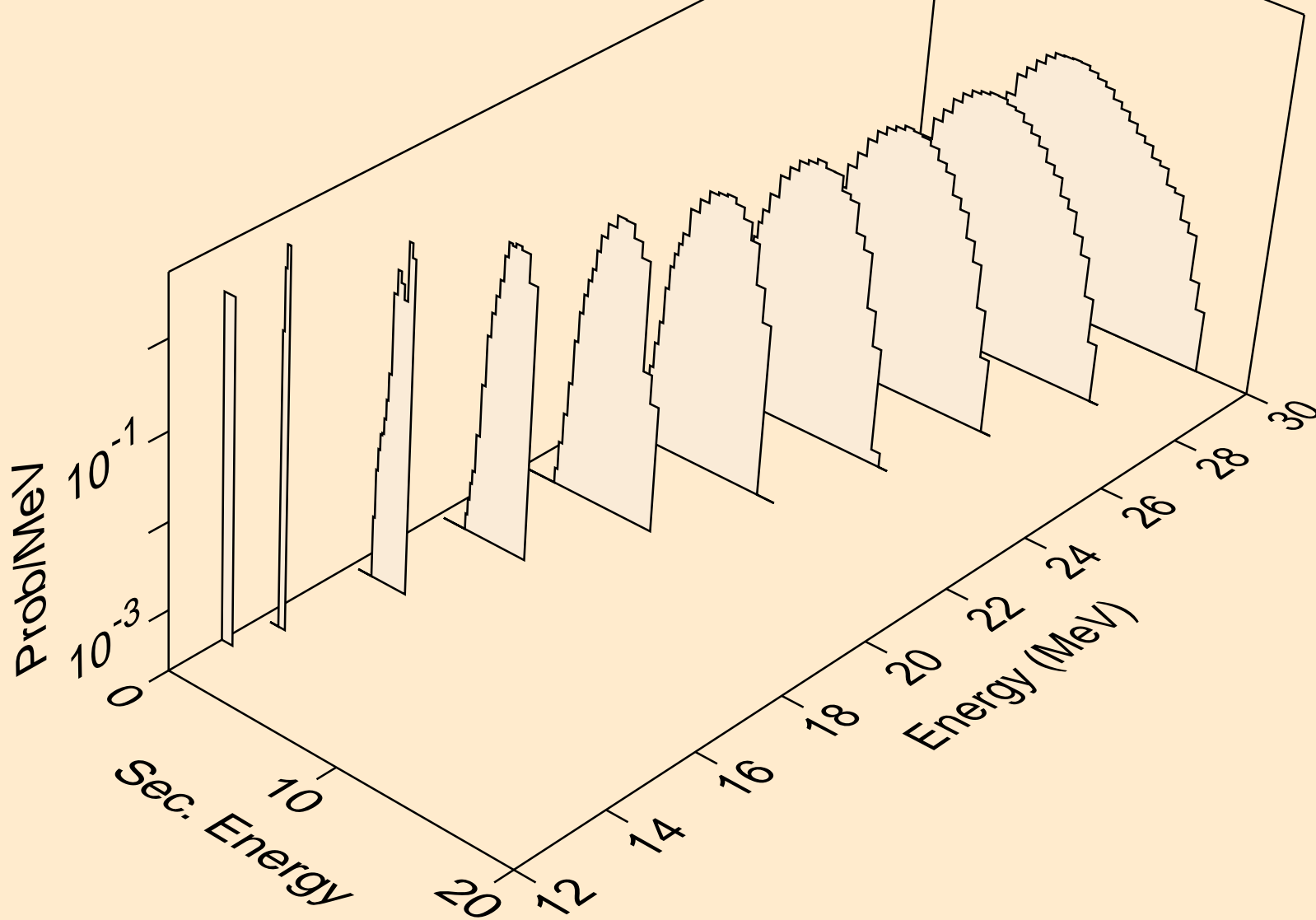

SM145 NEUTRON ACER TENDL-2019 LIBRARY; T=293.16K
protons from (n,3np)

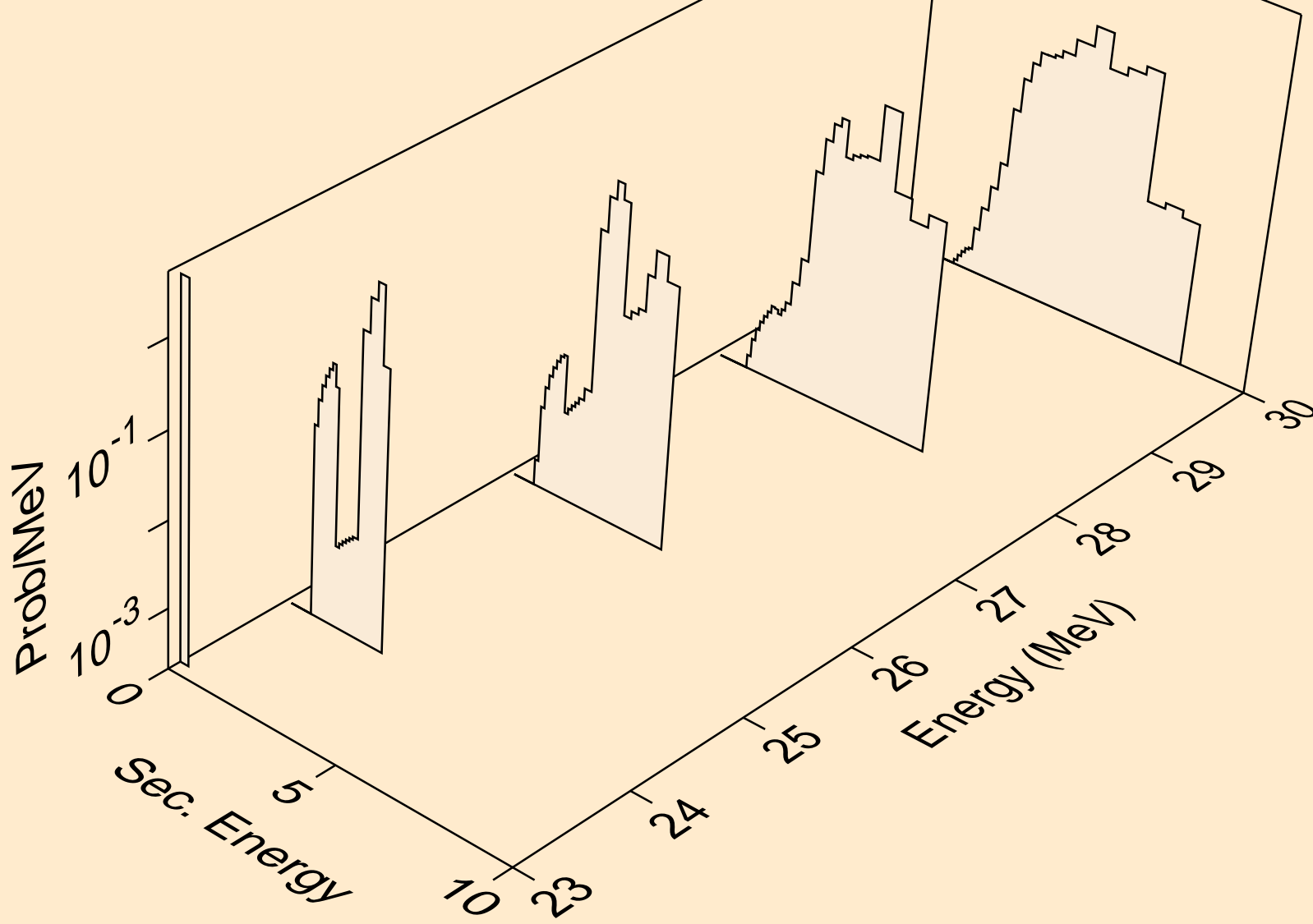

SM145 NEUTRON ACER TENDL-2019 LIBRARY; T=293.16K
protons from (n,2np)

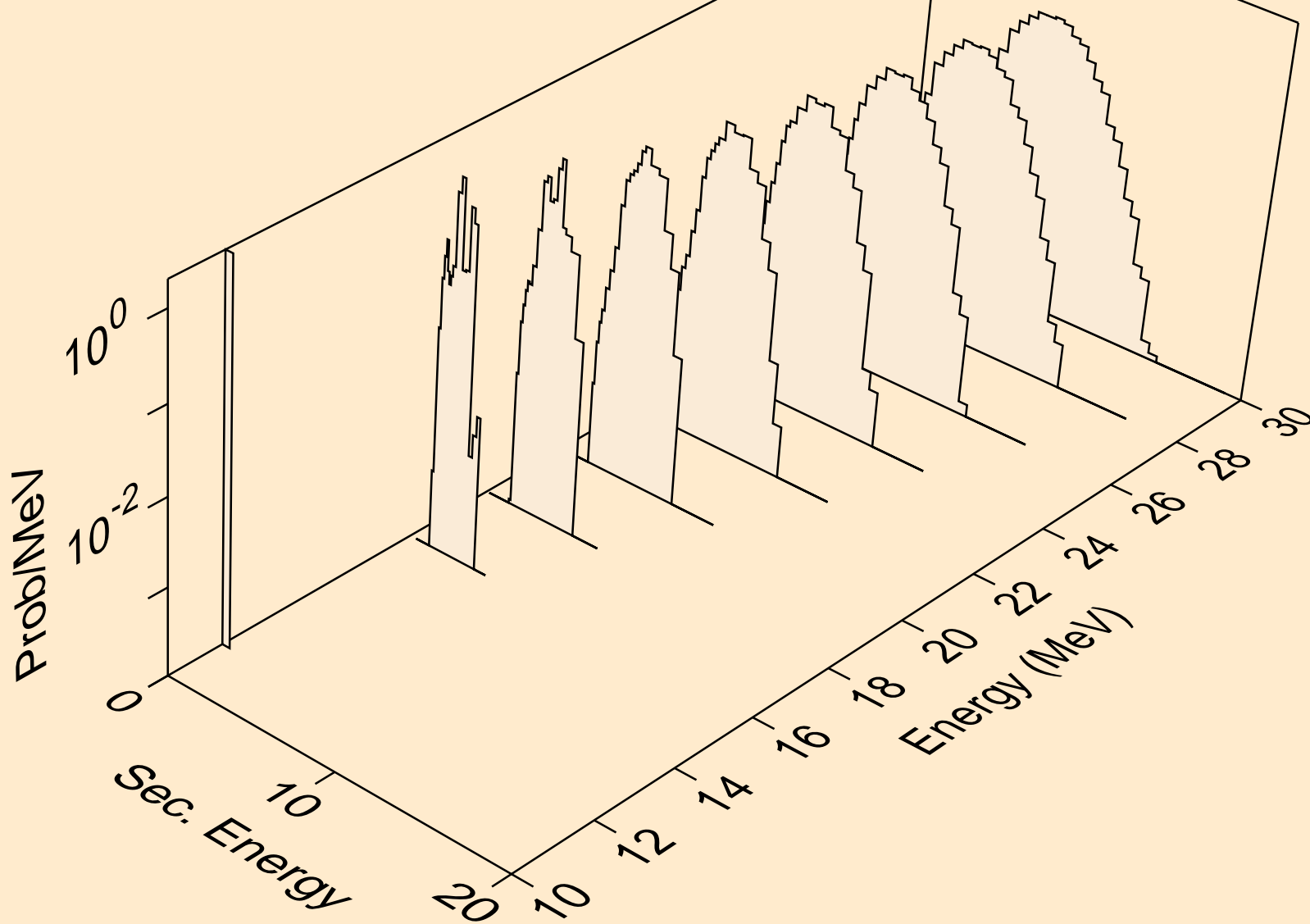

SM145 NEUTRON ACER TENDL-2019 LIBRARY; T=293.16K
protons from (n,npa)

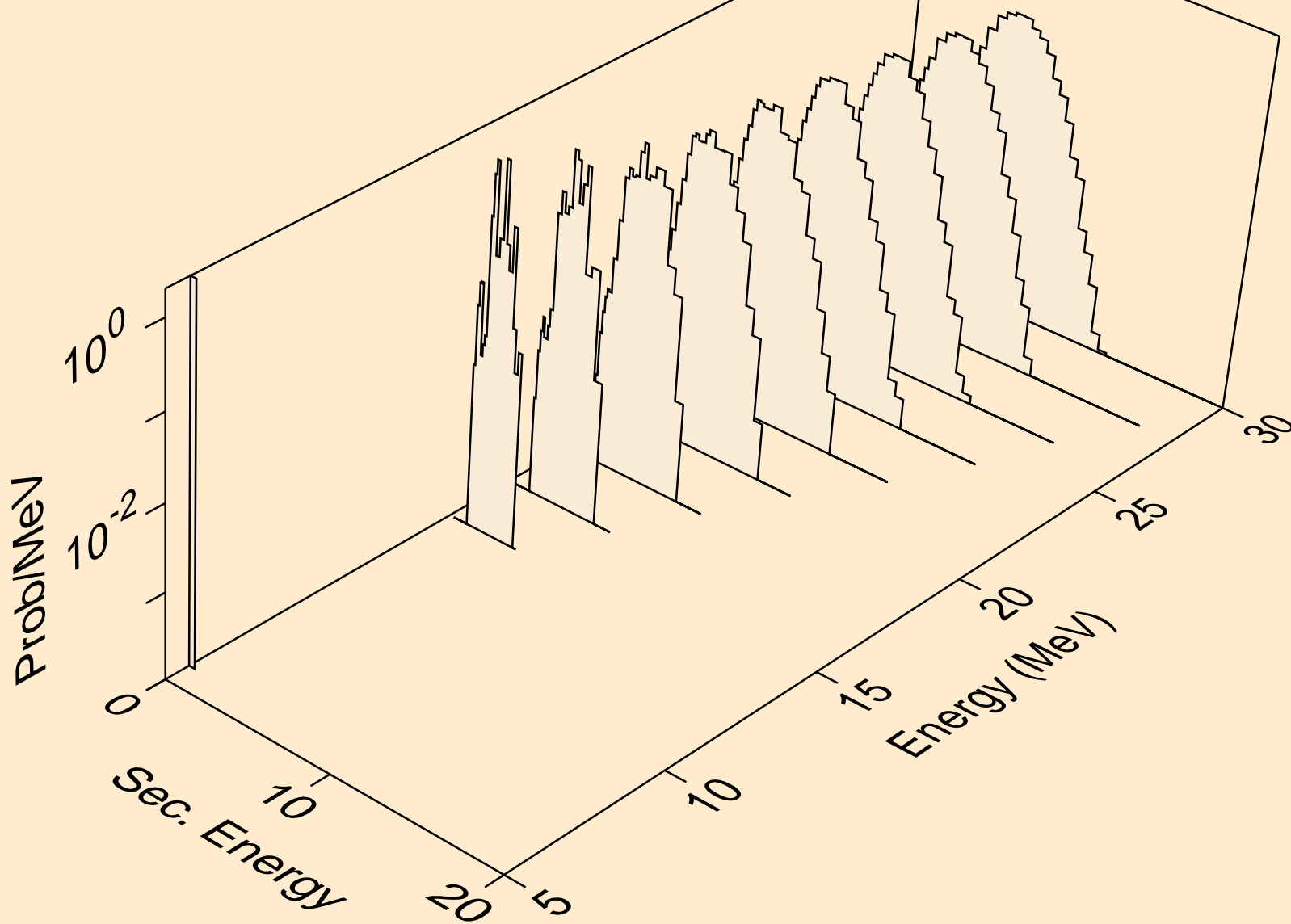

SM145 NEUTRON ACER TENDL-2019 LIBRARY; T=293.16K
protons from (n,p)

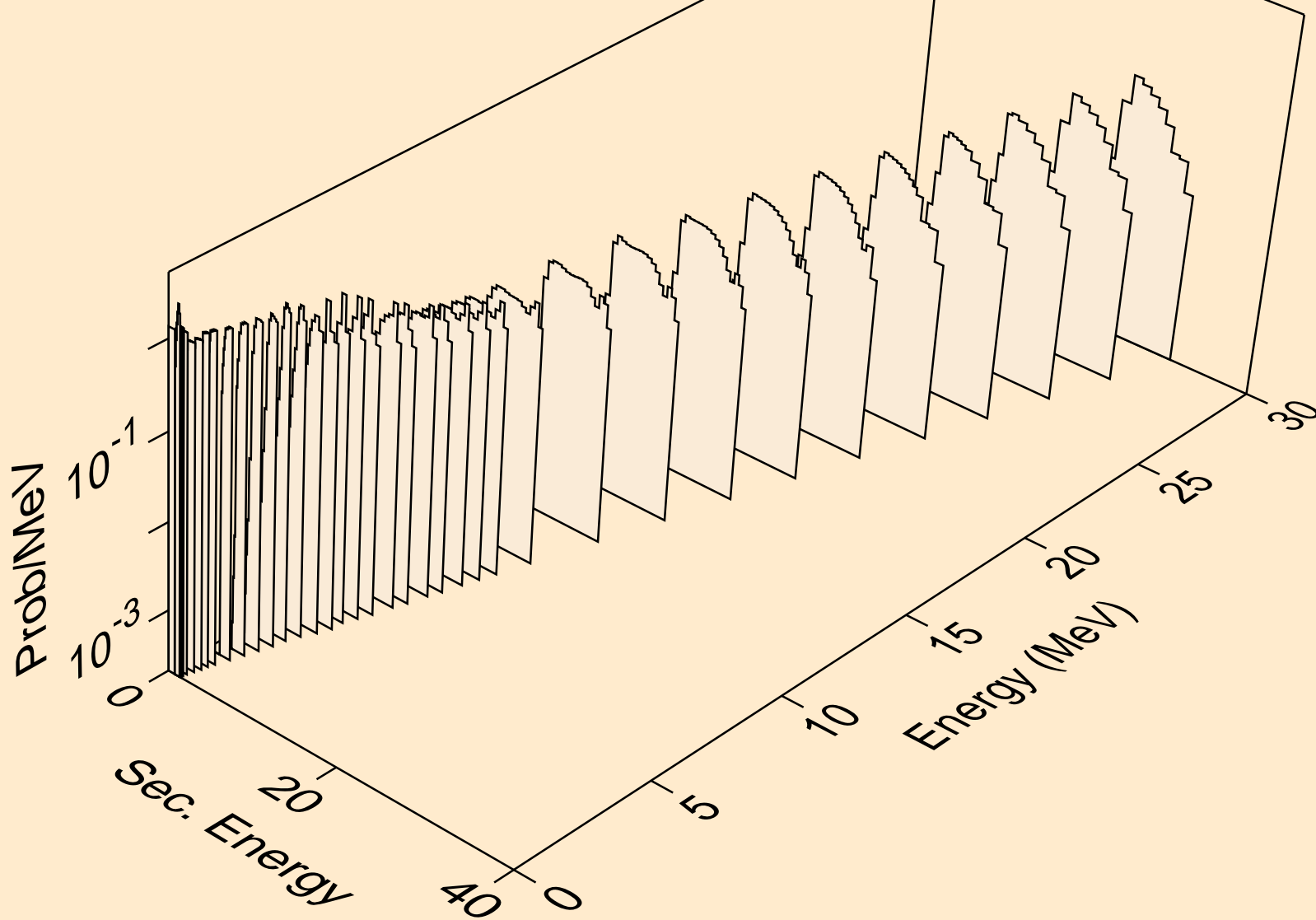

SM145 NEUTRON ACER TENDL-2019 LIBRARY; T=293.16K
protons from (n,2p)

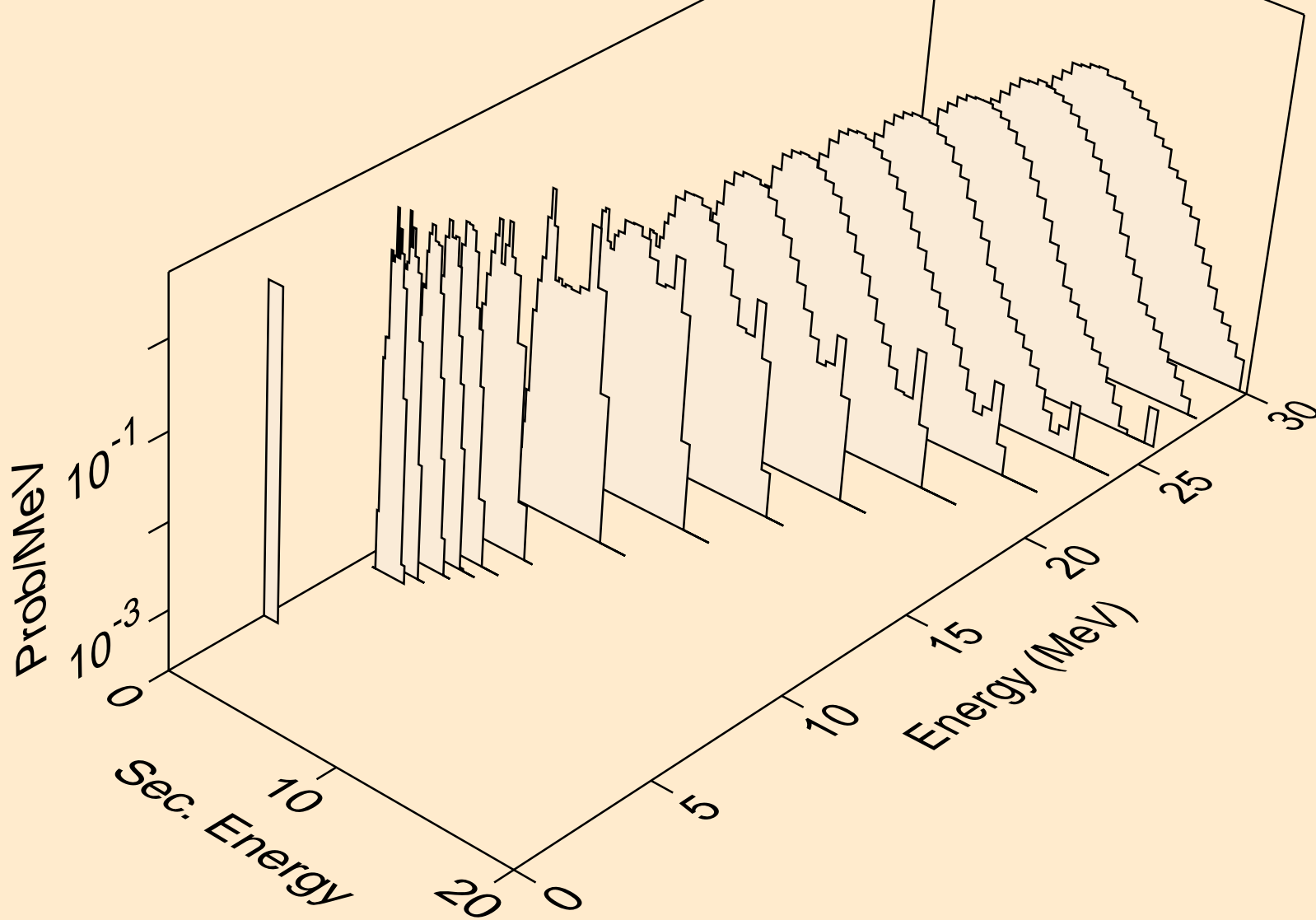

SM145 NEUTRON ACER TENDL-2019 LIBRARY; T=293.16K
protons from (n,p)

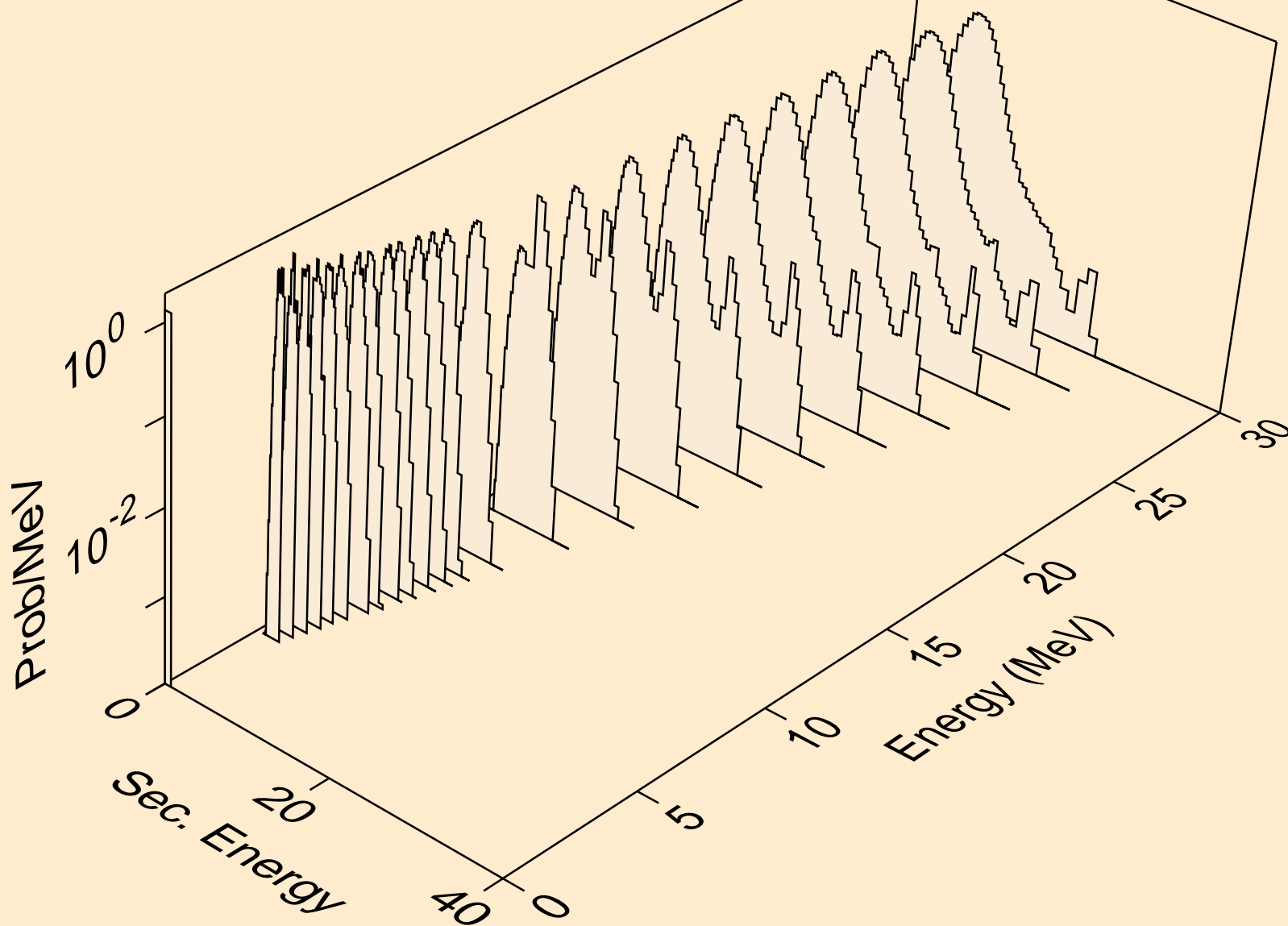

SM145 NEUTRON ACER TENDL-2019 LIBRARY; T=293.16K
protons from (n,pd)

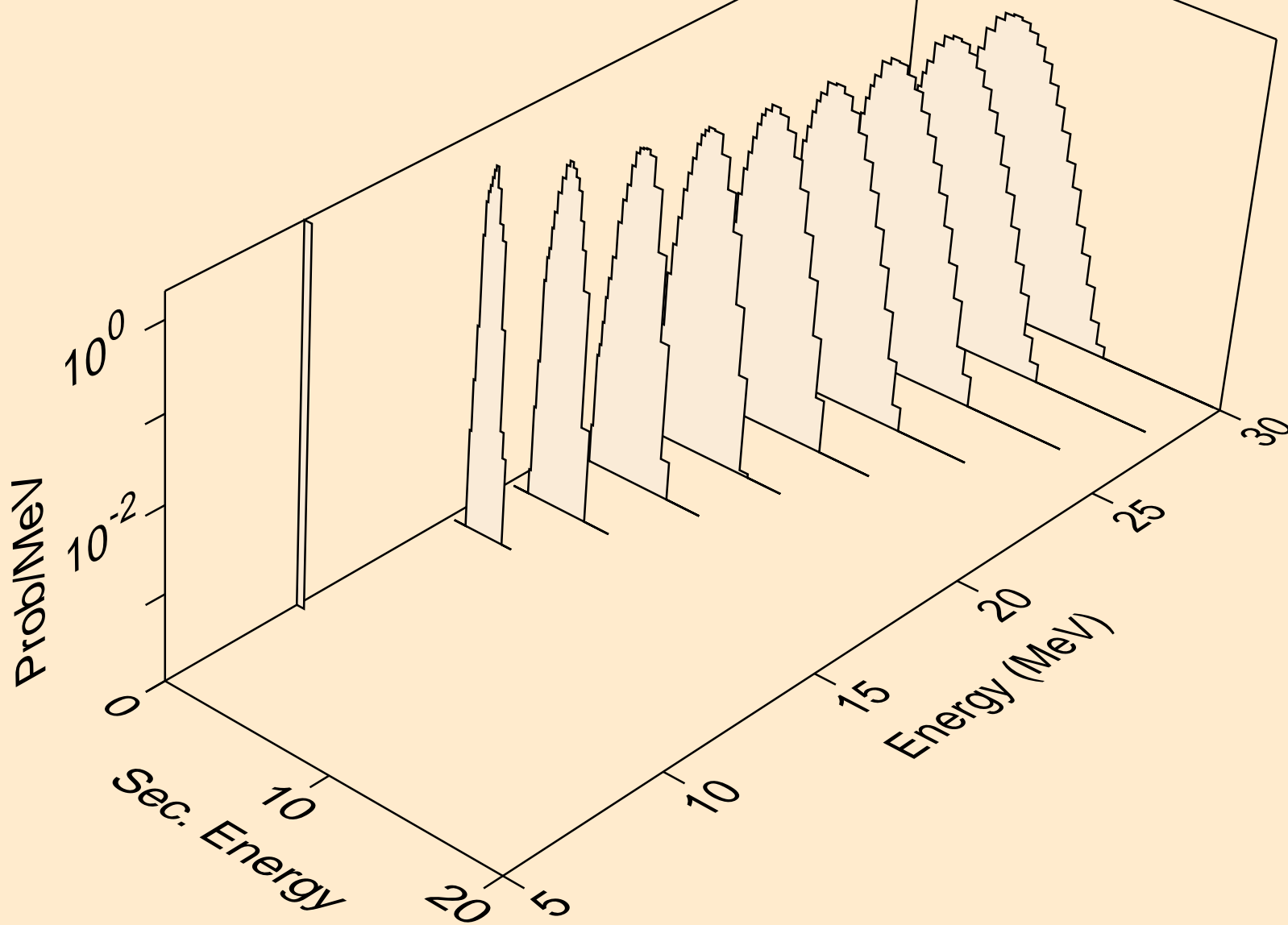

SM145 NEUTRON ACER TENDL-2019 LIBRARY; T=293.16K
protons from (n,pt)

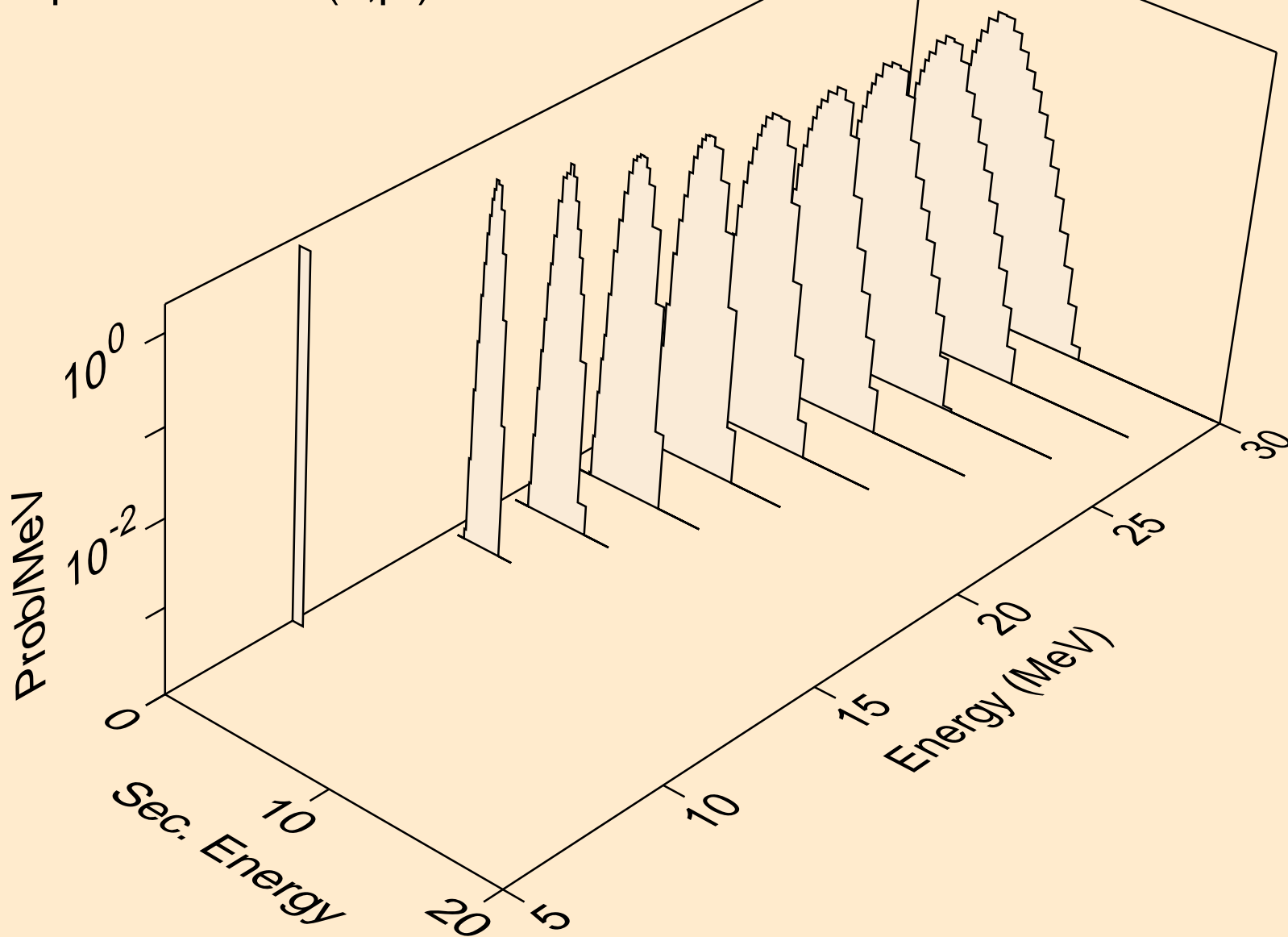

SM145 NEUTRON ACER TENDL-2019 LIBRARY; T=293.16K
deuterons from (n,x)

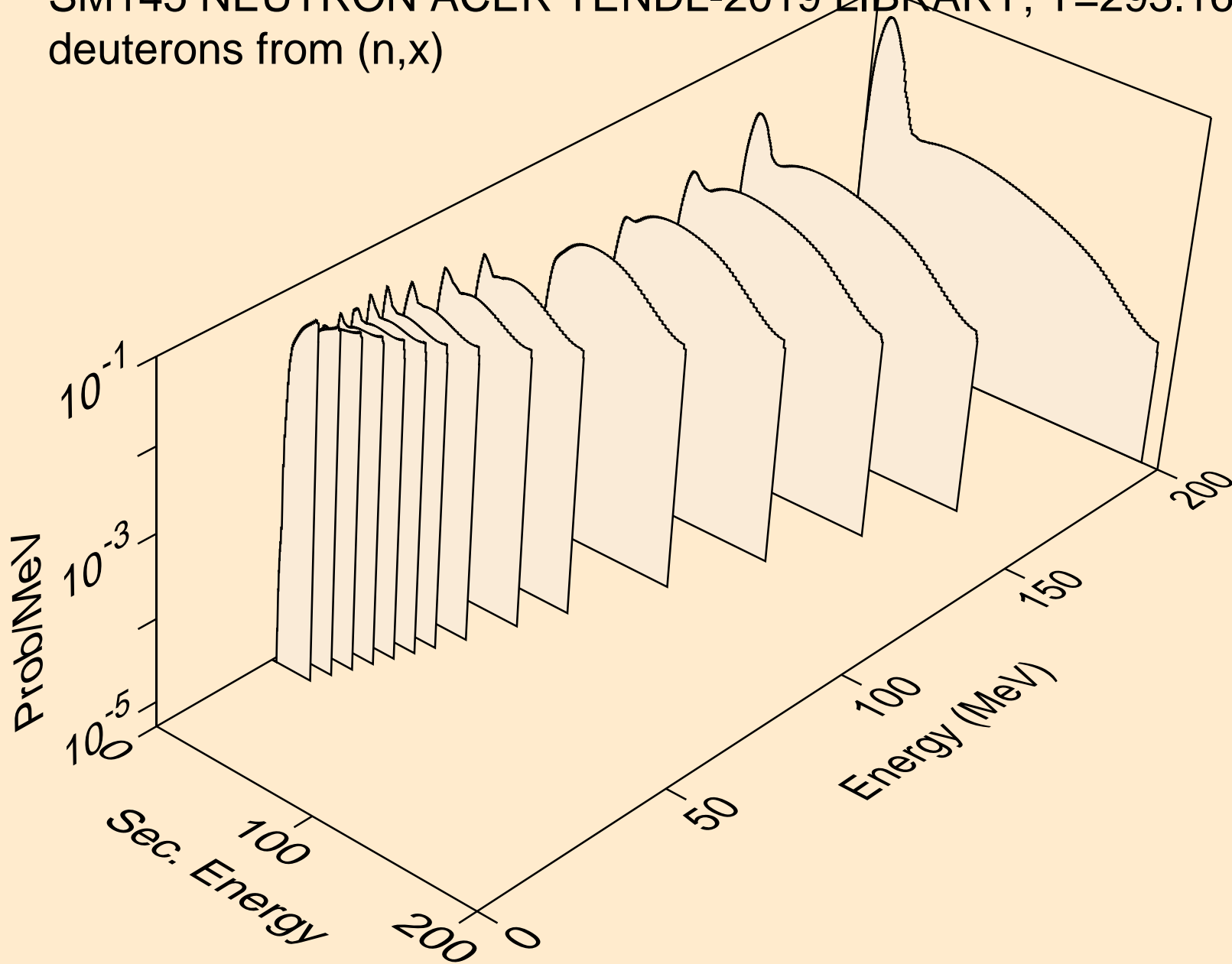

SM145 NEUTRON ACER TENDL-2019 LIBRARY; T=293.16K
deuterons from (n,2nd)

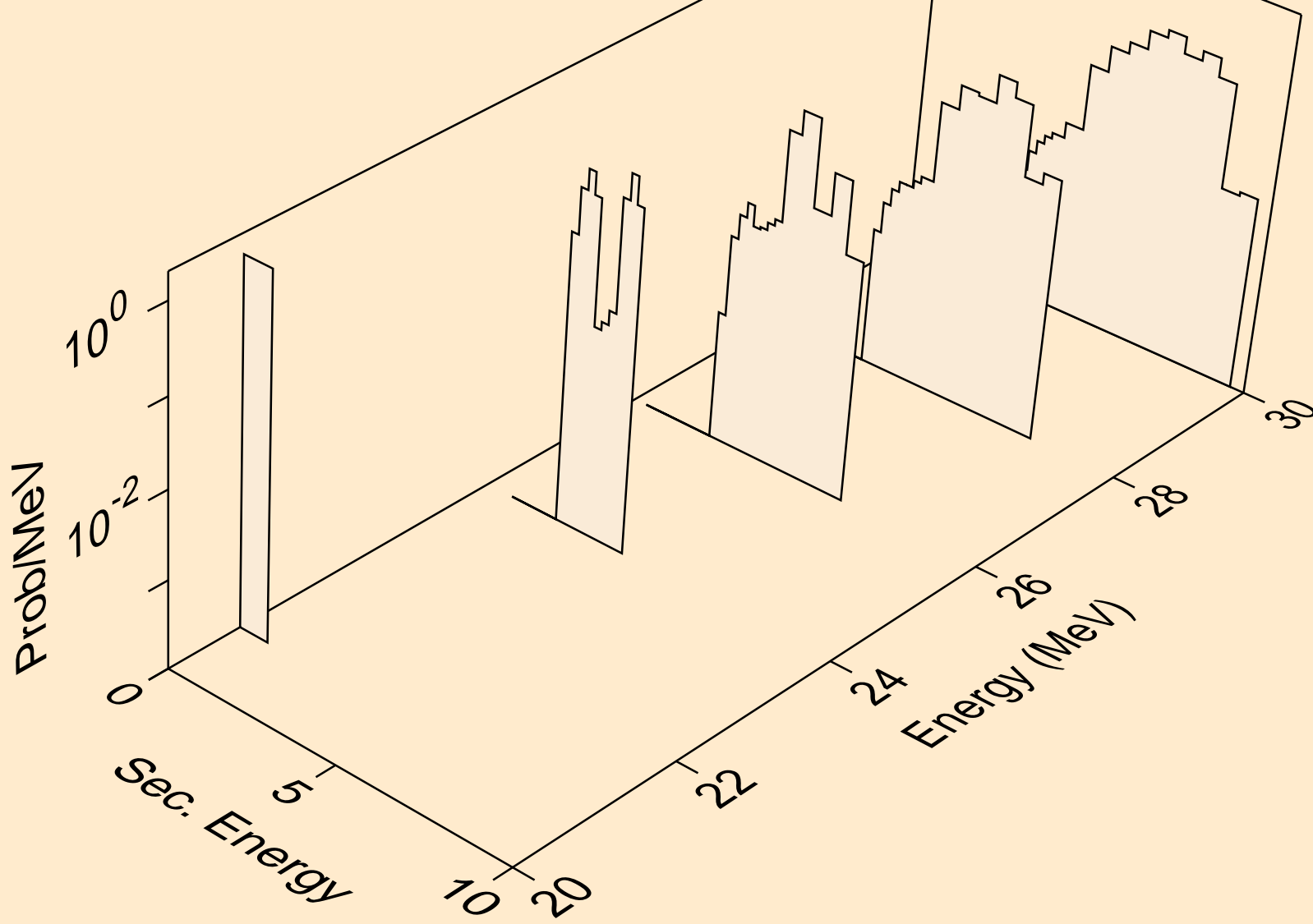

SM145 NEUTRON ACER TENDL-2019 LIBRARY; T=293.16K
deuterons from (n,n*)d

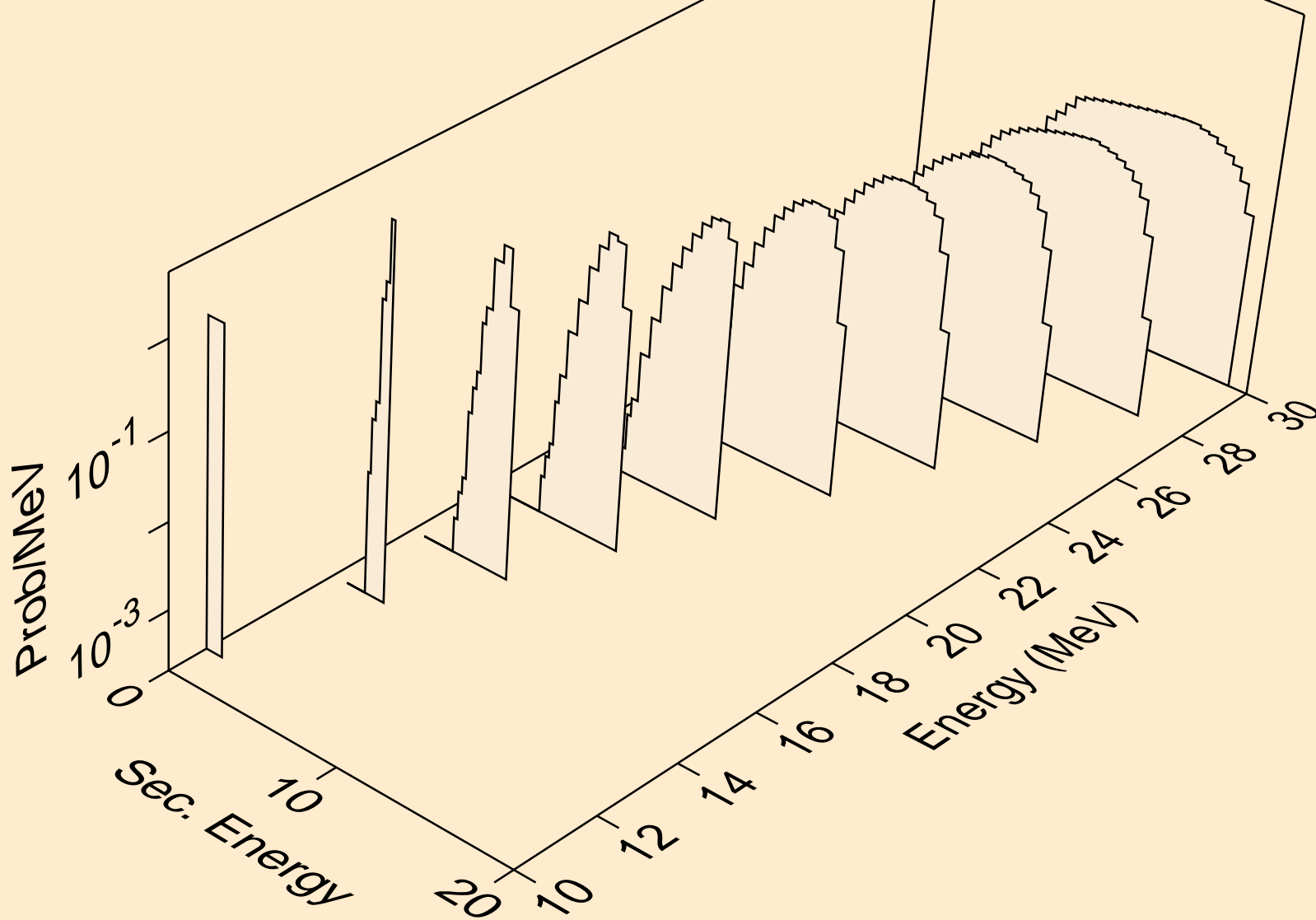

SM145 NEUTRON ACER TENDL-2019 LIBRARY; T=293.16K
deuterons from (n,d)

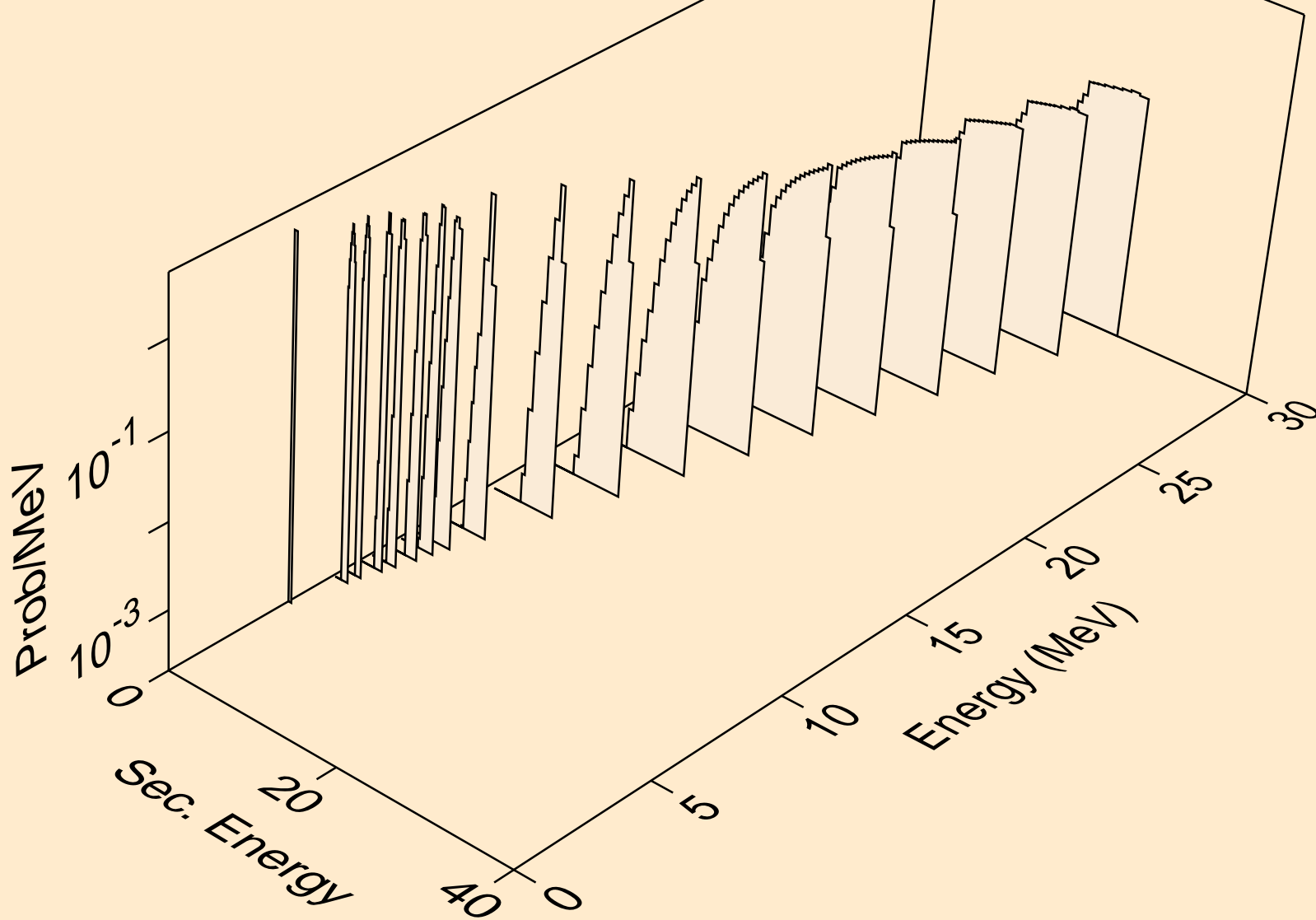

SM145 NEUTRON ACER TENDL-2019 LIBRARY; T=293.16K
deuterons from (n,pd)

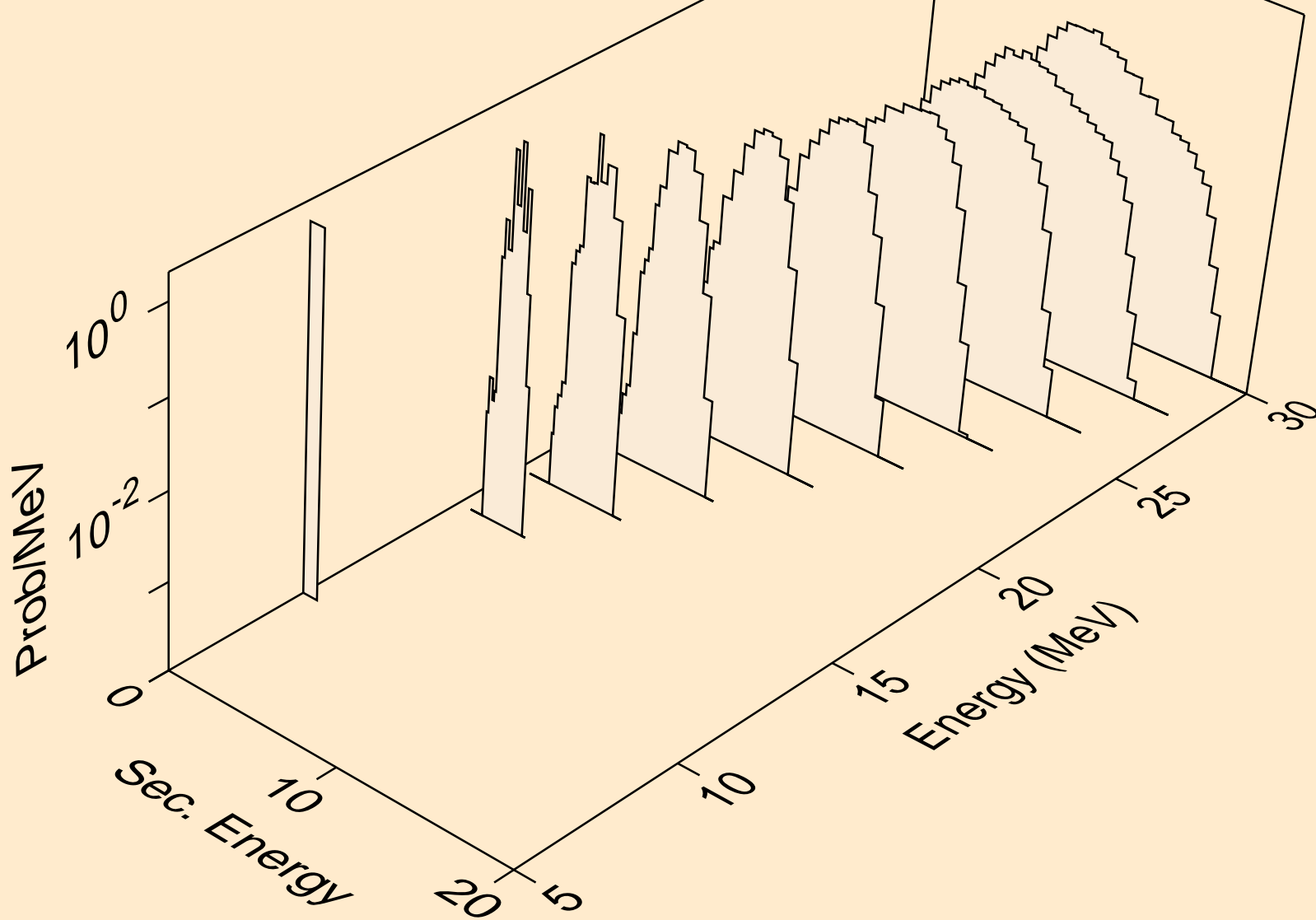

SM145 NEUTRON ACER TENDL-2019 LIBRARY; T=293.16K
deuterons from (n,da)

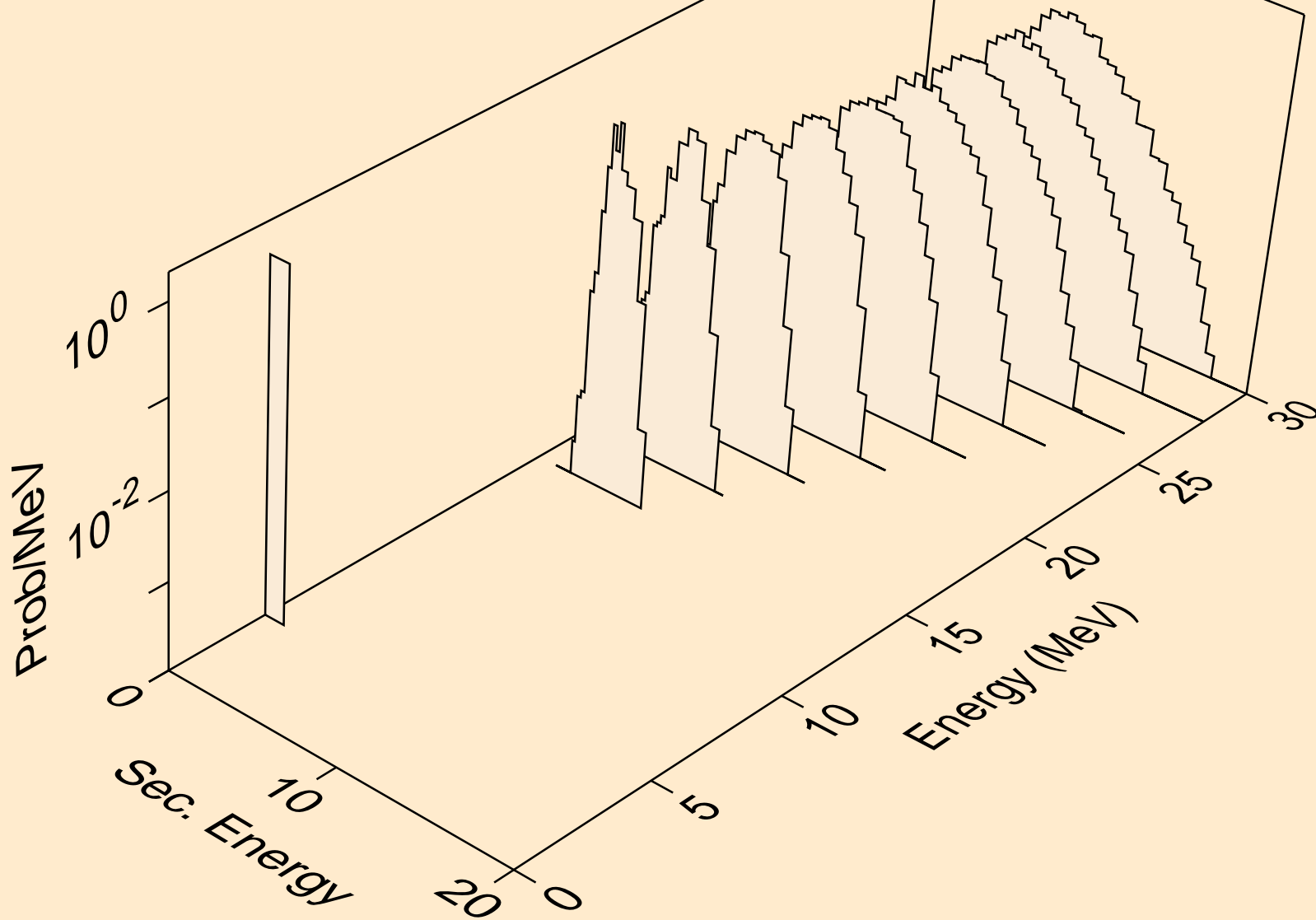

SM145 NEUTRON ACER TENDL-2019 LIBRARY; T=293.16K
tritons from (n,x)

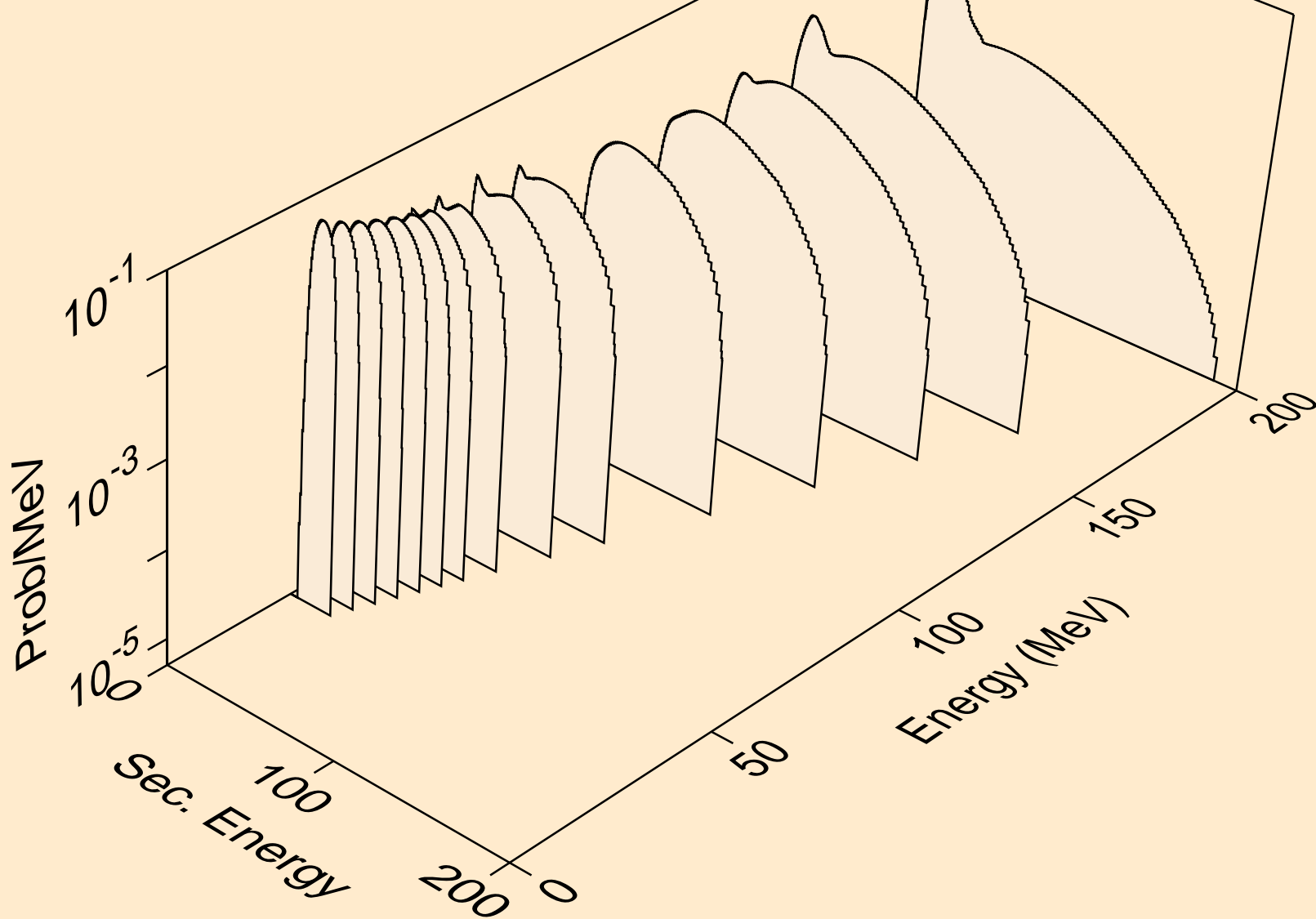

SM145 NEUTRON ACER TENDL-2019 LIBRARY; T=293.16K
tritons from (n,n*)t

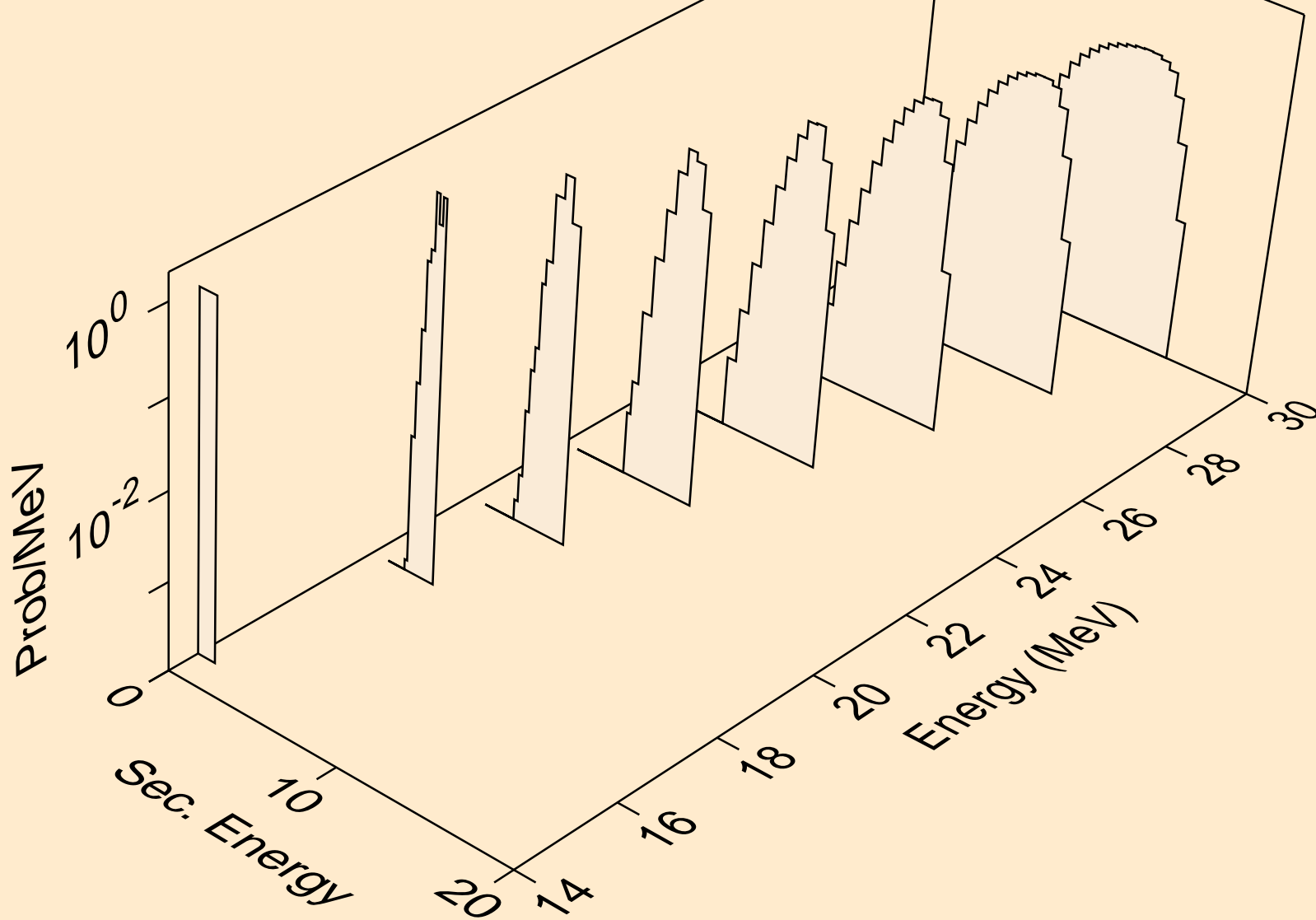

SM145 NEUTRON ACER TENDL-2019 LIBRARY; T=293.16K
tritons from (n,t)

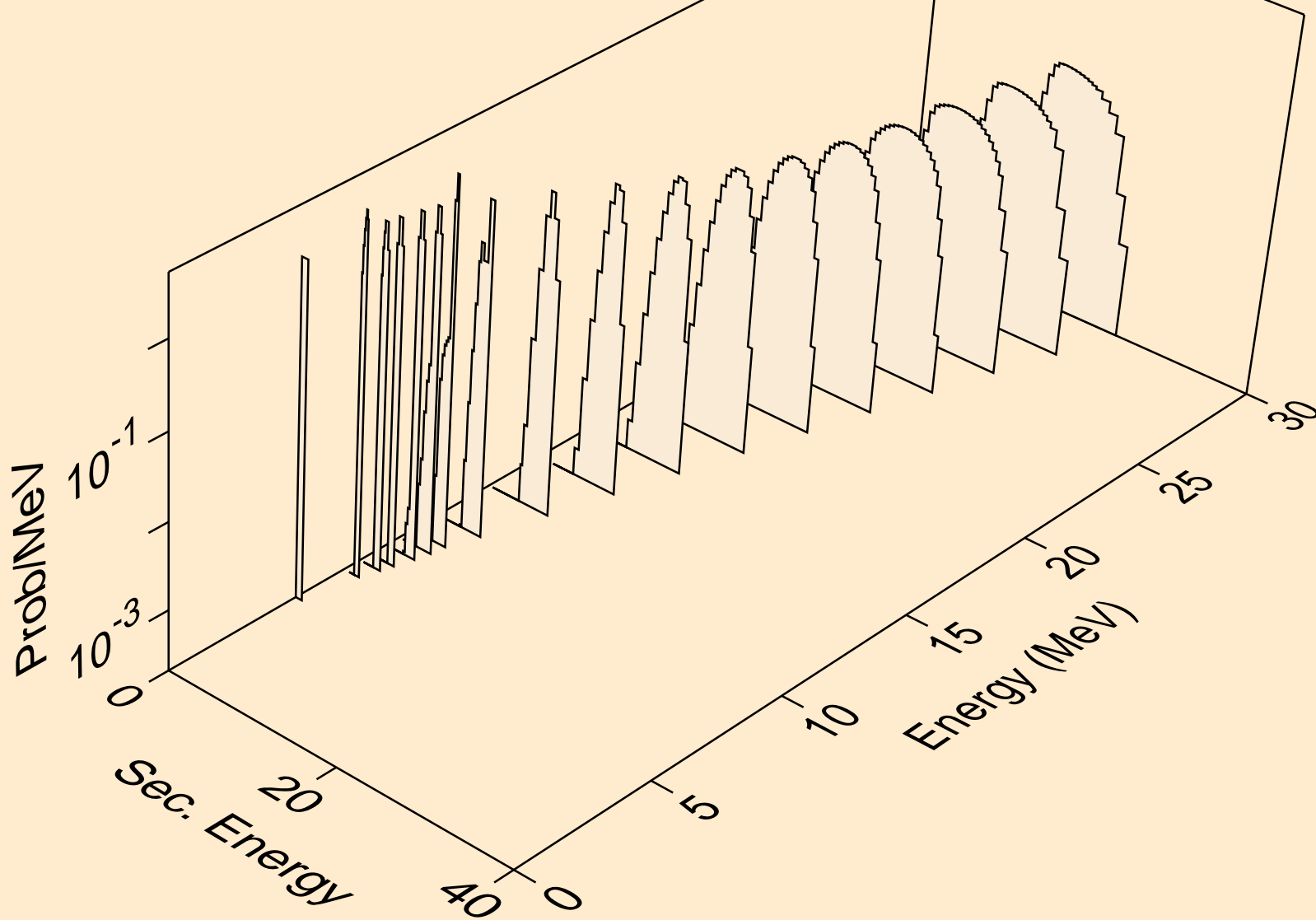

SM145 NEUTRON ACER TENDL-2019 LIBRARY; T=293.16K
tritons from (n,pt)

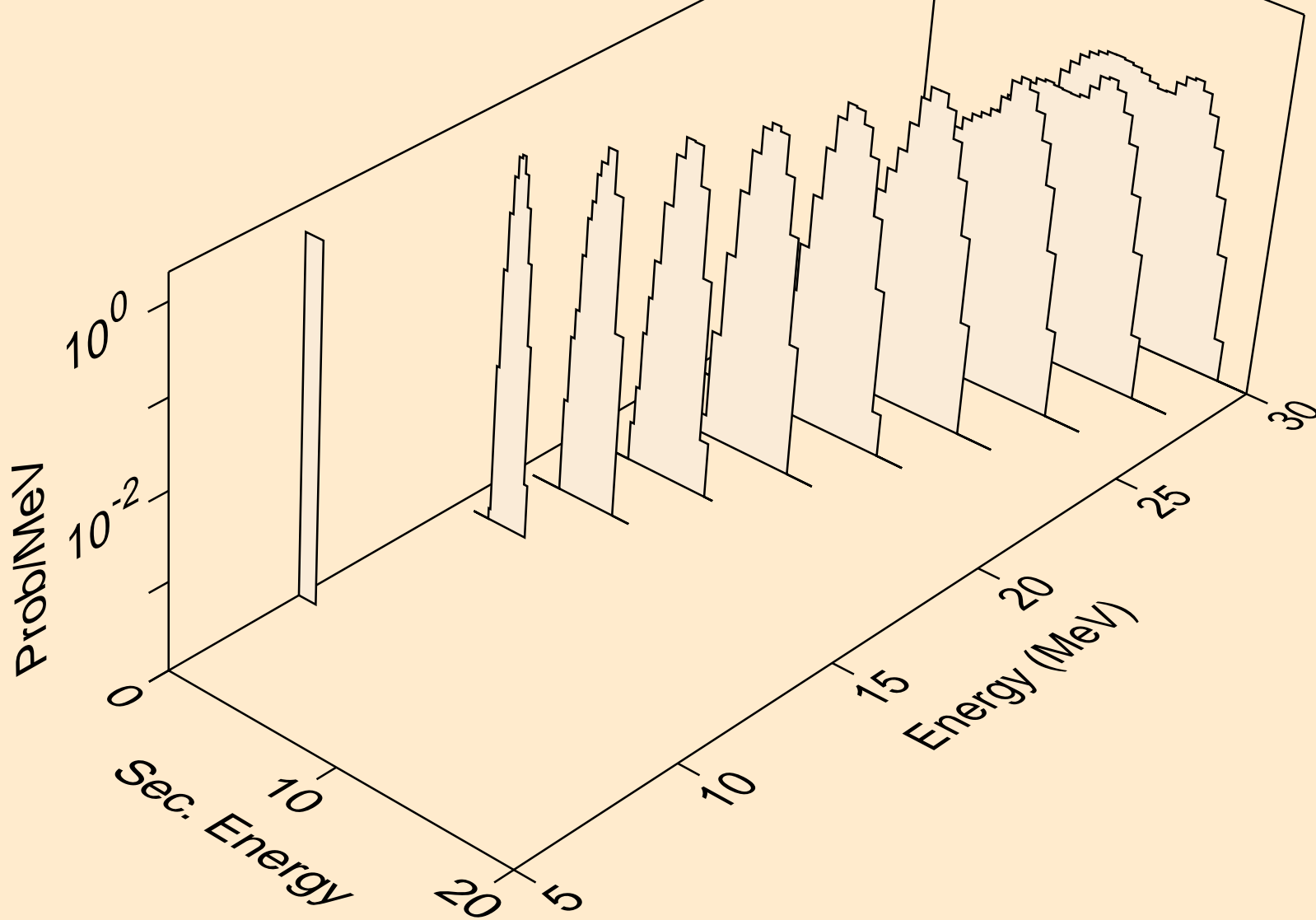

SM145 NEUTRON ACER TENDL-2019 LIBRARY; T=293.16K
he3s from (n,x)

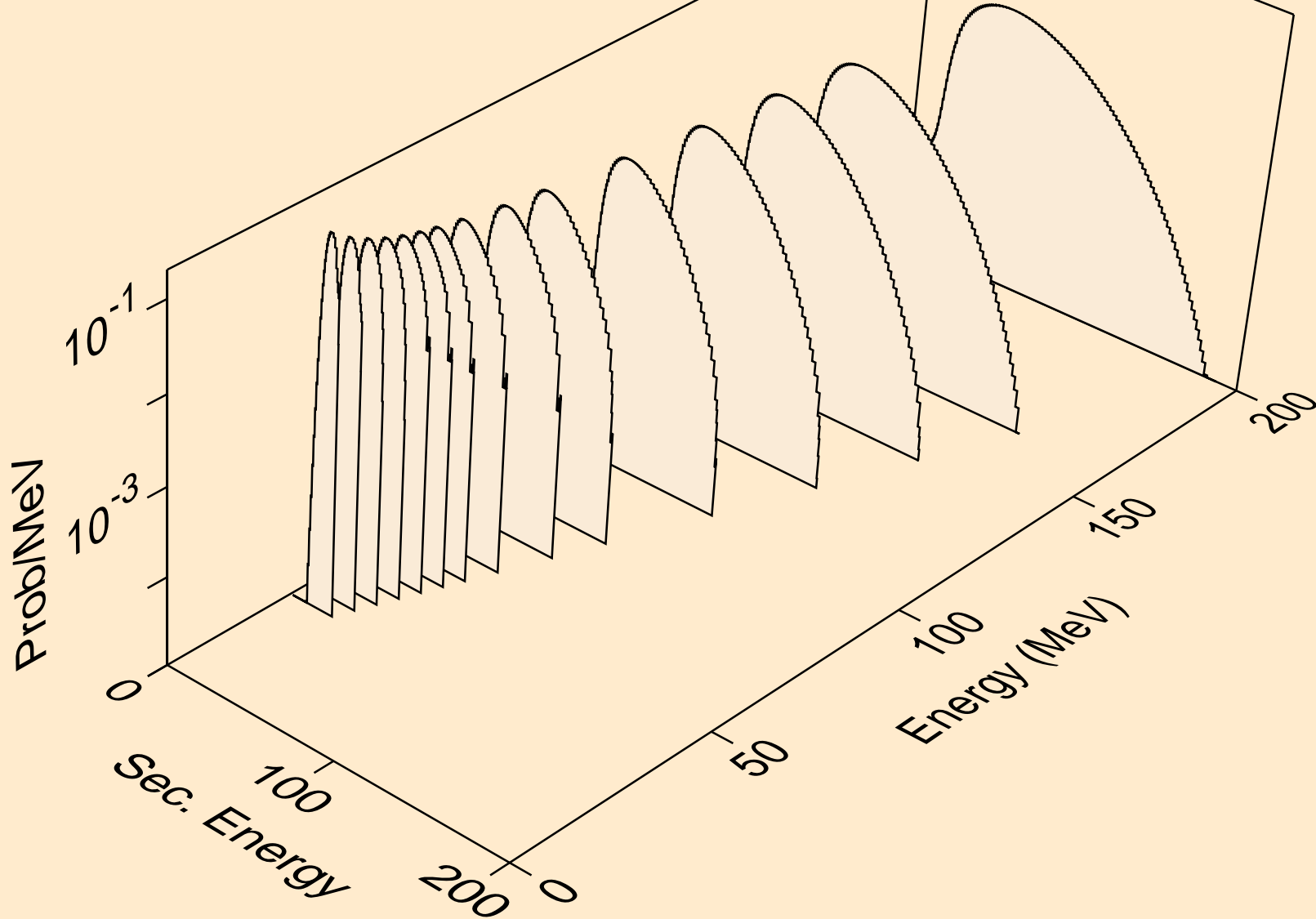

SM145 NEUTRON ACER TENDL-2019 LIBRARY; T=293.16K
he3s from (n,n*)he3

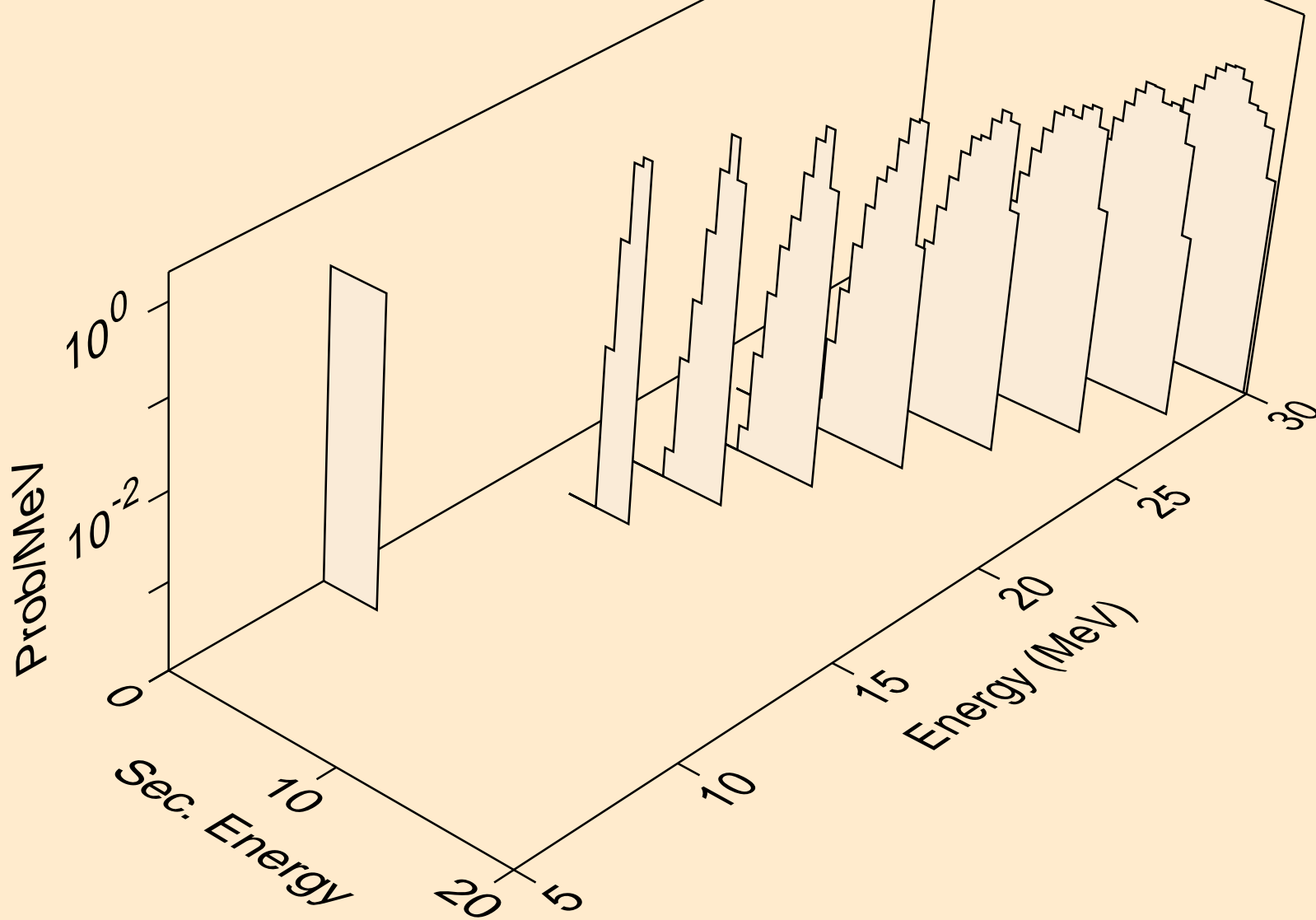

SM145 NEUTRON ACER TENDL-2019 LIBRARY; T=293.16K
he3s from (n,he3)

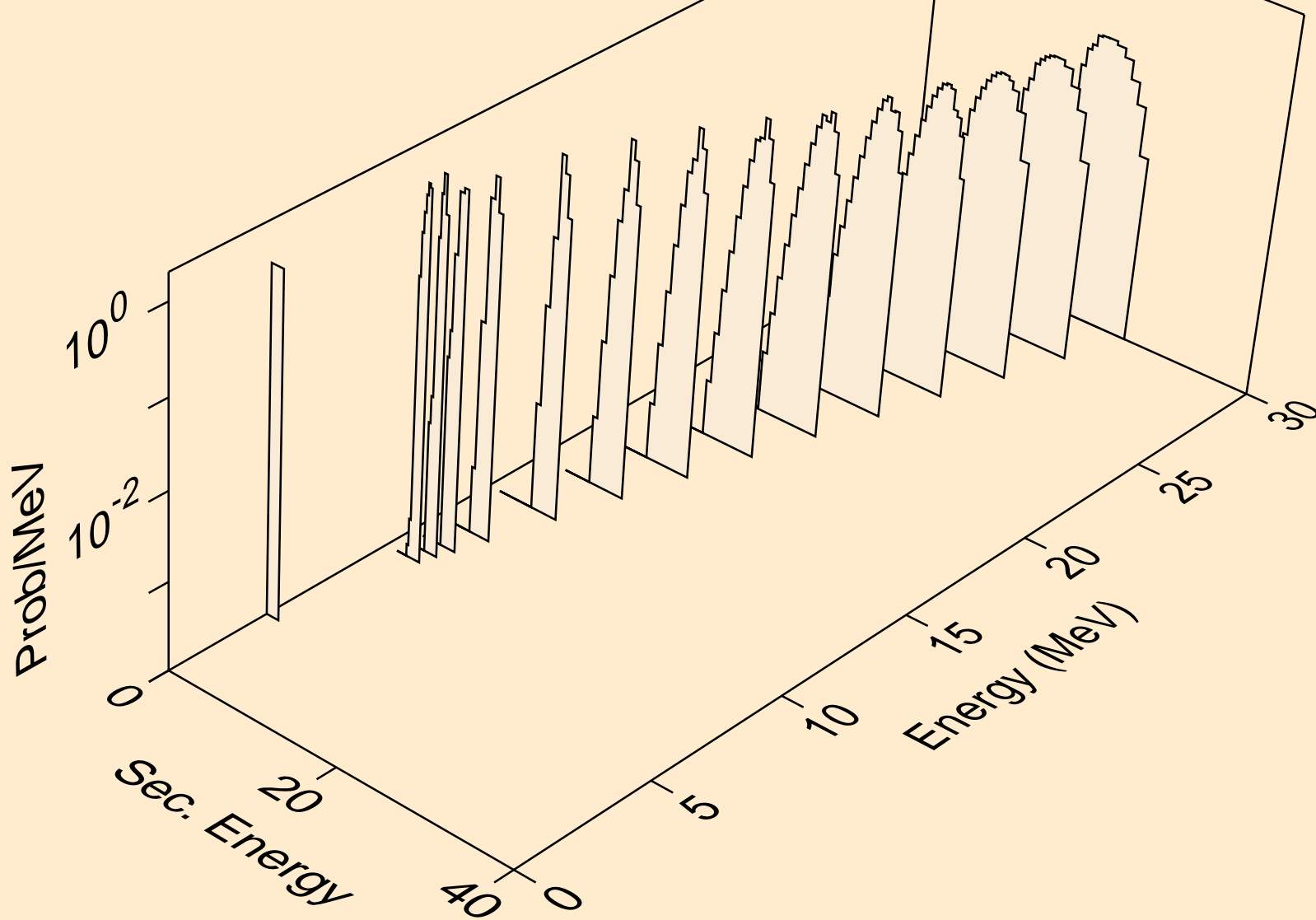

SM145 NEUTRON ACER TENDL-2019 LIBRARY; T=293.16K
alphas from (n,x)

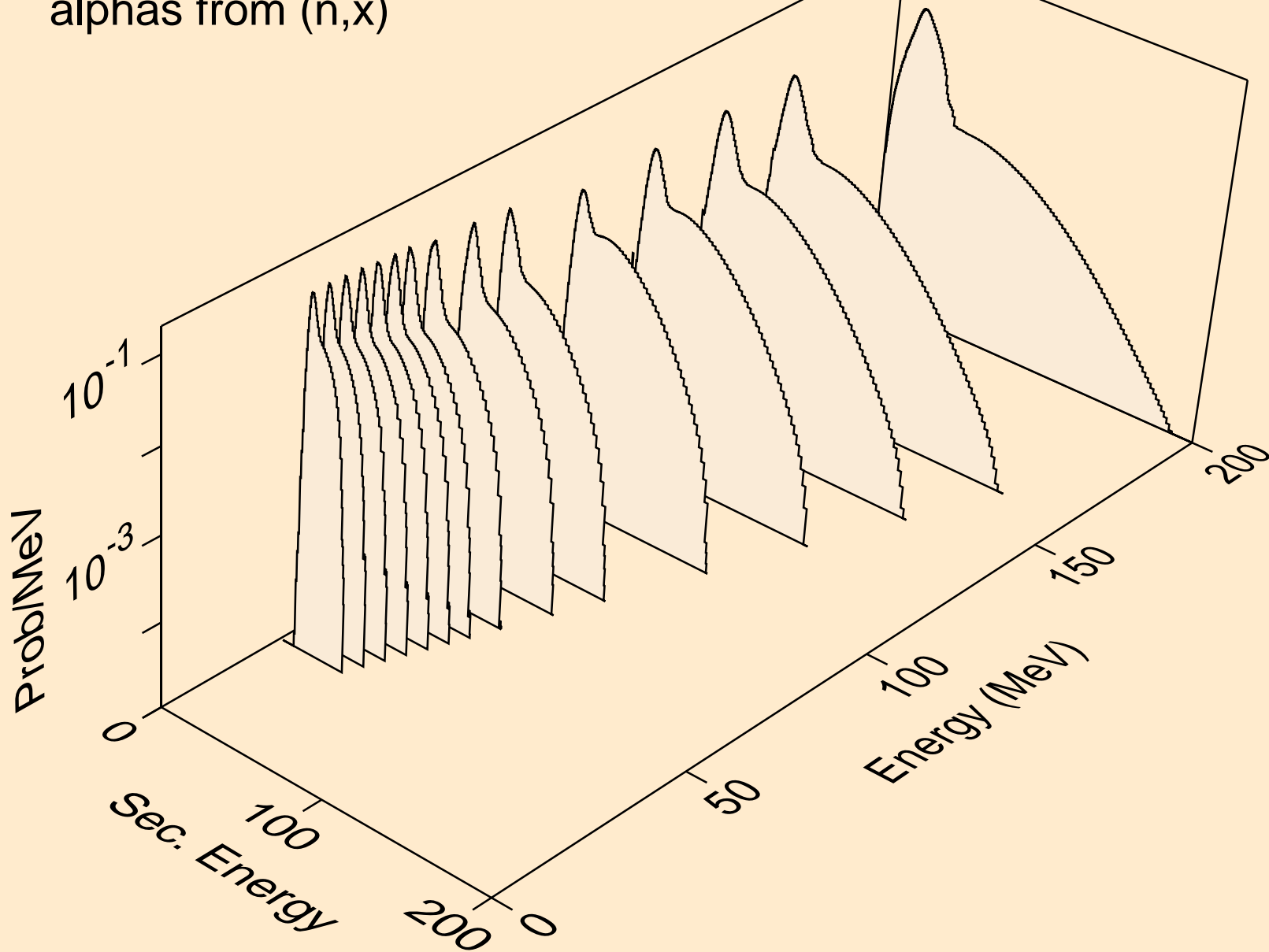

SM145 NEUTRON ACER TENDL-2019 LIBRARY; T=293.16K
alphas from (n,n*)a

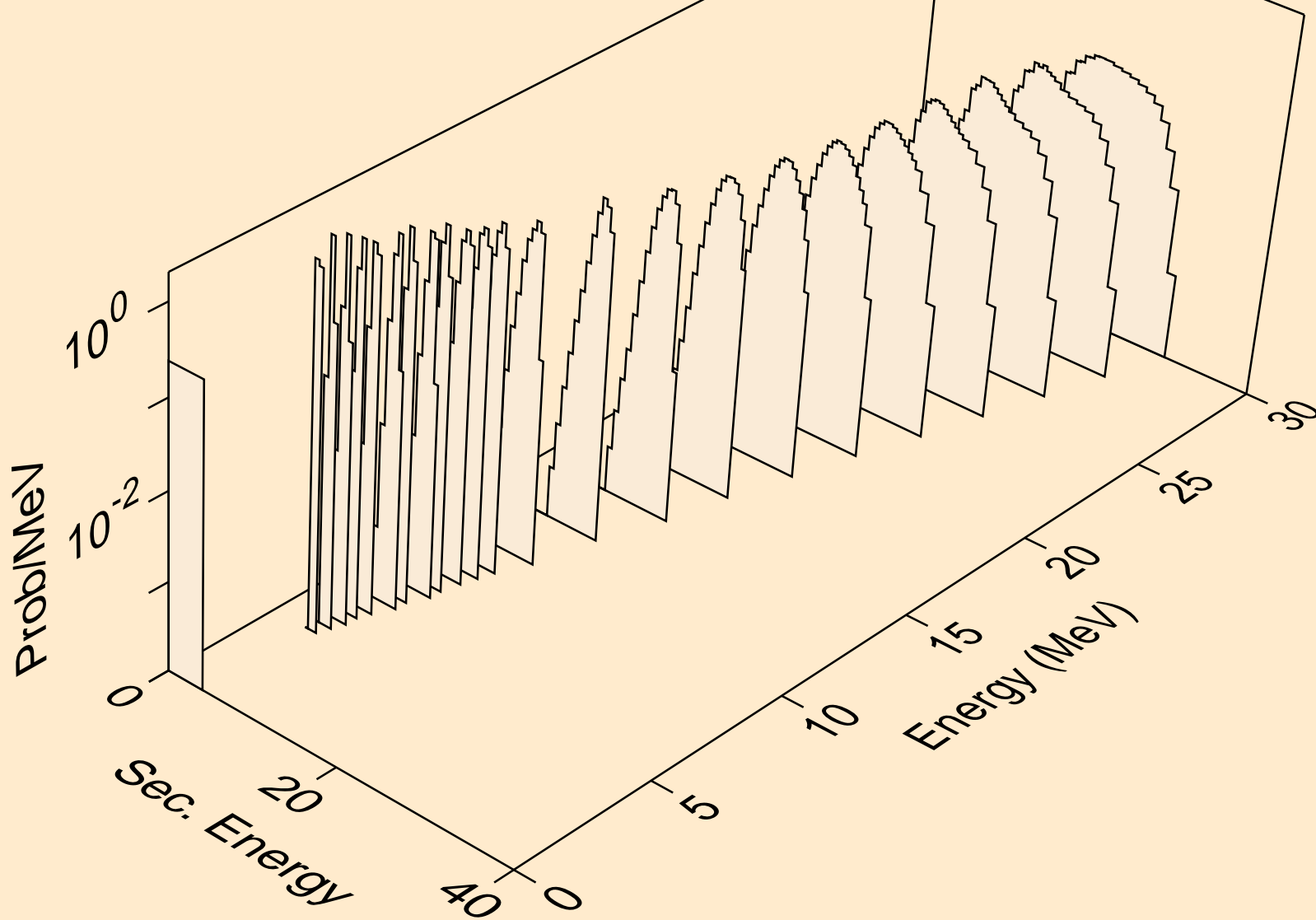

SM145 NEUTRON ACER TENDL-2019 LIBRARY; T=293.16K
alphas from (n,2n)a

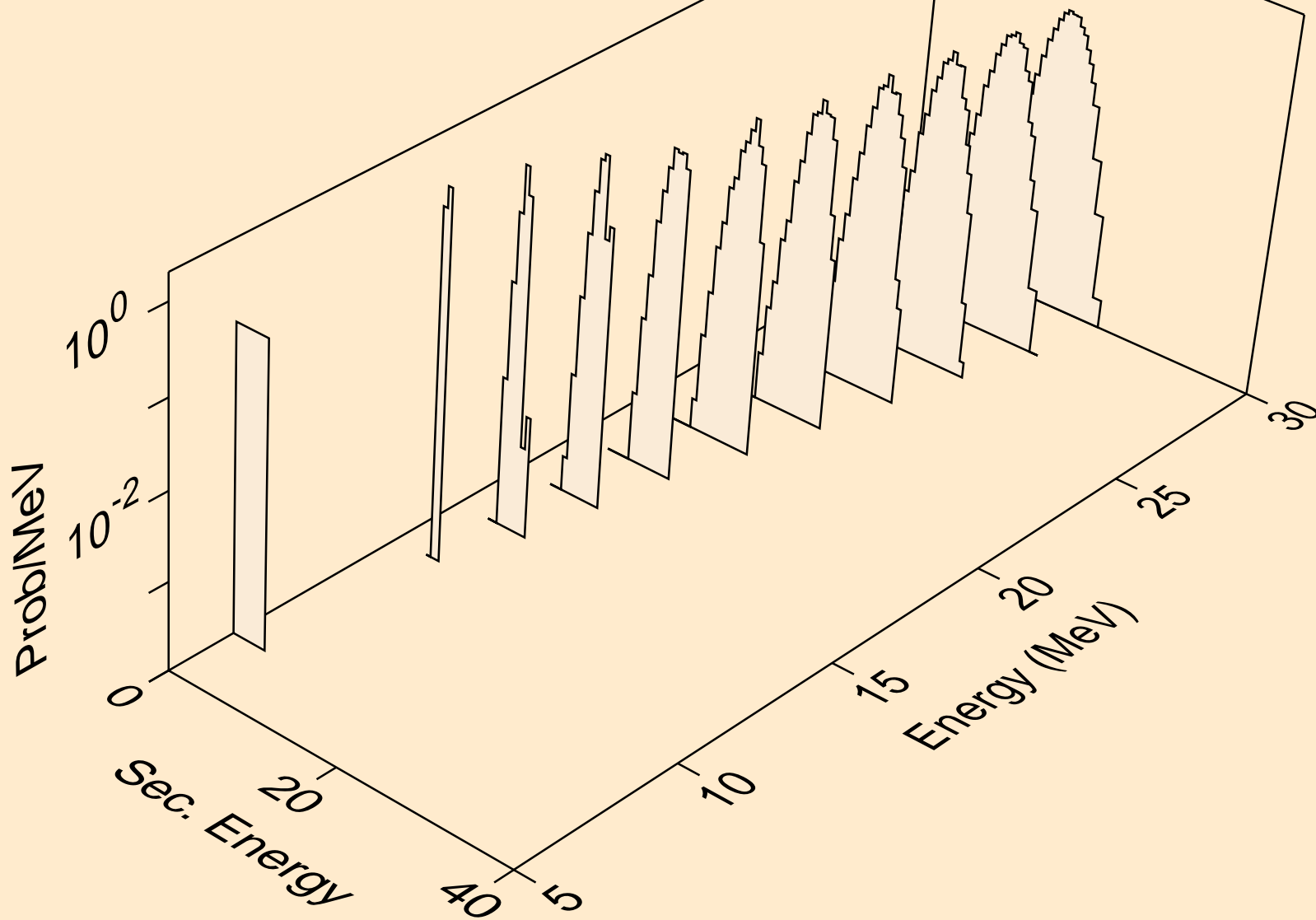

SM145 NEUTRON ACER TENDL-2019 LIBRARY; T=293.16K
alphas from (n,3n)a

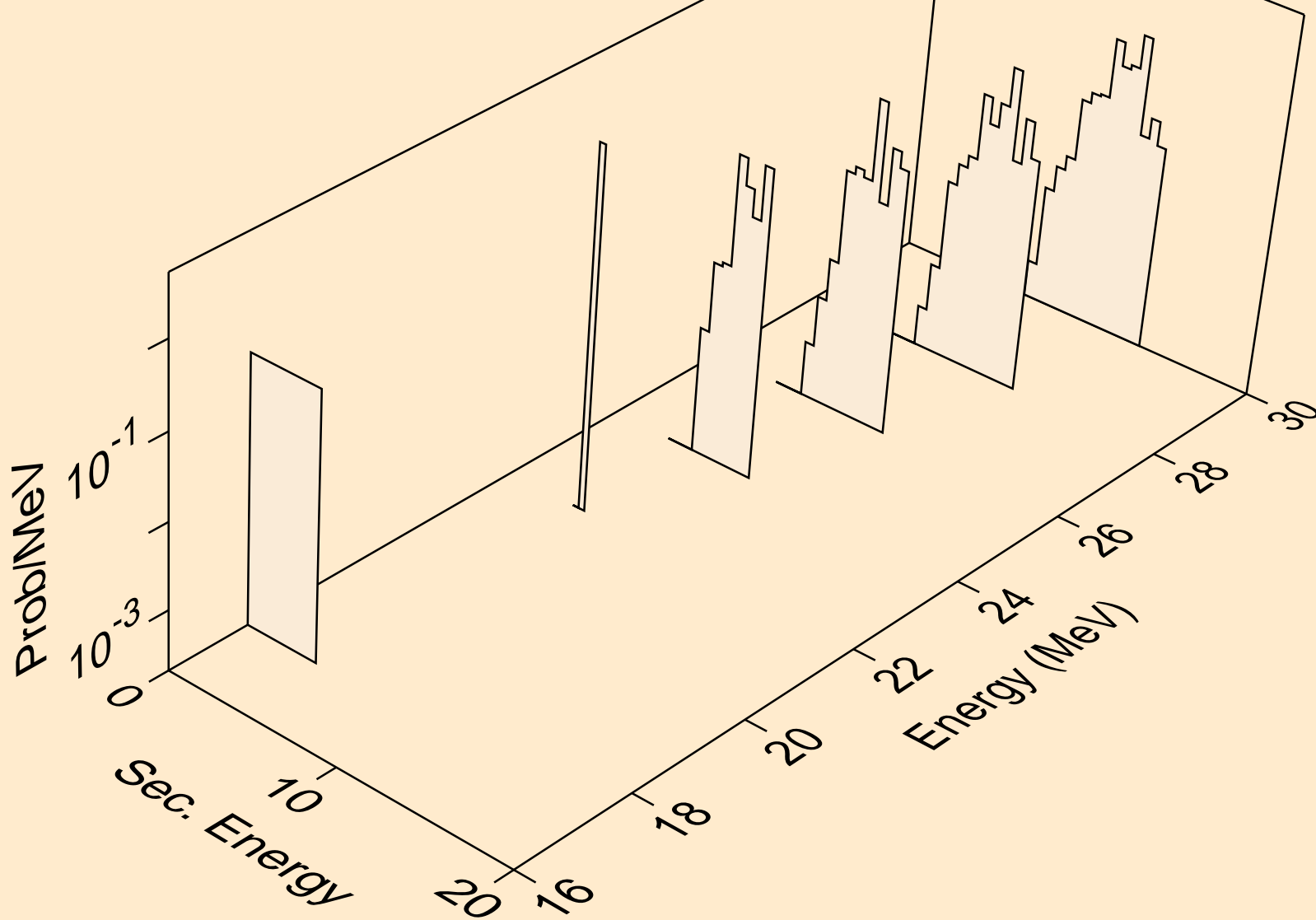

SM145 NEUTRON ACER TENDL-2019 LIBRARY; T=293.16K
alphas from (n,n*)2a

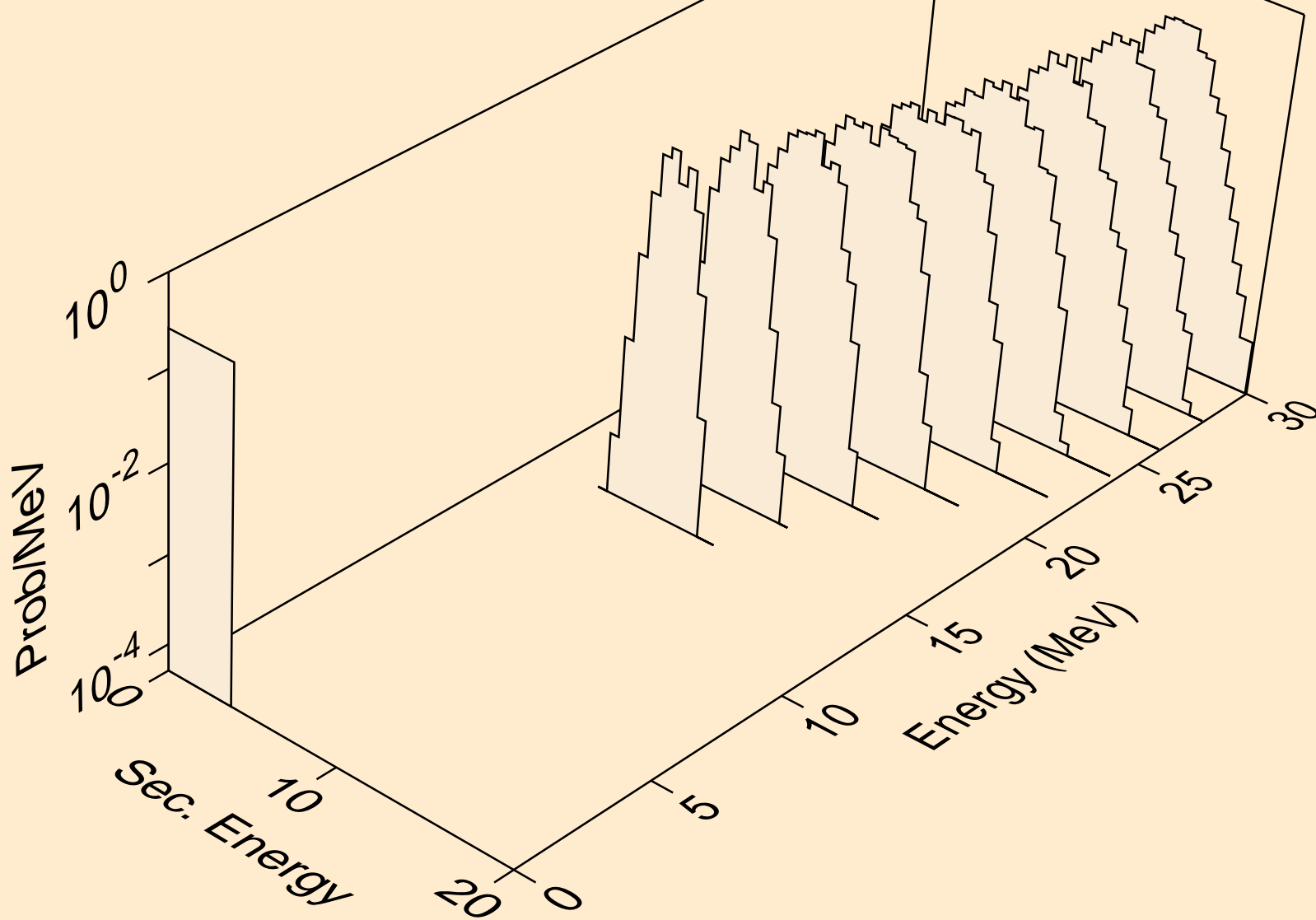

SM145 NEUTRON ACER TENDL-2019 LIBRARY; T=293.16K
alphas from (n,npa)

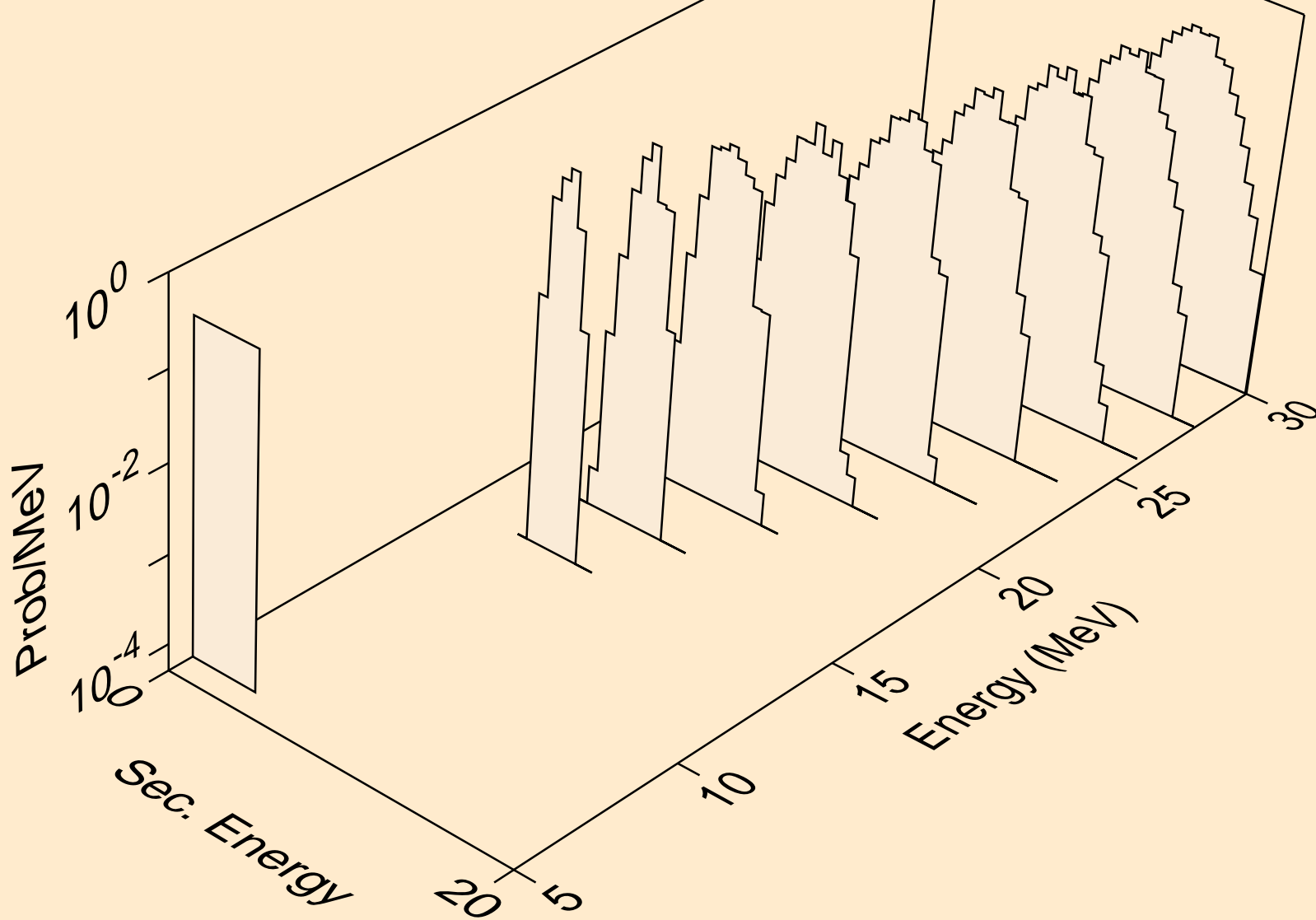

SM145 NEUTRON ACER TENDL-2019 LIBRARY; T=293.16K
alphas from (n,a)

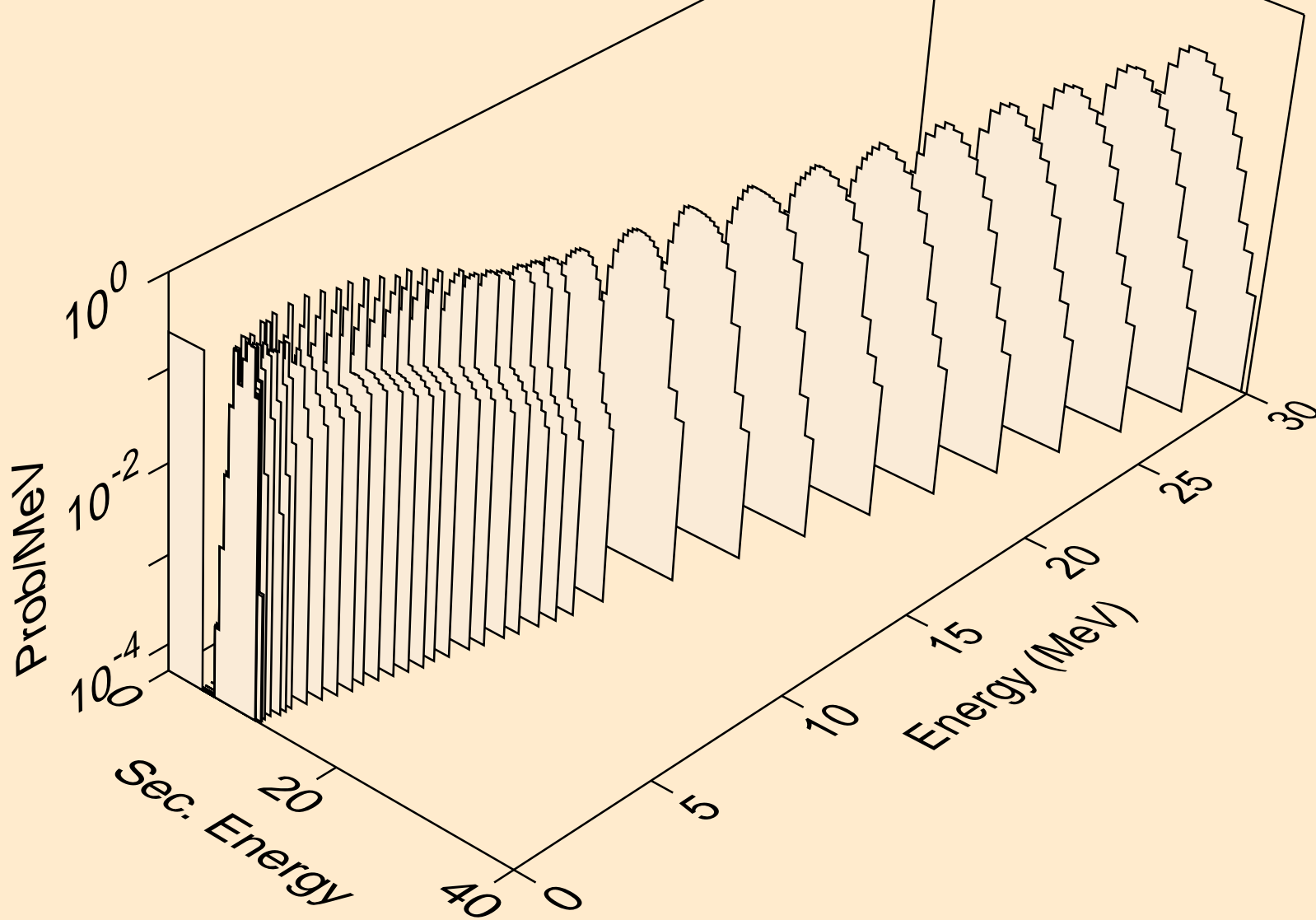

SM145 NEUTRON ACER TENDL-2019 LIBRARY; T=293.16K
alphas from (n,2a)

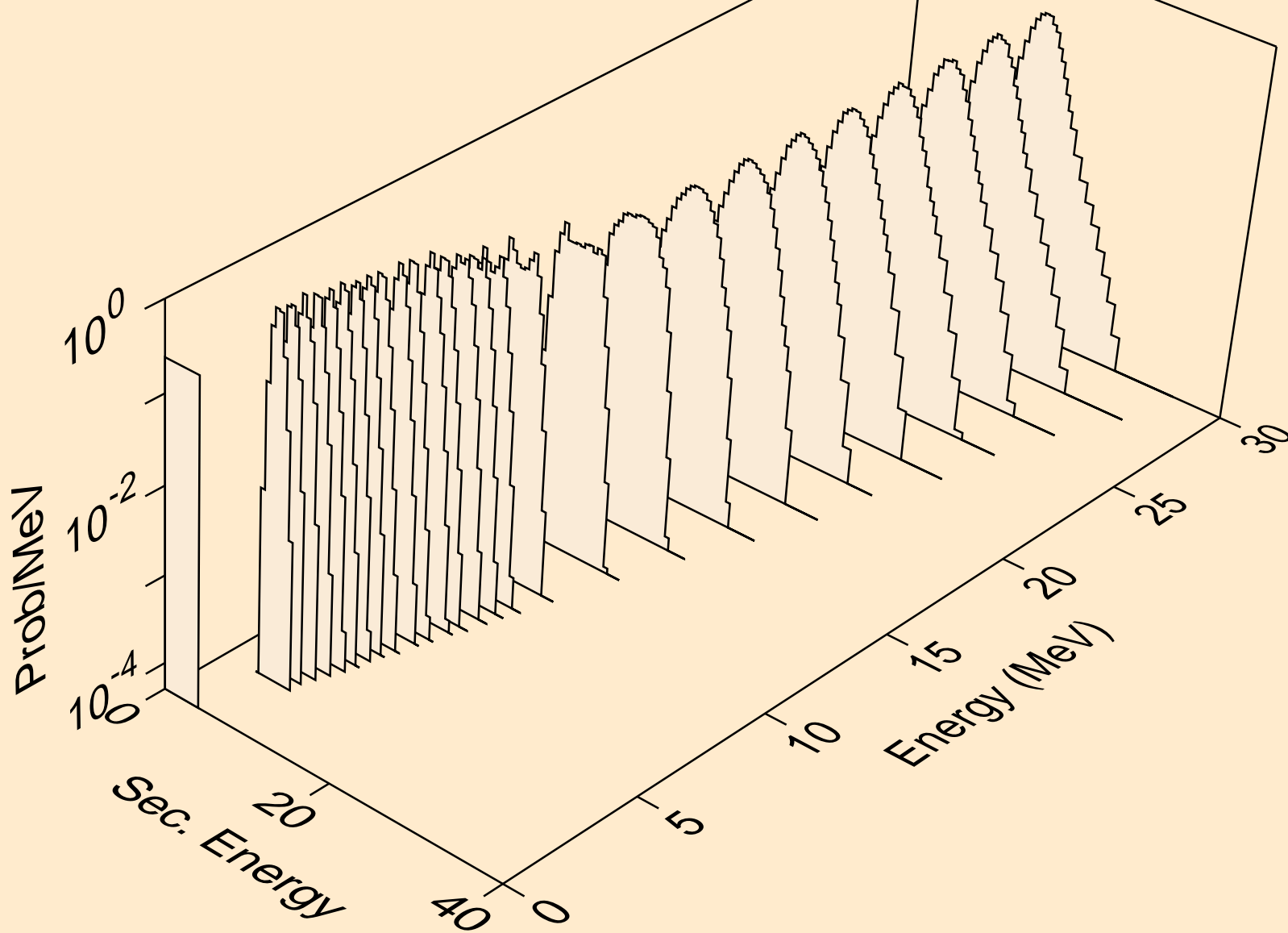

SM145 NEUTRON ACER TENDL-2019 LIBRARY; T=293.16K
alphas from (n,pa)

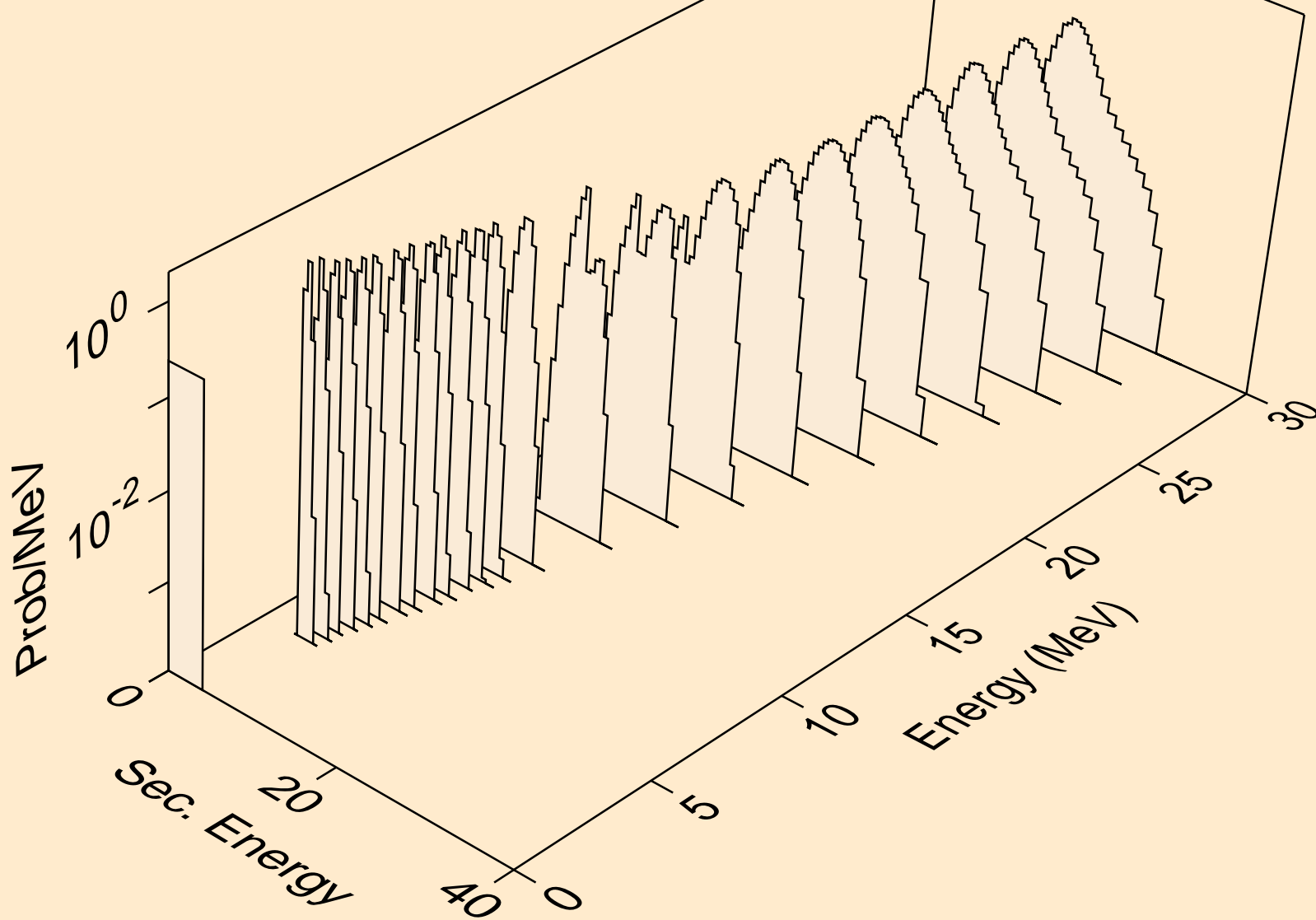

SM145 NEUTRON ACER TENDL-2019 LIBRARY; T=293.16K
alphas from (n,da)

