

TB139 NEUTRON ACER TENDL-2019 LIBRARY; T=293.16K
Principal cross sections

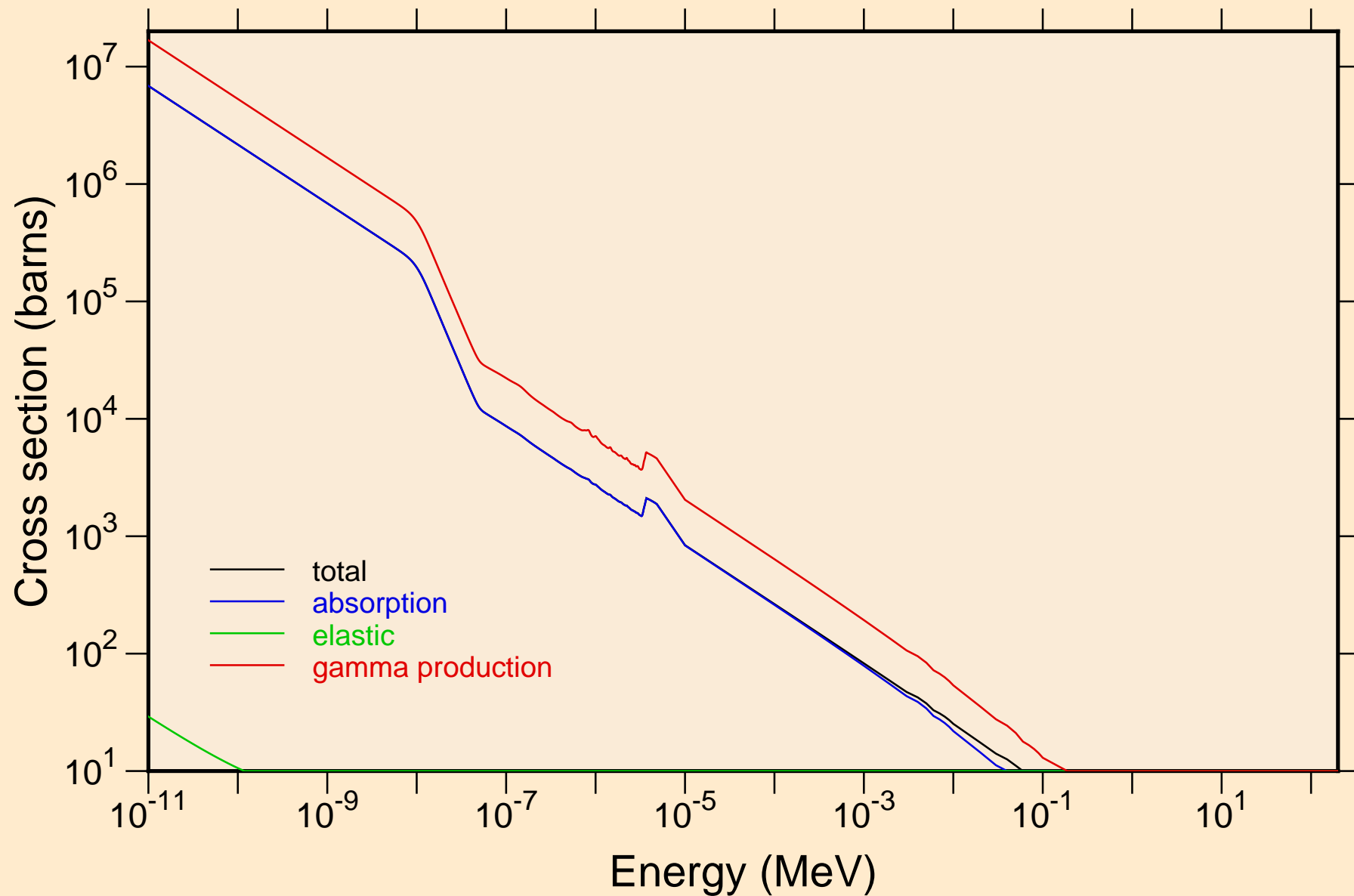

TB139 NEUTRON ACER TENDL-2019 LIBRARY; T=293.16K
resonance total cross section

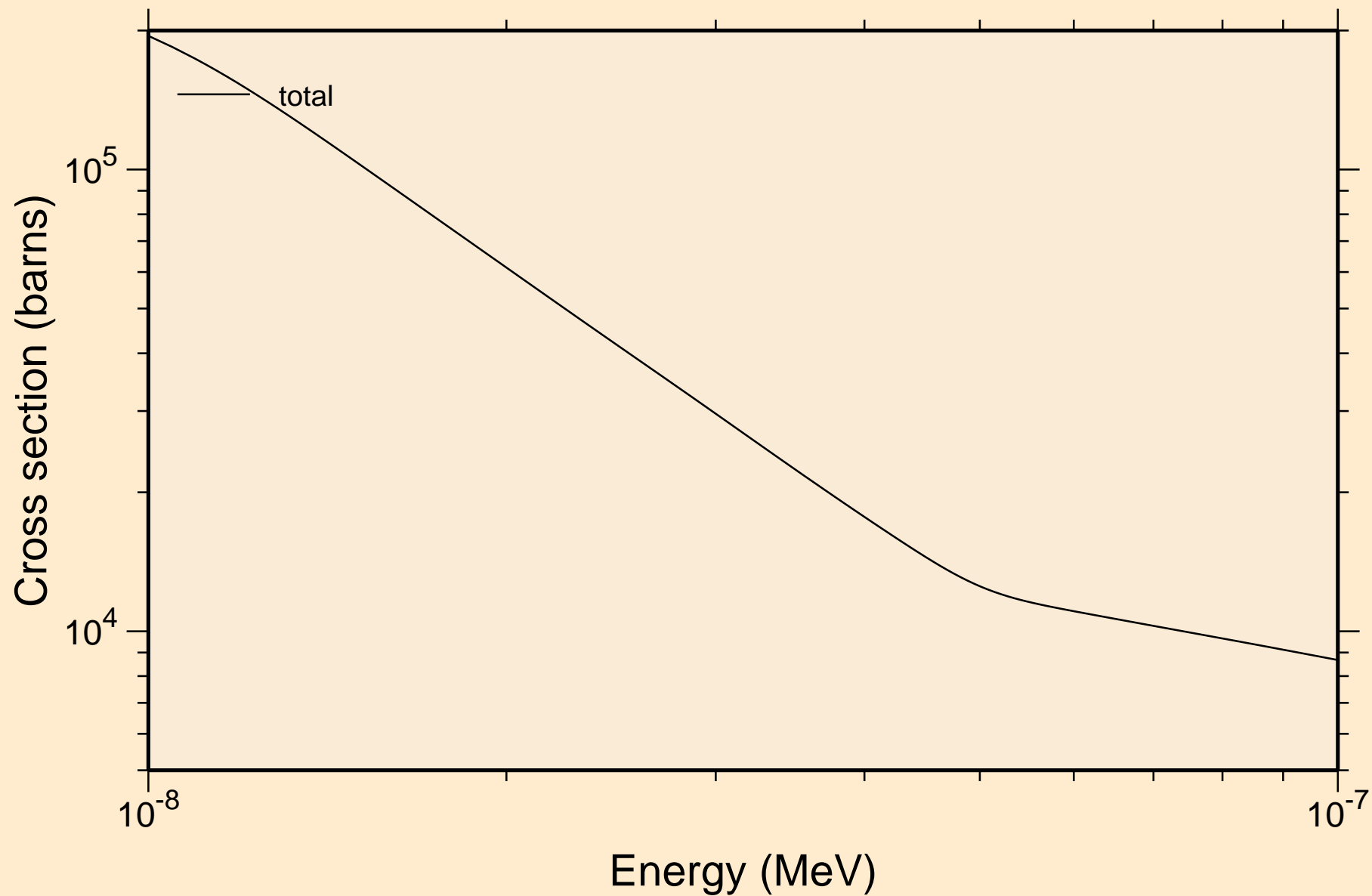

TB139 NEUTRON ACER TENDL-2019 LIBRARY; T=293.16K
resonance total cross section

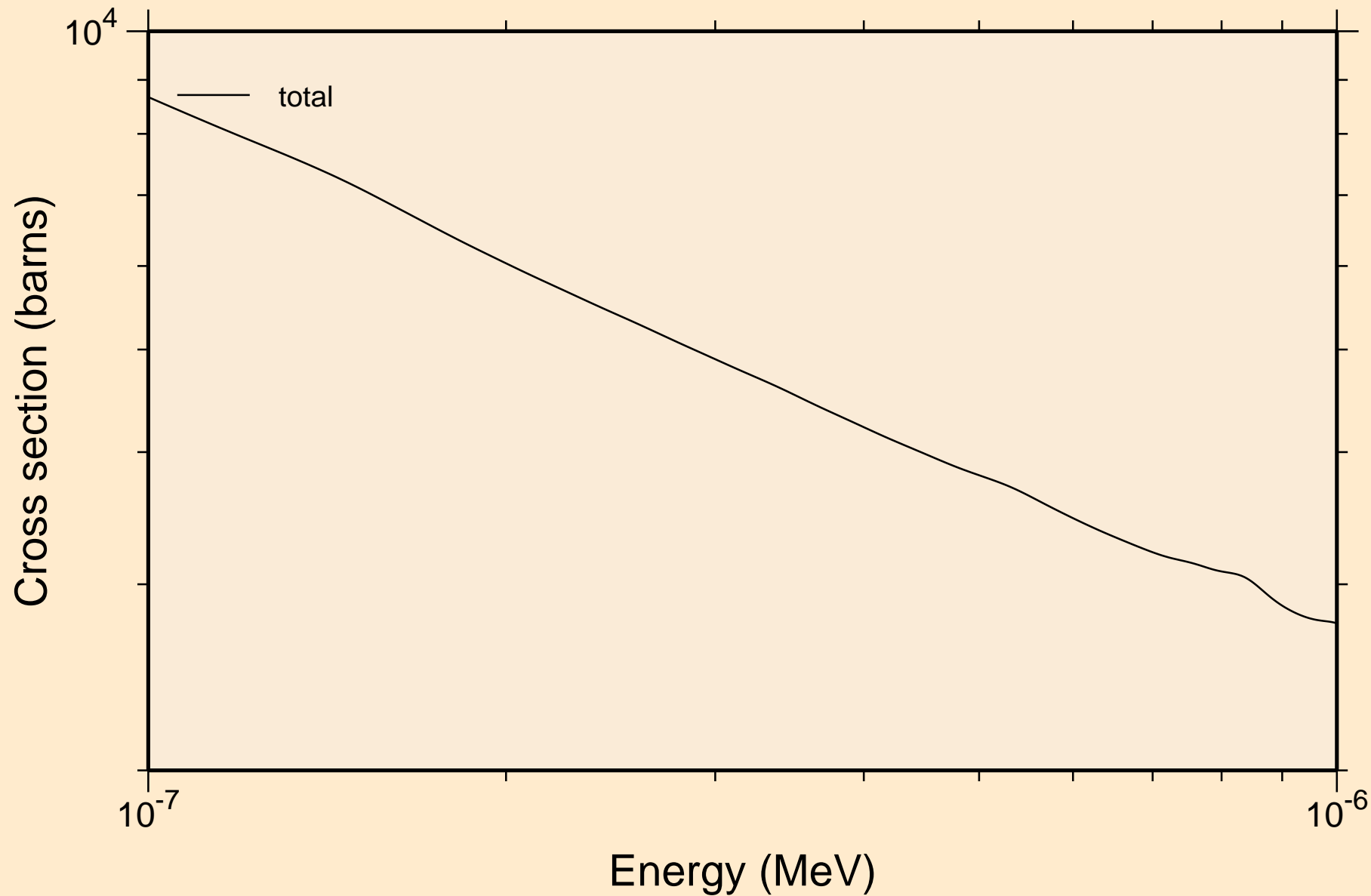

TB139 NEUTRON ACER TENDL-2019 LIBRARY; T=293.16K
resonance total cross section

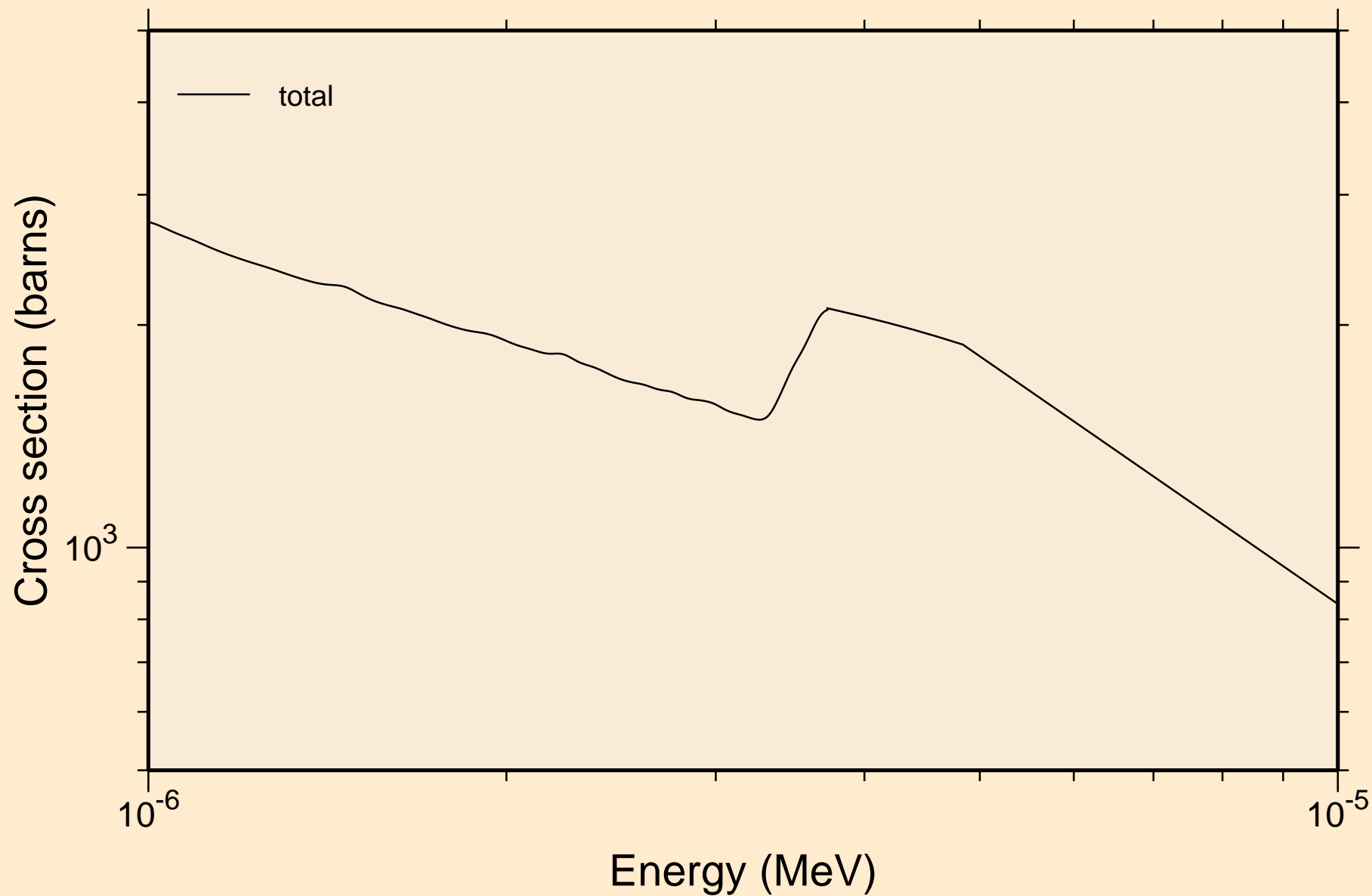

TB139 NEUTRON ACER TENDL-2019 LIBRARY; T=293.16K
resonance total cross section

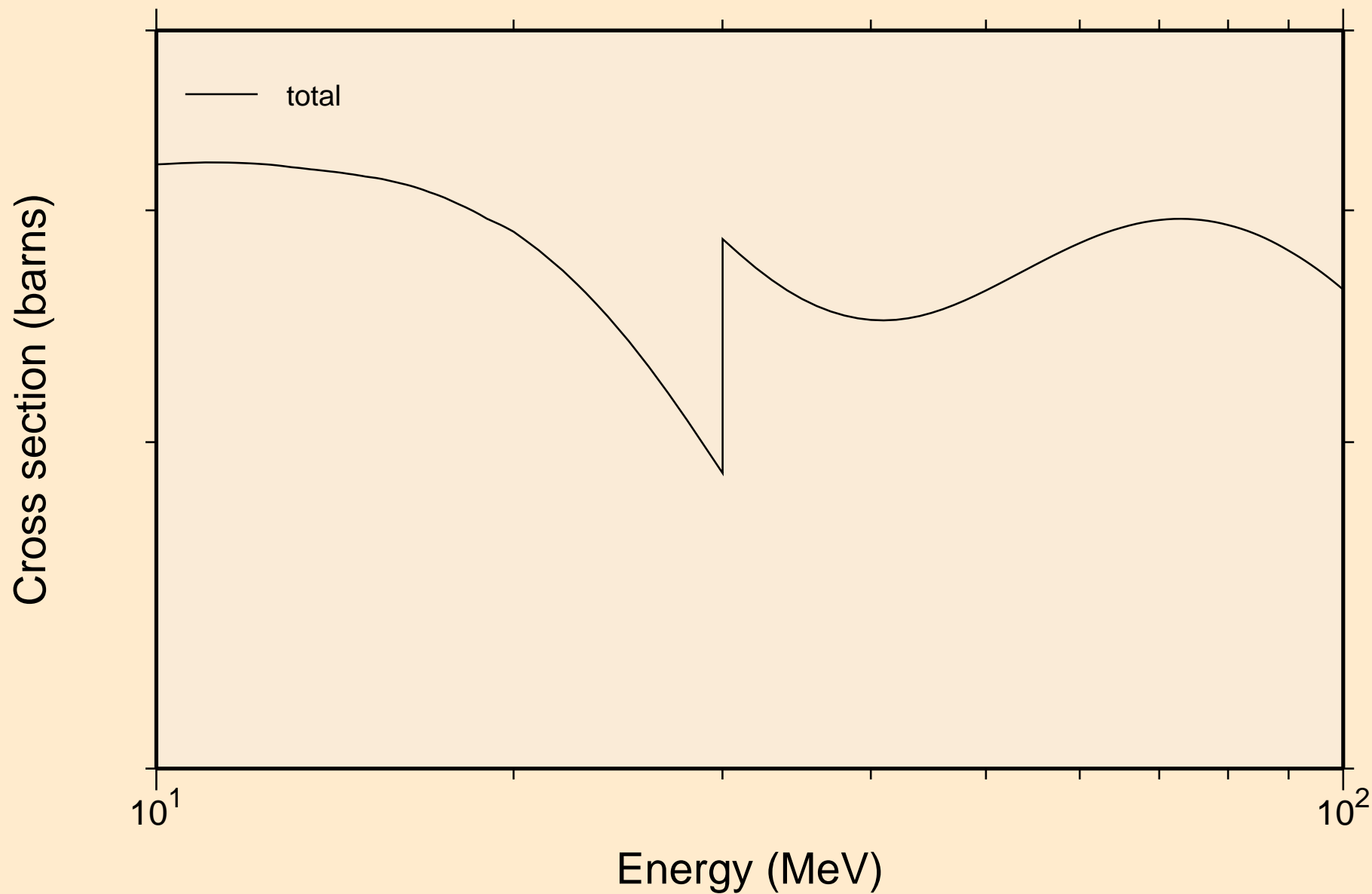

TB139 NEUTRON ACER TENDL-2019 LIBRARY; T=293.16K
resonance absorption cross sections

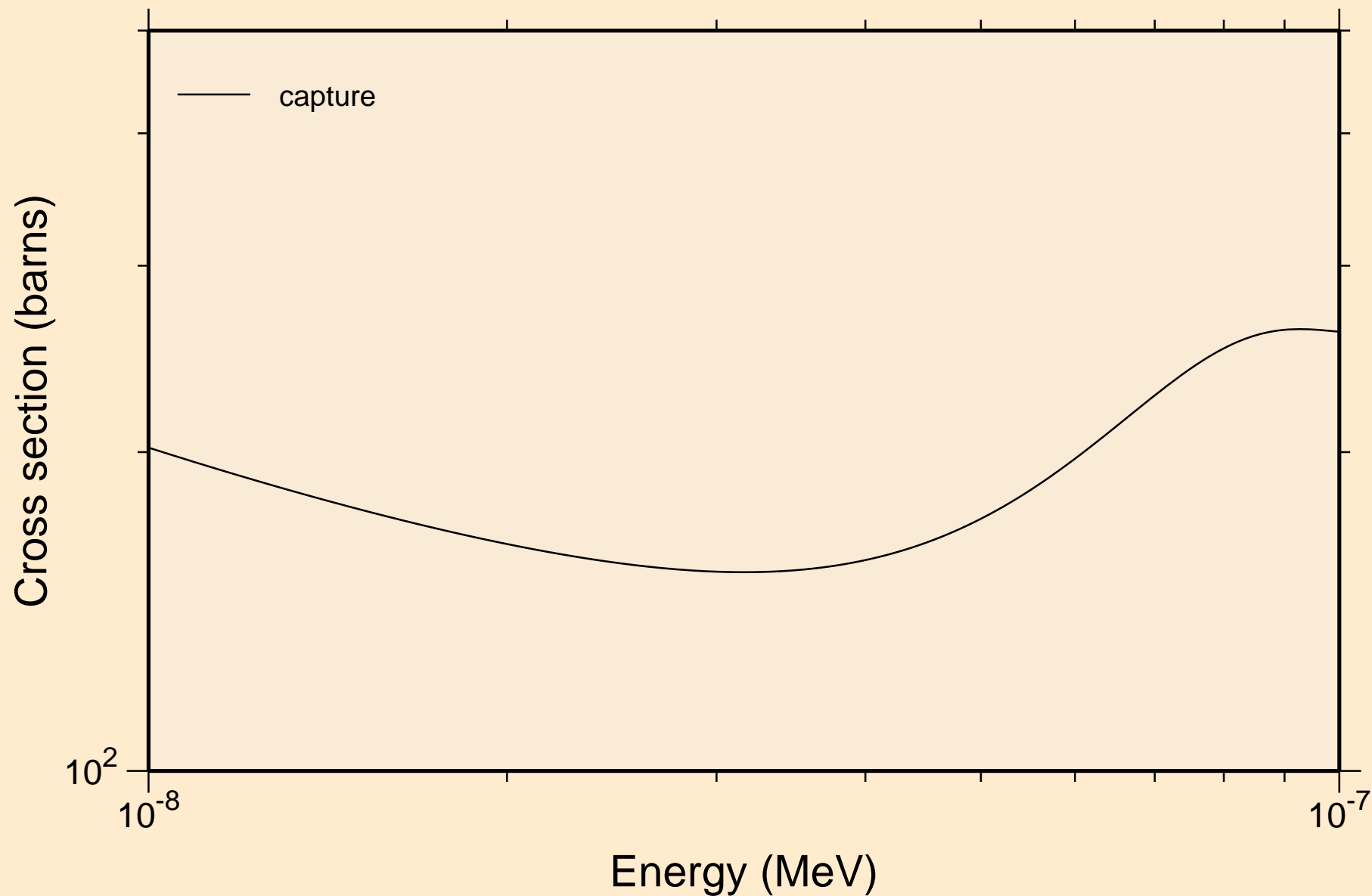

TB139 NEUTRON ACER TENDL-2019 LIBRARY; T=293.16K
resonance absorption cross sections

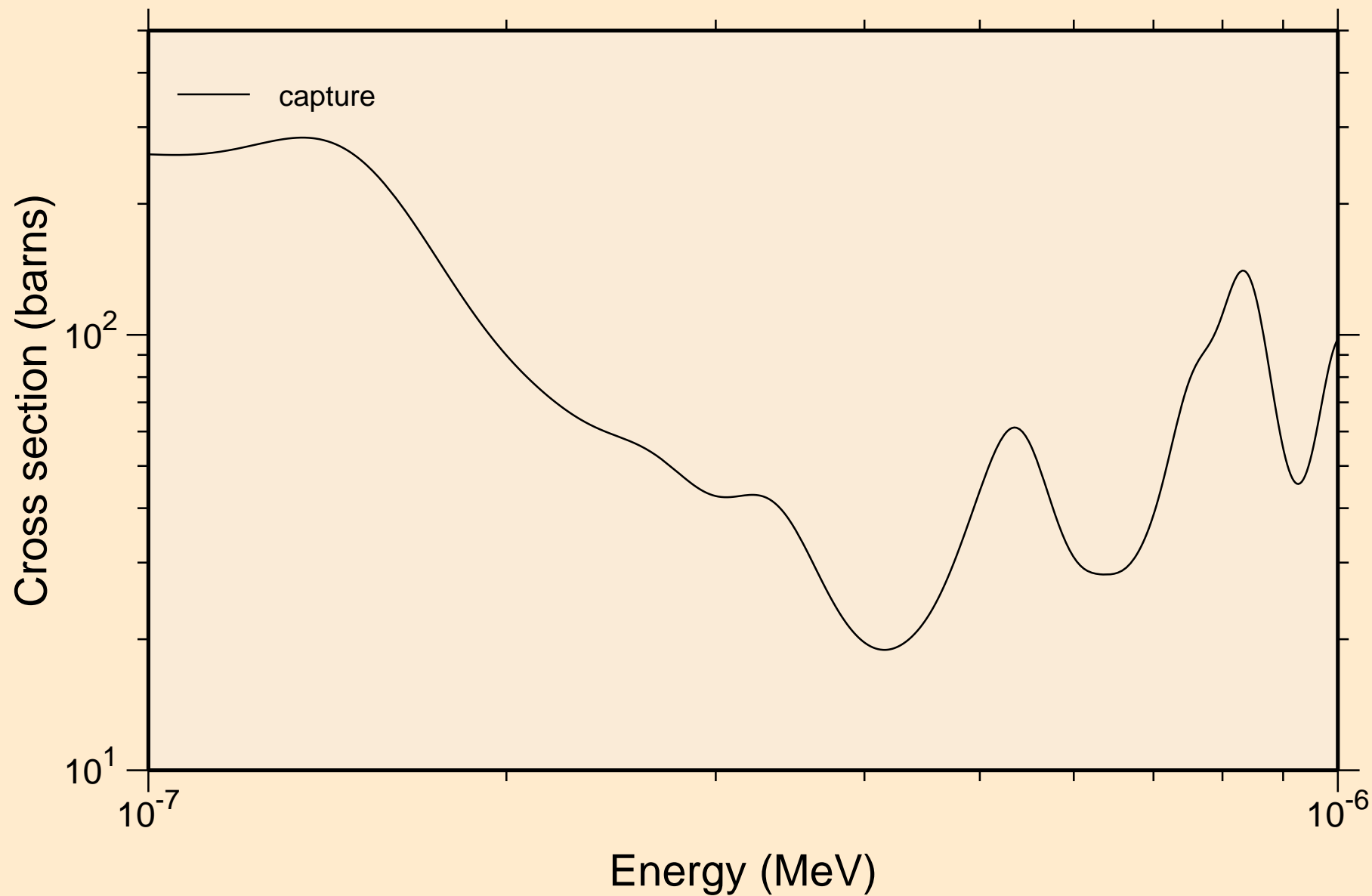

TB139 NEUTRON ACER TENDL-2019 LIBRARY; T=293.16K
resonance absorption cross sections

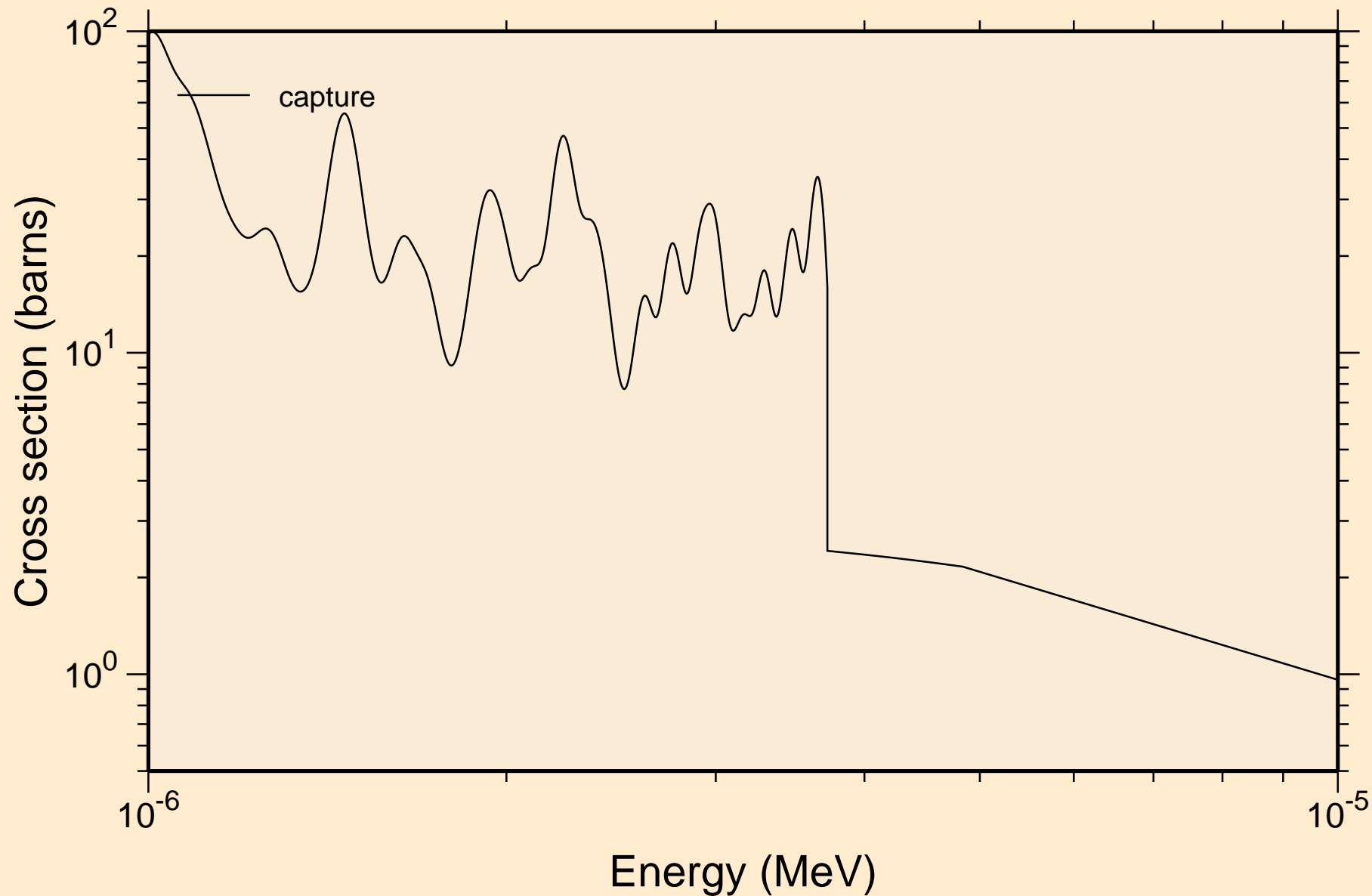

TB139 NEUTRON ACER TENDL-2019 LIBRARY; T=293.16K
resonance absorption cross sections

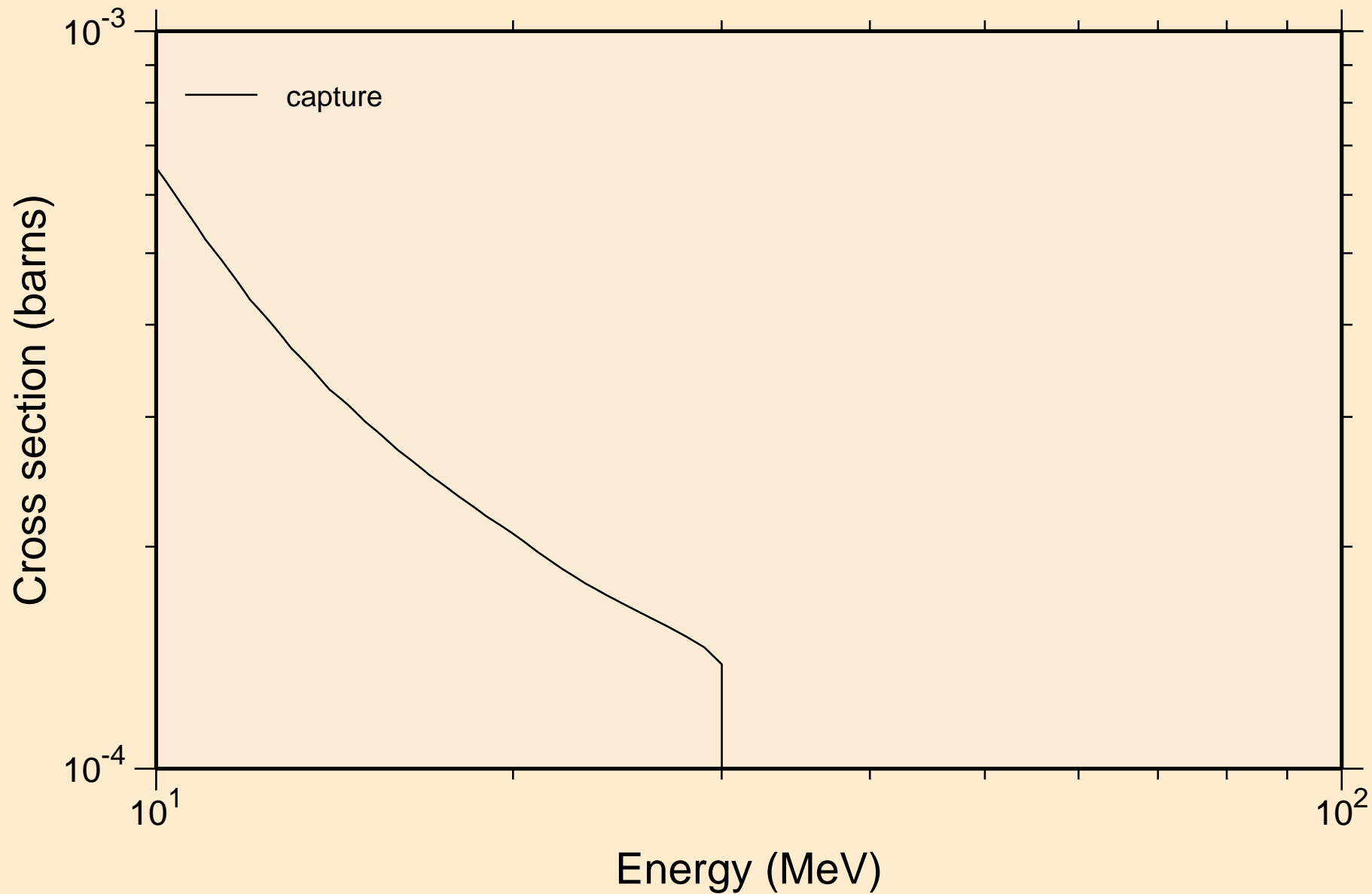

TB139 NEUTRON ACER TENDL-2019 LIBRARY; T=293.16K
Heating

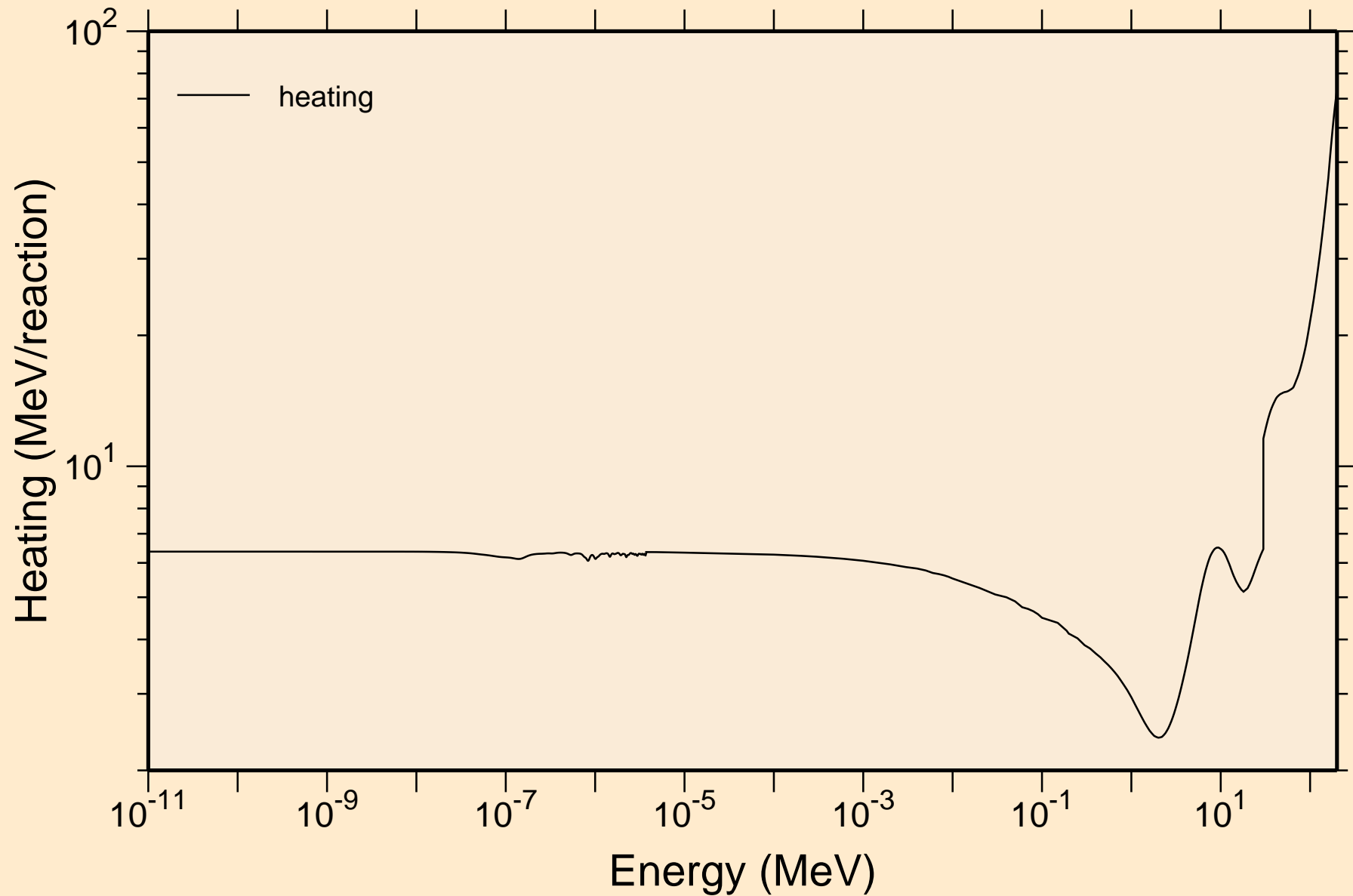

TB139 NEUTRON ACER TENDL-2019 LIBRARY; T=293.16K
Damage

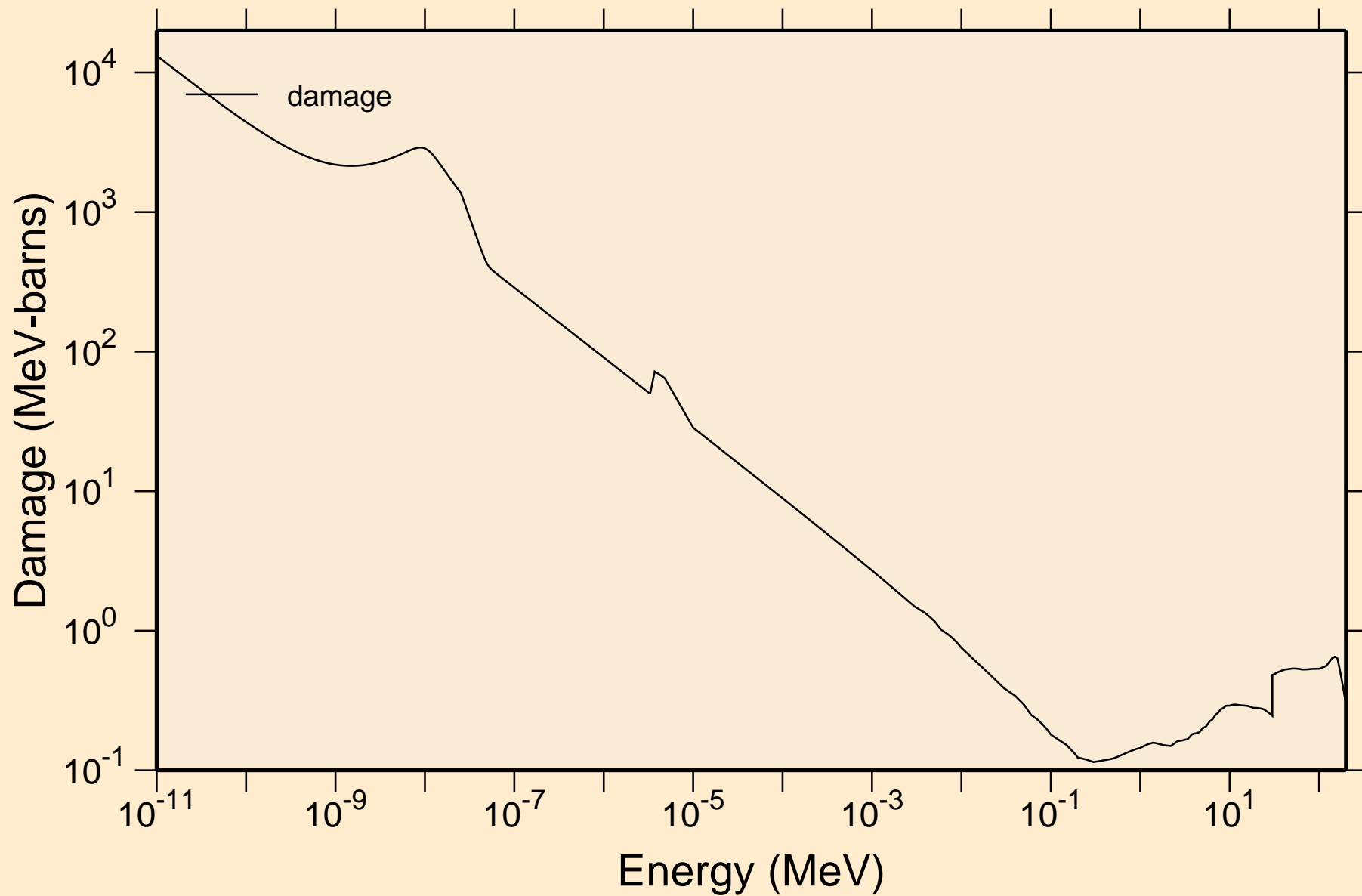

TB139 NEUTRON ACER TENDL-2019 LIBRARY; T=293.16K
Non-threshold reactions

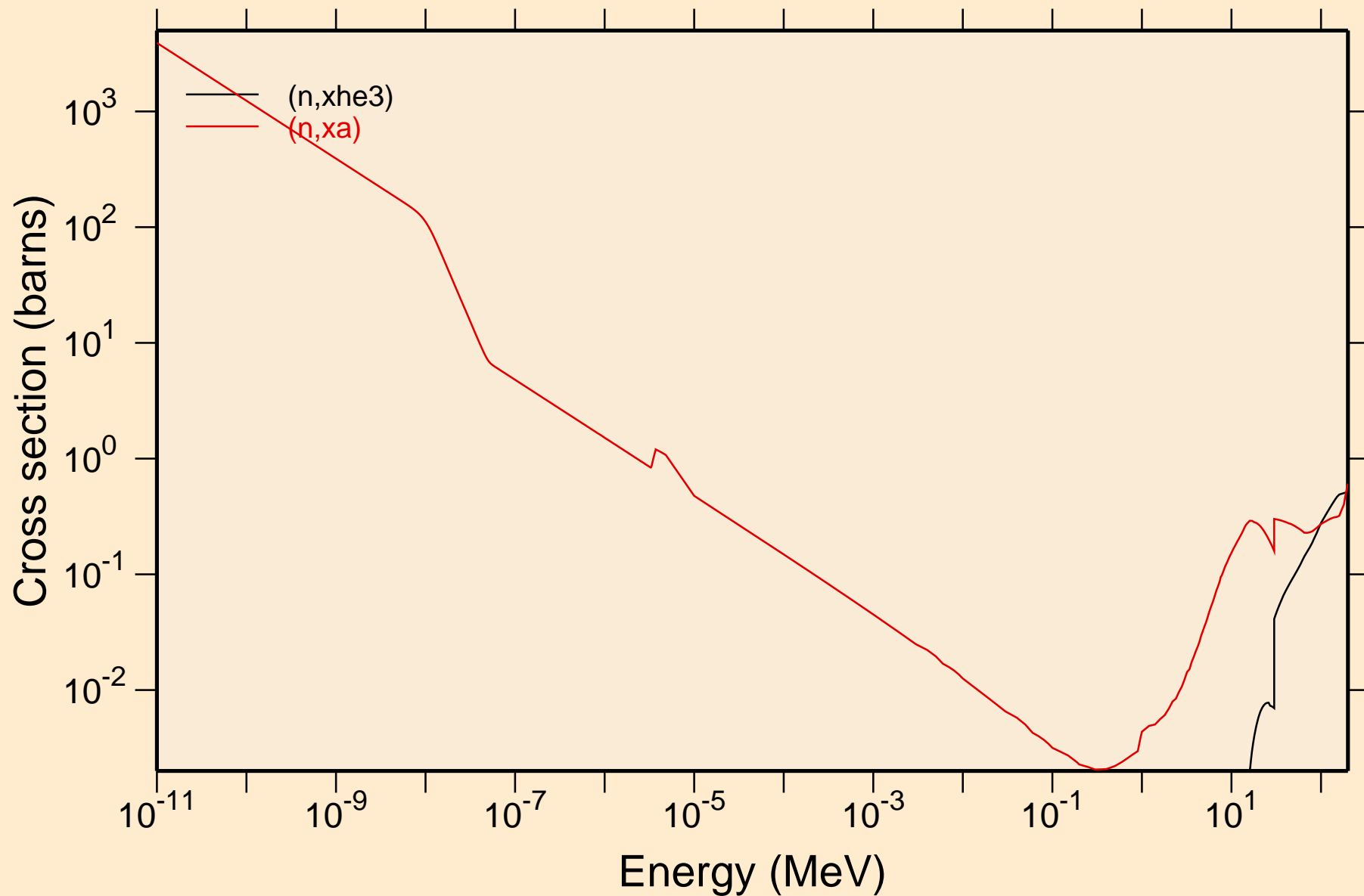

TB139 NEUTRON ACER TENDL-2019 LIBRARY; T=293.16K
Principal cross sections

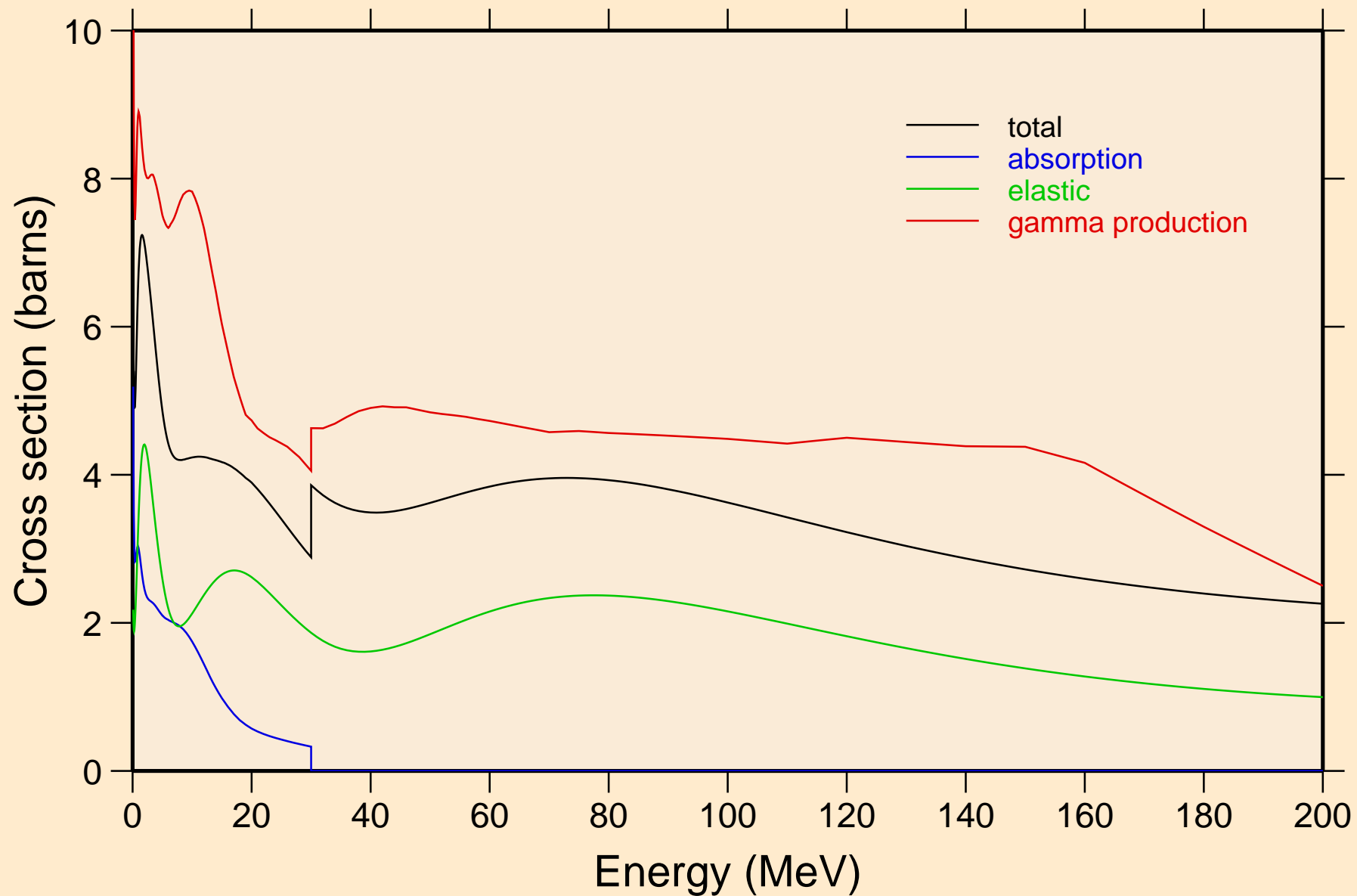

TB139 NEUTRON ACER TENDL-2019 LIBRARY; T=293.16K
Heating

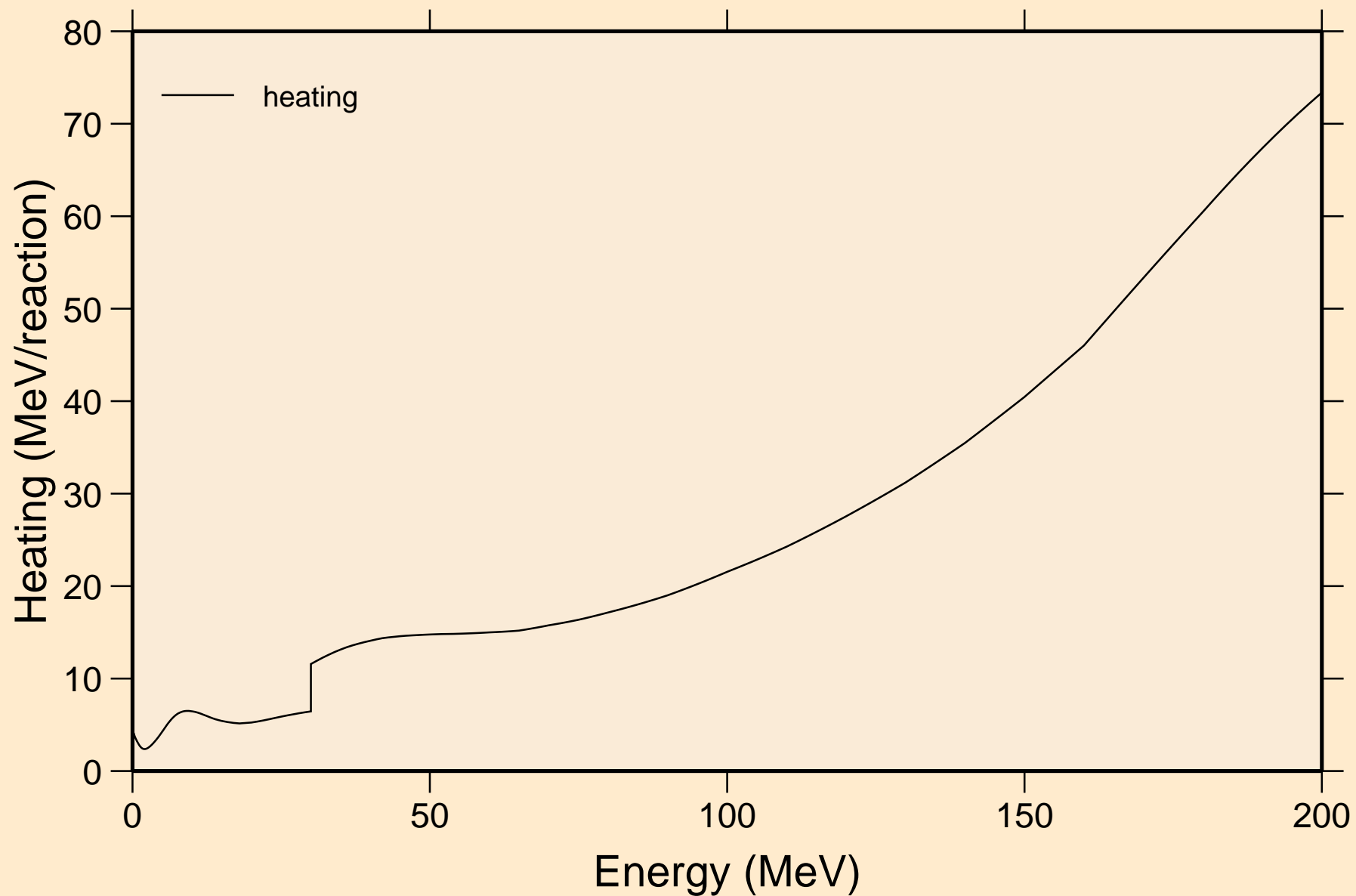

TB139 NEUTRON ACER TENDL-2019 LIBRARY; T=293.16K
Damage

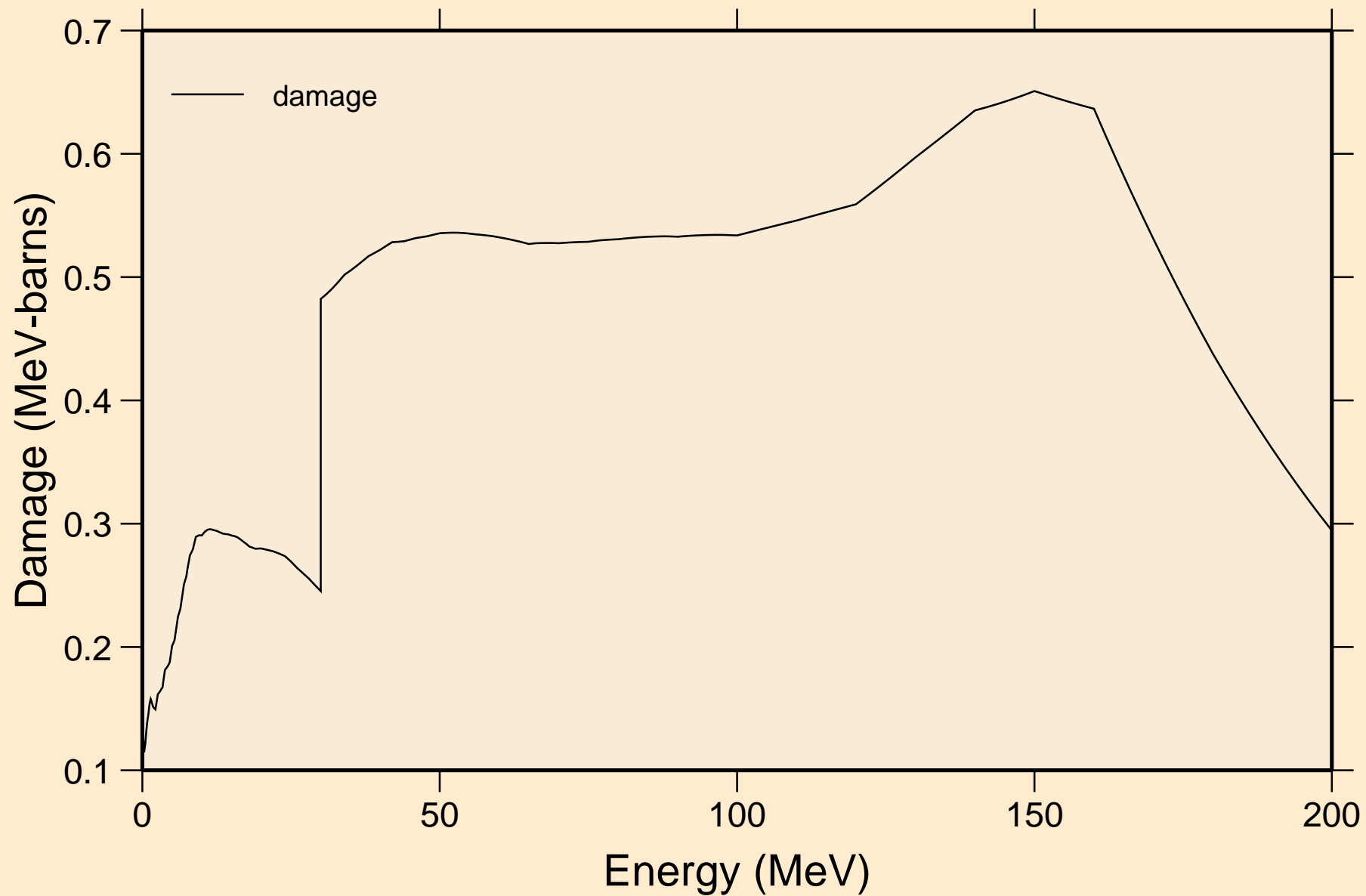

TB139 NEUTRON ACER TENDL-2019 LIBRARY; T=293.16K
Non-threshold reactions

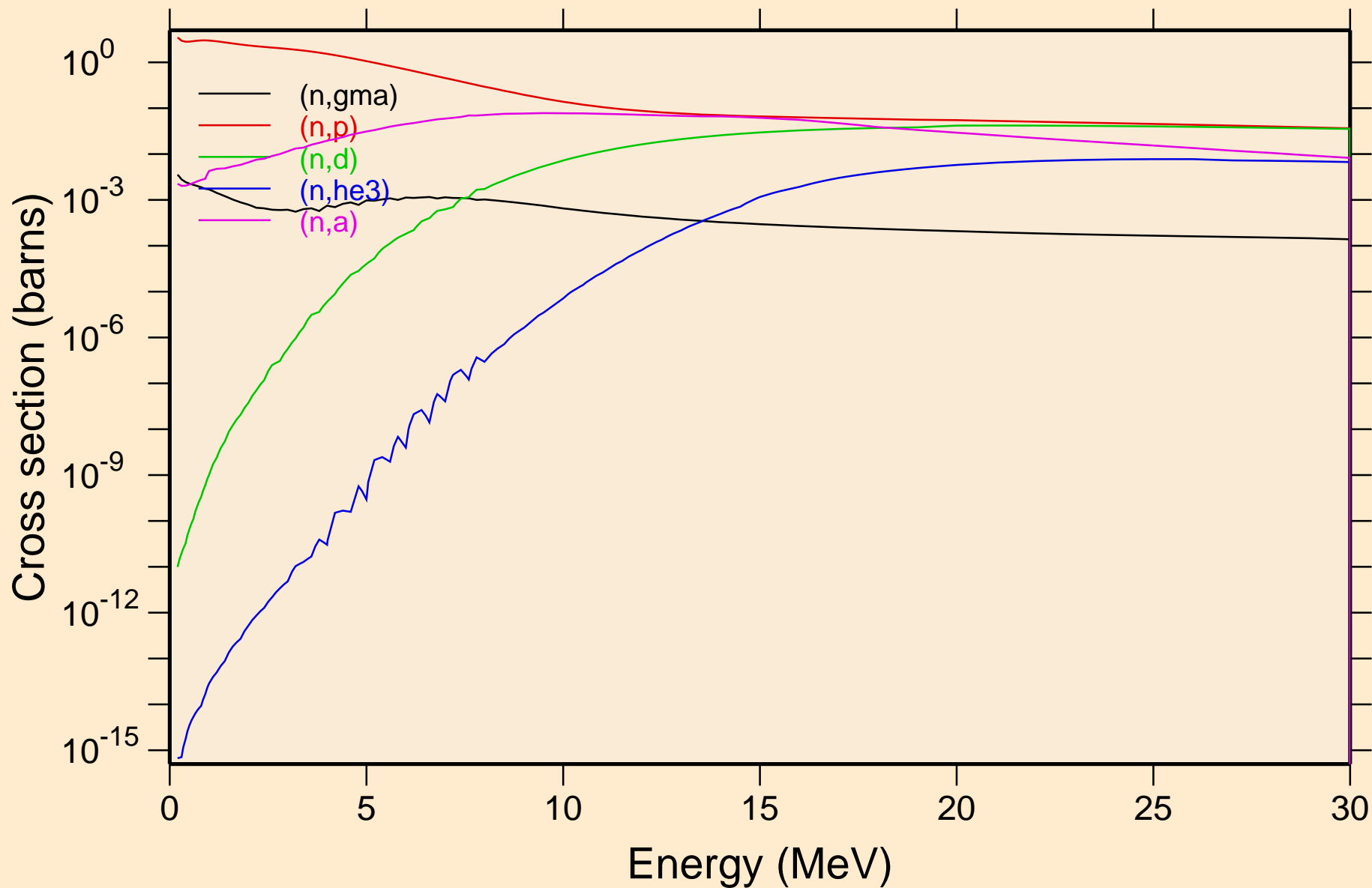

TB139 NEUTRON ACER TENDL-2019 LIBRARY; T=293.16K
Non-threshold reactions

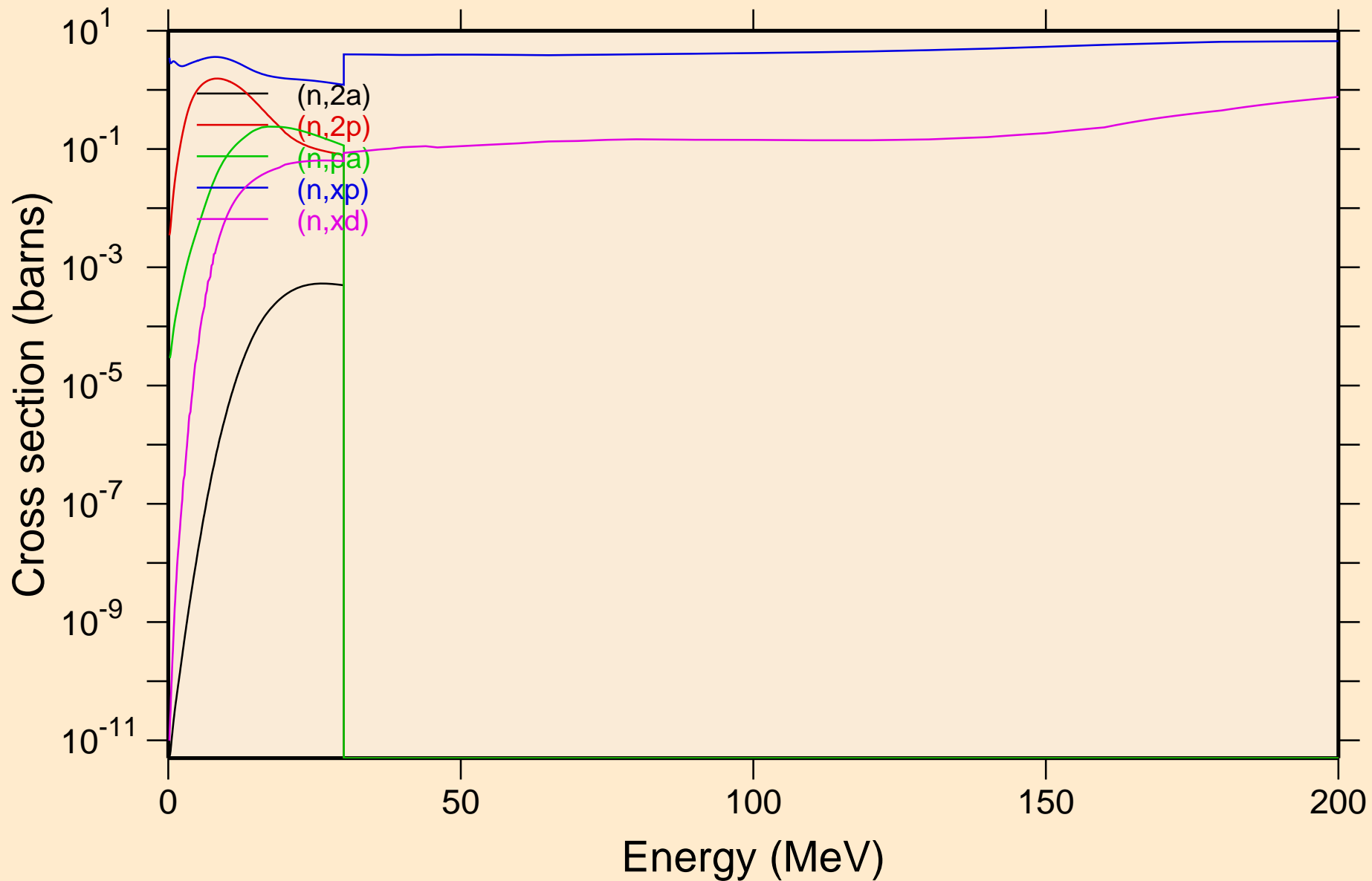

TB139 NEUTRON ACER TENDL-2019 LIBRARY; T=293.16K
Non-threshold reactions

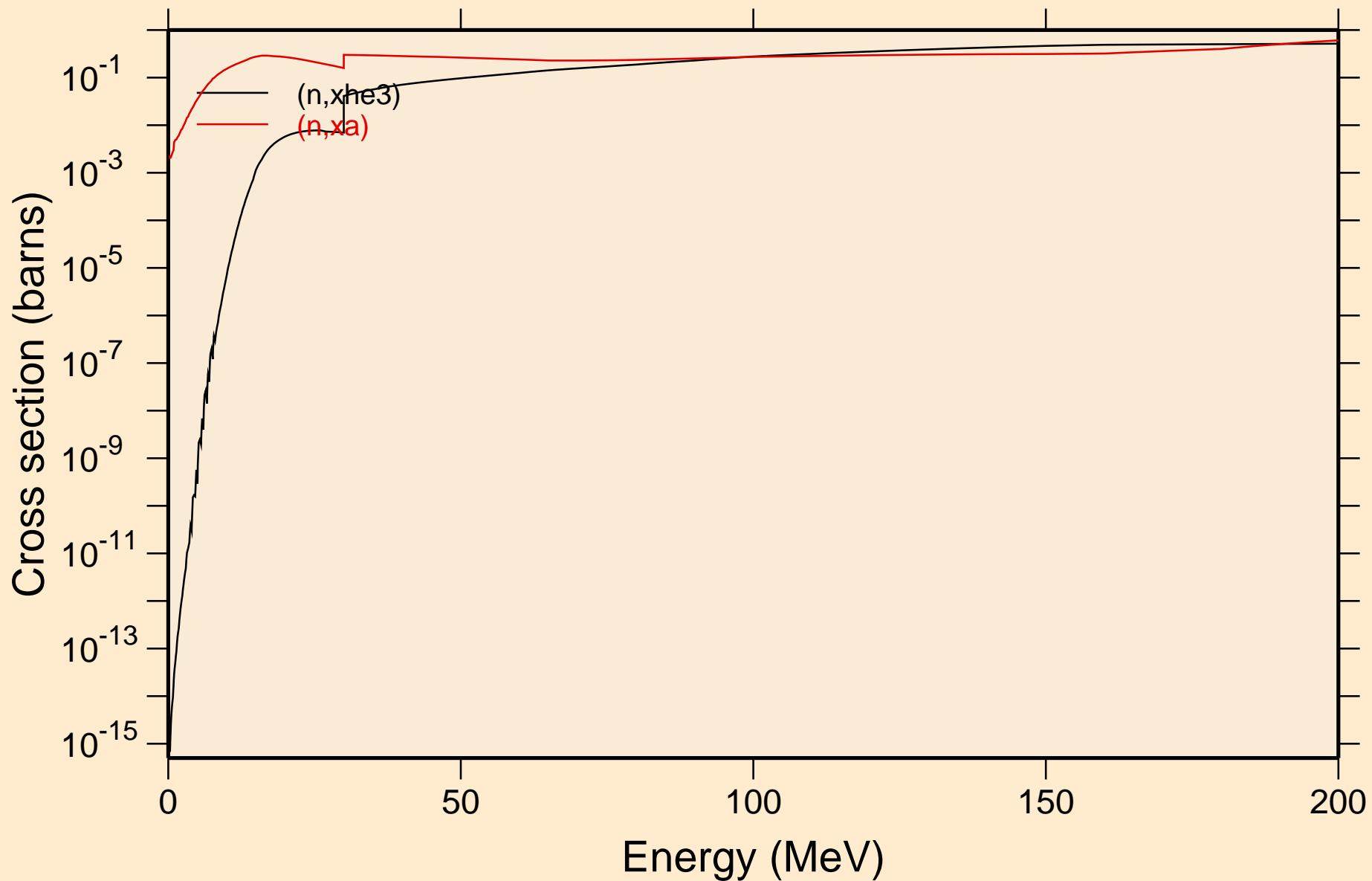

TB139 NEUTRON ACER TENDL-2019 LIBRARY; T=293.16K
Inelastic levels

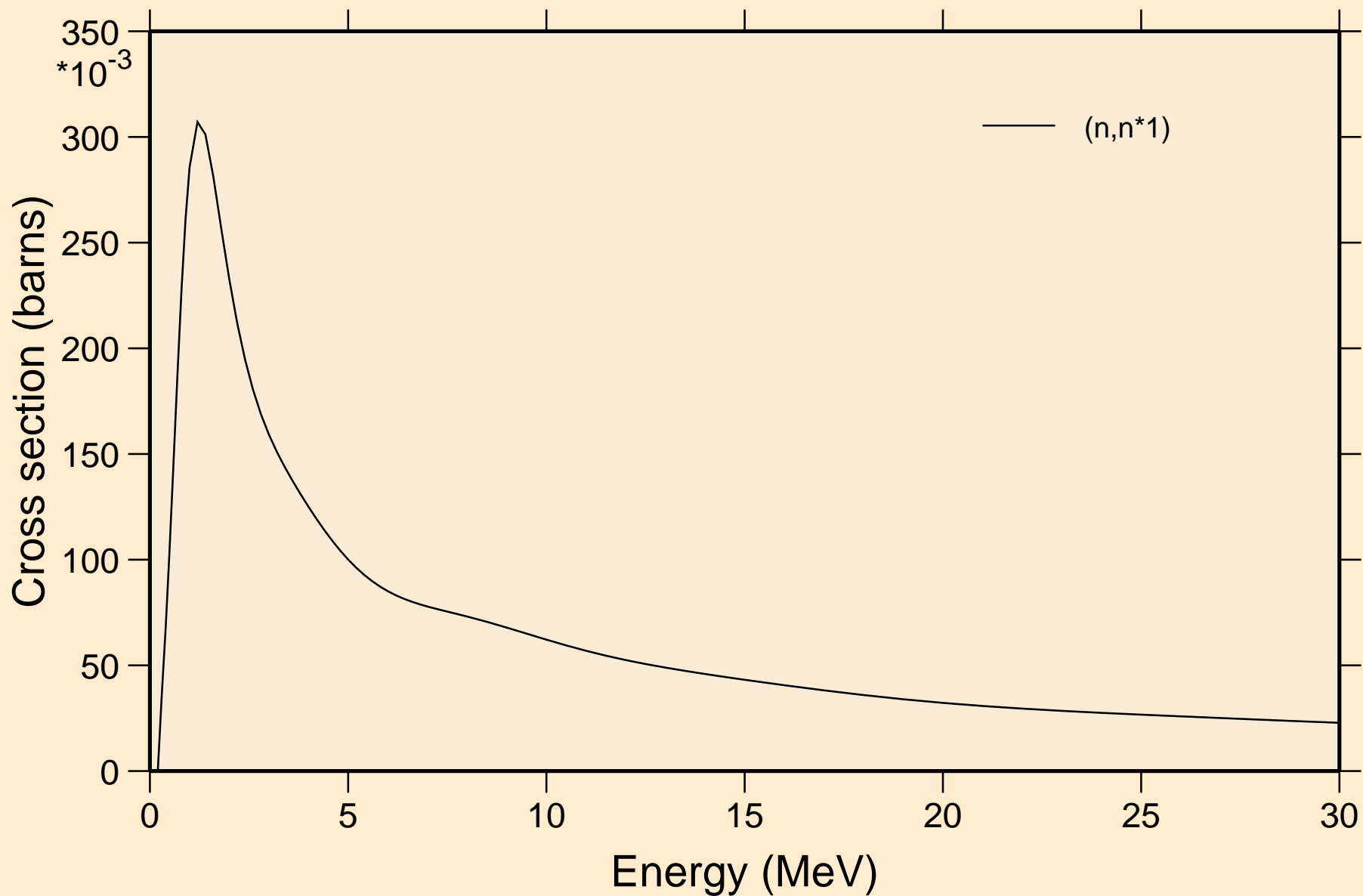

TB139 NEUTRON ACER TENDL-2019 LIBRARY; T=293.16K
Threshold reactions

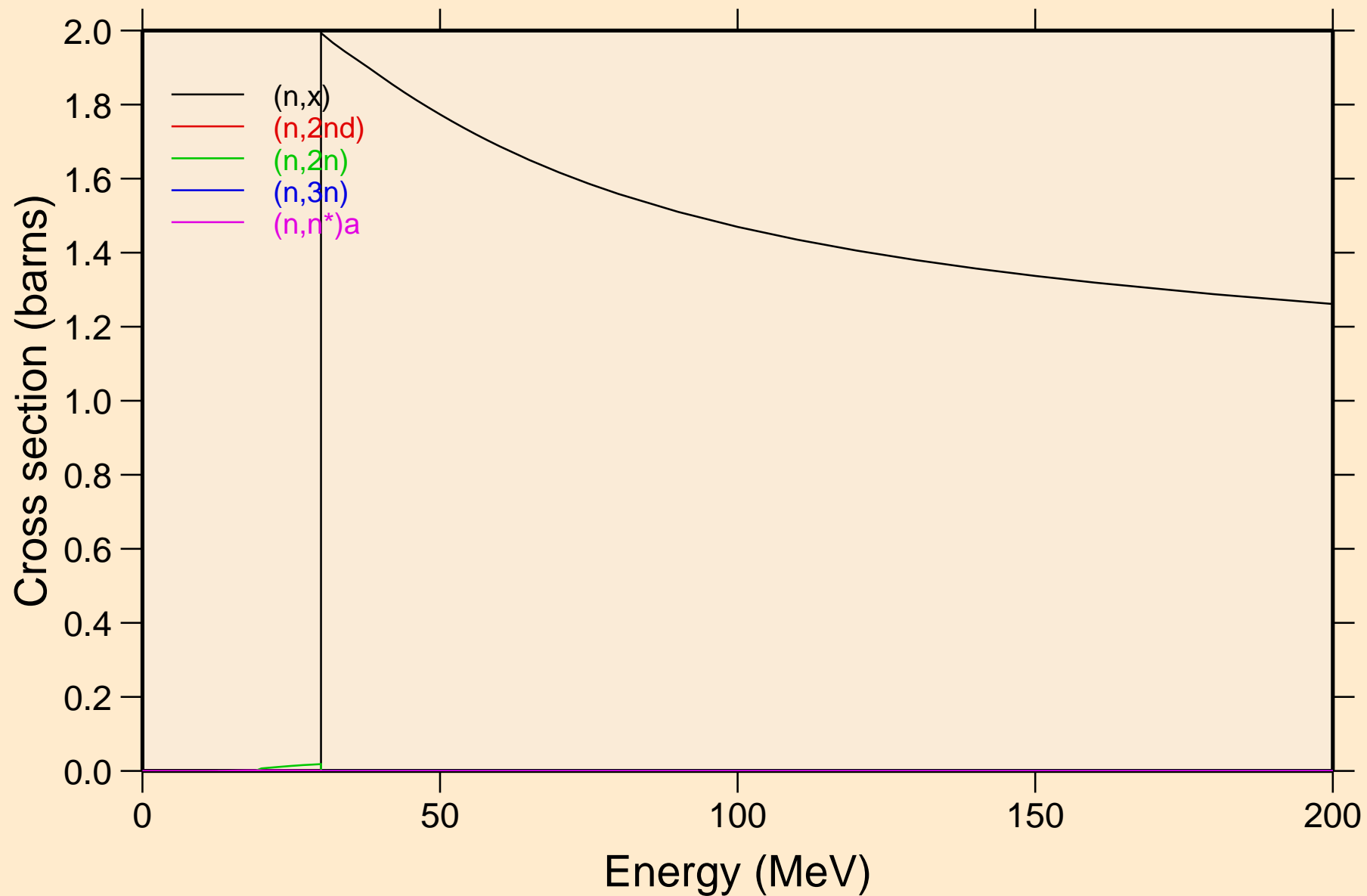

TB139 NEUTRON ACER TENDL-2019 LIBRARY; T=293.16K
Threshold reactions

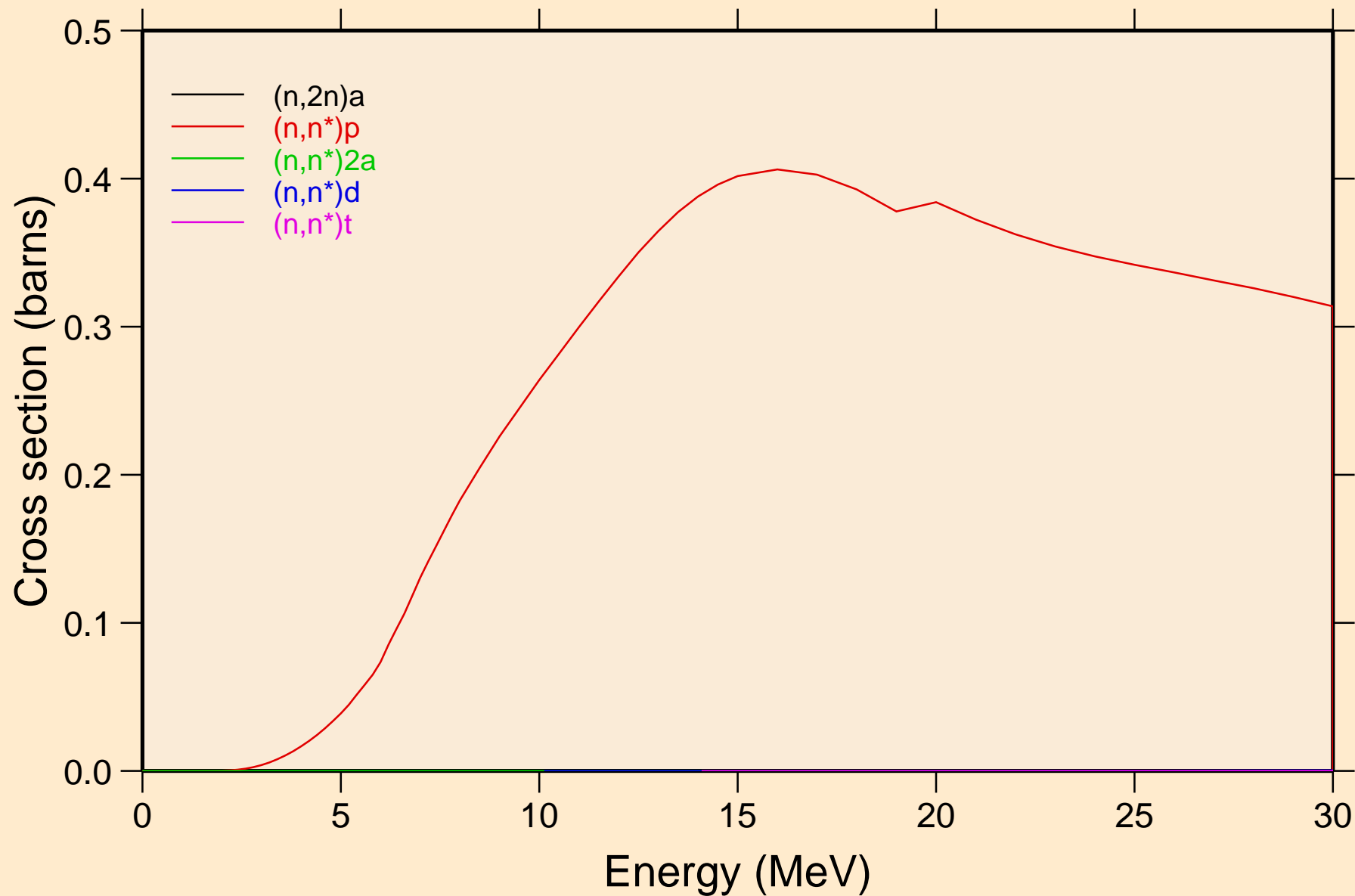

TB139 NEUTRON ACER TENDL-2019 LIBRARY; T=293.16K
Threshold reactions

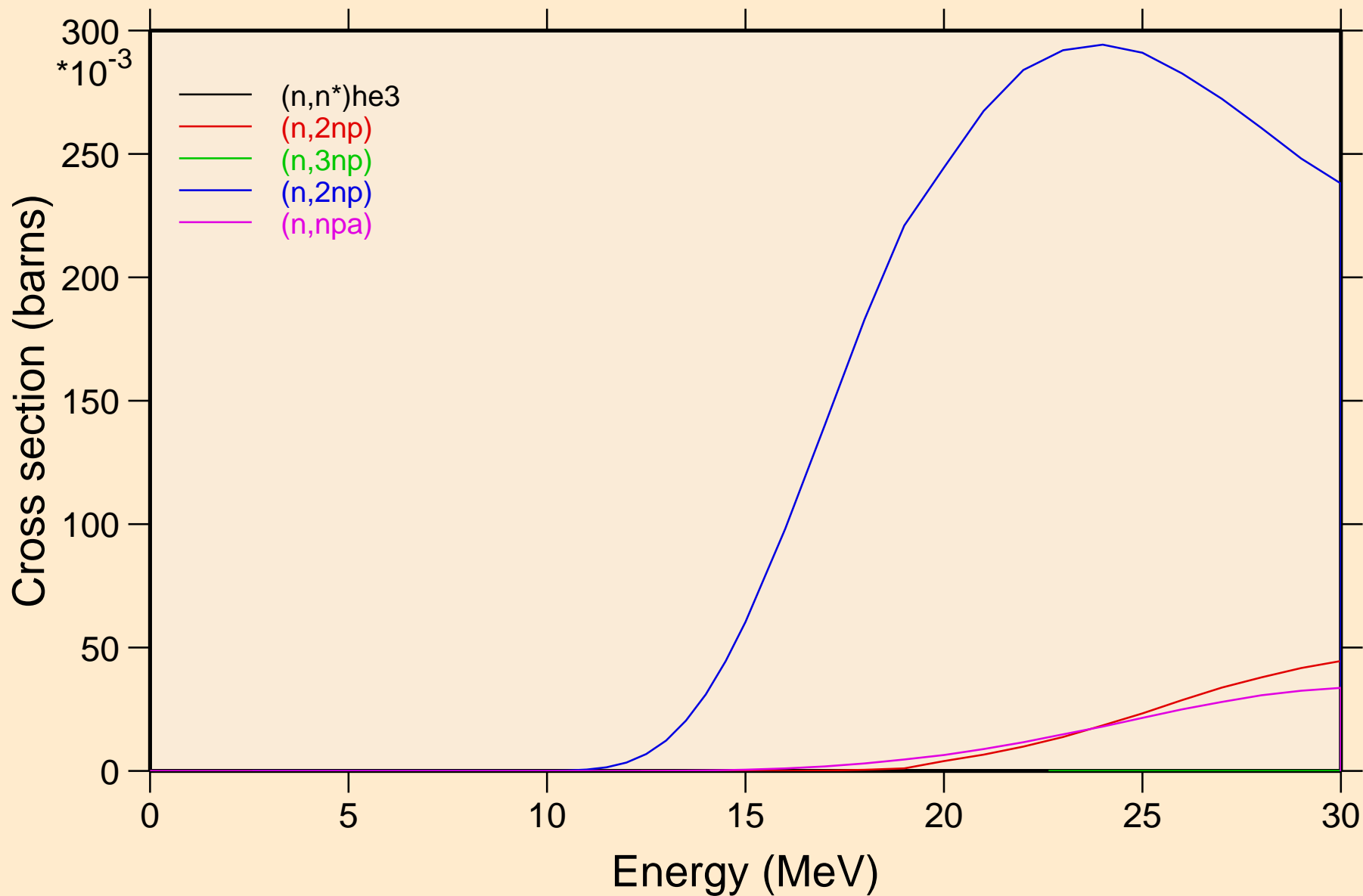

TB139 NEUTRON ACER TENDL-2019 LIBRARY; T=293.16K
Threshold reactions

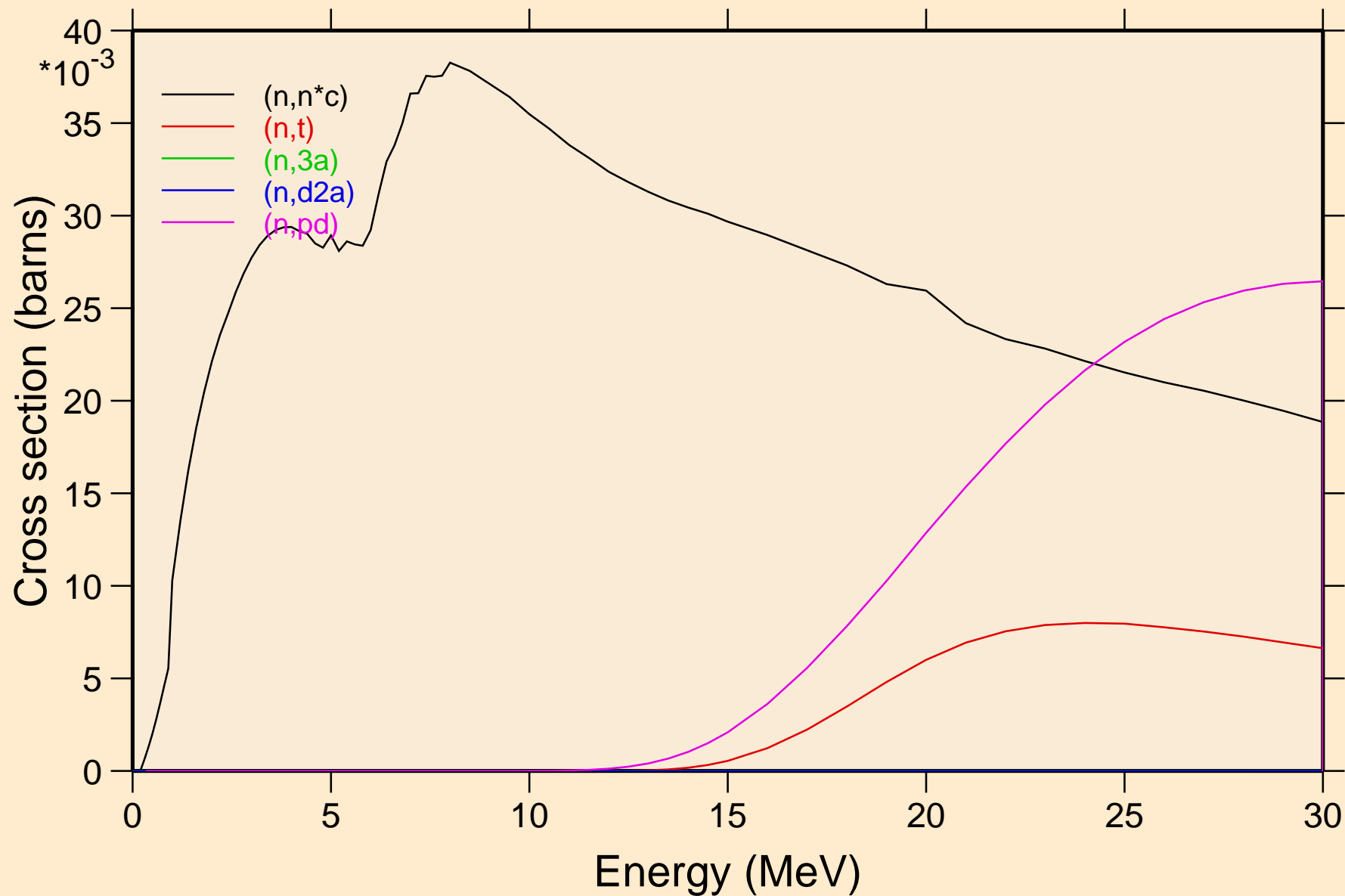

TB139 NEUTRON ACER TENDL-2019 LIBRARY; T=293.16K
Threshold reactions

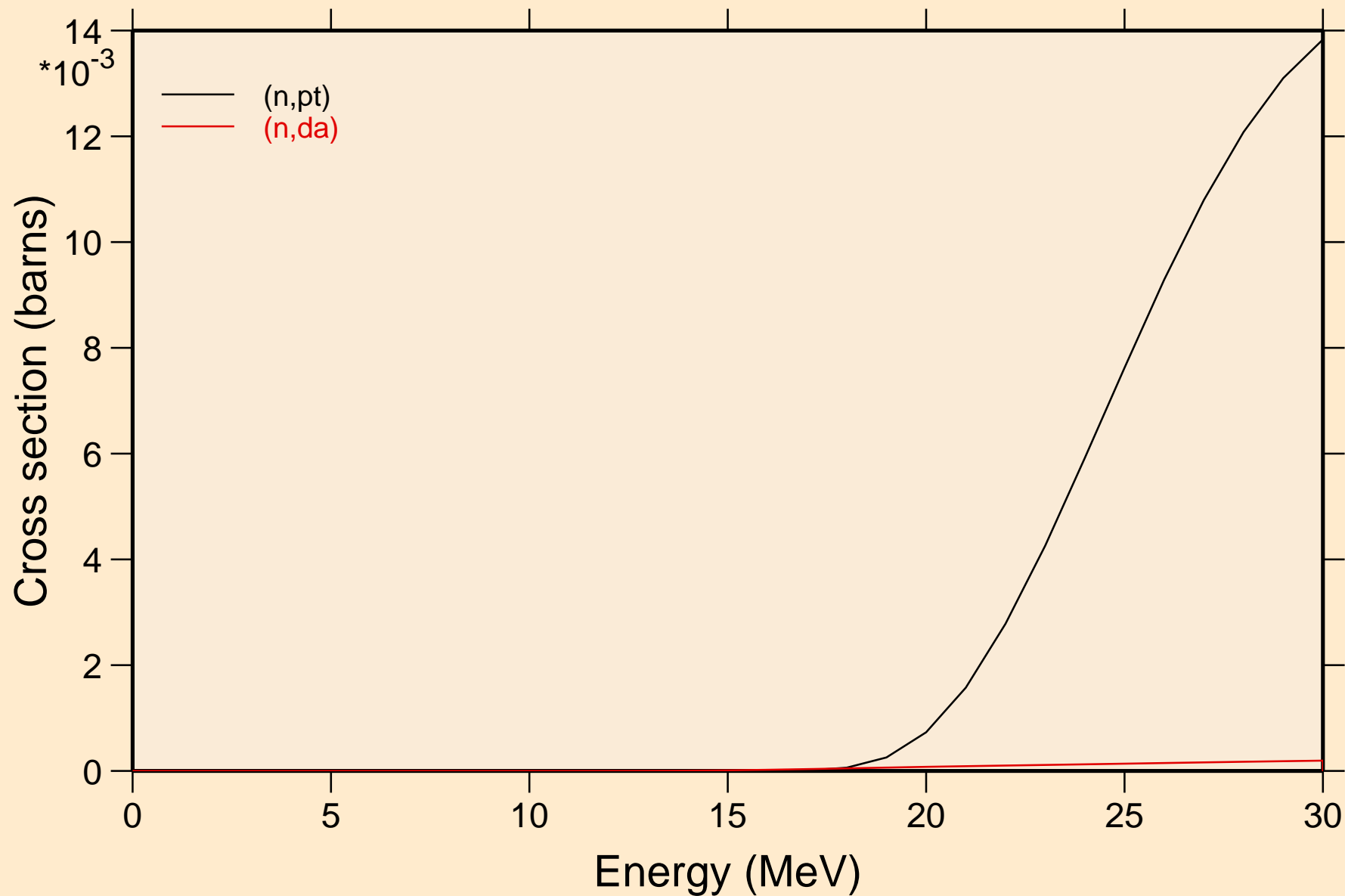

TB139 NEUTRON ACER TENDL-2019 LIBRARY; T=293.16K
Threshold reactions

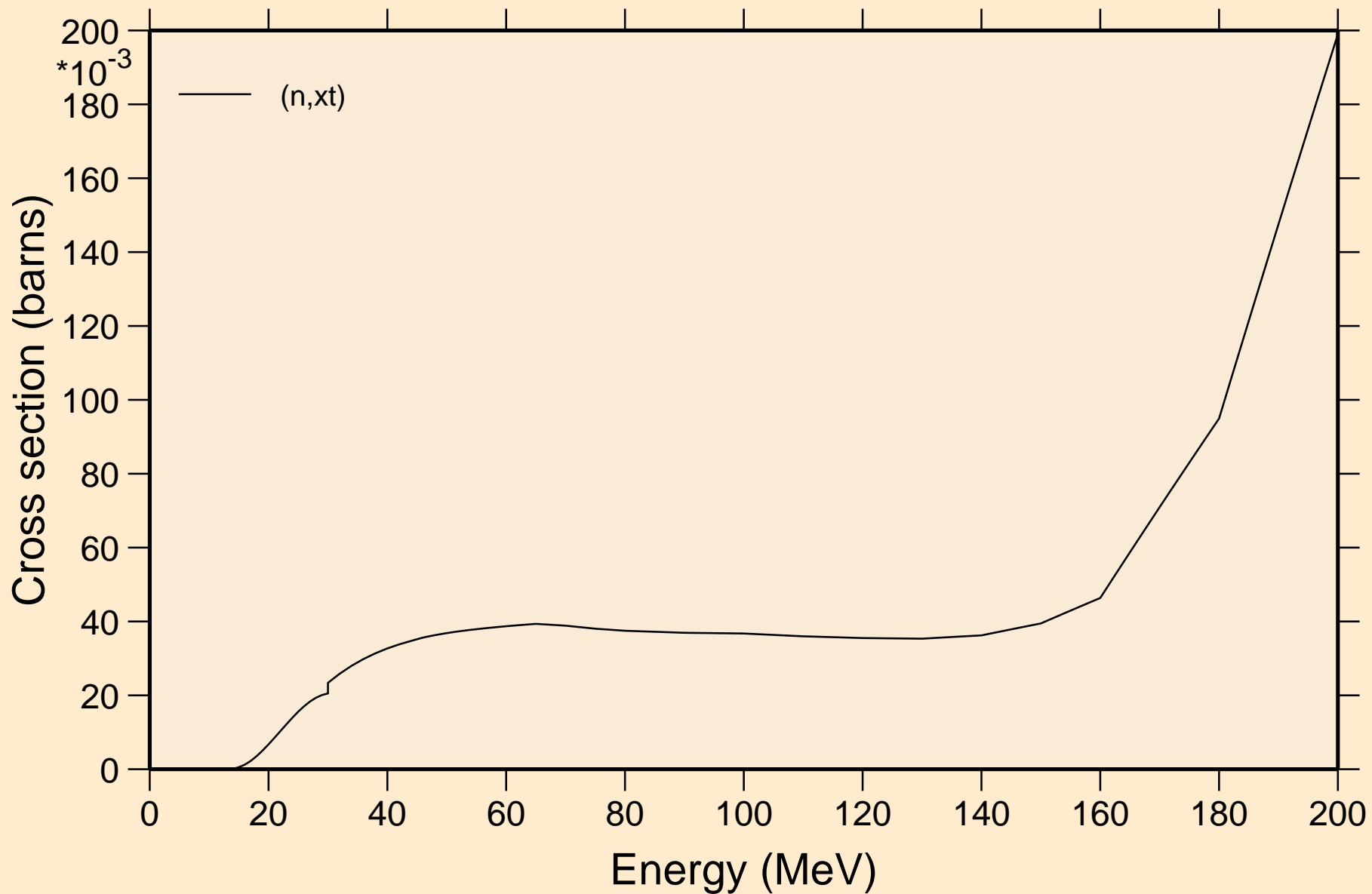

TB139 NEUTRON ACER TENDL-2019 LIBRARY; T=293.16K
angular distribution for elastic

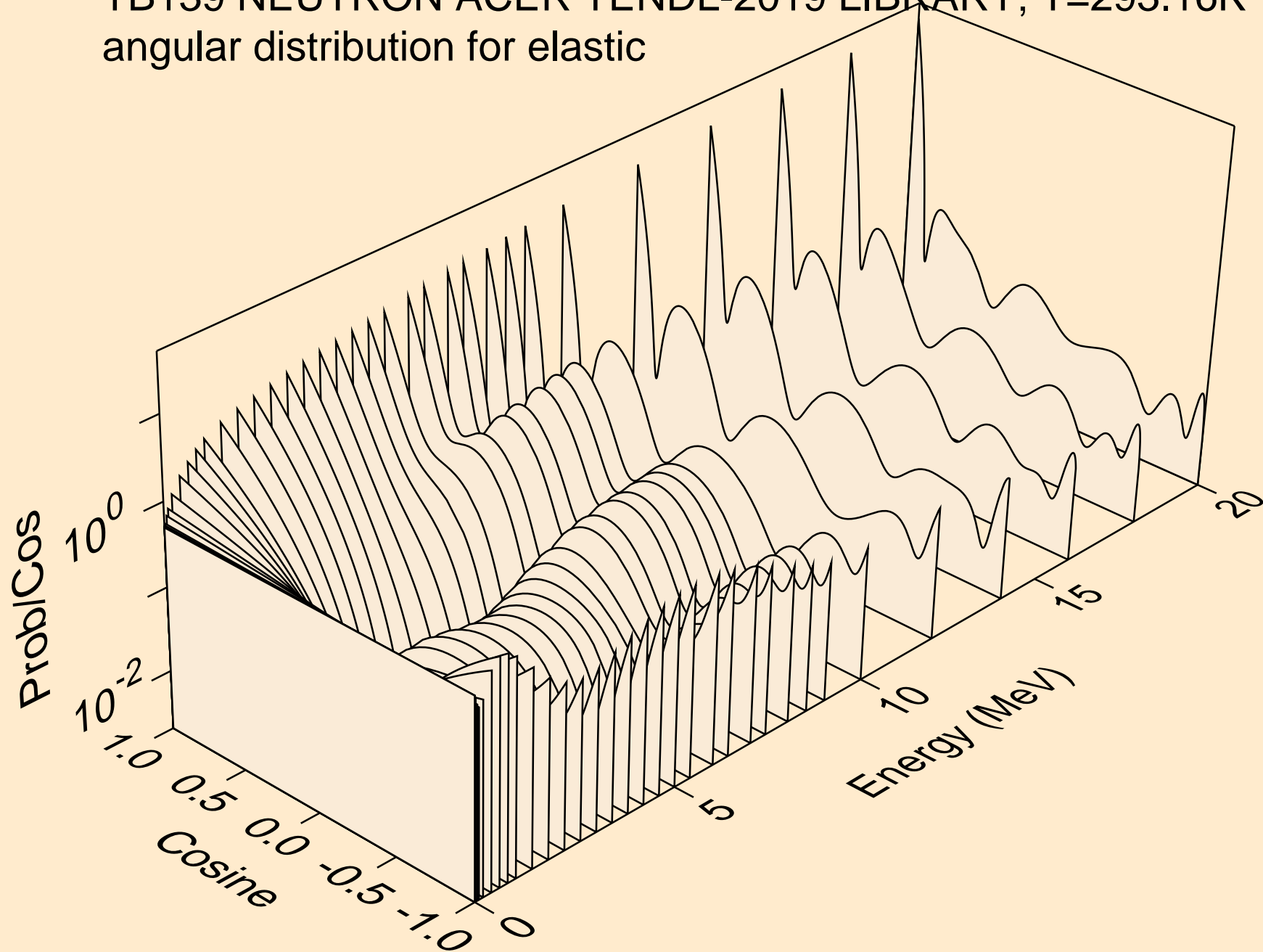

TB139 NEUTRON ACER TENDL-2019 LIBRARY; T=293.16K
angular distribution for elastic

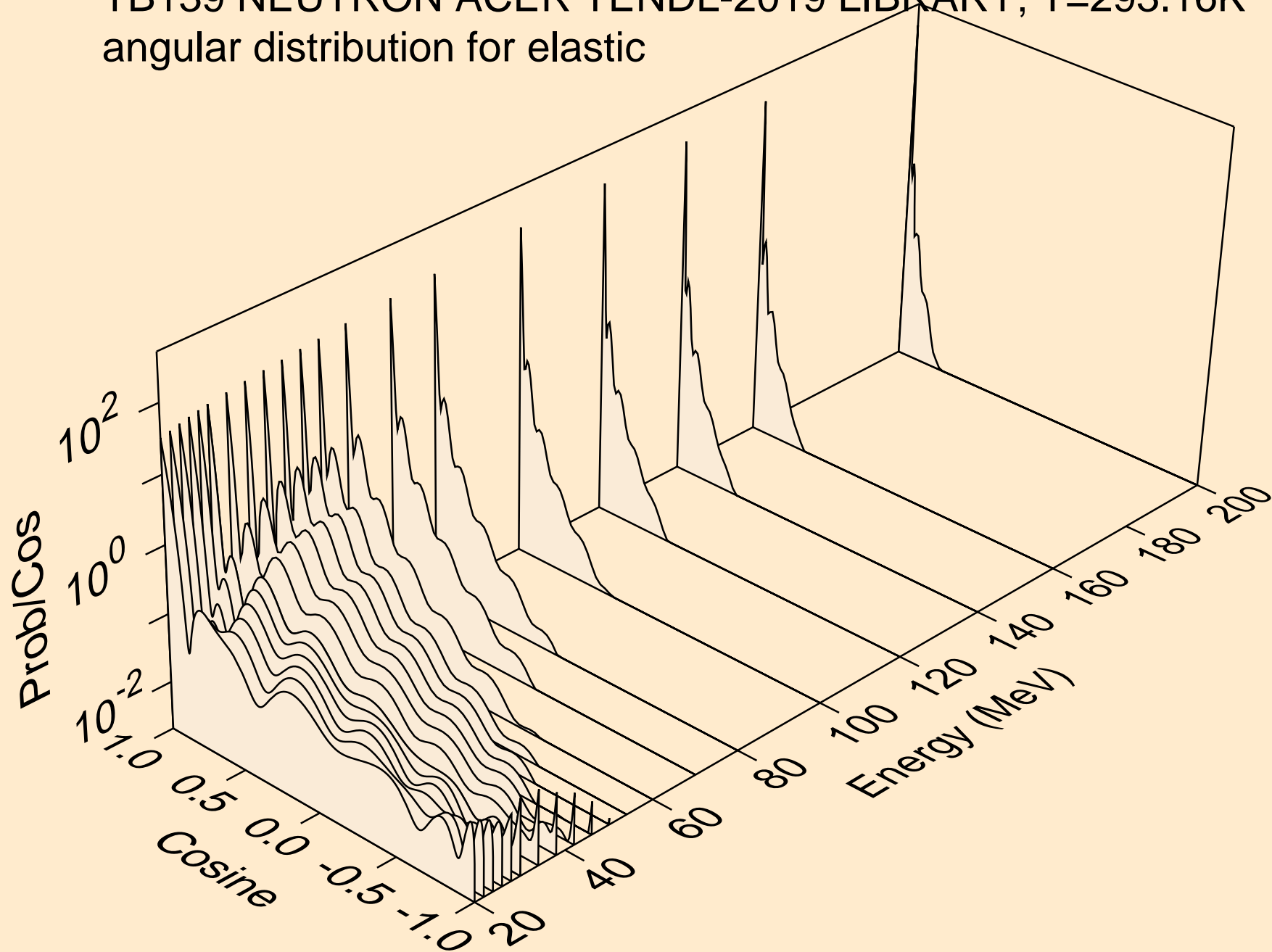

TB139 NEUTRON ACER TENDL-2019 LIBRARY; T=293.16K
angular distribution for (n,n*1)

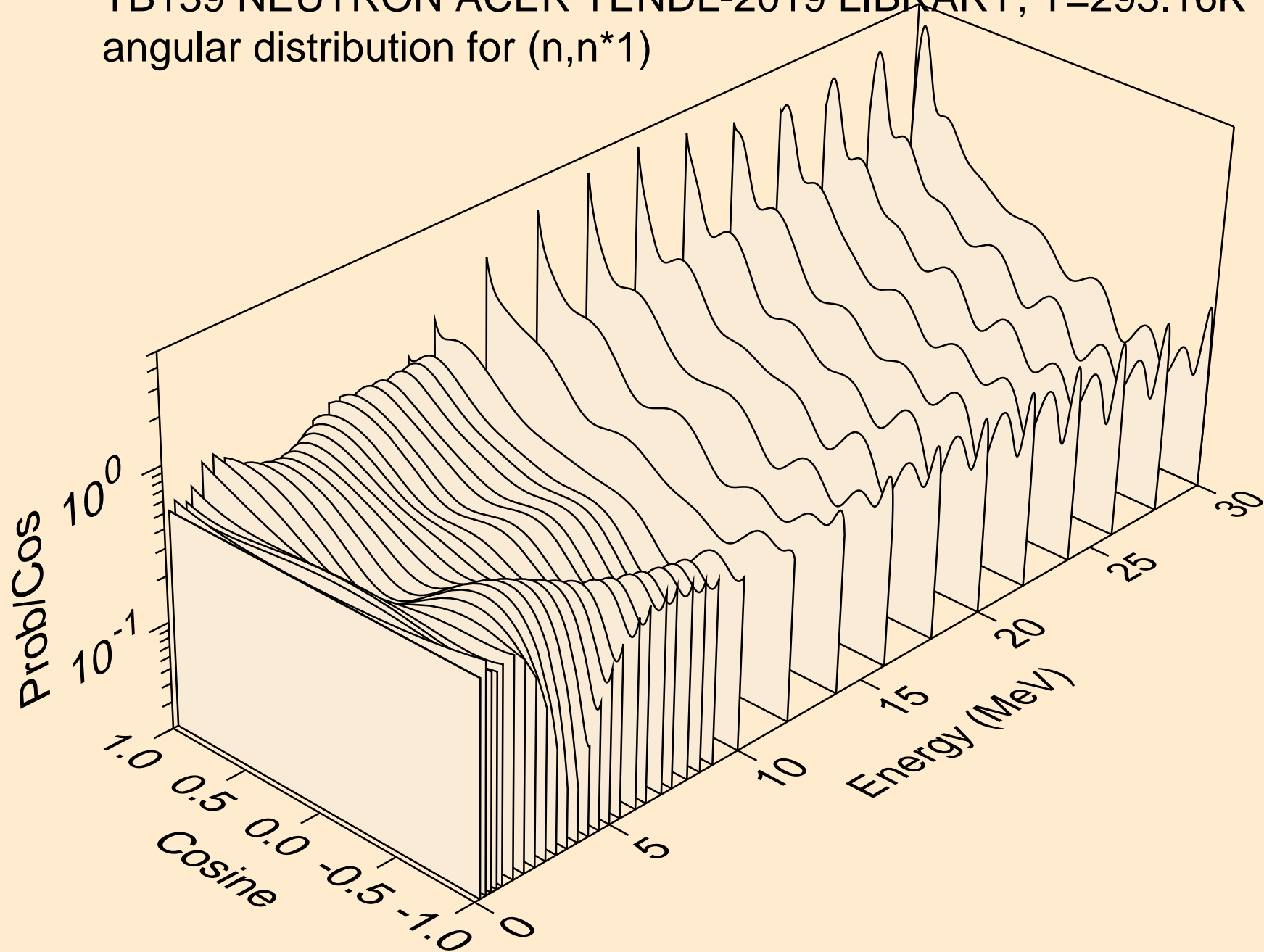

TB139 NEUTRON ACER TENDL-2019 LIBRARY; T=293.16K
Neutron emission for (n,x)

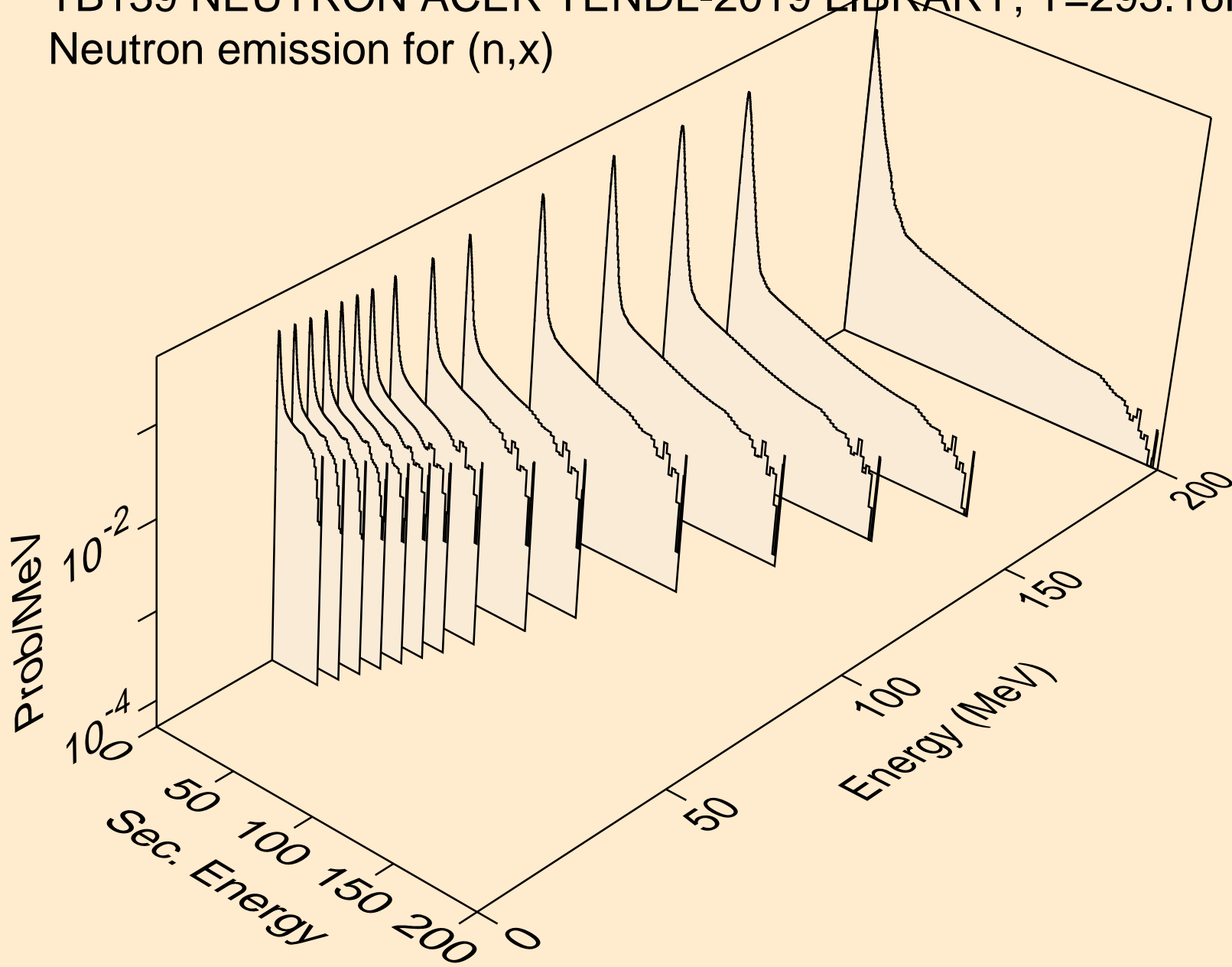

TB139 NEUTRON ACER TENDL-2019 LIBRARY; T=293.16K
Neutron emission for (n,2nd)

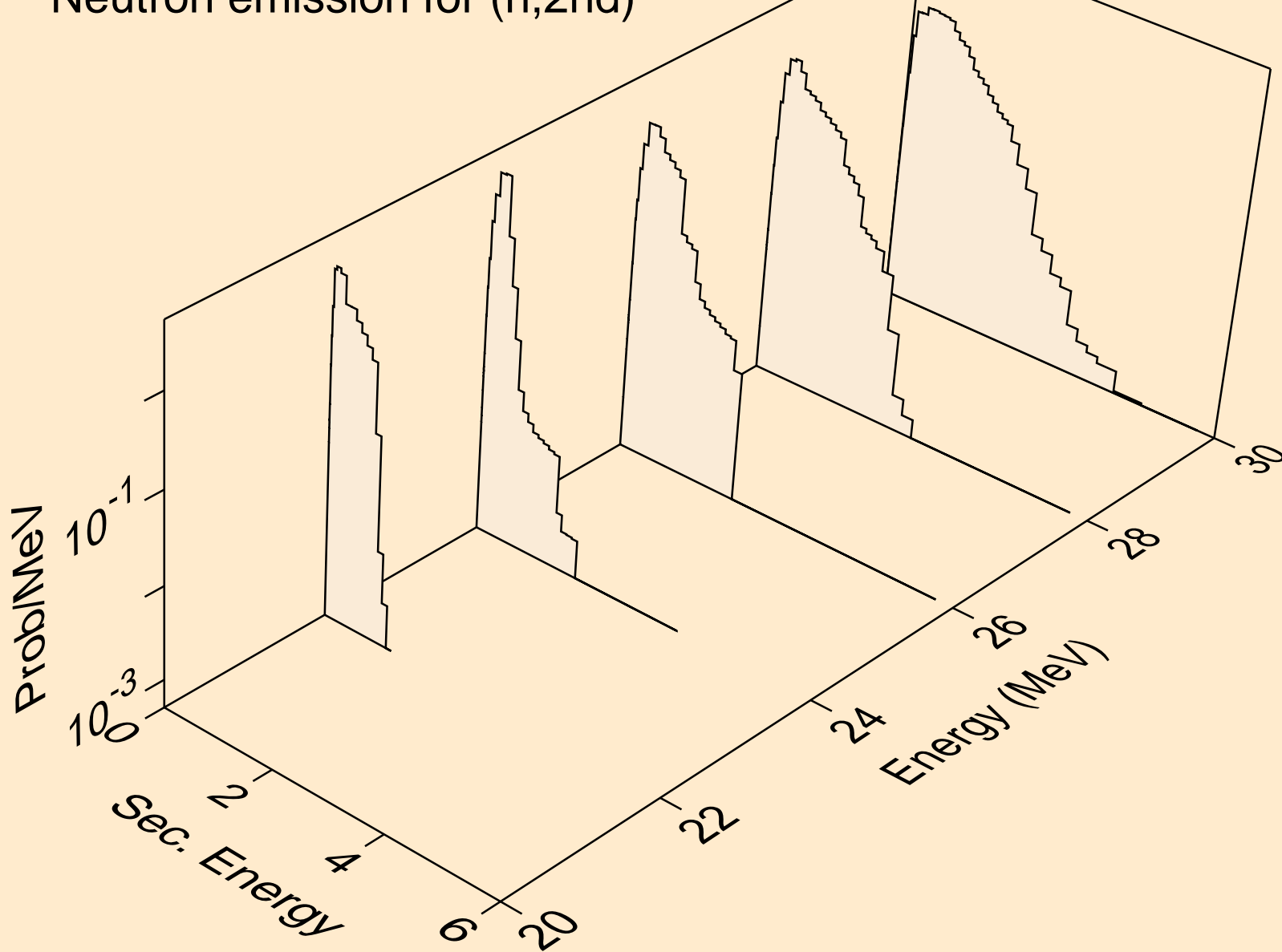

TB139 NEUTRON ACER TENDL-2019 LIBRARY; T=293.16K
Neutron emission for (n,2n)

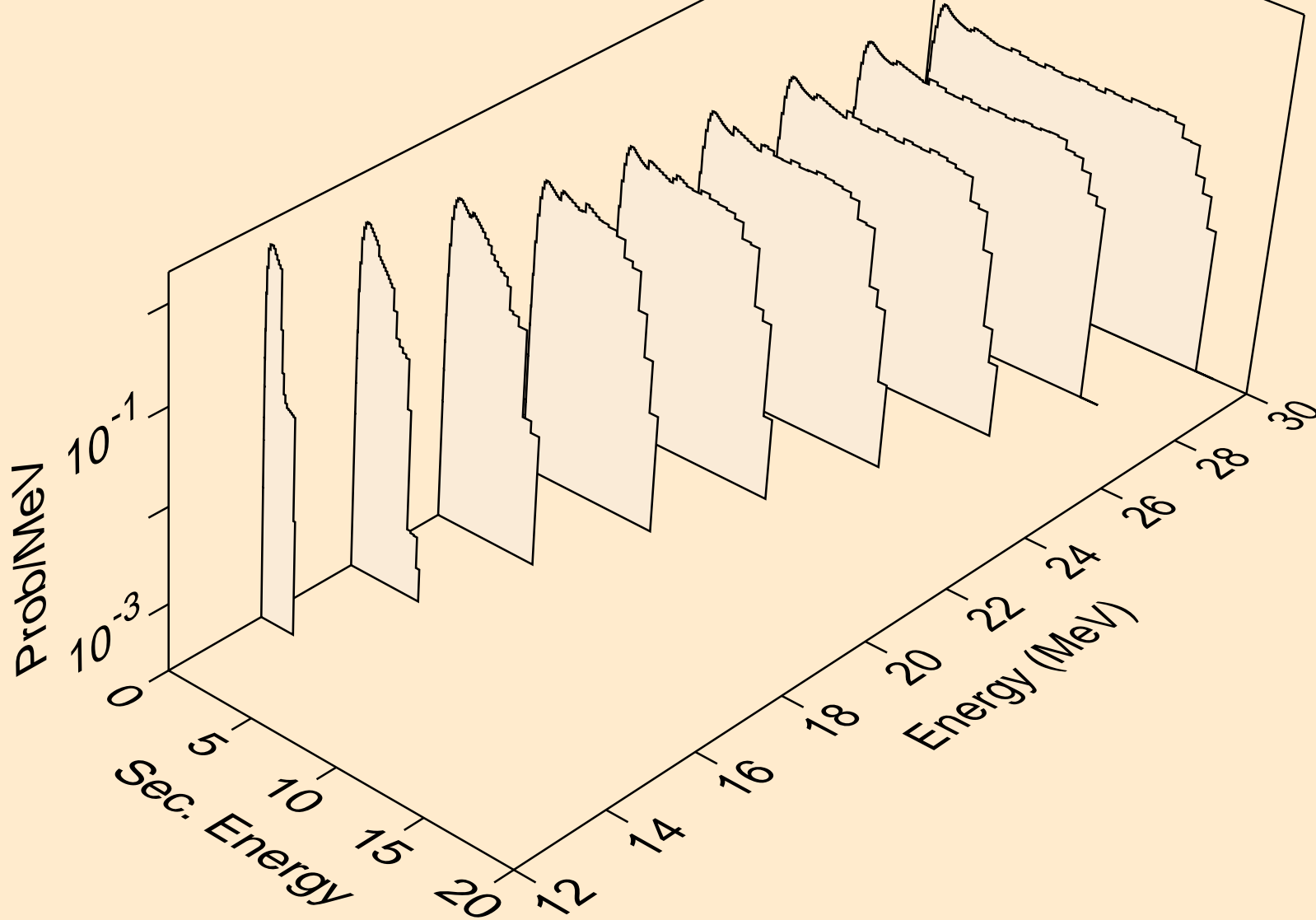

TB139 NEUTRON ACER TENDL-2019 LIBRARY; T=293.16K
Neutron emission for (n,3n)

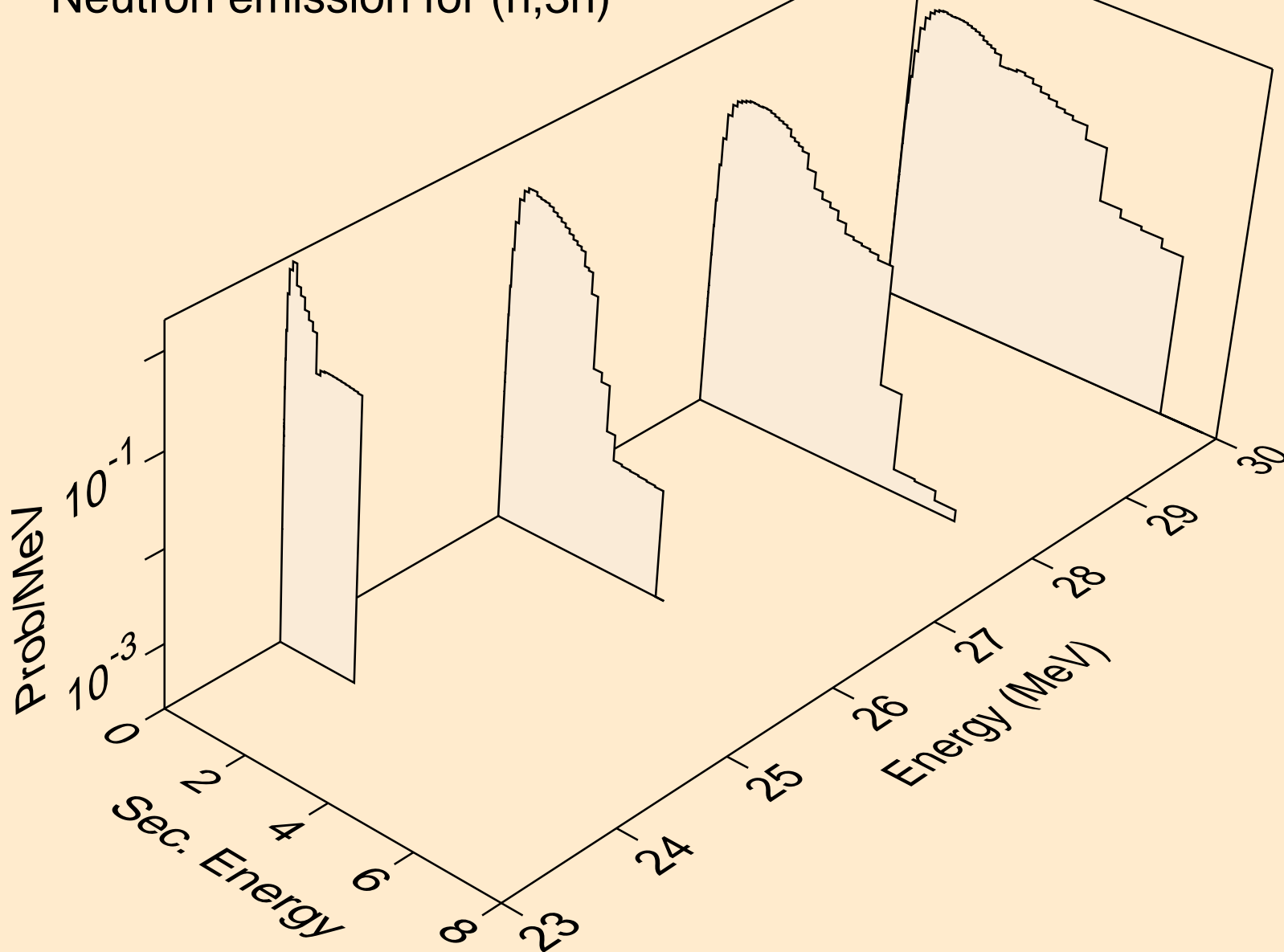

TB139 NEUTRON ACER TENDL-2019 LIBRARY; T=293.16K
Neutron emission for (n,n*)a

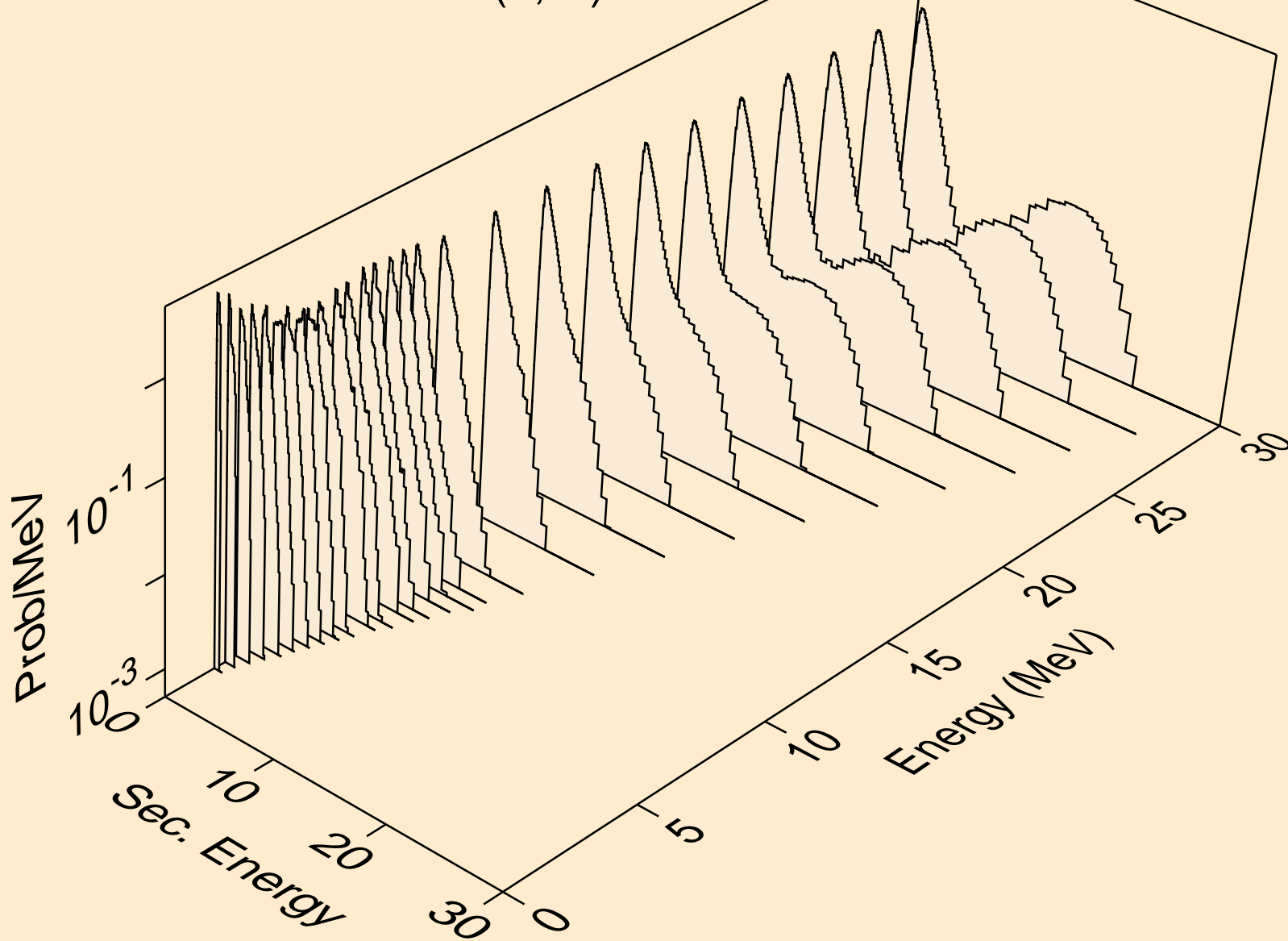

TB139 NEUTRON ACER TENDL-2019 LIBRARY; T=293.16K
Neutron emission for (n,2n)a

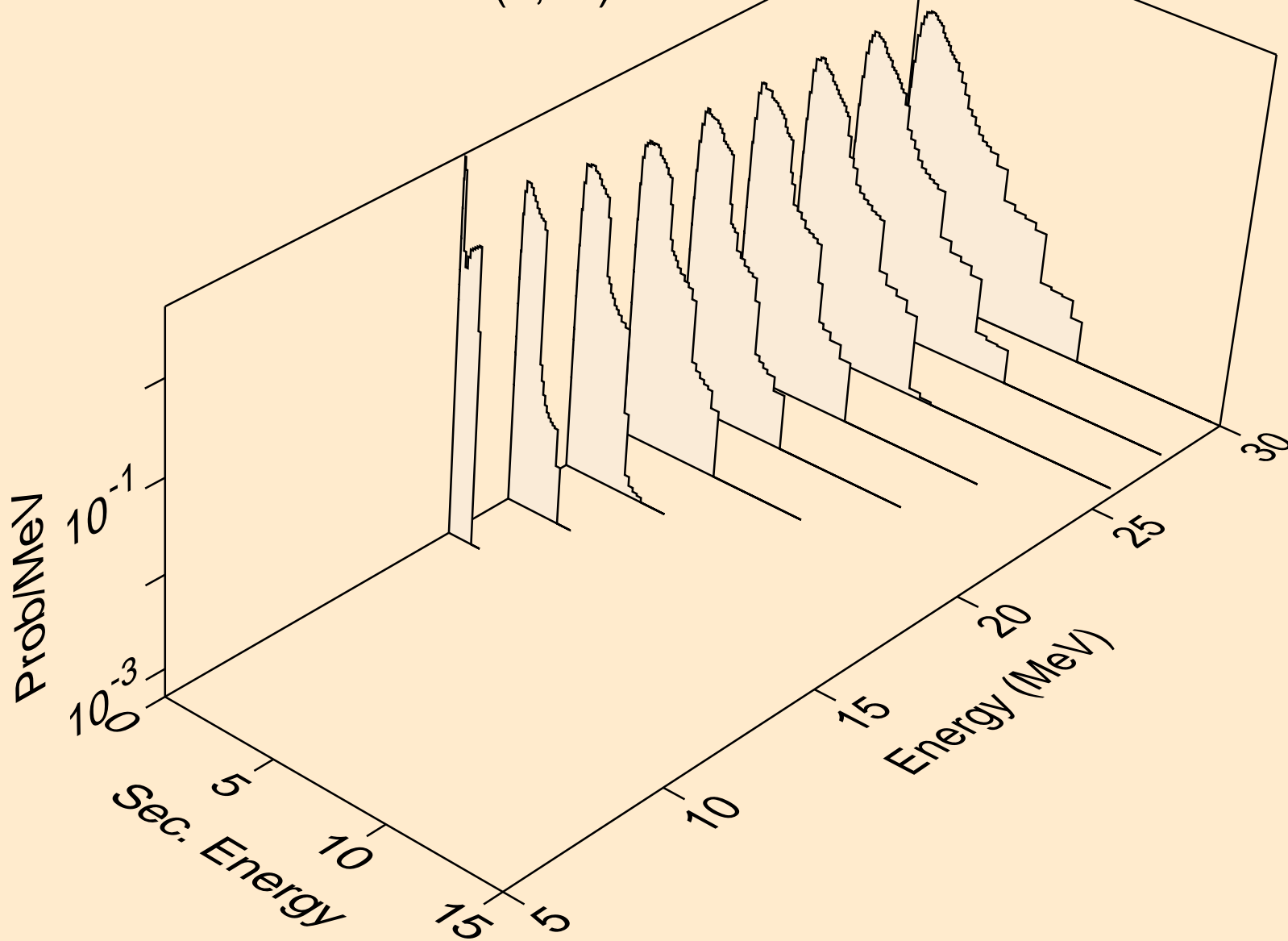

TB139 NEUTRON ACER TENDL-2019 LIBRARY; T=293.16K
Neutron emission for (n,n*)p

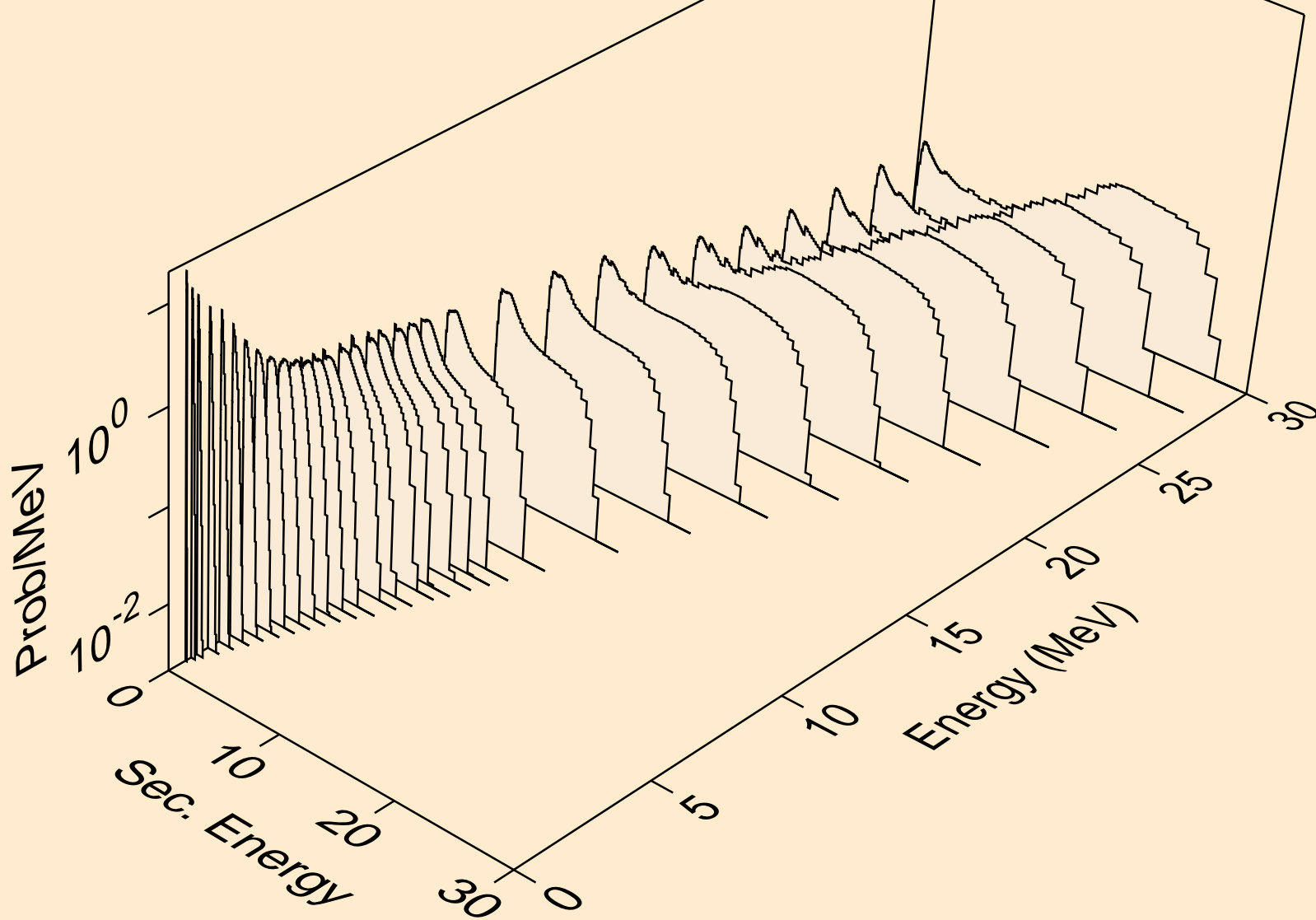

TB139 NEUTRON ACER TENDL-2019 LIBRARY; T=293.16K
Neutron emission for (n,n*)2a

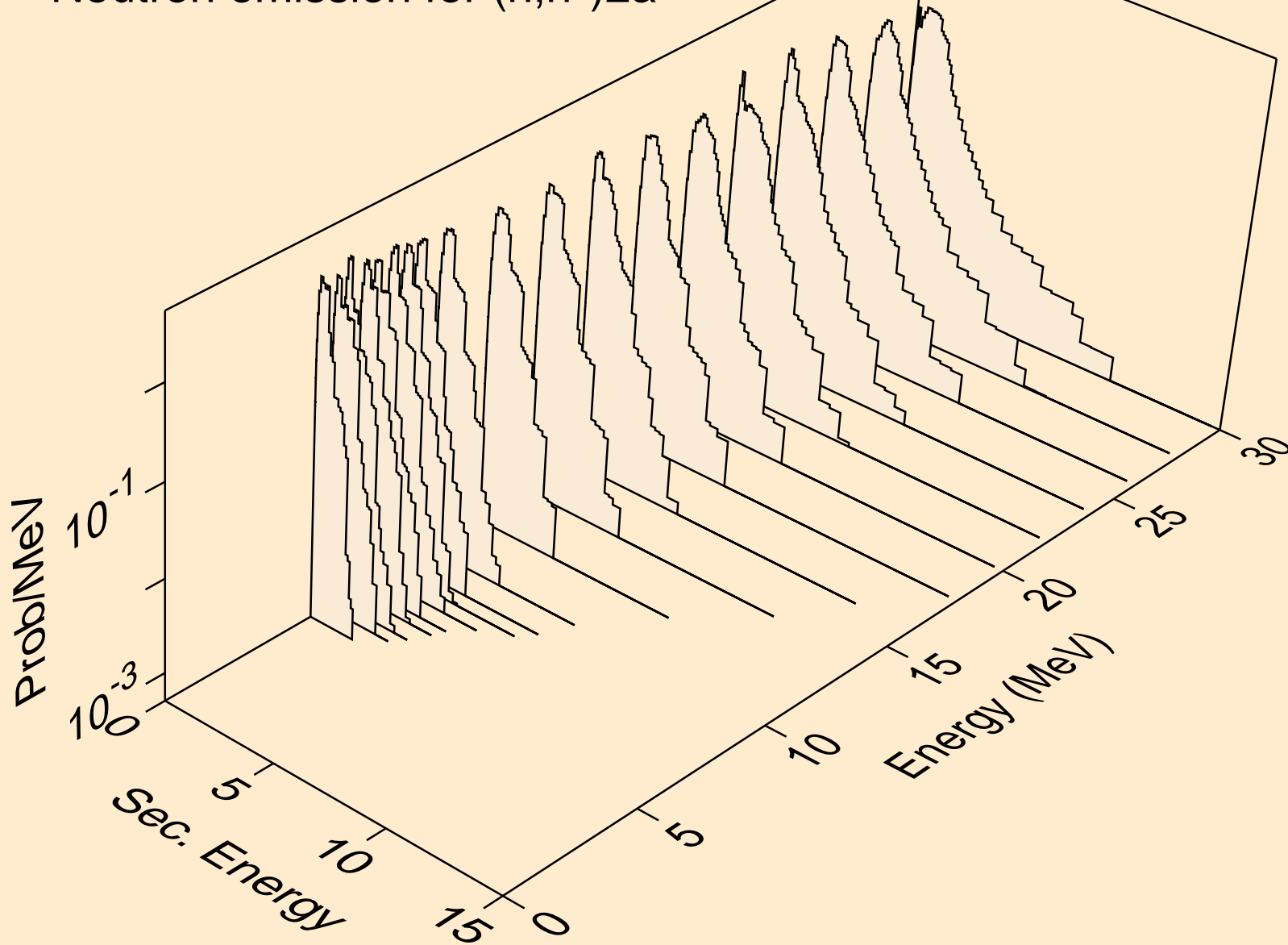

TB139 NEUTRON ACER TENDL-2019 LIBRARY; T=293.16K
Neutron emission for (n,n*)d

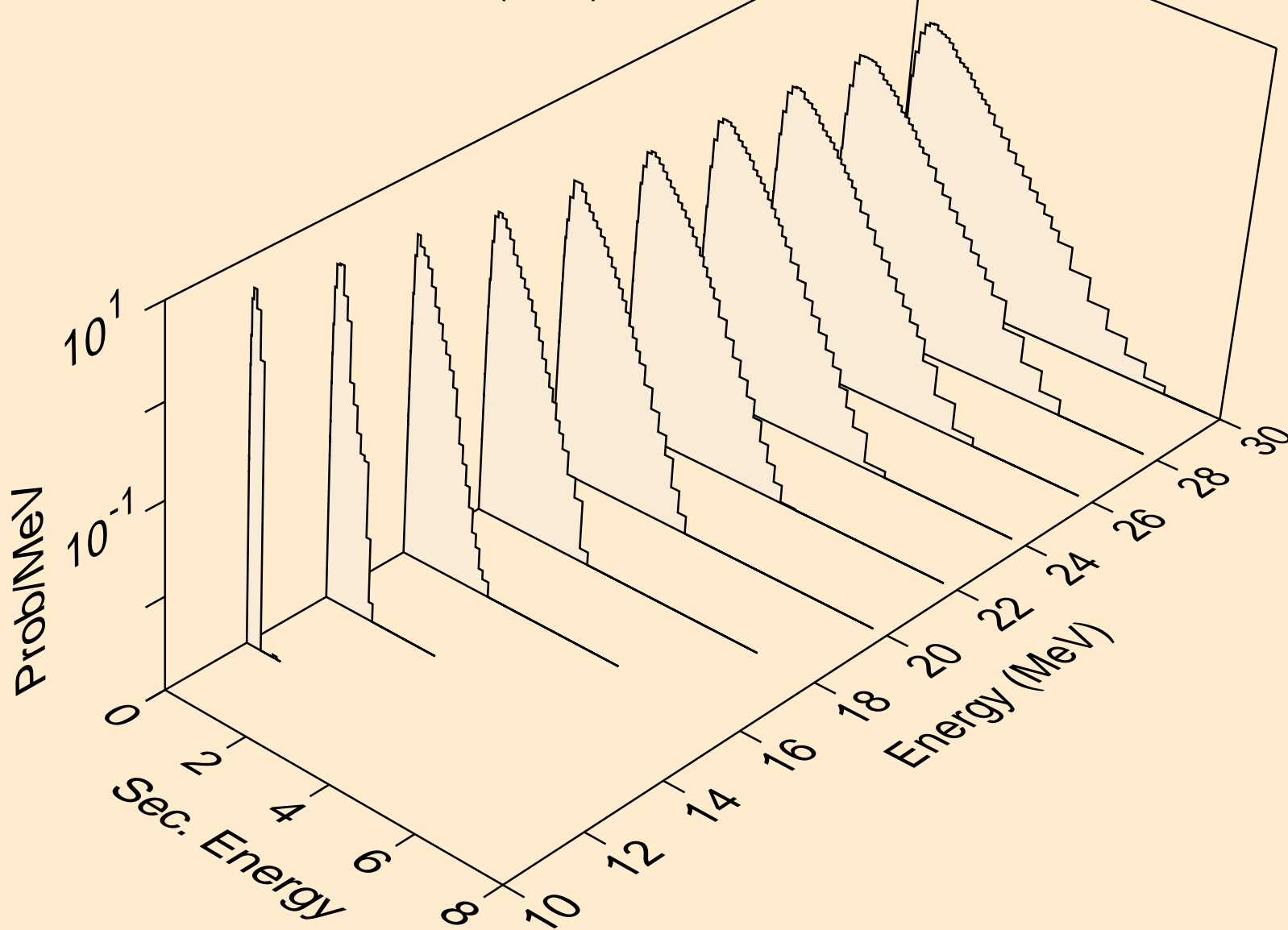

TB139 NEUTRON ACER TENDL-2019 LIBRARY; T=293.16K
Neutron emission for (n,n*)t

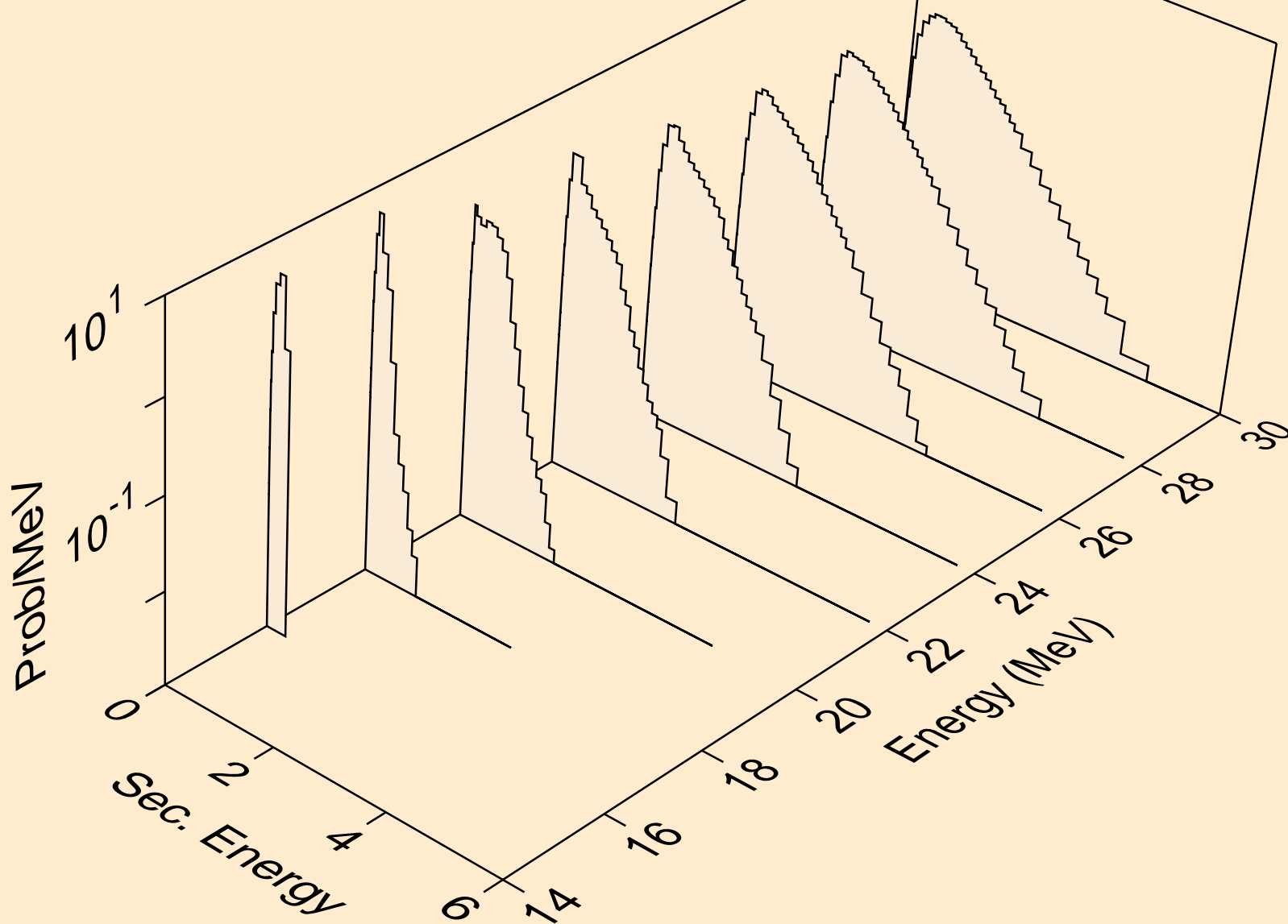

TB139 NEUTRON ACER TENDL-2019 LIBRARY; T=293.16K
Neutron emission for (n,n*)he3

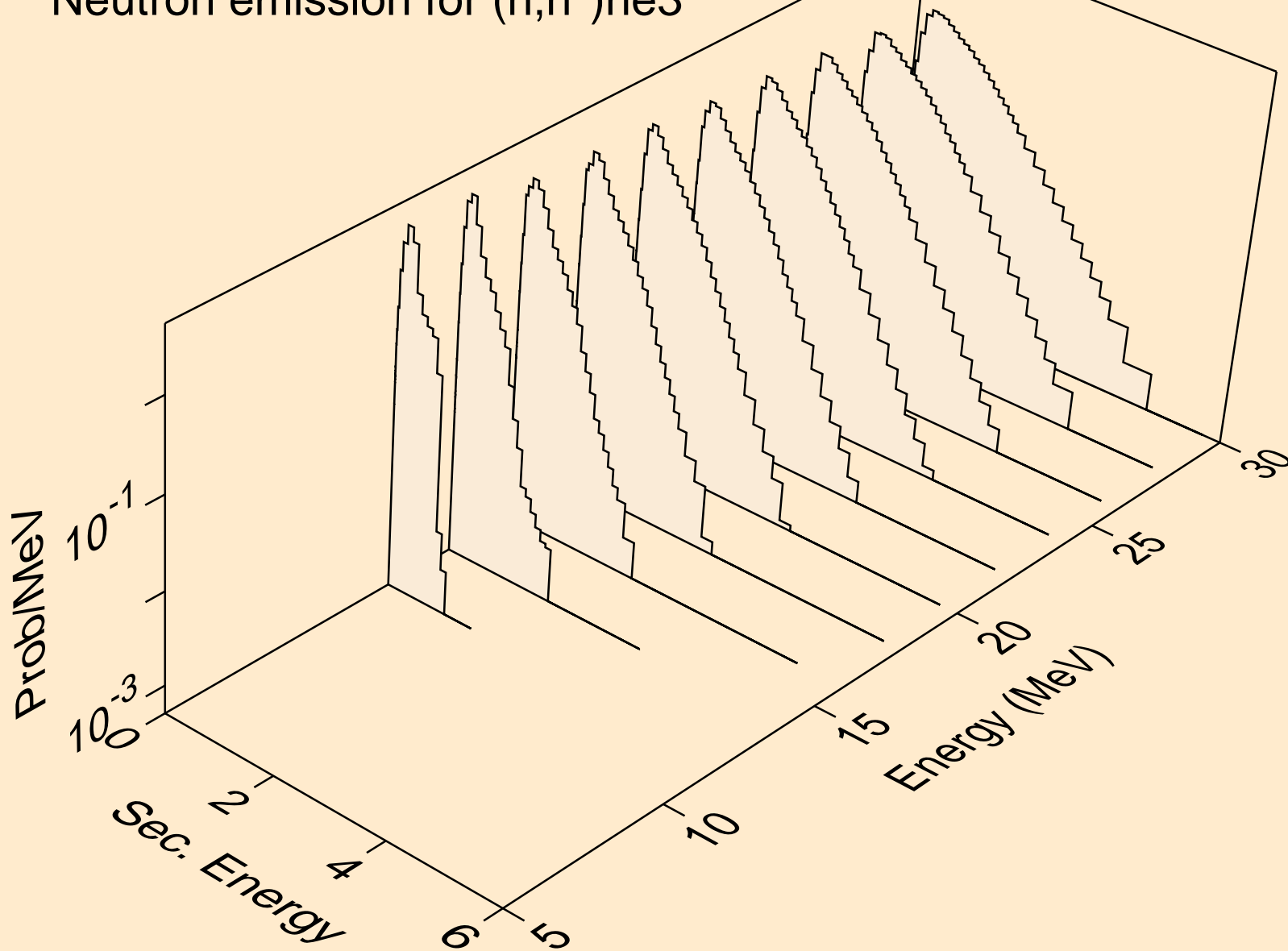

TB139 NEUTRON ACER TENDL-2019 LIBRARY; T=293.16K
Neutron emission for (n,2np)

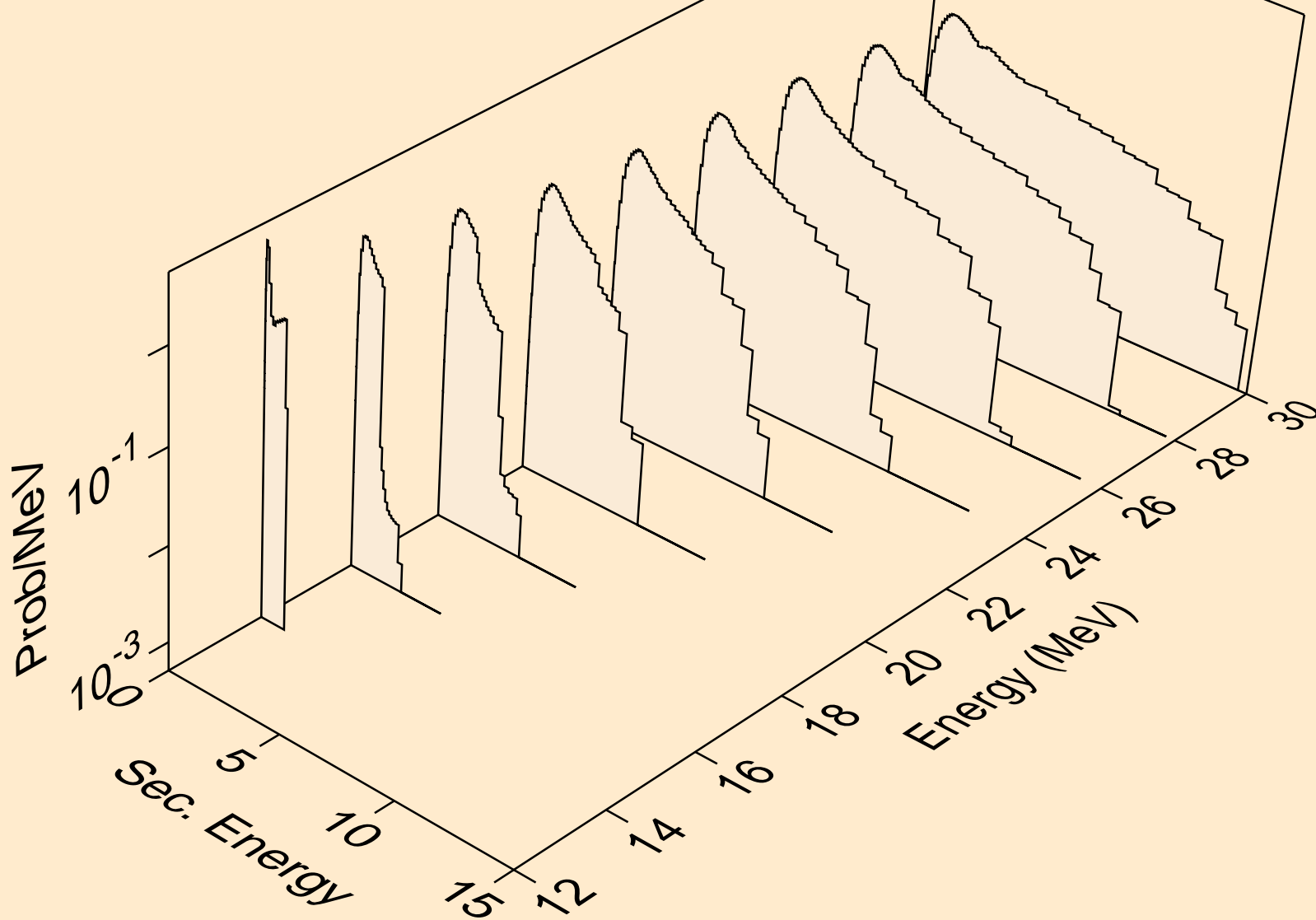

TB139 NEUTRON ACER TENDL-2019 LIBRARY; T=293.16K
Neutron emission for (n,3np)

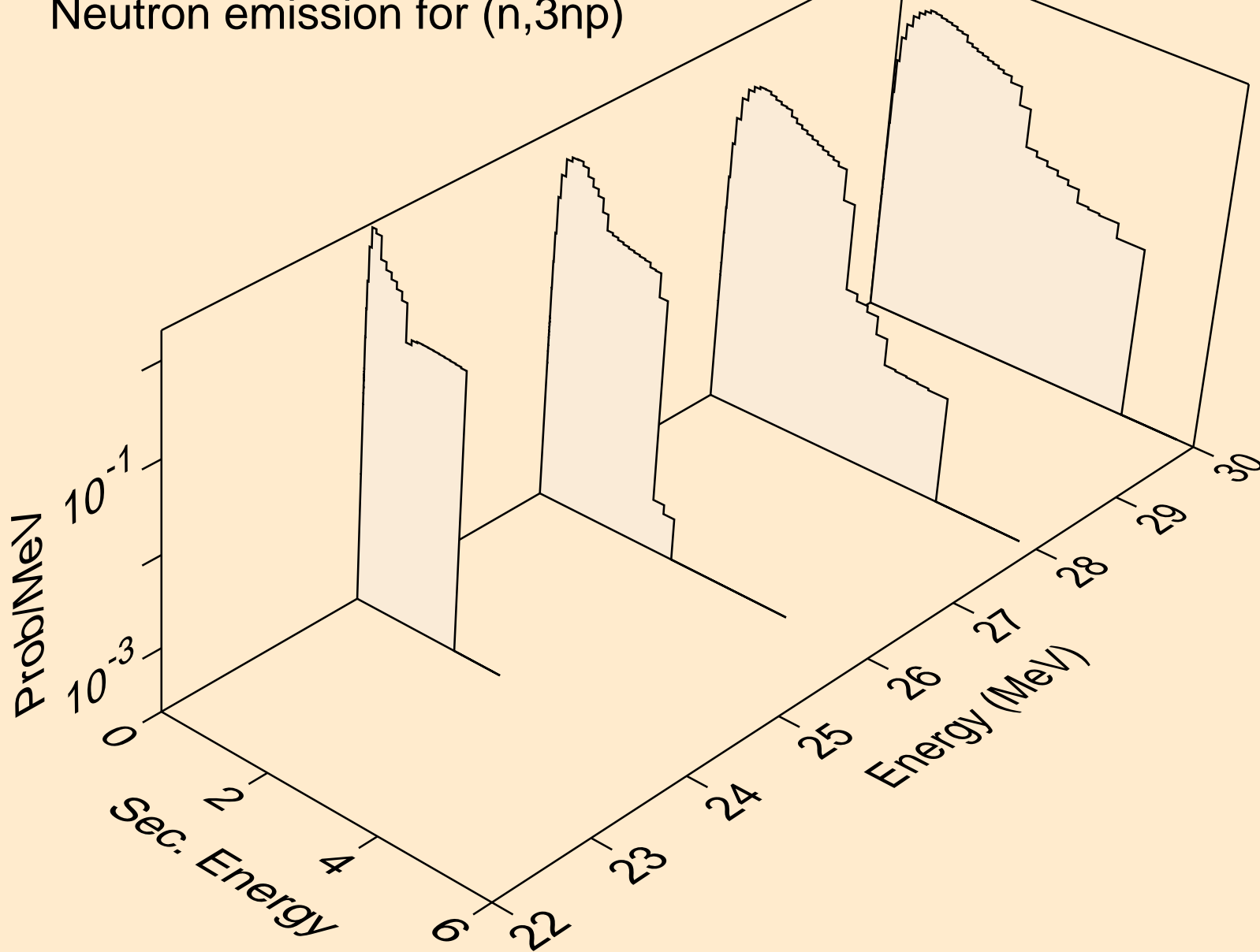

TB139 NEUTRON ACER TENDL-2019 LIBRARY; T=293.16K
Neutron emission for (n,2np)

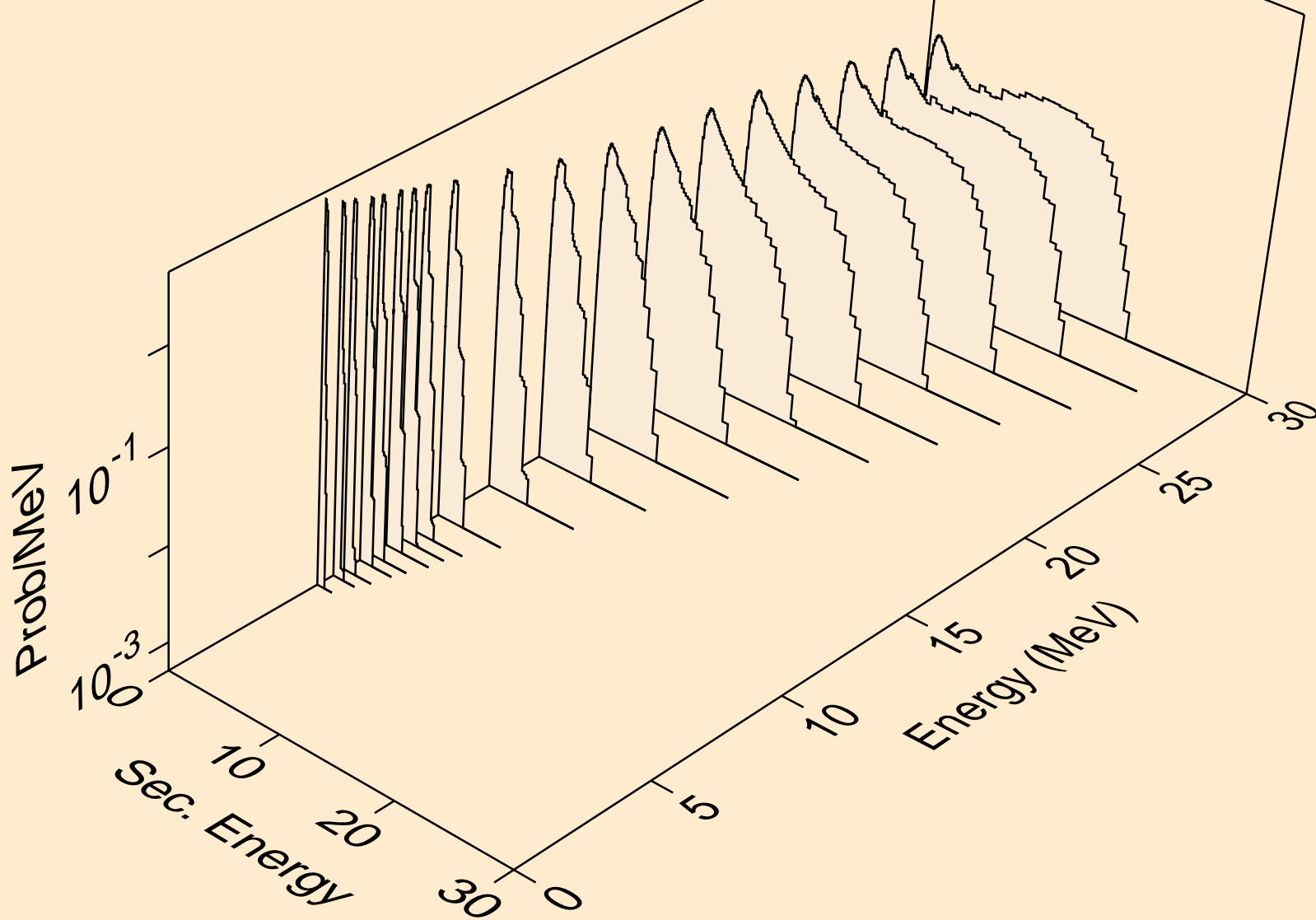

TB139 NEUTRON ACER TENDL-2019 LIBRARY; T=293.16K
Neutron emission for (n,npa)

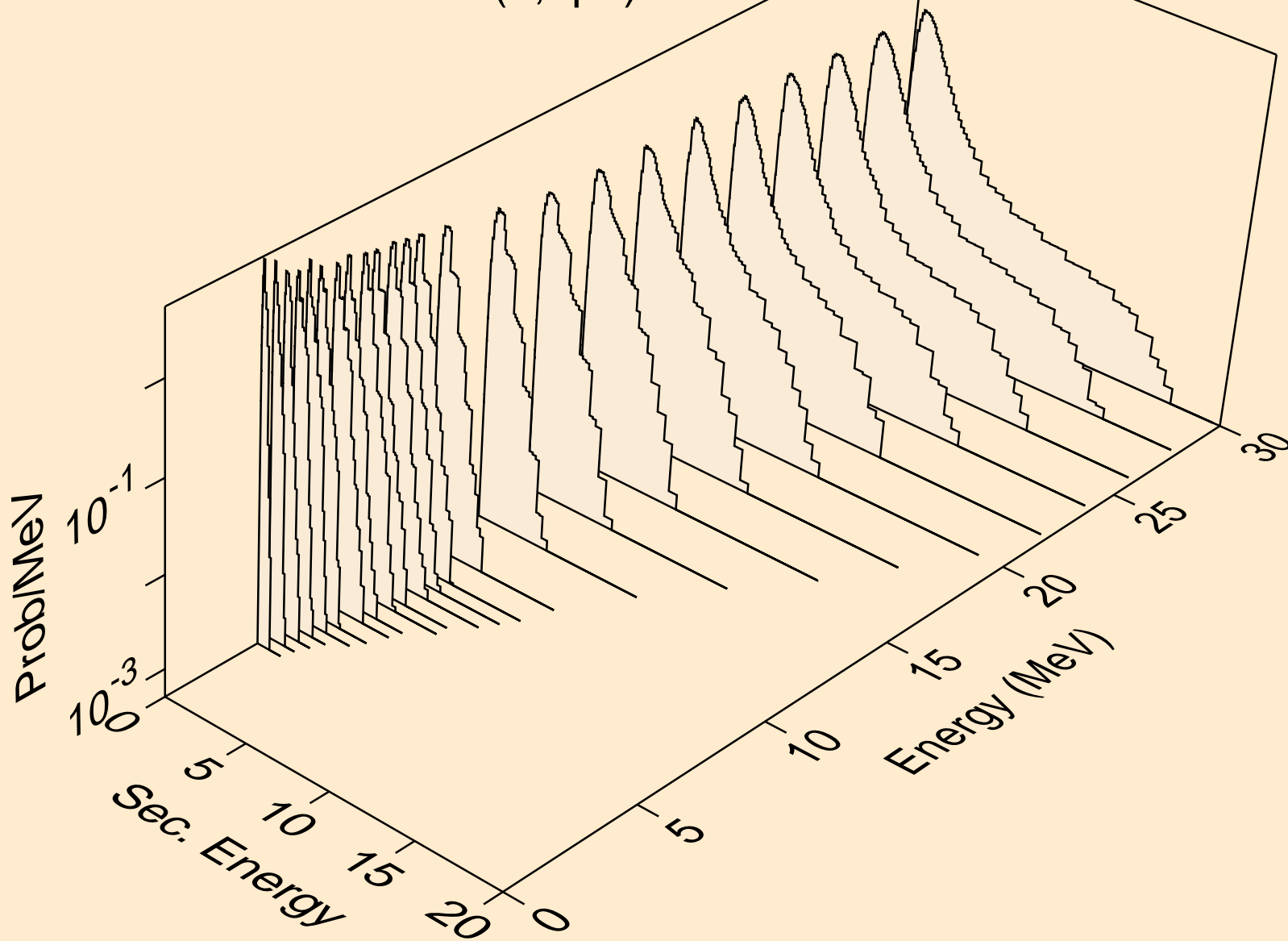

TB139 NEUTRON ACER TENDL-2019 LIBRARY; T=293.16K
Neutron emission for (n,n*c)

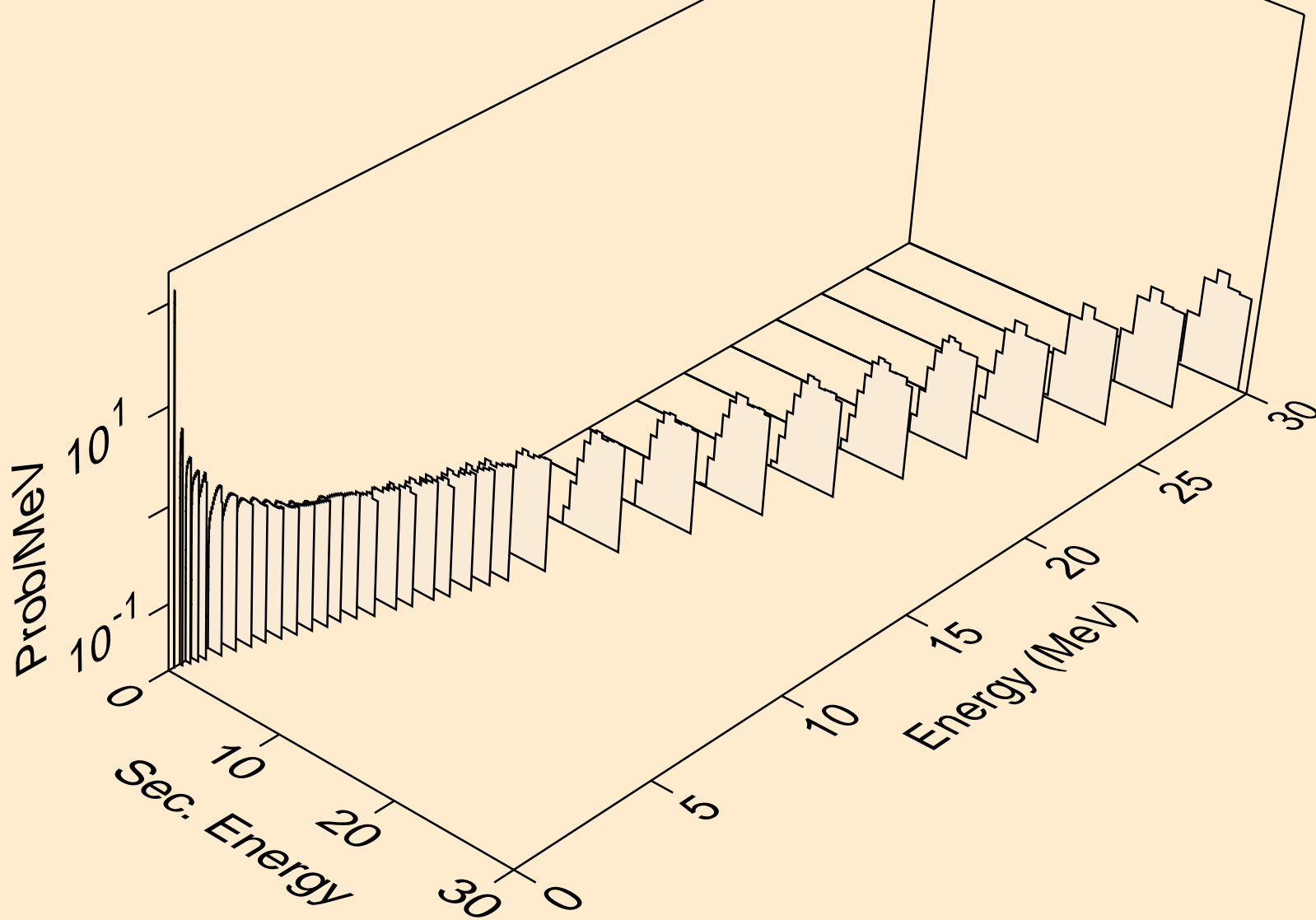

TB139 NEUTRON ACER TENDL-2019 LIBRARY; T=293.16K
Photon emission for (n,x)

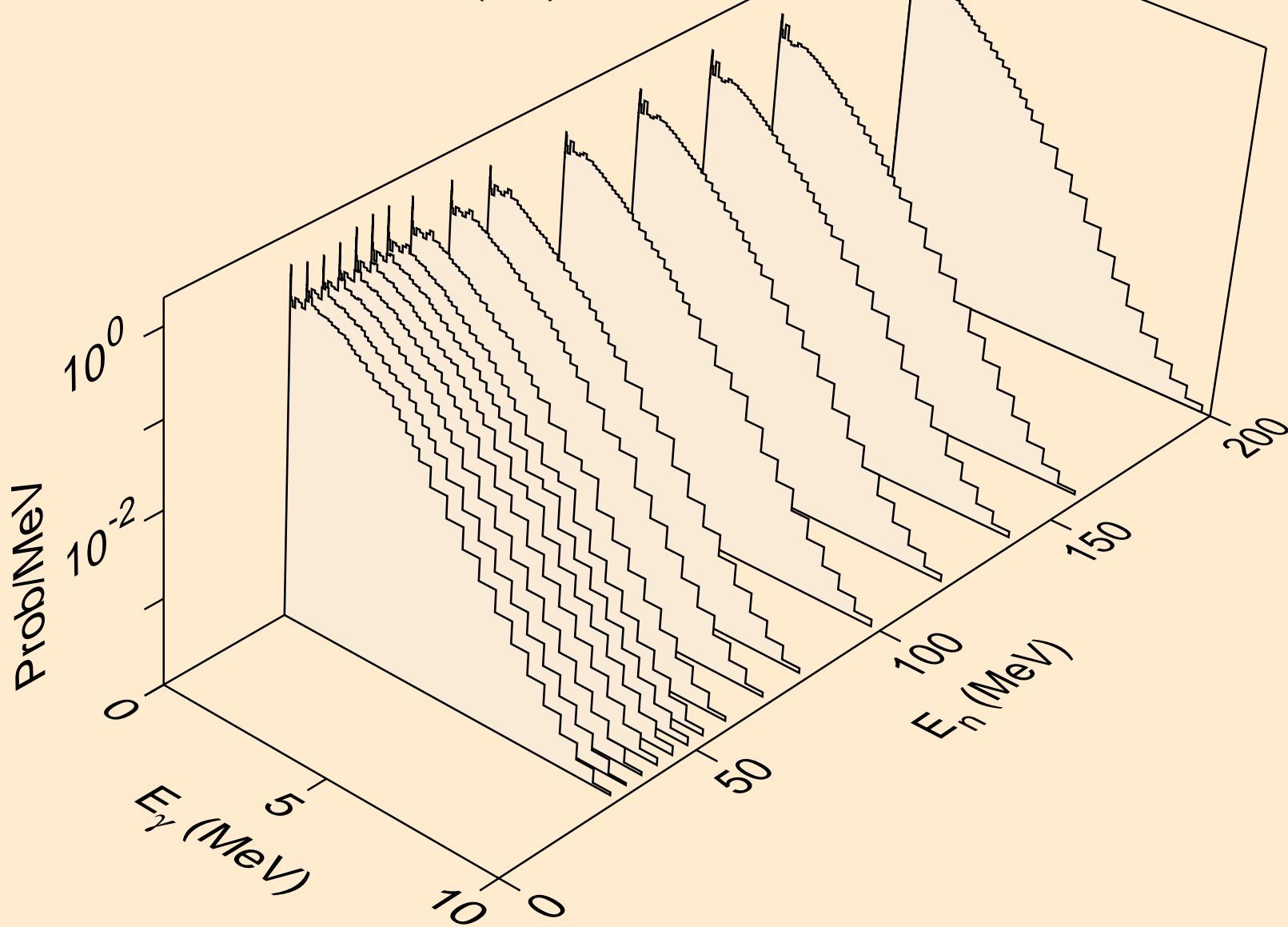

TB139 NEUTRON ACER TENDL-2019 LIBRARY; T=293.16K
Photon emission for (n,2nd)

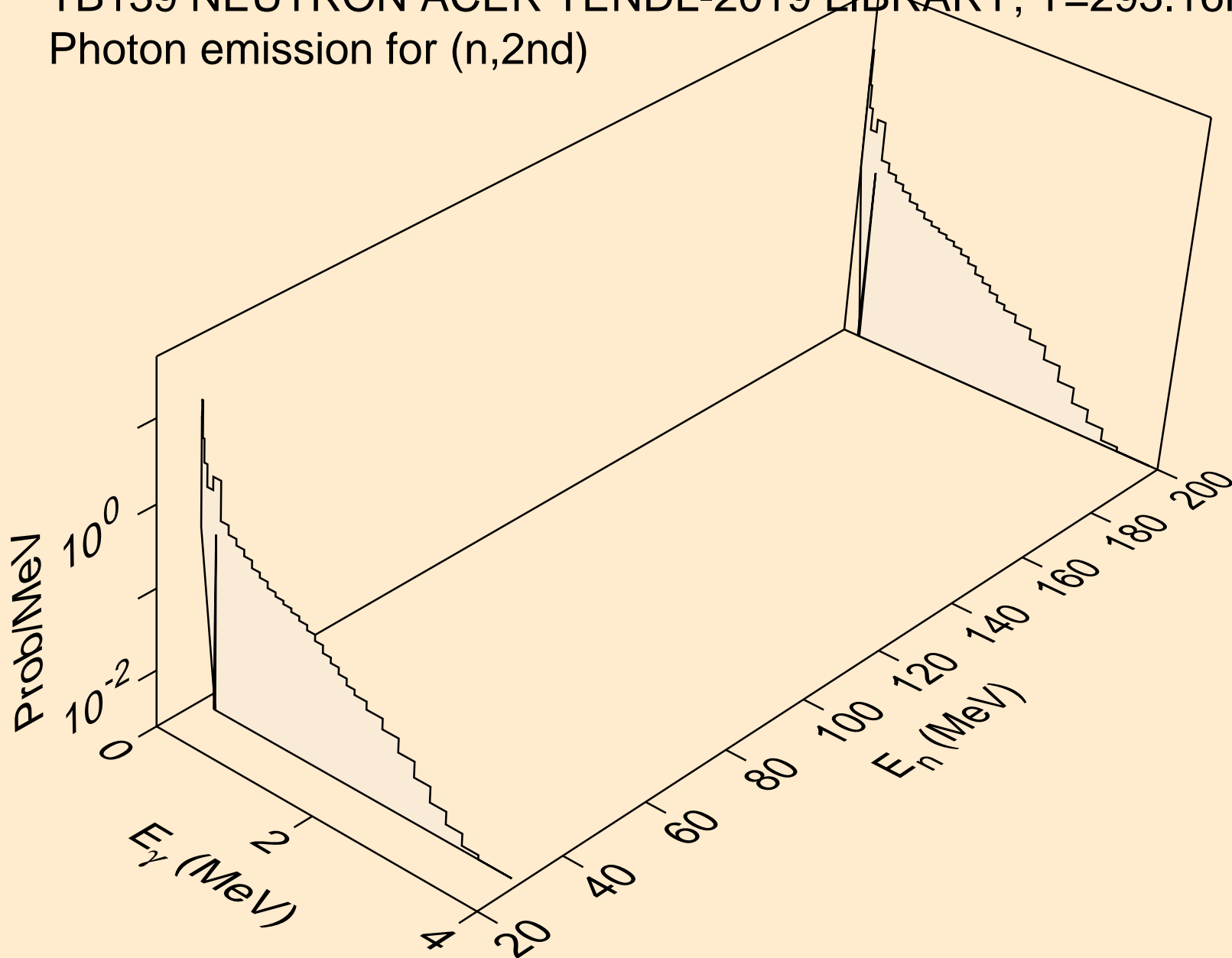

TB139 NEUTRON ACER TENDL-2019 LIBRARY; T=293.16K
Photon emission for (n,2n)

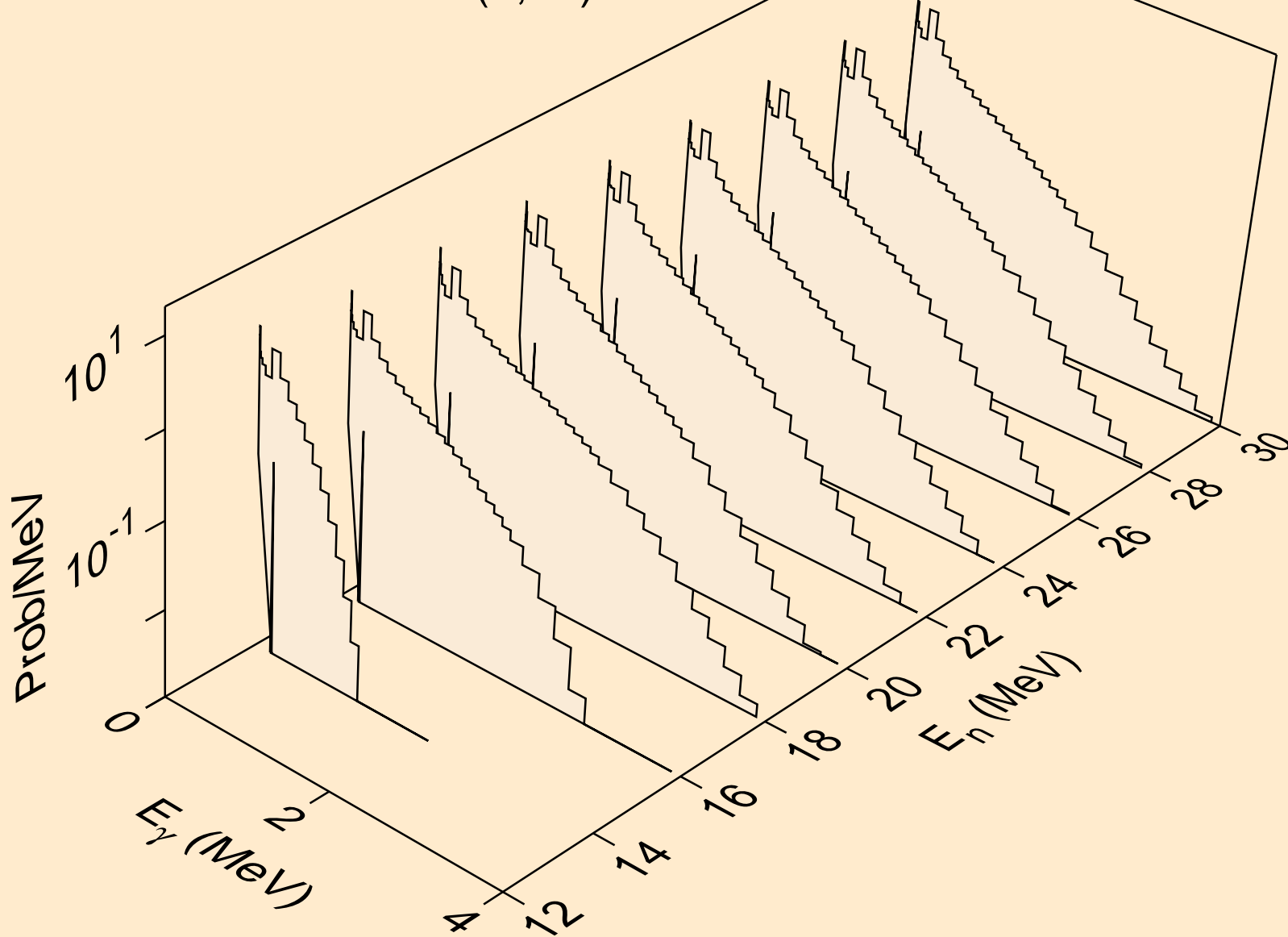

TB139 NEUTRON ACER TENDL-2019 LIBRARY; T=293.16K
Photon emission for (n,3n)

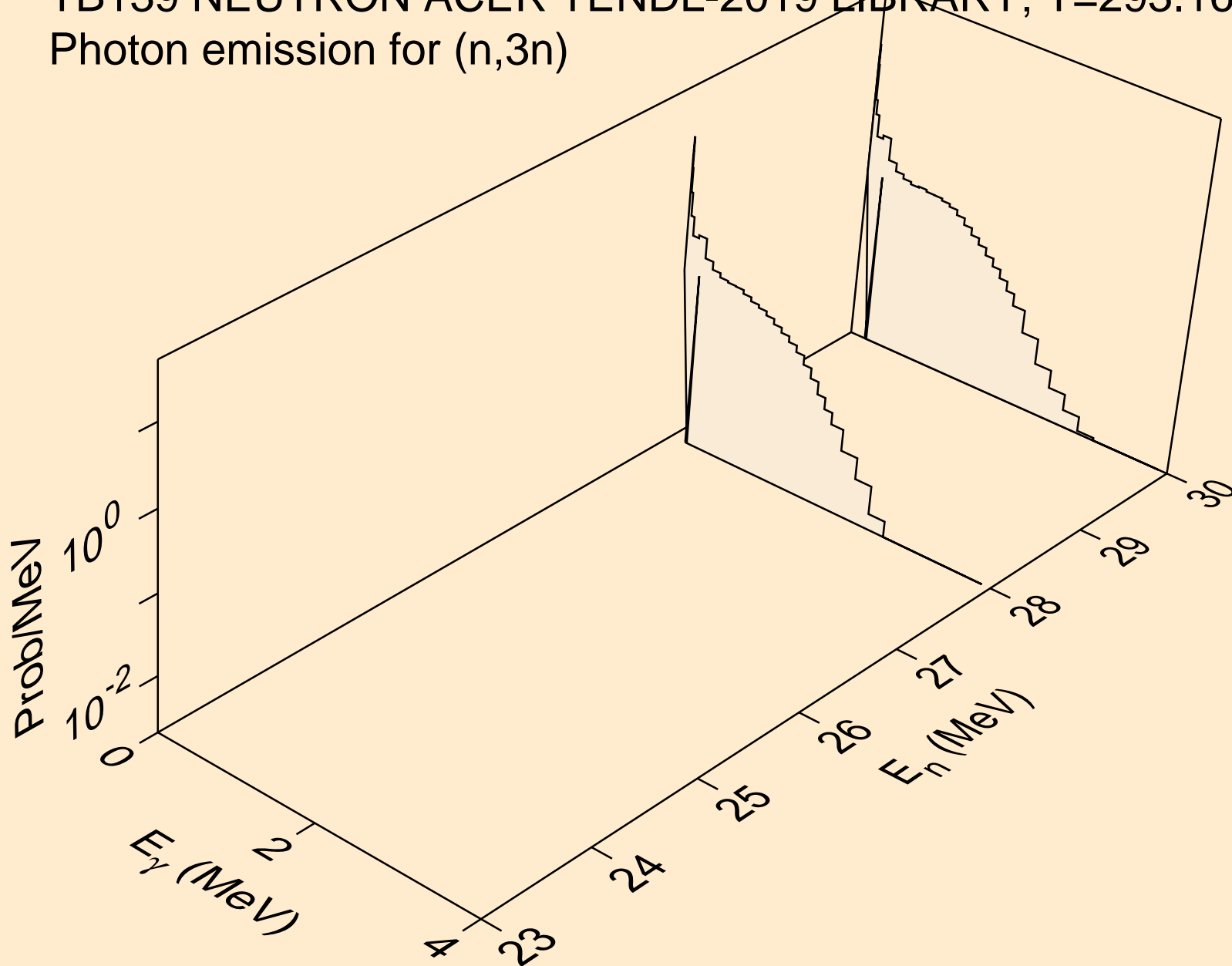

TB139 NEUTRON ACER TENDL-2019 LIBRARY; T=293.16K
Photon emission for (n,n*)a

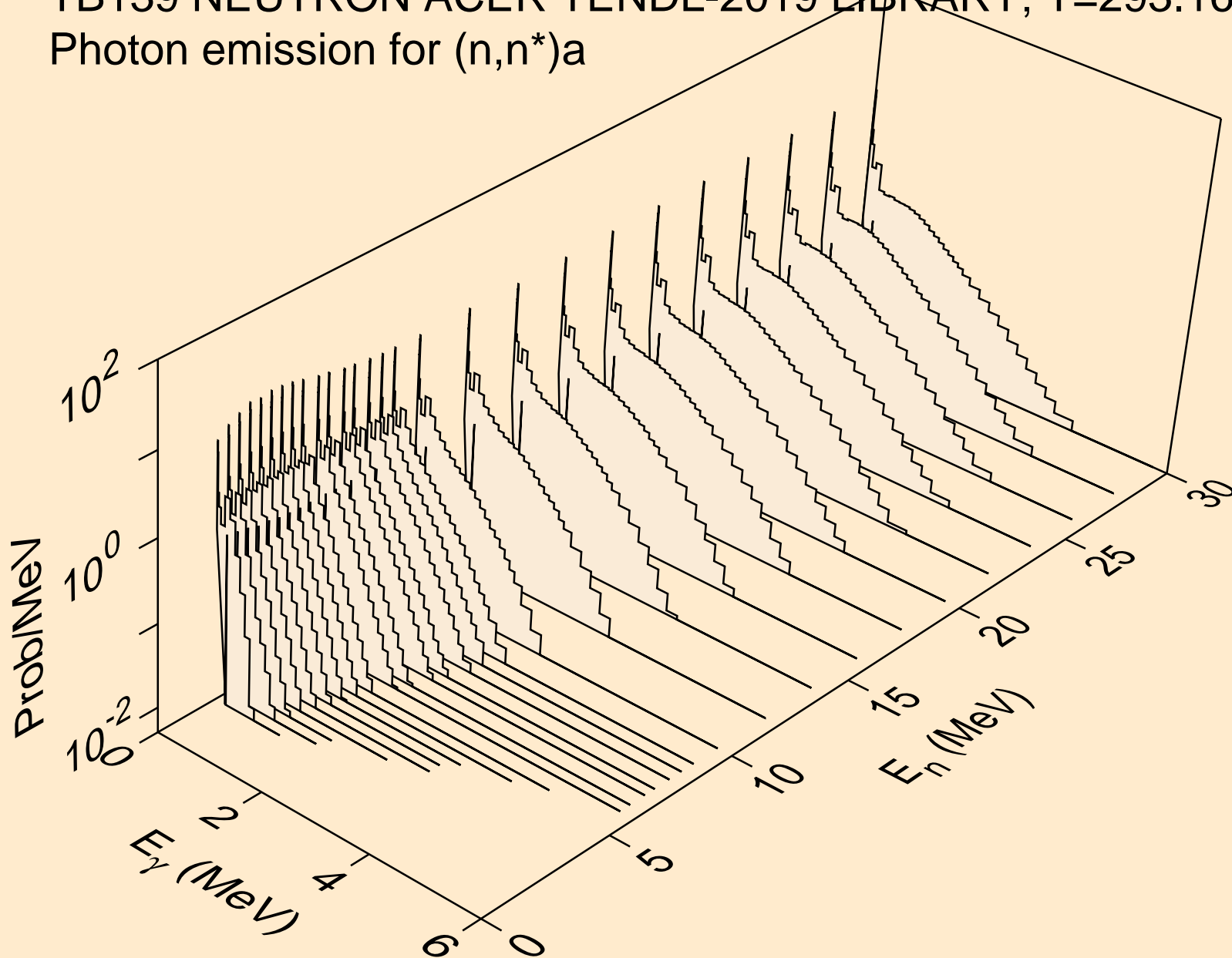

TB139 NEUTRON ACER TENDL-2019 LIBRARY; T=293.16K
Photon emission for (n,2n)a

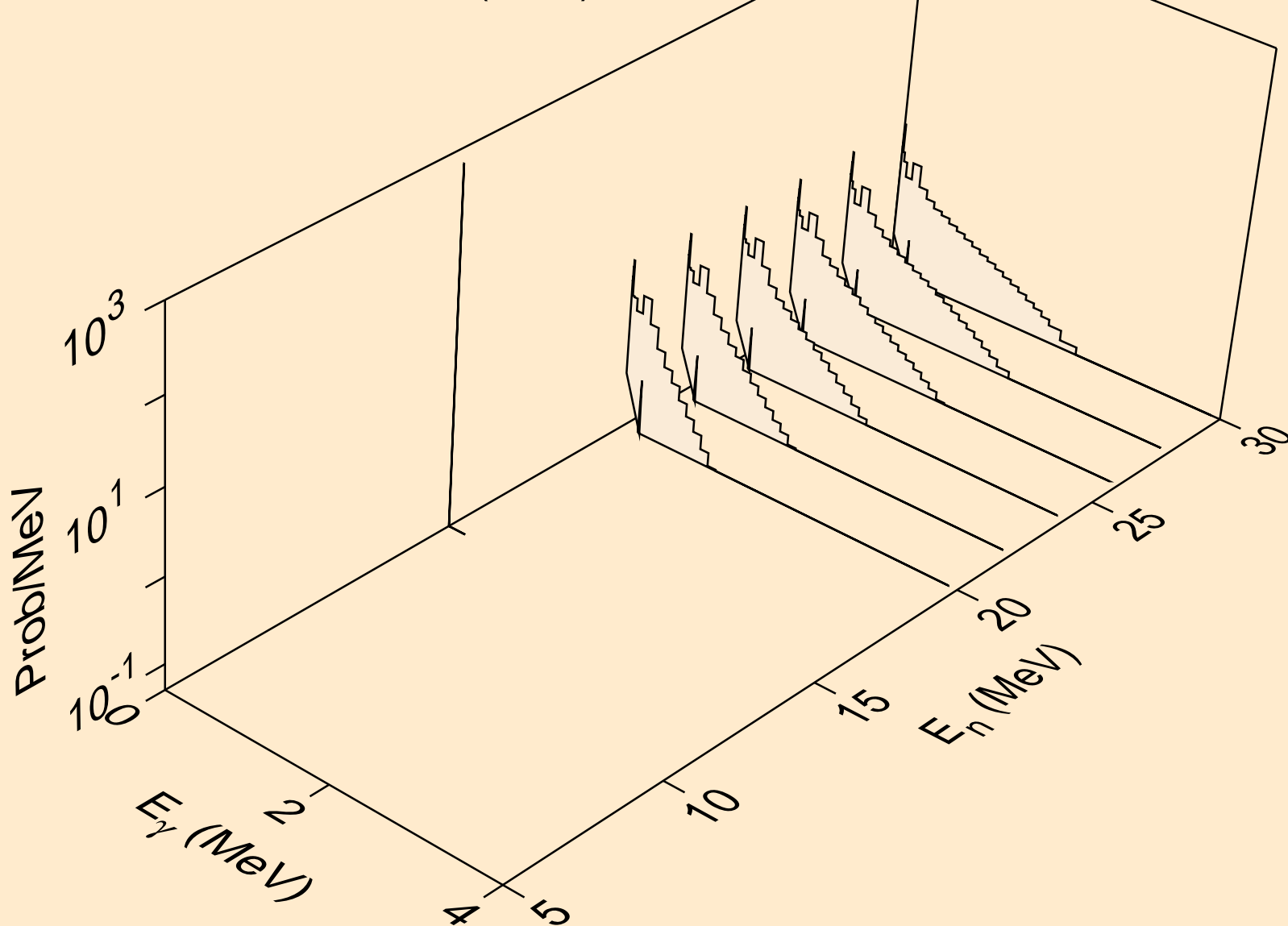

TB139 NEUTRON ACER TENDL-2019 LIBRARY; T=293.16K
Photon emission for (n,n*)p

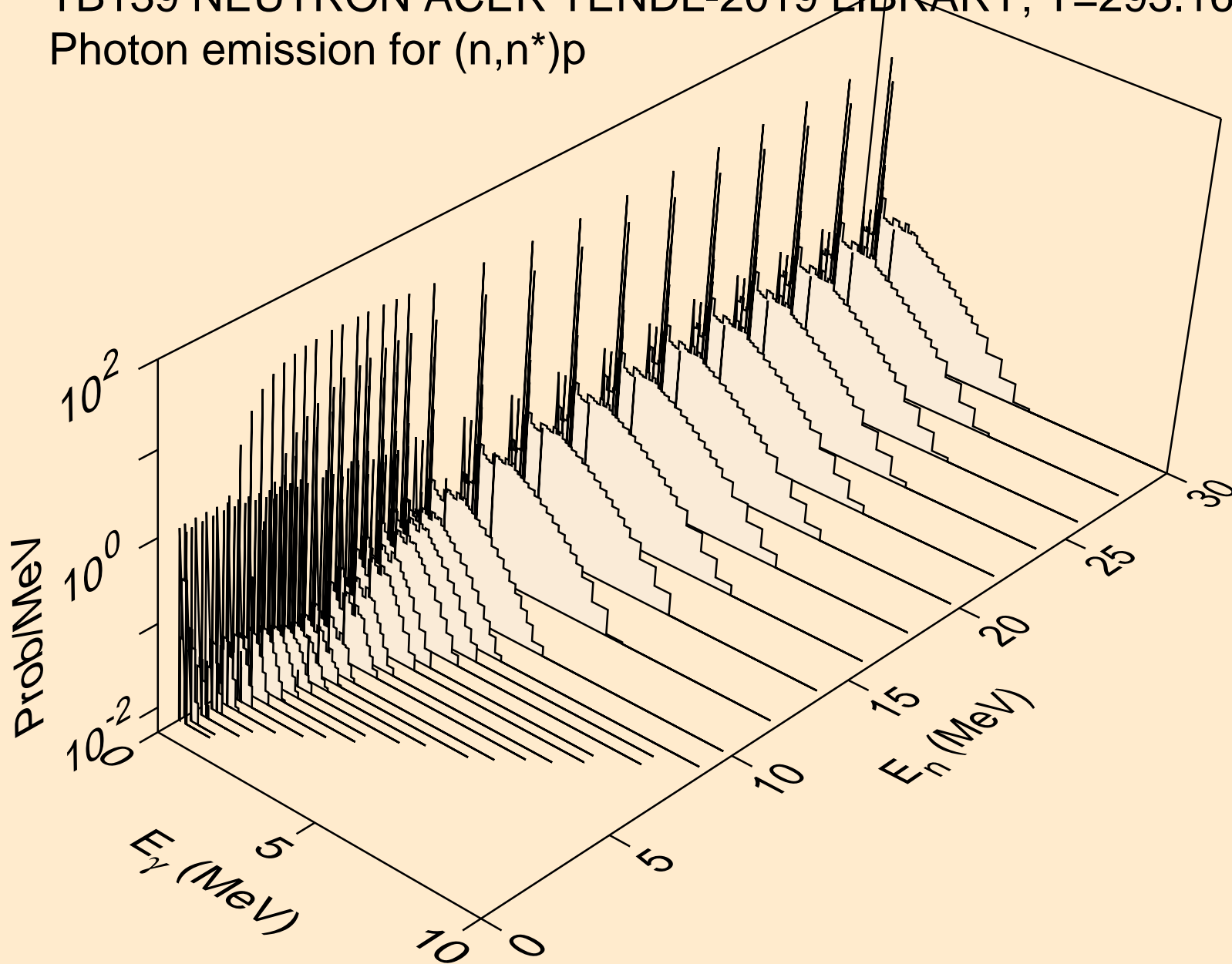

TB139 NEUTRON ACER TENDL-2019 LIBRARY; T=293.16K
Photon emission for (n,n*)2a

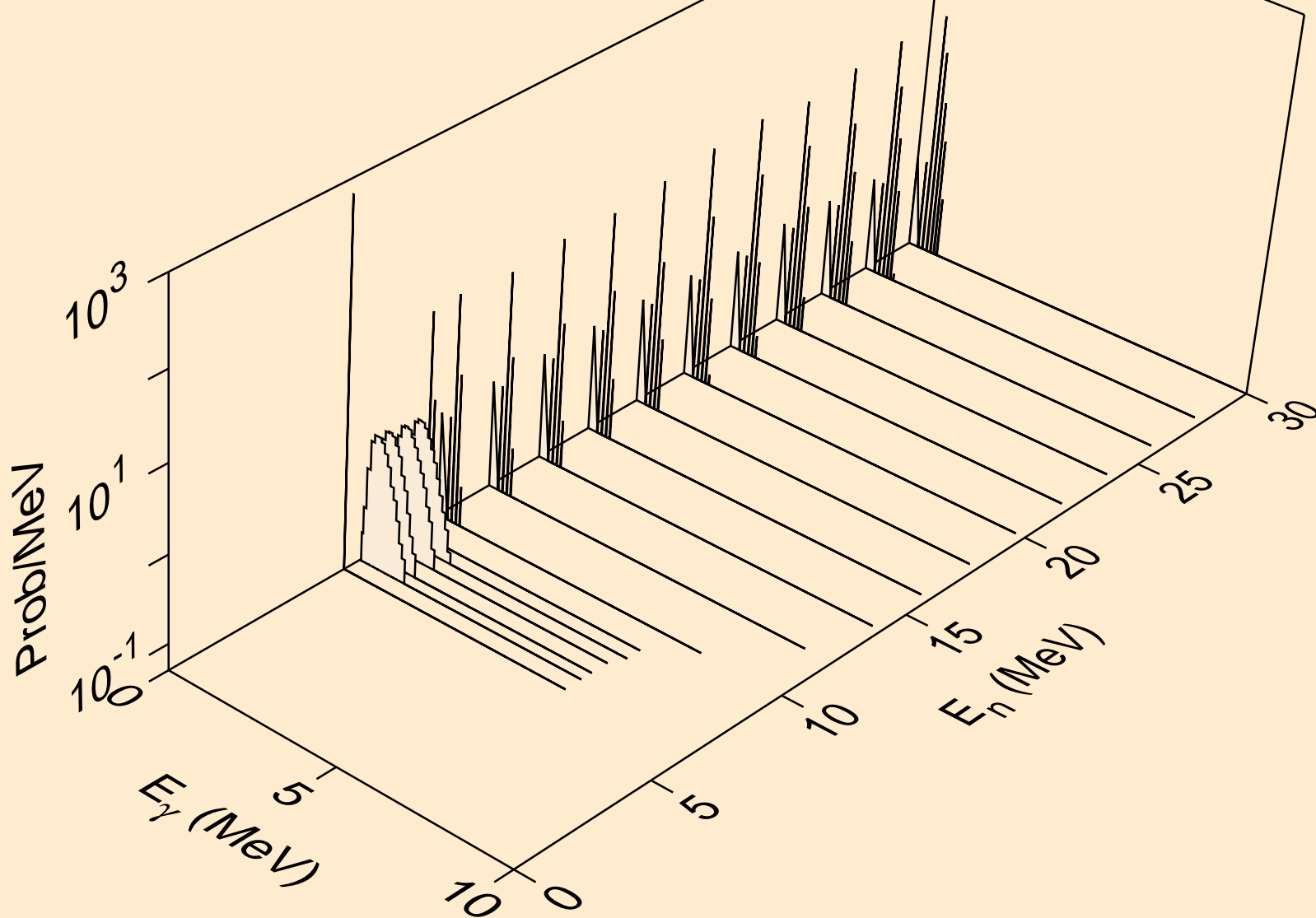

TB139 NEUTRON ACER TENDL-2019 LIBRARY; T=293.16K
Photon emission for (n,n*)d

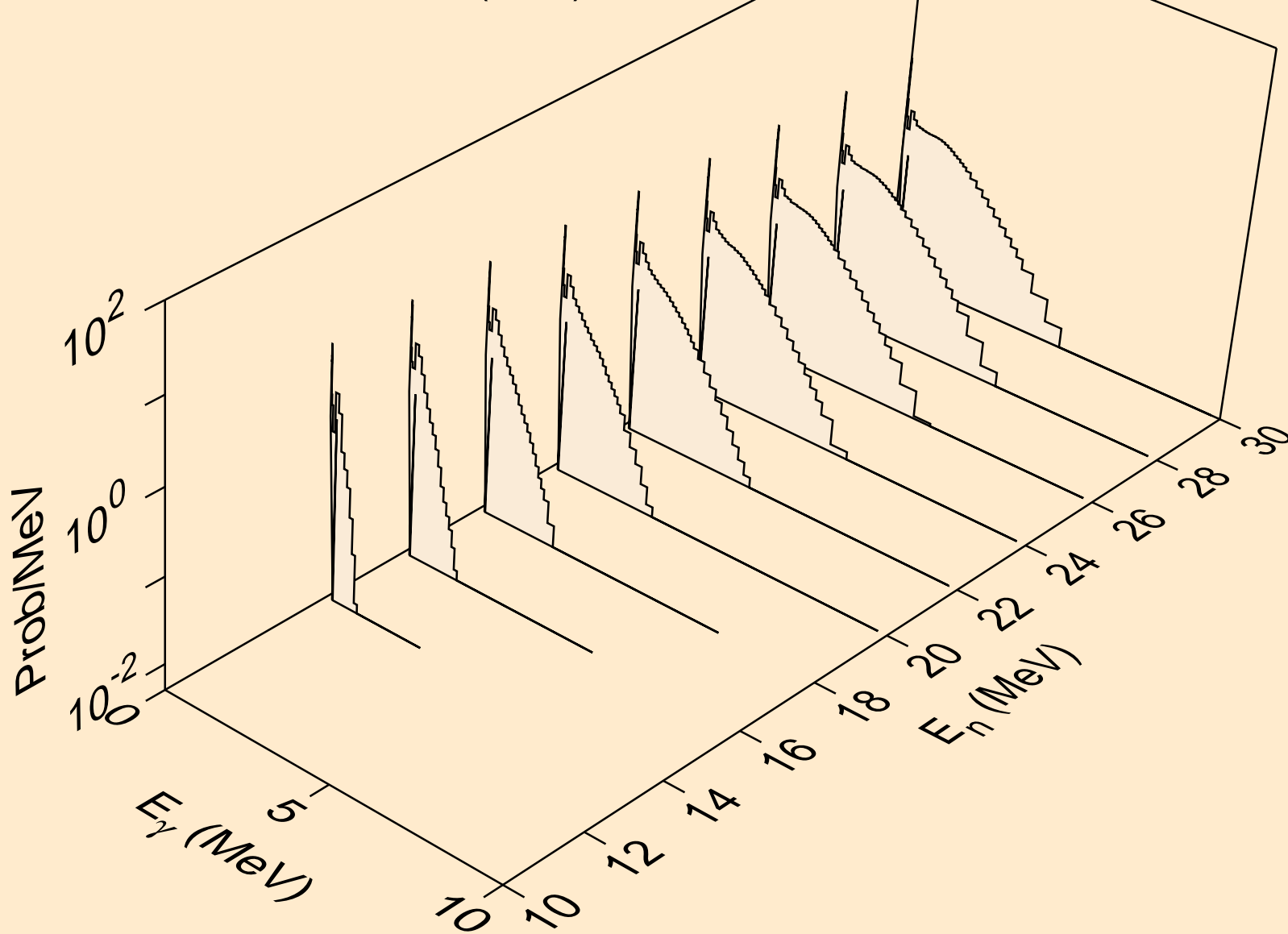

TB139 NEUTRON ACER TENDL-2019 LIBRARY; T=293.16K
Photon emission for (n,n*)t

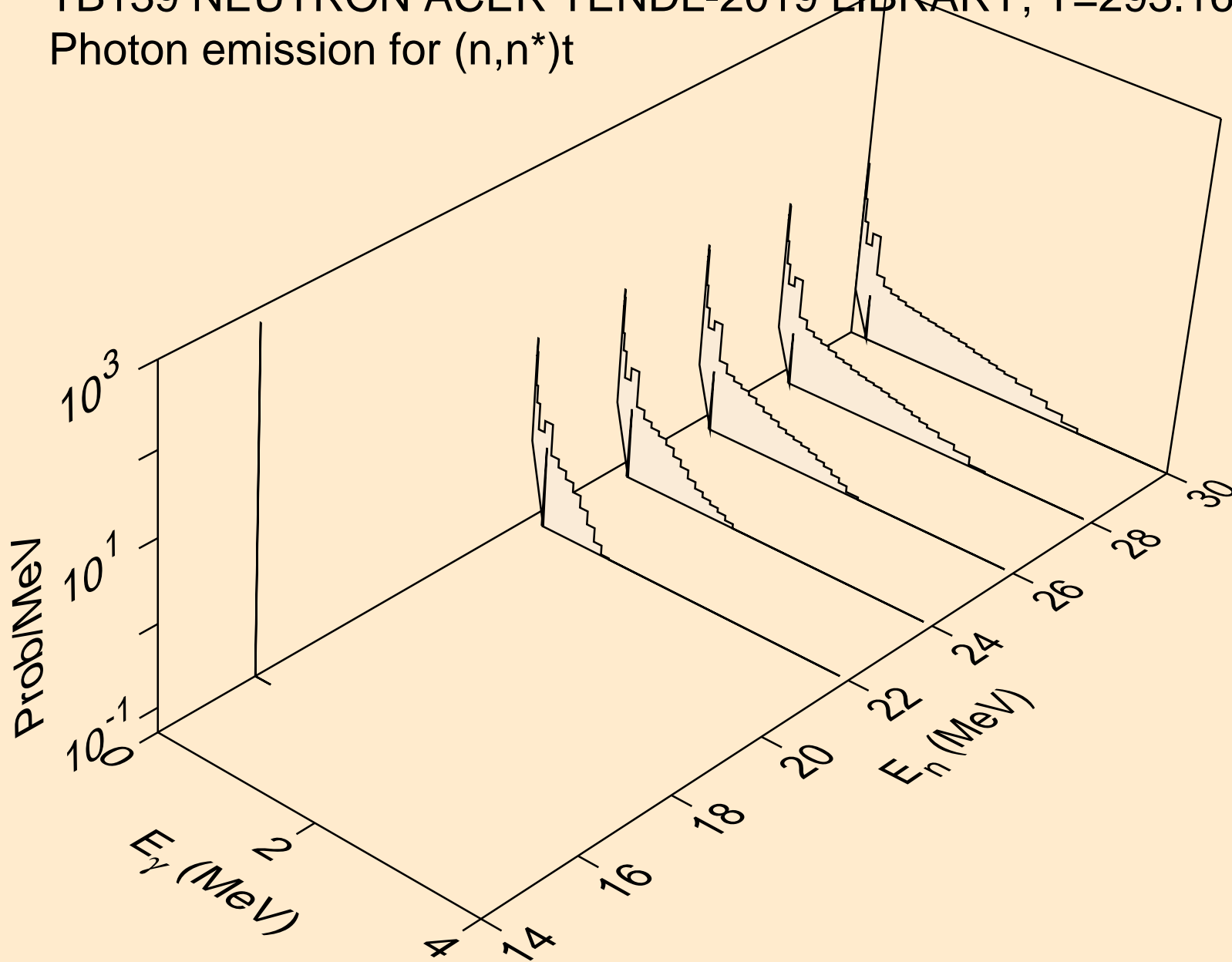

TB139 NEUTRON ACER TENDL-2019 LIBRARY; T=293.16K
Photon emission for (n,n*)he3

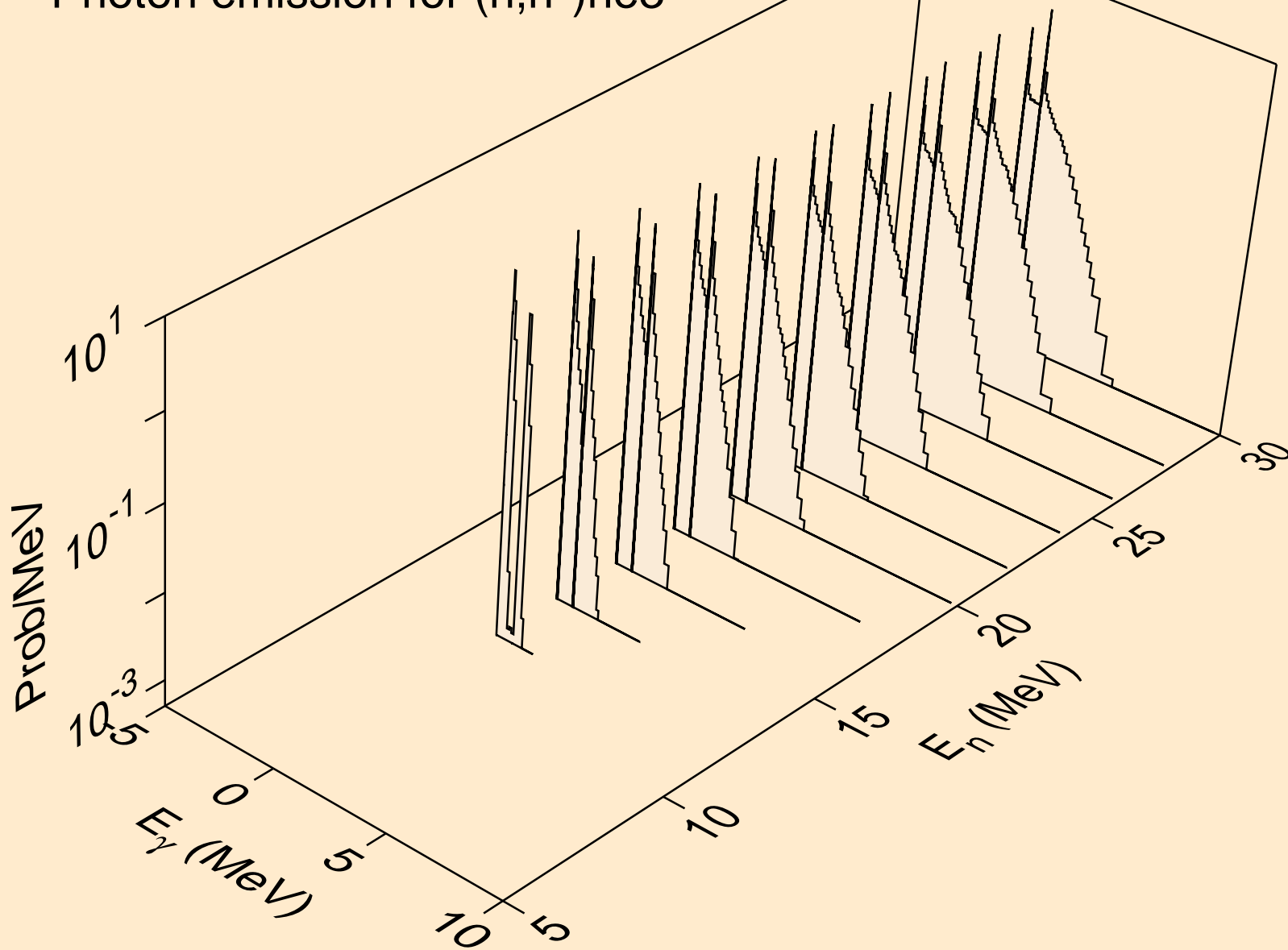

TB139 NEUTRON ACER TENDL-2019 LIBRARY; T=293.16K
Photon emission for (n,2np)

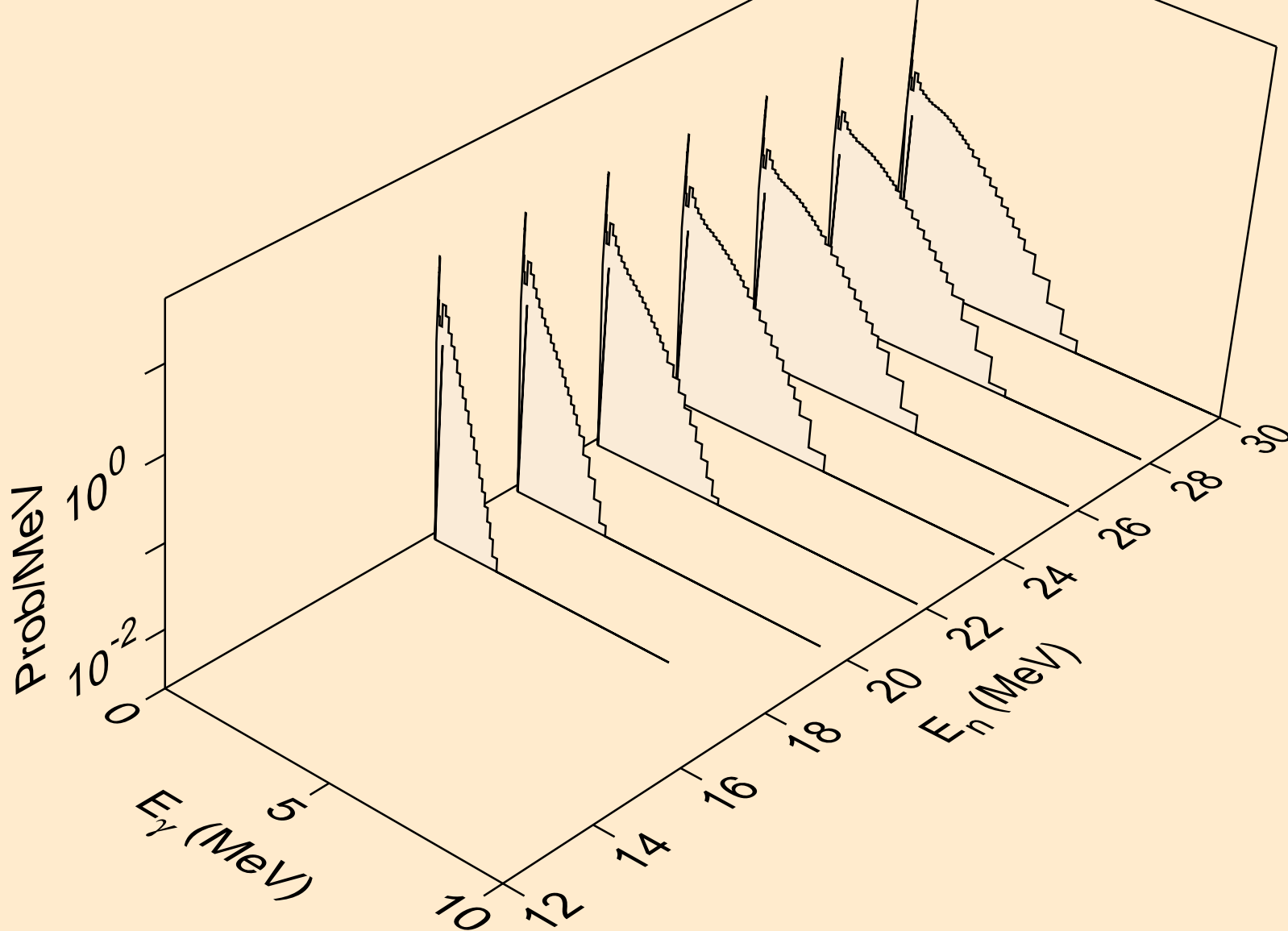

TB139 NEUTRON ACER TENDL-2019 LIBRARY; T=293.16K
Photon emission for (n,3np)

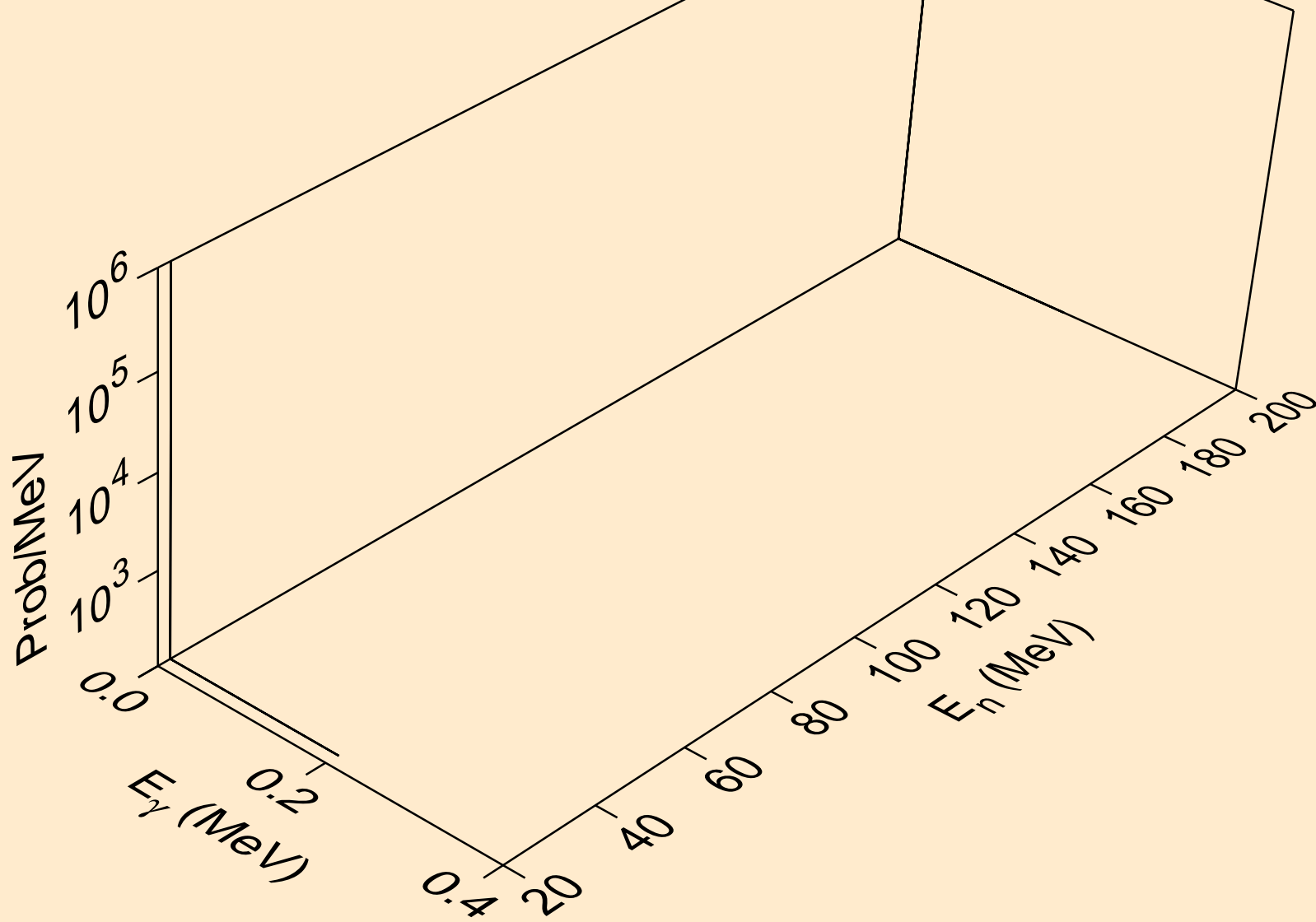

TB139 NEUTRON ACER TENDL-2019 LIBRARY; T=293.16K
Photon emission for (n,2np)

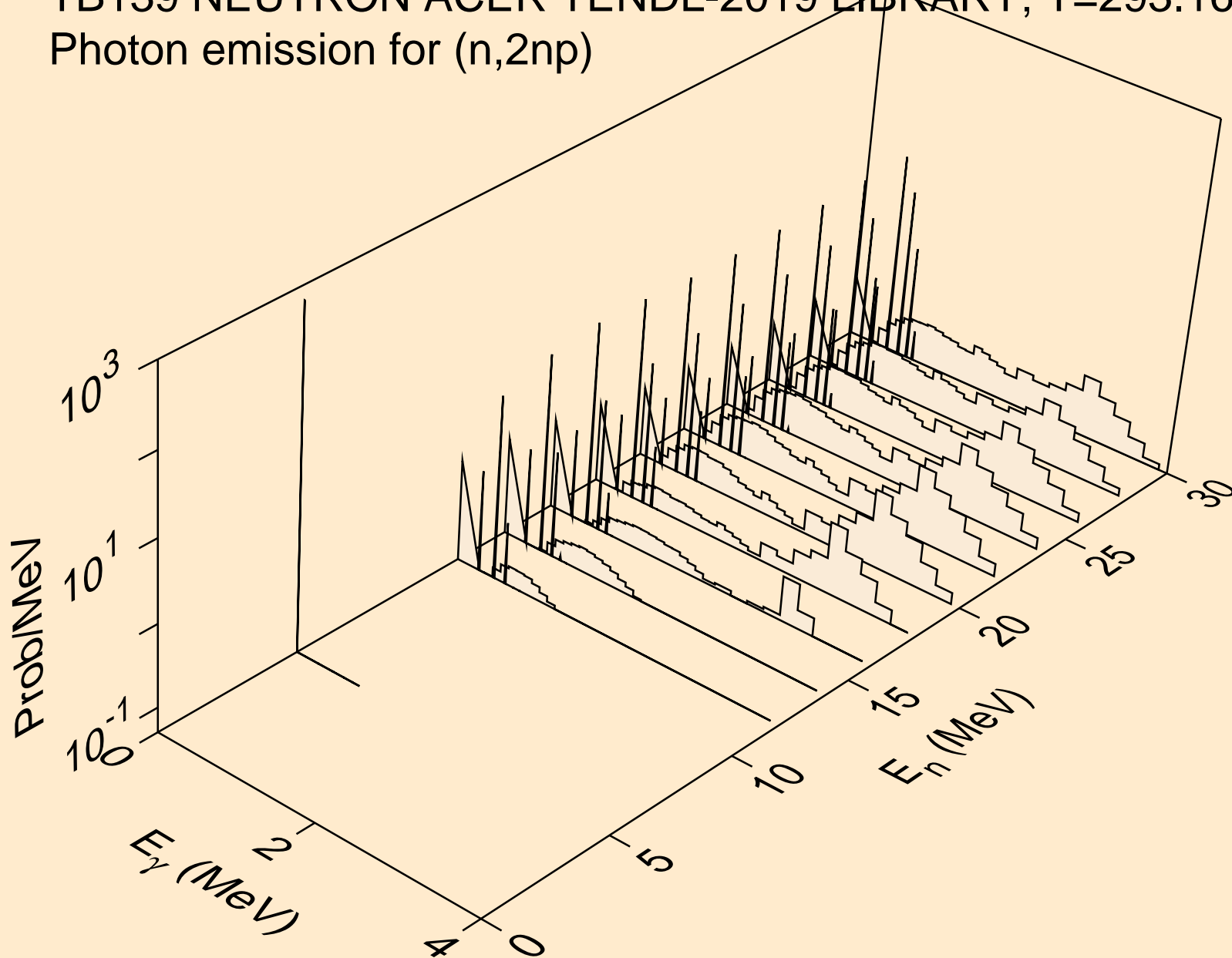

TB139 NEUTRON ACER TENDL-2019 LIBRARY; T=293.16K
Photon emission for (n,npa)

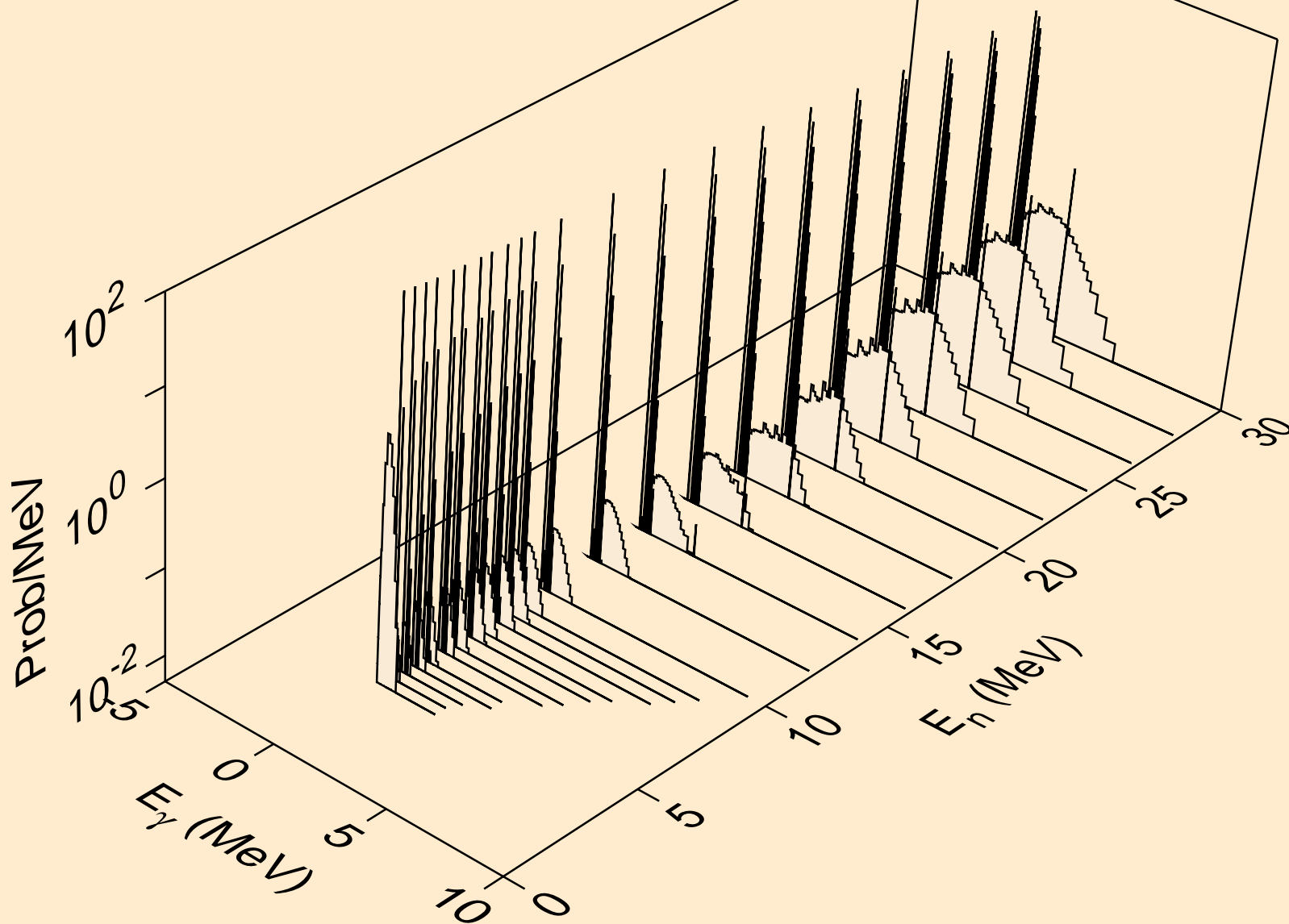

TB139 NEUTRON ACER TENDL-2019 LIBRARY; T=293.16K
Photon emission for (n,n*c)

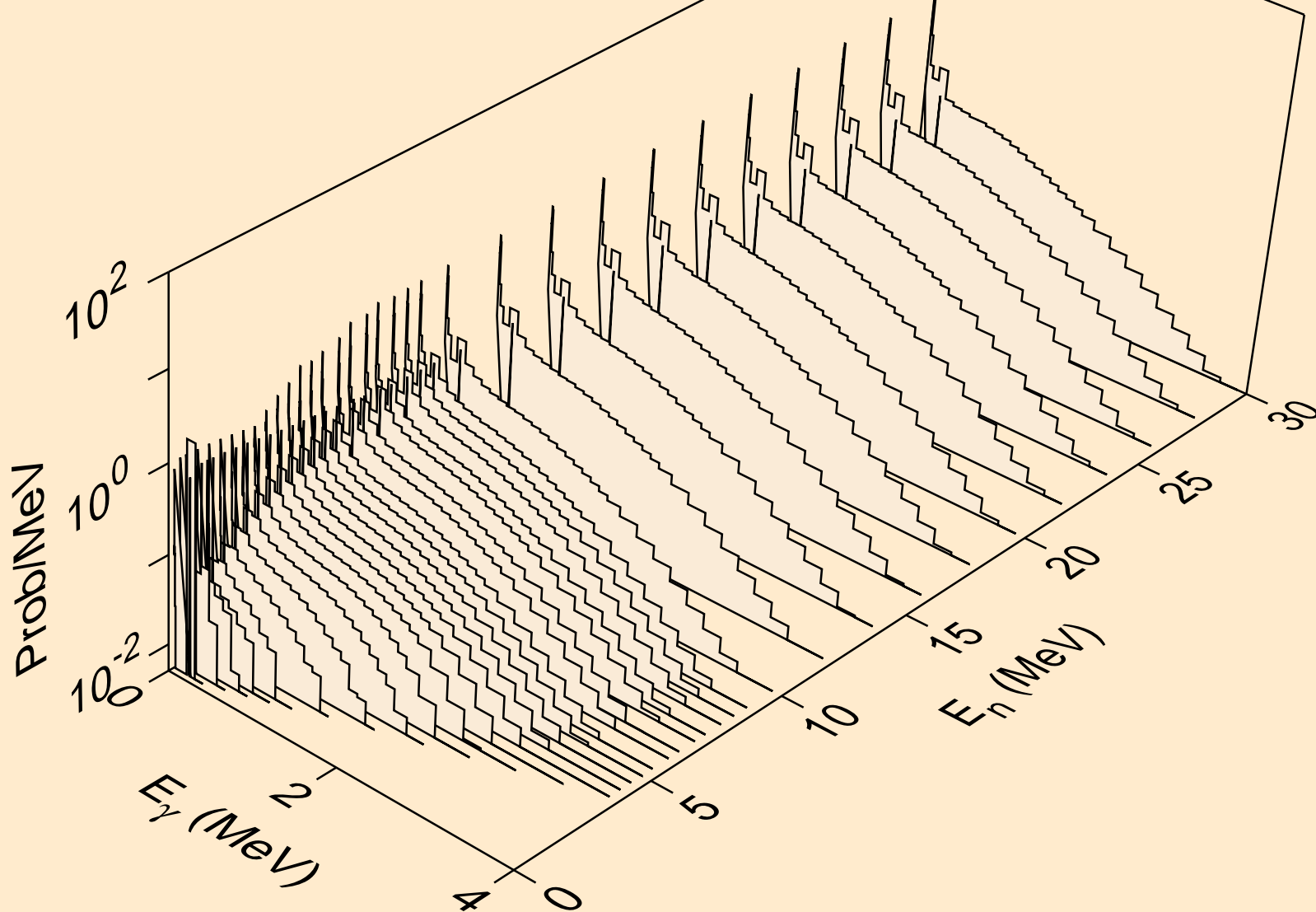

TB139 NEUTRON ACER TENDL-2019 LIBRARY; T=293.16K
Photon emission for (n,gma)

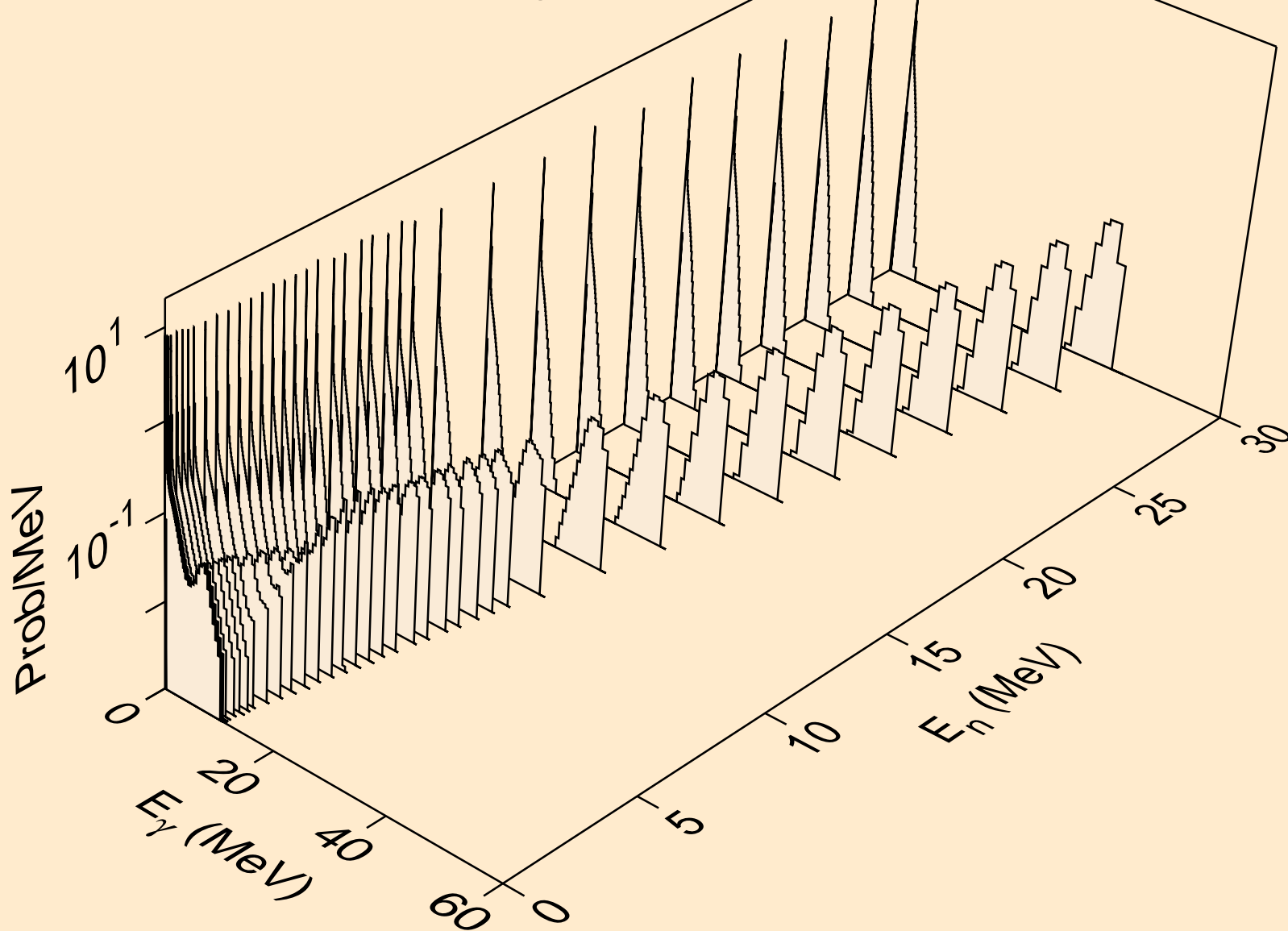

TB139 NEUTRON ACER TENDL-2019 LIBRARY; T=293.16K
Photon emission for (n,p)

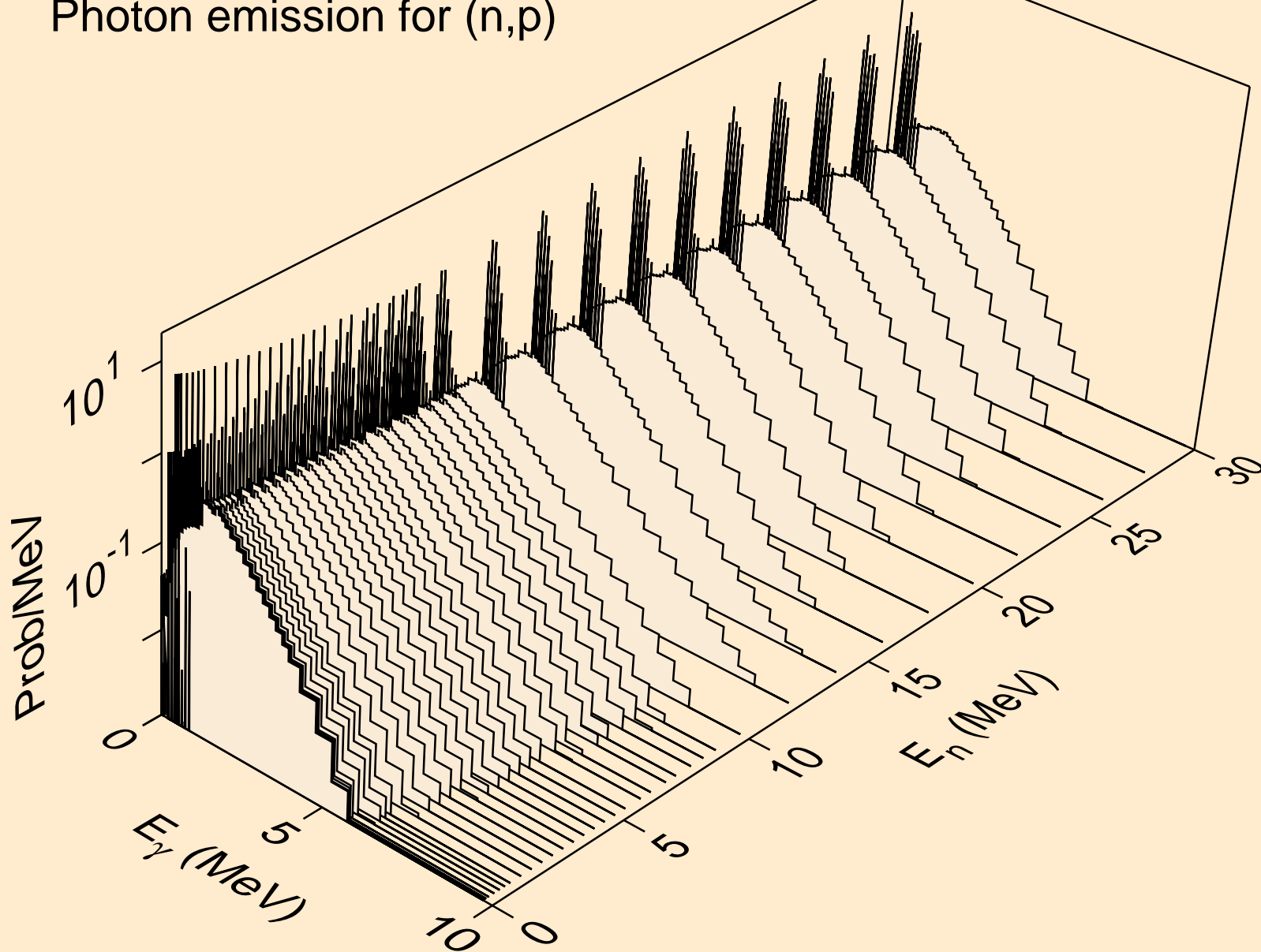

TB139 NEUTRON ACER TENDL-2019 LIBRARY; T=293.16K
Photon emission for (n,d)

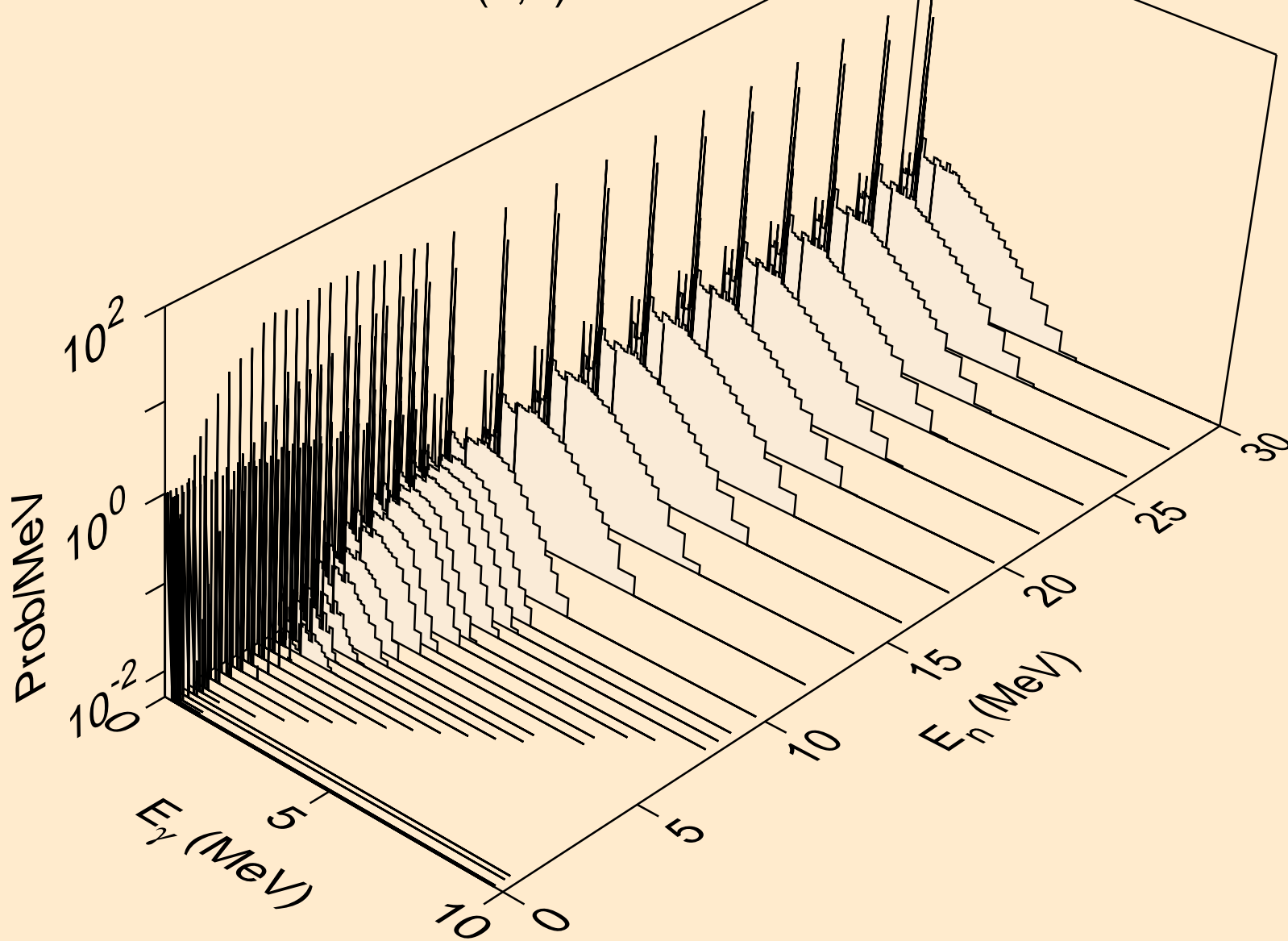

TB139 NEUTRON ACER TENDL-2019 LIBRARY; T=293.16K
Photon emission for (n,t)

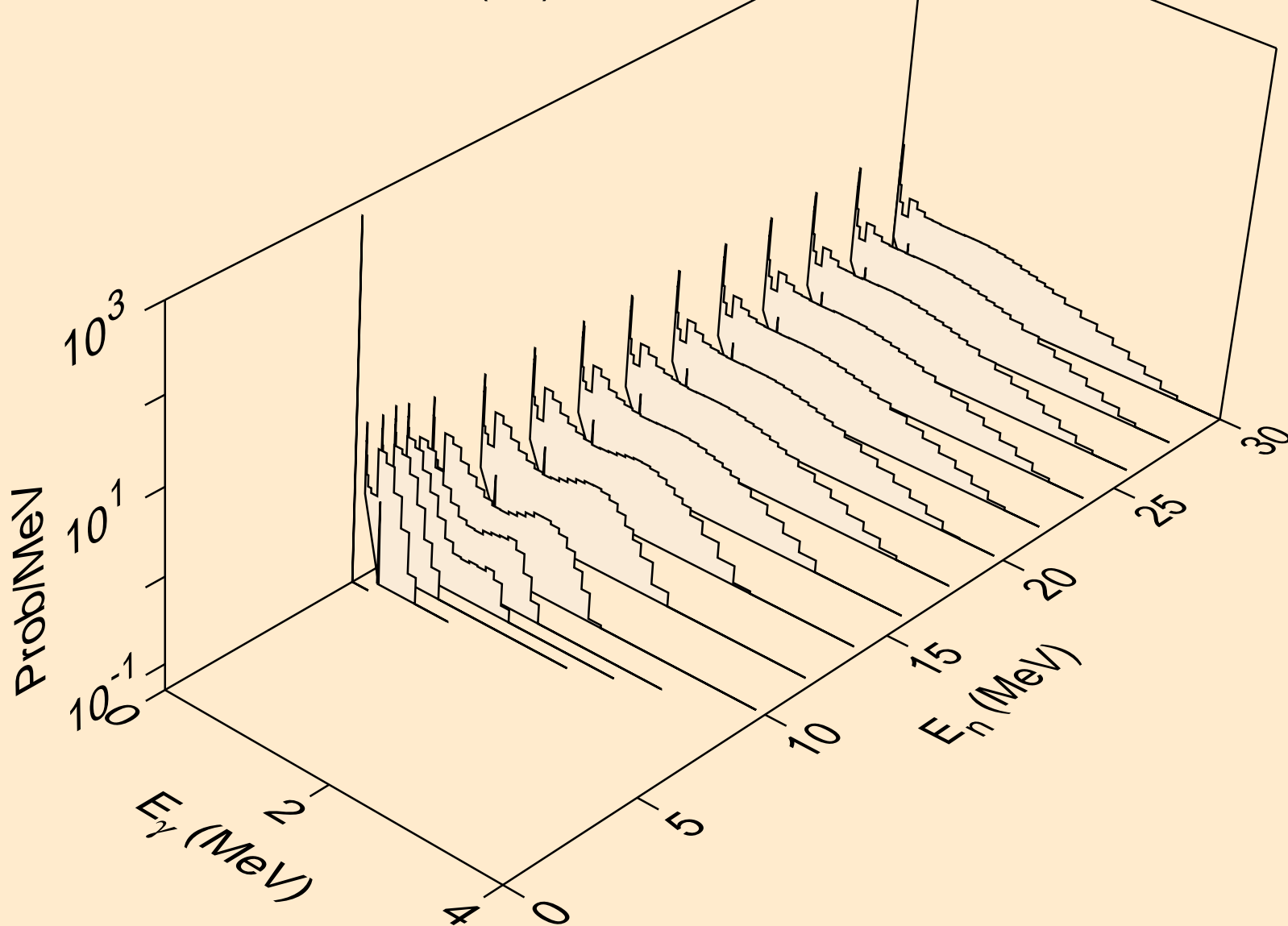

TB139 NEUTRON ACER TENDL-2019 LIBRARY; T=293.16K
Photon emission for (n,he3)

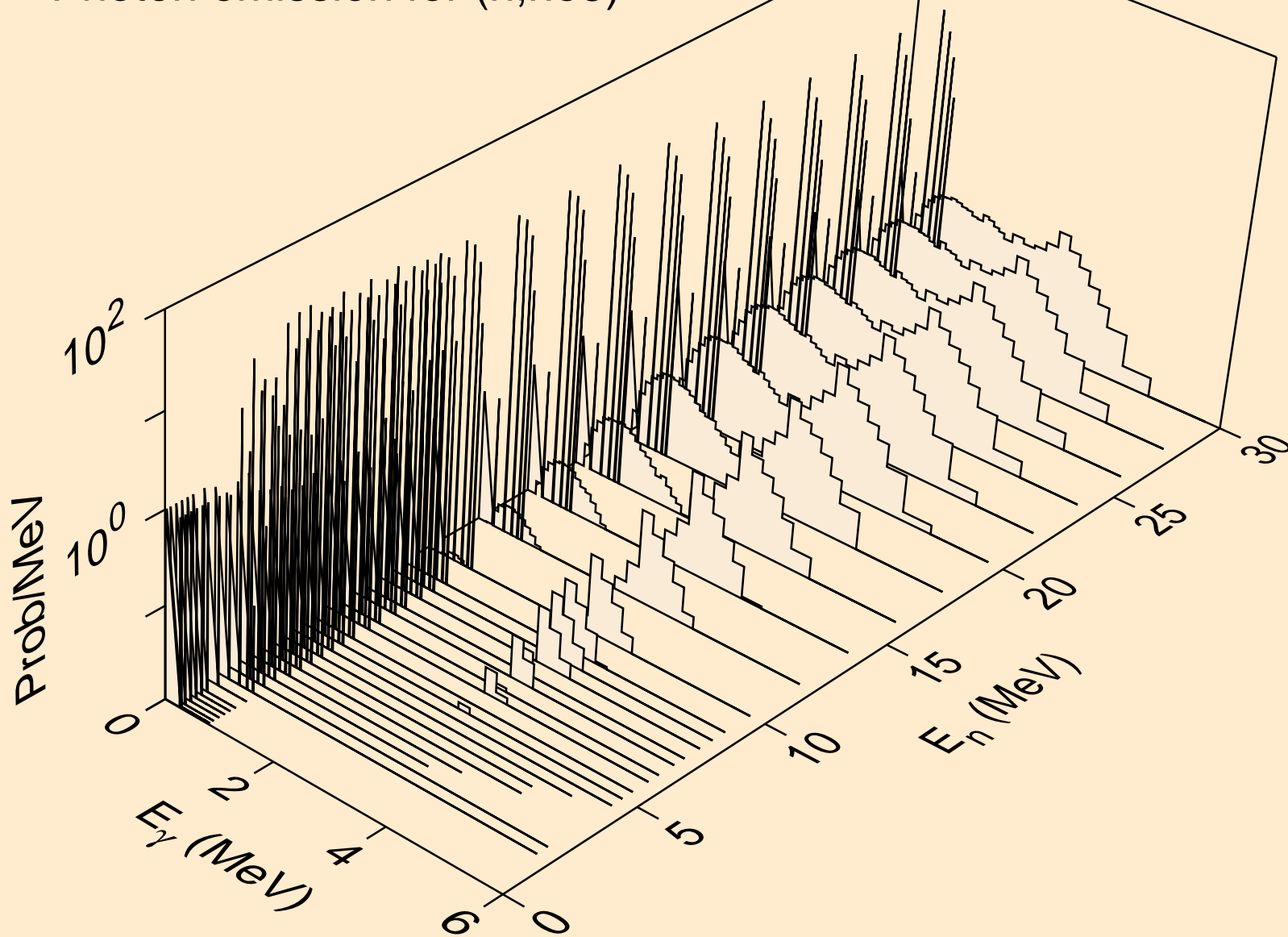

TB139 NEUTRON ACER TENDL-2019 LIBRARY; T=293.16K
Photon emission for (n,a)

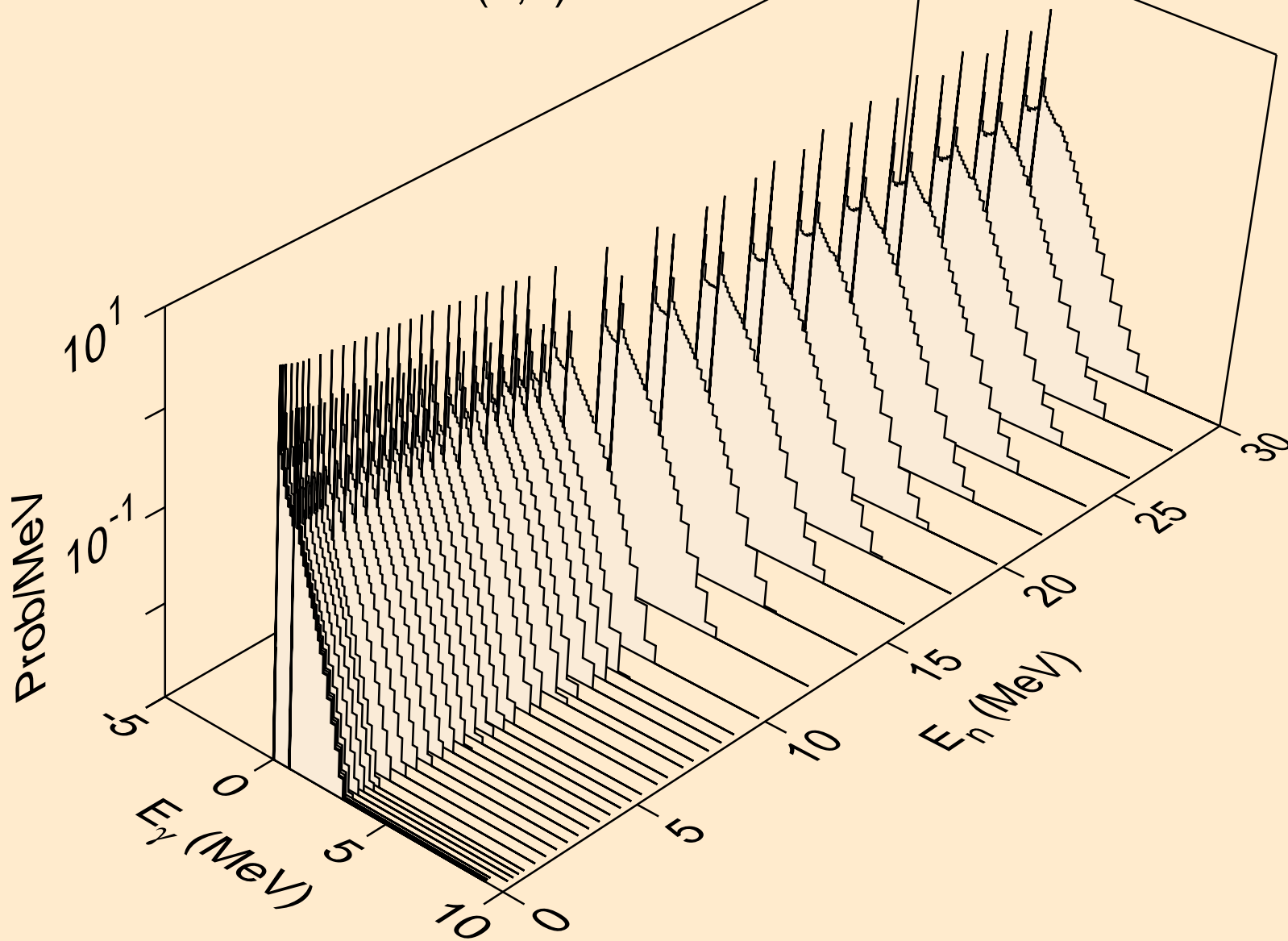

TB139 NEUTRON ACER TENDL-2019 LIBRARY; T=293.16K
Photon emission for (n,2a)

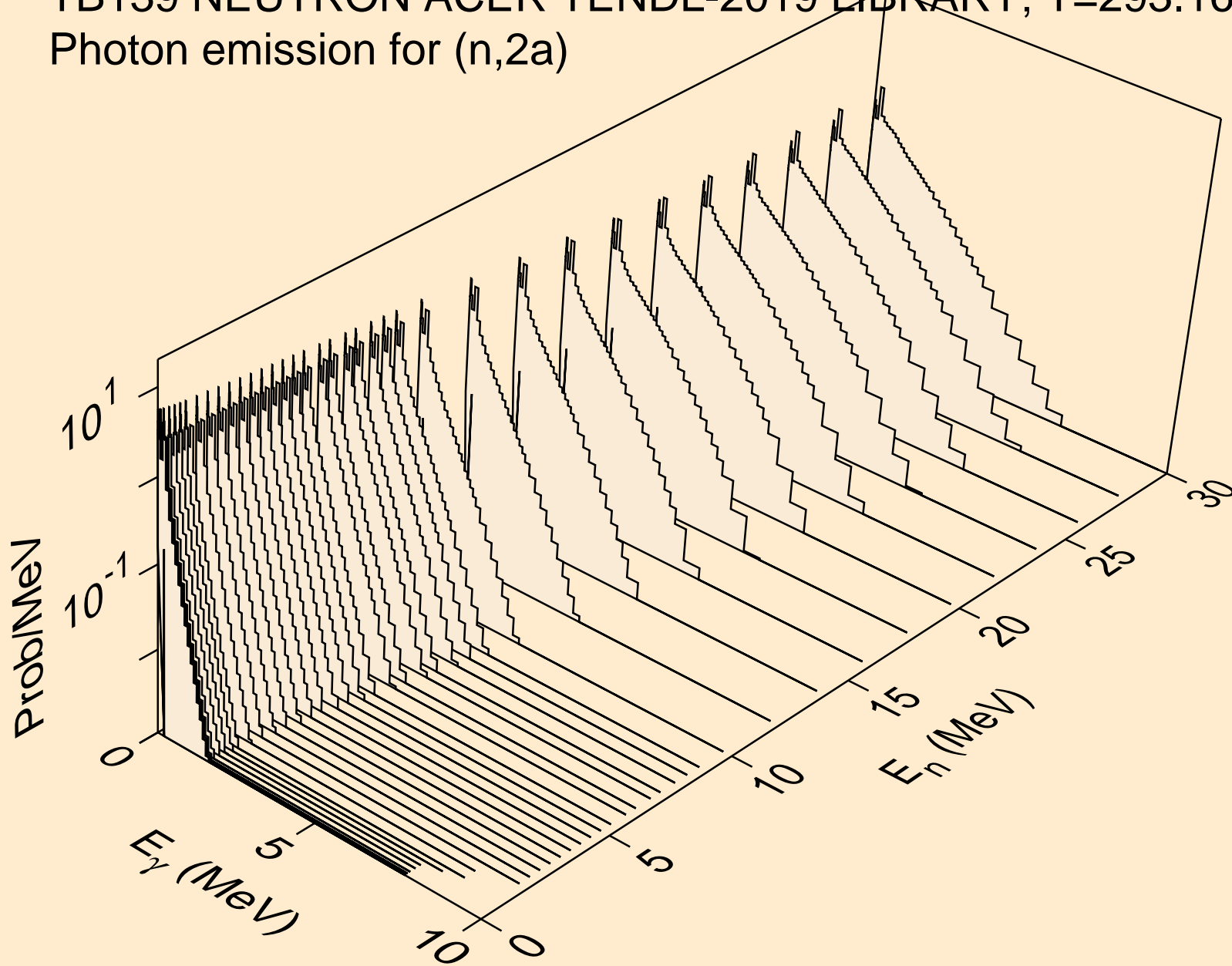

TB139 NEUTRON ACER TENDL-2019 LIBRARY; T=293.16K
Photon emission for (n,3a)

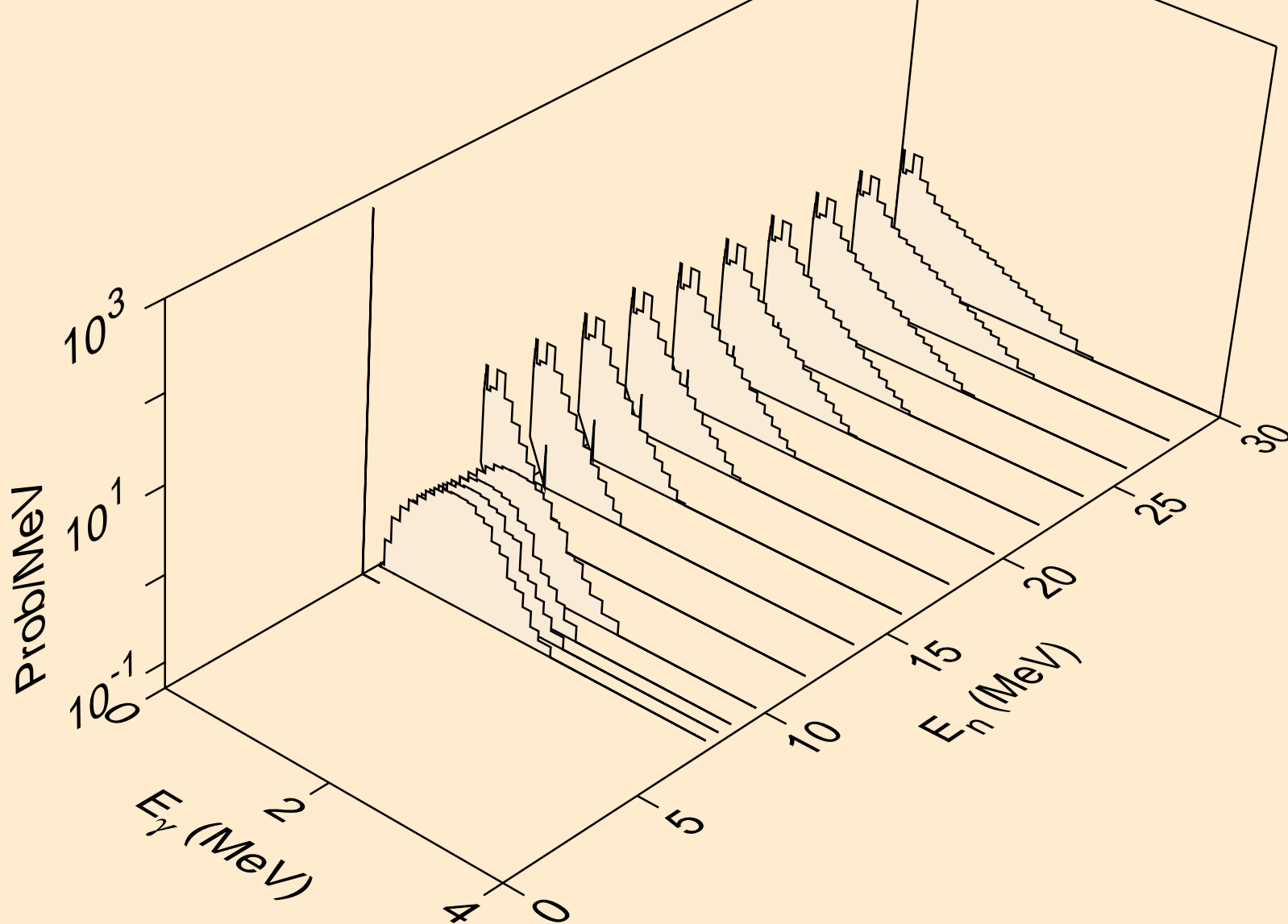

TB139 NEUTRON ACER TENDL-2019 LIBRARY; T=293.16K
Photon emission for (n,2p)

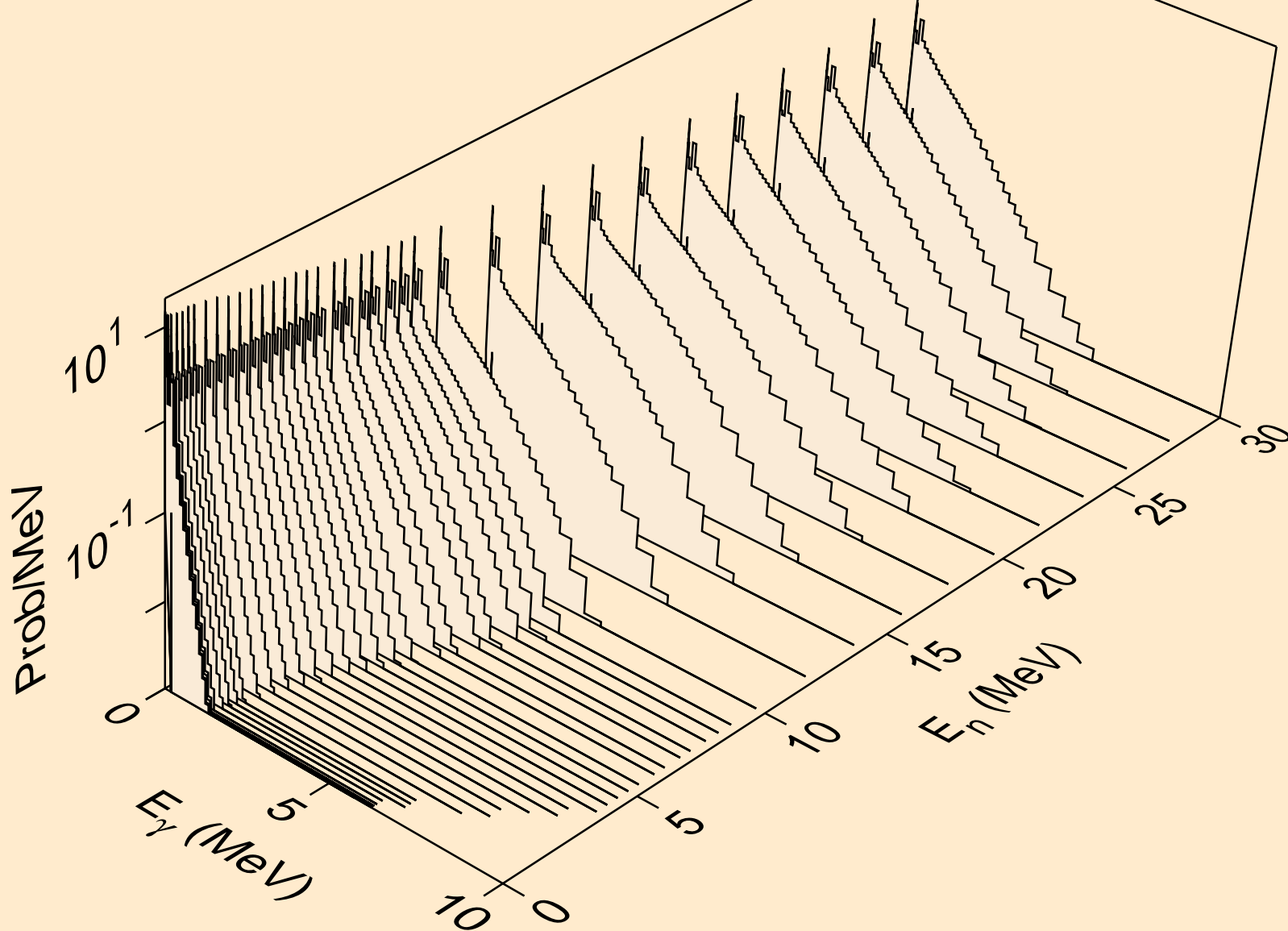

TB139 NEUTRON ACER TENDL-2019 LIBRARY; T=293.16K
Photon emission for (n,p α)

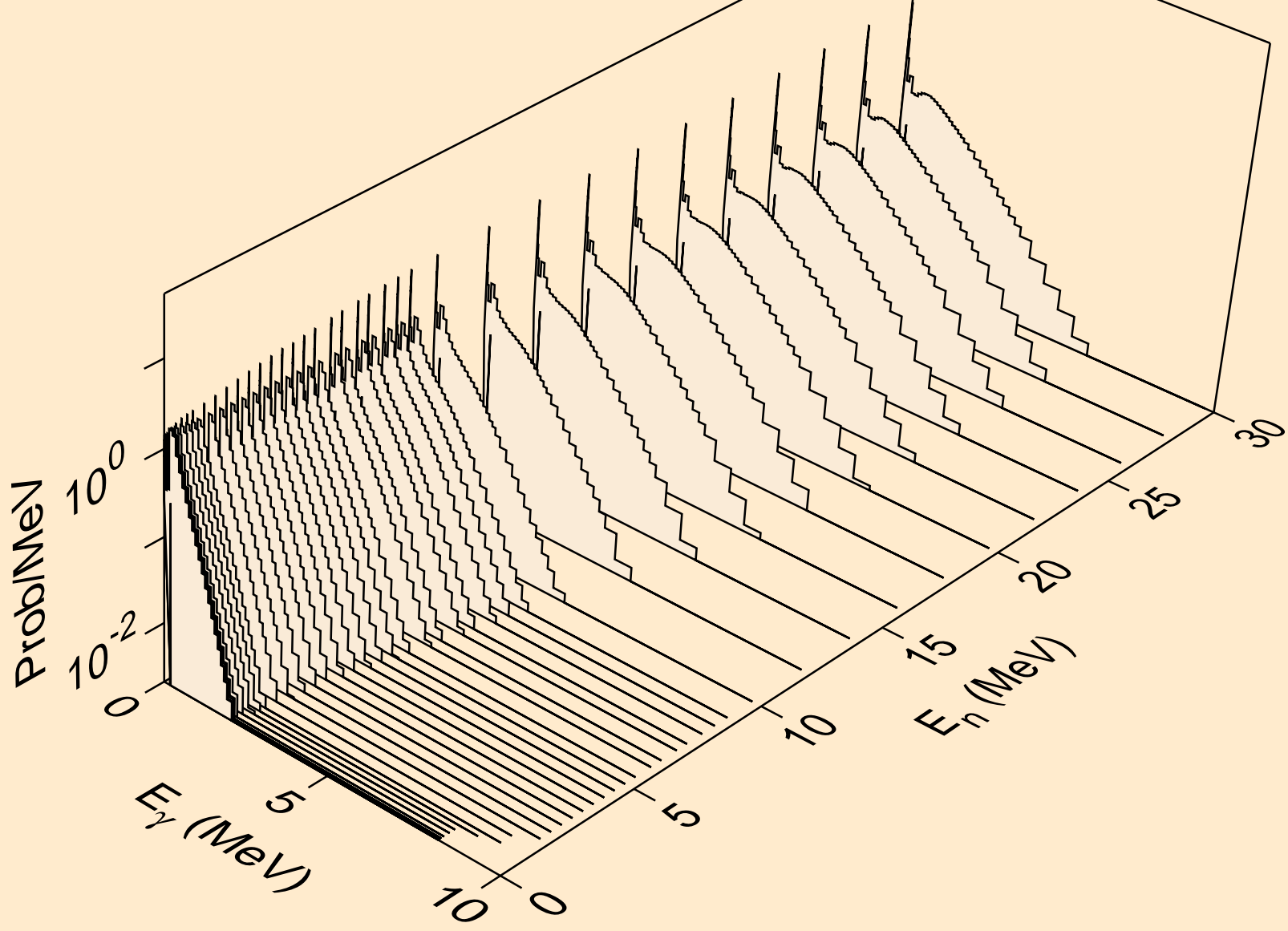

TB139 NEUTRON ACER TENDL-2019 LIBRARY; T=293.16K
Photon emission for (n,d2a)

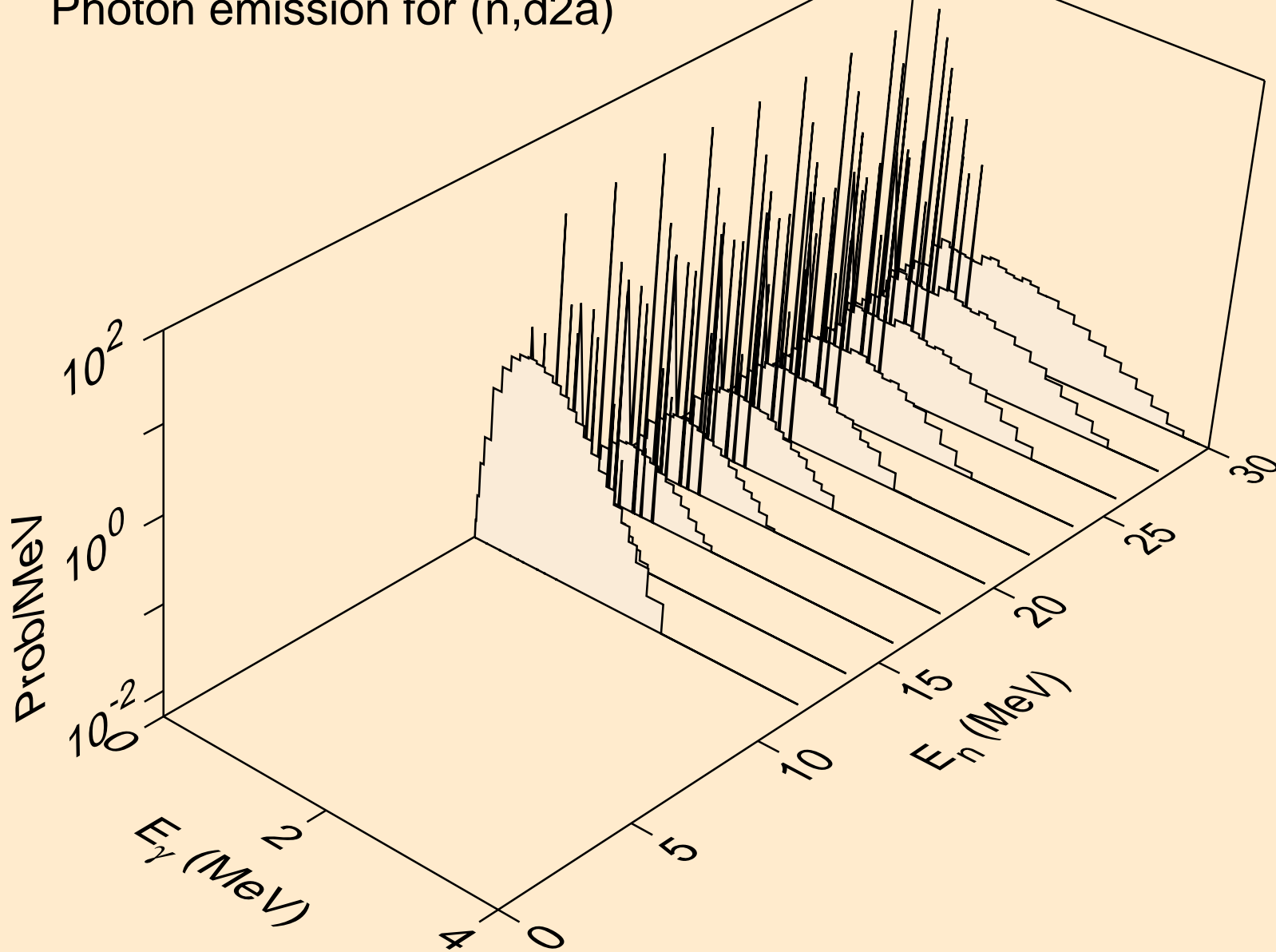

TB139 NEUTRON ACER TENDL-2019 LIBRARY; T=293.16K
Photon emission for (n,pd)

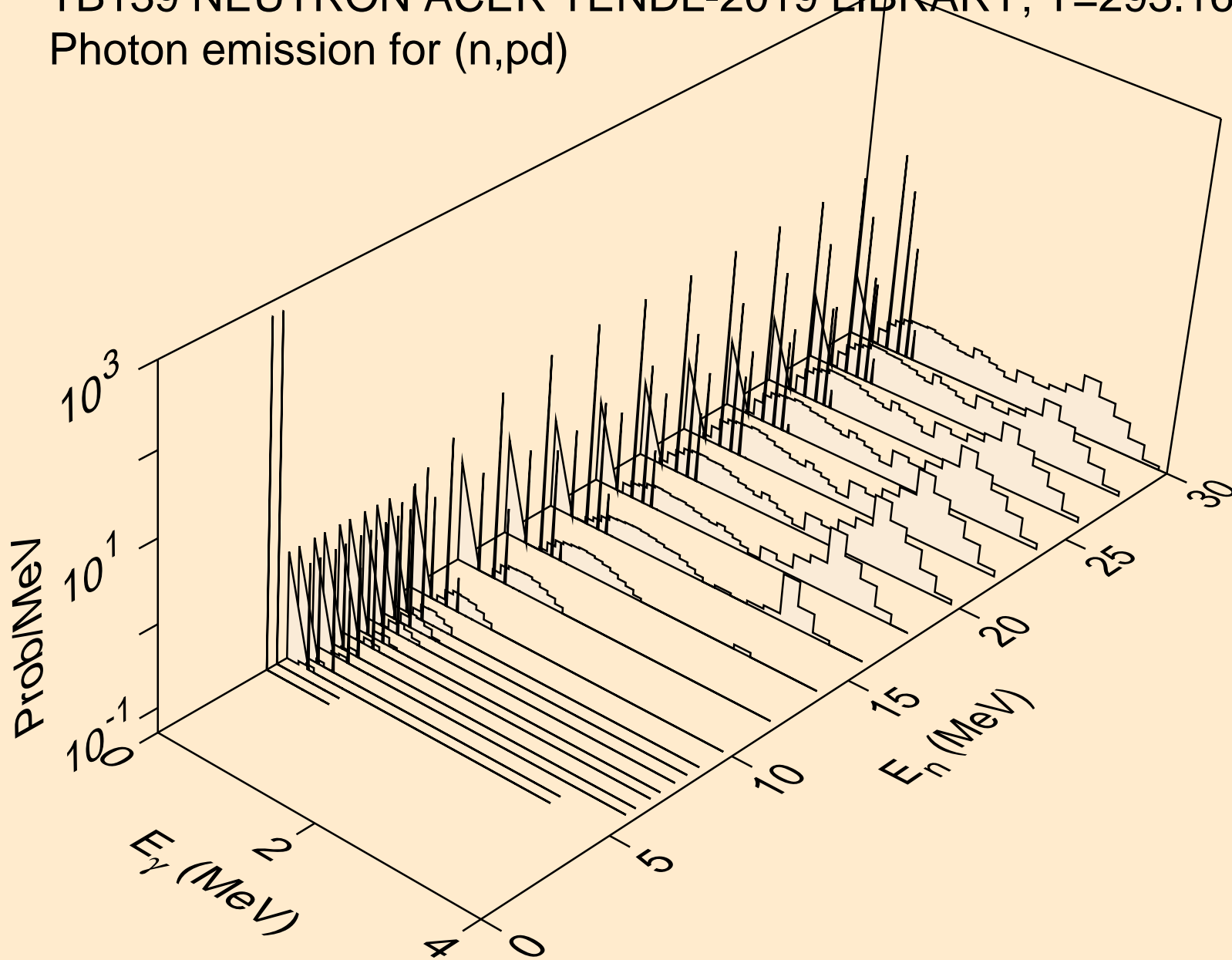

TB139 NEUTRON ACER TENDL-2019 LIBRARY; T=293.16K
Photon emission for (n,pt)

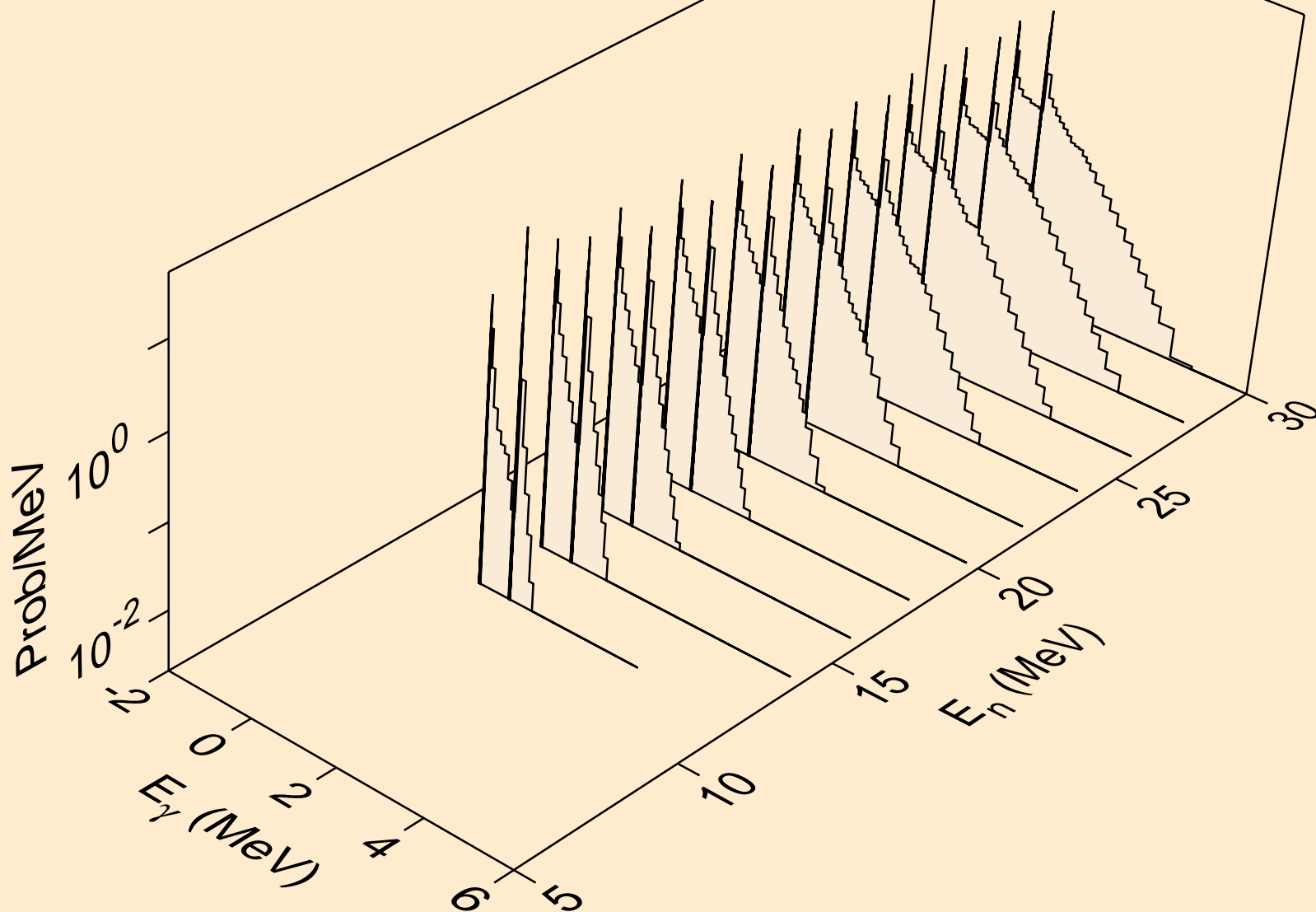

TB139 NEUTRON ACER TENDL-2019 LIBRARY; T=293.16K
Photon emission for (n,da)

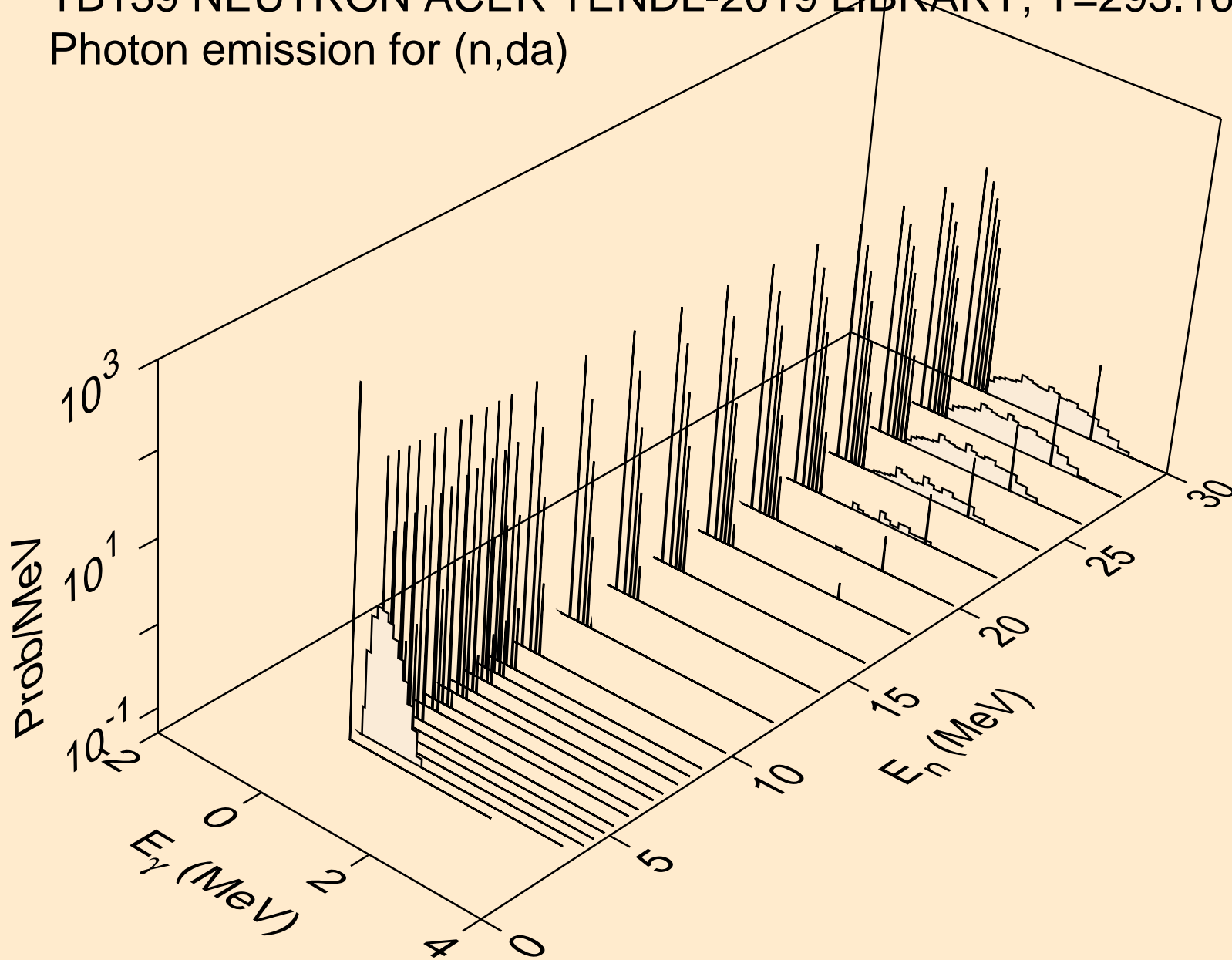

TB139 NEUTRON ACER TENDL-2019 LIBRARY; T=293.16K
thermal capture photon spectrum

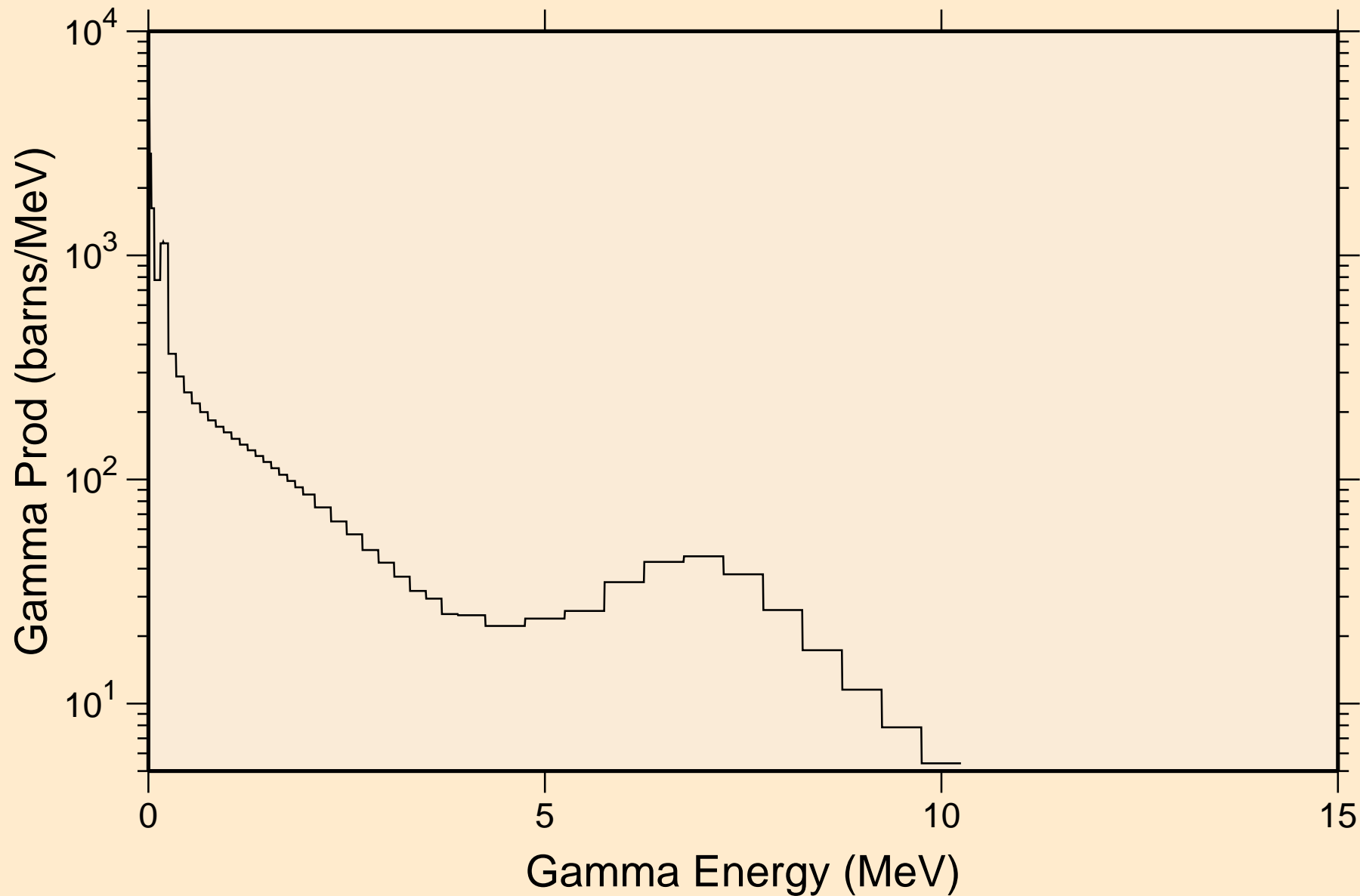

TB139 NEUTRON ACER TENDL-2019 LIBRARY; T=293.16K
14 MeV photon spectrum

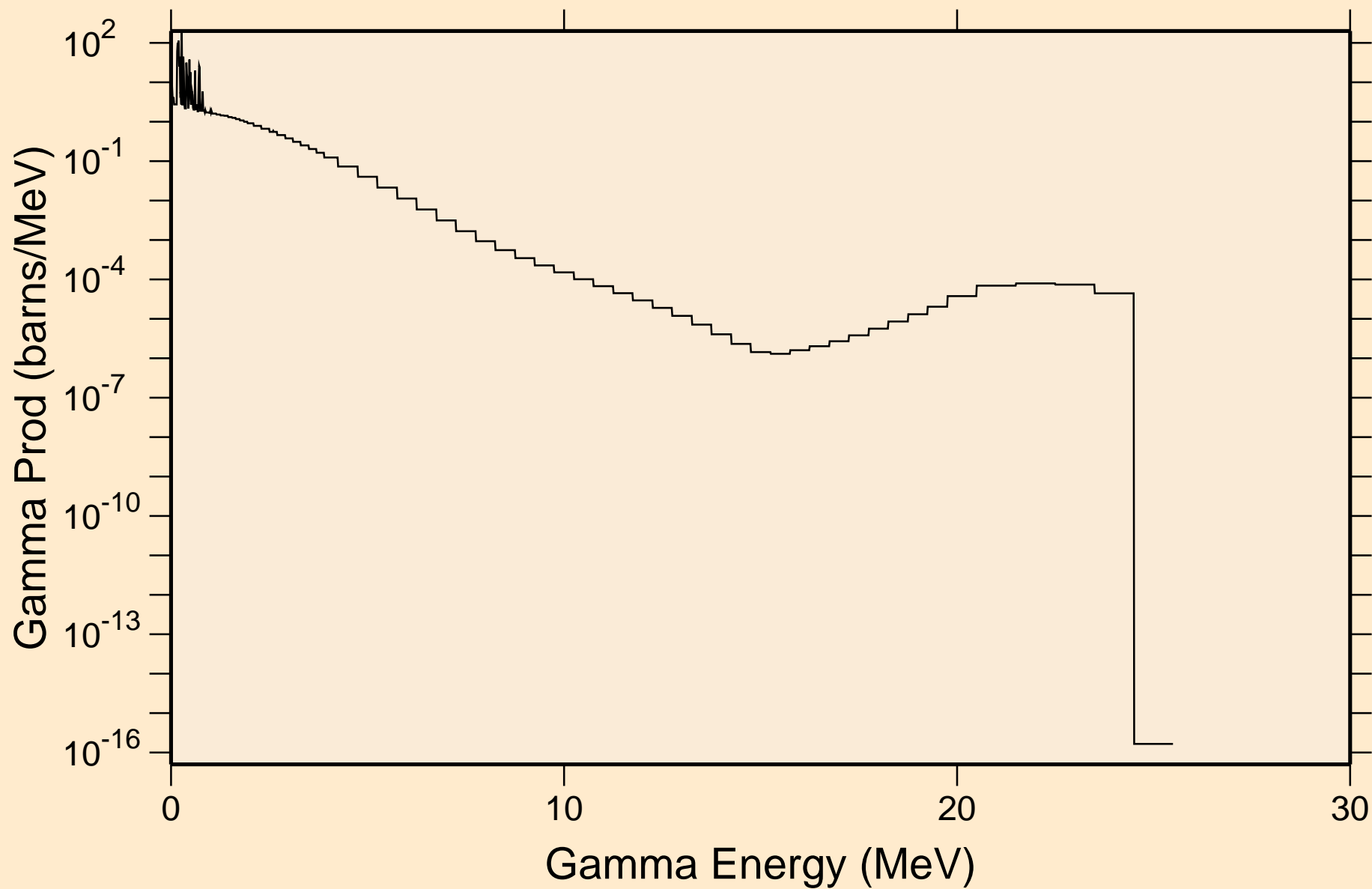

TB139 NEUTRON ACER TENDL-2019 LIBRARY; T=293.16K

Particle heating contributions

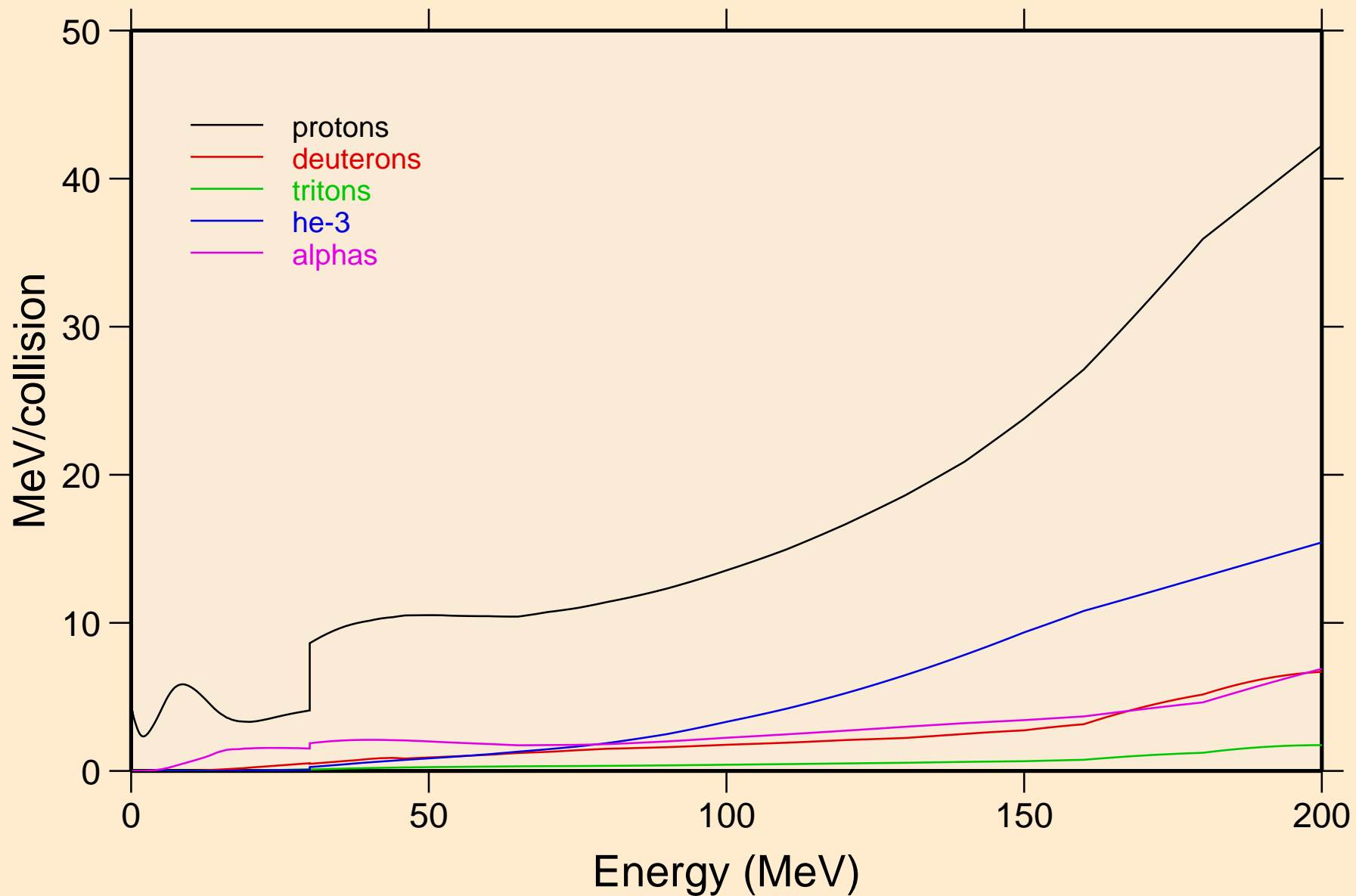

TB139 NEUTRON ACER TENDL-2019 LIBRARY; T=293.16K
Recoil Heating

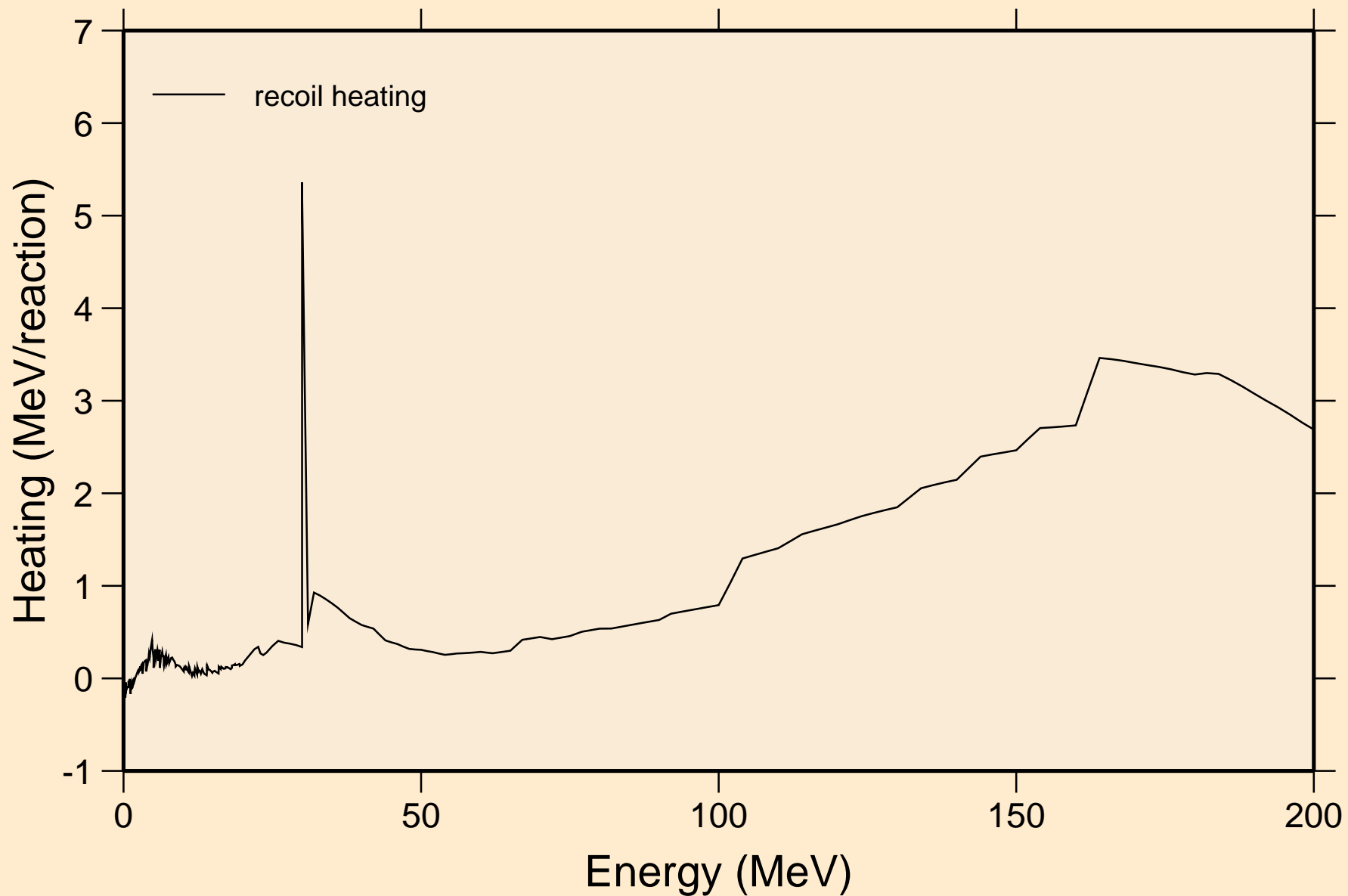

TB139 NEUTRON ACER TENDL-2019 LIBRARY; T=293.16K
Particle production cross sections

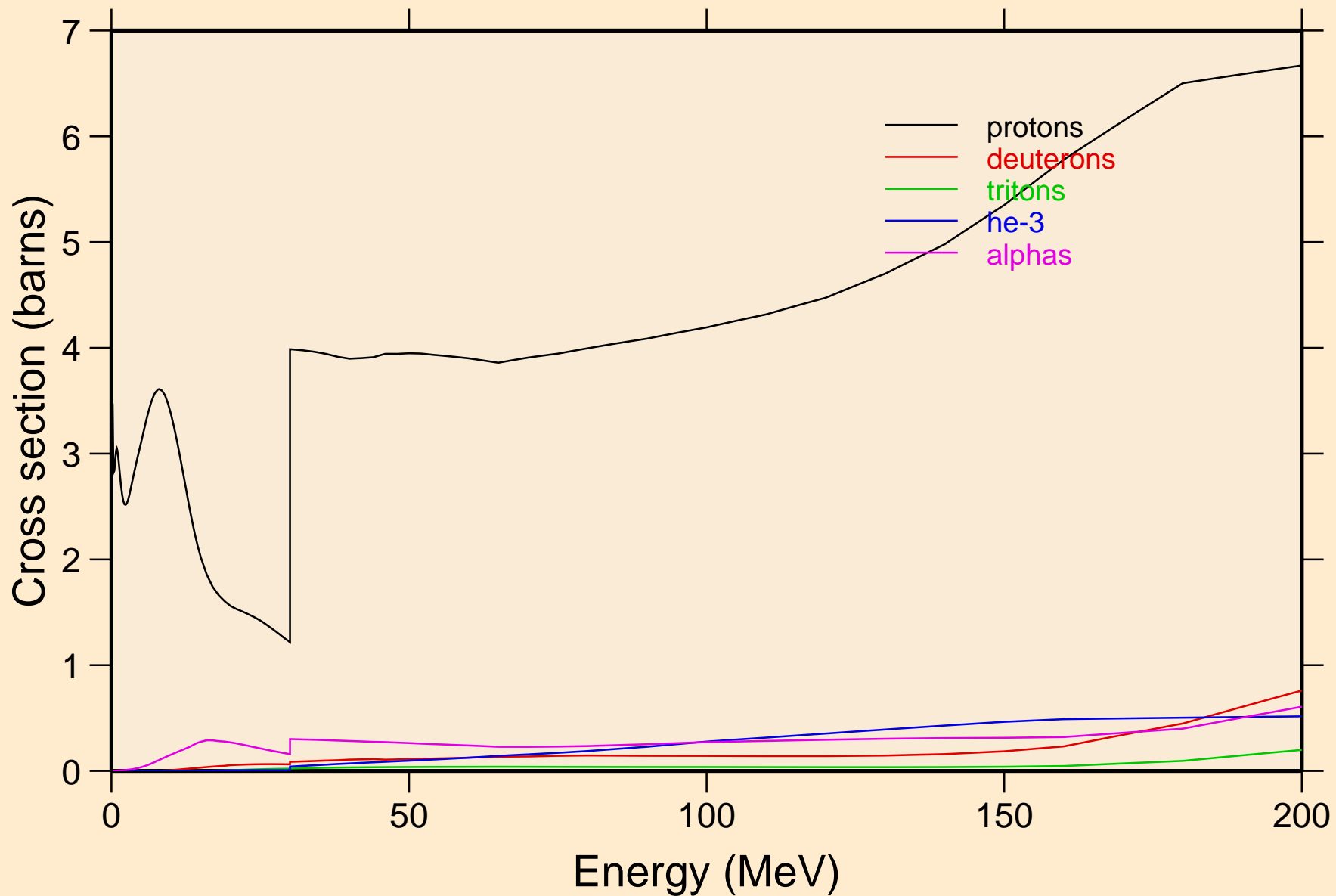

TB139 NEUTRON ACER TENDL-2019 LIBRARY; T=293.16K
protons from (n,x)

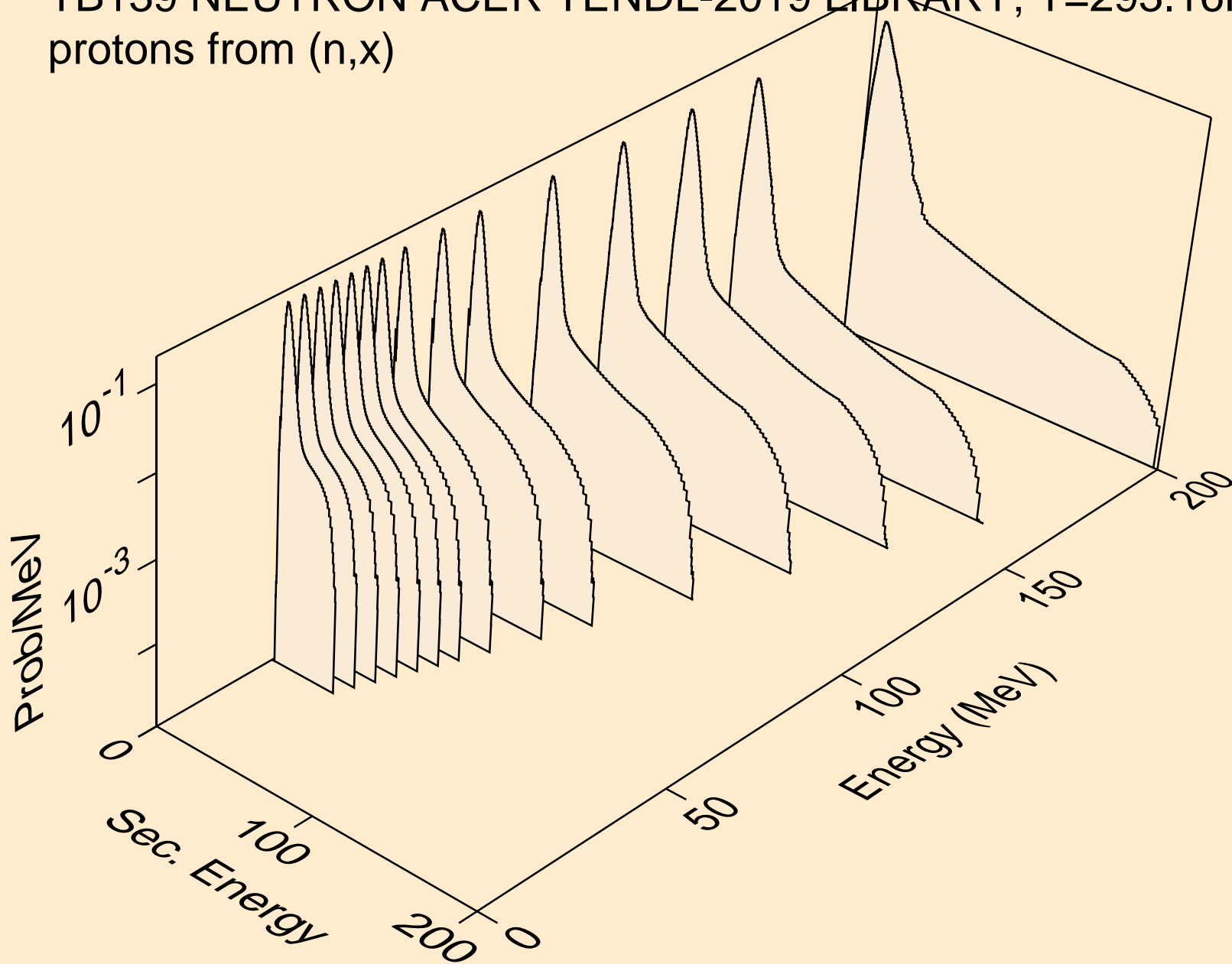

TB139 NEUTRON ACER TENDL-2019 LIBRARY; T=293.16K
protons from (n,n*)p

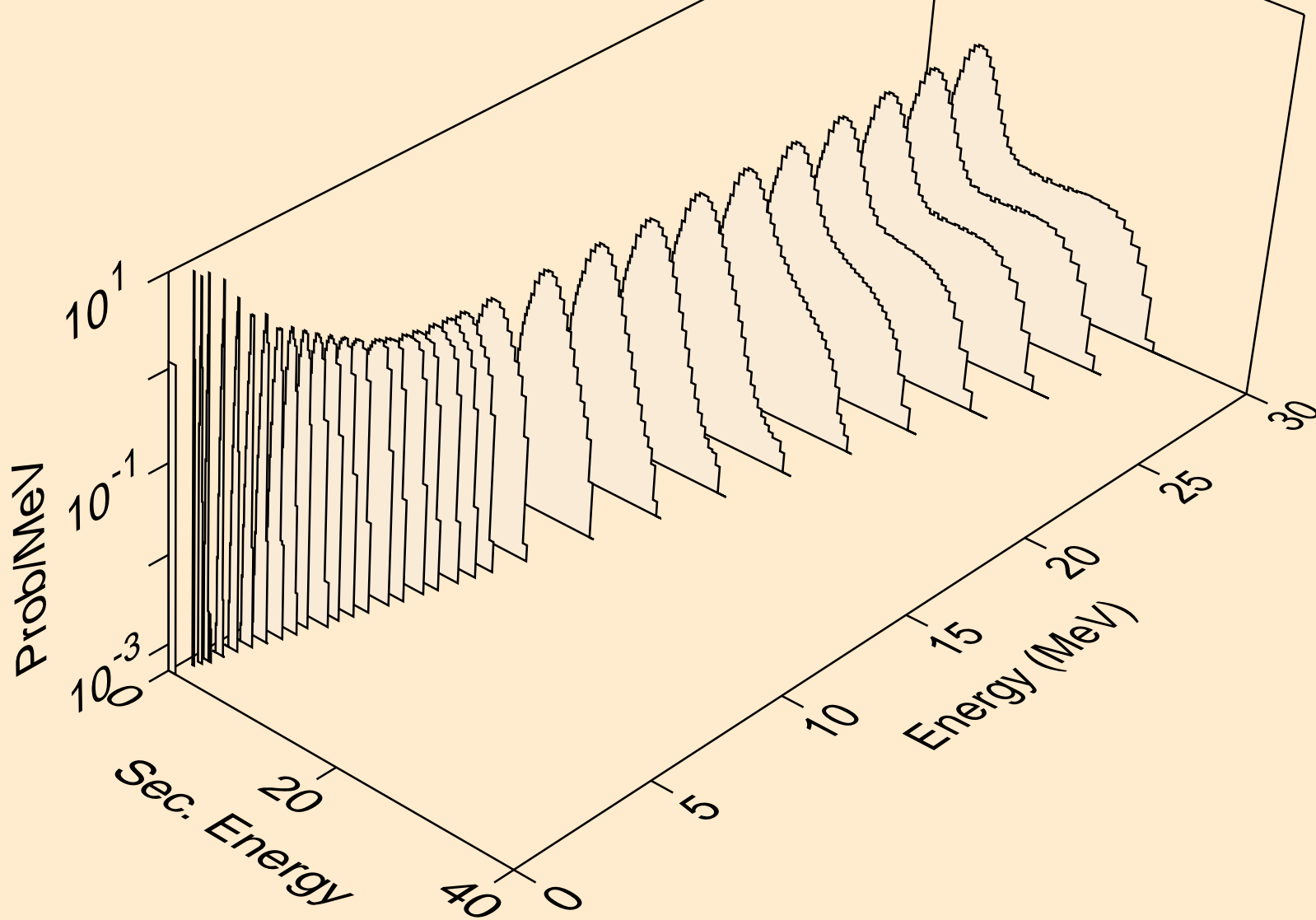

TB139 NEUTRON ACER TENDL-2019 LIBRARY; T=293.16K
protons from (n,2np)

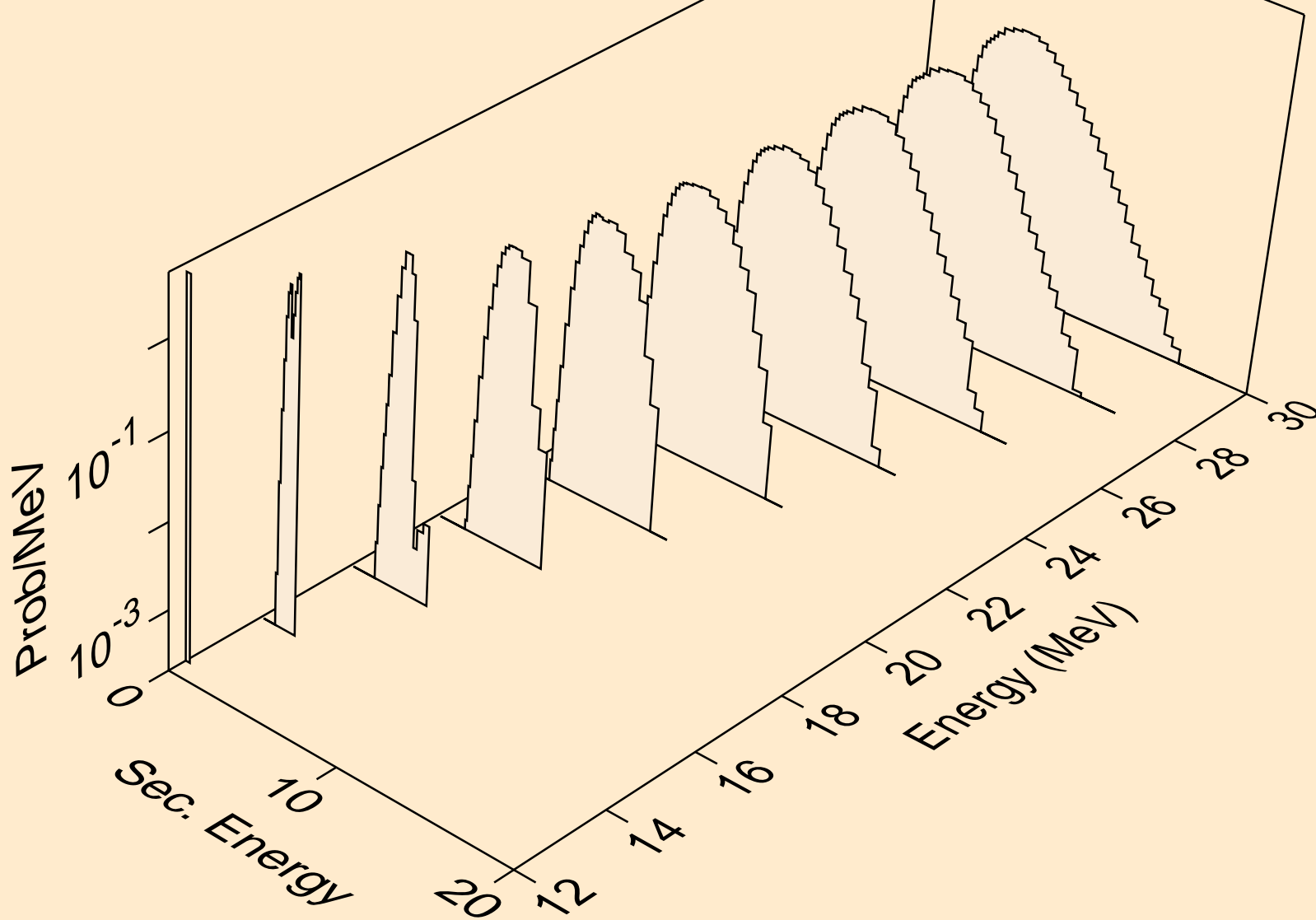

TB139 NEUTRON ACER TENDL-2019 LIBRARY; T=293.16K
protons from (n,3np)

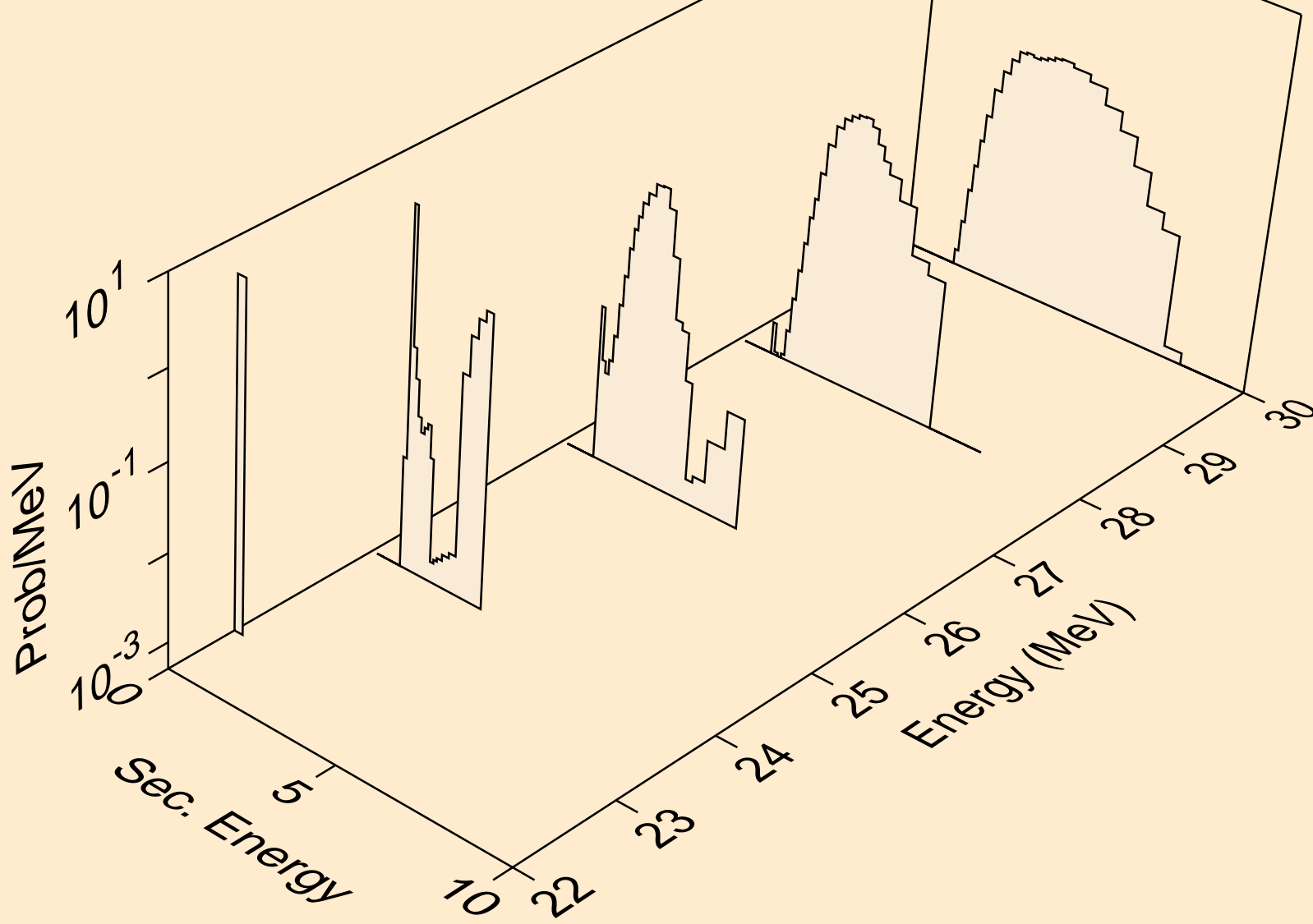

TB139 NEUTRON ACER TENDL-2019 LIBRARY; T=293.16K
protons from (n,2np)

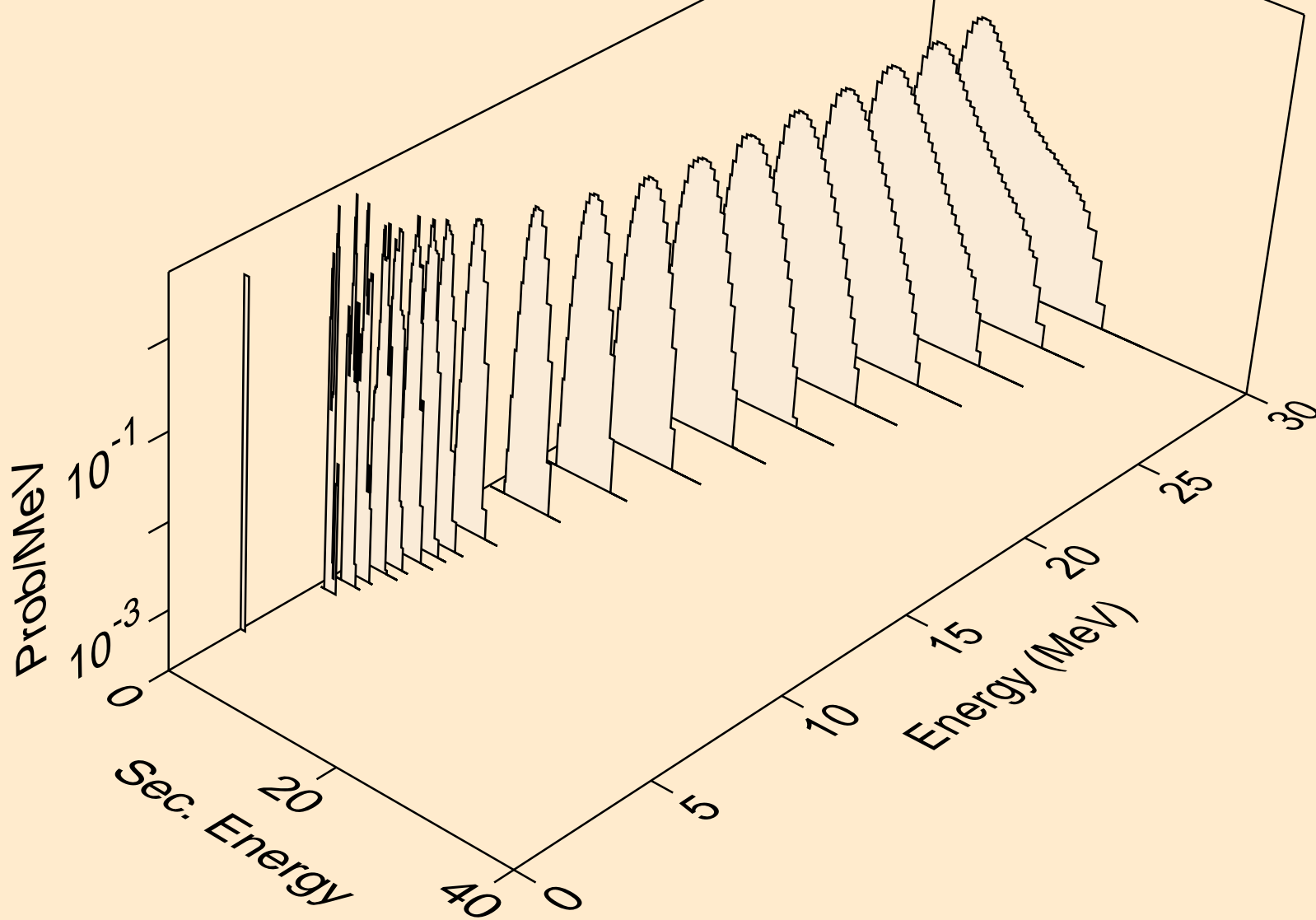

TB139 NEUTRON ACER TENDL-2019 LIBRARY; T=293.16K
protons from (n,npa)

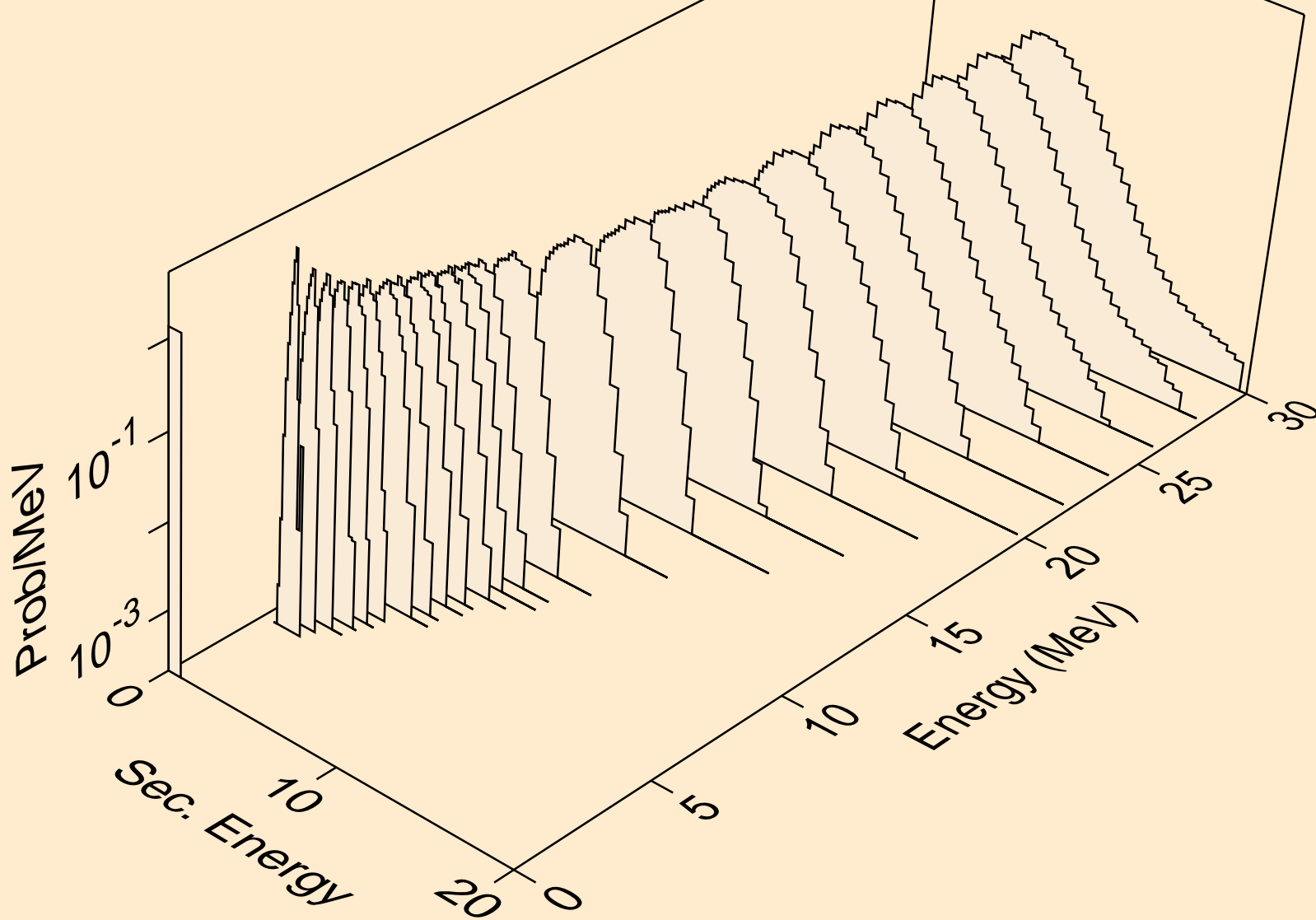

TB139 NEUTRON ACER TENDL-2019 LIBRARY; T=293.16K
protons from (n,p)

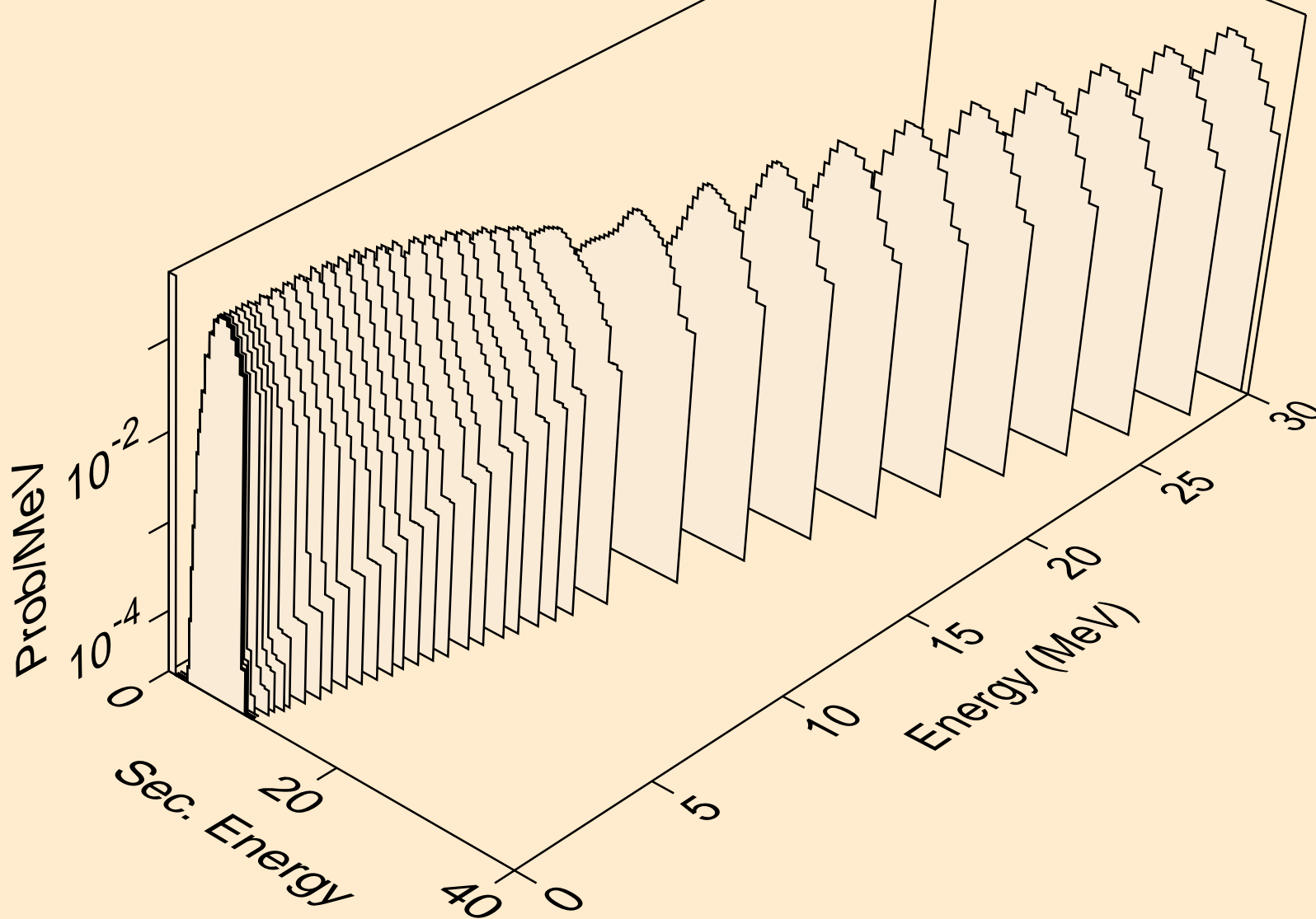

TB139 NEUTRON ACER TENDL-2019 LIBRARY; T=293.16K
protons from (n,2p)

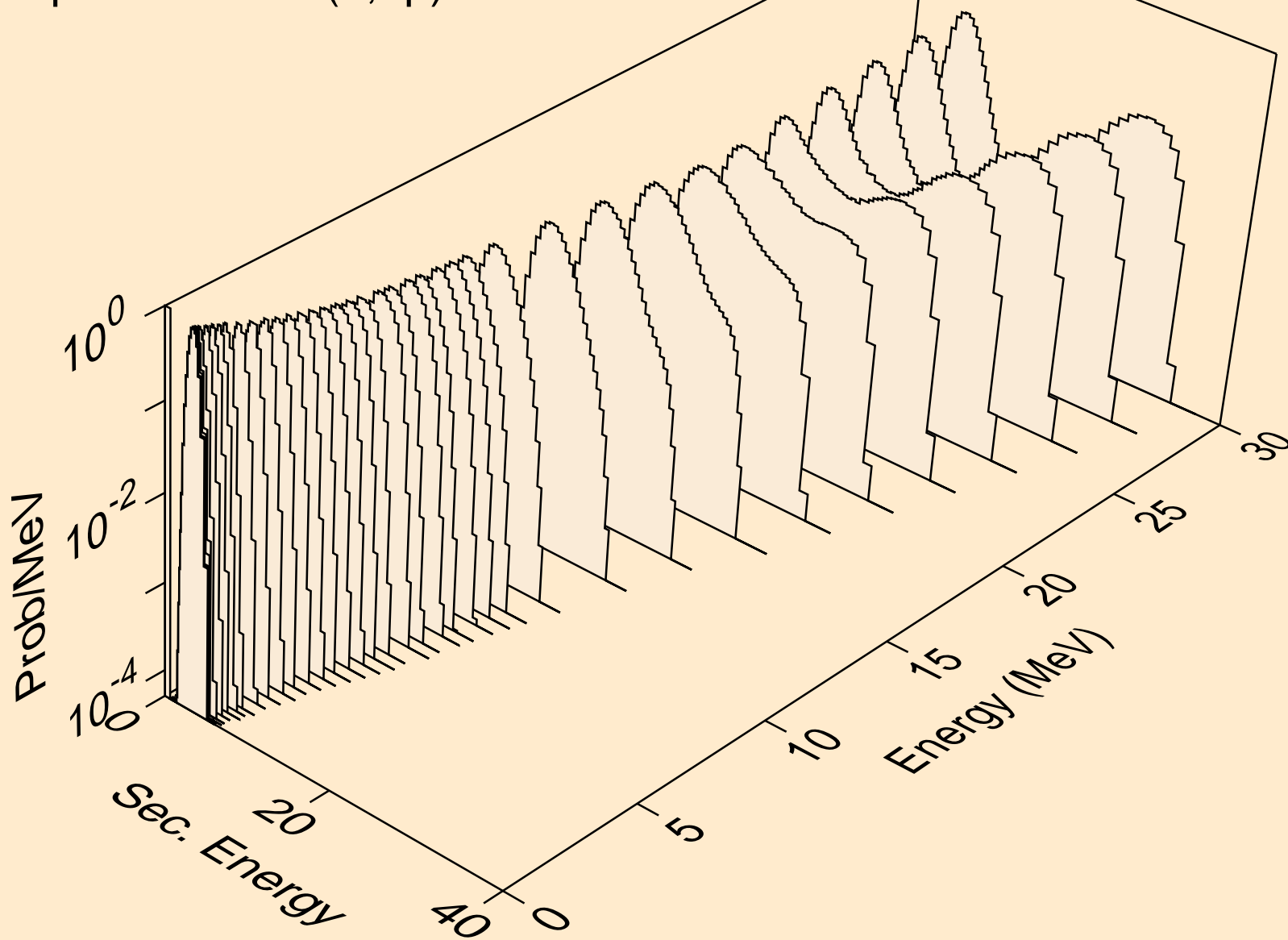

TB139 NEUTRON ACER TENDL-2019 LIBRARY; T=293.16K
protons from (n,p)

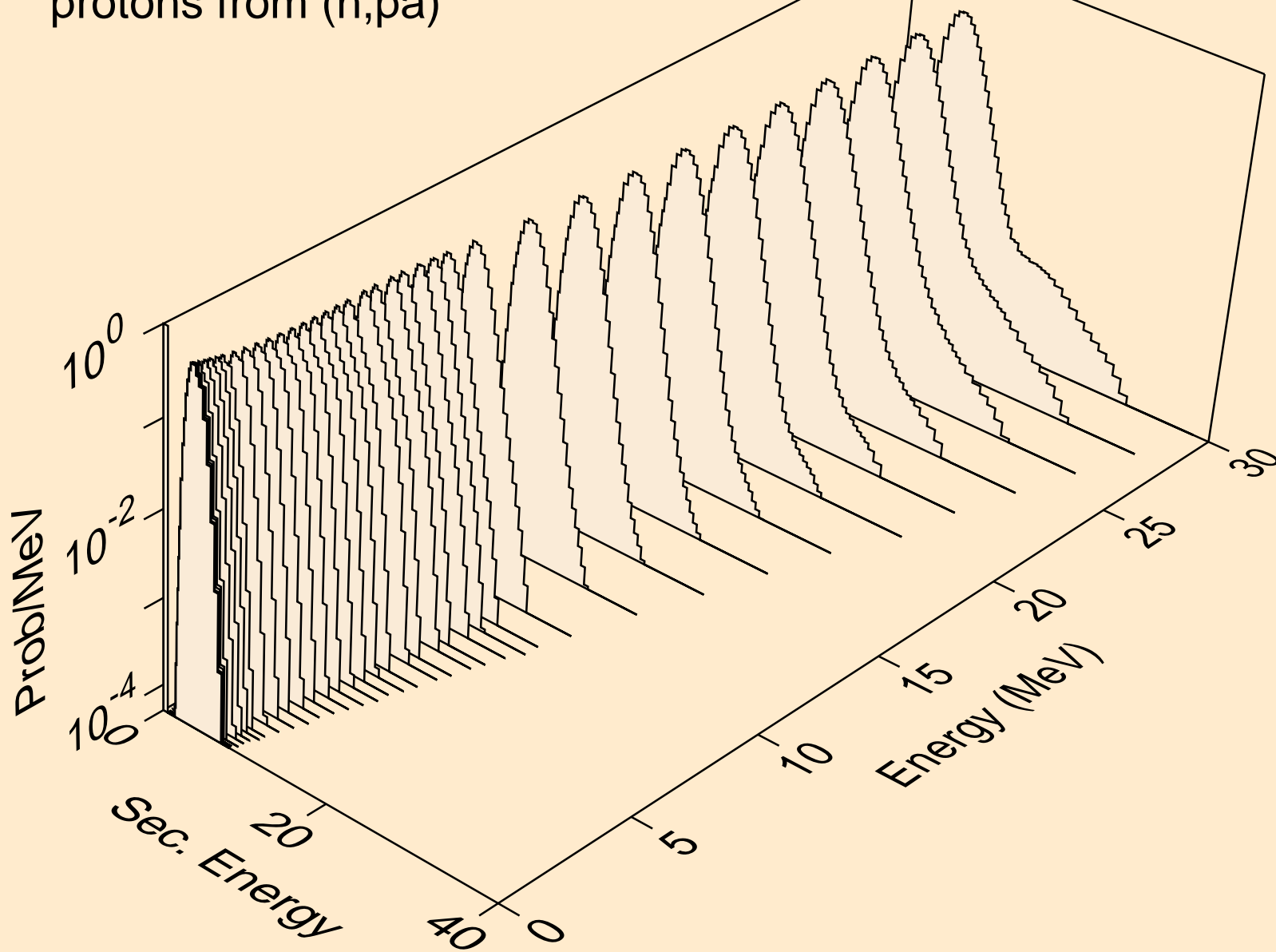

TB139 NEUTRON ACER TENDL-2019 LIBRARY; T=293.16K
protons from (n,pd)

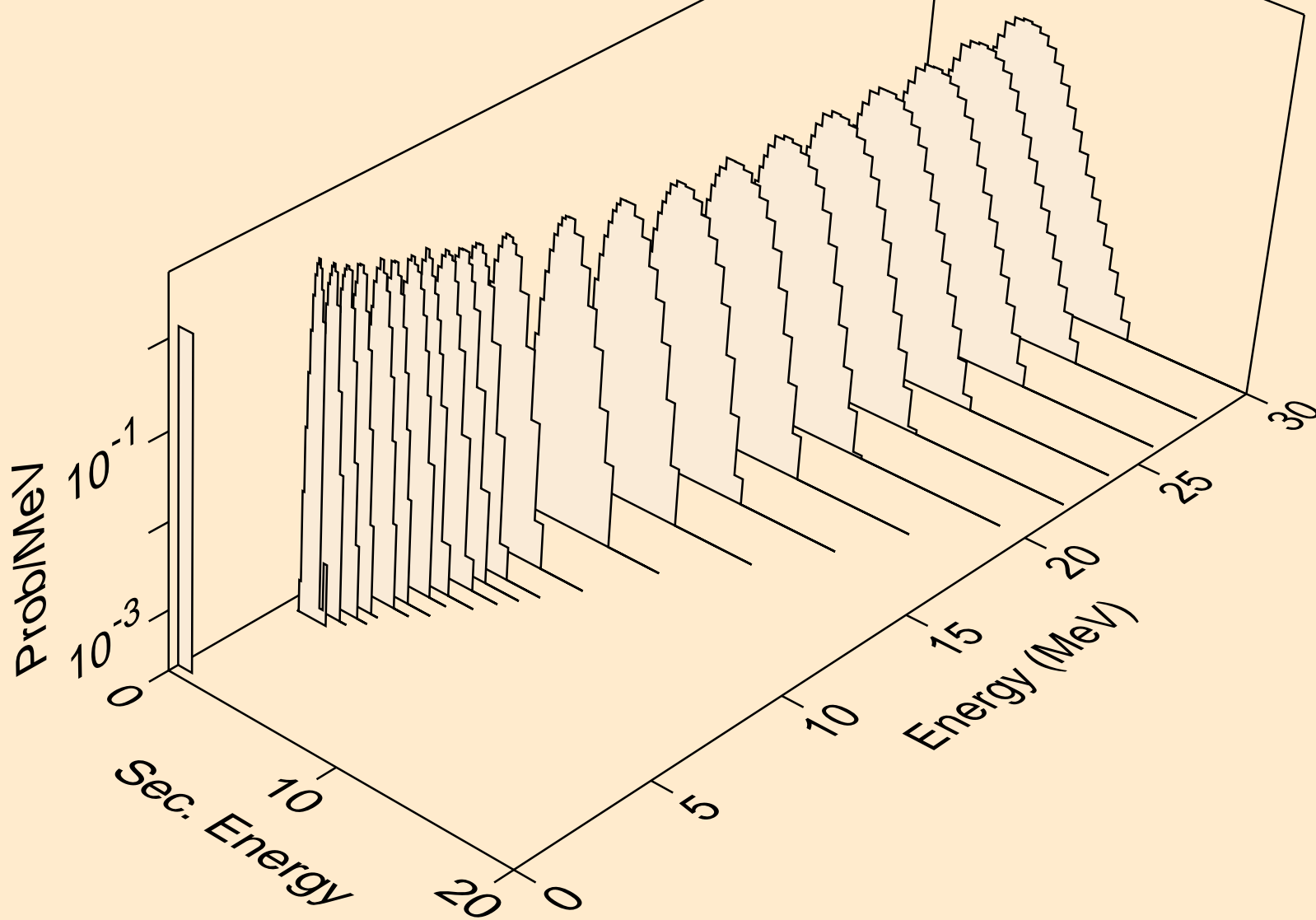

TB139 NEUTRON ACER TENDL-2019 LIBRARY; T=293.16K
protons from (n,pt)

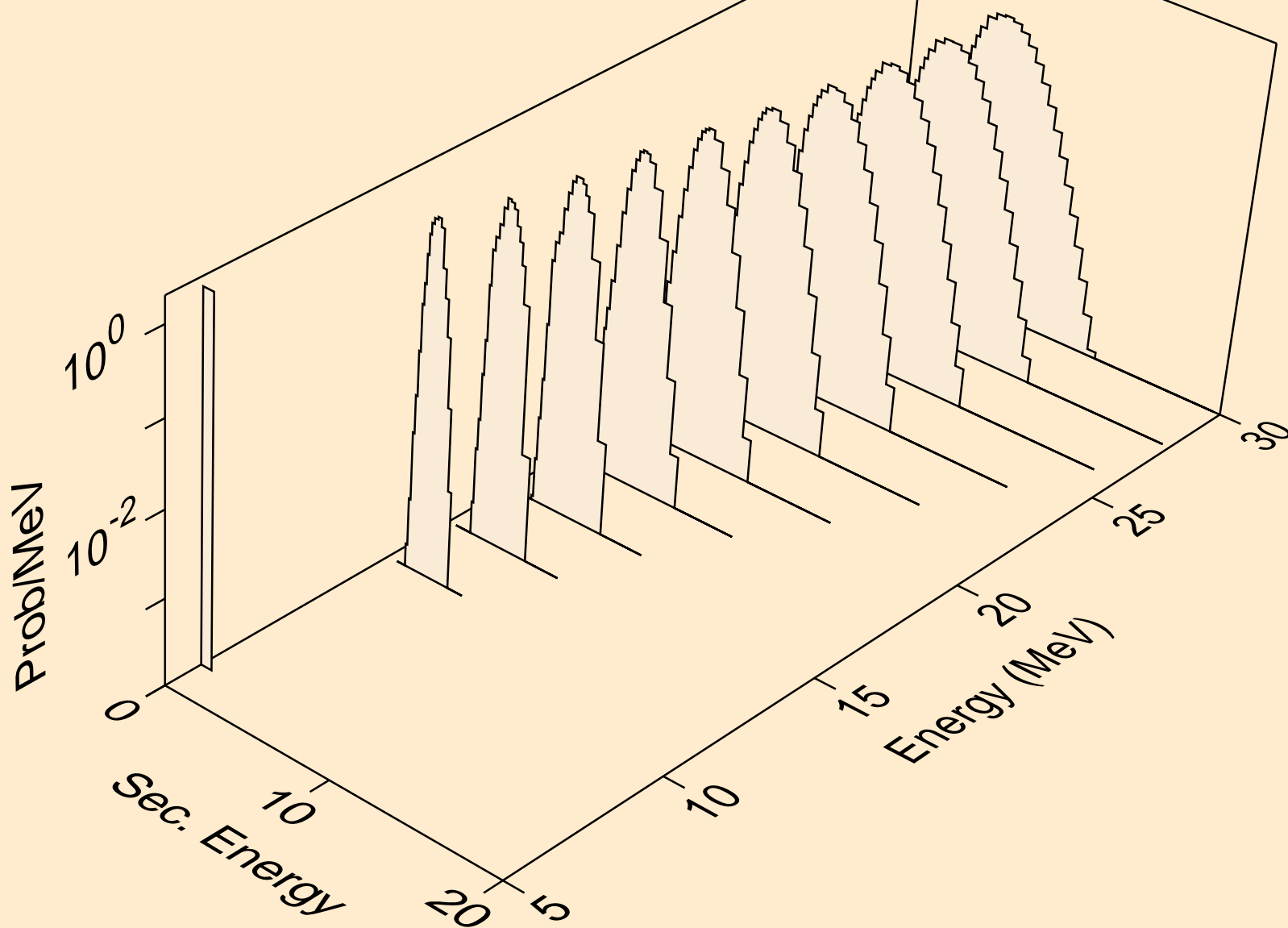

TB139 NEUTRON ACER TENDL-2019 LIBRARY; T=293.16K
deuterons from (n,x)

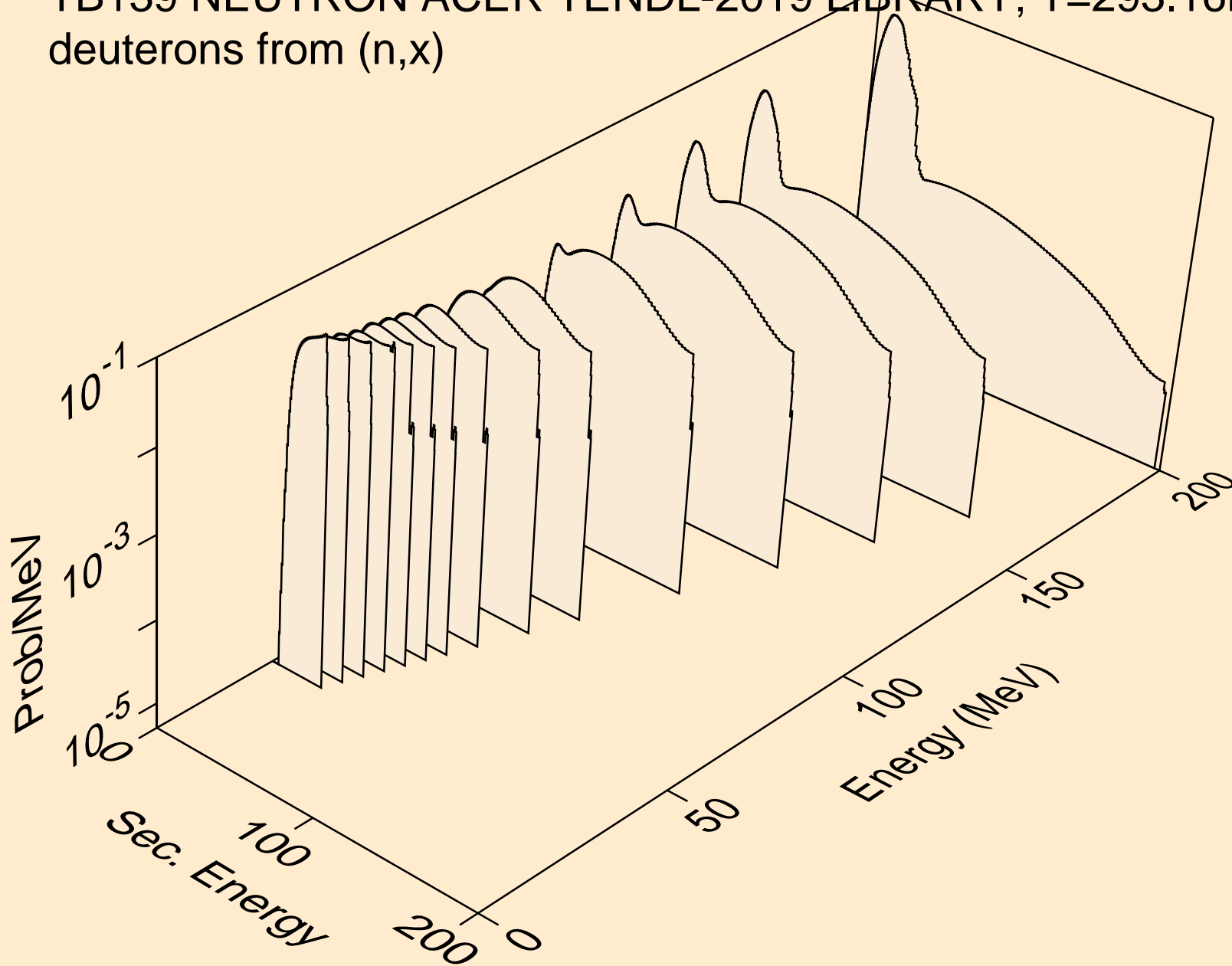

TB139 NEUTRON ACER TENDL-2019 LIBRARY; T=293.16K
deuterons from (n,2nd)

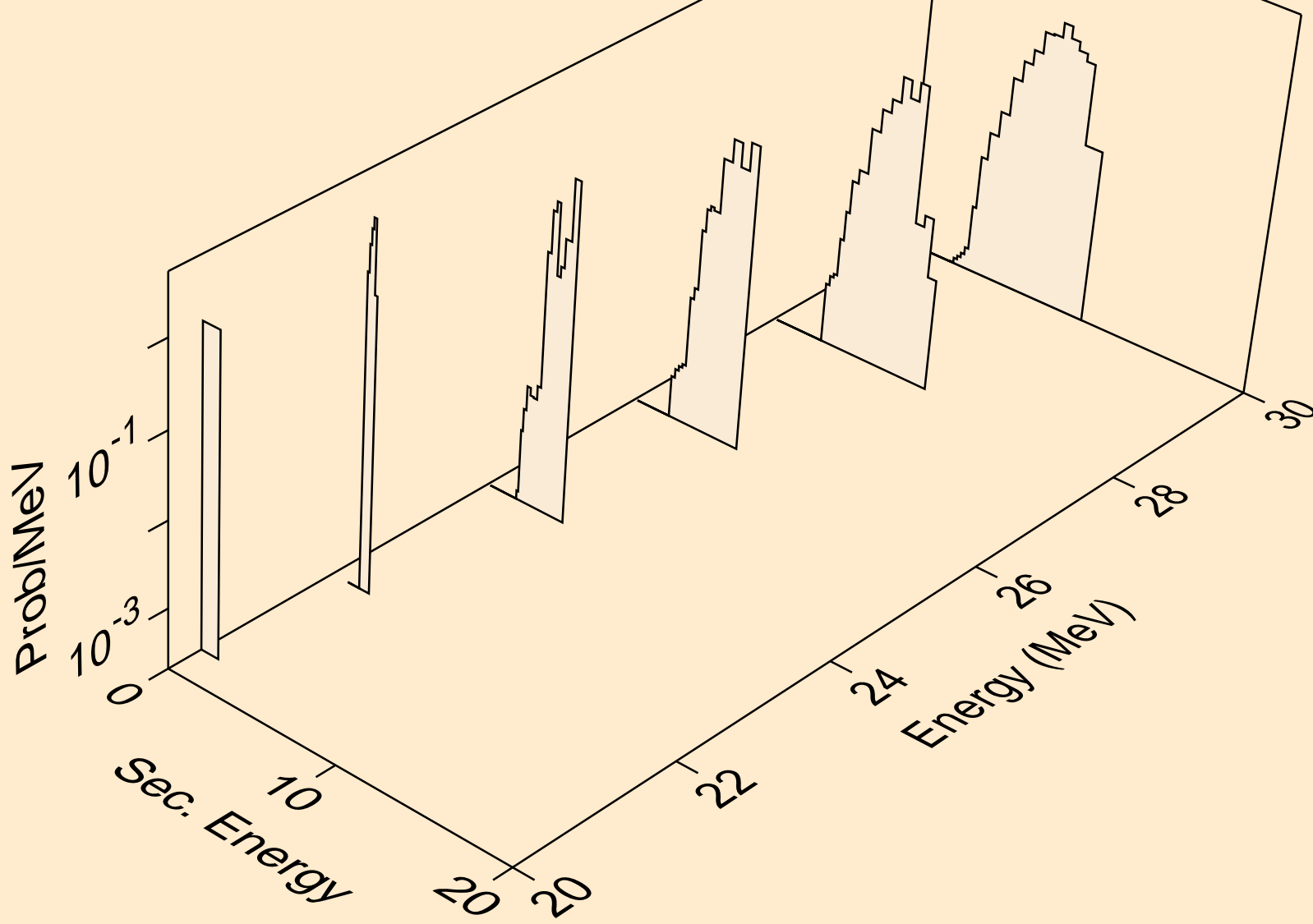

TB139 NEUTRON ACER TENDL-2019 LIBRARY; T=293.16K
deuterons from (n,n*)d

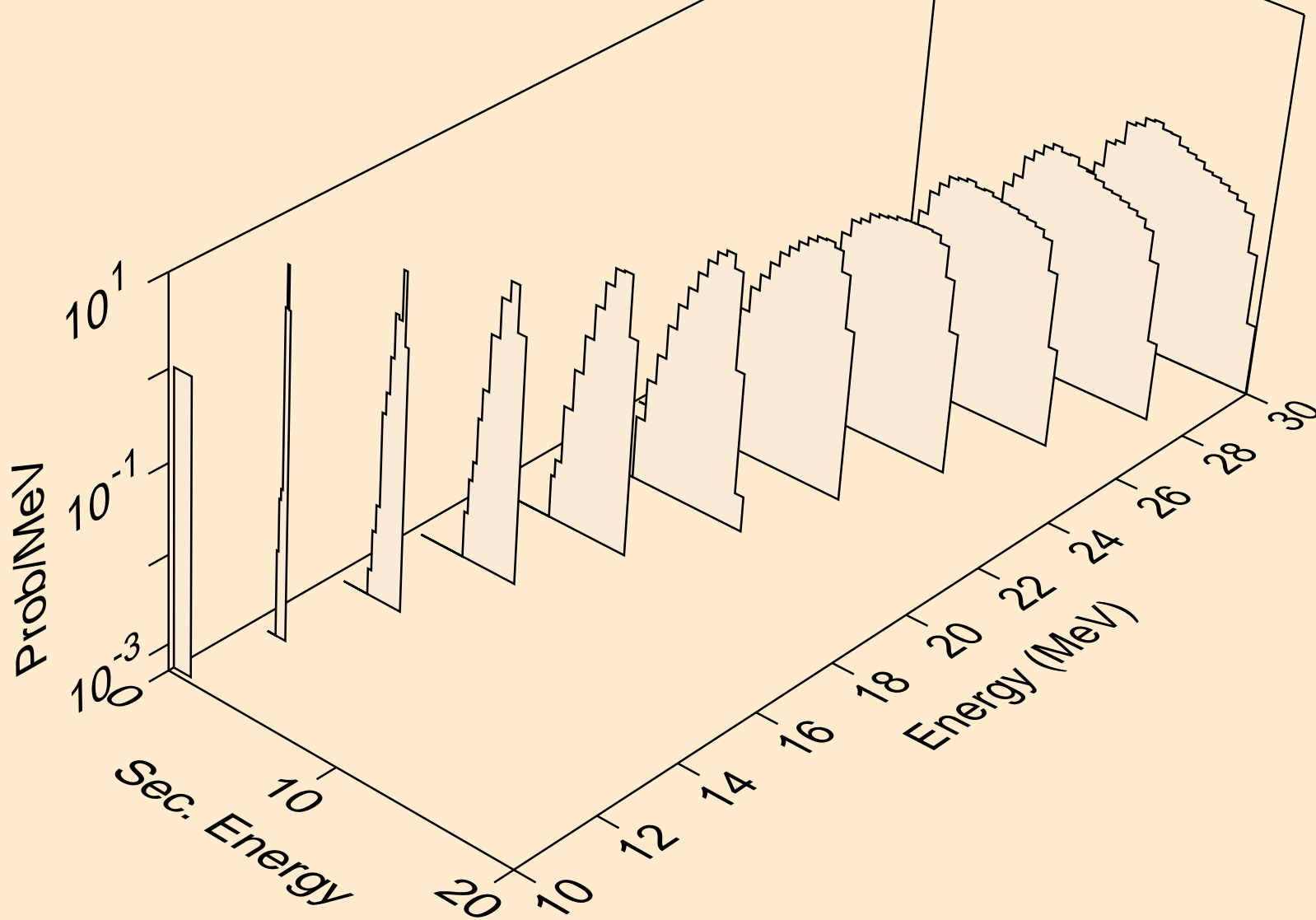

TB139 NEUTRON ACER TENDL-2019 LIBRARY; T=293.16K
deuterons from (n,d)

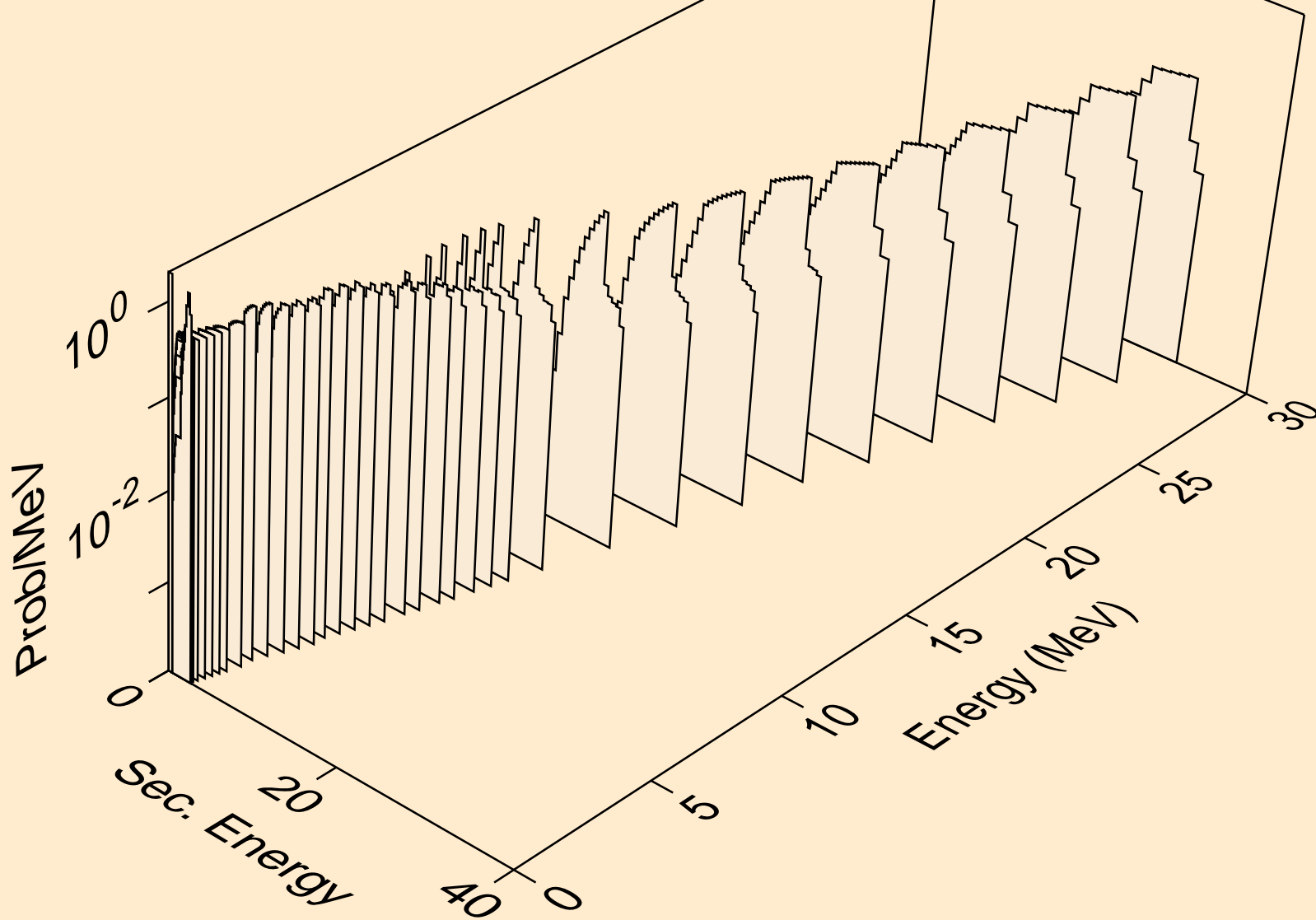

TB139 NEUTRON ACER TENDL-2019 LIBRARY; T=293.16K
deuterons from (n,d2a)

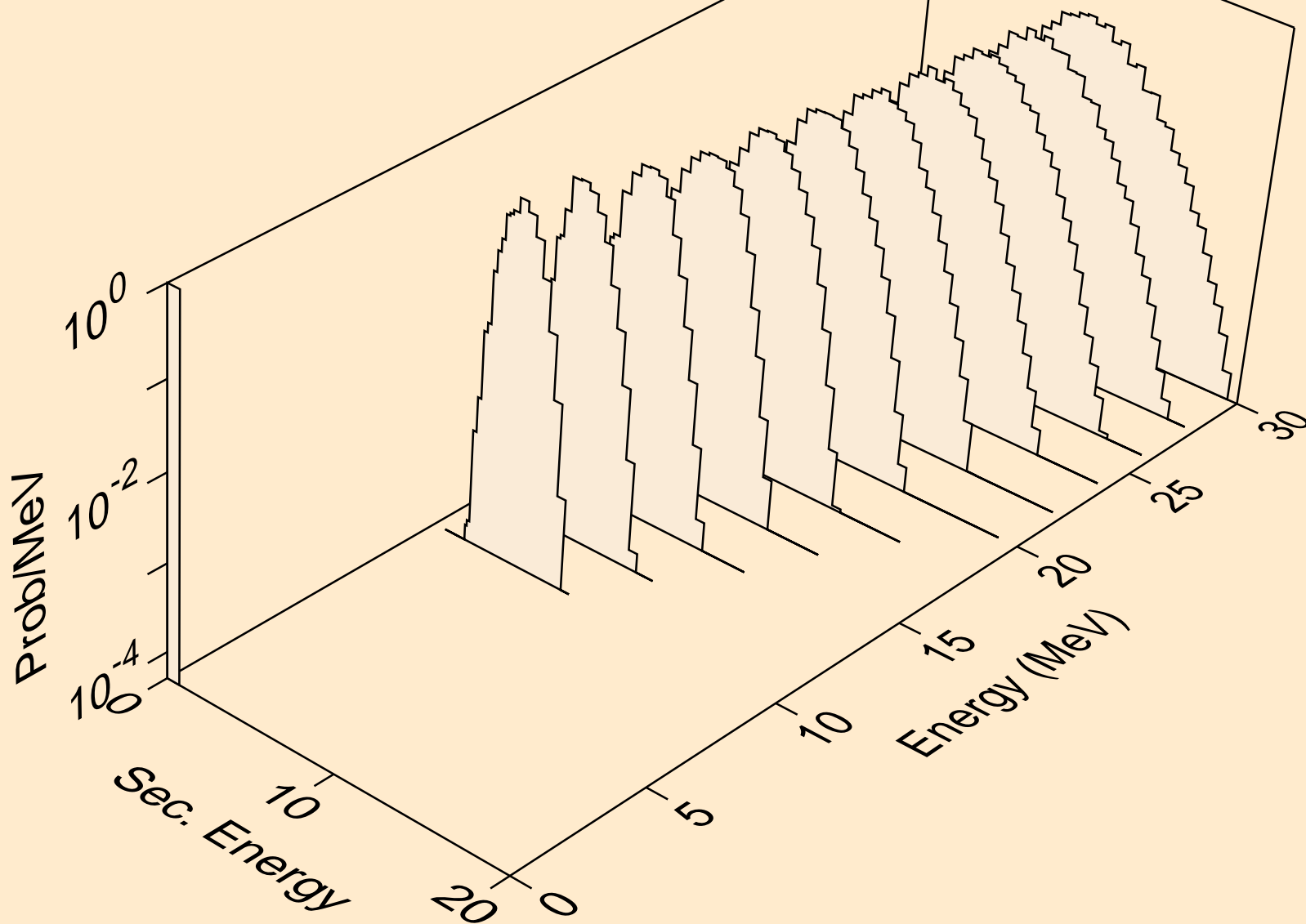

TB139 NEUTRON ACER TENDL-2019 LIBRARY; T=293.16K
deuterons from (n,pd)

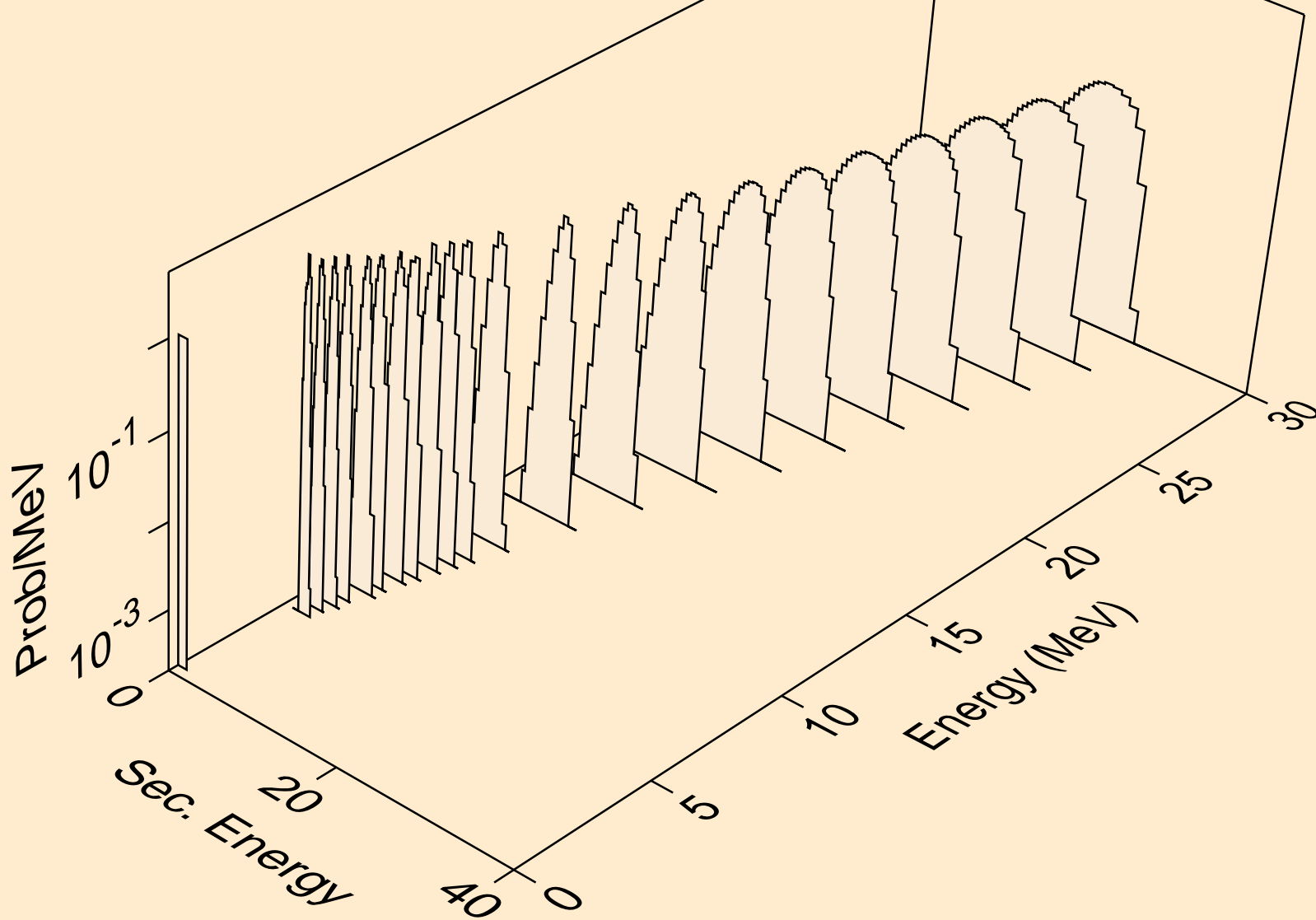

TB139 NEUTRON ACER TENDL-2019 LIBRARY; T=293.16K
deuterons from (n,da)

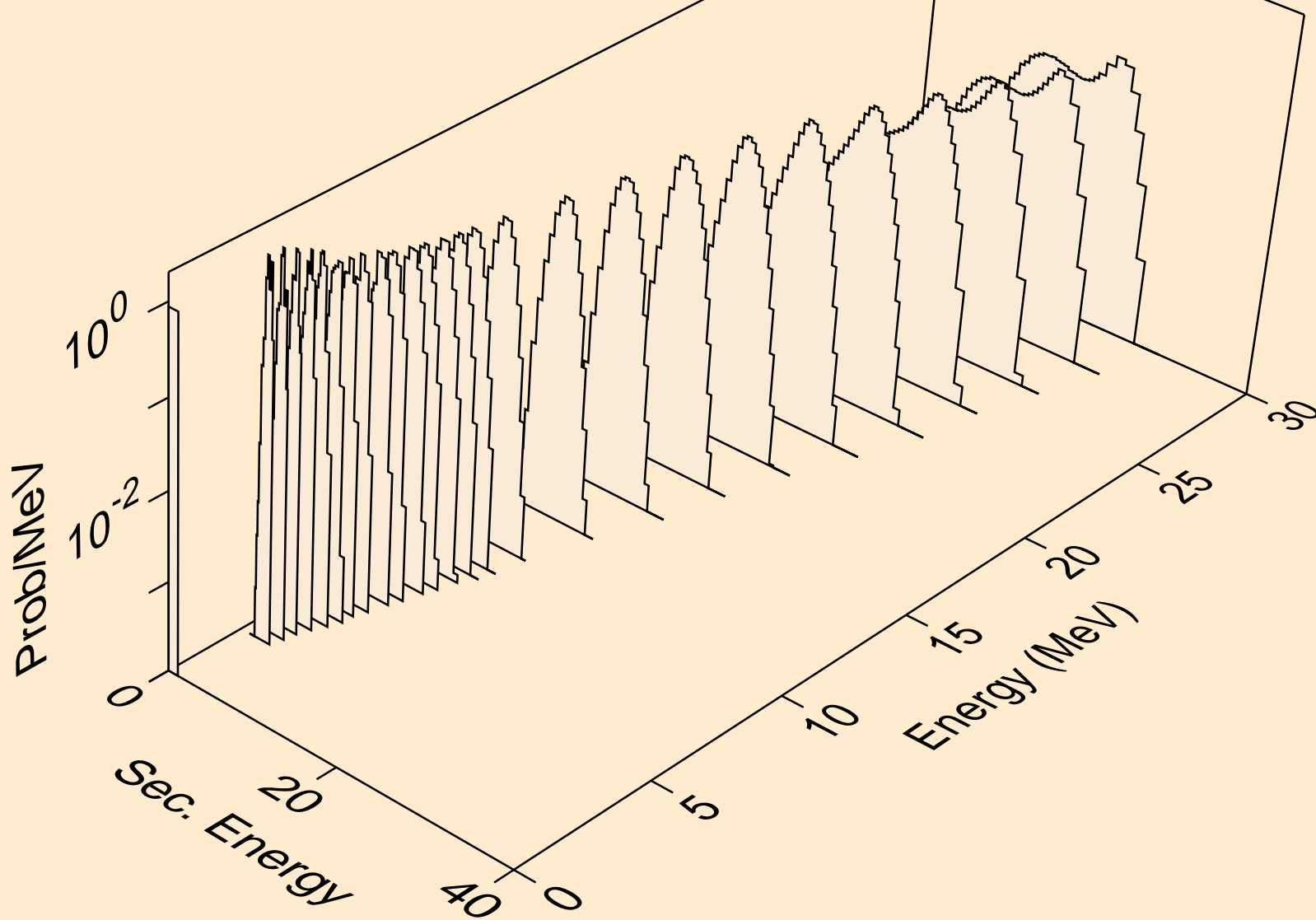

TB139 NEUTRON ACER TENDL-2019 LIBRARY; T=293.16K
tritons from (n,x)

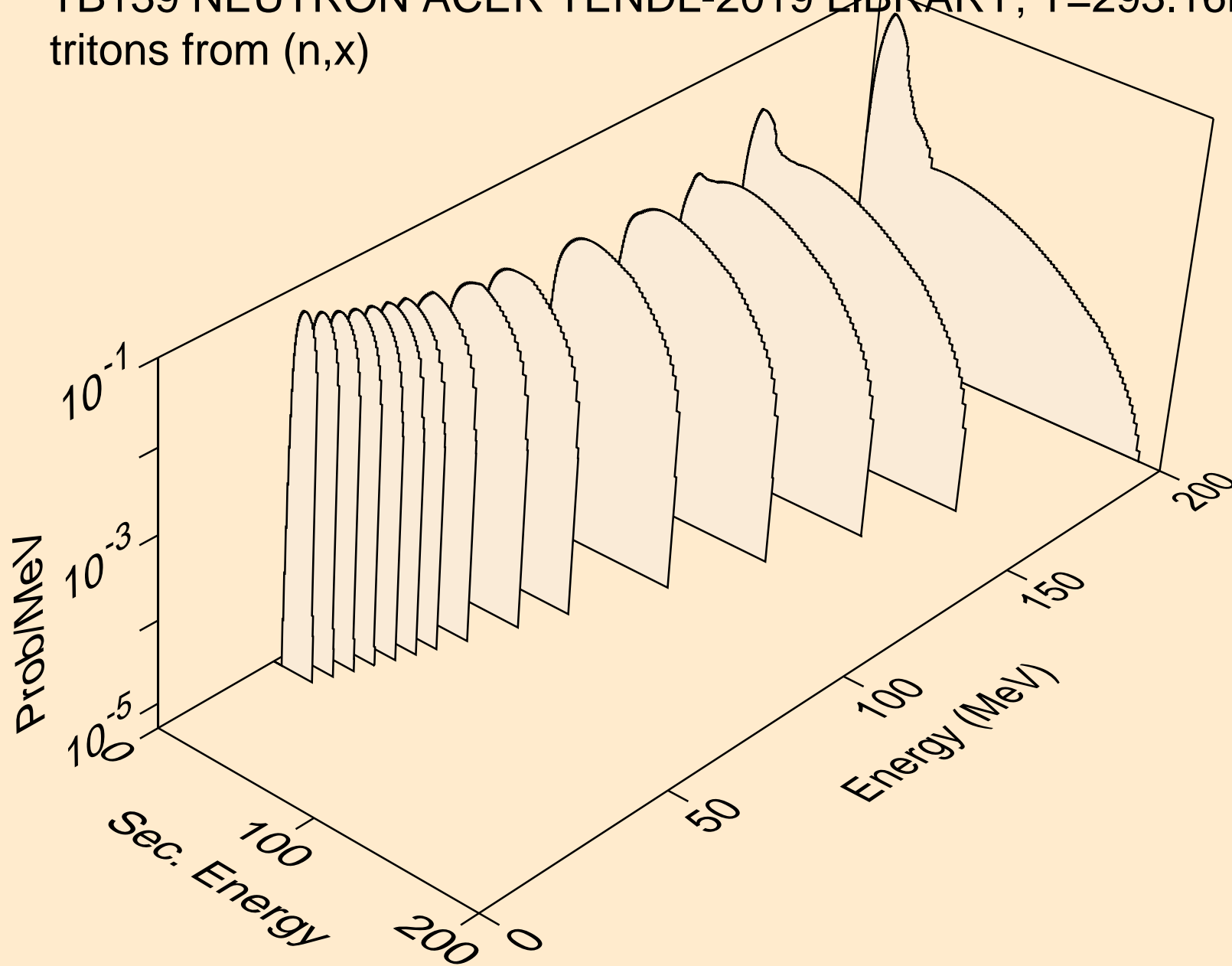

TB139 NEUTRON ACER TENDL-2019 LIBRARY; T=293.16K
tritons from (n,n*)t

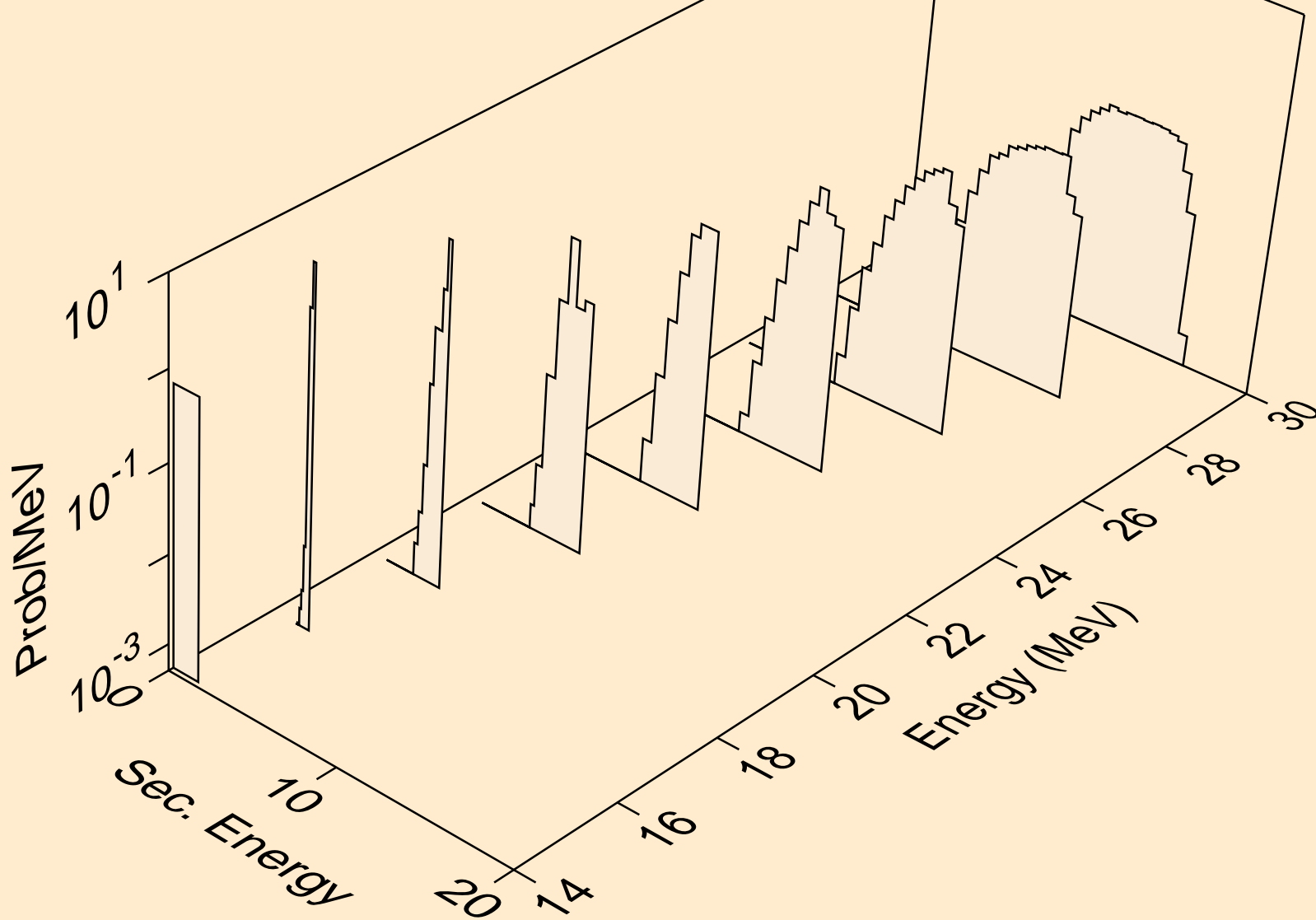

TB139 NEUTRON ACER TENDL-2019 LIBRARY; T=293.16K
tritons from (n,t)

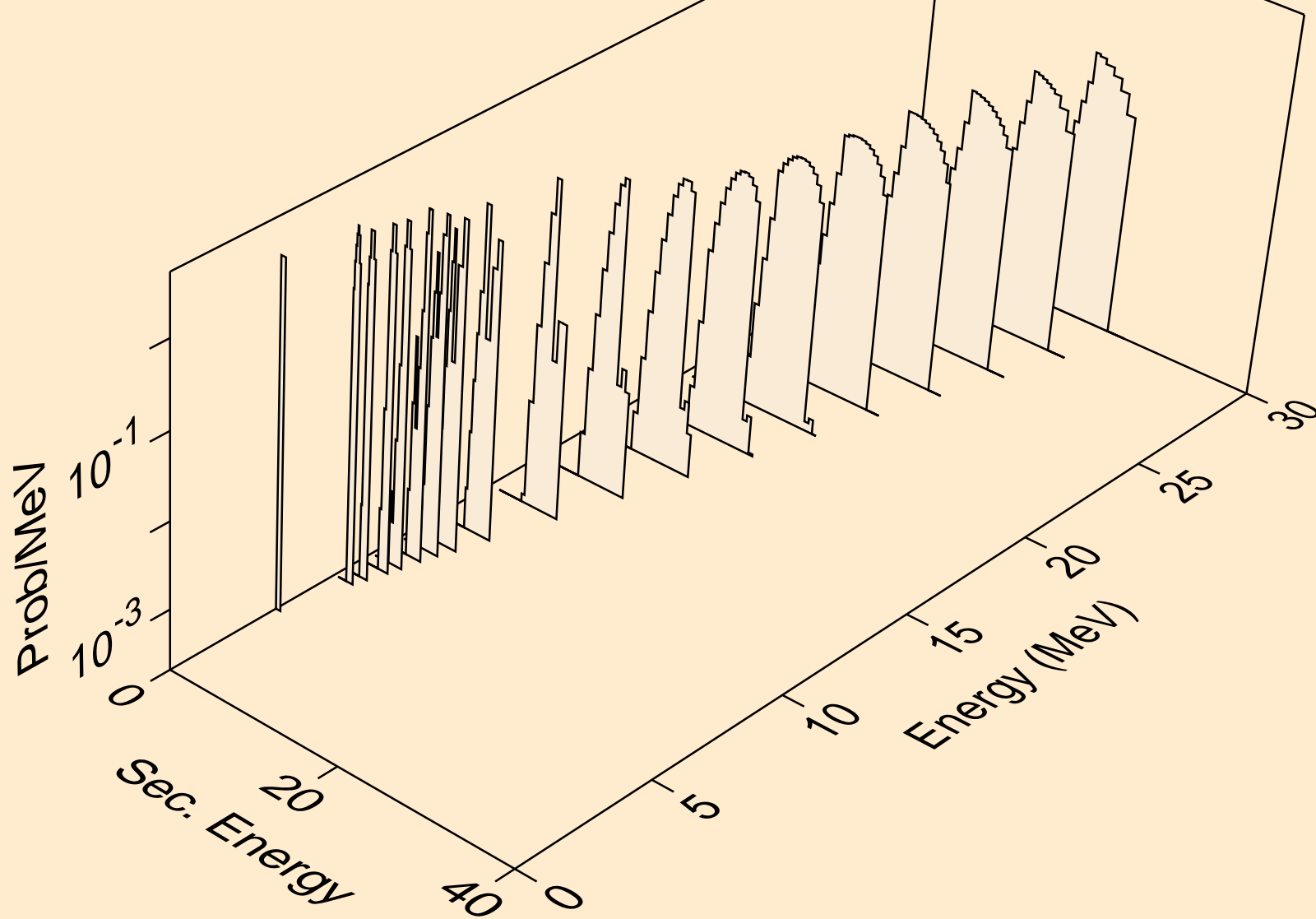

TB139 NEUTRON ACER TENDL-2019 LIBRARY; T=293.16K
tritons from (n,pt)

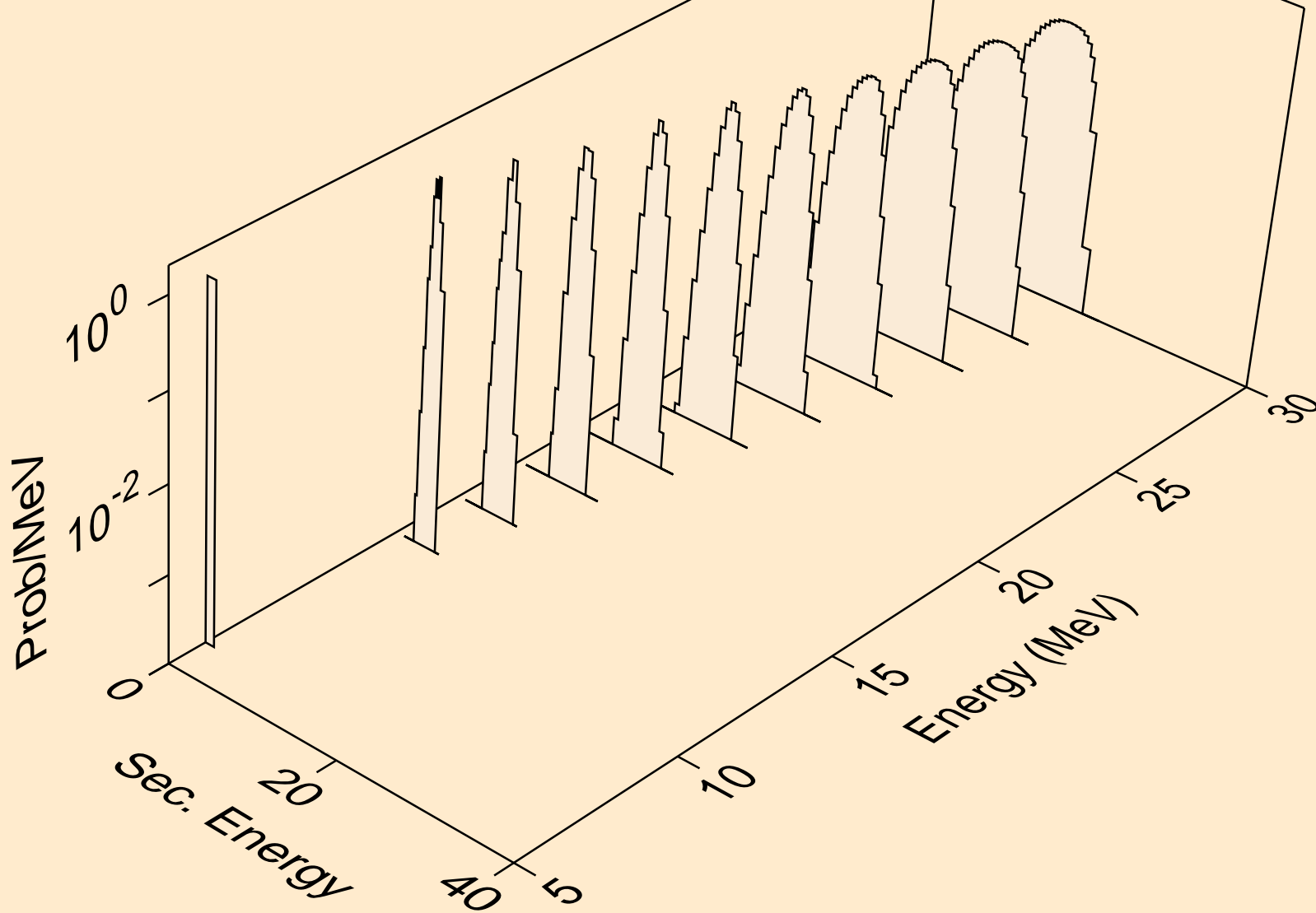

TB139 NEUTRON ACER TENDL-2019 LIBRARY; T=293.16K
he3s from (n,x)

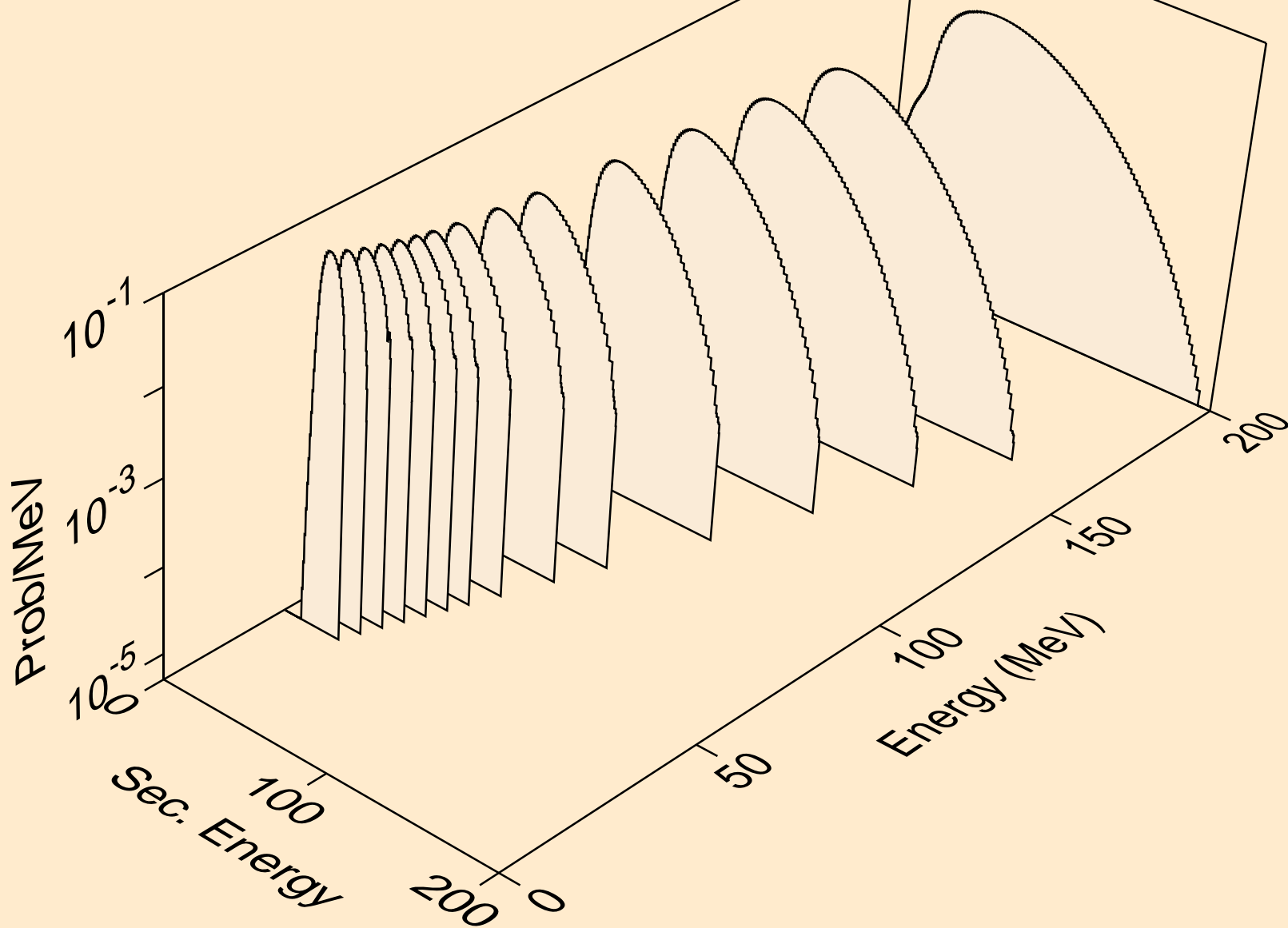

TB139 NEUTRON ACER TENDL-2019 LIBRARY; T=293.16K
he3s from (n,n*)he3

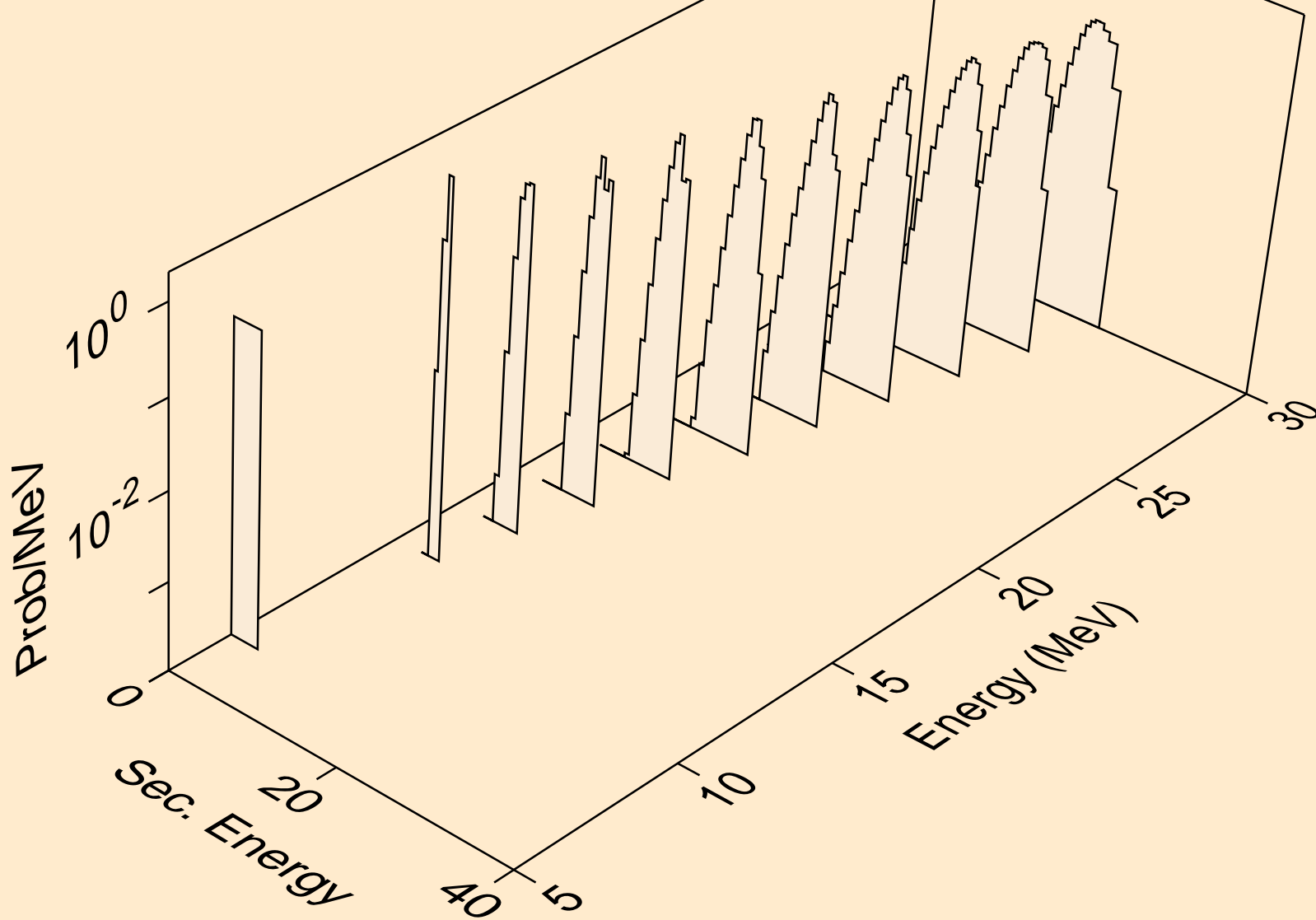

TB139 NEUTRON ACER TENDL-2019 LIBRARY; T=293.16K
he3s from (n,he3)

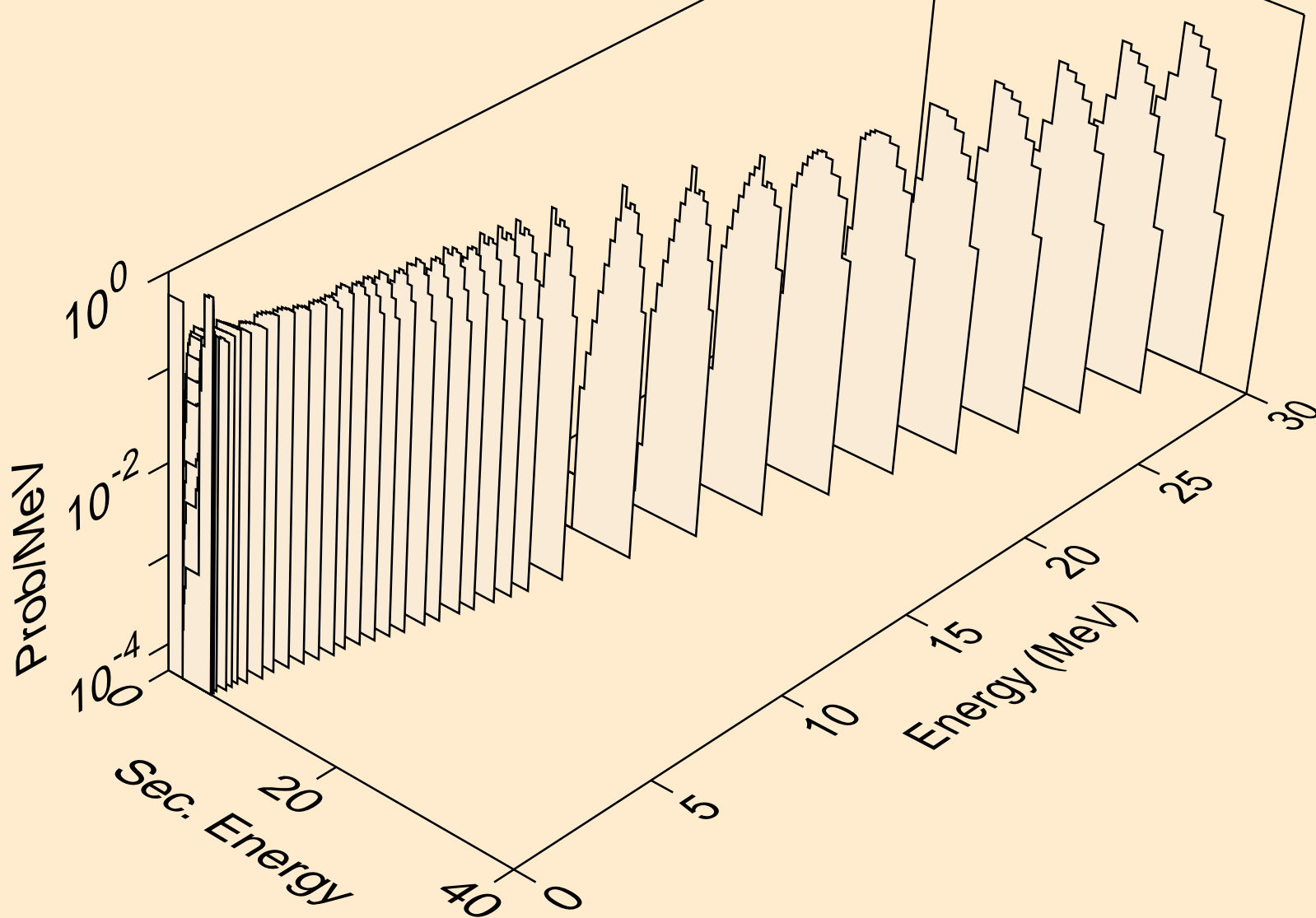

TB139 NEUTRON ACER TENDL-2019 LIBRARY; T=293.16K
alphas from (n,x)

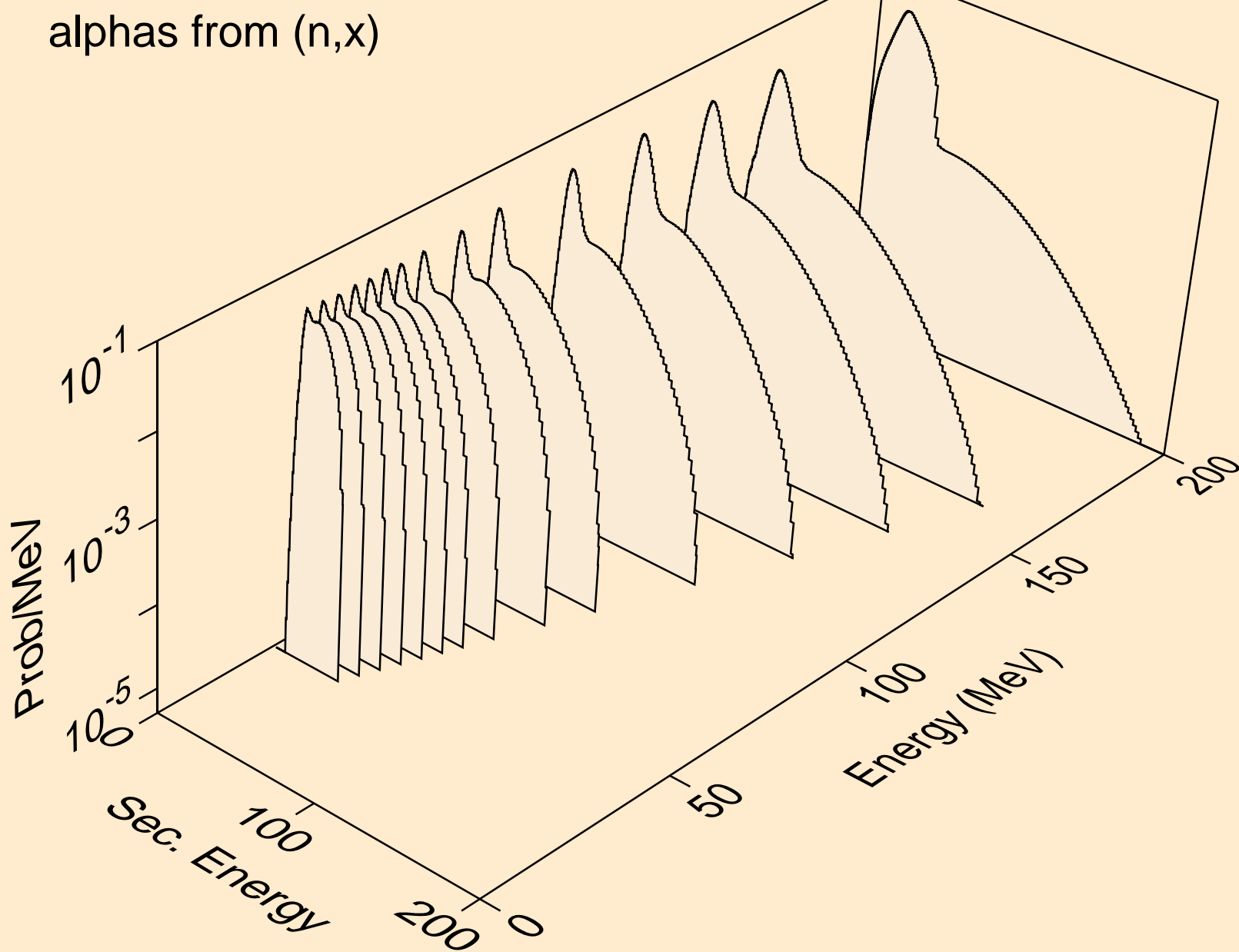

TB139 NEUTRON ACER TENDL-2019 LIBRARY; T=293.16K
alphas from (n,n*)a

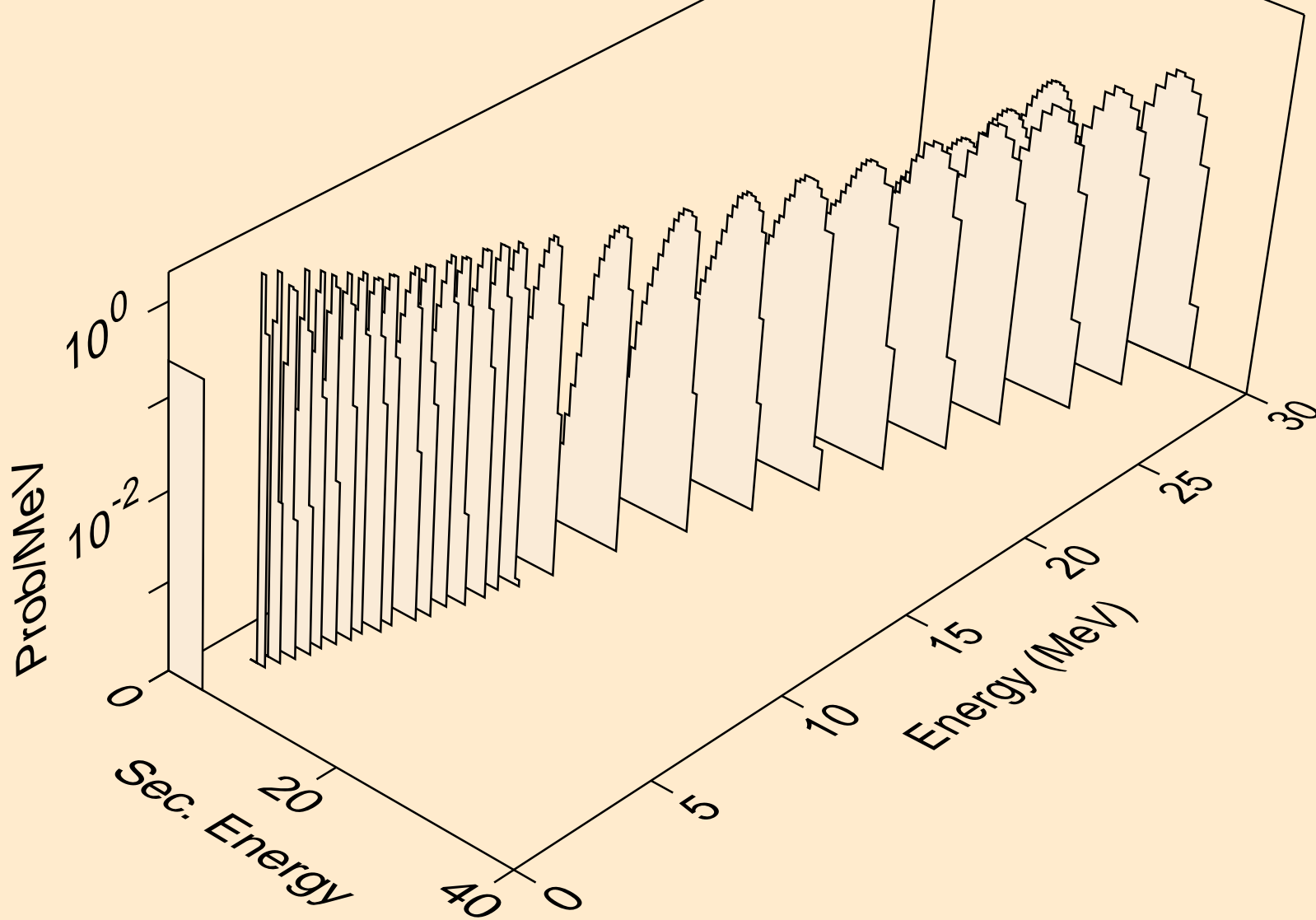

TB139 NEUTRON ACER TENDL-2019 LIBRARY; T=293.16K
alphas from (n,2n)a

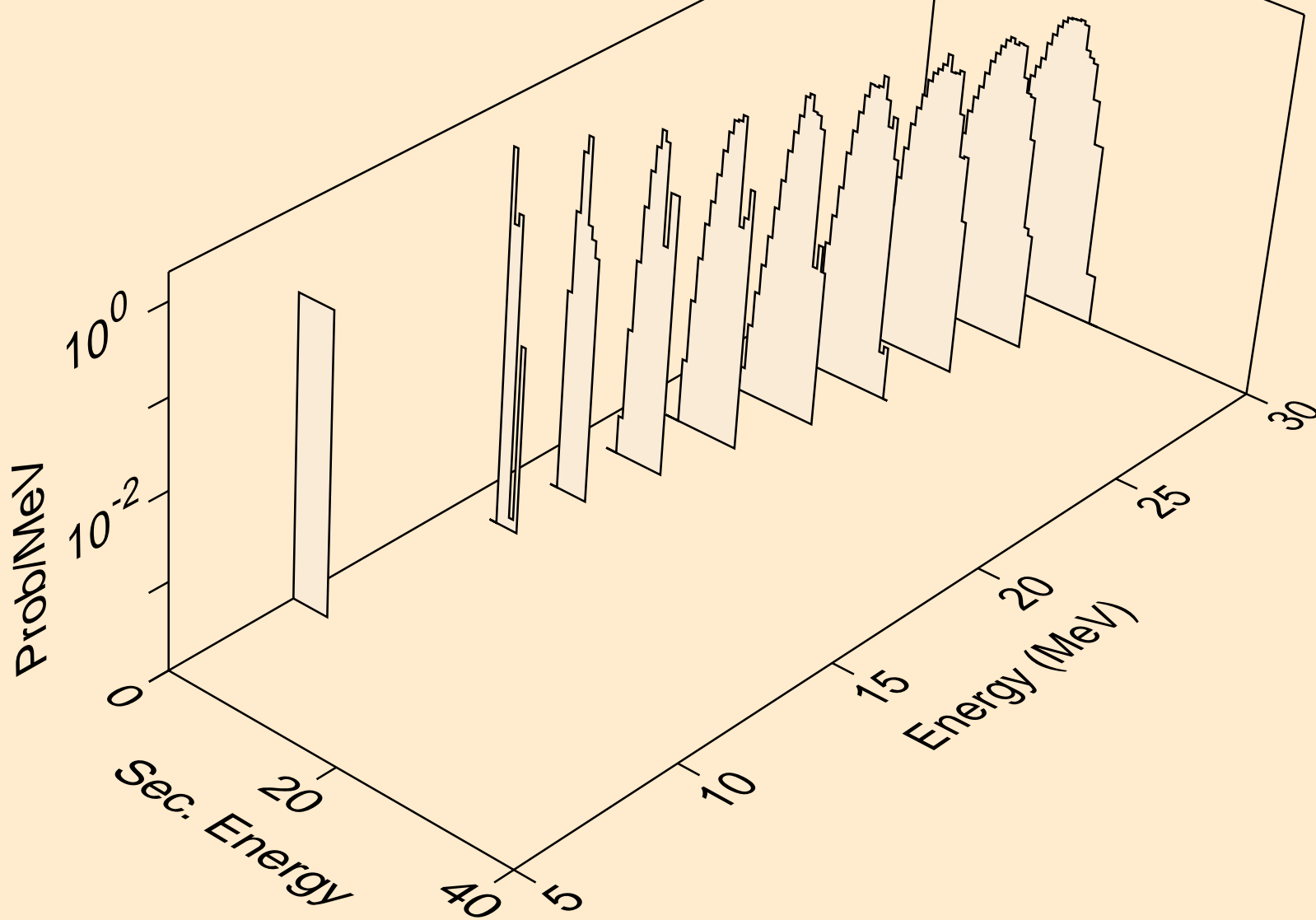

TB139 NEUTRON ACER TENDL-2019 LIBRARY; T=293.16K
alphas from (n,n*)2a

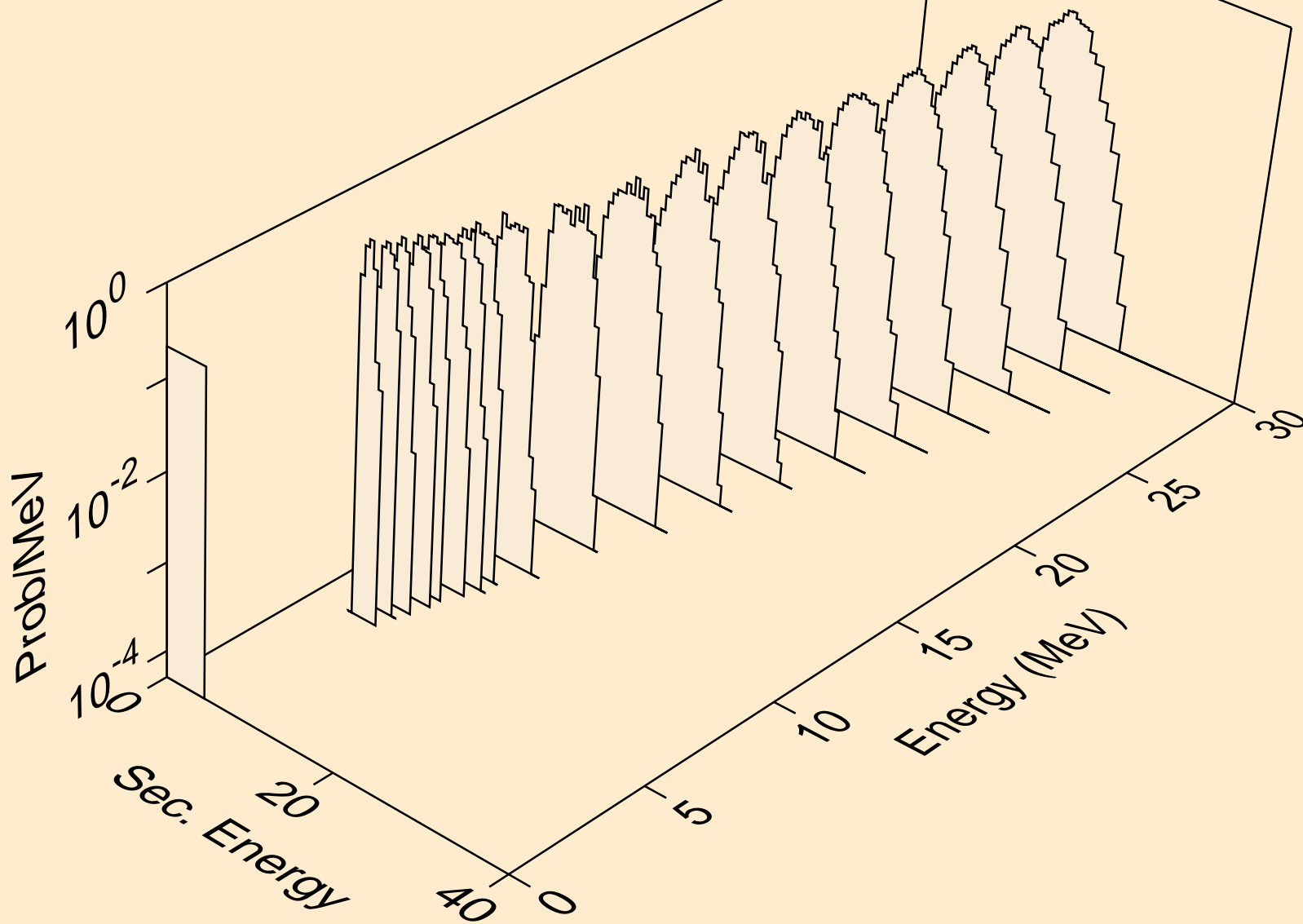

TB139 NEUTRON ACER TENDL-2019 LIBRARY; T=293.16K
alphas from (n,npa)

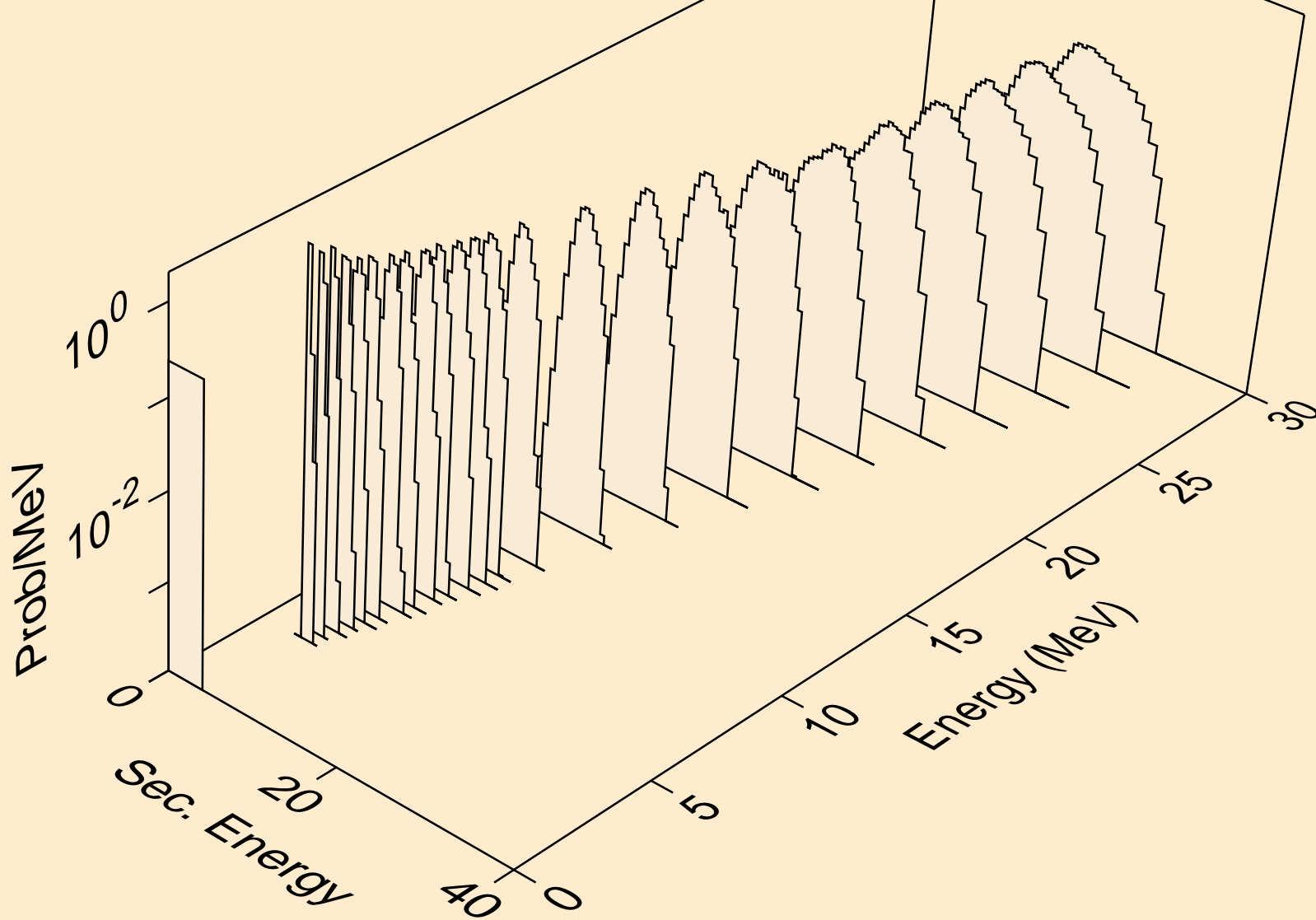

TB139 NEUTRON ACER TENDL-2019 LIBRARY; T=293.16K
alphas from (n,a)

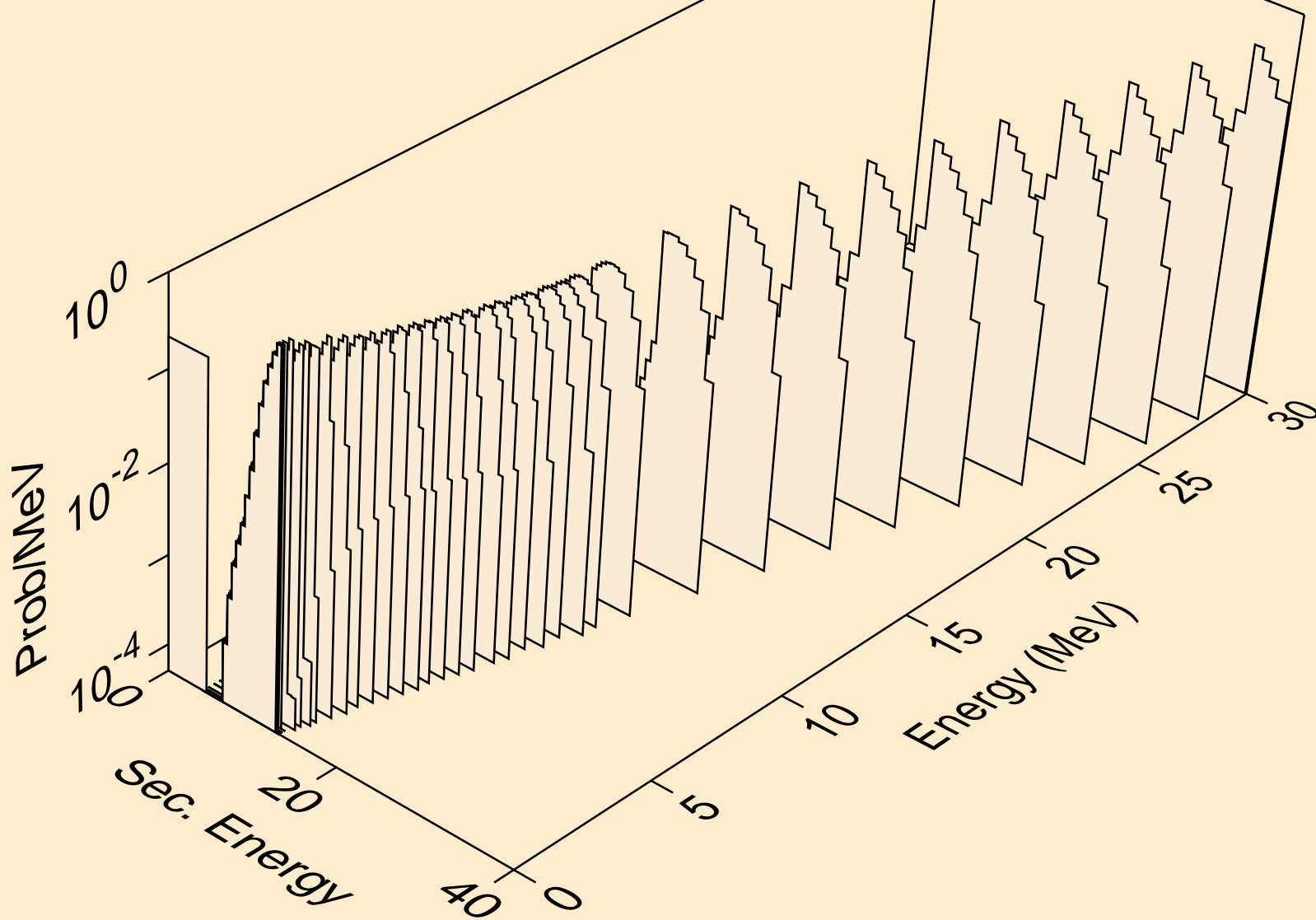

TB139 NEUTRON ACER TENDL-2019 LIBRARY; T=293.16K
alphas from (n,2a)

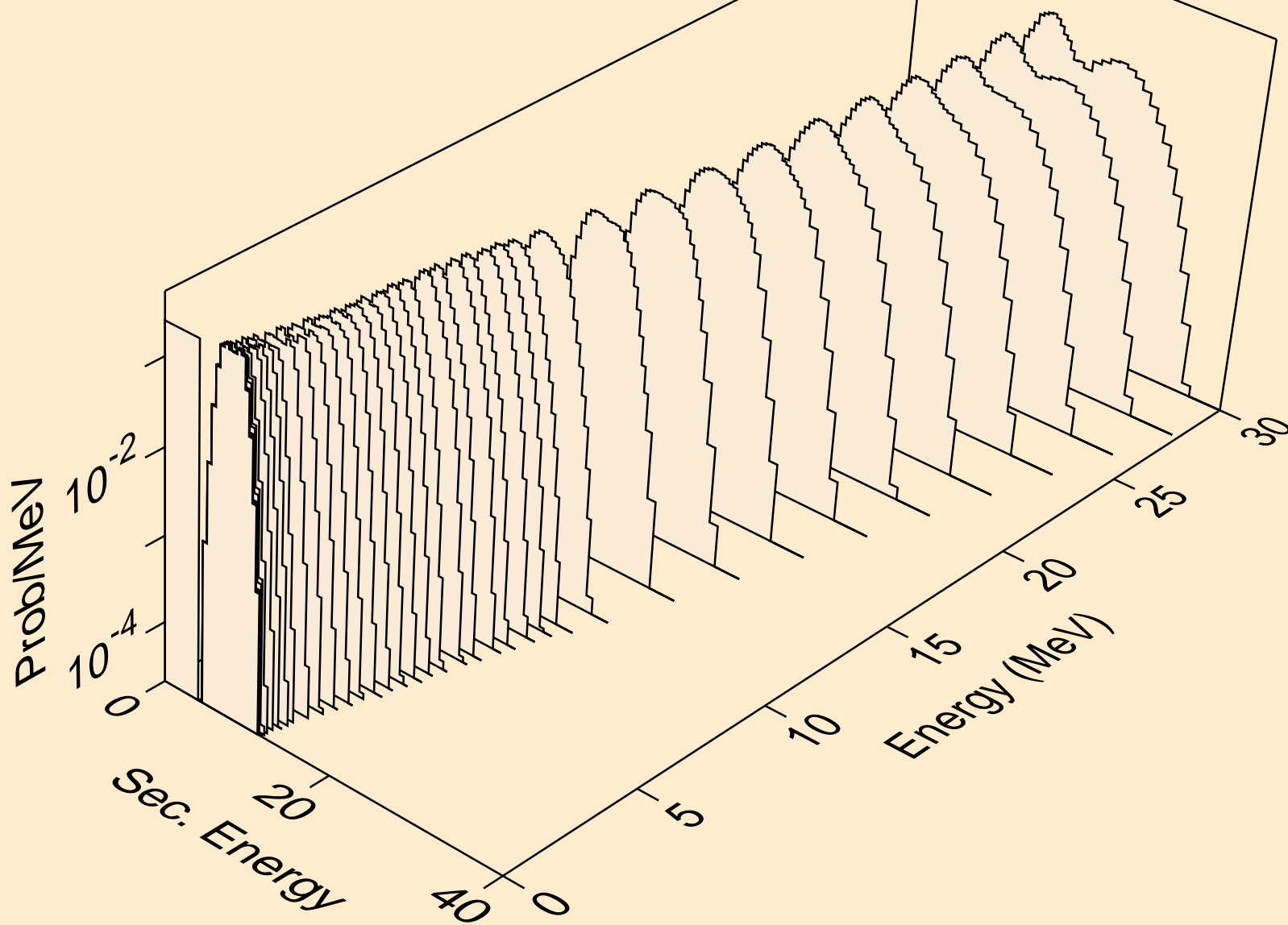

TB139 NEUTRON ACER TENDL-2019 LIBRARY; T=293.16K
alphas from (n,3a)

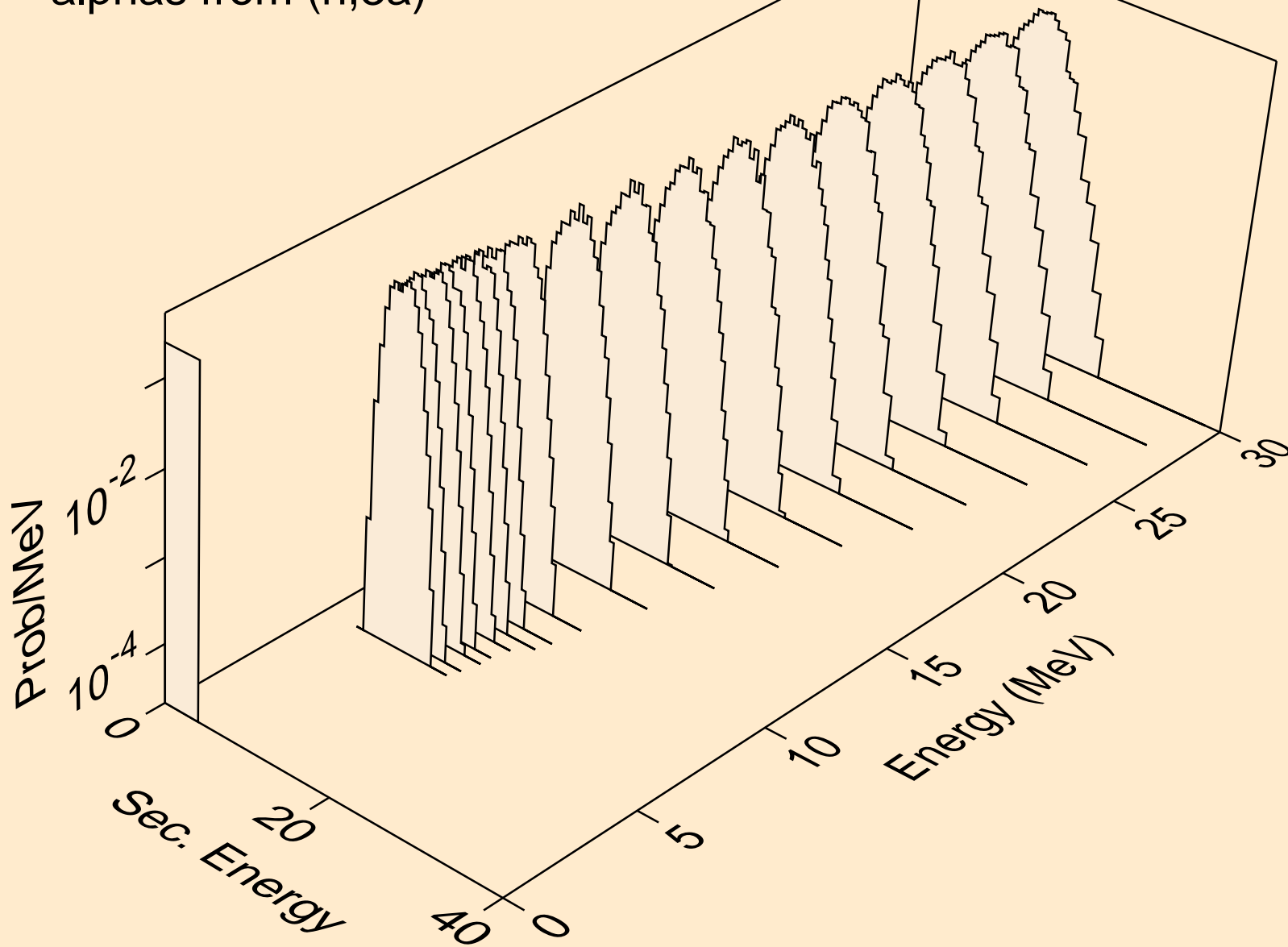

TB139 NEUTRON ACER TENDL-2019 LIBRARY; T=293.16K
alphas from (n,pa)

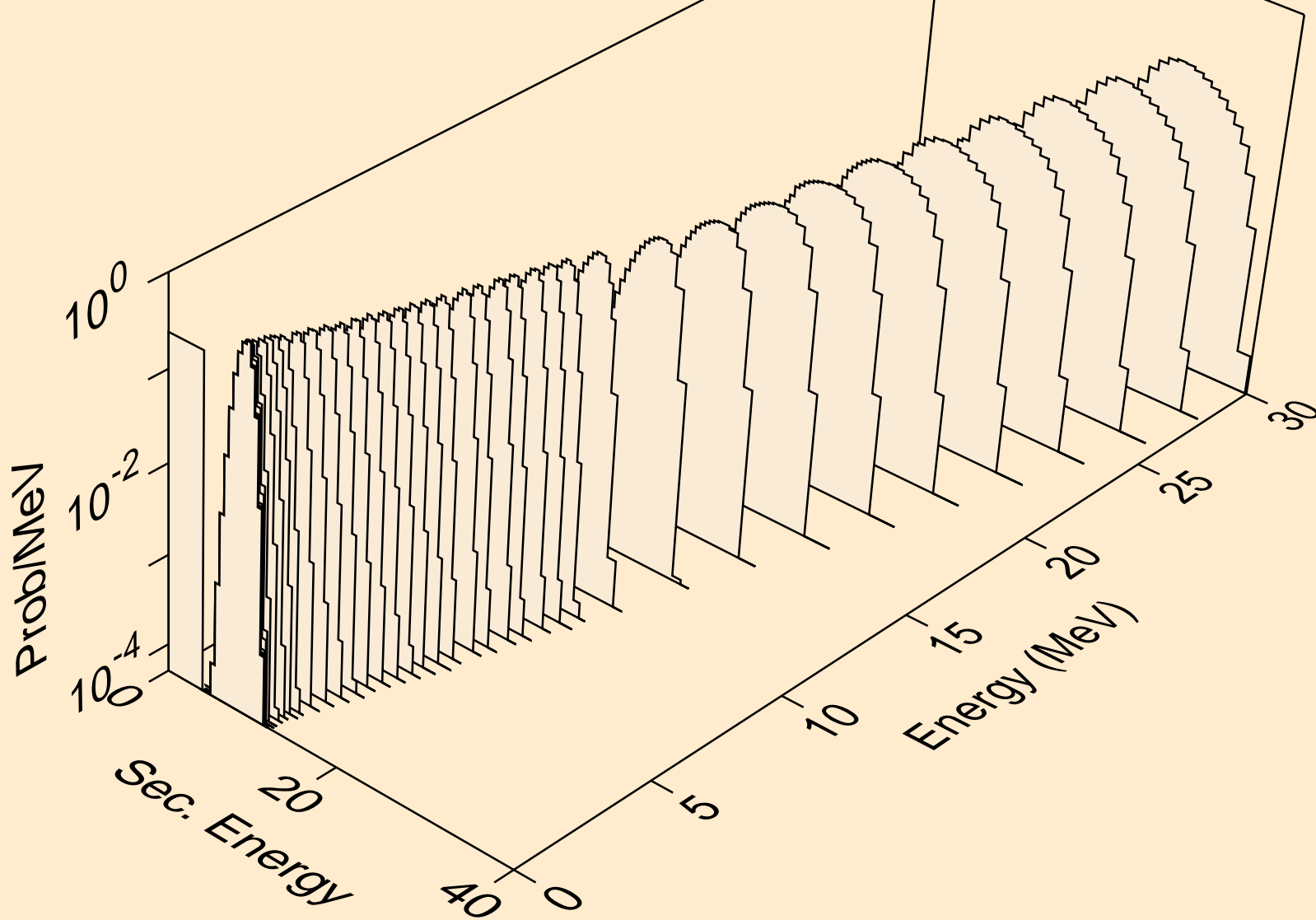

TB139 NEUTRON ACER TENDL-2019 LIBRARY; T=293.16K
alphas from (n,d2a)

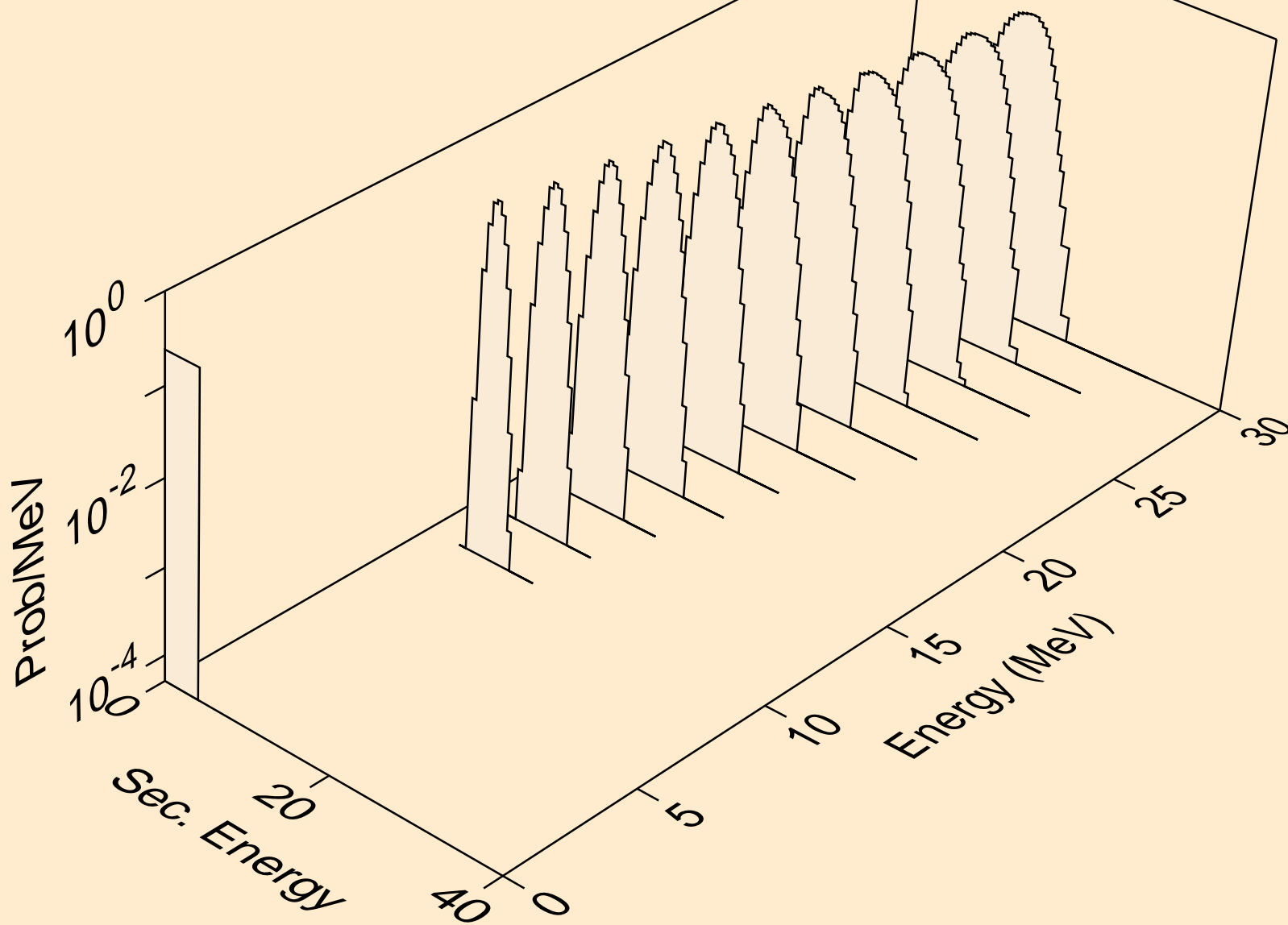

TB139 NEUTRON ACER TENDL-2019 LIBRARY; T=293.16K
alphas from (n,da)

