

TB146M NEUTRON ACER TENDL-2019 LIBRARY; T=293.16K
Principal cross sections

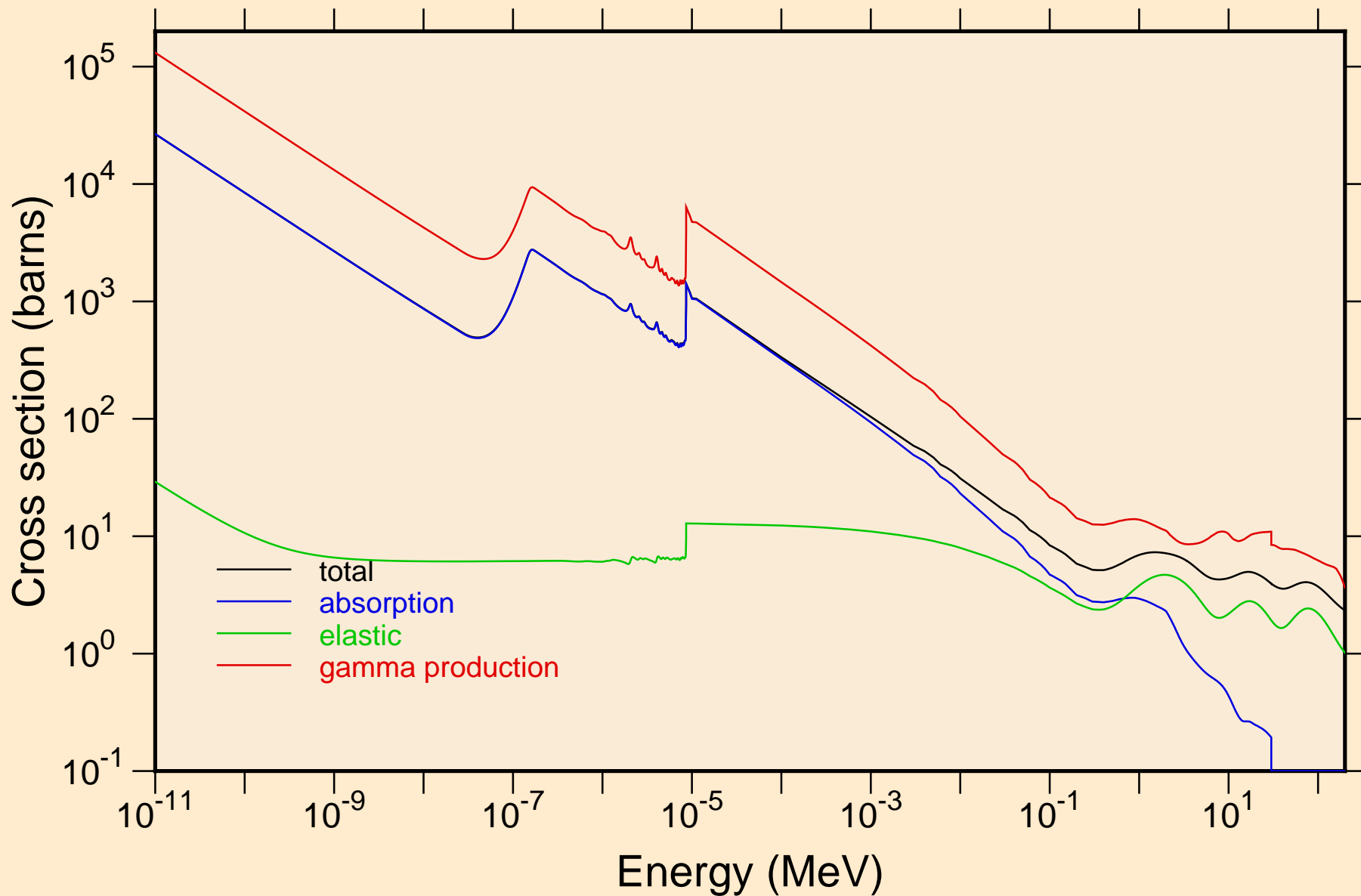

TB146M NEUTRON ACER TENDL-2019 LIBRARY; T=293.16K
resonance total cross section

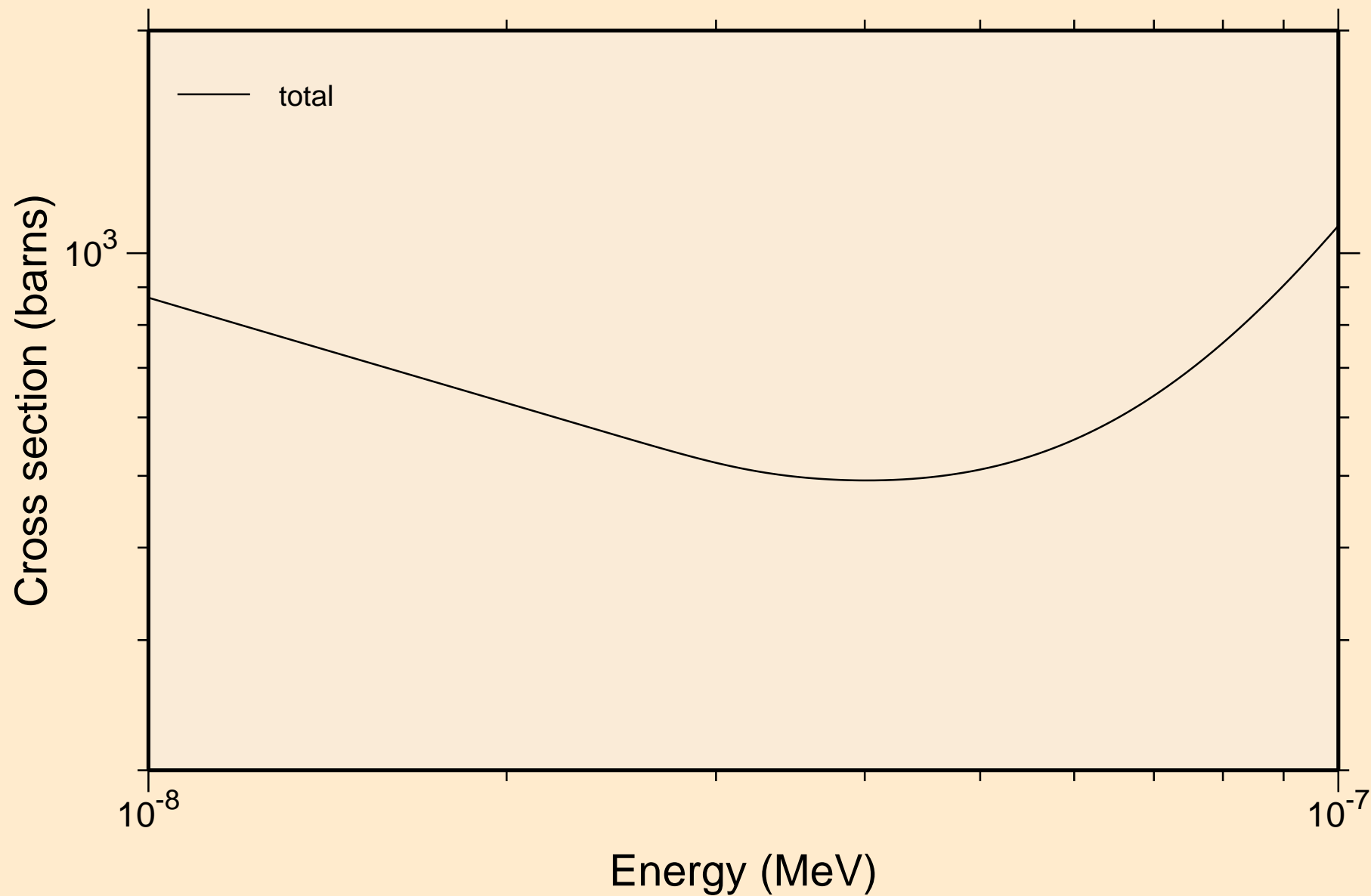

TB146M NEUTRON ACER TENDL-2019 LIBRARY; T=293.16K
resonance total cross section

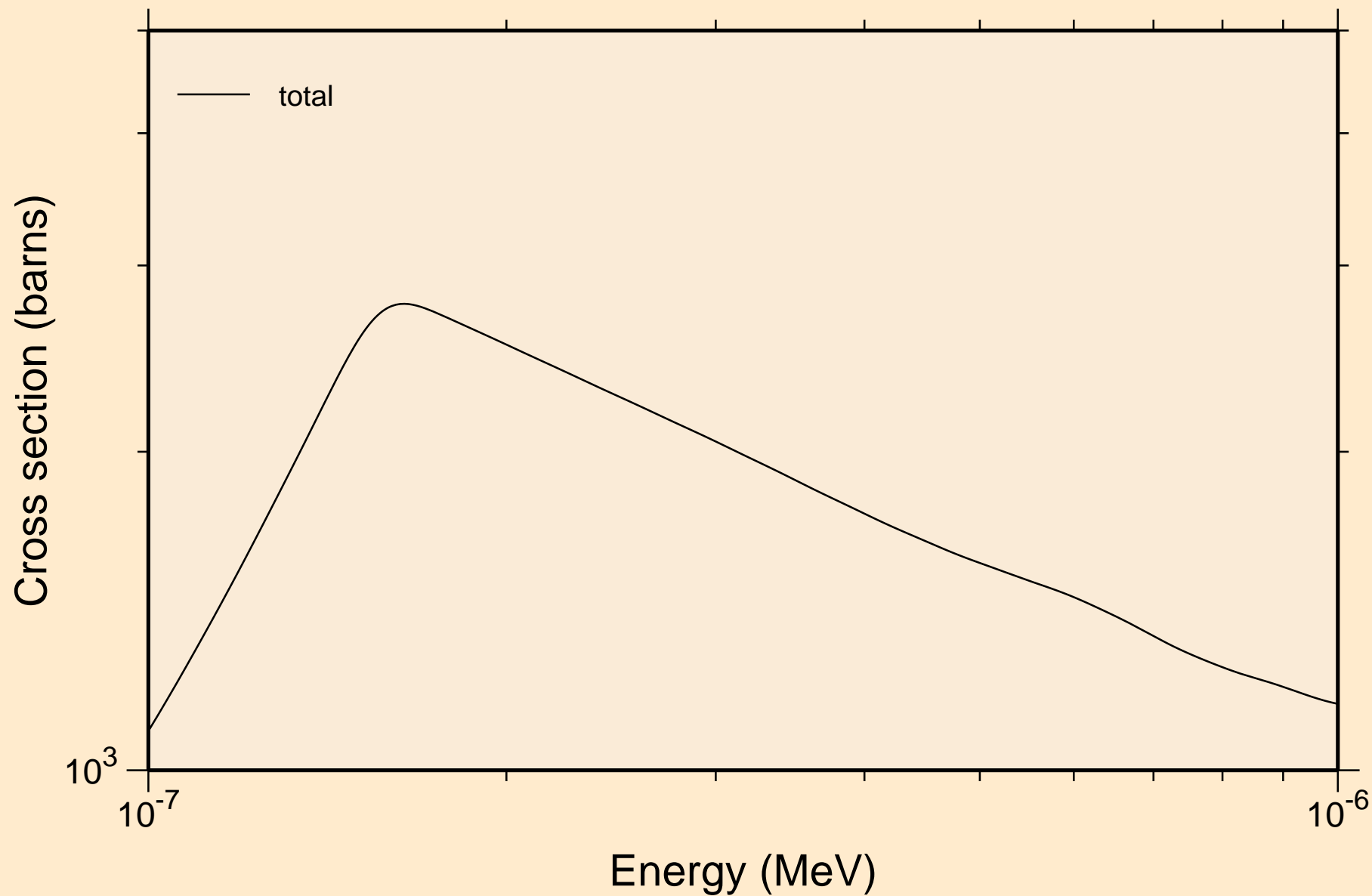

TB146M NEUTRON ACER TENDL-2019 LIBRARY; T=293.16K
resonance total cross section

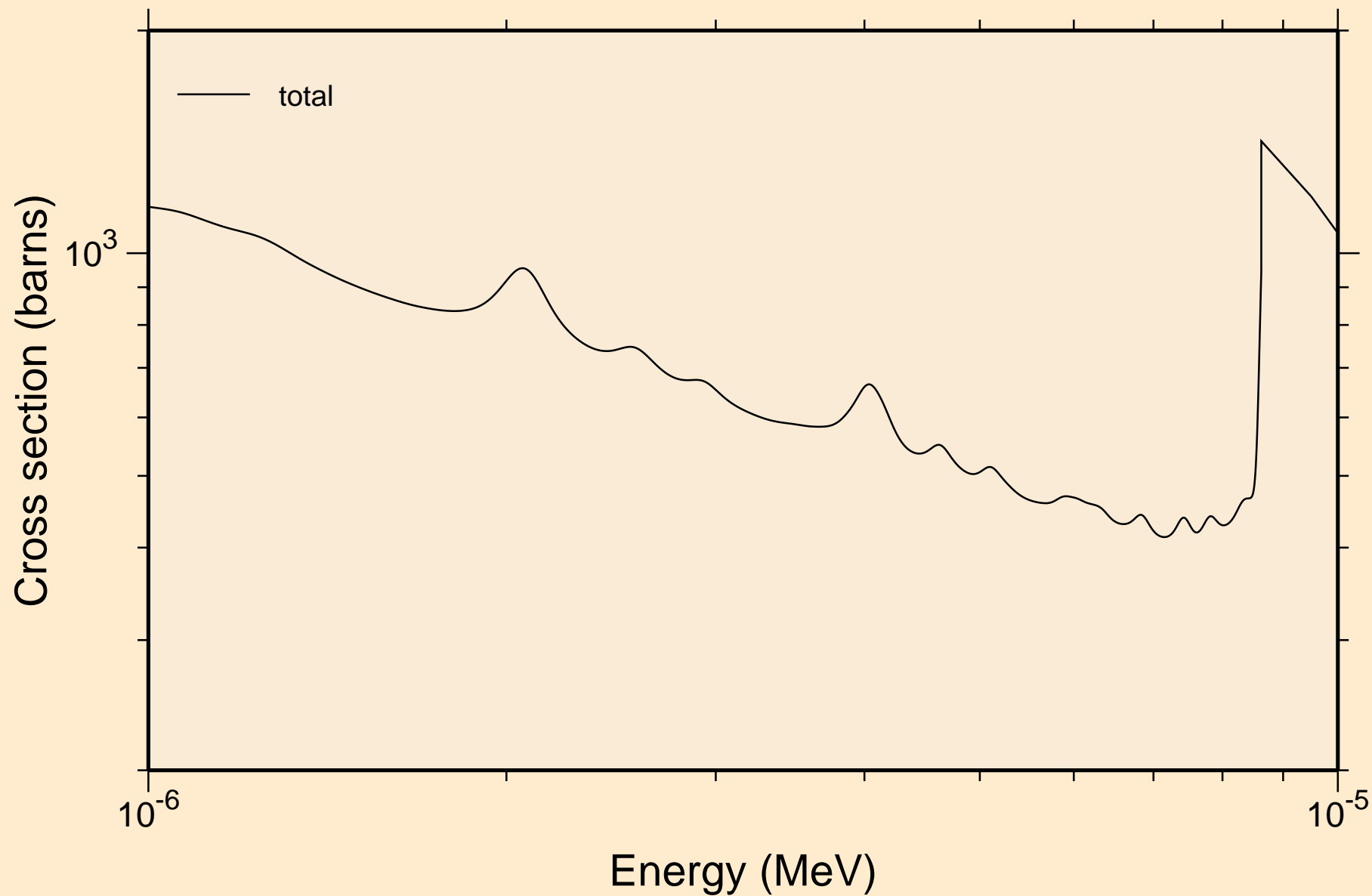

TB146M NEUTRON ACER TENDL-2019 LIBRARY; T=293.16K
resonance total cross section

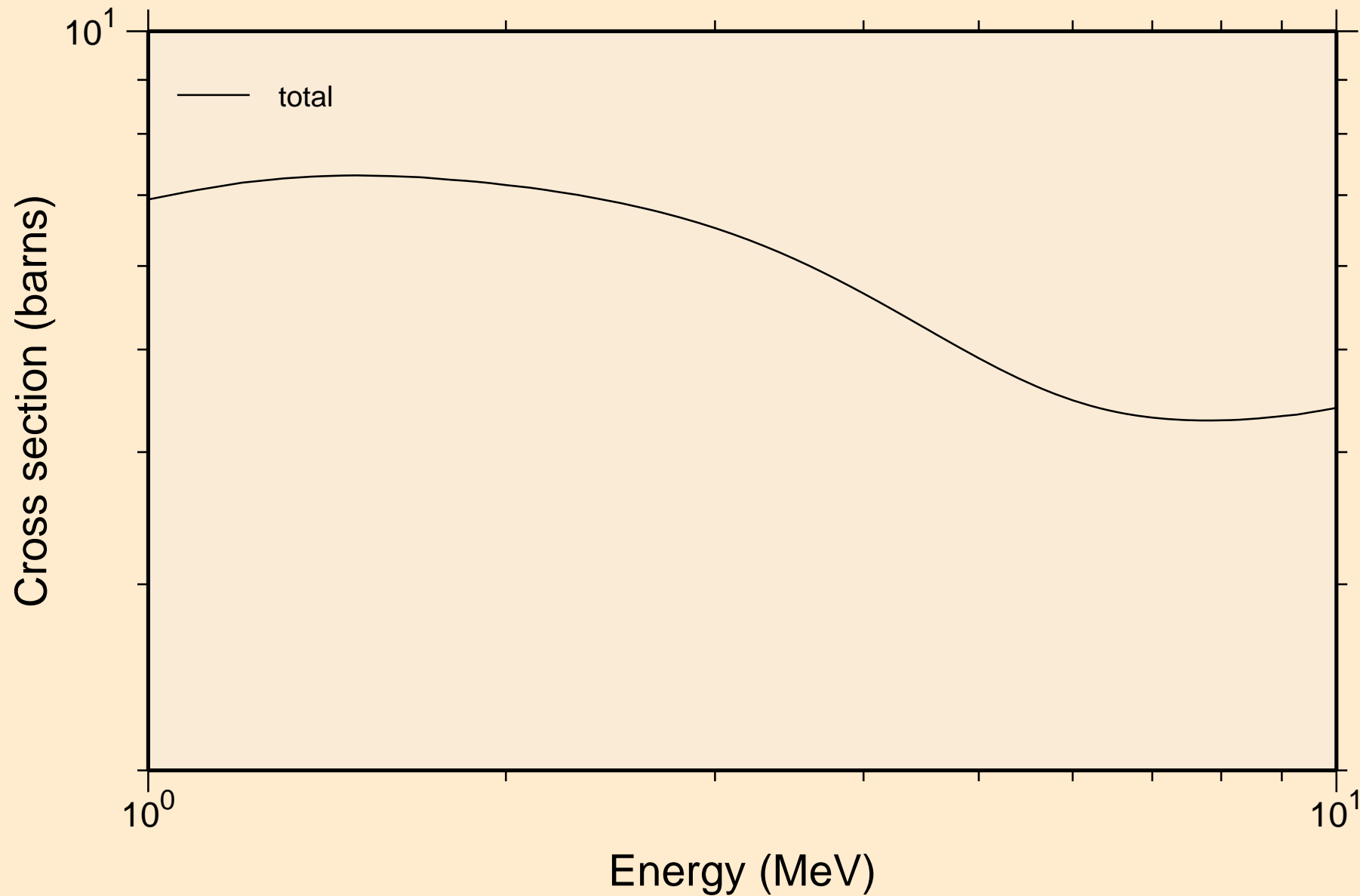

TB146M NEUTRON ACER TENDL-2019 LIBRARY; T=293.16K
resonance absorption cross sections

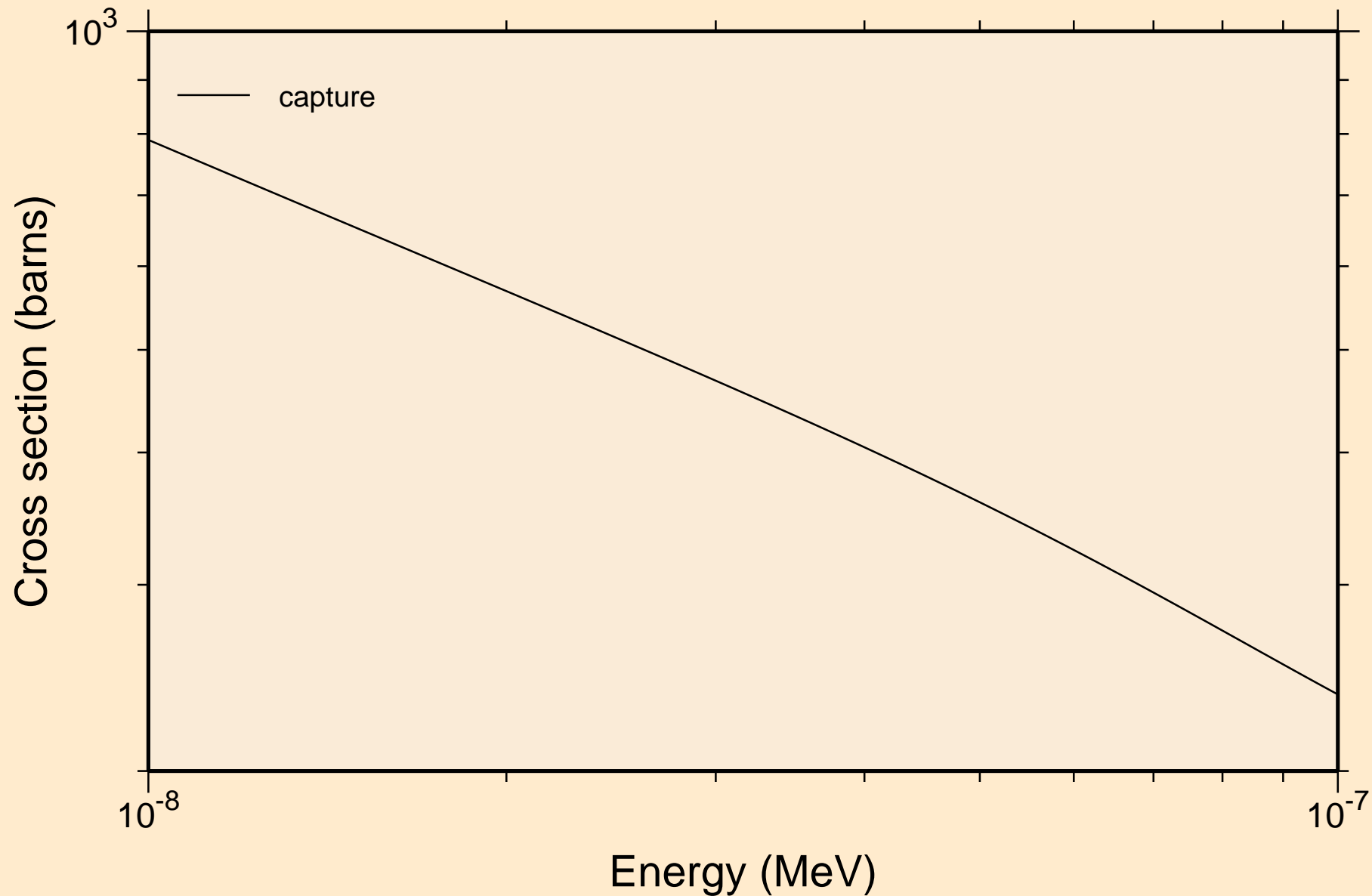

TB146M NEUTRON ACER TENDL-2019 LIBRARY; T=293.16K
resonance absorption cross sections

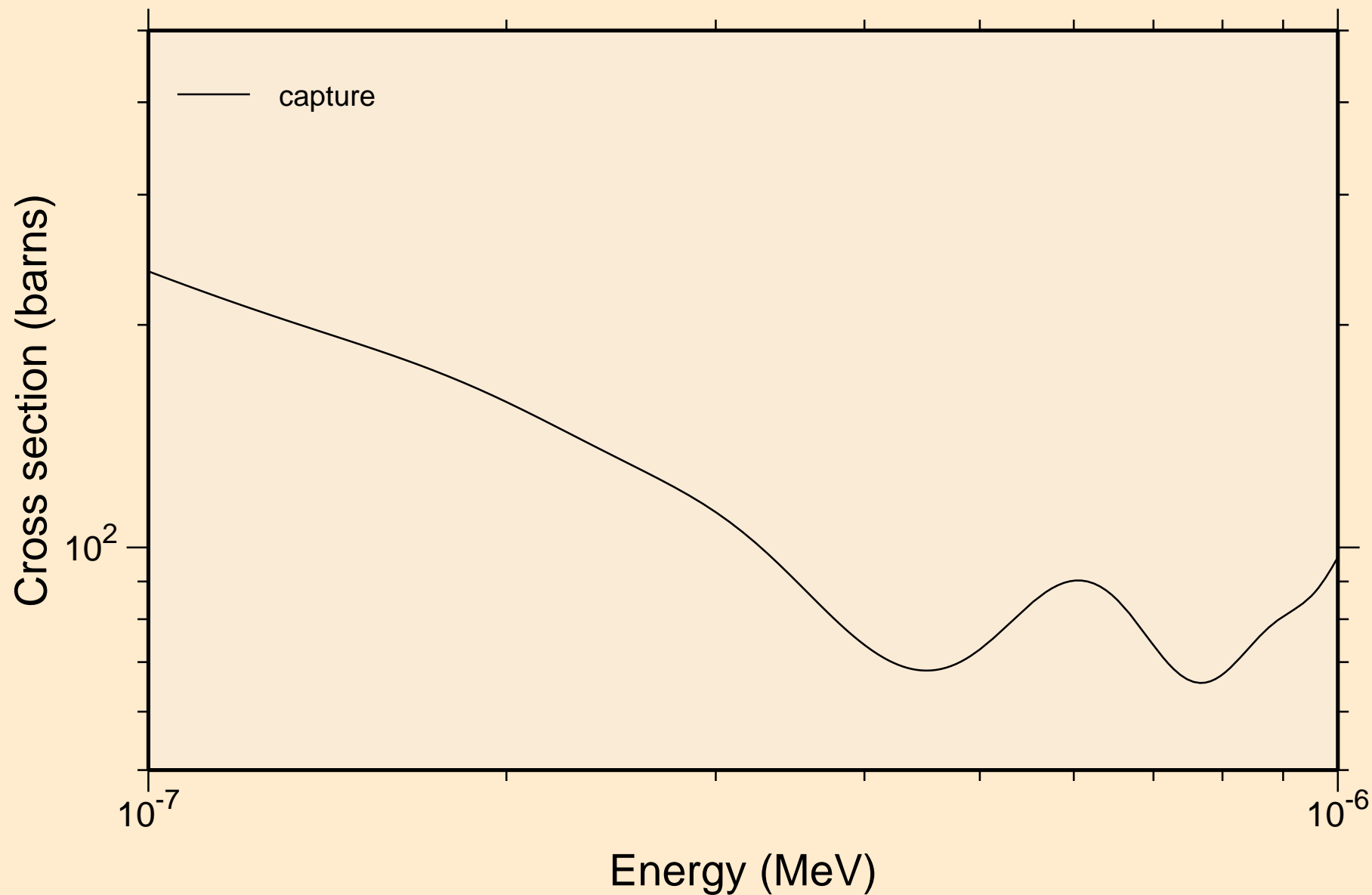

TB146M NEUTRON ACER TENDL-2019 LIBRARY; T=293.16K
resonance absorption cross sections

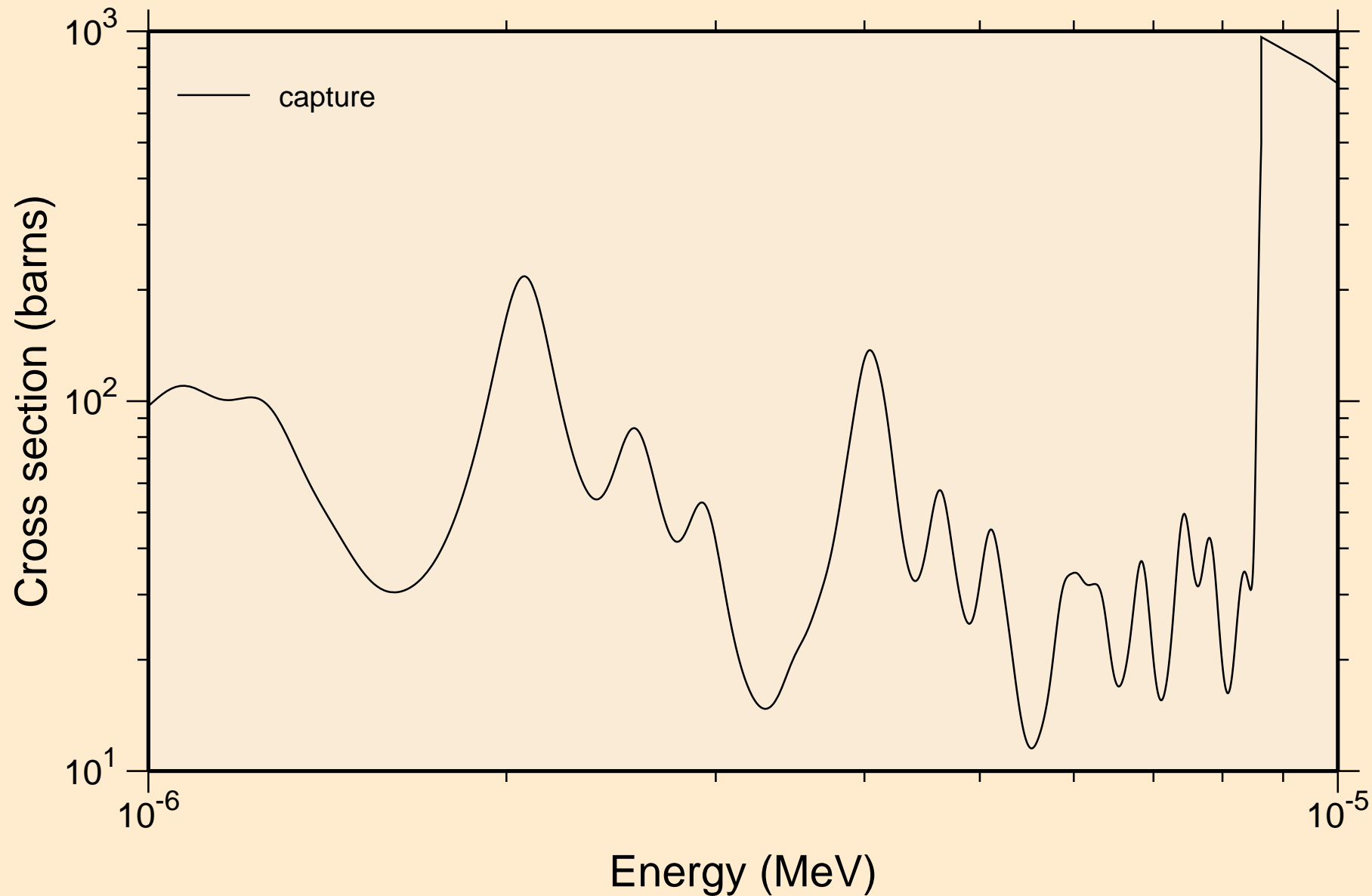

TB146M NEUTRON ACER TENDL-2019 LIBRARY; T=293.16K
resonance absorption cross sections

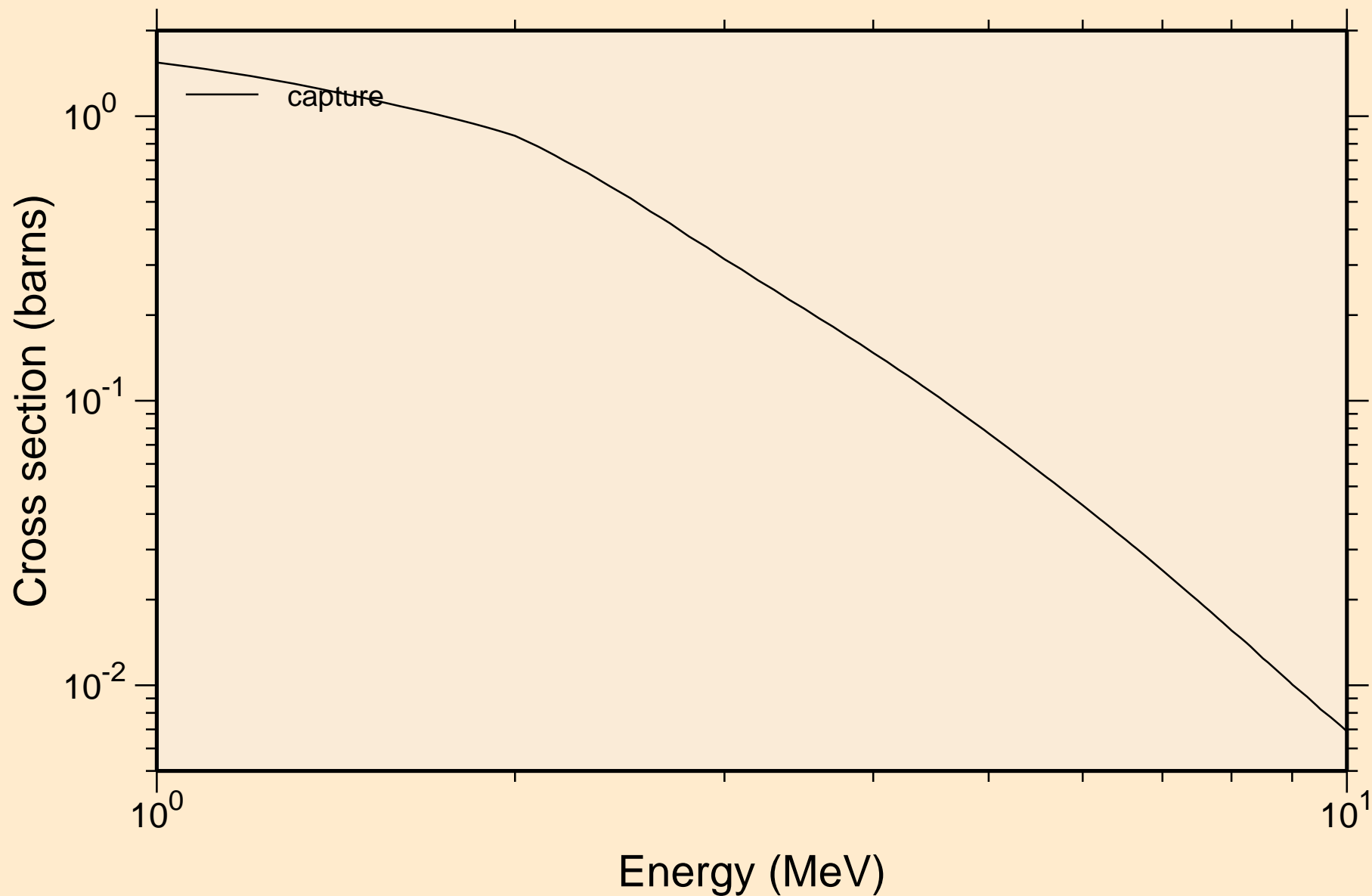

TB146M NEUTRON ACER TENDL-2019 LIBRARY; T=293.16K
Heating

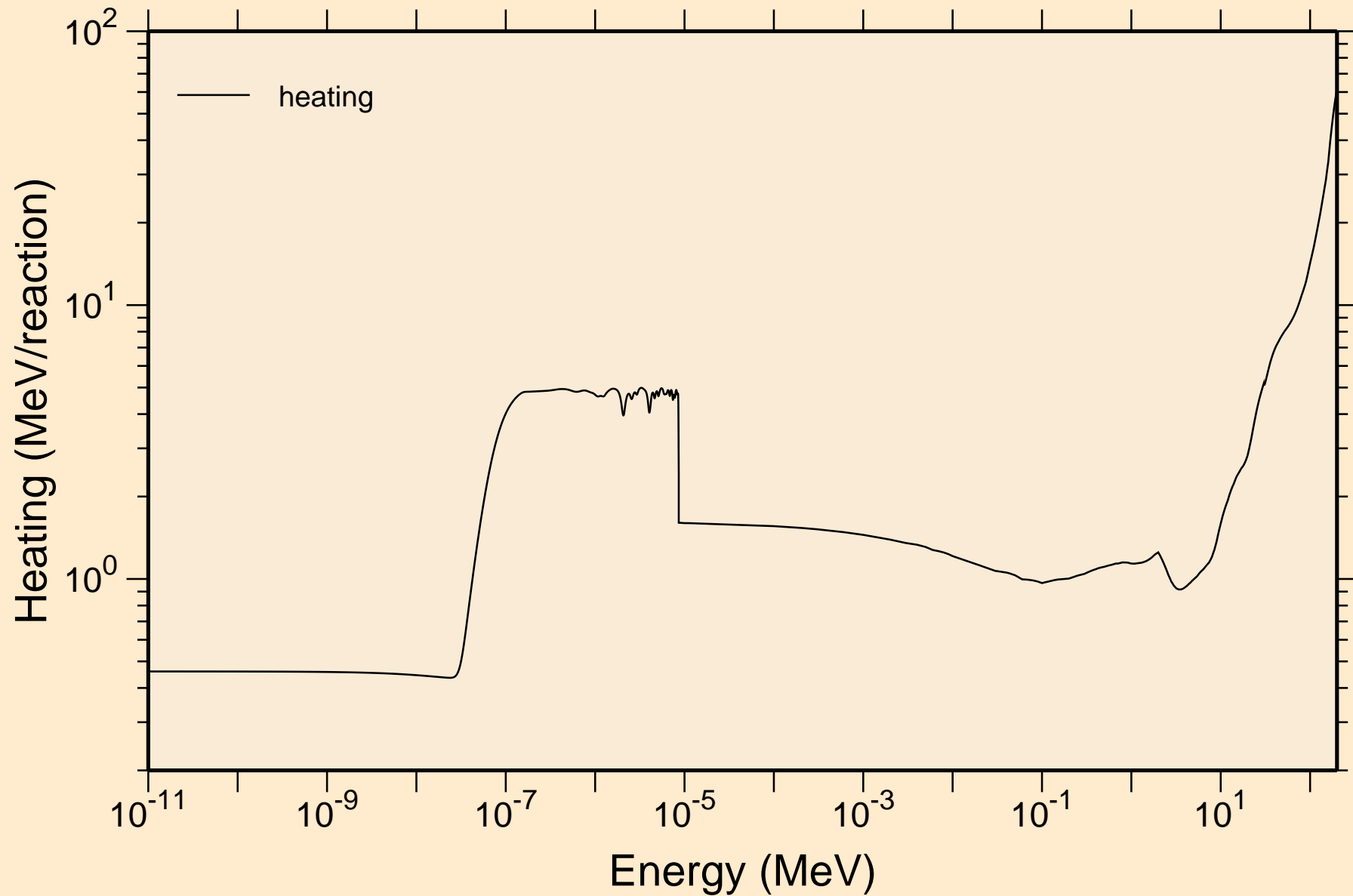

TB146M NEUTRON ACER TENDL-2019 LIBRARY; T=293.16K
Damage

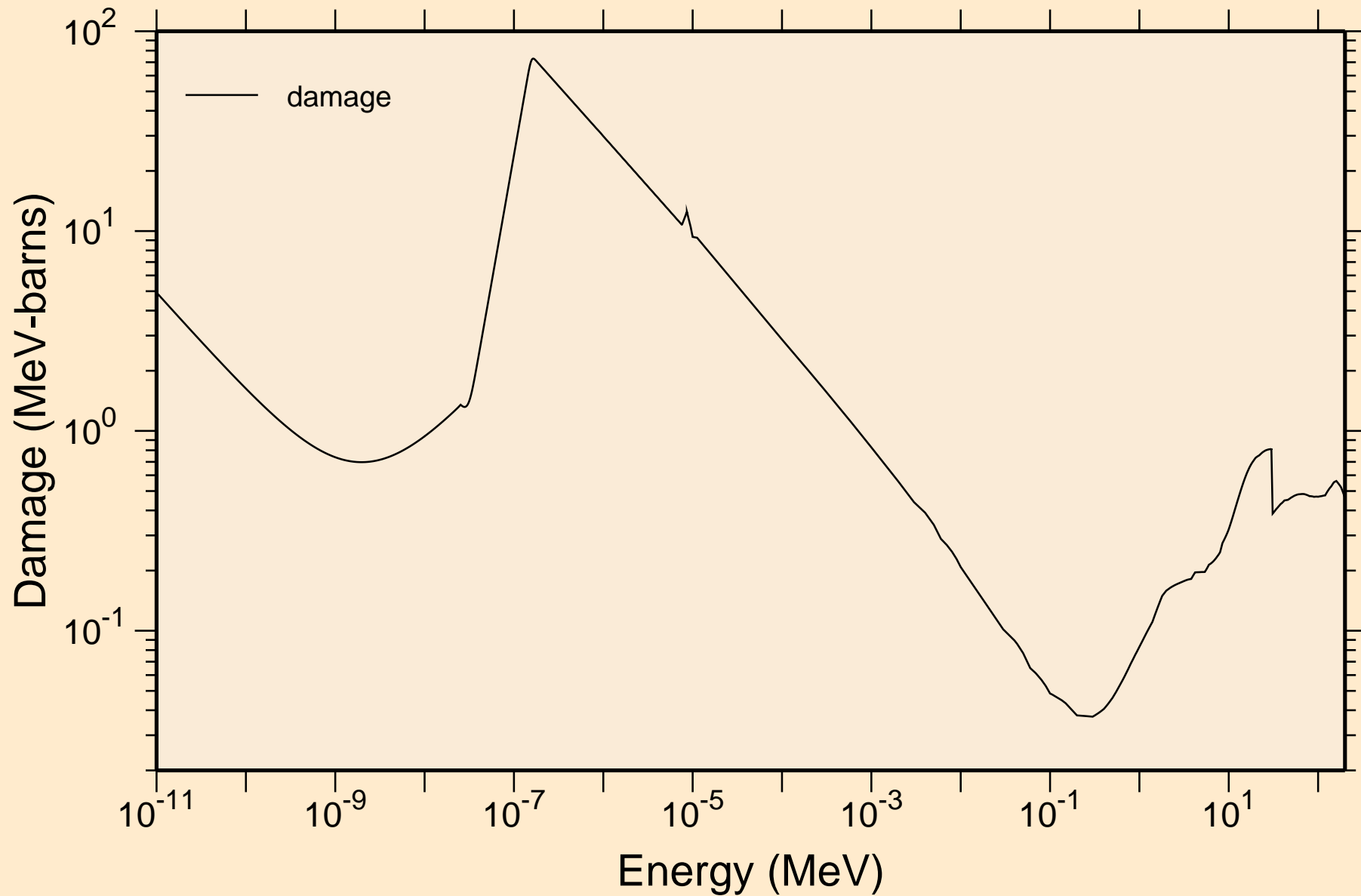

TB146M NEUTRON ACER TENDL-2019 LIBRARY; T=293.16K
Non-threshold reactions

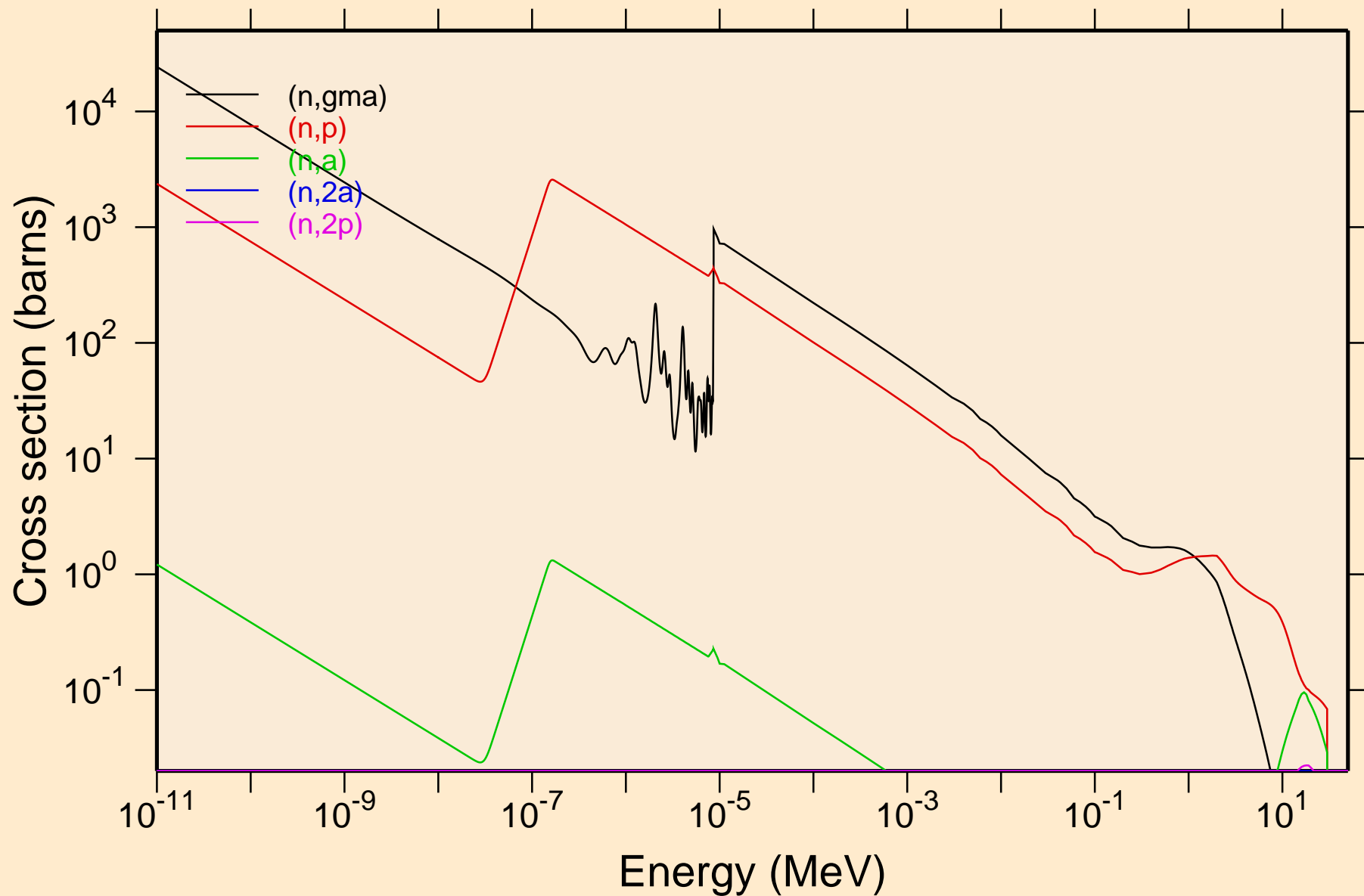

TB146M NEUTRON ACER TENDL-2019 LIBRARY; T=293.16K
Non-threshold reactions

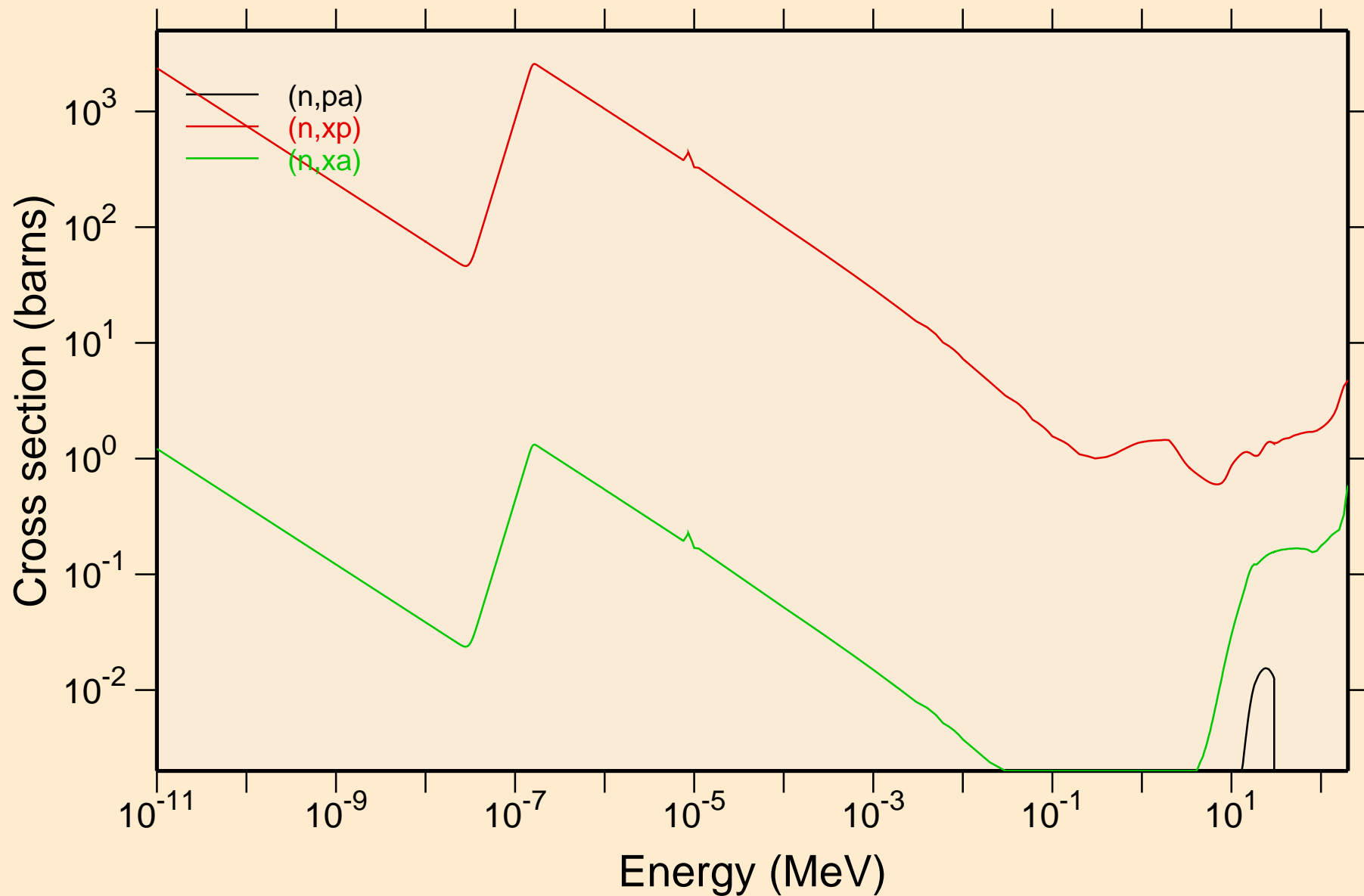

TB146M NEUTRON ACER TENDL-2019 LIBRARY; T=293.16K
Principal cross sections

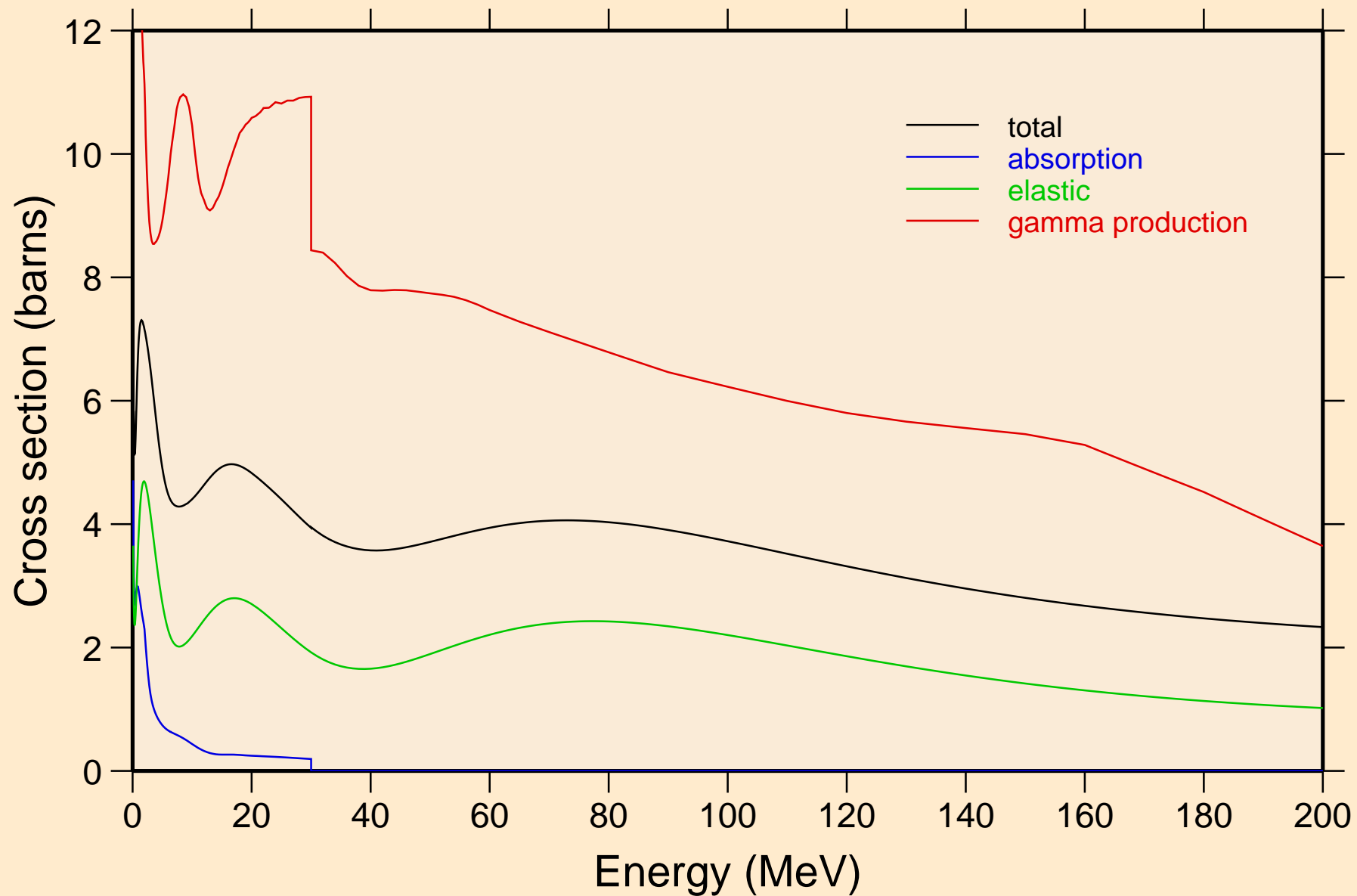

TB146M NEUTRON ACER TENDL-2019 LIBRARY; T=293.16K
Heating

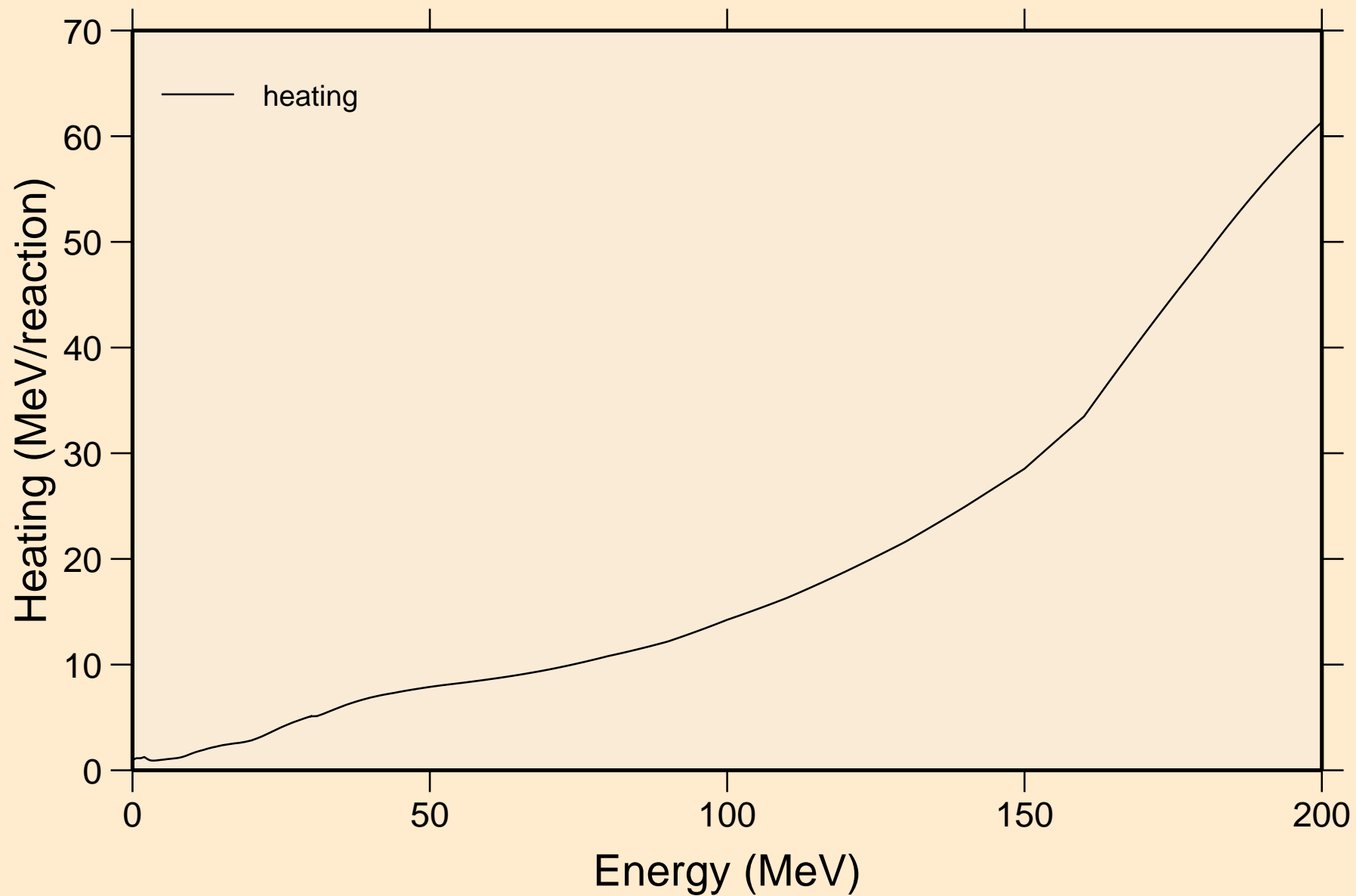

TB146M NEUTRON ACER TENDL-2019 LIBRARY; T=293.16K
Damage

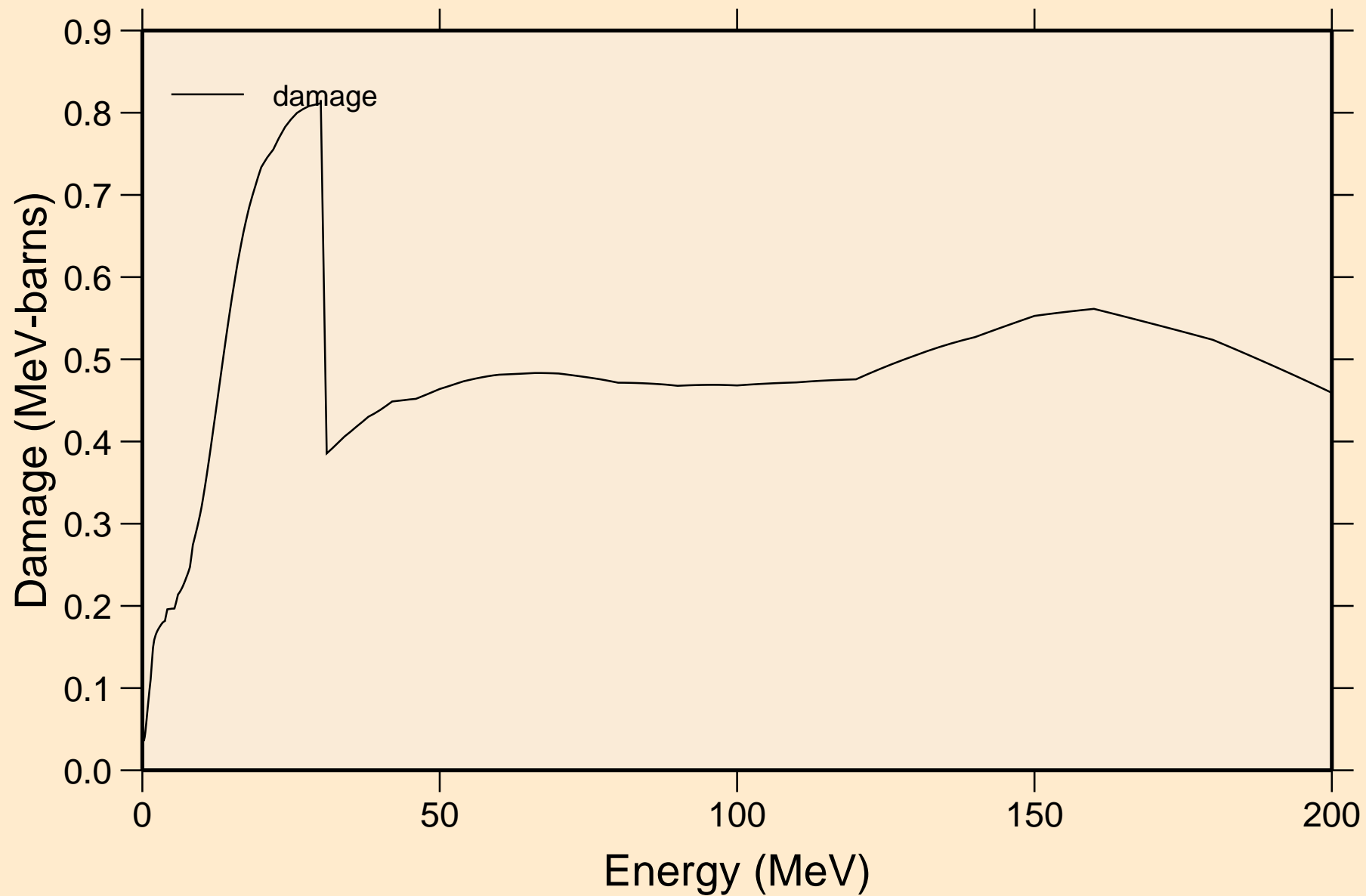

TB146M NEUTRON ACER TENDL-2019 LIBRARY; T=293.16K
Non-threshold reactions

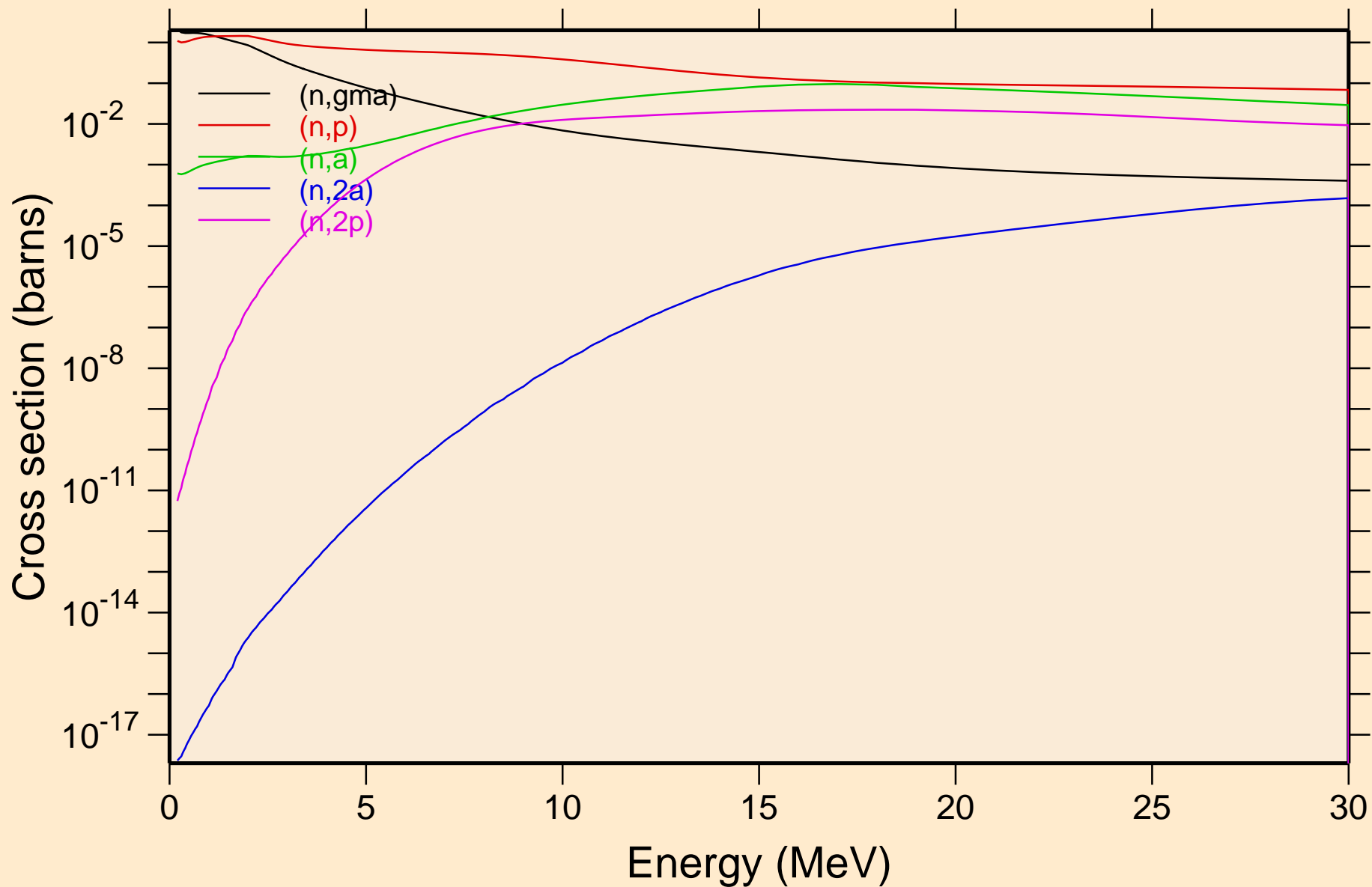

TB146M NEUTRON ACER TENDL-2019 LIBRARY; T=293.16K
Non-threshold reactions

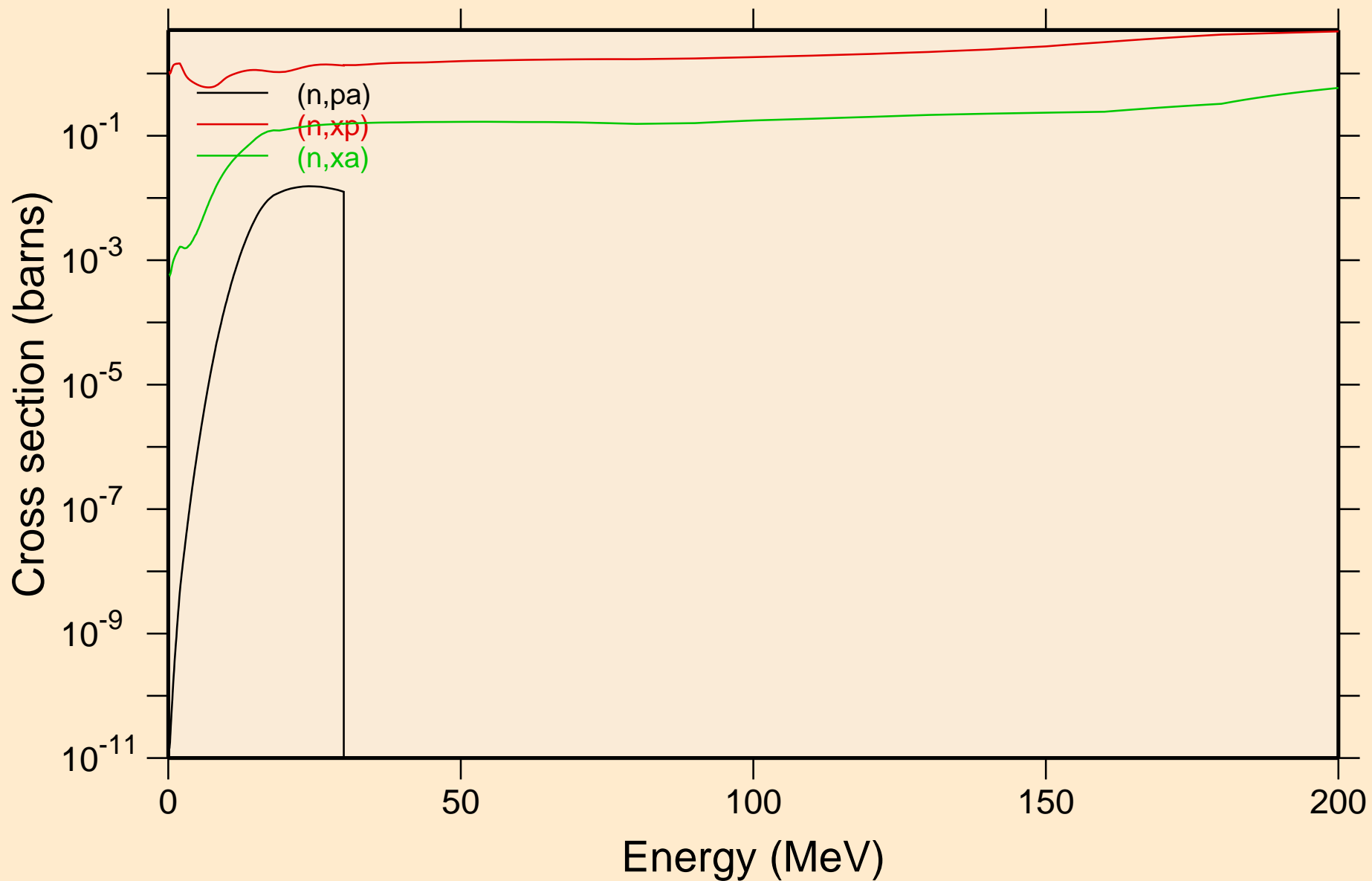

TB146M NEUTRON ACER TENDL-2019 LIBRARY; T=293.16K
Inelastic levels

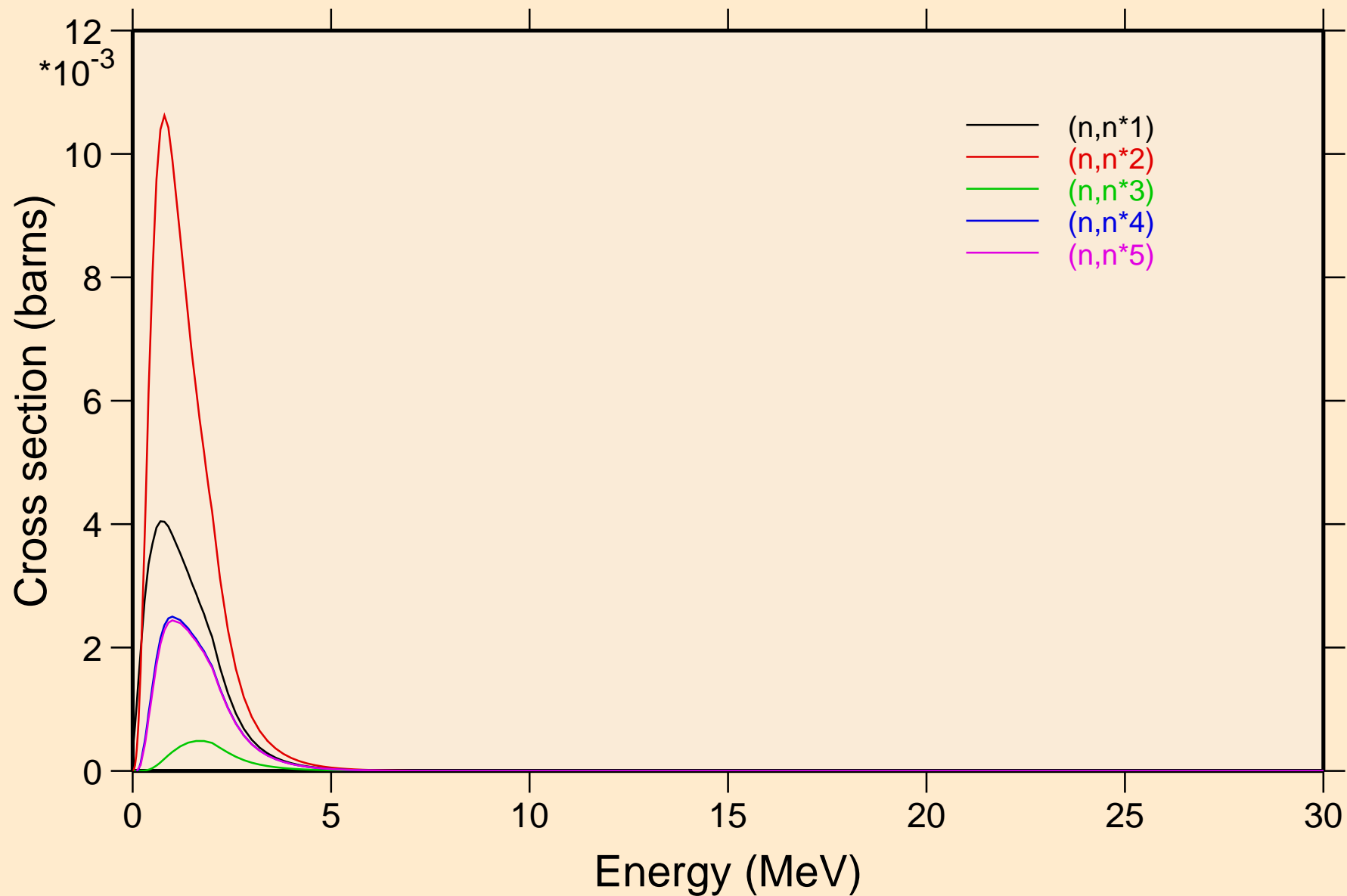

TB146M NEUTRON ACER TENDL-2019 LIBRARY; T=293.16K
Inelastic levels

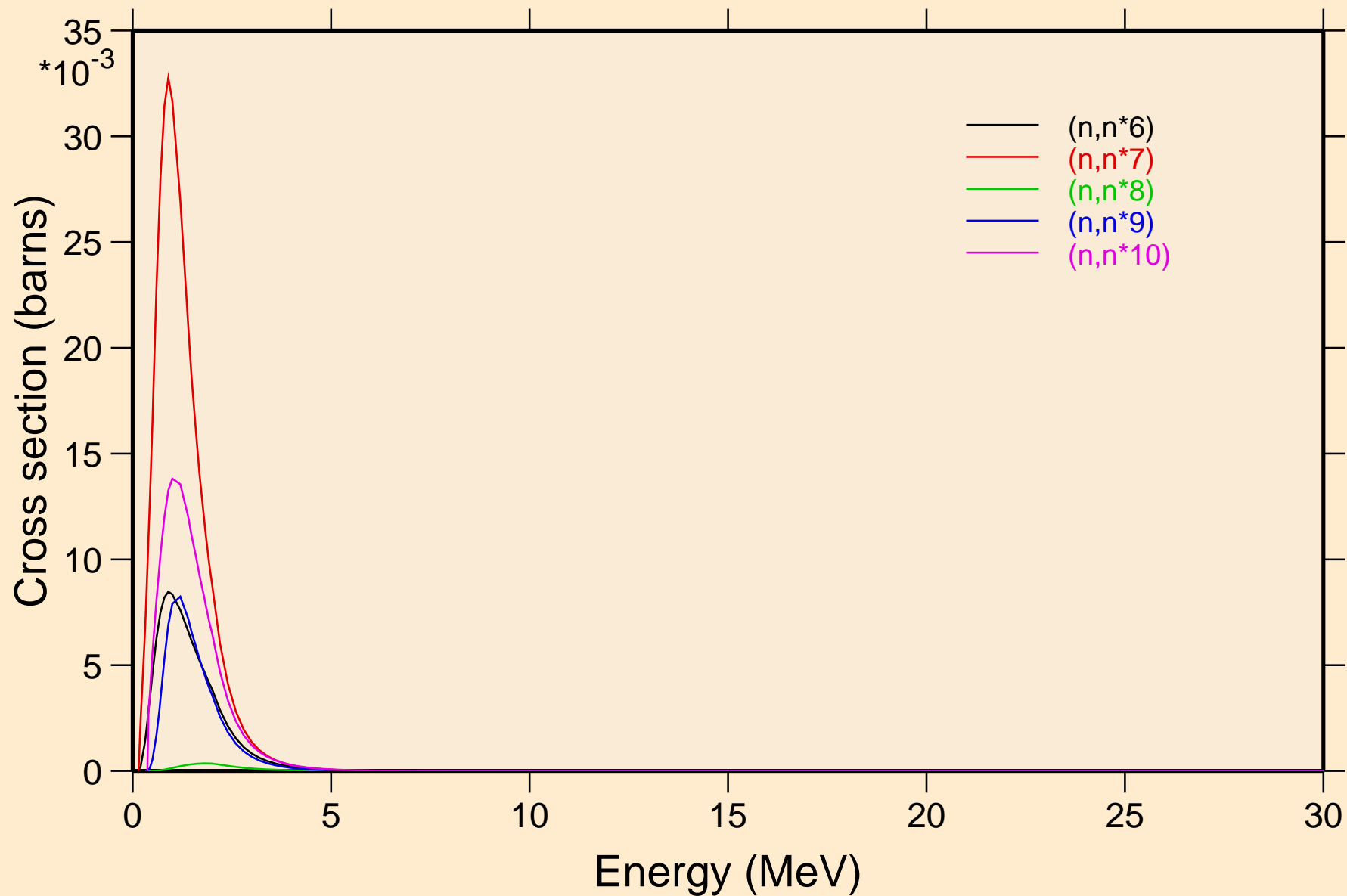

TB146M NEUTRON ACER TENDL-2019 LIBRARY; T=293.16K
Inelastic levels

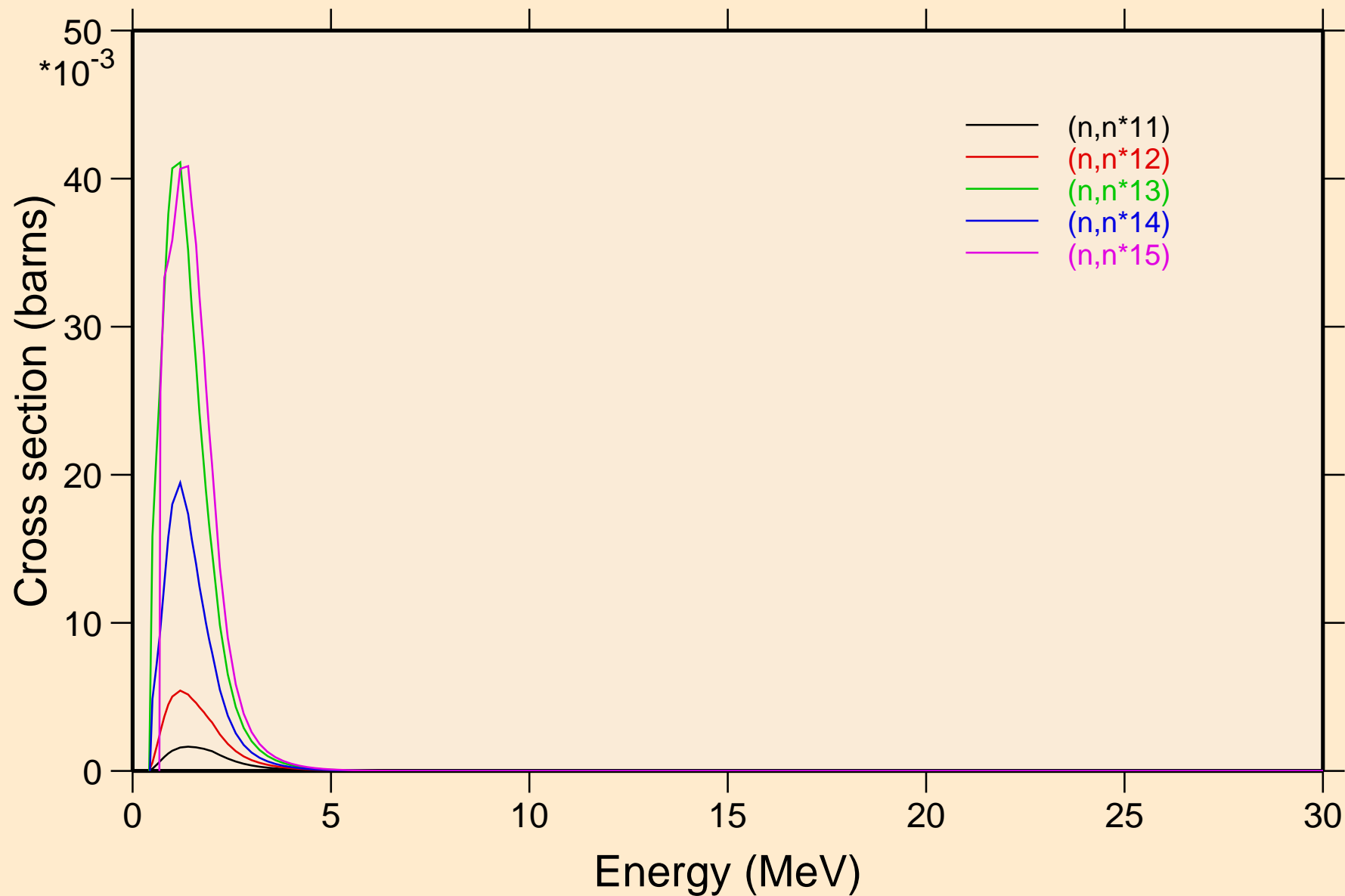

TB146M NEUTRON ACER TENDL-2019 LIBRARY; T=293.16K
Inelastic levels

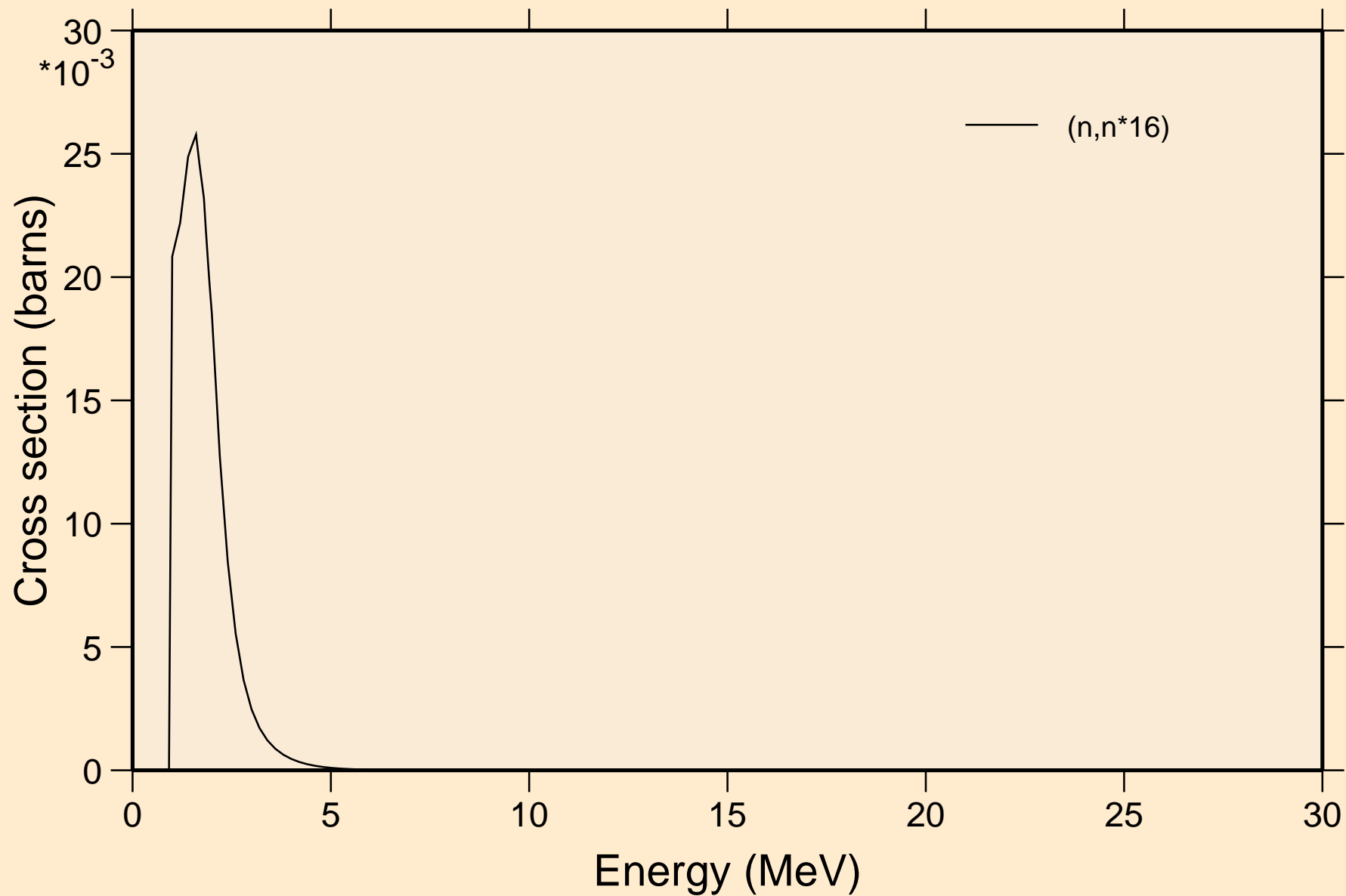

TB146M NEUTRON ACER TENDL-2019 LIBRARY; T=293.16K
Threshold reactions

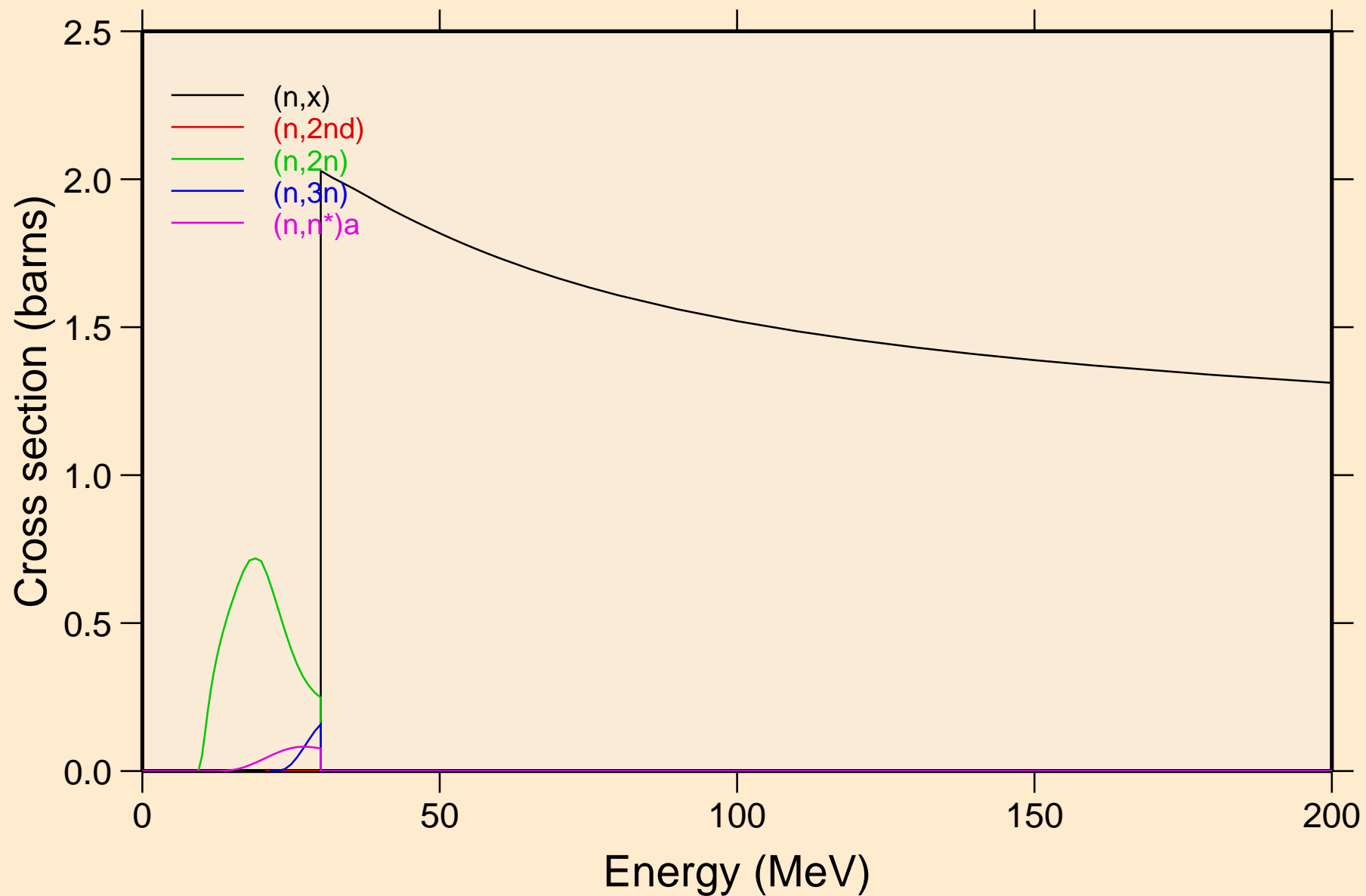

TB146M NEUTRON ACER TENDL-2019 LIBRARY; T=293.16K
Threshold reactions

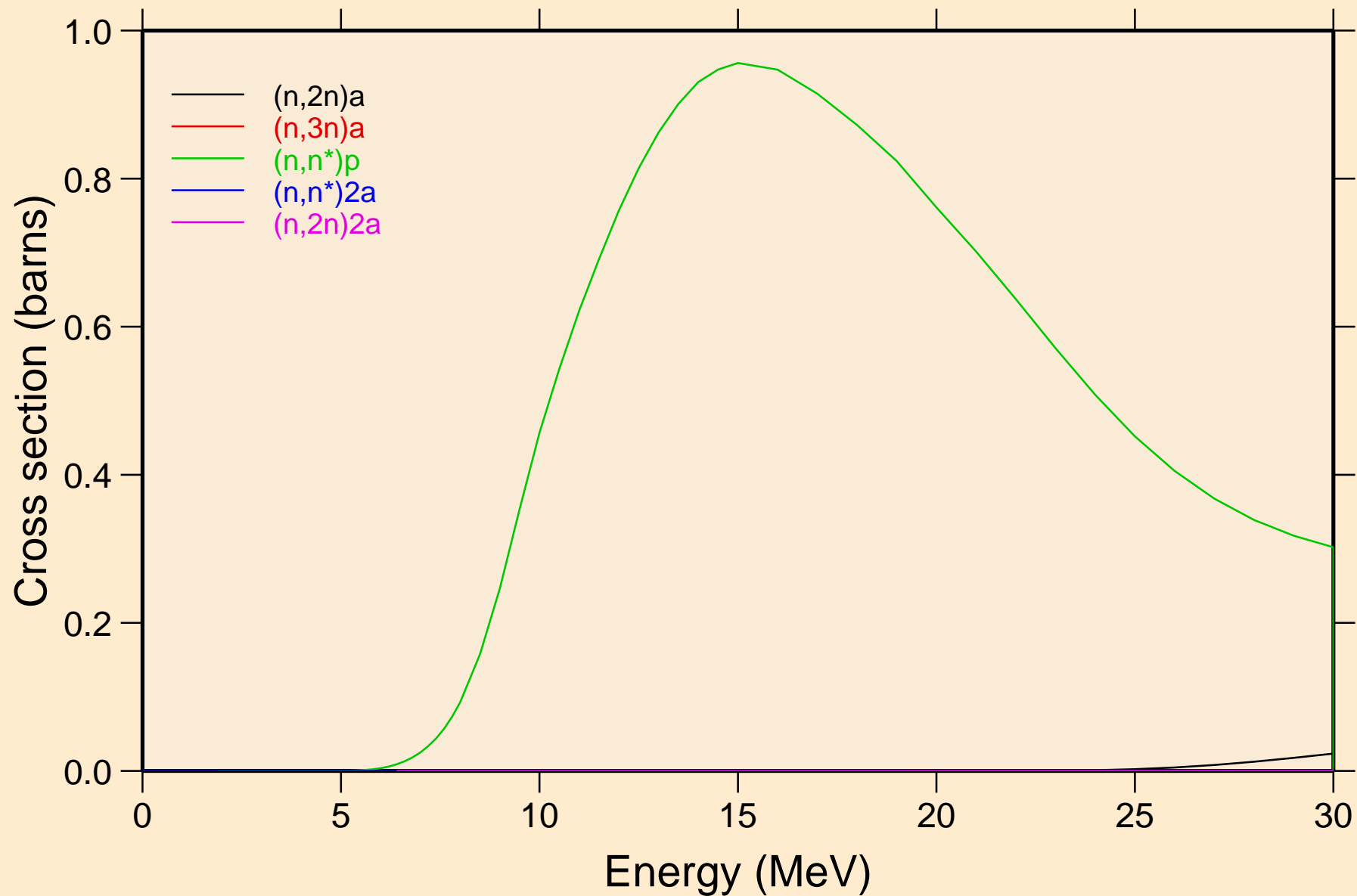

TB146M NEUTRON ACER TENDL-2019 LIBRARY; T=293.16K
Threshold reactions

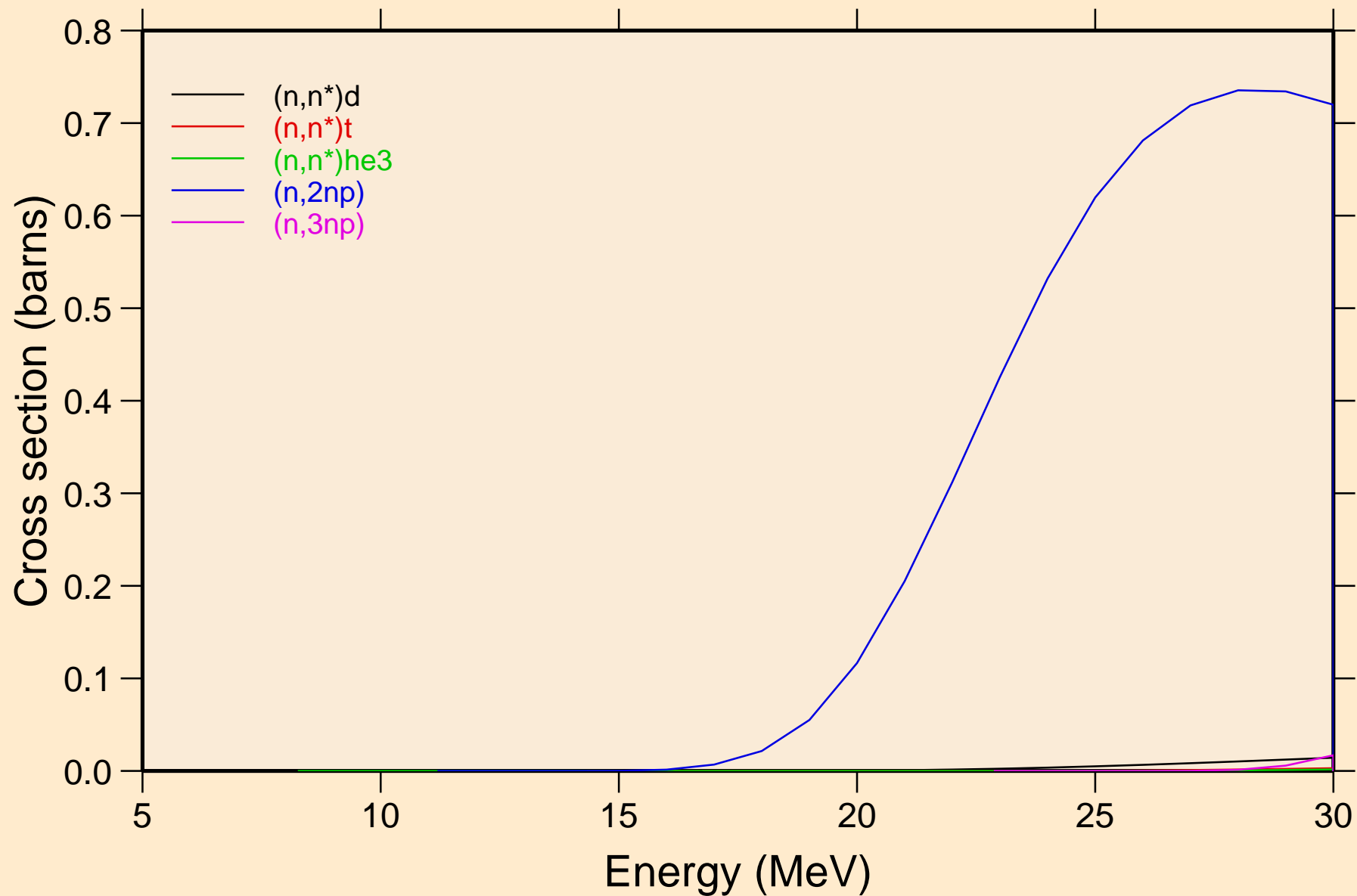

TB146M NEUTRON ACER TENDL-2019 LIBRARY; T=293.16K
Threshold reactions

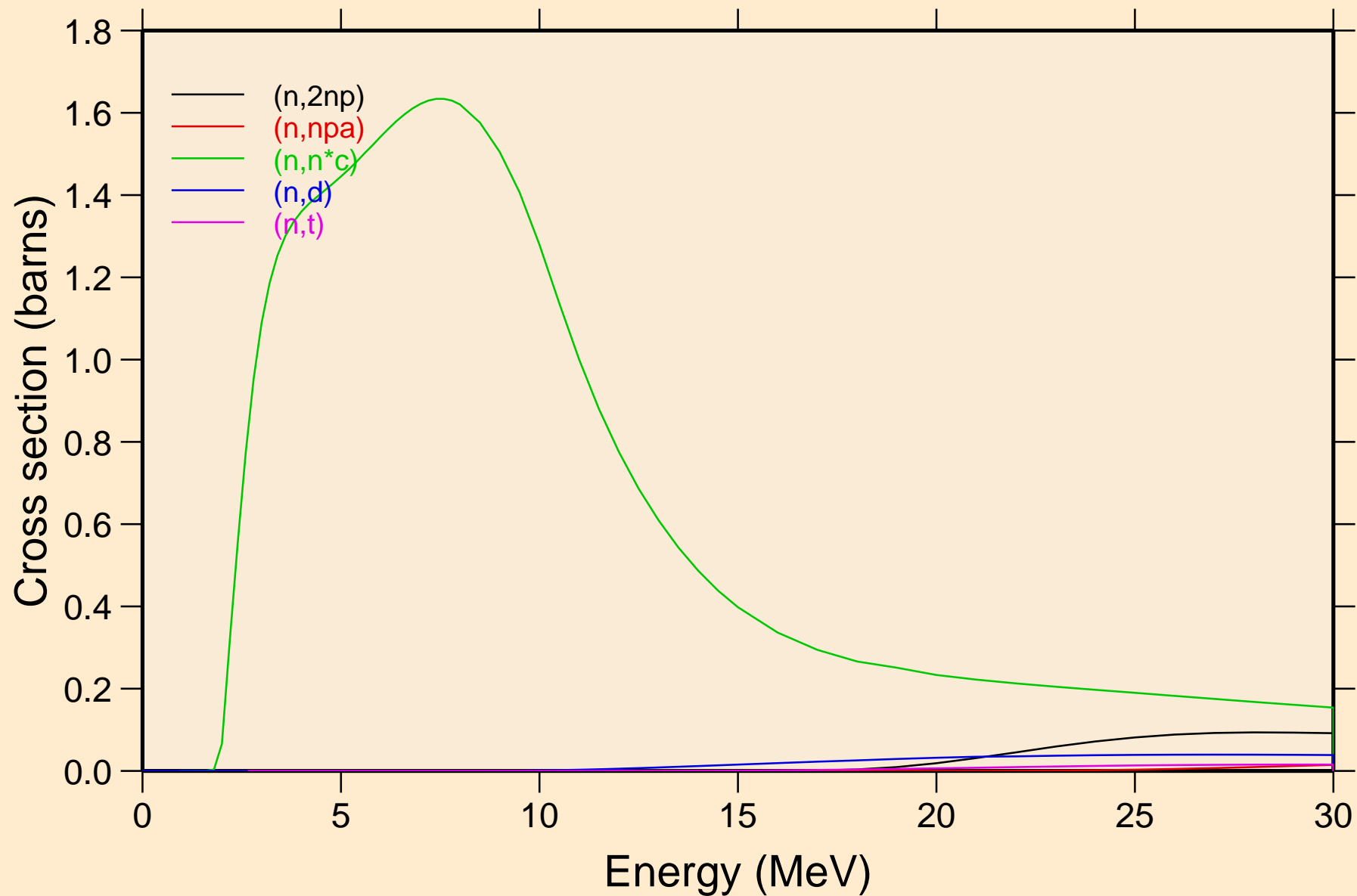

TB146M NEUTRON ACER TENDL-2019 LIBRARY; T=293.16K
Threshold reactions

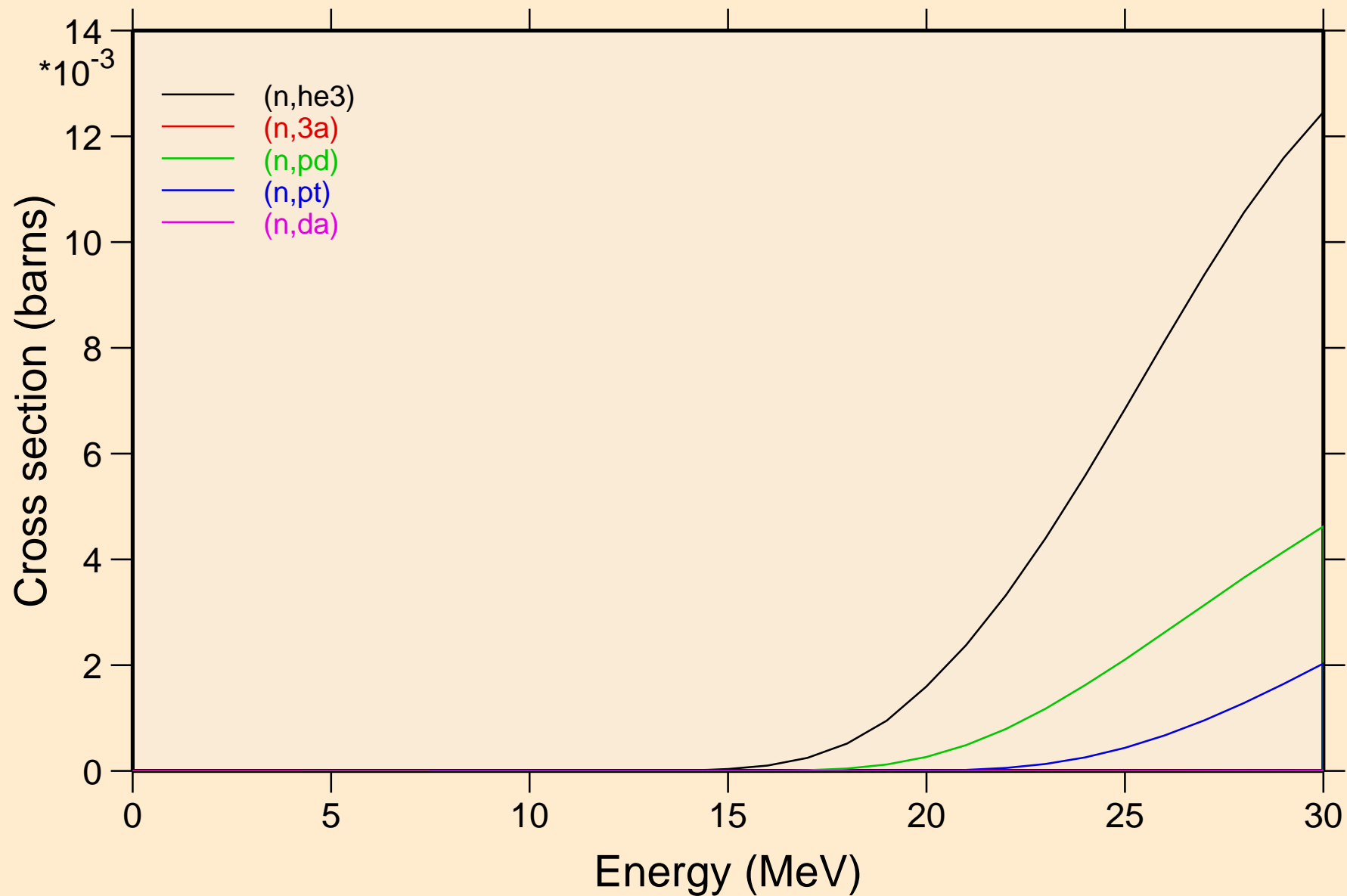

TB146M NEUTRON ACER TENDL-2019 LIBRARY; T=293.16K
Threshold reactions

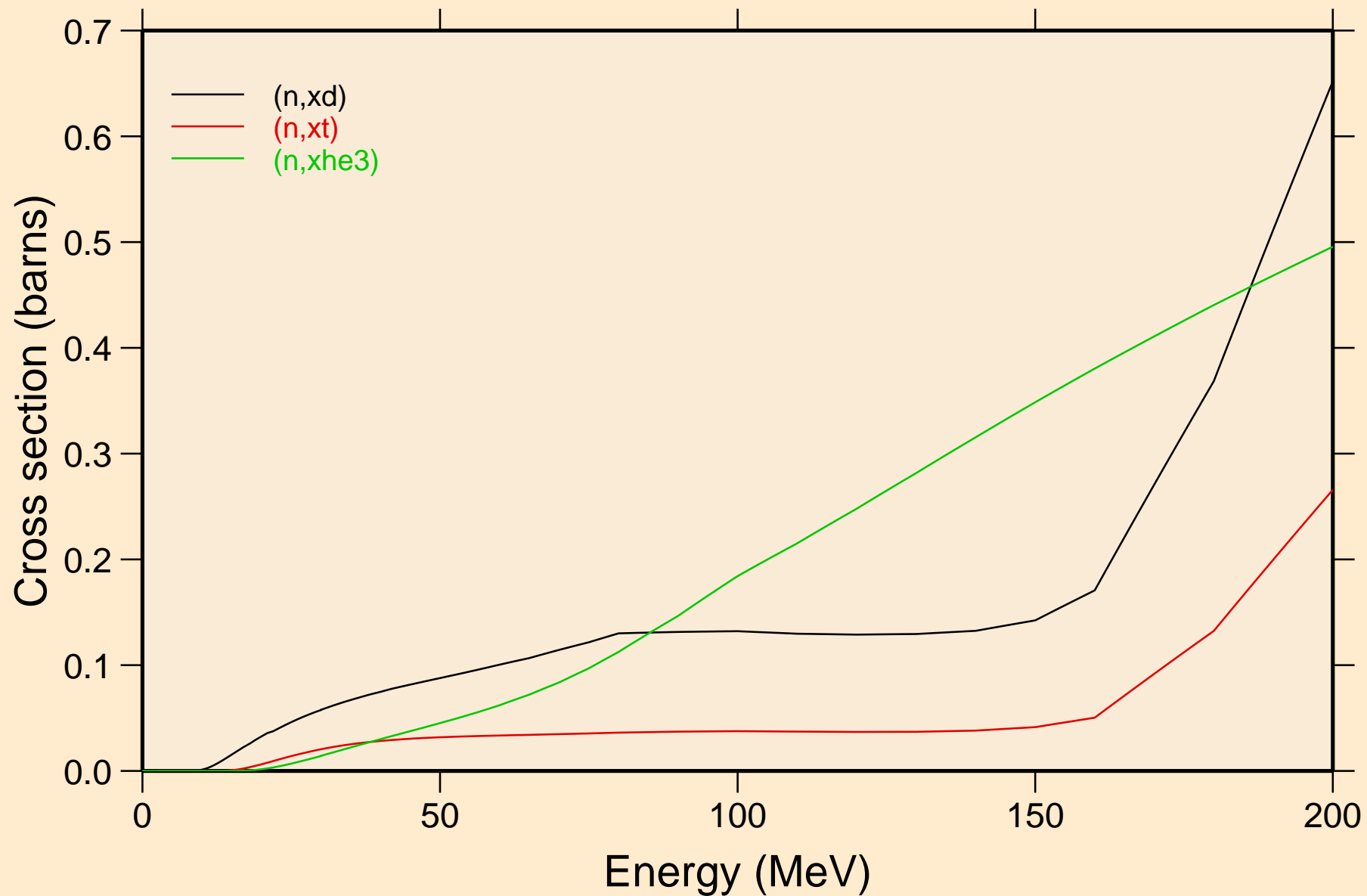

TB146M NEUTRON ACER TENDL-2019 LIBRARY; T=293.16K
angular distribution for elastic

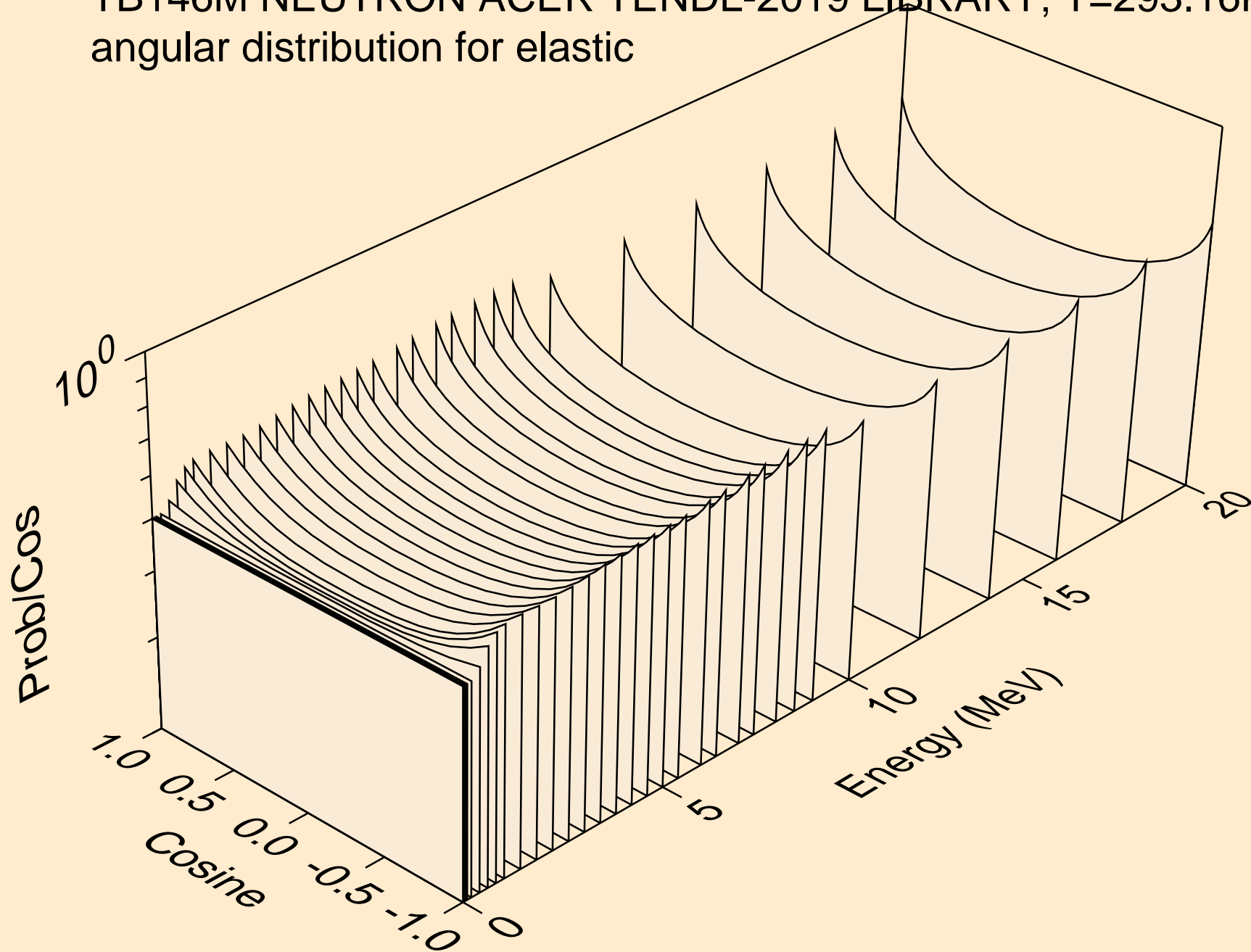

TB146M NEUTRON ACER TENDL-2019 LIBRARY; T=293.16K
angular distribution for elastic

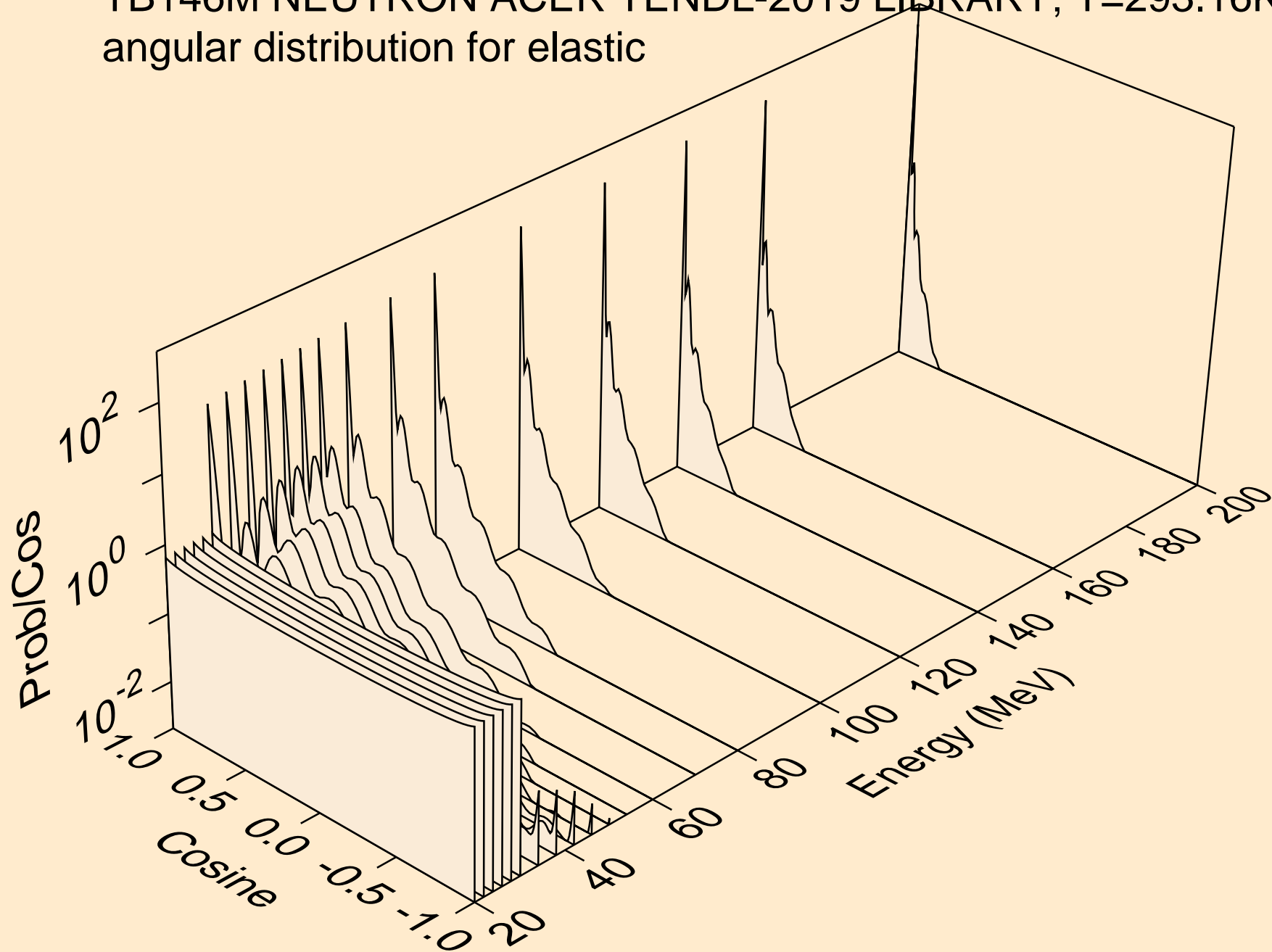

TB146M NEUTRON ACER TENDL-2019 LIBRARY; T=293.16K
angular distribution for (n,n*1)

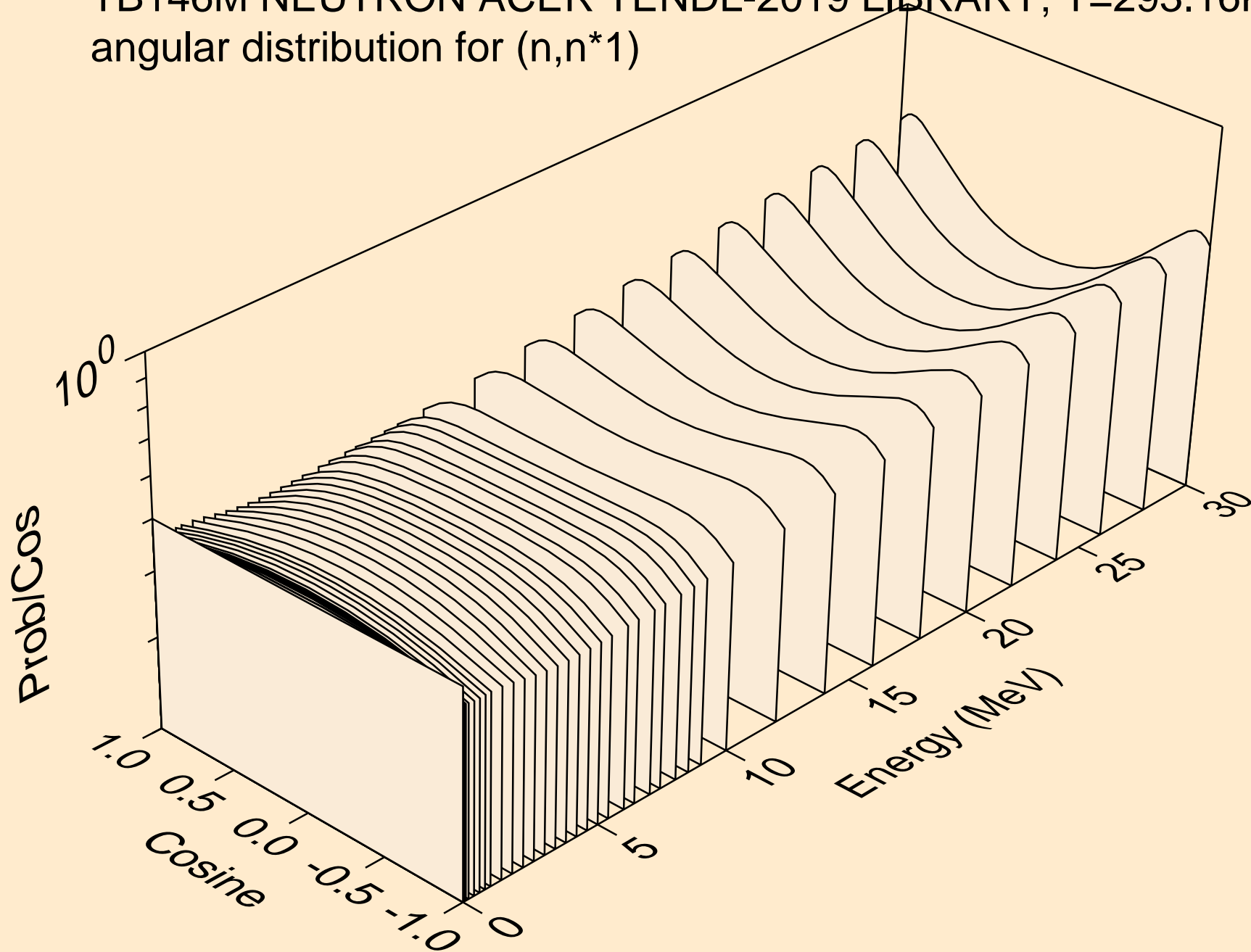

TB146M NEUTRON ACER TENDL-2019 LIBRARY; T=293.16K
angular distribution for (n,n*2)

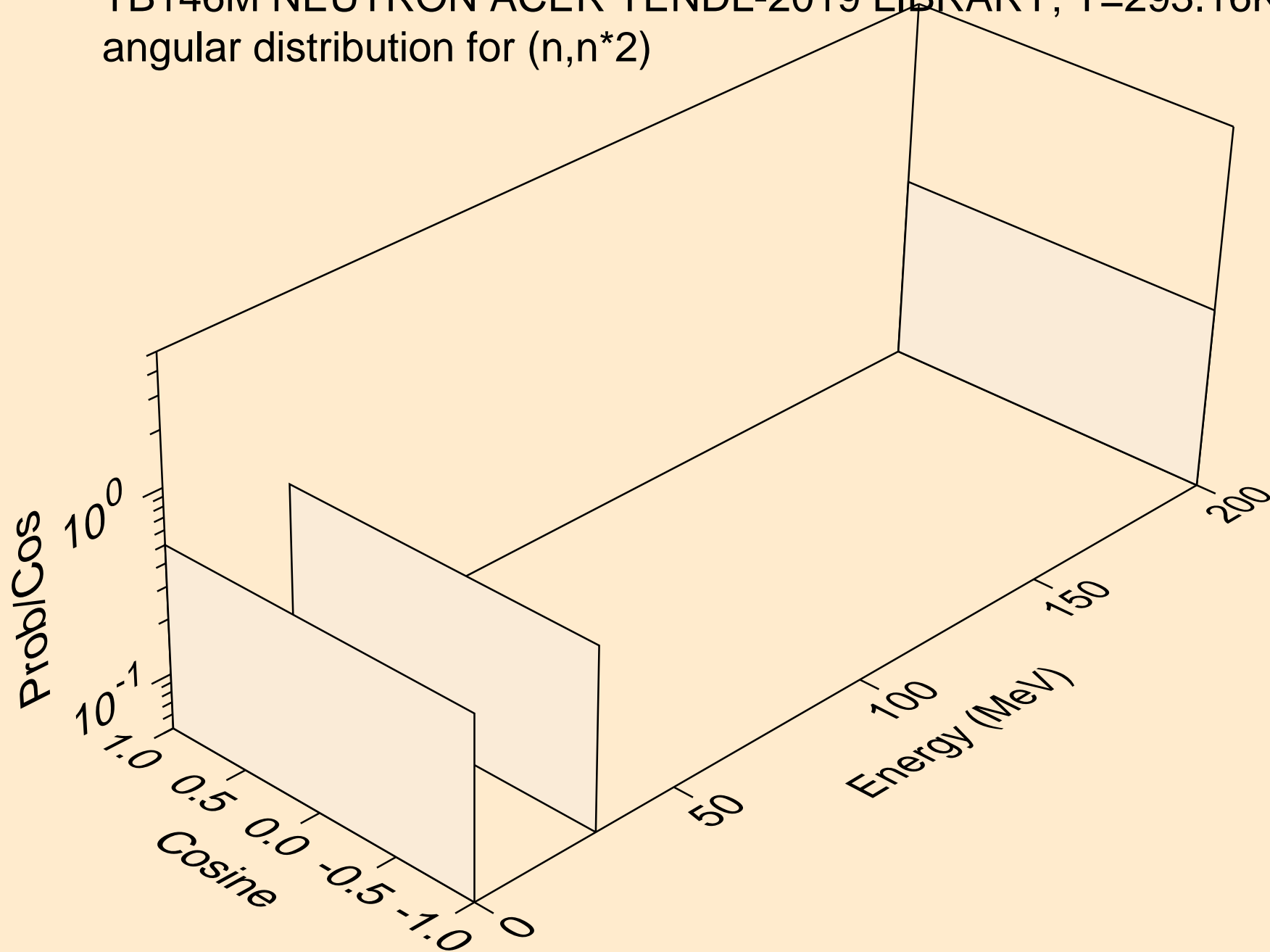

TB146M NEUTRON ACER TENDL-2019 LIBRARY; T=293.16K
angular distribution for (n,n*3)

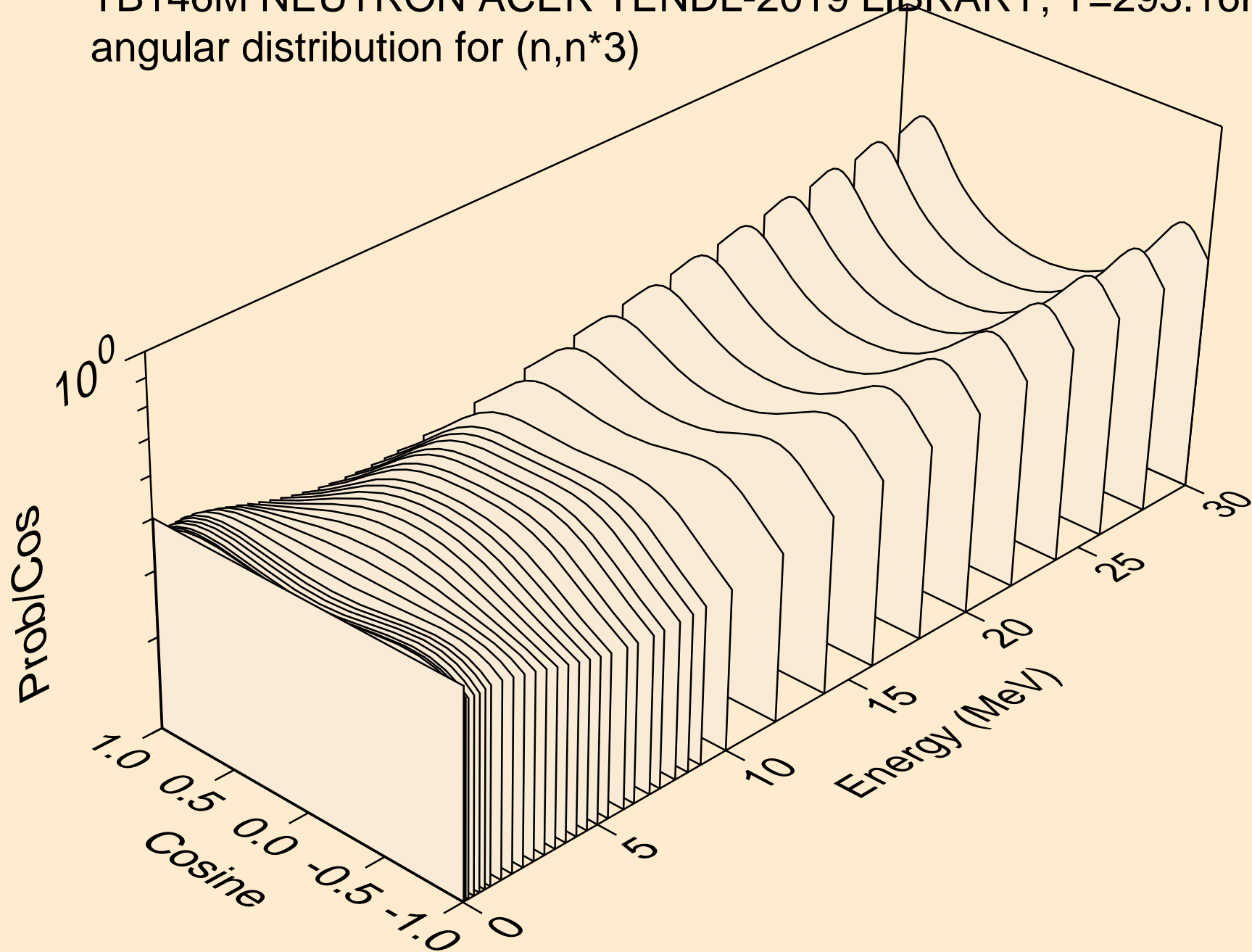

TB146M NEUTRON ACER TENDL-2019 LIBRARY; T=293.16K
angular distribution for (n,n*4)

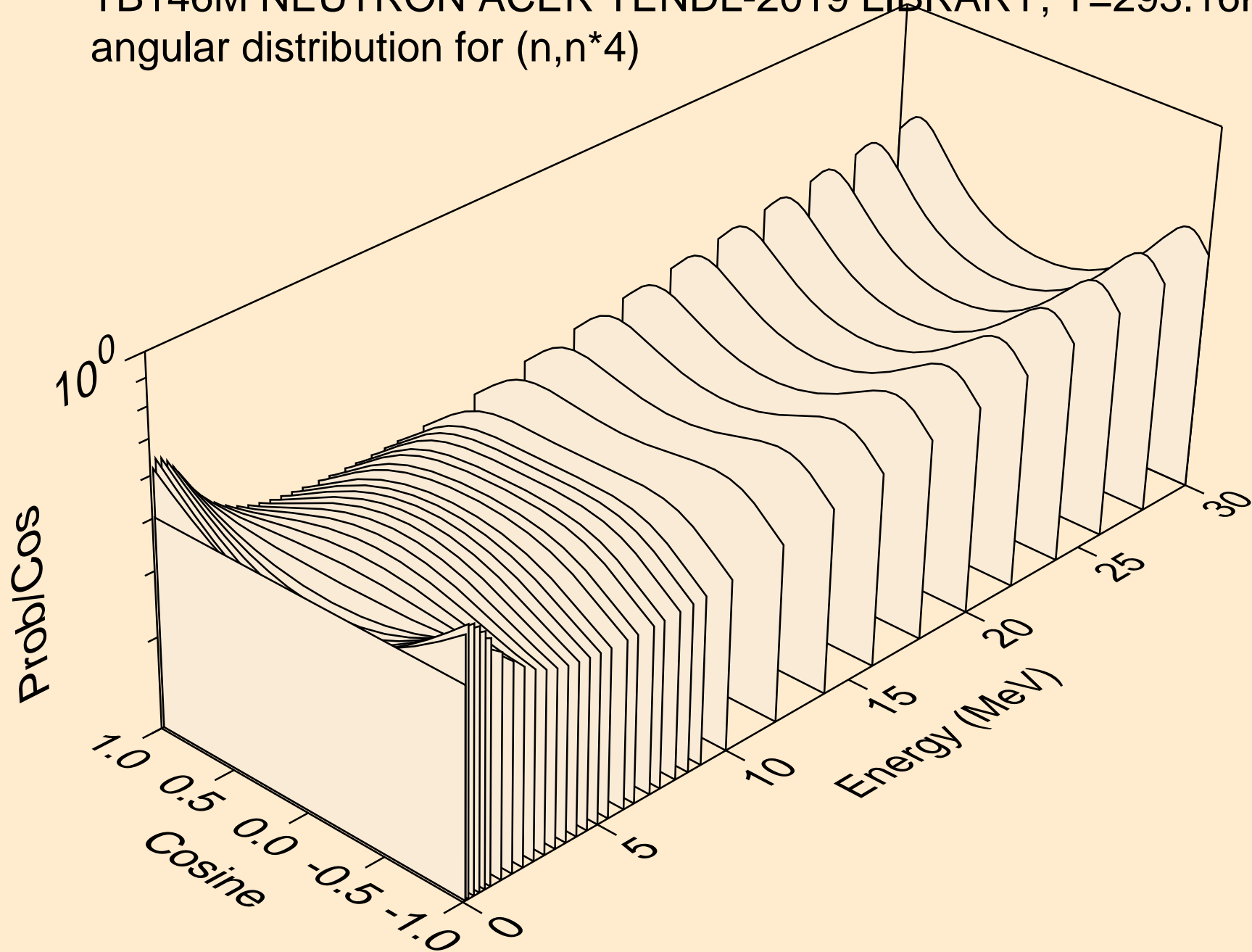

TB146M NEUTRON ACER TENDL-2019 LIBRARY; T=293.16K
angular distribution for (n,n*5)

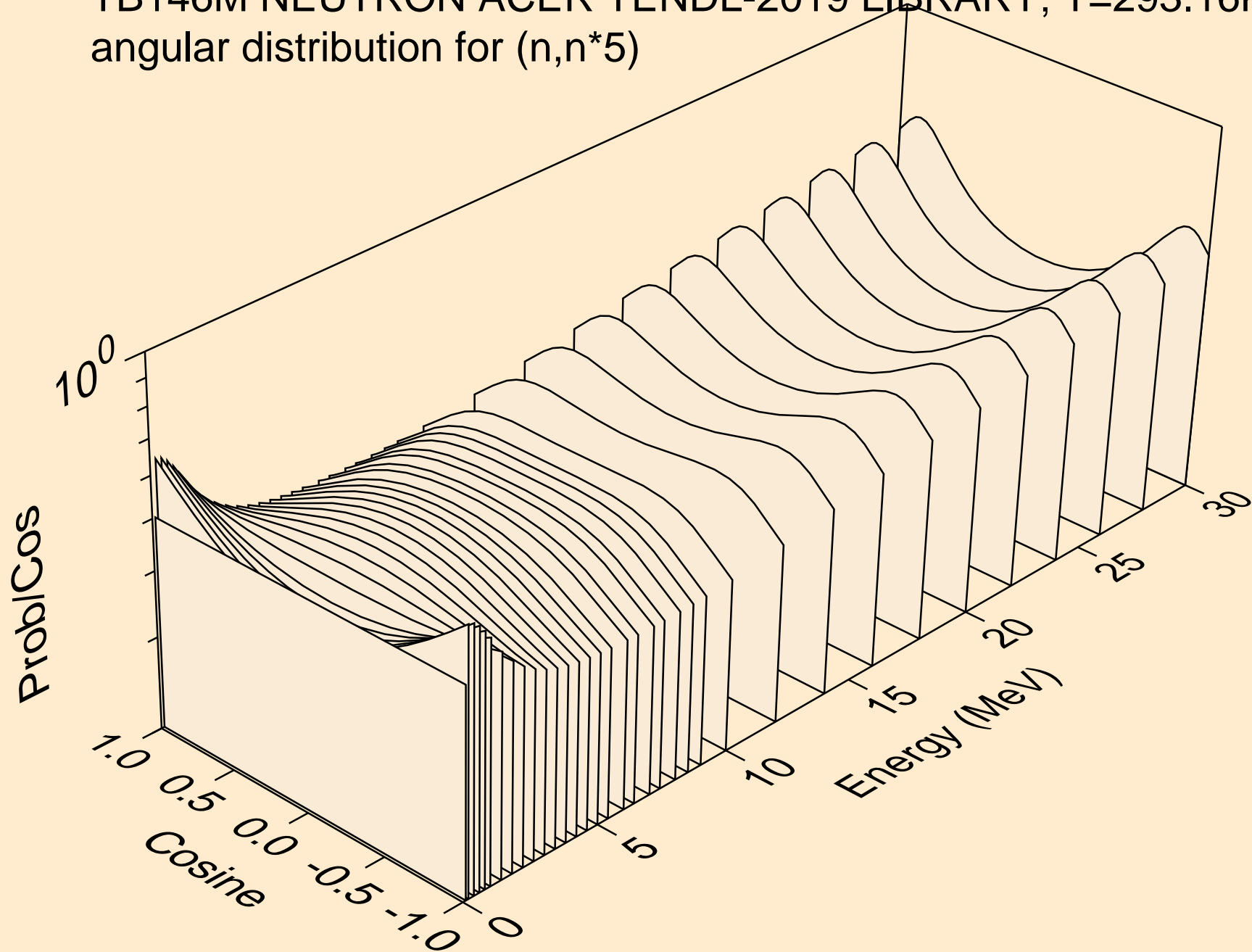

TB146M NEUTRON ACER TENDL-2019 LIBRARY; T=293.16K
angular distribution for (n,n*6)

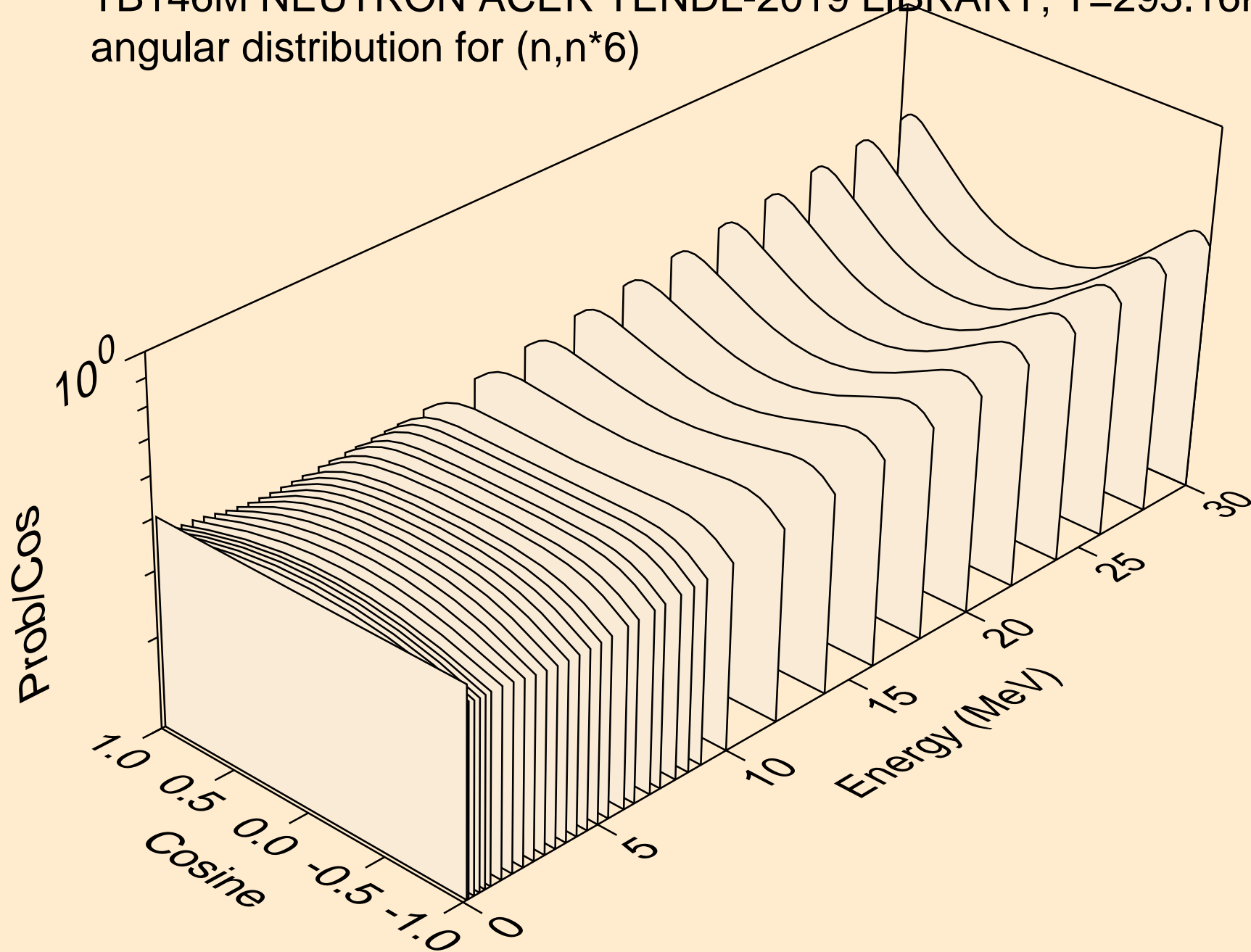

TB146M NEUTRON ACER TENDL-2019 LIBRARY; T=293.16K
angular distribution for (n,n*7)

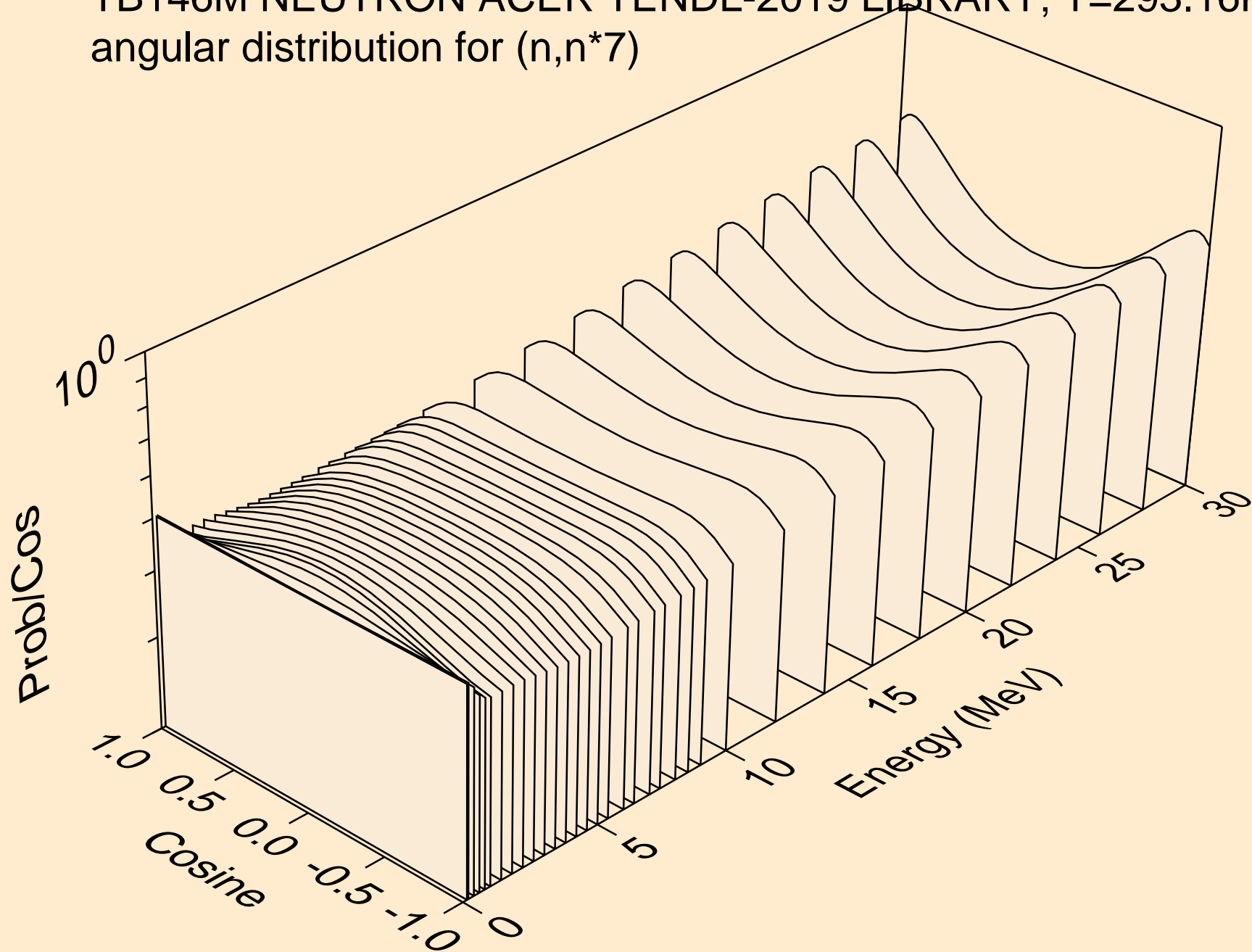

TB146M NEUTRON ACER TENDL-2019 LIBRARY; T=293.16K
angular distribution for (n,n*8)

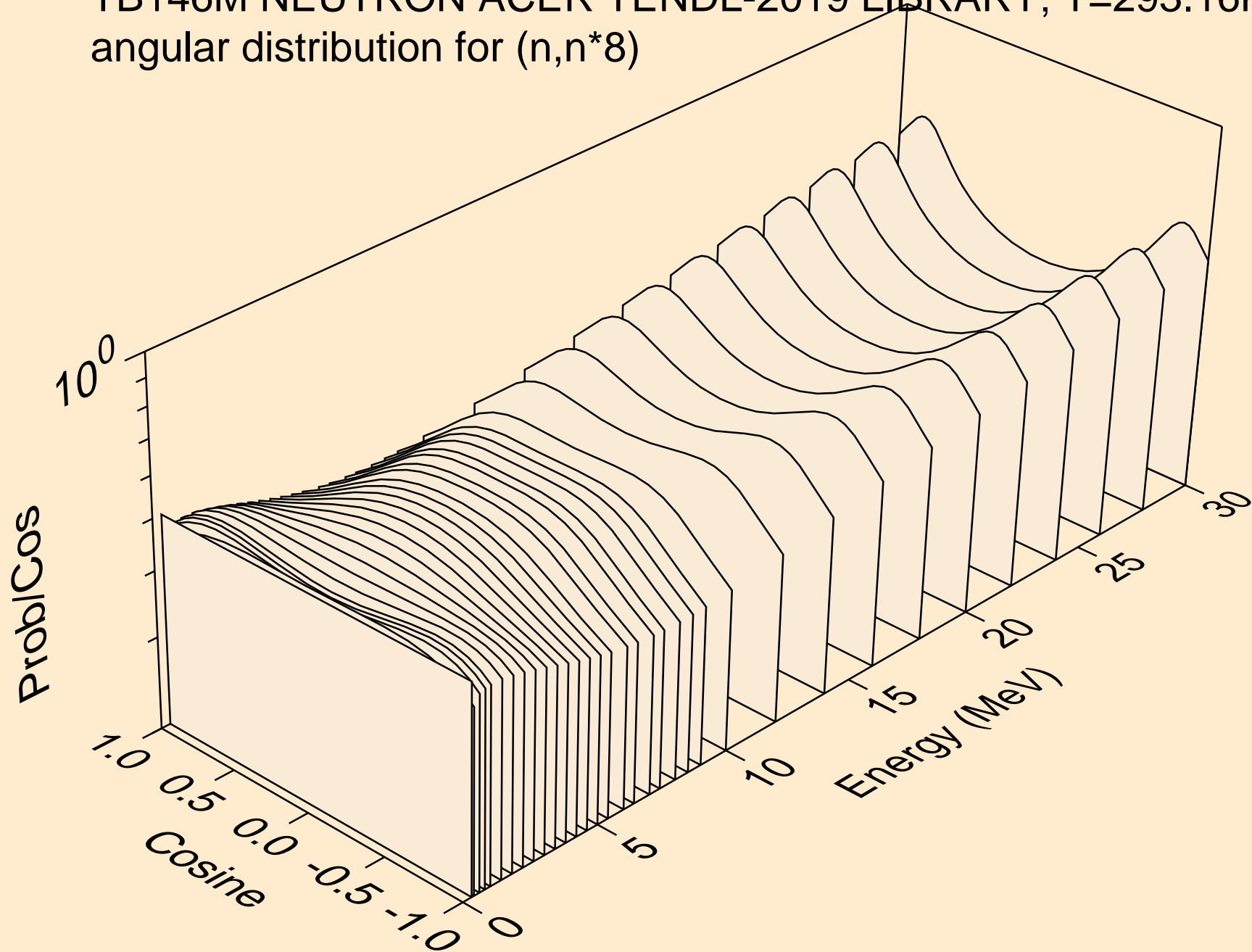

TB146M NEUTRON ACER TENDL-2019 LIBRARY; T=293.16K
angular distribution for (n,n*9)

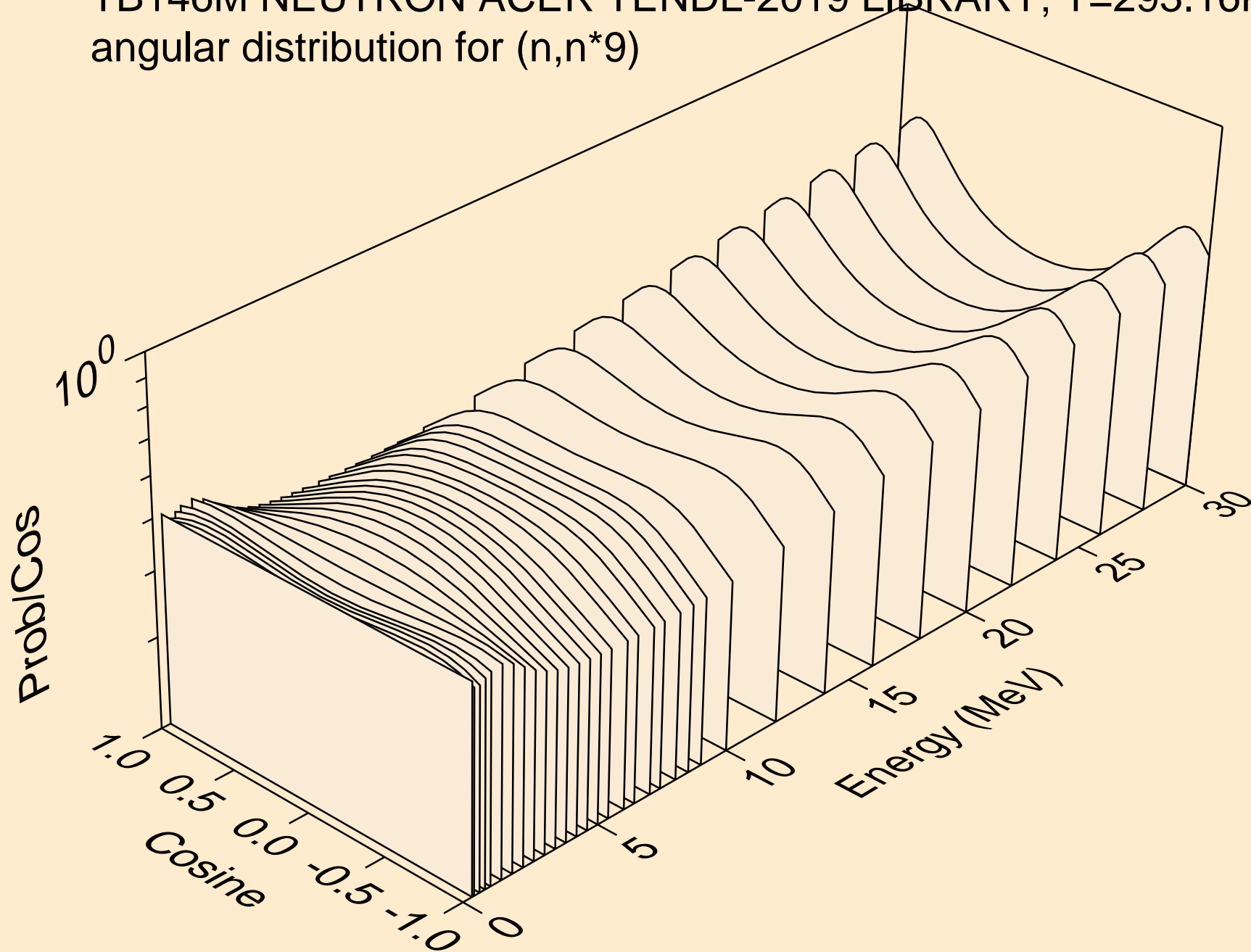

TB146M NEUTRON ACER TENDL-2019 LIBRARY; T=293.16K
angular distribution for (n,n*10)

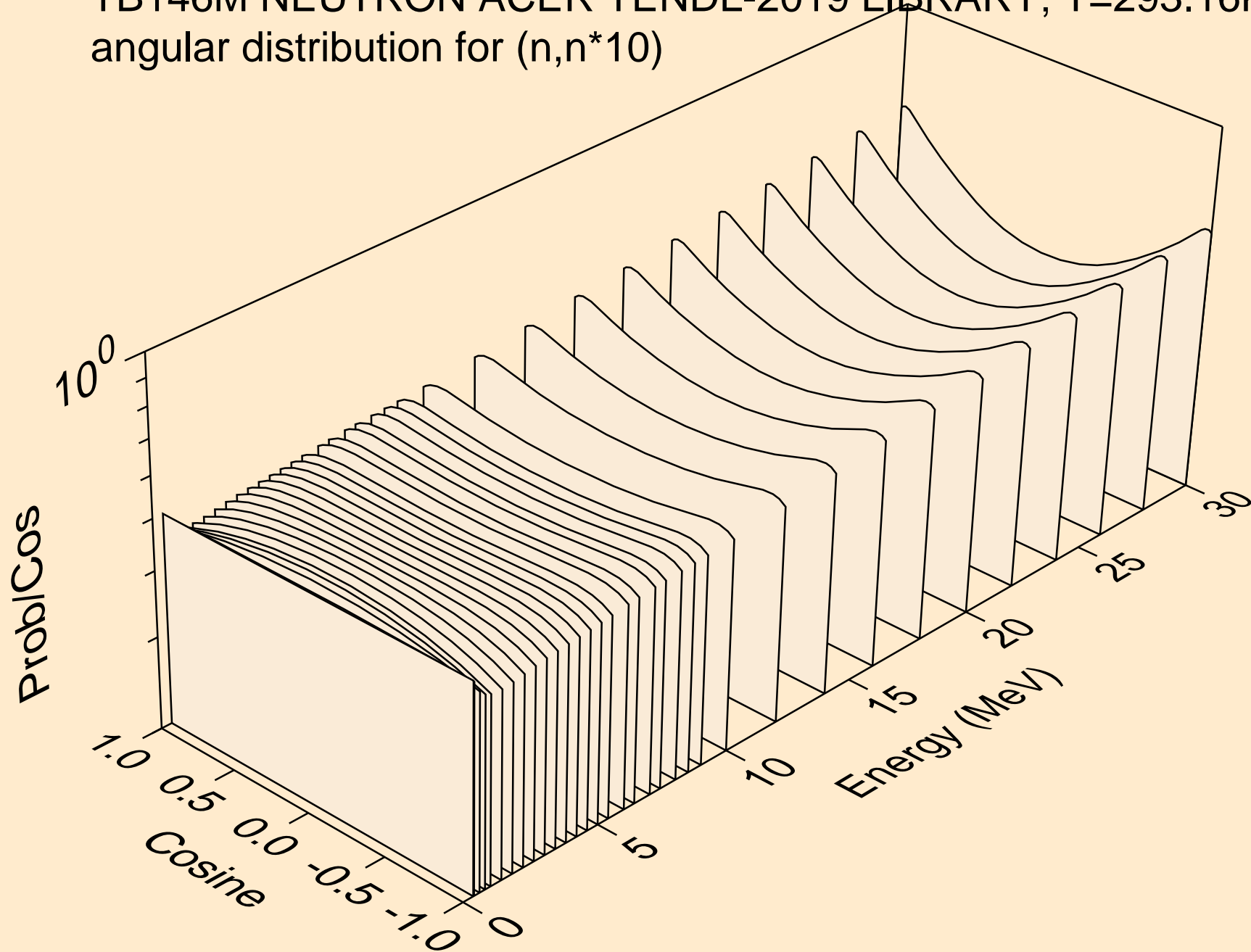

TB146M NEUTRON ACER TENDL-2019 LIBRARY; T=293.16K
angular distribution for (n,n*11)

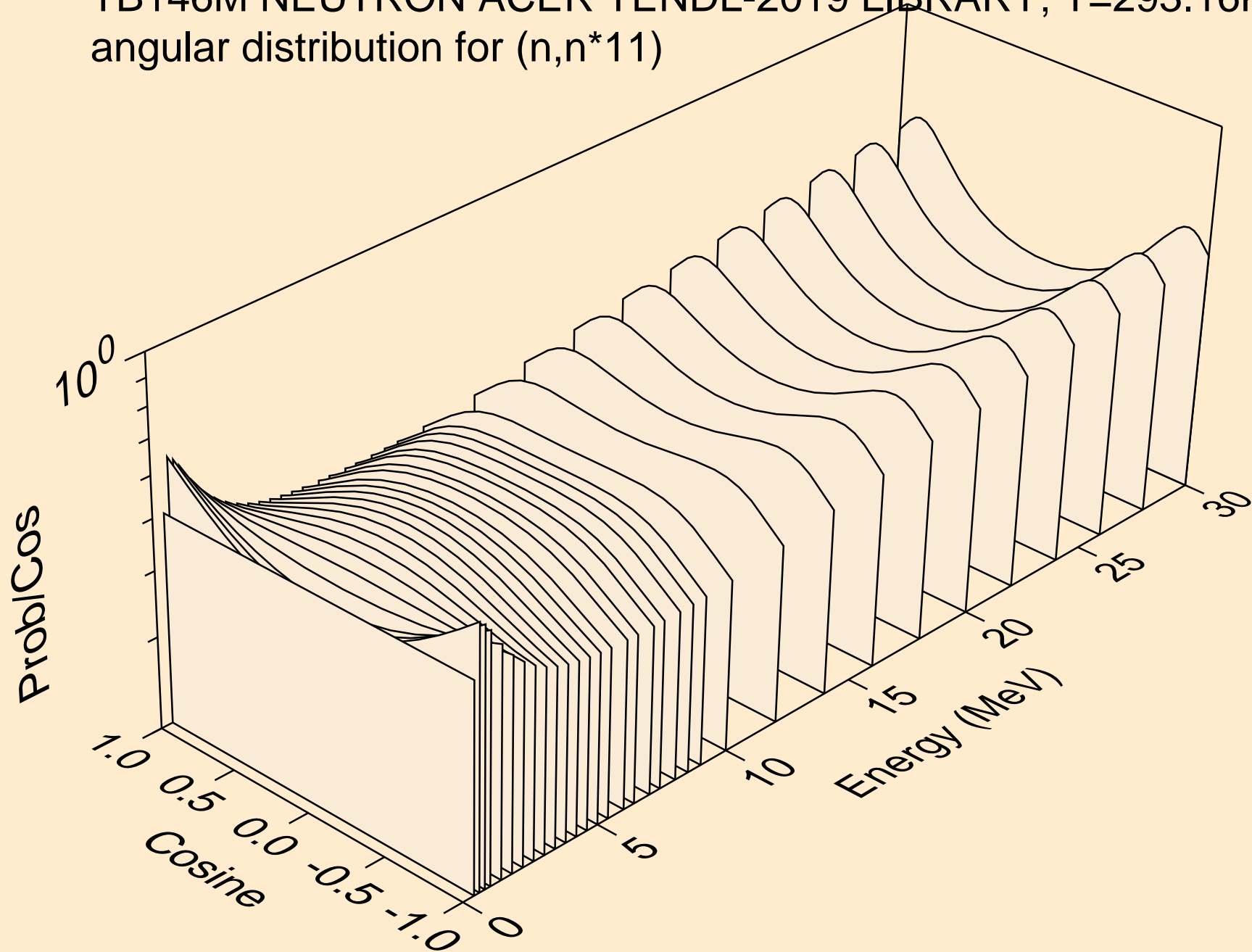

TB146M NEUTRON ACER TENDL-2019 LIBRARY; T=293.16K
angular distribution for (n,n*12)

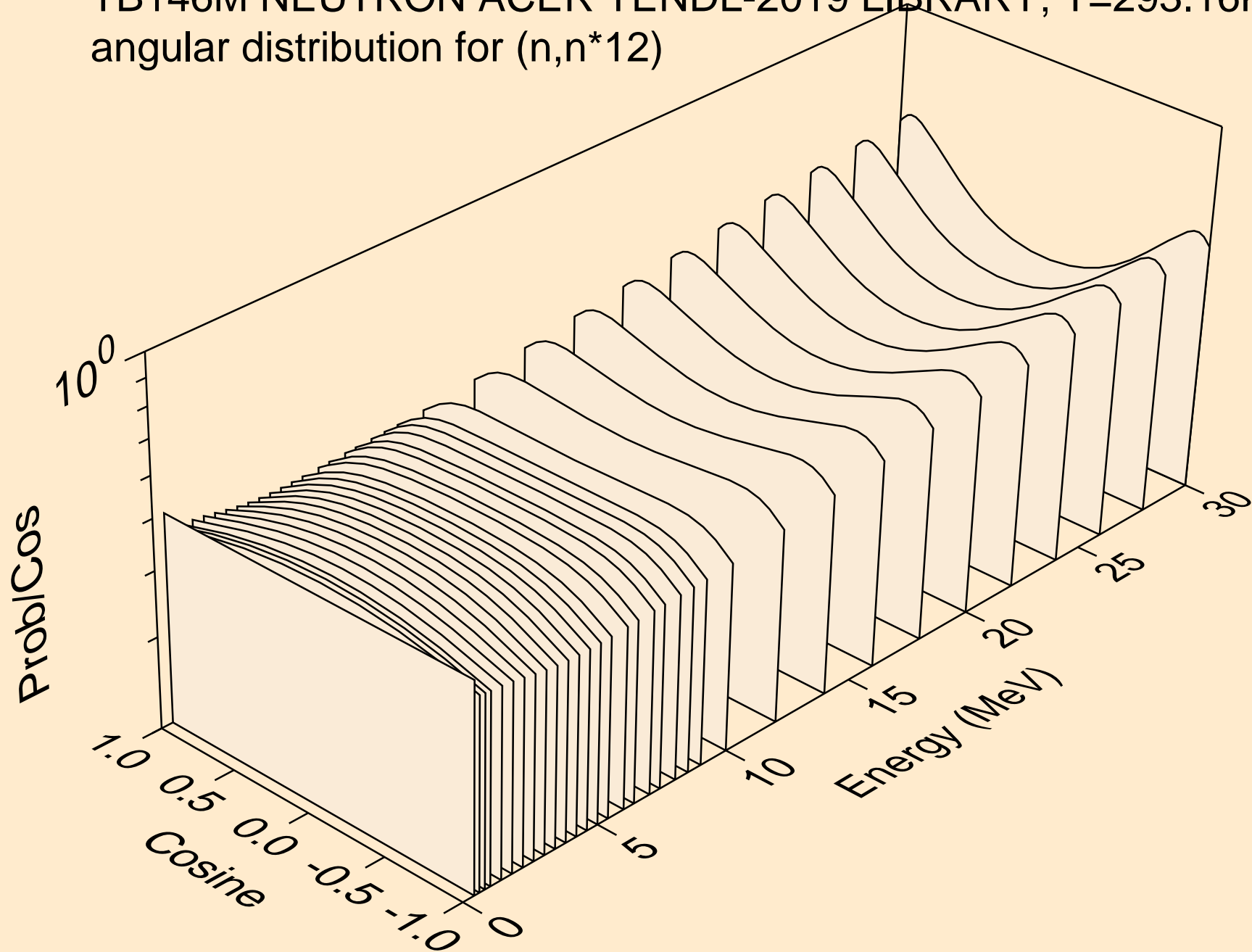

TB146M NEUTRON ACER TENDL-2019 LIBRARY; T=293.16K
angular distribution for (n,n*13)

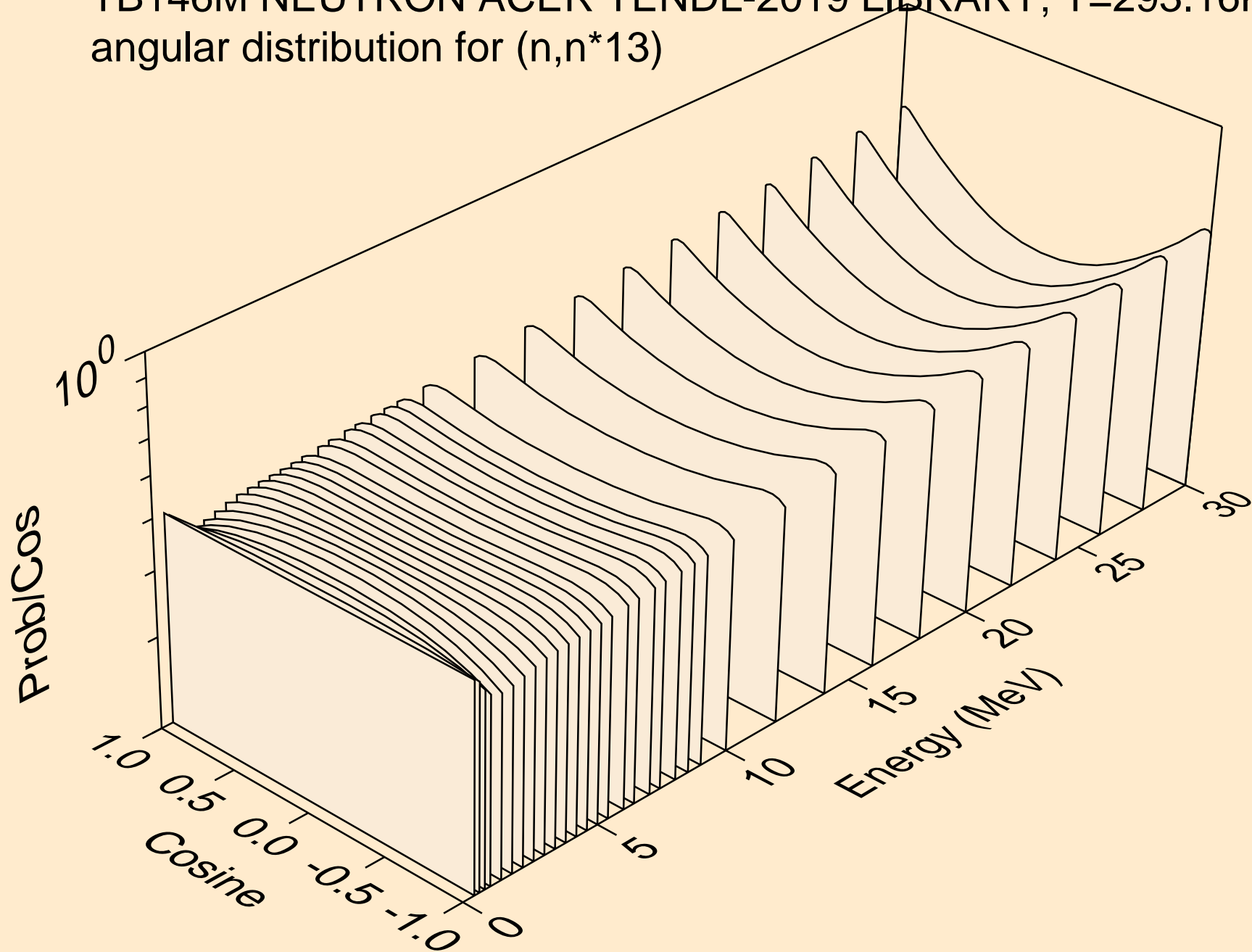

TB146M NEUTRON ACER TENDL-2019 LIBRARY; T=293.16K
angular distribution for (n,n*14)

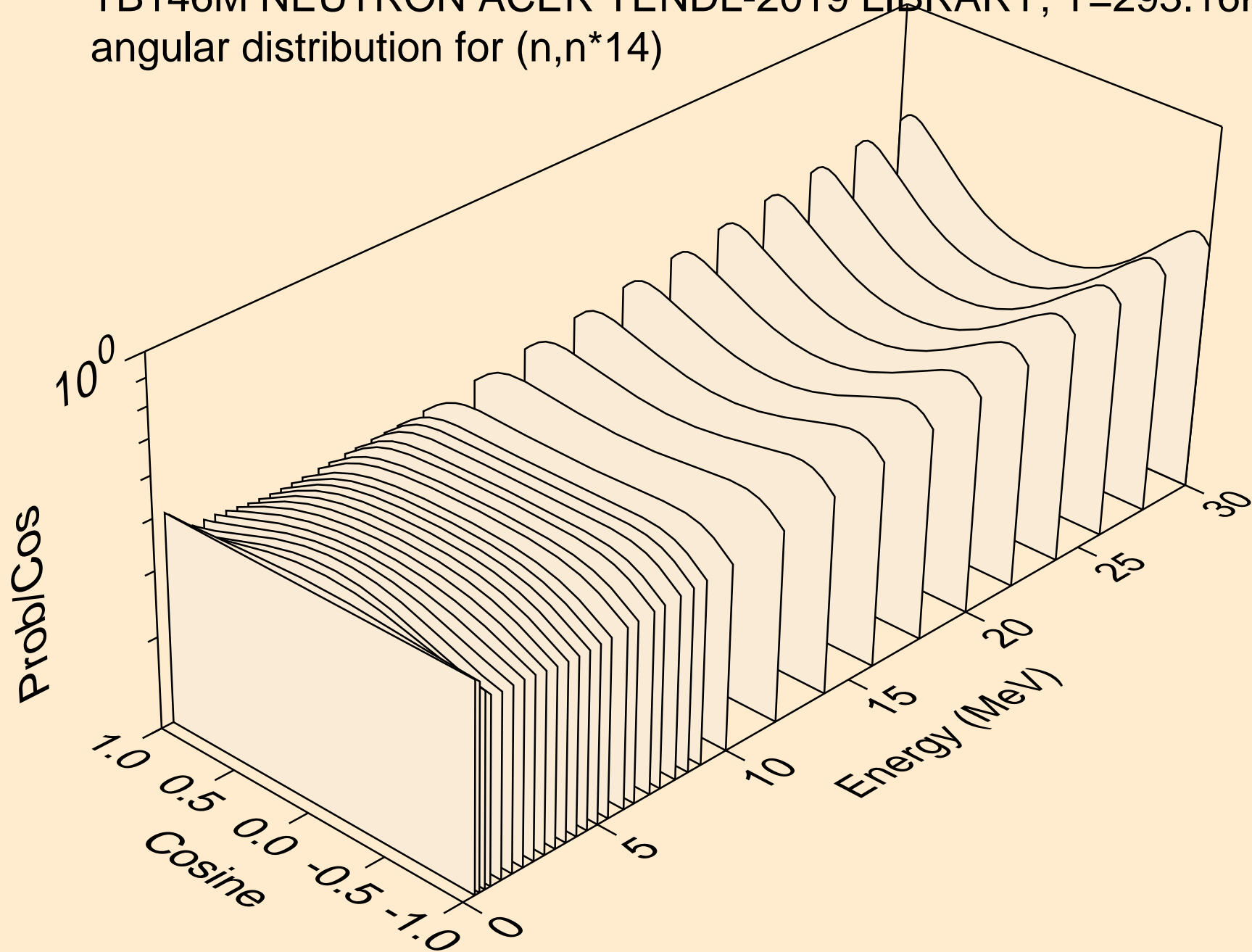

TB146M NEUTRON ACER TENDL-2019 LIBRARY; T=293.16K
angular distribution for (n,n*15)

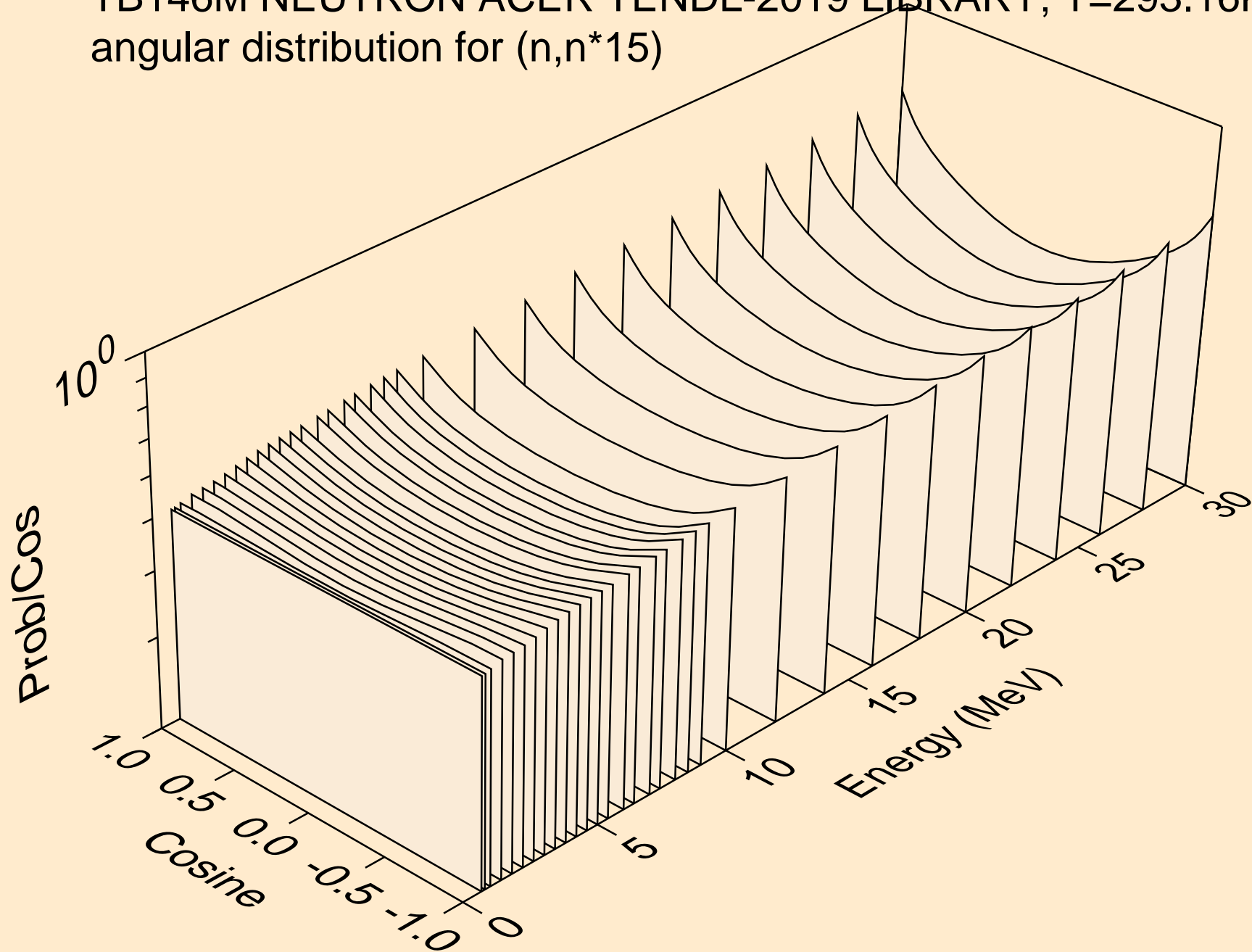

TB146M NEUTRON ACER TENDL-2019 LIBRARY; T=293.16K
angular distribution for (n,n*16)

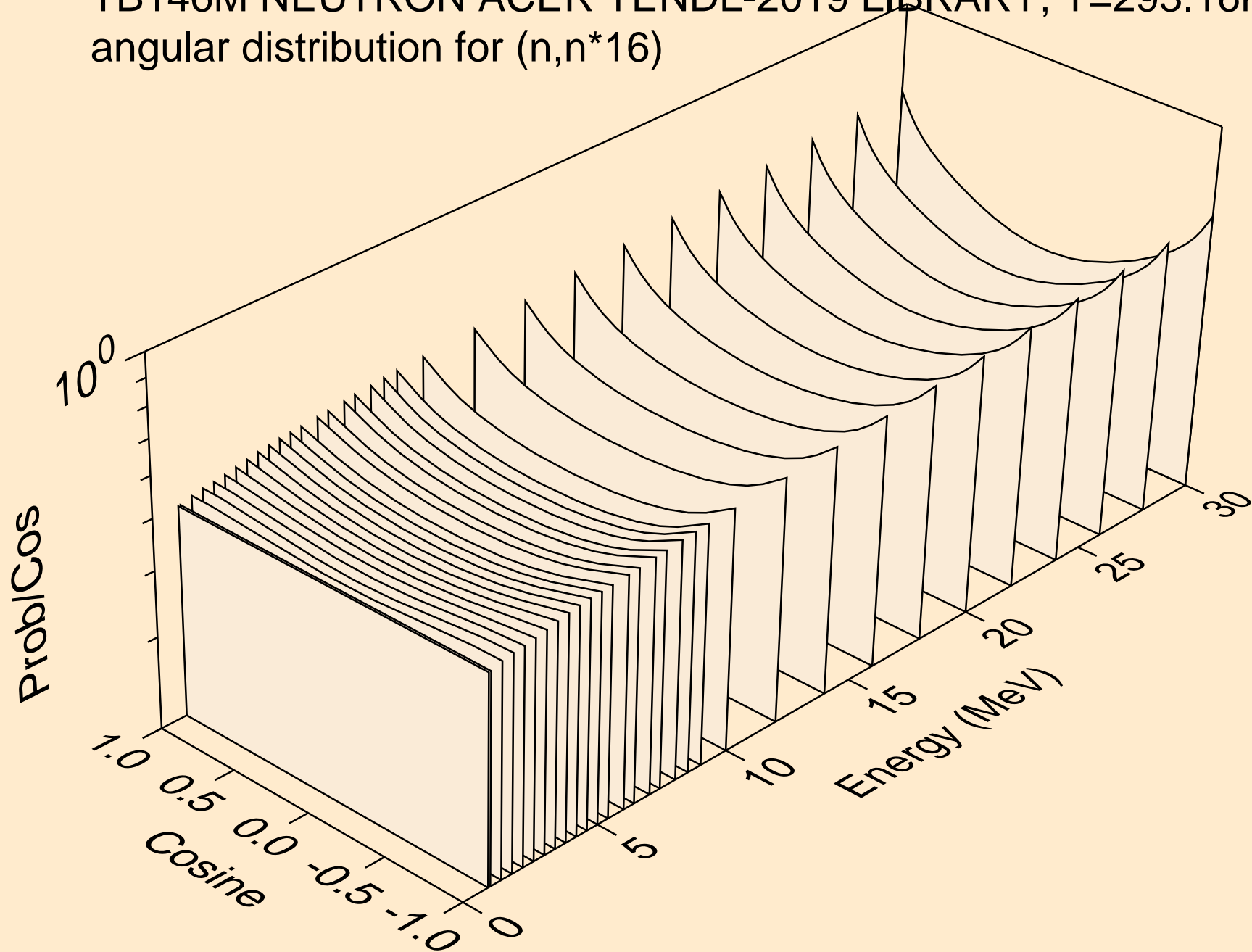

TB146M NEUTRON ACER TENDL-2019 LIBRARY; T=293.16K
Neutron emission for (n,x)

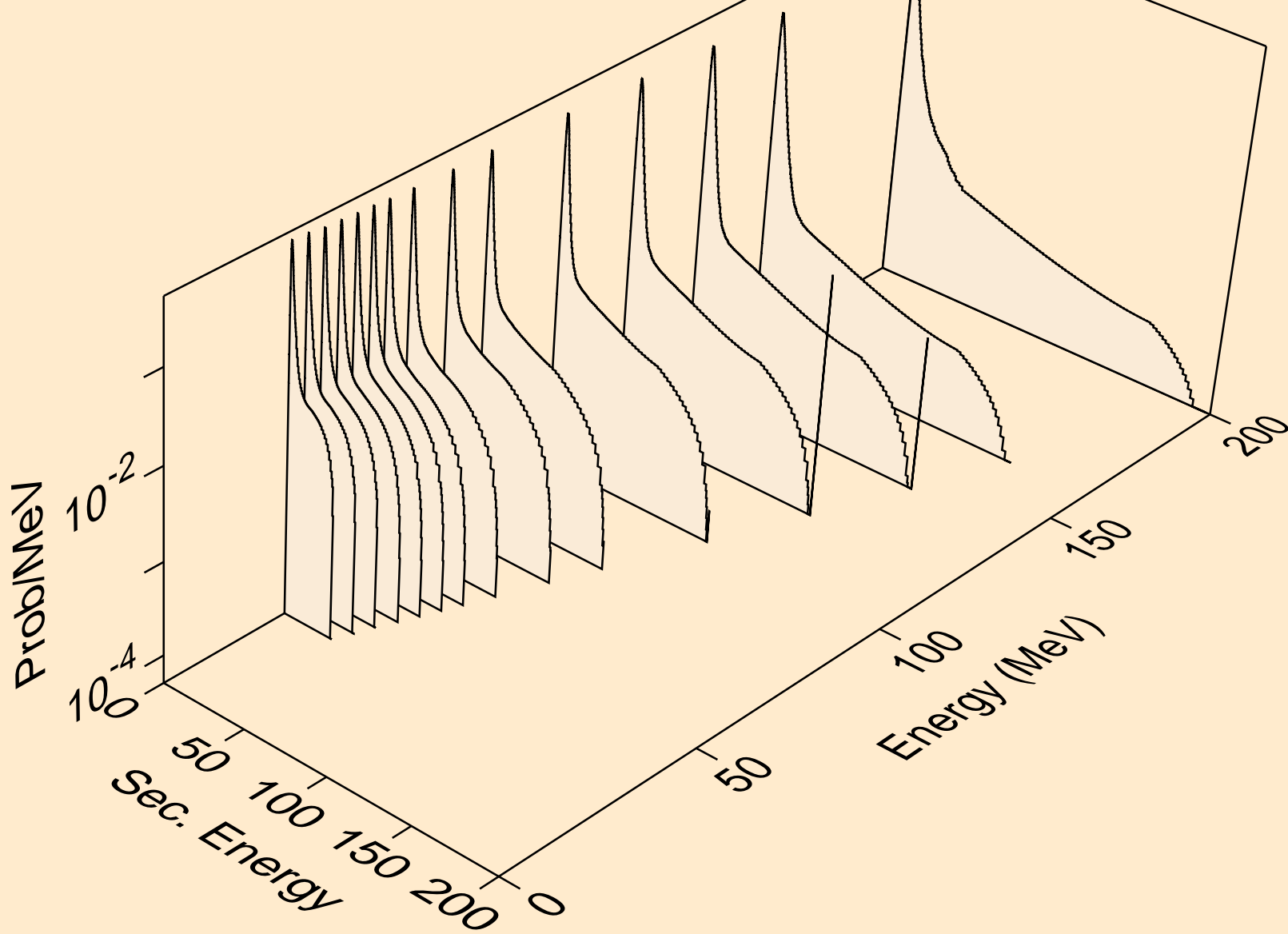

TB146M NEUTRON ACER TENDL-2019 LIBRARY; T=293.16K
Neutron emission for (n,2nd)

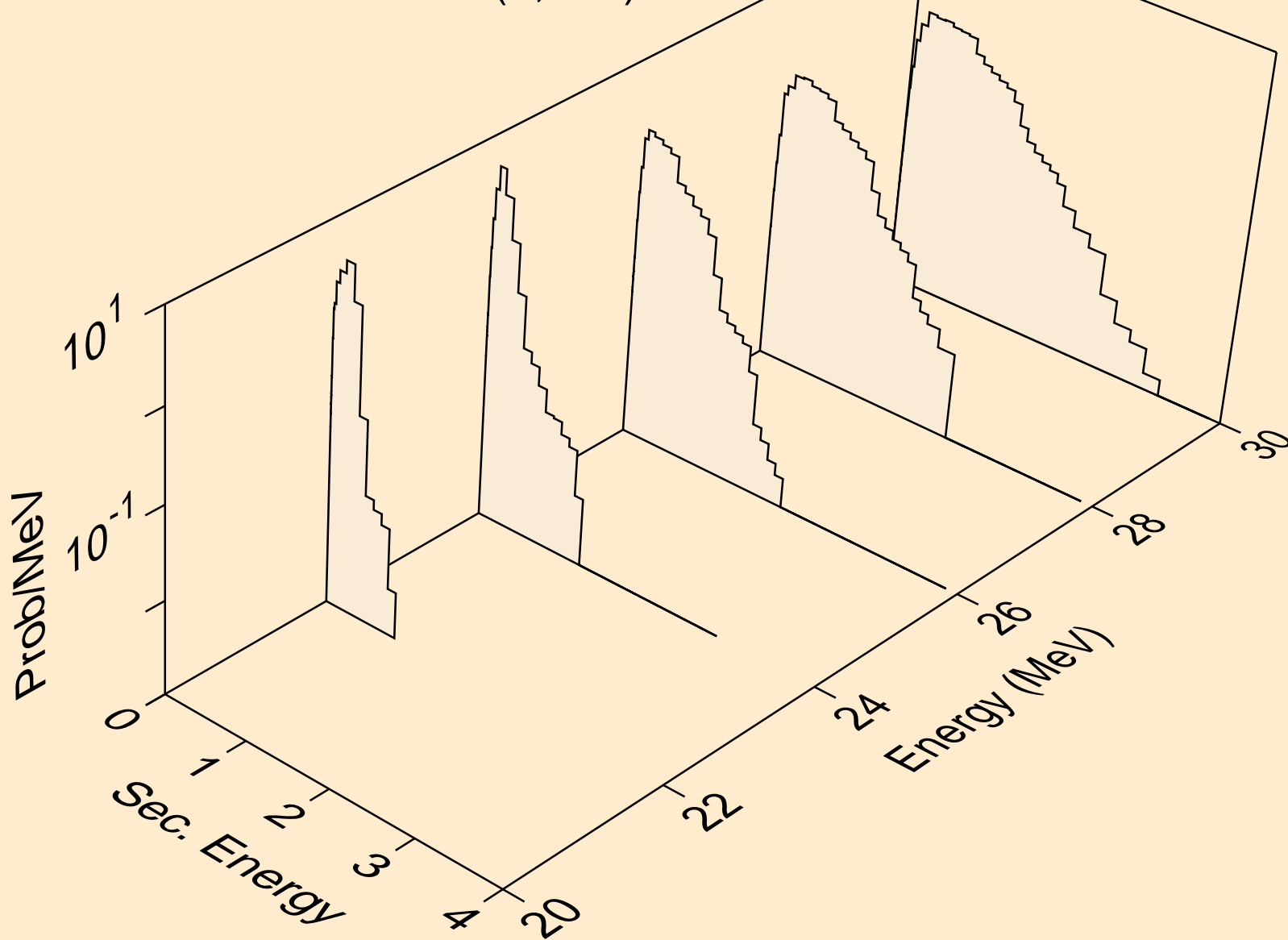

TB146M NEUTRON ACER TENDL-2019 LIBRARY; T=293.16K
Neutron emission for (n,2n)

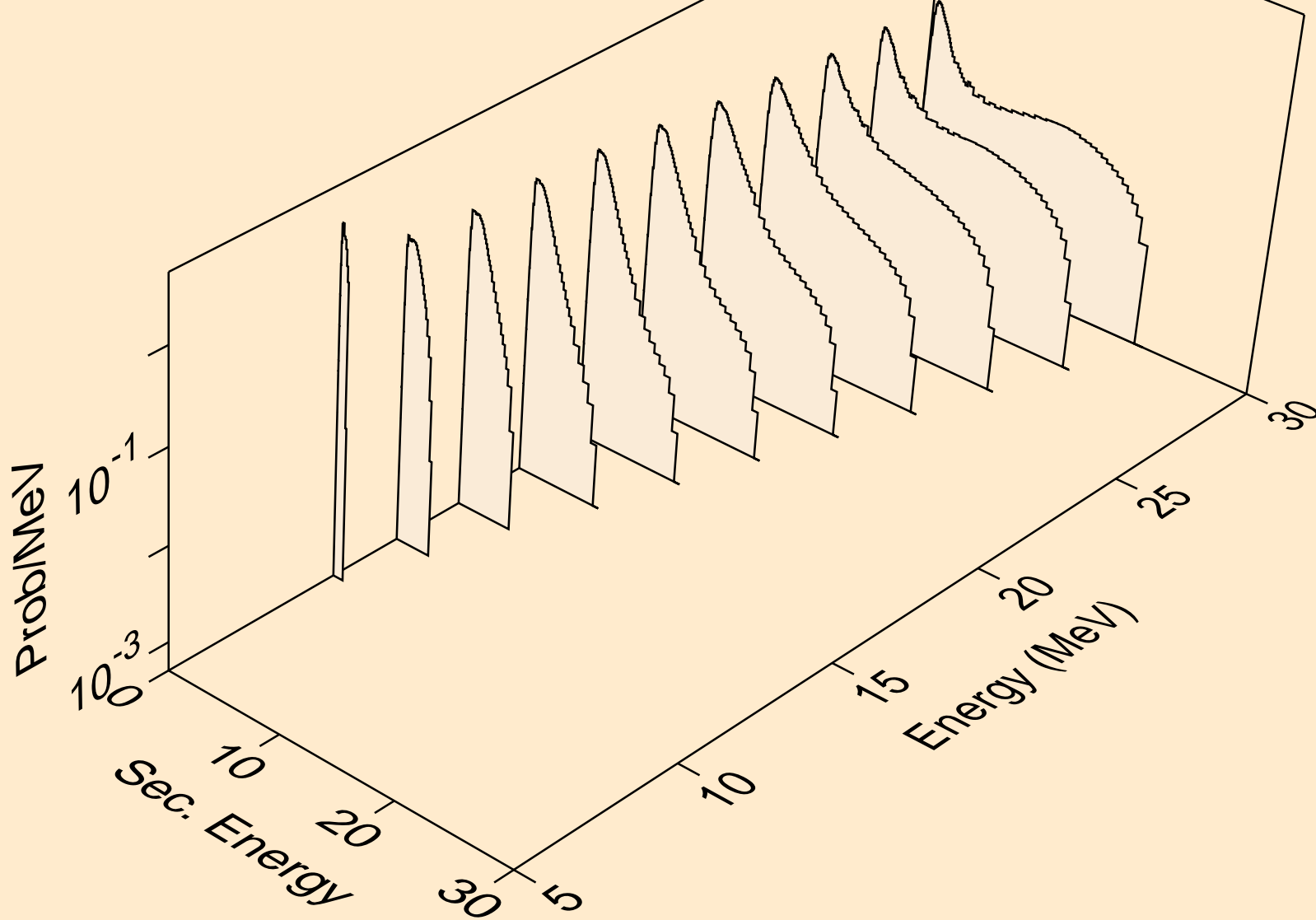

TB146M NEUTRON ACER TENDL-2019 LIBRARY; T=293.16K
Neutron emission for (n,3n)

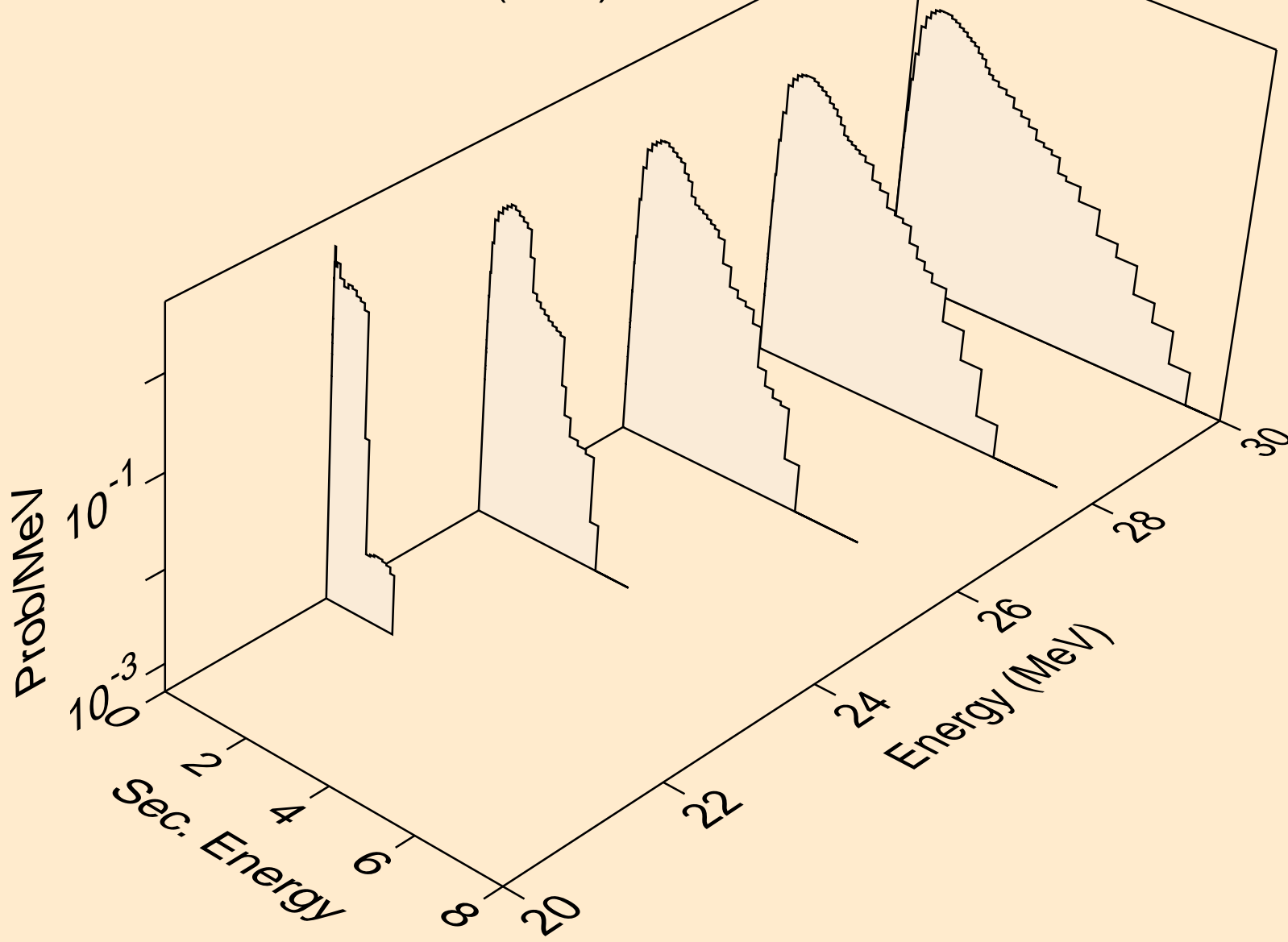

TB146M NEUTRON ACER TENDL-2019 LIBRARY; T=293.16K
Neutron emission for (n,n*)a

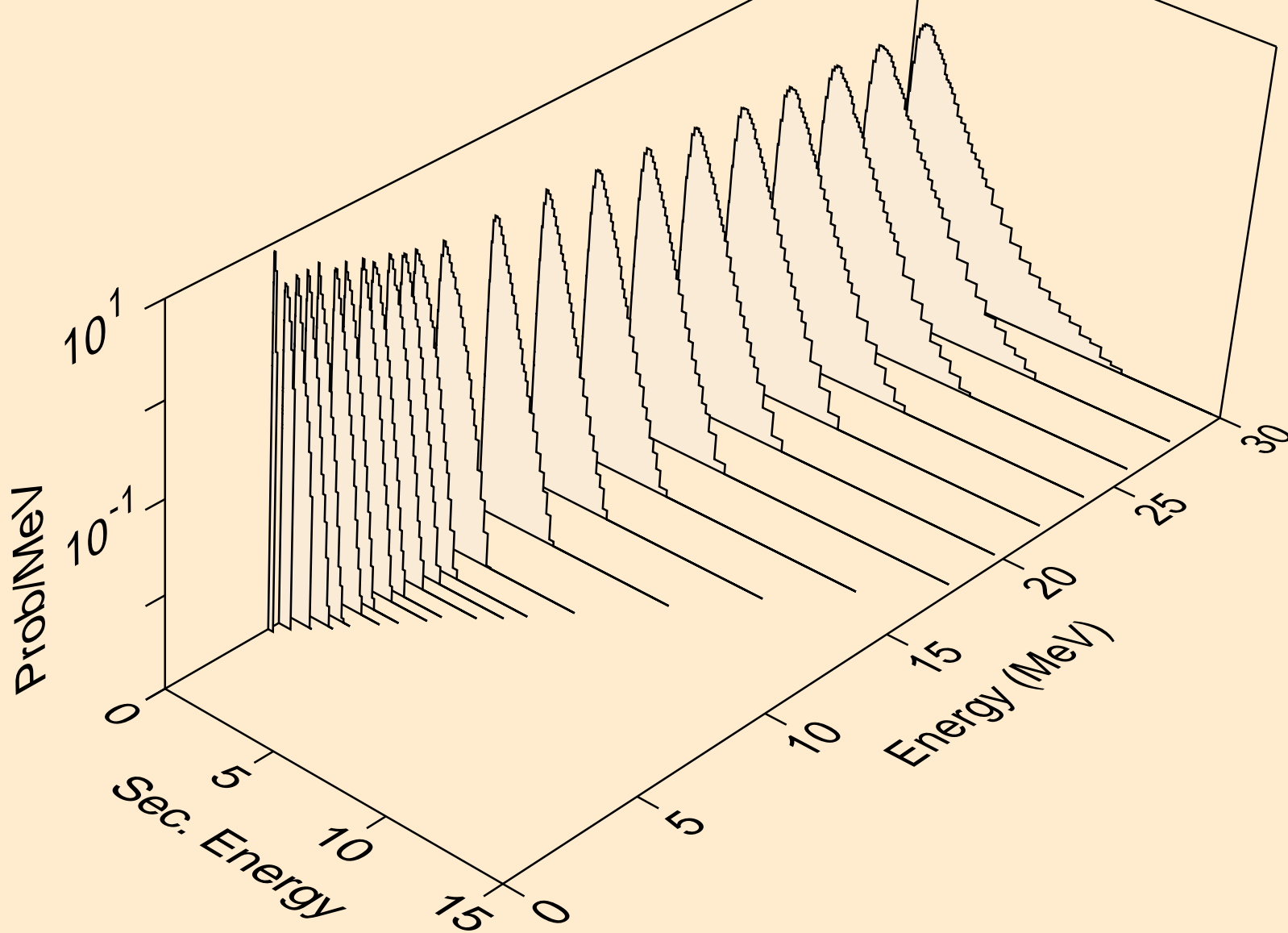

TB146M NEUTRON ACER TENDL-2019 LIBRARY; T=293.16K
Neutron emission for (n,2n)a

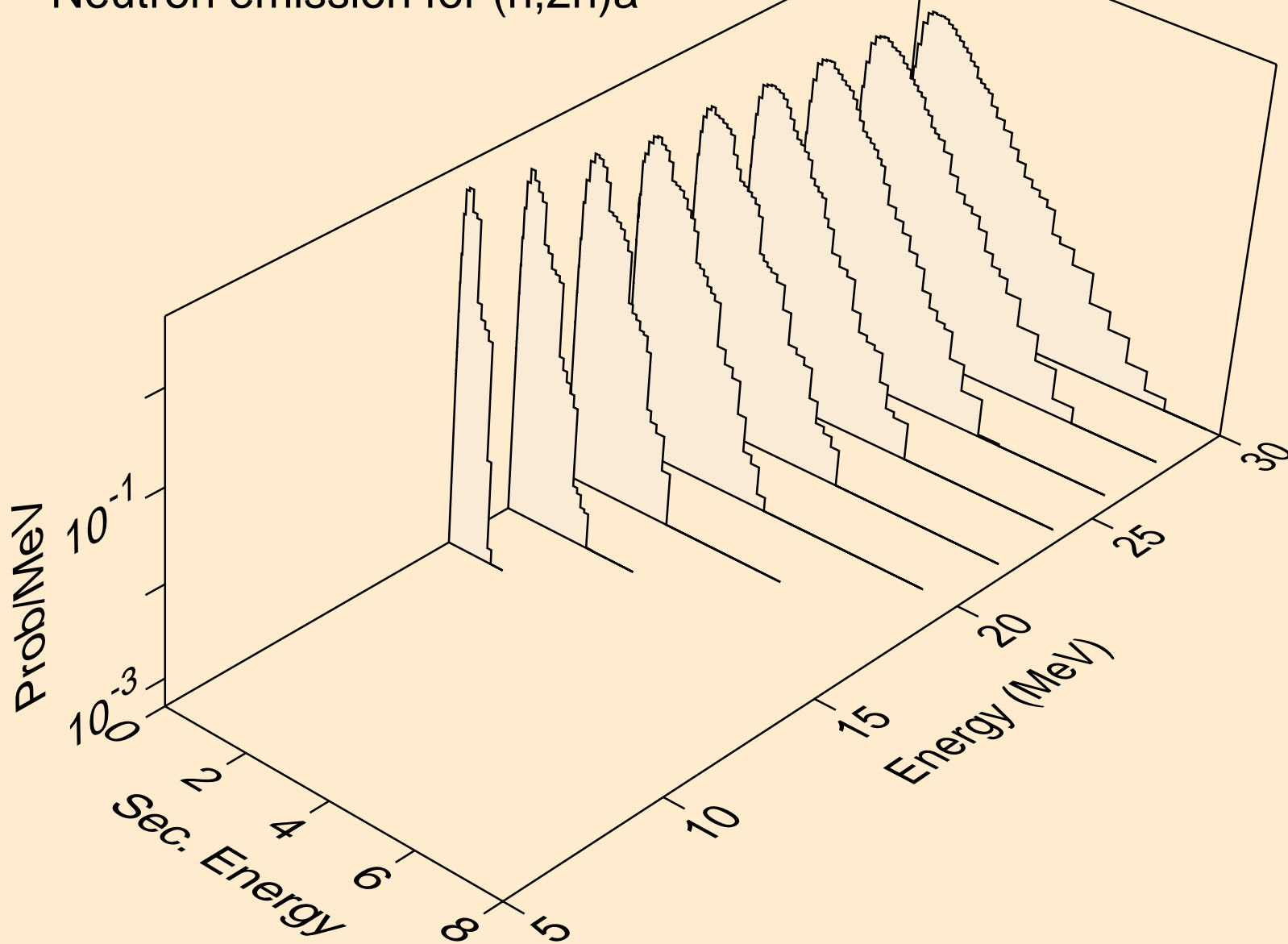

TB146M NEUTRON ACER TENDL-2019 LIBRARY; T=293.16K
Neutron emission for (n,3n)a

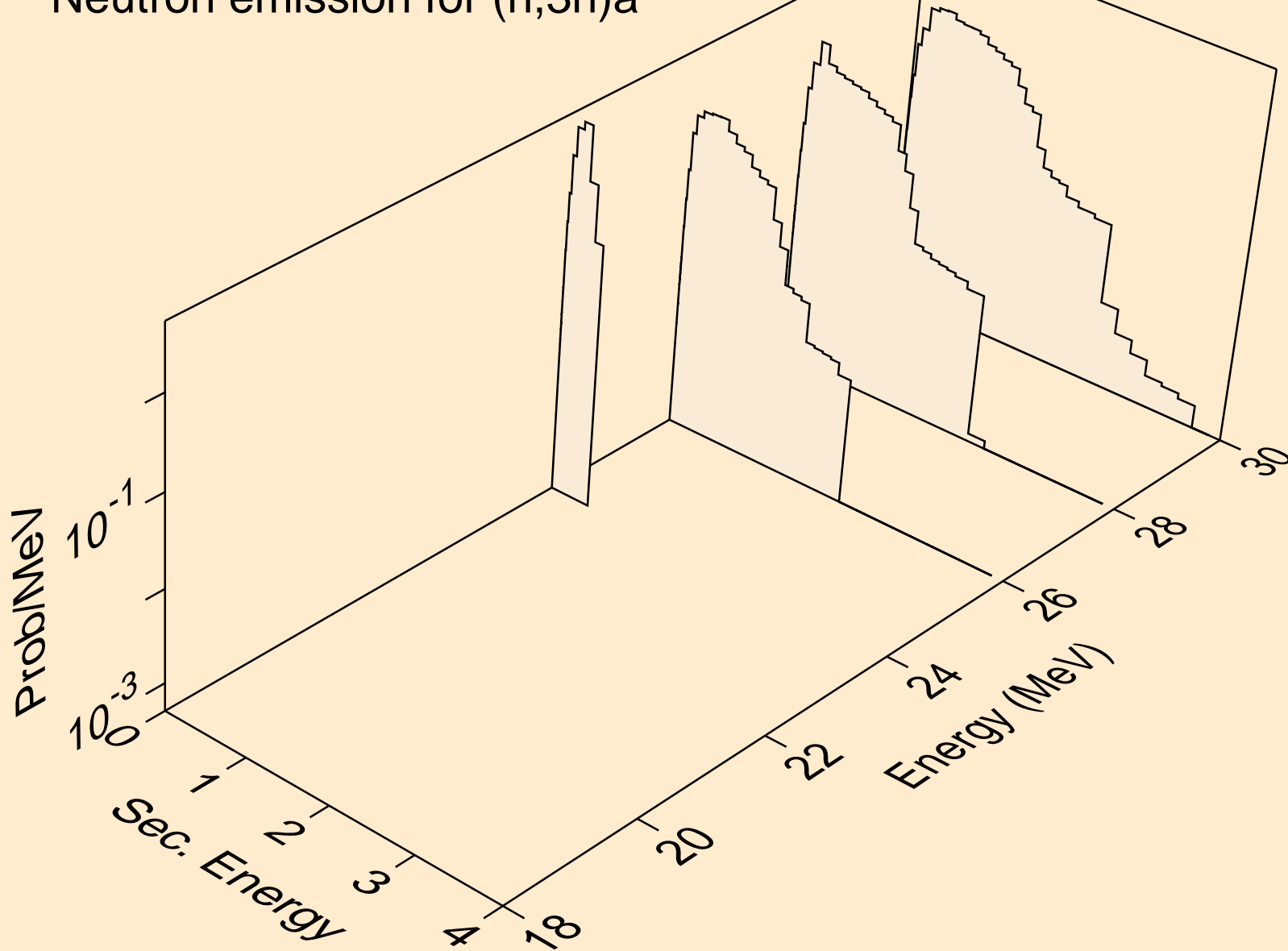

TB146M NEUTRON ACER TENDL-2019 LIBRARY; T=293.16K
Neutron emission for (n,n*)p

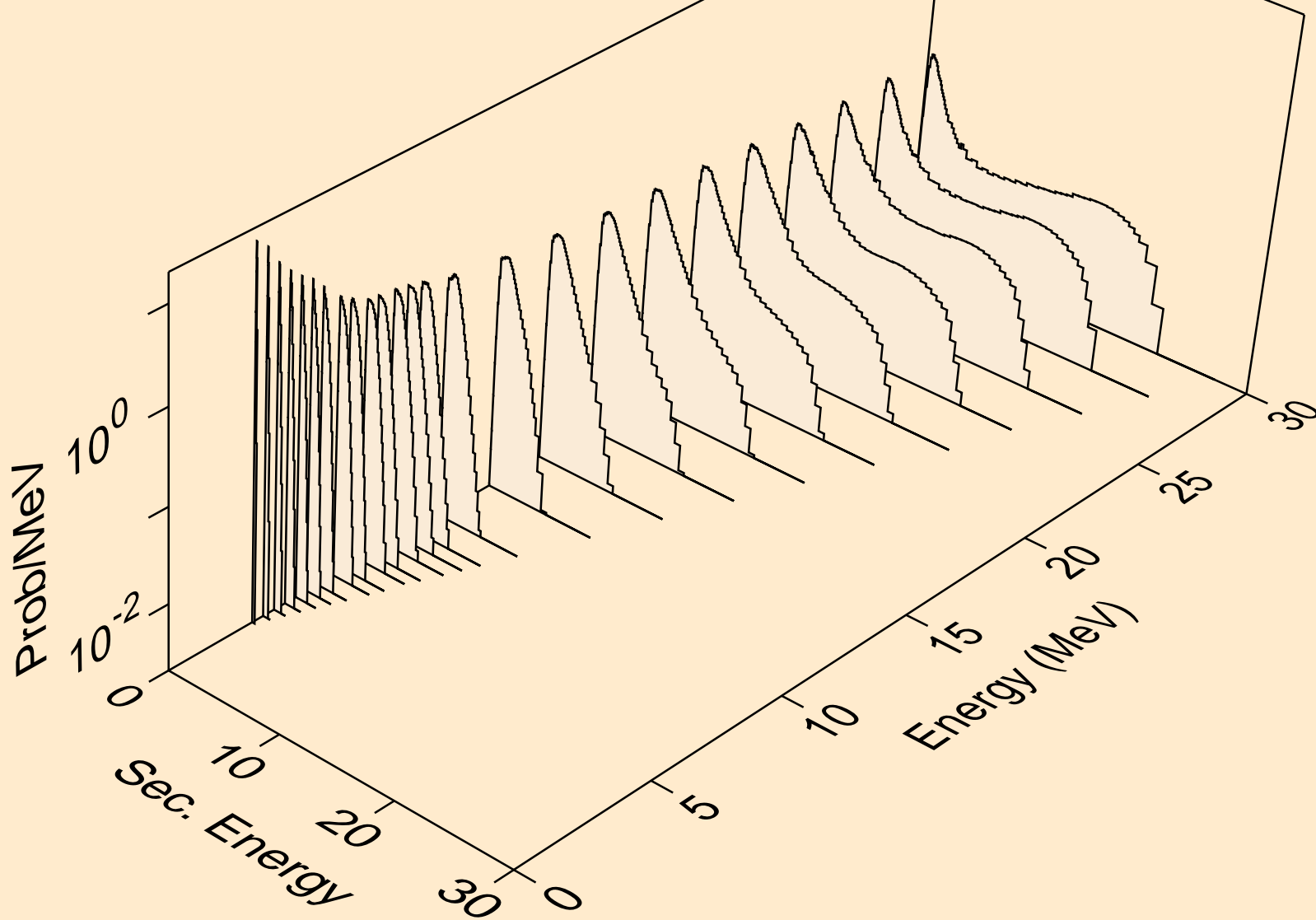

TB146M NEUTRON ACER TENDL-2019 LIBRARY; T=293.16K
Neutron emission for (n,n*)2a

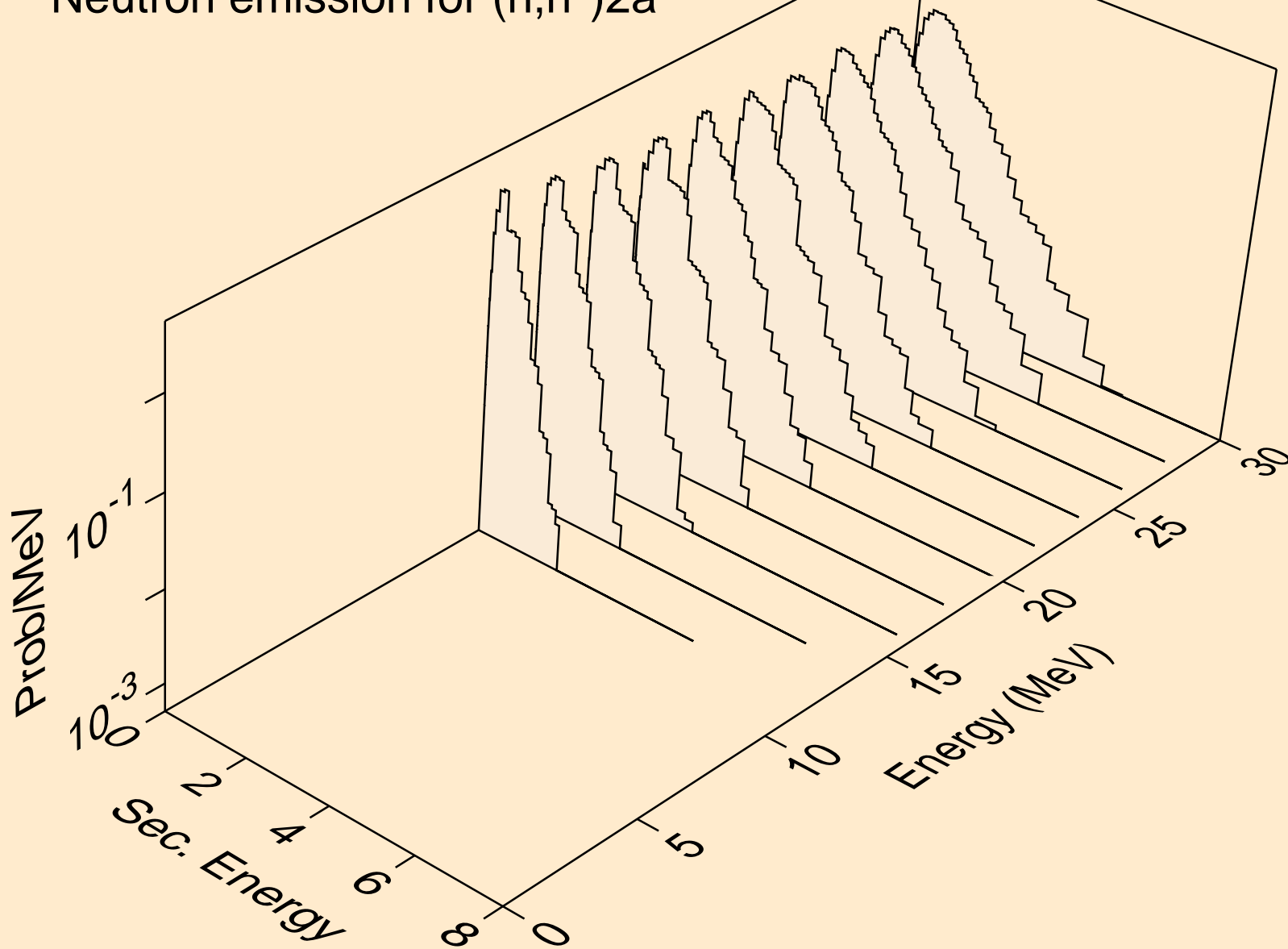

TB146M NEUTRON ACER TENDL-2019 LIBRARY; T=293.16K
Neutron emission for (n,2n)2a

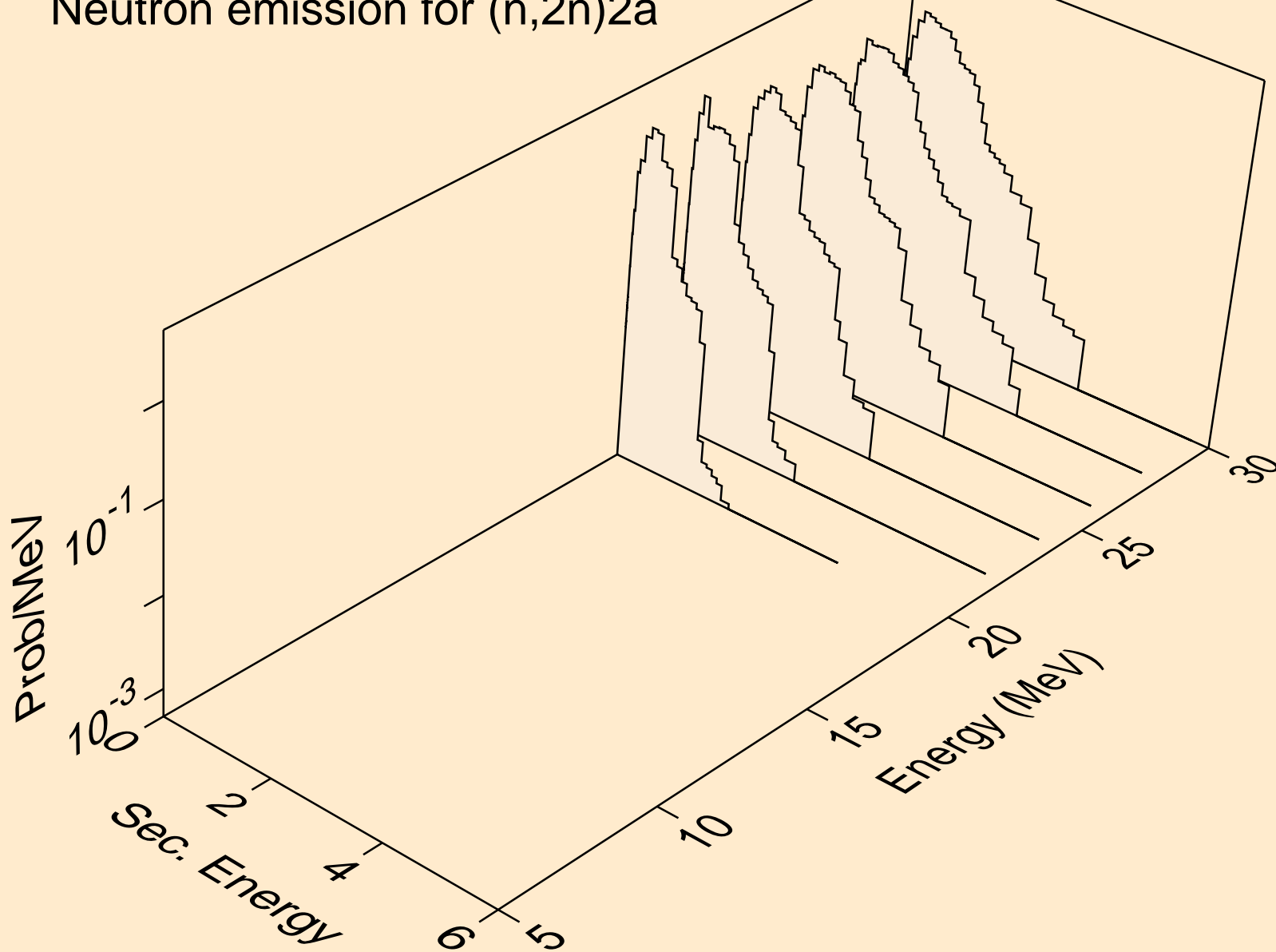

TB146M NEUTRON ACER TENDL-2019 LIBRARY; T=293.16K
Neutron emission for (n,n*)d

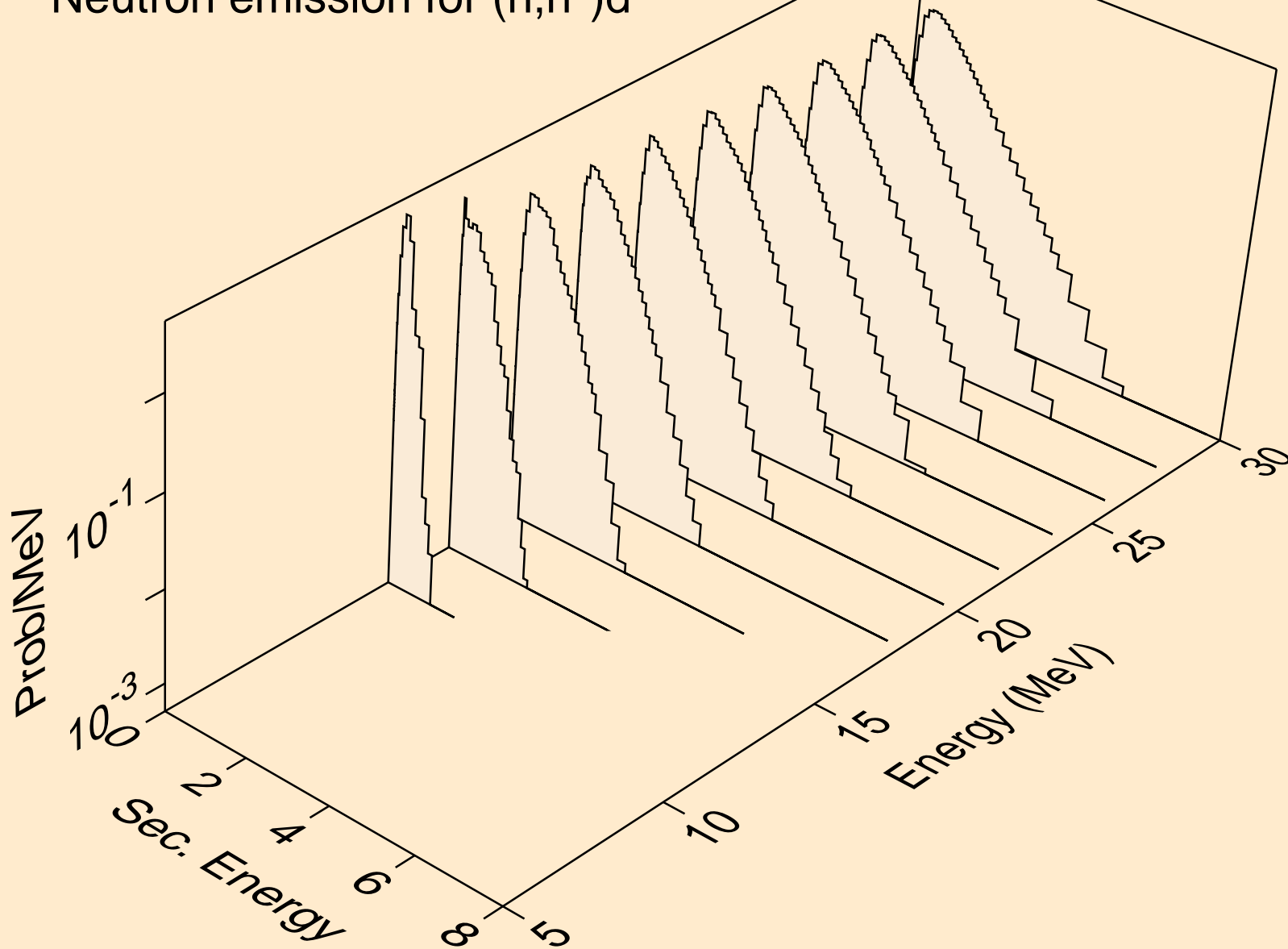

TB146M NEUTRON ACER TENDL-2019 LIBRARY; T=293.16K
Neutron emission for (n,n*)t

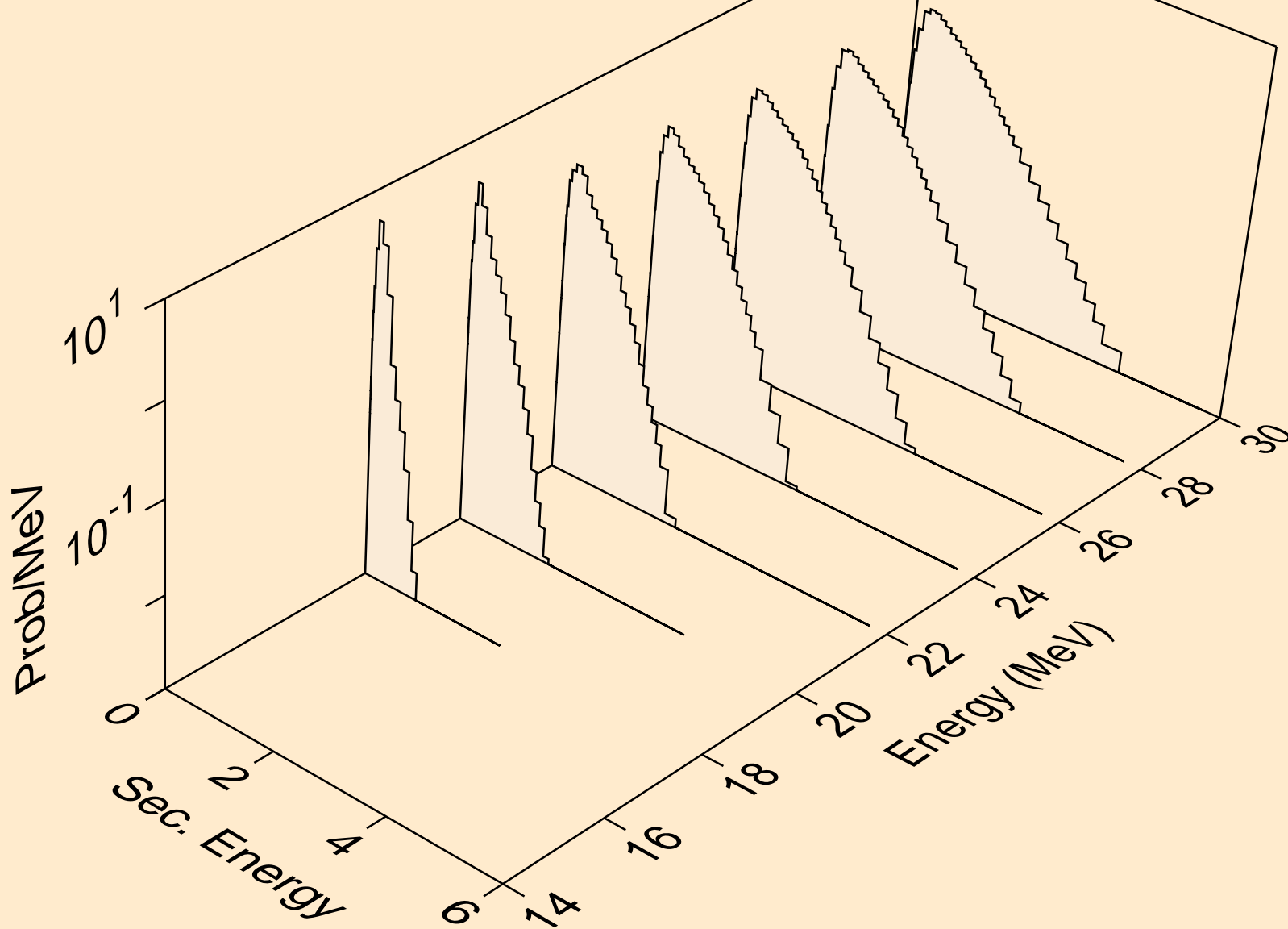

TB146M NEUTRON ACER TENDL-2019 LIBRARY; T=293.16K
Neutron emission for (n,n*)he3

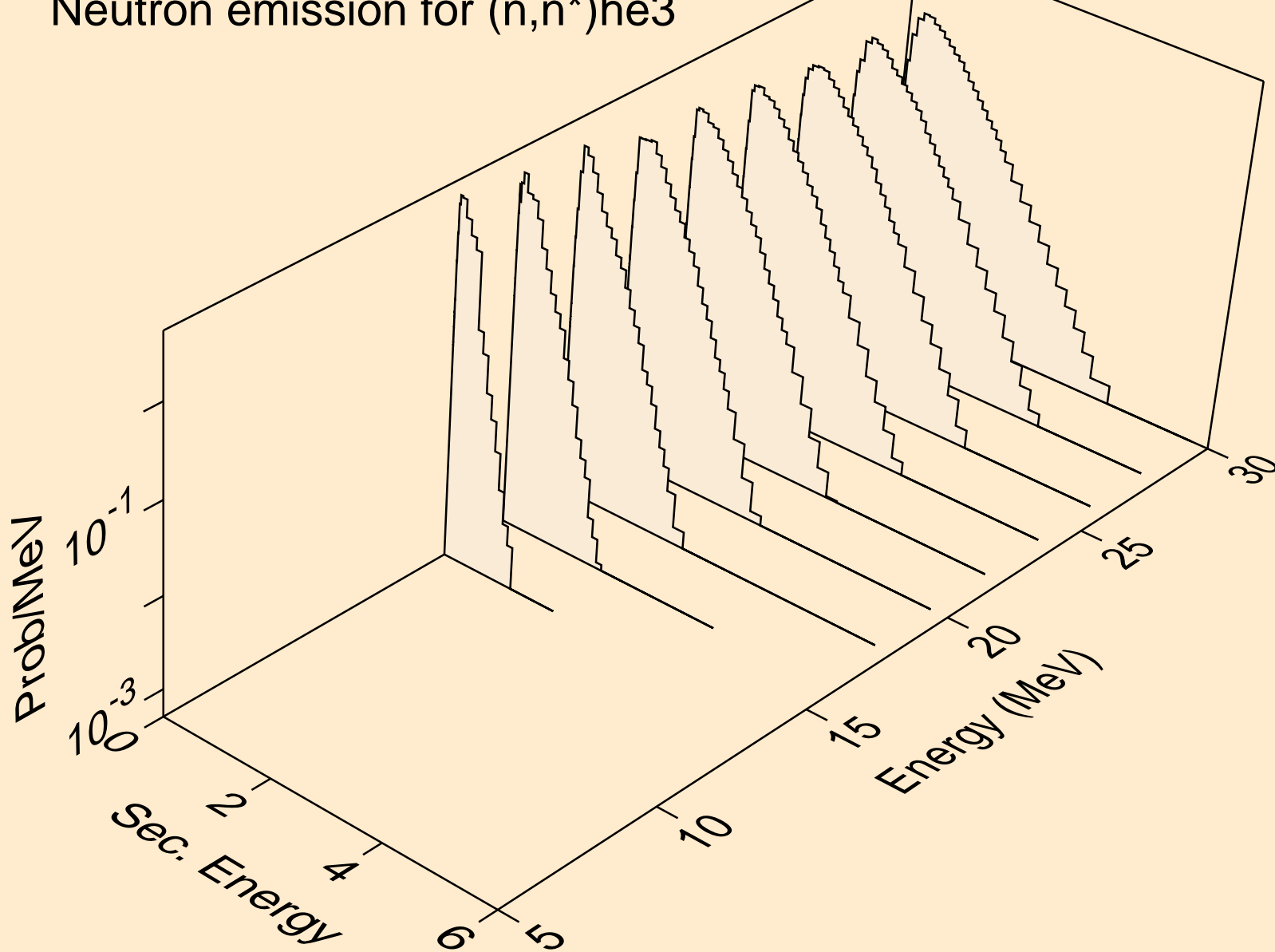

TB146M NEUTRON ACER TENDL-2019 LIBRARY; T=293.16K
Neutron emission for (n,2np)

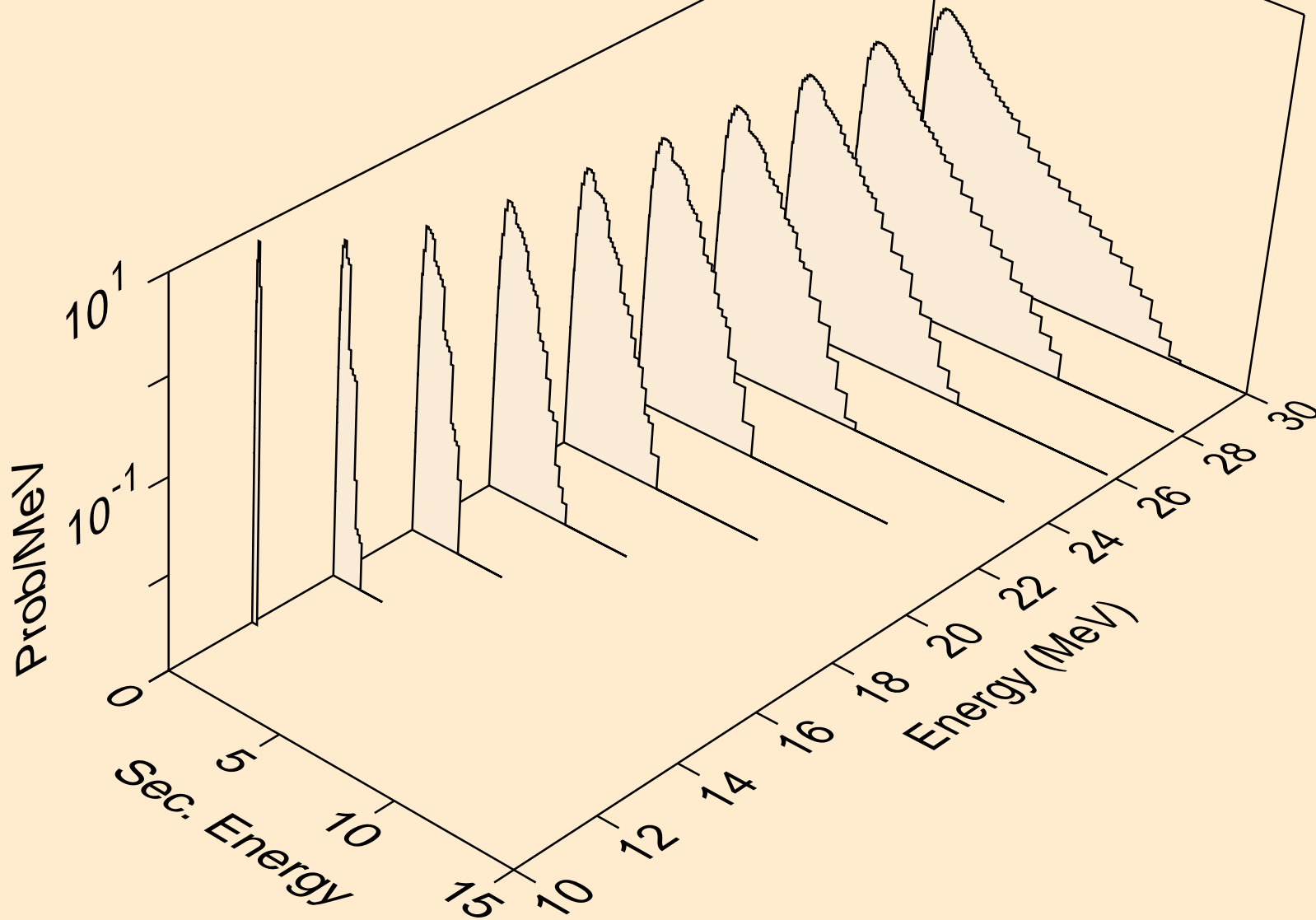

TB146M NEUTRON ACER TENDL-2019 LIBRARY; T=293.16K
Neutron emission for (n,3np)

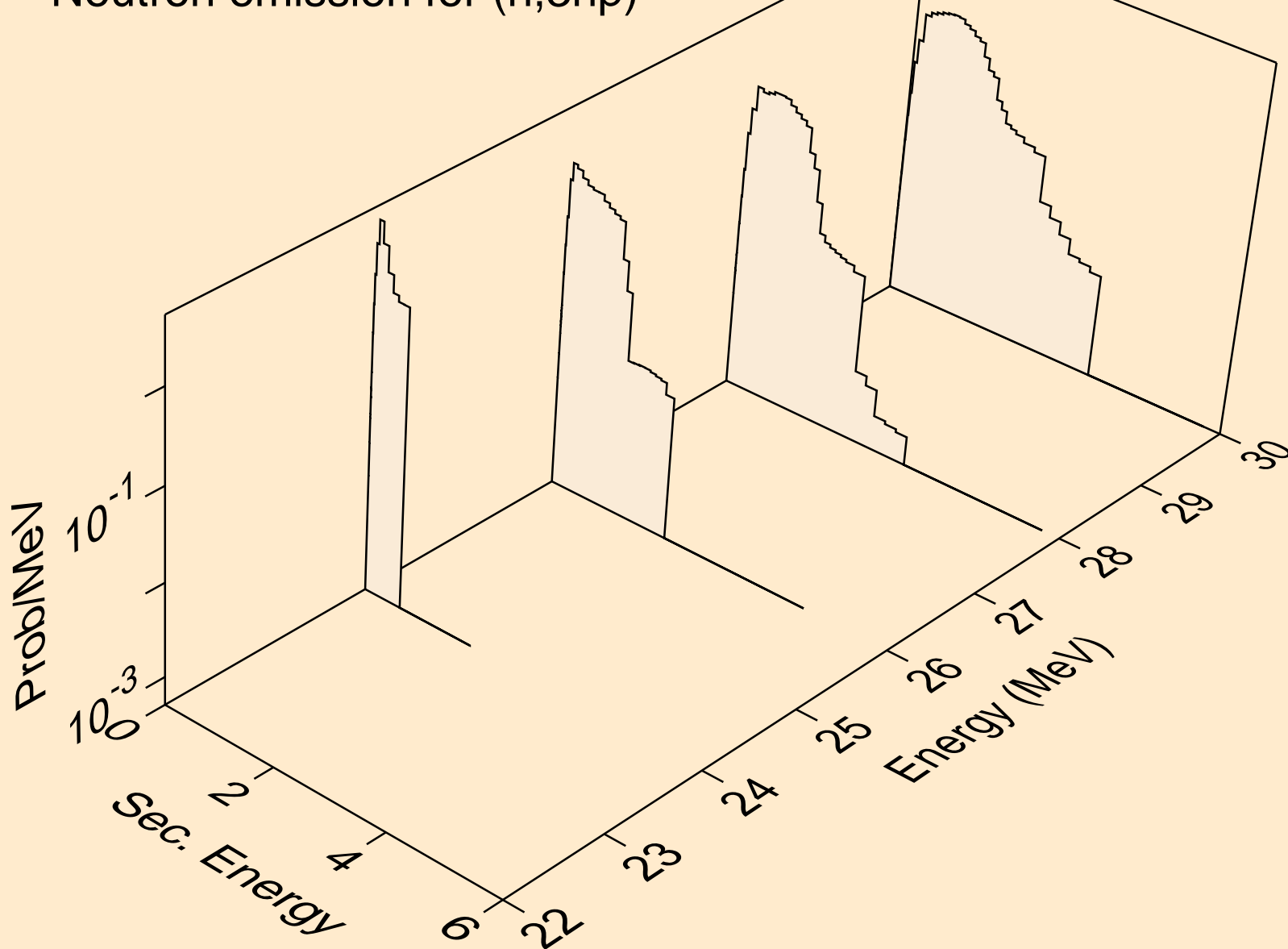

TB146M NEUTRON ACER TENDL-2019 LIBRARY; T=293.16K
Neutron emission for (n,2np)

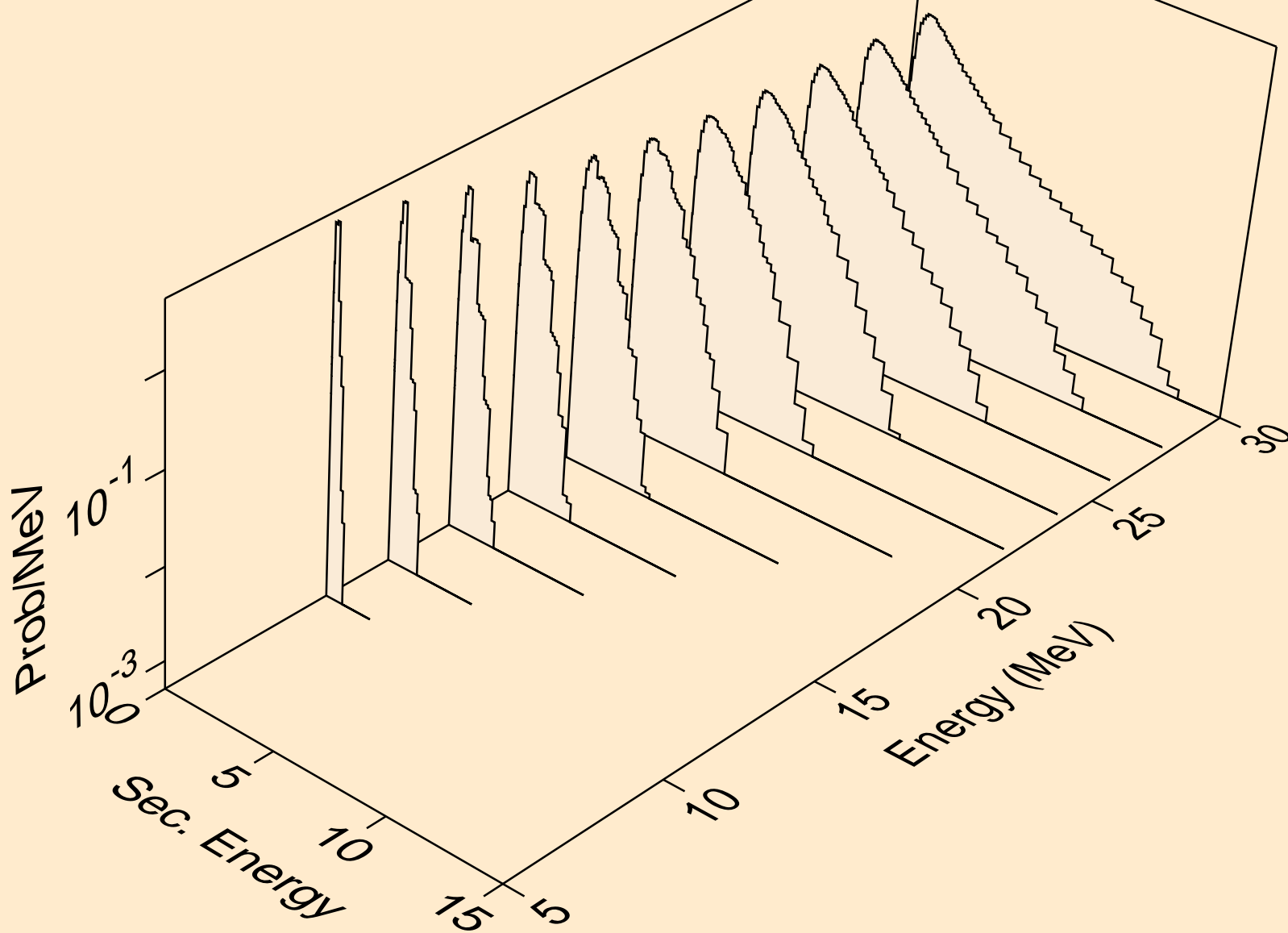

TB146M NEUTRON ACER TENDL-2019 LIBRARY; T=293.16K
Neutron emission for (n,npa)

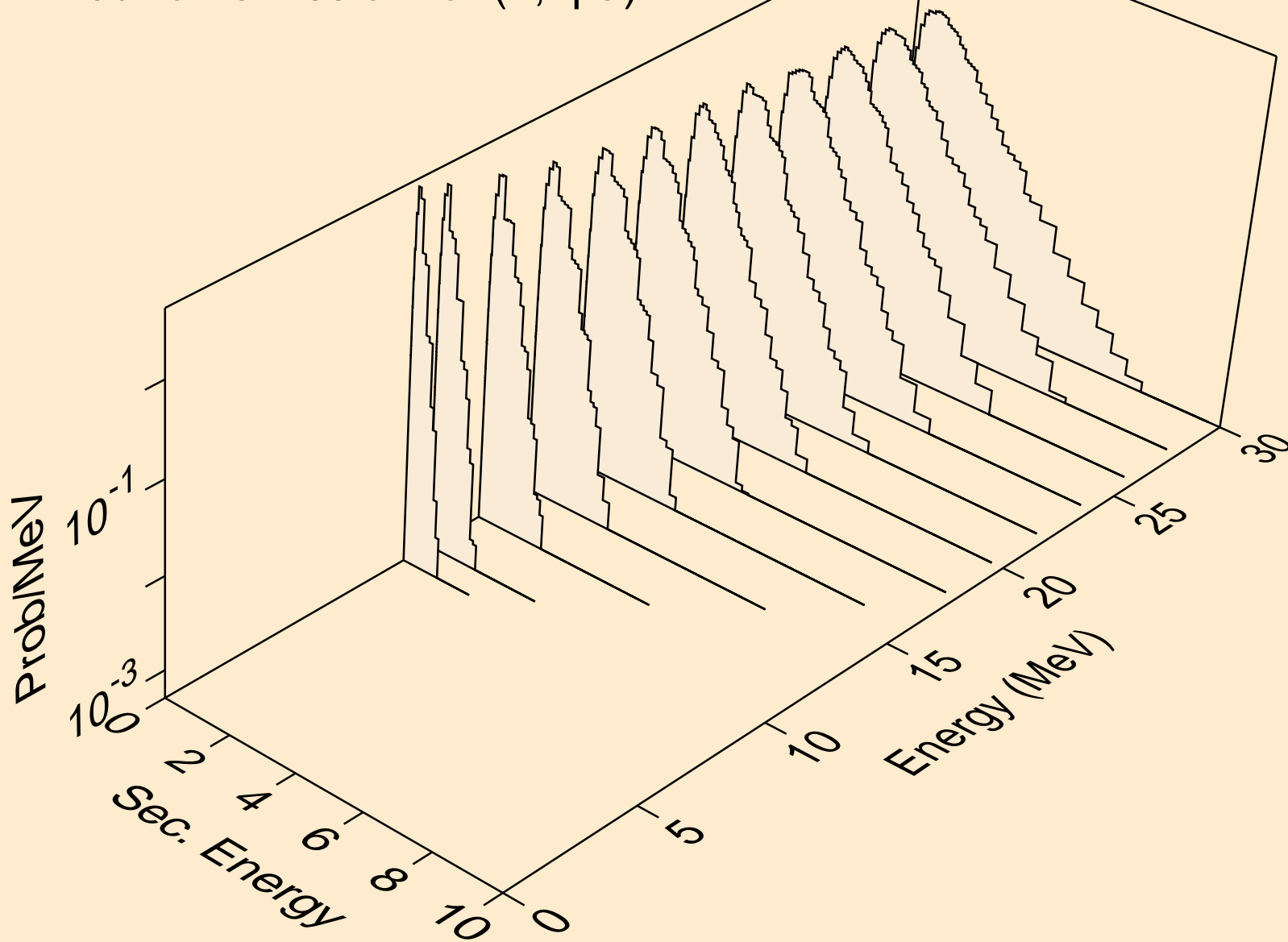

TB146M NEUTRON ACER TENDL-2019 LIBRARY; T=293.16K
Neutron emission for (n,n*c)

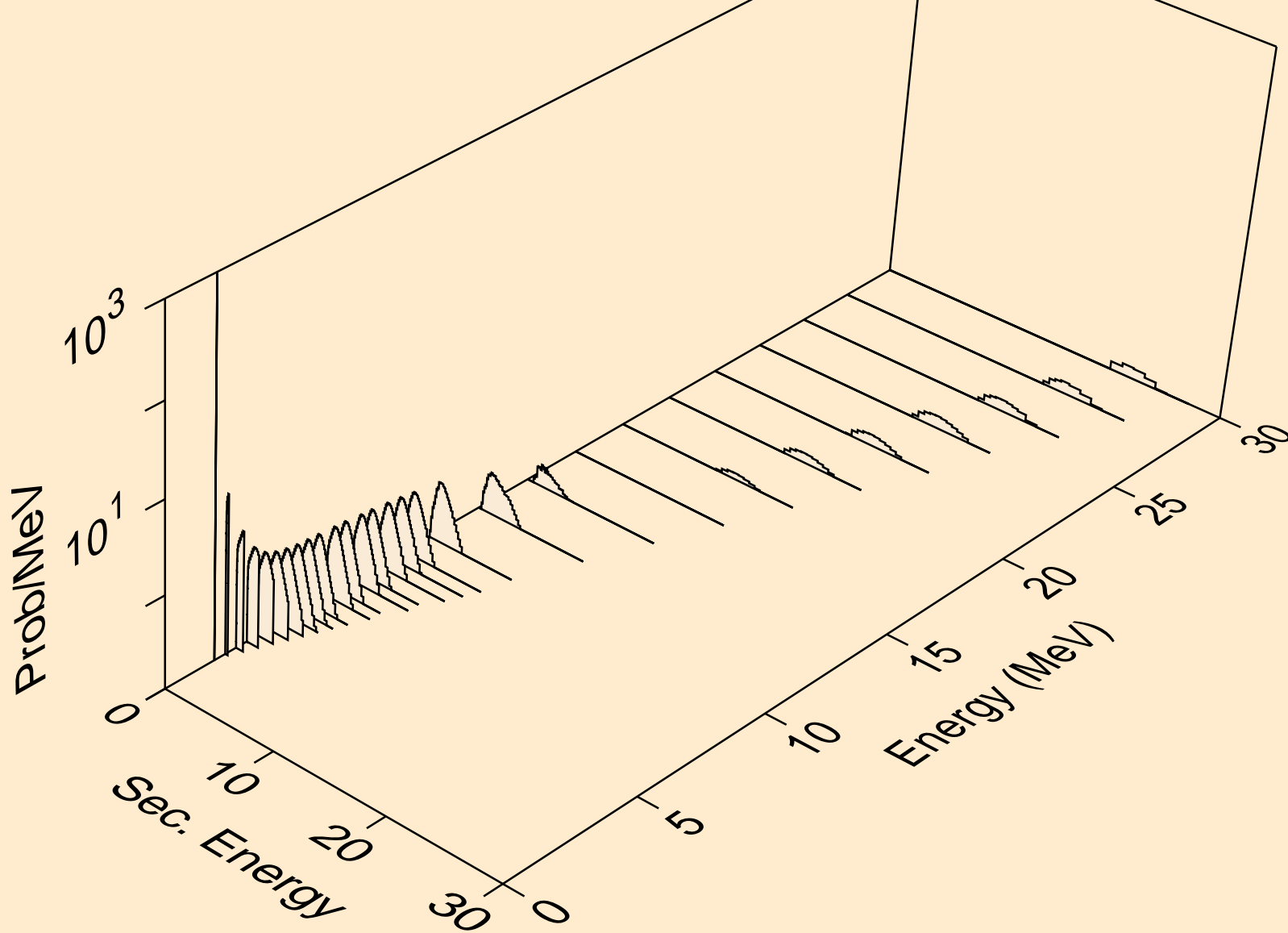

TB146M NEUTRON ACER TENDL-2019 LIBRARY; T=293.16K
Photon emission for (n,x)

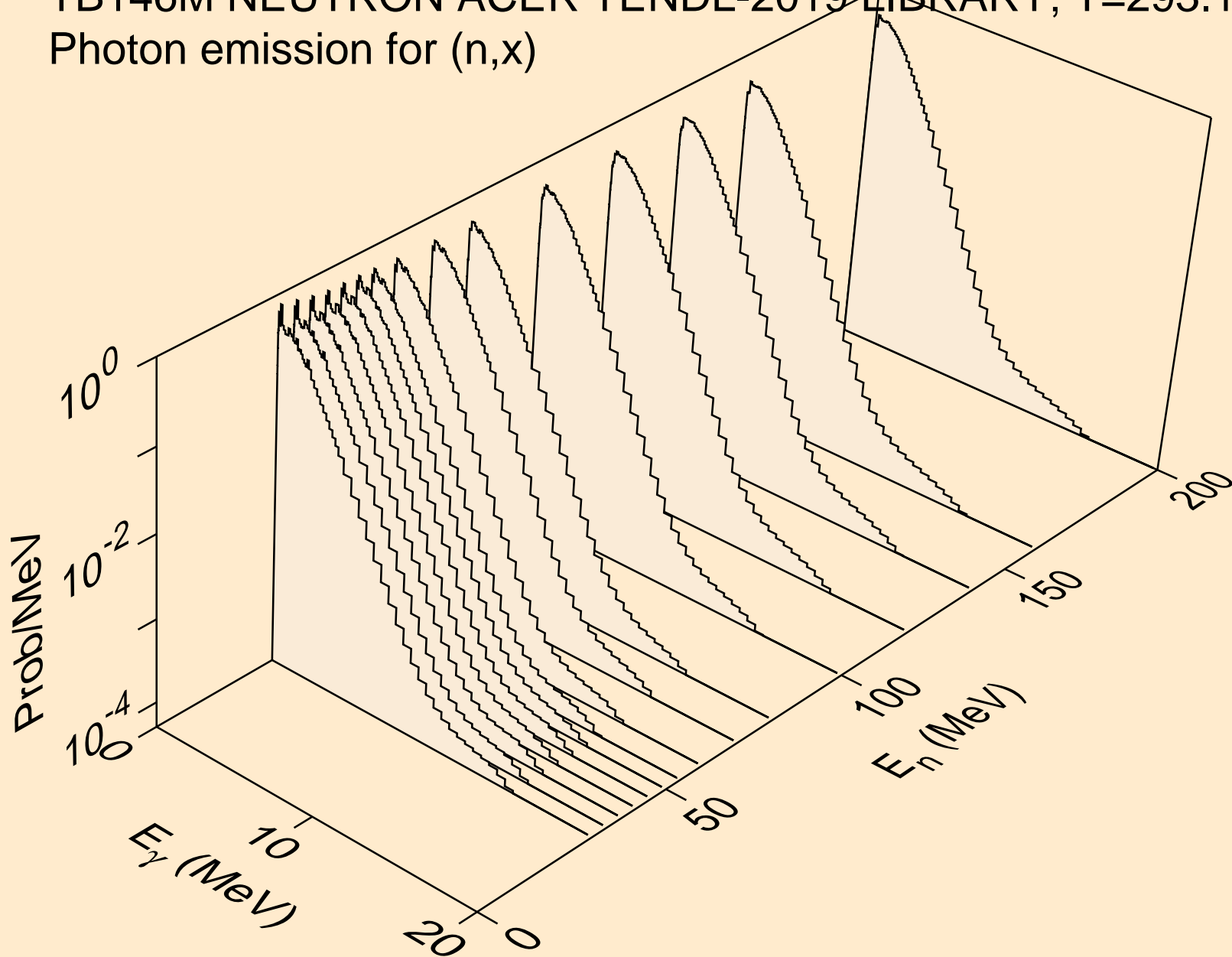

TB146M NEUTRON ACER TENDL-2019 LIBRARY; T=293.16K
Photon emission for (n,2nd)

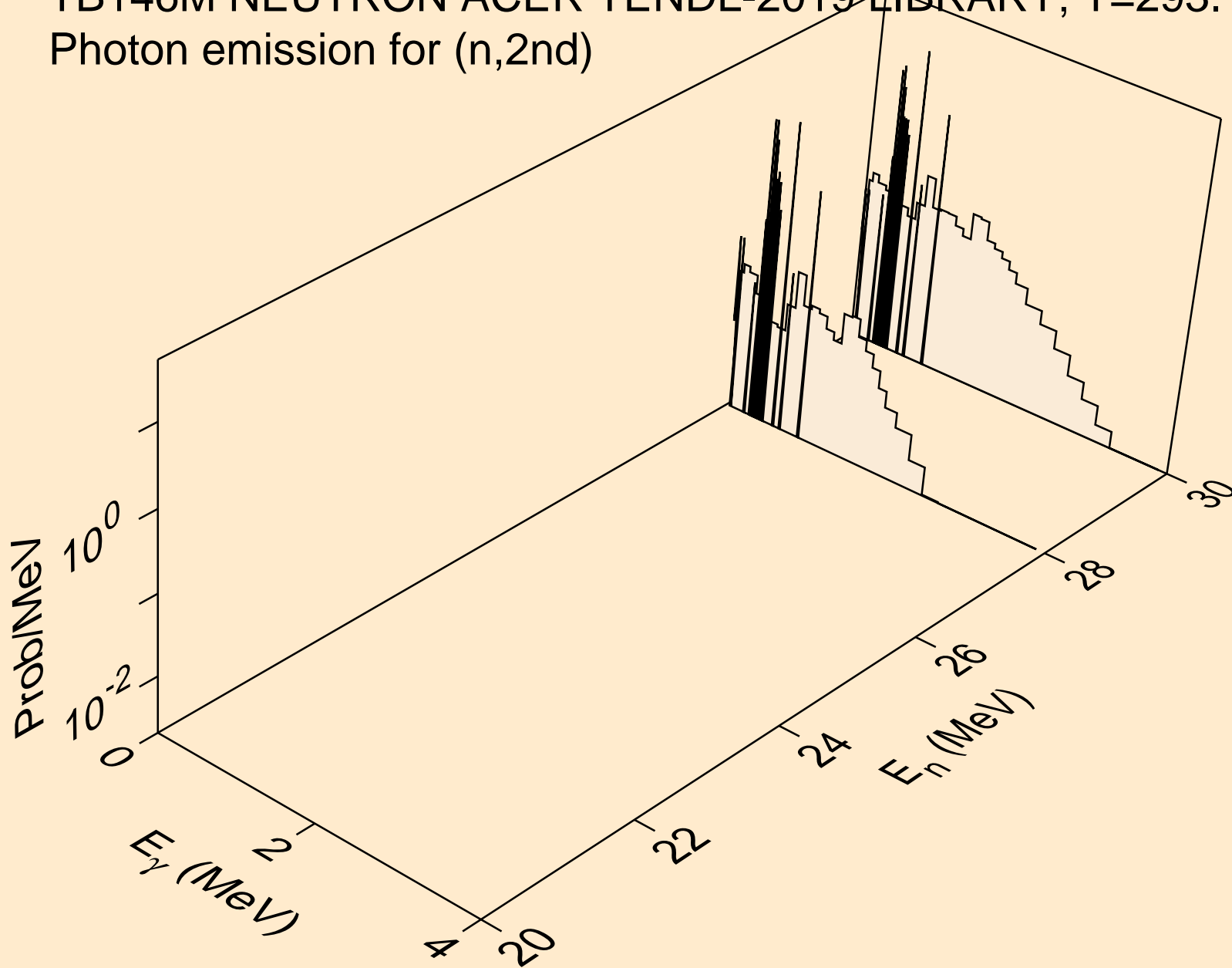

TB146M NEUTRON ACER TENDL-2019 LIBRARY; T=293.16K
Photon emission for (n,2n)

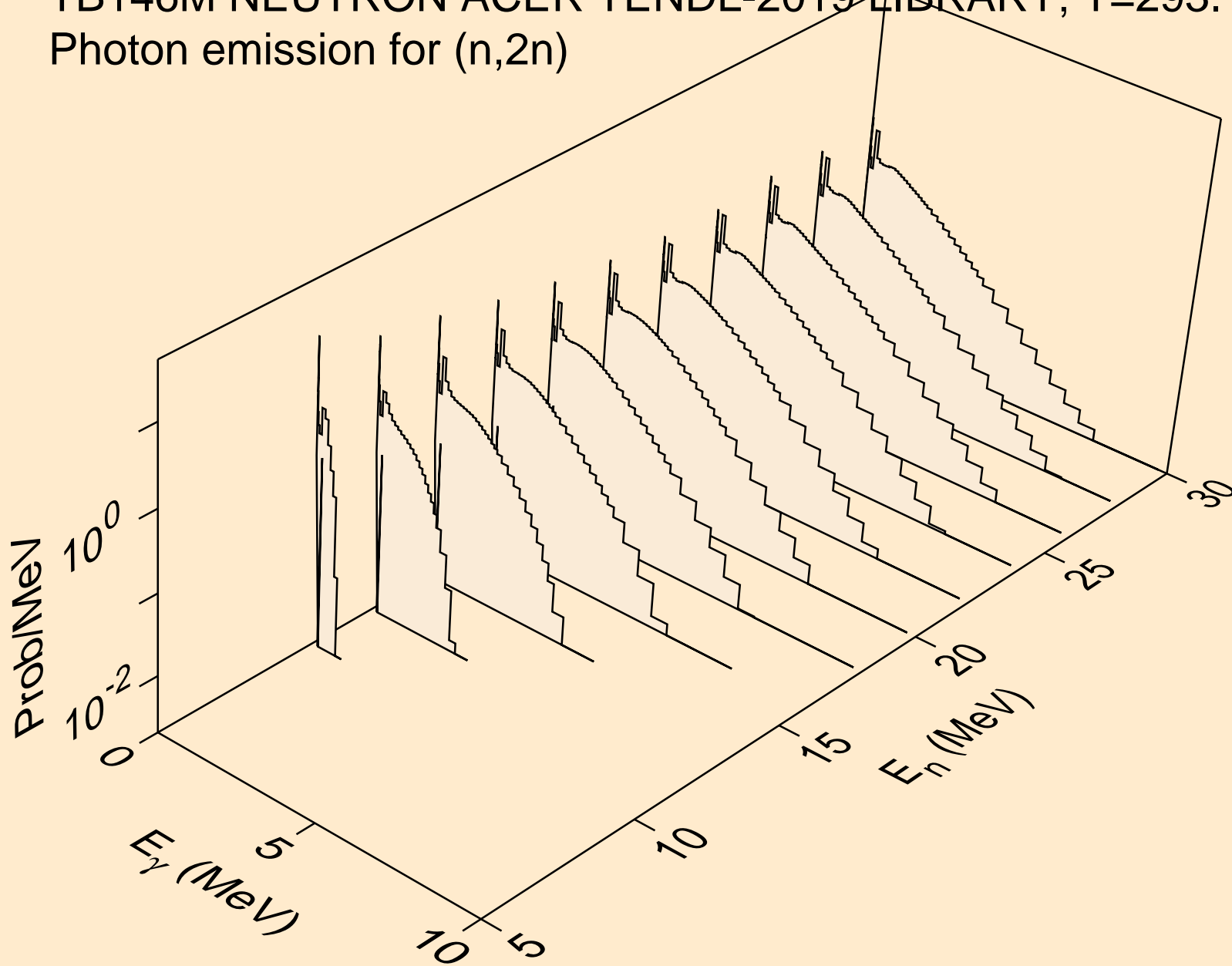

TB146M NEUTRON ACER TENDL-2019 LIBRARY; T=293.16K
Photon emission for (n,3n)

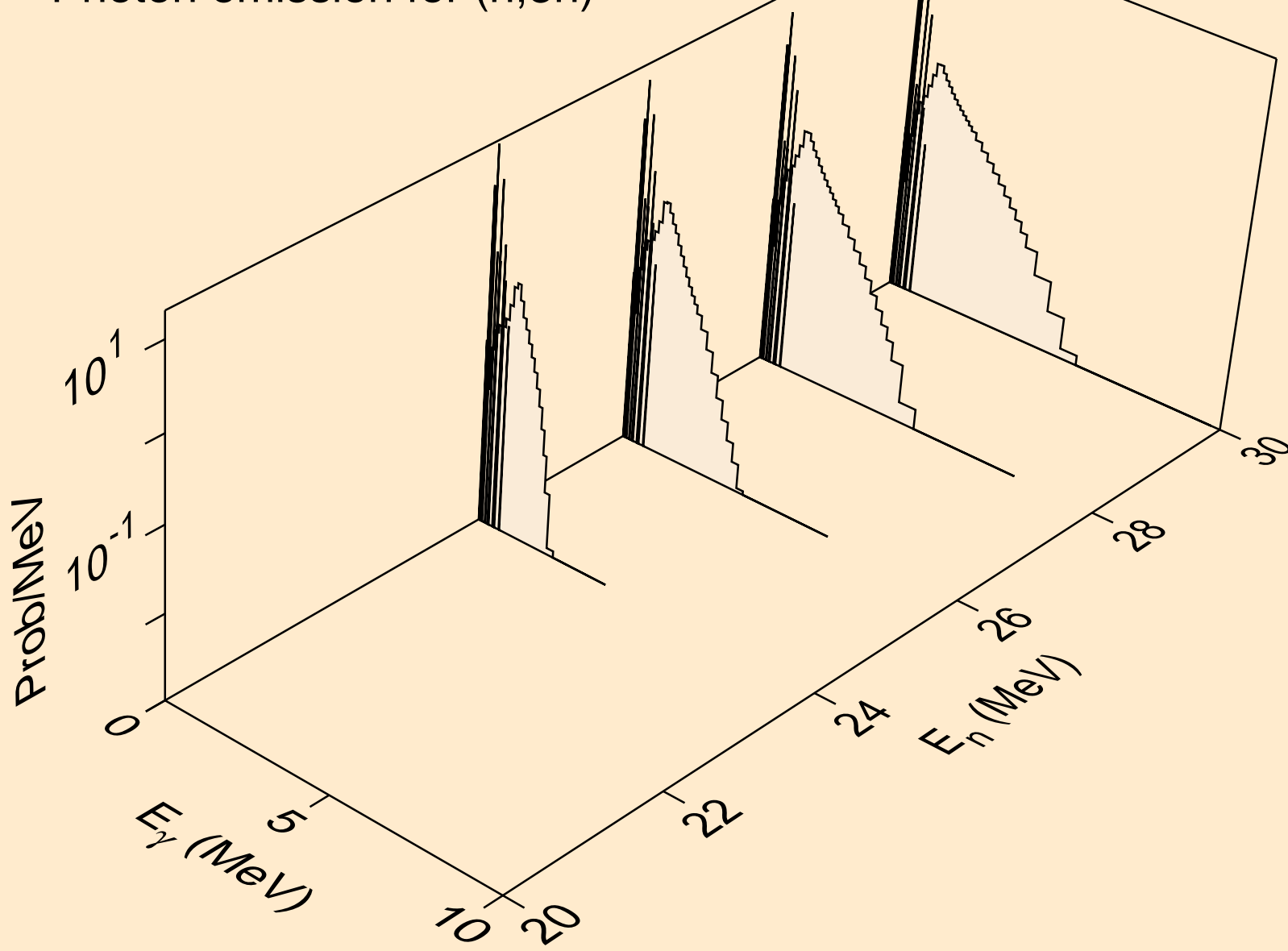

TB146M NEUTRON ACER TENDL-2019 LIBRARY; T=293.16K
Photon emission for (n,n*)a

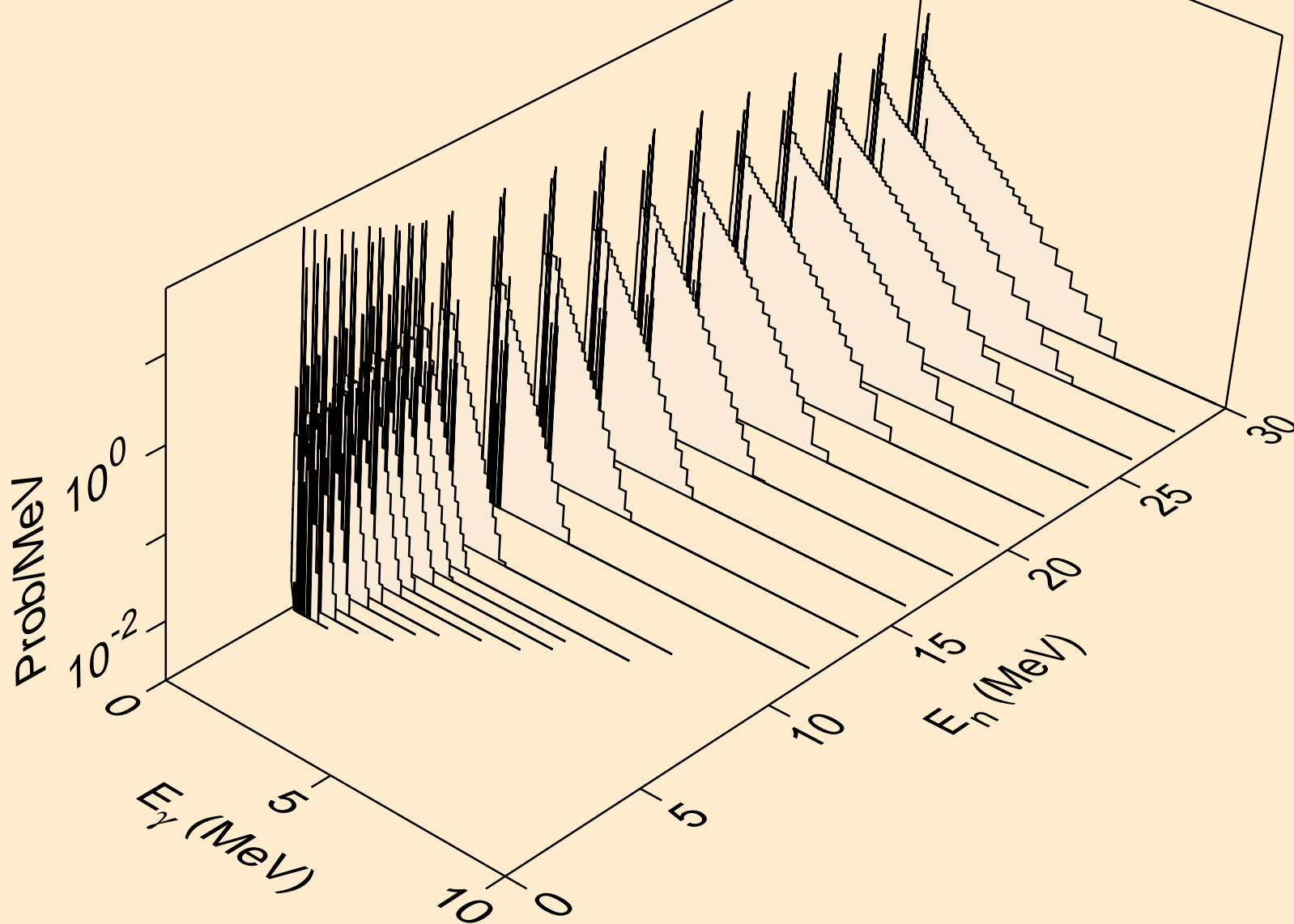

TB146M NEUTRON ACER TENDL-2019 LIBRARY; T=293.16K
Photon emission for (n,2n)a

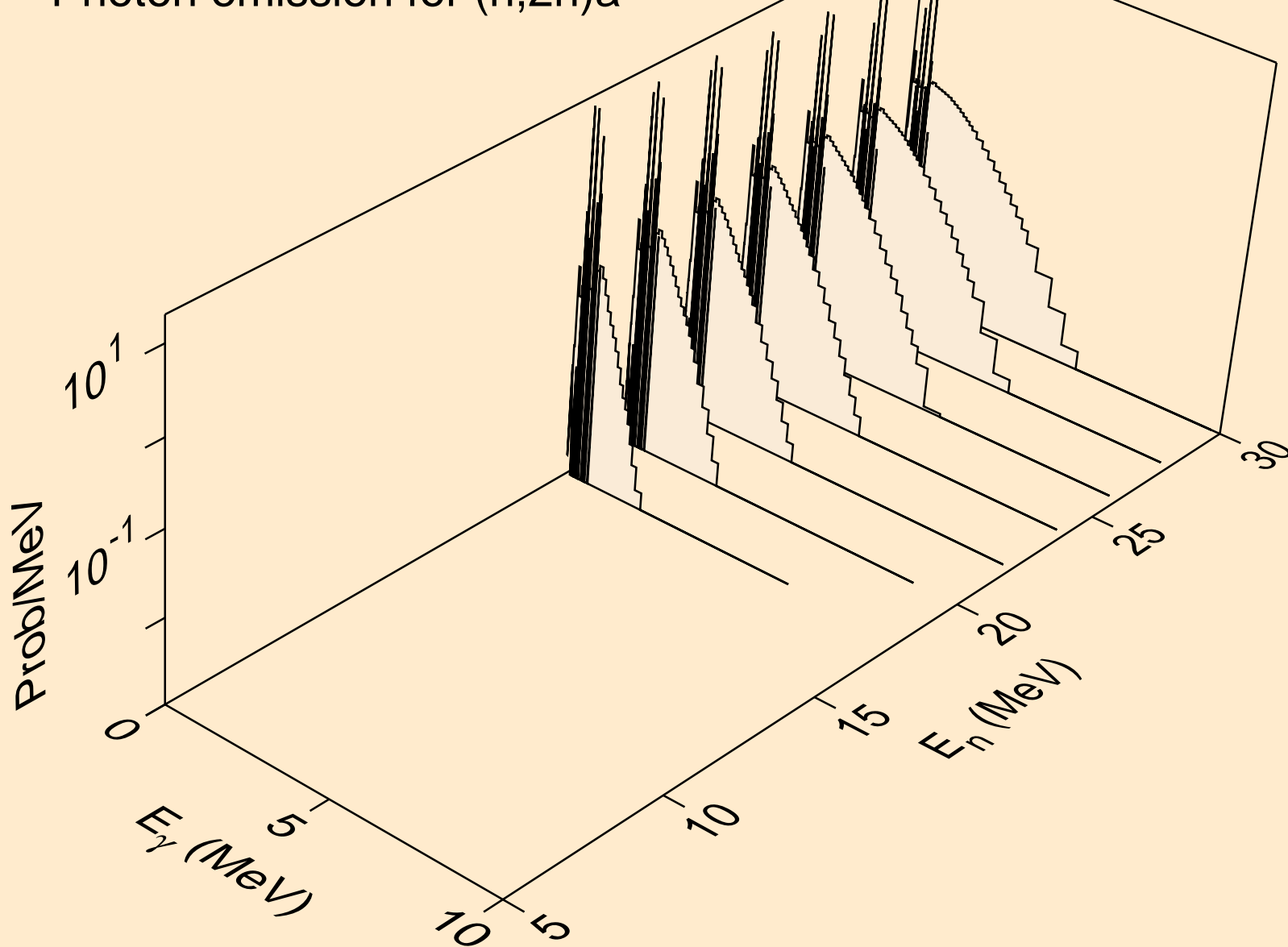

TB146M NEUTRON ACER TENDL-2019 LIBRARY; T=293.16K
Photon emission for (n,3n)a

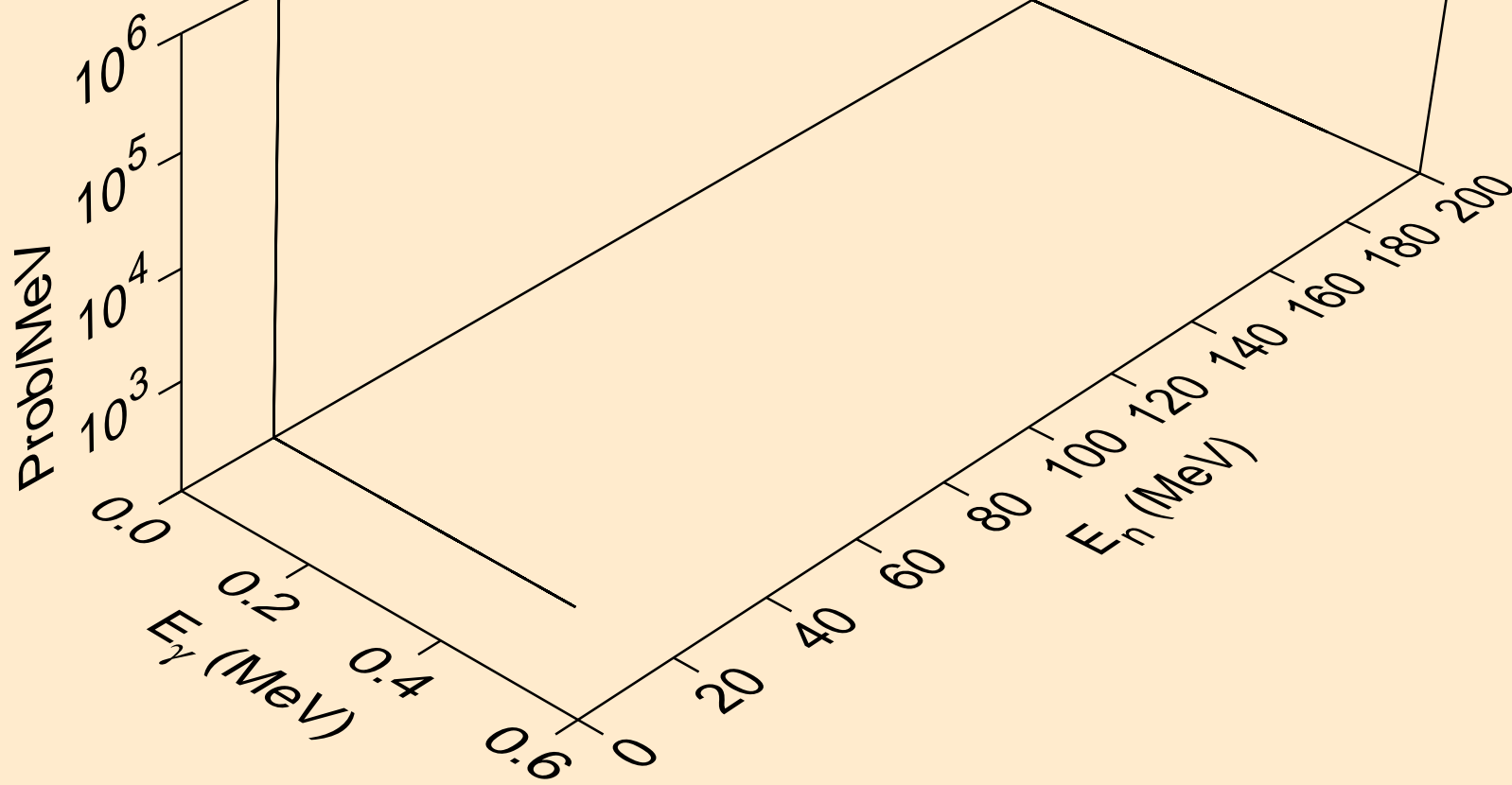

TB146M NEUTRON ACER TENDL-2019 LIBRARY; T=293.16K
Photon emission for (n,n*)p

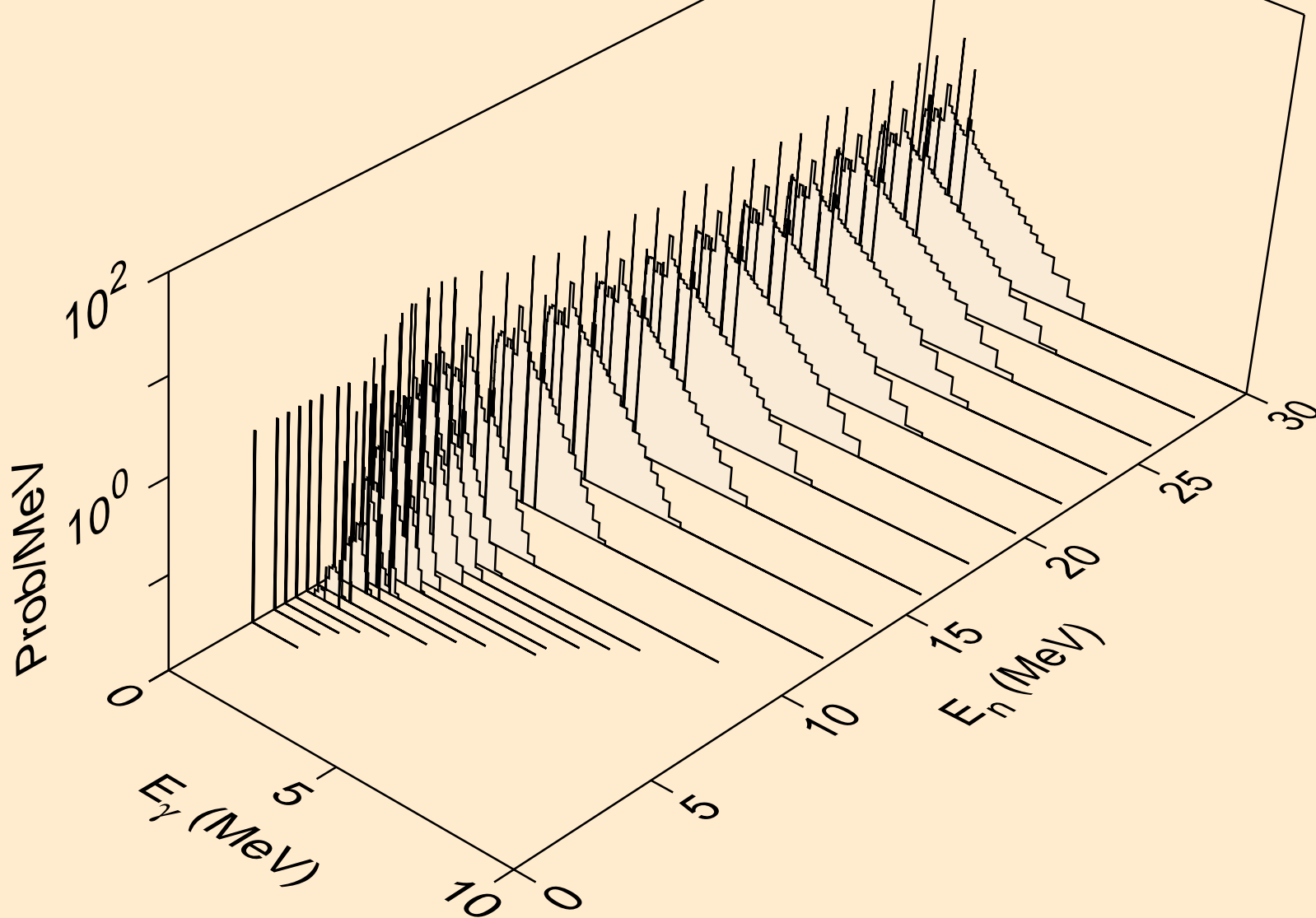

TB146M NEUTRON ACER TENDL-2019 LIBRARY; T=293.16K
Photon emission for (n,n*)2a

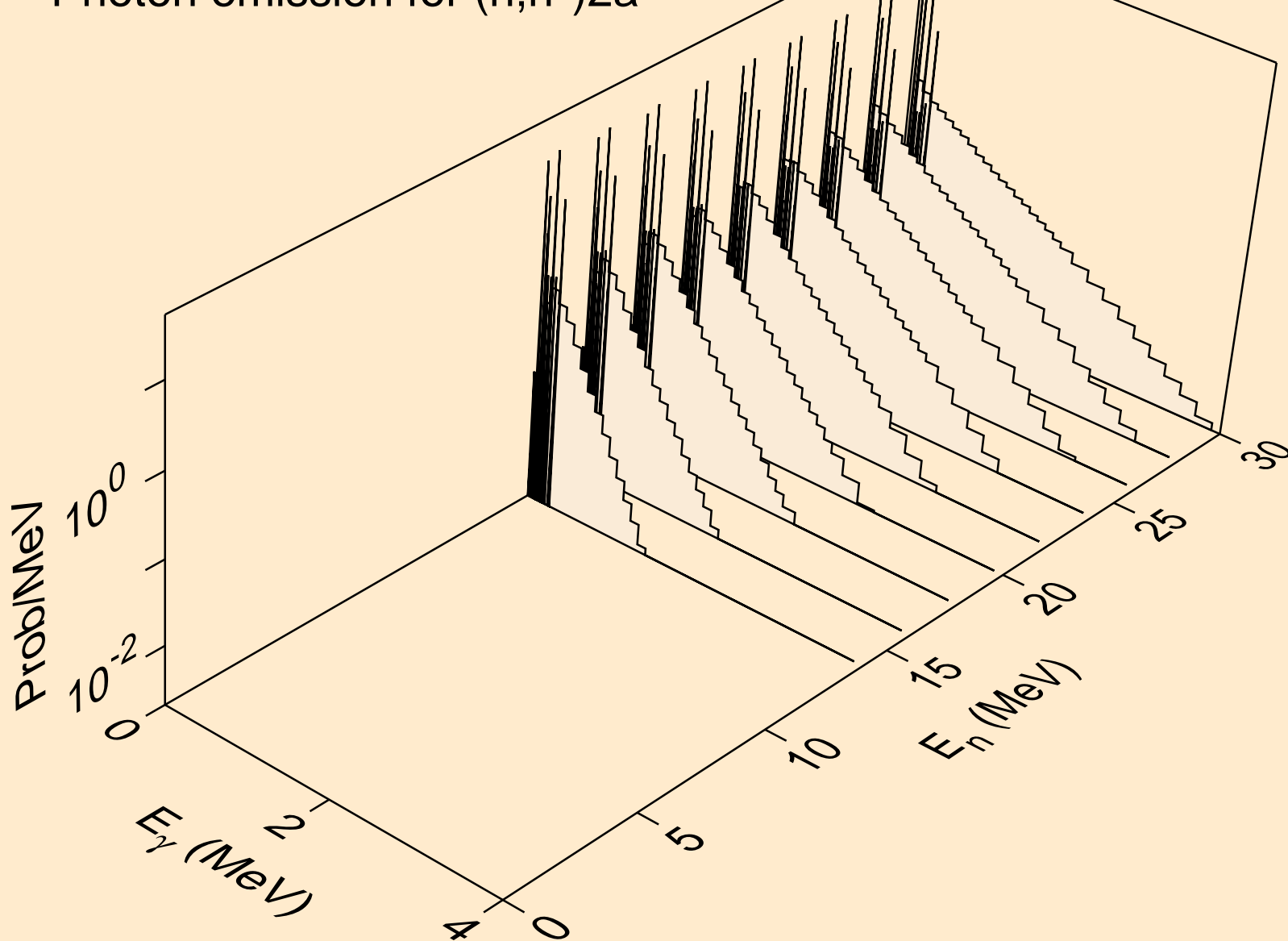

TB146M NEUTRON ACER TENDL-2019 LIBRARY; T=293.16K
Photon emission for (n,2n)2a

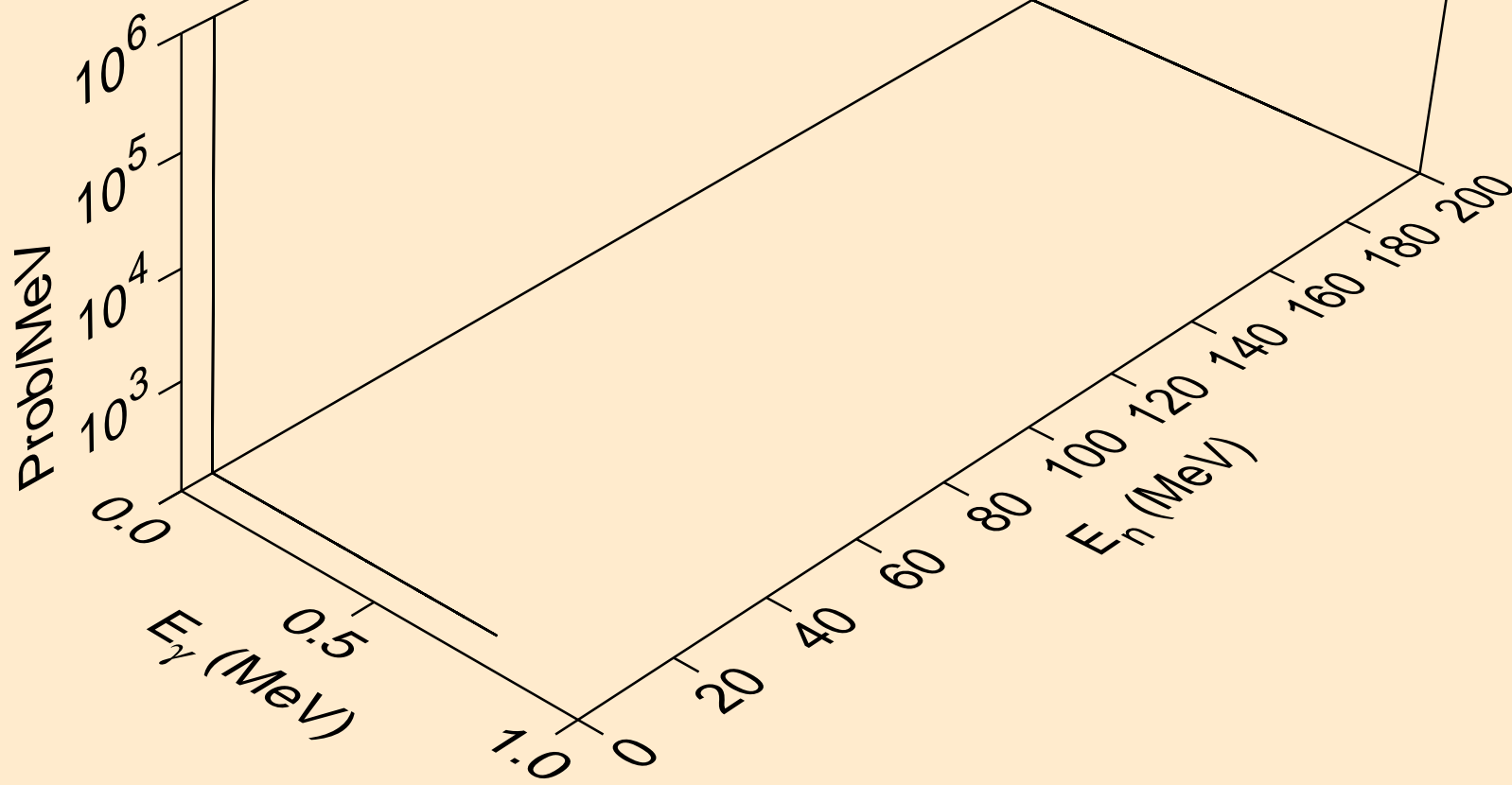

TB146M NEUTRON ACER TENDL-2019 LIBRARY; T=293.16K
Photon emission for (n,n*)d

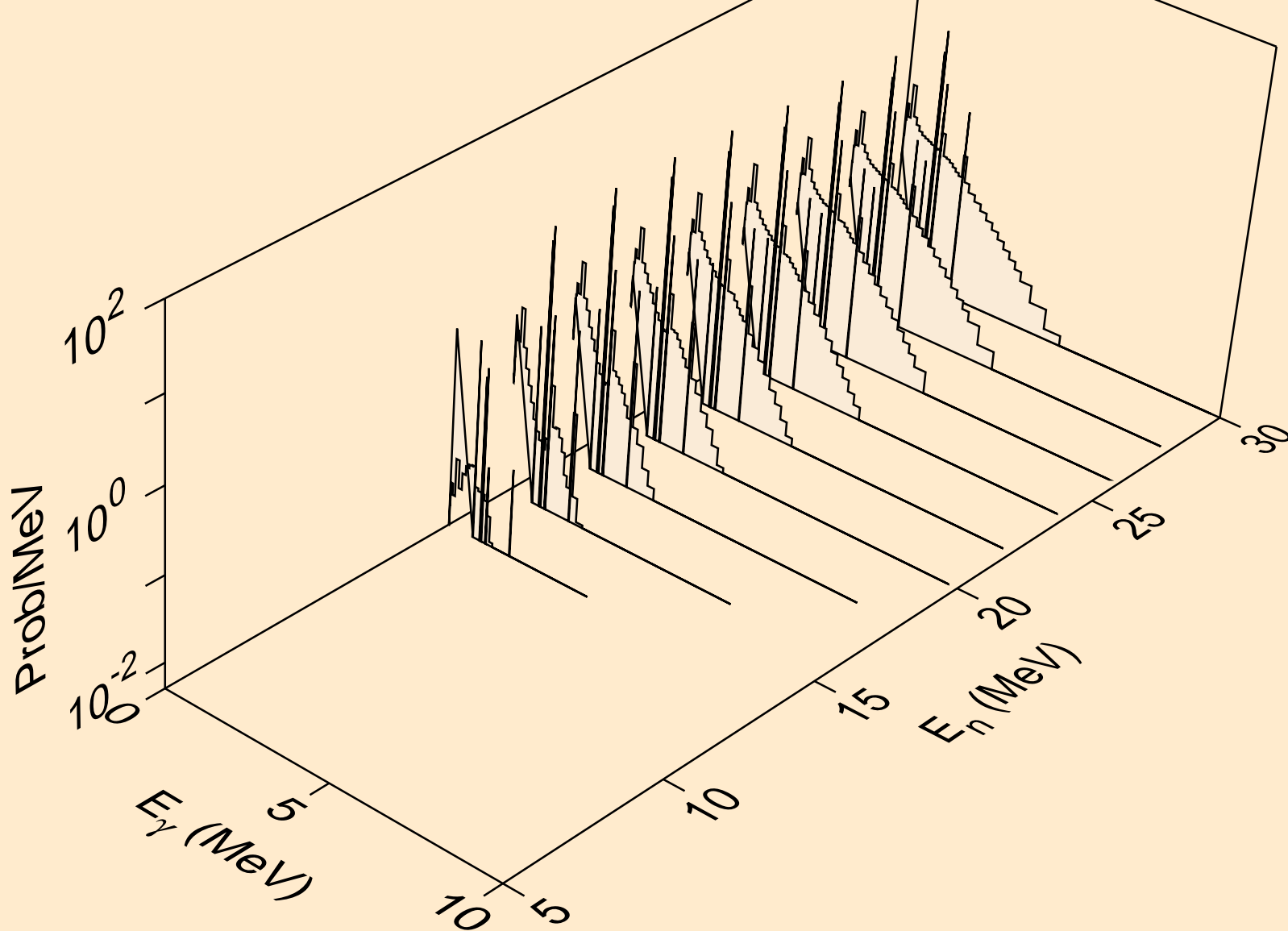

TB146M NEUTRON ACER TENDL-2019 LIBRARY; T=293.16K
Photon emission for (n,n*)t

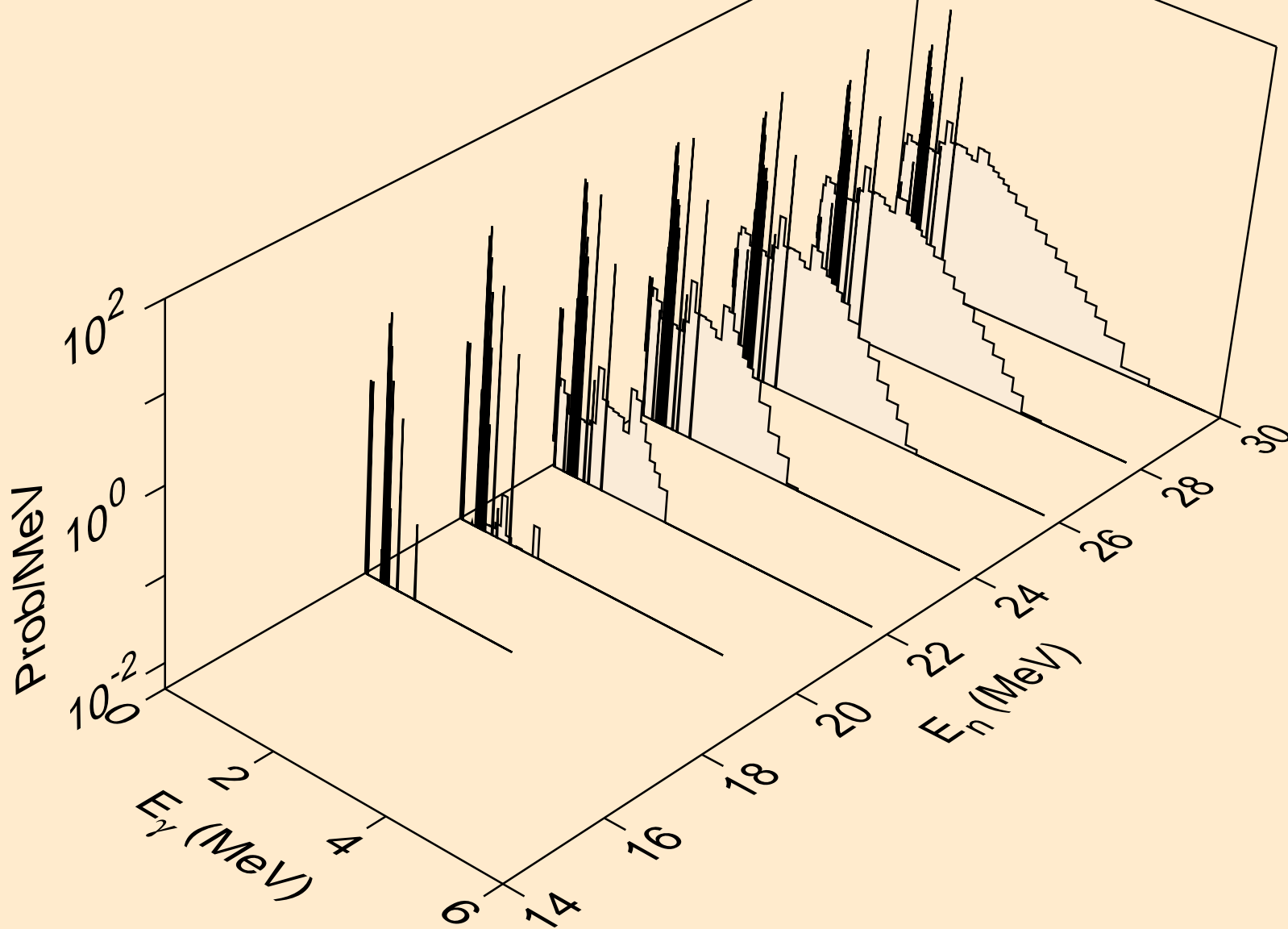

TB146M NEUTRON ACER TENDL-2019 LIBRARY; T=293.16K
Photon emission for (n,n*)he3

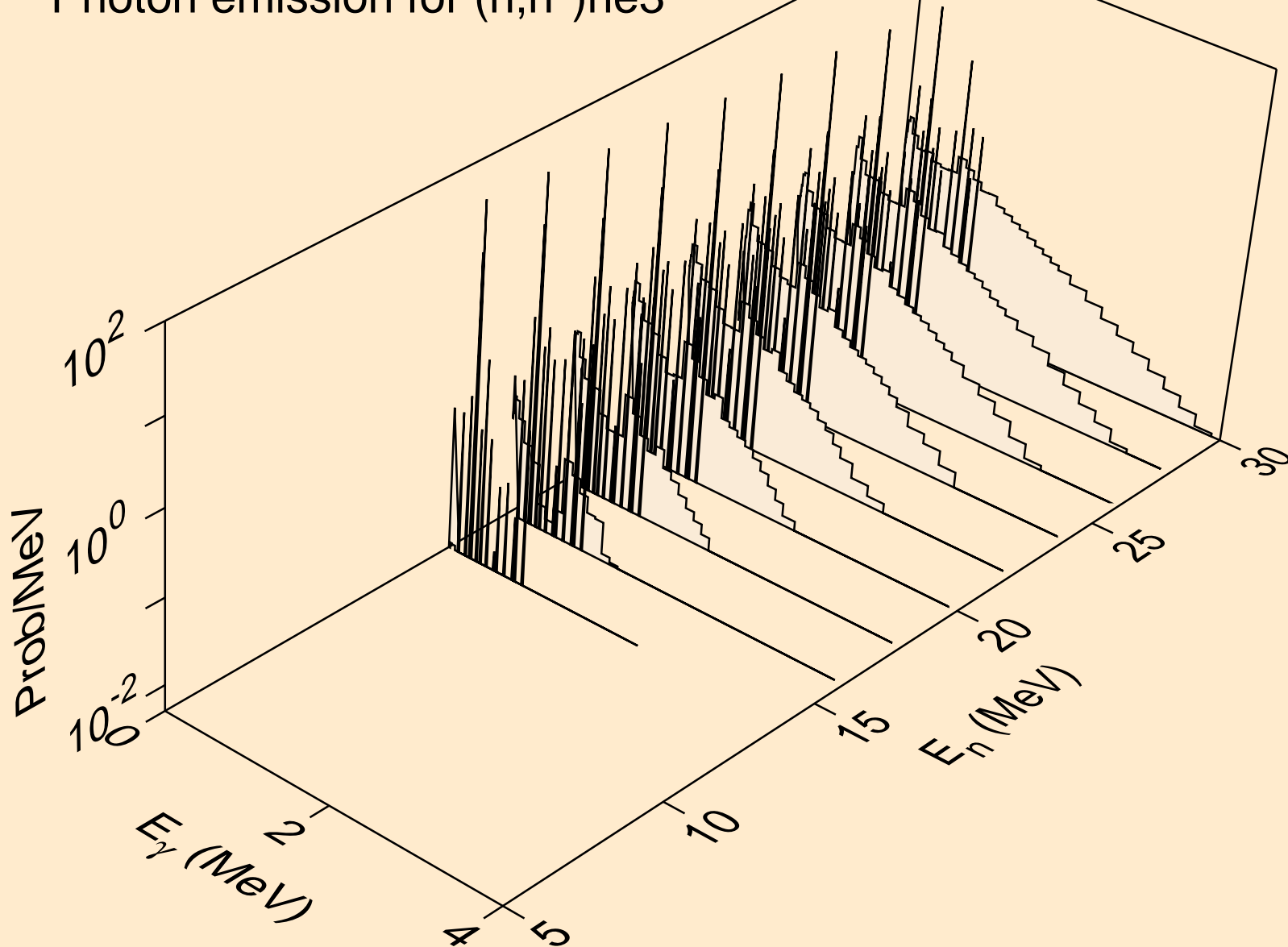

TB146M NEUTRON ACER TENDL-2019 LIBRARY; T=293.16K
Photon emission for (n,2np)

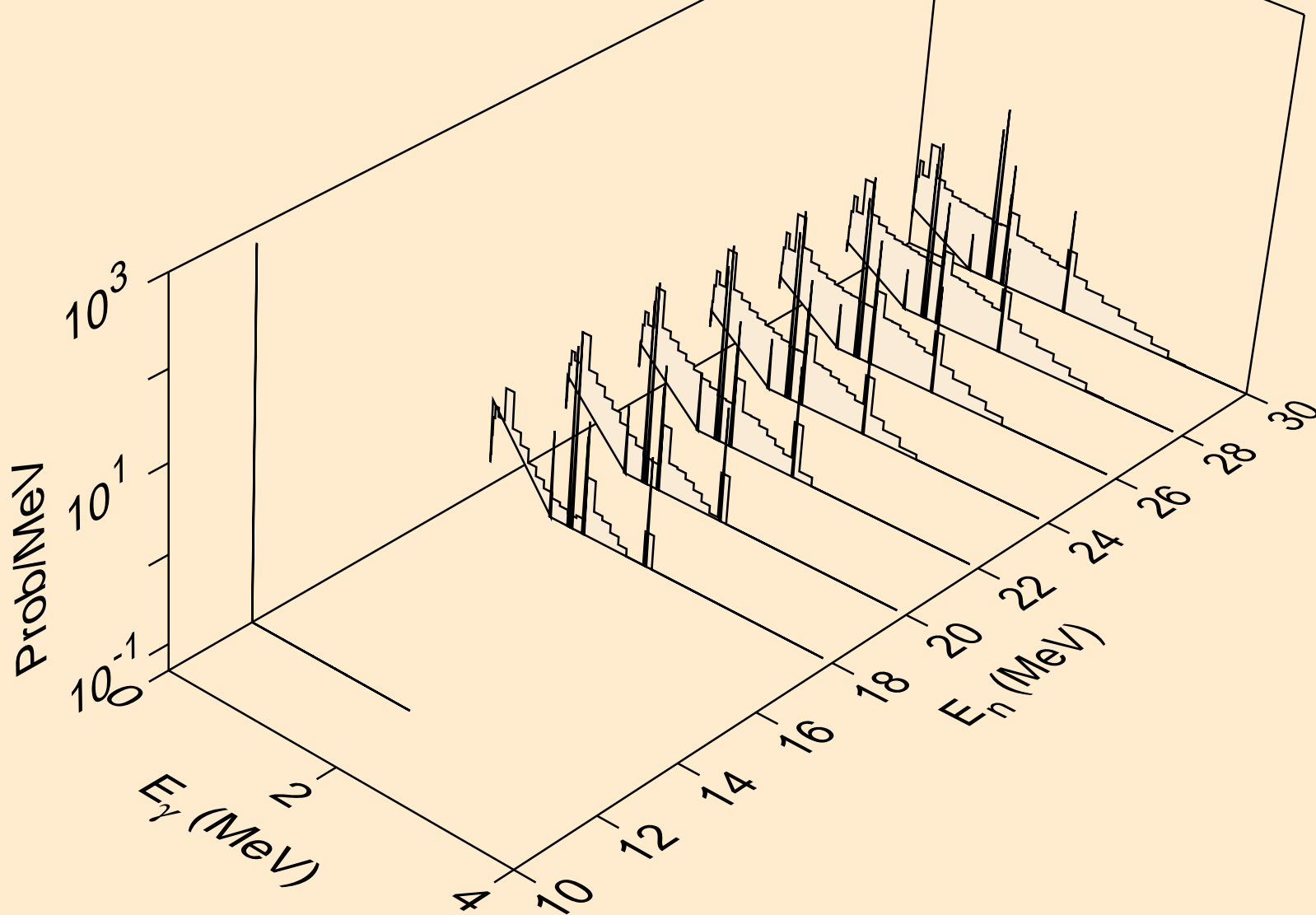

TB146M NEUTRON ACER TENDL-2019 LIBRARY; T=293.16K
Photon emission for (n,3np)

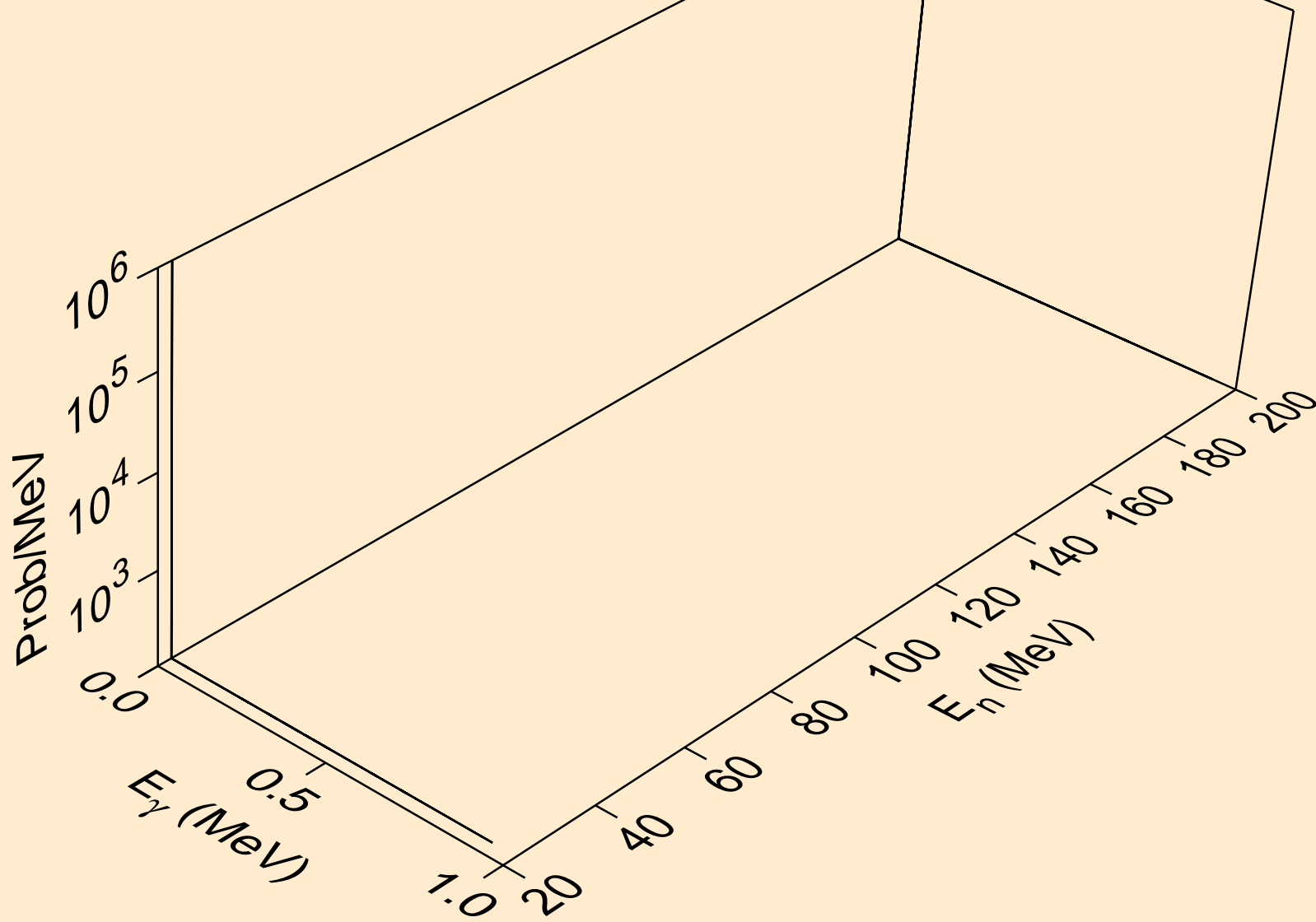

TB146M NEUTRON ACER TENDL-2019 LIBRARY; T=293.16K
Photon emission for (n,2np)

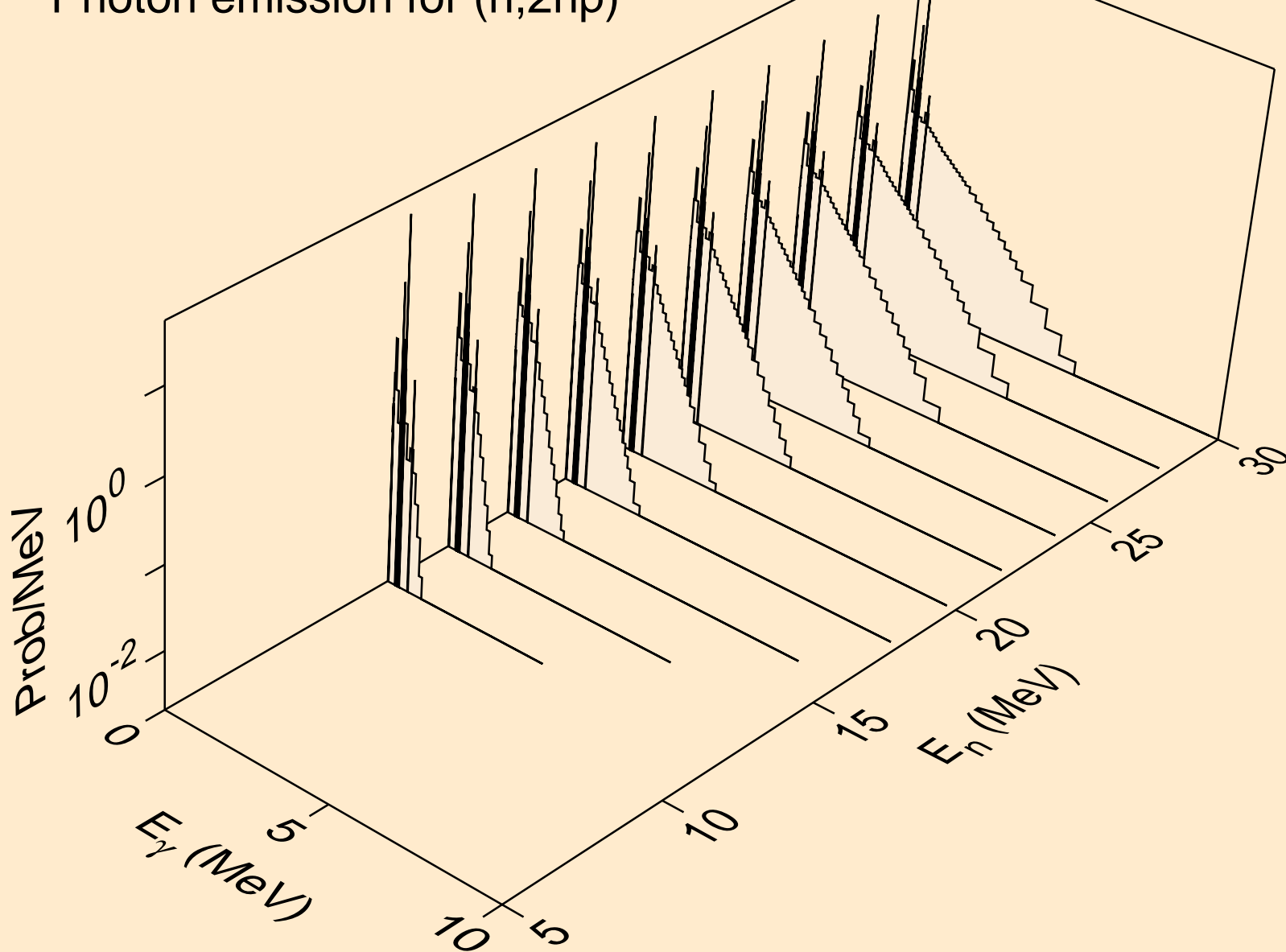

TB146M NEUTRON ACER TENDL-2019 LIBRARY; T=293.16K
Photon emission for (n,npa)

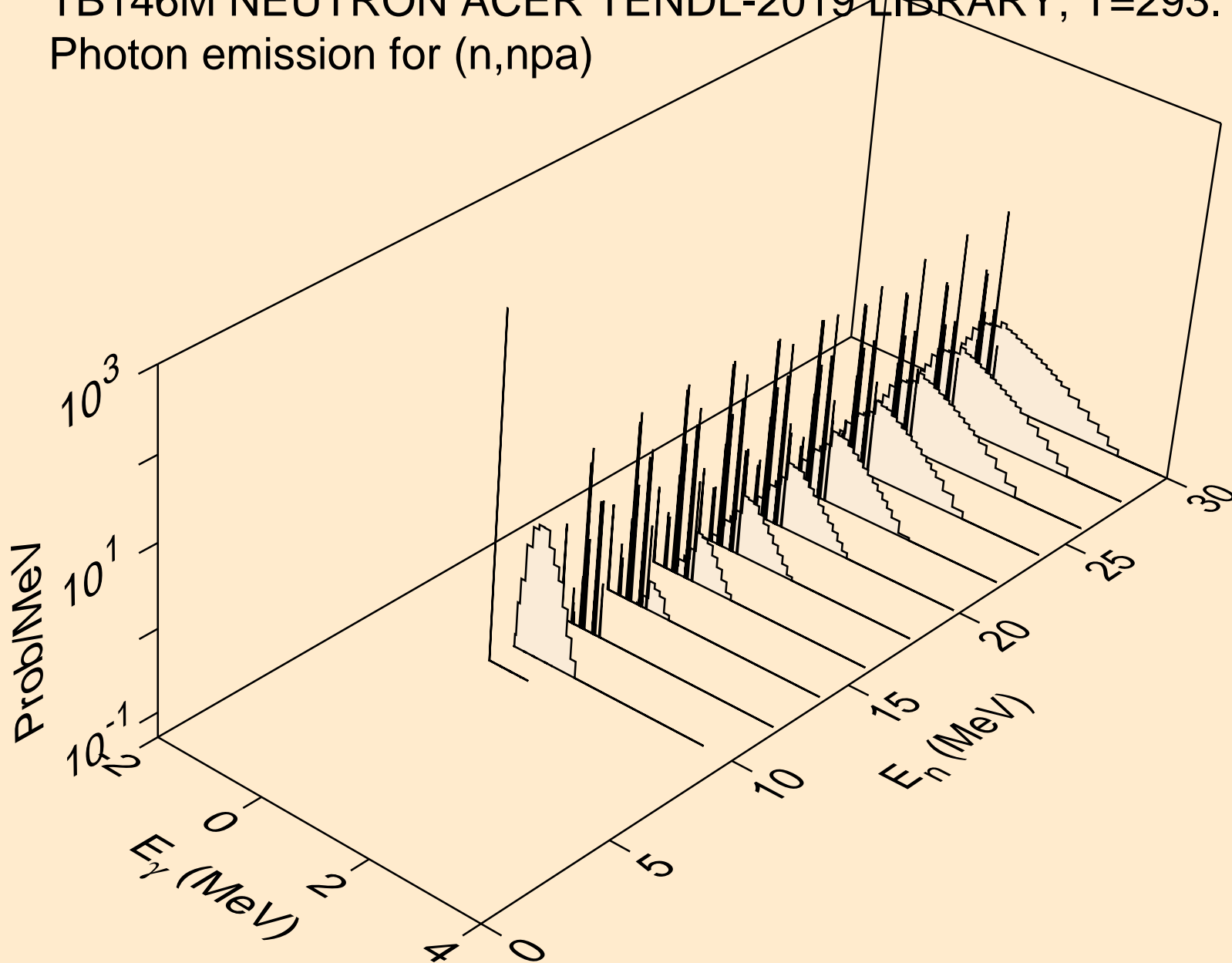

TB146M NEUTRON ACER TENDL-2019 LIBRARY; T=293.16K
Photon emission for (n,n*1)

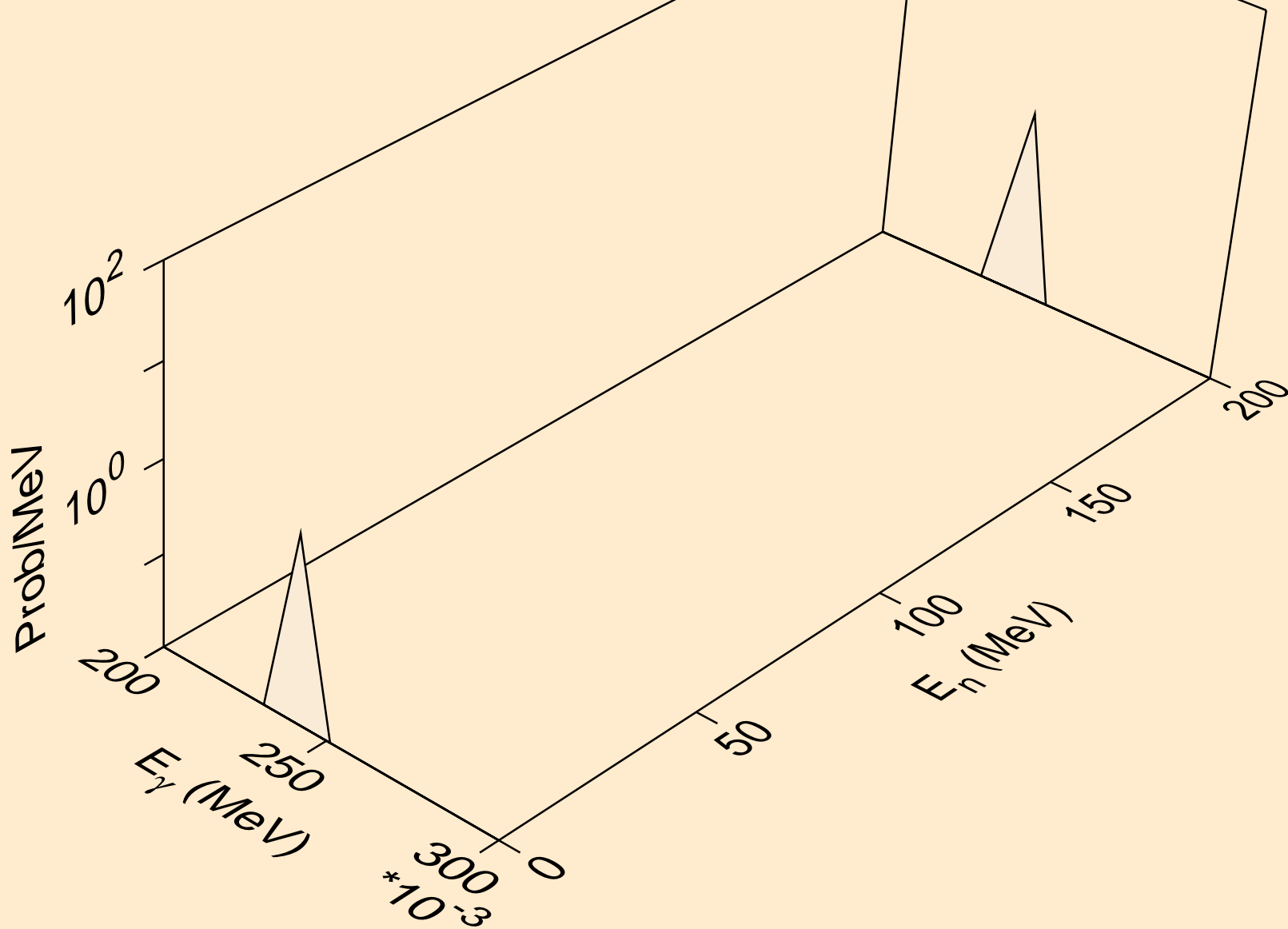

TB146M NEUTRON ACER TENDL-2019 LIBRARY; T=293.16K
Photon emission for (n,n*3)

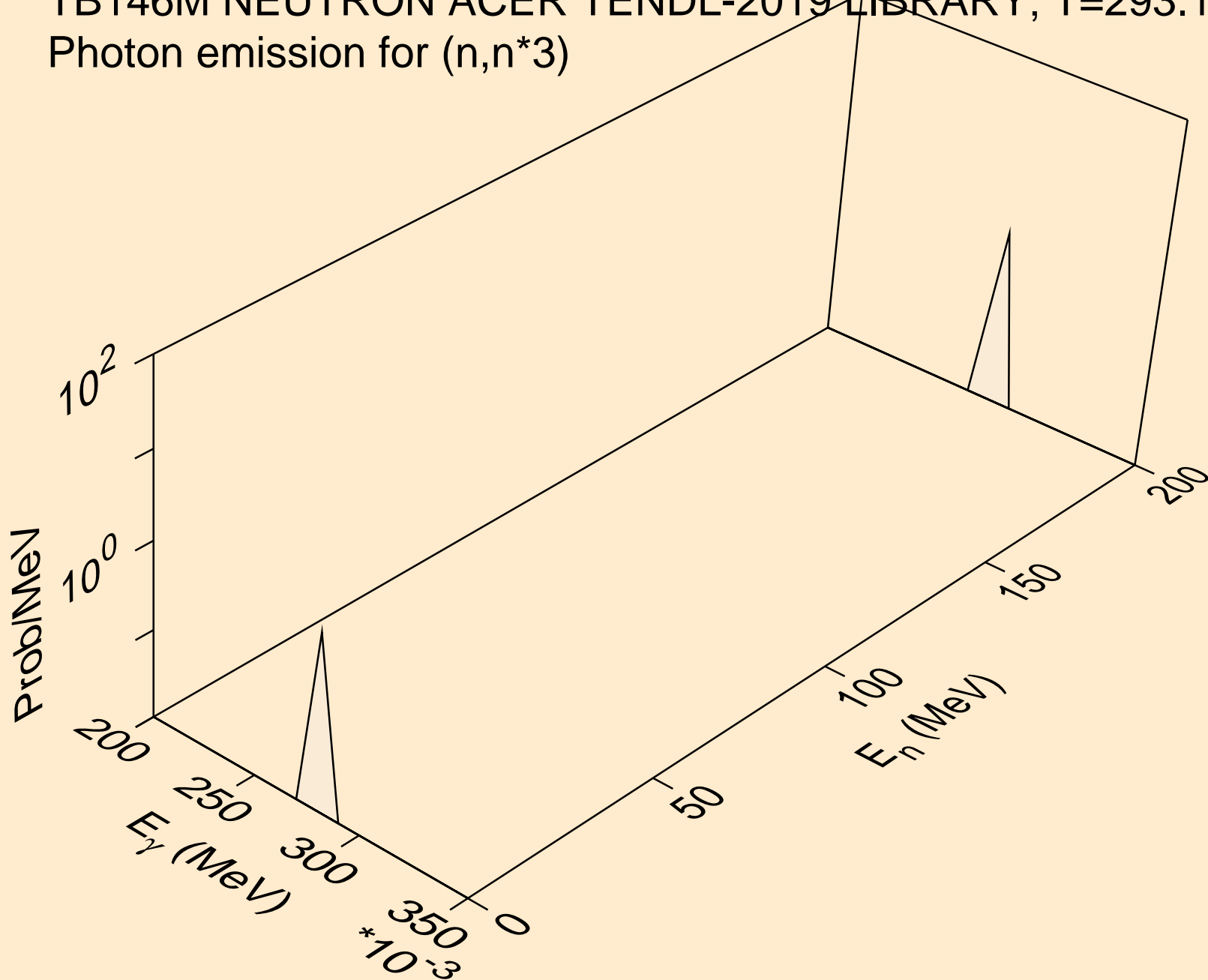

TB146M NEUTRON ACER TENDL-2019 LIBRARY; T=293.16K
Photon emission for (n,n*4)

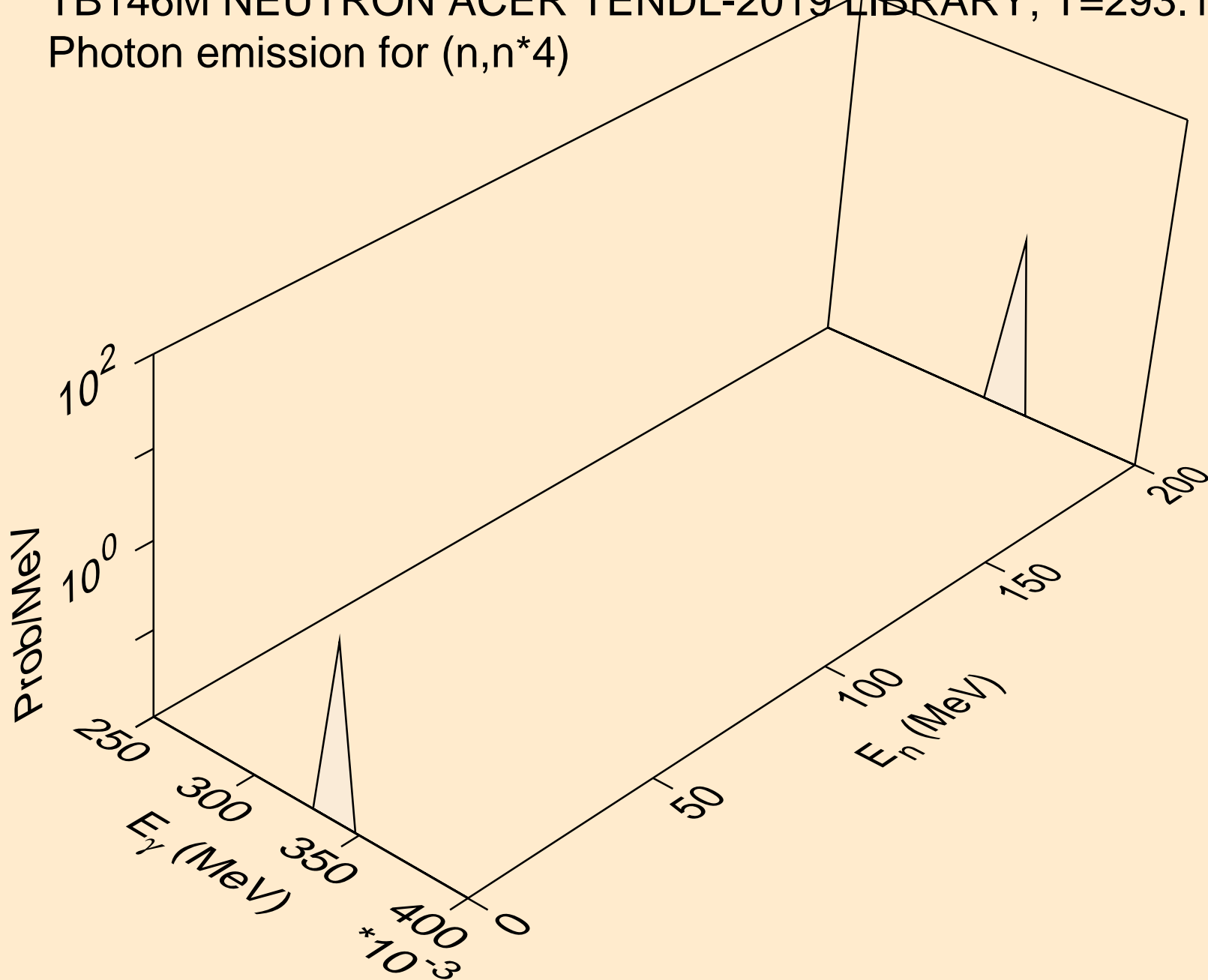

TB146M NEUTRON ACER TENDL-2019 LIBRARY; T=293.16K
Photon emission for (n,n*5)

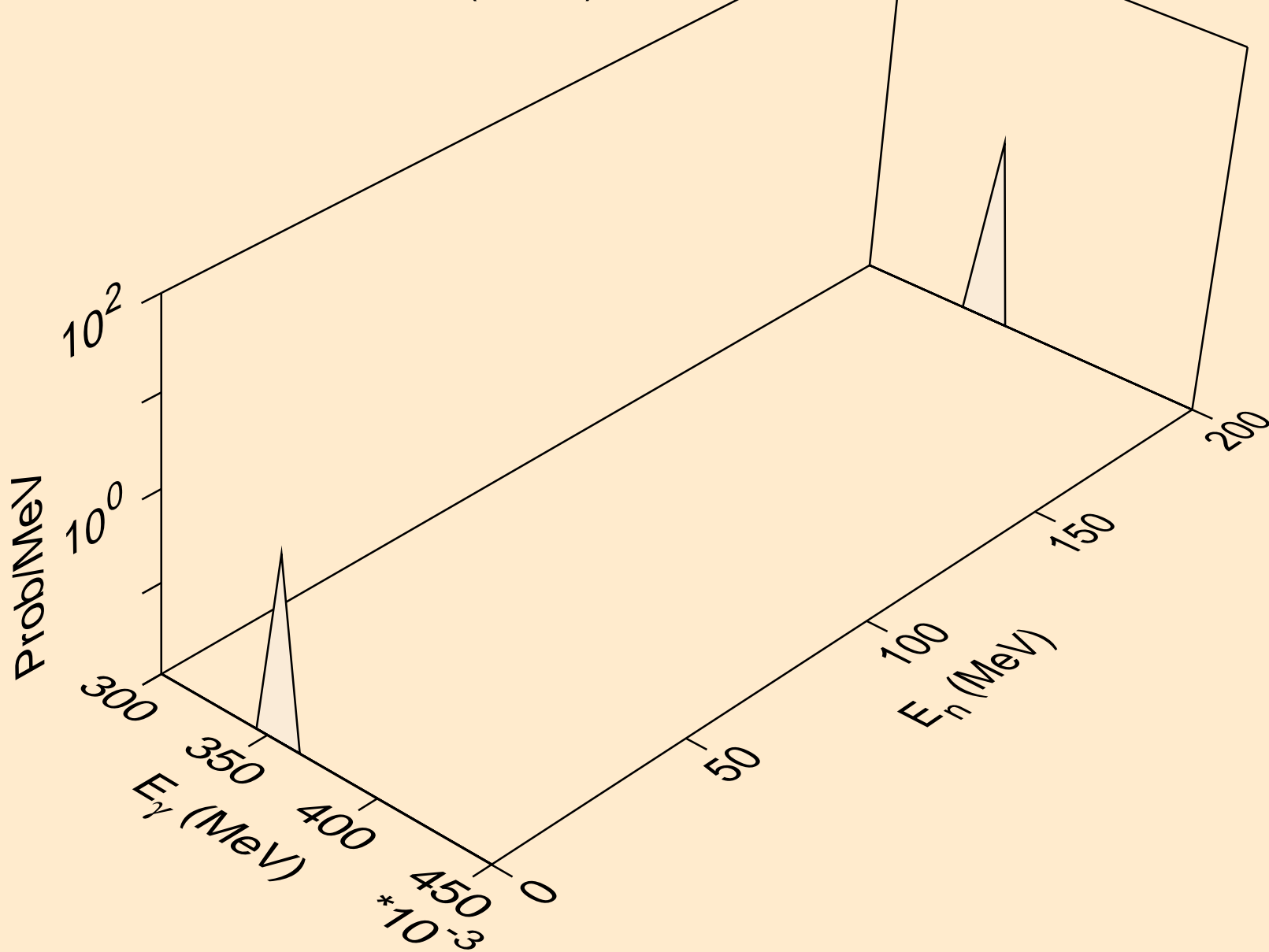

TB146M NEUTRON ACER TENDL-2019 LIBRARY; T=293.16K
Photon emission for (n,n*6)

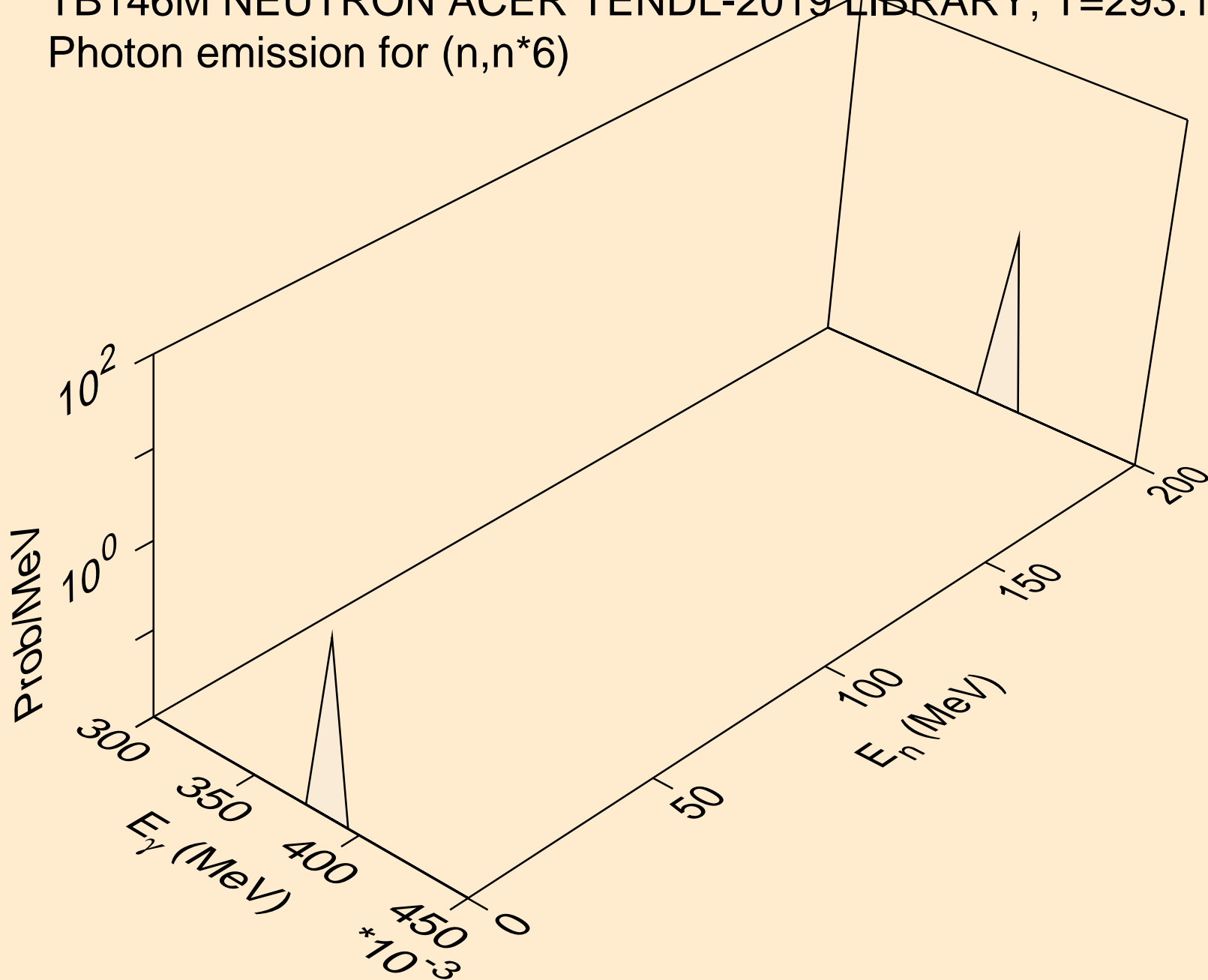

TB146M NEUTRON ACER TENDL-2019 LIBRARY; T=293.16K
Photon emission for (n,n*7)

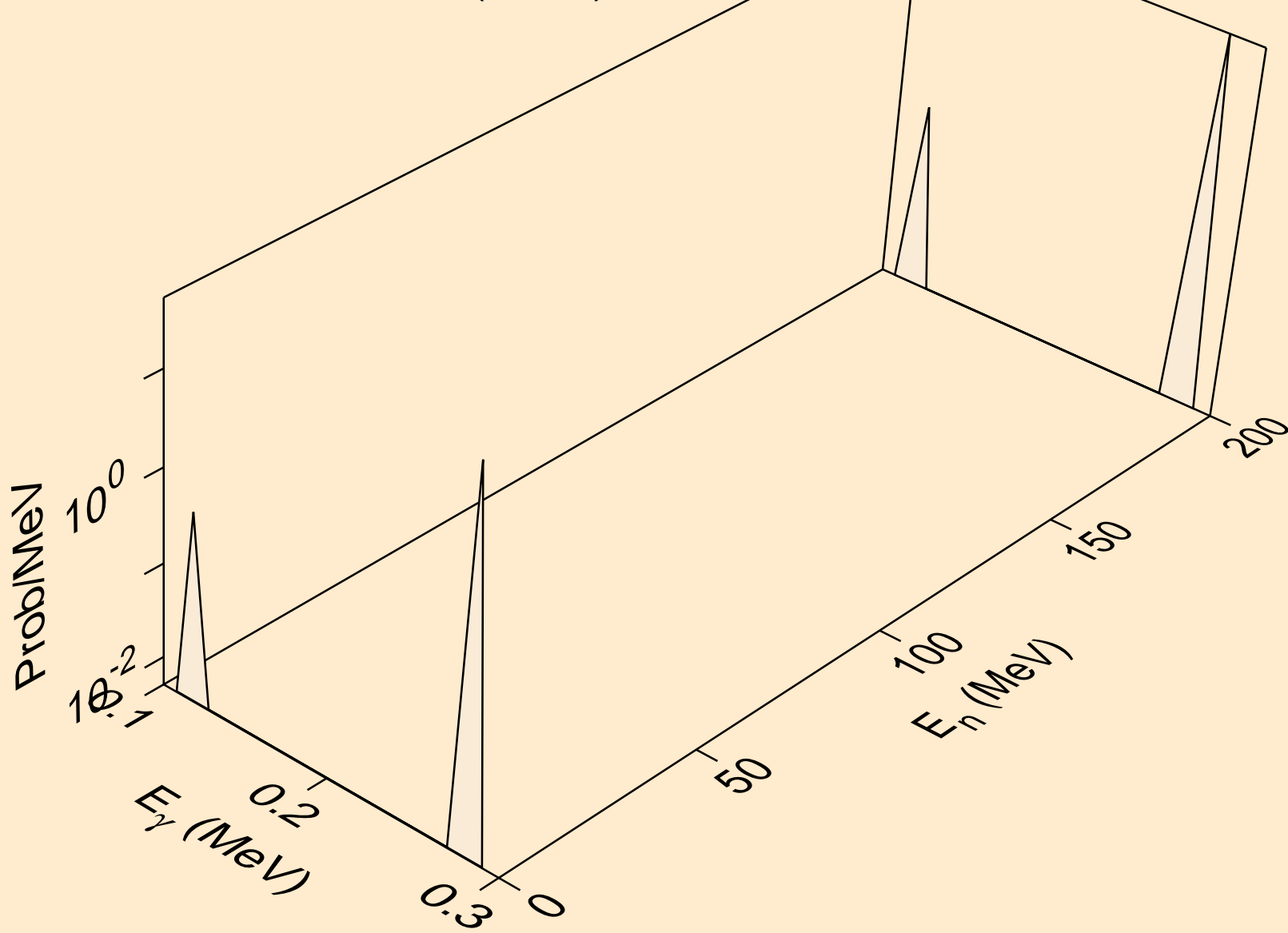

TB146M NEUTRON ACER TENDL-2019 LIBRARY; T=293.16K
Photon emission for (n,n*8)

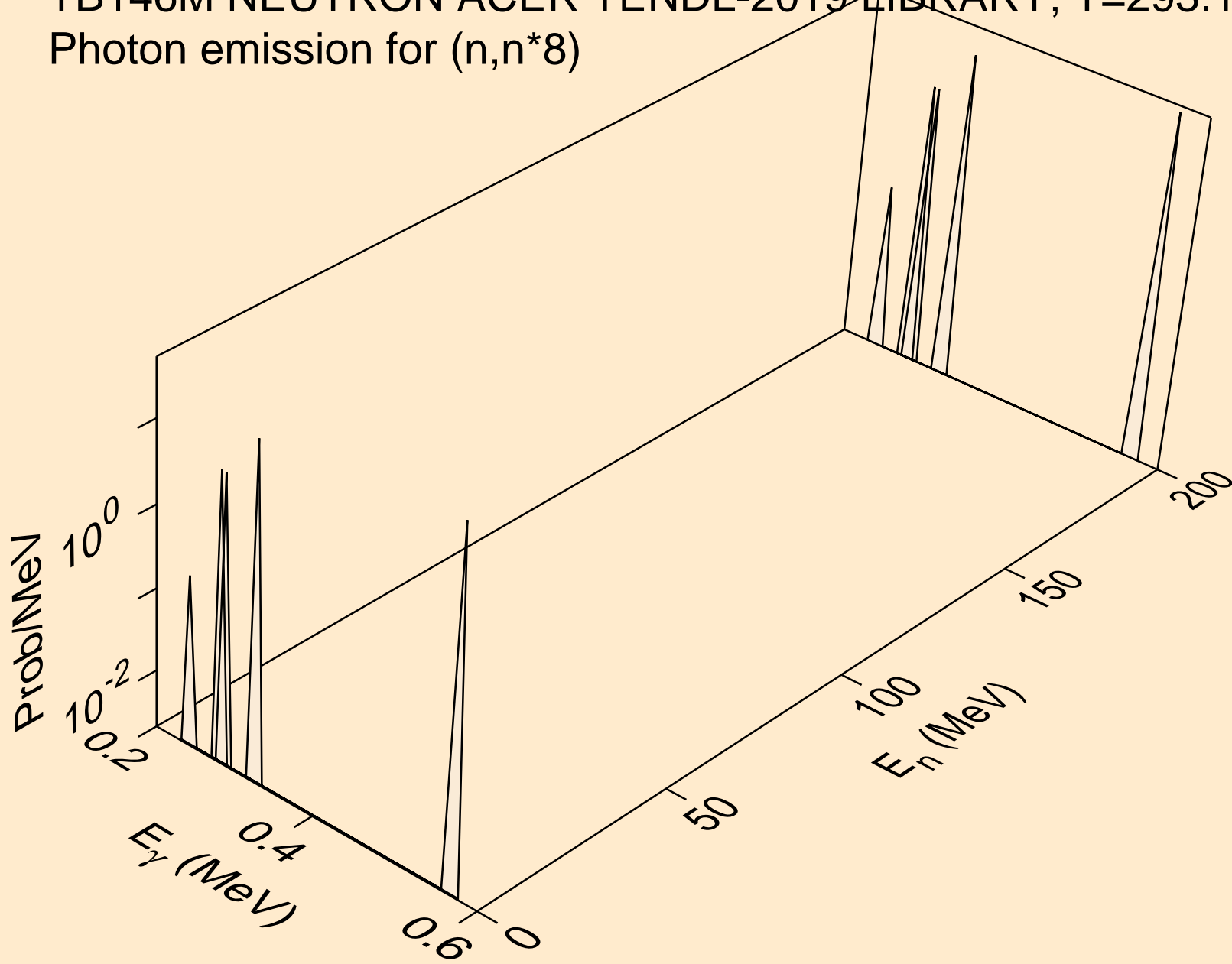

TB146M NEUTRON ACER TENDL-2019 LIBRARY; T=293.16K
Photon emission for (n,n*9)

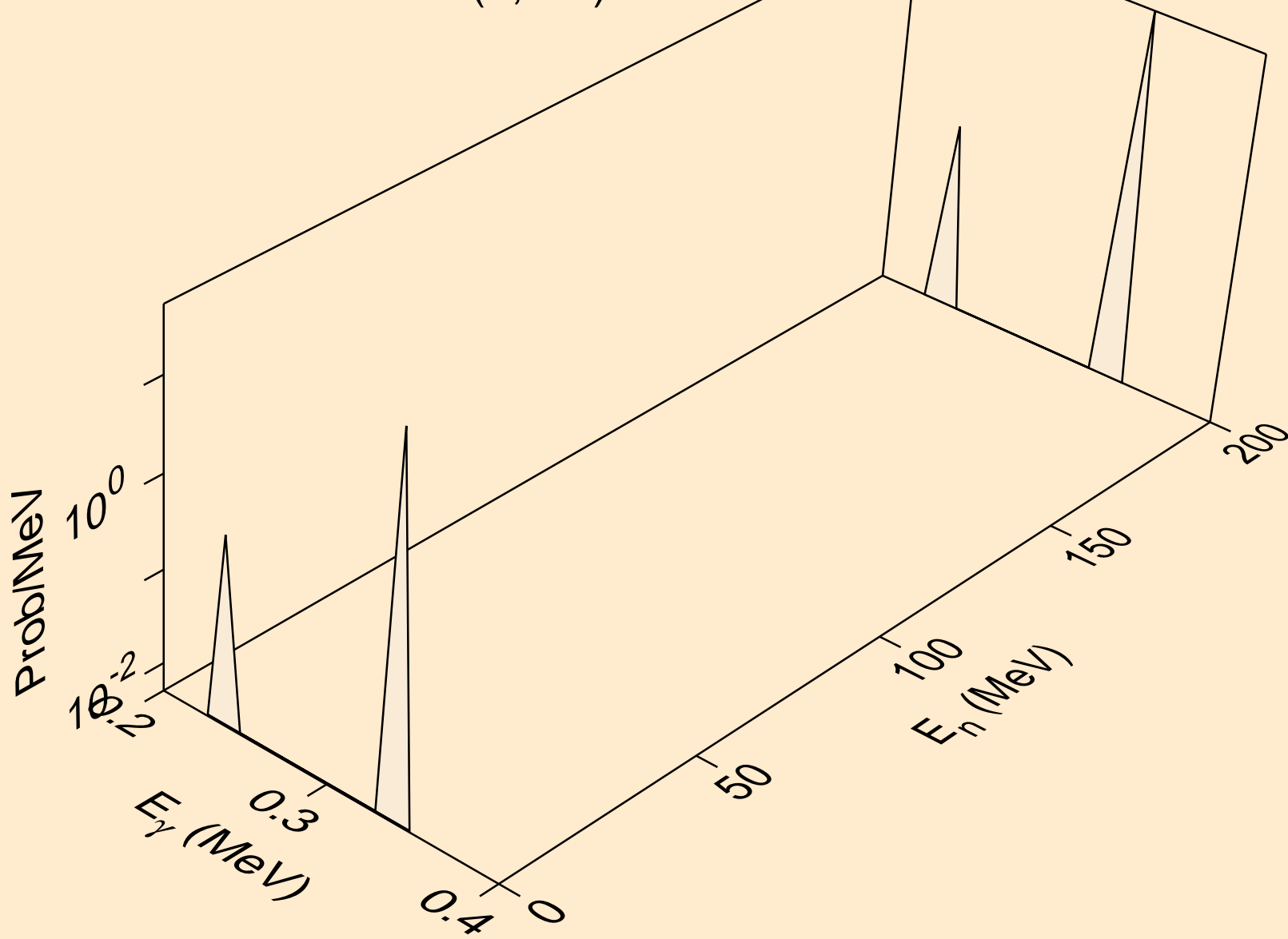

TB146M NEUTRON ACER TENDL-2019 LIBRARY; T=293.16K
Photon emission for (n,n*10)

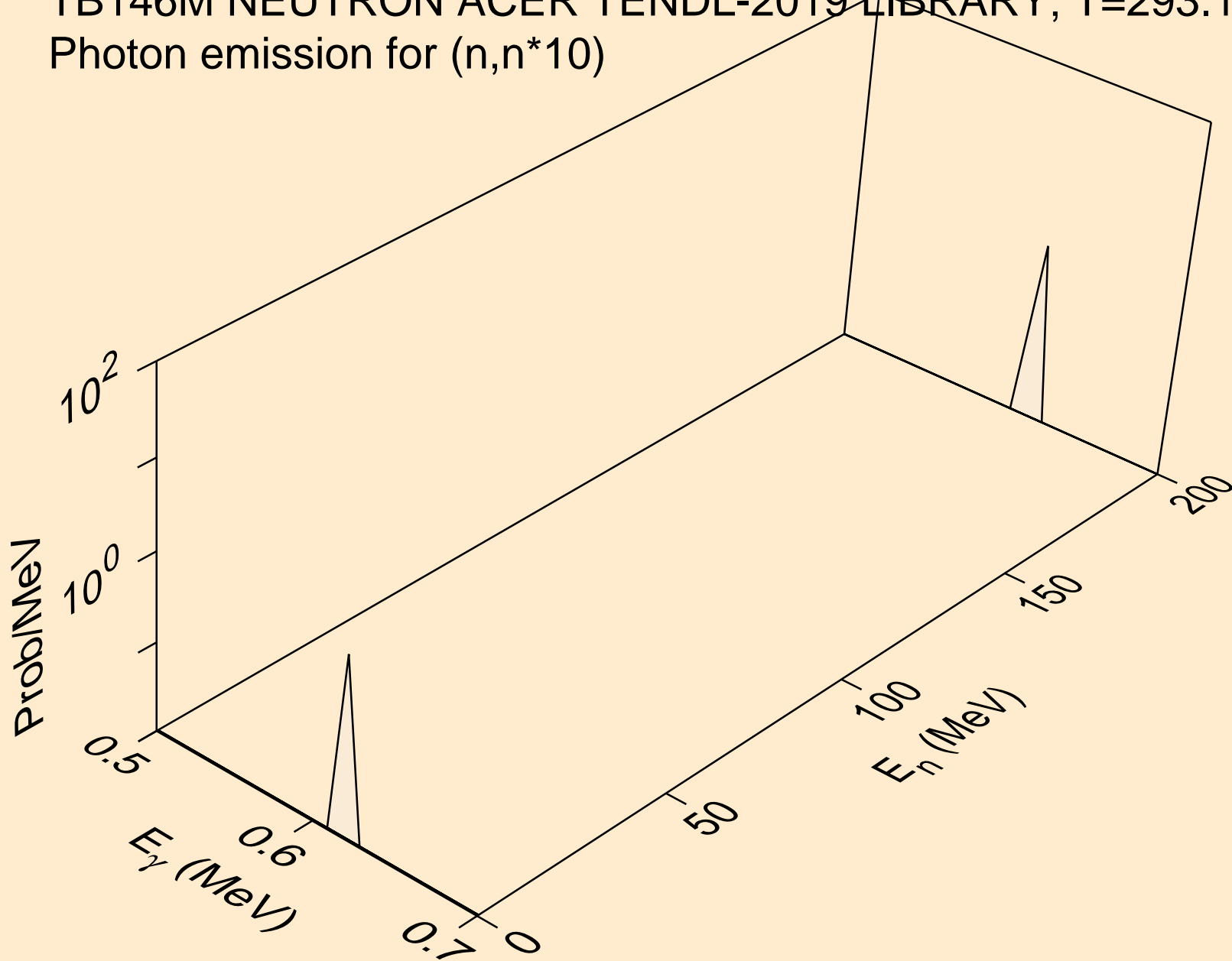

TB146M NEUTRON ACER TENDL-2019 LIBRARY; T=293.16K
Photon emission for (n,n*11)

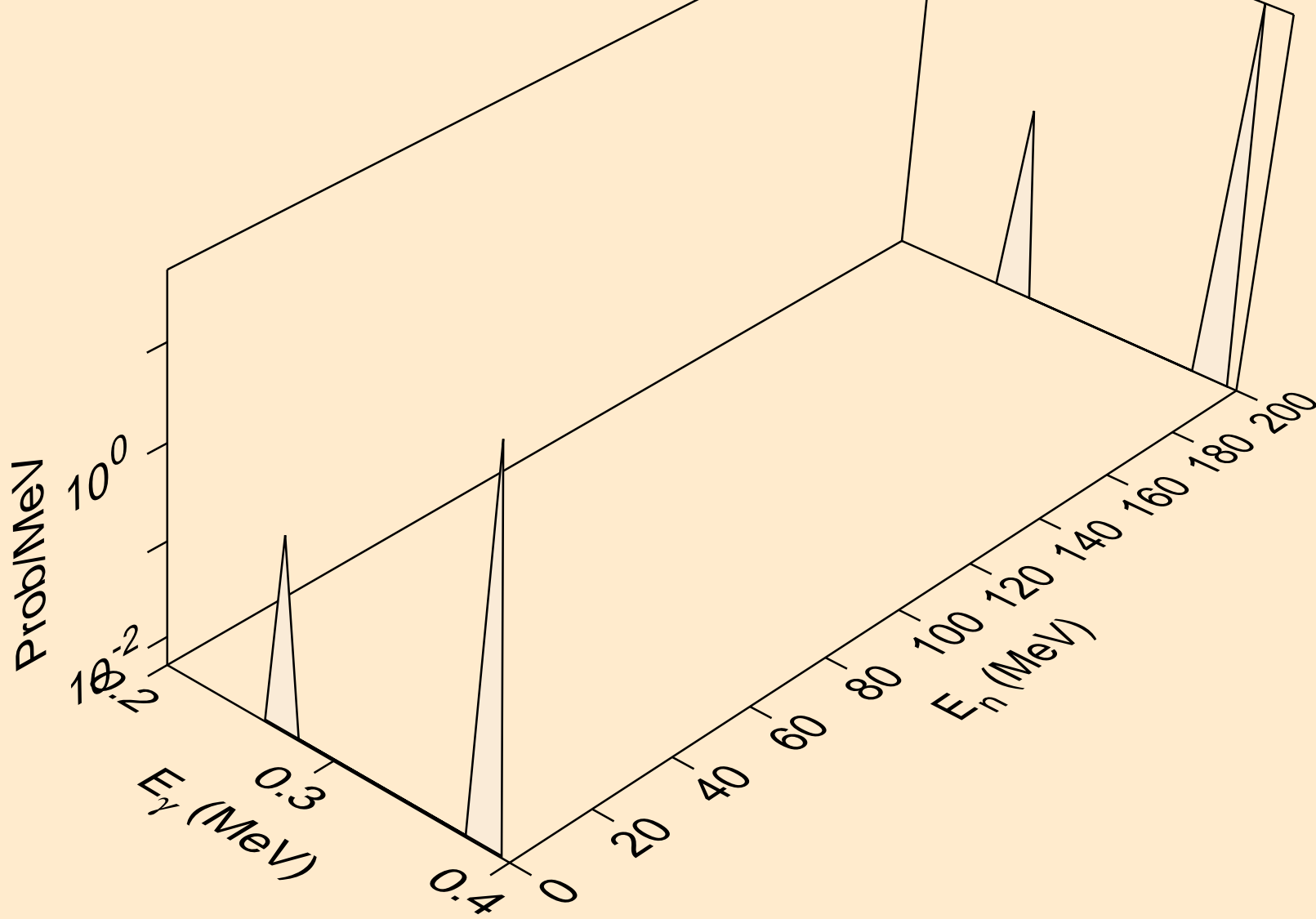

TB146M NEUTRON ACER TENDL-2019 LIBRARY; T=293.16K
Photon emission for (n,n*12)

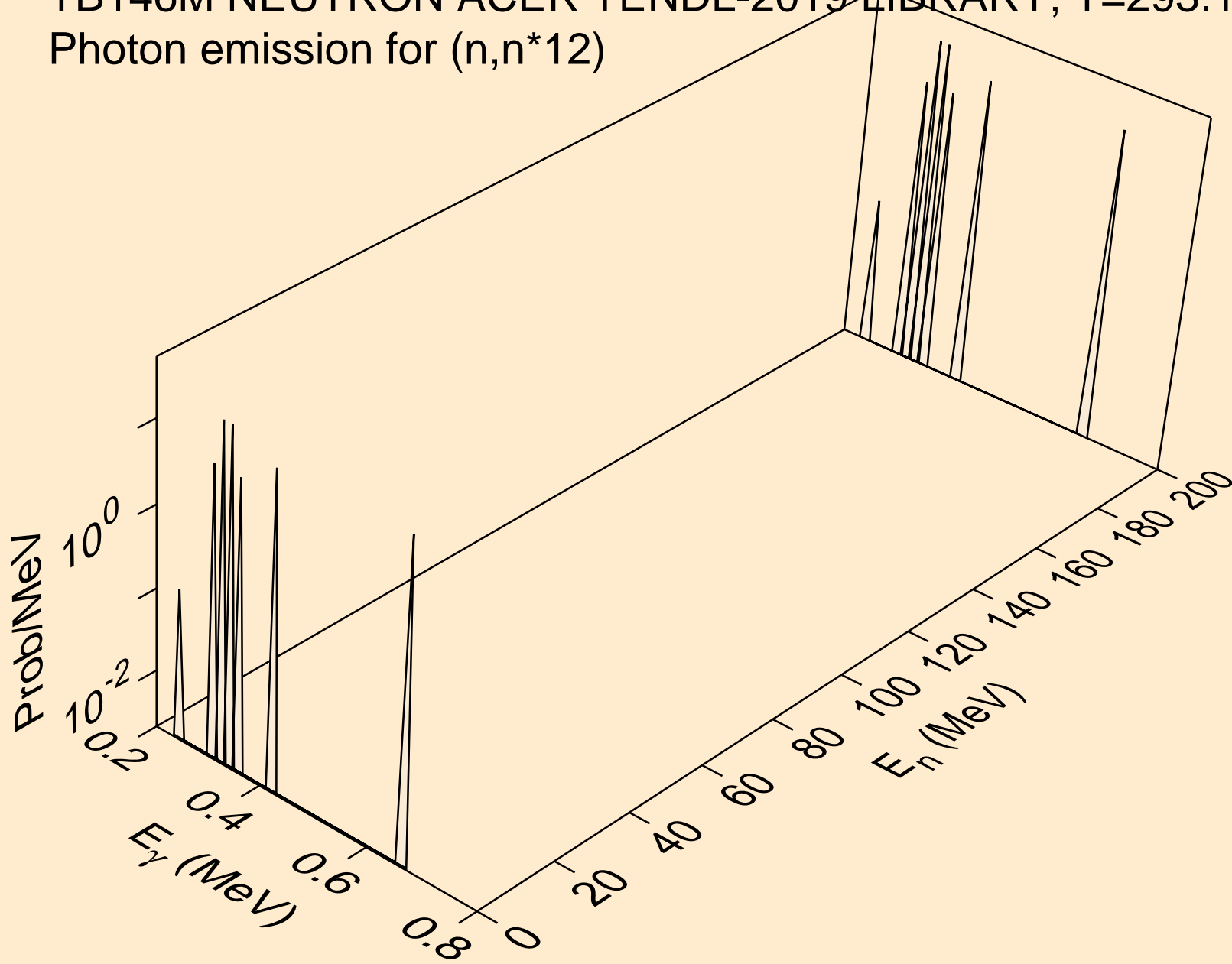

TB146M NEUTRON ACER TENDL-2019 LIBRARY; T=293.16K
Photon emission for (n,n*13)

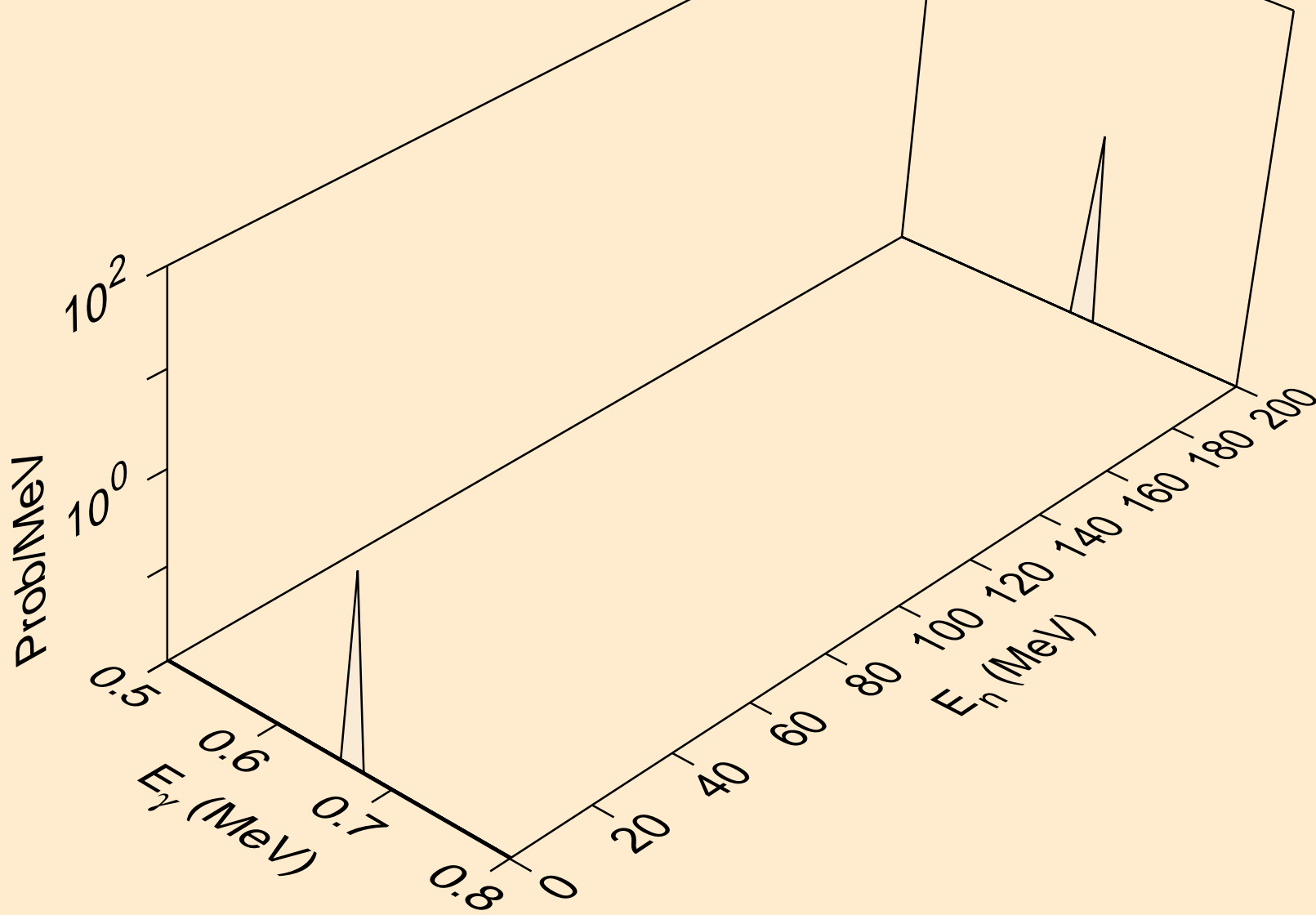

TB146M NEUTRON ACER TENDL-2019 LIBRARY; T=293.16K
Photon emission for (n,n*14)

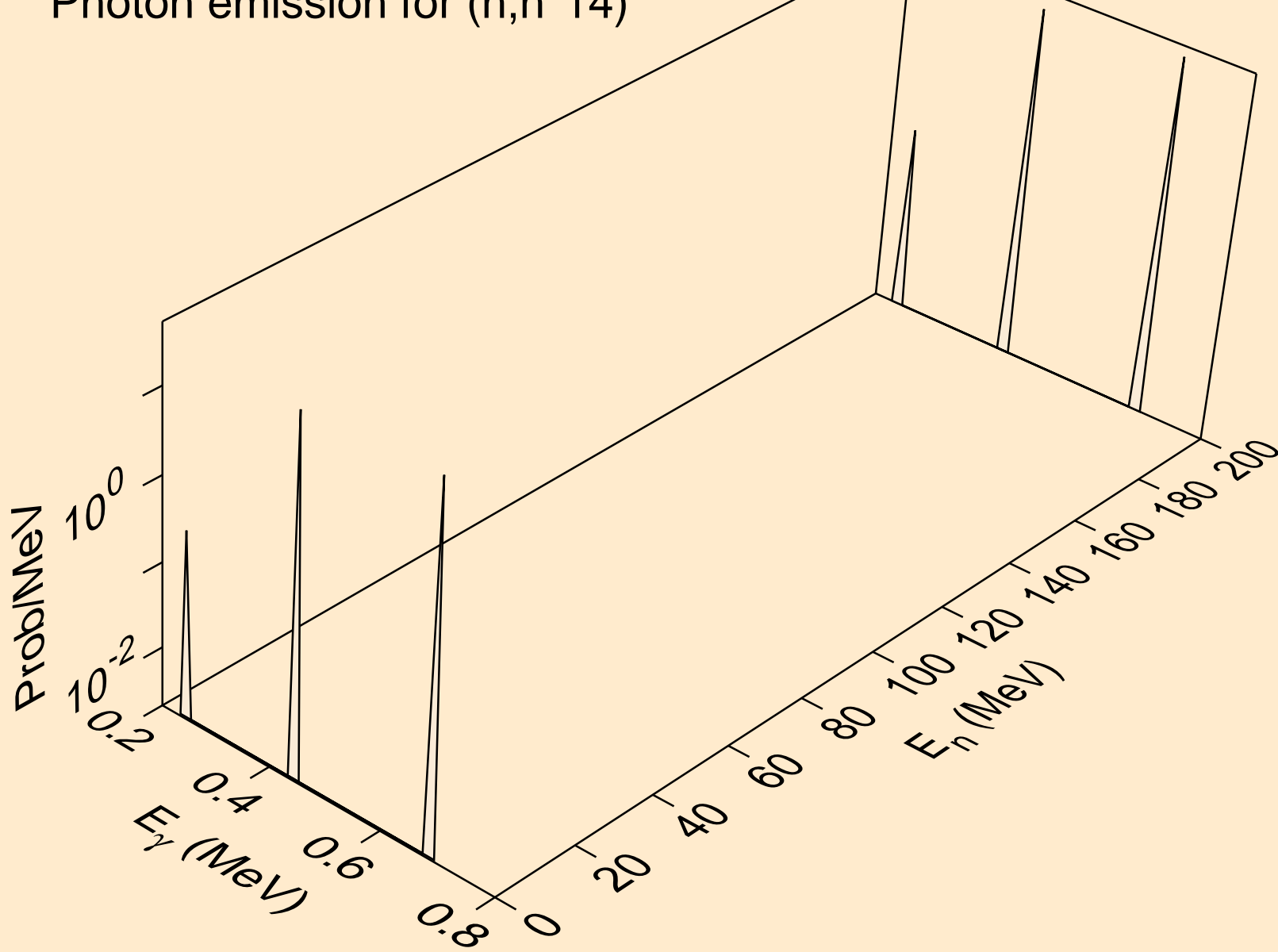

TB146M NEUTRON ACER TENDL-2019 LIBRARY; T=293.16K
Photon emission for (n,n*15)

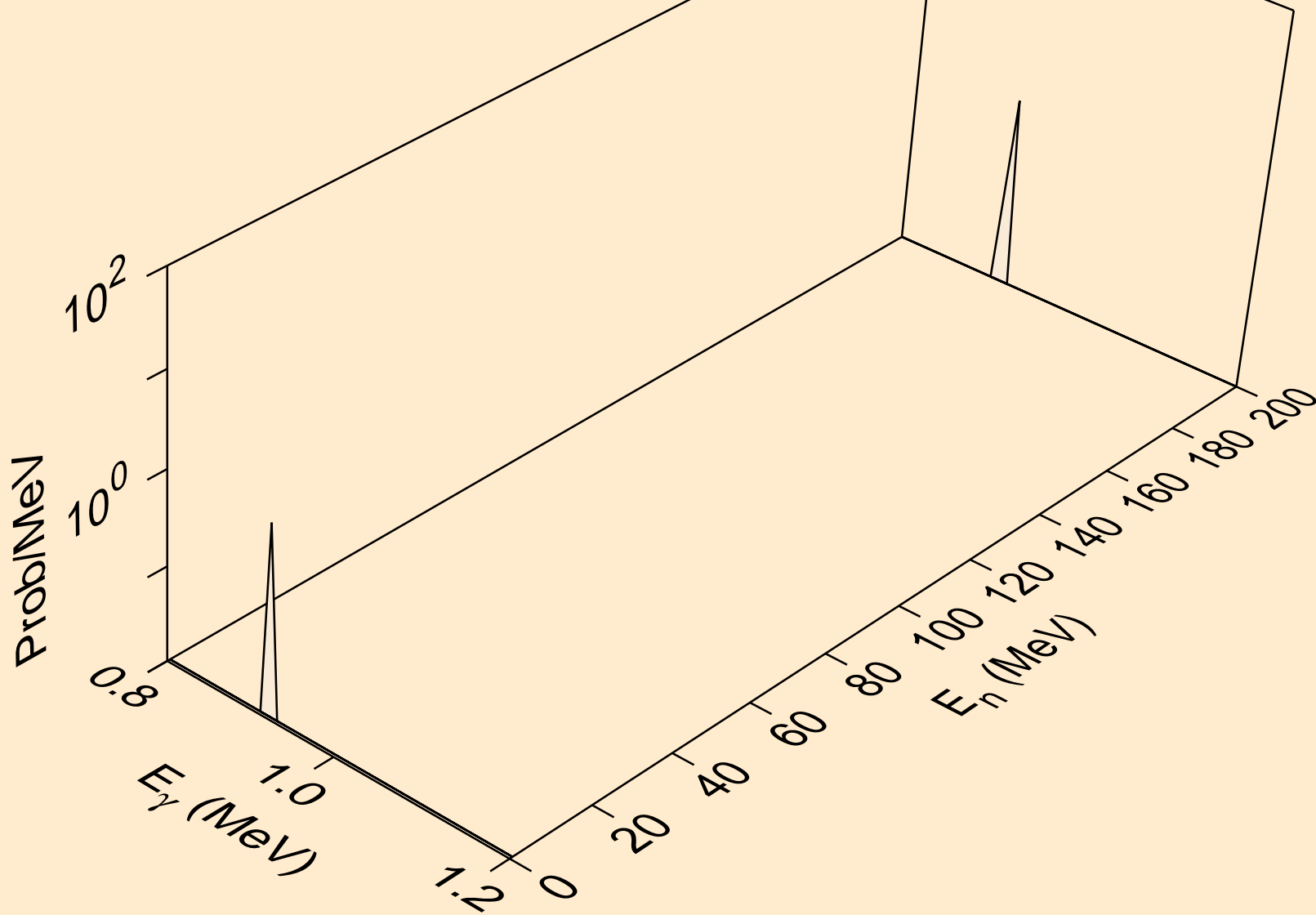

TB146M NEUTRON ACER TENDL-2019 LIBRARY; T=293.16K
Photon emission for (n,n*16)

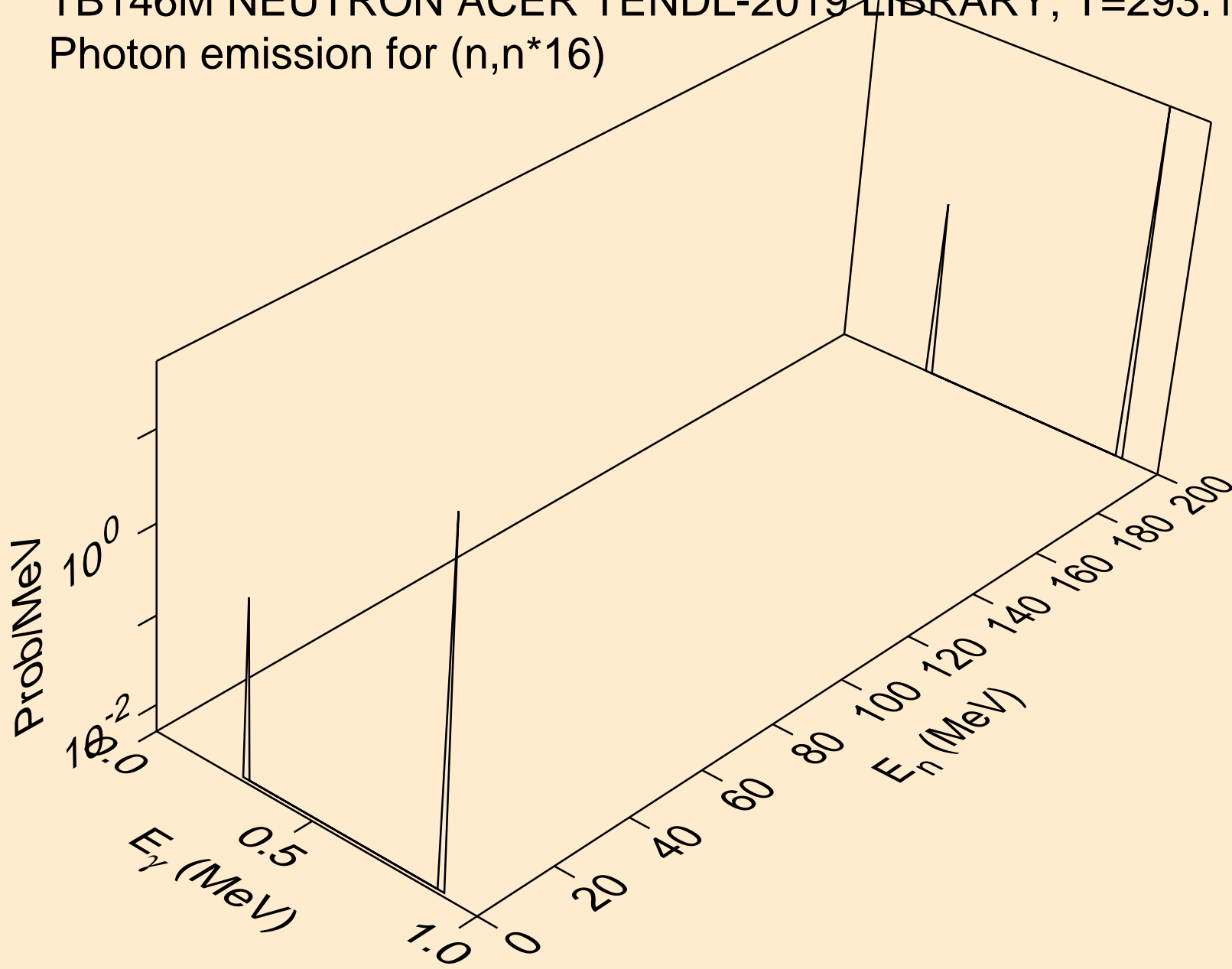

TB146M NEUTRON ACER TENDL-2019 LIBRARY; T=293.16K
Photon emission for (n,n*c)

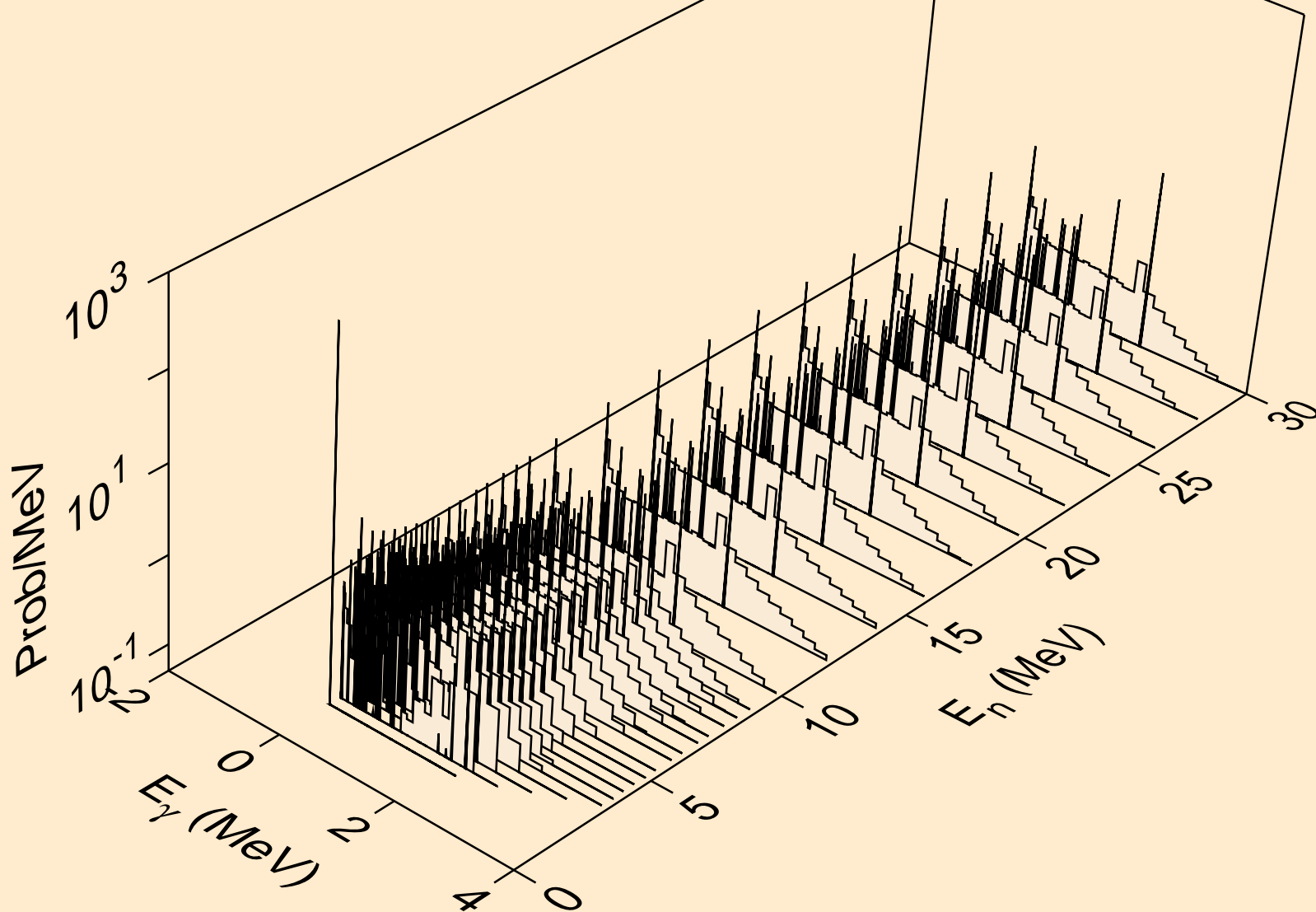

TB146M NEUTRON ACER TENDL-2019 LIBRARY; T=293.16K
Photon emission for (n,gma)

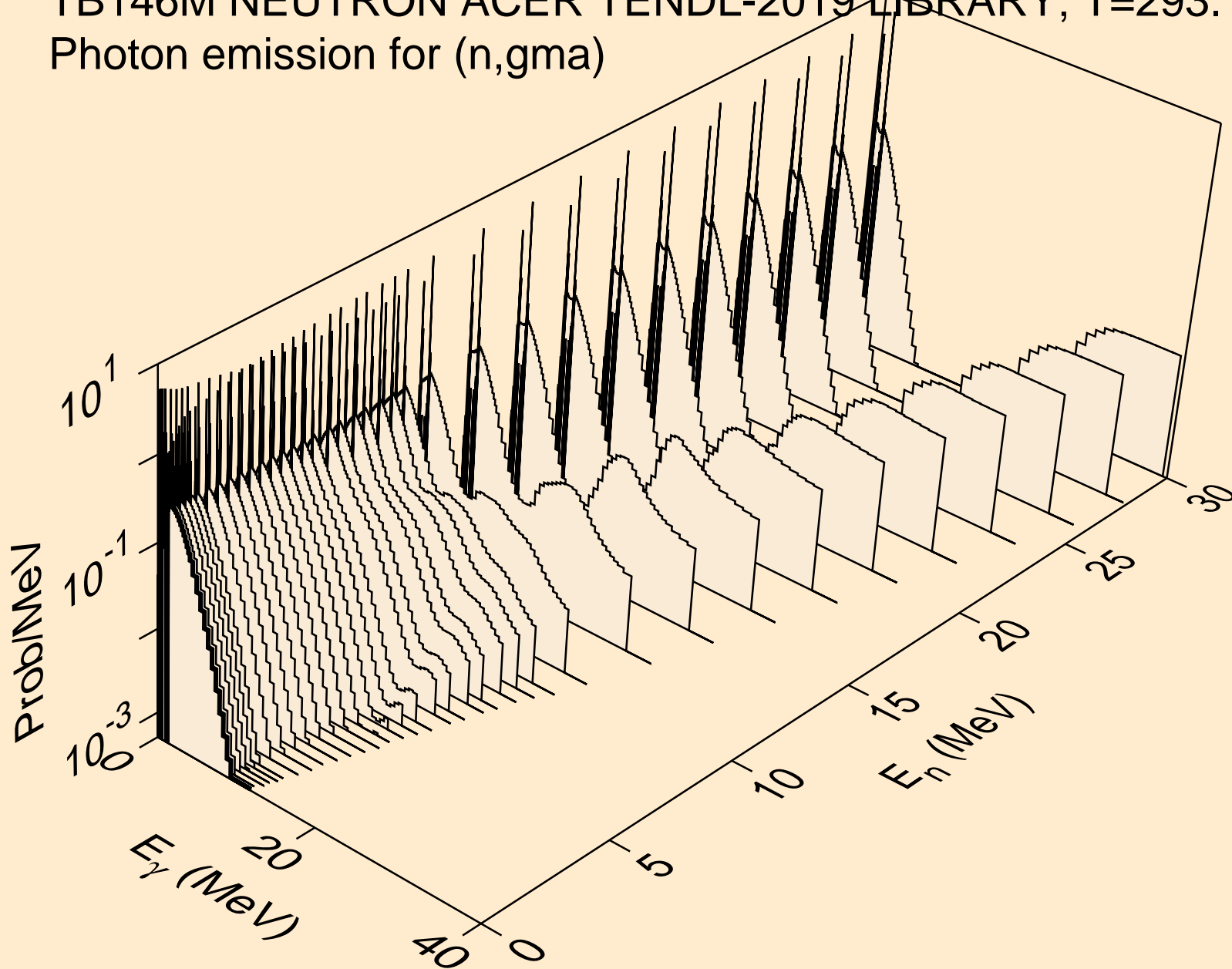

TB146M NEUTRON ACER TENDL-2019 LIBRARY; T=293.16K
Photon emission for (n,p)

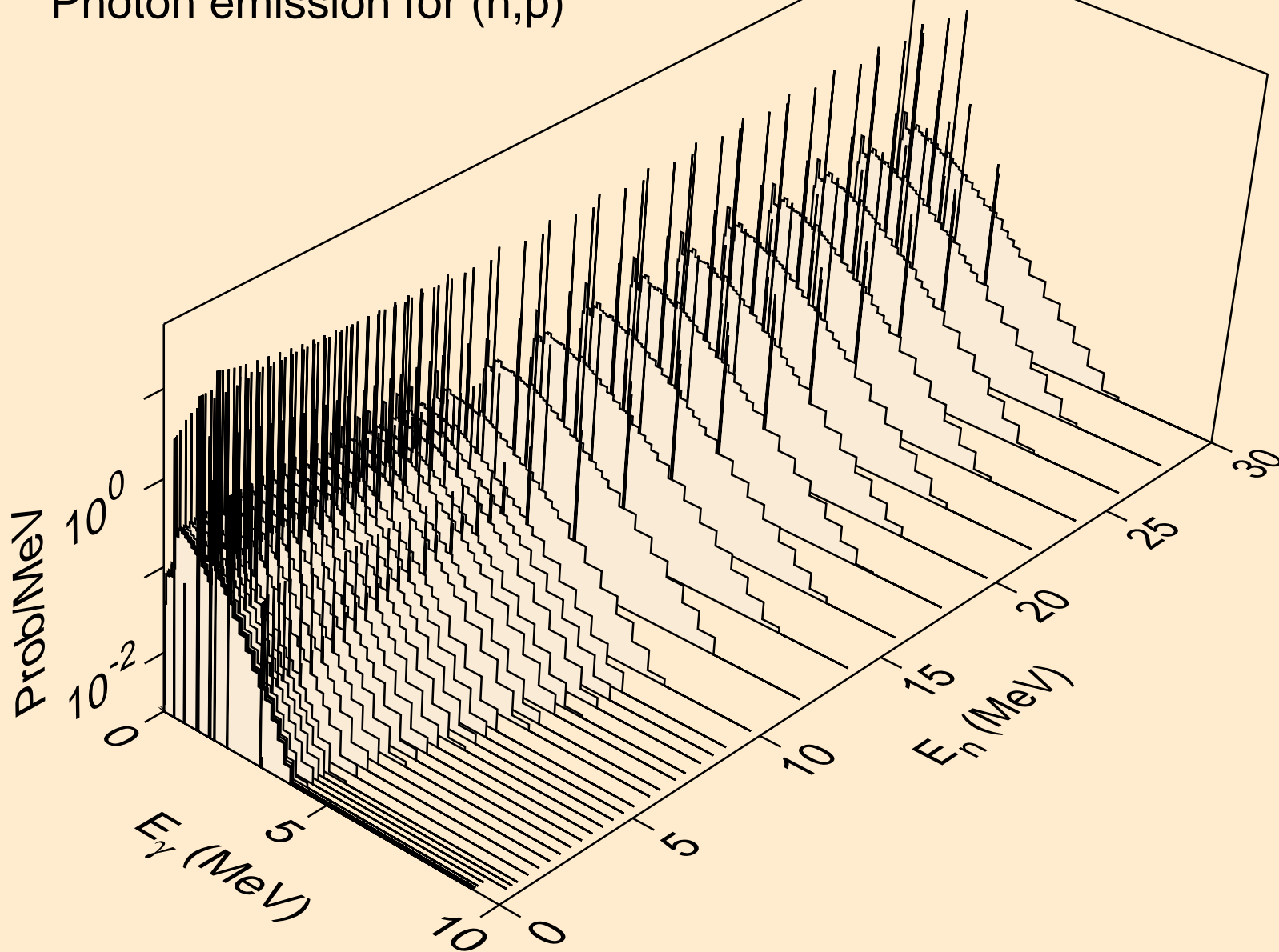

TB146M NEUTRON ACER TENDL-2019 LIBRARY; T=293.16K
Photon emission for (n,d)

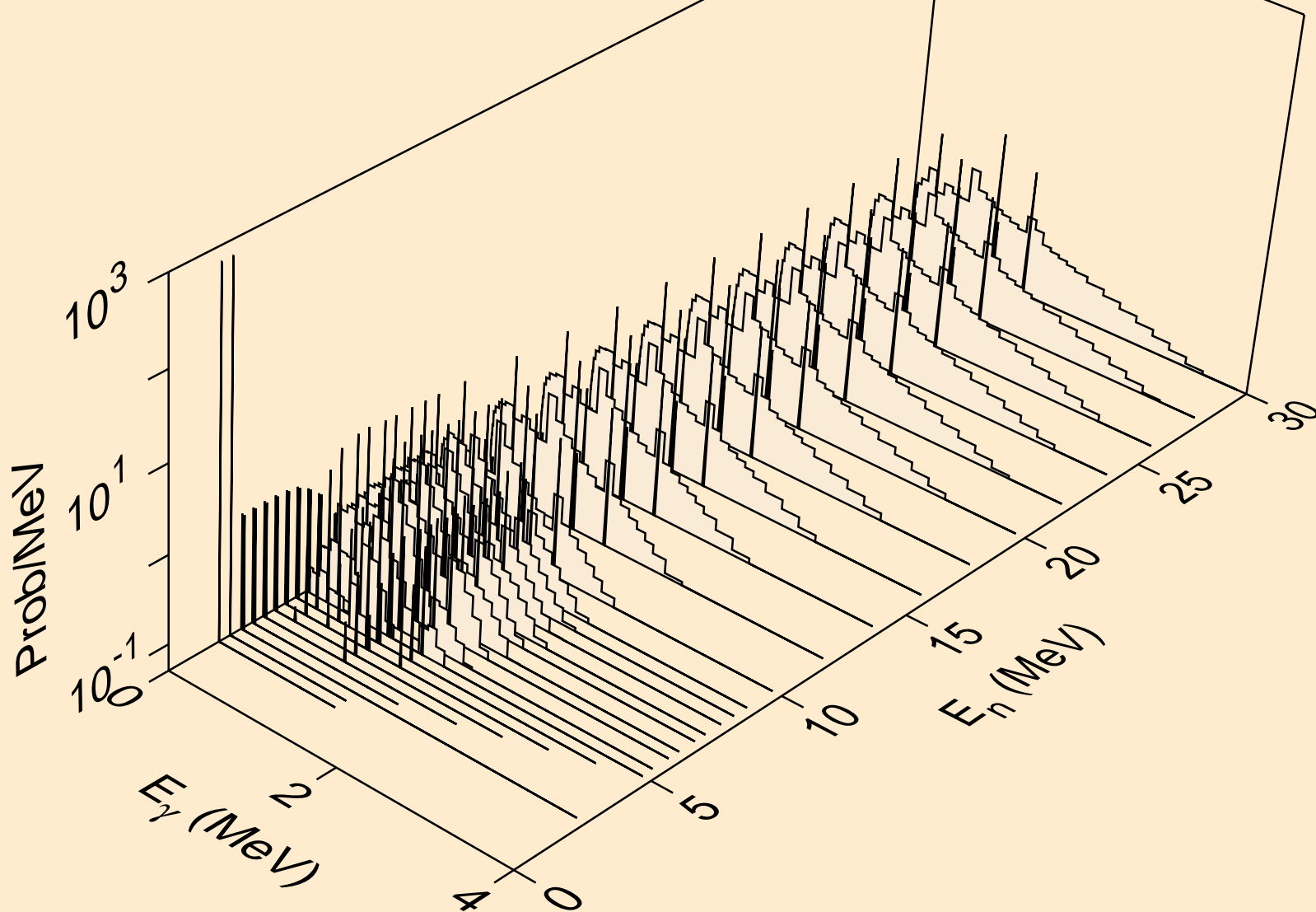

TB146M NEUTRON ACER TENDL-2019 LIBRARY; T=293.16K
Photon emission for (n,t)

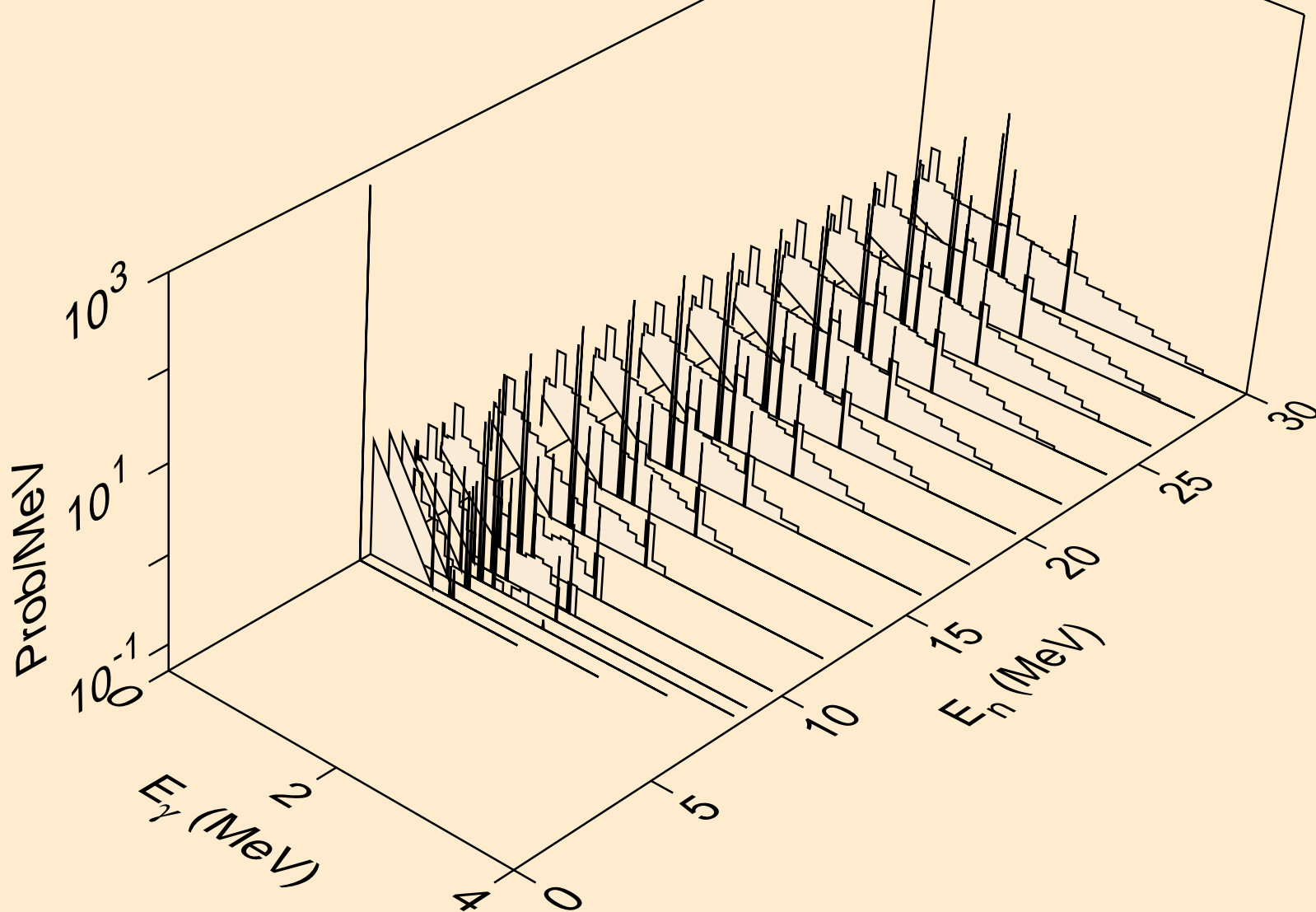

TB146M NEUTRON ACER TENDL-2019 LIBRARY; T=293.16K
Photon emission for (n,he3)

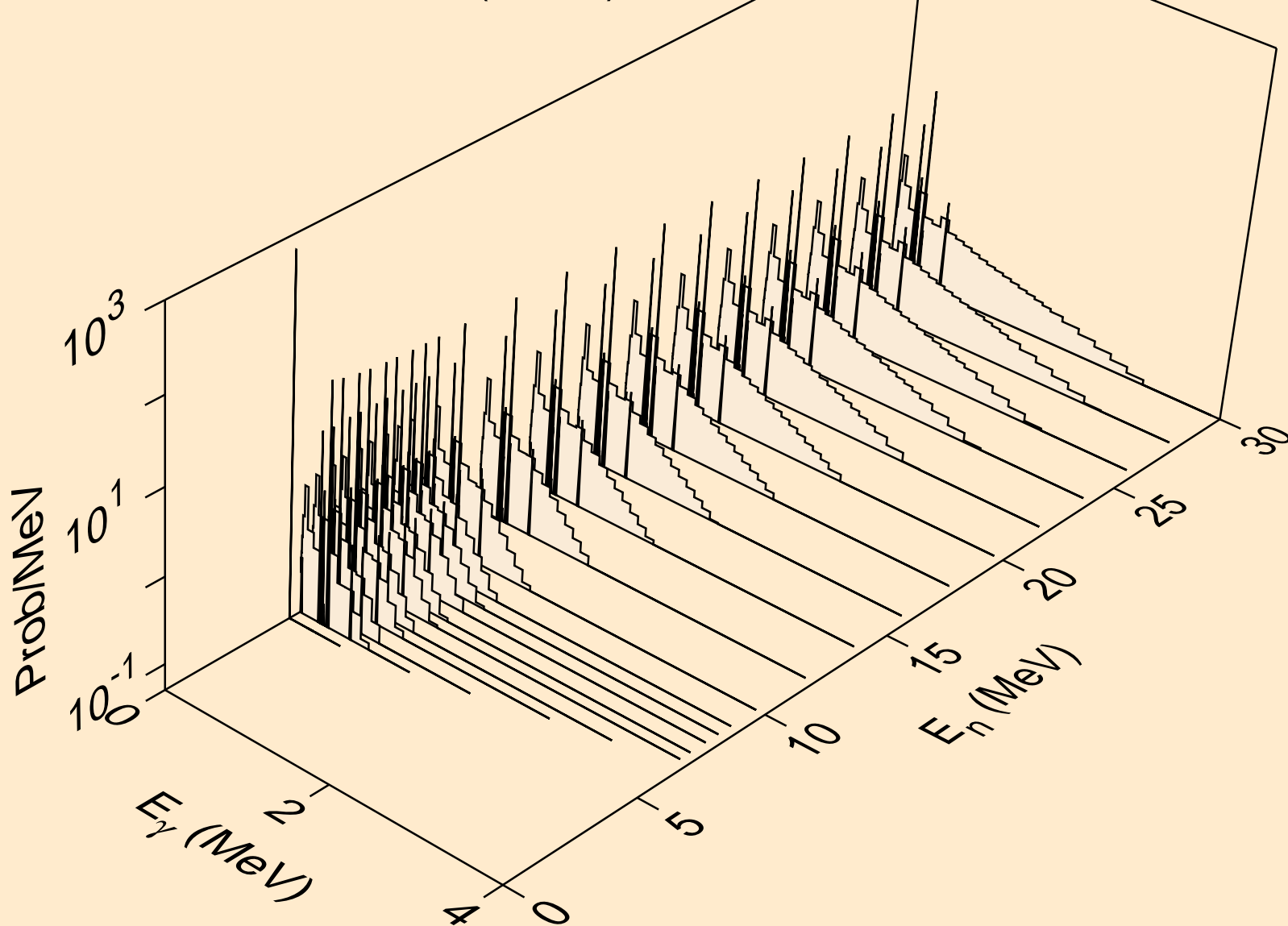

TB146M NEUTRON ACER TENDL-2019 LIBRARY; T=293.16K
Photon emission for (n,a)

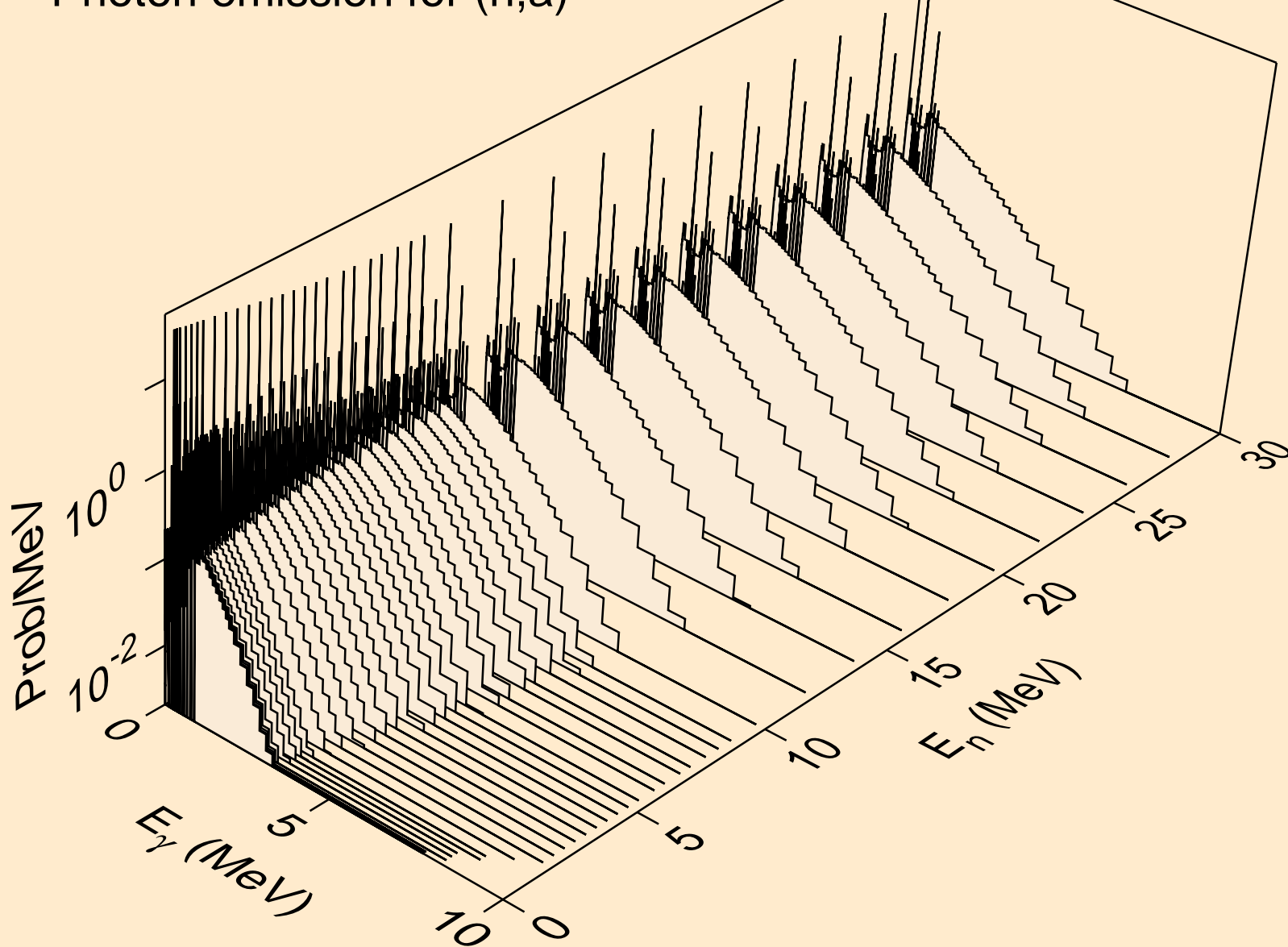

TB146M NEUTRON ACER TENDL-2019 LIBRARY; T=293.16K
Photon emission for (n,2a)

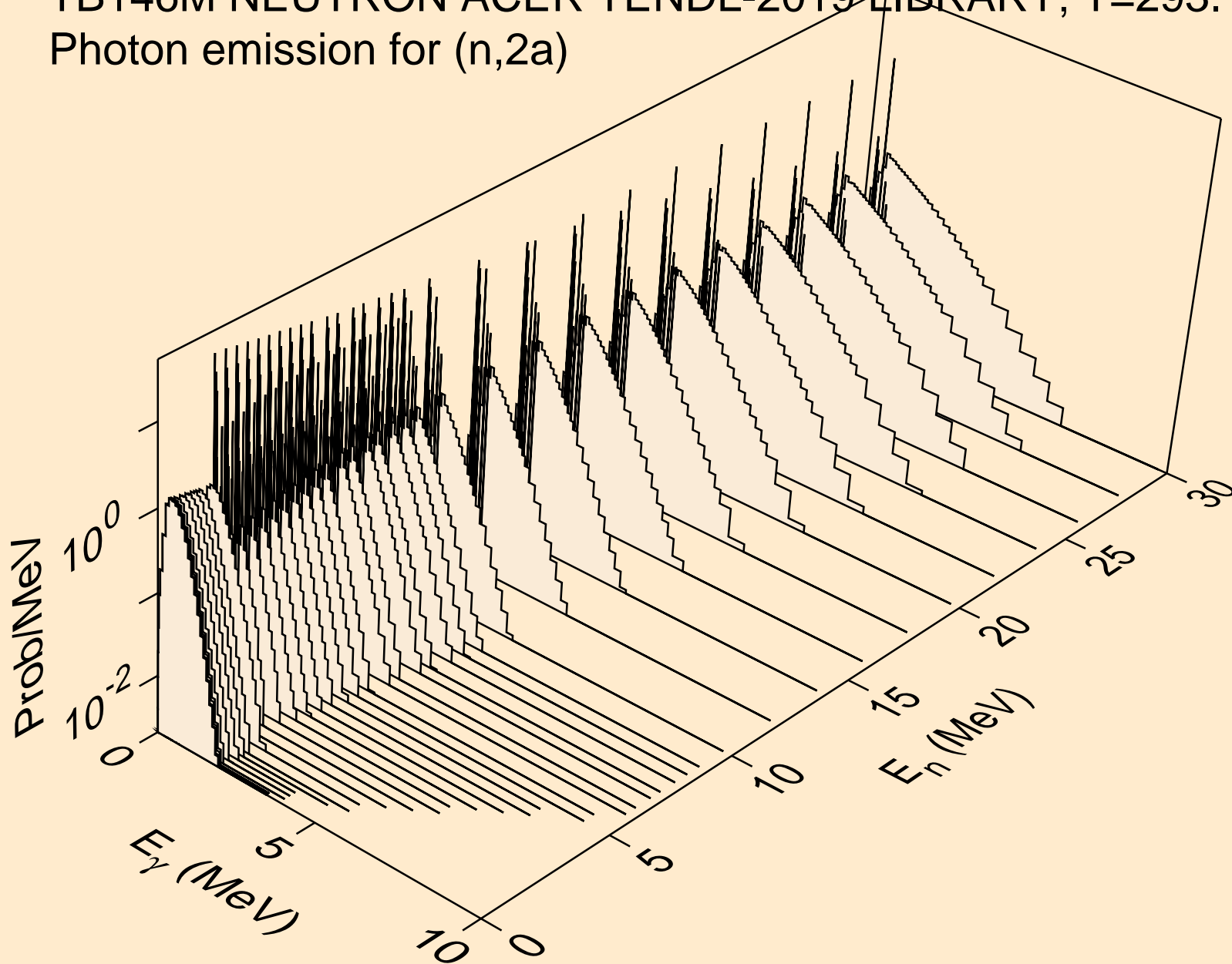

TB146M NEUTRON ACER TENDL-2019 LIBRARY; T=293.16K
Photon emission for (n,3a)

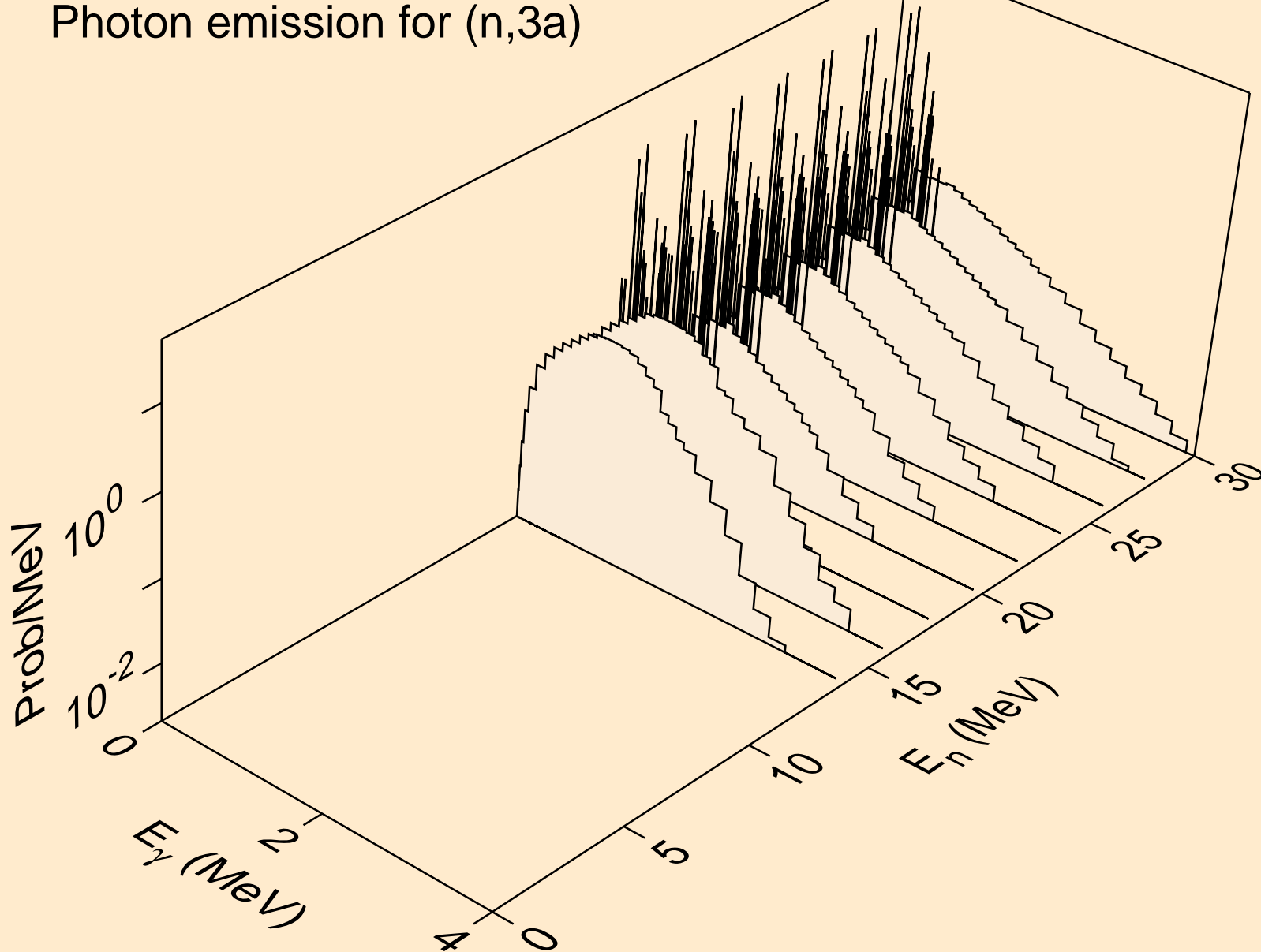

TB146M NEUTRON ACER TENDL-2019 LIBRARY; T=293.16K
Photon emission for (n,2p)

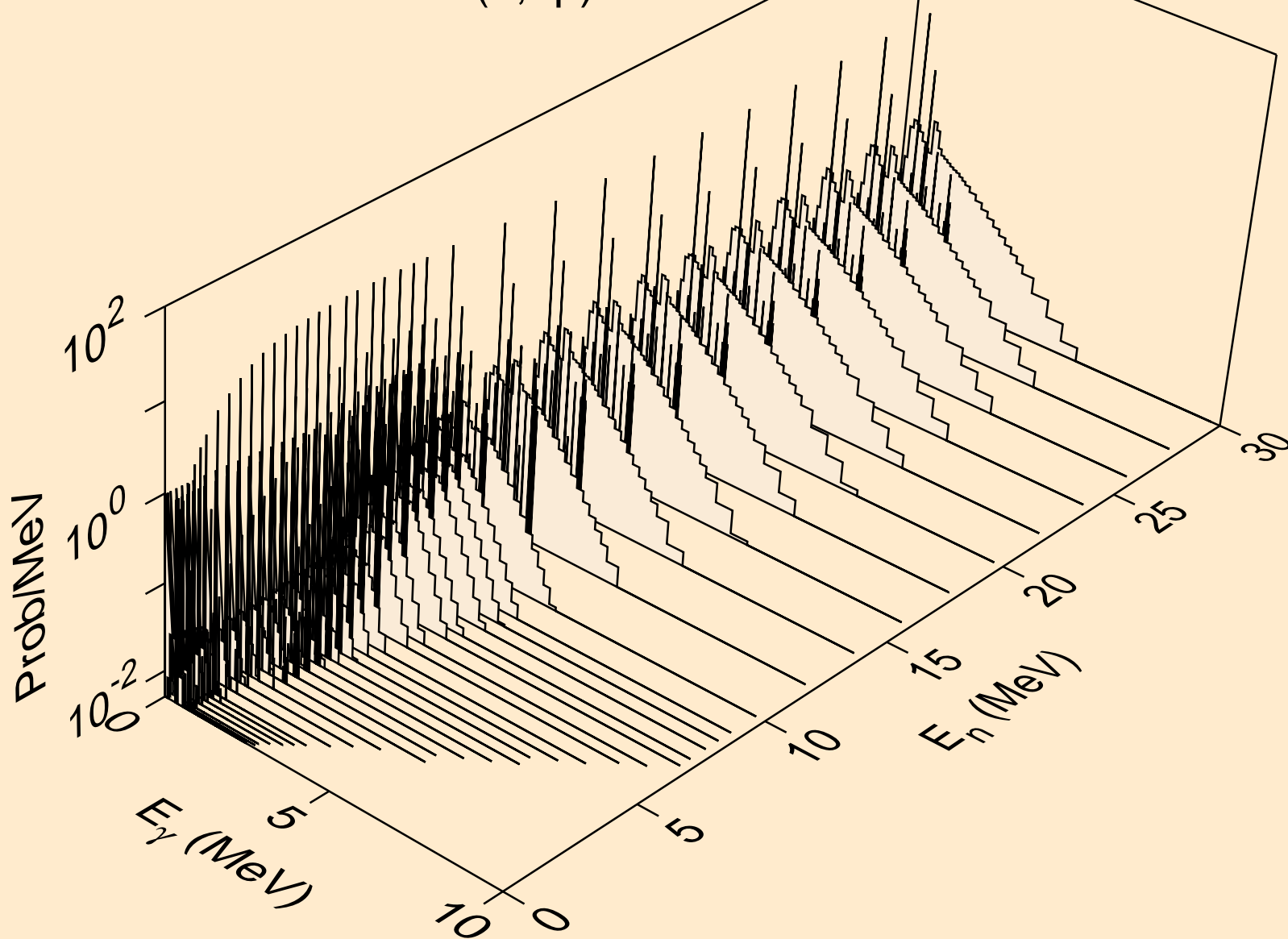

TB146M NEUTRON ACER TENDL-2019 LIBRARY; T=293.16K
Photon emission for (n,p α)

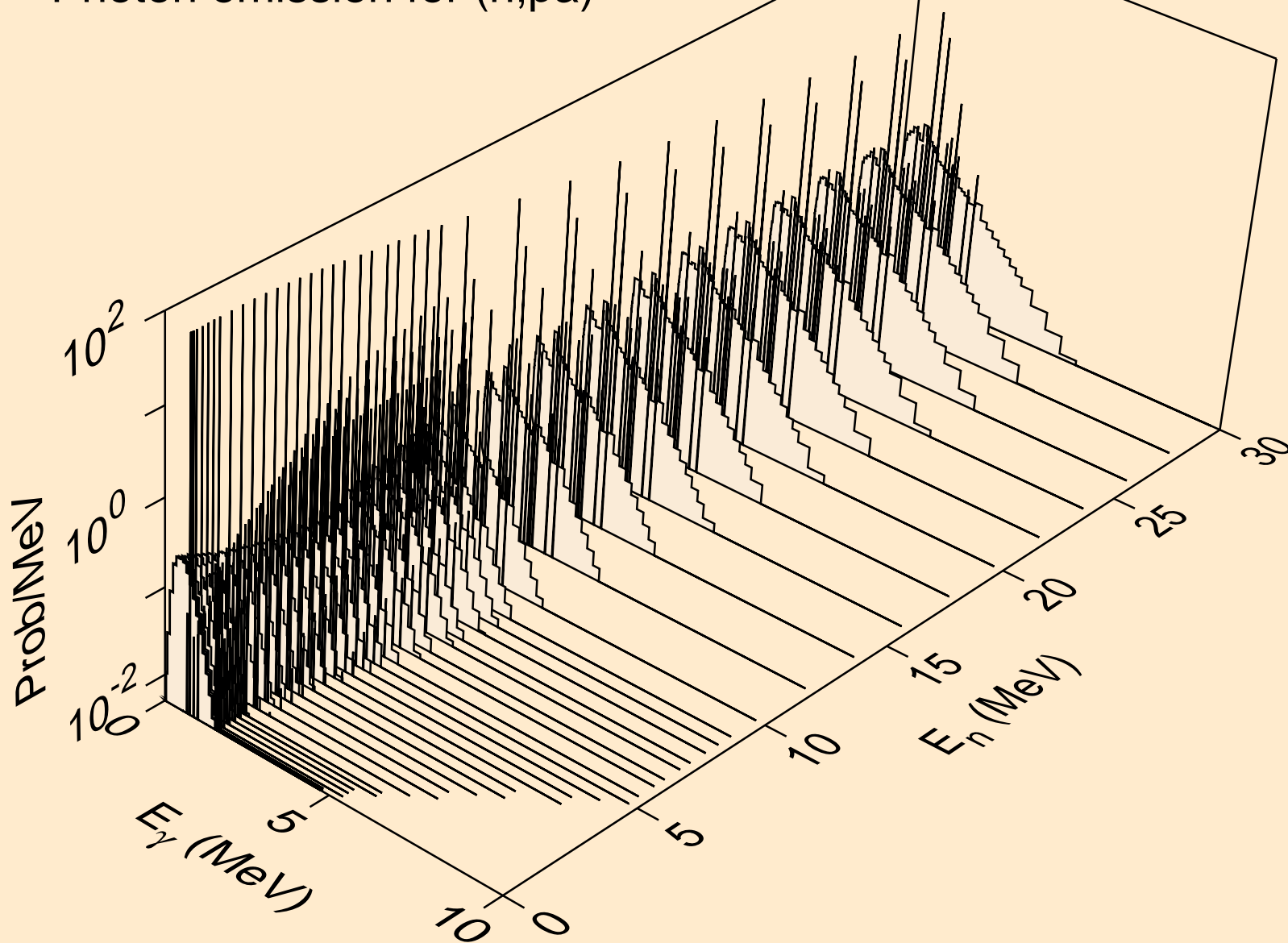

TB146M NEUTRON ACER TENDL-2019 LIBRARY; T=293.16K
Photon emission for (n,pd)

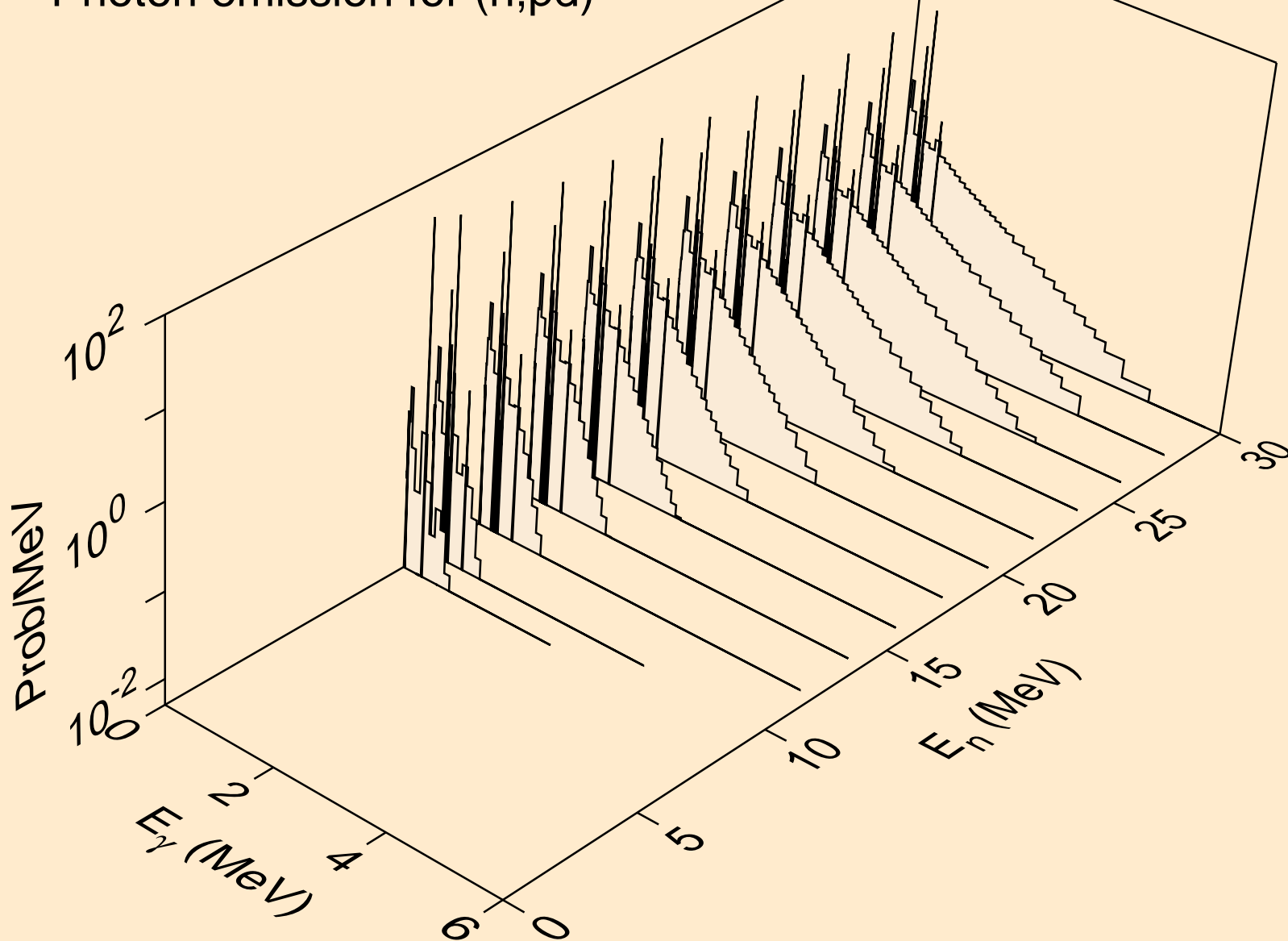

TB146M NEUTRON ACER TENDL-2019 LIBRARY; T=293.16K
Photon emission for (n,pt)

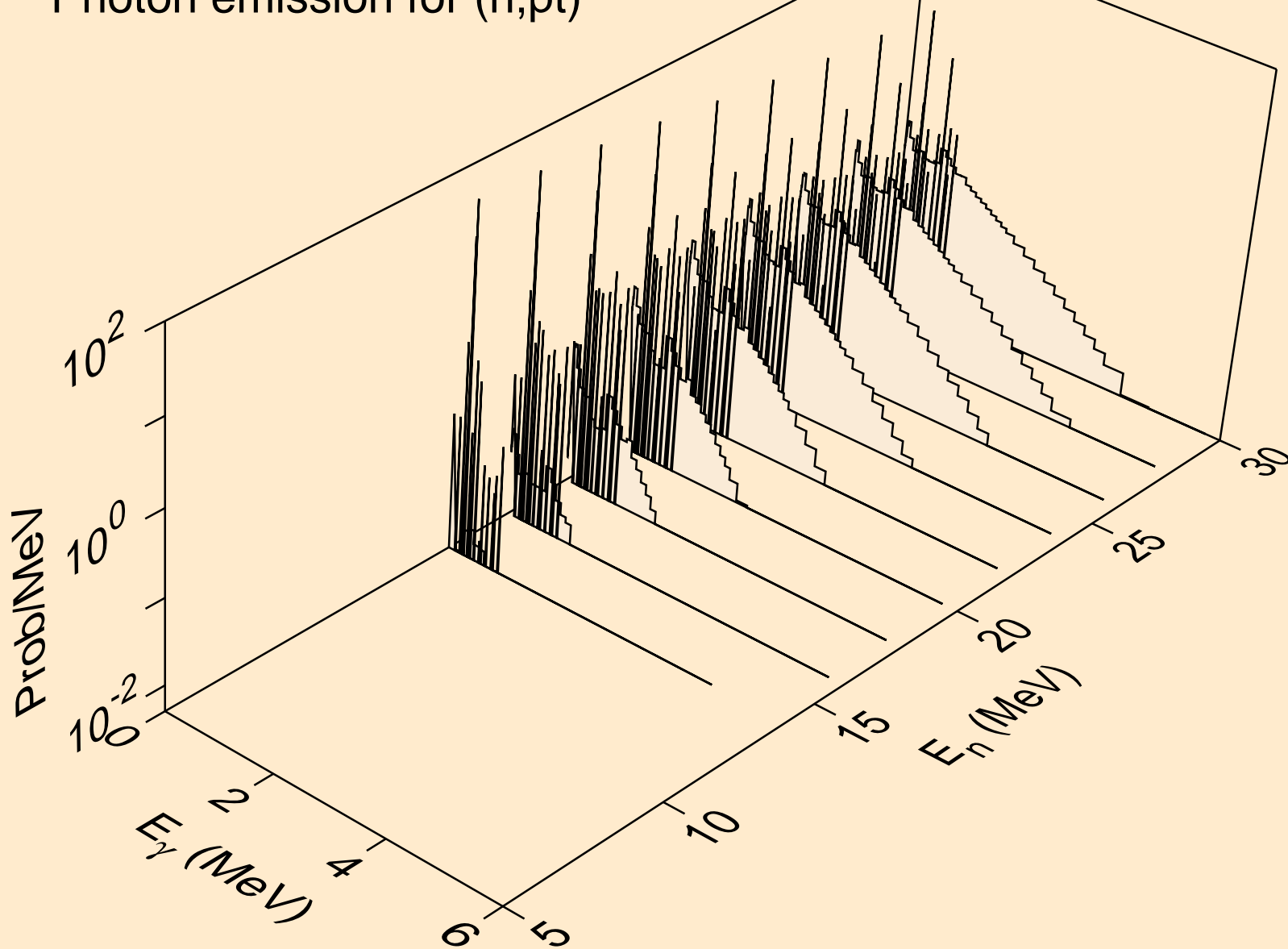

TB146M NEUTRON ACER TENDL-2019 LIBRARY; T=293.16K
Photon emission for (n,da)

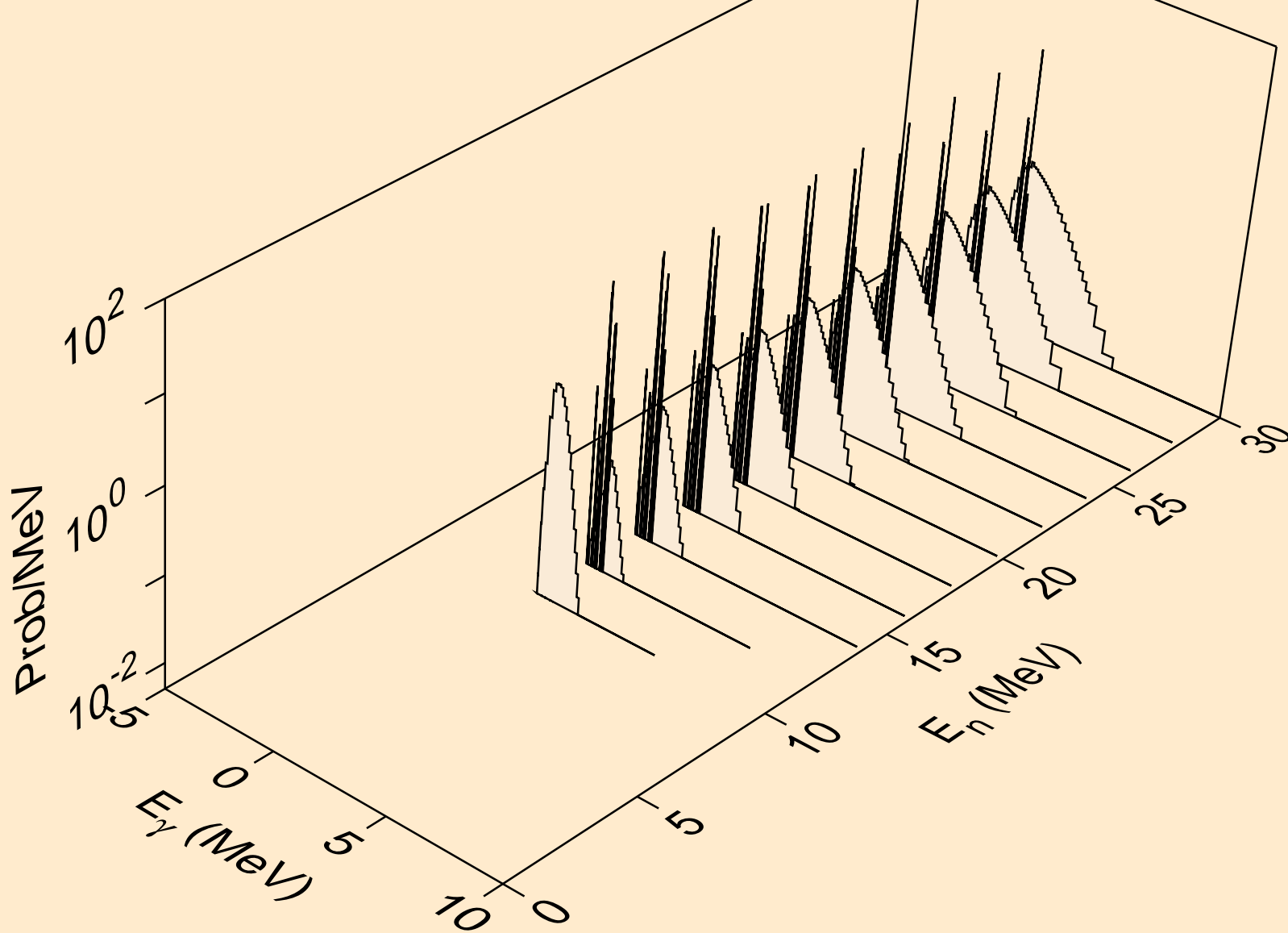

TB146M NEUTRON ACER TENDL-2019 LIBRARY; T=293.16K
thermal capture photon spectrum

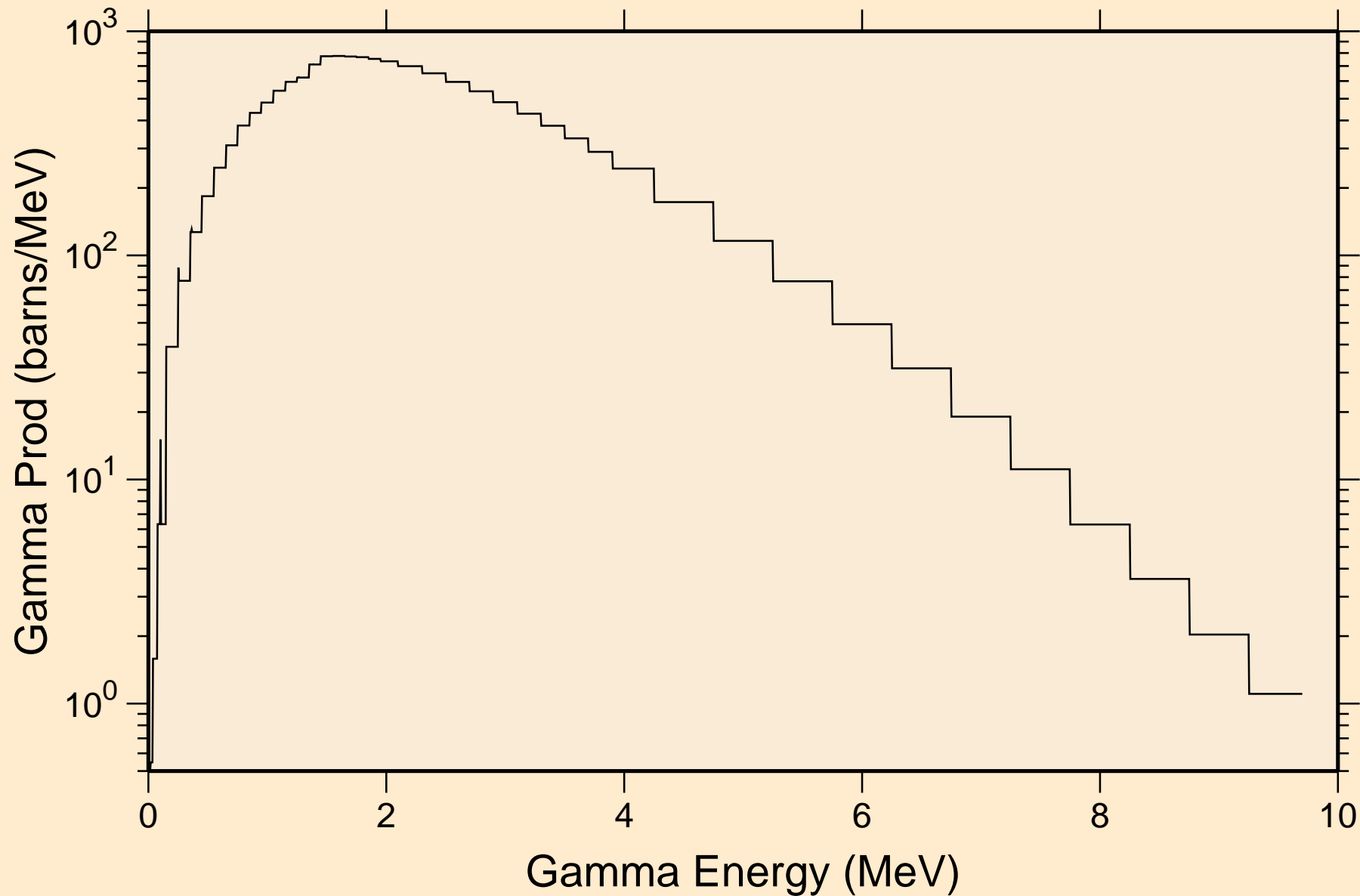

TB146M NEUTRON ACER TENDL-2019 LIBRARY; T=293.16K
14 MeV photon spectrum

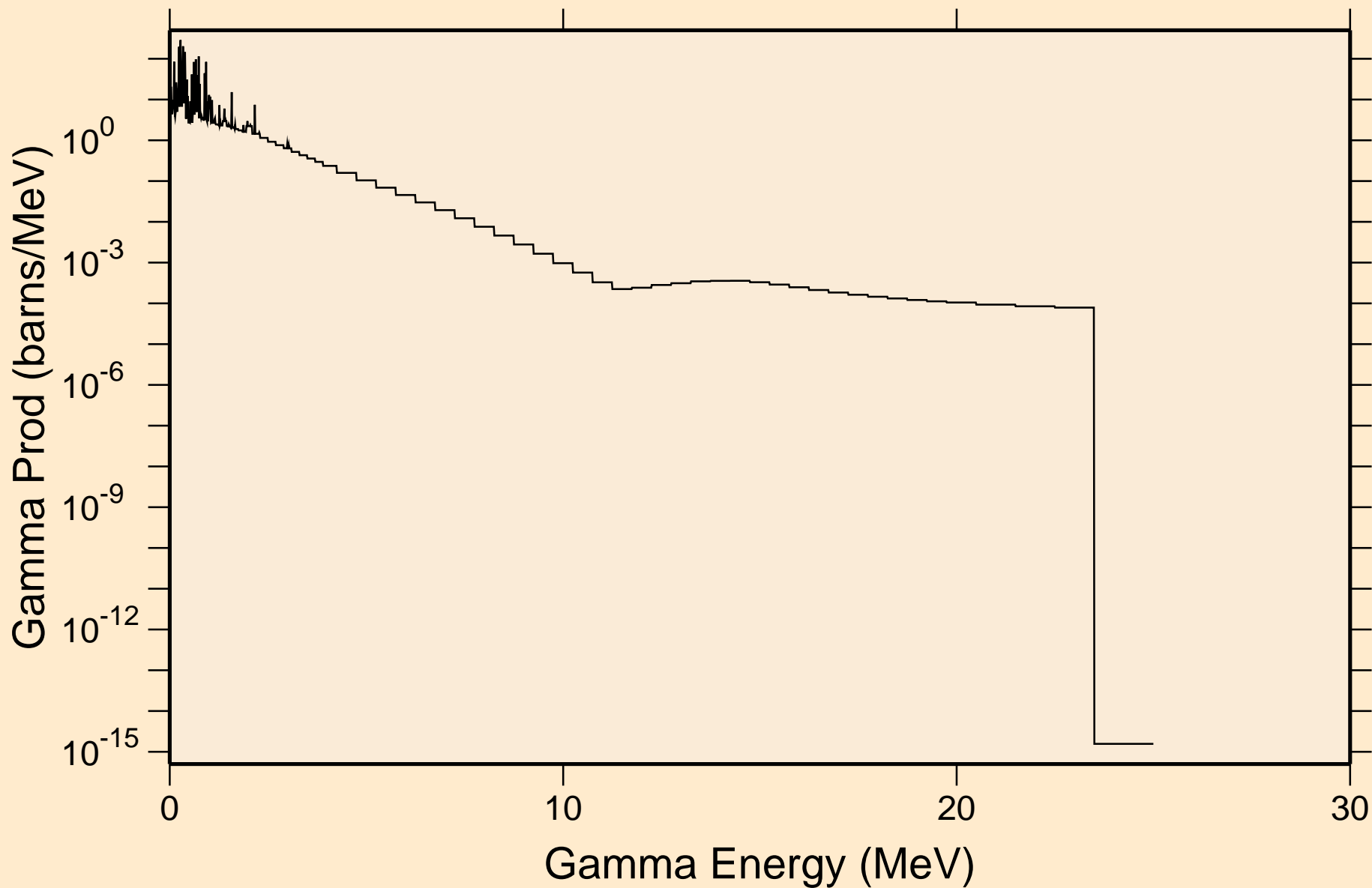

TB146M NEUTRON ACER TENDL-2019 LIBRARY; T=293.16K
Particle heating contributions

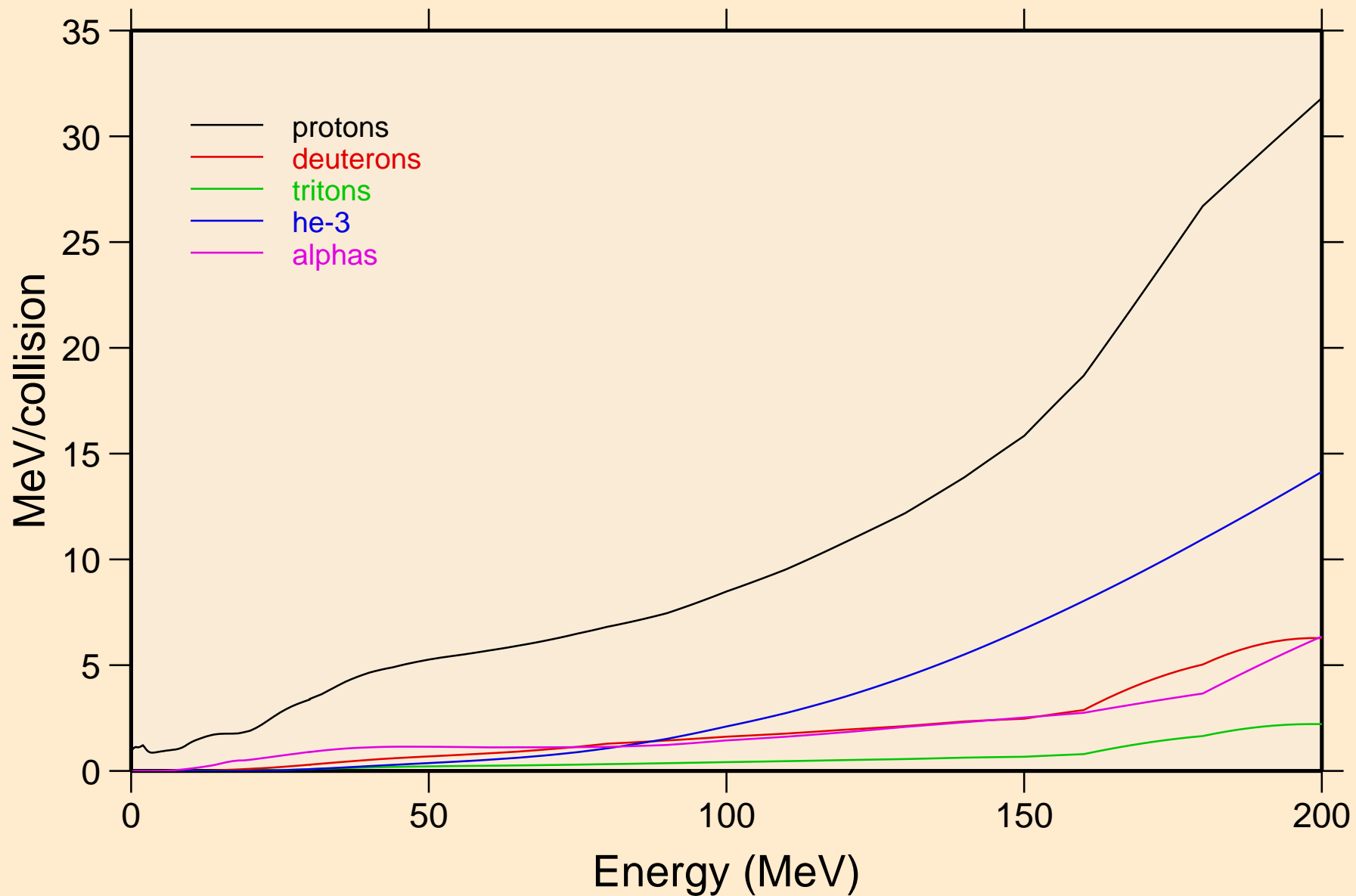

TB146M NEUTRON ACER TENDL-2019 LIBRARY; T=293.16K
Recoil Heating

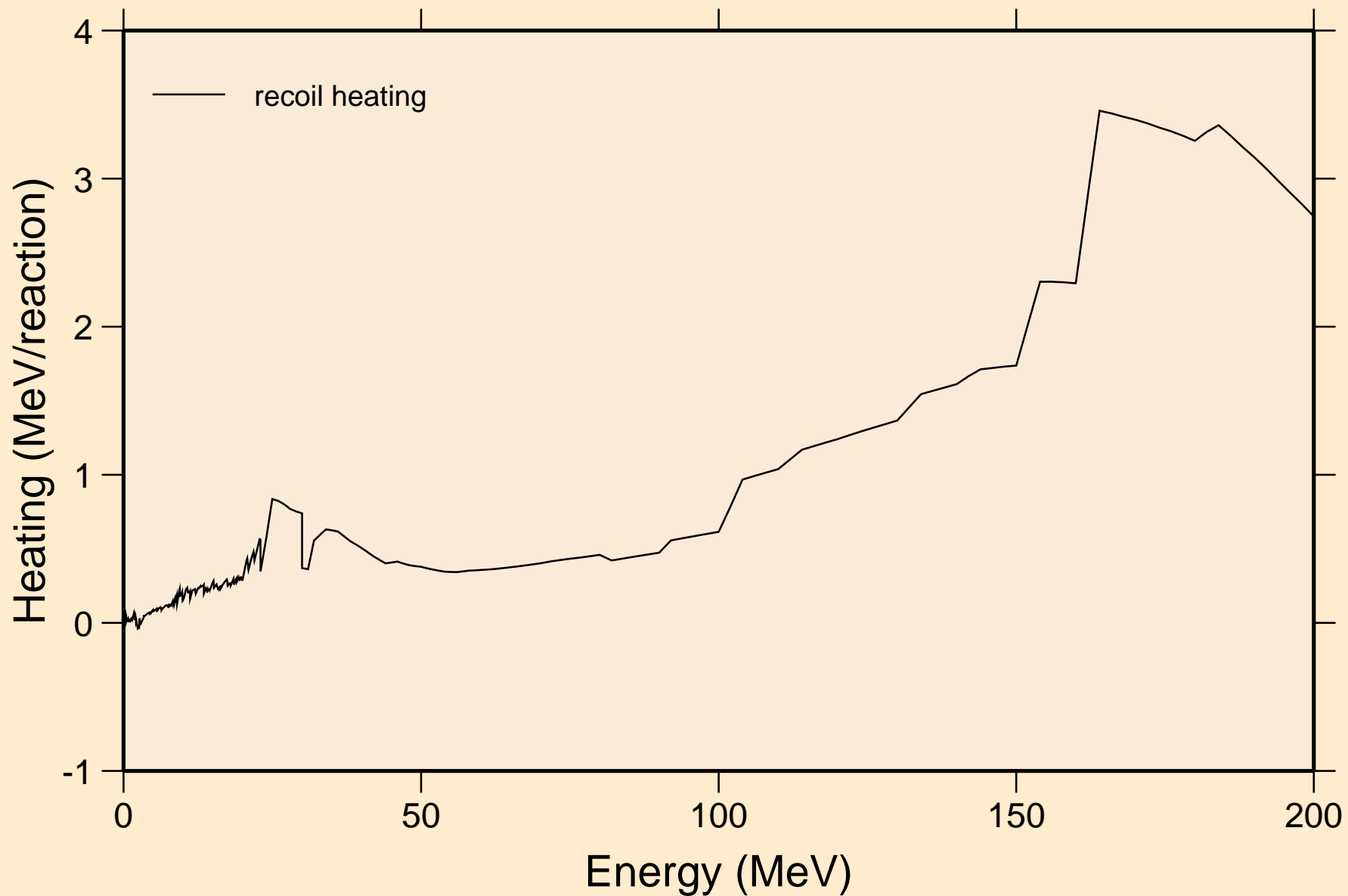

TB146M NEUTRON ACER TENDL-2019 LIBRARY; T=293.16K
Particle production cross sections

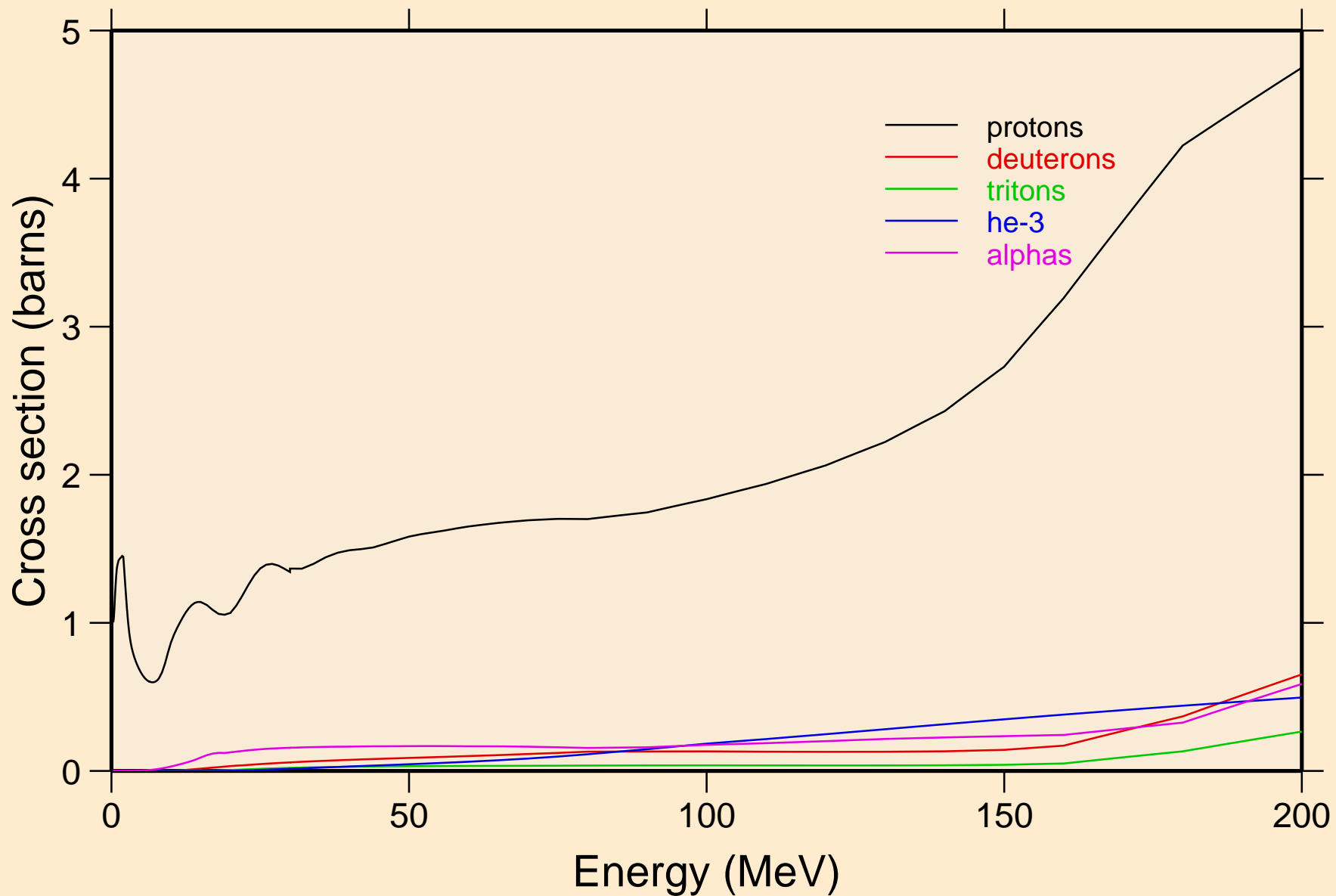

TB146M NEUTRON ACER TENDL-2019 LIBRARY; T=293.16K
protons from (n,x)

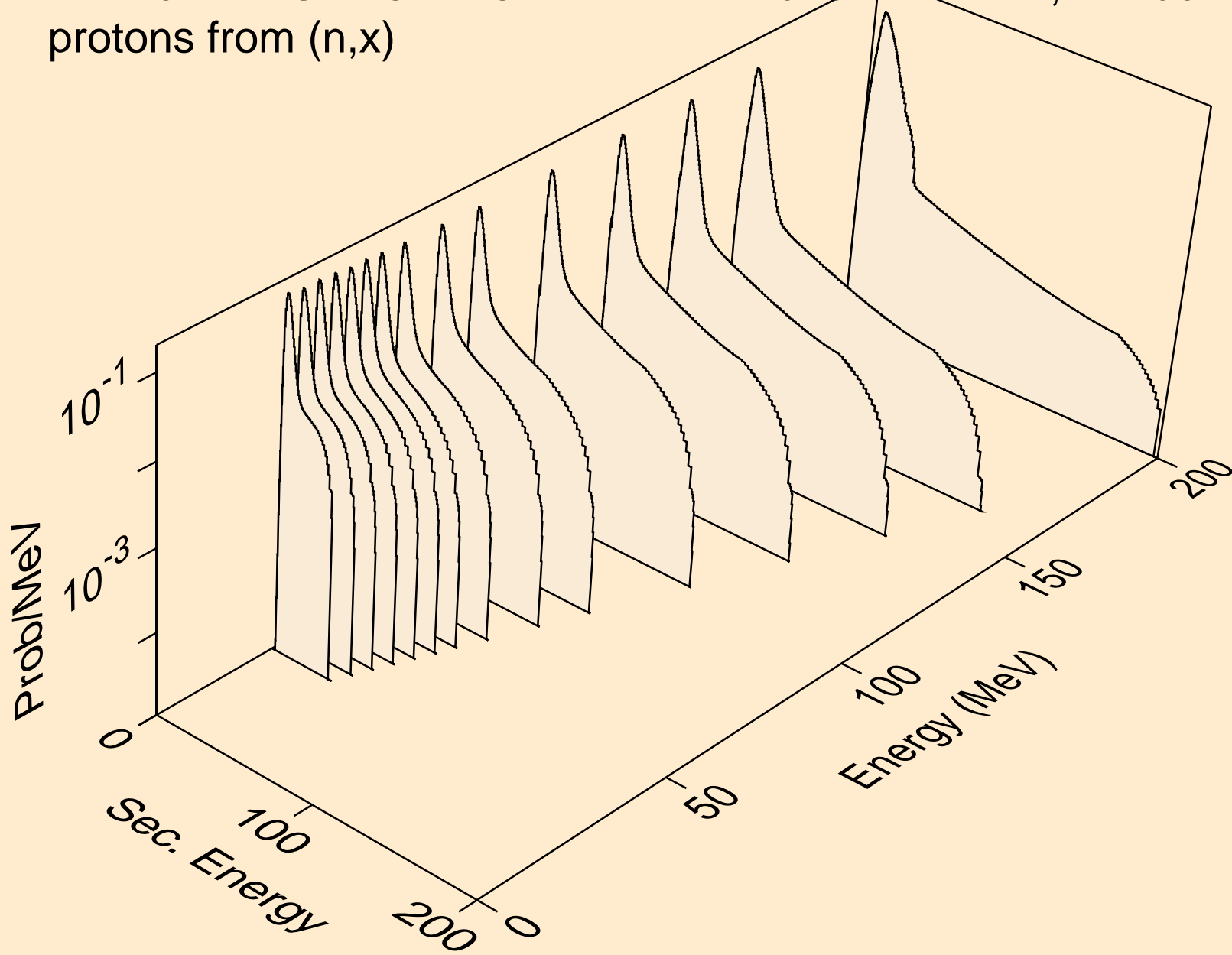

TB146M NEUTRON ACER TENDL-2019 LIBRARY; T=293.16K
protons from (n,n*)p

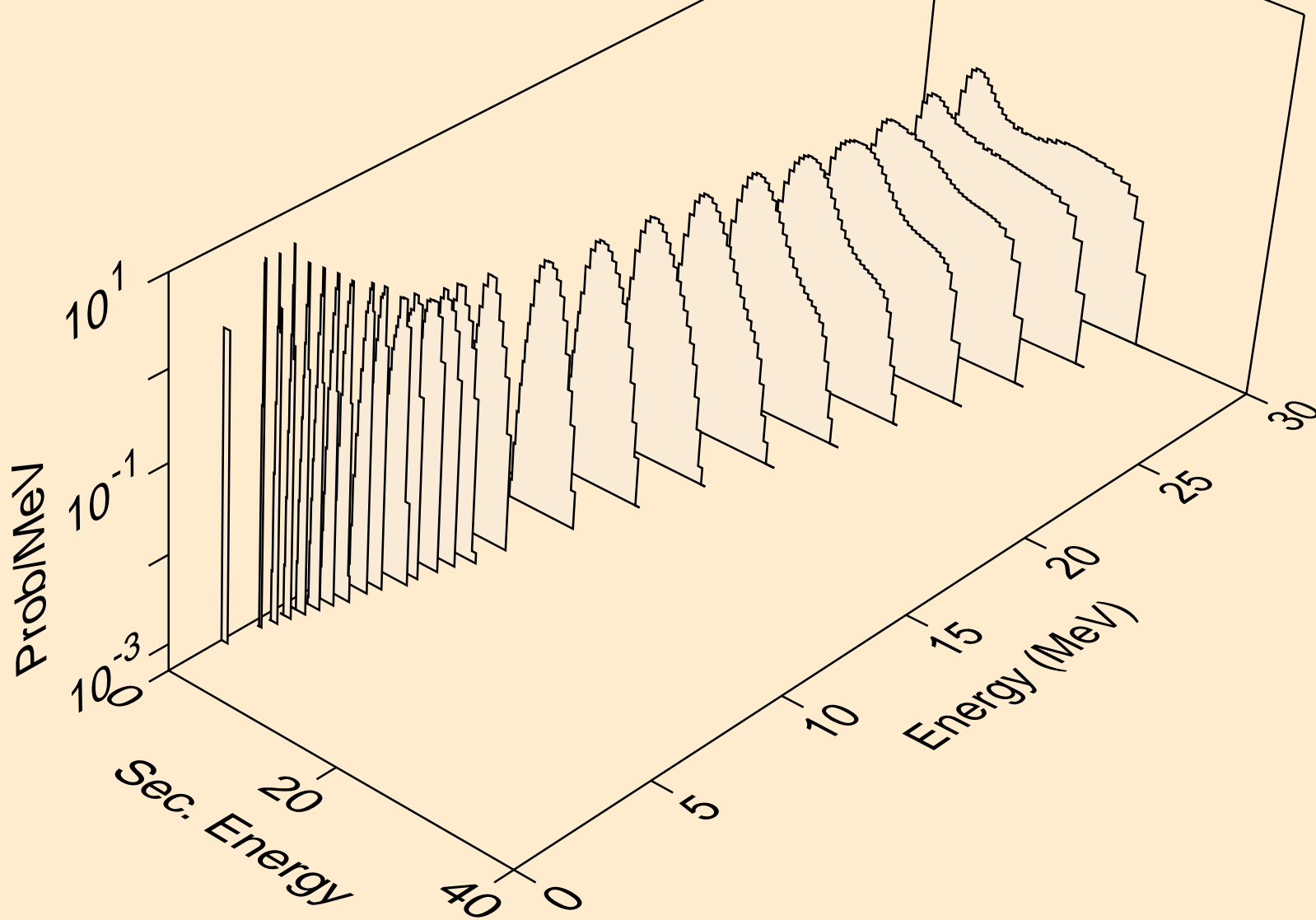

TB146M NEUTRON ACER TENDL-2019 LIBRARY; T=293.16K
protons from (n,2np)

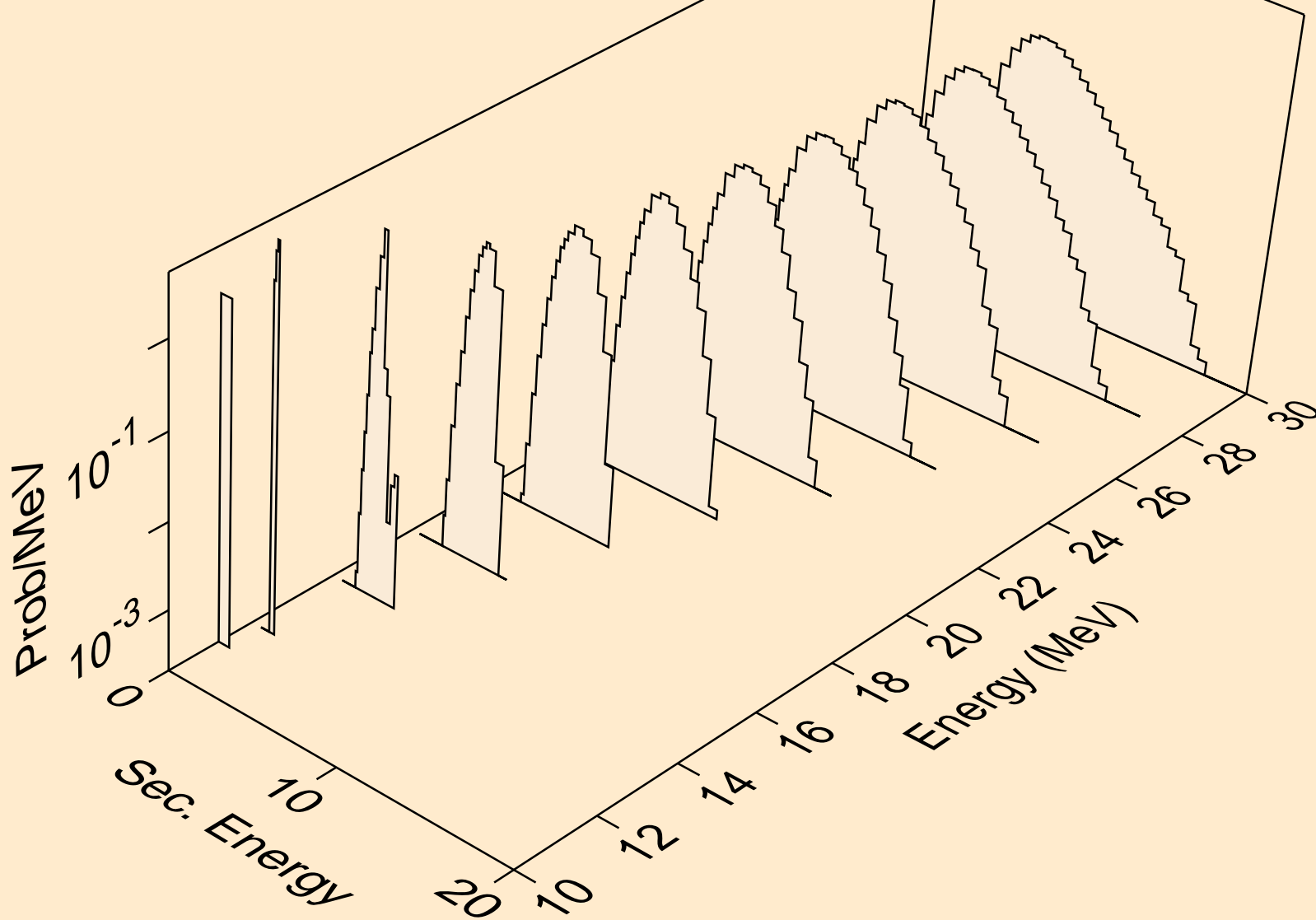

TB146M NEUTRON ACER TENDL-2019 LIBRARY; T=293.16K
protons from (n,3np)

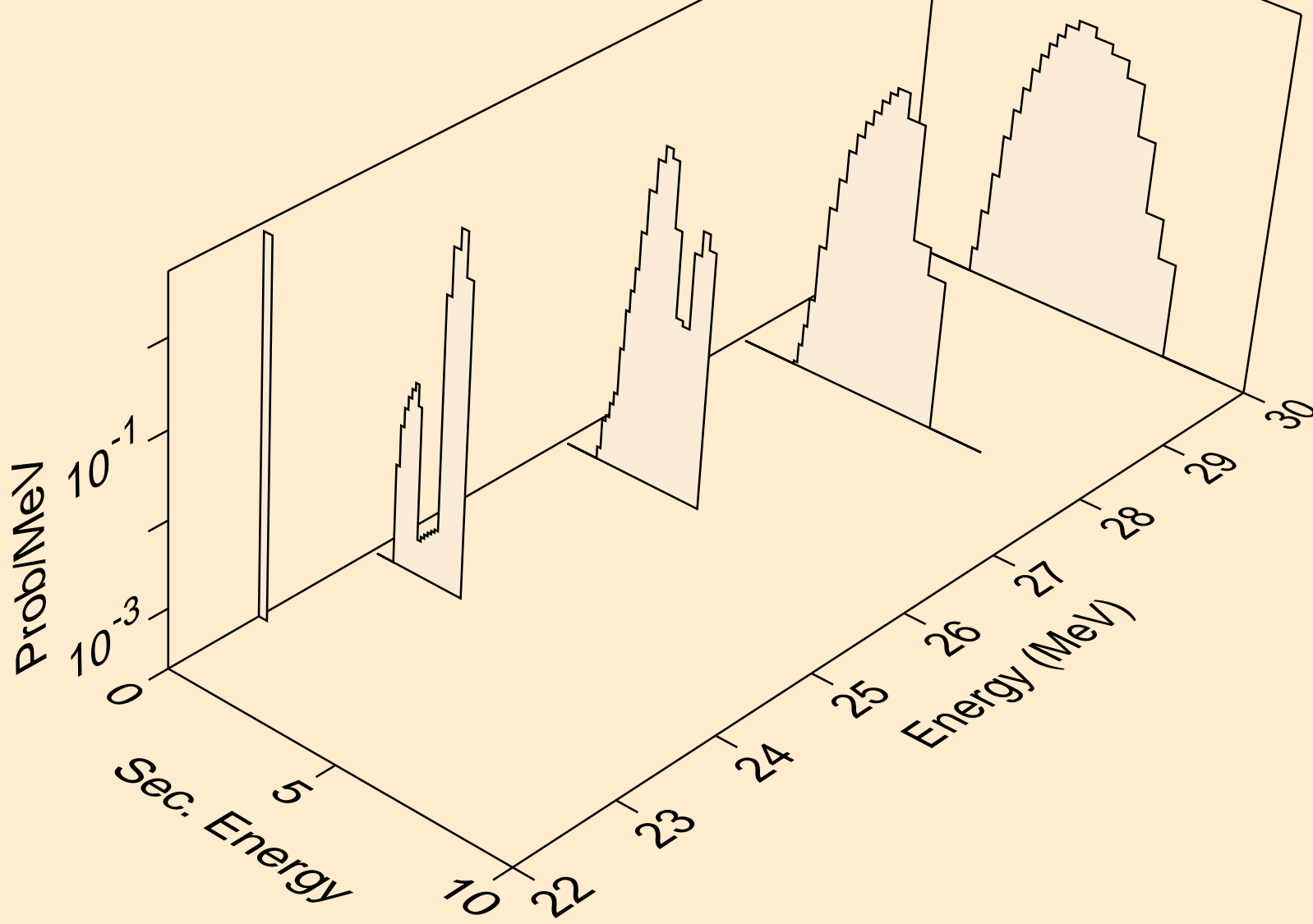

TB146M NEUTRON ACER TENDL-2019 LIBRARY; T=293.16K
protons from (n,2np)

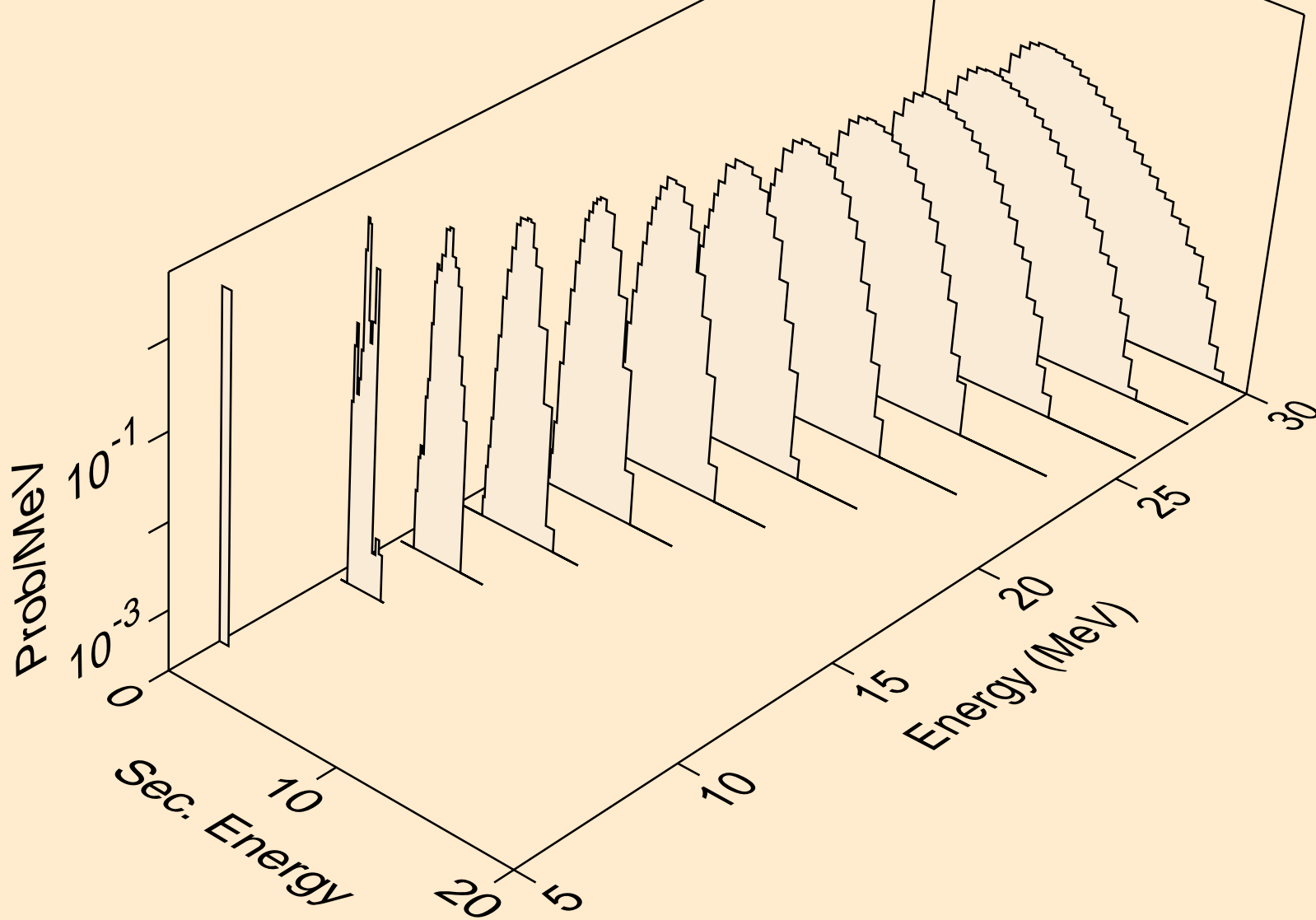

TB146M NEUTRON ACER TENDL-2019 LIBRARY; T=293.16K
protons from (n,npa)

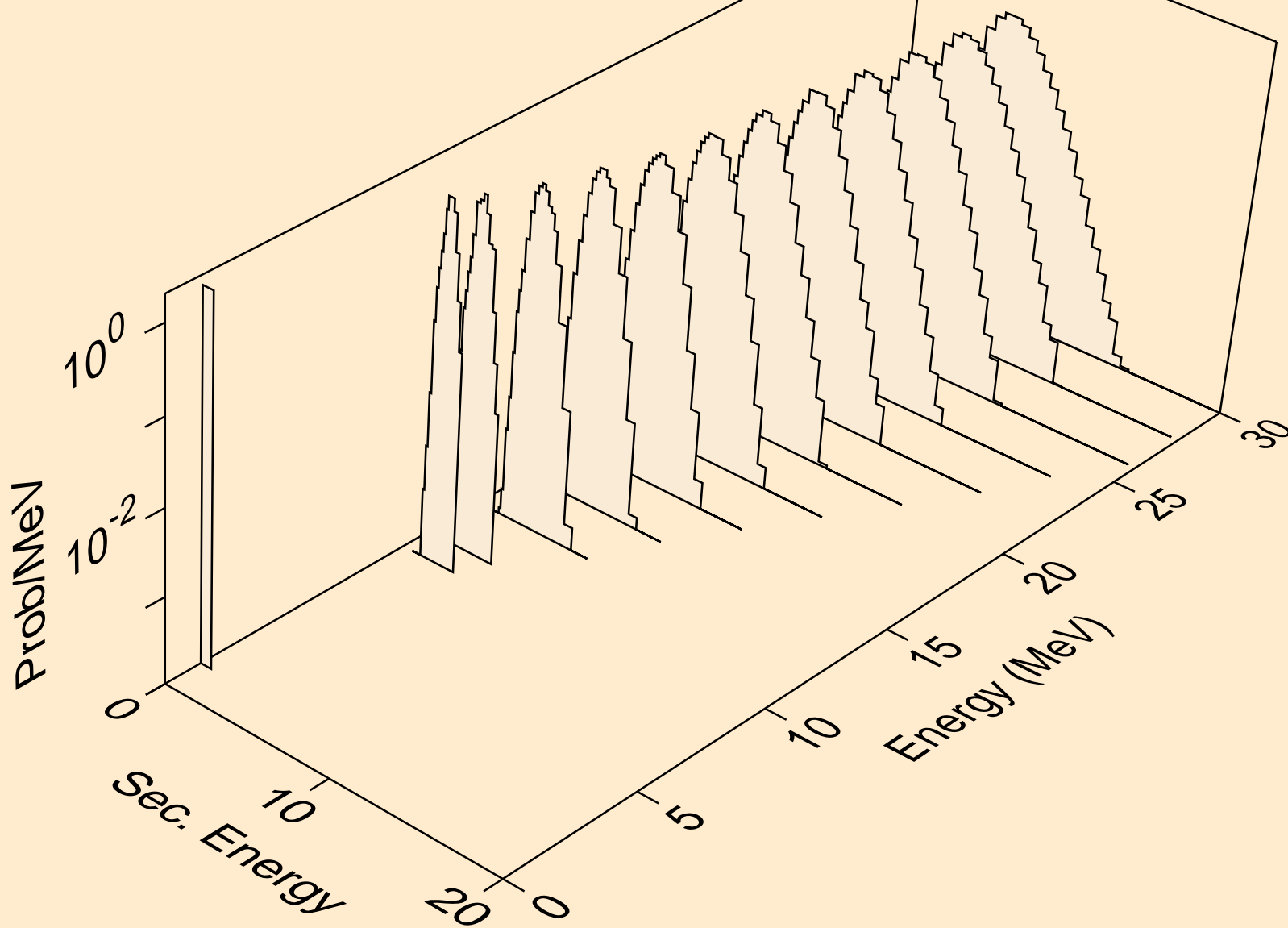

TB146M NEUTRON ACER TENDL-2019 LIBRARY; T=293.16K
protons from (n,p)

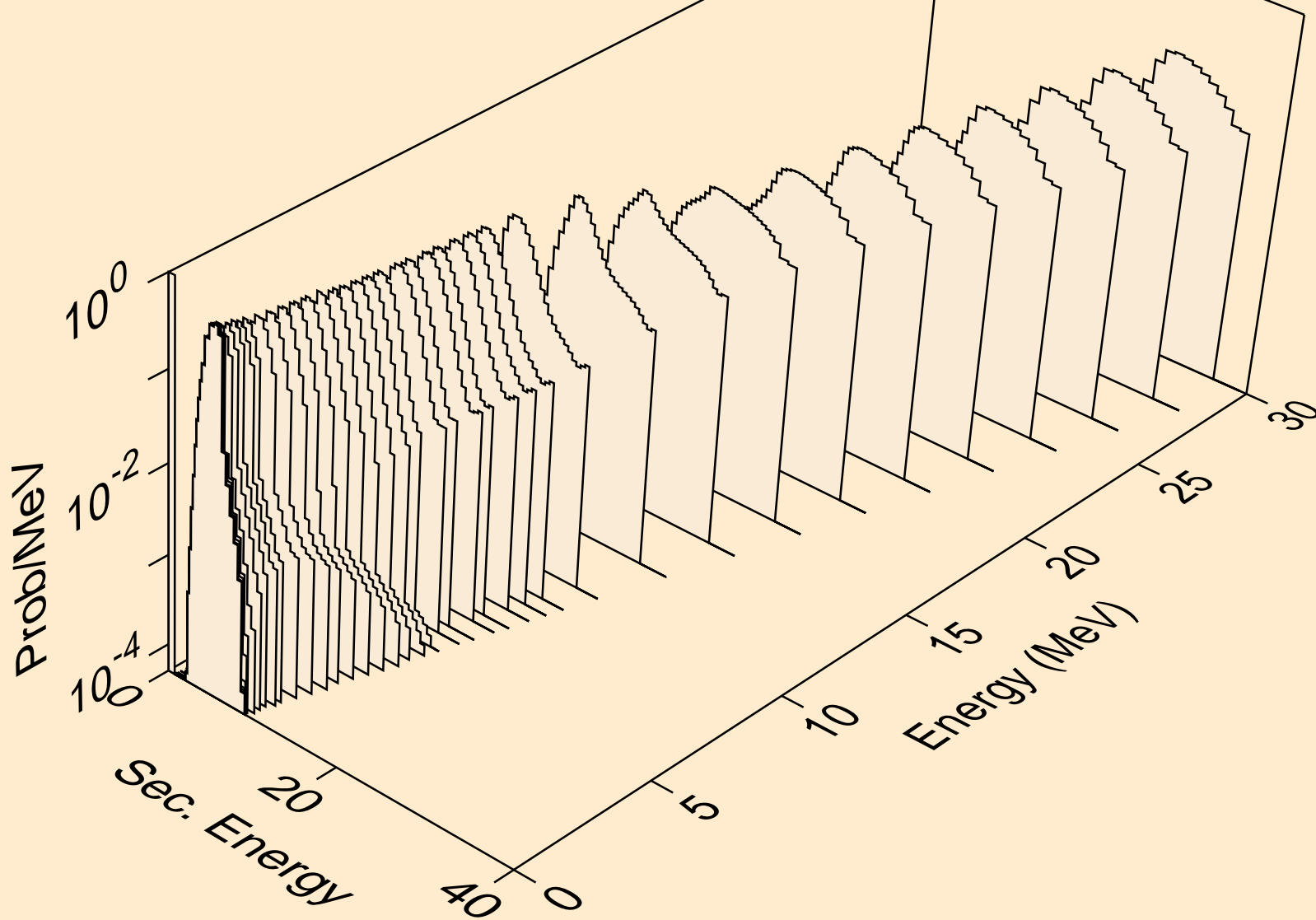

TB146M NEUTRON ACER TENDL-2019 LIBRARY; T=293.16K
protons from (n,2p)

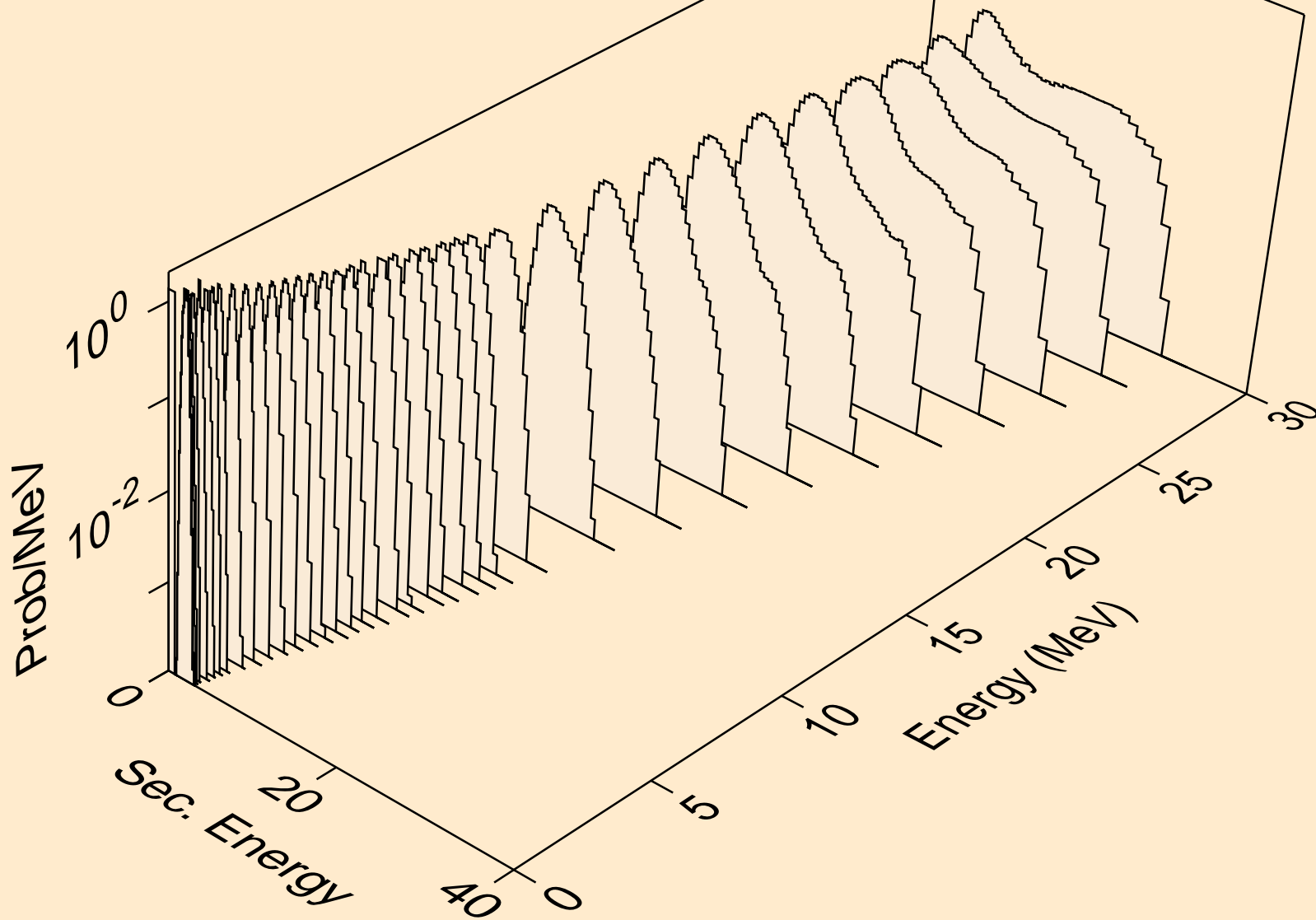

TB146M NEUTRON ACER TENDL-2019 LIBRARY; T=293.16K
protons from (n,p)

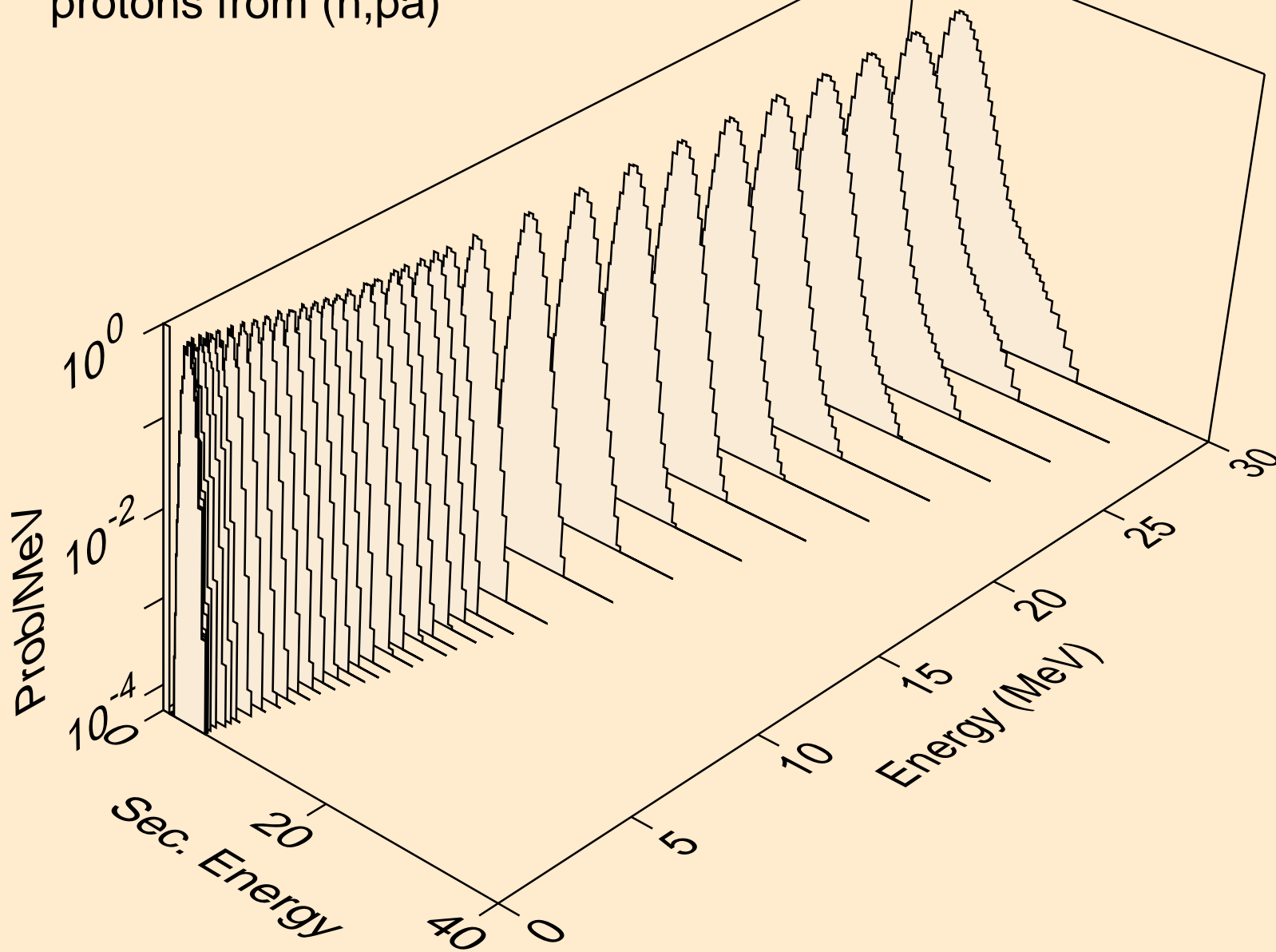

TB146M NEUTRON ACER TENDL-2019 LIBRARY; T=293.16K
protons from (n,pd)

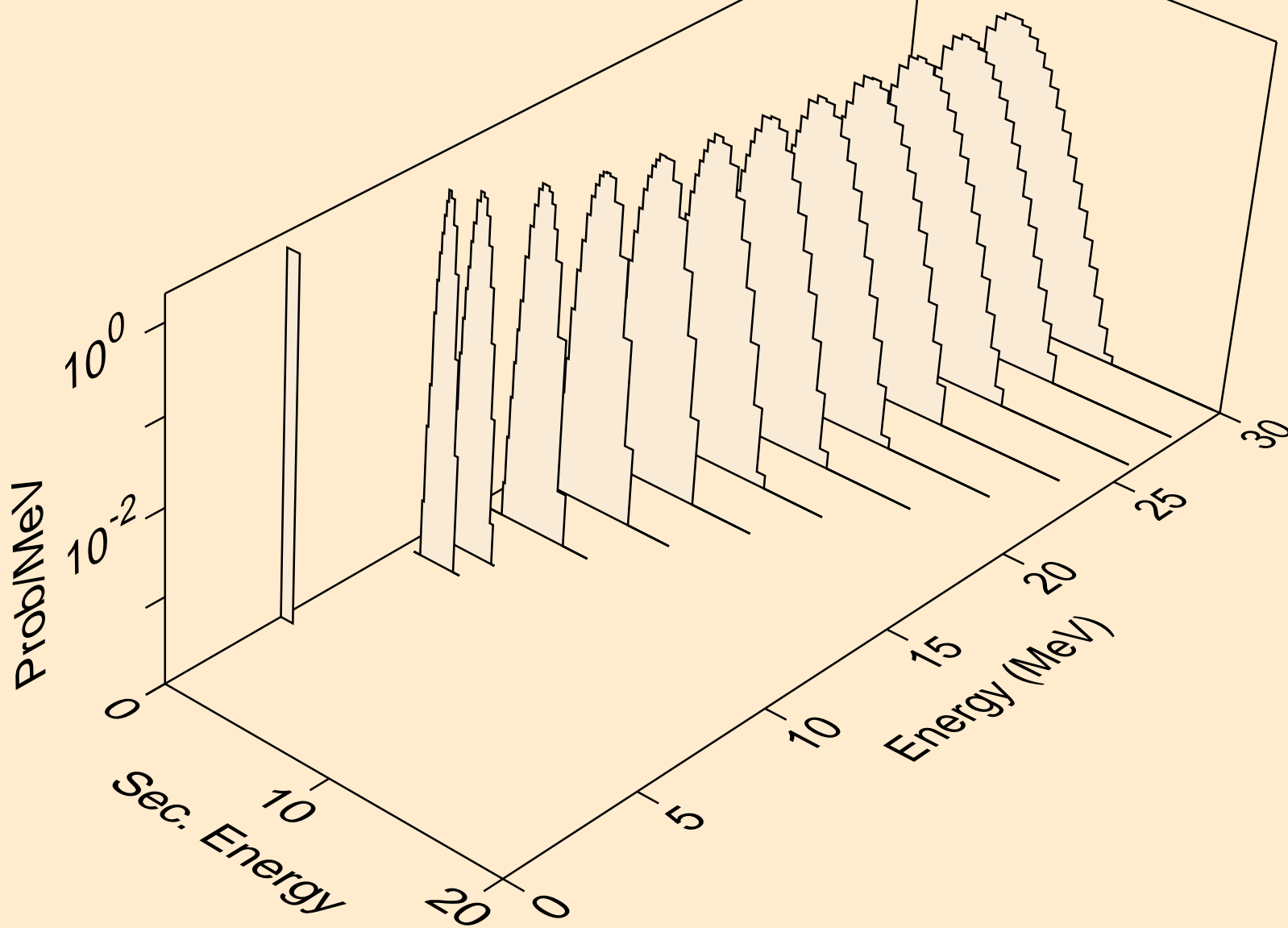

TB146M NEUTRON ACER TENDL-2019 LIBRARY; T=293.16K
protons from (n,pt)

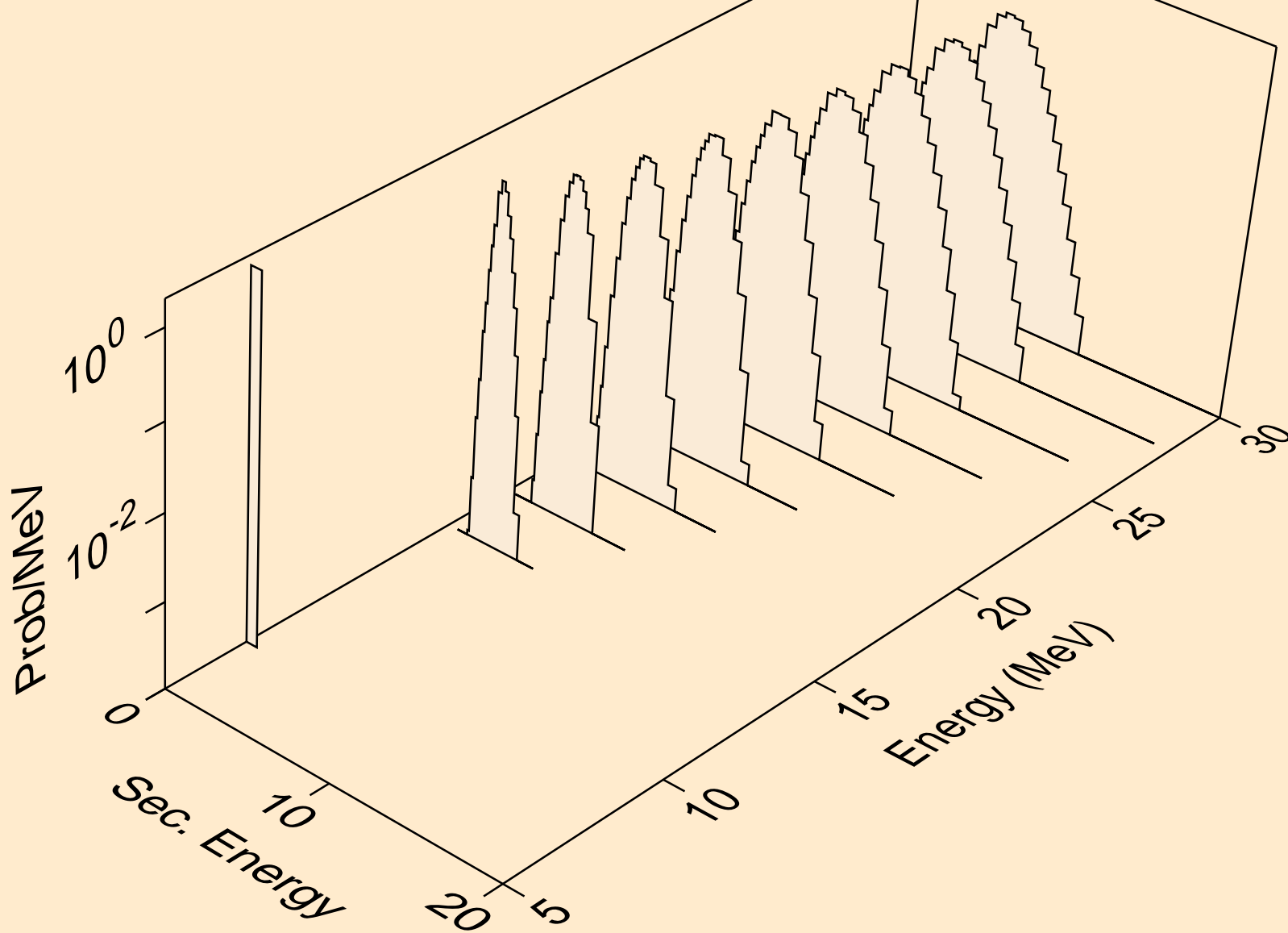

TB146M NEUTRON ACER TENDL-2019 LIBRARY; T=293.16K
deuterons from (n,x)

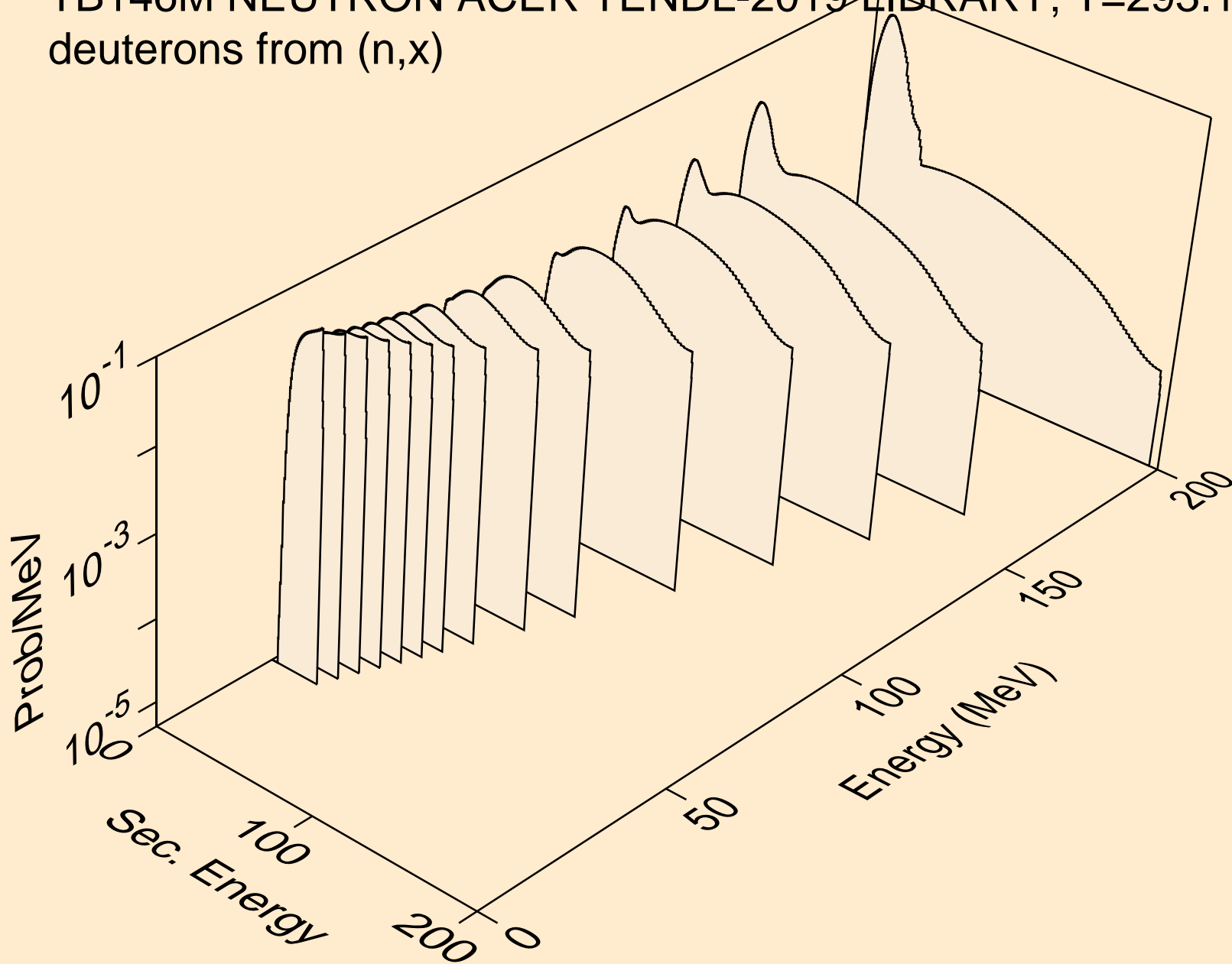

TB146M NEUTRON ACER TENDL-2019 LIBRARY; T=293.16K
deuterons from (n,2nd)

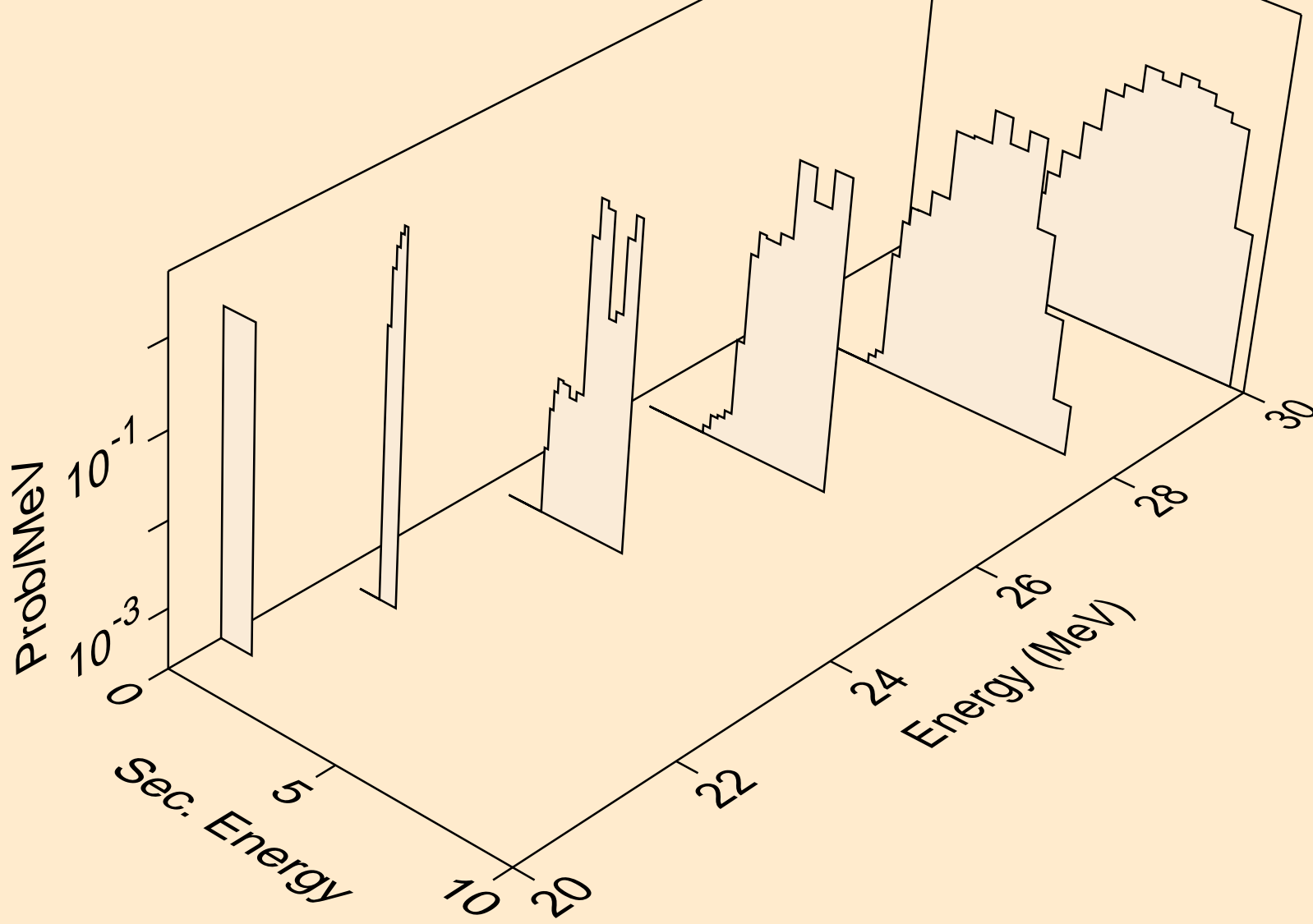

TB146M NEUTRON ACER TENDL-2019 LIBRARY; T=293.16K
deuterons from (n,n*)d

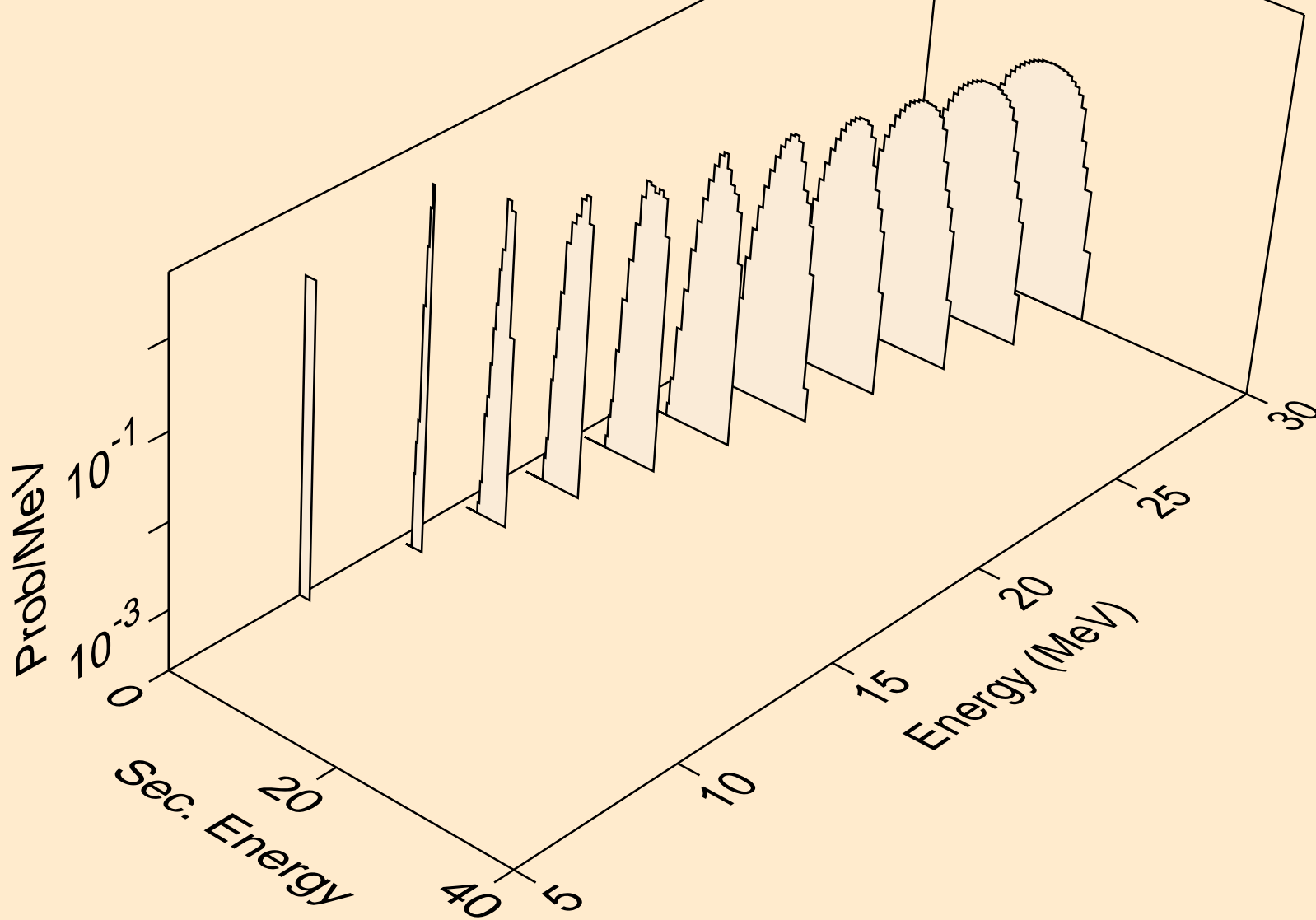

TB146M NEUTRON ACER TENDL-2019 LIBRARY; T=293.16K
deuterons from (n,d)

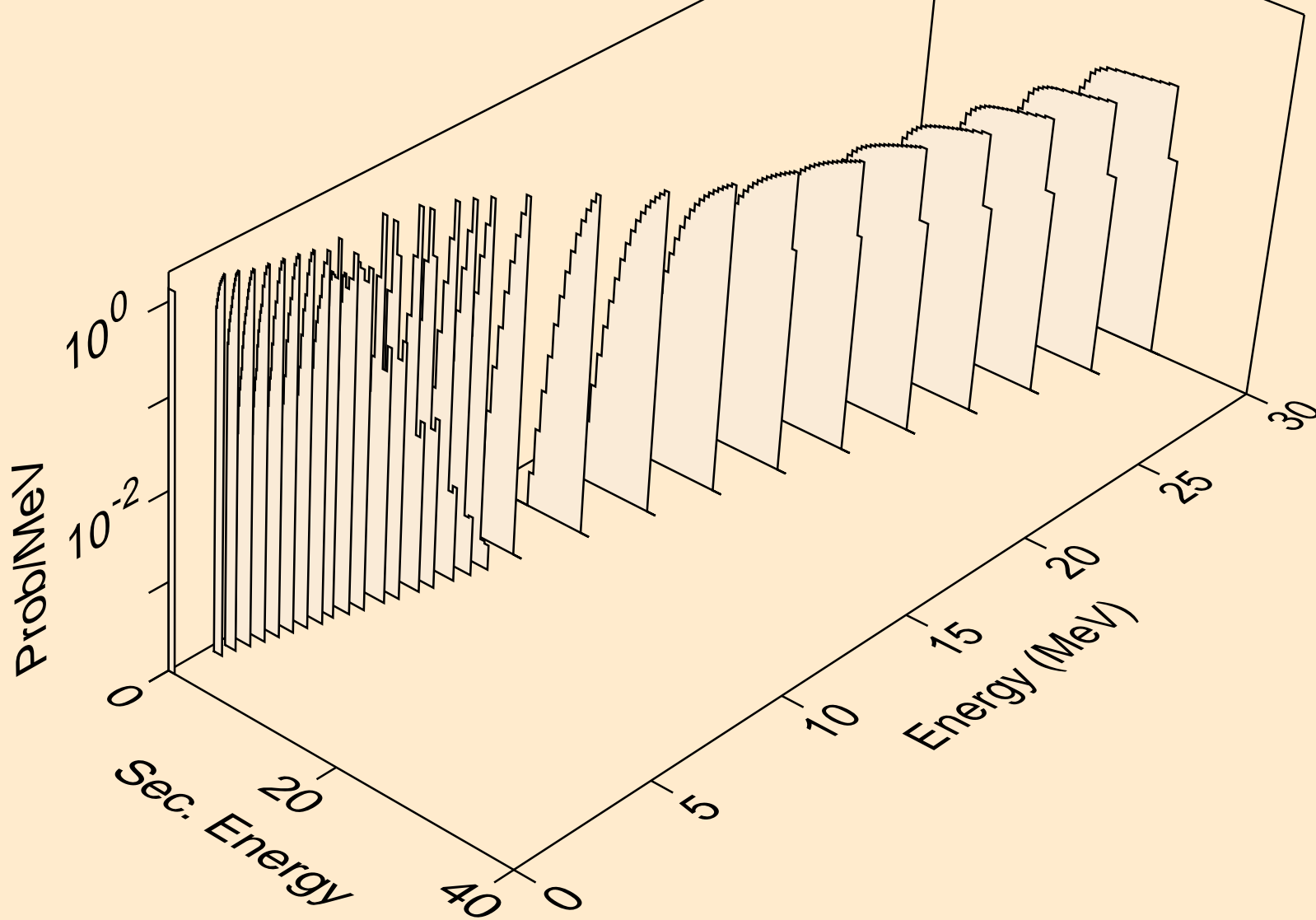

TB146M NEUTRON ACER TENDL-2019 LIBRARY; T=293.16K
deuterons from (n,pd)

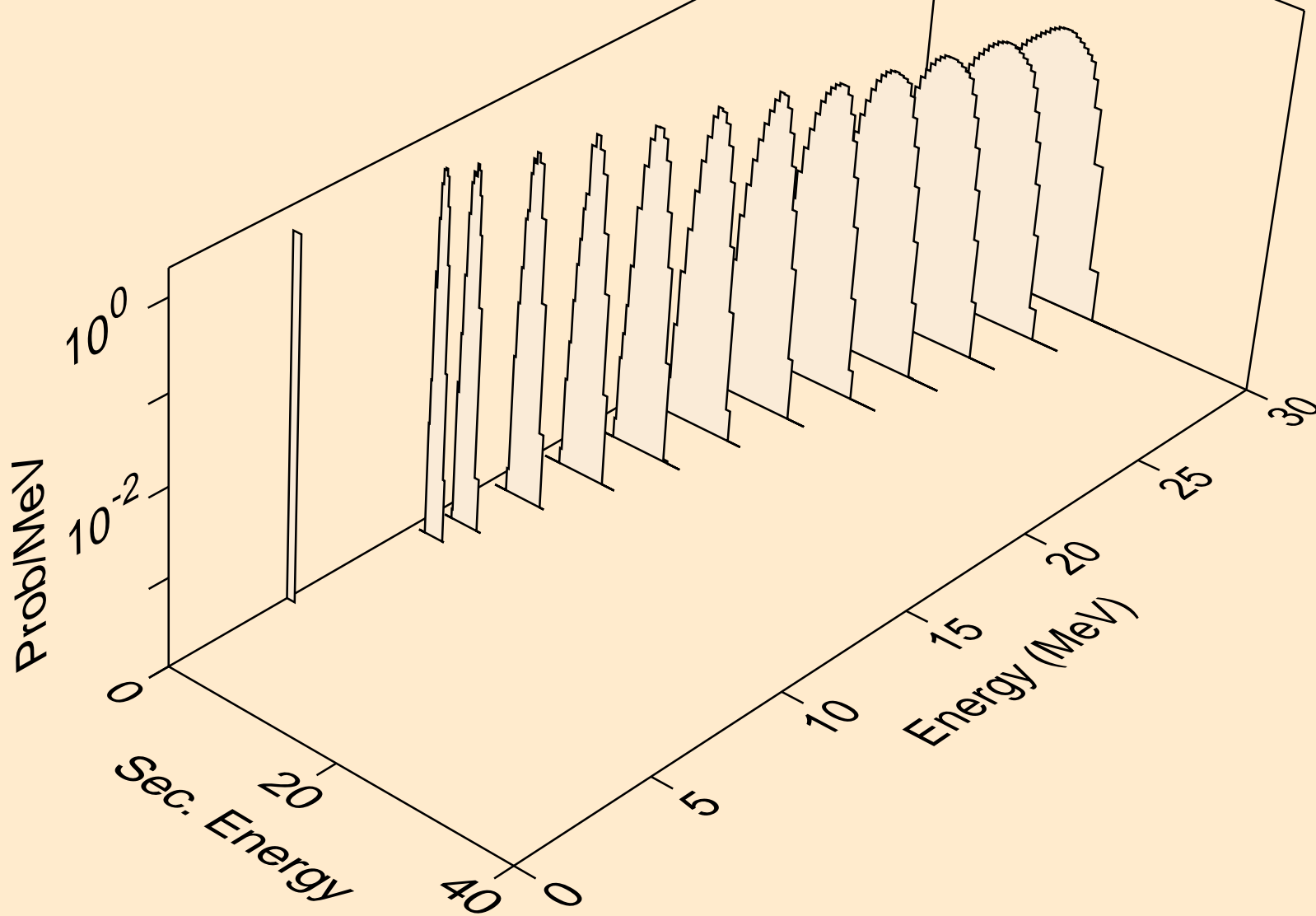

TB146M NEUTRON ACER TENDL-2019 LIBRARY; T=293.16K
deuterons from (n,da)

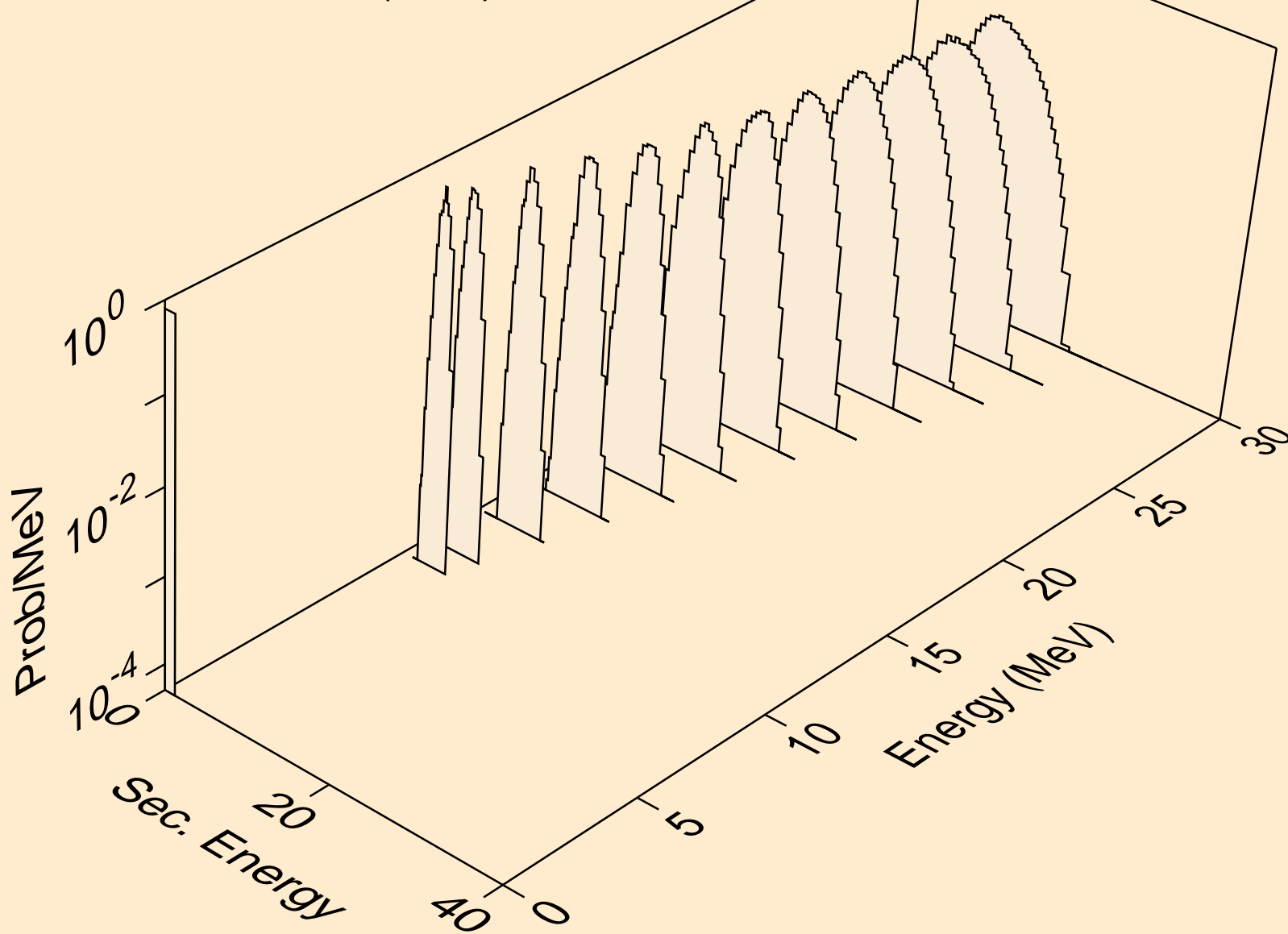

TB146M NEUTRON ACER TENDL-2019 LIBRARY; T=293.16K
tritons from (n,x)

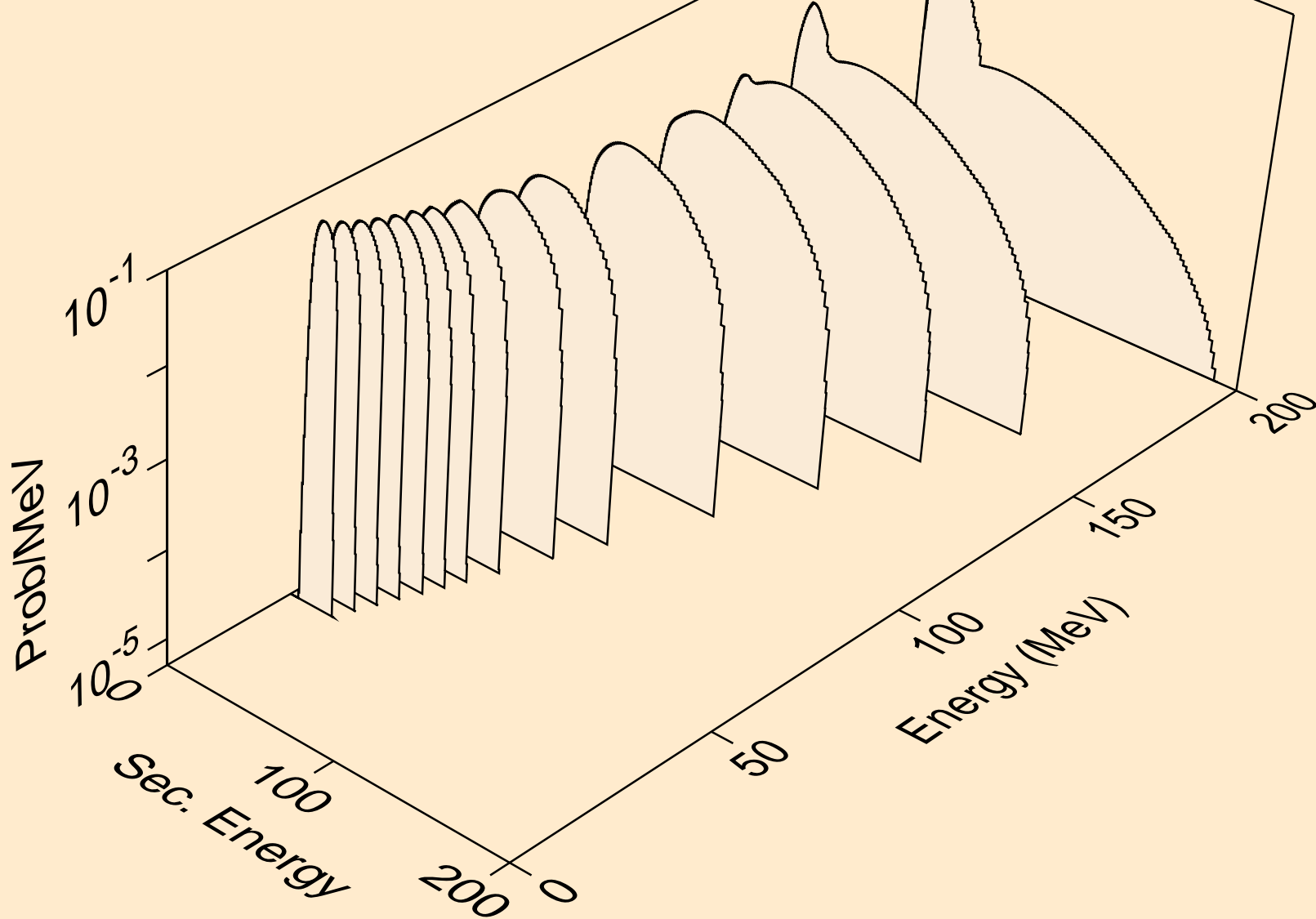

TB146M NEUTRON ACER TENDL-2019 LIBRARY; T=293.16K
tritons from (n,n*)t

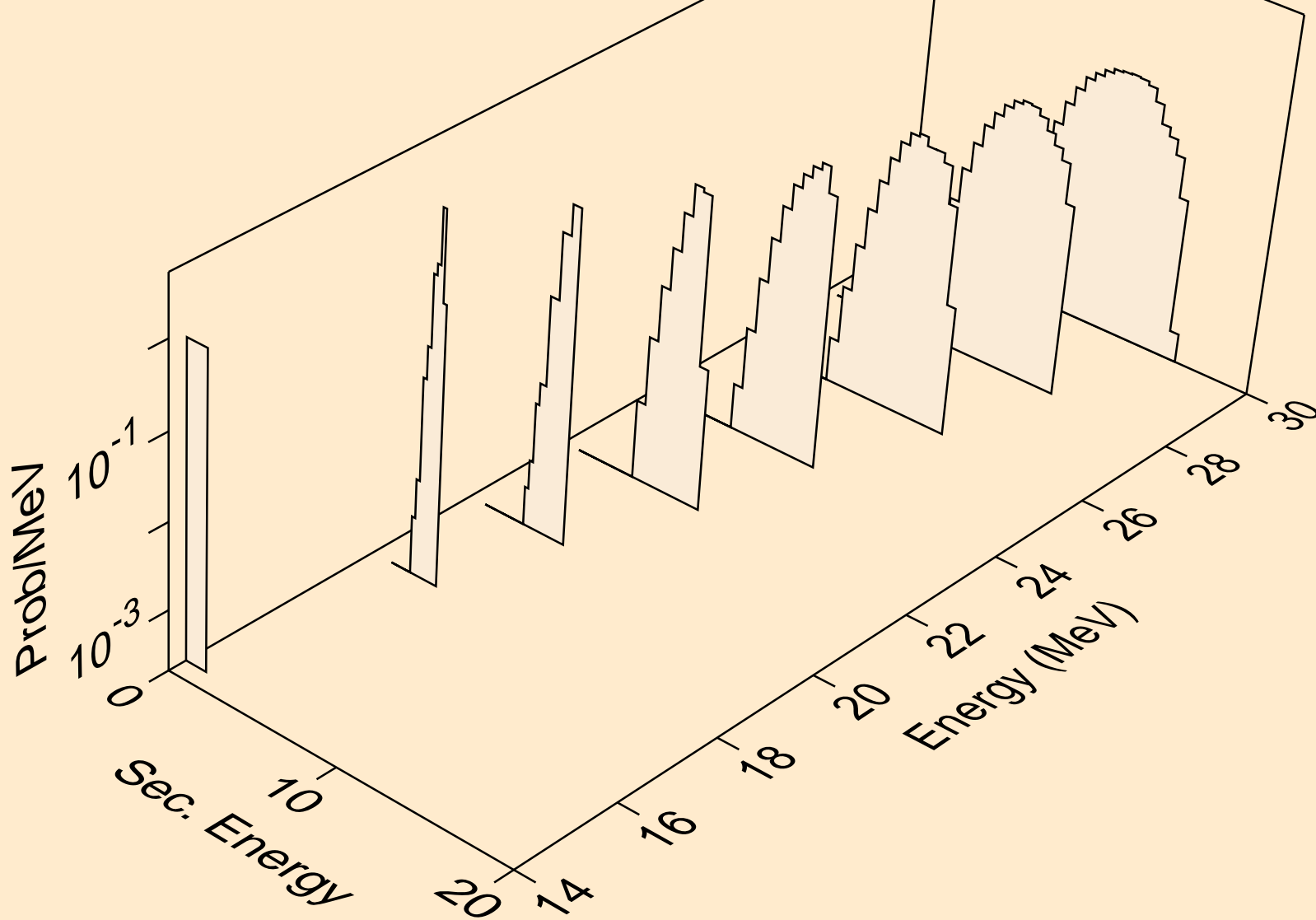

TB146M NEUTRON ACER TENDL-2019 LIBRARY; T=293.16K
tritons from (n,t)

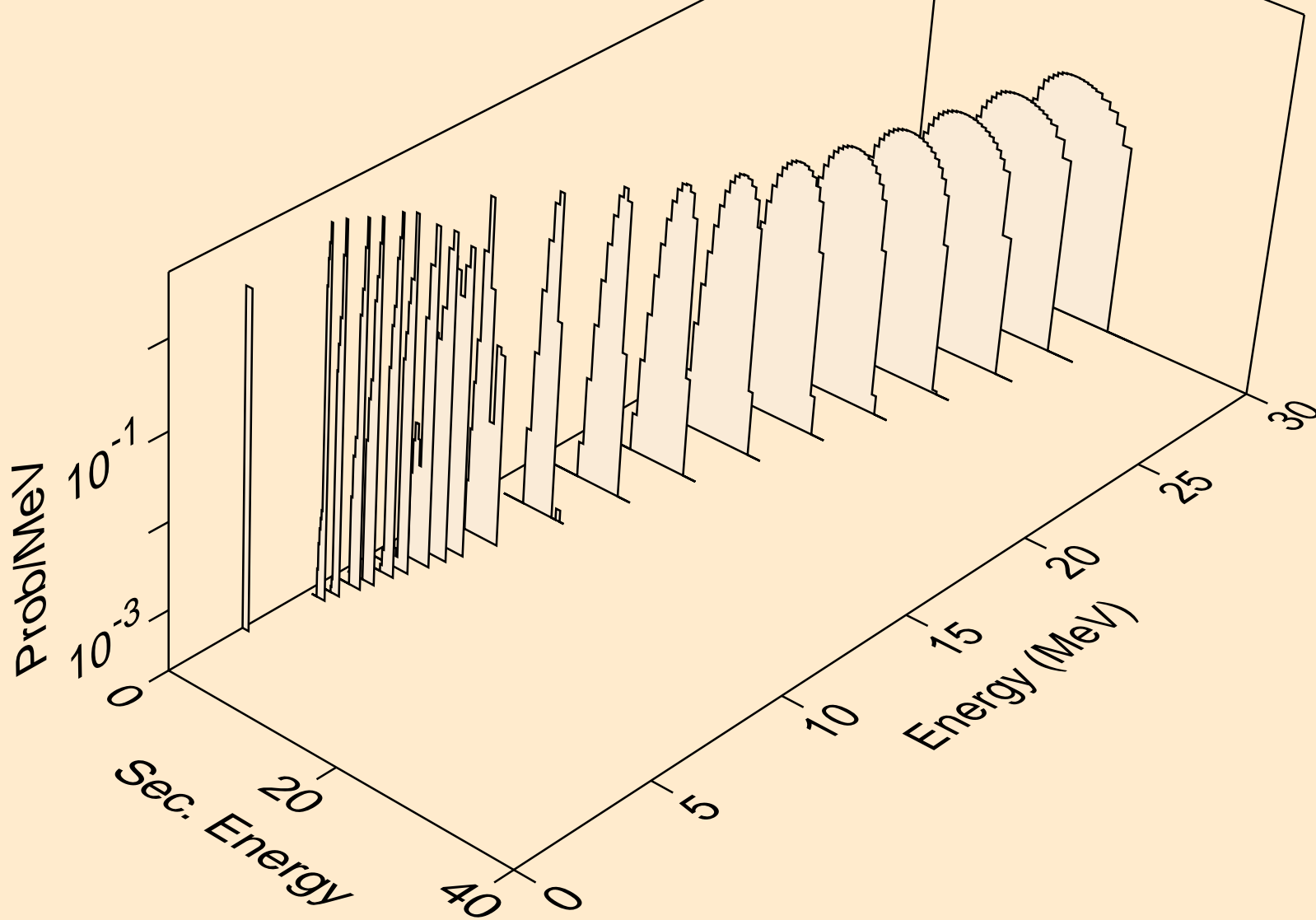

TB146M NEUTRON ACER TENDL-2019 LIBRARY; T=293.16K
tritons from (n,pt)

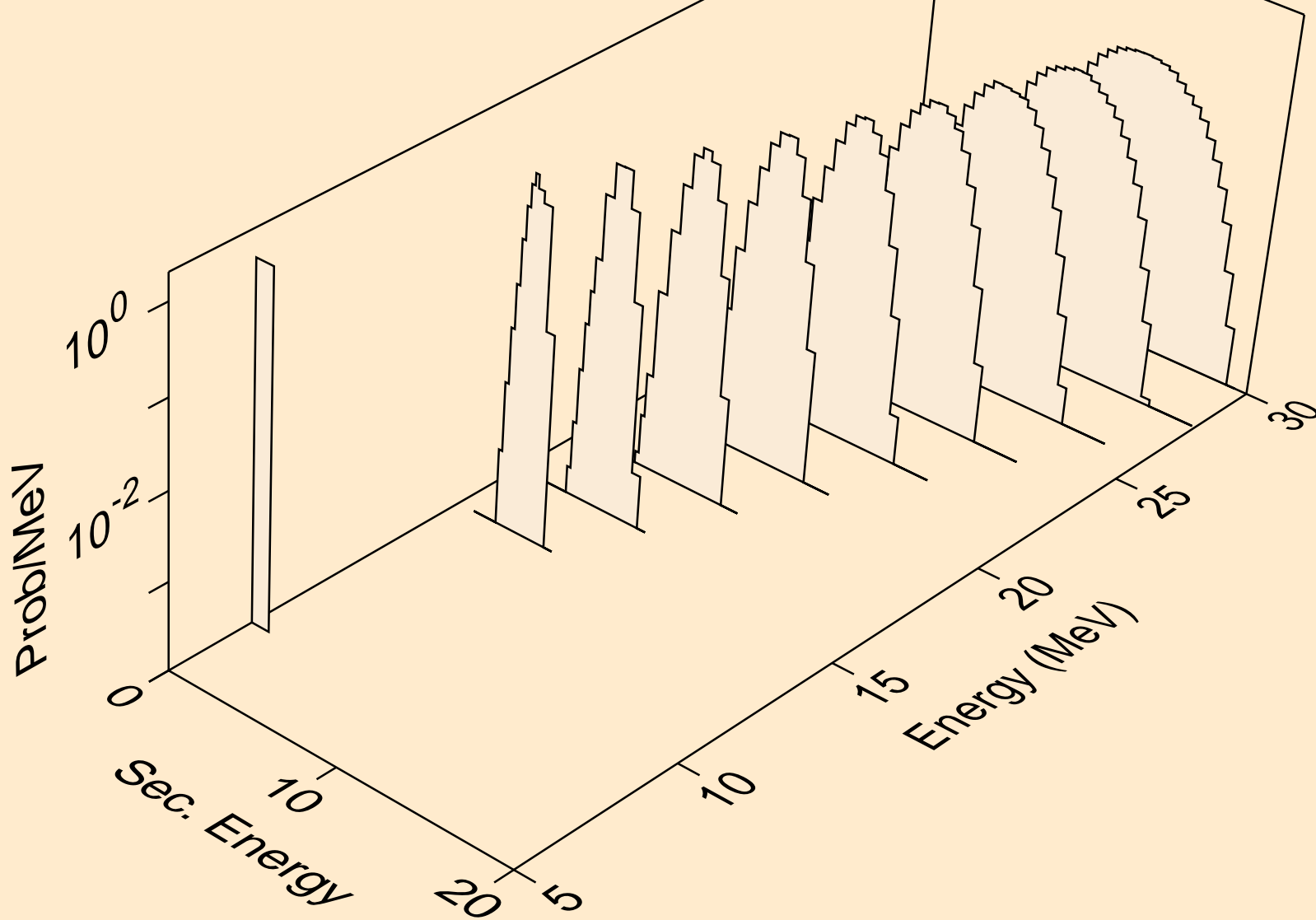

TB146M NEUTRON ACER TENDL-2019 LIBRARY; T=293.16K
he3s from (n,x)

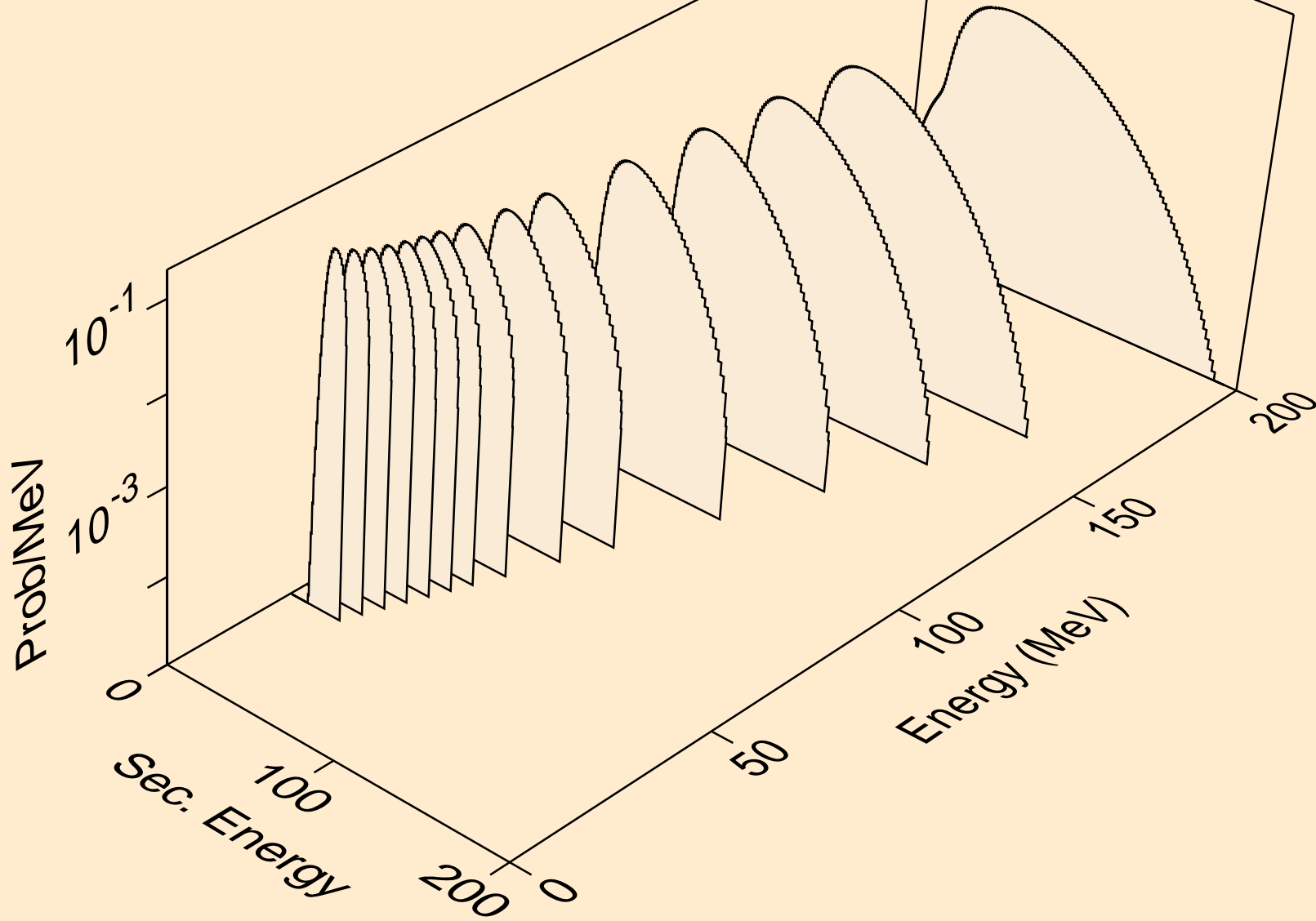

TB146M NEUTRON ACER TENDL-2019 LIBRARY; T=293.16K
he3s from (n,n*)he3

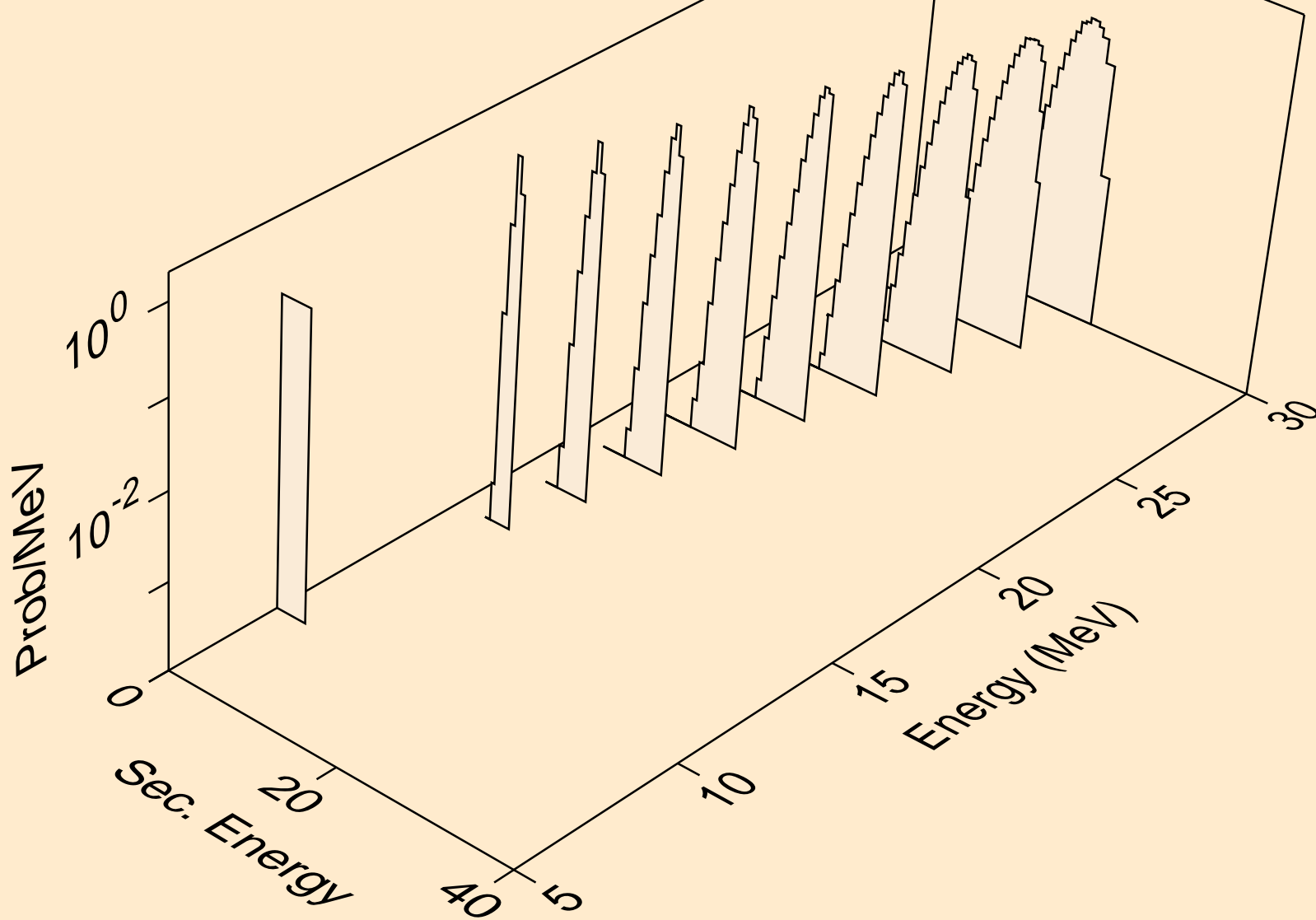

TB146M NEUTRON ACER TENDL-2019 LIBRARY; T=293.16K
he3s from (n,he3)

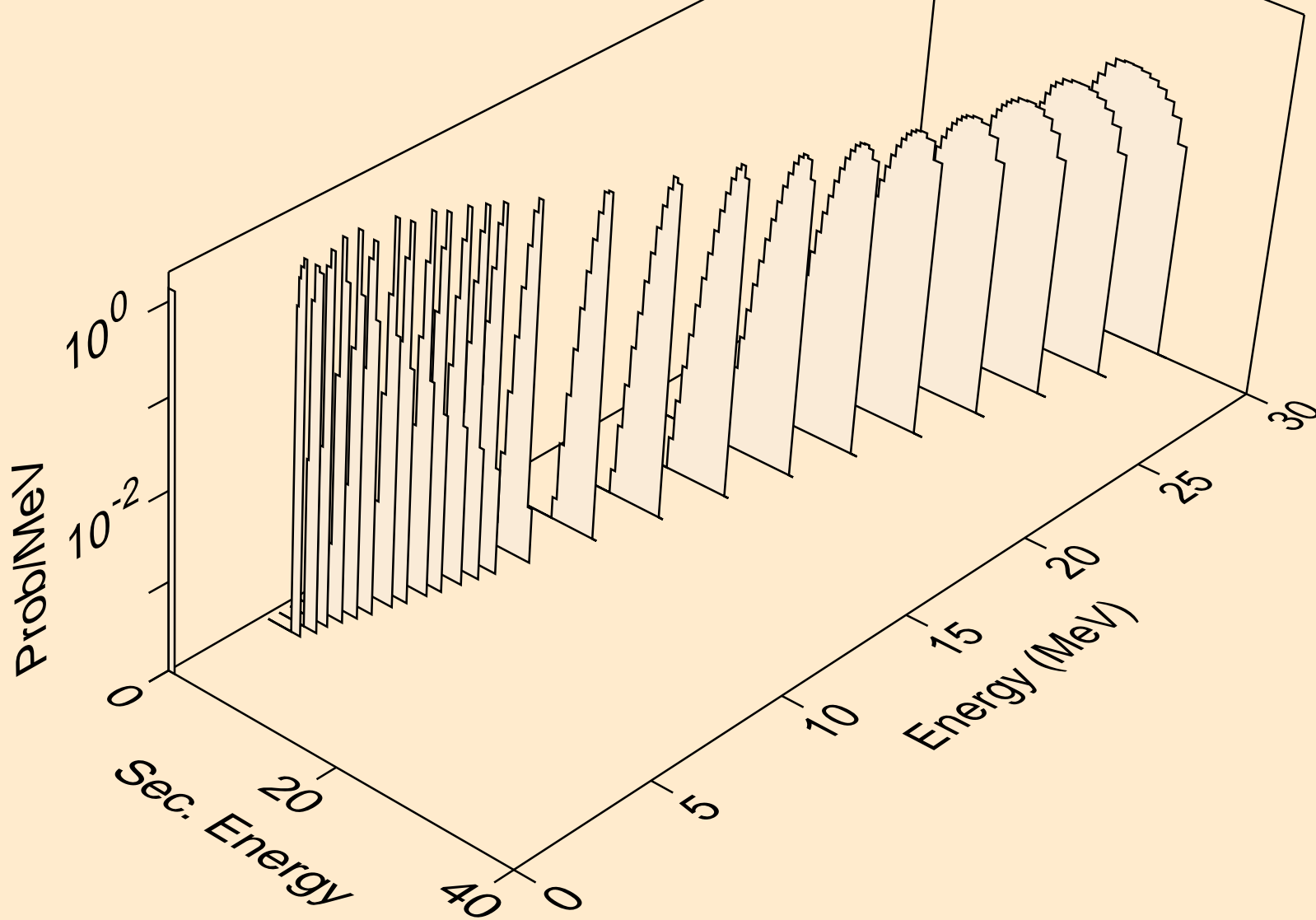

TB146M NEUTRON ACER TENDL-2019 LIBRARY; T=293.16K
alphas from (n,x)

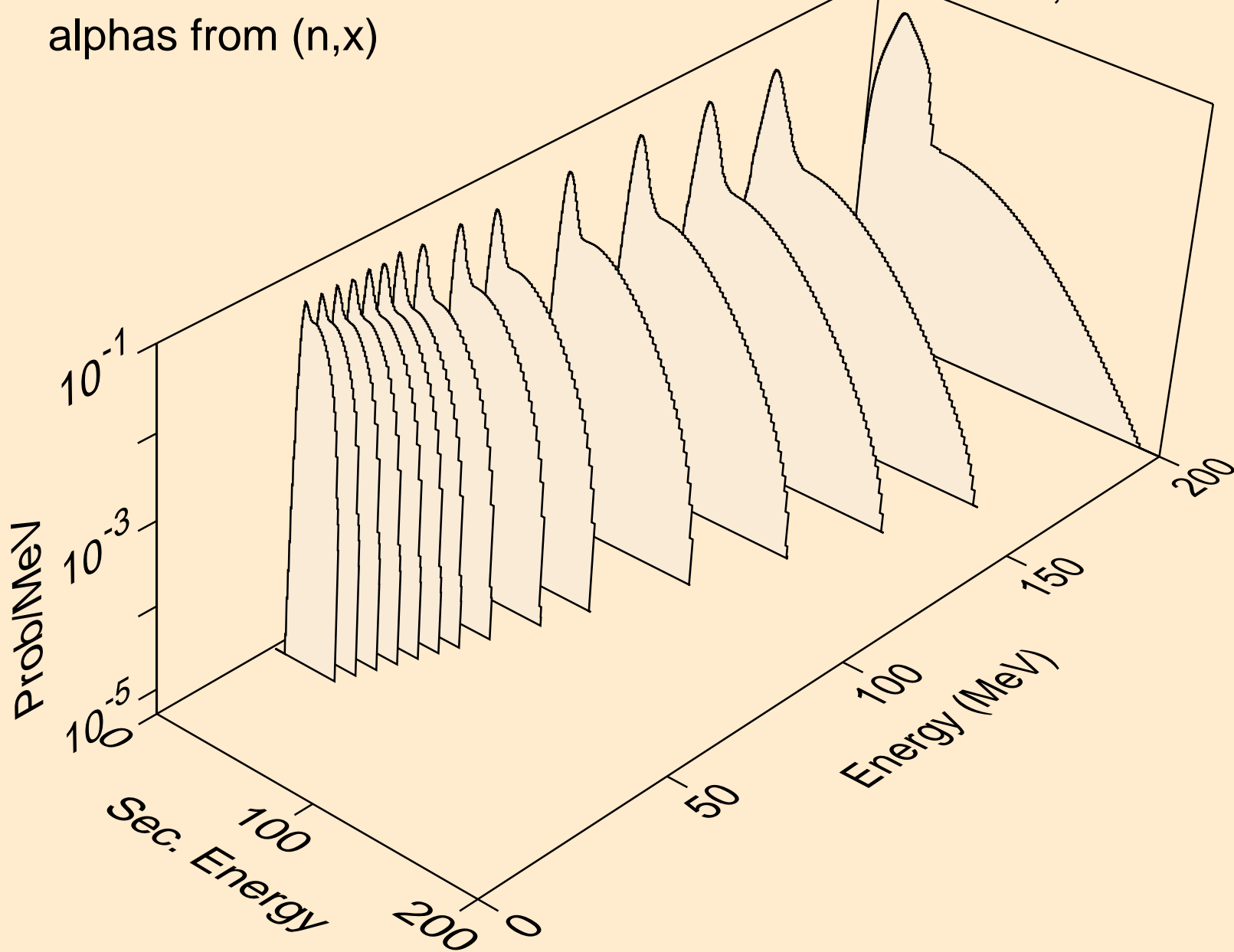

TB146M NEUTRON ACER TENDL-2019 LIBRARY; T=293.16K
alphas from (n,n*)a

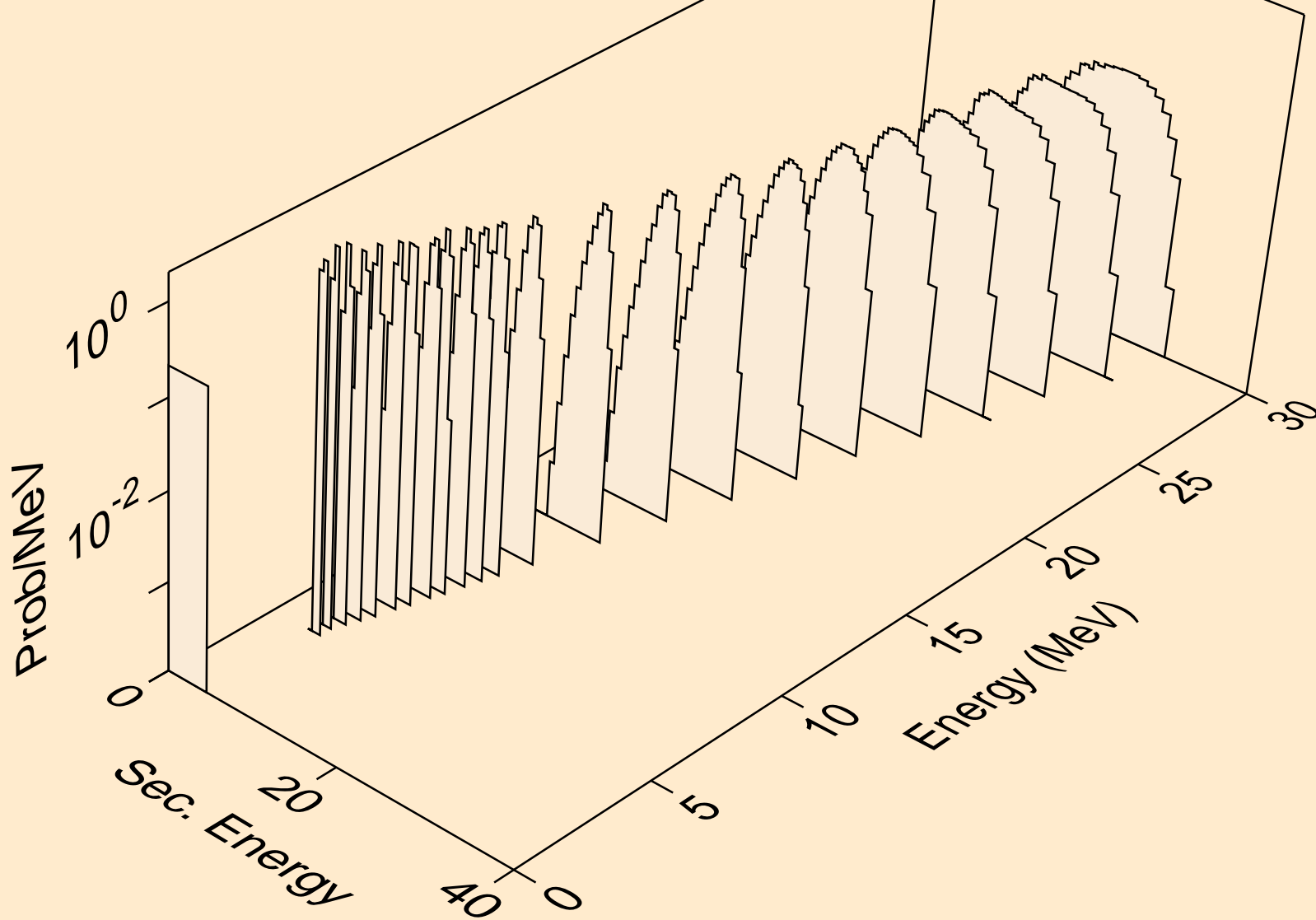

TB146M NEUTRON ACER TENDL-2019 LIBRARY; T=293.16K
alphas from (n,2n)a

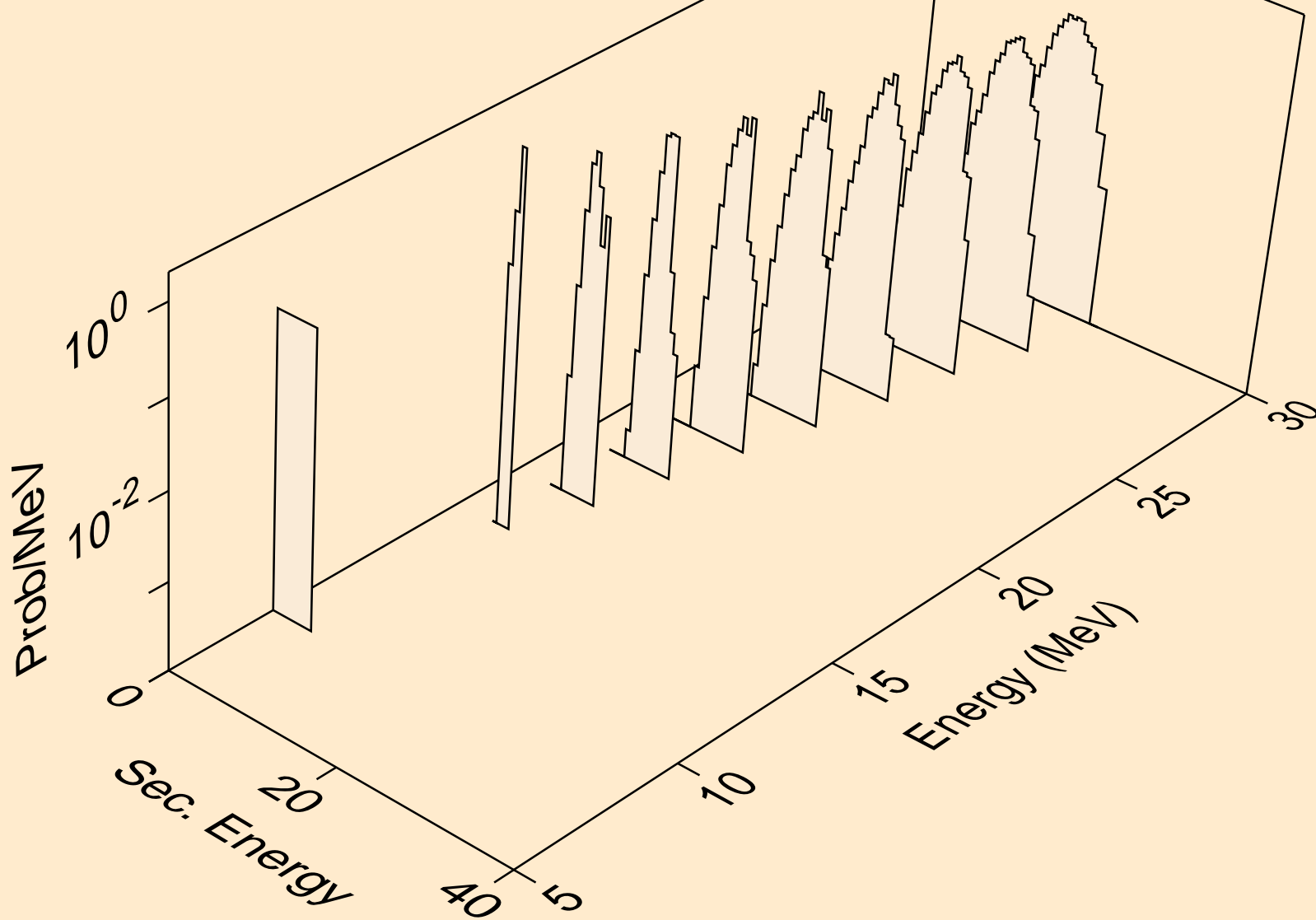

TB146M NEUTRON ACER TENDL-2019 LIBRARY; T=293.16K
alphas from (n,3n)a

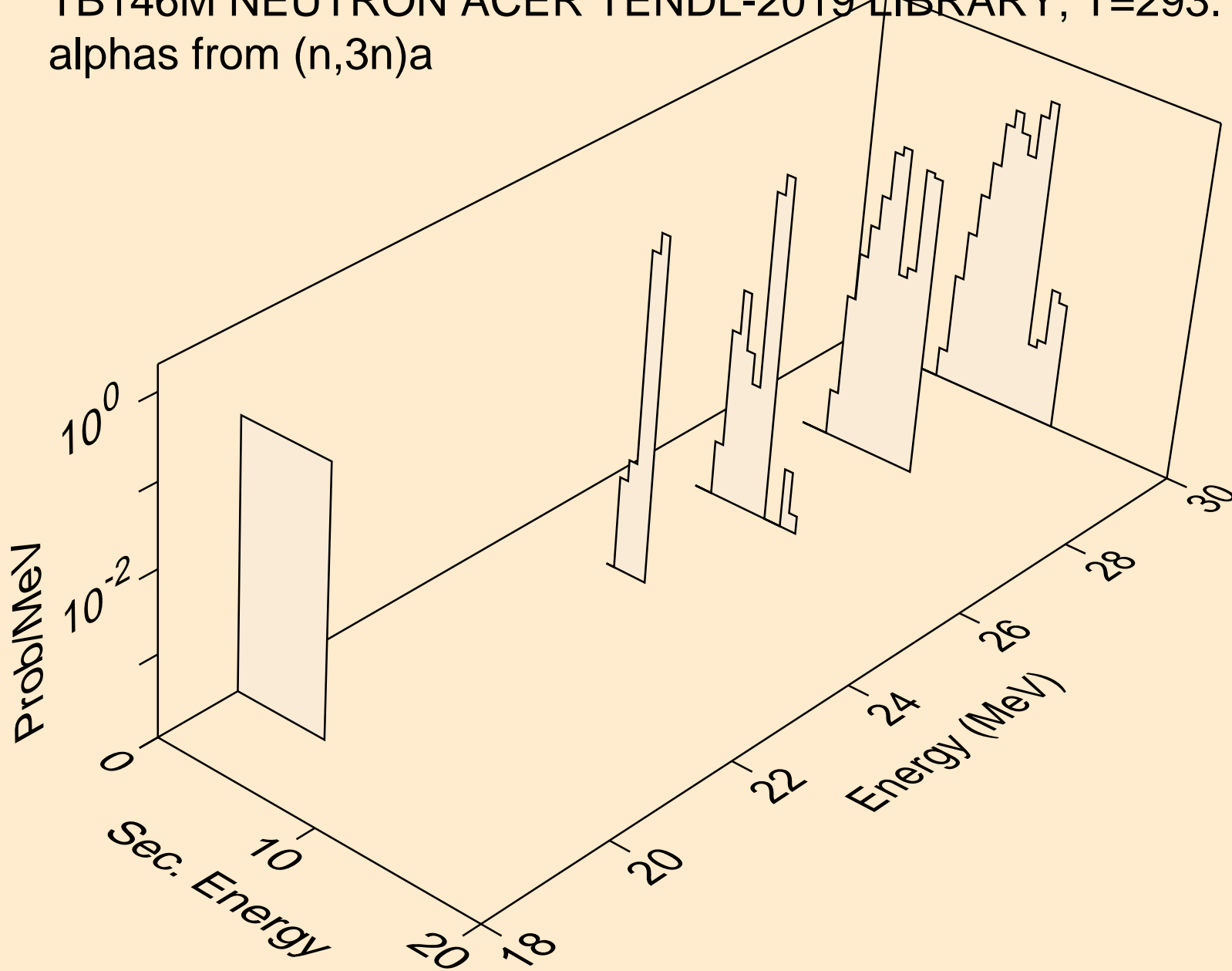

TB146M NEUTRON ACER TENDL-2019 LIBRARY; T=293.16K
alphas from (n,n*)2a

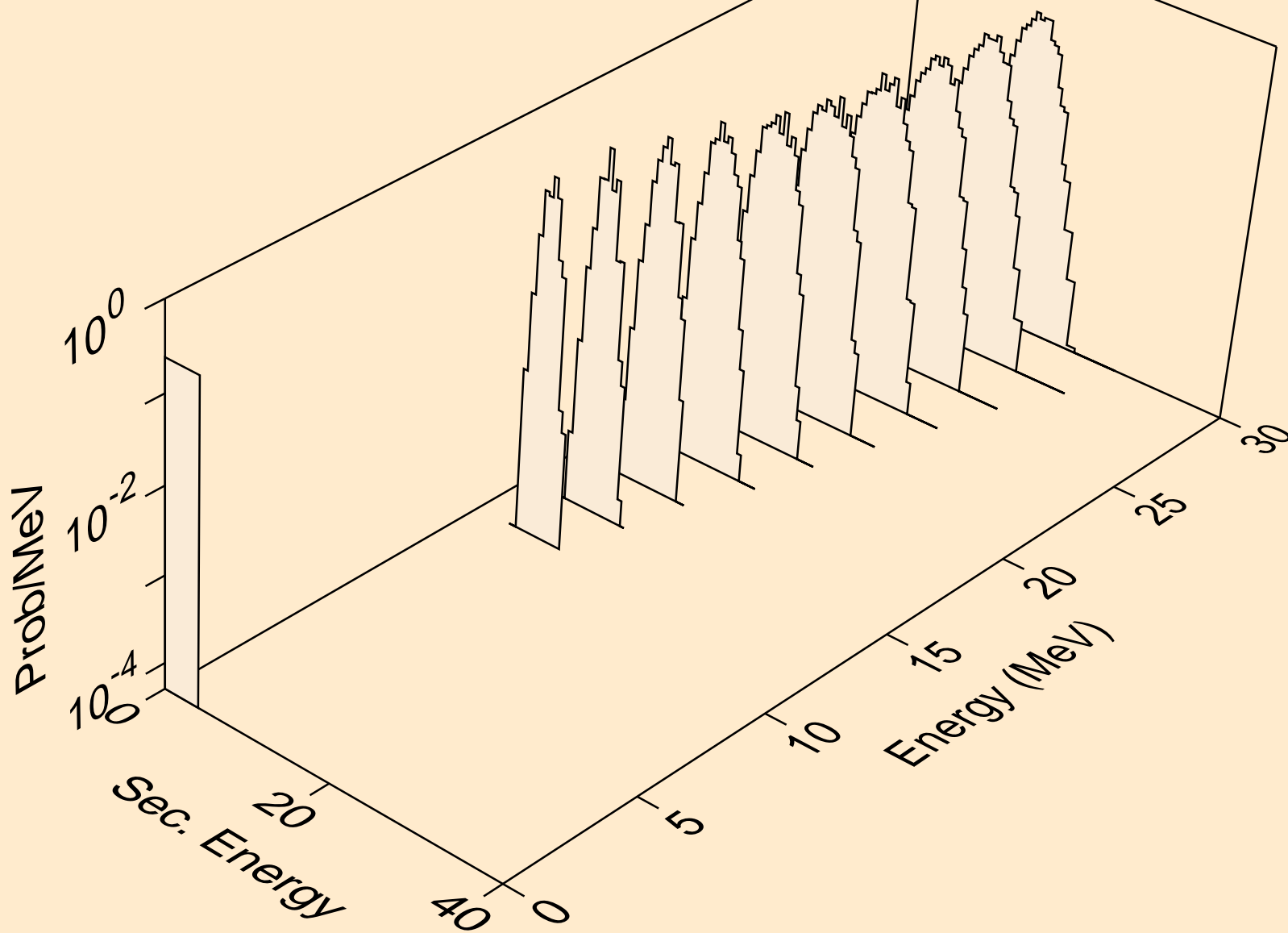

TB146M NEUTRON ACER TENDL-2019 LIBRARY; T=293.16K
alphas from (n,2n)2a

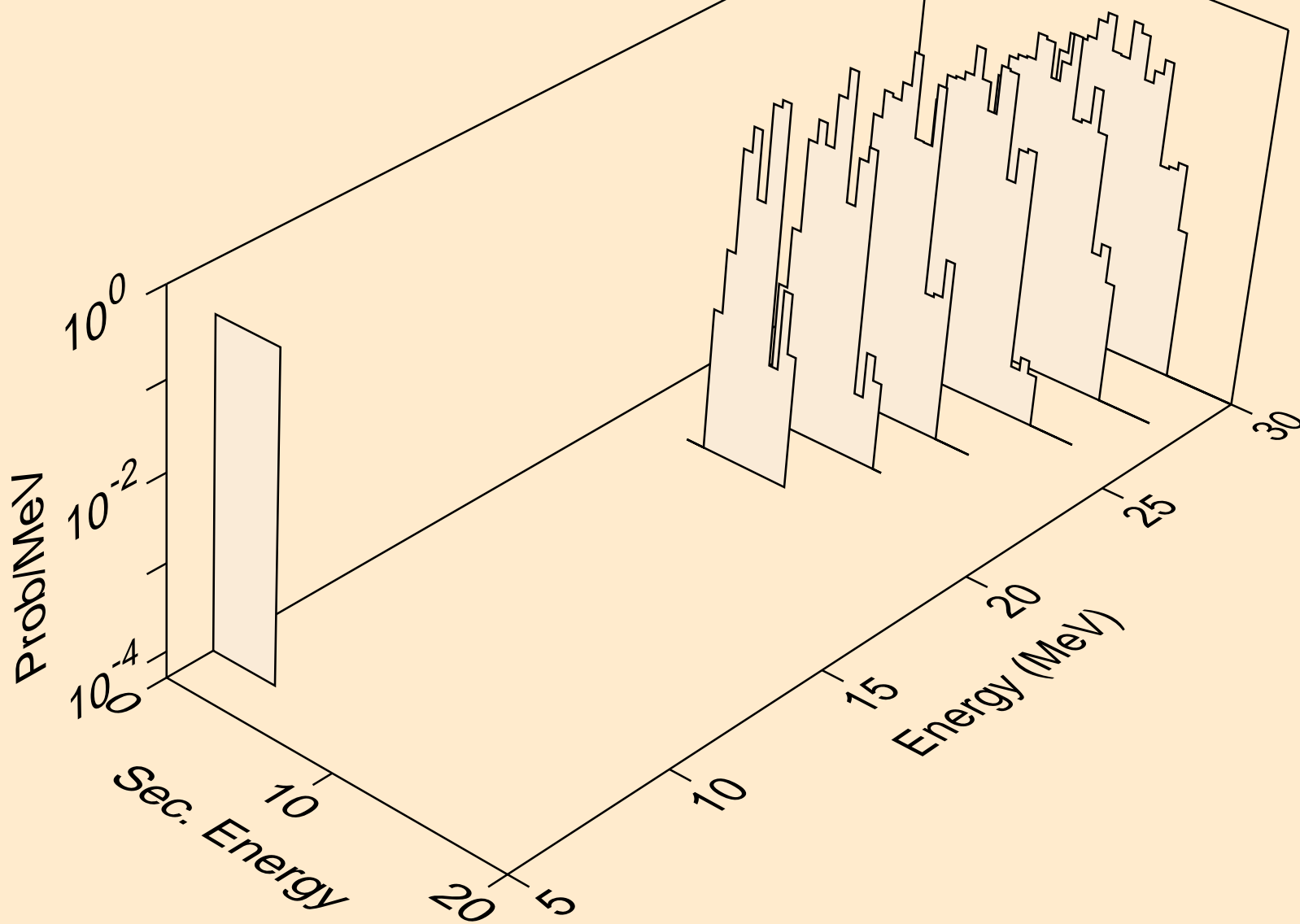

TB146M NEUTRON ACER TENDL-2019 LIBRARY; T=293.16K
alphas from (n,npa)

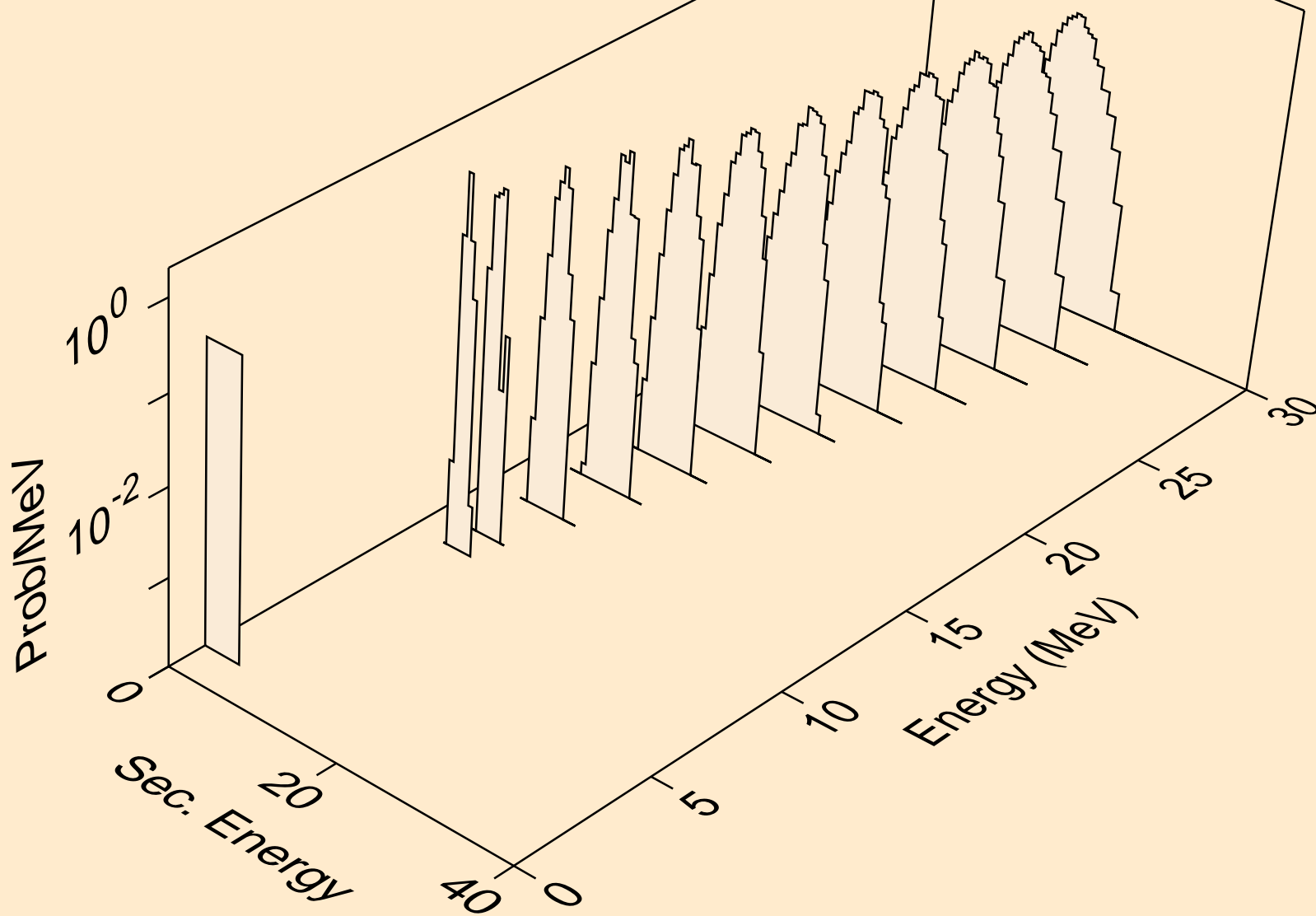

TB146M NEUTRON ACER TENDL-2019 LIBRARY; T=293.16K
alphas from (n,a)

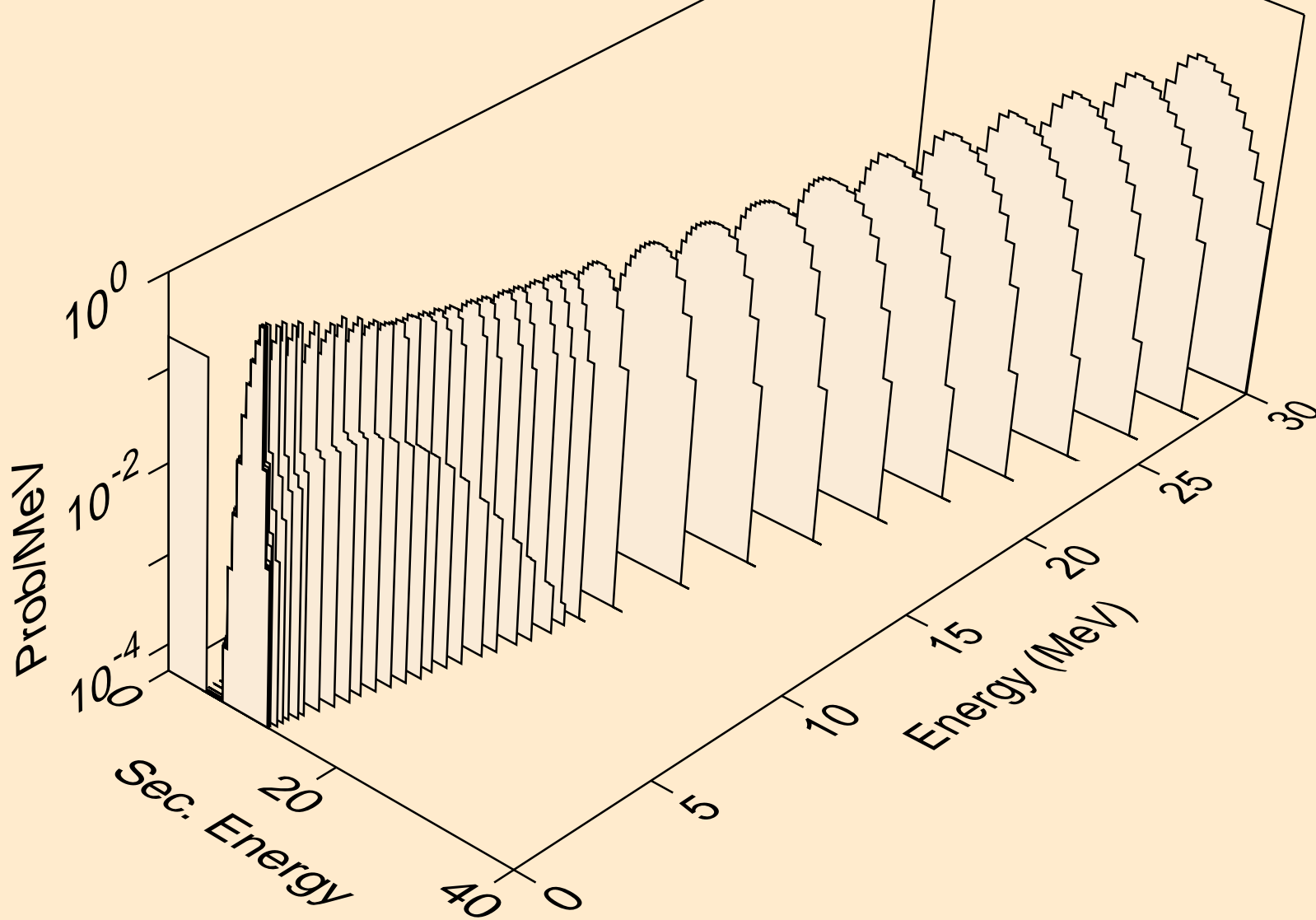

TB146M NEUTRON ACER TENDL-2019 LIBRARY; T=293.16K
alphas from (n,2a)

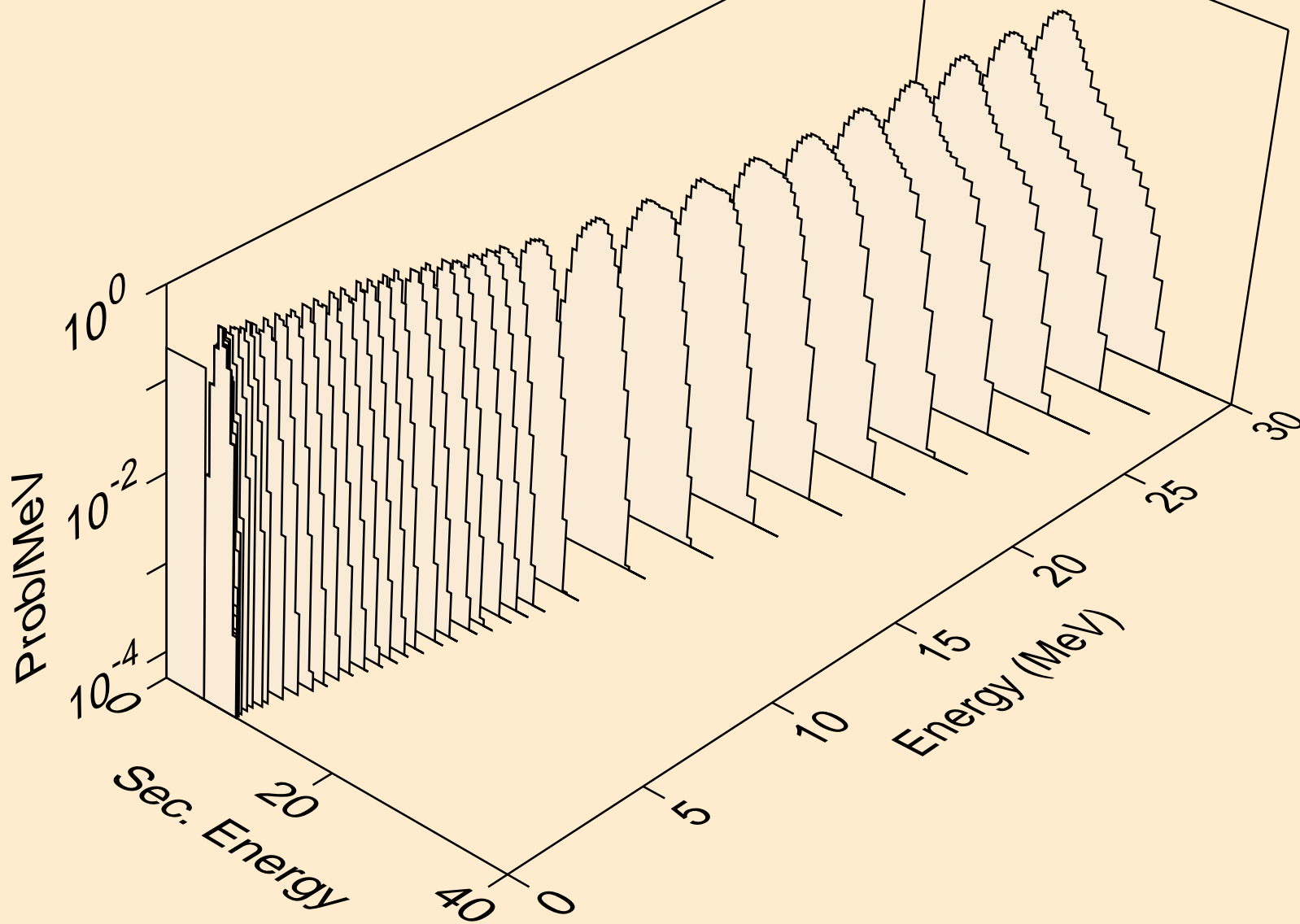

TB146M NEUTRON ACER TENDL-2019 LIBRARY; T=293.16K
alphas from (n,3a)

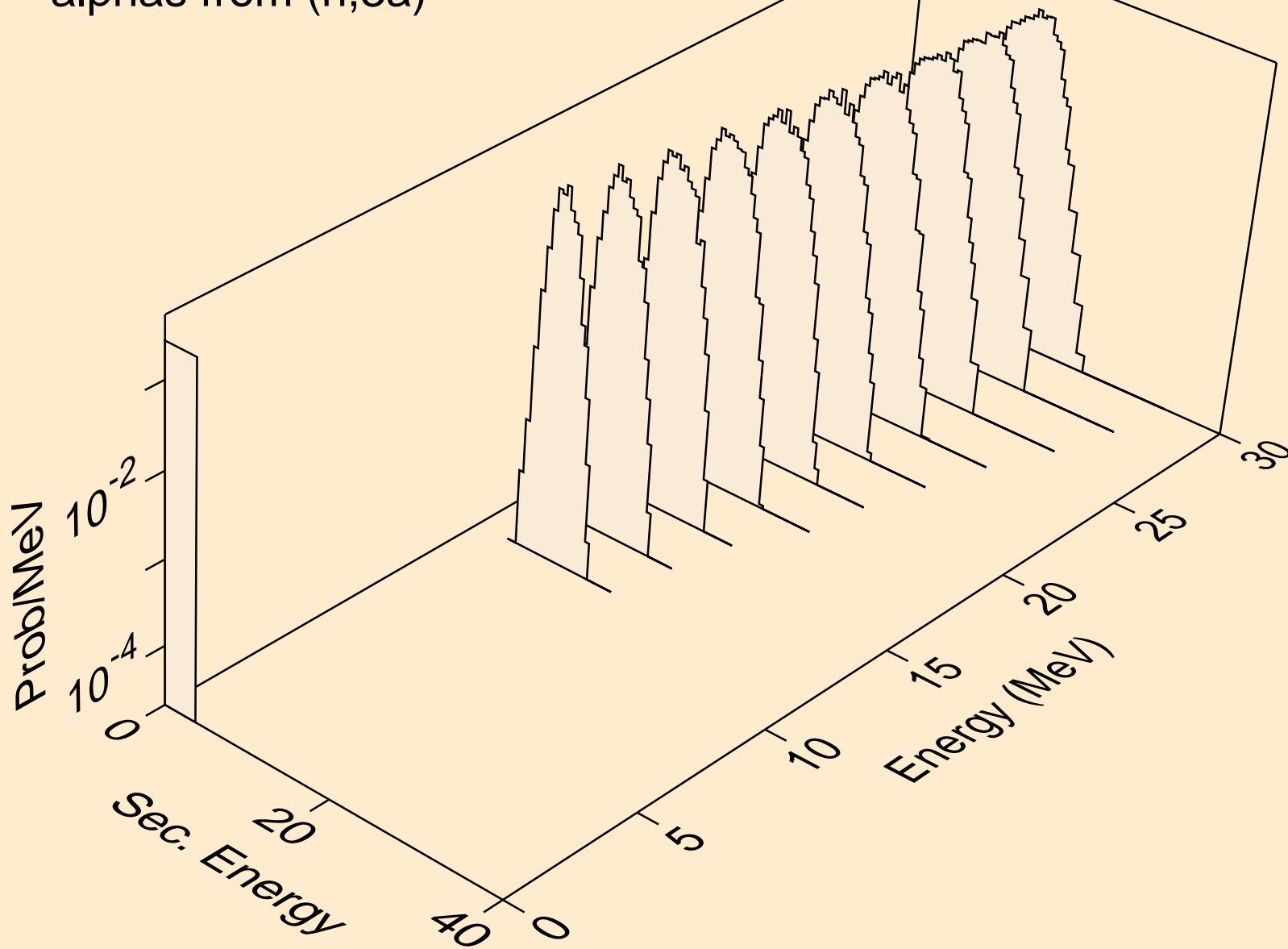

TB146M NEUTRON ACER TENDL-2019 LIBRARY; T=293.16K
alphas from (n,p)

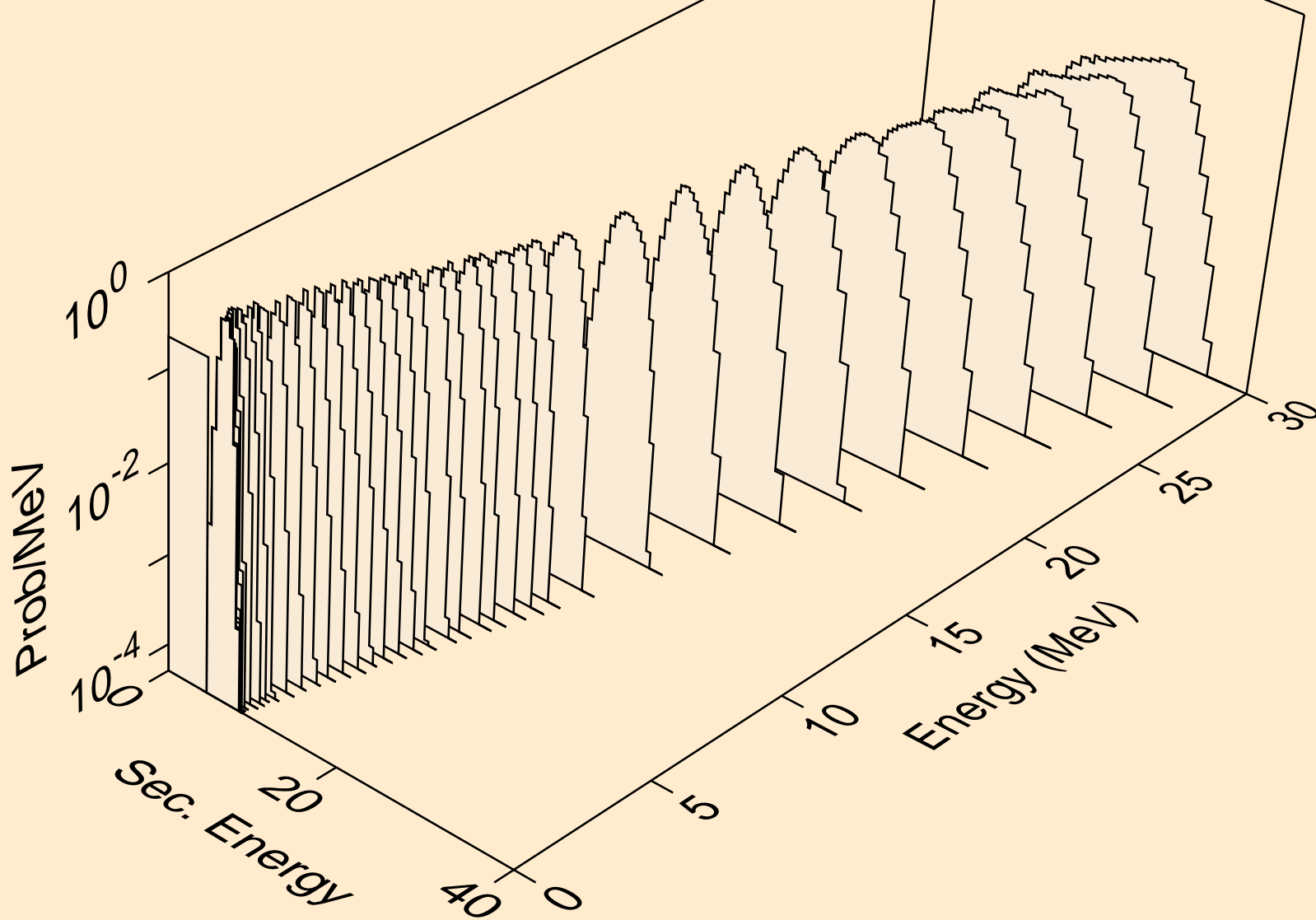

TB146M NEUTRON ACER TENDL-2019 LIBRARY; T=293.16K
alphas from (n,da)

