

TB156 NEUTRON ACER TENDL-2019 LIBRARY; T=293.16K  
Principal cross sections

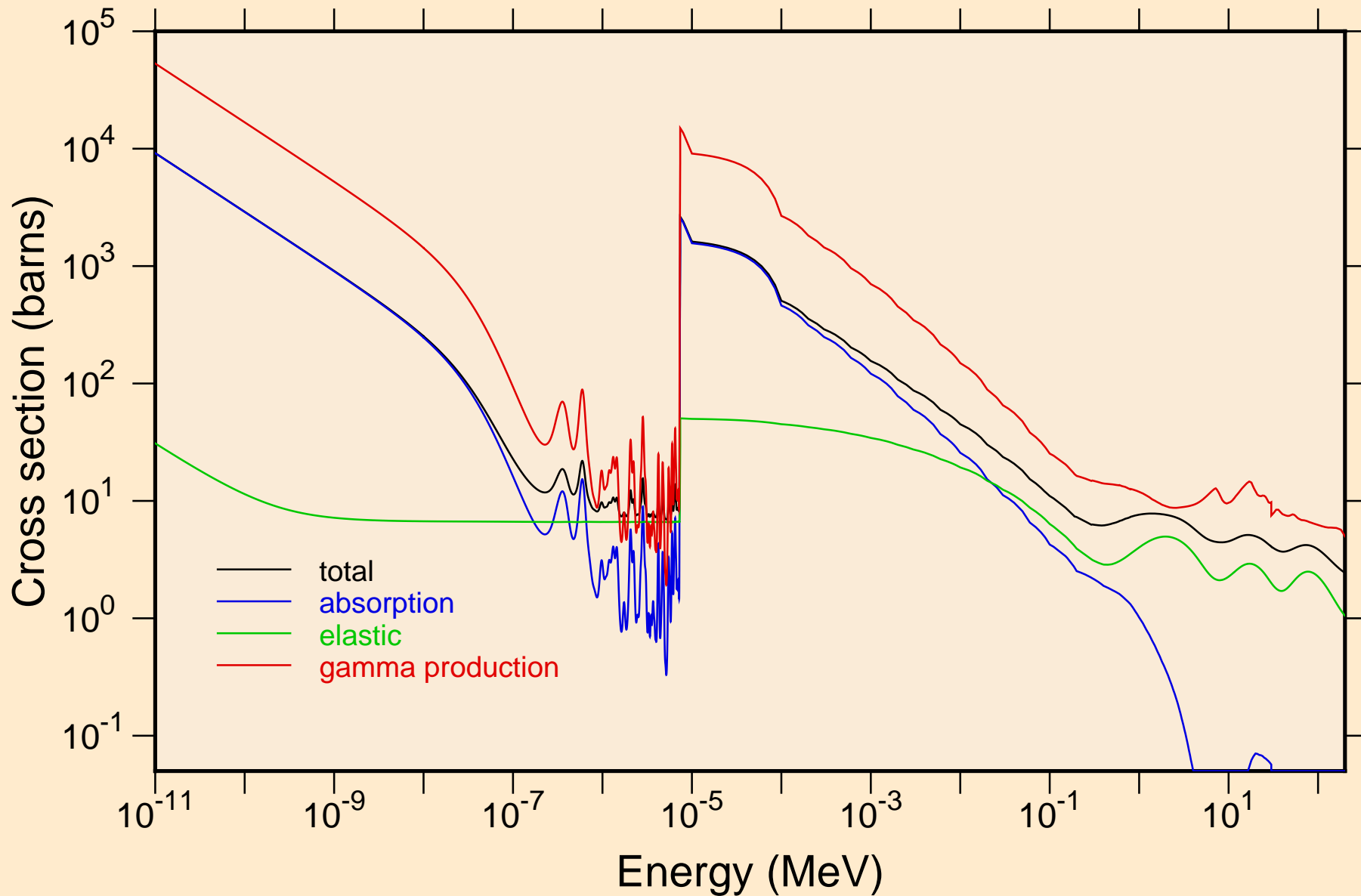

TB156 NEUTRON ACER TENDL-2019 LIBRARY; T=293.16K  
resonance total cross section

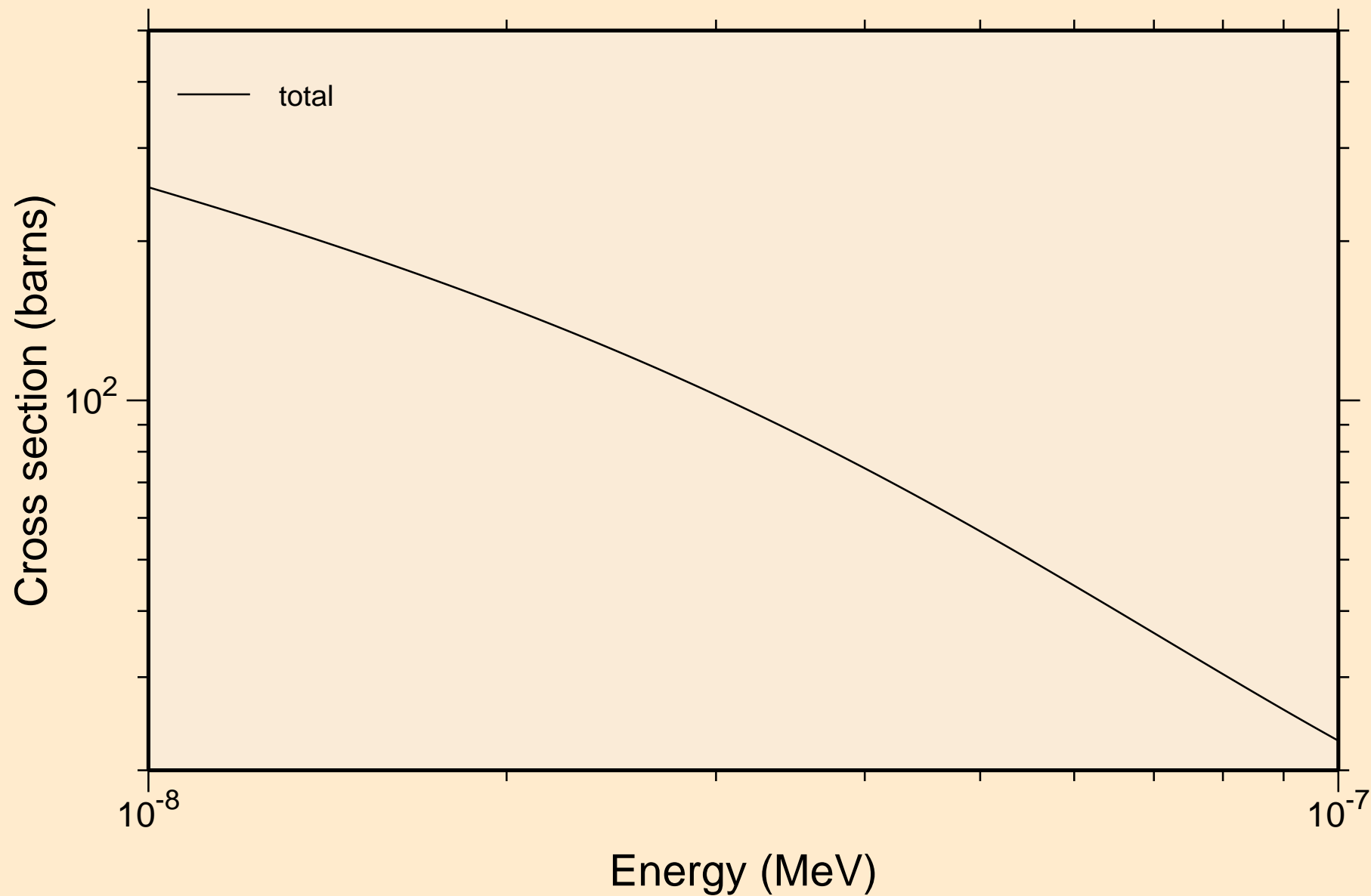

TB156 NEUTRON ACER TENDL-2019 LIBRARY; T=293.16K  
resonance total cross section

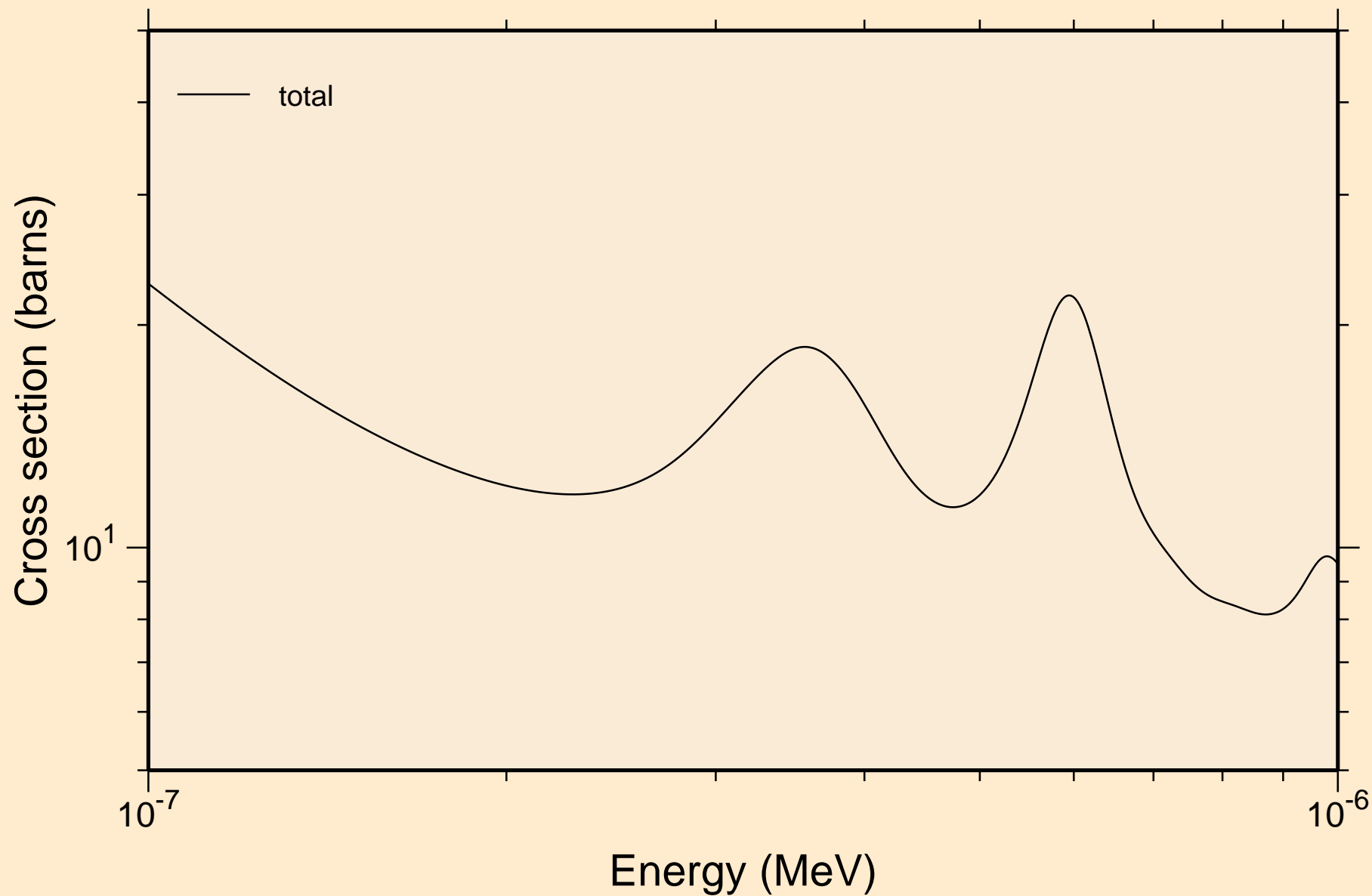

TB156 NEUTRON ACER TENDL-2019 LIBRARY; T=293.16K  
resonance total cross section

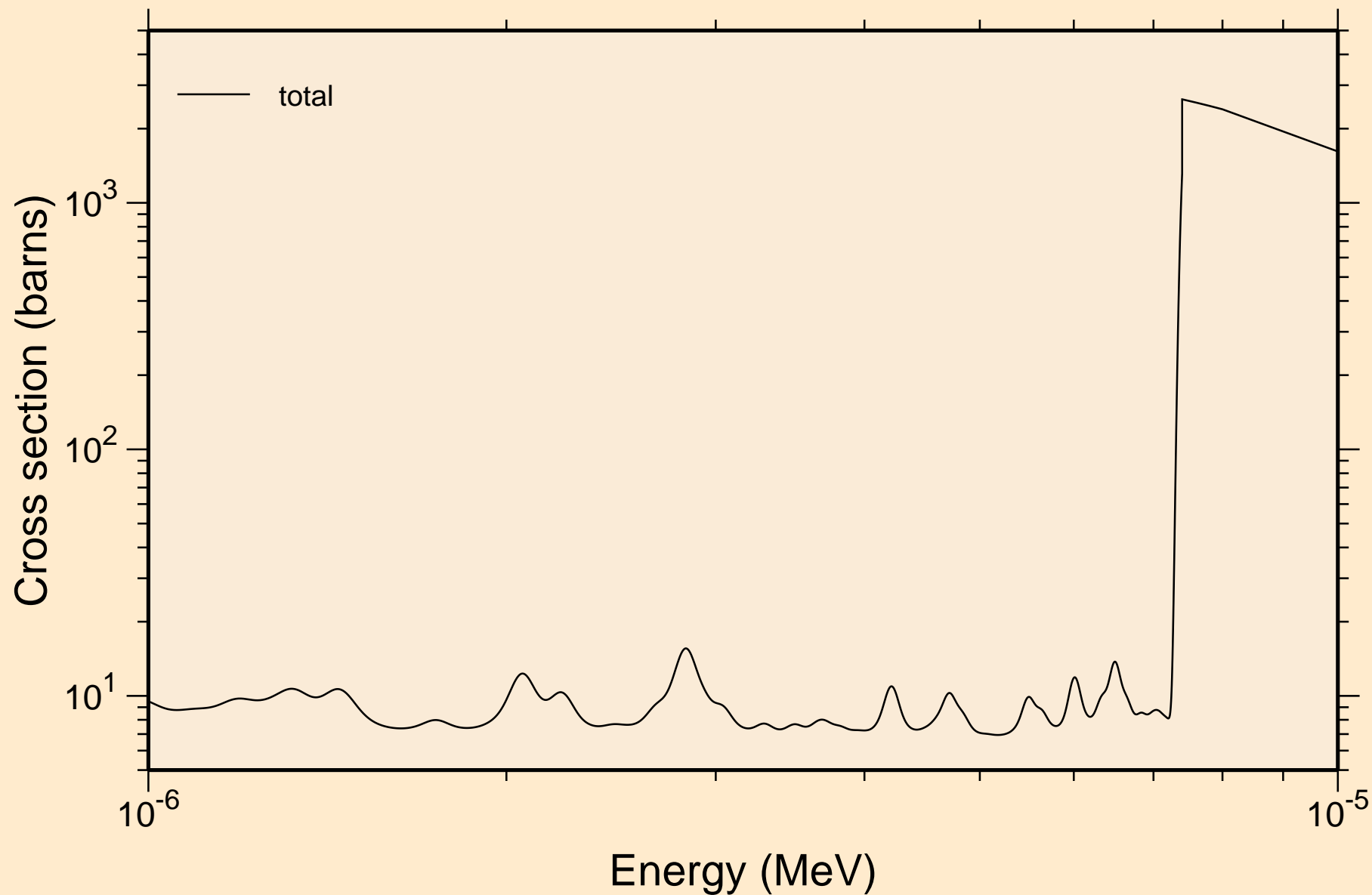

TB156 NEUTRON ACER TENDL-2019 LIBRARY; T=293.16K  
resonance total cross section

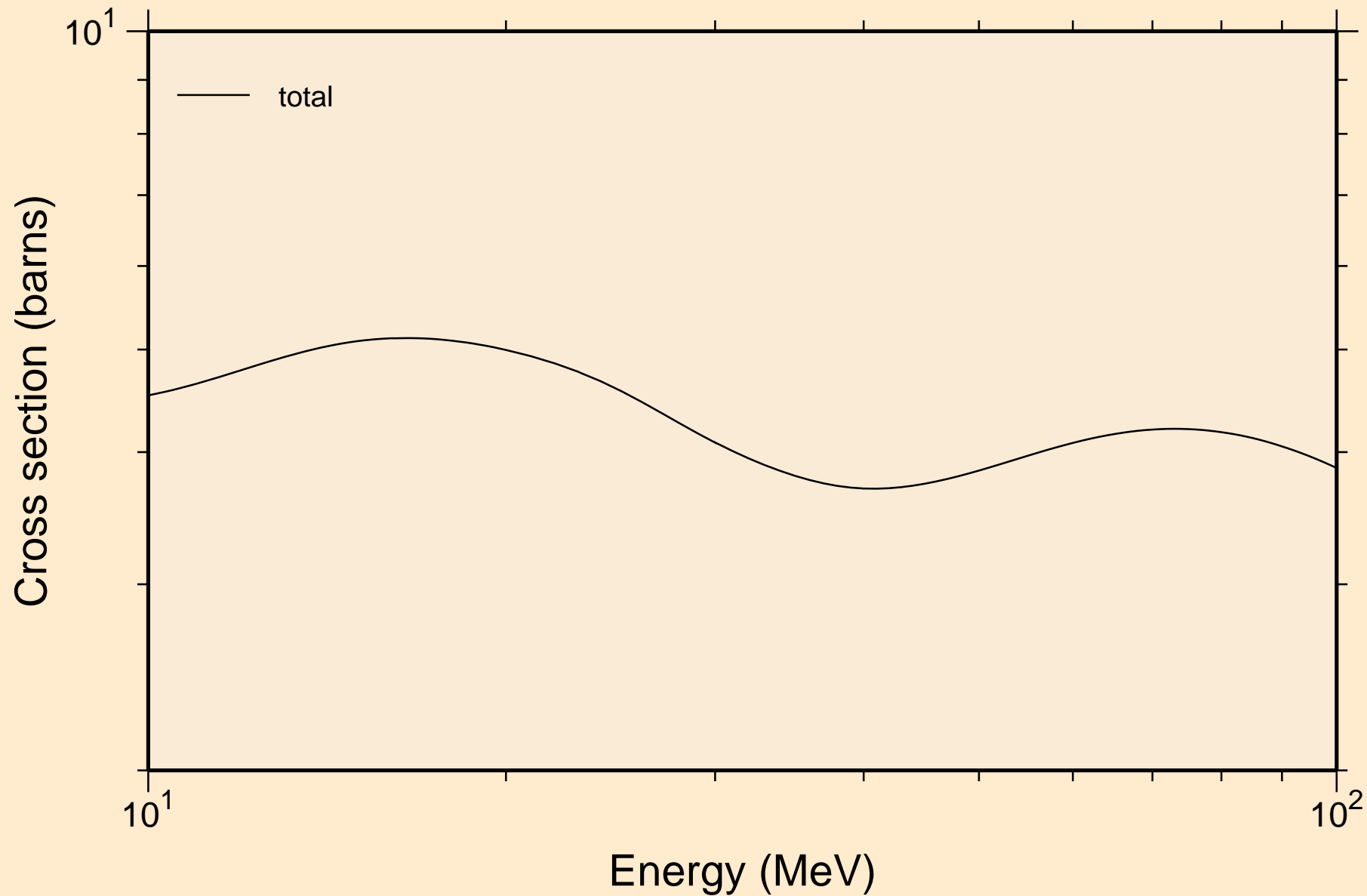

TB156 NEUTRON ACER TENDL-2019 LIBRARY; T=293.16K  
resonance absorption cross sections

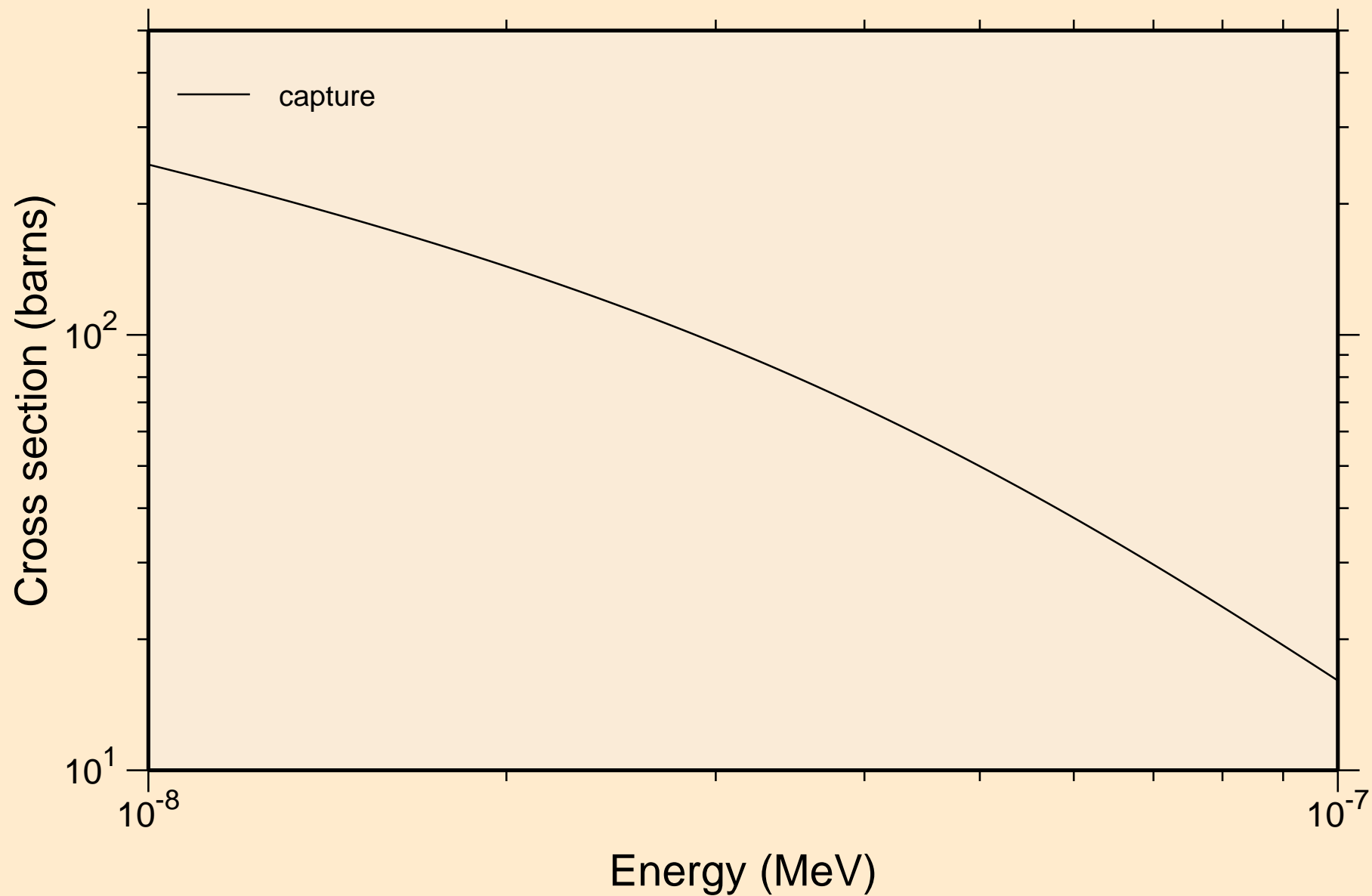

TB156 NEUTRON ACER TENDL-2019 LIBRARY; T=293.16K  
resonance absorption cross sections

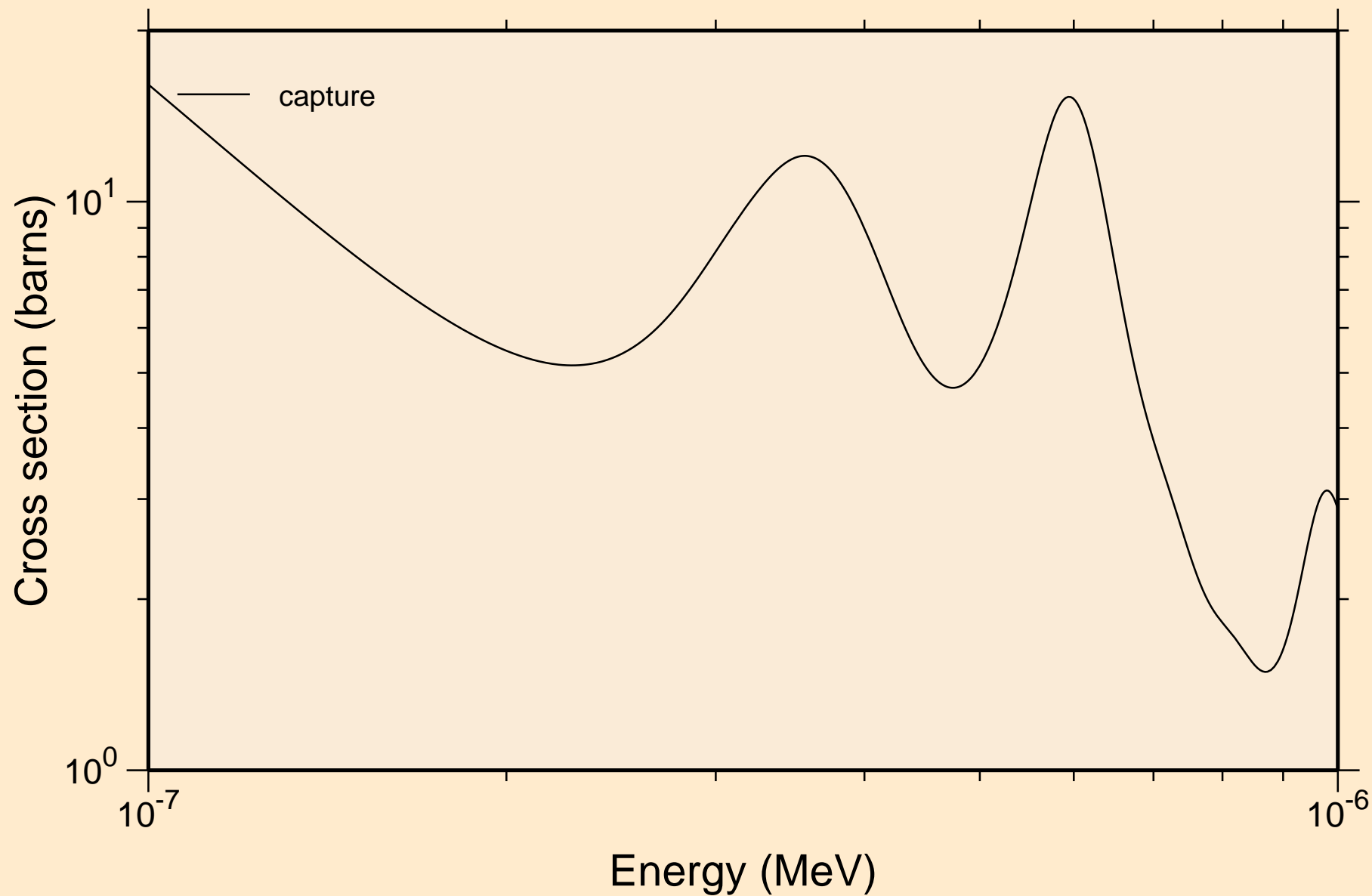

TB156 NEUTRON ACER TENDL-2019 LIBRARY; T=293.16K  
resonance absorption cross sections

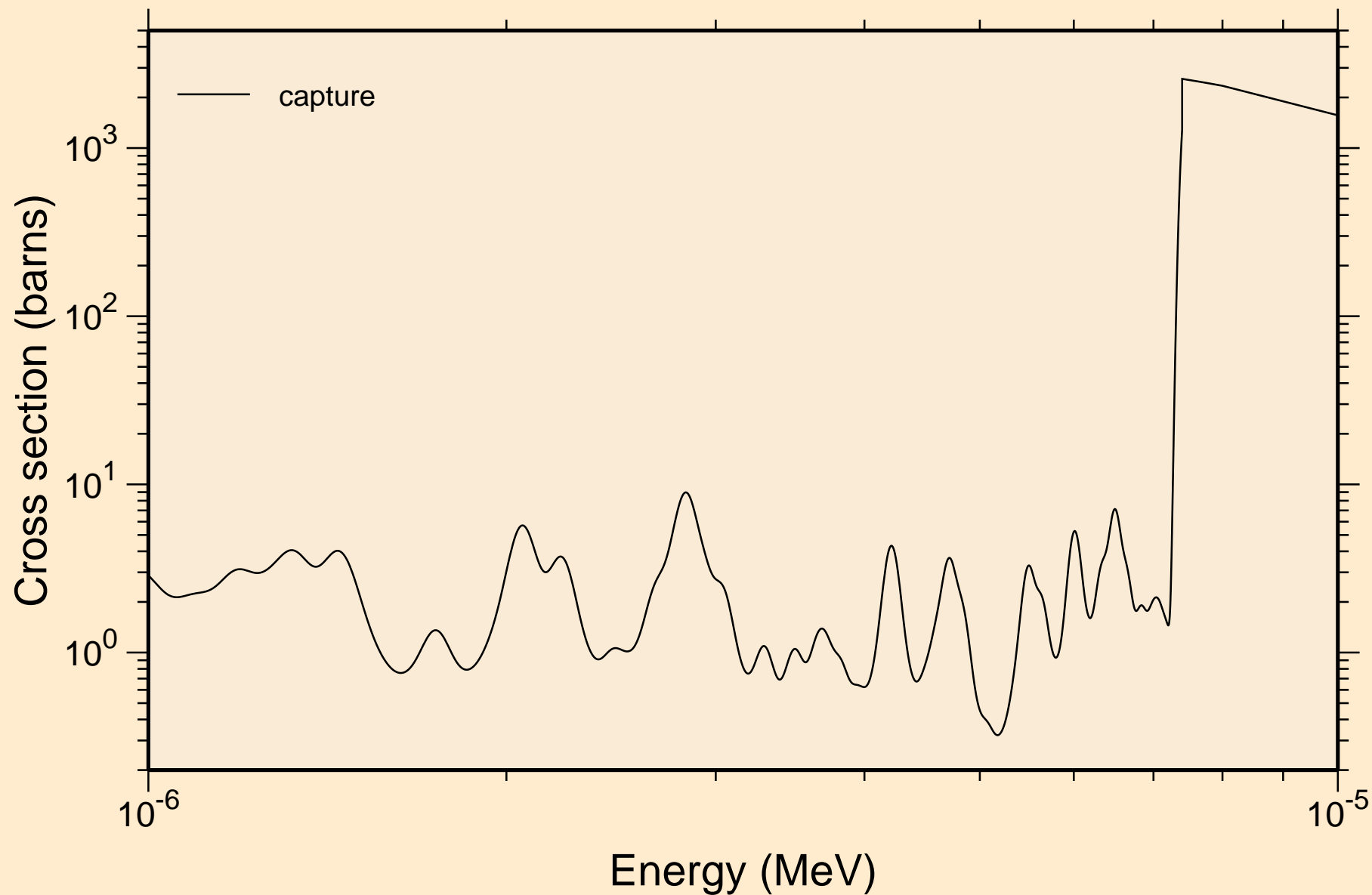



TB156 NEUTRON ACER TENDL-2019 LIBRARY; T=293.16K  
resonance absorption cross sections

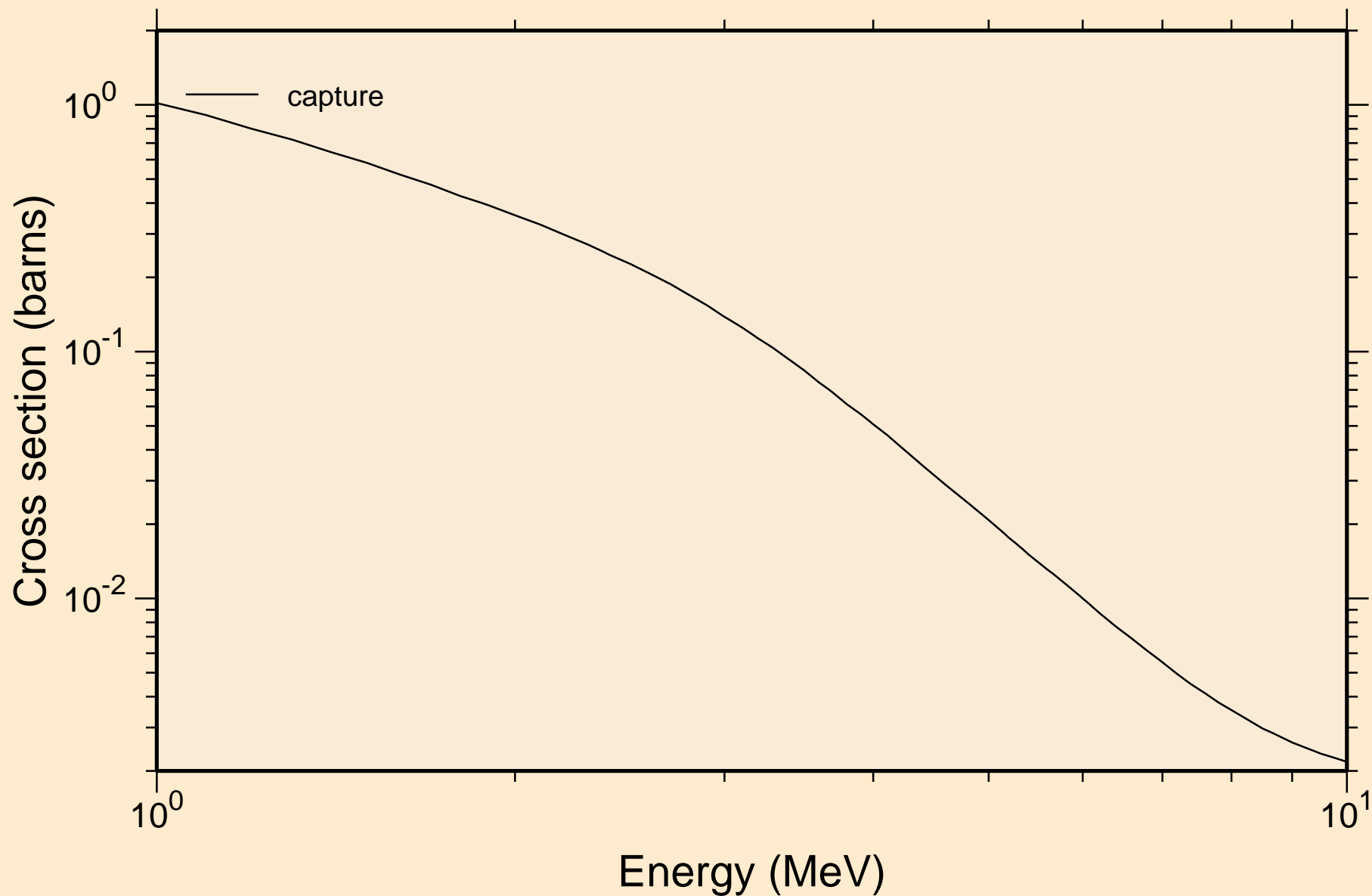

TB156 NEUTRON ACER TENDL-2019 LIBRARY; T=293.16K  
Heating

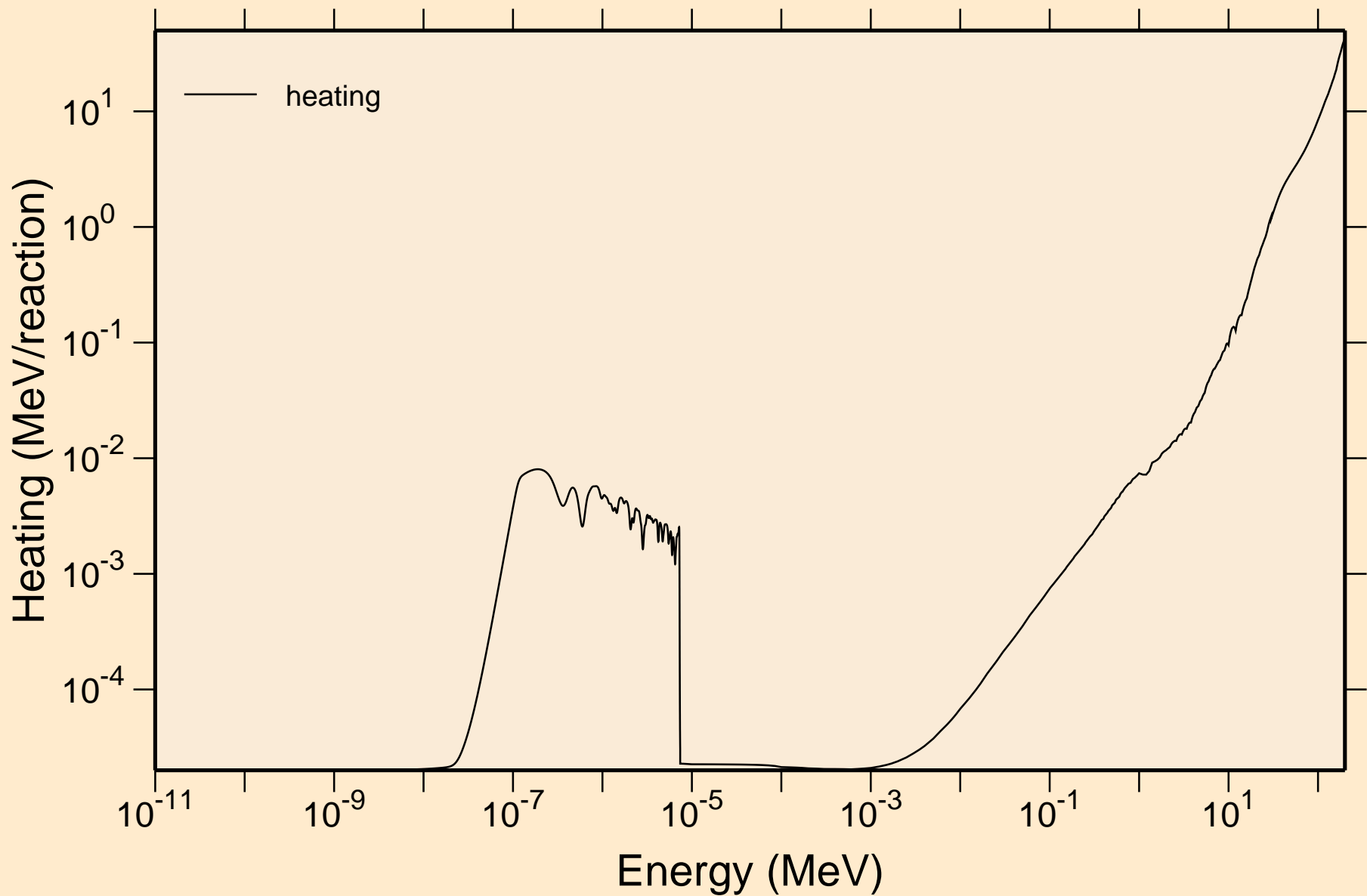

TB156 NEUTRON ACER TENDL-2019 LIBRARY; T=293.16K  
Damage

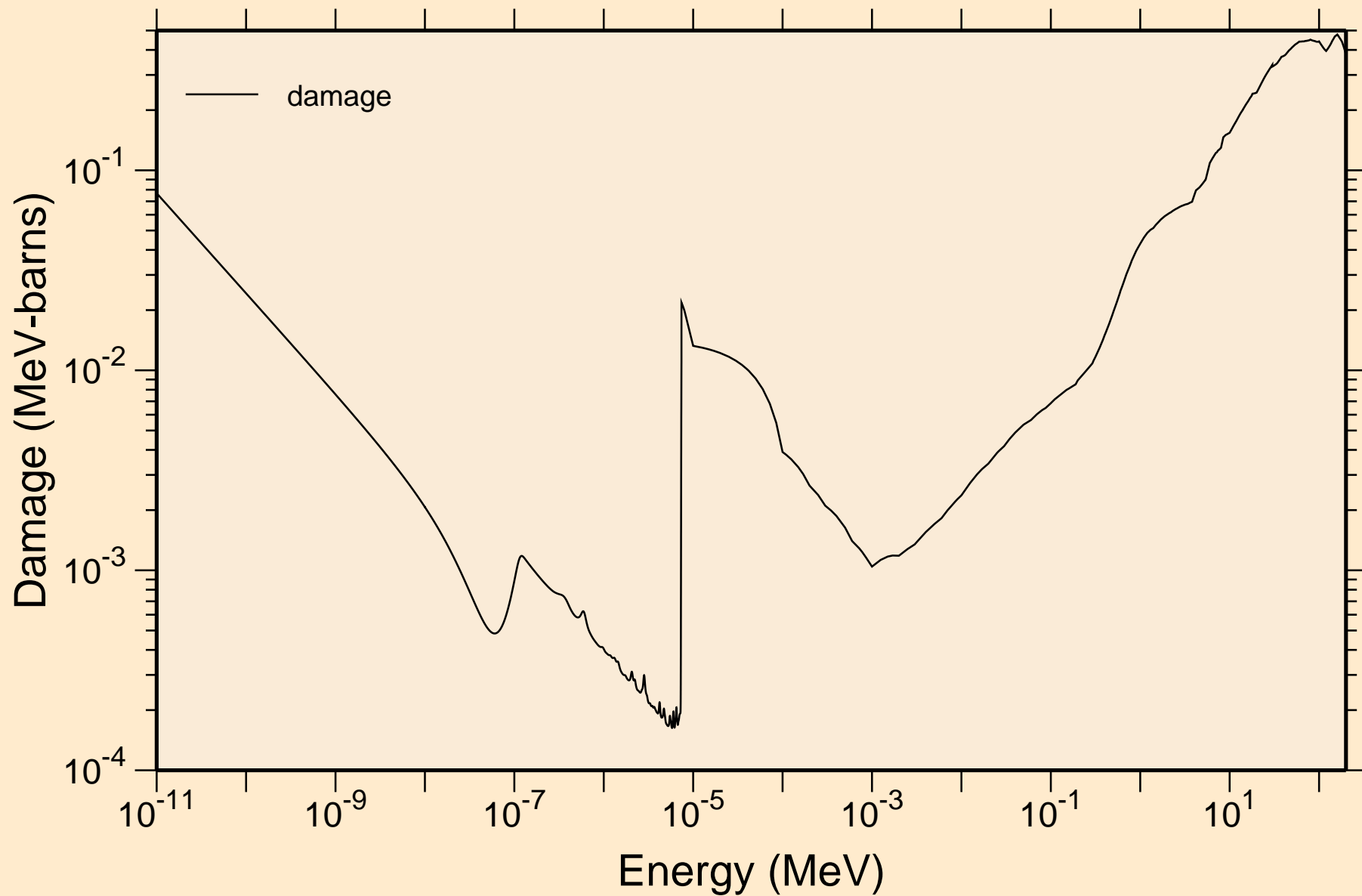

TB156 NEUTRON ACER TENDL-2019 LIBRARY; T=293.16K  
Non-threshold reactions

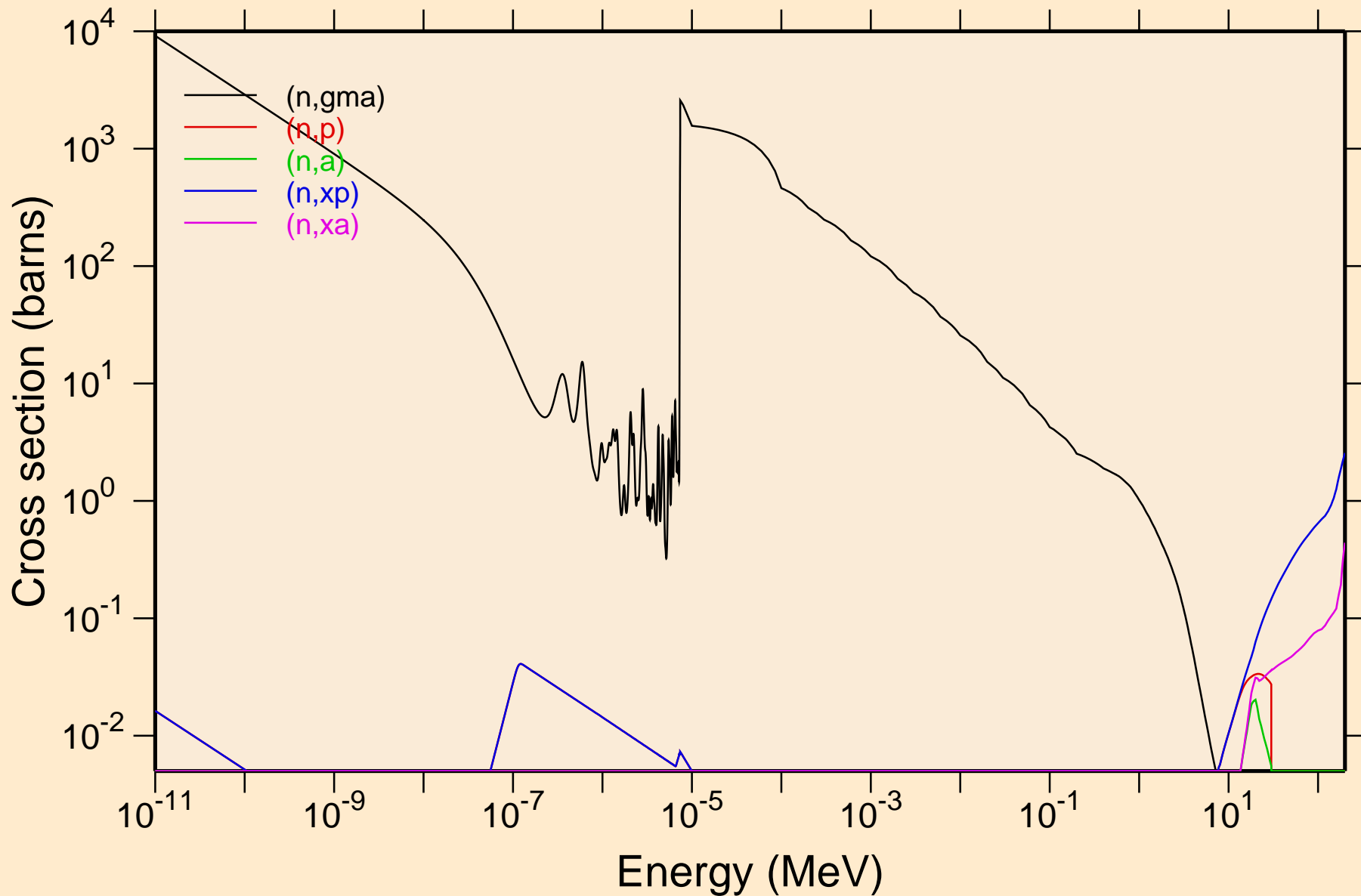

TB156 NEUTRON ACER TENDL-2019 LIBRARY; T=293.16K  
Principal cross sections

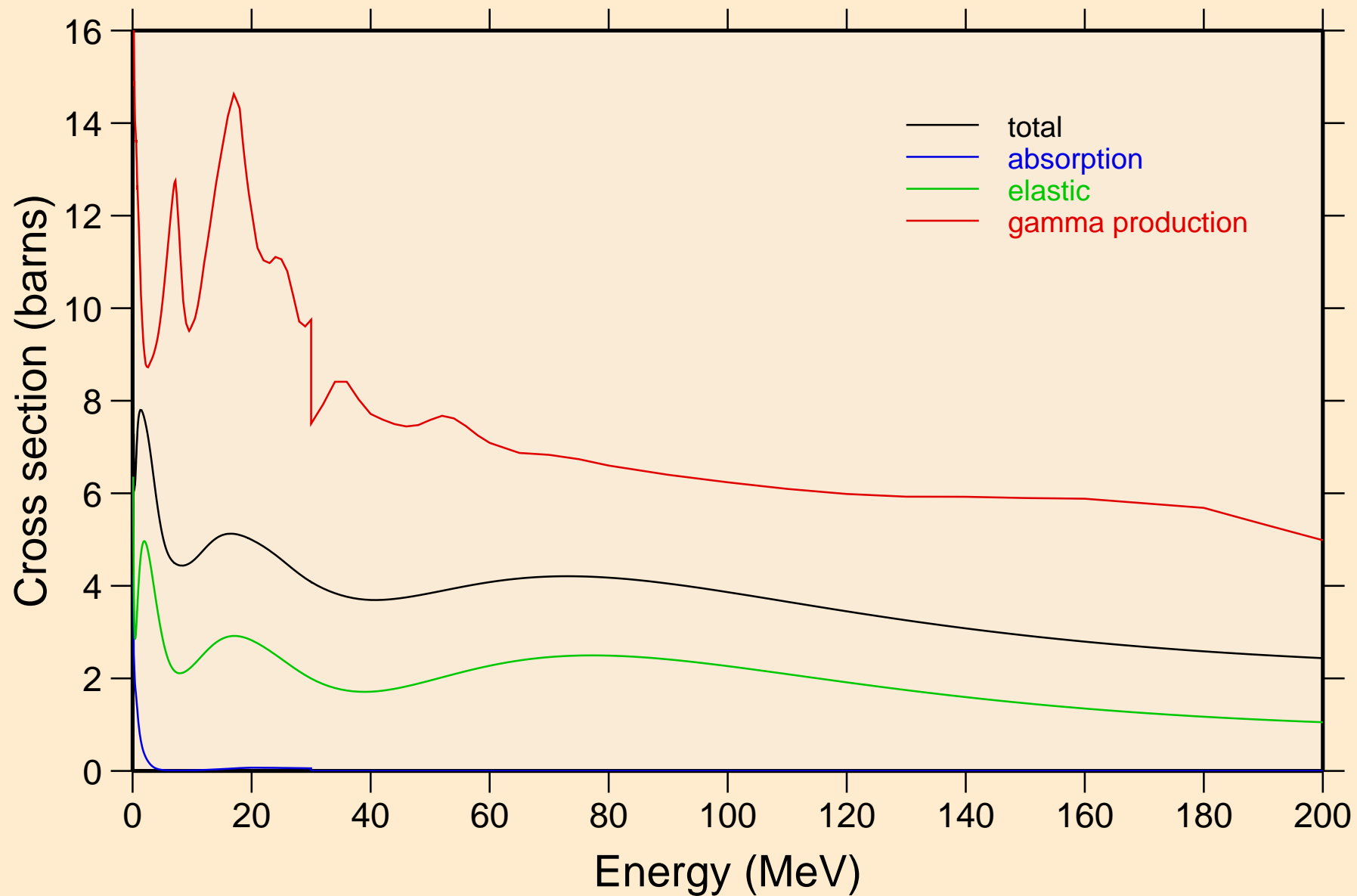

TB156 NEUTRON ACER TENDL-2019 LIBRARY; T=293.16K  
Heating

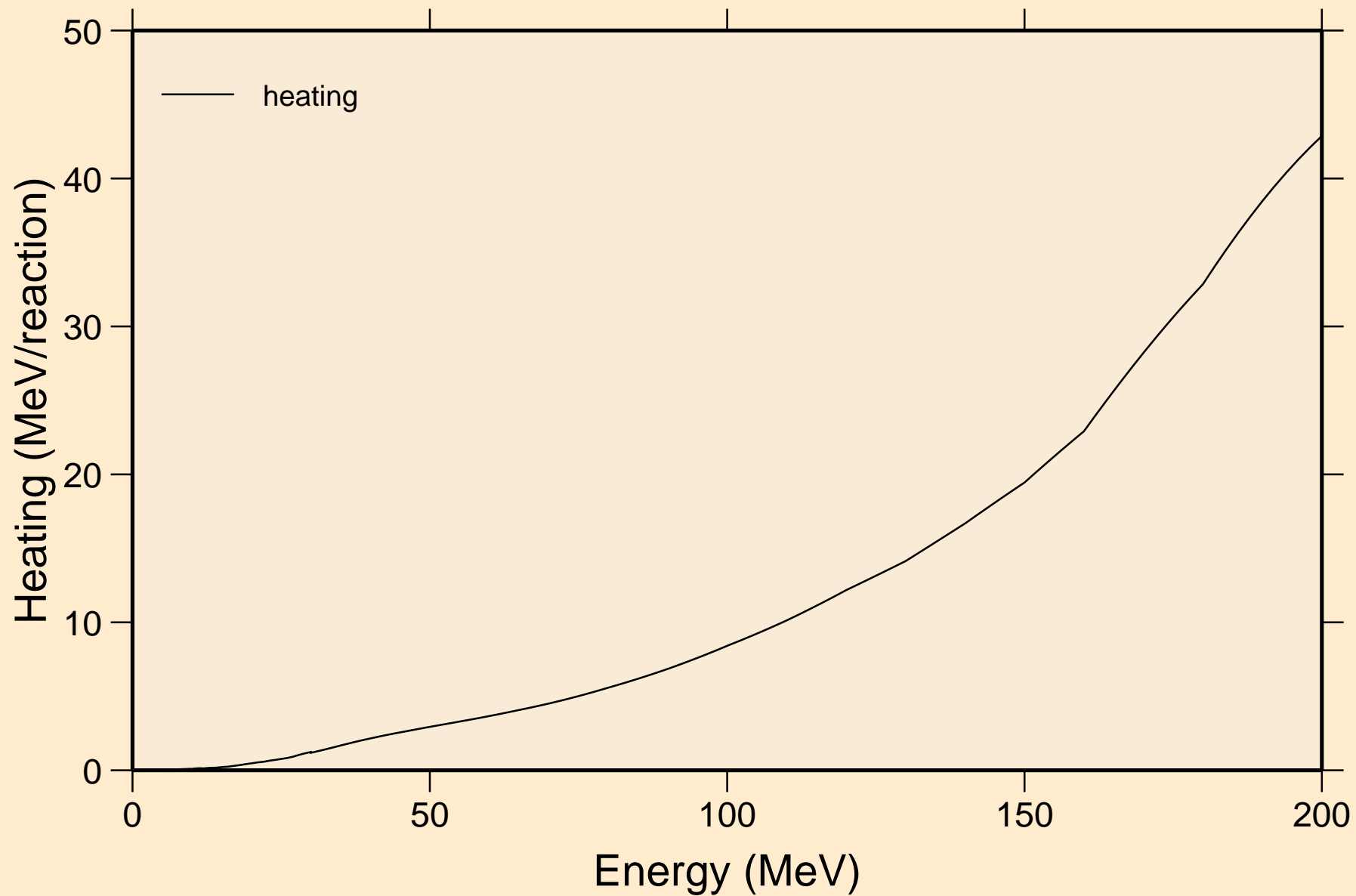

TB156 NEUTRON ACER TENDL-2019 LIBRARY; T=293.16K  
Damage

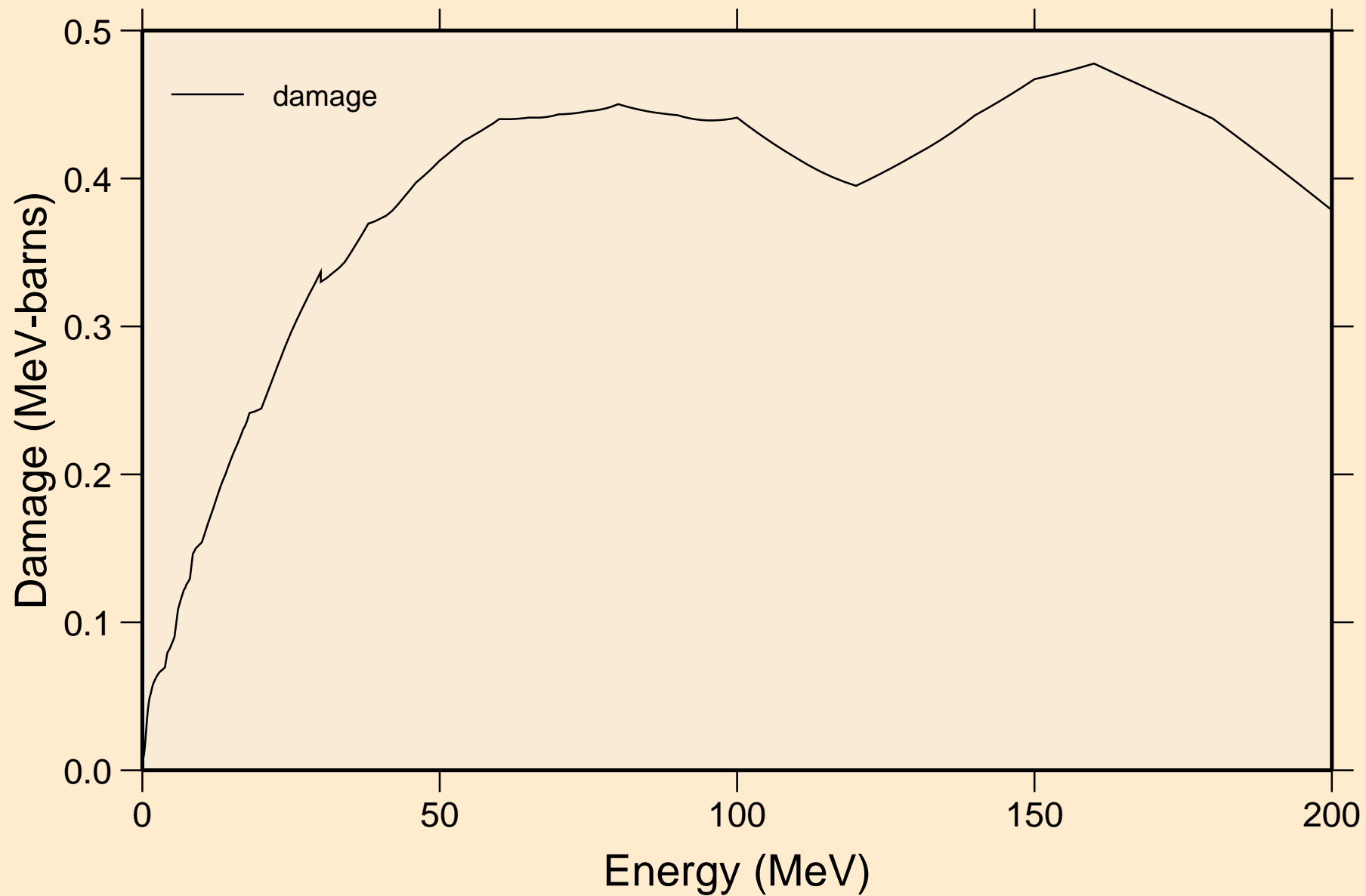

TB156 NEUTRON ACER TENDL-2019 LIBRARY; T=293.16K  
Non-threshold reactions

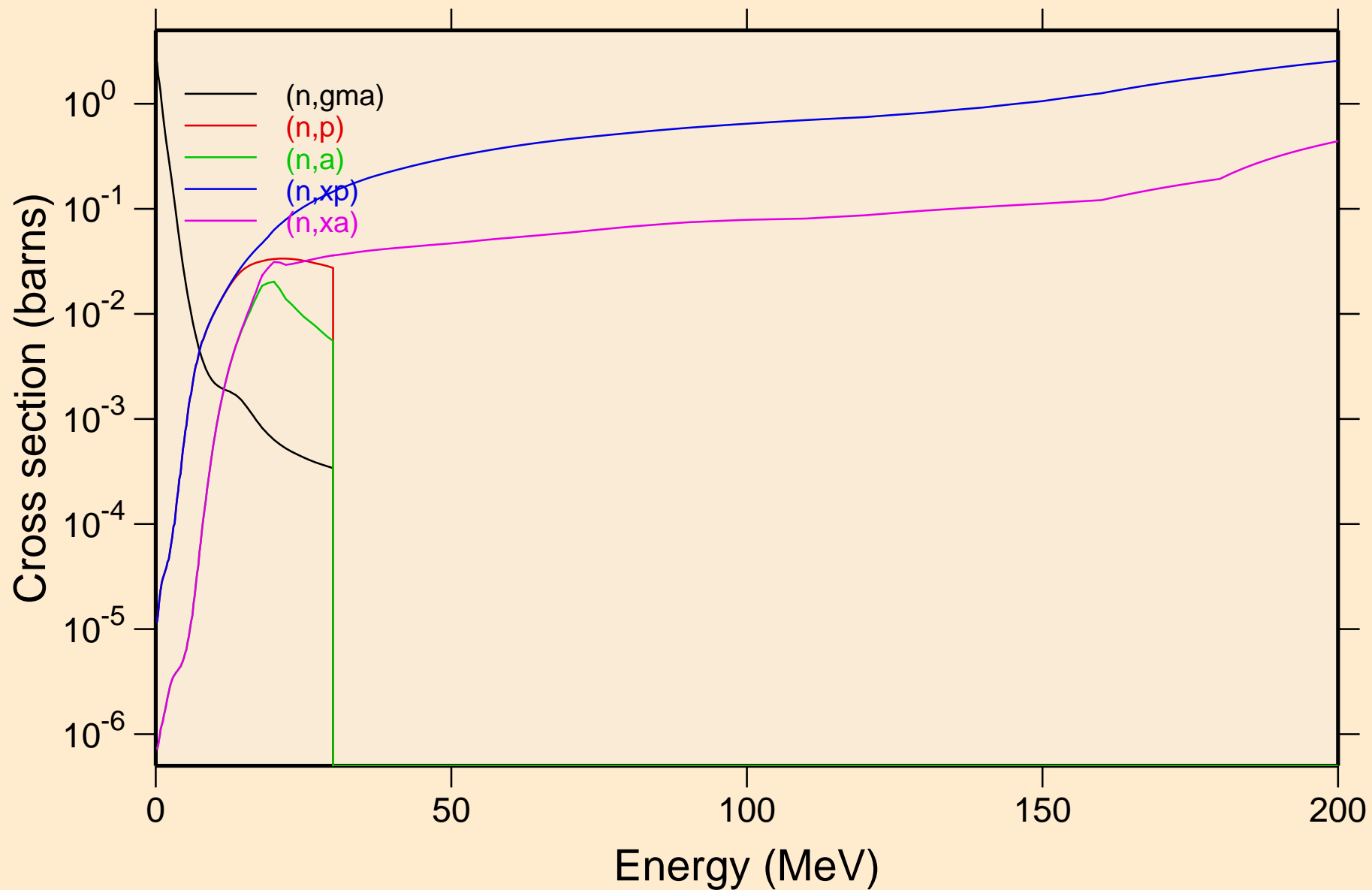



TB156 NEUTRON ACER TENDL-2019 LIBRARY; T=293.16K  
Inelastic levels

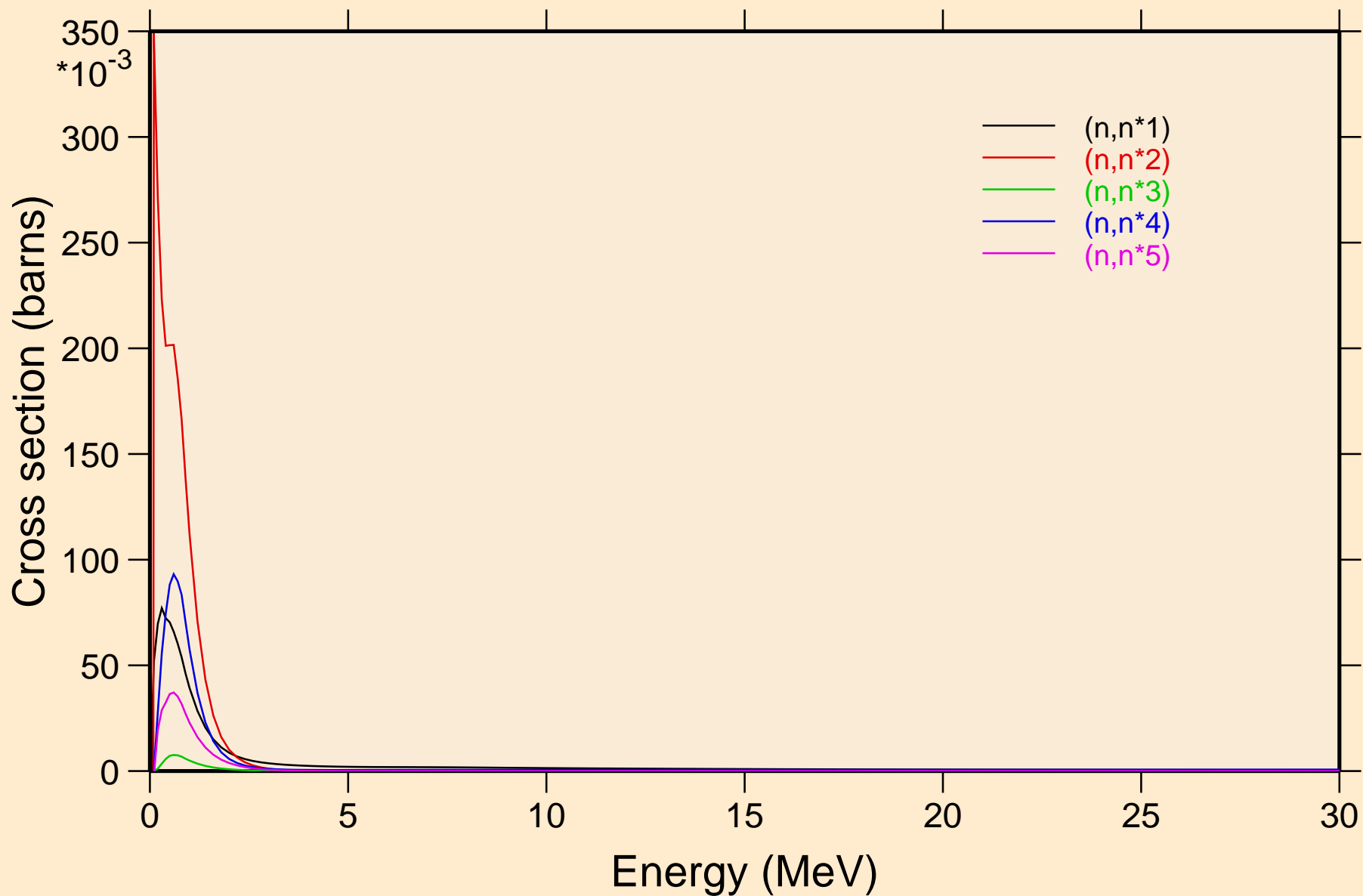

TB156 NEUTRON ACER TENDL-2019 LIBRARY; T=293.16K  
Inelastic levels

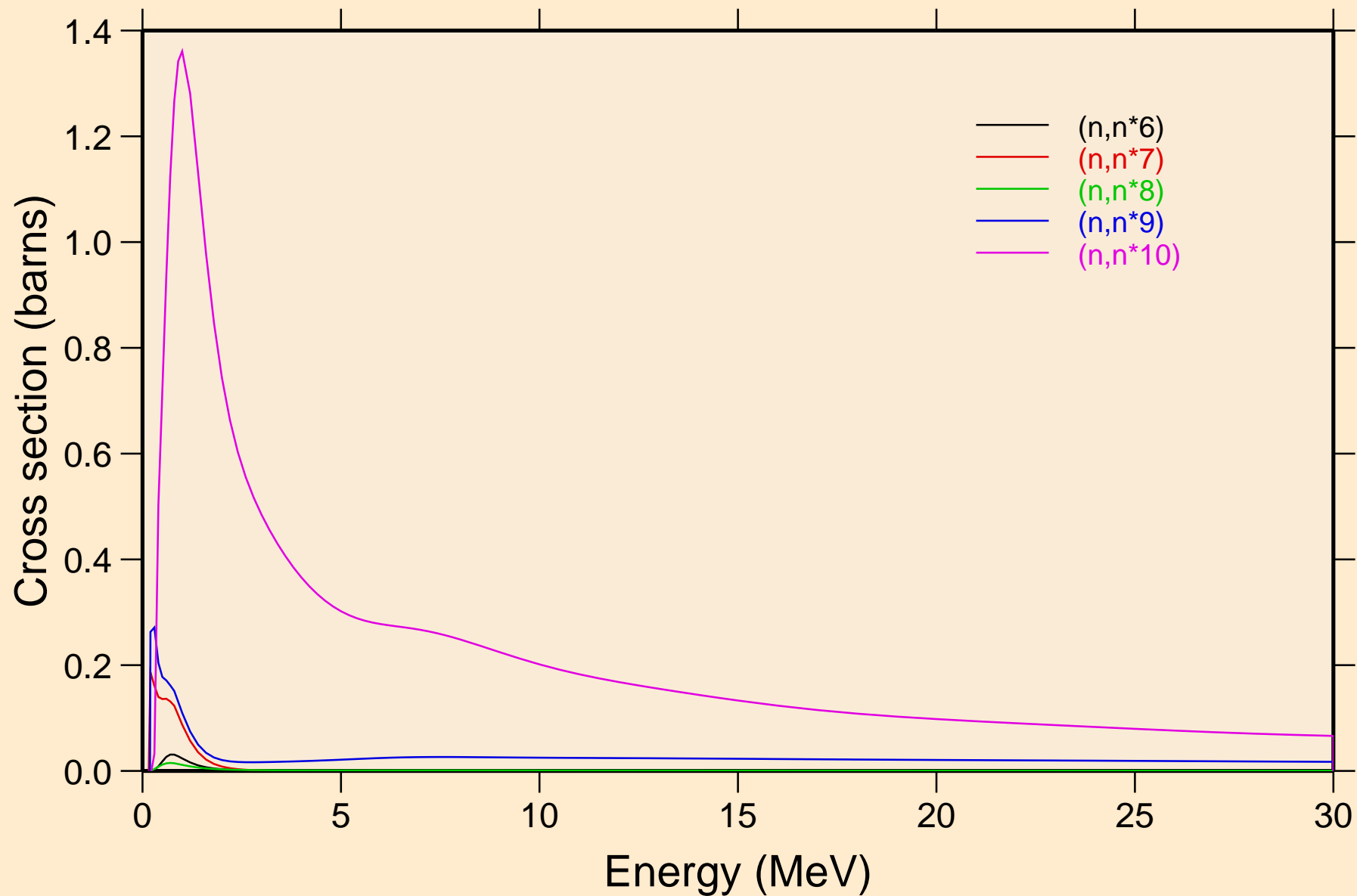

TB156 NEUTRON ACER TENDL-2019 LIBRARY; T=293.16K  
Inelastic levels

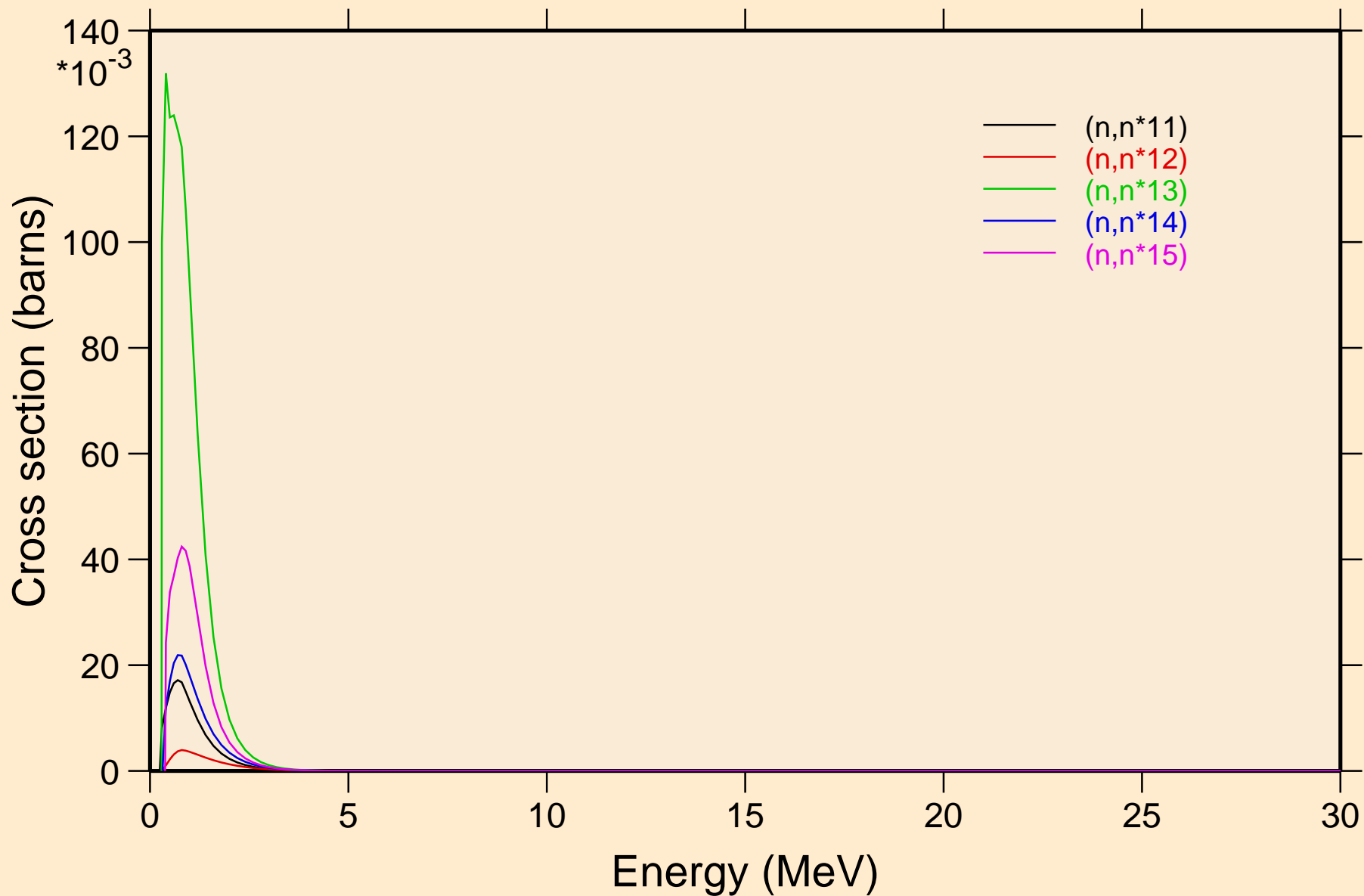

TB156 NEUTRON ACER TENDL-2019 LIBRARY; T=293.16K  
Inelastic levels

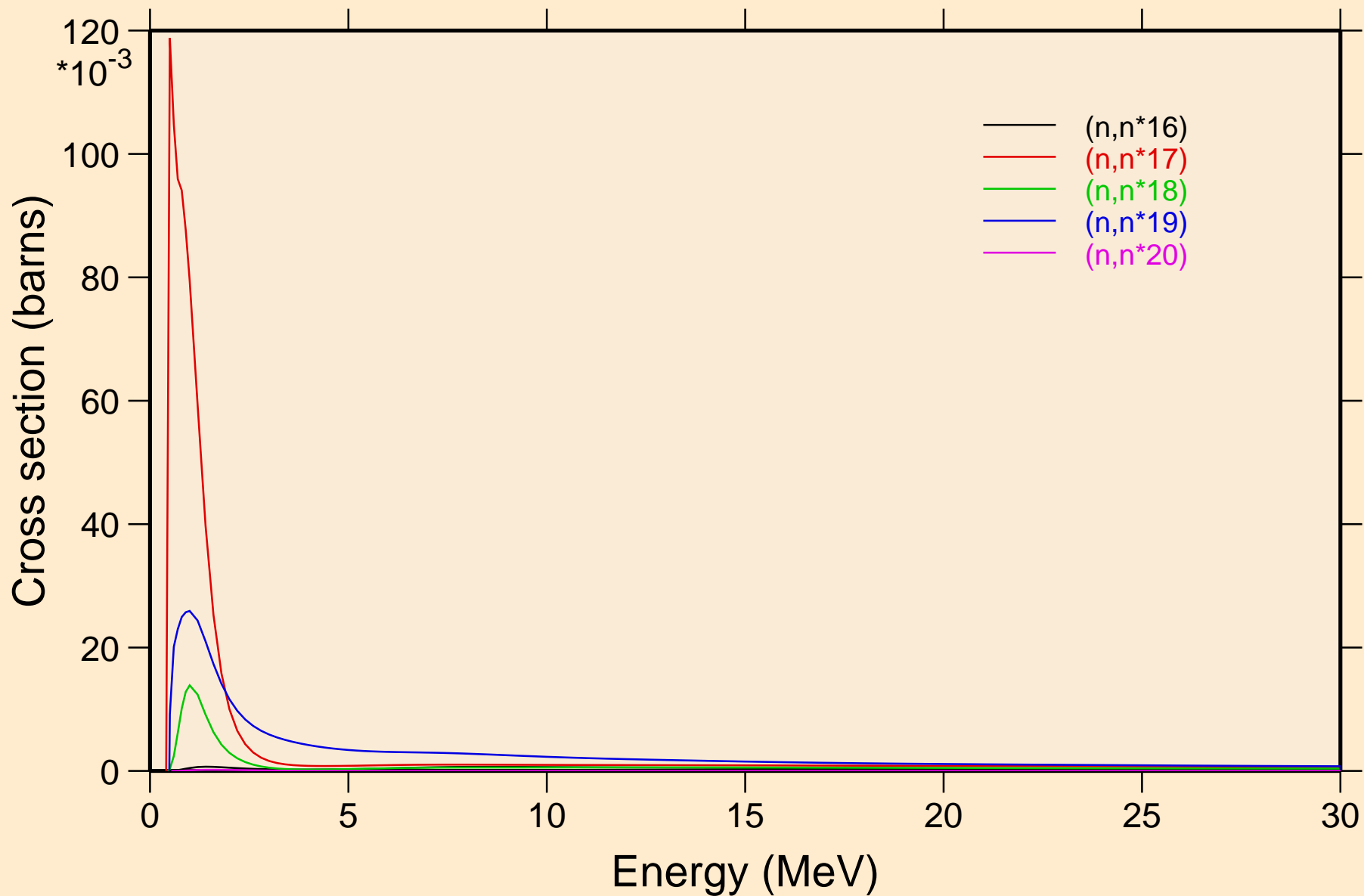

TB156 NEUTRON ACER TENDL-2019 LIBRARY; T=293.16K  
Inelastic levels

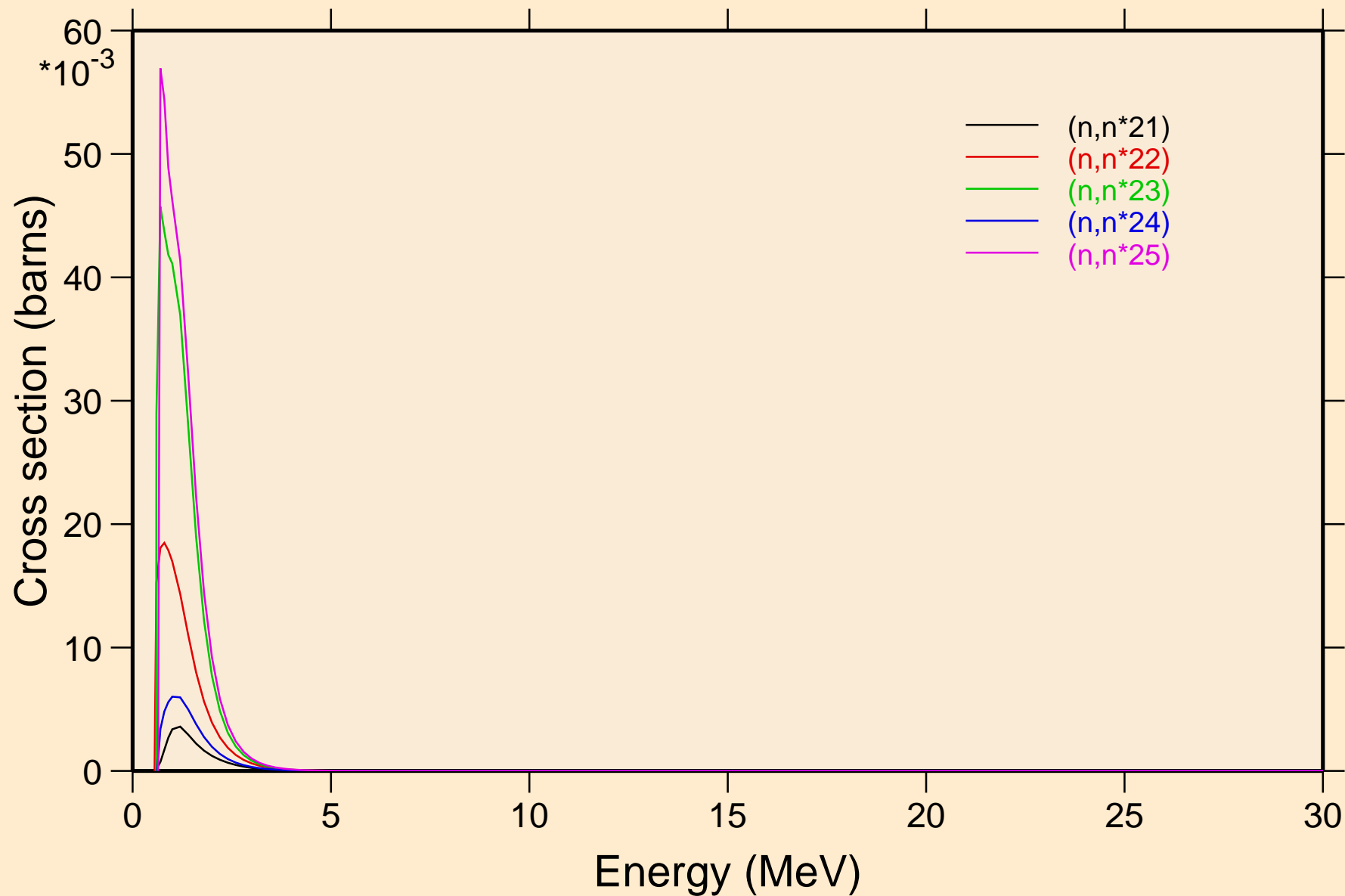

TB156 NEUTRON ACER TENDL-2019 LIBRARY; T=293.16K  
Inelastic levels

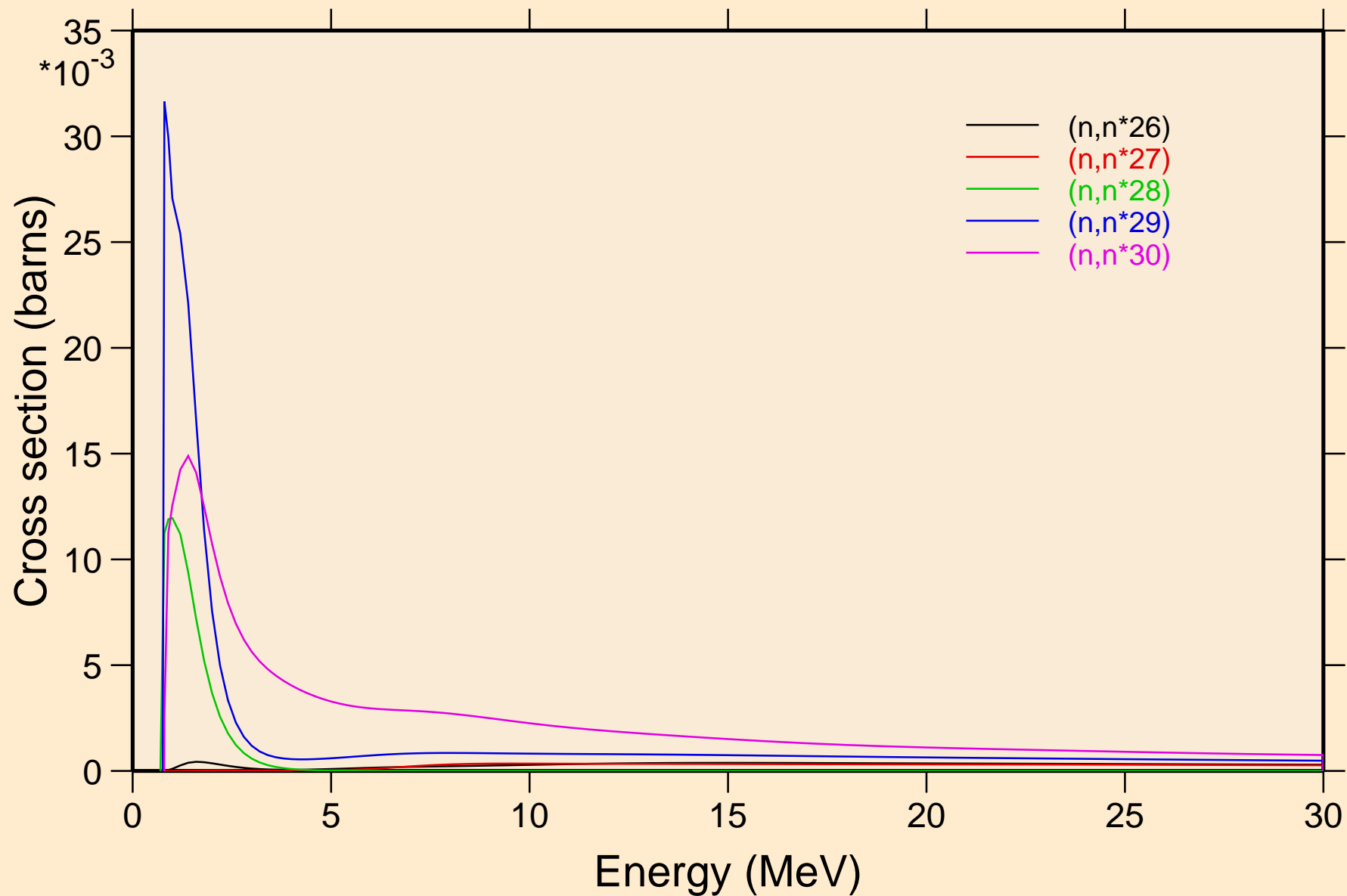

TB156 NEUTRON ACER TENDL-2019 LIBRARY; T=293.16K  
Threshold reactions

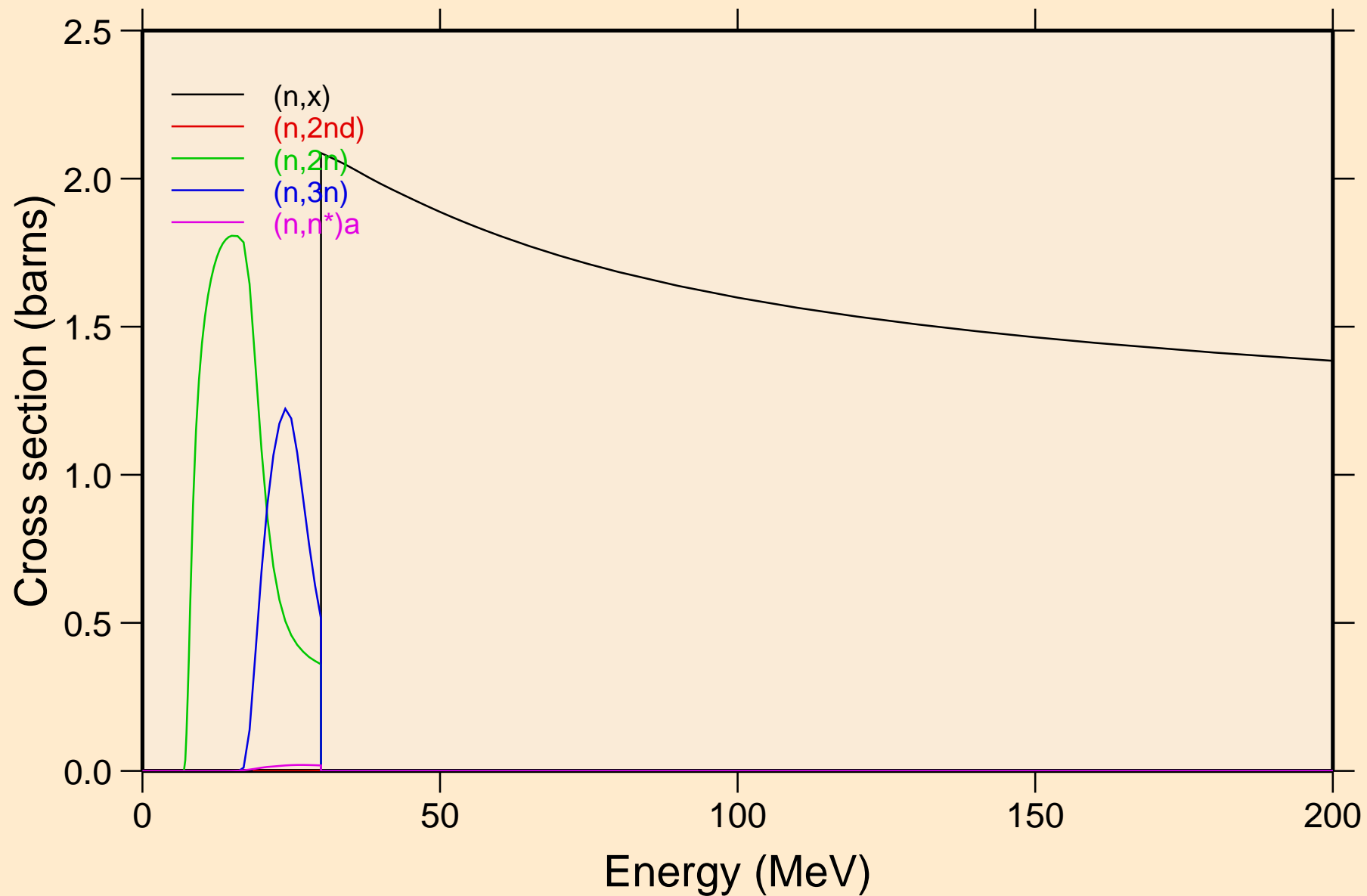

TB156 NEUTRON ACER TENDL-2019 LIBRARY; T=293.16K  
Threshold reactions

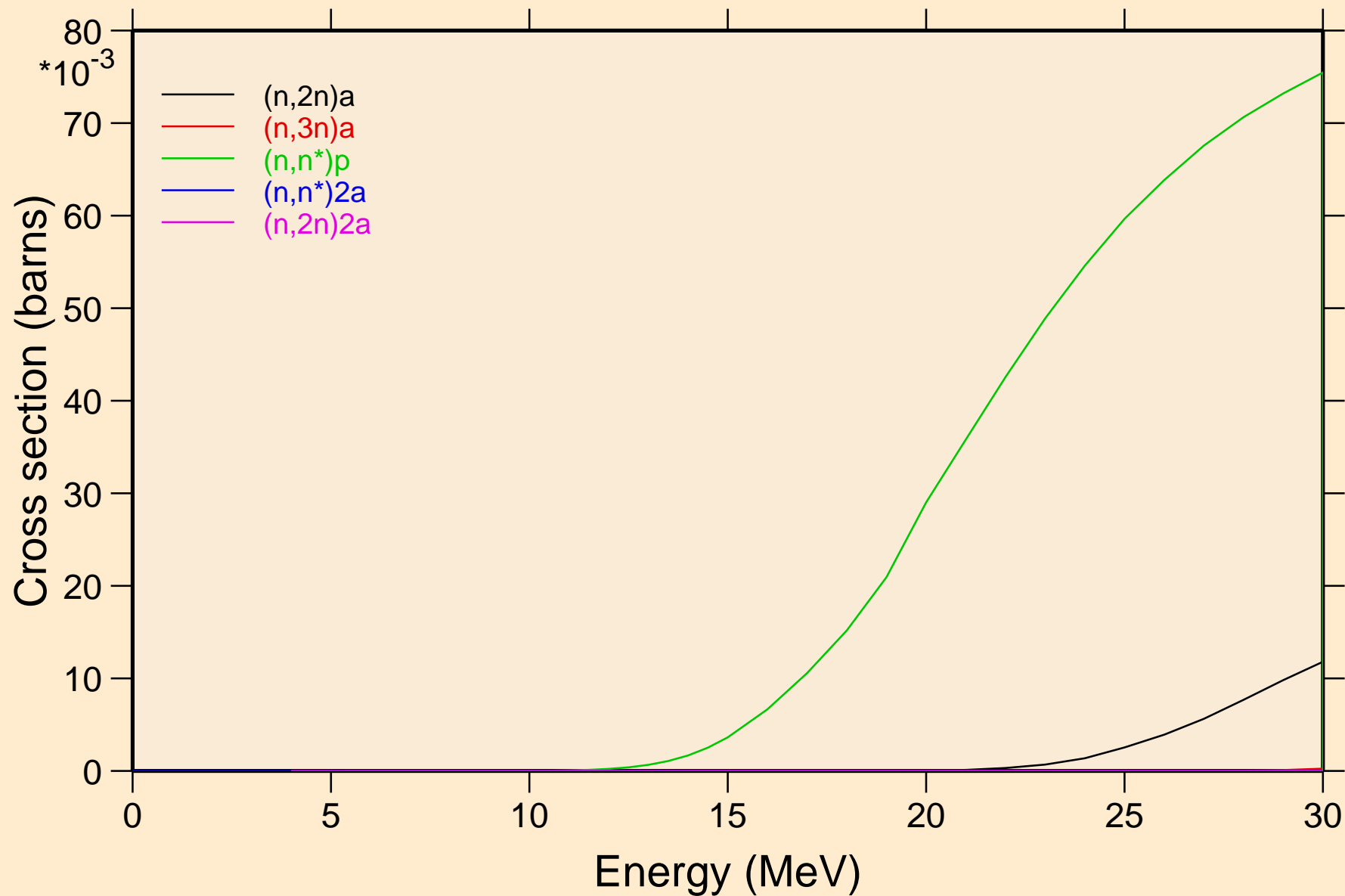



TB156 NEUTRON ACER TENDL-2019 LIBRARY; T=293.16K  
Threshold reactions

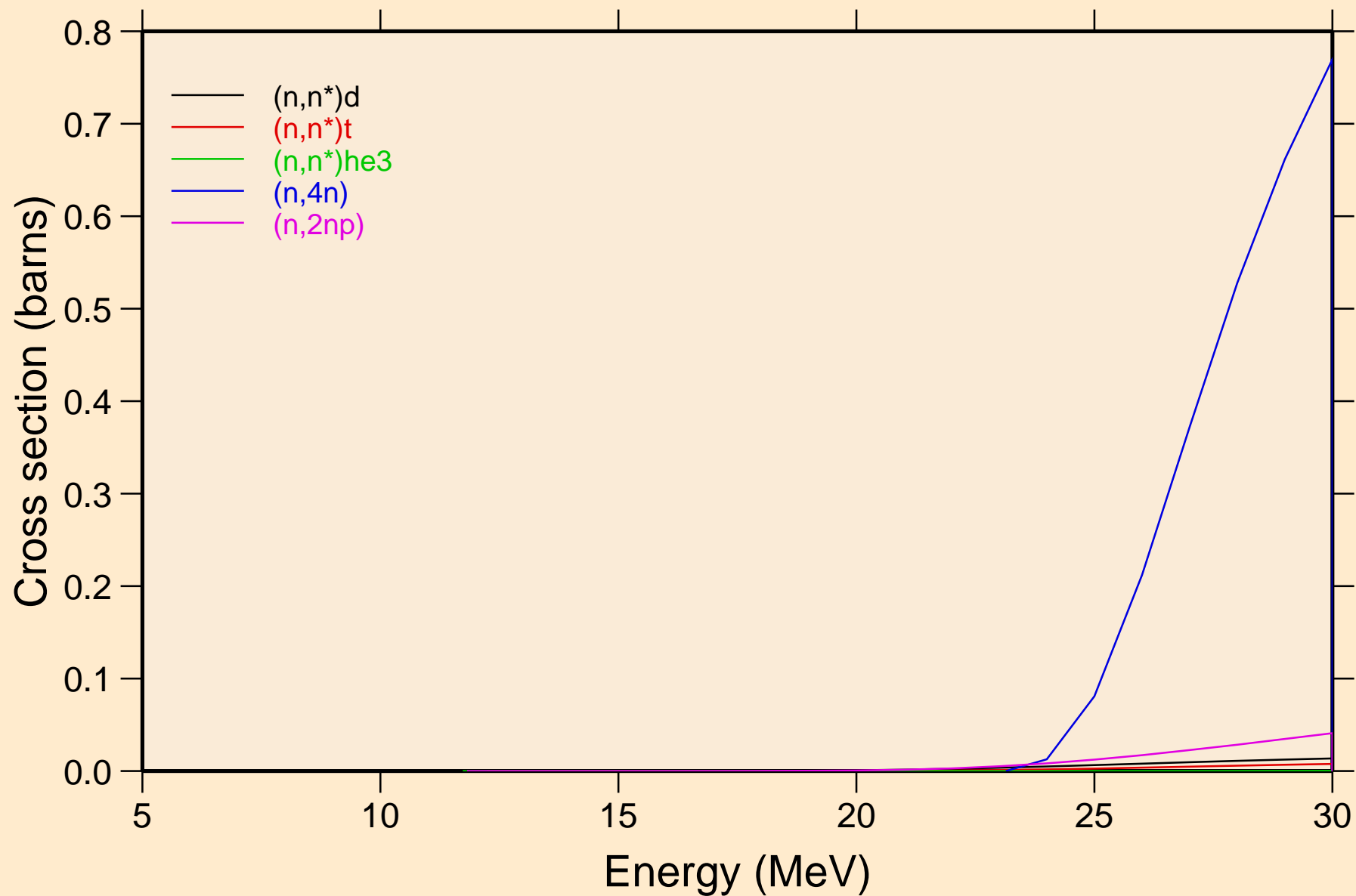

TB156 NEUTRON ACER TENDL-2019 LIBRARY; T=293.16K  
Threshold reactions

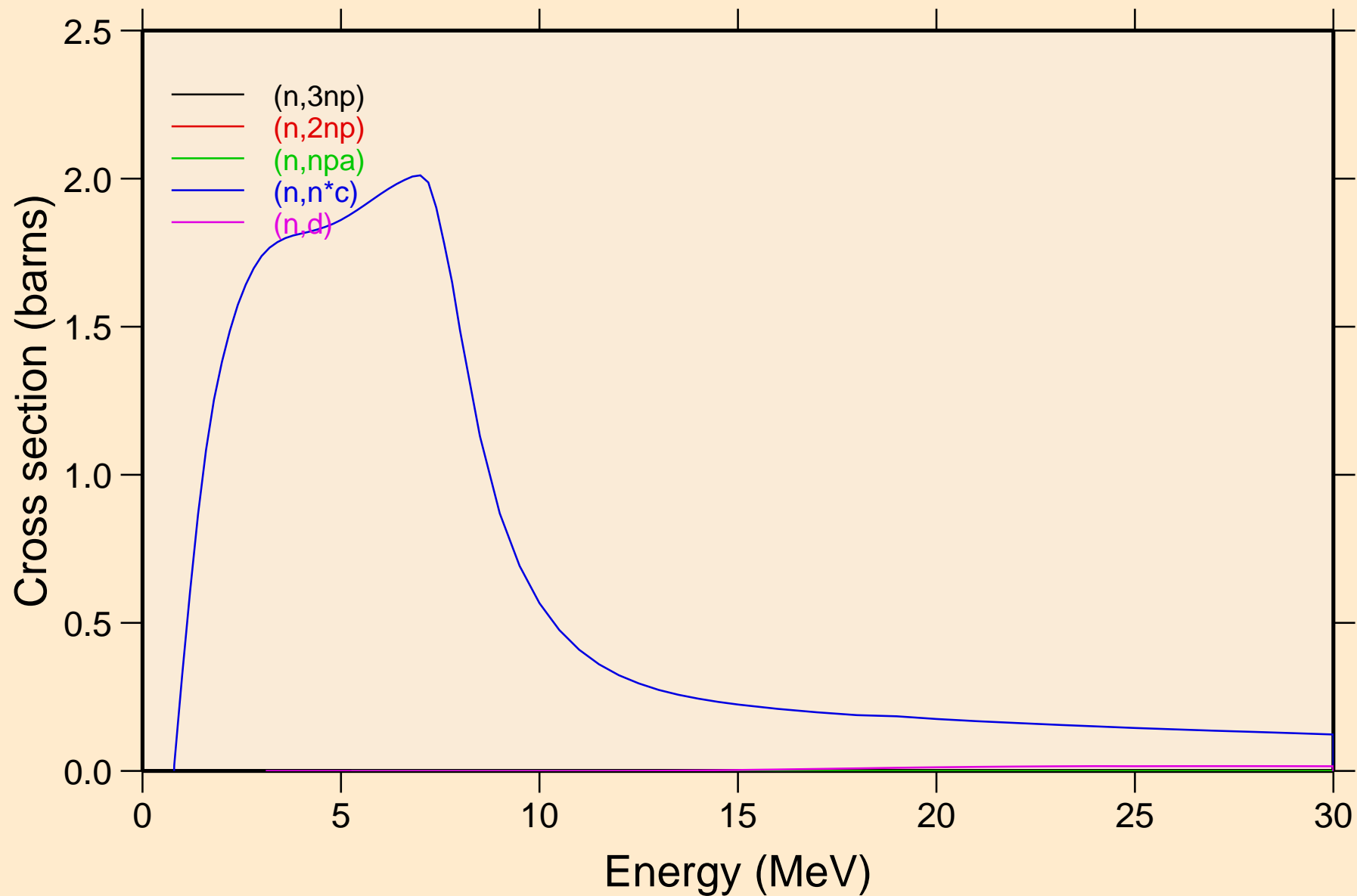

TB156 NEUTRON ACER TENDL-2019 LIBRARY; T=293.16K  
Threshold reactions

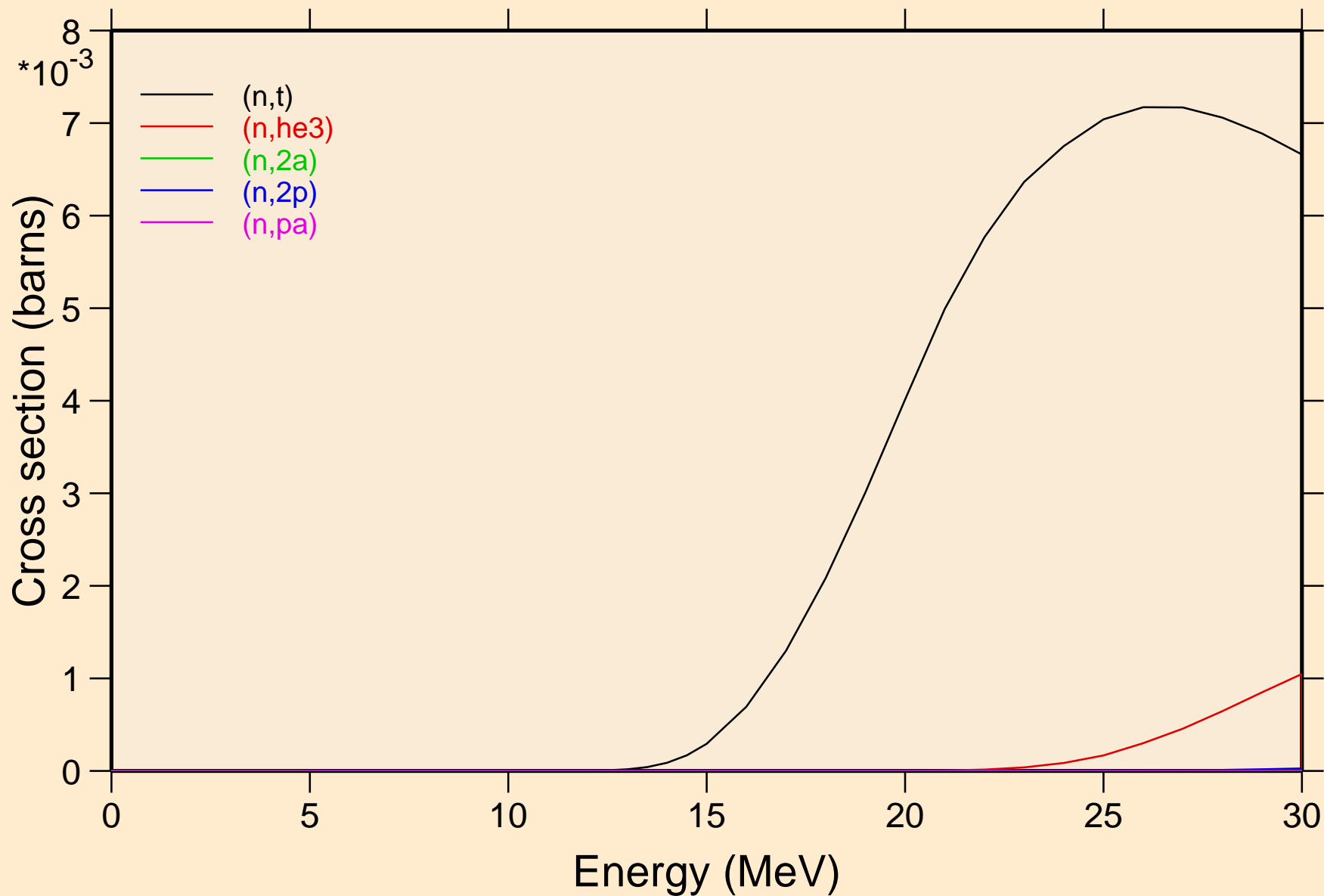

TB156 NEUTRON ACER TENDL-2019 LIBRARY; T=293.16K  
Threshold reactions

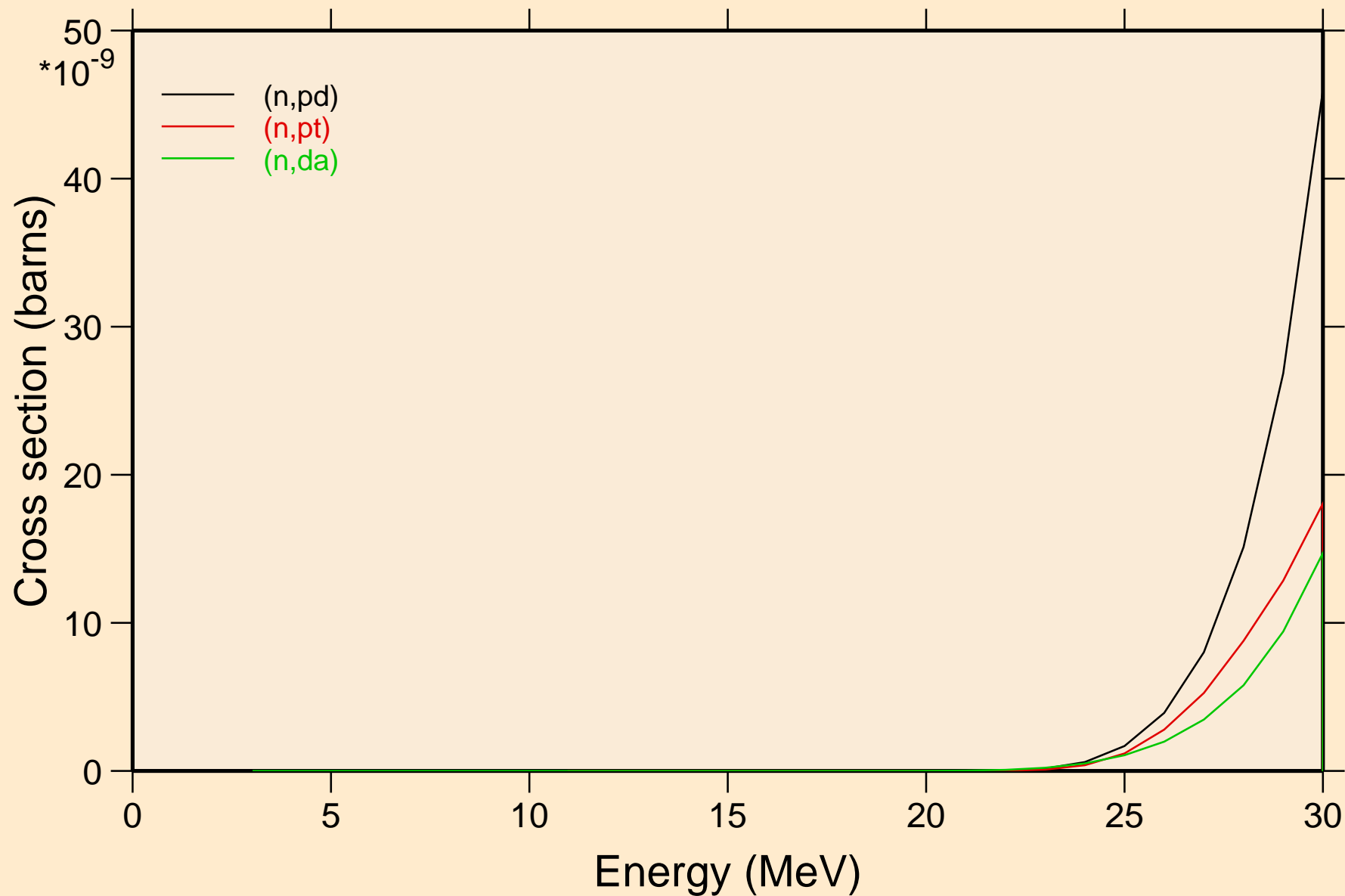

TB156 NEUTRON ACER TENDL-2019 LIBRARY; T=293.16K  
Threshold reactions

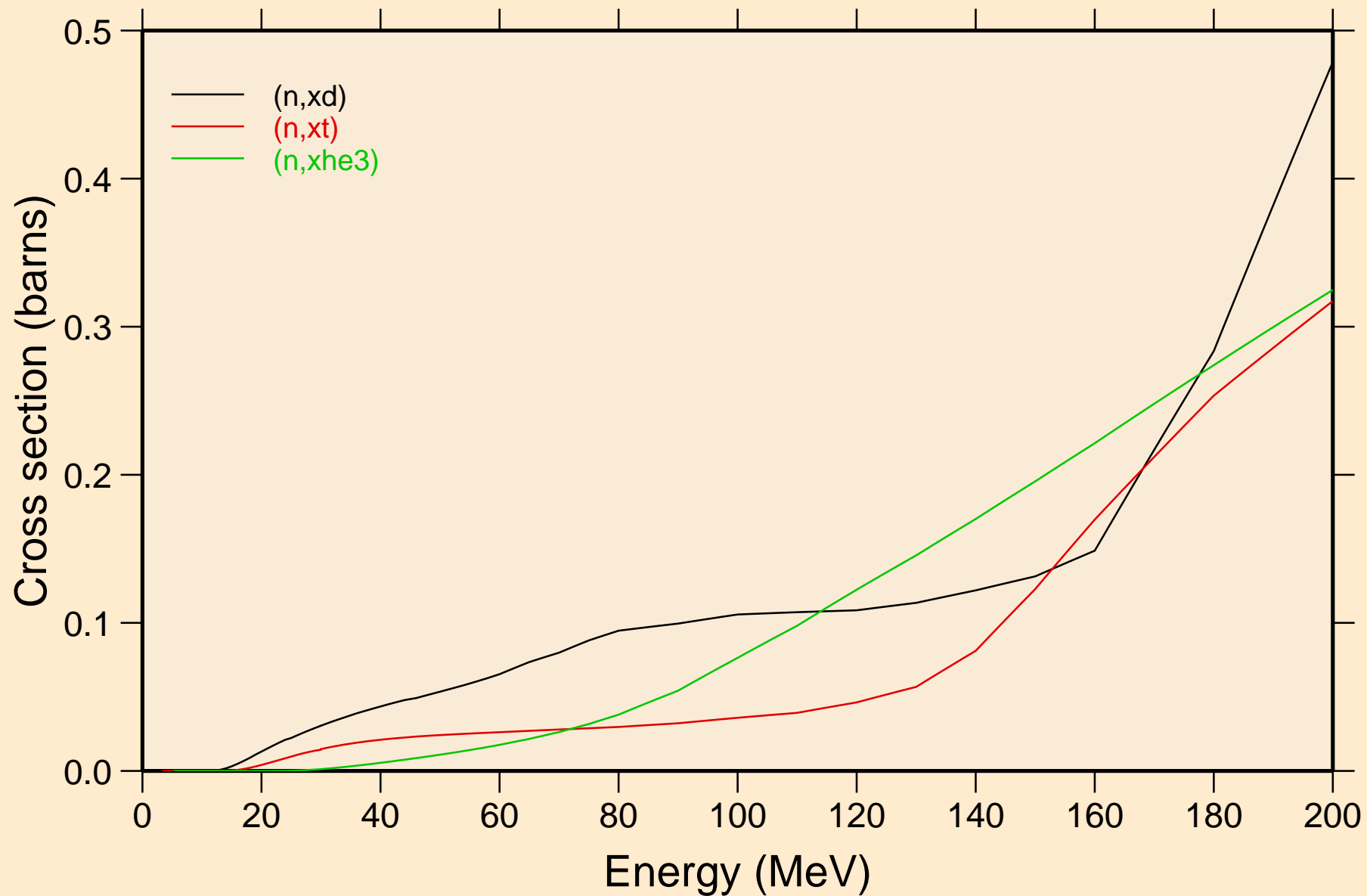

TB156 NEUTRON ACER TENDL-2019 LIBRARY; T=293.16K  
angular distribution for elastic

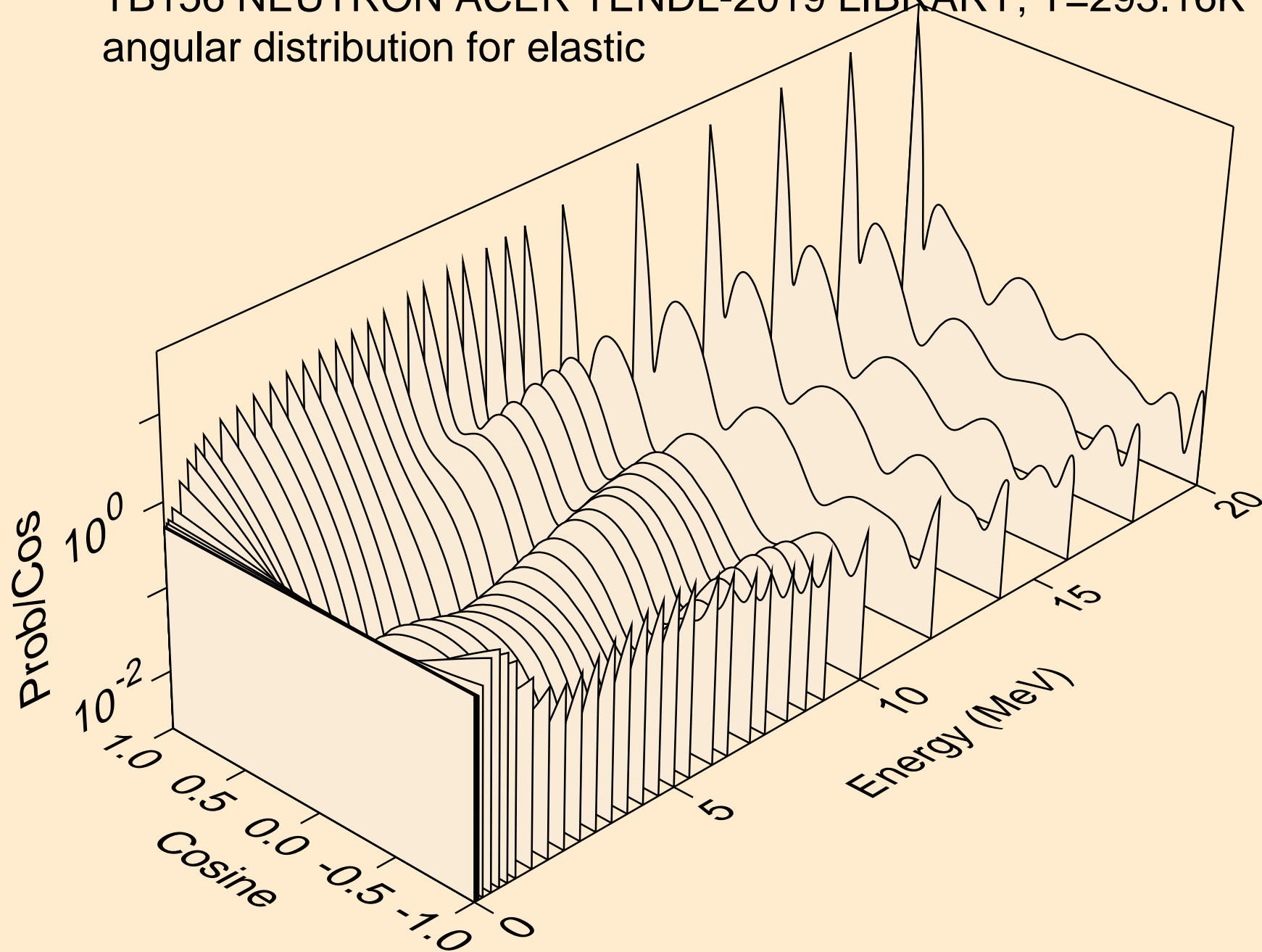

TB156 NEUTRON ACER TENDL-2019 LIBRARY; T=293.16K  
angular distribution for elastic

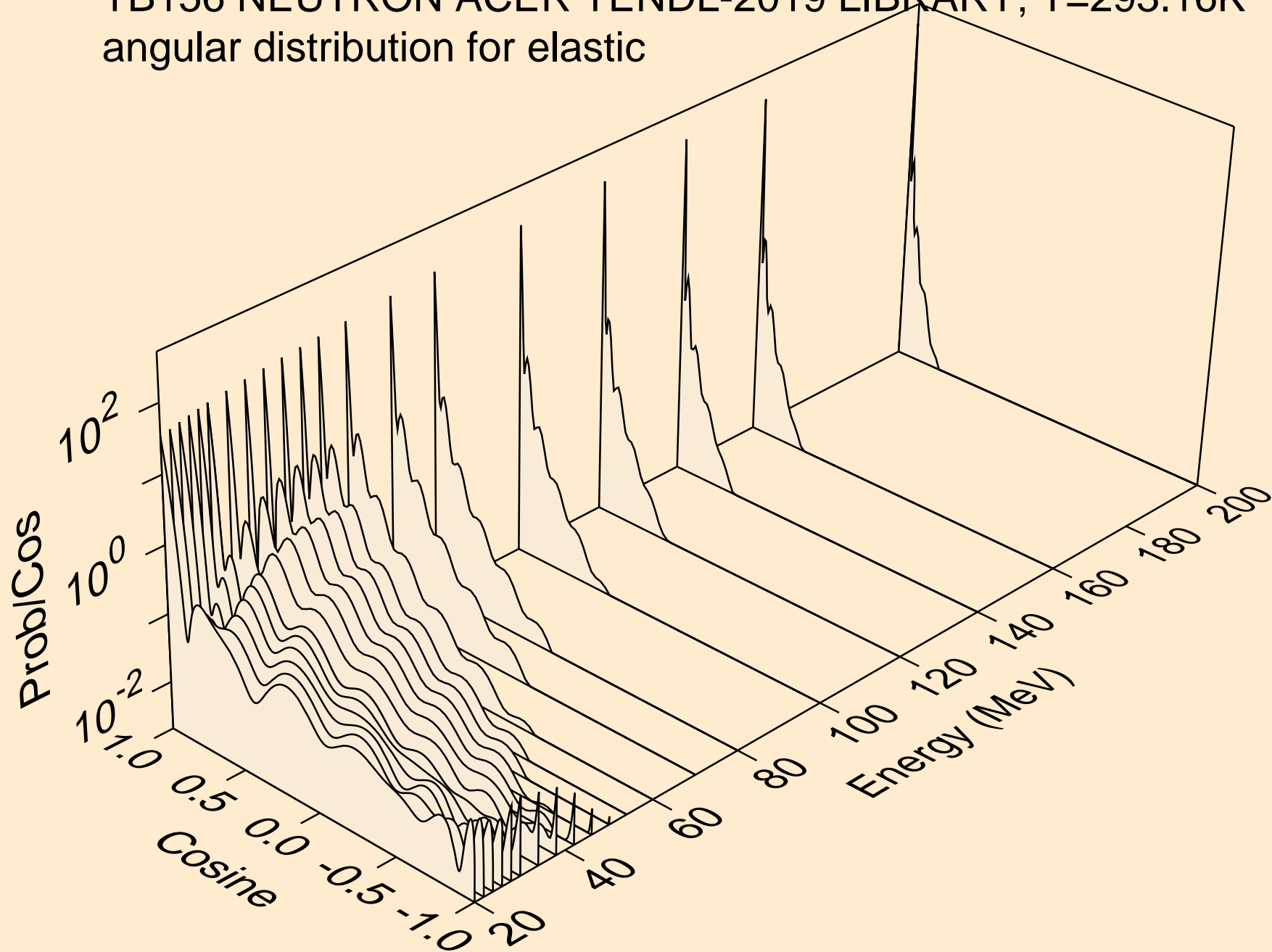

TB156 NEUTRON ACER TENDL-2019 LIBRARY; T=293.16K  
angular distribution for (n,n\*1)

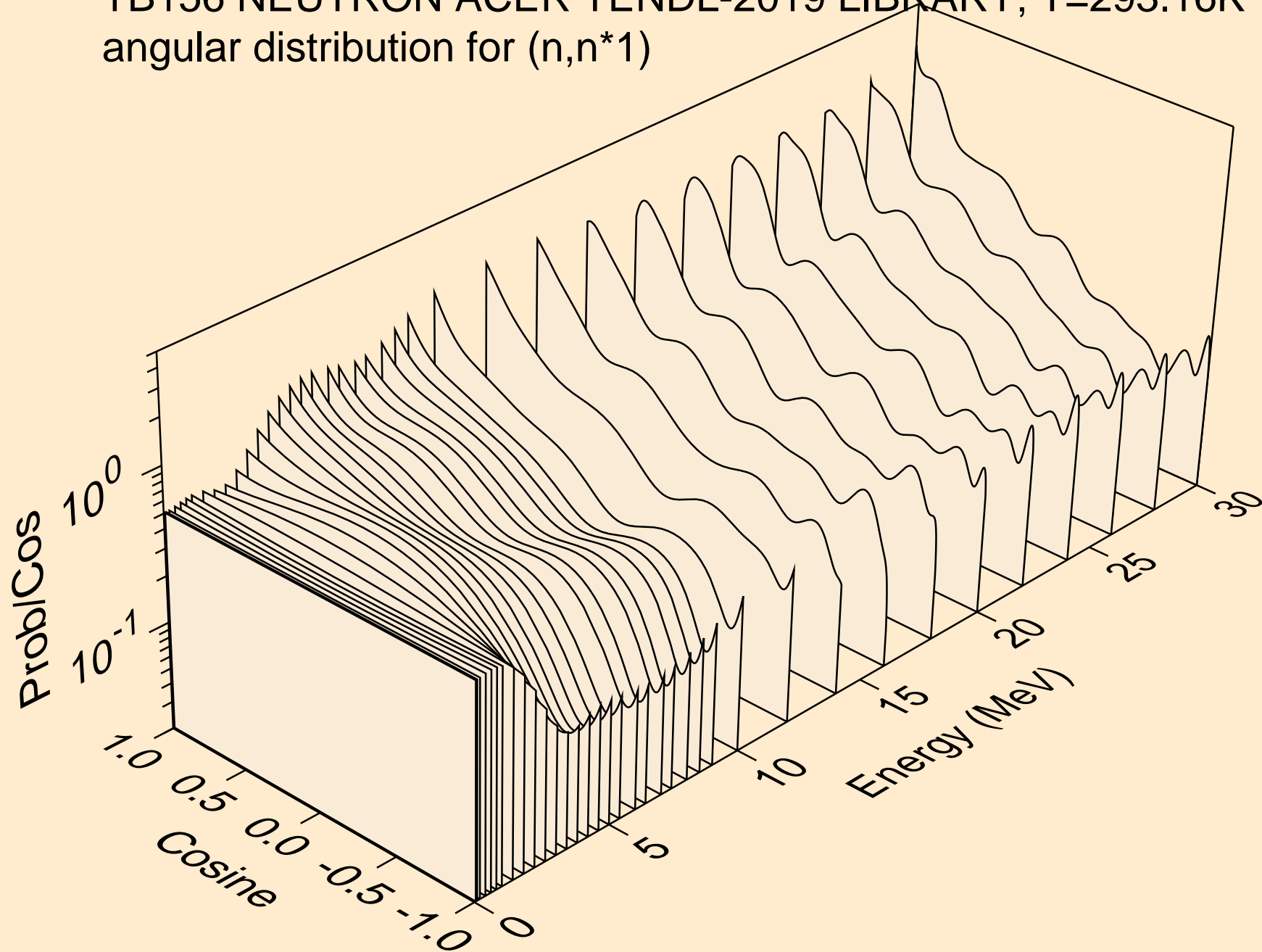



TB156 NEUTRON ACER TENDL-2019 LIBRARY; T=293.16K  
angular distribution for (n,n\*2)

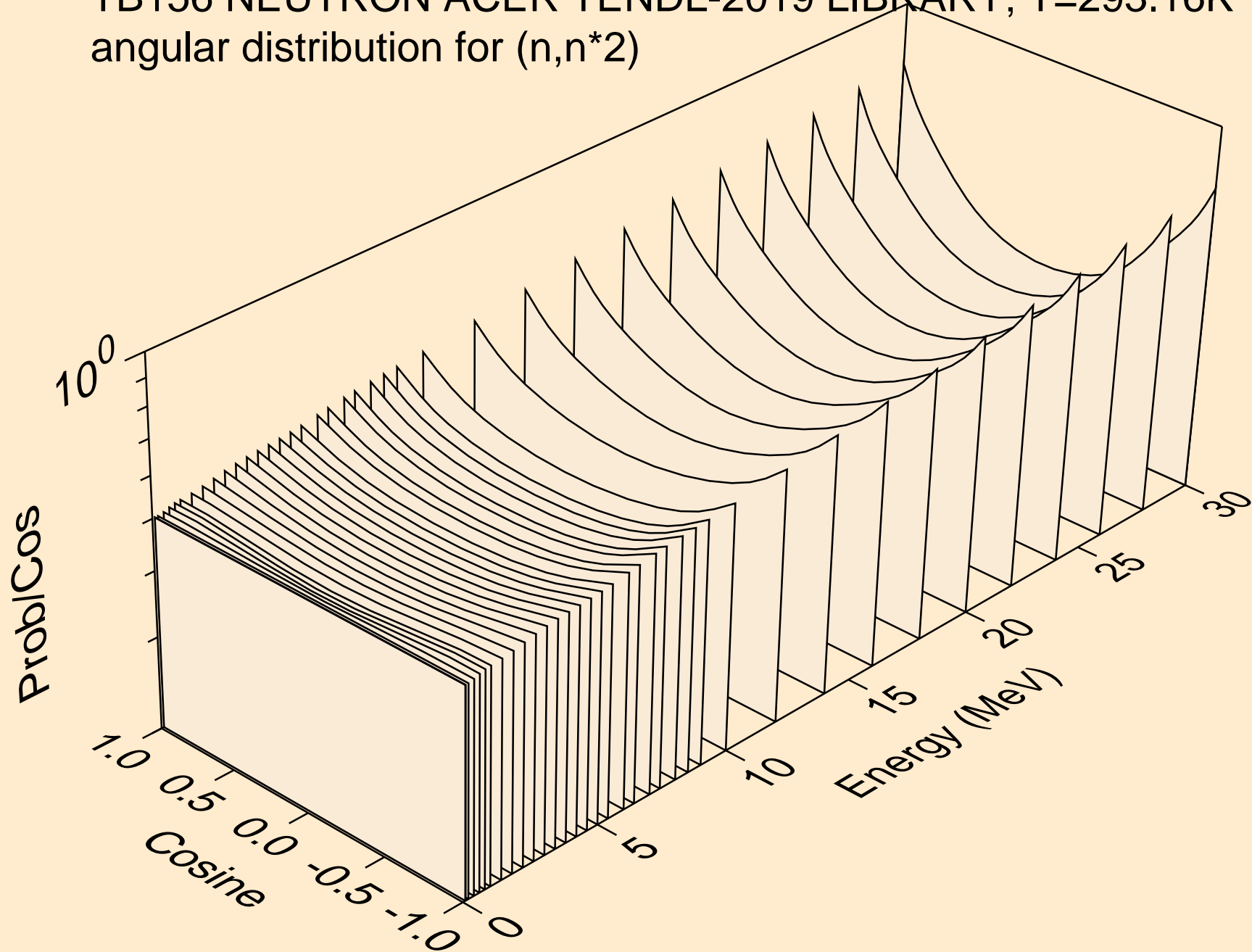

TB156 NEUTRON ACER TENDL-2019 LIBRARY; T=293.16K  
angular distribution for (n,n\*3)

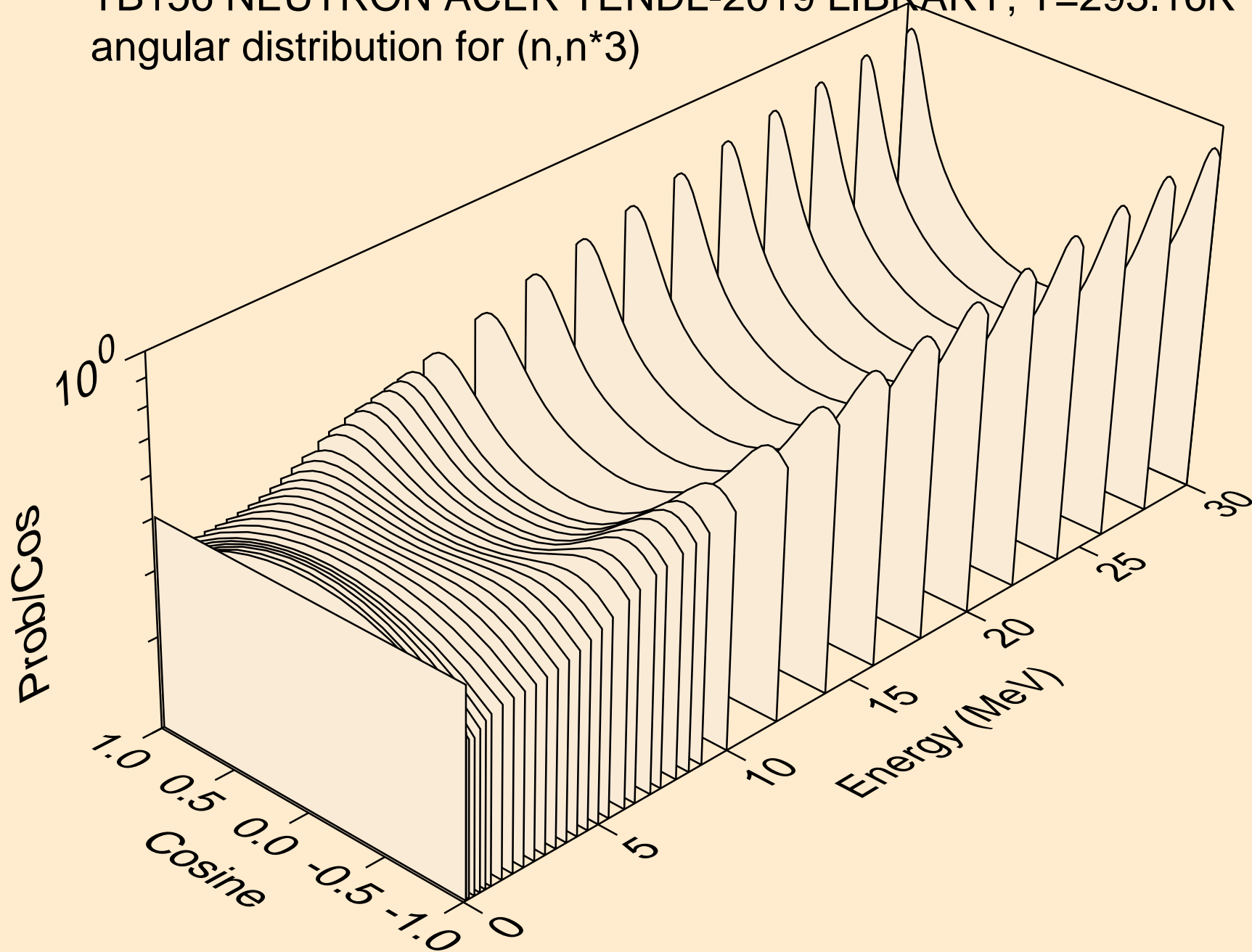

TB156 NEUTRON ACER TENDL-2019 LIBRARY; T=293.16K  
angular distribution for (n,n\*4)

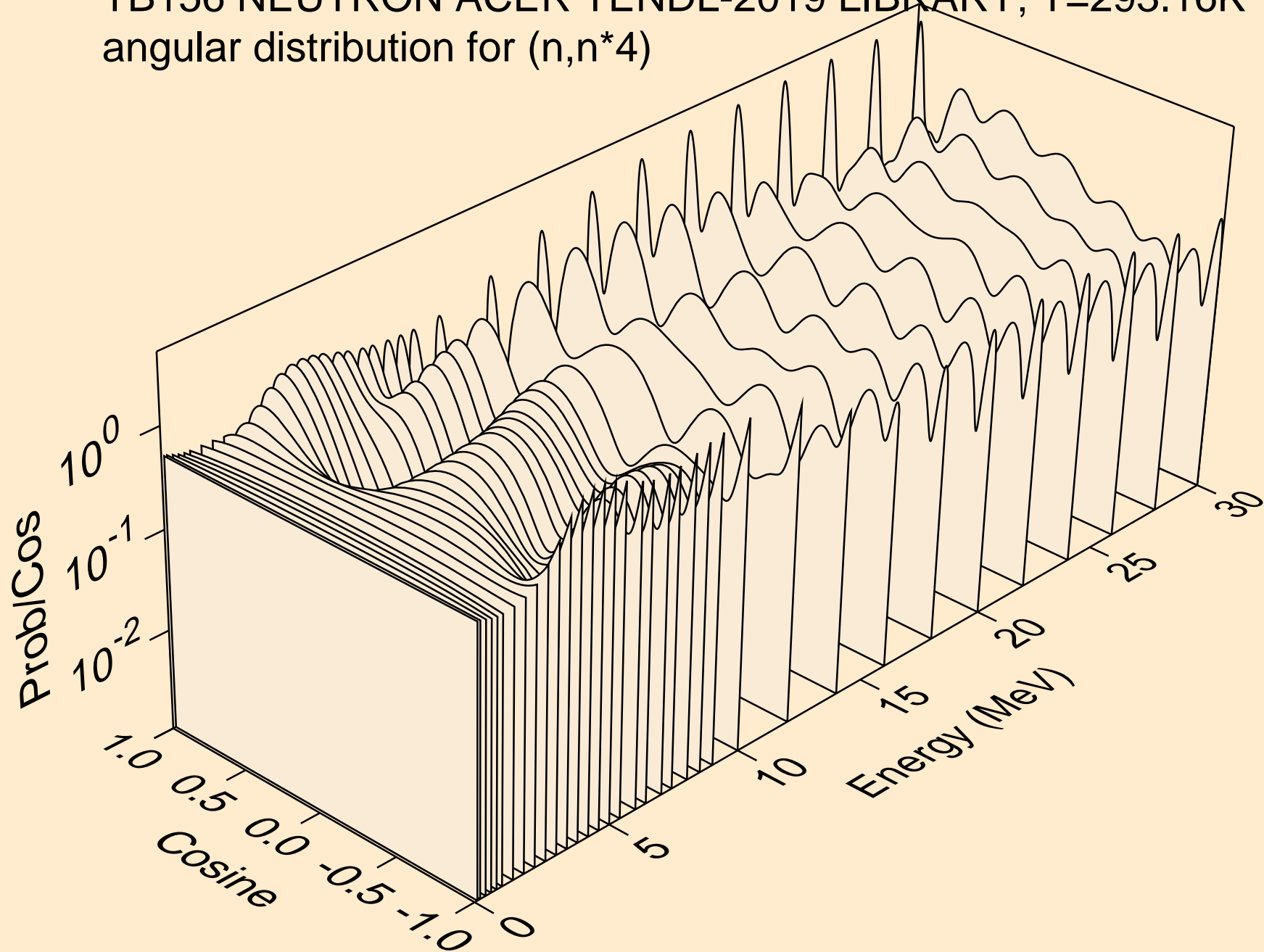

TB156 NEUTRON ACER TENDL-2019 LIBRARY; T=293.16K  
angular distribution for (n,n\*5)

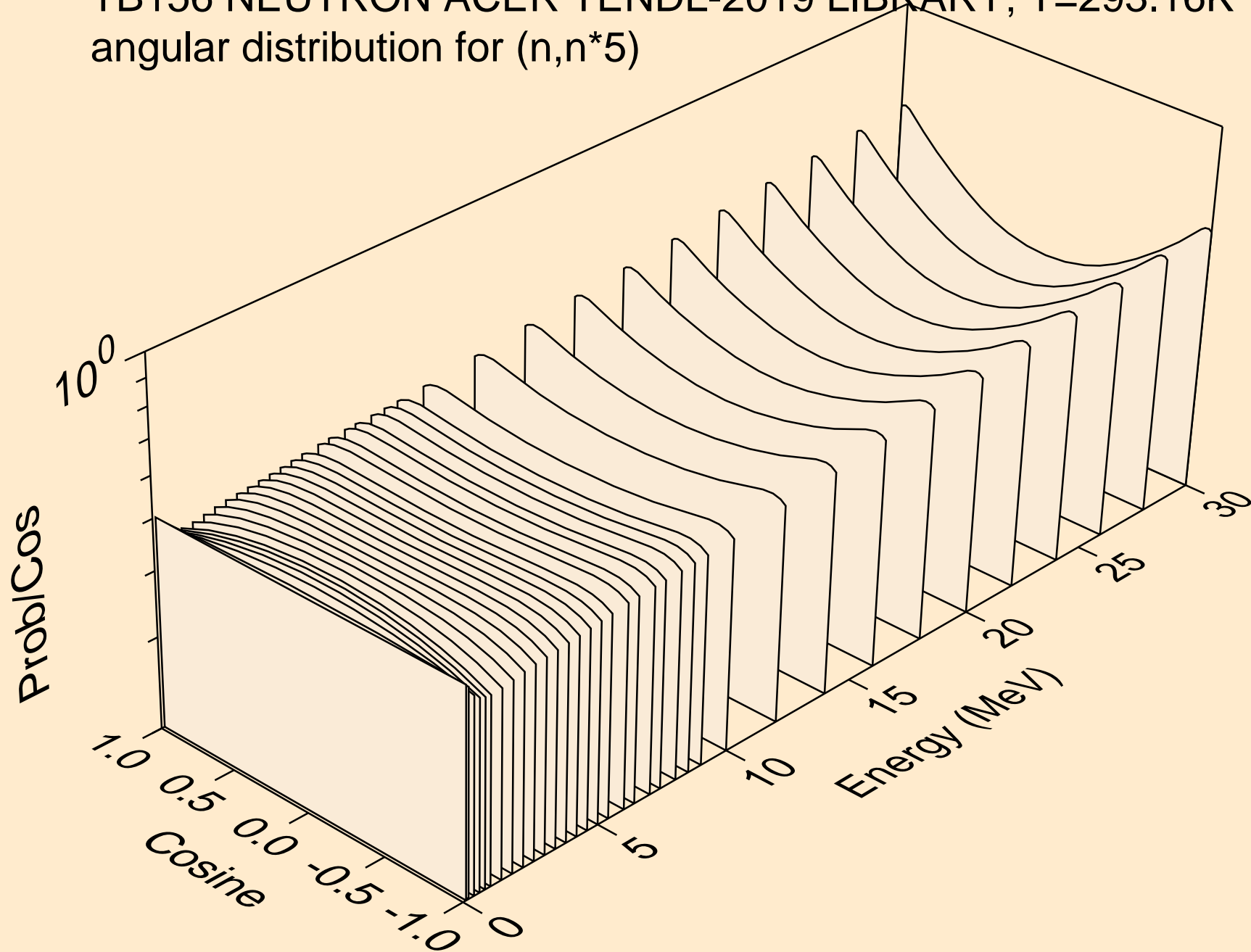

TB156 NEUTRON ACER TENDL-2019 LIBRARY; T=293.16K  
angular distribution for (n,n\*6)

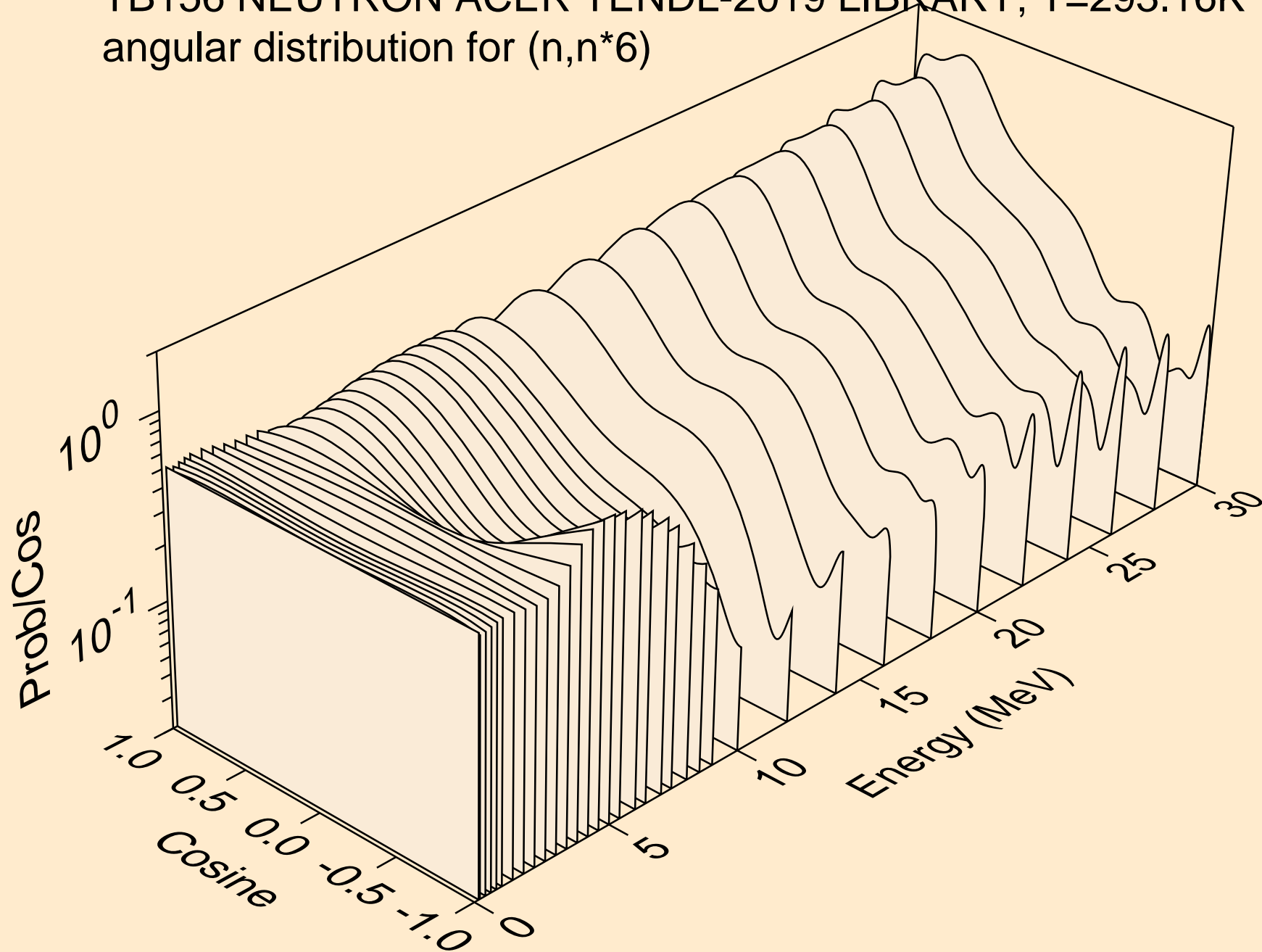

TB156 NEUTRON ACER TENDL-2019 LIBRARY; T=293.16K  
angular distribution for (n,n\*7)

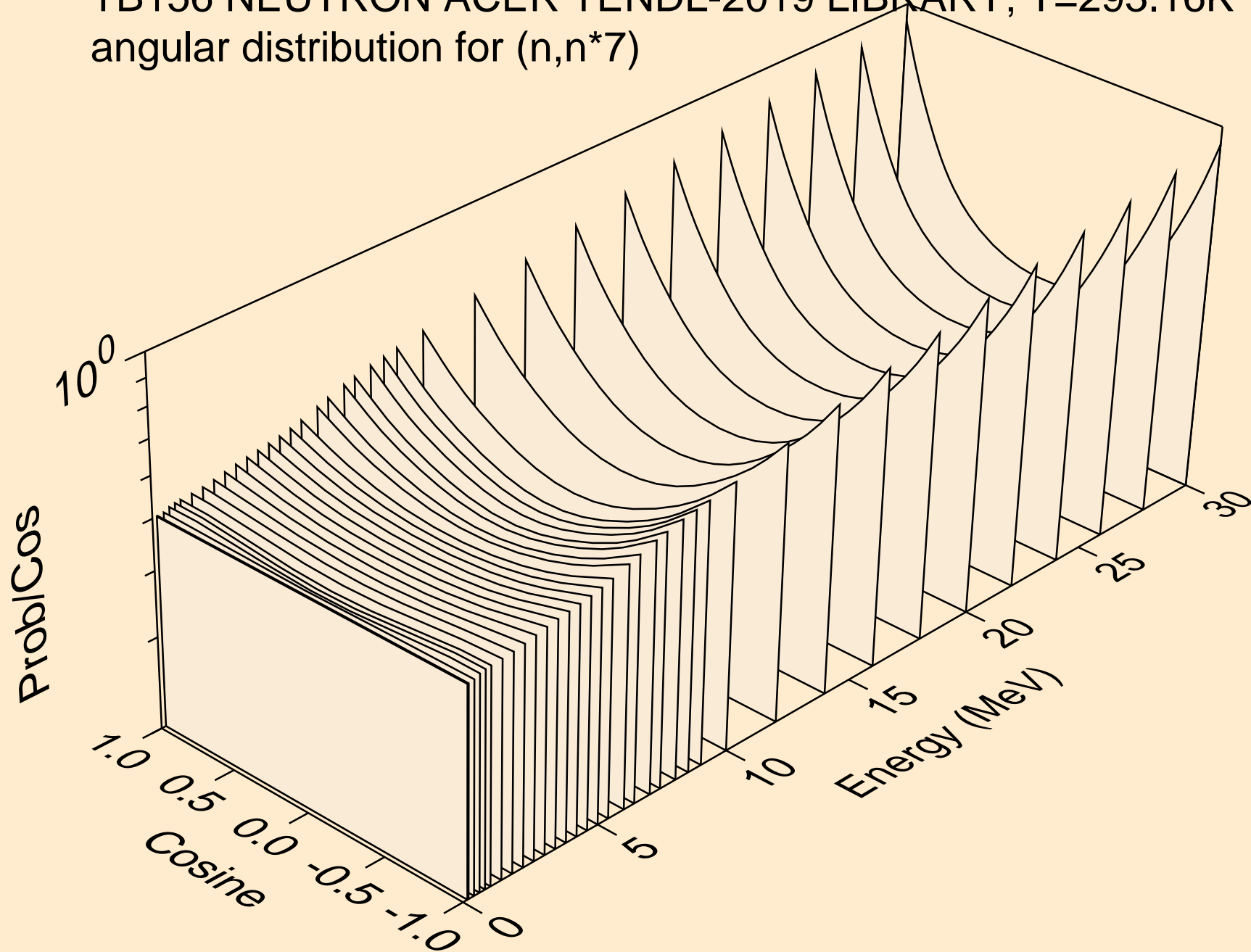

TB156 NEUTRON ACER TENDL-2019 LIBRARY; T=293.16K  
angular distribution for (n,n\*8)

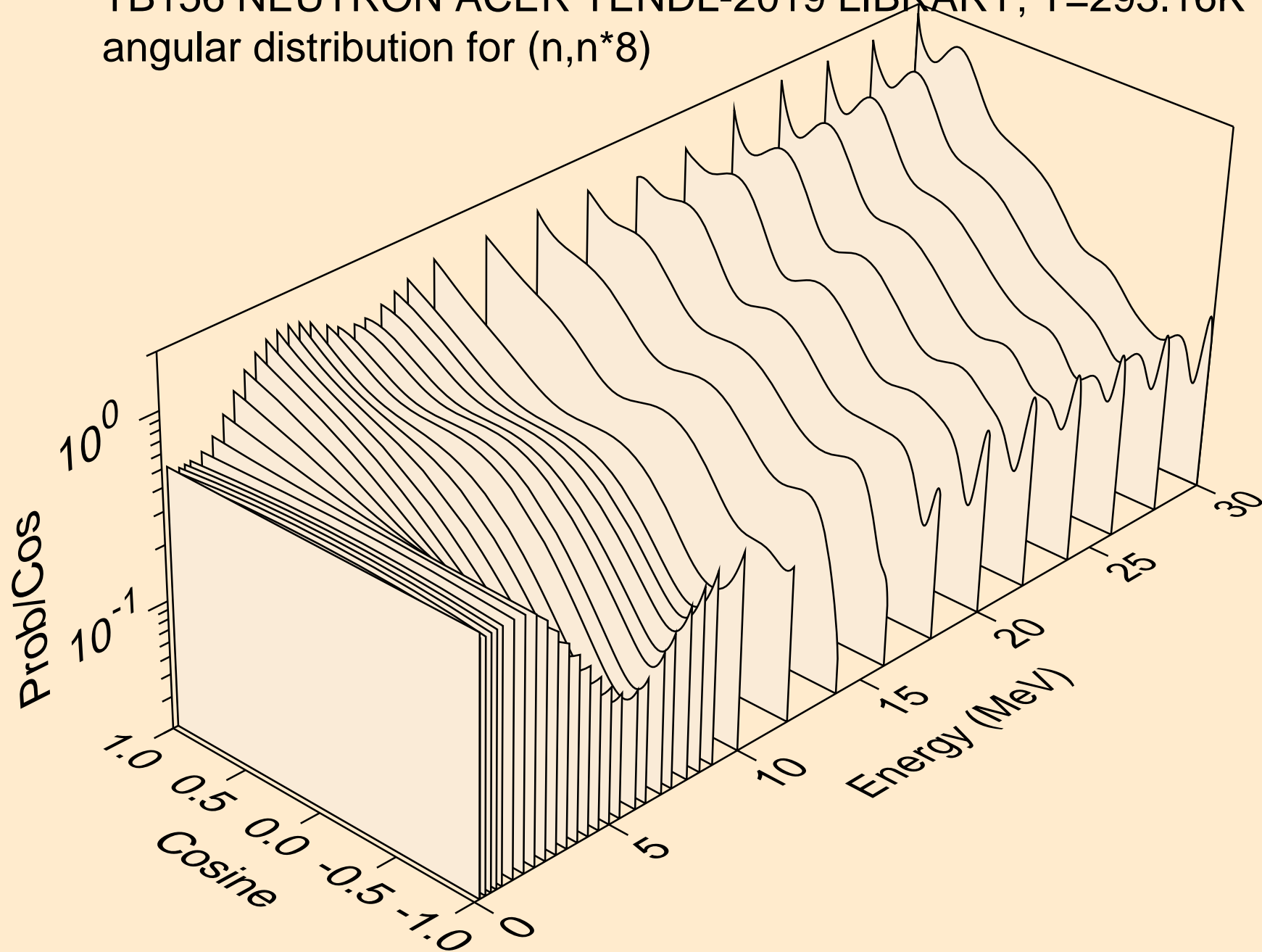

TB156 NEUTRON ACER TENDL-2019 LIBRARY; T=293.16K  
angular distribution for (n,n\*9)

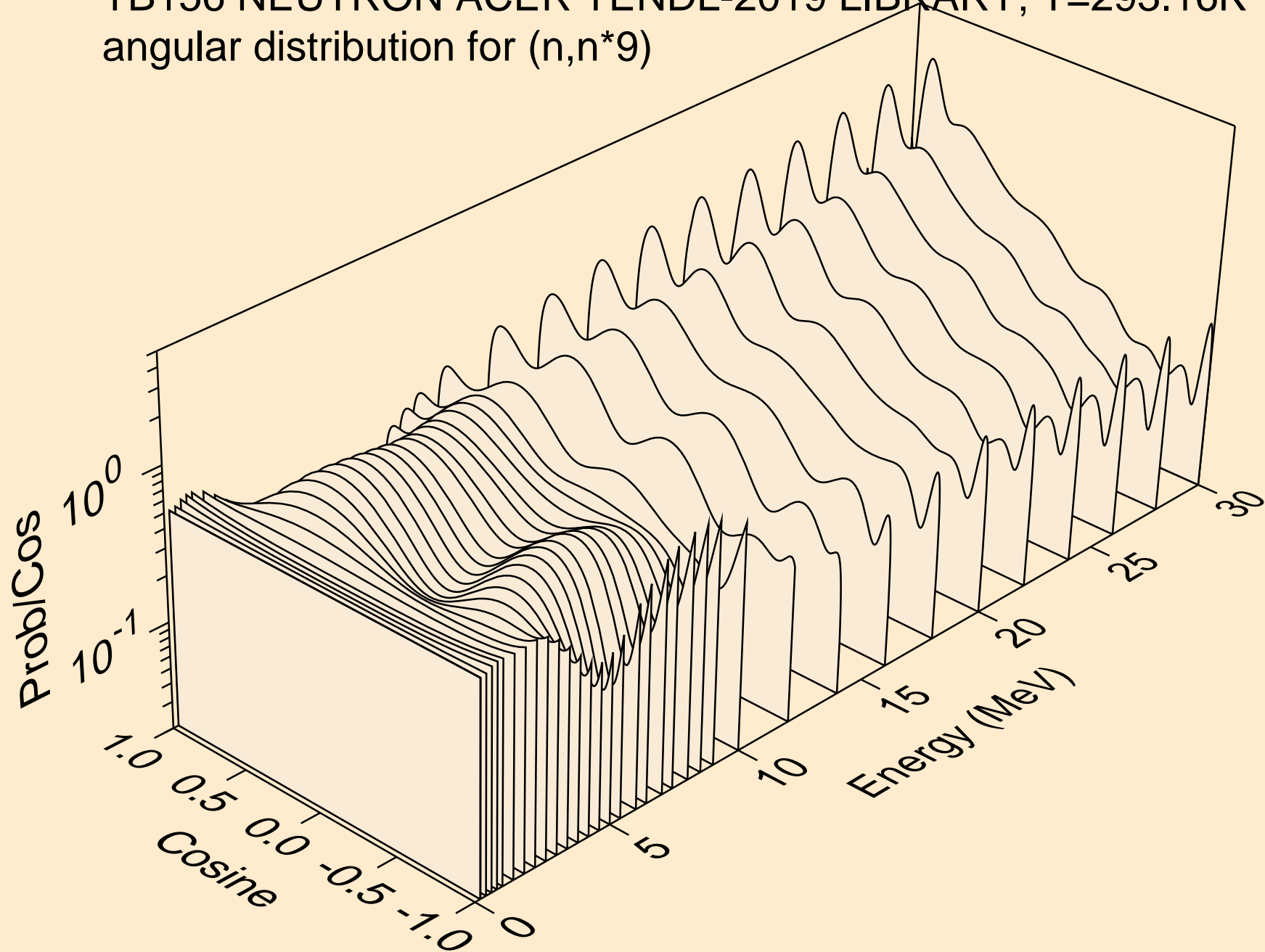



TB156 NEUTRON ACER TENDL-2019 LIBRARY; T=293.16K  
angular distribution for (n,n\*10)

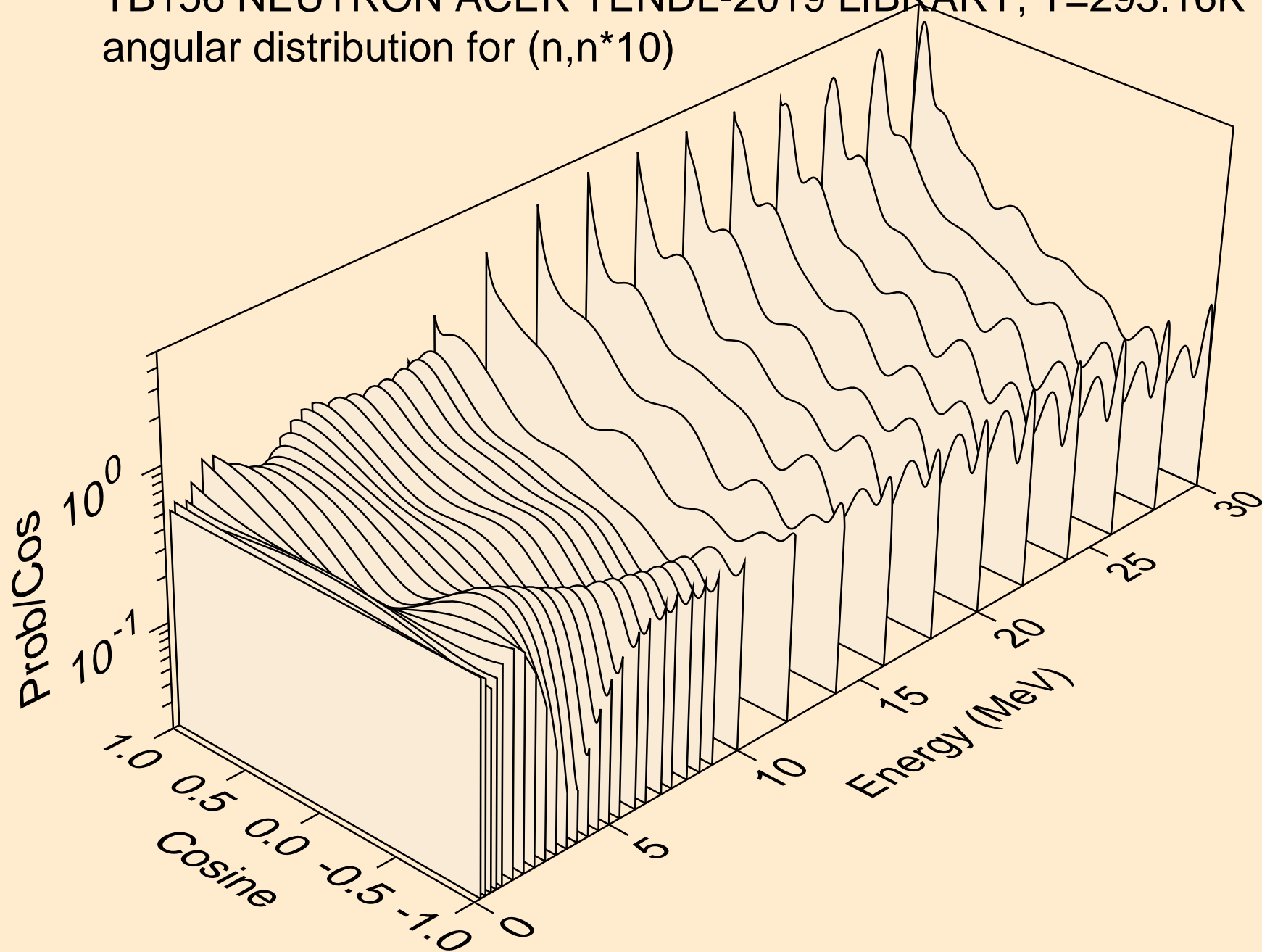

TB156 NEUTRON ACER TENDL-2019 LIBRARY; T=293.16K  
angular distribution for (n,n\*11)

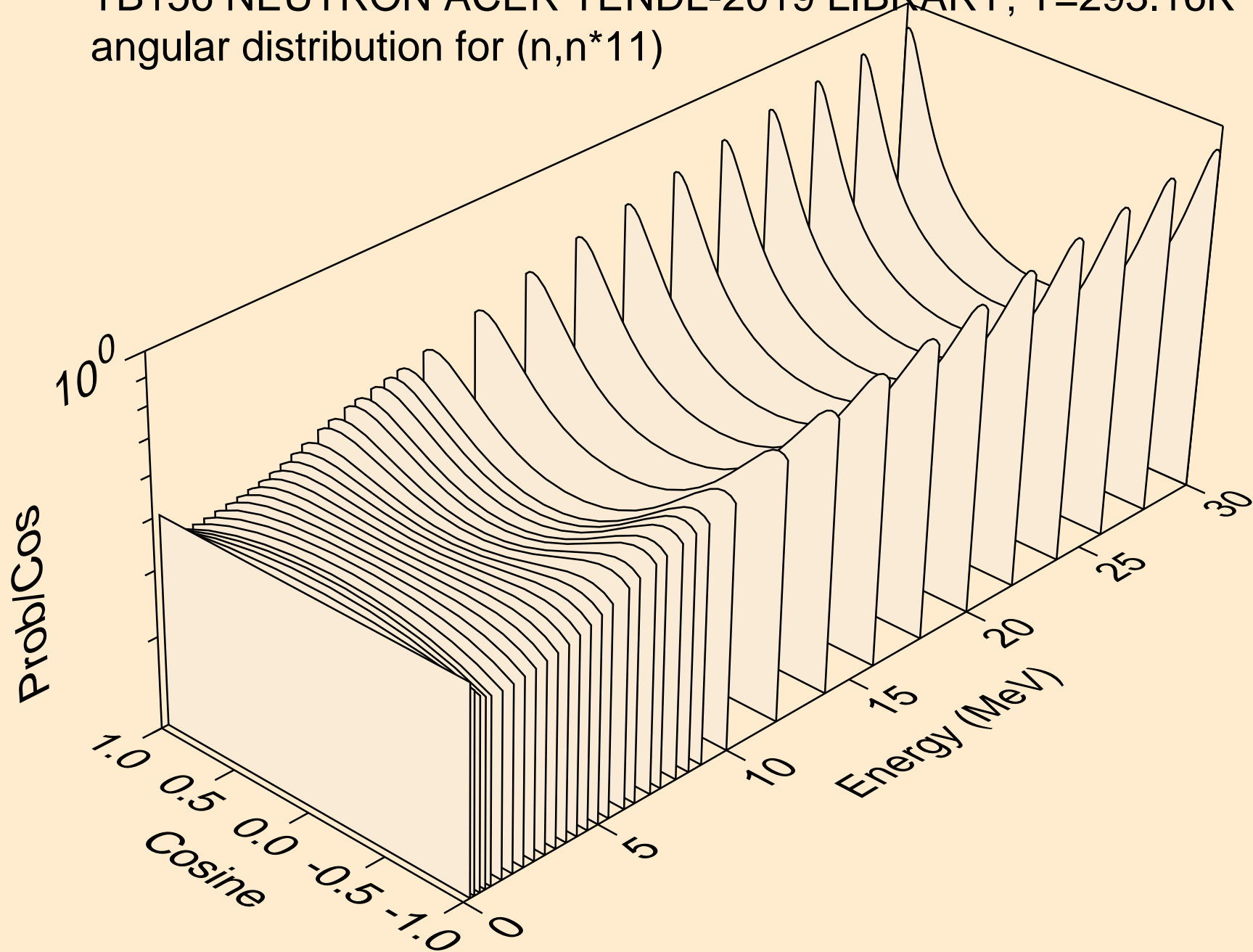

TB156 NEUTRON ACER TENDL-2019 LIBRARY; T=293.16K  
angular distribution for (n,n\*12)

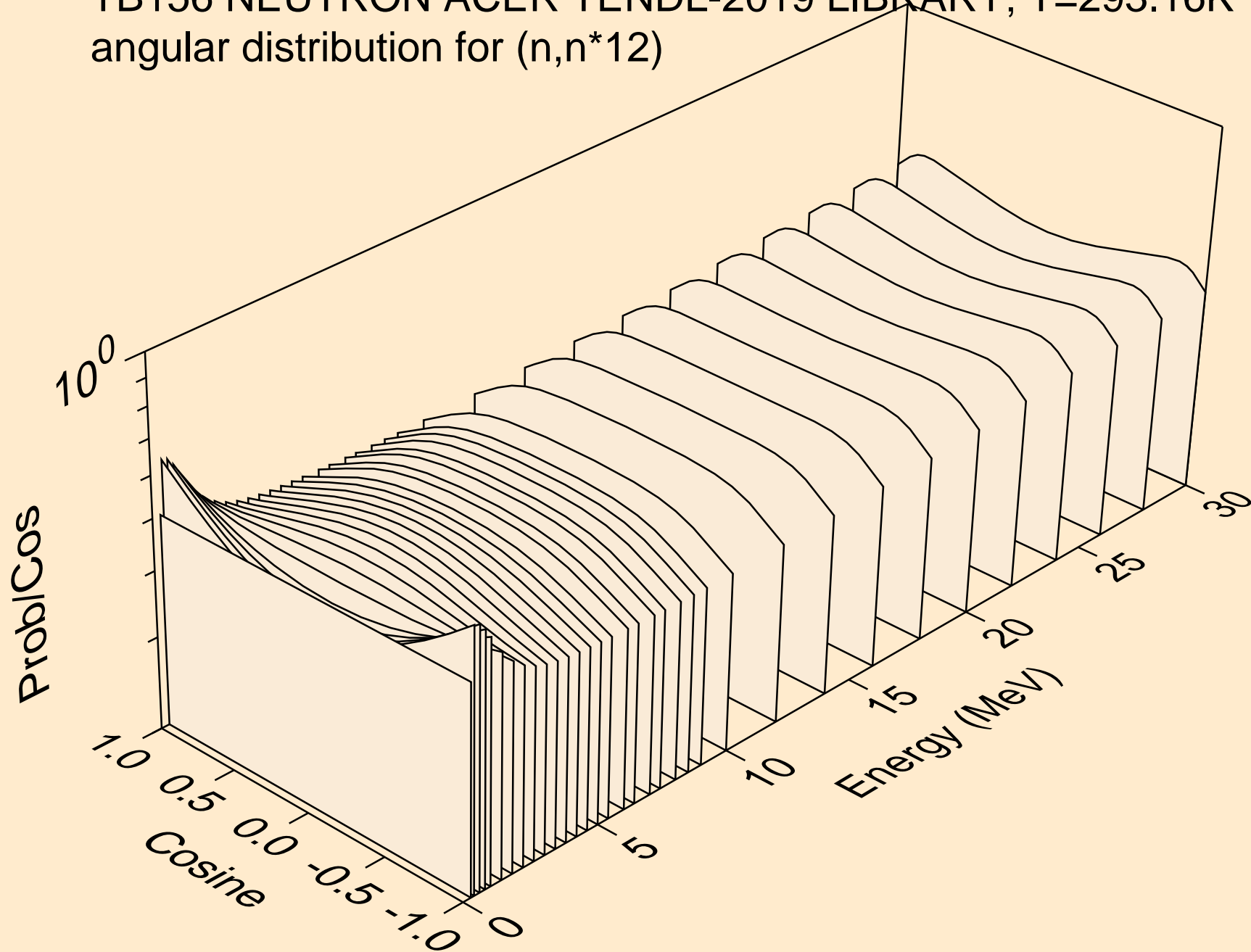

TB156 NEUTRON ACER TENDL-2019 LIBRARY; T=293.16K  
angular distribution for (n,n\*13)

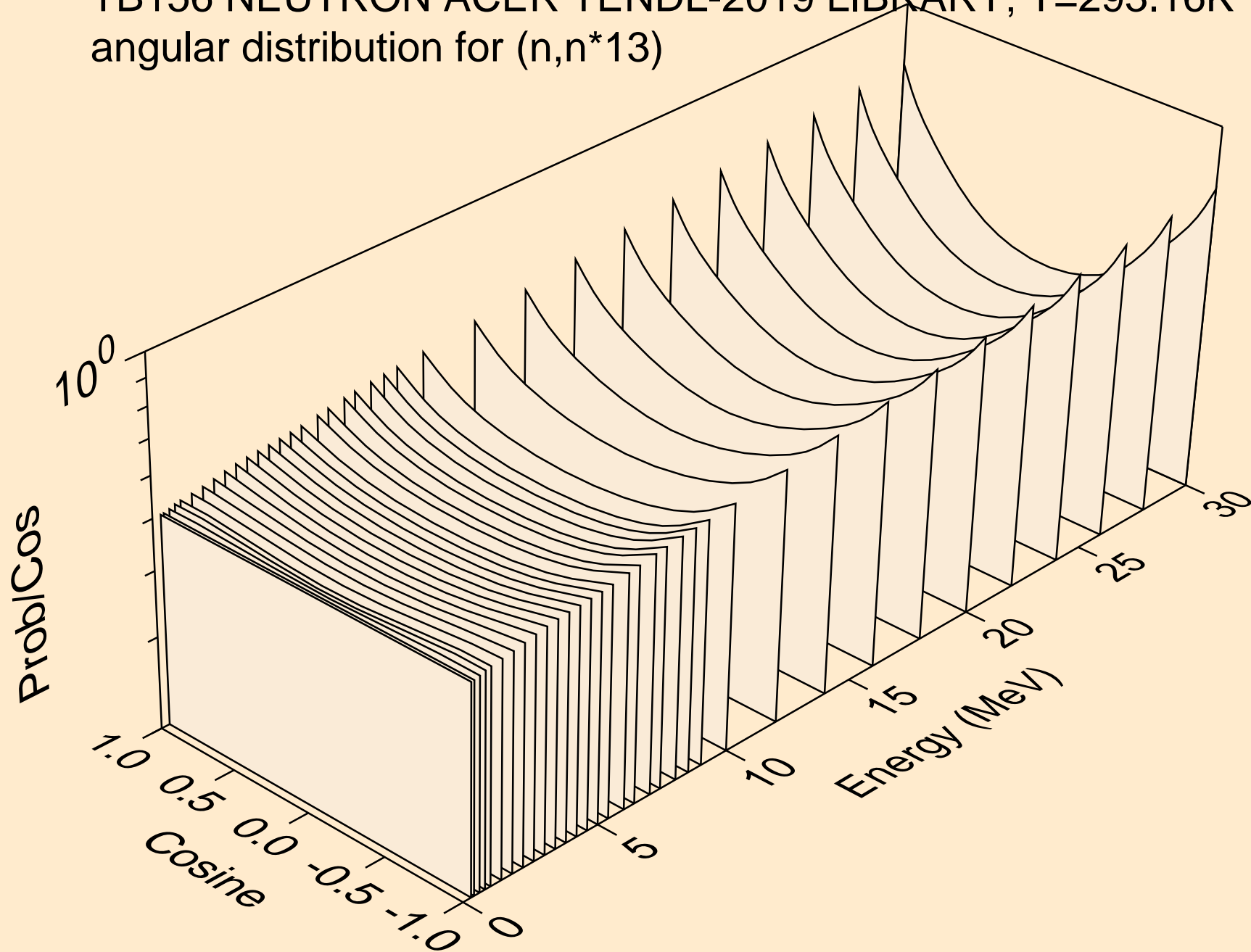

TB156 NEUTRON ACER TENDL-2019 LIBRARY; T=293.16K  
angular distribution for (n,n\*14)

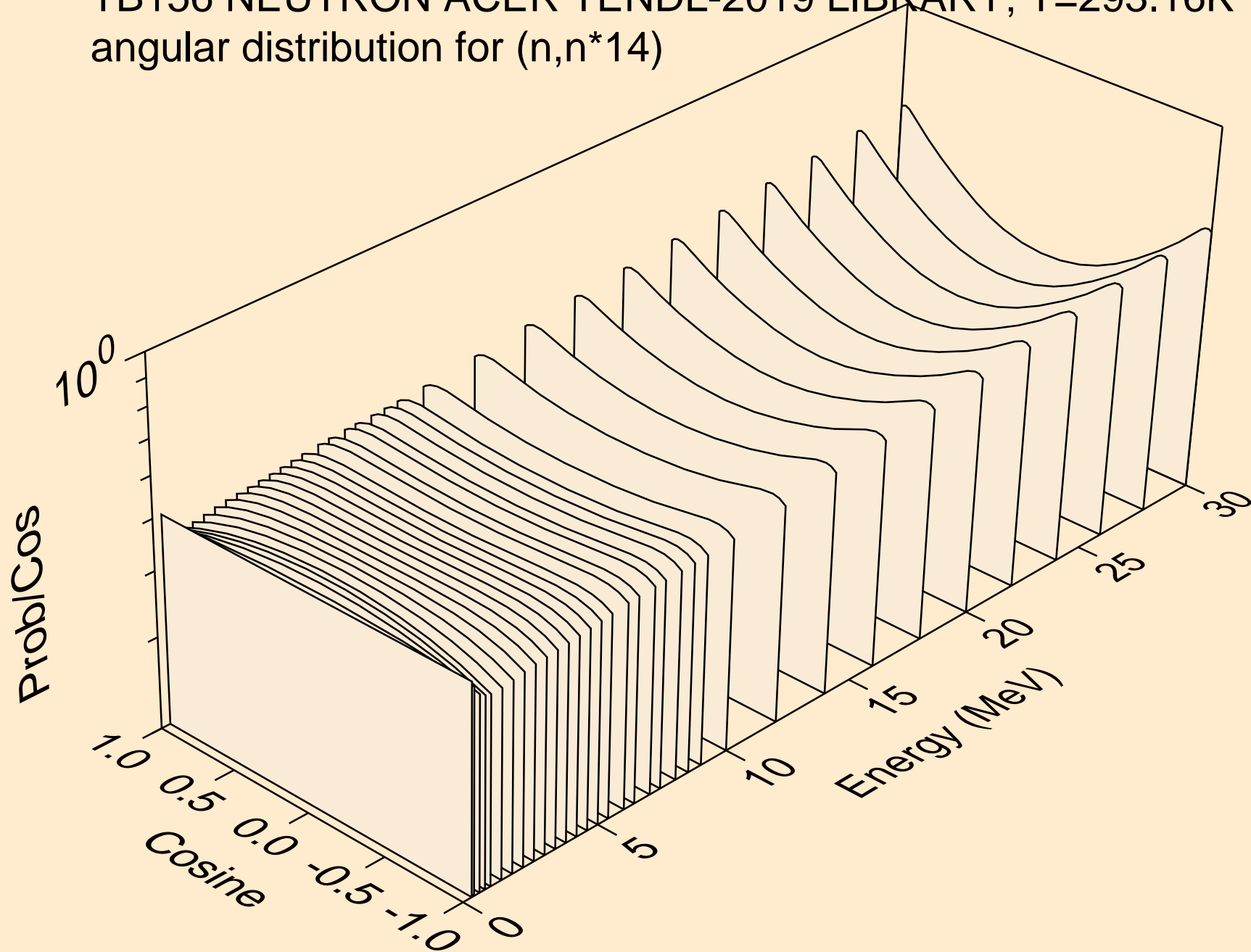

TB156 NEUTRON ACER TENDL-2019 LIBRARY; T=293.16K  
angular distribution for (n,n\*15)

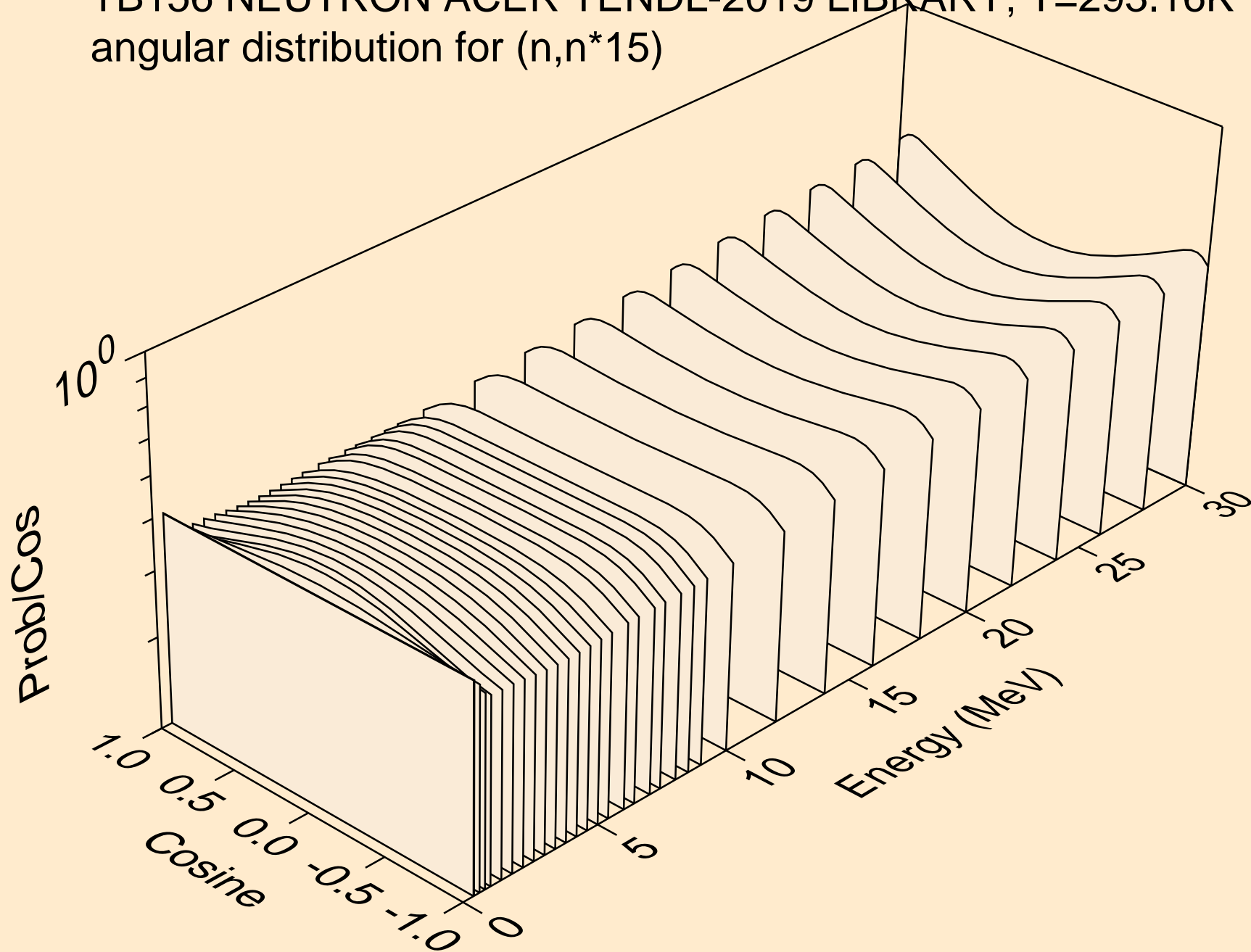

TB156 NEUTRON ACER TENDL-2019 LIBRARY; T=293.16K  
angular distribution for (n,n\*16)

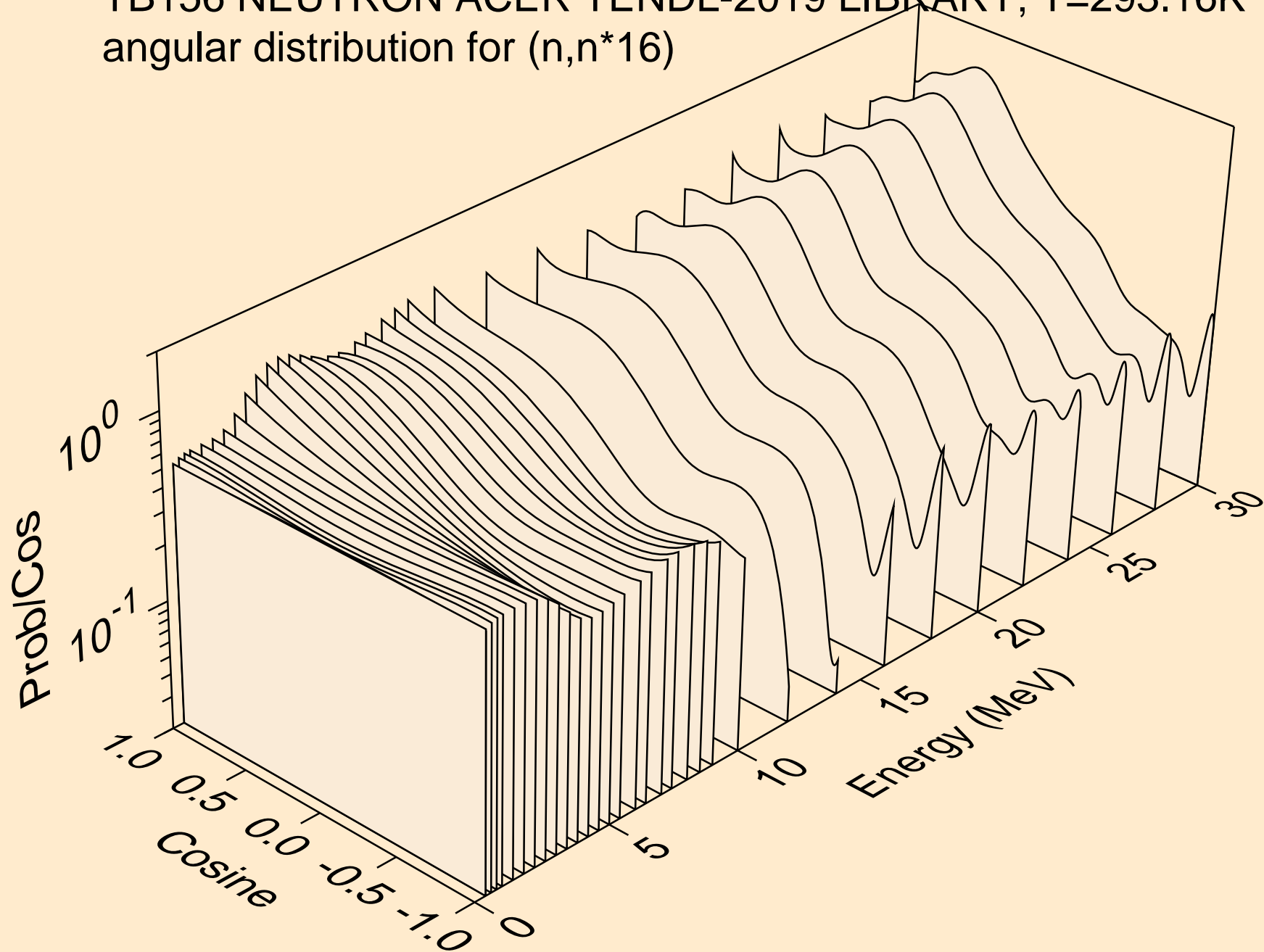

TB156 NEUTRON ACER TENDL-2019 LIBRARY; T=293.16K  
angular distribution for (n,n\*17)

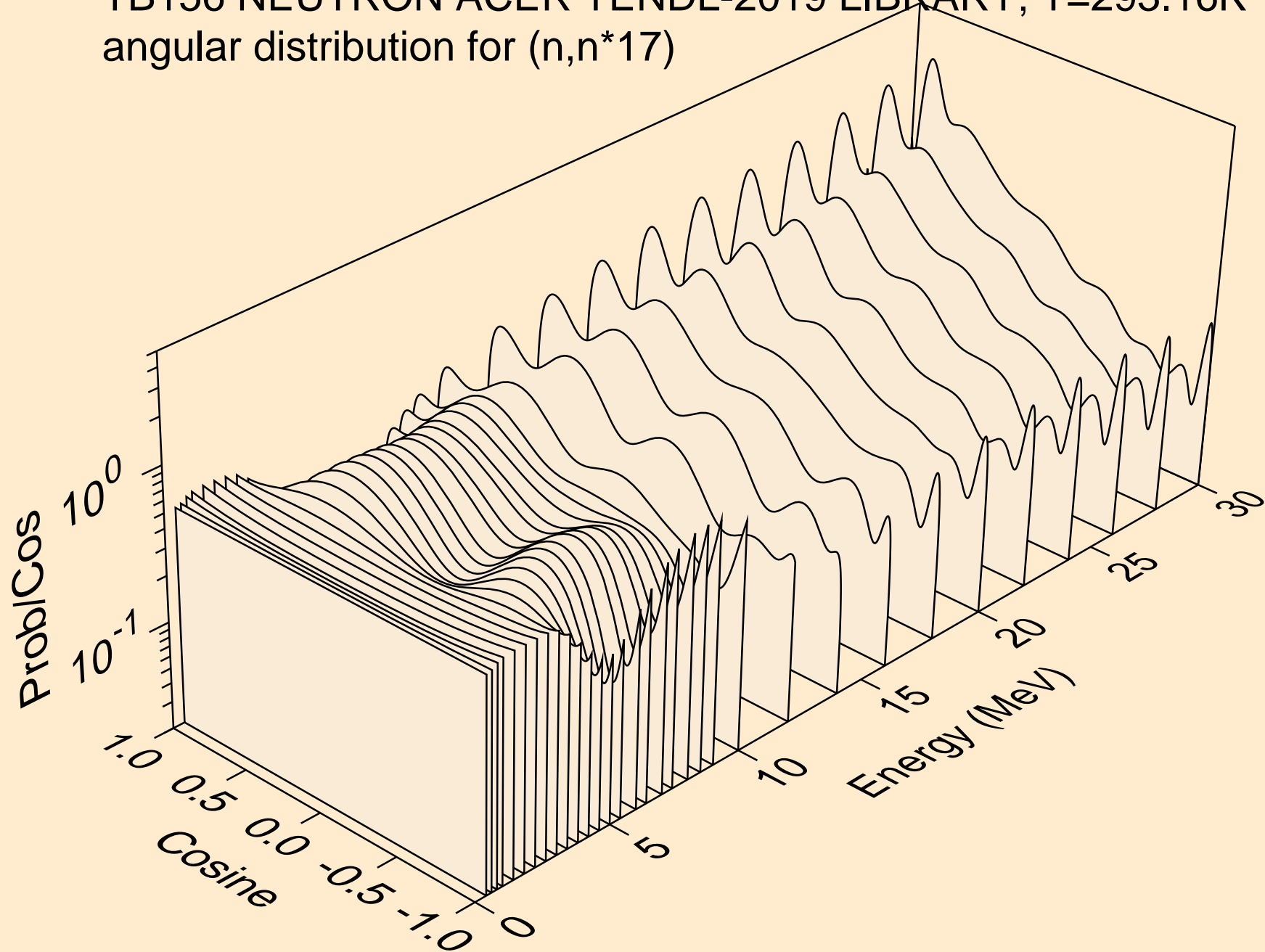



TB156 NEUTRON ACER TENDL-2019 LIBRARY; T=293.16K  
angular distribution for (n,n\*18)

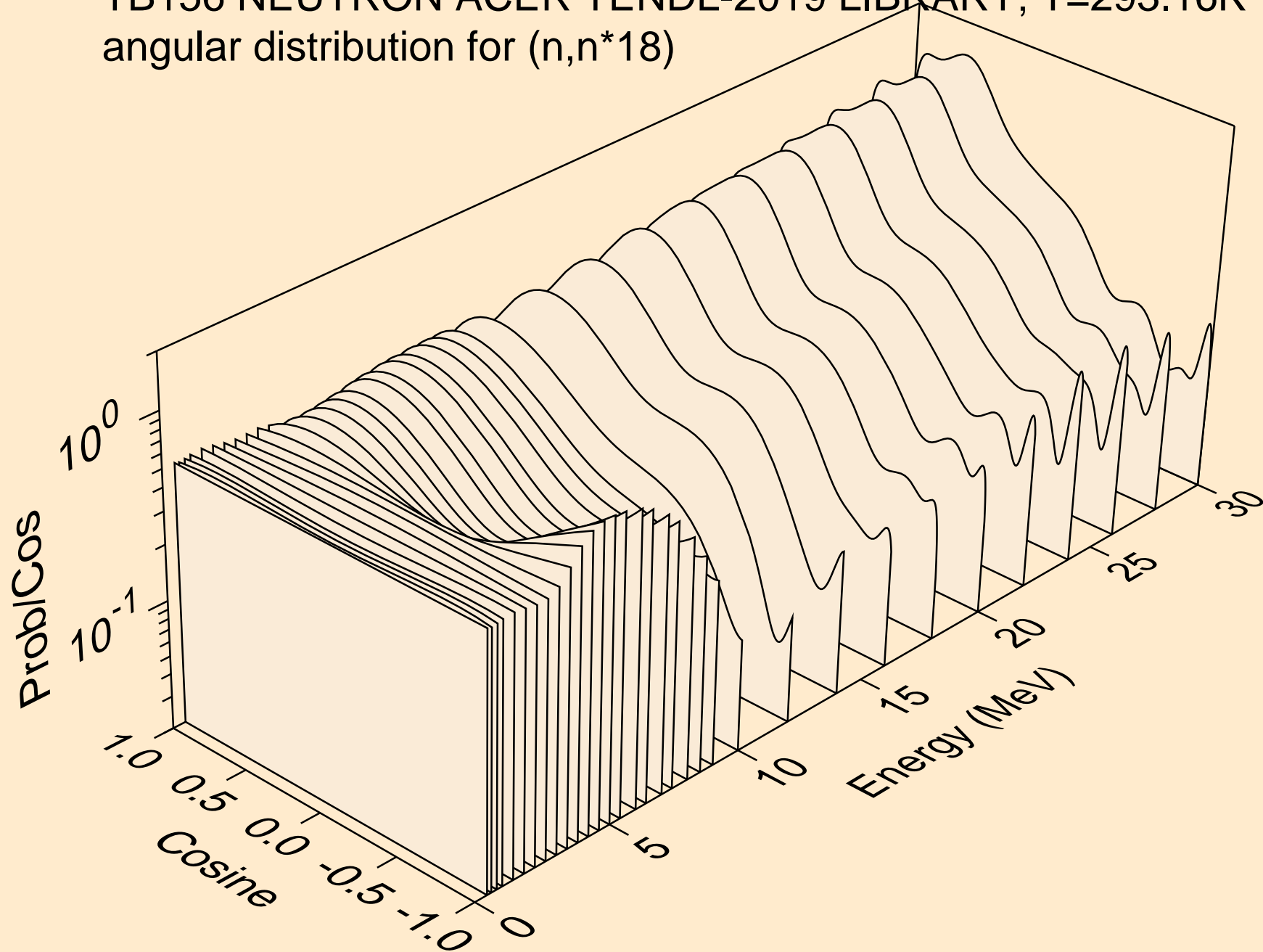

TB156 NEUTRON ACER TENDL-2019 LIBRARY; T=293.16K  
angular distribution for (n,n\*19)

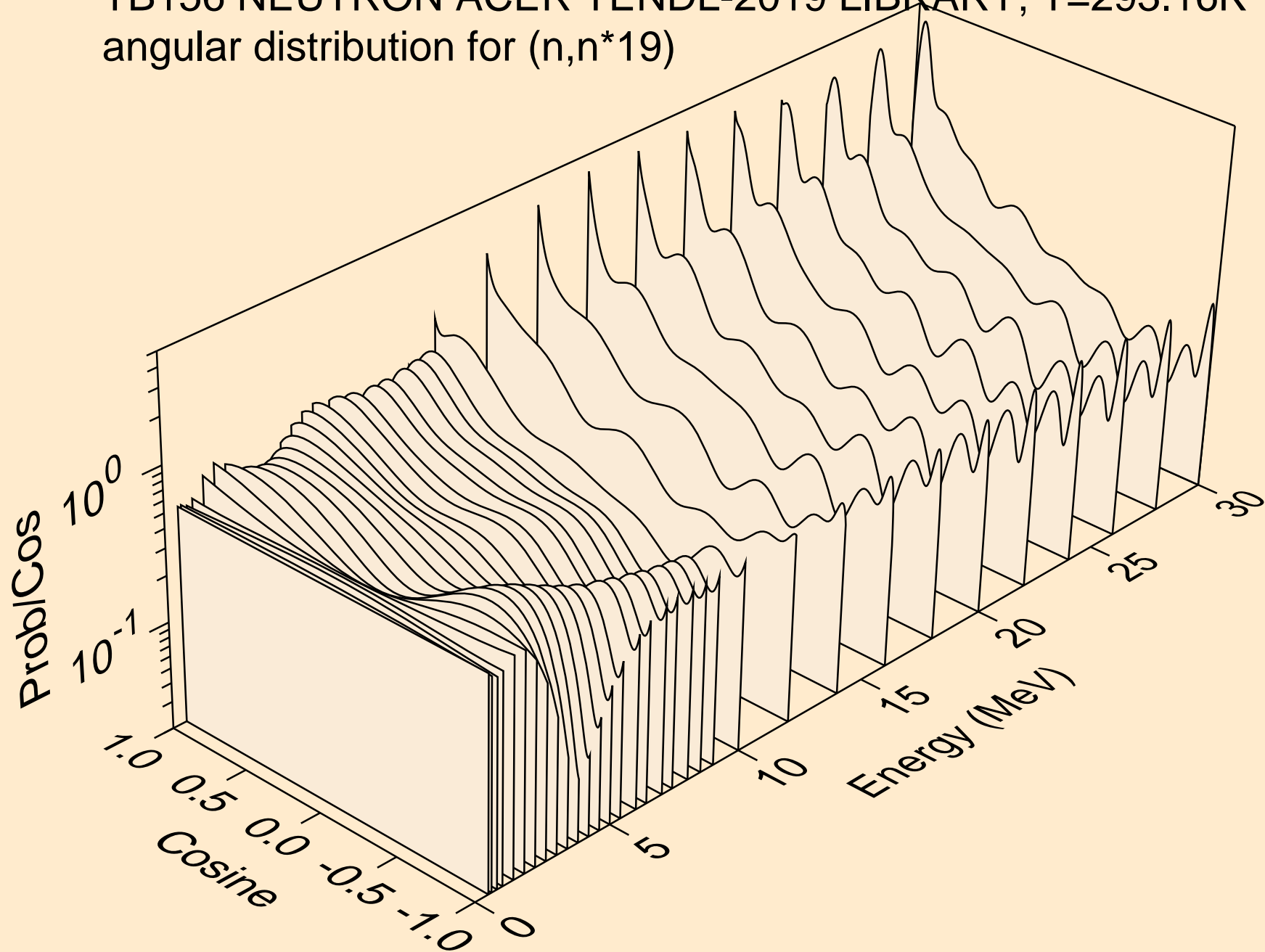

TB156 NEUTRON ACER TENDL-2019 LIBRARY; T=293.16K  
angular distribution for (n,n\*20)

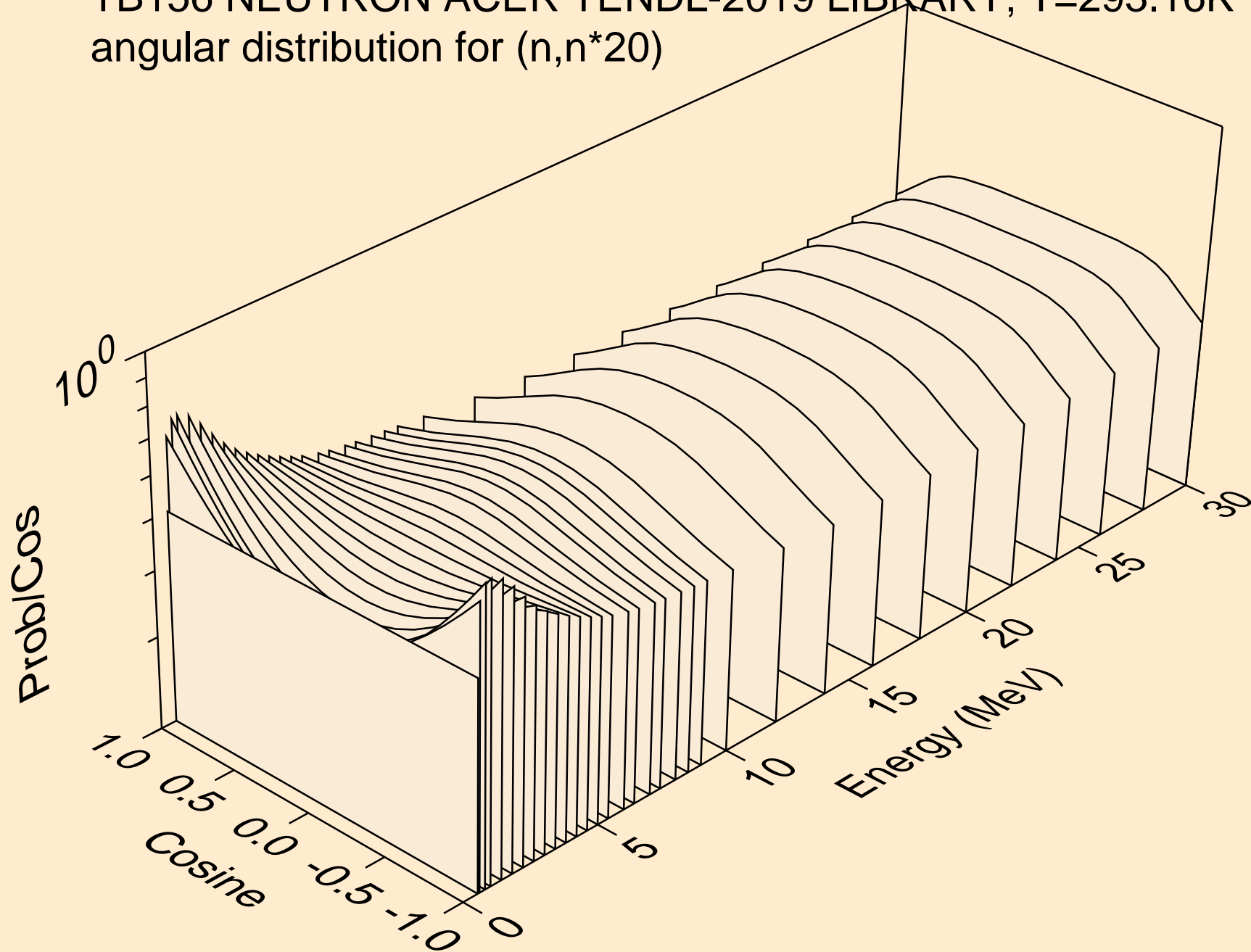

TB156 NEUTRON ACER TENDL-2019 LIBRARY; T=293.16K  
angular distribution for (n,n\*21)

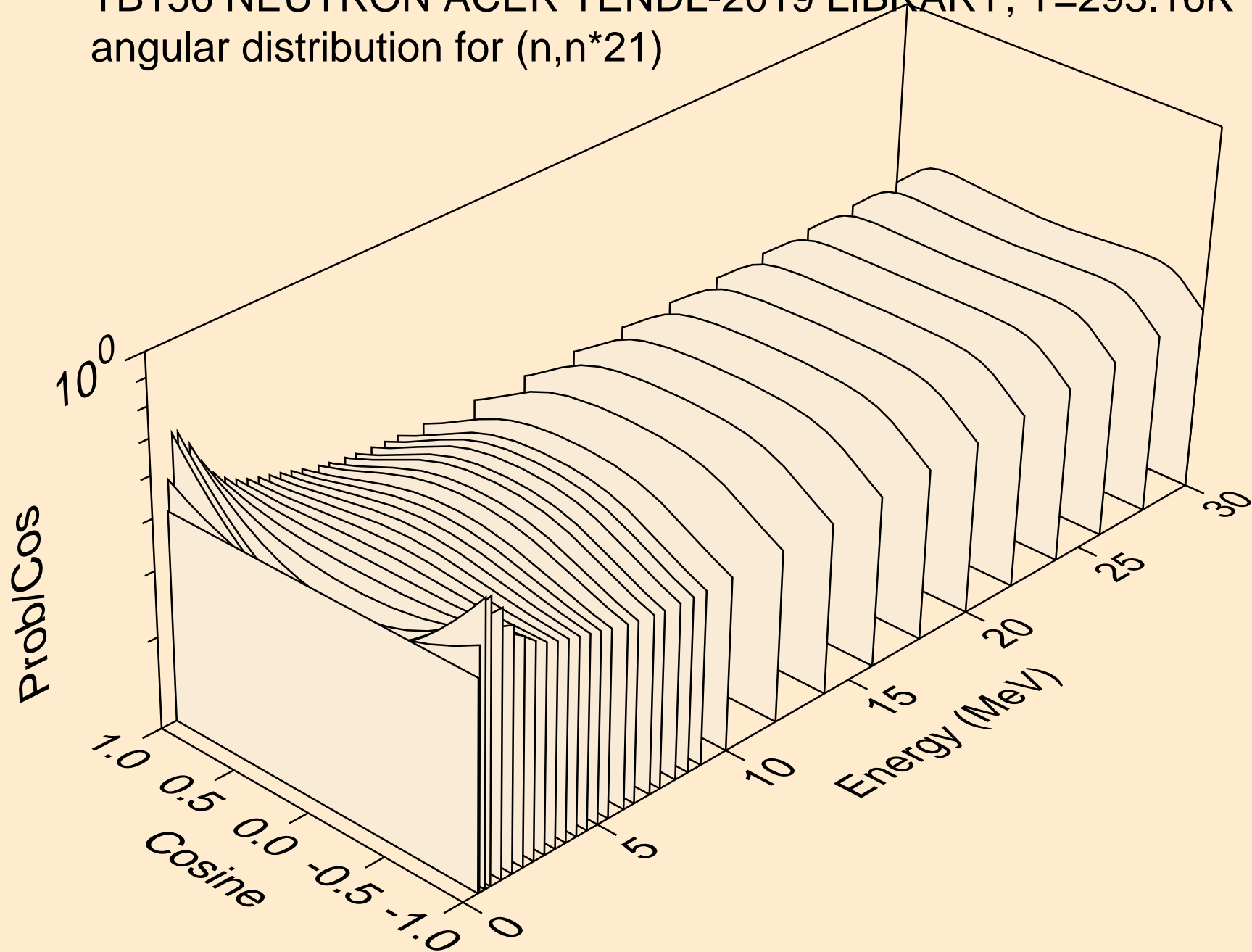

TB156 NEUTRON ACER TENDL-2019 LIBRARY; T=293.16K  
angular distribution for (n,n\*22)

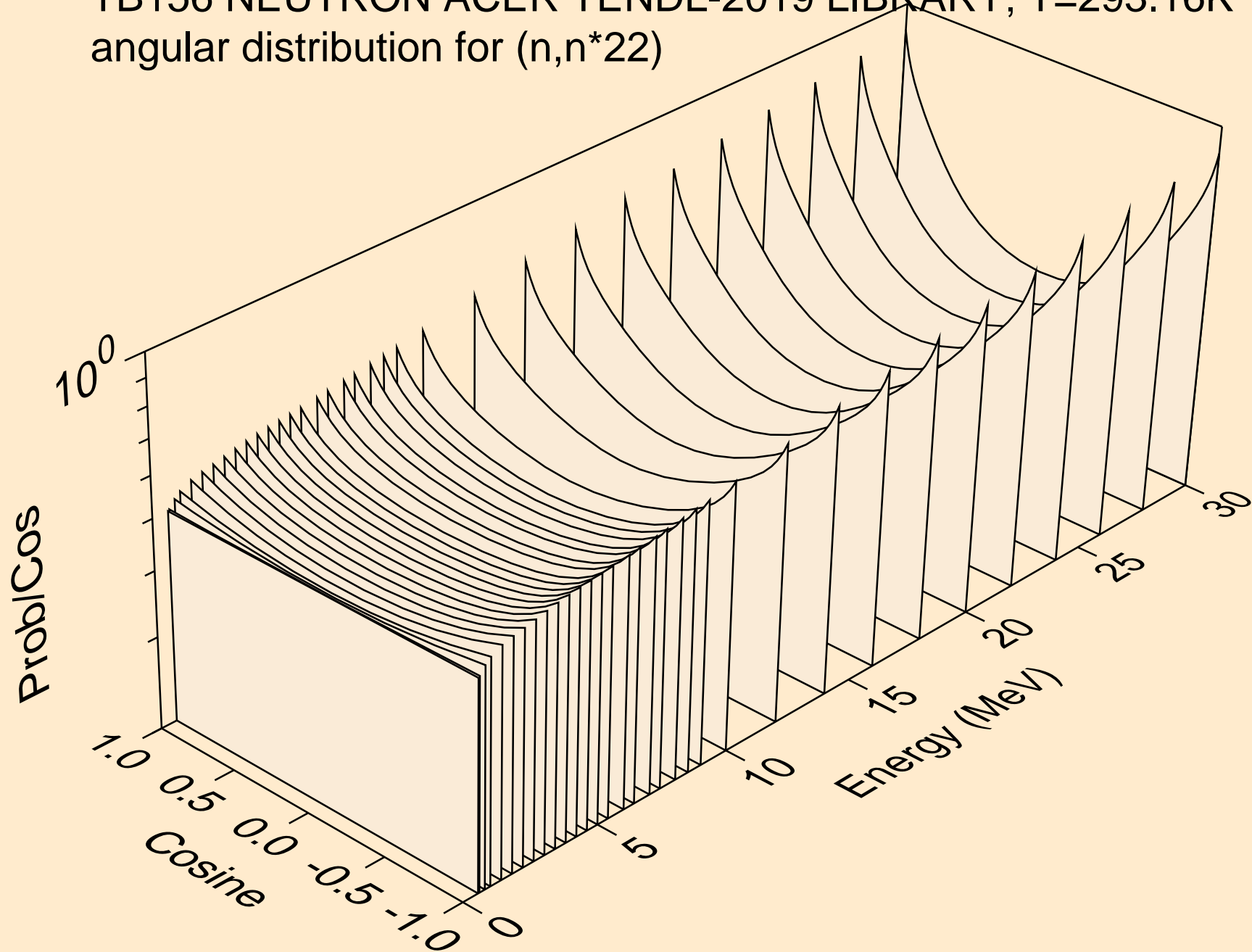

TB156 NEUTRON ACER TENDL-2019 LIBRARY; T=293.16K  
angular distribution for (n,n\*23)

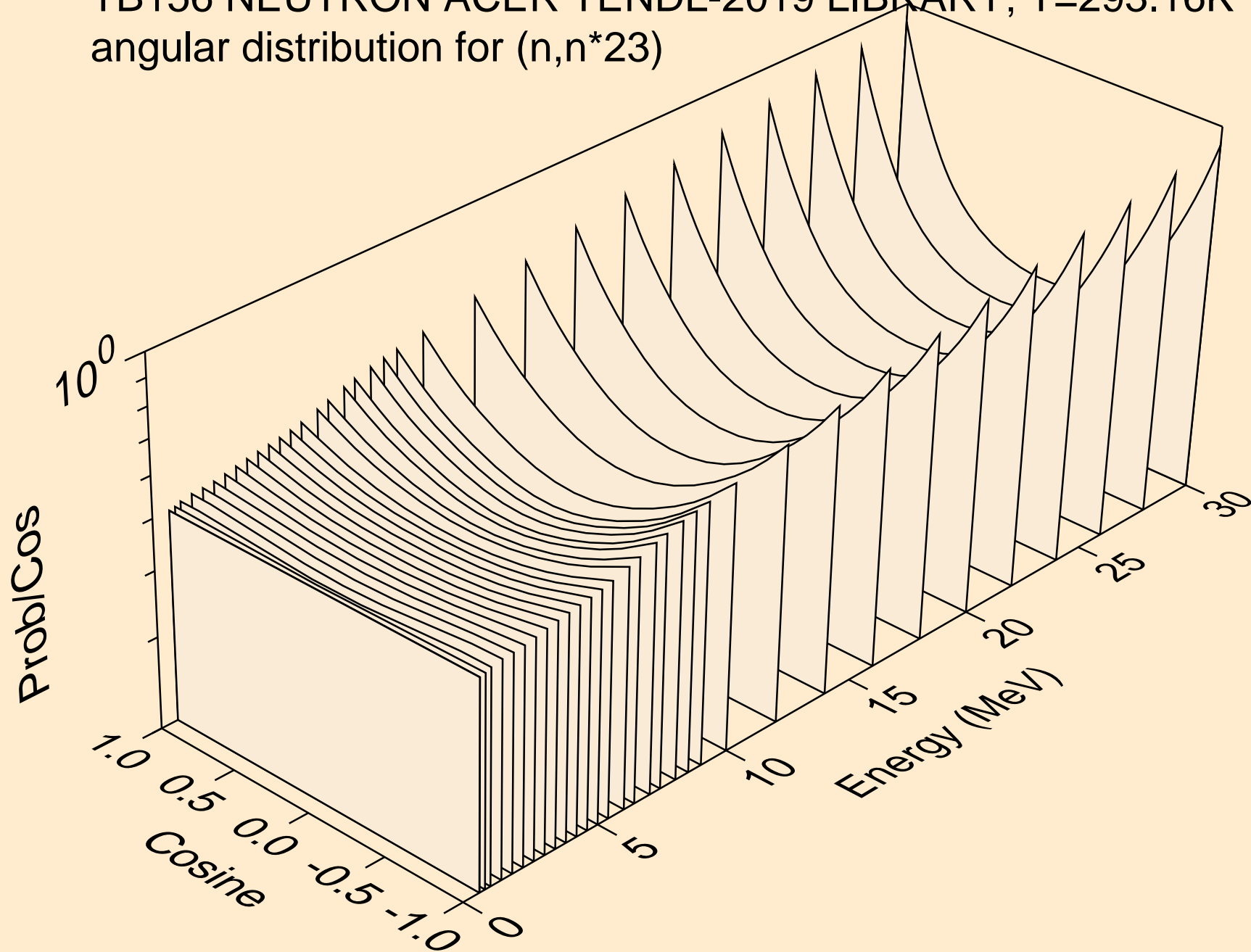

TB156 NEUTRON ACER TENDL-2019 LIBRARY; T=293.16K  
angular distribution for (n,n\*24)

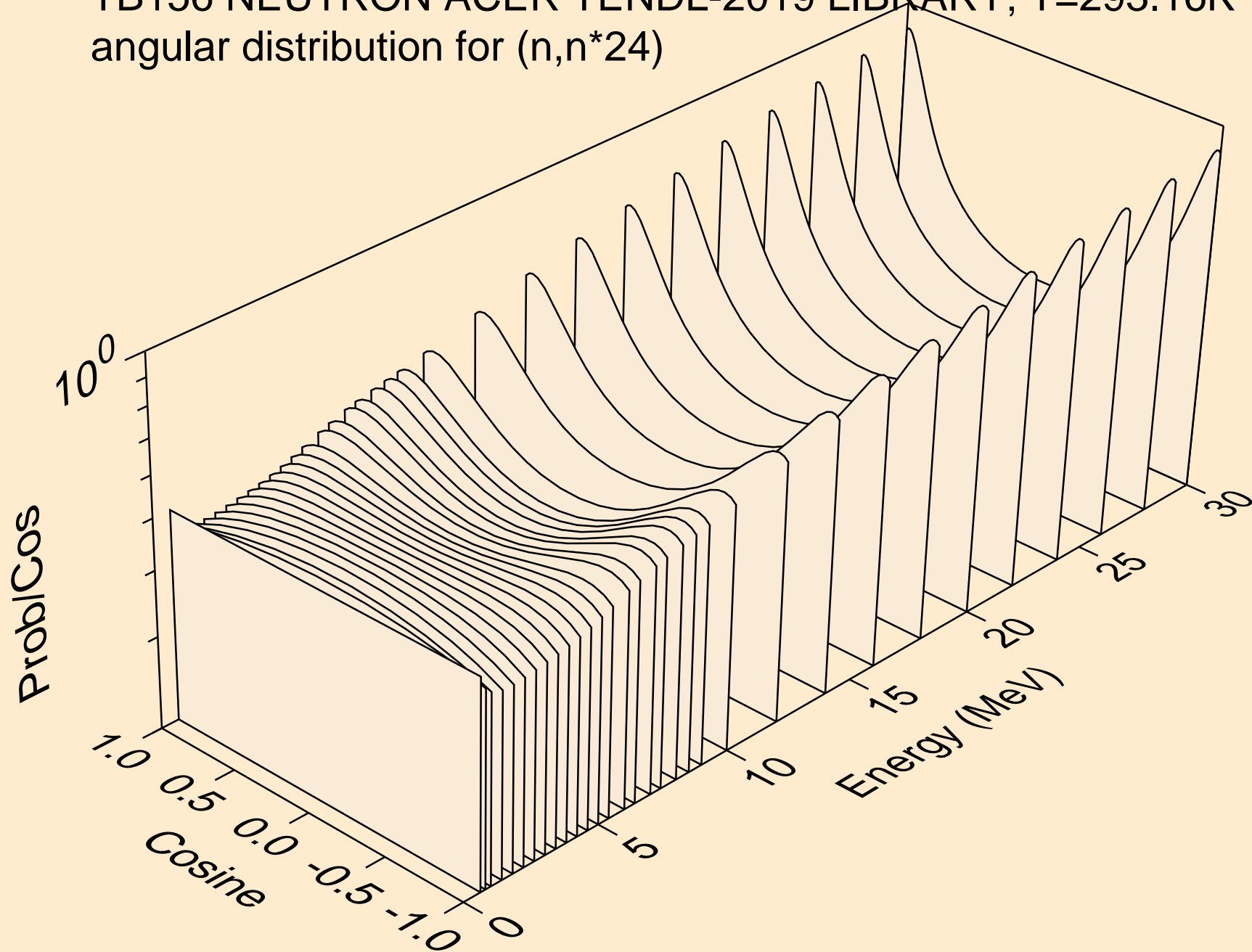

TB156 NEUTRON ACER TENDL-2019 LIBRARY; T=293.16K  
angular distribution for (n,n\*25)

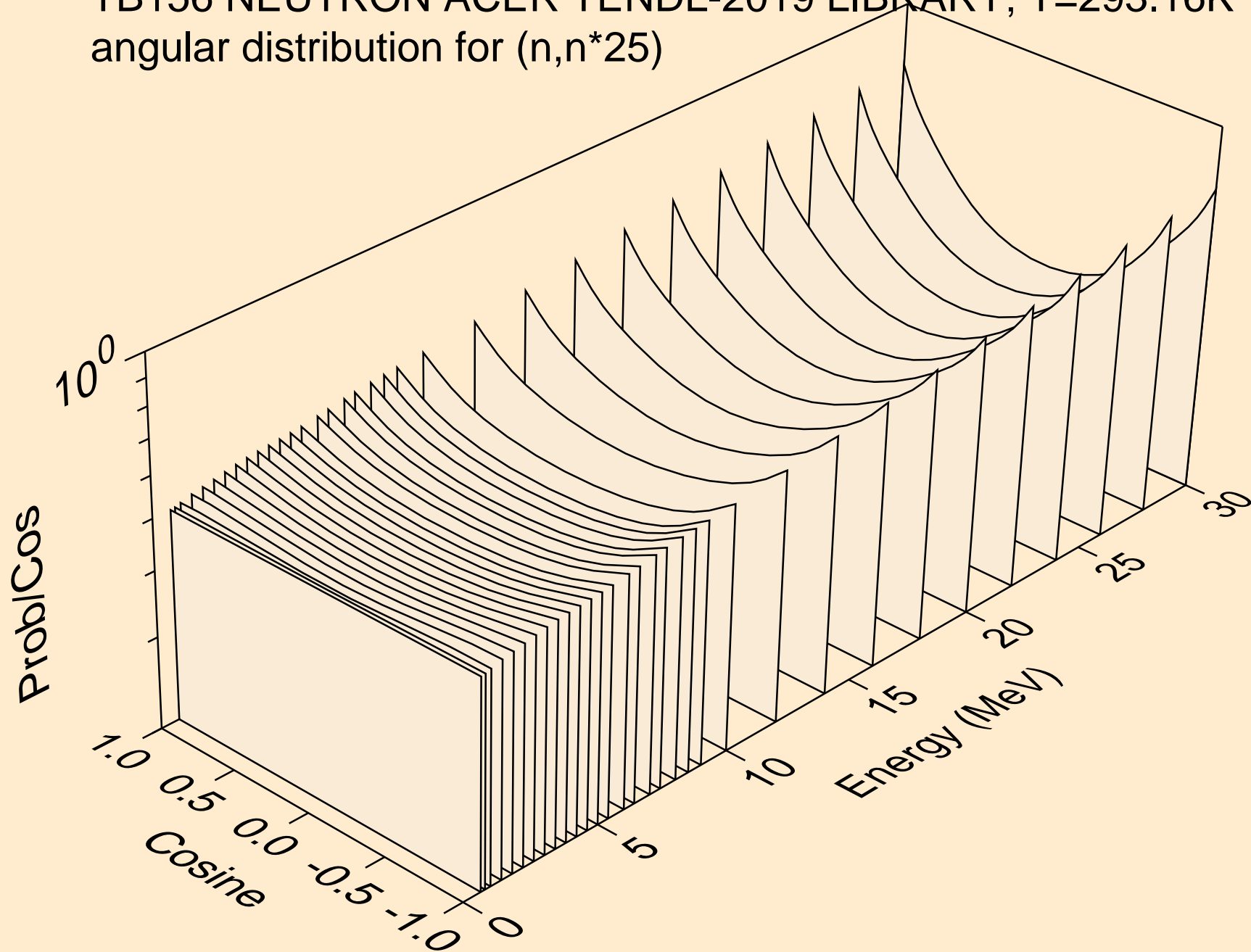



TB156 NEUTRON ACER TENDL-2019 LIBRARY; T=293.16K  
angular distribution for (n,n\*26)

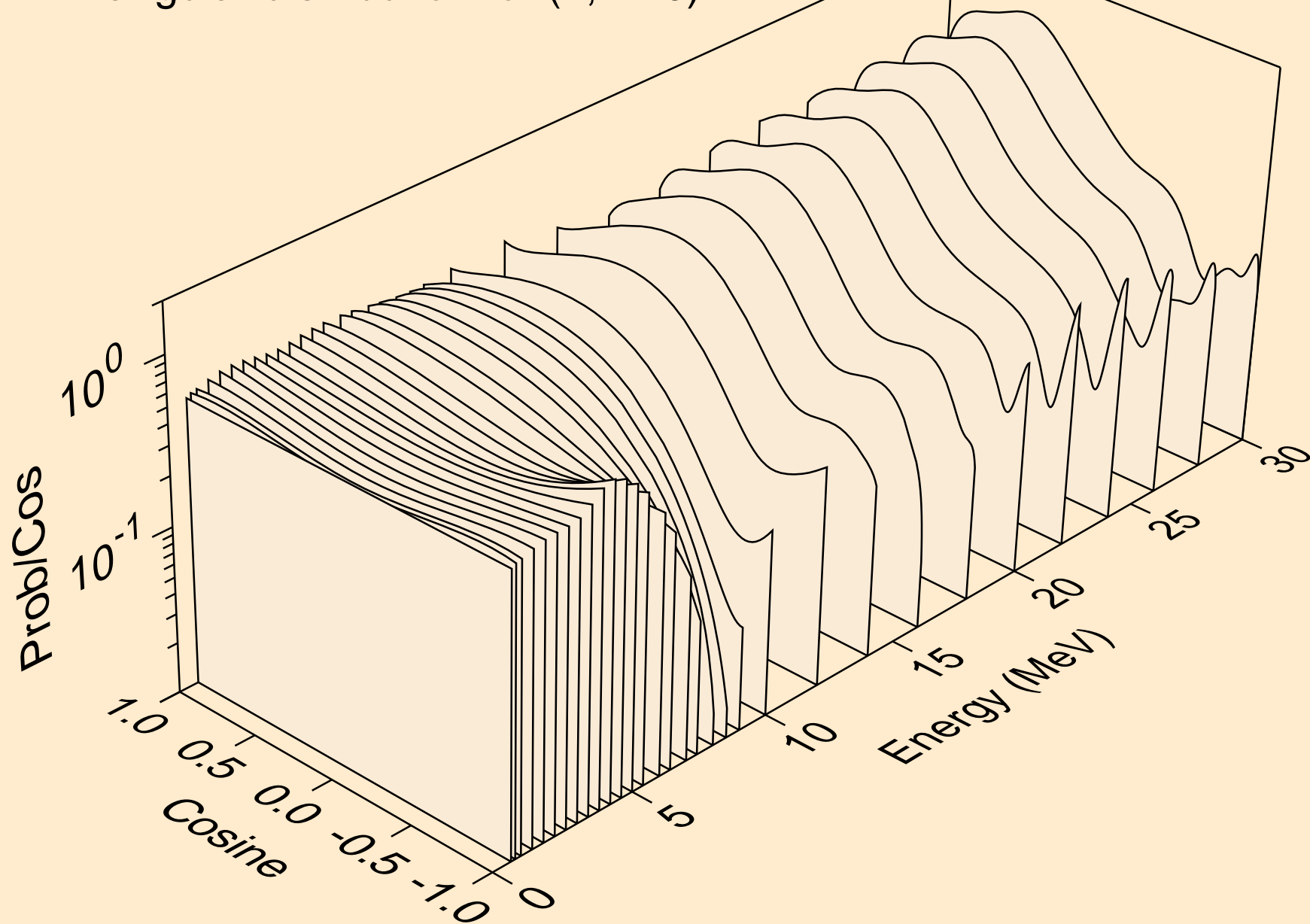

TB156 NEUTRON ACER TENDL-2019 LIBRARY; T=293.16K  
angular distribution for (n,n\*27)

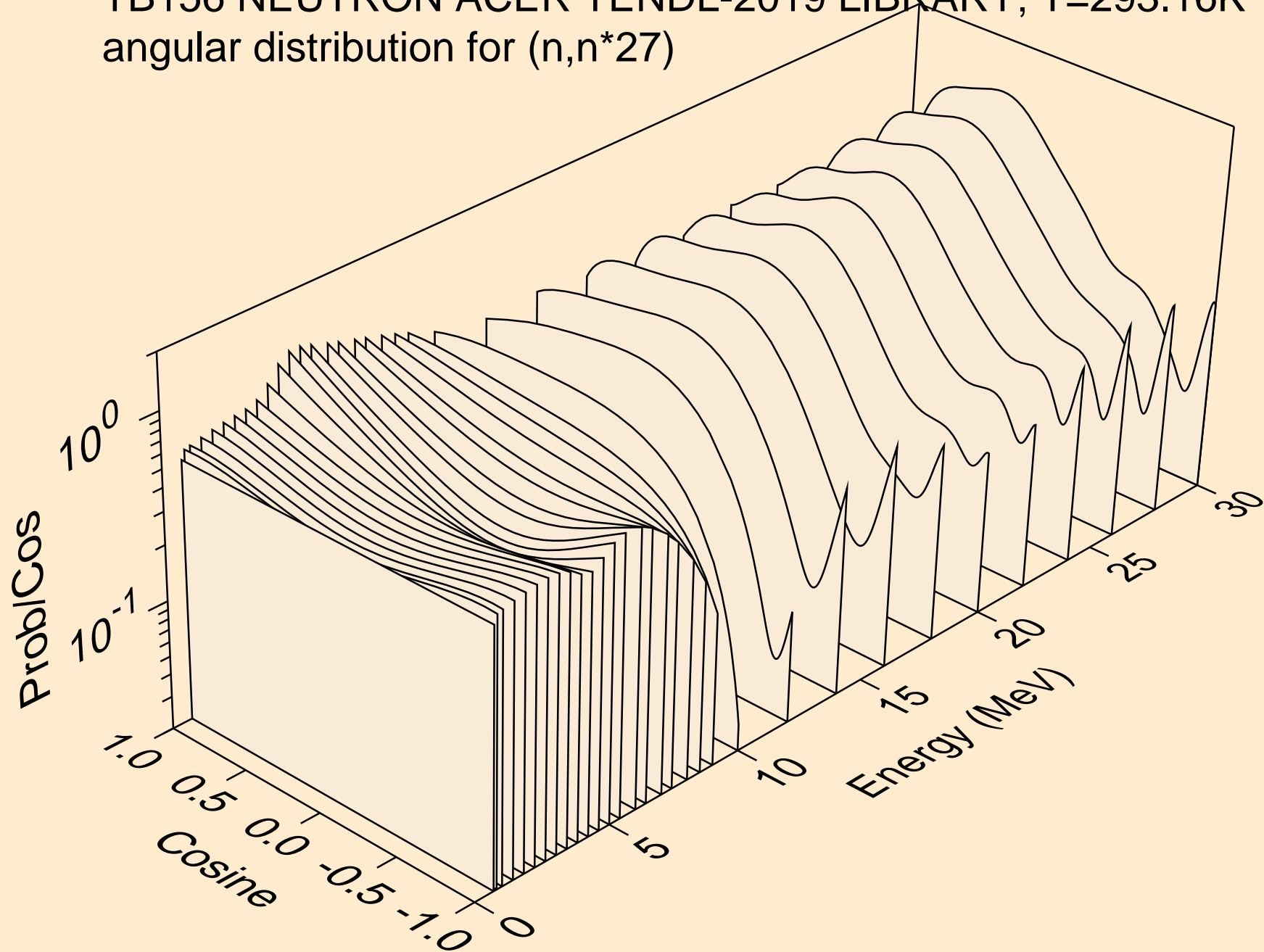

TB156 NEUTRON ACER TENDL-2019 LIBRARY; T=293.16K  
angular distribution for (n,n\*28)

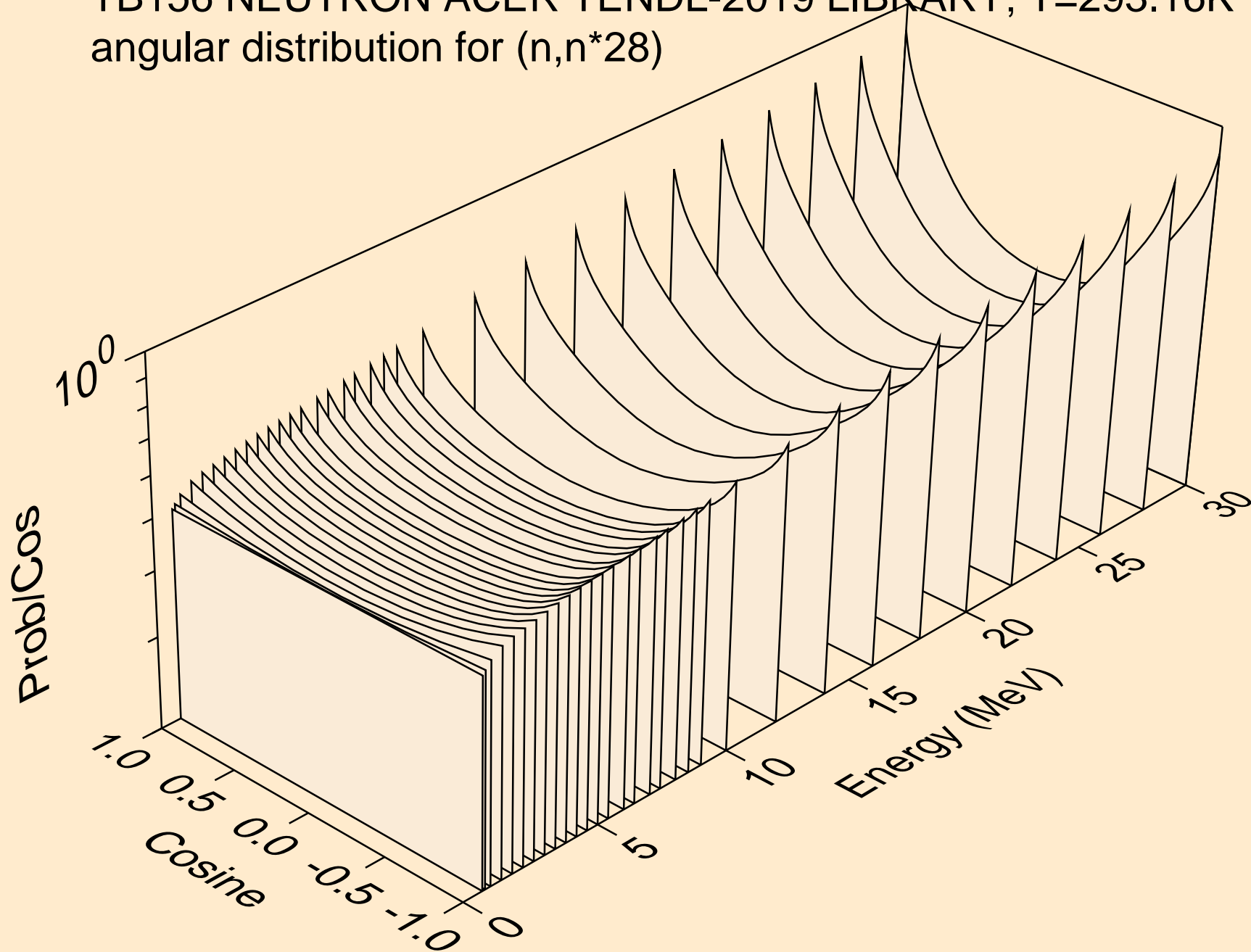

TB156 NEUTRON ACER TENDL-2019 LIBRARY; T=293.16K  
angular distribution for (n,n\*29)

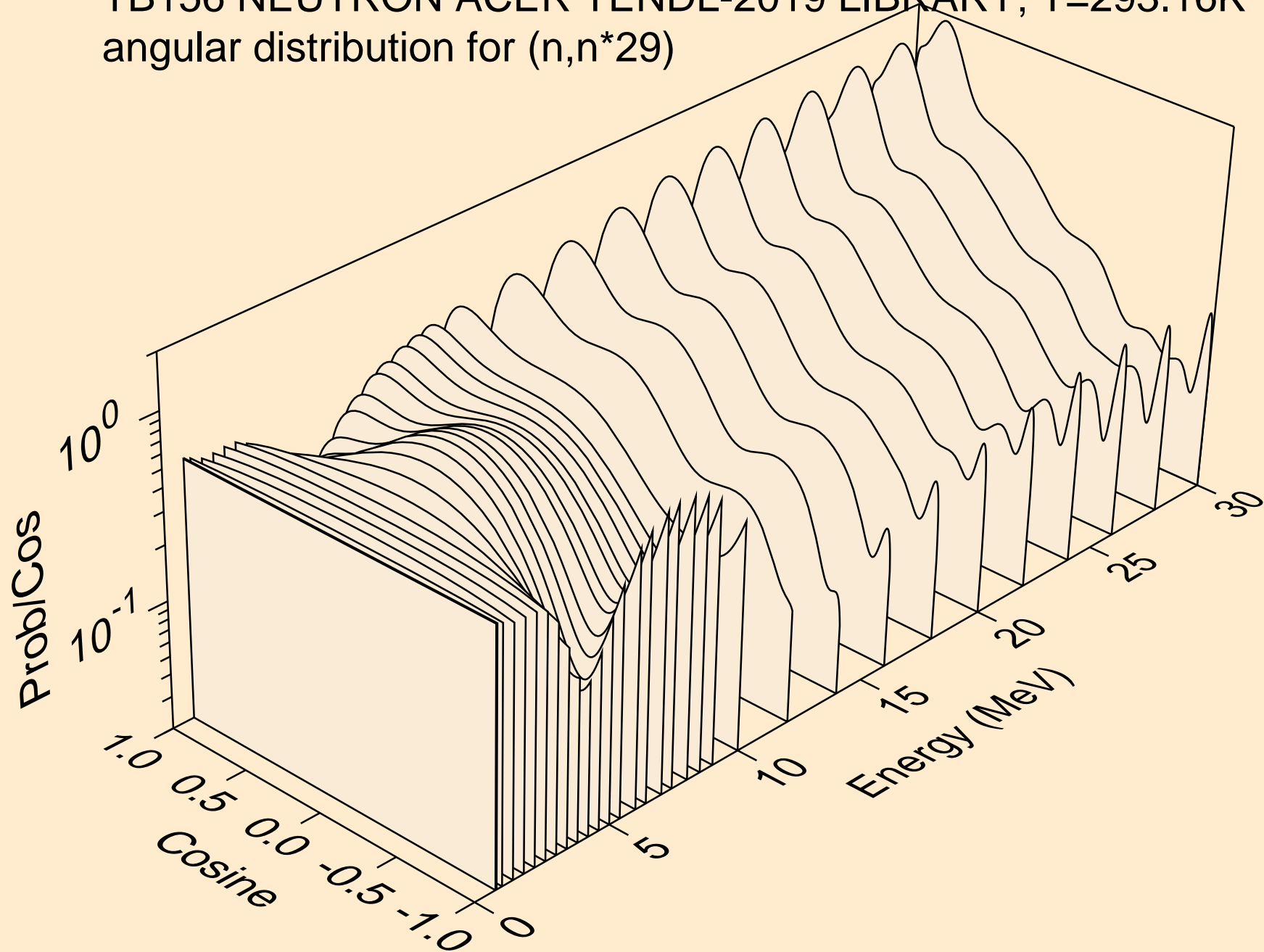

TB156 NEUTRON ACER TENDL-2019 LIBRARY; T=293.16K  
angular distribution for (n,n\*30)

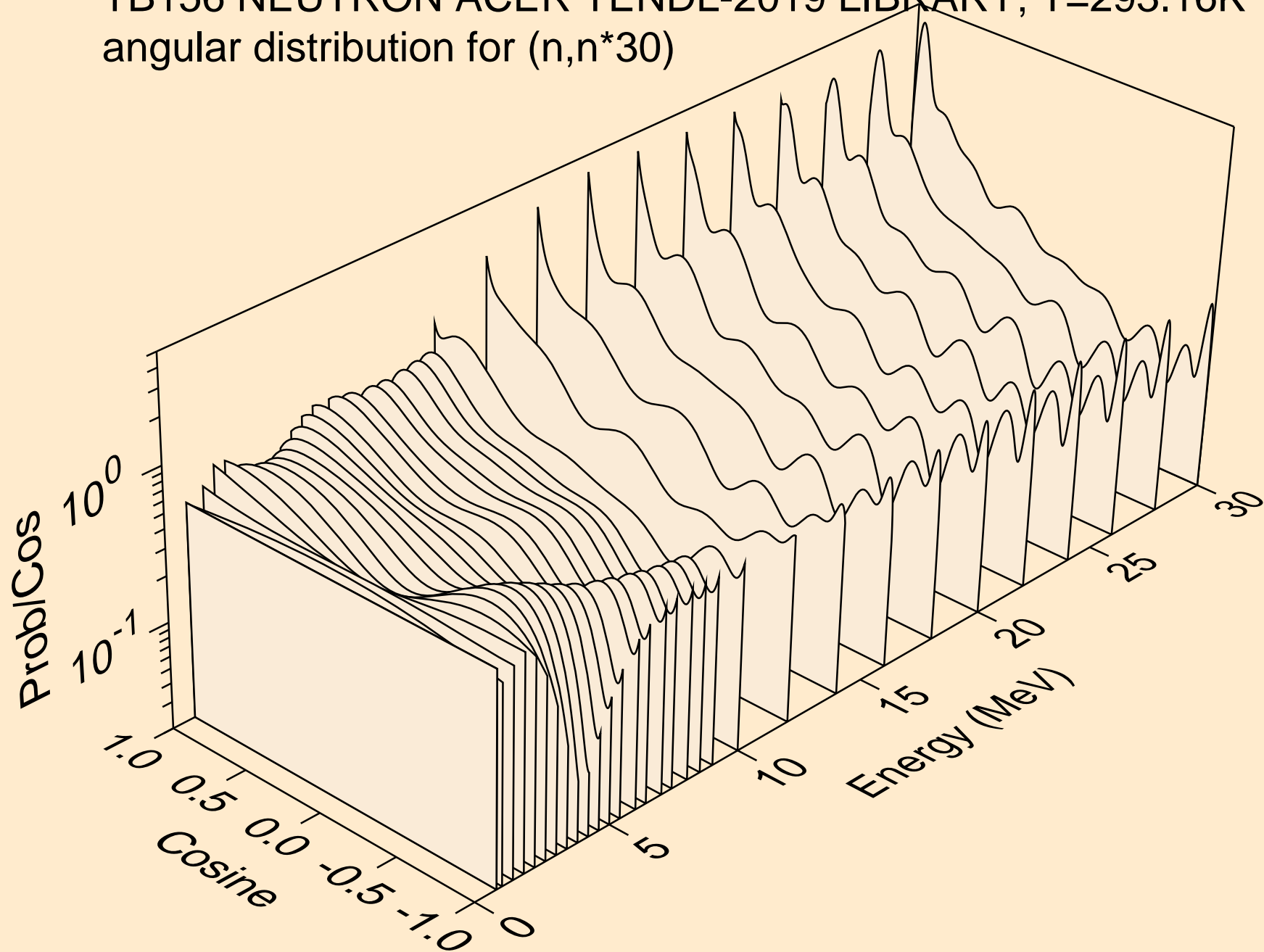

TB156 NEUTRON ACER TENDL-2019 LIBRARY; T=293.16K  
Neutron emission for (n,x)

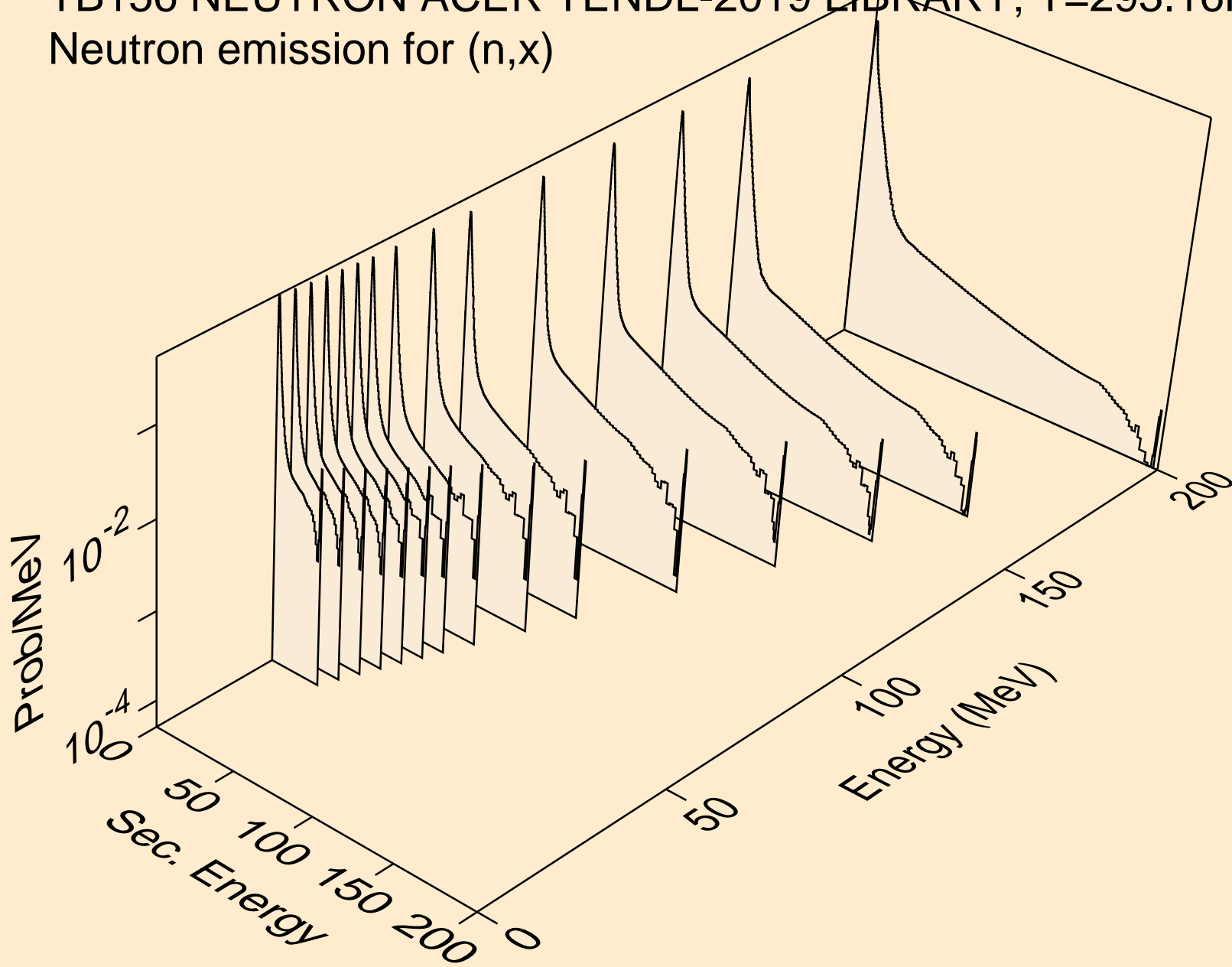

TB156 NEUTRON ACER TENDL-2019 LIBRARY; T=293.16K  
Neutron emission for (n,2nd)

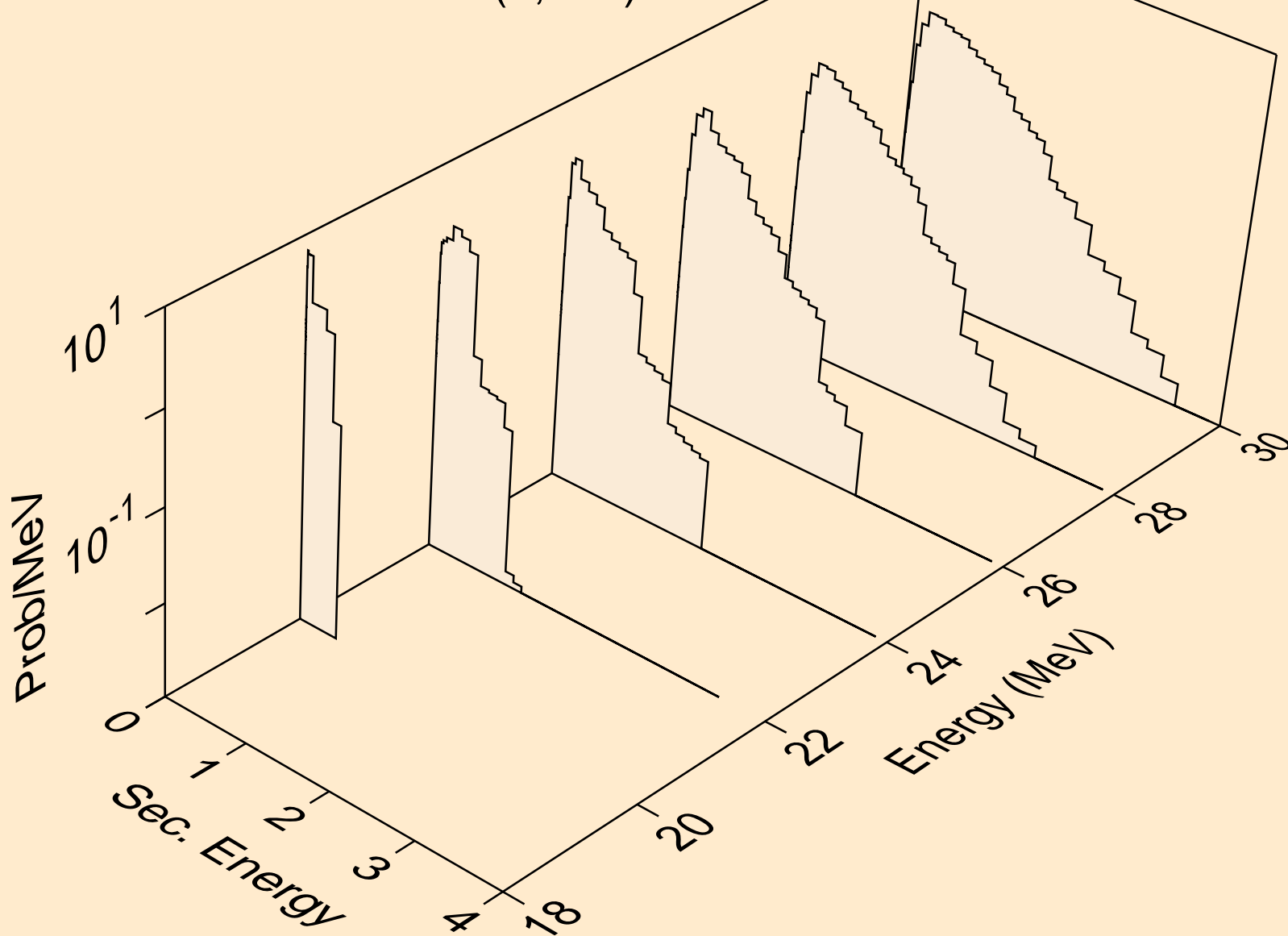

TB156 NEUTRON ACER TENDL-2019 LIBRARY; T=293.16K  
Neutron emission for (n,2n)

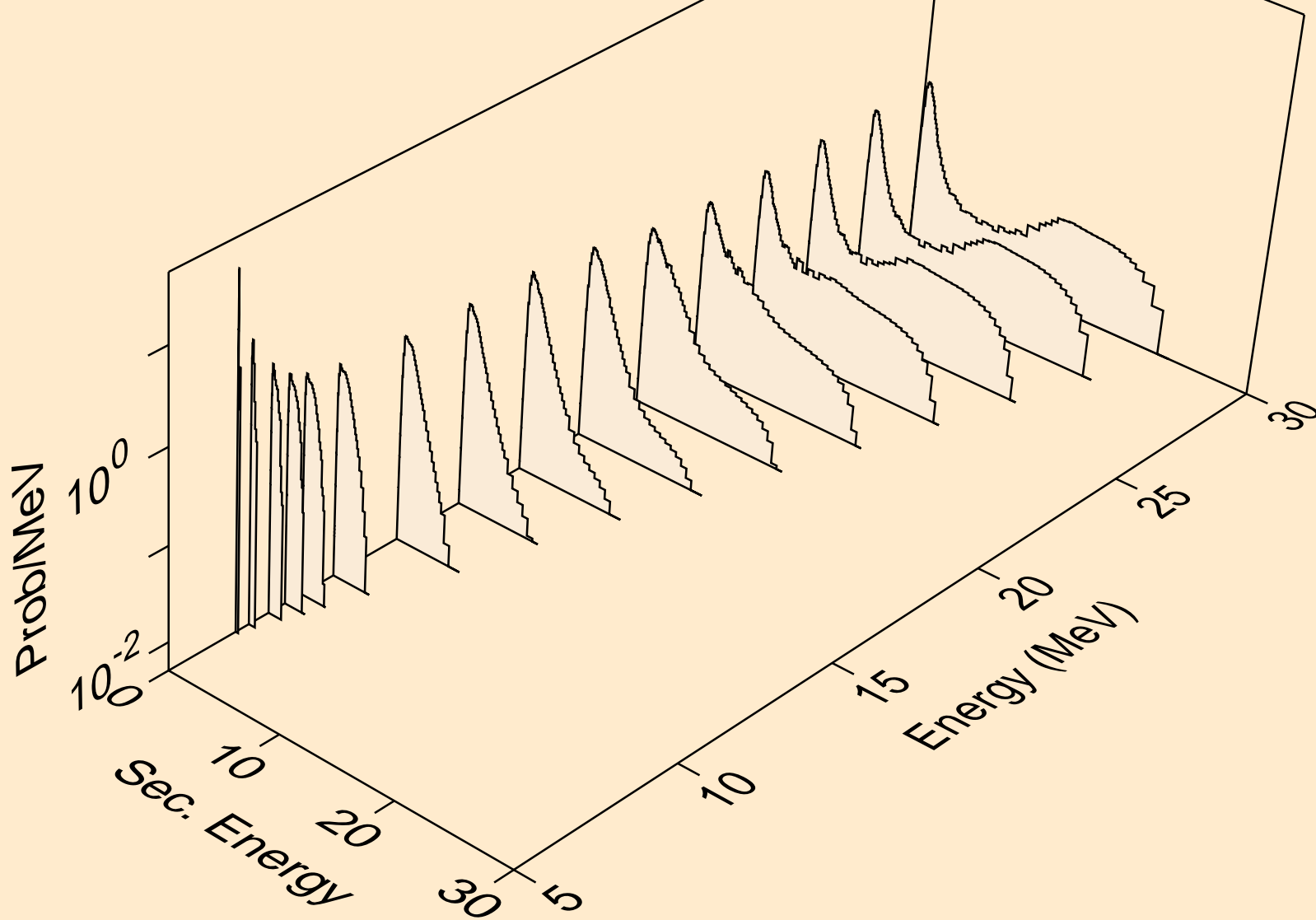



TB156 NEUTRON ACER TENDL-2019 LIBRARY; T=293.16K  
Neutron emission for (n,3n)

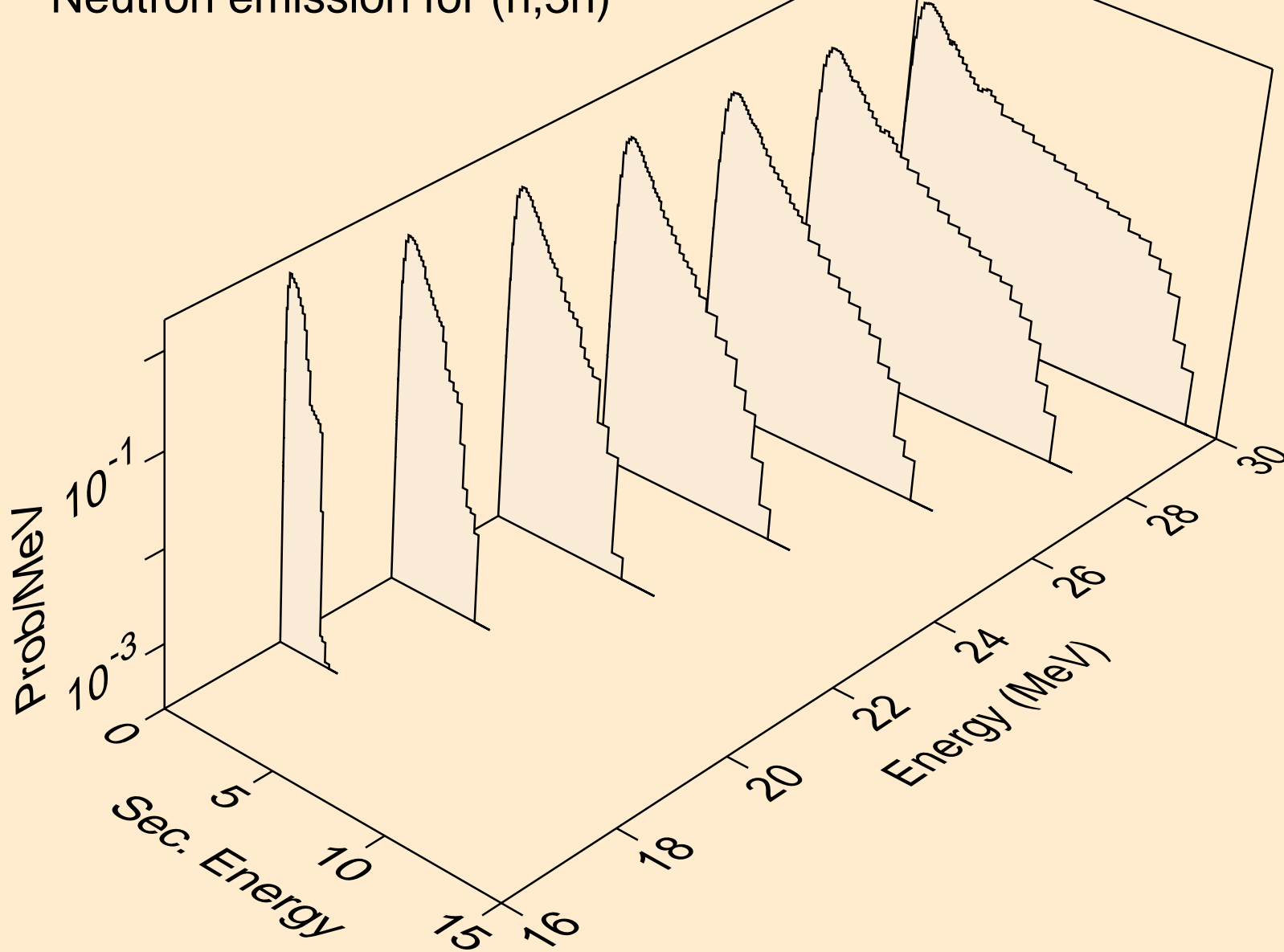

TB156 NEUTRON ACER TENDL-2019 LIBRARY; T=293.16K  
Neutron emission for (n,n\*)a

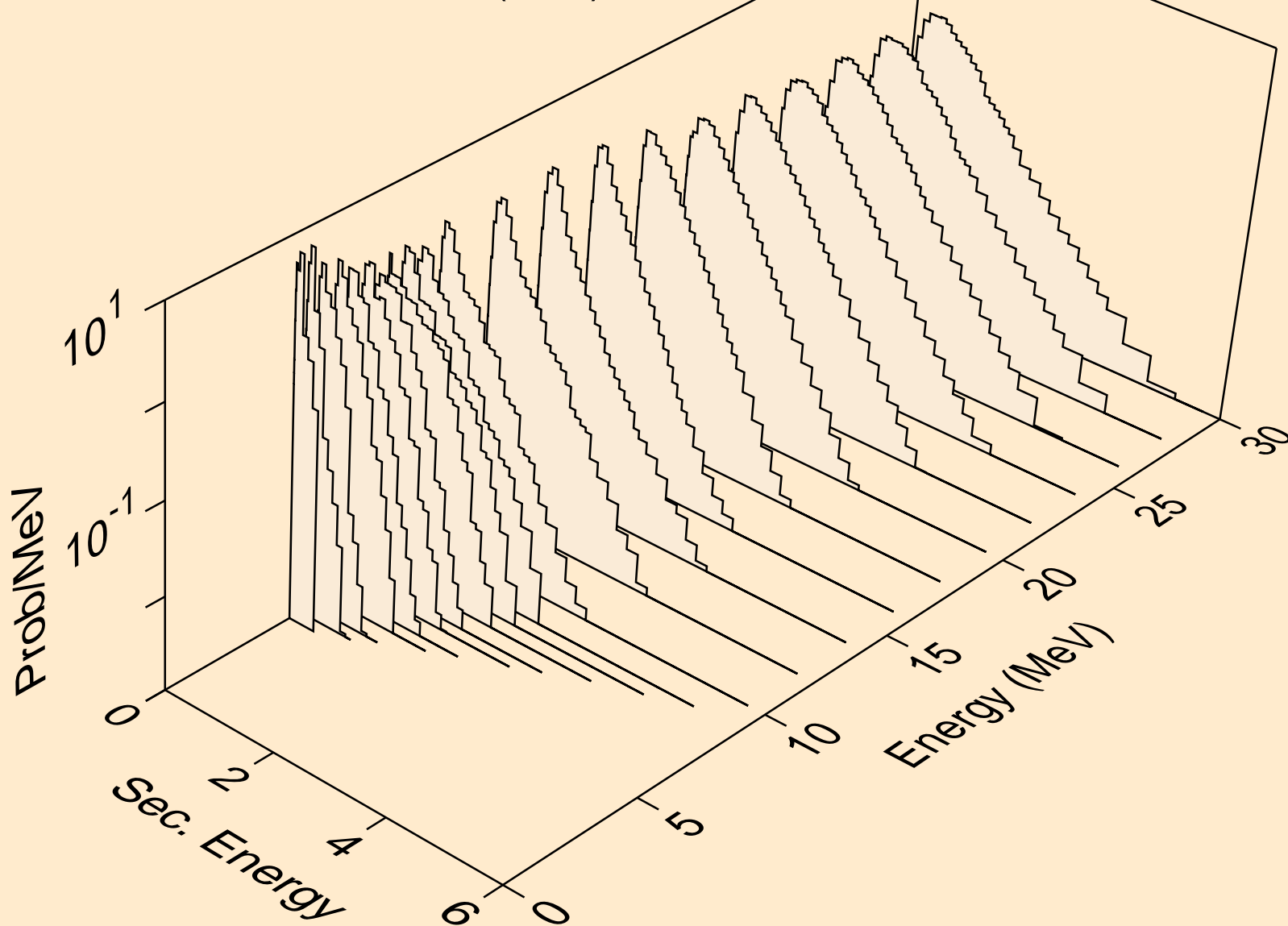

TB156 NEUTRON ACER TENDL-2019 LIBRARY; T=293.16K  
Neutron emission for (n,2n)a

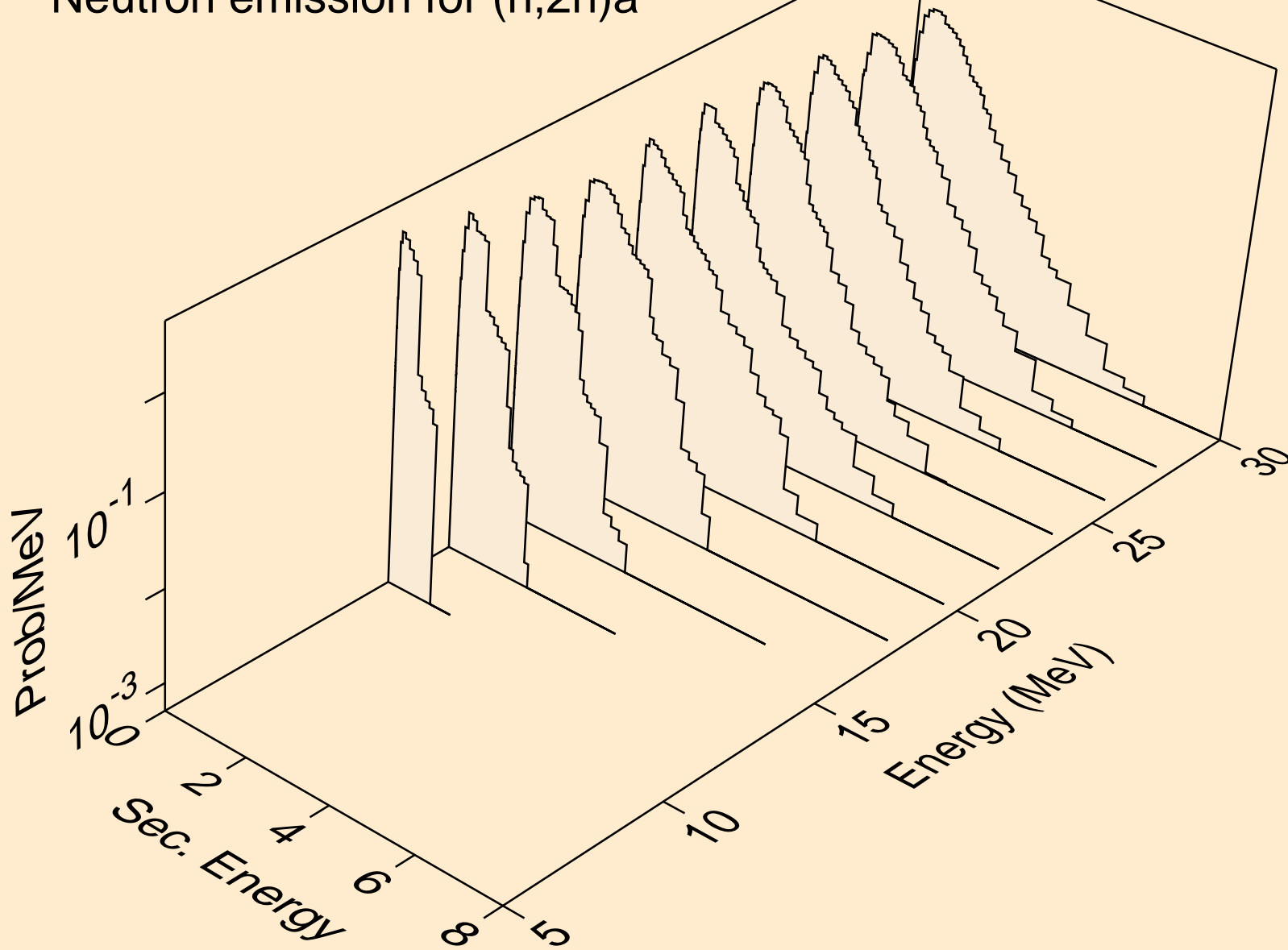

TB156 NEUTRON ACER TENDL-2019 LIBRARY; T=293.16K  
Neutron emission for (n,3n)a

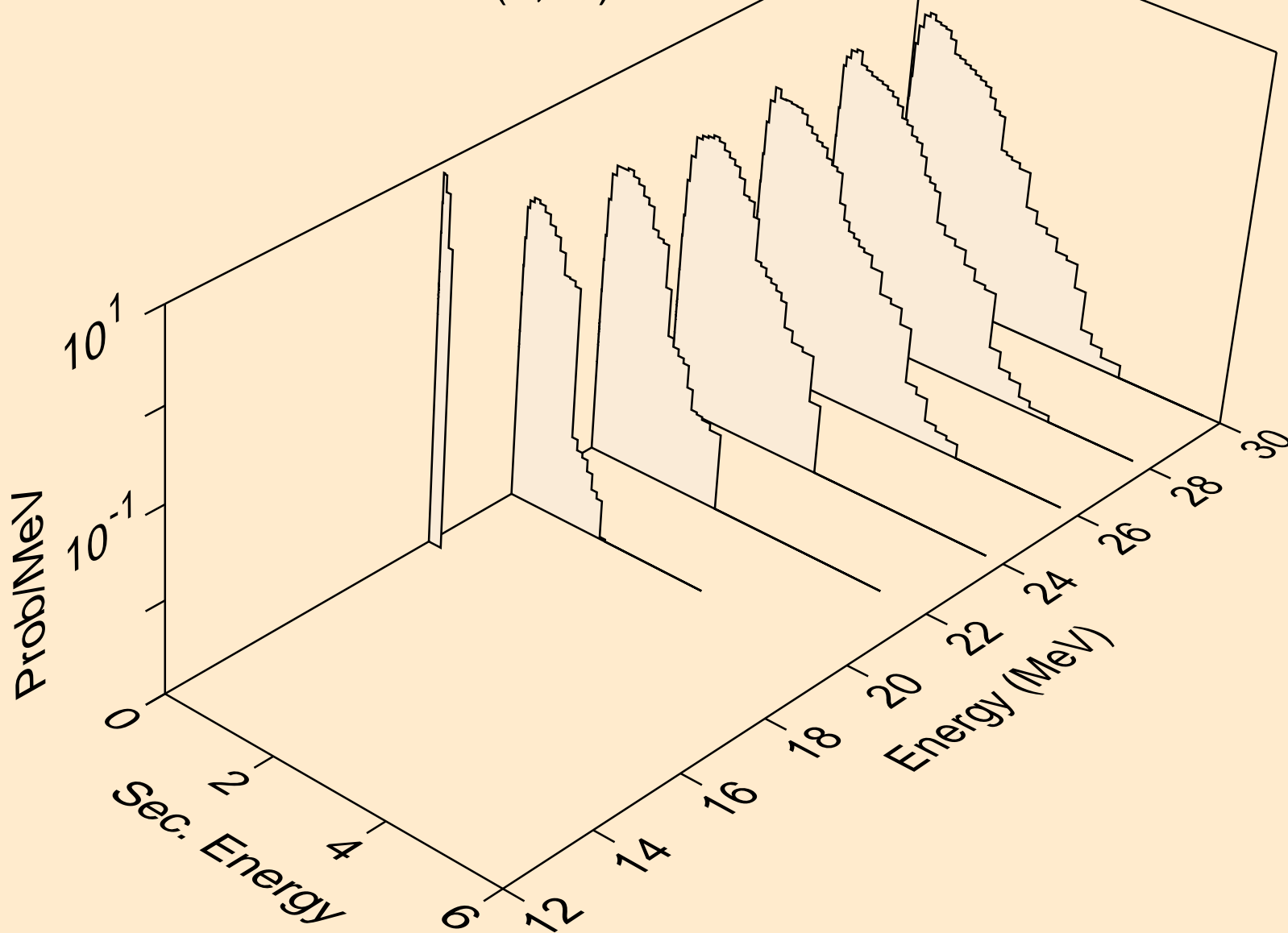

TB156 NEUTRON ACER TENDL-2019 LIBRARY; T=293.16K  
Neutron emission for (n,n\*)p

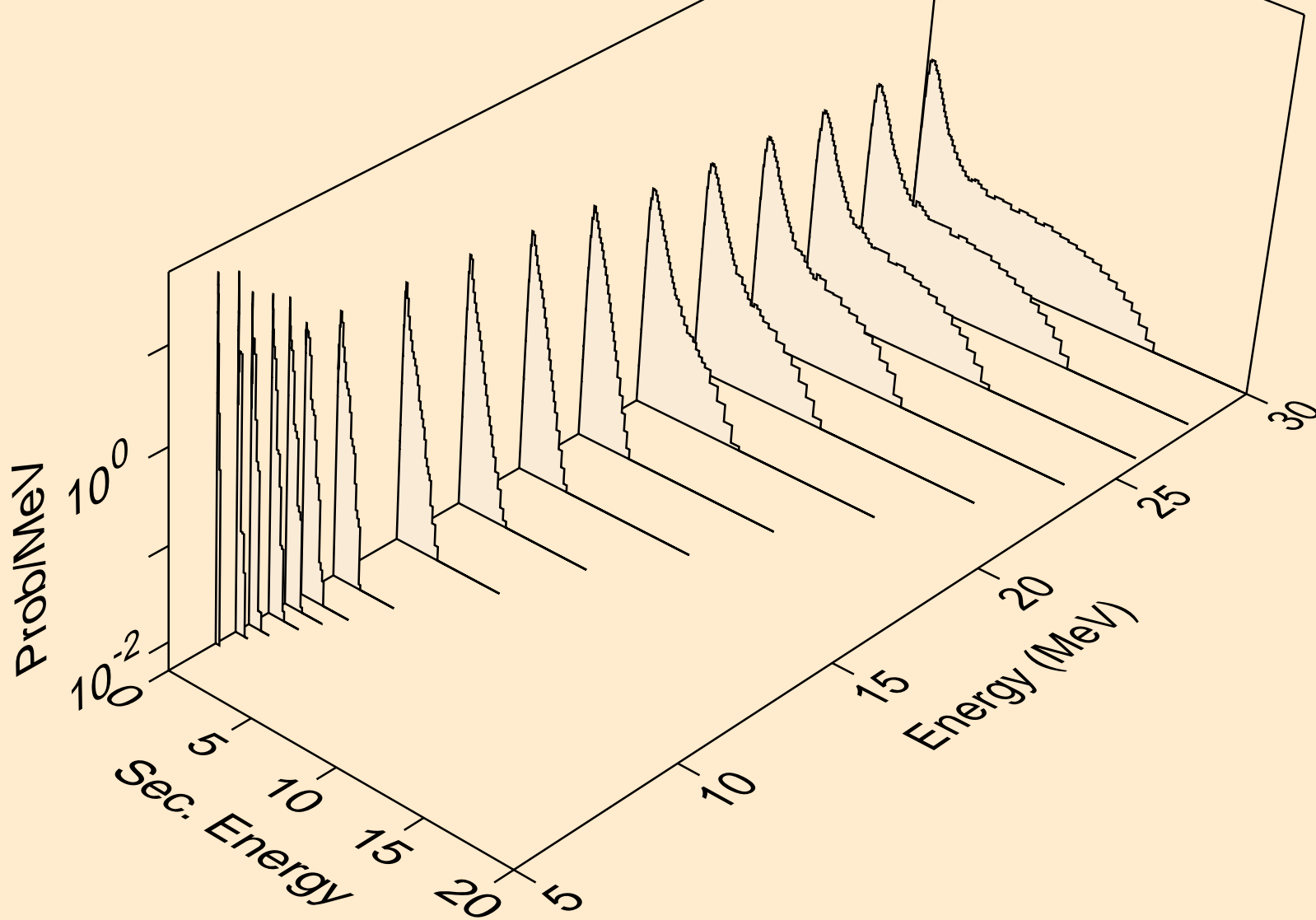

TB156 NEUTRON ACER TENDL-2019 LIBRARY; T=293.16K  
Neutron emission for (n,n\*)2a

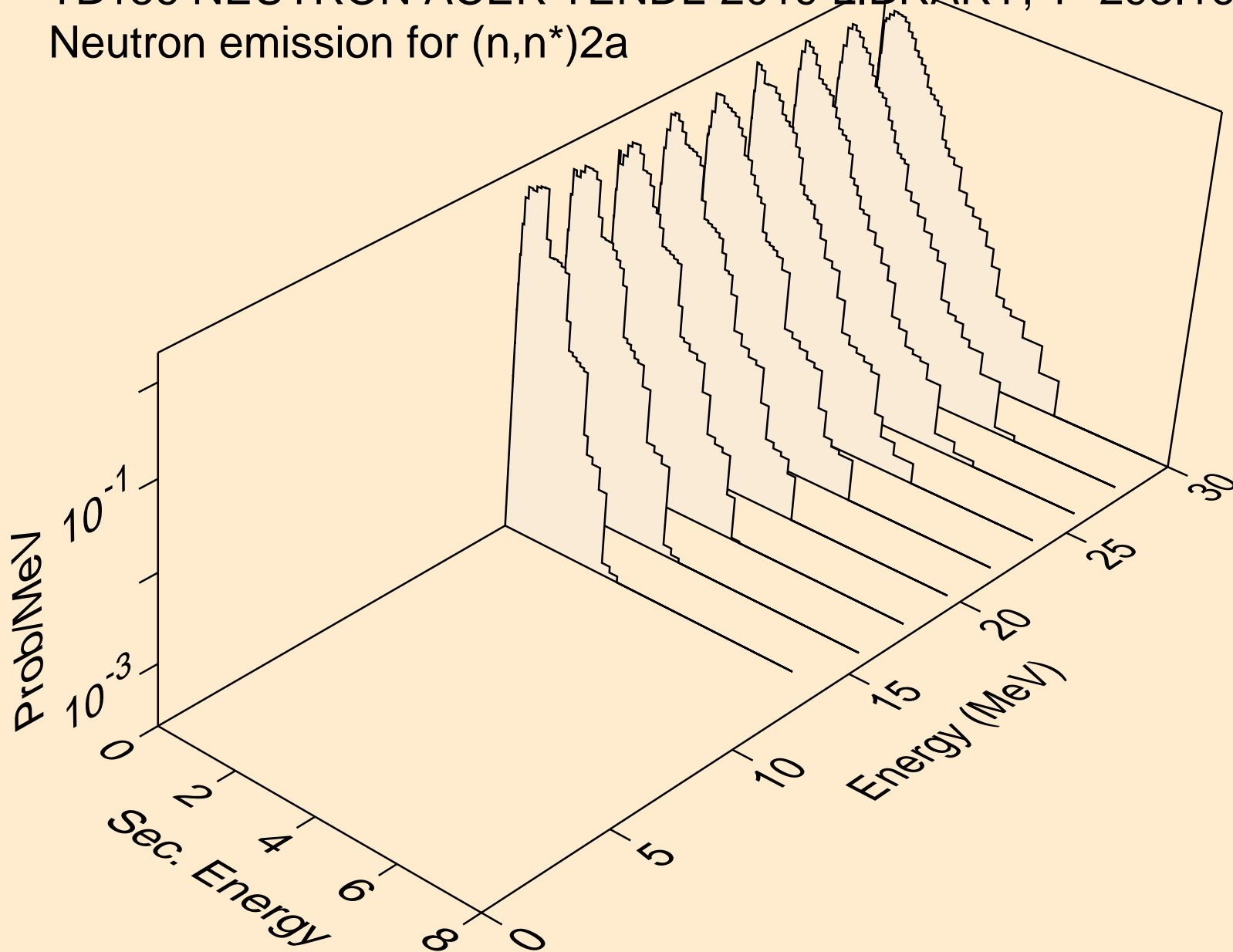

TB156 NEUTRON ACER TENDL-2019 LIBRARY; T=293.16K  
Neutron emission for (n,2n)2a

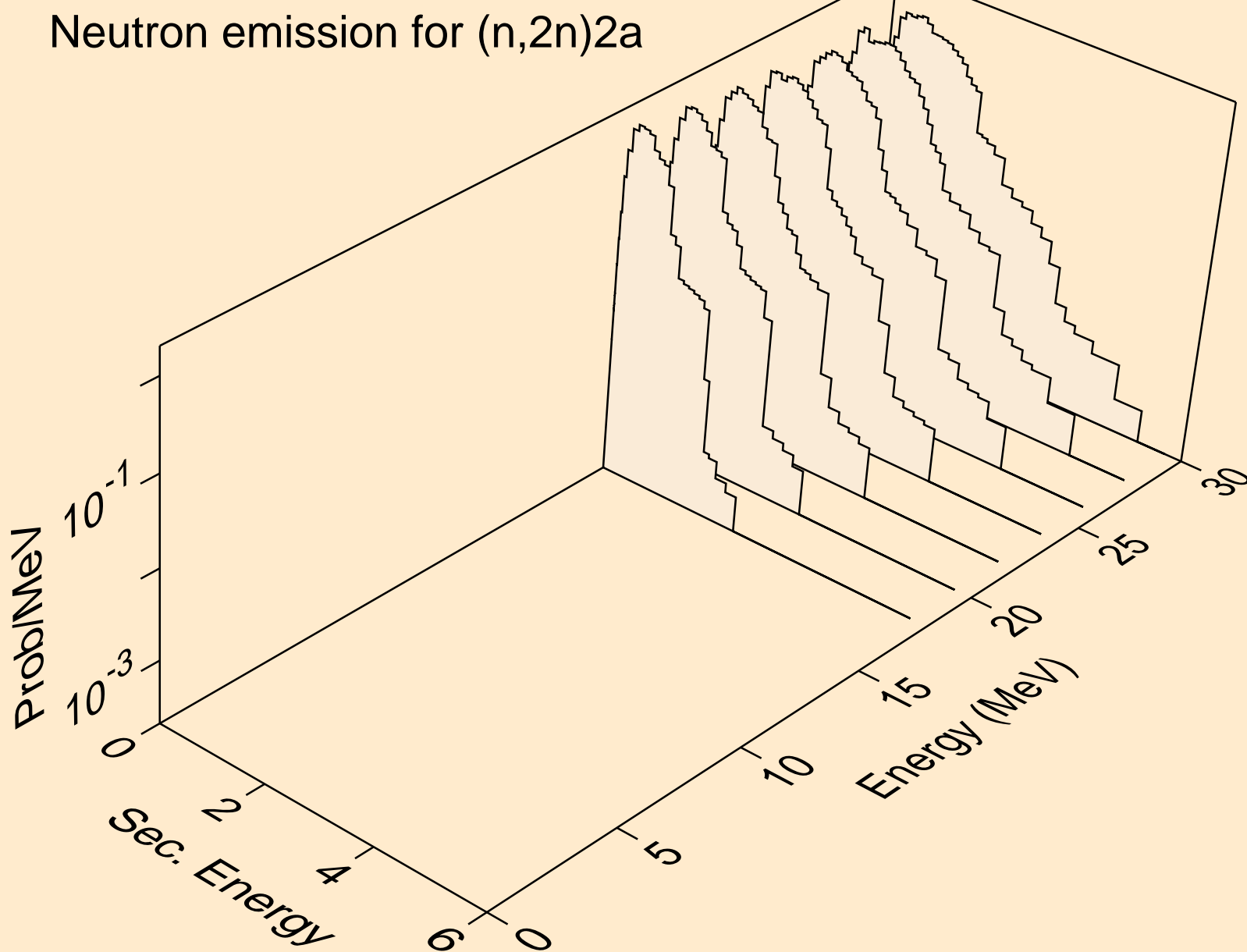

TB156 NEUTRON ACER TENDL-2019 LIBRARY; T=293.16K  
Neutron emission for (n,n\*)d

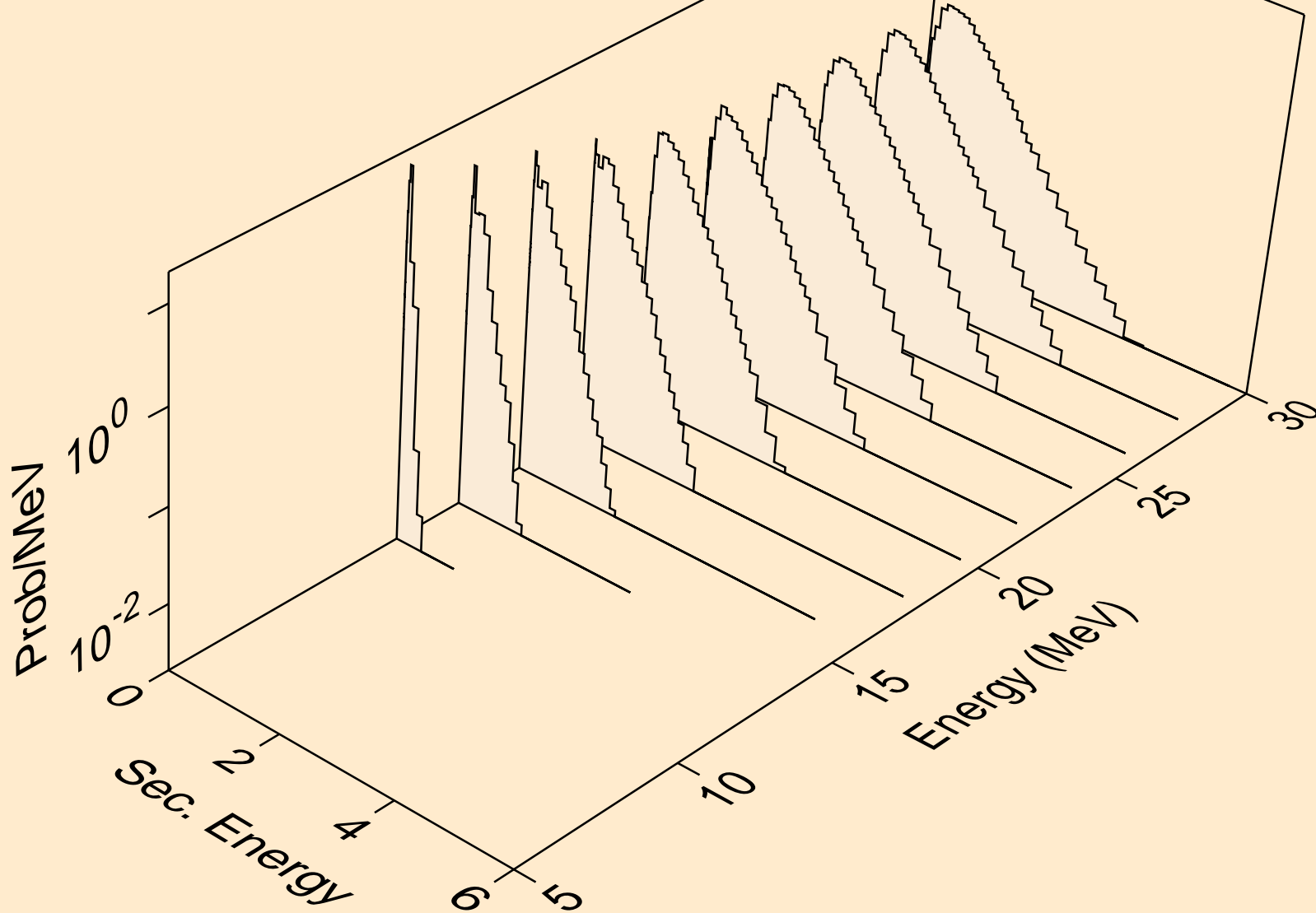



TB156 NEUTRON ACER TENDL-2019 LIBRARY; T=293.16K  
Neutron emission for (n,n\*)t

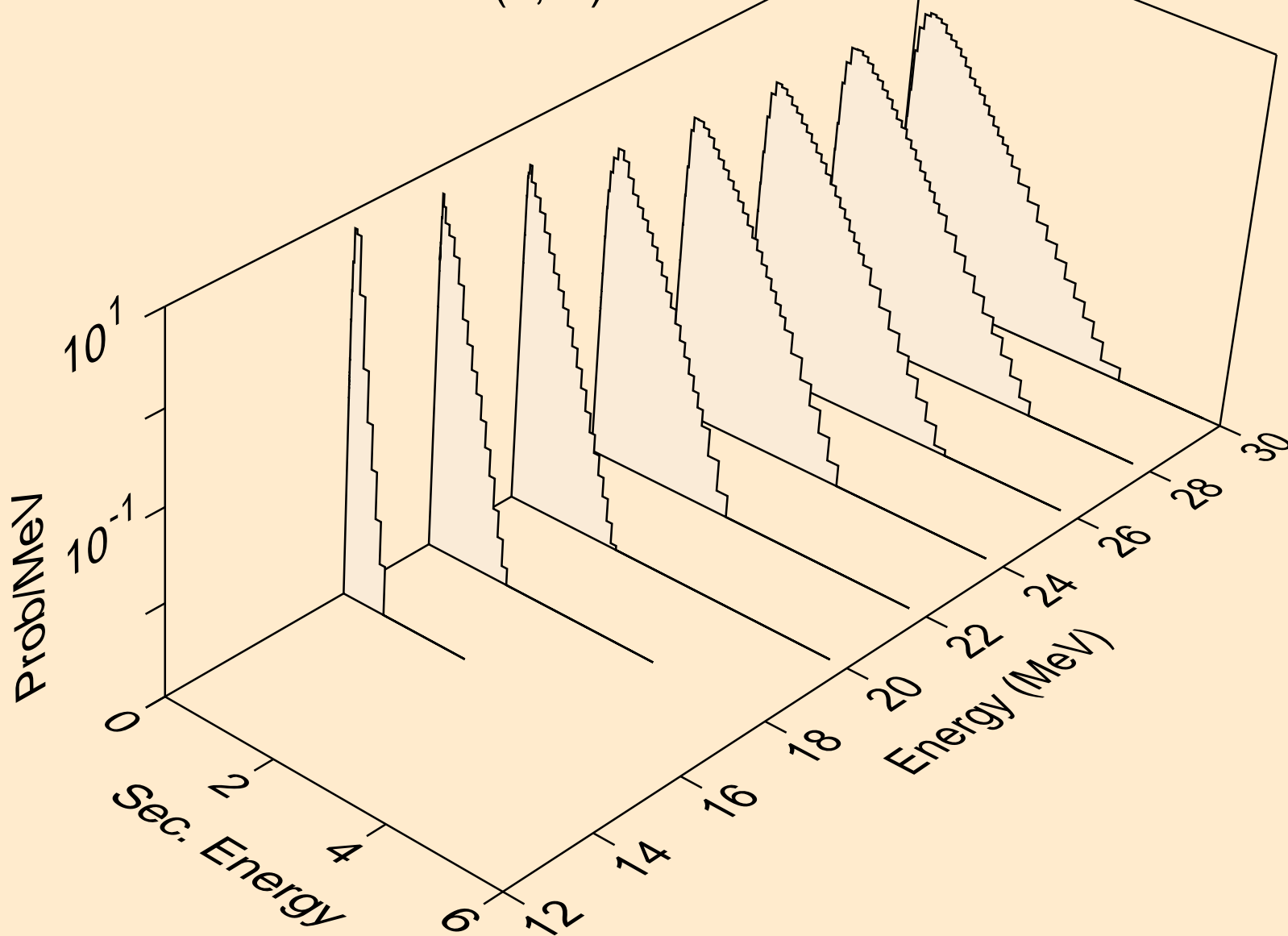

TB156 NEUTRON ACER TENDL-2019 LIBRARY; T=293.16K  
Neutron emission for (n,n\*)he3

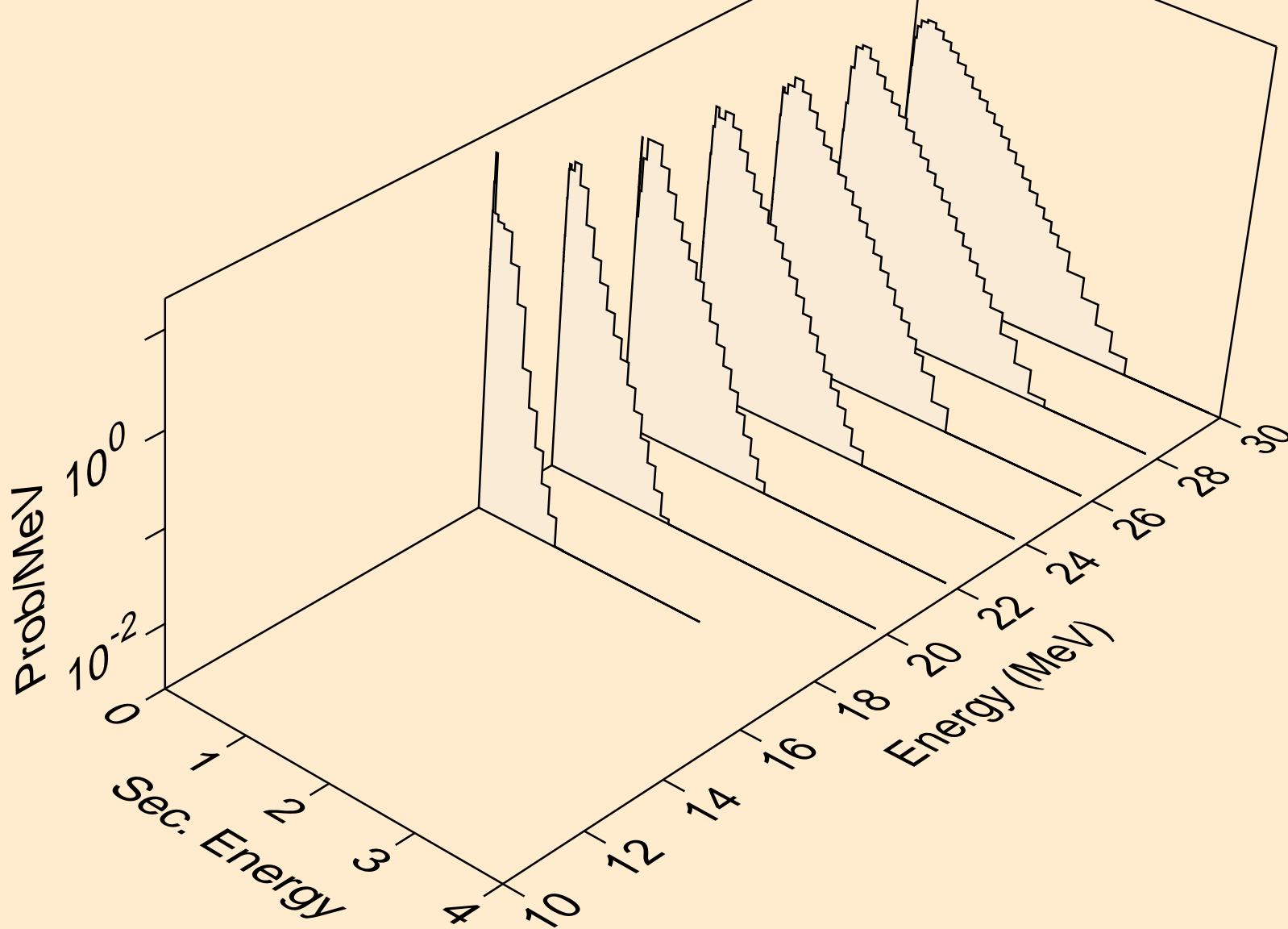

TB156 NEUTRON ACER TENDL-2019 LIBRARY; T=293.16K  
Neutron emission for (n,4n)

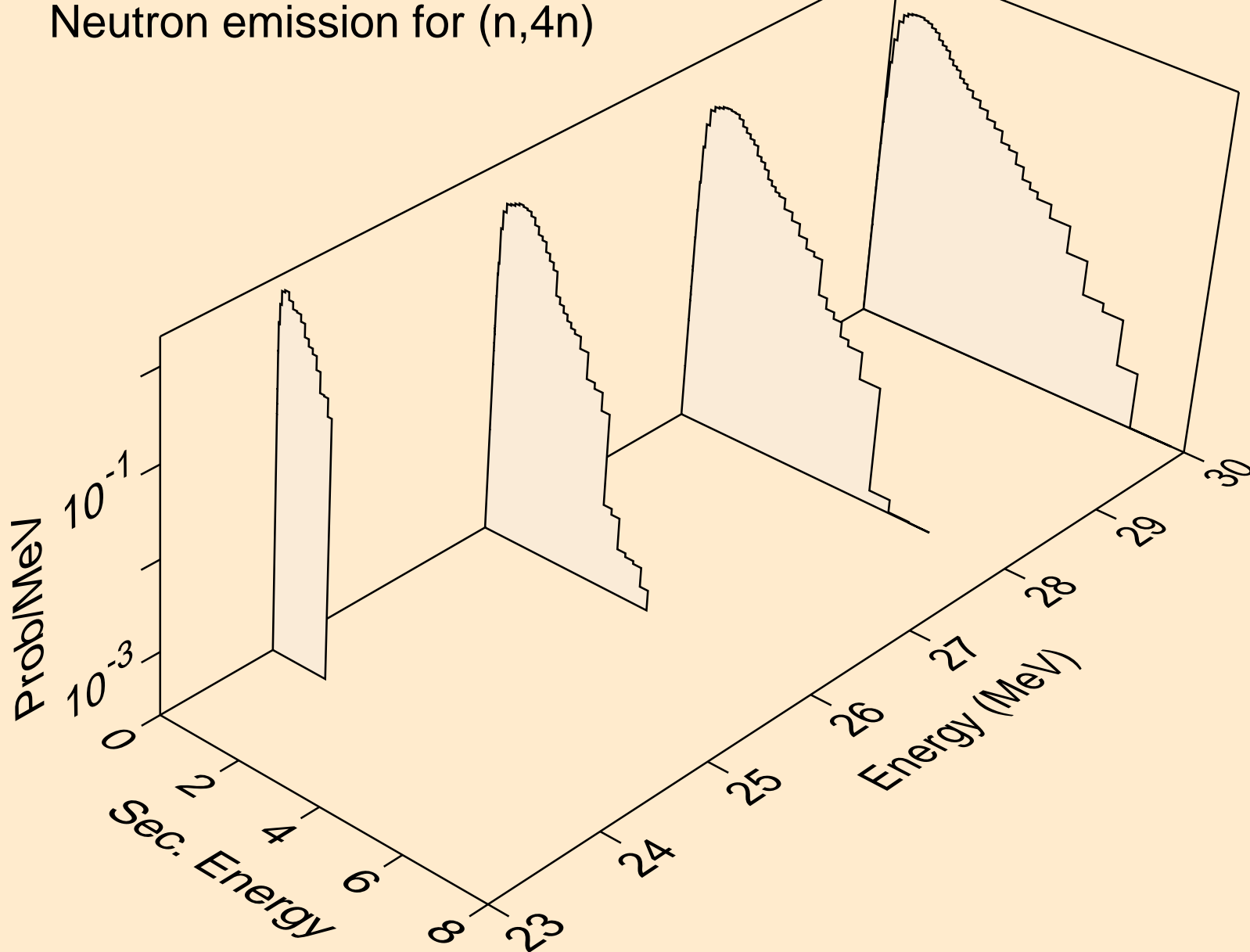

TB156 NEUTRON ACER TENDL-2019 LIBRARY; T=293.16K  
Neutron emission for (n,2np)

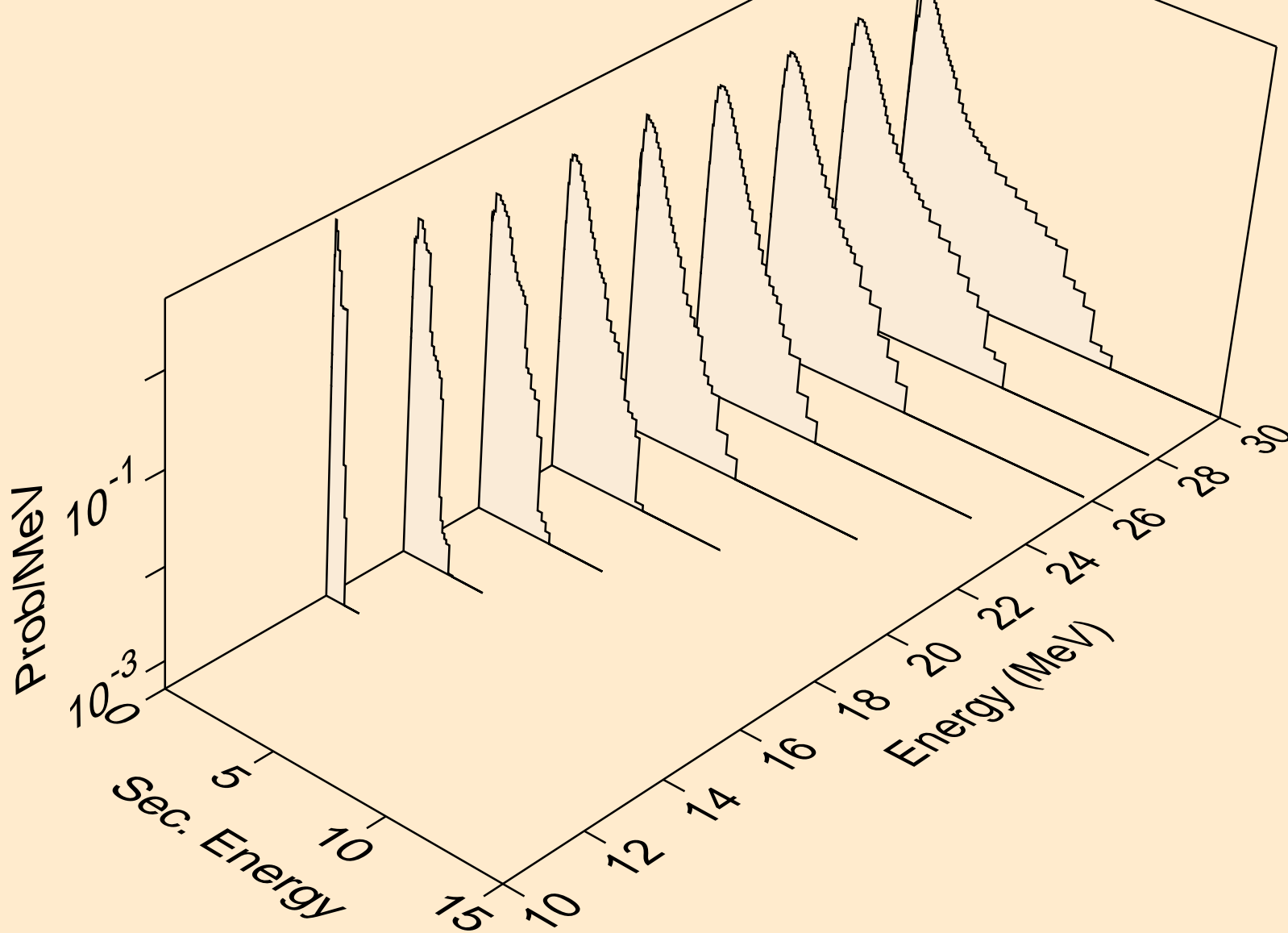

TB156 NEUTRON ACER TENDL-2019 LIBRARY; T=293.16K  
Neutron emission for (n,3np)

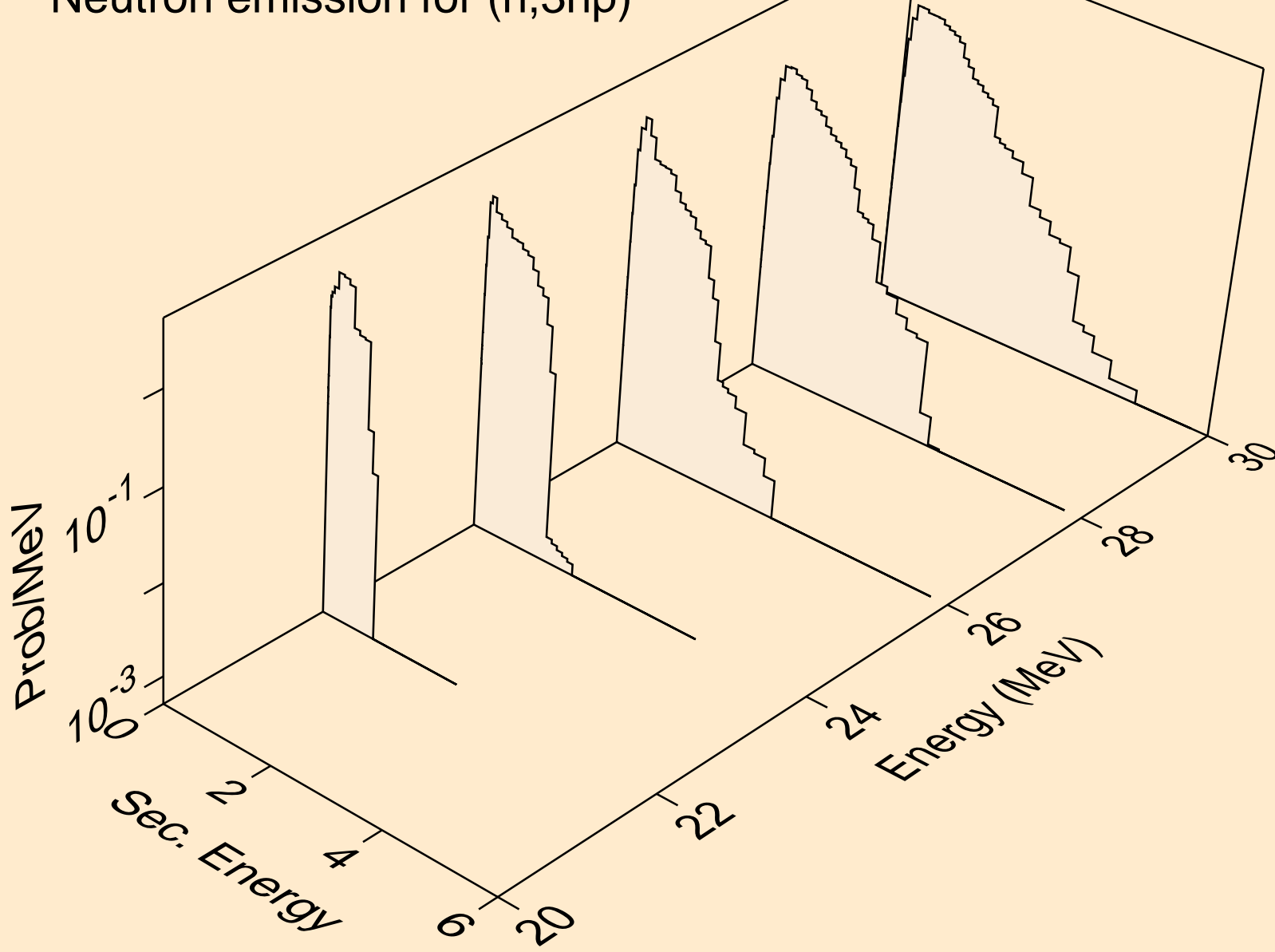

TB156 NEUTRON ACER TENDL-2019 LIBRARY; T=293.16K  
Neutron emission for (n,2np)

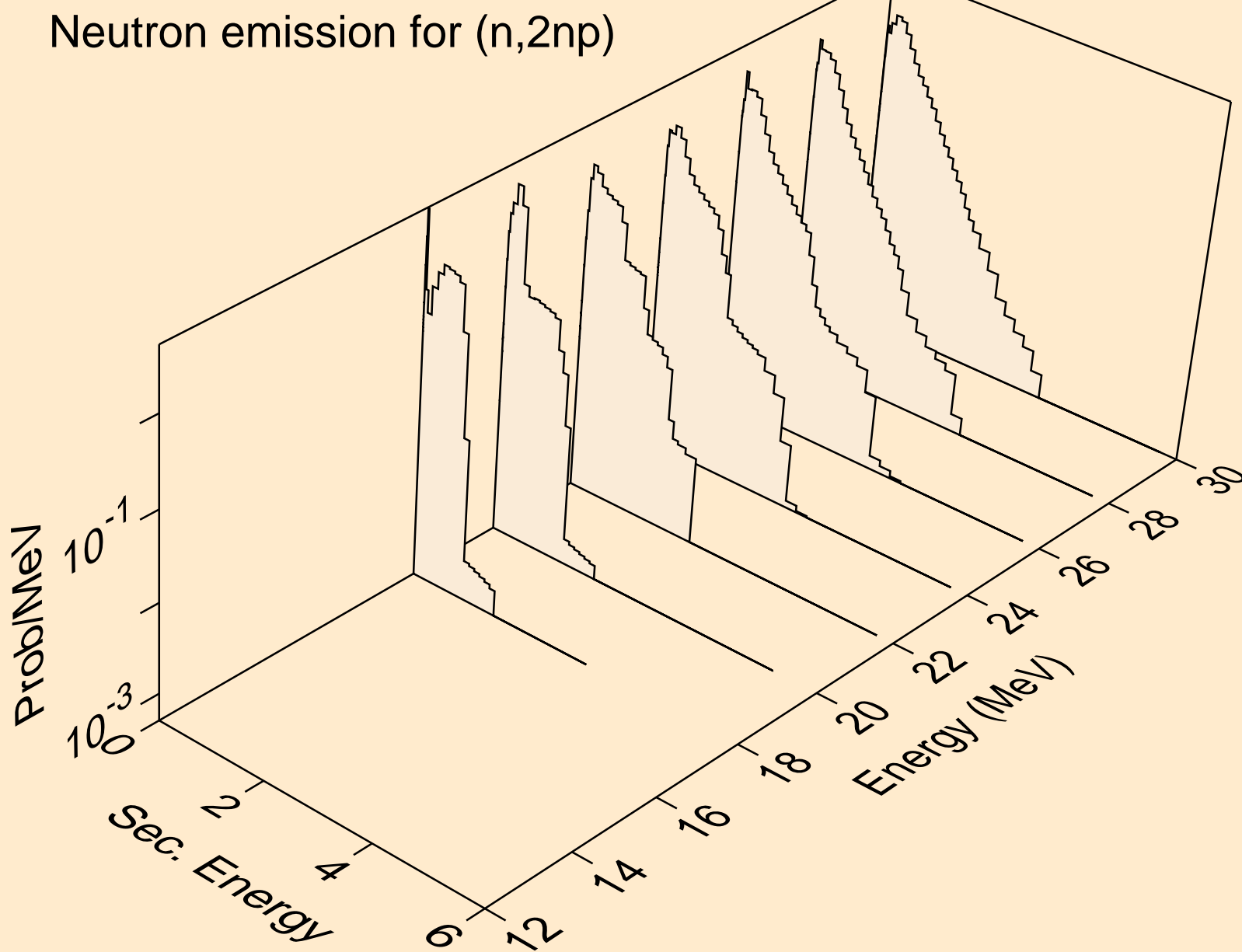

TB156 NEUTRON ACER TENDL-2019 LIBRARY; T=293.16K  
Neutron emission for (n,npa)

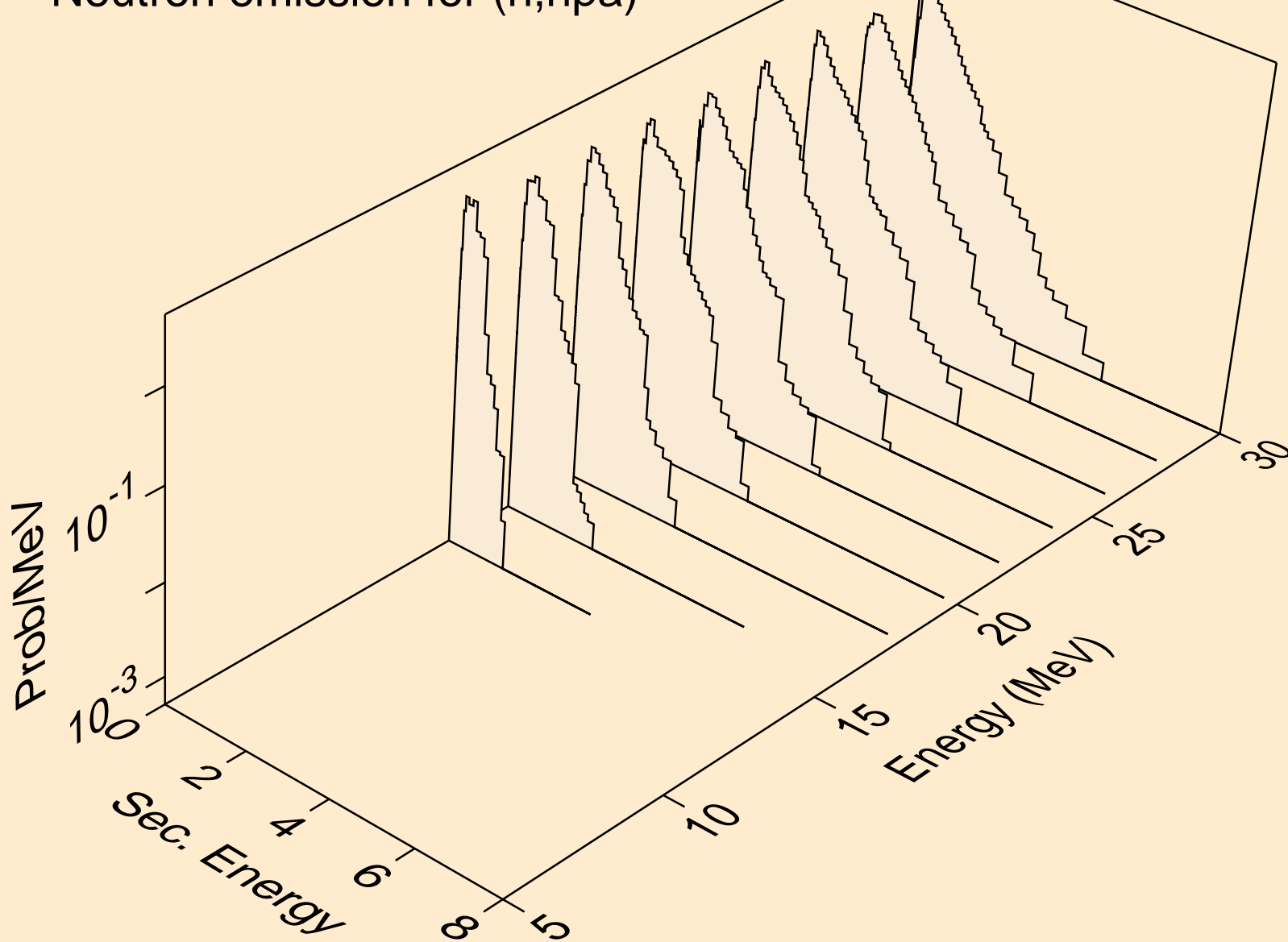

TB156 NEUTRON ACER TENDL-2019 LIBRARY; T=293.16K  
Neutron emission for (n,n\*c)

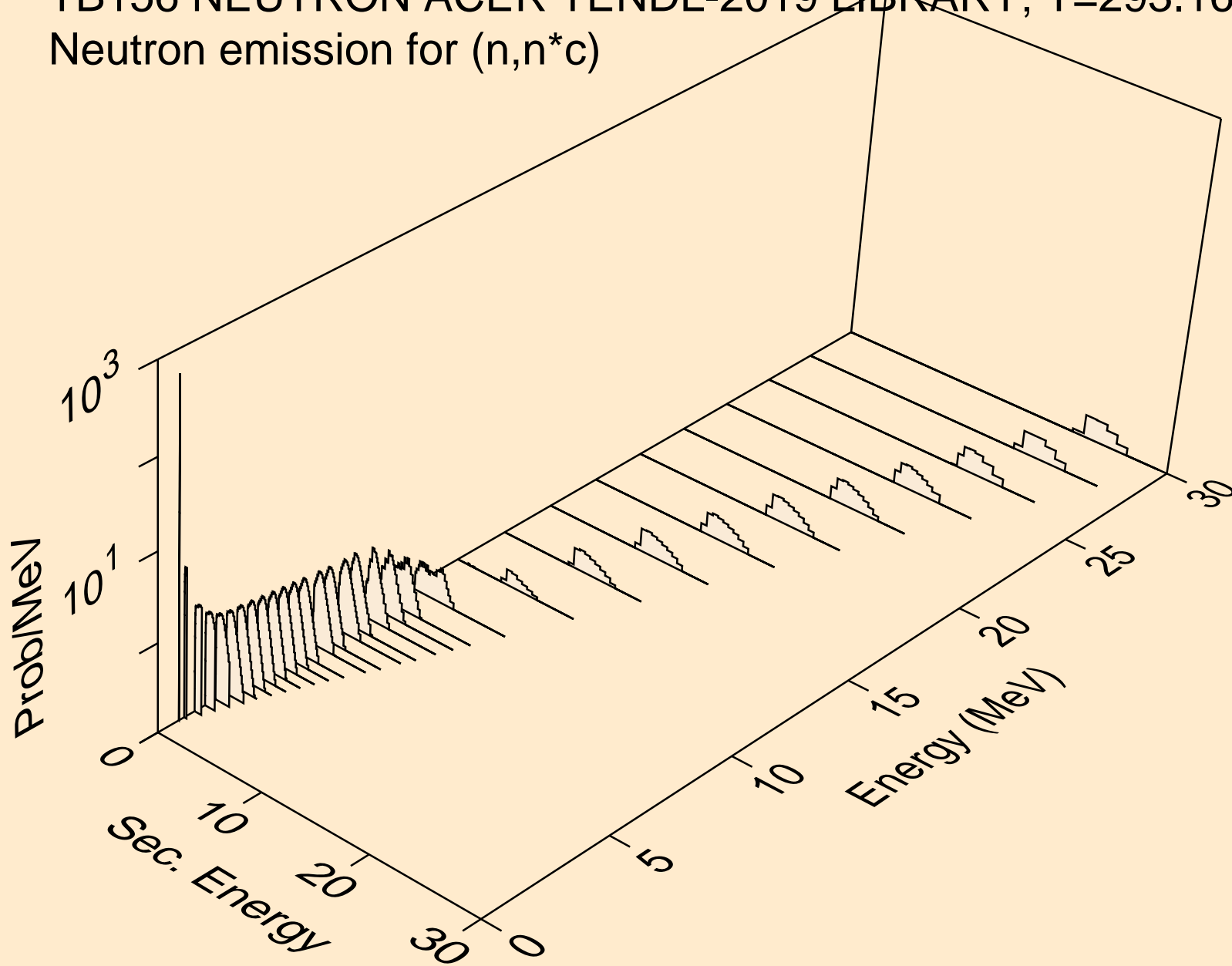



TB156 NEUTRON ACER TENDL-2019 LIBRARY; T=293.16K  
Photon emission for (n,x)

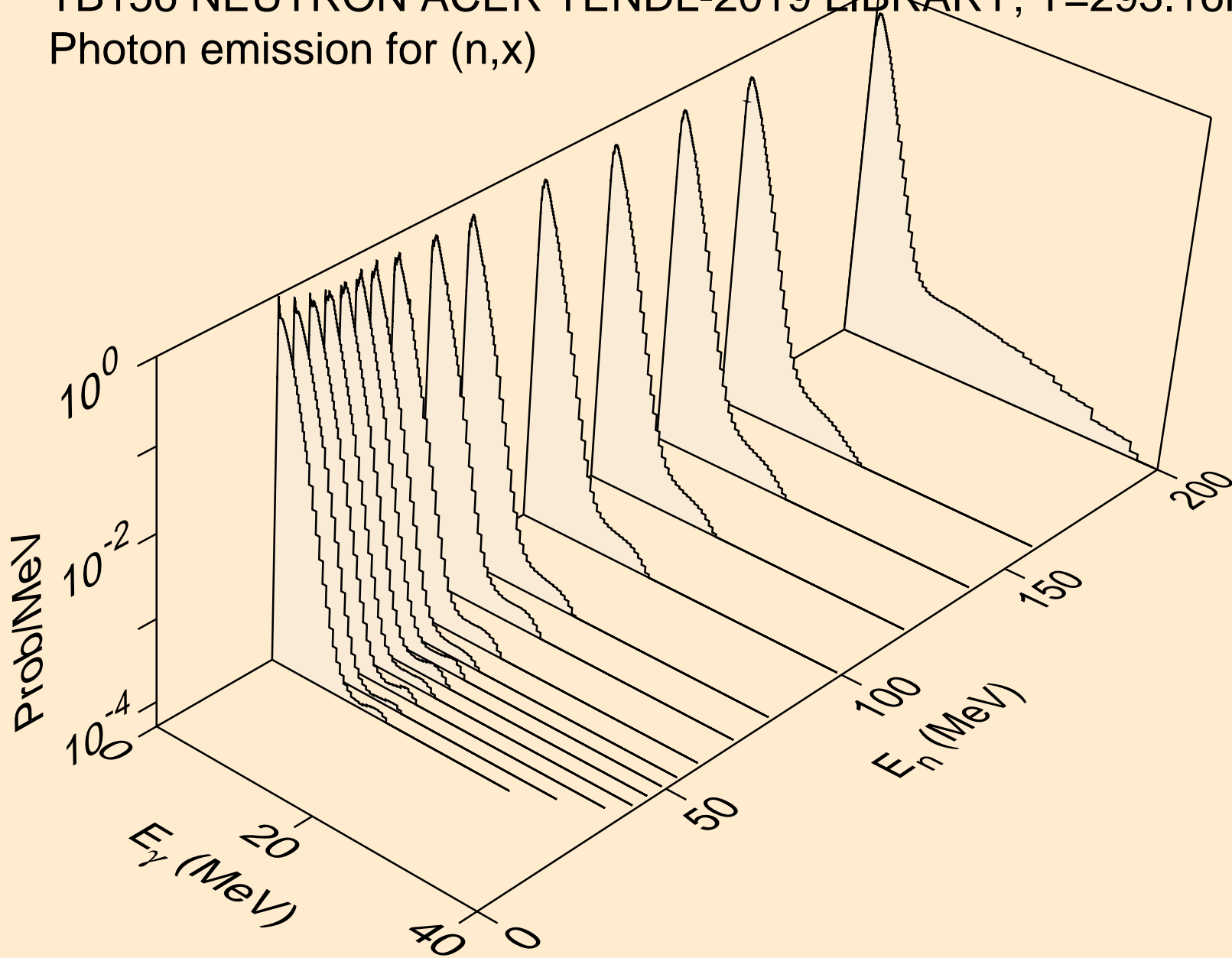

TB156 NEUTRON ACER TENDL-2019 LIBRARY; T=293.16K  
Photon emission for (n,2nd)

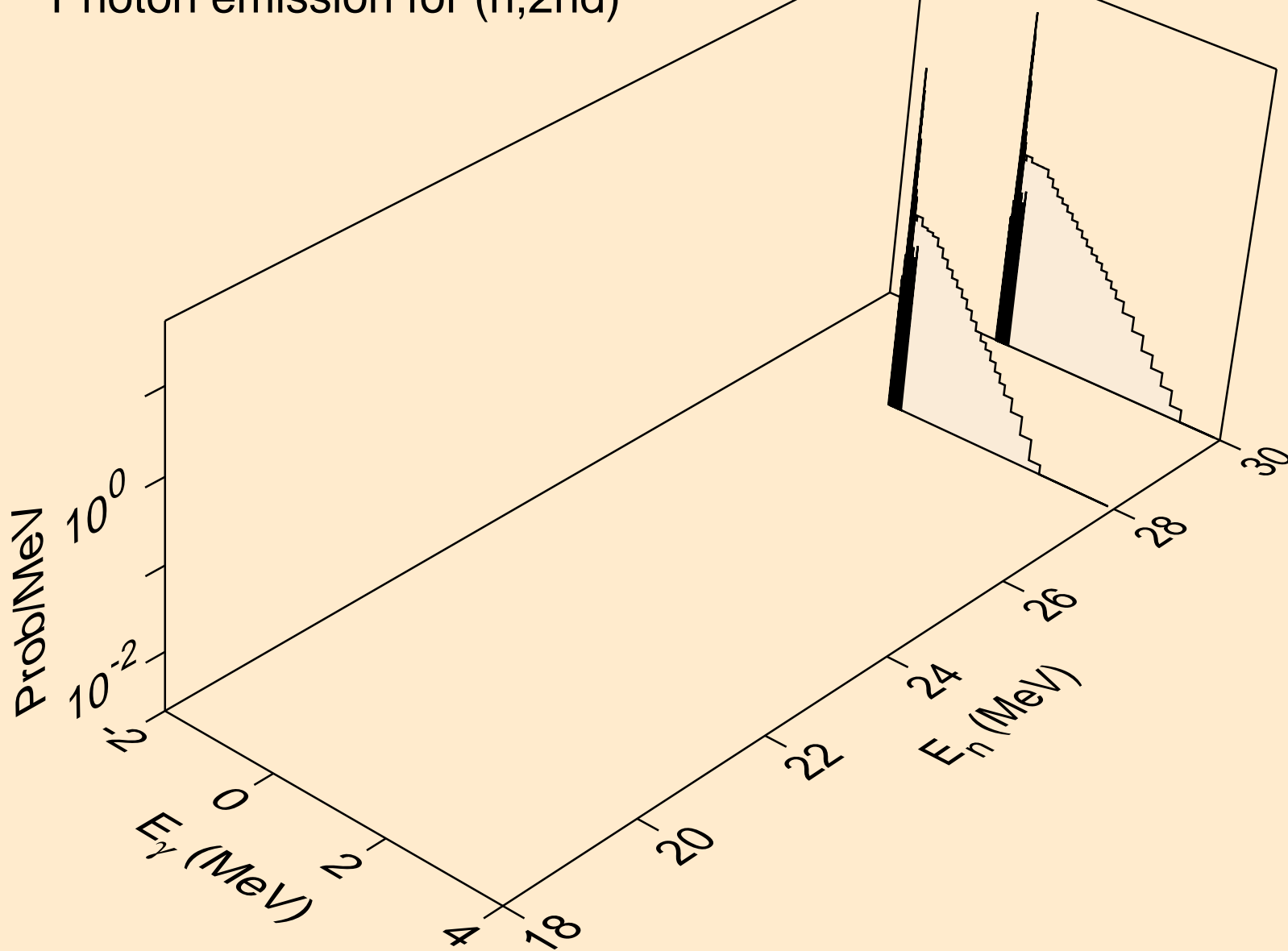

TB156 NEUTRON ACER TENDL-2019 LIBRARY; T=293.16K  
Photon emission for (n,2n)

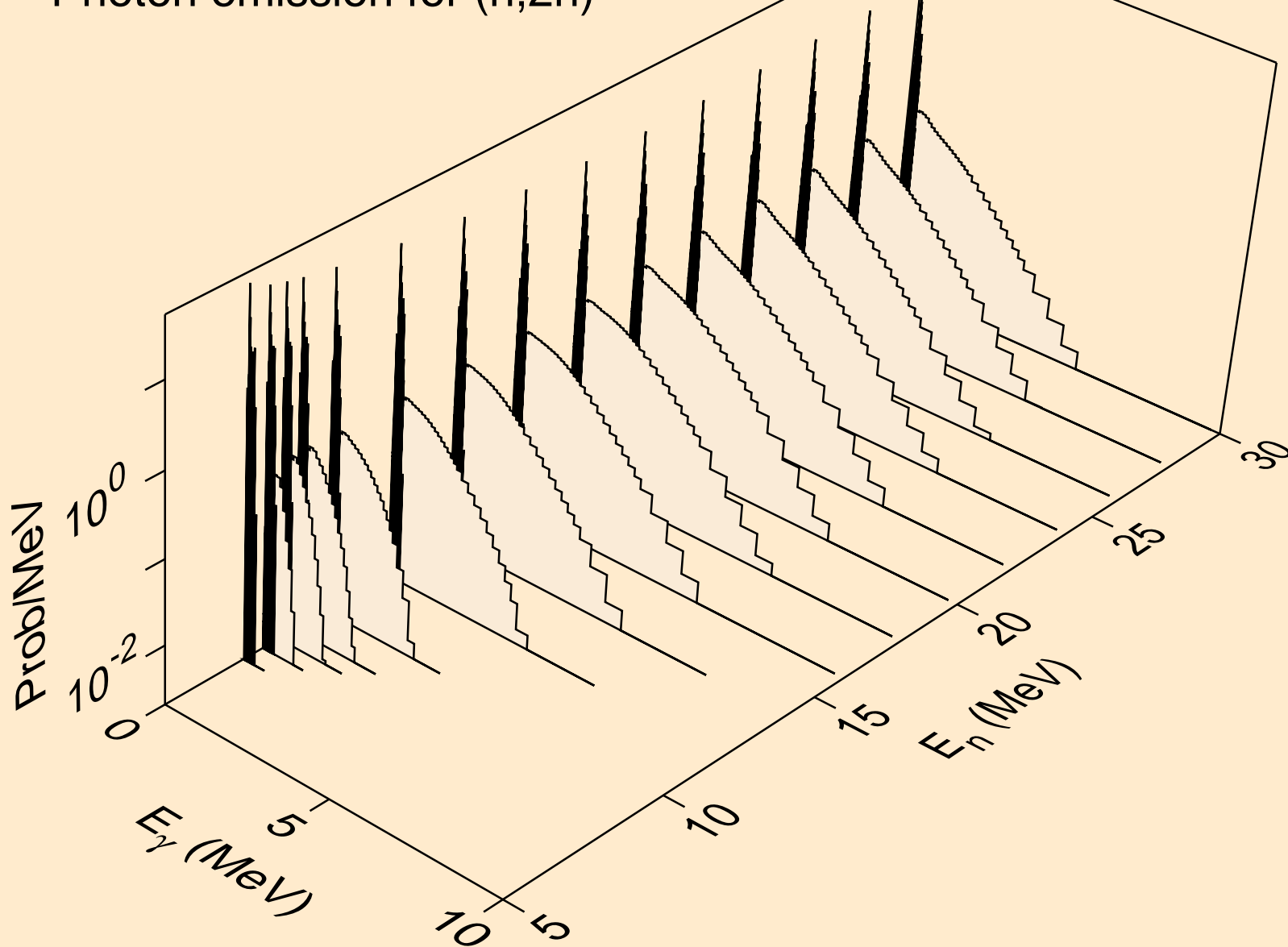

TB156 NEUTRON ACER TENDL-2019 LIBRARY; T=293.16K  
Photon emission for (n,3n)

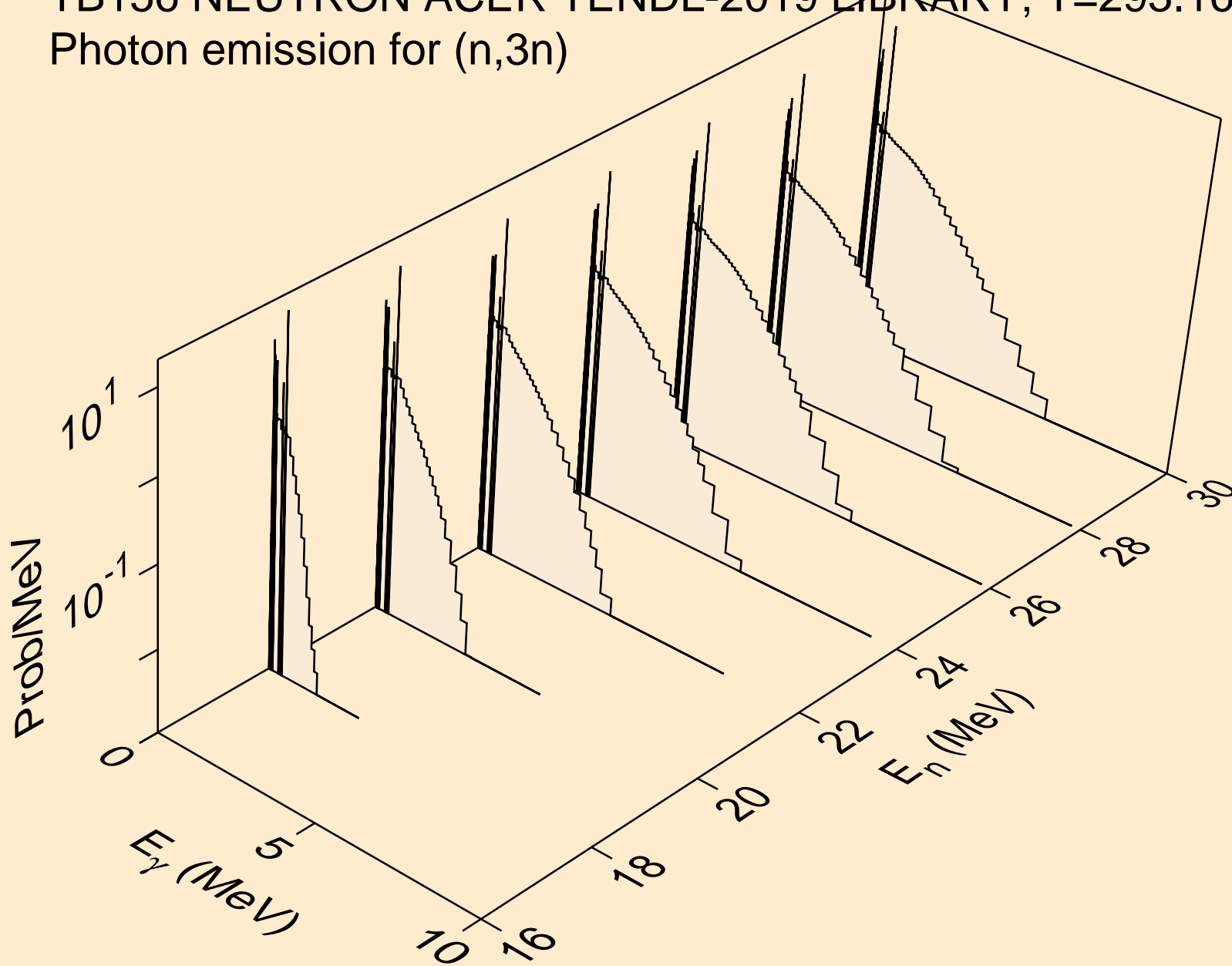

TB156 NEUTRON ACER TENDL-2019 LIBRARY; T=293.16K  
Photon emission for (n,n\*)a

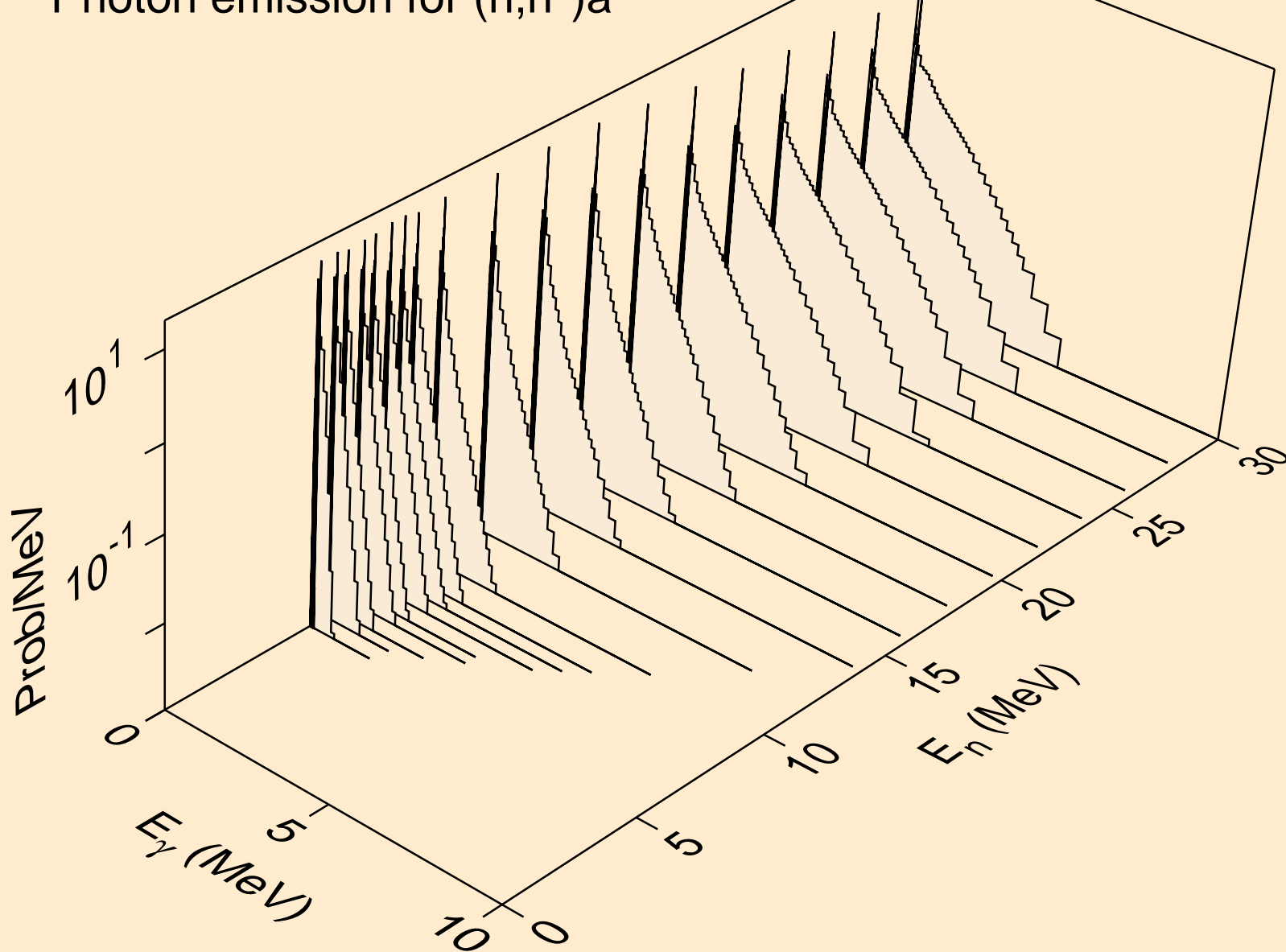

TB156 NEUTRON ACER TENDL-2019 LIBRARY; T=293.16K  
Photon emission for (n,2n)a

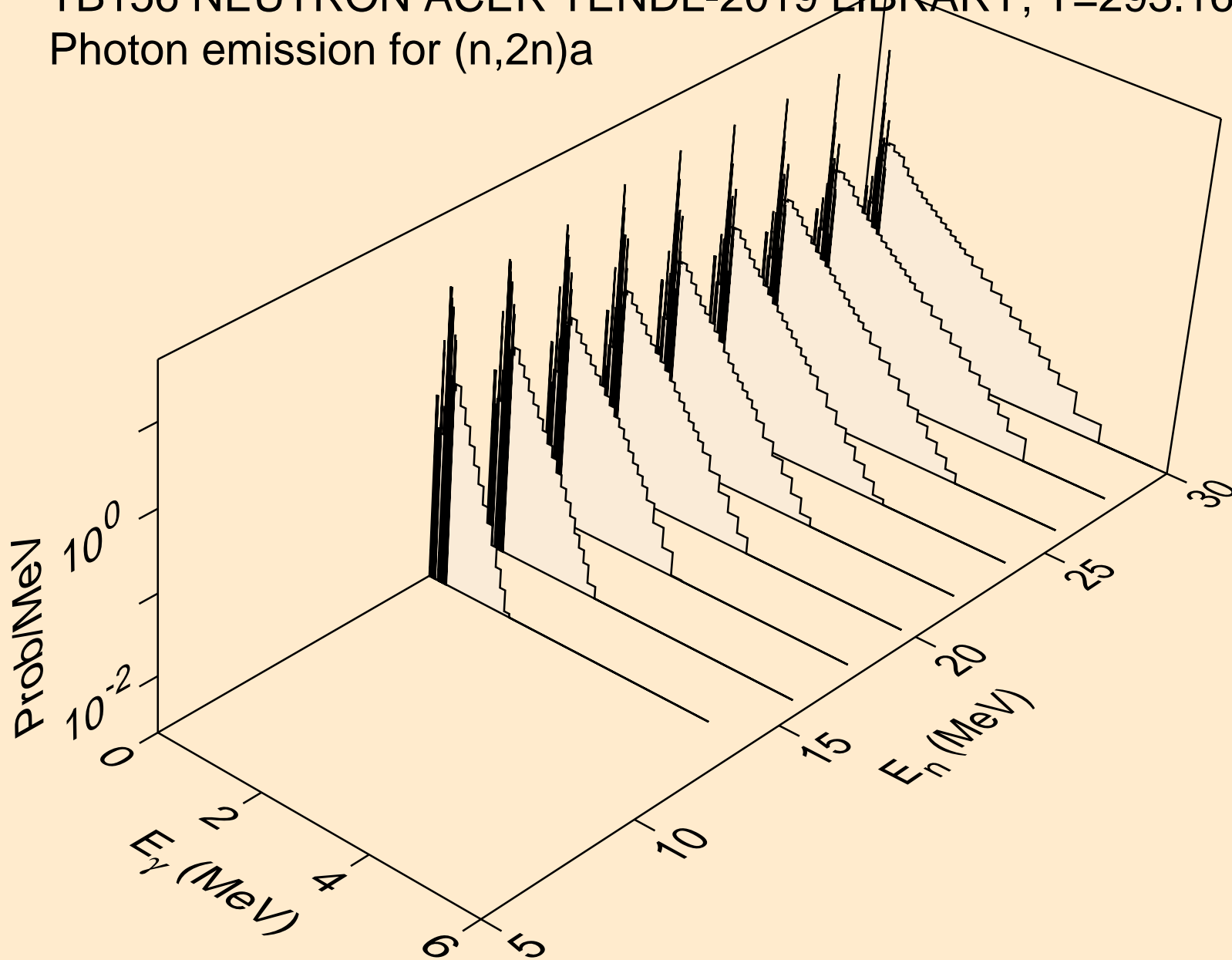

TB156 NEUTRON ACER TENDL-2019 LIBRARY; T=293.16K  
Photon emission for (n,3n)a

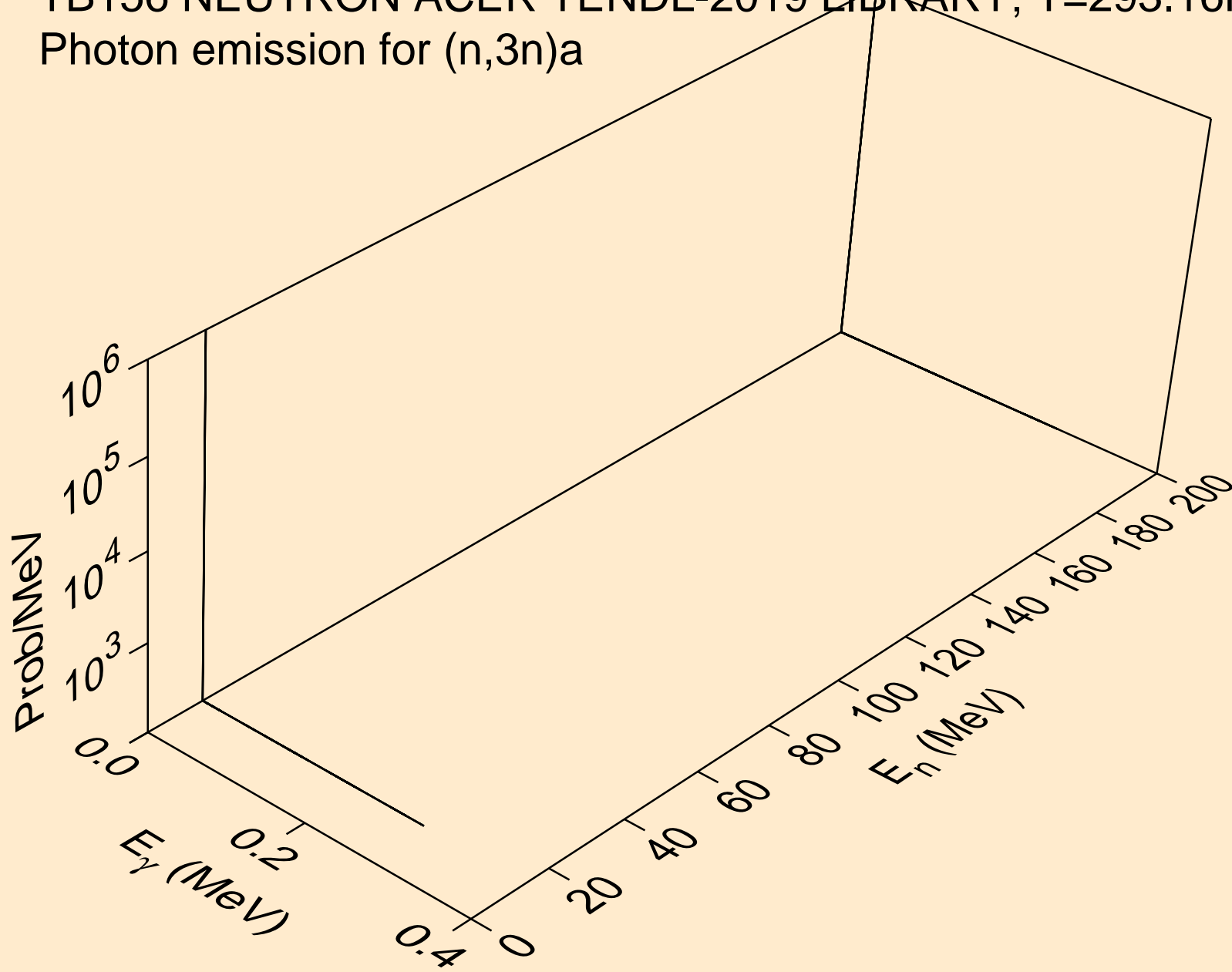

TB156 NEUTRON ACER TENDL-2019 LIBRARY; T=293.16K  
Photon emission for (n,n\*)p

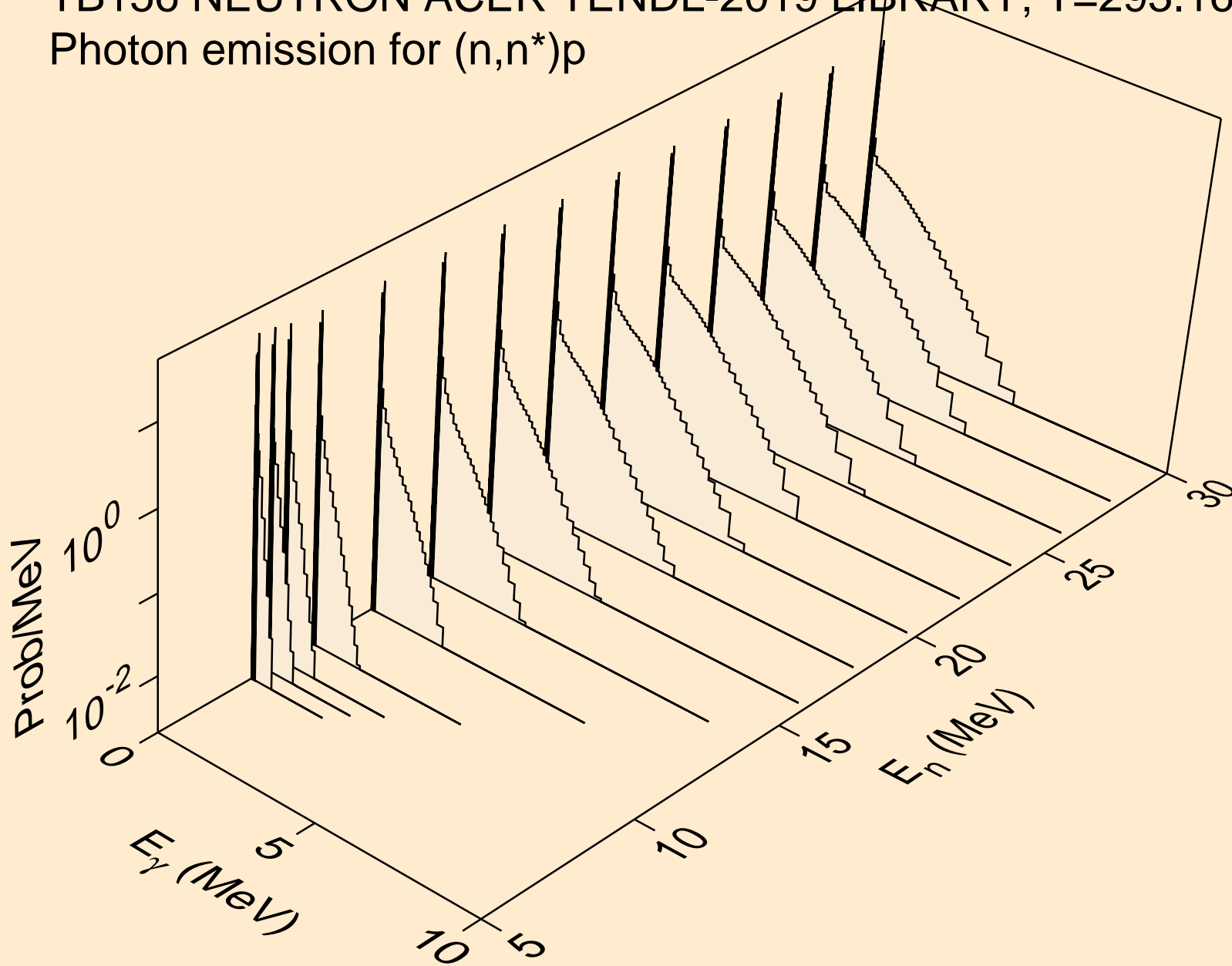



TB156 NEUTRON ACER TENDL-2019 LIBRARY; T=293.16K  
Photon emission for (n,n\*)2a

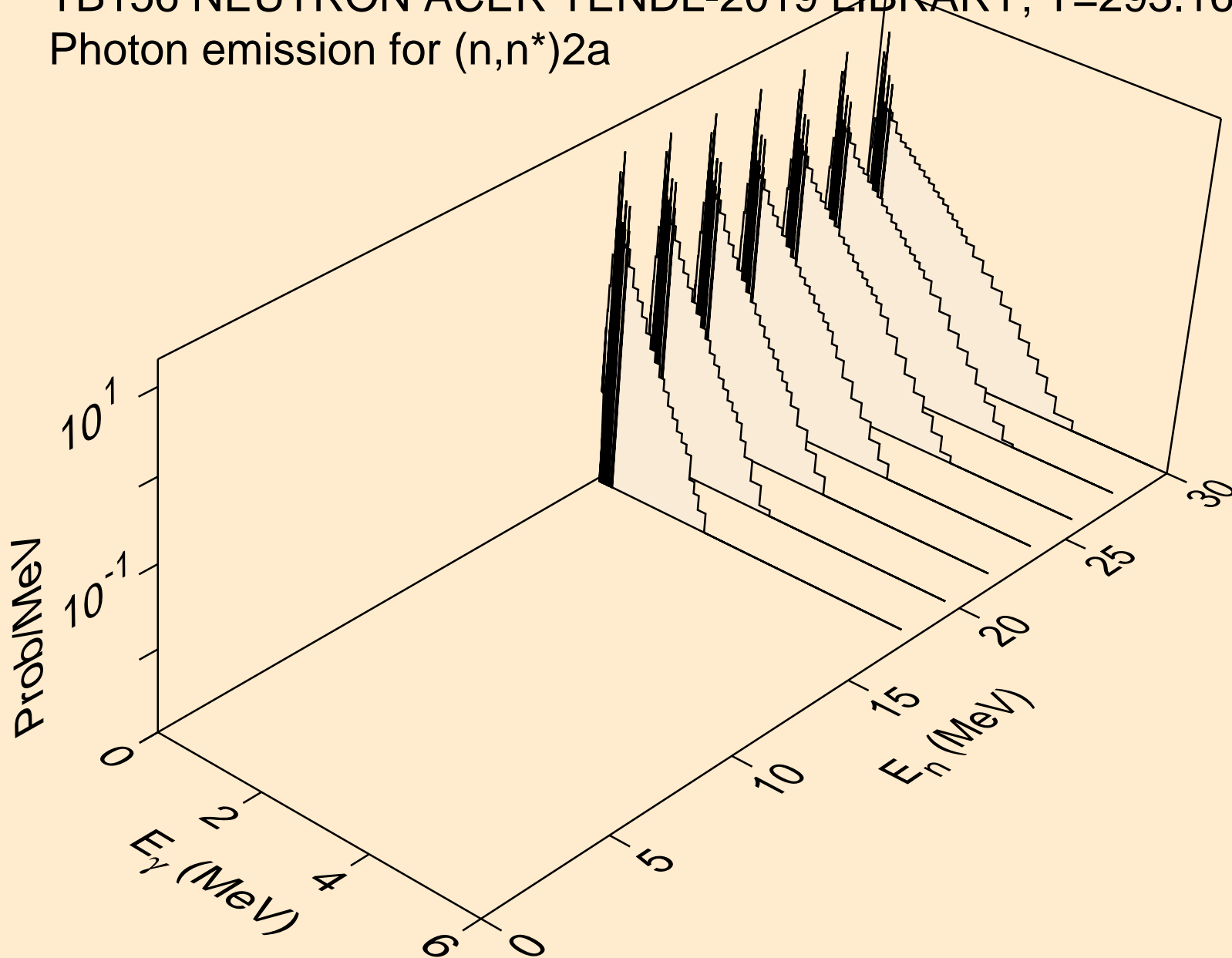

TB156 NEUTRON ACER TENDL-2019 LIBRARY; T=293.16K  
Photon emission for (n,2n)2a

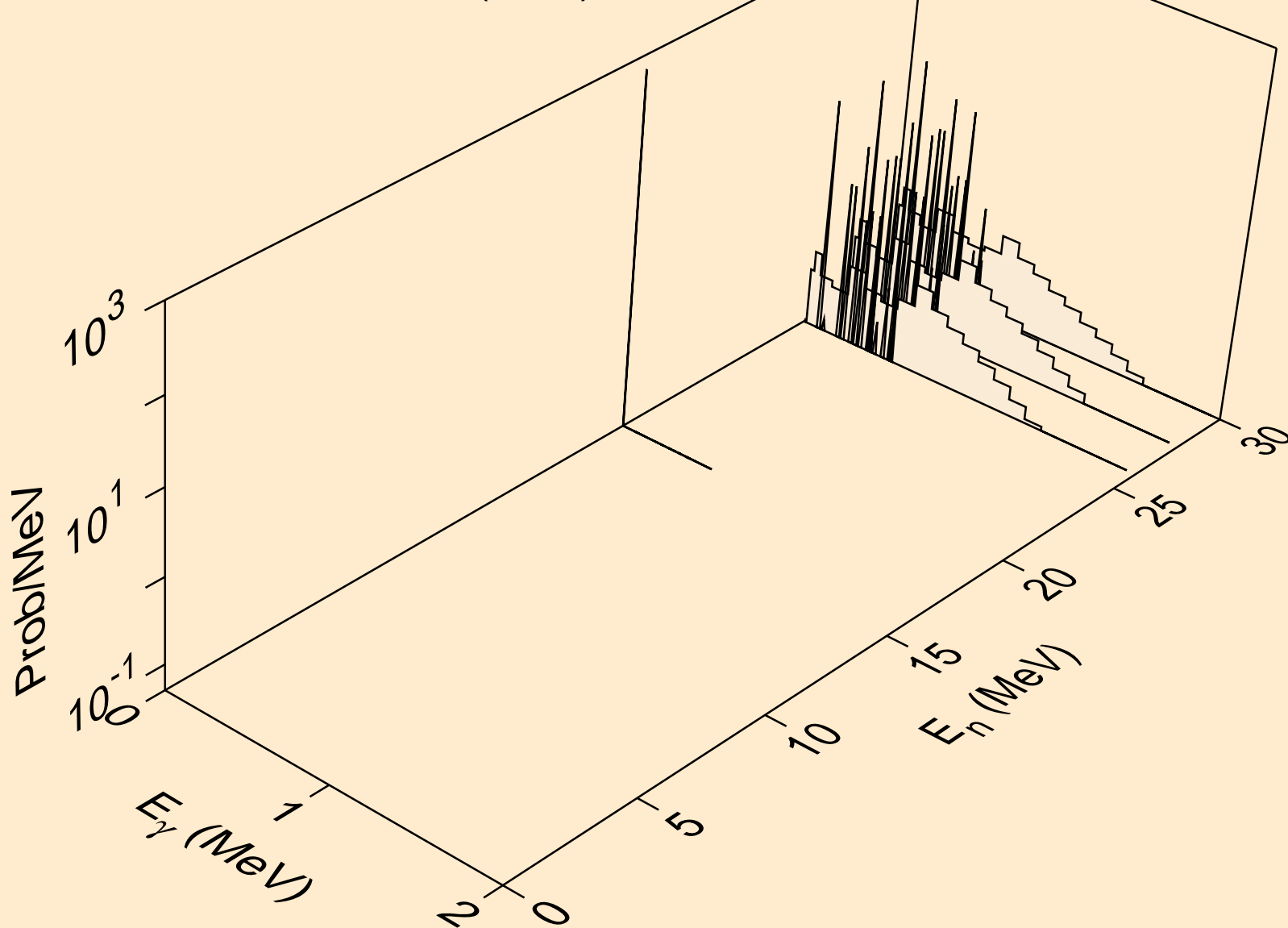

TB156 NEUTRON ACER TENDL-2019 LIBRARY; T=293.16K  
Photon emission for (n,n\*)d

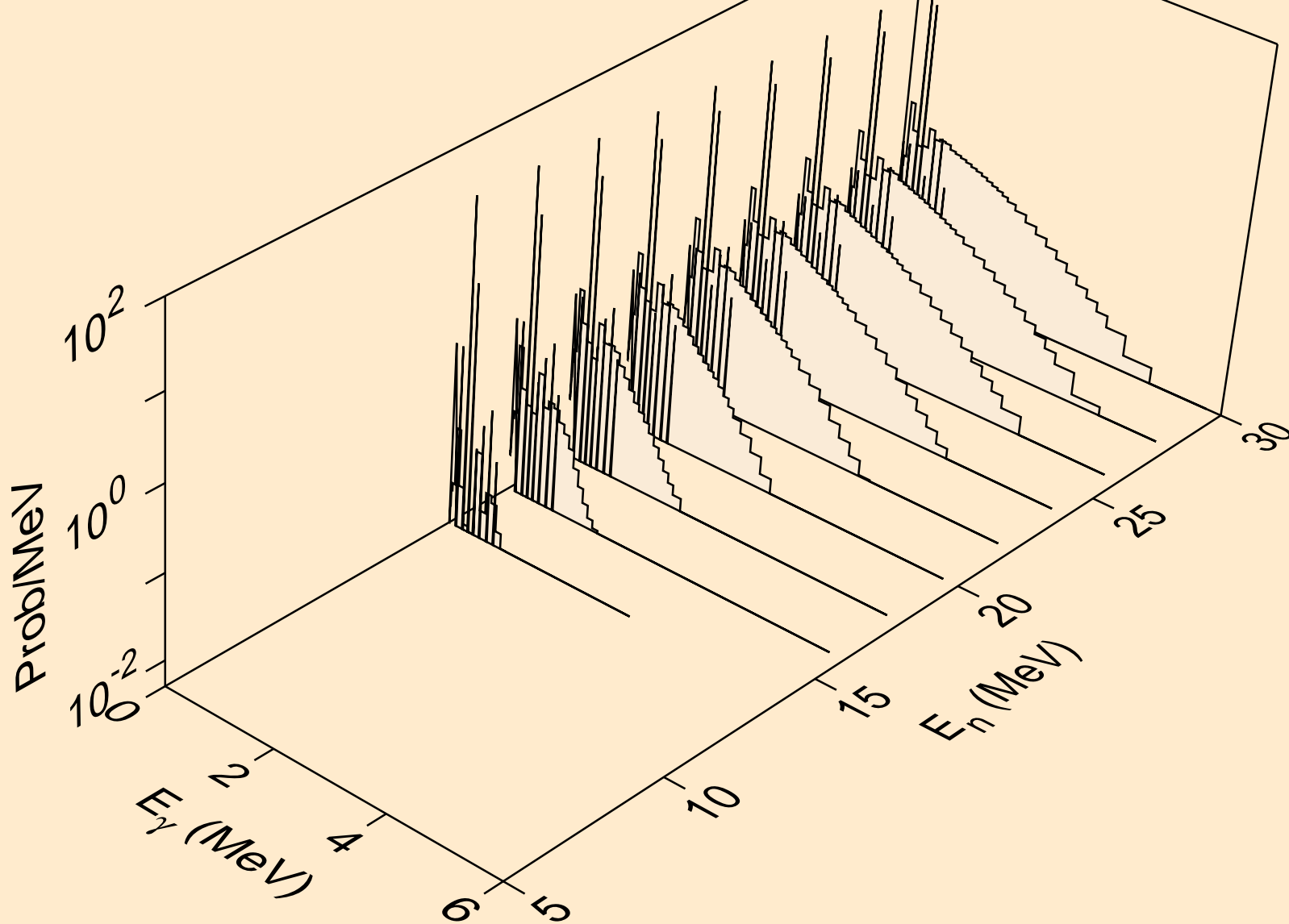

TB156 NEUTRON ACER TENDL-2019 LIBRARY; T=293.16K  
Photon emission for (n,n\*)t

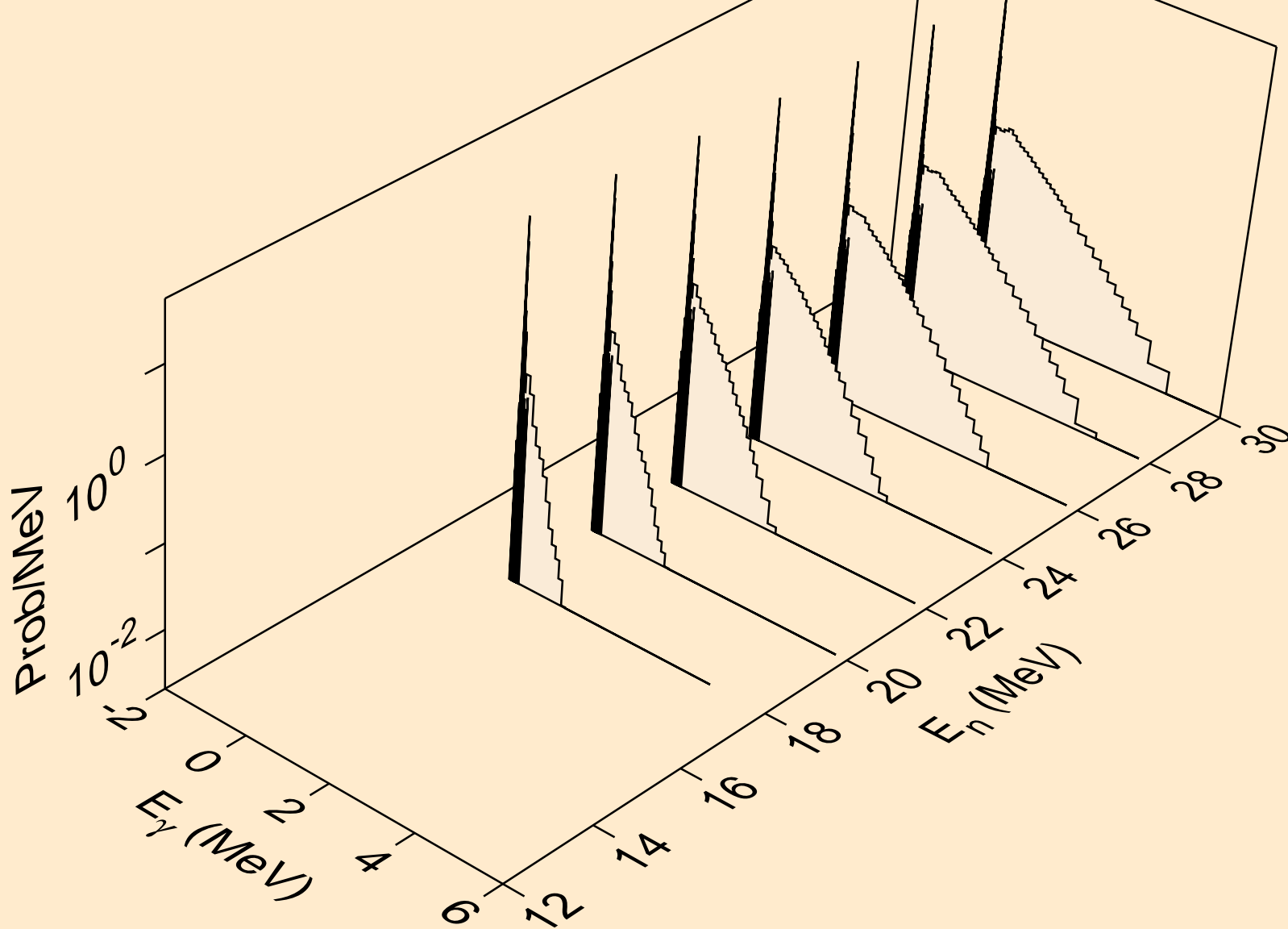

TB156 NEUTRON ACER TENDL-2019 LIBRARY; T=293.16K  
Photon emission for (n,n\*)he3

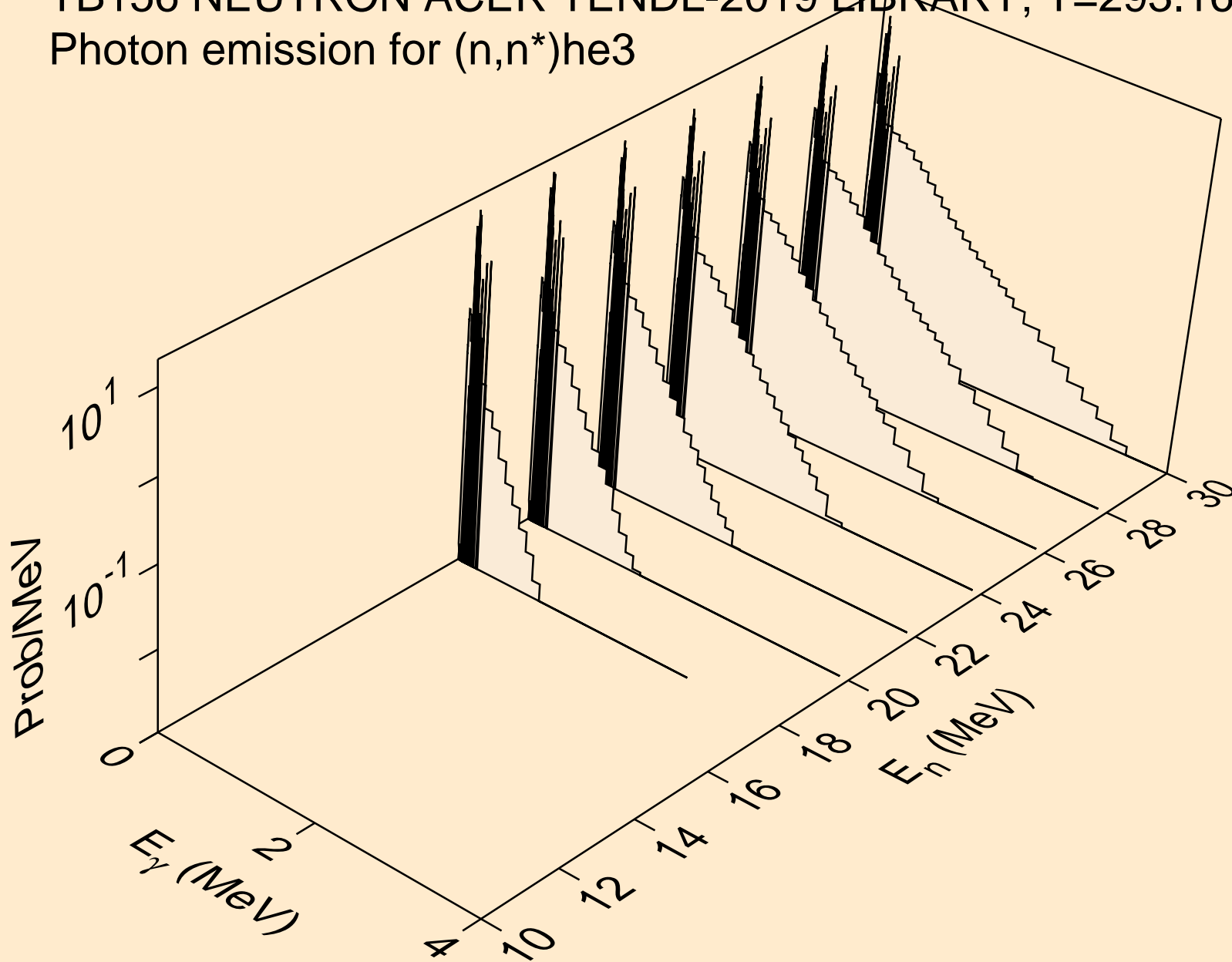

TB156 NEUTRON ACER TENDL-2019 LIBRARY; T=293.16K  
Photon emission for (n,4n)

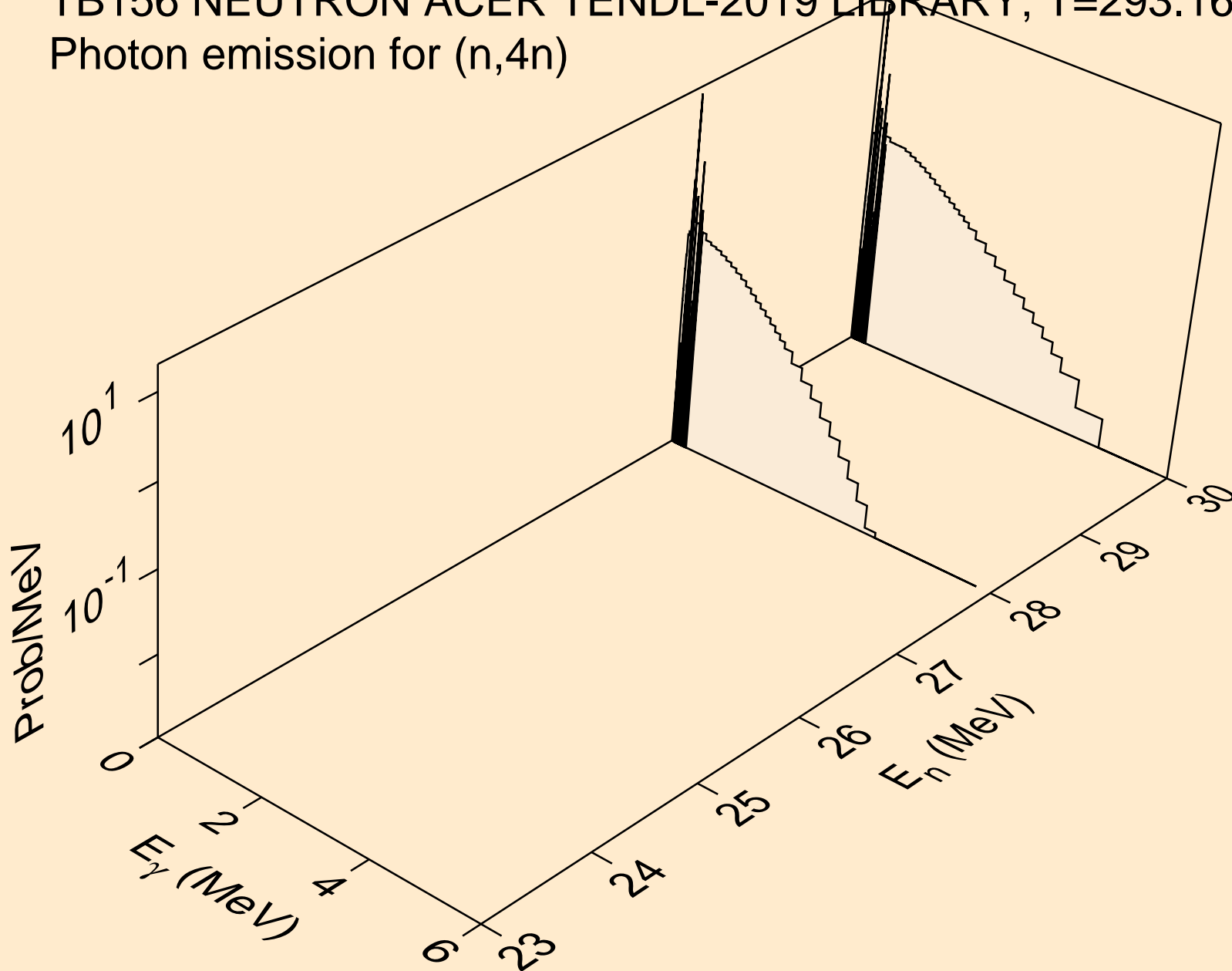

TB156 NEUTRON ACER TENDL-2019 LIBRARY; T=293.16K  
Photon emission for (n,2np)

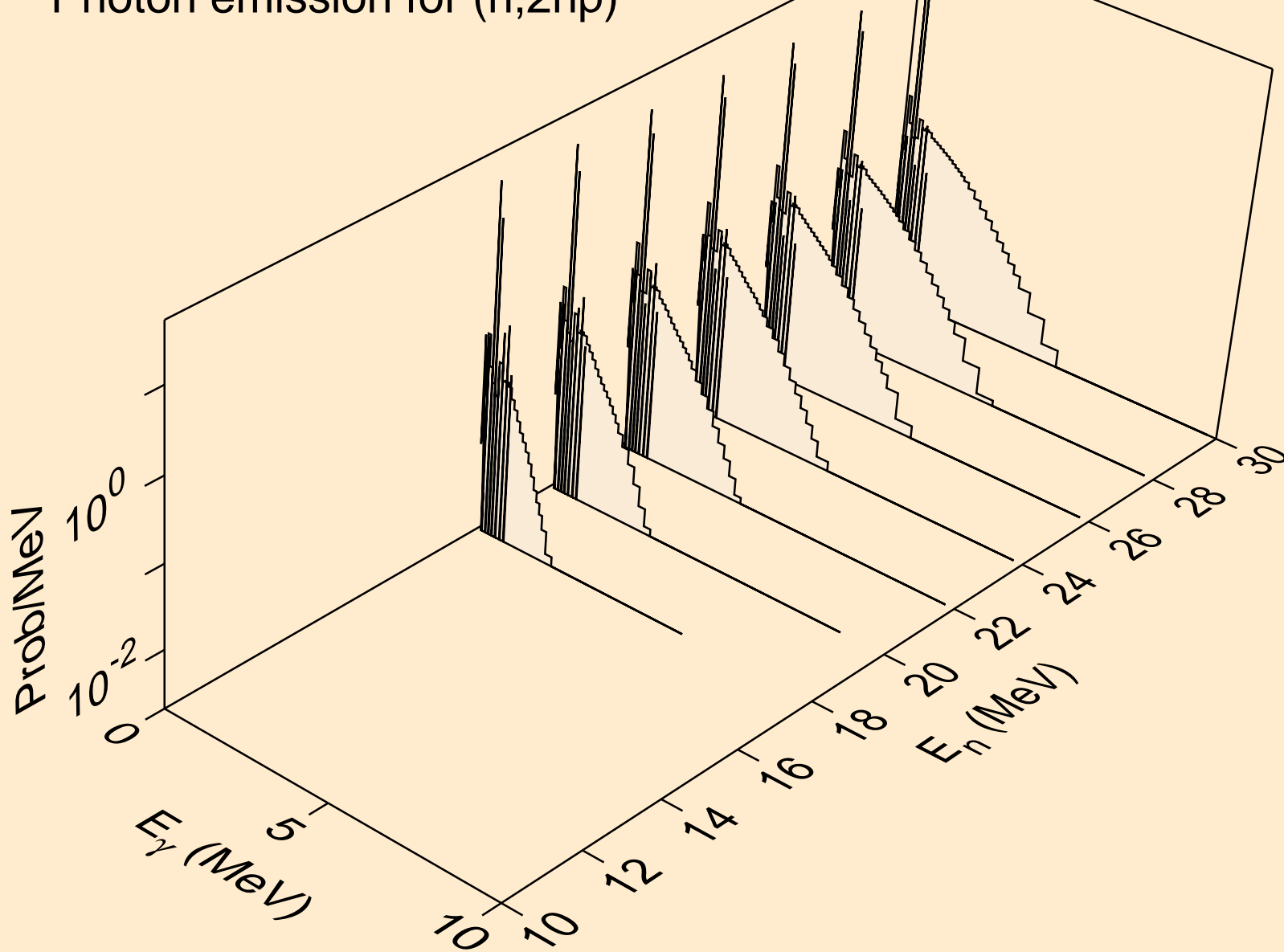

TB156 NEUTRON ACER TENDL-2019 LIBRARY; T=293.16K  
Photon emission for (n,3np)

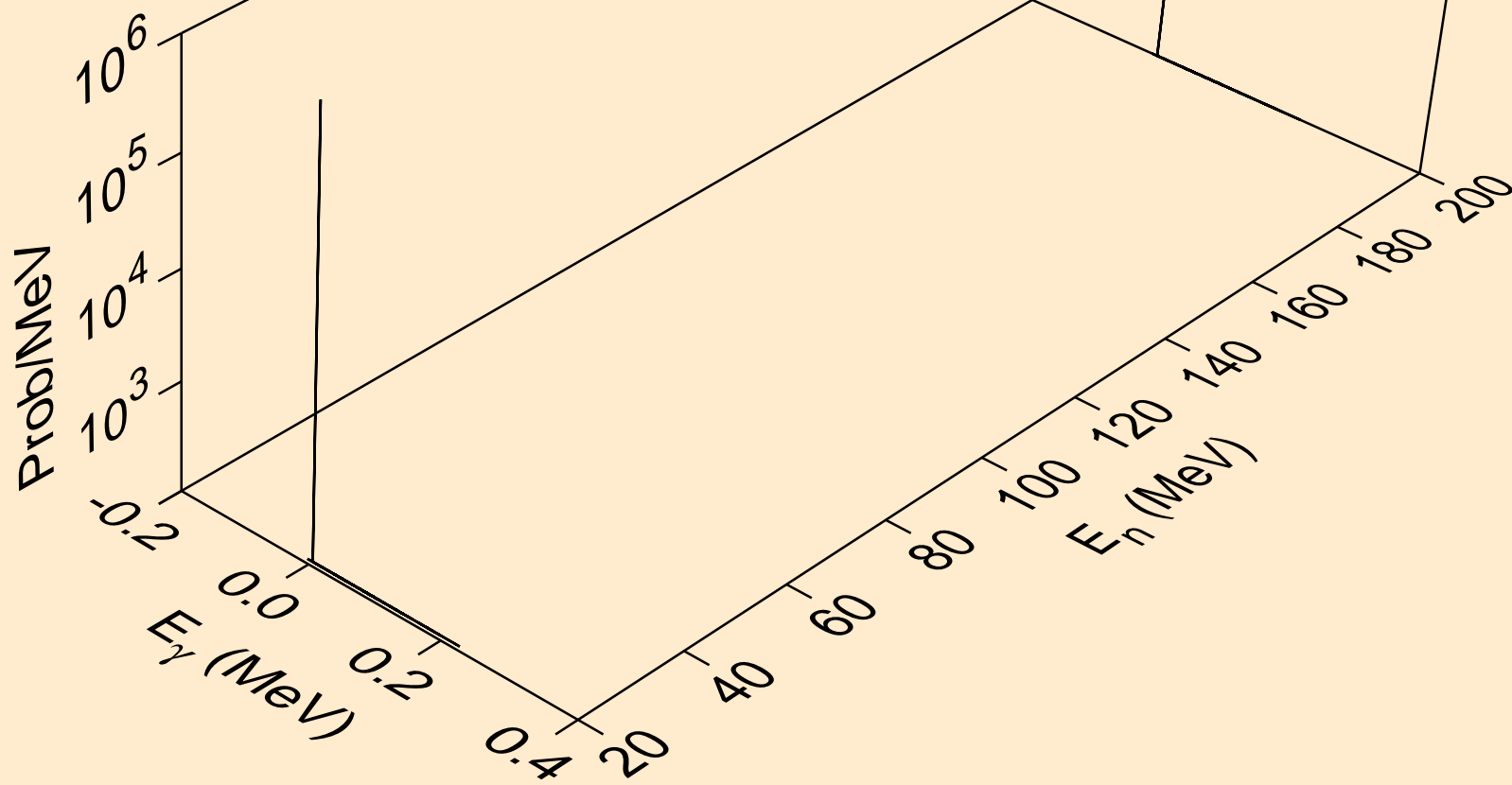



TB156 NEUTRON ACER TENDL-2019 LIBRARY; T=293.16K  
Photon emission for (n,2np)

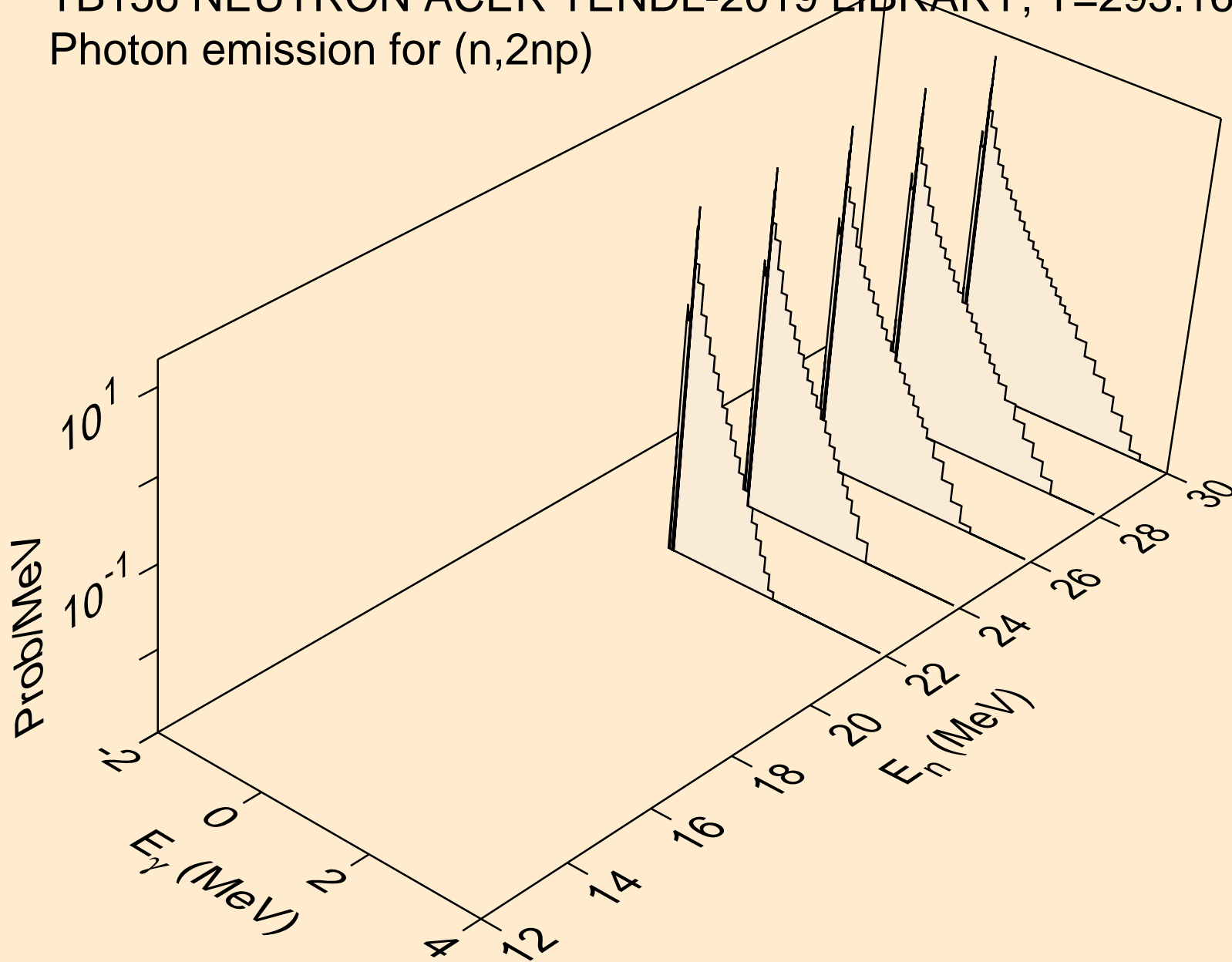

TB156 NEUTRON ACER TENDL-2019 LIBRARY; T=293.16K  
Photon emission for (n,npa)

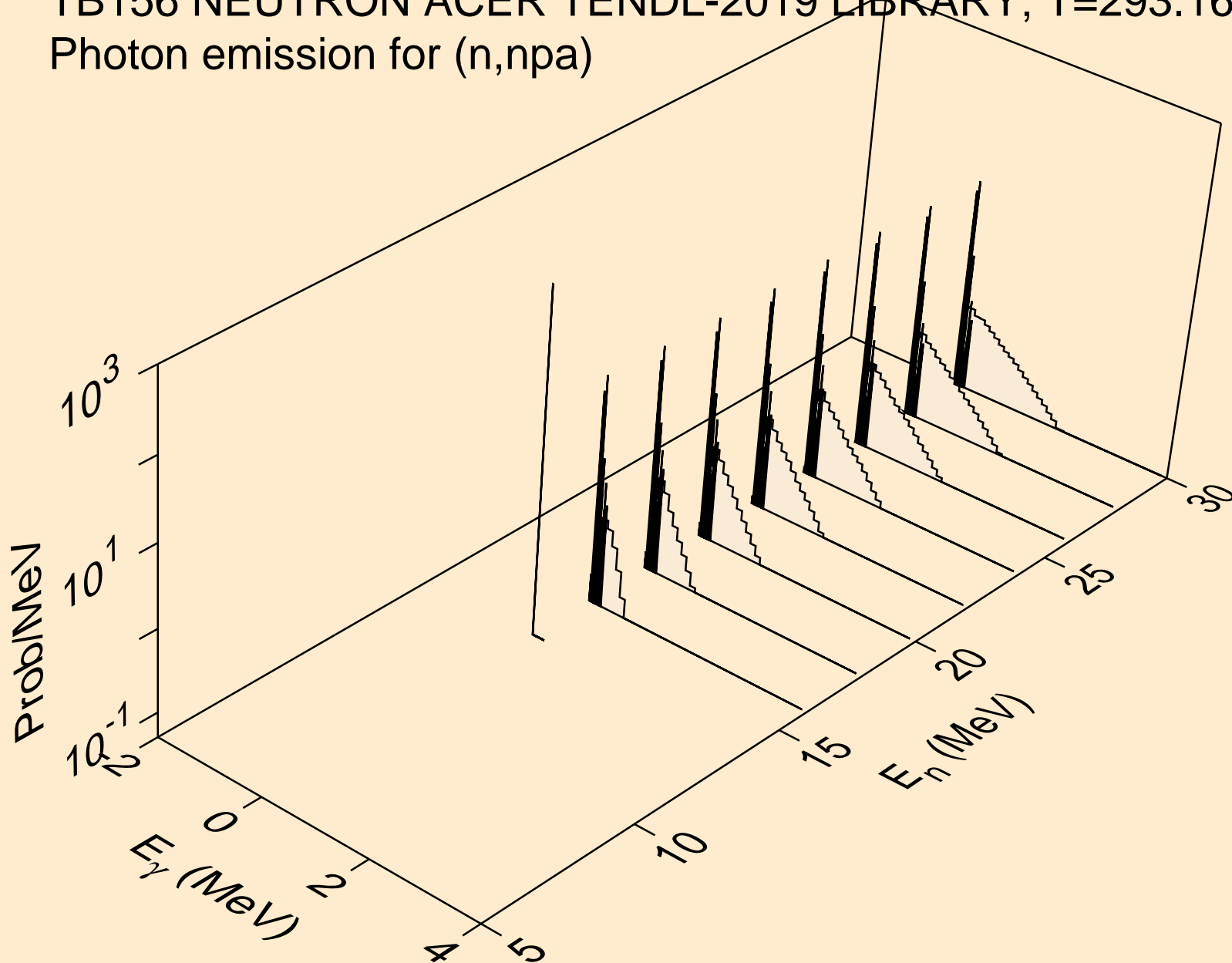

TB156 NEUTRON ACER TENDL-2019 LIBRARY; T=293.16K  
Photon emission for (n,n\*c)

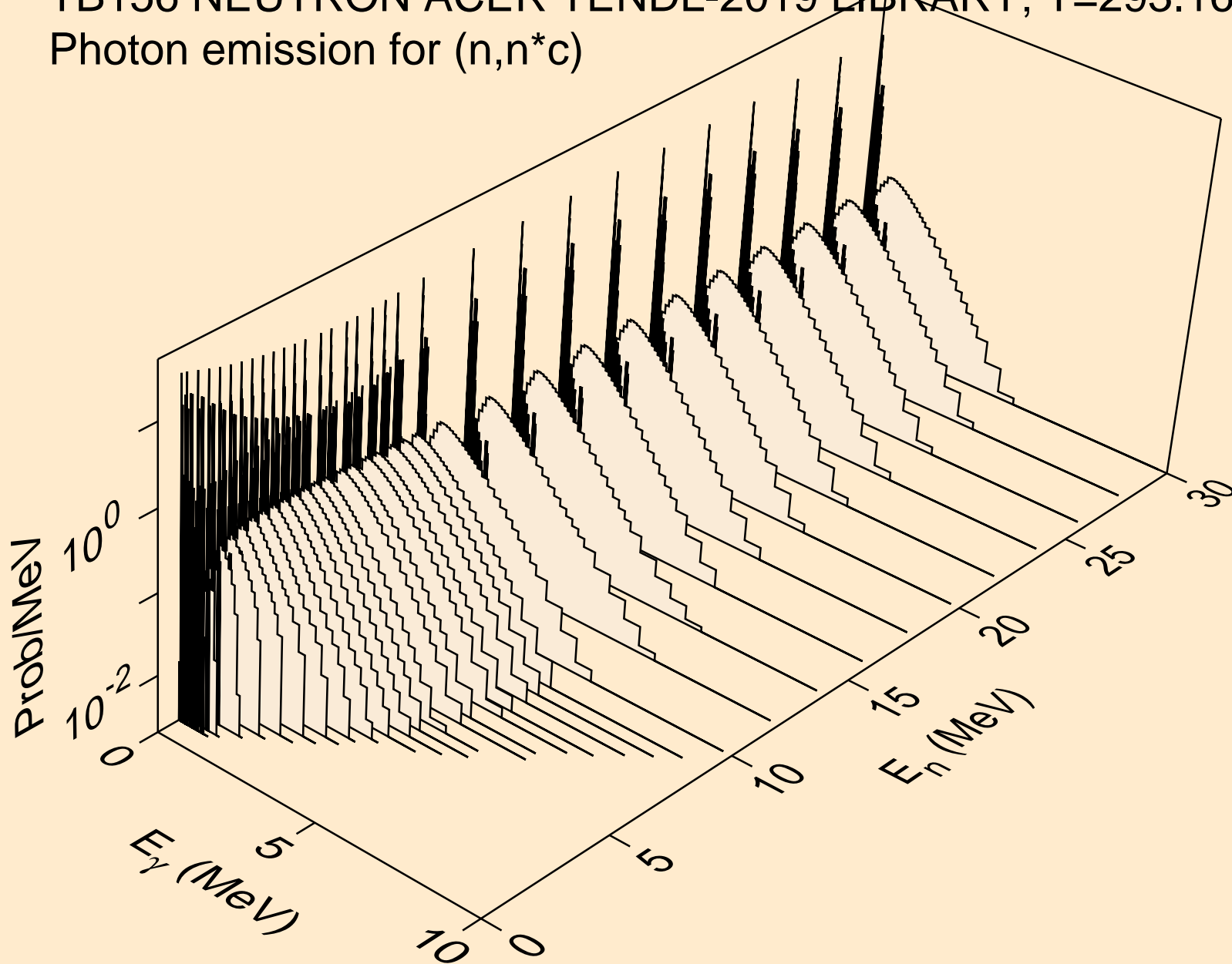

TB156 NEUTRON ACER TENDL-2019 LIBRARY; T=293.16K  
Photon emission for (n,gma)

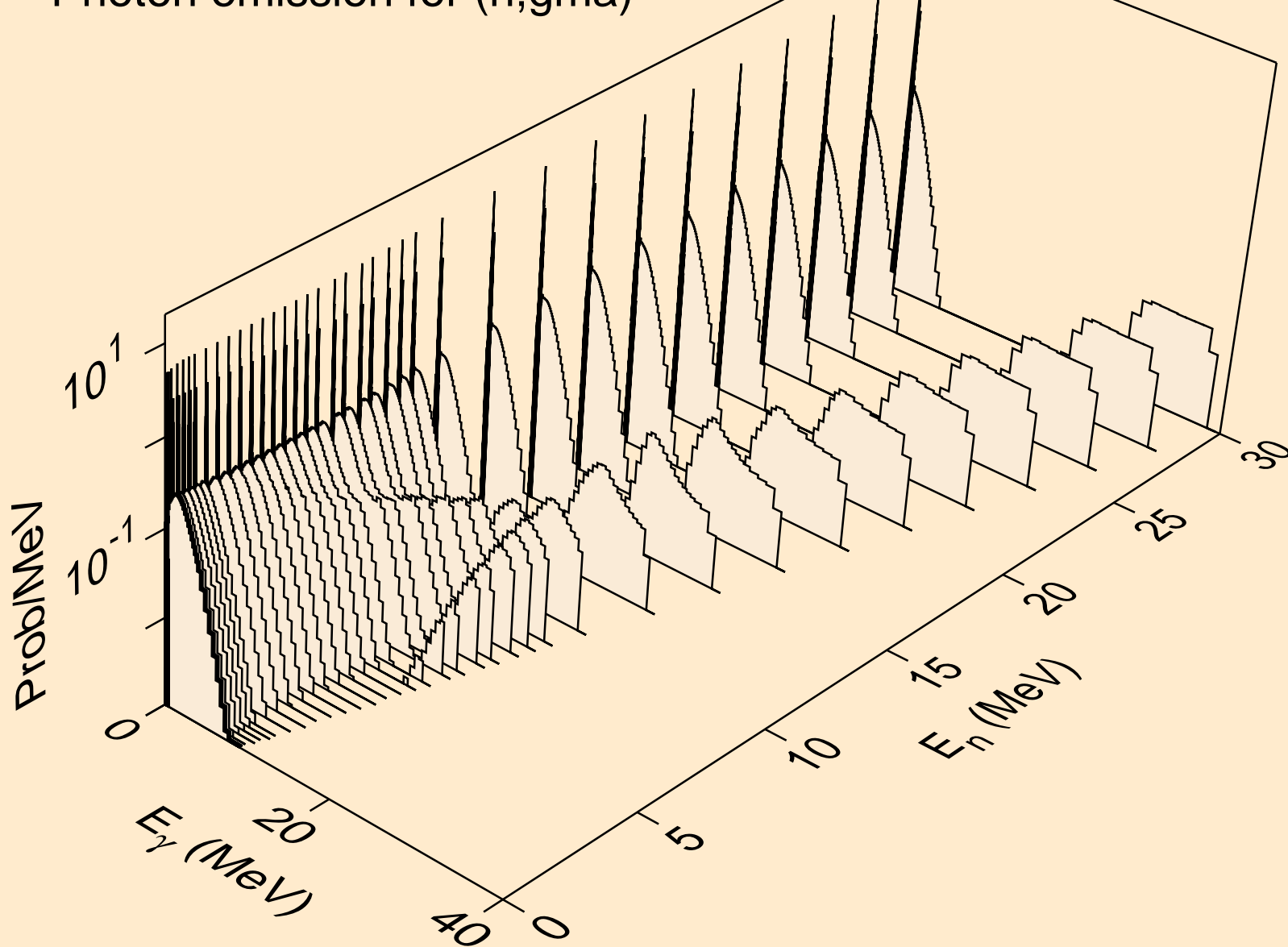

TB156 NEUTRON ACER TENDL-2019 LIBRARY; T=293.16K  
Photon emission for (n,p)

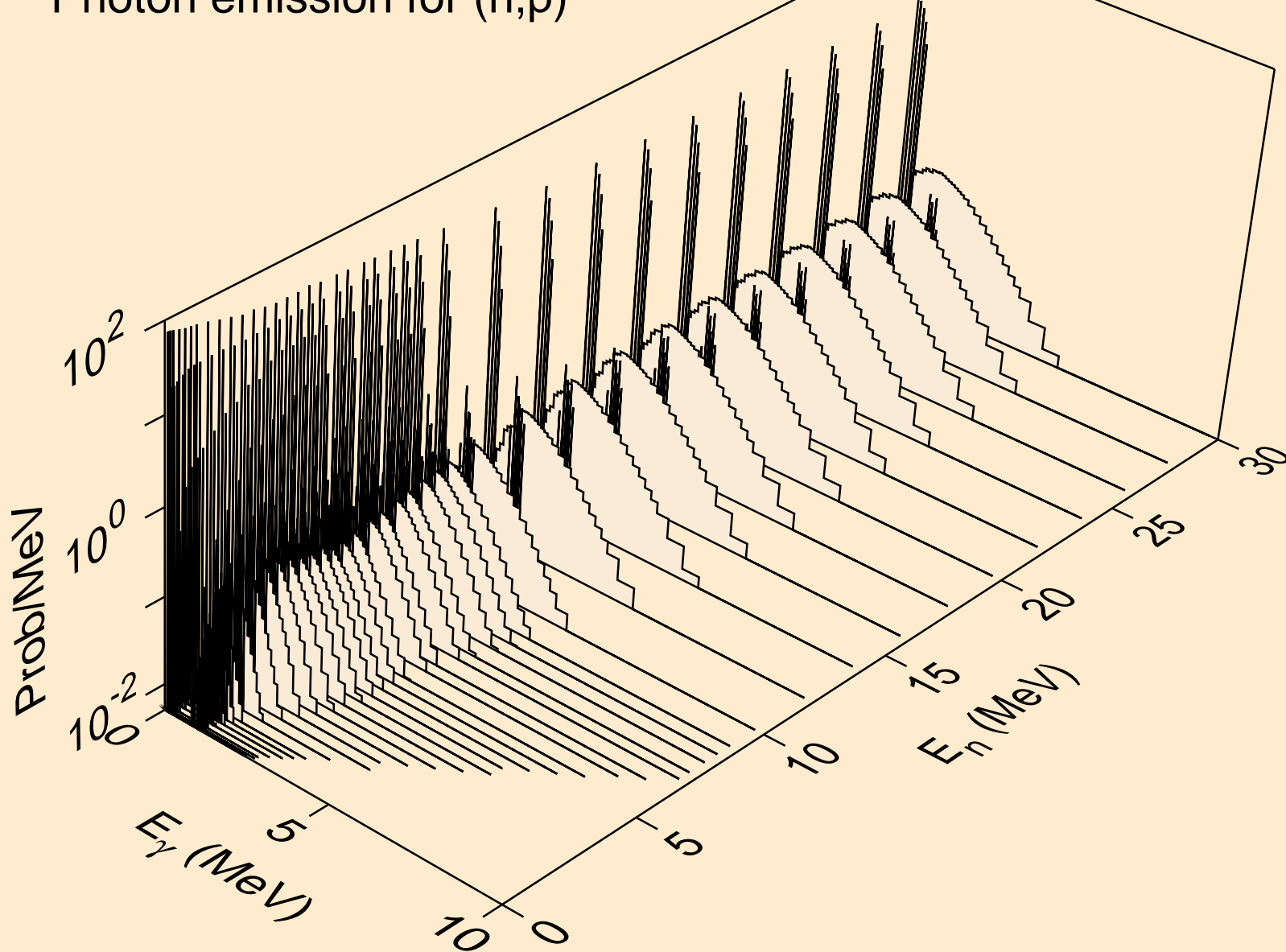

TB156 NEUTRON ACER TENDL-2019 LIBRARY; T=293.16K  
Photon emission for (n,d)

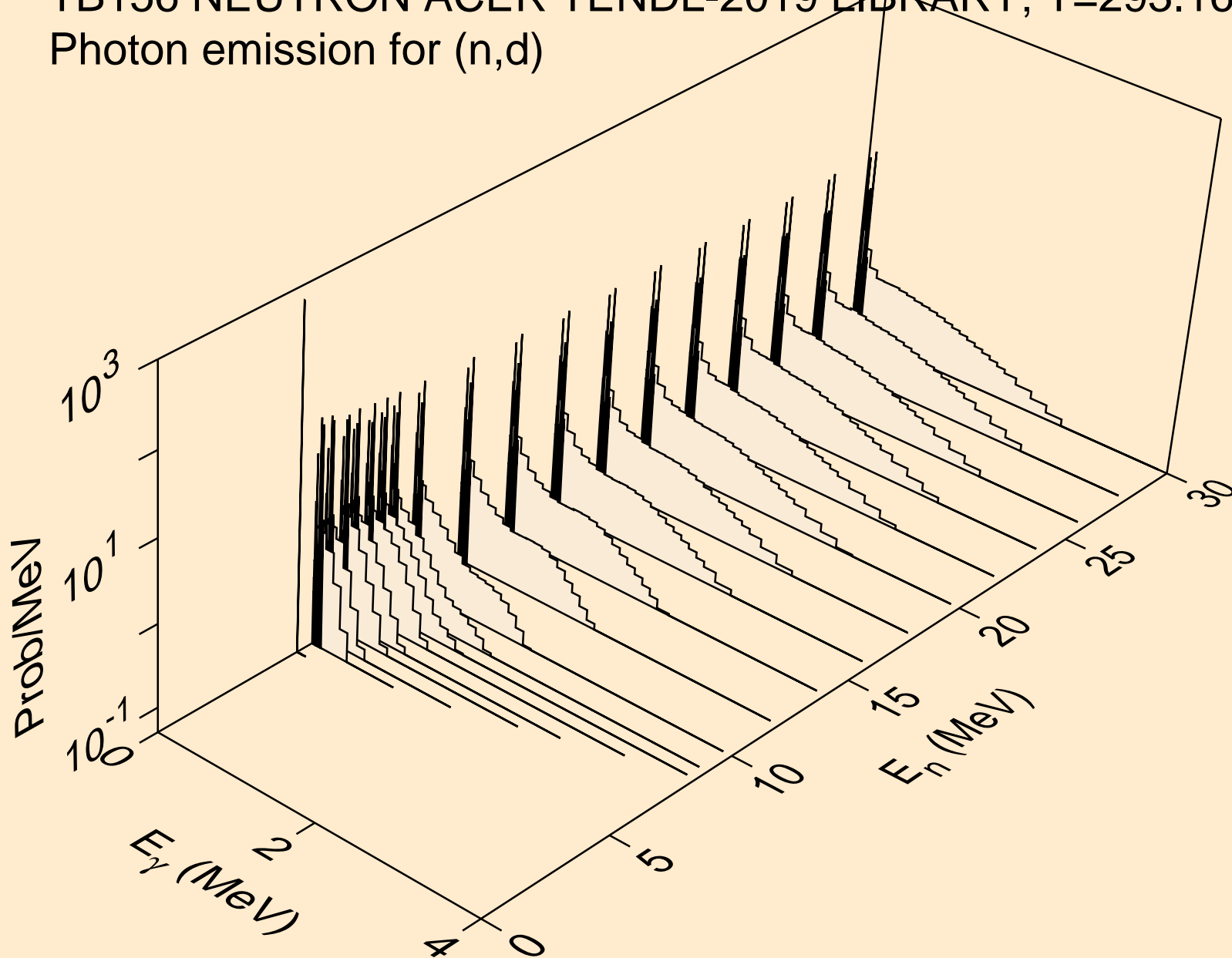

TB156 NEUTRON ACER TENDL-2019 LIBRARY; T=293.16K  
Photon emission for (n,t)

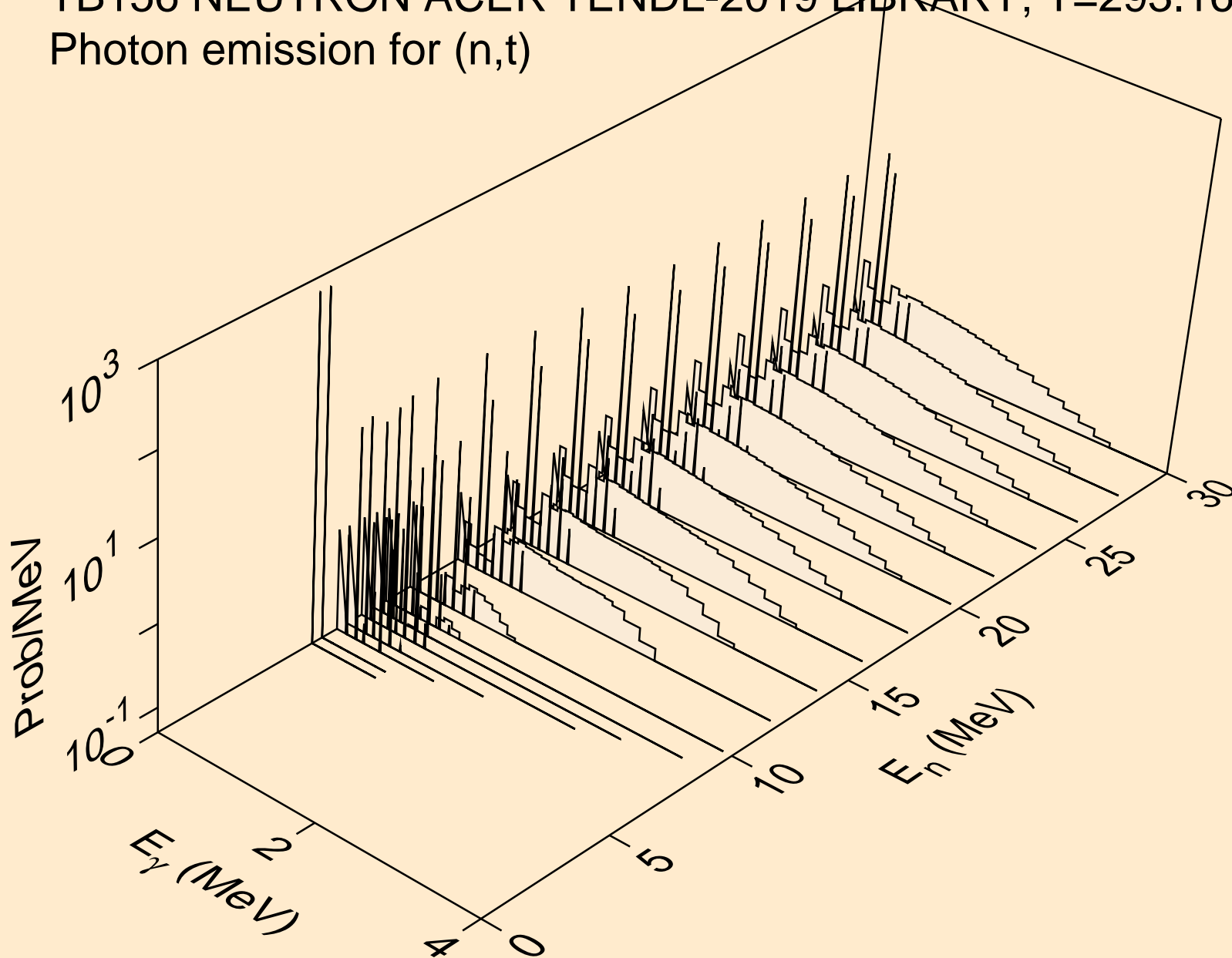

TB156 NEUTRON ACER TENDL-2019 LIBRARY; T=293.16K  
Photon emission for (n,he3)

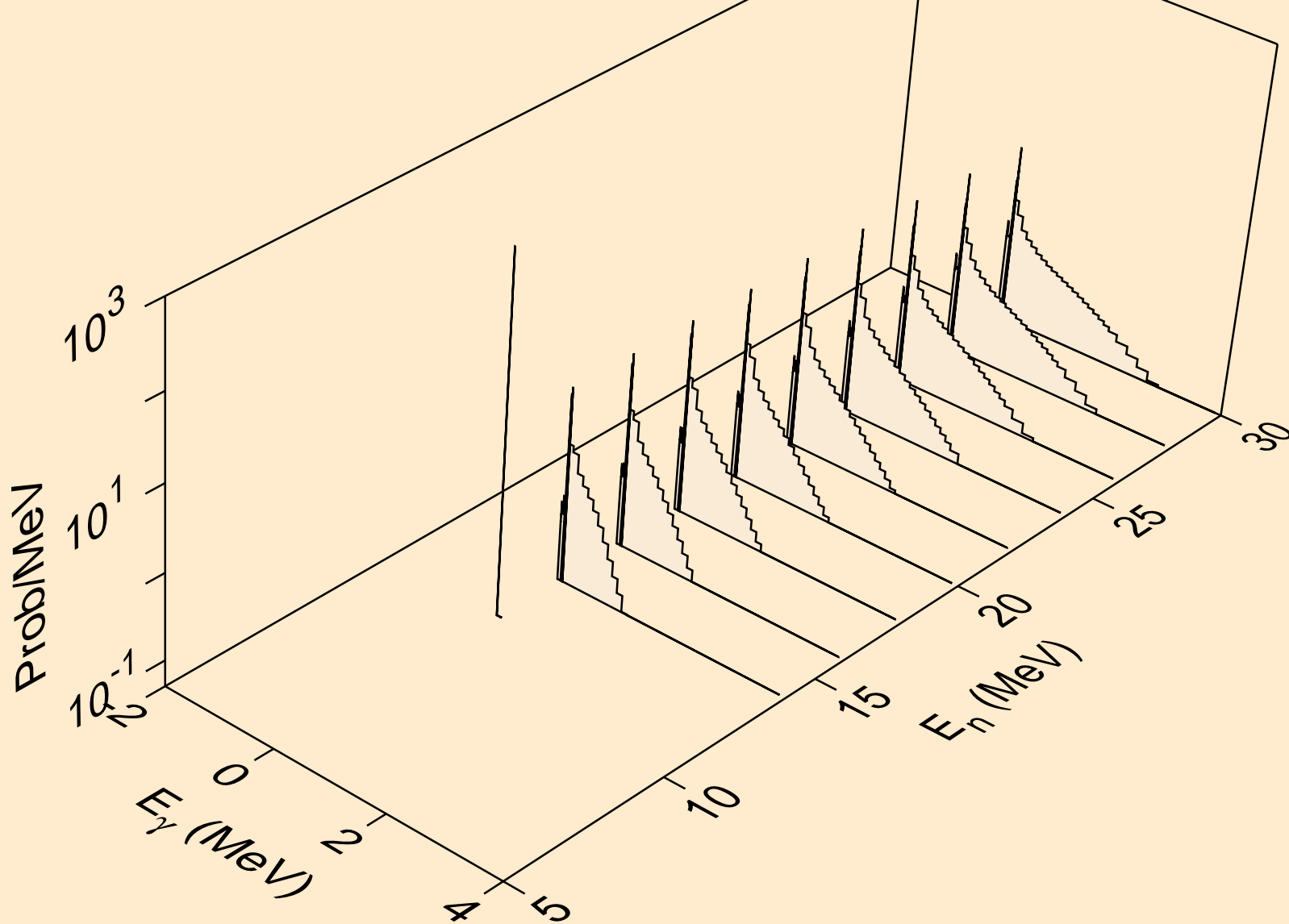



TB156 NEUTRON ACER TENDL-2019 LIBRARY; T=293.16K  
Photon emission for (n,a)

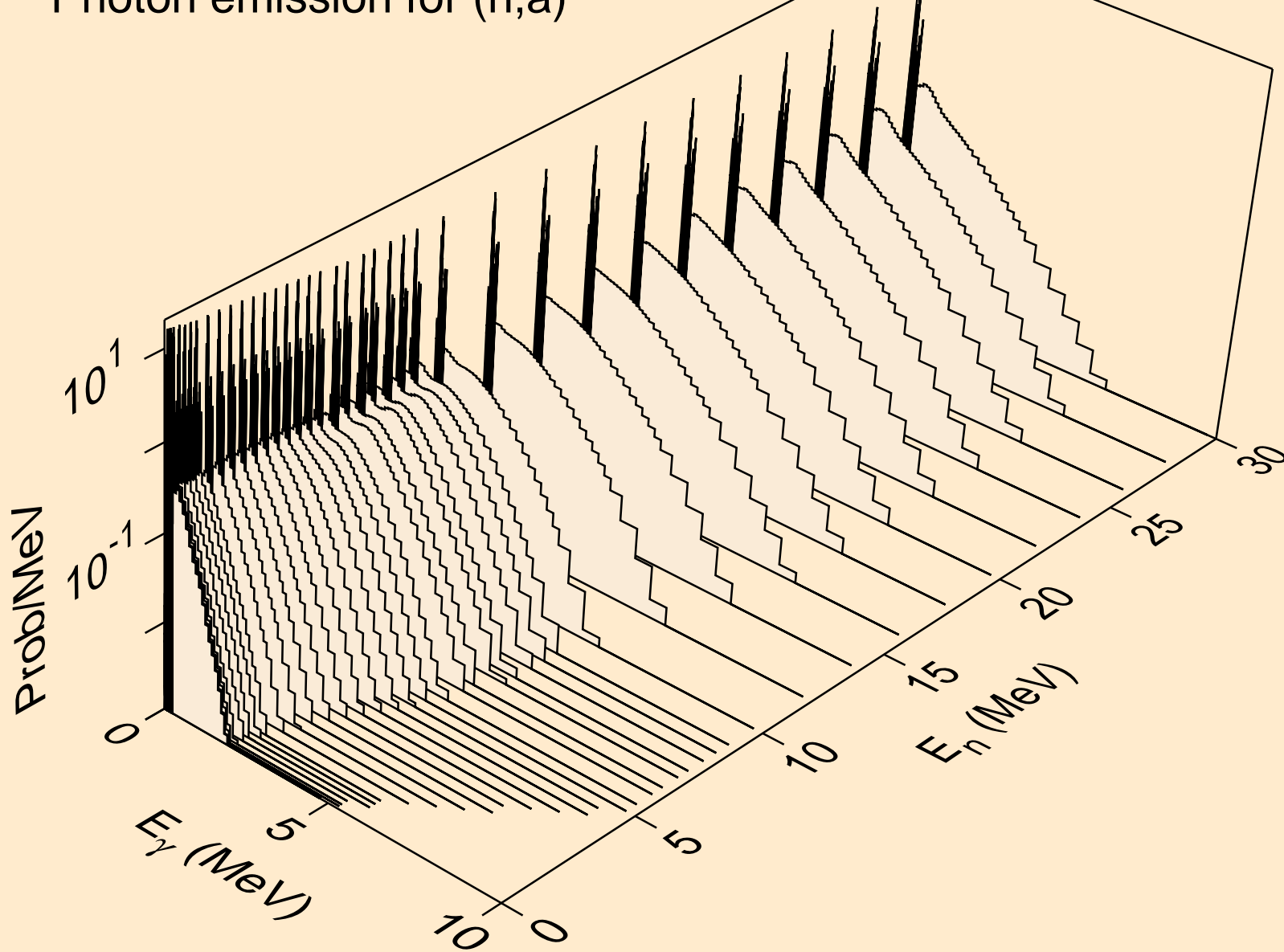

TB156 NEUTRON ACER TENDL-2019 LIBRARY; T=293.16K  
Photon emission for (n,2a)

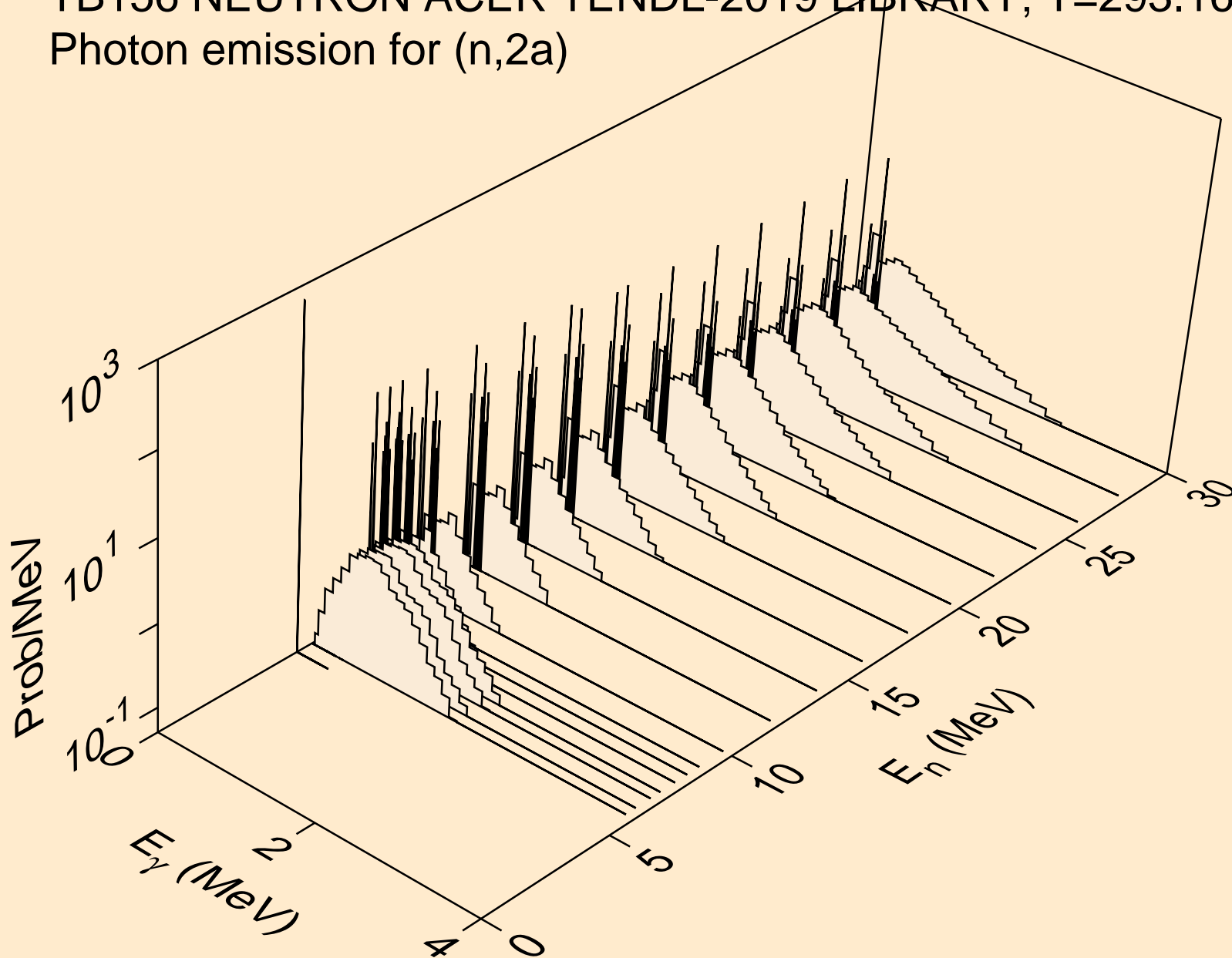

TB156 NEUTRON ACER TENDL-2019 LIBRARY; T=293.16K  
Photon emission for (n,2p)

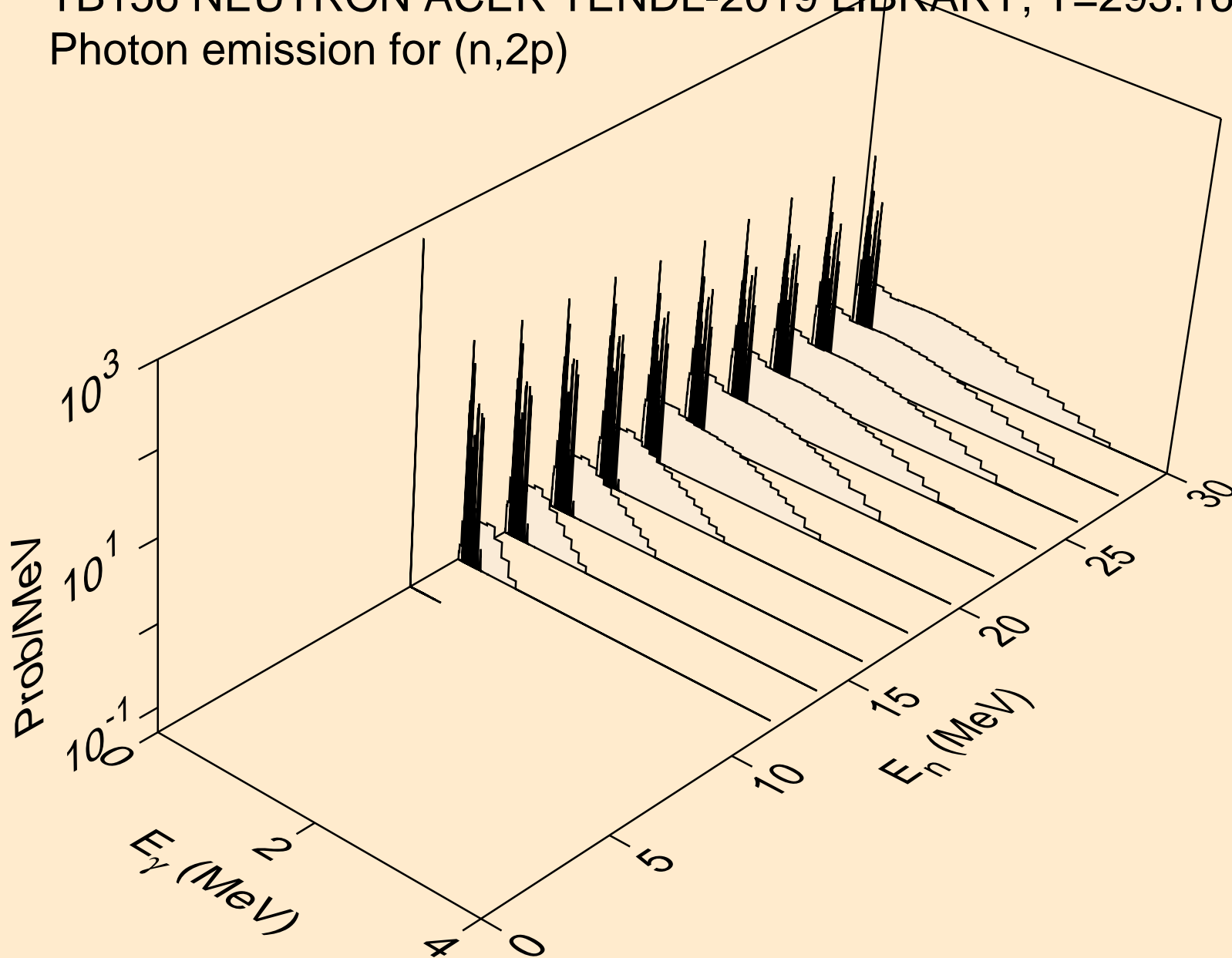

TB156 NEUTRON ACER TENDL-2019 LIBRARY; T=293.16K  
Photon emission for (n,p $\alpha$ )

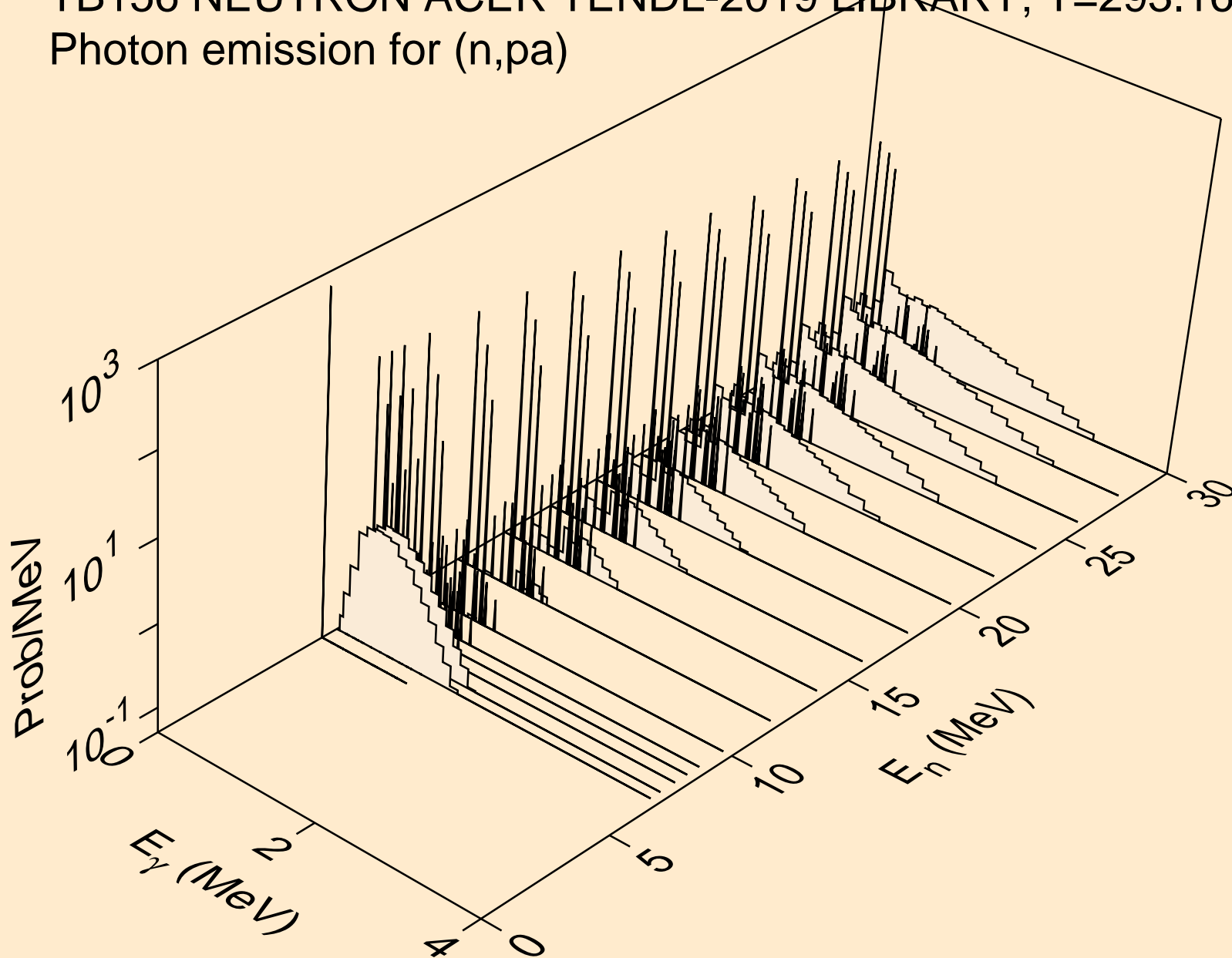

TB156 NEUTRON ACER TENDL-2019 LIBRARY; T=293.16K  
Photon emission for (n,pd)

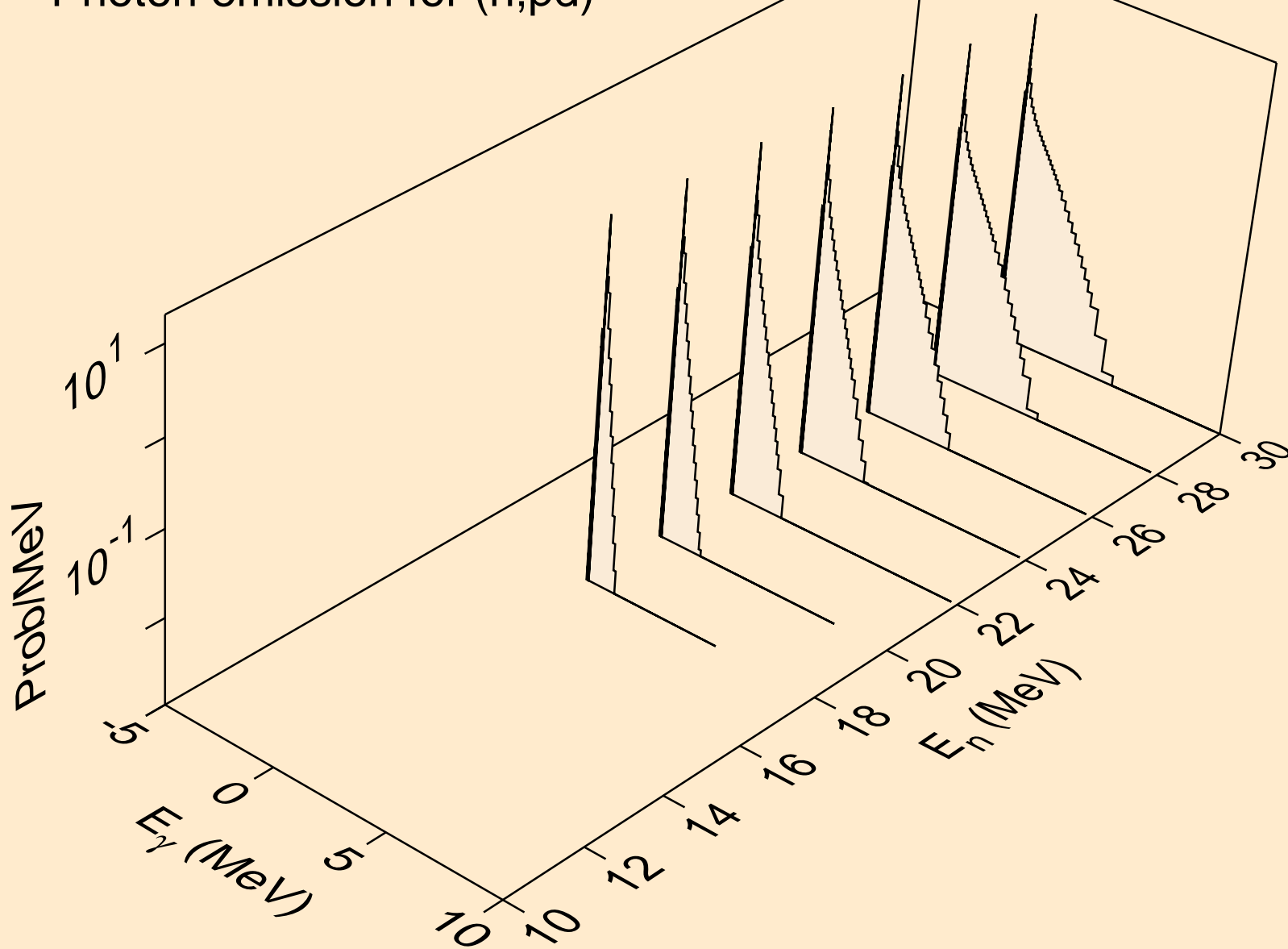

TB156 NEUTRON ACER TENDL-2019 LIBRARY; T=293.16K  
Photon emission for (n,pt)

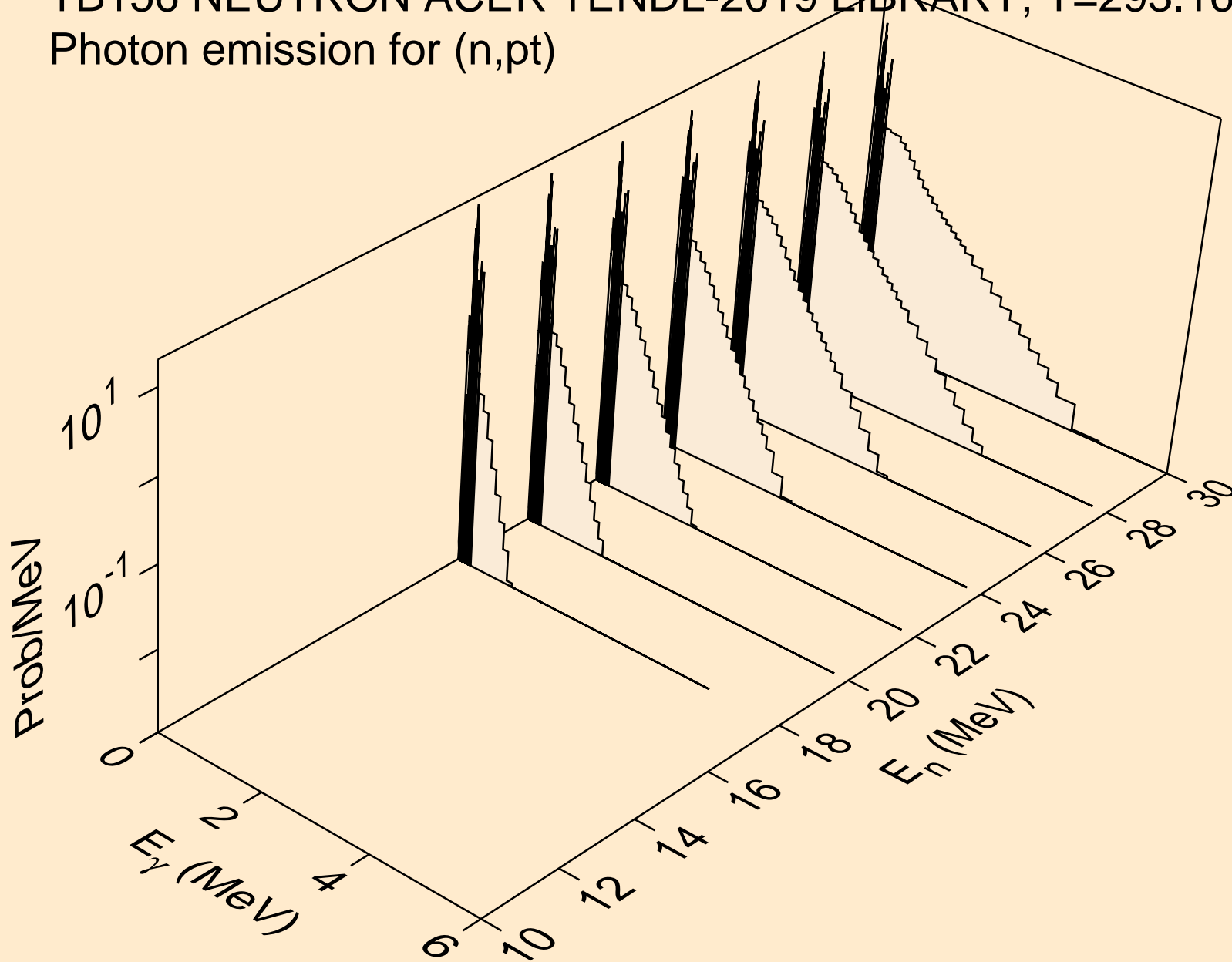

TB156 NEUTRON ACER TENDL-2019 LIBRARY; T=293.16K  
Photon emission for (n,da)

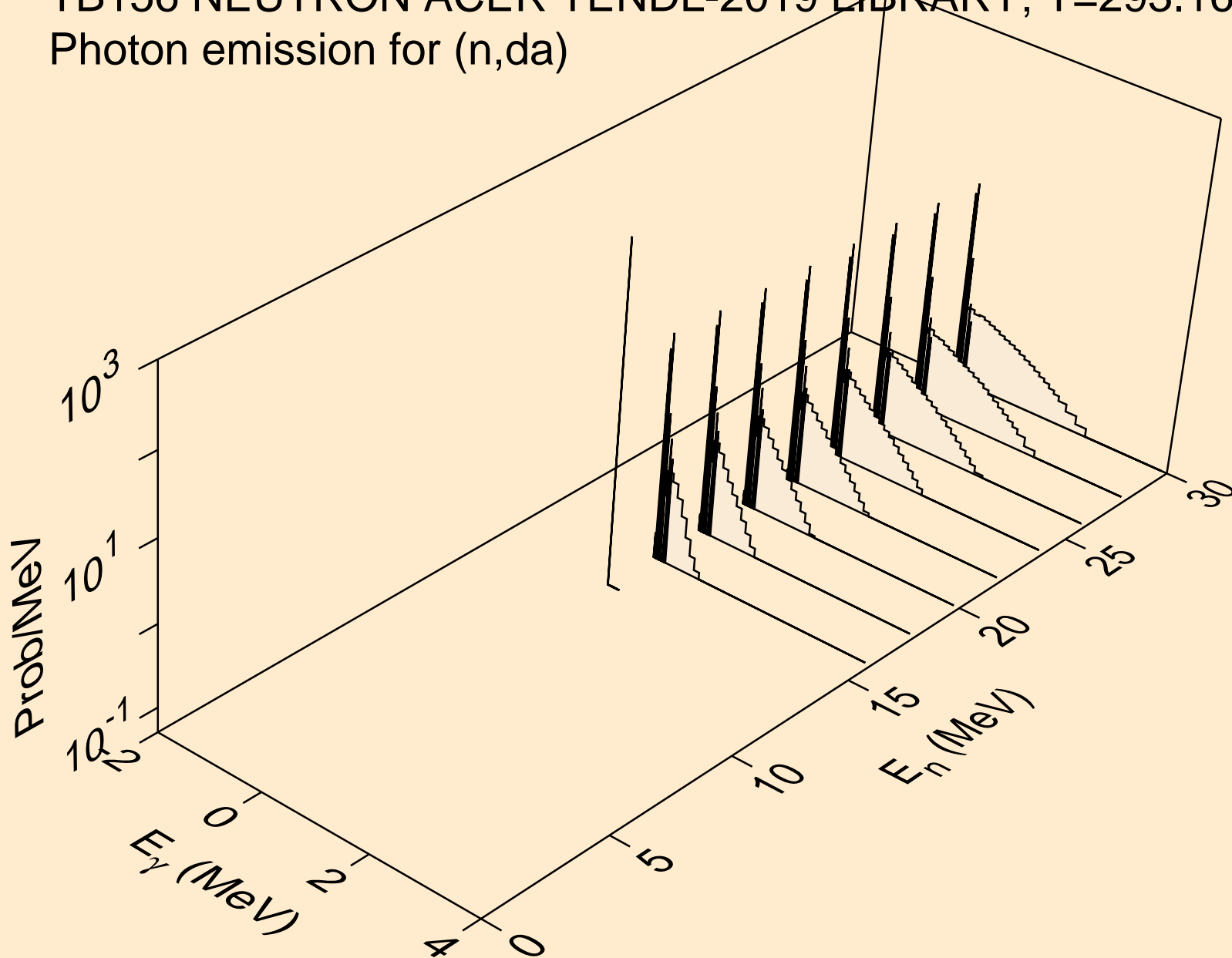

TB156 NEUTRON ACER TENDL-2019 LIBRARY; T=293.16K  
thermal capture photon spectrum

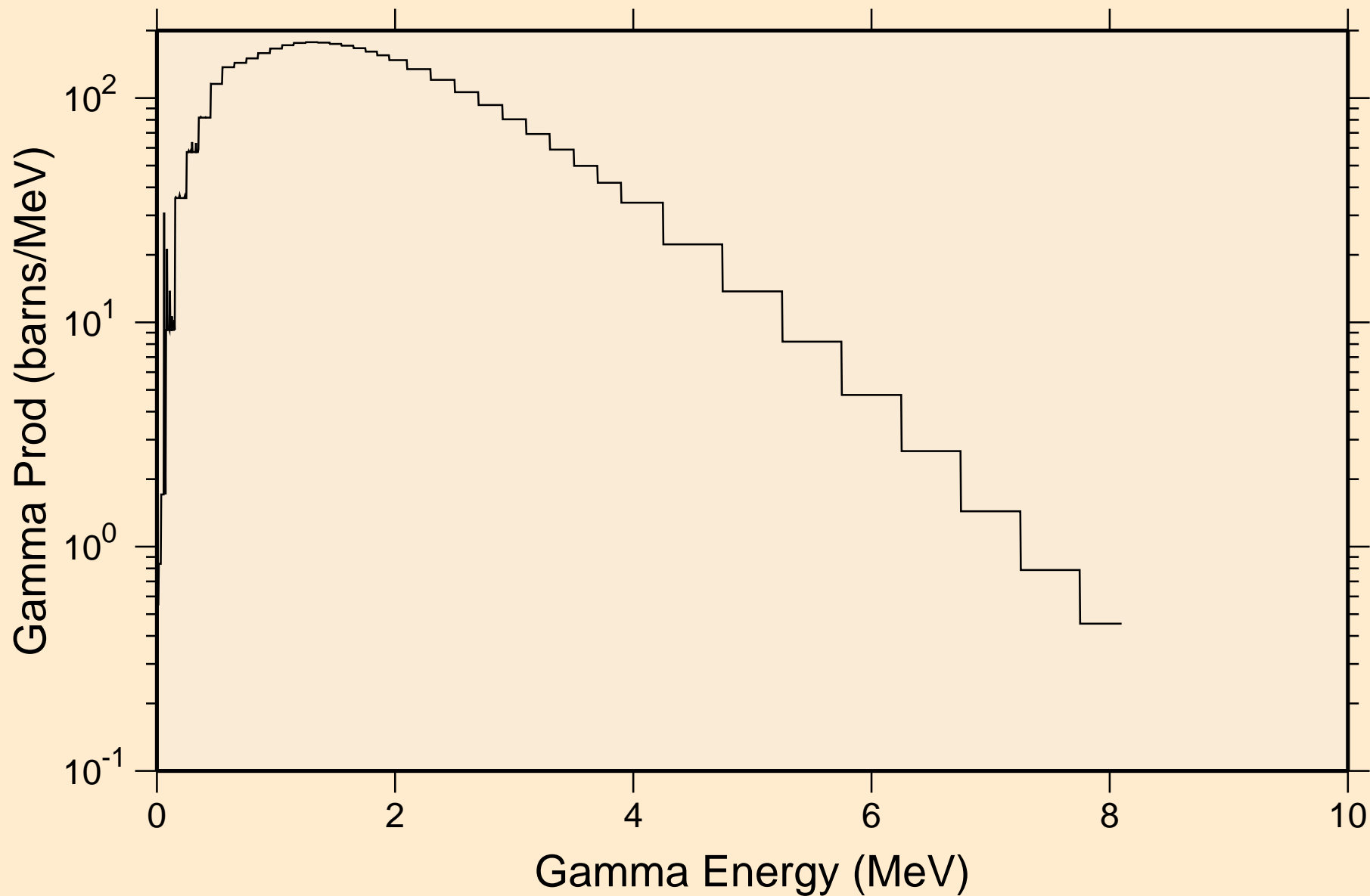



TB156 NEUTRON ACER TENDL-2019 LIBRARY; T=293.16K  
14 MeV photon spectrum

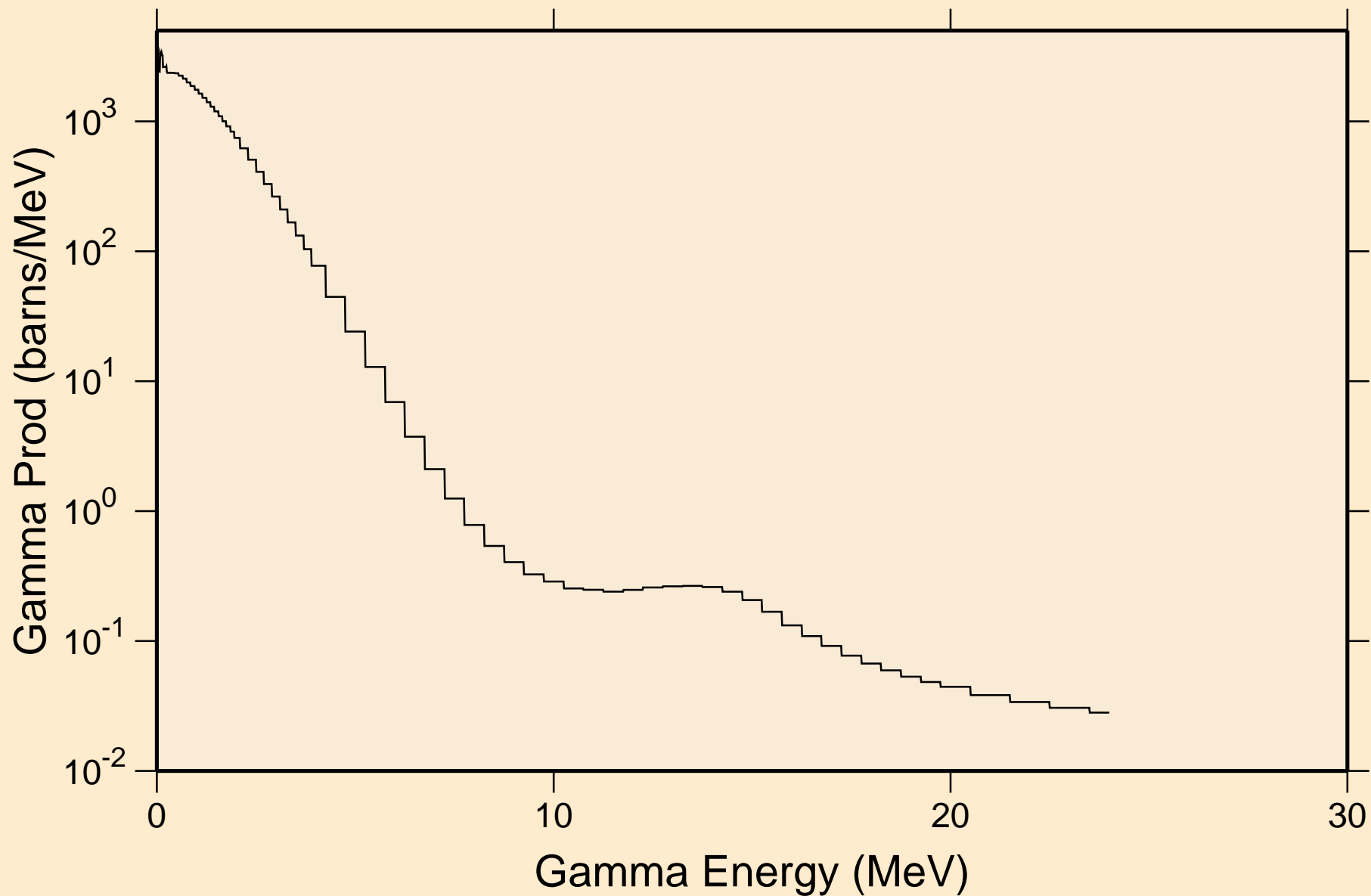

TB156 NEUTRON ACER TENDL-2019 LIBRARY; T=293.16K  
Particle heating contributions

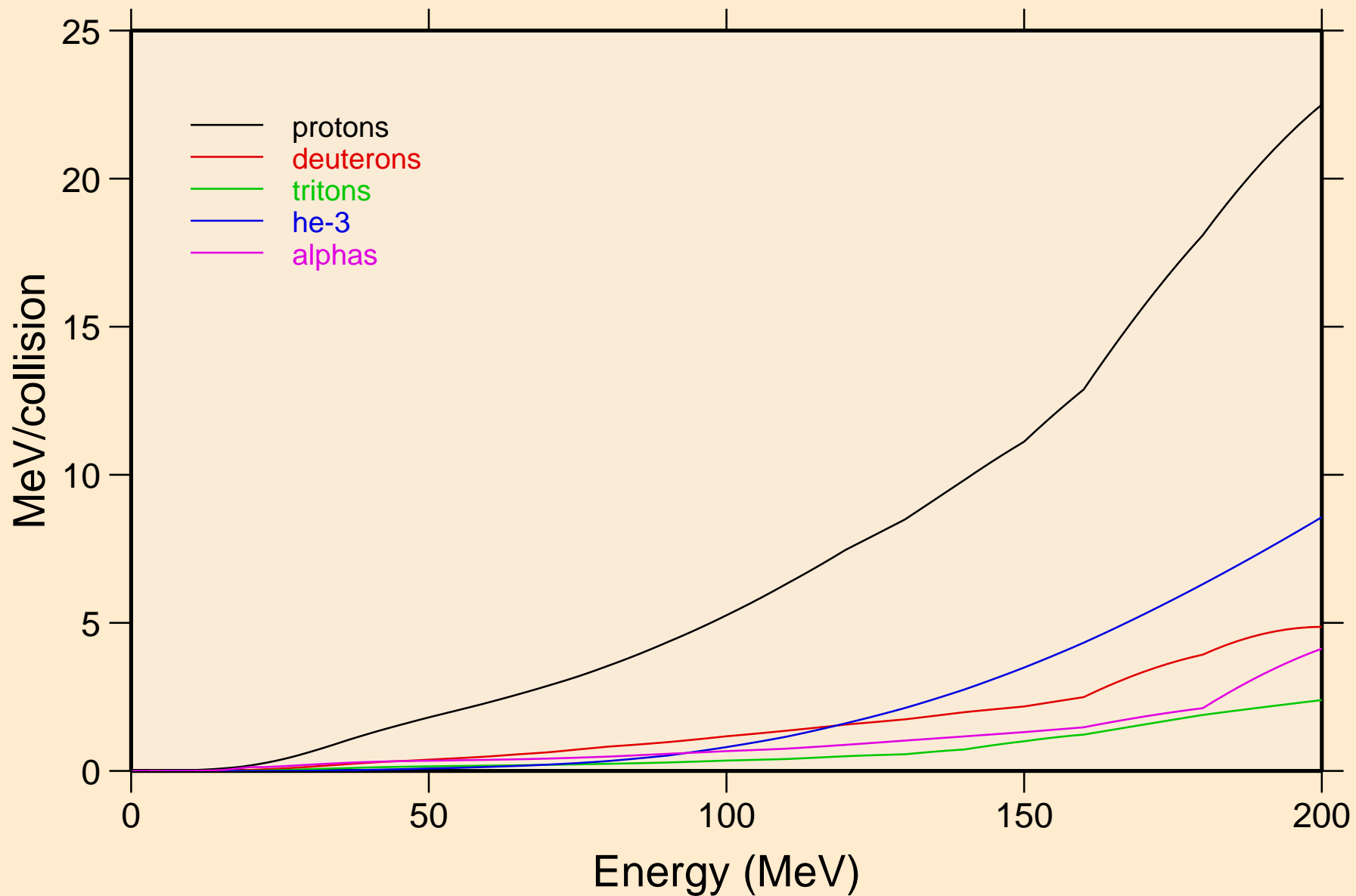

TB156 NEUTRON ACER TENDL-2019 LIBRARY; T=293.16K  
Recoil Heating

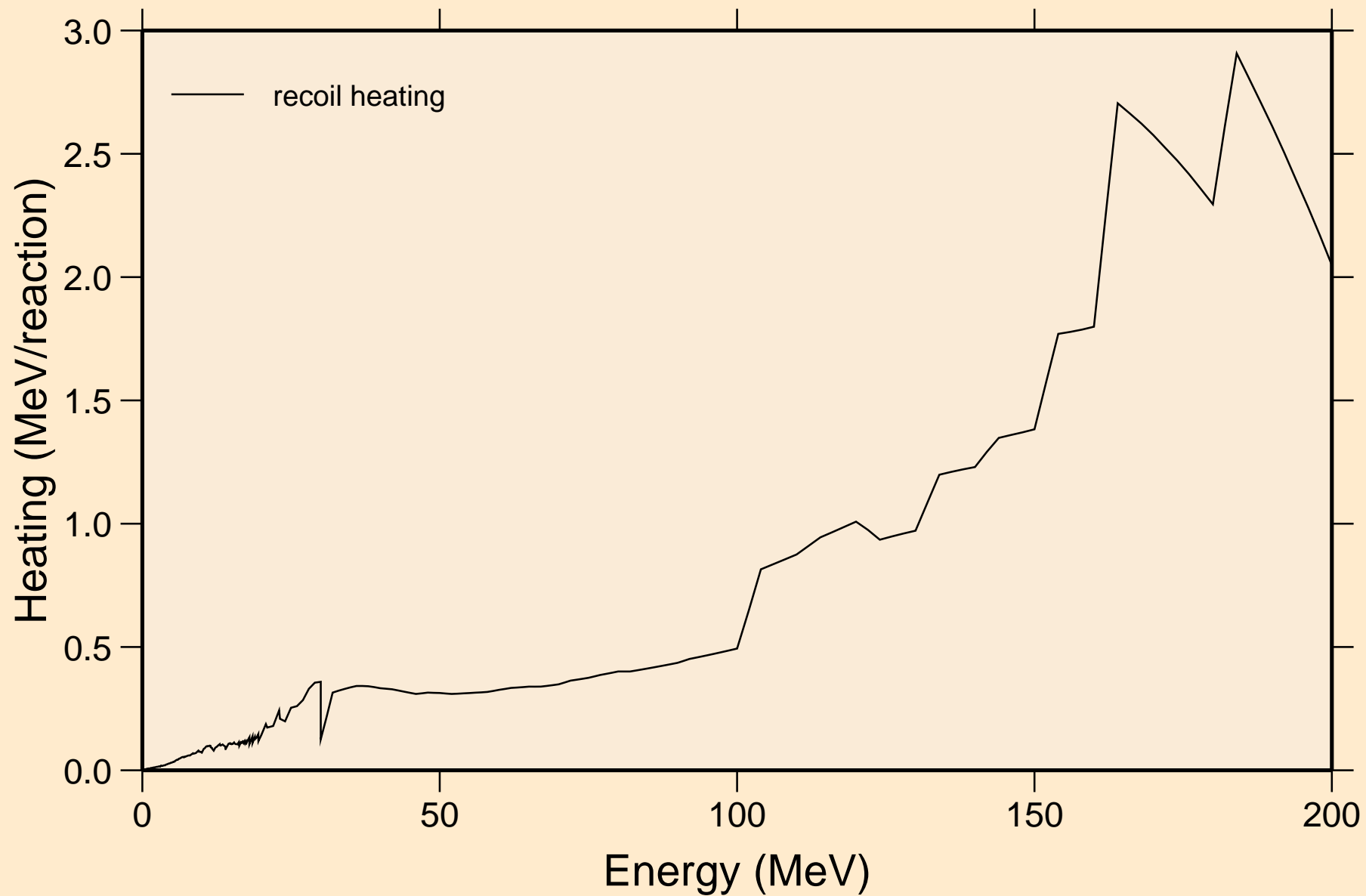

TB156 NEUTRON ACER TENDL-2019 LIBRARY; T=293.16K  
Particle production cross sections

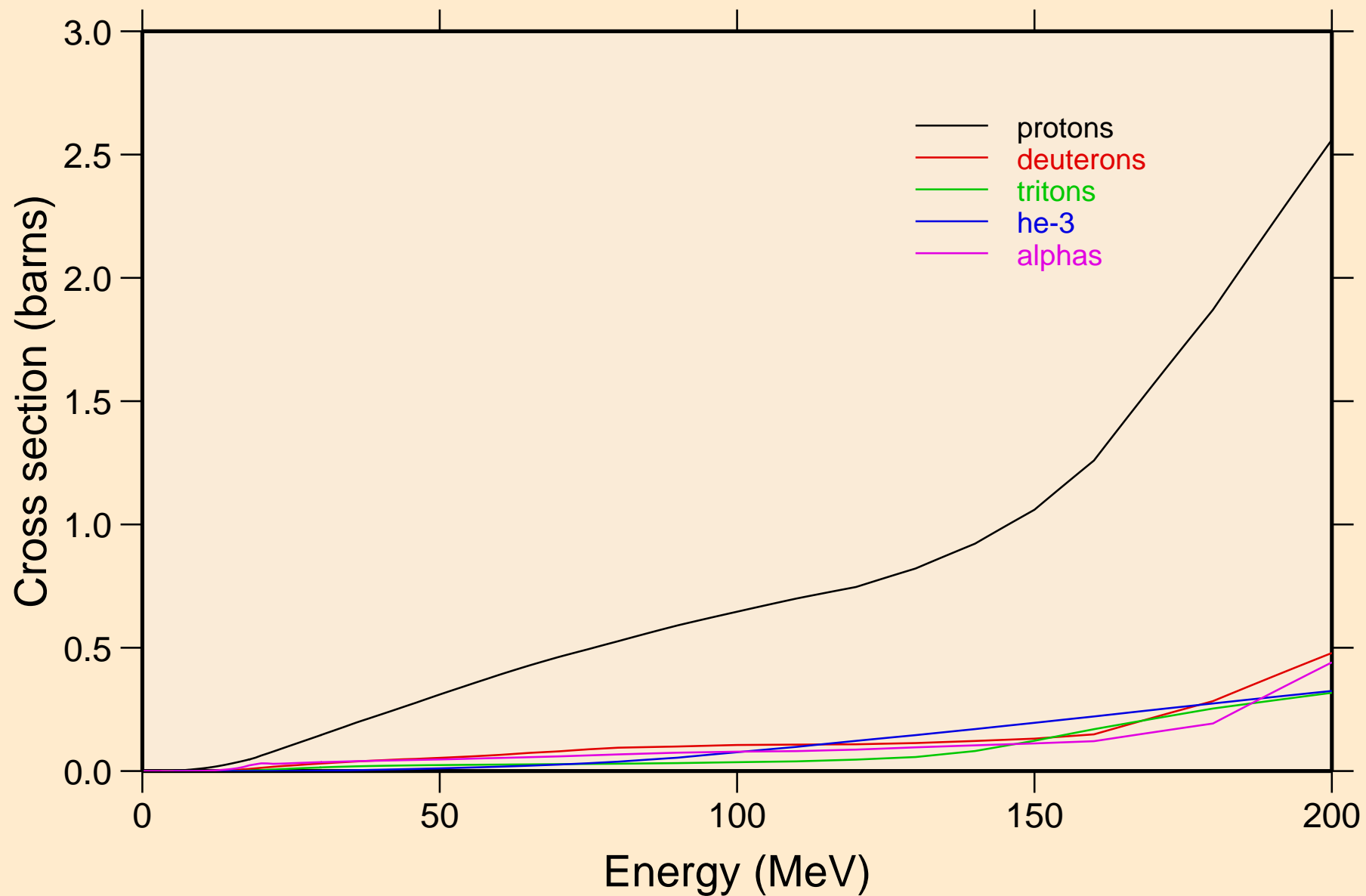

TB156 NEUTRON ACER TENDL-2019 LIBRARY; T=293.16K  
protons from (n,x)

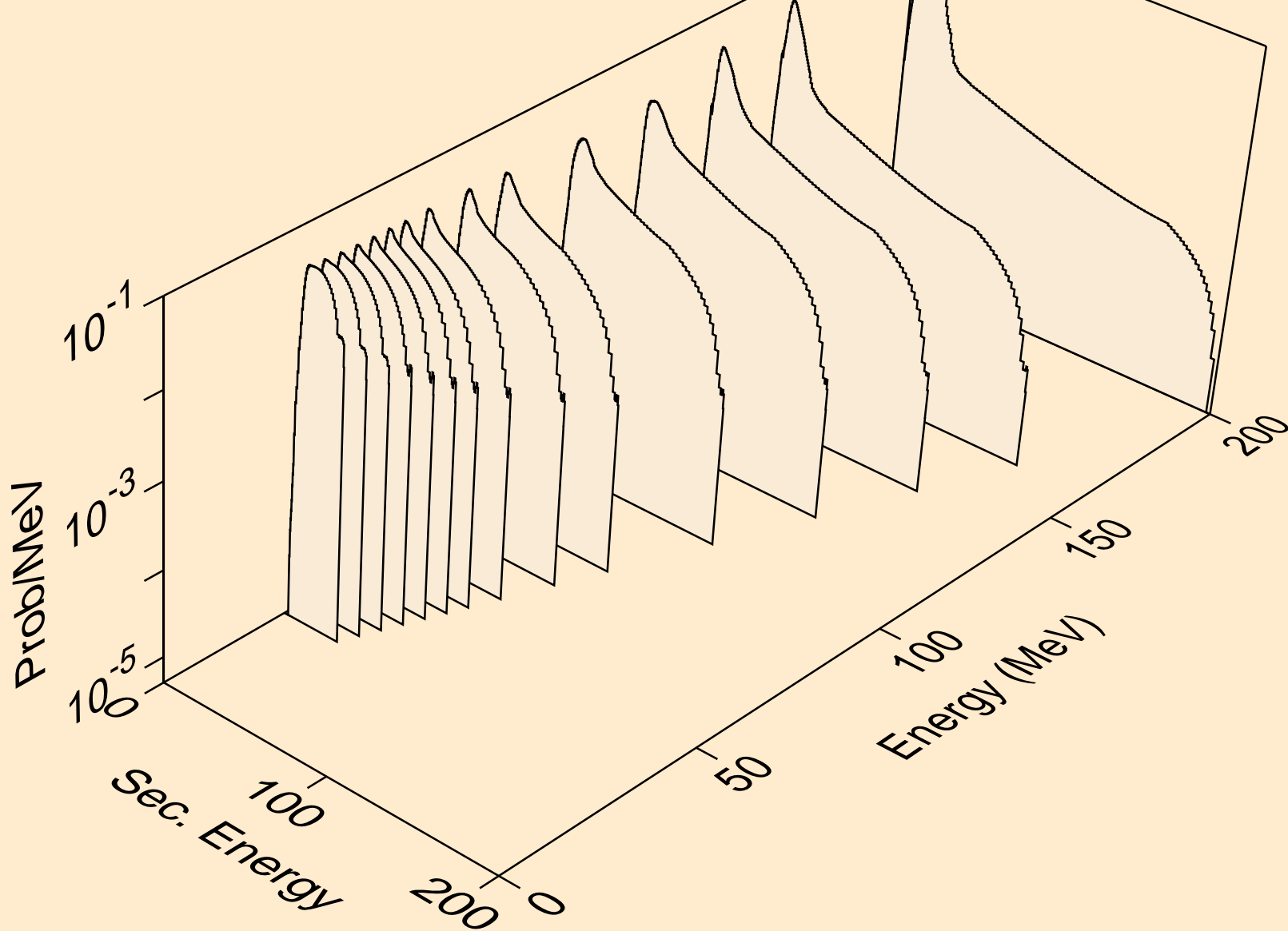

TB156 NEUTRON ACER TENDL-2019 LIBRARY; T=293.16K  
protons from (n,n\*)p

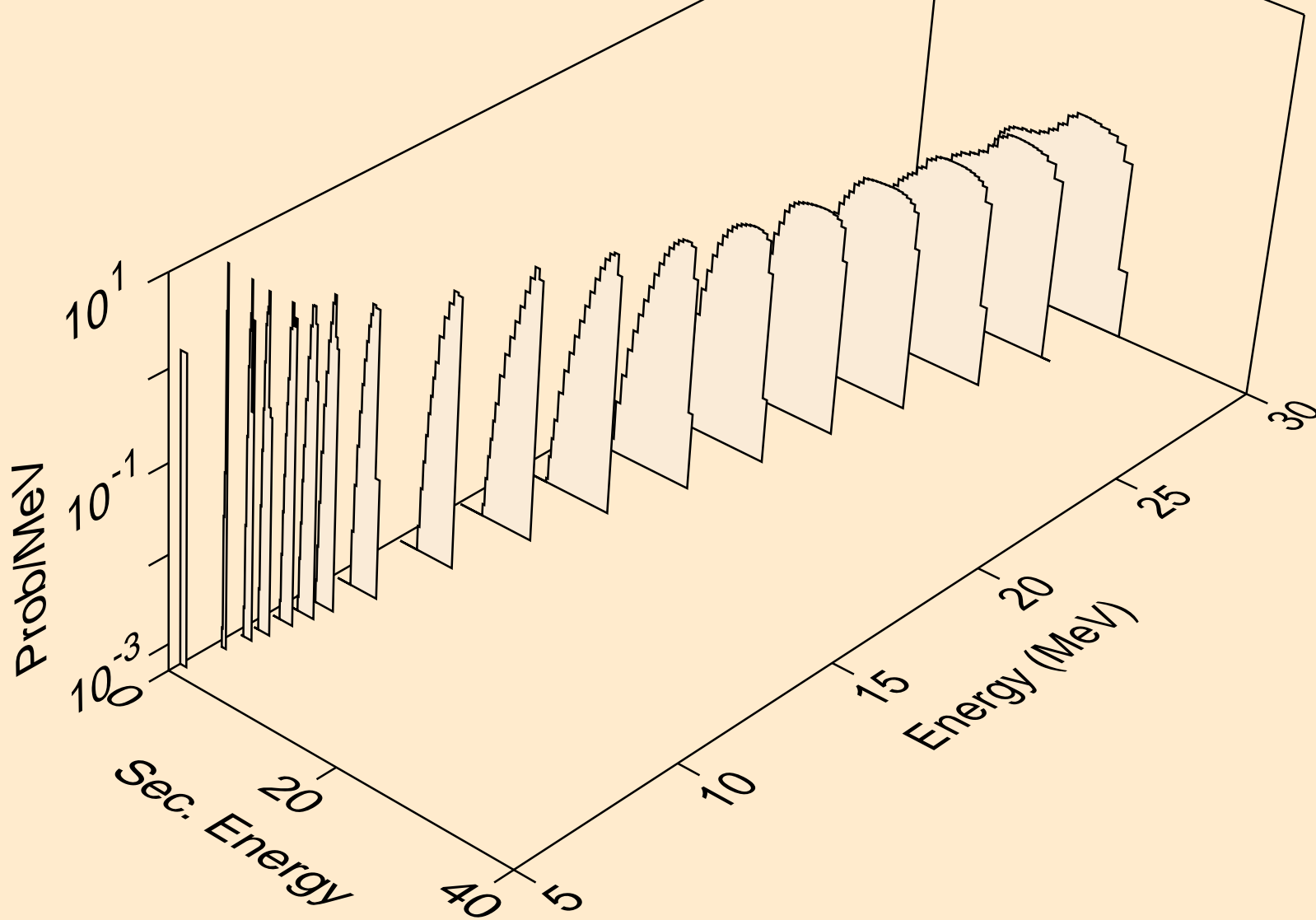

TB156 NEUTRON ACER TENDL-2019 LIBRARY; T=293.16K  
protons from (n,2np)

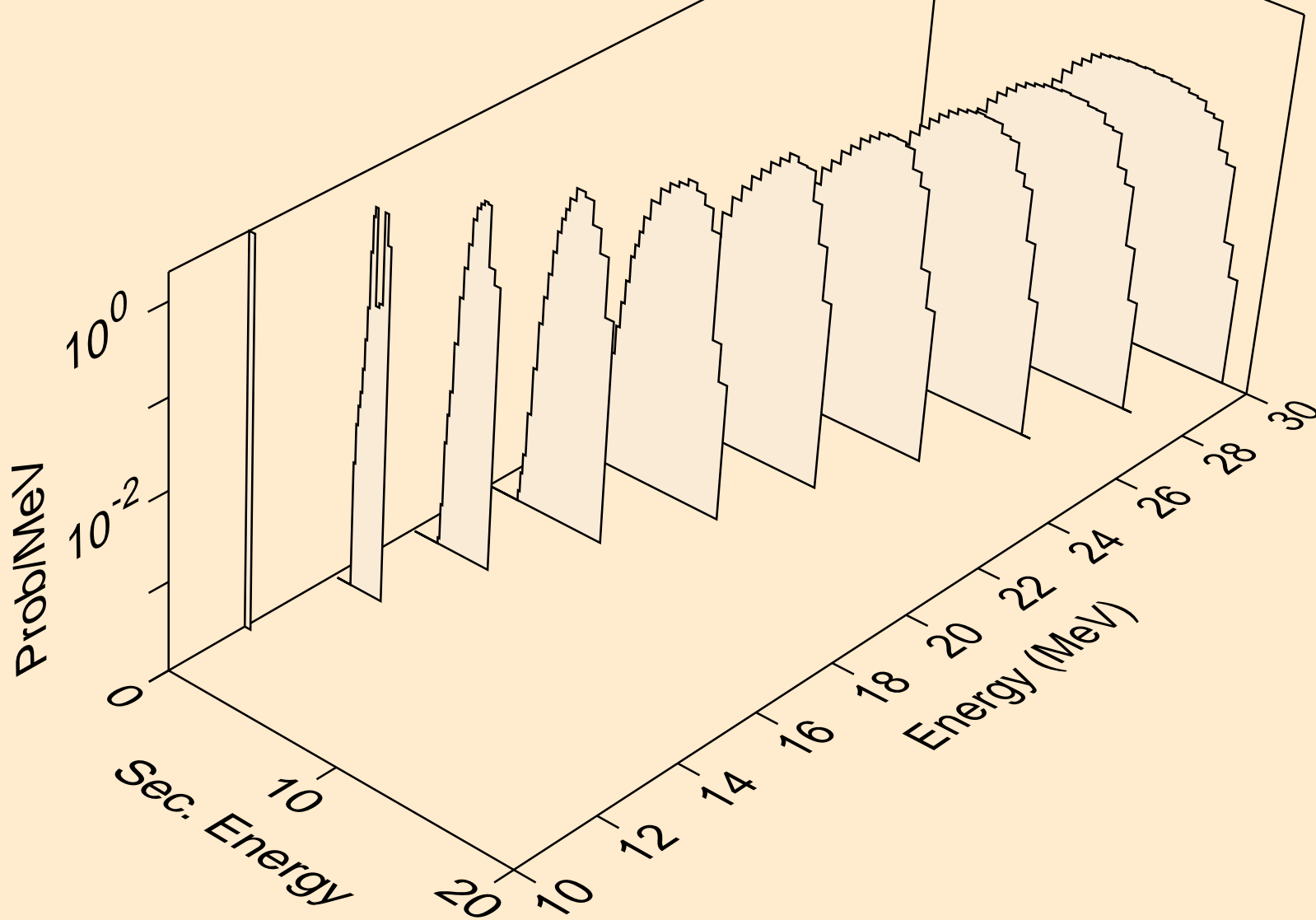

TB156 NEUTRON ACER TENDL-2019 LIBRARY; T=293.16K  
protons from (n,3np)

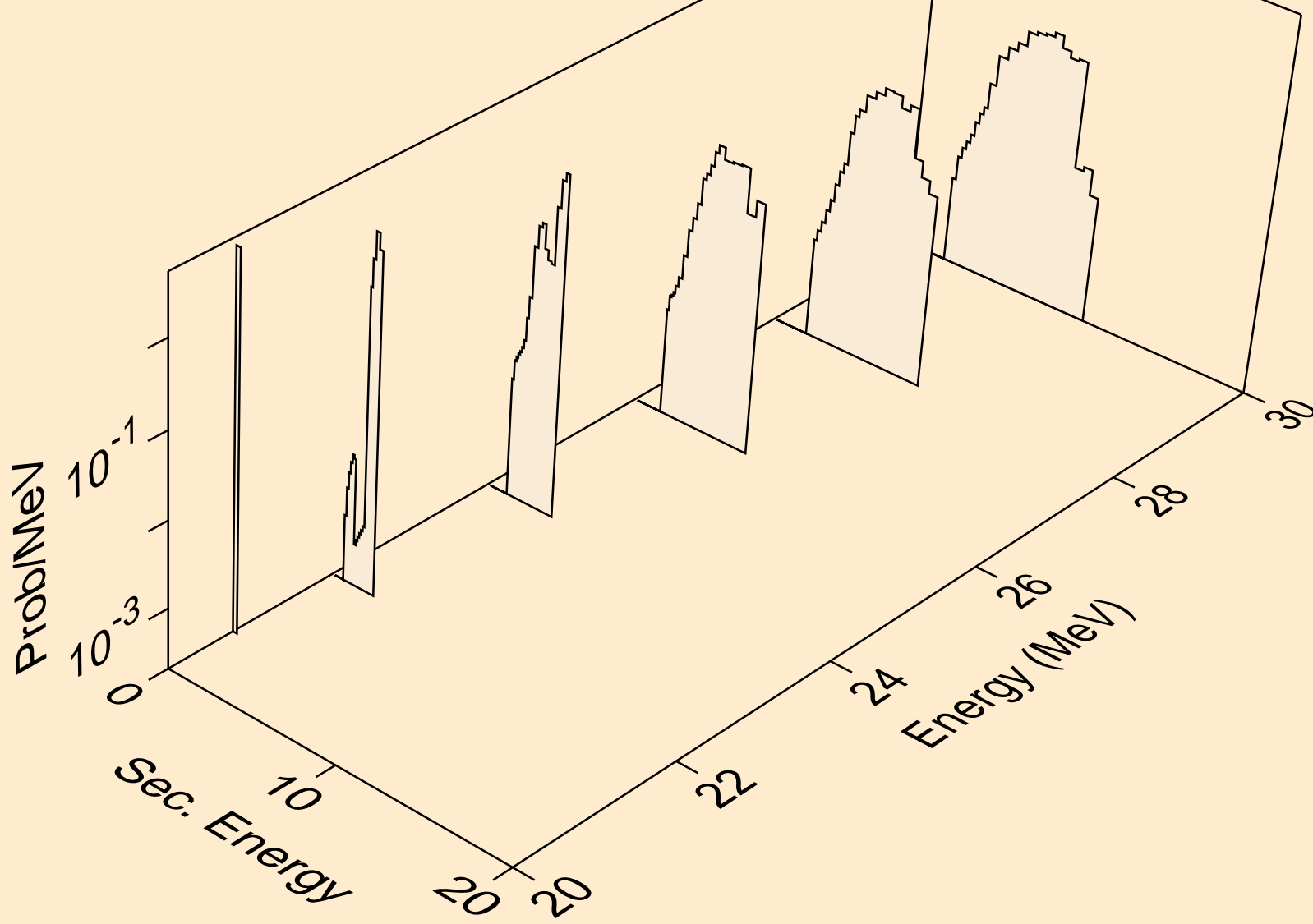



TB156 NEUTRON ACER TENDL-2019 LIBRARY; T=293.16K  
protons from (n,2np)

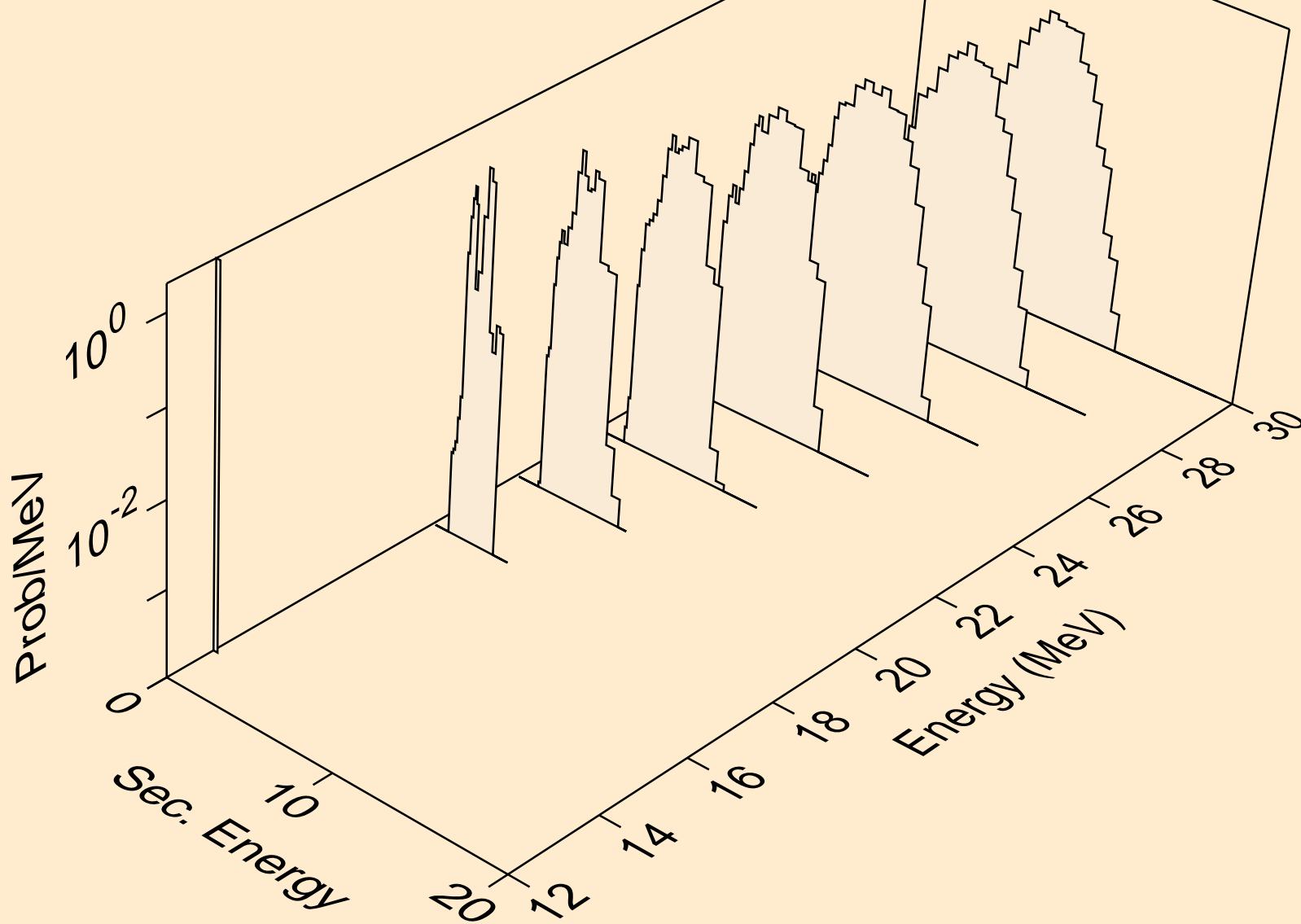

TB156 NEUTRON ACER TENDL-2019 LIBRARY; T=293.16K  
protons from (n,npa)

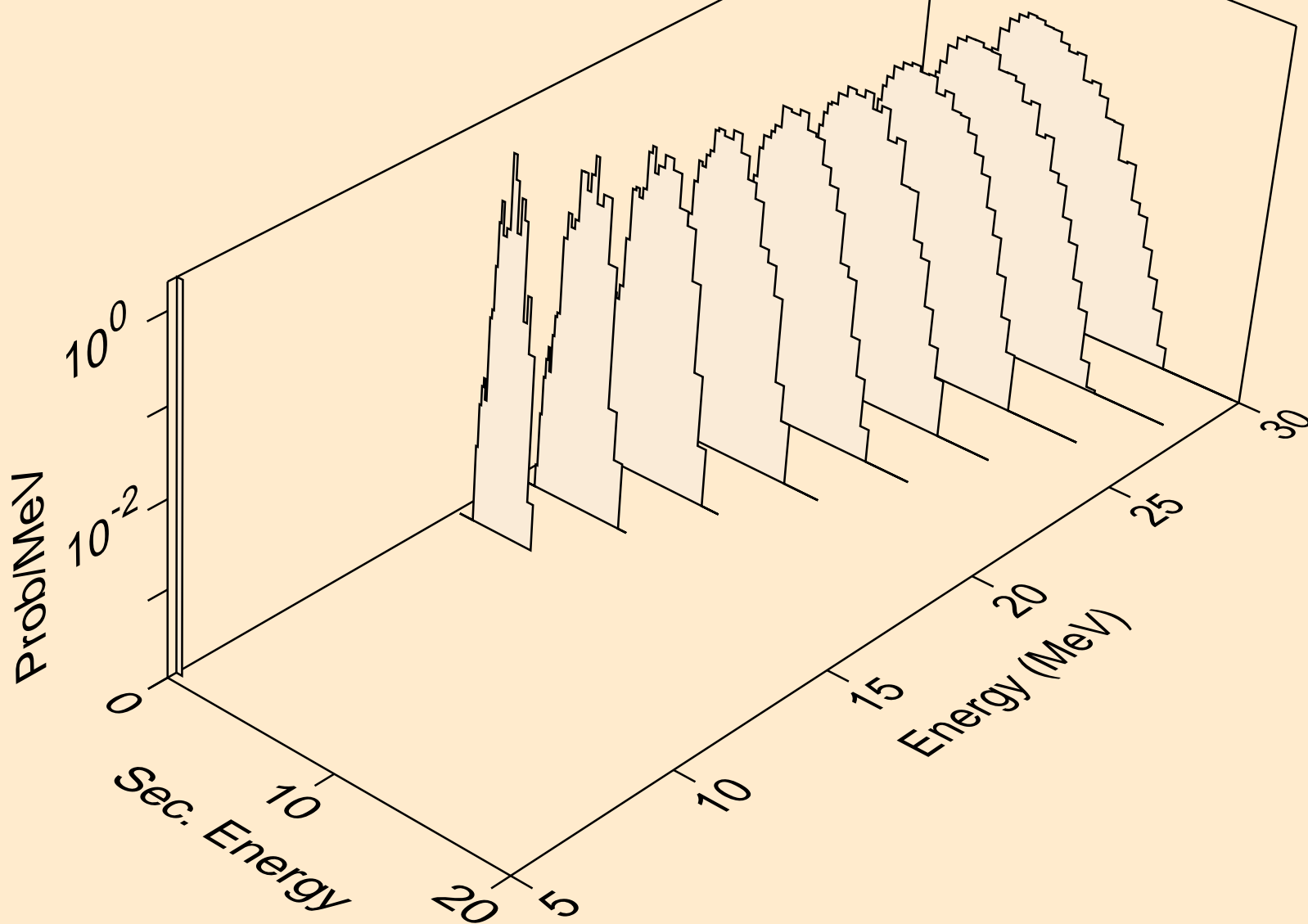

TB156 NEUTRON ACER TENDL-2019 LIBRARY; T=293.16K  
protons from (n,p)

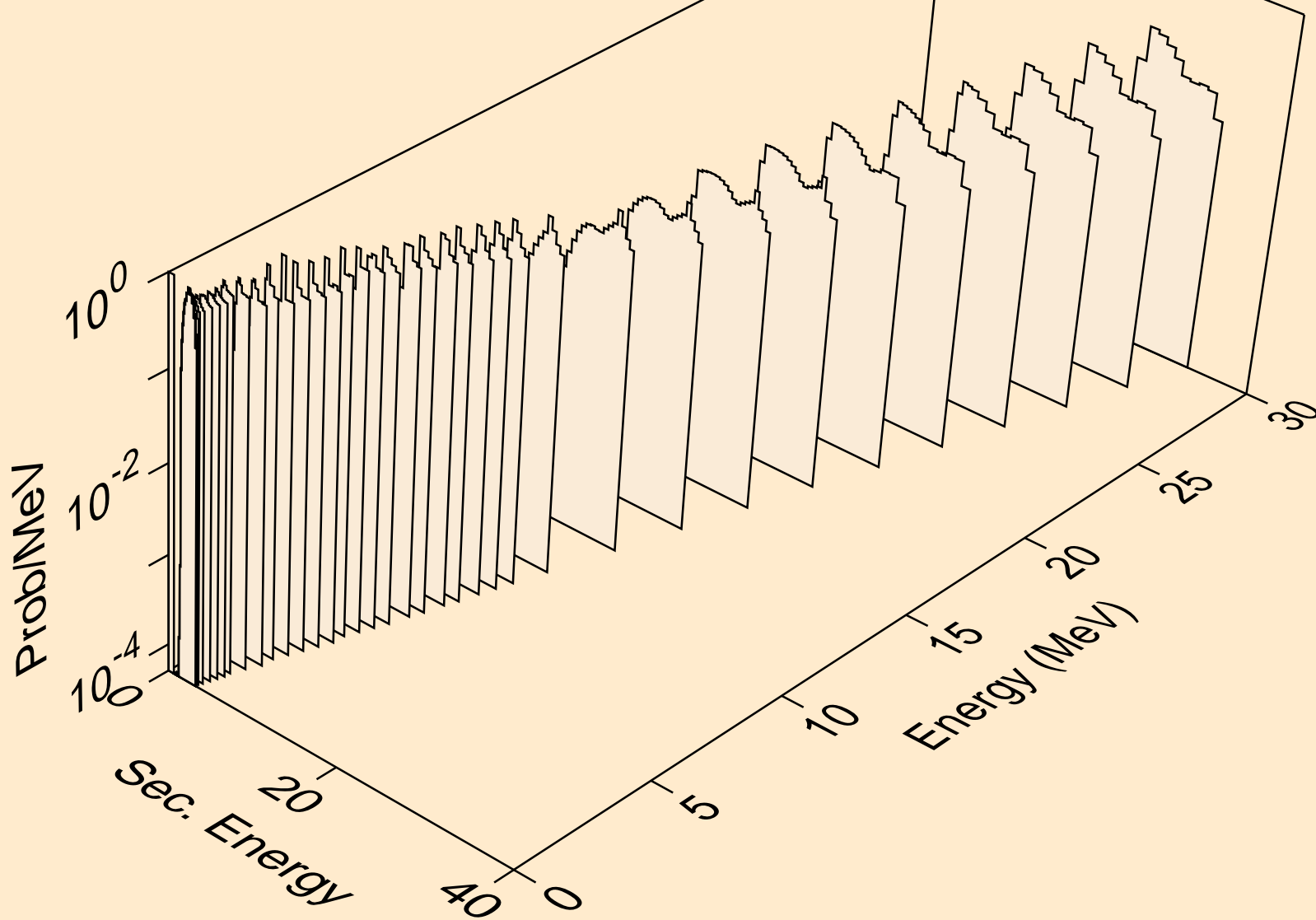

TB156 NEUTRON ACER TENDL-2019 LIBRARY; T=293.16K  
protons from (n,2p)

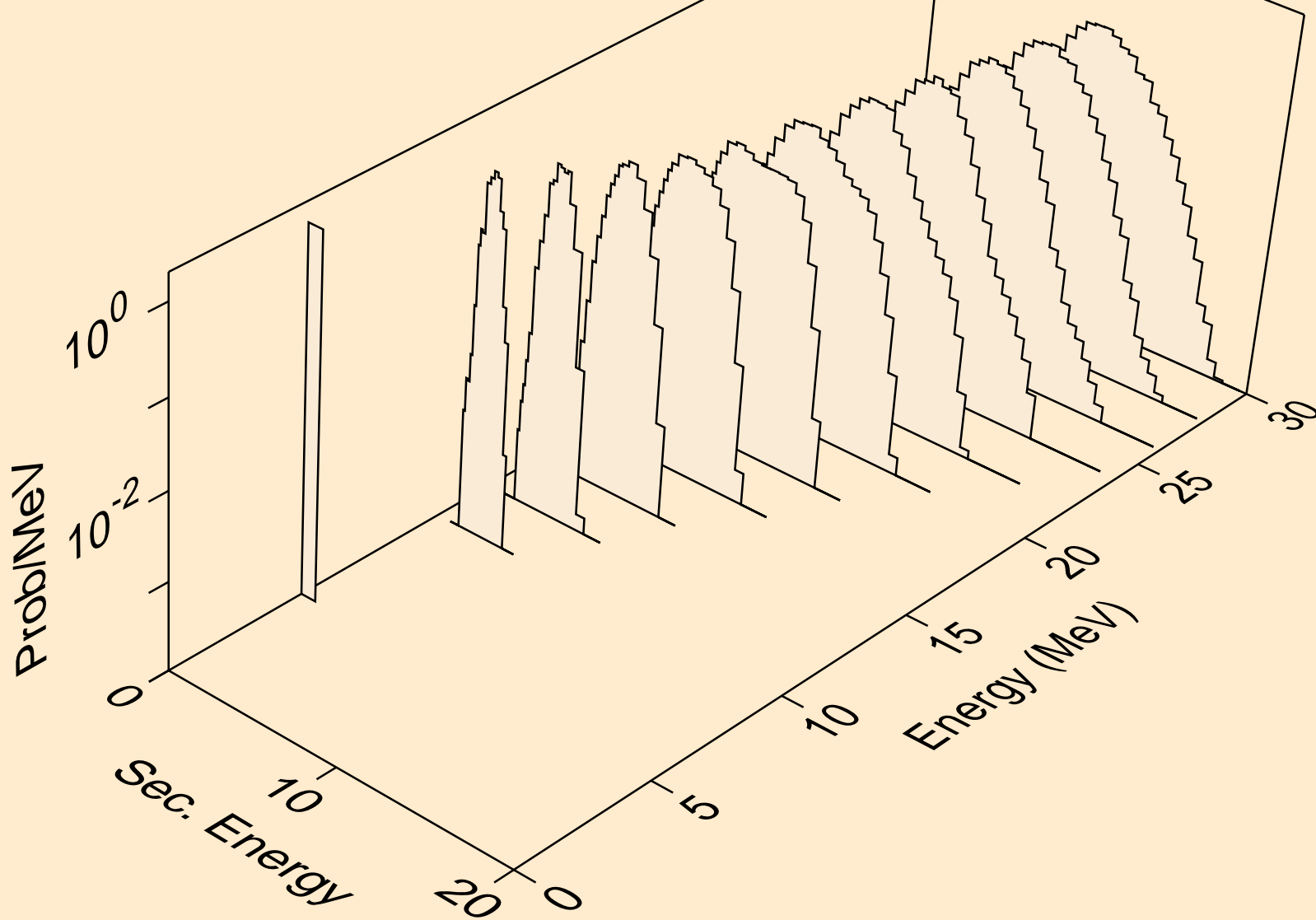

TB156 NEUTRON ACER TENDL-2019 LIBRARY; T=293.16K  
protons from (n,p)

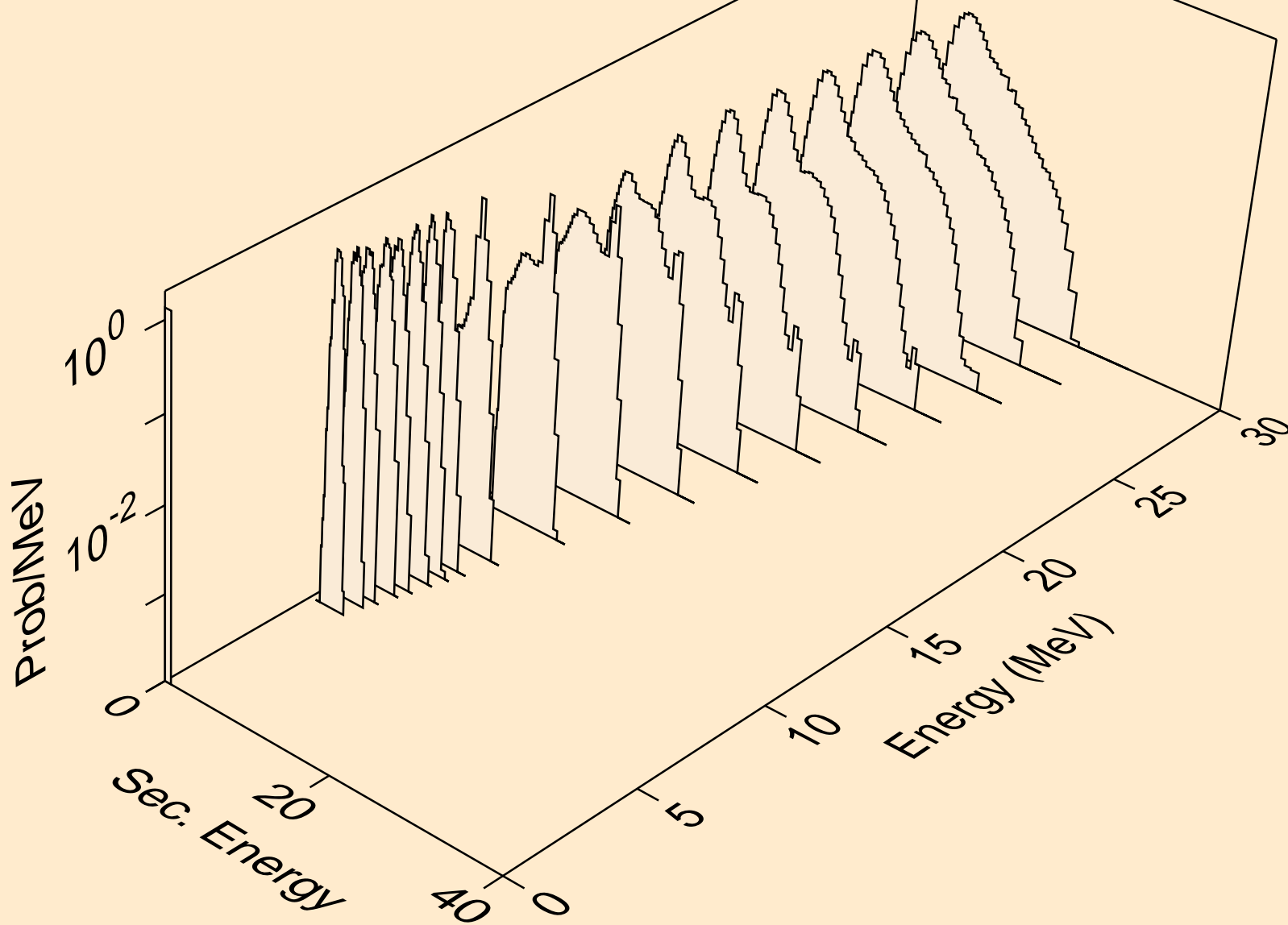

TB156 NEUTRON ACER TENDL-2019 LIBRARY; T=293.16K  
protons from (n,pd)

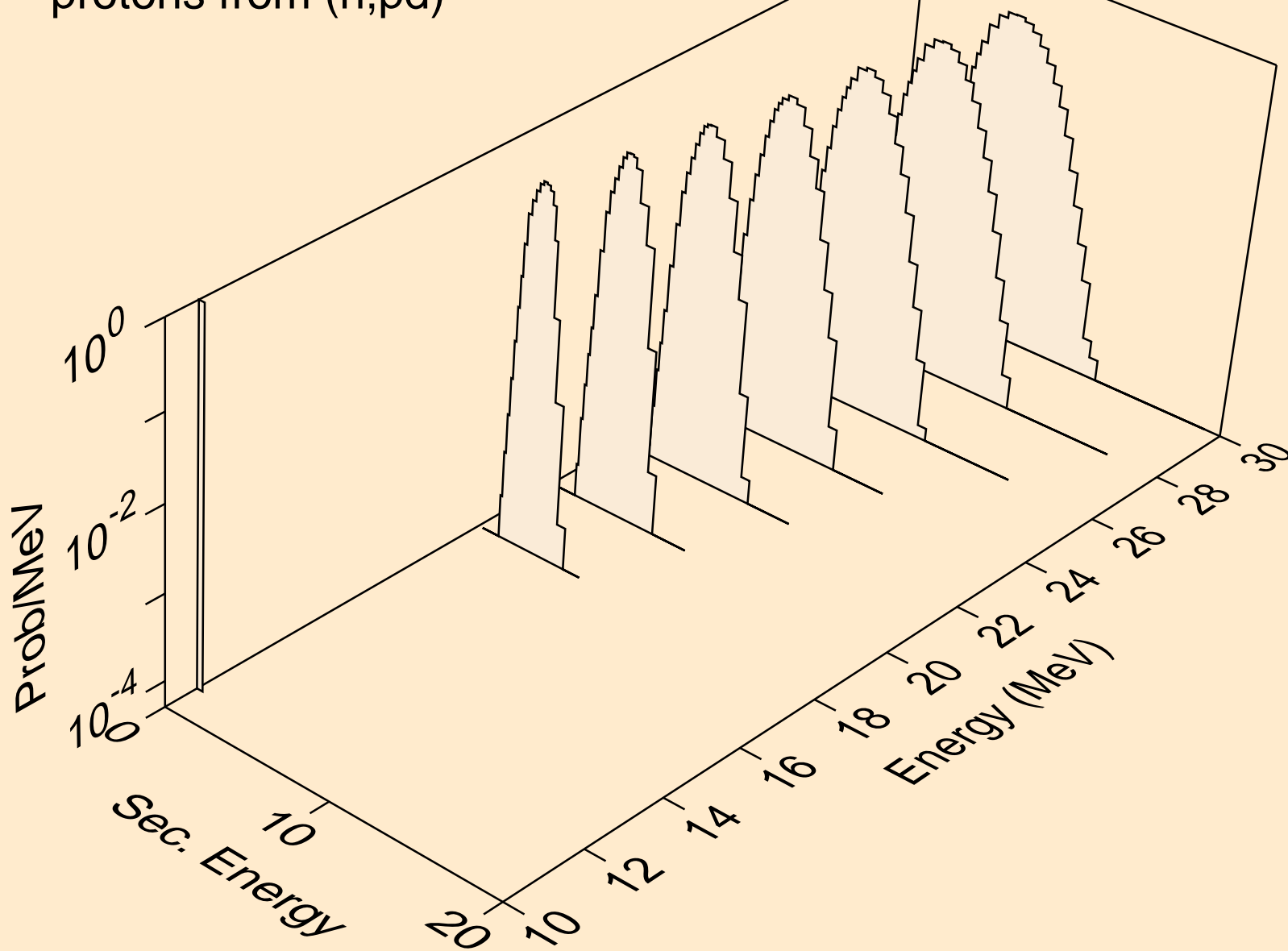

TB156 NEUTRON ACER TENDL-2019 LIBRARY; T=293.16K  
protons from (n,pt)

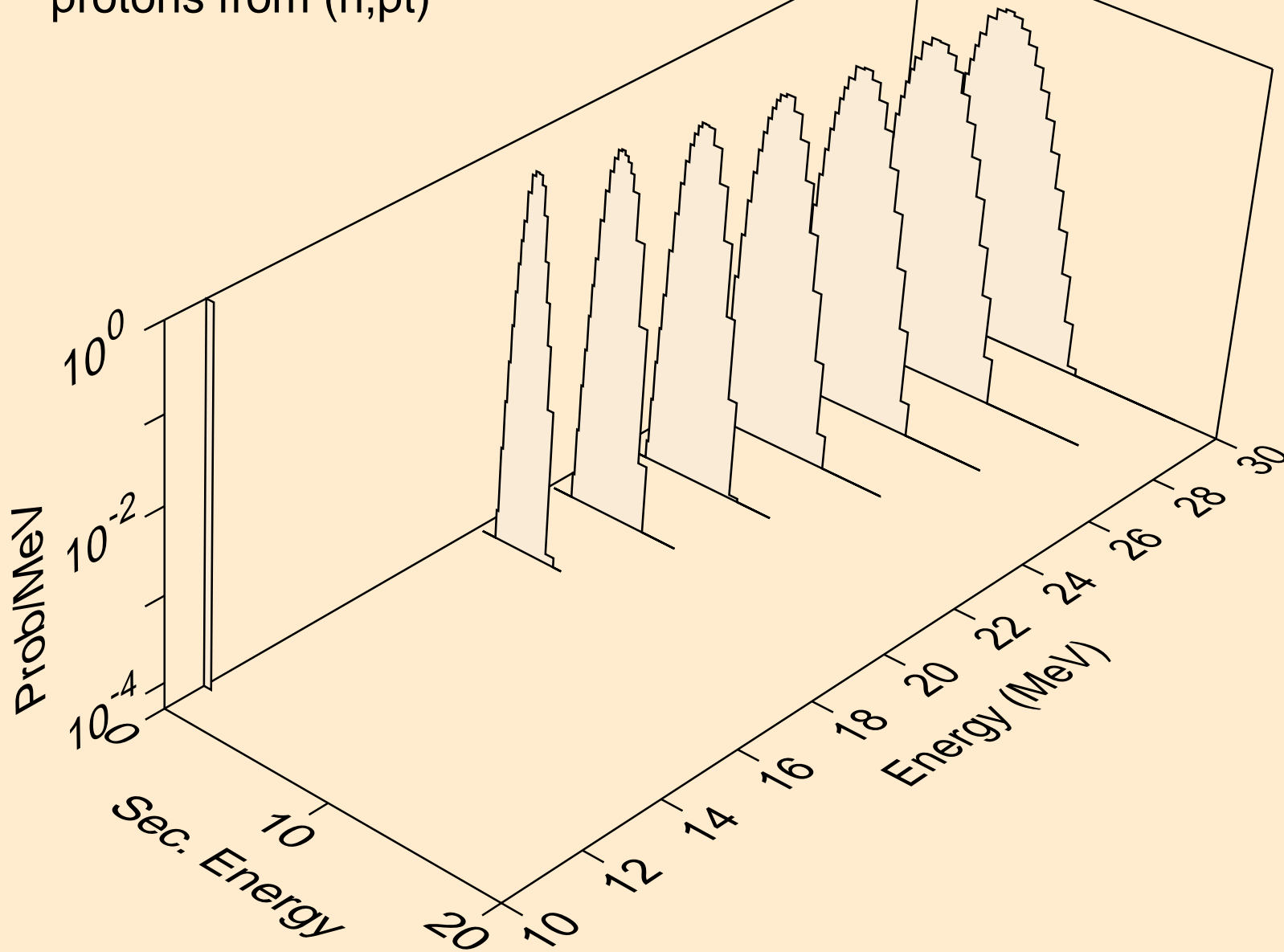

TB156 NEUTRON ACER TENDL-2019 LIBRARY; T=293.16K  
deuterons from (n,x)

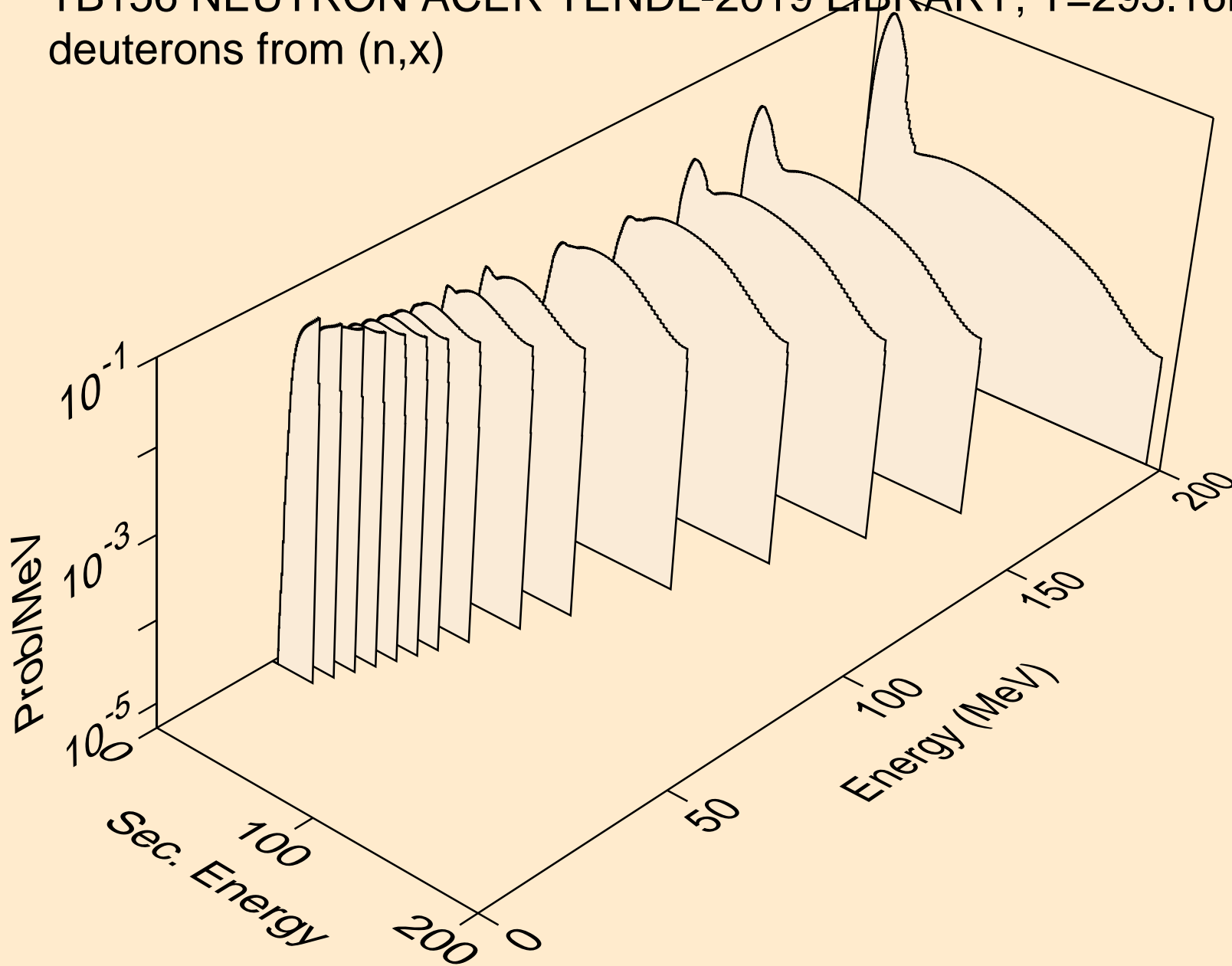



TB156 NEUTRON ACER TENDL-2019 LIBRARY; T=293.16K  
deuterons from (n,2nd)

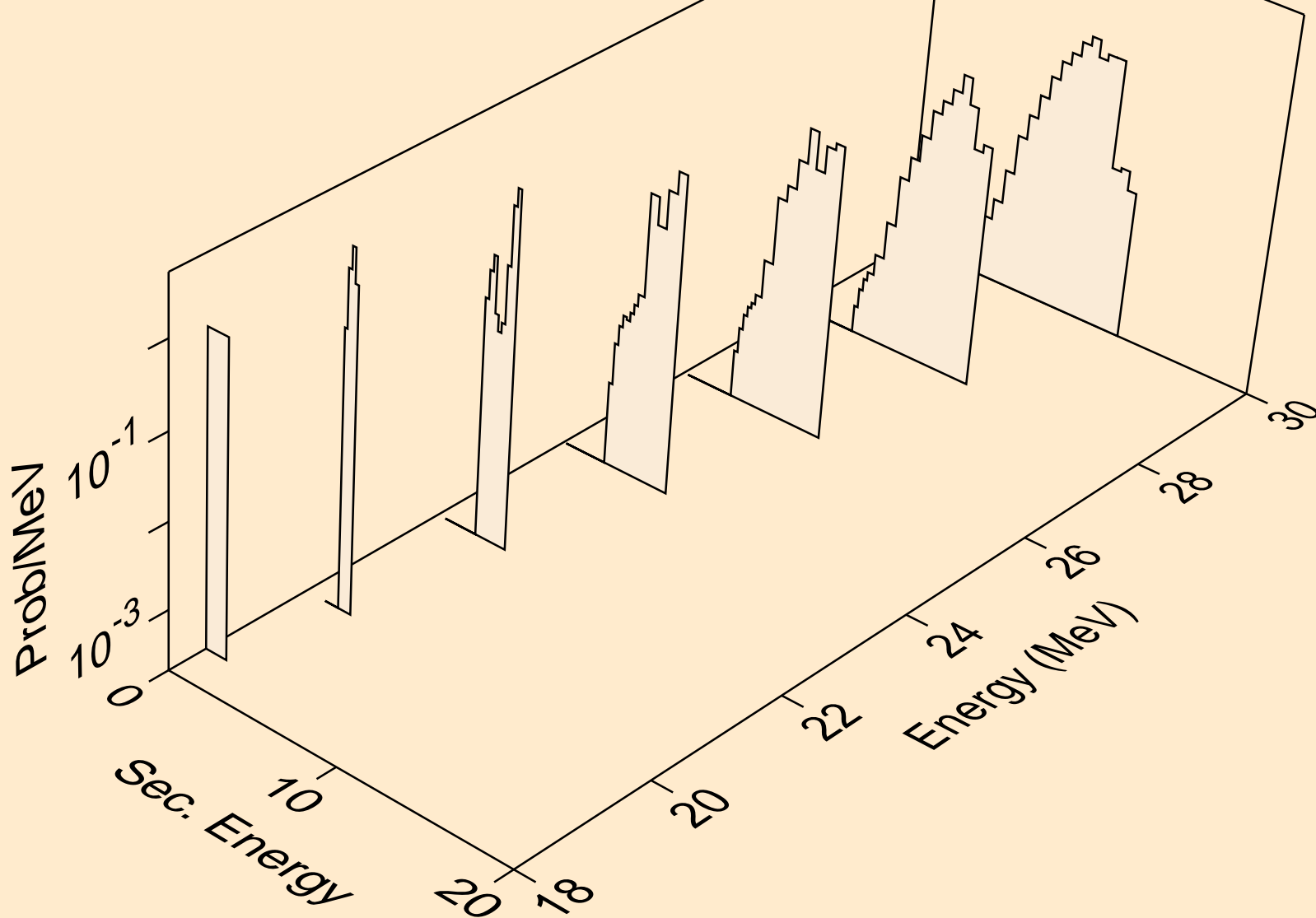

TB156 NEUTRON ACER TENDL-2019 LIBRARY; T=293.16K  
deuterons from (n,n\*)d

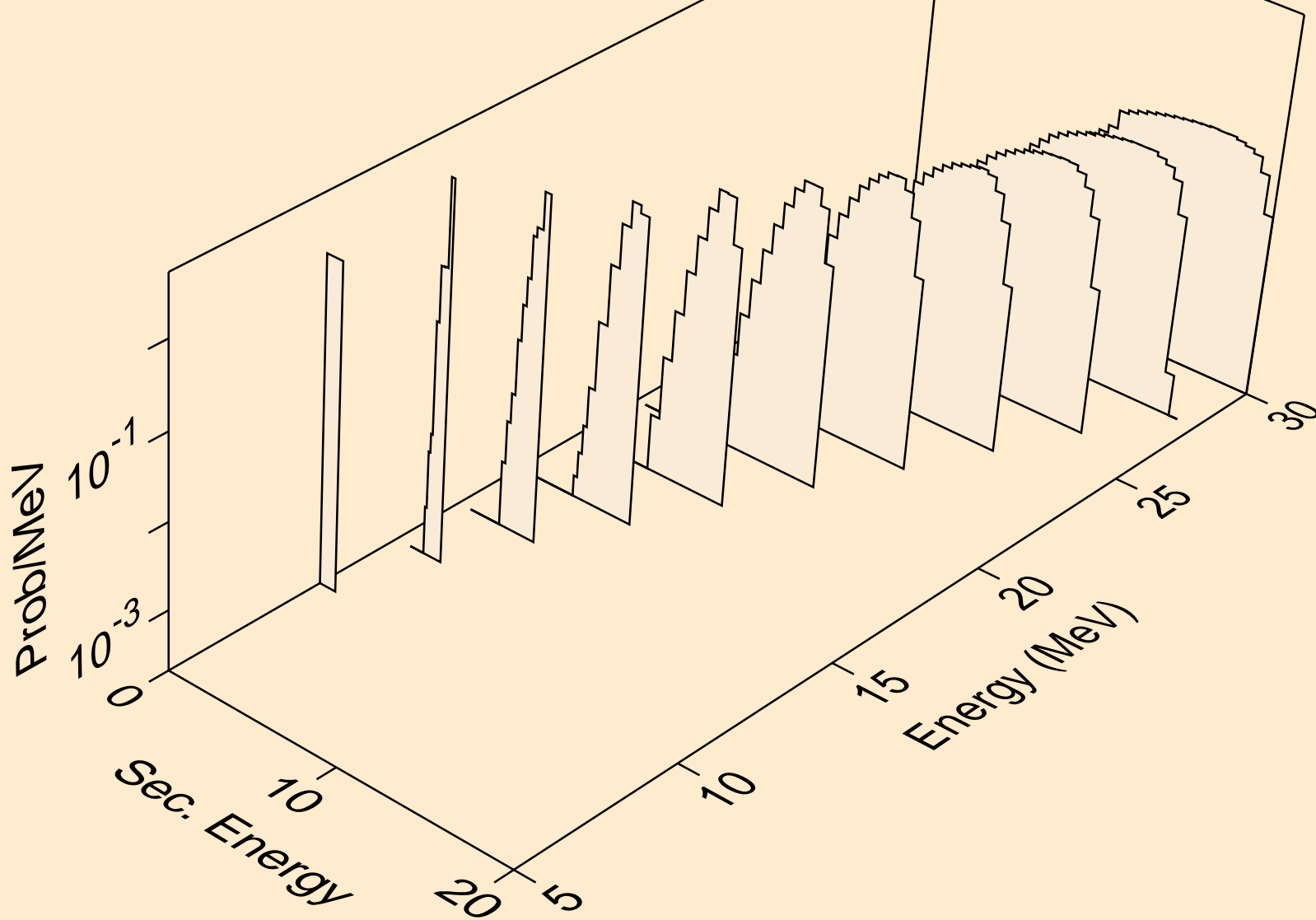

TB156 NEUTRON ACER TENDL-2019 LIBRARY; T=293.16K  
deuterons from (n,d)

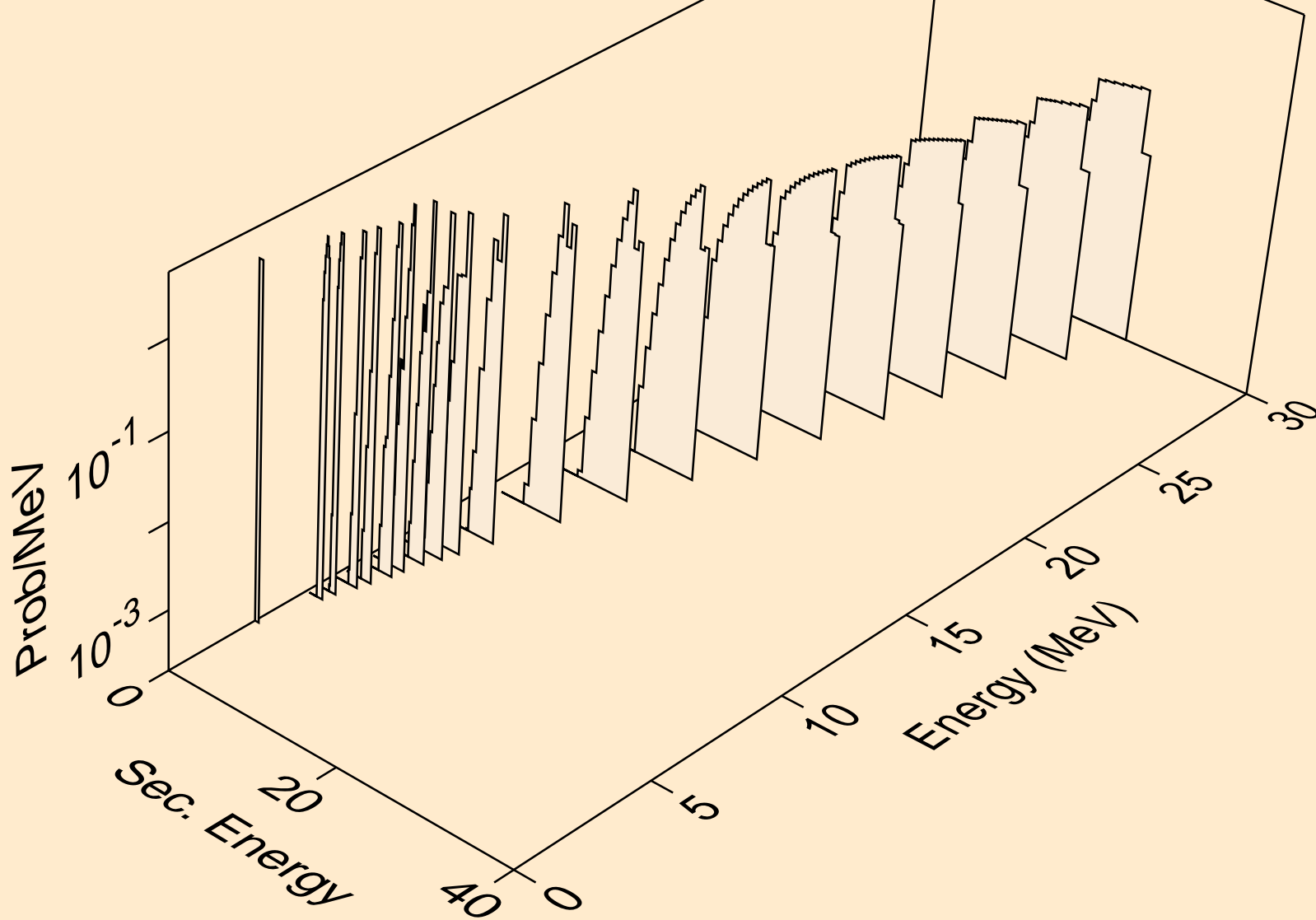

TB156 NEUTRON ACER TENDL-2019 LIBRARY; T=293.16K  
deuterons from (n,pd)

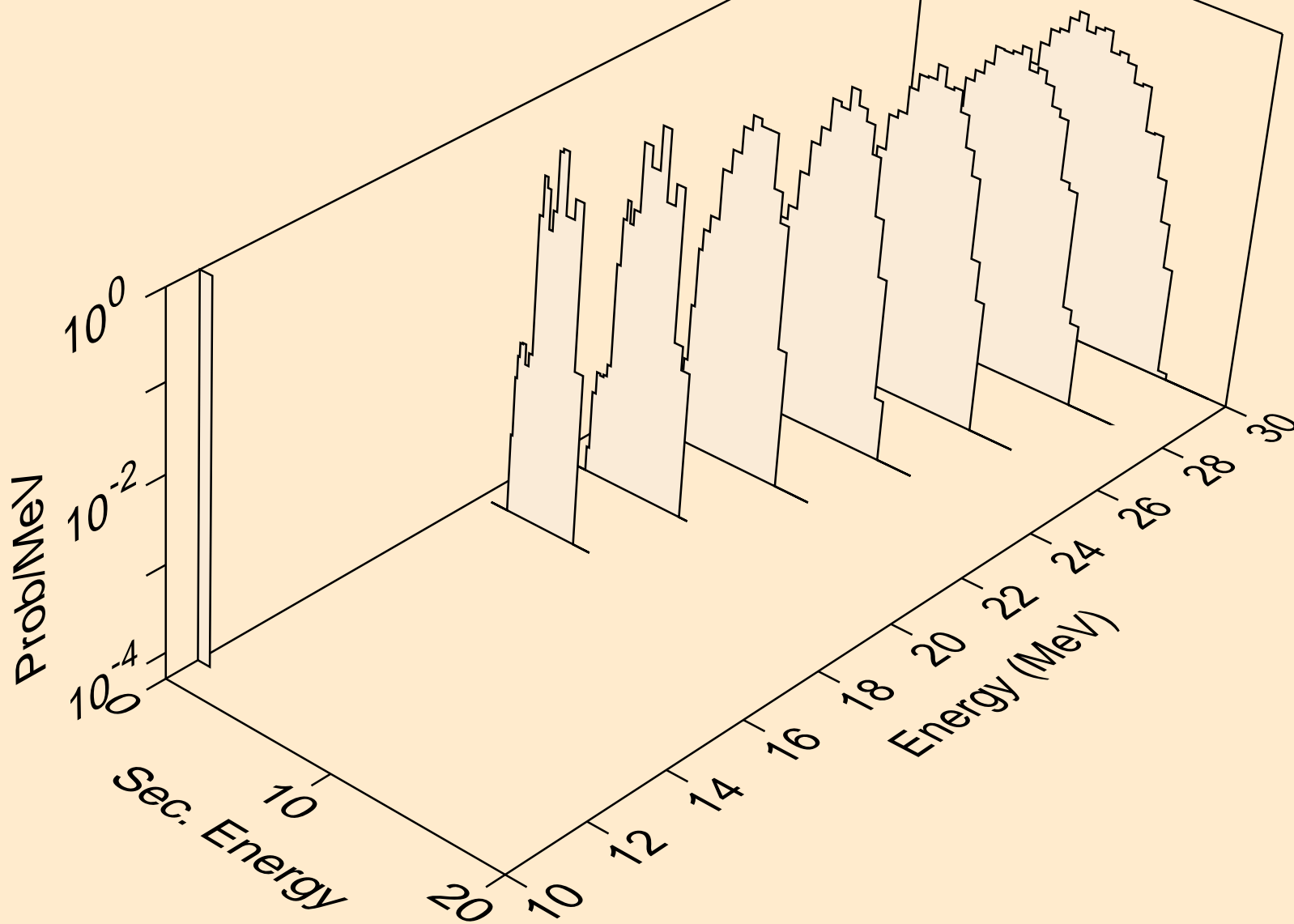

TB156 NEUTRON ACER TENDL-2019 LIBRARY; T=293.16K  
deuterons from (n,da)

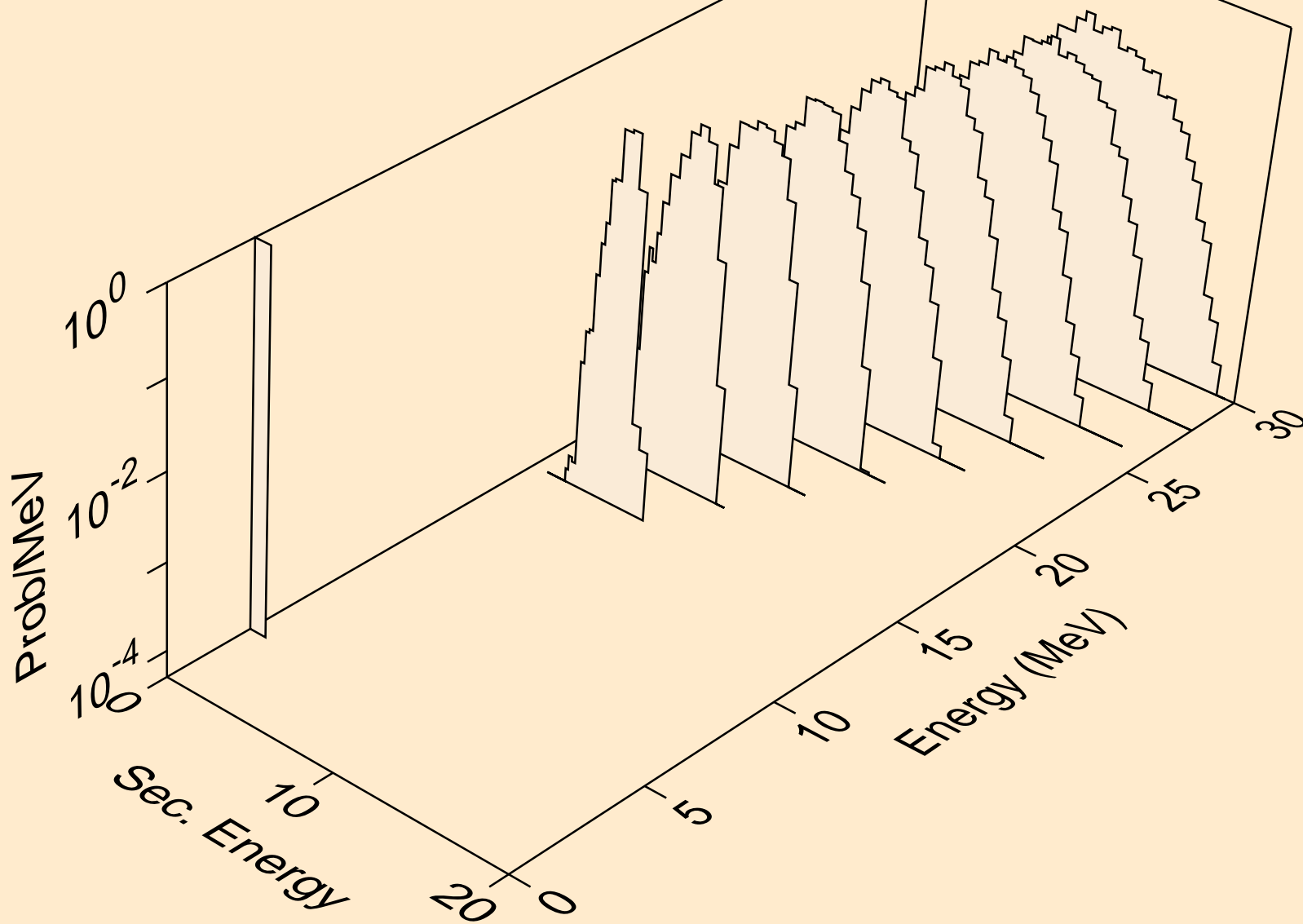

TB156 NEUTRON ACER TENDL-2019 LIBRARY; T=293.16K  
tritons from (n,x)

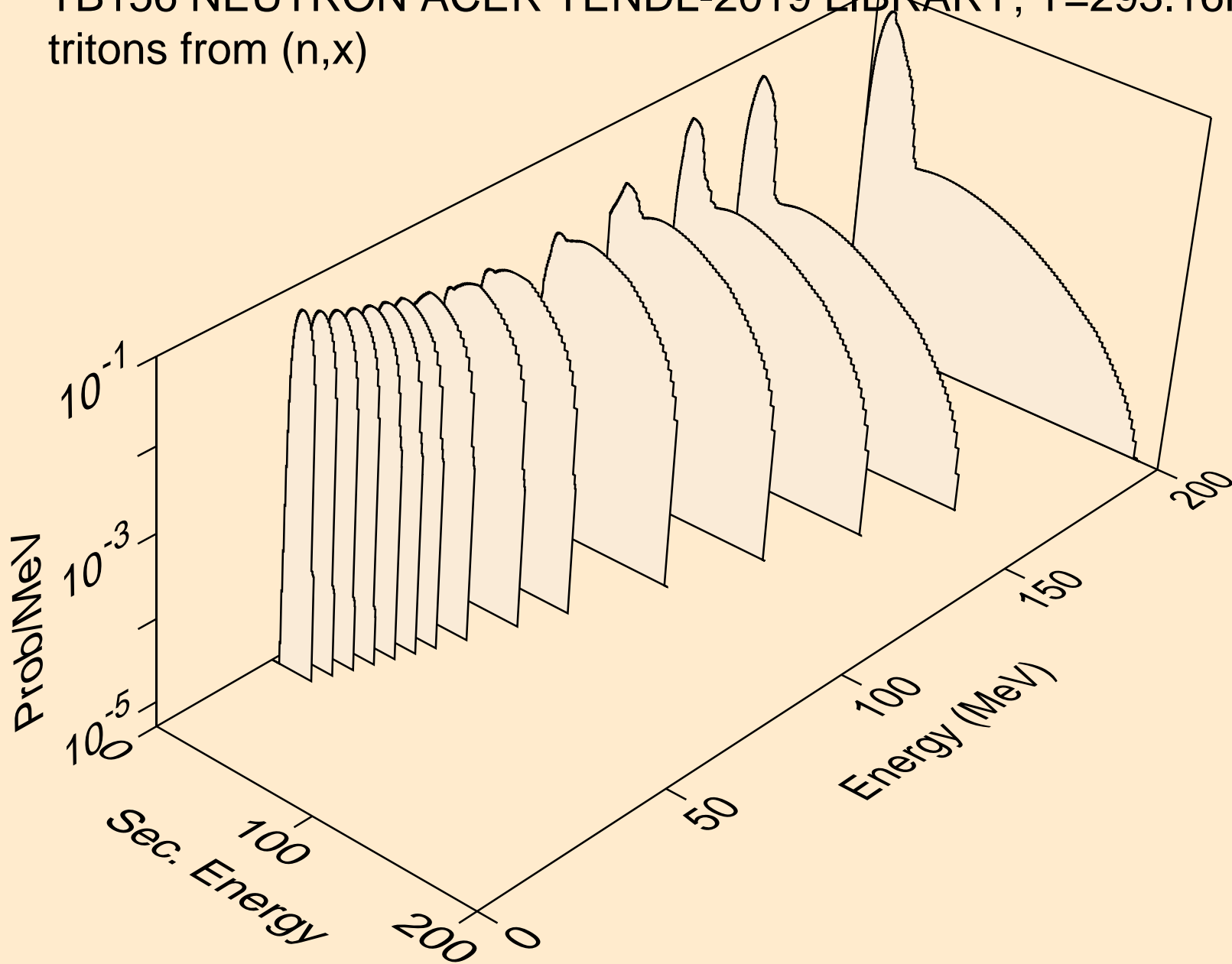

TB156 NEUTRON ACER TENDL-2019 LIBRARY; T=293.16K  
tritons from (n,n\*)t

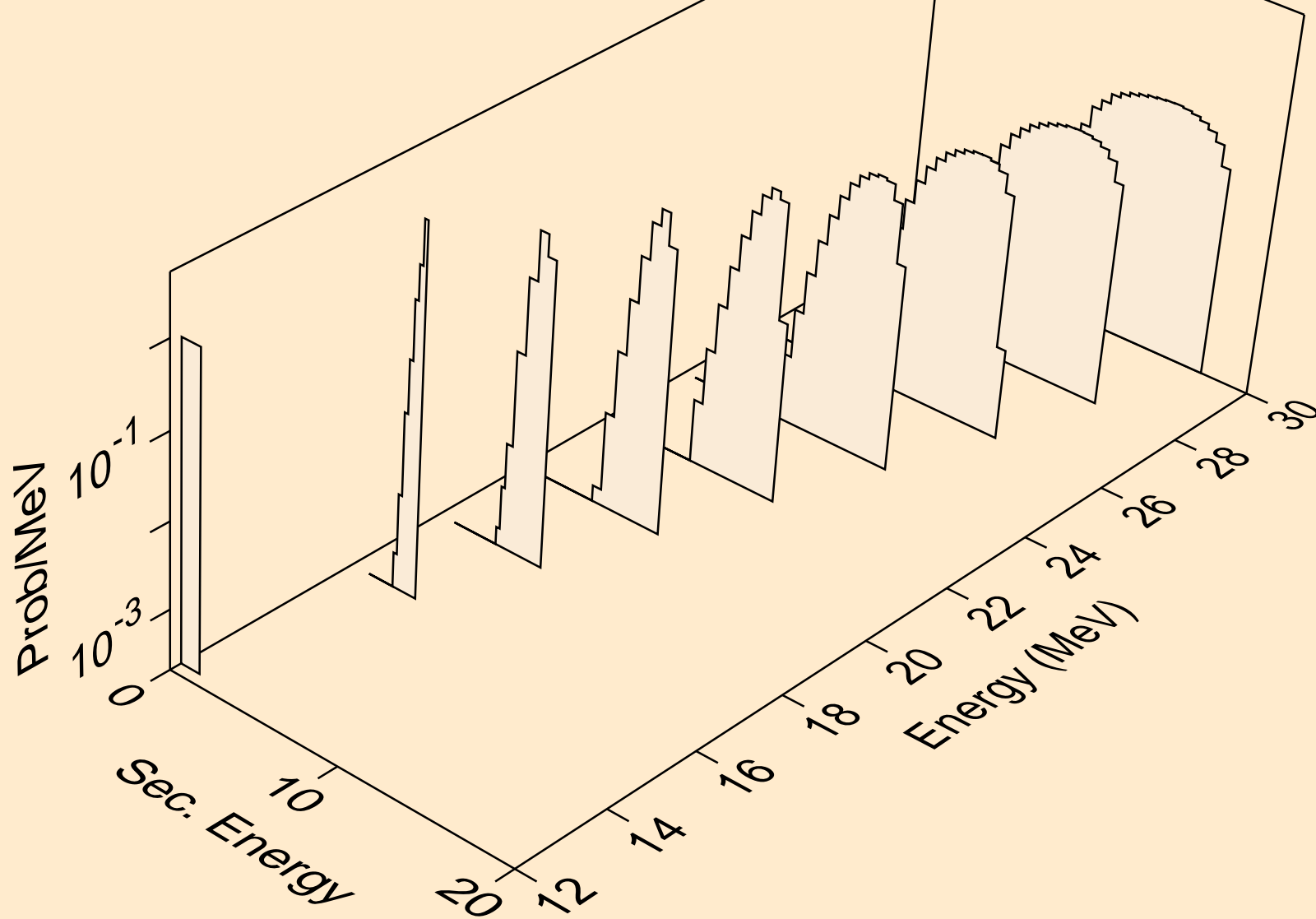

TB156 NEUTRON ACER TENDL-2019 LIBRARY; T=293.16K  
tritons from (n,t)

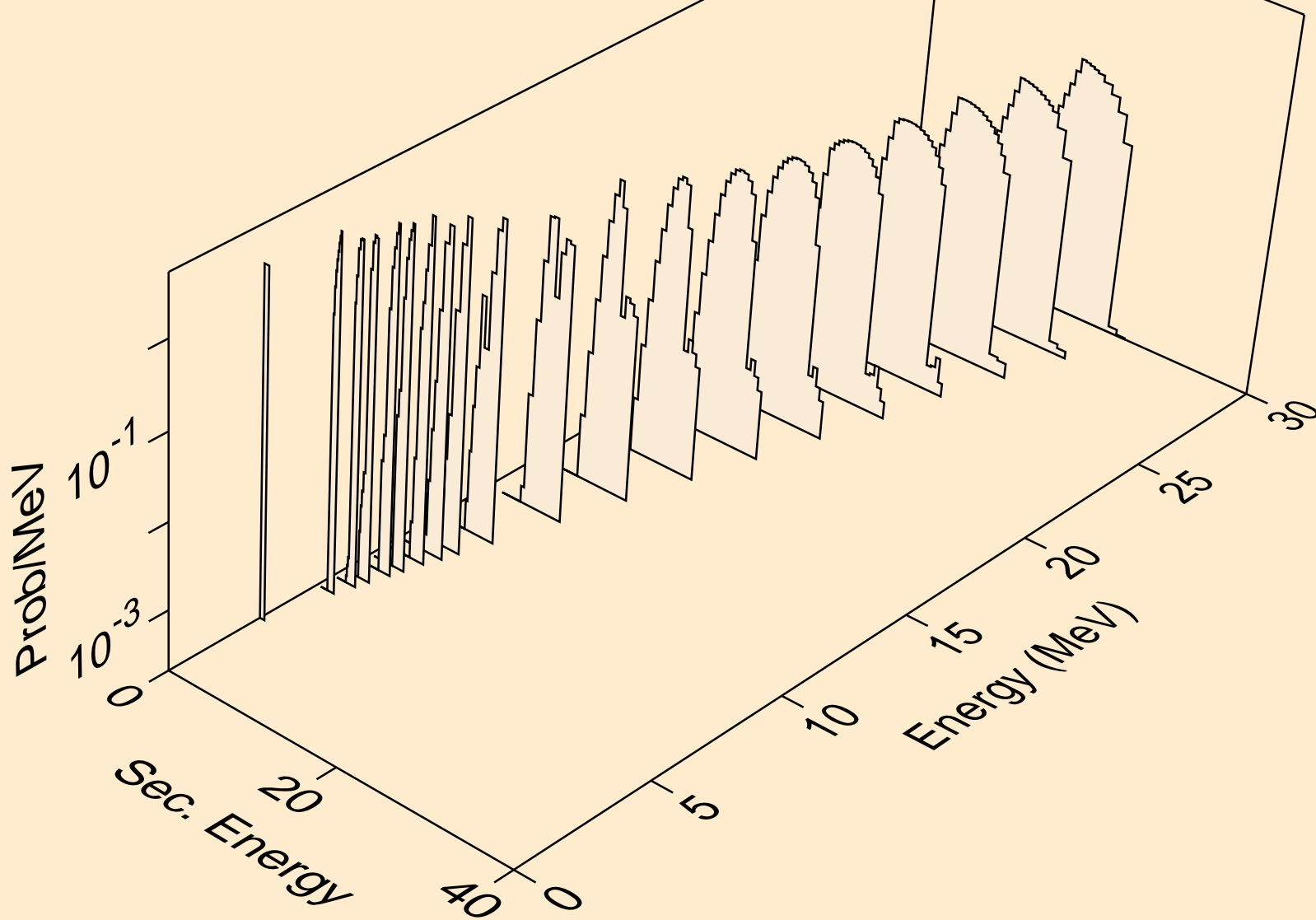



TB156 NEUTRON ACER TENDL-2019 LIBRARY; T=293.16K  
tritons from (n,pt)

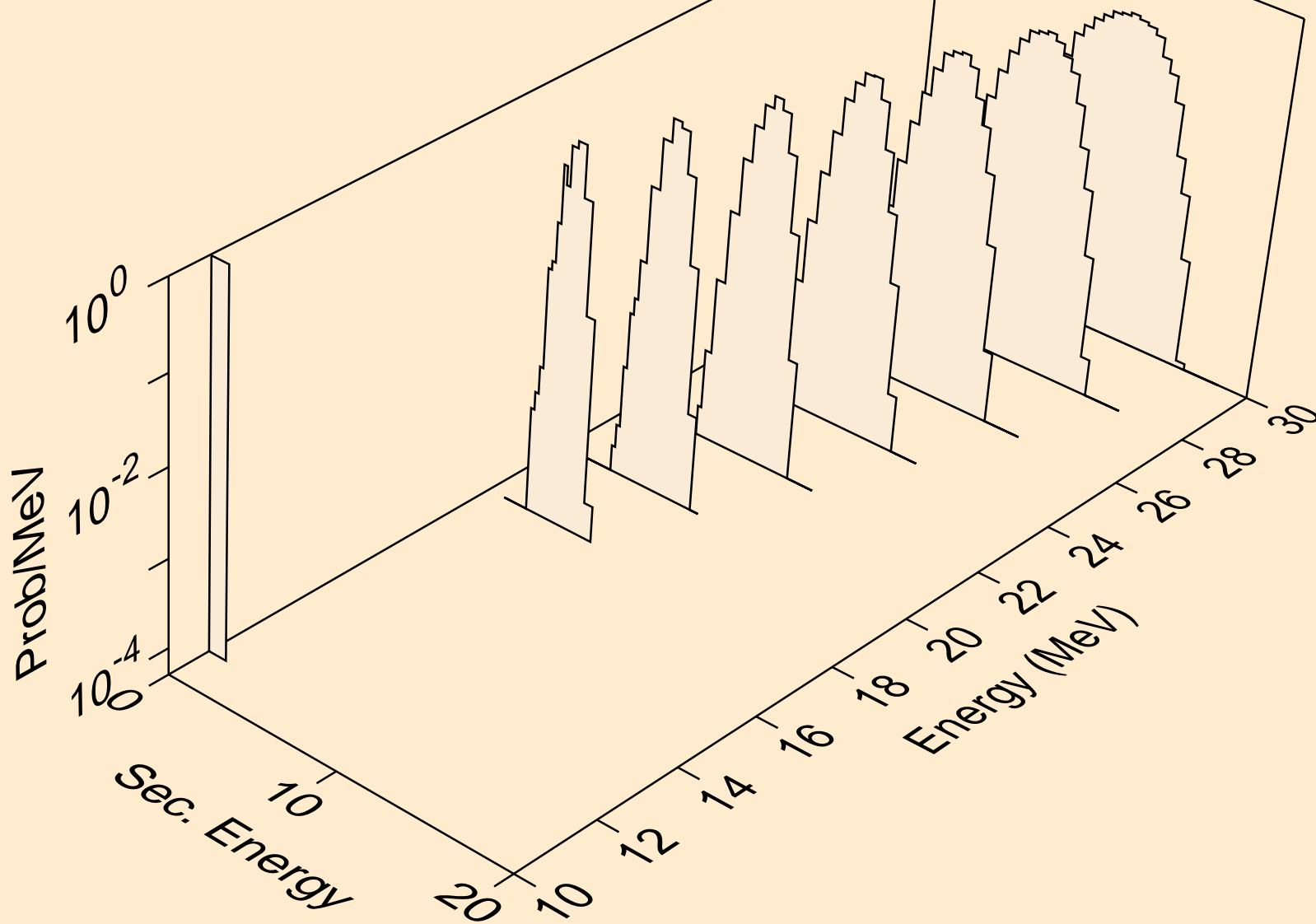

TB156 NEUTRON ACER TENDL-2019 LIBRARY; T=293.16K  
he3s from (n,x)

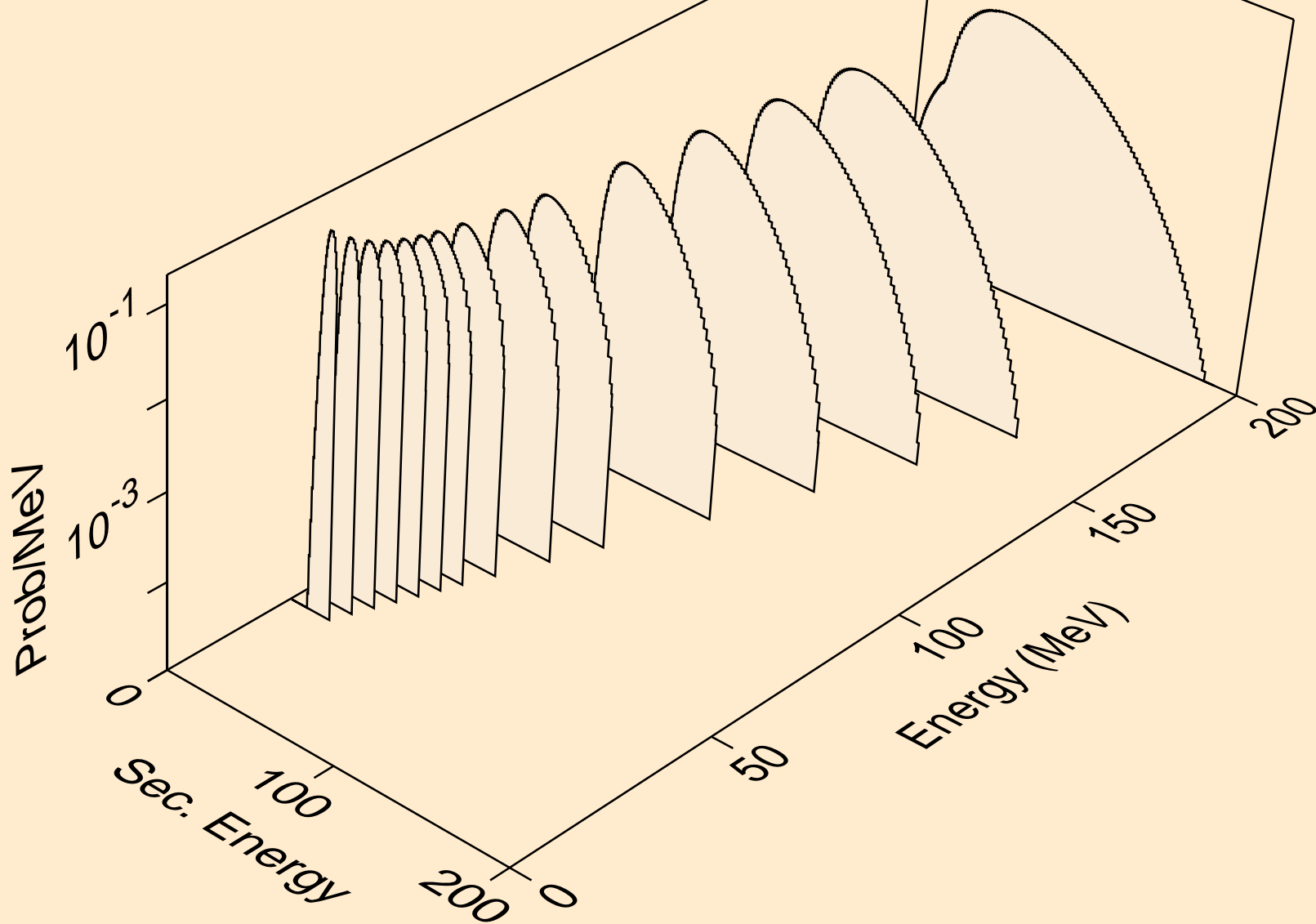

TB156 NEUTRON ACER TENDL-2019 LIBRARY; T=293.16K  
he3s from (n,n\*)he3

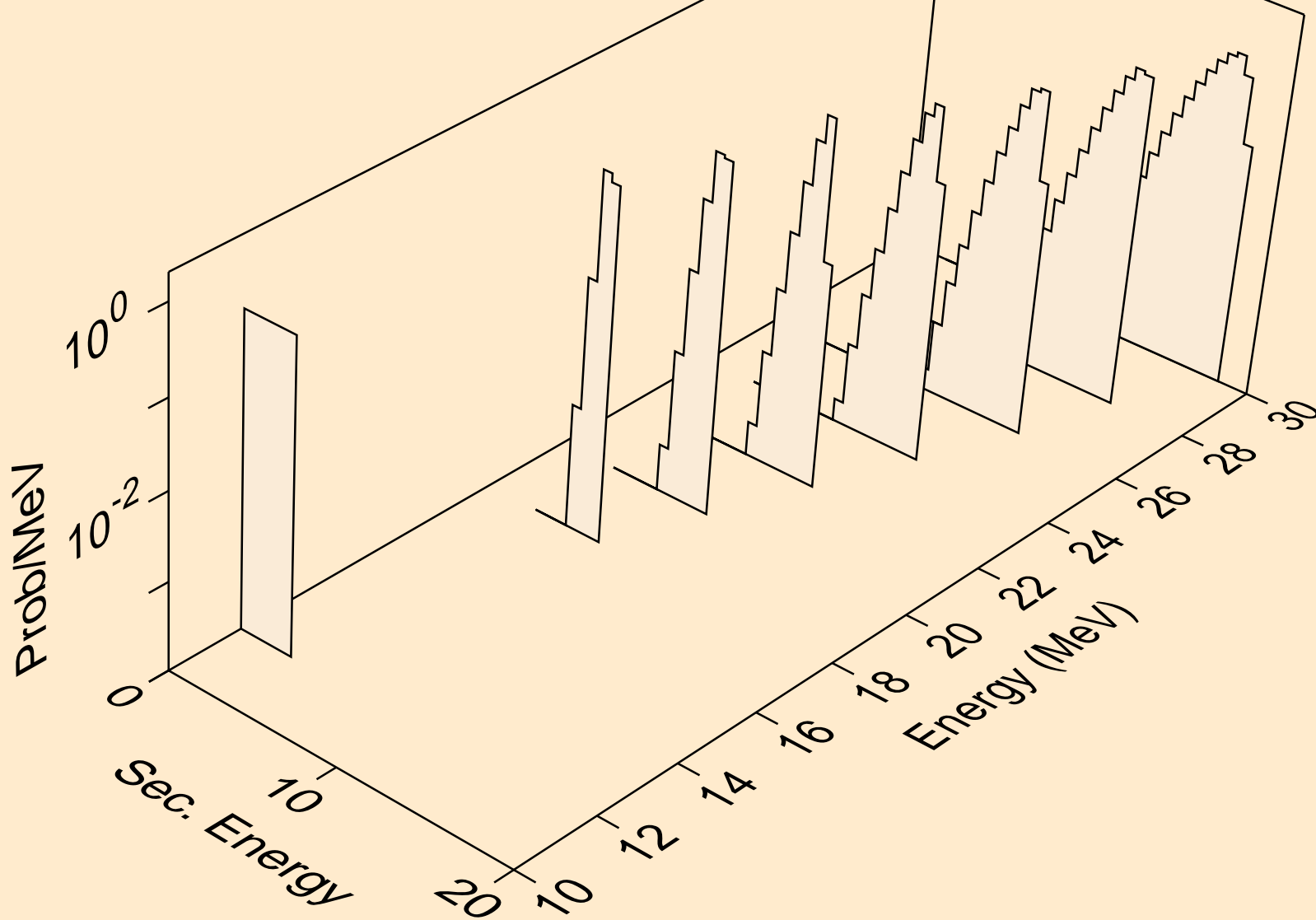

TB156 NEUTRON ACER TENDL-2019 LIBRARY; T=293.16K  
he3s from (n,he3)

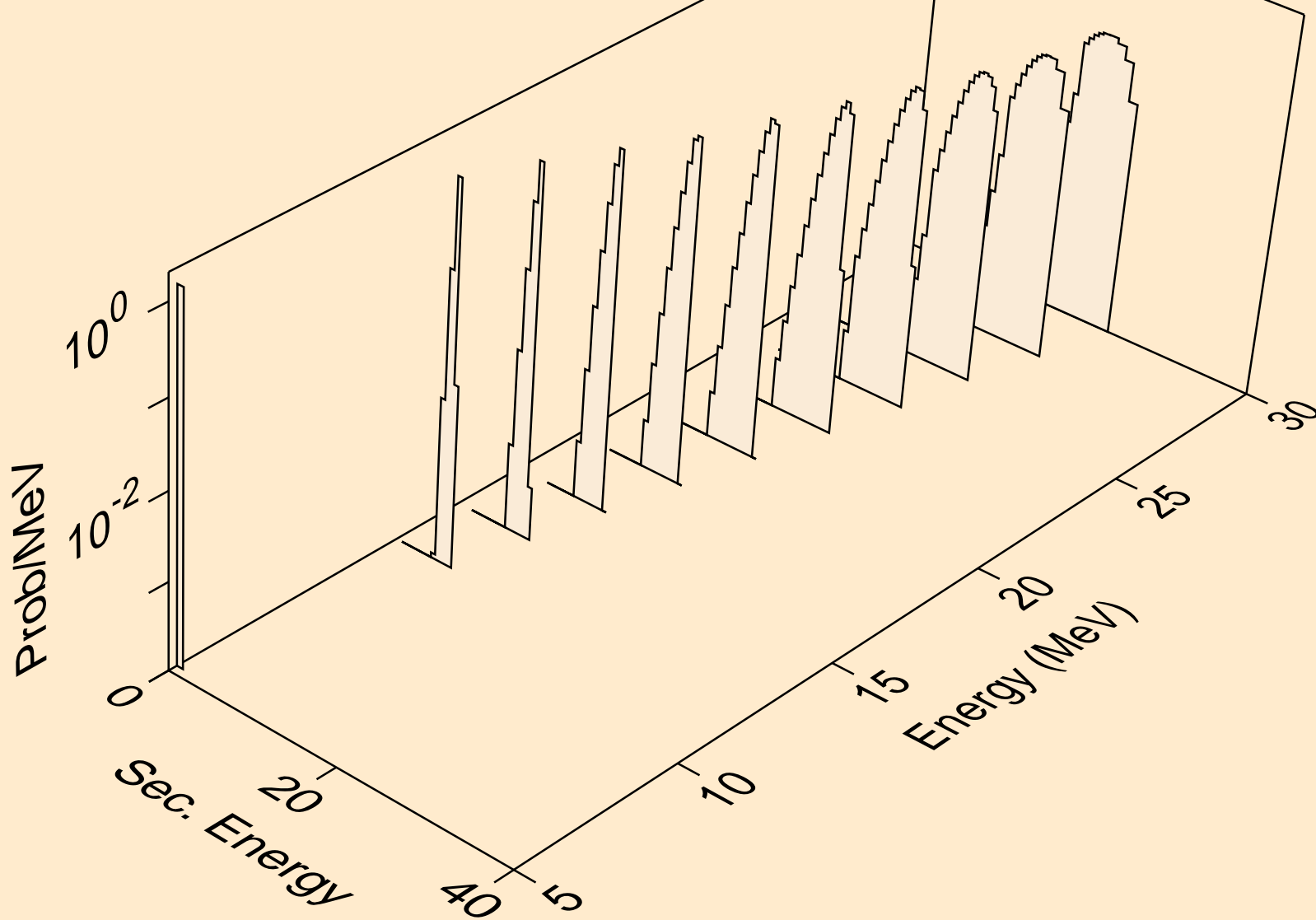

TB156 NEUTRON ACER TENDL-2019 LIBRARY; T=293.16K  
alphas from (n,x)

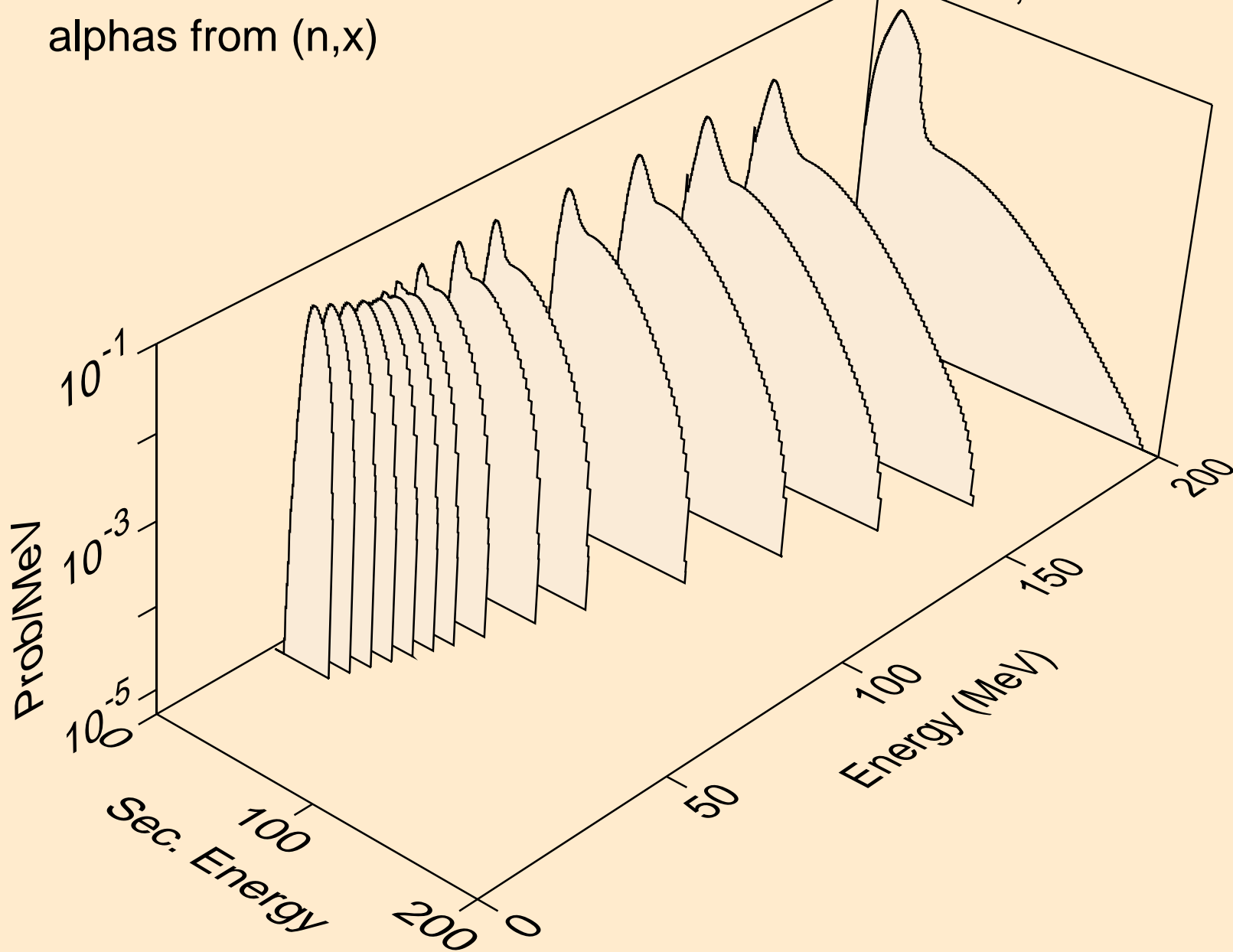

TB156 NEUTRON ACER TENDL-2019 LIBRARY; T=293.16K  
alphas from (n,n\*)a

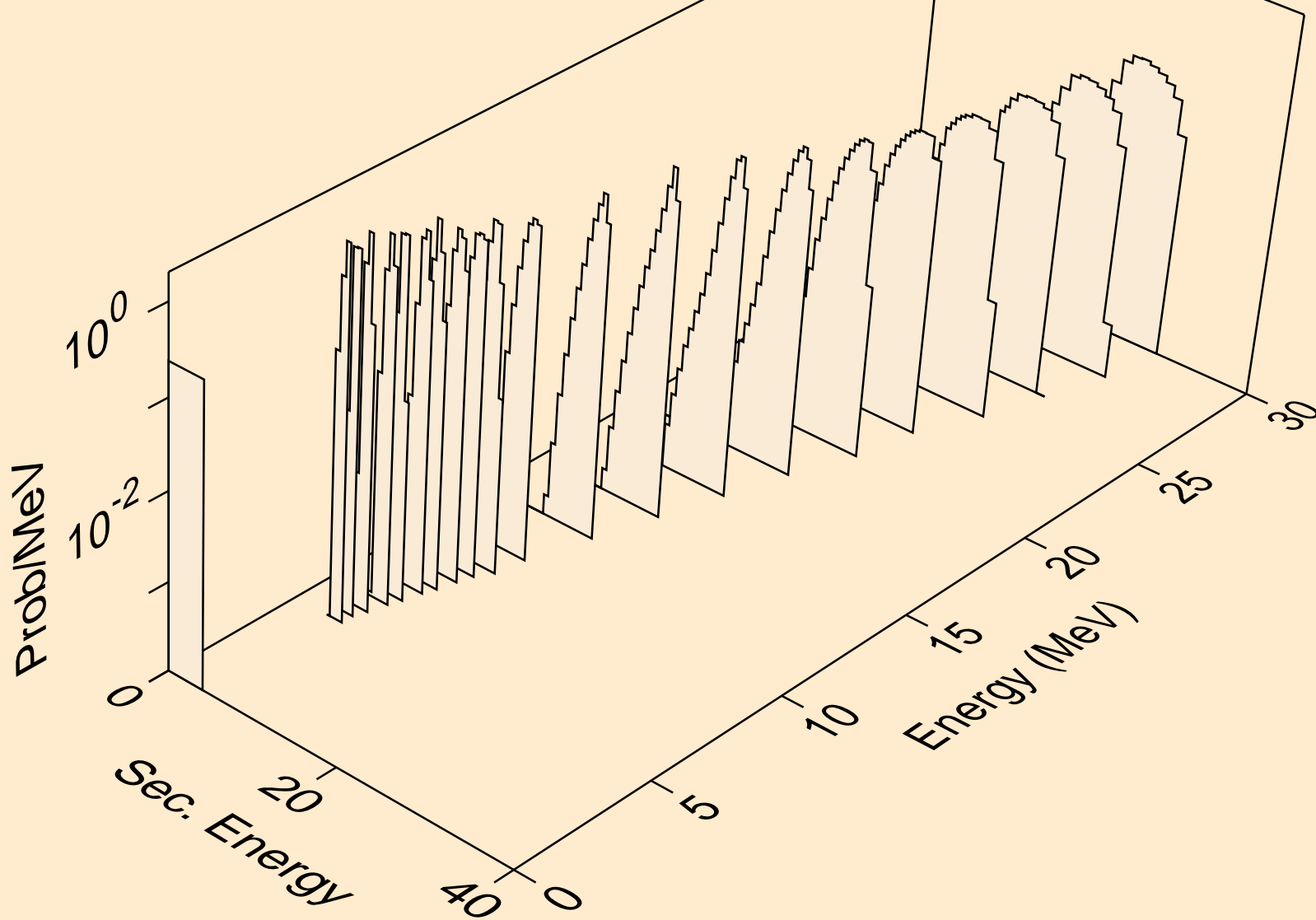

TB156 NEUTRON ACER TENDL-2019 LIBRARY; T=293.16K  
alphas from (n,2n)a

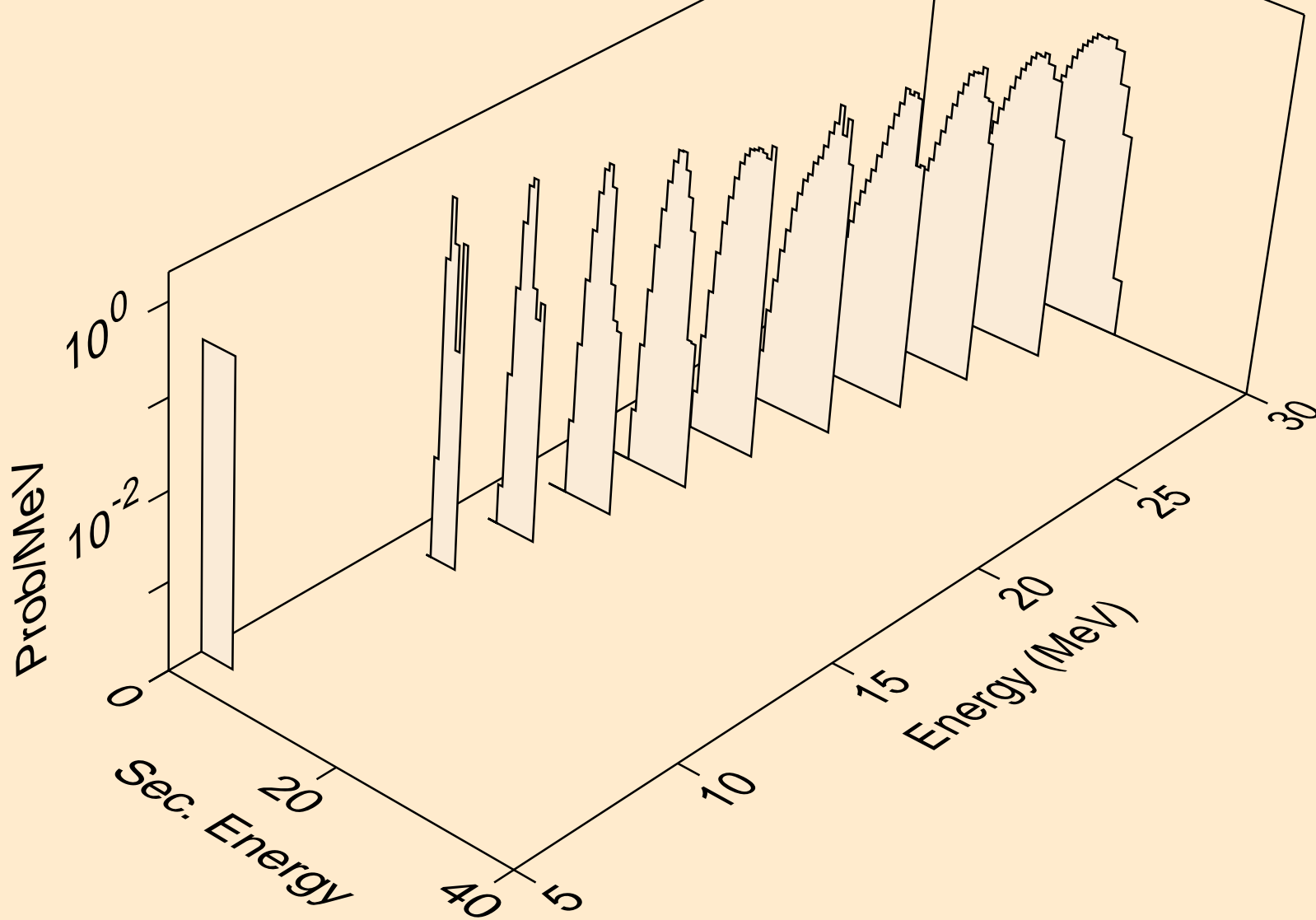

TB156 NEUTRON ACER TENDL-2019 LIBRARY; T=293.16K  
alphas from (n,3n)a

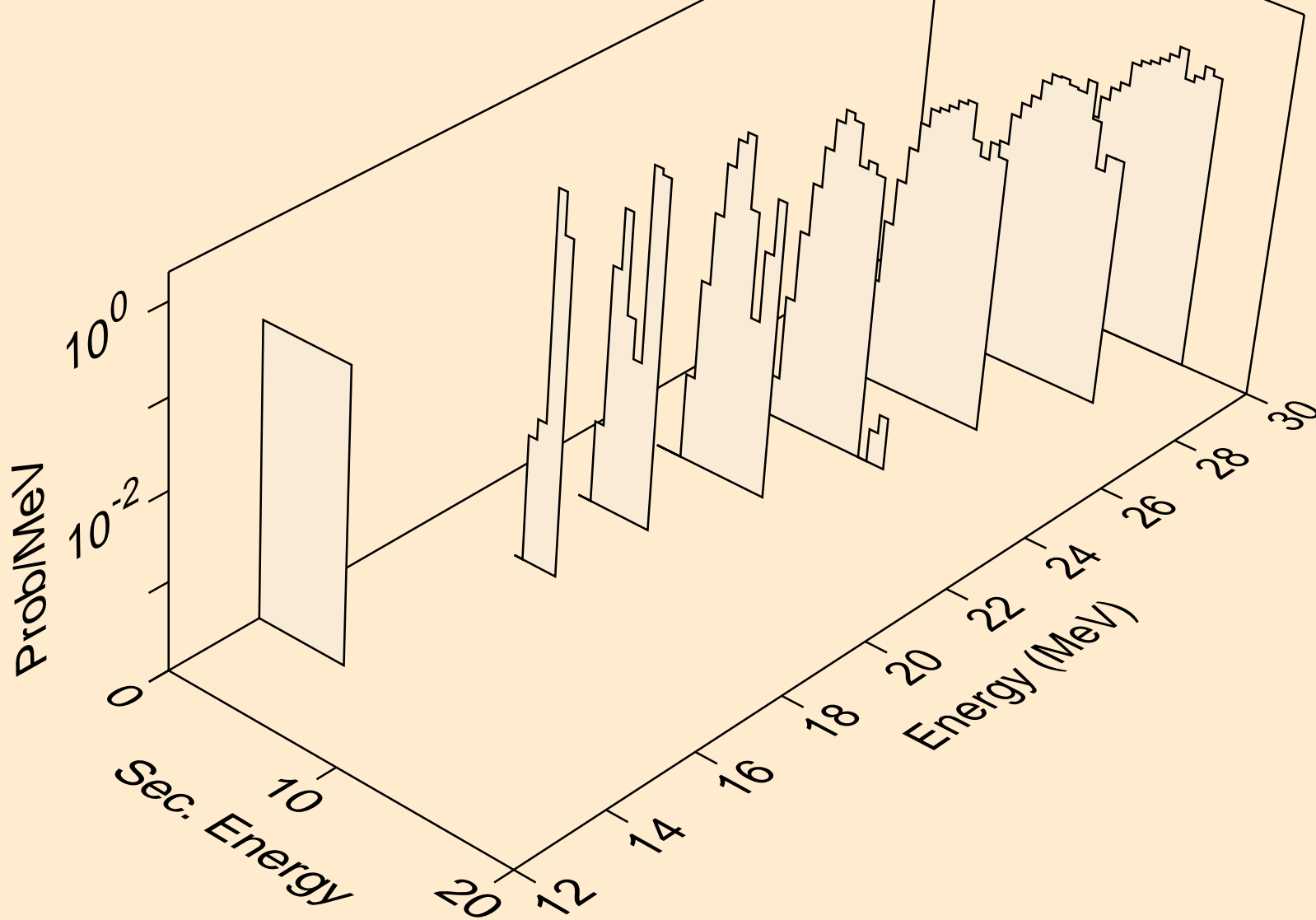



TB156 NEUTRON ACER TENDL-2019 LIBRARY; T=293.16K  
alphas from (n,n\*)2a

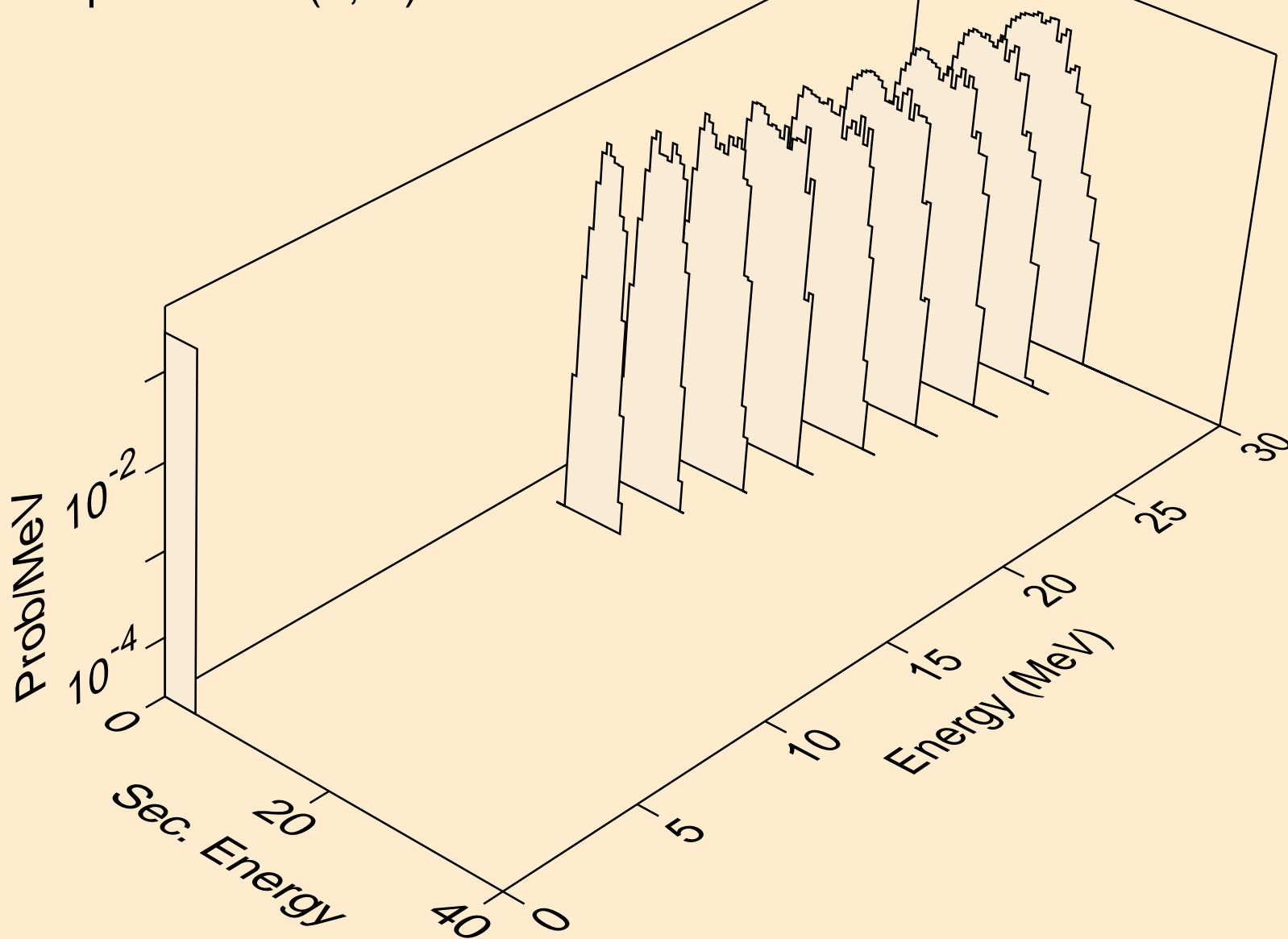

TB156 NEUTRON ACER TENDL-2019 LIBRARY; T=293.16K  
alphas from (n,2n)2a

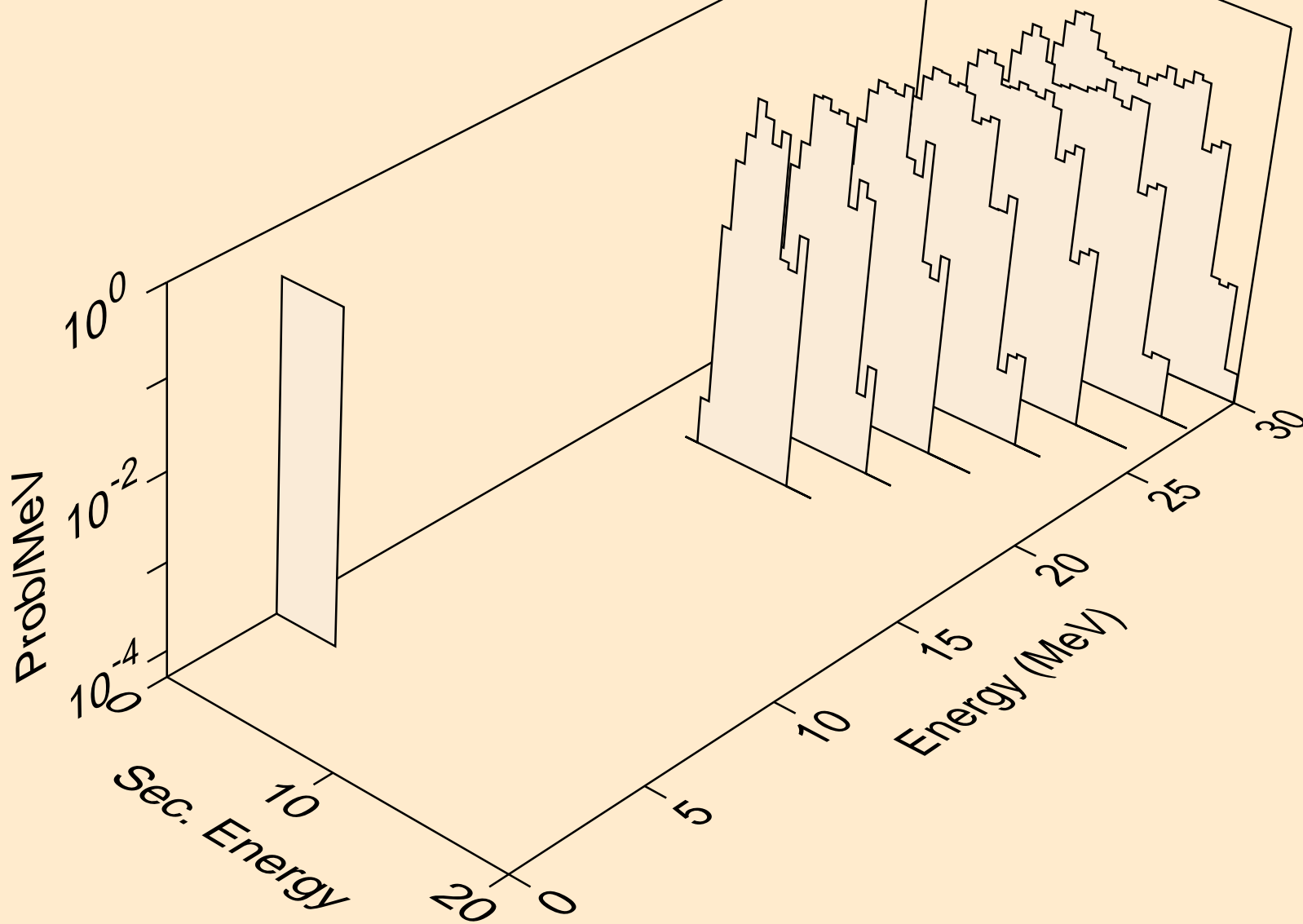

TB156 NEUTRON ACER TENDL-2019 LIBRARY; T=293.16K  
alphas from (n,npa)

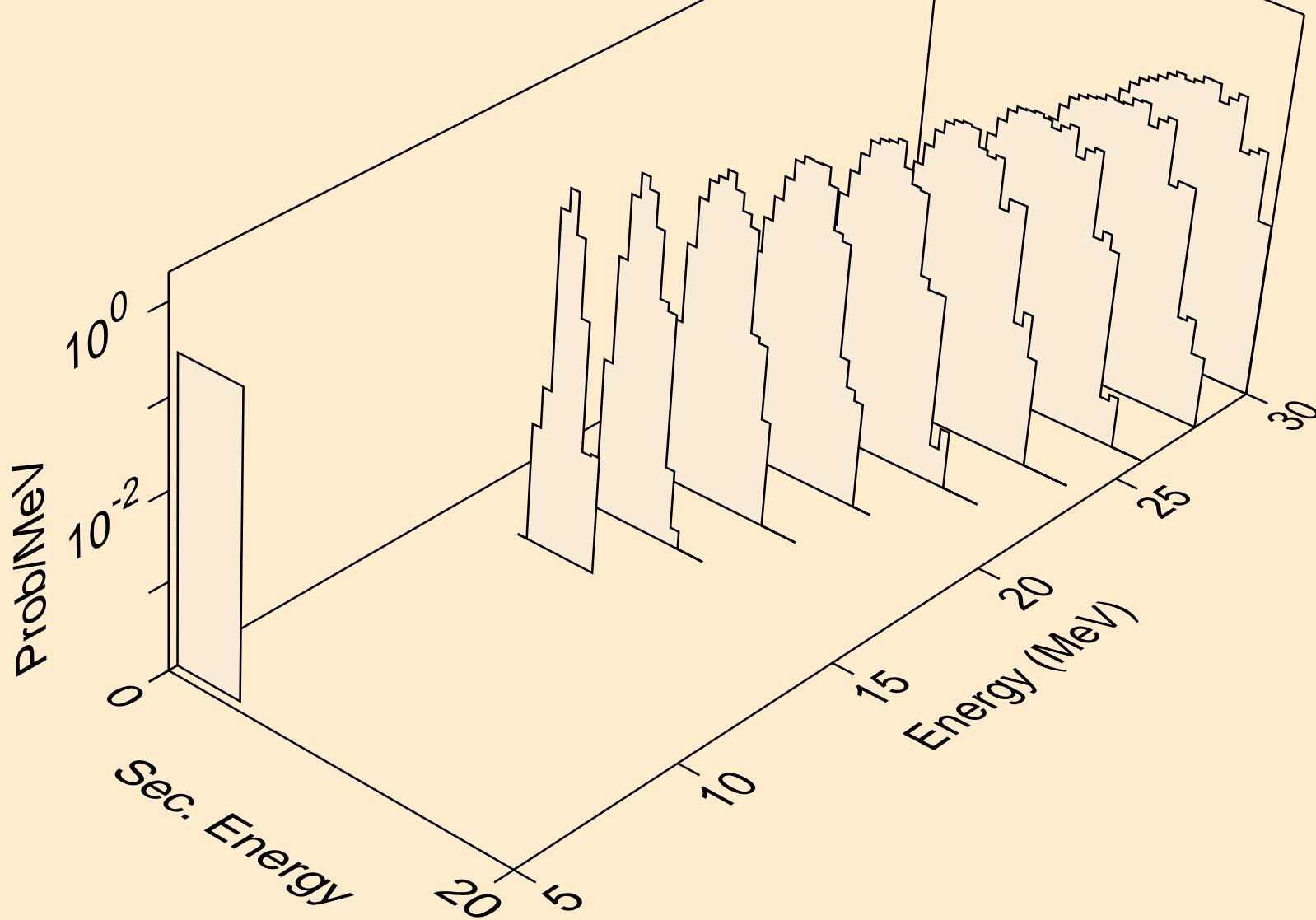

TB156 NEUTRON ACER TENDL-2019 LIBRARY; T=293.16K  
alphas from (n,a)

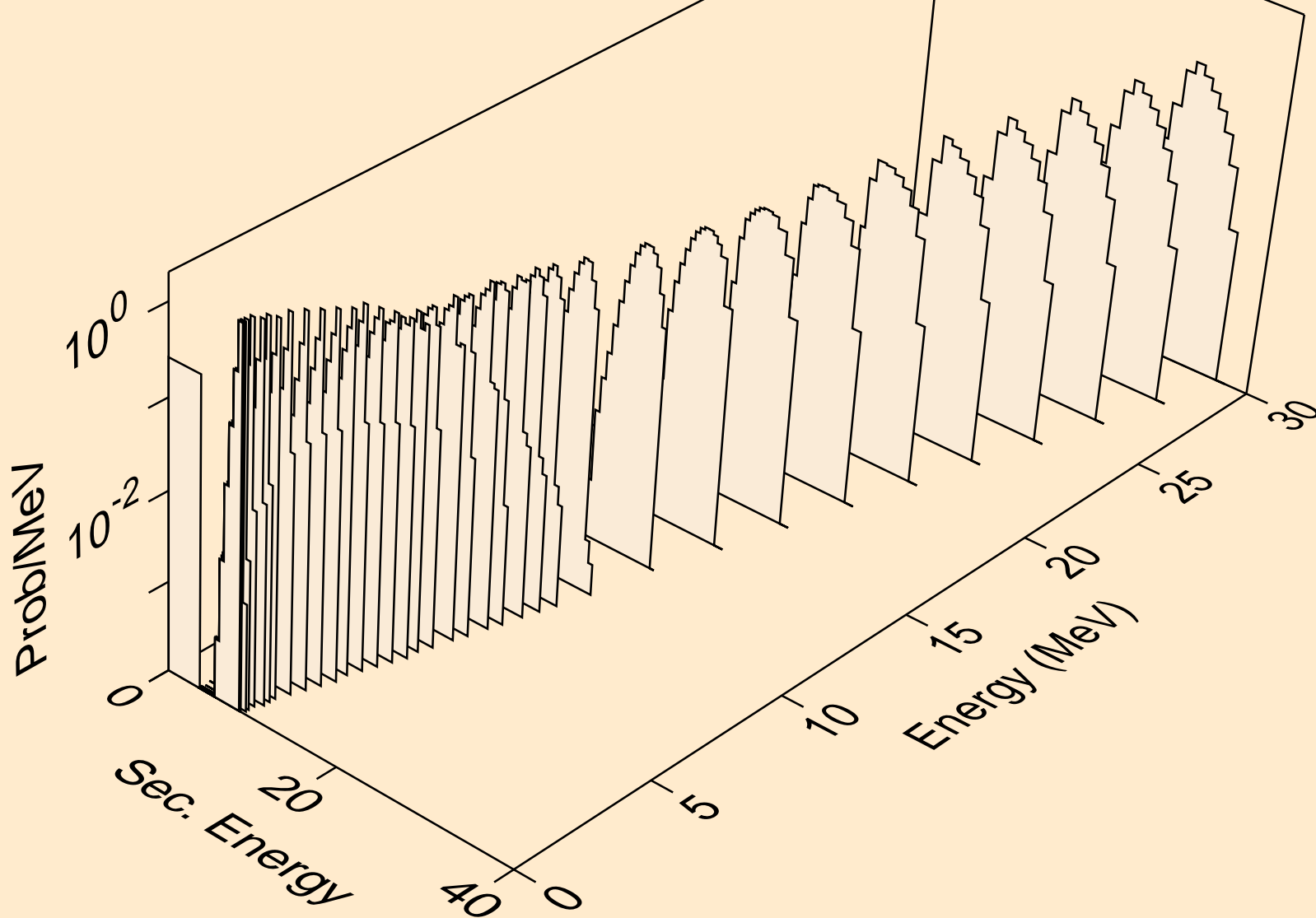

TB156 NEUTRON ACER TENDL-2019 LIBRARY; T=293.16K  
alphas from (n,2a)

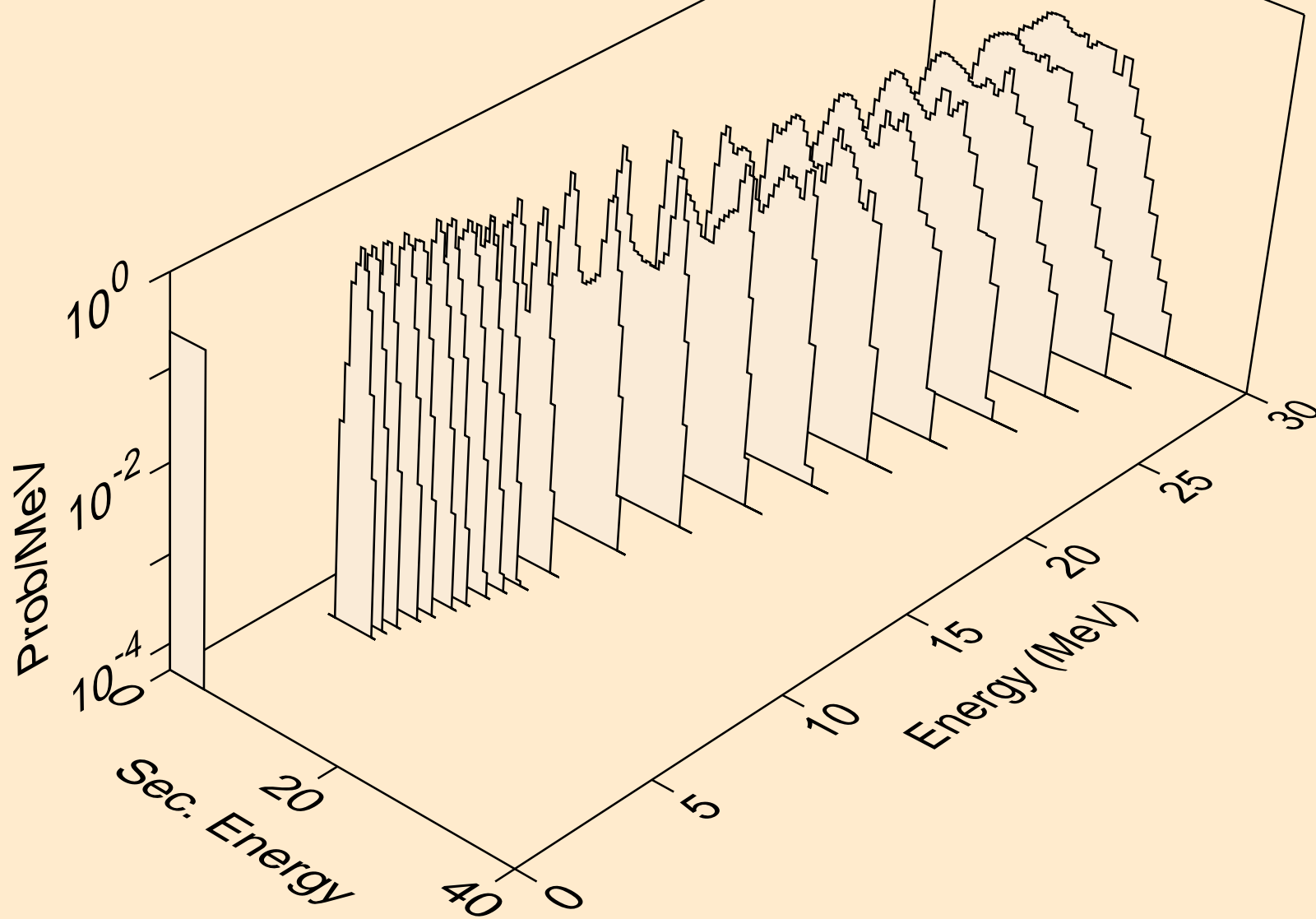

TB156 NEUTRON ACER TENDL-2019 LIBRARY; T=293.16K  
alphas from (n,pa)

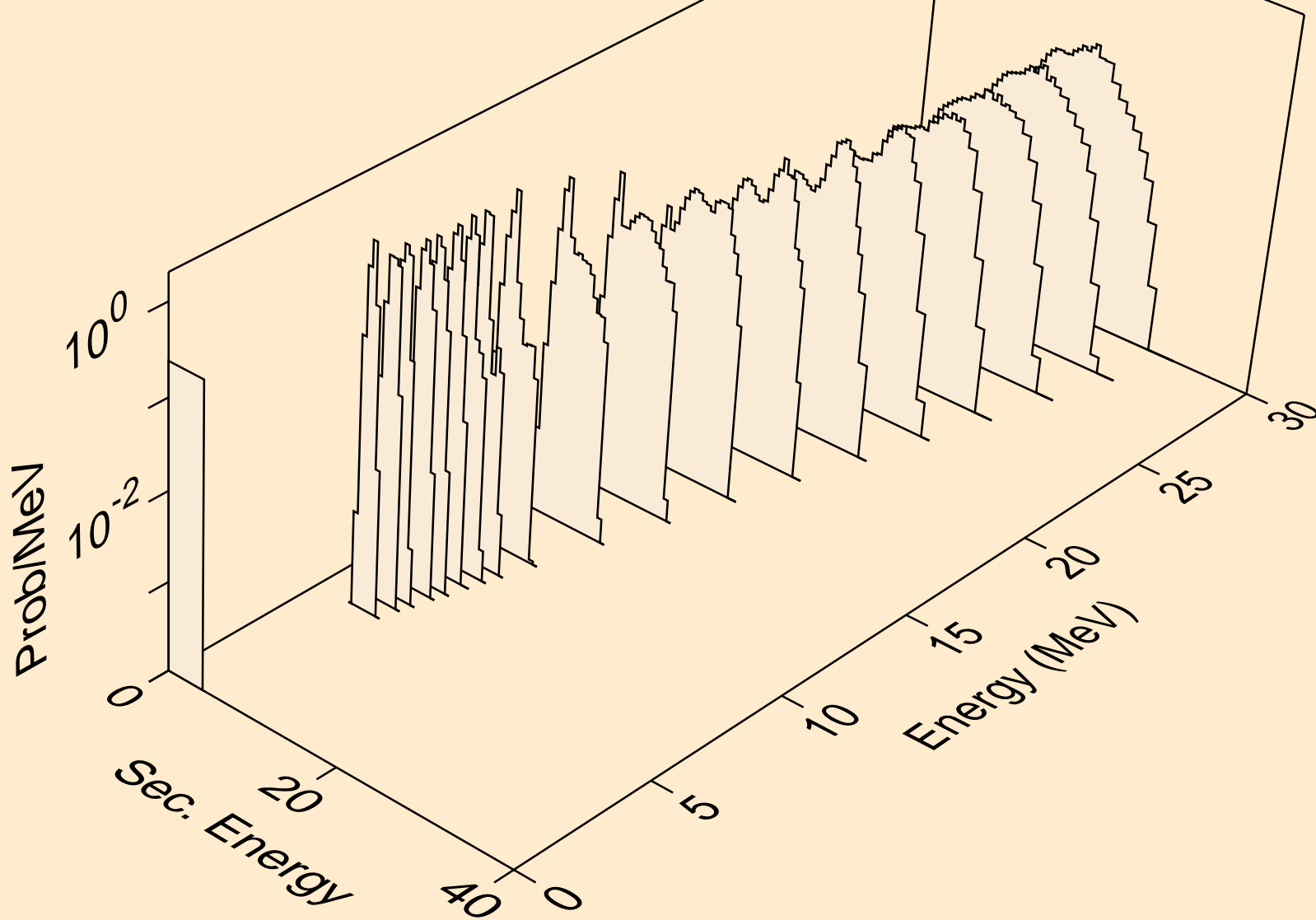

TB156 NEUTRON ACER TENDL-2019 LIBRARY; T=293.16K  
alphas from (n,da)

