

TH236 NEUTRON ACER TENDL-2019 LIBRARY; T=293.16K
Principal cross sections

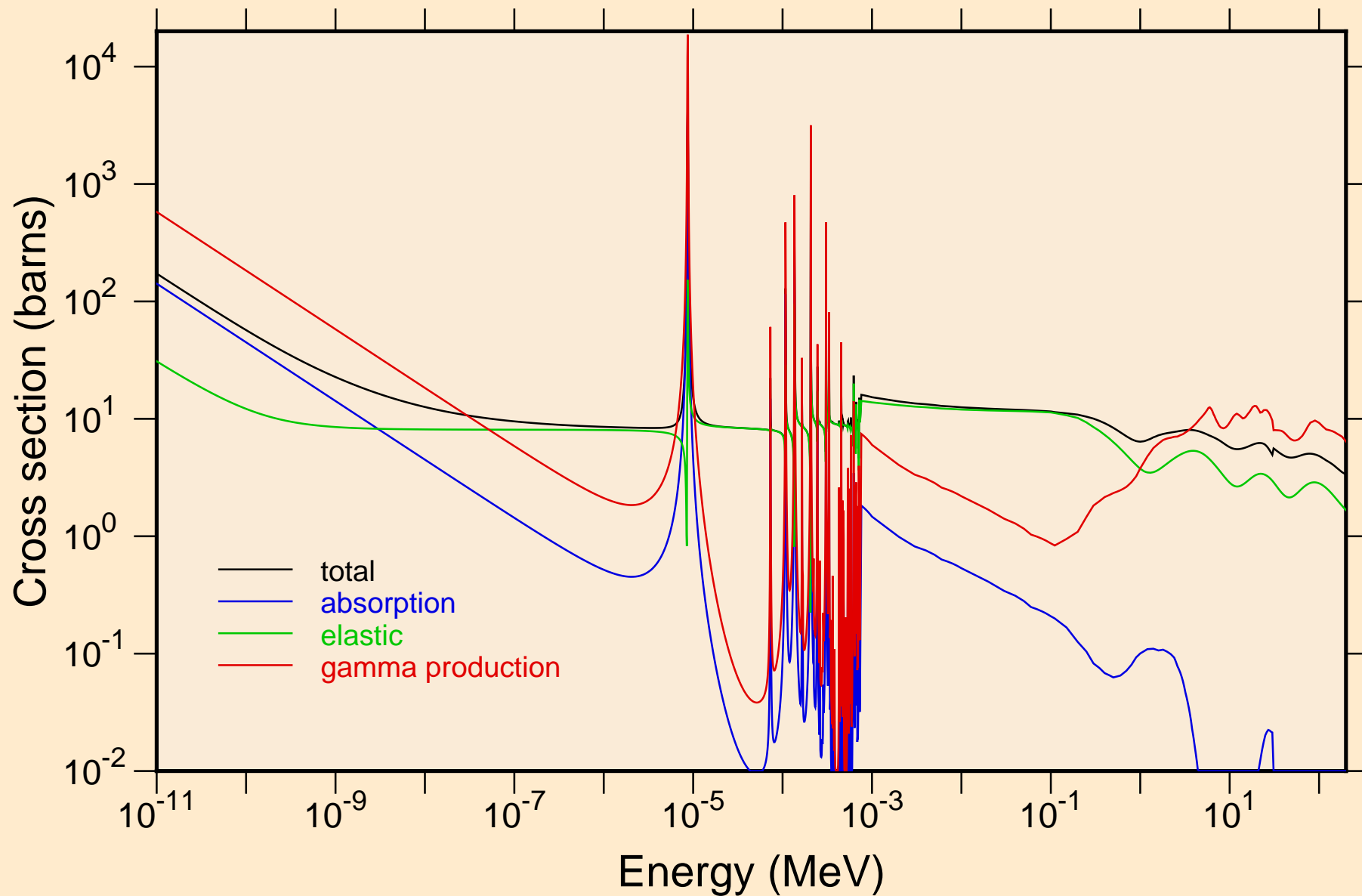

TH236 NEUTRON ACER TENDL-2019 LIBRARY; T=293.16K
resonance total cross section

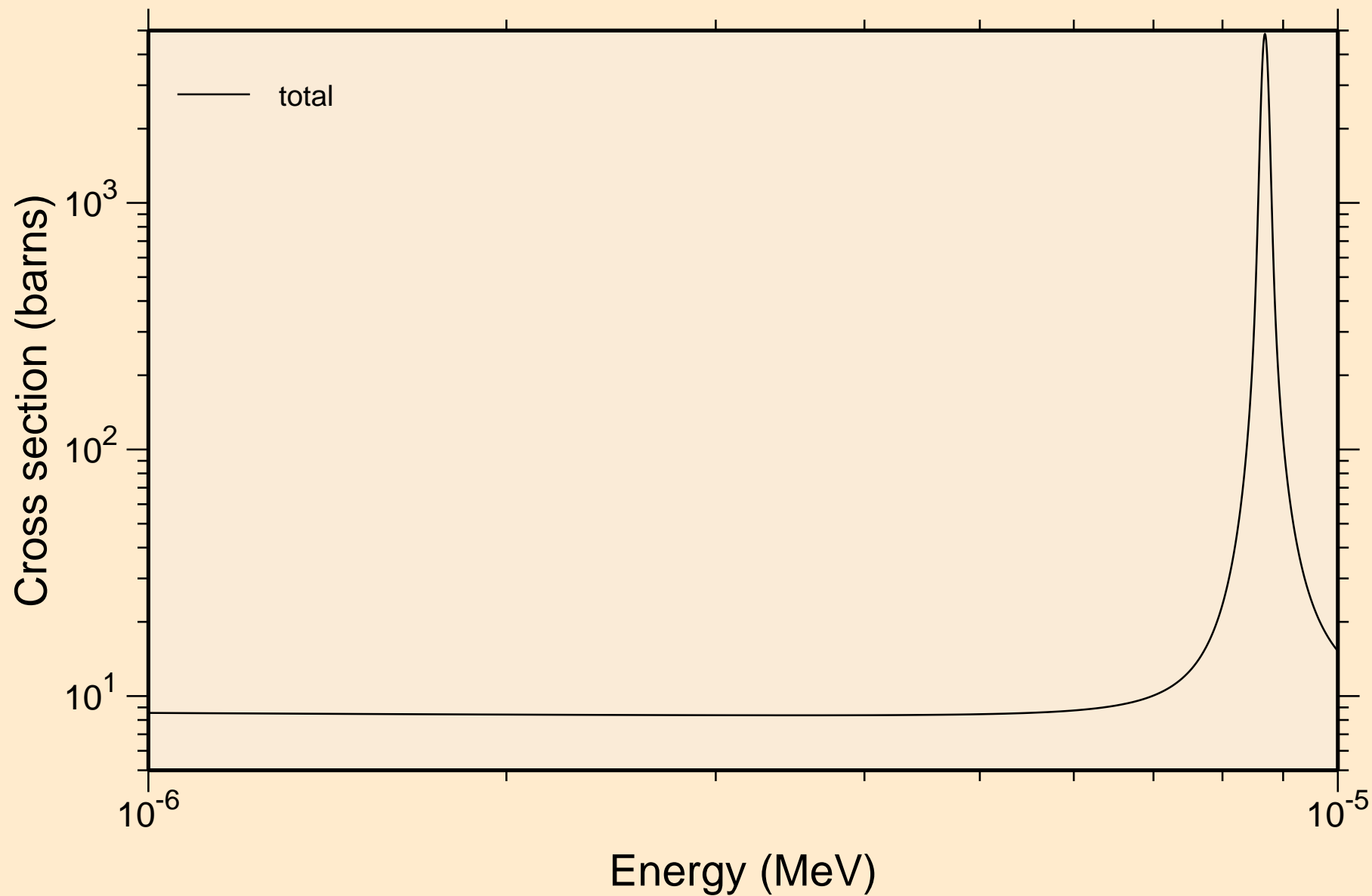

TH236 NEUTRON ACER TENDL-2019 LIBRARY; T=293.16K
resonance total cross section

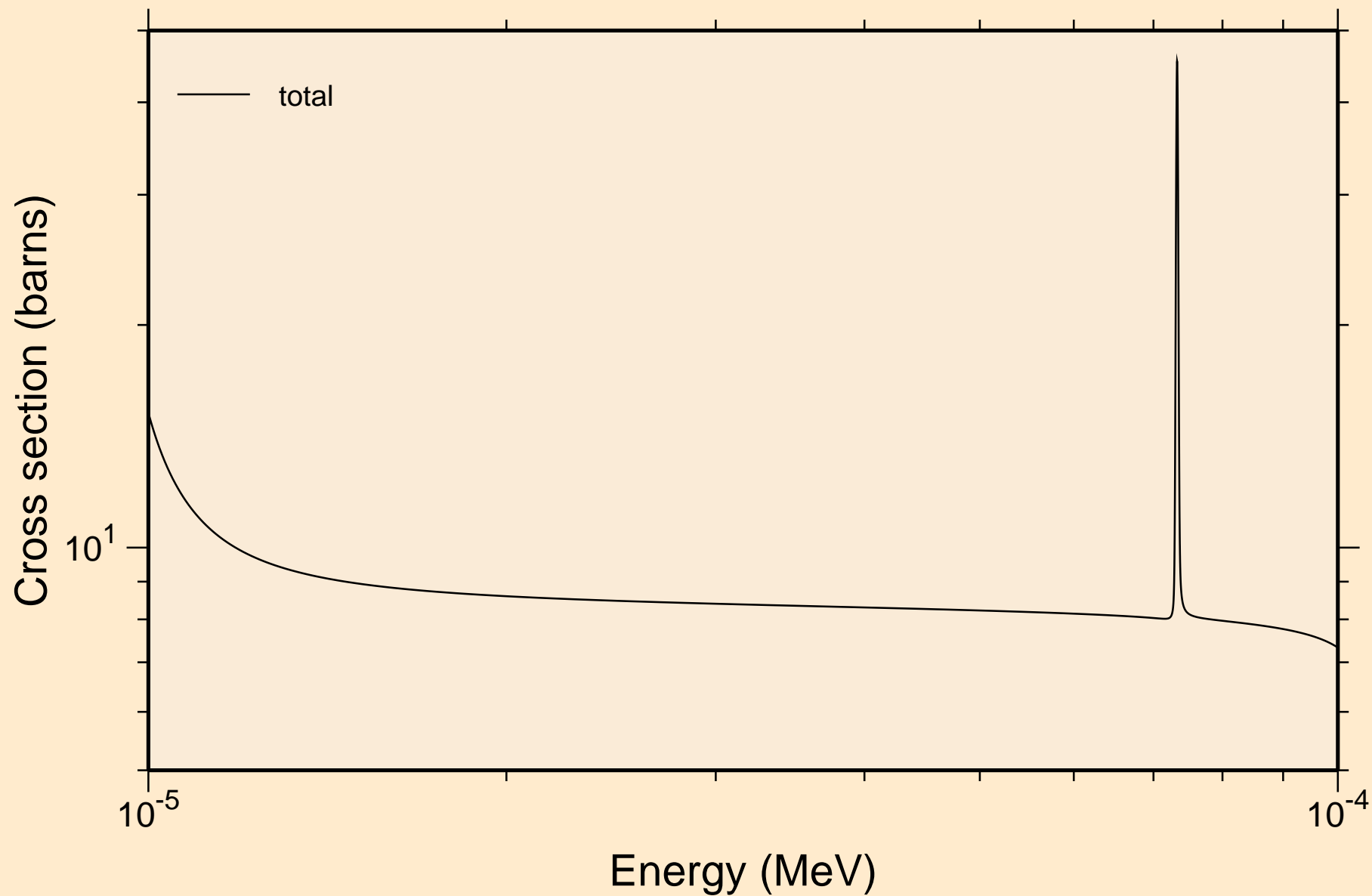

TH236 NEUTRON ACER TENDL-2019 LIBRARY; T=293.16K
resonance total cross section

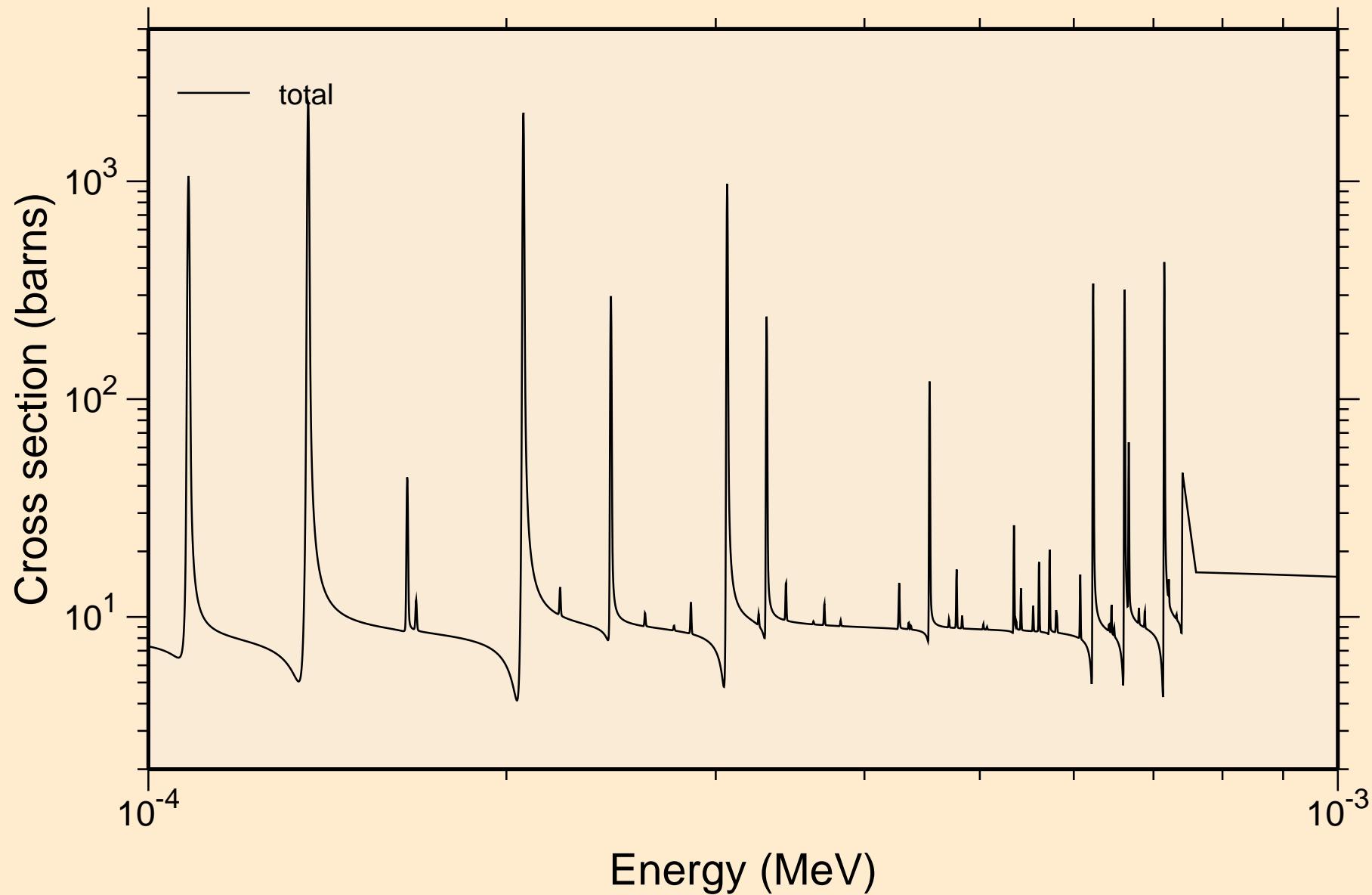

TH236 NEUTRON ACER TENDL-2019 LIBRARY; T=293.16K
resonance total cross section

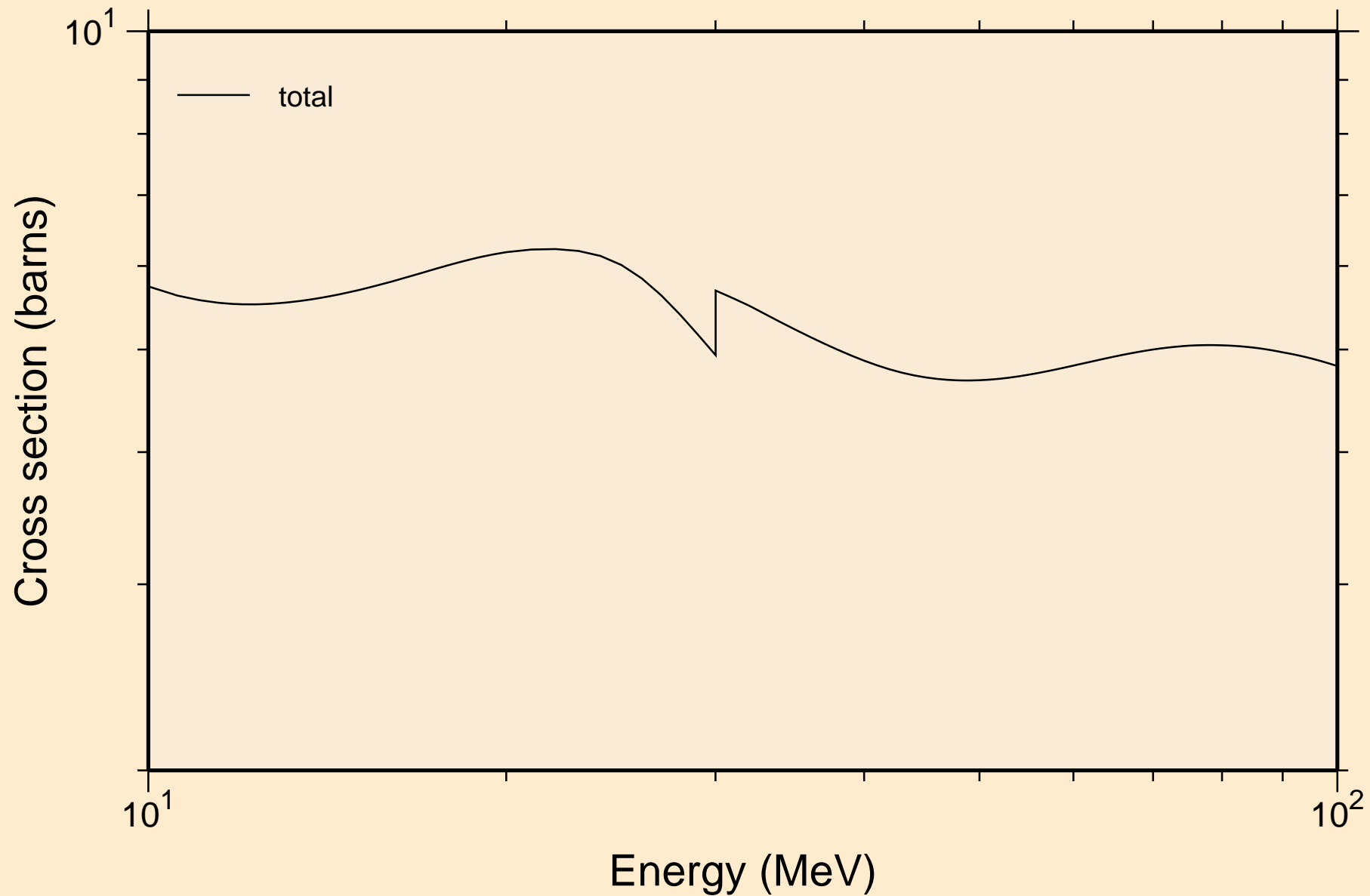

TH236 NEUTRON ACER TENDL-2019 LIBRARY; T=293.16K
resonance absorption cross sections

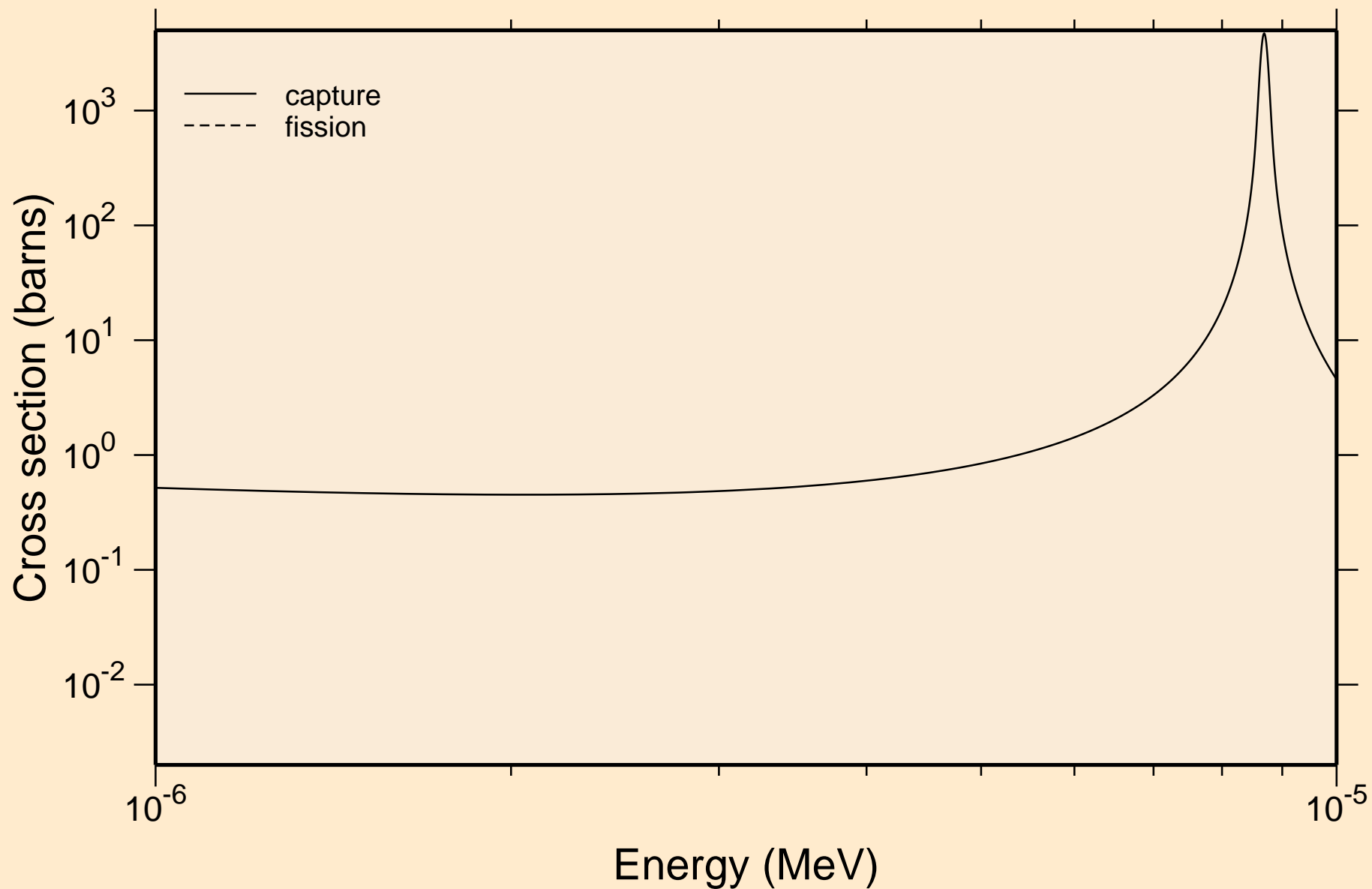

TH236 NEUTRON ACER TENDL-2019 LIBRARY; T=293.16K
resonance absorption cross sections

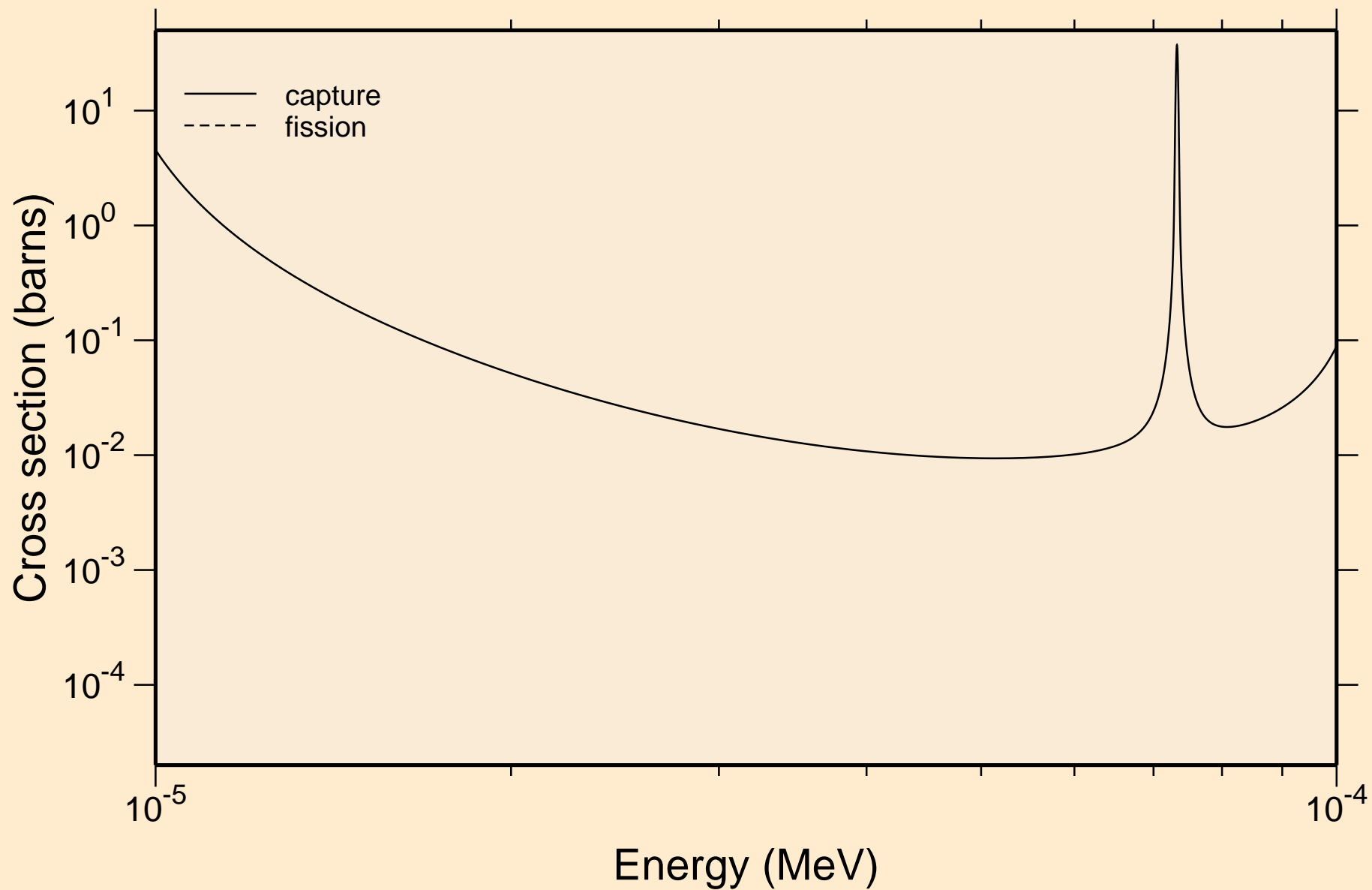

TH236 NEUTRON ACER TENDL-2019 LIBRARY; T=293.16K
resonance absorption cross sections

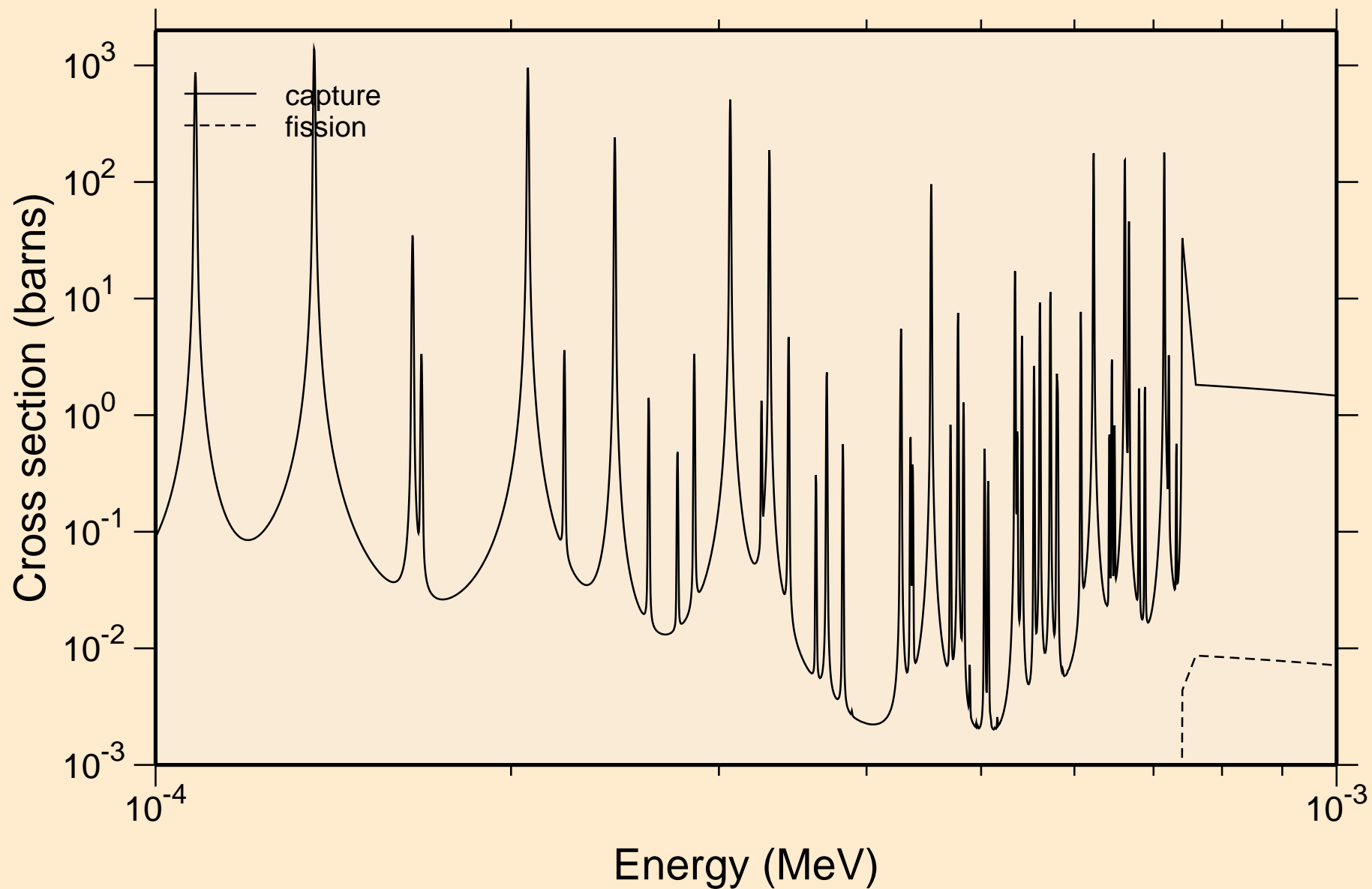

TH236 NEUTRON ACER TENDL-2019 LIBRARY; T=293.16K
resonance absorption cross sections

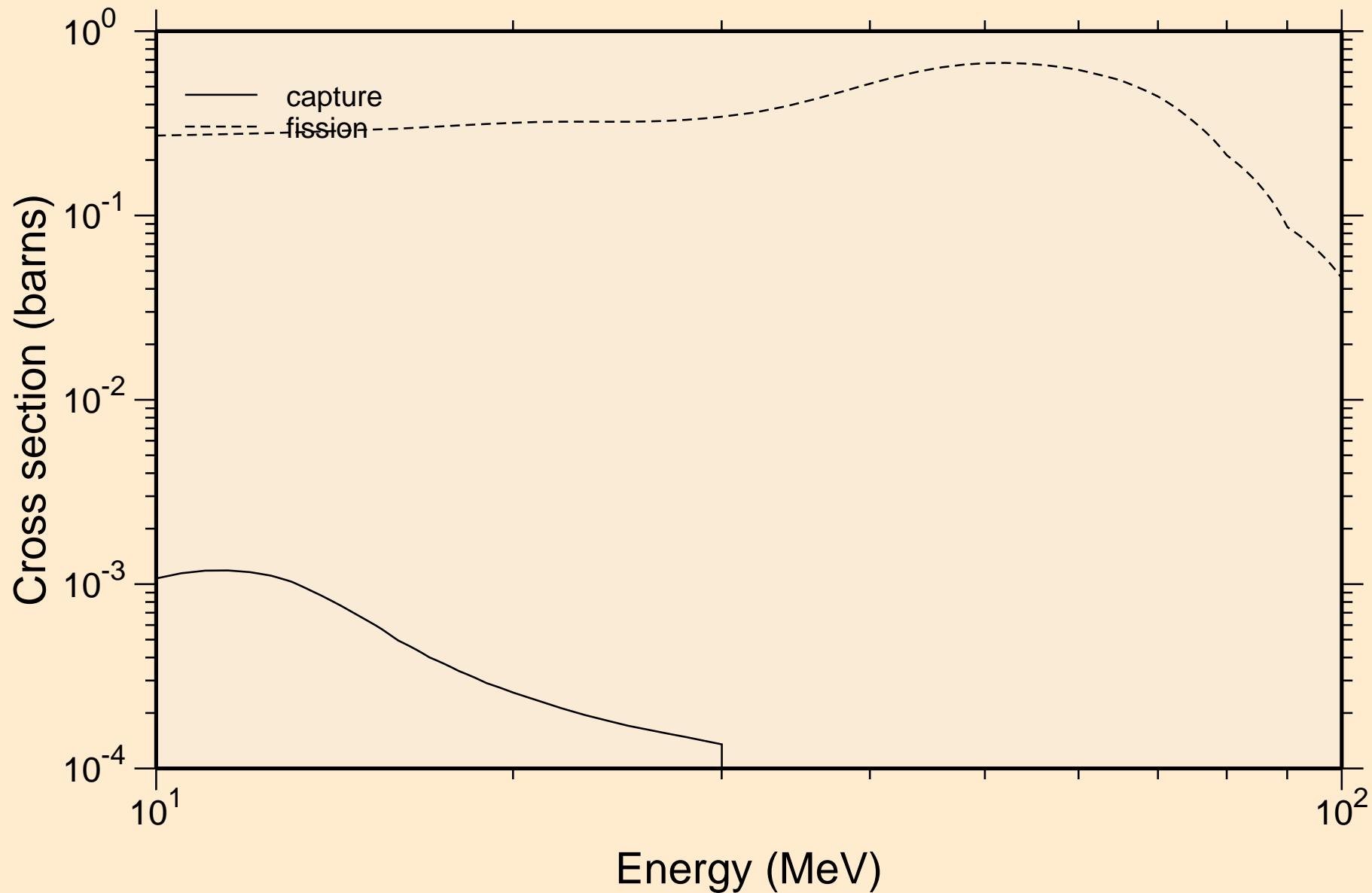

TH236 NEUTRON ACER TENDL-2019 LIBRARY; T=293.16K
Heating

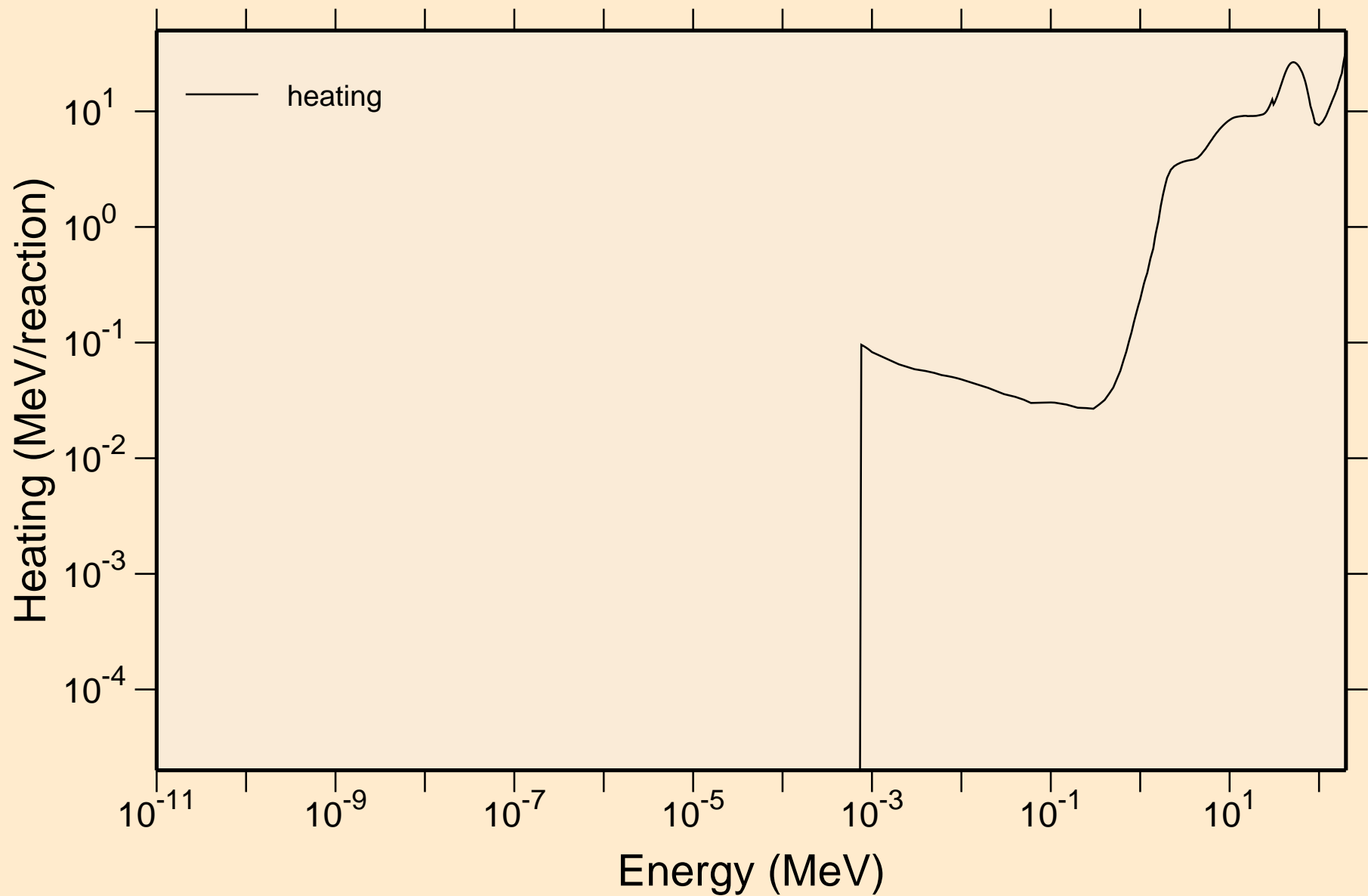

TH236 NEUTRON ACER TENDL-2019 LIBRARY; T=293.16K
Damage

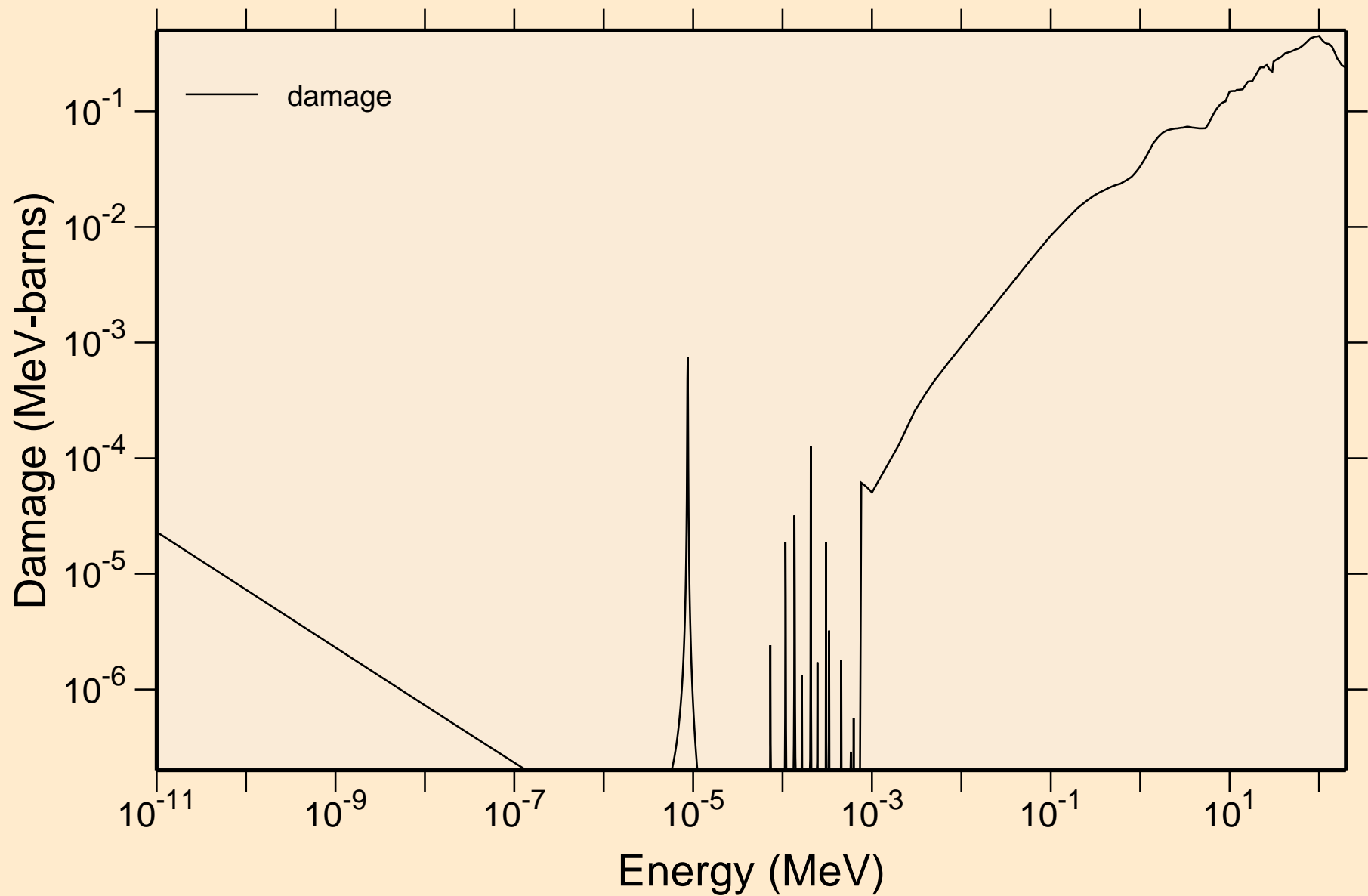

TH236 NEUTRON ACER TENDL-2019 LIBRARY; T=293.16K
Non-threshold reactions

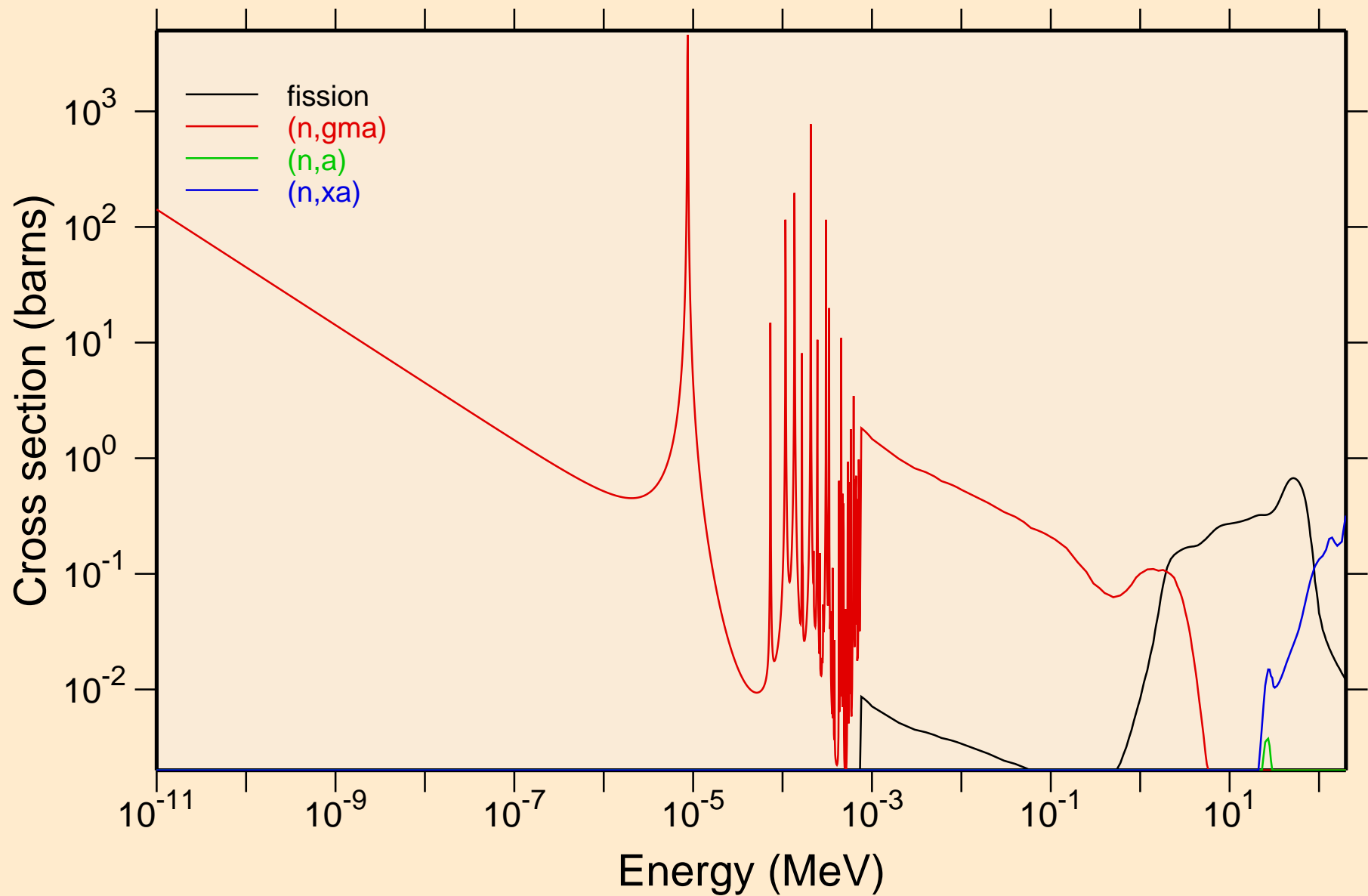

TH236 NEUTRON ACER TENDL-2019 LIBRARY; T=293.16K
Principal cross sections

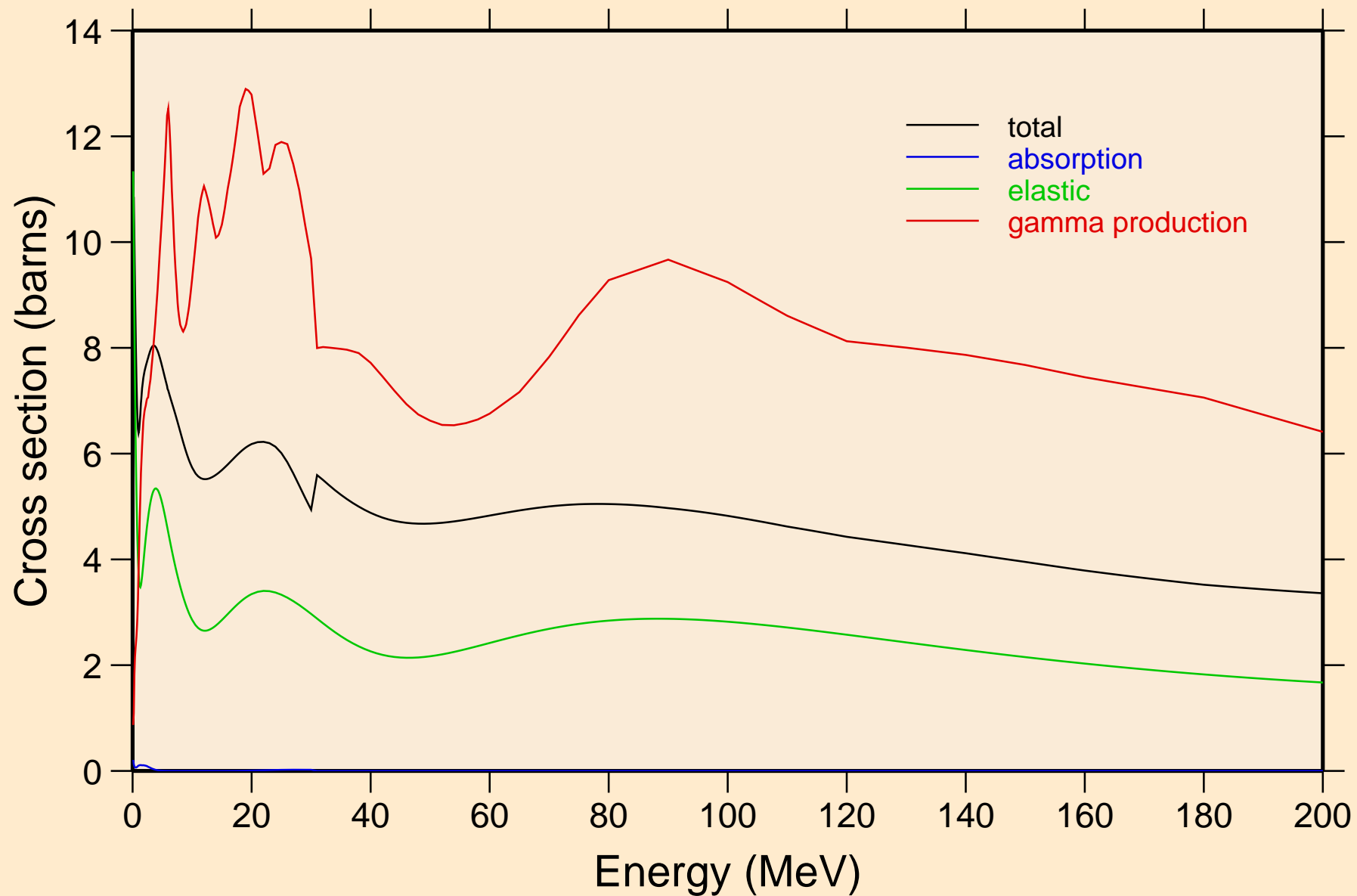

TH236 NEUTRON ACER TENDL-2019 LIBRARY; T=293.16K
Heating

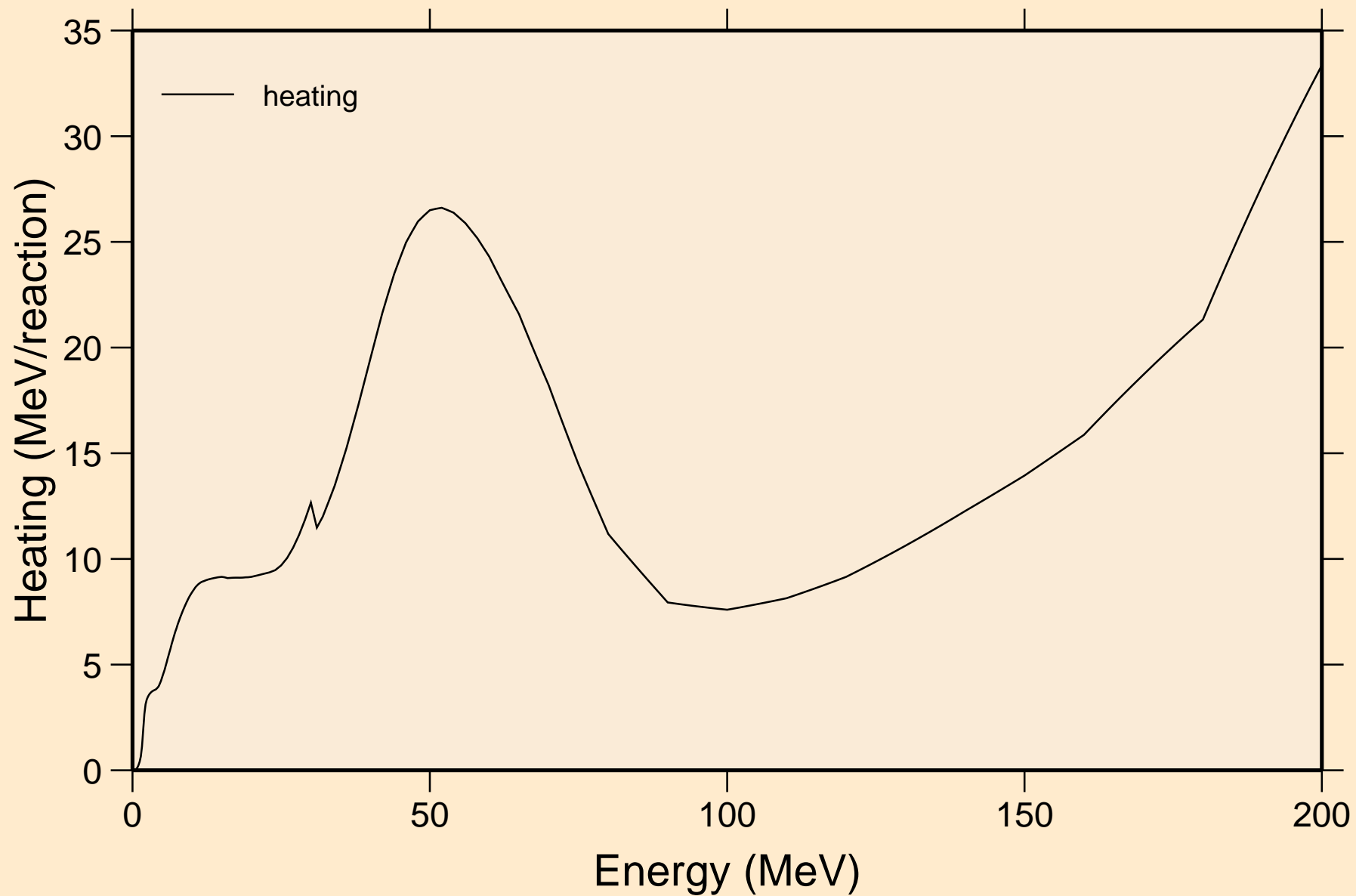

TH236 NEUTRON ACER TENDL-2019 LIBRARY; T=293.16K
Damage

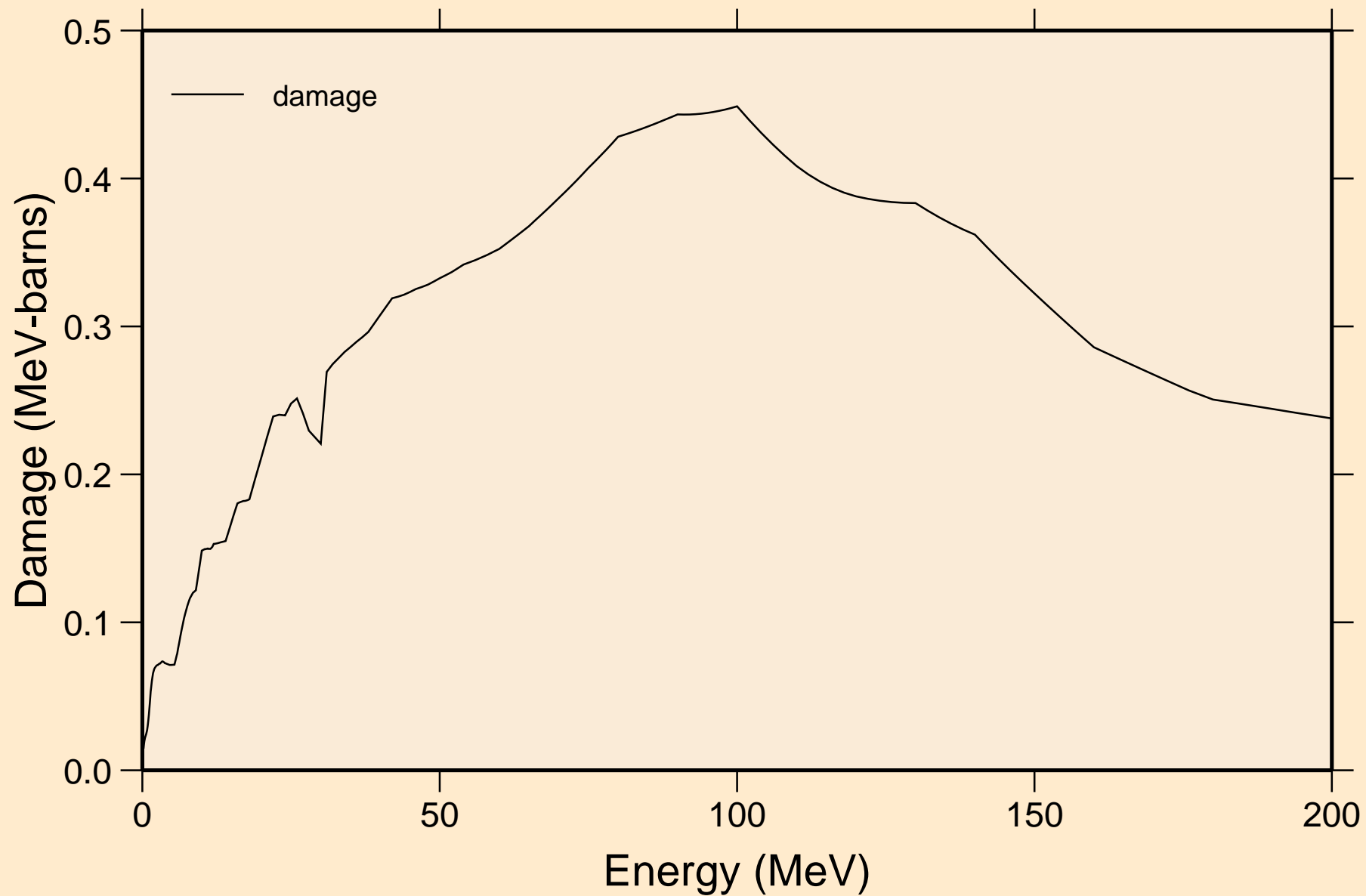

TH236 NEUTRON ACER TENDL-2019 LIBRARY; T=293.16K
Non-threshold reactions

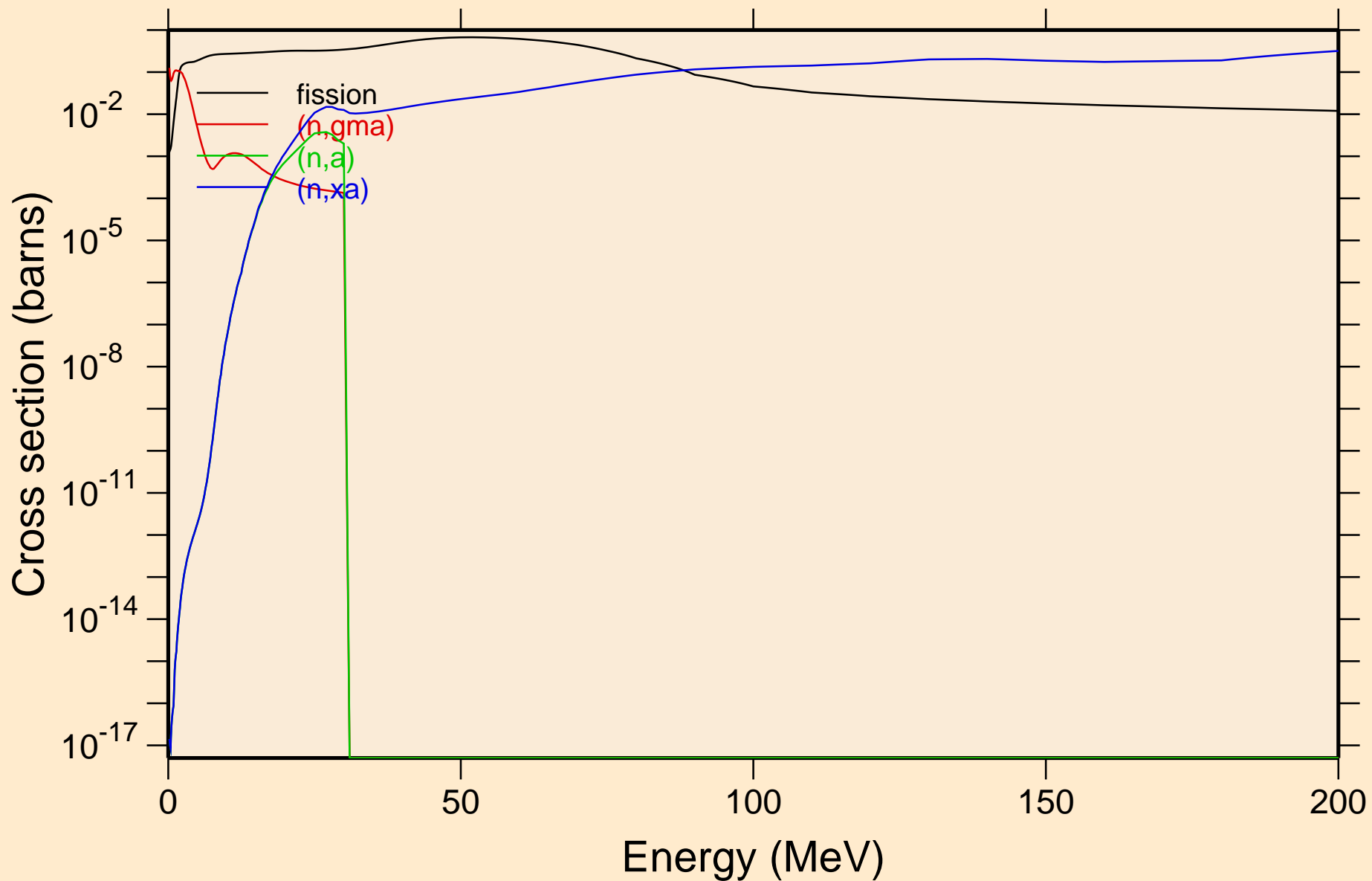

TH236 NEUTRON ACER TENDL-2019 LIBRARY; T=293.16K
Inelastic levels

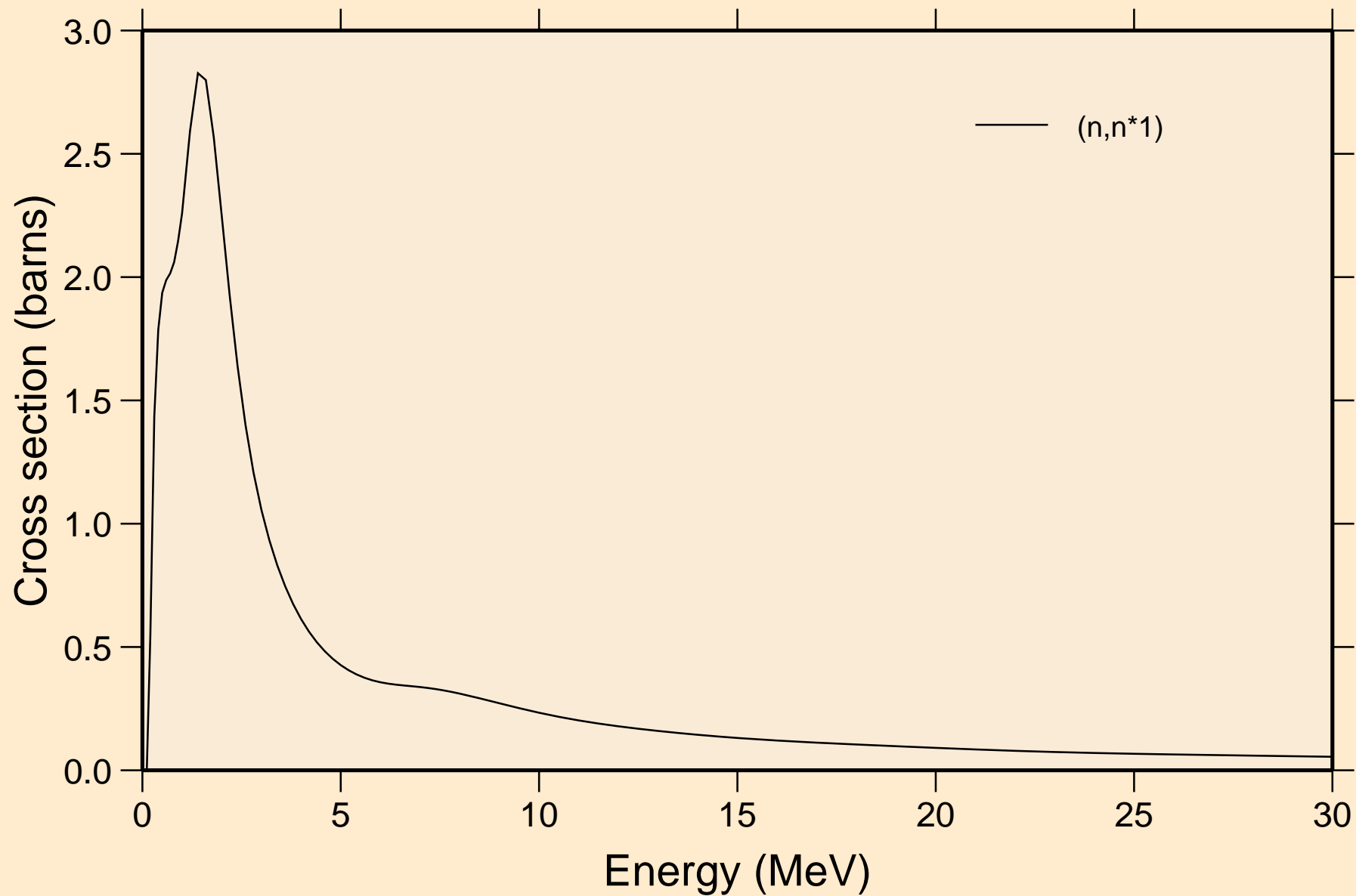

TH236 NEUTRON ACER TENDL-2019 LIBRARY; T=293.16K
Threshold reactions

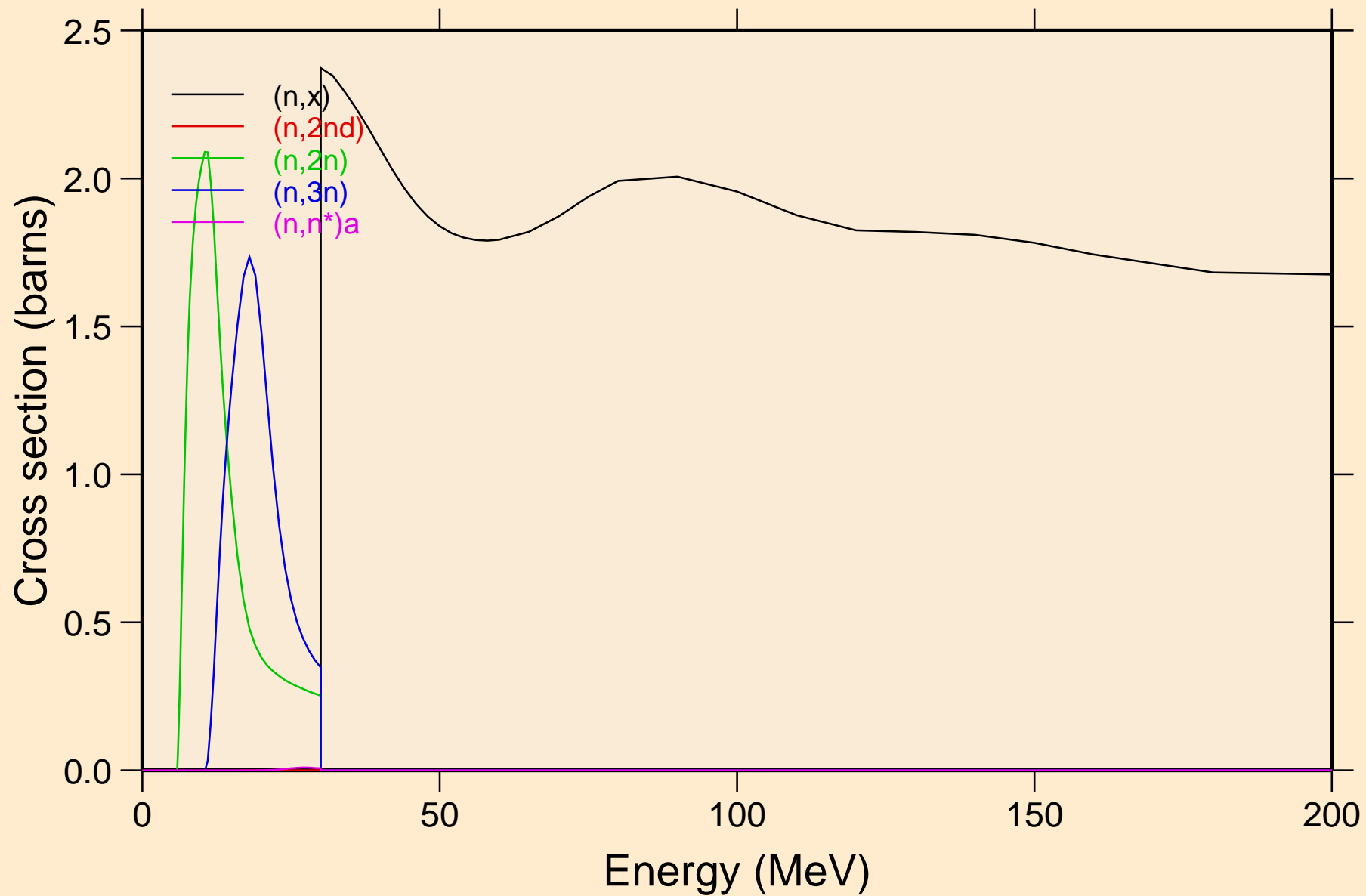

TH236 NEUTRON ACER TENDL-2019 LIBRARY; T=293.16K
Threshold reactions

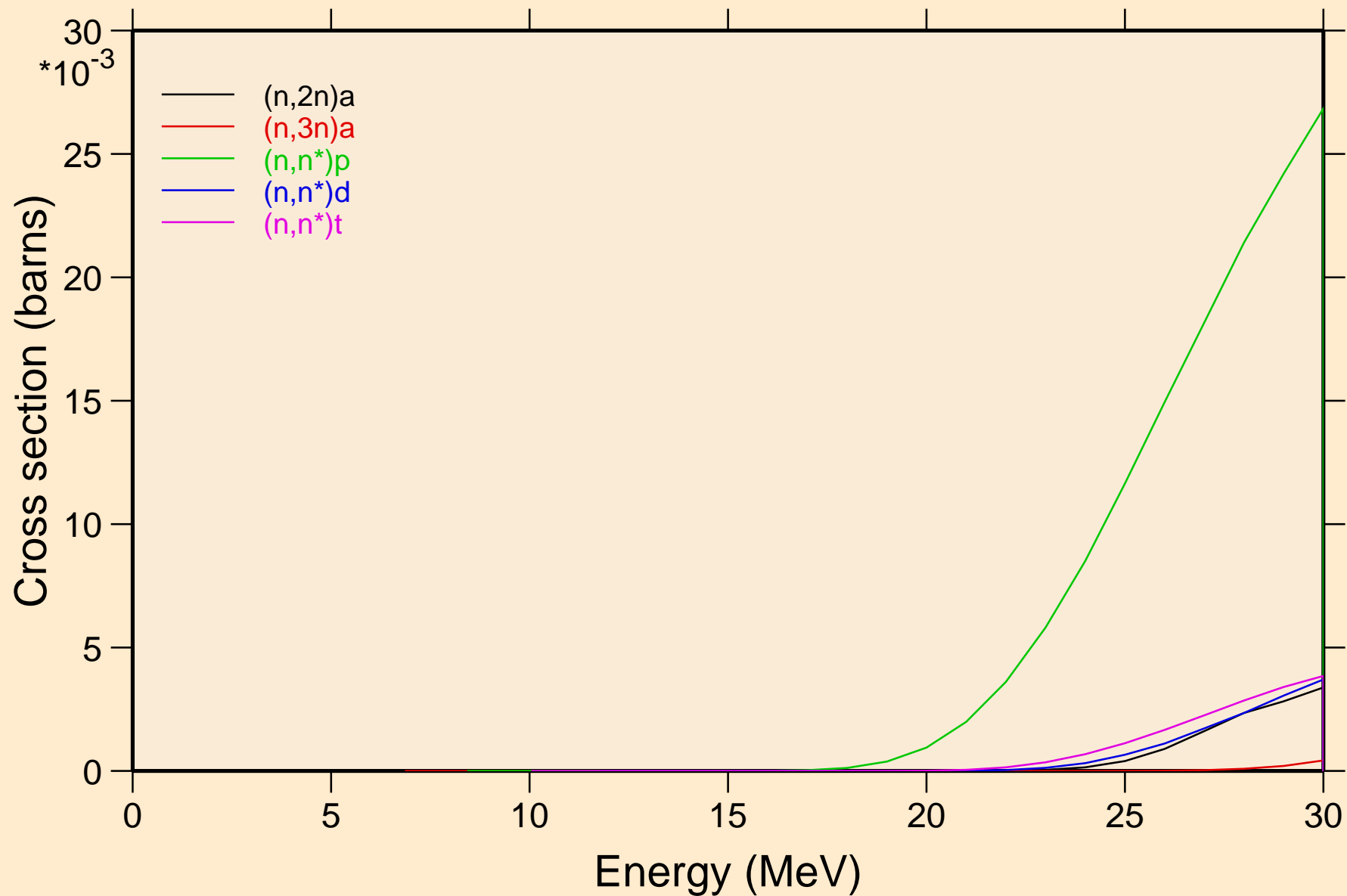

TH236 NEUTRON ACER TENDL-2019 LIBRARY; T=293.16K
Threshold reactions

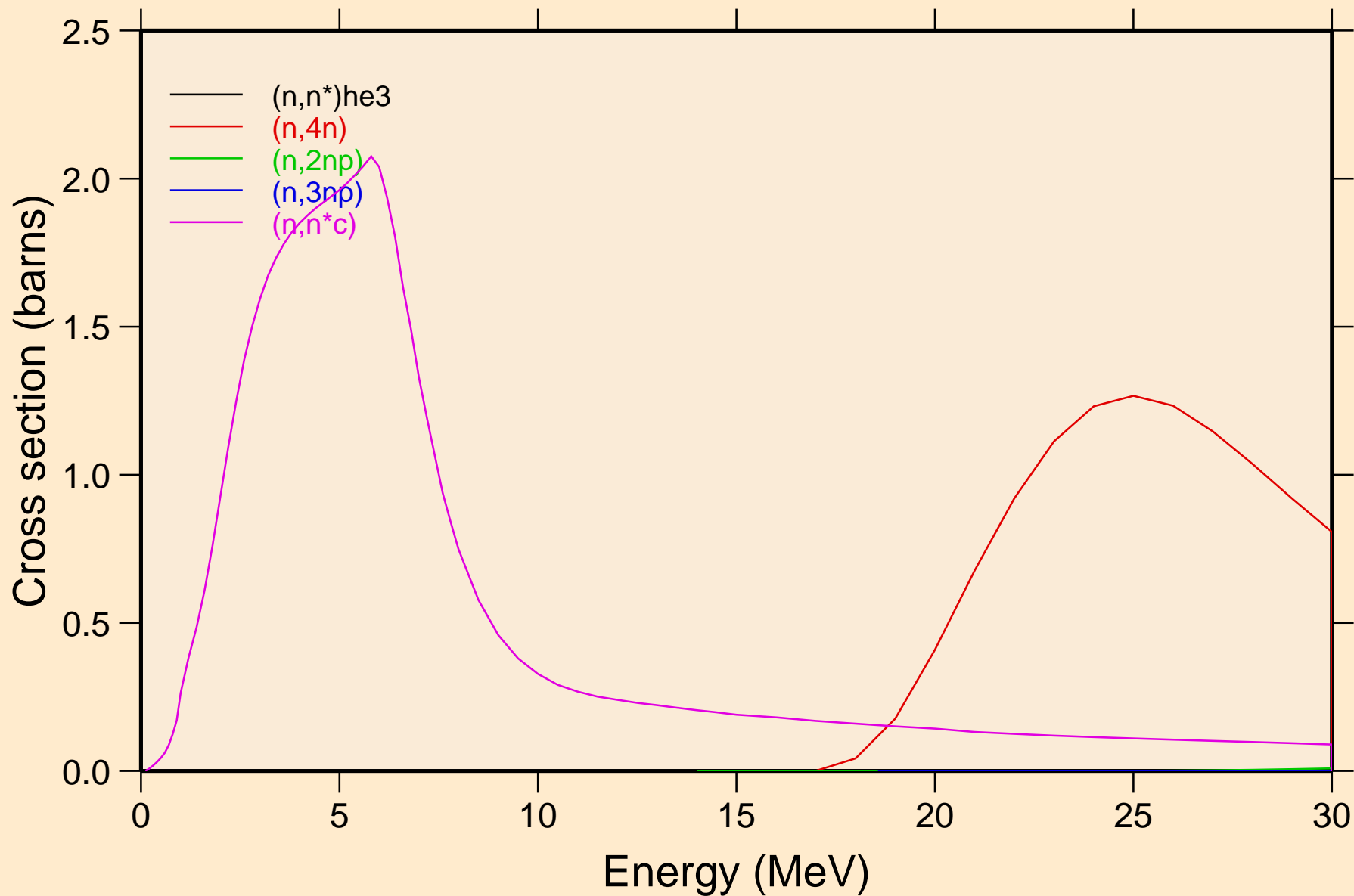

TH236 NEUTRON ACER TENDL-2019 LIBRARY; T=293.16K
Threshold reactions

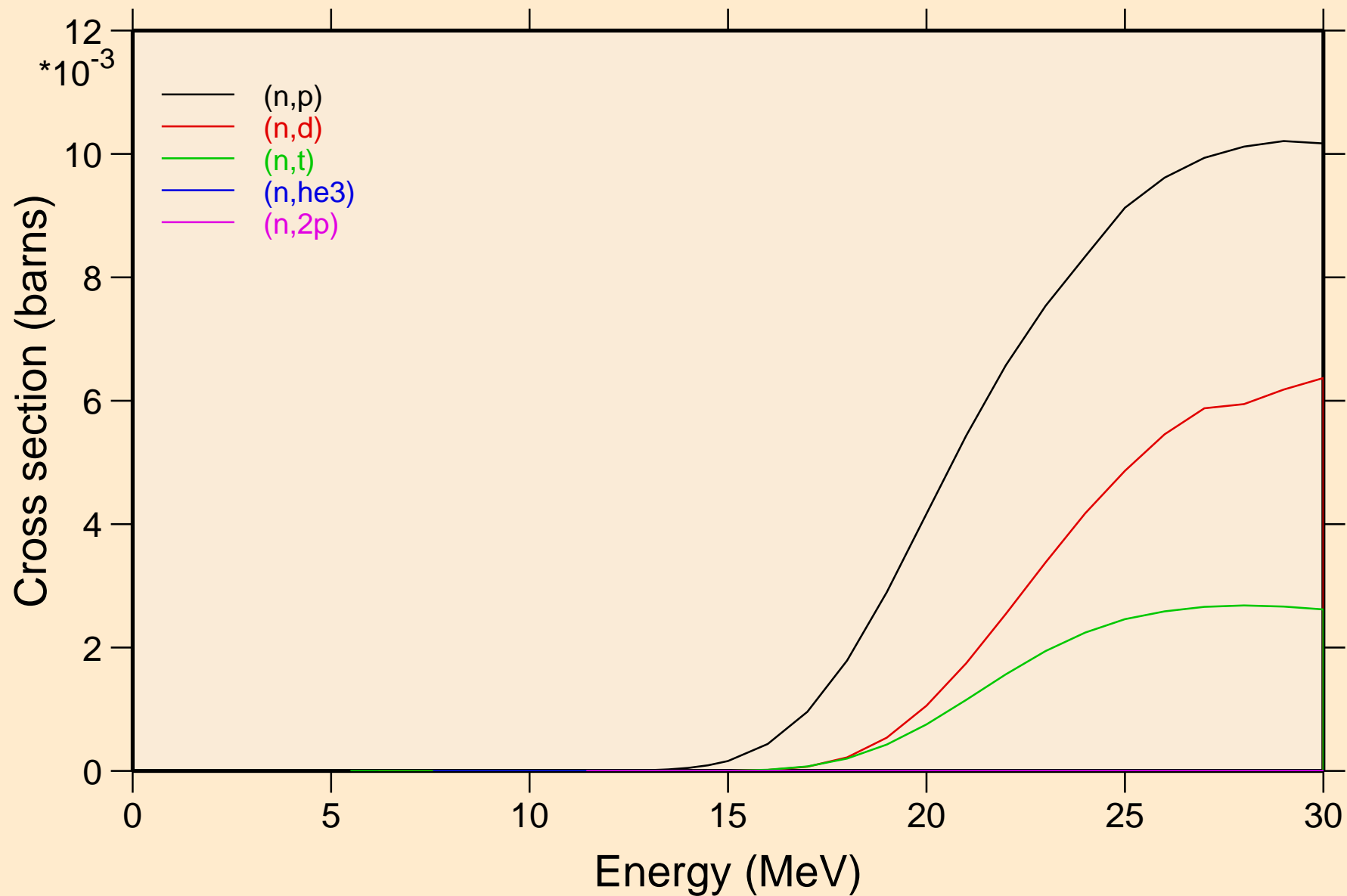

TH236 NEUTRON ACER TENDL-2019 LIBRARY; T=293.16K
Threshold reactions

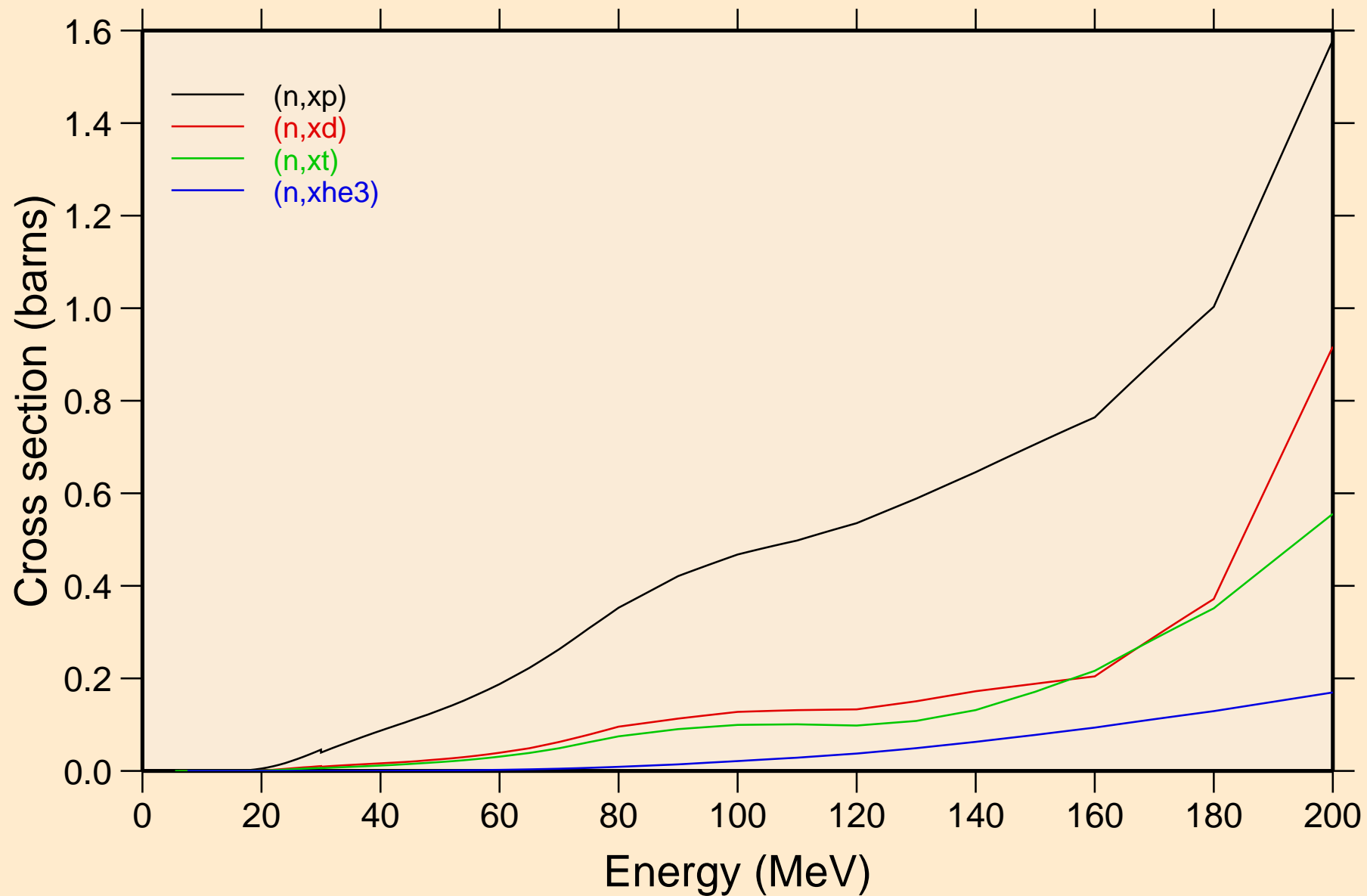

TH236 NEUTRON ACER TENDL-2019 LIBRARY; T=293.16K
angular distribution for elastic

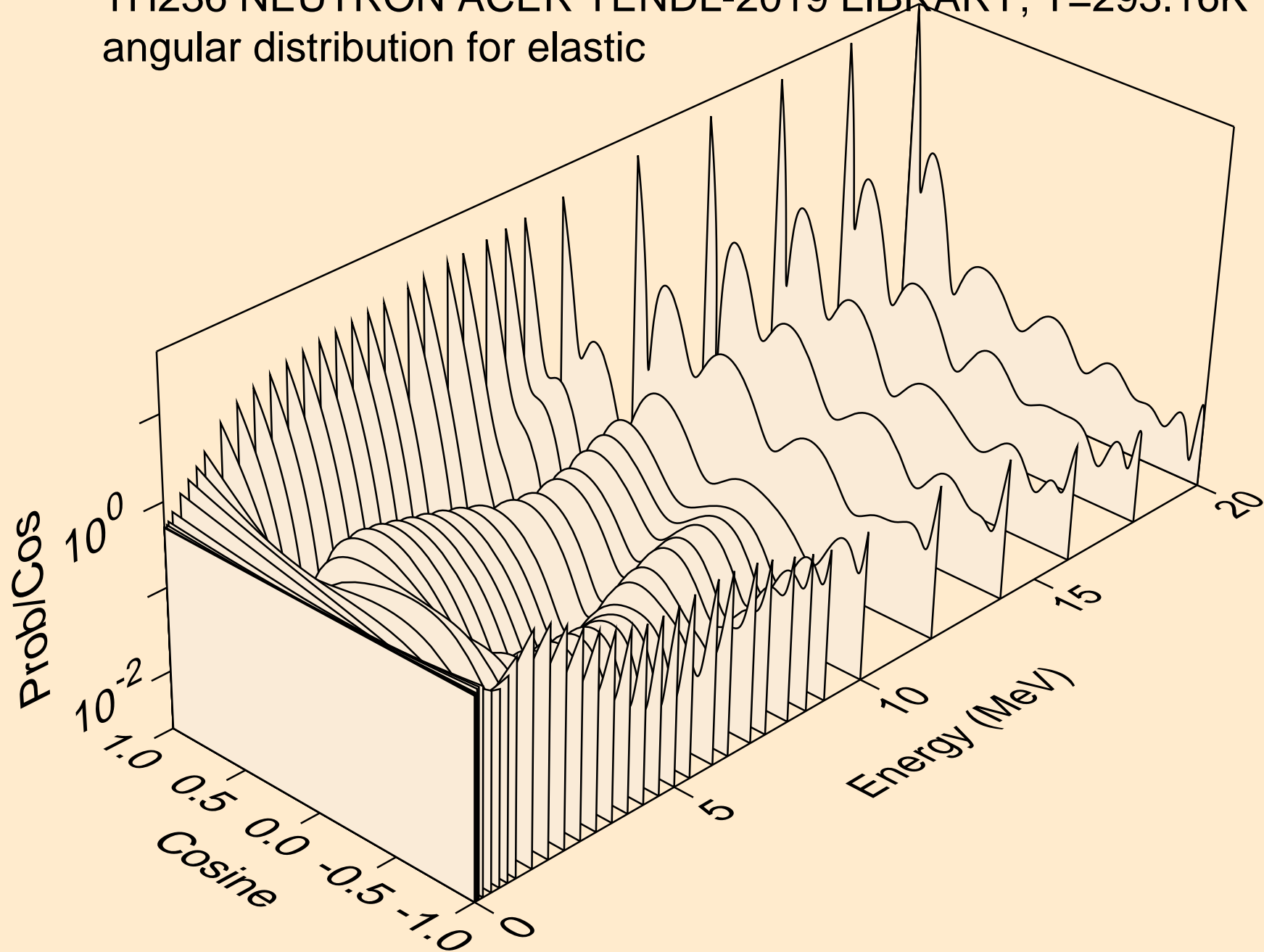

TH236 NEUTRON ACER TENDL-2019 LIBRARY; T=293.16K
angular distribution for elastic

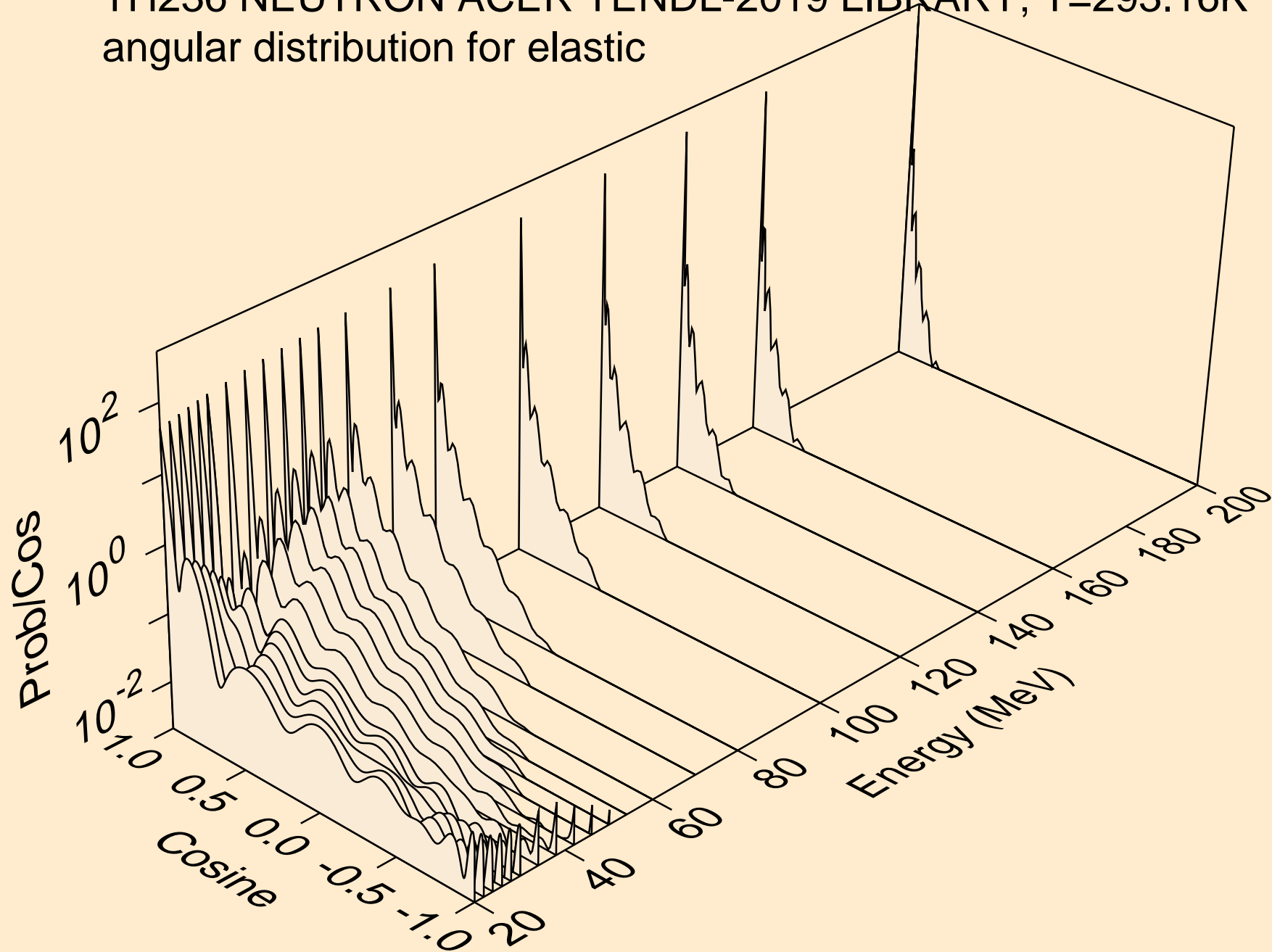

TH236 NEUTRON ACER TENDL-2019 LIBRARY; T=293.16K
angular distribution for (n,n*1)

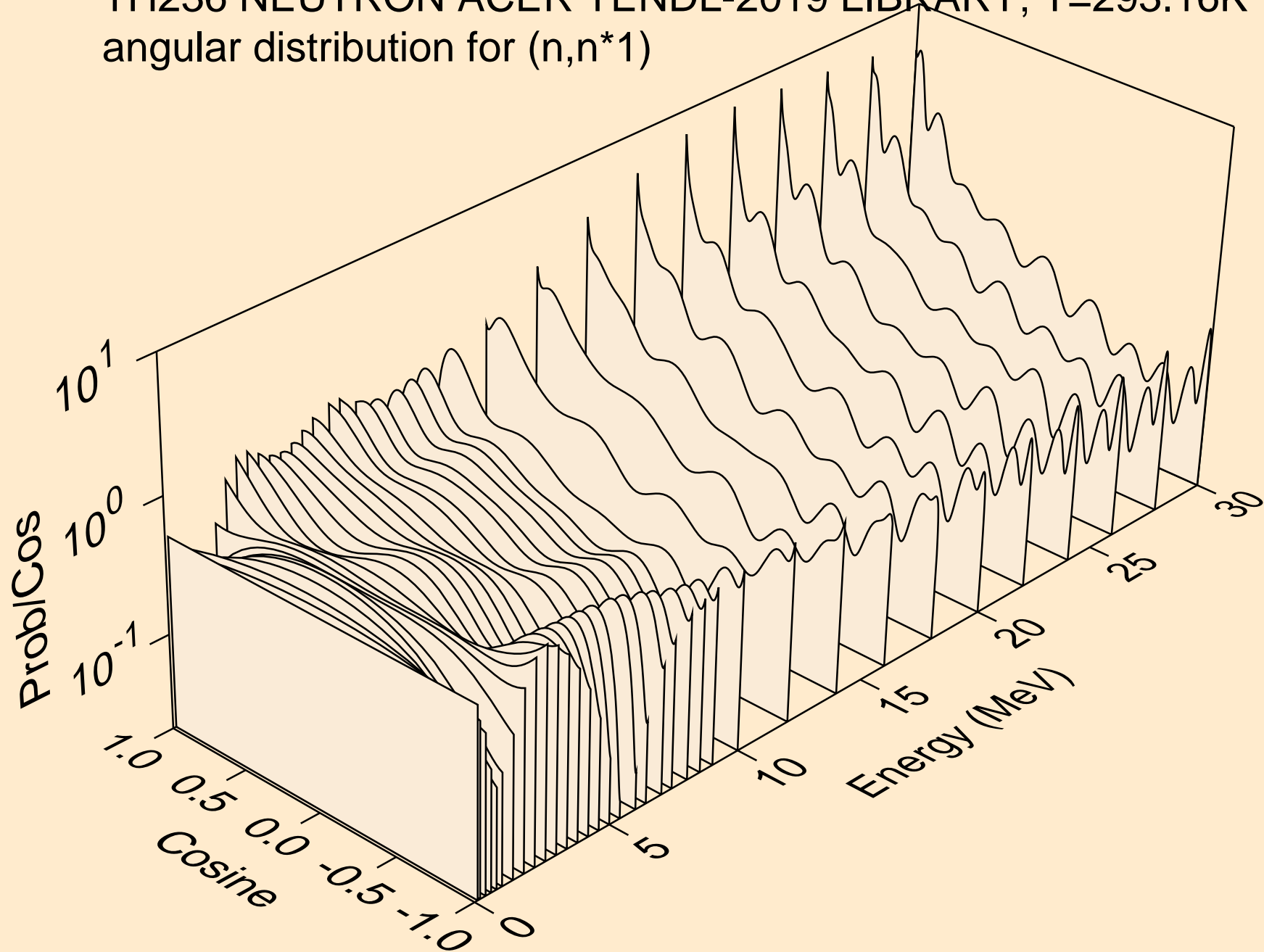

TH236 NEUTRON ACER TENDL-2019 LIBRARY; T=293.16K
Total fission nubar

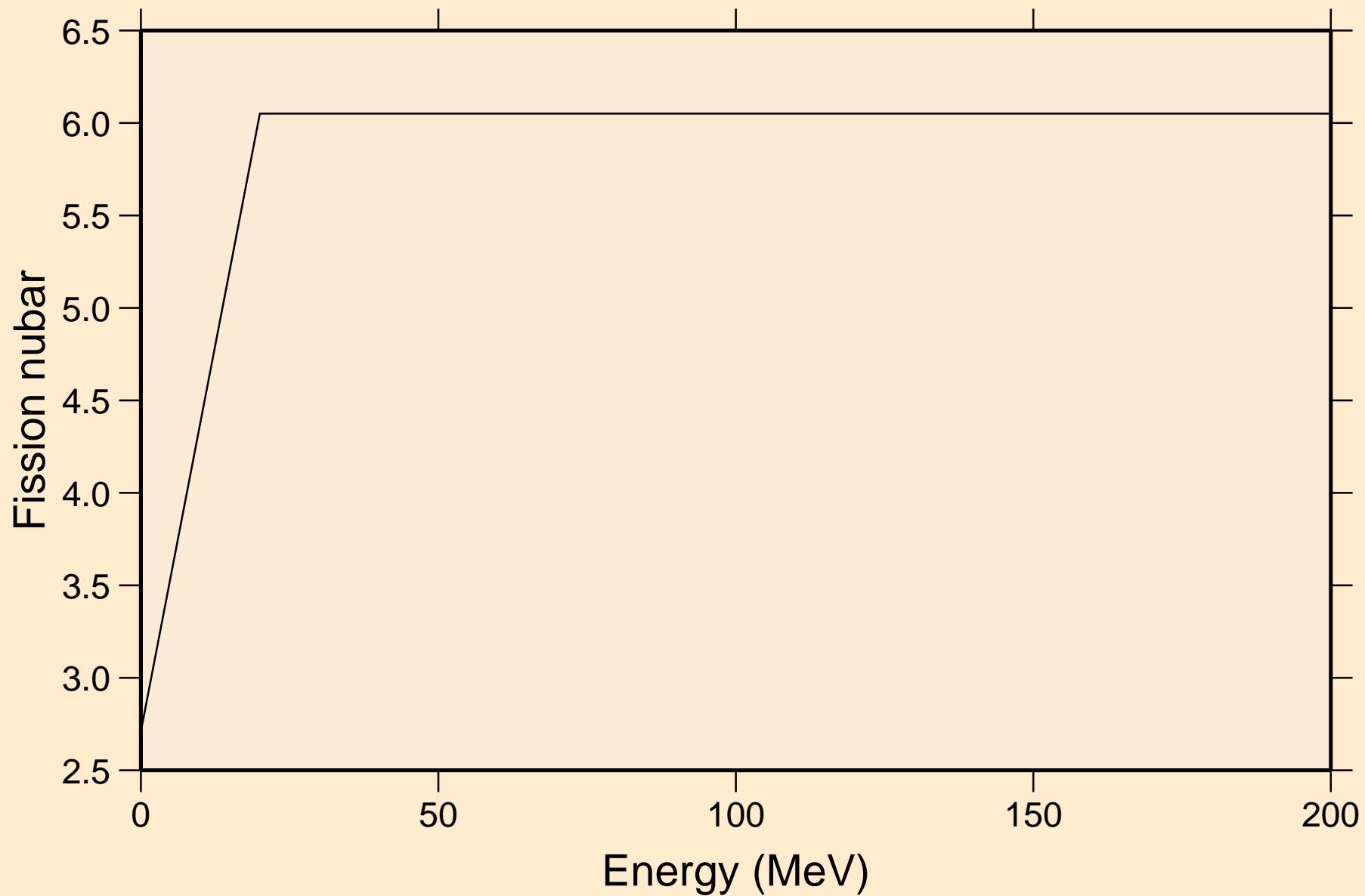

TH236 NEUTRON ACER TENDL-2019 LIBRARY; T=293.16K
Neutron emission for (n,x)

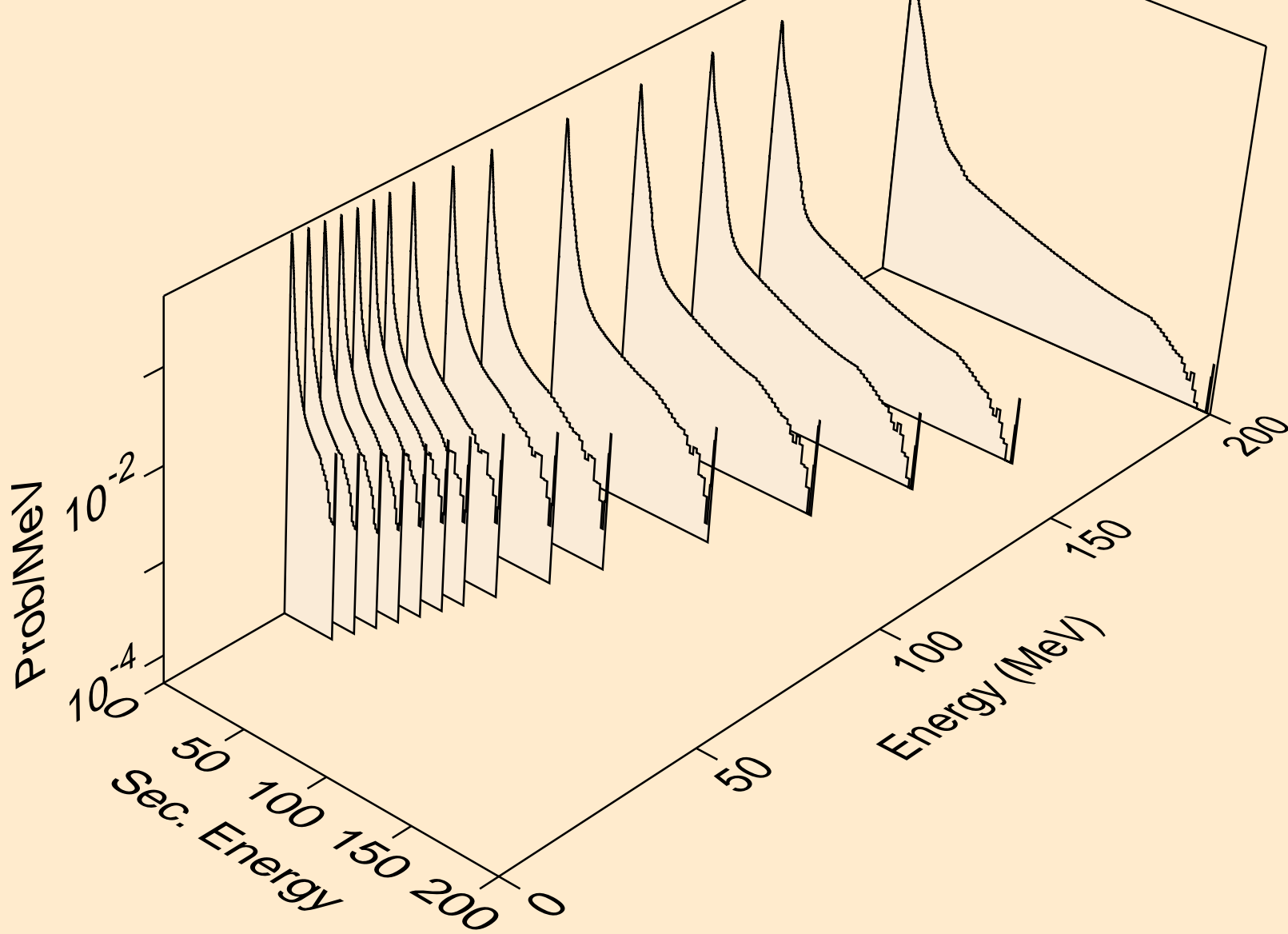

TH236 NEUTRON ACER TENDL-2019 LIBRARY; T=293.16K
Neutron emission for (n,2nd)

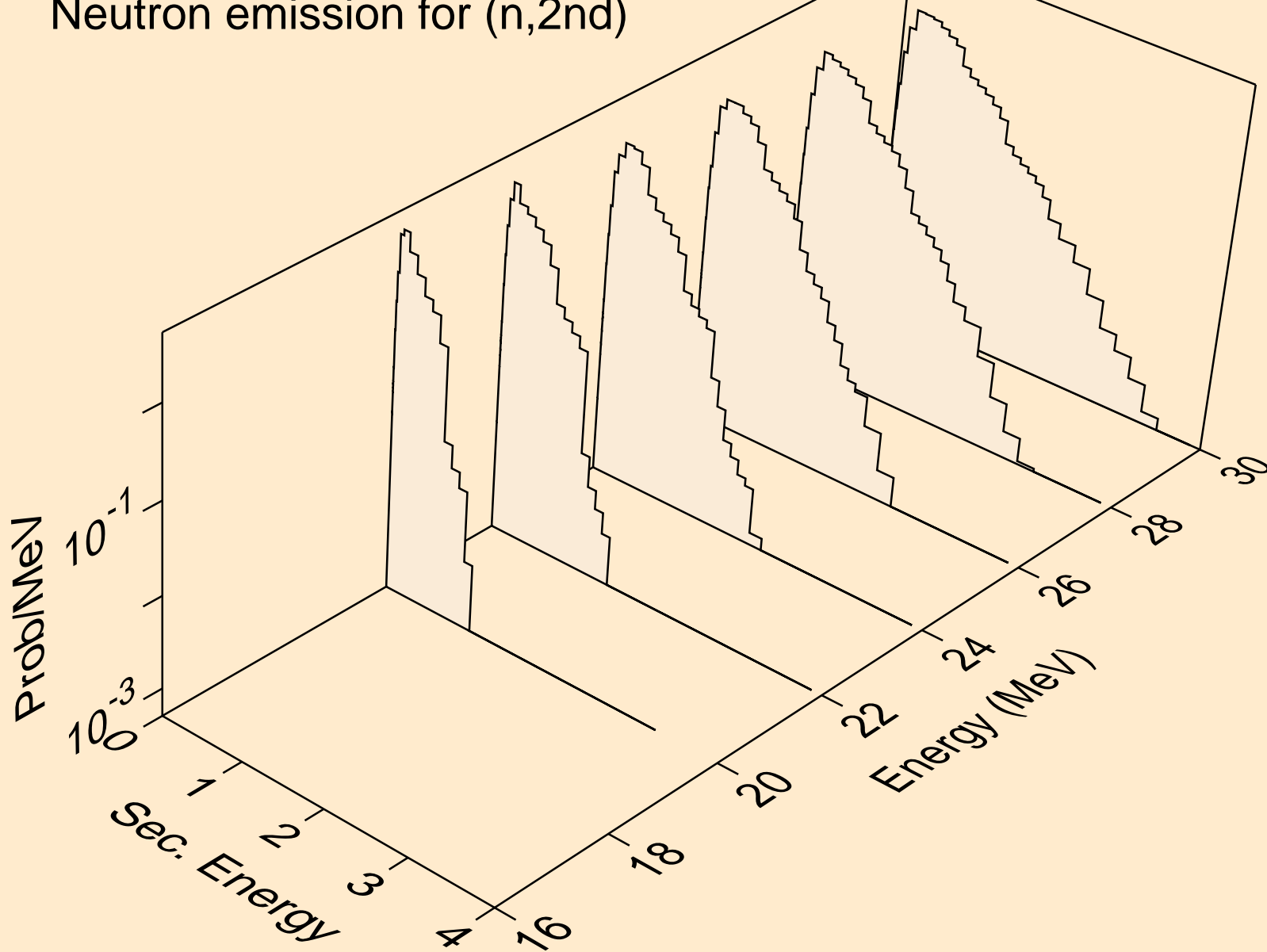

TH236 NEUTRON ACER TENDL-2019 LIBRARY; T=293.16K
Neutron emission for (n,2n)

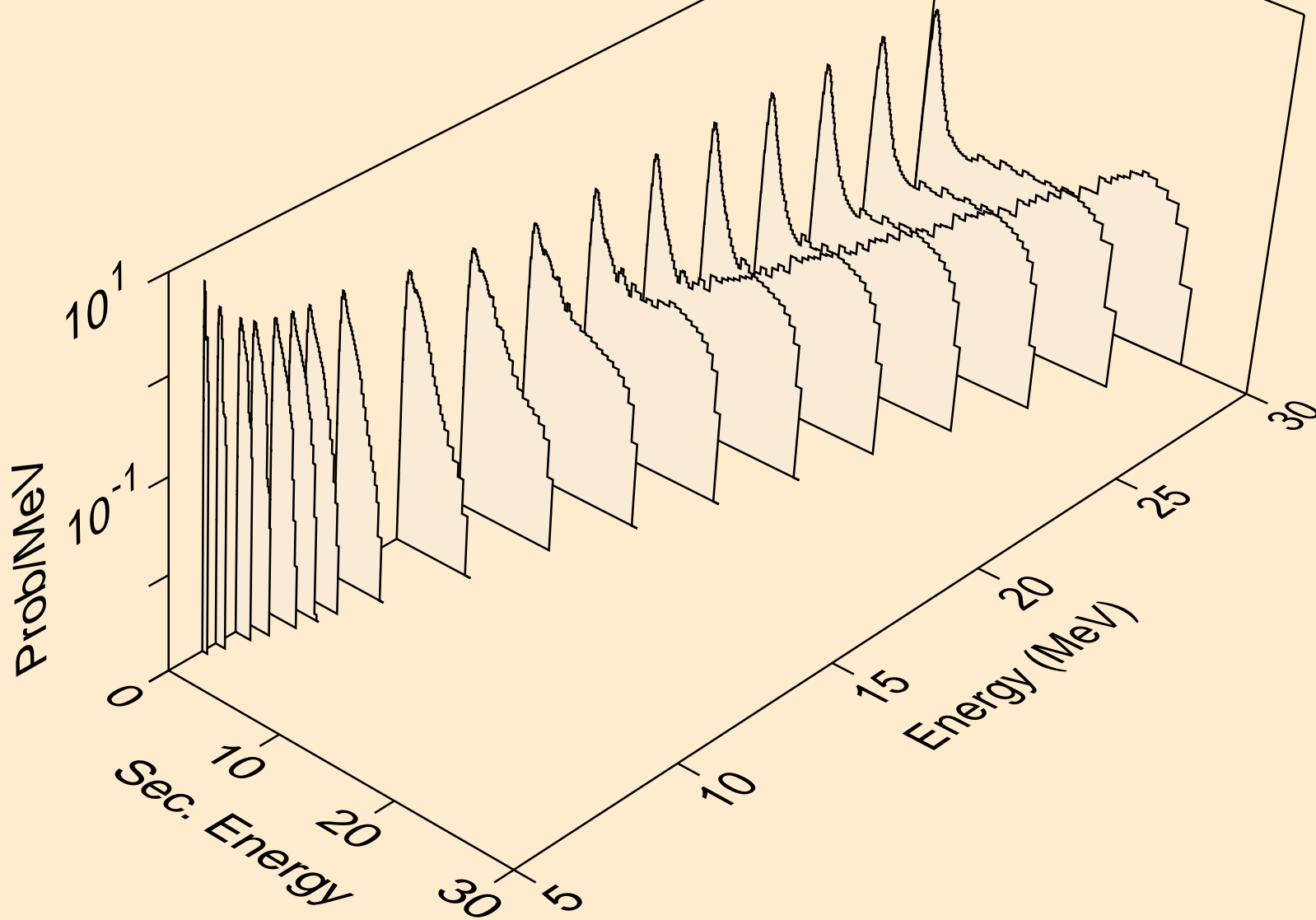

TH236 NEUTRON ACER TENDL-2019 LIBRARY; T=293.16K
Neutron emission for (n,3n)

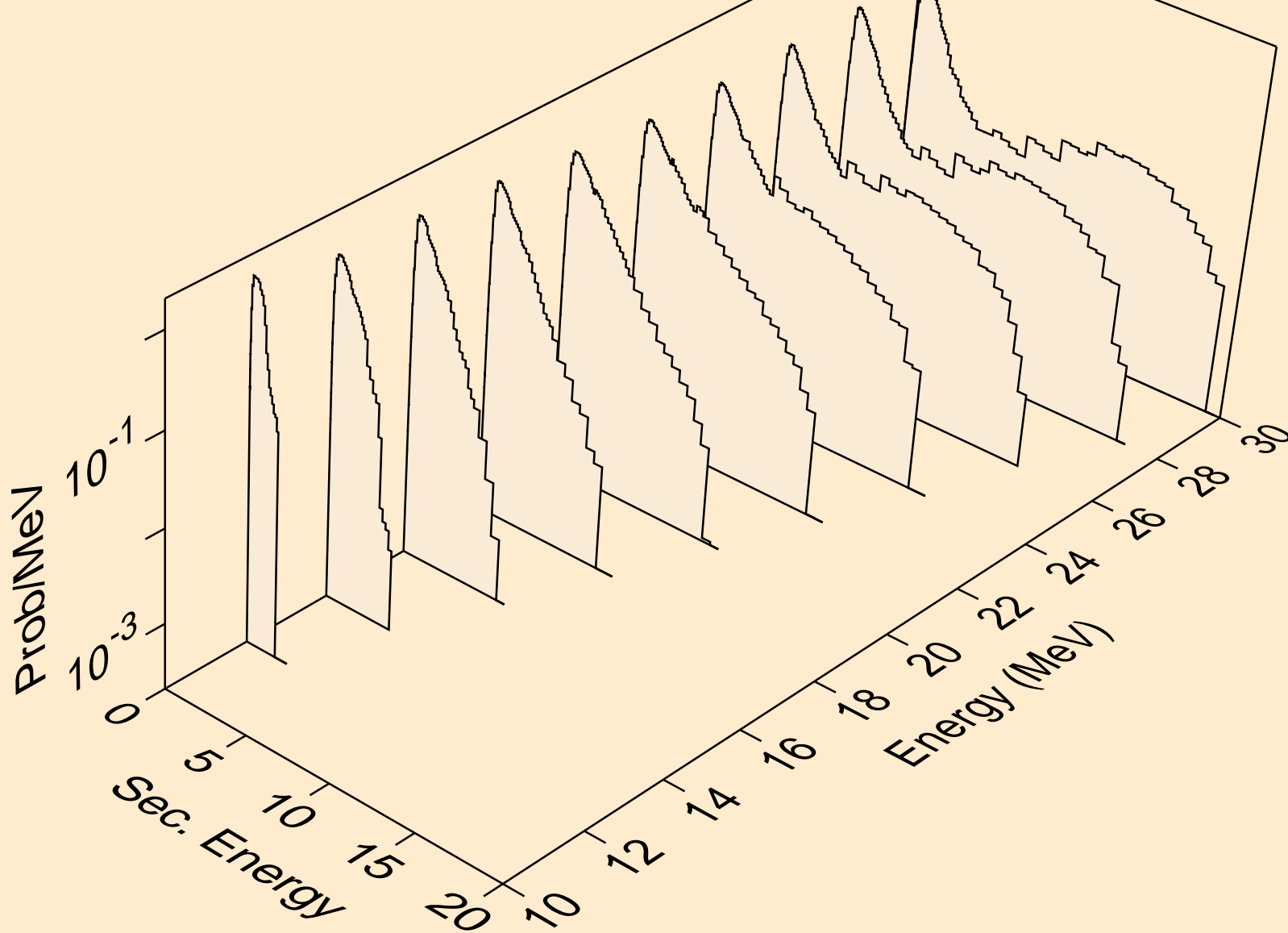

TH236 NEUTRON ACER TENDL-2019 LIBRARY; T=293.16K
Neutron emission for fission

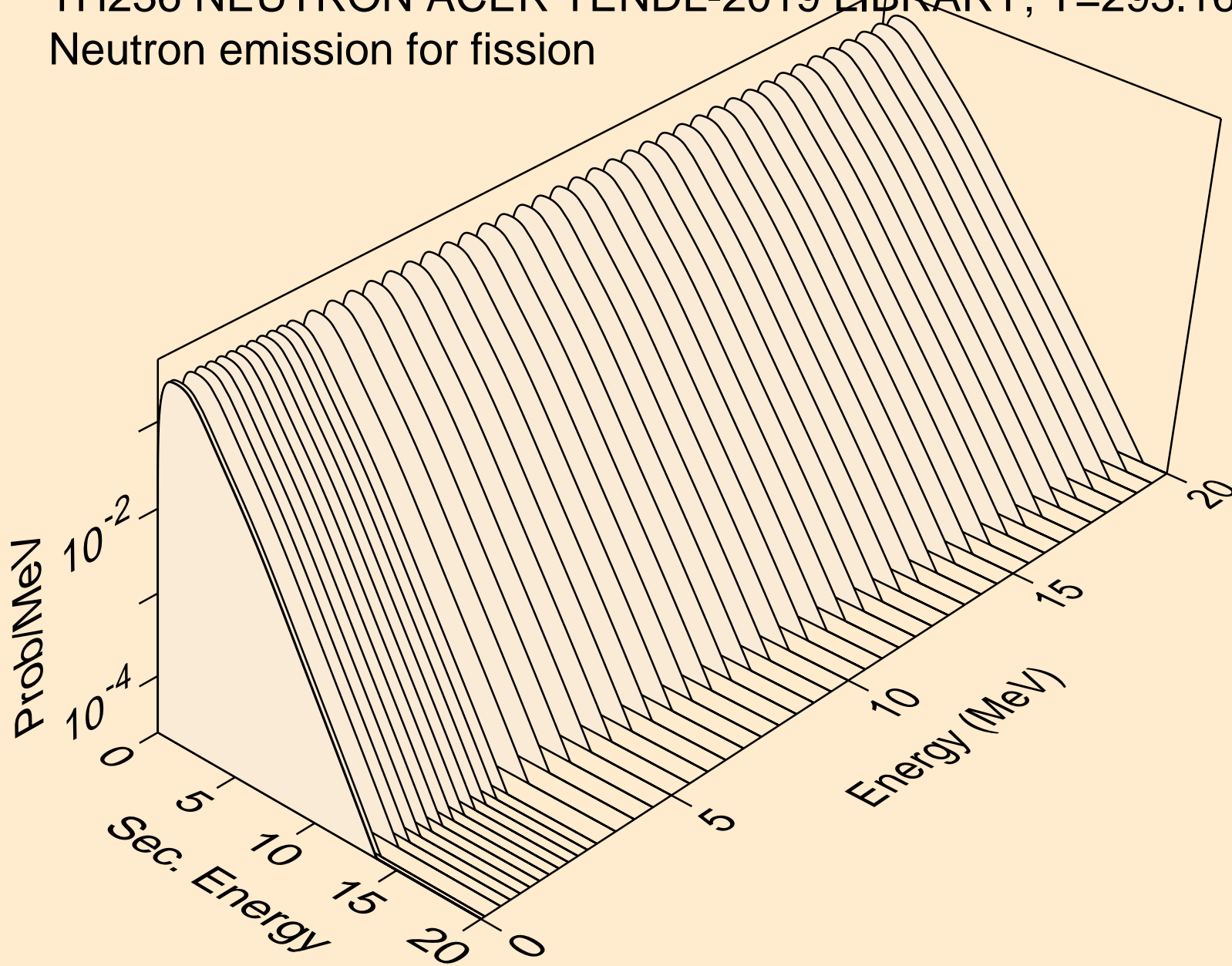

TH236 NEUTRON ACER TENDL-2019 LIBRARY; T=293.16K
Neutron emission for (n,n*)a

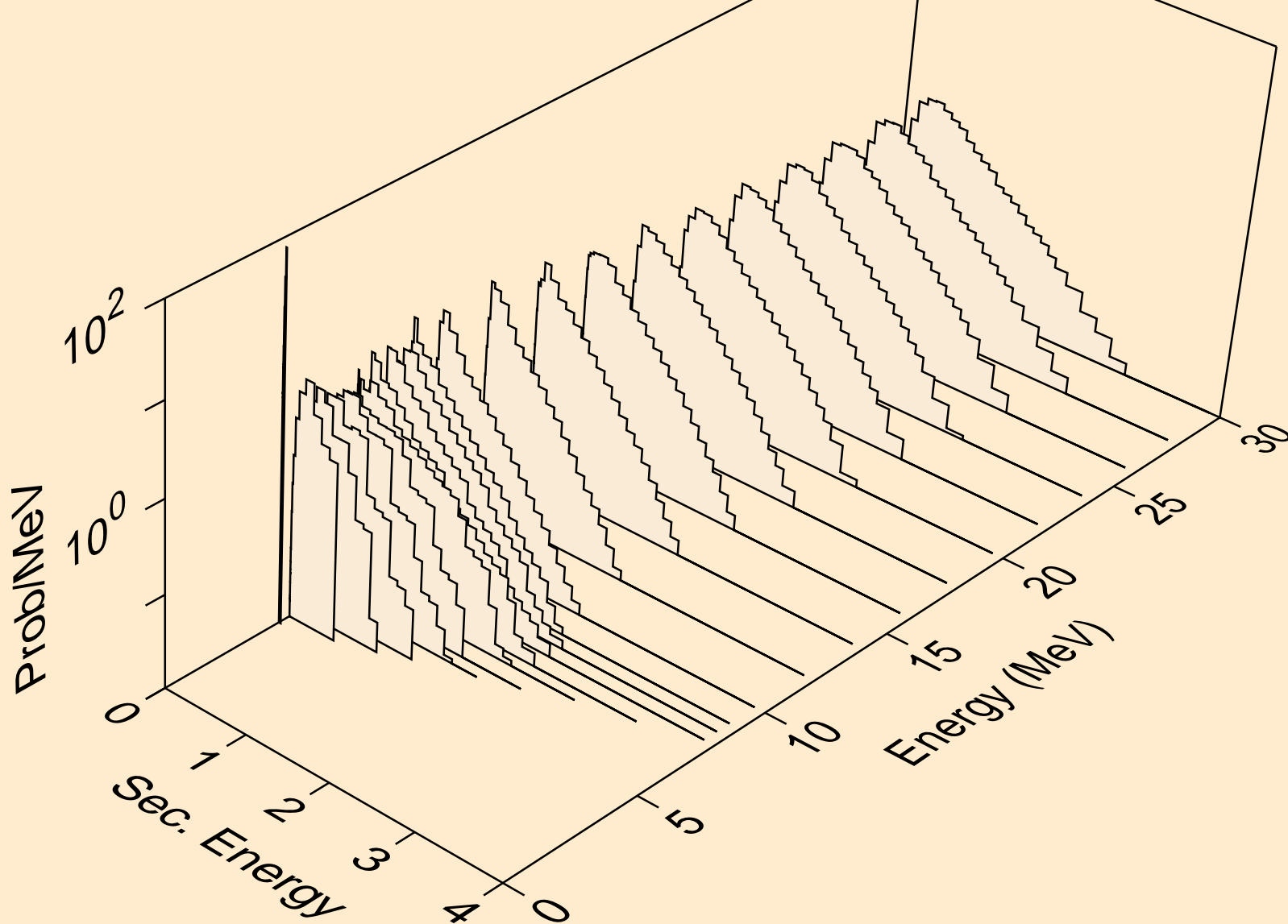

TH236 NEUTRON ACER TENDL-2019 LIBRARY; T=293.16K
Neutron emission for (n,2n)a

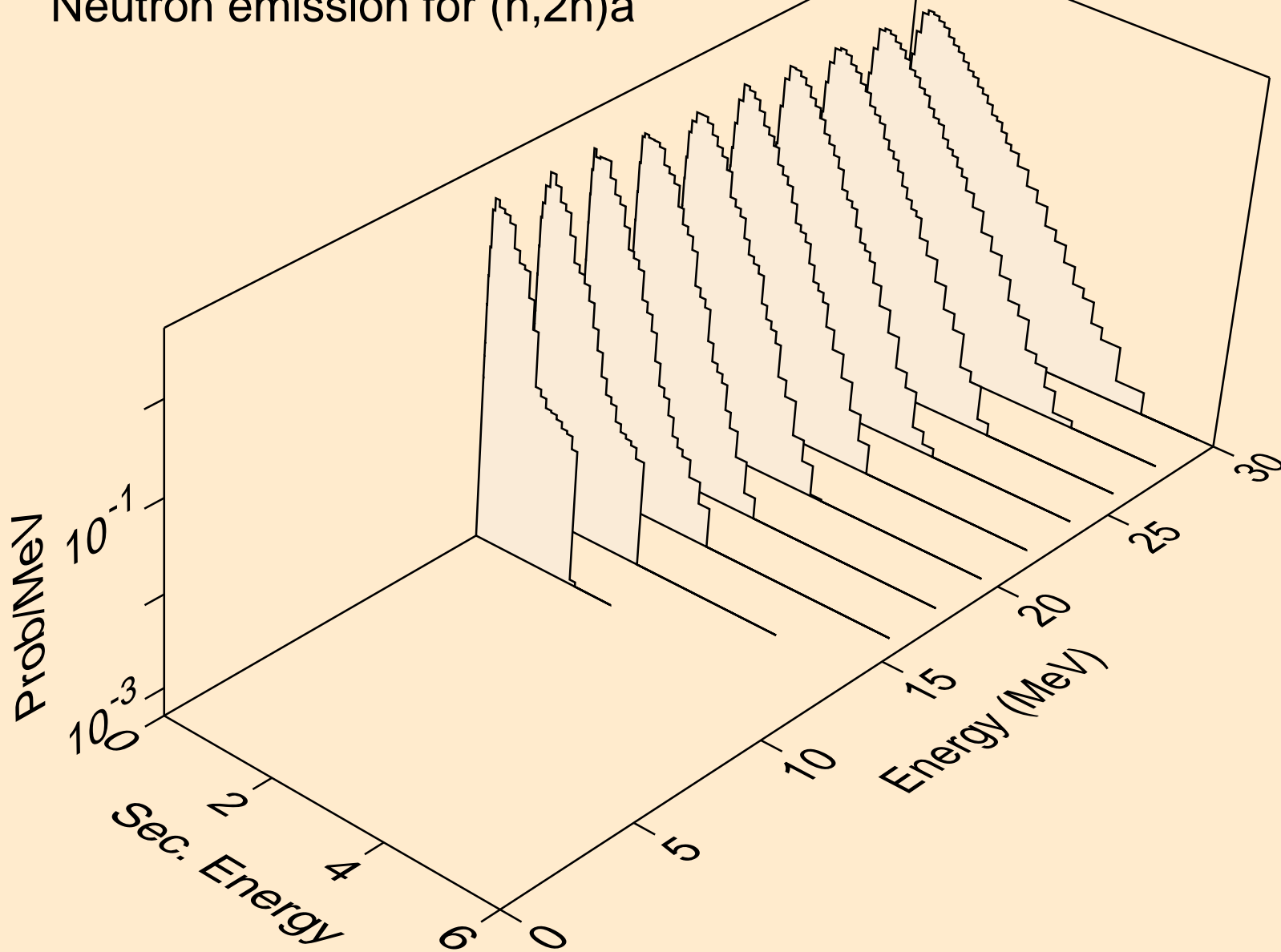

TH236 NEUTRON ACER TENDL-2019 LIBRARY; T=293.16K
Neutron emission for (n,3n)a

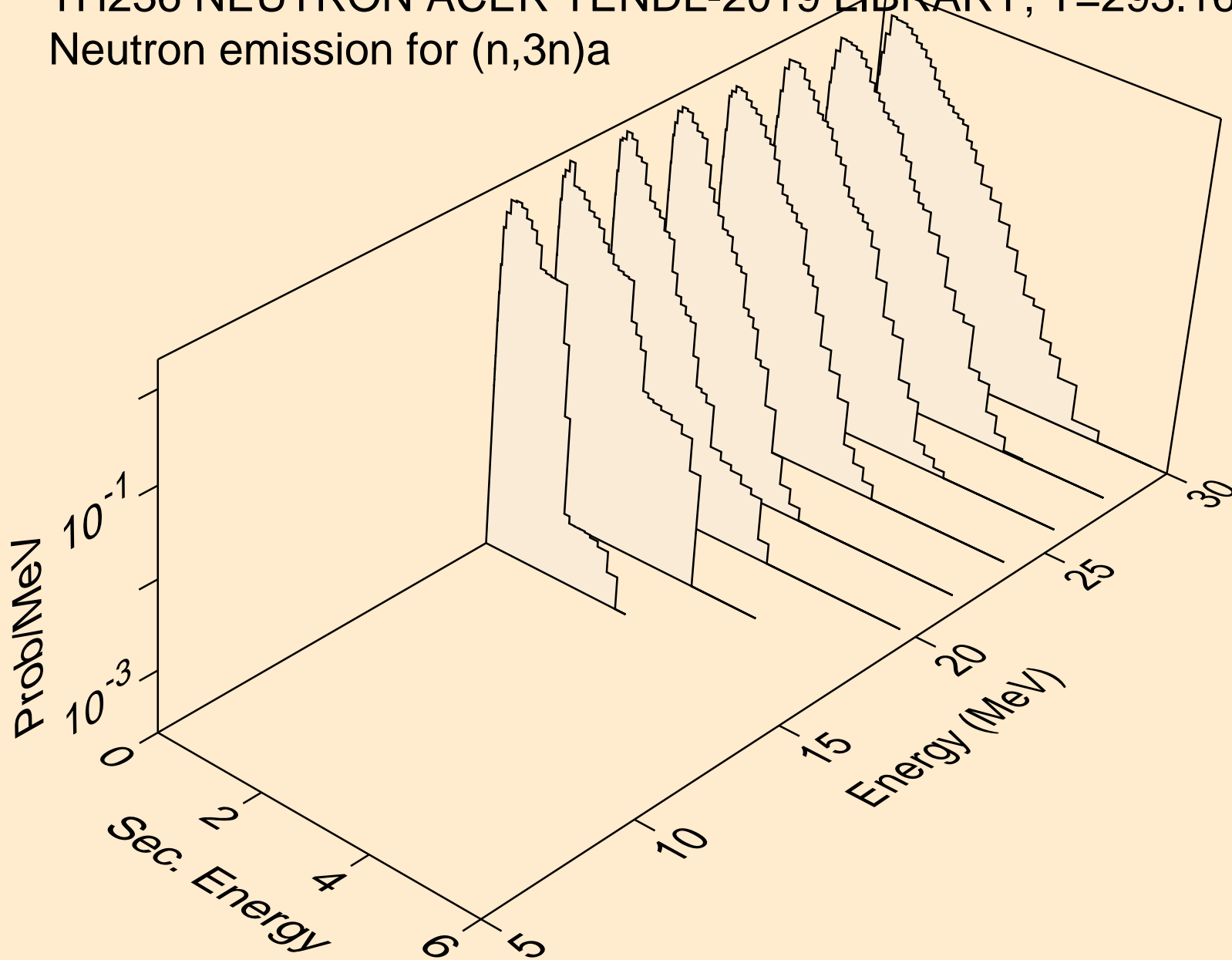

TH236 NEUTRON ACER TENDL-2019 LIBRARY; T=293.16K
Neutron emission for (n,n*)p

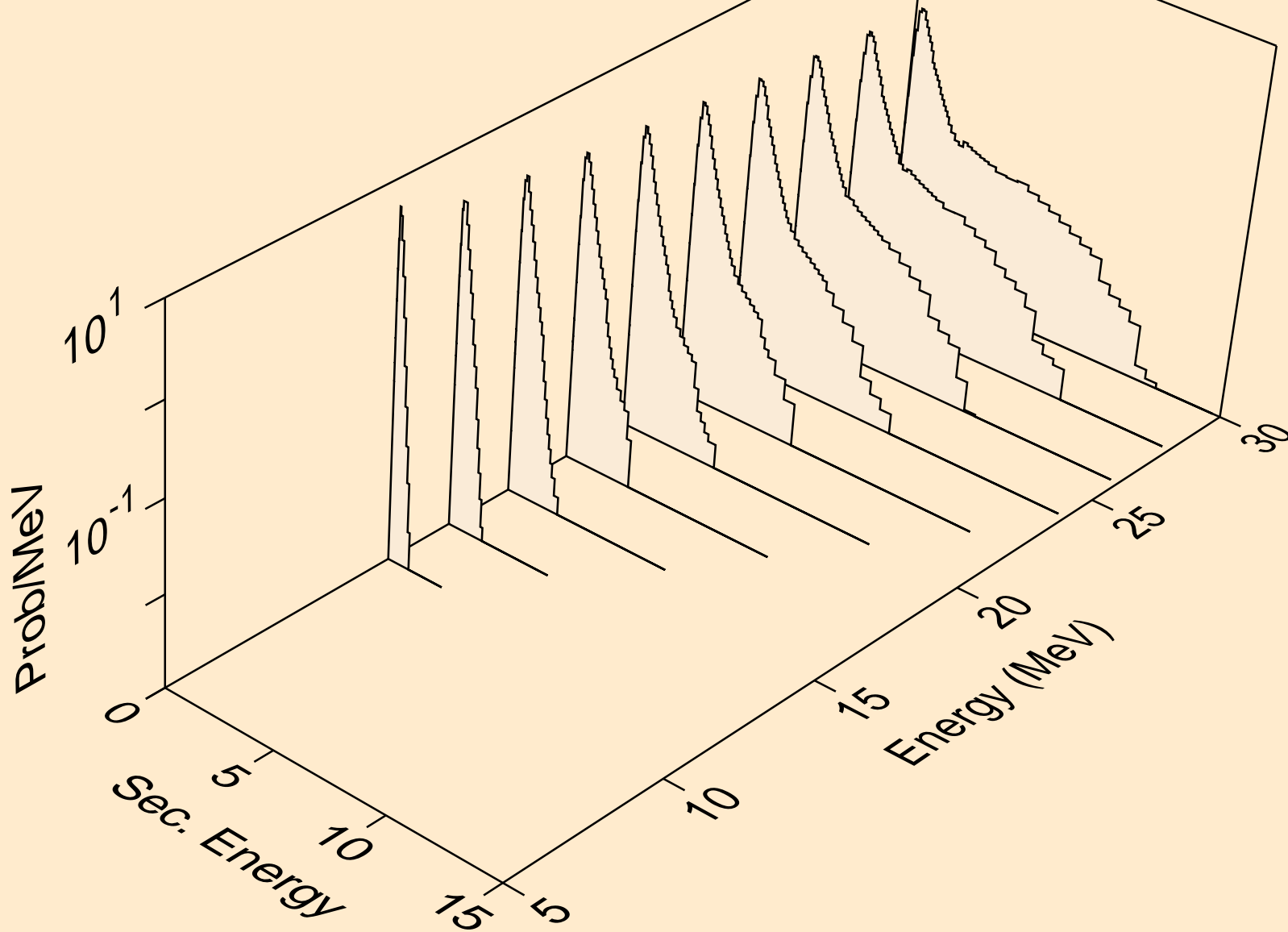

TH236 NEUTRON ACER TENDL-2019 LIBRARY; T=293.16K
Neutron emission for (n,n*)d

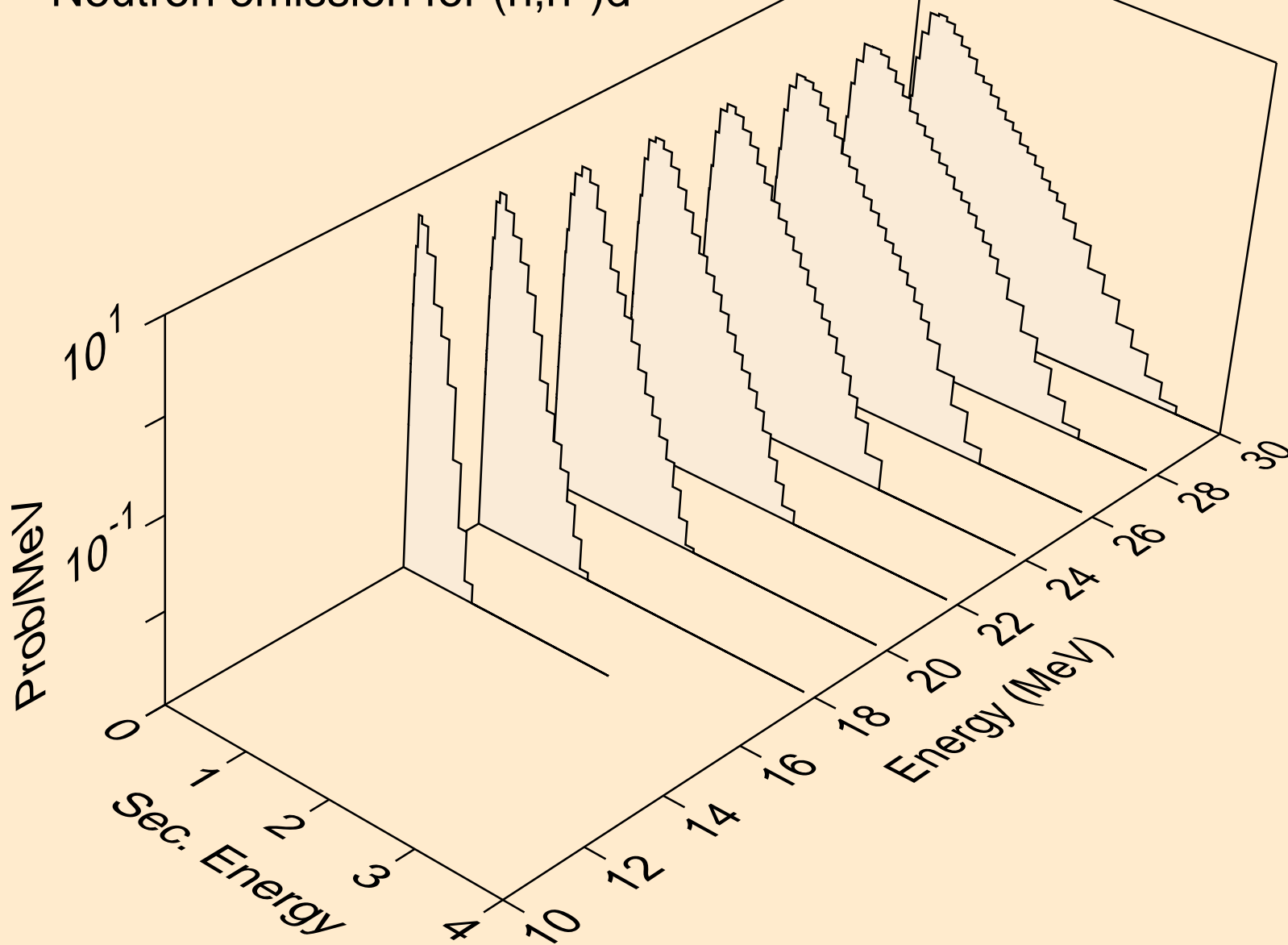

TH236 NEUTRON ACER TENDL-2019 LIBRARY; T=293.16K
Neutron emission for (n,n*)t

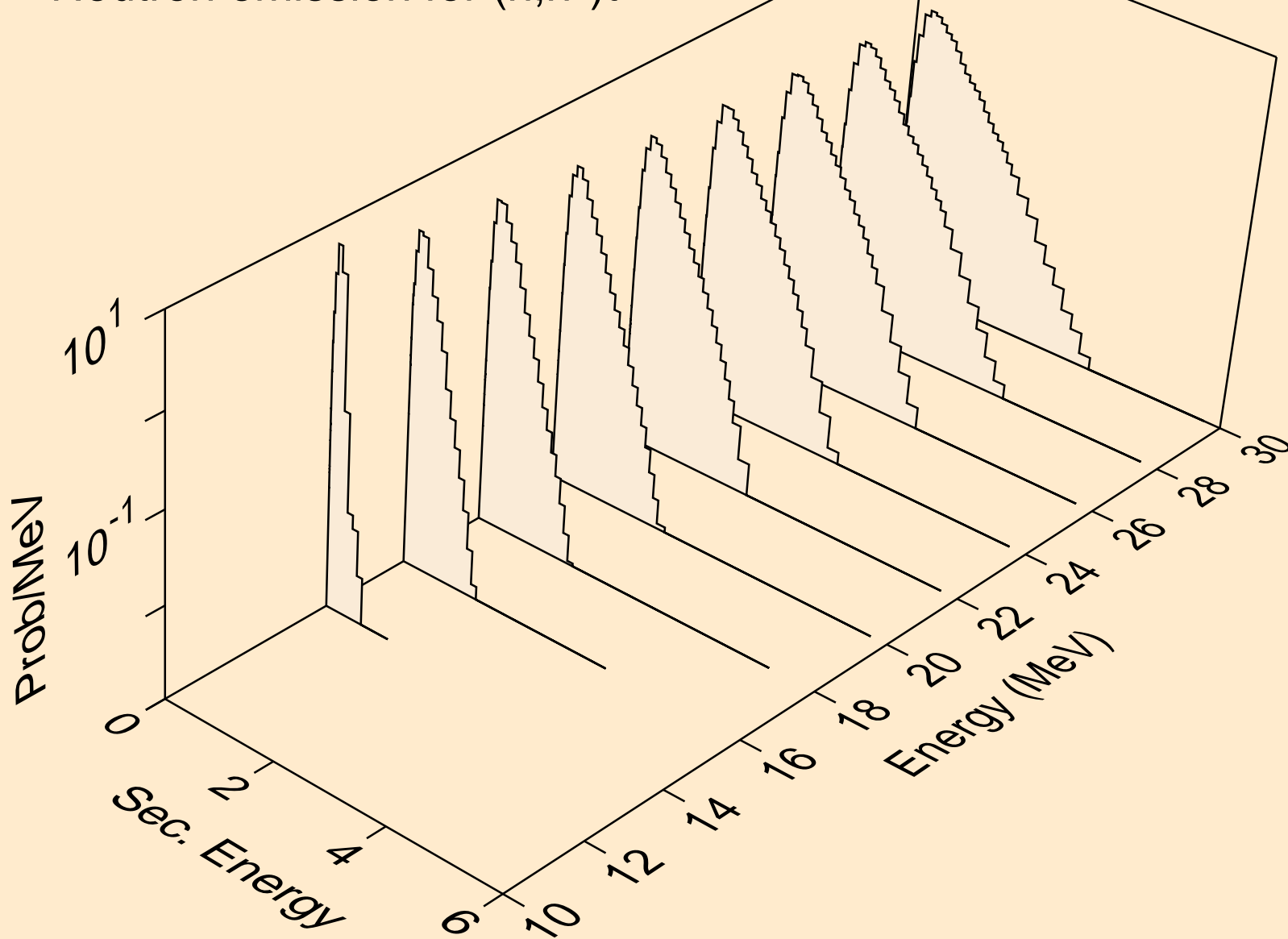

TH236 NEUTRON ACER TENDL-2019 LIBRARY; T=293.16K
Neutron emission for (n,n*)he3

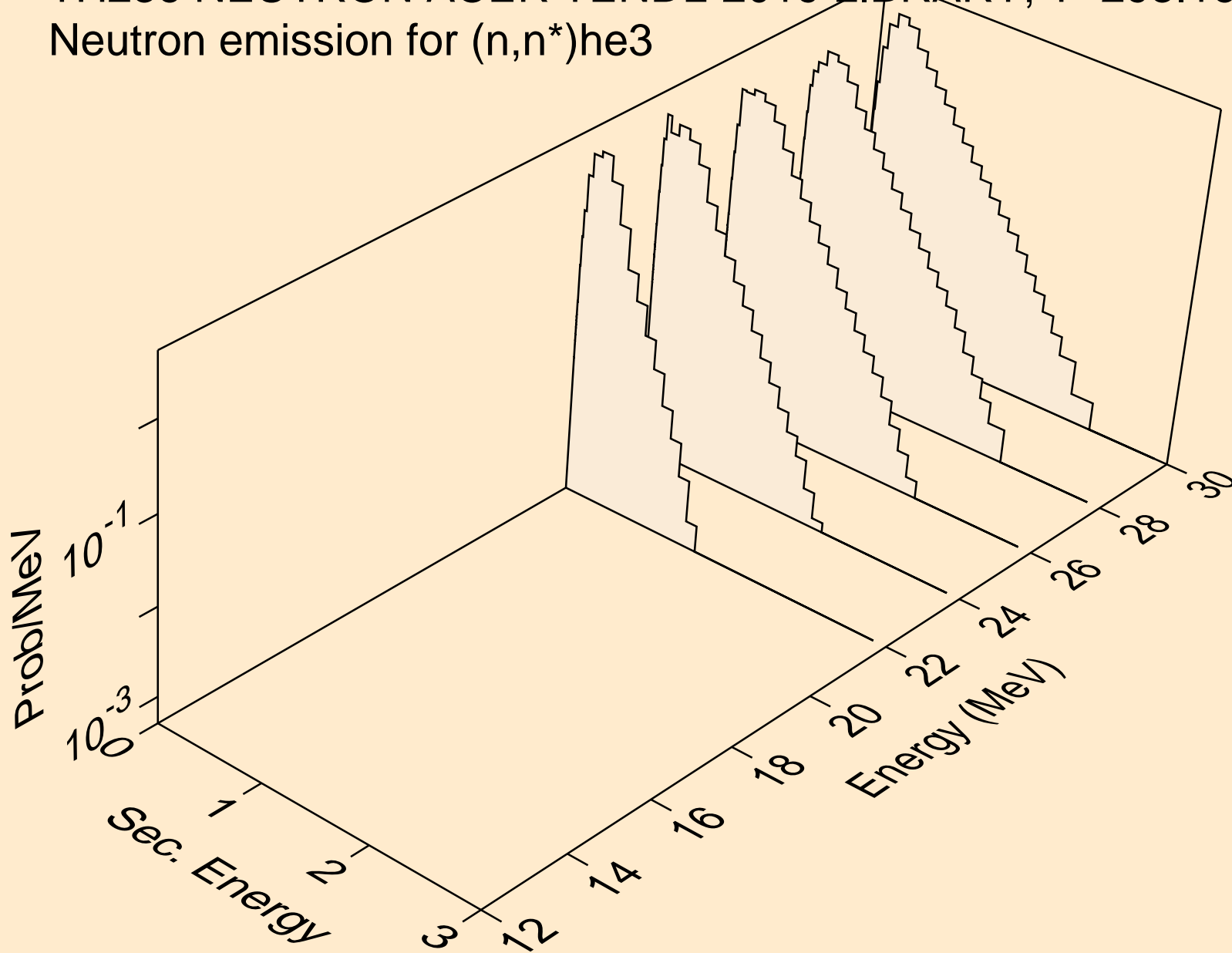

TH236 NEUTRON ACER TENDL-2019 LIBRARY; T=293.16K
Neutron emission for (n,4n)

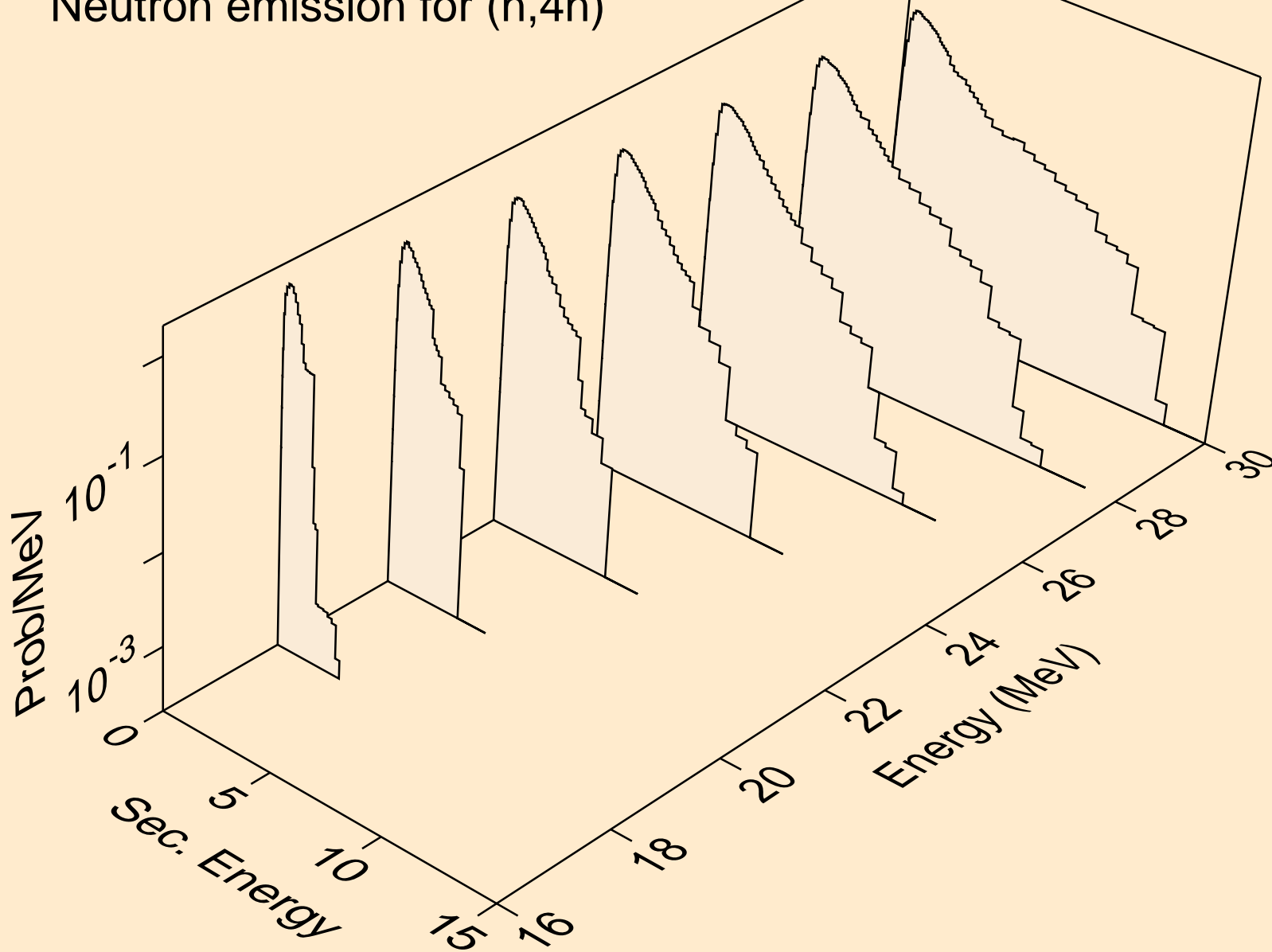

TH236 NEUTRON ACER TENDL-2019 LIBRARY; T=293.16K
Neutron emission for (n,2np)

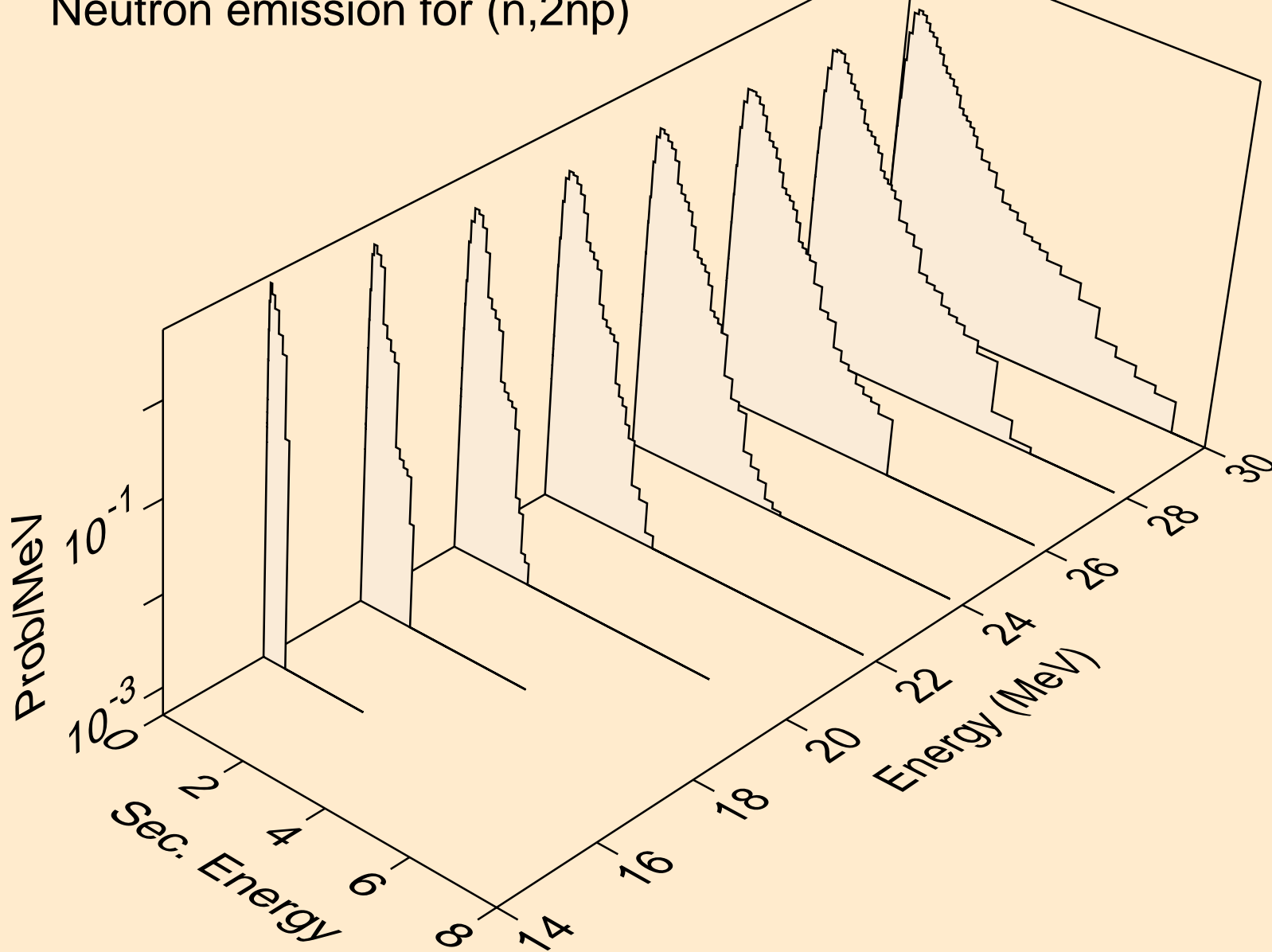

TH236 NEUTRON ACER TENDL-2019 LIBRARY; T=293.16K
Neutron emission for (n,3np)

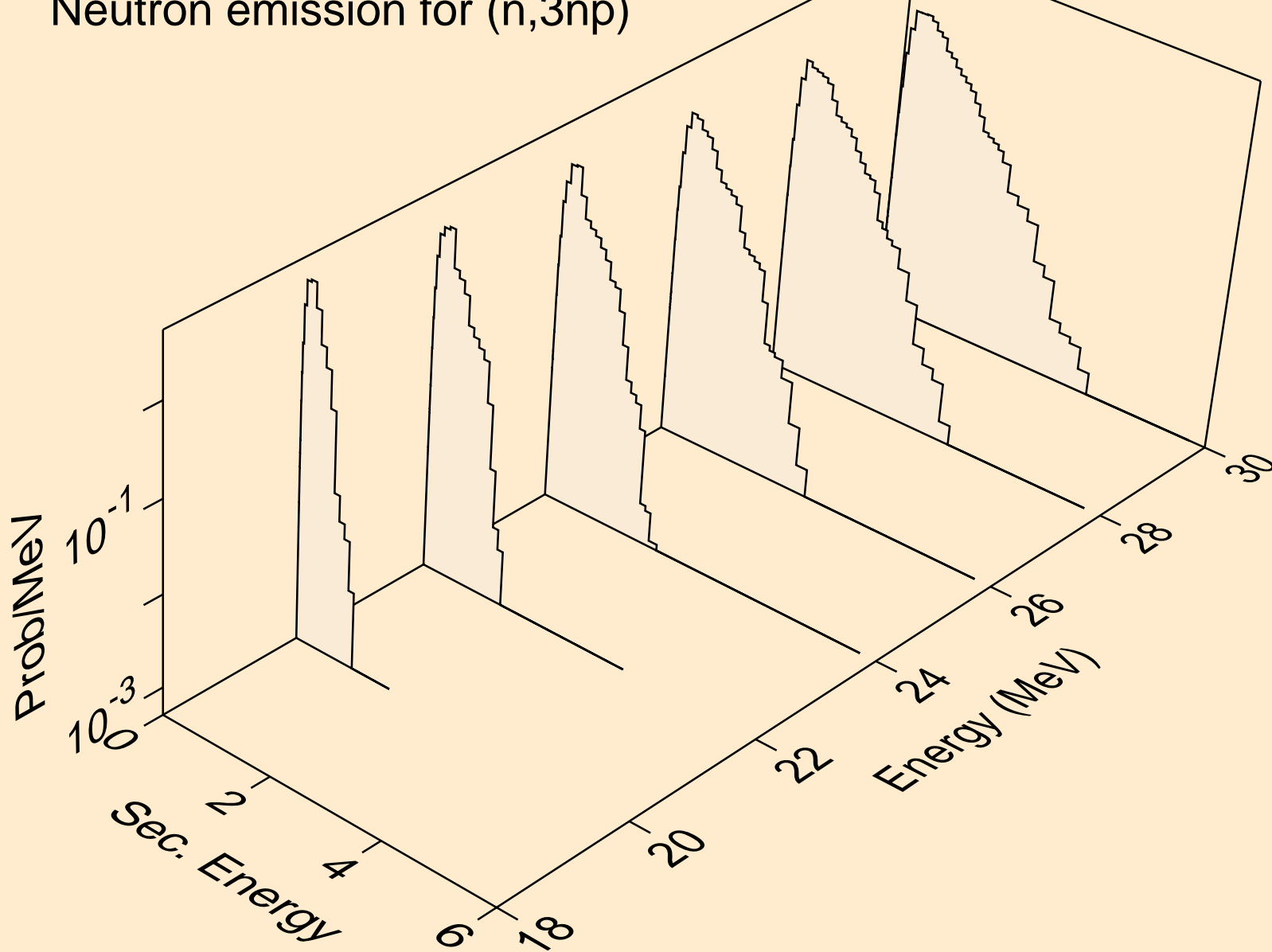

TH236 NEUTRON ACER TENDL-2019 LIBRARY; T=293.16K
Neutron emission for (n,n*c)

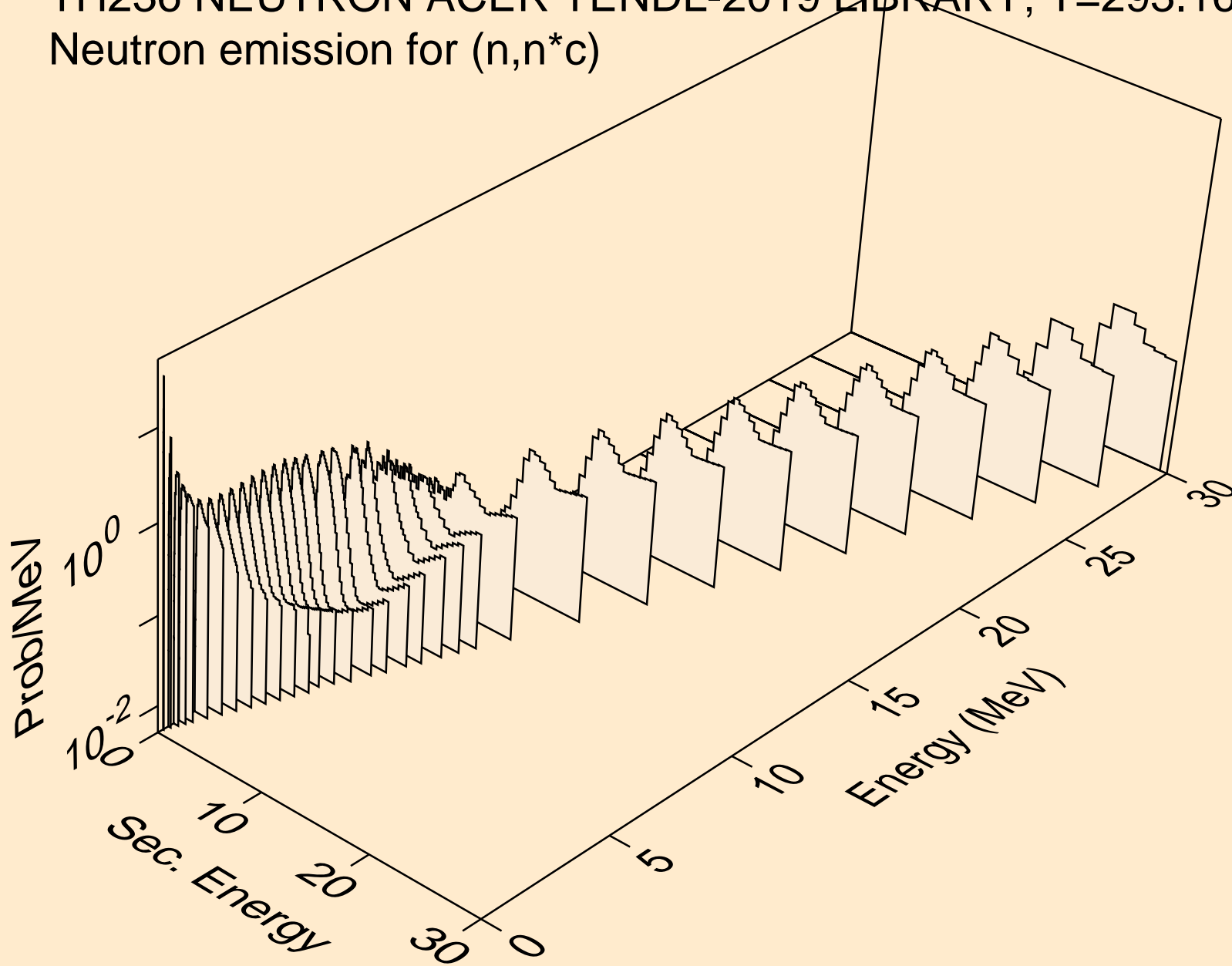

TH236 NEUTRON ACER TENDL-2019 LIBRARY; T=293.16K
Delayed nubar

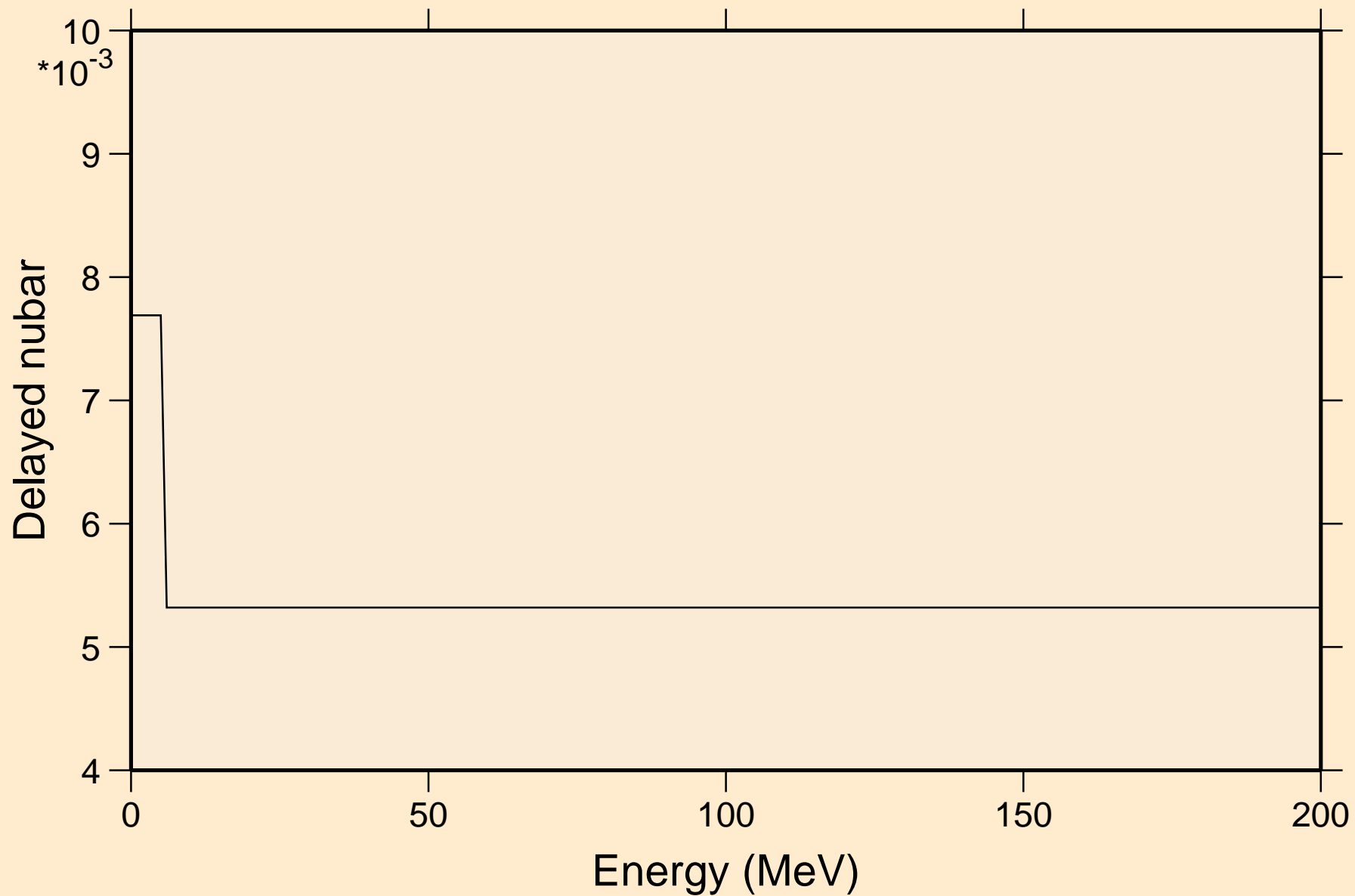

TH236 NEUTRON ACER TENDL-2019 LIBRARY; T=293.16K

Delayed neutron spectra

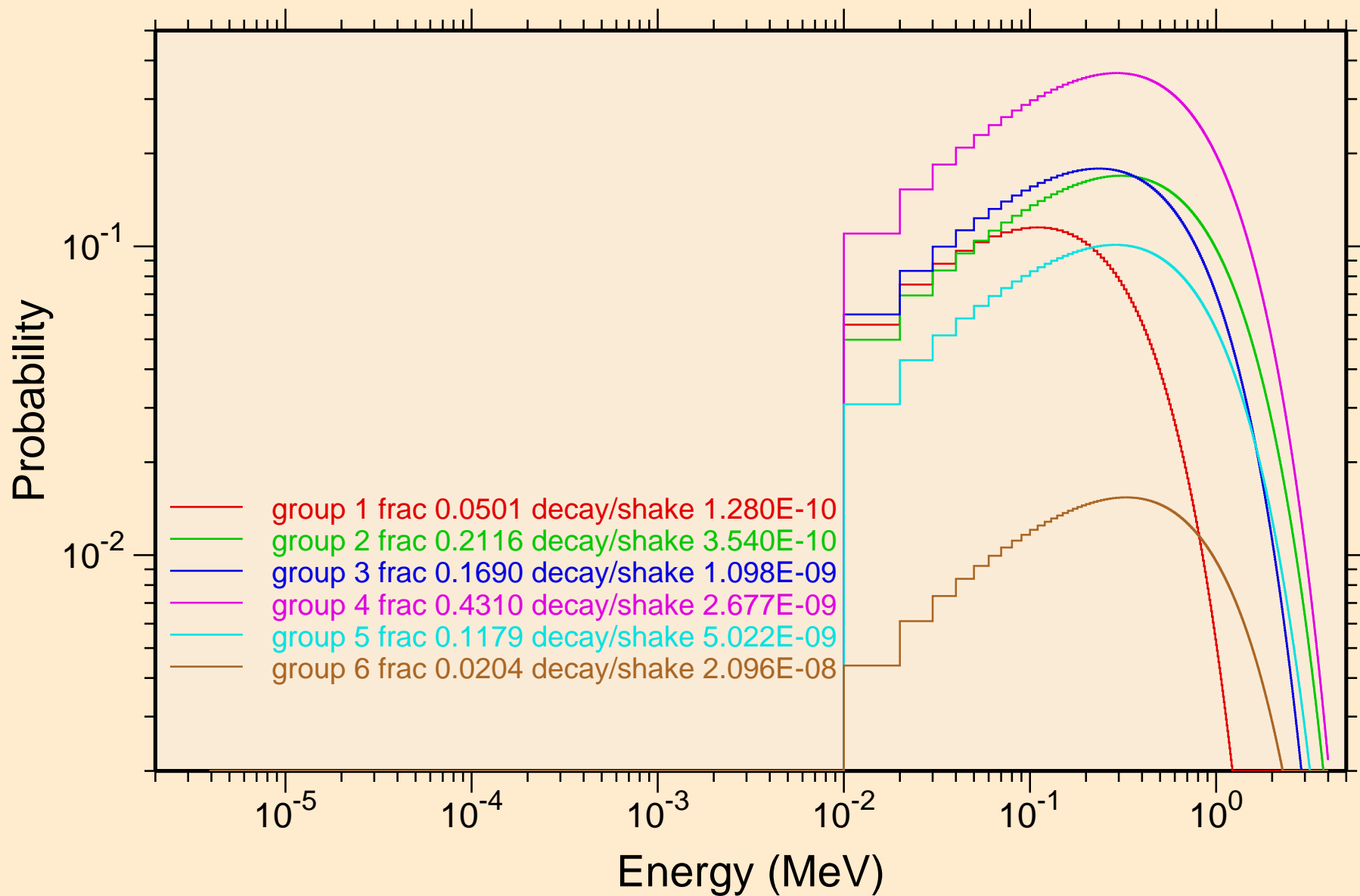

TH236 NEUTRON ACER TENDL-2019 LIBRARY; T=293.16K
Photon emission for (n,x)

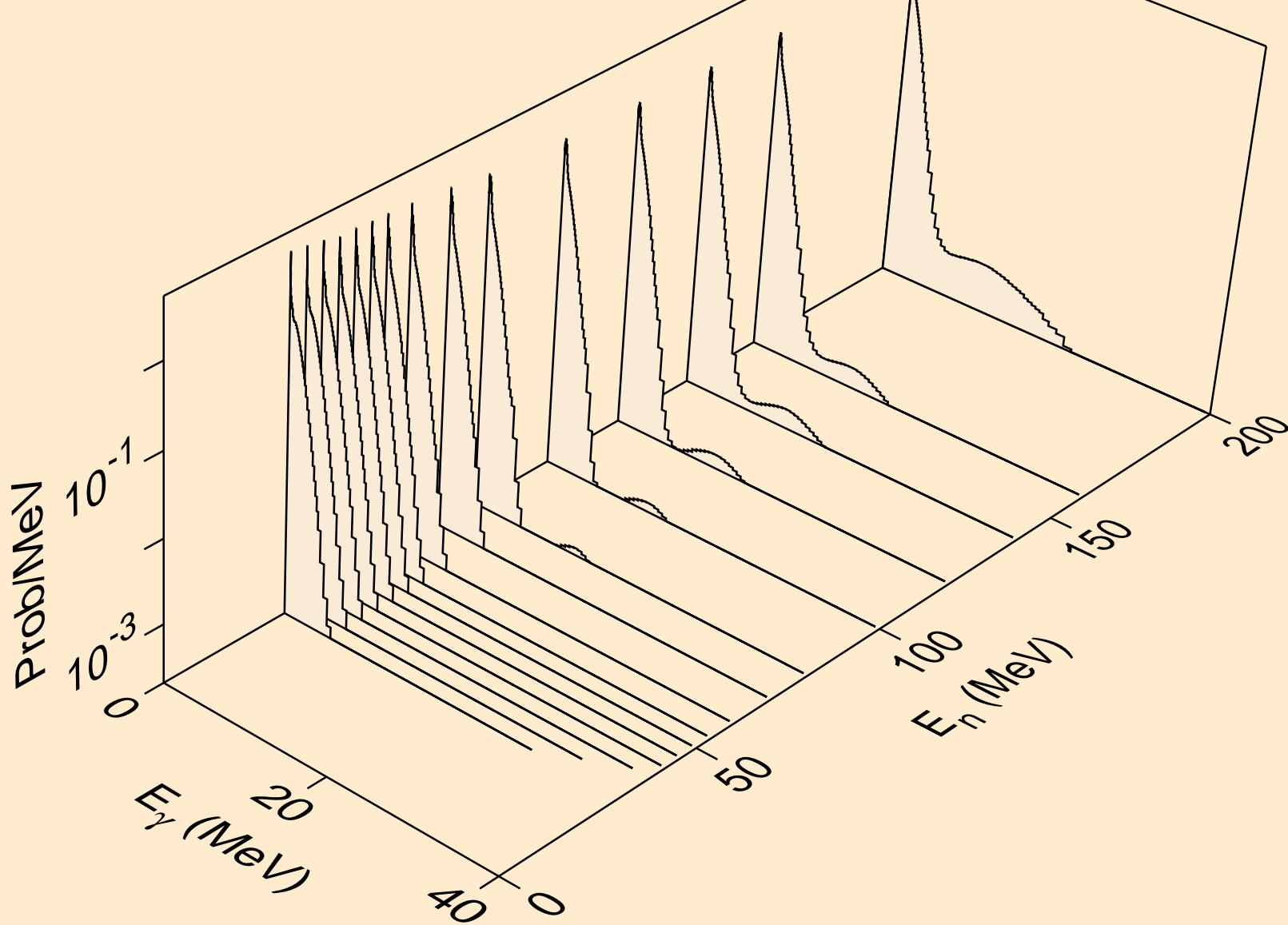

TH236 NEUTRON ACER TENDL-2019 LIBRARY; T=293.16K
Photon emission for (n,2nd)

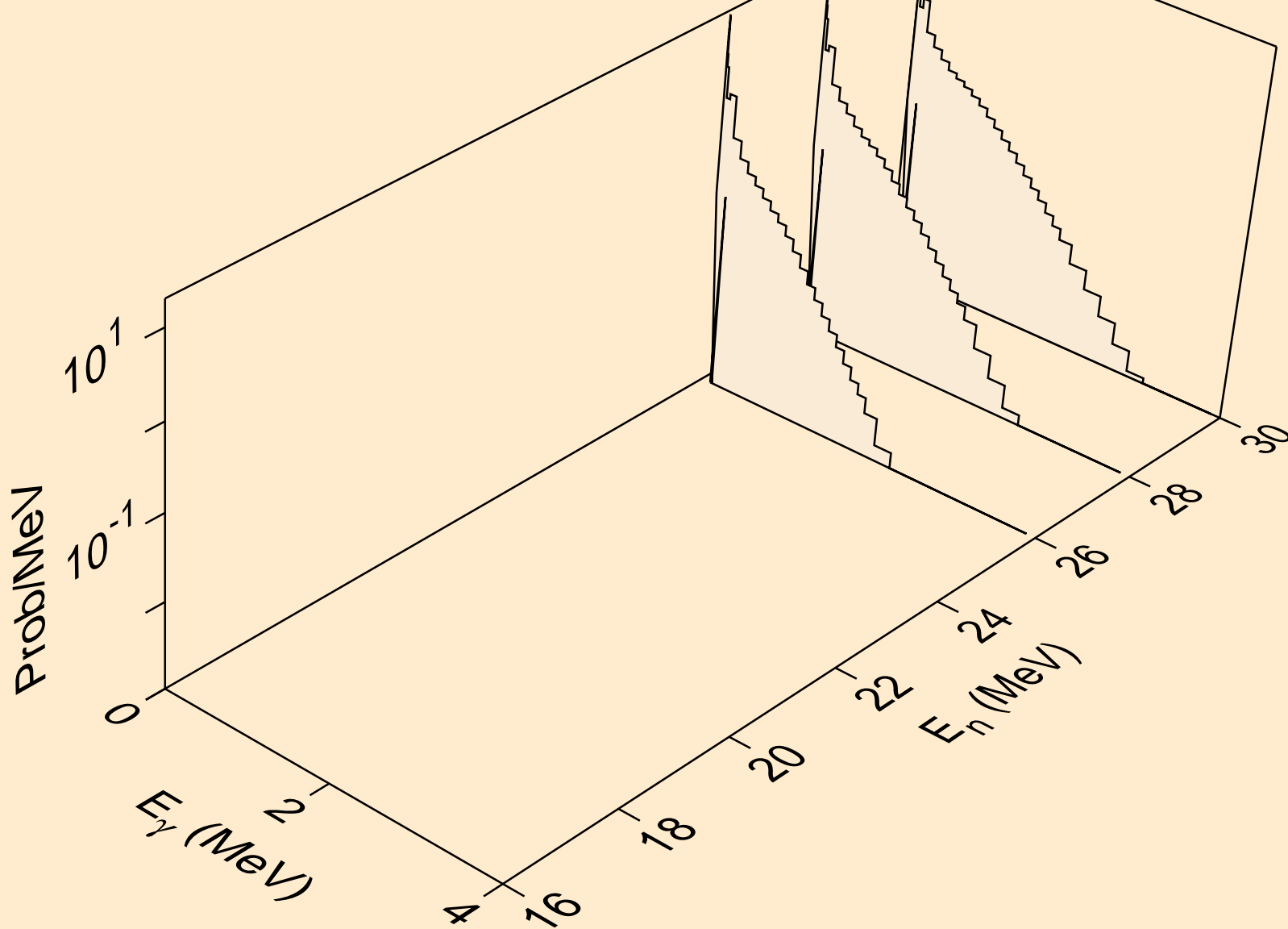

TH236 NEUTRON ACER TENDL-2019 LIBRARY; T=293.16K
Photon emission for (n,2n)

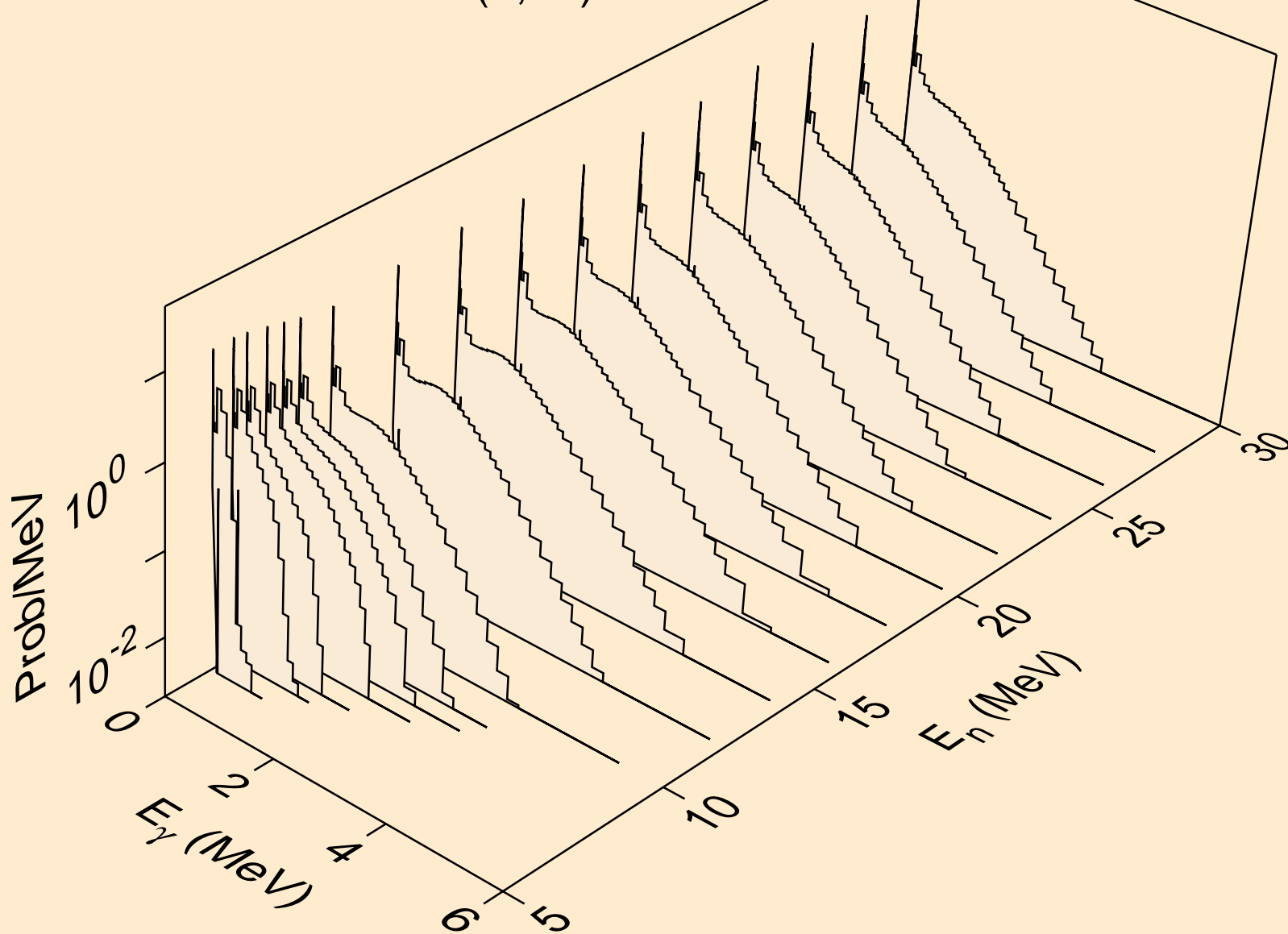

TH236 NEUTRON ACER TENDL-2019 LIBRARY; T=293.16K
Photon emission for (n,3n)

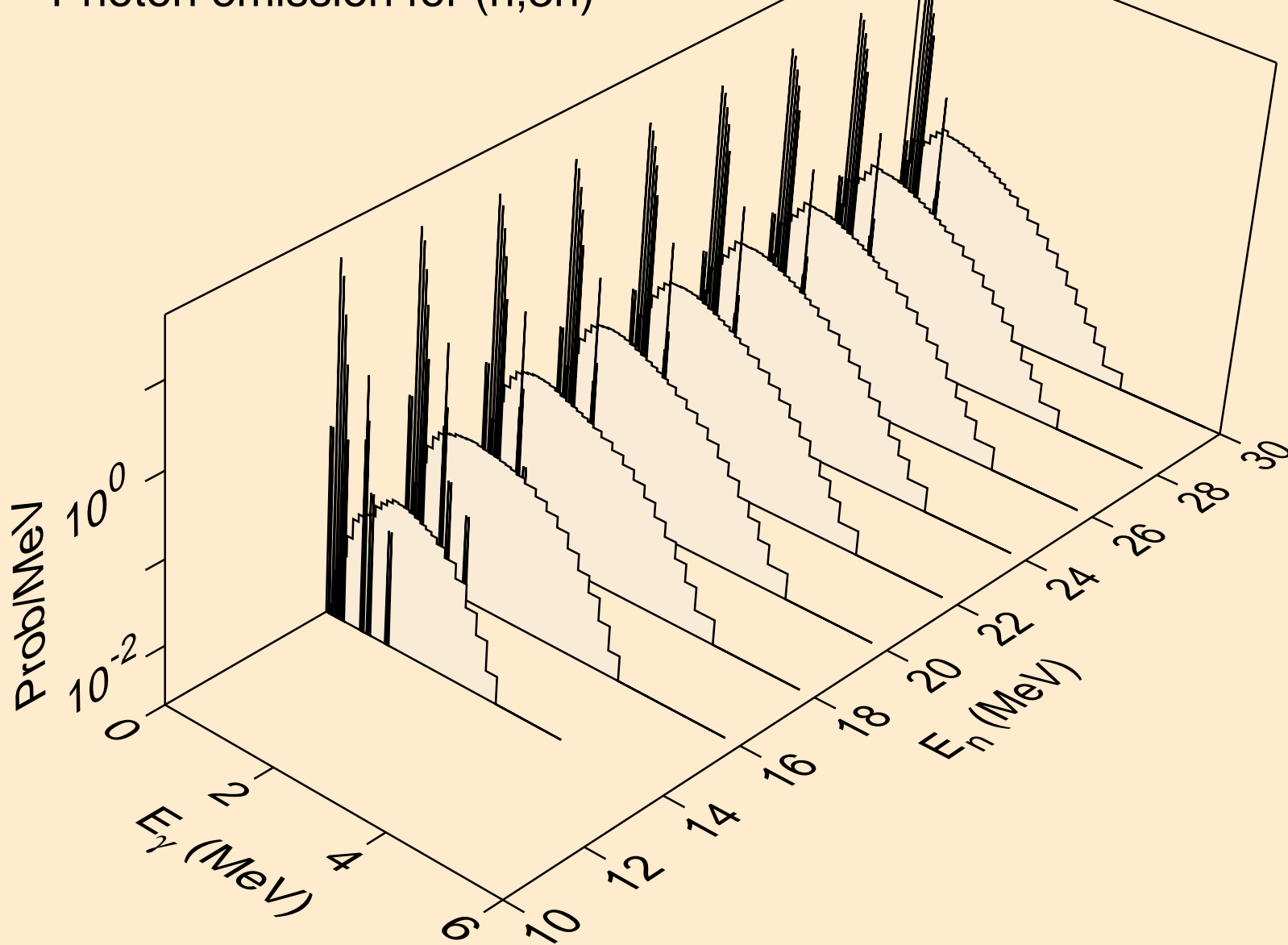

TH236 NEUTRON ACER TENDL-2019 LIBRARY; T=293.16K
Photon emission for (n,n*)a

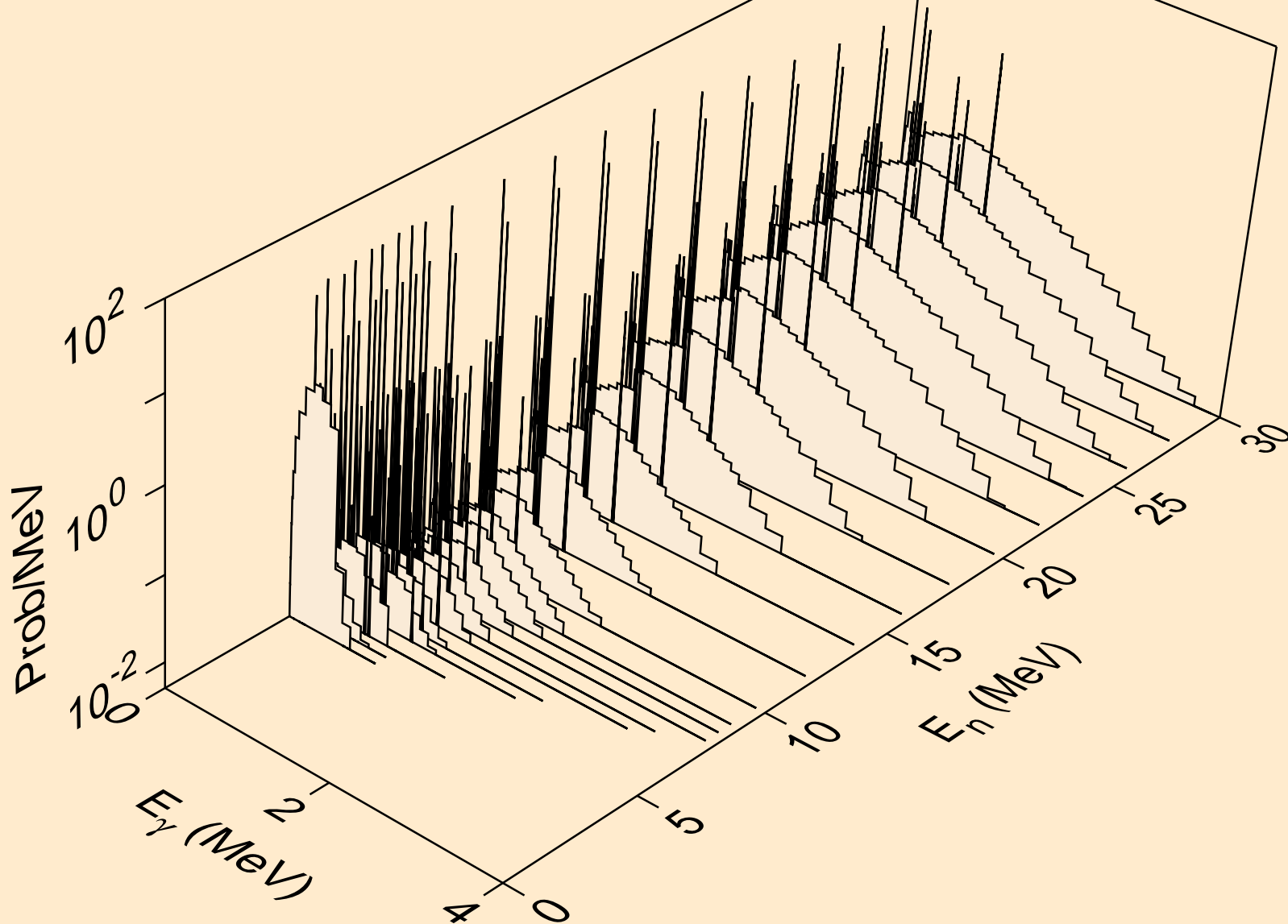

TH236 NEUTRON ACER TENDL-2019 LIBRARY; T=293.16K
Photon emission for (n,2n)a

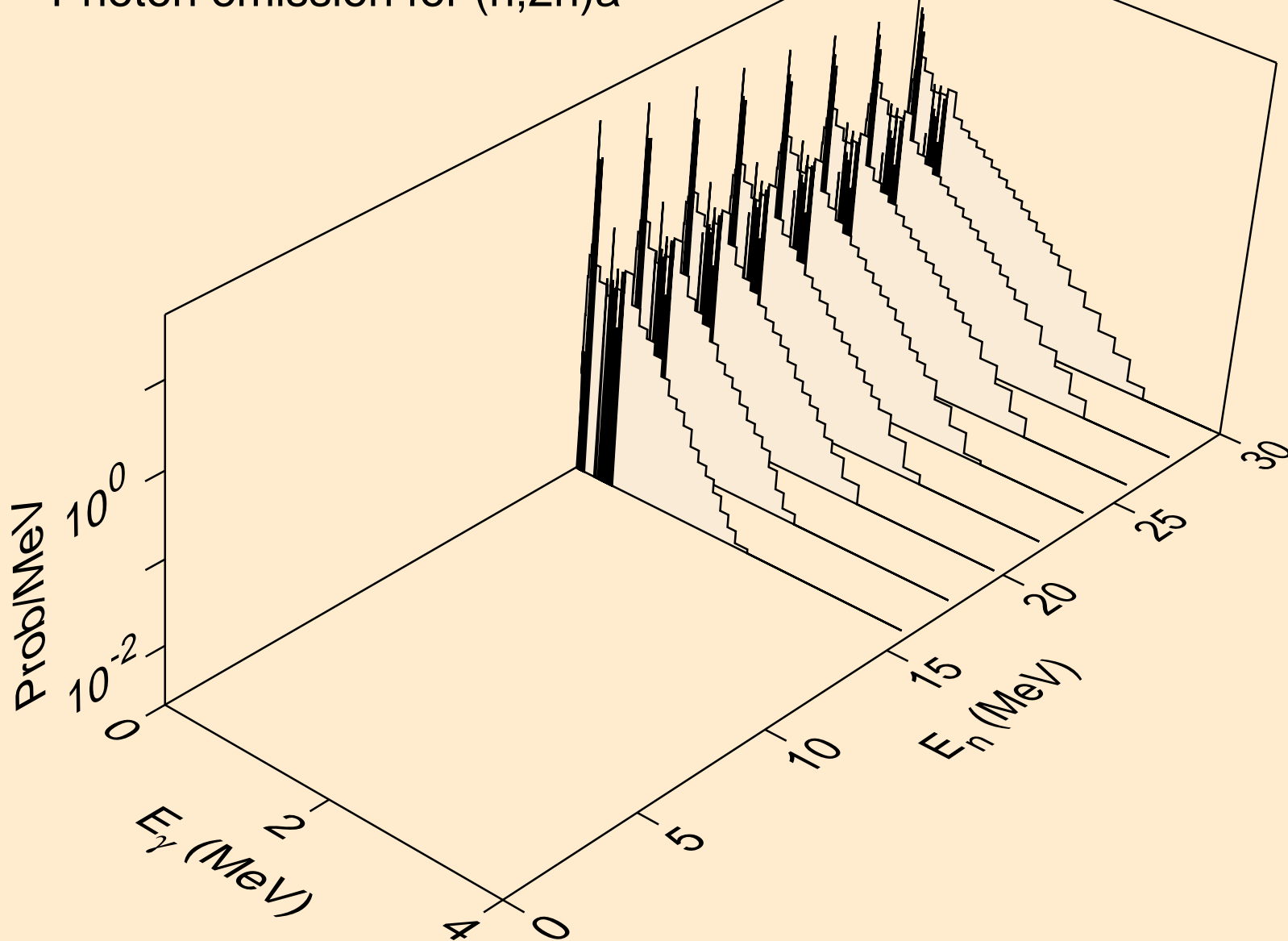

TH236 NEUTRON ACER TENDL-2019 LIBRARY; T=293.16K
Photon emission for (n,3n)a

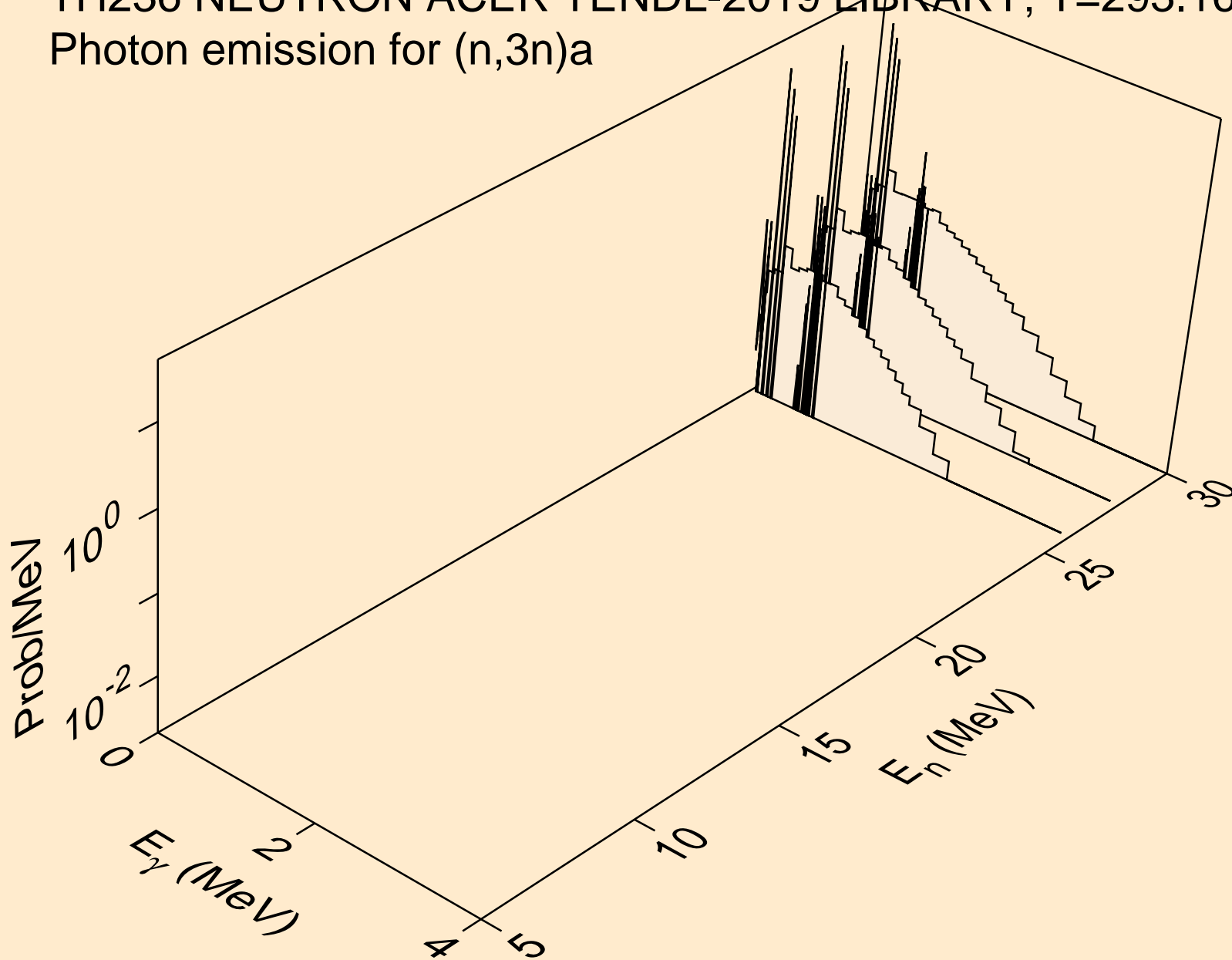

TH236 NEUTRON ACER TENDL-2019 LIBRARY; T=293.16K
Photon emission for (n,n*)p

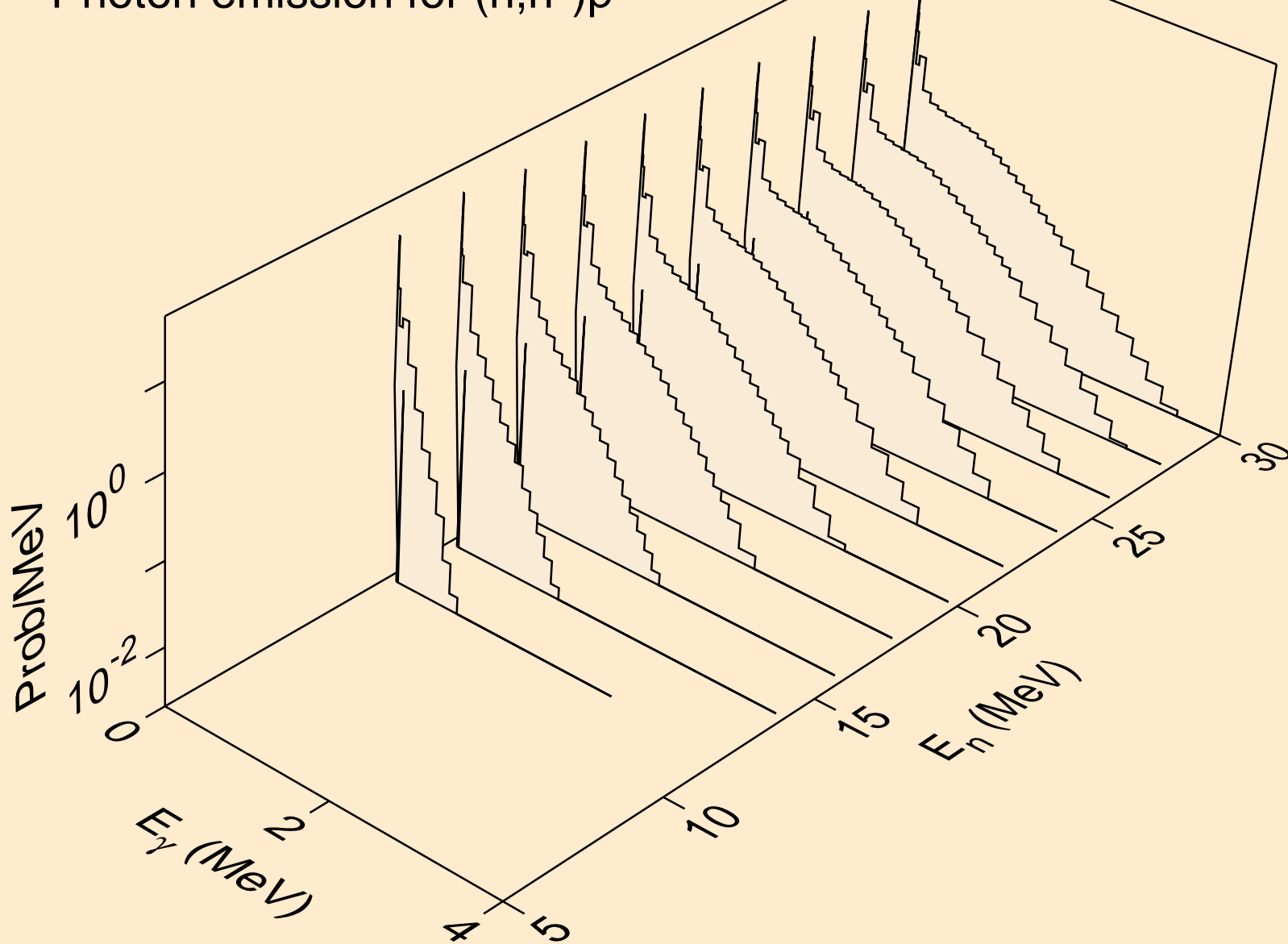

TH236 NEUTRON ACER TENDL-2019 LIBRARY; T=293.16K
Photon emission for (n,n*)d

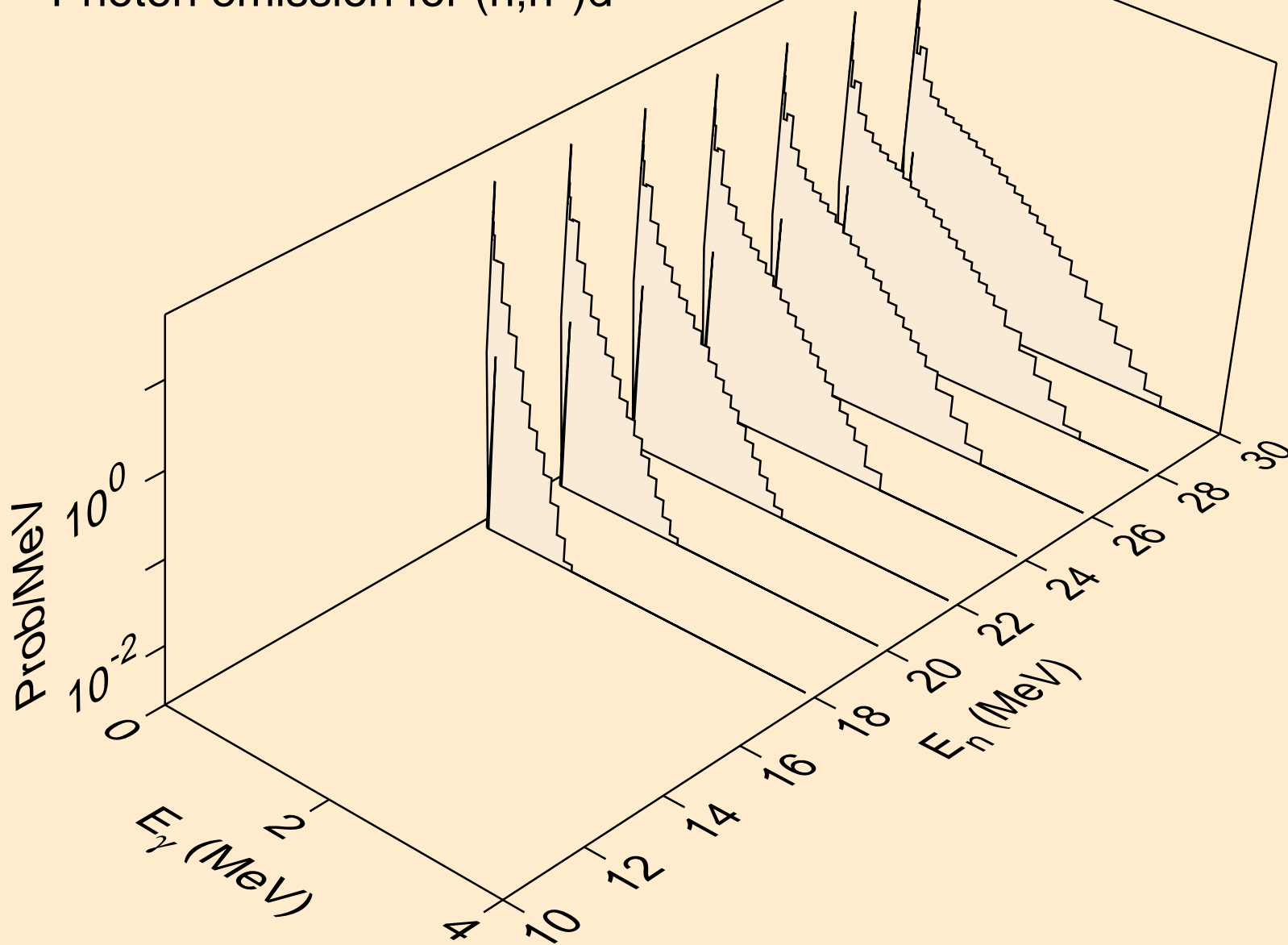

TH236 NEUTRON ACER TENDL-2019 LIBRARY; T=293.16K
Photon emission for (n,n*)t

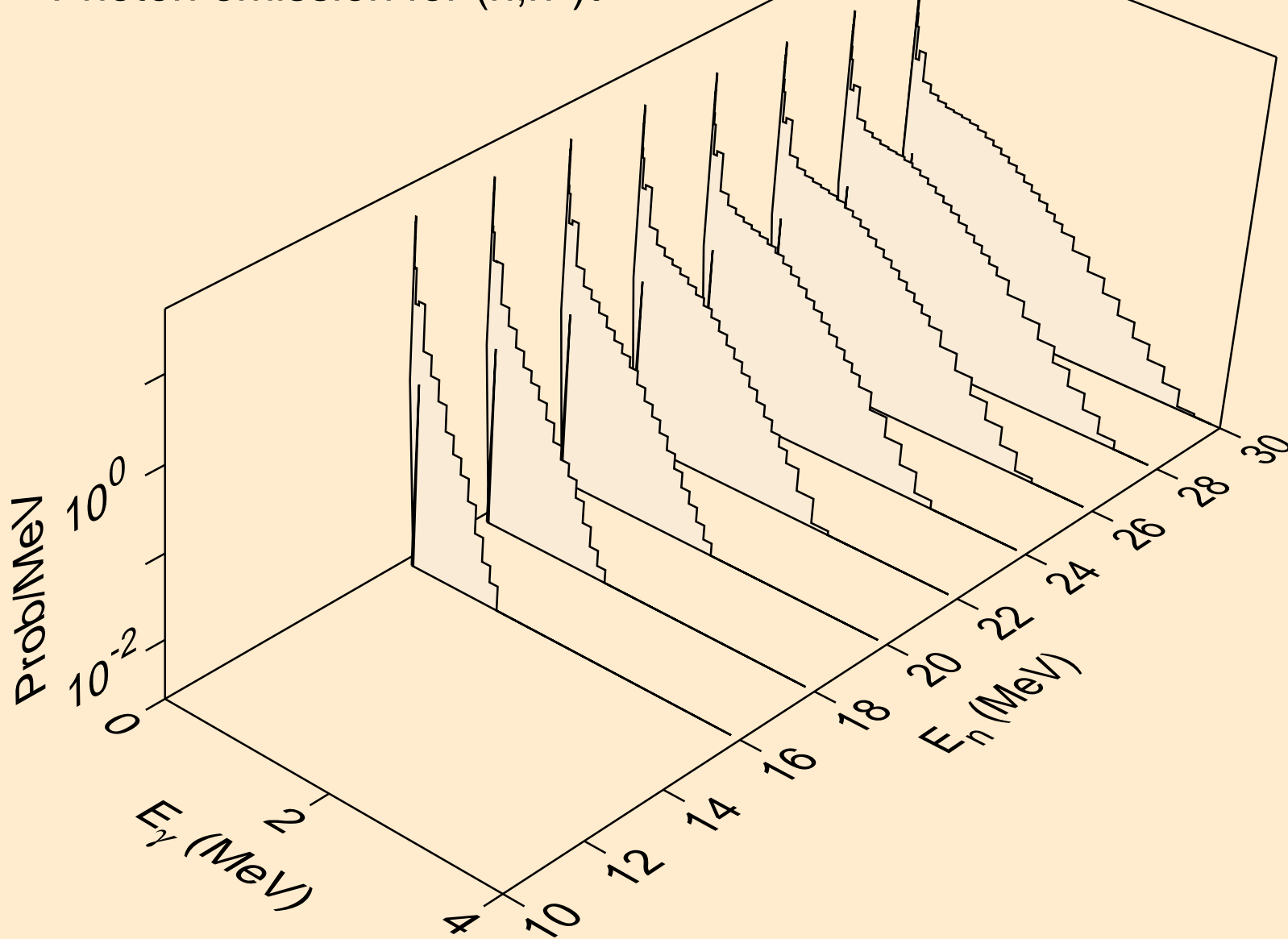

TH236 NEUTRON ACER TENDL-2019 LIBRARY; T=293.16K
Photon emission for (n,n*)he3

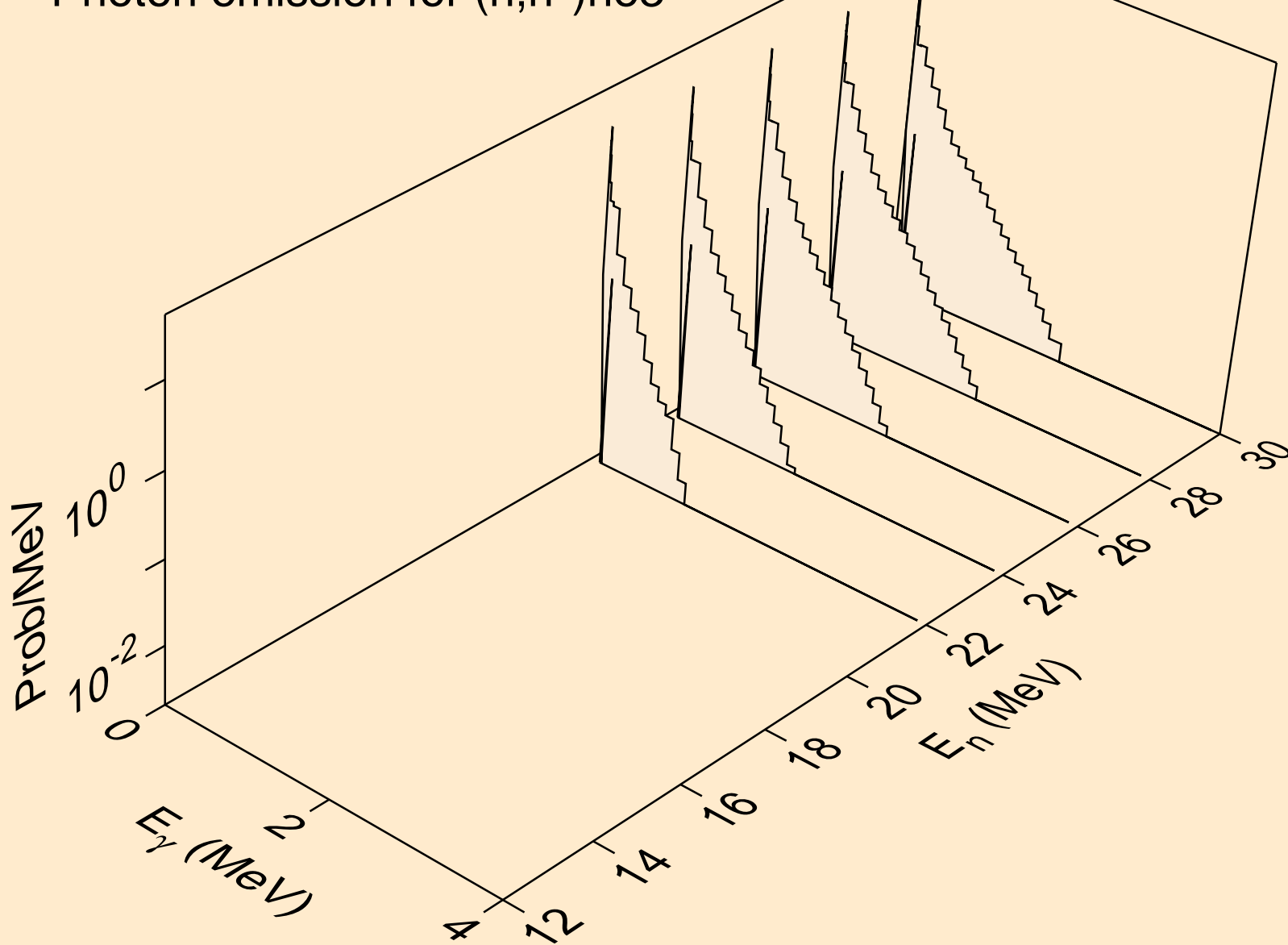

TH236 NEUTRON ACER TENDL-2019 LIBRARY; T=293.16K
Photon emission for (n,4n)

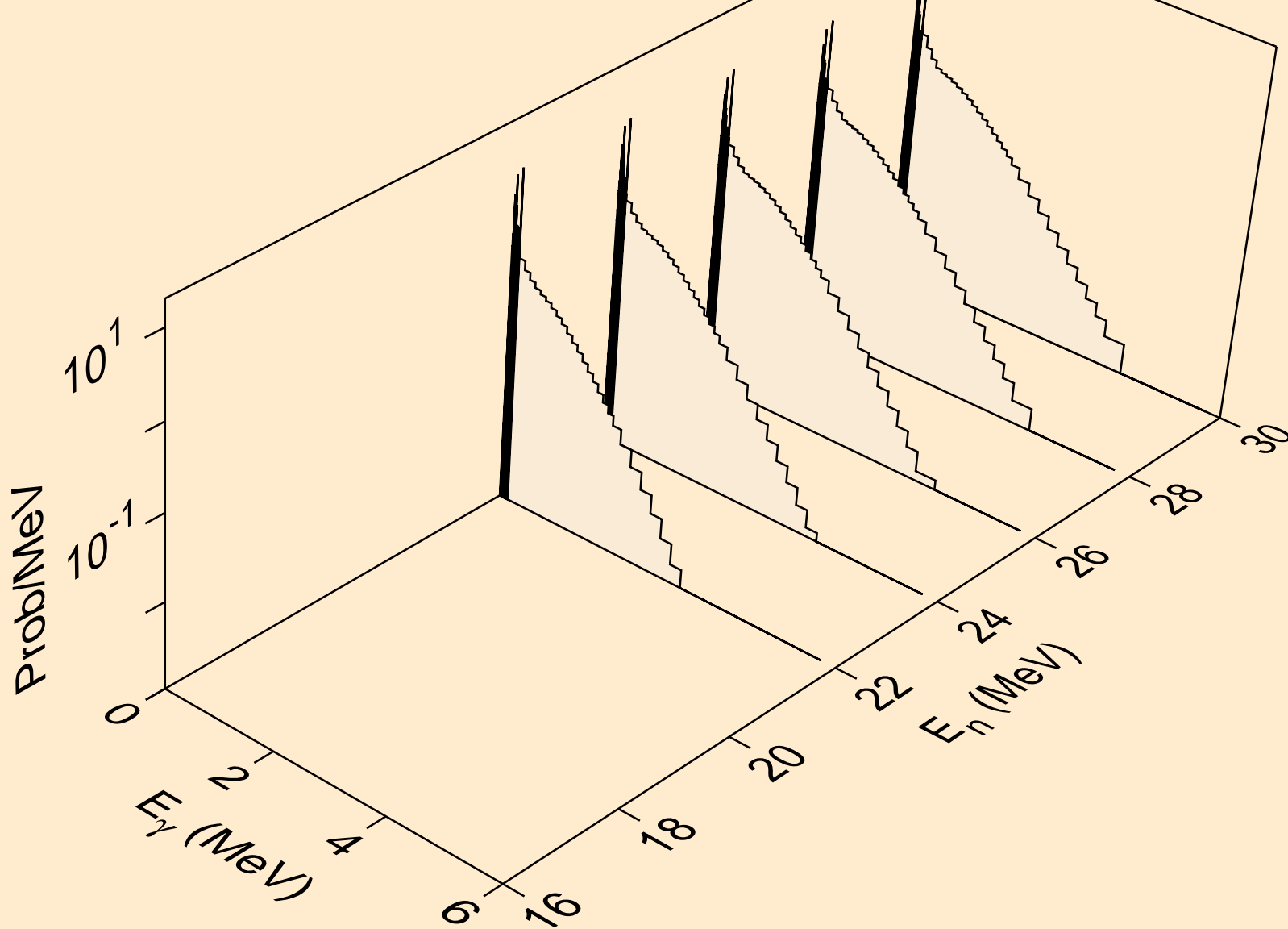

TH236 NEUTRON ACER TENDL-2019 LIBRARY; T=293.16K
Photon emission for (n,2np)

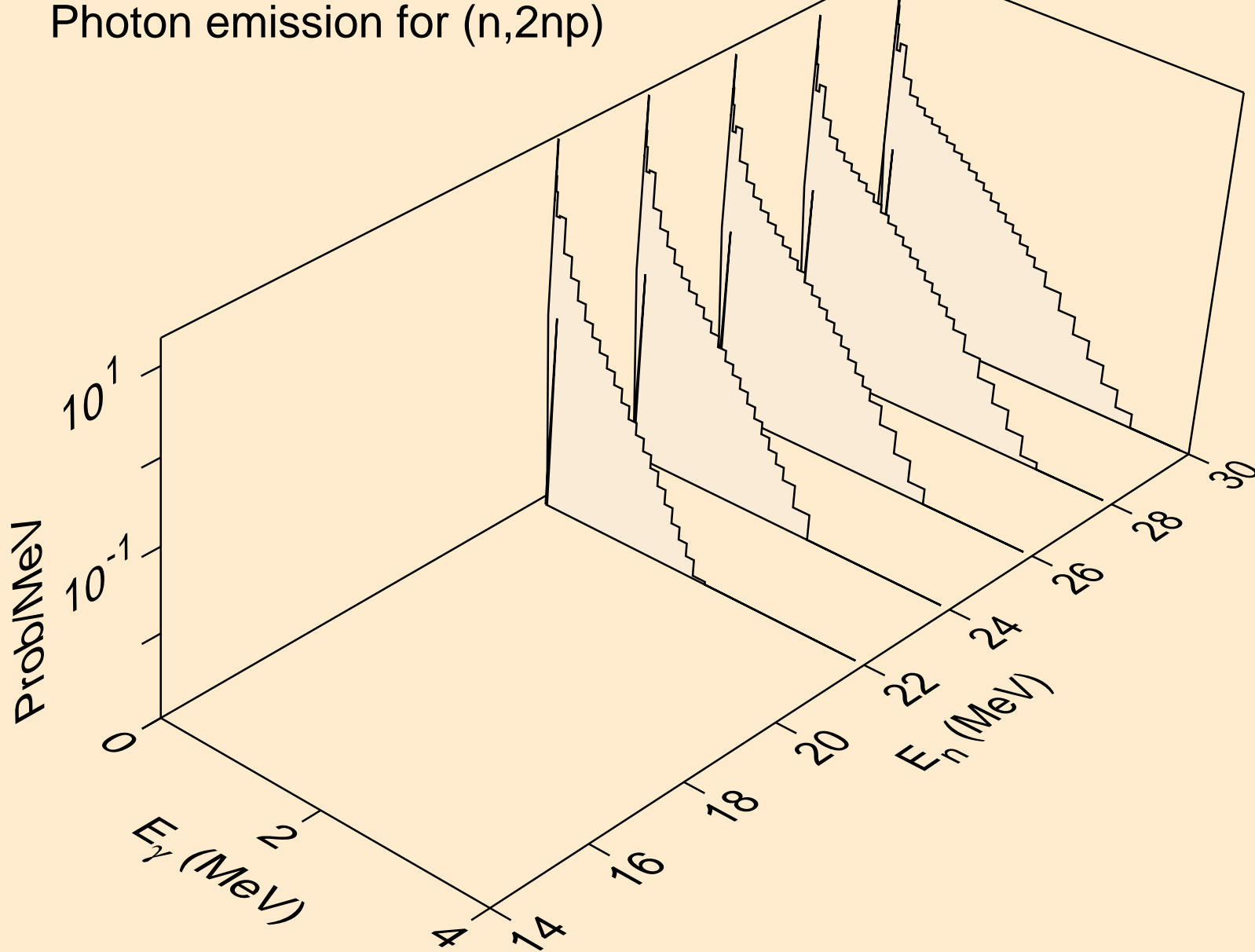

TH236 NEUTRON ACER TENDL-2019 LIBRARY; T=293.16K
Photon emission for (n,3np)

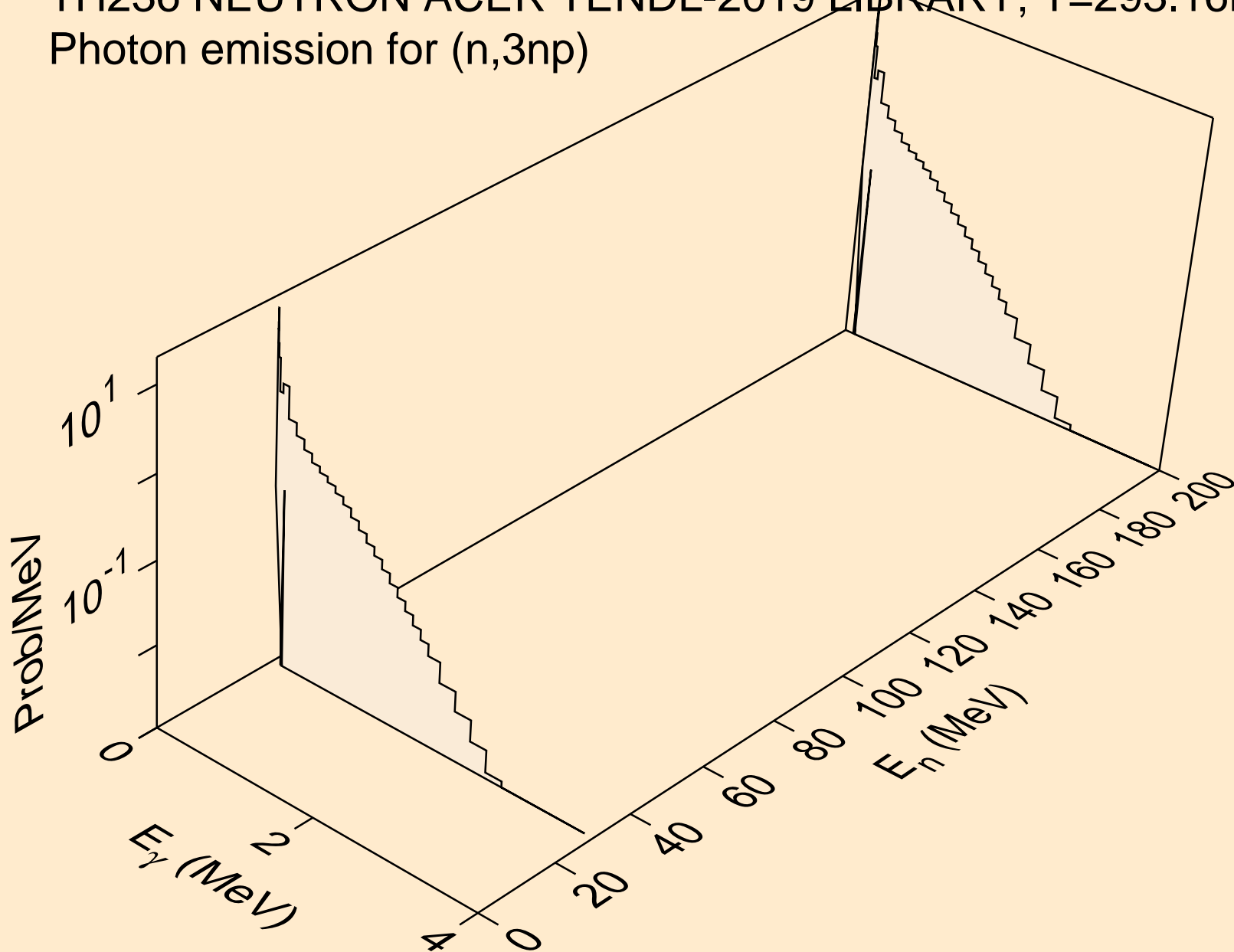

TH236 NEUTRON ACER TENDL-2019 LIBRARY; T=293.16K
Photon emission for (n,n*c)

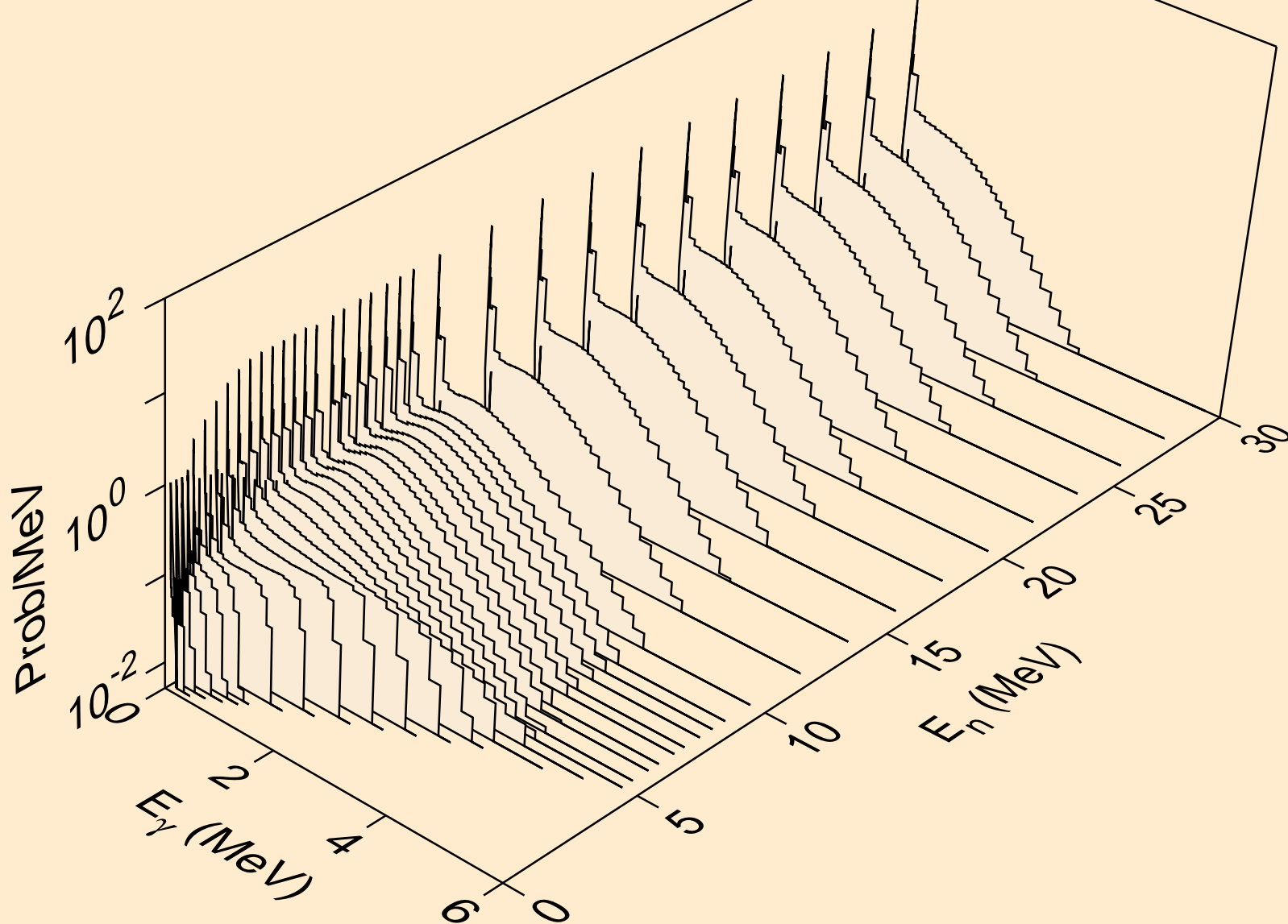

TH236 NEUTRON ACER TENDL-2019 LIBRARY; T=293.16K
Photon emission for (n,gma)

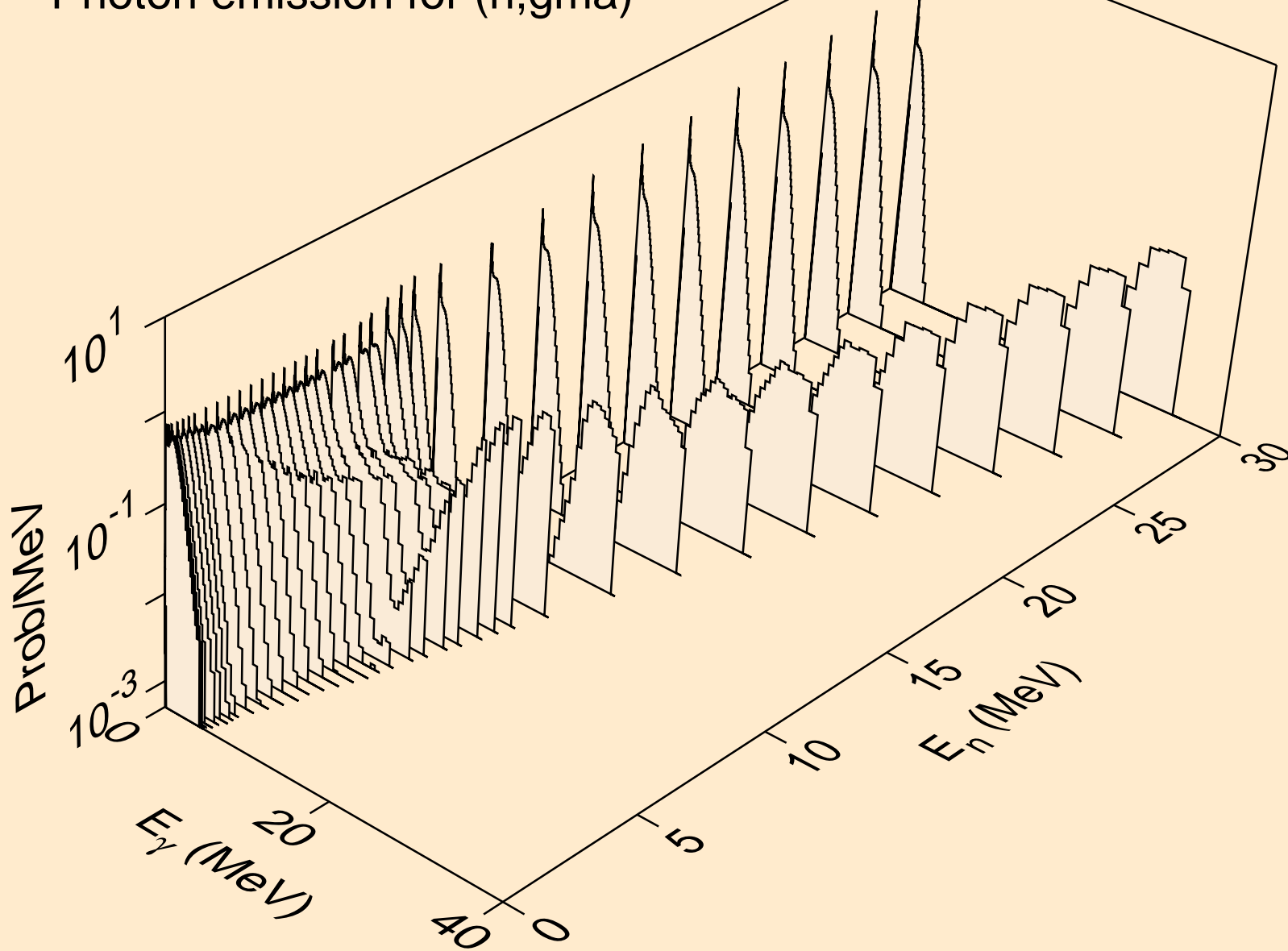

TH236 NEUTRON ACER TENDL-2019 LIBRARY; T=293.16K
Photon emission for (n,p)

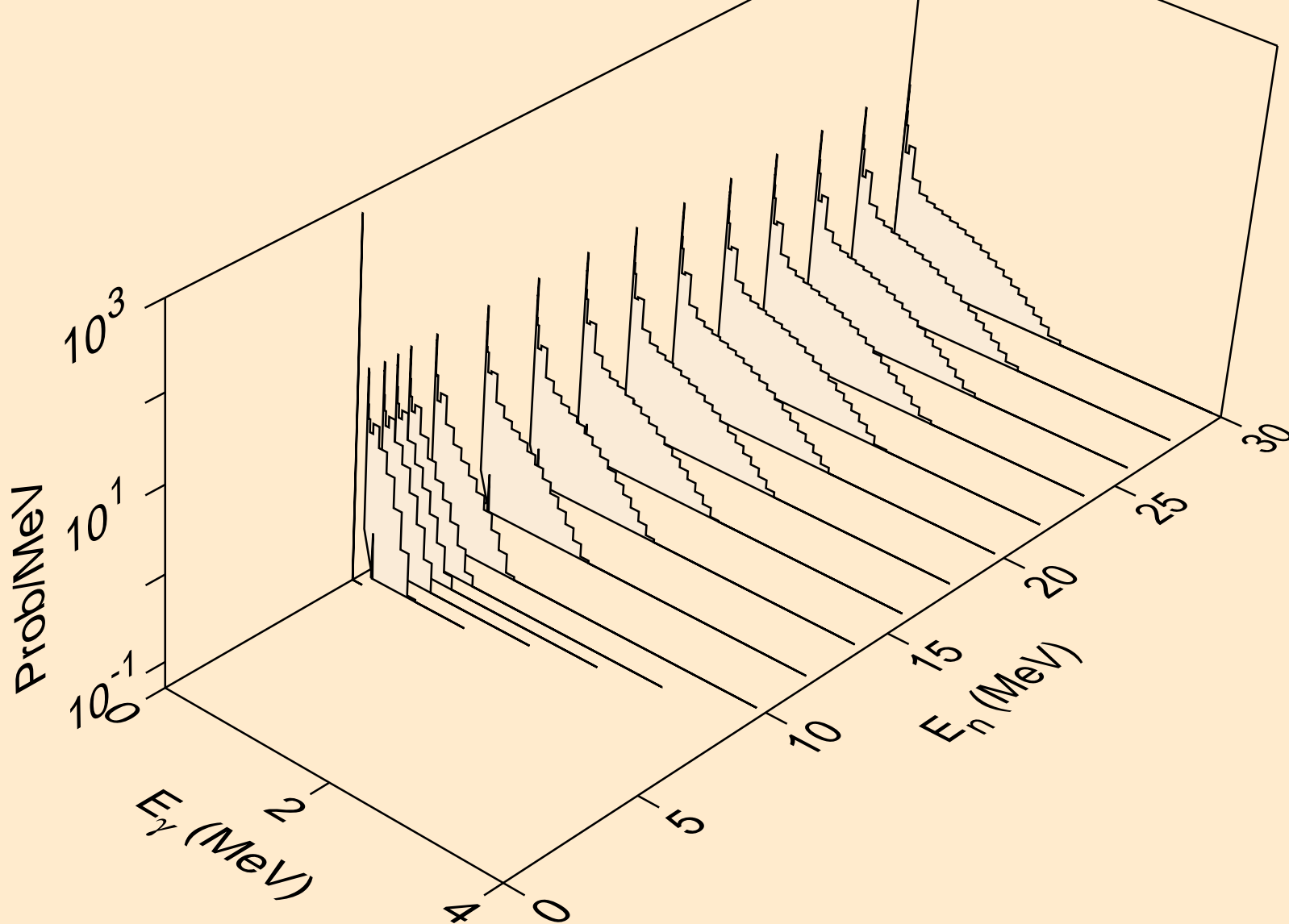

TH236 NEUTRON ACER TENDL-2019 LIBRARY; T=293.16K
Photon emission for (n,d)

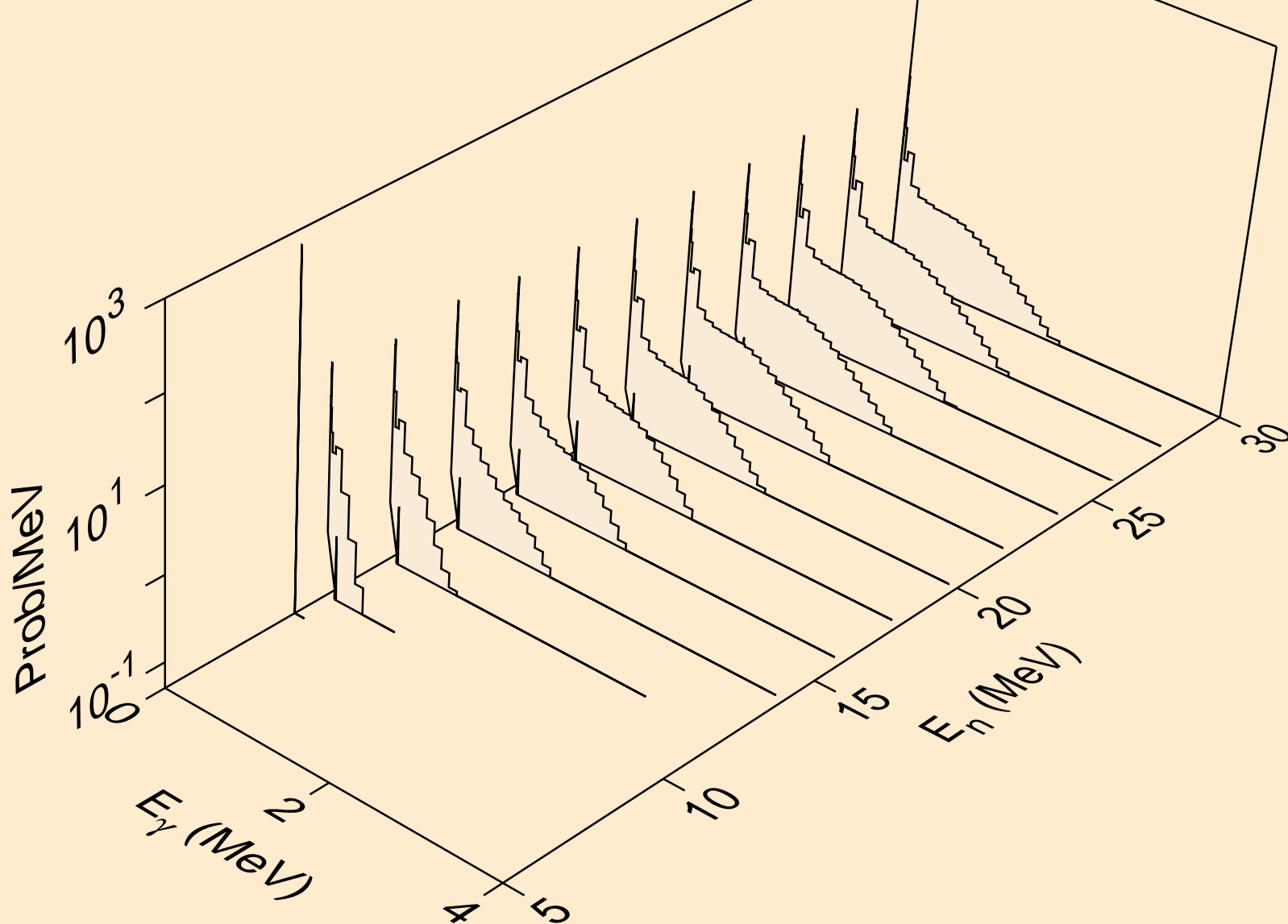

TH236 NEUTRON ACER TENDL-2019 LIBRARY; T=293.16K
Photon emission for (n,t)

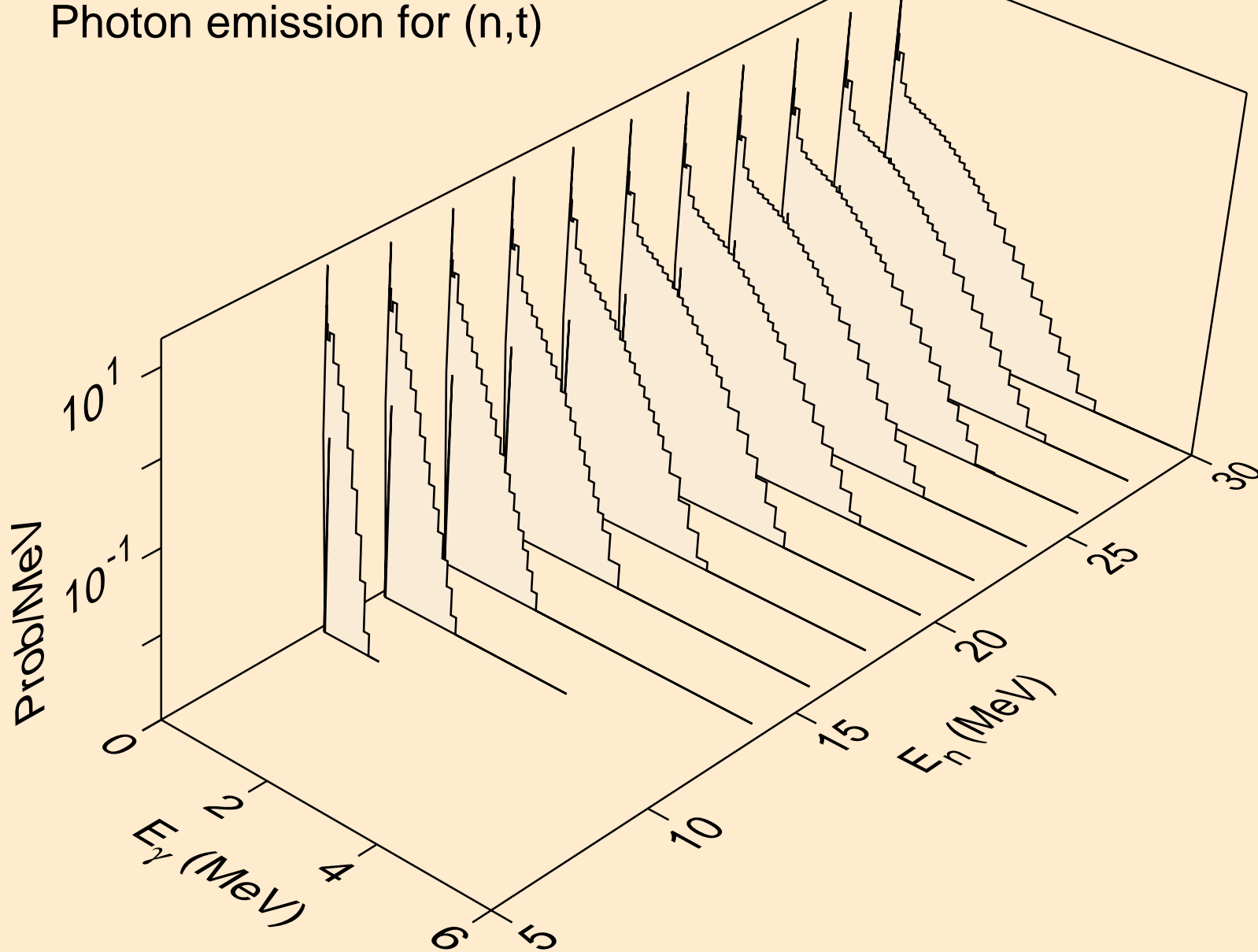

TH236 NEUTRON ACER TENDL-2019 LIBRARY; T=293.16K
Photon emission for (n,he3)

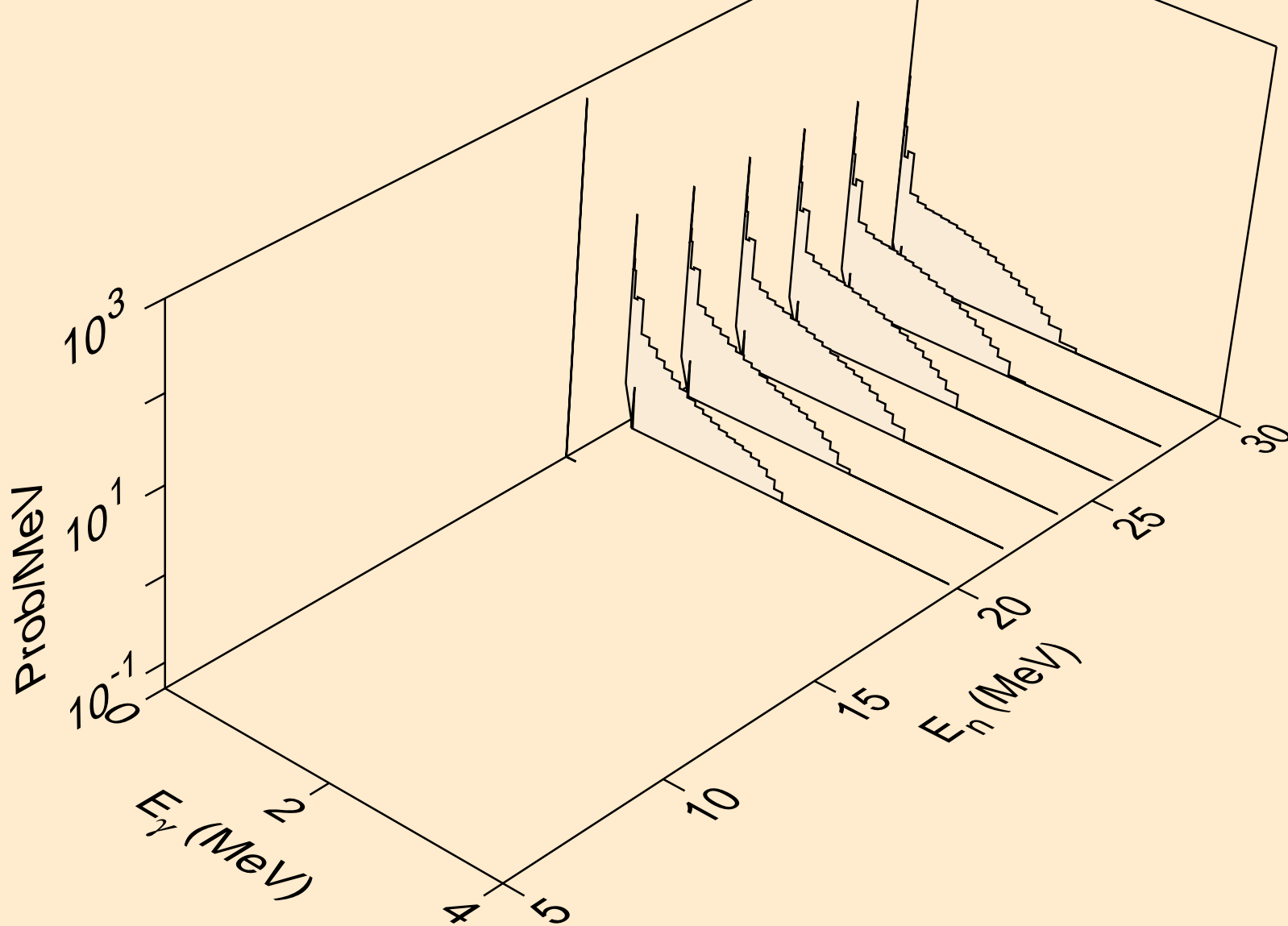

TH236 NEUTRON ACER TENDL-2019 LIBRARY; T=293.16K
Photon emission for (n,a)

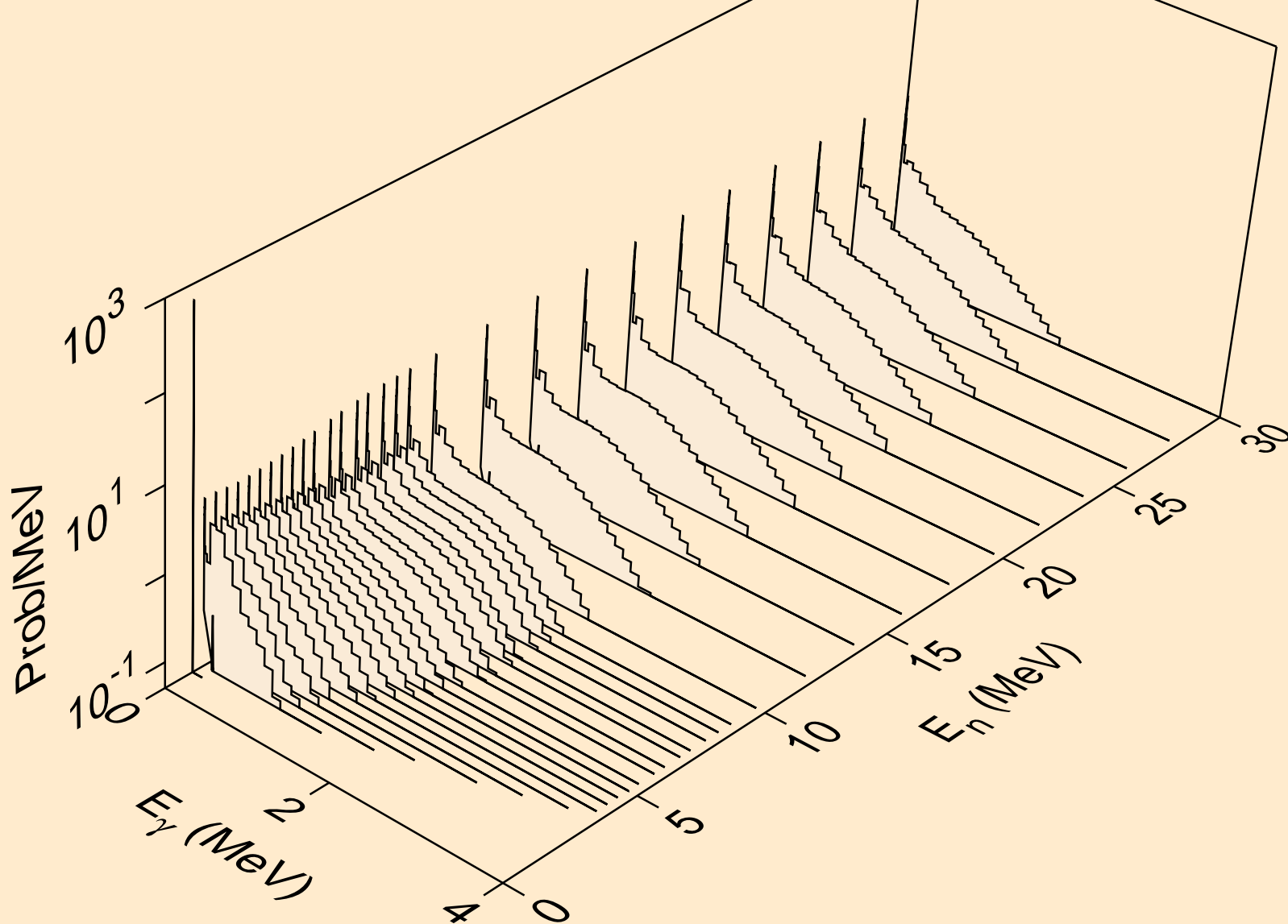

TH236 NEUTRON ACER TENDL-2019 LIBRARY; T=293.16K
Photon emission for (n,2p)

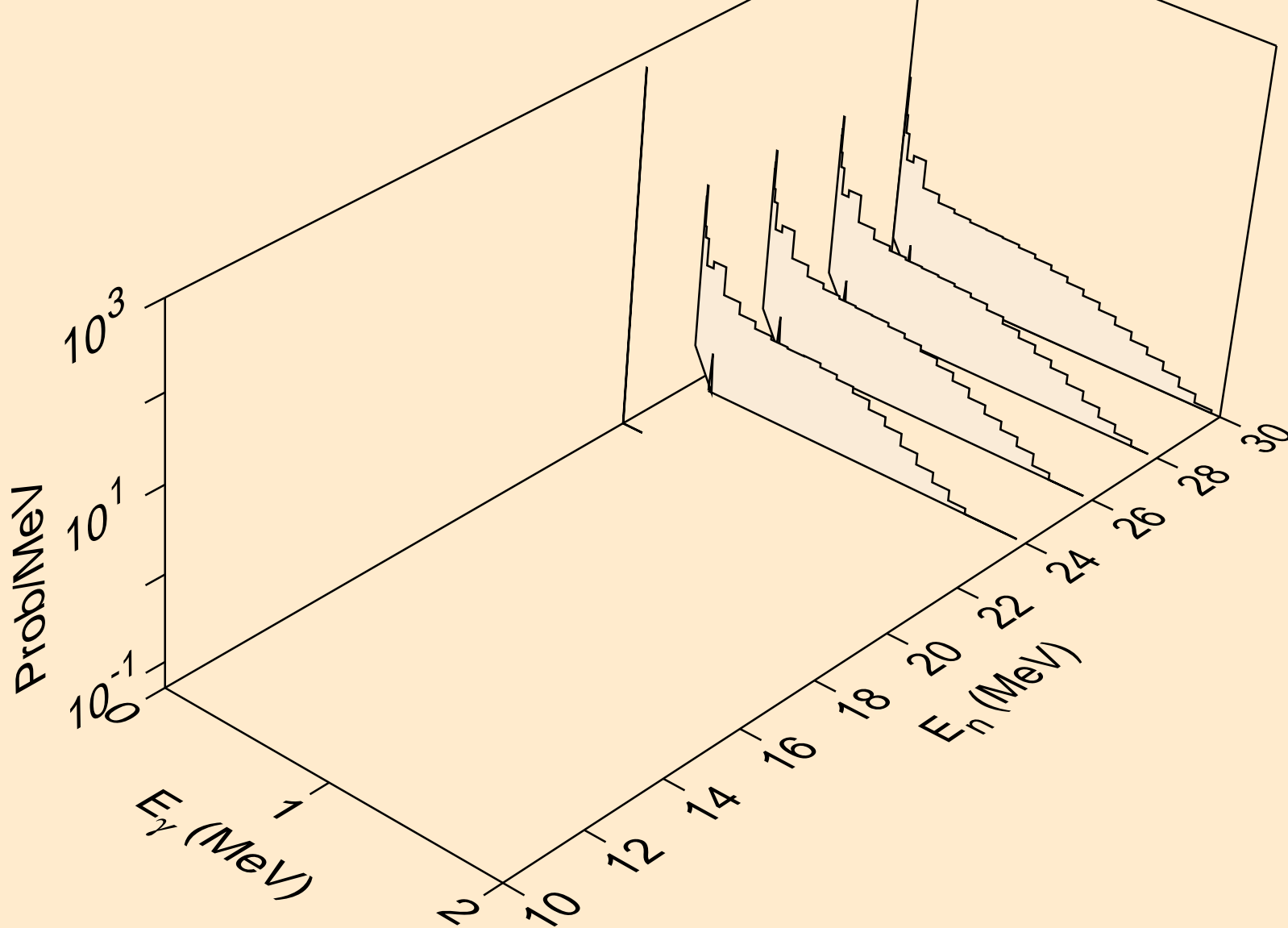

TH236 NEUTRON ACER TENDL-2019 LIBRARY; T=293.16K
thermal capture photon spectrum

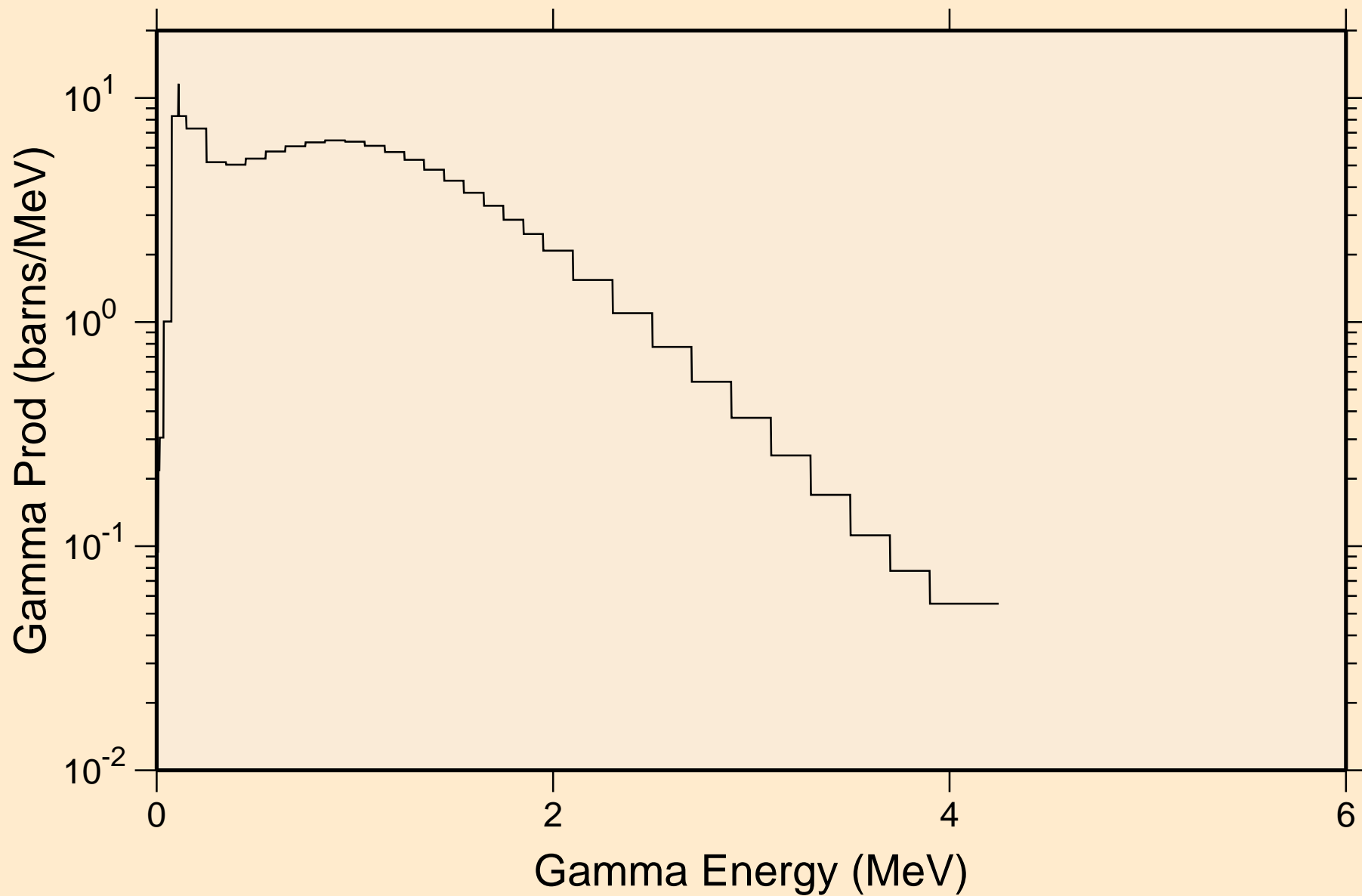

TH236 NEUTRON ACER TENDL-2019 LIBRARY; T=293.16K
14 MeV photon spectrum

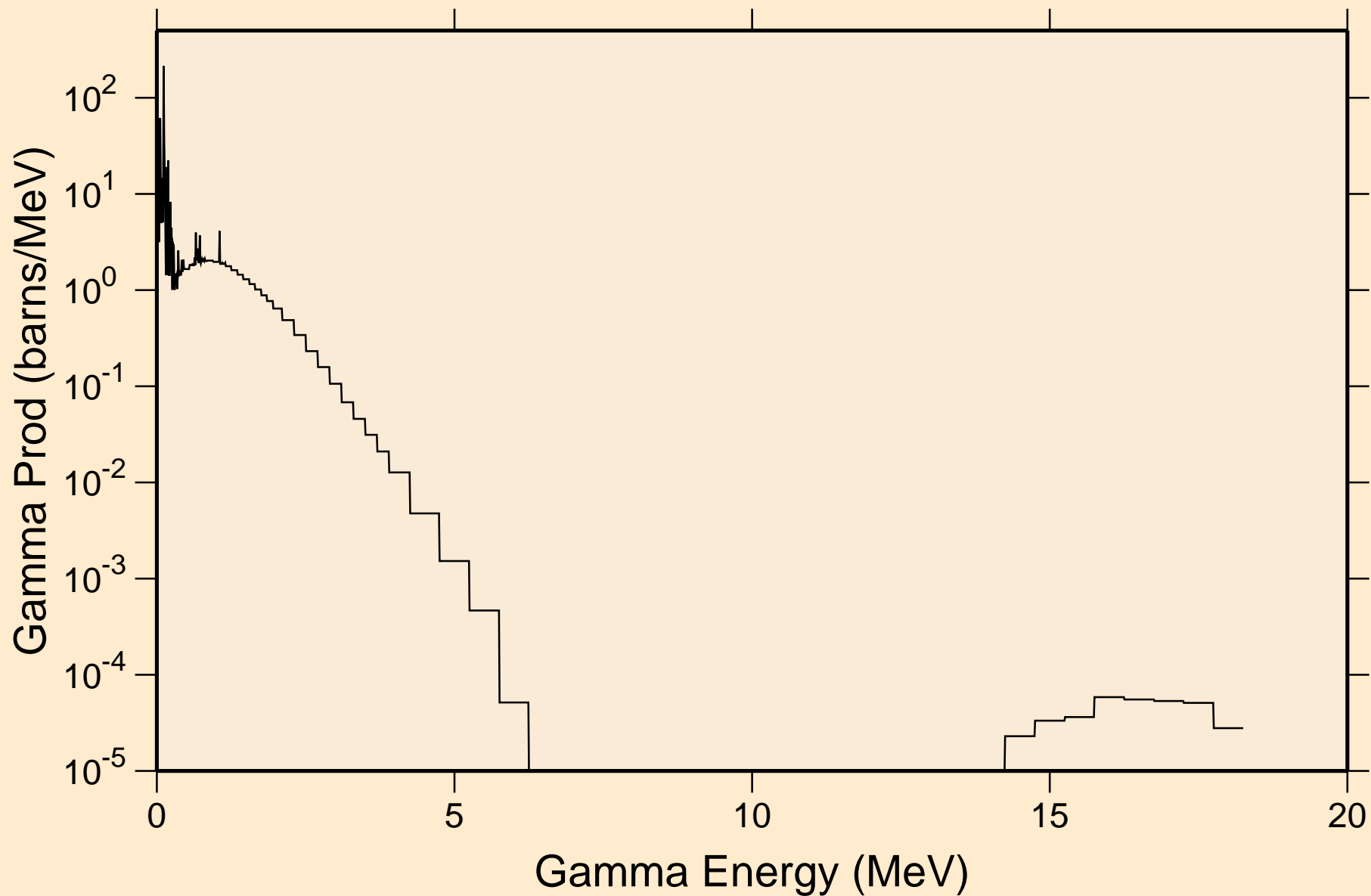

TH236 NEUTRON ACER TENDL-2019 LIBRARY; T=293.16K

Particle heating contributions

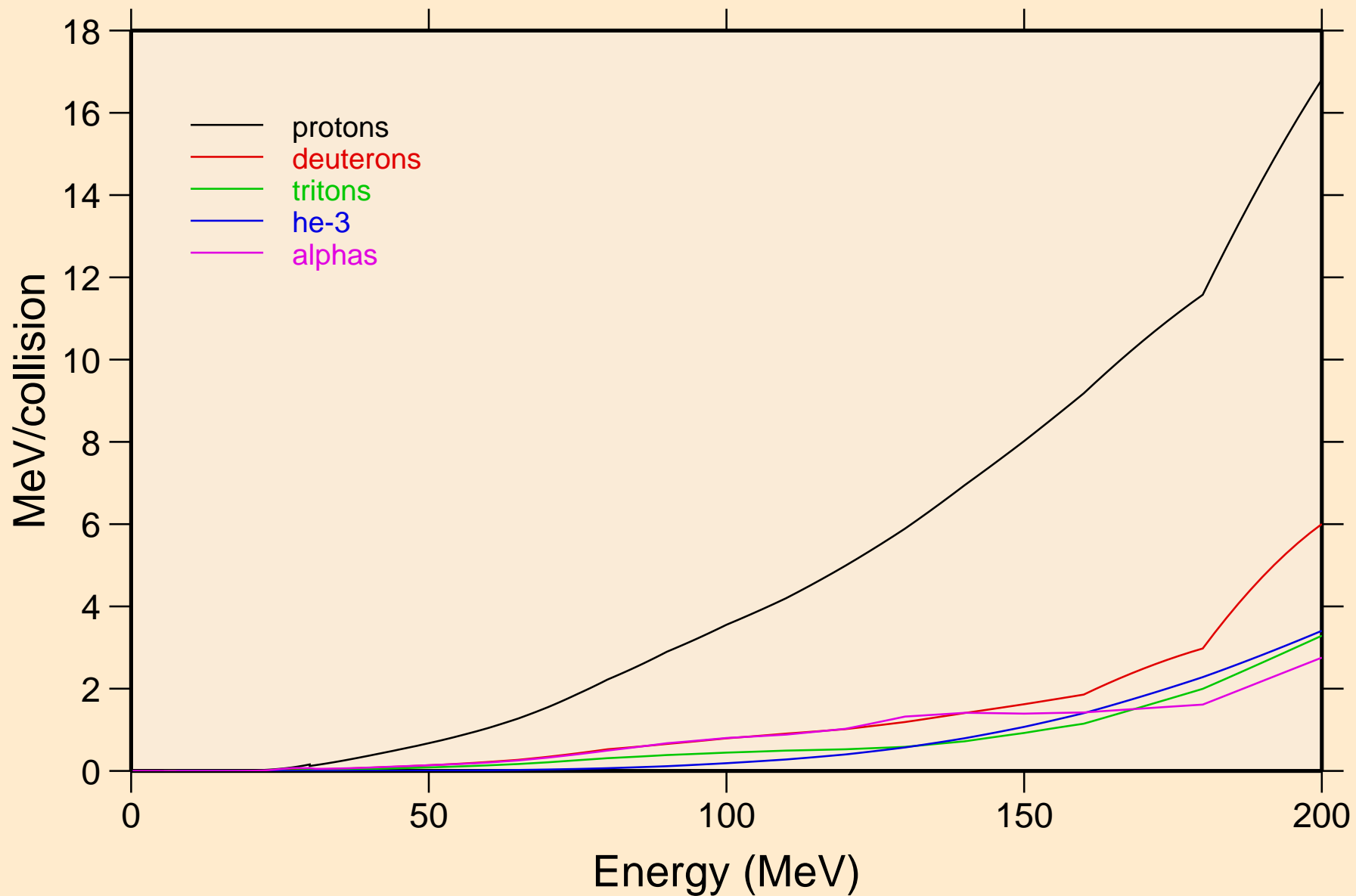

TH236 NEUTRON ACER TENDL-2019 LIBRARY; T=293.16K
Recoil Heating

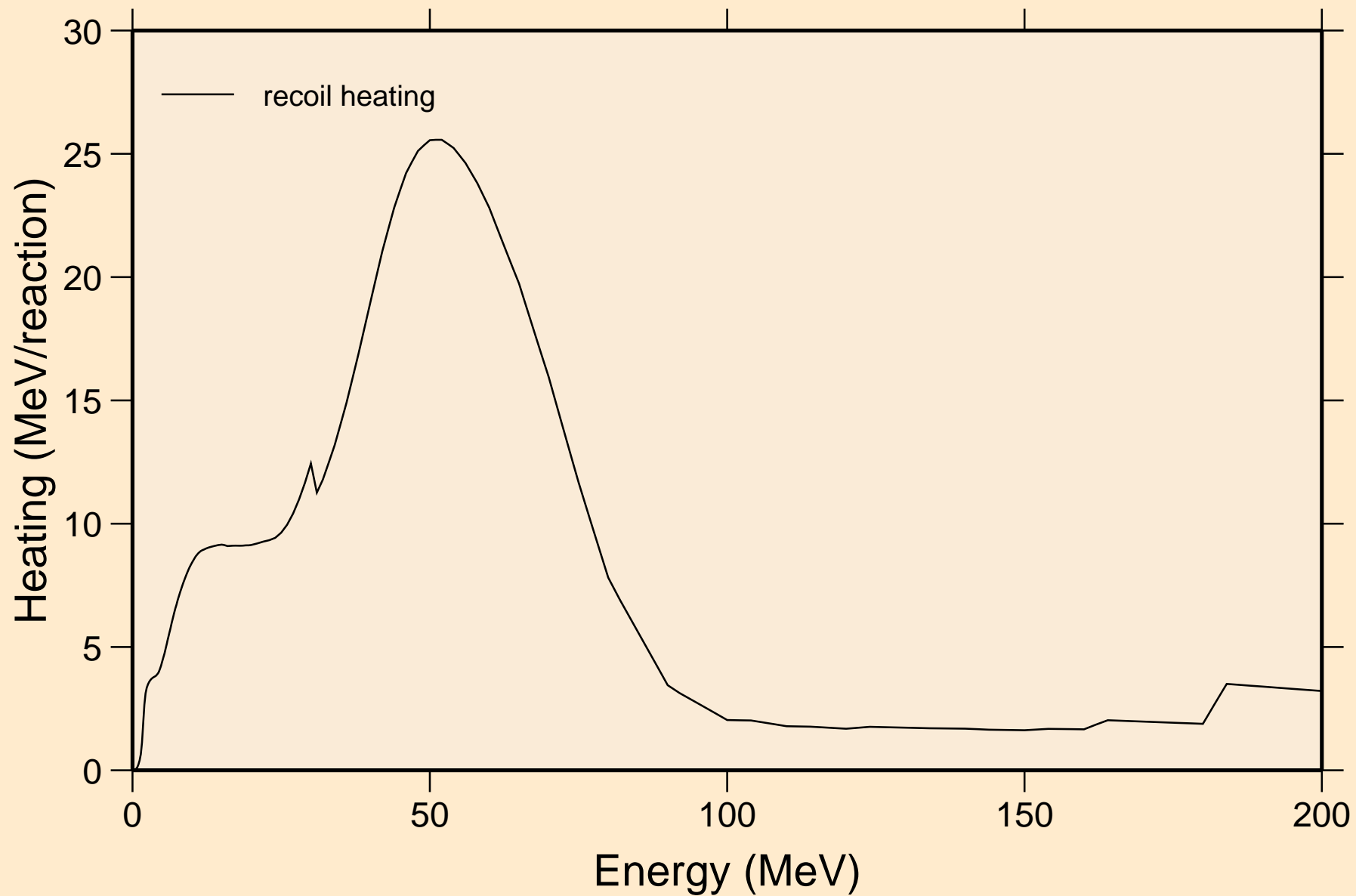

TH236 NEUTRON ACER TENDL-2019 LIBRARY; T=293.16K
Particle production cross sections

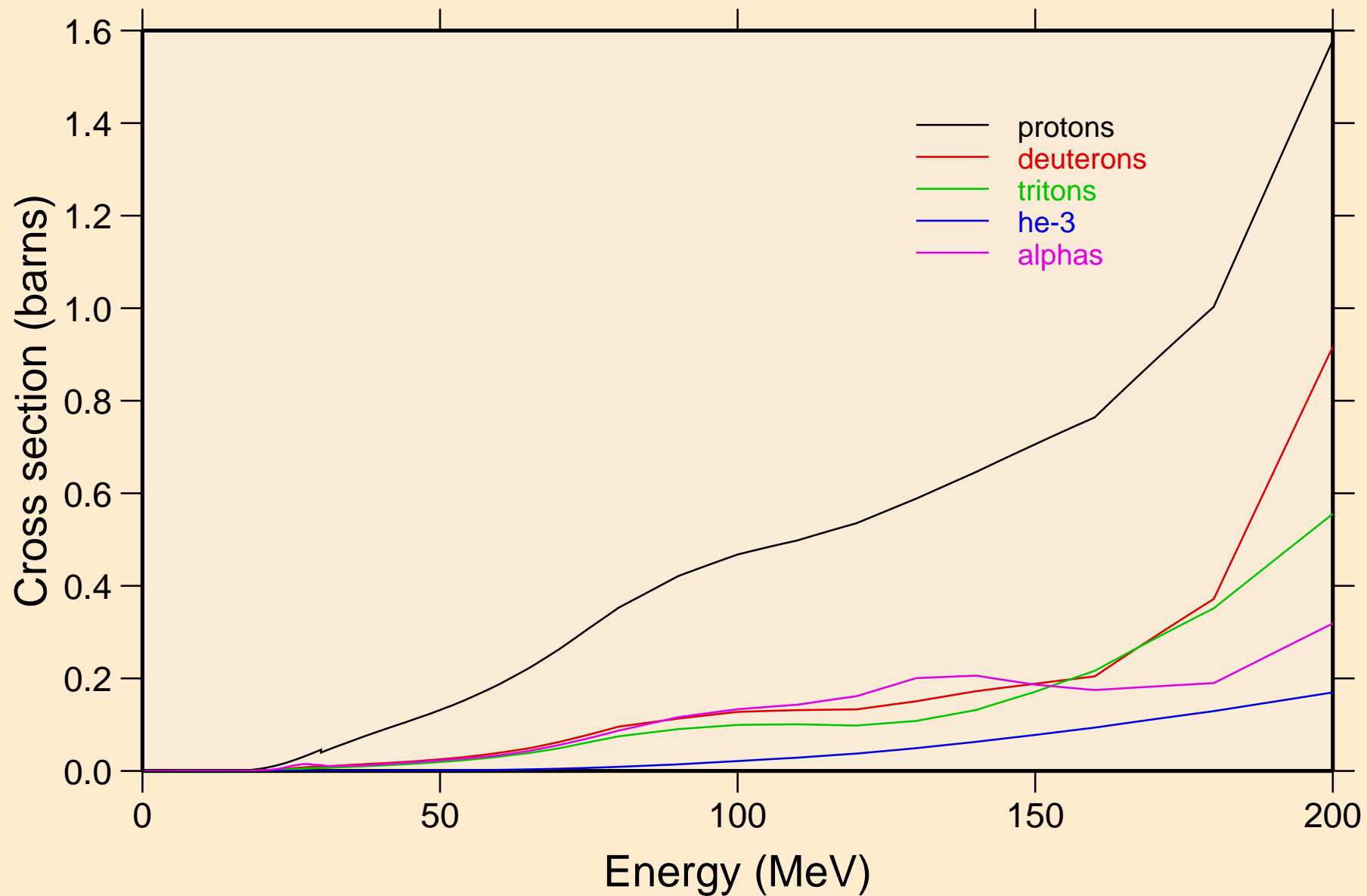

TH236 NEUTRON ACER TENDL-2019 LIBRARY; T=293.16K
protons from (n,x)

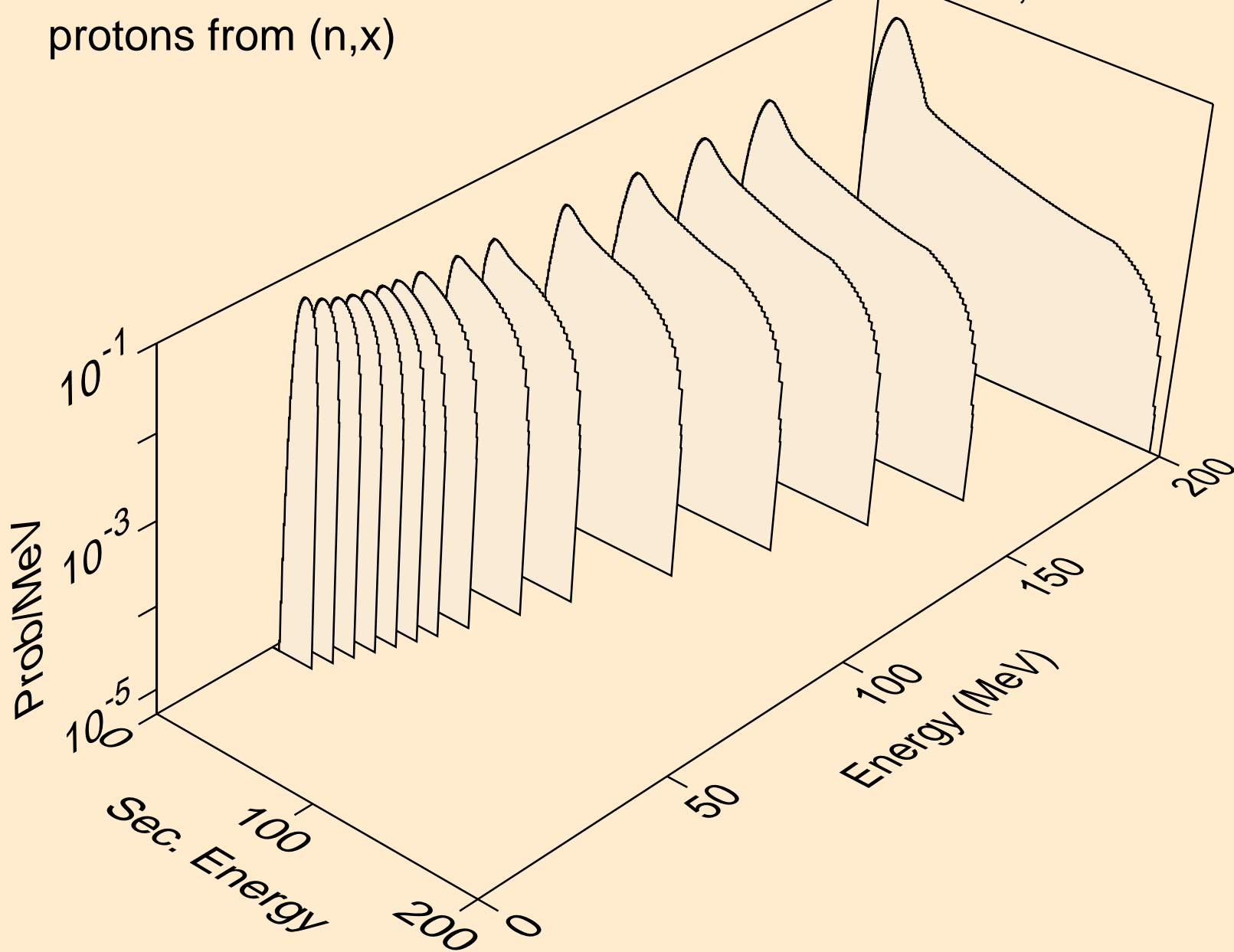

TH236 NEUTRON ACER TENDL-2019 LIBRARY; T=293.16K
protons from (n,n*)p

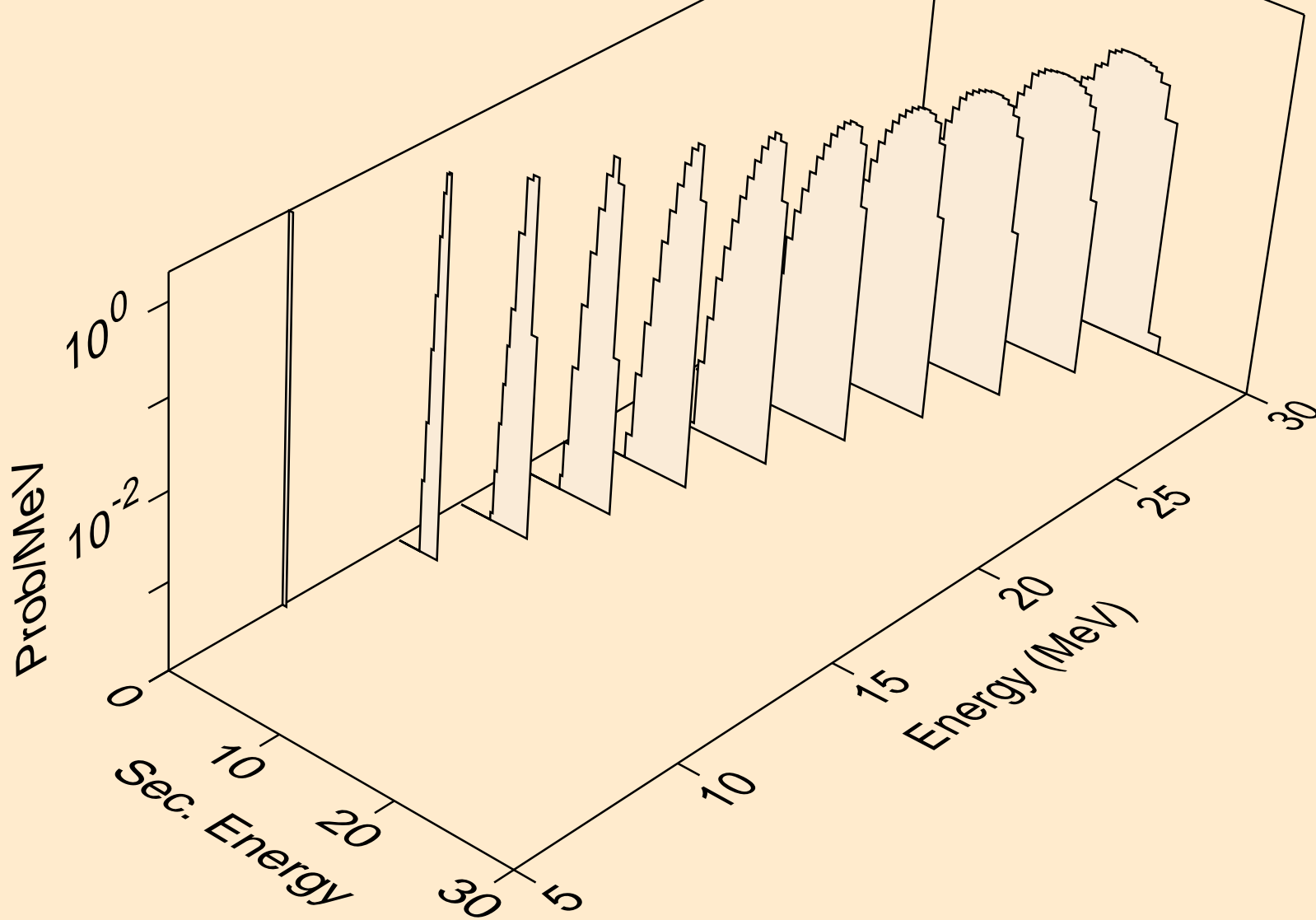

TH236 NEUTRON ACER TENDL-2019 LIBRARY; T=293.16K
protons from (n,2np)

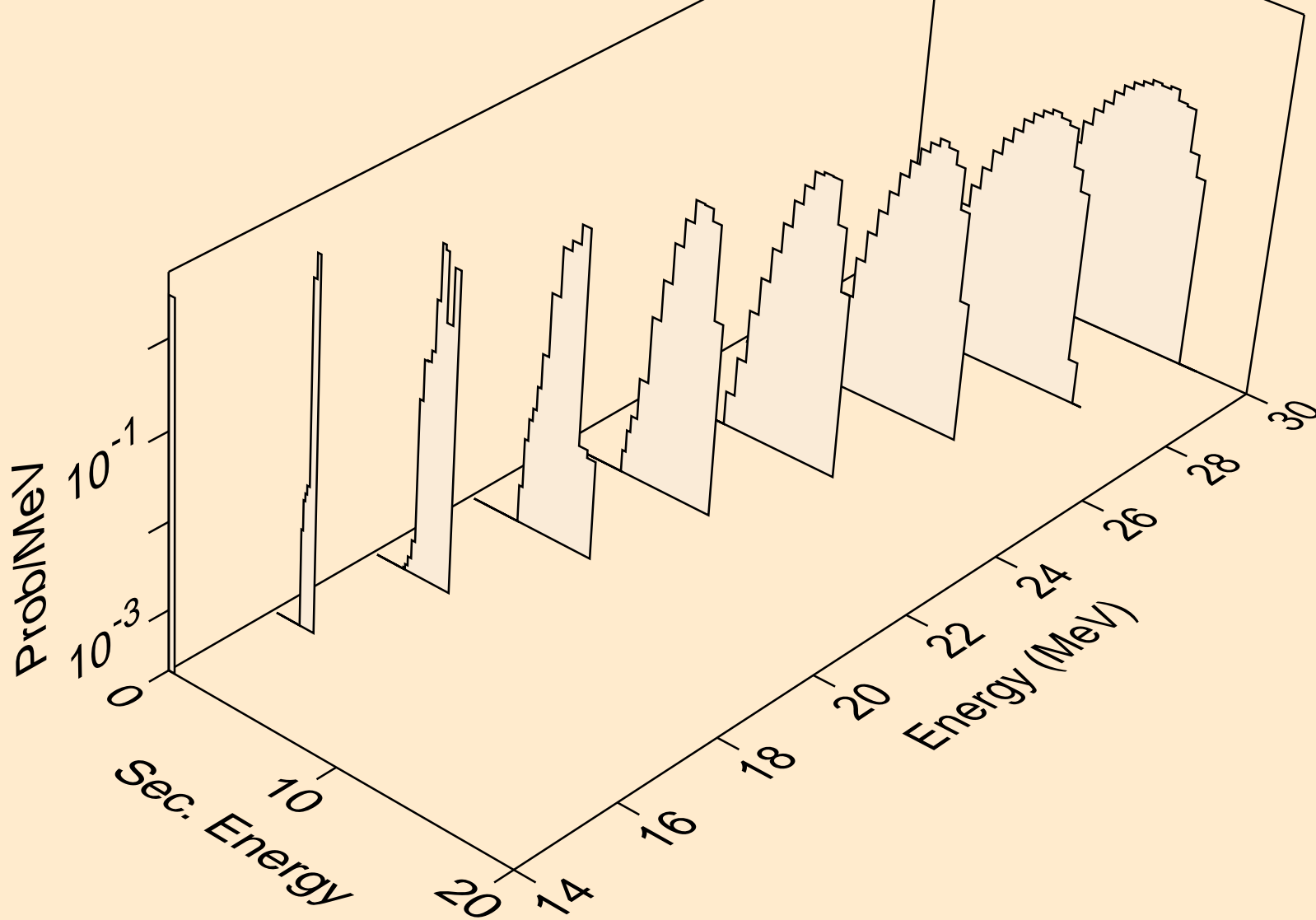

TH236 NEUTRON ACER TENDL-2019 LIBRARY; T=293.16K
protons from (n,3np)

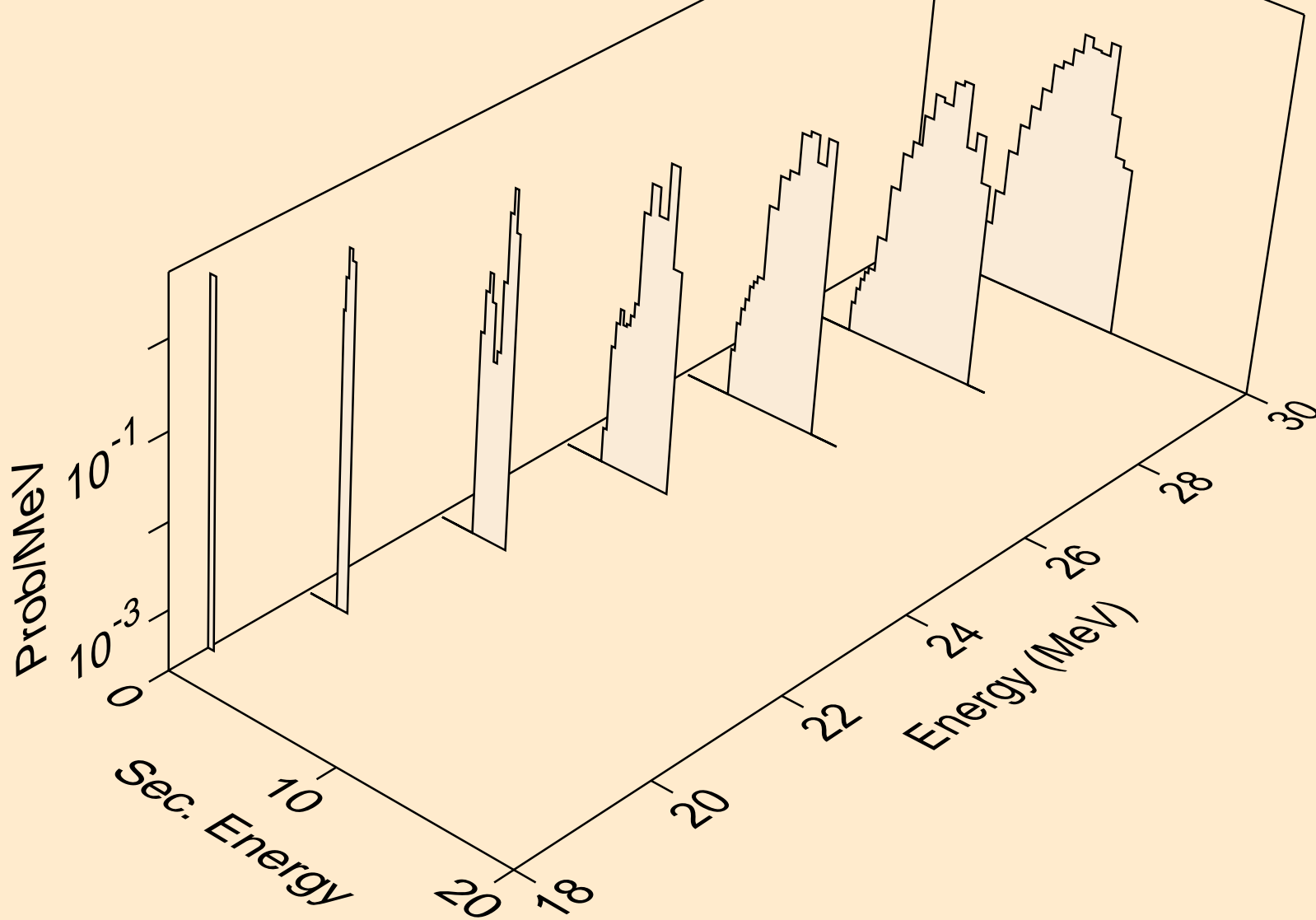

TH236 NEUTRON ACER TENDL-2019 LIBRARY; T=293.16K
protons from (n,p)

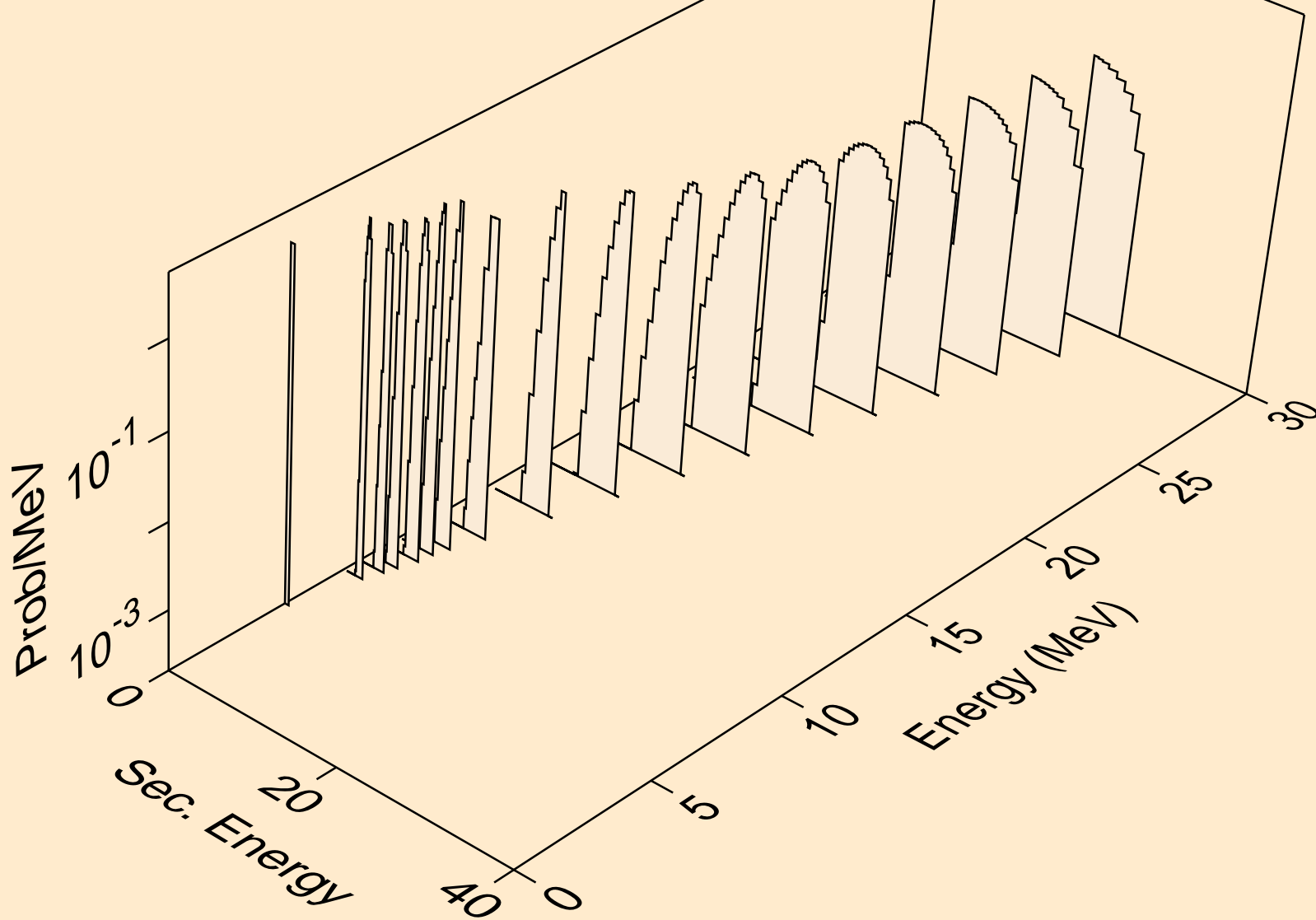

TH236 NEUTRON ACER TENDL-2019 LIBRARY; T=293.16K
protons from (n,2p)

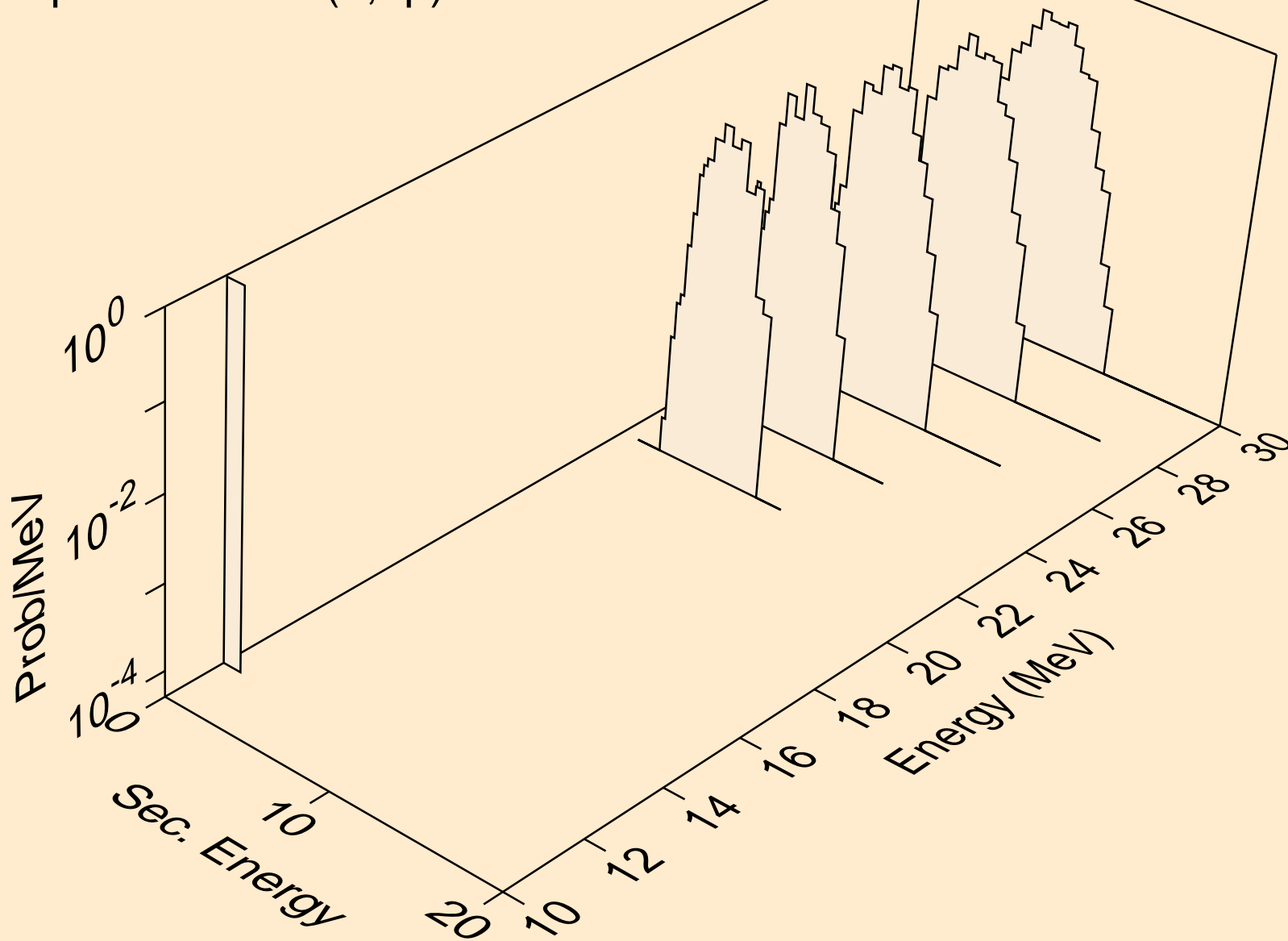

TH236 NEUTRON ACER TENDL-2019 LIBRARY; T=293.16K
deuterons from (n,x)

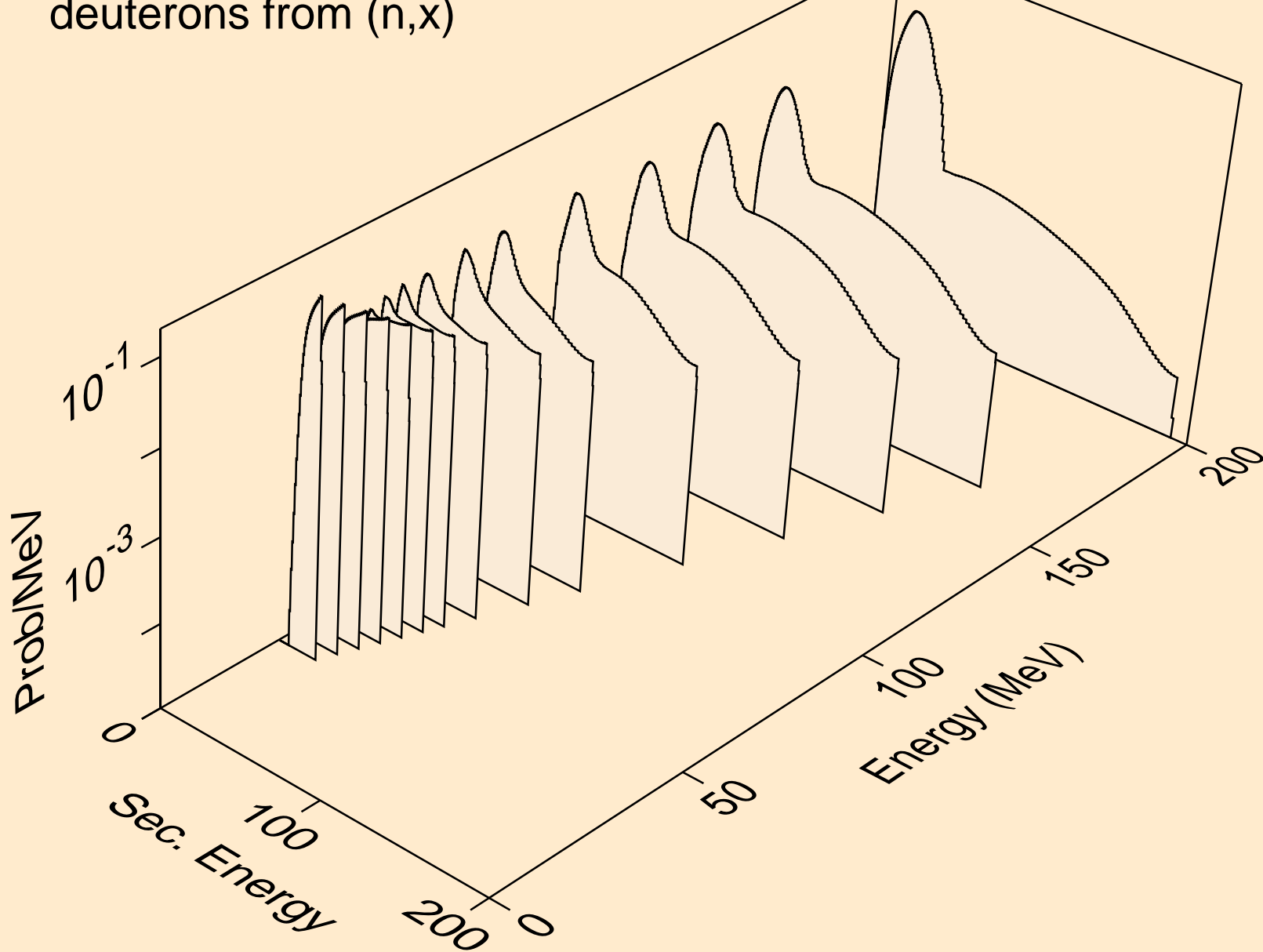

TH236 NEUTRON ACER TENDL-2019 LIBRARY; T=293.16K
deuterons from (n,2nd)

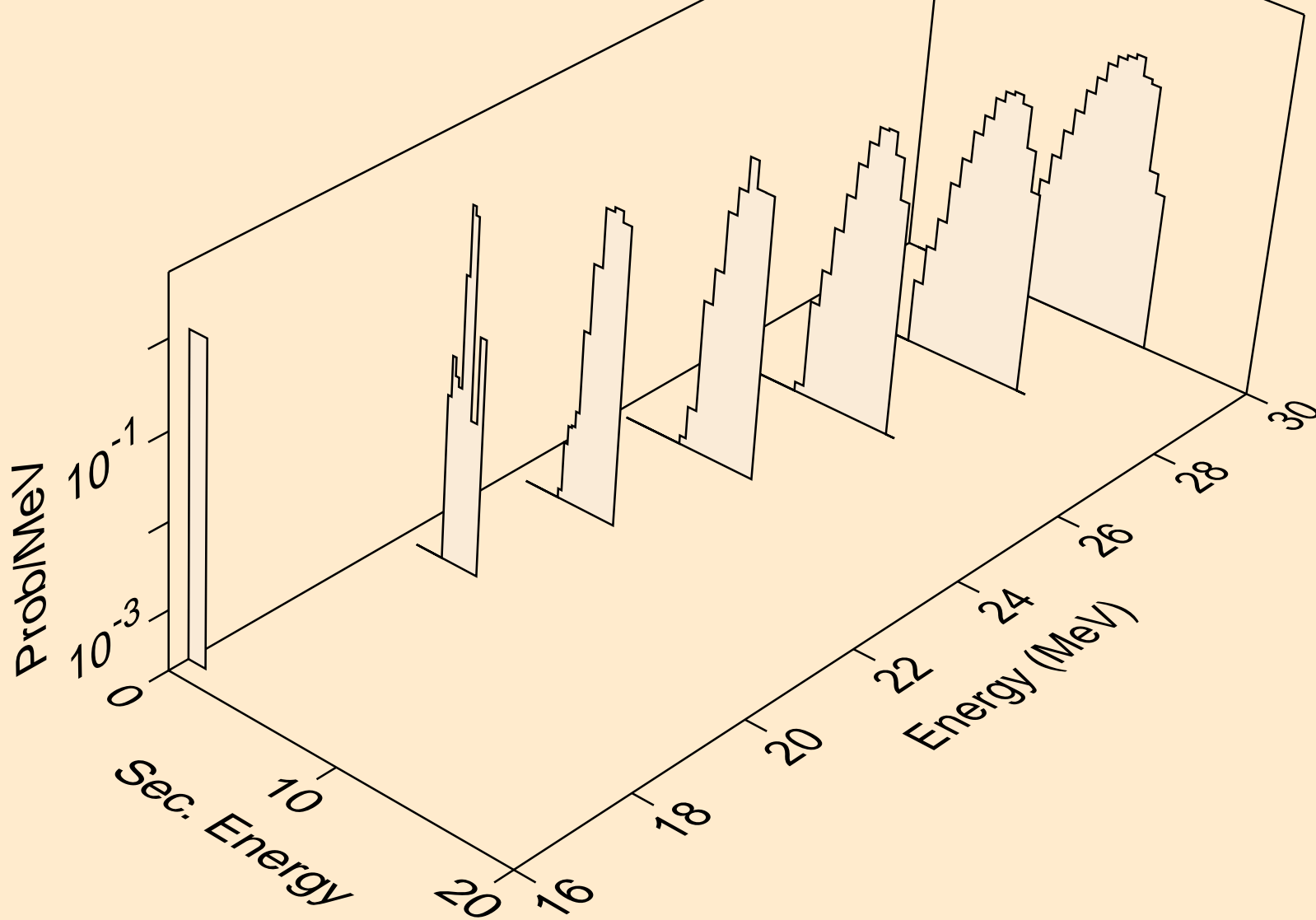

TH236 NEUTRON ACER TENDL-2019 LIBRARY; T=293.16K
deuterons from (n,n*)d

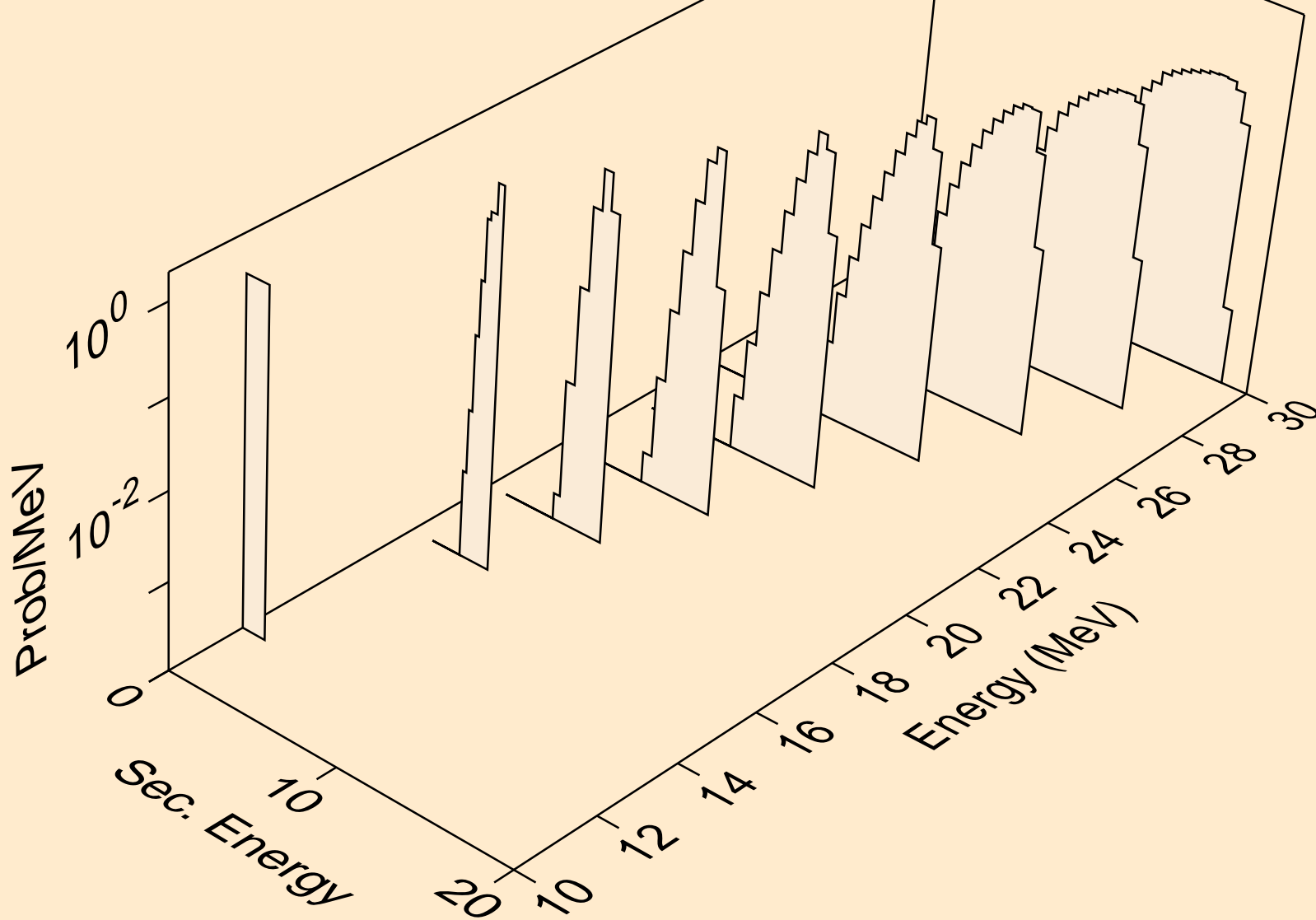

TH236 NEUTRON ACER TENDL-2019 LIBRARY; T=293.16K
deuterons from (n,d)

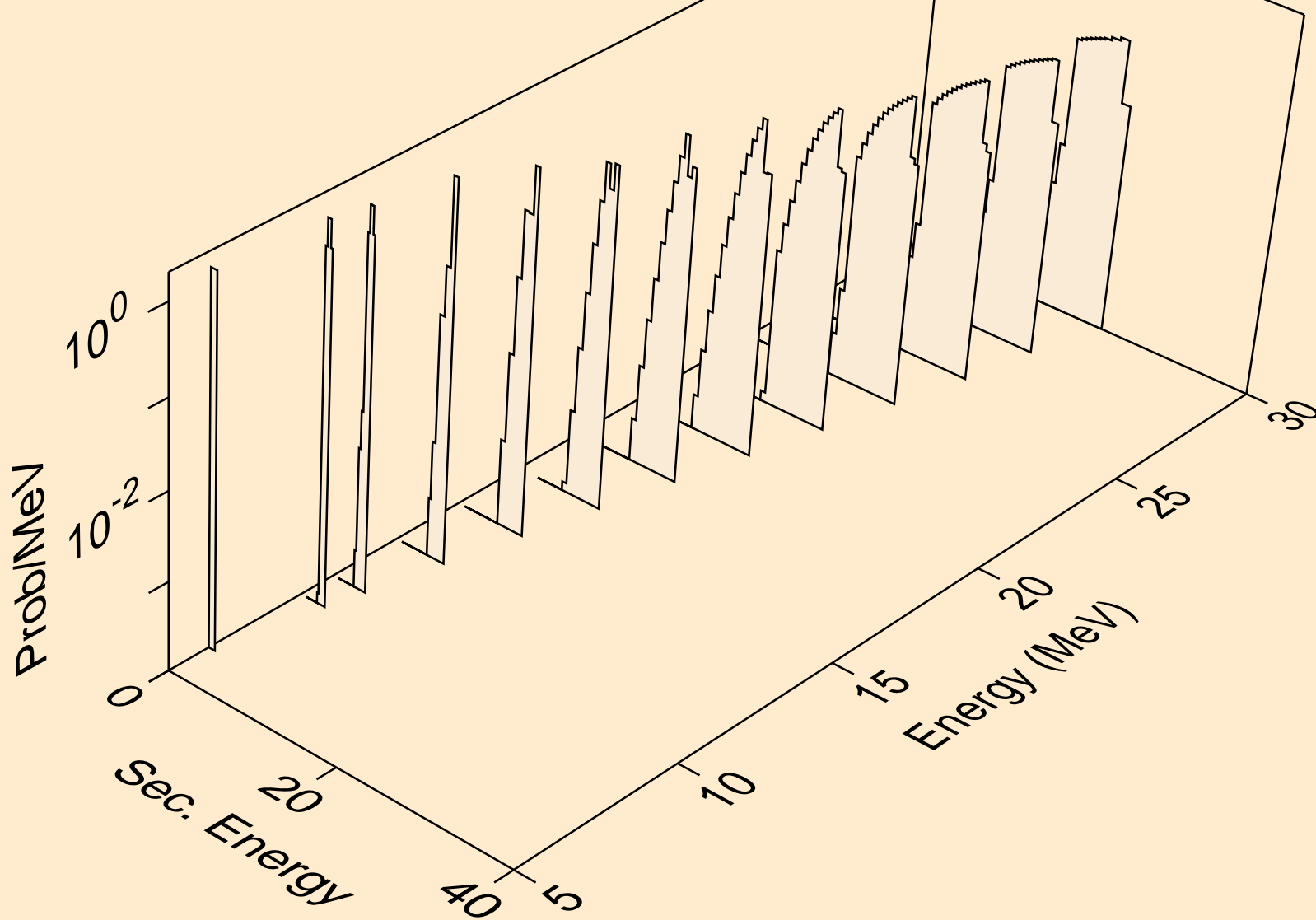

TH236 NEUTRON ACER TENDL-2019 LIBRARY; T=293.16K
tritons from (n,x)

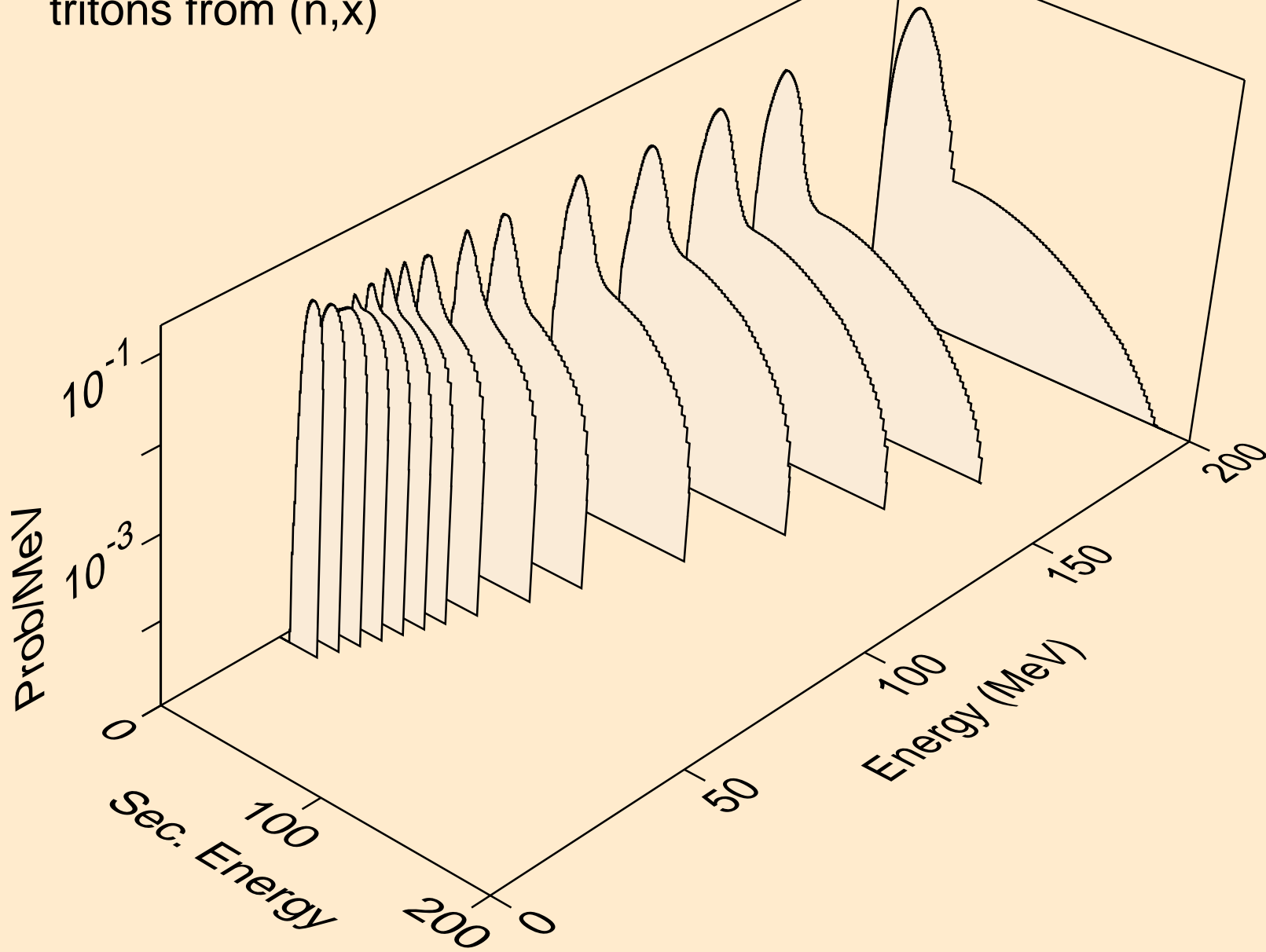

TH236 NEUTRON ACER TENDL-2019 LIBRARY; T=293.16K
tritons from (n,n*)t

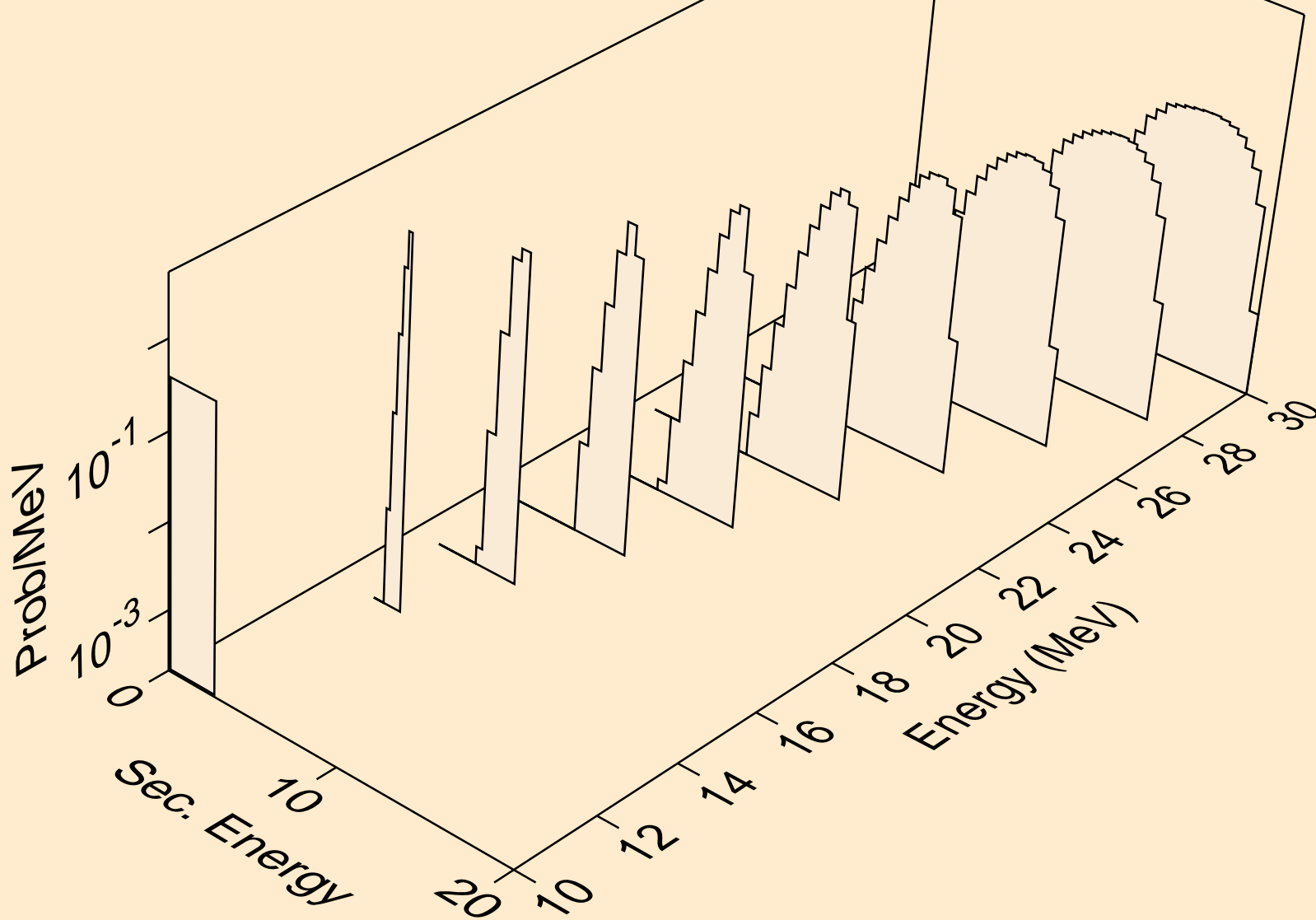

TH236 NEUTRON ACER TENDL-2019 LIBRARY; T=293.16K
tritons from (n,t)

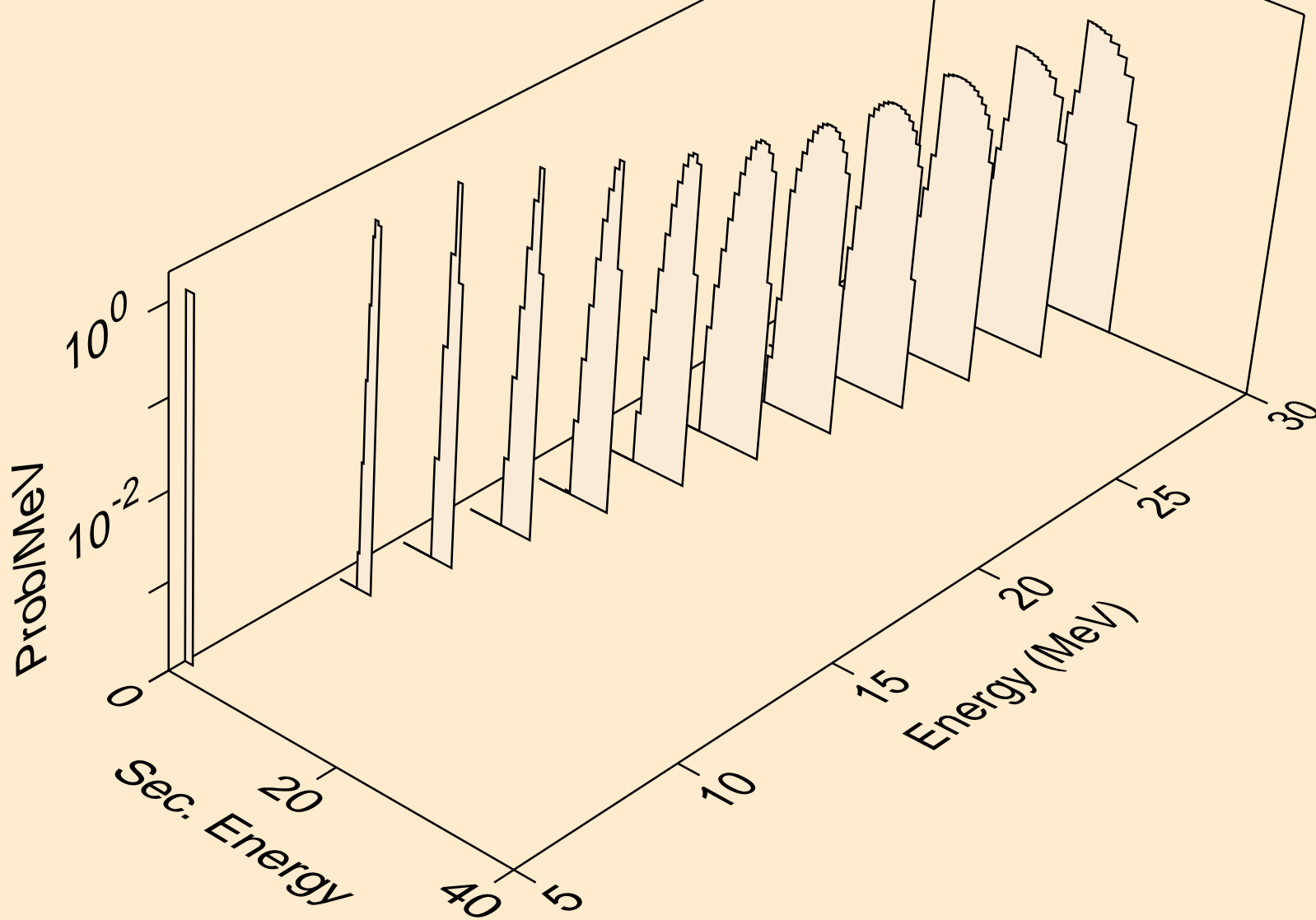

TH236 NEUTRON ACER TENDL-2019 LIBRARY; T=293.16K
he3s from (n,x)

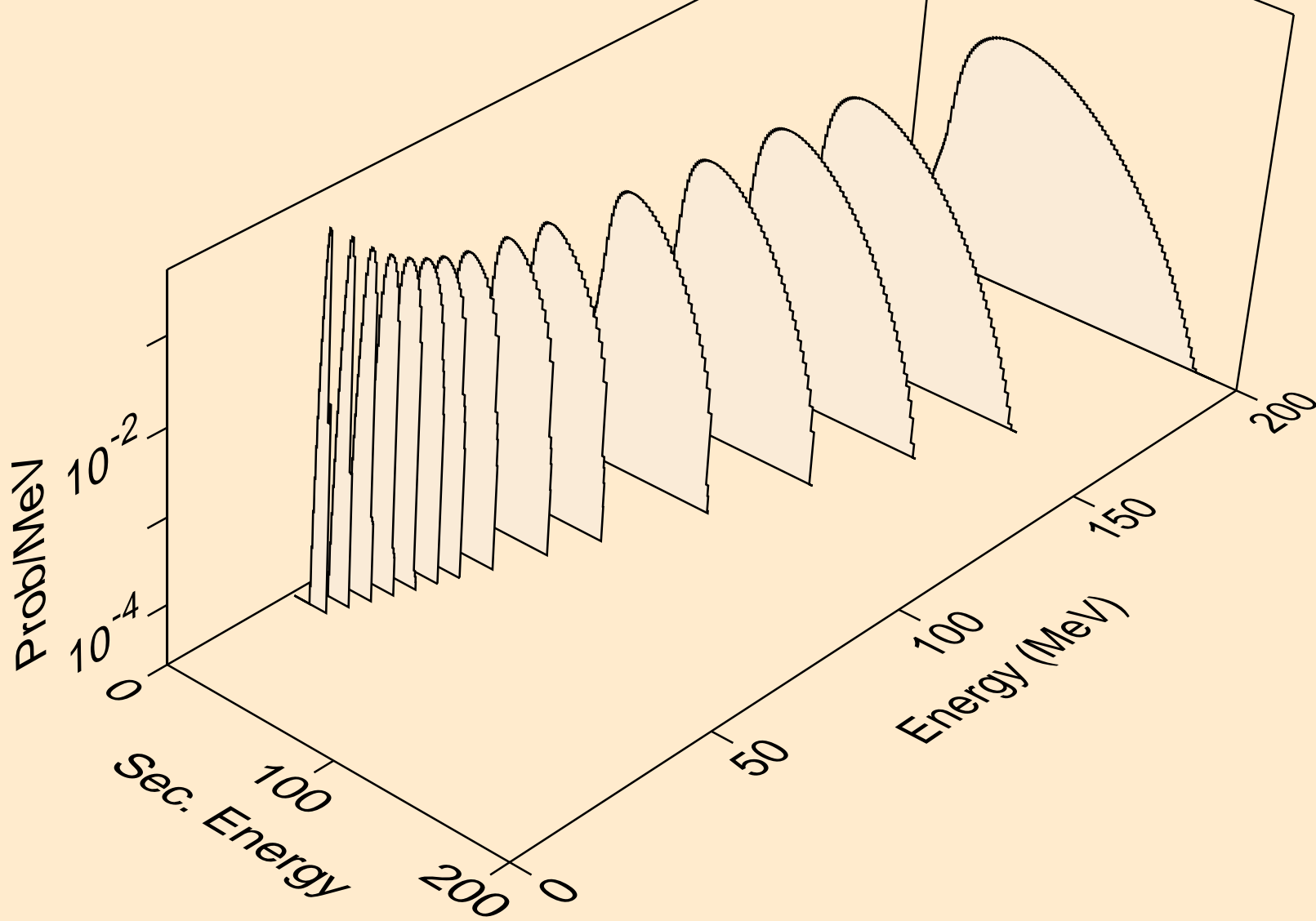

TH236 NEUTRON ACER TENDL-2019 LIBRARY; T=293.16K
he3s from (n,n*)he3

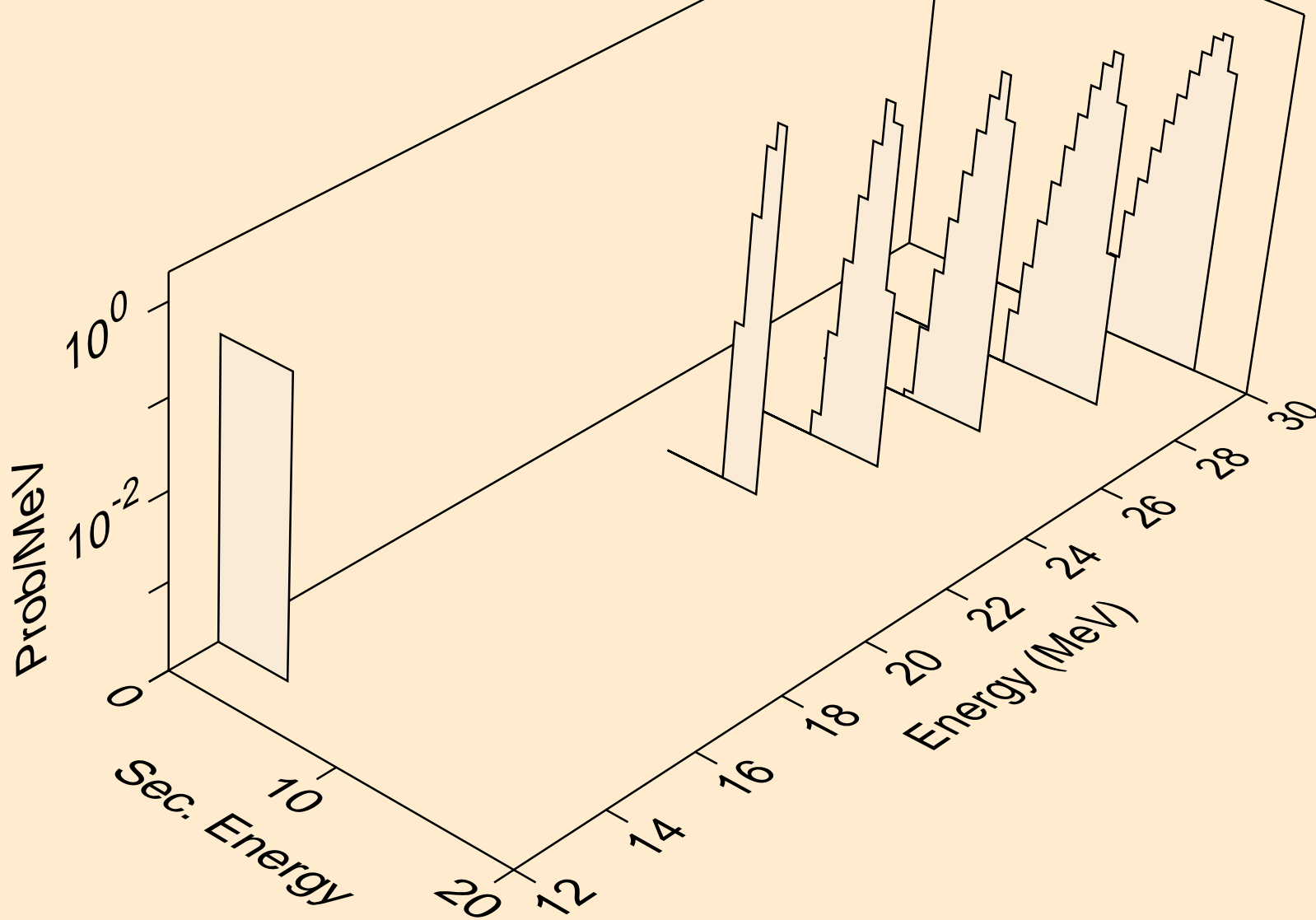

TH236 NEUTRON ACER TENDL-2019 LIBRARY; T=293.16K
he3s from (n,he3)

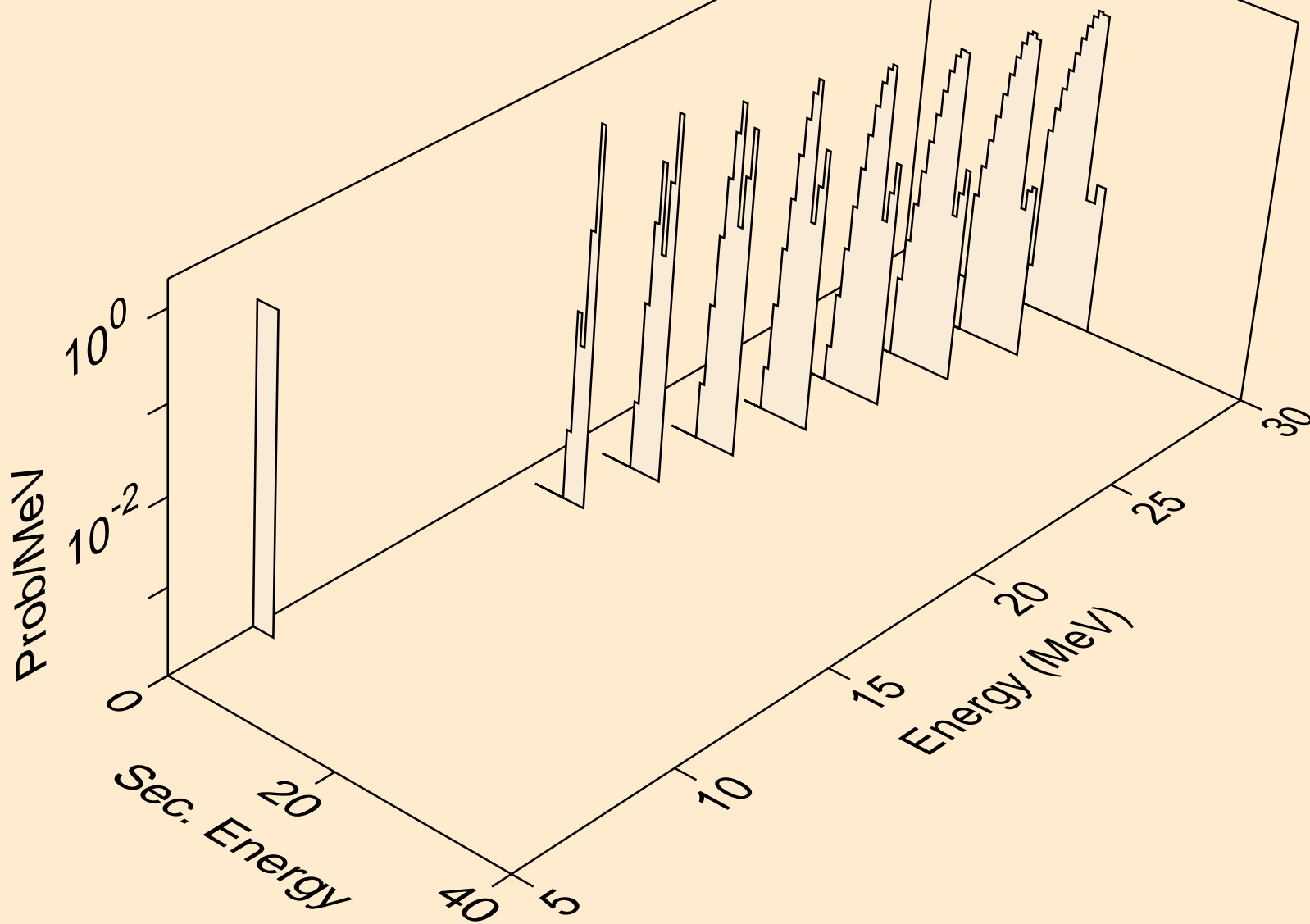

TH236 NEUTRON ACER TENDL-2019 LIBRARY; T=293.16K
alphas from (n,x)

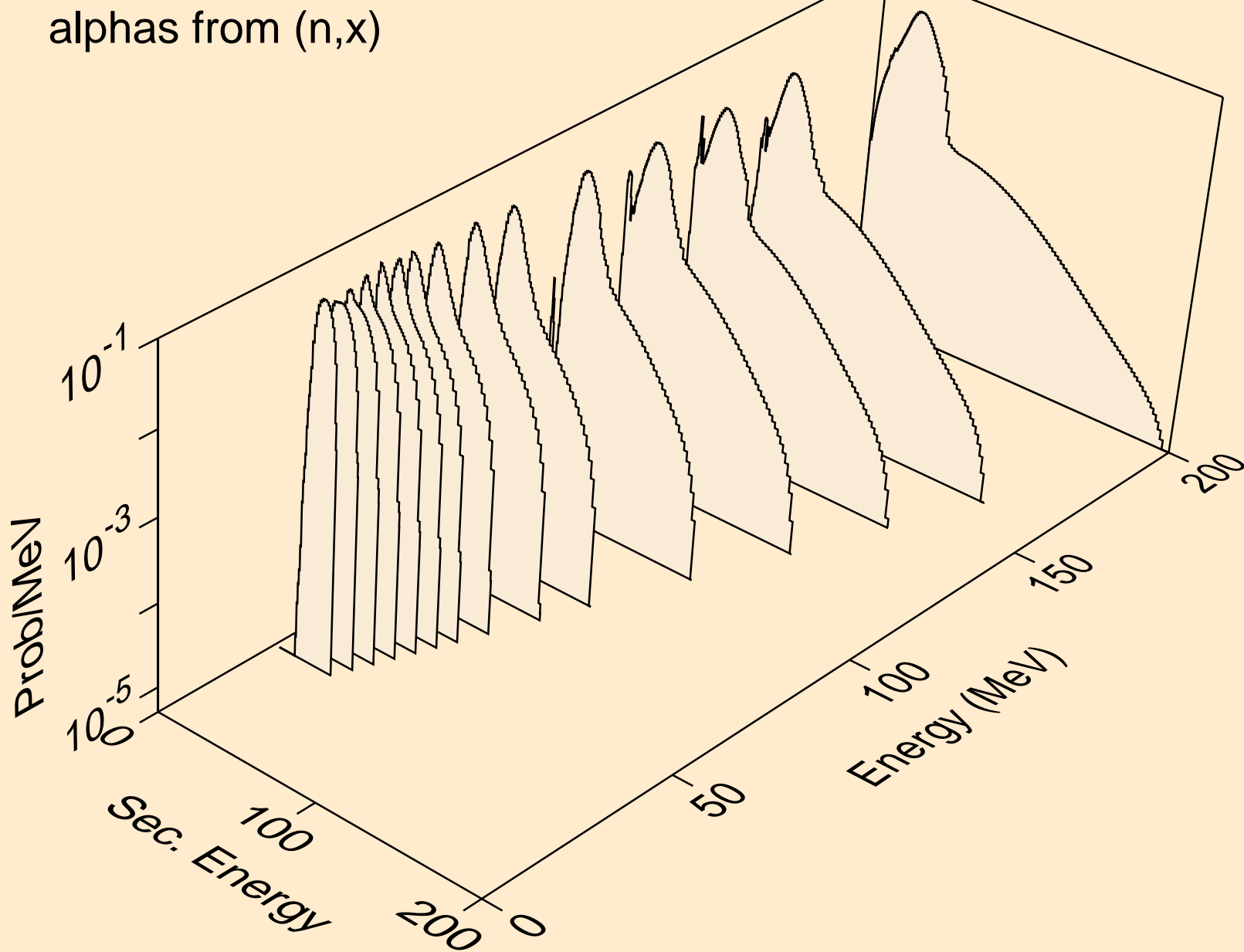

TH236 NEUTRON ACER TENDL-2019 LIBRARY; T=293.16K
alphas from (n,n*)a

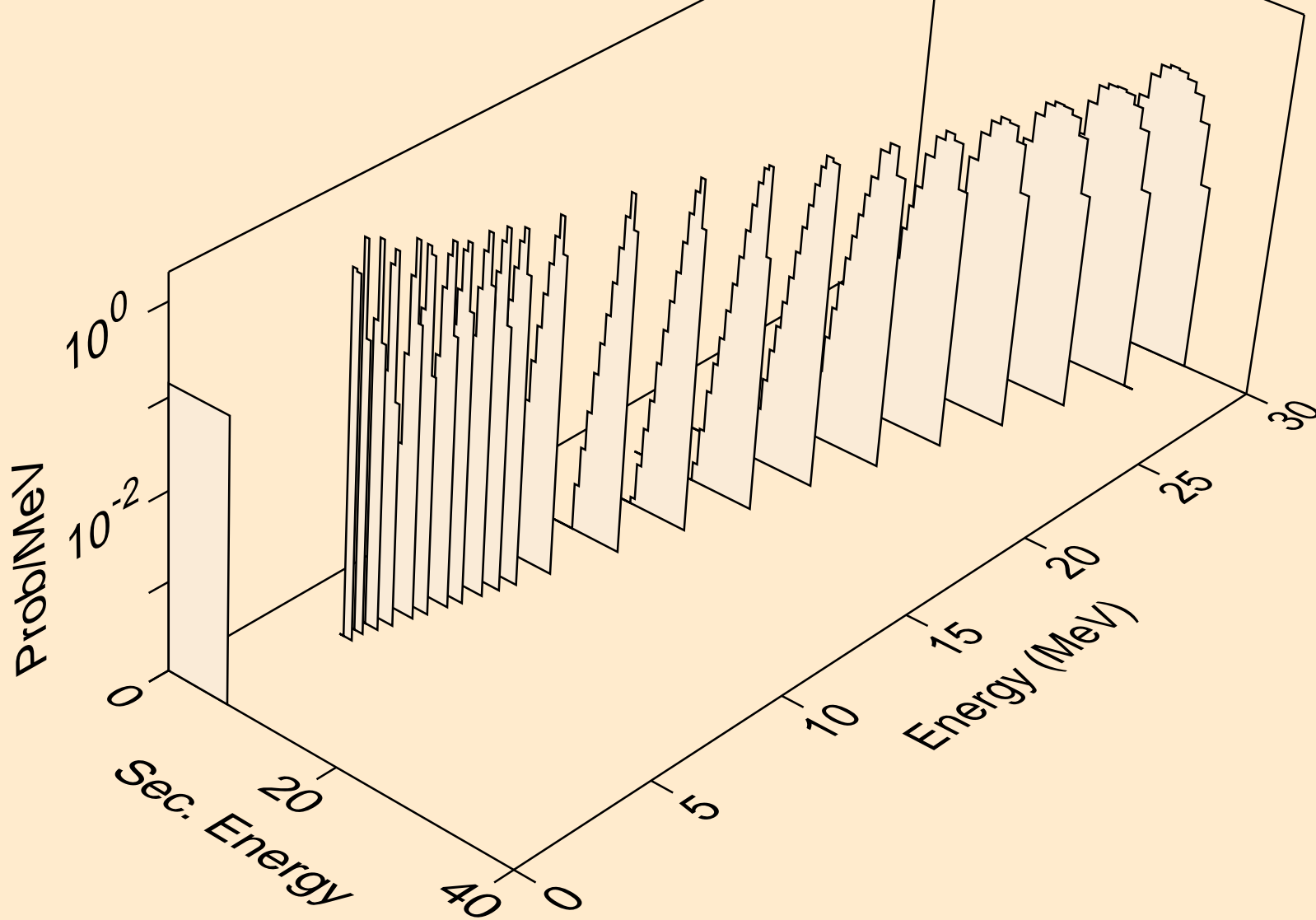

TH236 NEUTRON ACER TENDL-2019 LIBRARY; T=293.16K
alphas from (n,2n)a

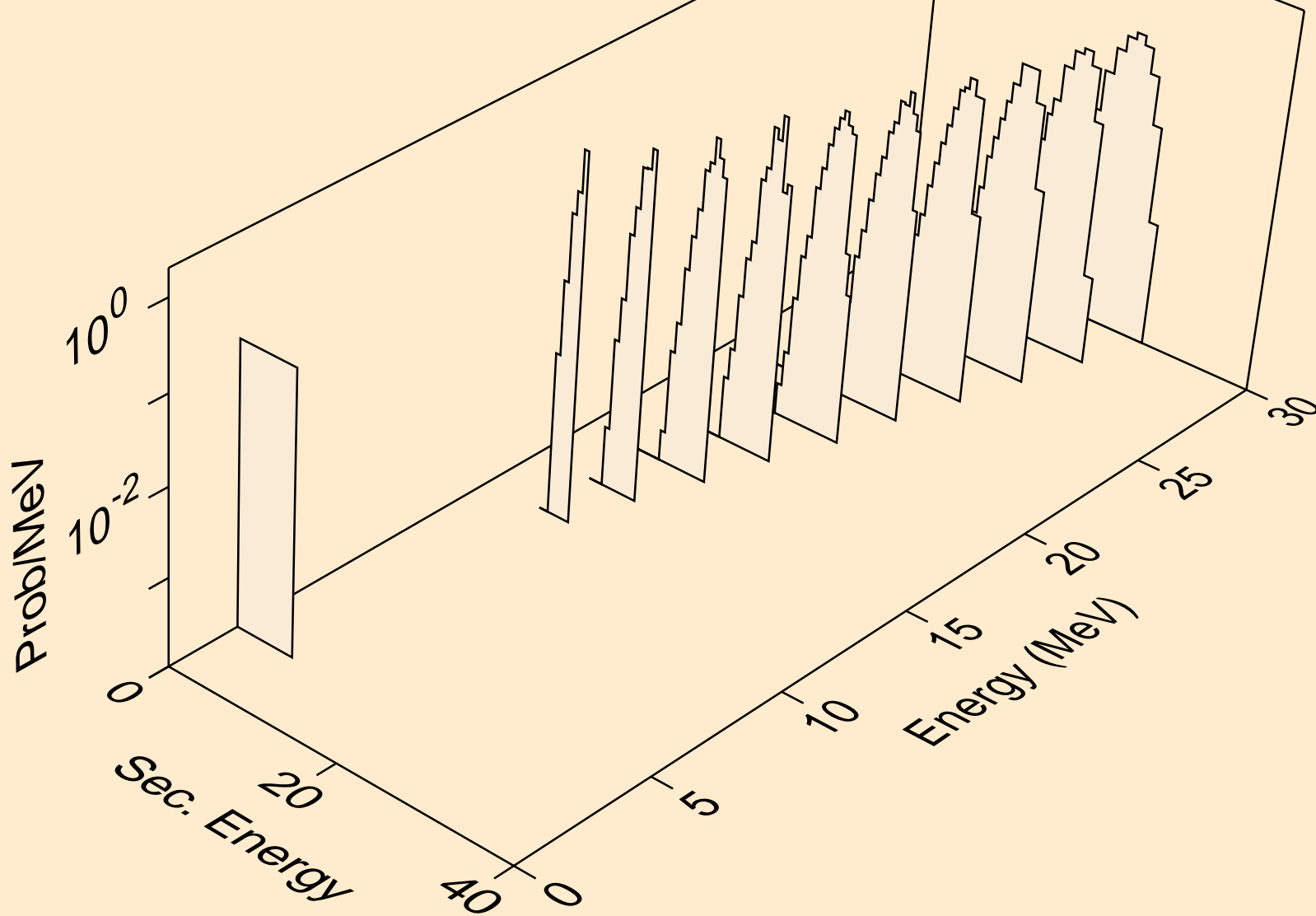

TH236 NEUTRON ACER TENDL-2019 LIBRARY; T=293.16K
alphas from (n,3n)a

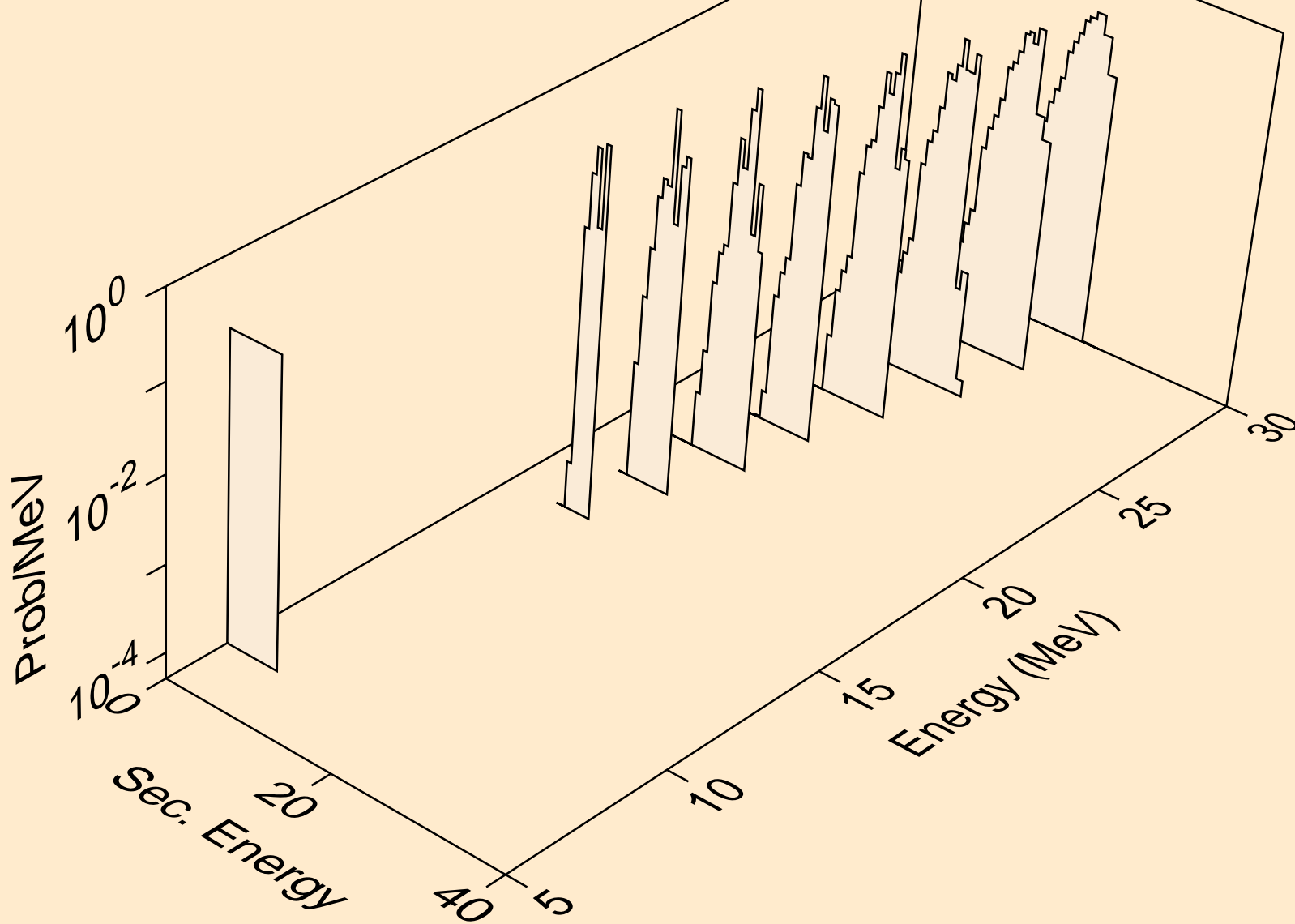

TH236 NEUTRON ACER TENDL-2019 LIBRARY; T=293.16K
alphas from (n,a)

