

TM151M NEUTRON ACER TENDL-2019 LIBRARY; T=293.16K
Principal cross sections

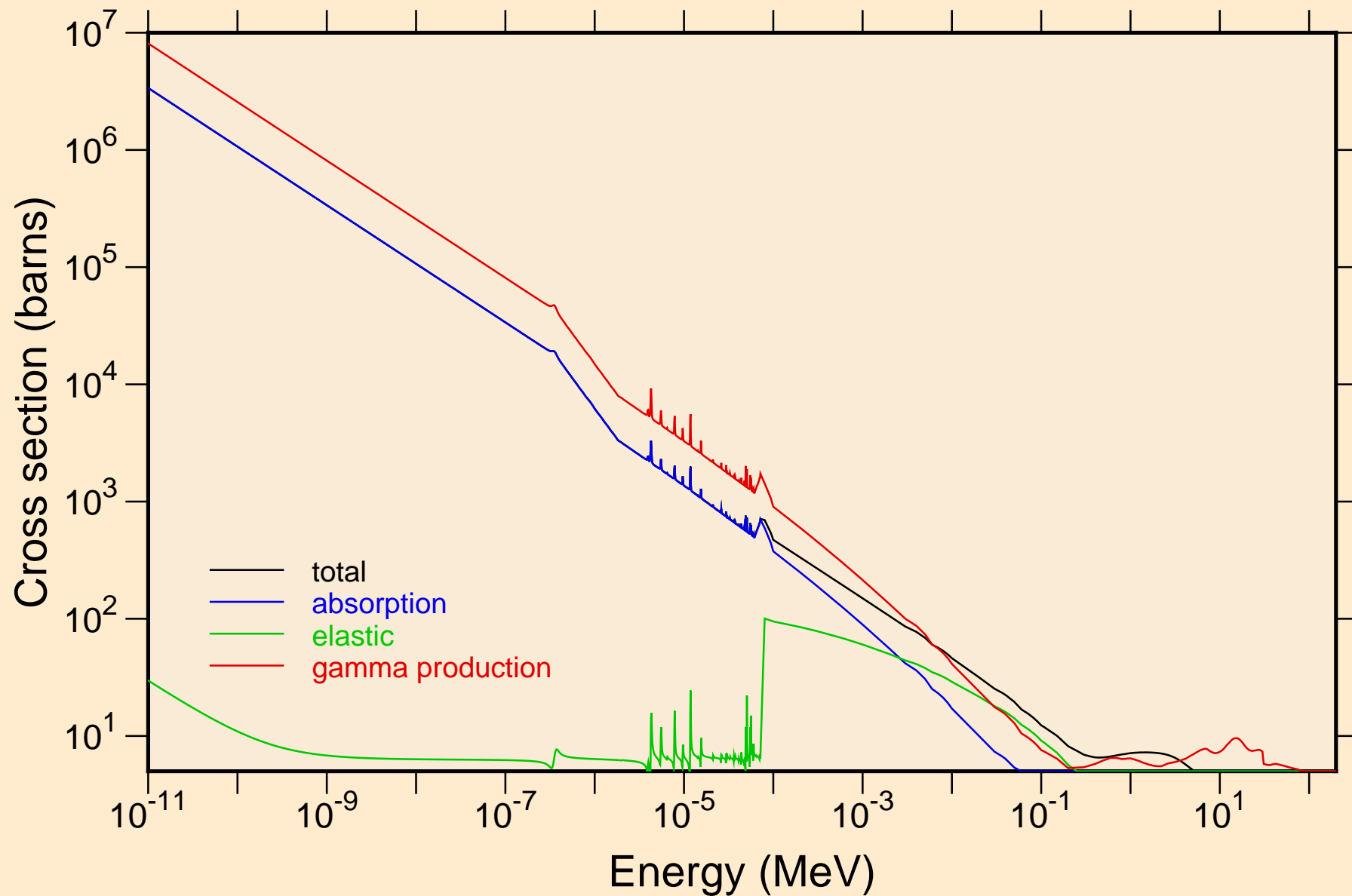

TM151M NEUTRON ACER TENDL-2019 LIBRARY; T=293.16K
resonance total cross section

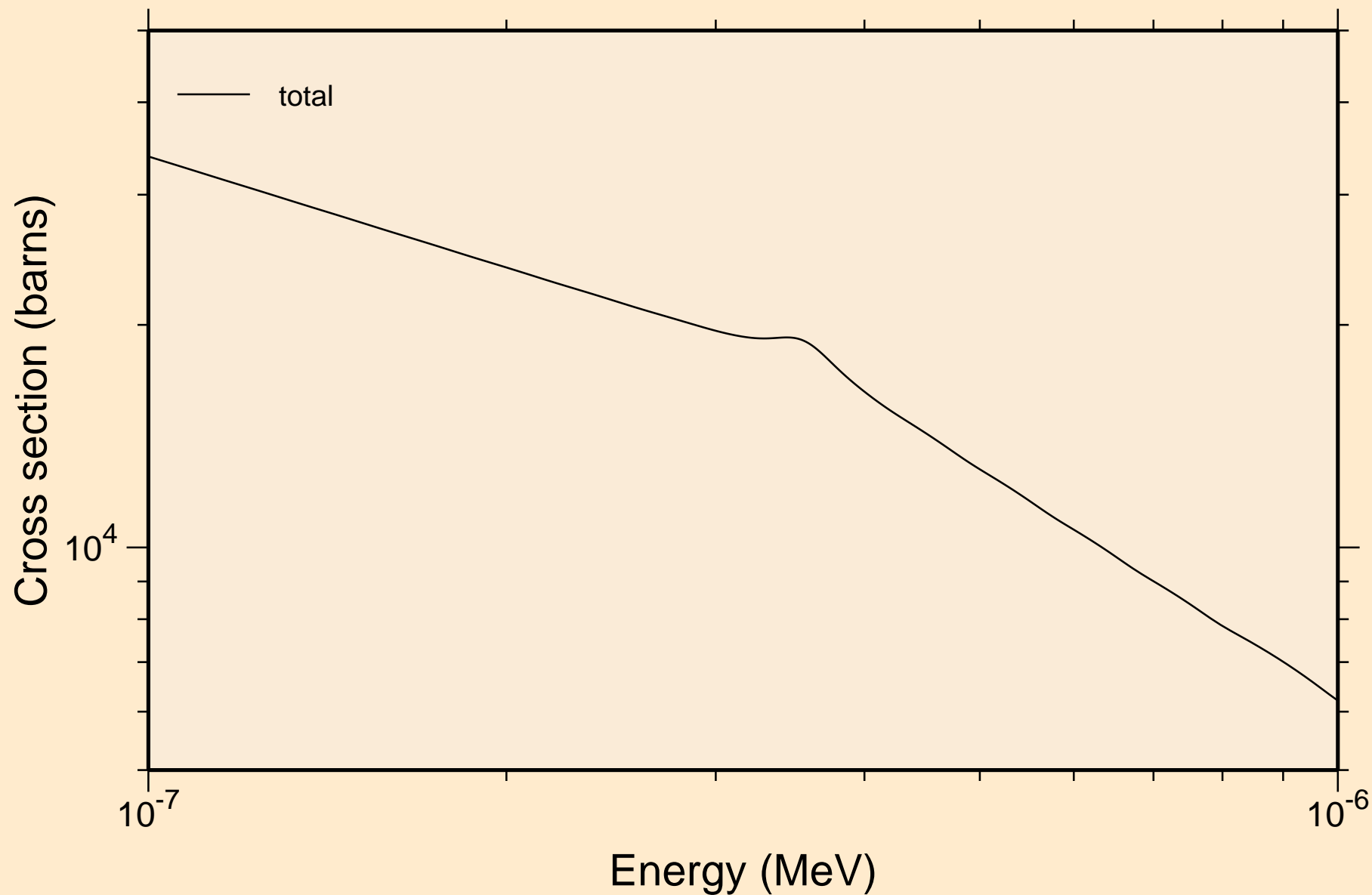

TM151M NEUTRON ACER TENDL-2019 LIBRARY; T=293.16K
resonance total cross section

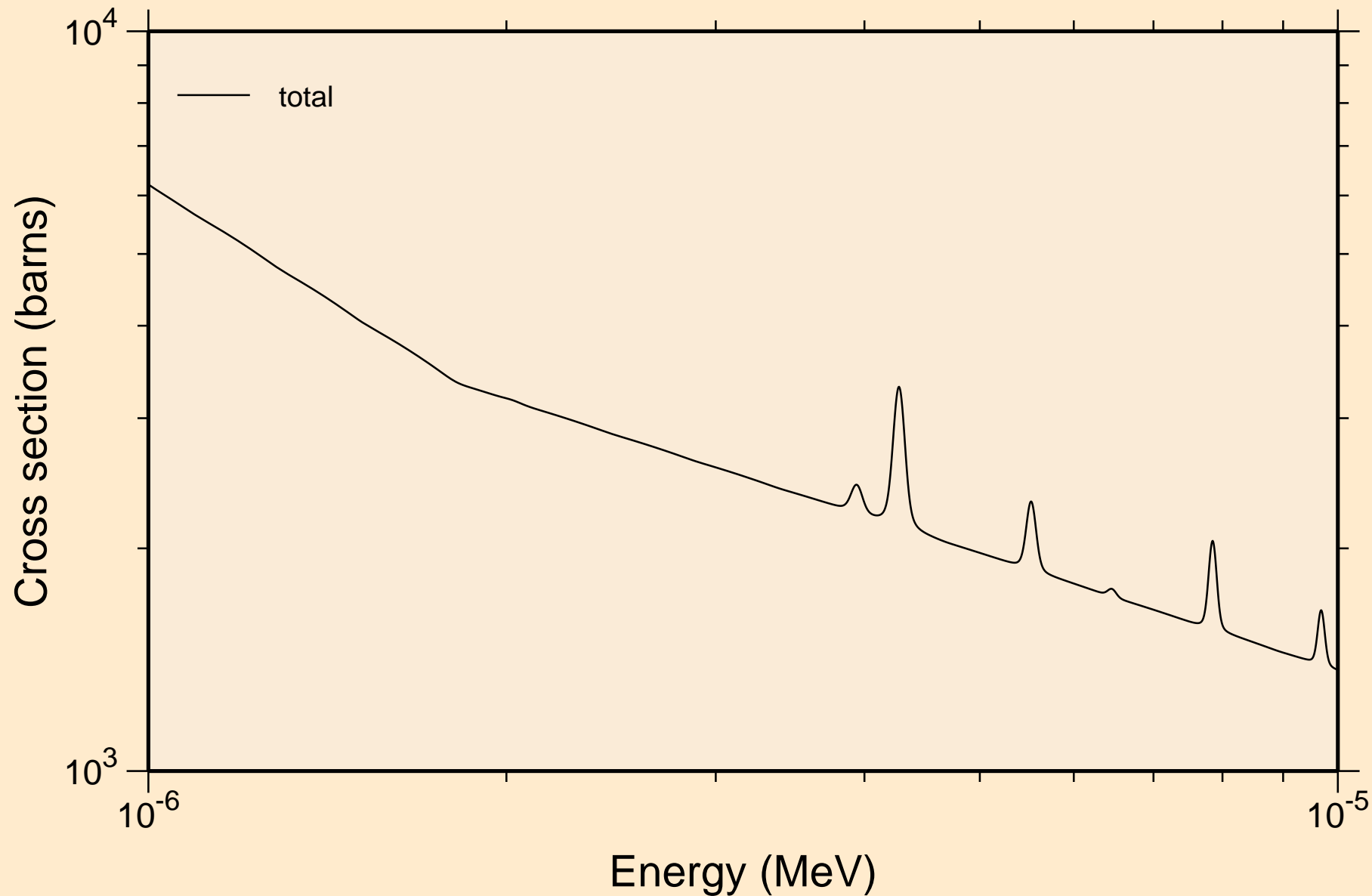

TM151M NEUTRON ACER TENDL-2019 LIBRARY; T=293.16K
resonance total cross section

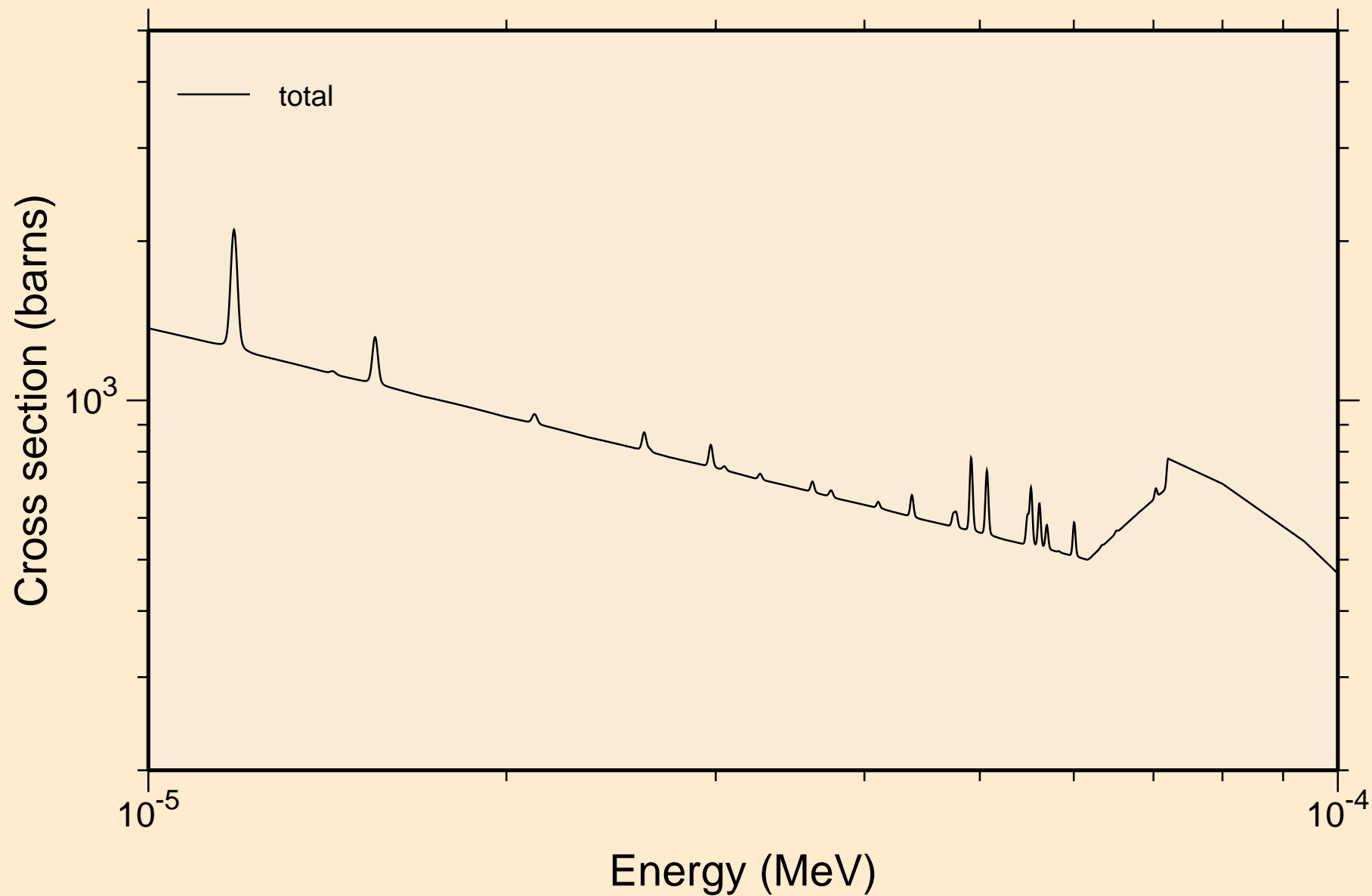

TM151M NEUTRON ACER TENDL-2019 LIBRARY; T=293.16K
resonance total cross section

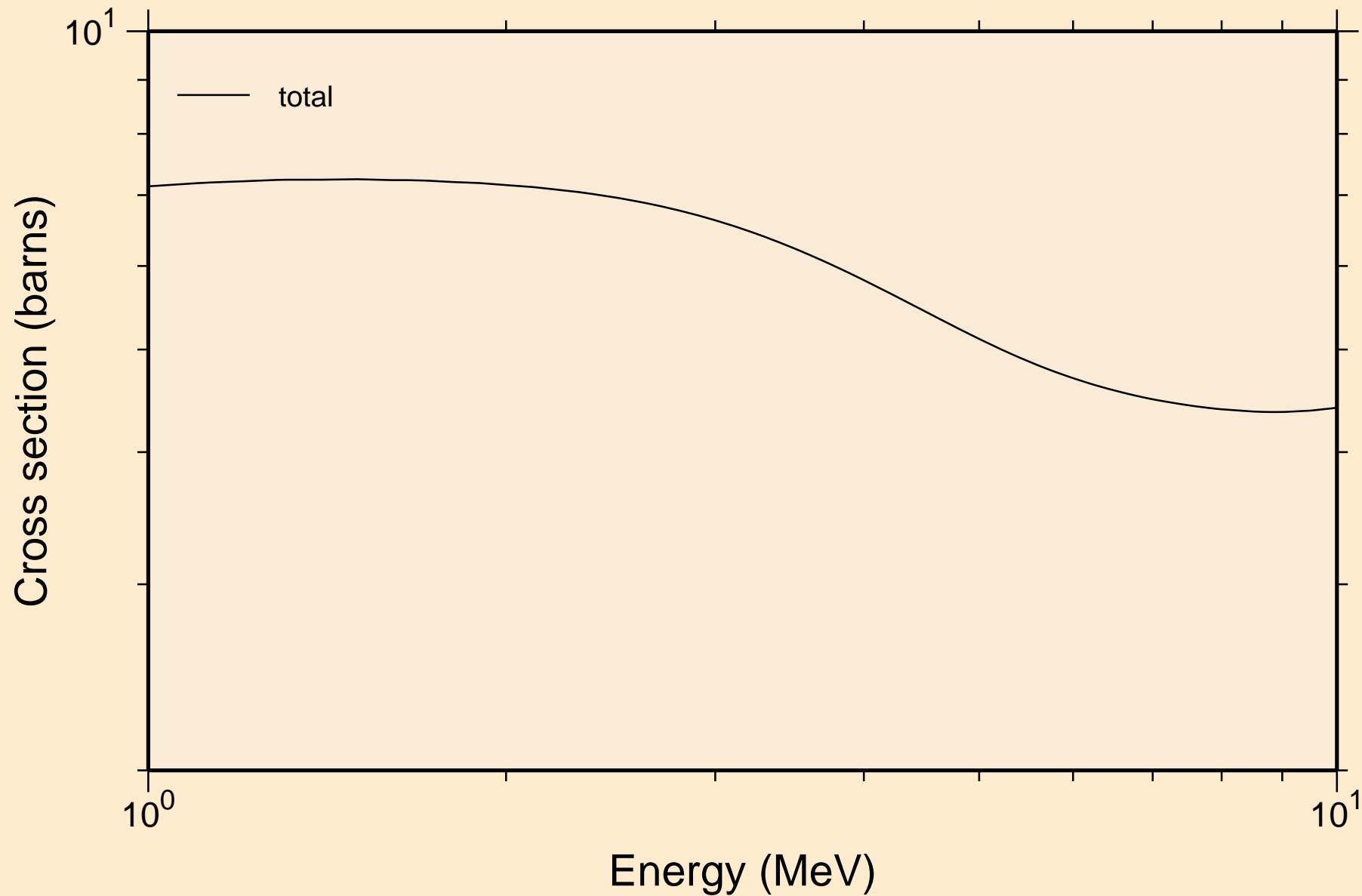

TM151M NEUTRON ACER TENDL-2019 LIBRARY; T=293.16K
resonance absorption cross sections

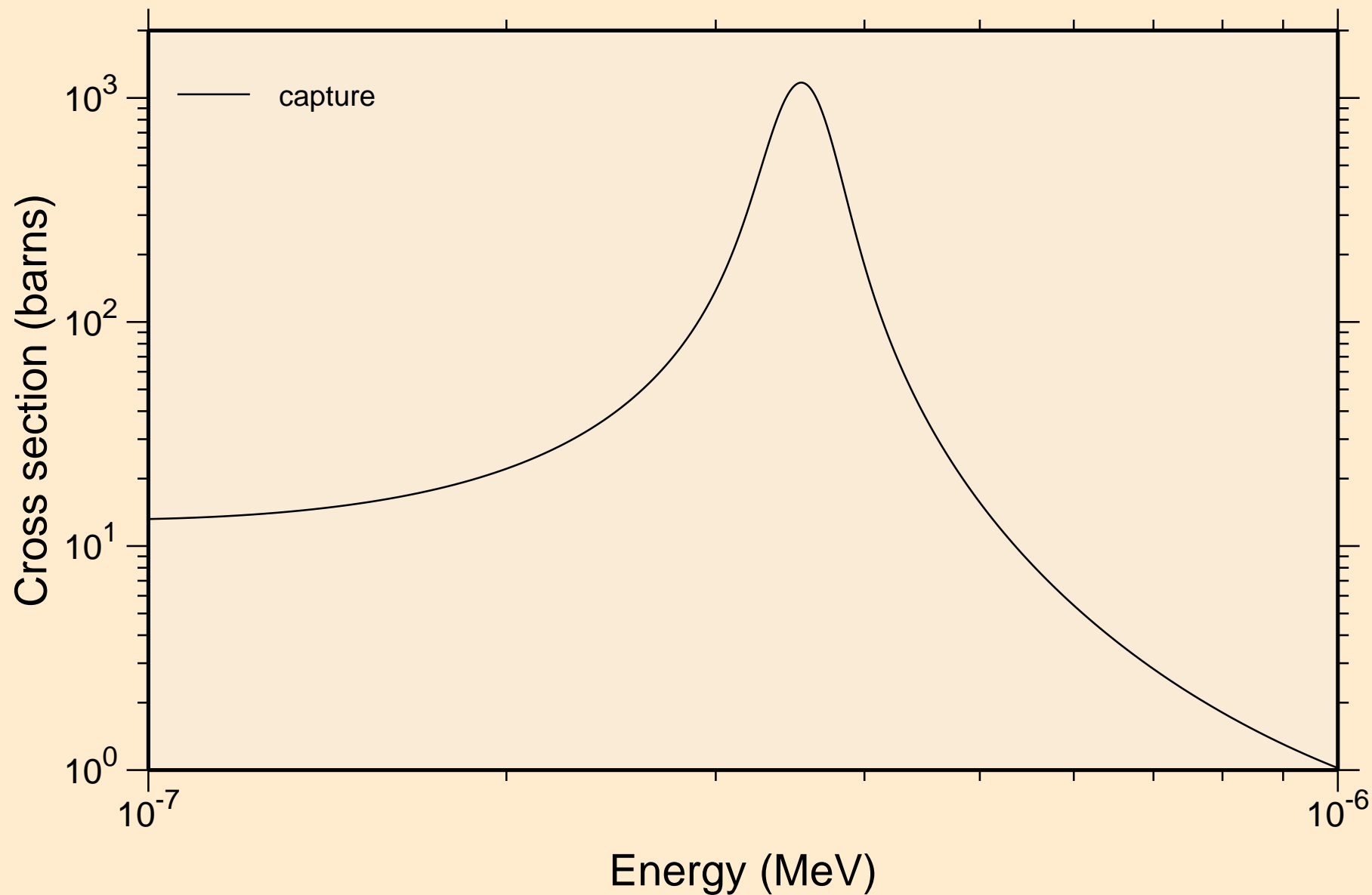

TM151M NEUTRON ACER TENDL-2019 LIBRARY; T=293.16K
resonance absorption cross sections

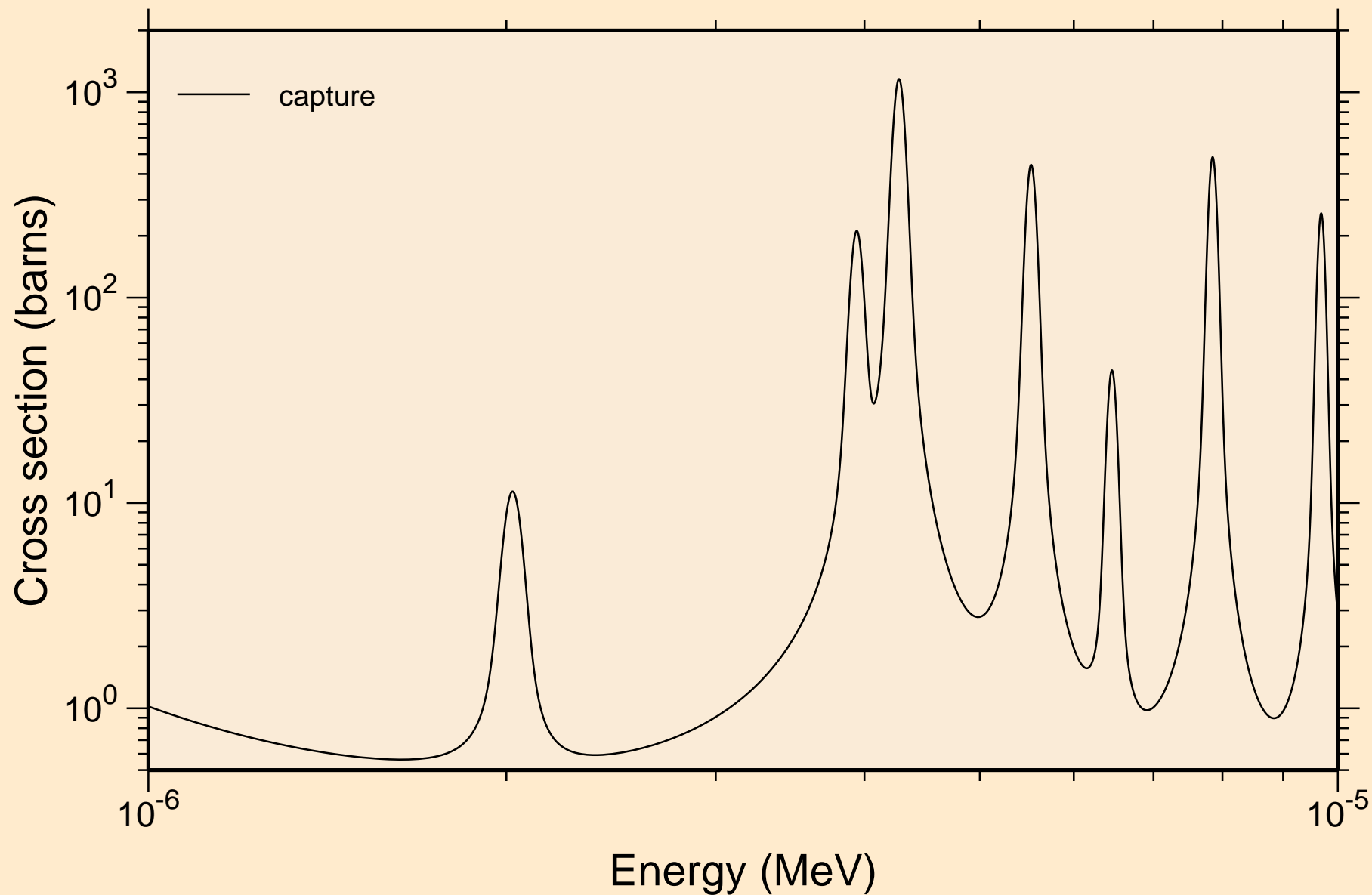

TM151M NEUTRON ACER TENDL-2019 LIBRARY; T=293.16K
resonance absorption cross sections

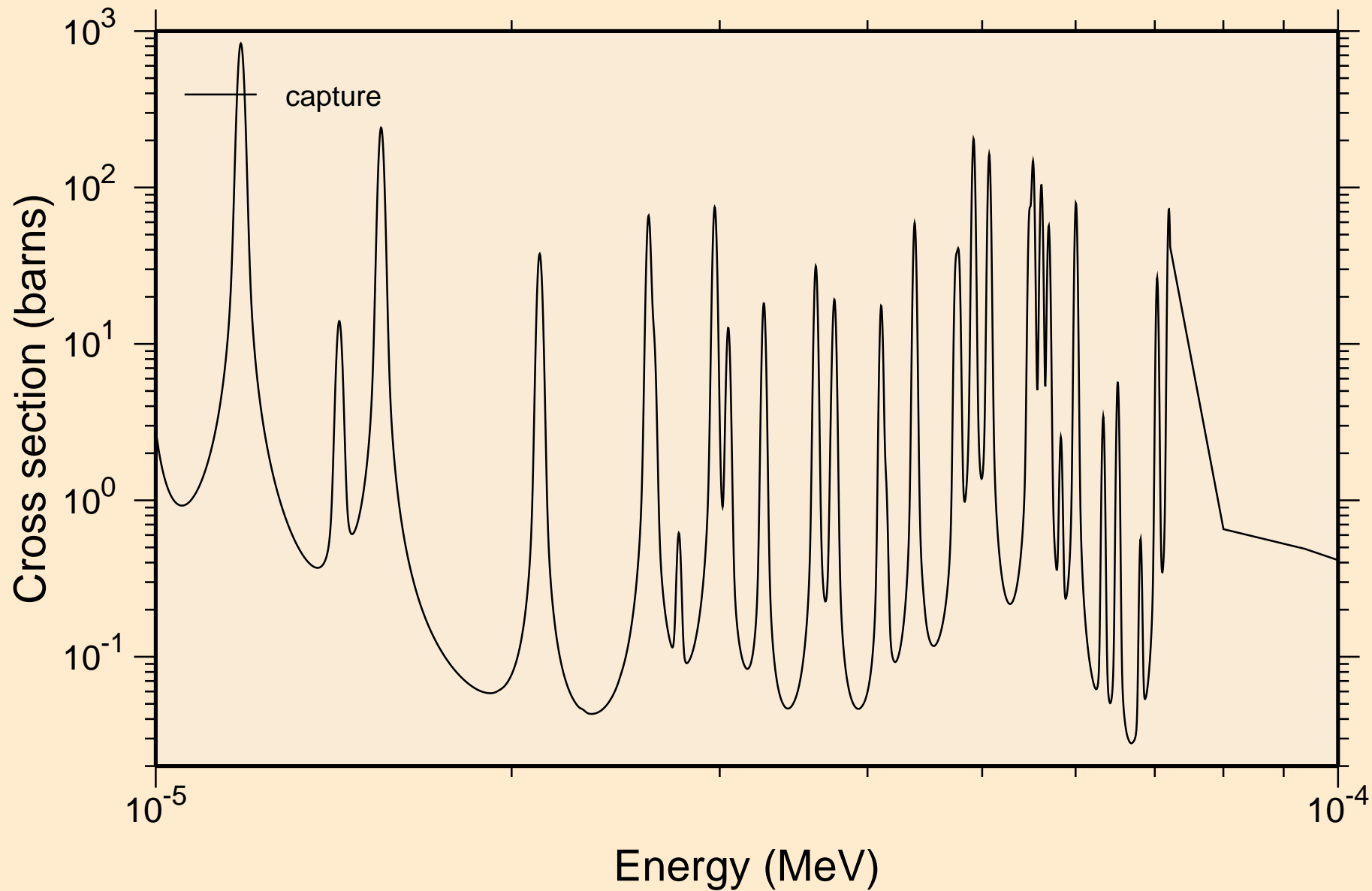

TM151M NEUTRON ACER TENDL-2019 LIBRARY; T=293.16K
resonance absorption cross sections

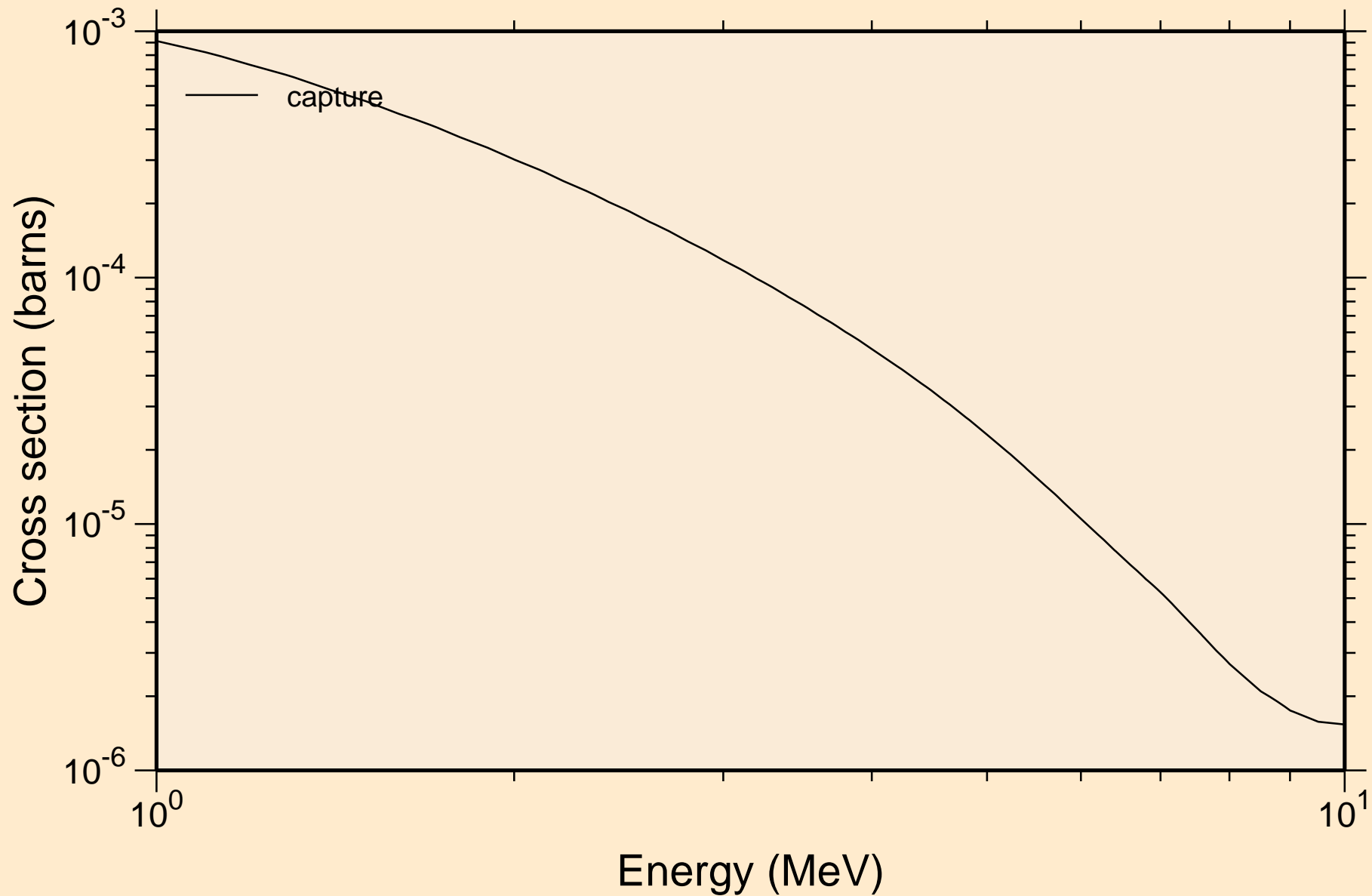

TM151M NEUTRON ACER TENDL-2019 LIBRARY; T=293.16K
Heating

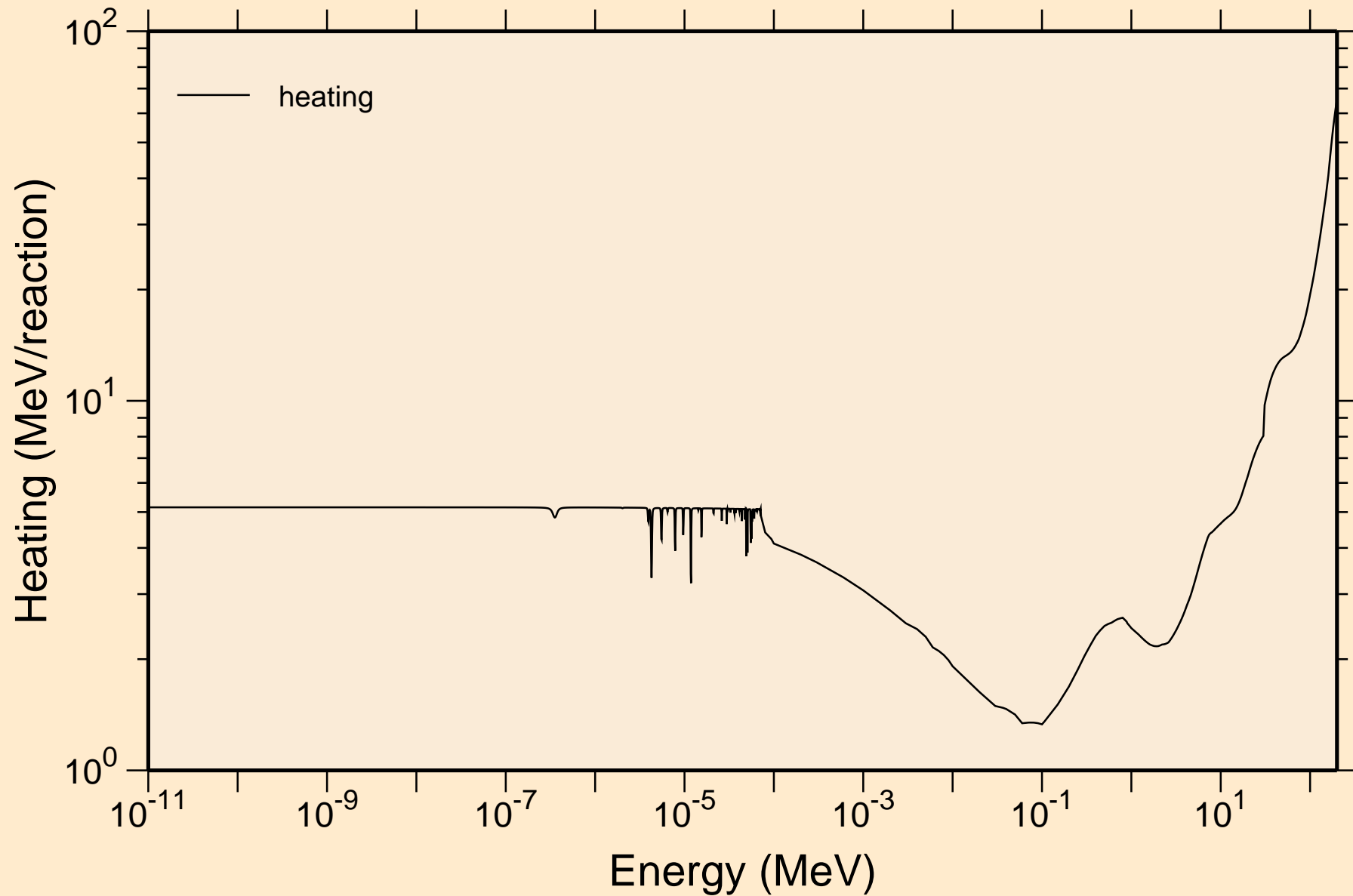

TM151M NEUTRON ACER TENDL-2019 LIBRARY; T=293.16K
Damage

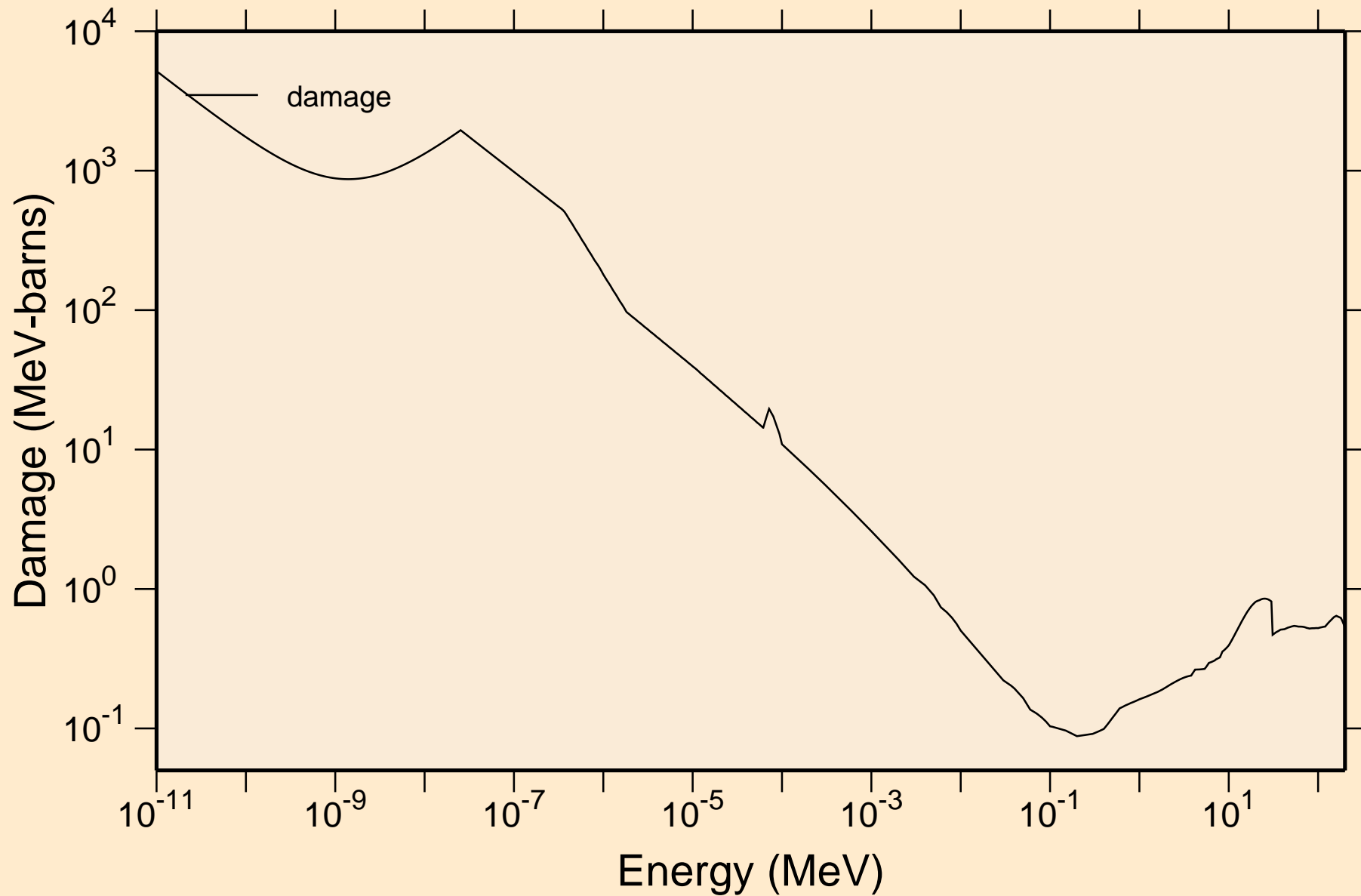

TM151M NEUTRON ACER TENDL-2019 LIBRARY; T=293.16K
Non-threshold reactions

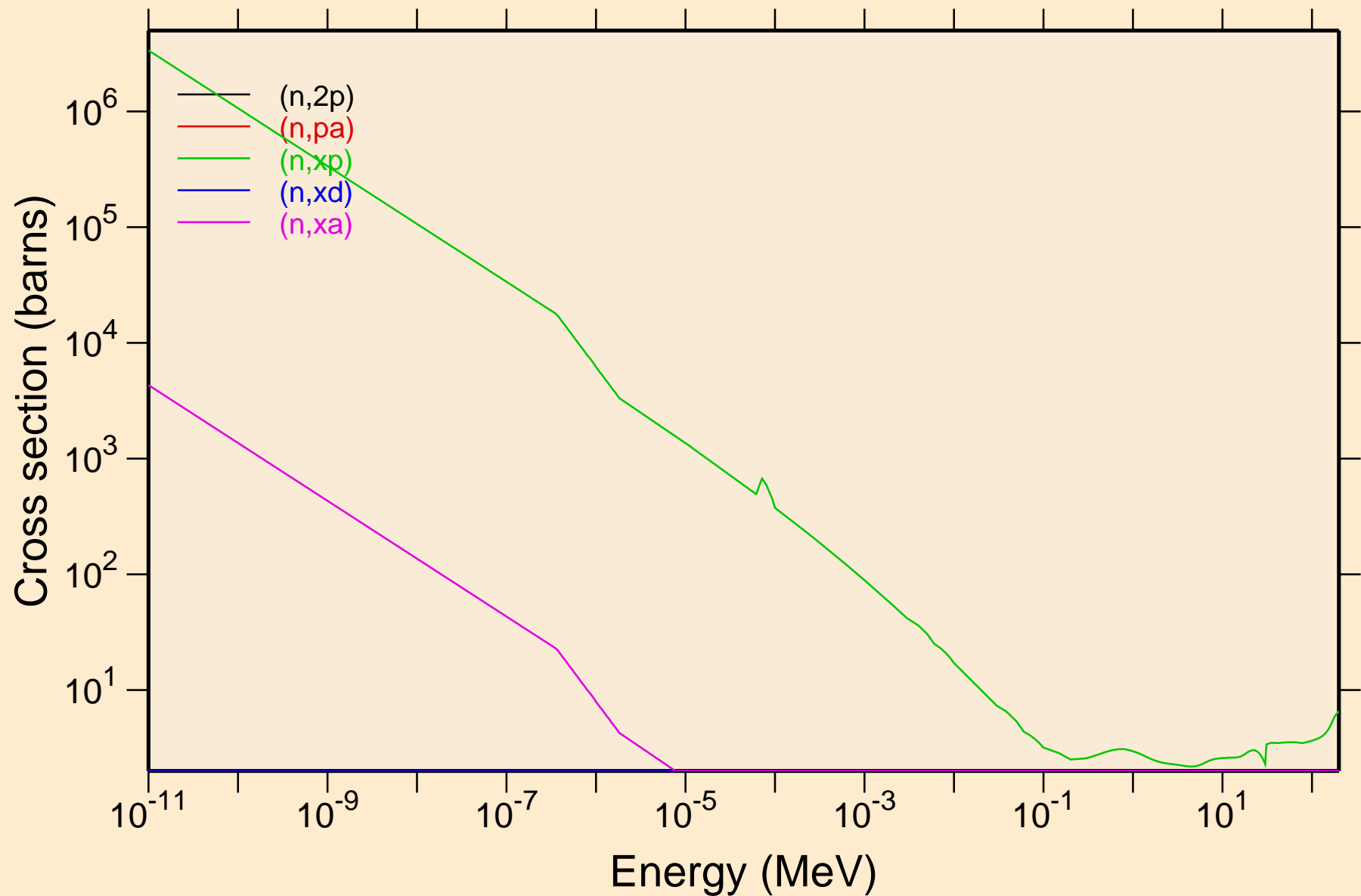

TM151M NEUTRON ACER TENDL-2019 LIBRARY; T=293.16K
Principal cross sections

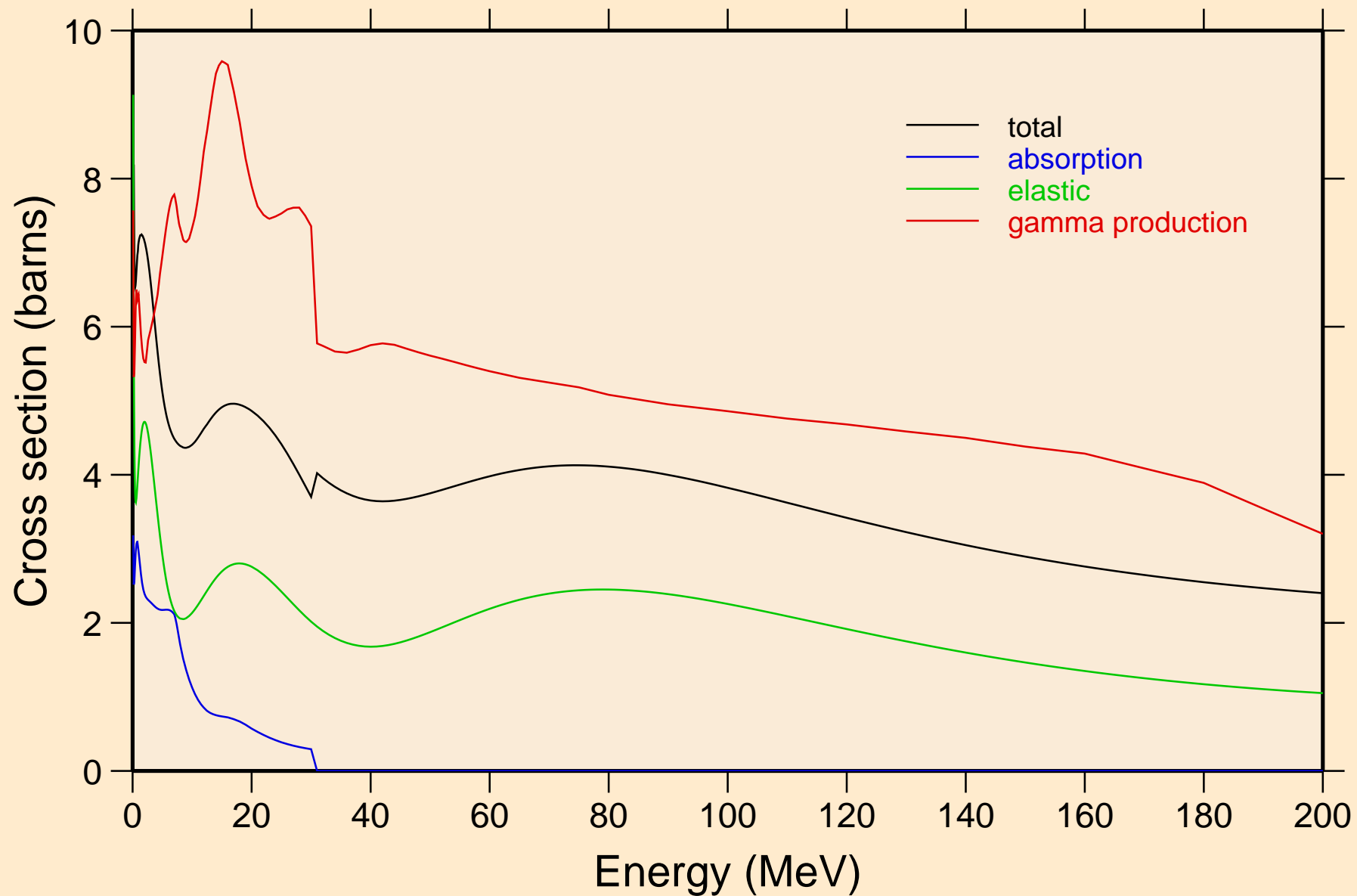

TM151M NEUTRON ACER TENDL-2019 LIBRARY; T=293.16K
Heating

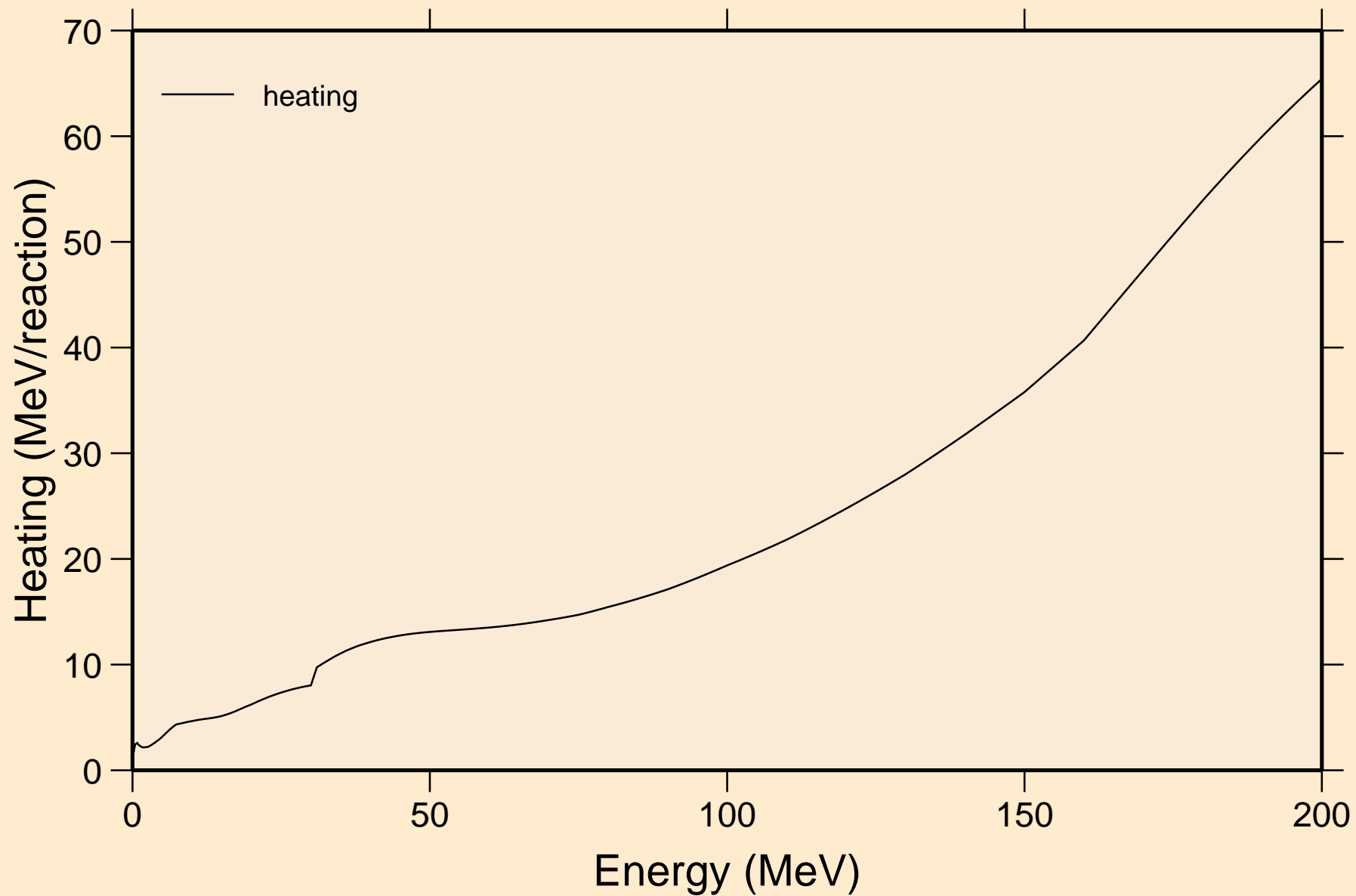

TM151M NEUTRON ACER TENDL-2019 LIBRARY; T=293.16K
Damage

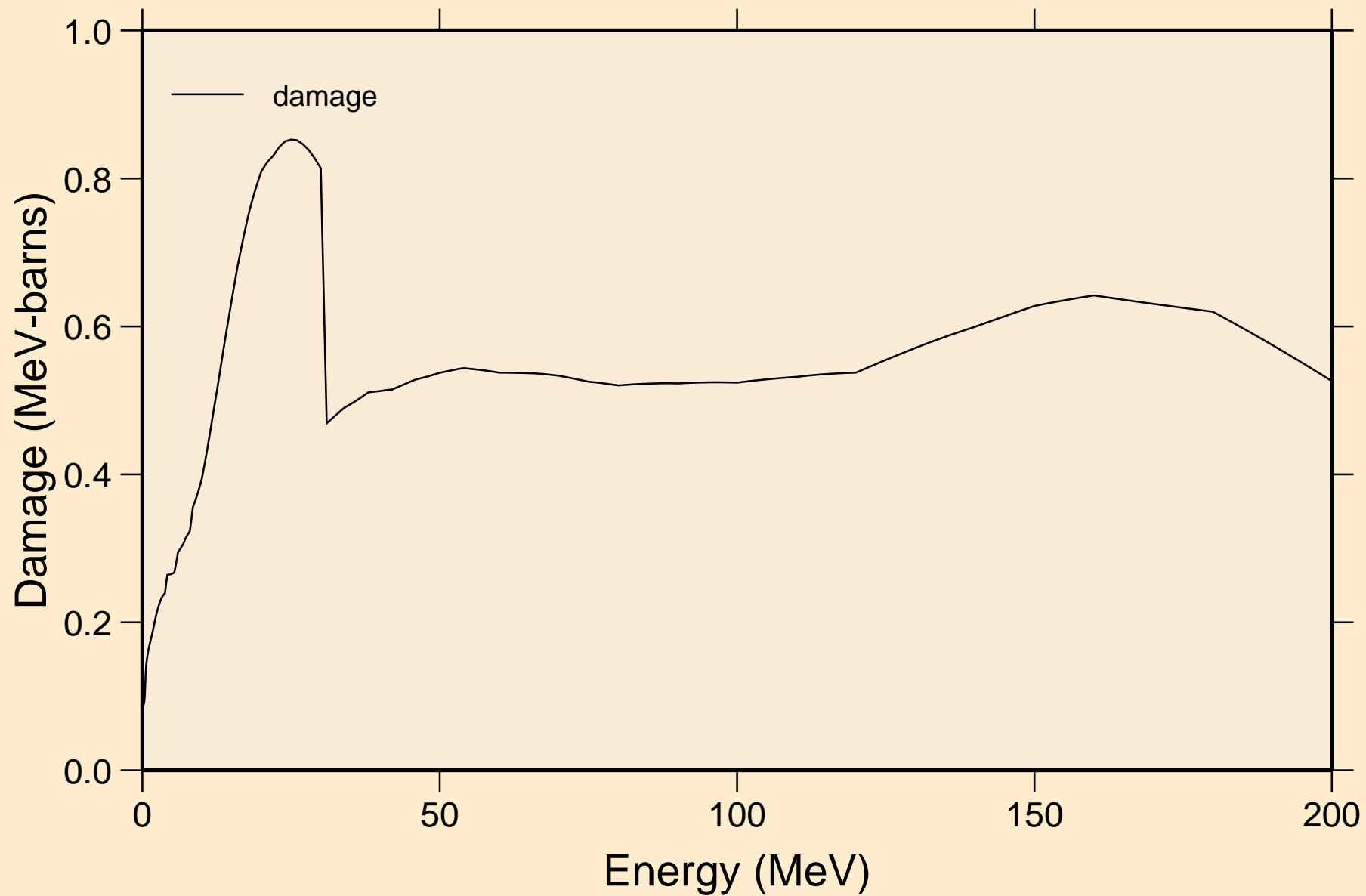

TM151M NEUTRON ACER TENDL-2019 LIBRARY; T=293.16K
Non-threshold reactions

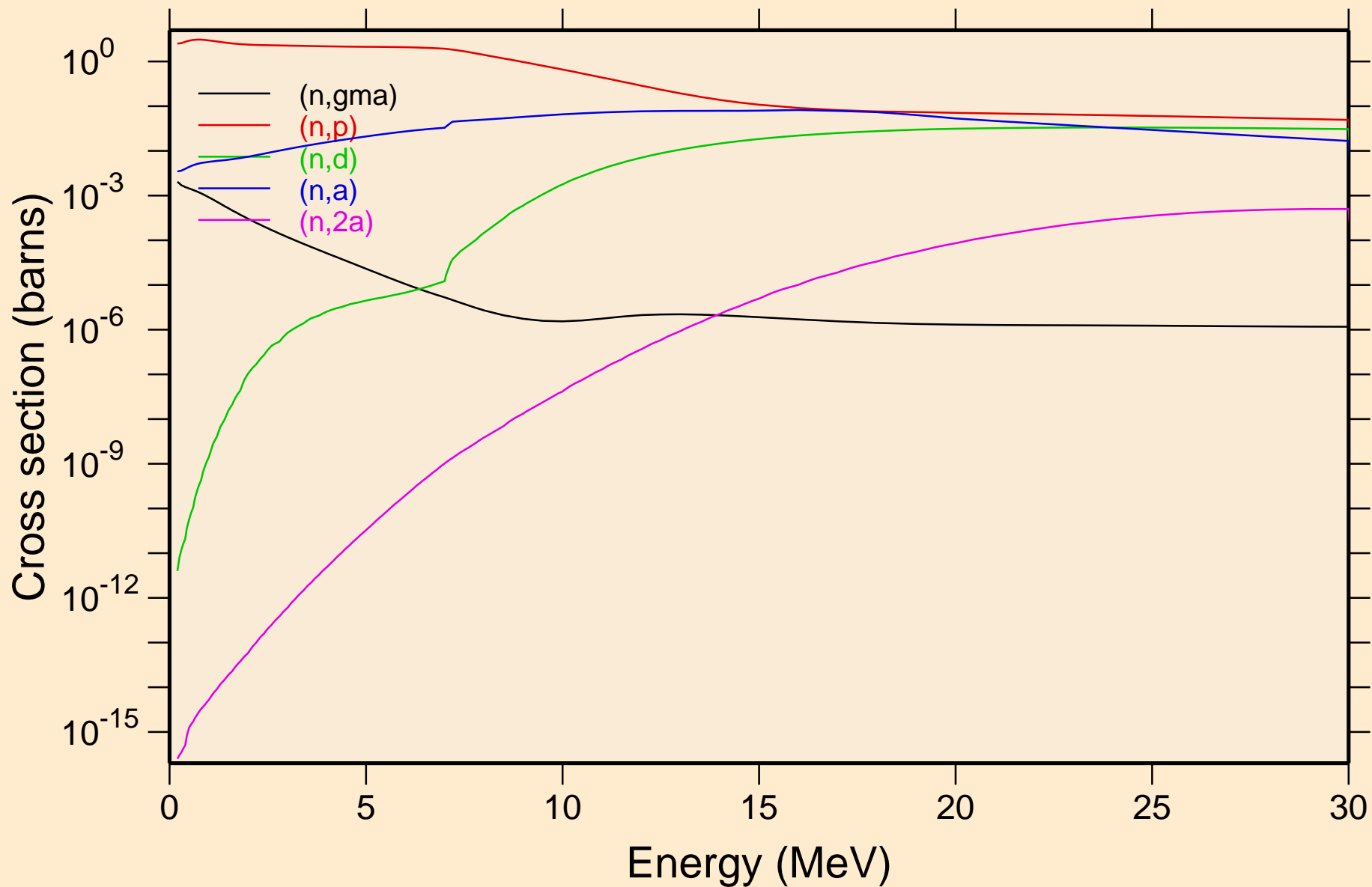

TM151M NEUTRON ACER TENDL-2019 LIBRARY; T=293.16K
Non-threshold reactions

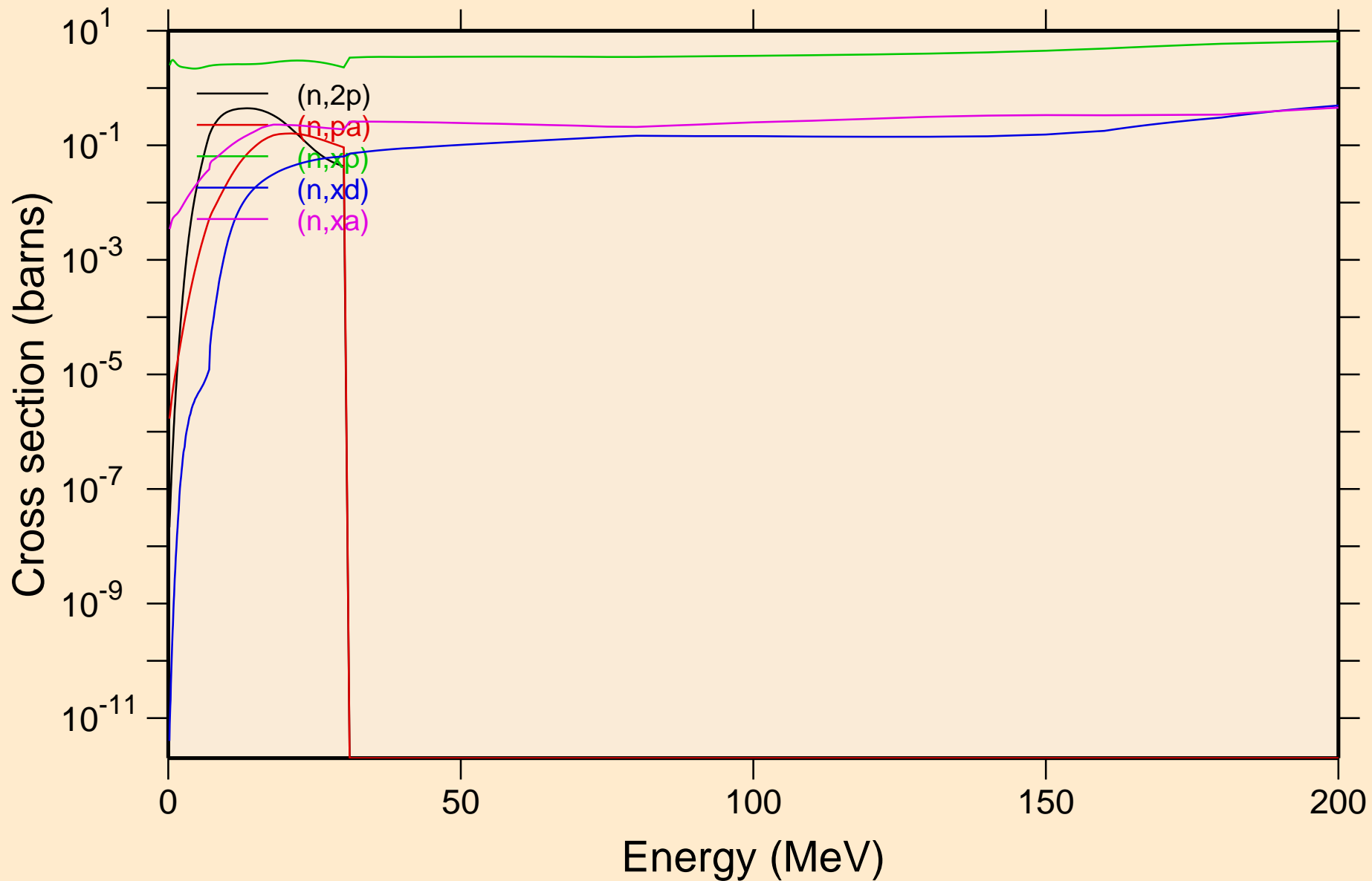

TM151M NEUTRON ACER TENDL-2019 LIBRARY; T=293.16K
Inelastic levels

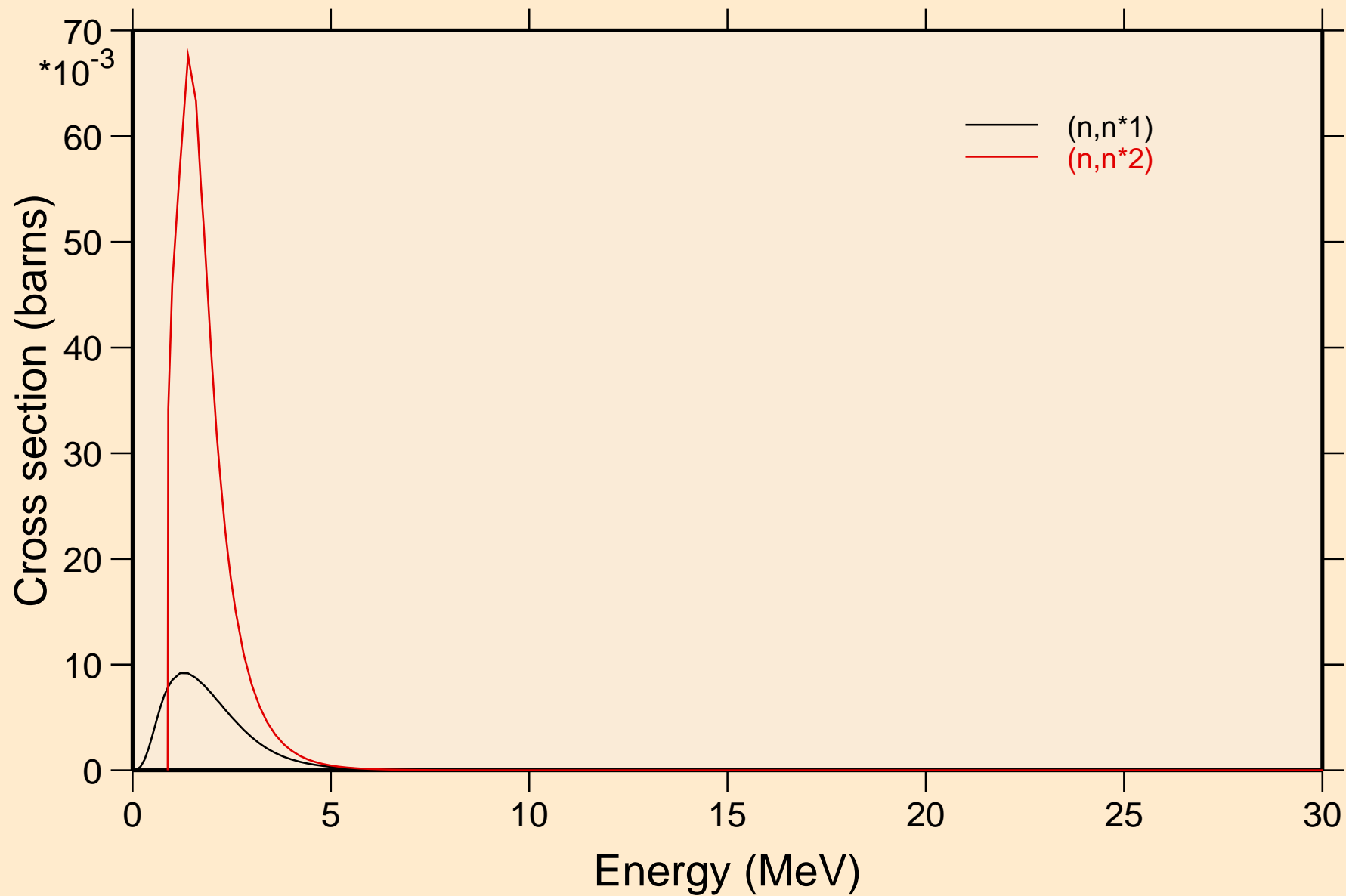

TM151M NEUTRON ACER TENDL-2019 LIBRARY; T=293.16K
Threshold reactions

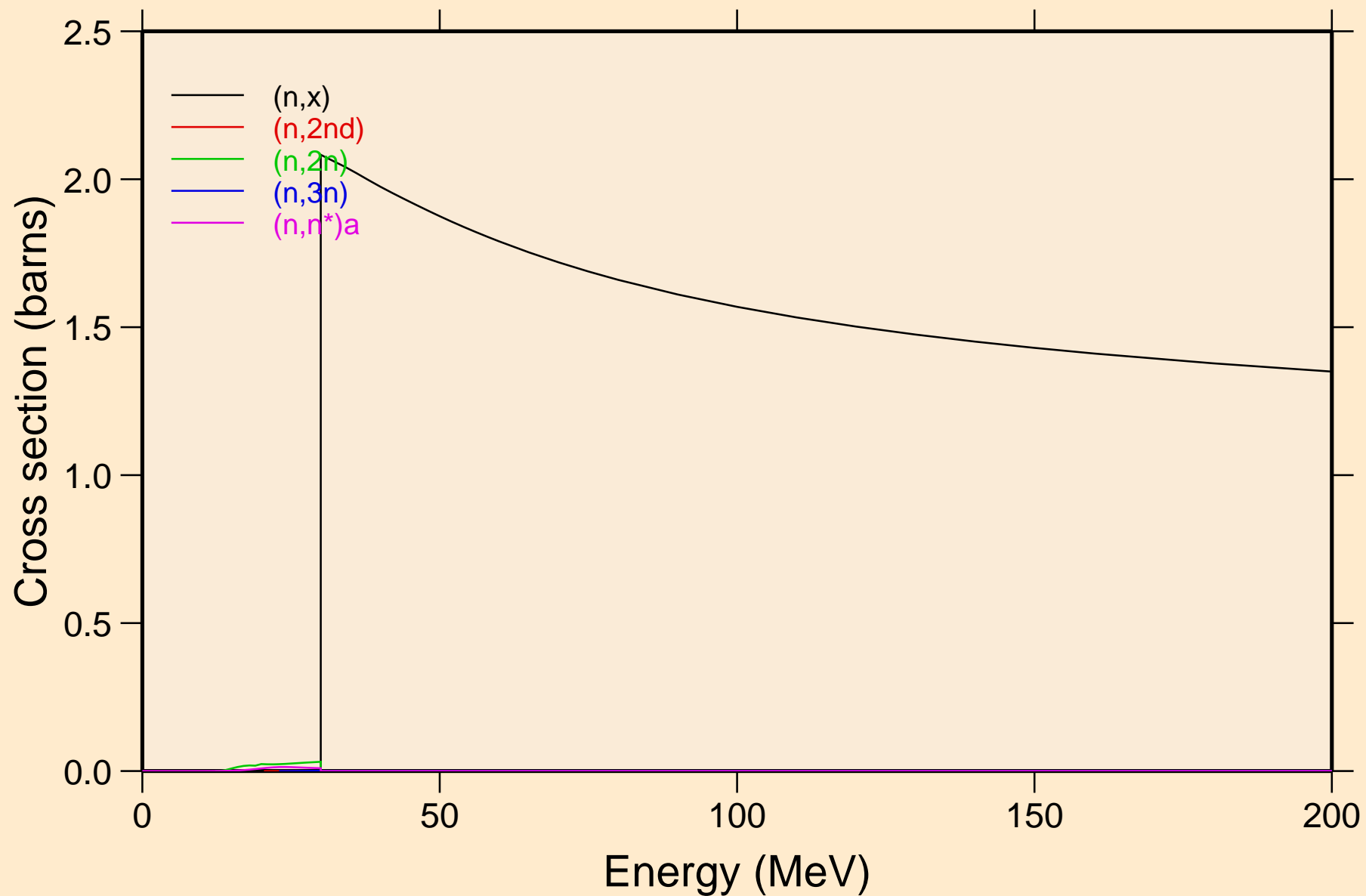

TM151M NEUTRON ACER TENDL-2019 LIBRARY; T=293.16K
Threshold reactions

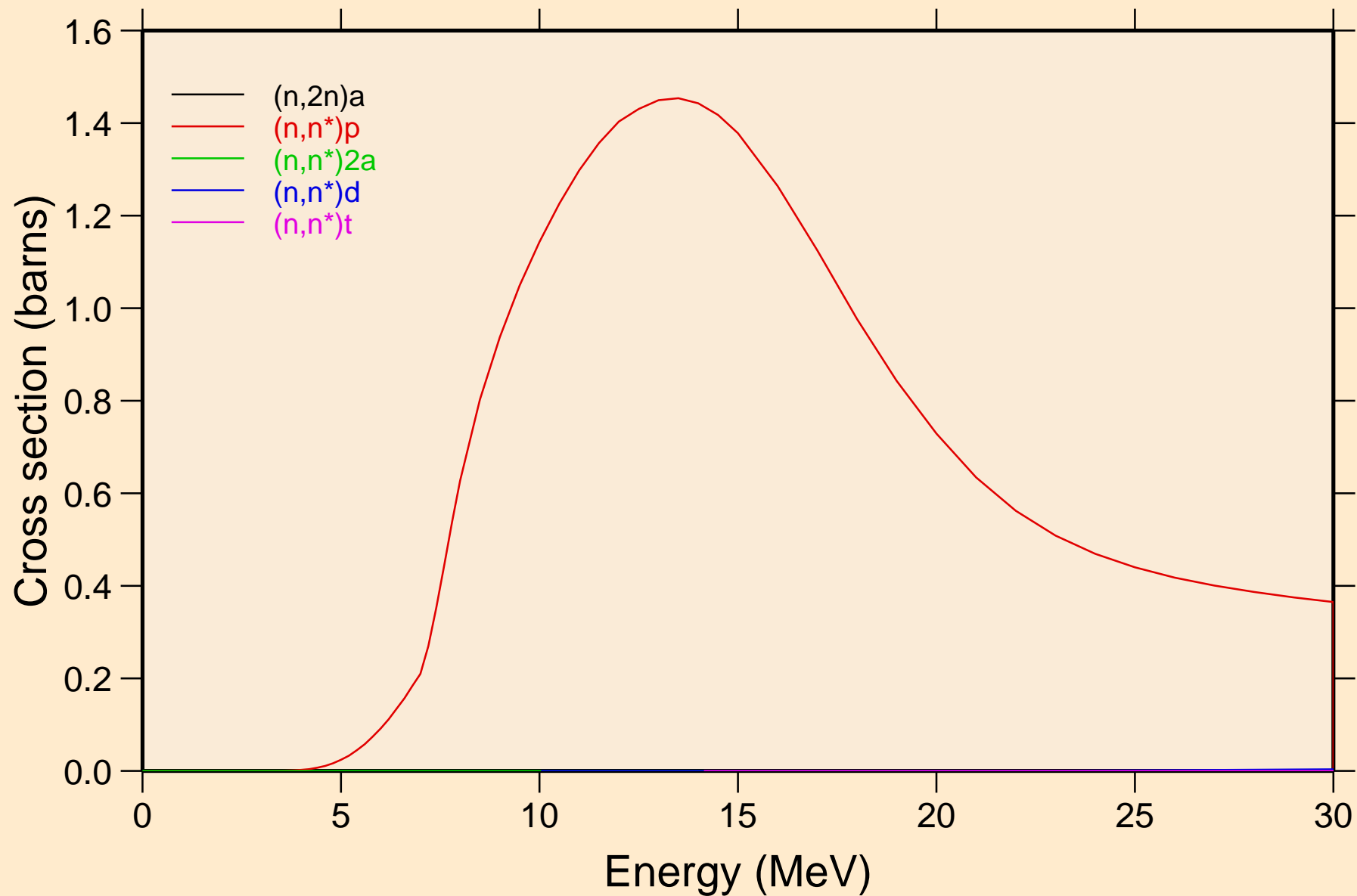

TM151M NEUTRON ACER TENDL-2019 LIBRARY; T=293.16K
Threshold reactions

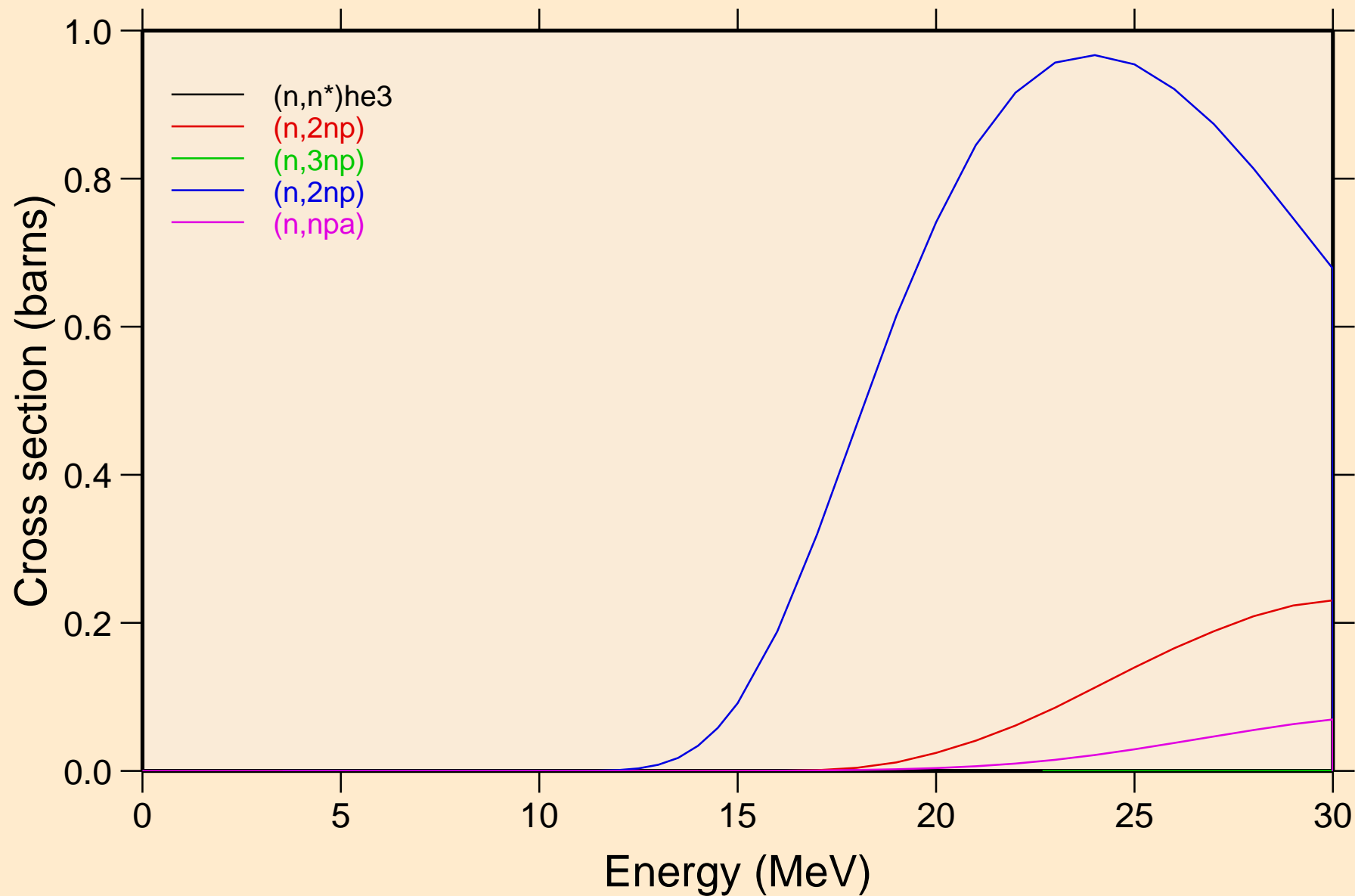

TM151M NEUTRON ACER TENDL-2019 LIBRARY; T=293.16K
Threshold reactions

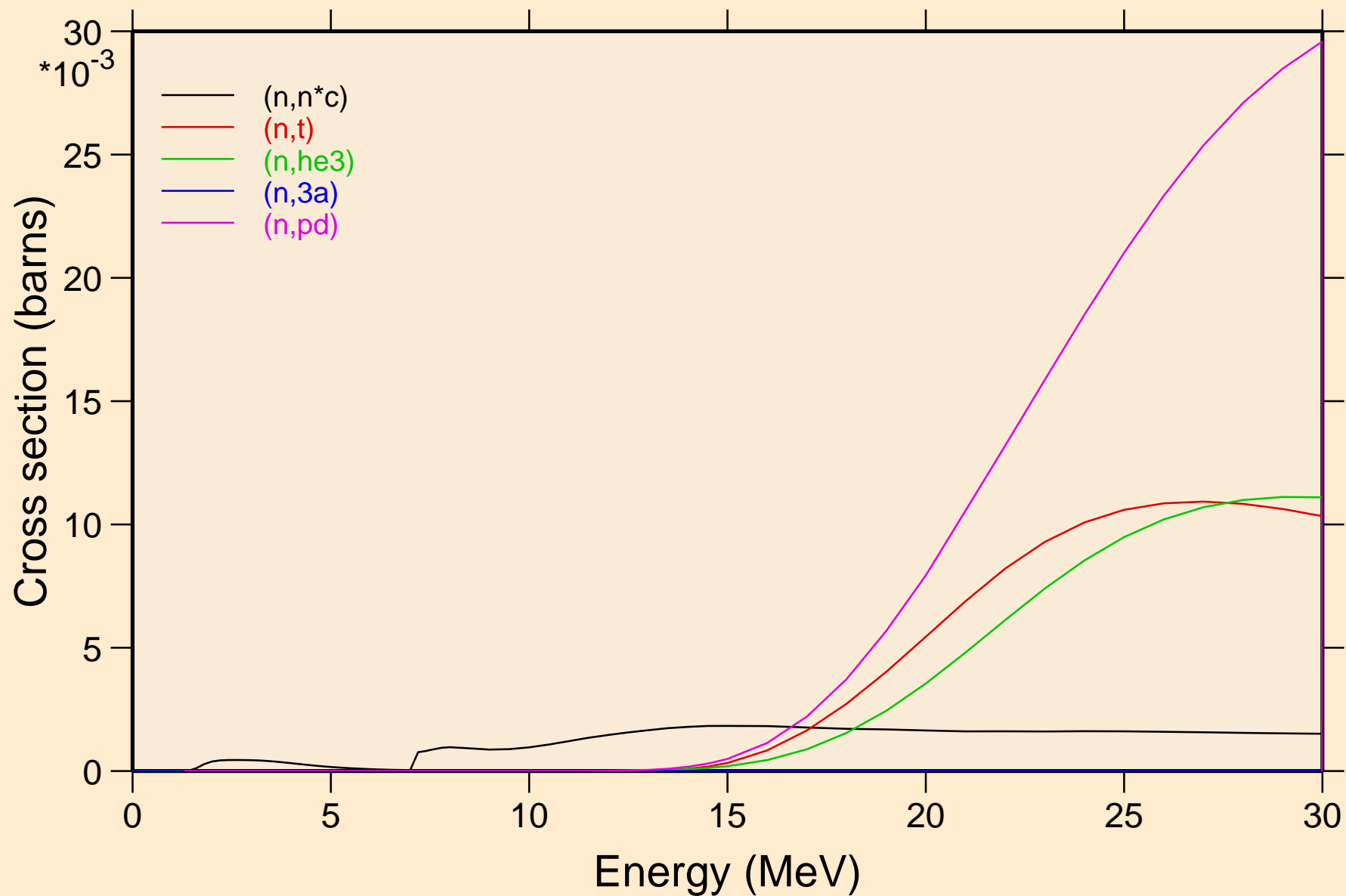

TM151M NEUTRON ACER TENDL-2019 LIBRARY; T=293.16K
Threshold reactions

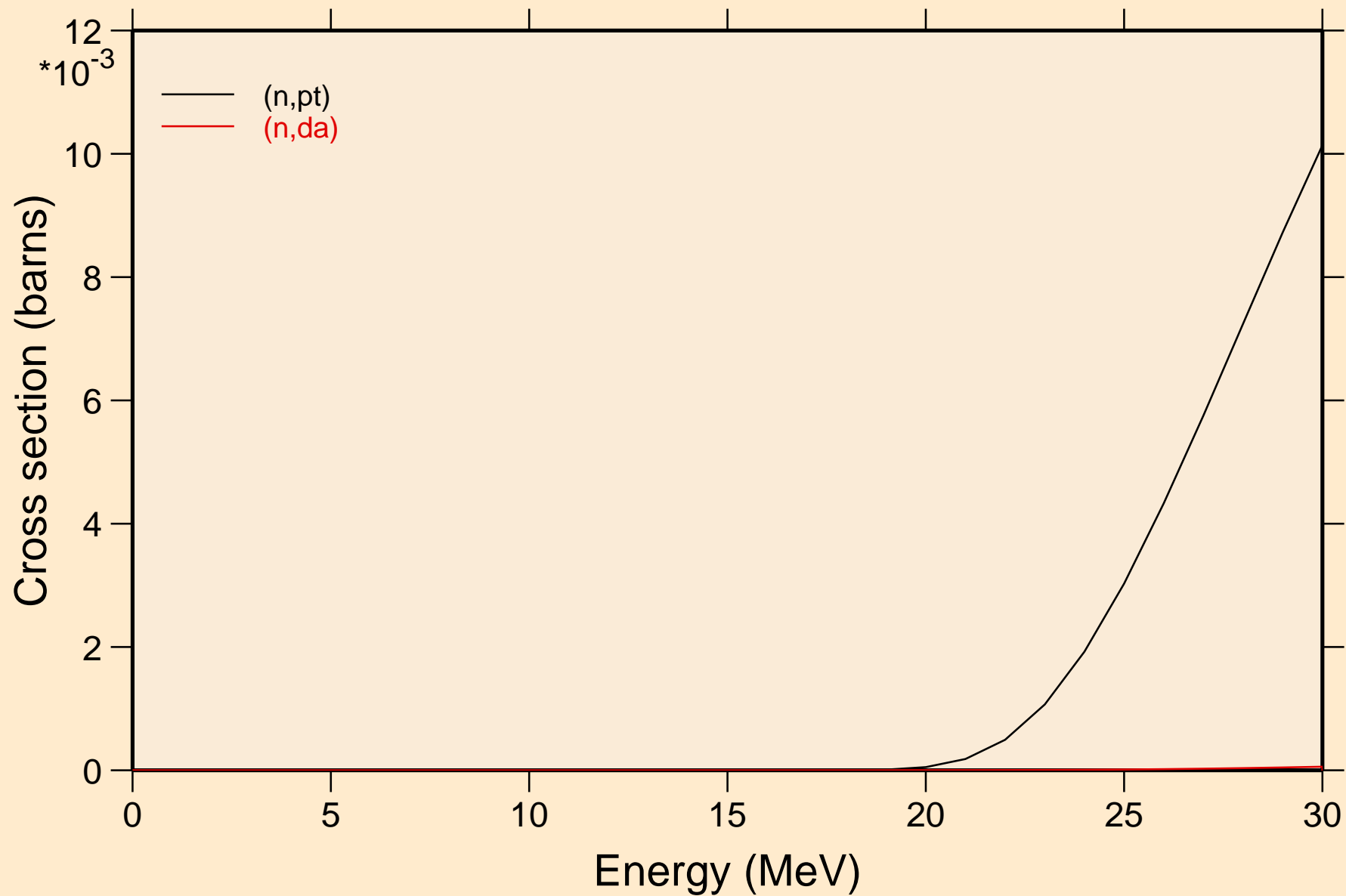

TM151M NEUTRON ACER TENDL-2019 LIBRARY; T=293.16K
Threshold reactions

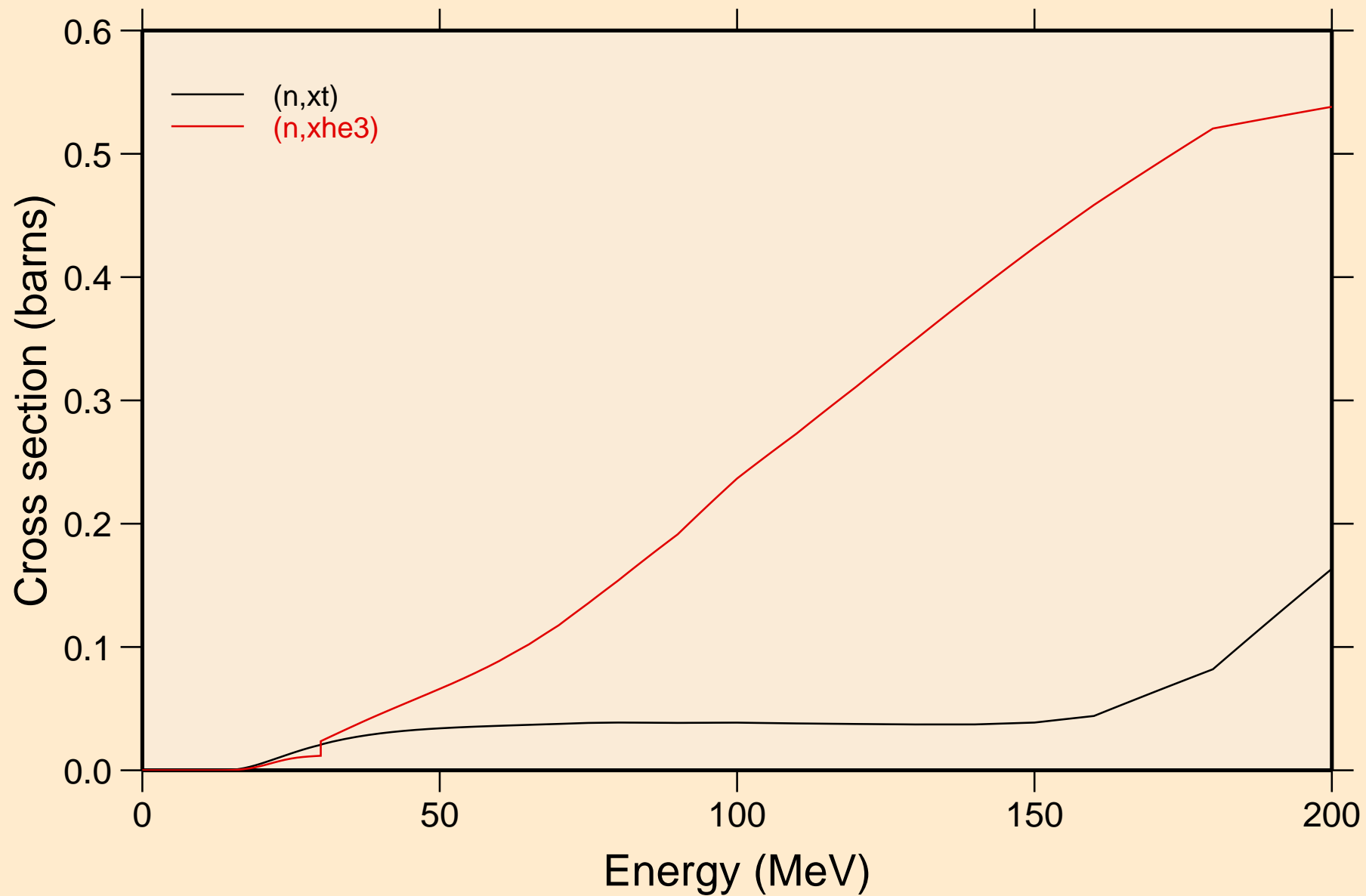

TM151M NEUTRON ACER TENDL-2019 LIBRARY; T=293.16K
angular distribution for elastic

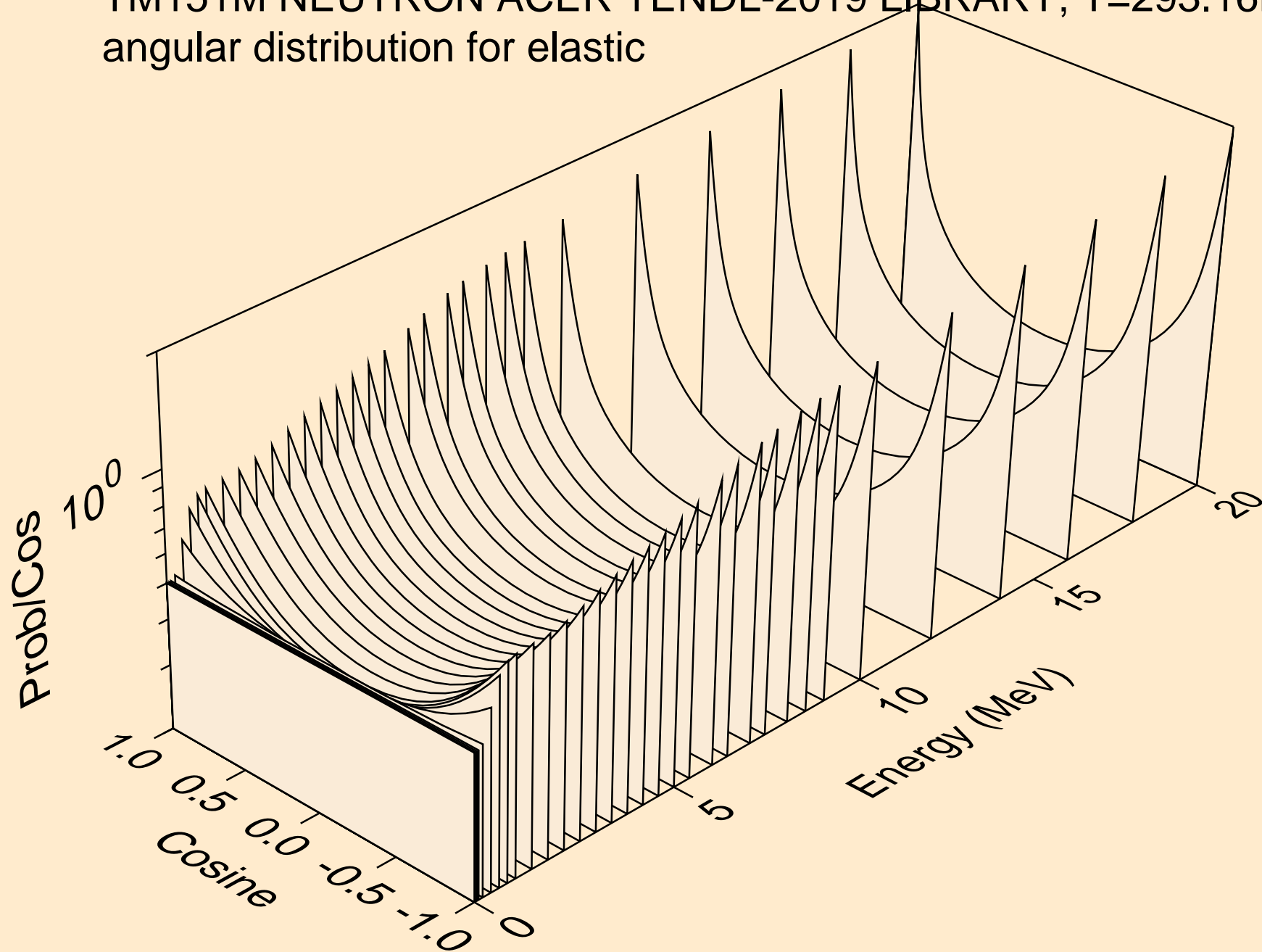

TM151M NEUTRON ACER TENDL-2019 LIBRARY; T=293.16K
angular distribution for elastic

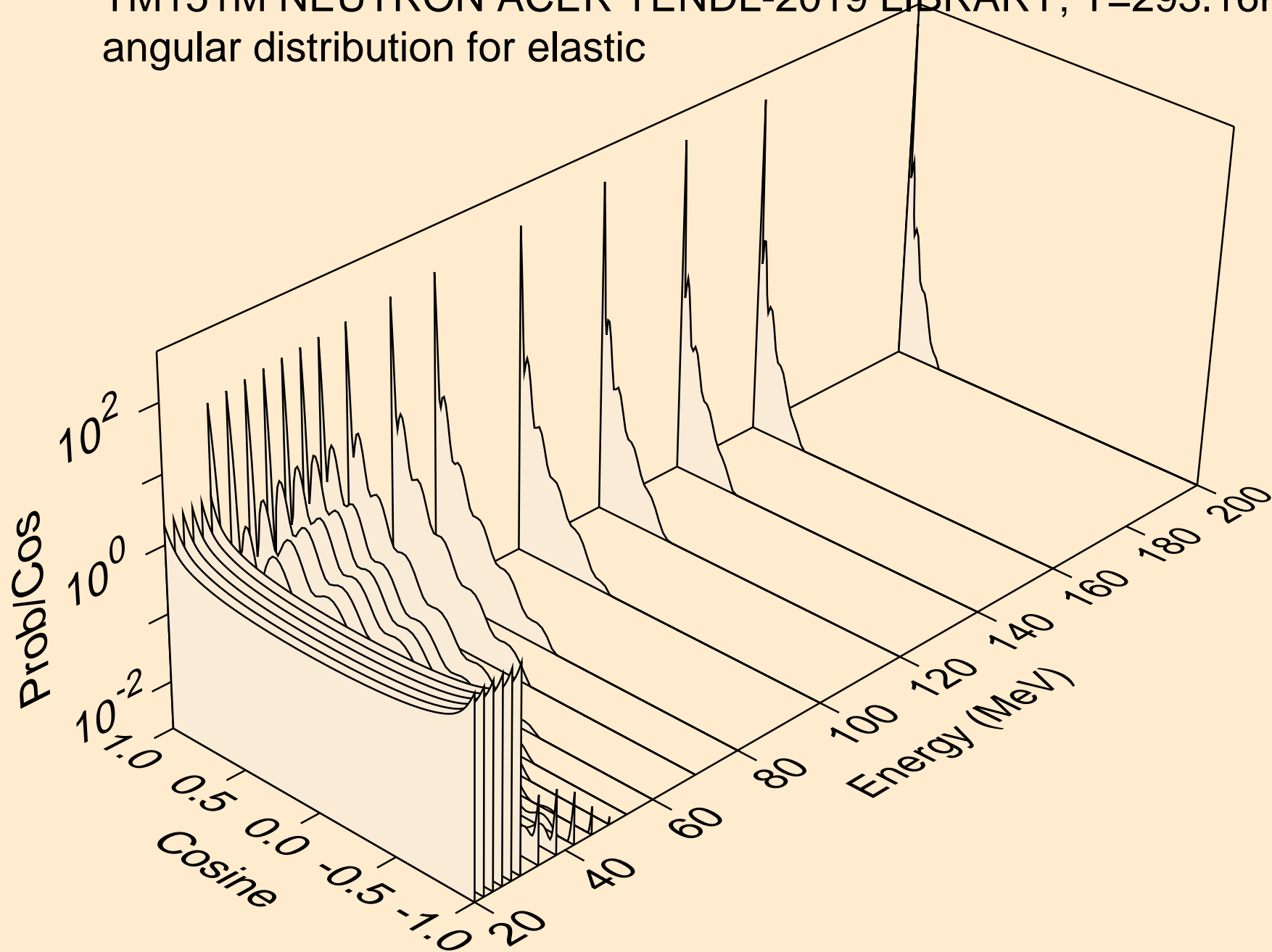

TM151M NEUTRON ACER TENDL-2019 LIBRARY; T=293.16K
angular distribution for (n,n*1)

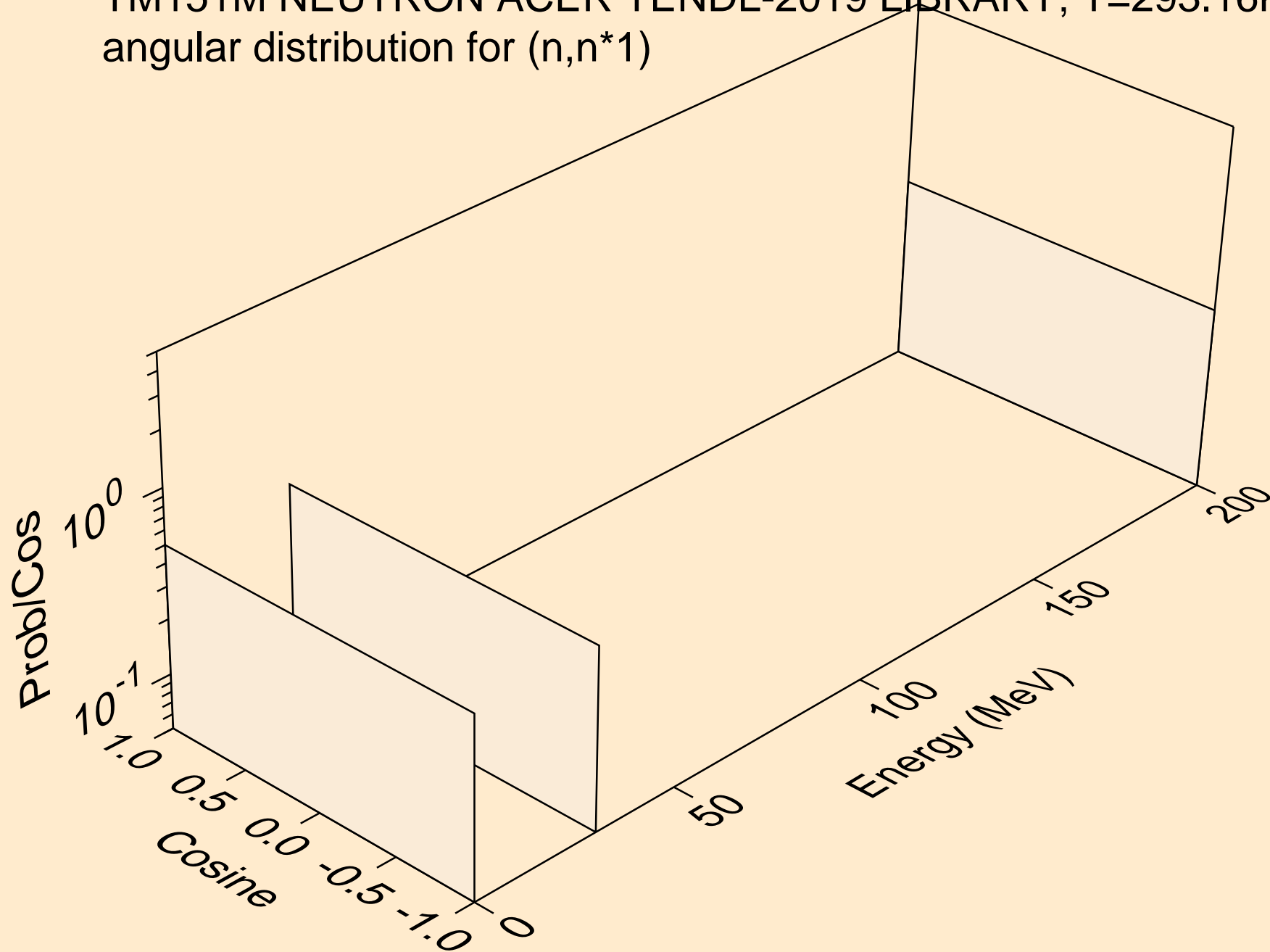

TM151M NEUTRON ACER TENDL-2019 LIBRARY; T=293.16K
angular distribution for (n,n*2)

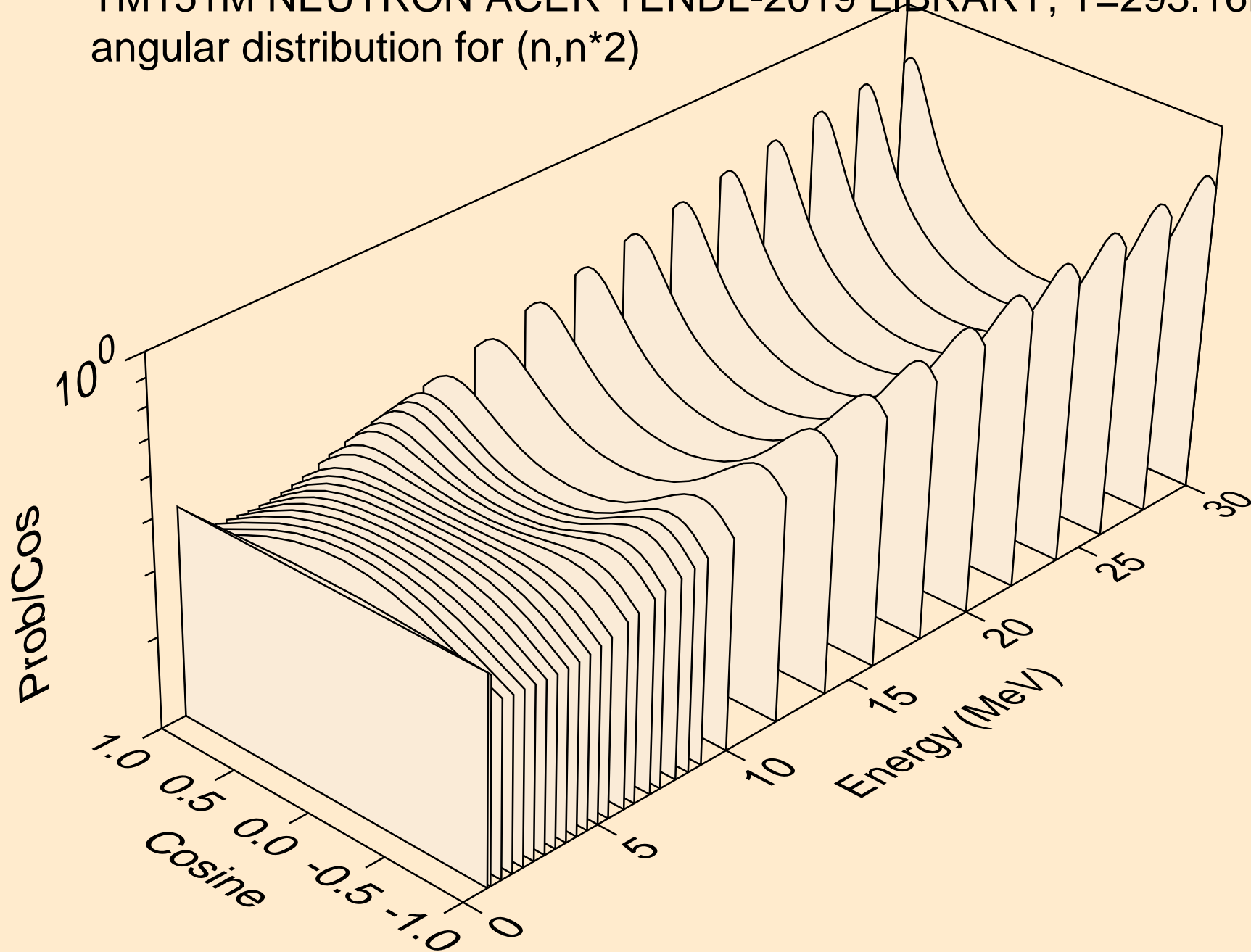

TM151M NEUTRON ACER TENDL-2019 LIBRARY; T=293.16K
Neutron emission for (n,x)

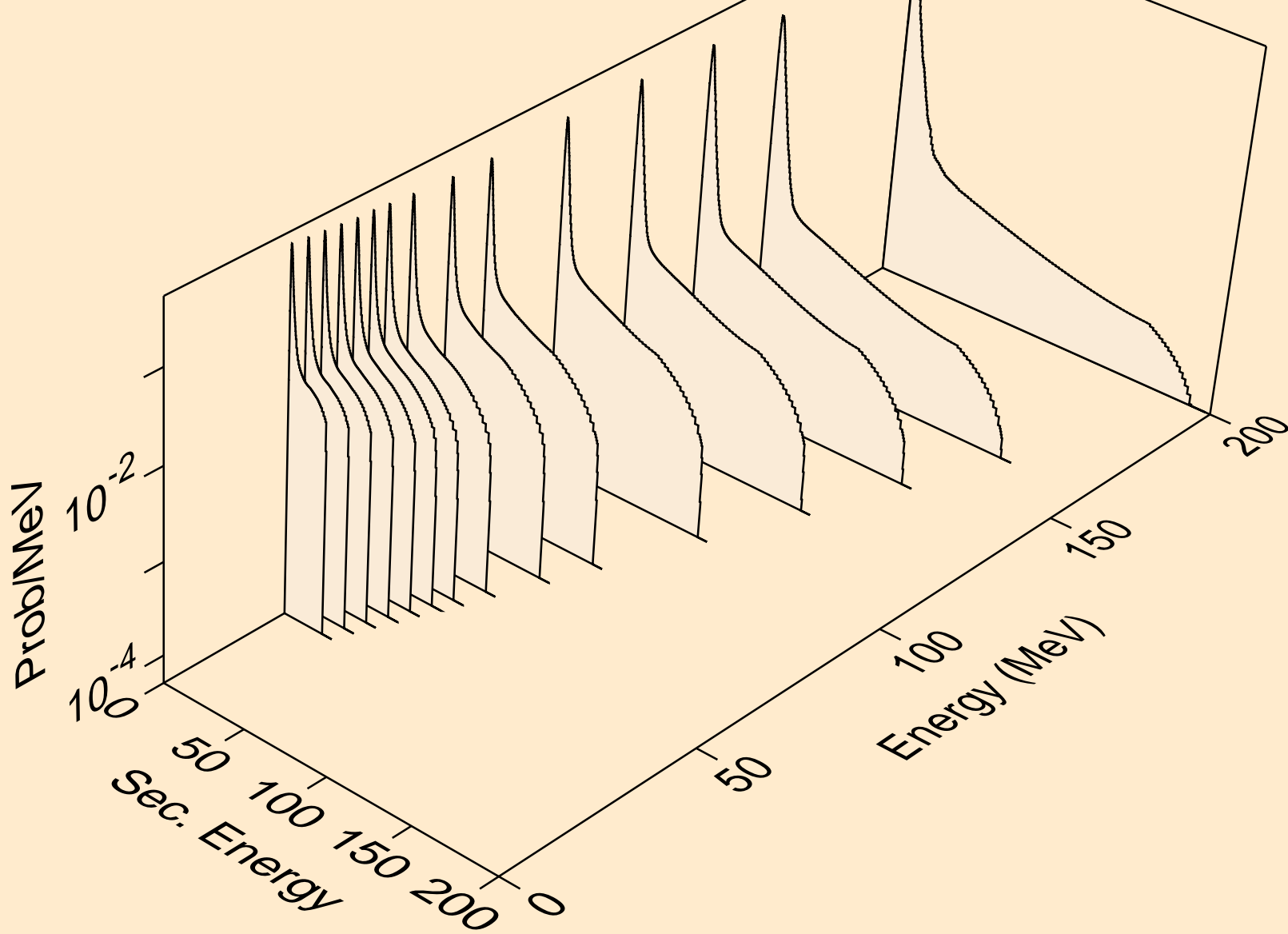

TM151M NEUTRON ACER TENDL-2019 LIBRARY; T=293.16K
Neutron emission for (n,2nd)

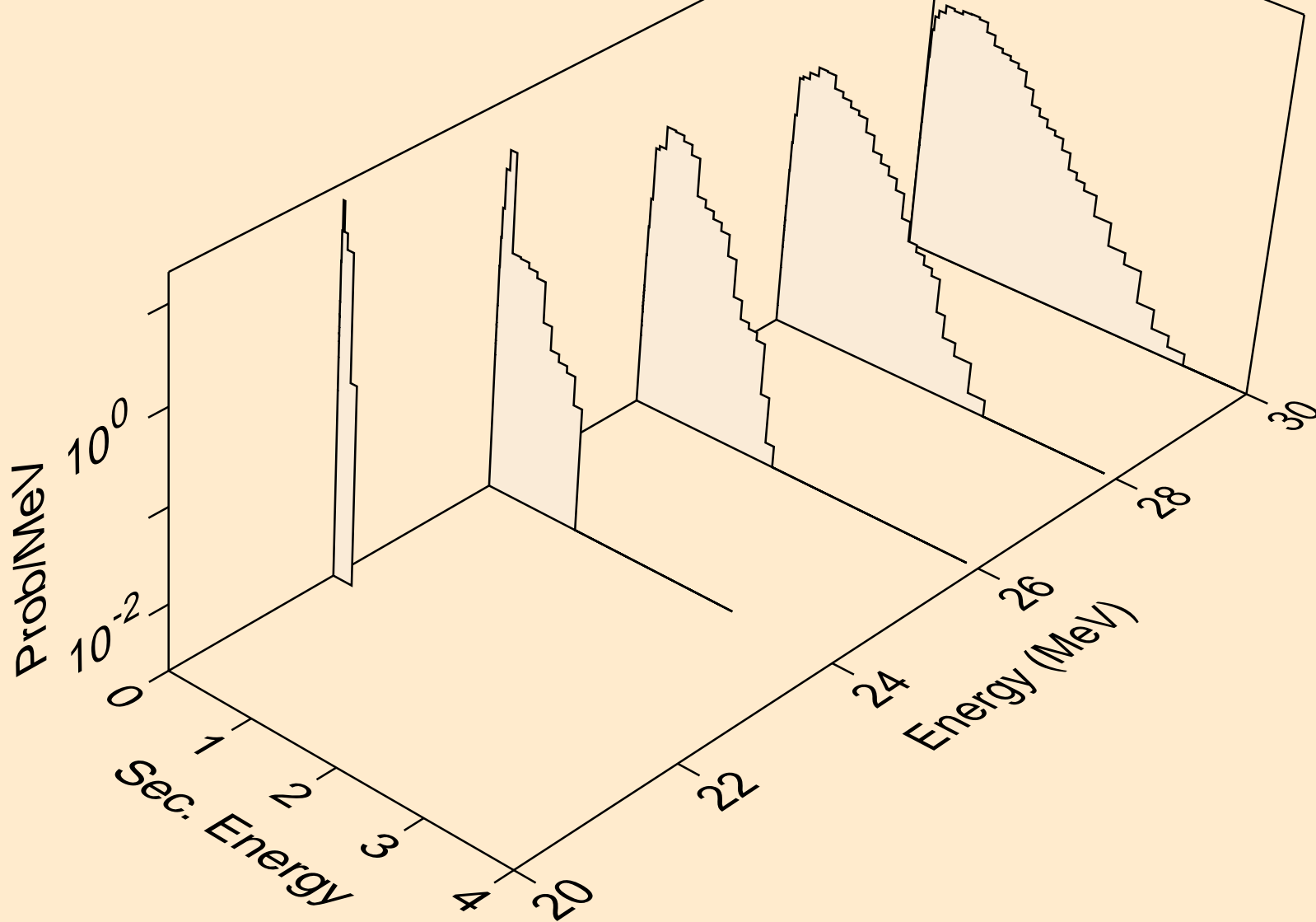

TM151M NEUTRON ACER TENDL-2019 LIBRARY; T=293.16K
Neutron emission for (n,2n)

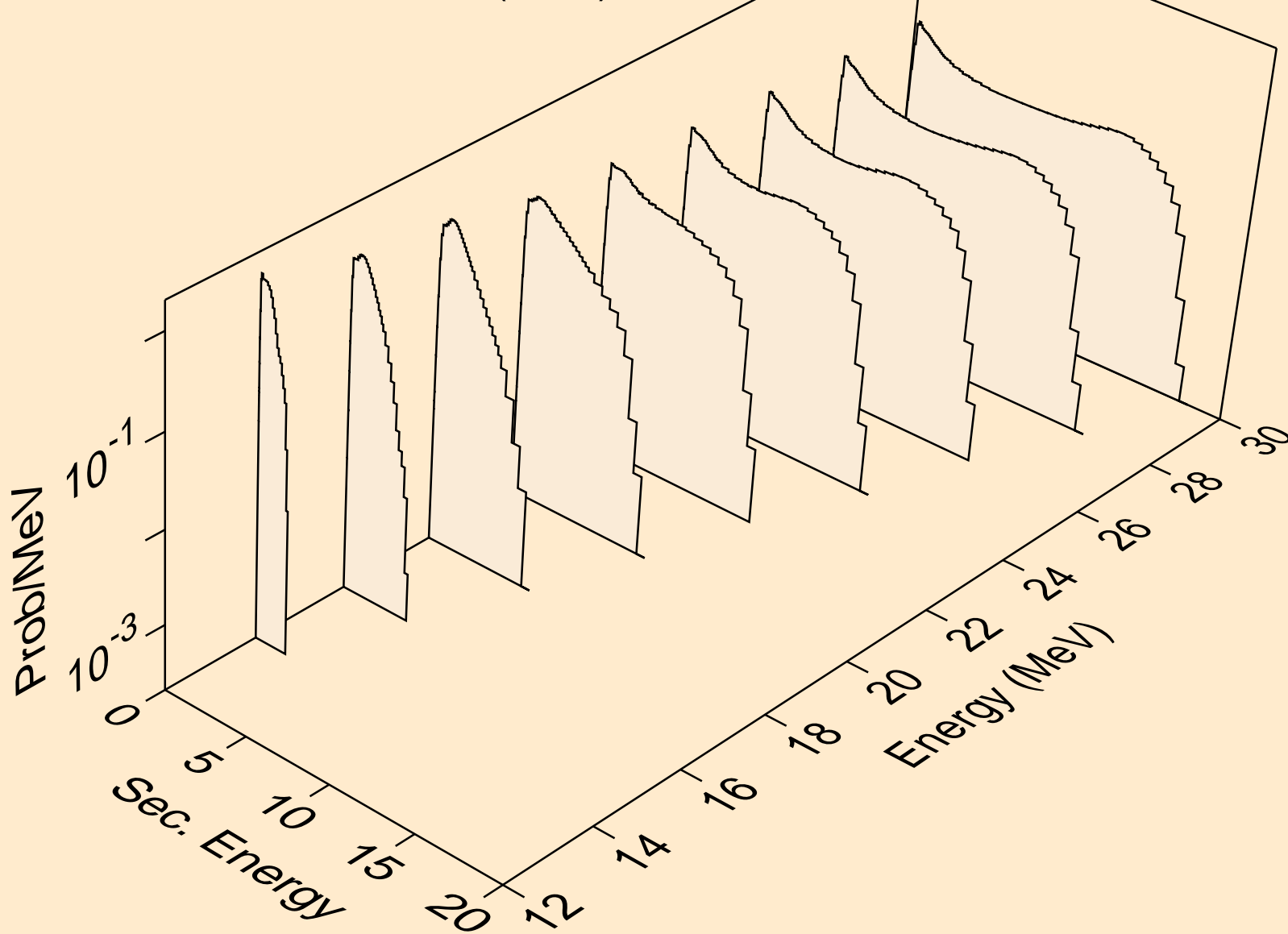

TM151M NEUTRON ACER TENDL-2019 LIBRARY; T=293.16K
Neutron emission for (n,3n)

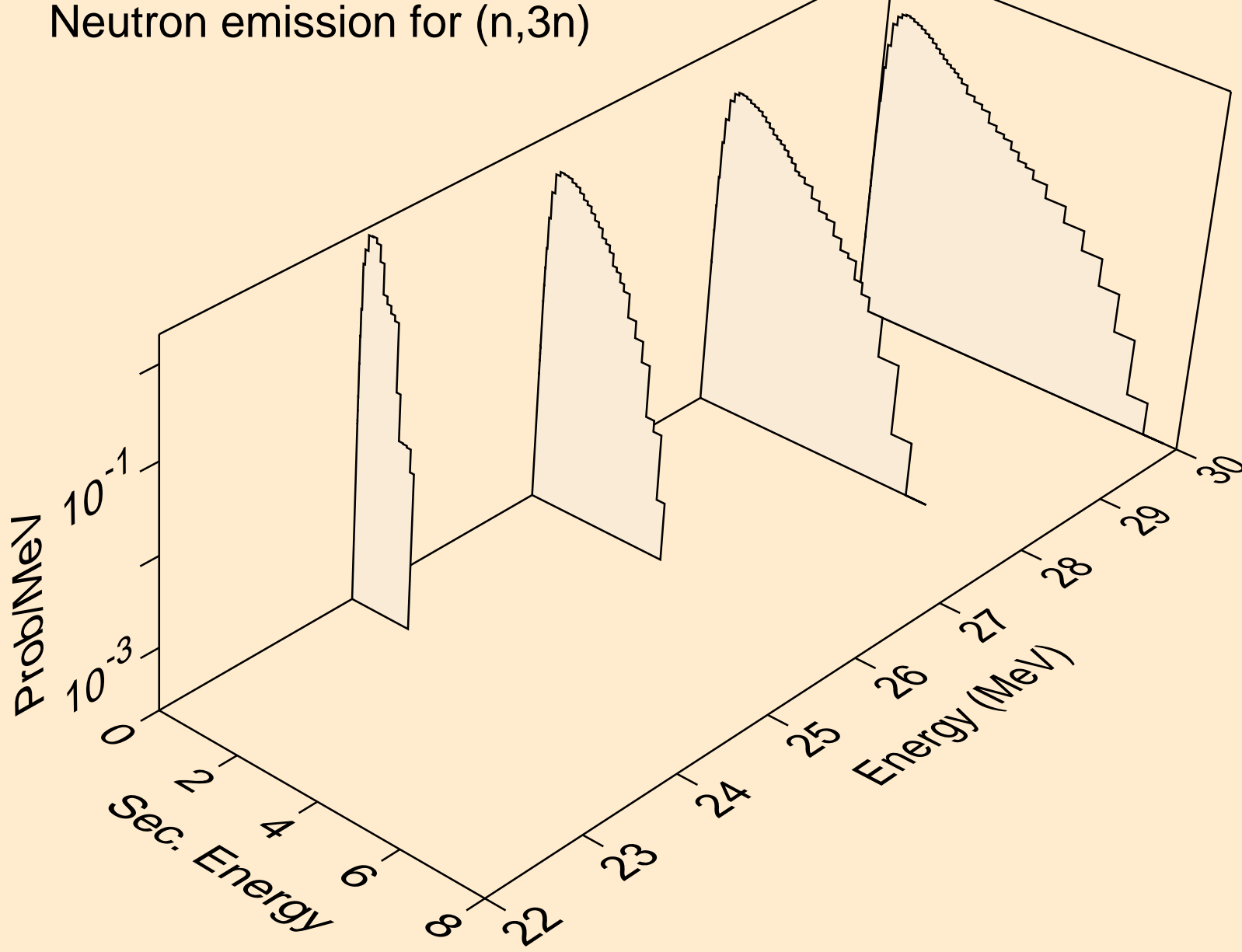

TM151M NEUTRON ACER TENDL-2019 LIBRARY; T=293.16K
Neutron emission for (n,n*)a

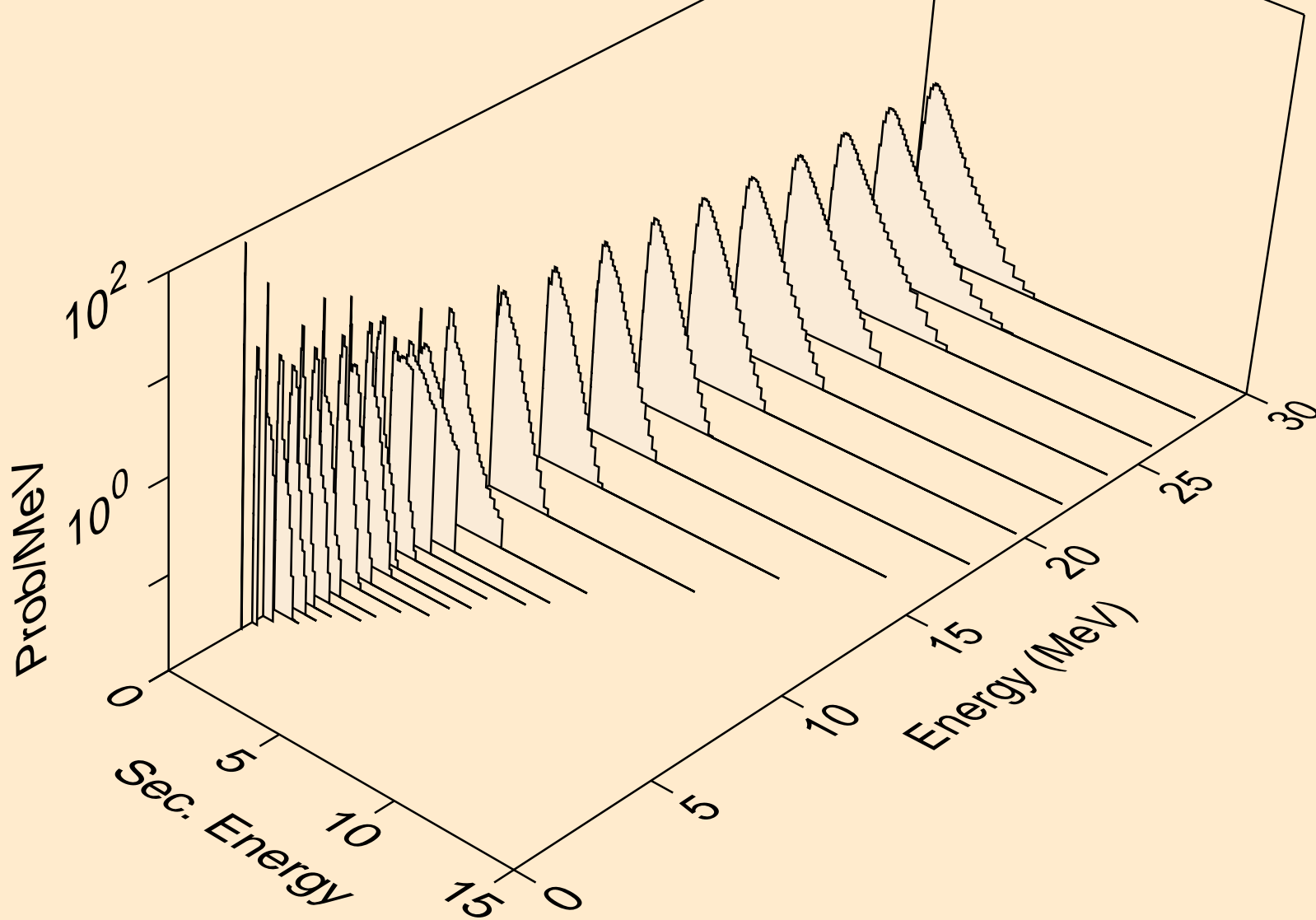

TM151M NEUTRON ACER TENDL-2019 LIBRARY; T=293.16K
Neutron emission for (n,2n)a

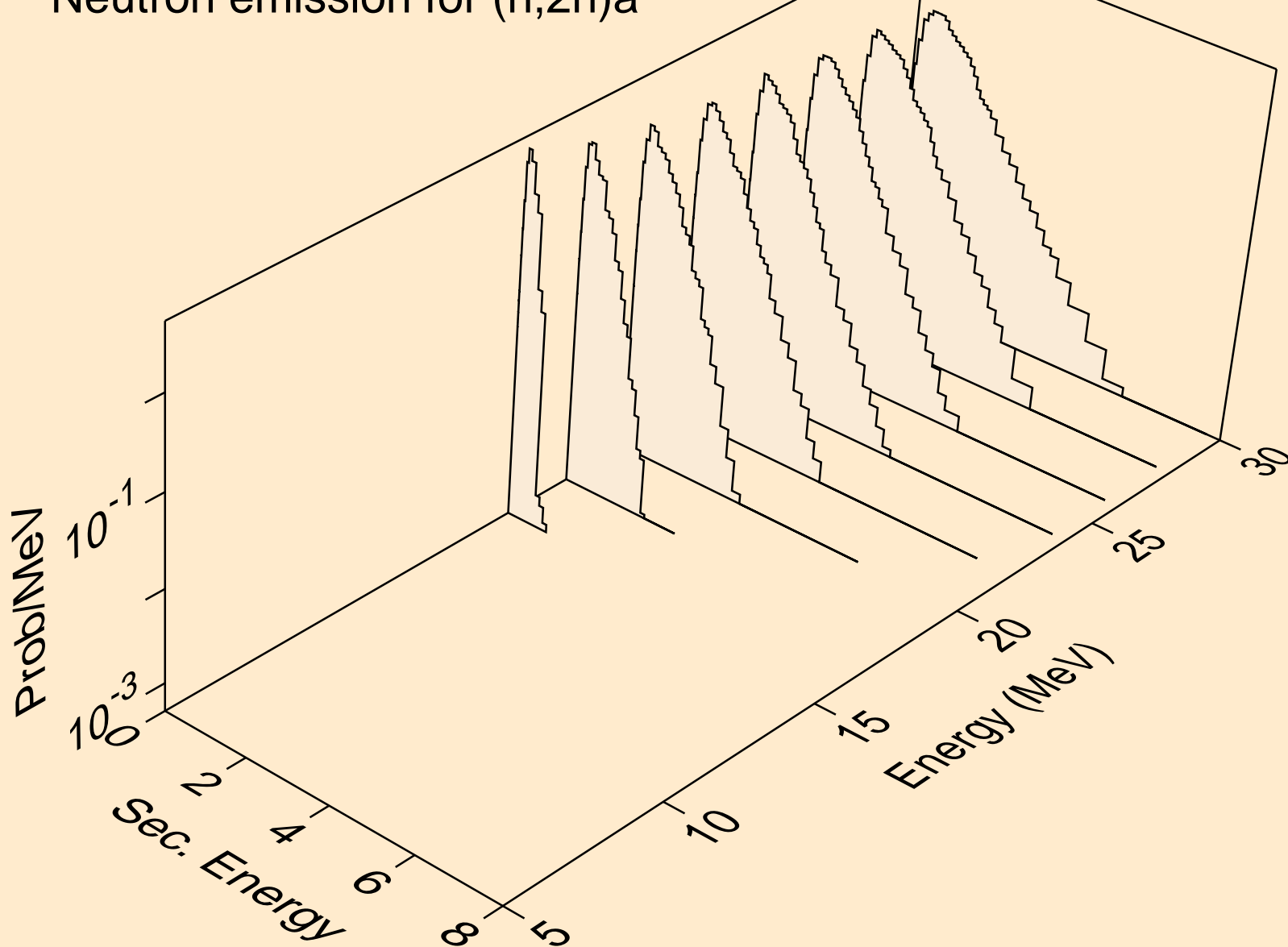

TM151M NEUTRON ACER TENDL-2019 LIBRARY; T=293.16K
Neutron emission for (n,n*)p

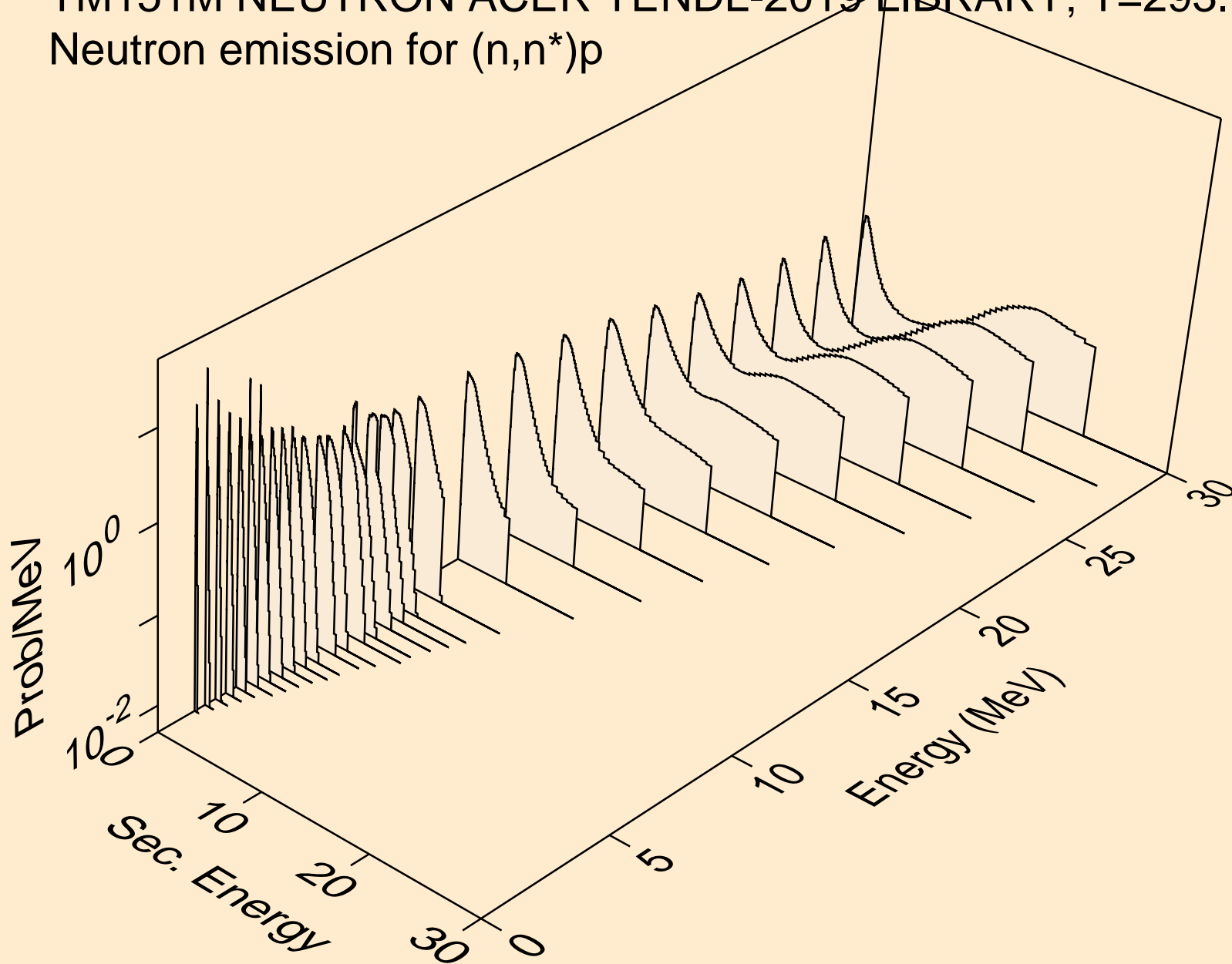

TM151M NEUTRON ACER TENDL-2019 LIBRARY; T=293.16K
Neutron emission for (n,n*)2a

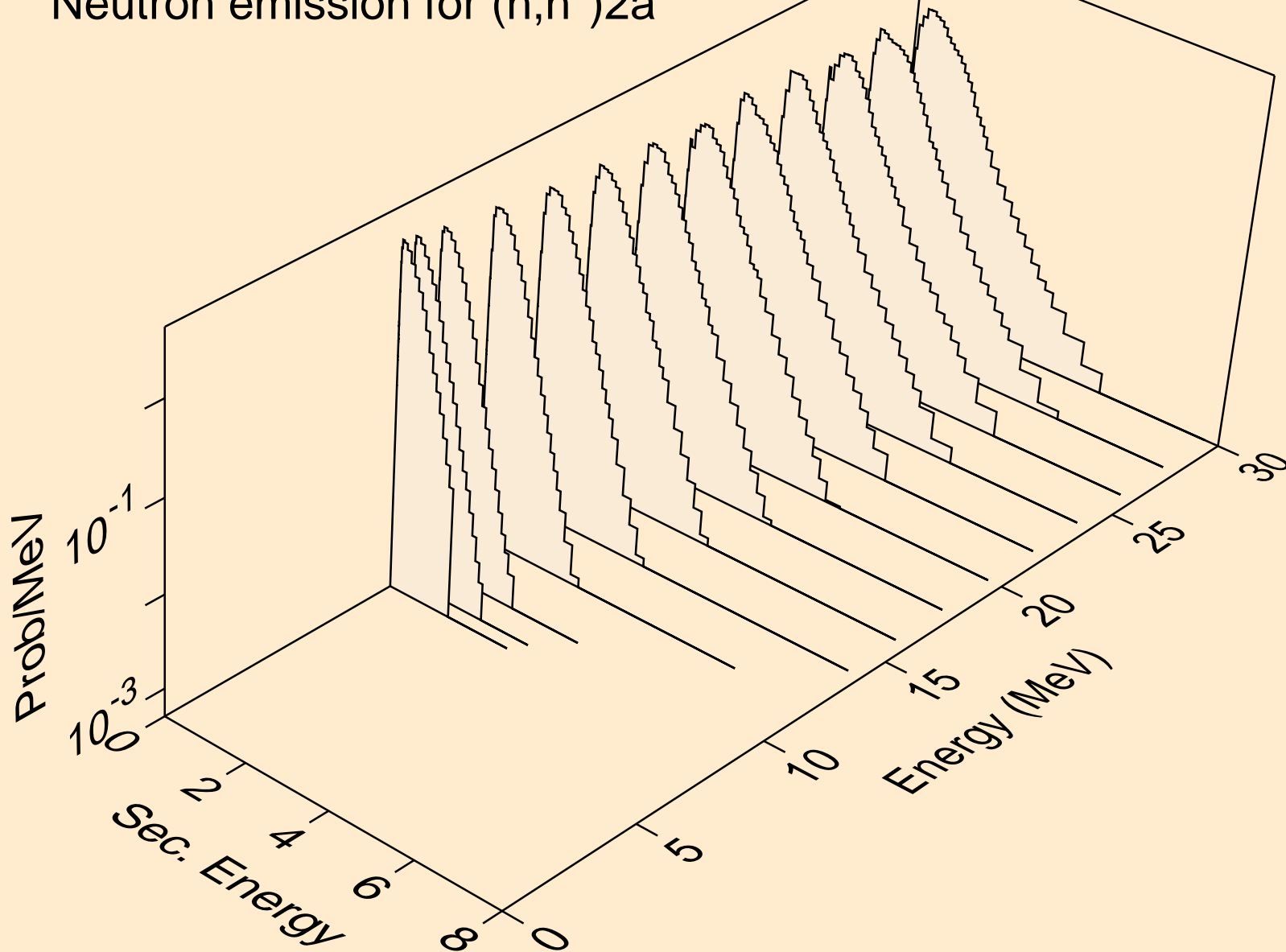

TM151M NEUTRON ACER TENDL-2019 LIBRARY; T=293.16K
Neutron emission for (n,n*)d

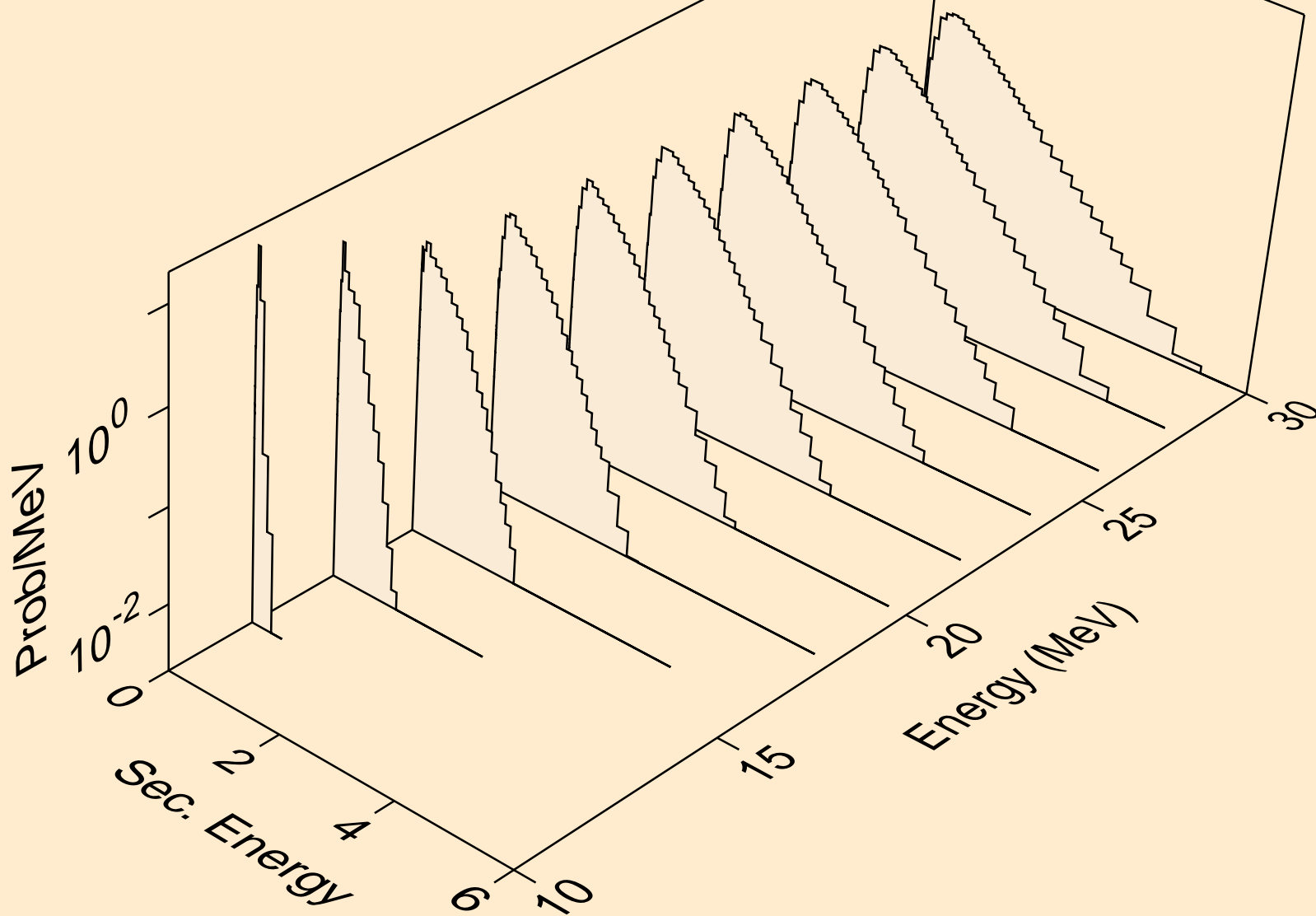

TM151M NEUTRON ACER TENDL-2019 LIBRARY; T=293.16K
Neutron emission for (n,n*)t

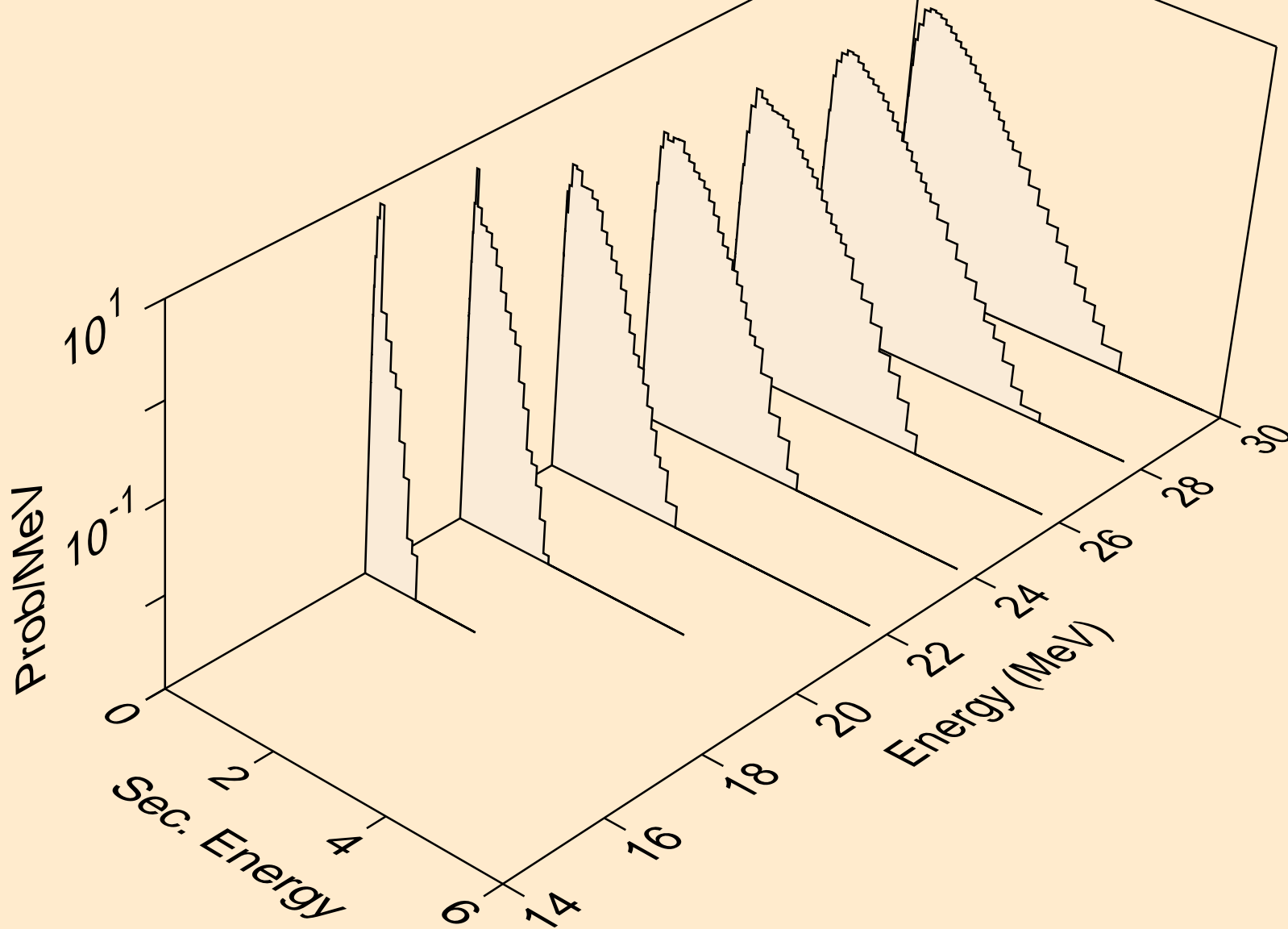

TM151M NEUTRON ACER TENDL-2019 LIBRARY; T=293.16K
Neutron emission for (n,n*)he3

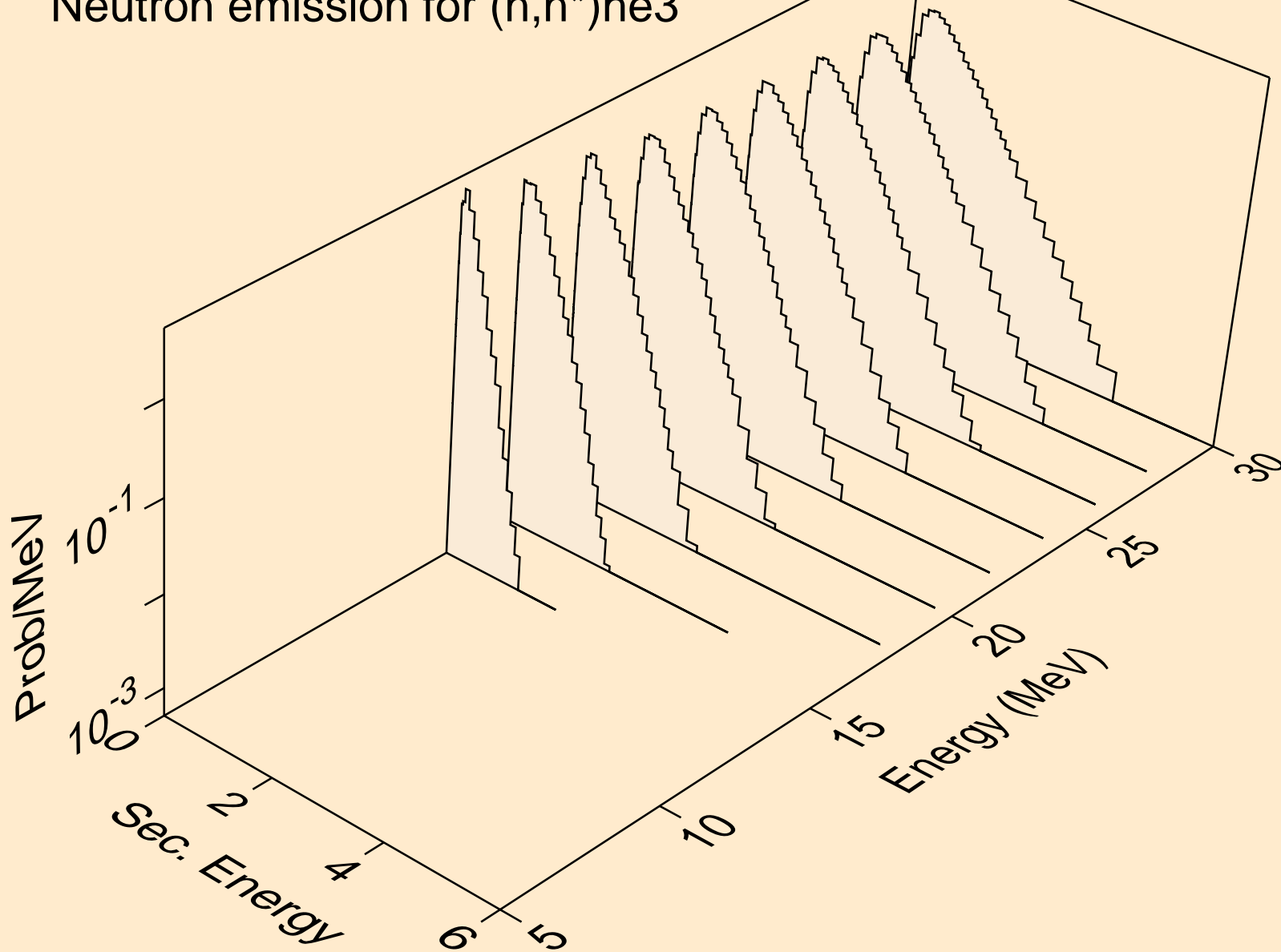

TM151M NEUTRON ACER TENDL-2019 LIBRARY; T=293.16K
Neutron emission for (n,2np)

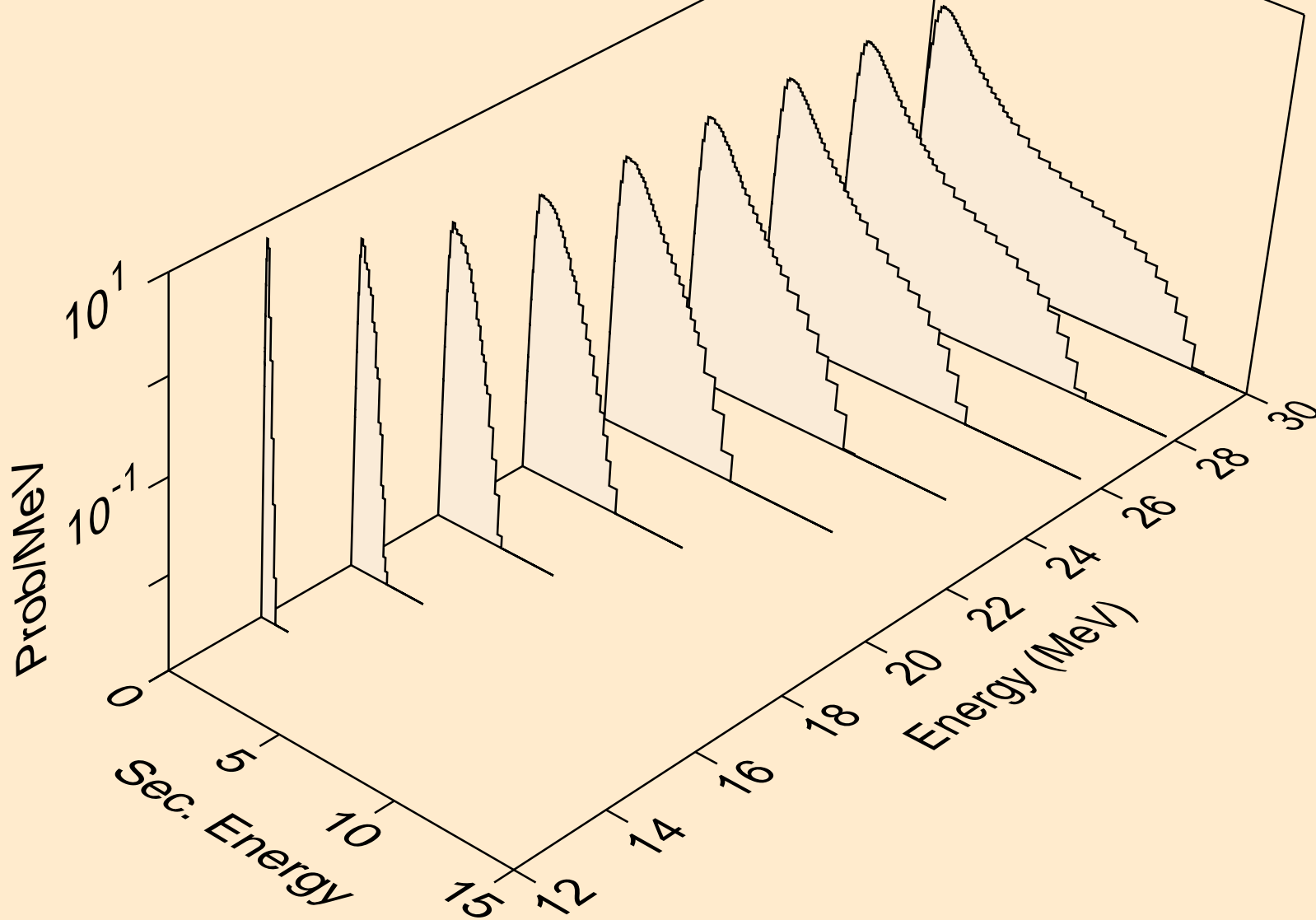

TM151M NEUTRON ACER TENDL-2019 LIBRARY; T=293.16K
Neutron emission for (n,3np)

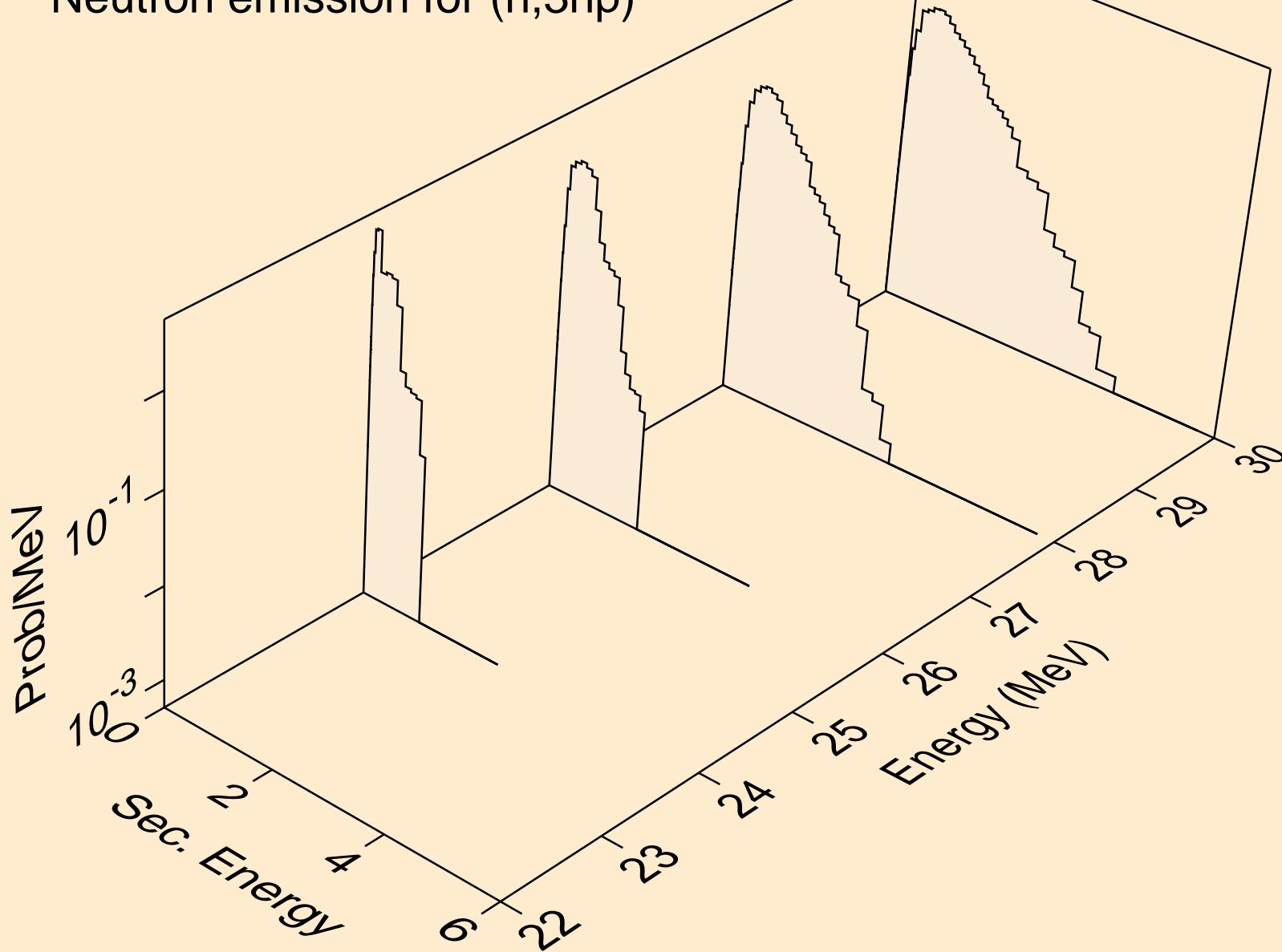

TM151M NEUTRON ACER TENDL-2019 LIBRARY; T=293.16K
Neutron emission for (n,2np)

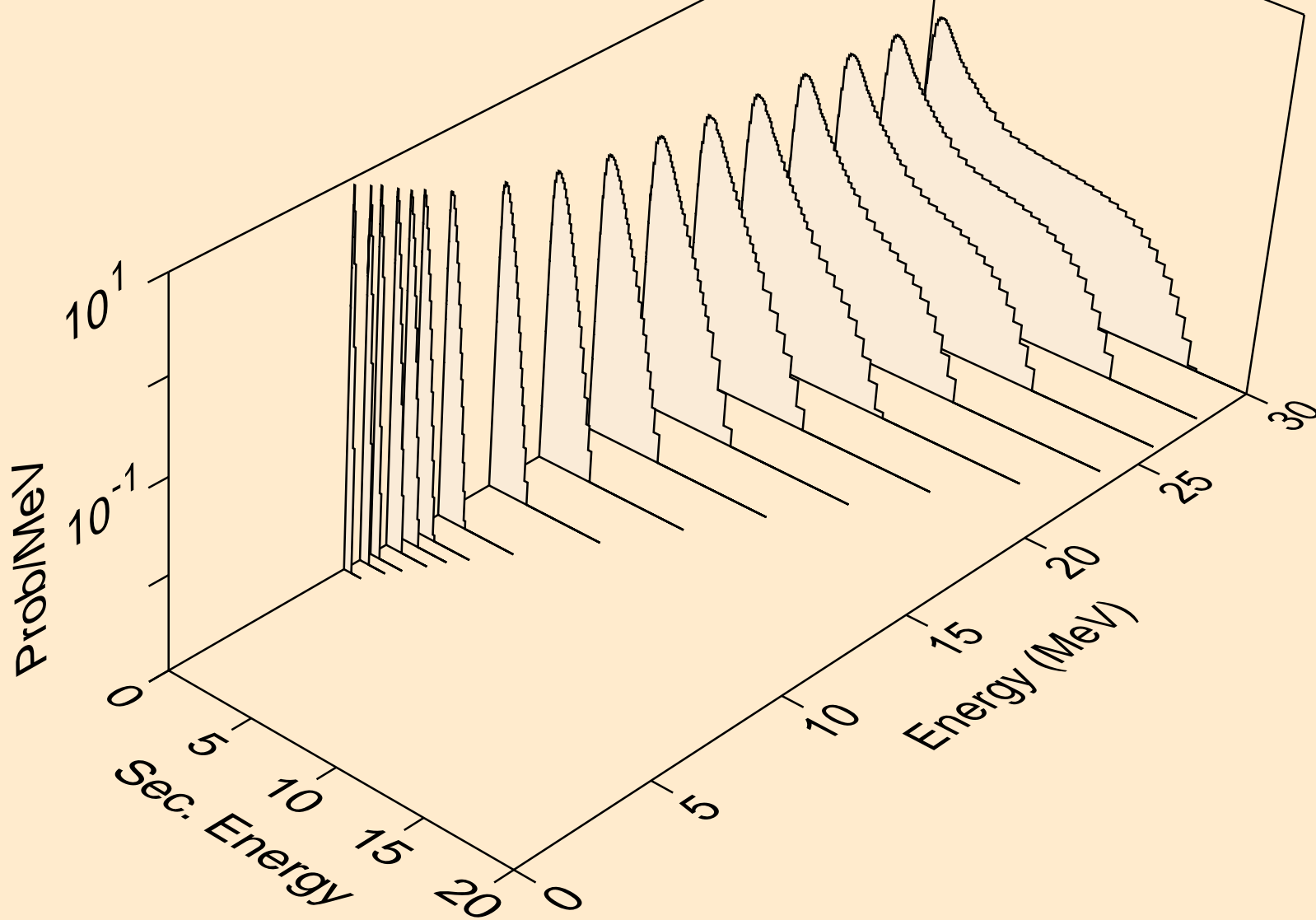

TM151M NEUTRON ACER TENDL-2019 LIBRARY; T=293.16K
Neutron emission for (n,npa)

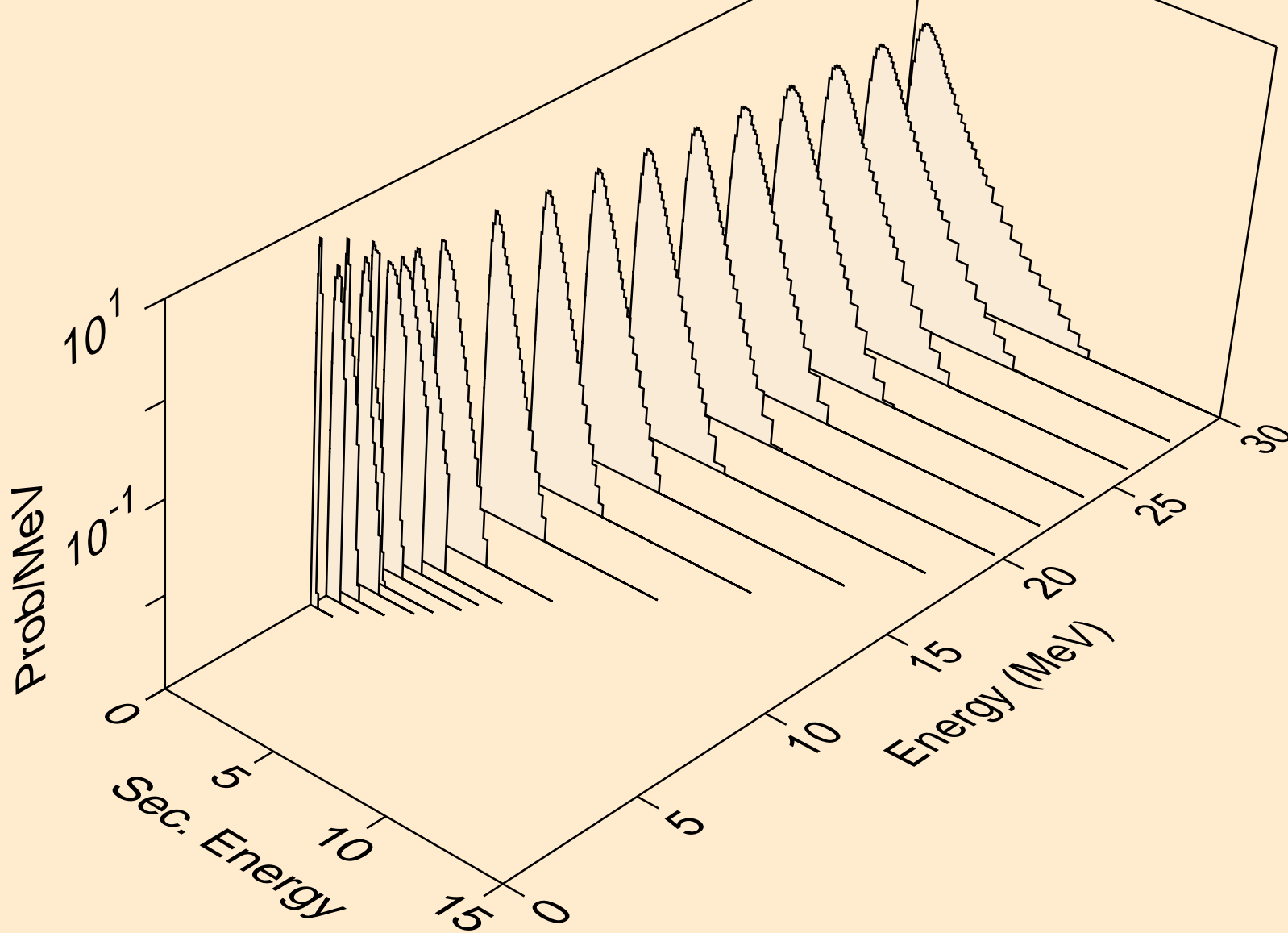

TM151M NEUTRON ACER TENDL-2019 LIBRARY; T=293.16K
Neutron emission for (n,n*c)

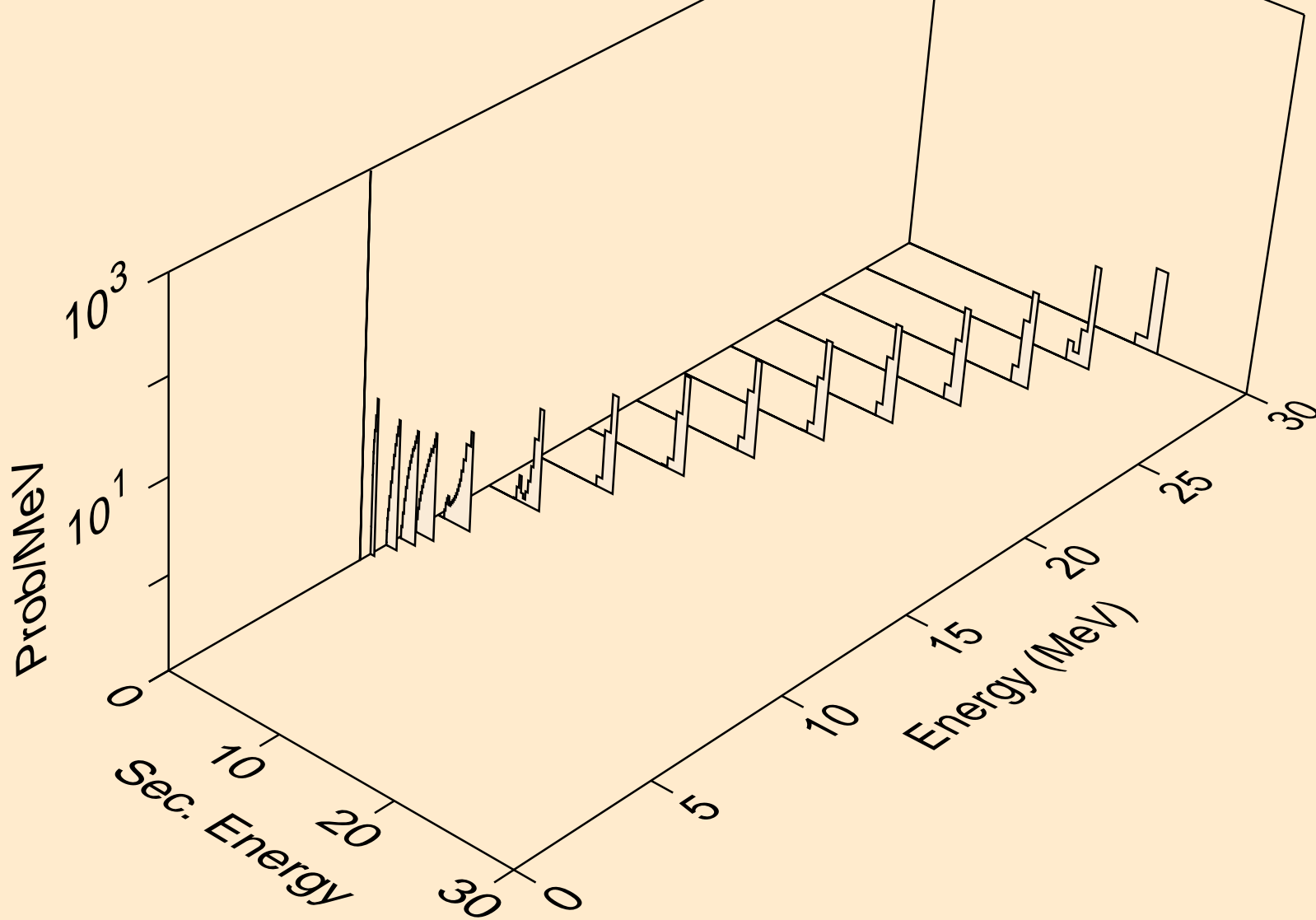

TM151M NEUTRON ACER TENDL-2019 LIBRARY; T=293.16K
Photon emission for (n,x)

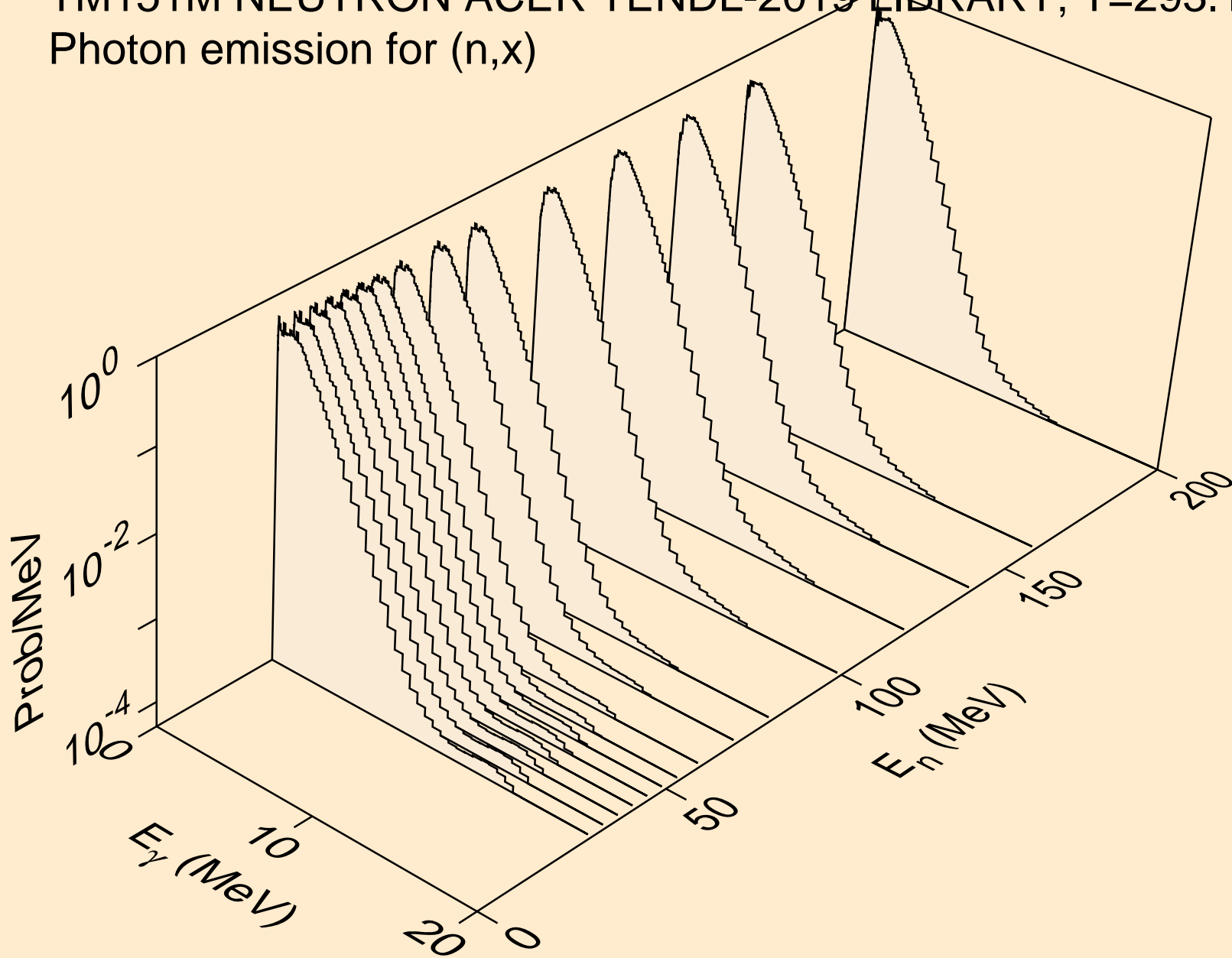

TM151M NEUTRON ACER TENDL-2019 LIBRARY; T=293.16K
Photon emission for (n,2nd)

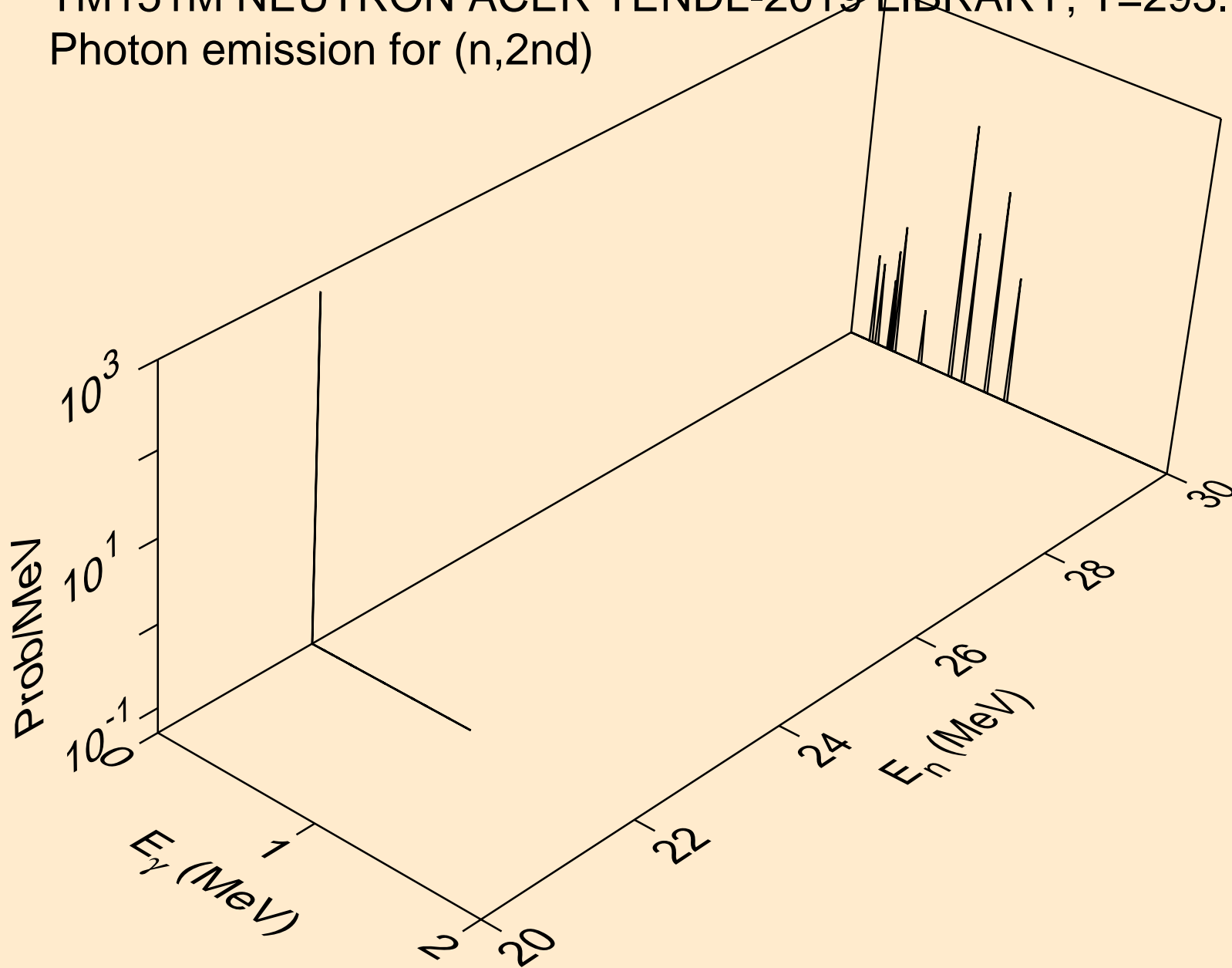

TM151M NEUTRON ACER TENDL-2019 LIBRARY; T=293.16K
Photon emission for (n,2n)

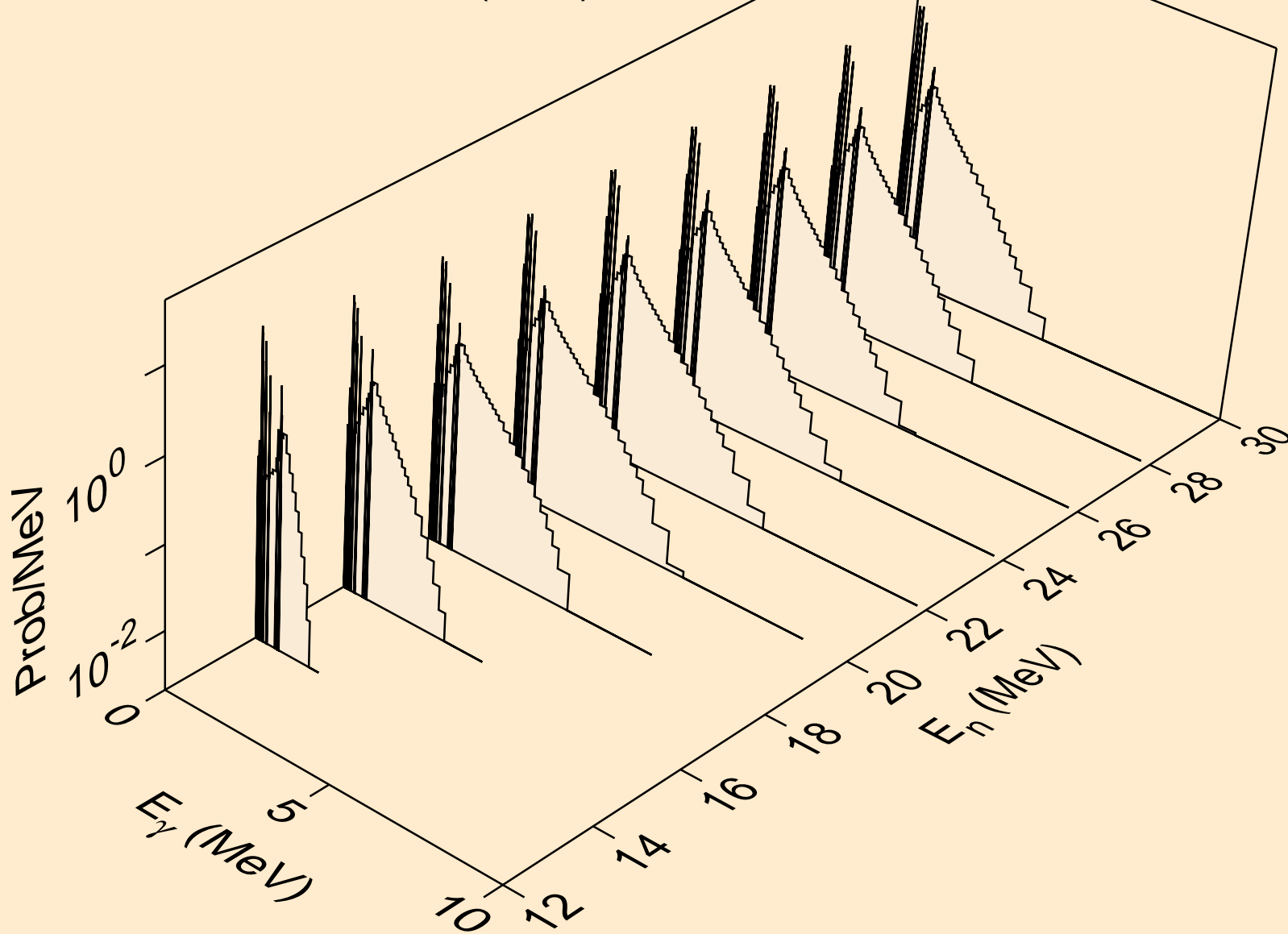

TM151M NEUTRON ACER TENDL-2019 LIBRARY; T=293.16K
Photon emission for (n,3n)

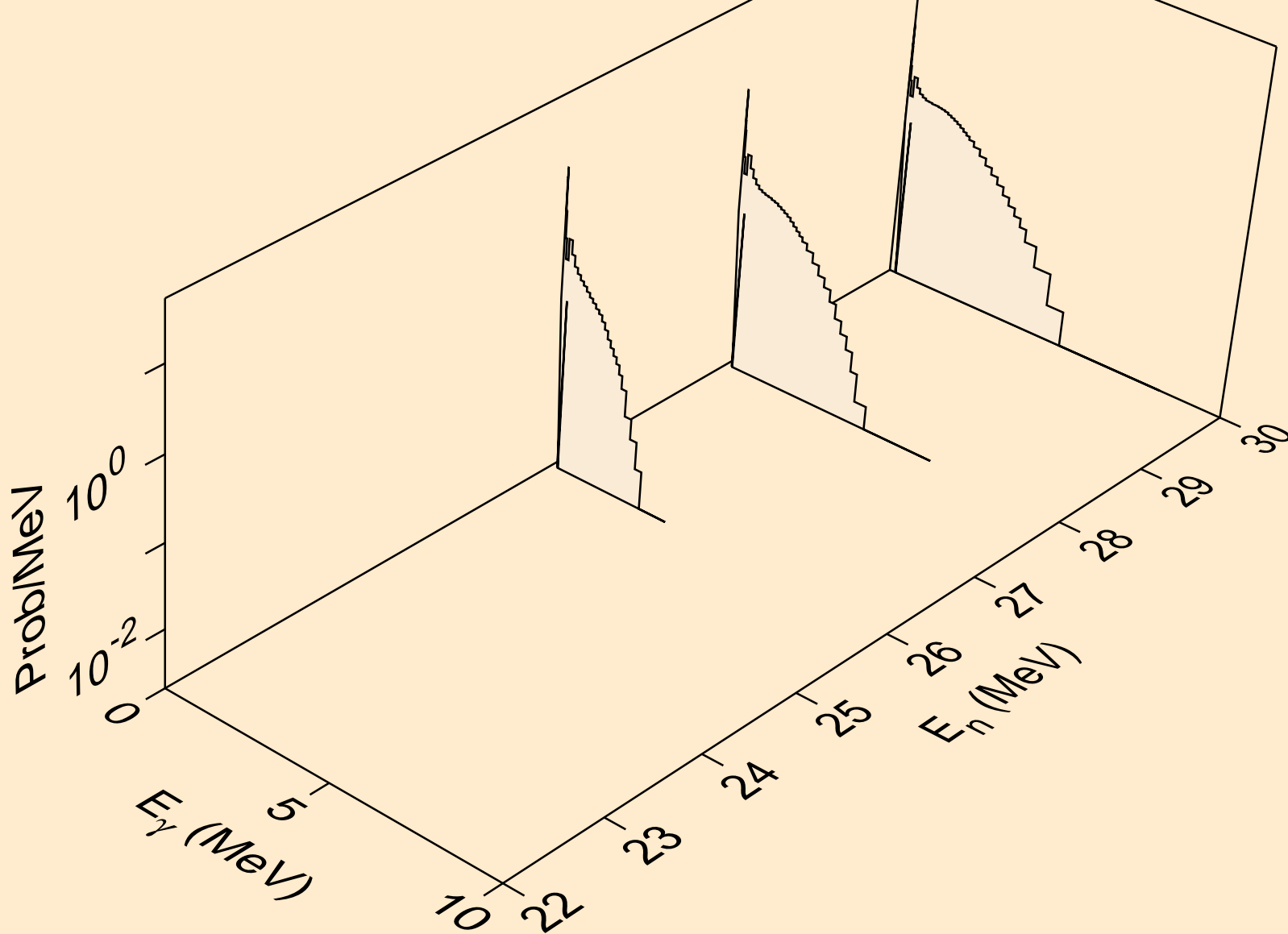

TM151M NEUTRON ACER TENDL-2019 LIBRARY; T=293.16K
Photon emission for (n,n*)a

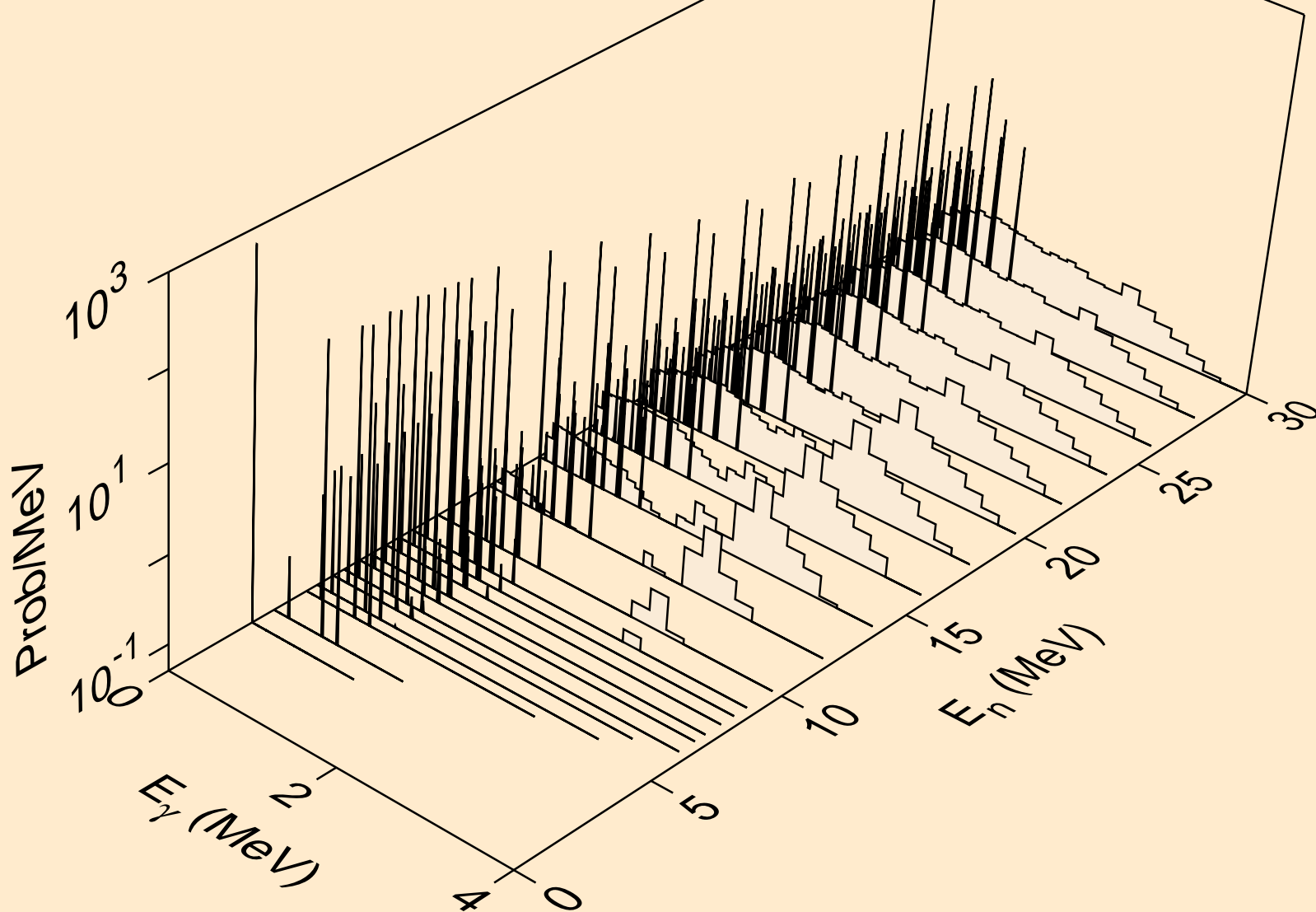

TM151M NEUTRON ACER TENDL-2019 LIBRARY; T=293.16K
Photon emission for (n,2n)a

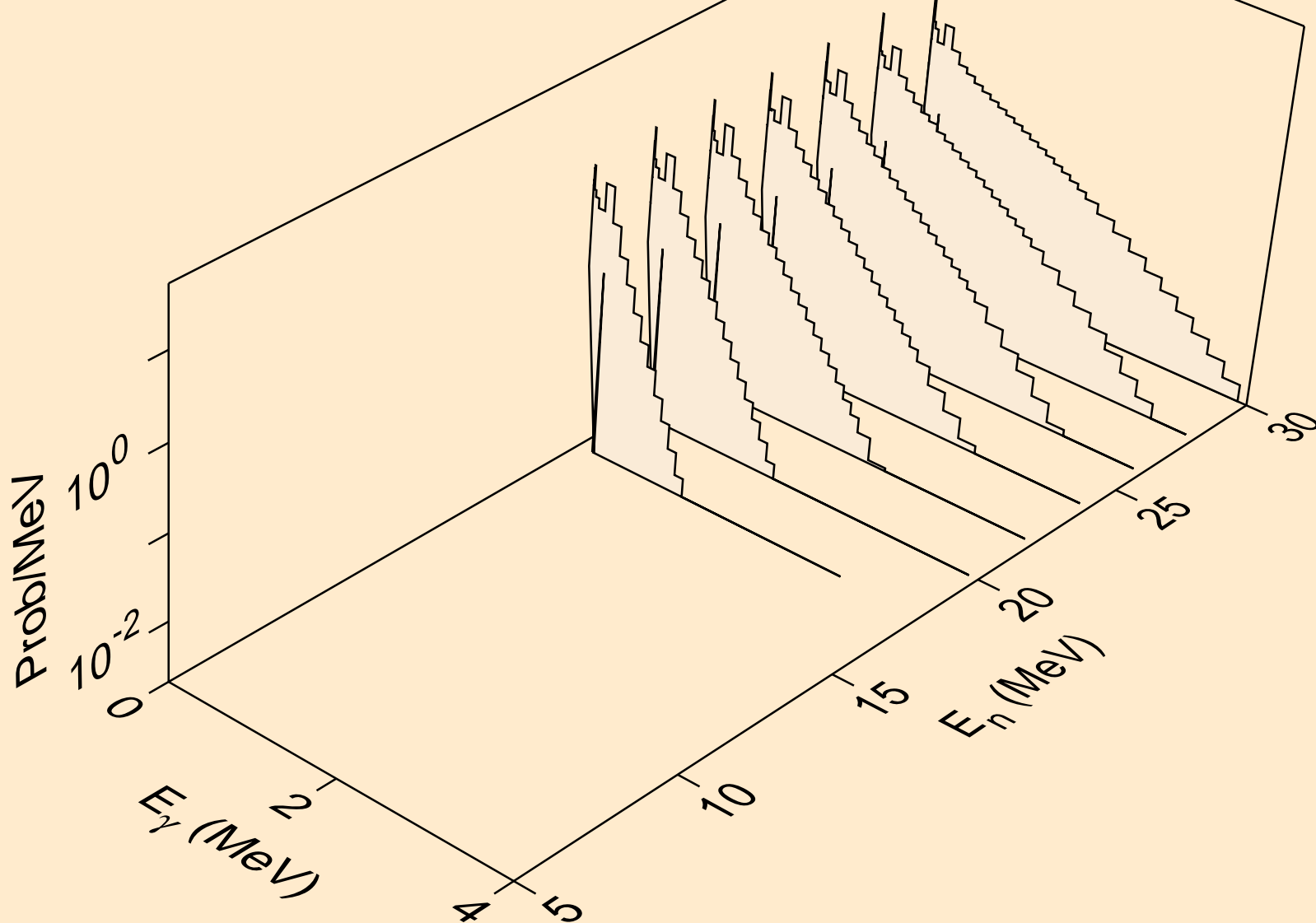

TM151M NEUTRON ACER TENDL-2019 LIBRARY; T=293.16K
Photon emission for (n,n*)p

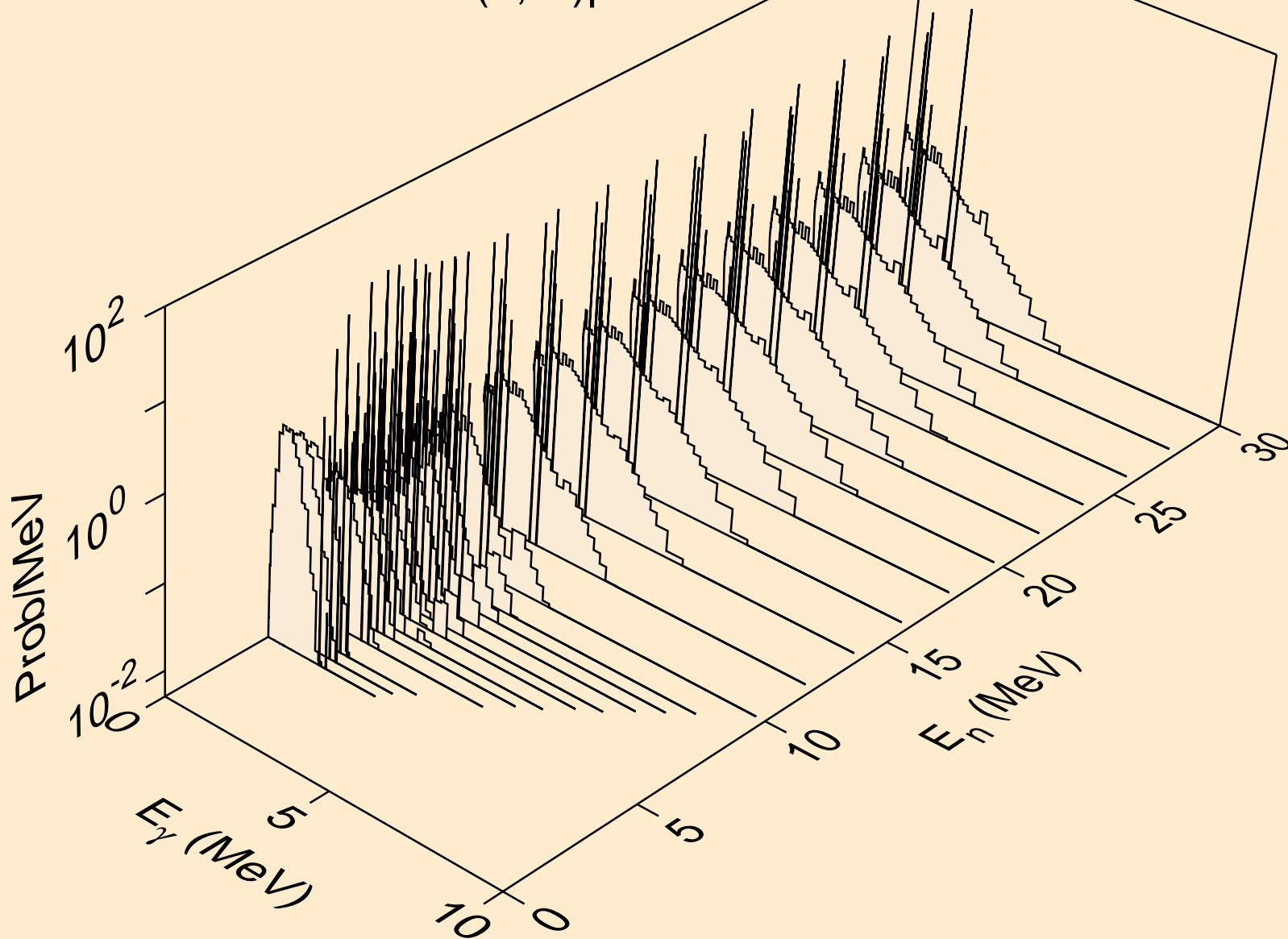

TM151M NEUTRON ACER TENDL-2019 LIBRARY; T=293.16K
Photon emission for (n,n*)2a

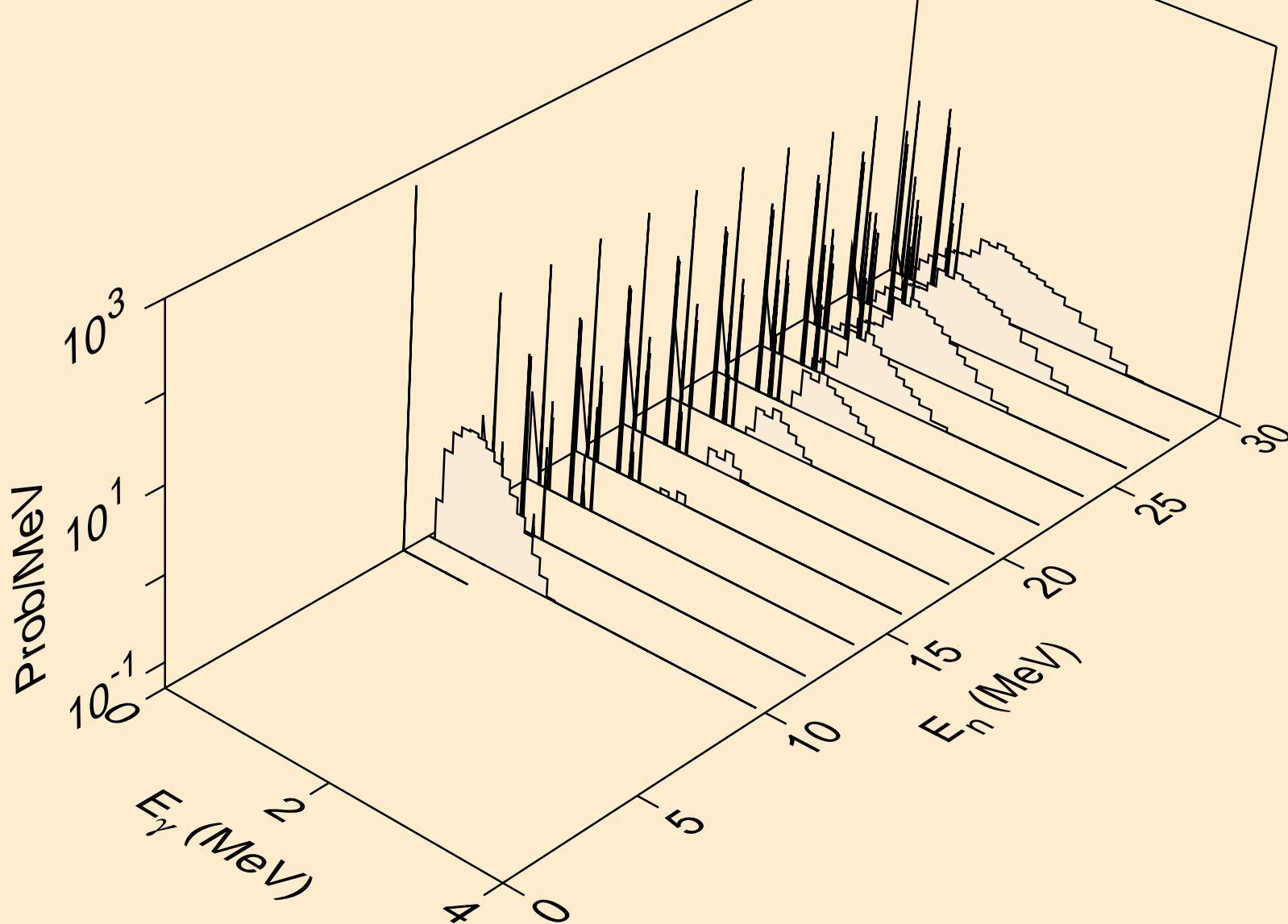

TM151M NEUTRON ACER TENDL-2019 LIBRARY; T=293.16K
Photon emission for (n,n*)d

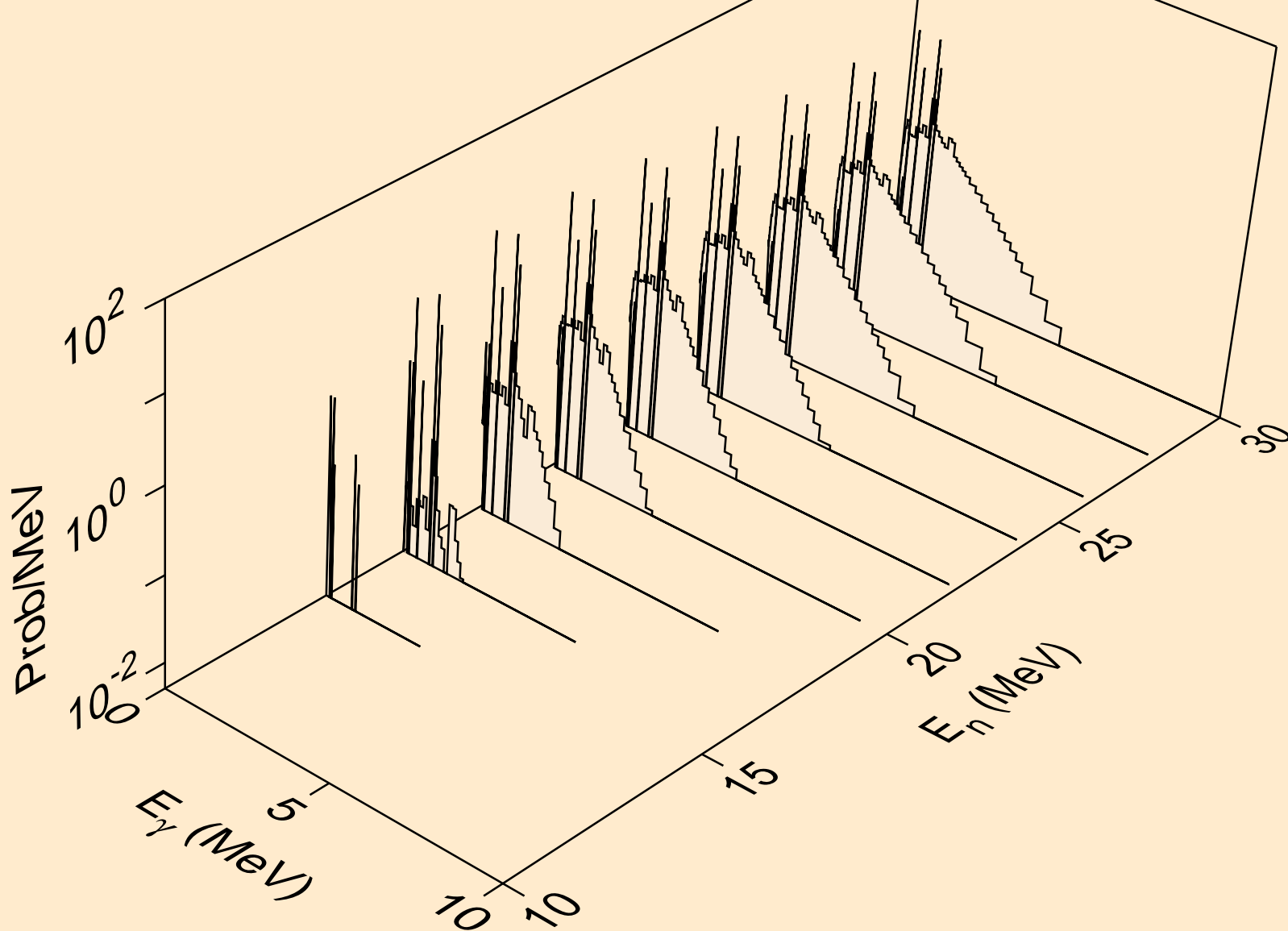

TM151M NEUTRON ACER TENDL-2019 LIBRARY; T=293.16K
Photon emission for (n,n*)t

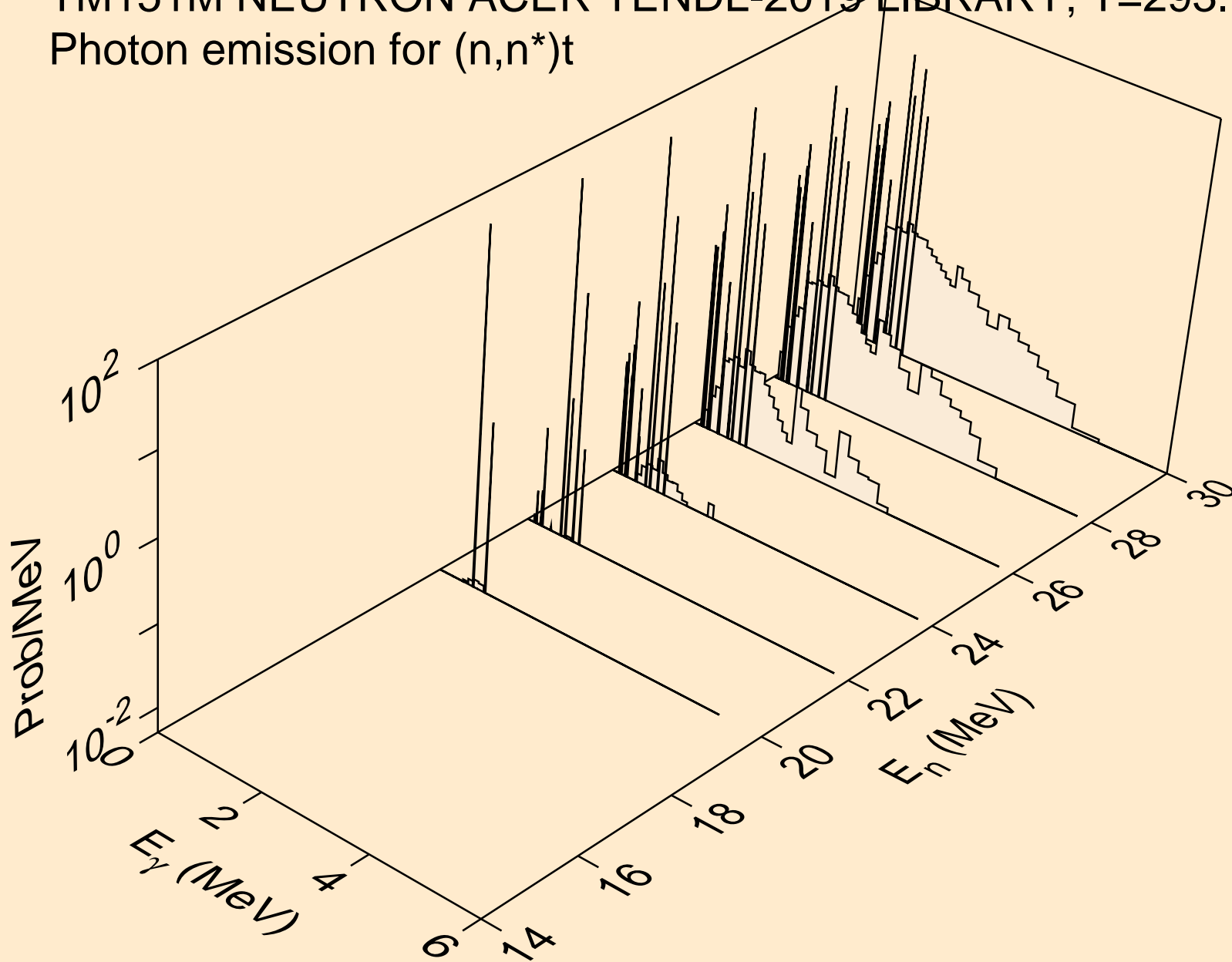

TM151M NEUTRON ACER TENDL-2019 LIBRARY; T=293.16K
Photon emission for (n,n*)he3

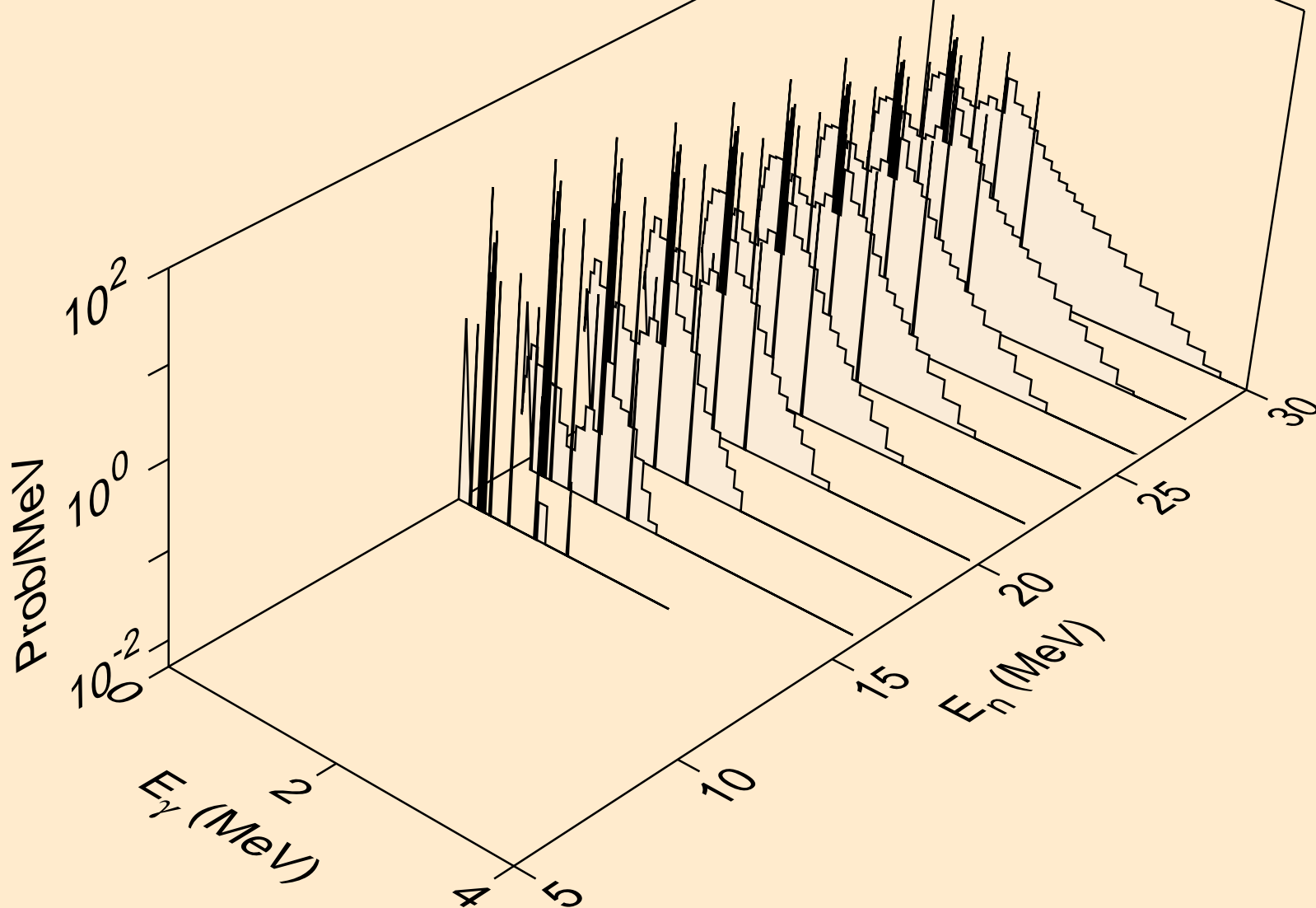

TM151M NEUTRON ACER TENDL-2019 LIBRARY; T=293.16K
Photon emission for (n,2np)

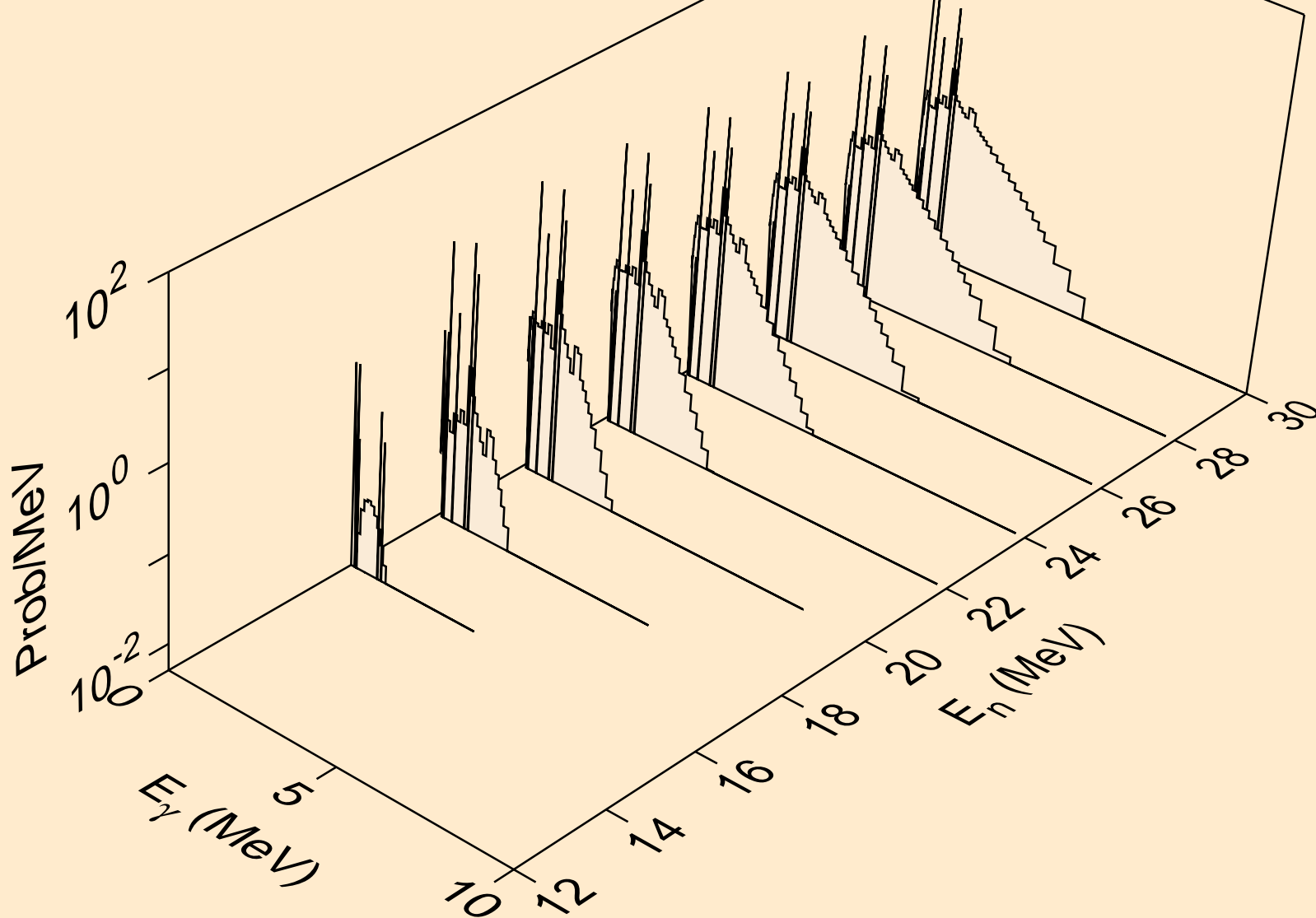

TM151M NEUTRON ACER TENDL-2019 LIBRARY; T=293.16K
Photon emission for (n,3np)

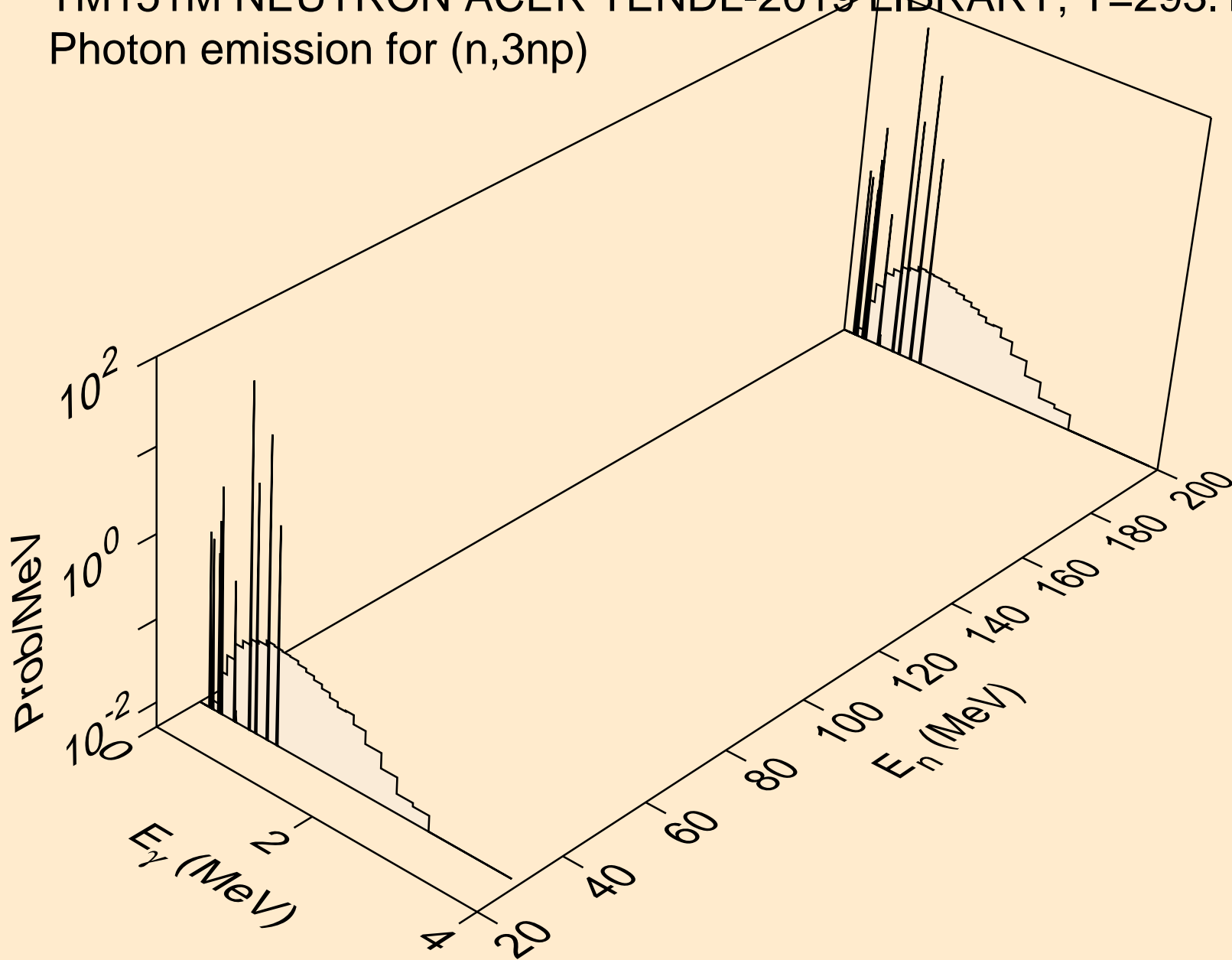

TM151M NEUTRON ACER TENDL-2019 LIBRARY; T=293.16K
Photon emission for (n,2np)

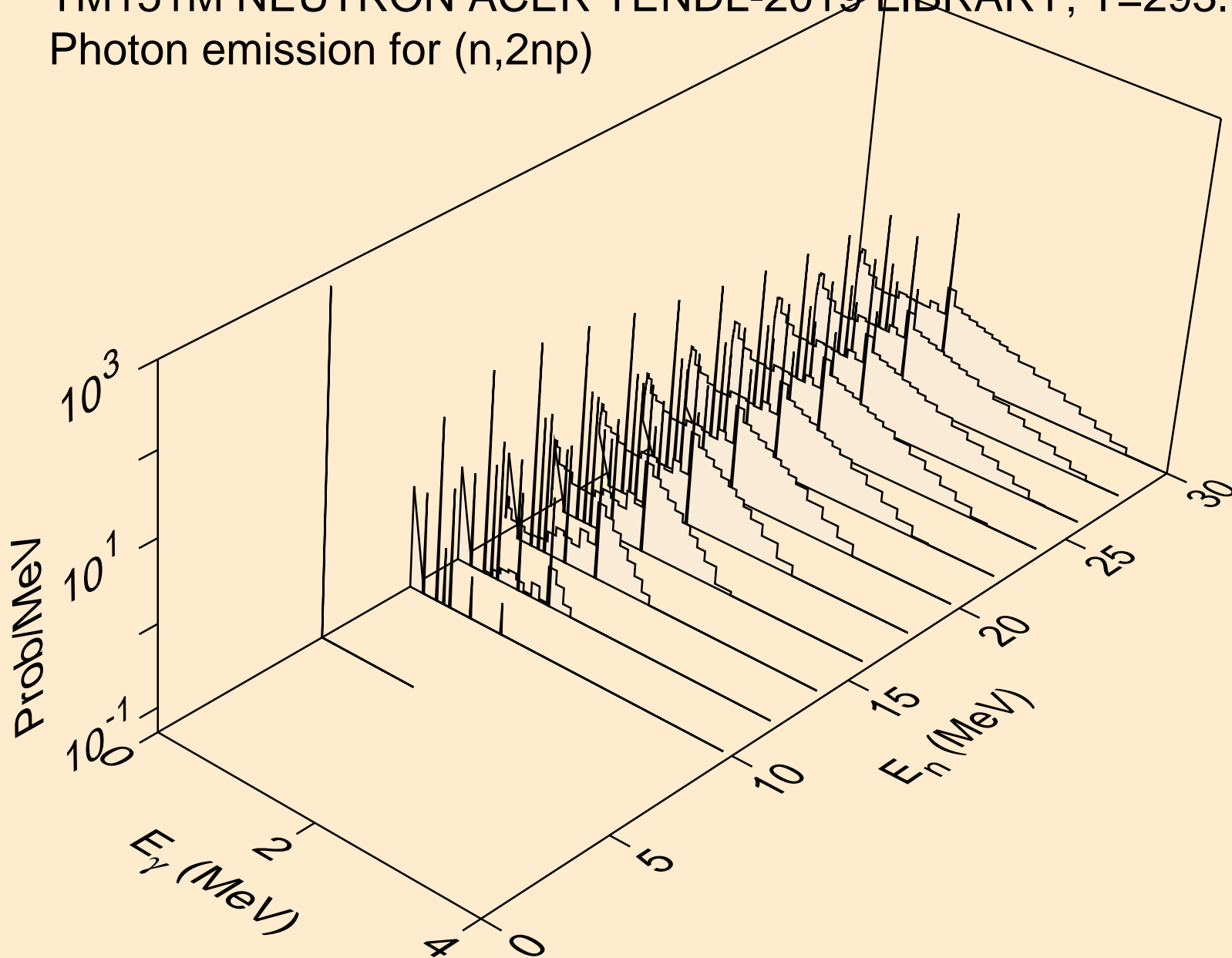

TM151M NEUTRON ACER TENDL-2019 LIBRARY; T=293.16K
Photon emission for (n,npa)

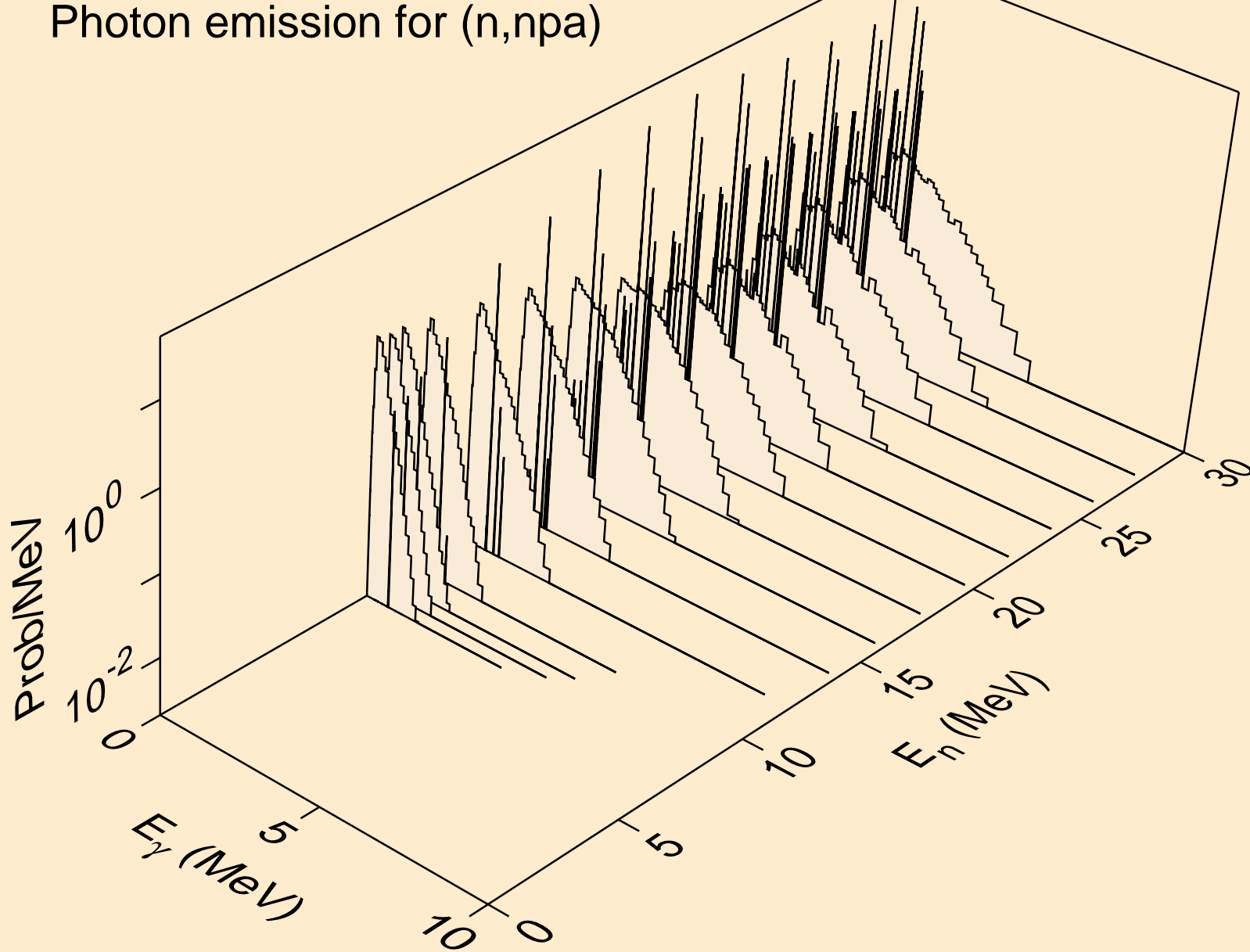

TM151M NEUTRON ACER TENDL-2019 LIBRARY; T=293.16K
Photon emission for (n,n*2)

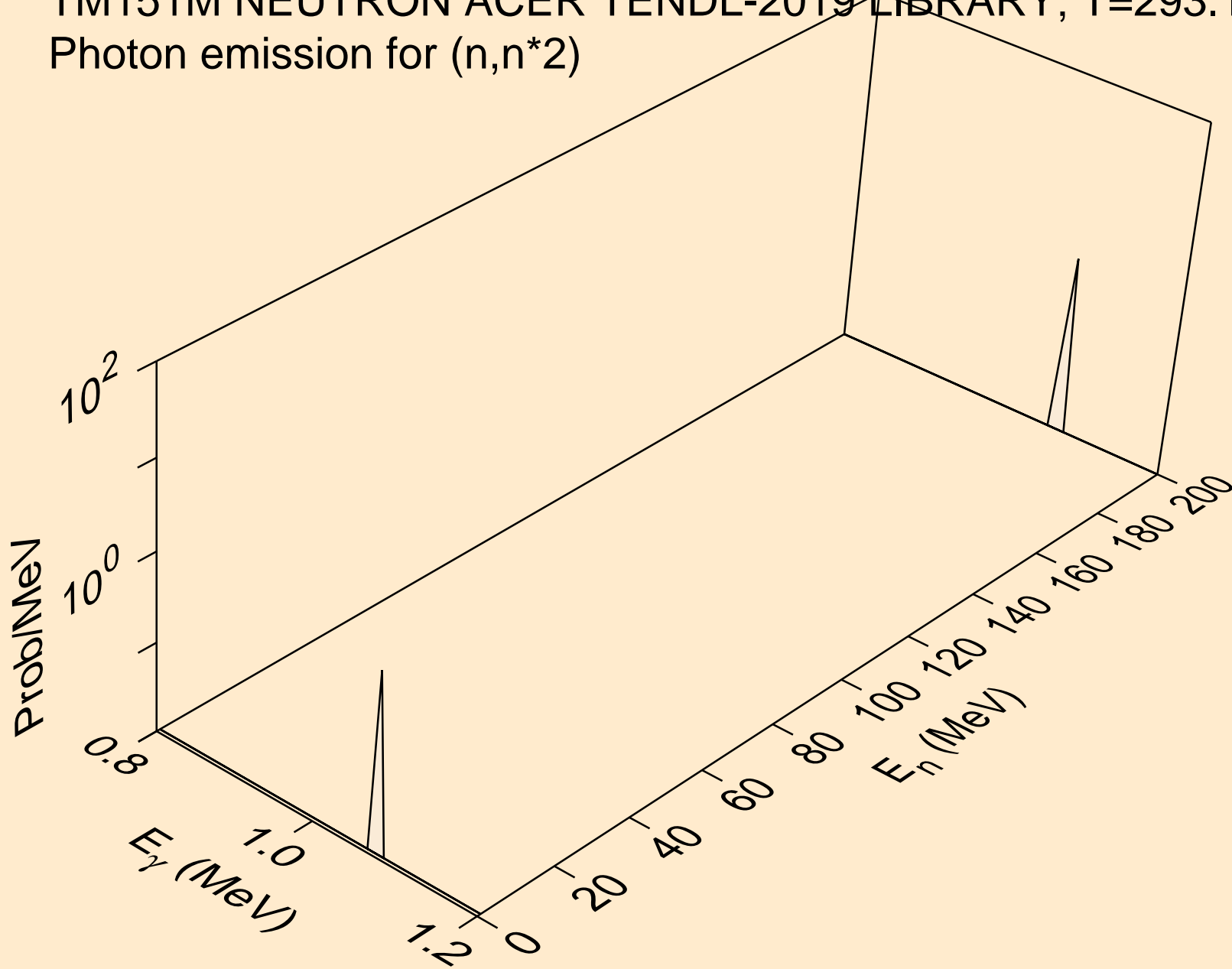

TM151M NEUTRON ACER TENDL-2019 LIBRARY; T=293.16K
Photon emission for (n,n*c)

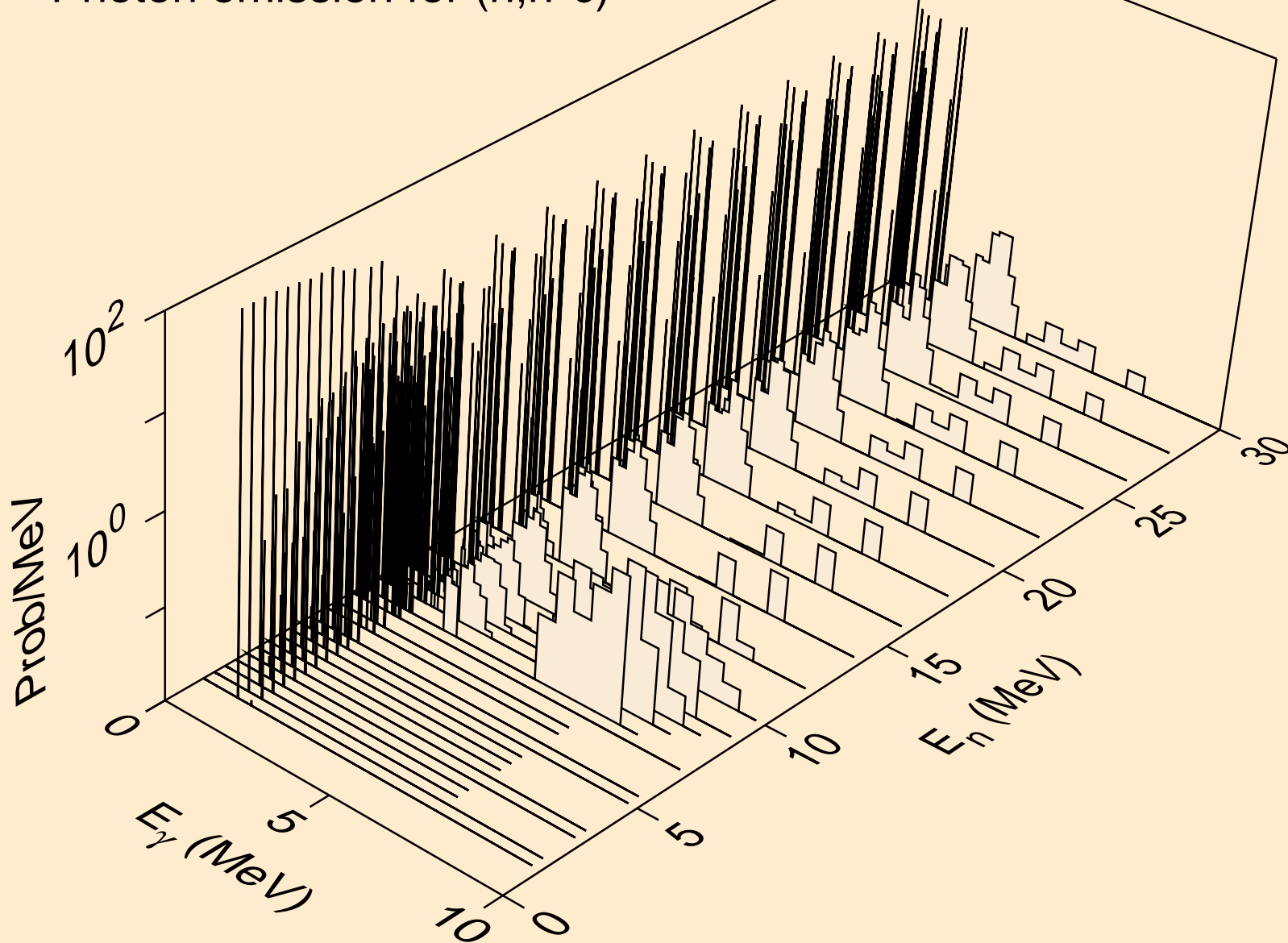

TM151M NEUTRON ACER TENDL-2019 LIBRARY; T=293.16K
Photon emission for (n,gma)

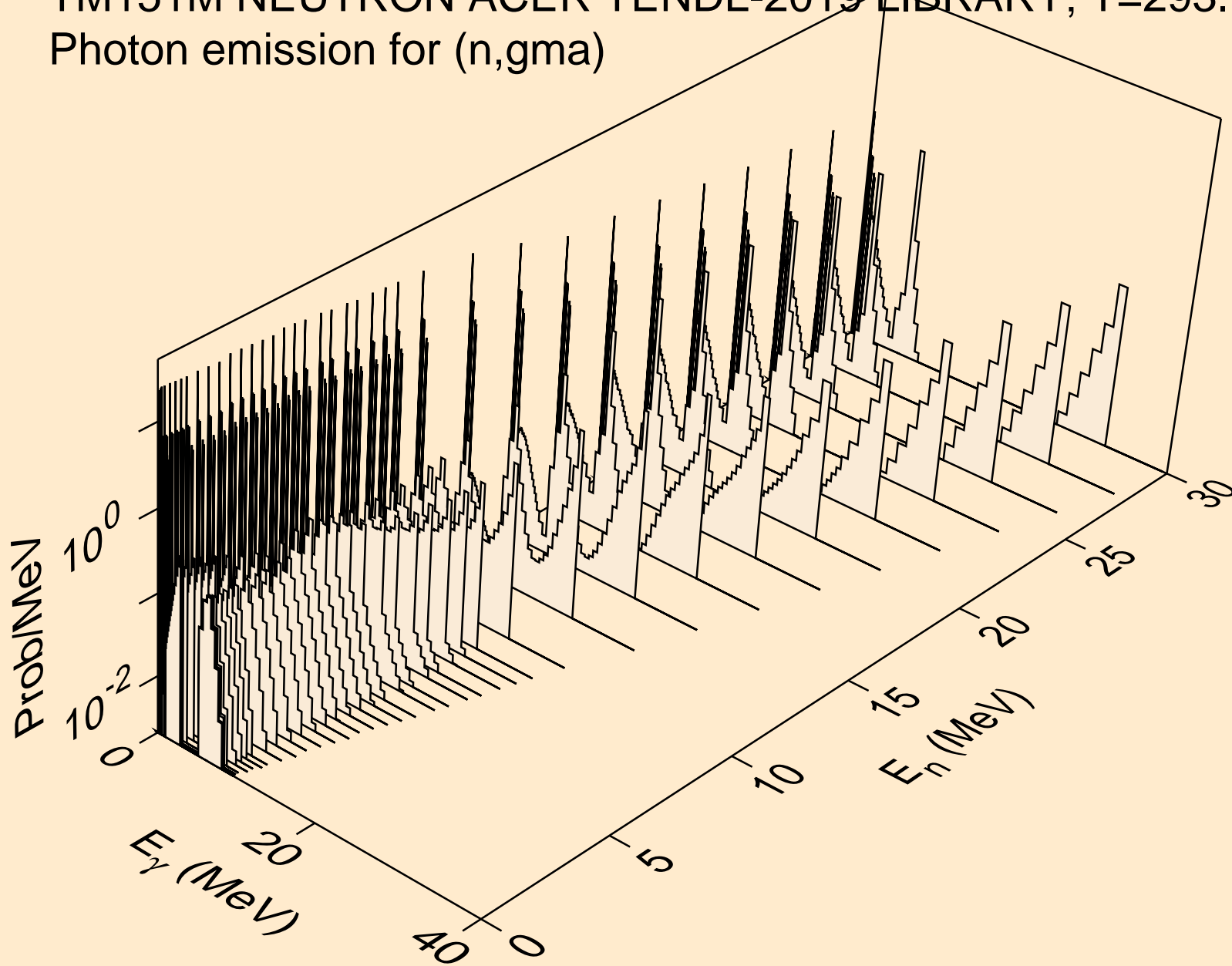

TM151M NEUTRON ACER TENDL-2019 LIBRARY; T=293.16K
Photon emission for (n,p)

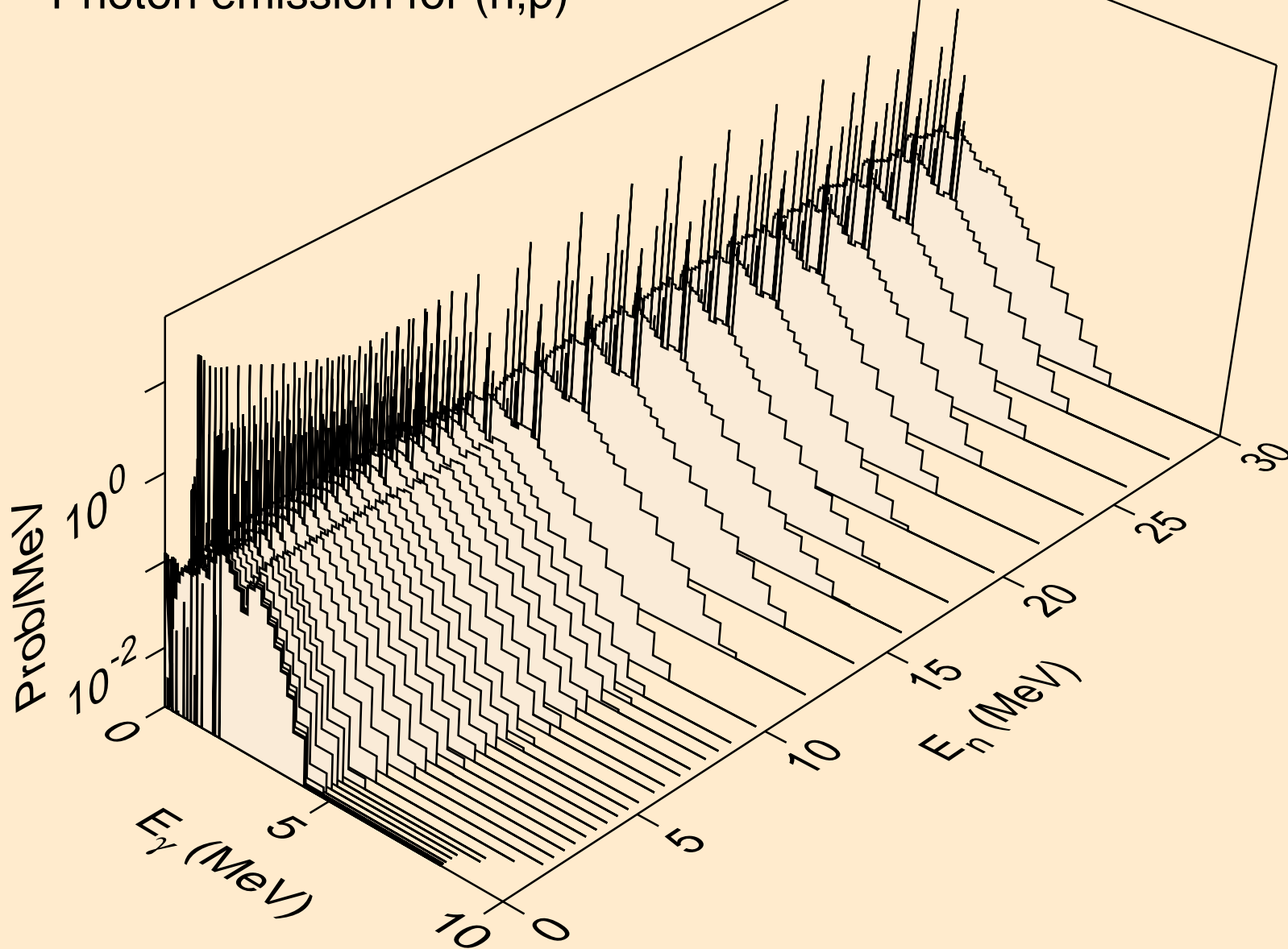

TM151M NEUTRON ACER TENDL-2019 LIBRARY; T=293.16K
Photon emission for (n,d)

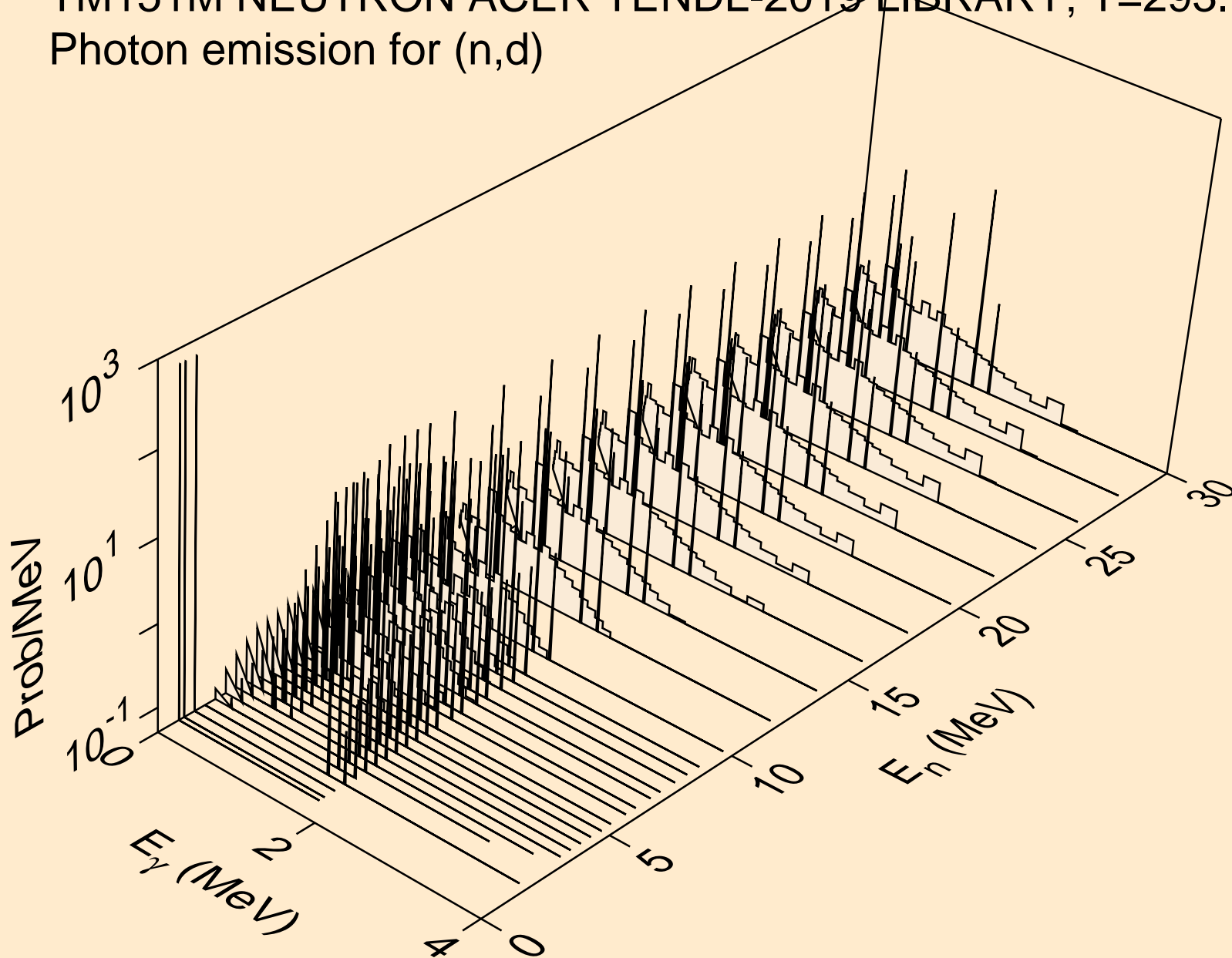

TM151M NEUTRON ACER TENDL-2019 LIBRARY; T=293.16K
Photon emission for (n,t)

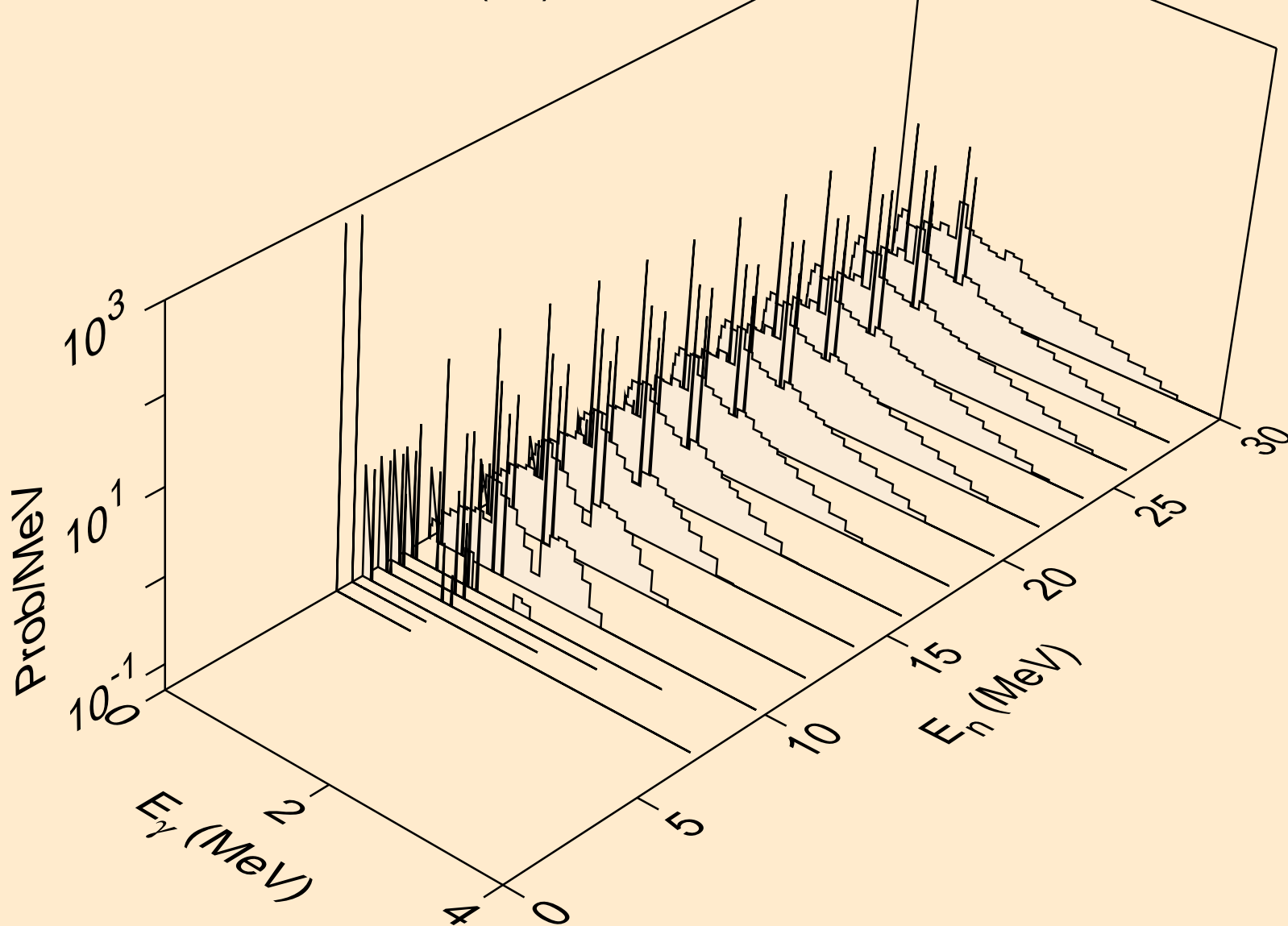

TM151M NEUTRON ACER TENDL-2019 LIBRARY; T=293.16K
Photon emission for (n,he3)

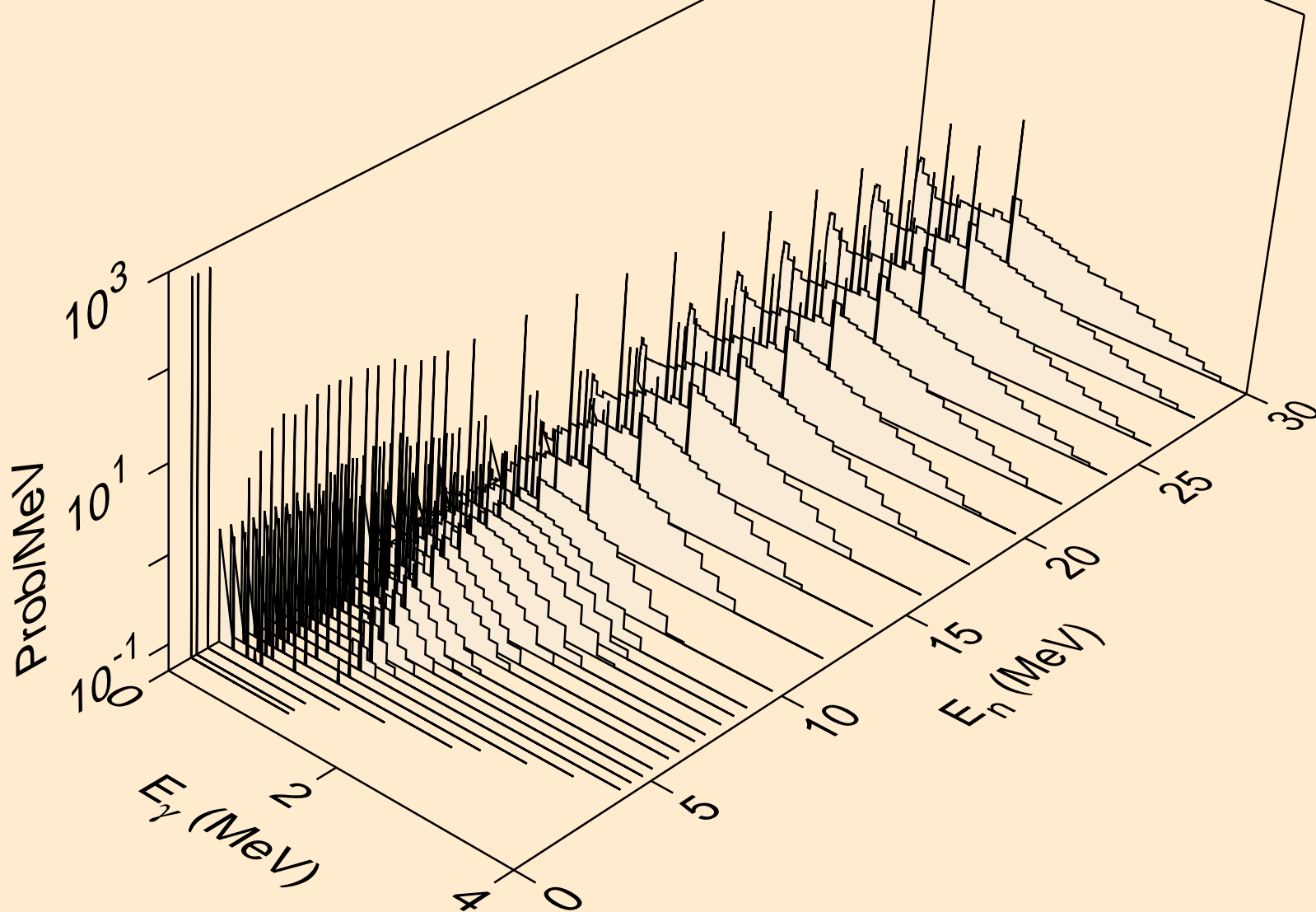

TM151M NEUTRON ACER TENDL-2019 LIBRARY; T=293.16K
Photon emission for (n,a)

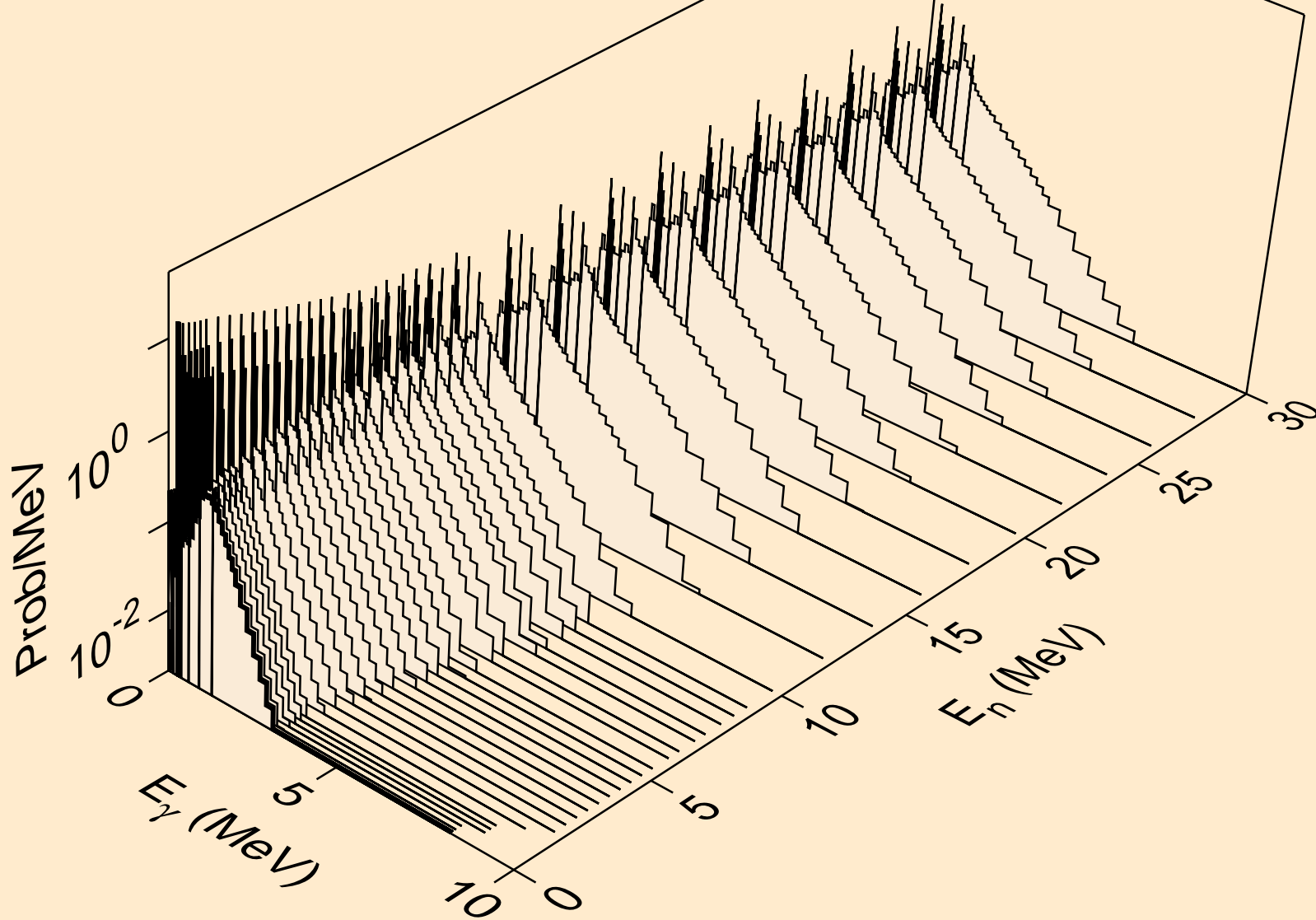

TM151M NEUTRON ACER TENDL-2019 LIBRARY; T=293.16K
Photon emission for (n,2a)

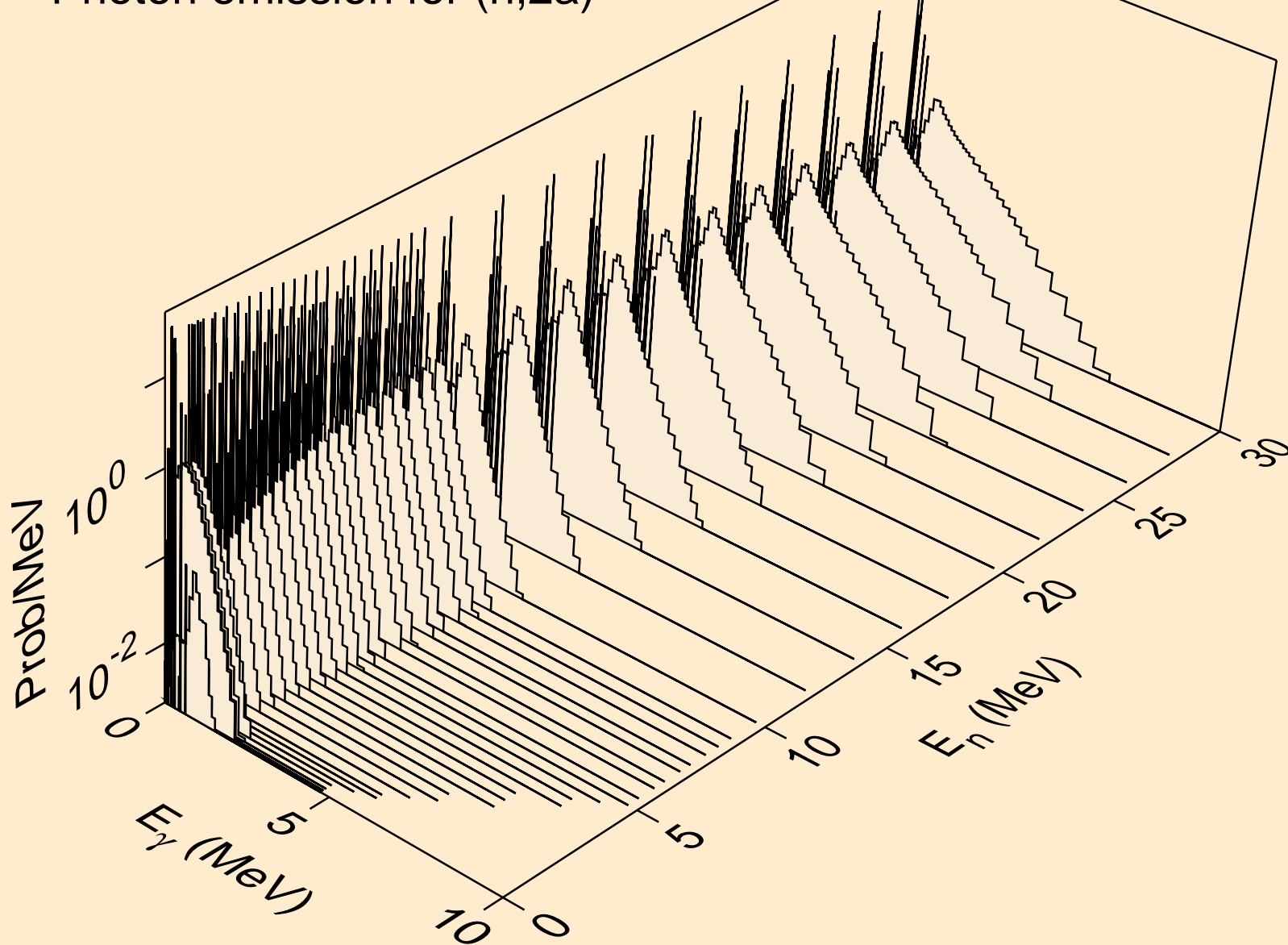

TM151M NEUTRON ACER TENDL-2019 LIBRARY; T=293.16K
Photon emission for (n,3a)

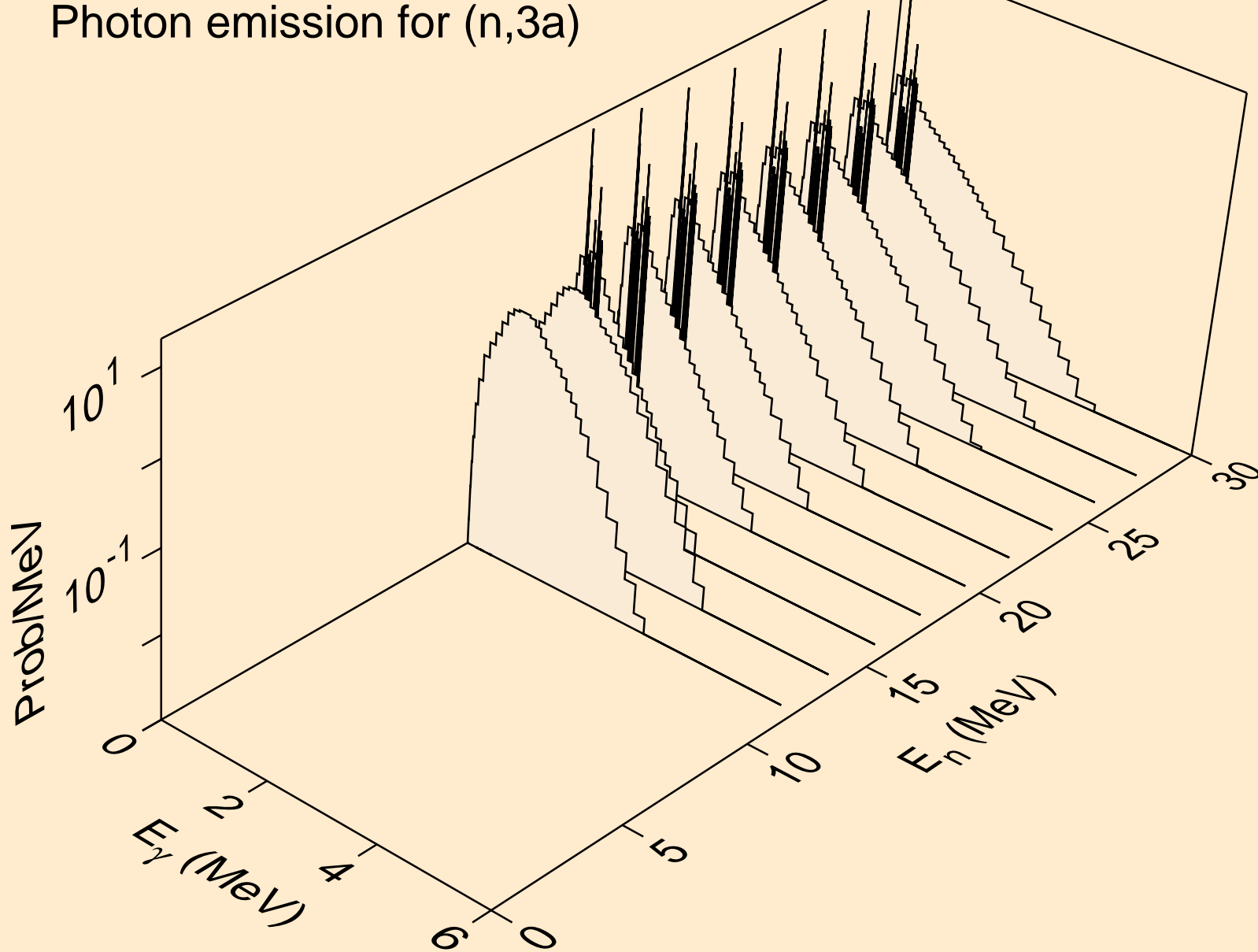

TM151M NEUTRON ACER TENDL-2019 LIBRARY; T=293.16K
Photon emission for (n,2p)

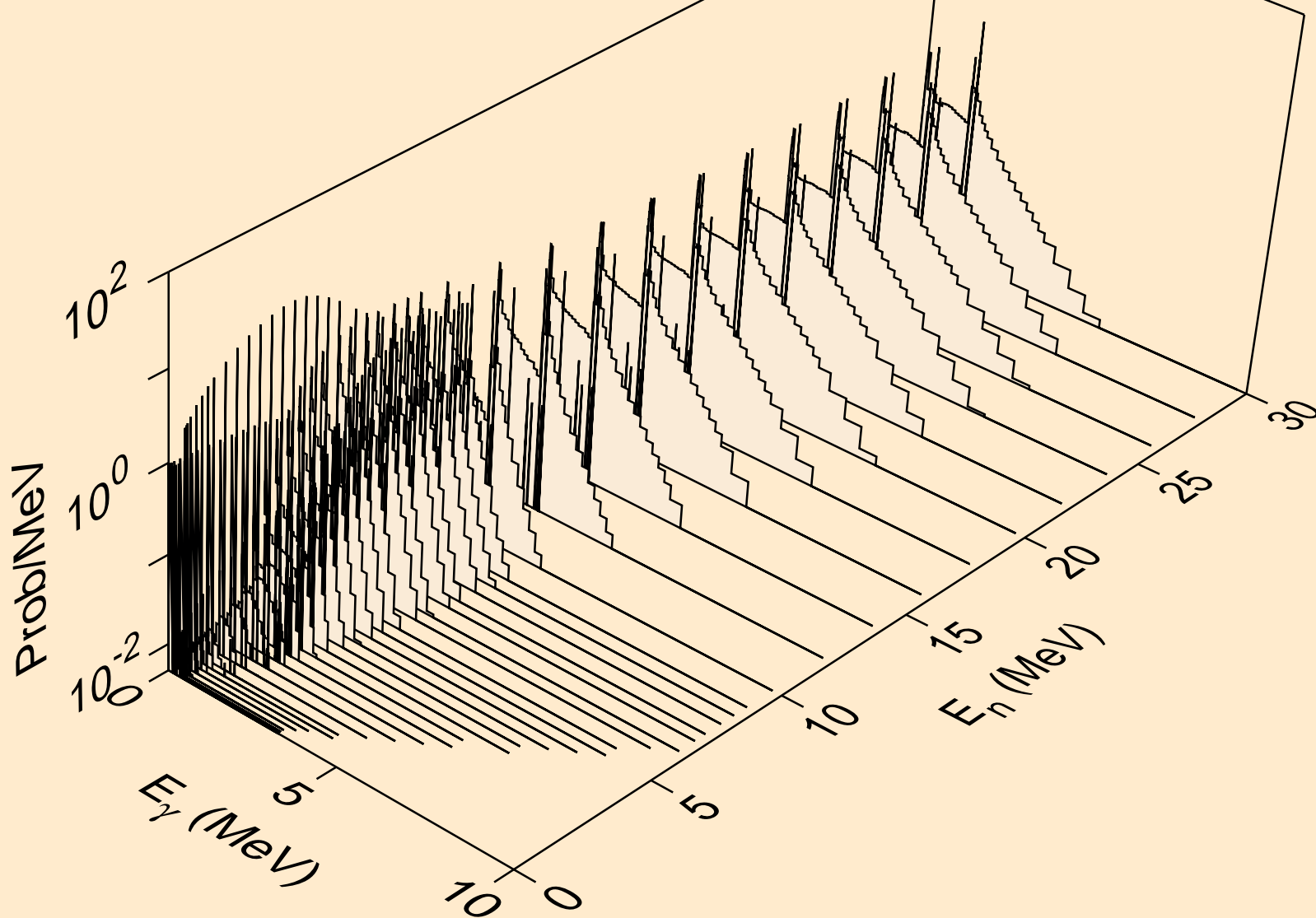

TM151M NEUTRON ACER TENDL-2019 LIBRARY; T=293.16K
Photon emission for (n,p α)

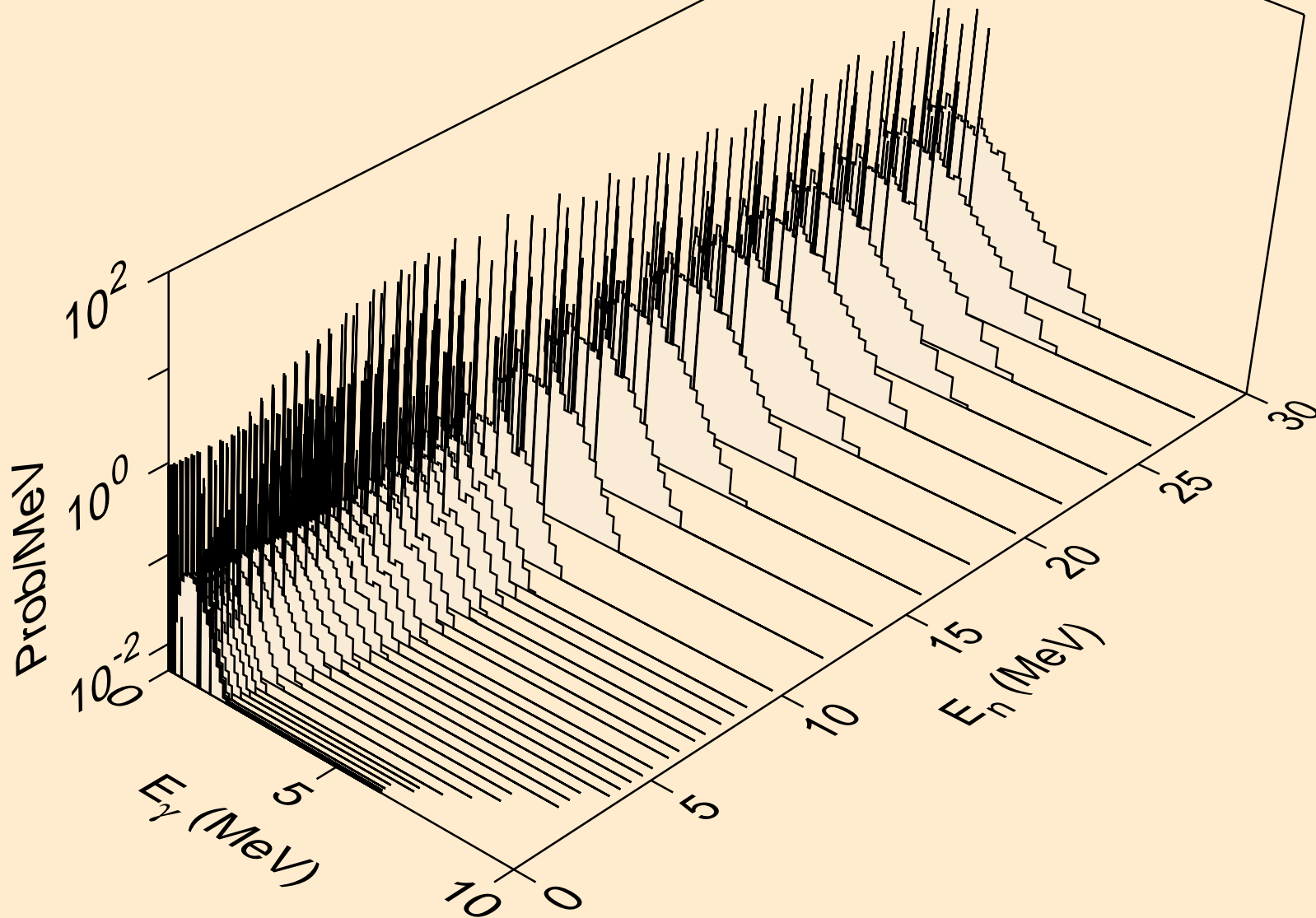

TM151M NEUTRON ACER TENDL-2019 LIBRARY; T=293.16K
Photon emission for (n,pd)

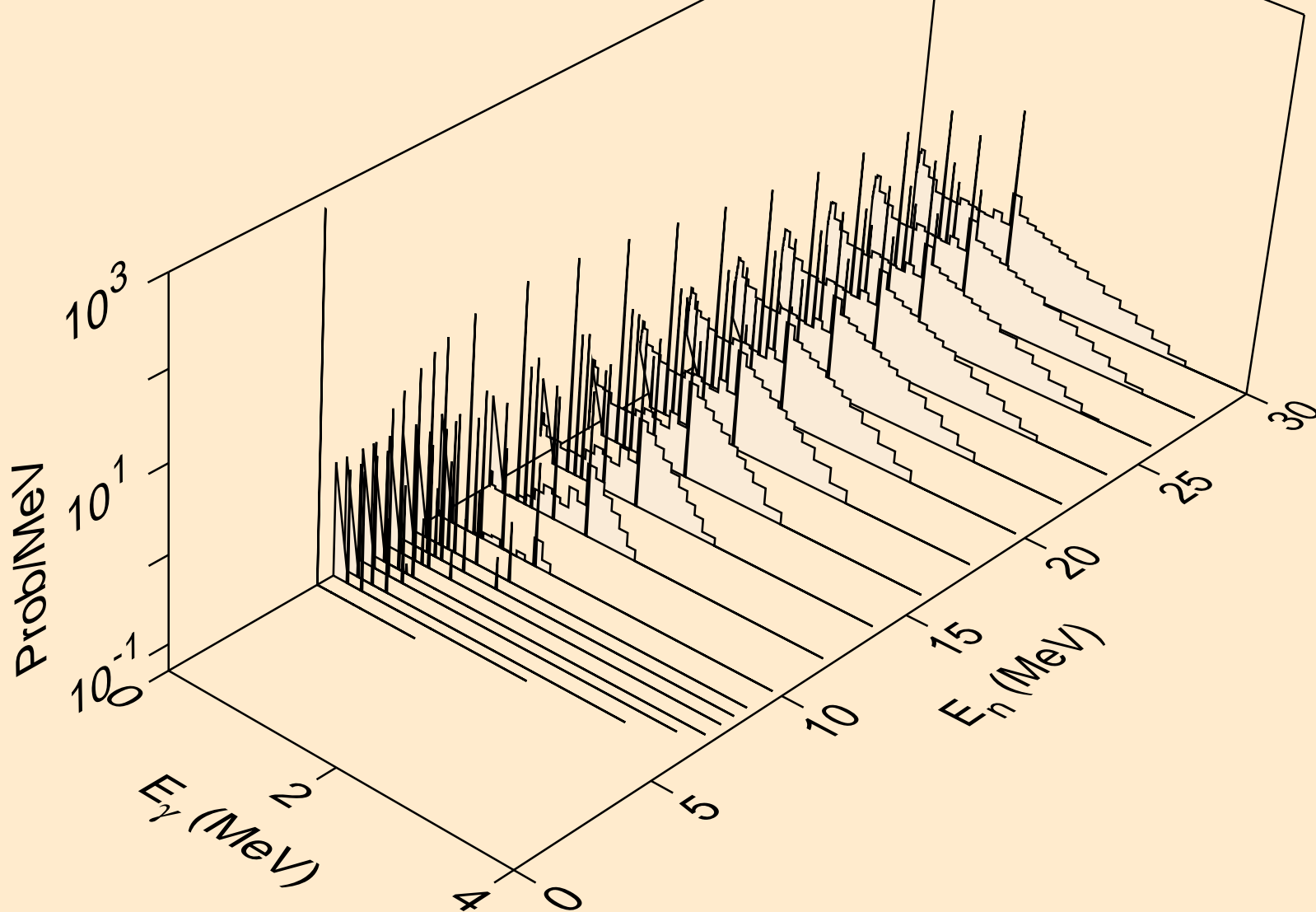

TM151M NEUTRON ACER TENDL-2019 LIBRARY; T=293.16K
Photon emission for (n,pt)

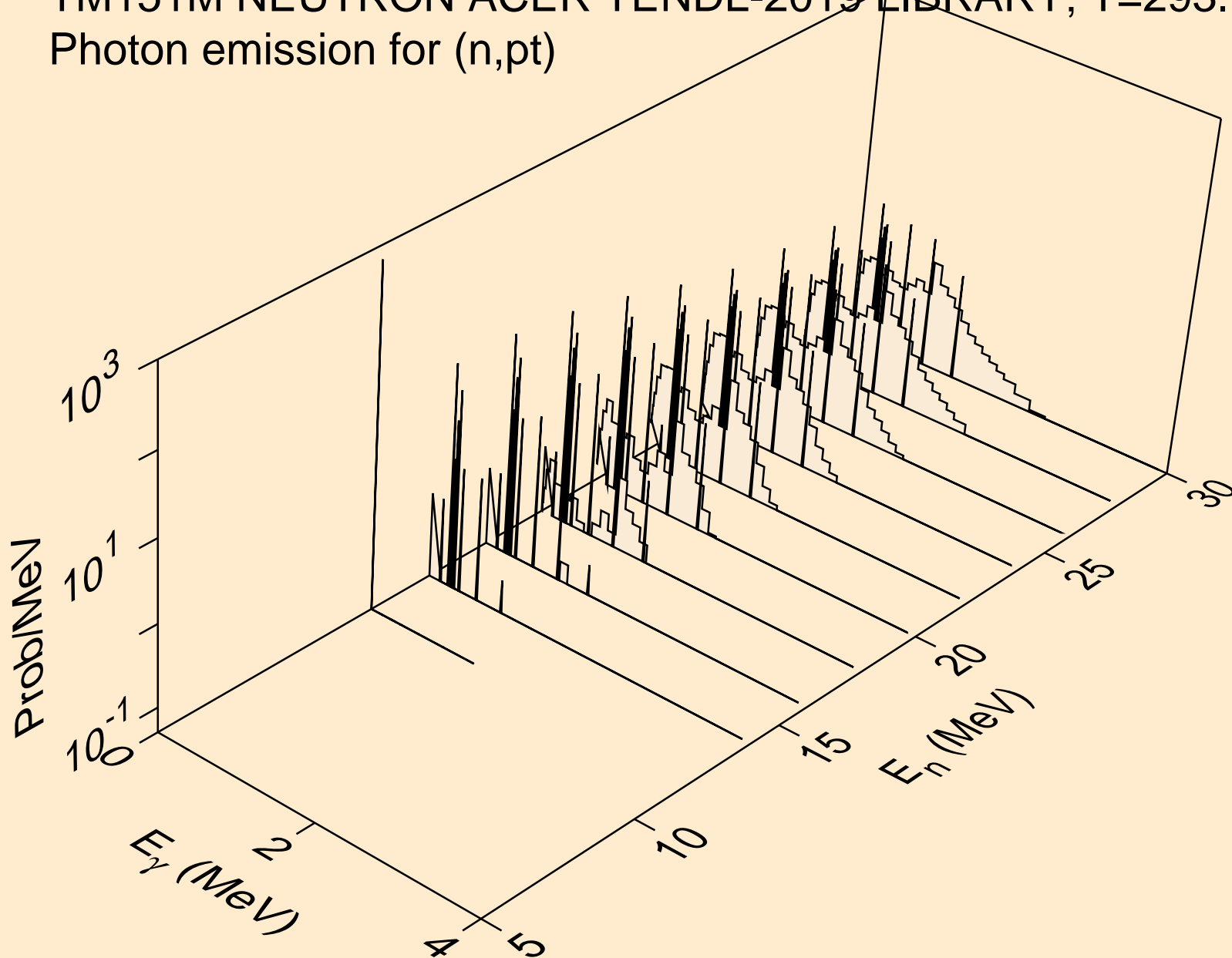

TM151M NEUTRON ACER TENDL-2019 LIBRARY; T=293.16K
Photon emission for (n,da)

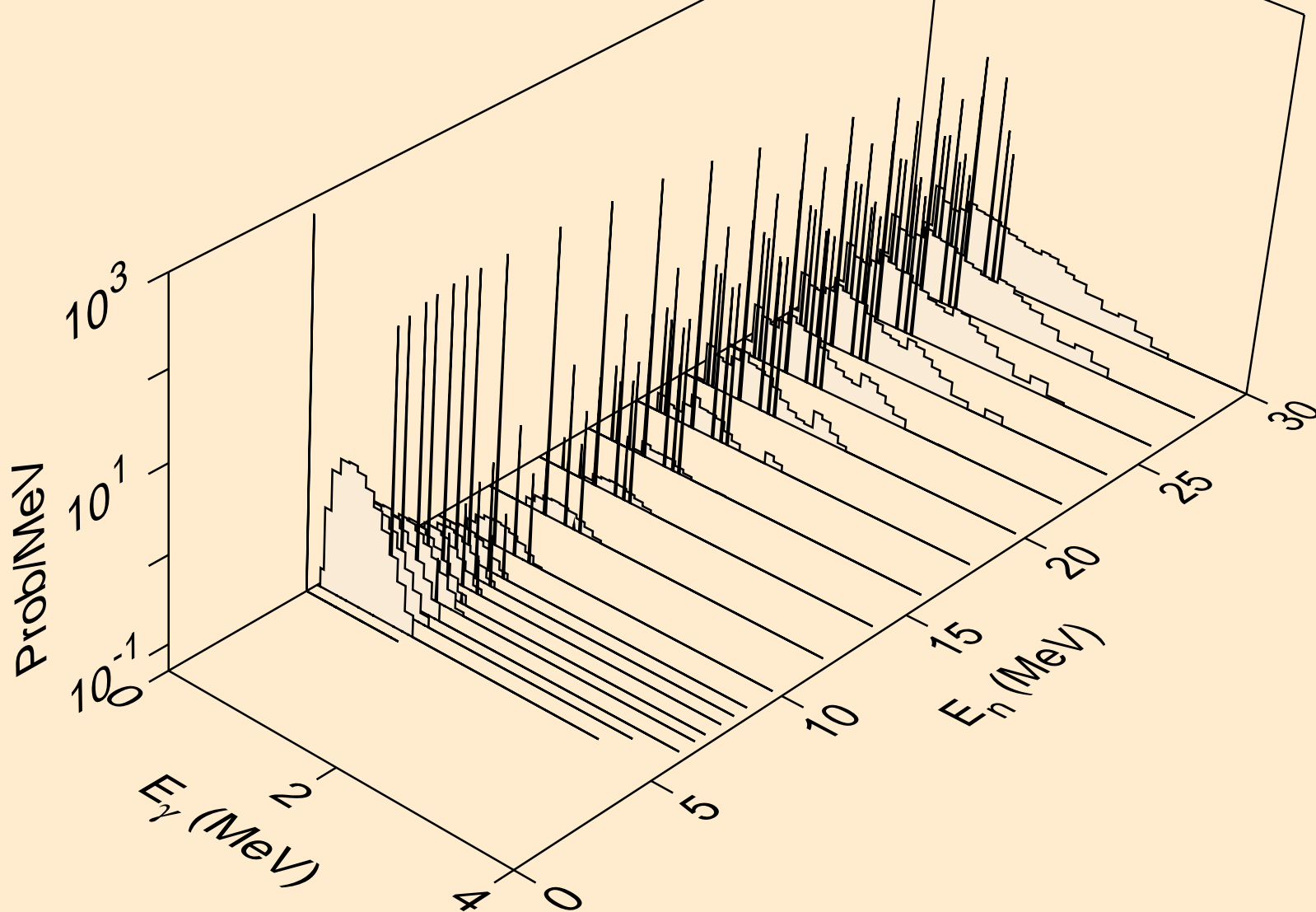

TM151M NEUTRON ACER TENDL-2019 LIBRARY; T=293.16K
thermal capture photon spectrum

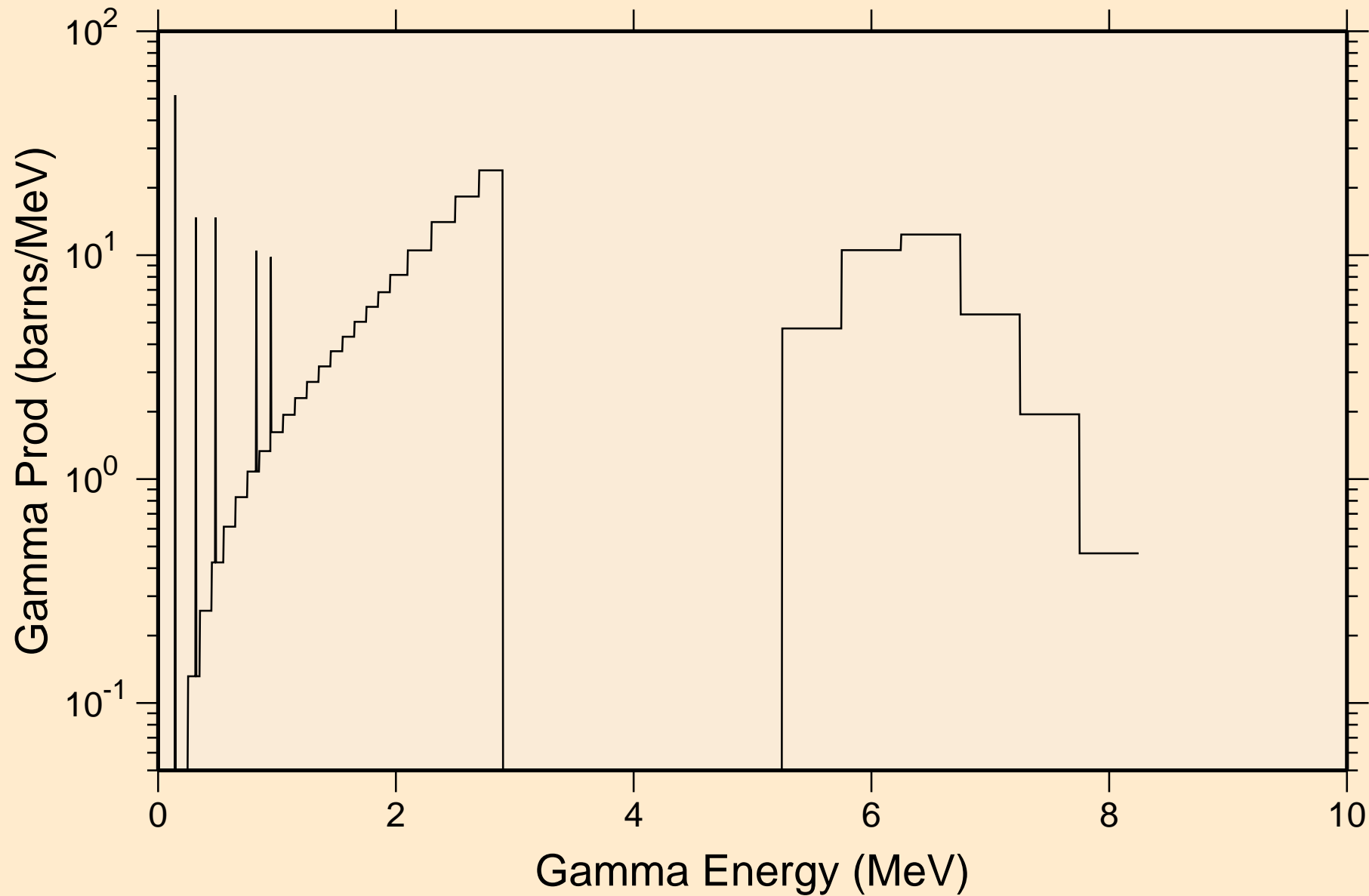

TM151M NEUTRON ACER TENDL-2019 LIBRARY; T=293.16K
14 MeV photon spectrum

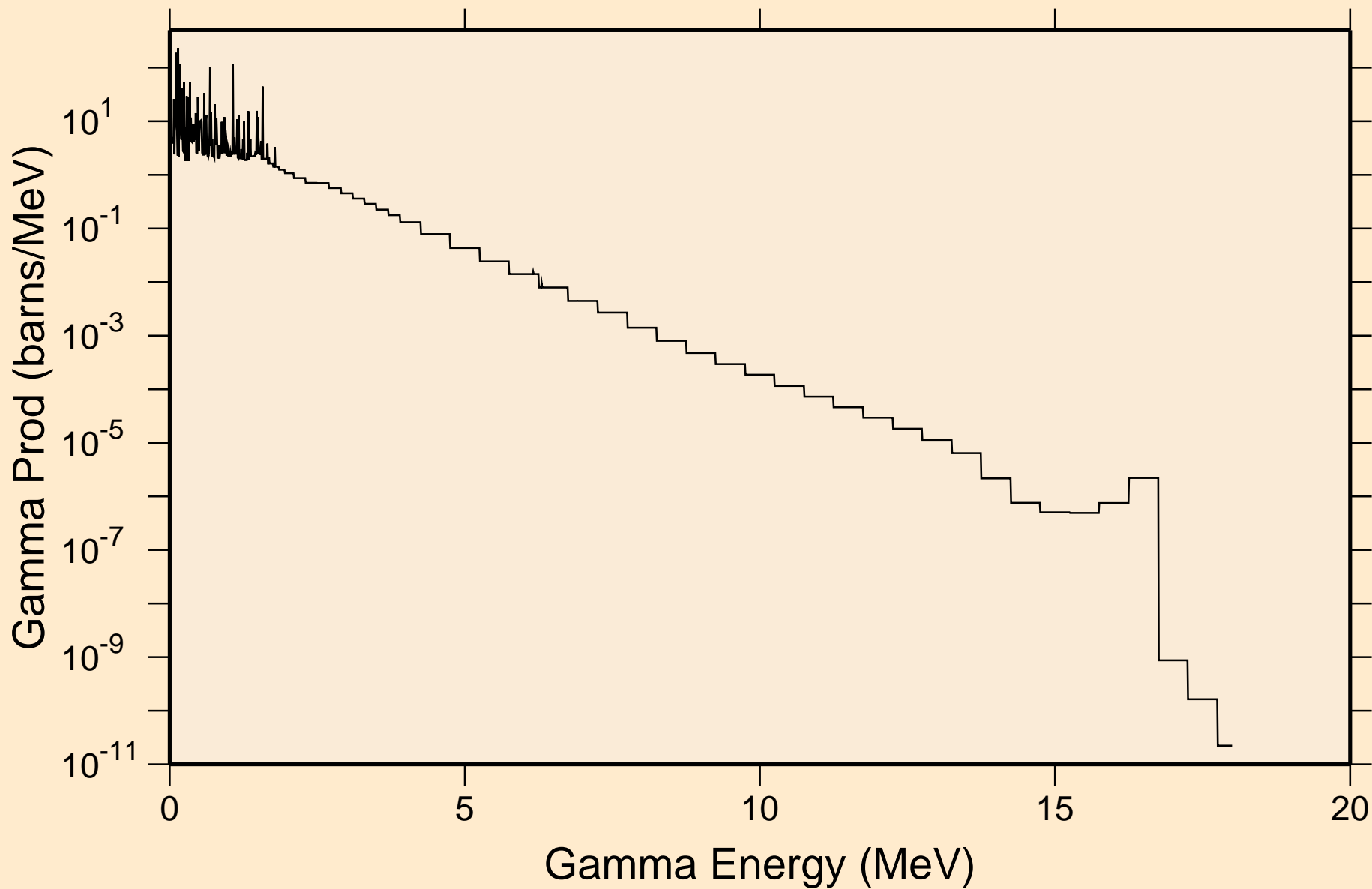

TM151M NEUTRON ACER TENDL-2019 LIBRARY; T=293.16K

Particle heating contributions

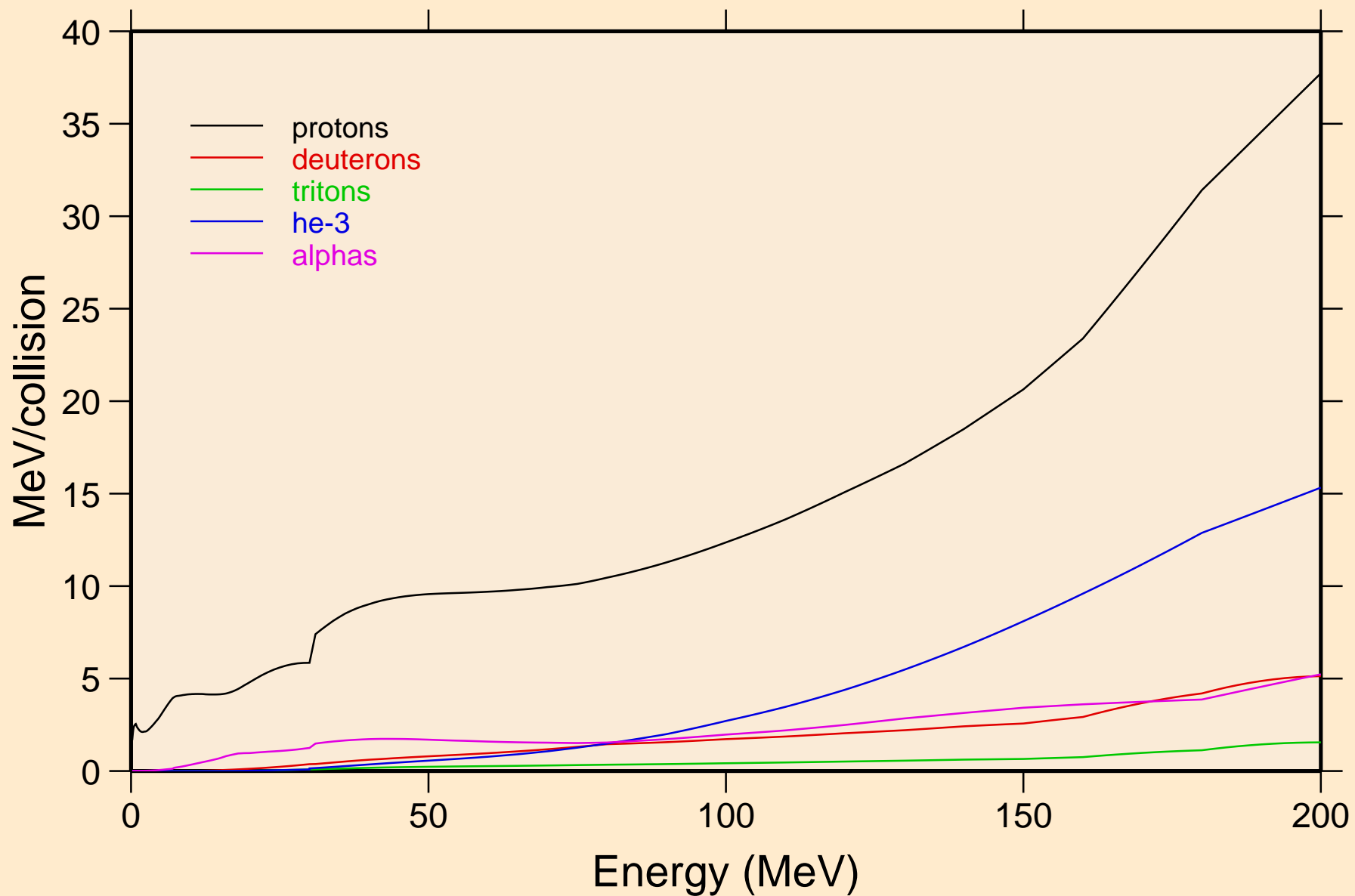

TM151M NEUTRON ACER TENDL-2019 LIBRARY; T=293.16K
Recoil Heating

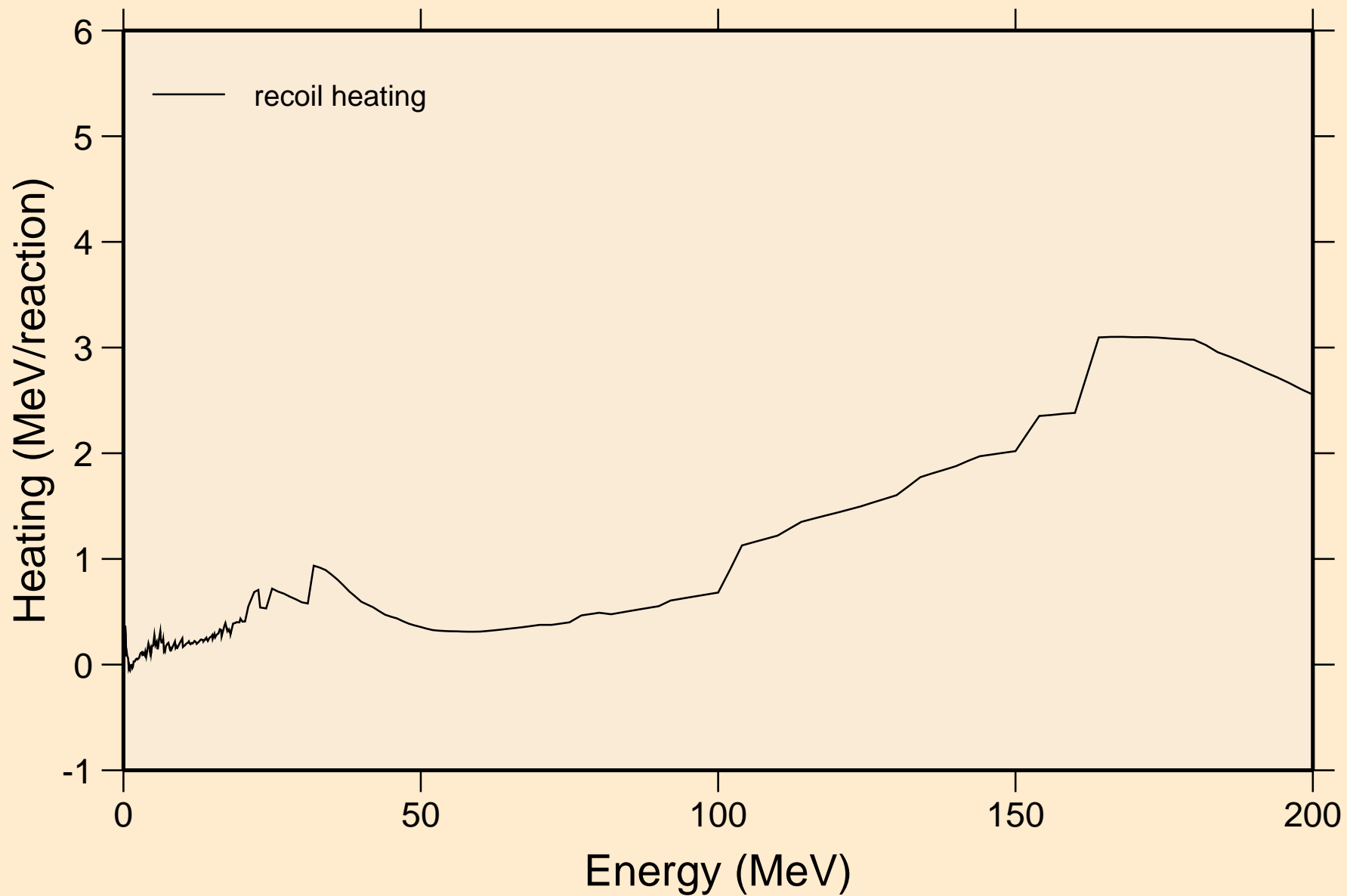

TM151M NEUTRON ACER TENDL-2019 LIBRARY; T=293.16K
Particle production cross sections

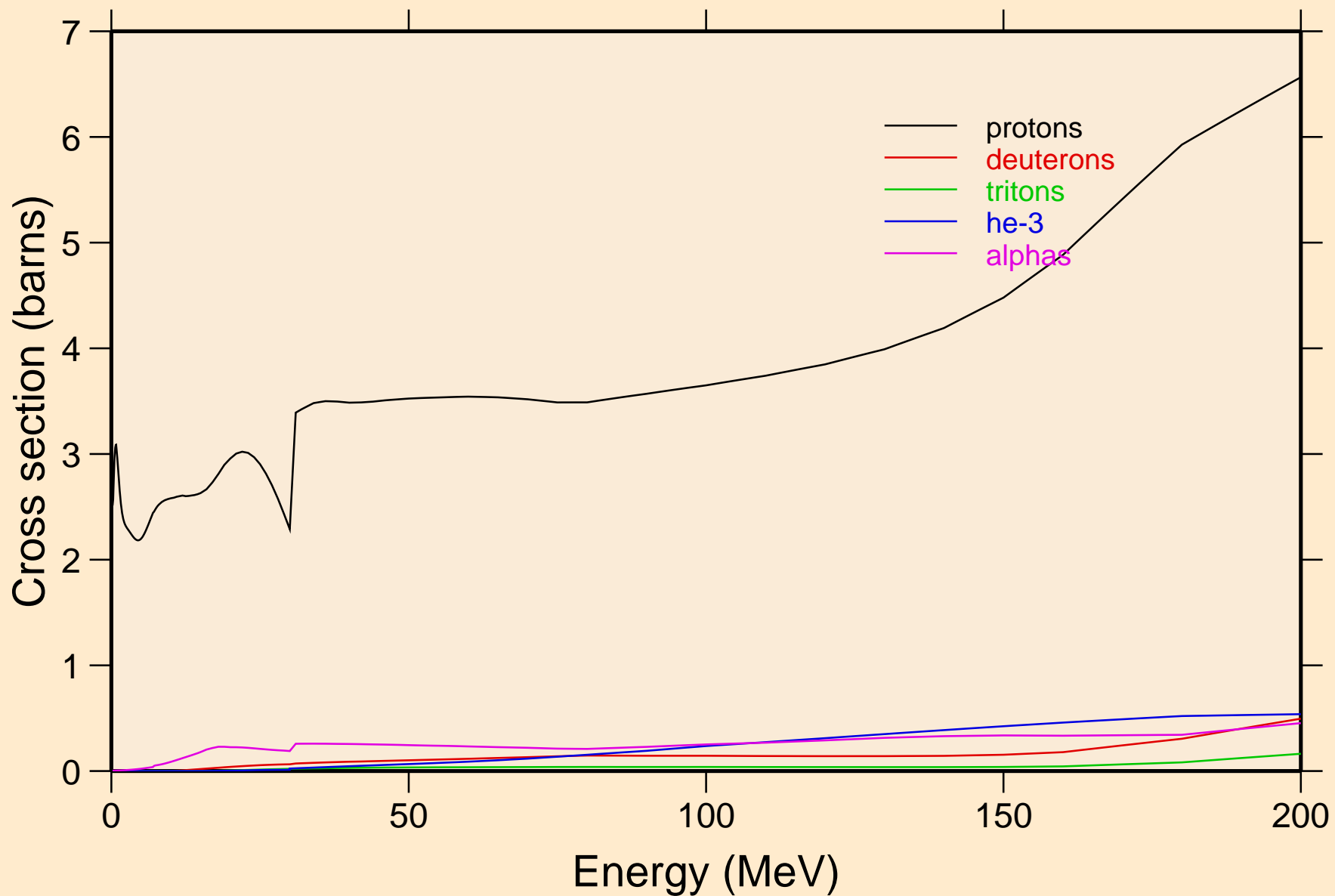

TM151M NEUTRON ACER TENDL-2019 LIBRARY; T=293.16K
protons from (n,x)

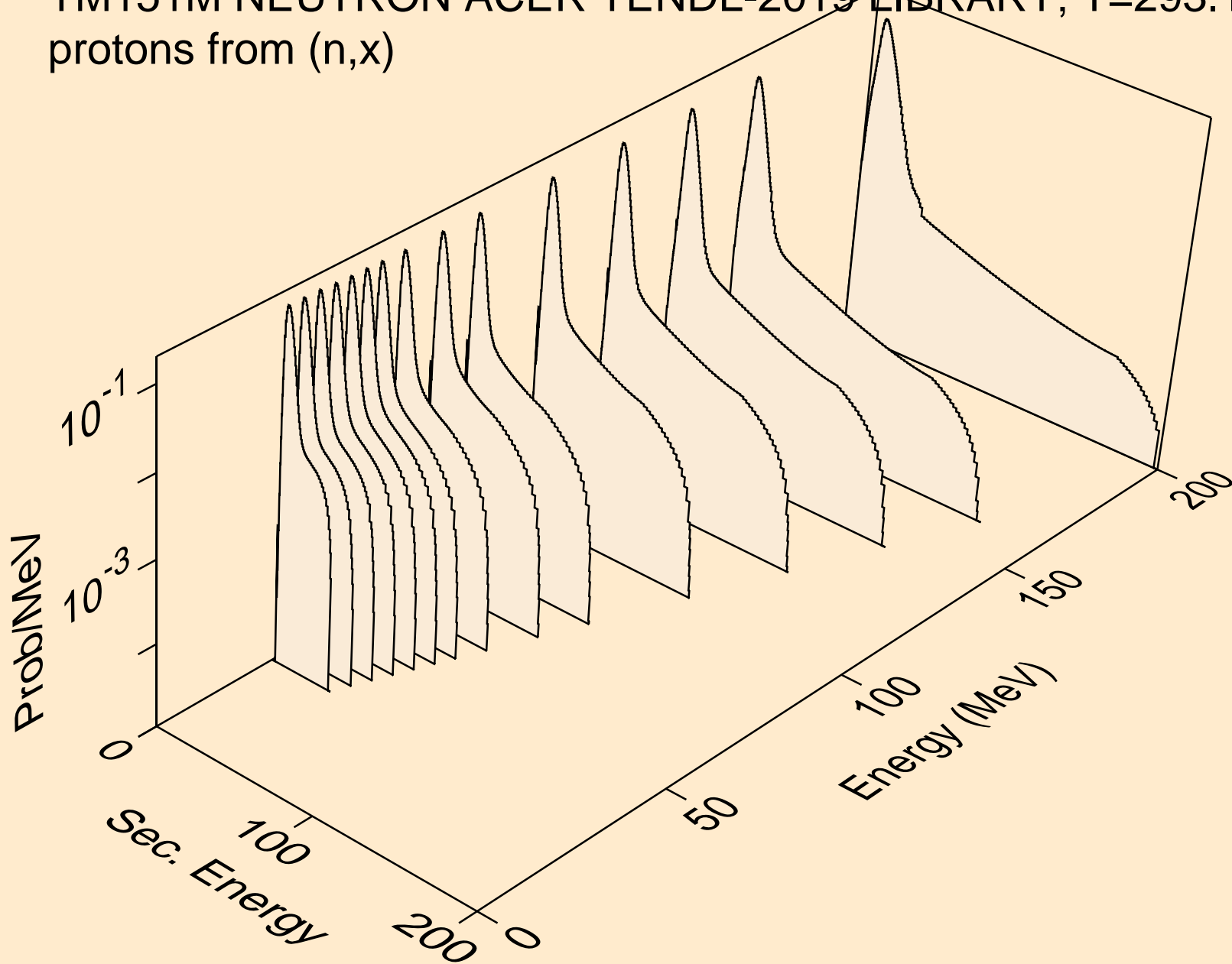

TM151M NEUTRON ACER TENDL-2019 LIBRARY; T=293.16K
protons from (n,n*)p

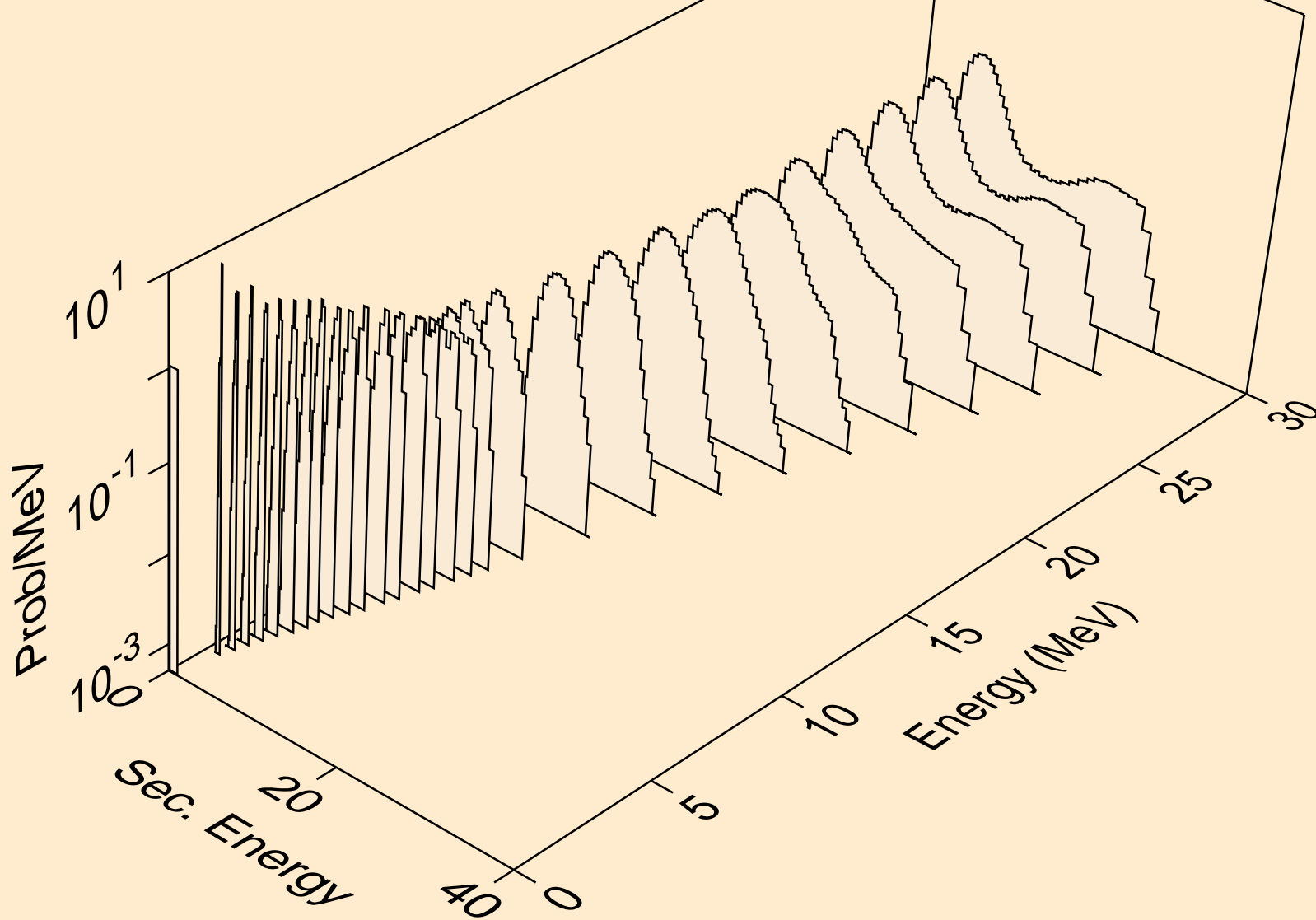

TM151M NEUTRON ACER TENDL-2019 LIBRARY; T=293.16K
protons from (n,2np)

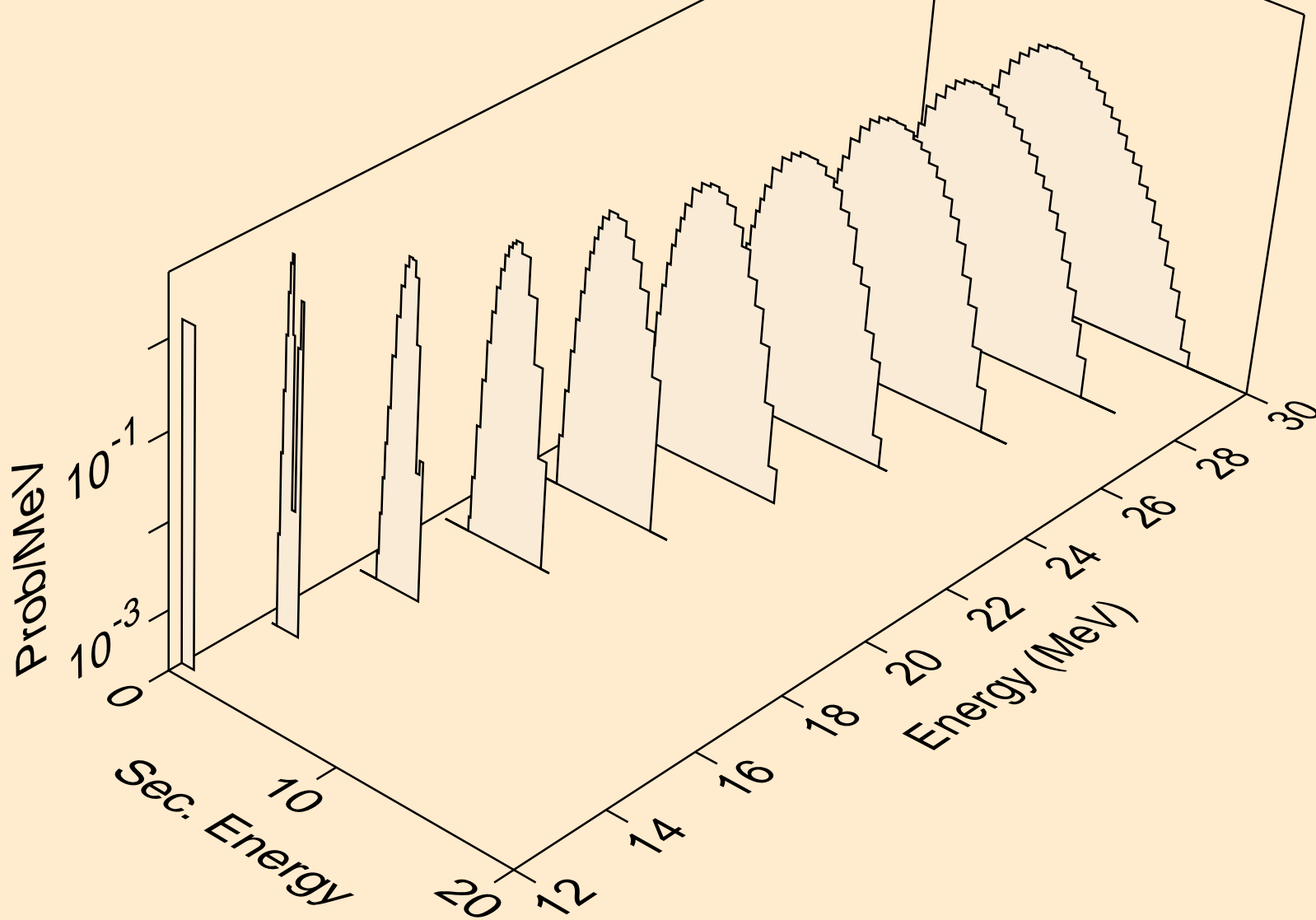

TM151M NEUTRON ACER TENDL-2019 LIBRARY; T=293.16K
protons from (n,3np)

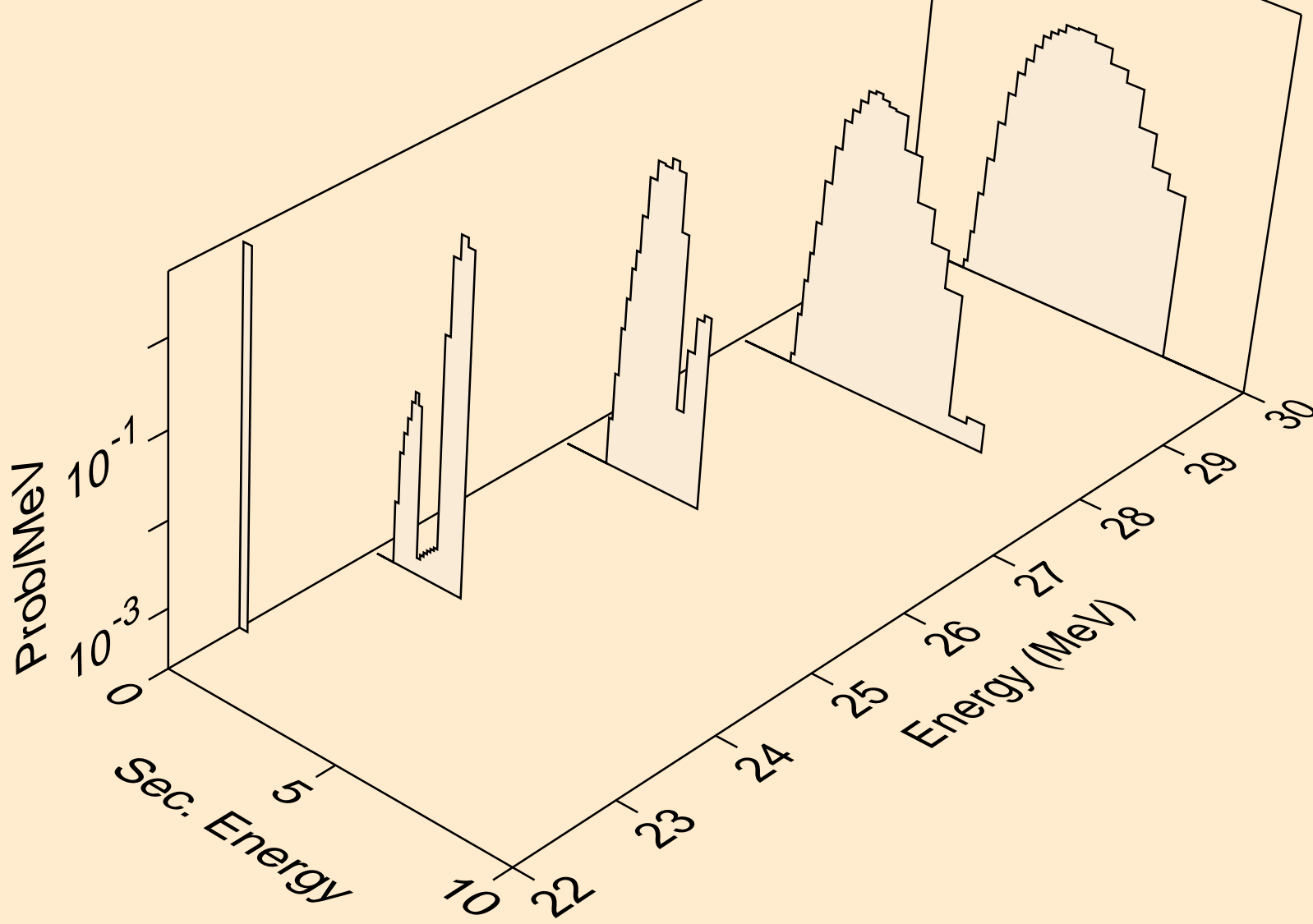

TM151M NEUTRON ACER TENDL-2019 LIBRARY; T=293.16K
protons from (n,2np)

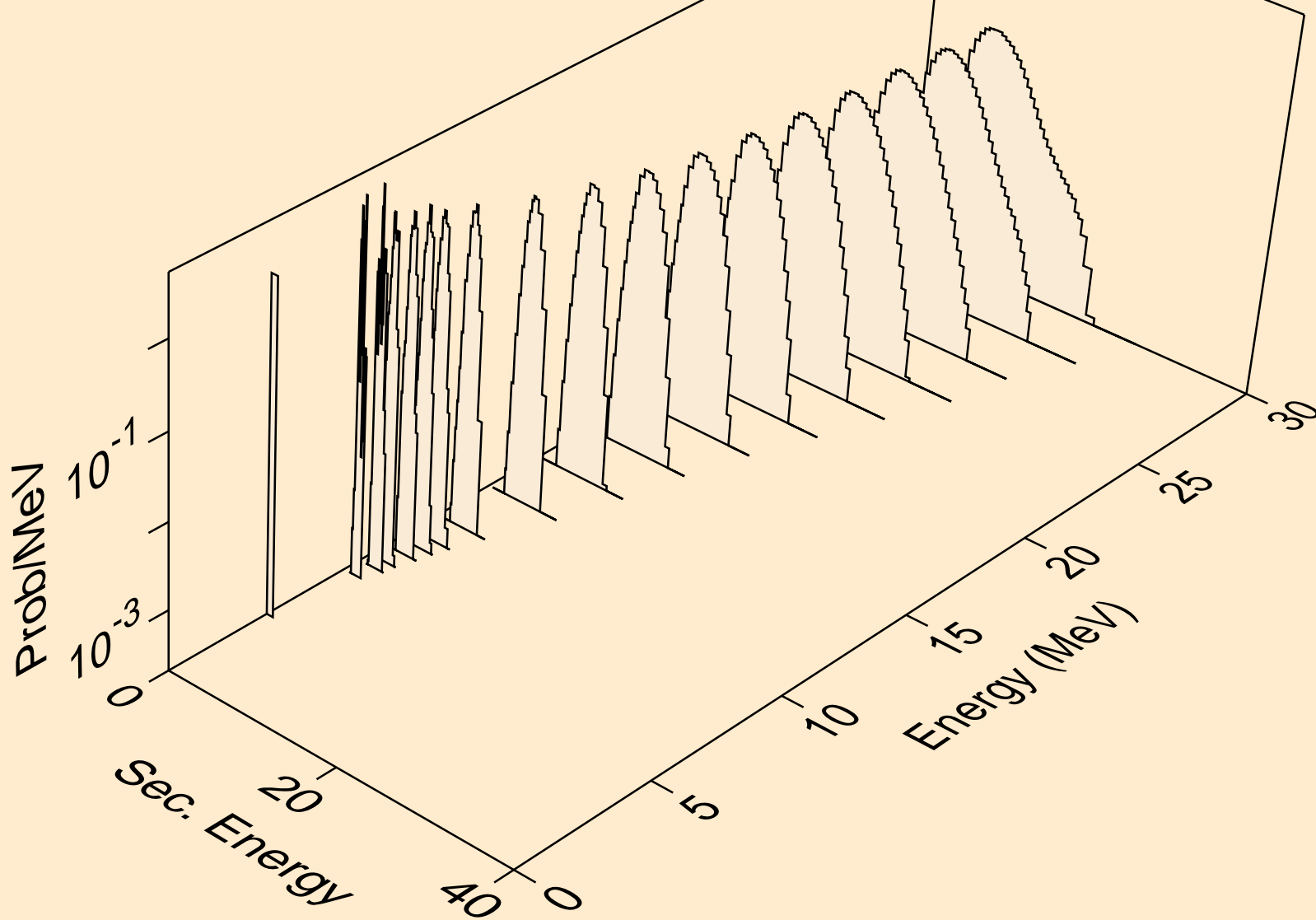

TM151M NEUTRON ACER TENDL-2019 LIBRARY; T=293.16K
protons from (n,npa)

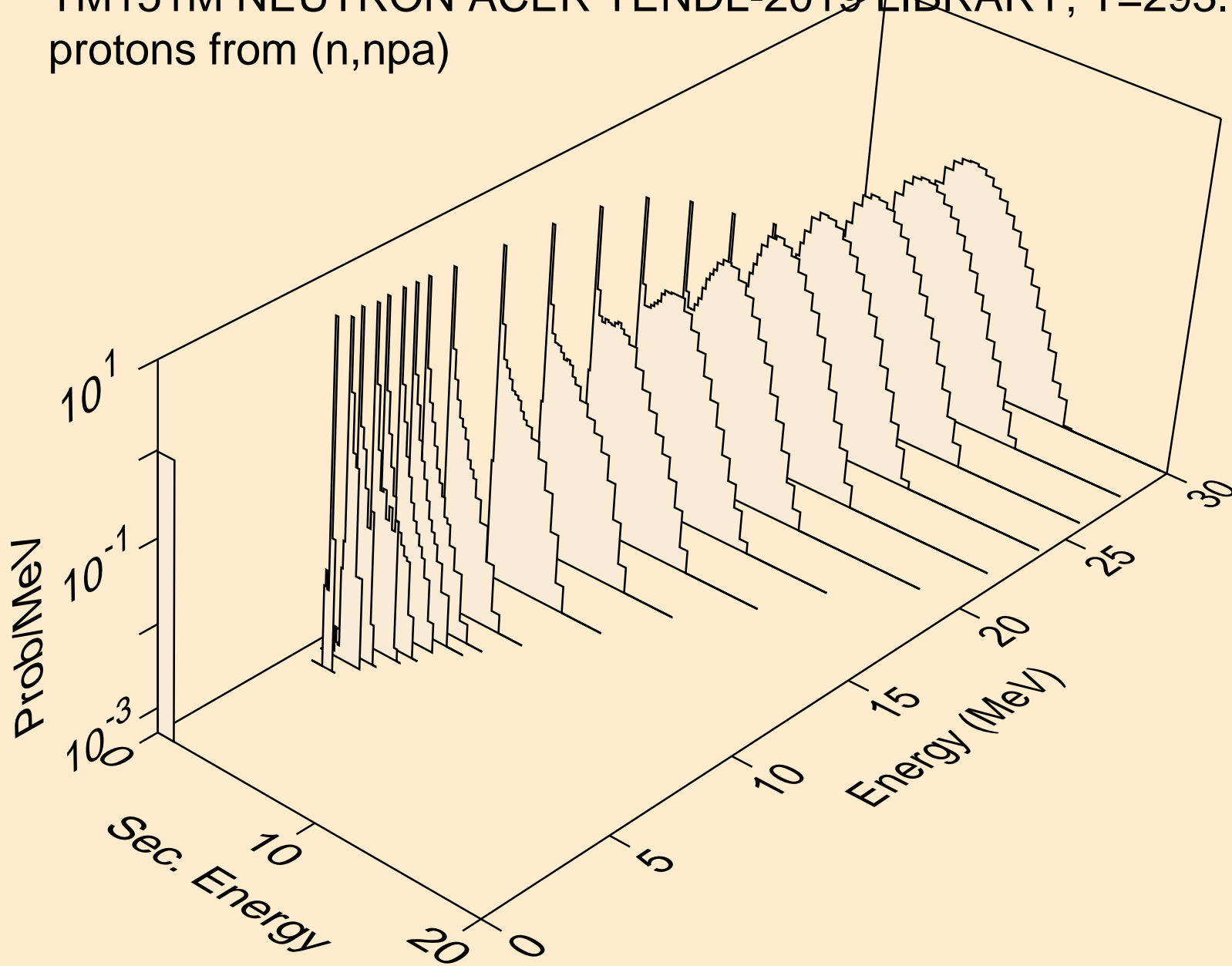

TM151M NEUTRON ACER TENDL-2019 LIBRARY; T=293.16K
protons from (n,p)

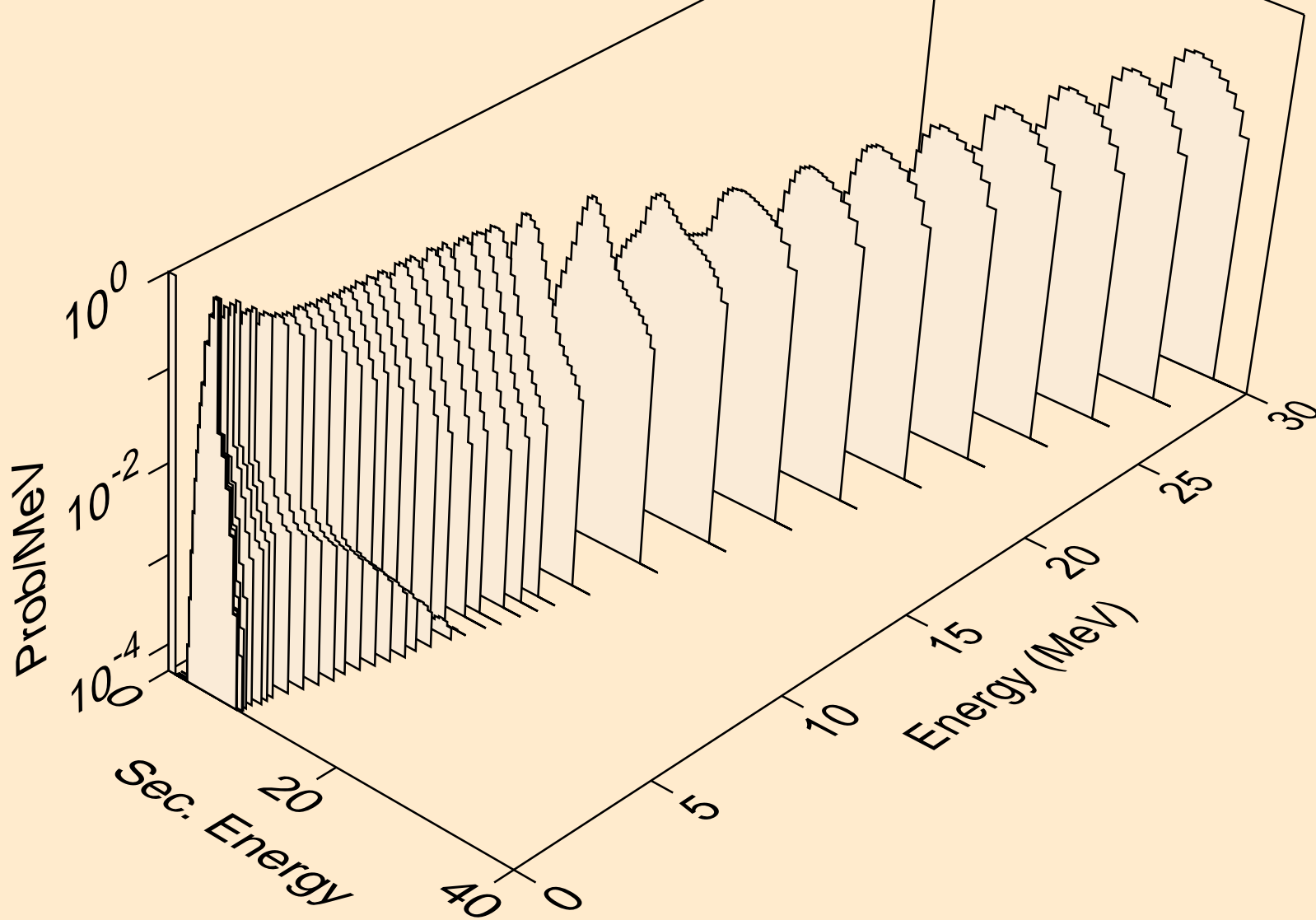

TM151M NEUTRON ACER TENDL-2019 LIBRARY; T=293.16K
protons from (n,2p)

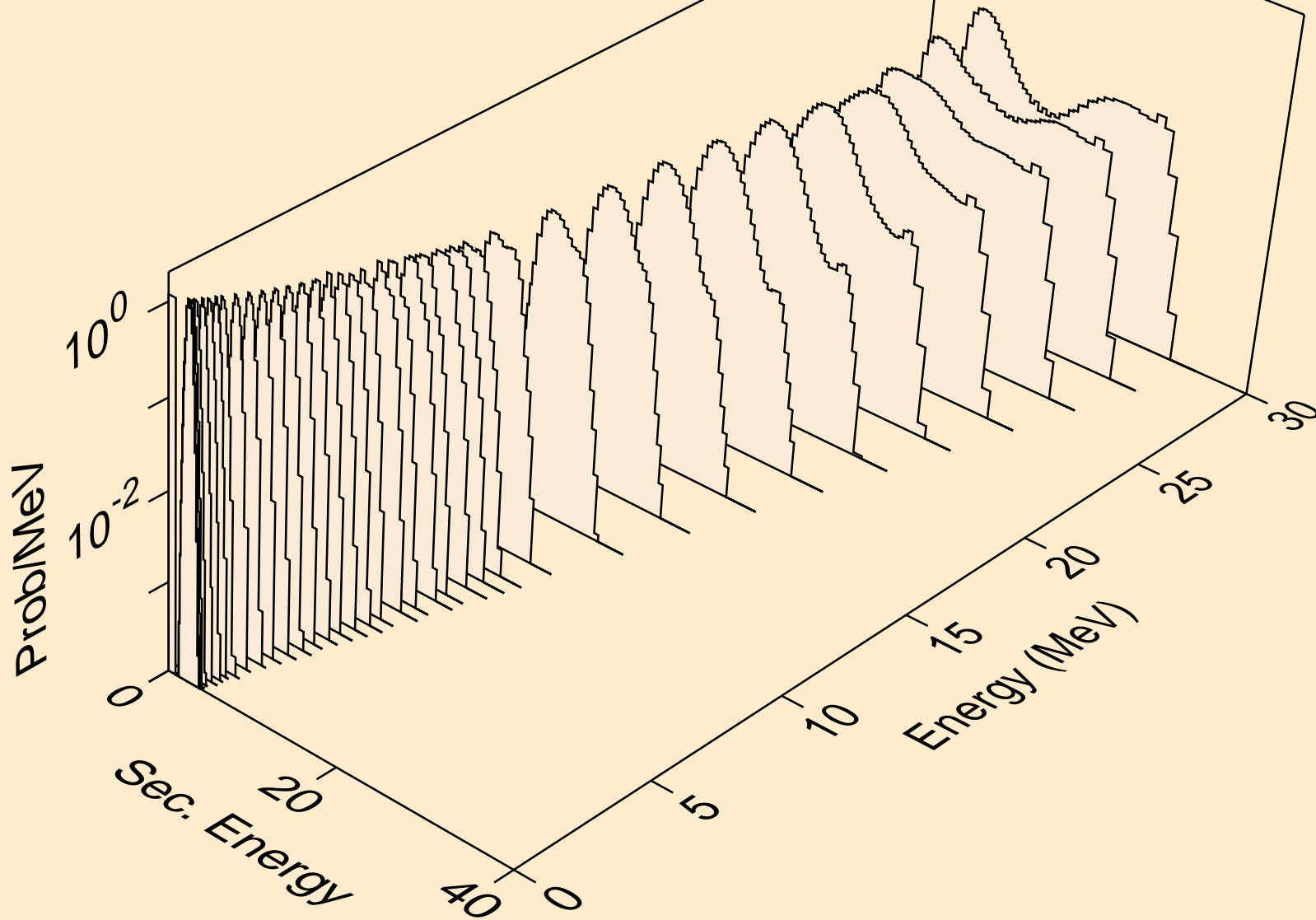

TM151M NEUTRON ACER TENDL-2019 LIBRARY; T=293.16K
protons from (n,p)

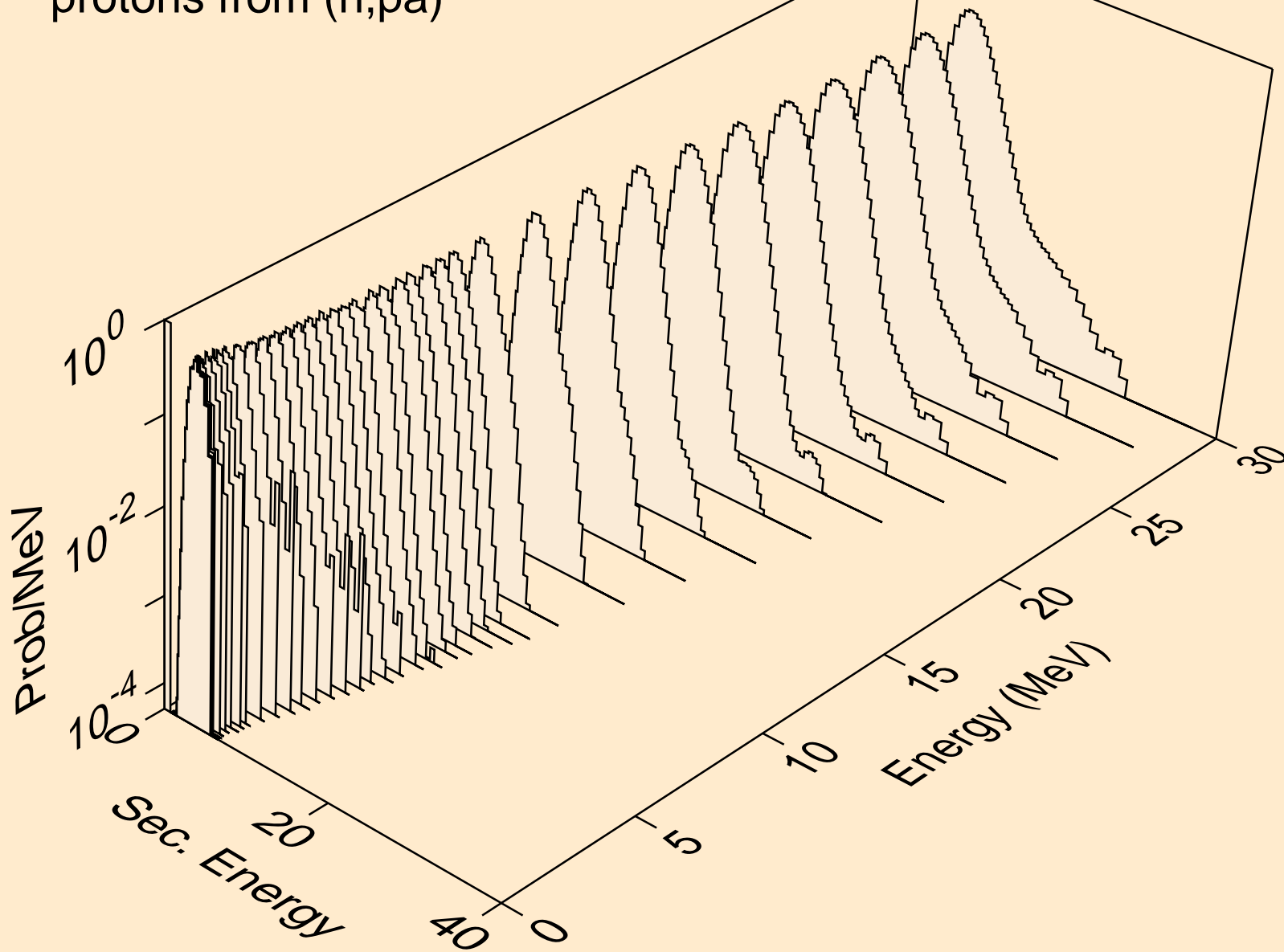

TM151M NEUTRON ACER TENDL-2019 LIBRARY; T=293.16K
protons from (n,pd)

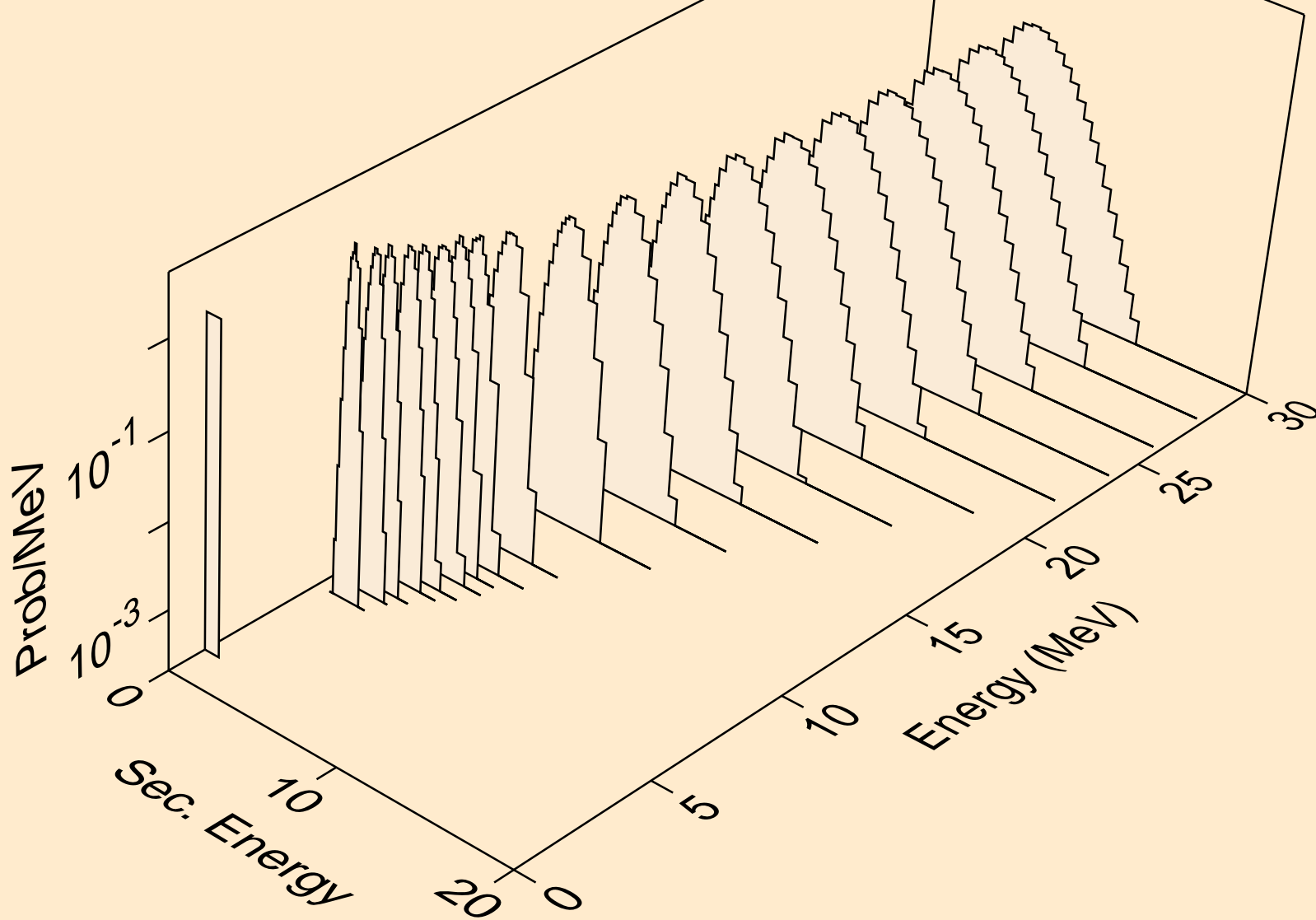

TM151M NEUTRON ACER TENDL-2019 LIBRARY; T=293.16K
protons from (n,pt)

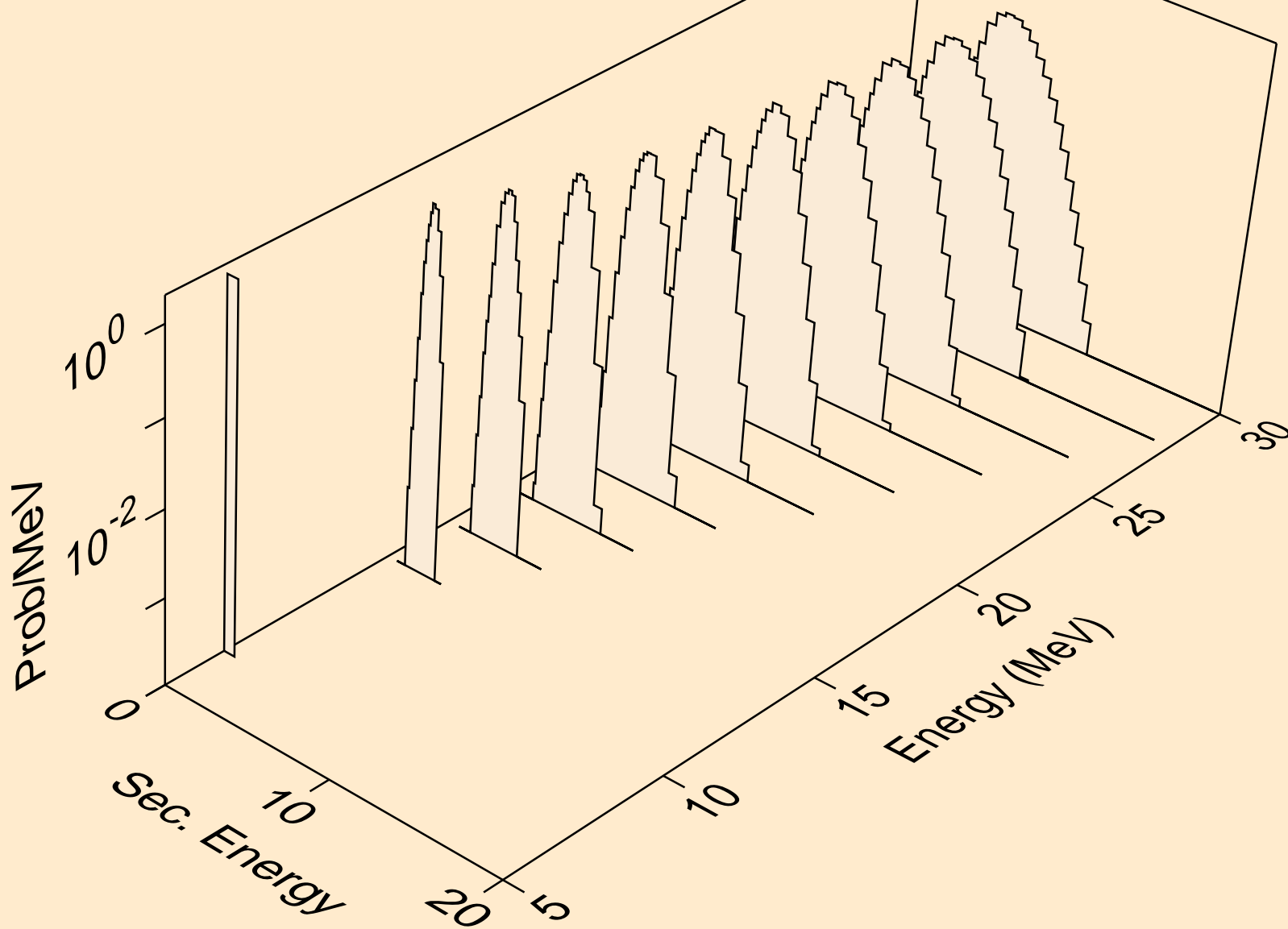

TM151M NEUTRON ACER TENDL-2019 LIBRARY; T=293.16K
deuterons from (n,x)

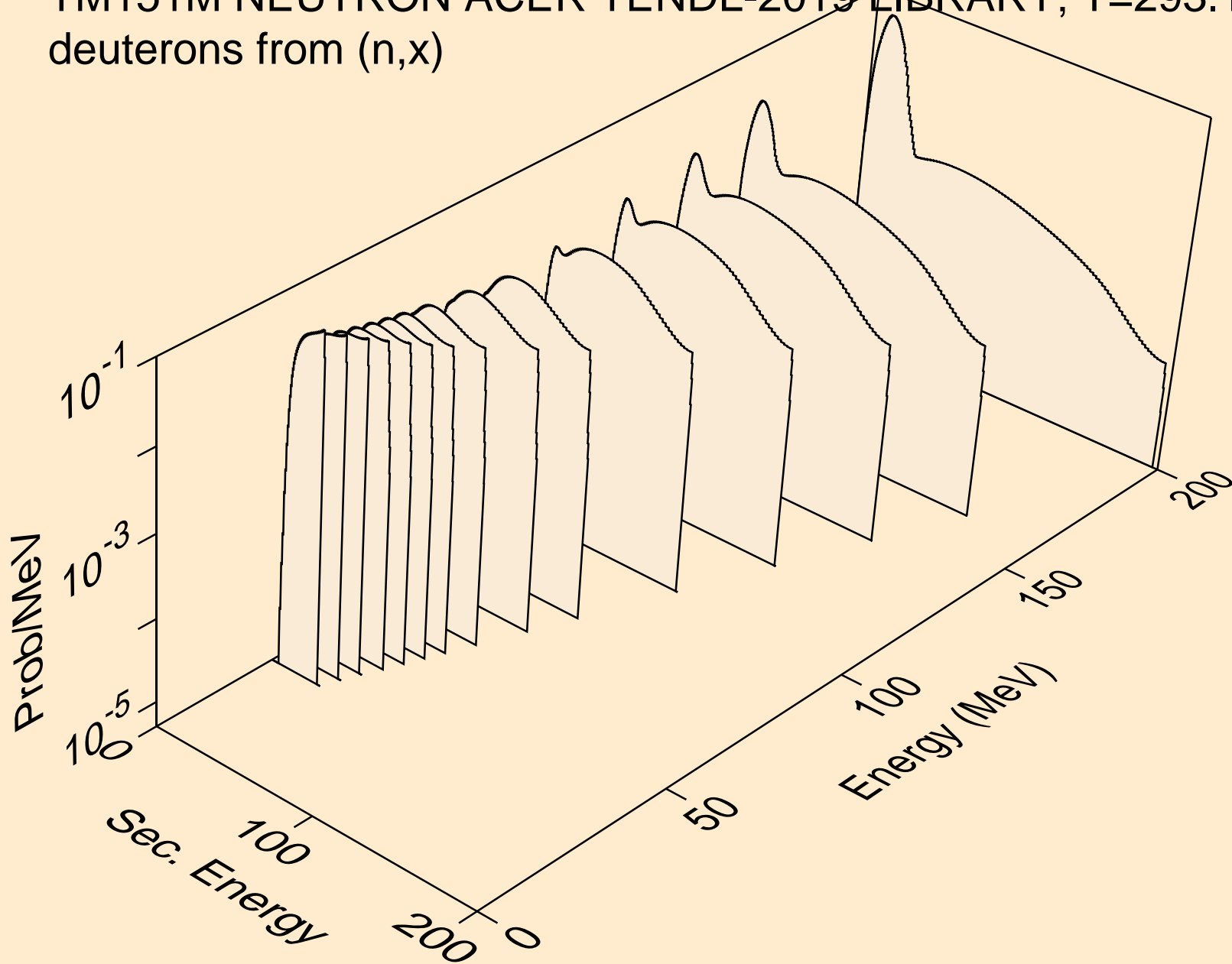

TM151M NEUTRON ACER TENDL-2019 LIBRARY; T=293.16K
deuterons from (n,2nd)

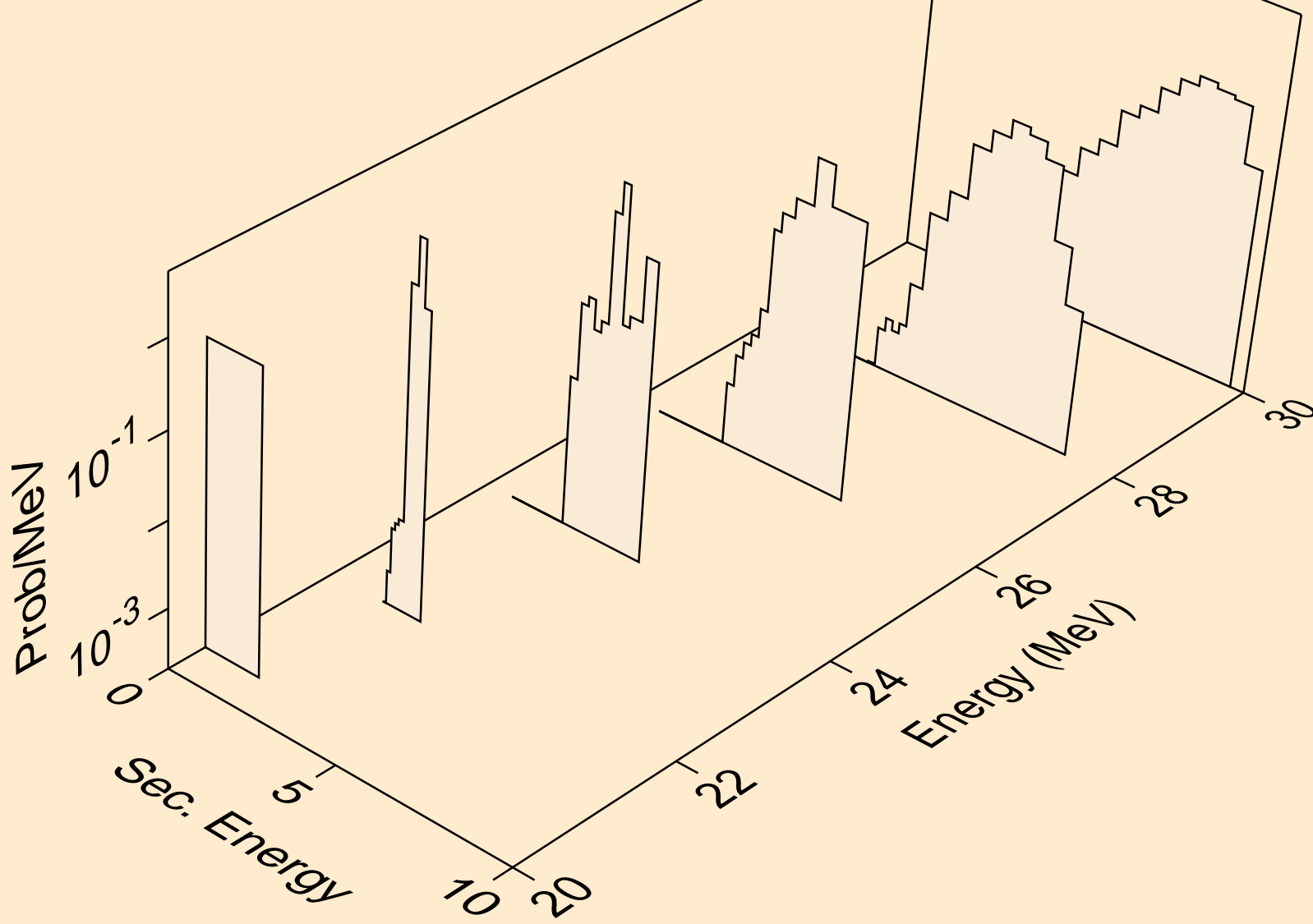

TM151M NEUTRON ACER TENDL-2019 LIBRARY; T=293.16K
deuterons from (n,n*)d

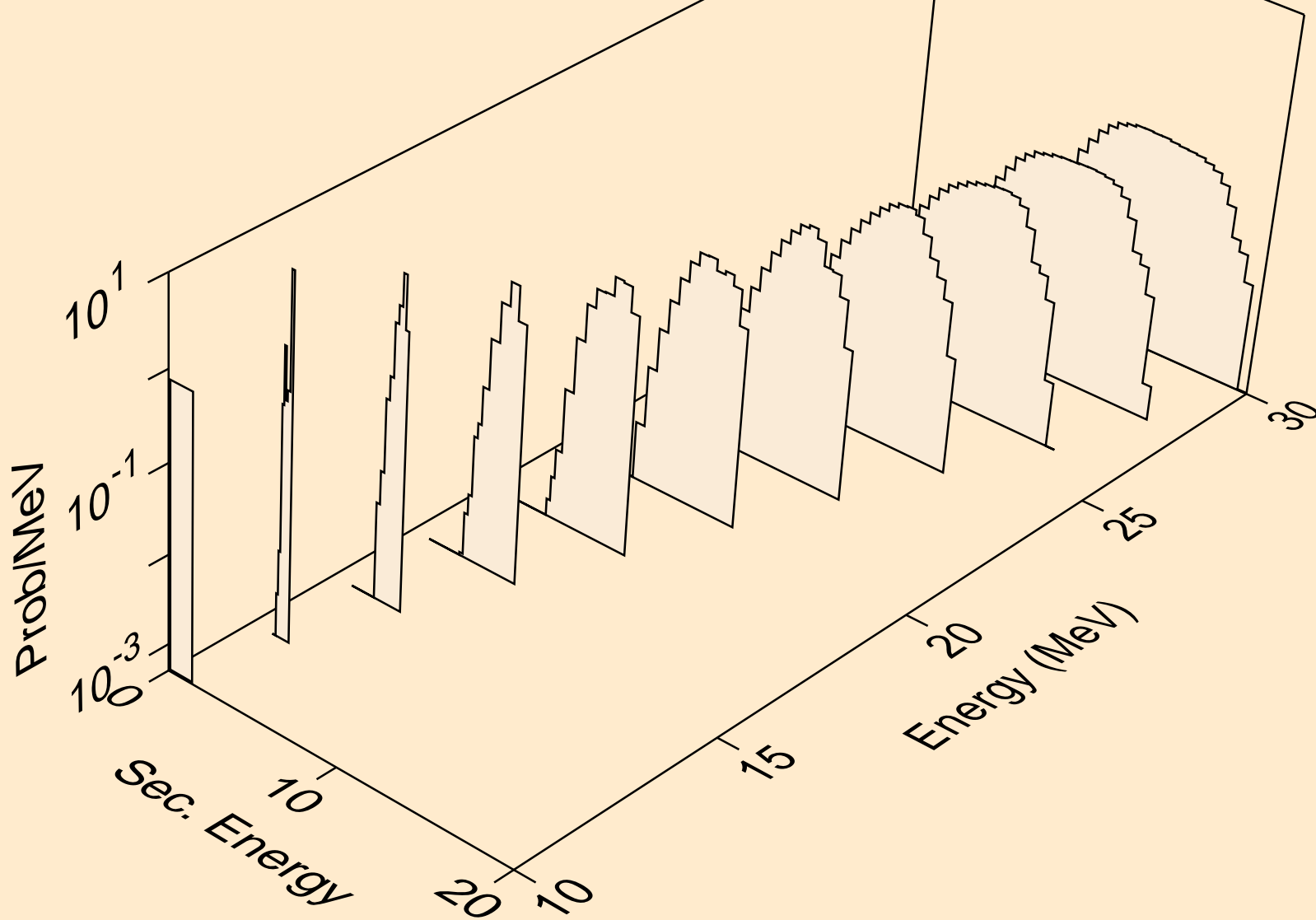

TM151M NEUTRON ACER TENDL-2019 LIBRARY; T=293.16K
deuterons from (n,d)

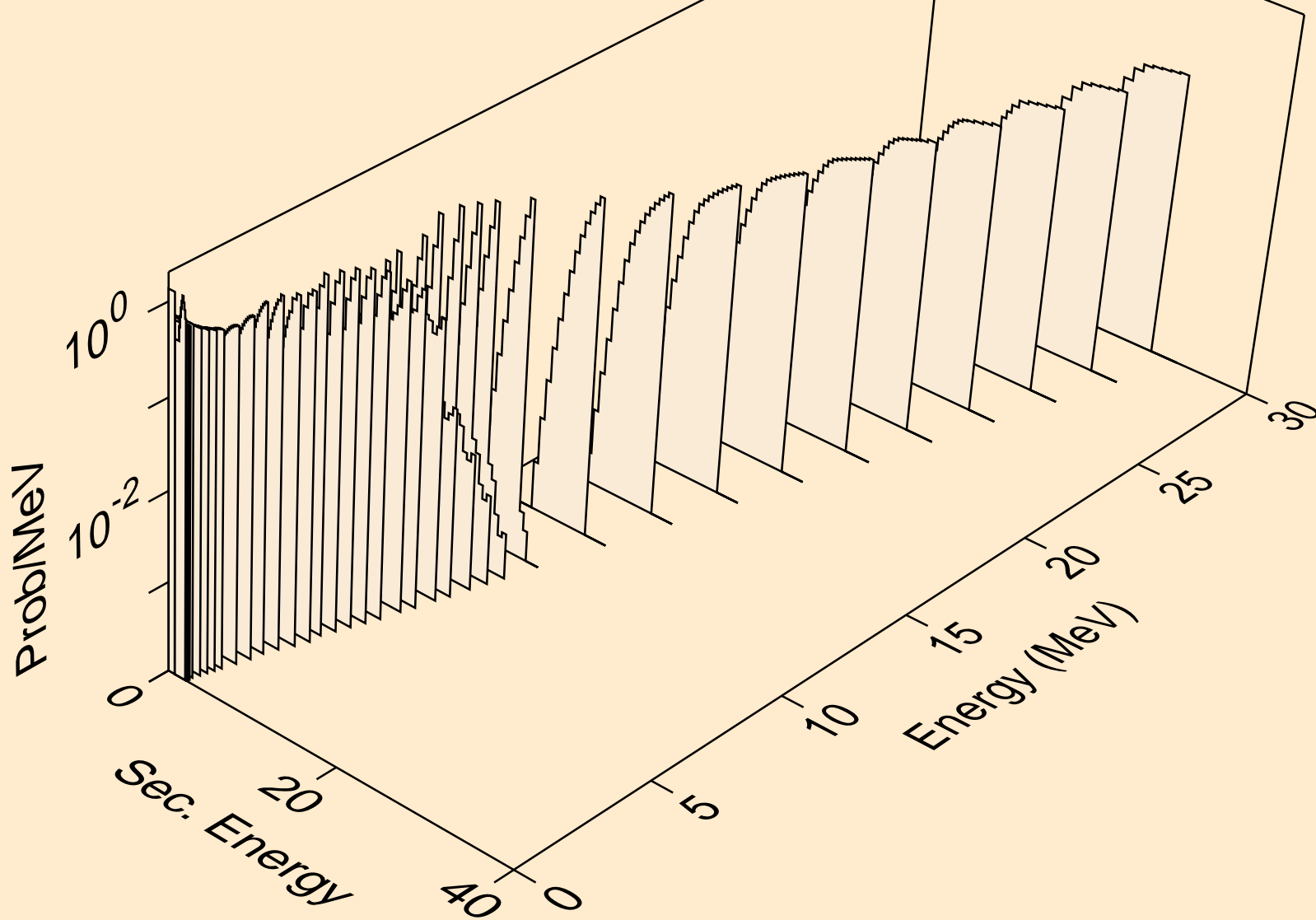

TM151M NEUTRON ACER TENDL-2019 LIBRARY; T=293.16K
deuterons from (n,pd)

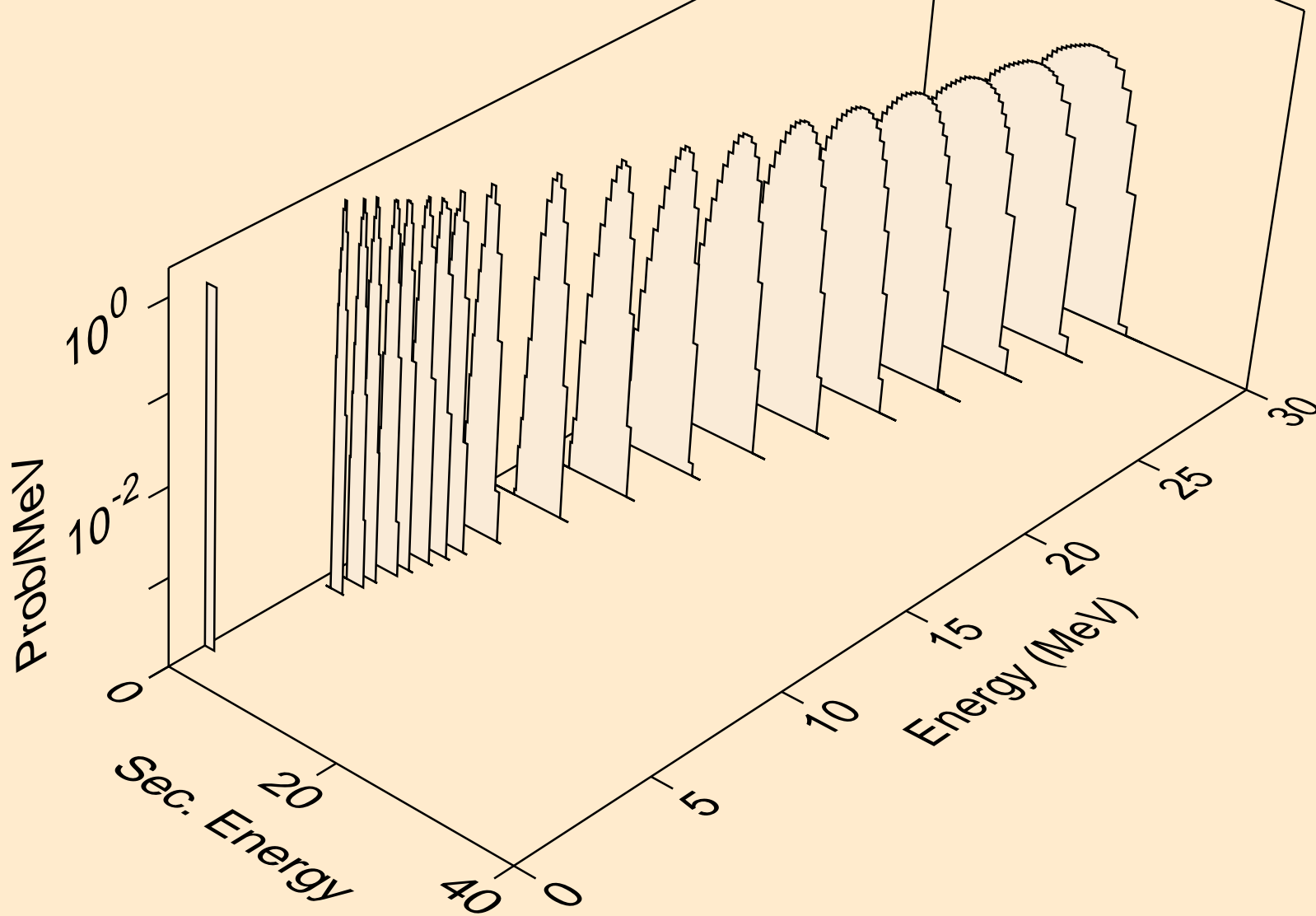

TM151M NEUTRON ACER TENDL-2019 LIBRARY; T=293.16K
deuterons from (n,da)

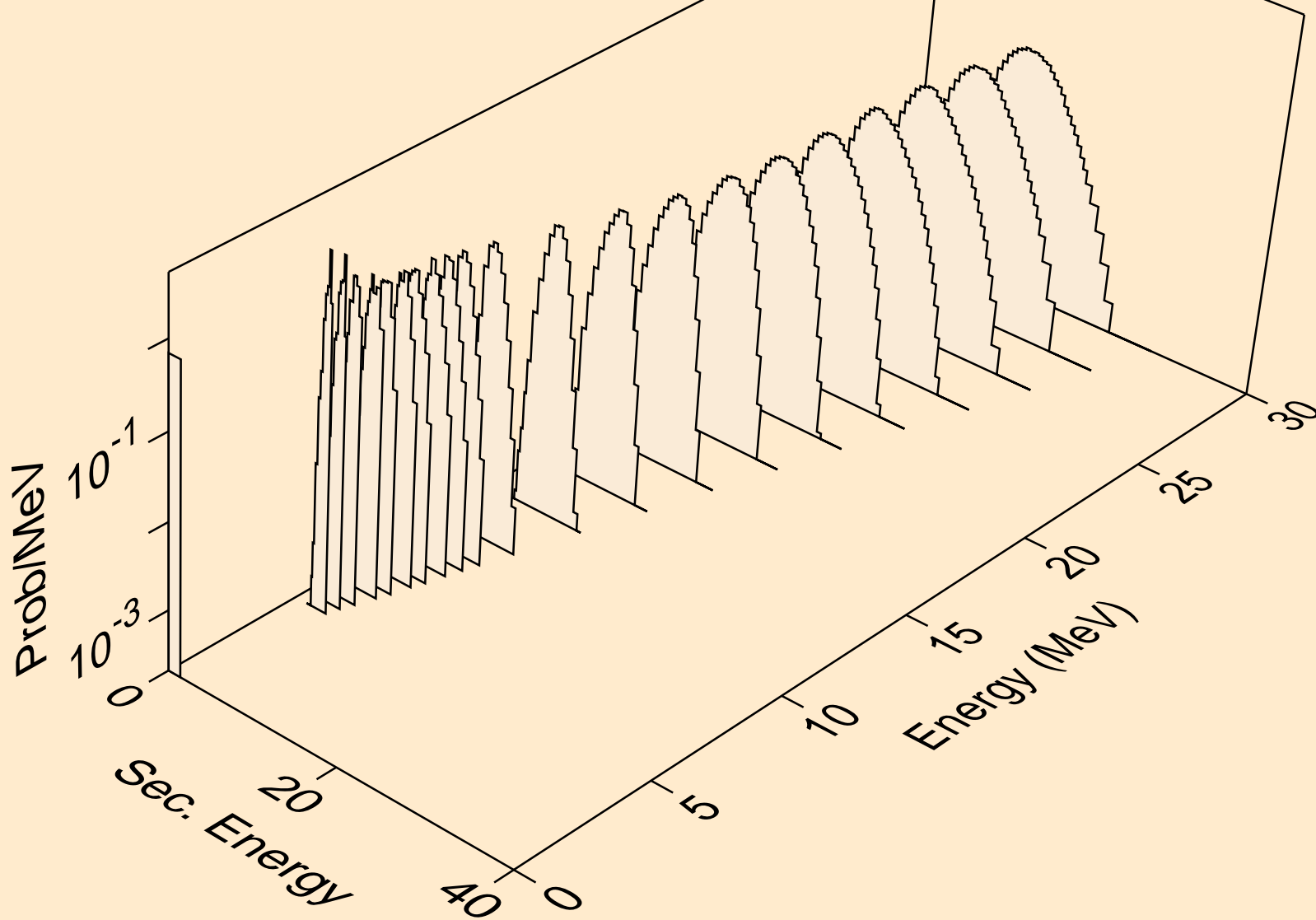

TM151M NEUTRON ACER TENDL-2019 LIBRARY; T=293.16K
tritons from (n,x)

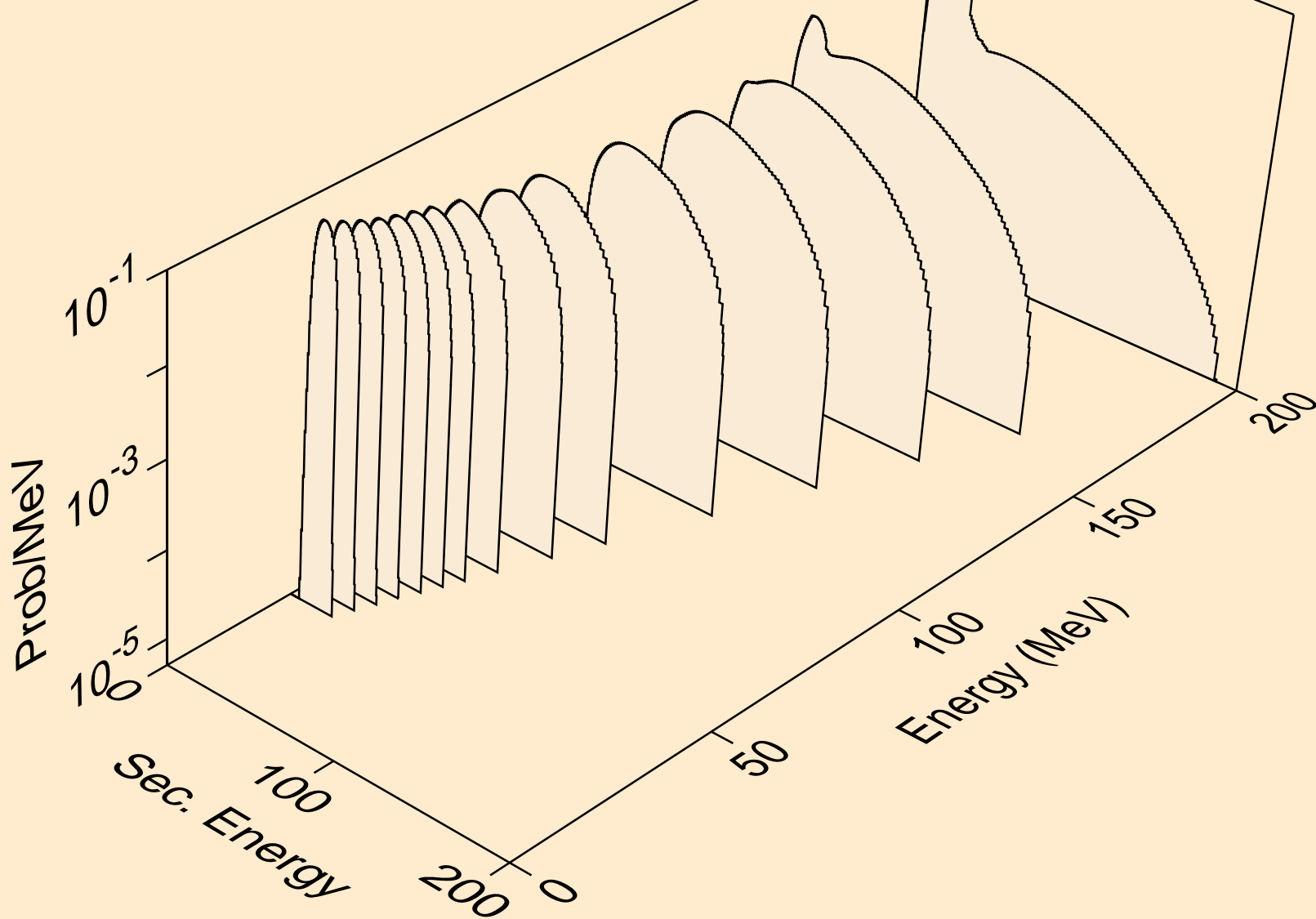

TM151M NEUTRON ACER TENDL-2019 LIBRARY; T=293.16K
tritons from (n,n*)t

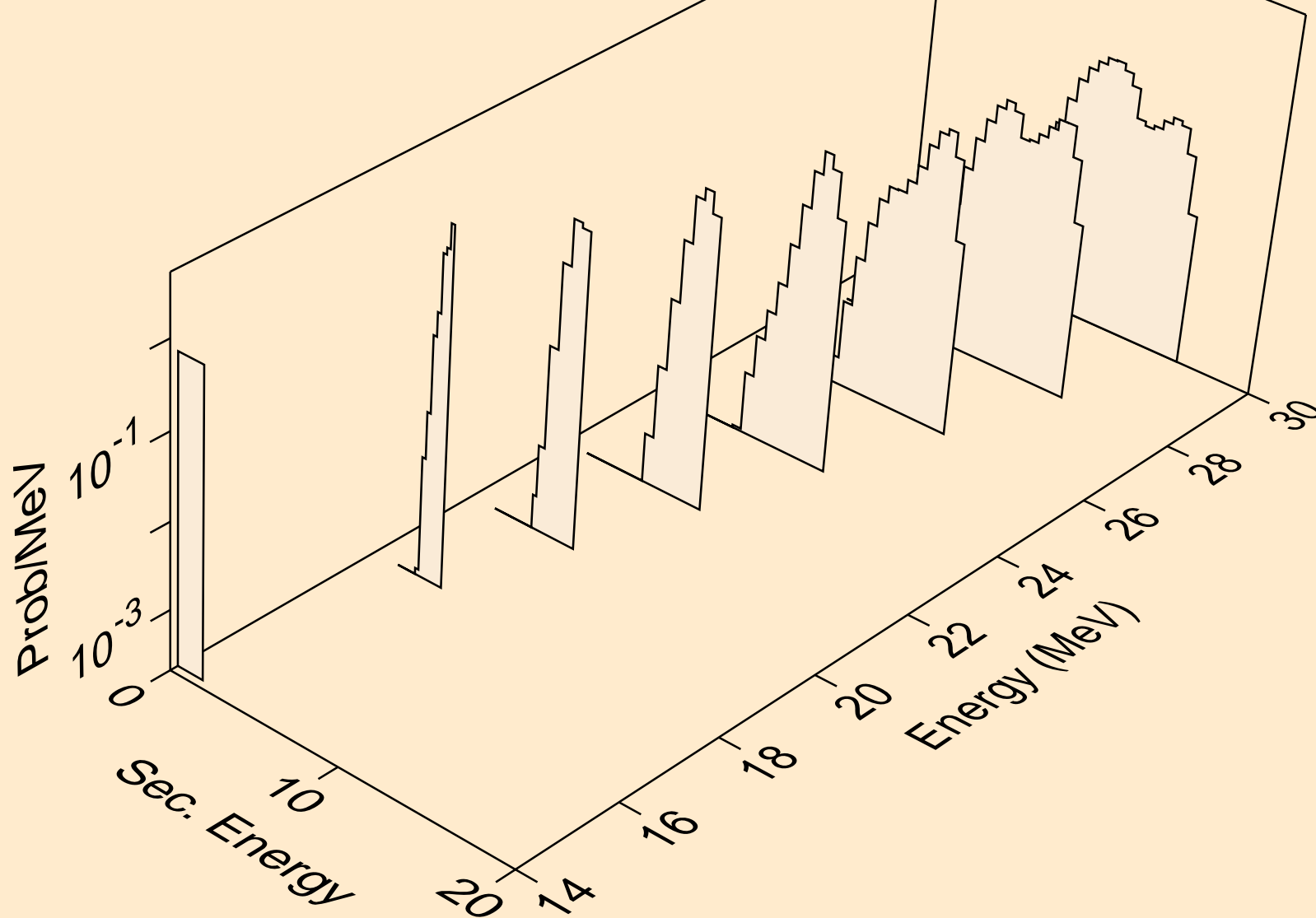

TM151M NEUTRON ACER TENDL-2019 LIBRARY; T=293.16K
tritons from (n,t)

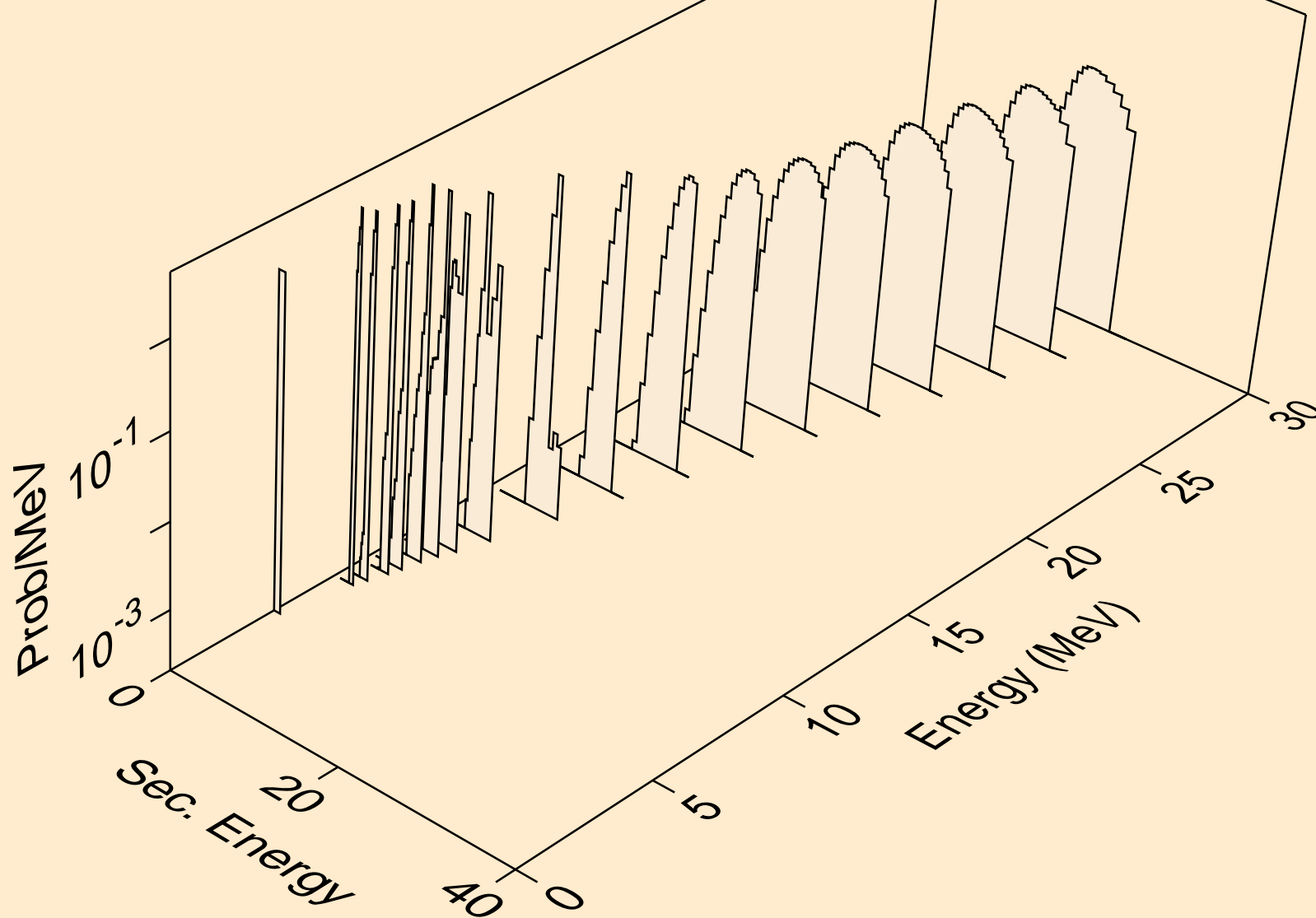

TM151M NEUTRON ACER TENDL-2019 LIBRARY; T=293.16K
tritons from (n,pt)

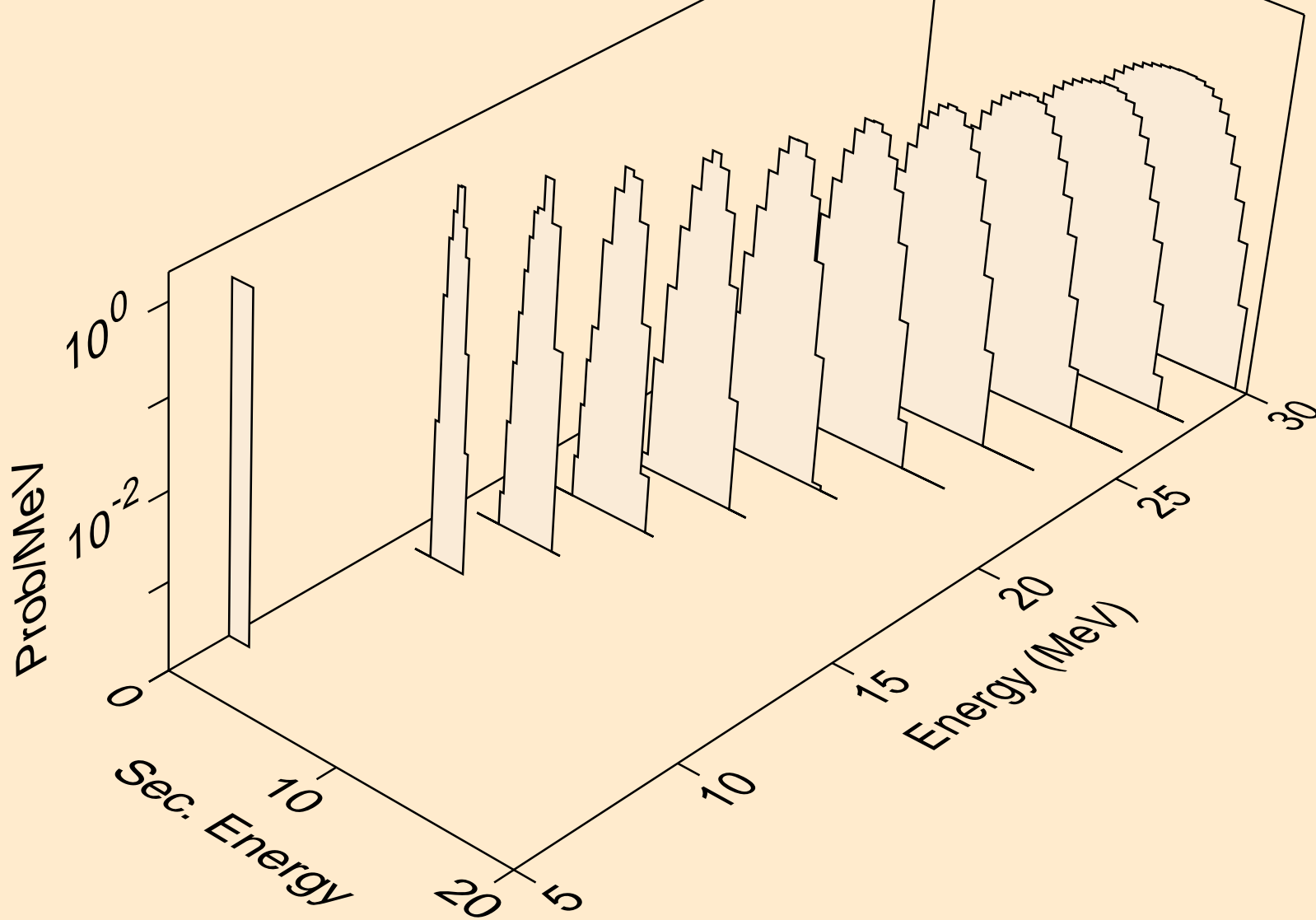

TM151M NEUTRON ACER TENDL-2019 LIBRARY; T=293.16K
he3s from (n,x)

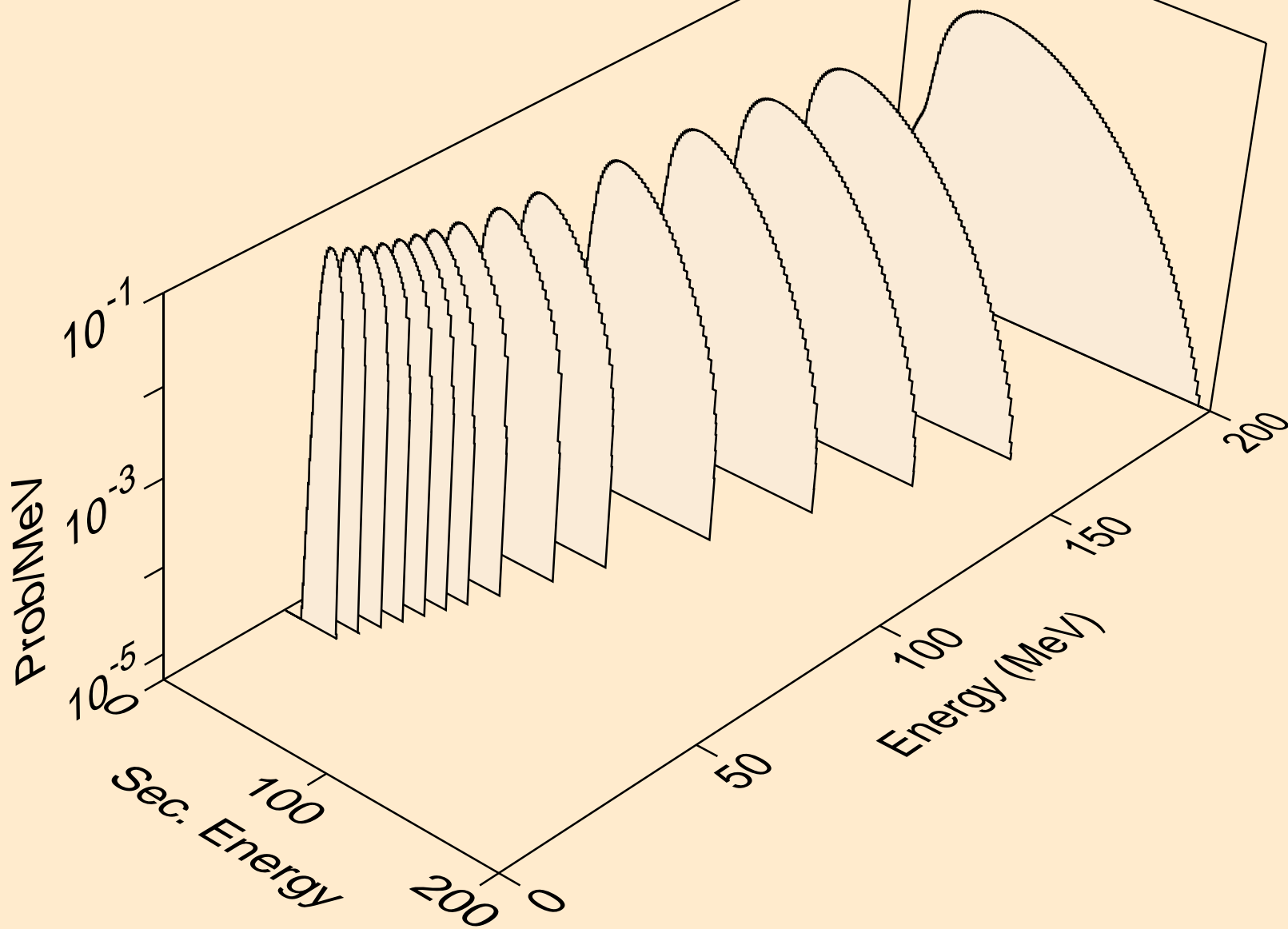

TM151M NEUTRON ACER TENDL-2019 LIBRARY; T=293.16K
he3s from (n,n*)he3

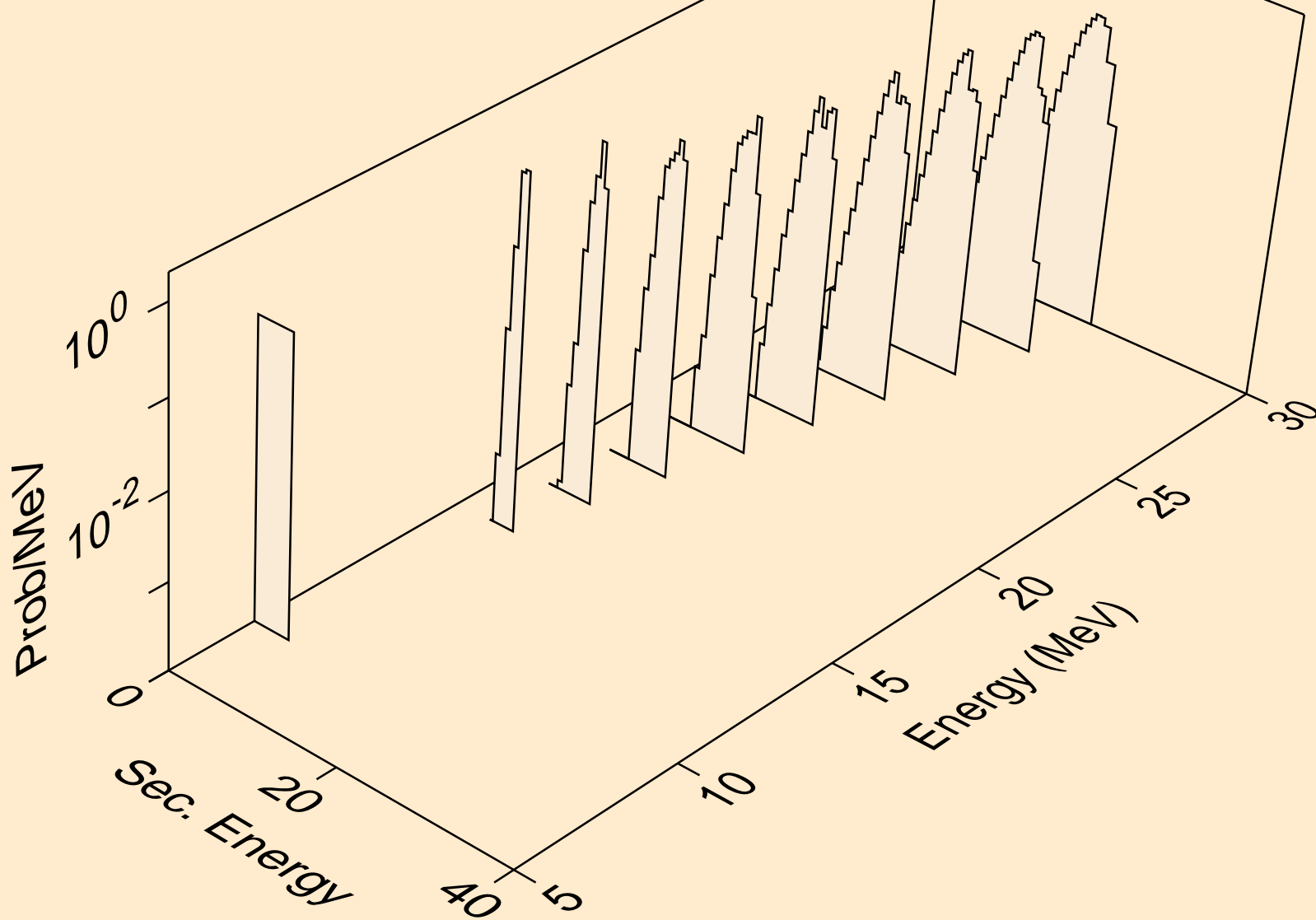

TM151M NEUTRON ACER TENDL-2019 LIBRARY; T=293.16K
he3s from (n,he3)

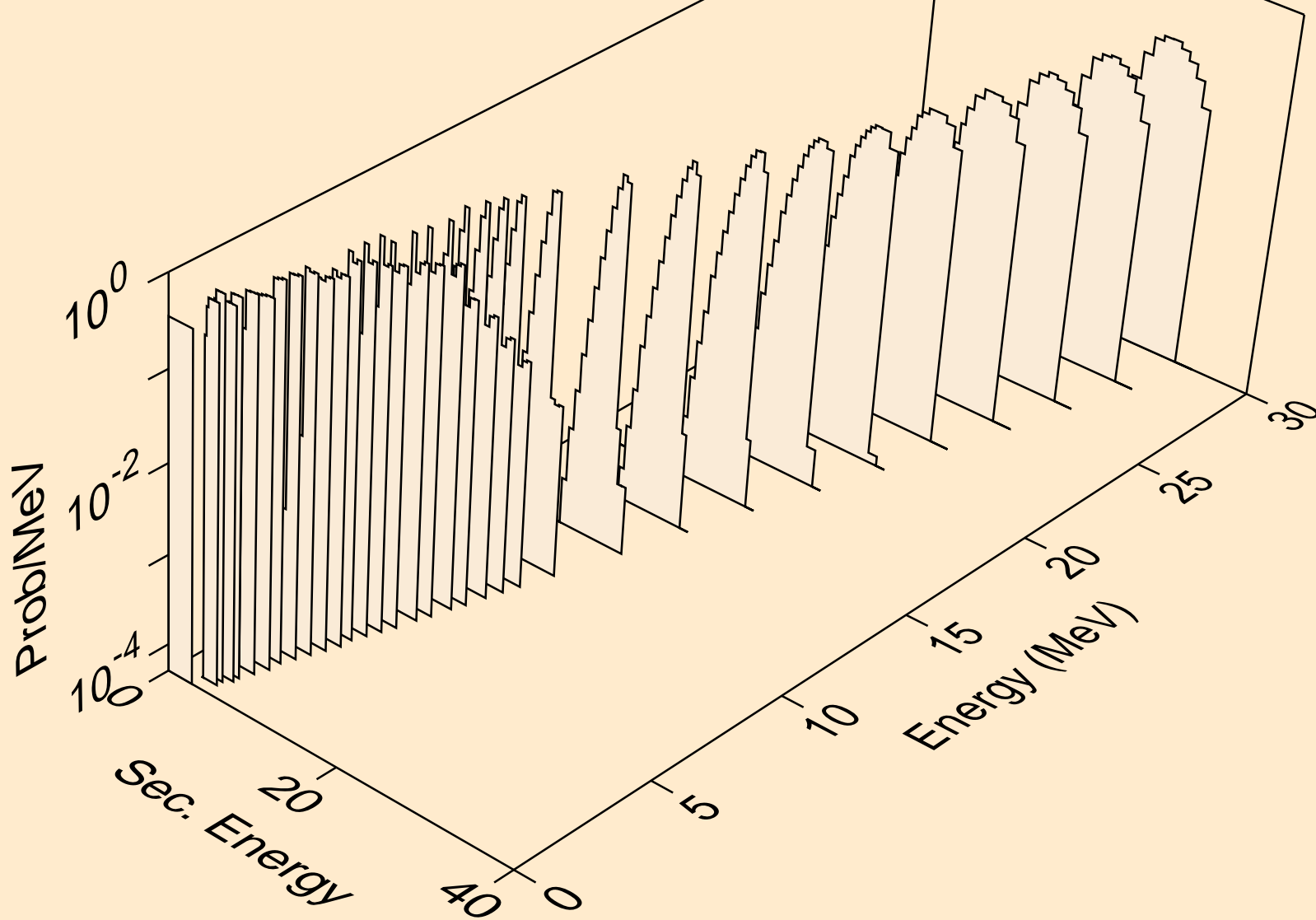

TM151M NEUTRON ACER TENDL-2019 LIBRARY; T=293.16K
alphas from (n,x)

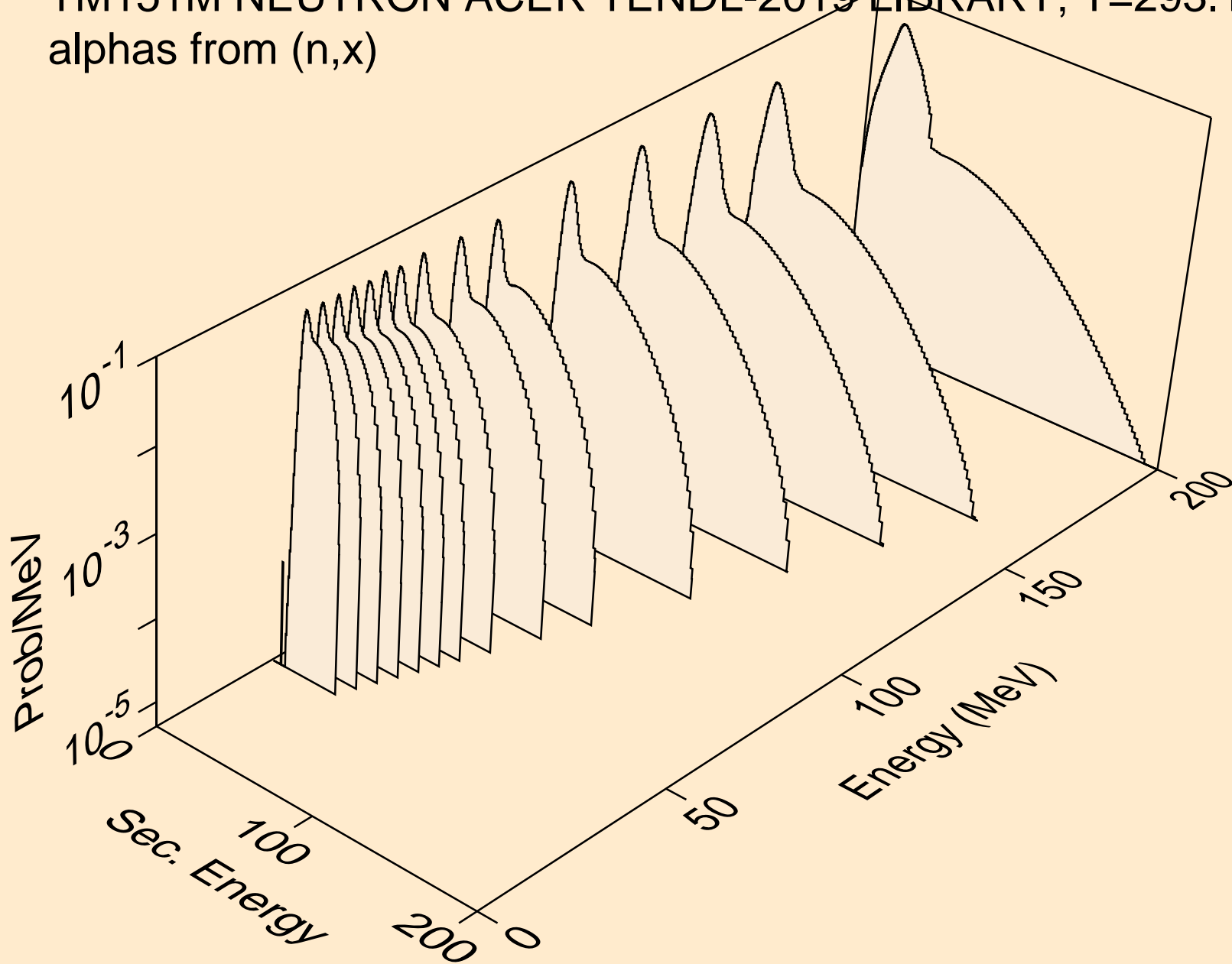

TM151M NEUTRON ACER TENDL-2019 LIBRARY; T=293.16K
alphas from (n,n*)a

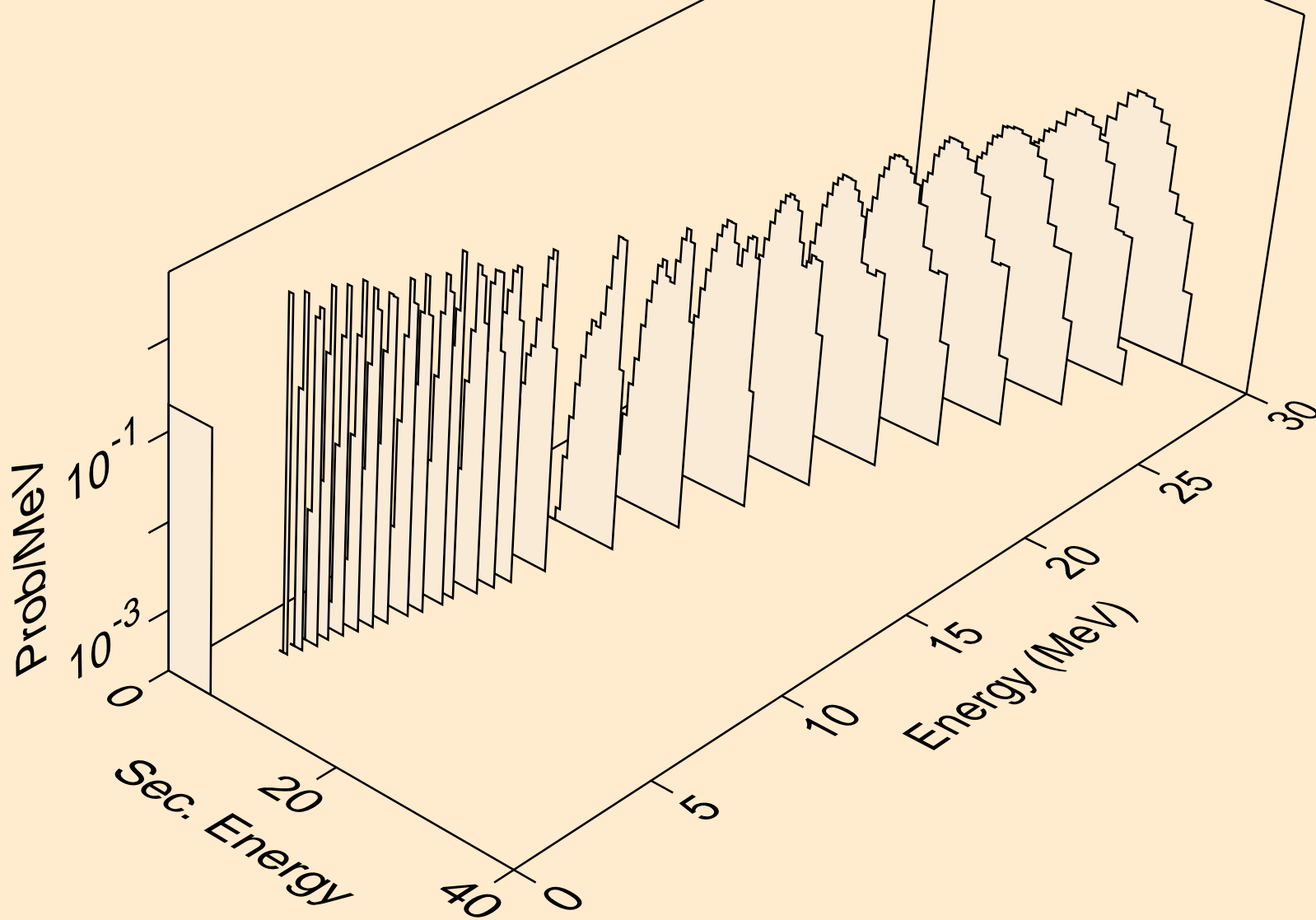

TM151M NEUTRON ACER TENDL-2019 LIBRARY; T=293.16K
alphas from (n,2n)a

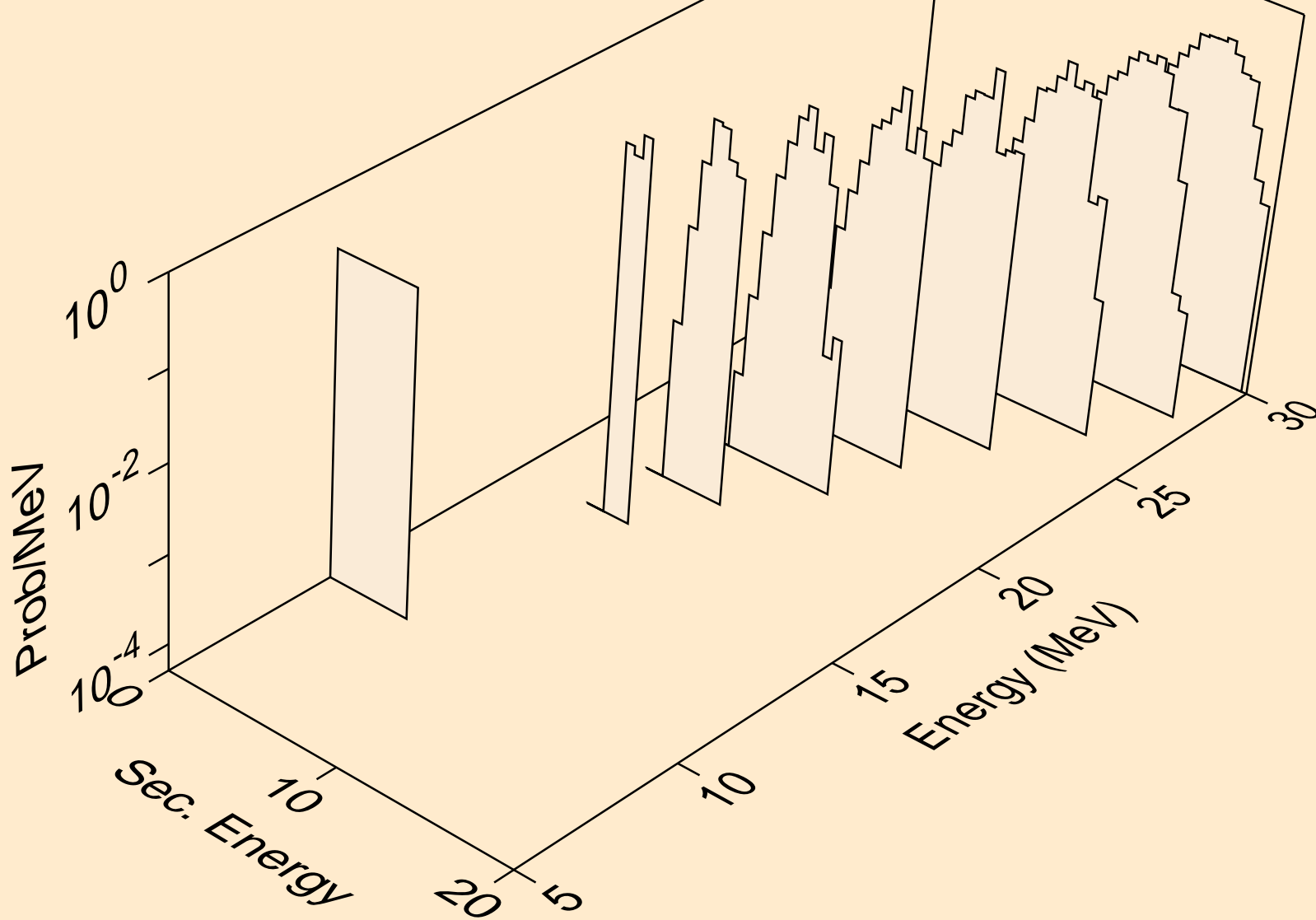

TM151M NEUTRON ACER TENDL-2019 LIBRARY; T=293.16K
alphas from (n,n*)2a

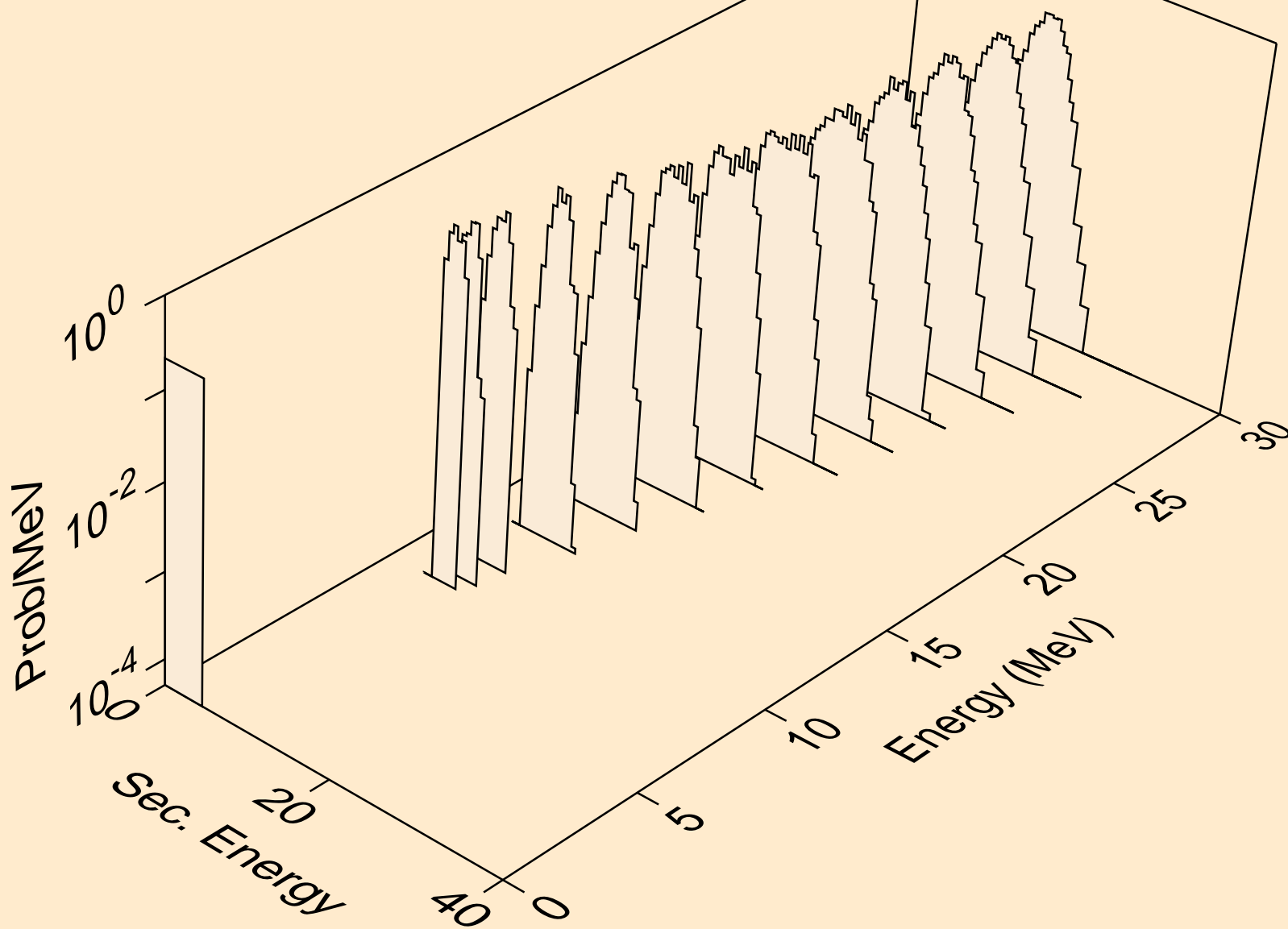

TM151M NEUTRON ACER TENDL-2019 LIBRARY; T=293.16K
alphas from (n,npa)

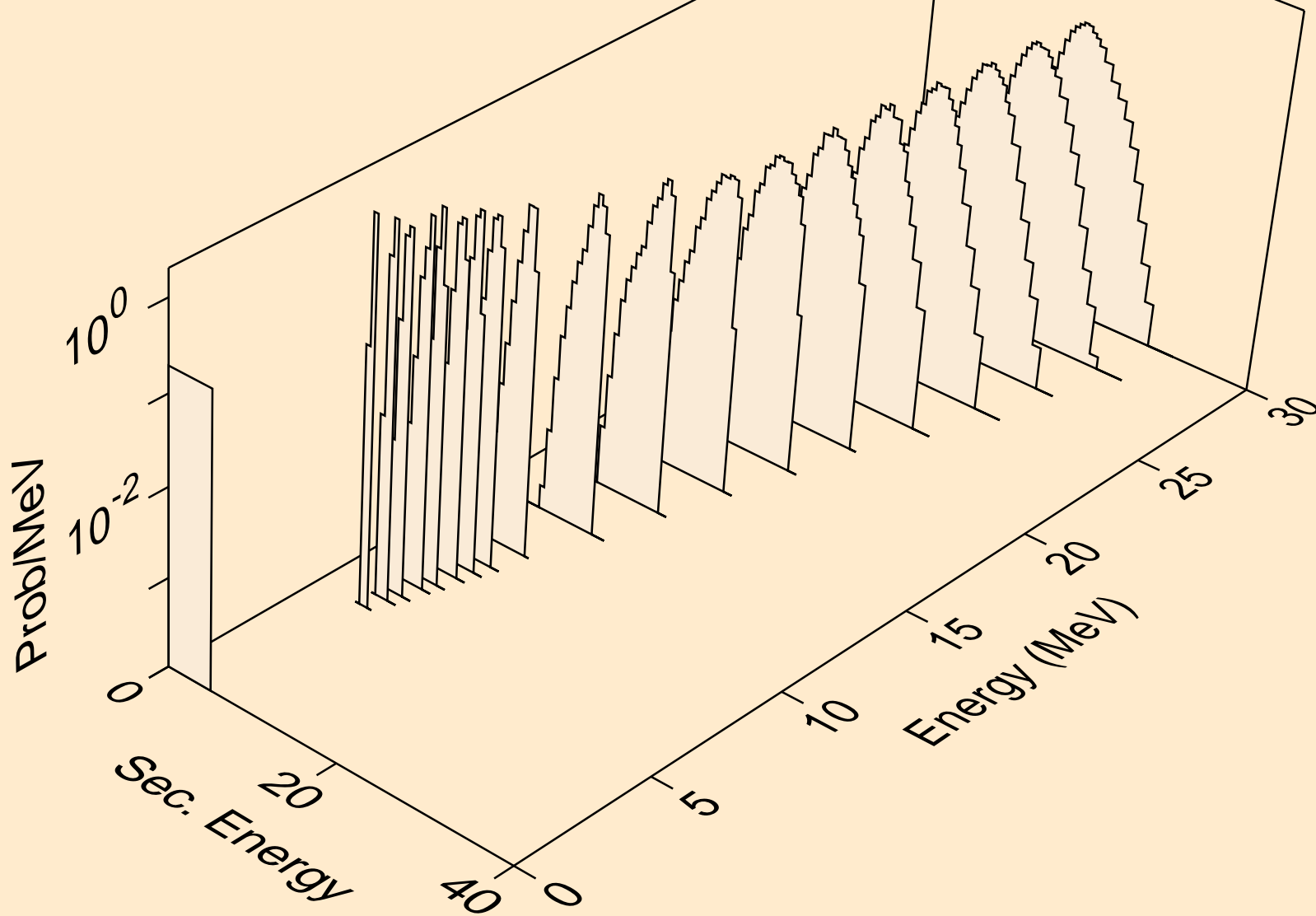

TM151M NEUTRON ACER TENDL-2019 LIBRARY; T=293.16K
alphas from (n,a)

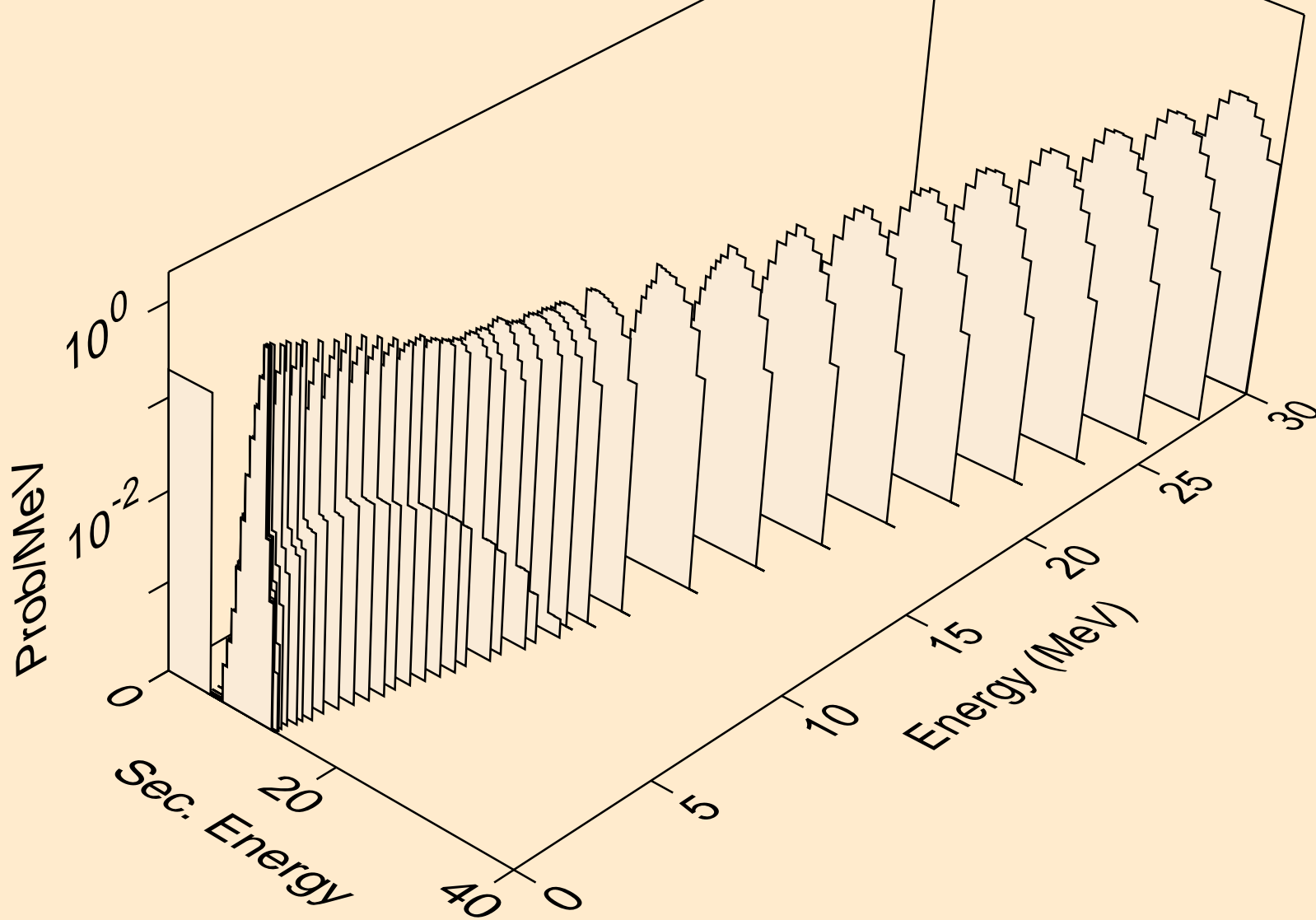

TM151M NEUTRON ACER TENDL-2019 LIBRARY; T=293.16K
alphas from (n,2a)

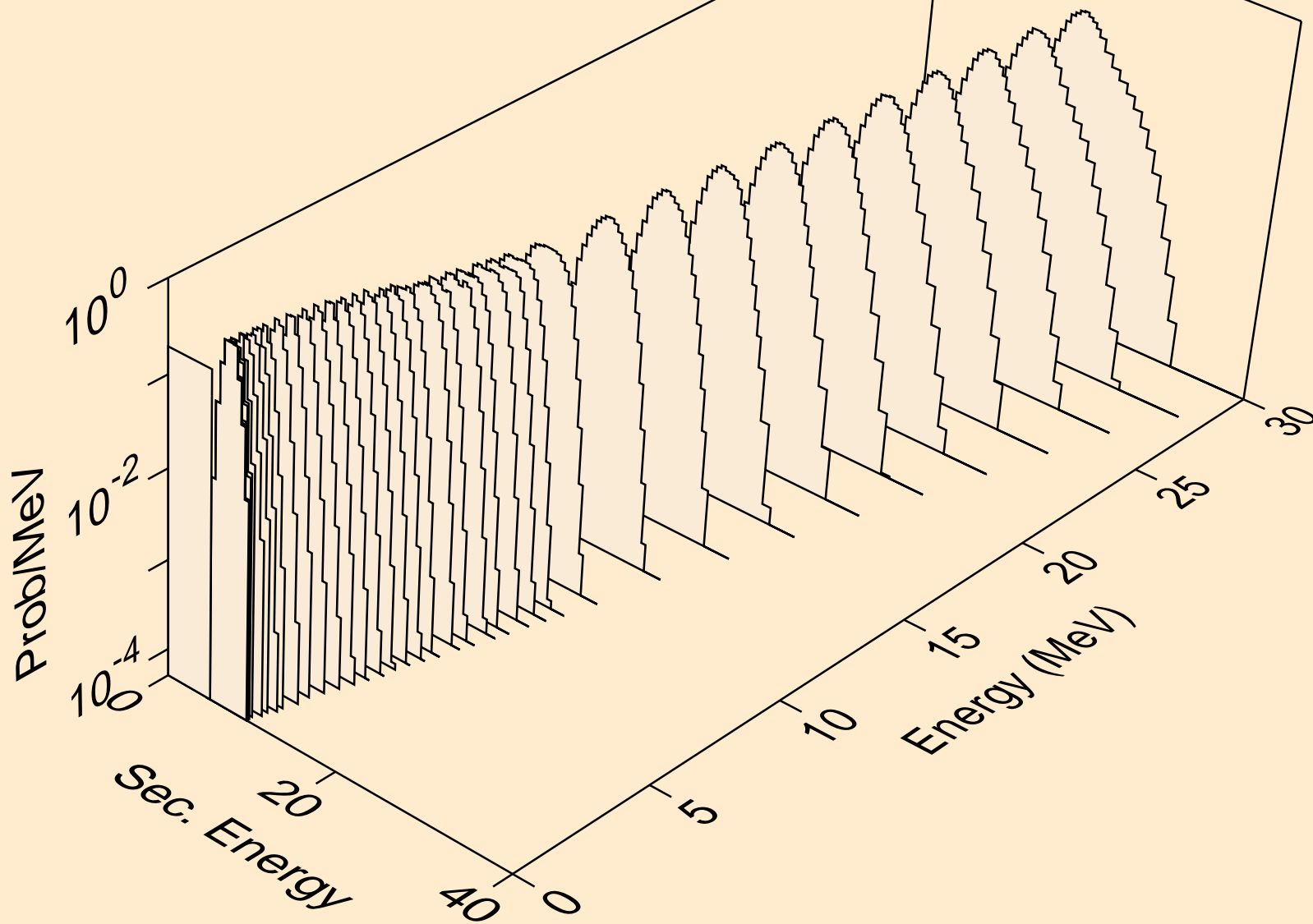

TM151M NEUTRON ACER TENDL-2019 LIBRARY; T=293.16K
alphas from (n,3a)

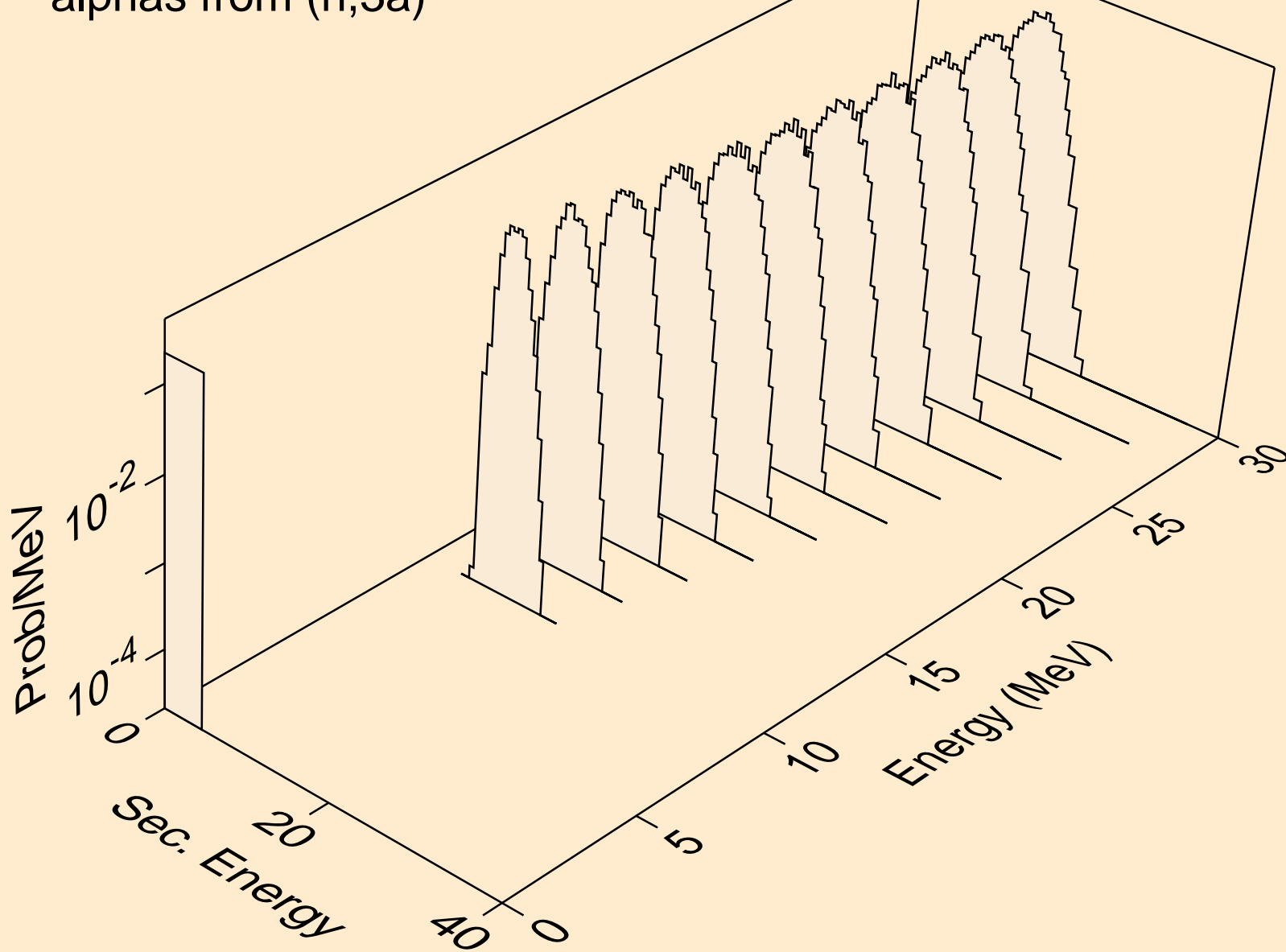

TM151M NEUTRON ACER TENDL-2019 LIBRARY; T=293.16K
alphas from (n,p)

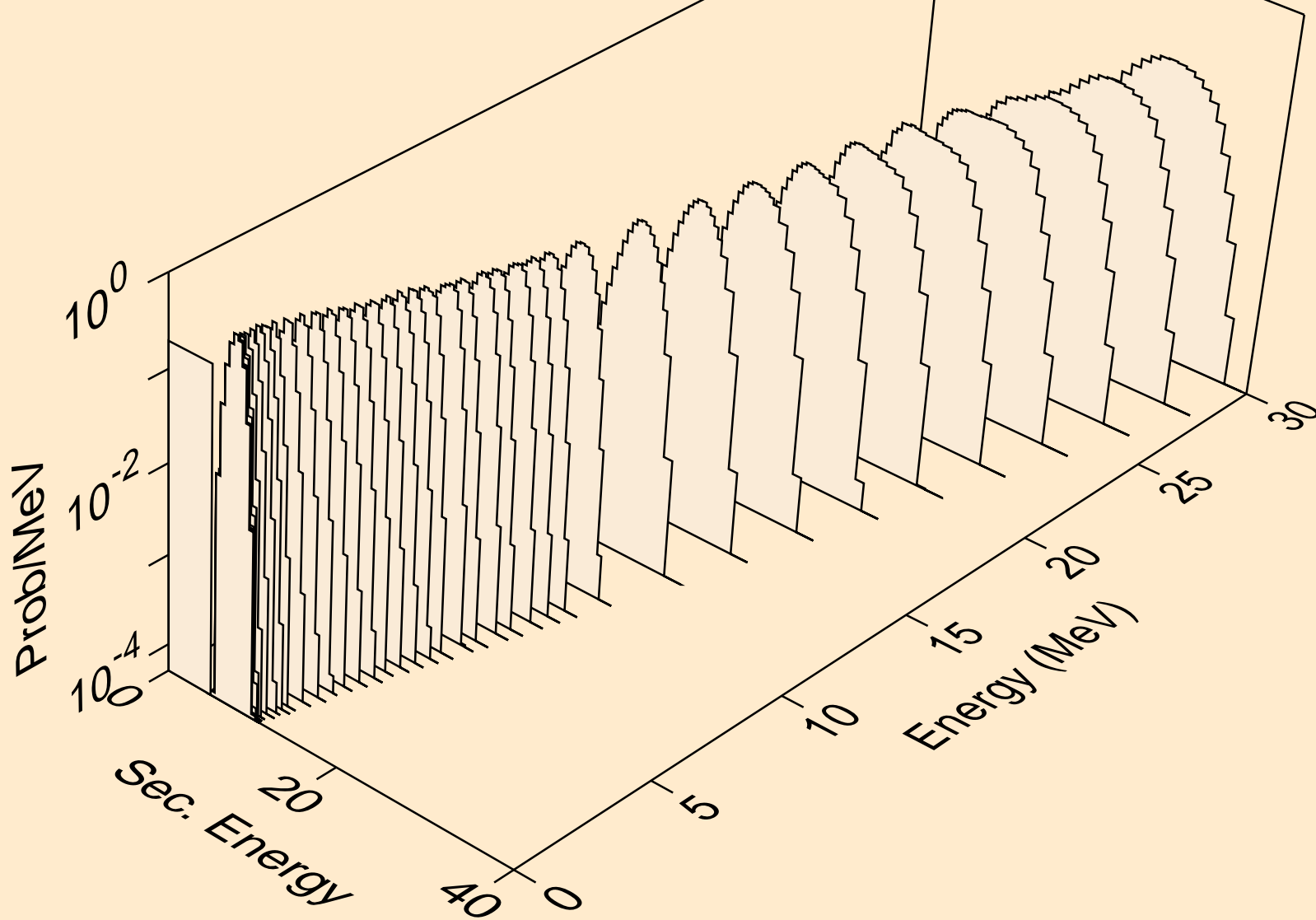

TM151M NEUTRON ACER TENDL-2019 LIBRARY; T=293.16K
alphas from (n,da)

