

TM159 NEUTRON ACER TENDL-2019 LIBRARY; T=293.16K  
Principal cross sections

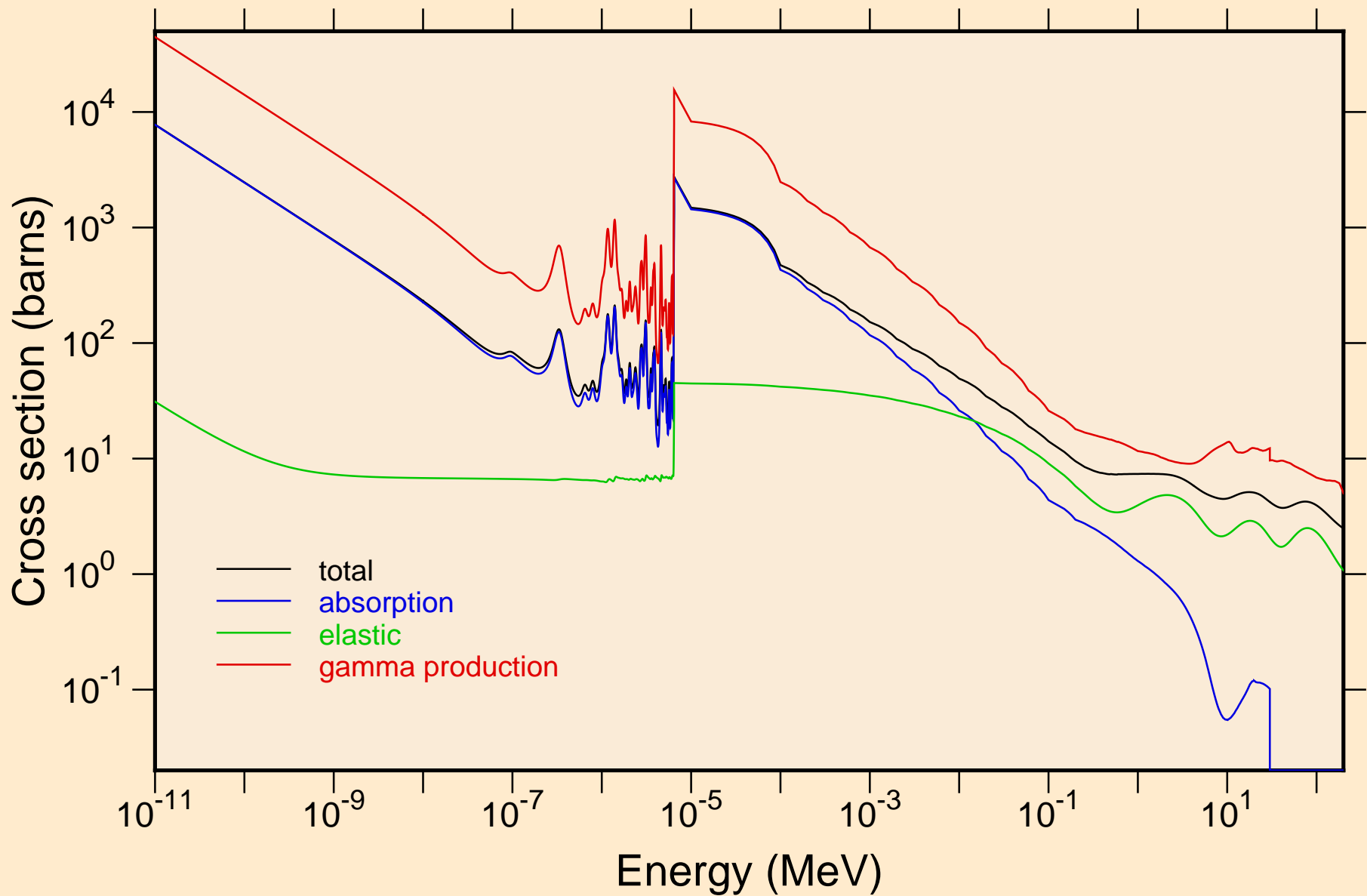

TM159 NEUTRON ACER TENDL-2019 LIBRARY; T=293.16K  
resonance total cross section

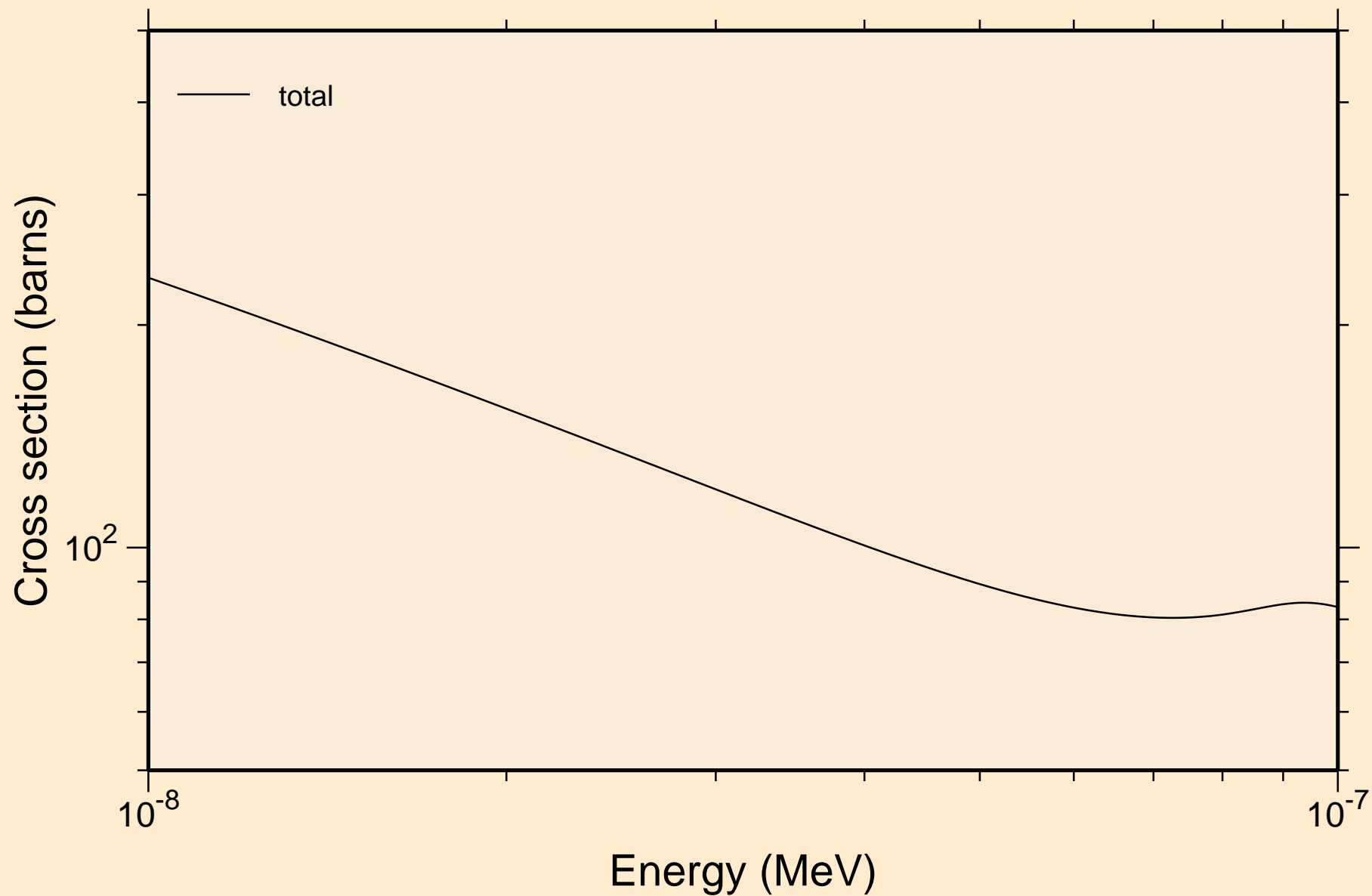

TM159 NEUTRON ACER TENDL-2019 LIBRARY; T=293.16K  
resonance total cross section

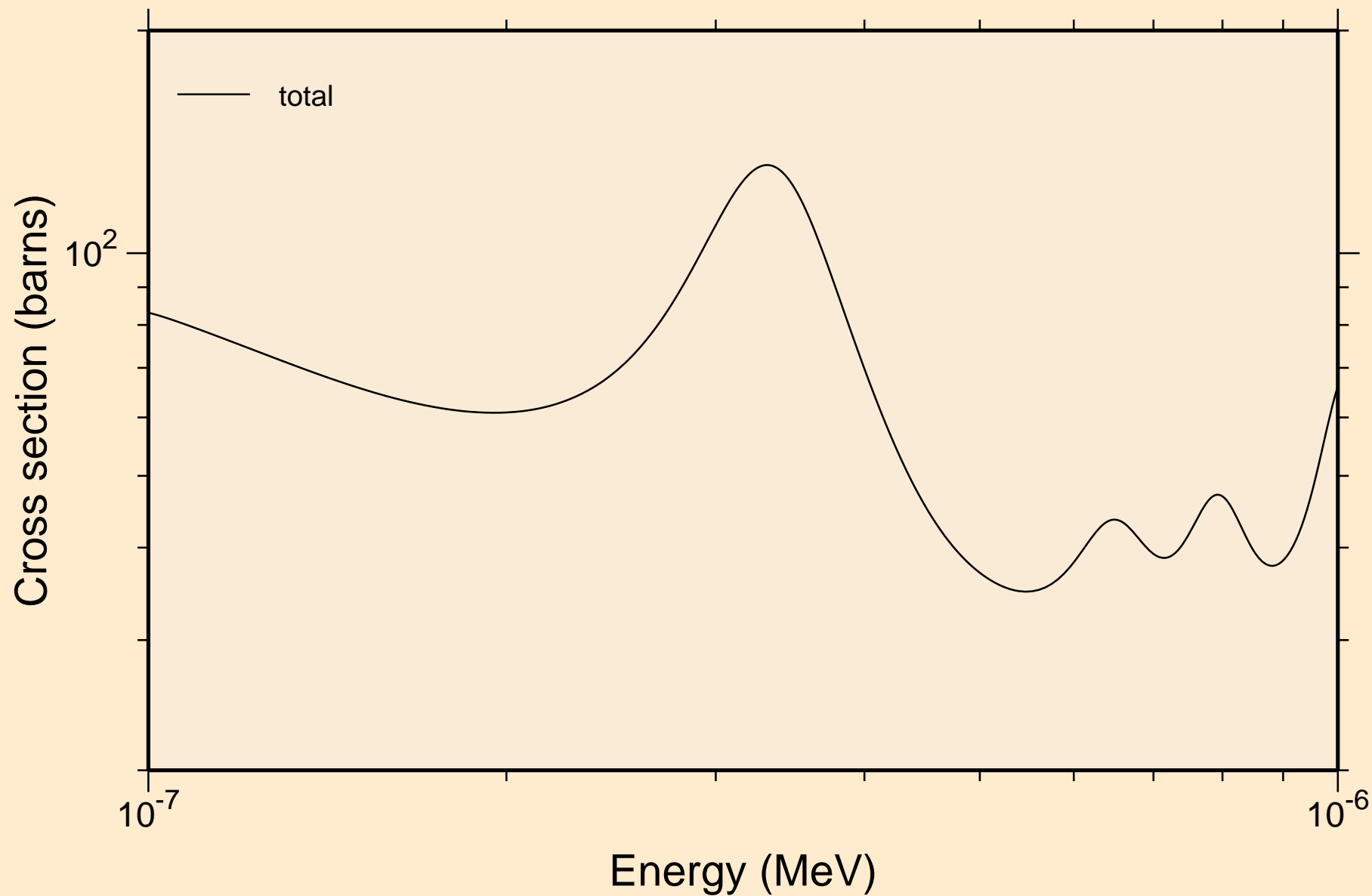

TM159 NEUTRON ACER TENDL-2019 LIBRARY; T=293.16K  
resonance total cross section

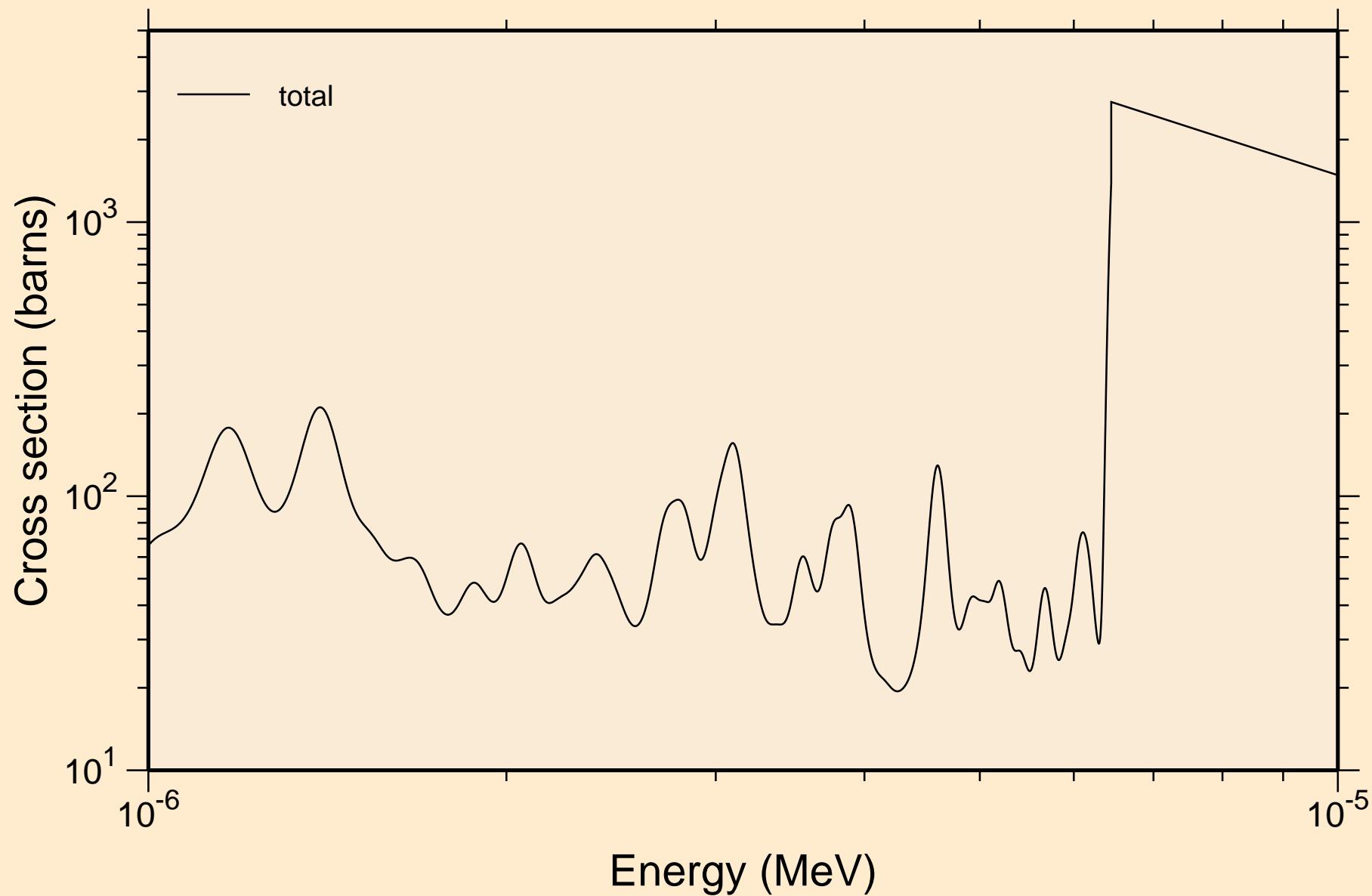

TM159 NEUTRON ACER TENDL-2019 LIBRARY; T=293.16K  
resonance total cross section

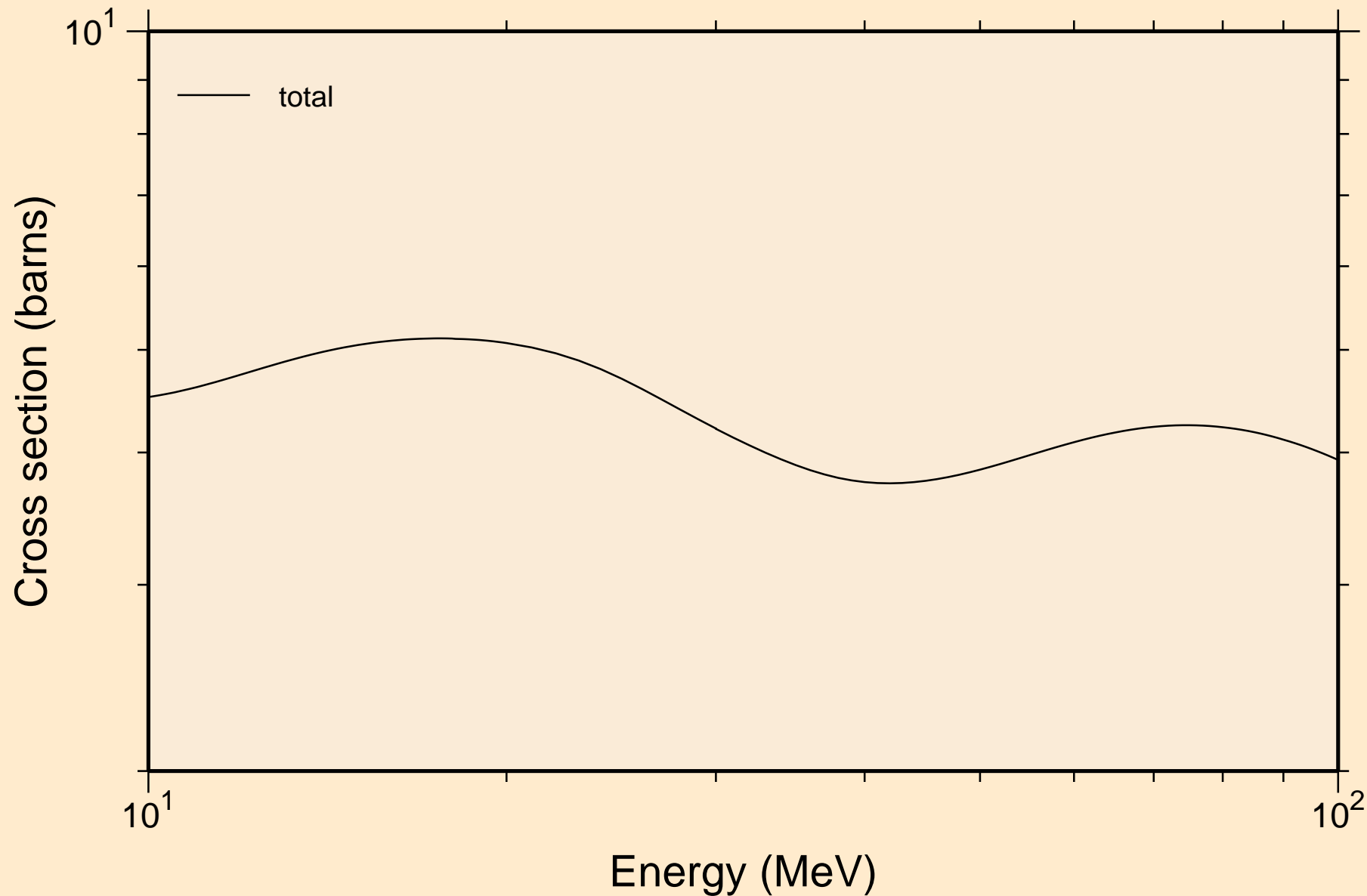

TM159 NEUTRON ACER TENDL-2019 LIBRARY; T=293.16K  
resonance absorption cross sections

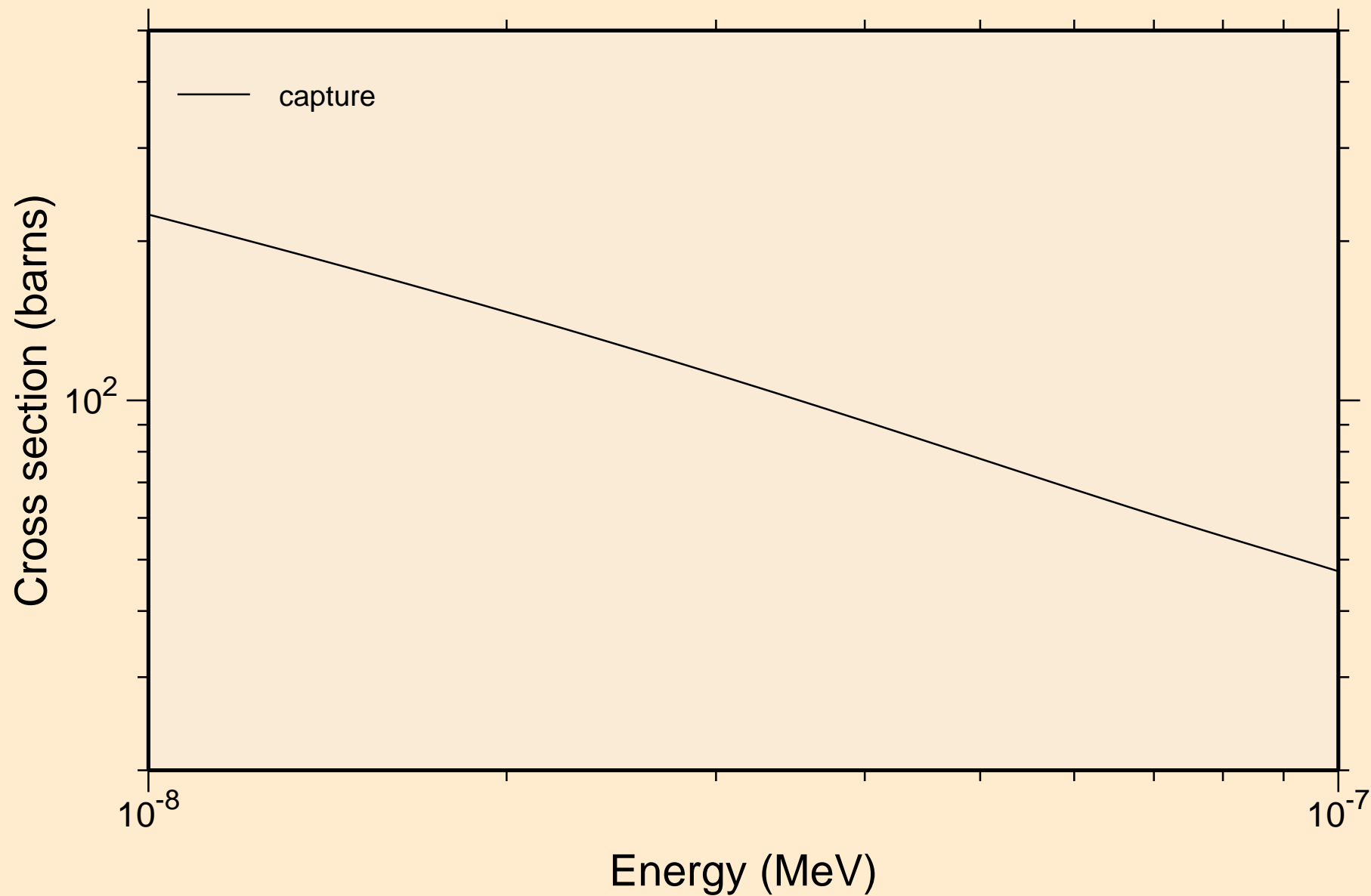

TM159 NEUTRON ACER TENDL-2019 LIBRARY; T=293.16K  
resonance absorption cross sections

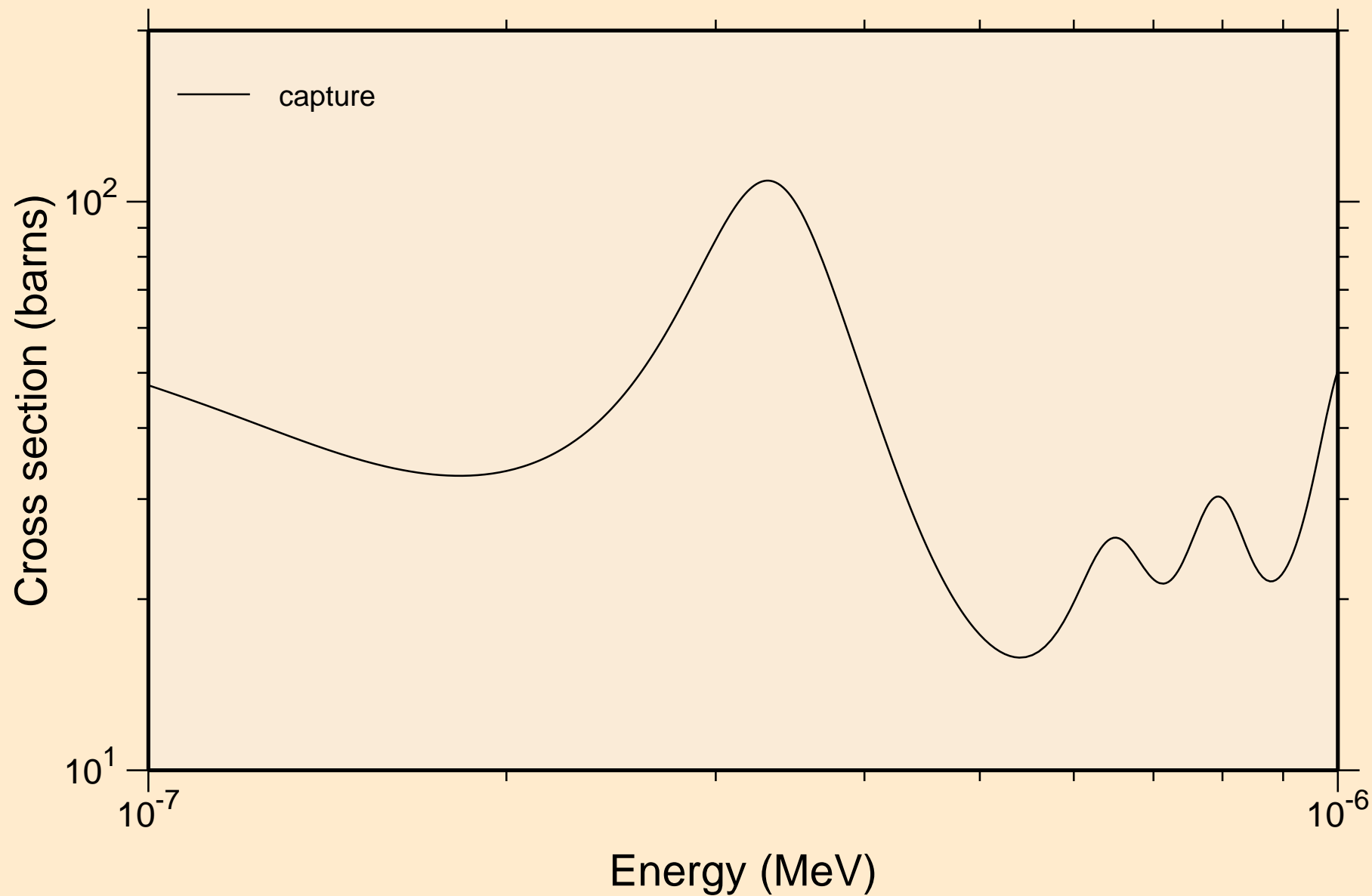

TM159 NEUTRON ACER TENDL-2019 LIBRARY; T=293.16K  
resonance absorption cross sections

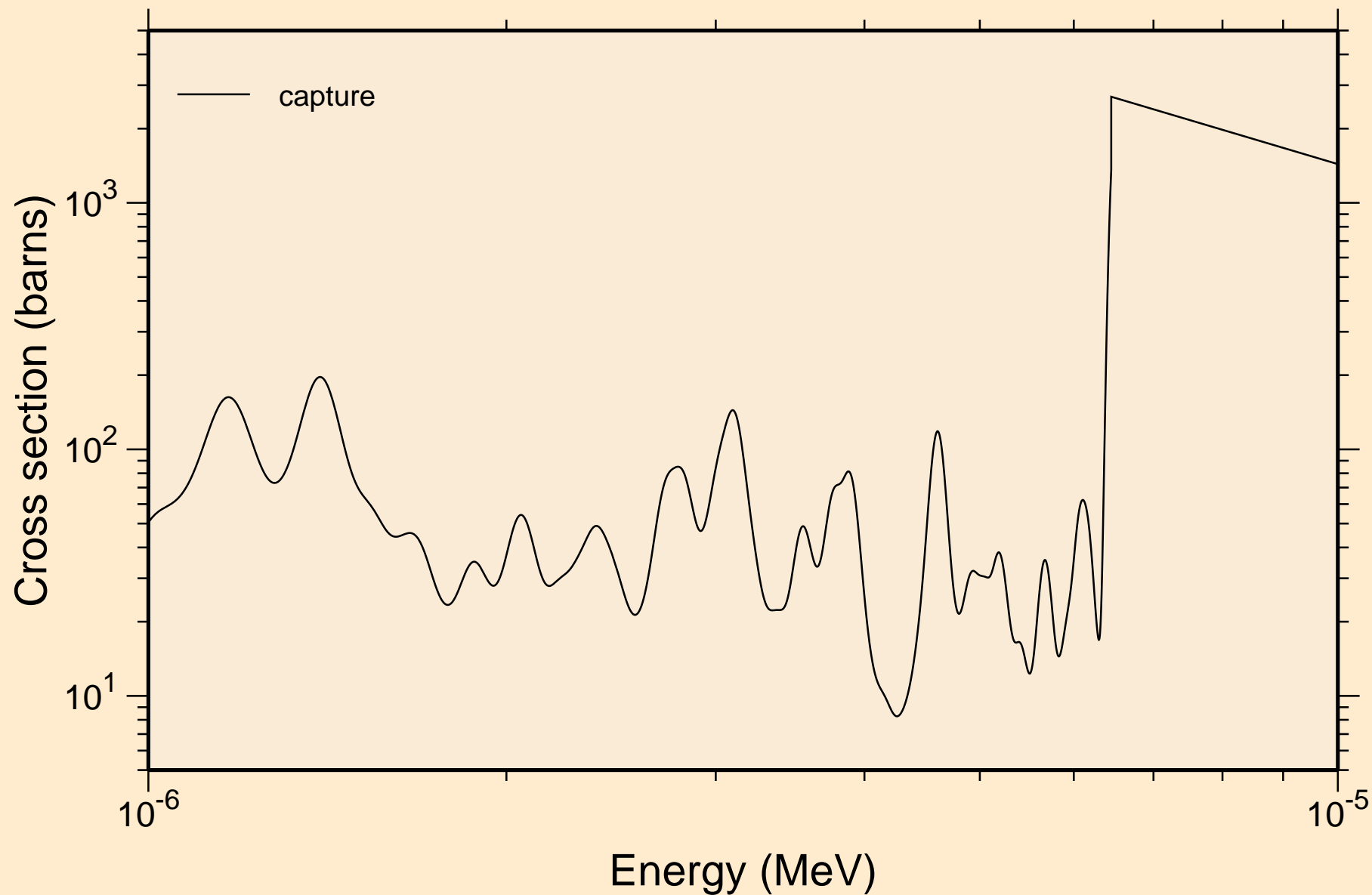



TM159 NEUTRON ACER TENDL-2019 LIBRARY; T=293.16K  
resonance absorption cross sections

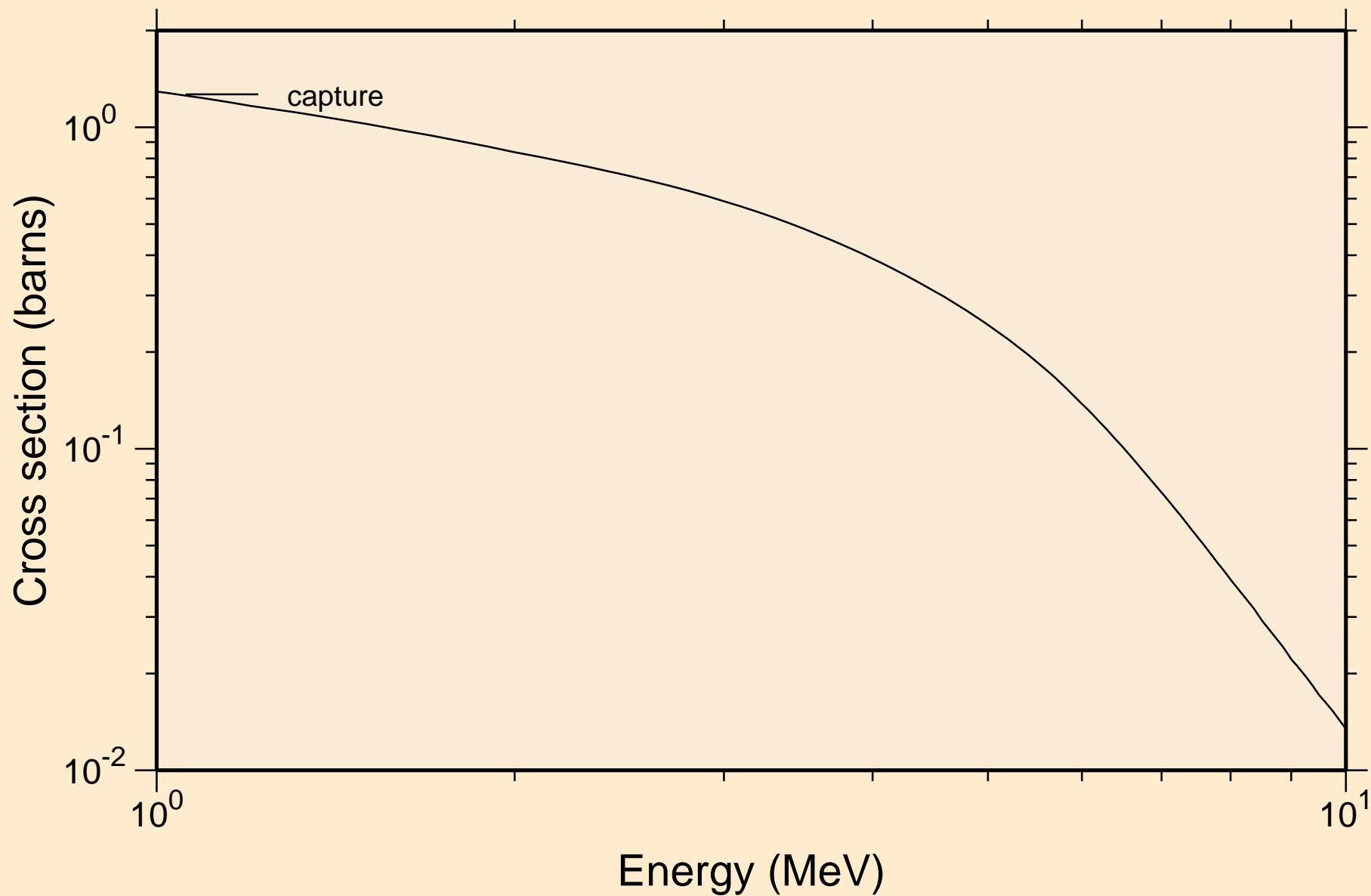

TM159 NEUTRON ACER TENDL-2019 LIBRARY; T=293.16K  
Heating

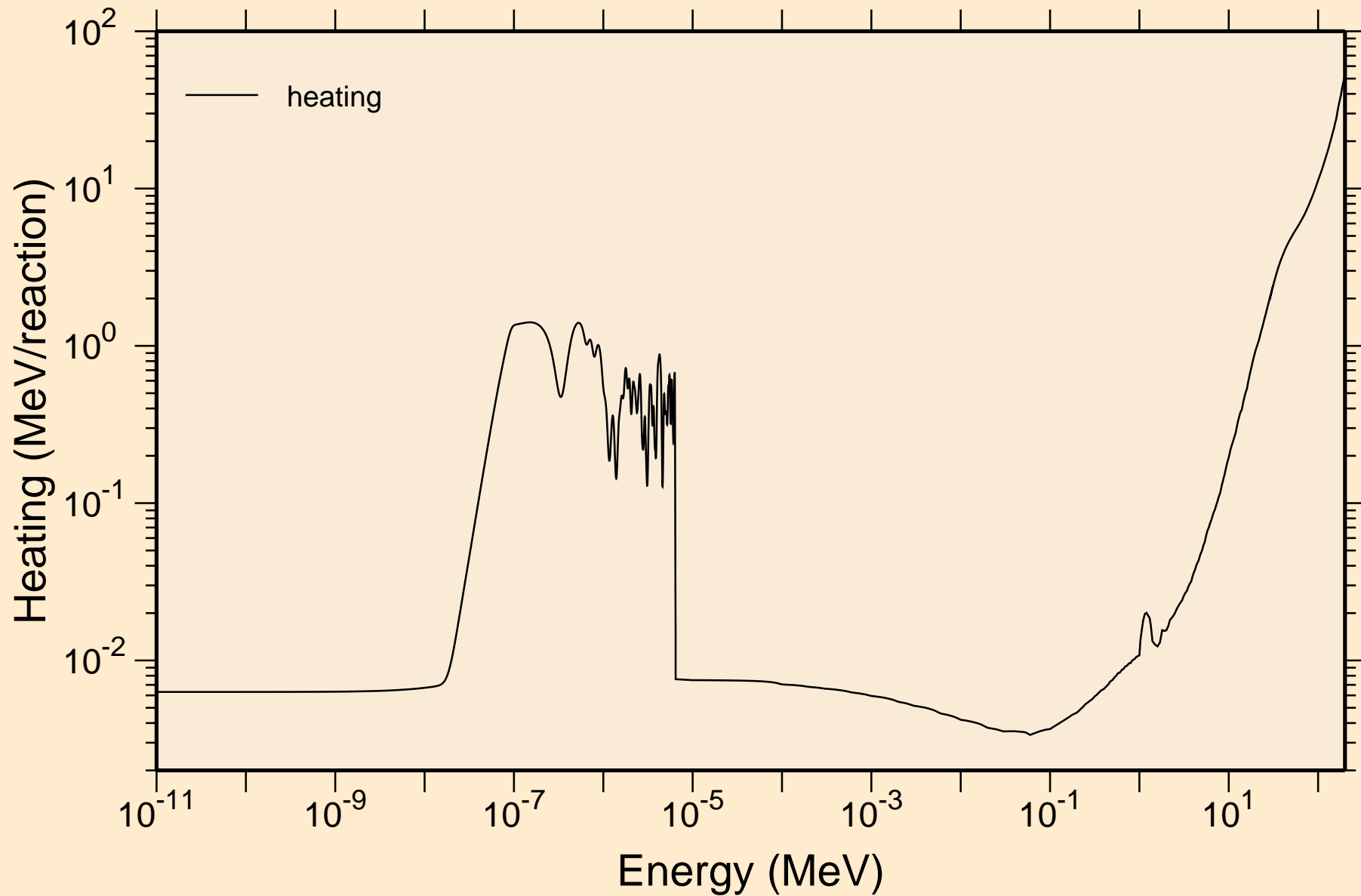

TM159 NEUTRON ACER TENDL-2019 LIBRARY; T=293.16K  
Damage

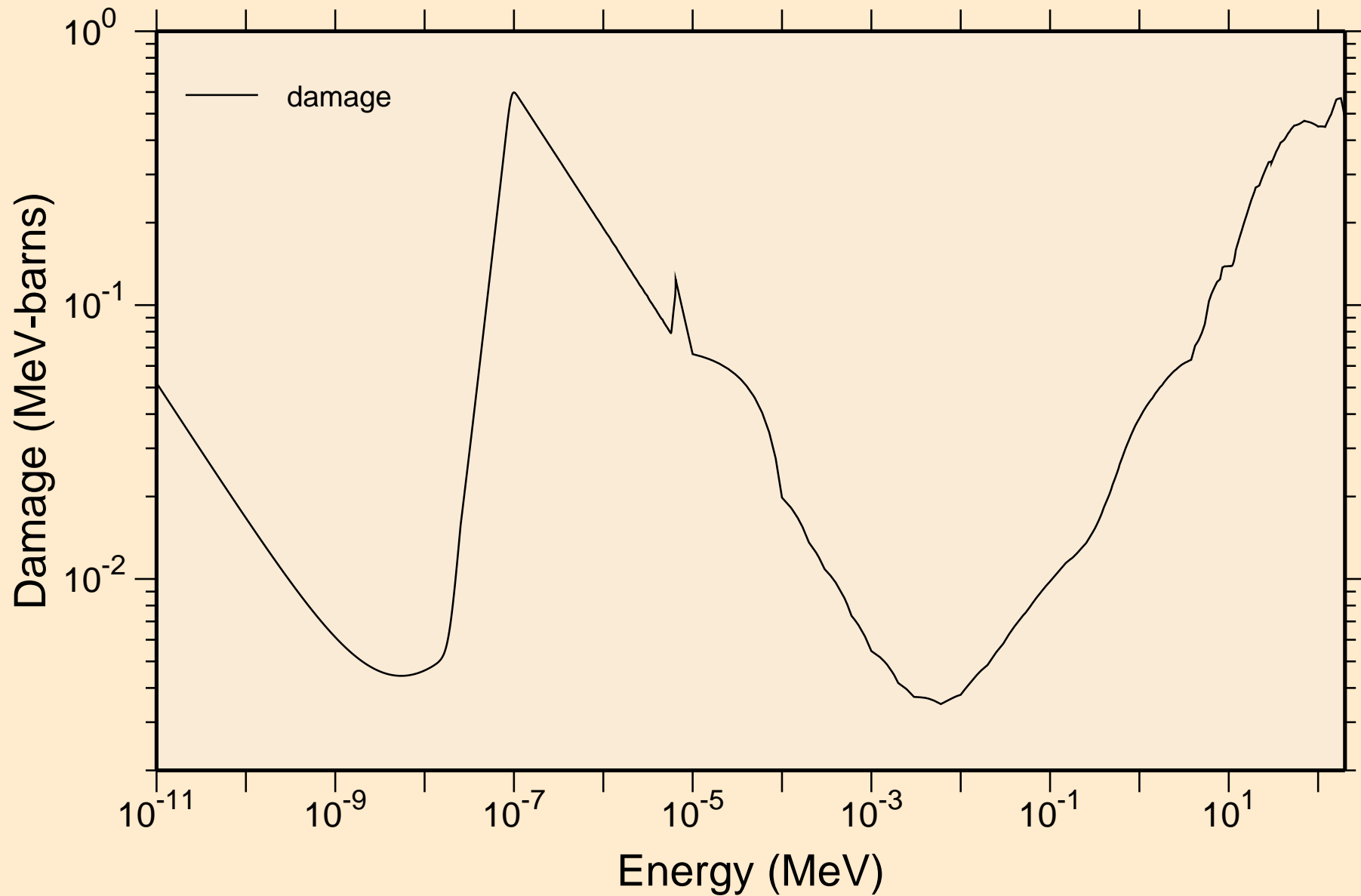

TM159 NEUTRON ACER TENDL-2019 LIBRARY; T=293.16K  
Non-threshold reactions

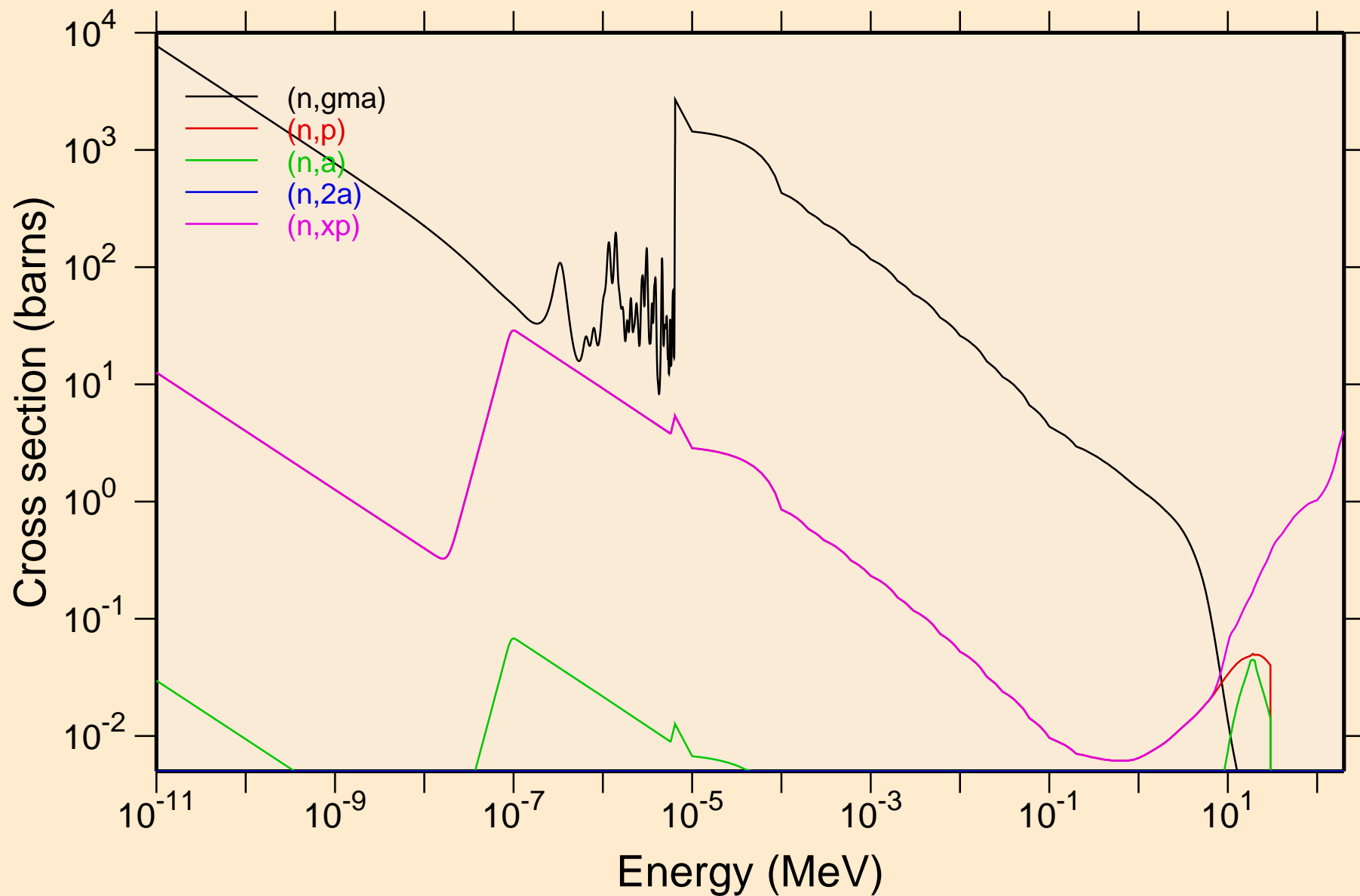

TM159 NEUTRON ACER TENDL-2019 LIBRARY; T=293.16K  
Non-threshold reactions

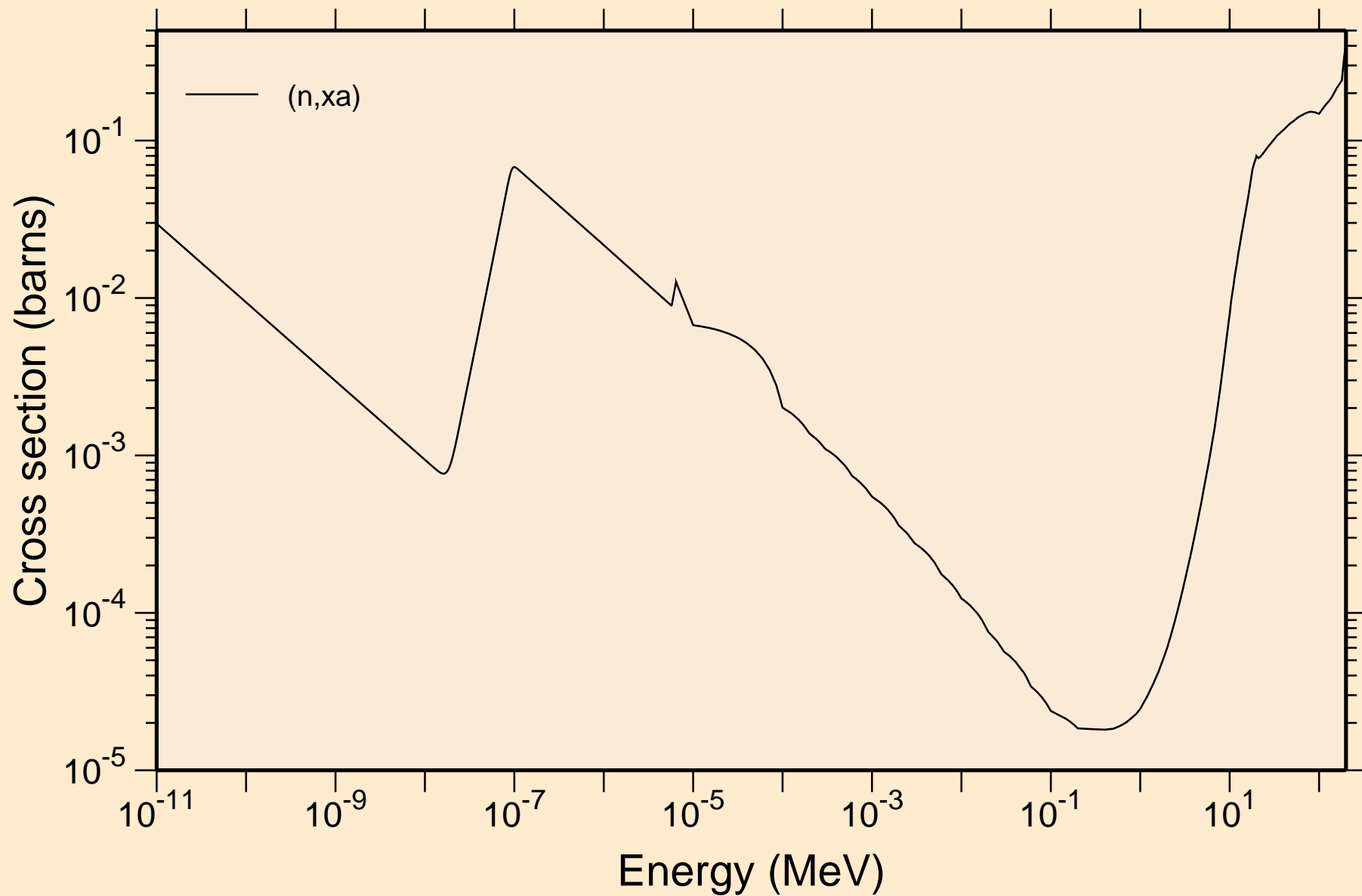

TM159 NEUTRON ACER TENDL-2019 LIBRARY; T=293.16K  
Principal cross sections

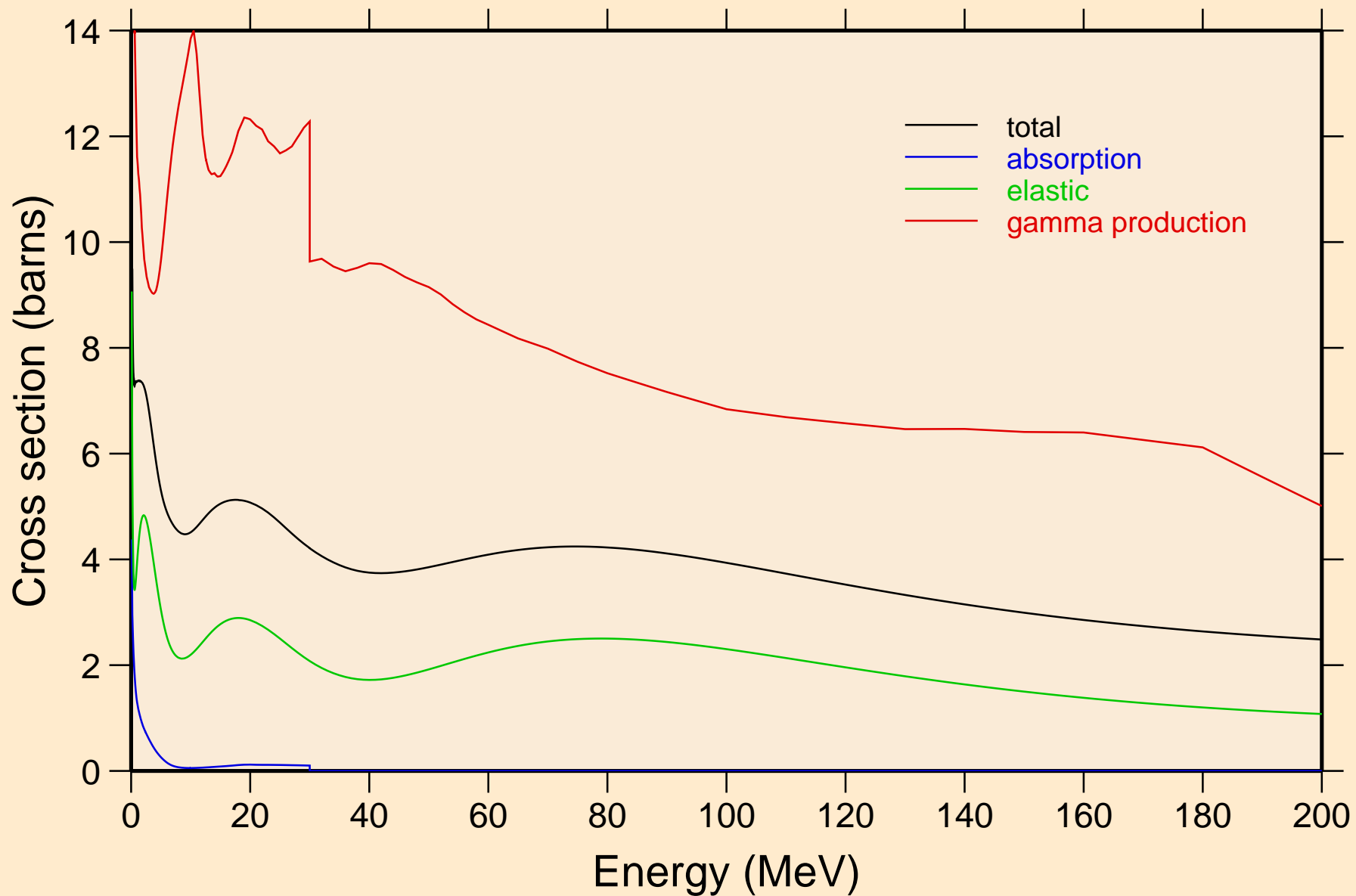

TM159 NEUTRON ACER TENDL-2019 LIBRARY; T=293.16K  
Heating

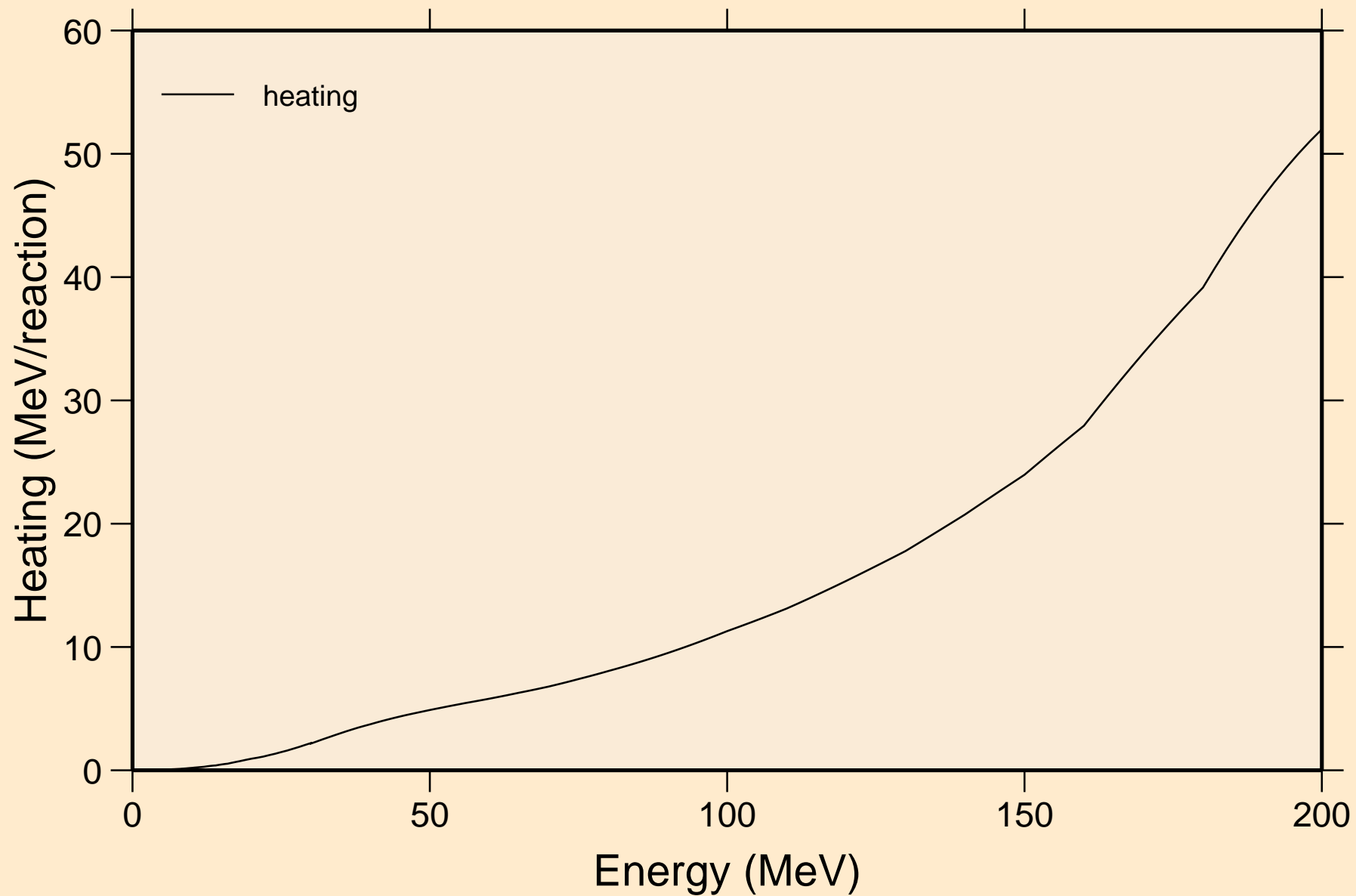

TM159 NEUTRON ACER TENDL-2019 LIBRARY; T=293.16K  
Damage

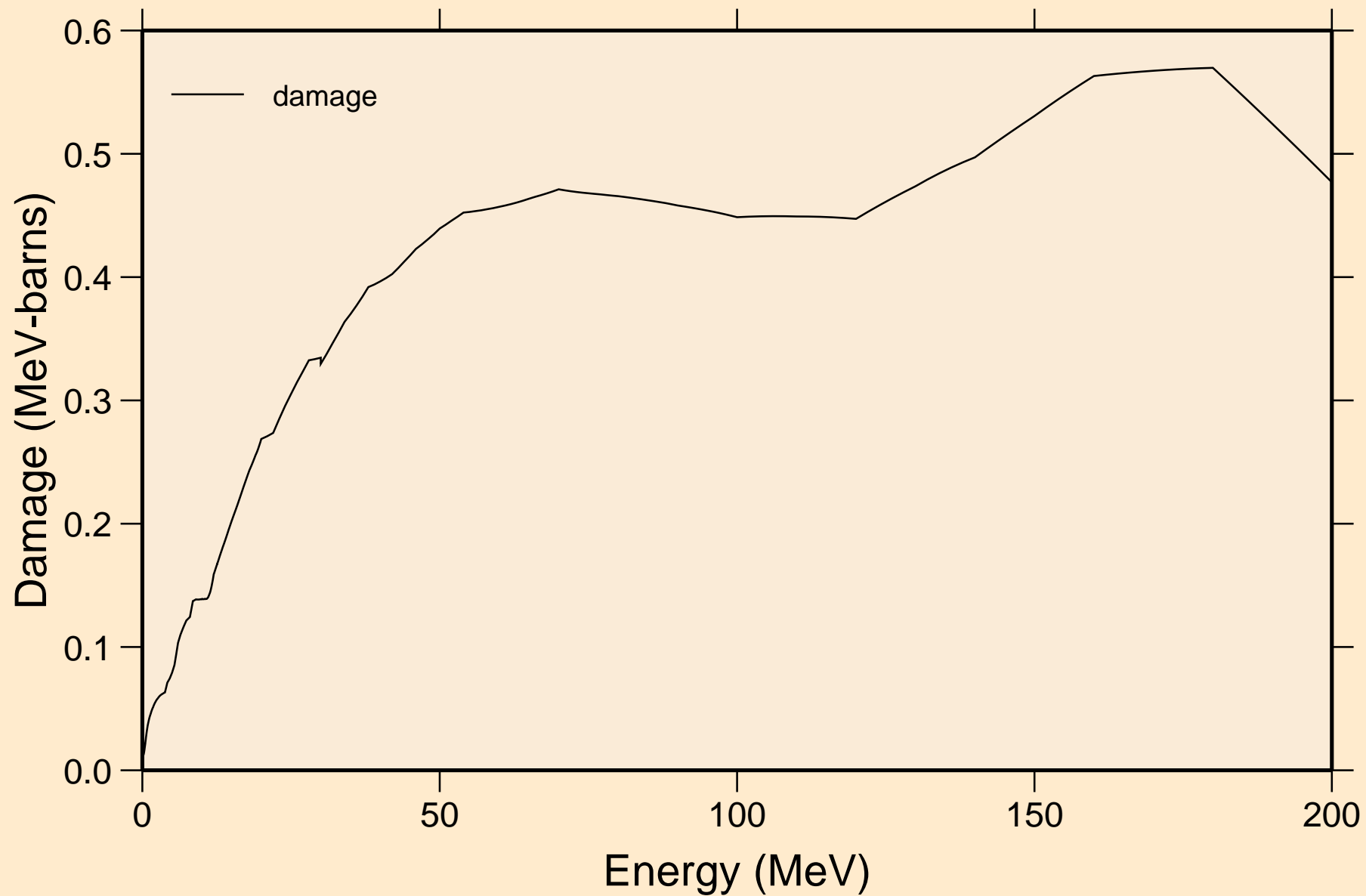



TM159 NEUTRON ACER TENDL-2019 LIBRARY; T=293.16K  
Non-threshold reactions

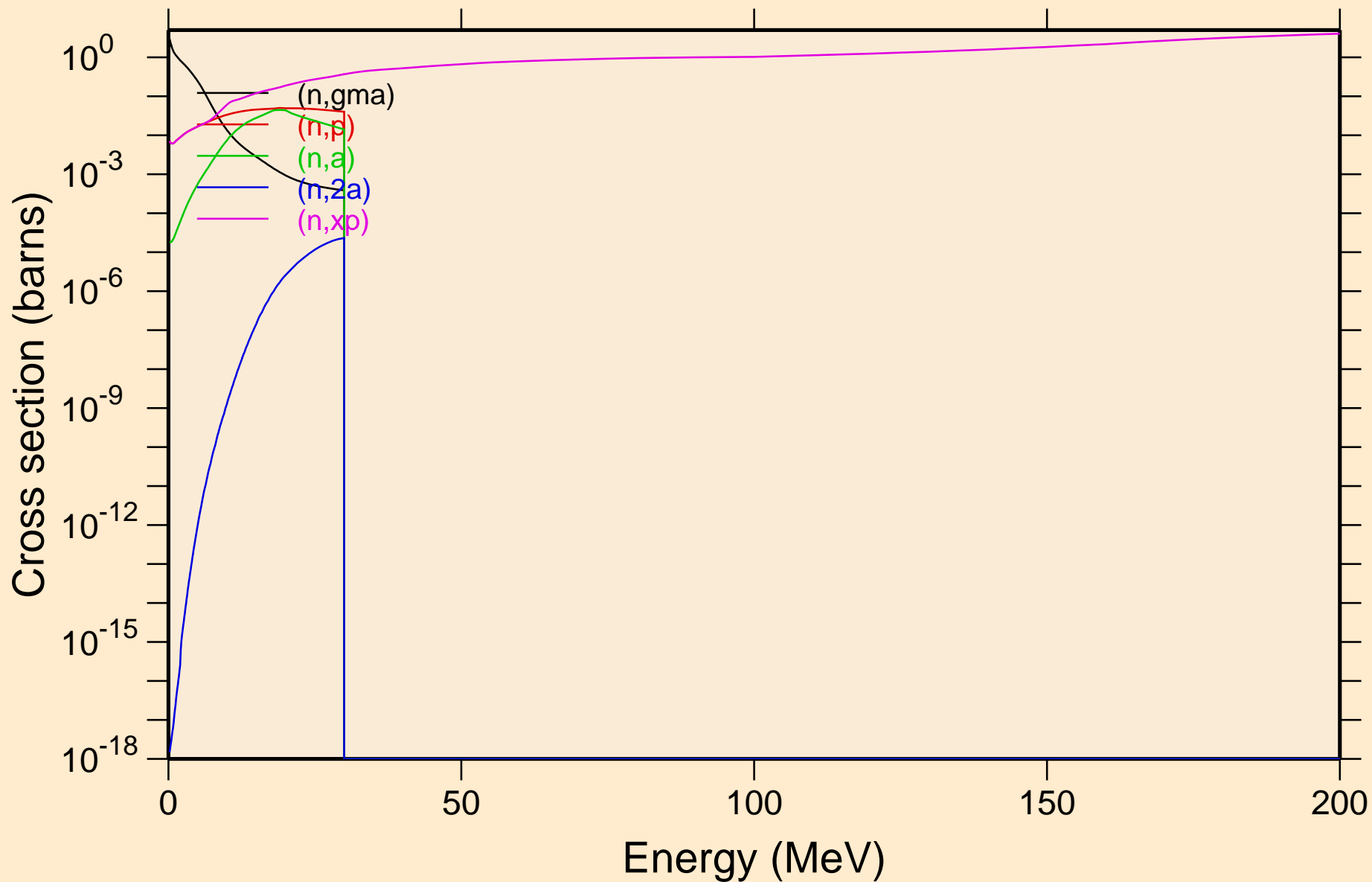

TM159 NEUTRON ACER TENDL-2019 LIBRARY; T=293.16K  
Non-threshold reactions

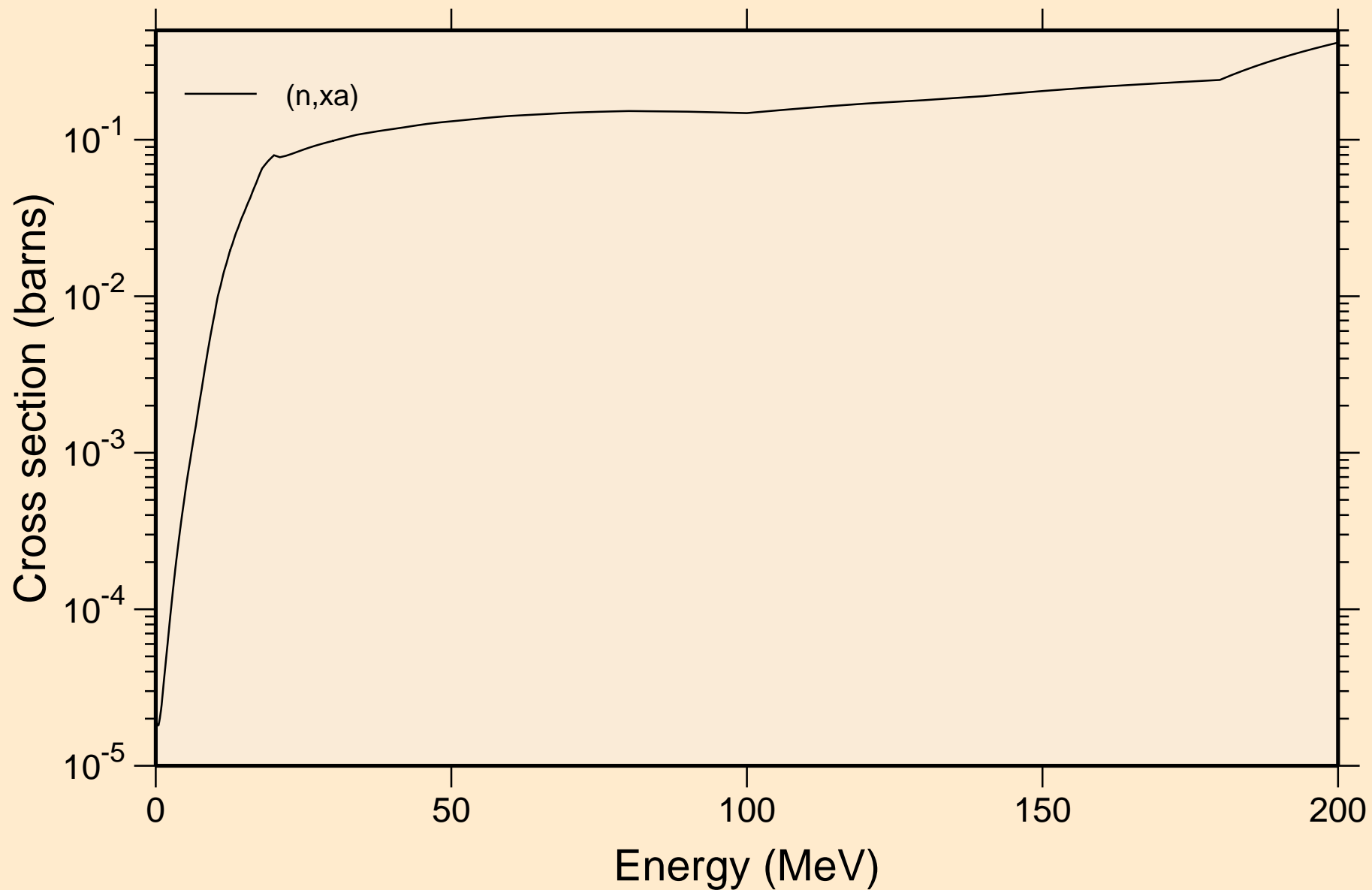

TM159 NEUTRON ACER TENDL-2019 LIBRARY; T=293.16K  
Inelastic levels

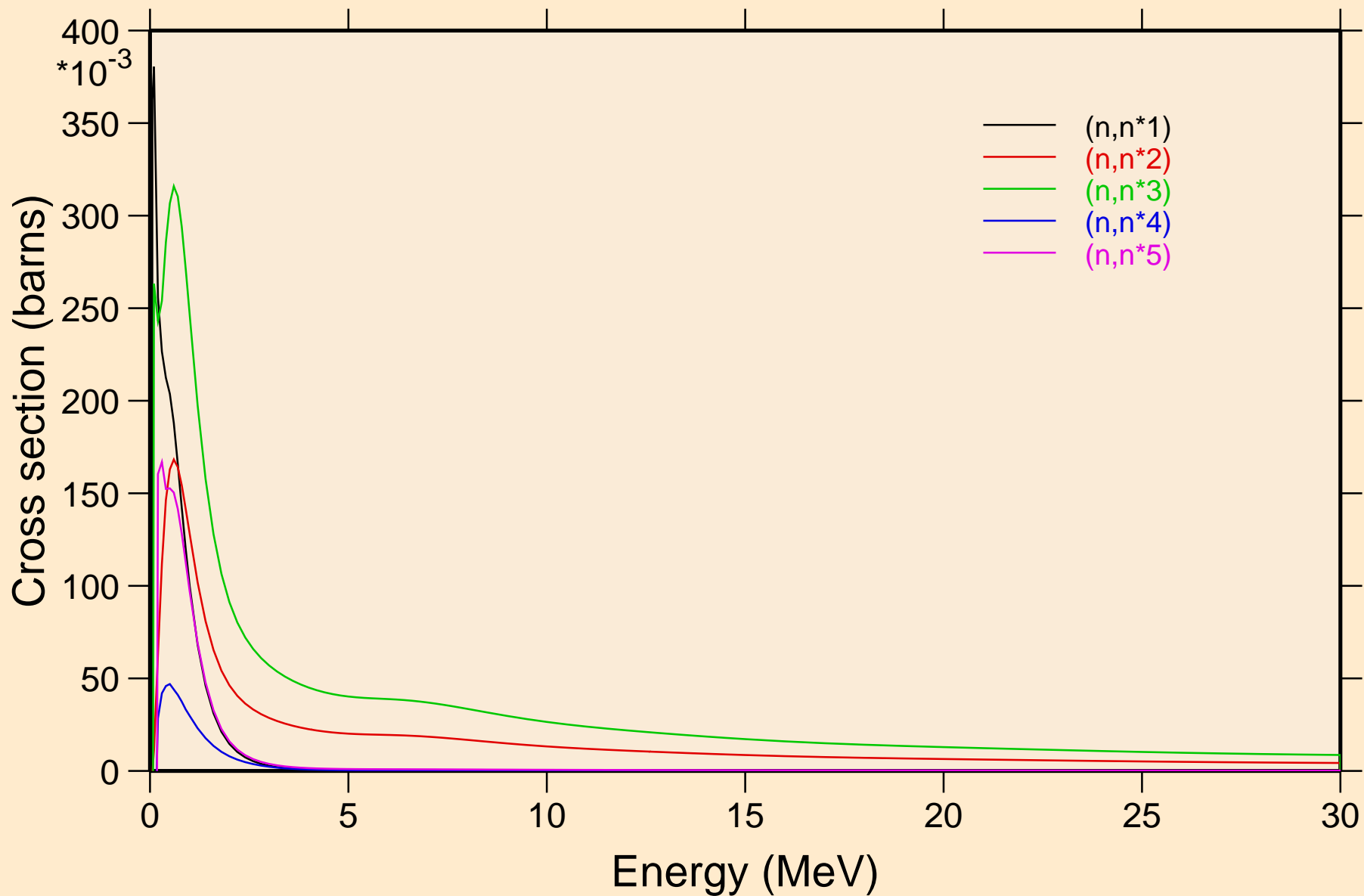

TM159 NEUTRON ACER TENDL-2019 LIBRARY; T=293.16K  
Inelastic levels

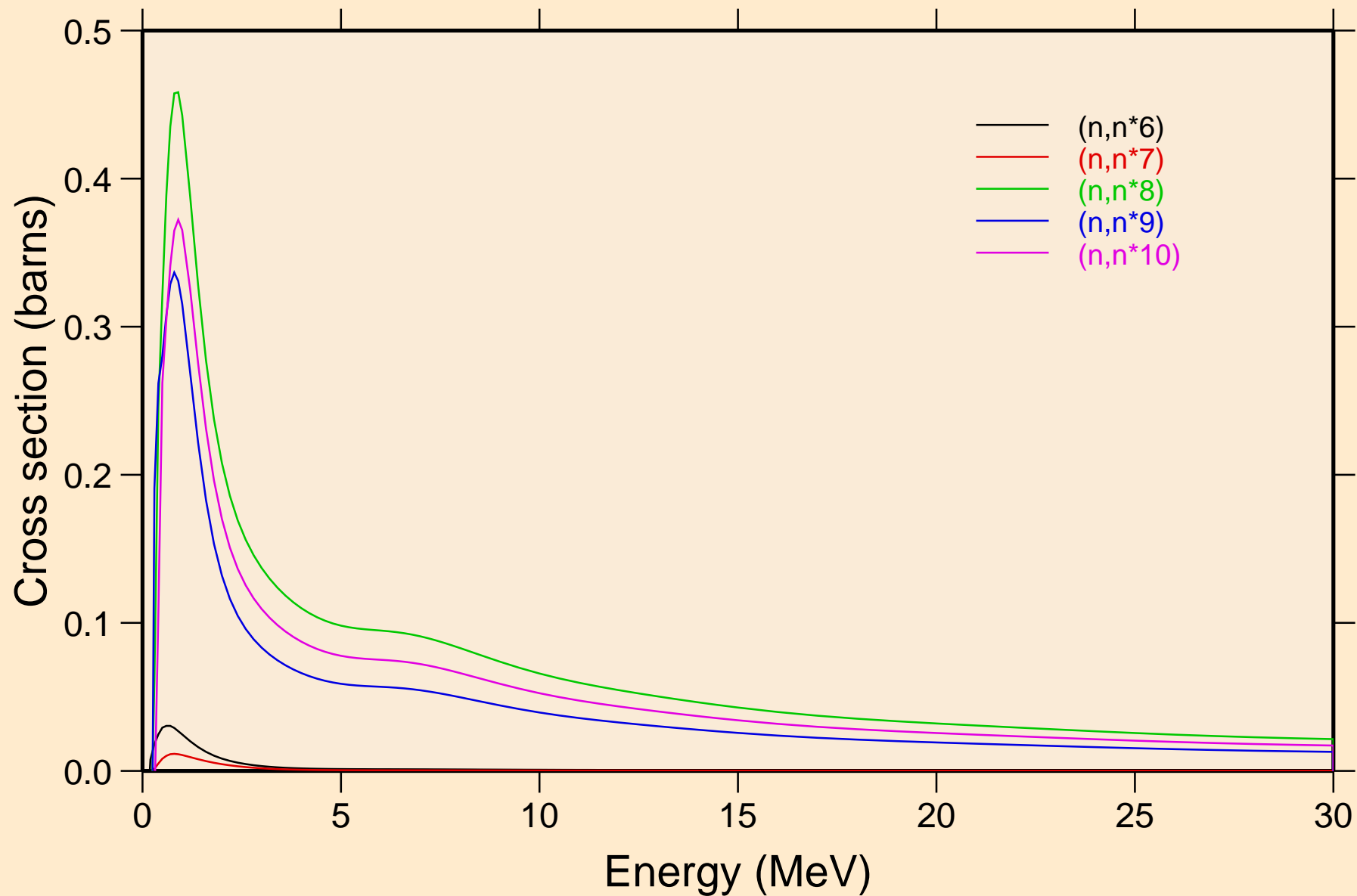

TM159 NEUTRON ACER TENDL-2019 LIBRARY; T=293.16K  
Inelastic levels

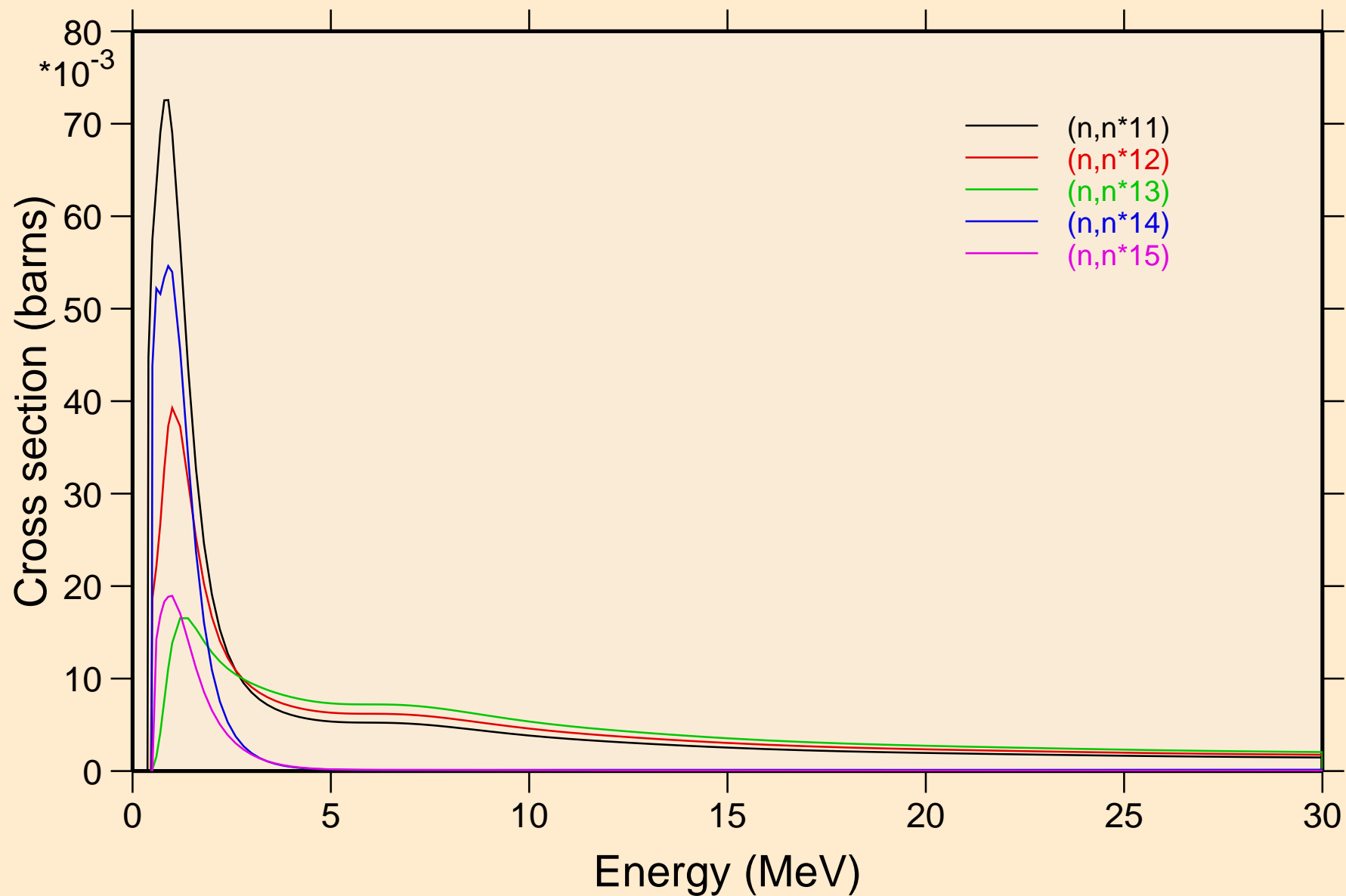

TM159 NEUTRON ACER TENDL-2019 LIBRARY; T=293.16K  
Inelastic levels

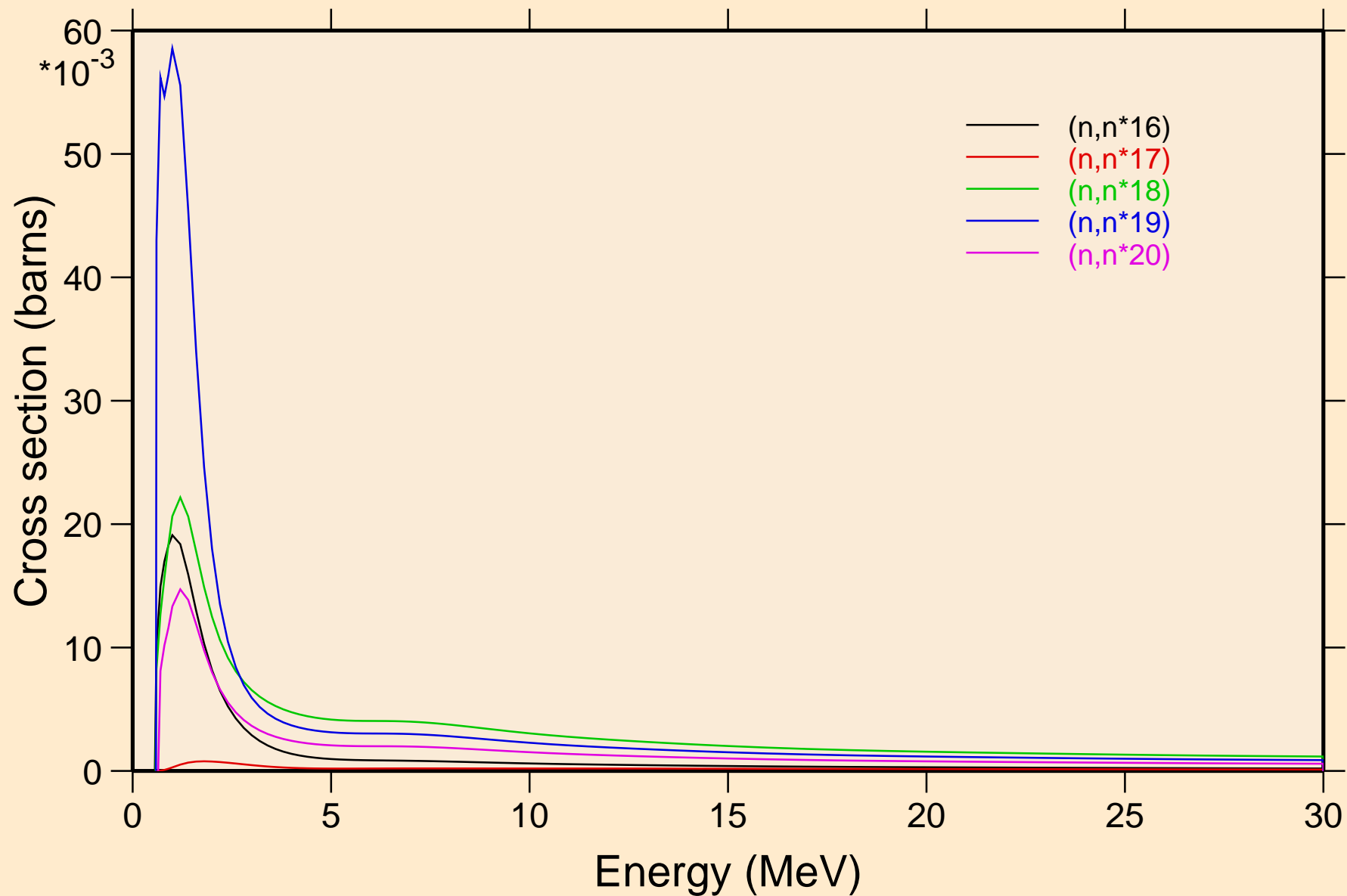

TM159 NEUTRON ACER TENDL-2019 LIBRARY; T=293.16K  
Inelastic levels

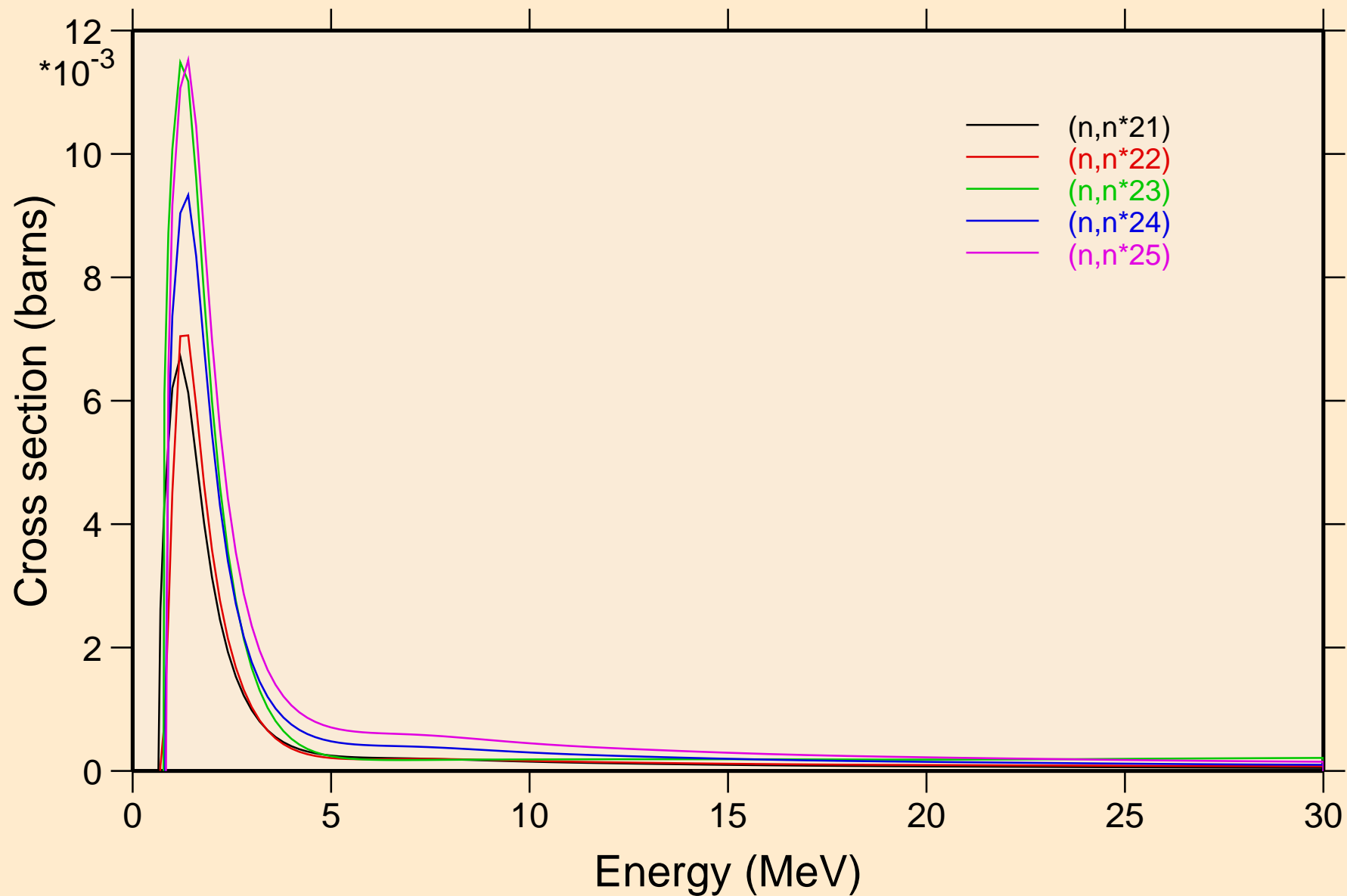

TM159 NEUTRON ACER TENDL-2019 LIBRARY; T=293.16K  
Inelastic levels

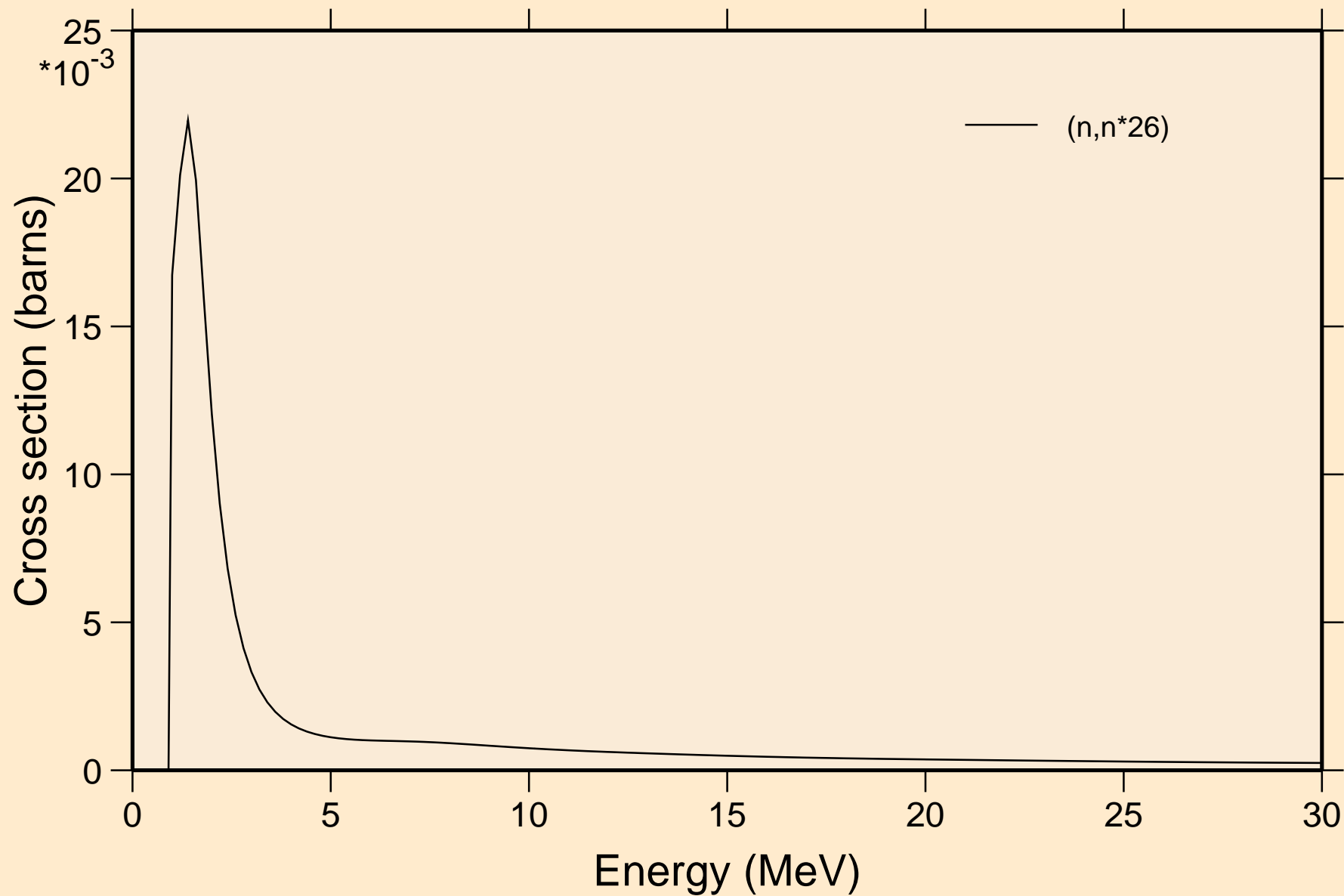



TM159 NEUTRON ACER TENDL-2019 LIBRARY; T=293.16K  
Threshold reactions

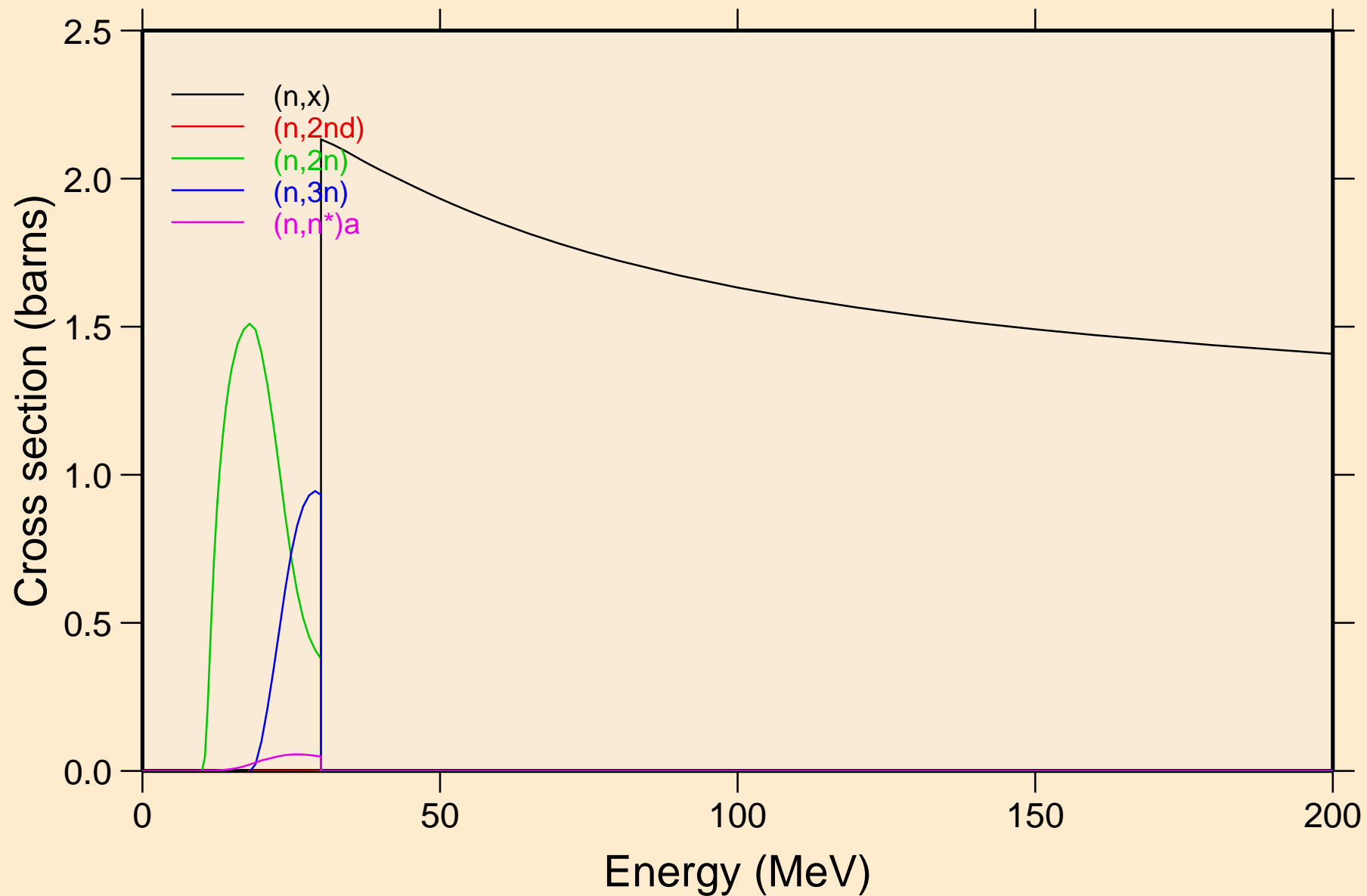

TM159 NEUTRON ACER TENDL-2019 LIBRARY; T=293.16K  
Threshold reactions

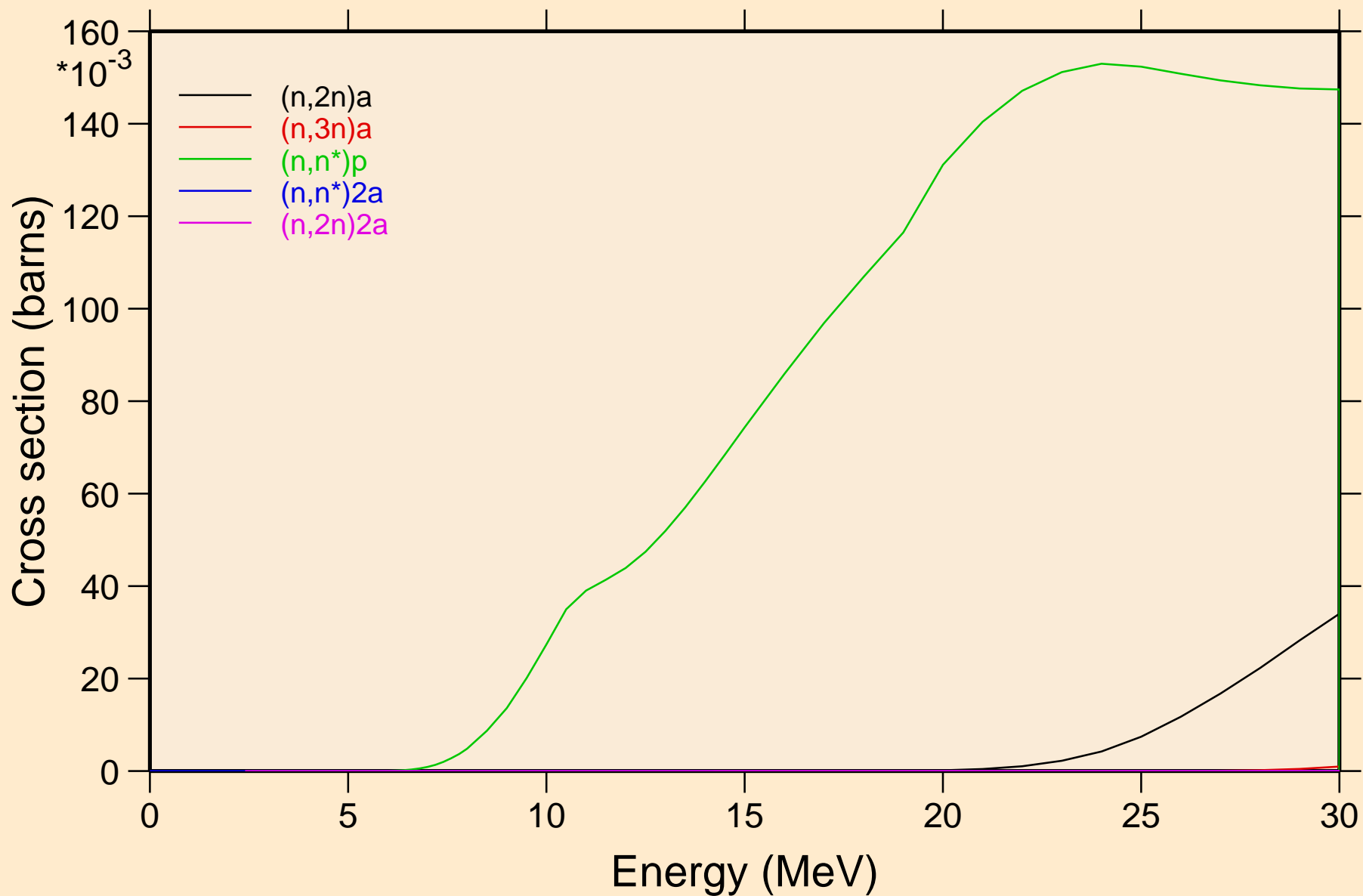

TM159 NEUTRON ACER TENDL-2019 LIBRARY; T=293.16K  
Threshold reactions

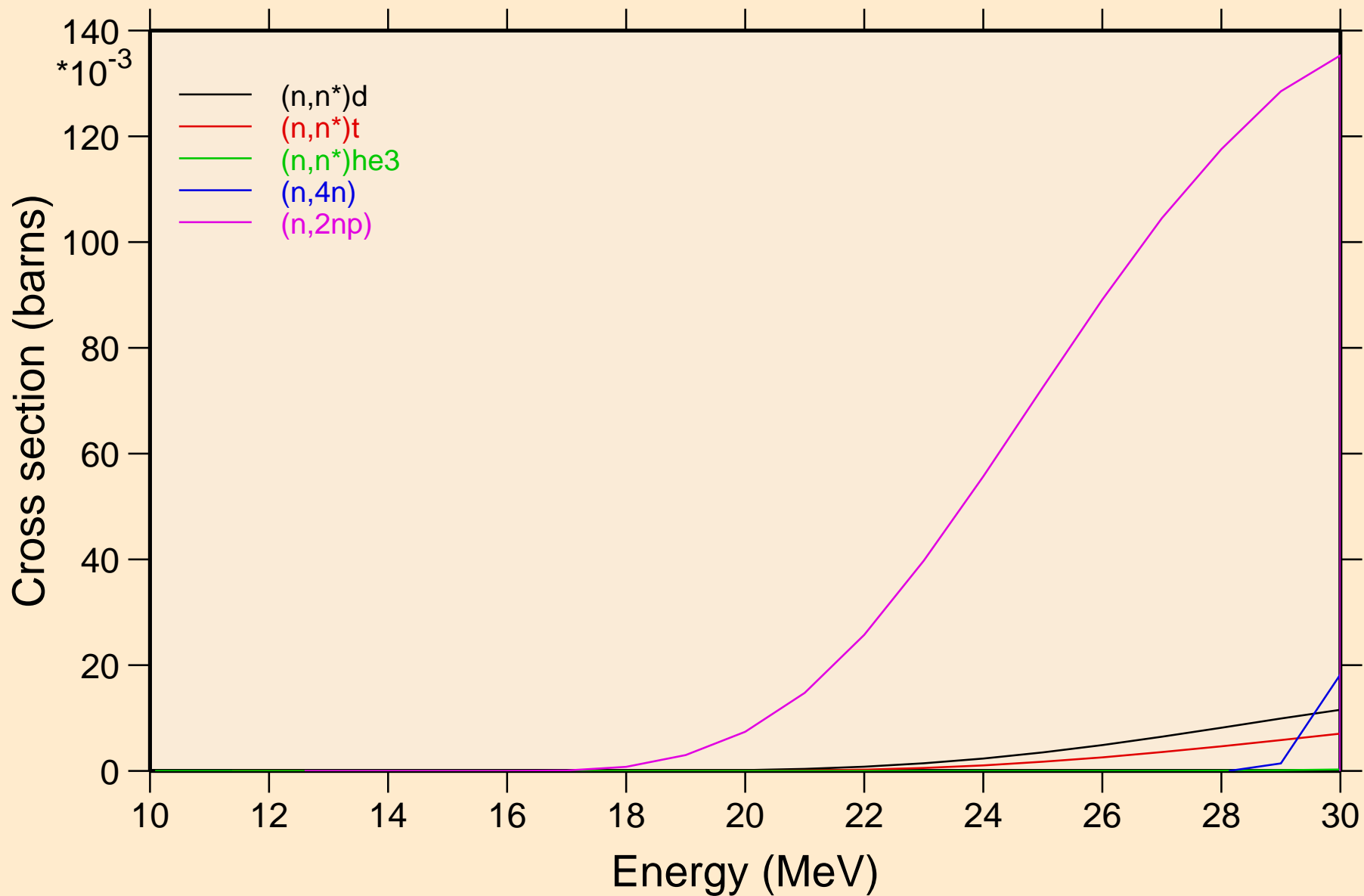

TM159 NEUTRON ACER TENDL-2019 LIBRARY; T=293.16K  
Threshold reactions

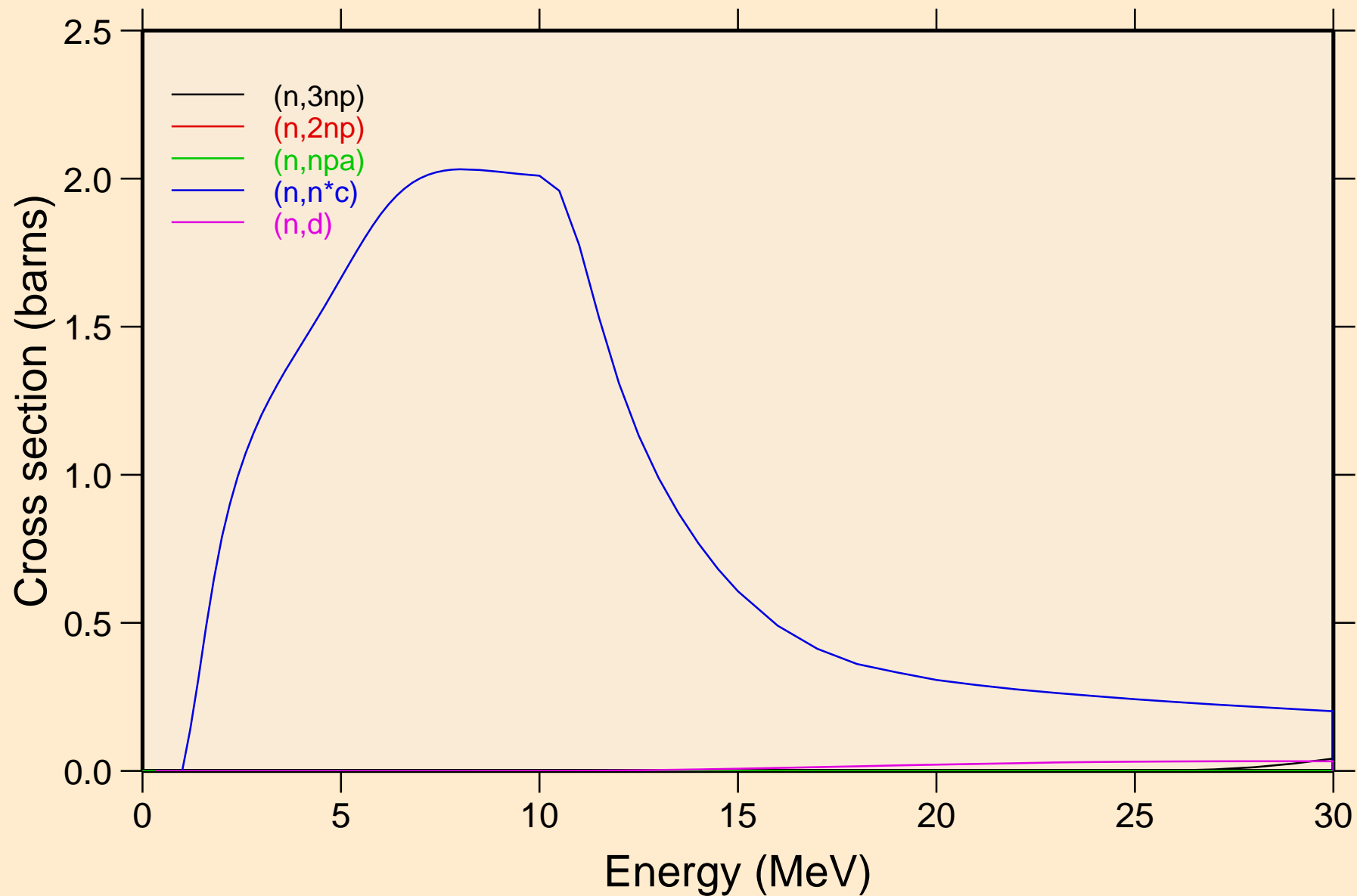

TM159 NEUTRON ACER TENDL-2019 LIBRARY; T=293.16K  
Threshold reactions

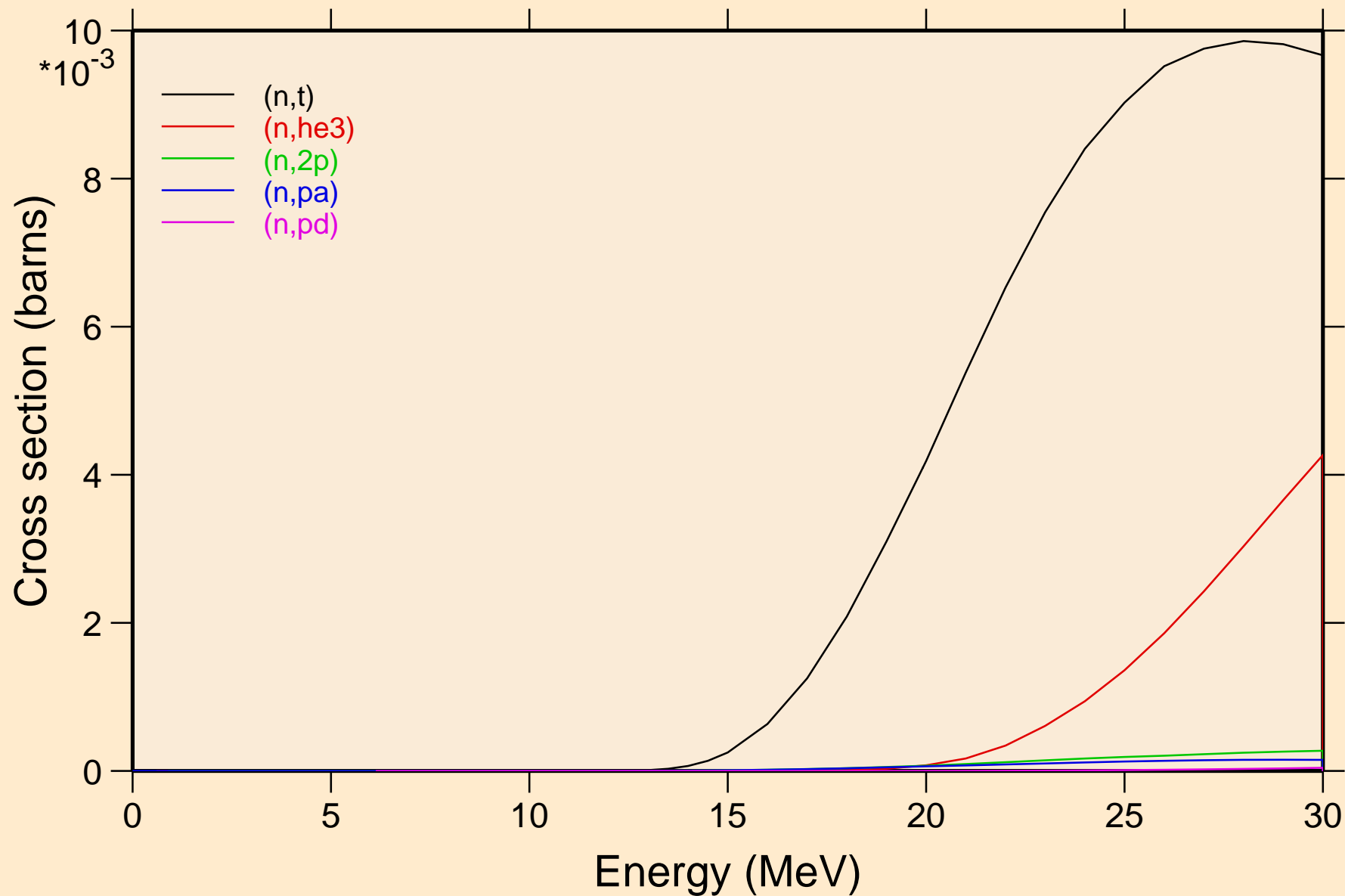

TM159 NEUTRON ACER TENDL-2019 LIBRARY; T=293.16K  
Threshold reactions

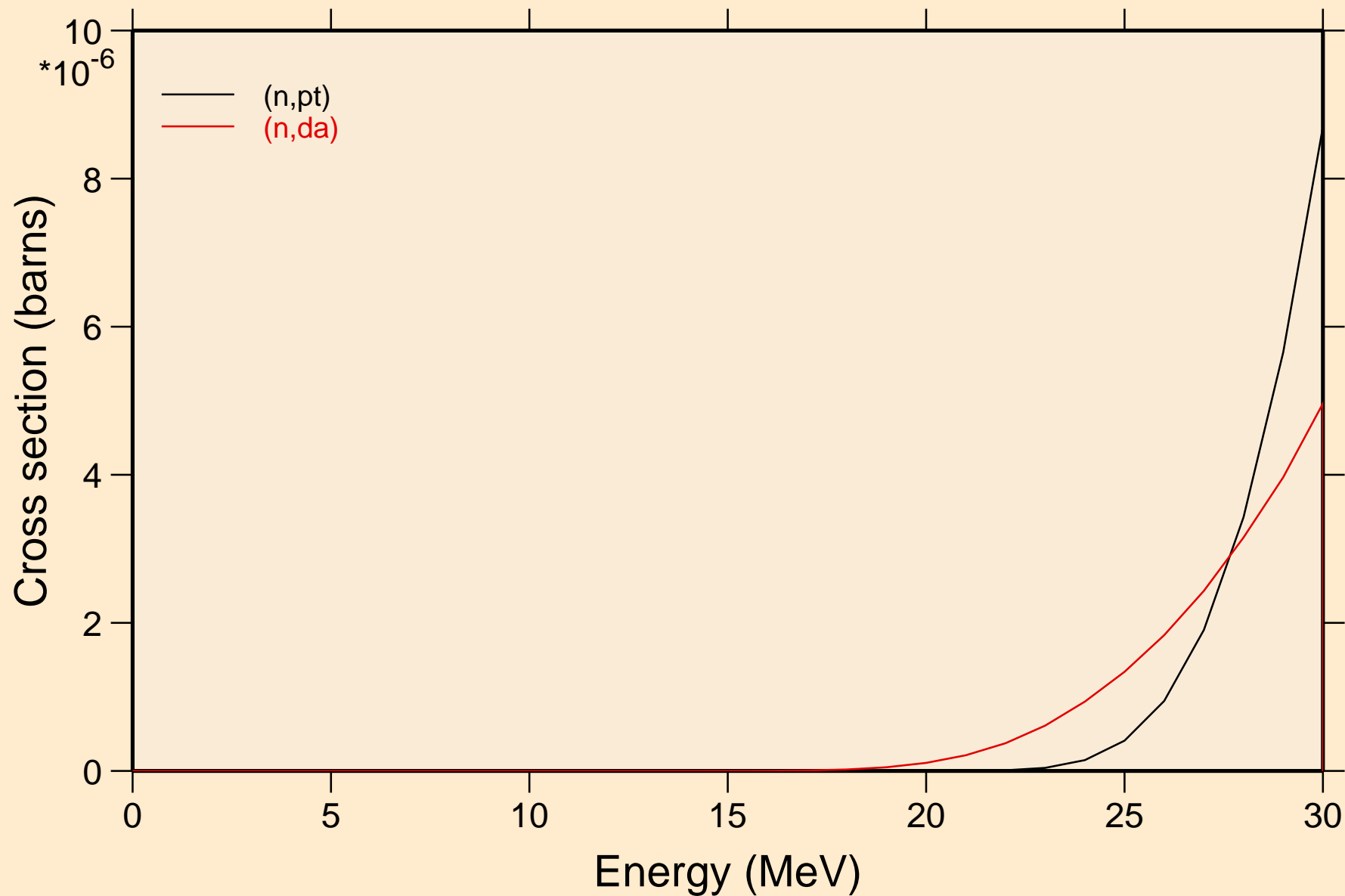

TM159 NEUTRON ACER TENDL-2019 LIBRARY; T=293.16K  
Threshold reactions

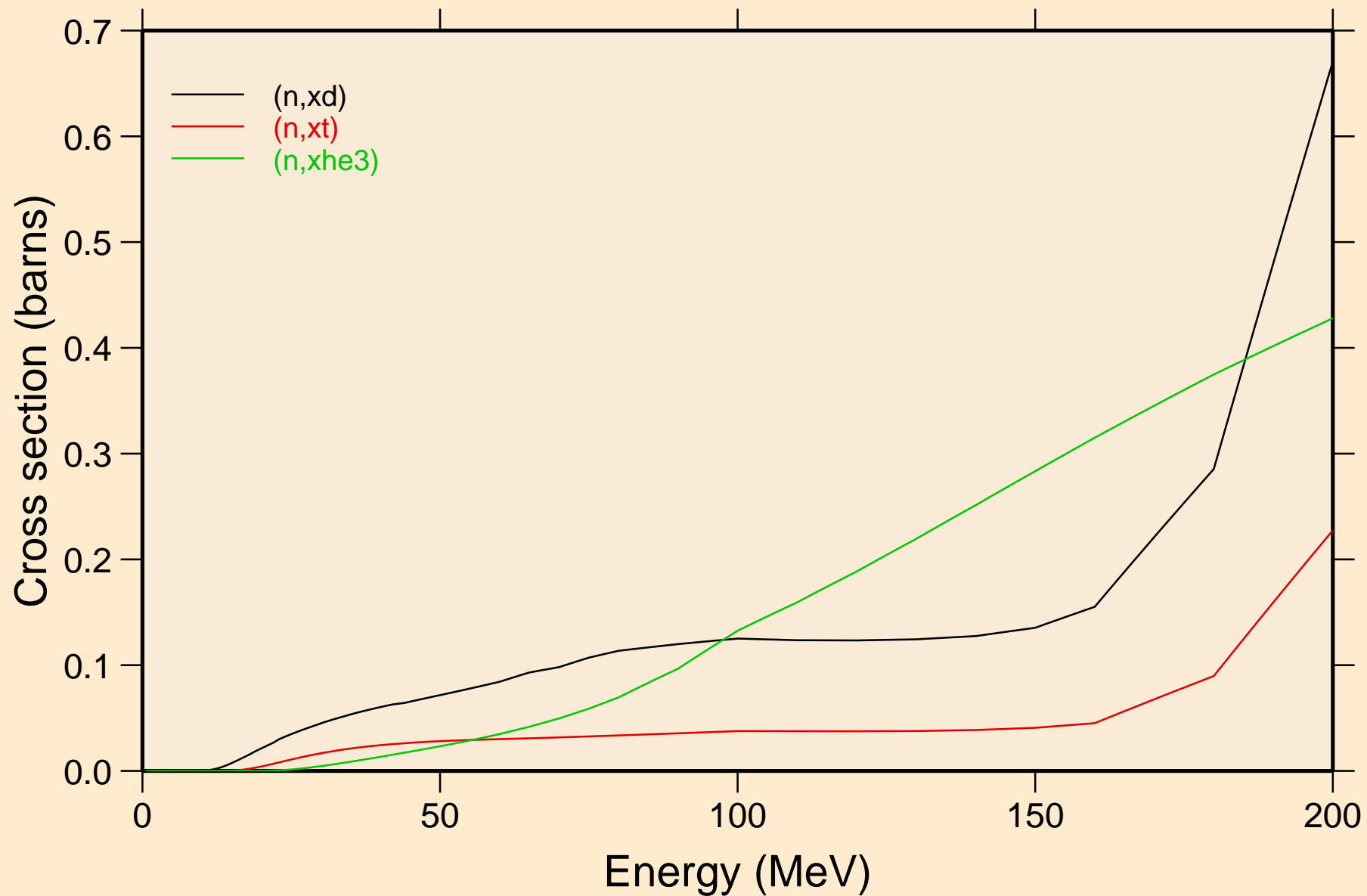

TM159 NEUTRON ACER TENDL-2019 LIBRARY; T=293.16K  
angular distribution for elastic

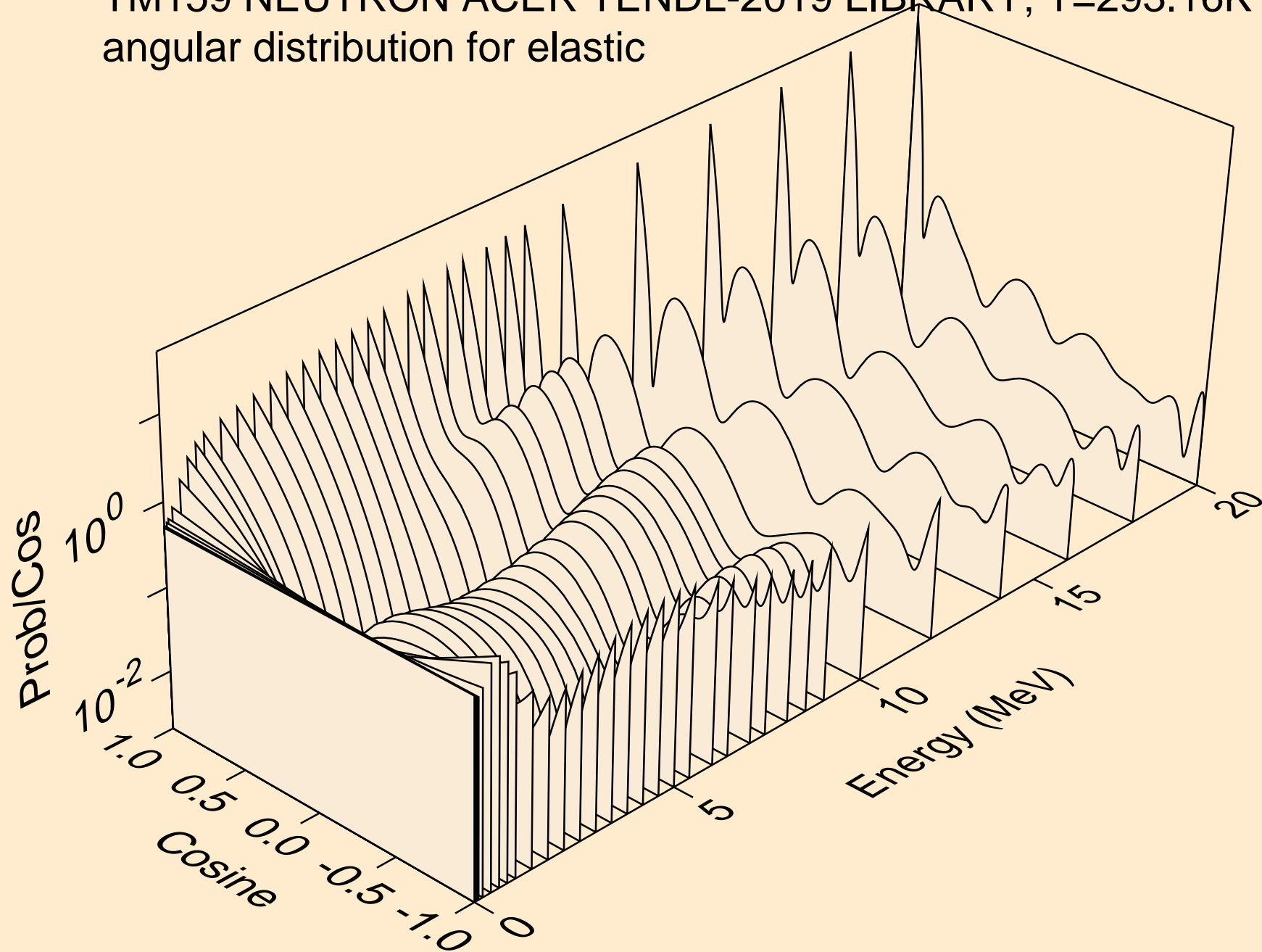



TM159 NEUTRON ACER TENDL-2019 LIBRARY; T=293.16K  
angular distribution for elastic

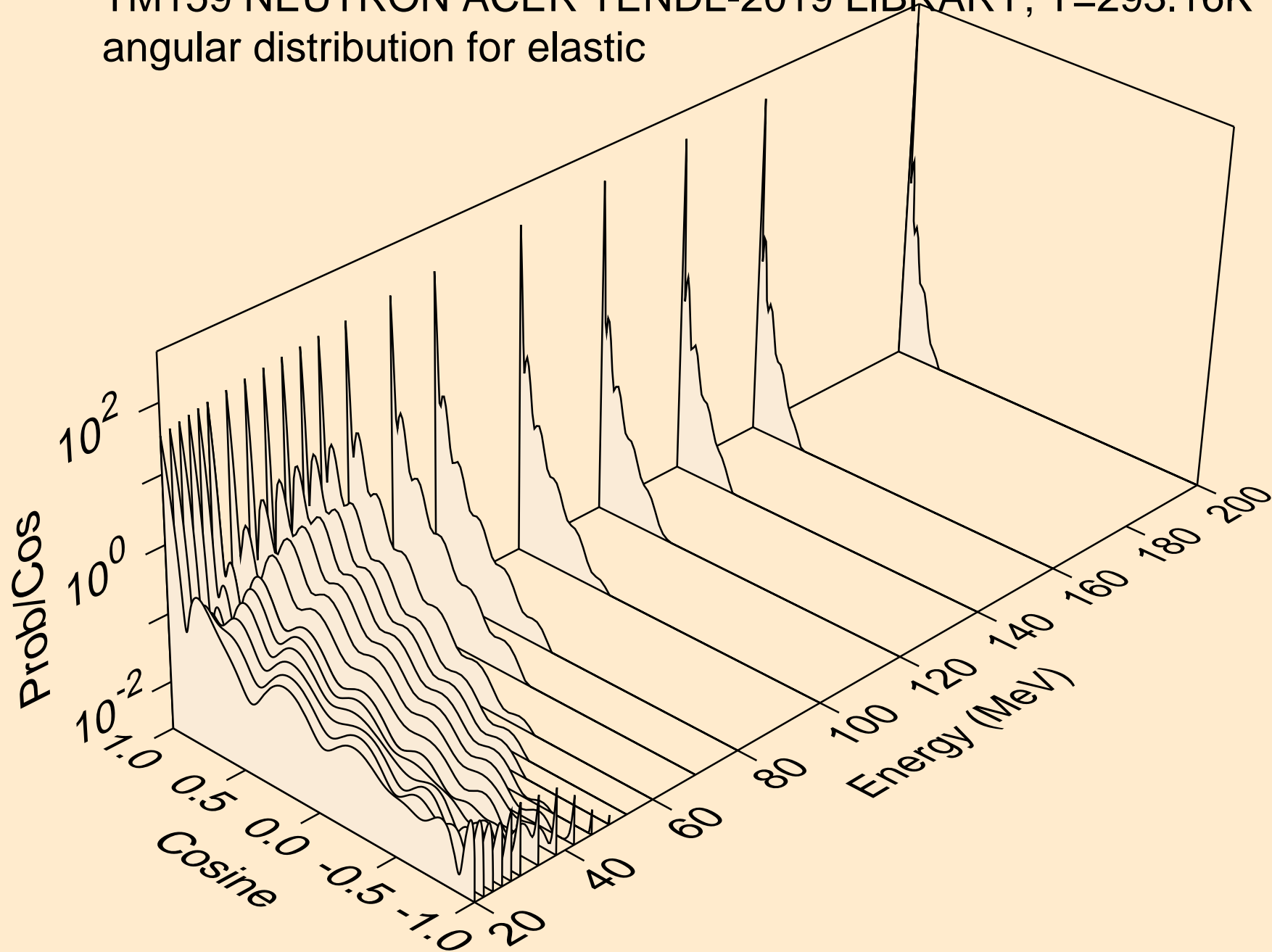

TM159 NEUTRON ACER TENDL-2019 LIBRARY; T=293.16K  
angular distribution for (n,n\*1)

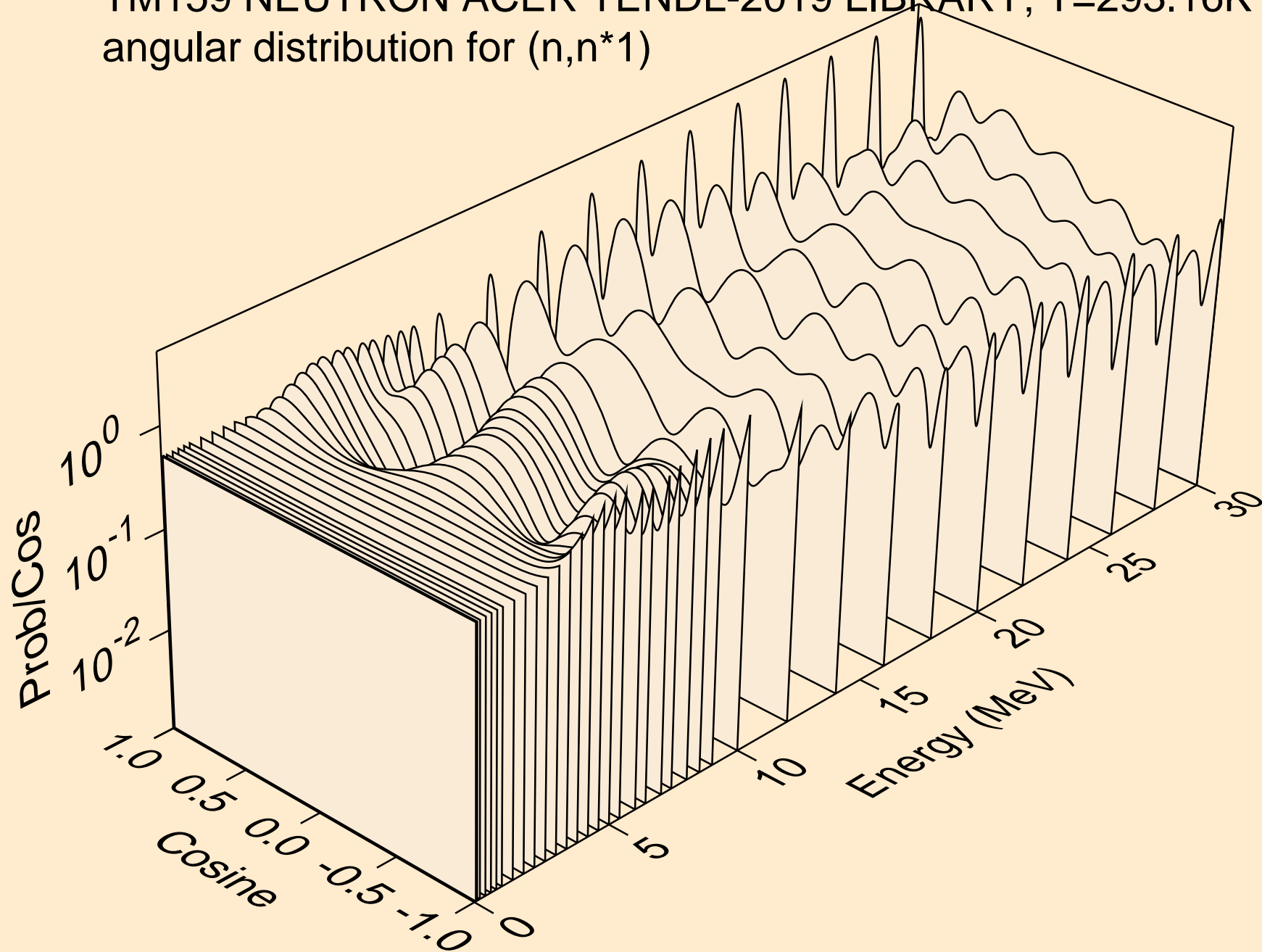

TM159 NEUTRON ACER TENDL-2019 LIBRARY; T=293.16K  
angular distribution for (n,n\*2)

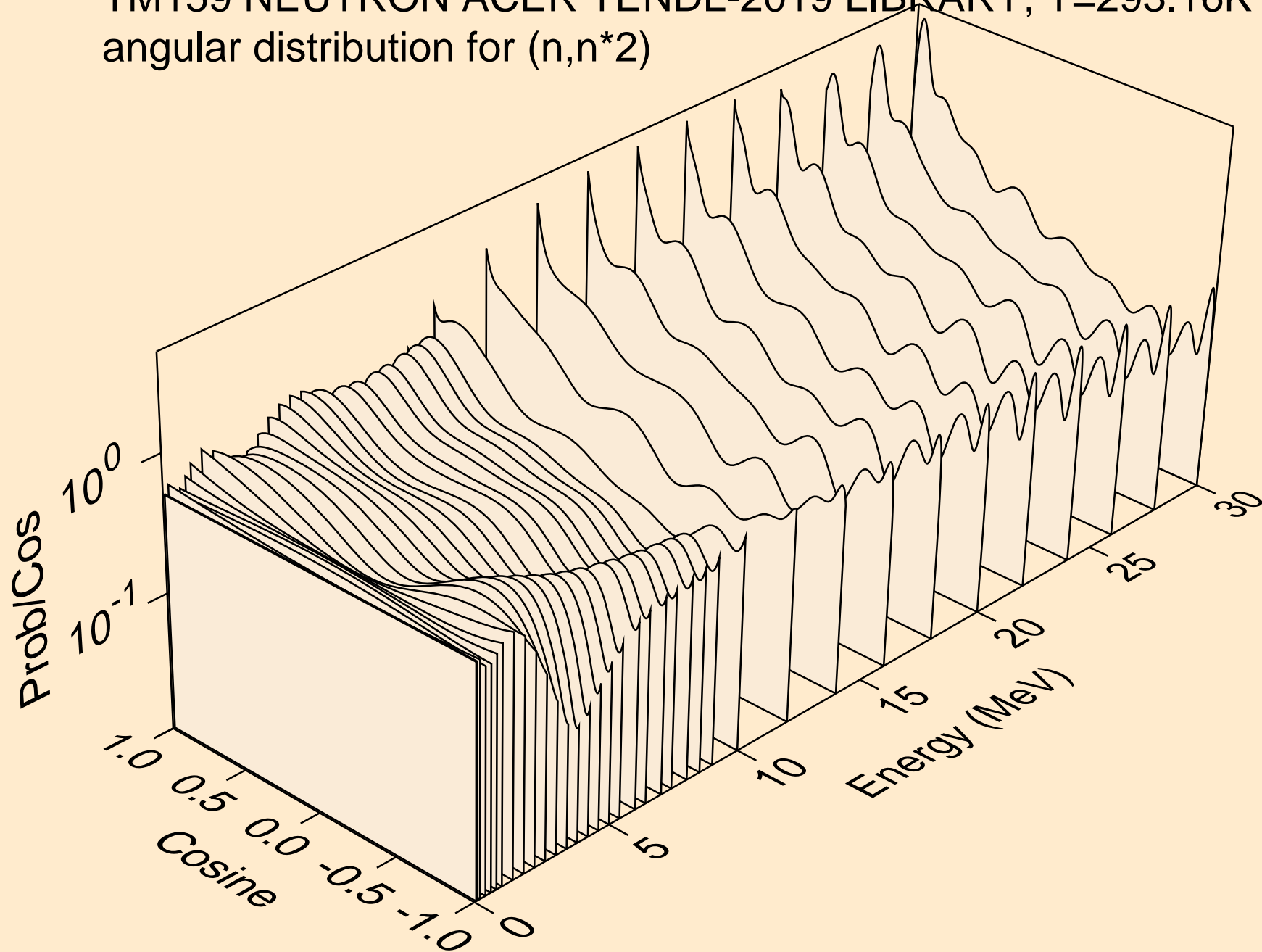

TM159 NEUTRON ACER TENDL-2019 LIBRARY; T=293.16K  
angular distribution for (n,n\*3)

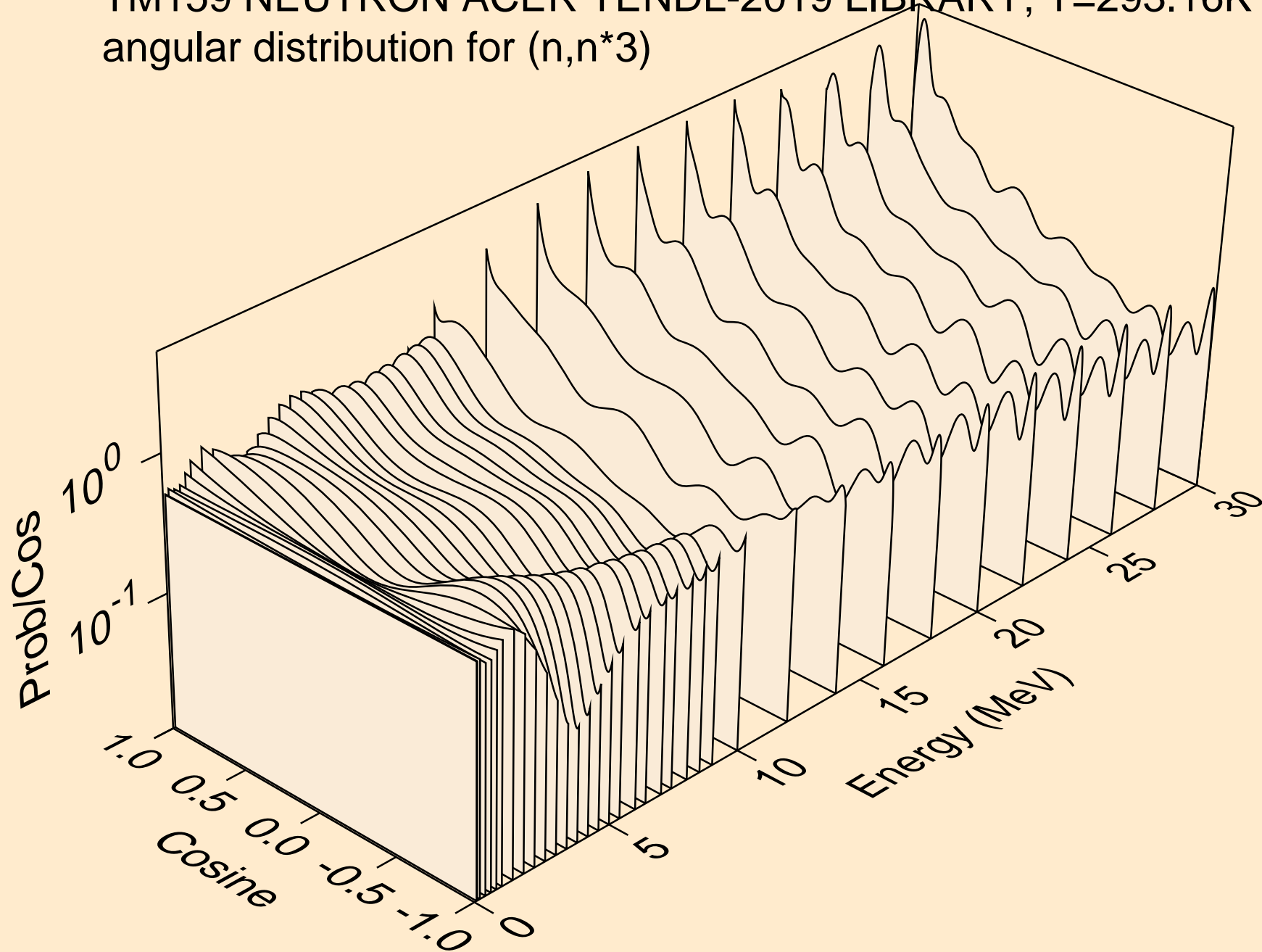

TM159 NEUTRON ACER TENDL-2019 LIBRARY; T=293.16K  
angular distribution for (n,n\*4)

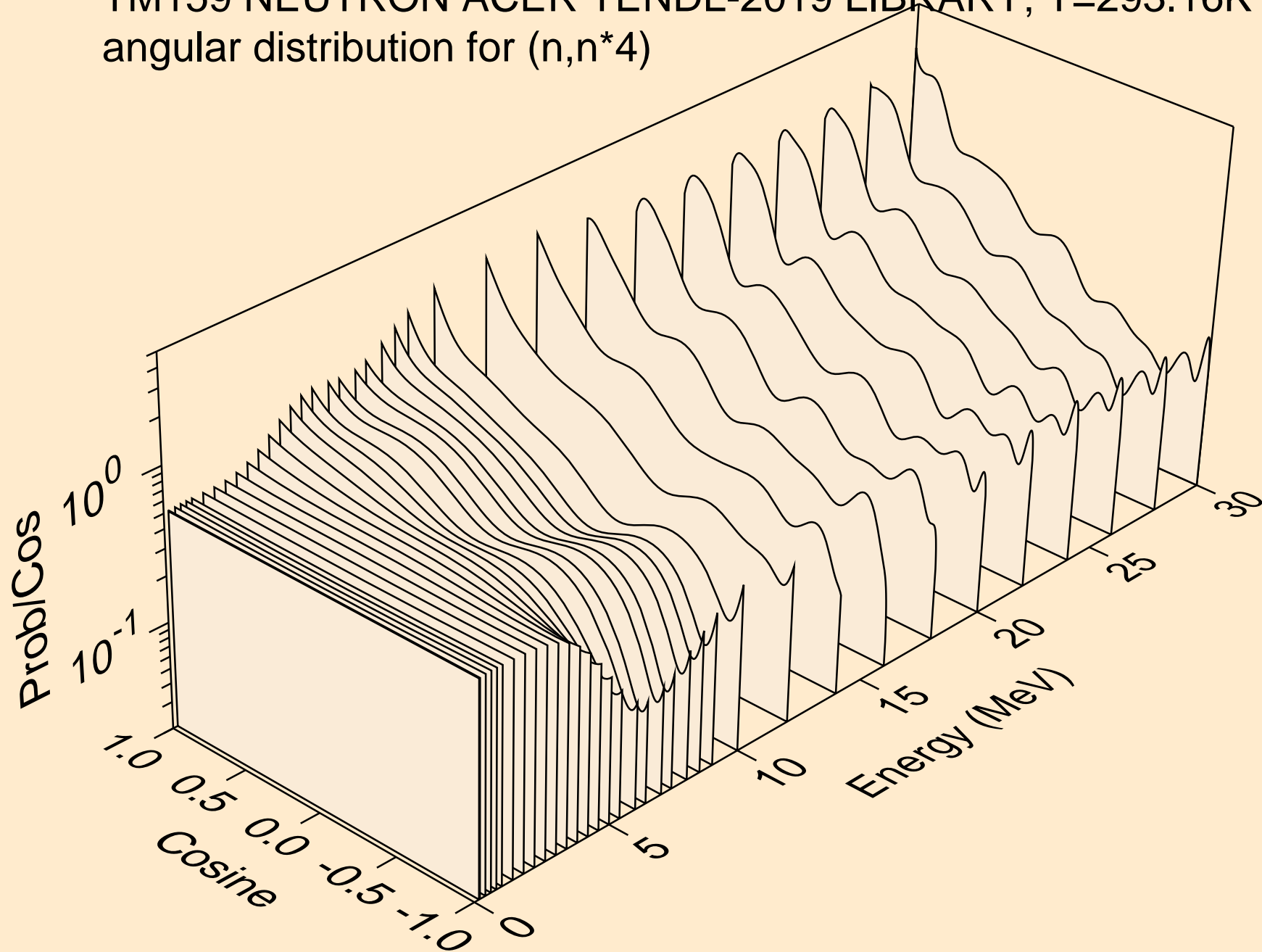

TM159 NEUTRON ACER TENDL-2019 LIBRARY; T=293.16K  
angular distribution for (n,n\*5)

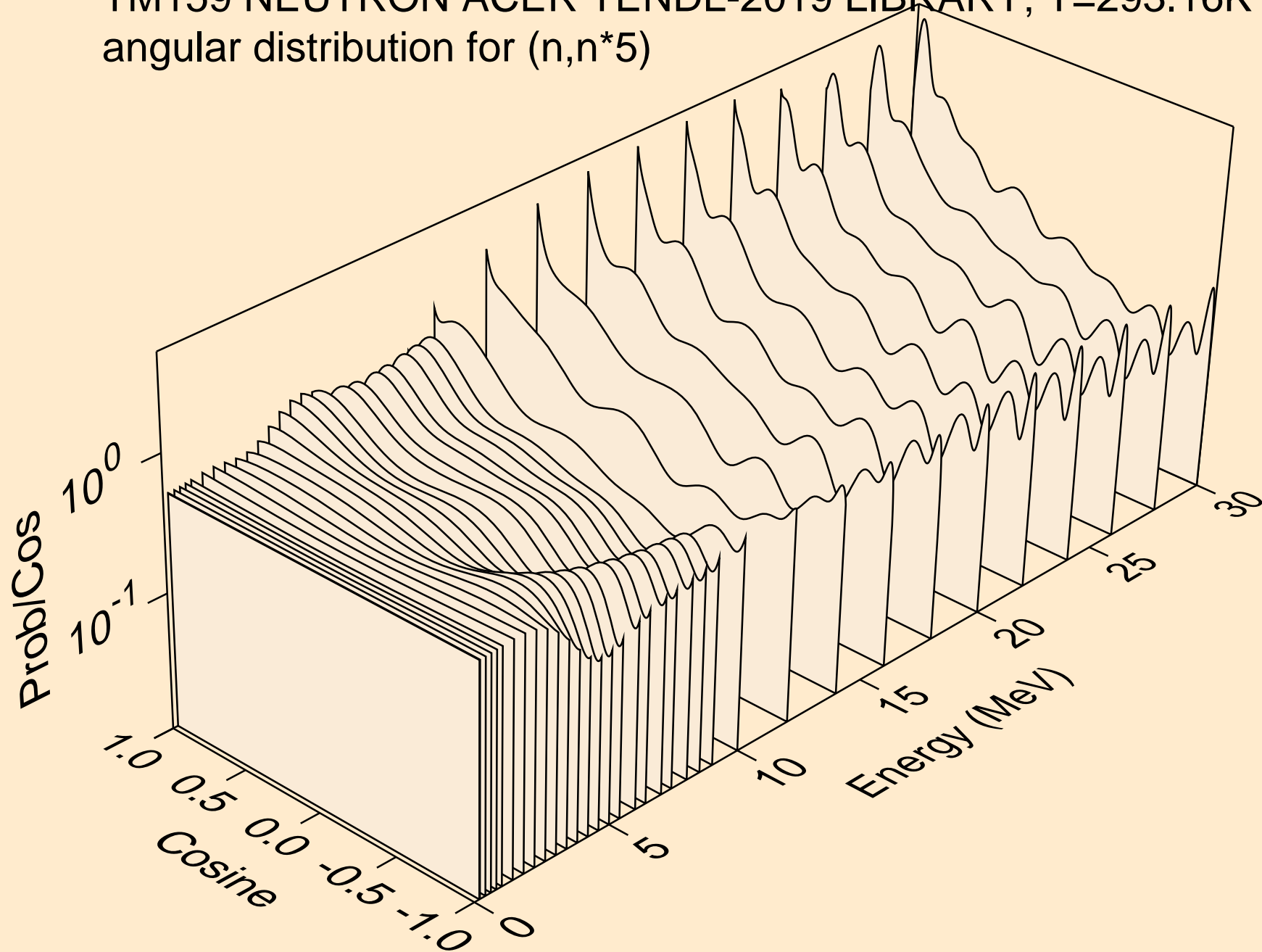

TM159 NEUTRON ACER TENDL-2019 LIBRARY; T=293.16K  
angular distribution for (n,n\*6)

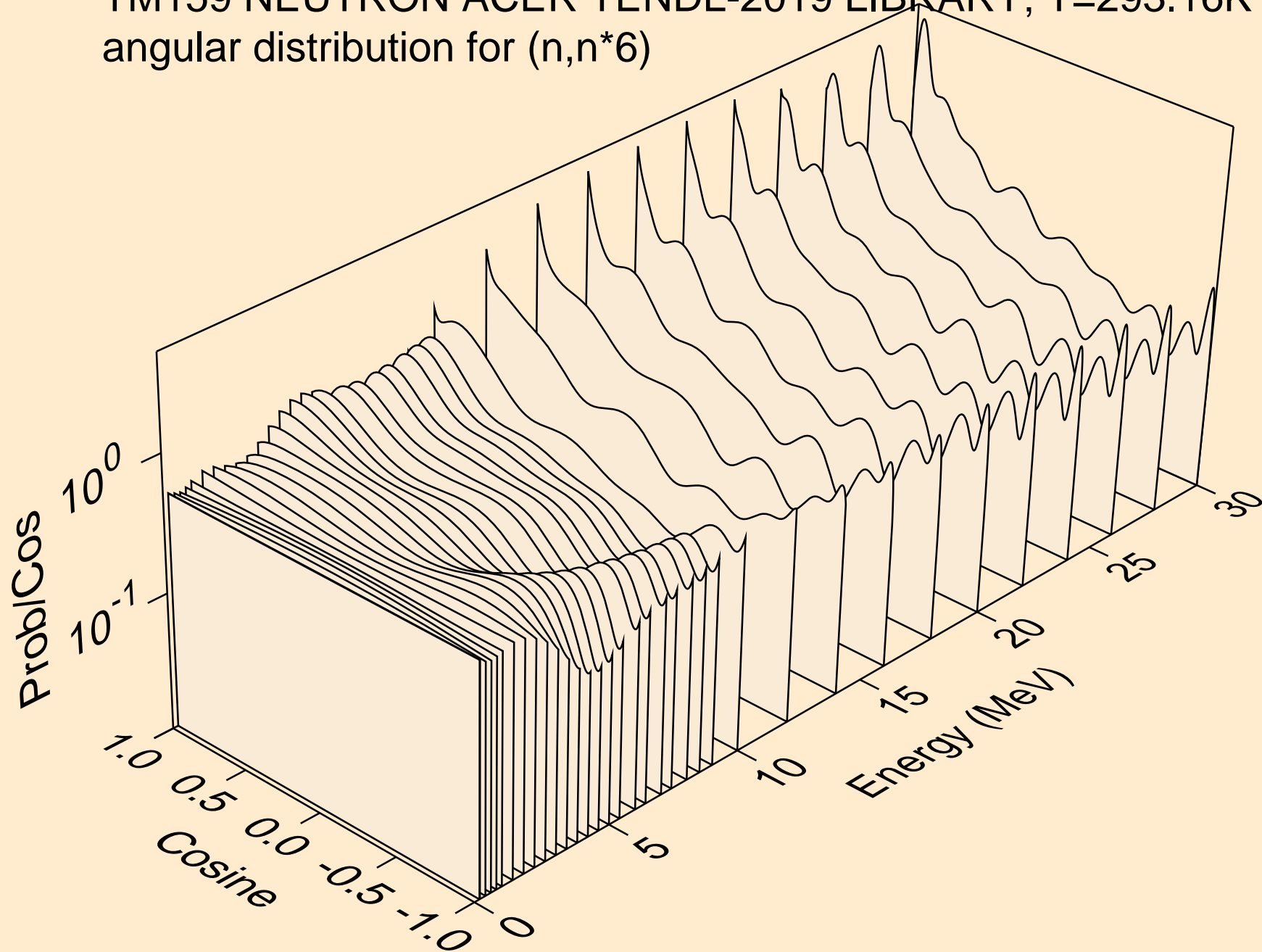

TM159 NEUTRON ACER TENDL-2019 LIBRARY; T=293.16K  
angular distribution for (n,n\*7)

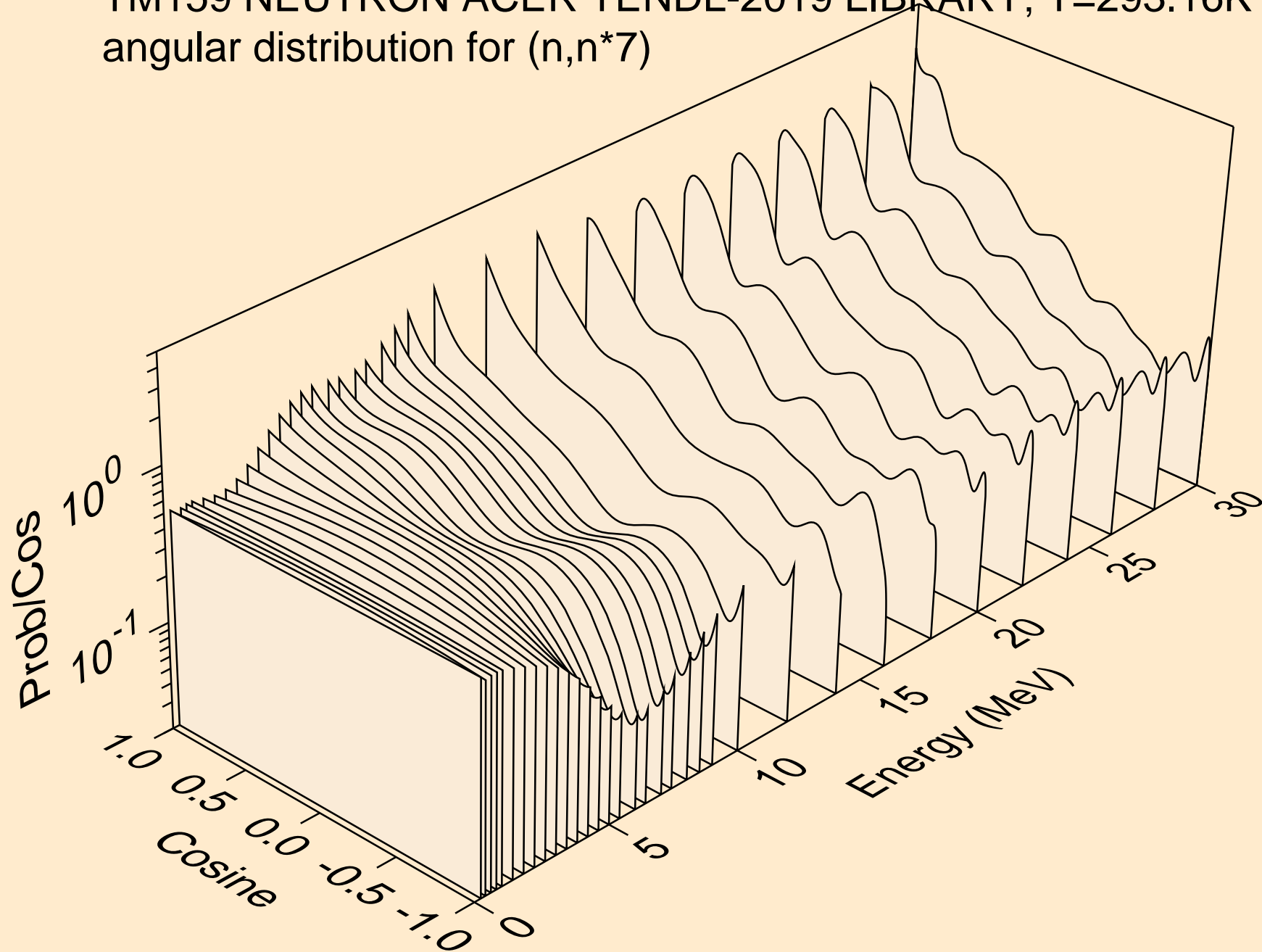



TM159 NEUTRON ACER TENDL-2019 LIBRARY; T=293.16K  
angular distribution for (n,n\*8)

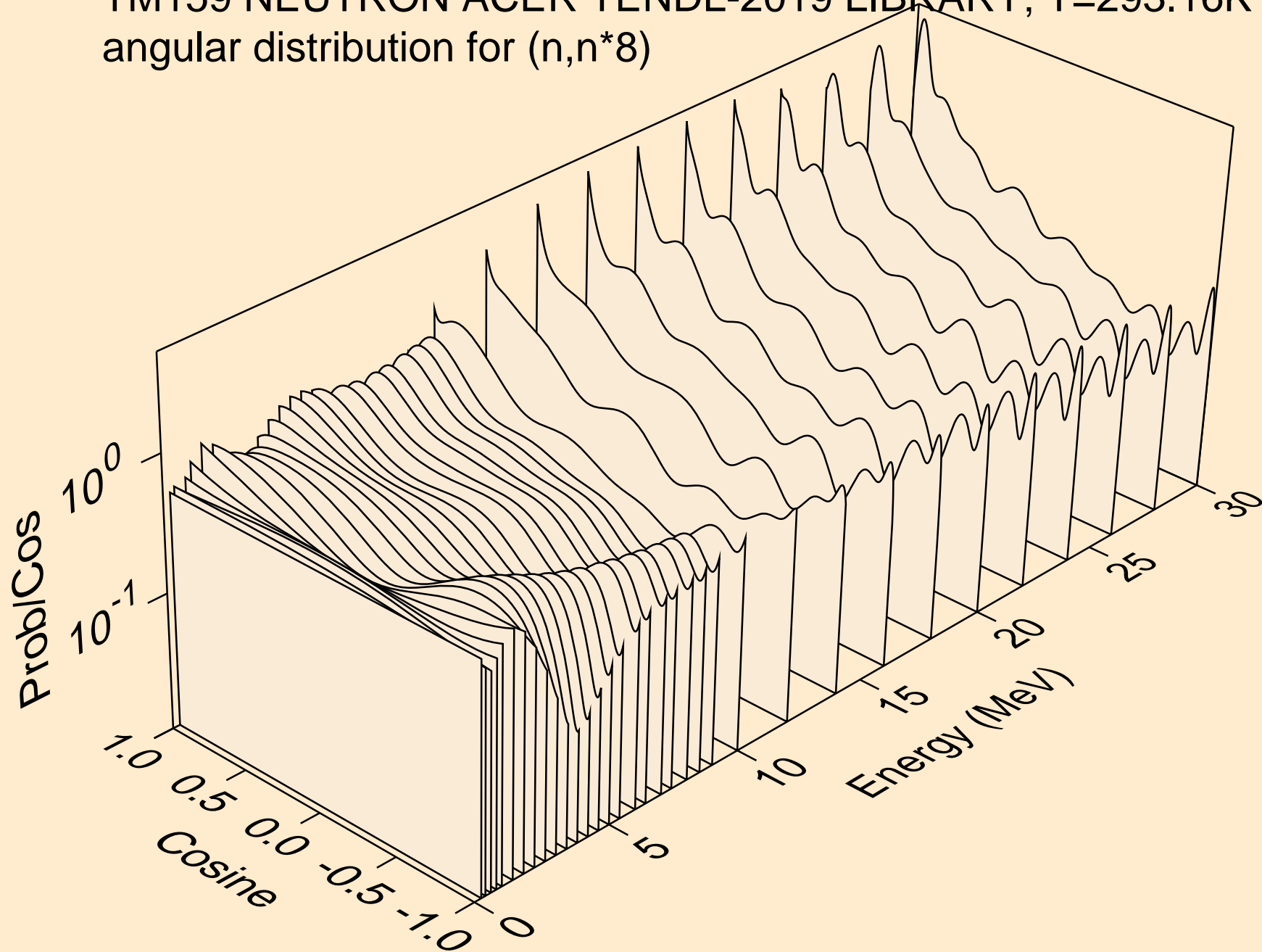

TM159 NEUTRON ACER TENDL-2019 LIBRARY; T=293.16K  
angular distribution for (n,n\*9)

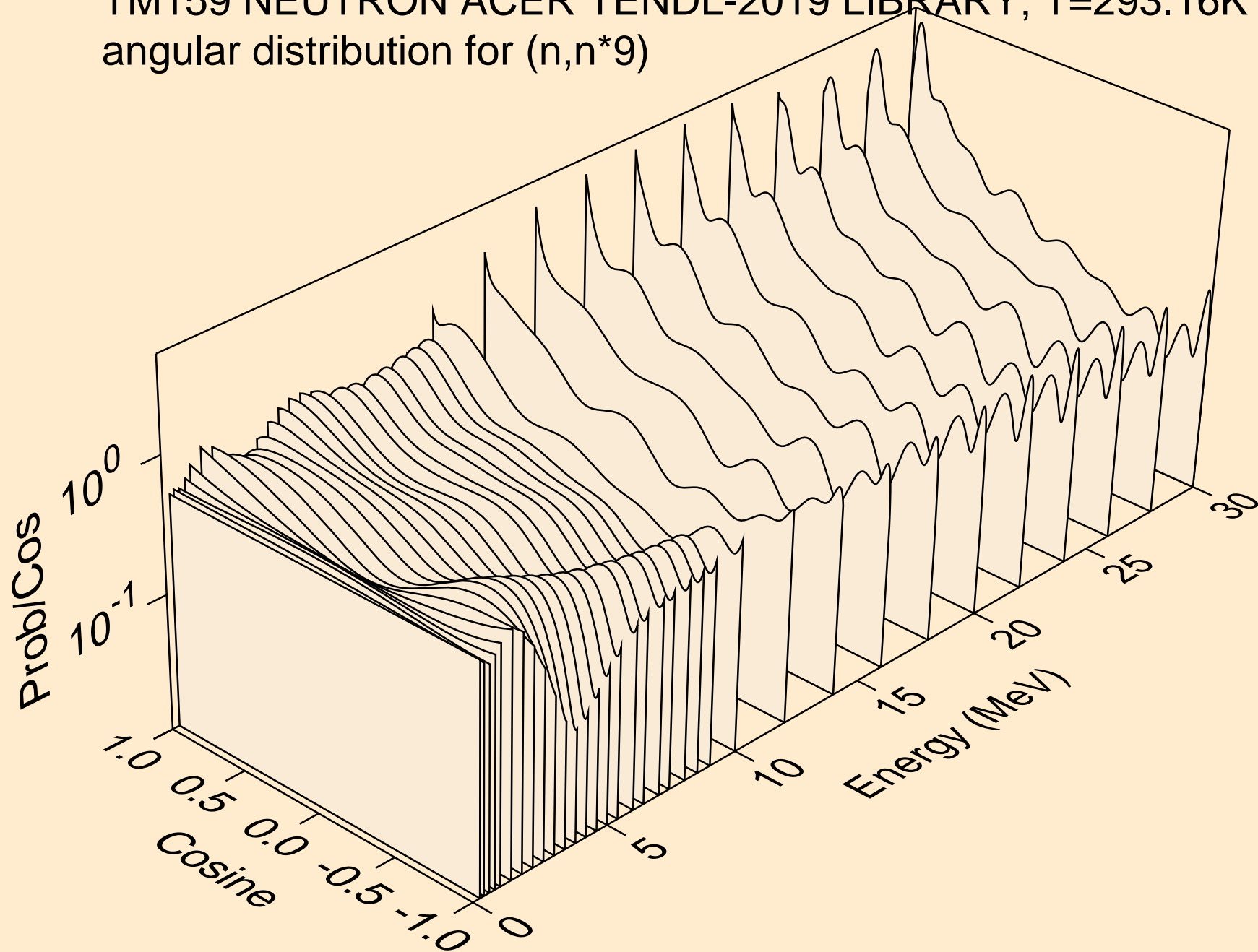

TM159 NEUTRON ACER TENDL-2019 LIBRARY; T=293.16K  
angular distribution for (n,n\*10)

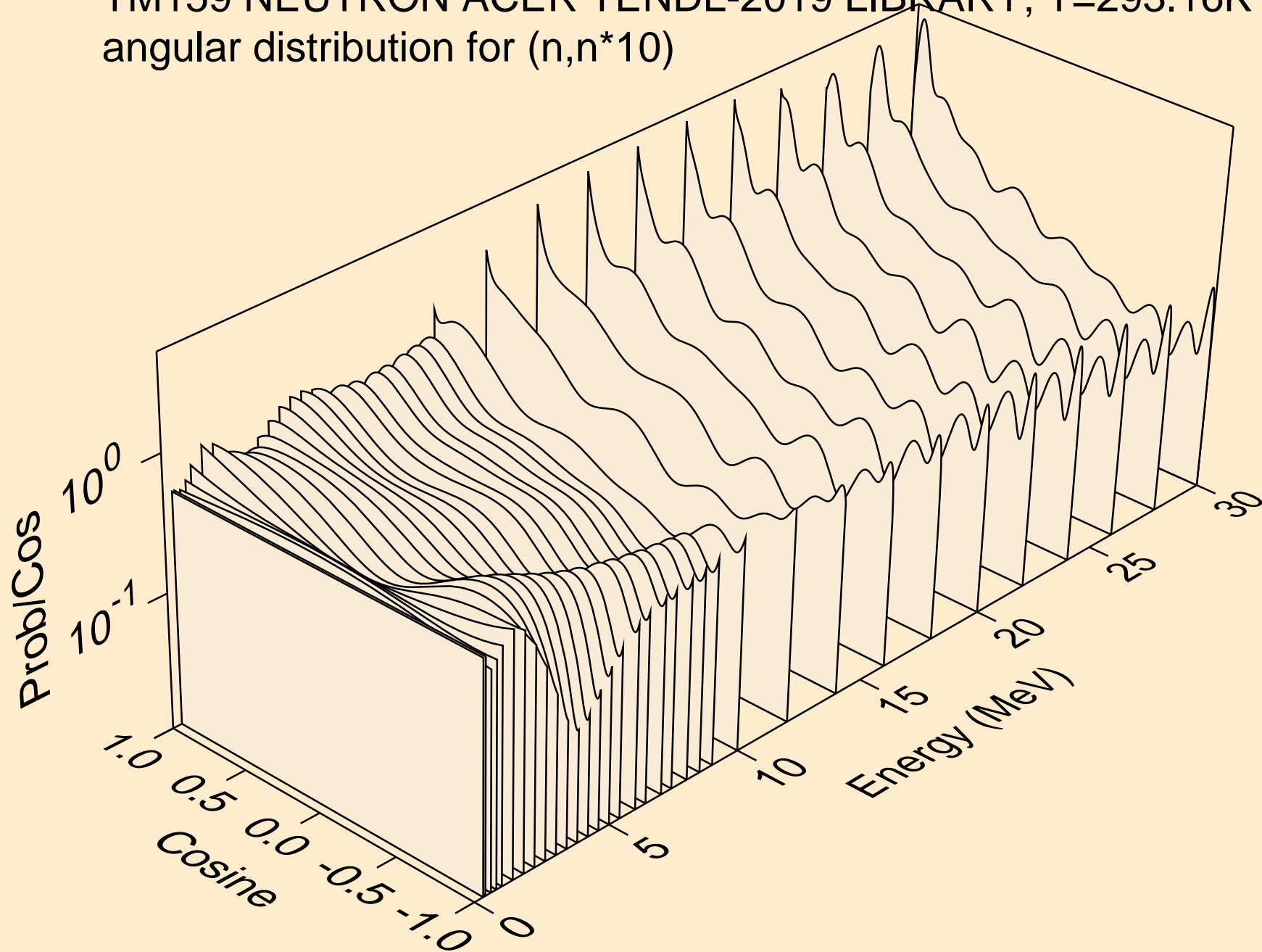

TM159 NEUTRON ACER TENDL-2019 LIBRARY; T=293.16K  
angular distribution for (n,n\*11)

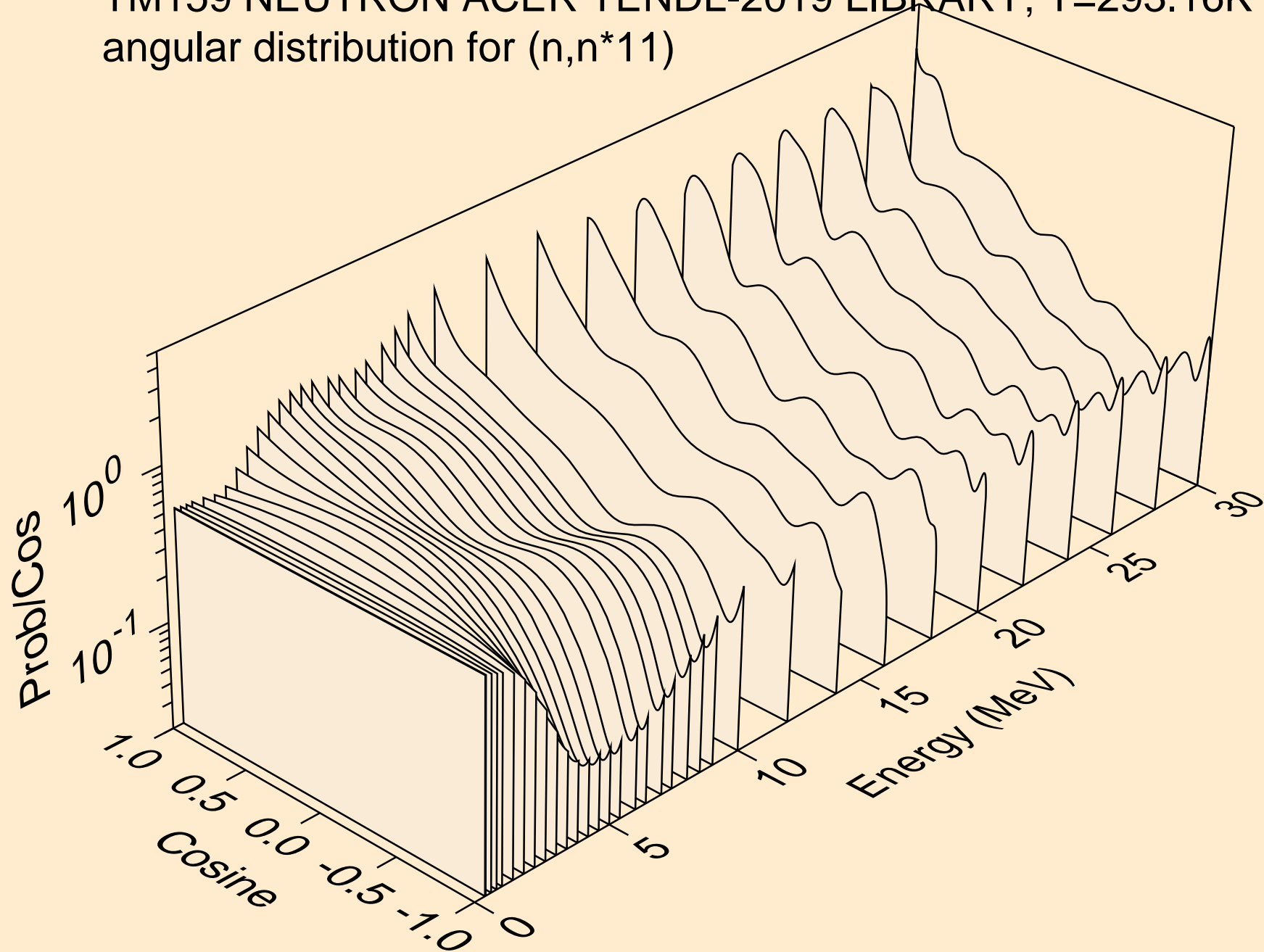

TM159 NEUTRON ACER TENDL-2019 LIBRARY; T=293.16K  
angular distribution for (n,n\*12)

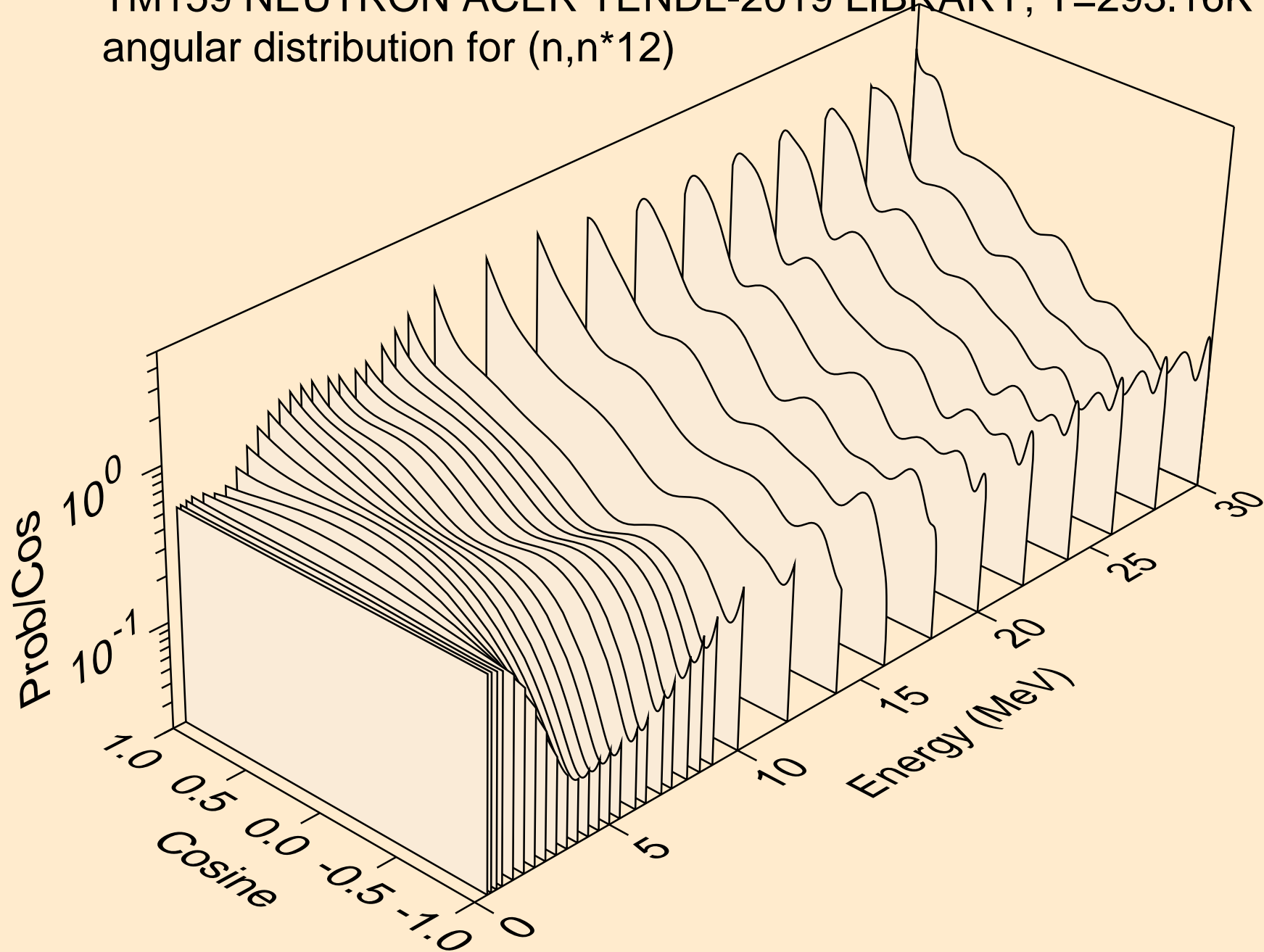

TM159 NEUTRON ACER TENDL-2019 LIBRARY; T=293.16K  
angular distribution for (n,n\*13)

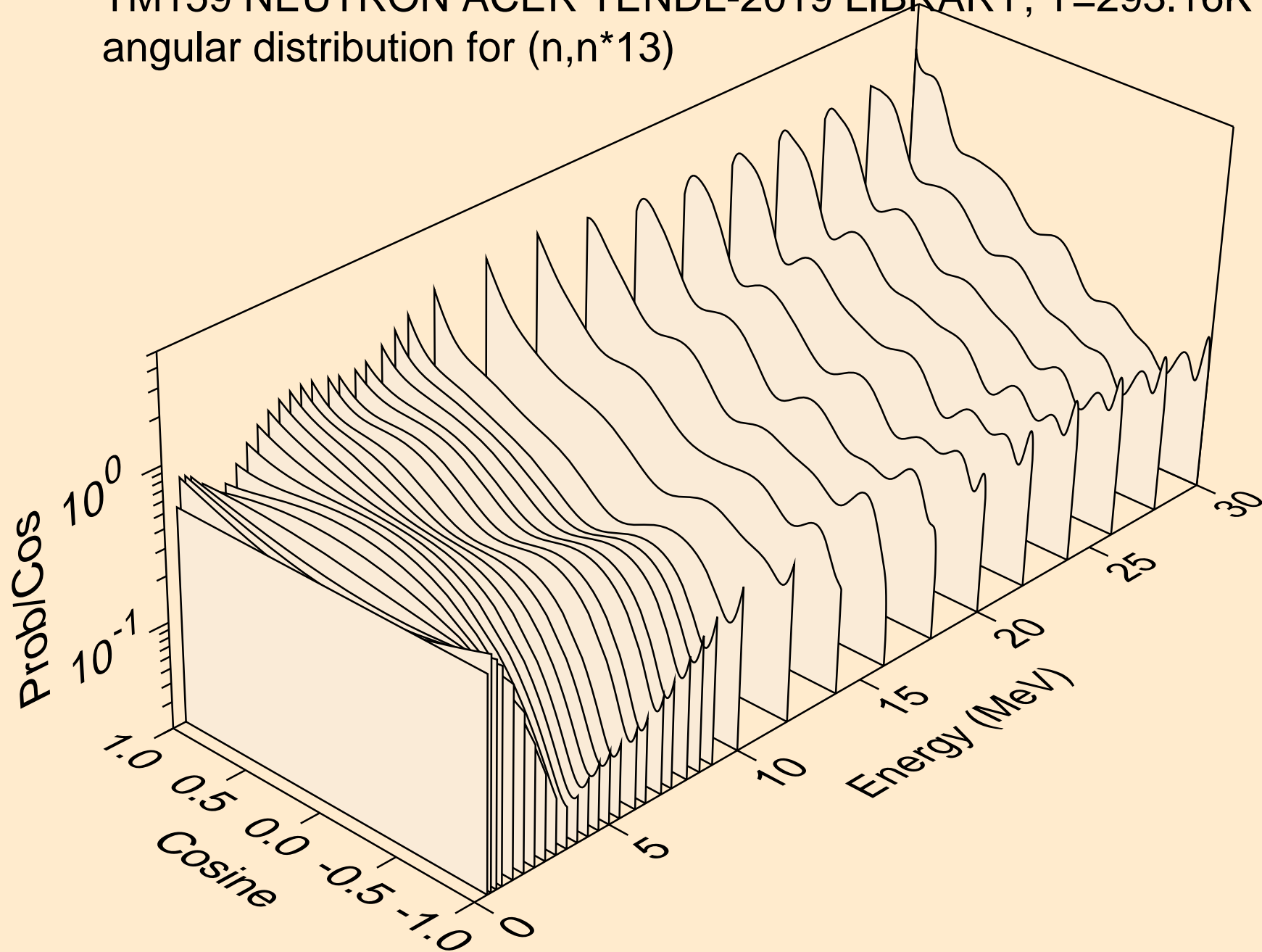

TM159 NEUTRON ACER TENDL-2019 LIBRARY; T=293.16K  
angular distribution for (n,n\*14)

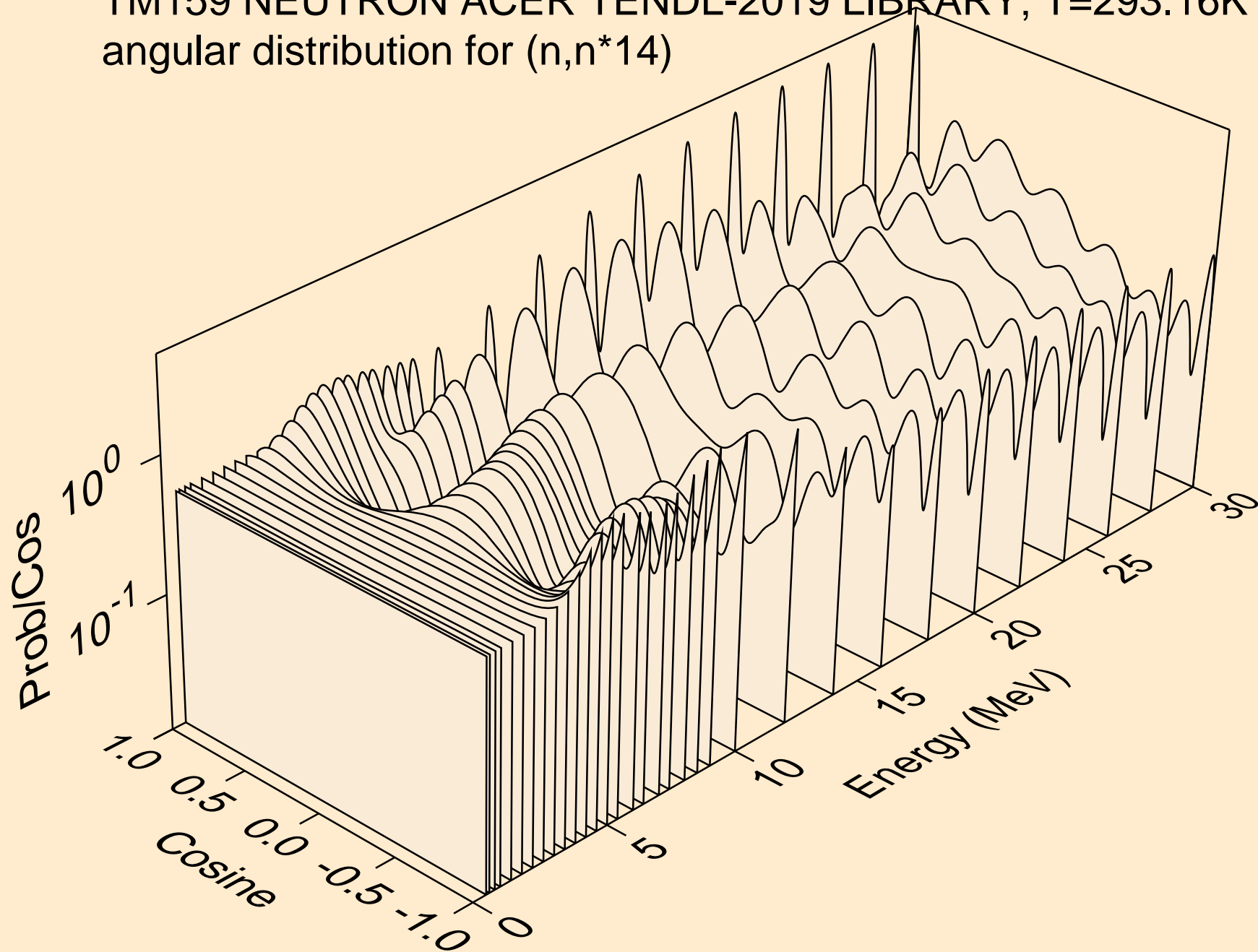

TM159 NEUTRON ACER TENDL-2019 LIBRARY; T=293.16K  
angular distribution for (n,n\*15)

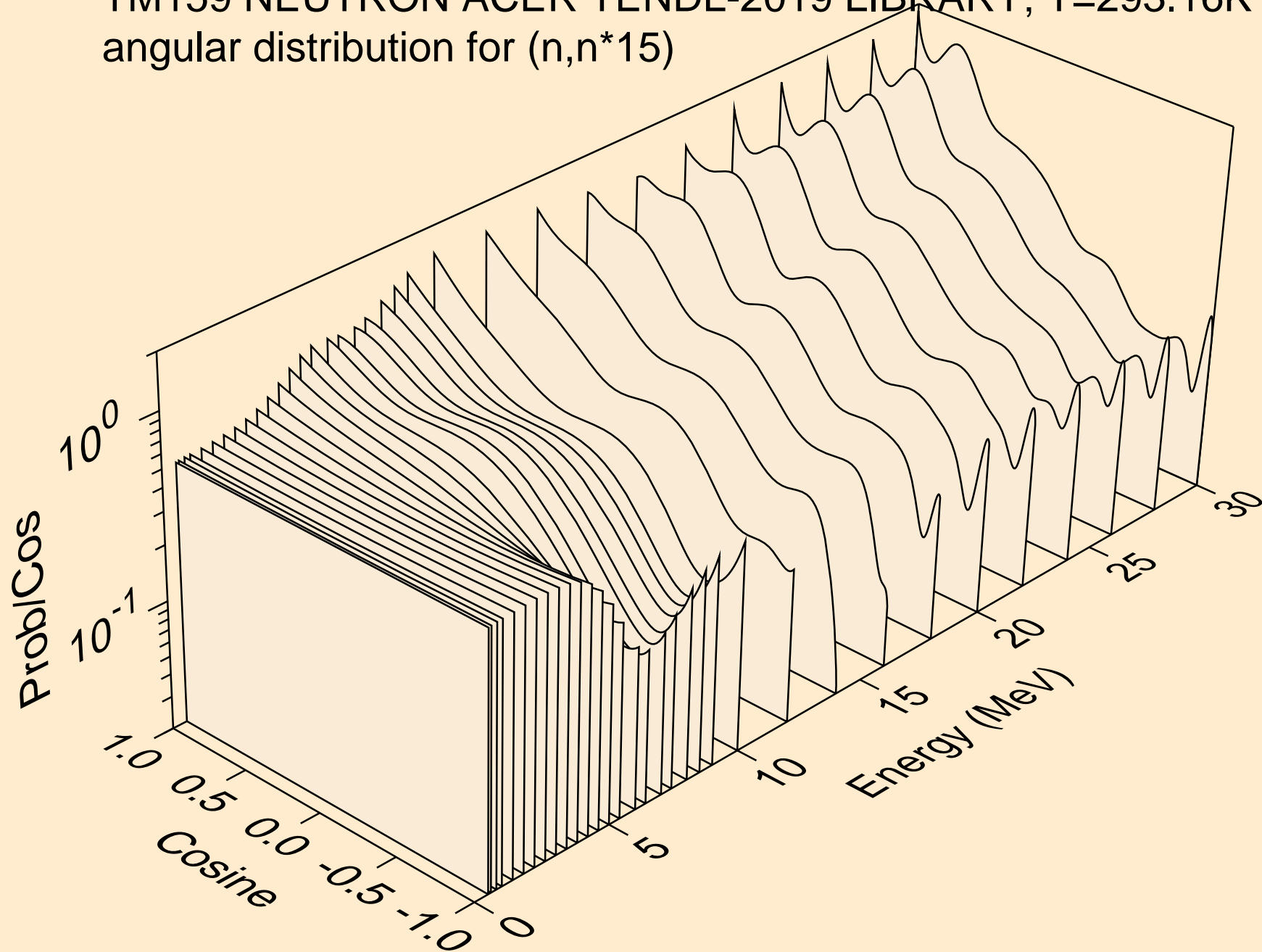



TM159 NEUTRON ACER TENDL-2019 LIBRARY; T=293.16K  
angular distribution for (n,n\*16)

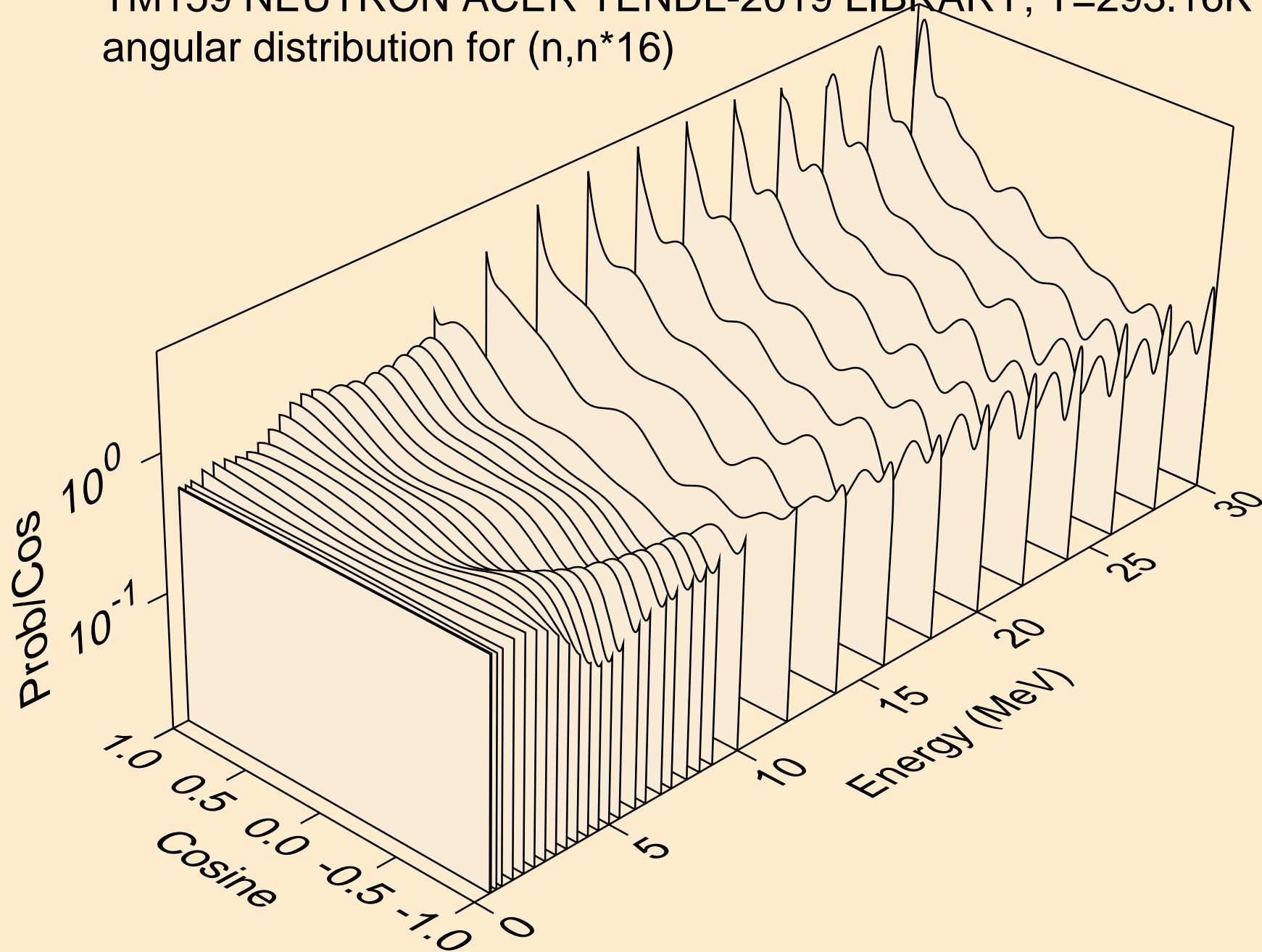

TM159 NEUTRON ACER TENDL-2019 LIBRARY; T=293.16K  
angular distribution for (n,n\*17)

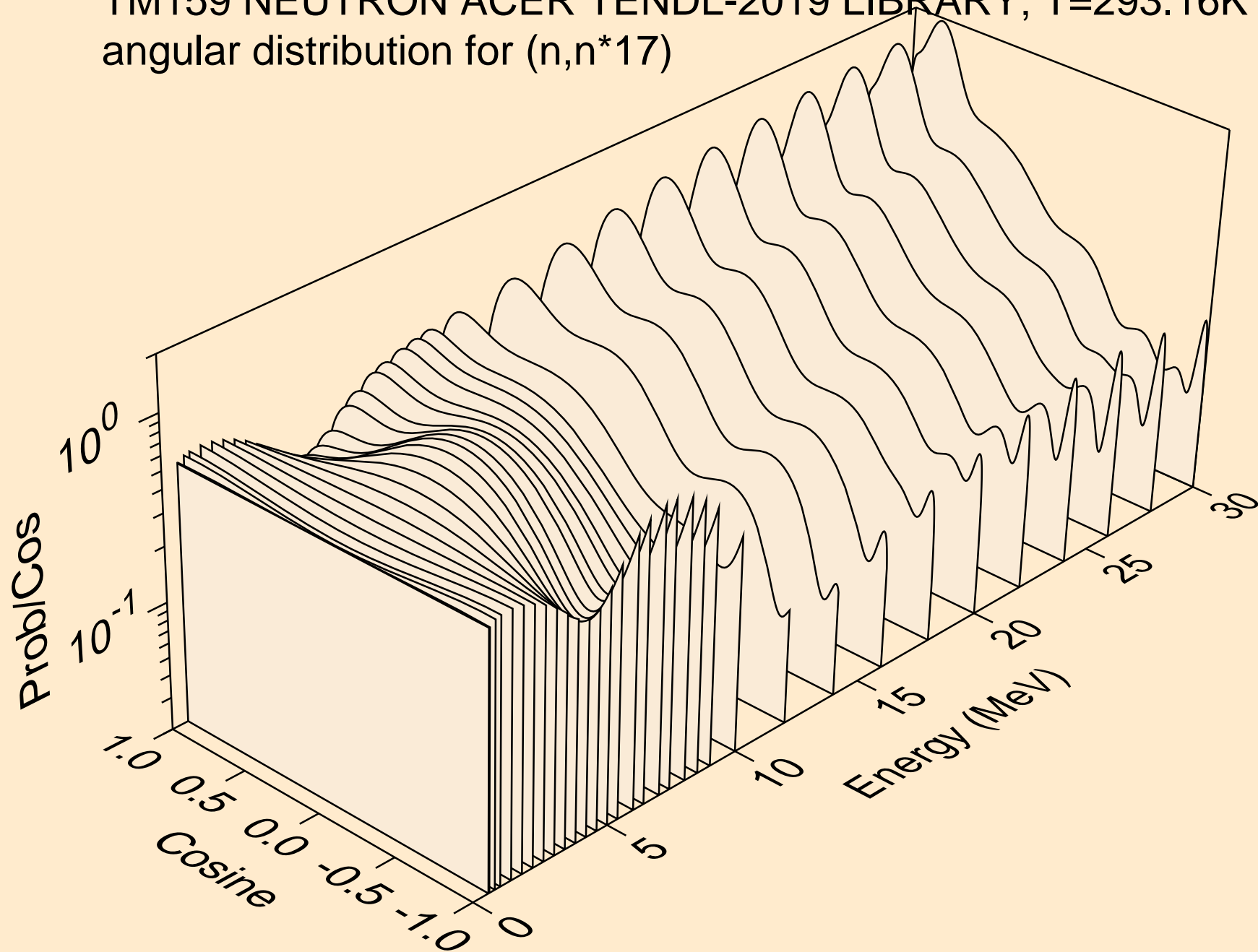

TM159 NEUTRON ACER TENDL-2019 LIBRARY; T=293.16K  
angular distribution for (n,n\*18)

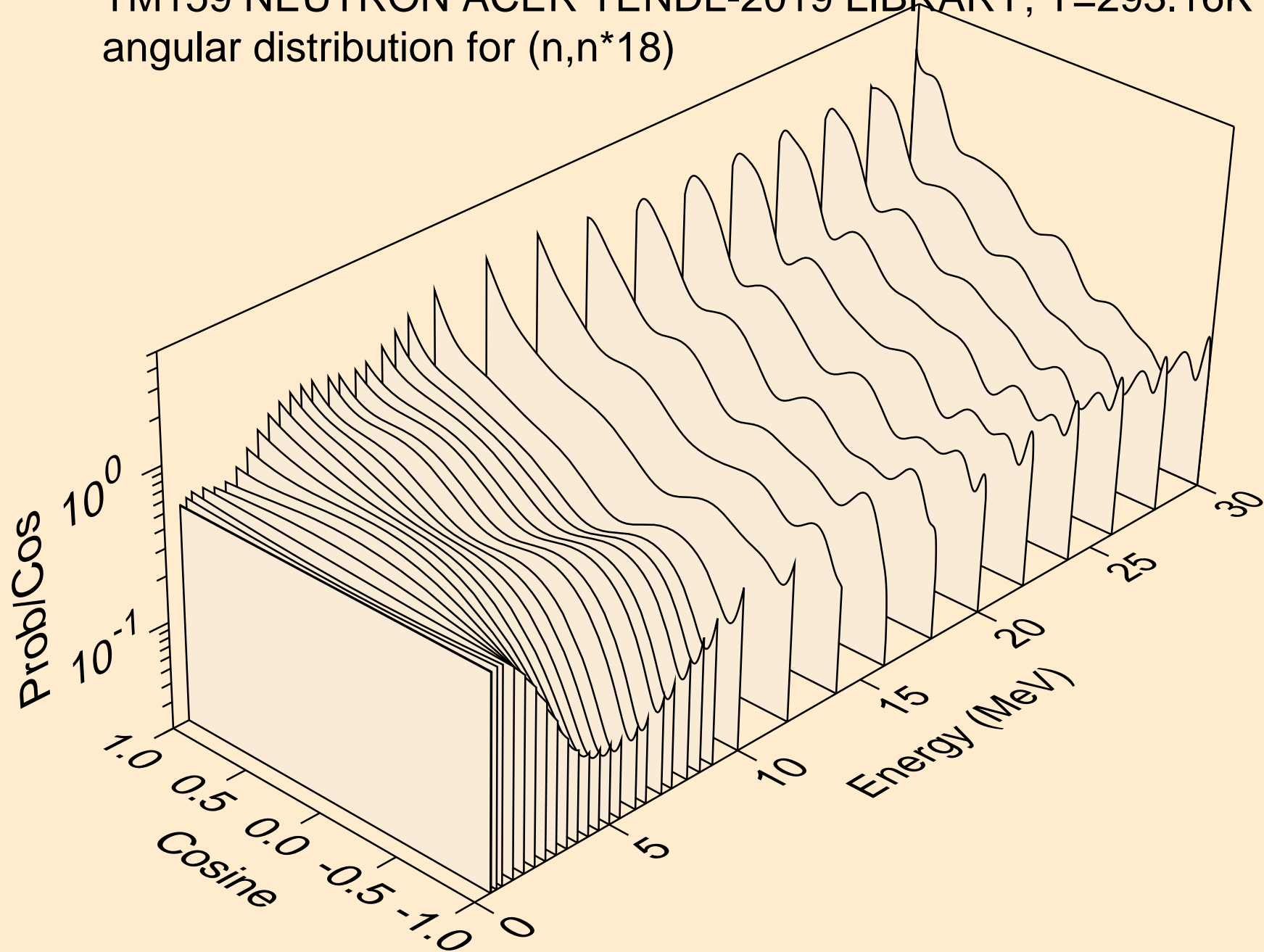

TM159 NEUTRON ACER TENDL-2019 LIBRARY; T=293.16K  
angular distribution for (n,n\*19)

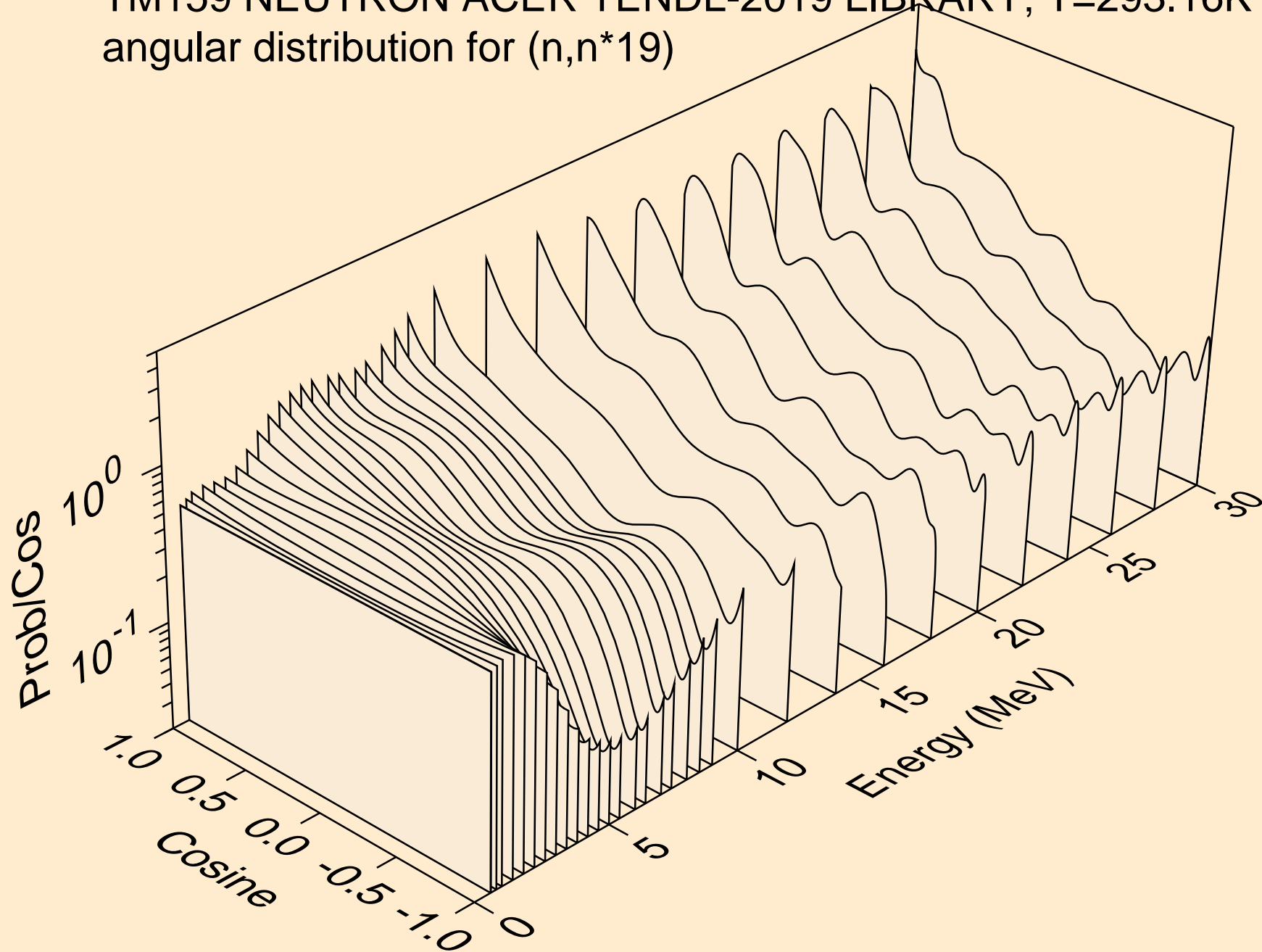

TM159 NEUTRON ACER TENDL-2019 LIBRARY; T=293.16K  
angular distribution for (n,n\*20)

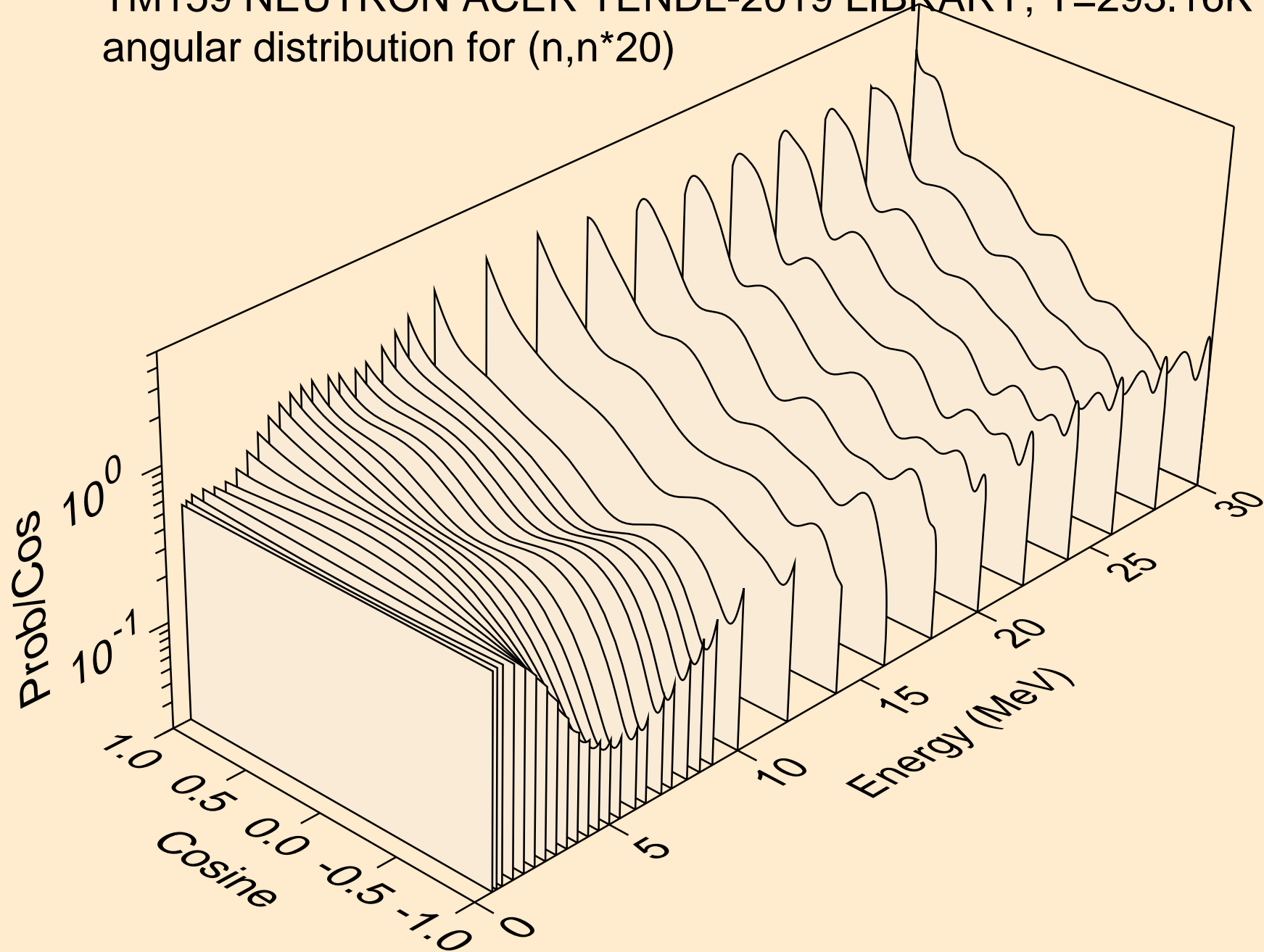

TM159 NEUTRON ACER TENDL-2019 LIBRARY; T=293.16K  
angular distribution for (n,n\*21)

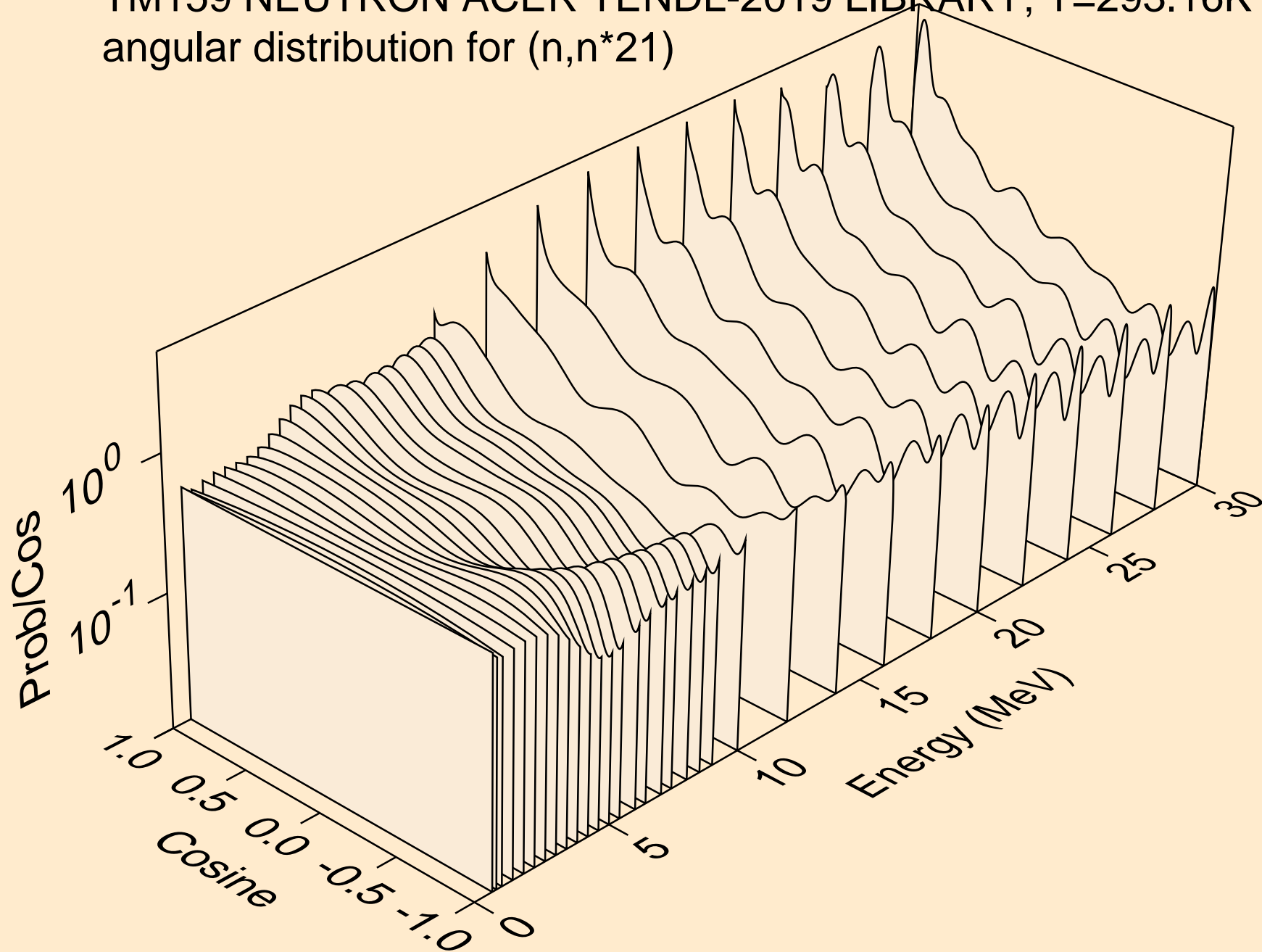

TM159 NEUTRON ACER TENDL-2019 LIBRARY; T=293.16K  
angular distribution for (n,n\*22)

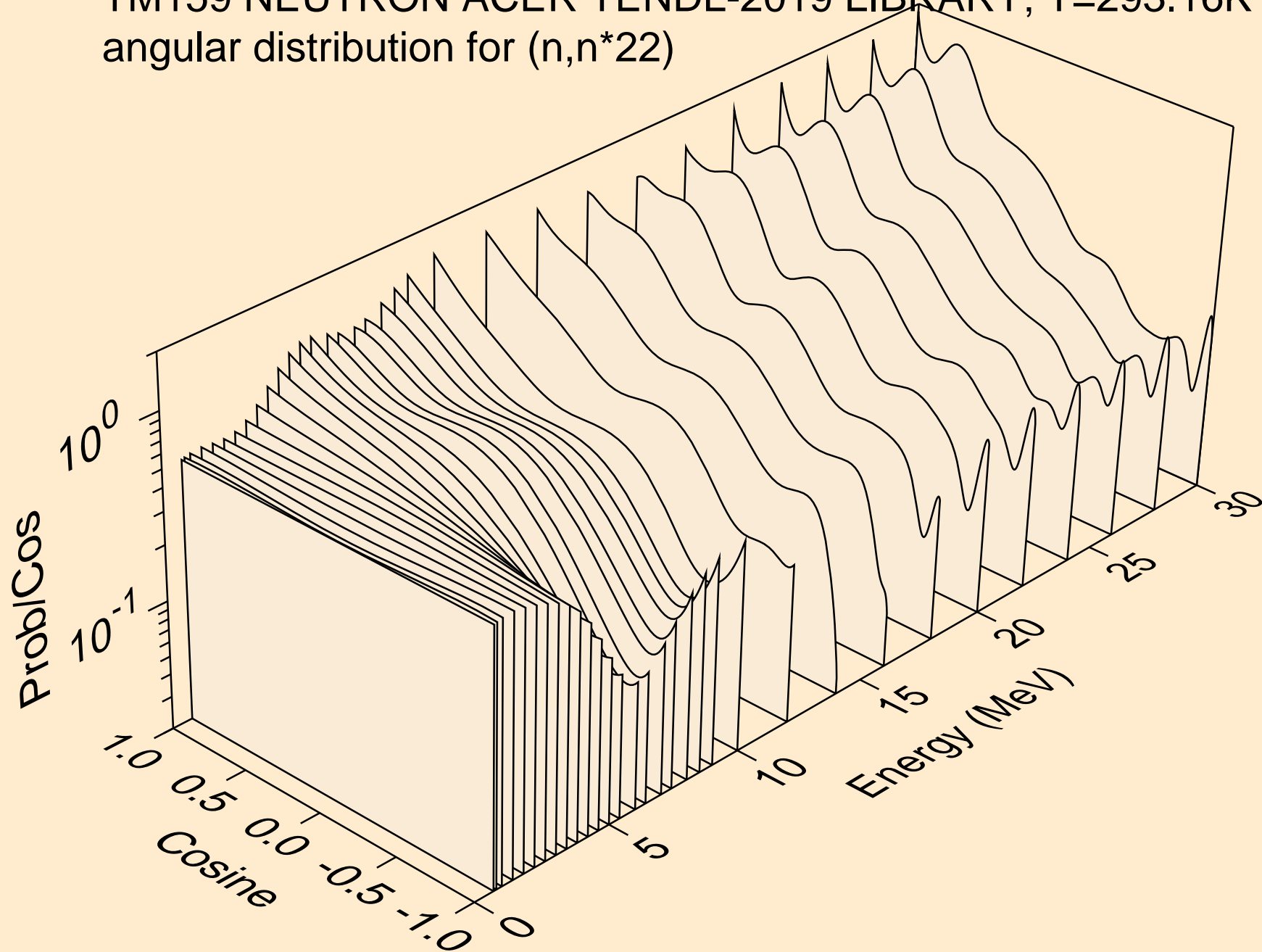

TM159 NEUTRON ACER TENDL-2019 LIBRARY; T=293.16K  
angular distribution for (n,n\*23)

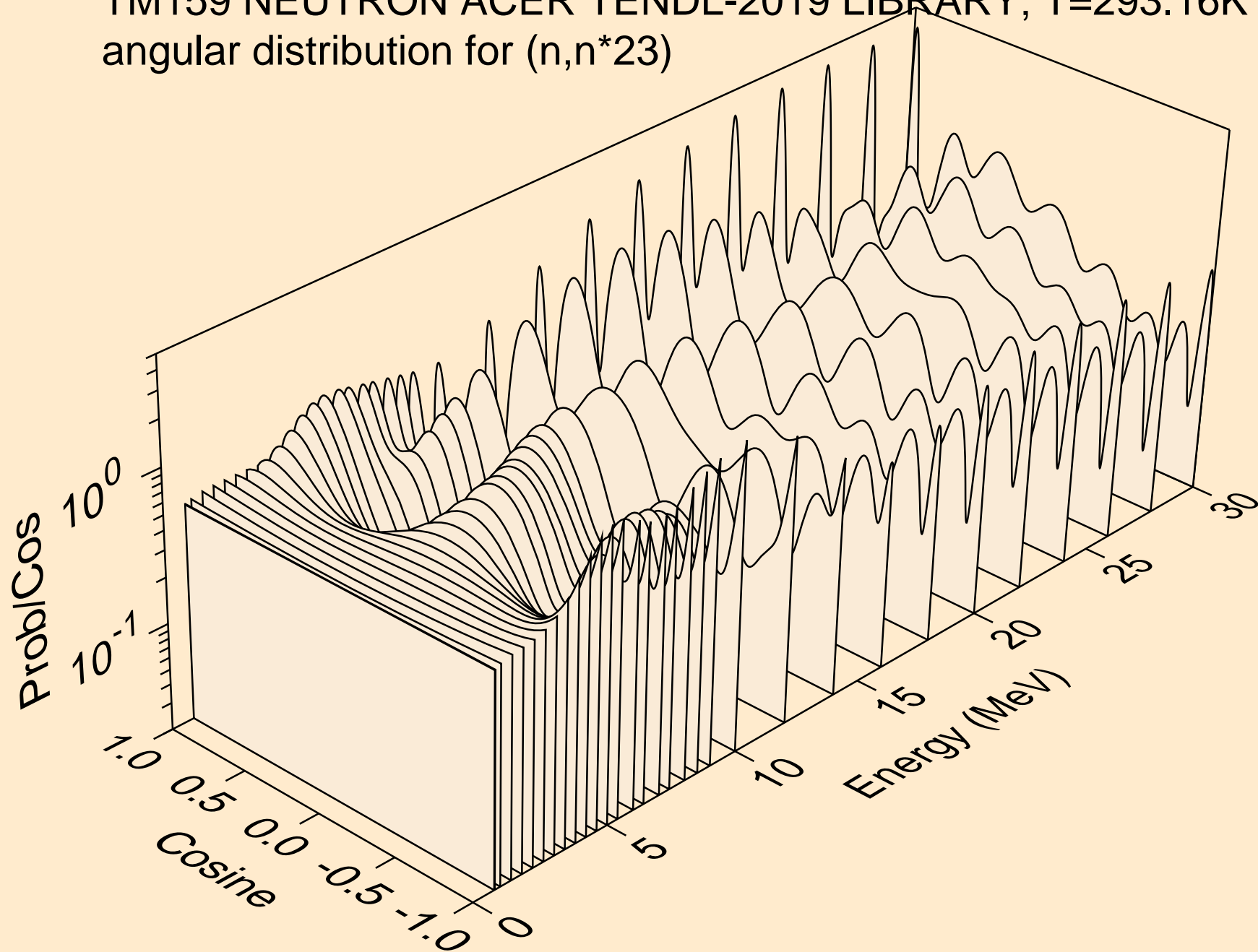



TM159 NEUTRON ACER TENDL-2019 LIBRARY; T=293.16K  
angular distribution for (n,n\*24)

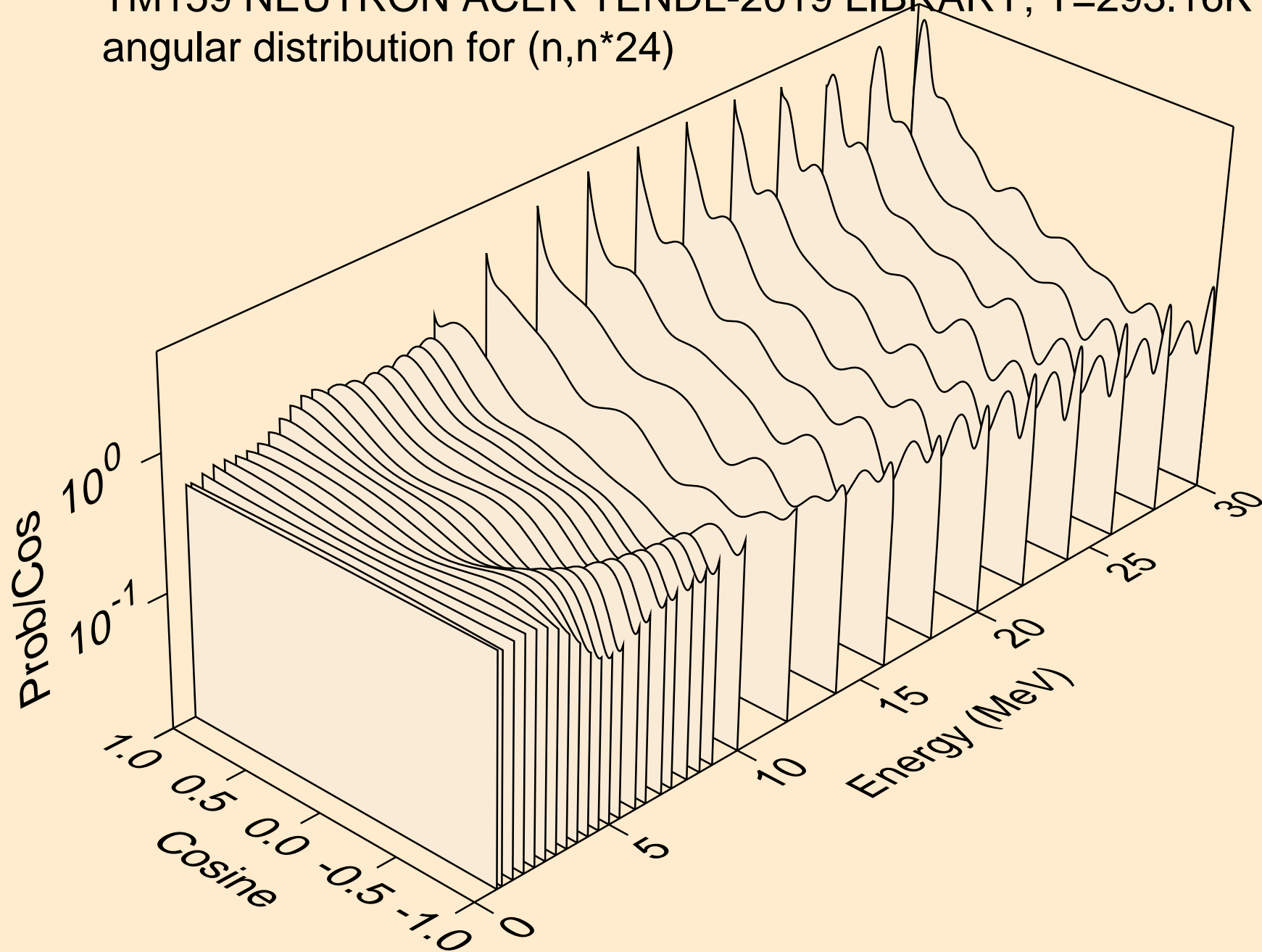

TM159 NEUTRON ACER TENDL-2019 LIBRARY; T=293.16K  
angular distribution for (n,n\*25)

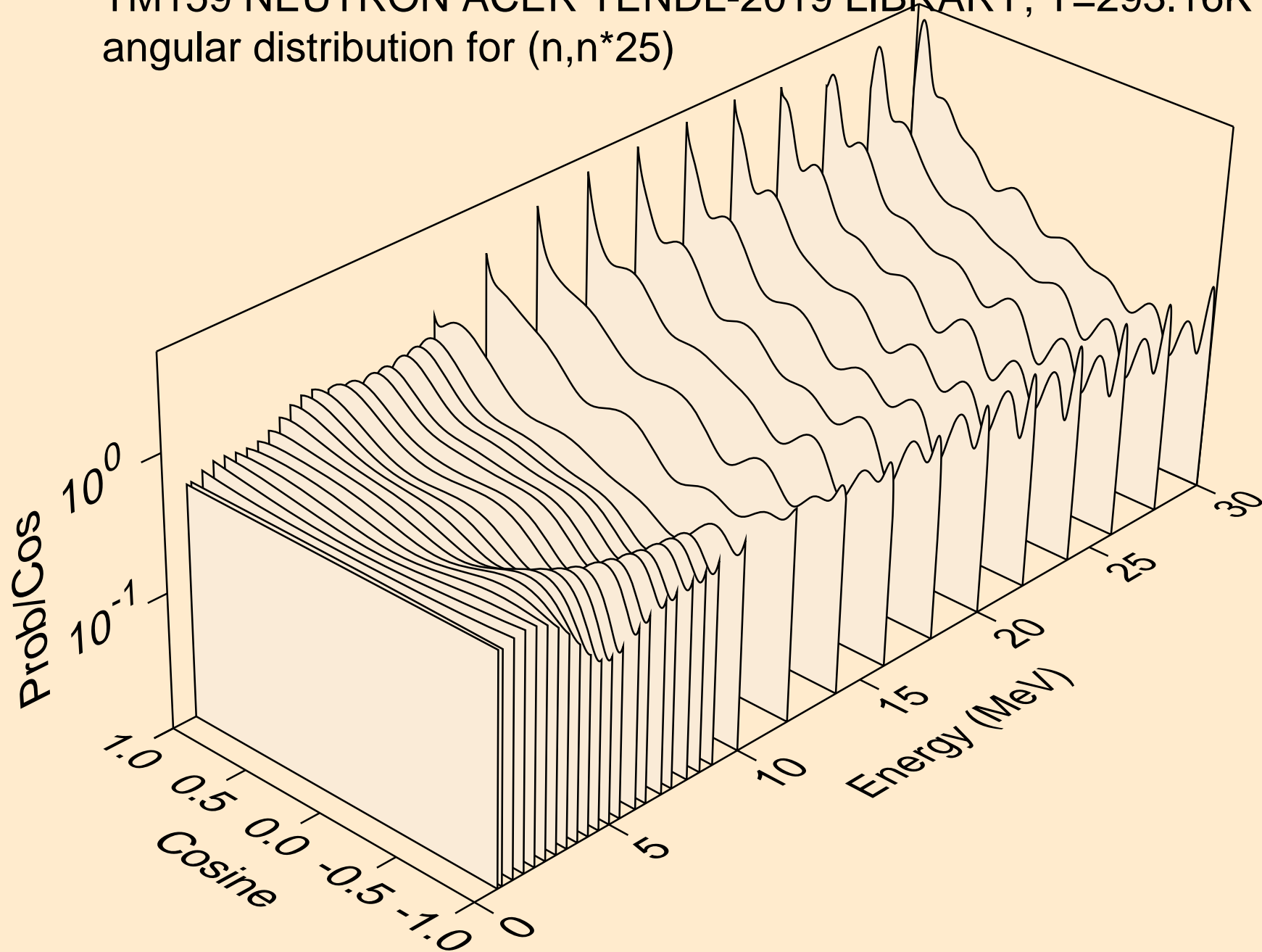

TM159 NEUTRON ACER TENDL-2019 LIBRARY; T=293.16K  
angular distribution for (n,n\*26)

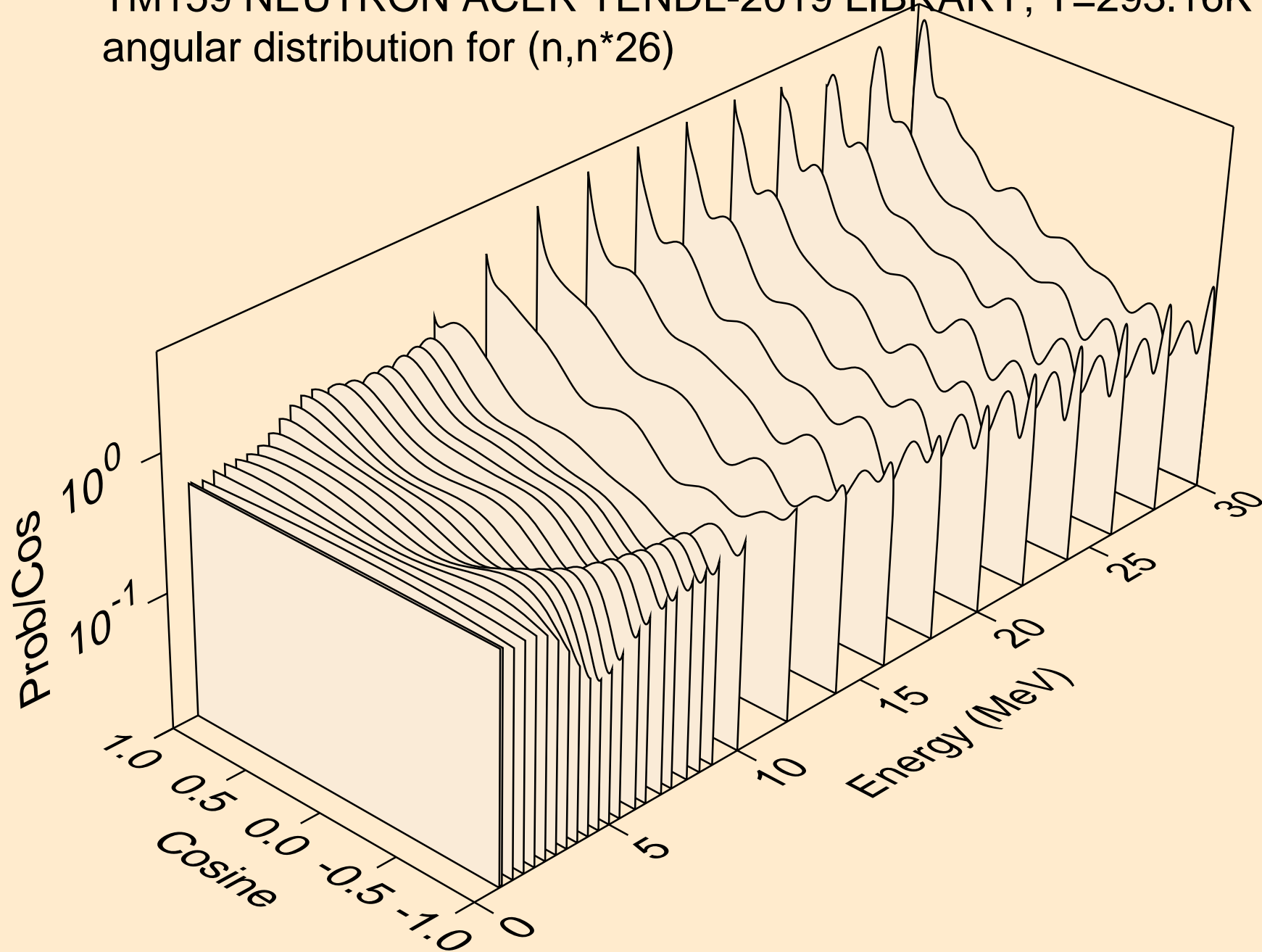

TM159 NEUTRON ACER TENDL-2019 LIBRARY; T=293.16K  
Neutron emission for (n,x)

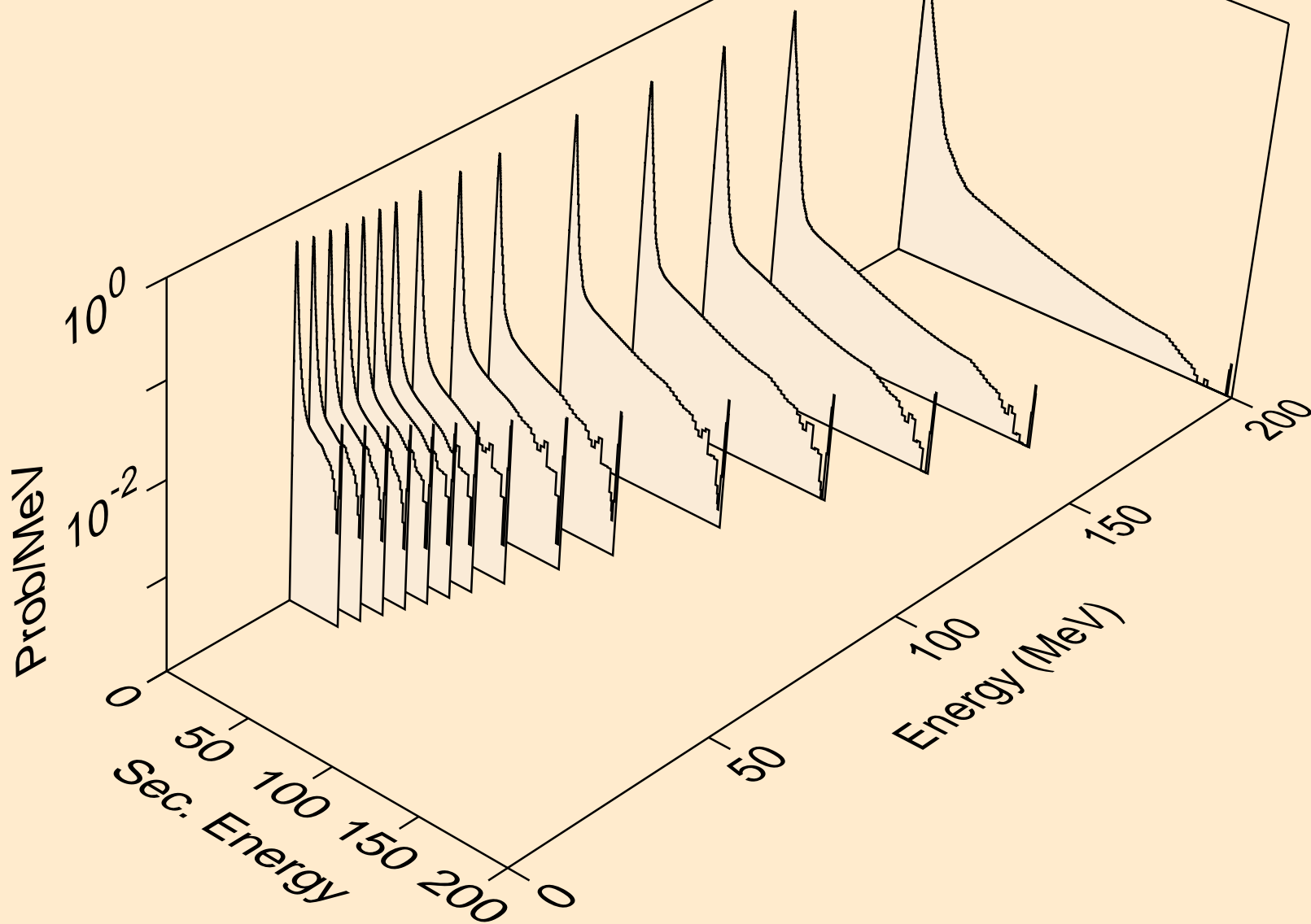

TM159 NEUTRON ACER TENDL-2019 LIBRARY; T=293.16K  
Neutron emission for (n,2nd)

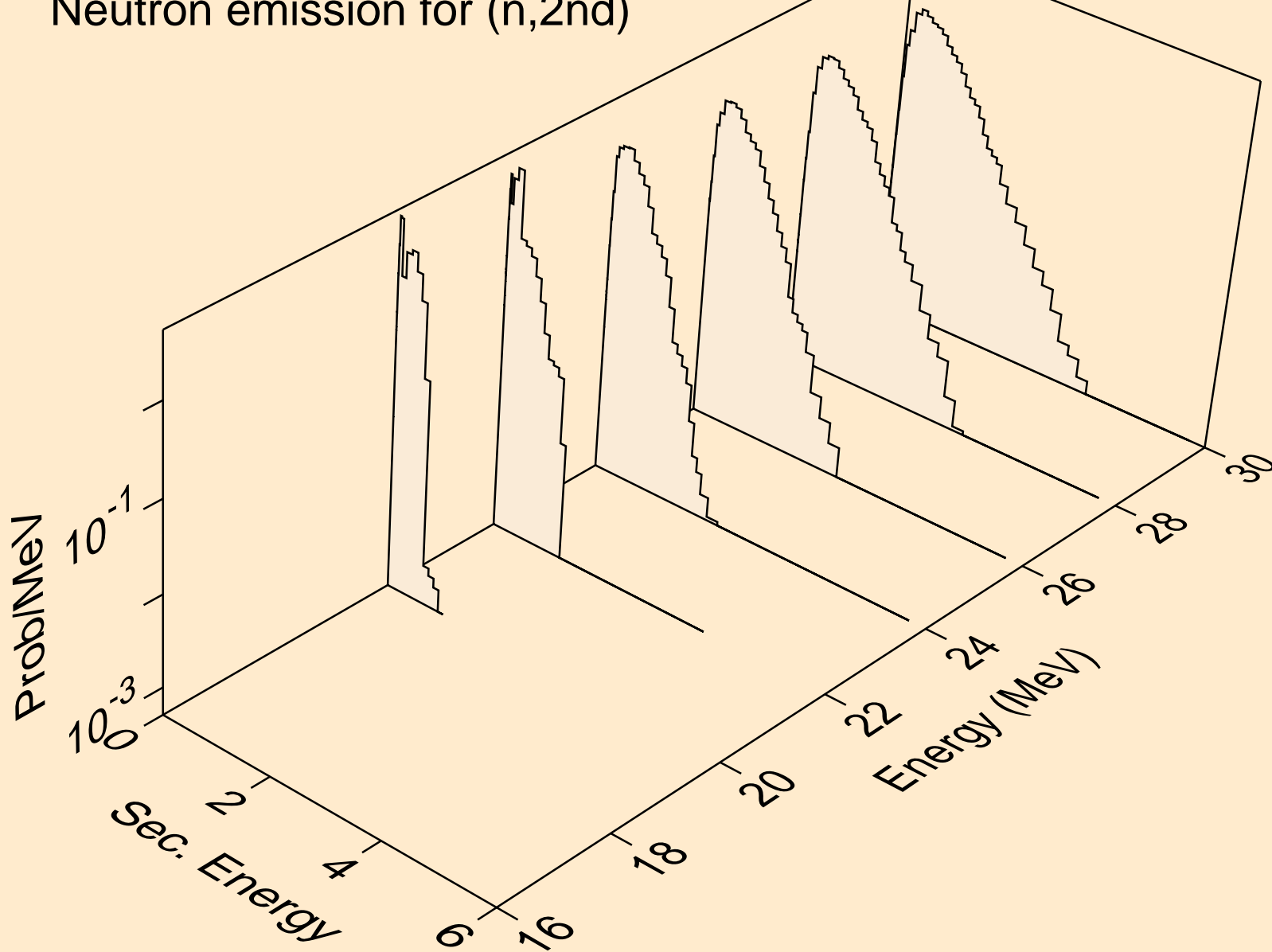

TM159 NEUTRON ACER TENDL-2019 LIBRARY; T=293.16K  
Neutron emission for (n,2n)

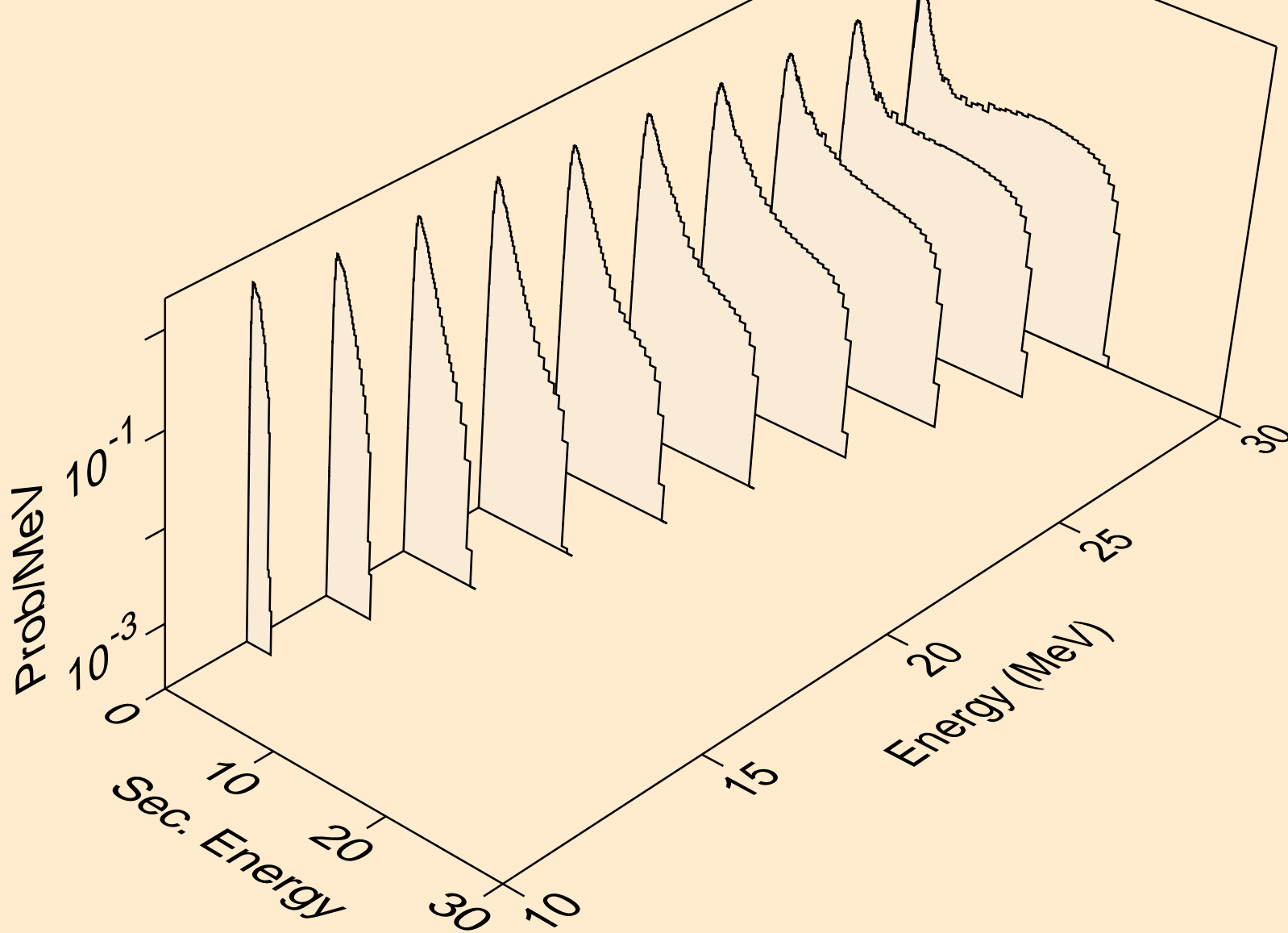

TM159 NEUTRON ACER TENDL-2019 LIBRARY; T=293.16K  
Neutron emission for (n,3n)

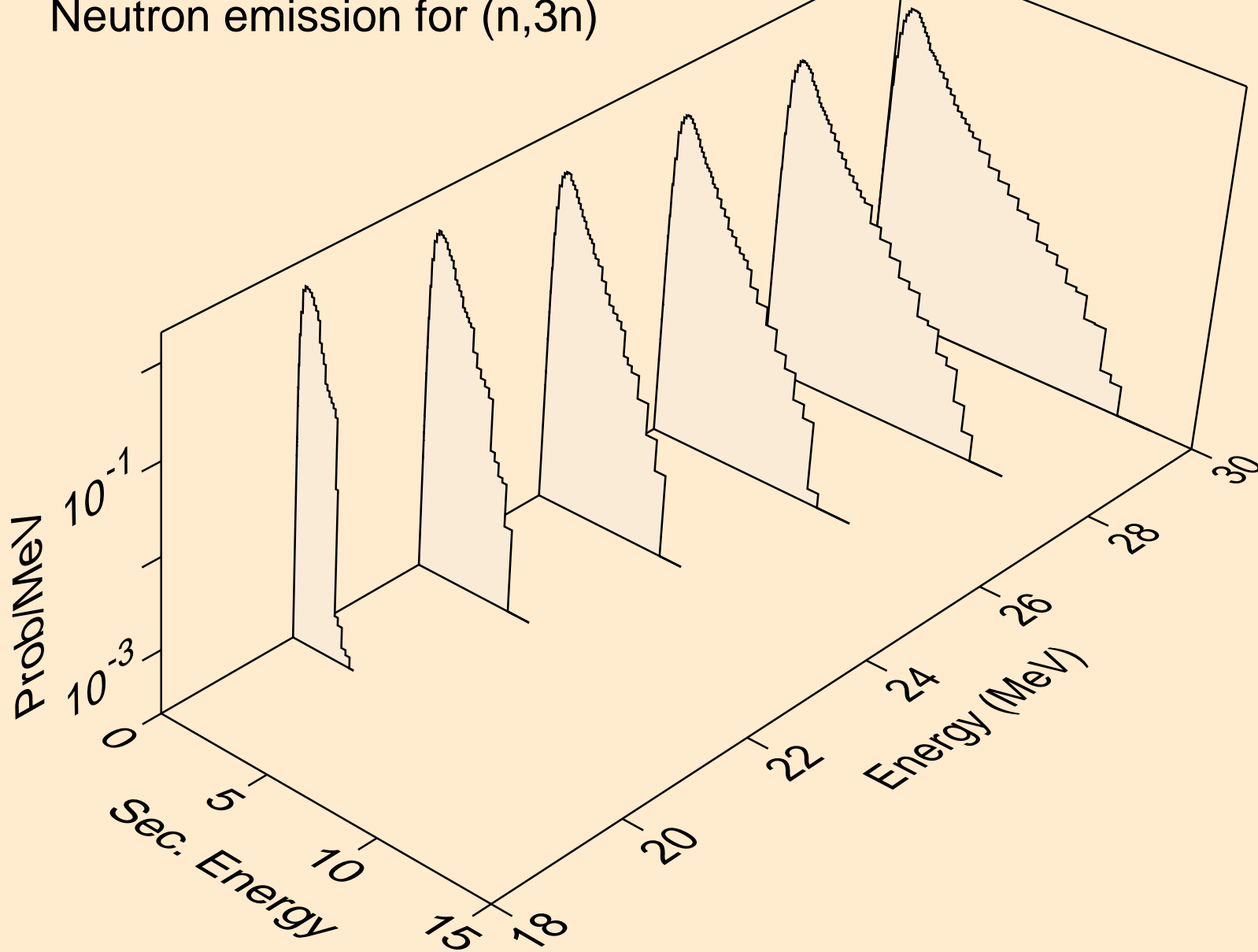

TM159 NEUTRON ACER TENDL-2019 LIBRARY; T=293.16K  
Neutron emission for (n,n\*)a

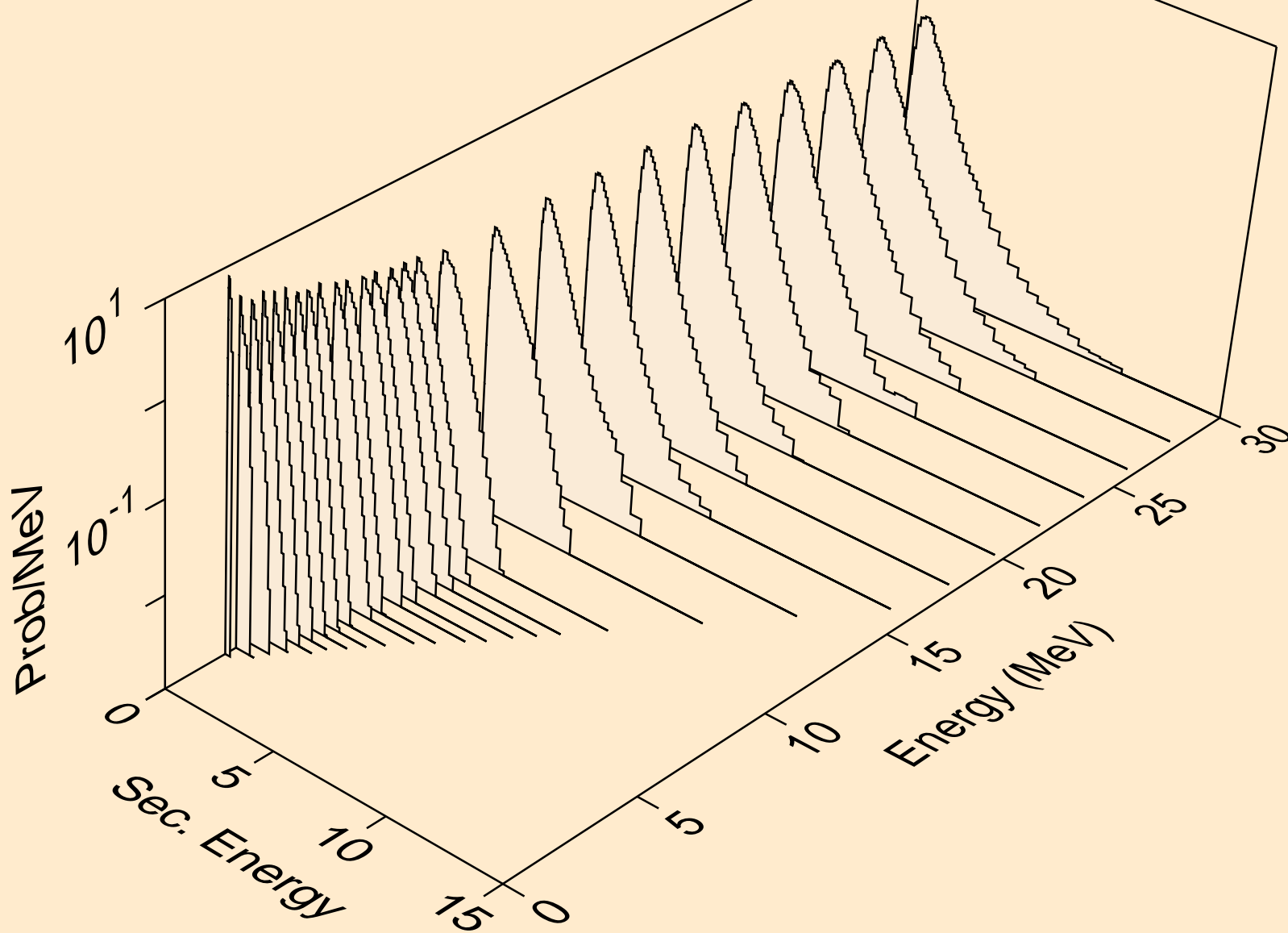



TM159 NEUTRON ACER TENDL-2019 LIBRARY; T=293.16K  
Neutron emission for (n,2n)a

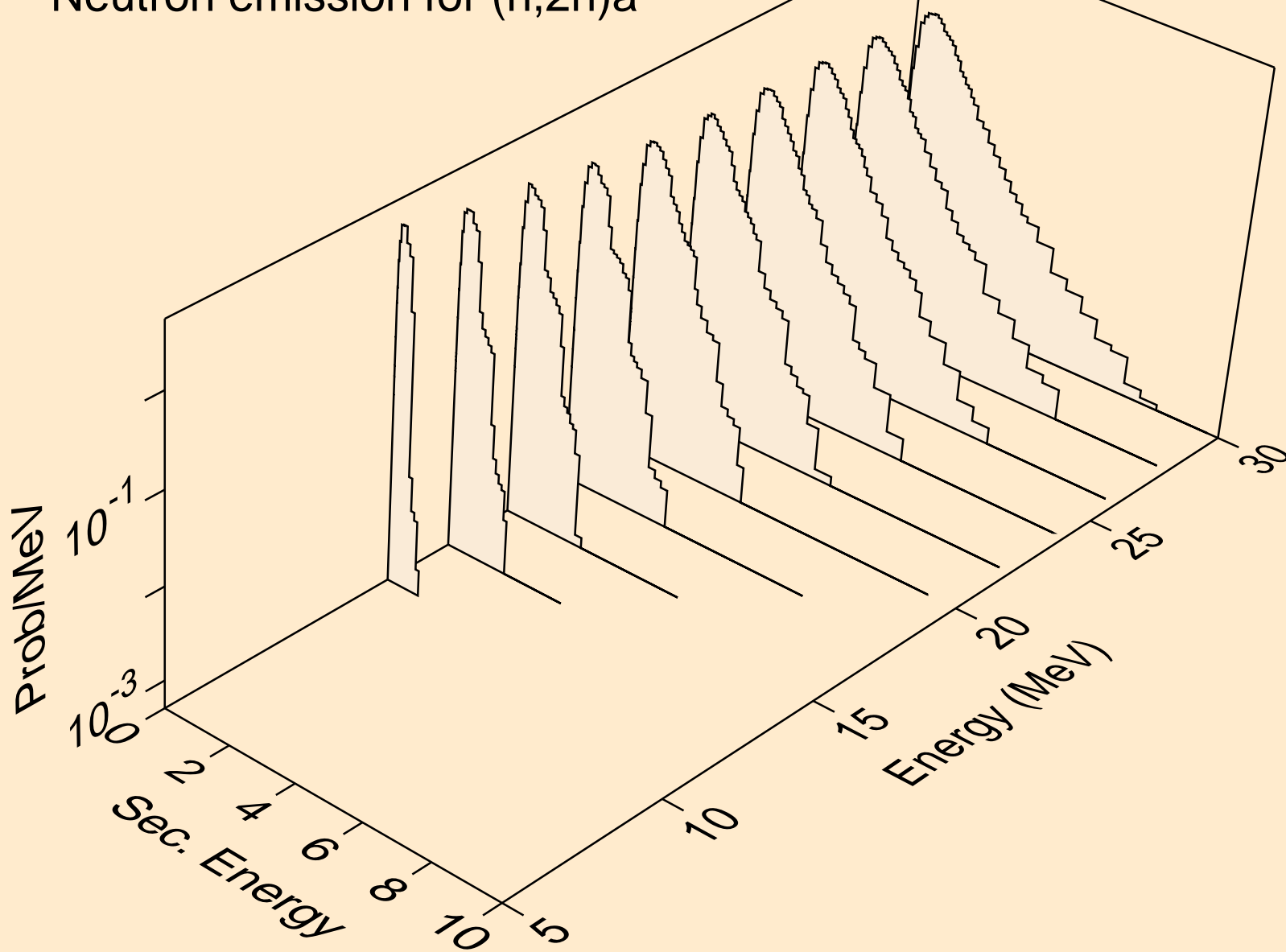

TM159 NEUTRON ACER TENDL-2019 LIBRARY; T=293.16K  
Neutron emission for (n,3n)a

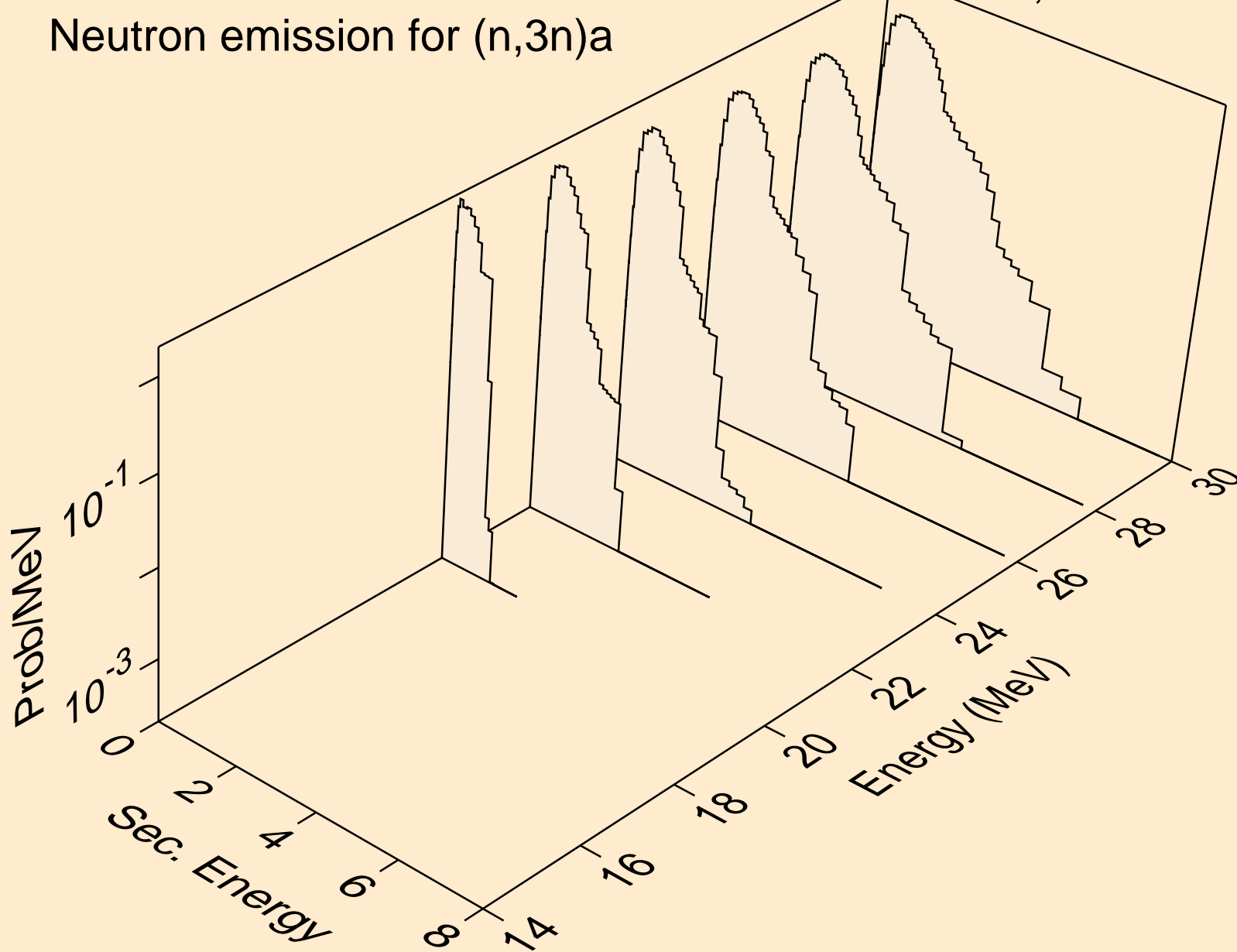

TM159 NEUTRON ACER TENDL-2019 LIBRARY; T=293.16K  
Neutron emission for (n,n\*)p

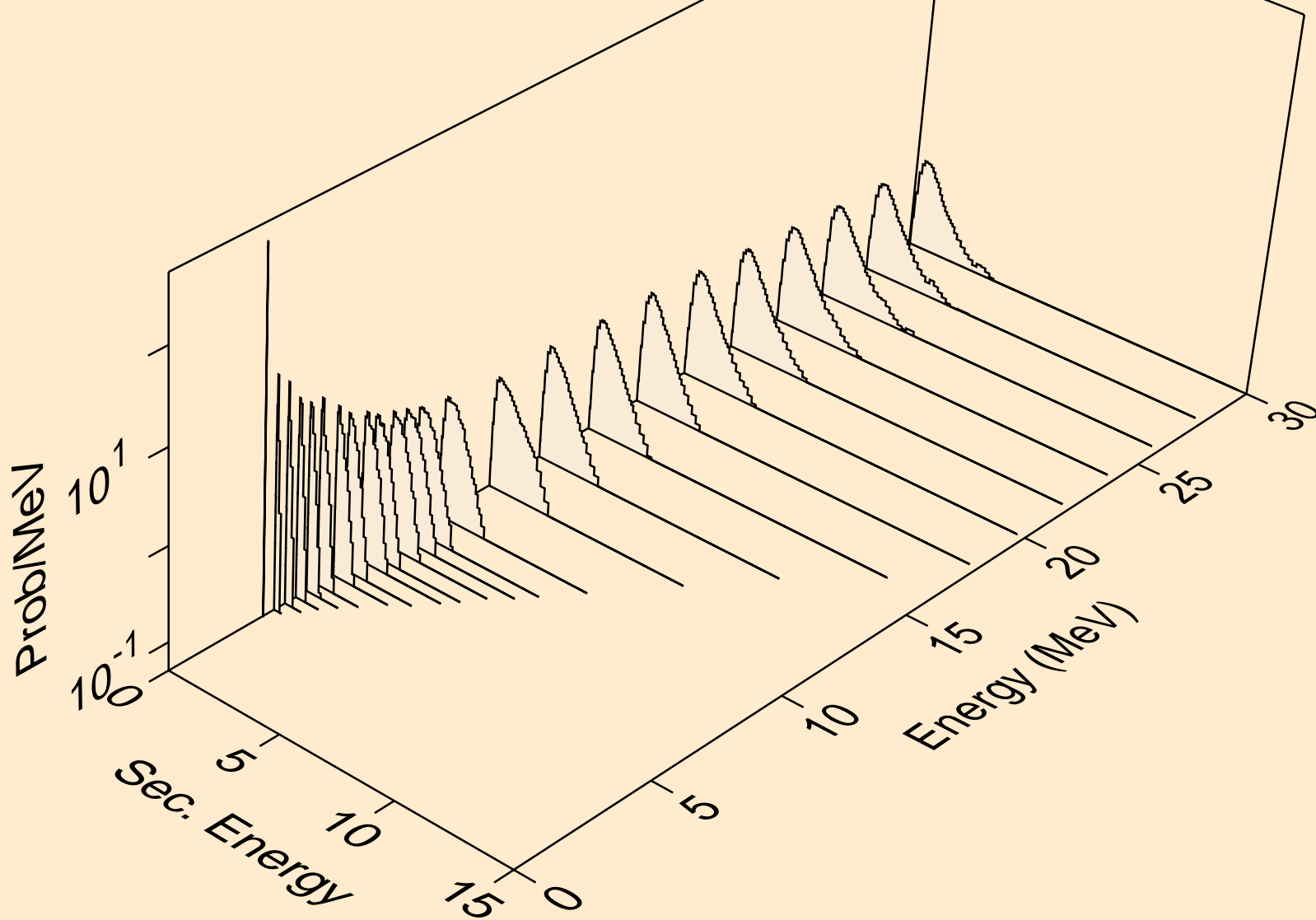

TM159 NEUTRON ACER TENDL-2019 LIBRARY; T=293.16K  
Neutron emission for (n,n\*)2a

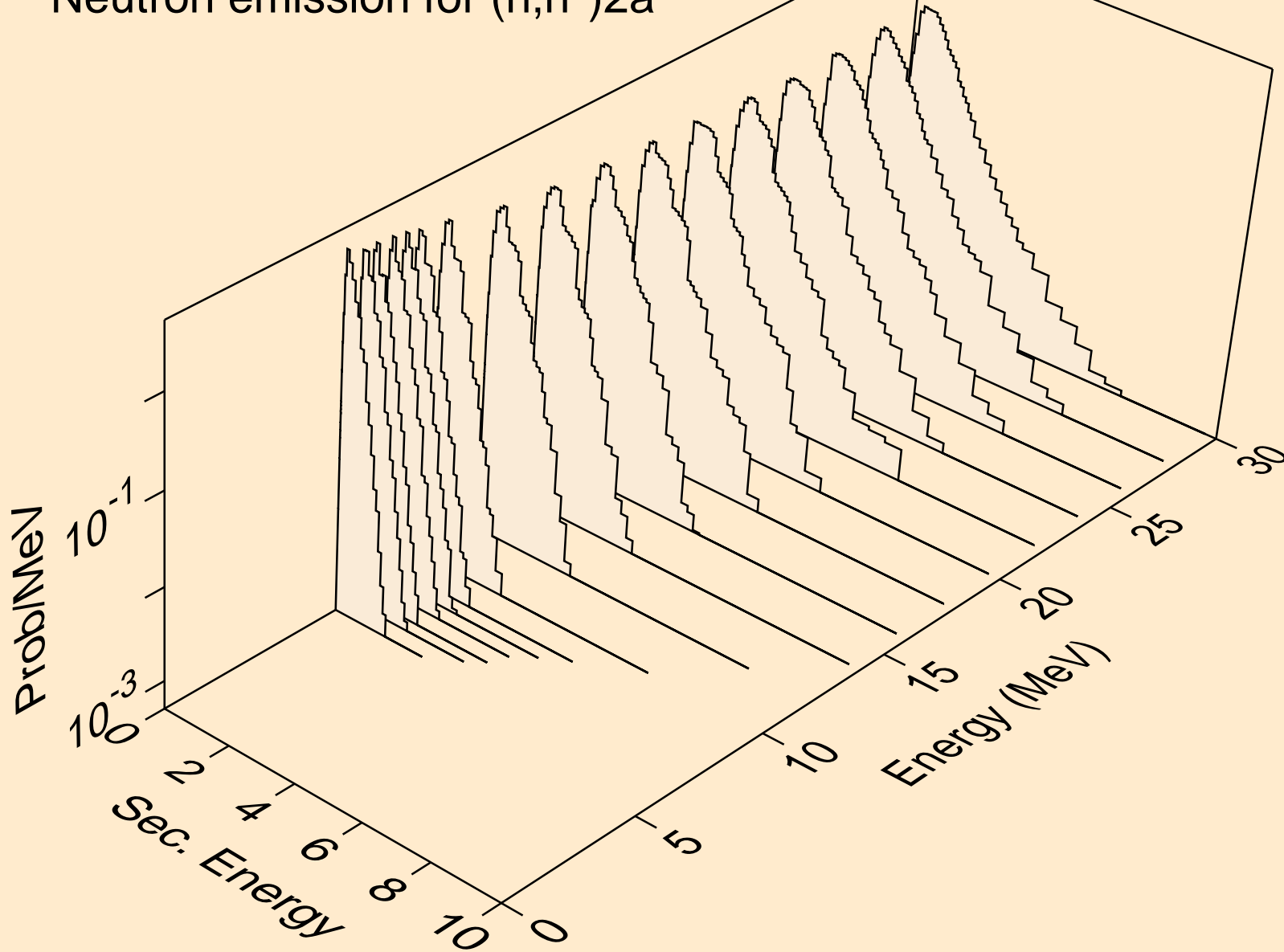

TM159 NEUTRON ACER TENDL-2019 LIBRARY; T=293.16K  
Neutron emission for (n,2n)2a

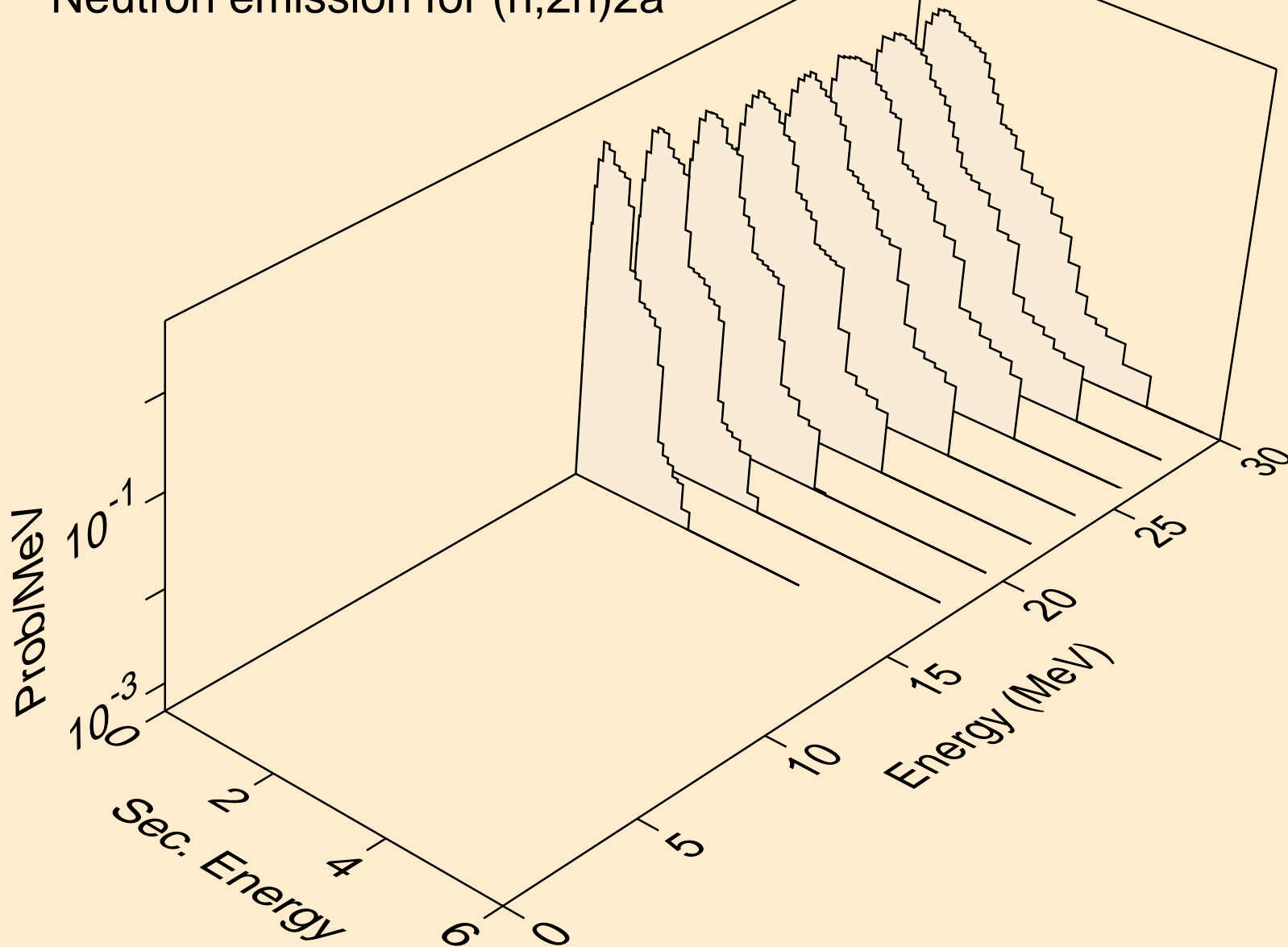

TM159 NEUTRON ACER TENDL-2019 LIBRARY; T=293.16K  
Neutron emission for (n,n\*)d

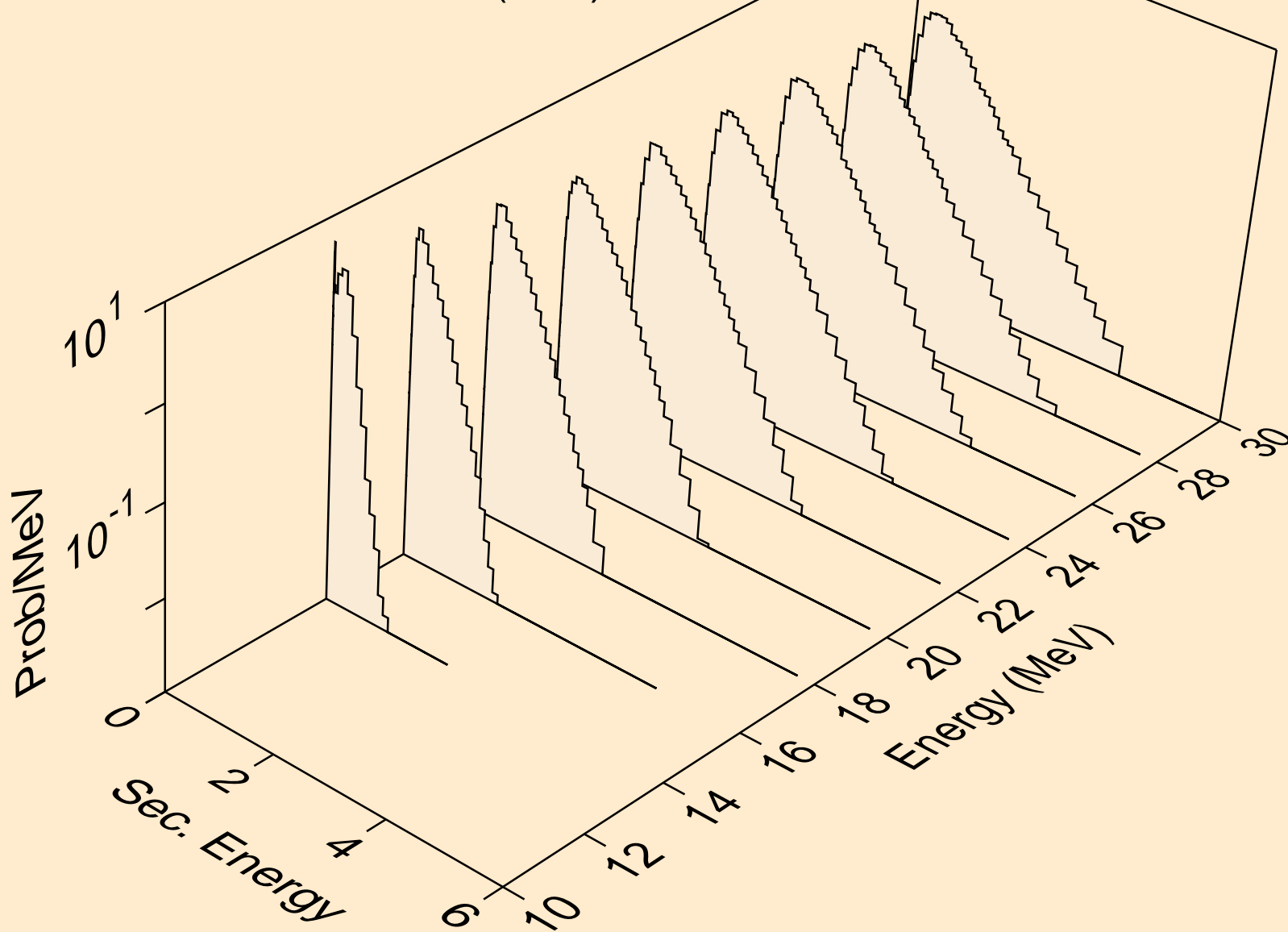

TM159 NEUTRON ACER TENDL-2019 LIBRARY; T=293.16K  
Neutron emission for (n,n\*)t

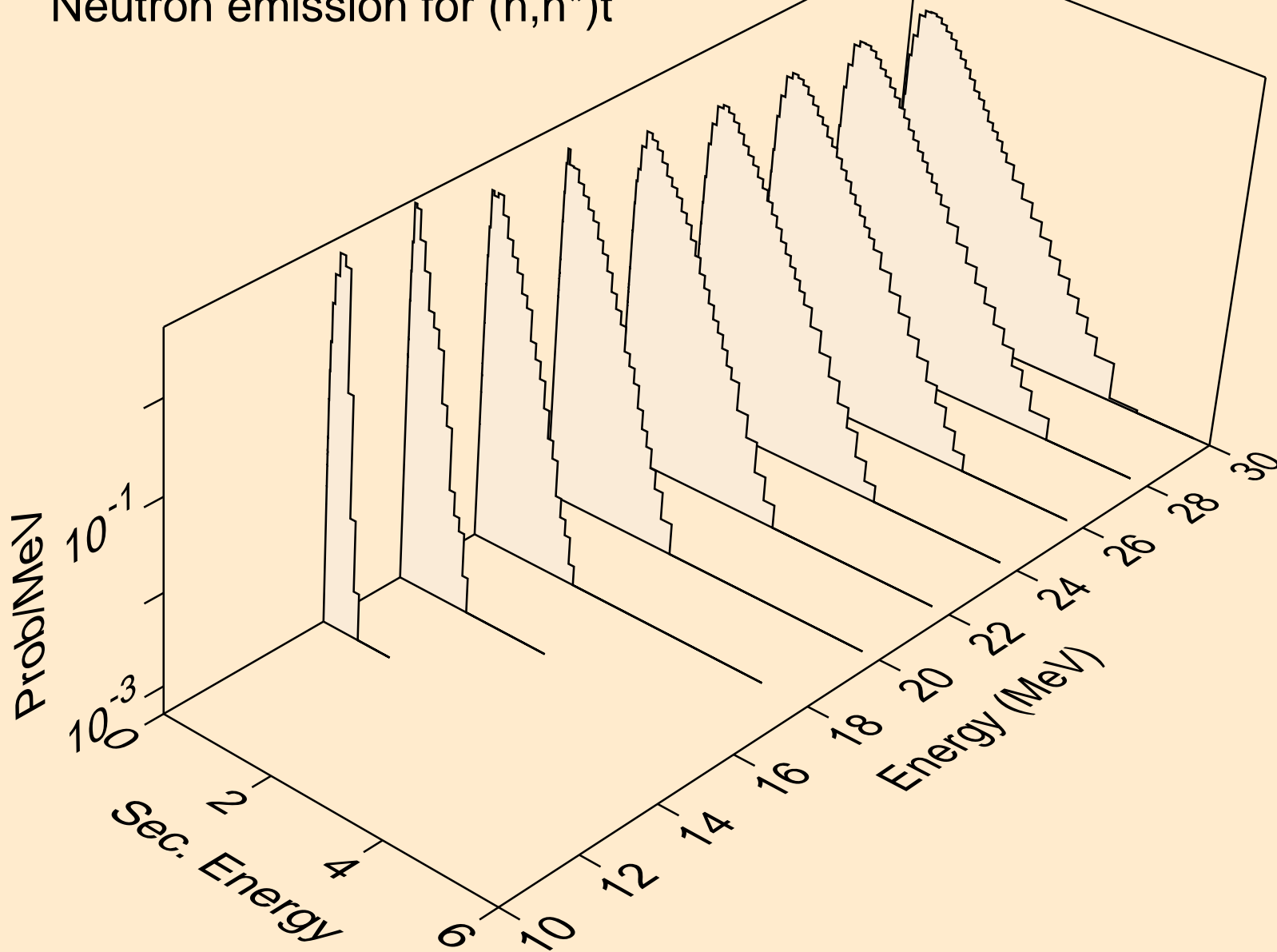

TM159 NEUTRON ACER TENDL-2019 LIBRARY; T=293.16K  
Neutron emission for (n,n\*)he3

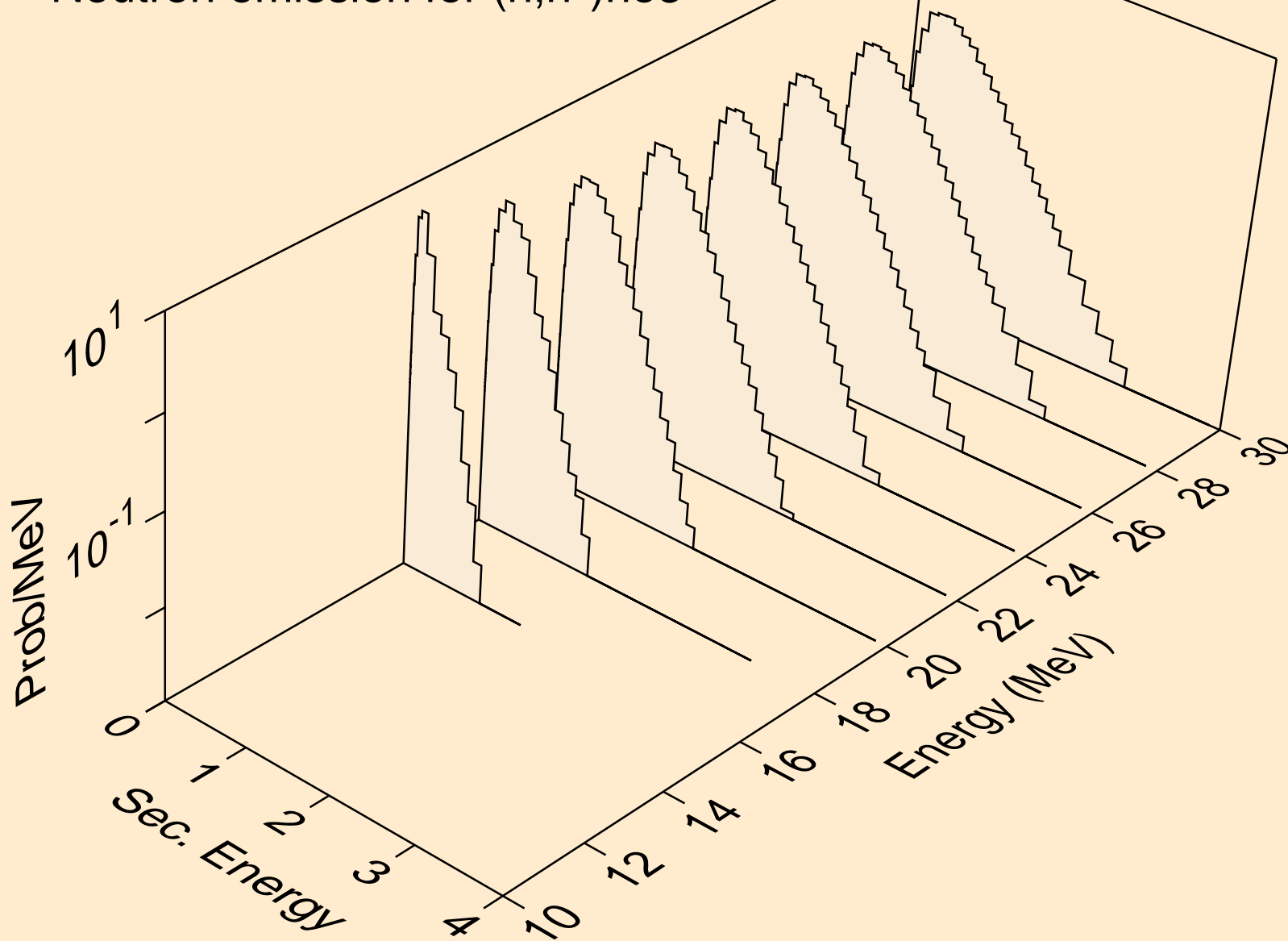



TM159 NEUTRON ACER TENDL-2019 LIBRARY; T=293.16K  
Neutron emission for (n,4n)

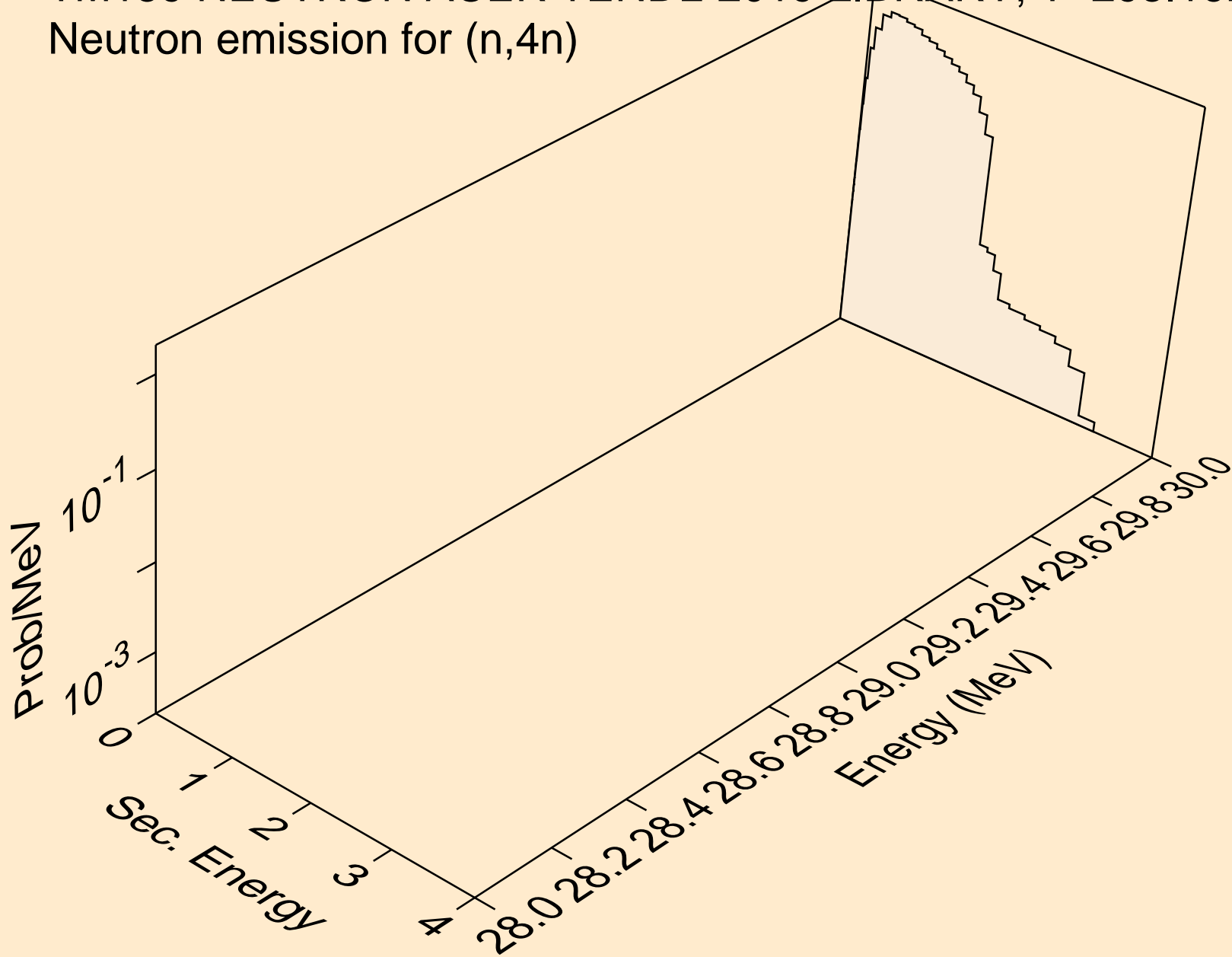

TM159 NEUTRON ACER TENDL-2019 LIBRARY; T=293.16K  
Neutron emission for (n,2np)

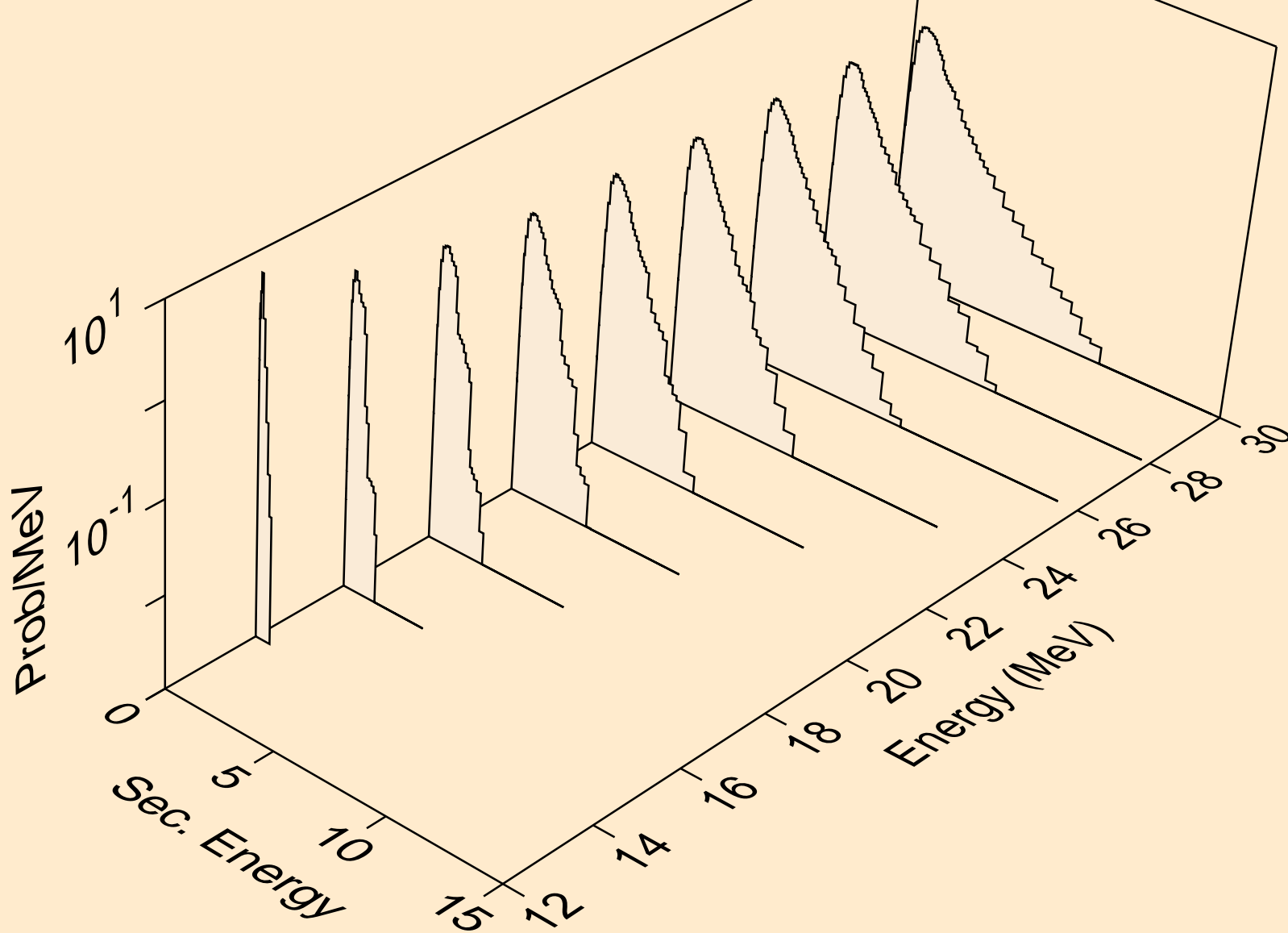

TM159 NEUTRON ACER TENDL-2019 LIBRARY; T=293.16K  
Neutron emission for (n,3np)

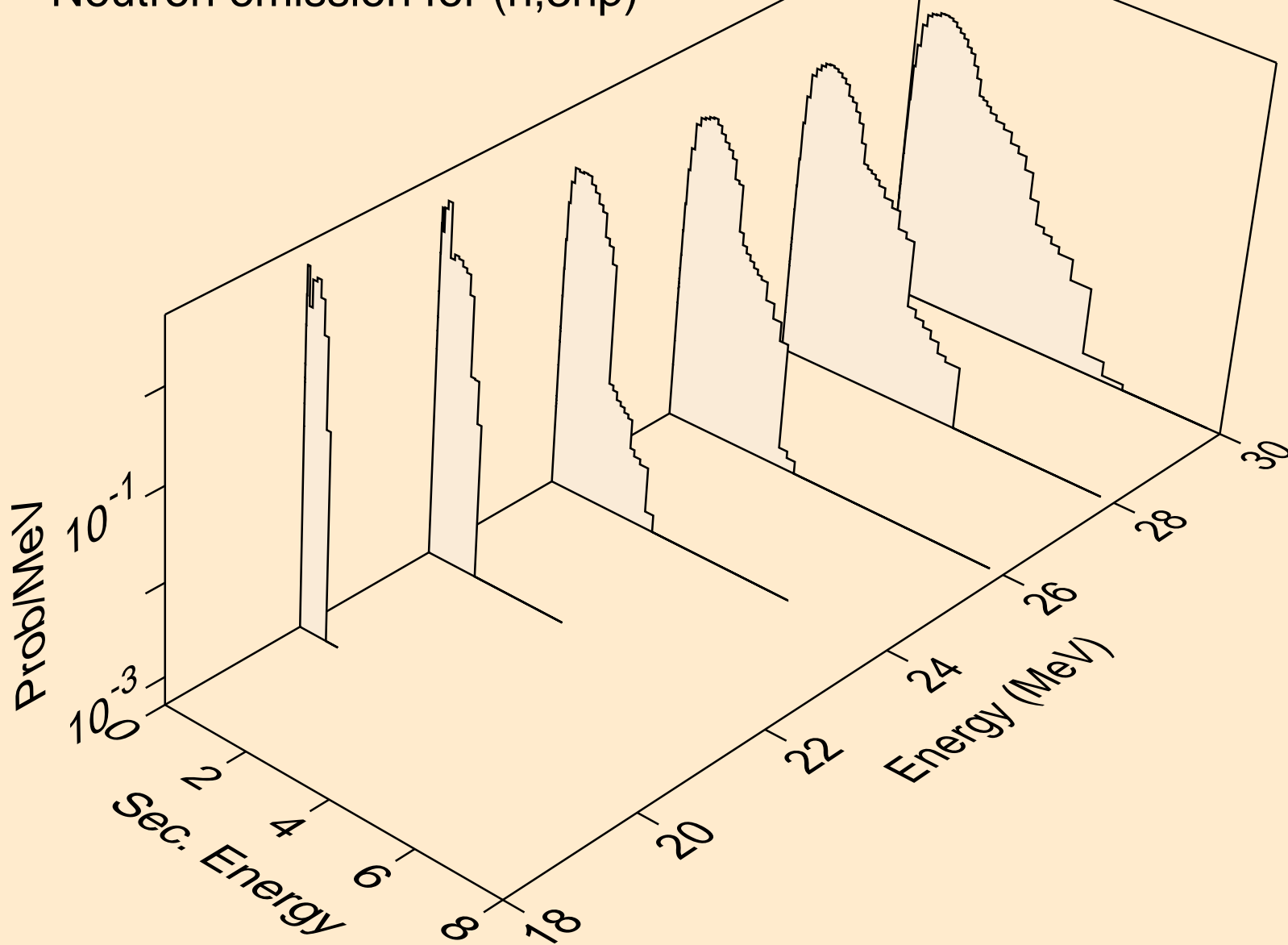

TM159 NEUTRON ACER TENDL-2019 LIBRARY; T=293.16K  
Neutron emission for (n,2np)

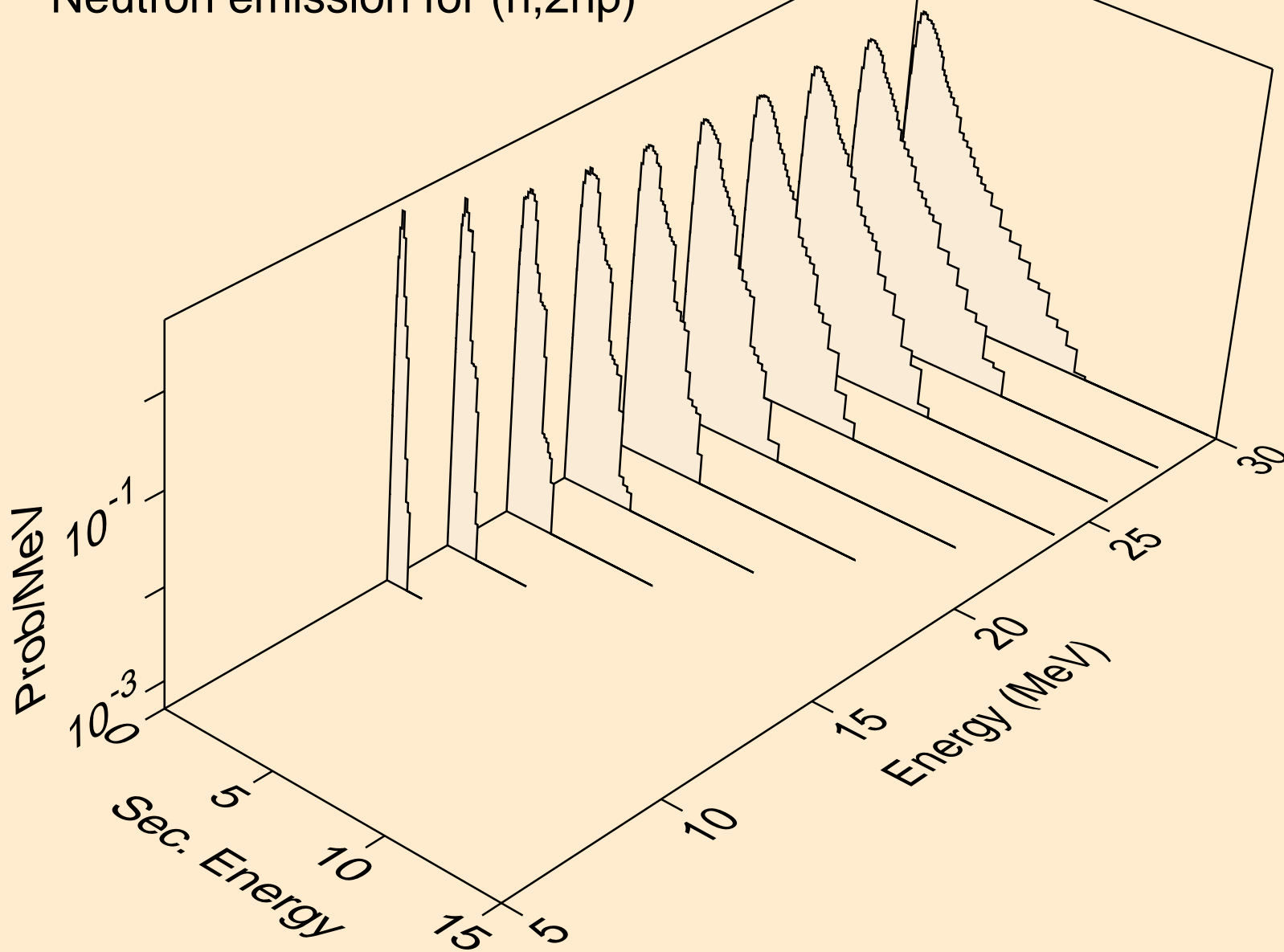

TM159 NEUTRON ACER TENDL-2019 LIBRARY; T=293.16K  
Neutron emission for (n,npa)

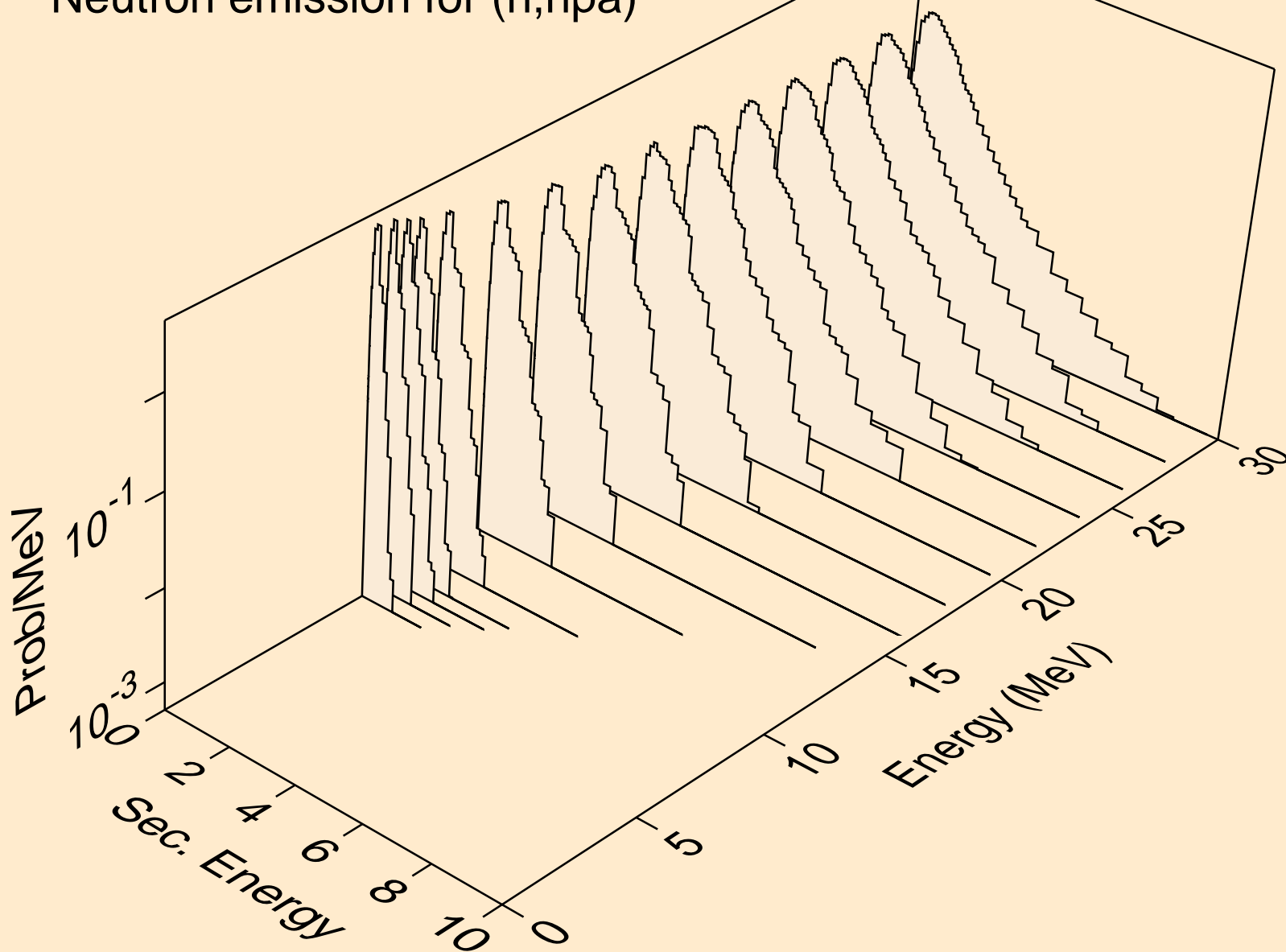

TM159 NEUTRON ACER TENDL-2019 LIBRARY; T=293.16K  
Neutron emission for (n,n\*c)

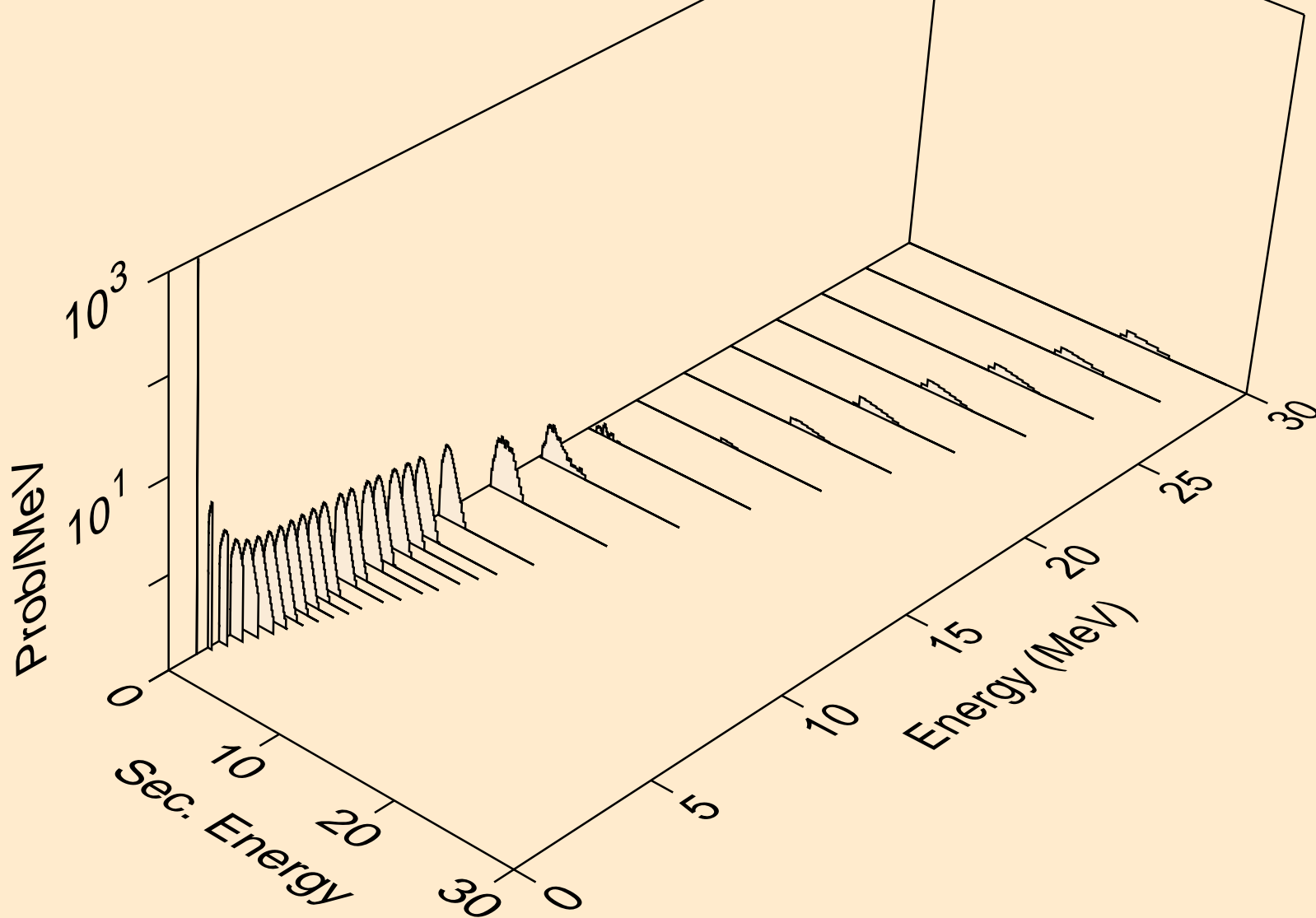

TM159 NEUTRON ACER TENDL-2019 LIBRARY; T=293.16K  
Photon emission for (n,x)

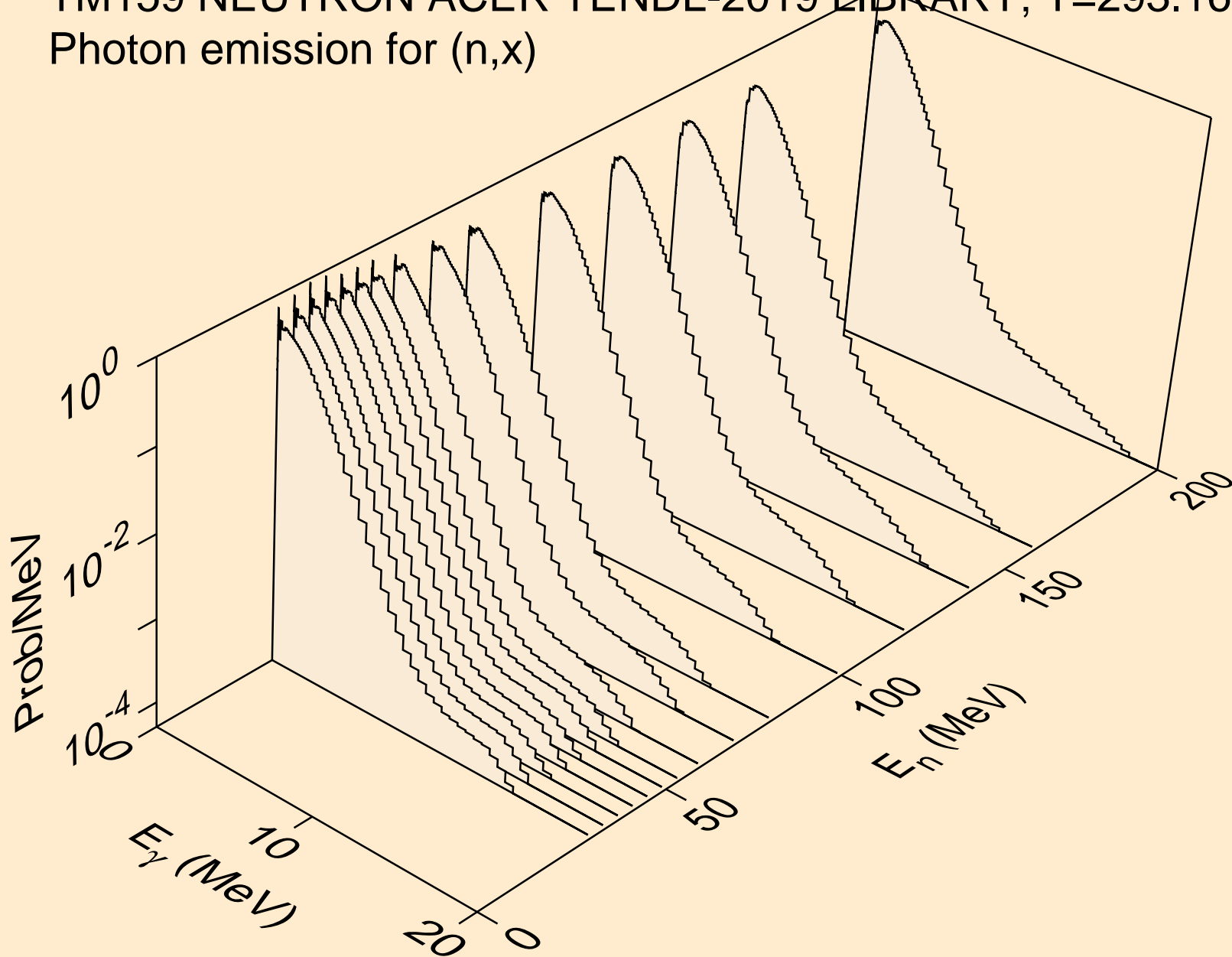

TM159 NEUTRON ACER TENDL-2019 LIBRARY; T=293.16K  
Photon emission for (n,2nd)

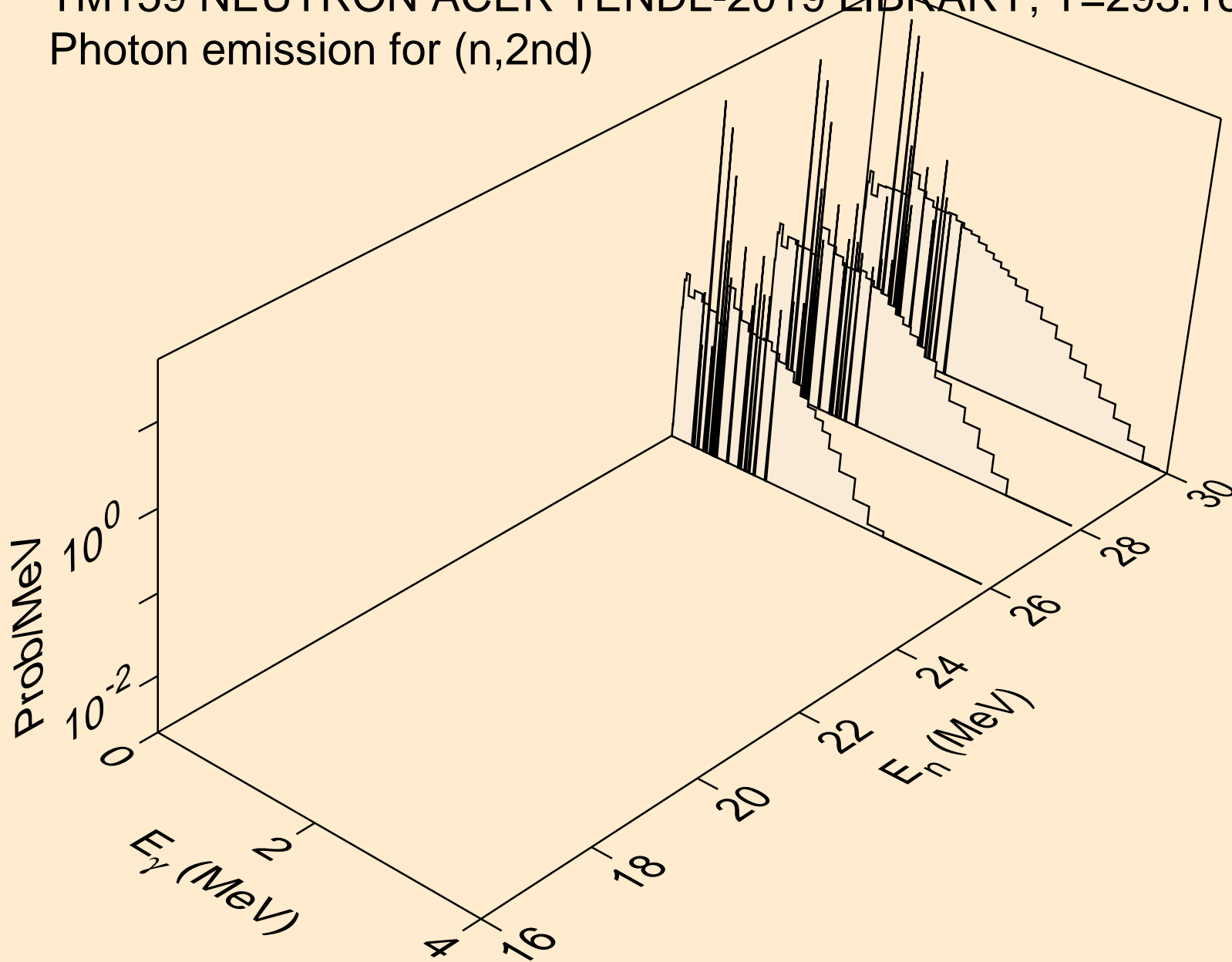



TM159 NEUTRON ACER TENDL-2019 LIBRARY; T=293.16K  
Photon emission for (n,2n)

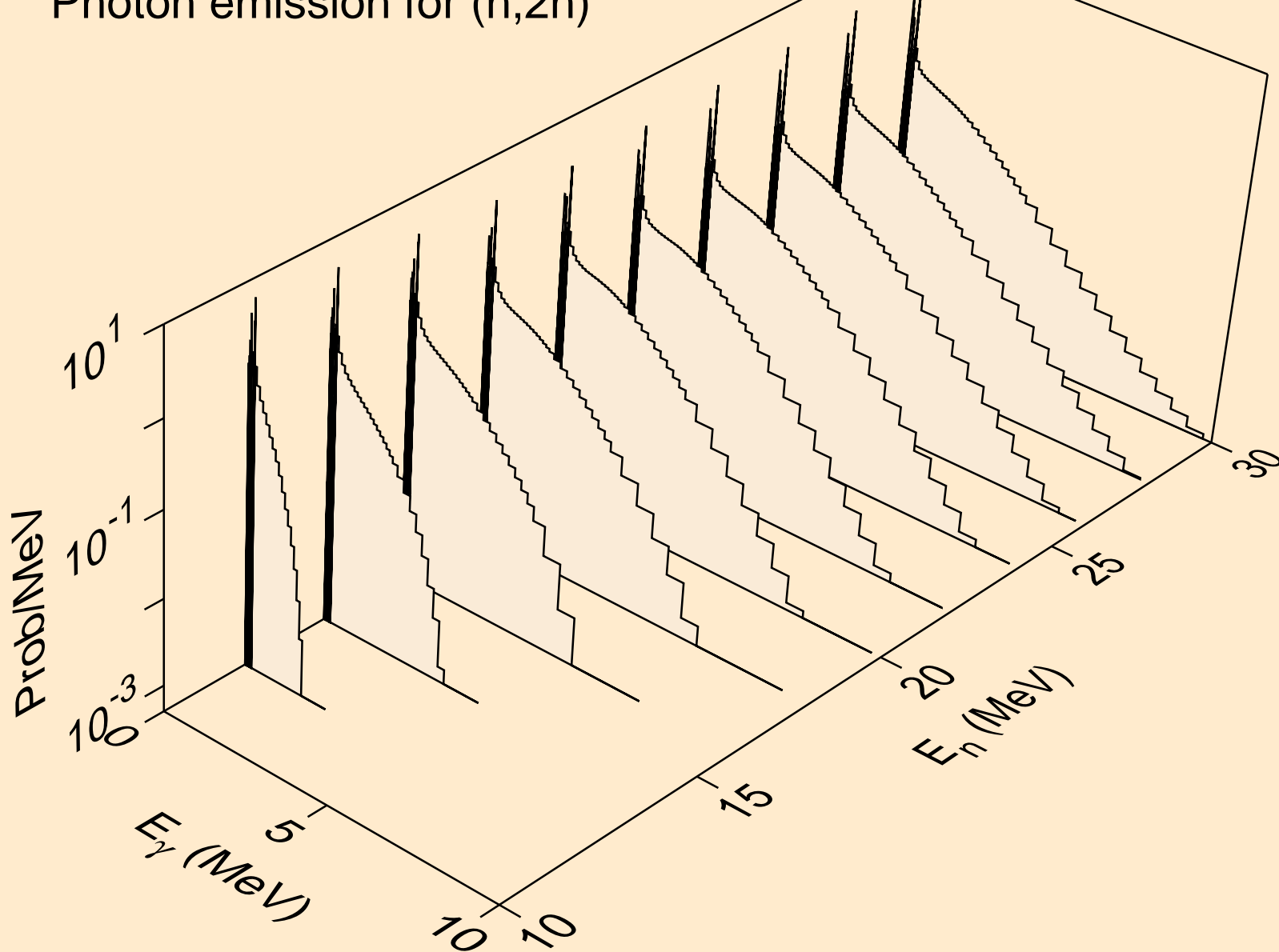

TM159 NEUTRON ACER TENDL-2019 LIBRARY; T=293.16K  
Photon emission for (n,3n)

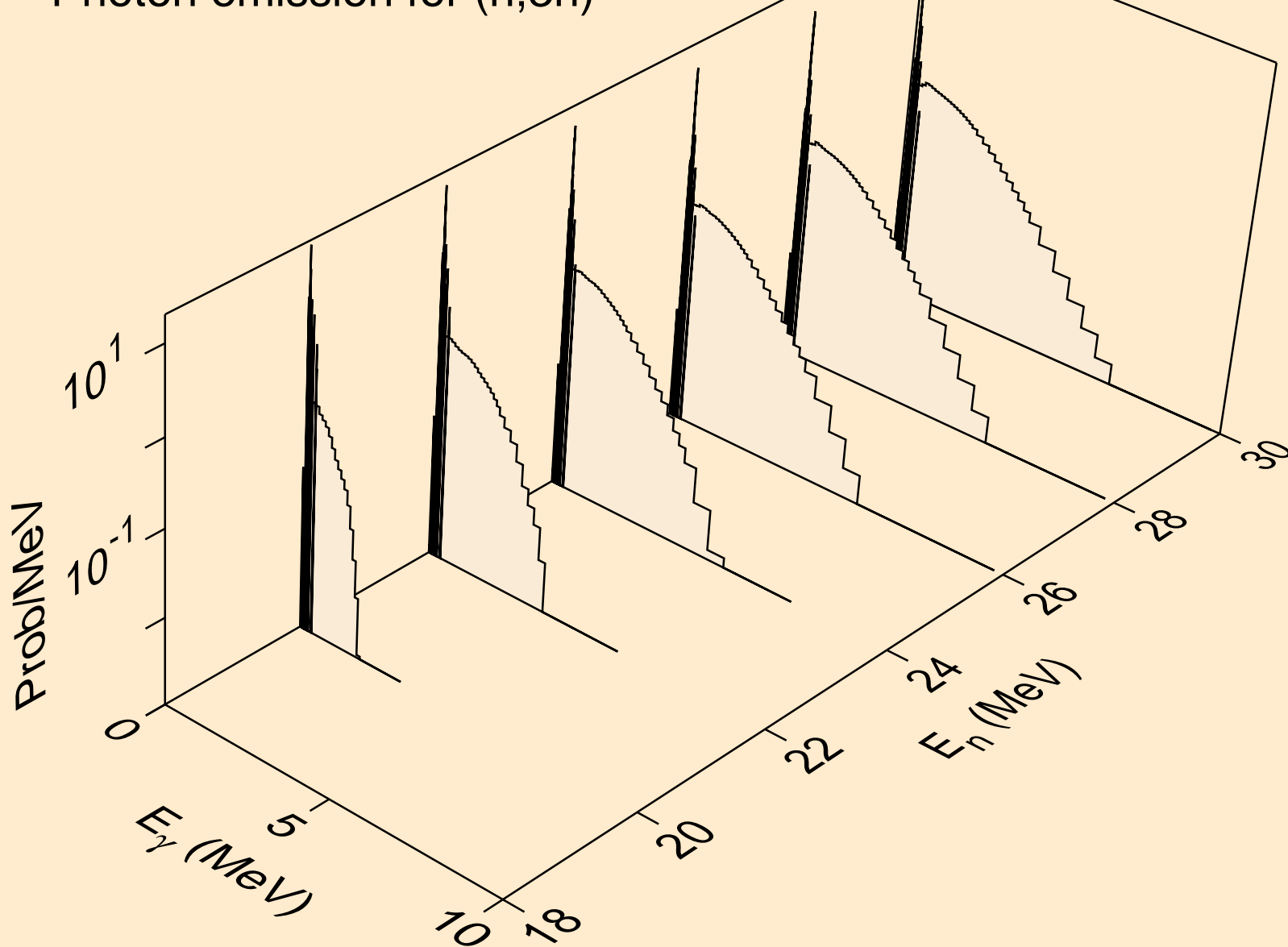

TM159 NEUTRON ACER TENDL-2019 LIBRARY; T=293.16K  
Photon emission for (n,n\*)a

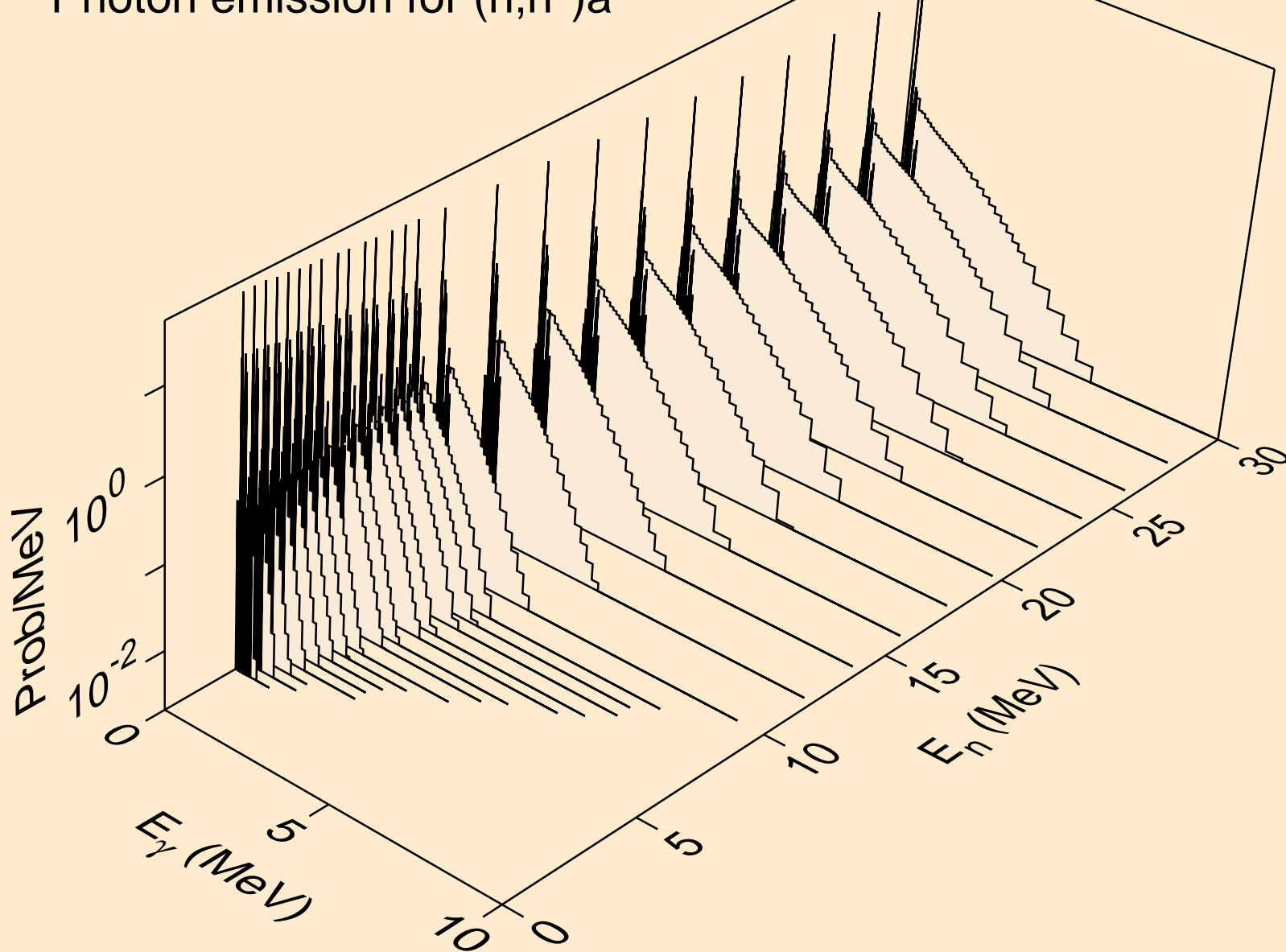

TM159 NEUTRON ACER TENDL-2019 LIBRARY; T=293.16K  
Photon emission for (n,2n)a

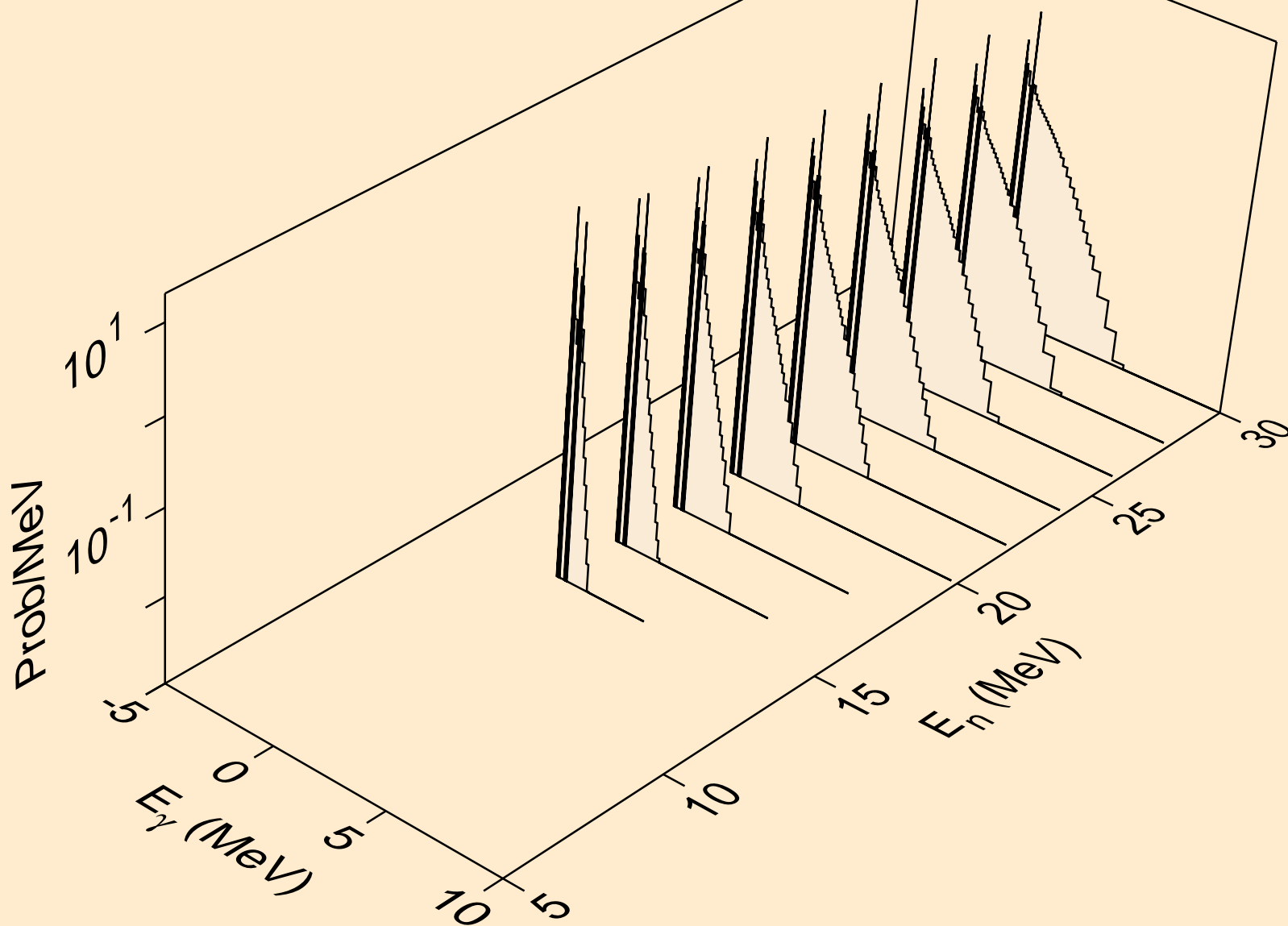

TM159 NEUTRON ACER TENDL-2019 LIBRARY; T=293.16K  
Photon emission for (n,3n)a

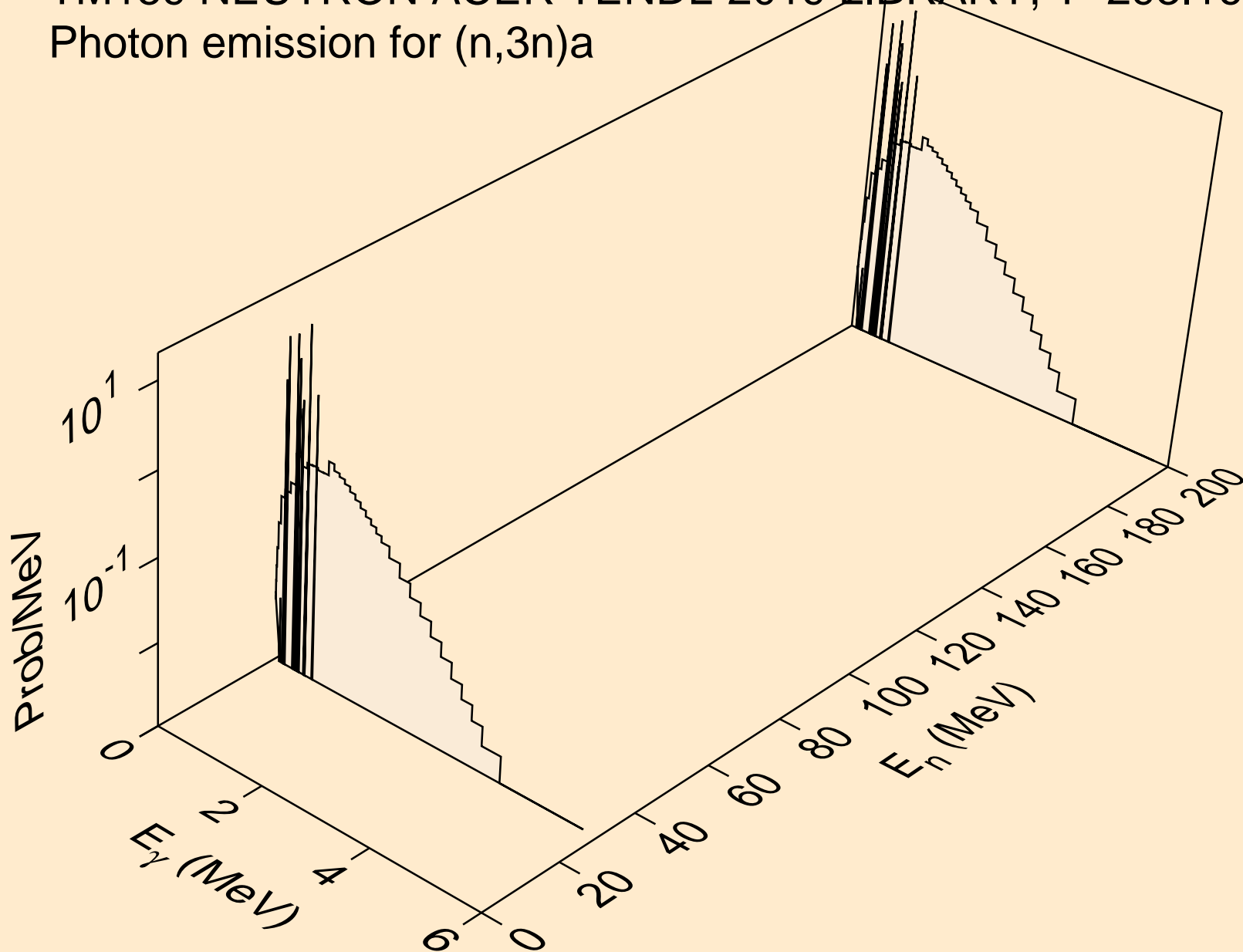

TM159 NEUTRON ACER TENDL-2019 LIBRARY; T=293.16K  
Photon emission for (n,n\*)p

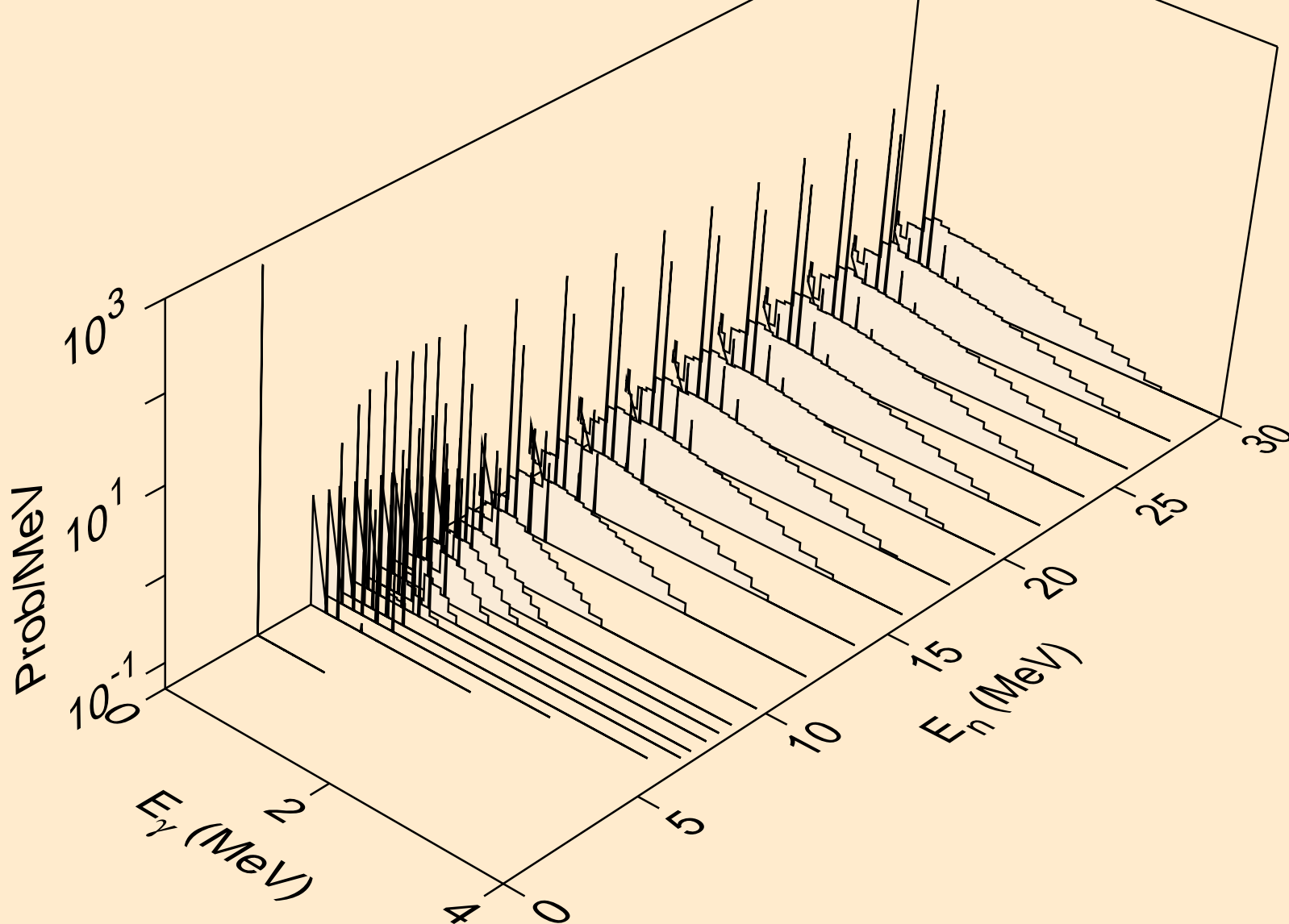

TM159 NEUTRON ACER TENDL-2019 LIBRARY; T=293.16K  
Photon emission for (n,n\*)2a

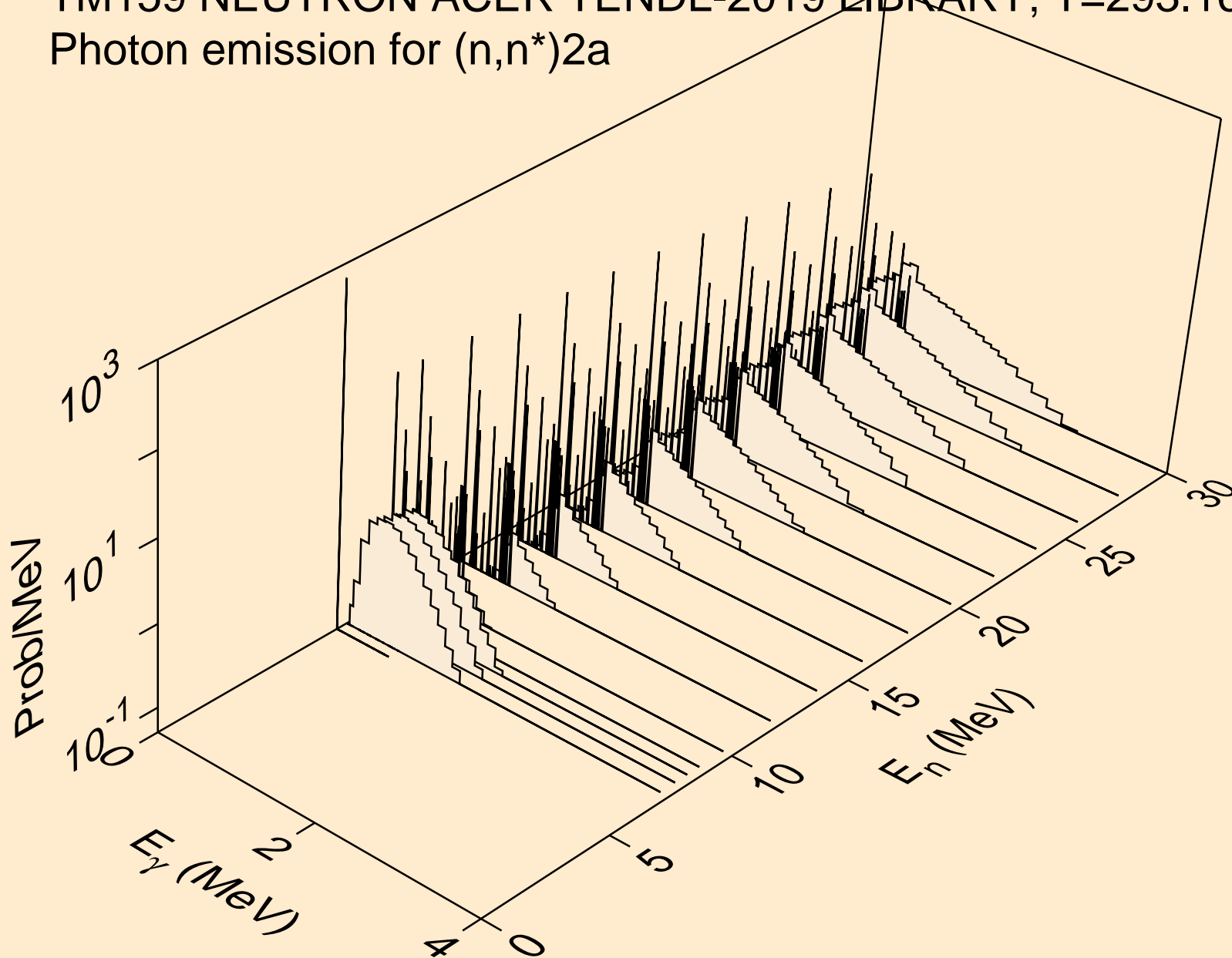

TM159 NEUTRON ACER TENDL-2019 LIBRARY; T=293.16K  
Photon emission for (n,2n)2a

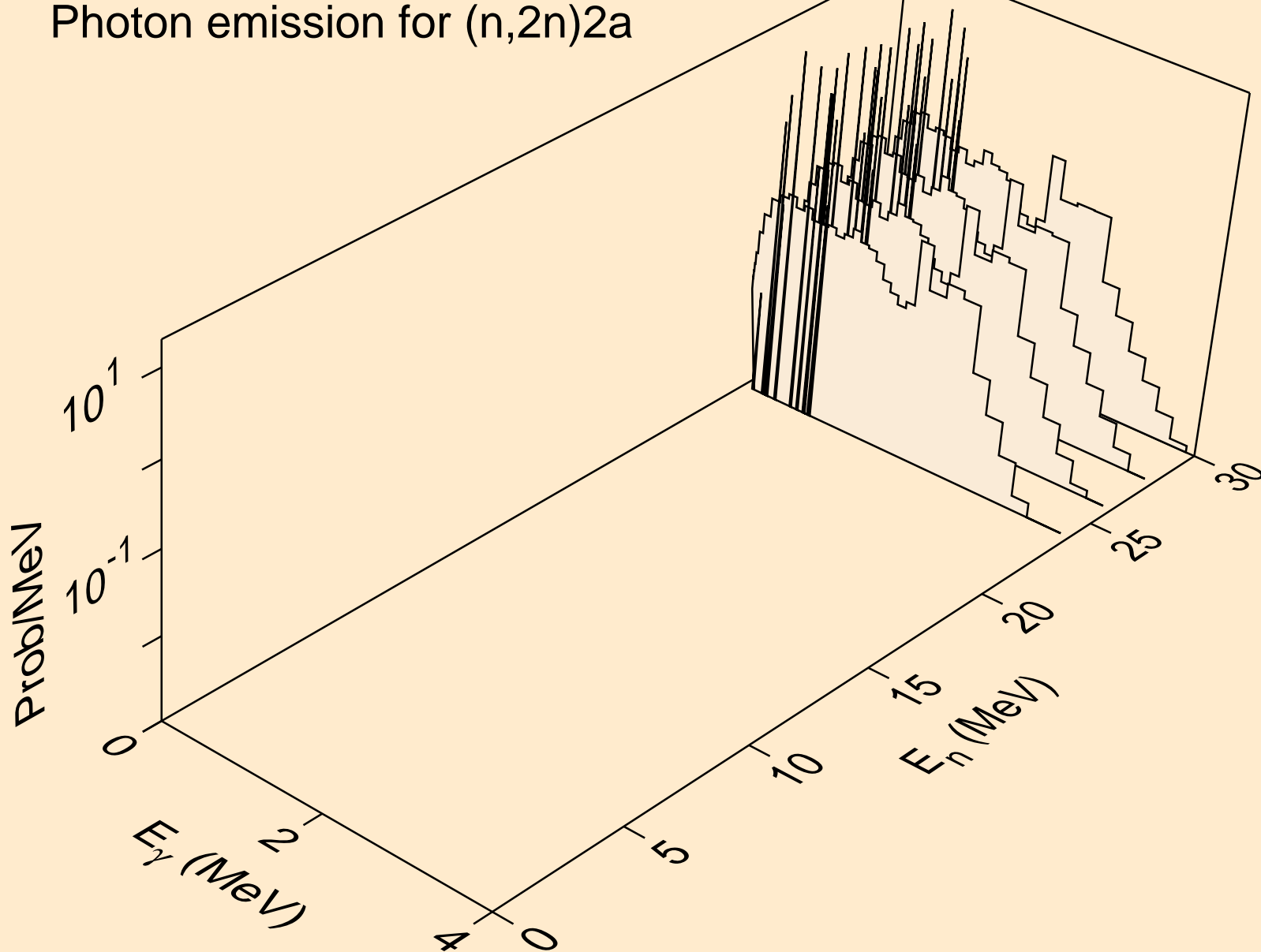



TM159 NEUTRON ACER TENDL-2019 LIBRARY; T=293.16K  
Photon emission for (n,n\*)d

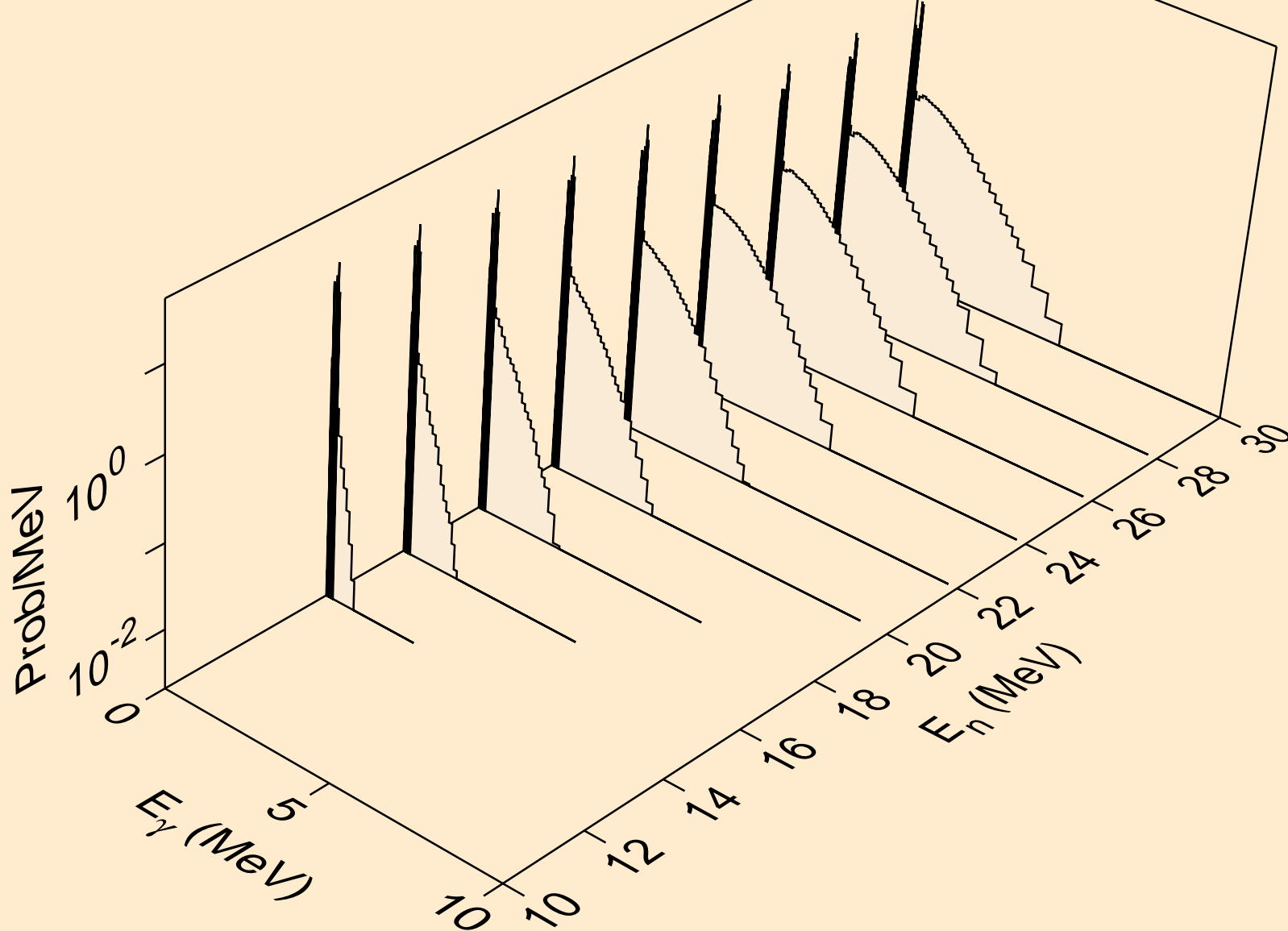

TM159 NEUTRON ACER TENDL-2019 LIBRARY; T=293.16K  
Photon emission for (n,n\*)t

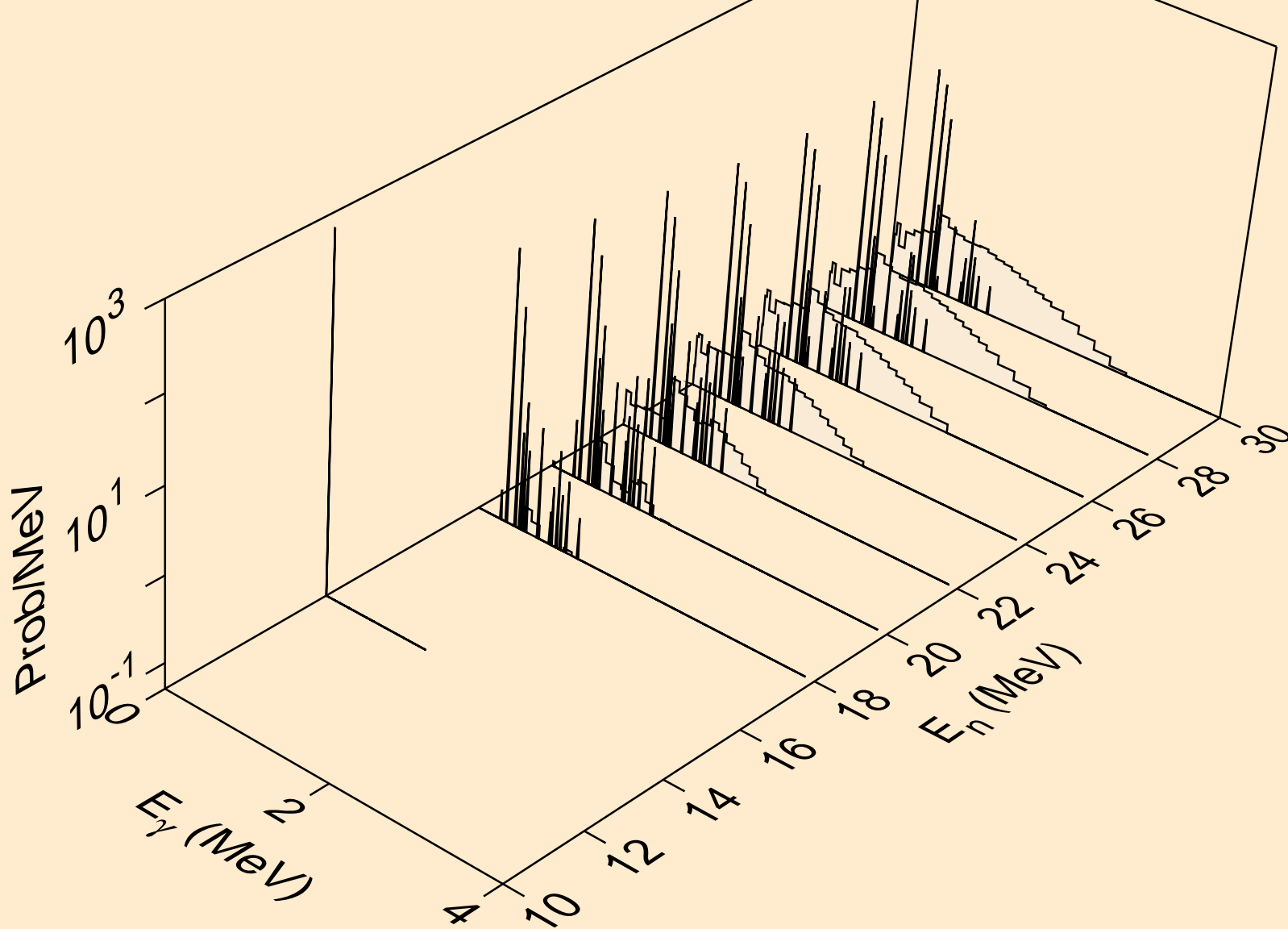

TM159 NEUTRON ACER TENDL-2019 LIBRARY; T=293.16K  
Photon emission for (n,n\*)he3

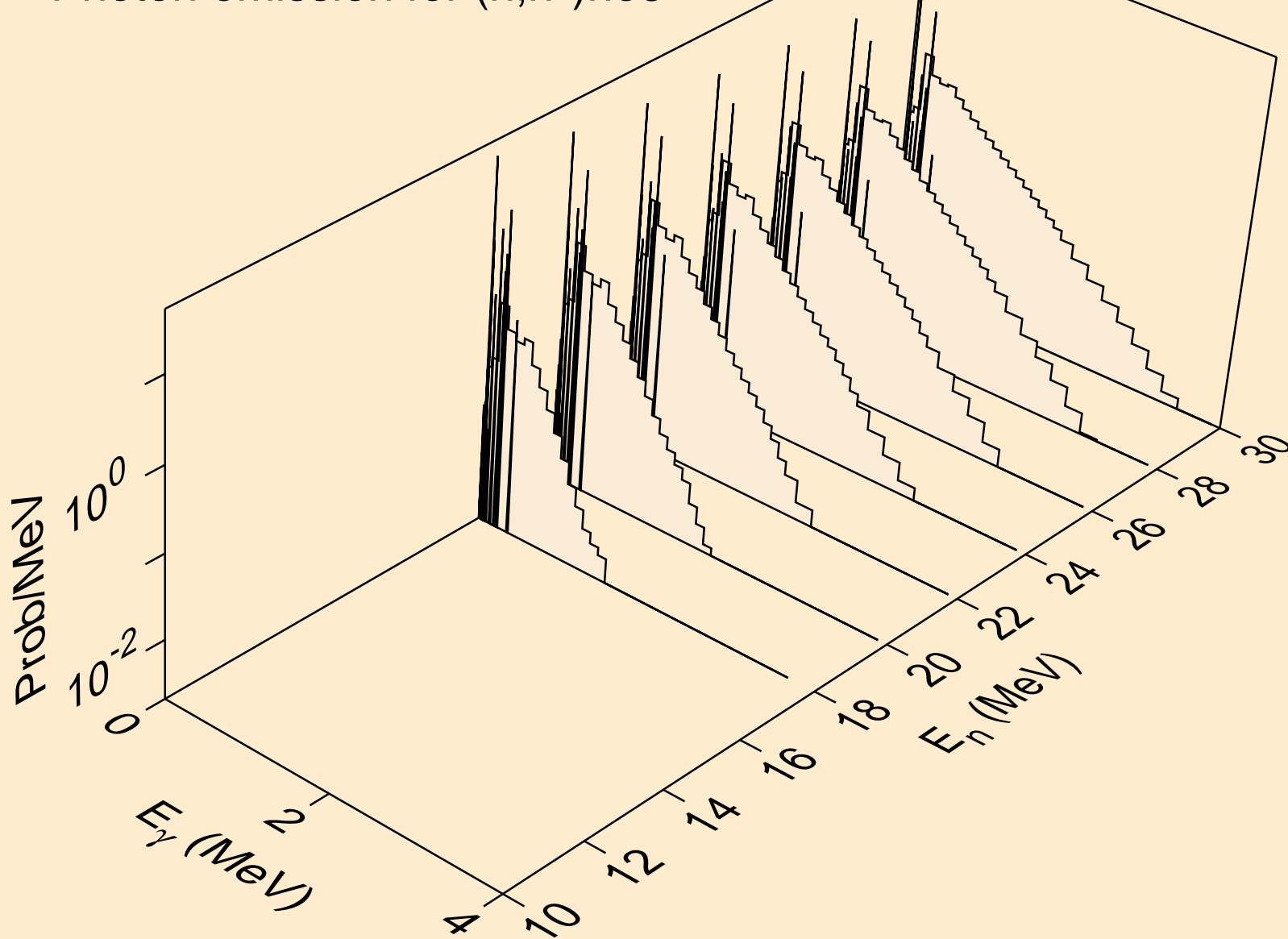

TM159 NEUTRON ACER TENDL-2019 LIBRARY; T=293.16K  
Photon emission for (n,4n)

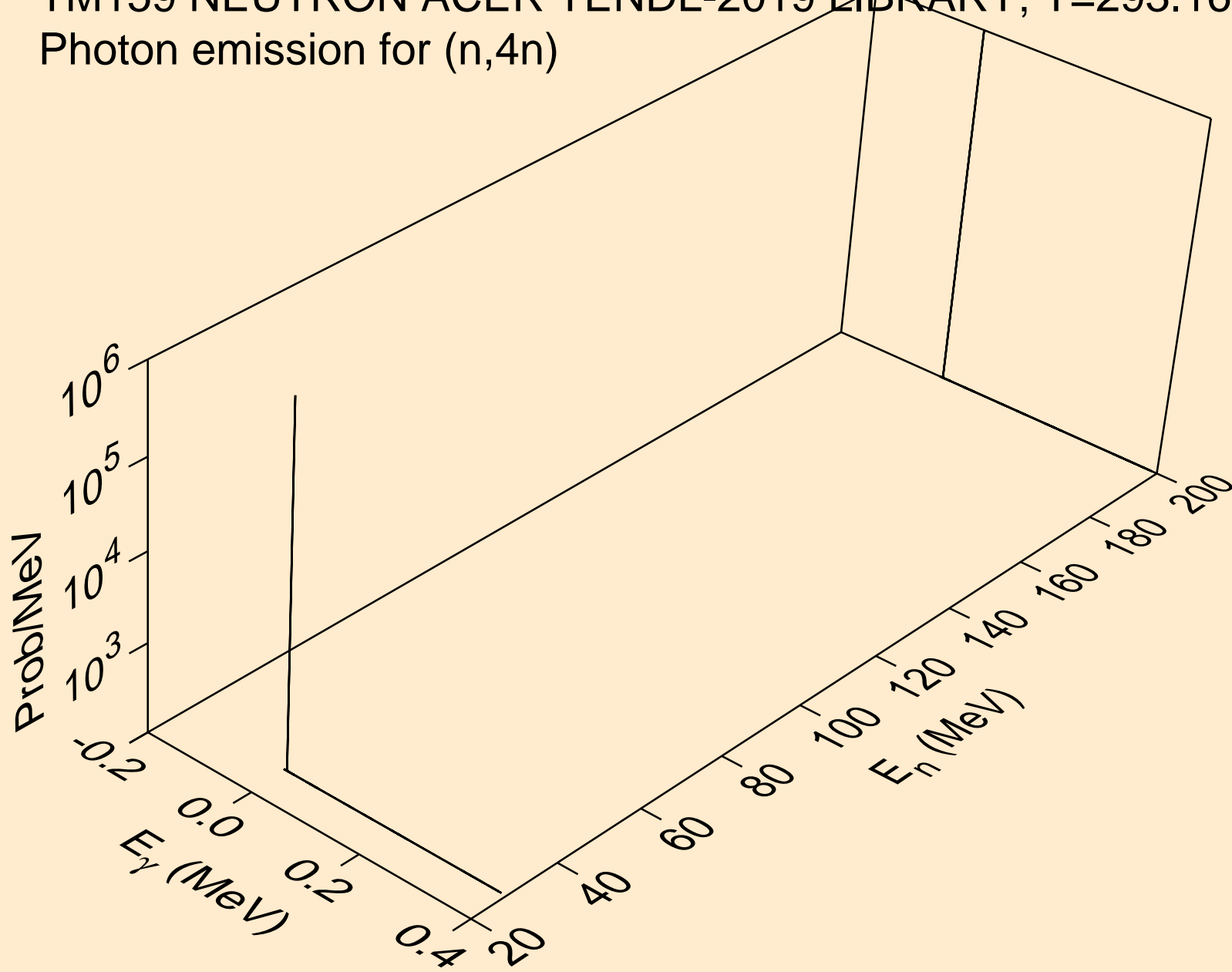

TM159 NEUTRON ACER TENDL-2019 LIBRARY; T=293.16K  
Photon emission for (n,2np)

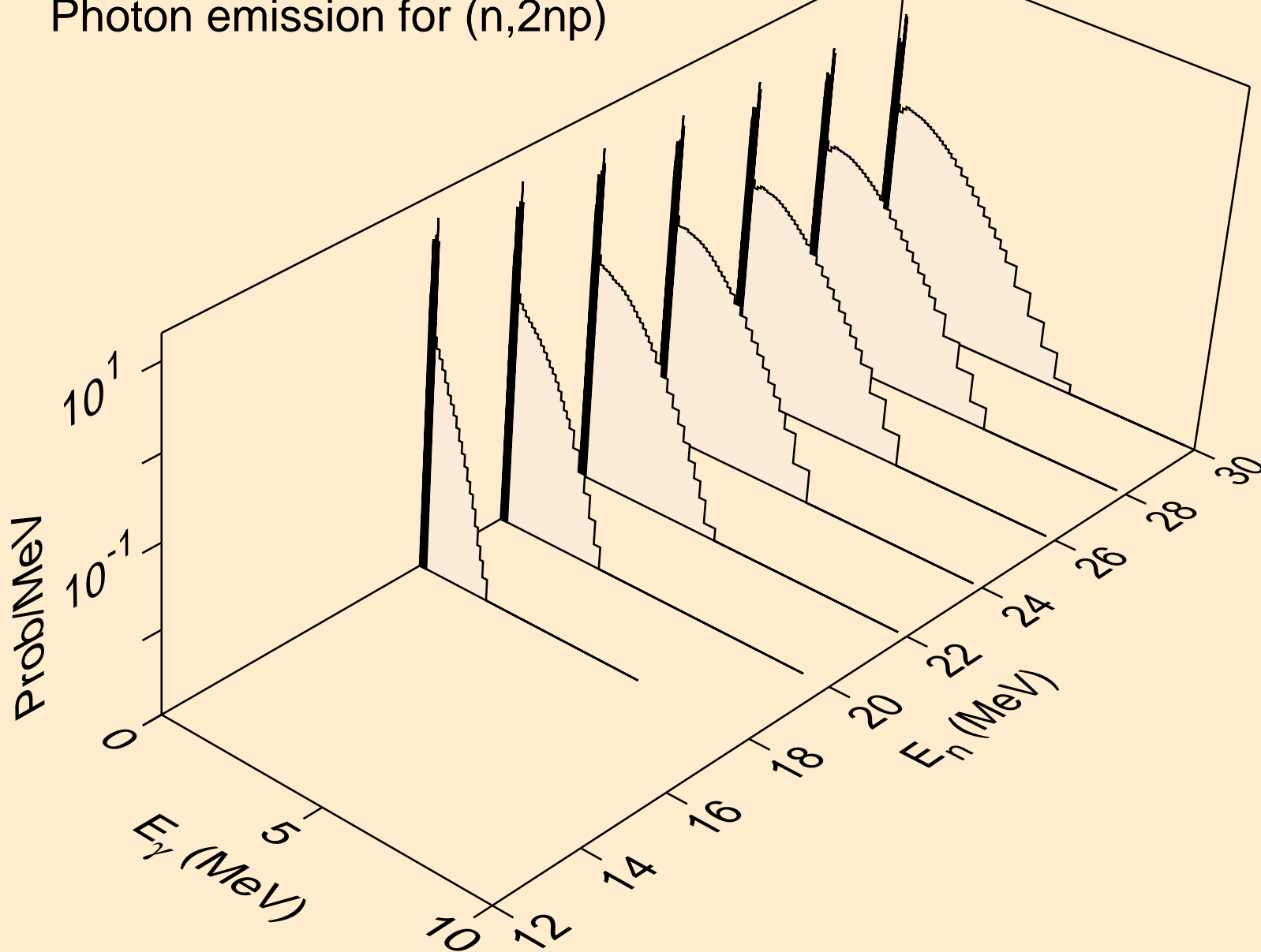

TM159 NEUTRON ACER TENDL-2019 LIBRARY; T=293.16K  
Photon emission for (n,3np)

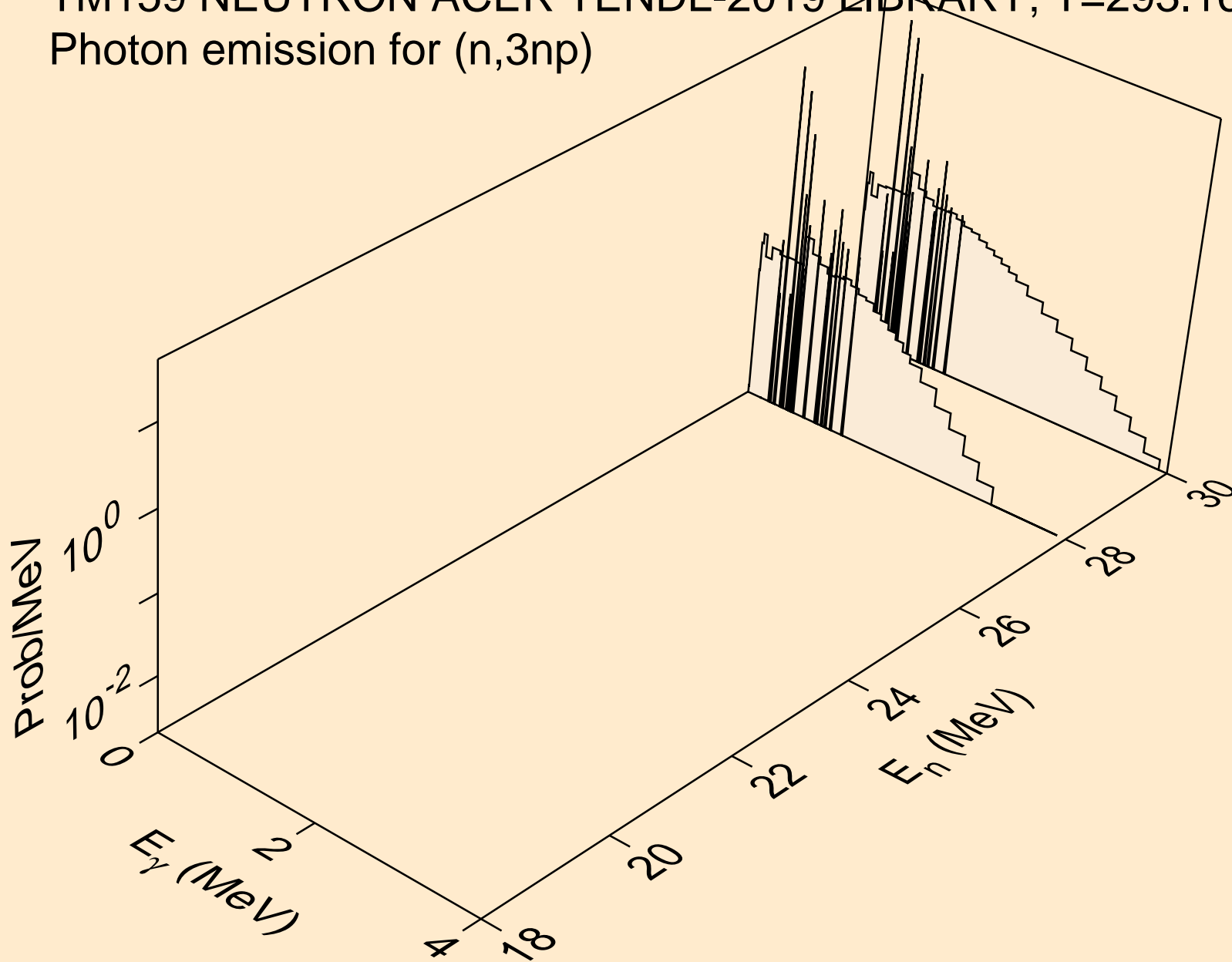

TM159 NEUTRON ACER TENDL-2019 LIBRARY; T=293.16K  
Photon emission for (n,2np)

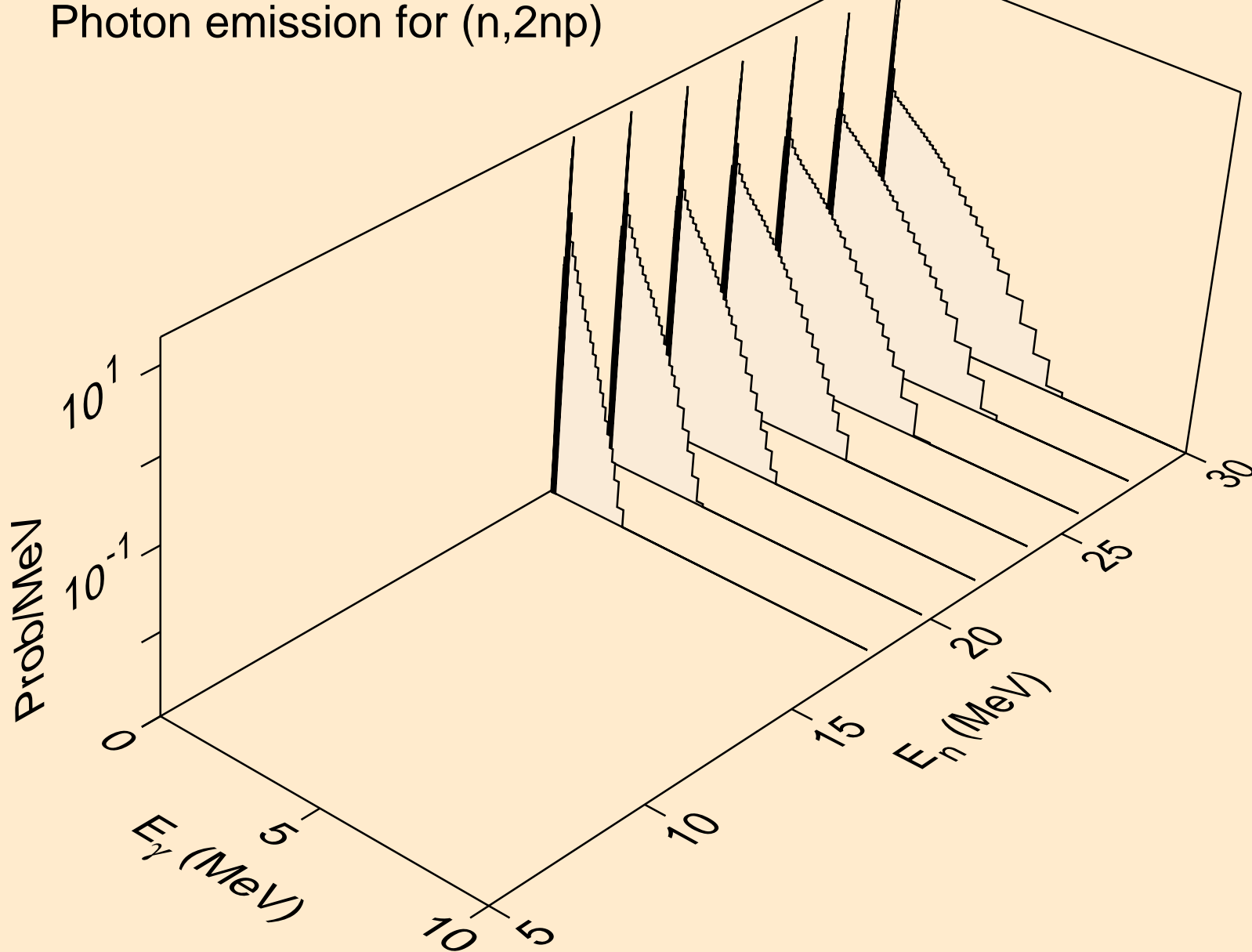

TM159 NEUTRON ACER TENDL-2019 LIBRARY; T=293.16K  
Photon emission for (n,npa)

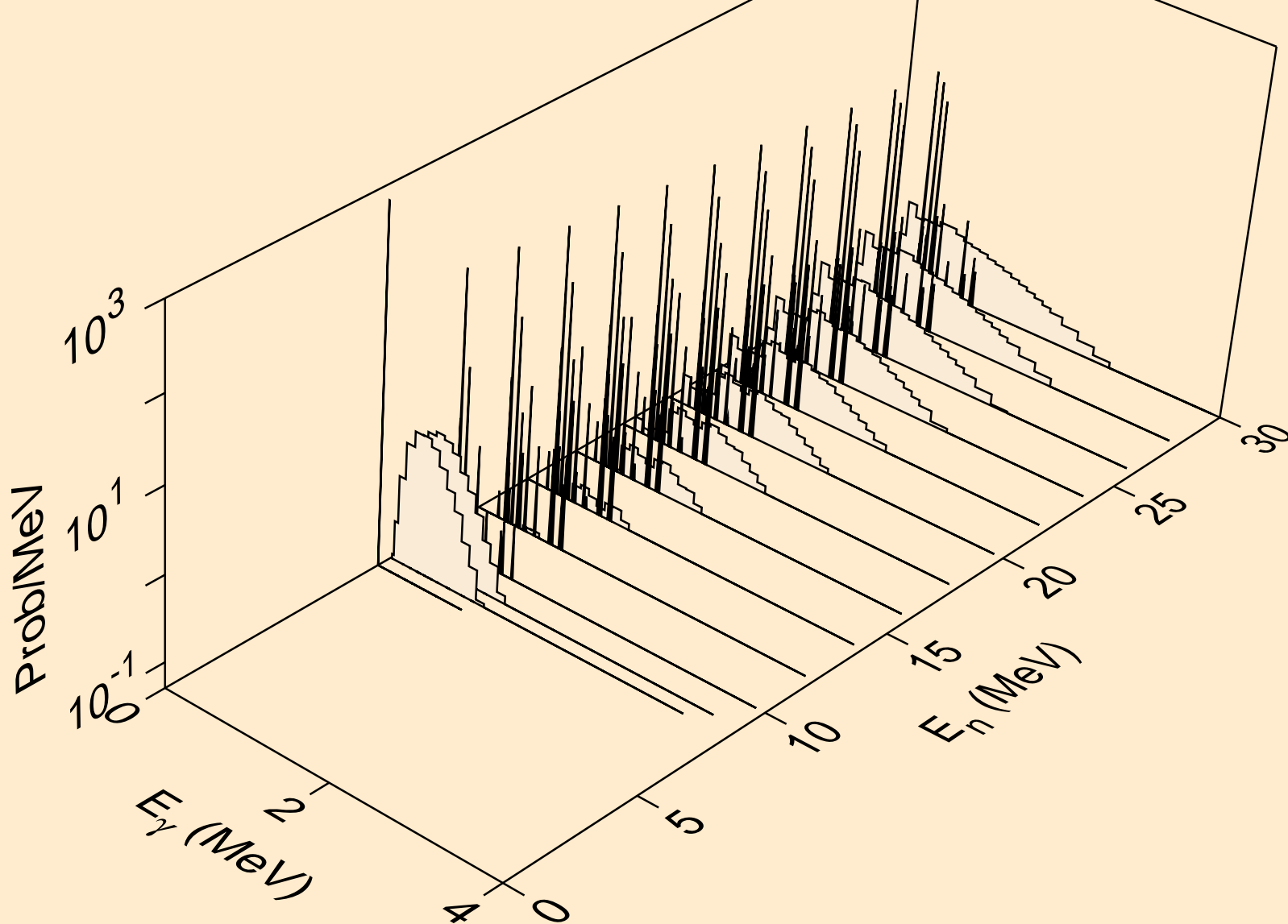



TM159 NEUTRON ACER TENDL-2019 LIBRARY; T=293.16K  
Photon emission for (n,n\*c)

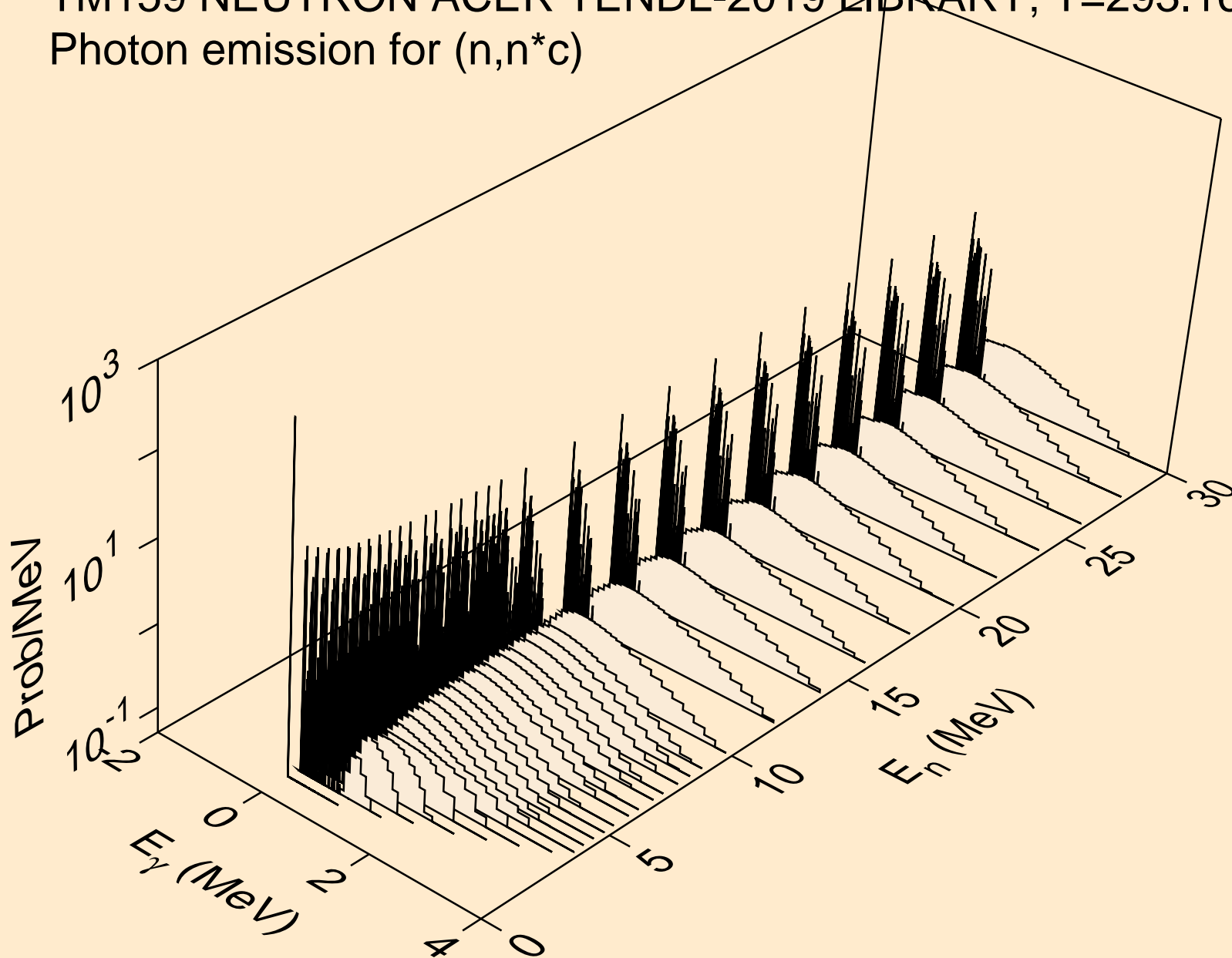

TM159 NEUTRON ACER TENDL-2019 LIBRARY; T=293.16K  
Photon emission for (n,gma)

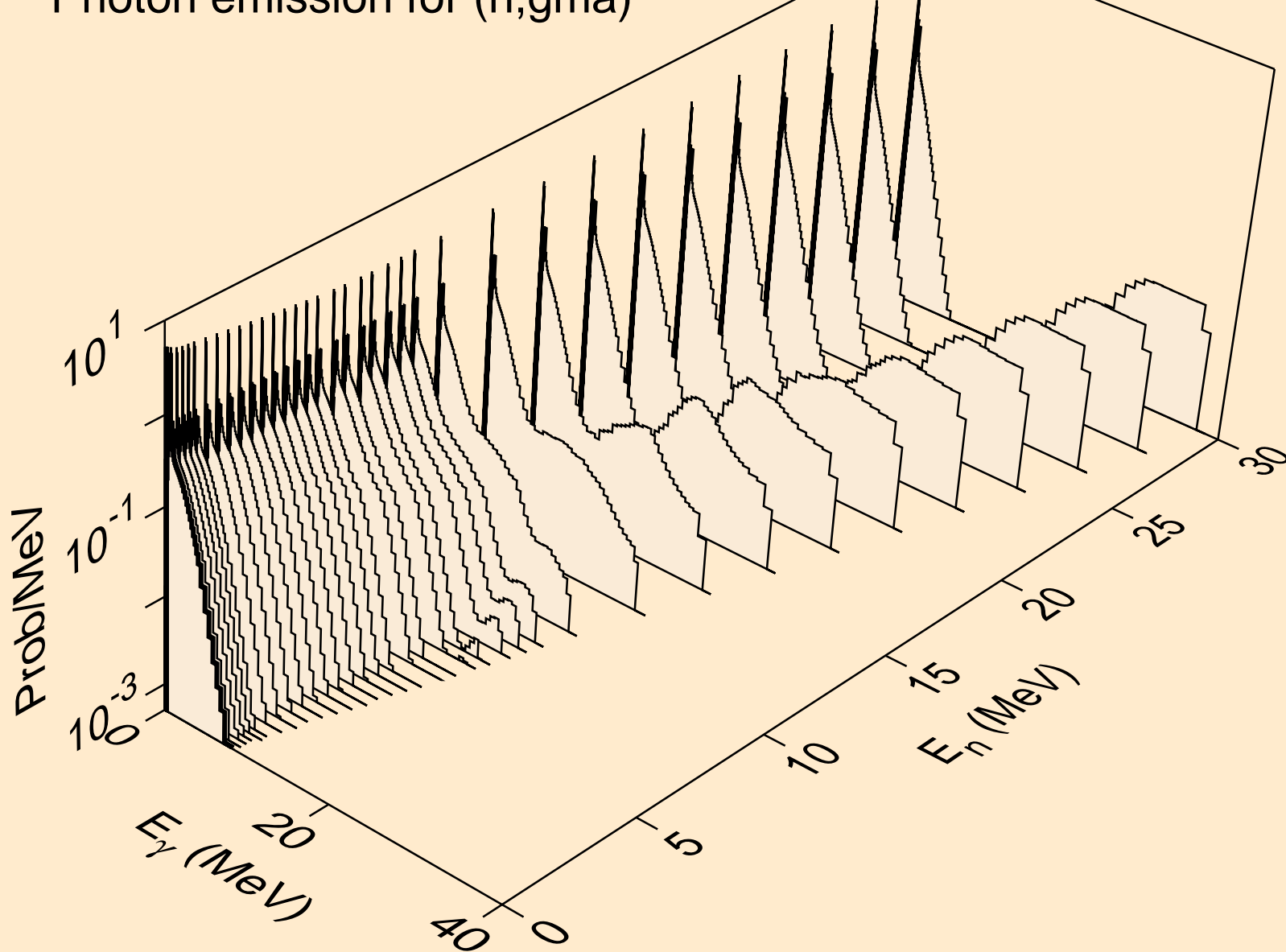

TM159 NEUTRON ACER TENDL-2019 LIBRARY; T=293.16K  
Photon emission for (n,p)

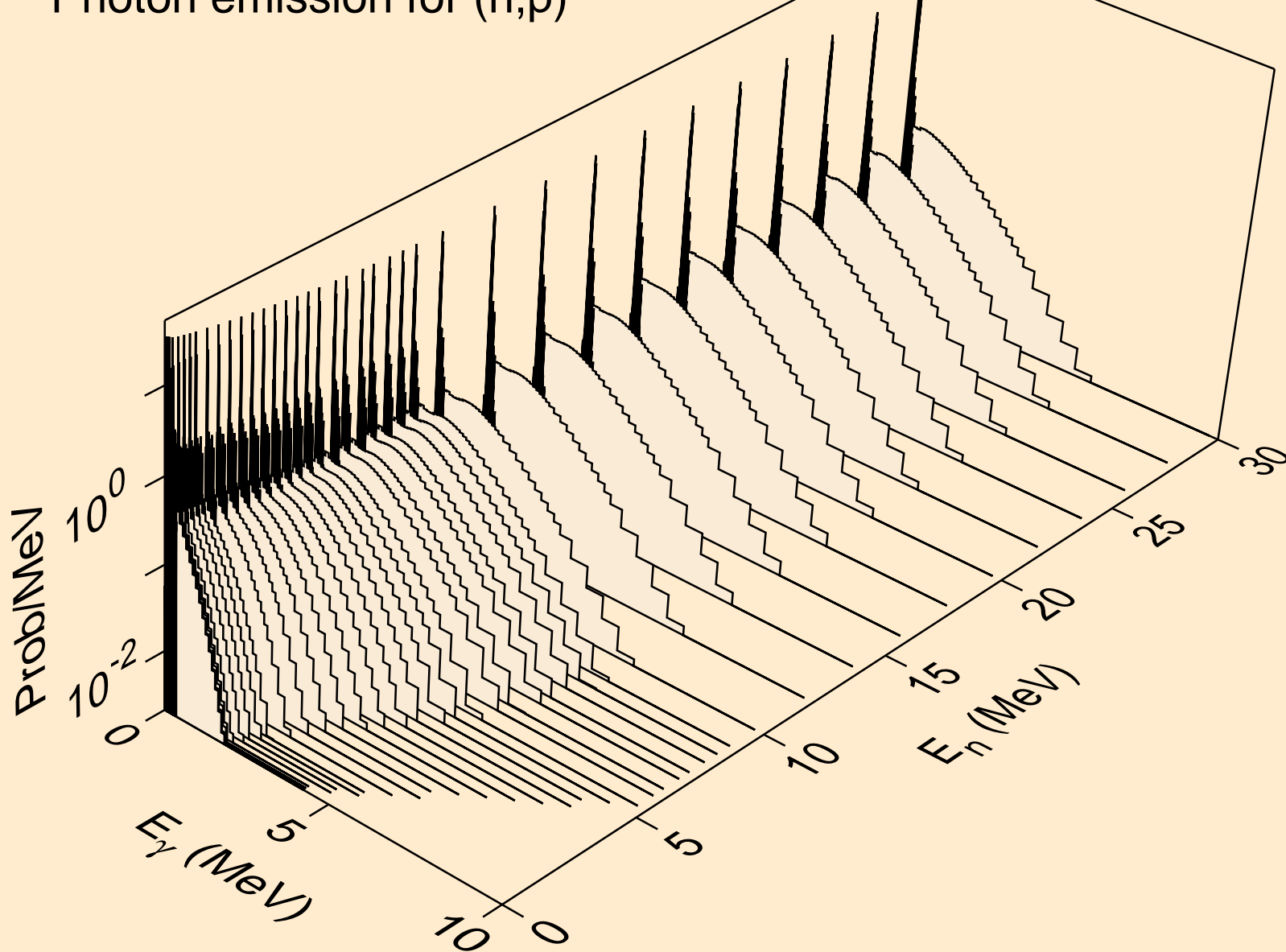

TM159 NEUTRON ACER TENDL-2019 LIBRARY; T=293.16K  
Photon emission for (n,d)

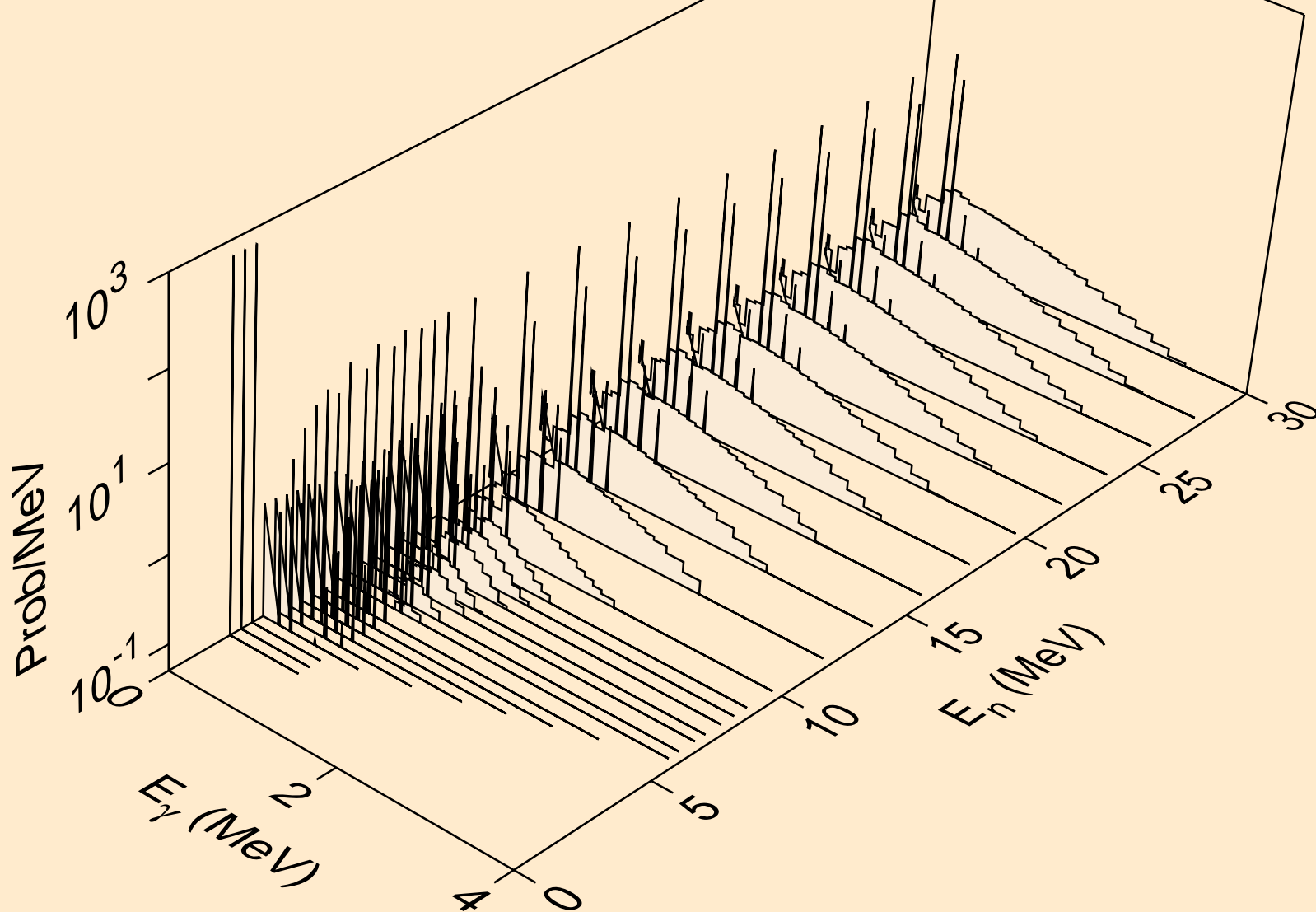

TM159 NEUTRON ACER TENDL-2019 LIBRARY; T=293.16K  
Photon emission for (n,t)

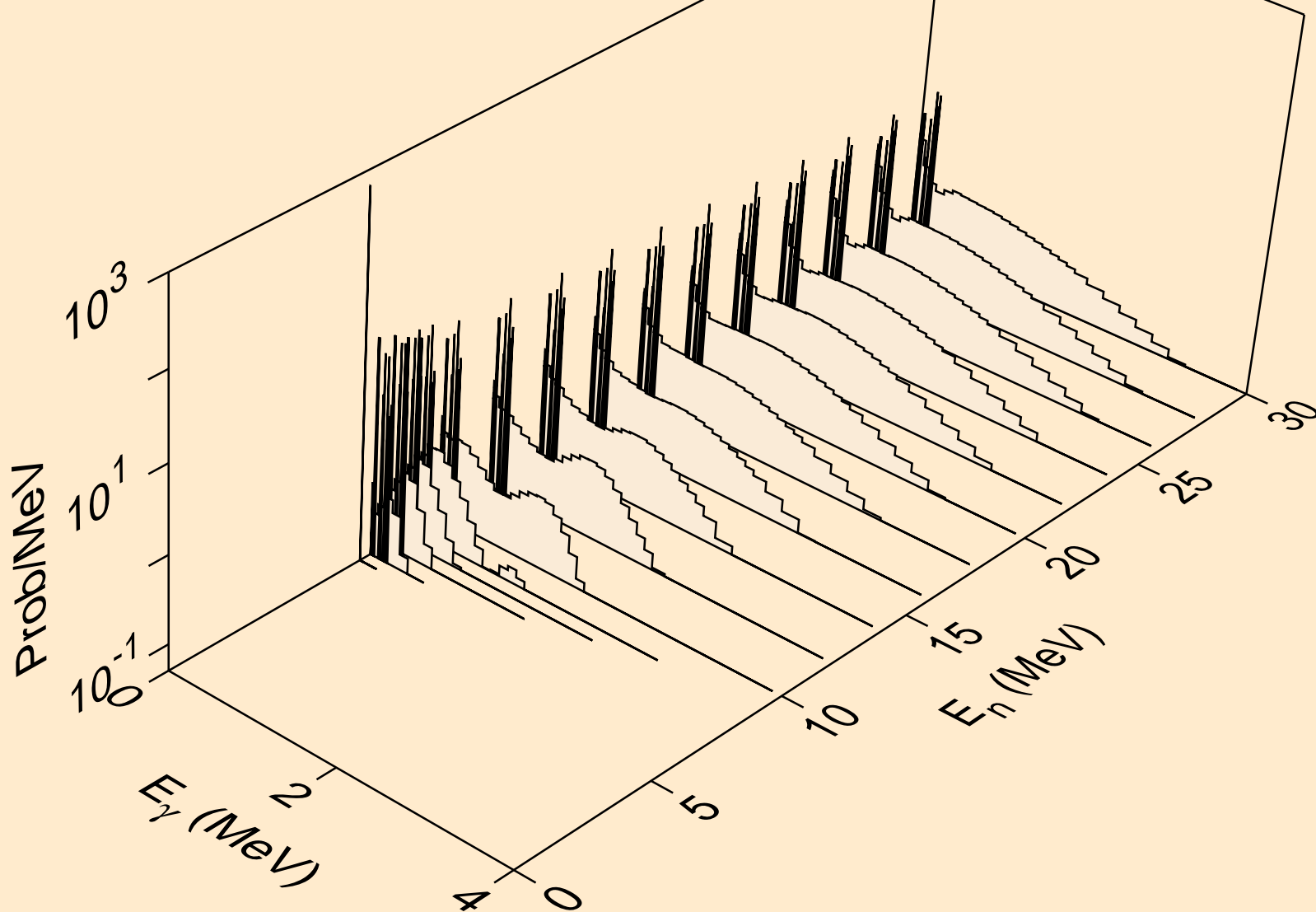

TM159 NEUTRON ACER TENDL-2019 LIBRARY; T=293.16K  
Photon emission for (n,he3)

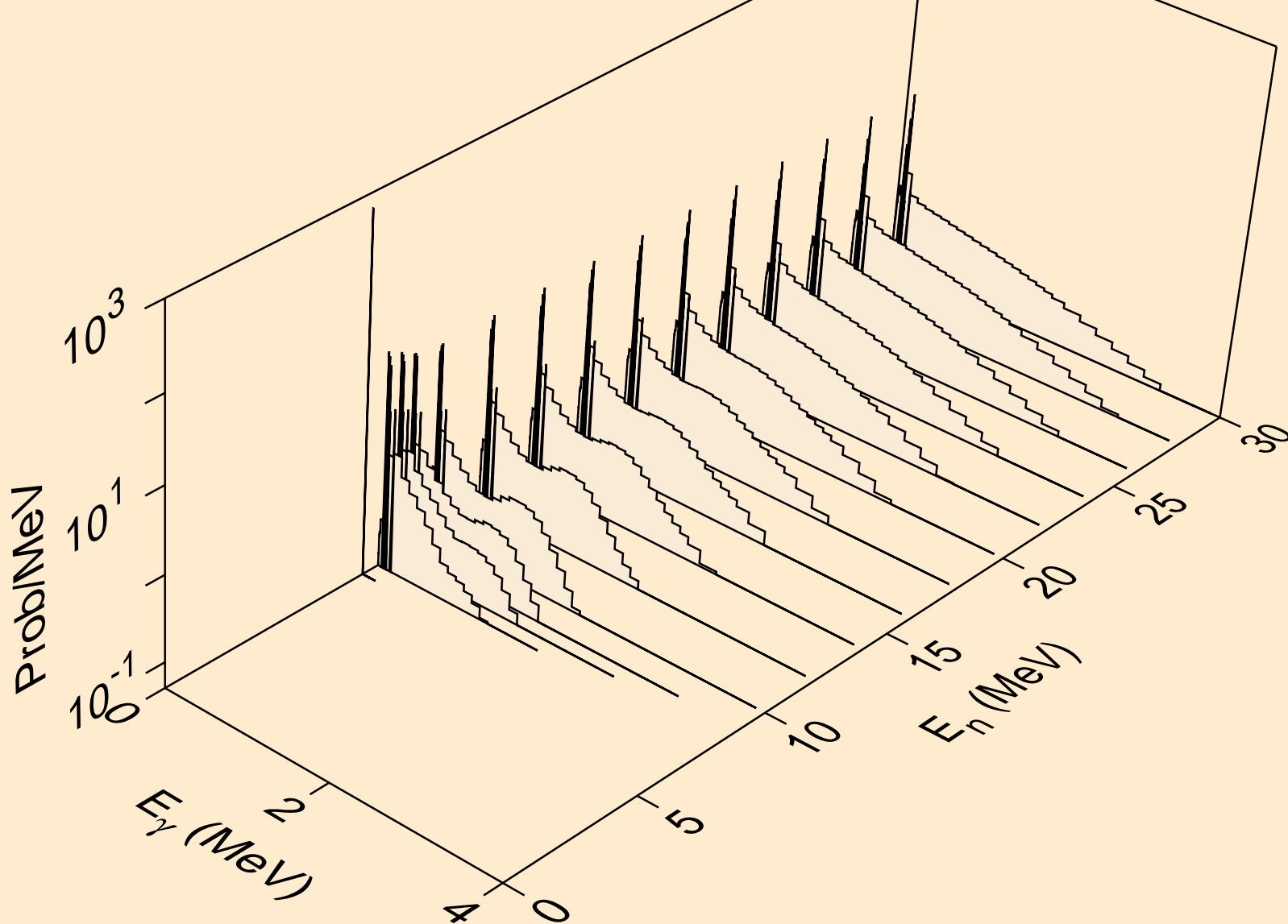

TM159 NEUTRON ACER TENDL-2019 LIBRARY; T=293.16K  
Photon emission for (n,a)

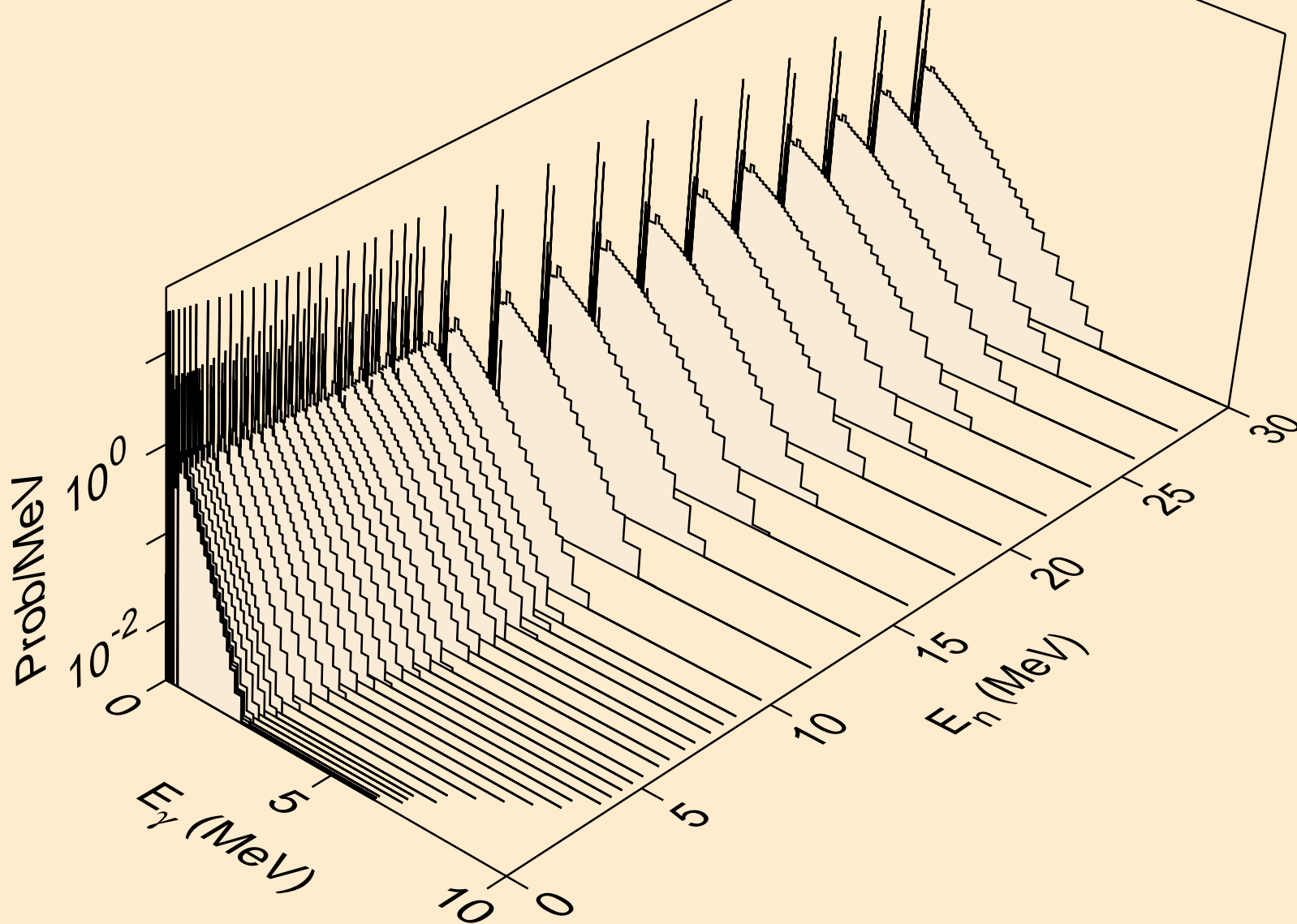

TM159 NEUTRON ACER TENDL-2019 LIBRARY; T=293.16K  
Photon emission for (n,2a)

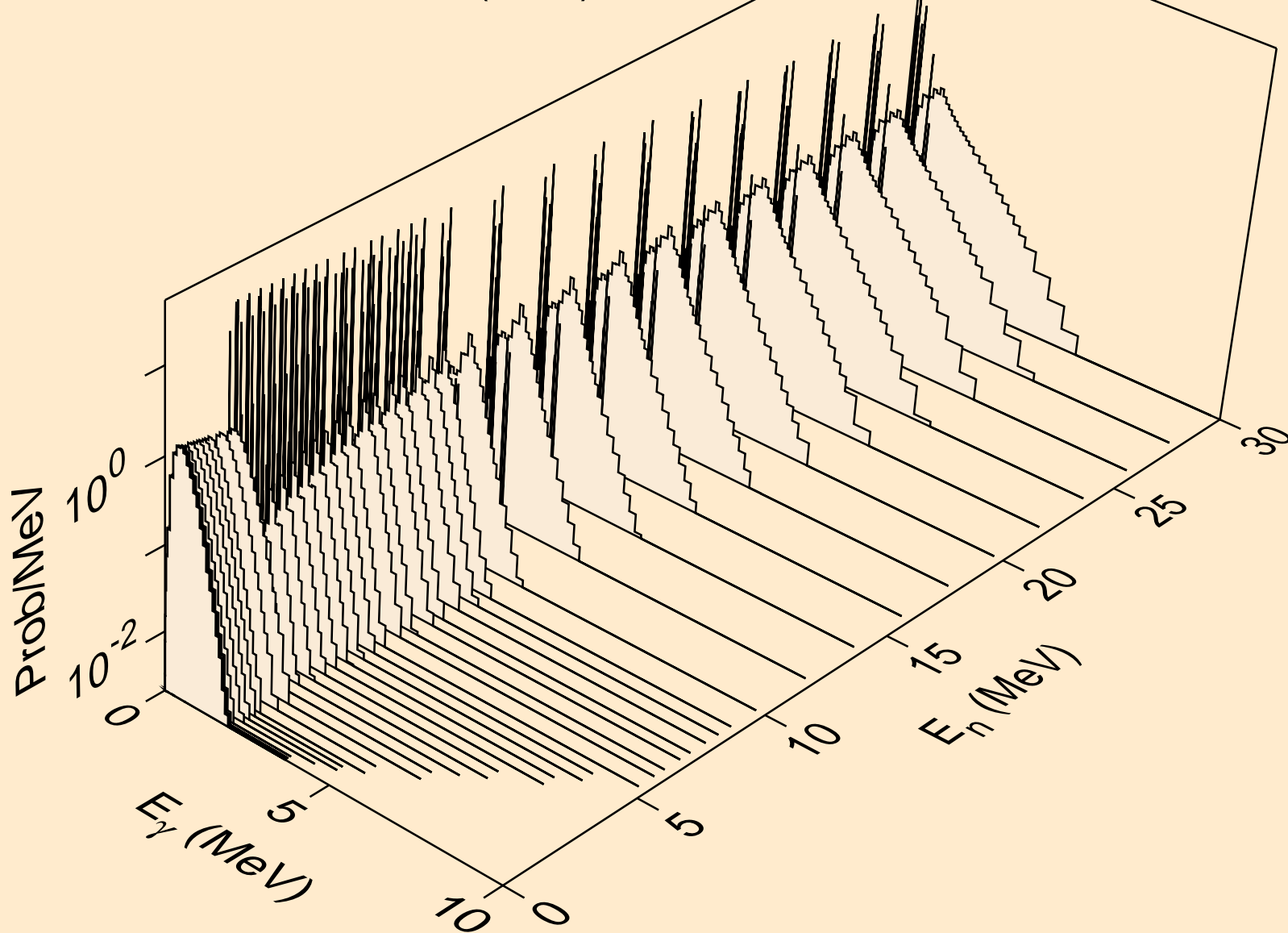



TM159 NEUTRON ACER TENDL-2019 LIBRARY; T=293.16K  
Photon emission for (n,2p)

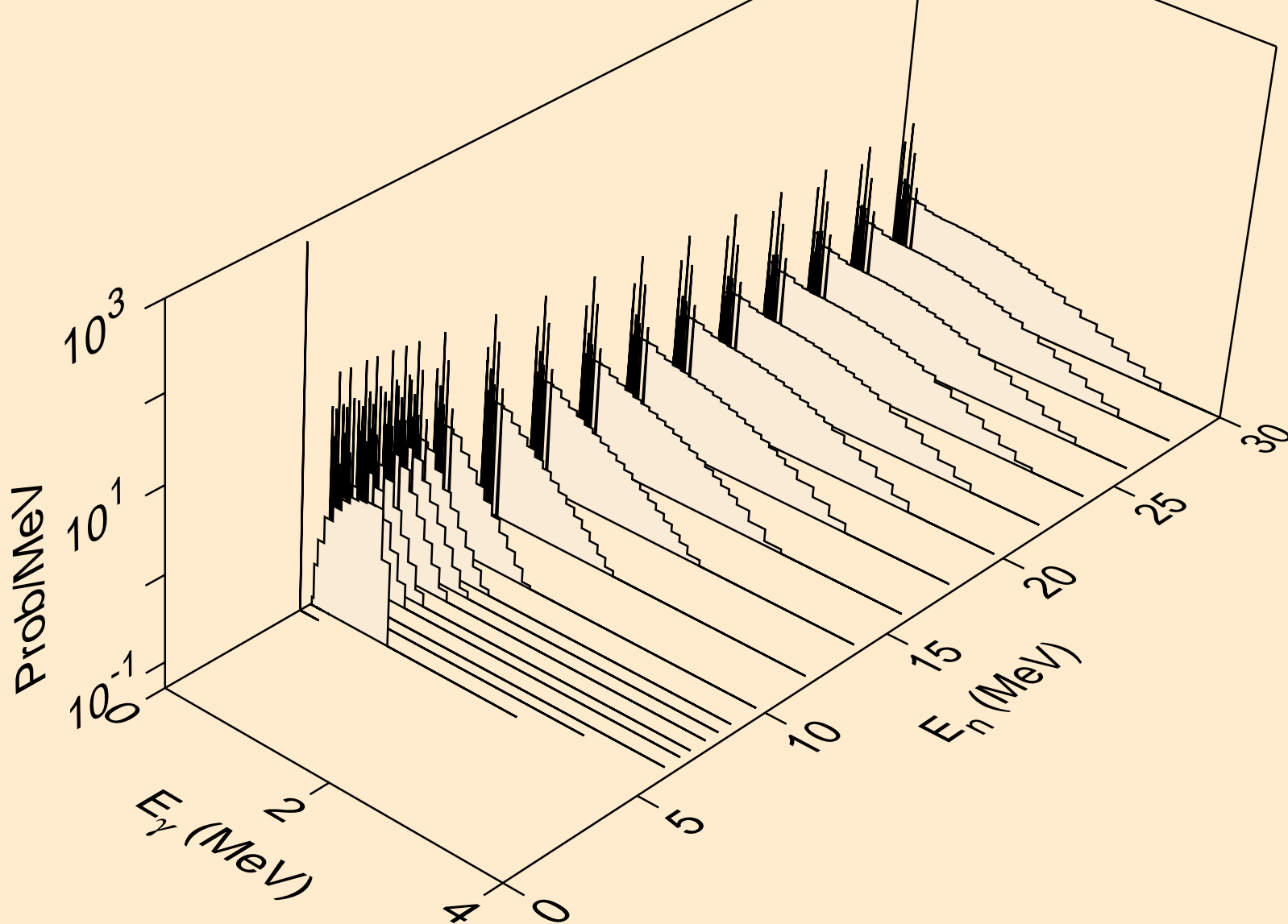

TM159 NEUTRON ACER TENDL-2019 LIBRARY; T=293.16K  
Photon emission for (n,p)

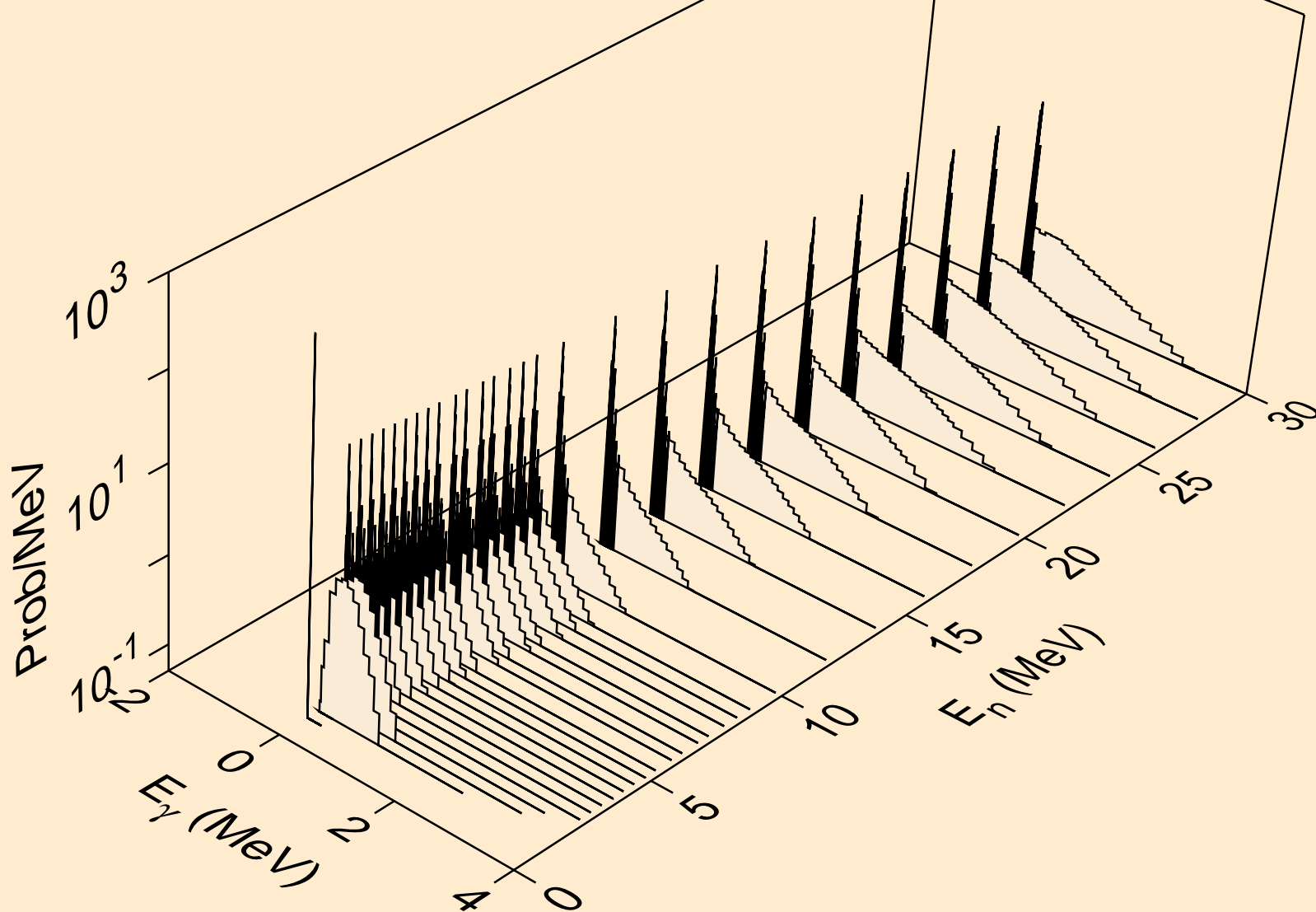

TM159 NEUTRON ACER TENDL-2019 LIBRARY; T=293.16K  
Photon emission for (n,pd)

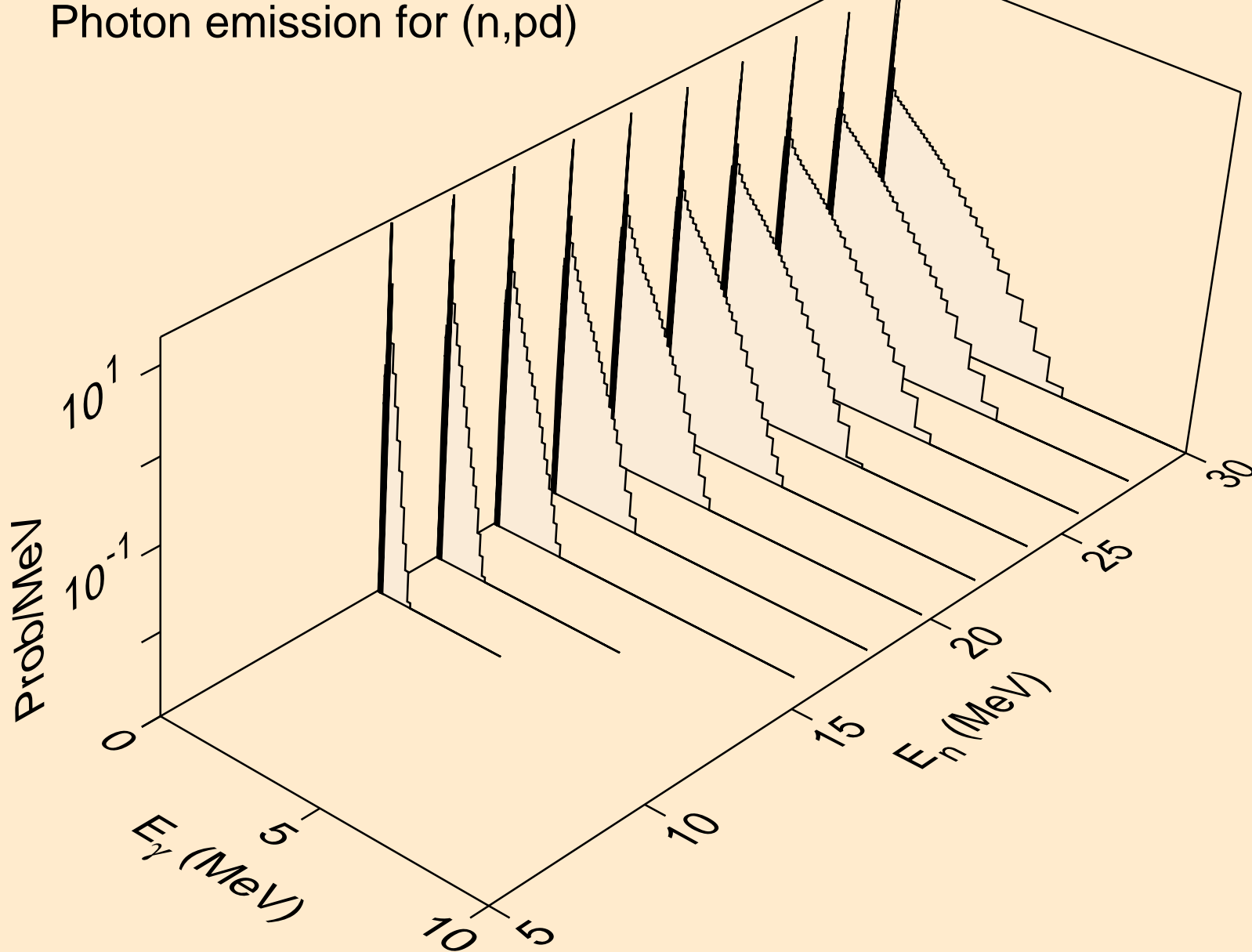

TM159 NEUTRON ACER TENDL-2019 LIBRARY; T=293.16K  
Photon emission for (n,pt)

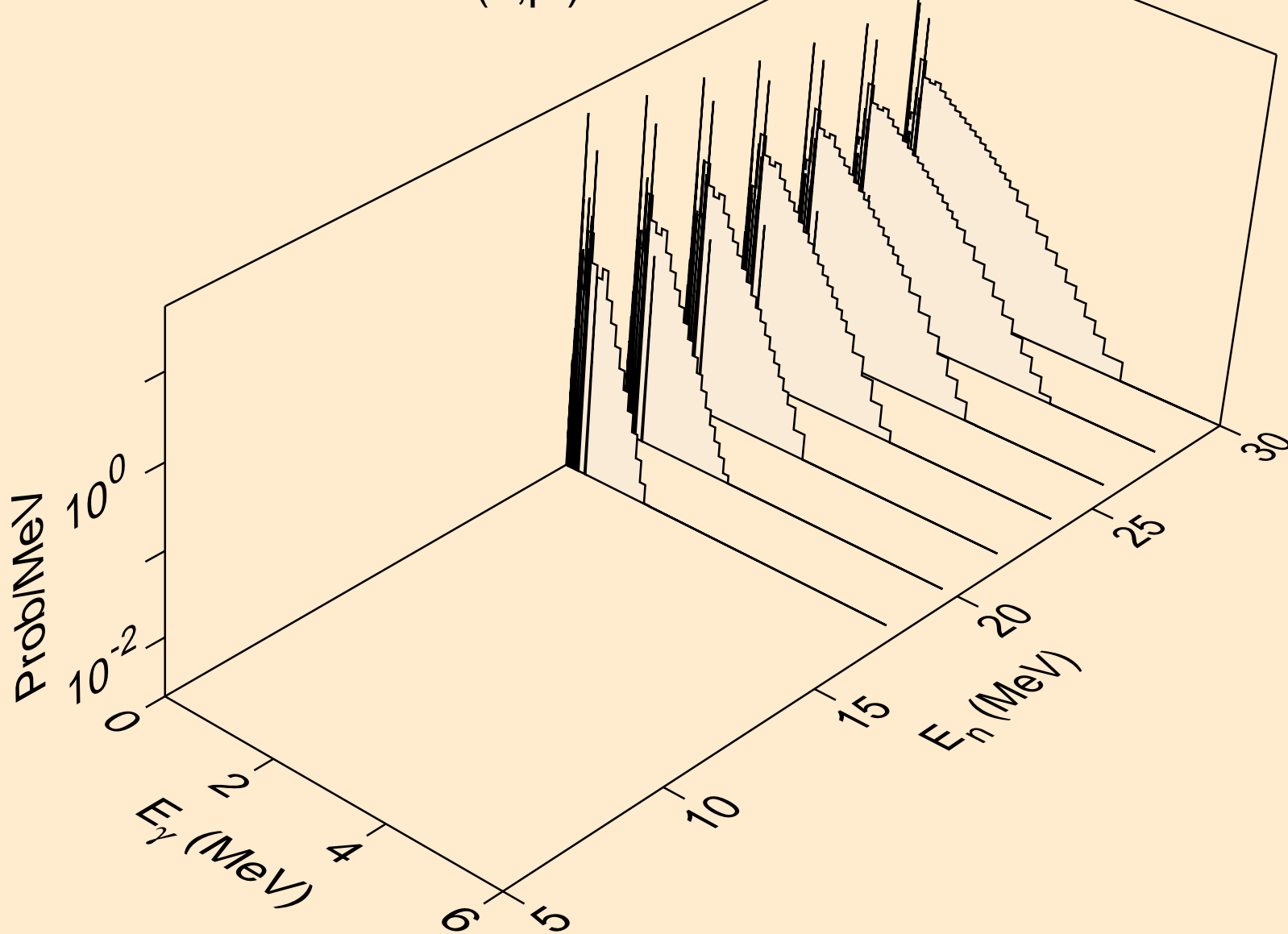

TM159 NEUTRON ACER TENDL-2019 LIBRARY; T=293.16K  
Photon emission for (n,da)

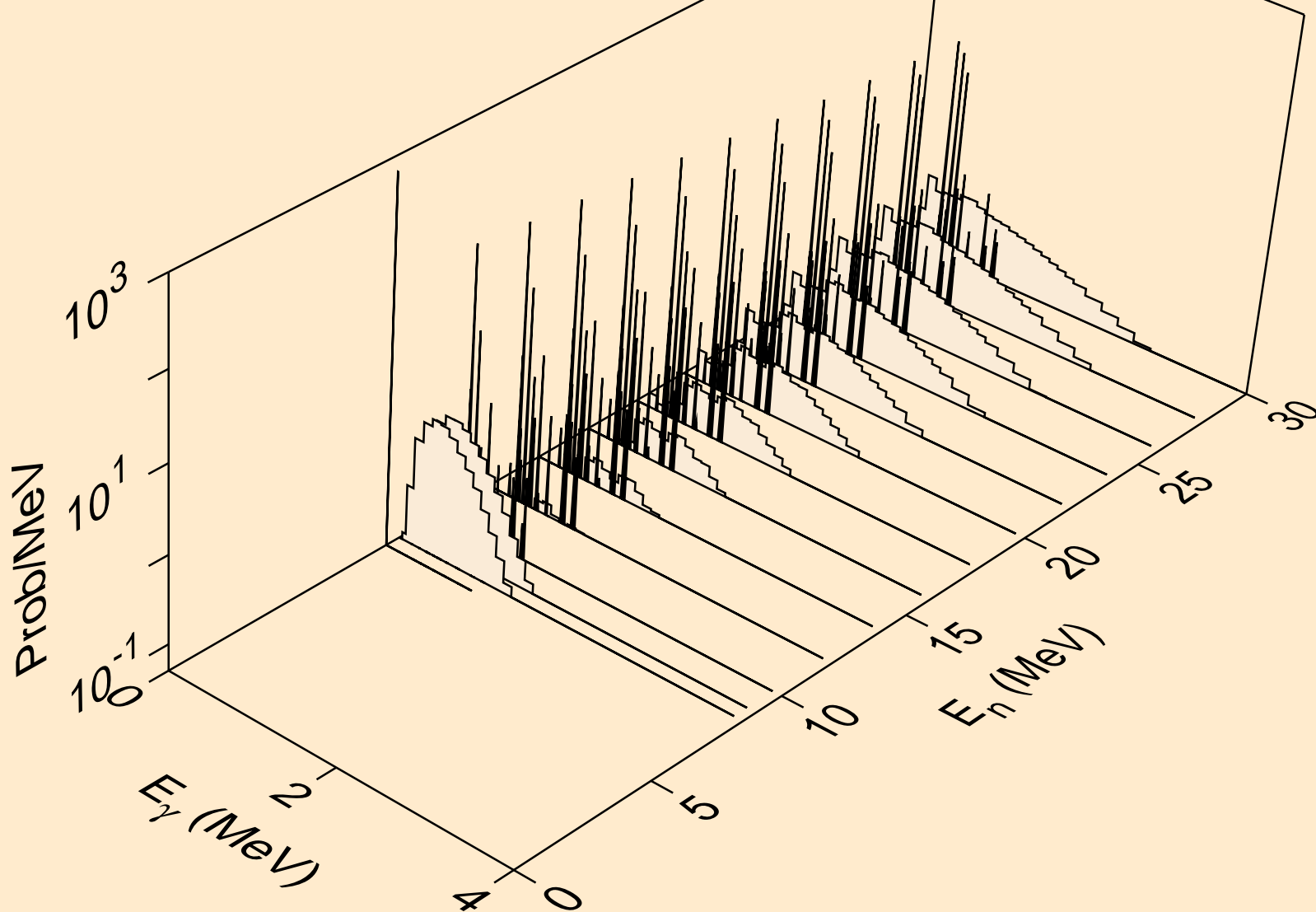

TM159 NEUTRON ACER TENDL-2019 LIBRARY; T=293.16K  
thermal capture photon spectrum

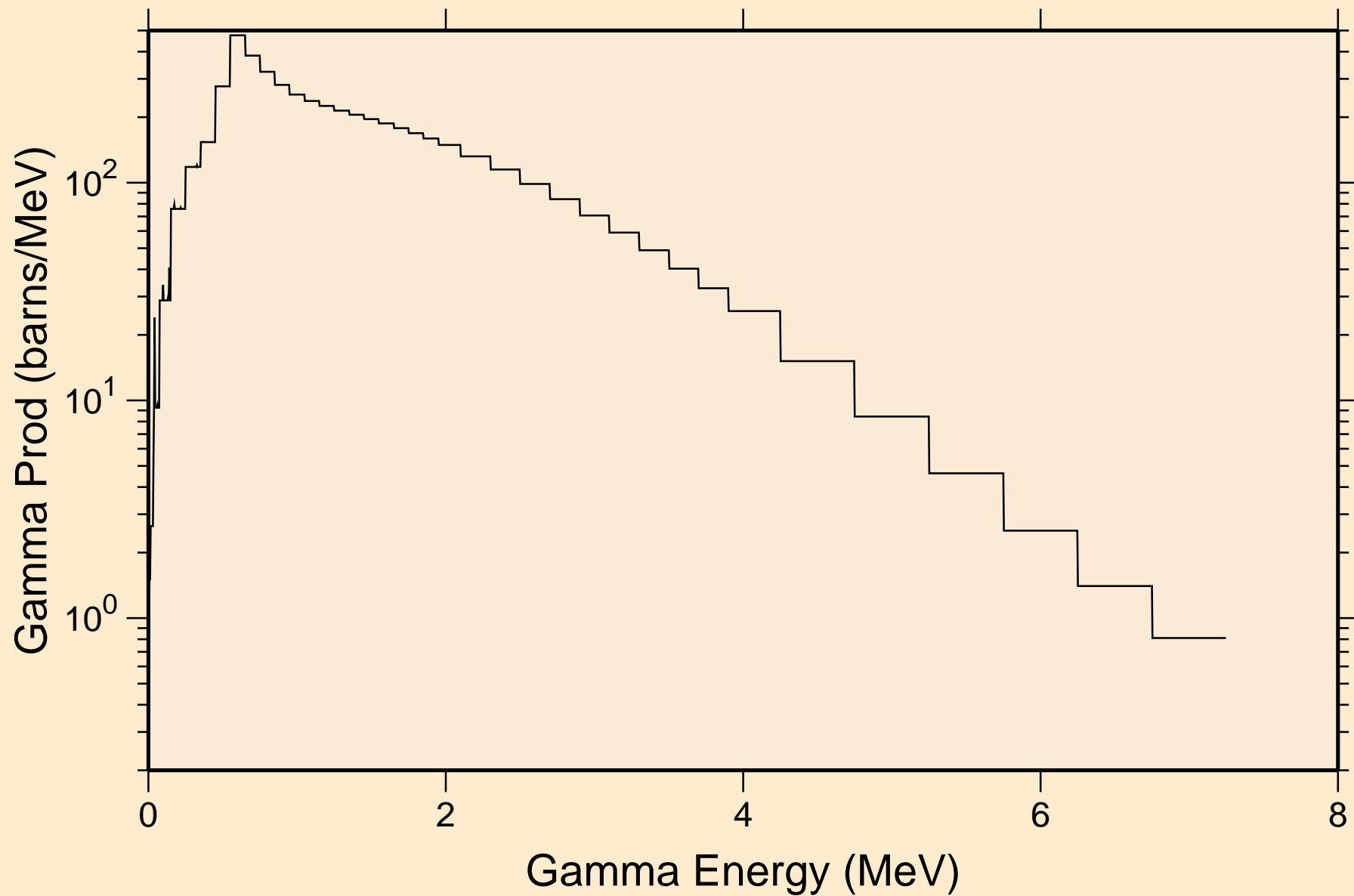

TM159 NEUTRON ACER TENDL-2019 LIBRARY; T=293.16K  
14 MeV photon spectrum

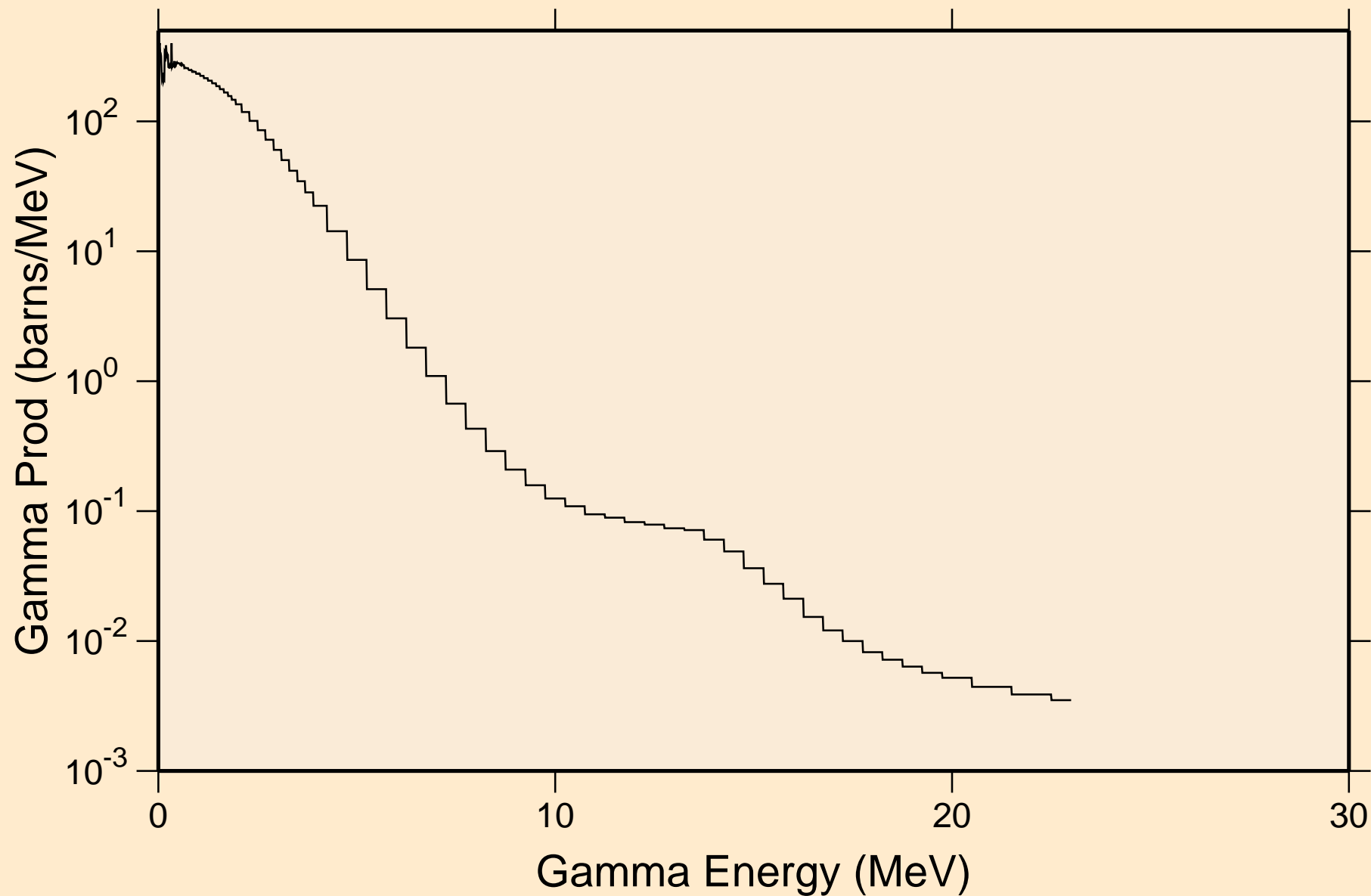

TM159 NEUTRON ACER TENDL-2019 LIBRARY; T=293.16K  
Particle heating contributions

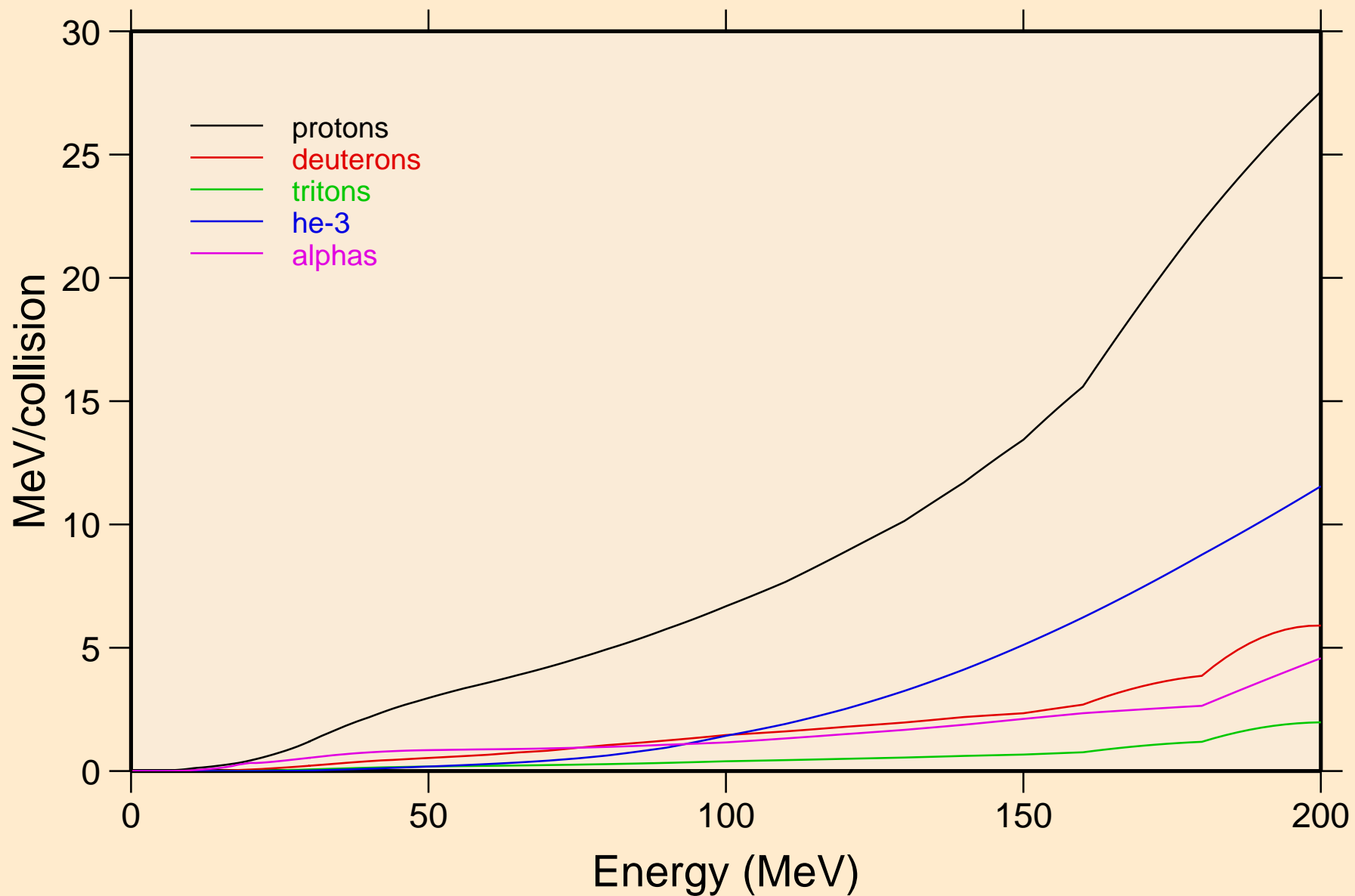



TM159 NEUTRON ACER TENDL-2019 LIBRARY; T=293.16K  
Recoil Heating

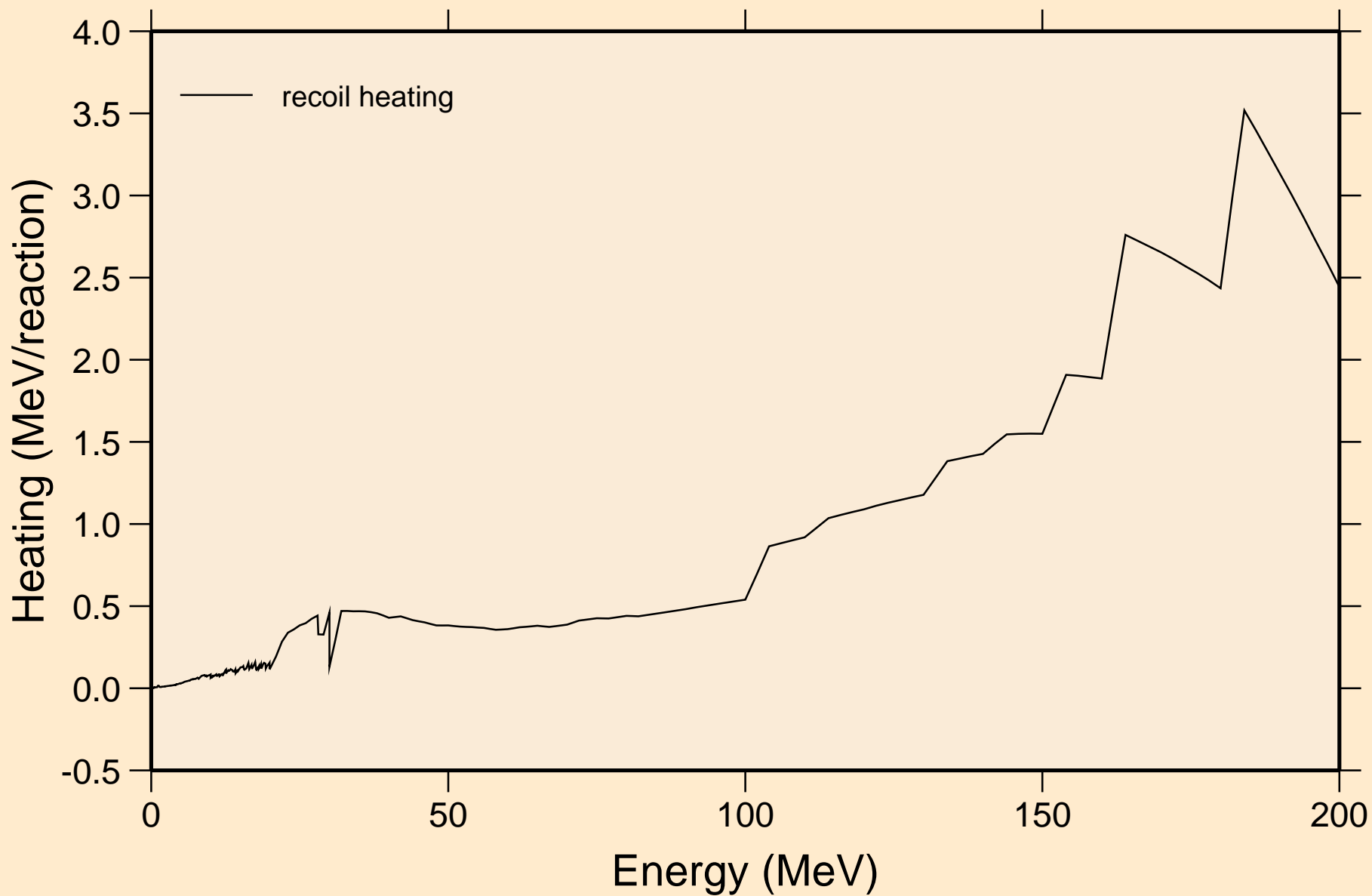

TM159 NEUTRON ACER TENDL-2019 LIBRARY; T=293.16K  
Particle production cross sections

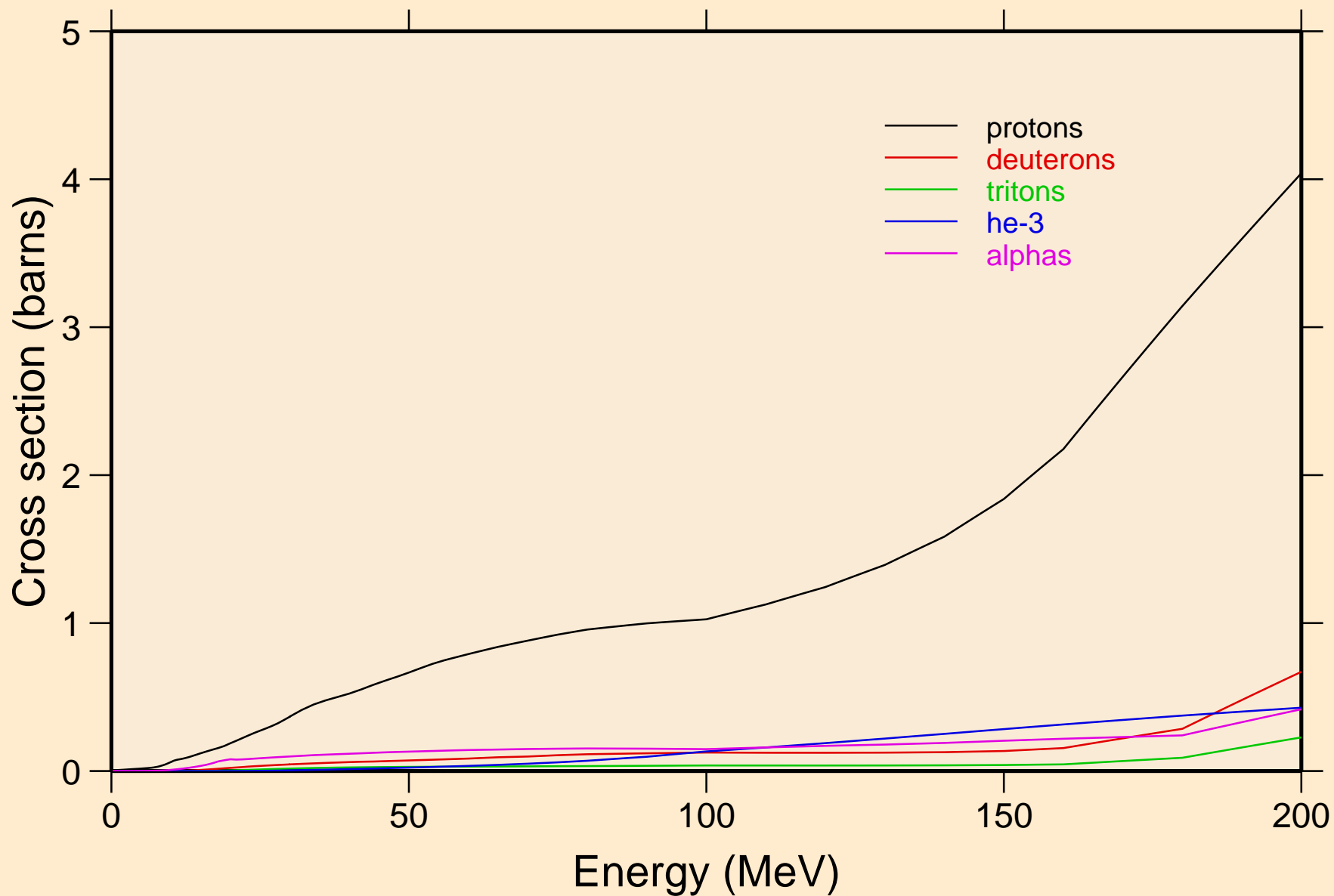

TM159 NEUTRON ACER TENDL-2019 LIBRARY; T=293.16K  
protons from (n,x)

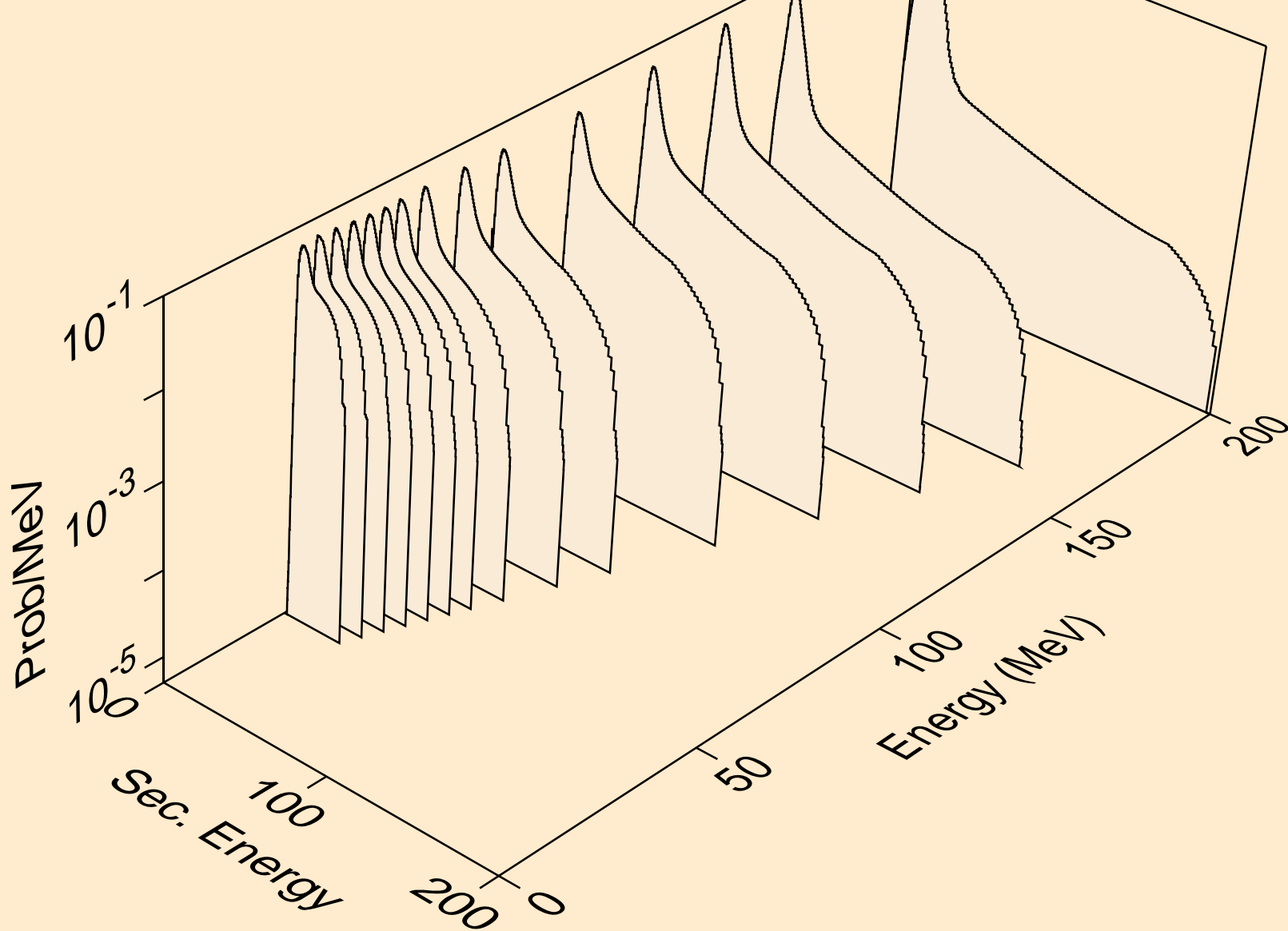

TM159 NEUTRON ACER TENDL-2019 LIBRARY; T=293.16K  
protons from (n,n\*)p

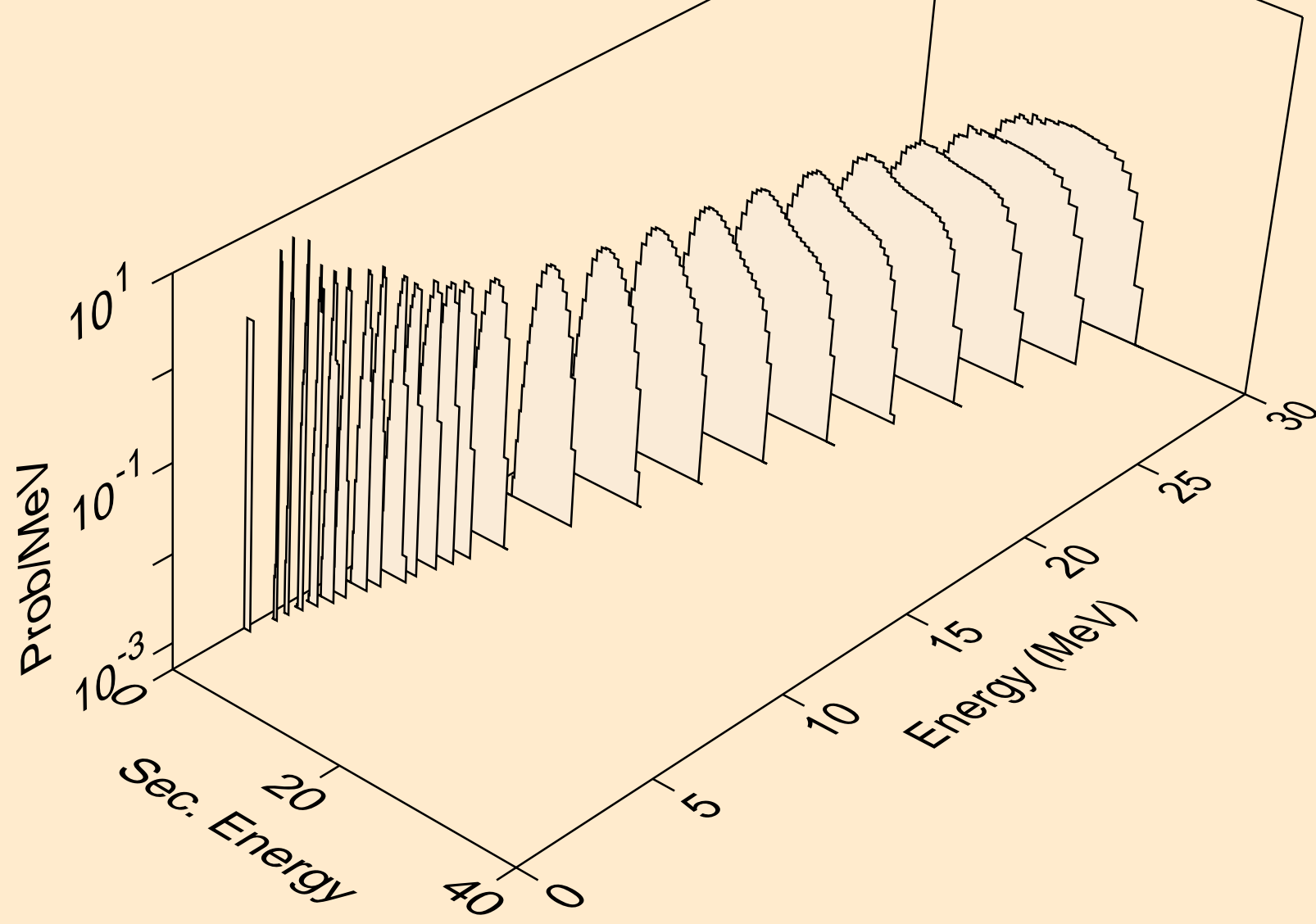

TM159 NEUTRON ACER TENDL-2019 LIBRARY; T=293.16K  
protons from (n,2np)

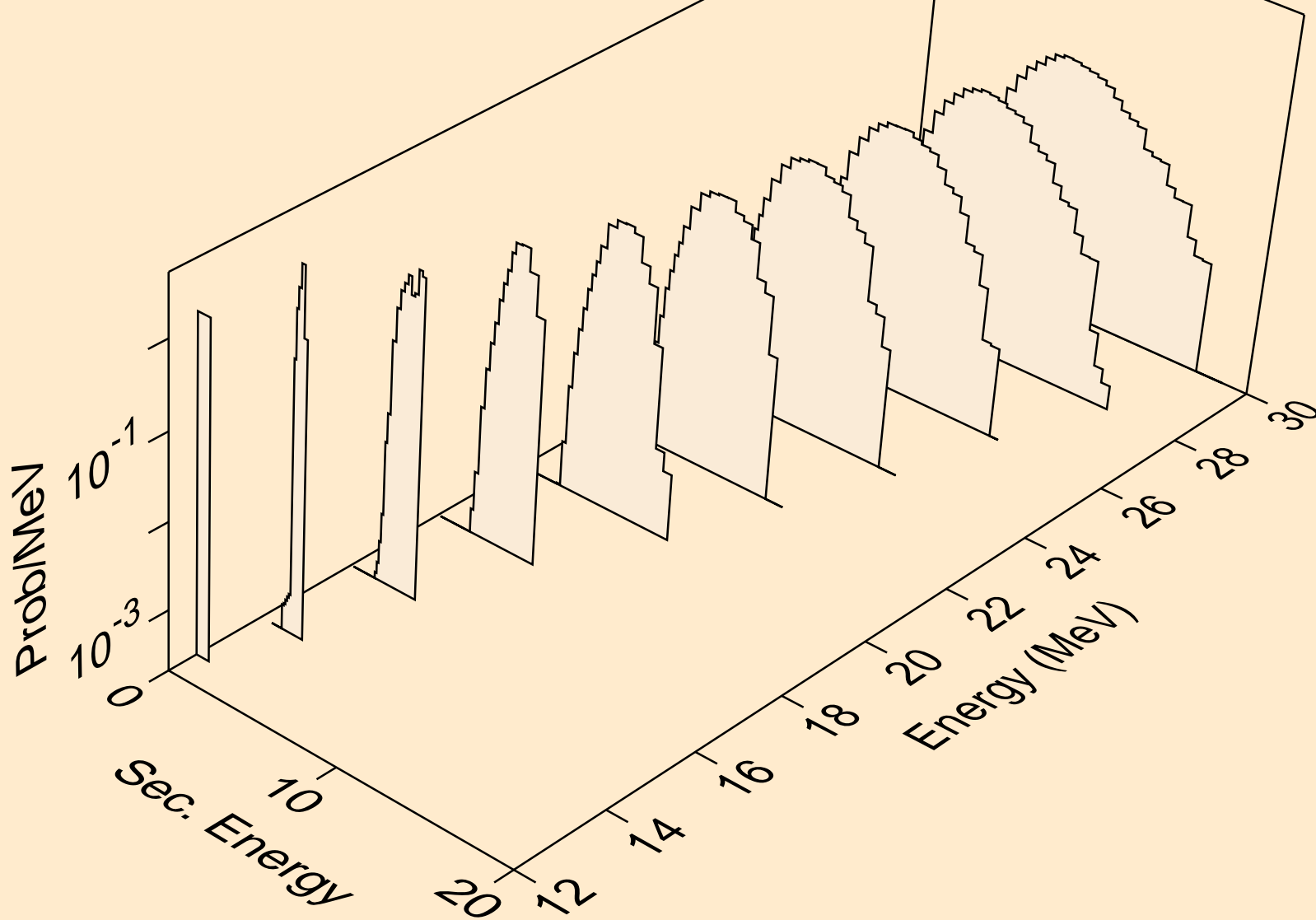

TM159 NEUTRON ACER TENDL-2019 LIBRARY; T=293.16K  
protons from (n,3np)

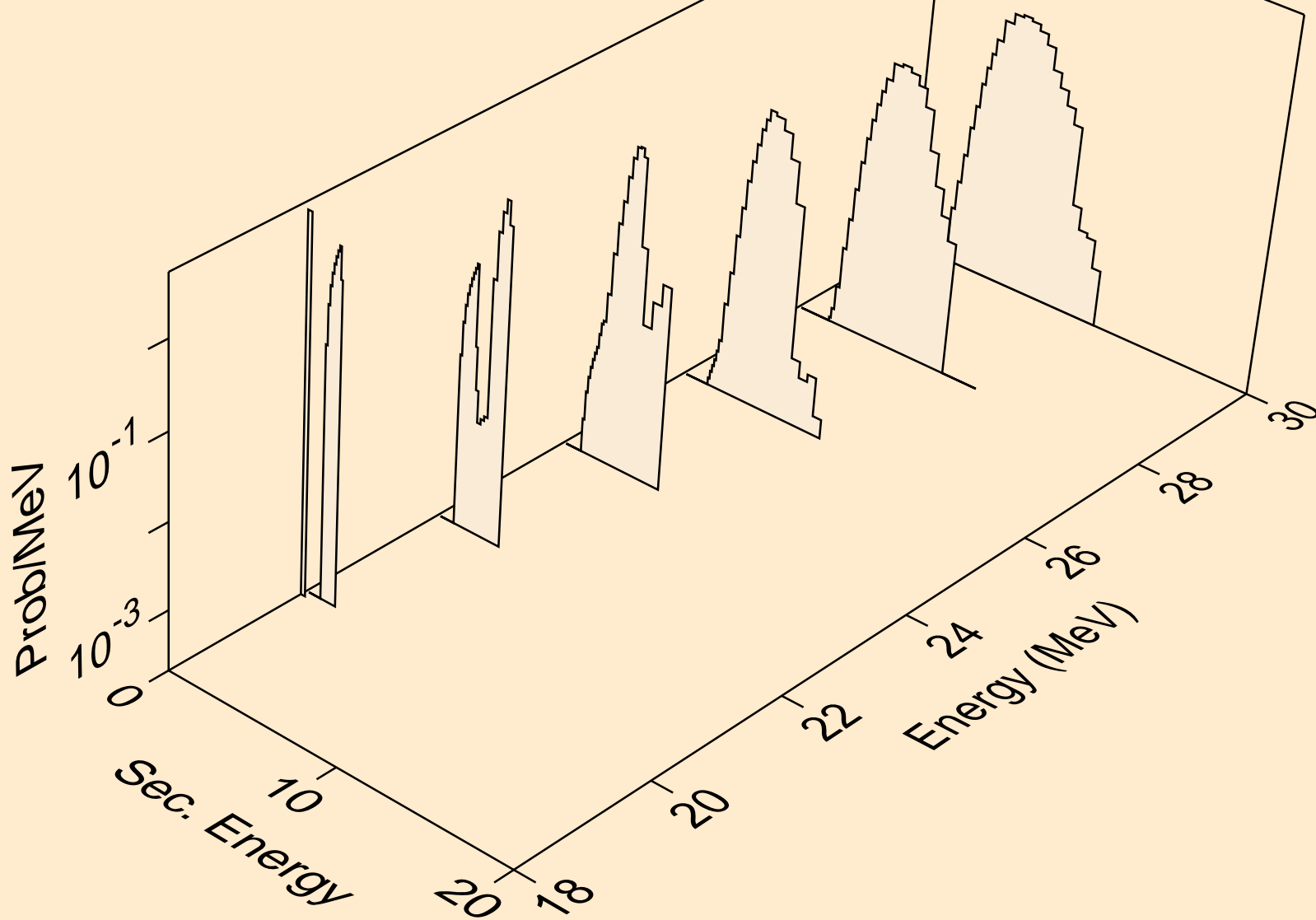

TM159 NEUTRON ACER TENDL-2019 LIBRARY; T=293.16K  
protons from (n,2np)

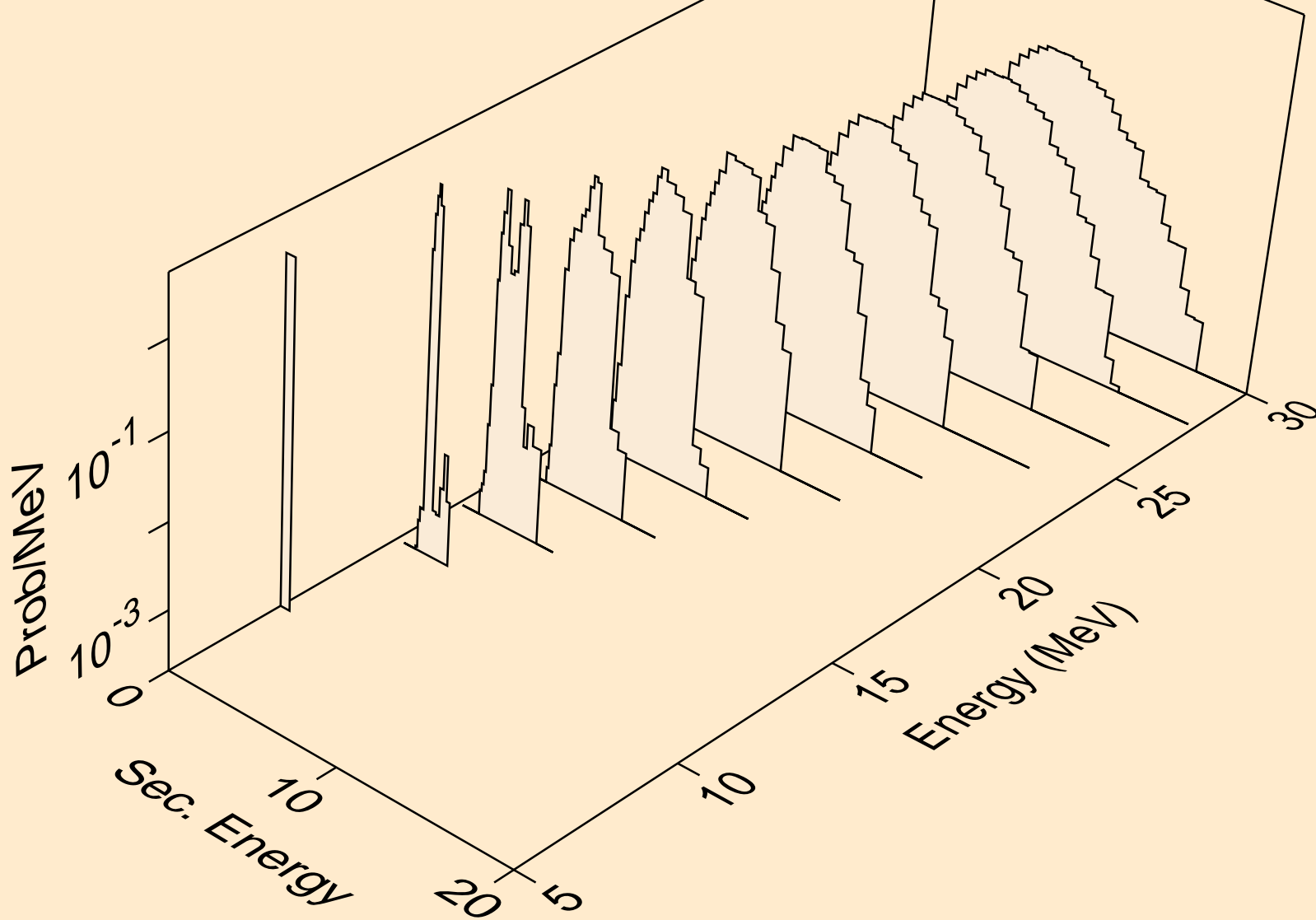

TM159 NEUTRON ACER TENDL-2019 LIBRARY; T=293.16K  
protons from (n,npa)

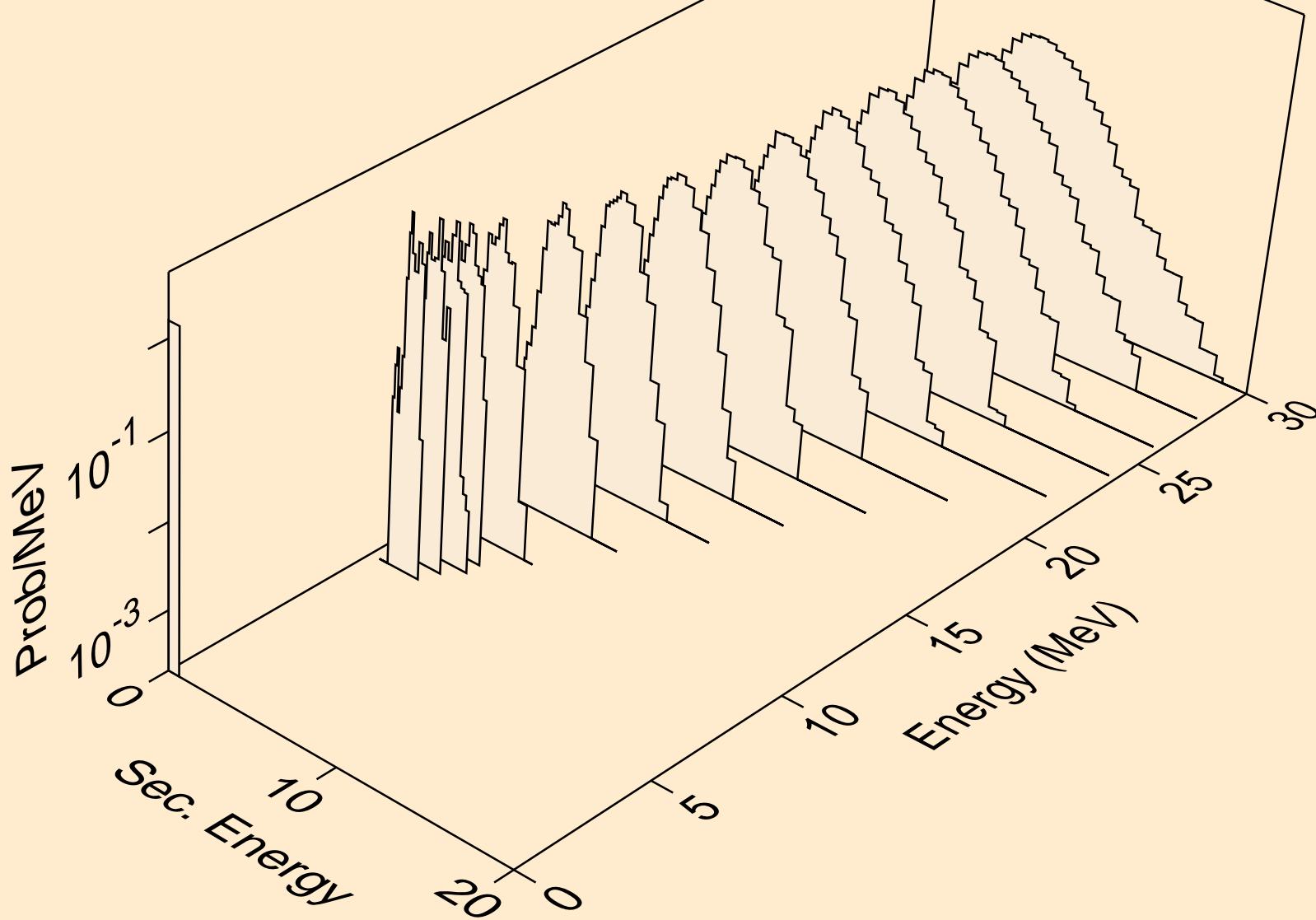



TM159 NEUTRON ACER TENDL-2019 LIBRARY; T=293.16K  
protons from (n,p)

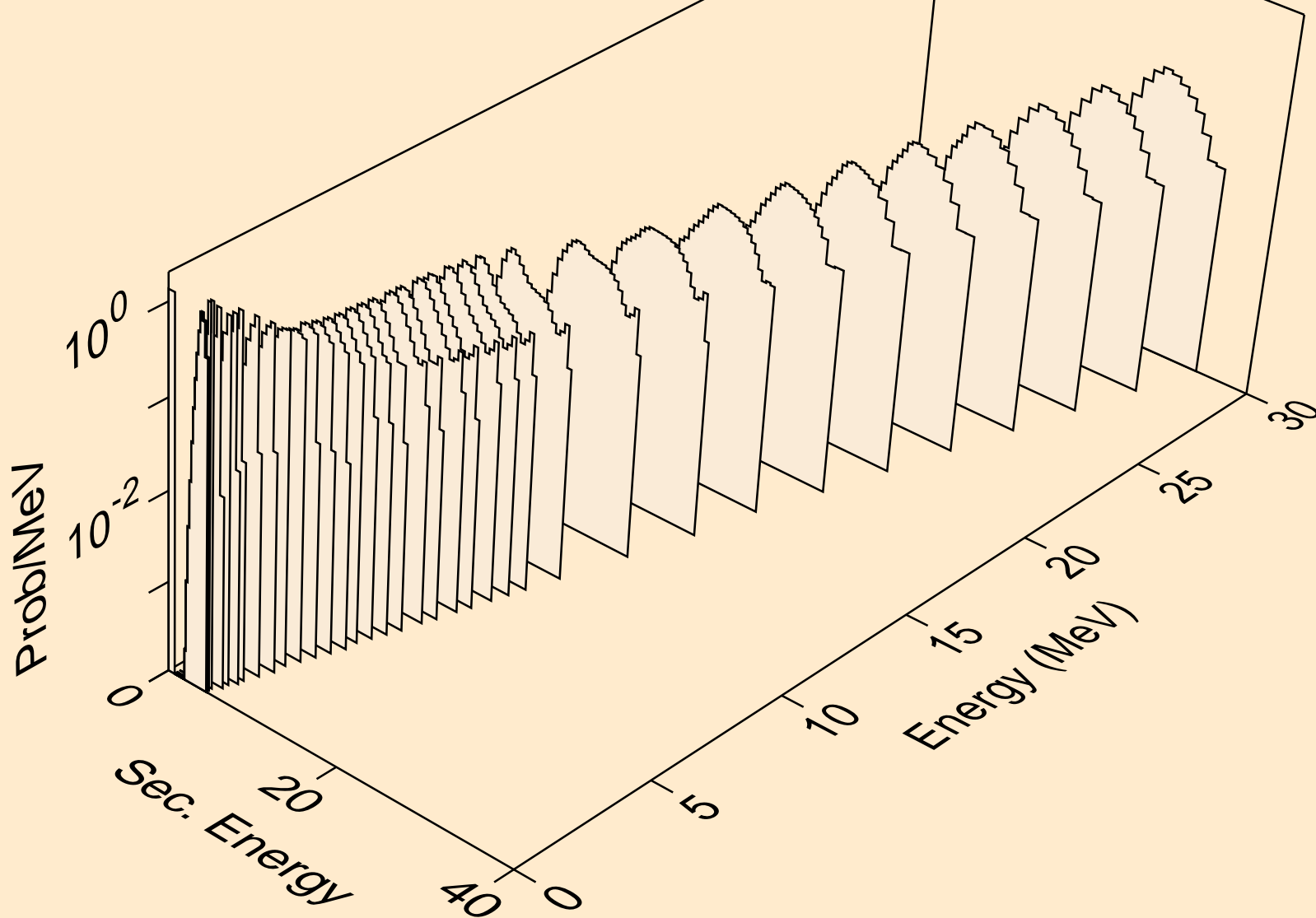

TM159 NEUTRON ACER TENDL-2019 LIBRARY; T=293.16K  
protons from (n,2p)

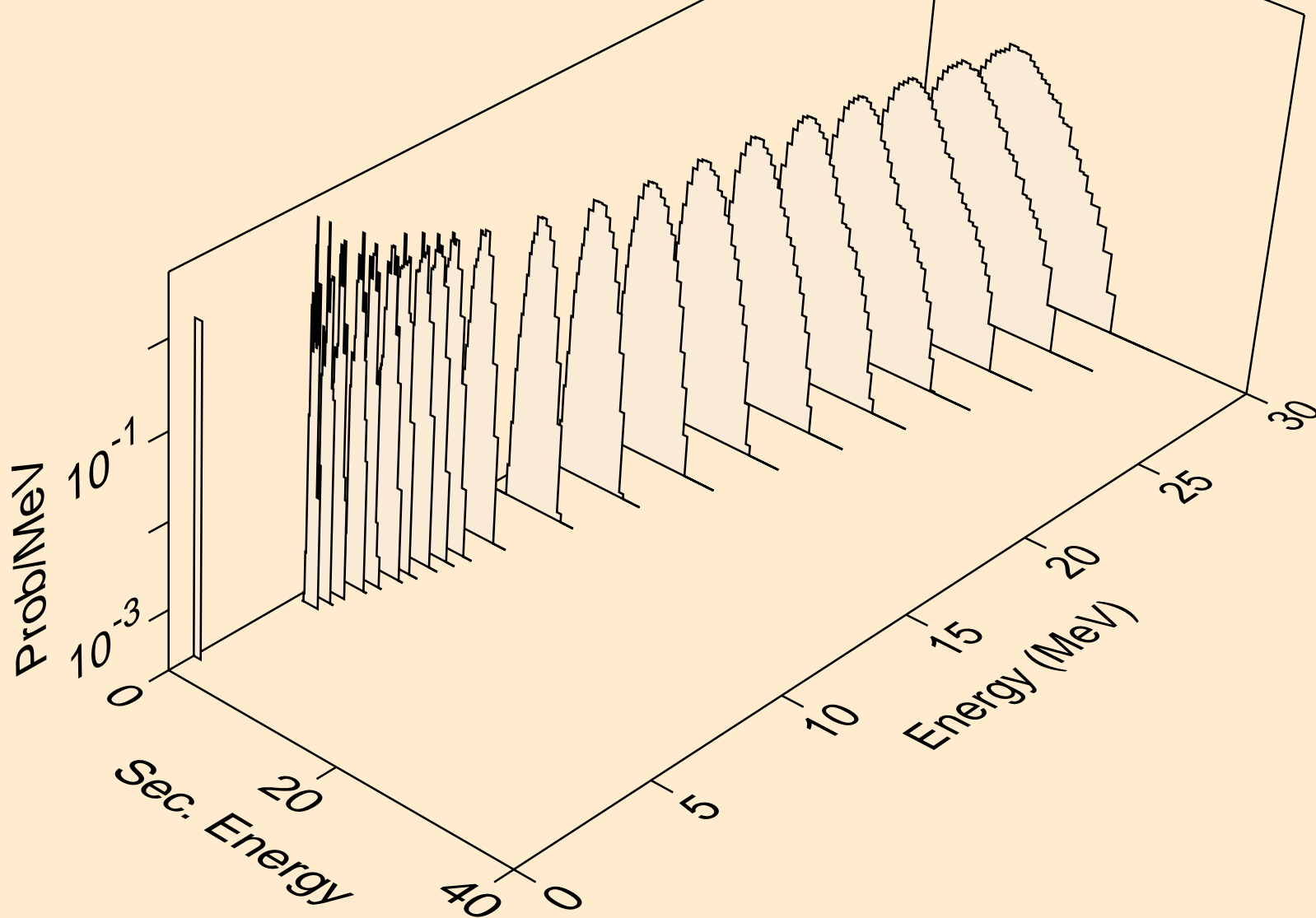

TM159 NEUTRON ACER TENDL-2019 LIBRARY; T=293.16K  
protons from (n,p)

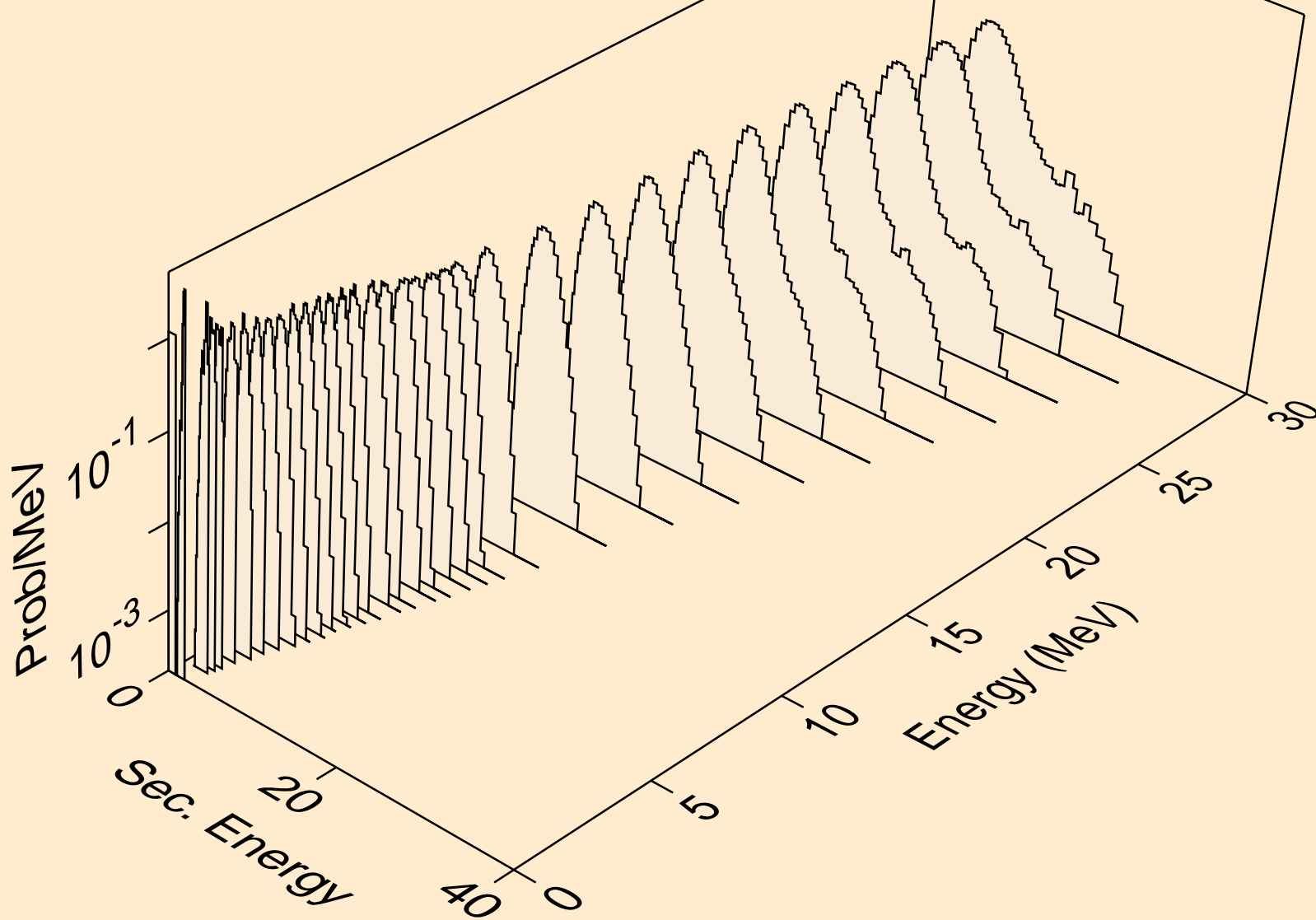

TM159 NEUTRON ACER TENDL-2019 LIBRARY; T=293.16K  
protons from (n,pd)

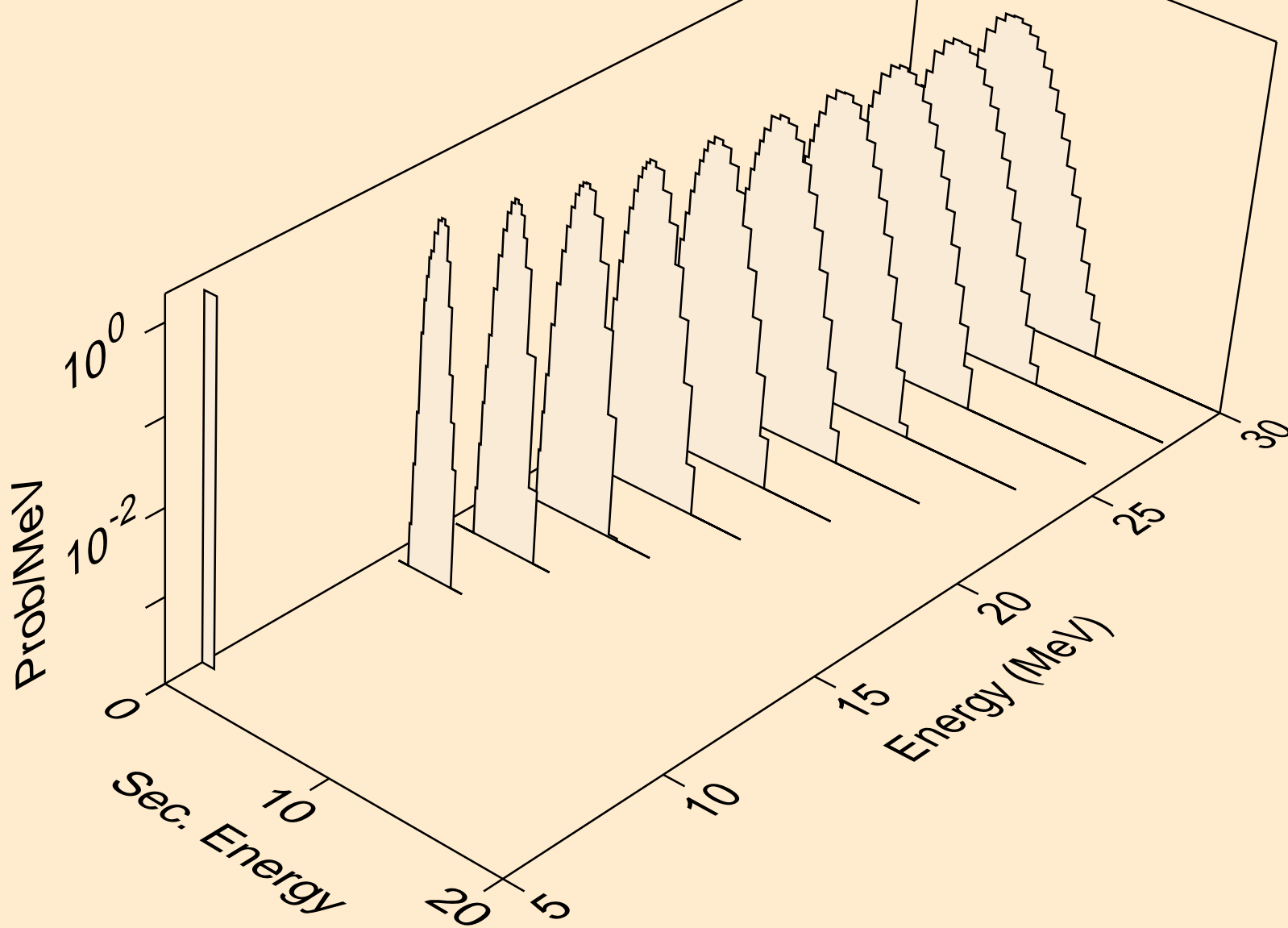

TM159 NEUTRON ACER TENDL-2019 LIBRARY; T=293.16K  
protons from (n,pt)

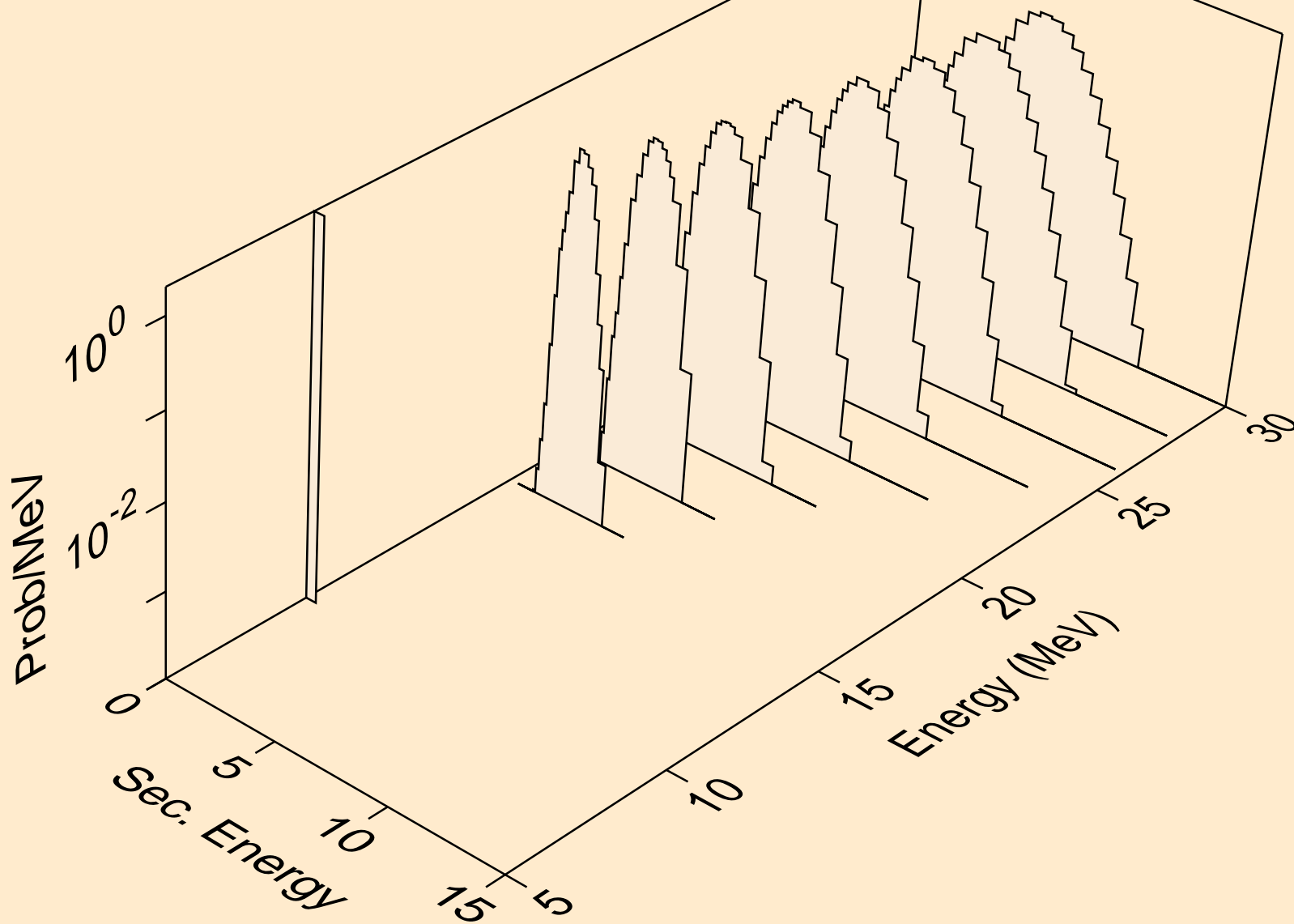

TM159 NEUTRON ACER TENDL-2019 LIBRARY; T=293.16K  
deuterons from (n,x)

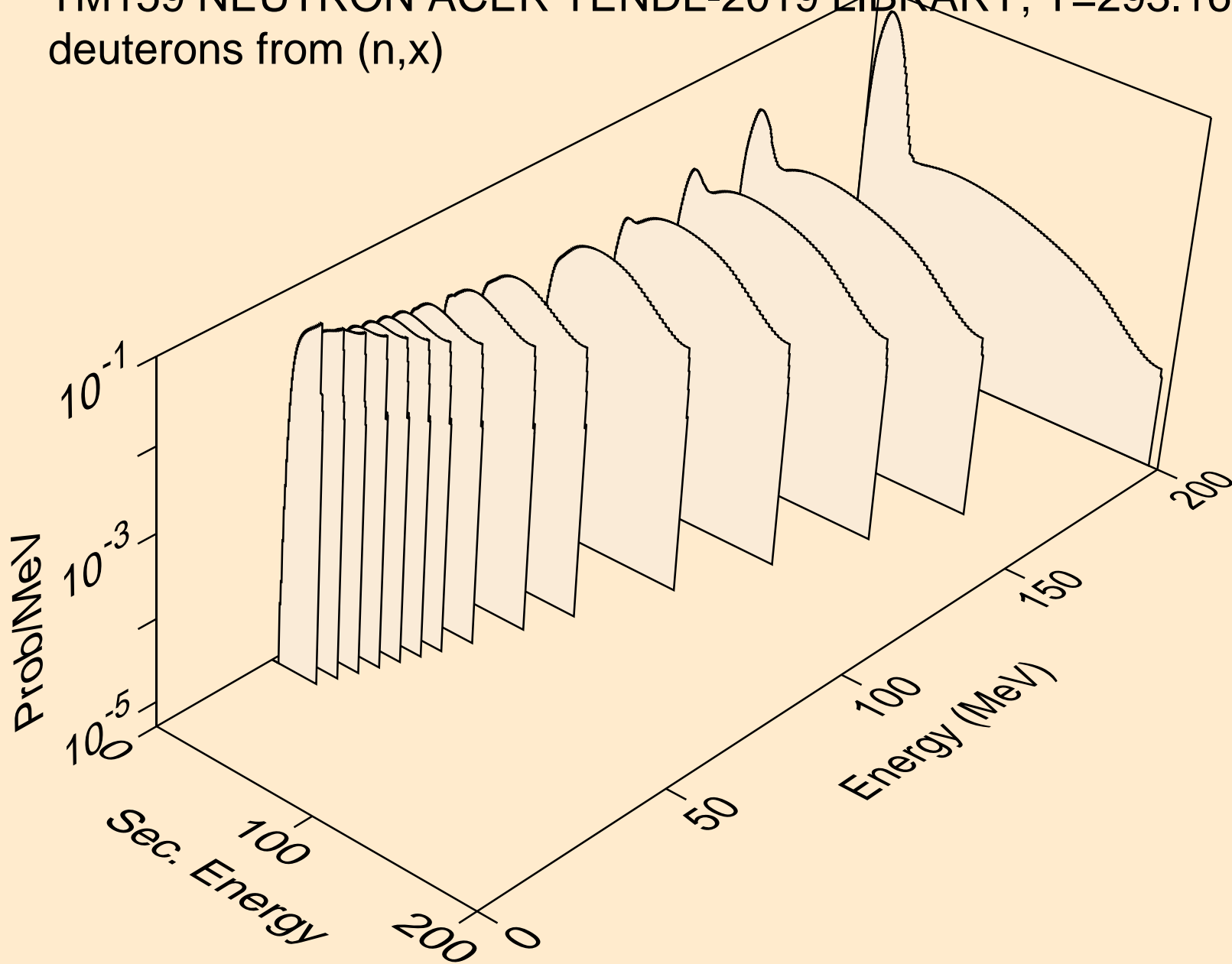

TM159 NEUTRON ACER TENDL-2019 LIBRARY; T=293.16K  
deuterons from (n,2nd)

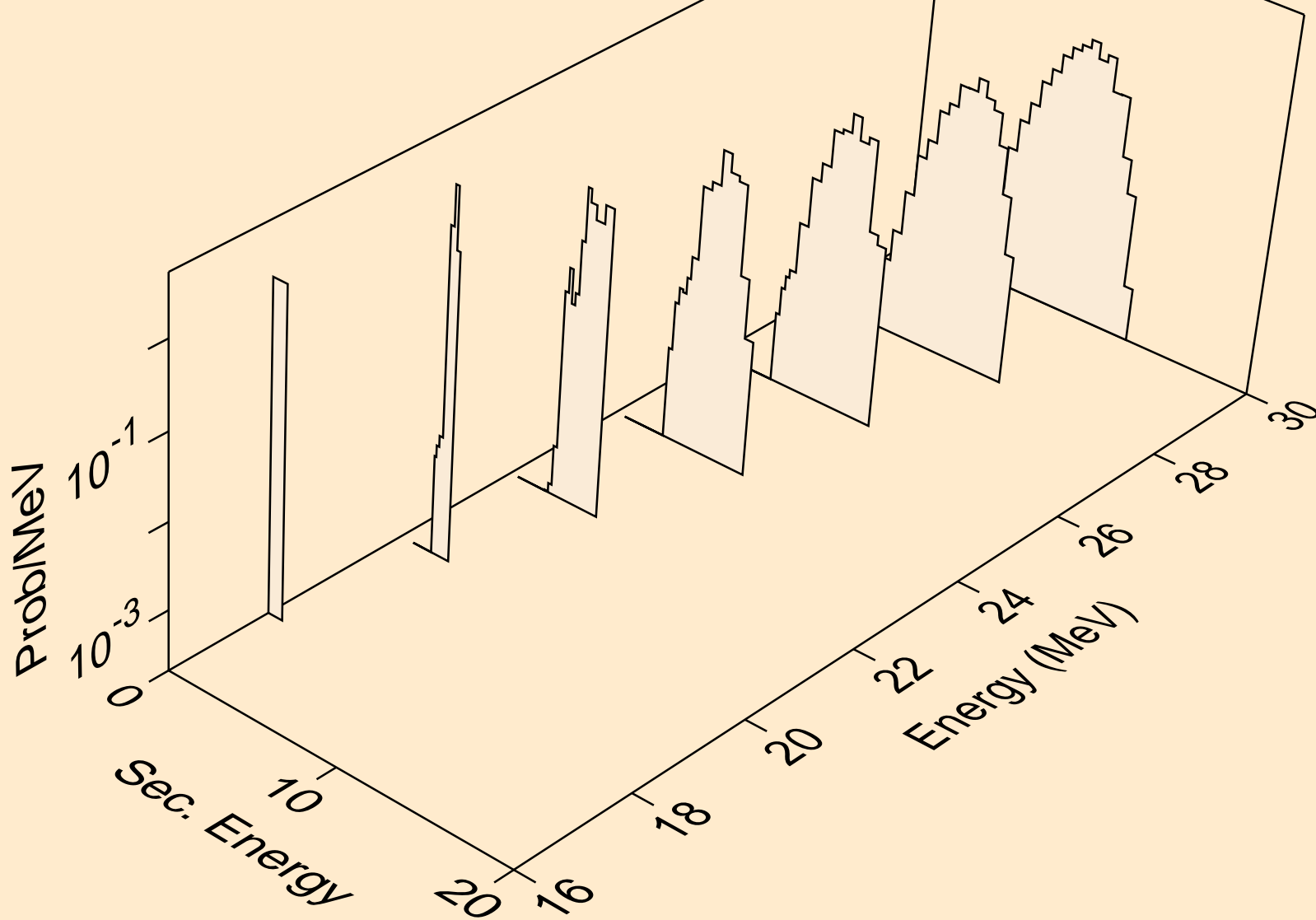

TM159 NEUTRON ACER TENDL-2019 LIBRARY; T=293.16K  
deuterons from (n,n\*)d

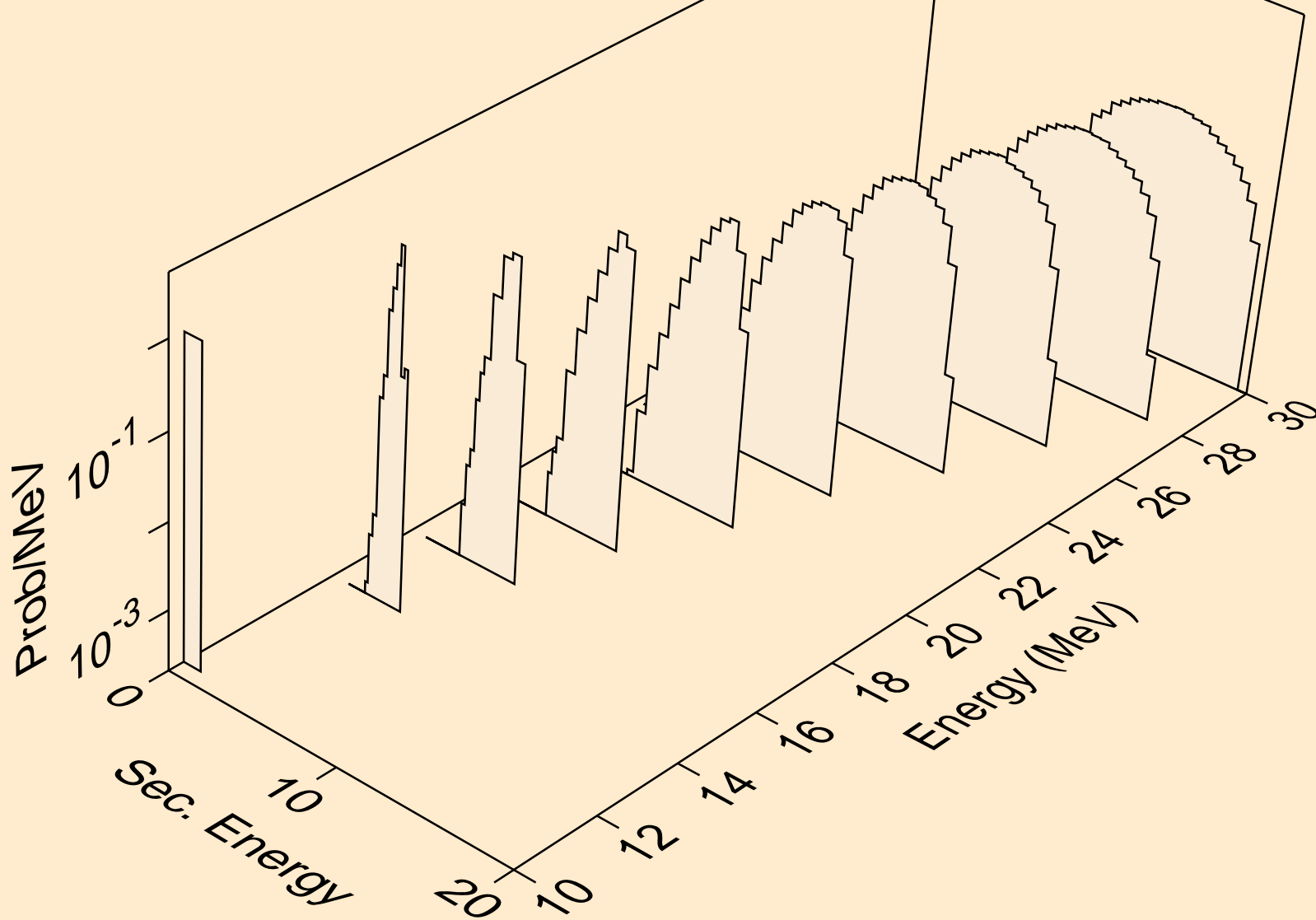



TM159 NEUTRON ACER TENDL-2019 LIBRARY; T=293.16K  
deuterons from (n,d)

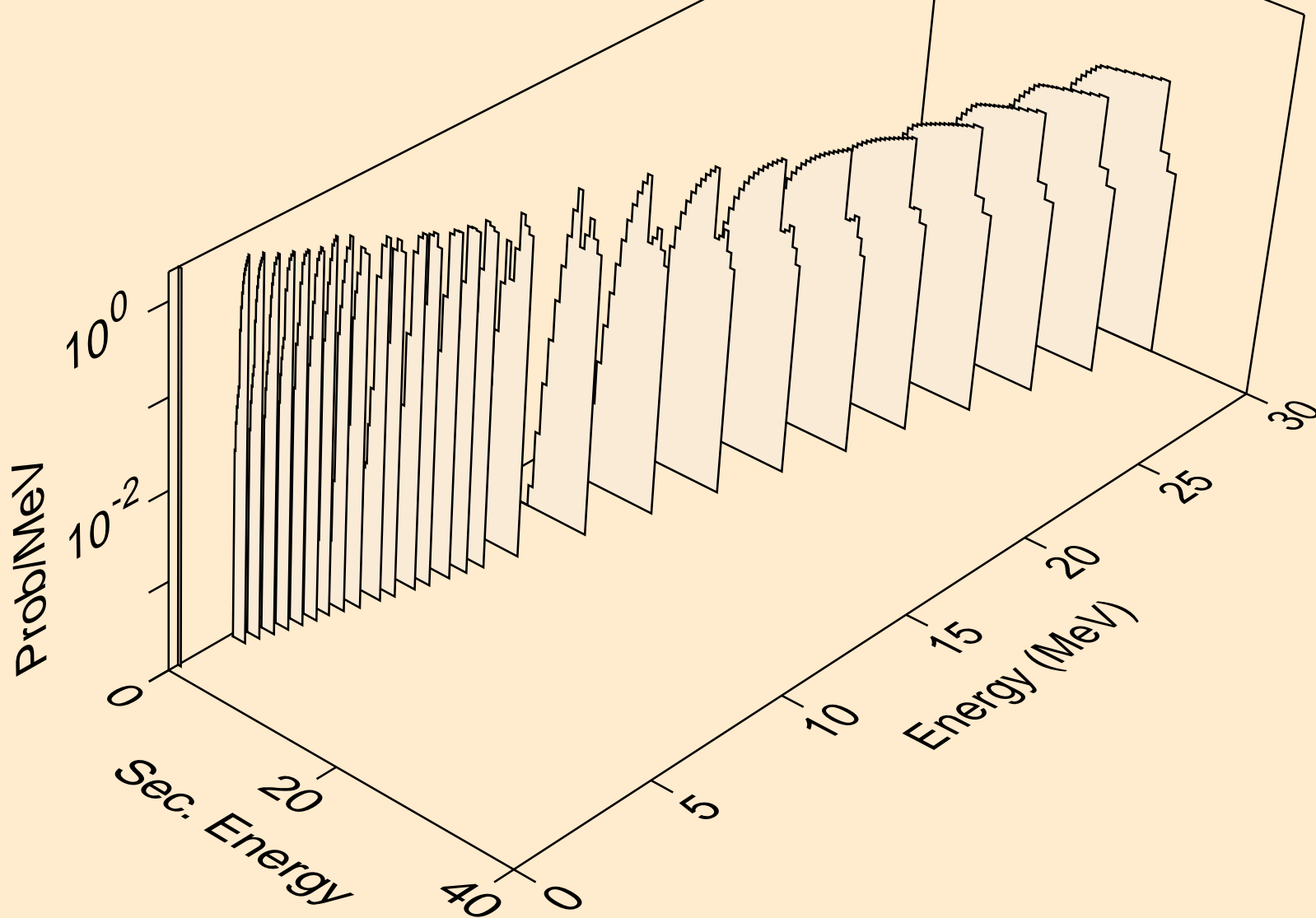

TM159 NEUTRON ACER TENDL-2019 LIBRARY; T=293.16K  
deuterons from (n,pd)

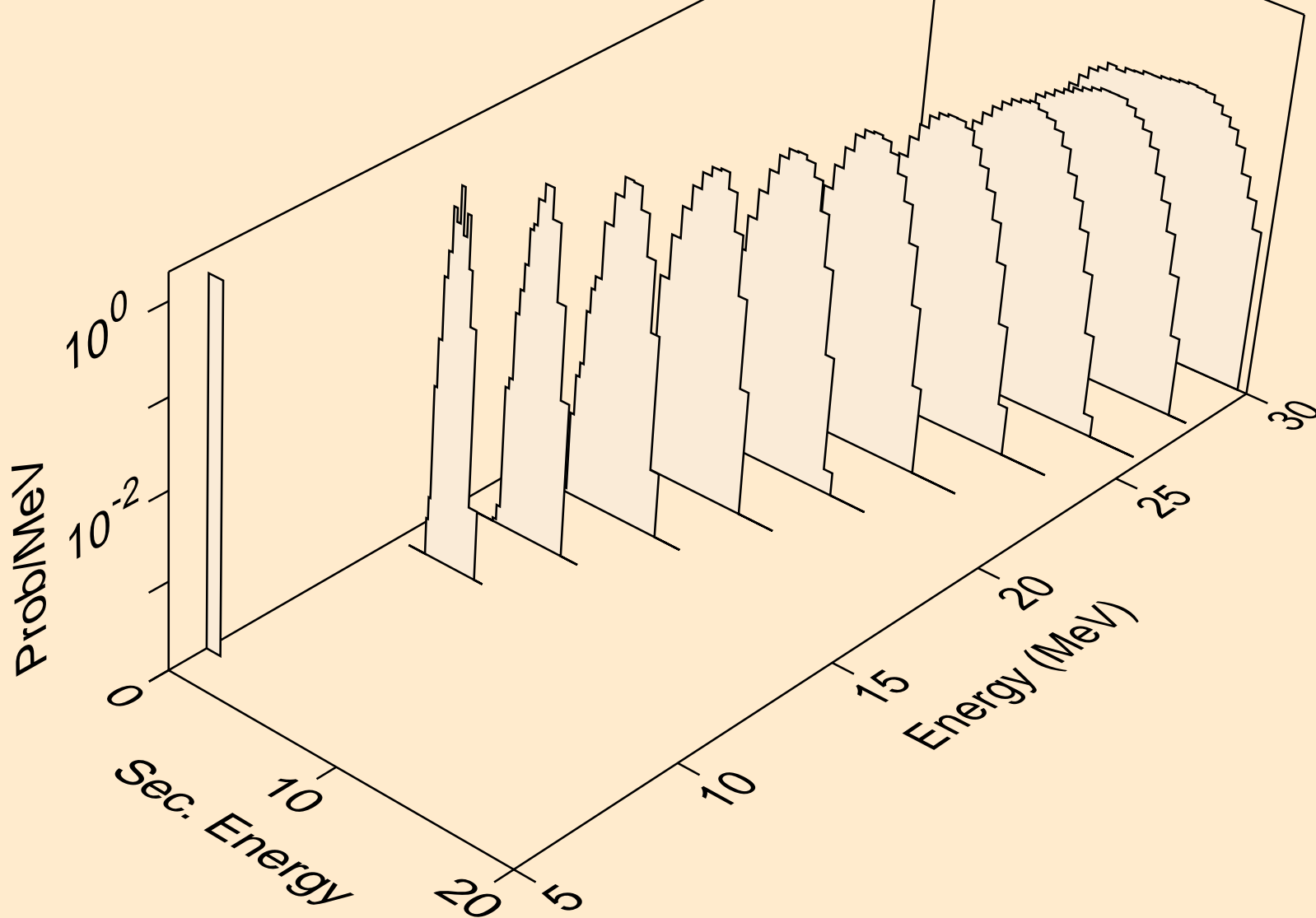

TM159 NEUTRON ACER TENDL-2019 LIBRARY; T=293.16K  
deuterons from (n,da)

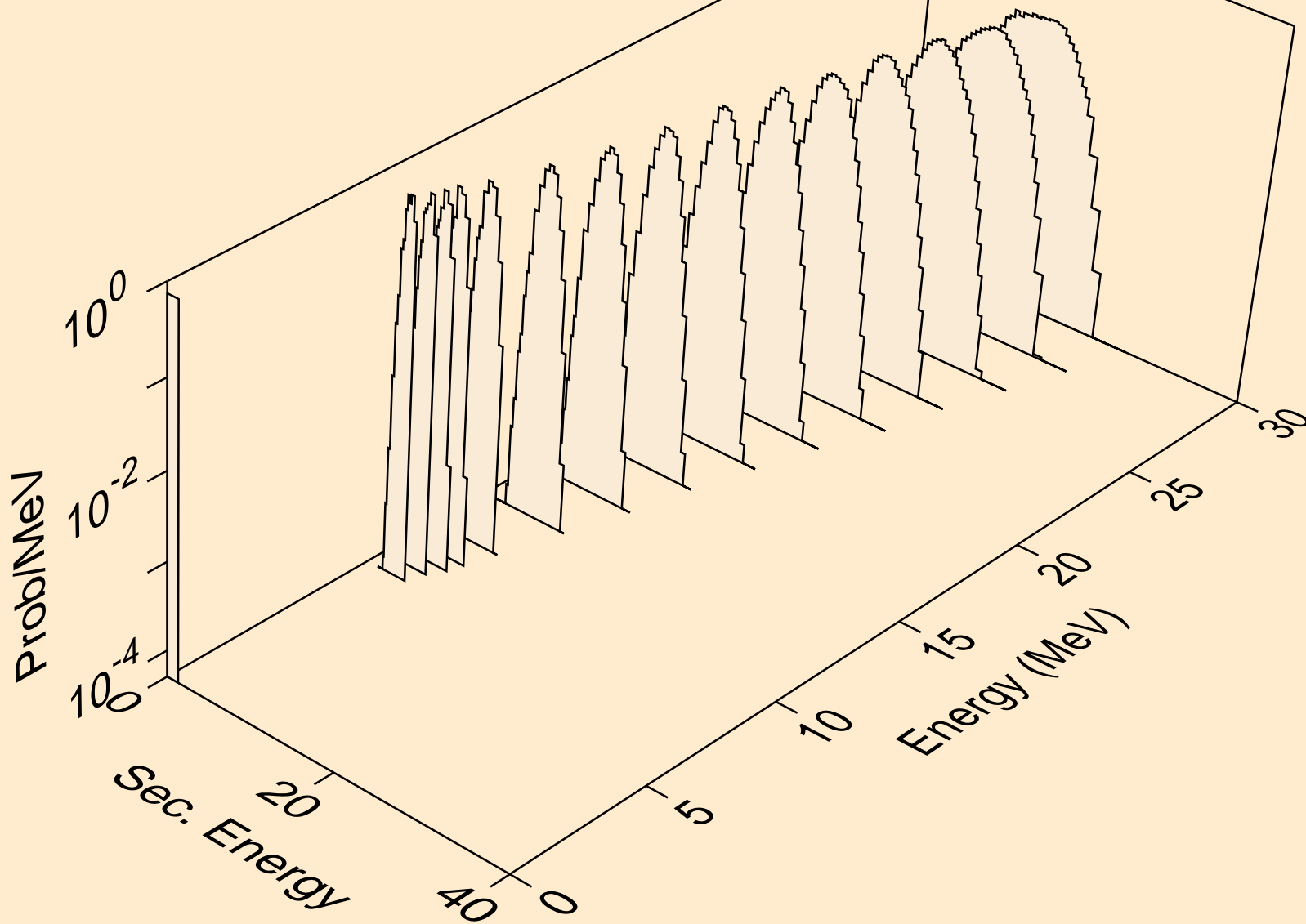

TM159 NEUTRON ACER TENDL-2019 LIBRARY; T=293.16K  
tritons from (n,x)

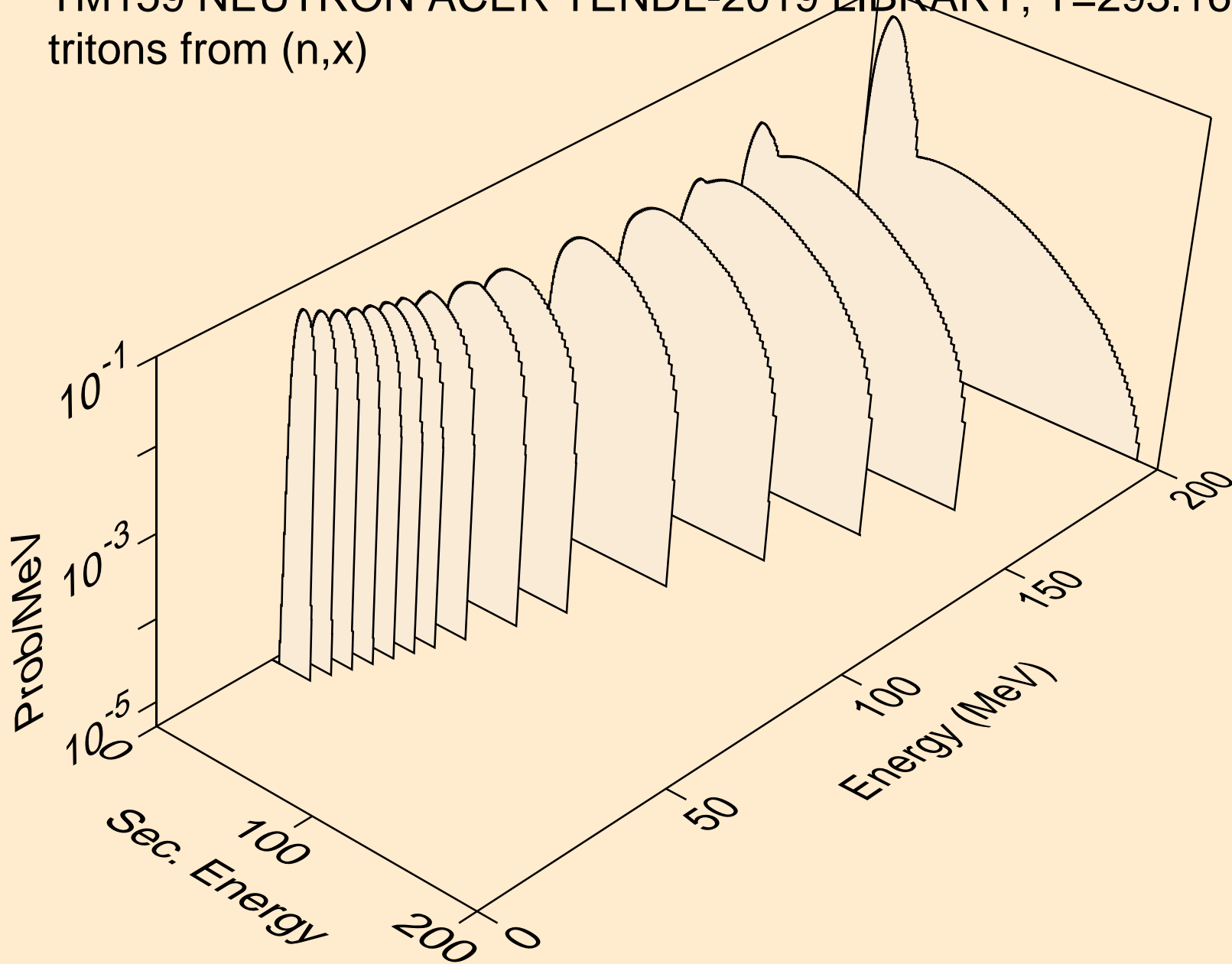

TM159 NEUTRON ACER TENDL-2019 LIBRARY; T=293.16K  
tritons from (n,n\*)t

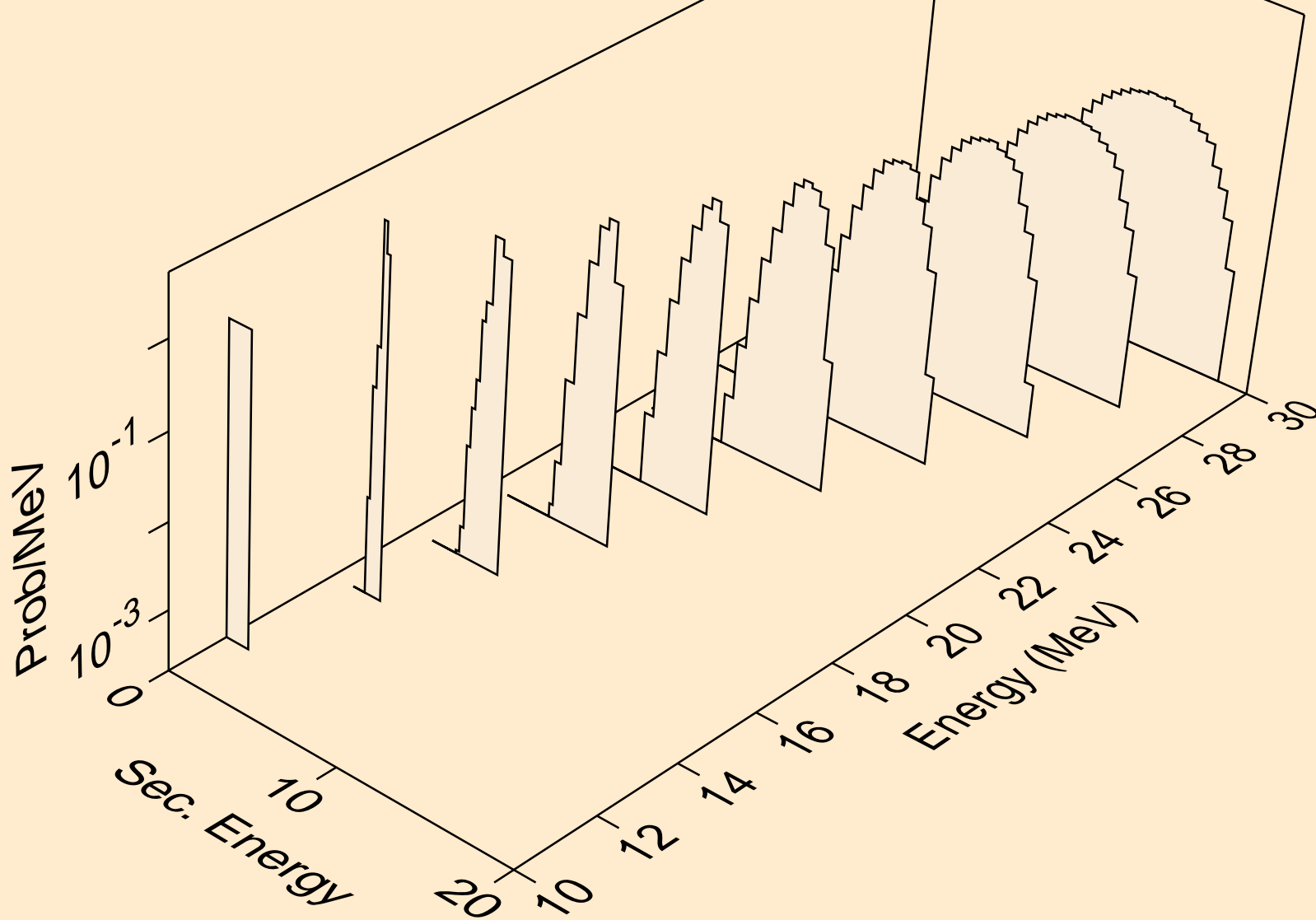

TM159 NEUTRON ACER TENDL-2019 LIBRARY; T=293.16K  
tritons from (n,t)

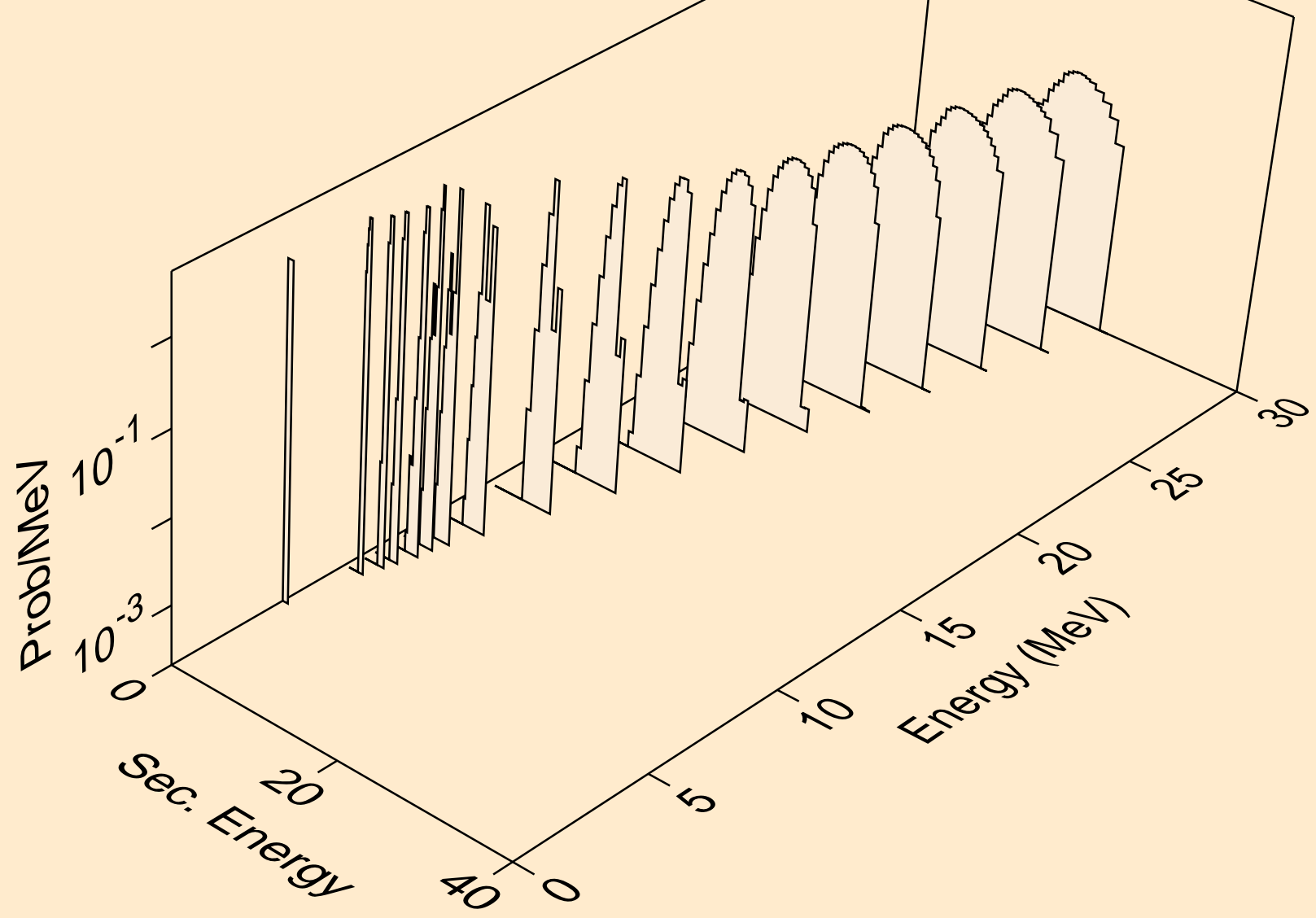

TM159 NEUTRON ACER TENDL-2019 LIBRARY; T=293.16K  
tritons from (n,pt)

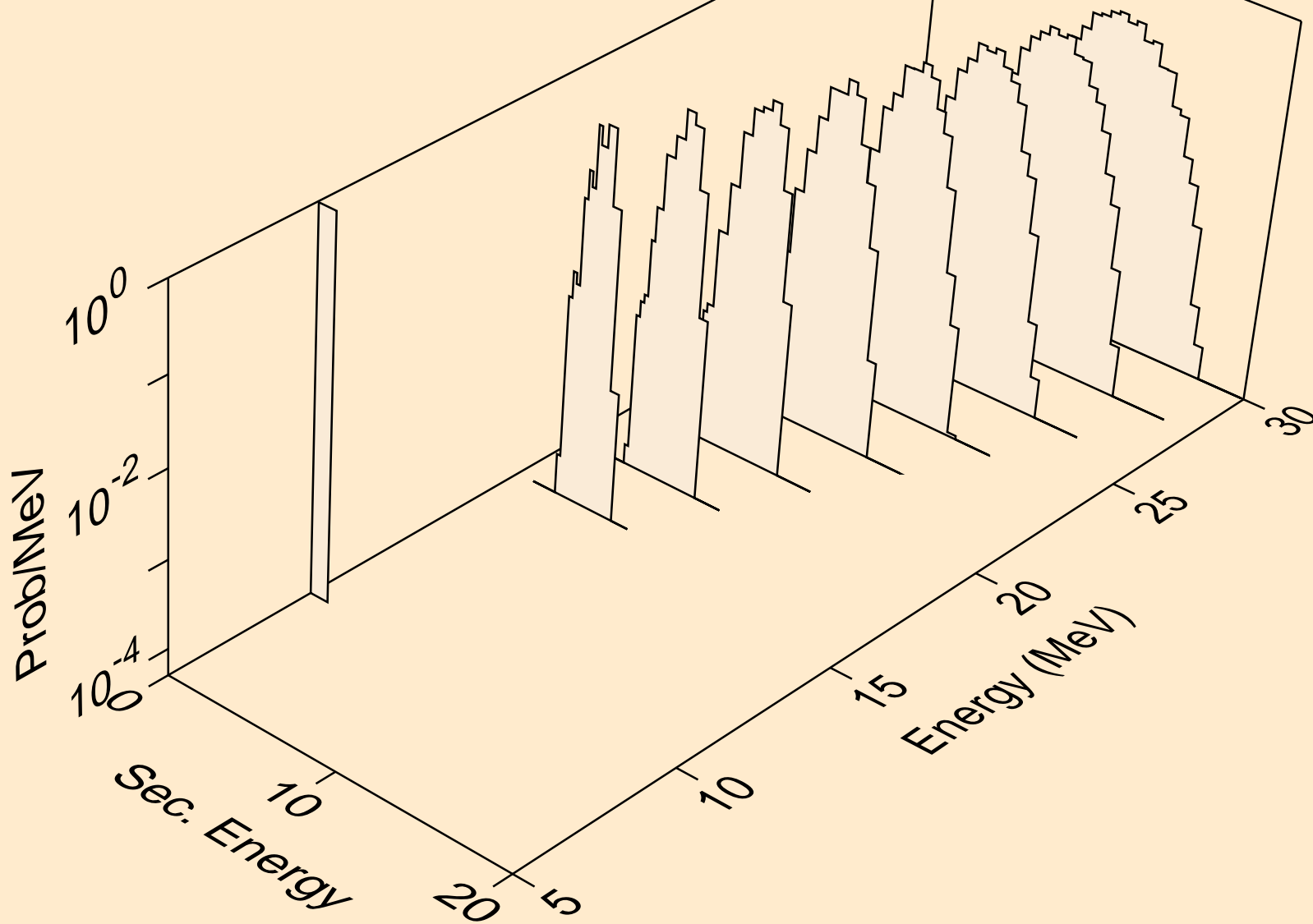

TM159 NEUTRON ACER TENDL-2019 LIBRARY; T=293.16K  
he3s from (n,x)

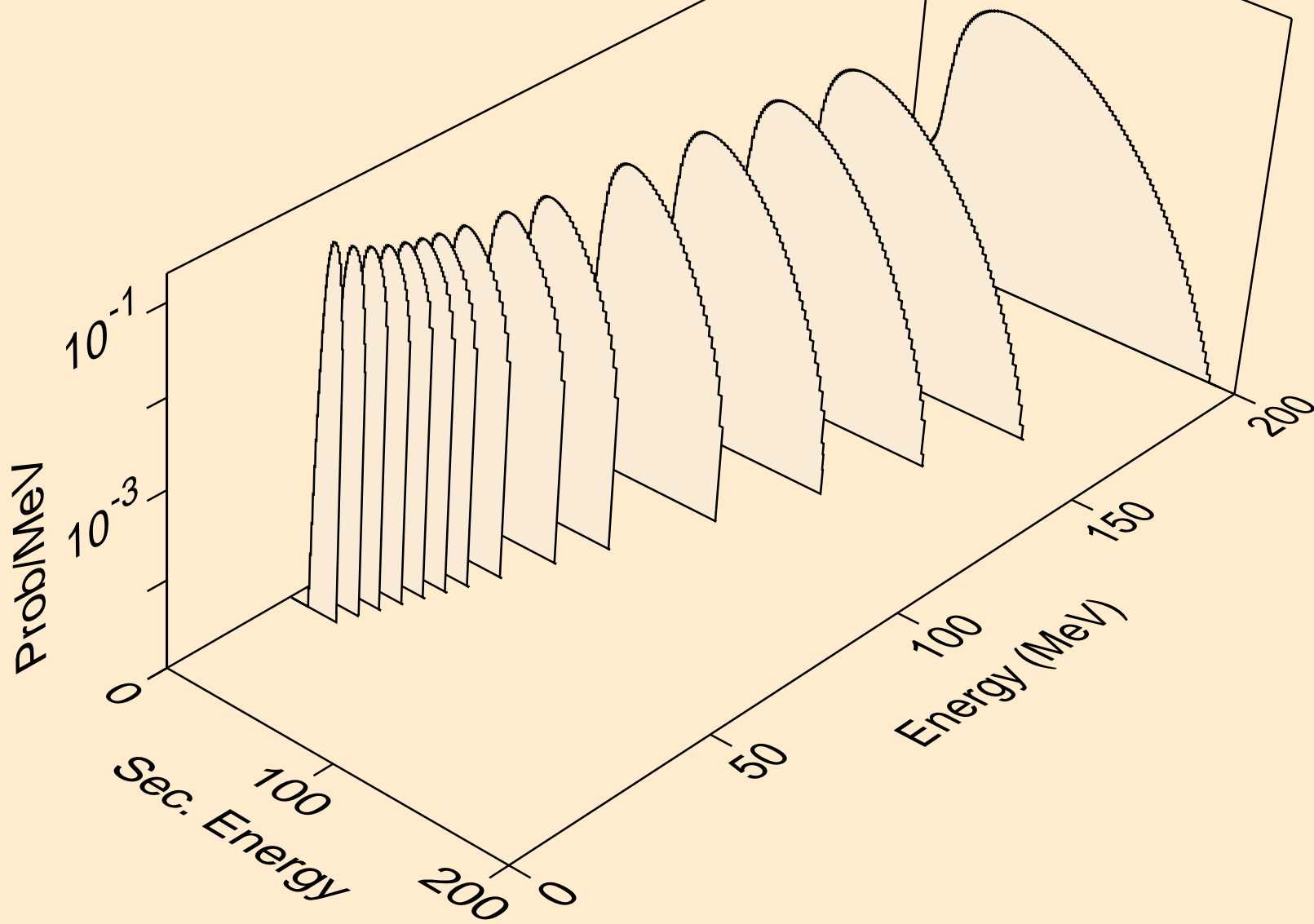



TM159 NEUTRON ACER TENDL-2019 LIBRARY; T=293.16K  
he3s from (n,n\*)he3

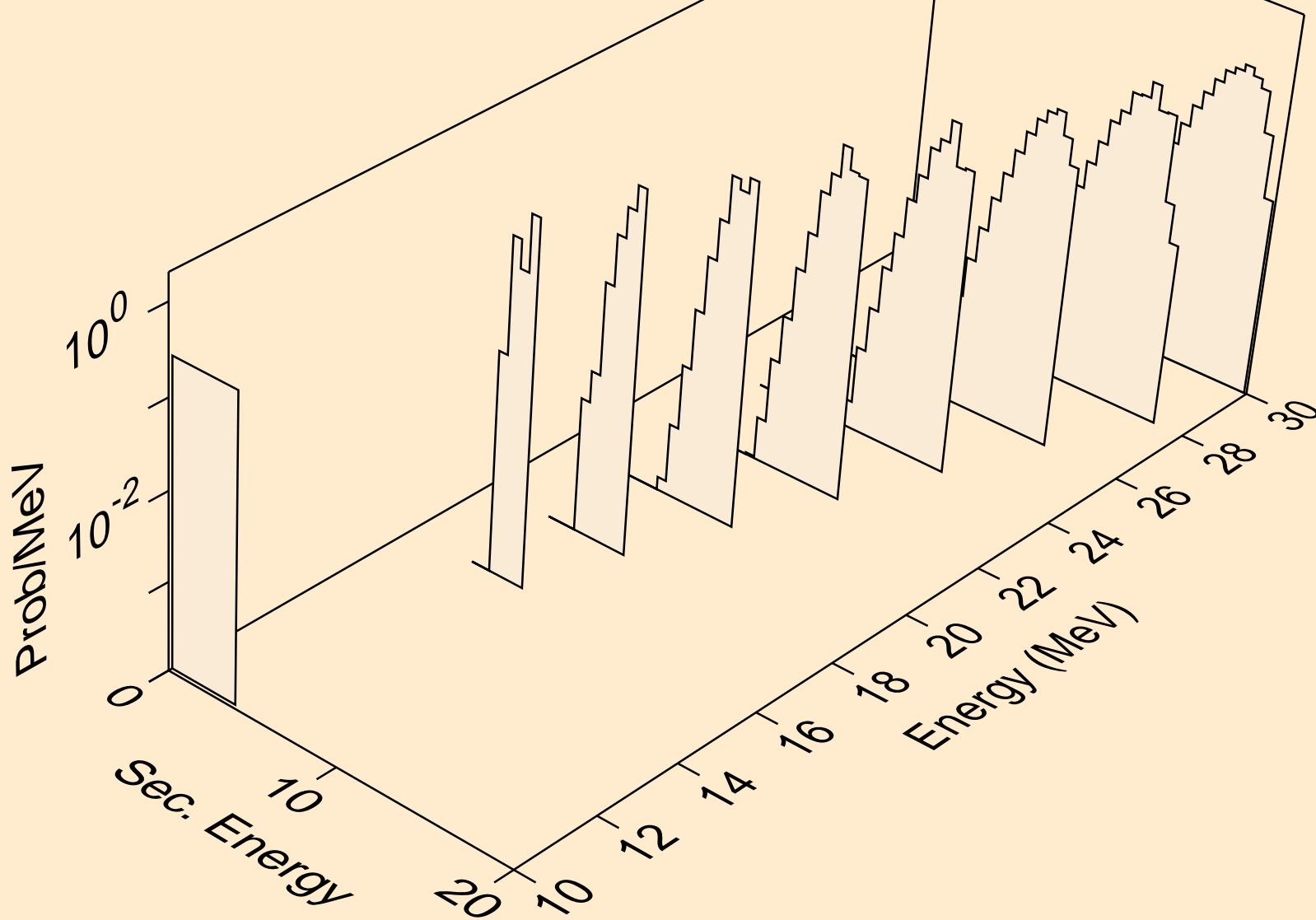

TM159 NEUTRON ACER TENDL-2019 LIBRARY; T=293.16K  
he3s from (n,he3)

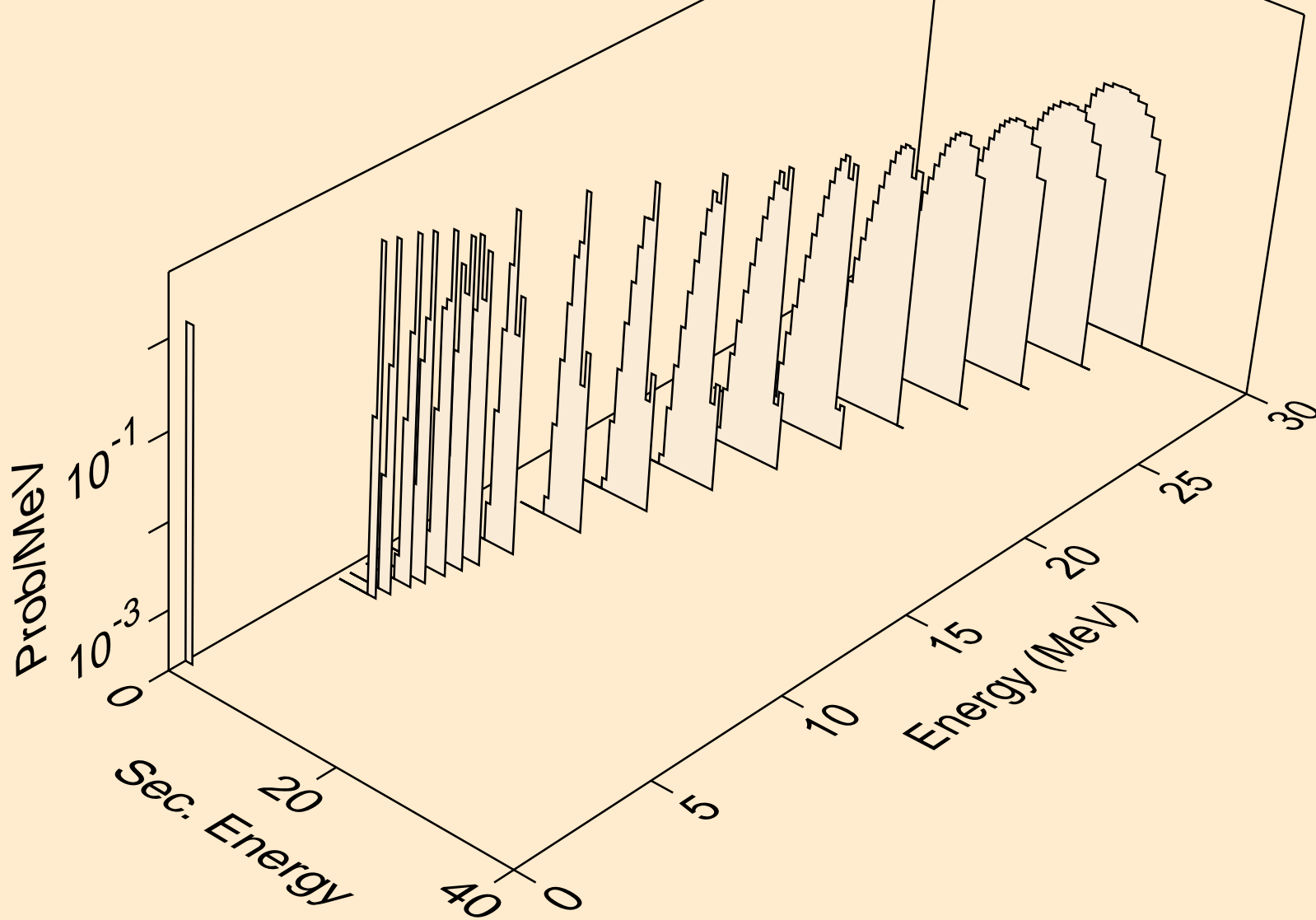

TM159 NEUTRON ACER TENDL-2019 LIBRARY; T=293.16K  
alphas from (n,x)

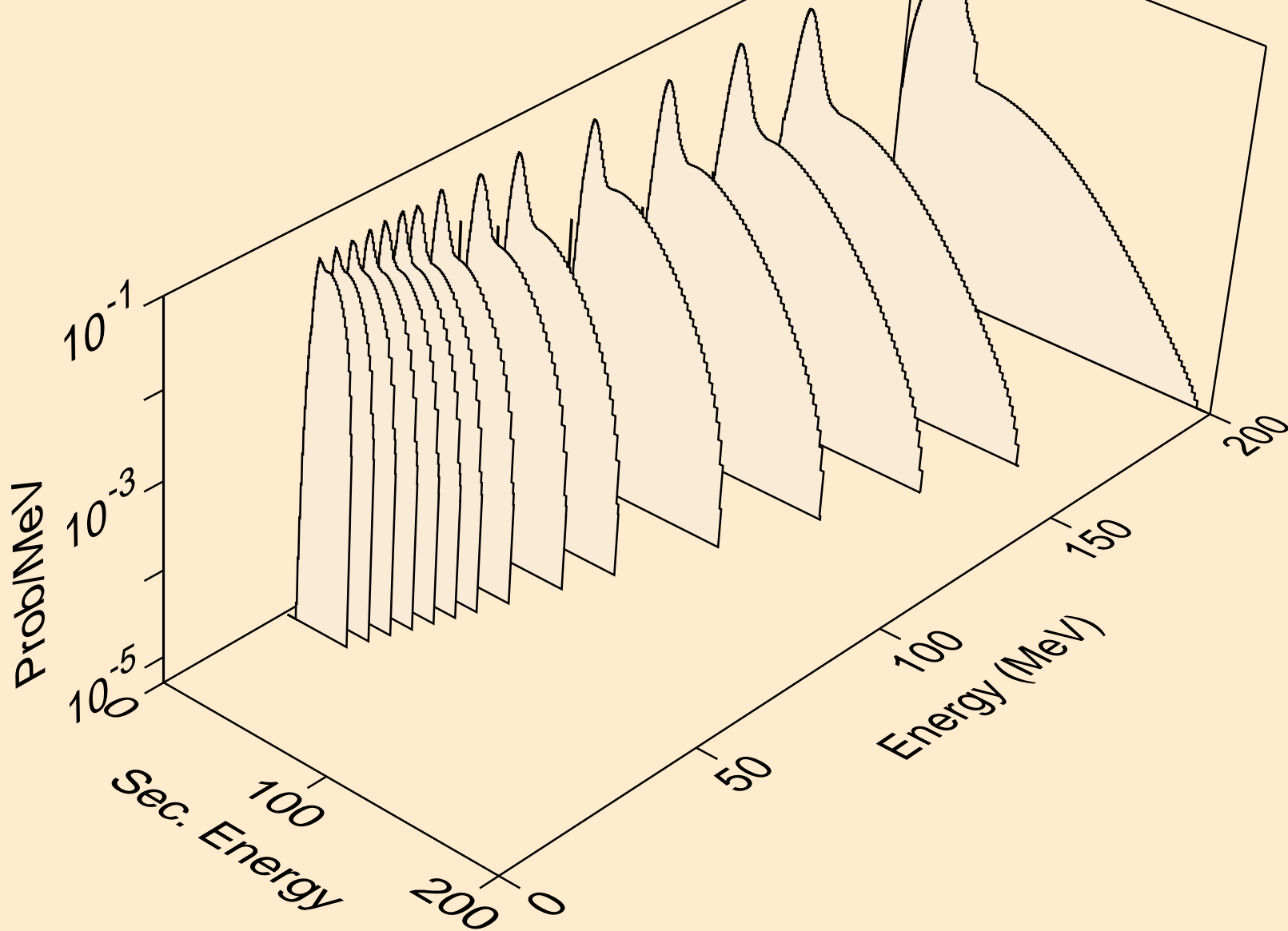

TM159 NEUTRON ACER TENDL-2019 LIBRARY; T=293.16K  
alphas from (n,n\*)a

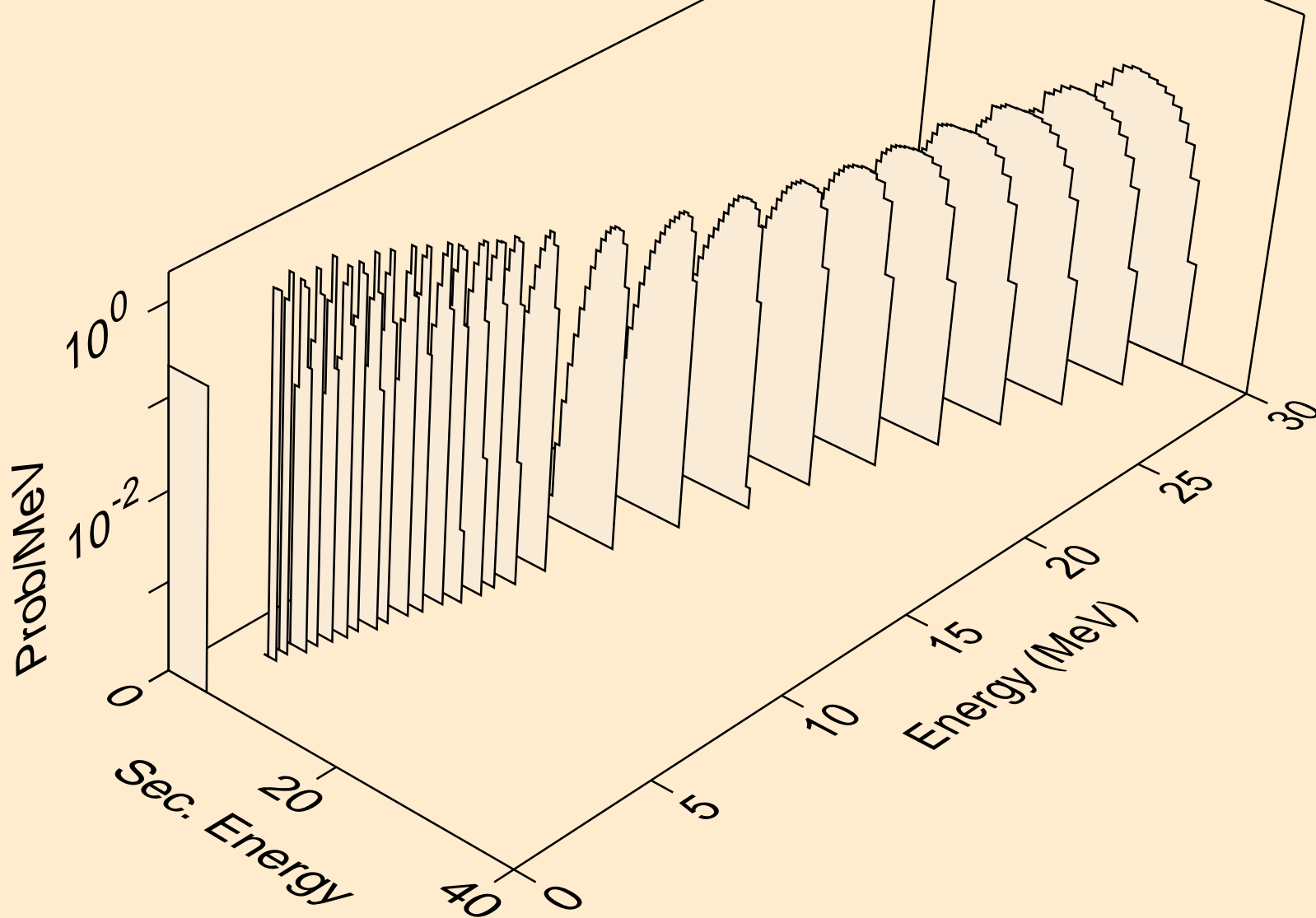

TM159 NEUTRON ACER TENDL-2019 LIBRARY; T=293.16K  
alphas from (n,2n)a

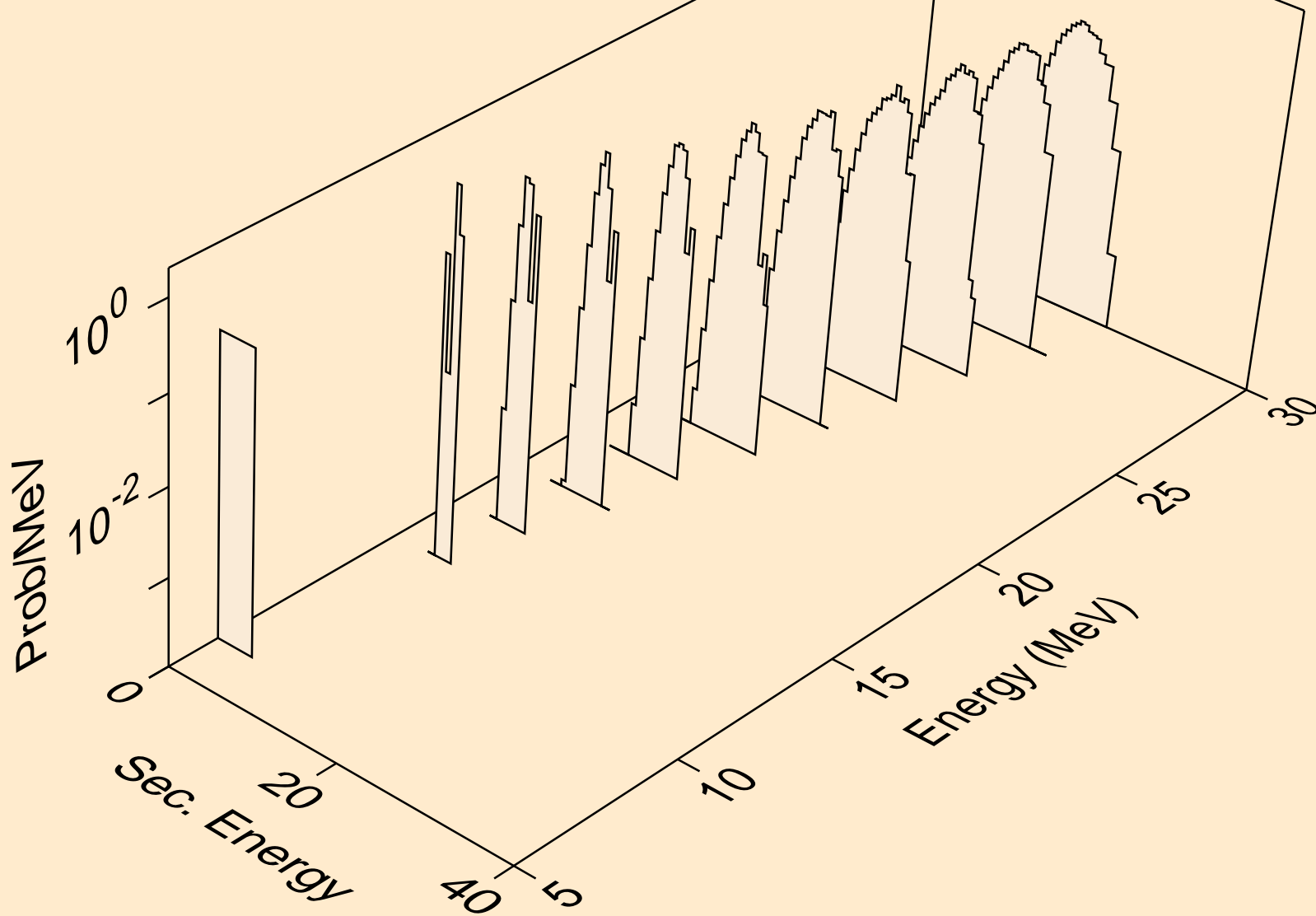

TM159 NEUTRON ACER TENDL-2019 LIBRARY; T=293.16K  
alphas from (n,3n)a

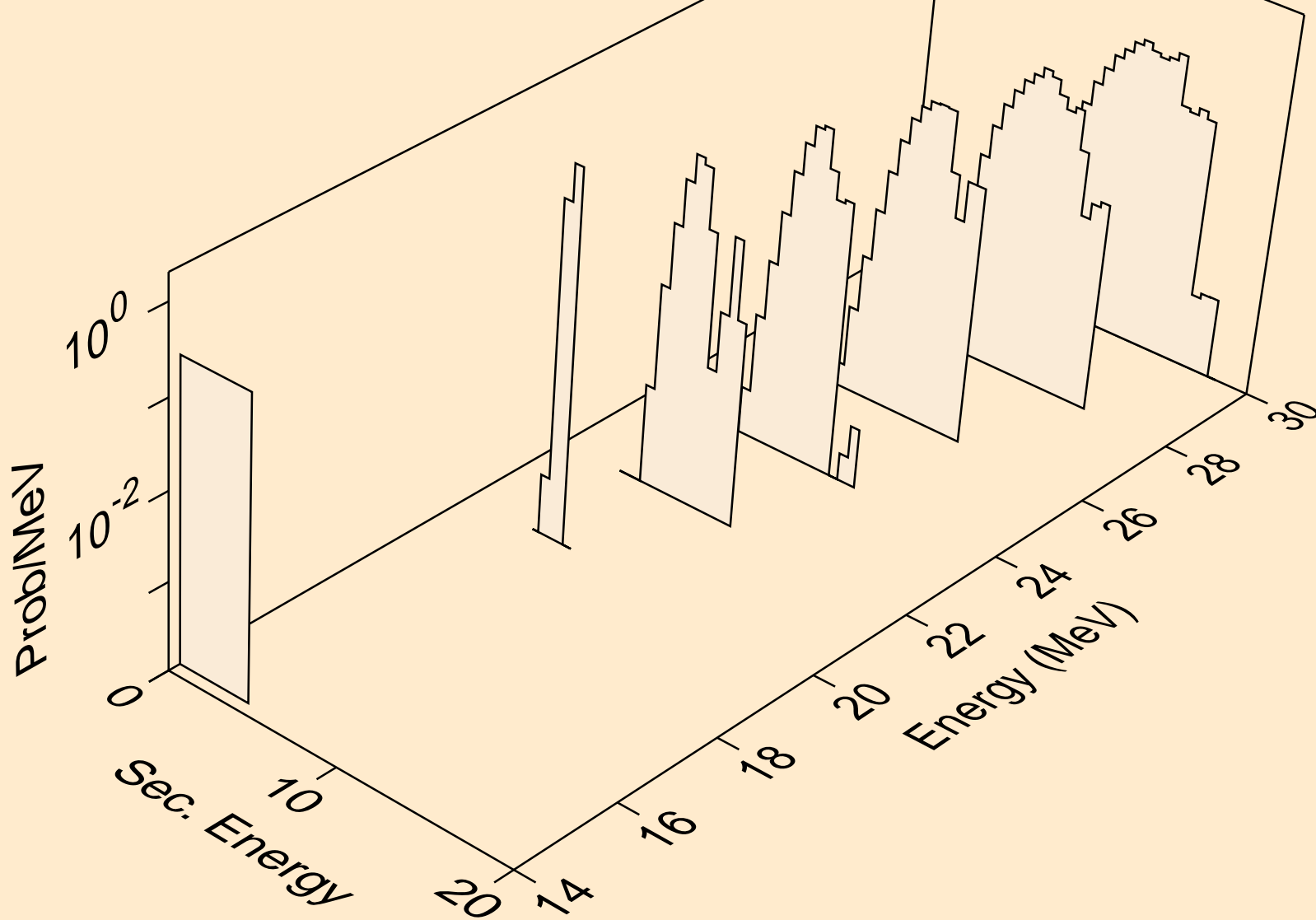

TM159 NEUTRON ACER TENDL-2019 LIBRARY; T=293.16K  
alphas from (n,n\*)2a

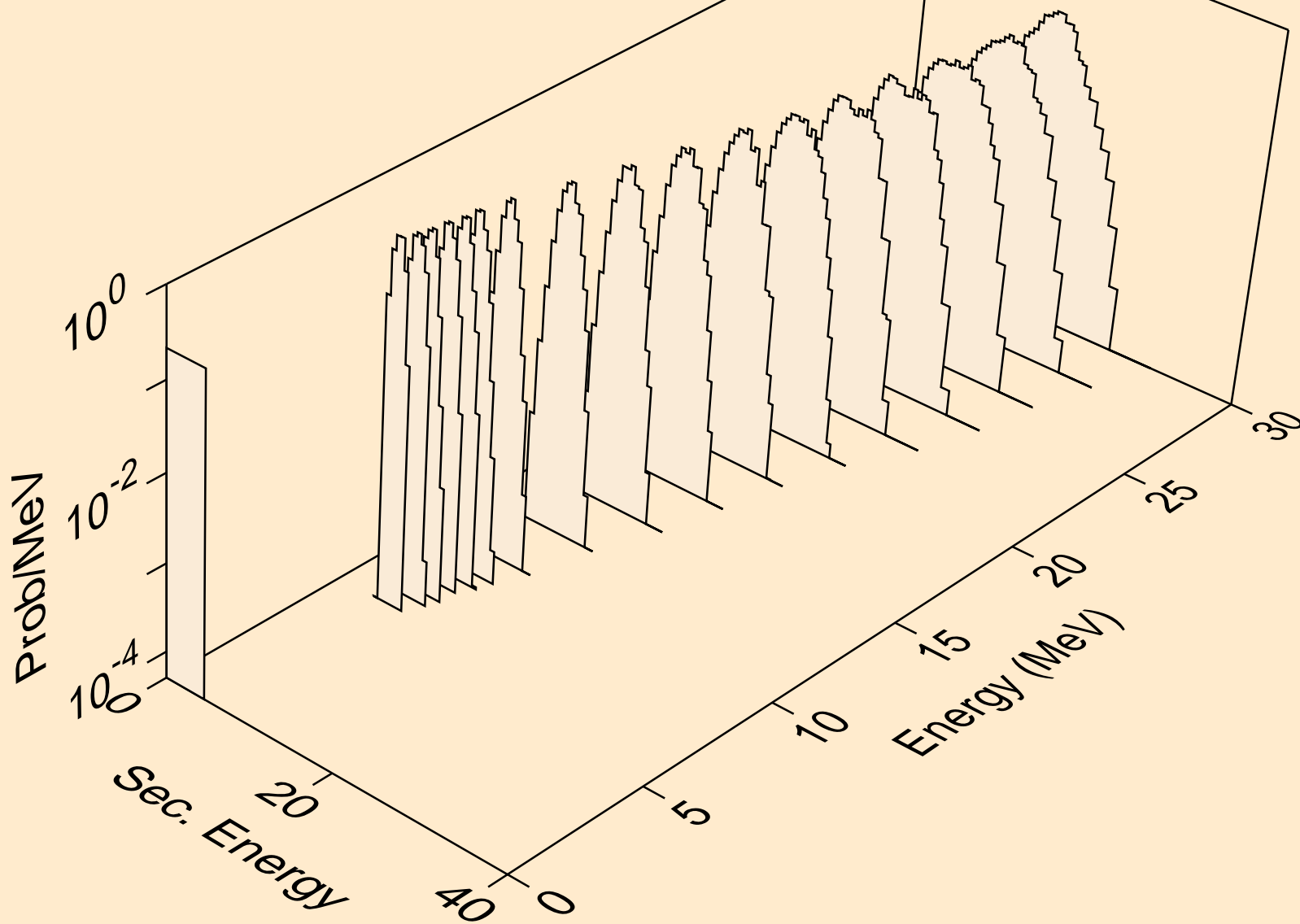

TM159 NEUTRON ACER TENDL-2019 LIBRARY; T=293.16K  
alphas from (n,2n)2a

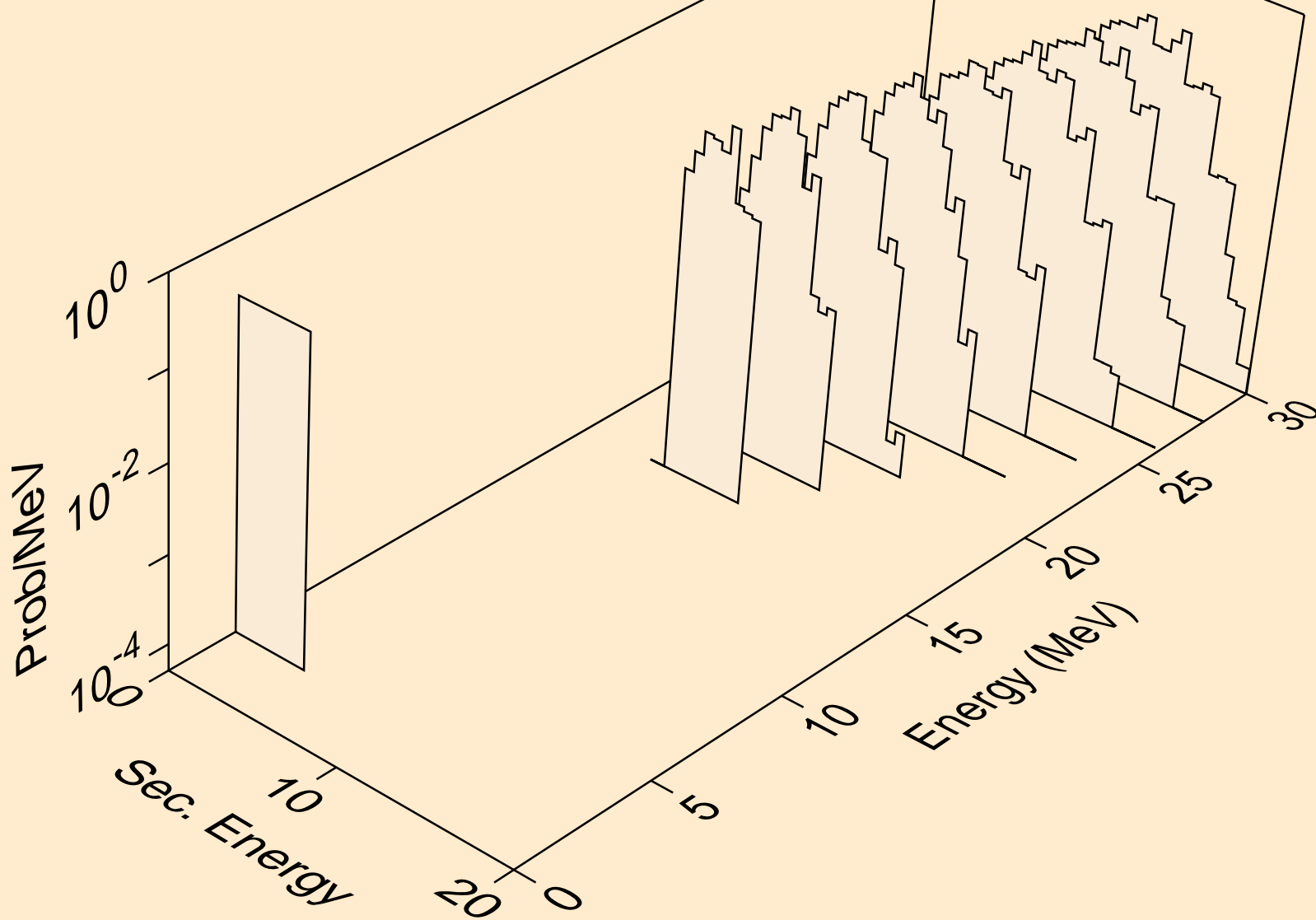



TM159 NEUTRON ACER TENDL-2019 LIBRARY; T=293.16K  
alphas from (n,npa)

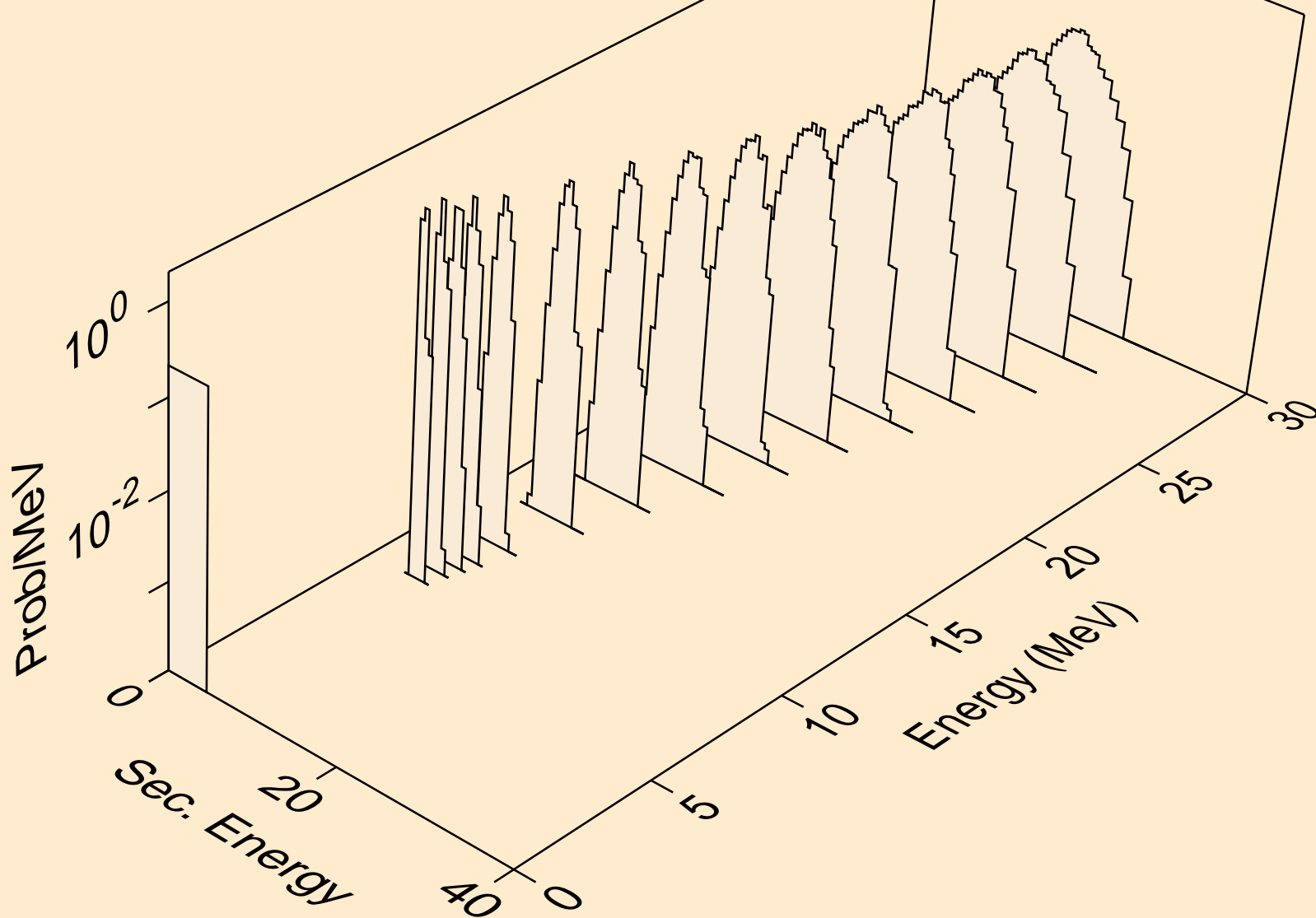

TM159 NEUTRON ACER TENDL-2019 LIBRARY; T=293.16K  
alphas from (n,a)

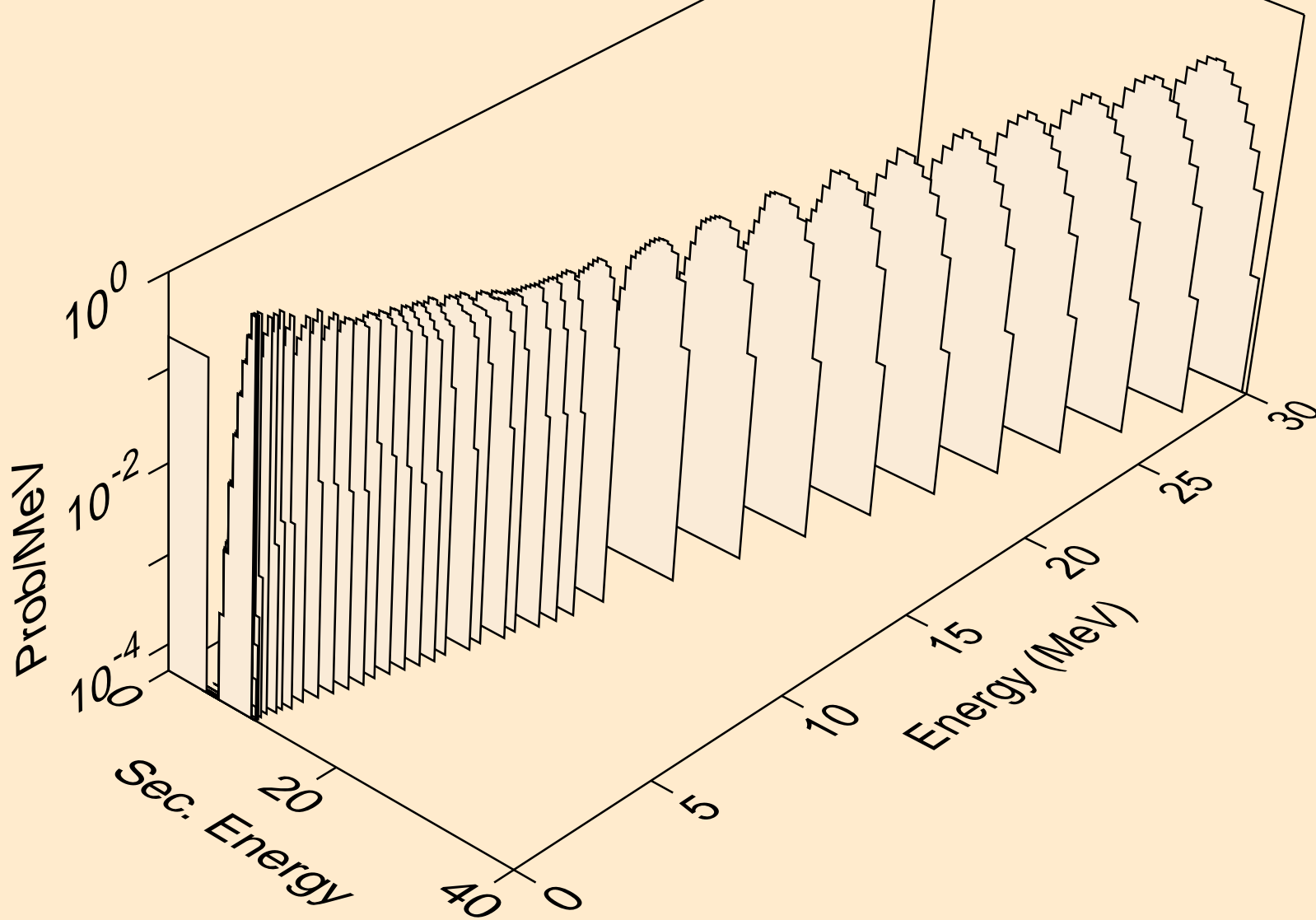

TM159 NEUTRON ACER TENDL-2019 LIBRARY; T=293.16K  
alphas from (n,2a)

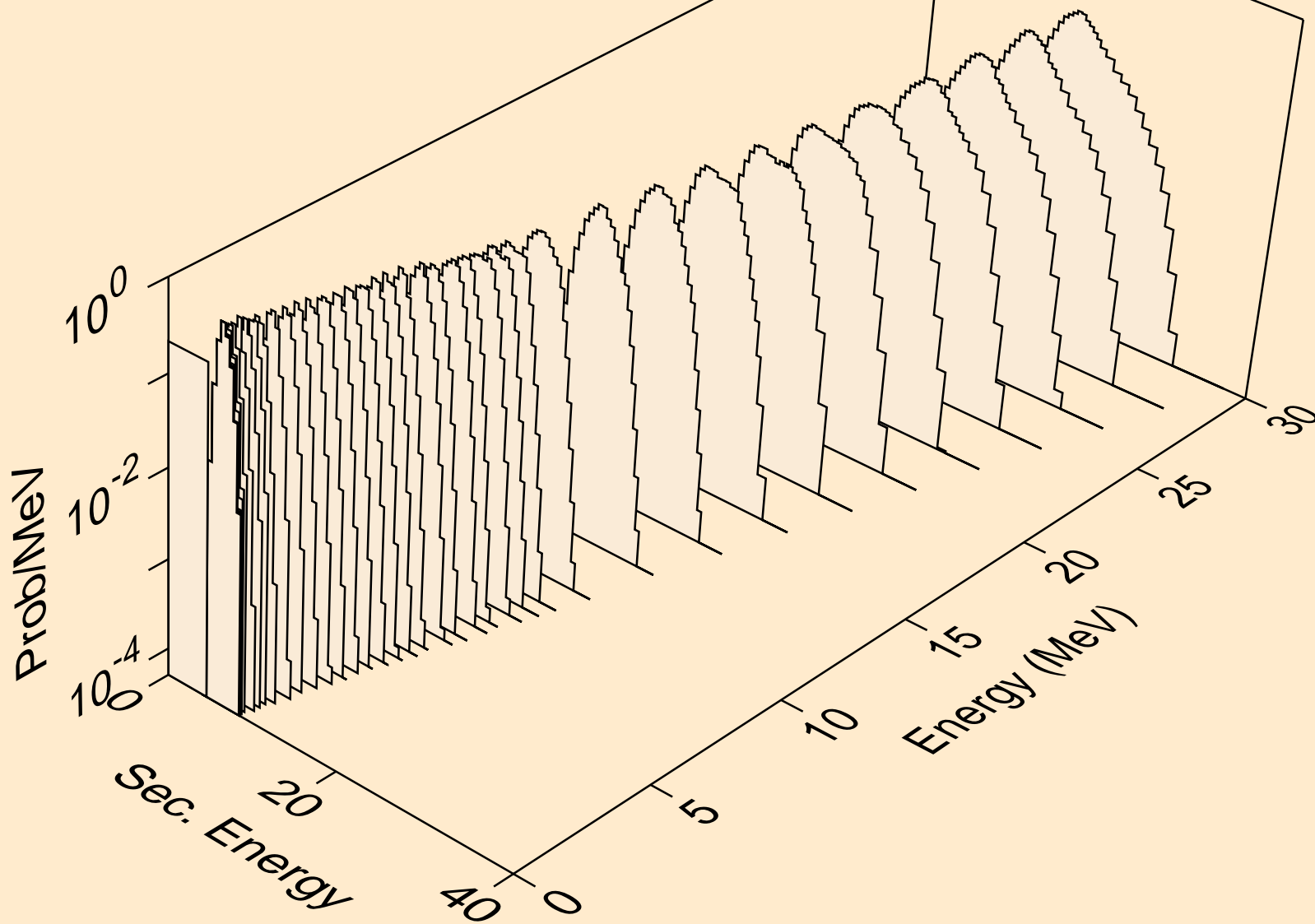

TM159 NEUTRON ACER TENDL-2019 LIBRARY; T=293.16K  
alphas from (n,pa)

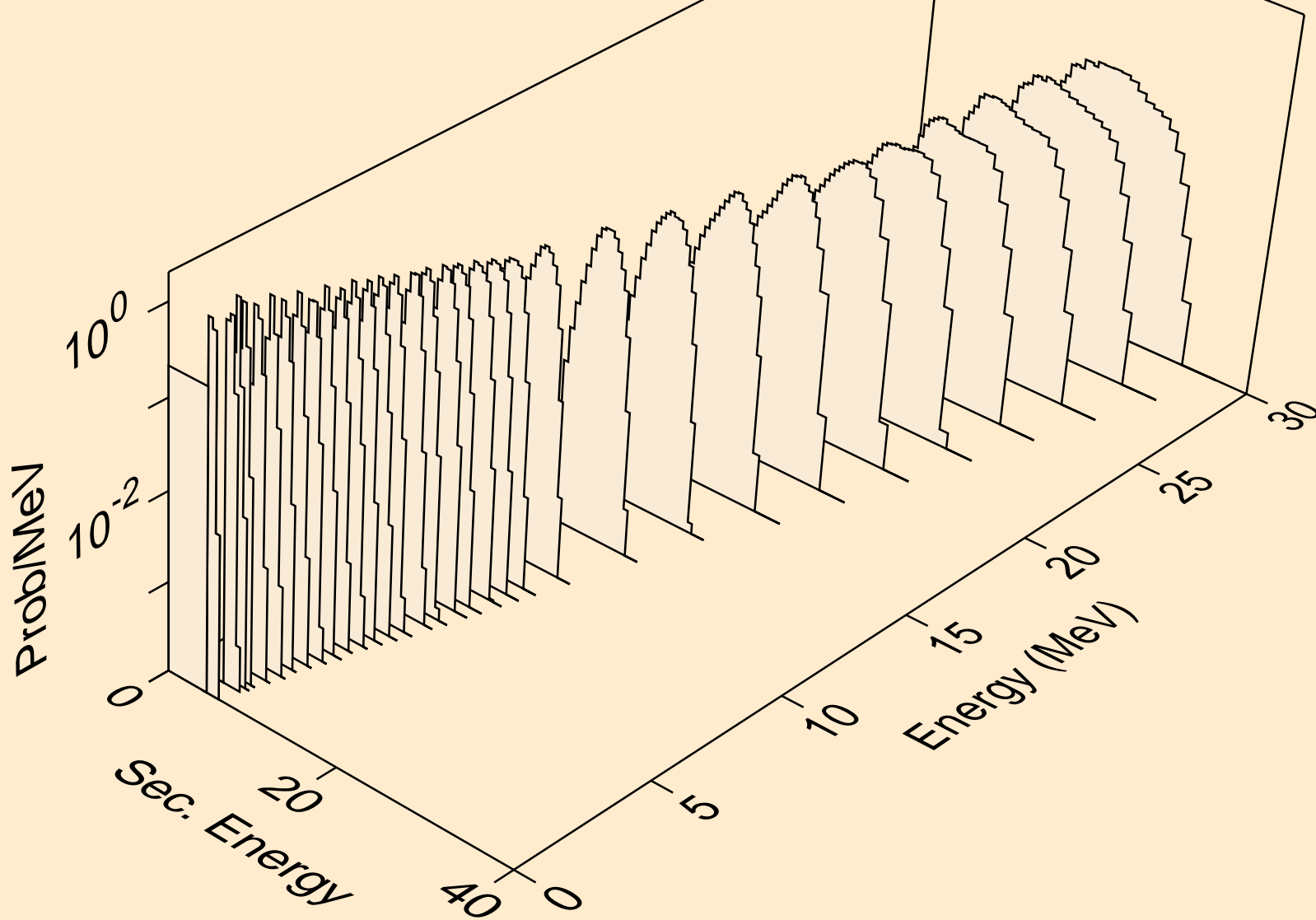

TM159 NEUTRON ACER TENDL-2019 LIBRARY; T=293.16K  
alphas from (n,da)

