

TM162 NEUTRON ACER TENDL-2019 LIBRARY; T=293.16K
Principal cross sections

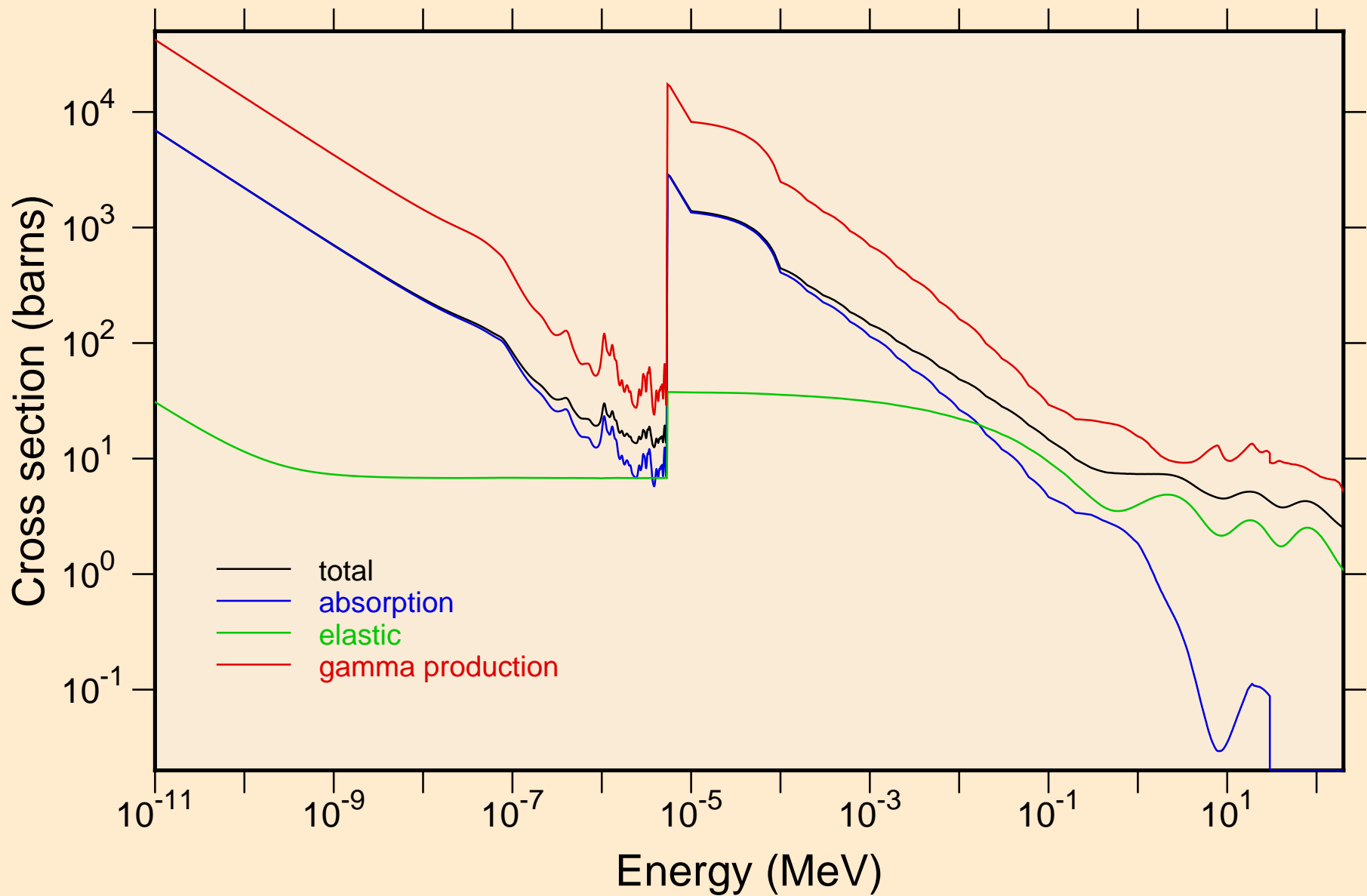

TM162 NEUTRON ACER TENDL-2019 LIBRARY; T=293.16K
resonance total cross section

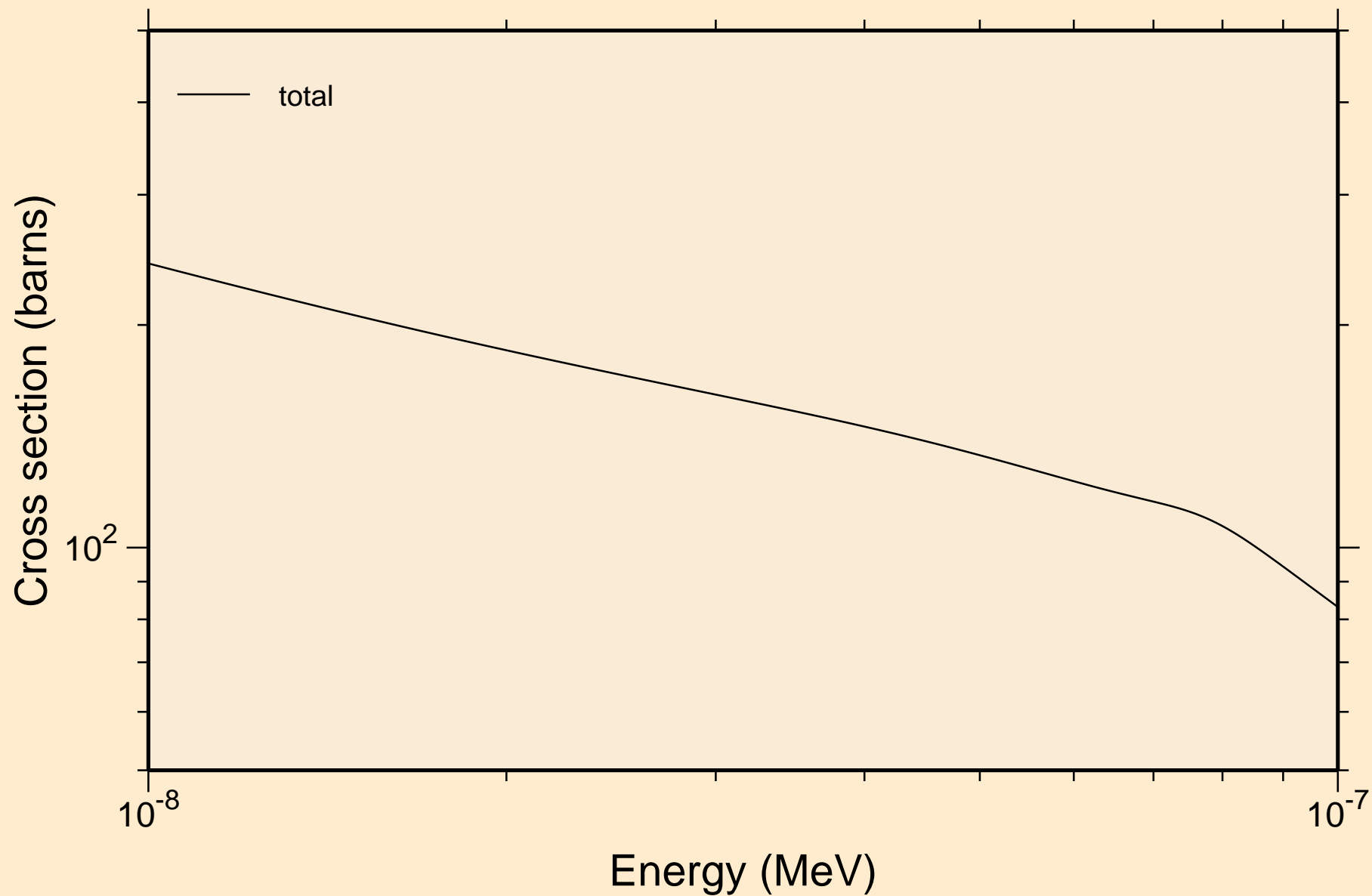

TM162 NEUTRON ACER TENDL-2019 LIBRARY; T=293.16K
resonance total cross section

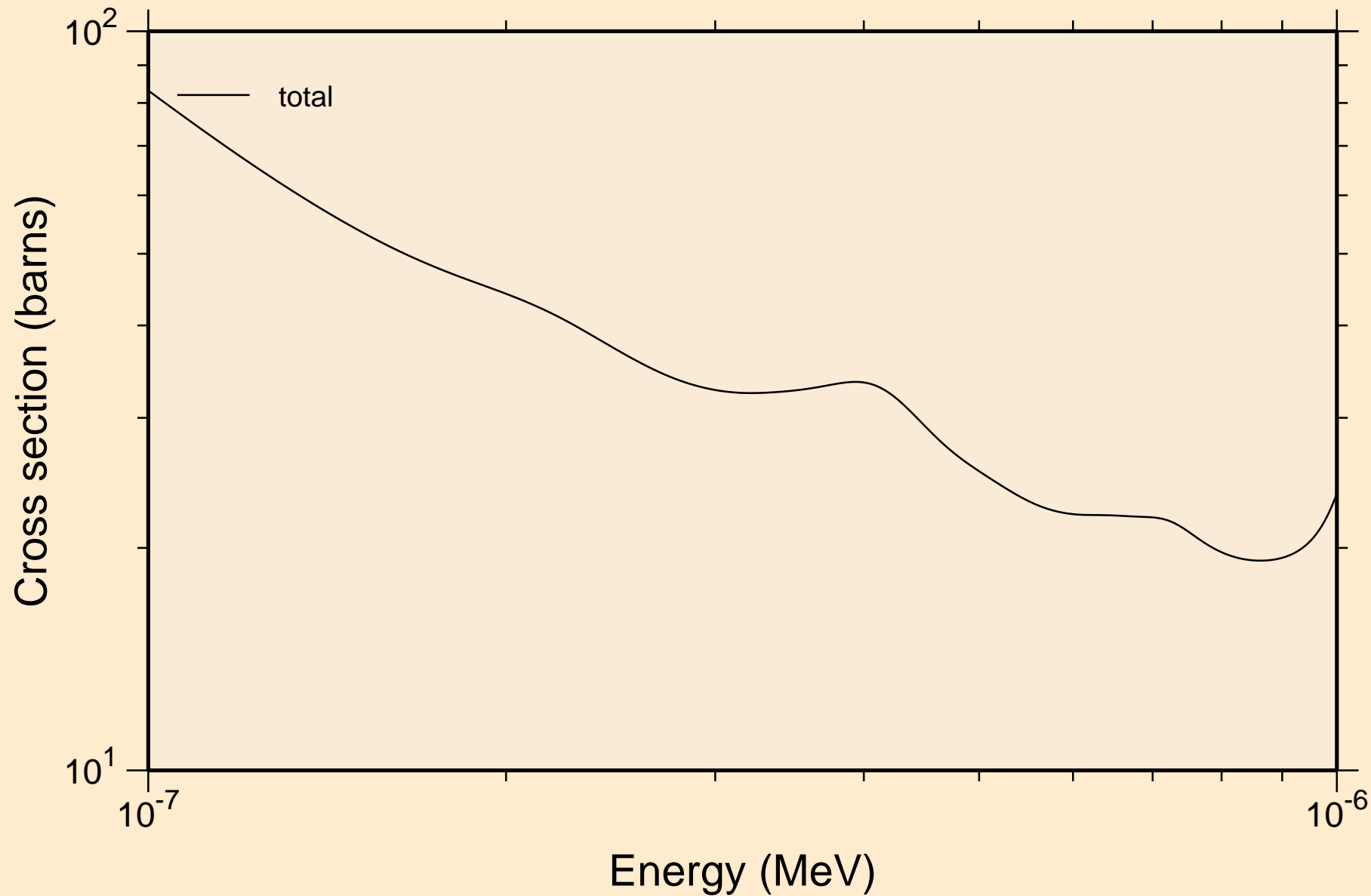

TM162 NEUTRON ACER TENDL-2019 LIBRARY; T=293.16K
resonance total cross section

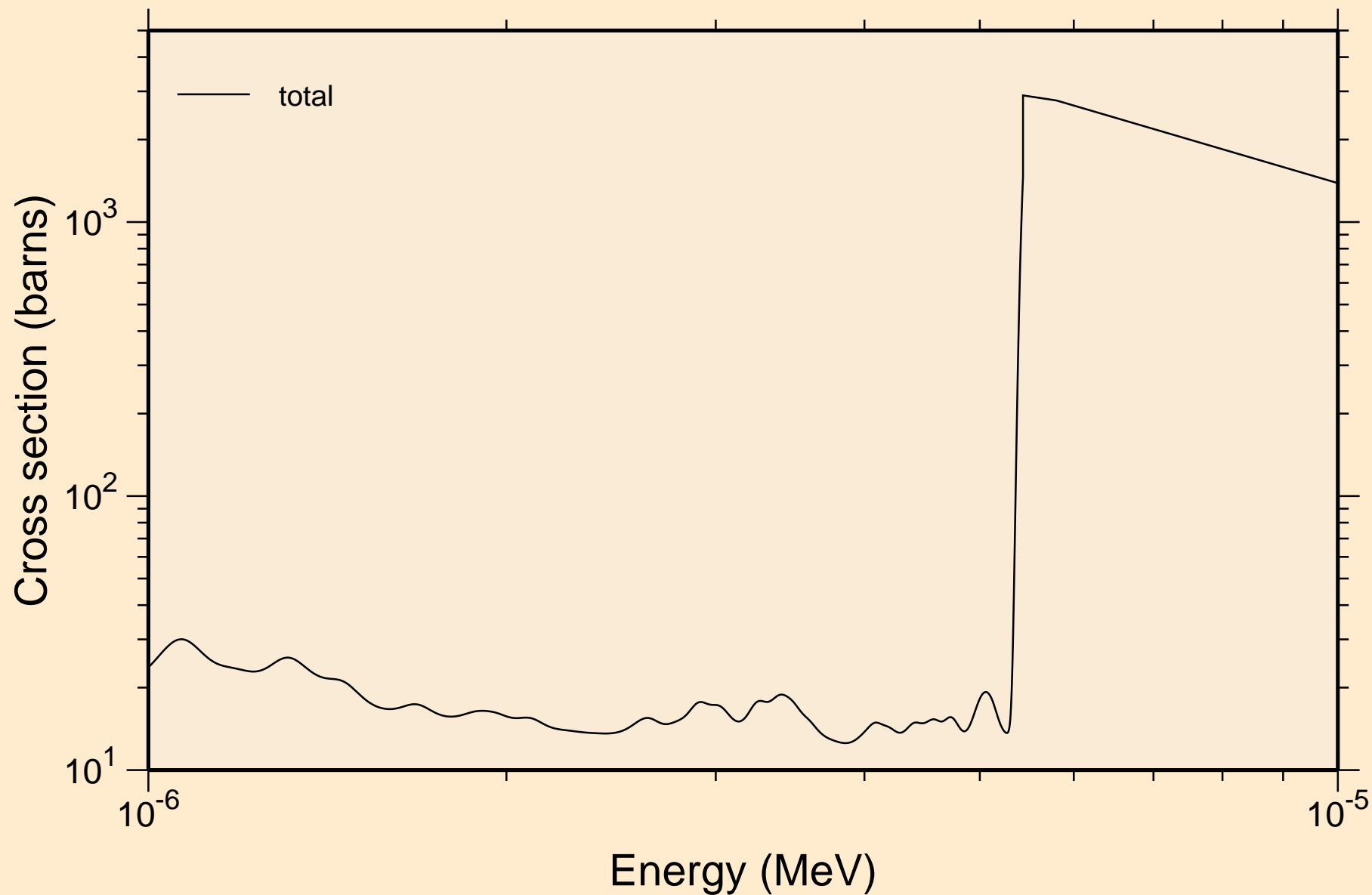

TM162 NEUTRON ACER TENDL-2019 LIBRARY; T=293.16K
resonance total cross section

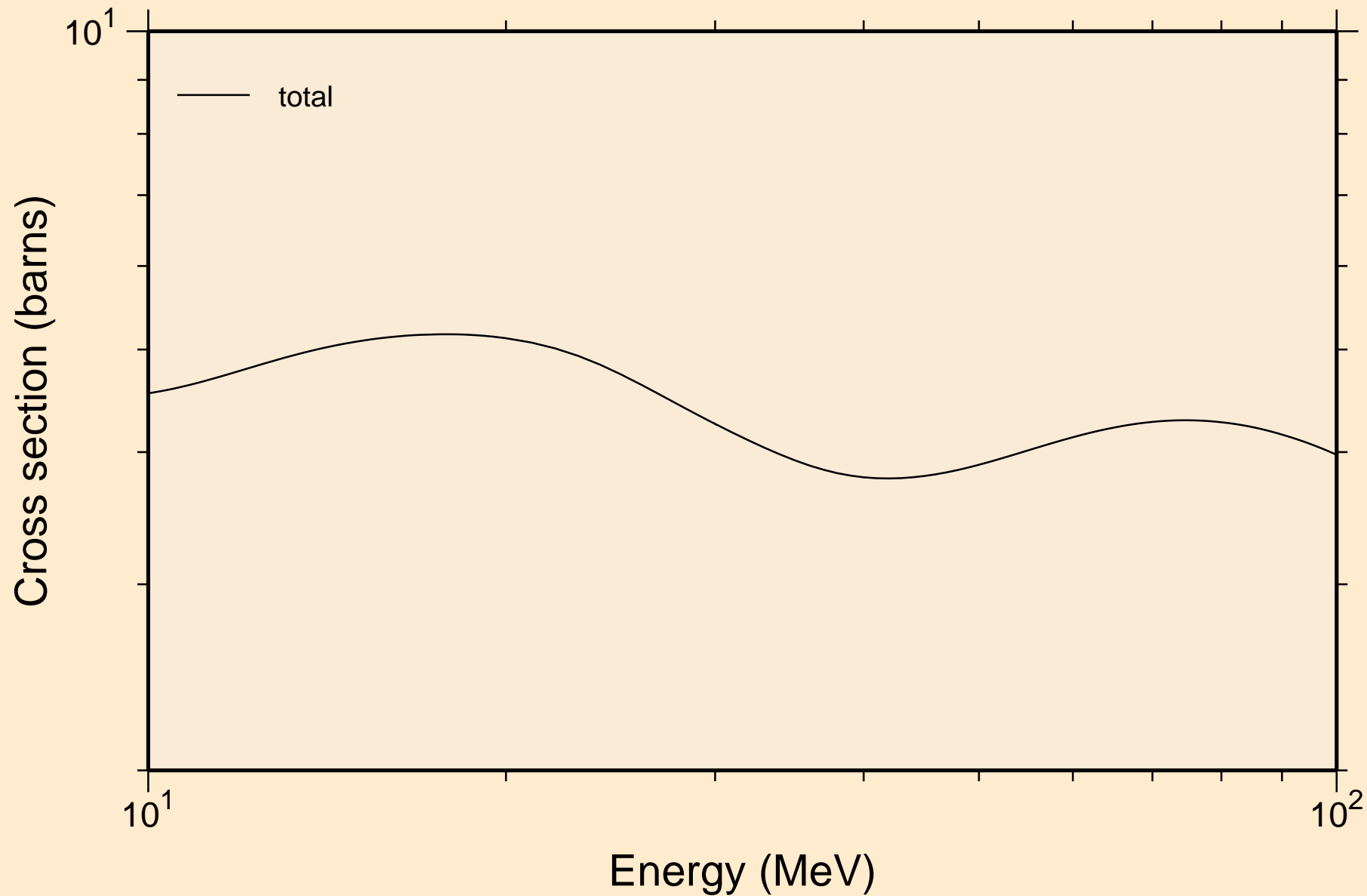

TM162 NEUTRON ACER TENDL-2019 LIBRARY; T=293.16K
resonance absorption cross sections

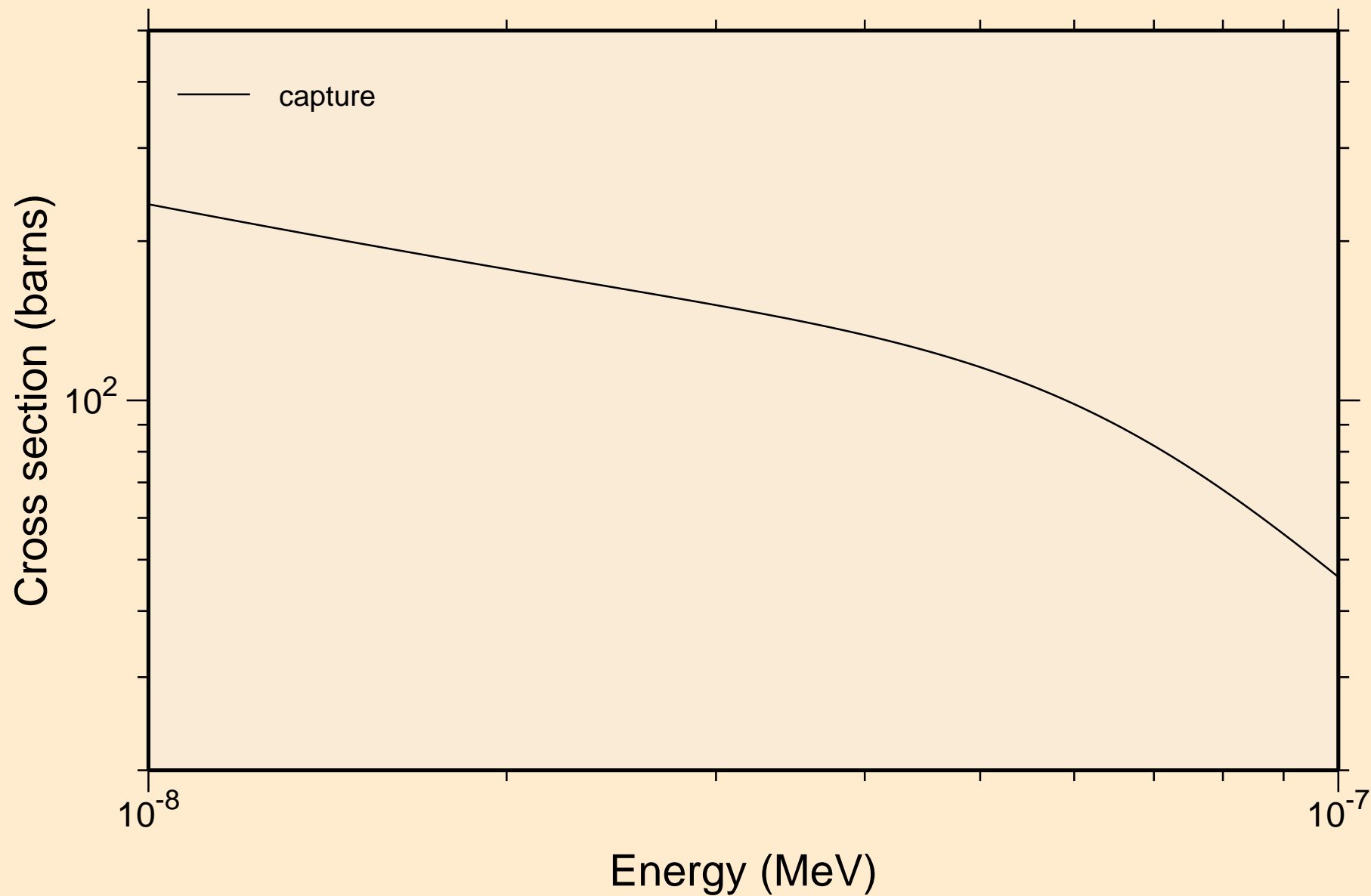

TM162 NEUTRON ACER TENDL-2019 LIBRARY; T=293.16K
resonance absorption cross sections

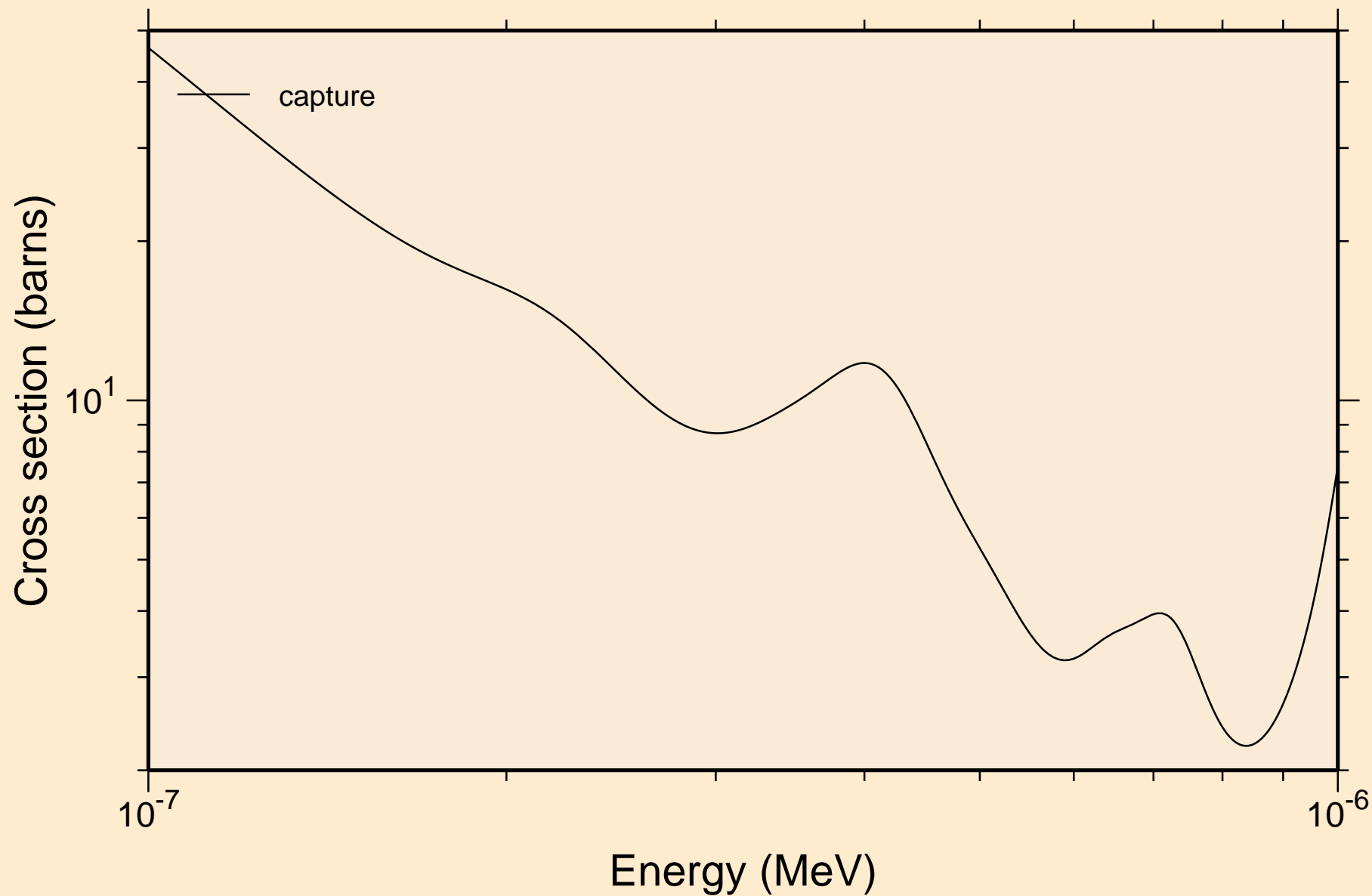

TM162 NEUTRON ACER TENDL-2019 LIBRARY; T=293.16K
resonance absorption cross sections

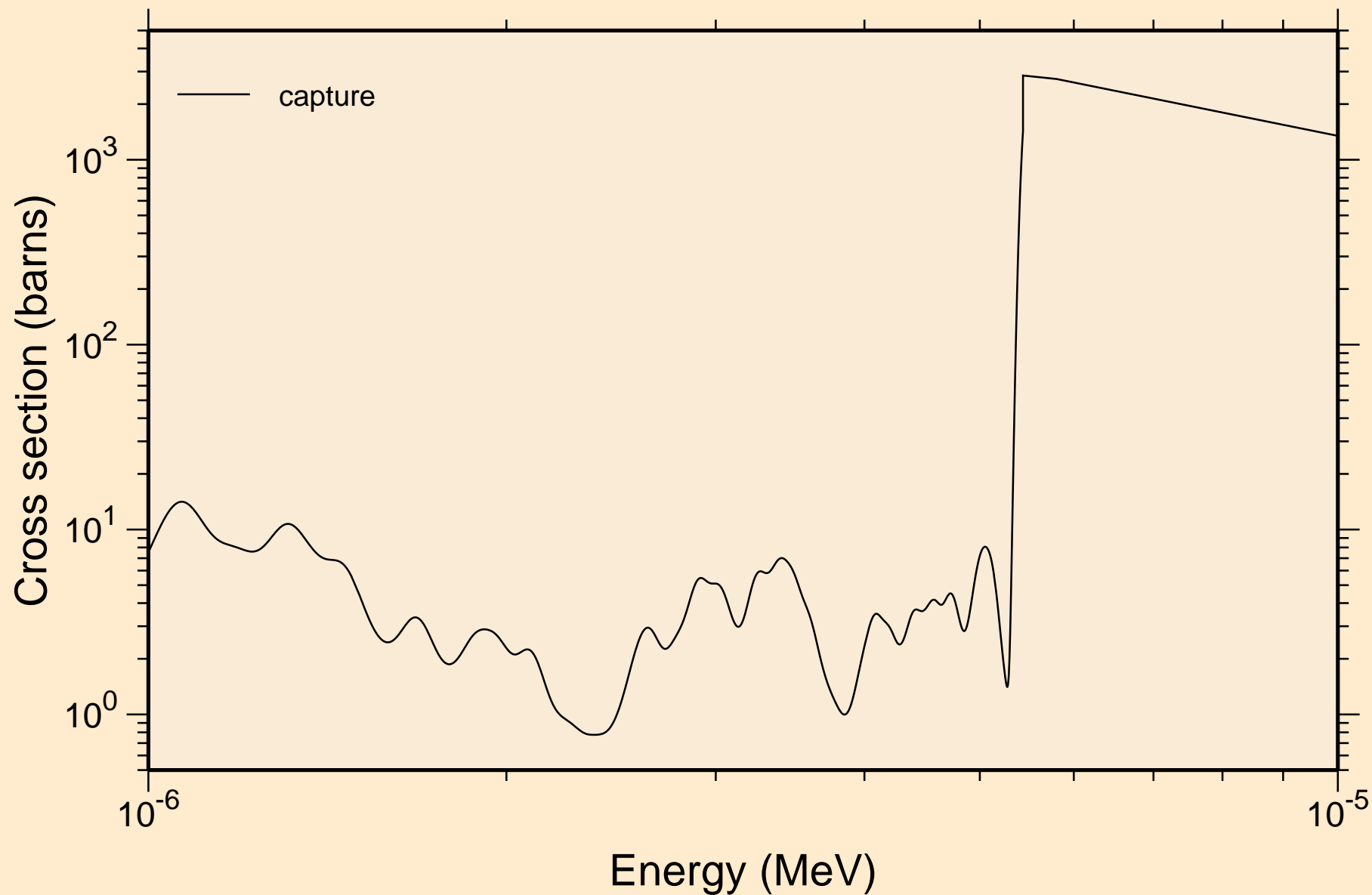

TM162 NEUTRON ACER TENDL-2019 LIBRARY; T=293.16K
resonance absorption cross sections

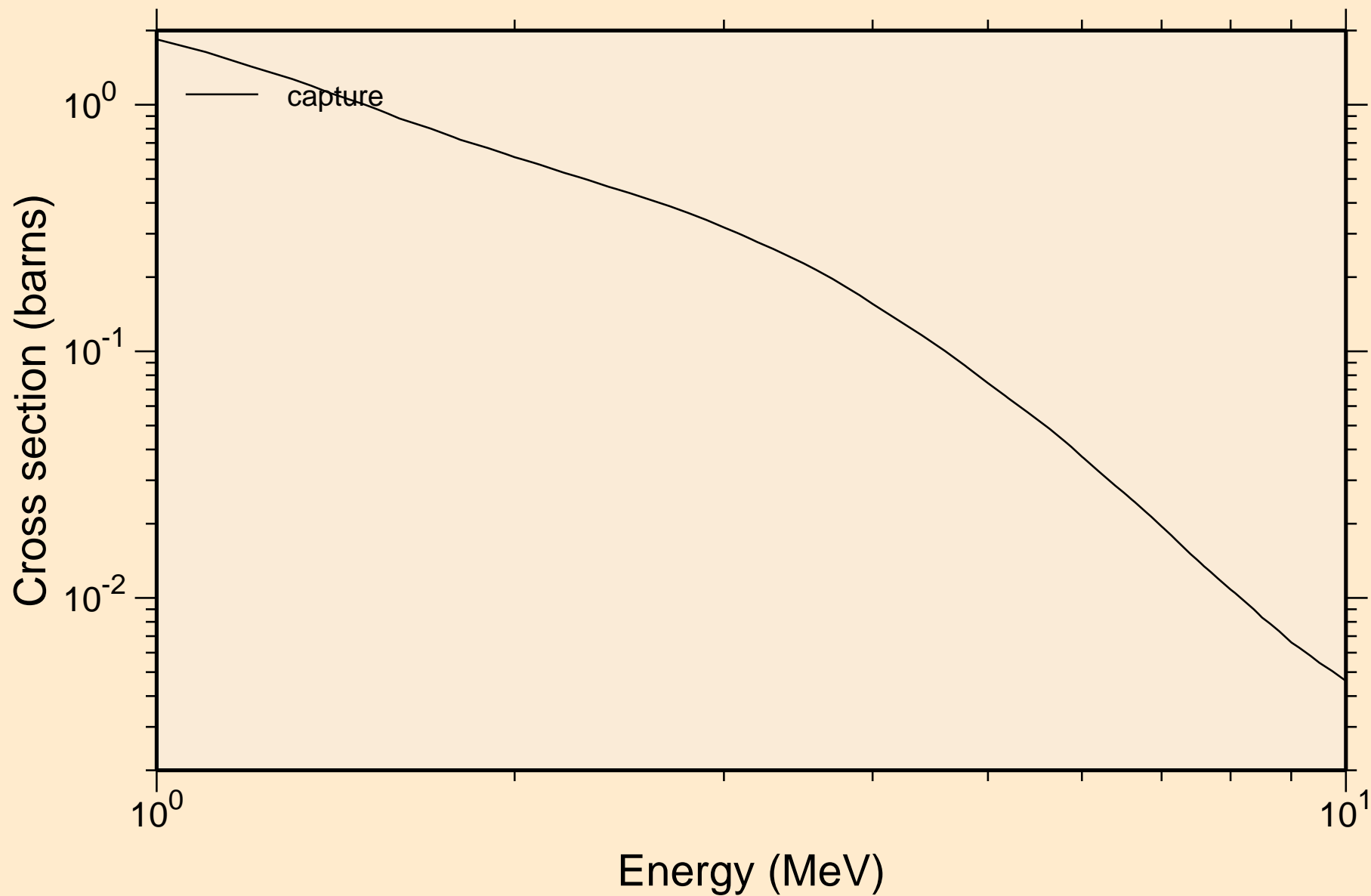

TM162 NEUTRON ACER TENDL-2019 LIBRARY; T=293.16K
Heating

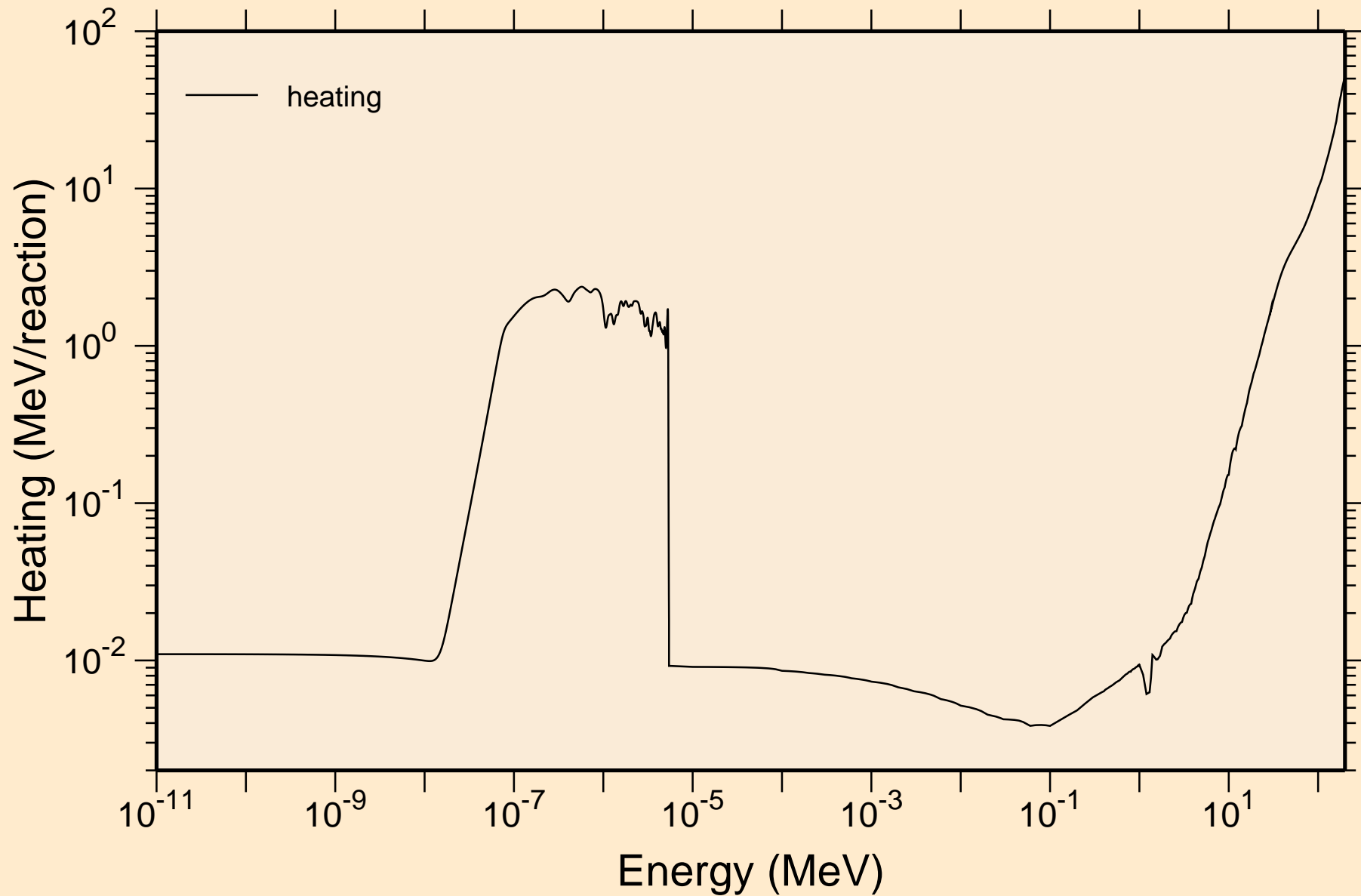

TM162 NEUTRON ACER TENDL-2019 LIBRARY; T=293.16K
Damage

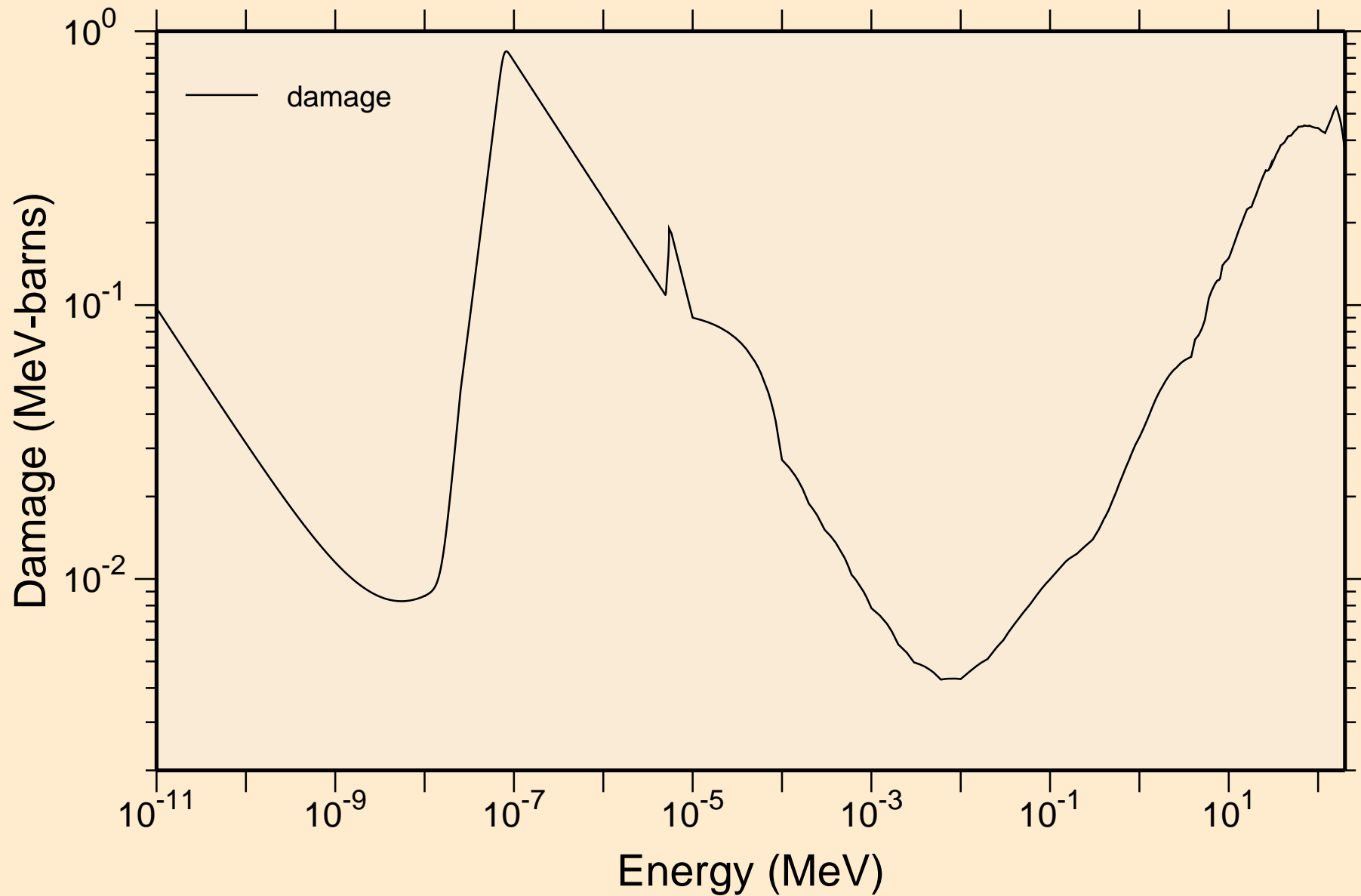

TM162 NEUTRON ACER TENDL-2019 LIBRARY; T=293.16K
Non-threshold reactions

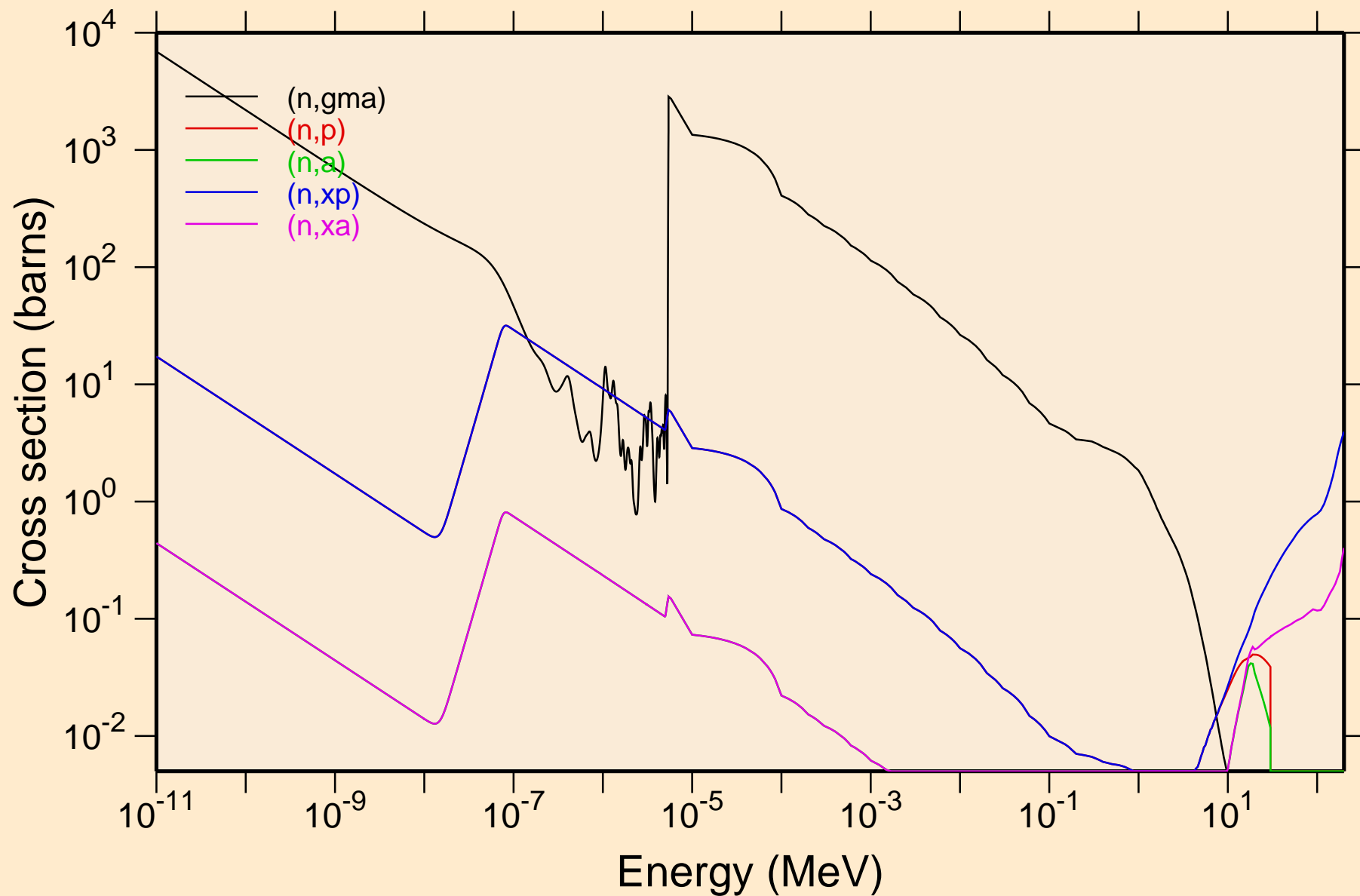

TM162 NEUTRON ACER TENDL-2019 LIBRARY; T=293.16K
Principal cross sections

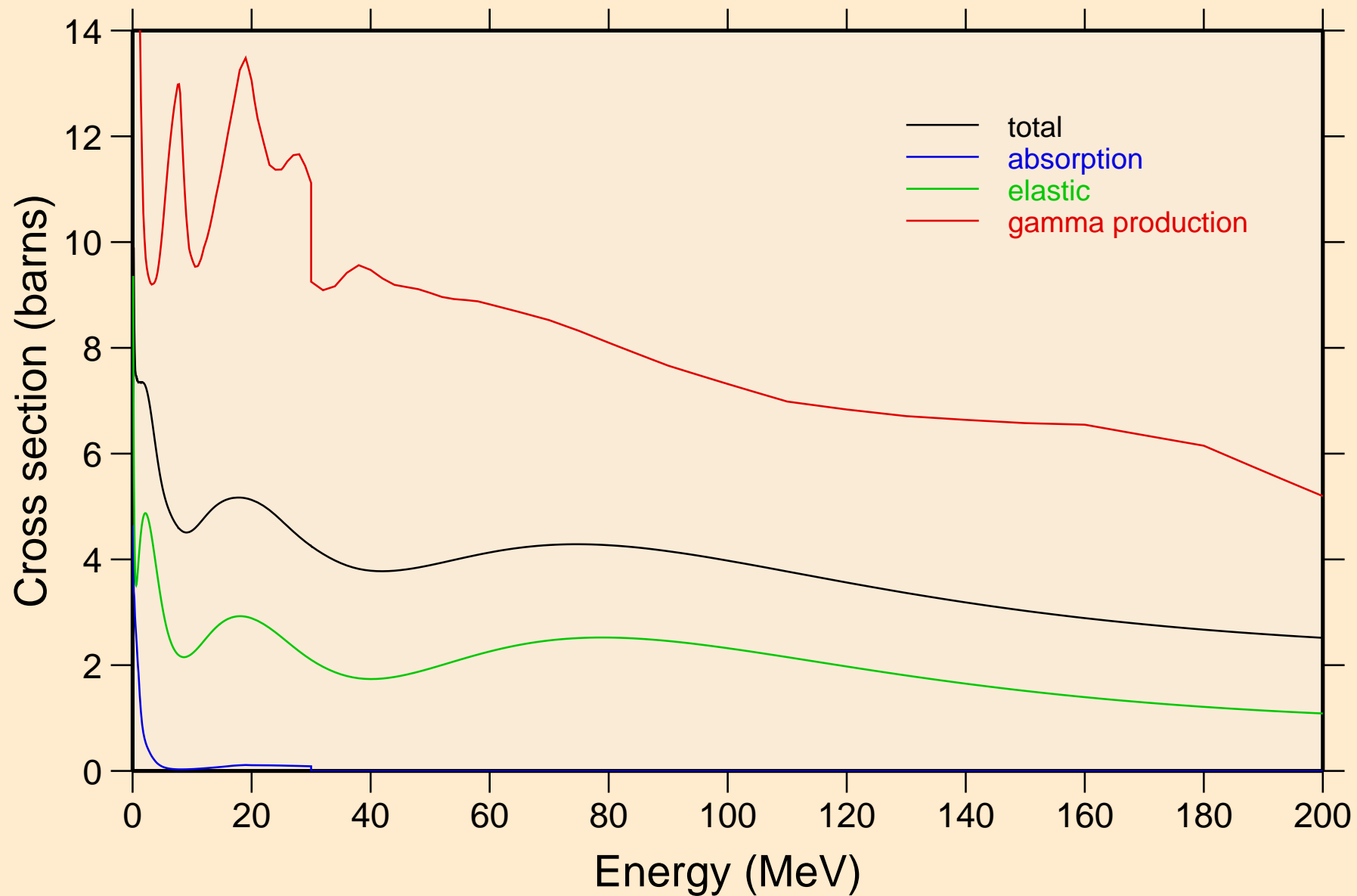

TM162 NEUTRON ACER TENDL-2019 LIBRARY; T=293.16K
Heating

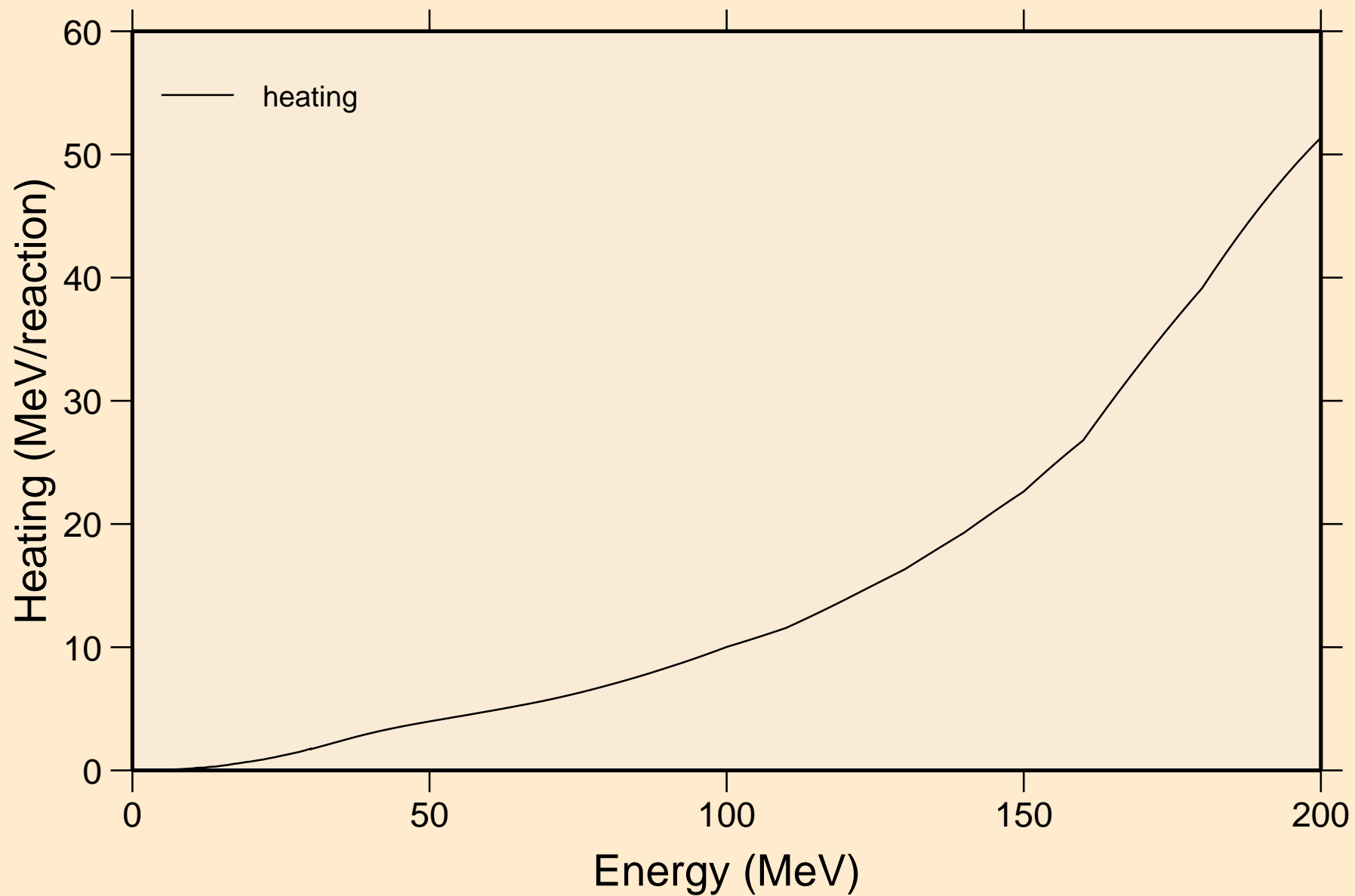

TM162 NEUTRON ACER TENDL-2019 LIBRARY; T=293.16K
Damage

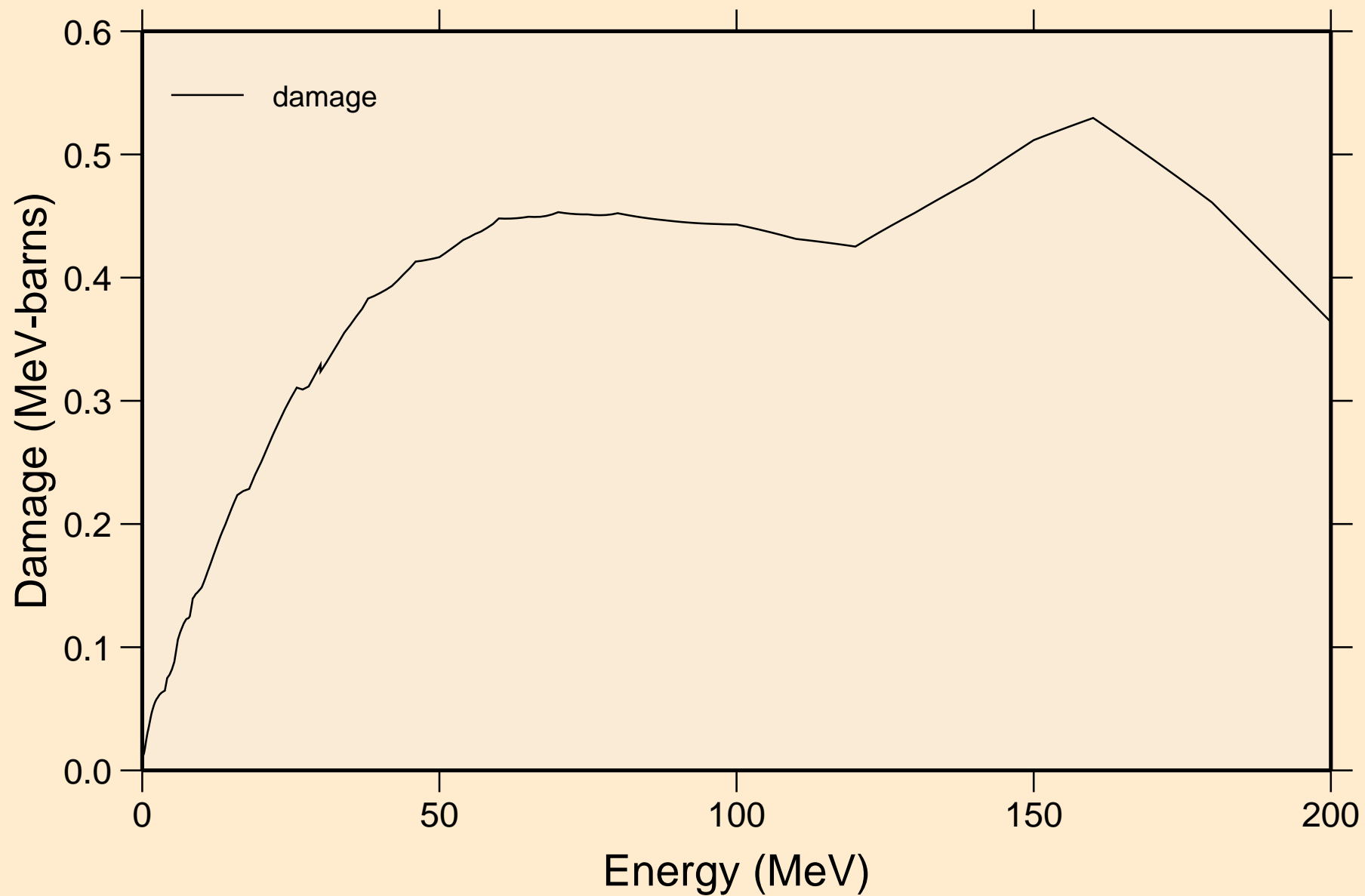

TM162 NEUTRON ACER TENDL-2019 LIBRARY; T=293.16K
Non-threshold reactions

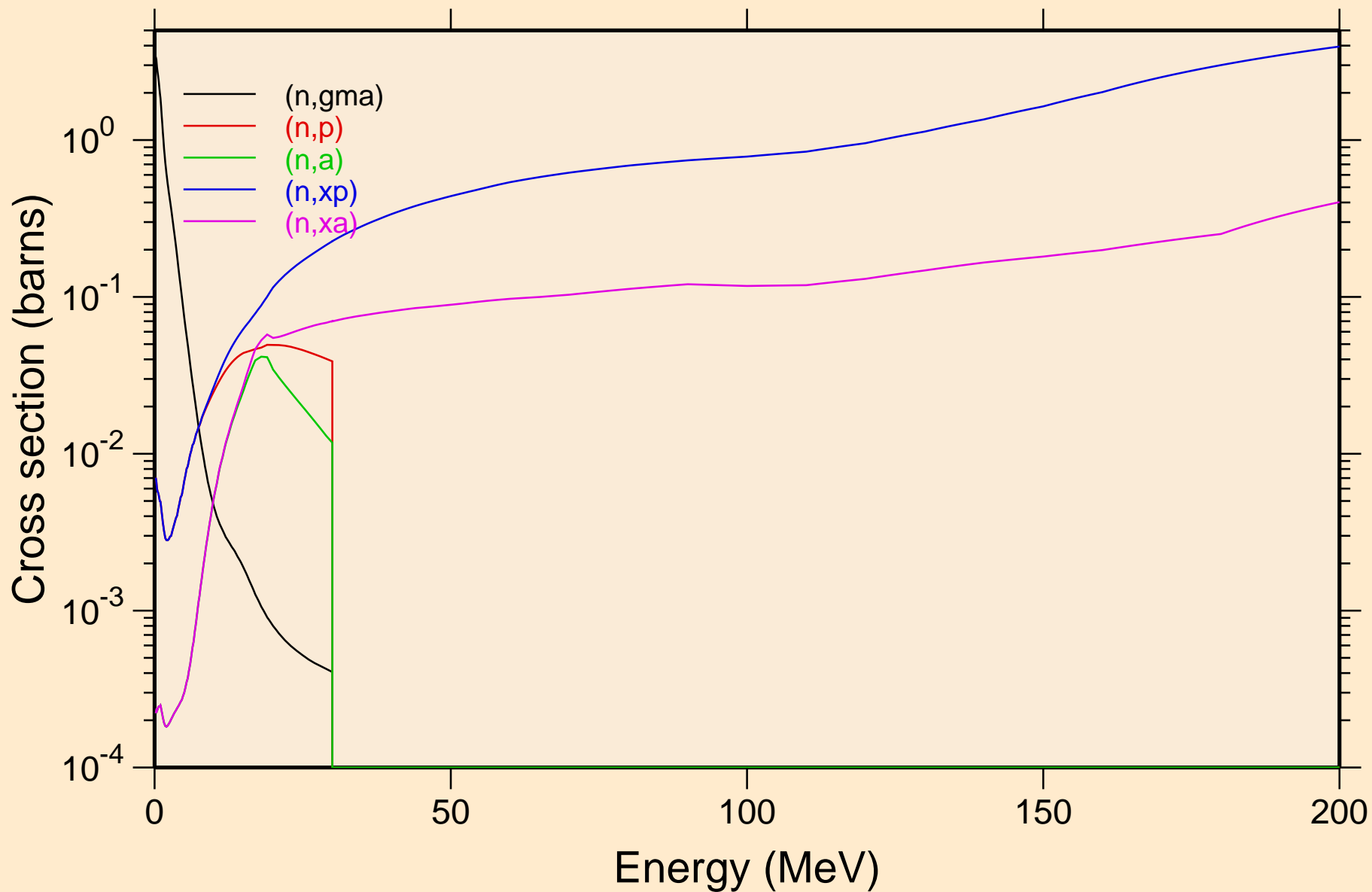

TM162 NEUTRON ACER TENDL-2019 LIBRARY; T=293.16K
Inelastic levels

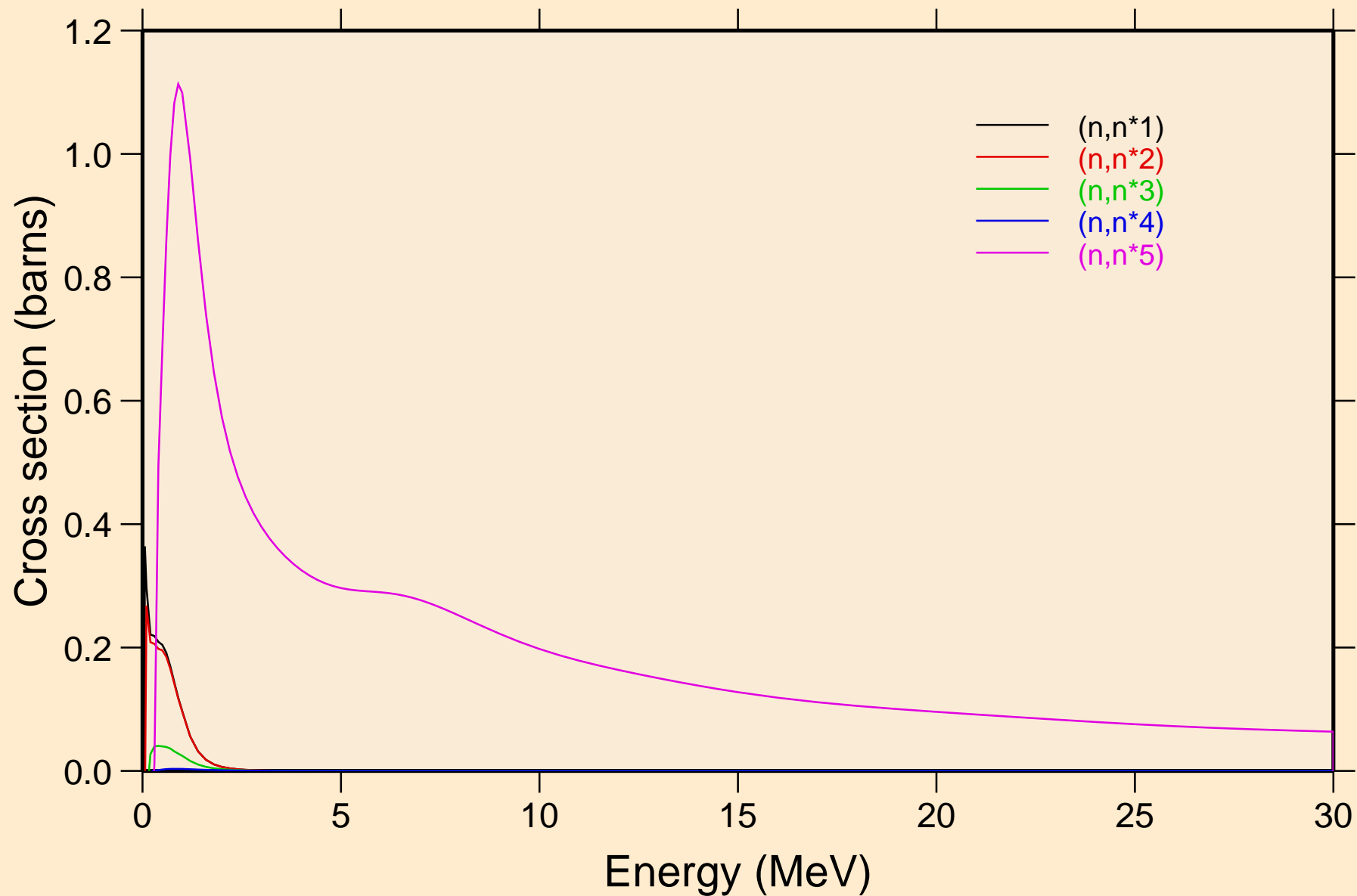

TM162 NEUTRON ACER TENDL-2019 LIBRARY; T=293.16K
Inelastic levels

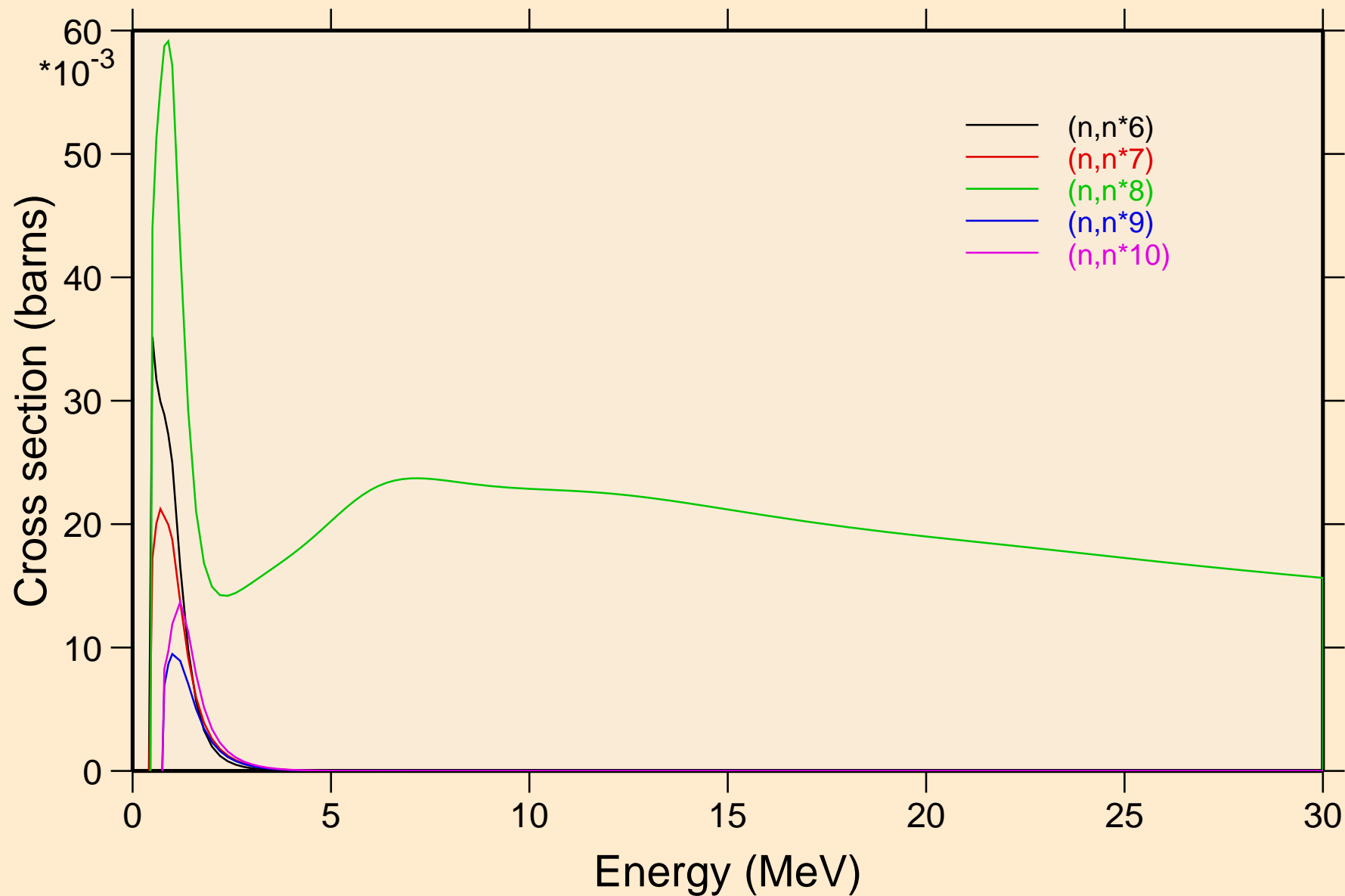

TM162 NEUTRON ACER TENDL-2019 LIBRARY; T=293.16K
Inelastic levels

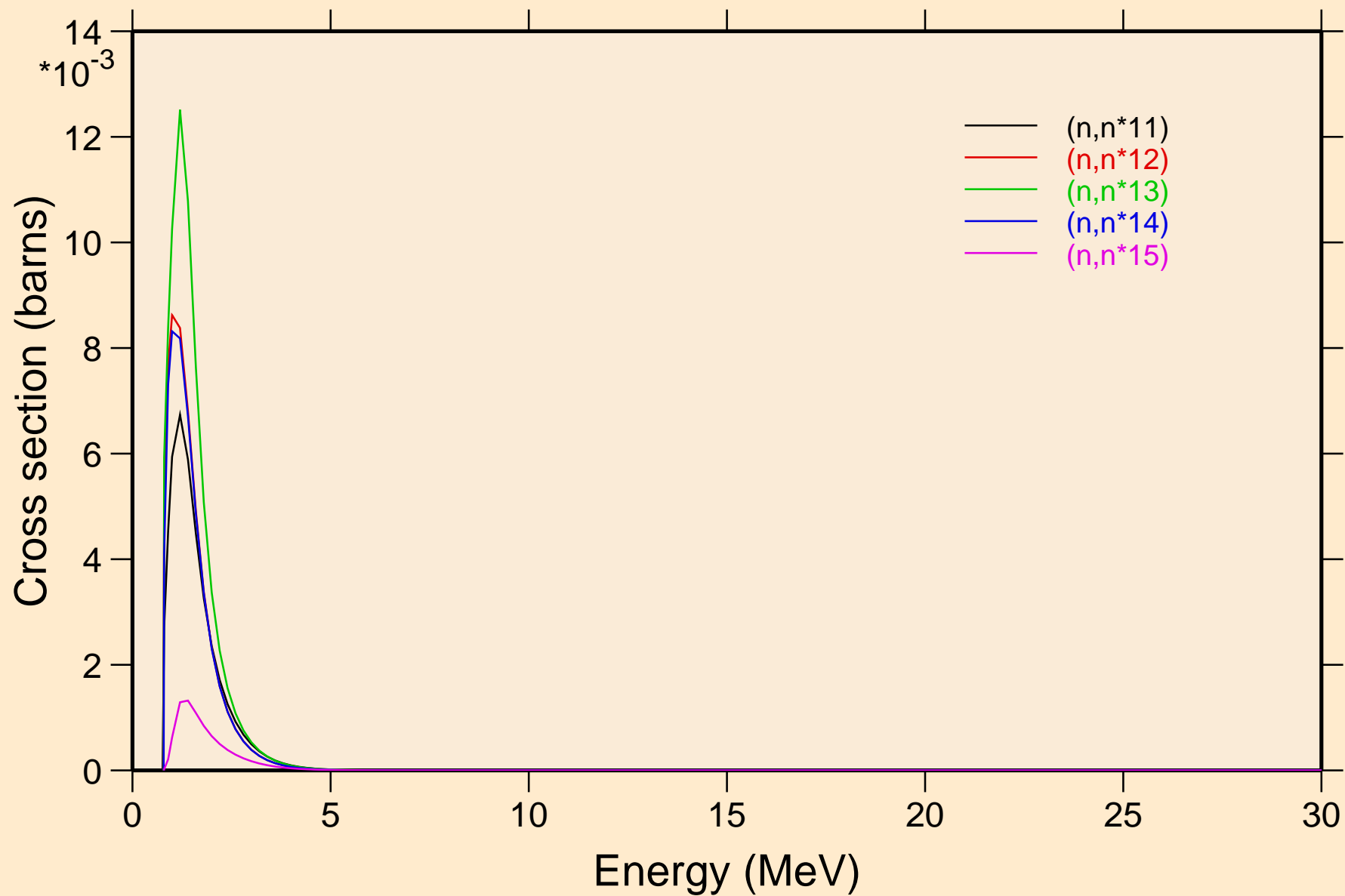

TM162 NEUTRON ACER TENDL-2019 LIBRARY; T=293.16K
Inelastic levels

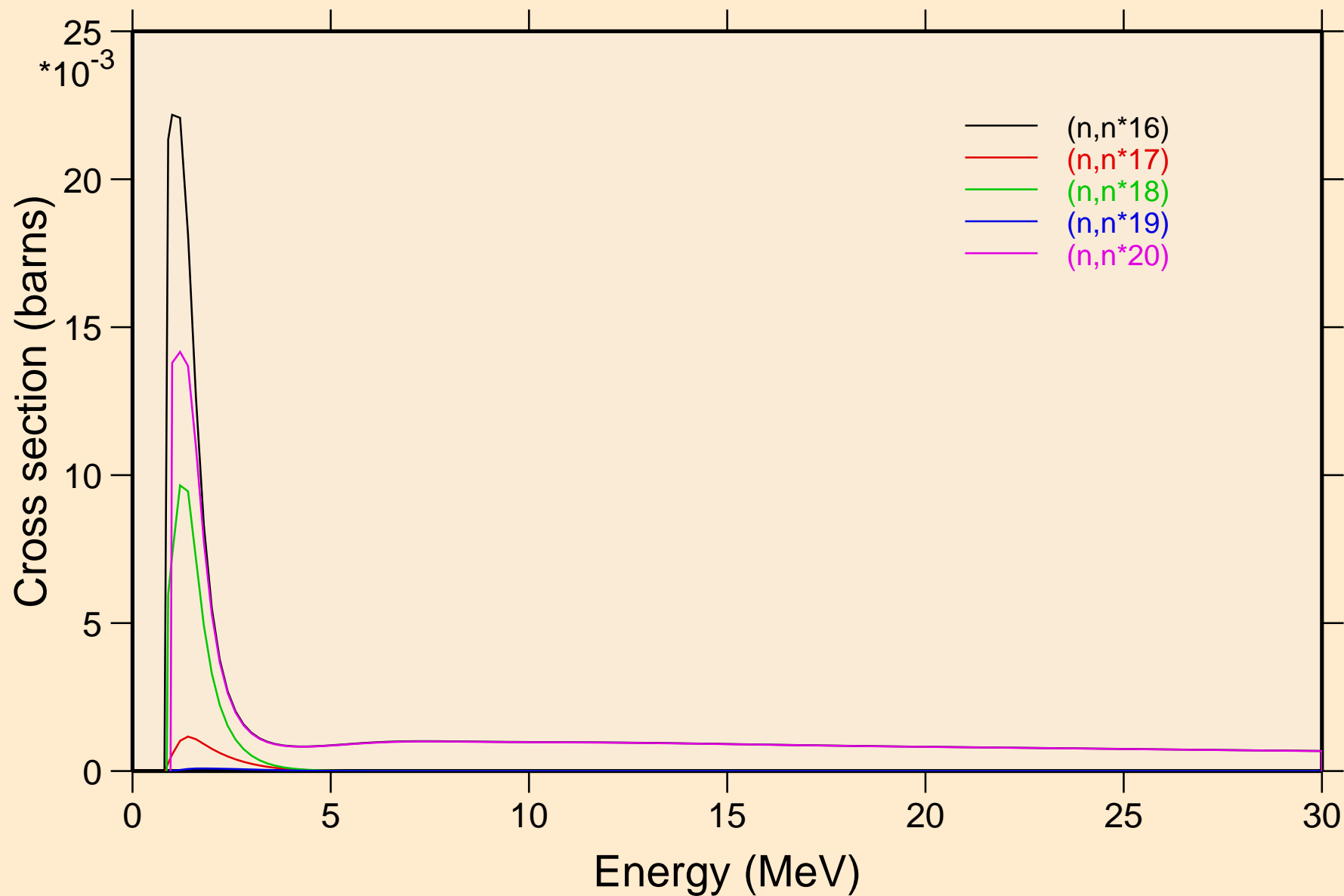

TM162 NEUTRON ACER TENDL-2019 LIBRARY; T=293.16K
Threshold reactions

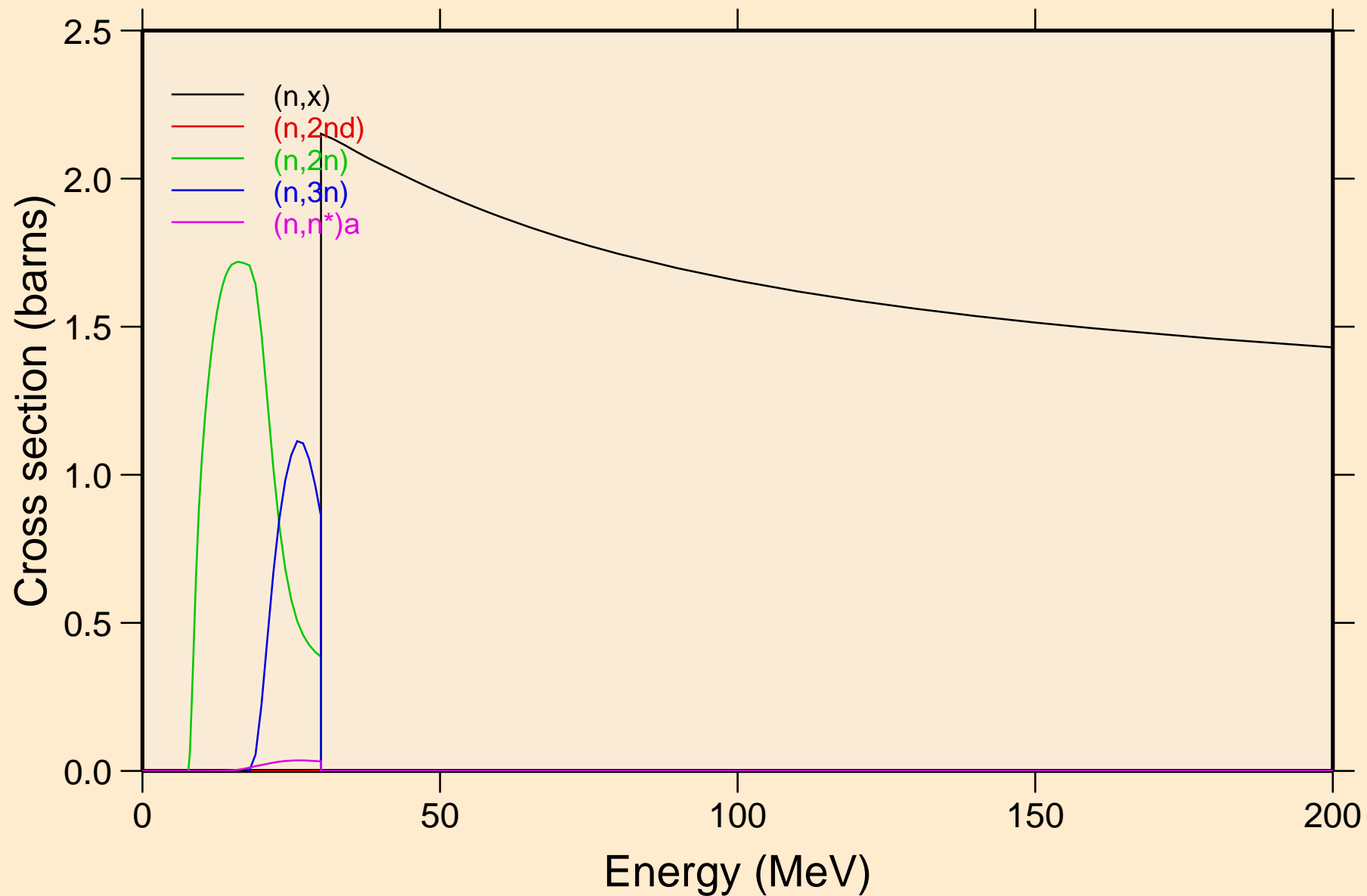

TM162 NEUTRON ACER TENDL-2019 LIBRARY; T=293.16K
Threshold reactions

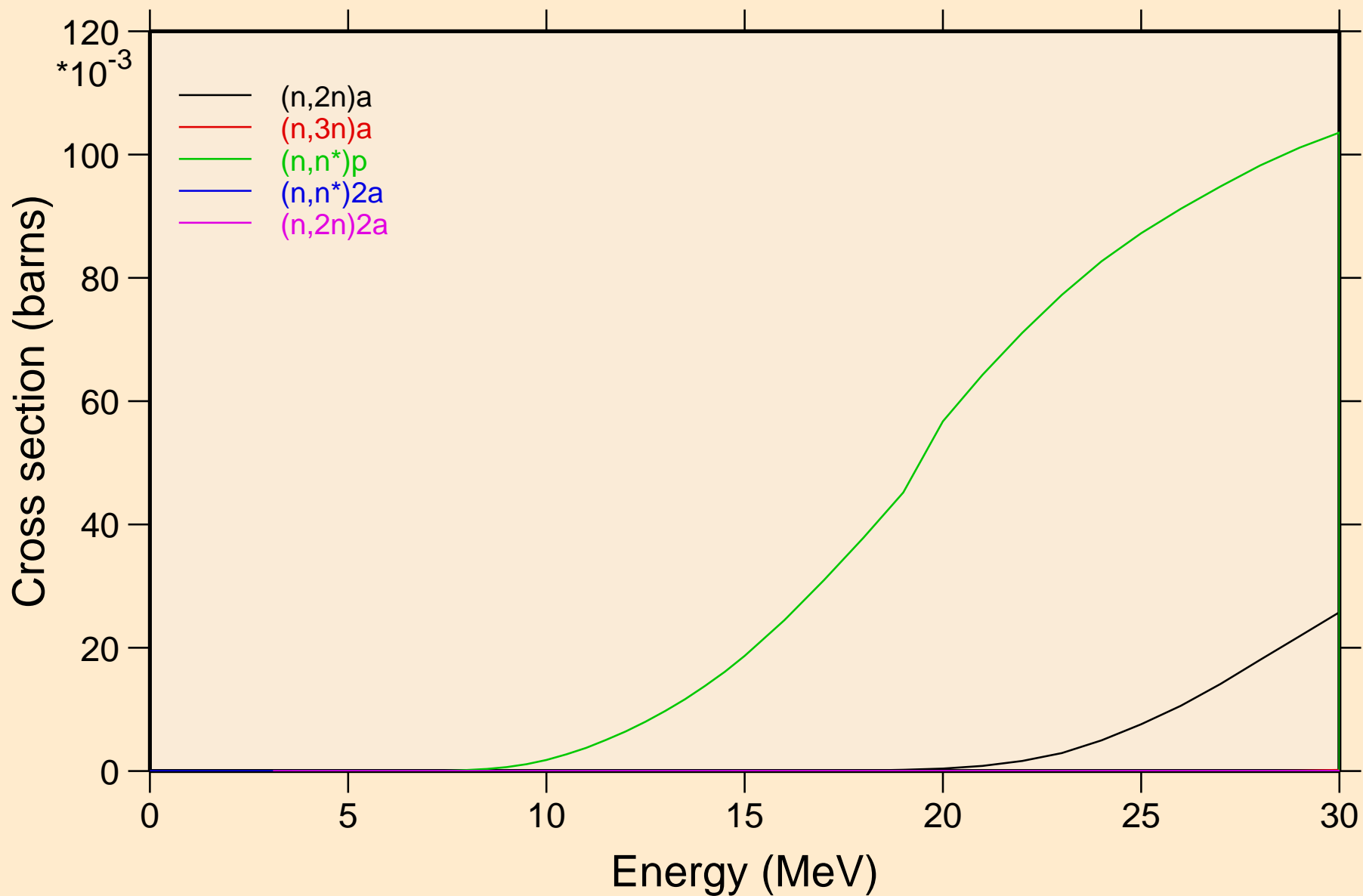

TM162 NEUTRON ACER TENDL-2019 LIBRARY; T=293.16K
Threshold reactions

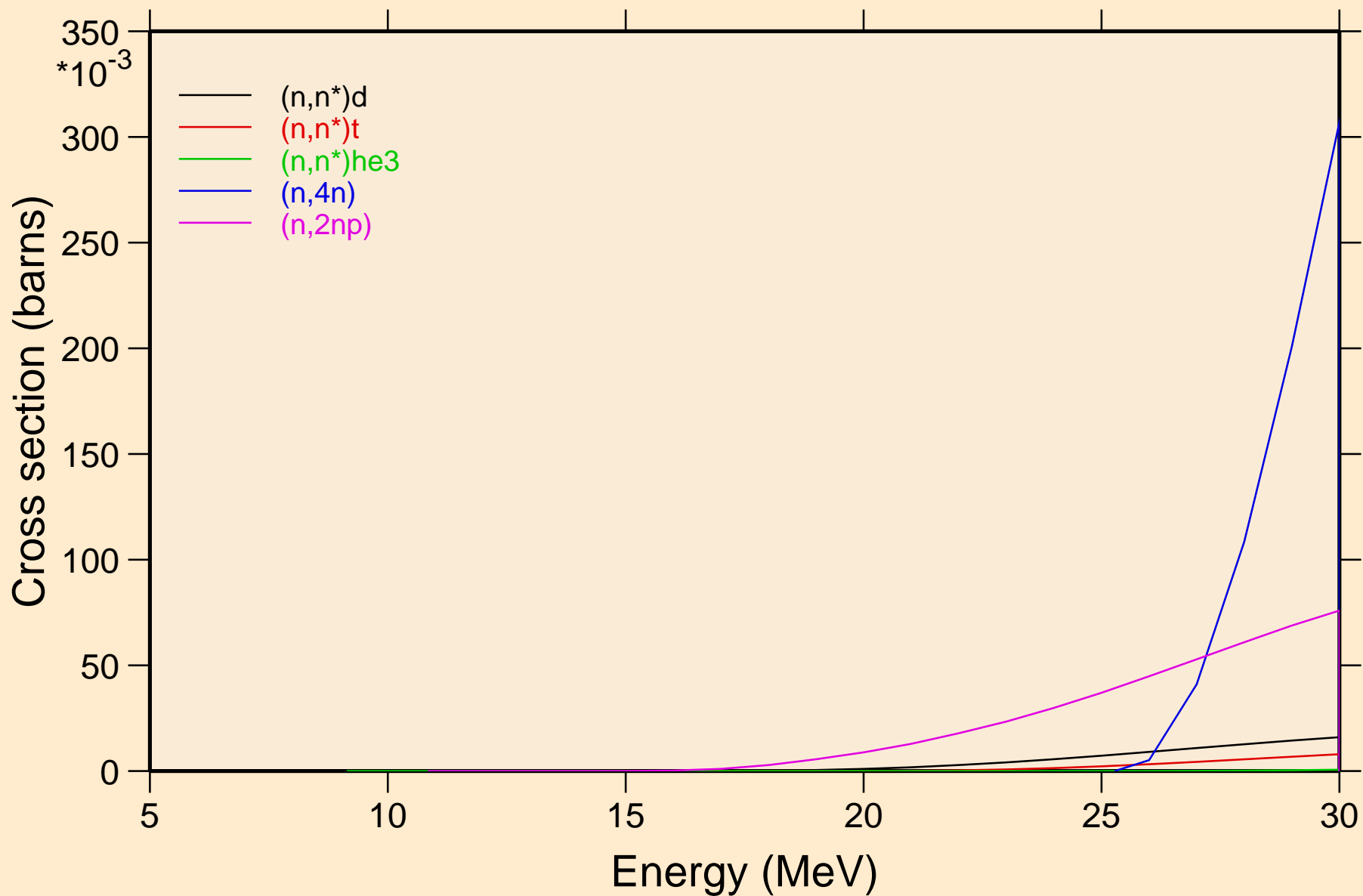

TM162 NEUTRON ACER TENDL-2019 LIBRARY; T=293.16K
Threshold reactions

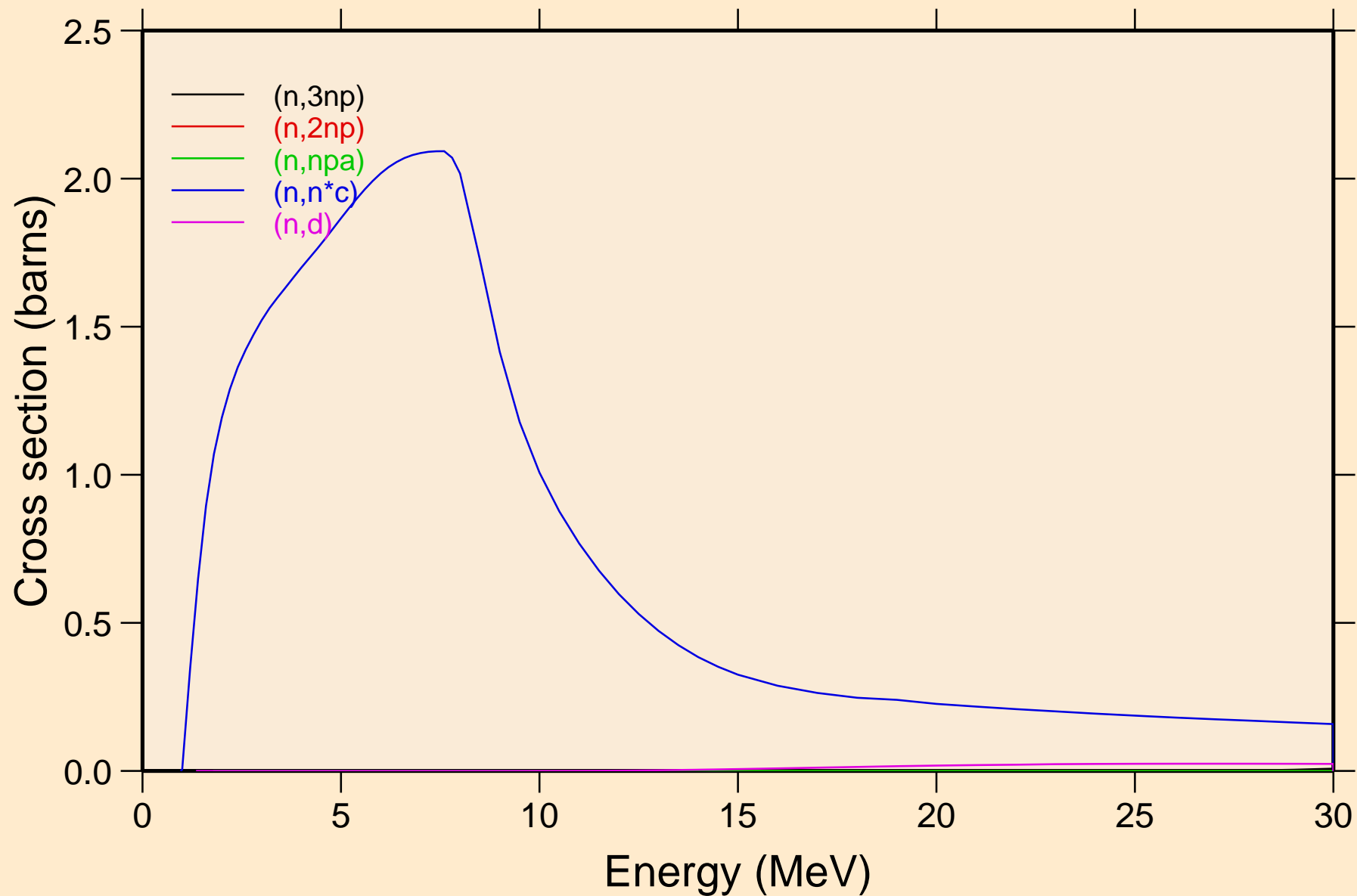

TM162 NEUTRON ACER TENDL-2019 LIBRARY; T=293.16K
Threshold reactions

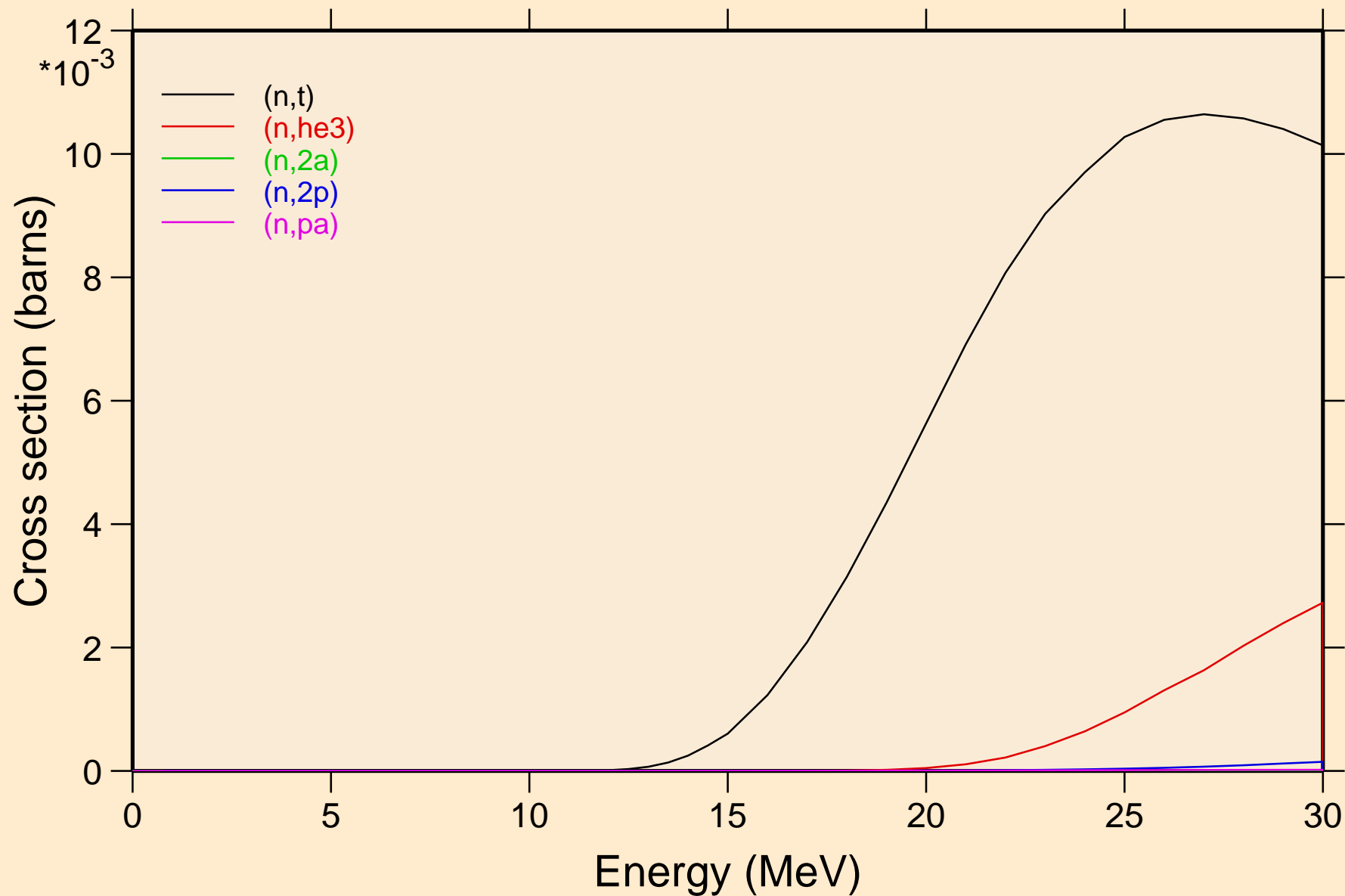

TM162 NEUTRON ACER TENDL-2019 LIBRARY; T=293.16K
Threshold reactions

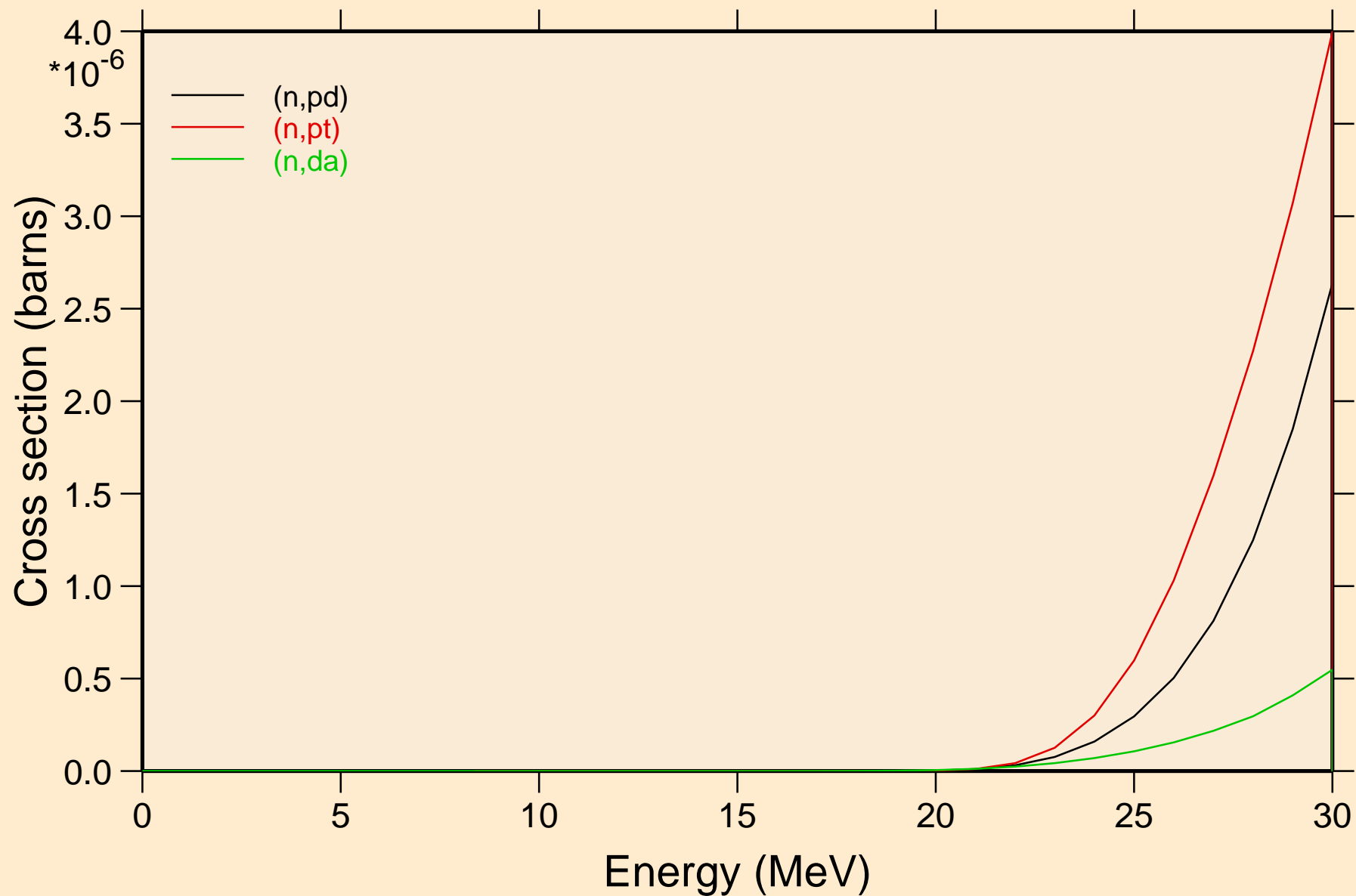

TM162 NEUTRON ACER TENDL-2019 LIBRARY; T=293.16K
Threshold reactions

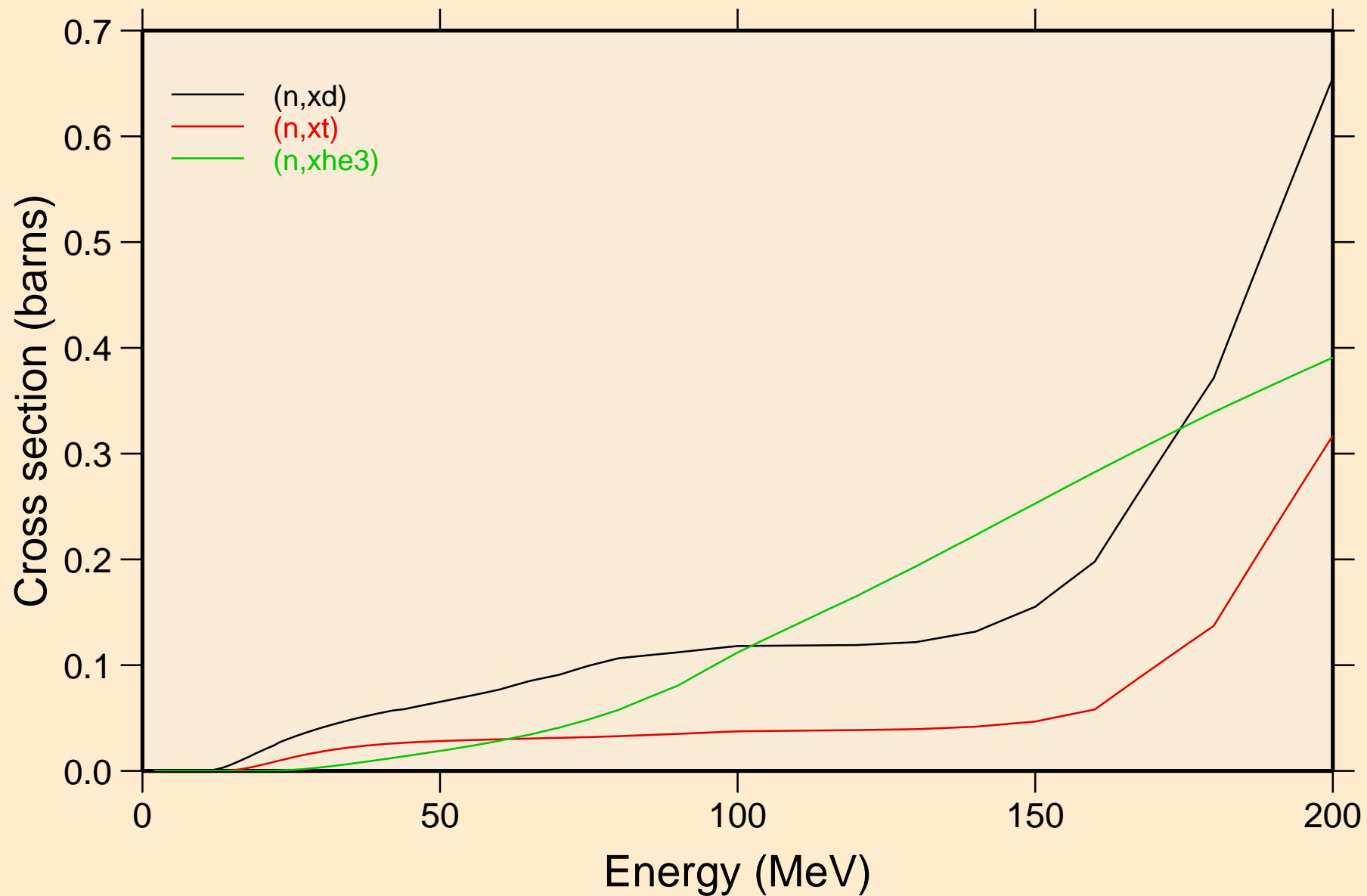

TM162 NEUTRON ACER TENDL-2019 LIBRARY; T=293.16K
angular distribution for elastic

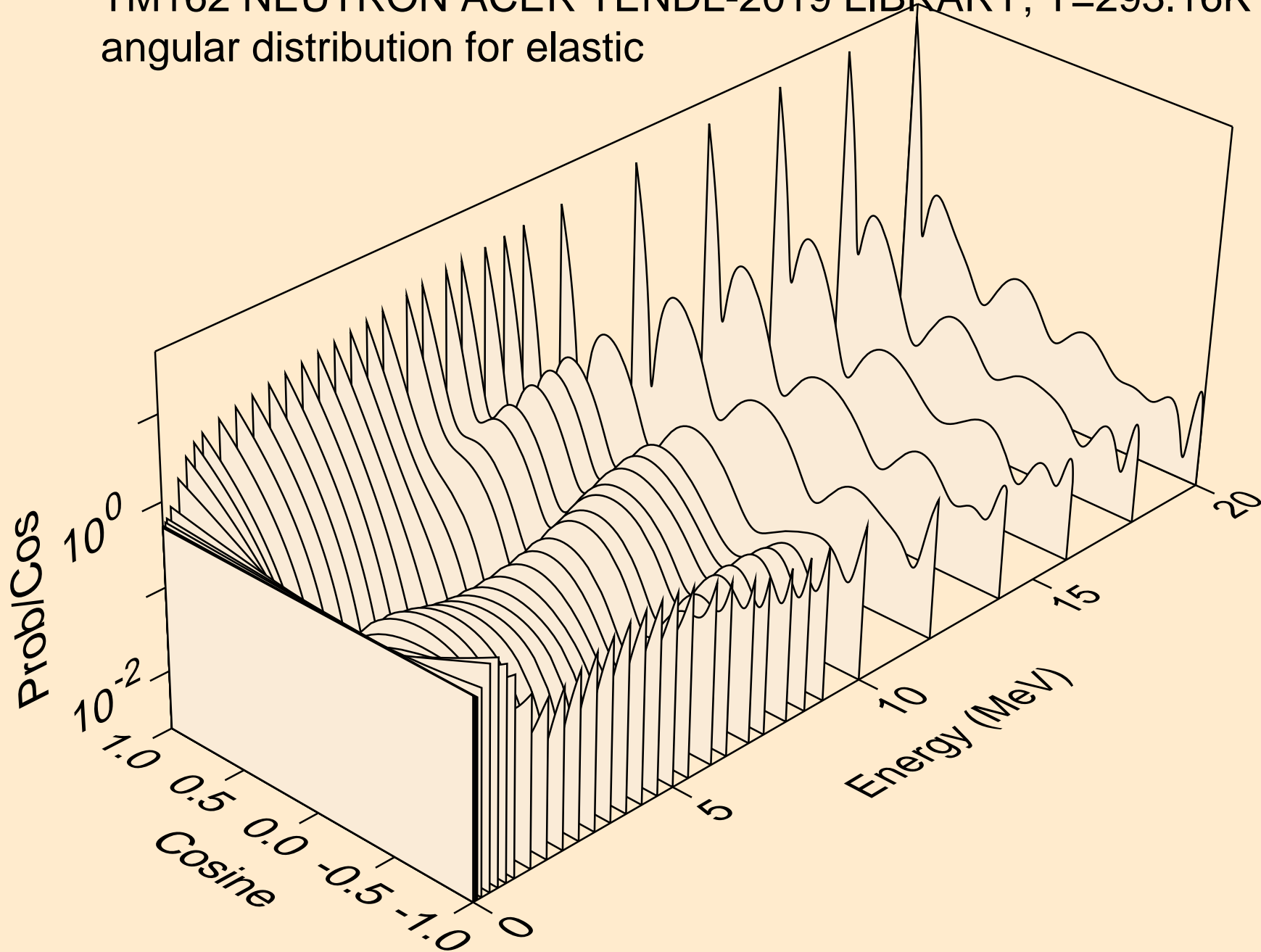

TM162 NEUTRON ACER TENDL-2019 LIBRARY; T=293.16K
angular distribution for elastic

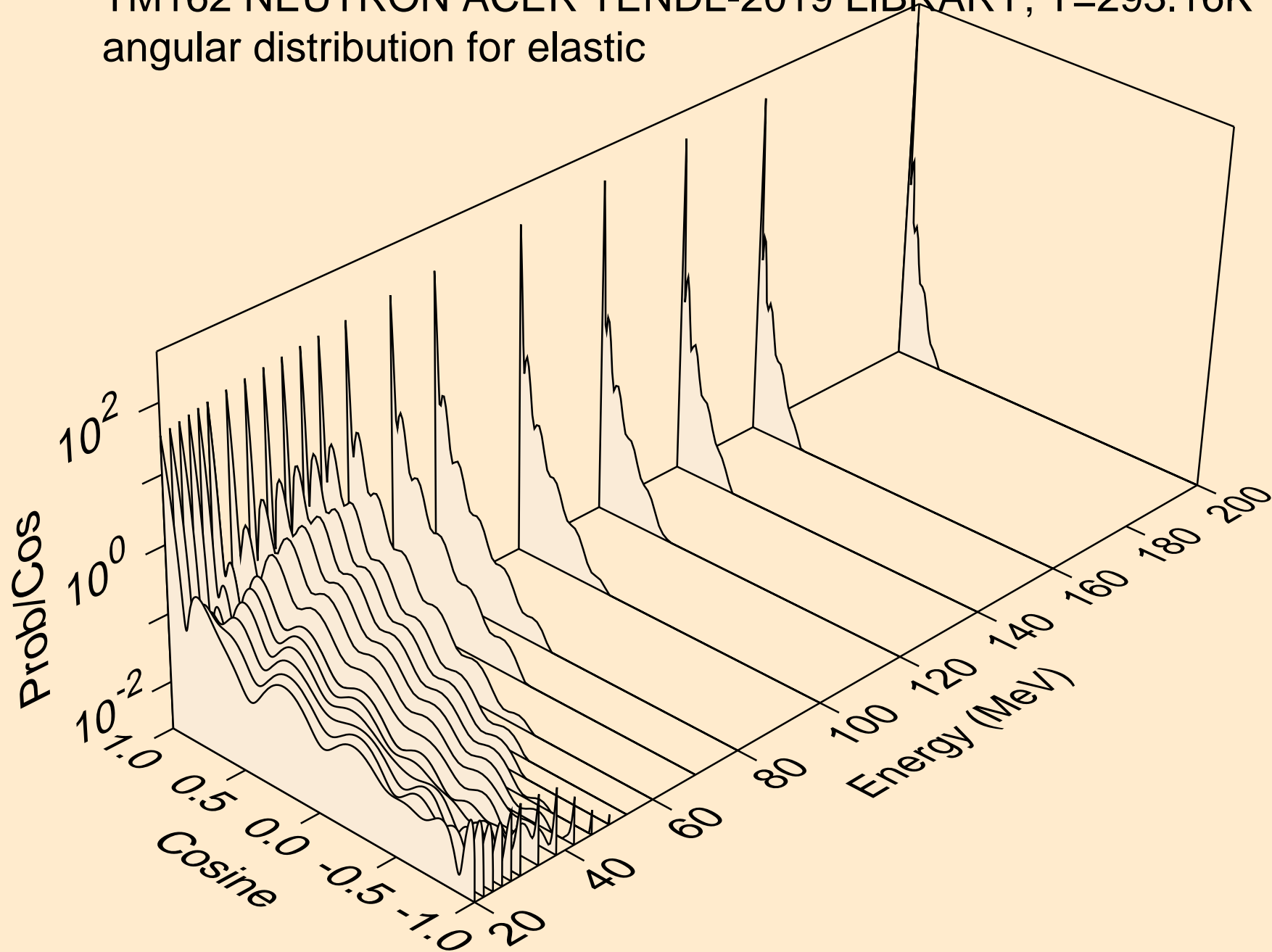

TM162 NEUTRON ACER TENDL-2019 LIBRARY; T=293.16K
angular distribution for (n,n*1)

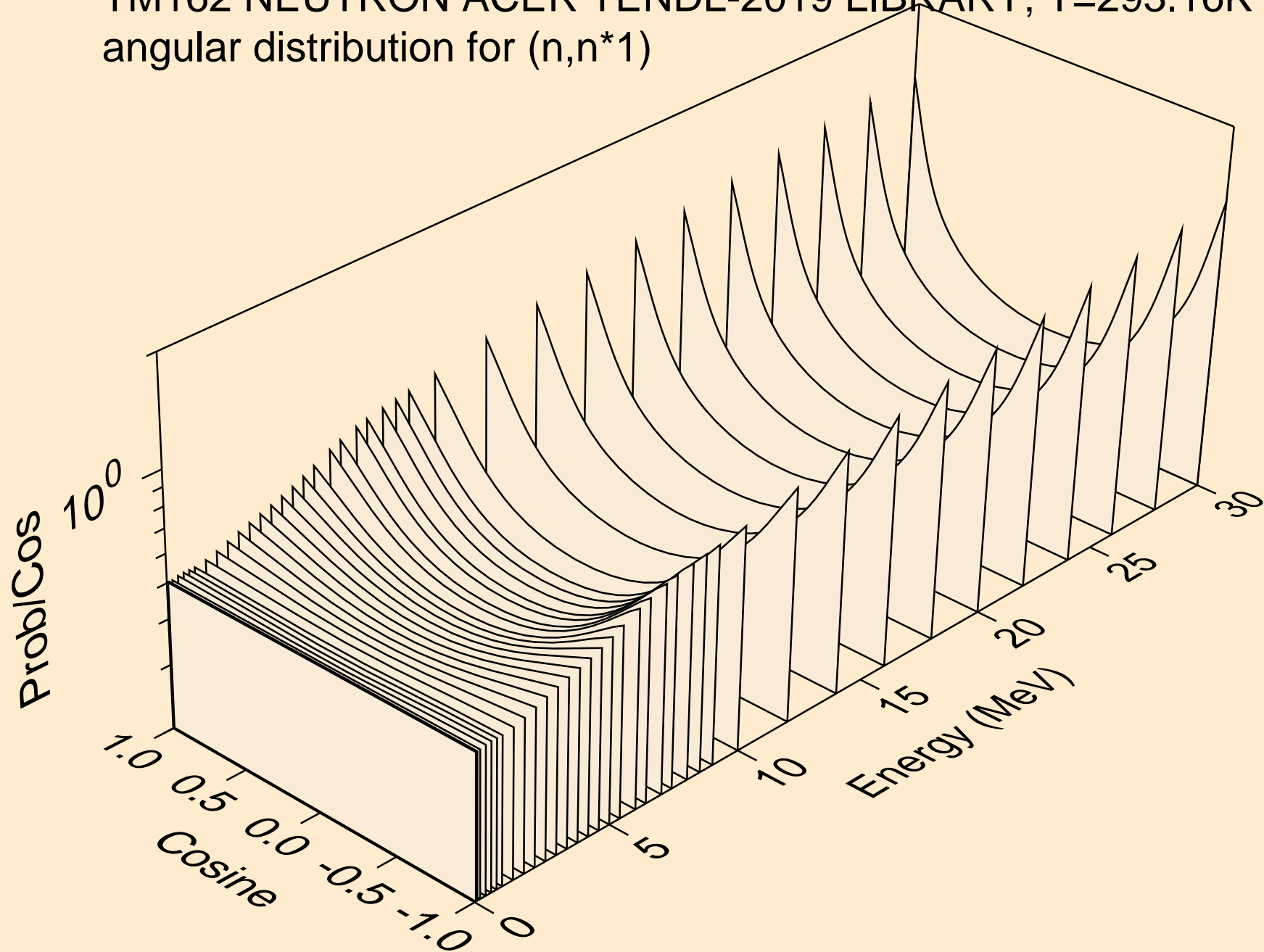

TM162 NEUTRON ACER TENDL-2019 LIBRARY; T=293.16K
angular distribution for (n,n*2)

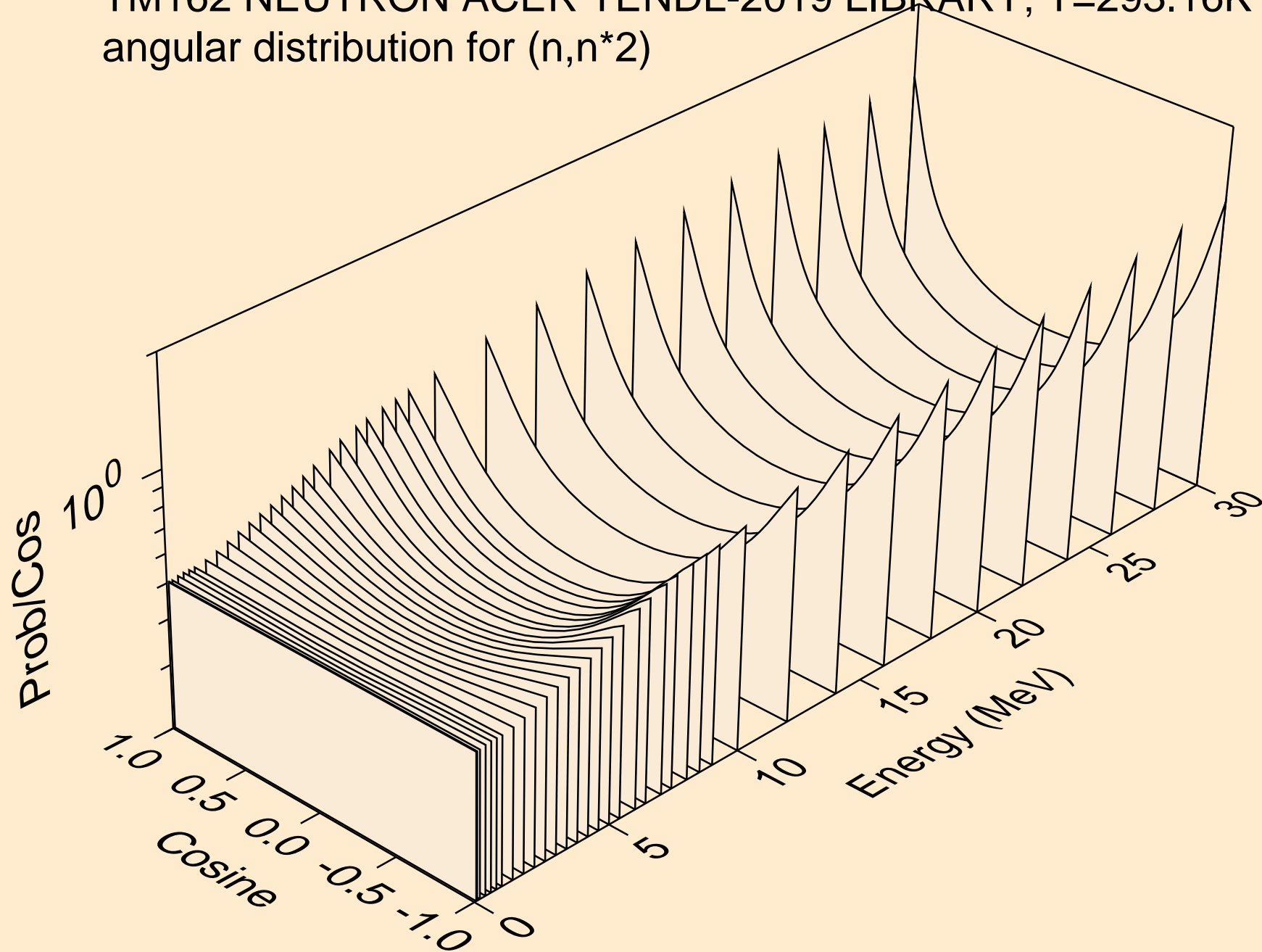

TM162 NEUTRON ACER TENDL-2019 LIBRARY; T=293.16K
angular distribution for (n,n*3)

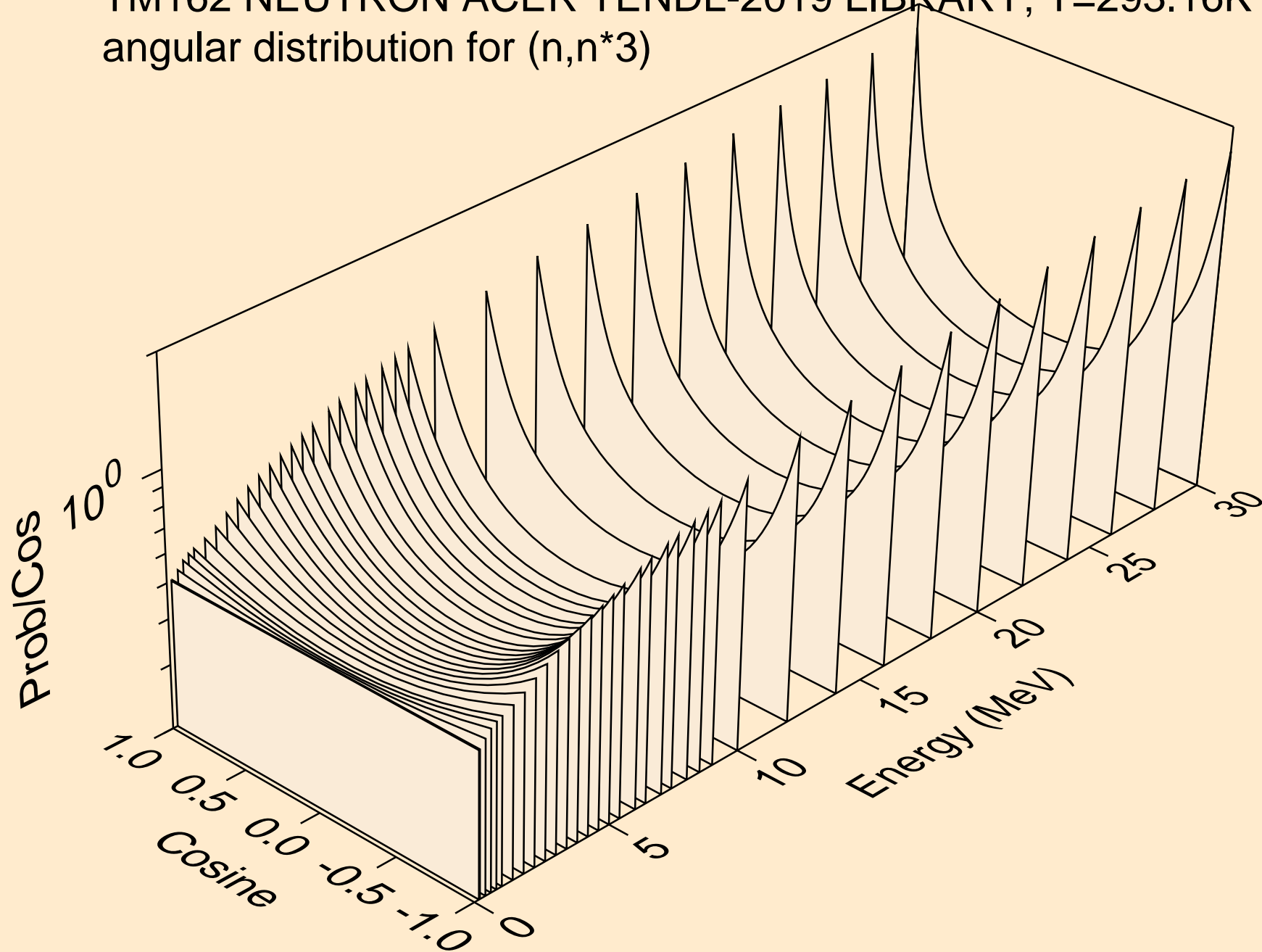

TM162 NEUTRON ACER TENDL-2019 LIBRARY; T=293.16K
angular distribution for (n,n*4)

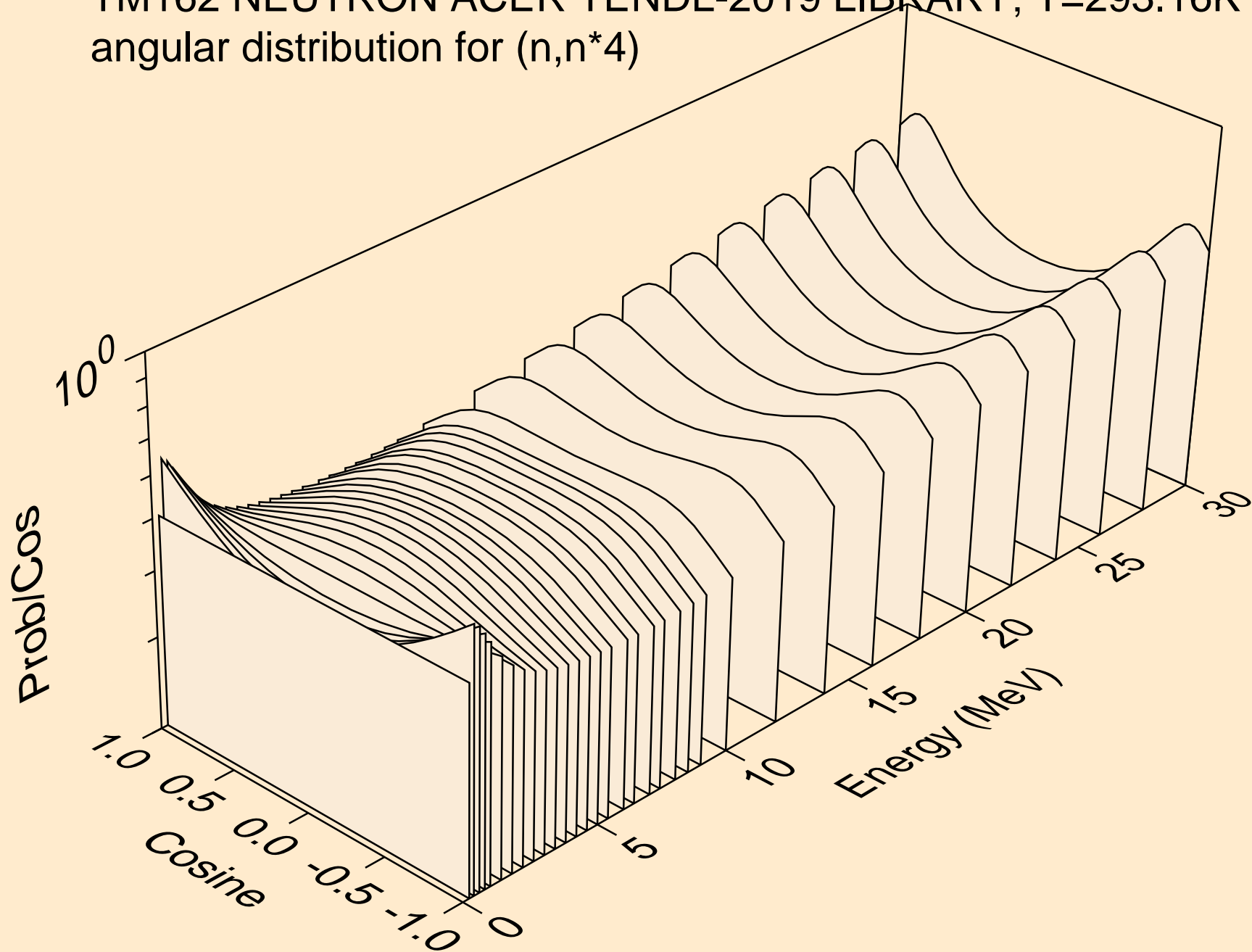

TM162 NEUTRON ACER TENDL-2019 LIBRARY; T=293.16K
angular distribution for (n,n*5)

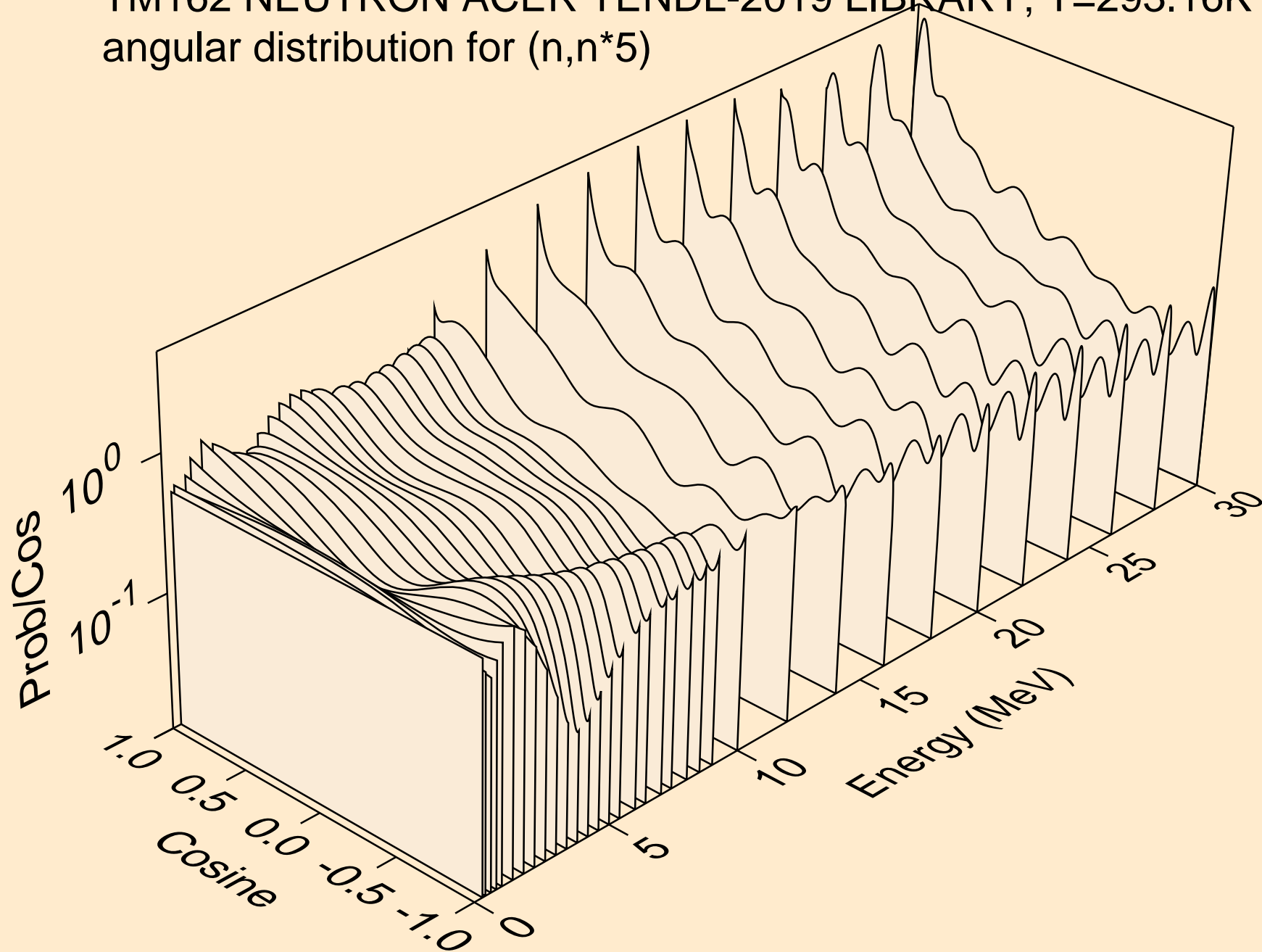

TM162 NEUTRON ACER TENDL-2019 LIBRARY; T=293.16K
angular distribution for (n,n*6)

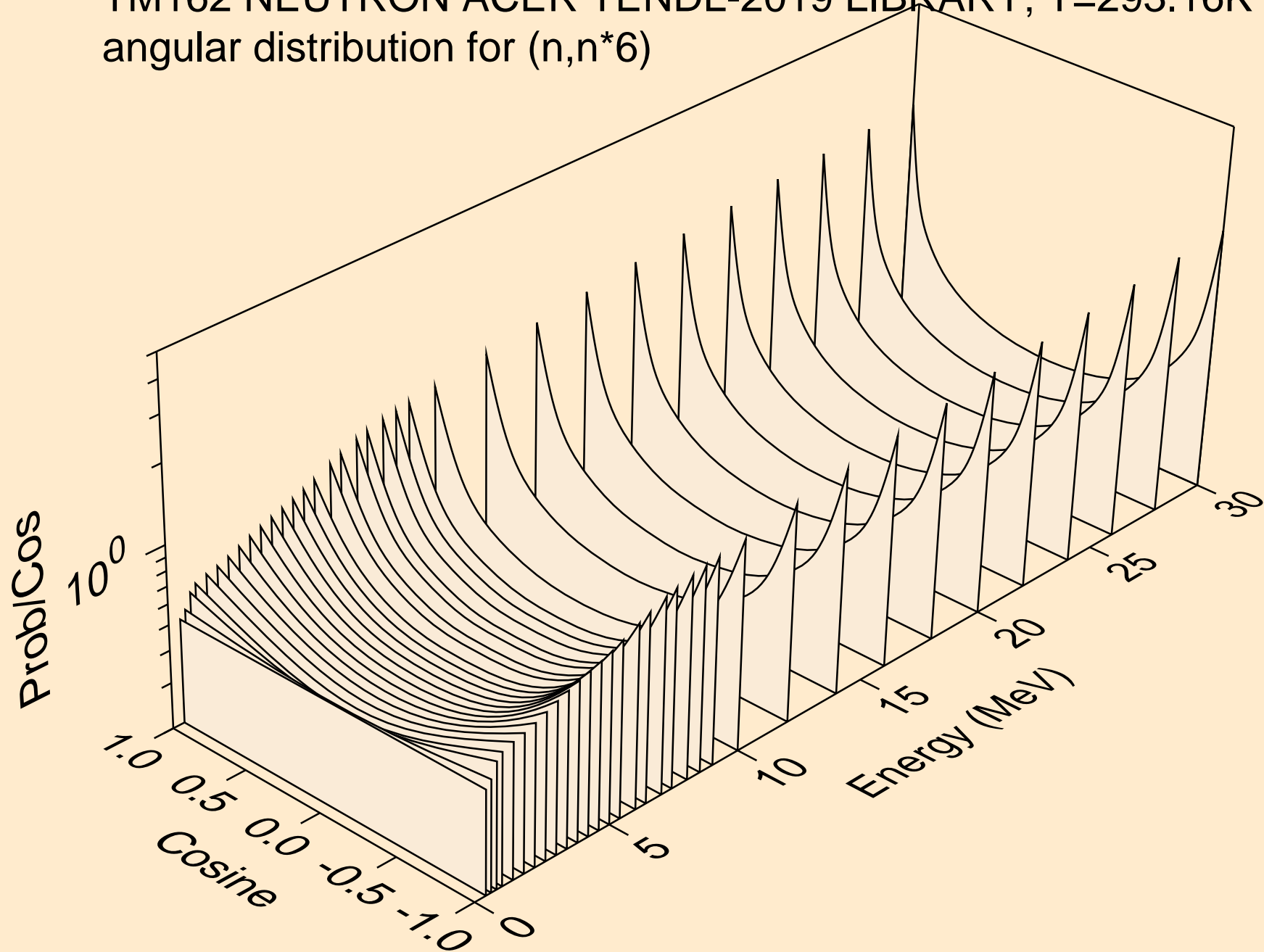

TM162 NEUTRON ACER TENDL-2019 LIBRARY; T=293.16K
angular distribution for (n,n*7)

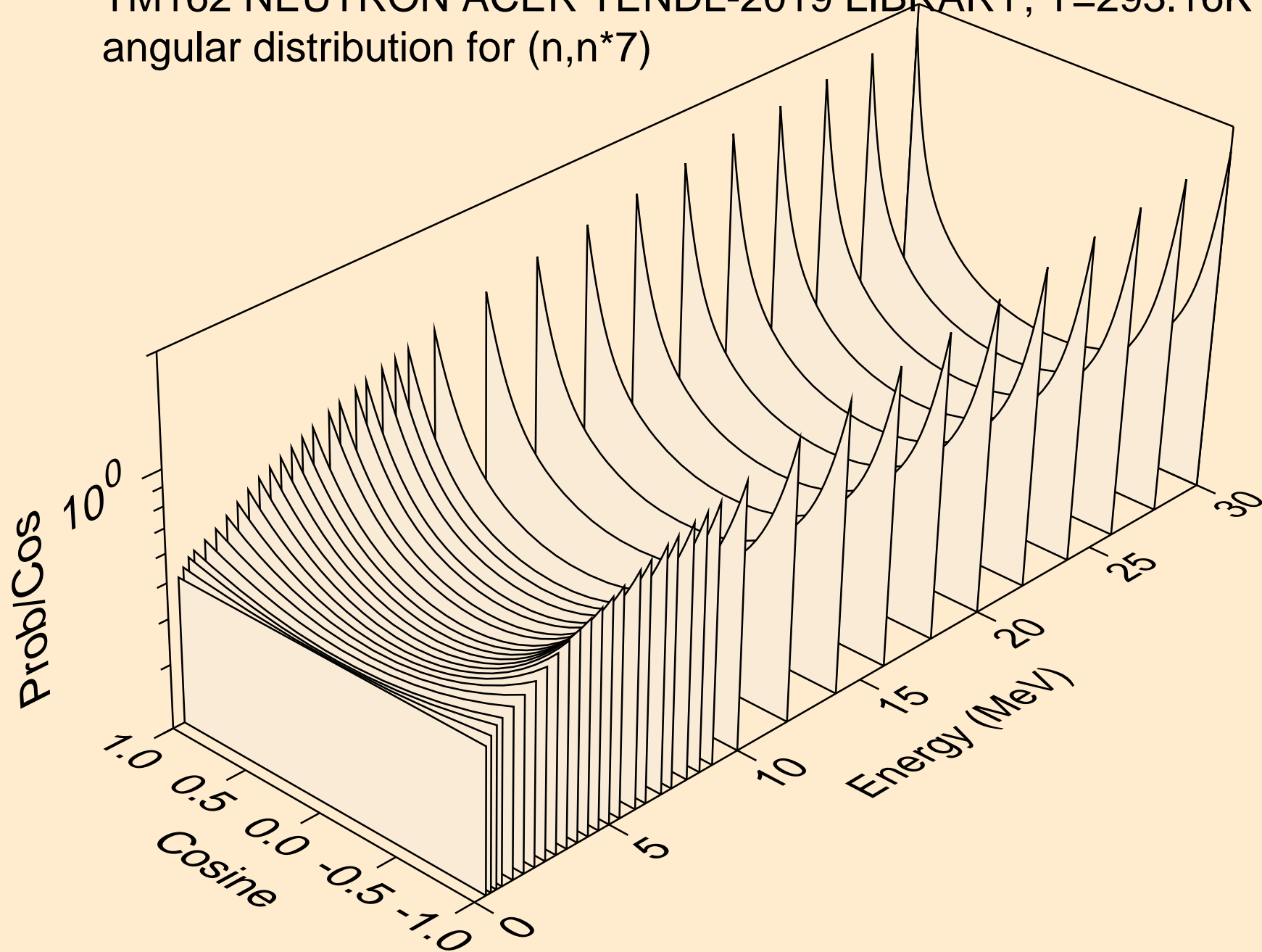

TM162 NEUTRON ACER TENDL-2019 LIBRARY; T=293.16K
angular distribution for (n,n*8)

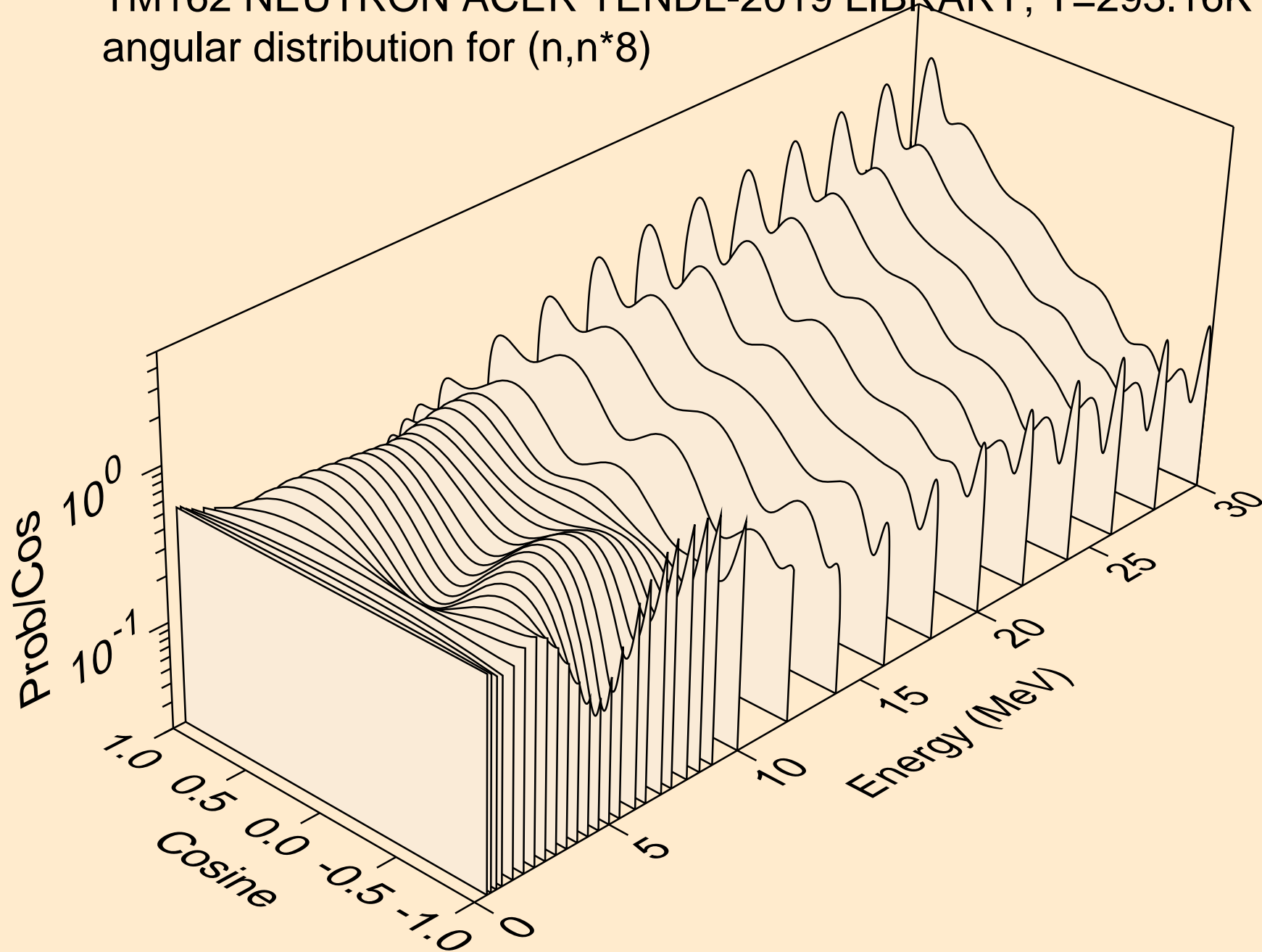

TM162 NEUTRON ACER TENDL-2019 LIBRARY; T=293.16K
angular distribution for (n,n*9)

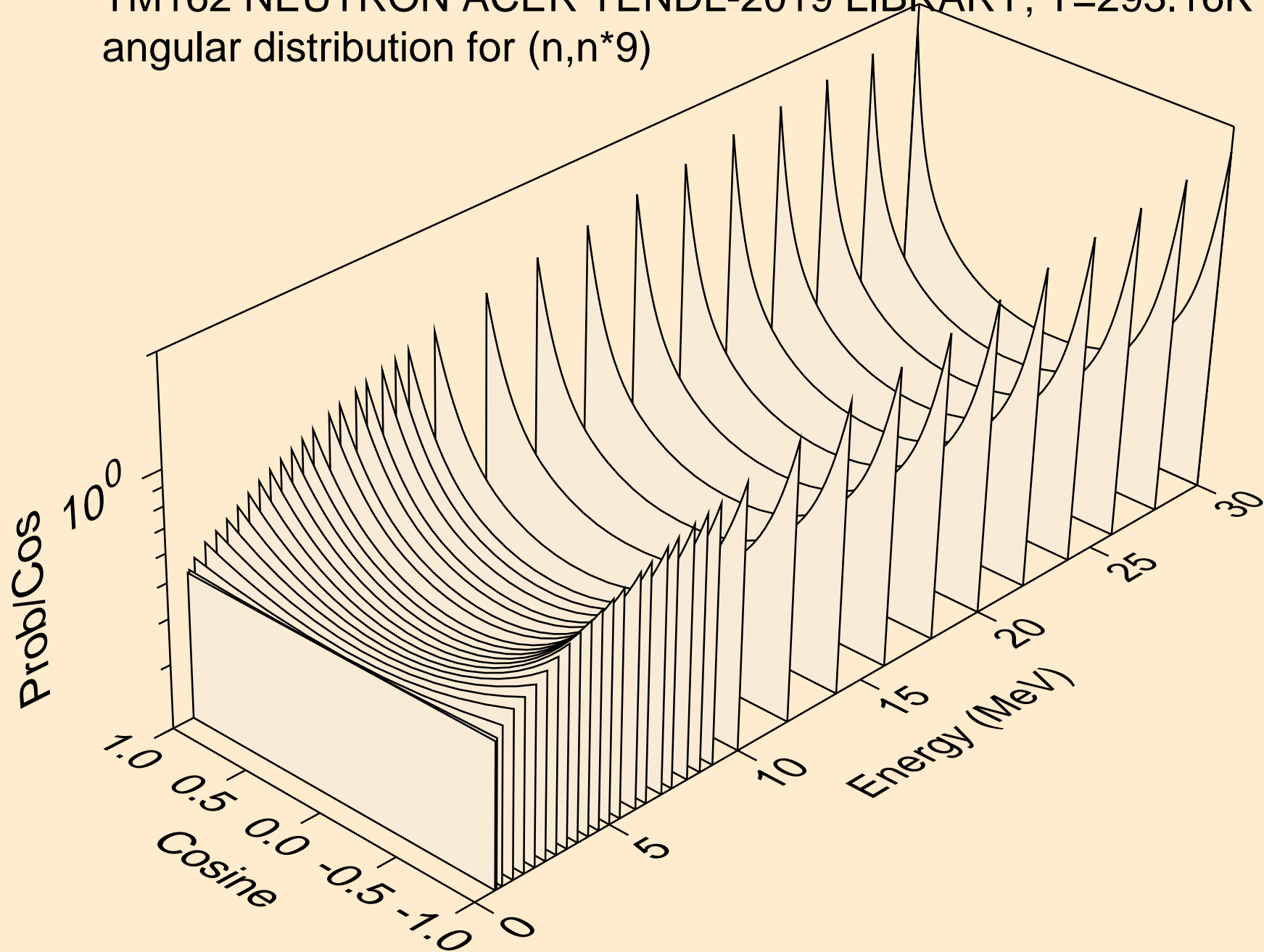

TM162 NEUTRON ACER TENDL-2019 LIBRARY; T=293.16K
angular distribution for (n,n*10)

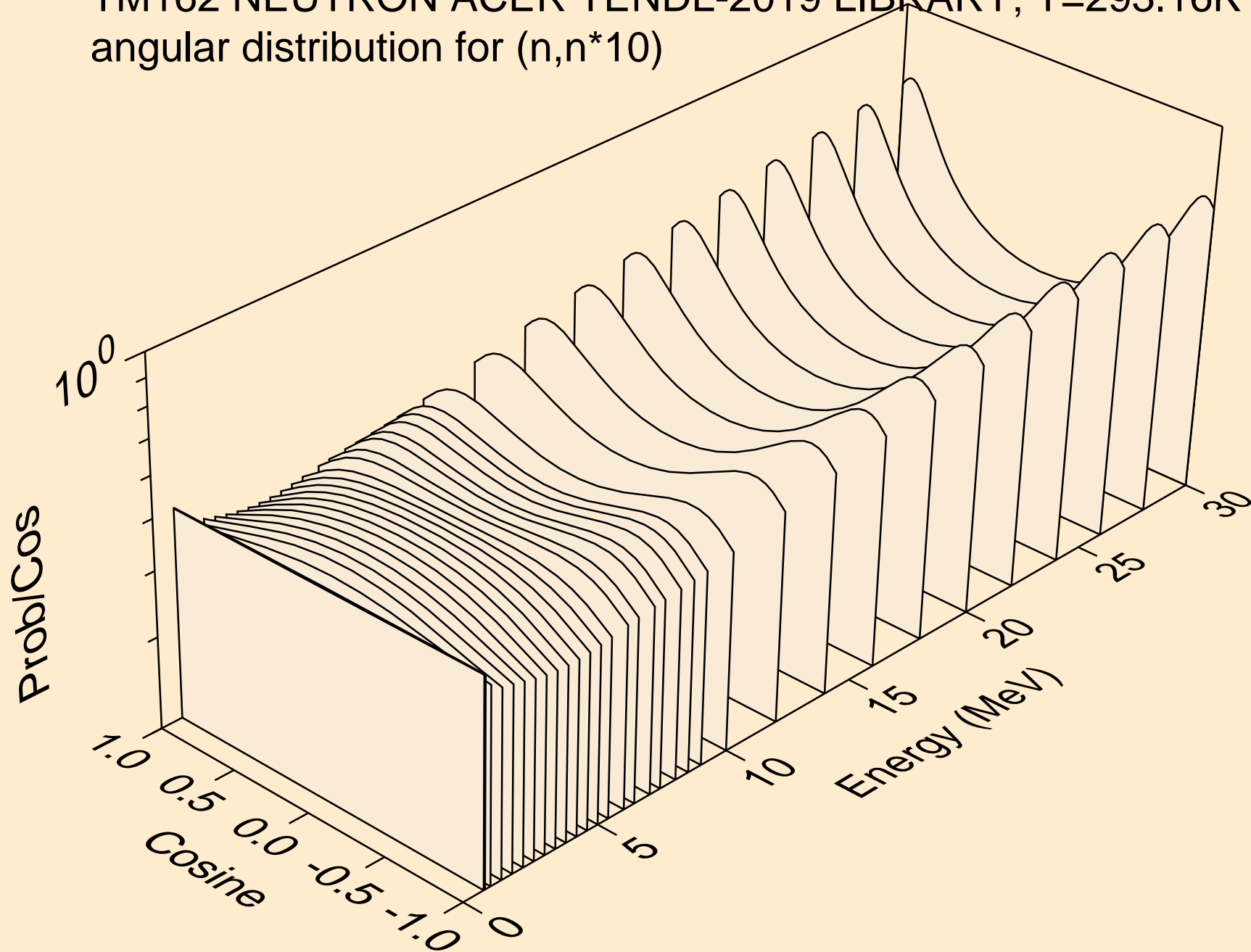

TM162 NEUTRON ACER TENDL-2019 LIBRARY; T=293.16K
angular distribution for (n,n*11)

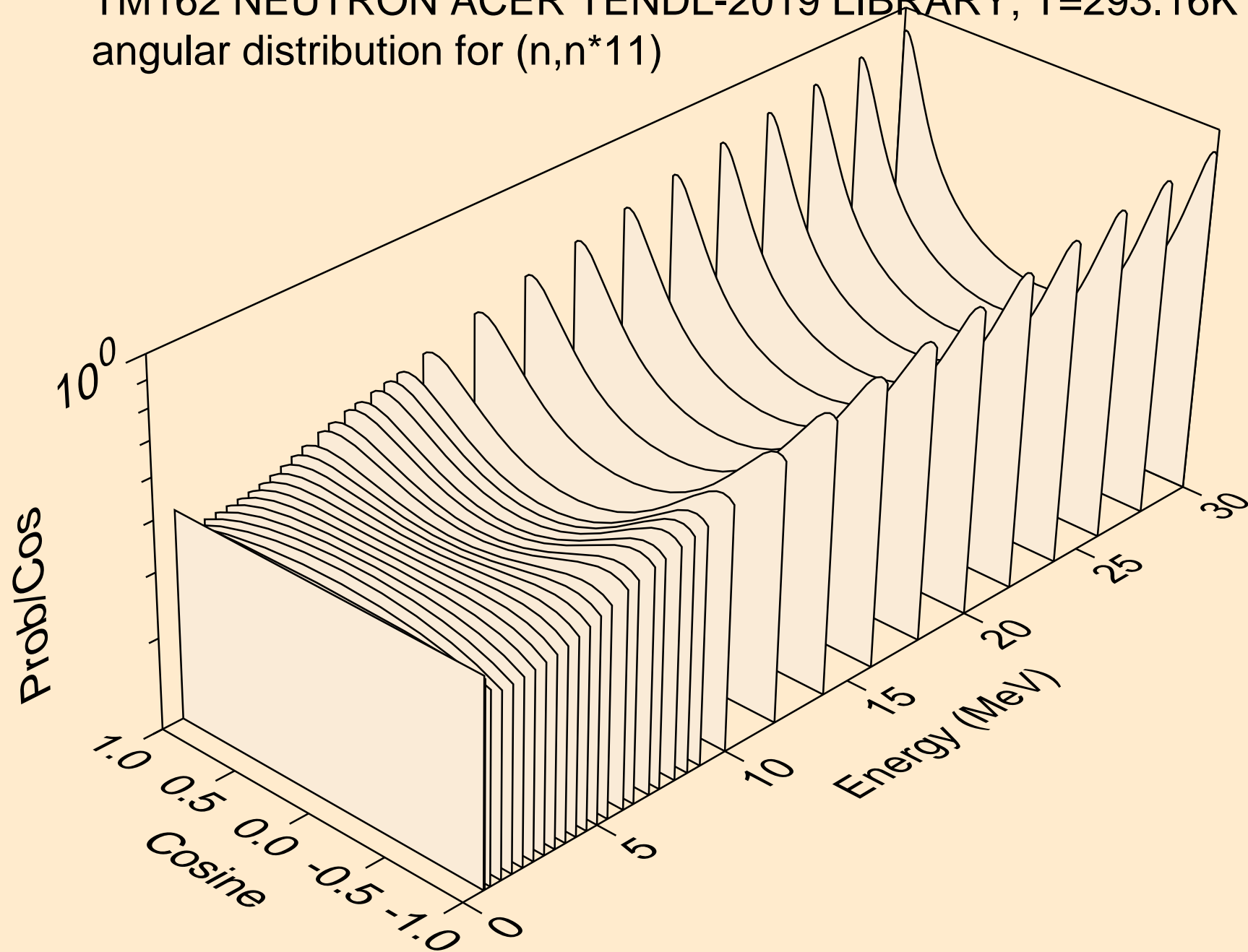

TM162 NEUTRON ACER TENDL-2019 LIBRARY; T=293.16K
angular distribution for (n,n*12)

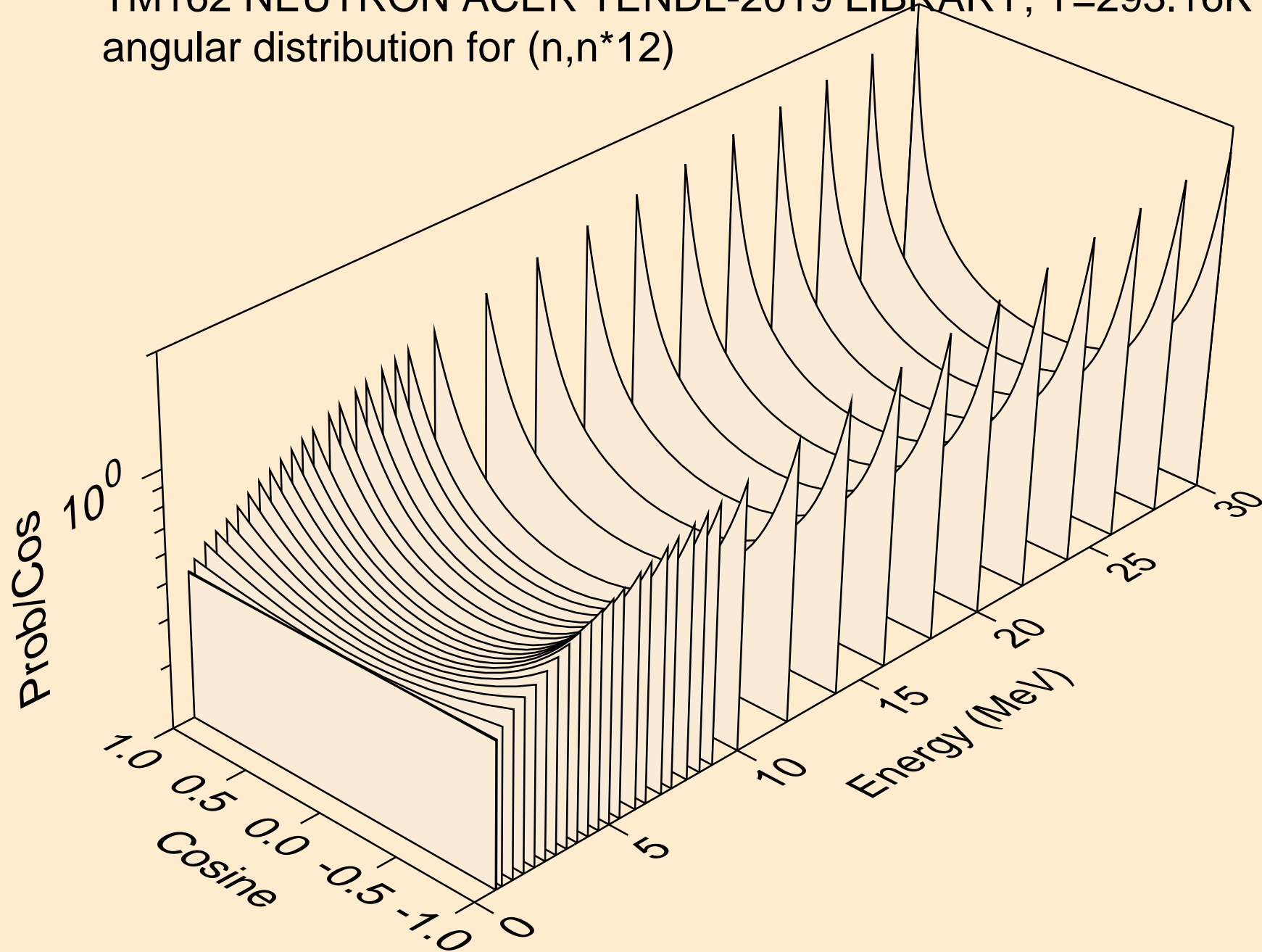

TM162 NEUTRON ACER TENDL-2019 LIBRARY; T=293.16K
angular distribution for (n,n*13)

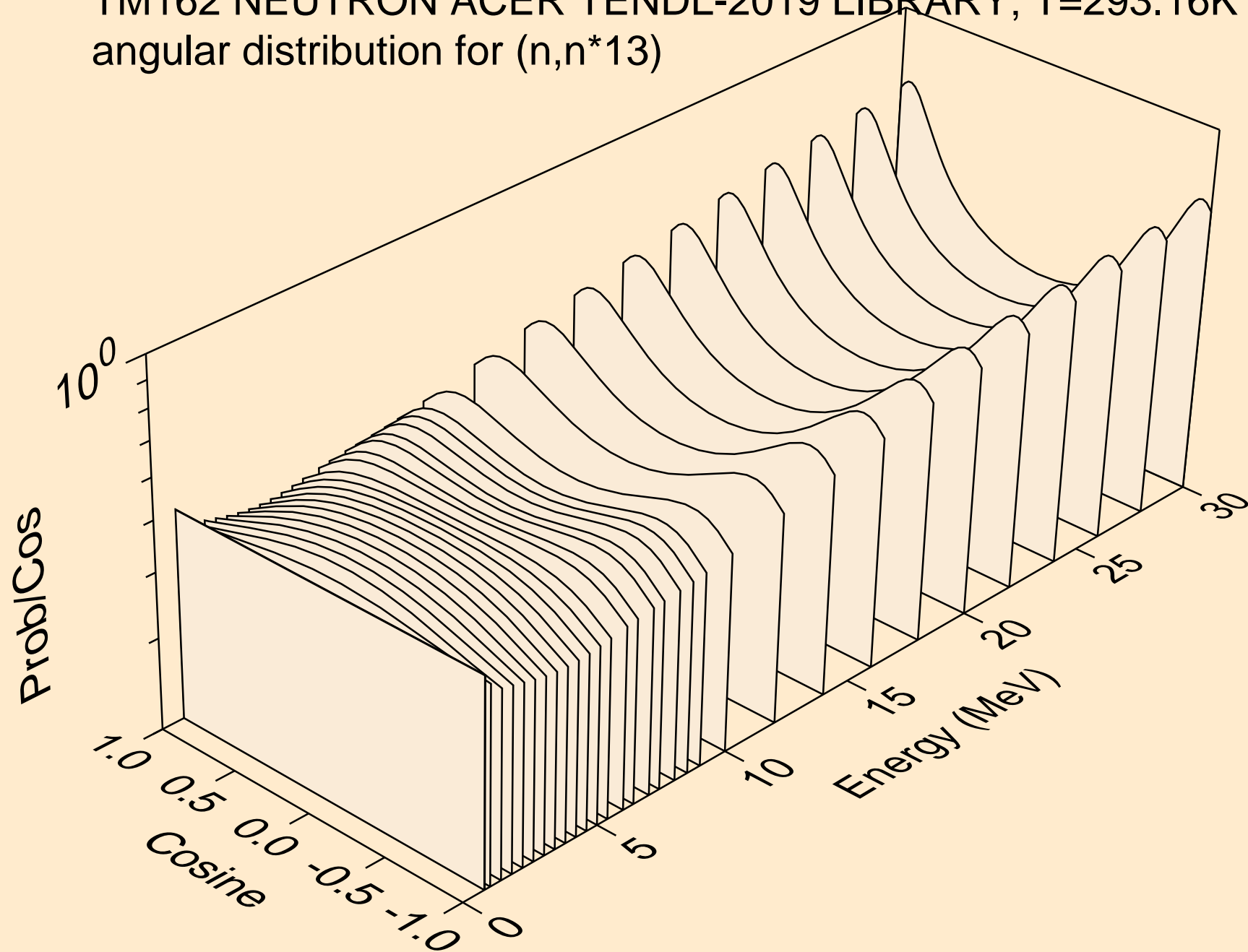

TM162 NEUTRON ACER TENDL-2019 LIBRARY; T=293.16K
angular distribution for (n,n*14)

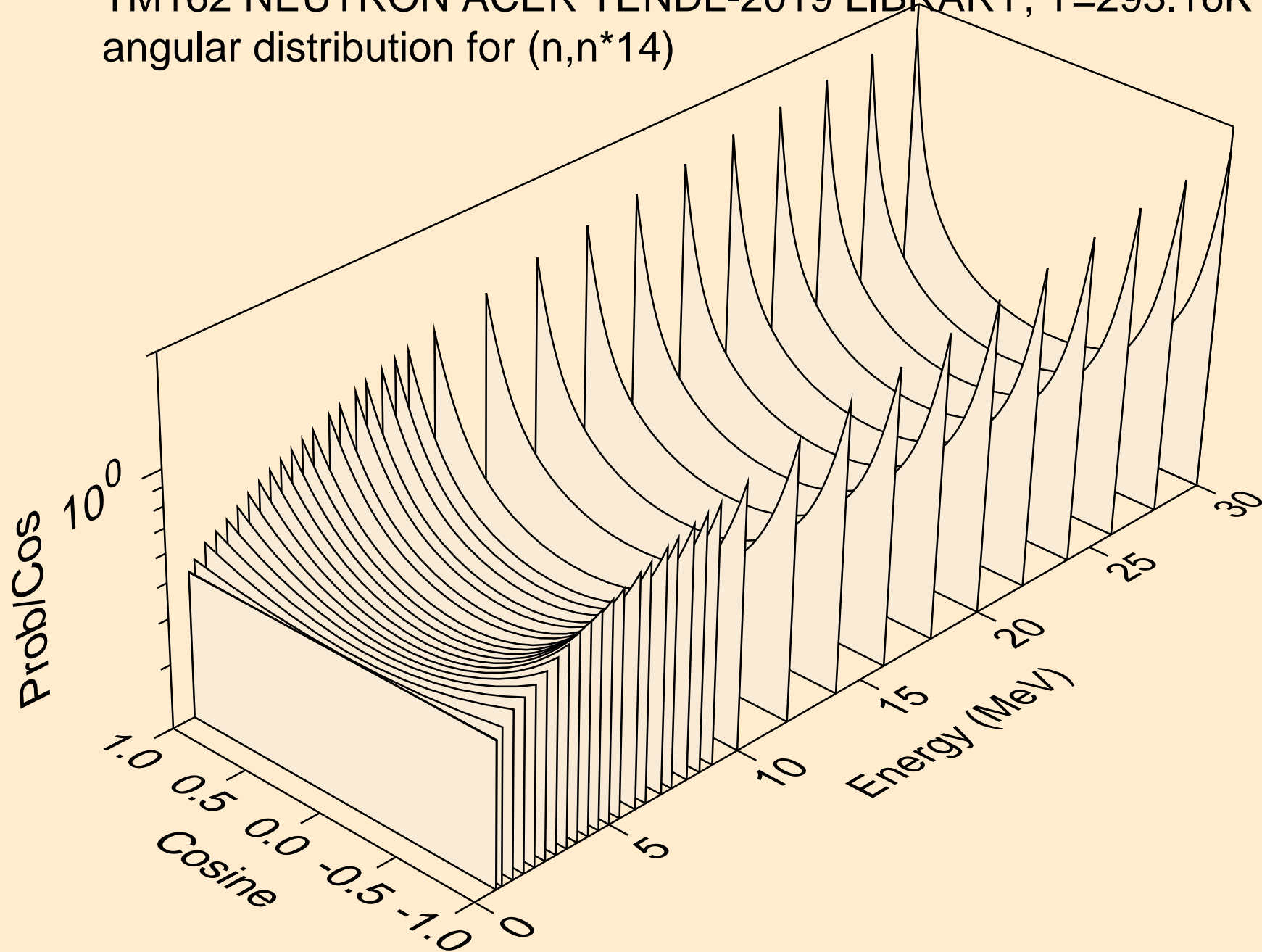

TM162 NEUTRON ACER TENDL-2019 LIBRARY; T=293.16K
angular distribution for (n,n*15)

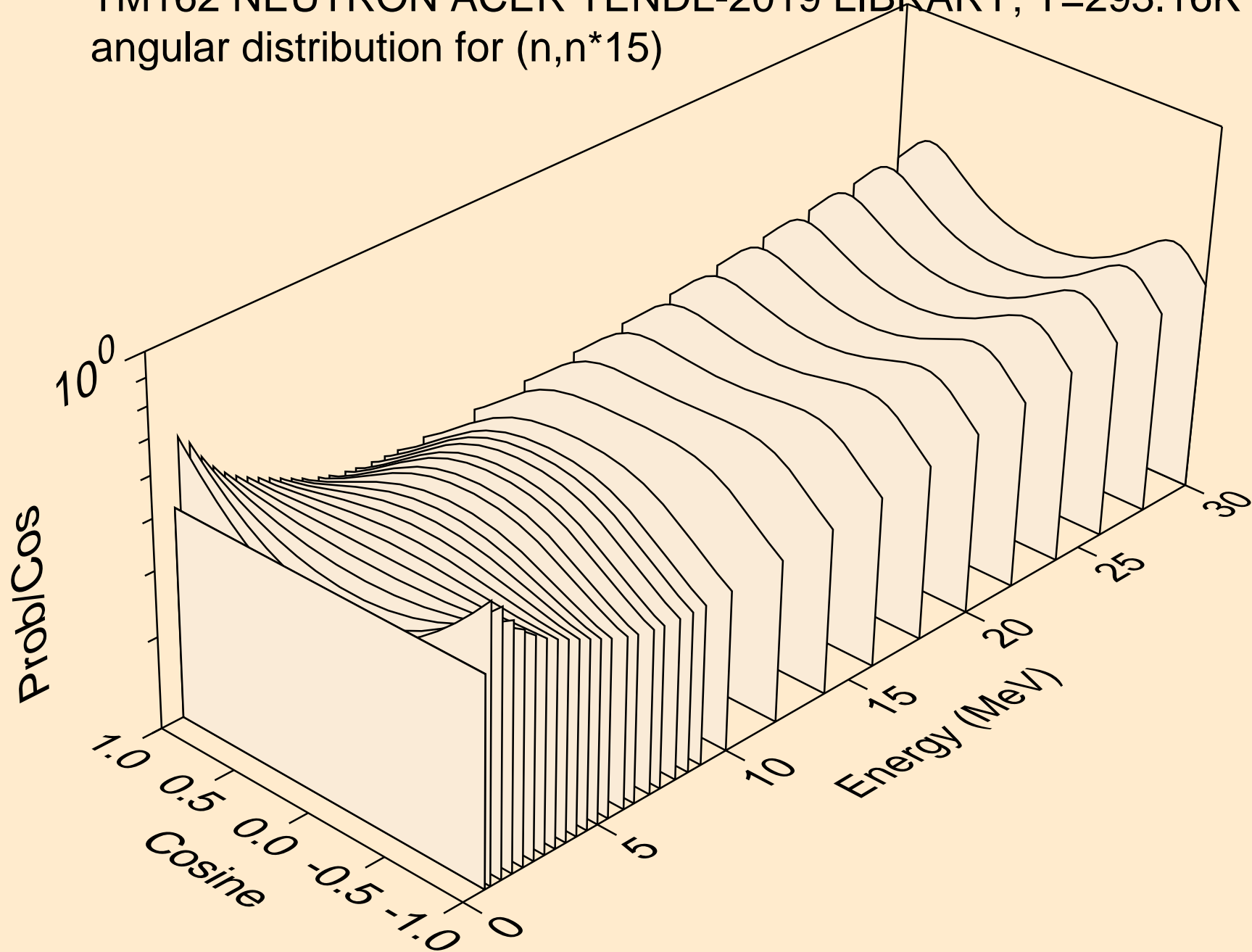

TM162 NEUTRON ACER TENDL-2019 LIBRARY; T=293.16K
angular distribution for (n,n*16)

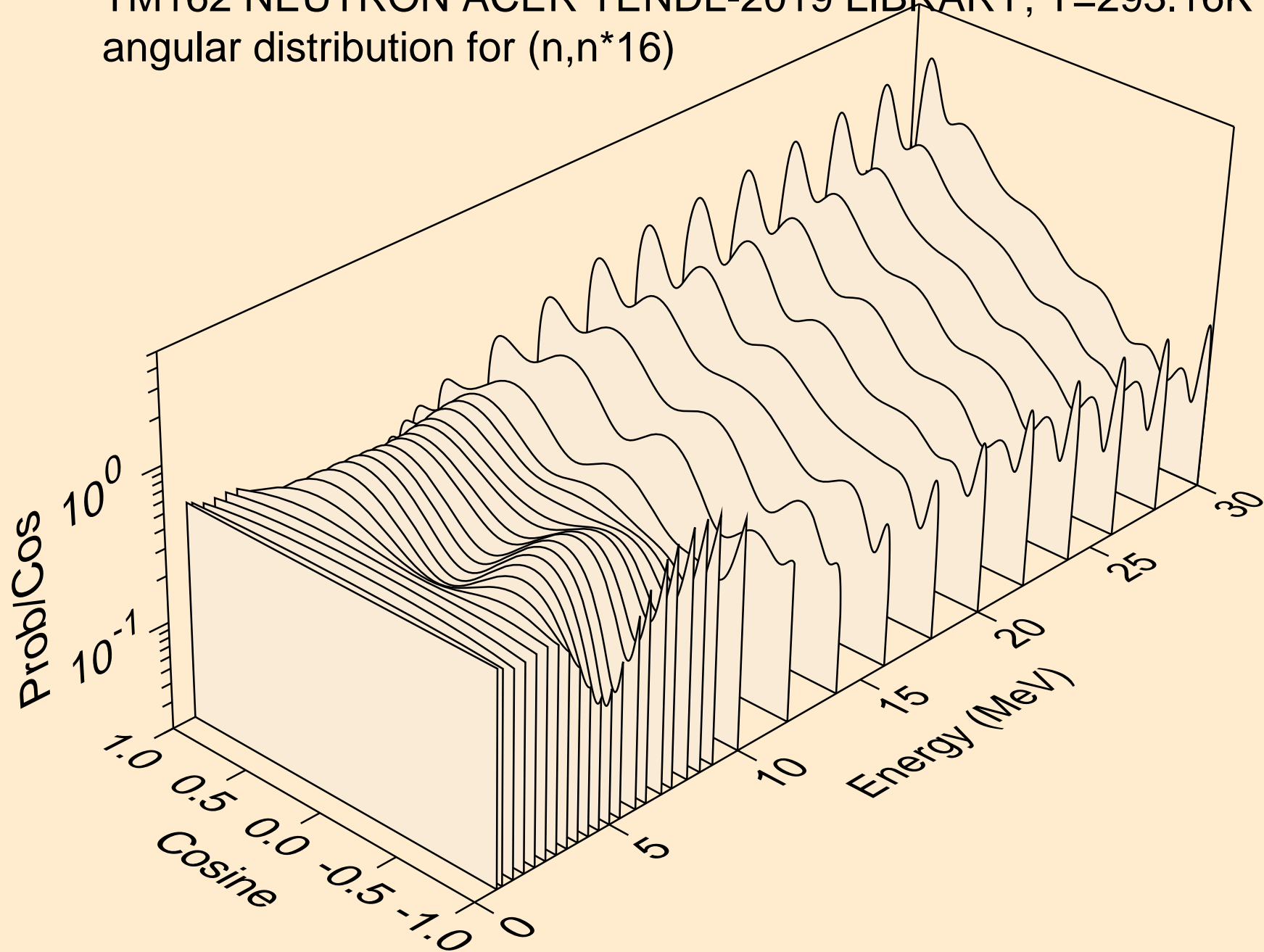

TM162 NEUTRON ACER TENDL-2019 LIBRARY; T=293.16K
angular distribution for (n,n*17)

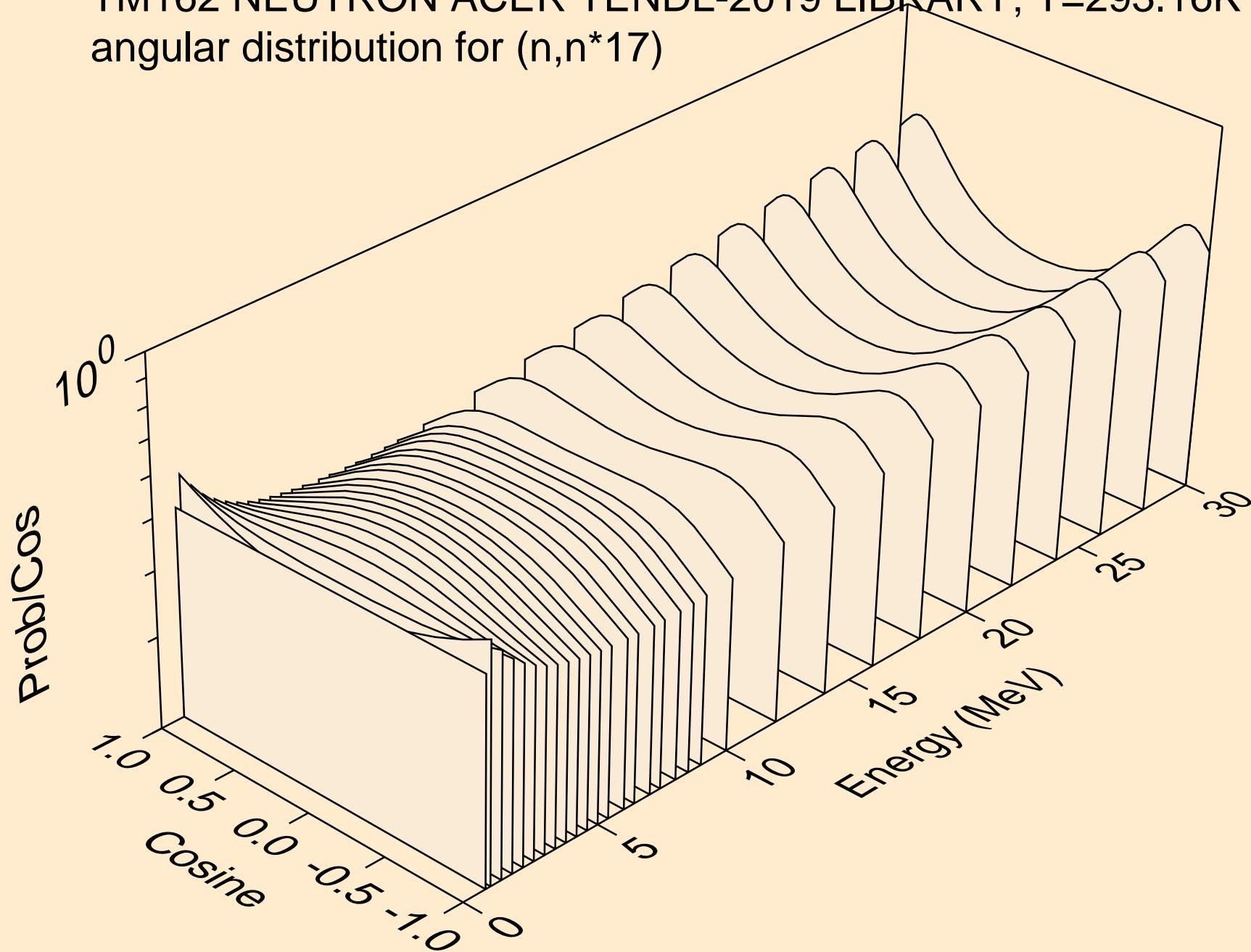

TM162 NEUTRON ACER TENDL-2019 LIBRARY; T=293.16K
angular distribution for (n,n*18)

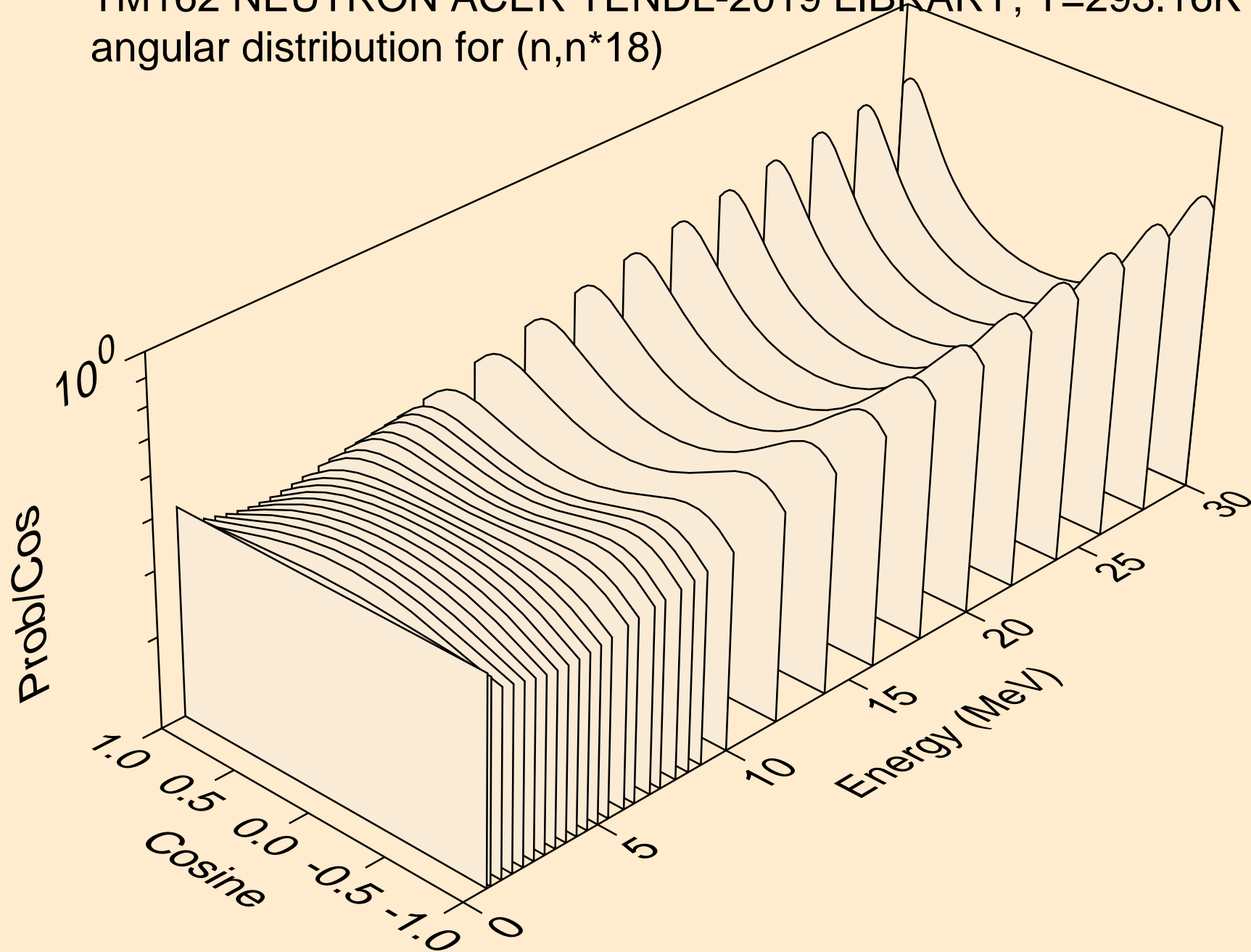

TM162 NEUTRON ACER TENDL-2019 LIBRARY; T=293.16K
angular distribution for (n,n*19)

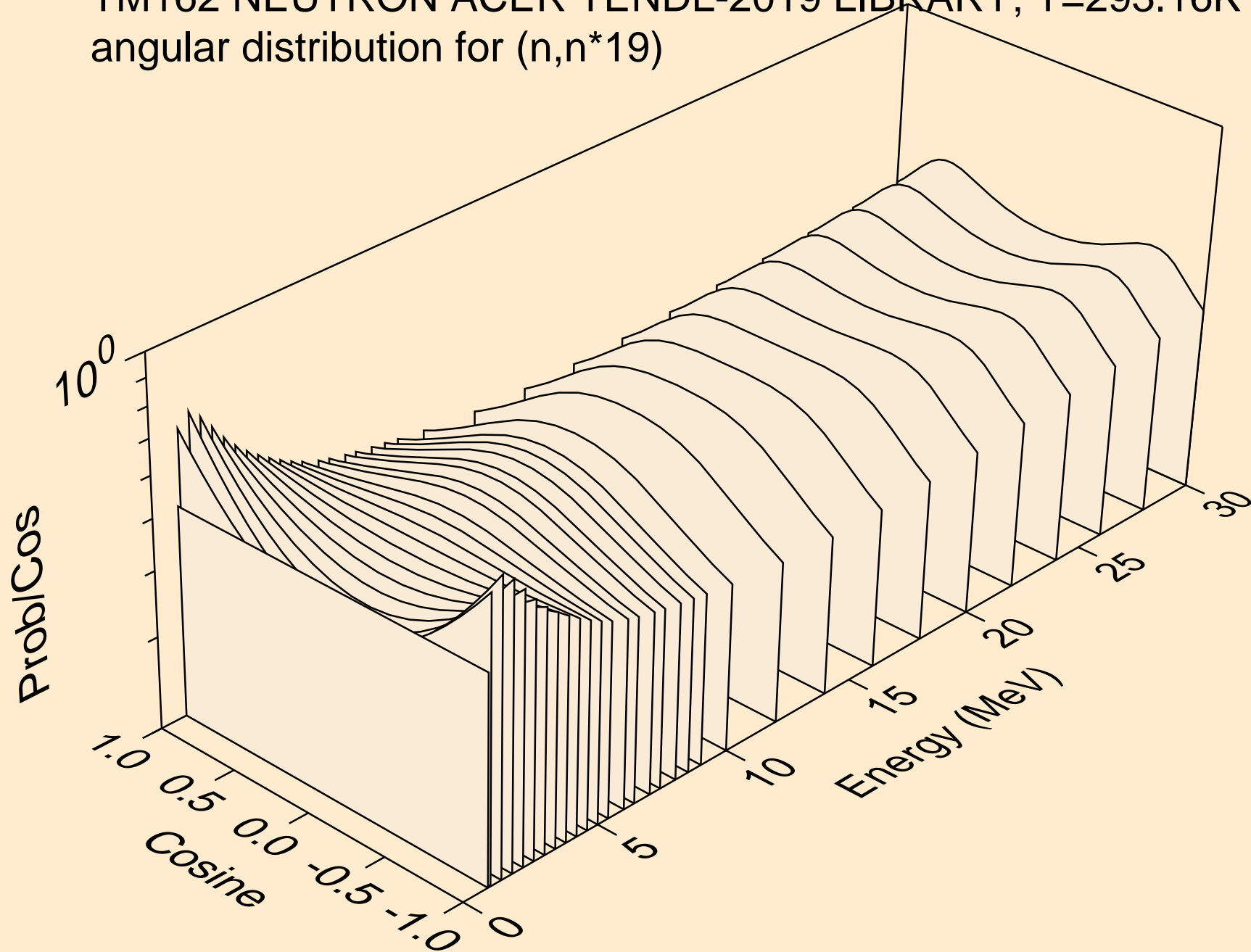

TM162 NEUTRON ACER TENDL-2019 LIBRARY; T=293.16K
angular distribution for (n,n*20)

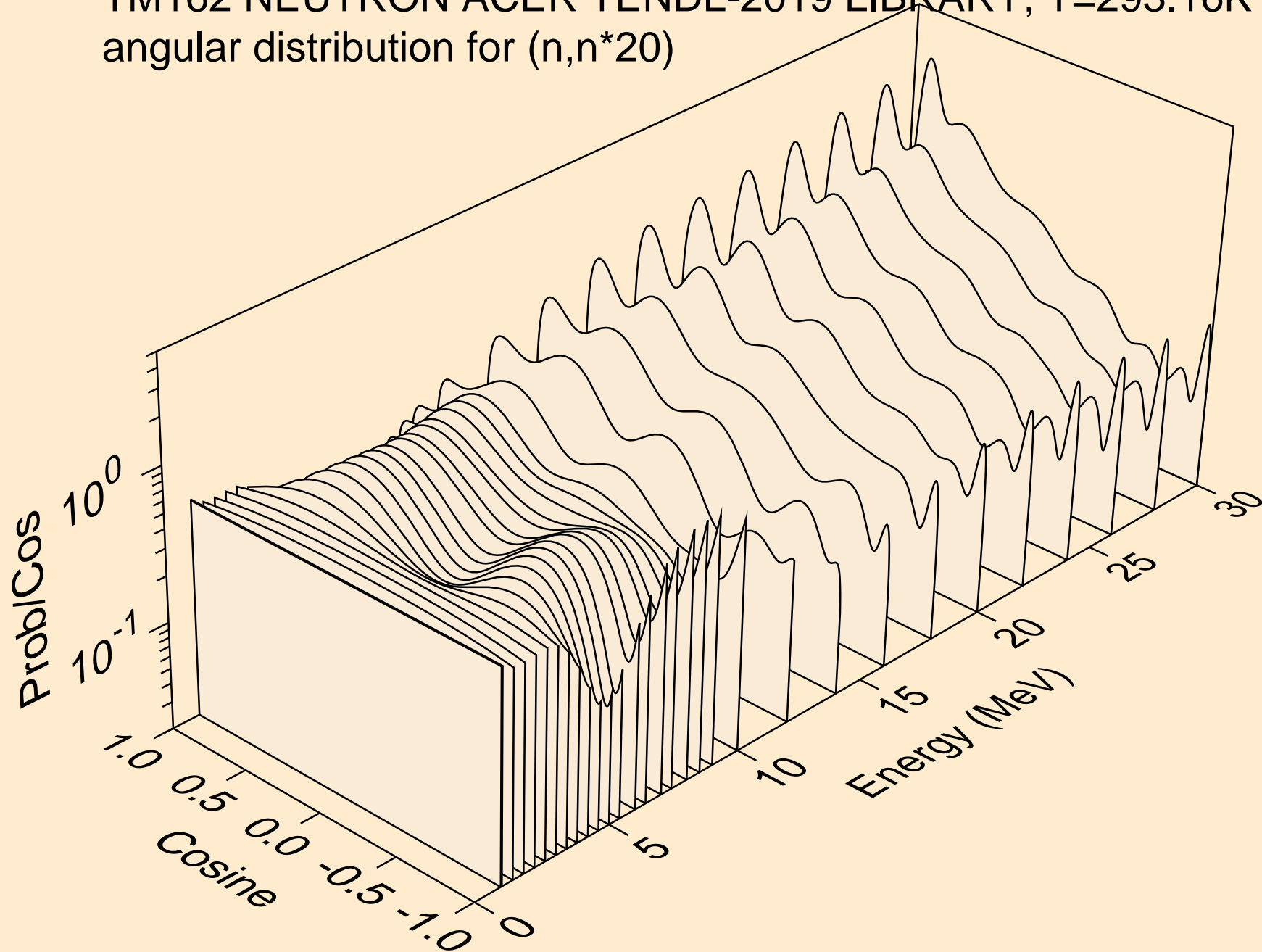

TM162 NEUTRON ACER TENDL-2019 LIBRARY; T=293.16K
Neutron emission for (n,x)

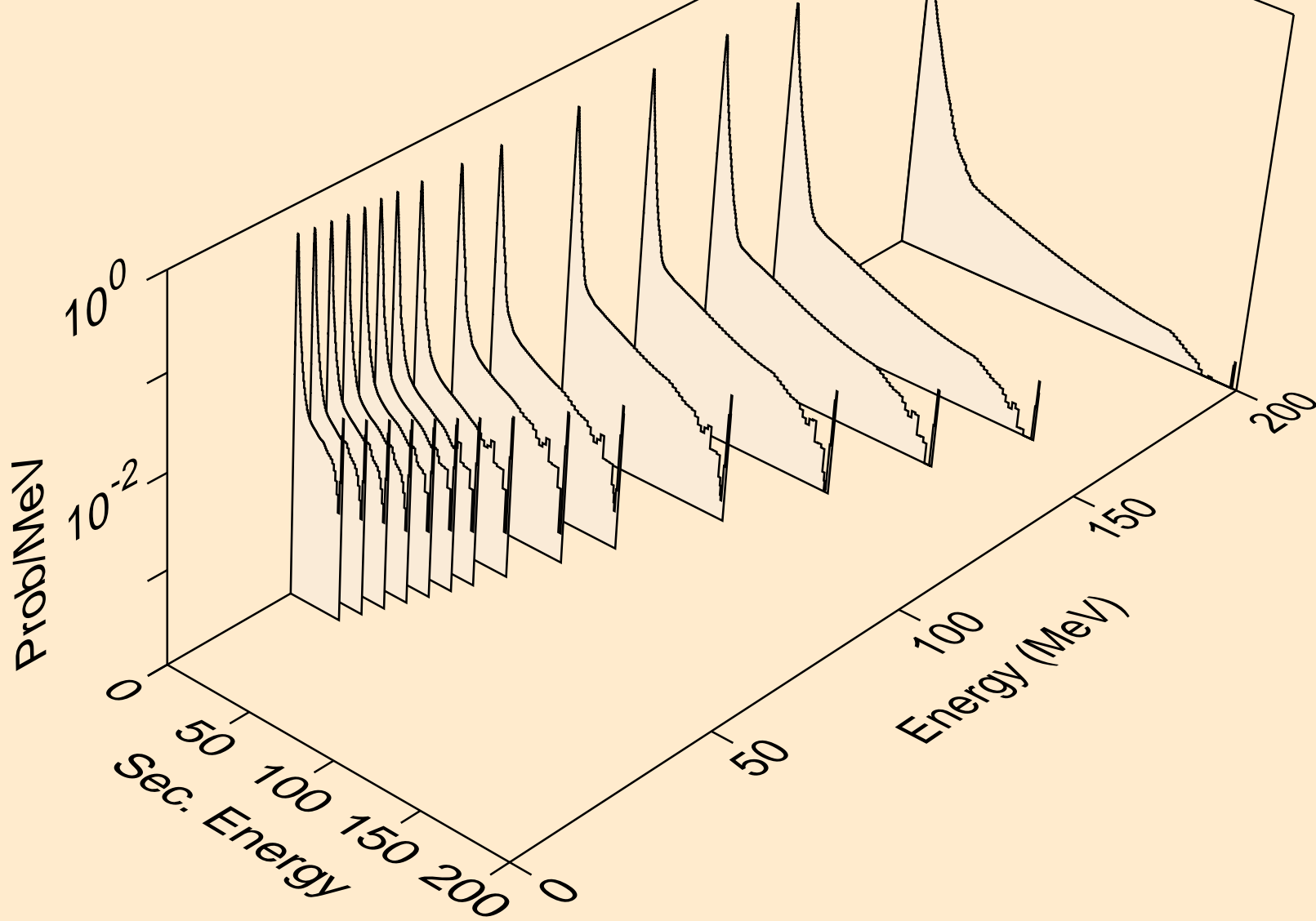

TM162 NEUTRON ACER TENDL-2019 LIBRARY; T=293.16K
Neutron emission for (n,2nd)

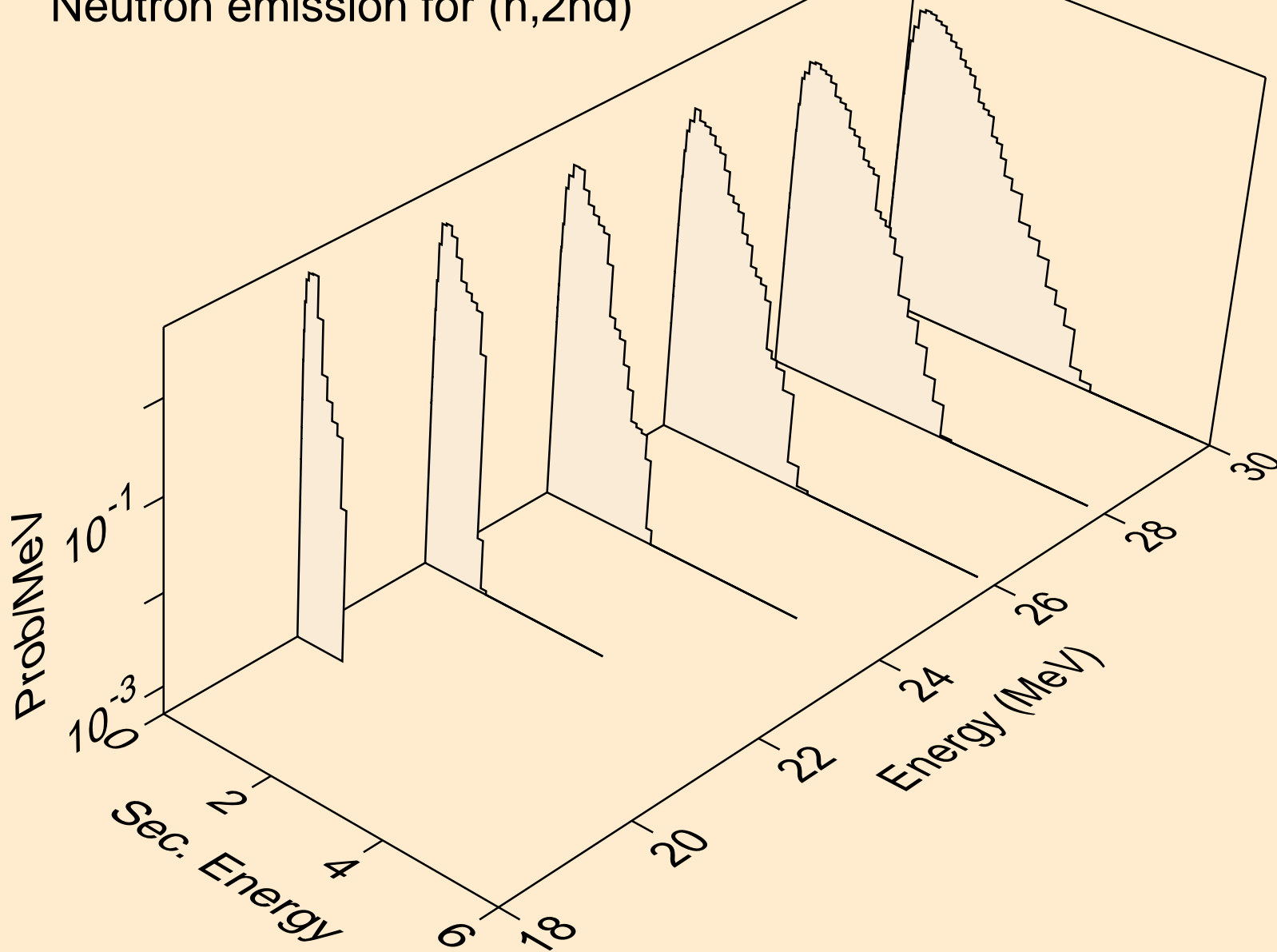

TM162 NEUTRON ACER TENDL-2019 LIBRARY; T=293.16K
Neutron emission for (n,2n)

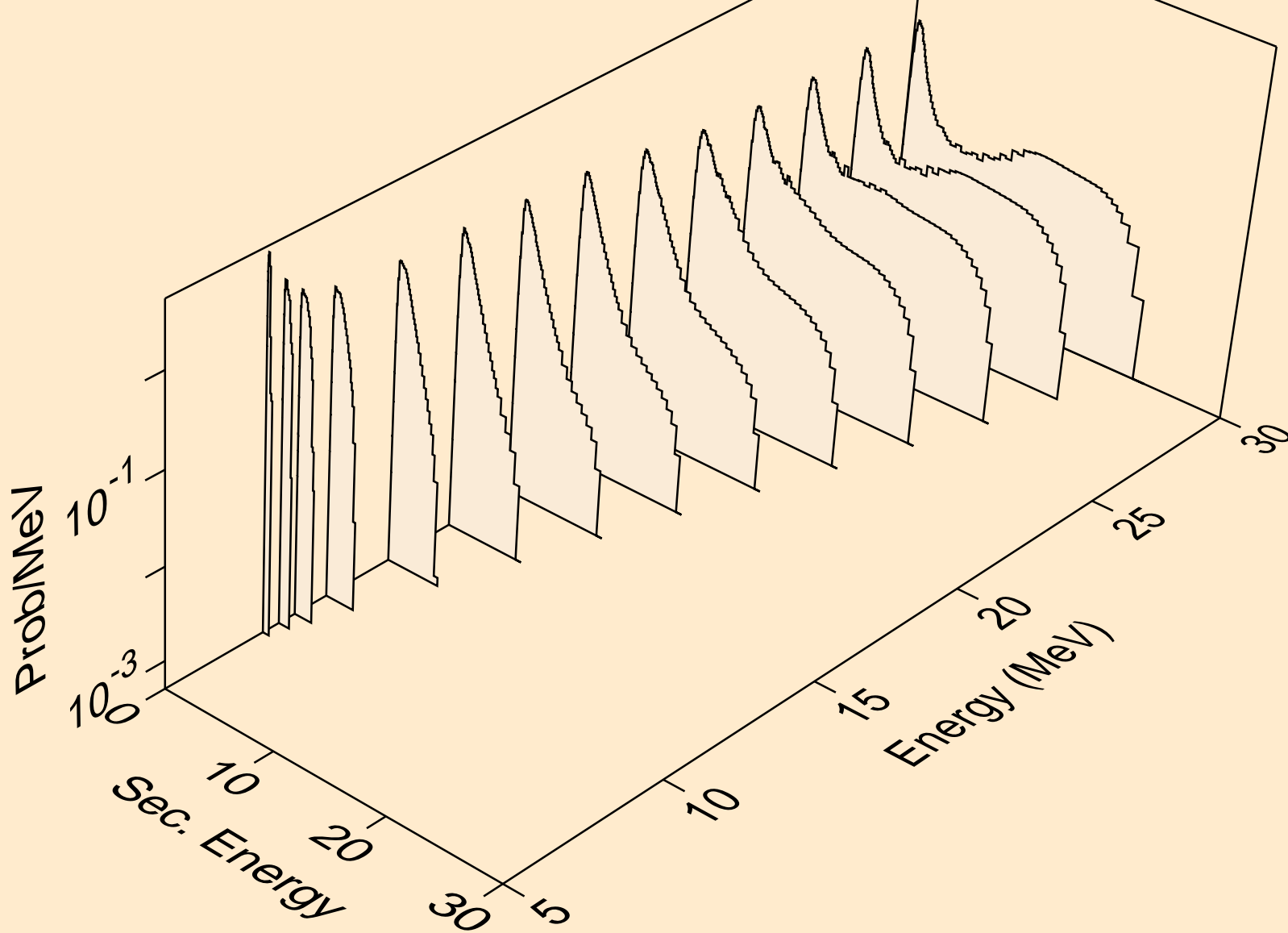

TM162 NEUTRON ACER TENDL-2019 LIBRARY; T=293.16K
Neutron emission for (n,3n)

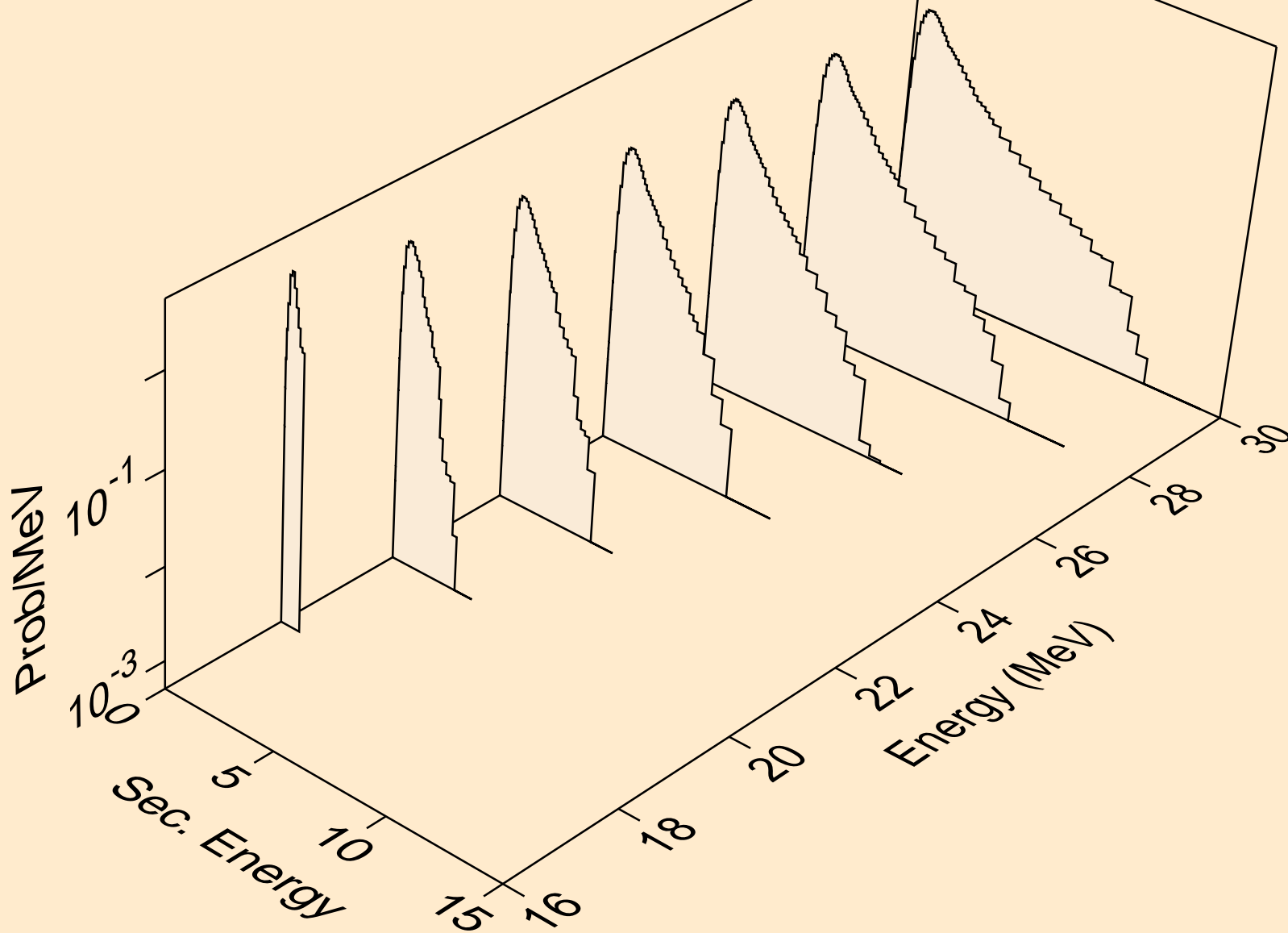

TM162 NEUTRON ACER TENDL-2019 LIBRARY; T=293.16K
Neutron emission for (n,n*)a

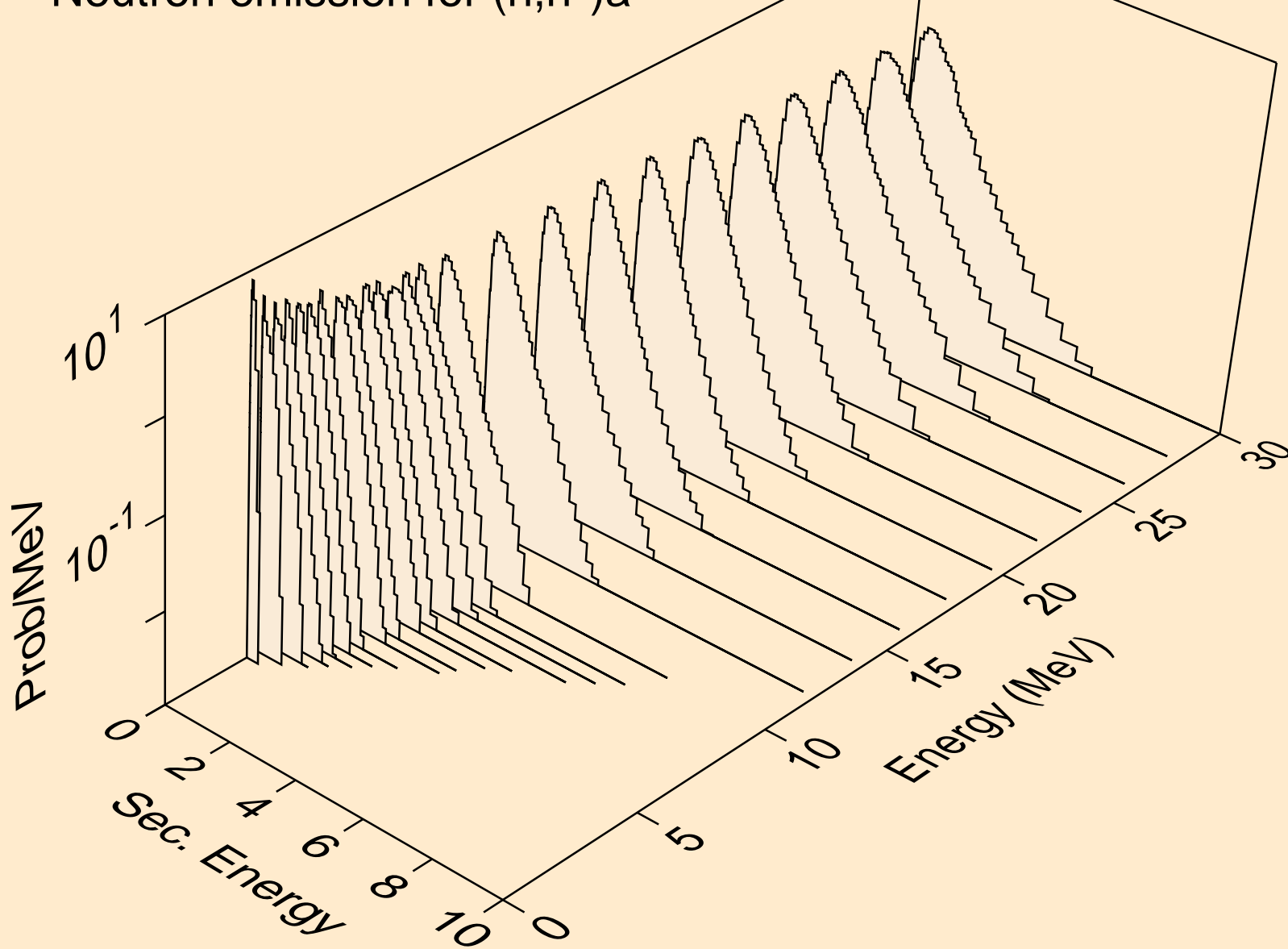

TM162 NEUTRON ACER TENDL-2019 LIBRARY; T=293.16K
Neutron emission for (n,2n)a

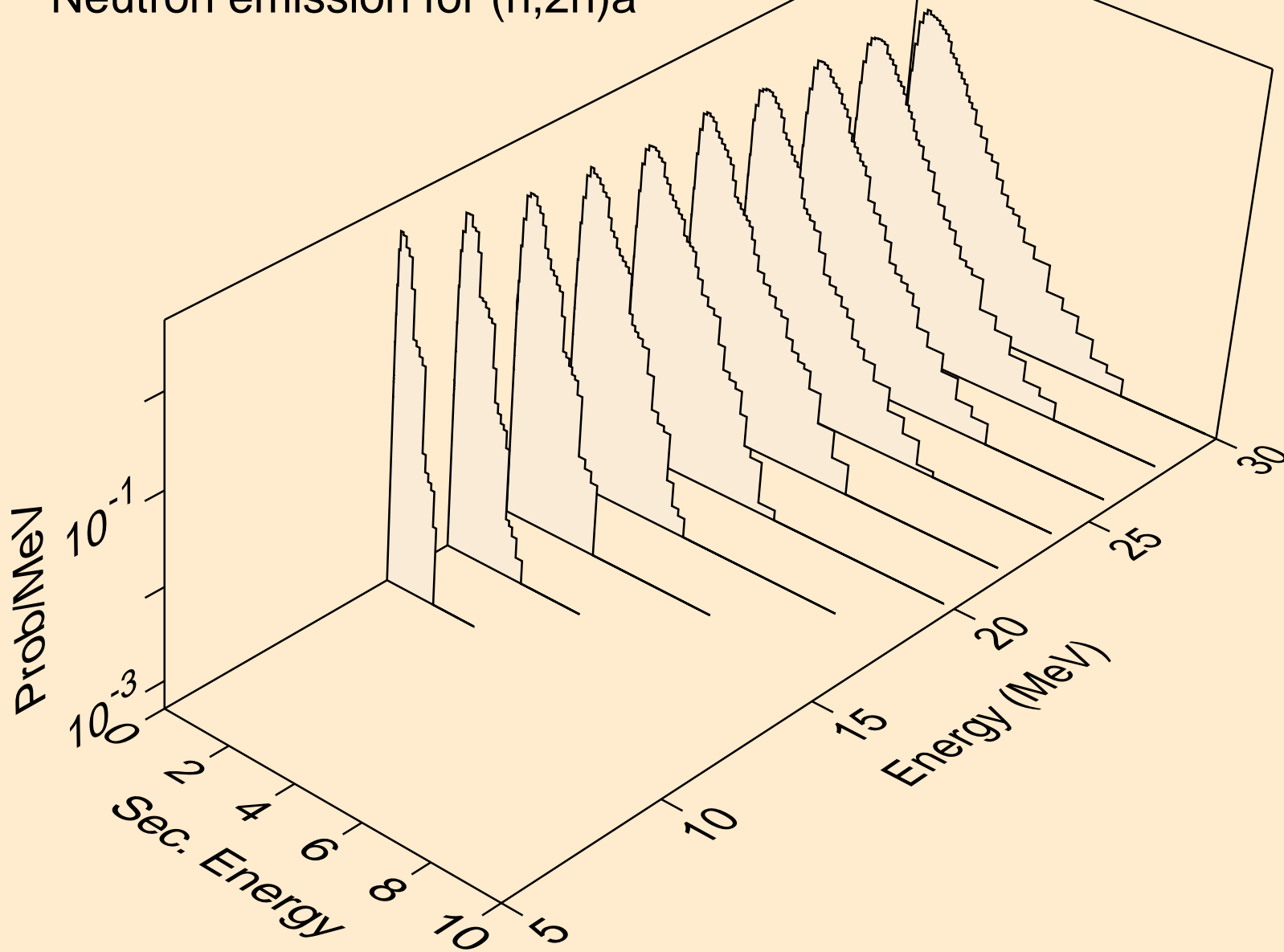

TM162 NEUTRON ACER TENDL-2019 LIBRARY; T=293.16K
Neutron emission for (n,3n)a

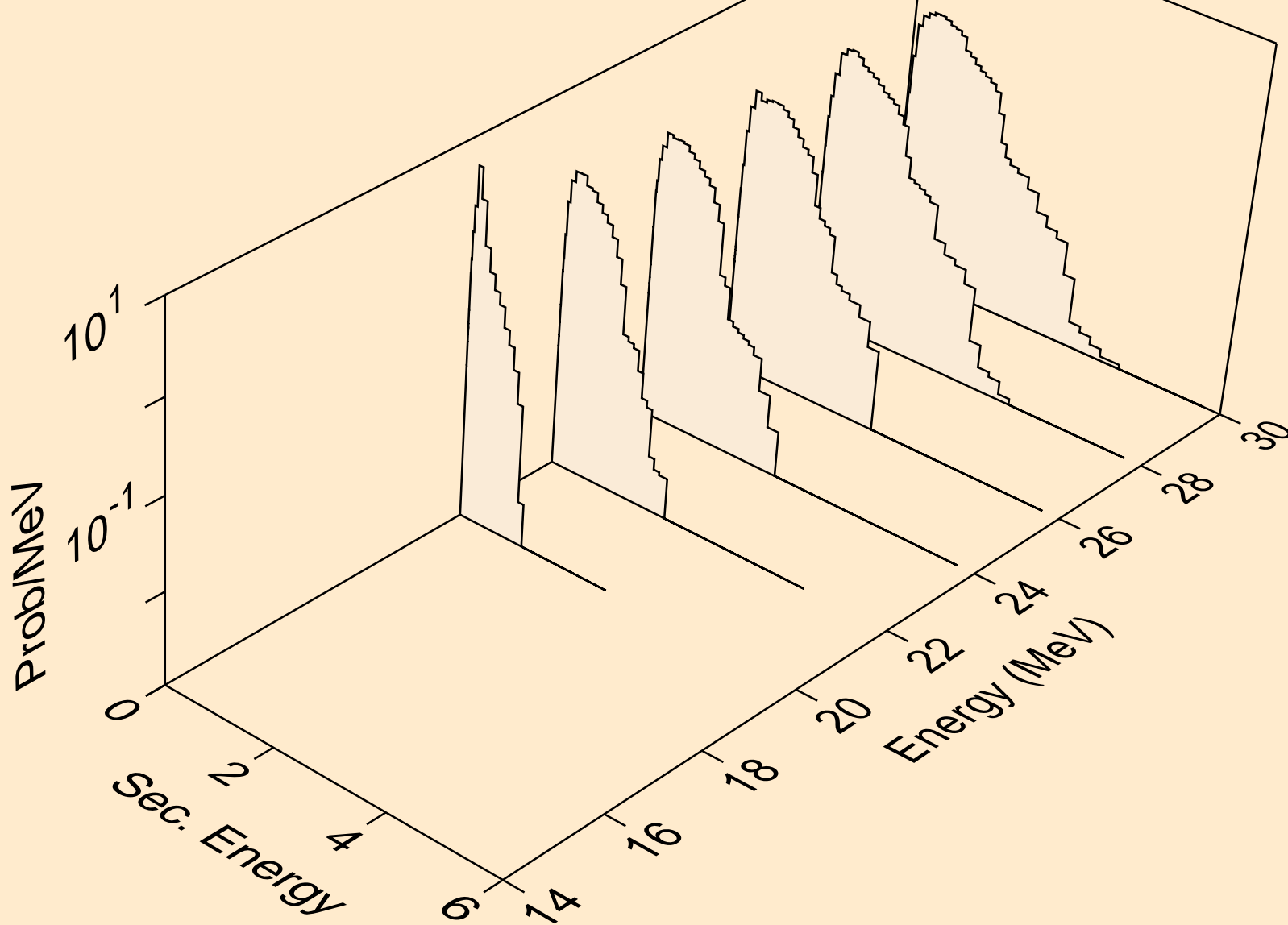

TM162 NEUTRON ACER TENDL-2019 LIBRARY; T=293.16K
Neutron emission for (n,n*)p

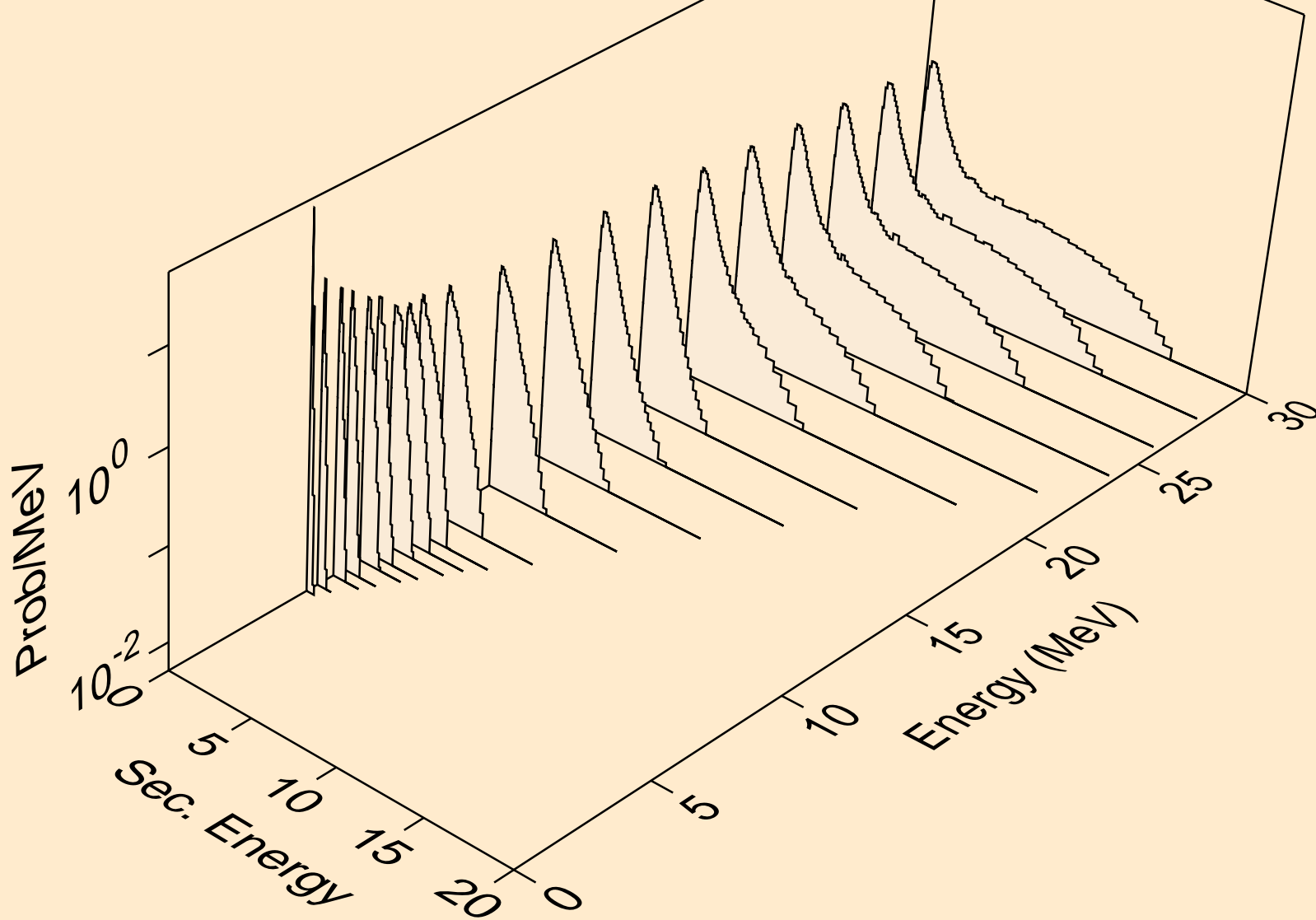

TM162 NEUTRON ACER TENDL-2019 LIBRARY; T=293.16K
Neutron emission for (n,n*)2a

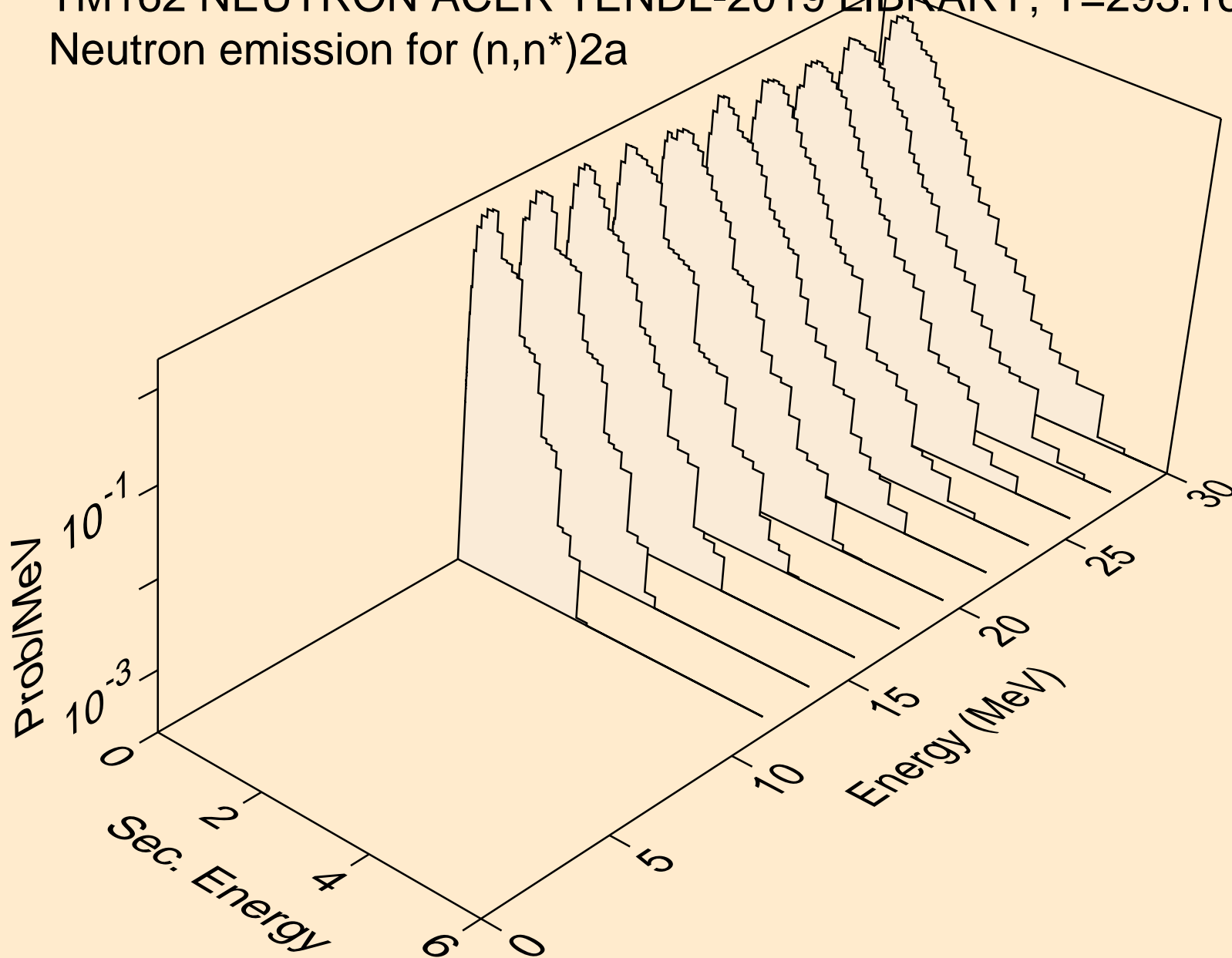

TM162 NEUTRON ACER TENDL-2019 LIBRARY; T=293.16K
Neutron emission for (n,2n)2a

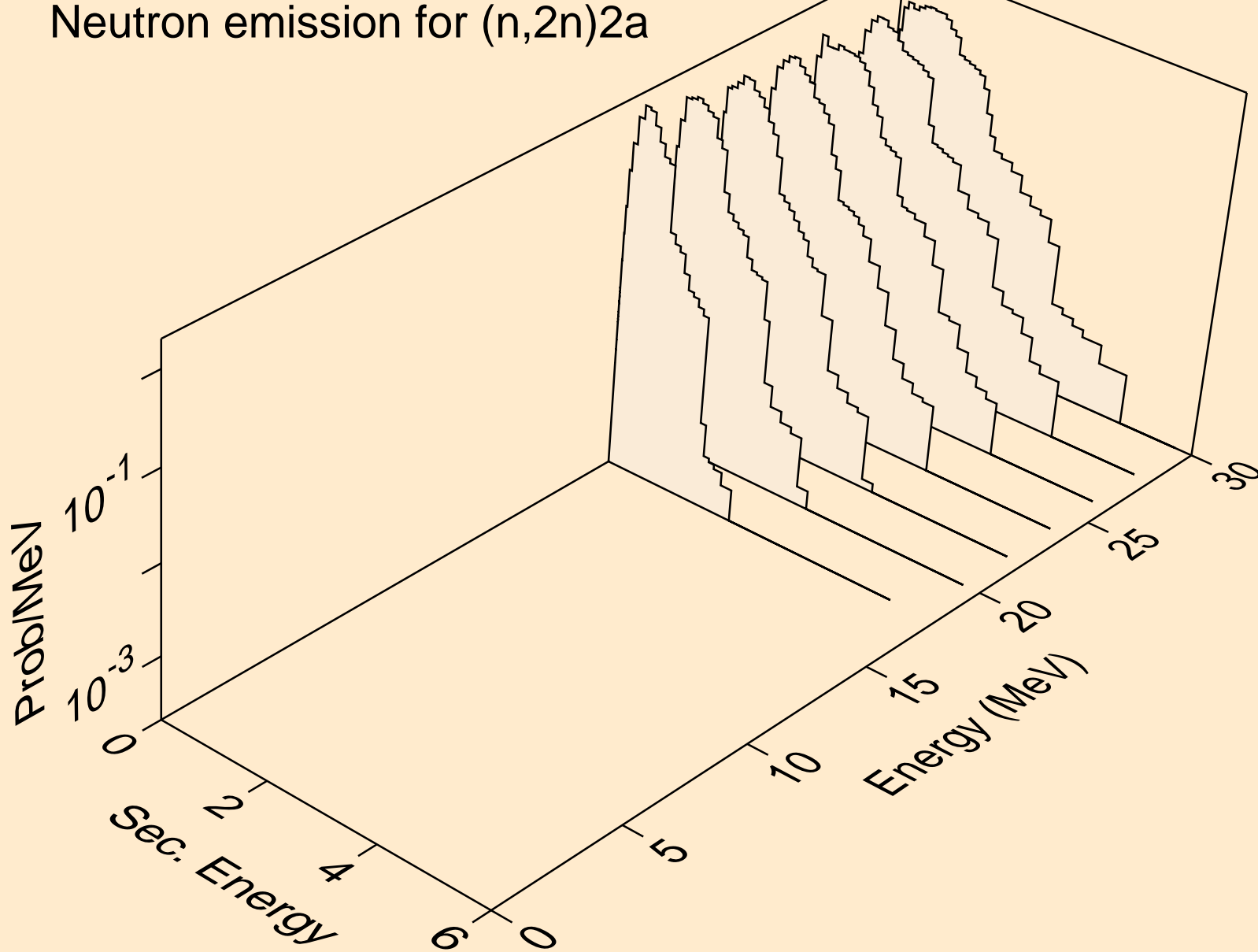

TM162 NEUTRON ACER TENDL-2019 LIBRARY; T=293.16K
Neutron emission for (n,n*)d

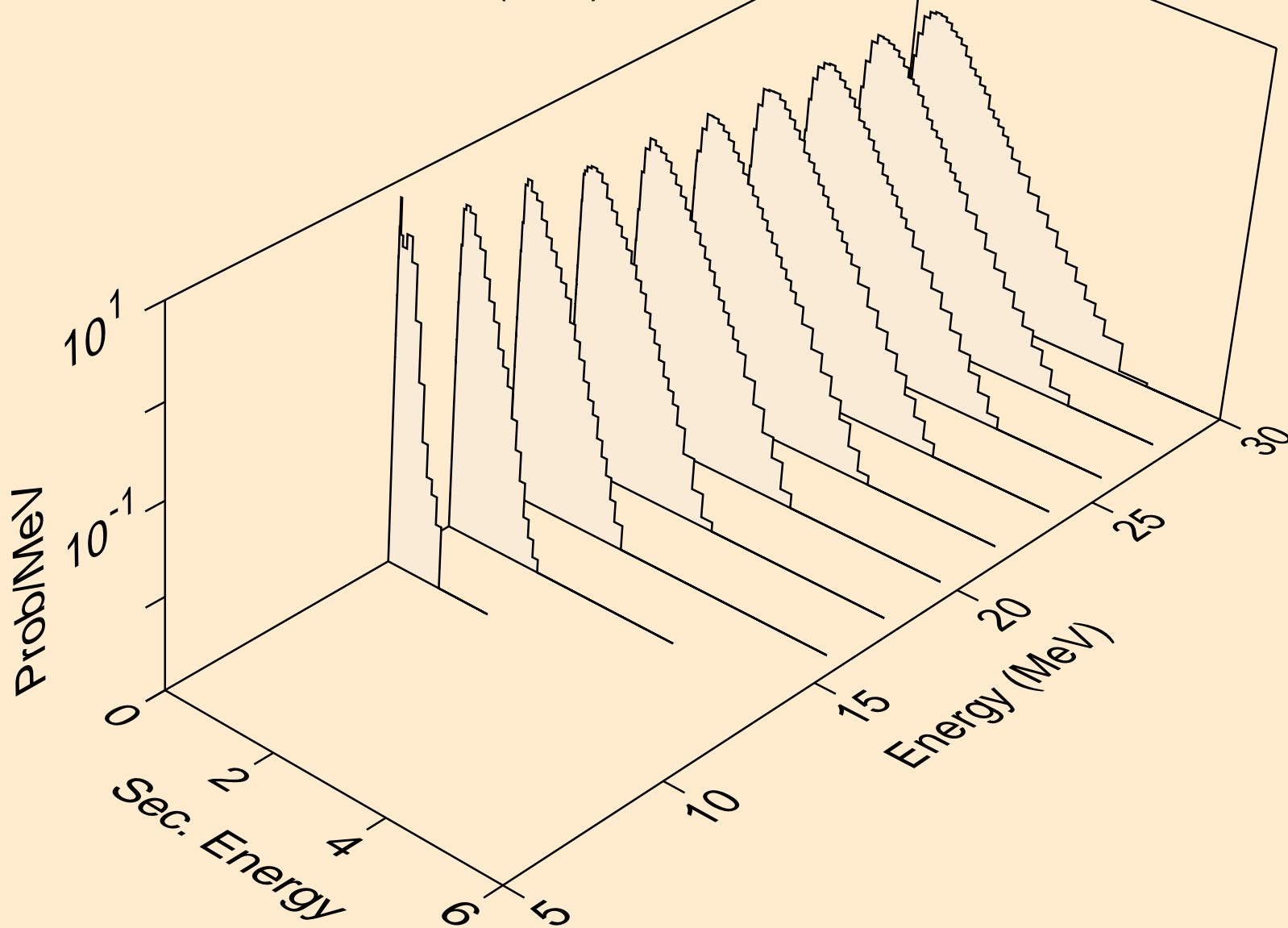

TM162 NEUTRON ACER TENDL-2019 LIBRARY; T=293.16K
Neutron emission for (n,n*)t

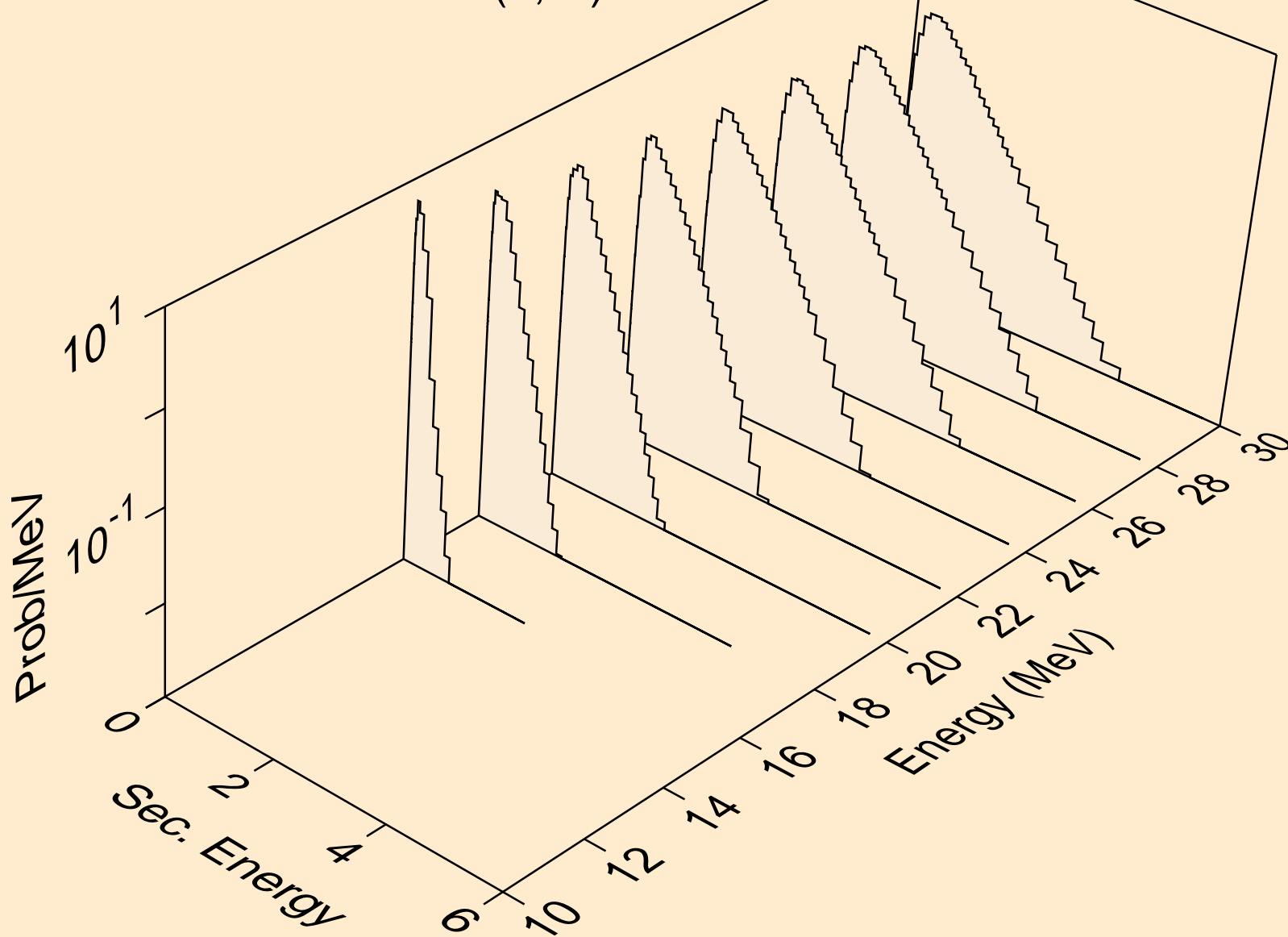

TM162 NEUTRON ACER TENDL-2019 LIBRARY; T=293.16K
Neutron emission for (n,n*)he3

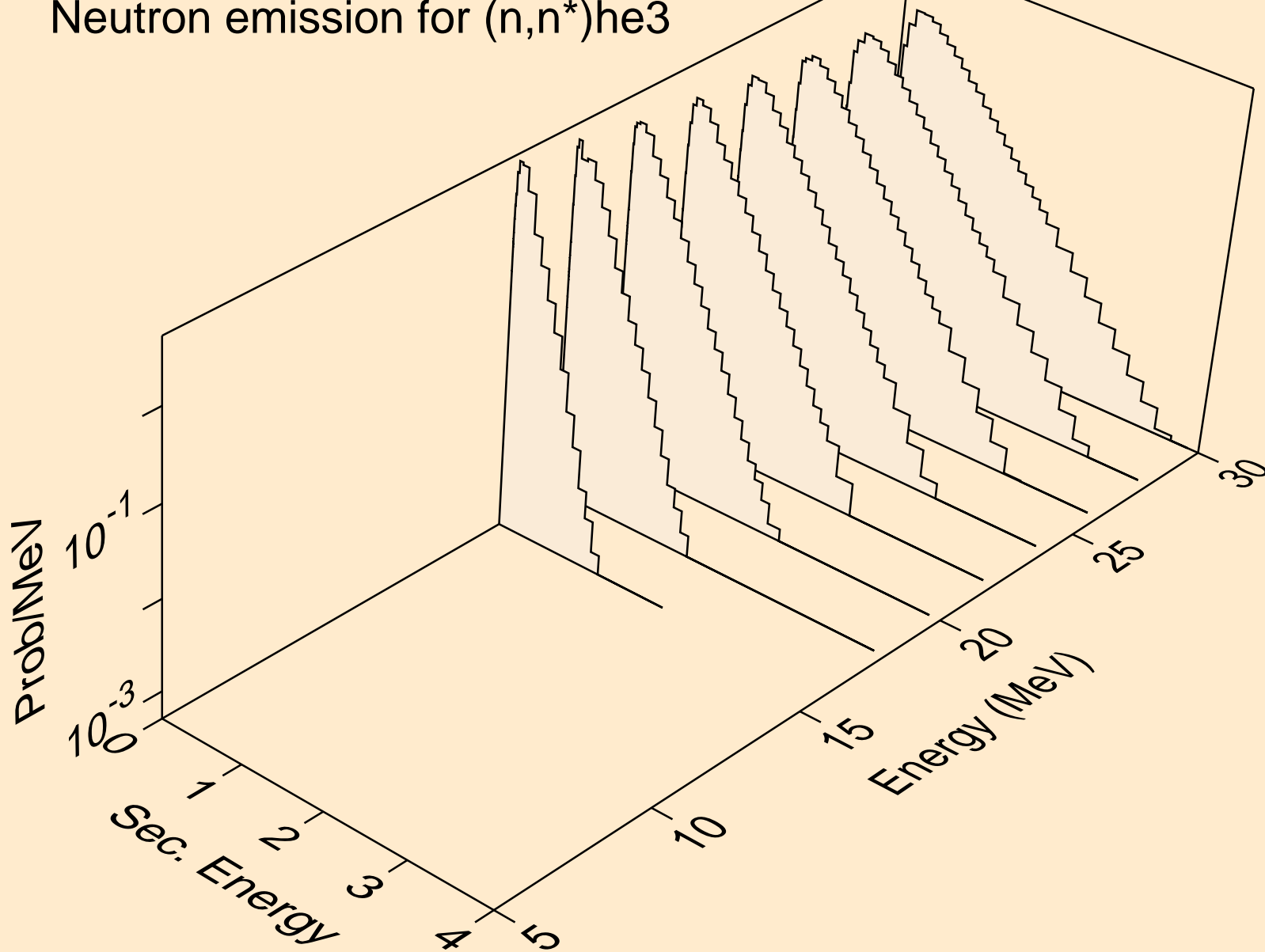

TM162 NEUTRON ACER TENDL-2019 LIBRARY; T=293.16K
Neutron emission for (n,4n)

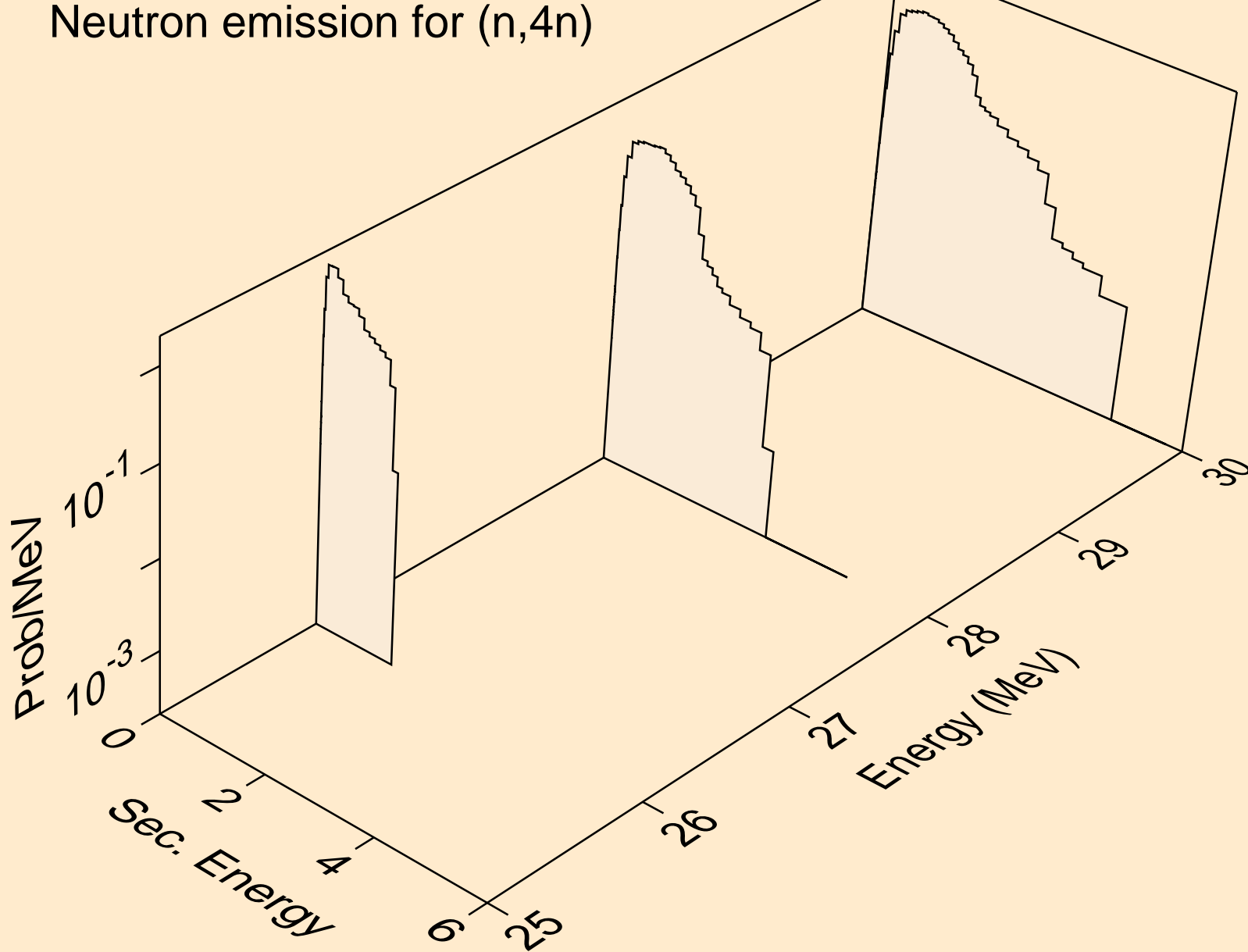

TM162 NEUTRON ACER TENDL-2019 LIBRARY; T=293.16K
Neutron emission for (n,2np)

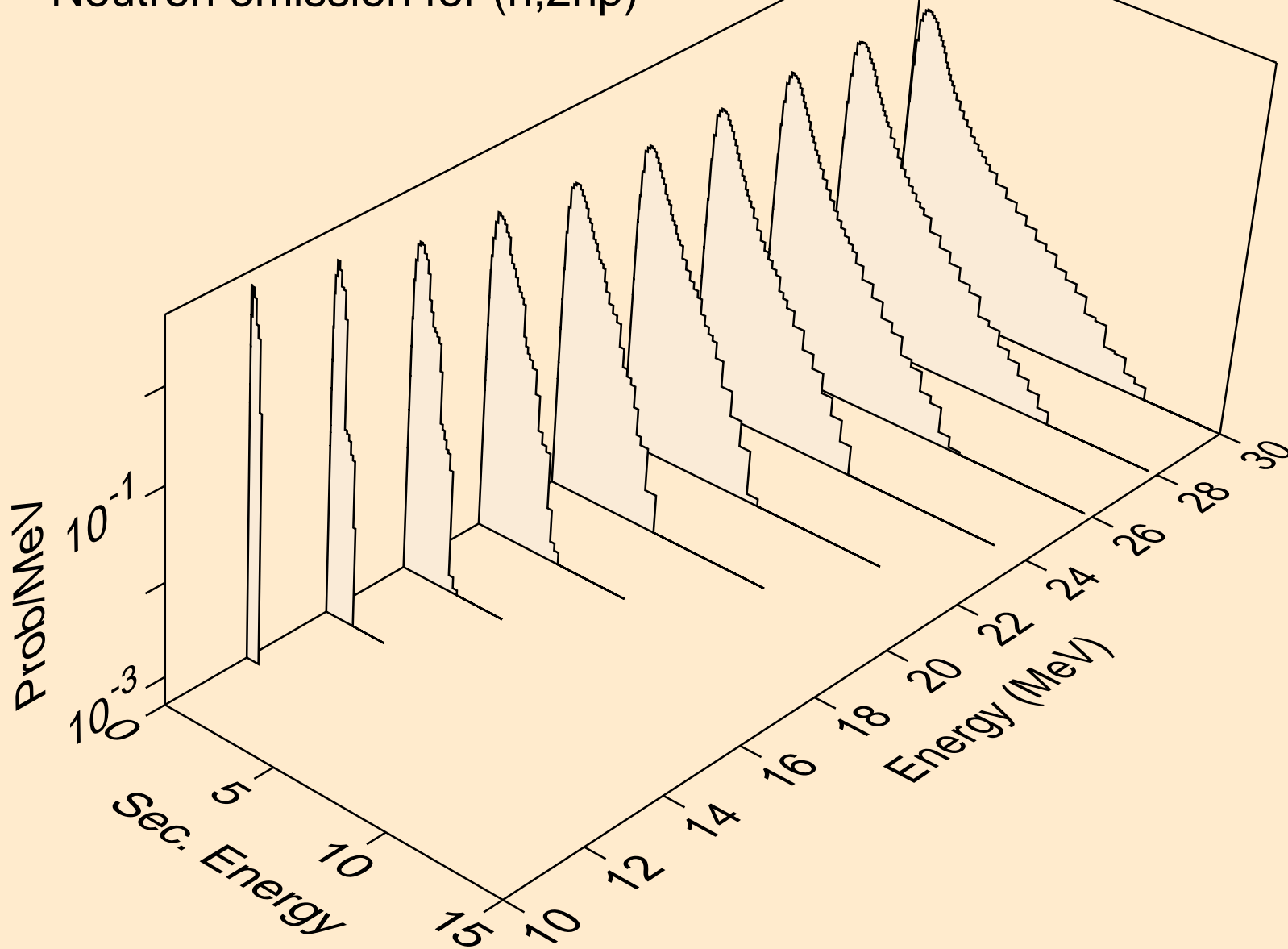

TM162 NEUTRON ACER TENDL-2019 LIBRARY; T=293.16K
Neutron emission for (n,3np)

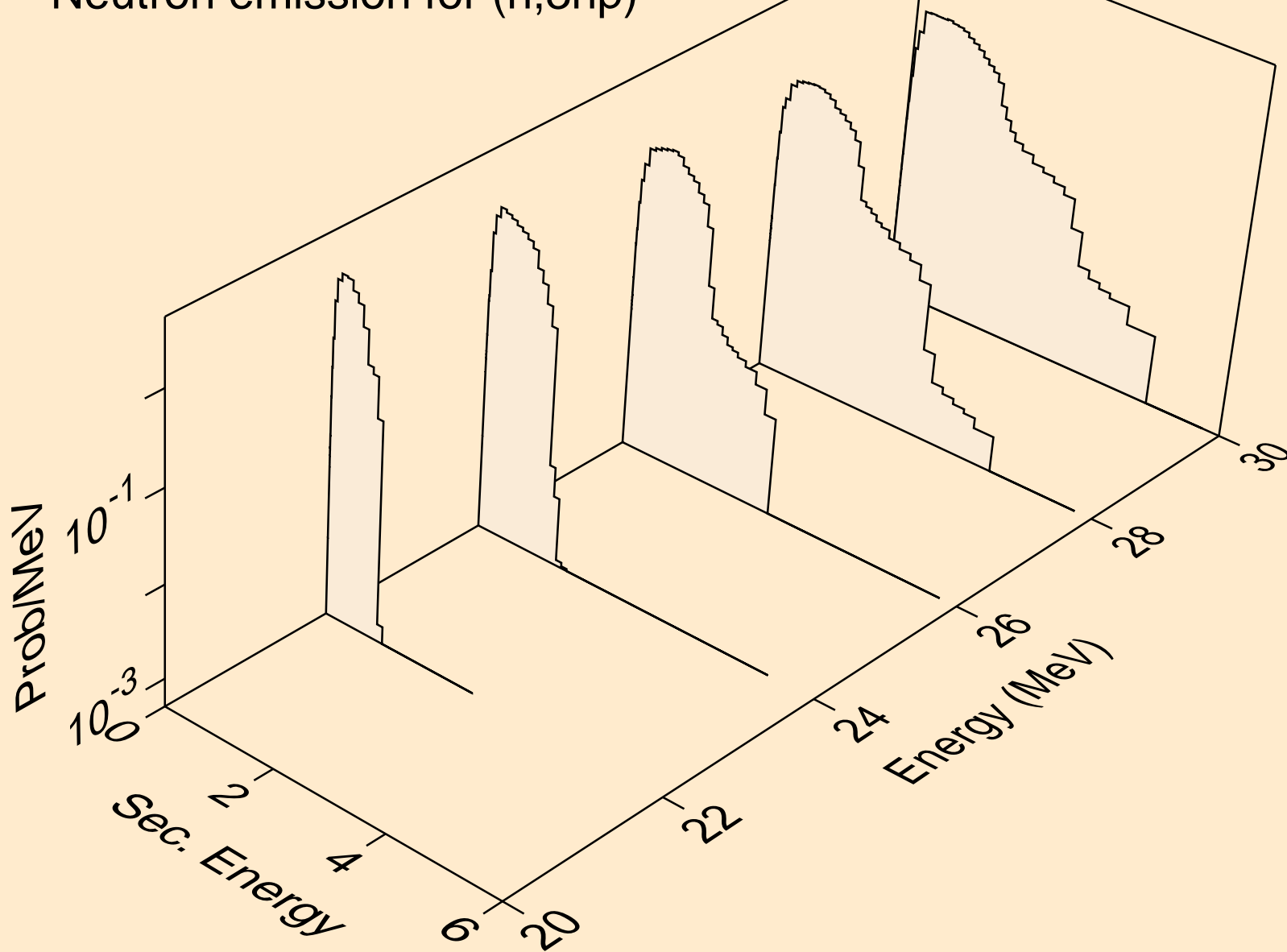

TM162 NEUTRON ACER TENDL-2019 LIBRARY; T=293.16K
Neutron emission for (n,2np)

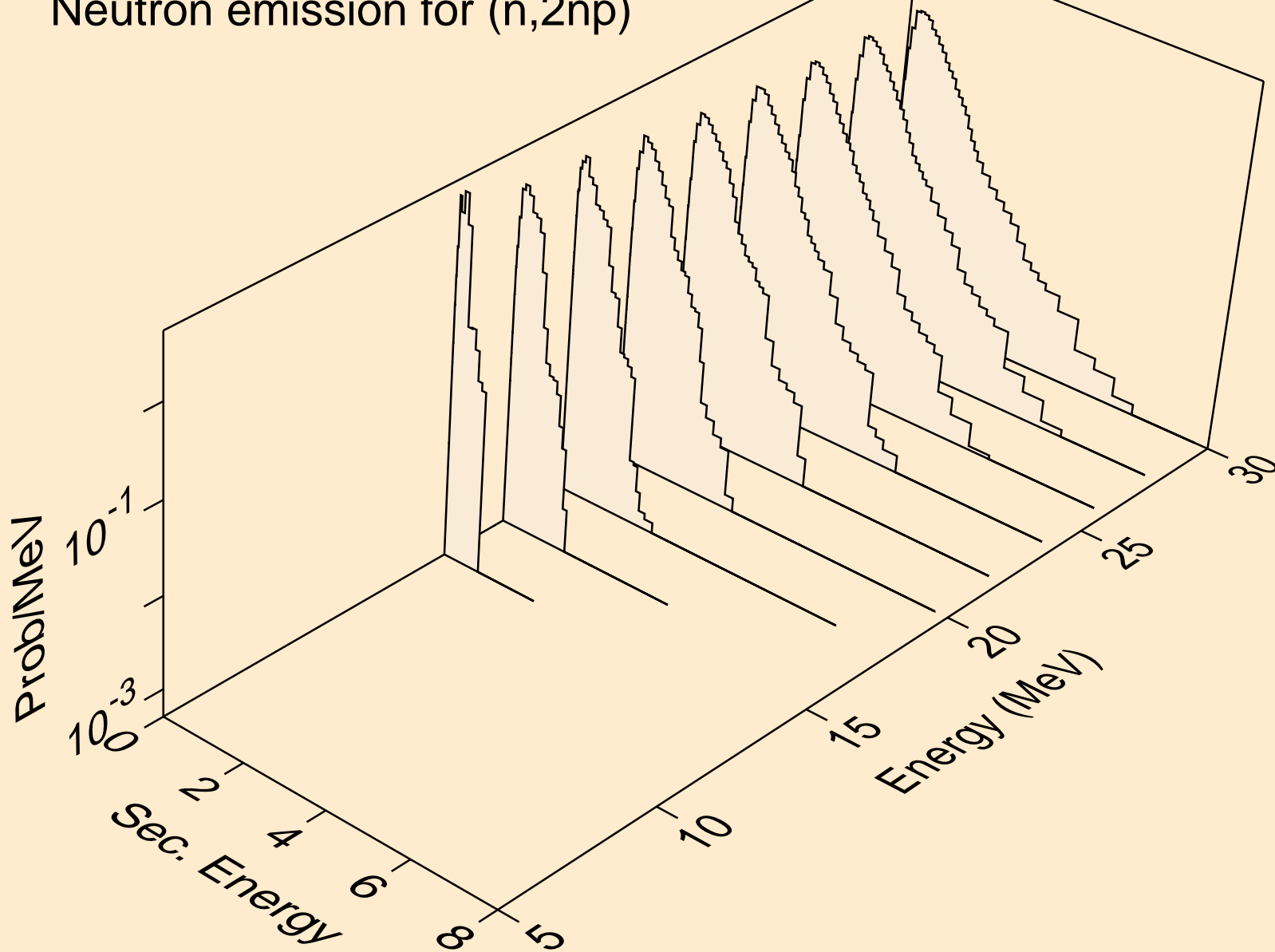

TM162 NEUTRON ACER TENDL-2019 LIBRARY; T=293.16K
Neutron emission for (n,npa)

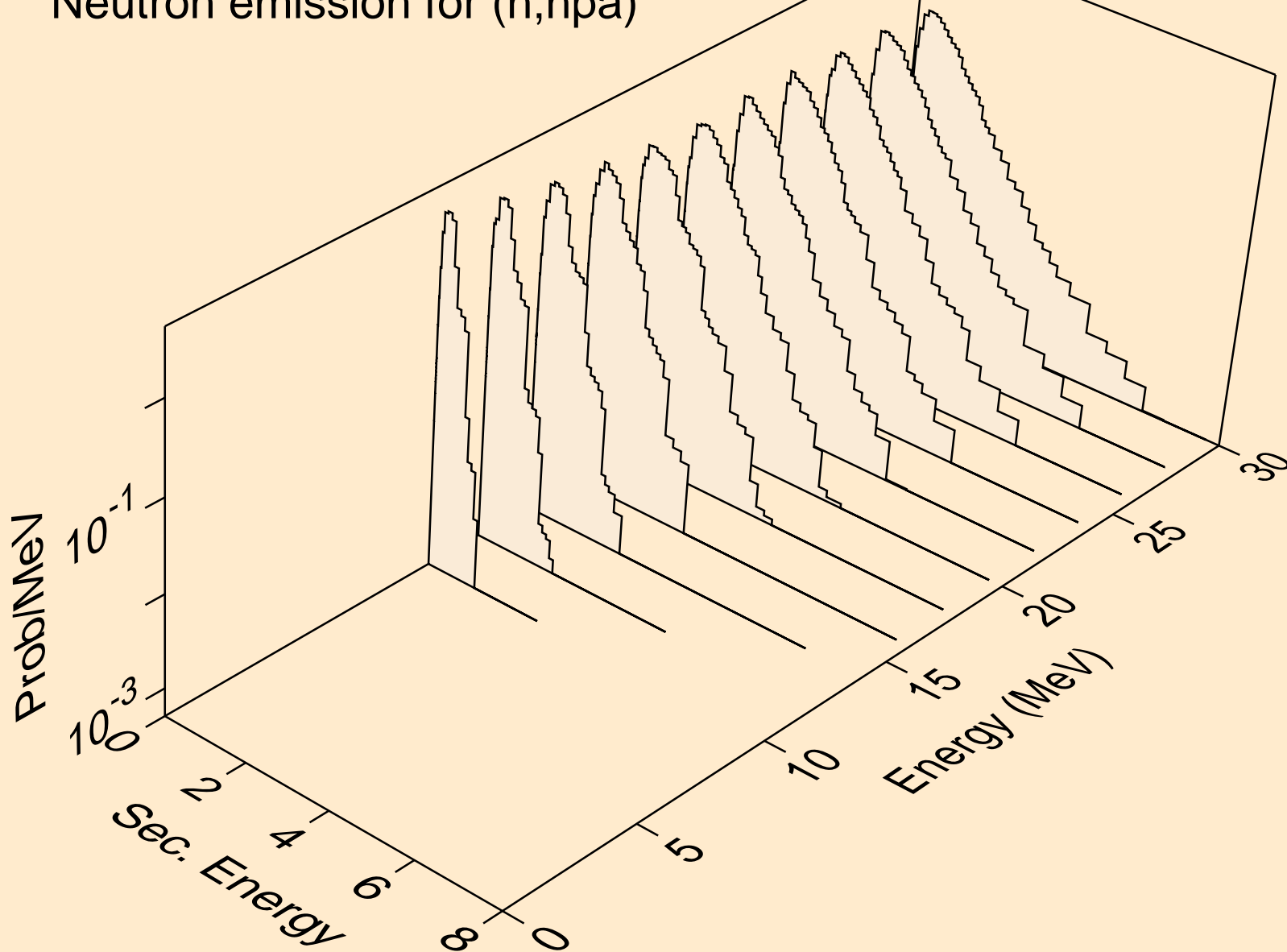

TM162 NEUTRON ACER TENDL-2019 LIBRARY; T=293.16K
Neutron emission for (n,n*c)

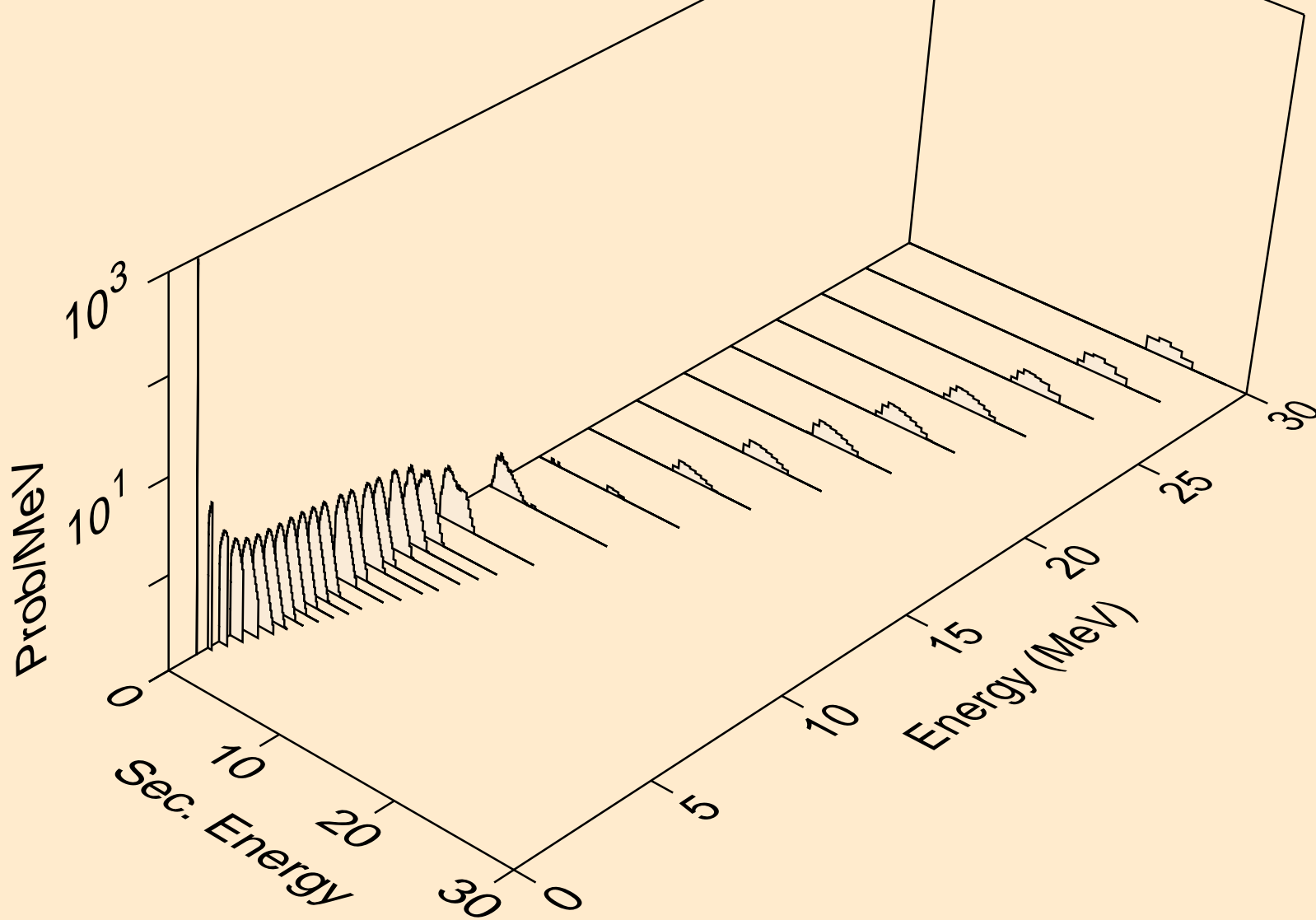

TM162 NEUTRON ACER TENDL-2019 LIBRARY; T=293.16K
Photon emission for (n,x)

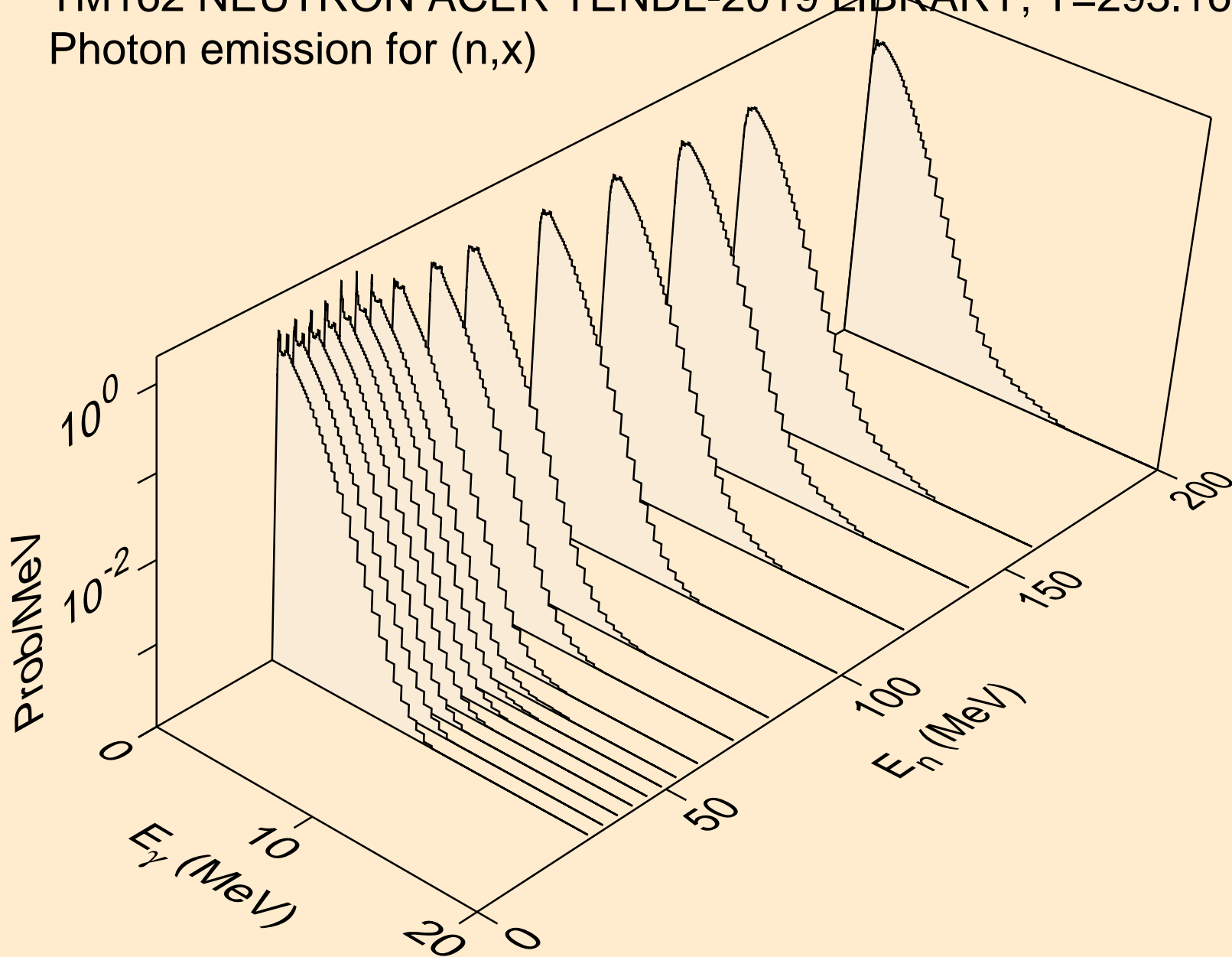

TM162 NEUTRON ACER TENDL-2019 LIBRARY; T=293.16K
Photon emission for (n,2nd)

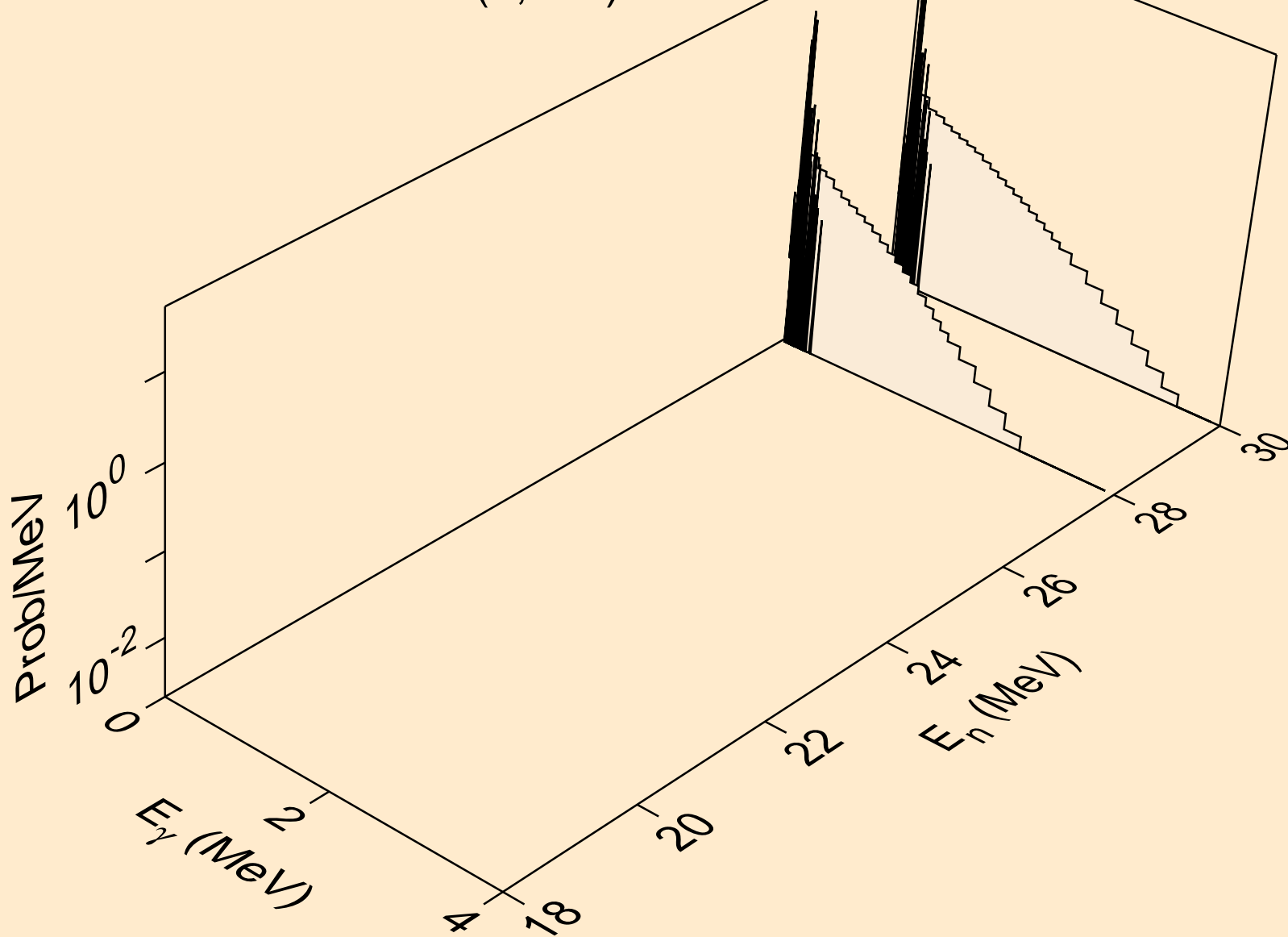

TM162 NEUTRON ACER TENDL-2019 LIBRARY; T=293.16K
Photon emission for (n,2n)

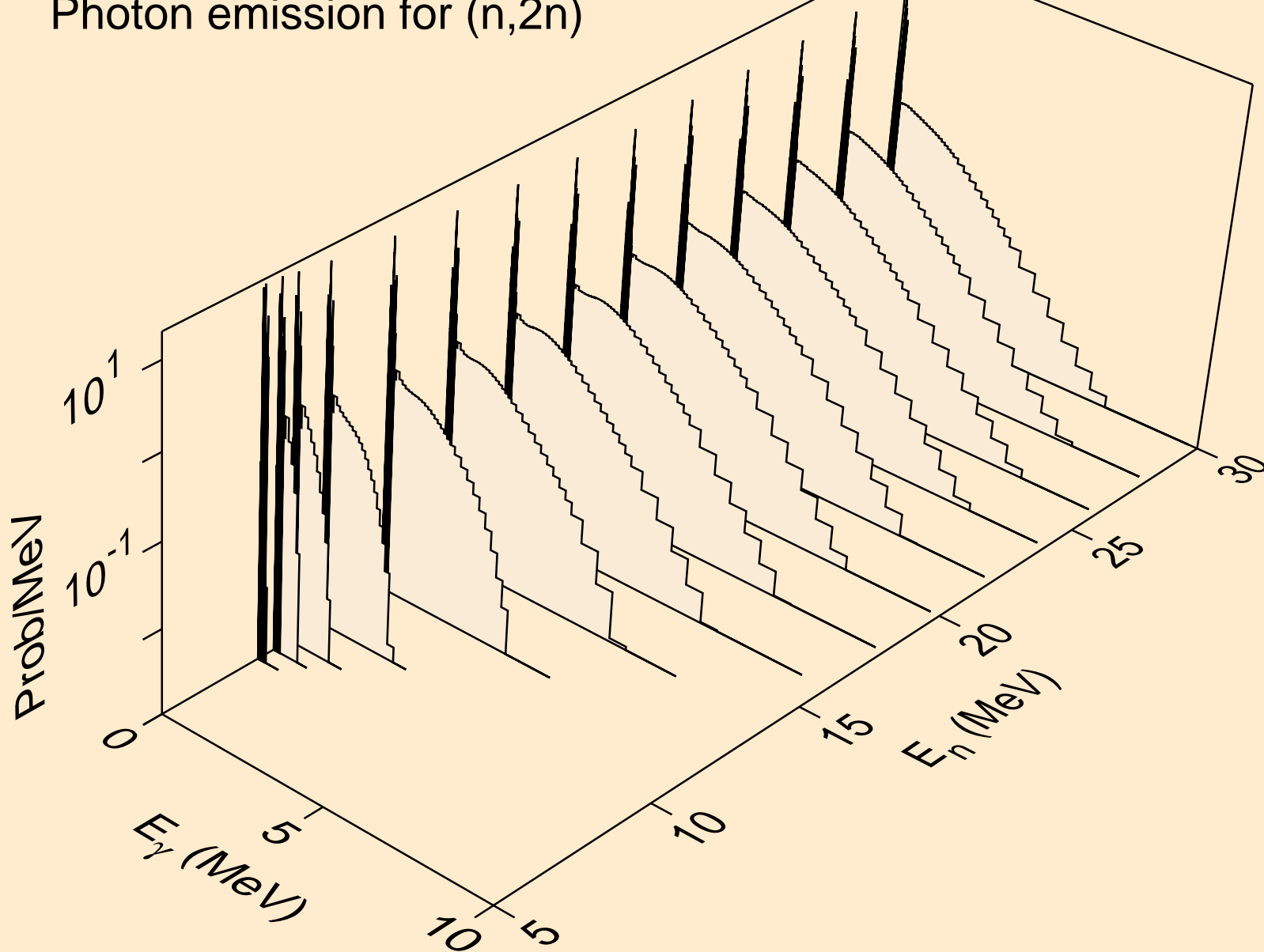

TM162 NEUTRON ACER TENDL-2019 LIBRARY; T=293.16K
Photon emission for (n,3n)

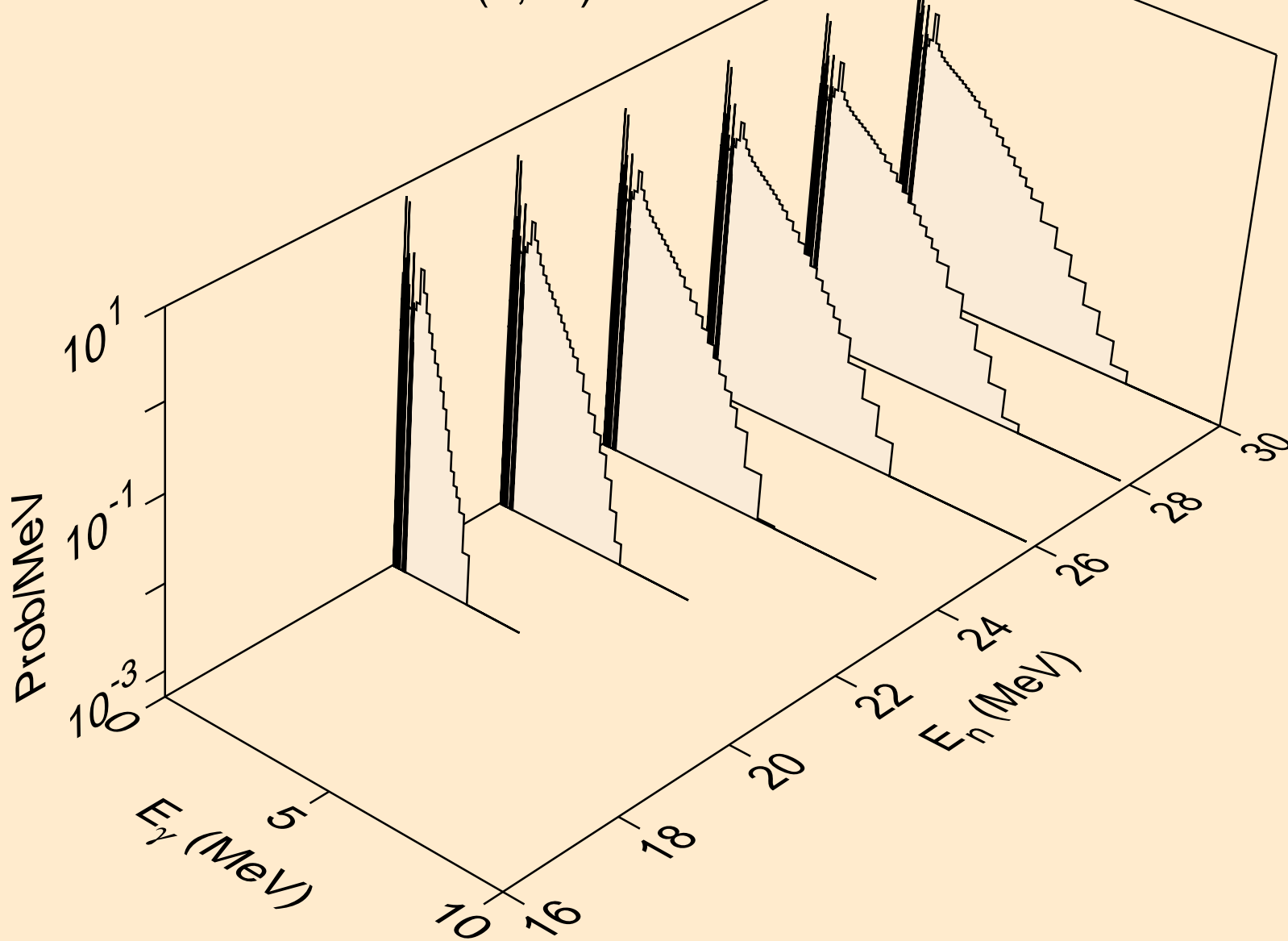

TM162 NEUTRON ACER TENDL-2019 LIBRARY; T=293.16K
Photon emission for (n,n*)a

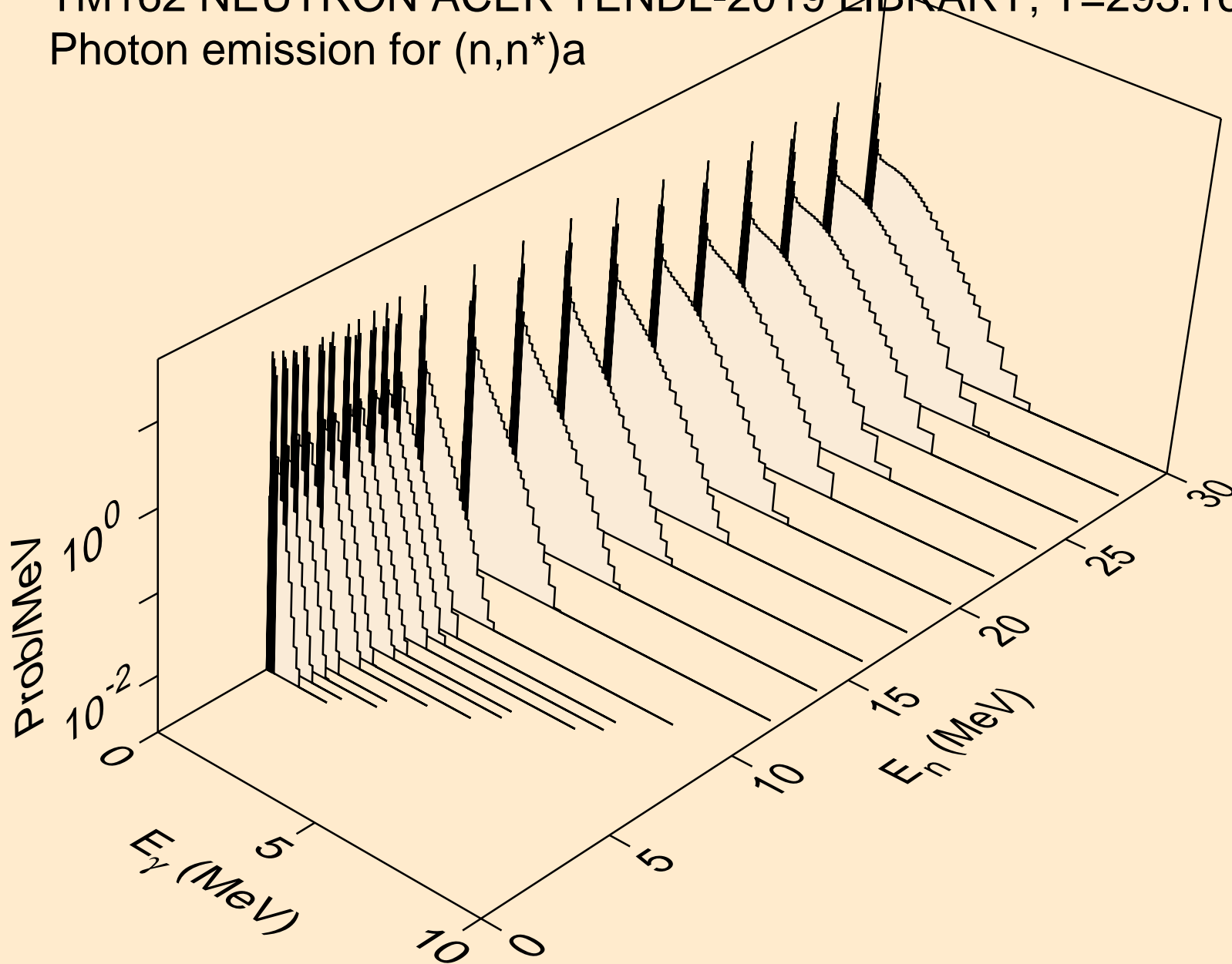

TM162 NEUTRON ACER TENDL-2019 LIBRARY; T=293.16K
Photon emission for (n,2n)a

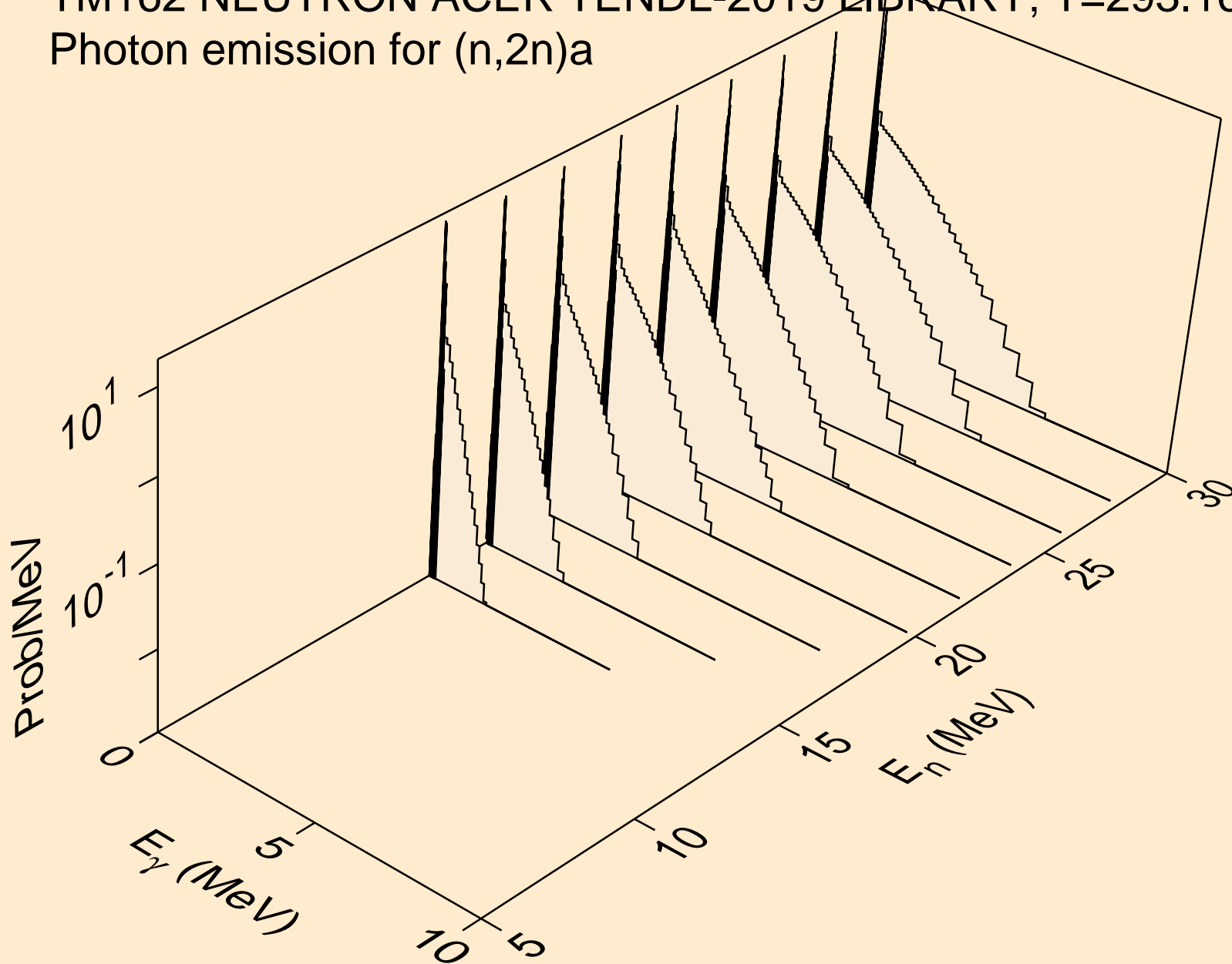

TM162 NEUTRON ACER TENDL-2019 LIBRARY; T=293.16K
Photon emission for (n,3n)a

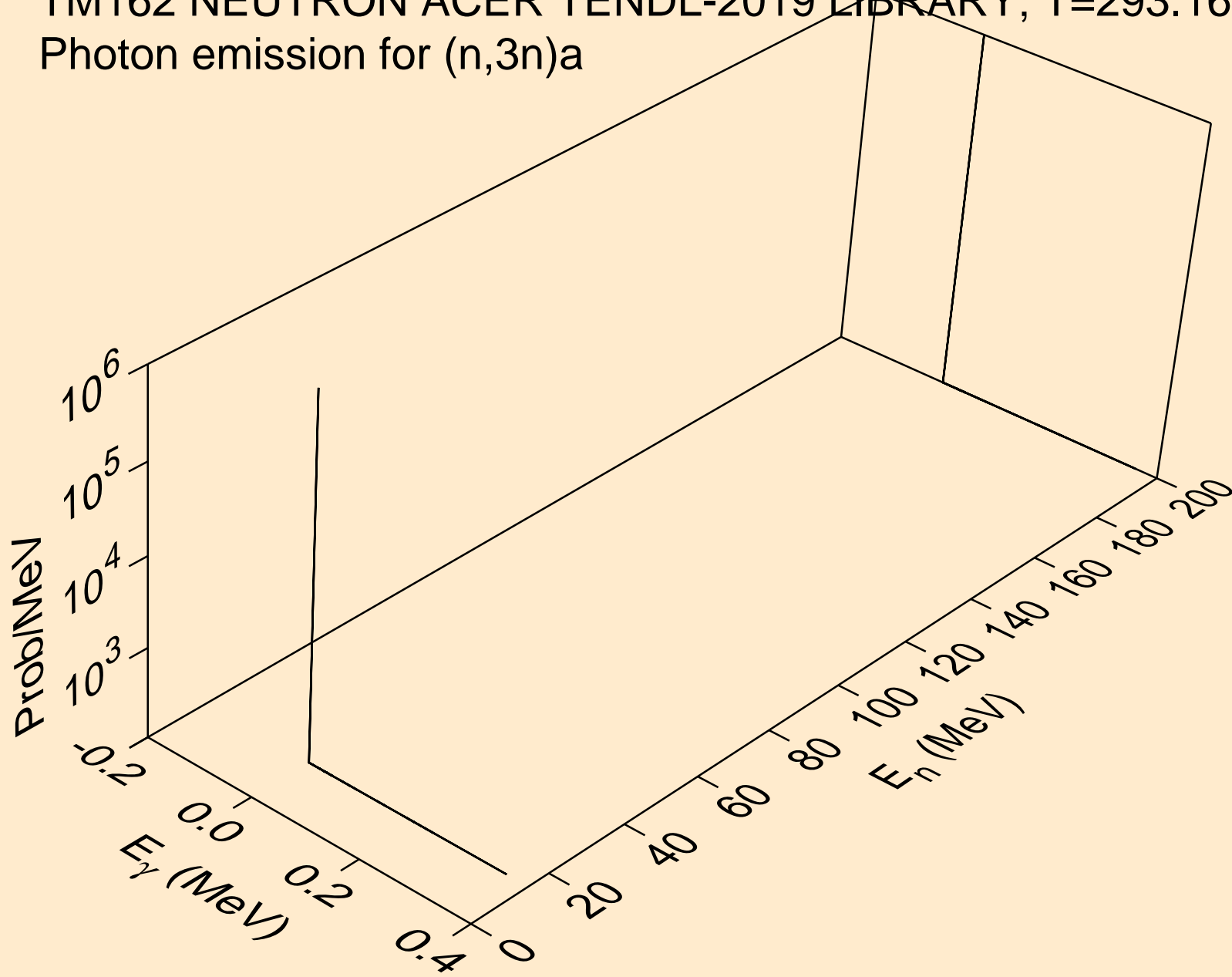

TM162 NEUTRON ACER TENDL-2019 LIBRARY; T=293.16K
Photon emission for (n,n*)p

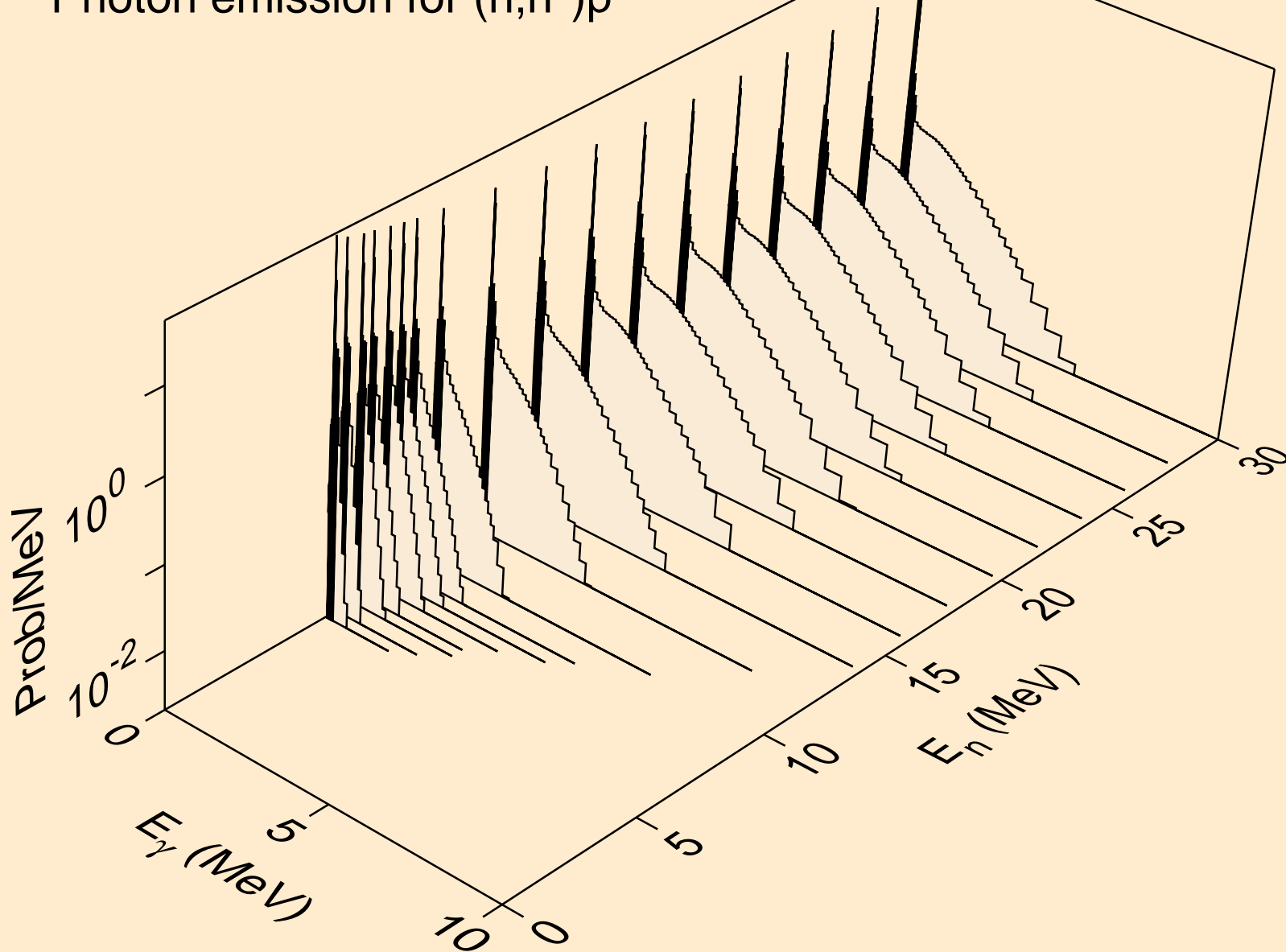

TM162 NEUTRON ACER TENDL-2019 LIBRARY; T=293.16K
Photon emission for (n,n*)2a

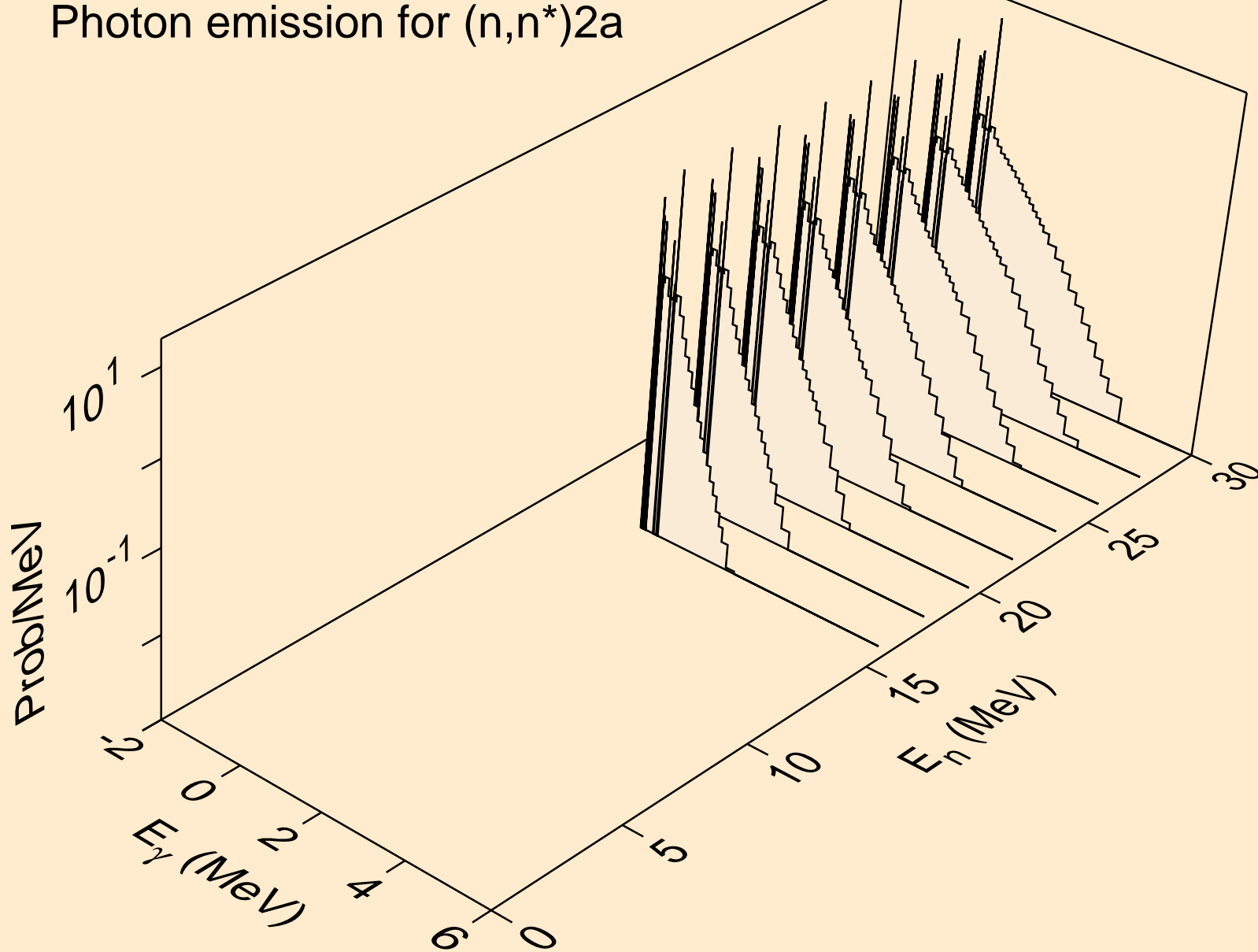

TM162 NEUTRON ACER TENDL-2019 LIBRARY; T=293.16K
Photon emission for (n,2n)2a

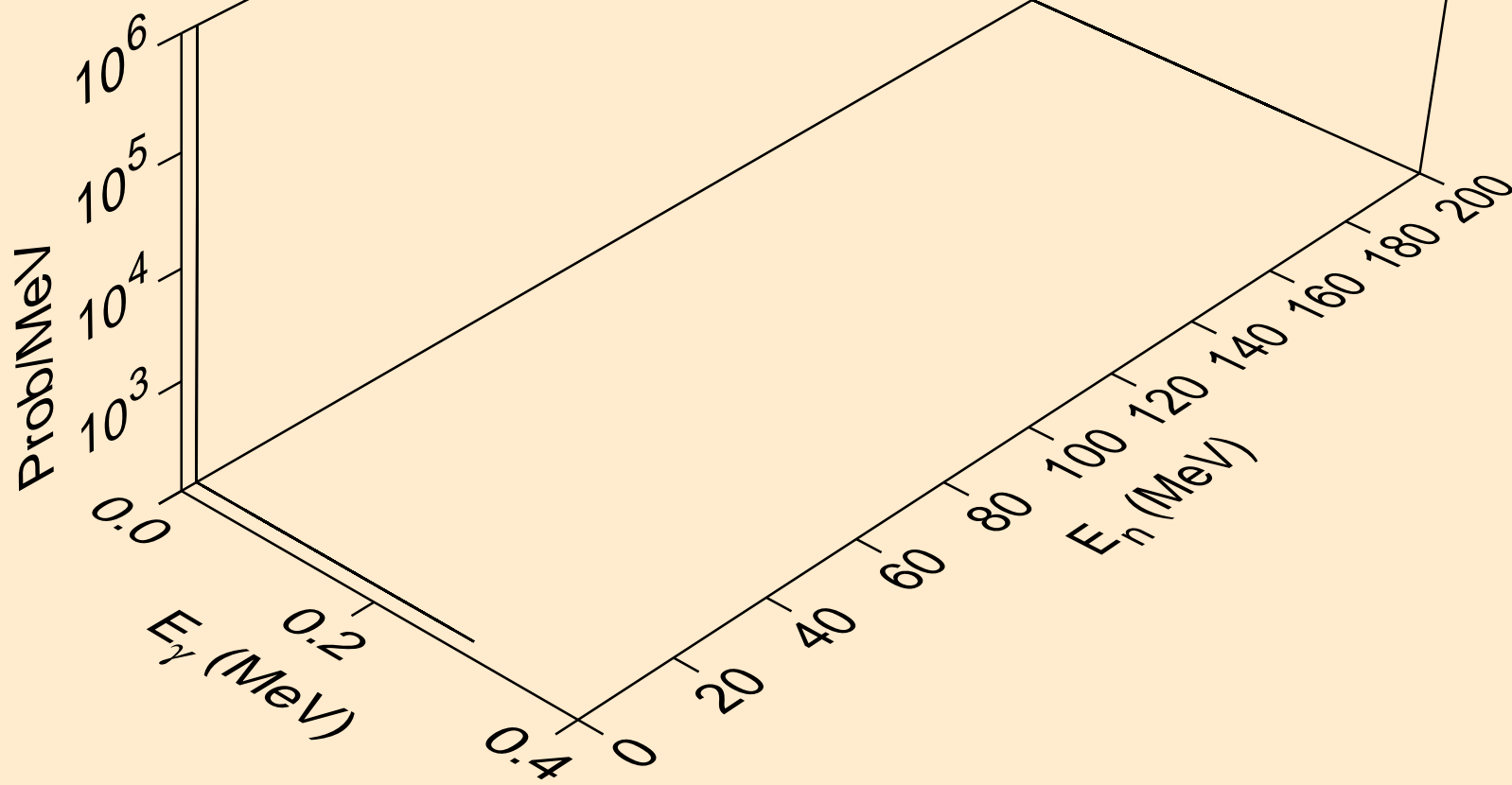

TM162 NEUTRON ACER TENDL-2019 LIBRARY; T=293.16K
Photon emission for (n,n*)d

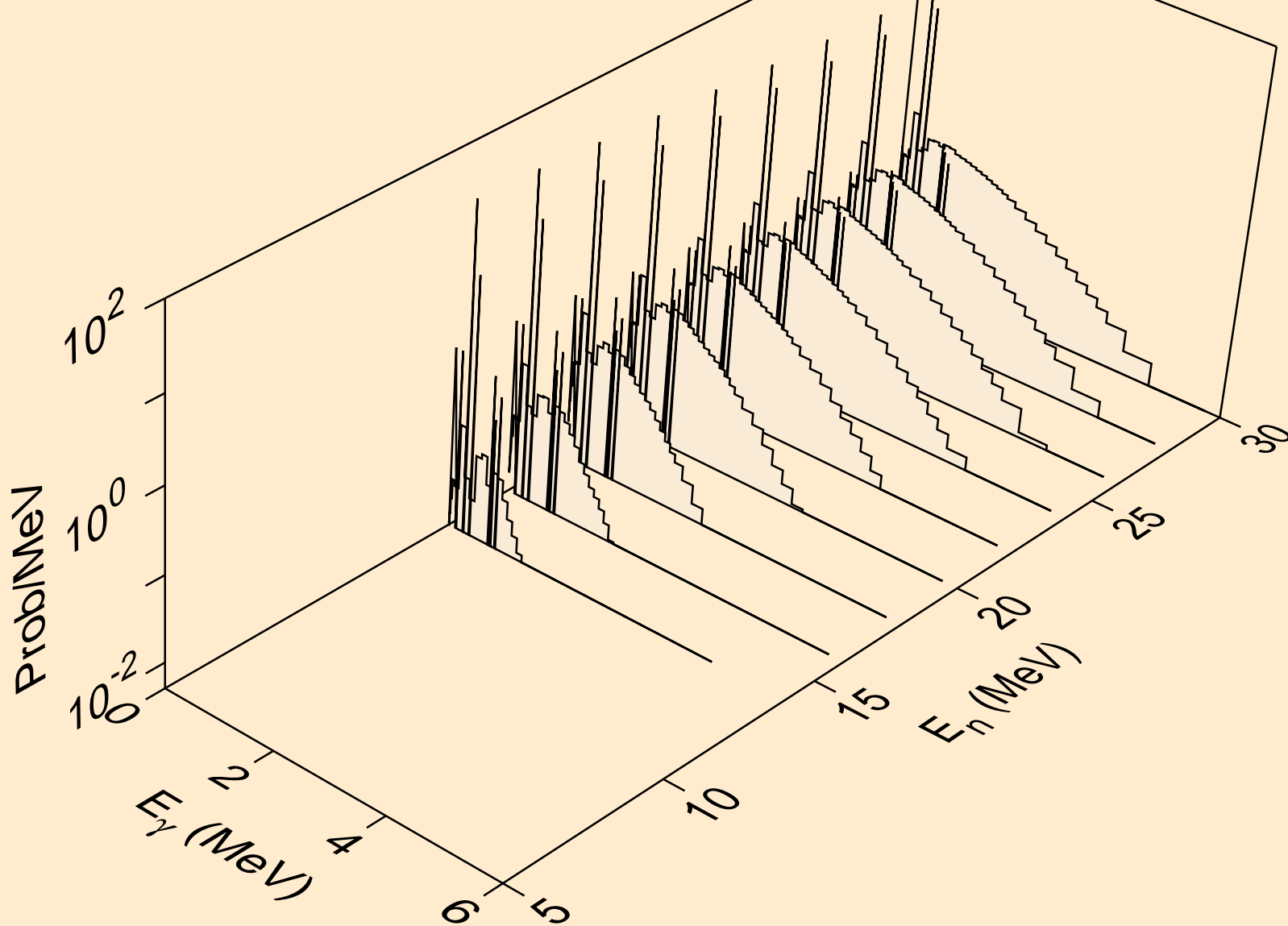

TM162 NEUTRON ACER TENDL-2019 LIBRARY; T=293.16K
Photon emission for (n,n*)t

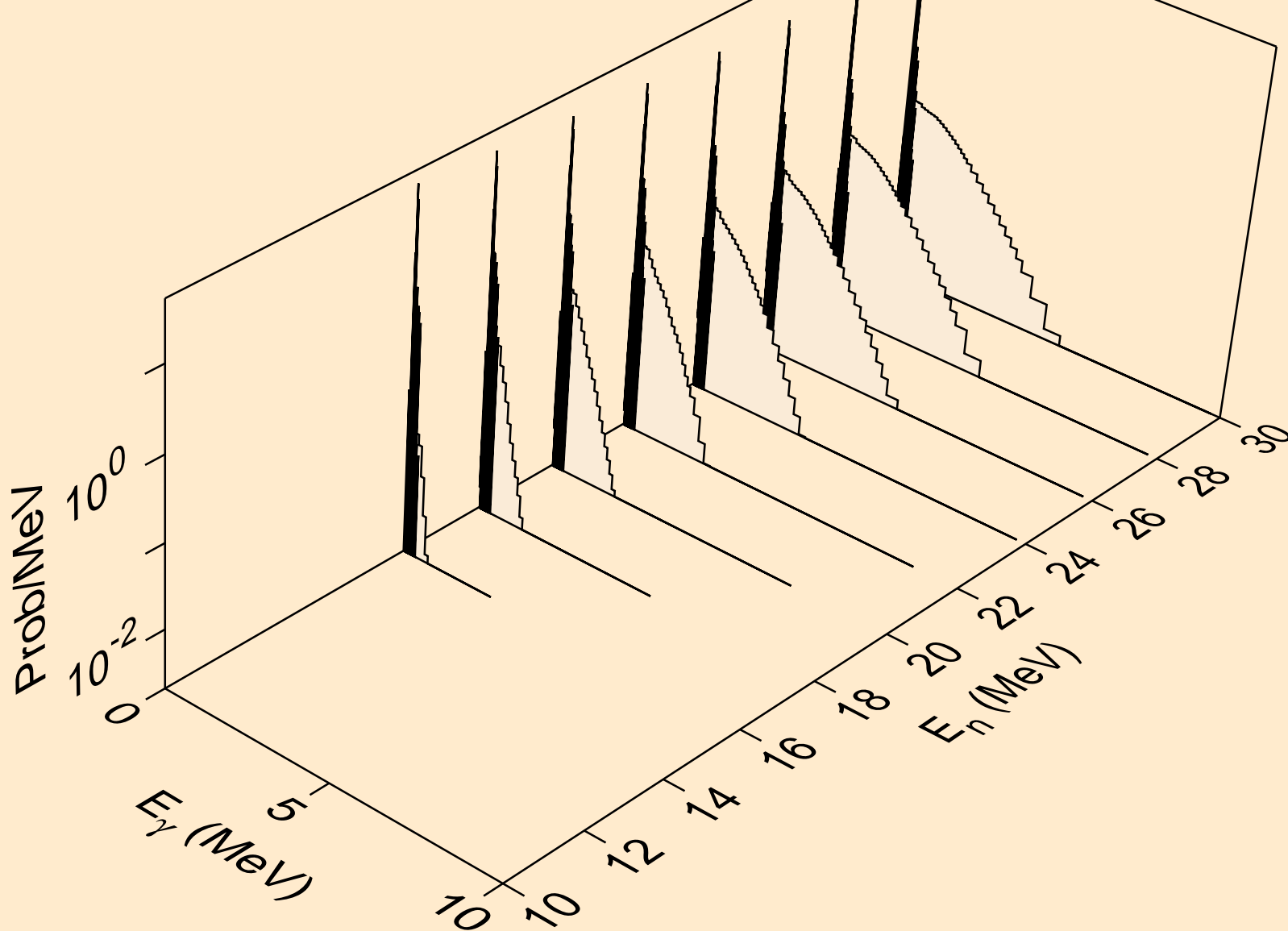

TM162 NEUTRON ACER TENDL-2019 LIBRARY; T=293.16K
Photon emission for (n,n*)he3

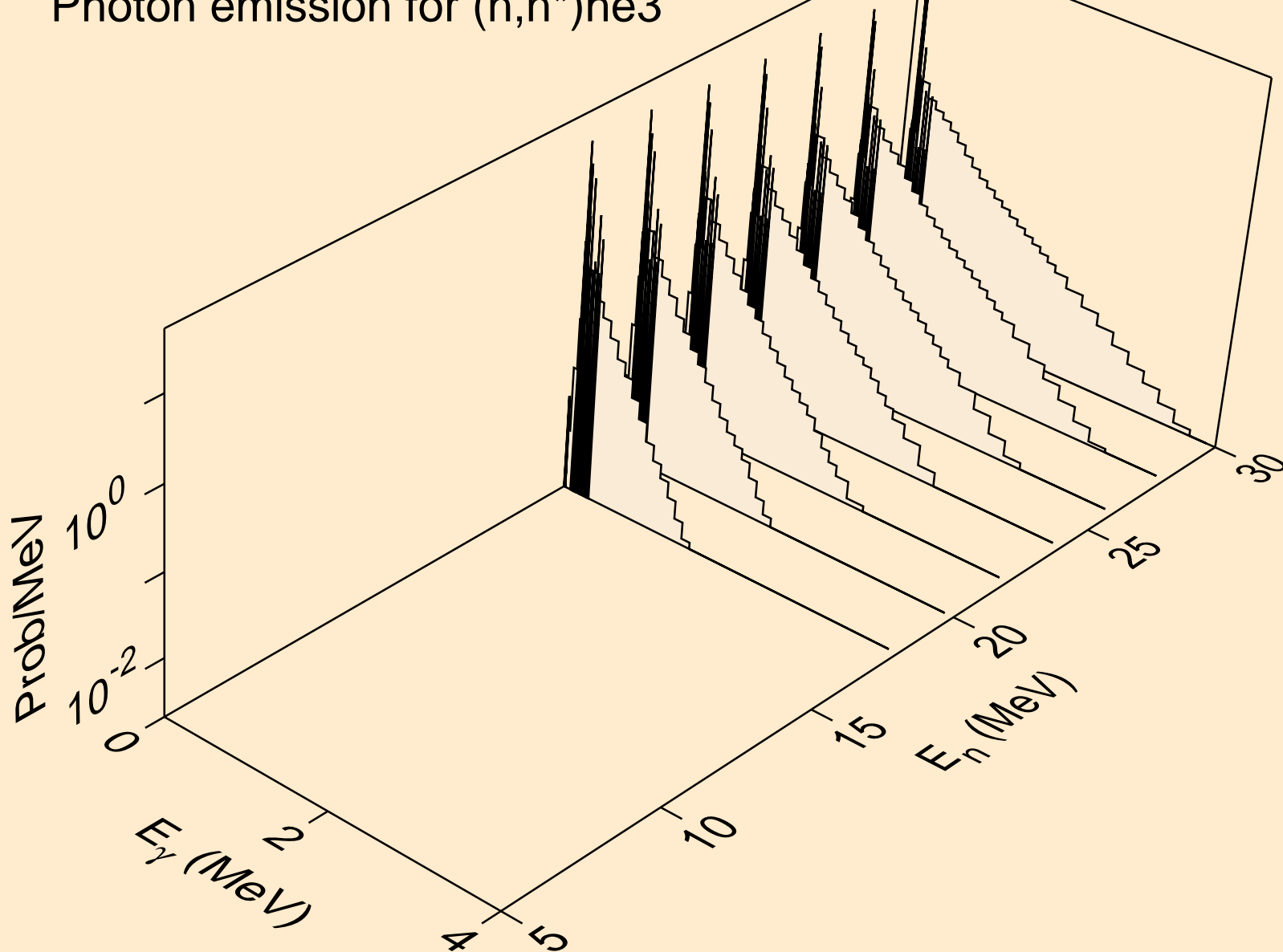

TM162 NEUTRON ACER TENDL-2019 LIBRARY; T=293.16K
Photon emission for (n,4n)

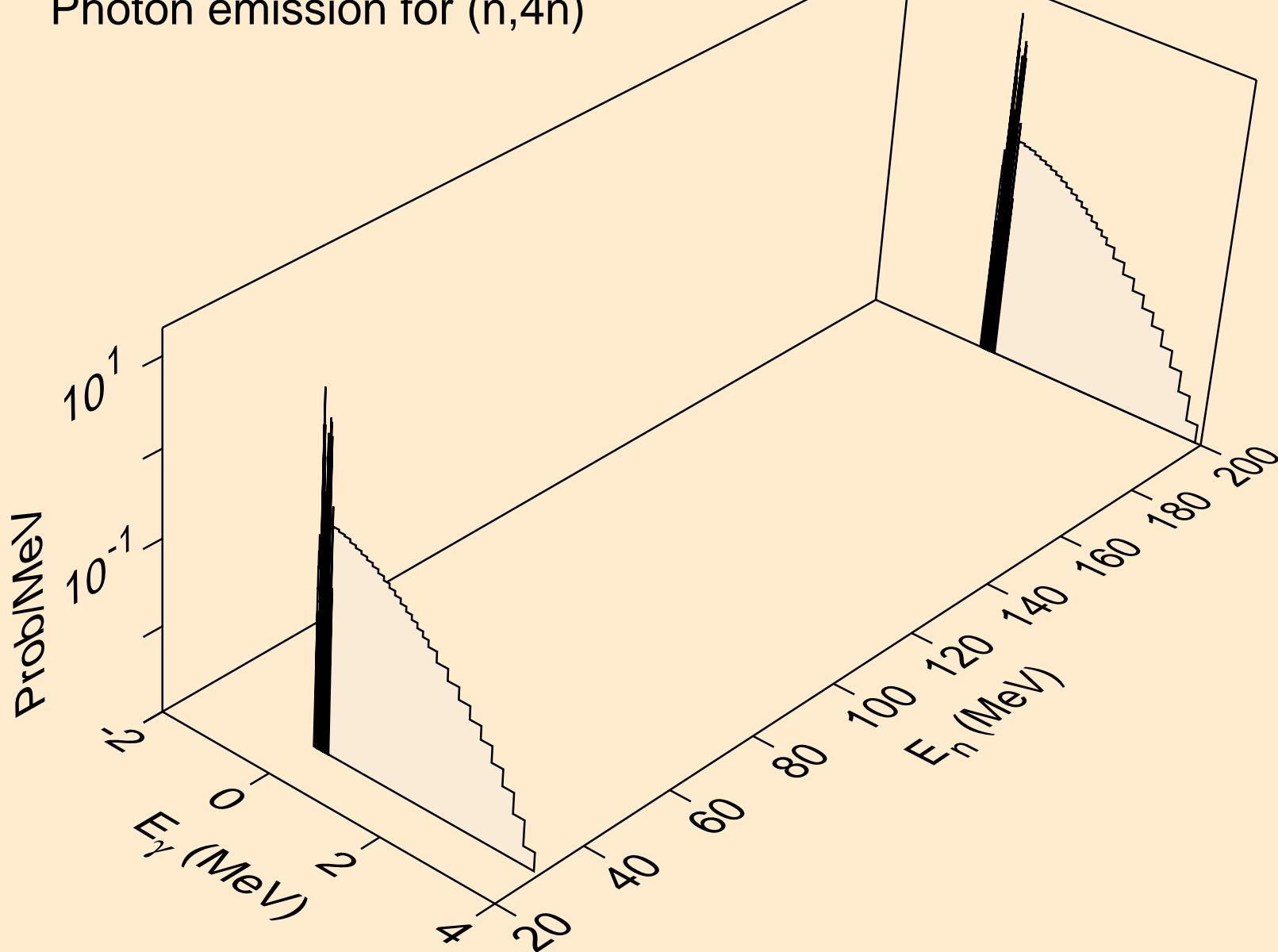

TM162 NEUTRON ACER TENDL-2019 LIBRARY; T=293.16K
Photon emission for (n,2np)

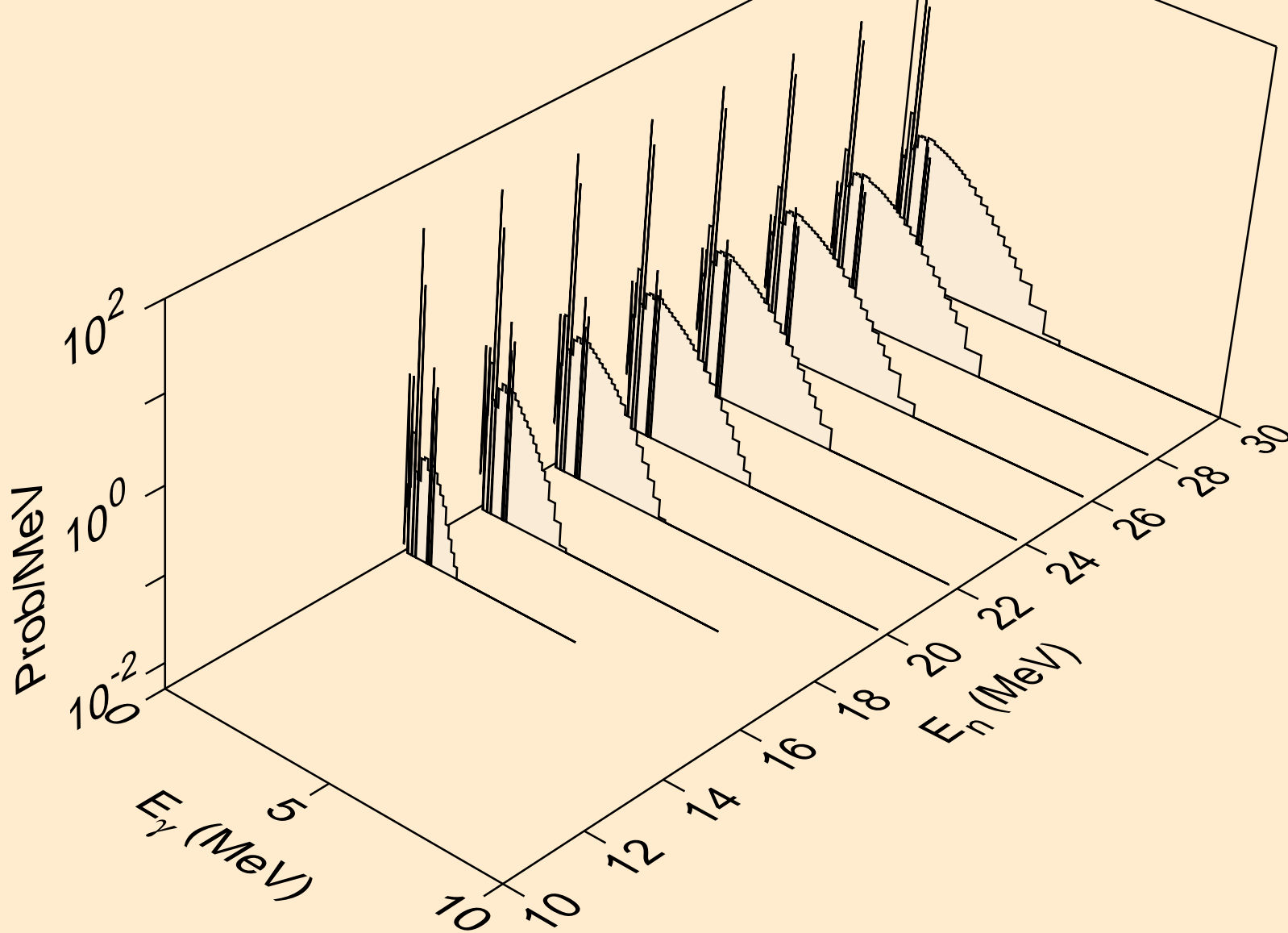

TM162 NEUTRON ACER TENDL-2019 LIBRARY; T=293.16K
Photon emission for (n,3np)

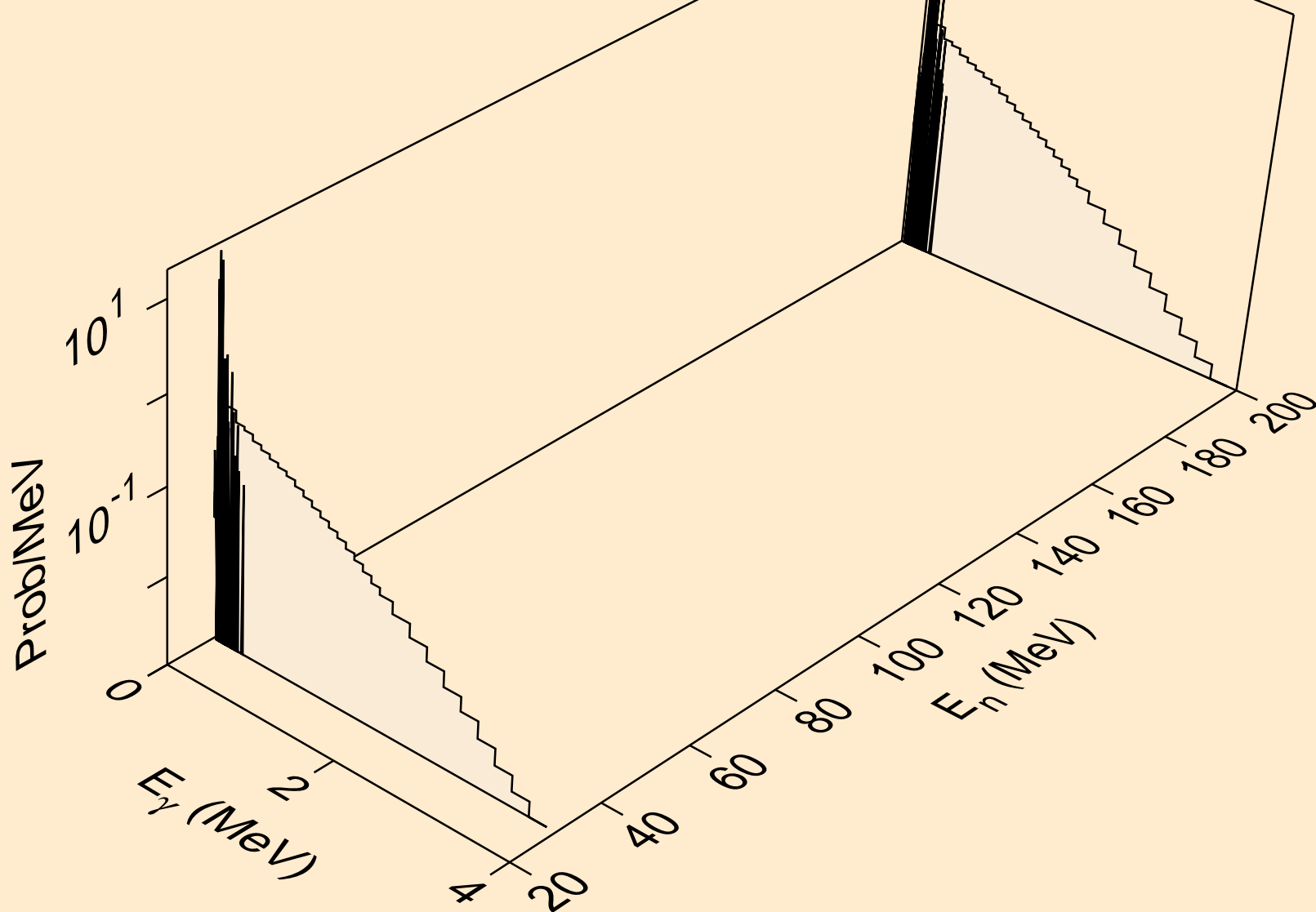

TM162 NEUTRON ACER TENDL-2019 LIBRARY; T=293.16K
Photon emission for (n,2np)

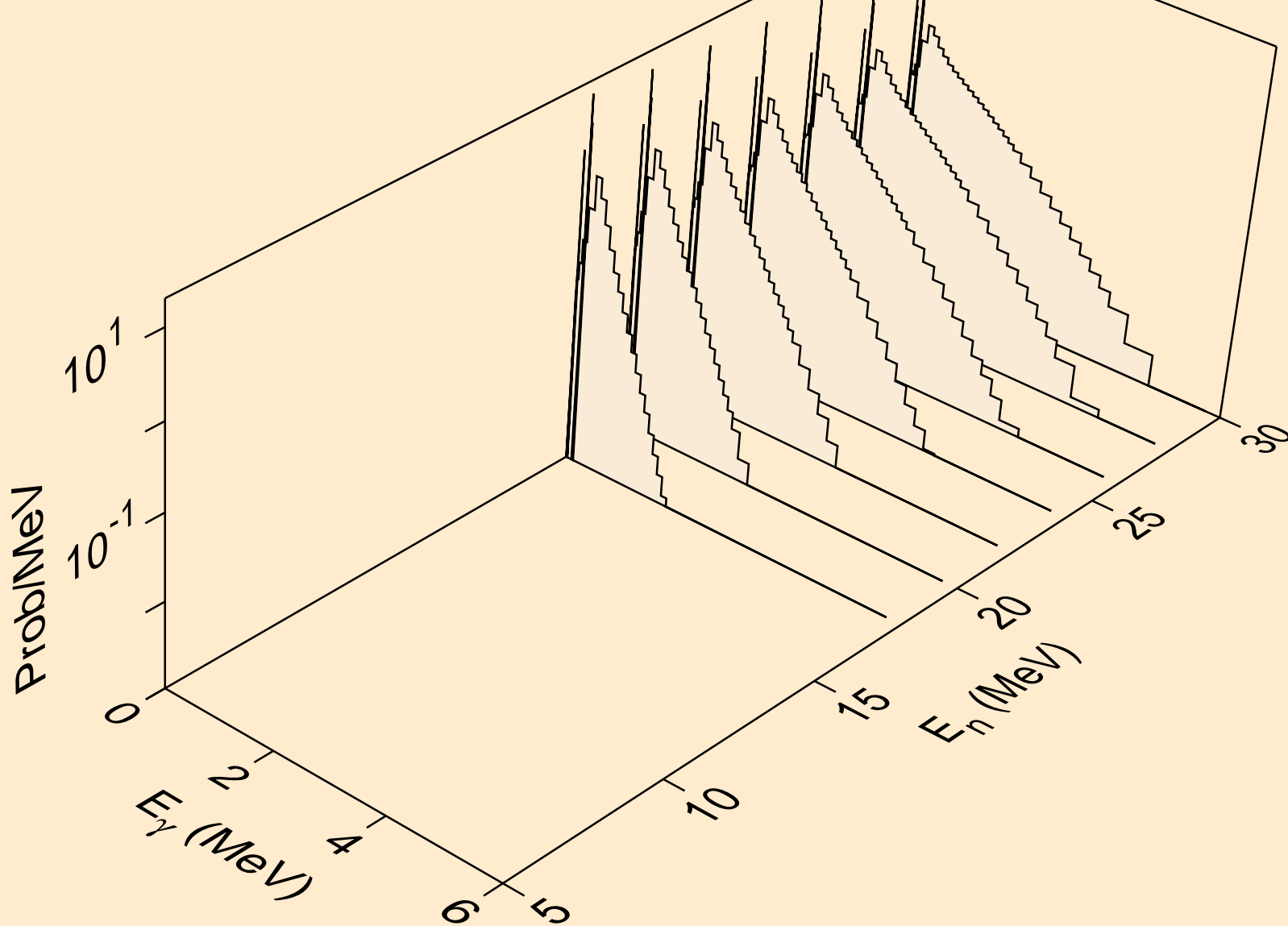

TM162 NEUTRON ACER TENDL-2019 LIBRARY; T=293.16K
Photon emission for (n,npa)

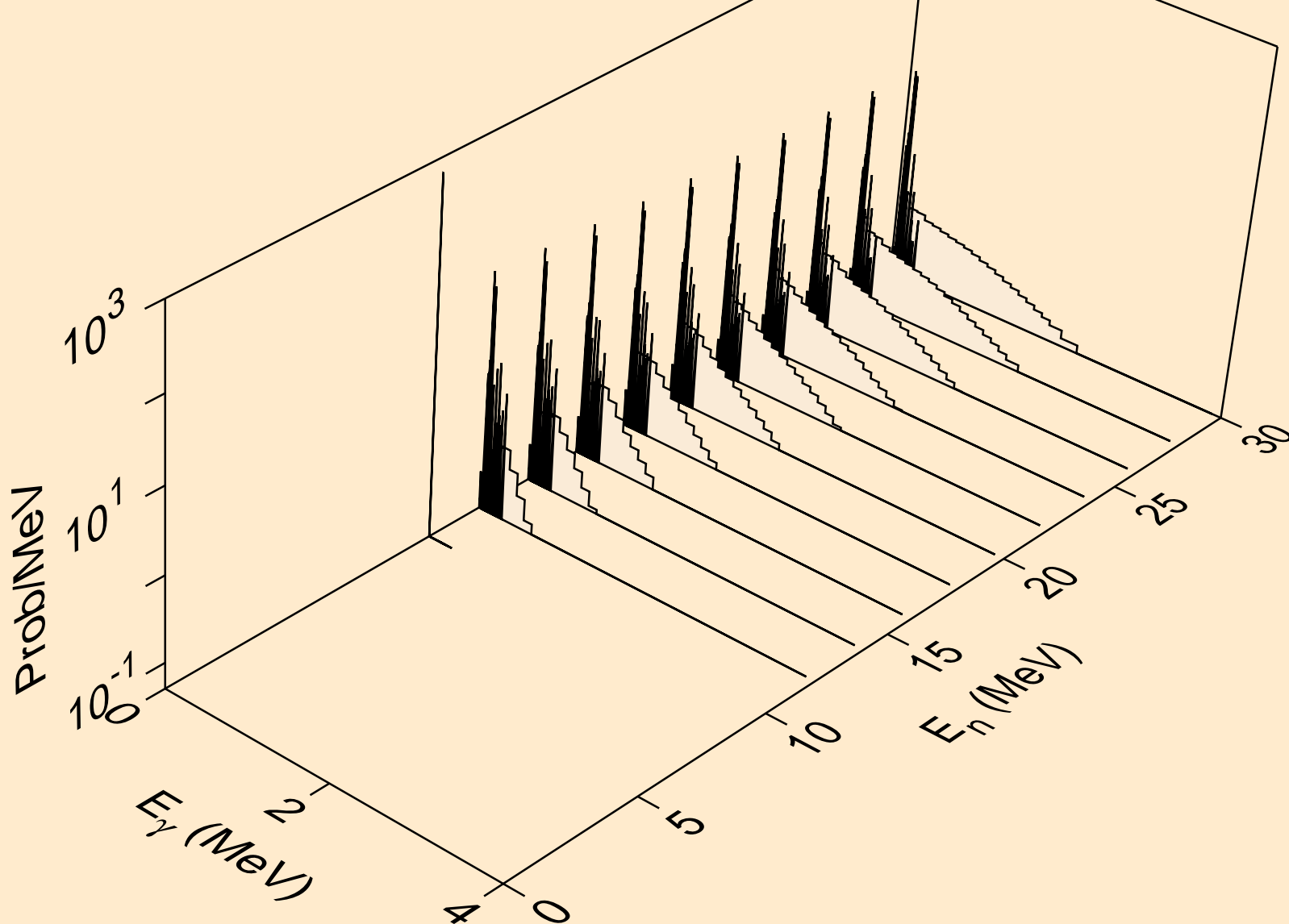

TM162 NEUTRON ACER TENDL-2019 LIBRARY; T=293.16K
Photon emission for (n,n*c)

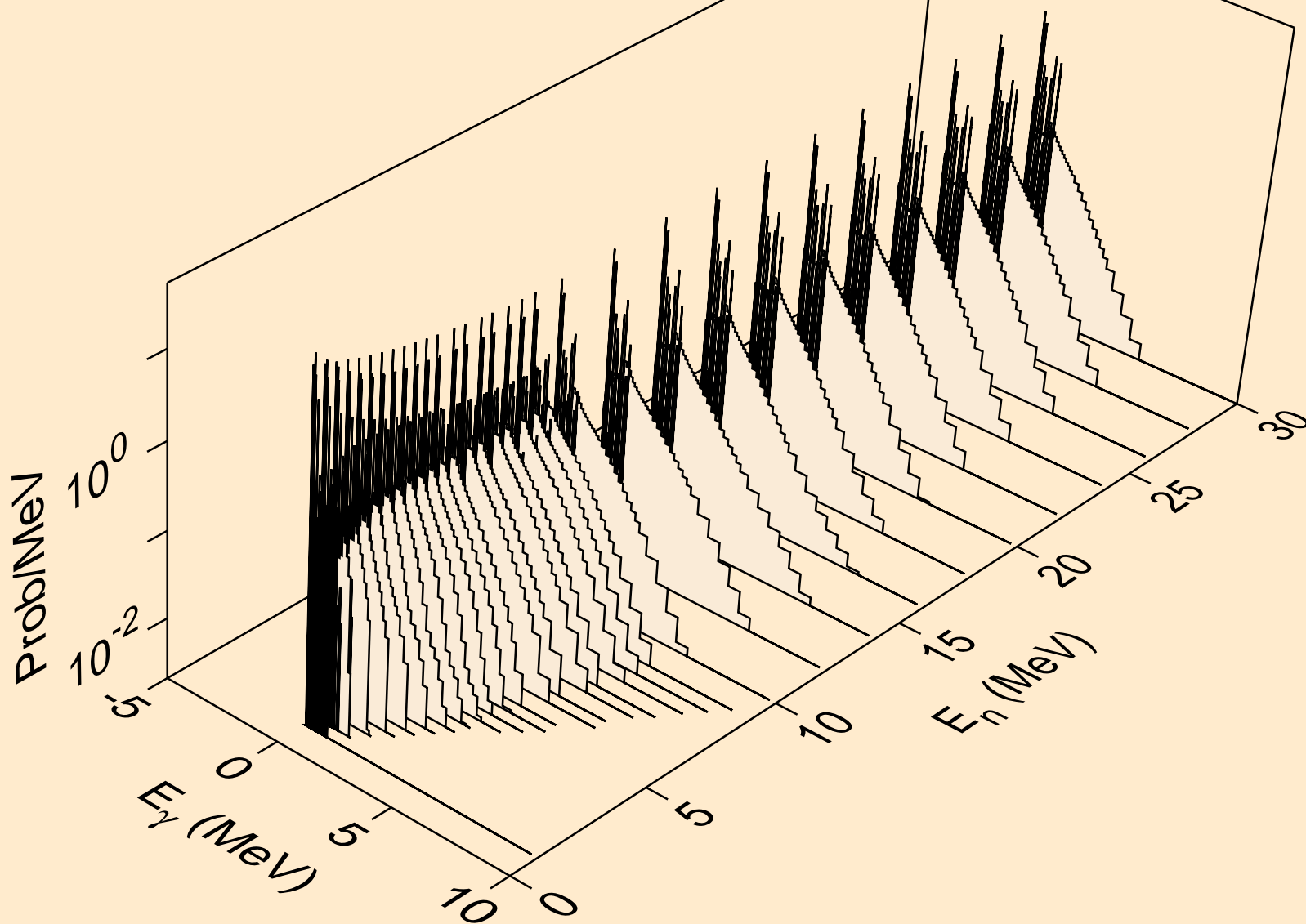

TM162 NEUTRON ACER TENDL-2019 LIBRARY; T=293.16K
Photon emission for (n,gma)

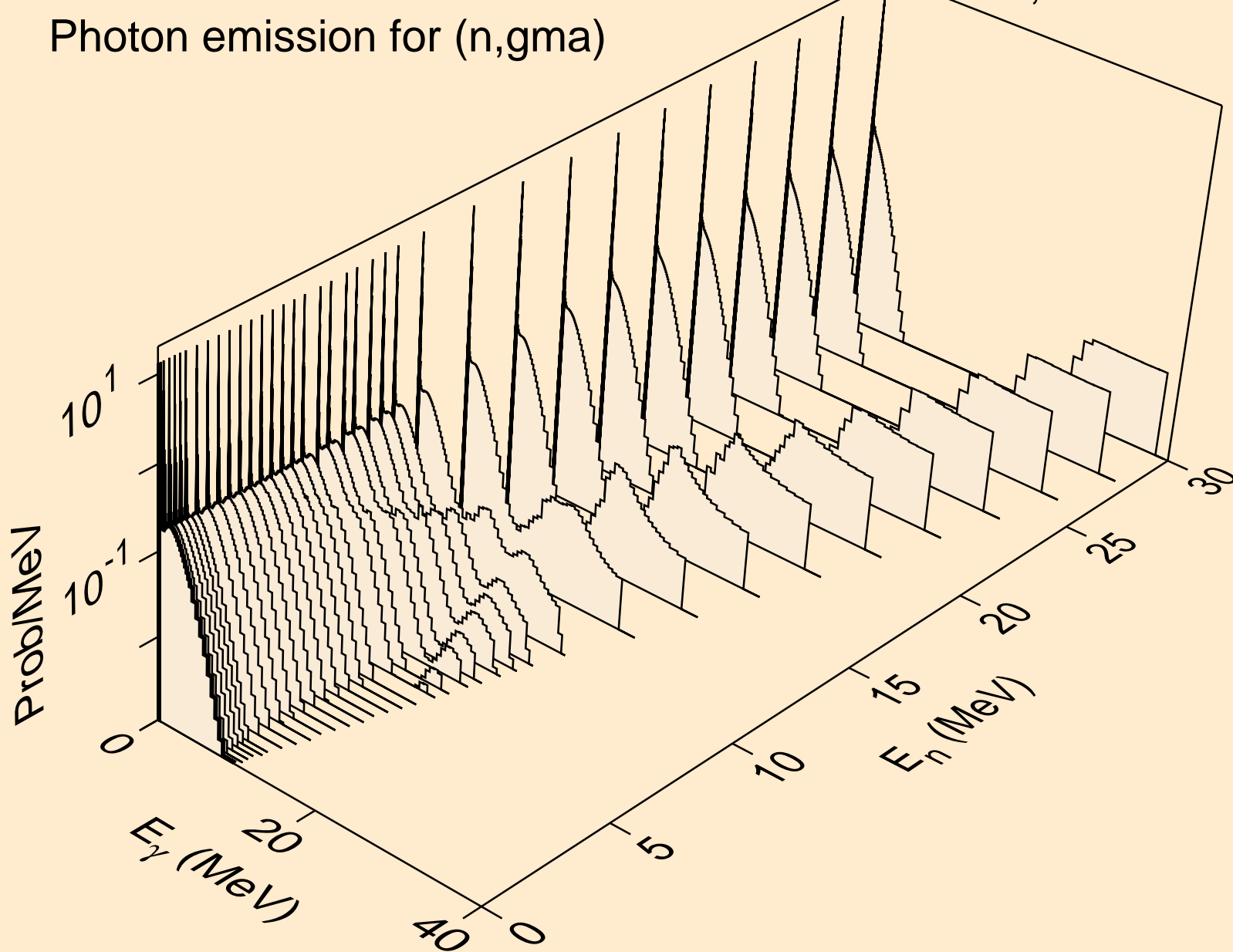

TM162 NEUTRON ACER TENDL-2019 LIBRARY; T=293.16K
Photon emission for (n,p)

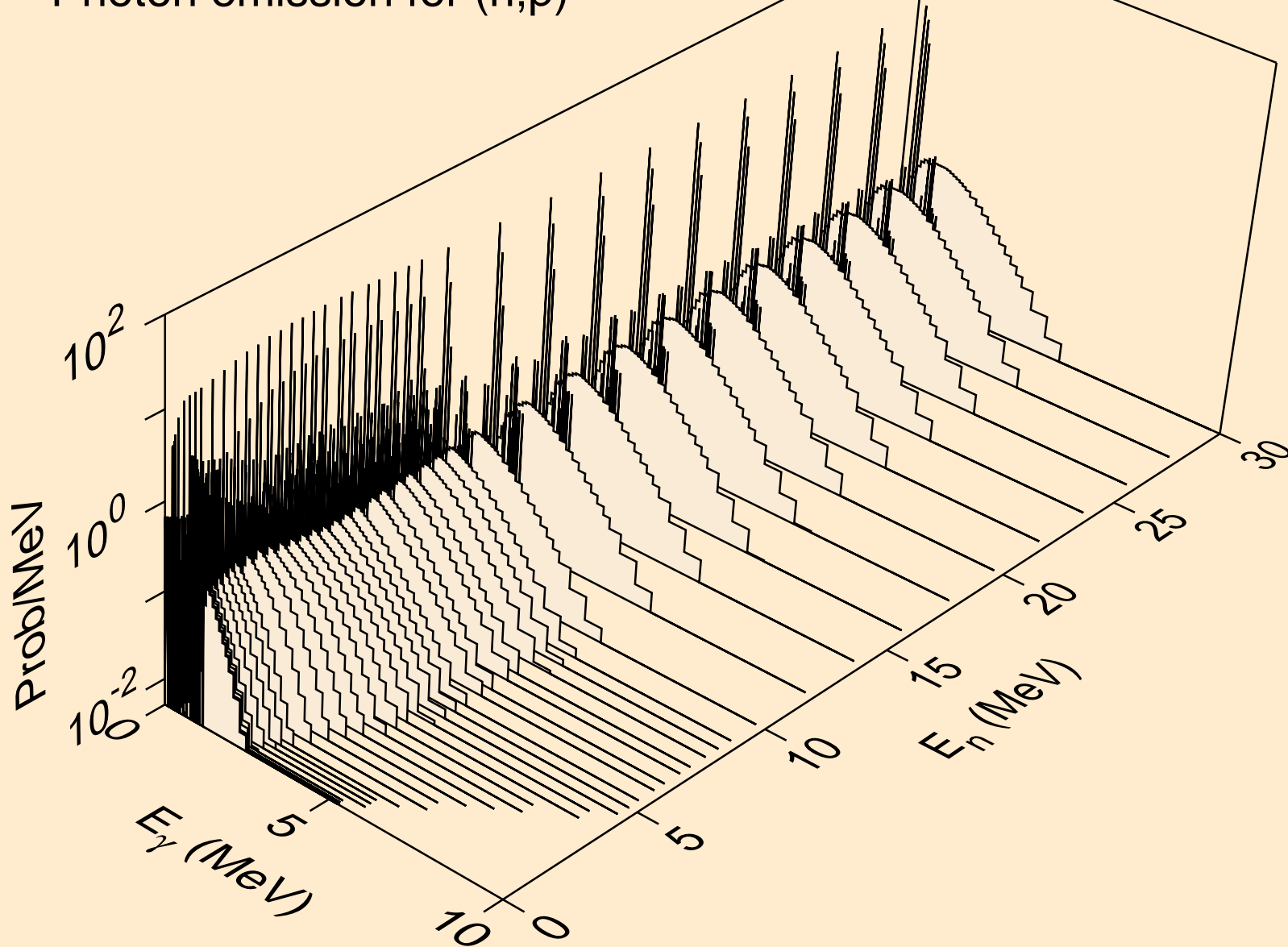

TM162 NEUTRON ACER TENDL-2019 LIBRARY; T=293.16K
Photon emission for (n,d)

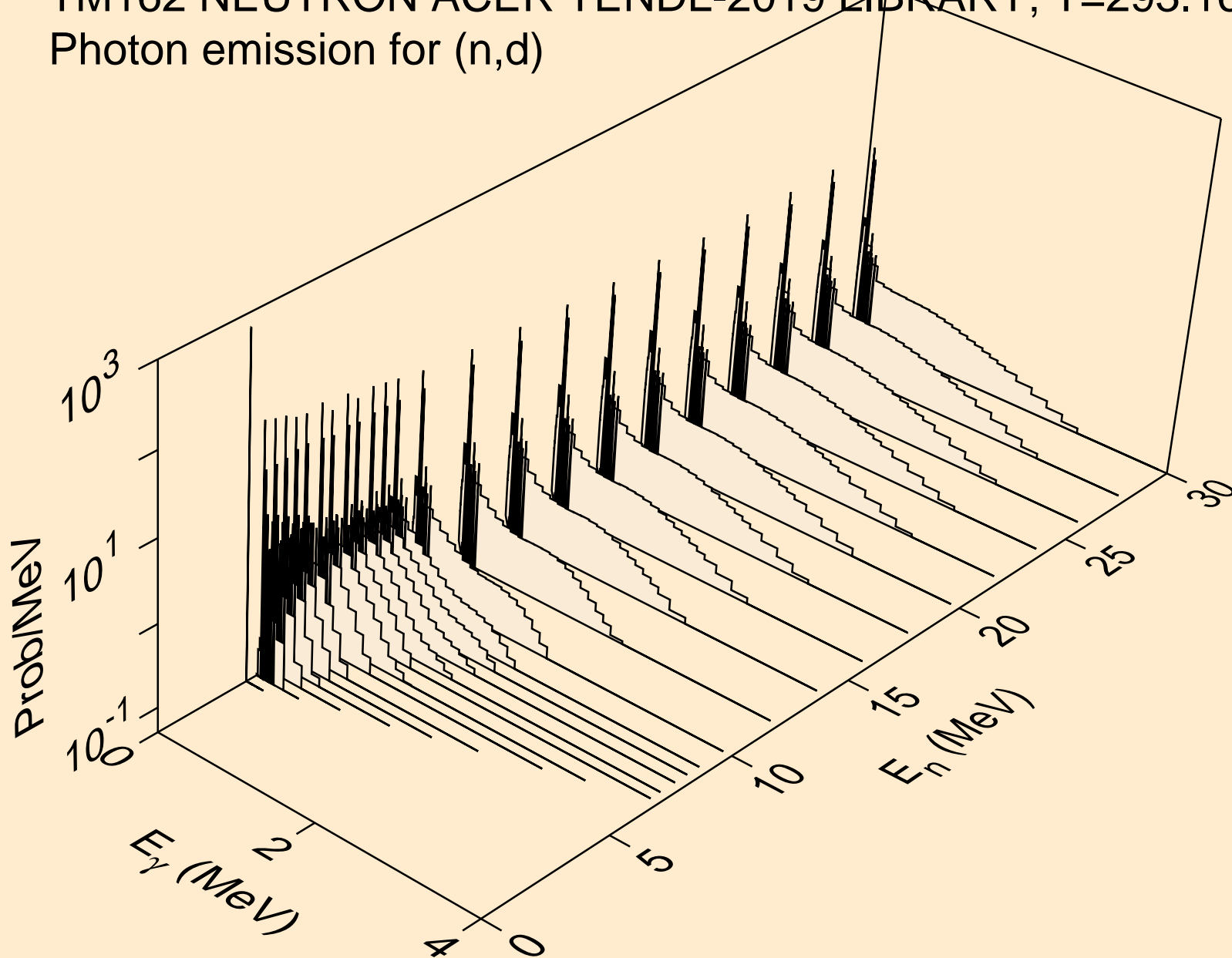

TM162 NEUTRON ACER TENDL-2019 LIBRARY; T=293.16K
Photon emission for (n,t)

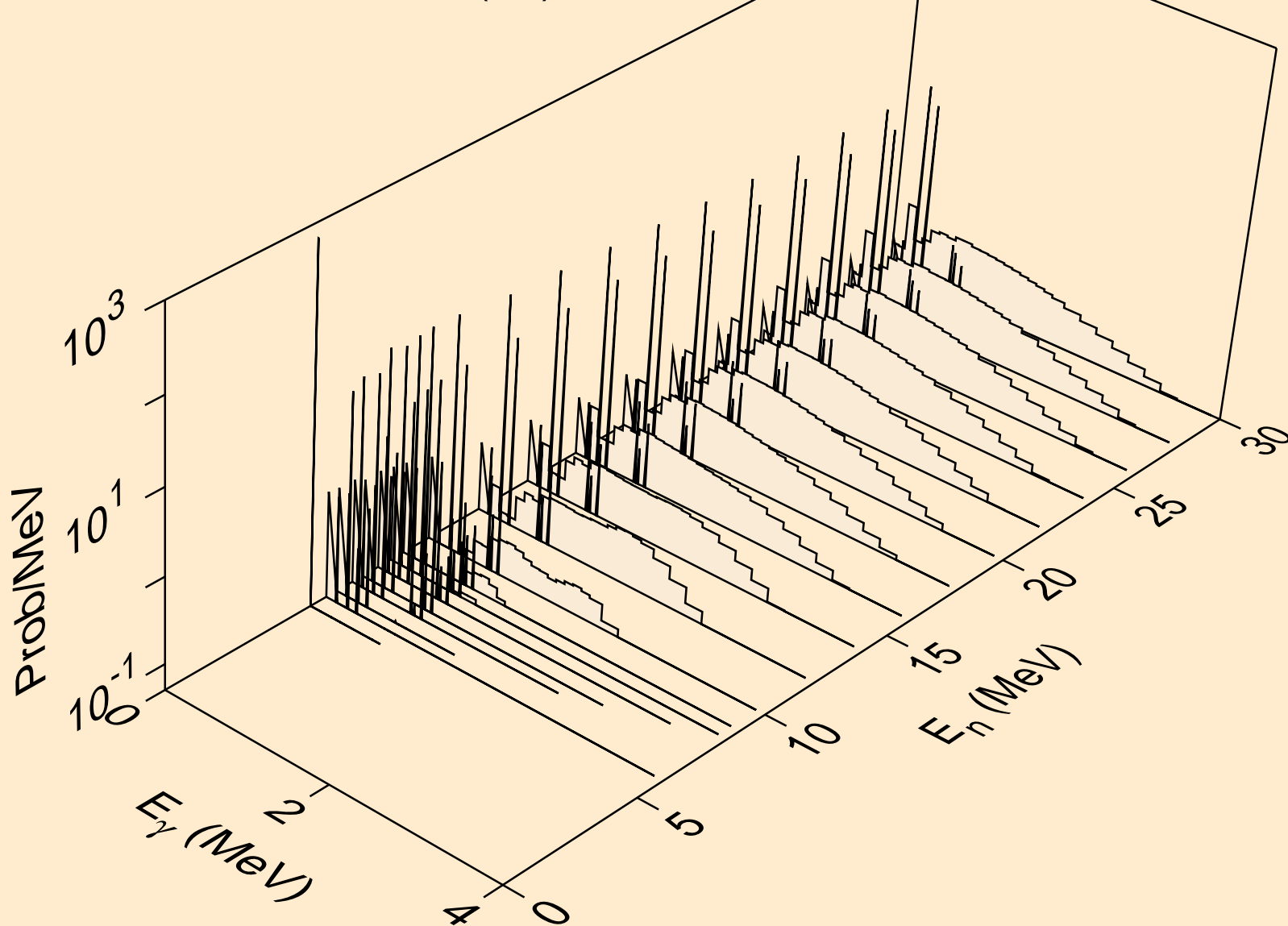

TM162 NEUTRON ACER TENDL-2019 LIBRARY; T=293.16K
Photon emission for (n,he3)

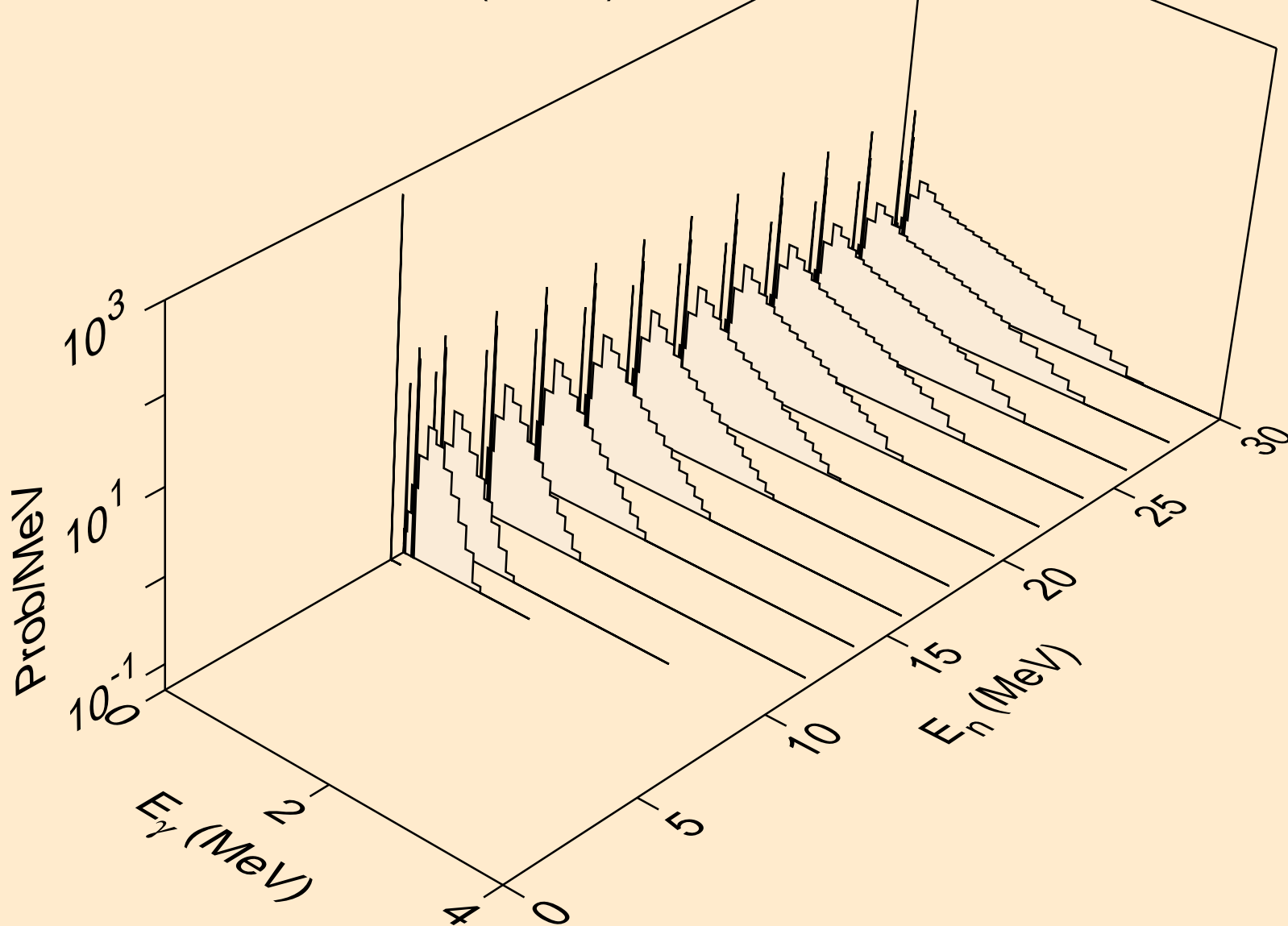

TM162 NEUTRON ACER TENDL-2019 LIBRARY; T=293.16K
Photon emission for (n,a)

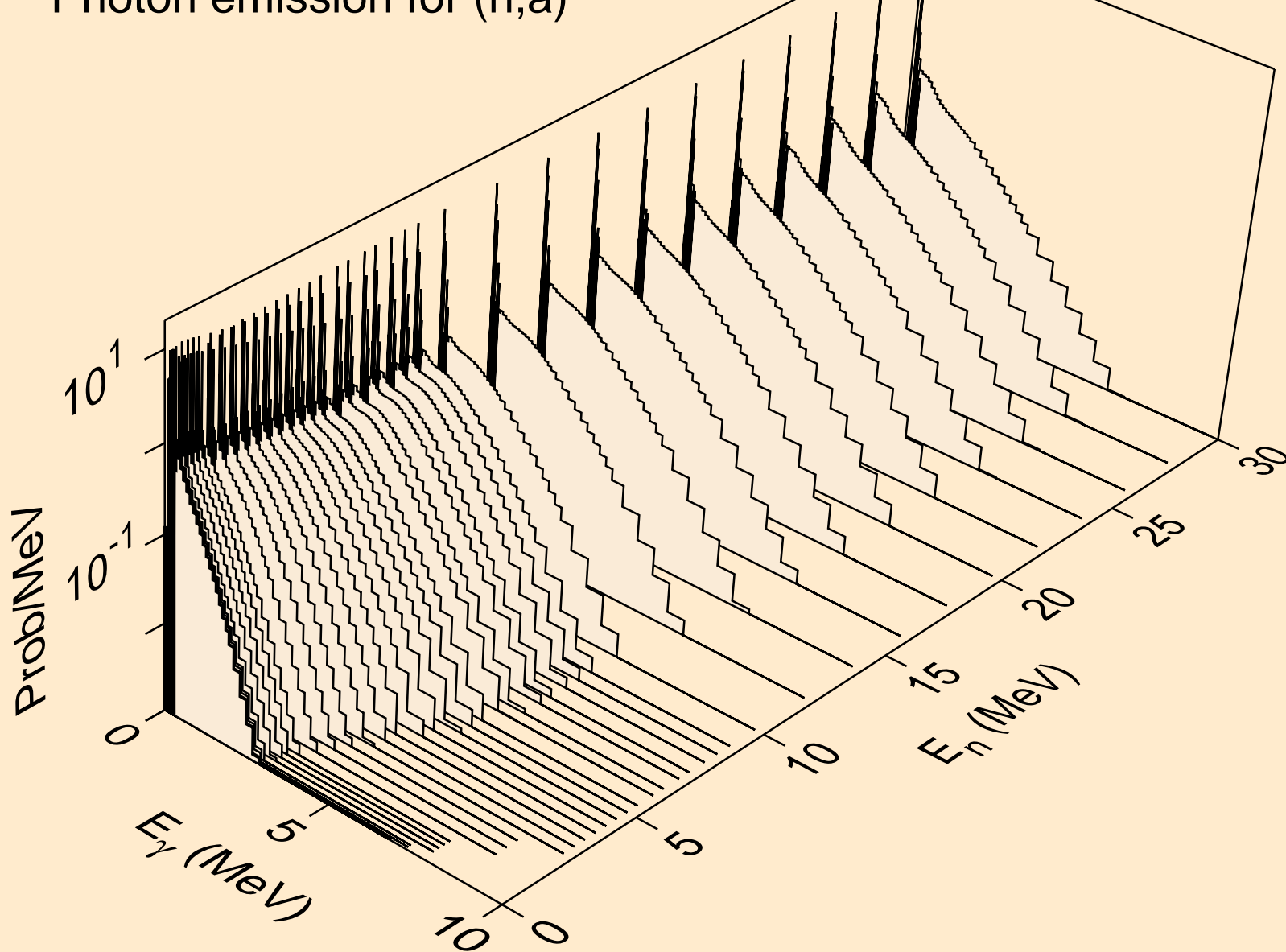

TM162 NEUTRON ACER TENDL-2019 LIBRARY; T=293.16K
Photon emission for (n,2a)

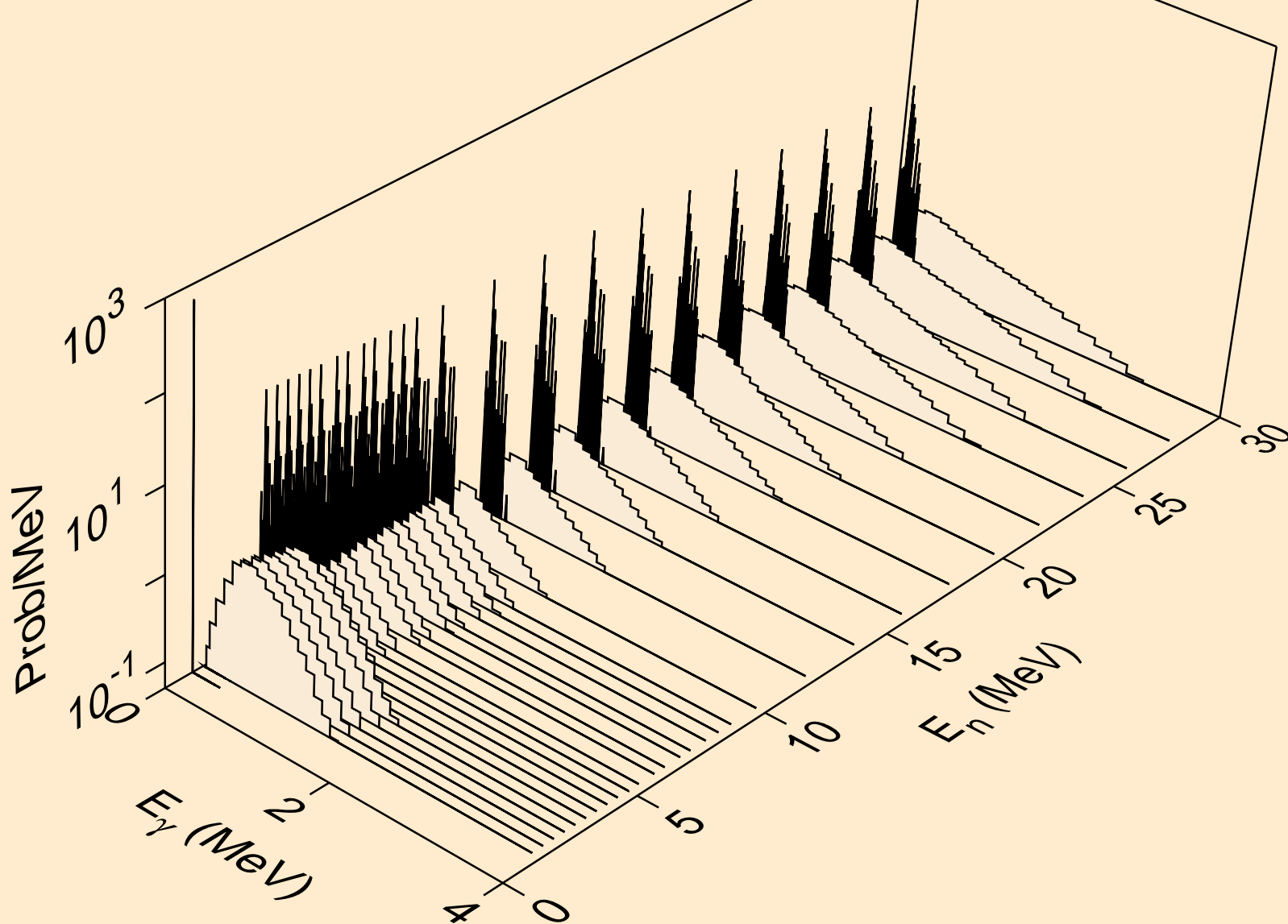

TM162 NEUTRON ACER TENDL-2019 LIBRARY; T=293.16K
Photon emission for (n,2p)

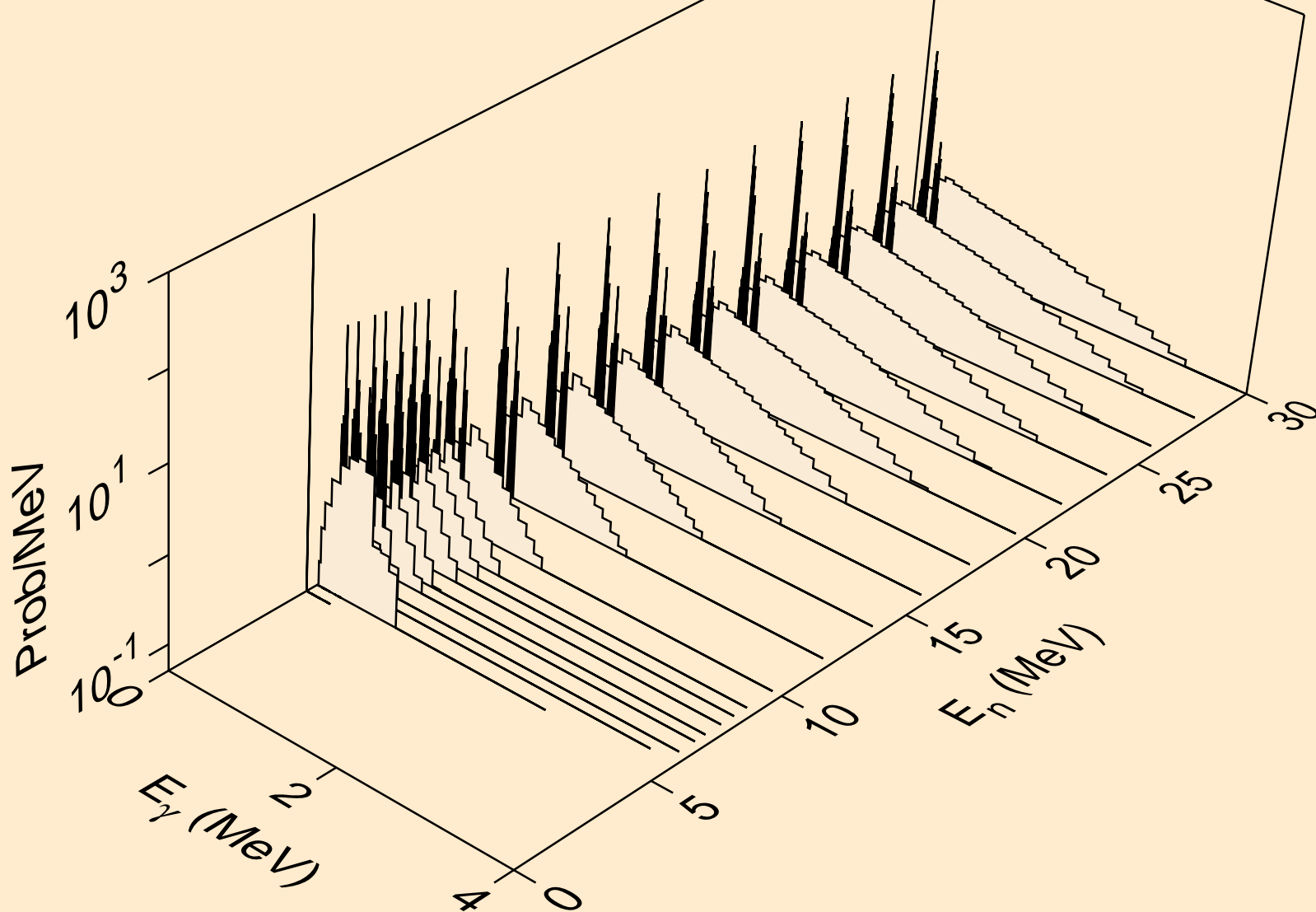

TM162 NEUTRON ACER TENDL-2019 LIBRARY; T=293.16K
Photon emission for (n,p α)

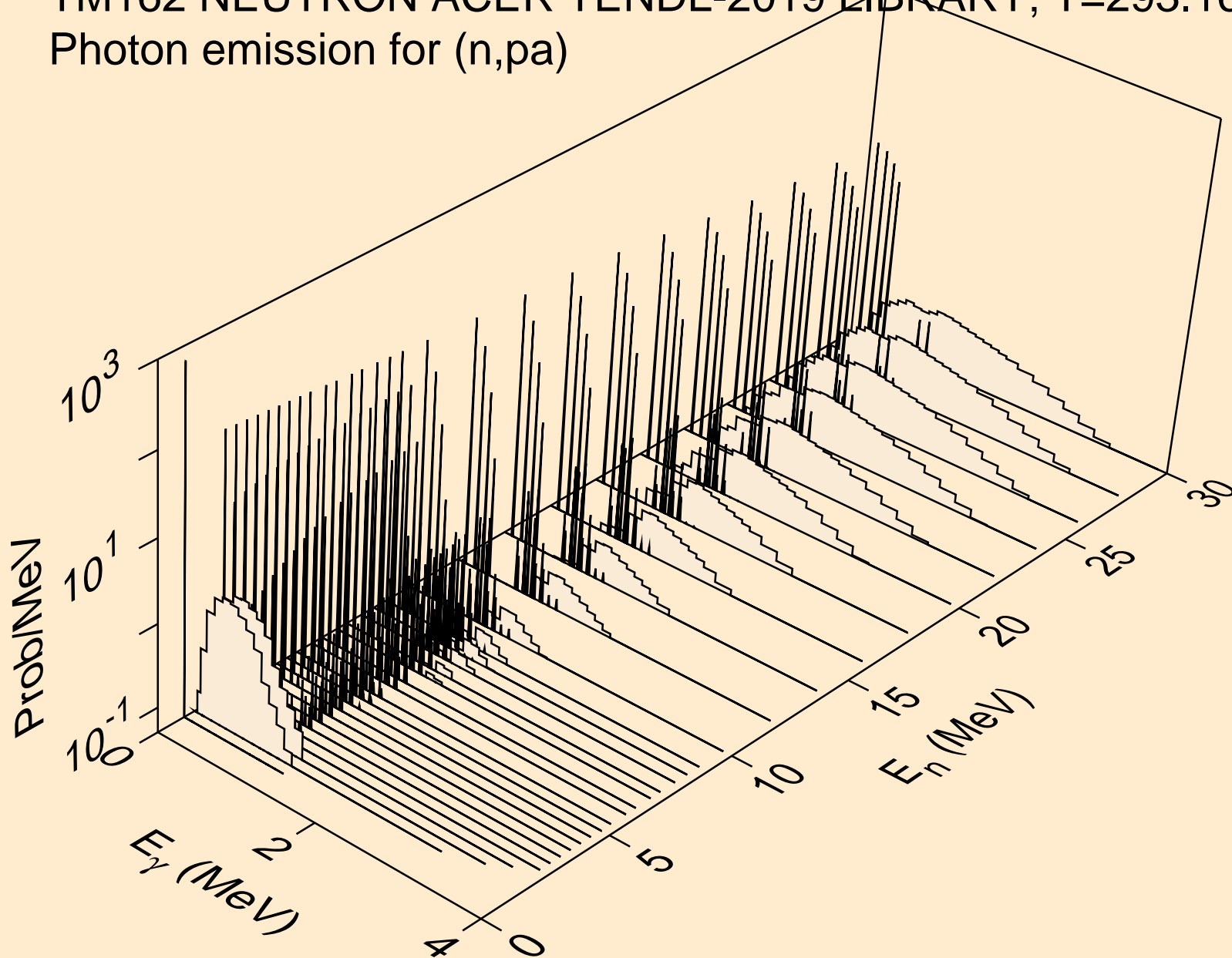

TM162 NEUTRON ACER TENDL-2019 LIBRARY; T=293.16K
Photon emission for (n,pd)

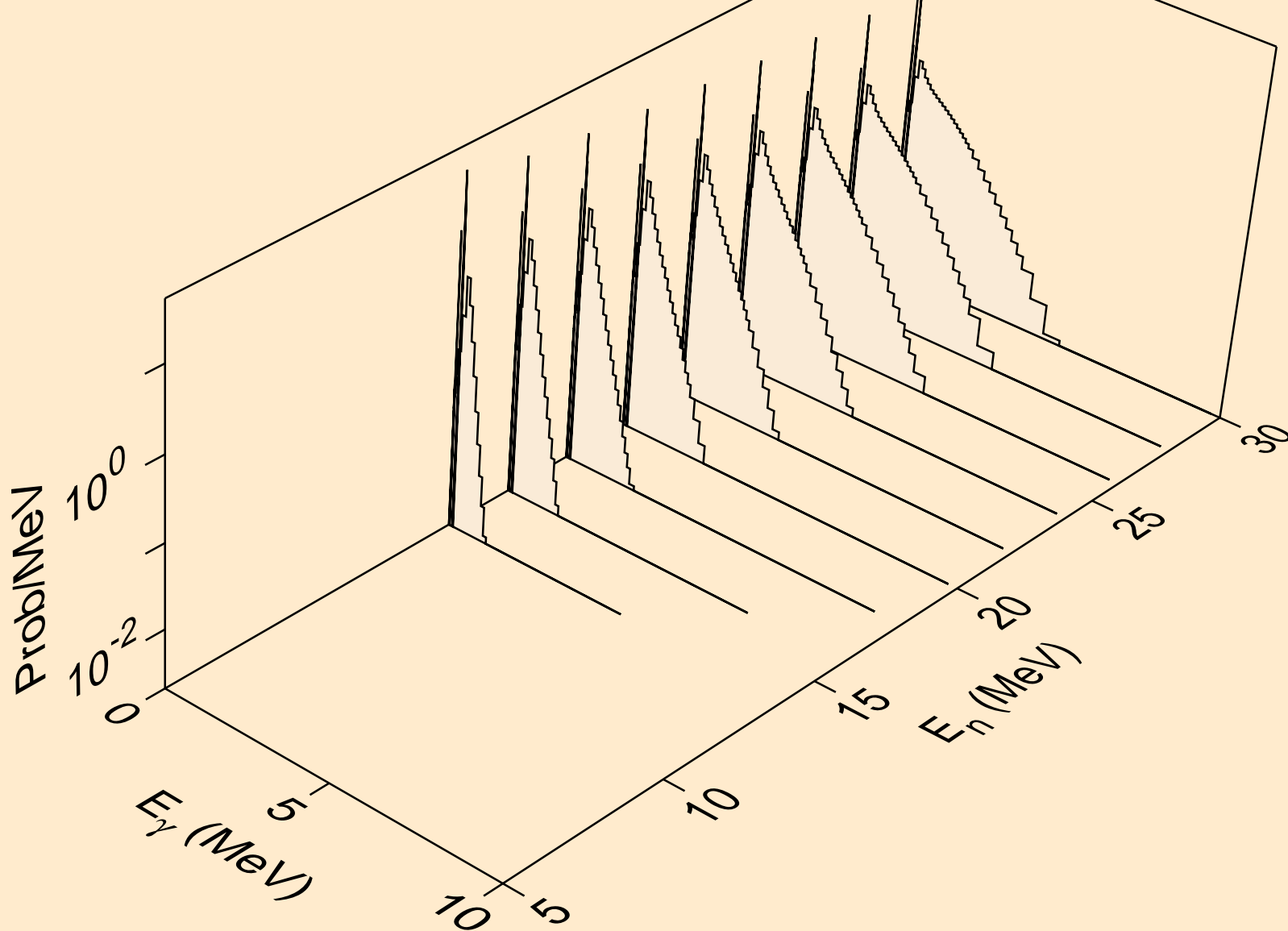

TM162 NEUTRON ACER TENDL-2019 LIBRARY; T=293.16K
Photon emission for (n,pt)

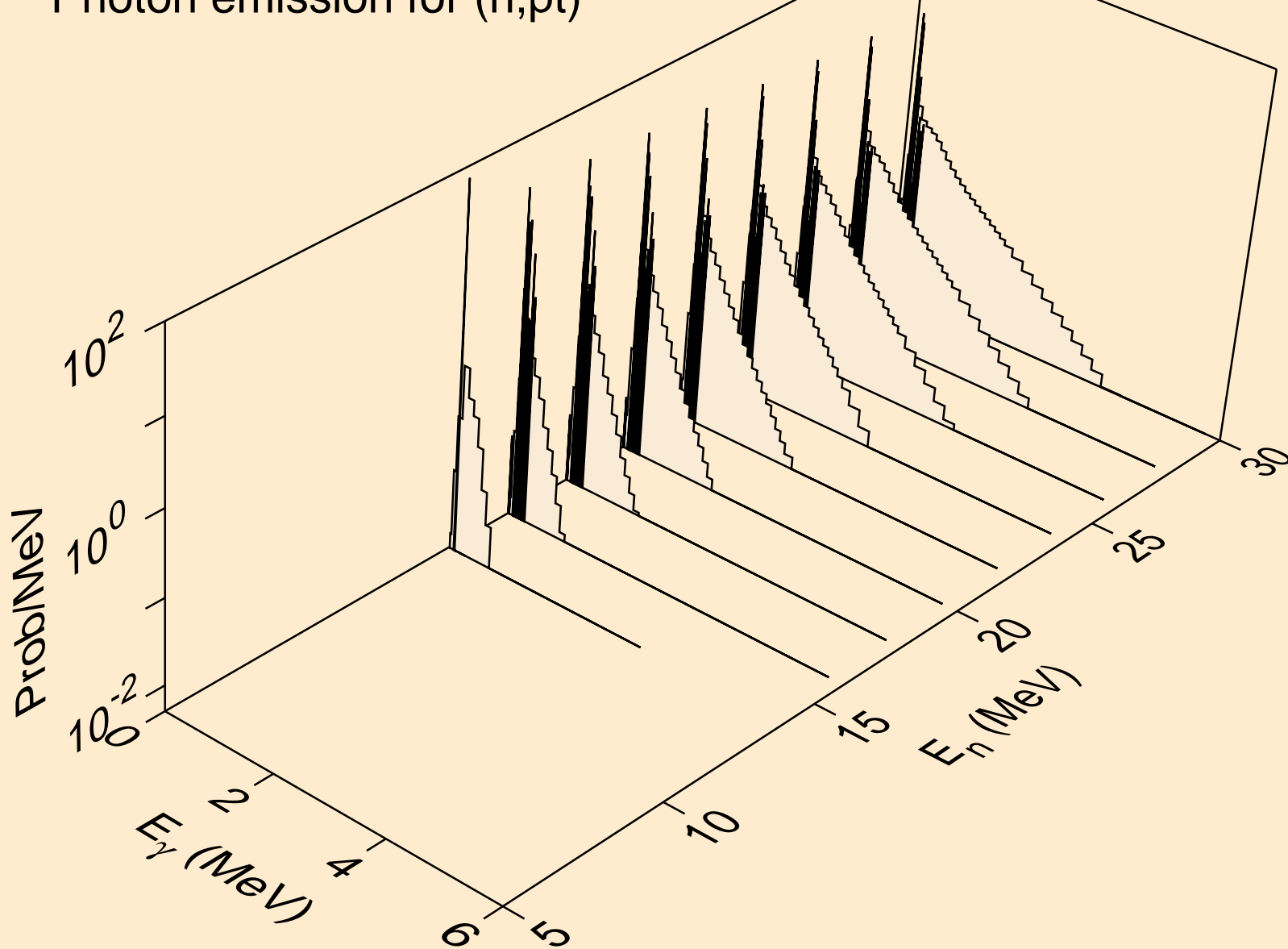

TM162 NEUTRON ACER TENDL-2019 LIBRARY; T=293.16K
Photon emission for (n,da)

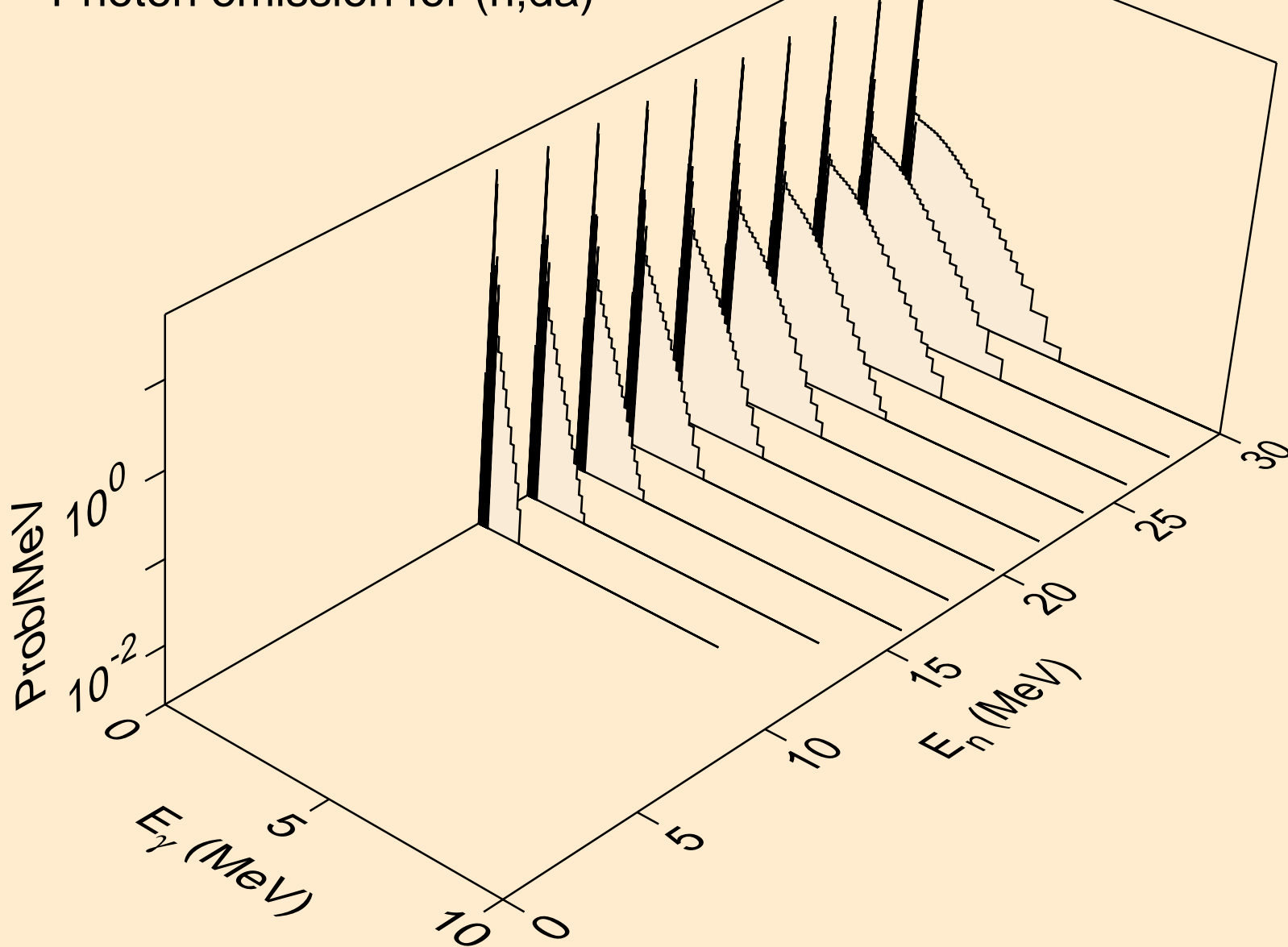

TM162 NEUTRON ACER TENDL-2019 LIBRARY; T=293.16K
thermal capture photon spectrum

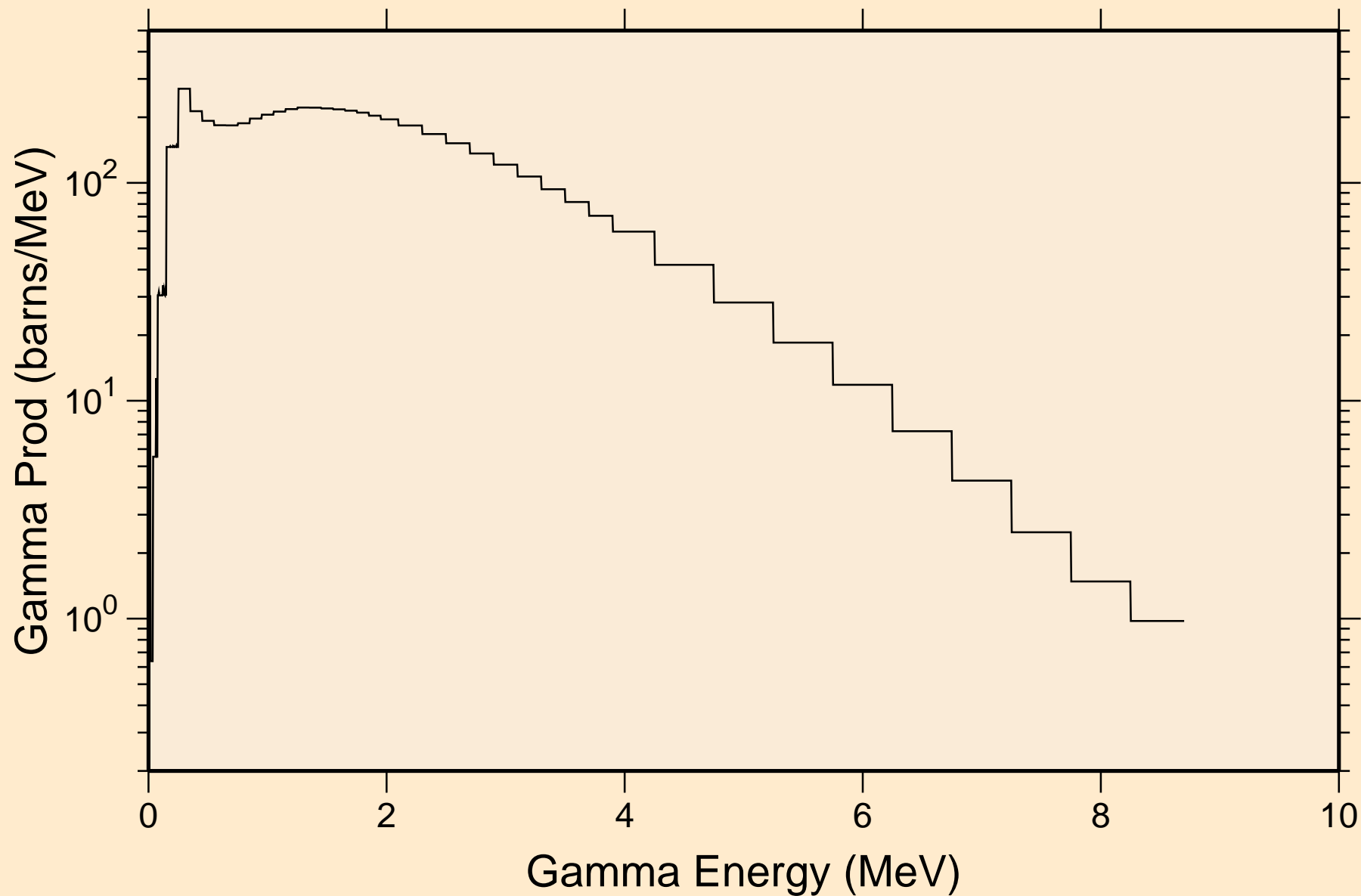

TM162 NEUTRON ACER TENDL-2019 LIBRARY; T=293.16K
14 MeV photon spectrum

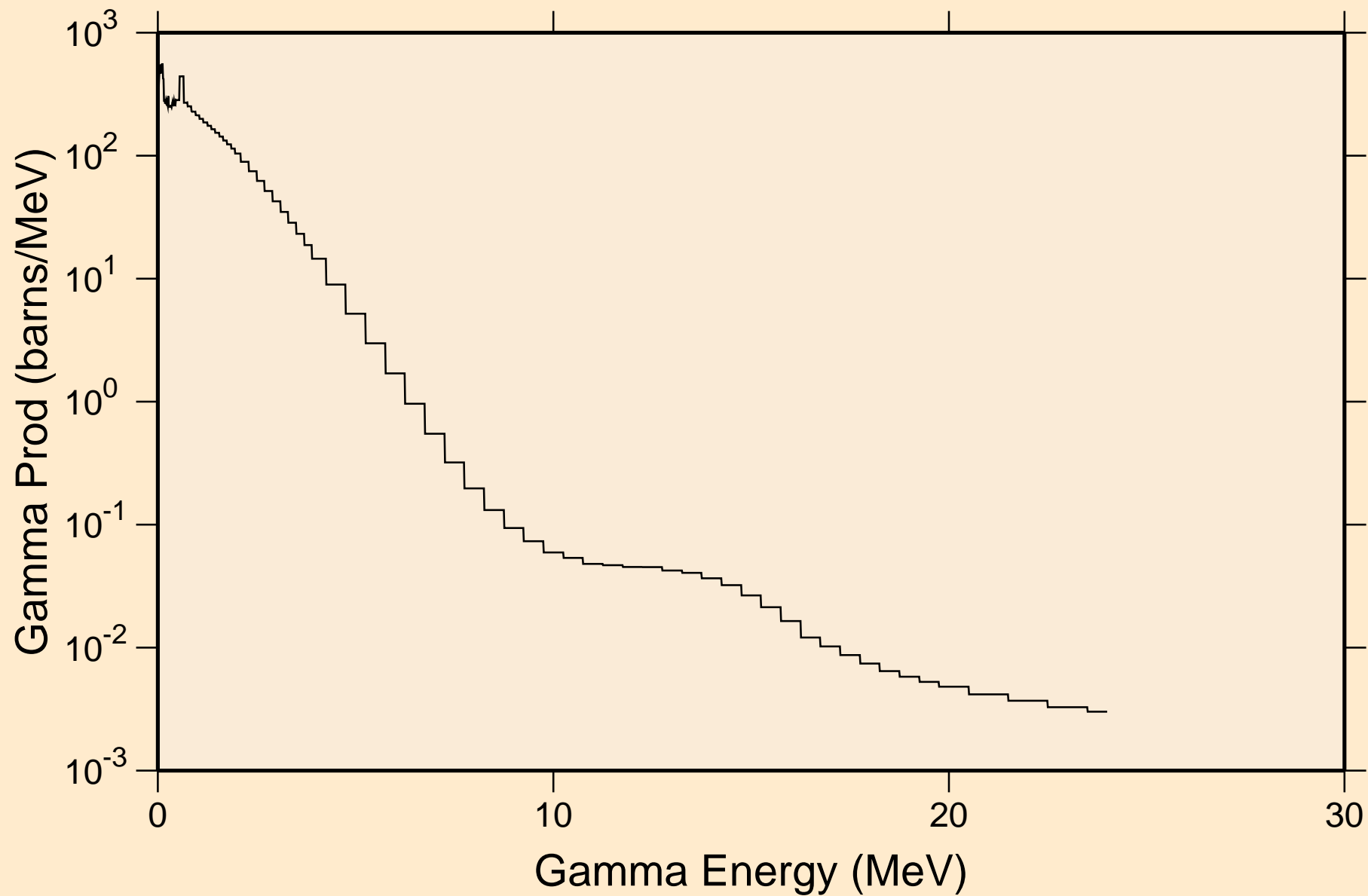

TM162 NEUTRON ACER TENDL-2019 LIBRARY; T=293.16K
Particle heating contributions

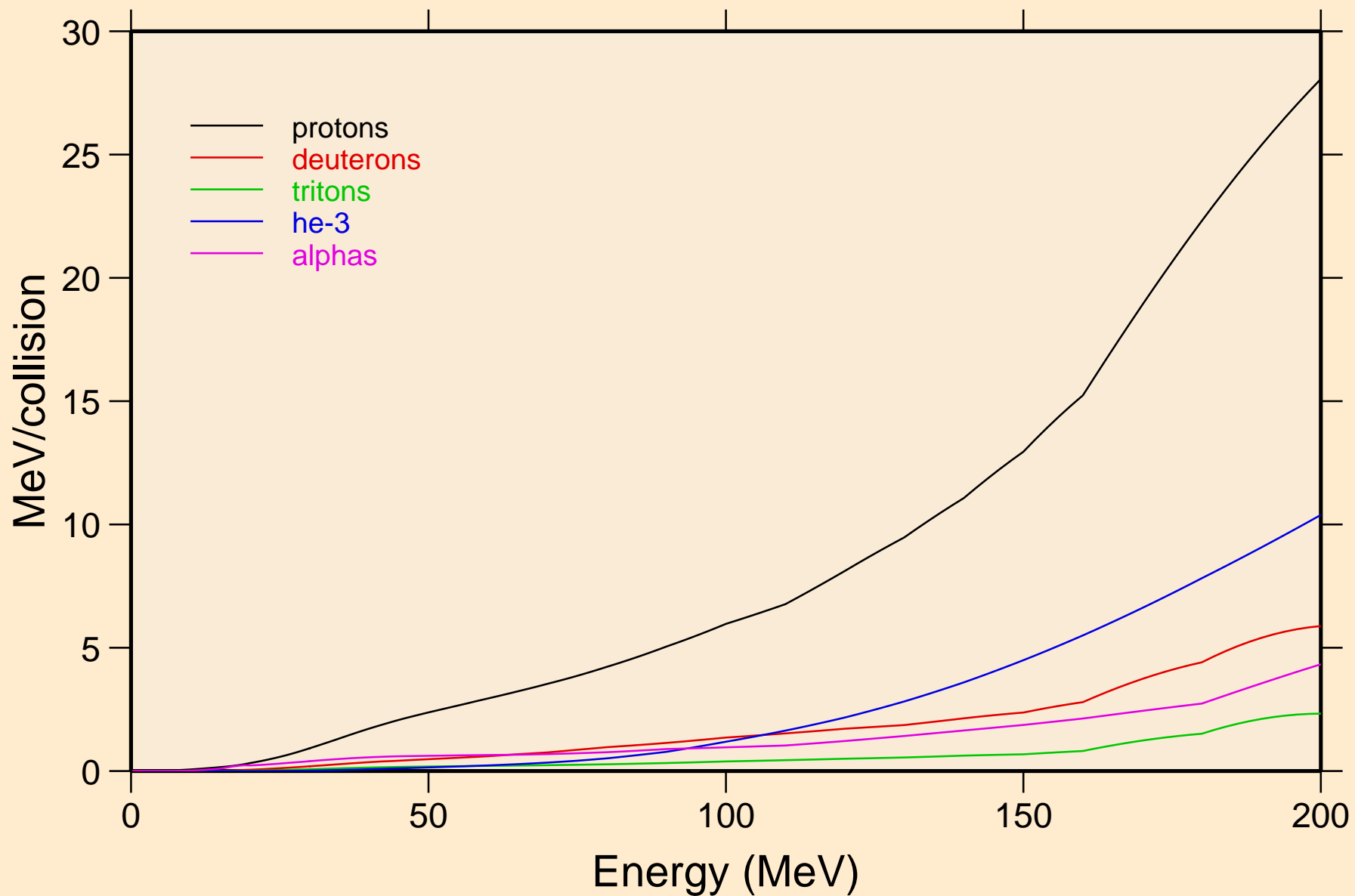

TM162 NEUTRON ACER TENDL-2019 LIBRARY; T=293.16K
Recoil Heating

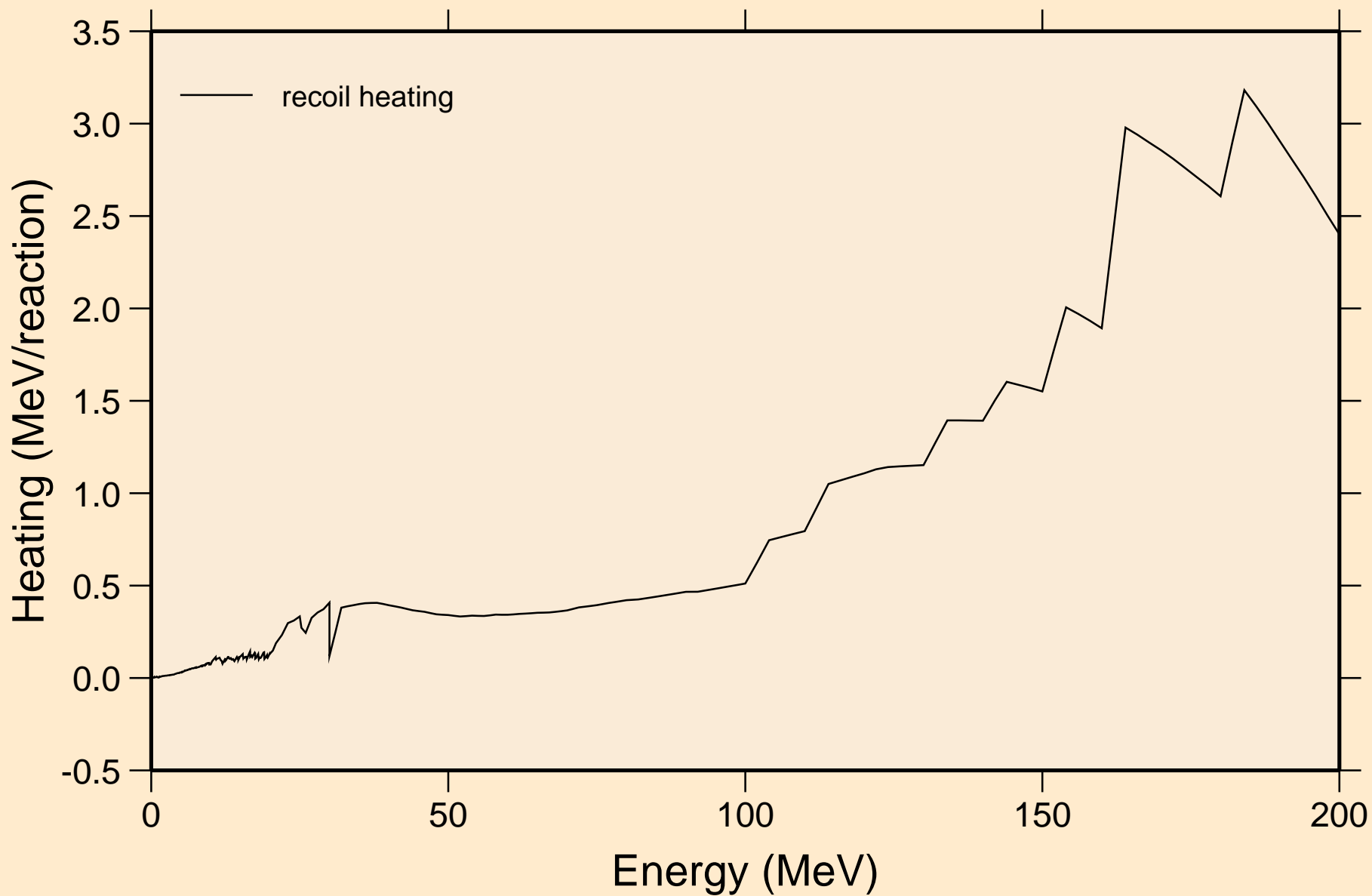

TM162 NEUTRON ACER TENDL-2019 LIBRARY; T=293.16K
Particle production cross sections

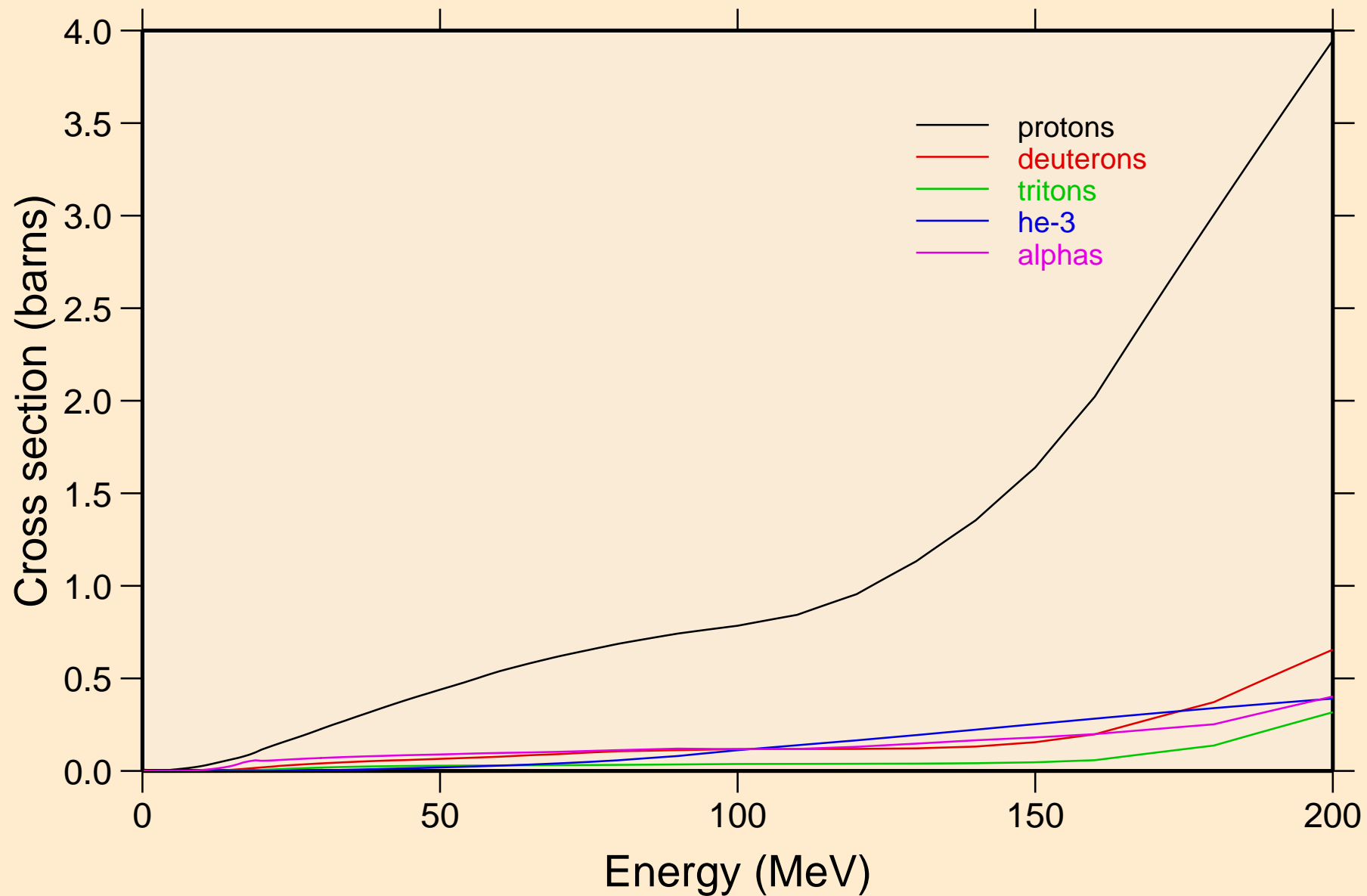

TM162 NEUTRON ACER TENDL-2019 LIBRARY; T=293.16K
protons from (n,x)

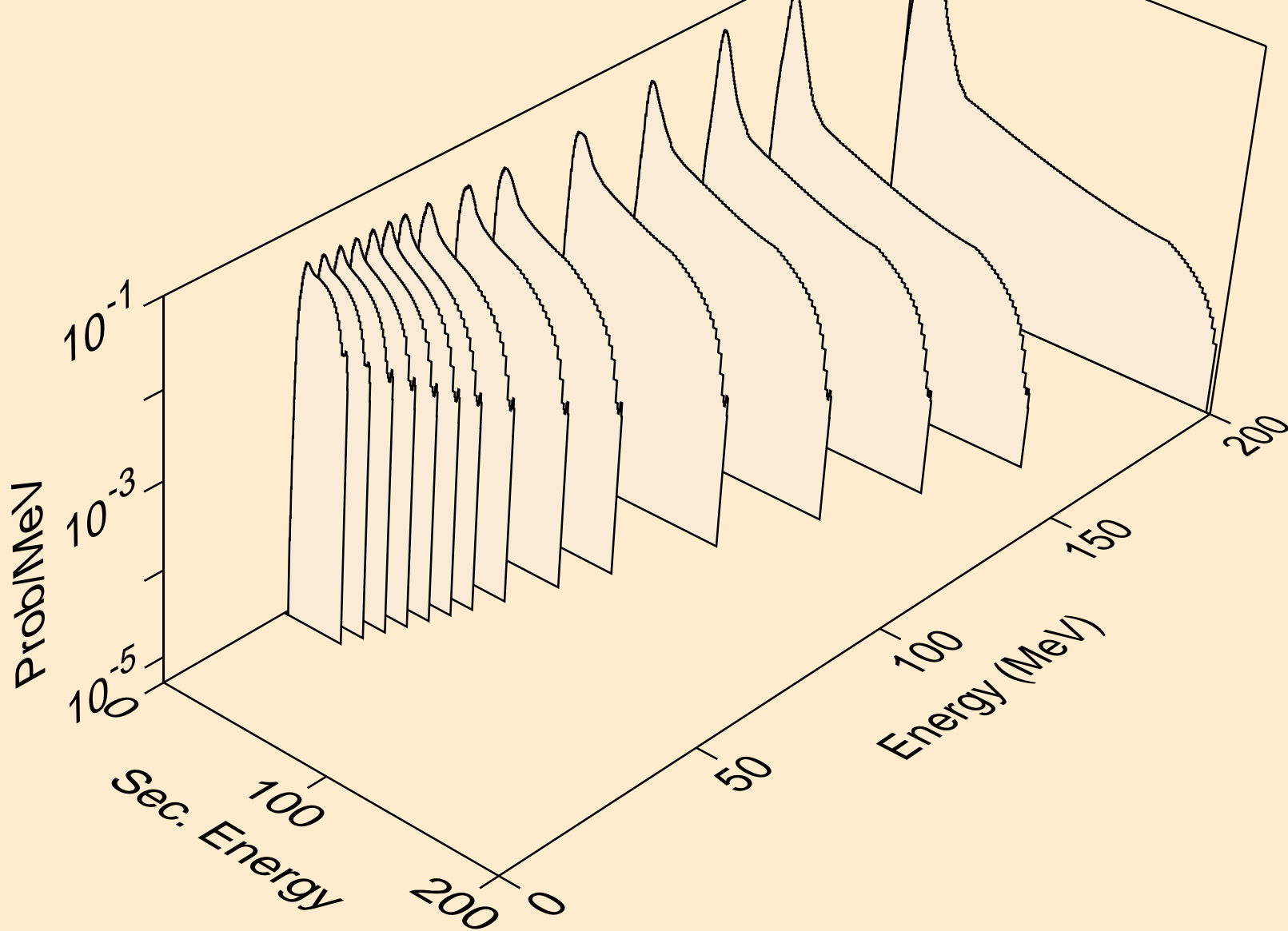

TM162 NEUTRON ACER TENDL-2019 LIBRARY; T=293.16K
protons from (n,n*)p

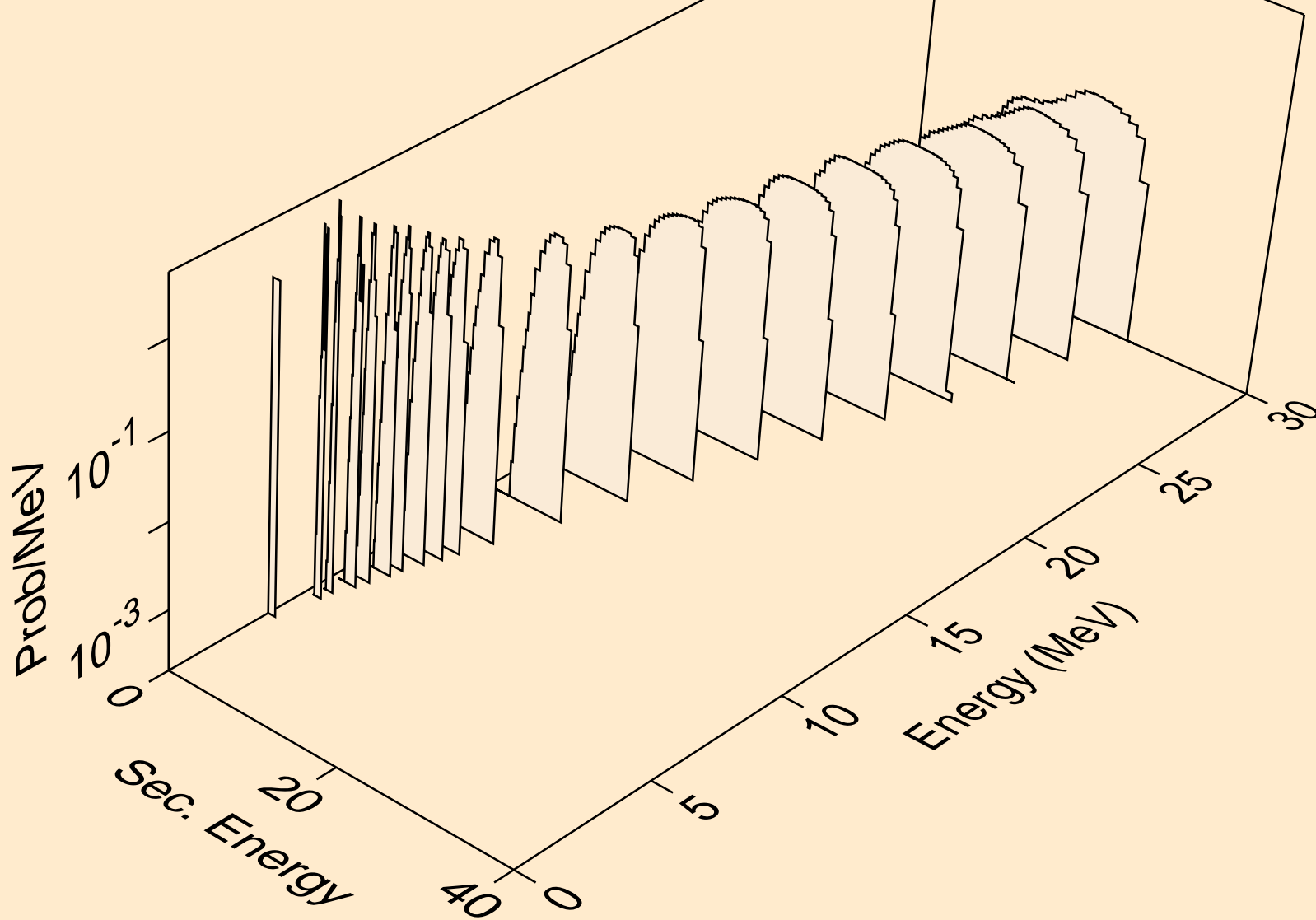

TM162 NEUTRON ACER TENDL-2019 LIBRARY; T=293.16K
protons from (n,2np)

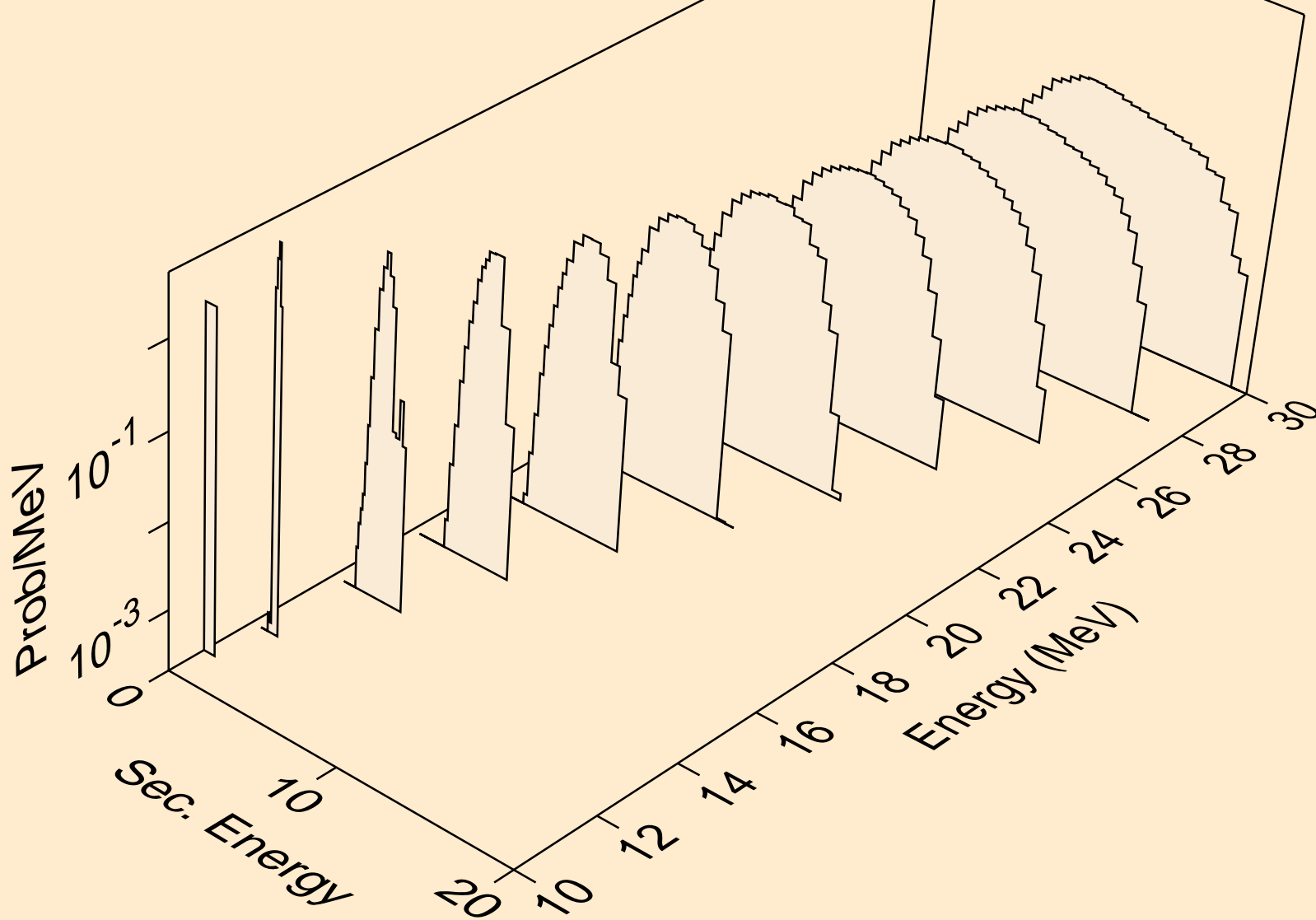

TM162 NEUTRON ACER TENDL-2019 LIBRARY; T=293.16K
protons from (n,3np)

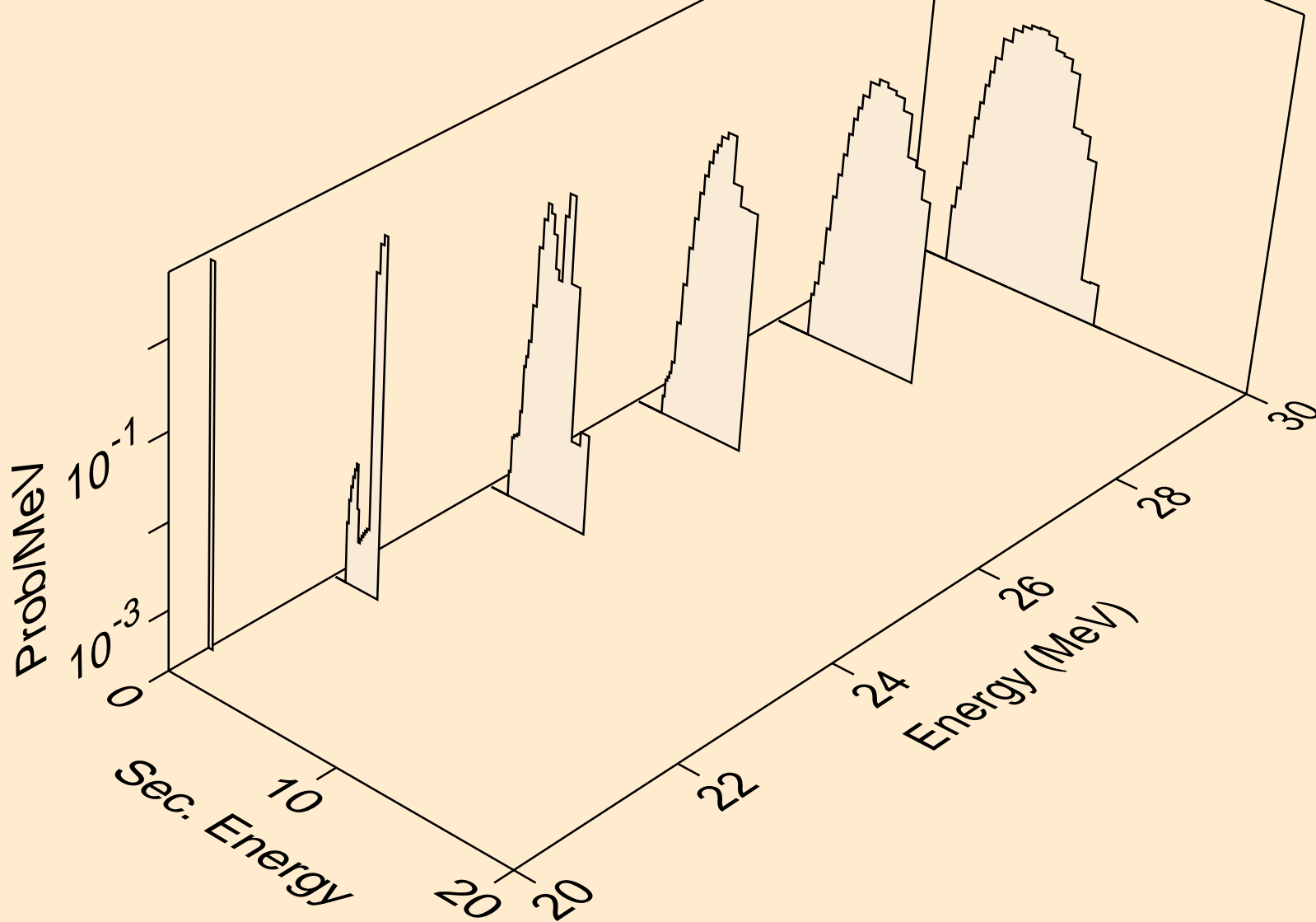

TM162 NEUTRON ACER TENDL-2019 LIBRARY; T=293.16K
protons from (n,2np)

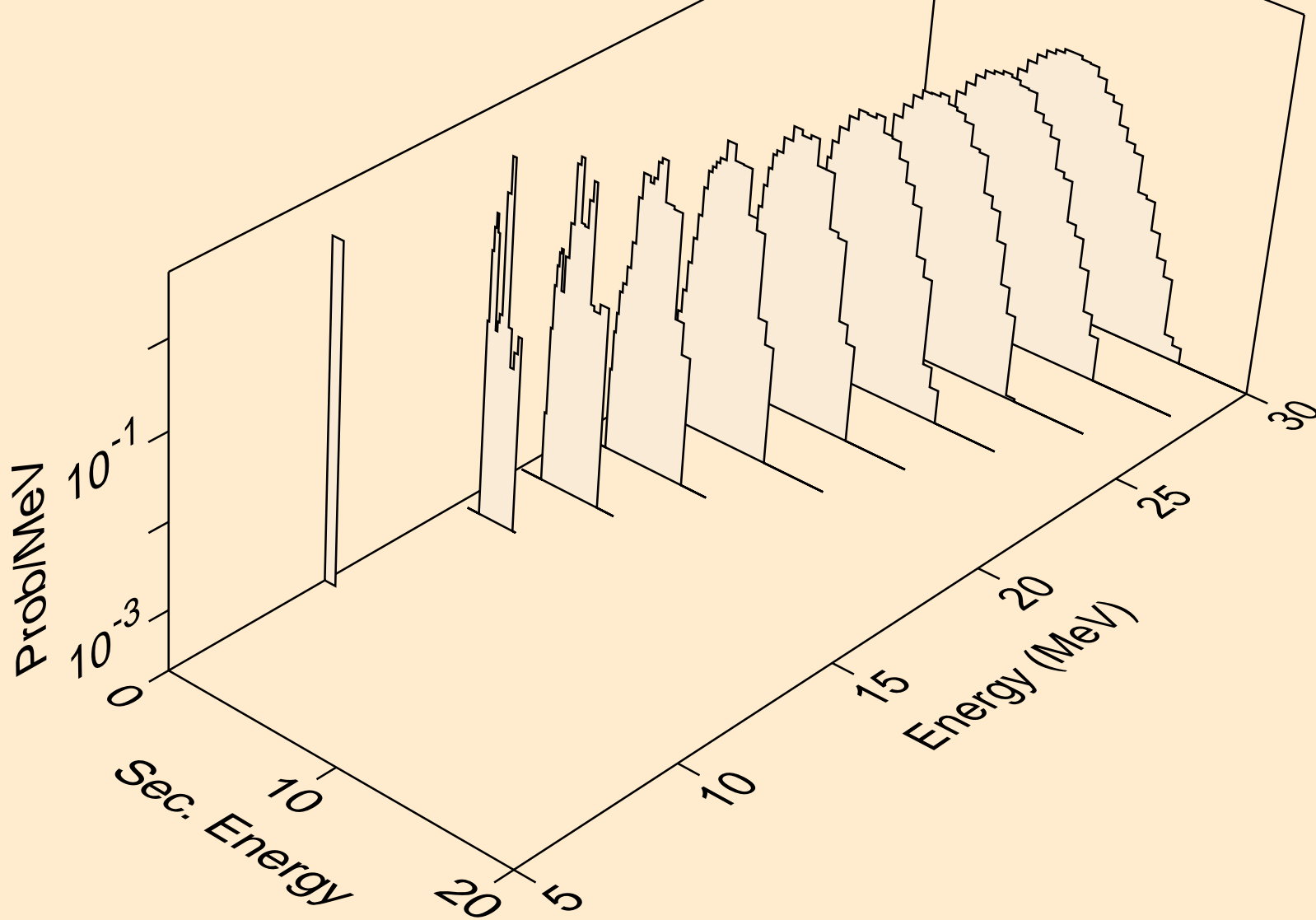

TM162 NEUTRON ACER TENDL-2019 LIBRARY; T=293.16K
protons from (n,npa)

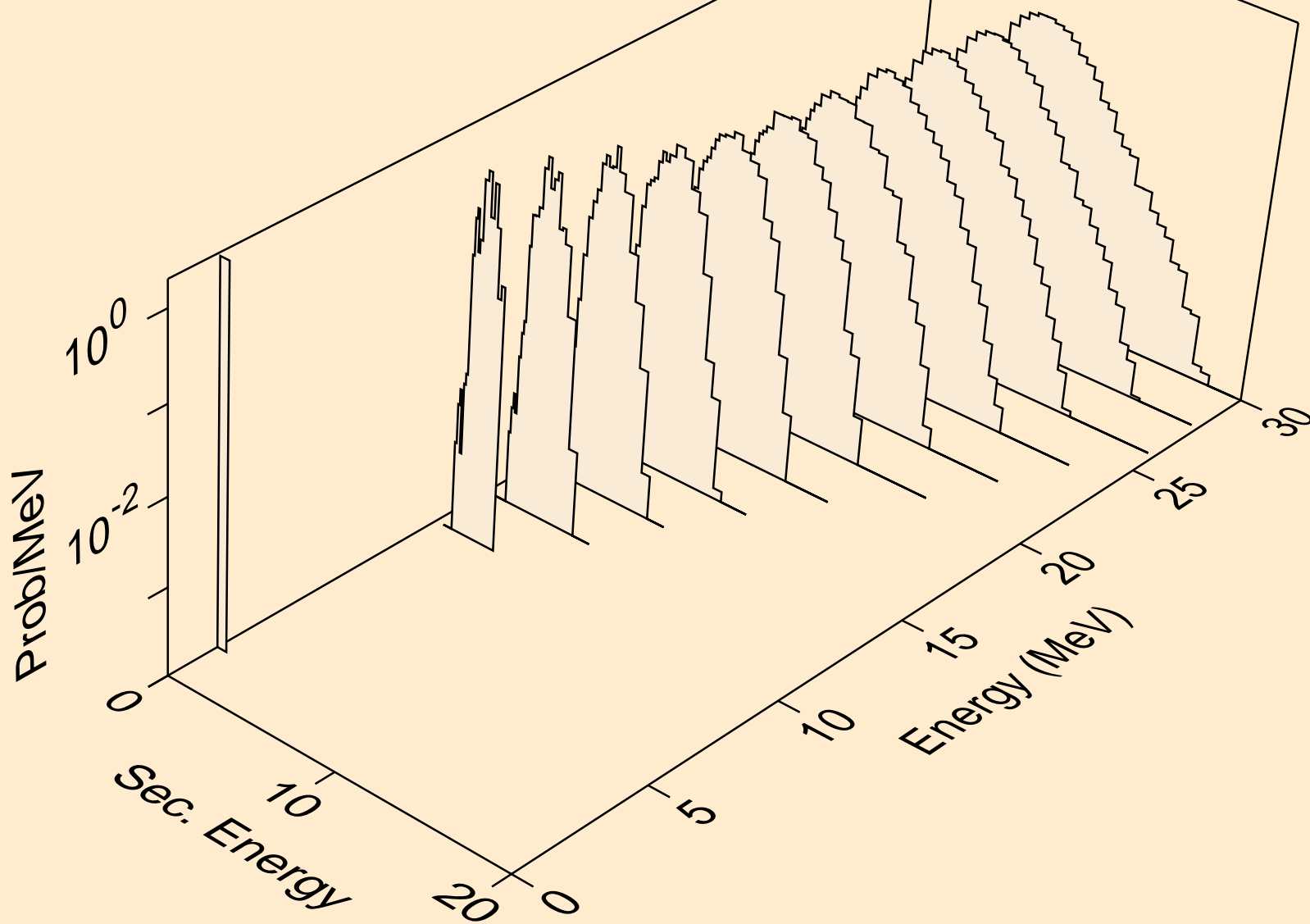

TM162 NEUTRON ACER TENDL-2019 LIBRARY; T=293.16K
protons from (n,p)

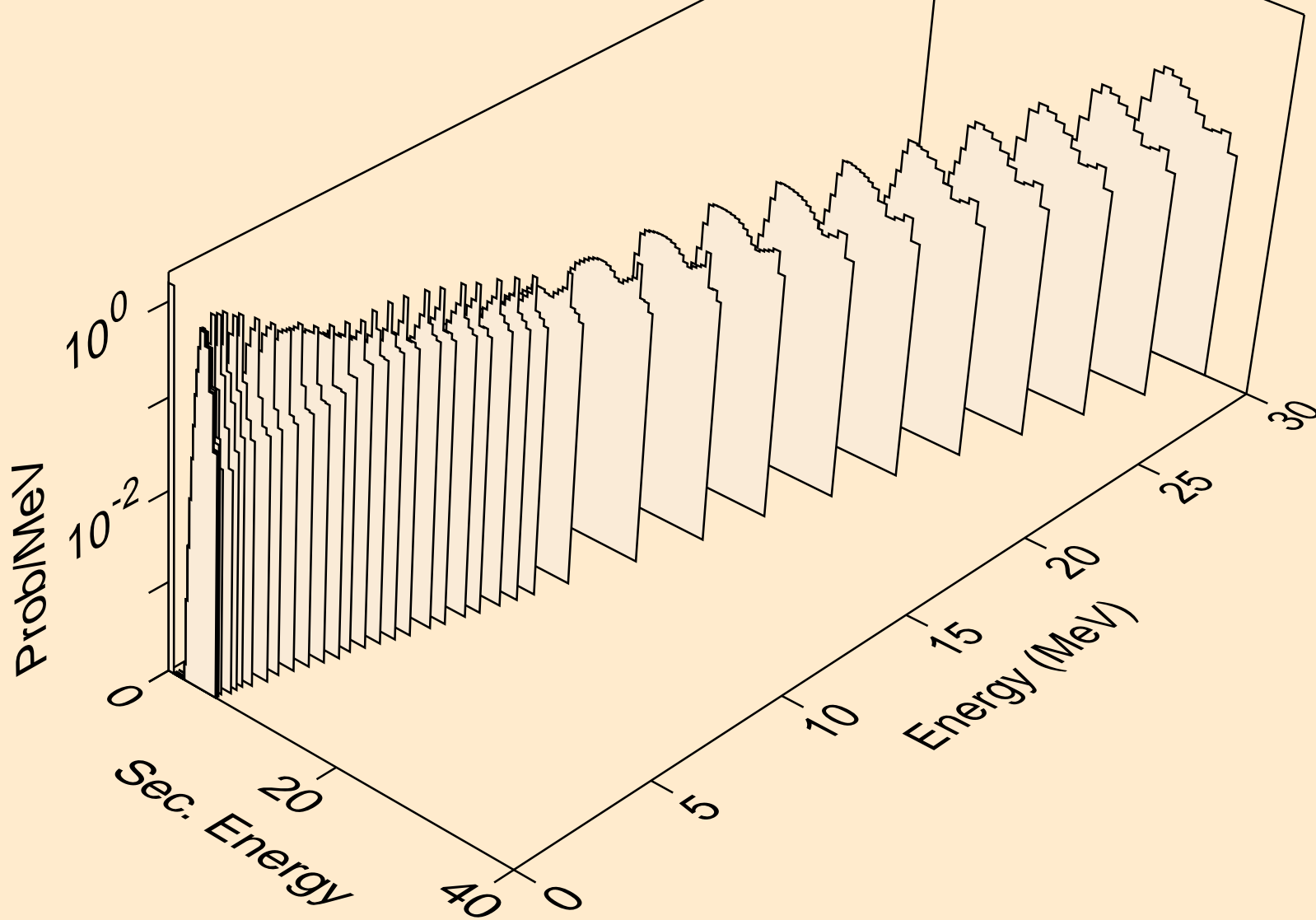

TM162 NEUTRON ACER TENDL-2019 LIBRARY; T=293.16K
protons from (n,2p)

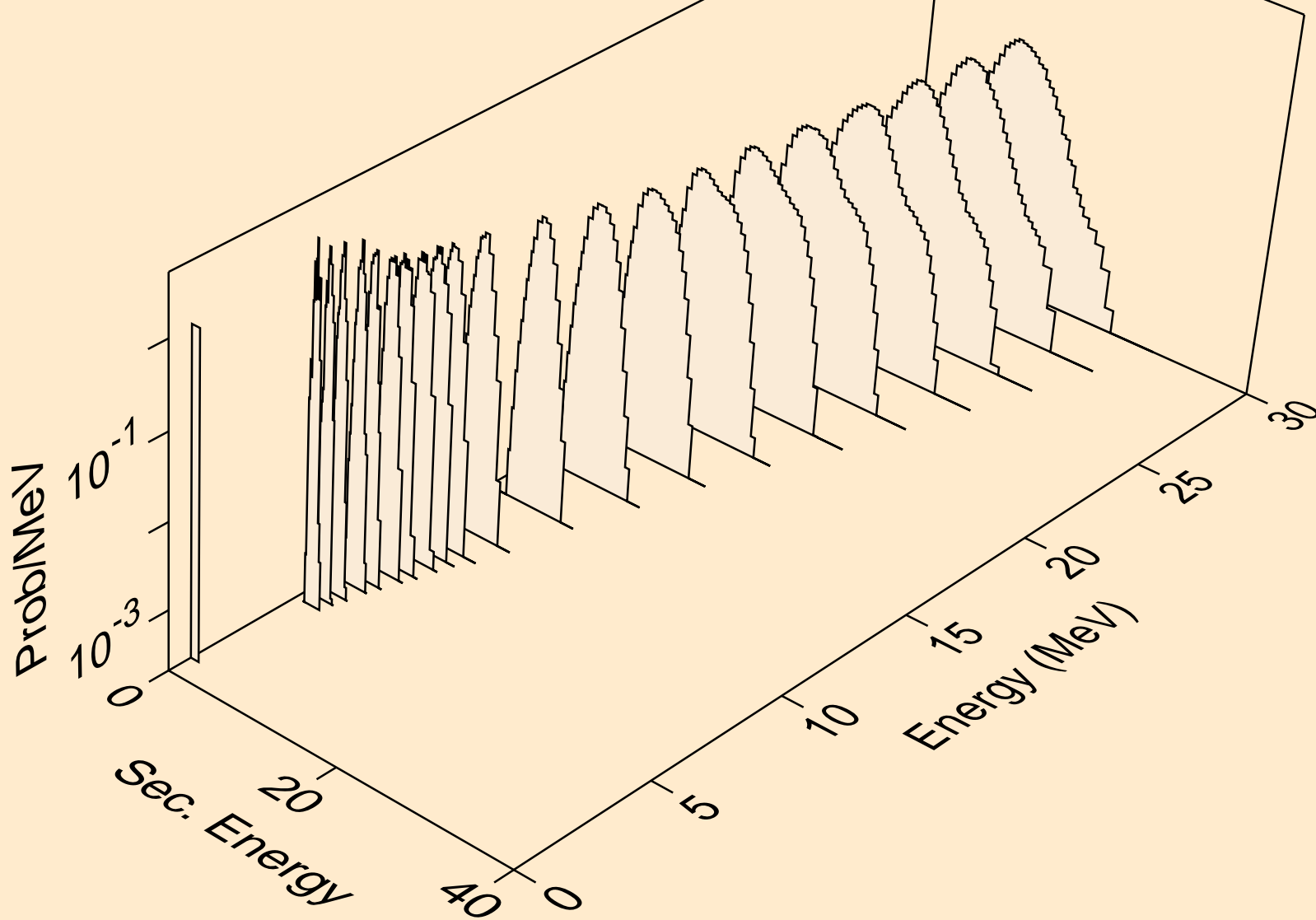

TM162 NEUTRON ACER TENDL-2019 LIBRARY; T=293.16K
protons from (n,p)

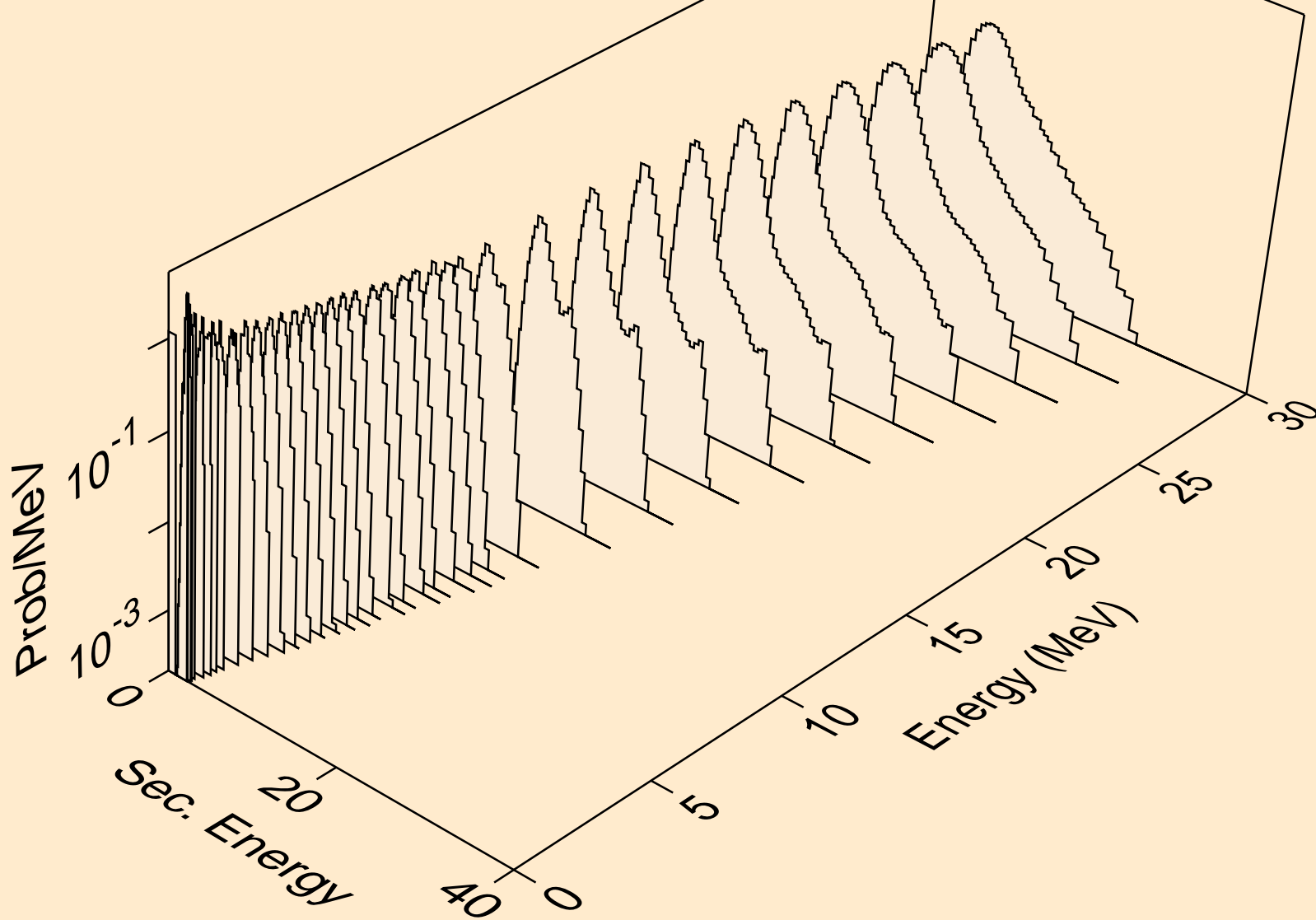

TM162 NEUTRON ACER TENDL-2019 LIBRARY; T=293.16K
protons from (n,pd)

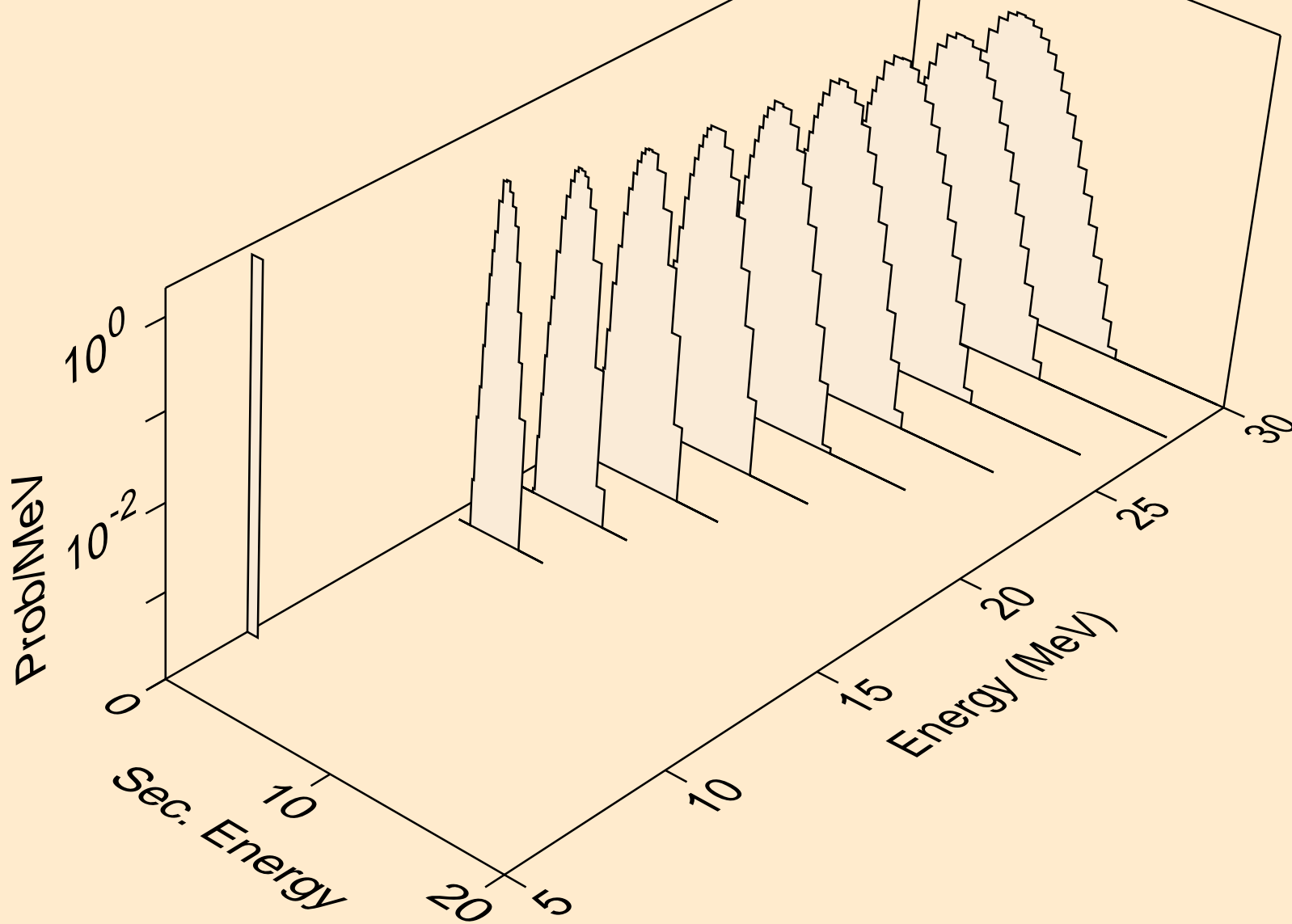

TM162 NEUTRON ACER TENDL-2019 LIBRARY; T=293.16K
protons from (n,pt)

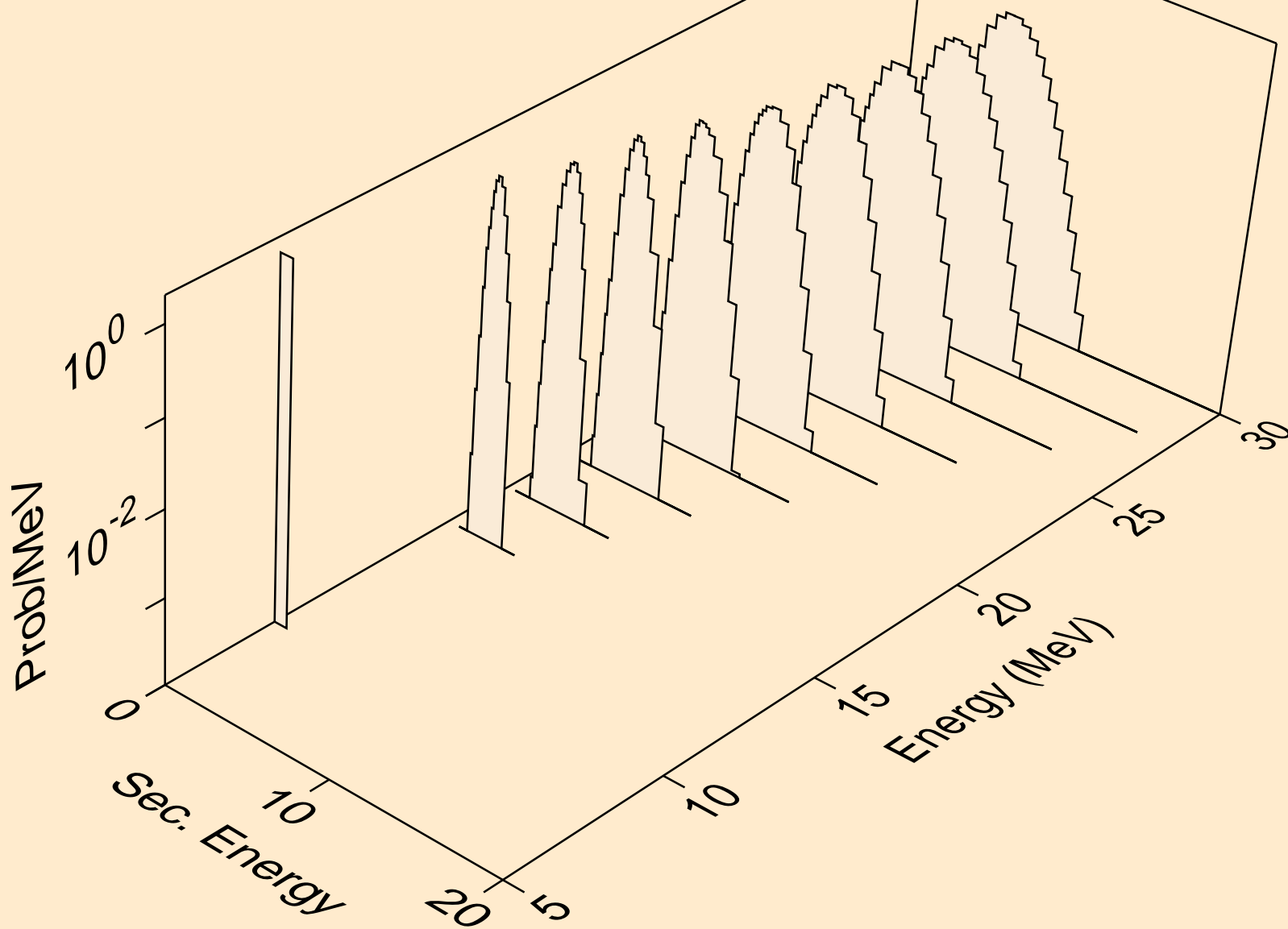

TM162 NEUTRON ACER TENDL-2019 LIBRARY; T=293.16K
deuterons from (n,x)

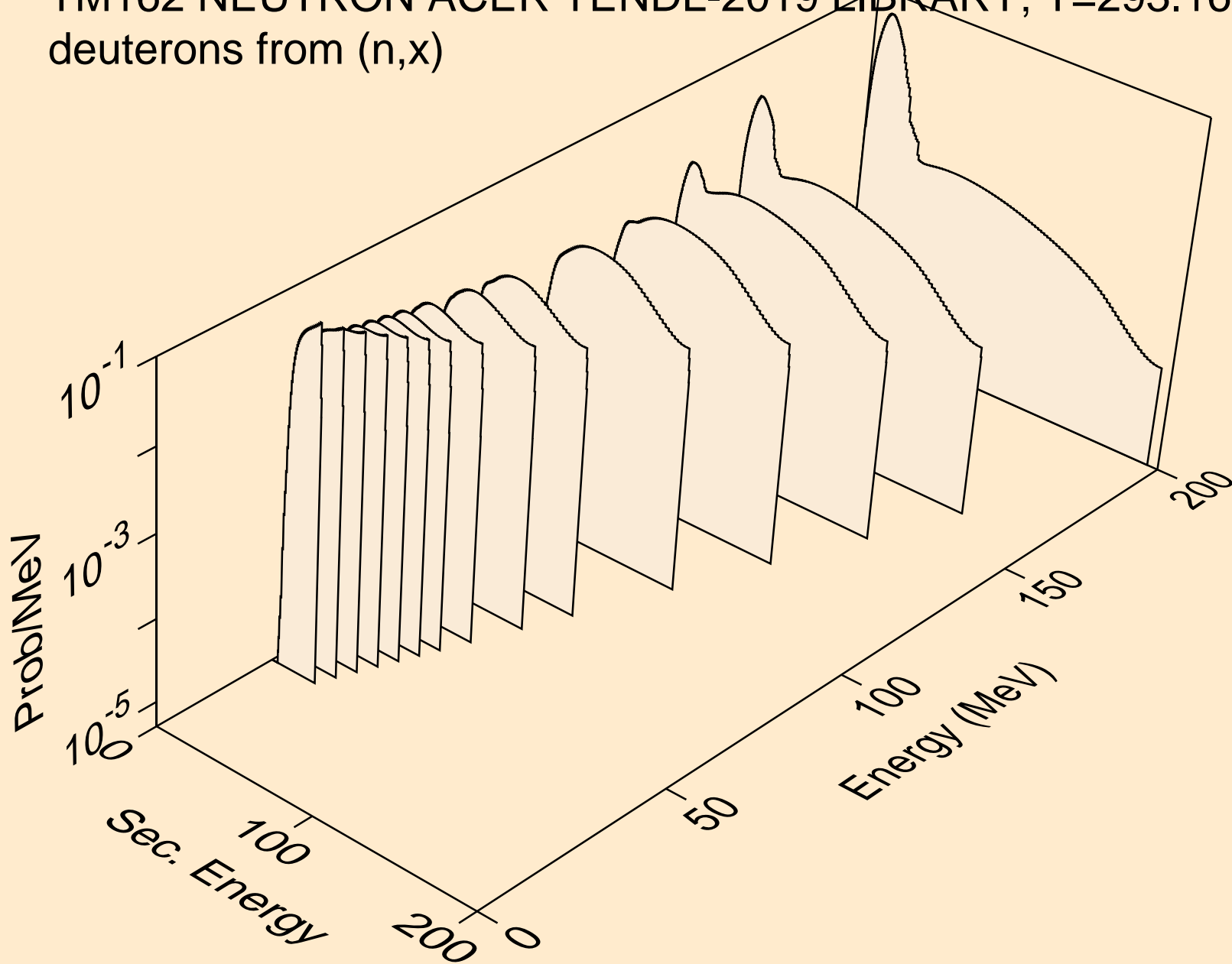

TM162 NEUTRON ACER TENDL-2019 LIBRARY; T=293.16K
deuterons from (n,2nd)

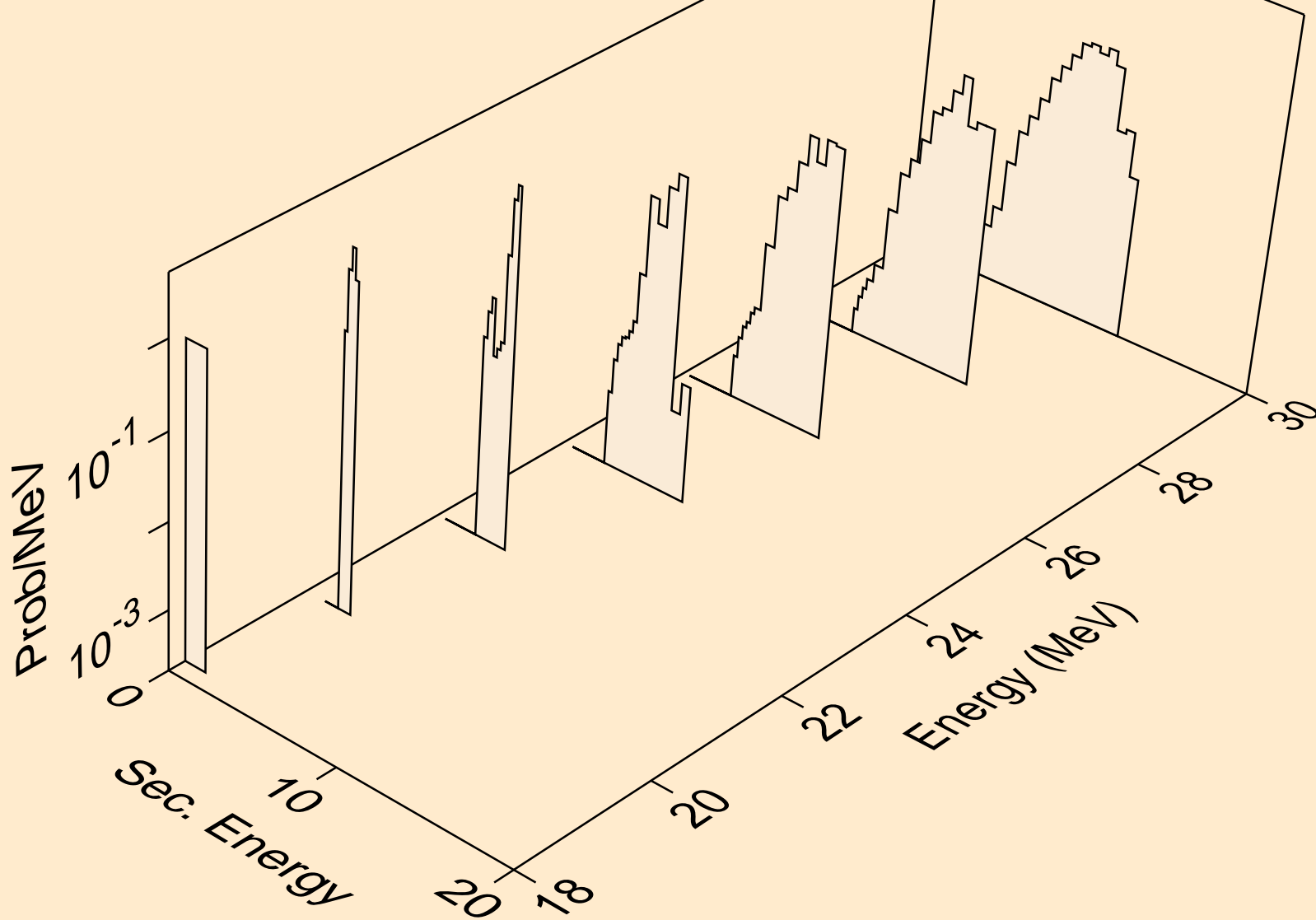

TM162 NEUTRON ACER TENDL-2019 LIBRARY; T=293.16K
deuterons from (n,n*)d

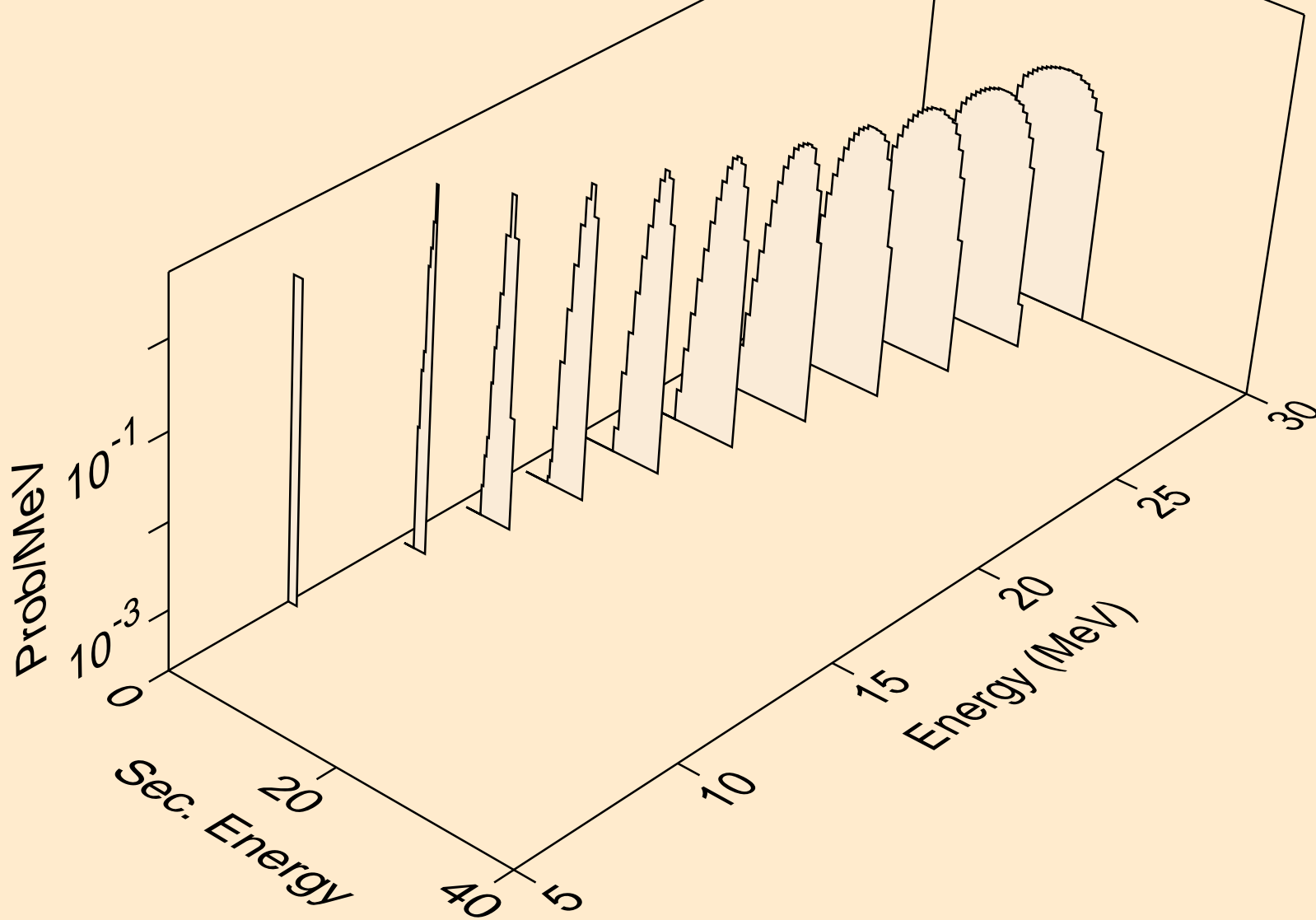

TM162 NEUTRON ACER TENDL-2019 LIBRARY; T=293.16K
deuterons from (n,d)

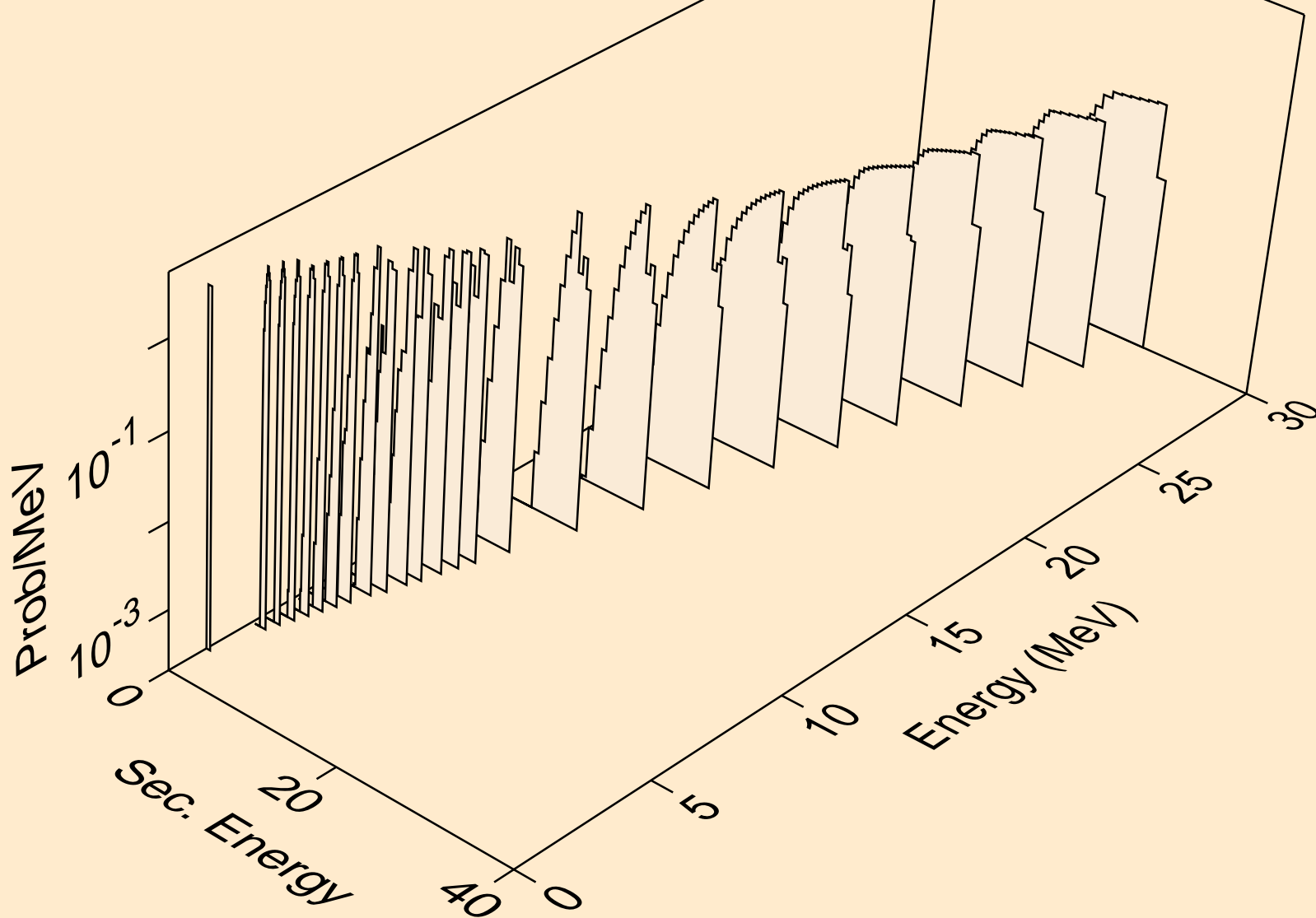

TM162 NEUTRON ACER TENDL-2019 LIBRARY; T=293.16K
deuterons from (n,pd)

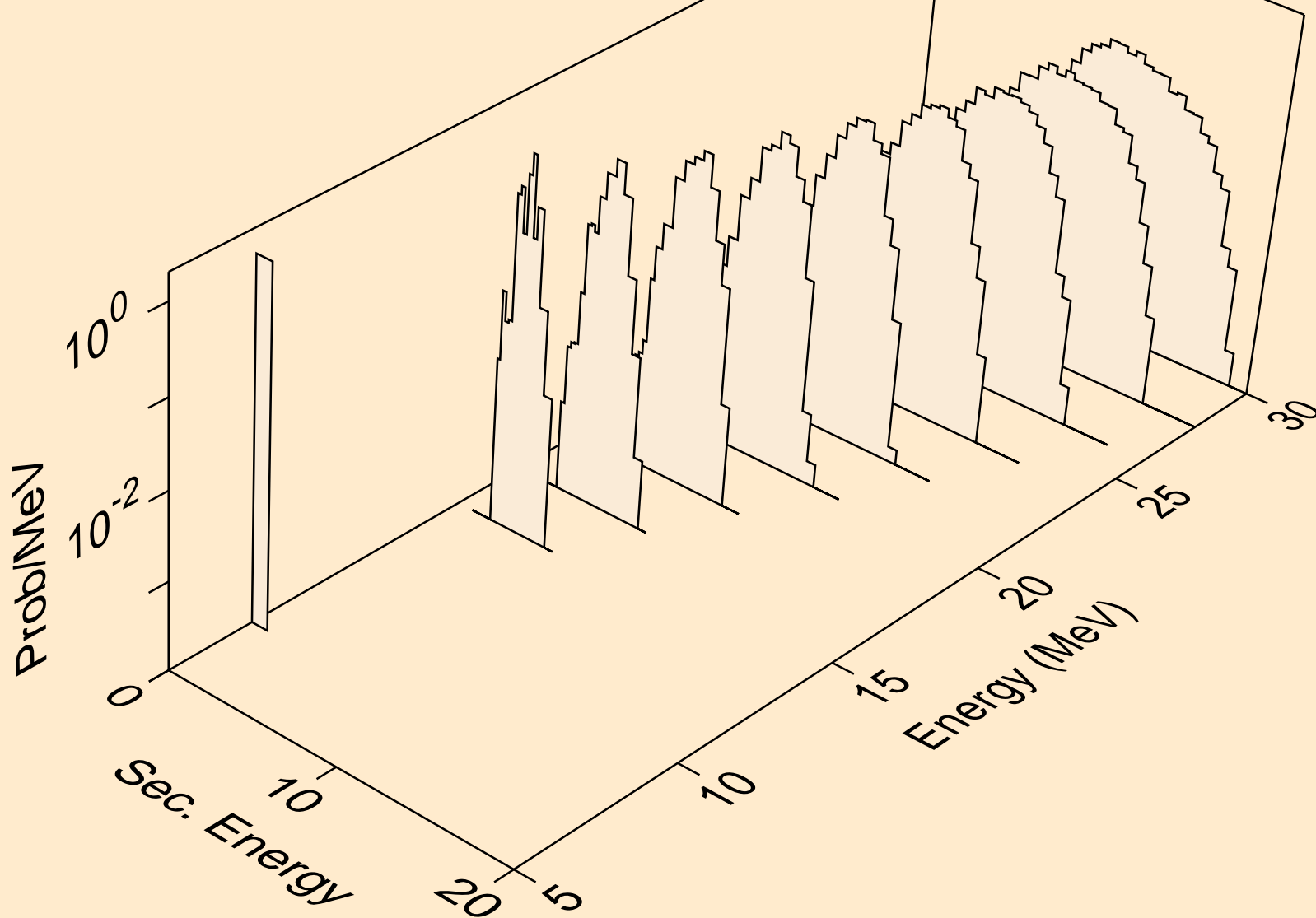

TM162 NEUTRON ACER TENDL-2019 LIBRARY; T=293.16K
deuterons from (n,da)

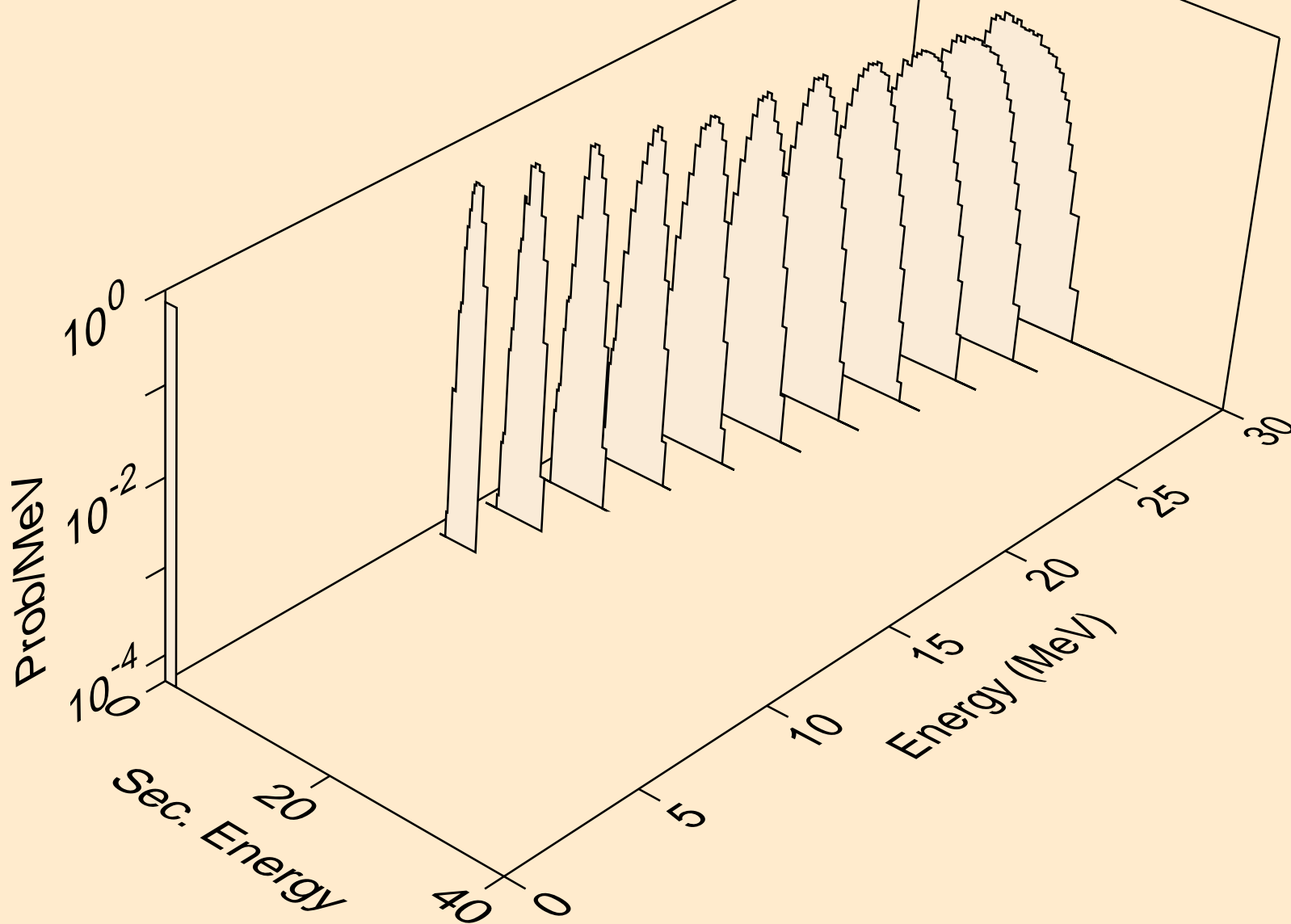

TM162 NEUTRON ACER TENDL-2019 LIBRARY; T=293.16K
tritons from (n,x)

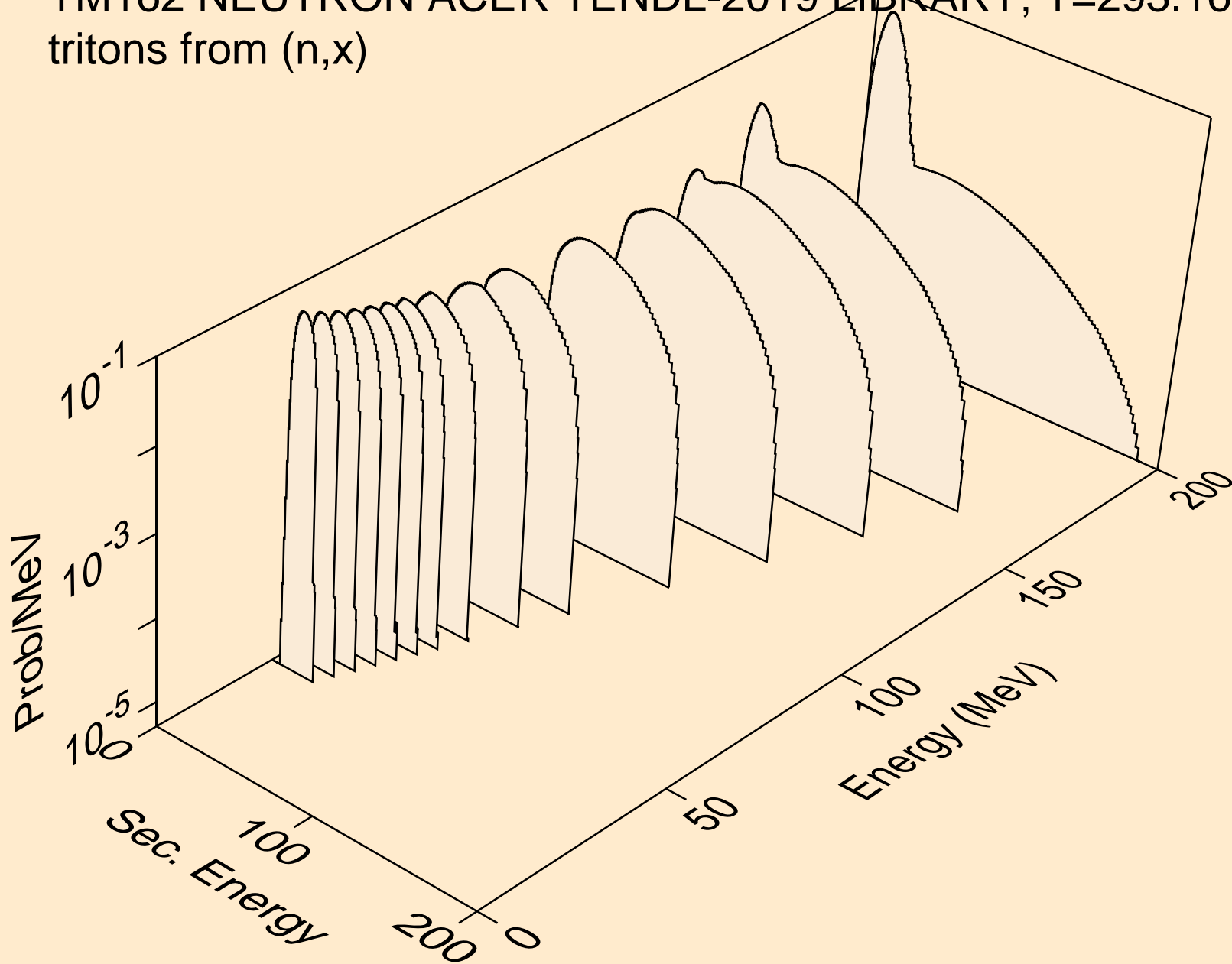

TM162 NEUTRON ACER TENDL-2019 LIBRARY; T=293.16K
tritons from (n,n*)t

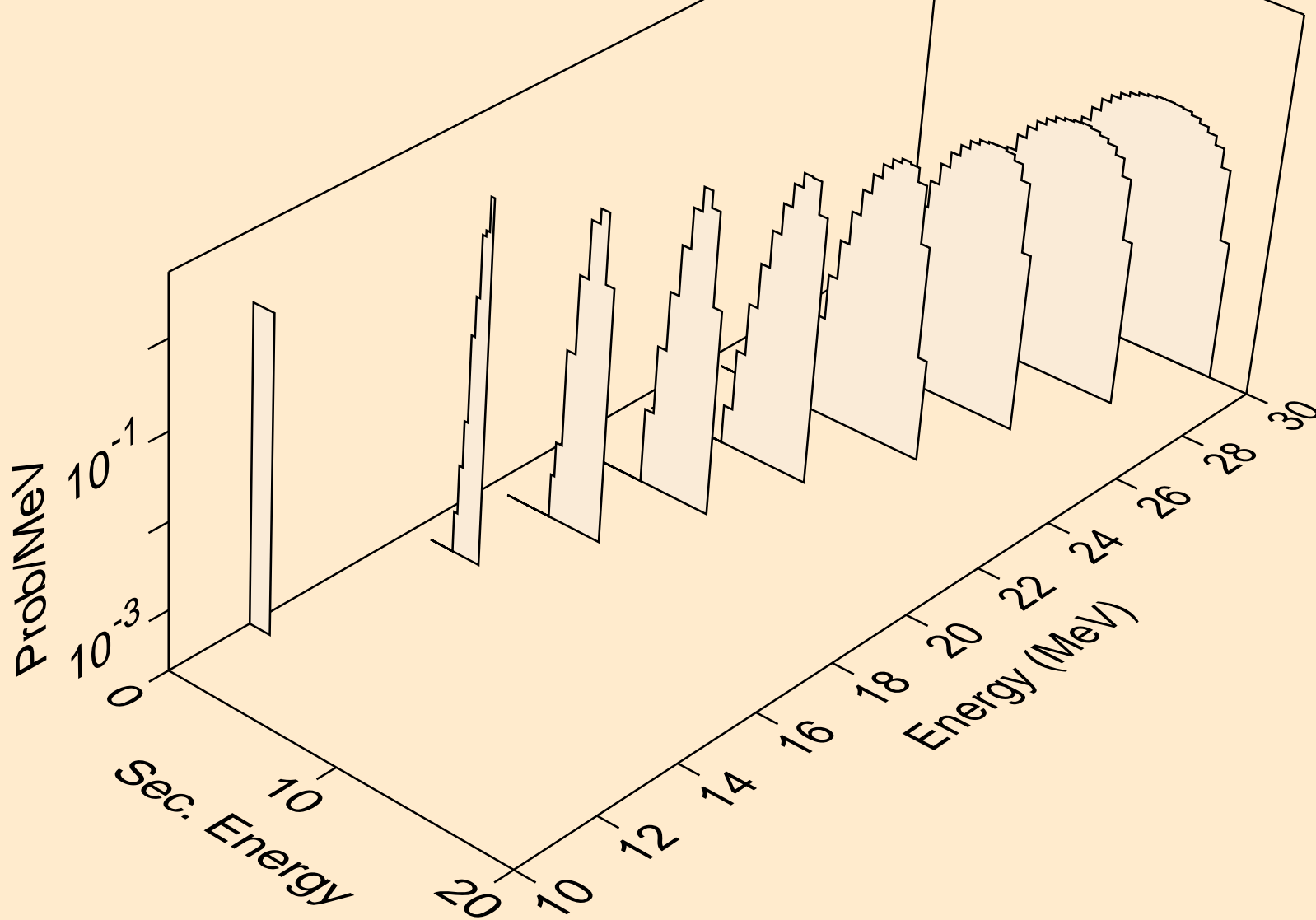

TM162 NEUTRON ACER TENDL-2019 LIBRARY; T=293.16K
tritons from (n,t)

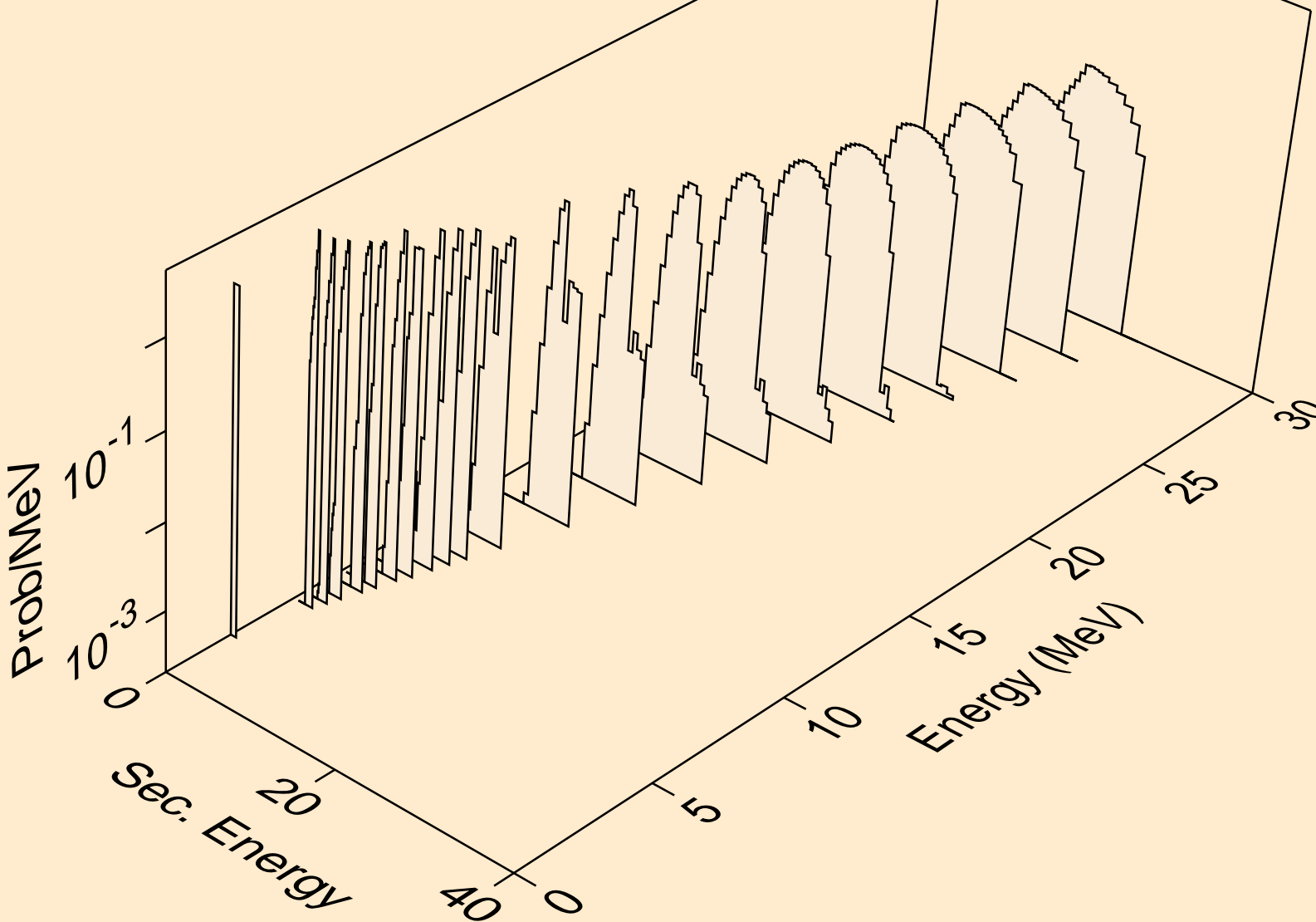

TM162 NEUTRON ACER TENDL-2019 LIBRARY; T=293.16K
tritons from (n,pt)

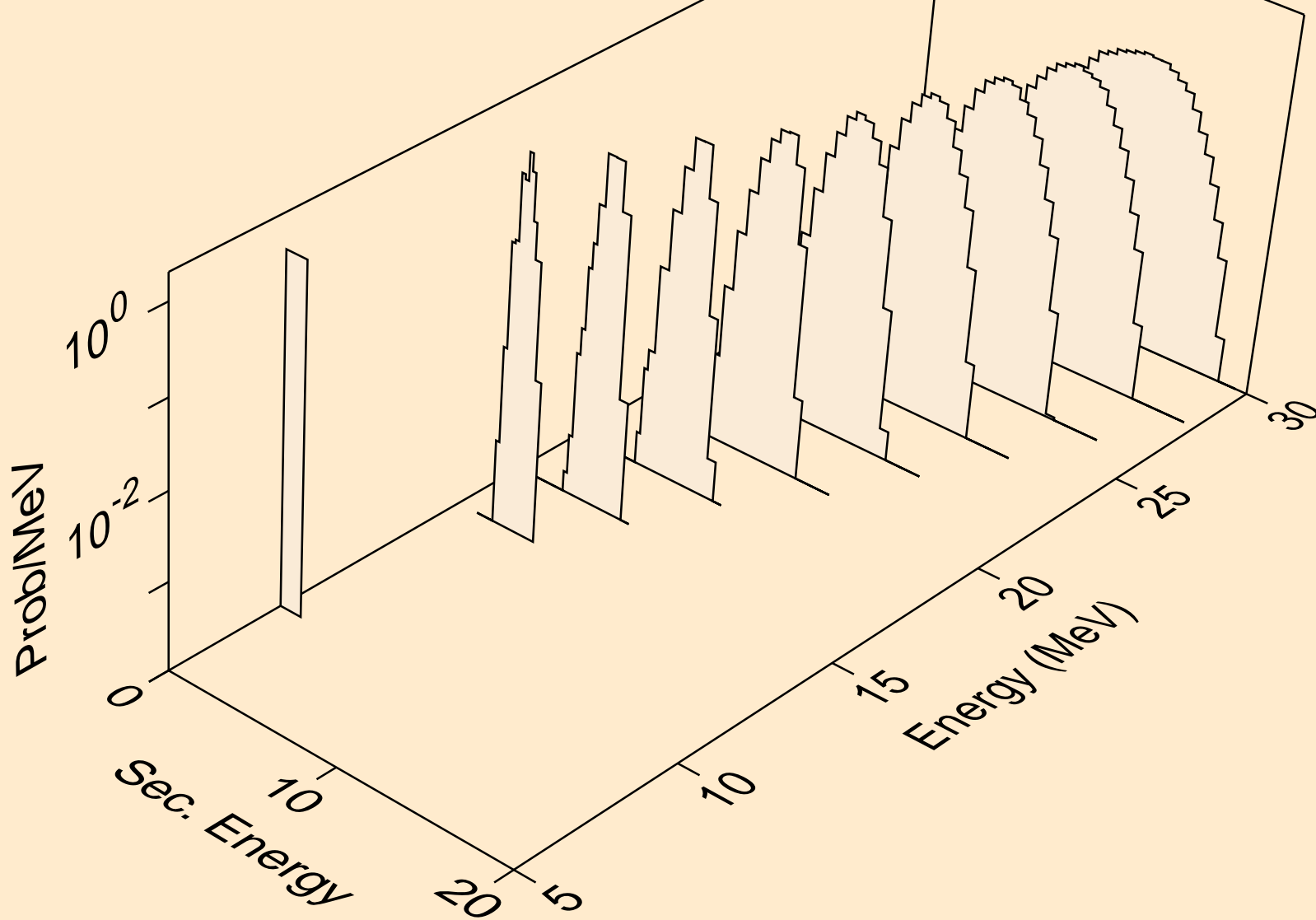

TM162 NEUTRON ACER TENDL-2019 LIBRARY; T=293.16K
he3s from (n,x)

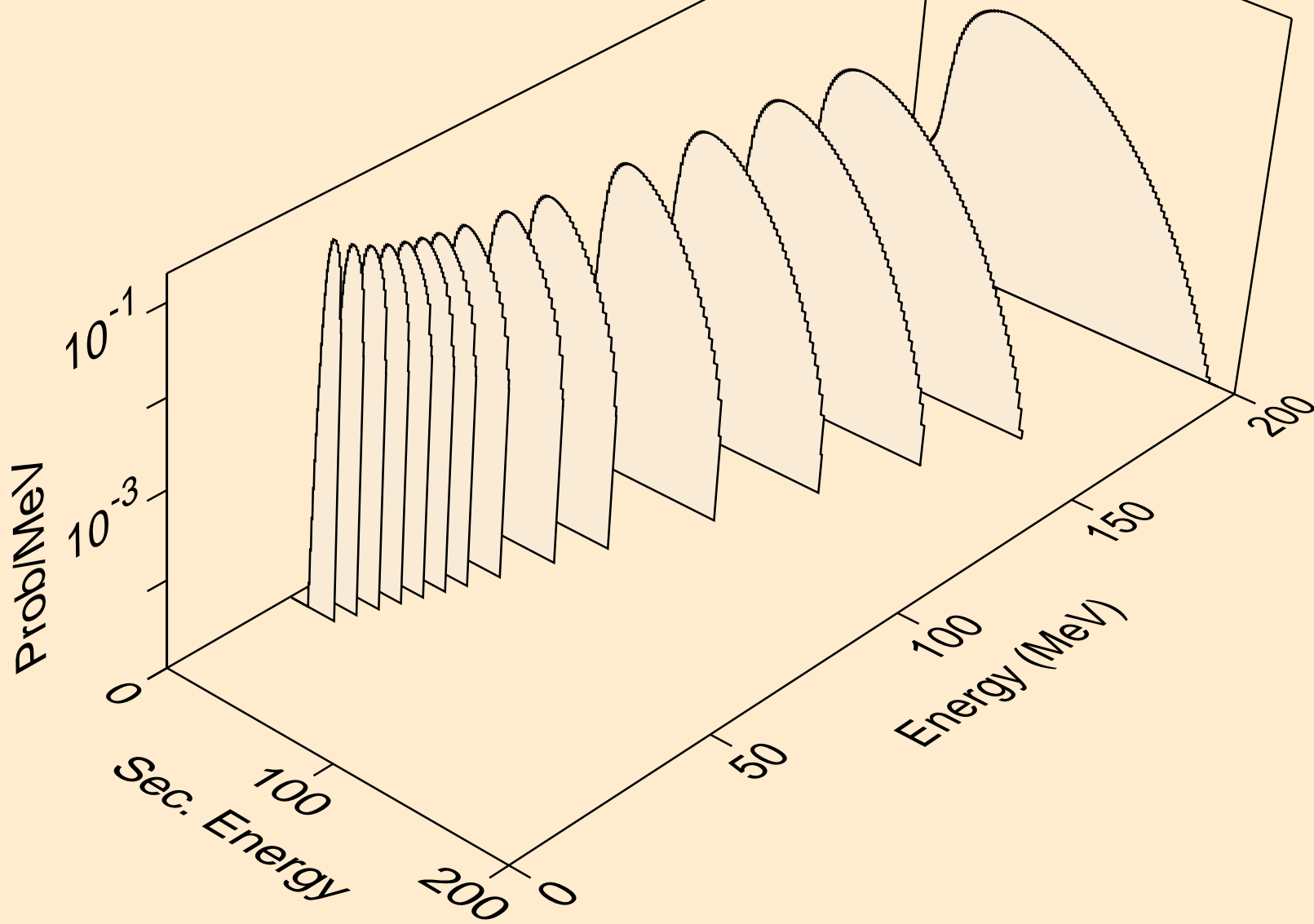

TM162 NEUTRON ACER TENDL-2019 LIBRARY; T=293.16K
he3s from (n,n*)he3

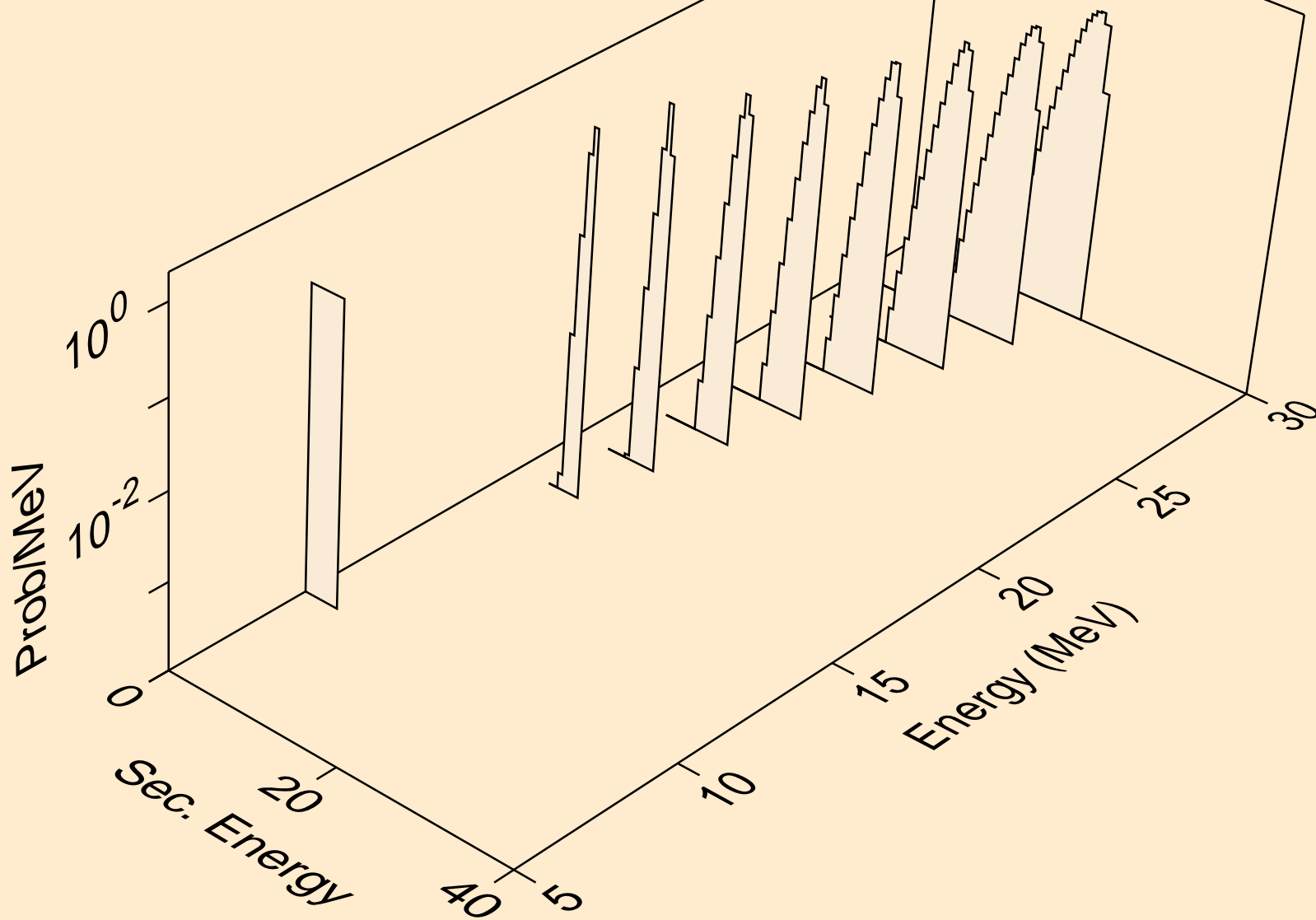

TM162 NEUTRON ACER TENDL-2019 LIBRARY; T=293.16K
he3s from (n,he3)

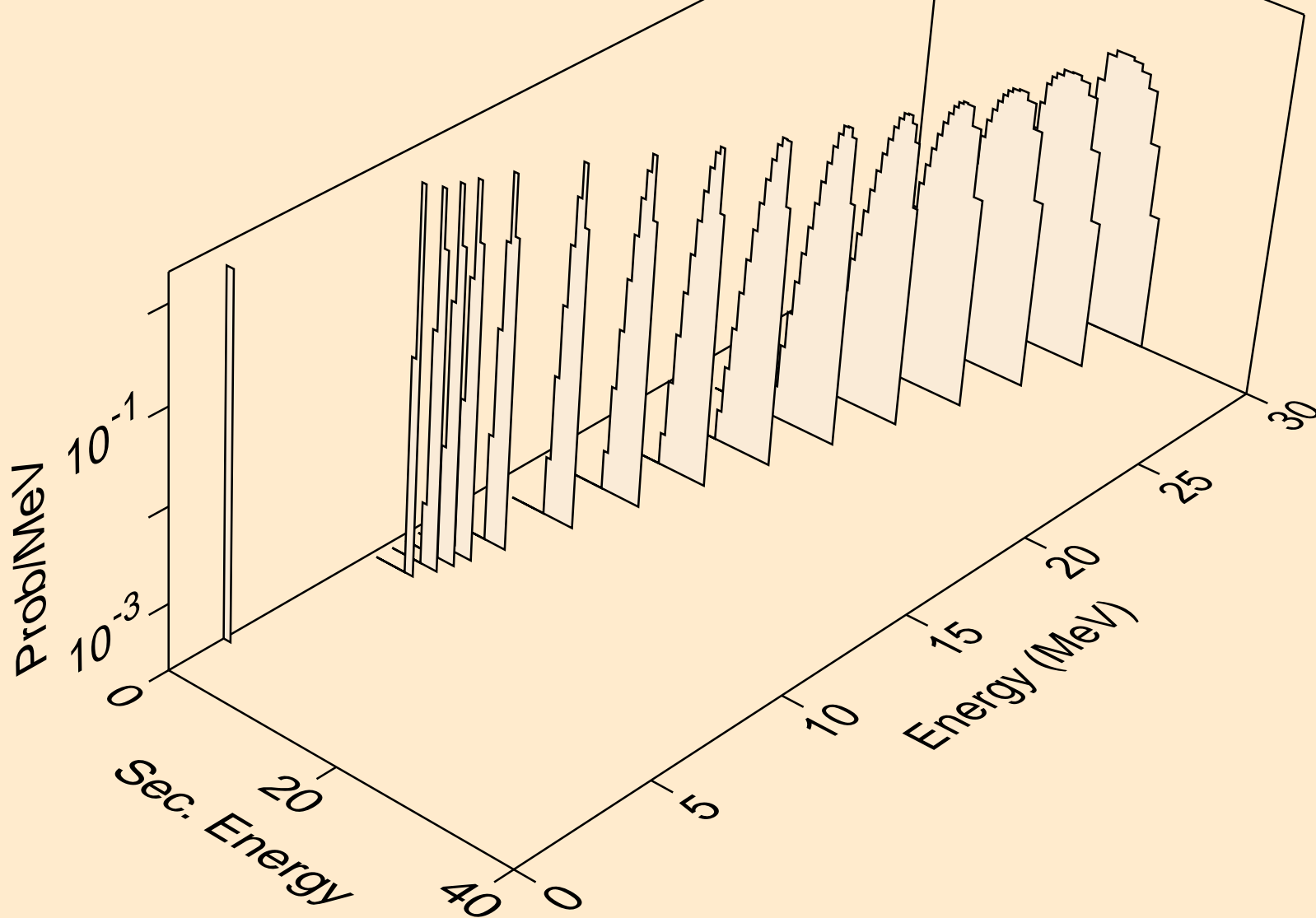

TM162 NEUTRON ACER TENDL-2019 LIBRARY; T=293.16K
alphas from (n,x)

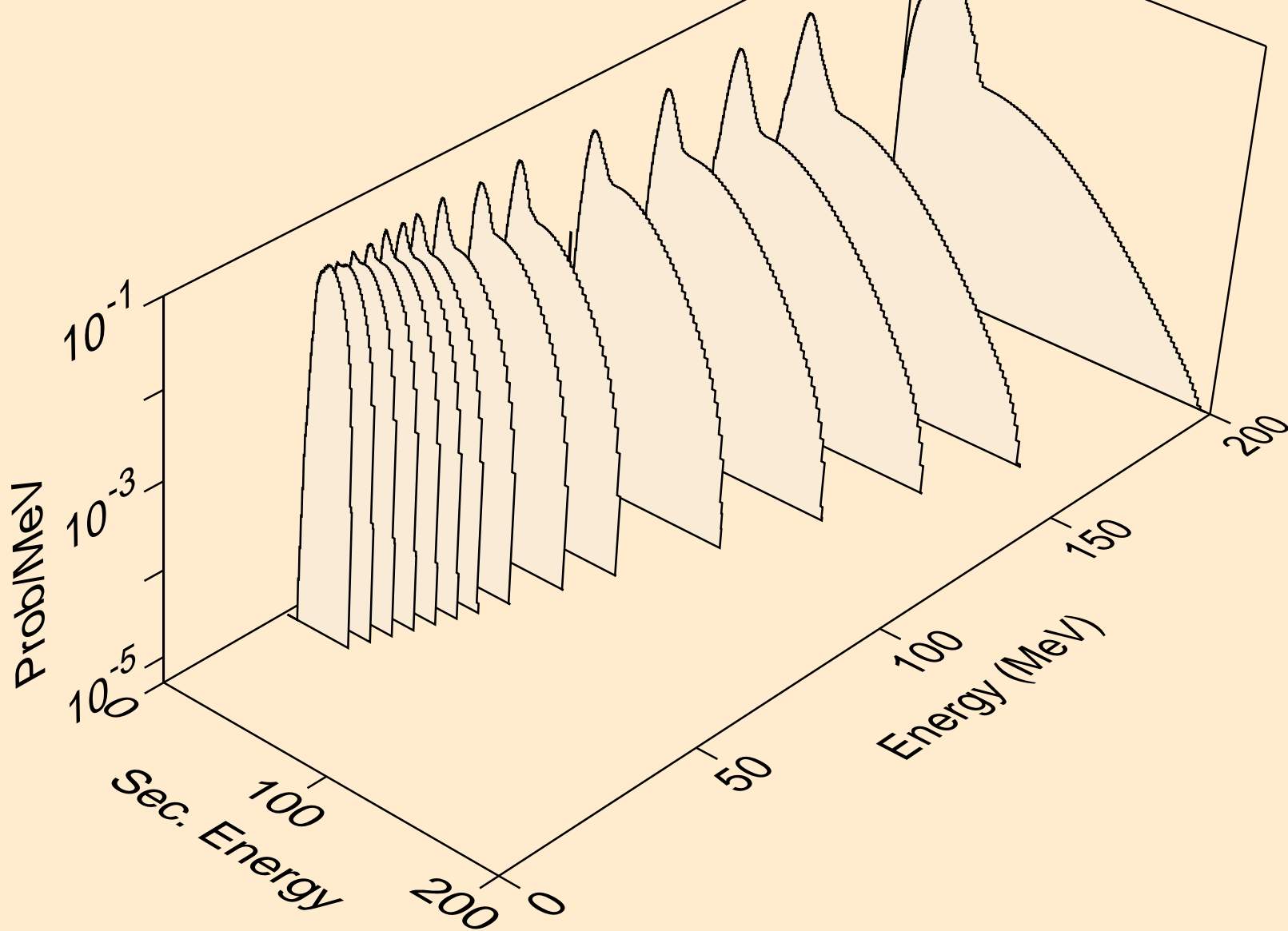

TM162 NEUTRON ACER TENDL-2019 LIBRARY; T=293.16K
alphas from (n,n*)a

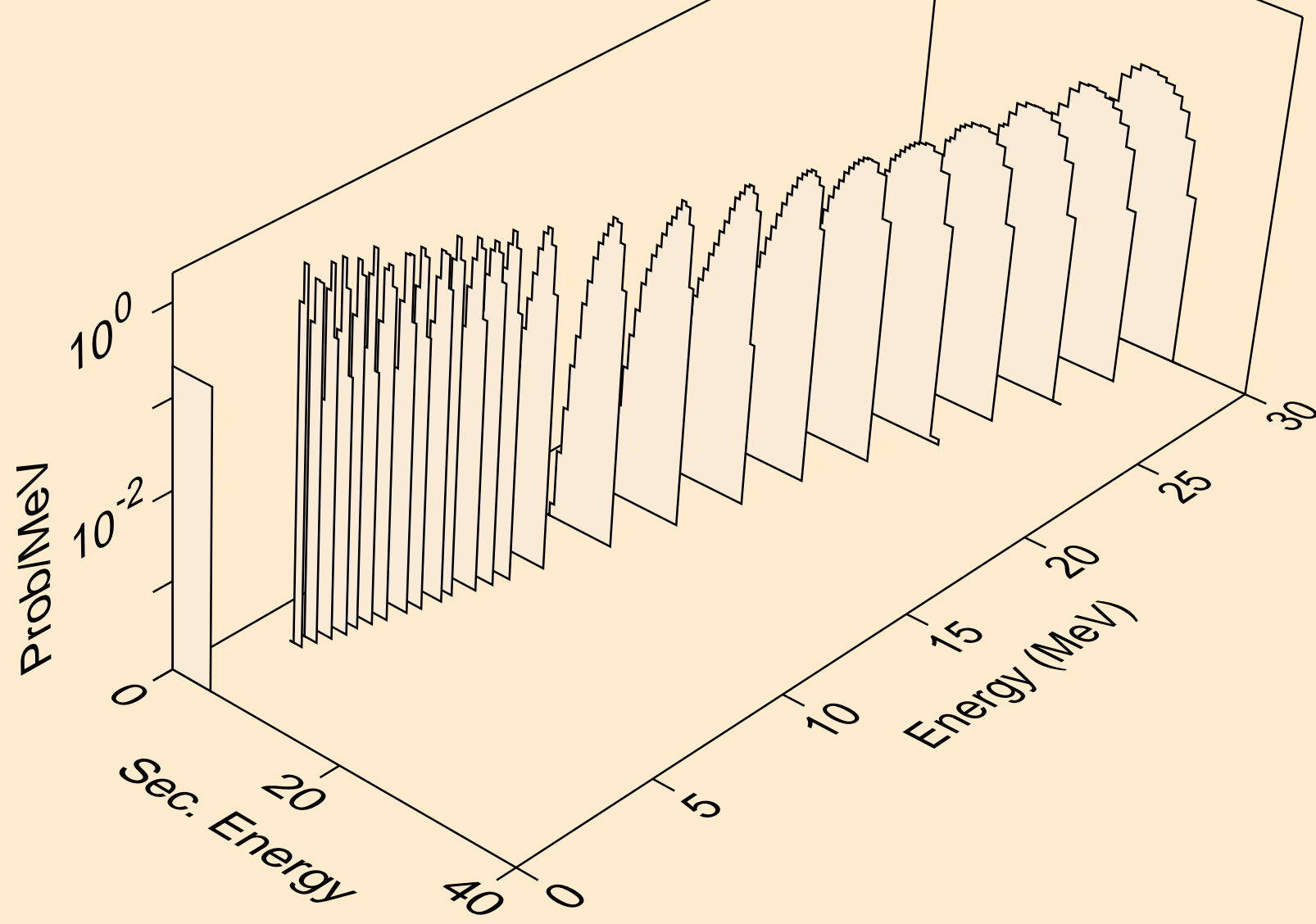

TM162 NEUTRON ACER TENDL-2019 LIBRARY; T=293.16K
alphas from (n,2n)a

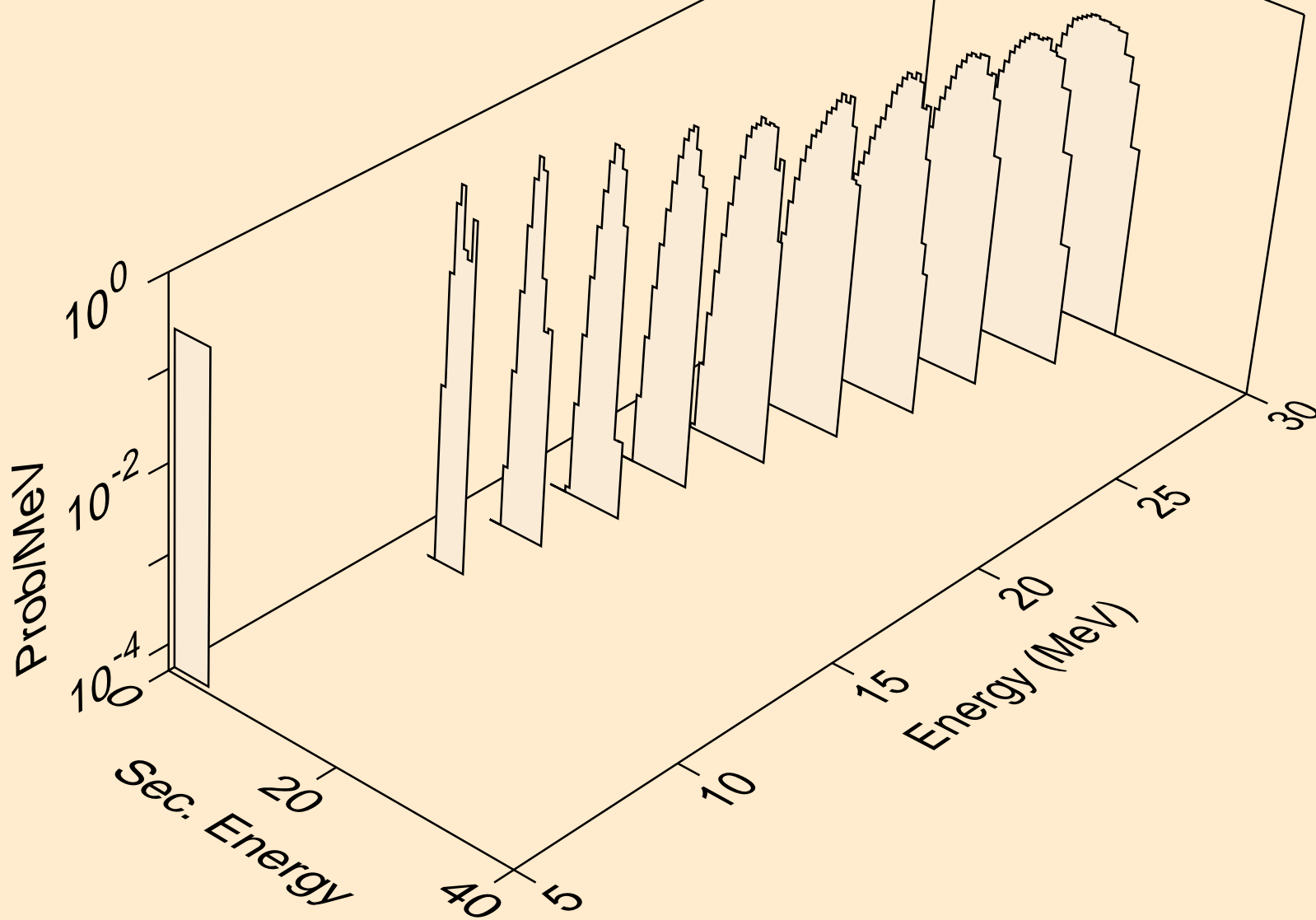

TM162 NEUTRON ACER TENDL-2019 LIBRARY; T=293.16K
alphas from (n,3n)a

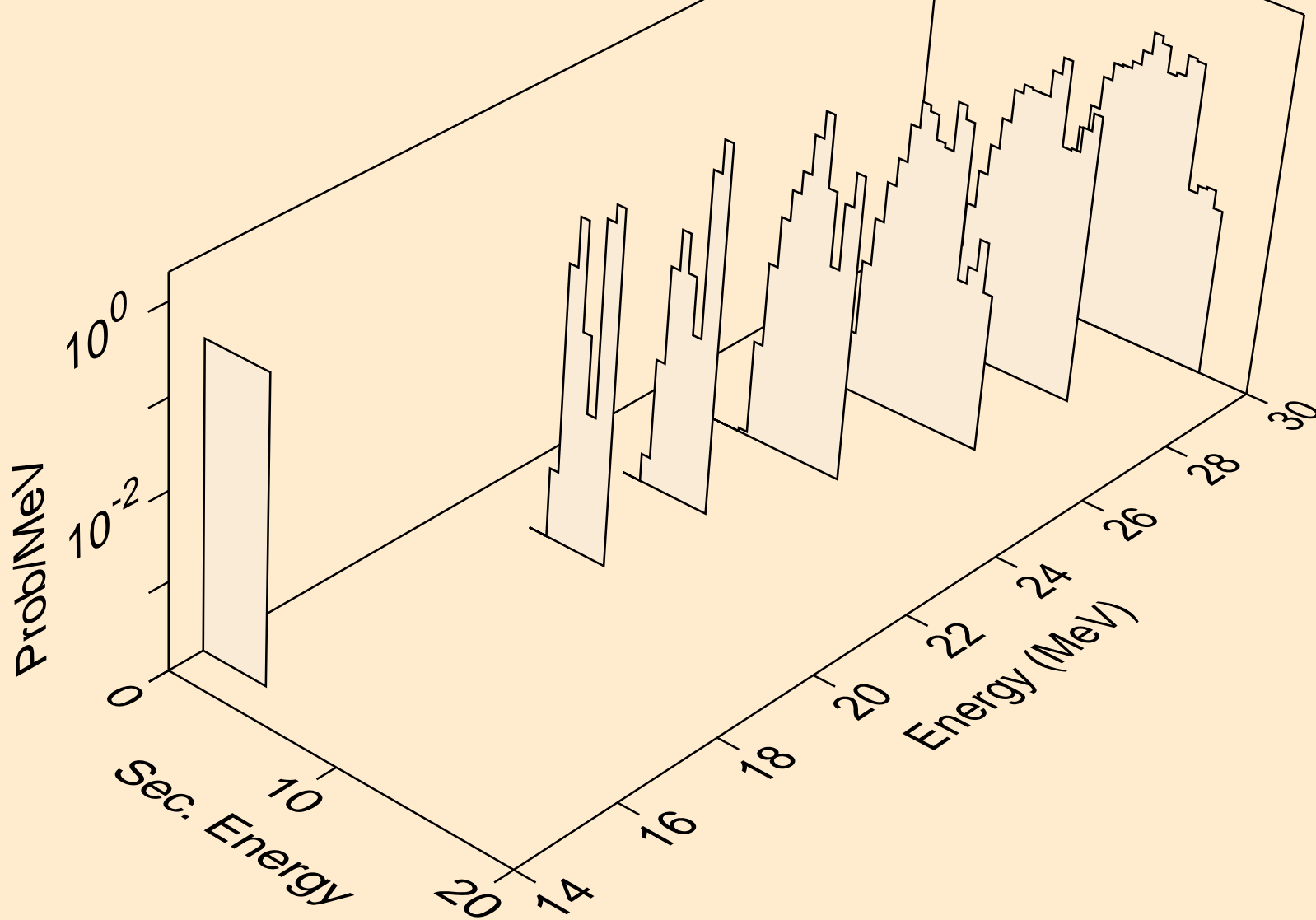

TM162 NEUTRON ACER TENDL-2019 LIBRARY; T=293.16K
alphas from (n,n*)2a

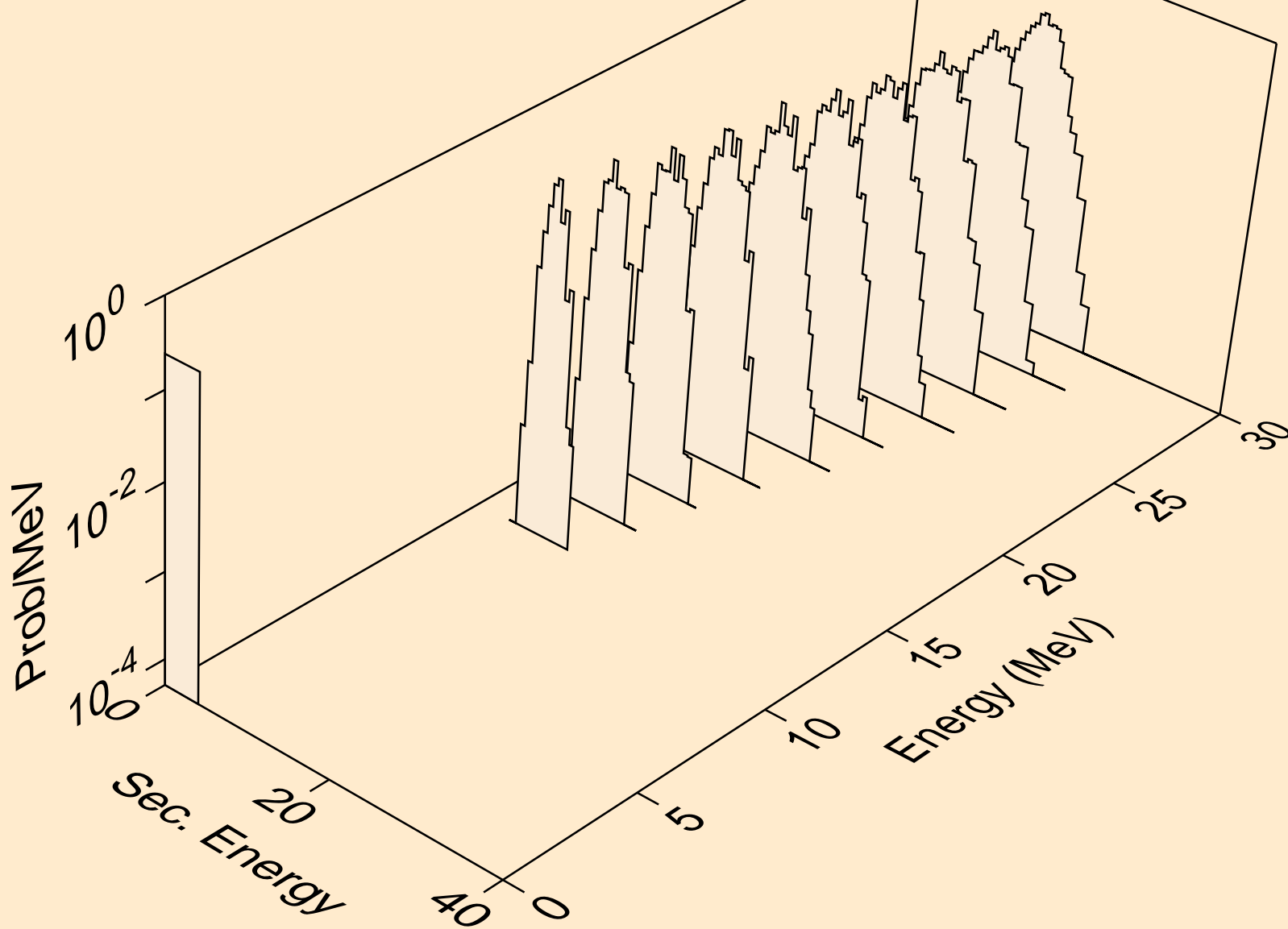

TM162 NEUTRON ACER TENDL-2019 LIBRARY; T=293.16K
alphas from (n,2n)2a

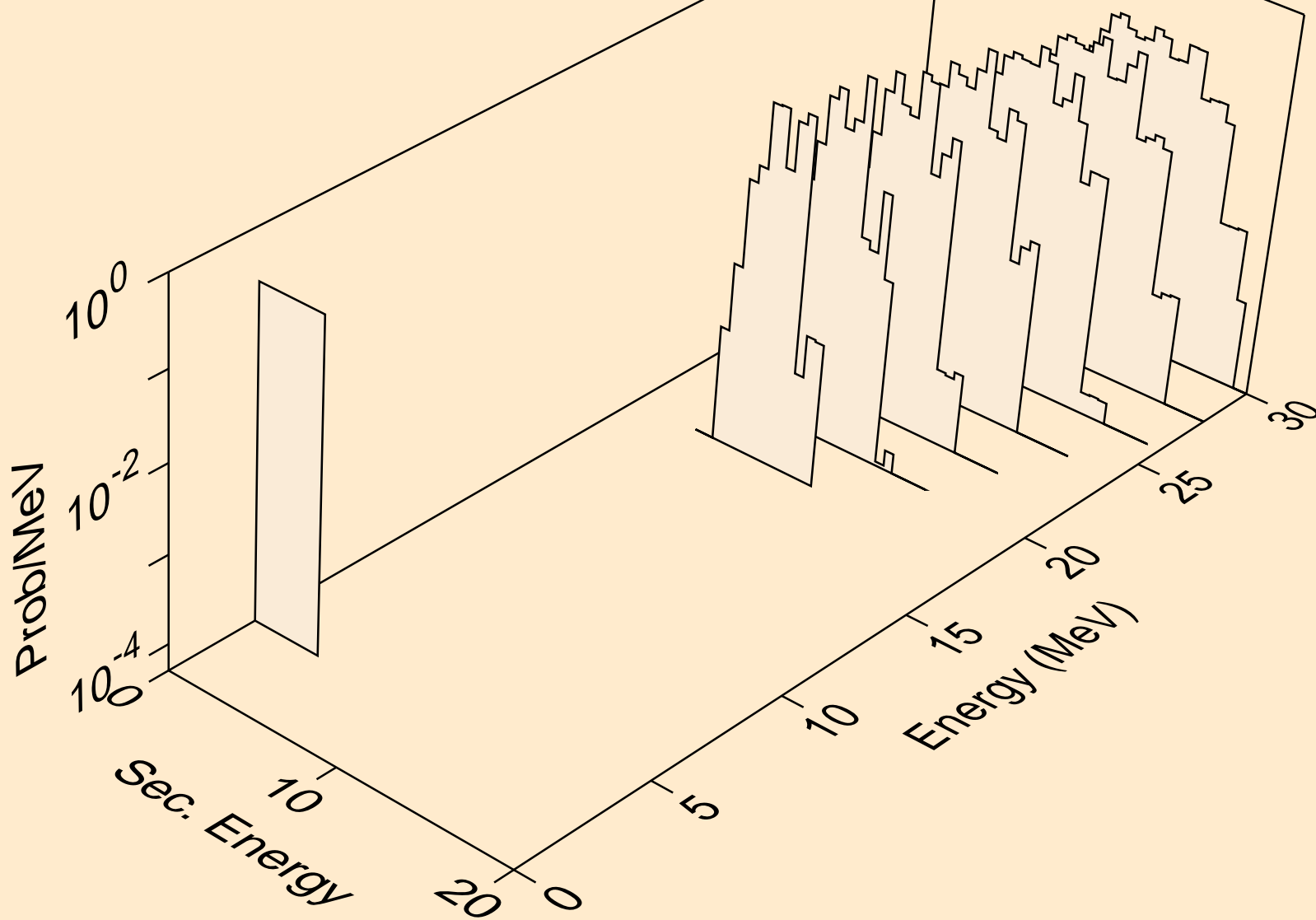

TM162 NEUTRON ACER TENDL-2019 LIBRARY; T=293.16K
alphas from (n,npa)

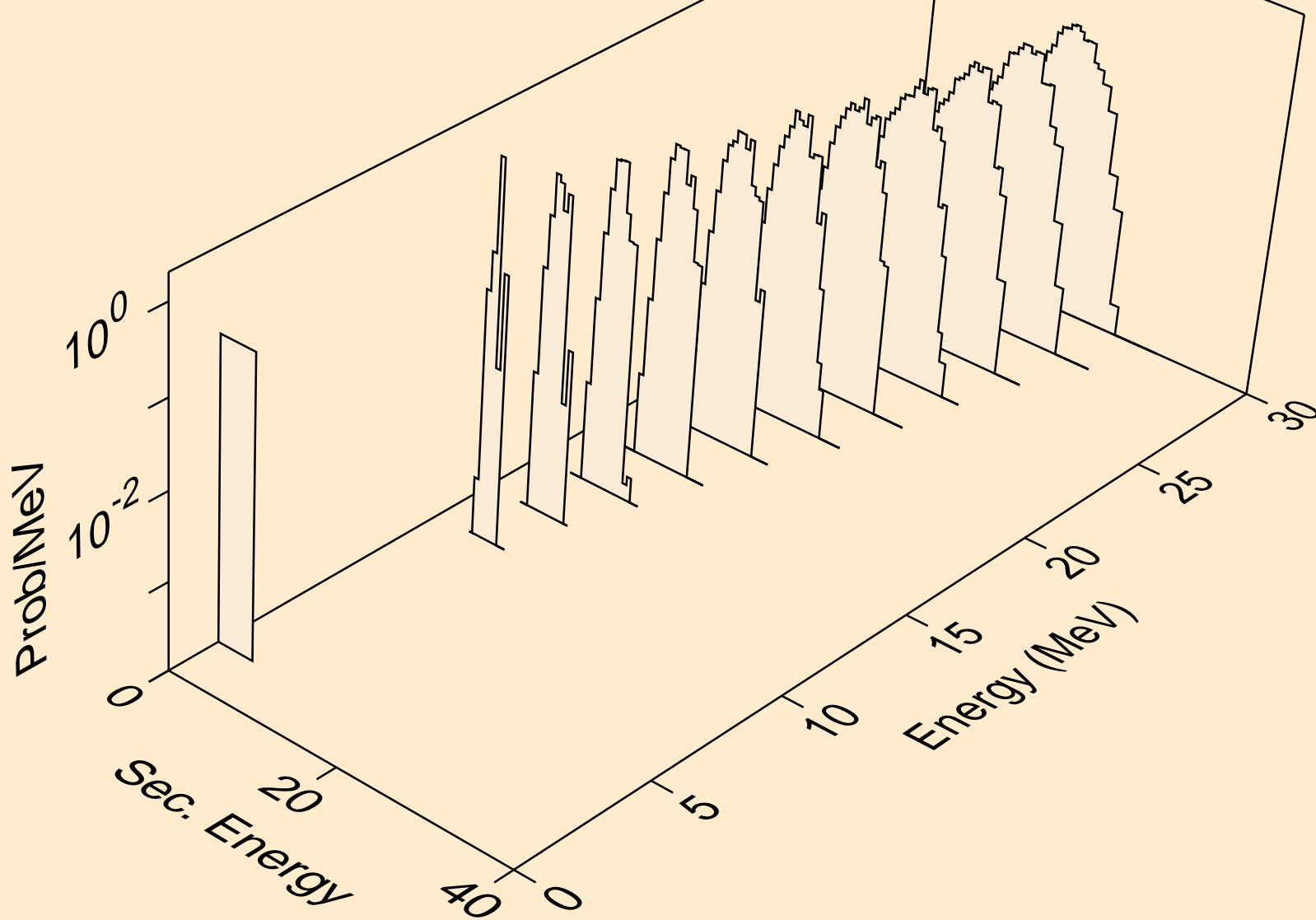

TM162 NEUTRON ACER TENDL-2019 LIBRARY; T=293.16K
alphas from (n,a)

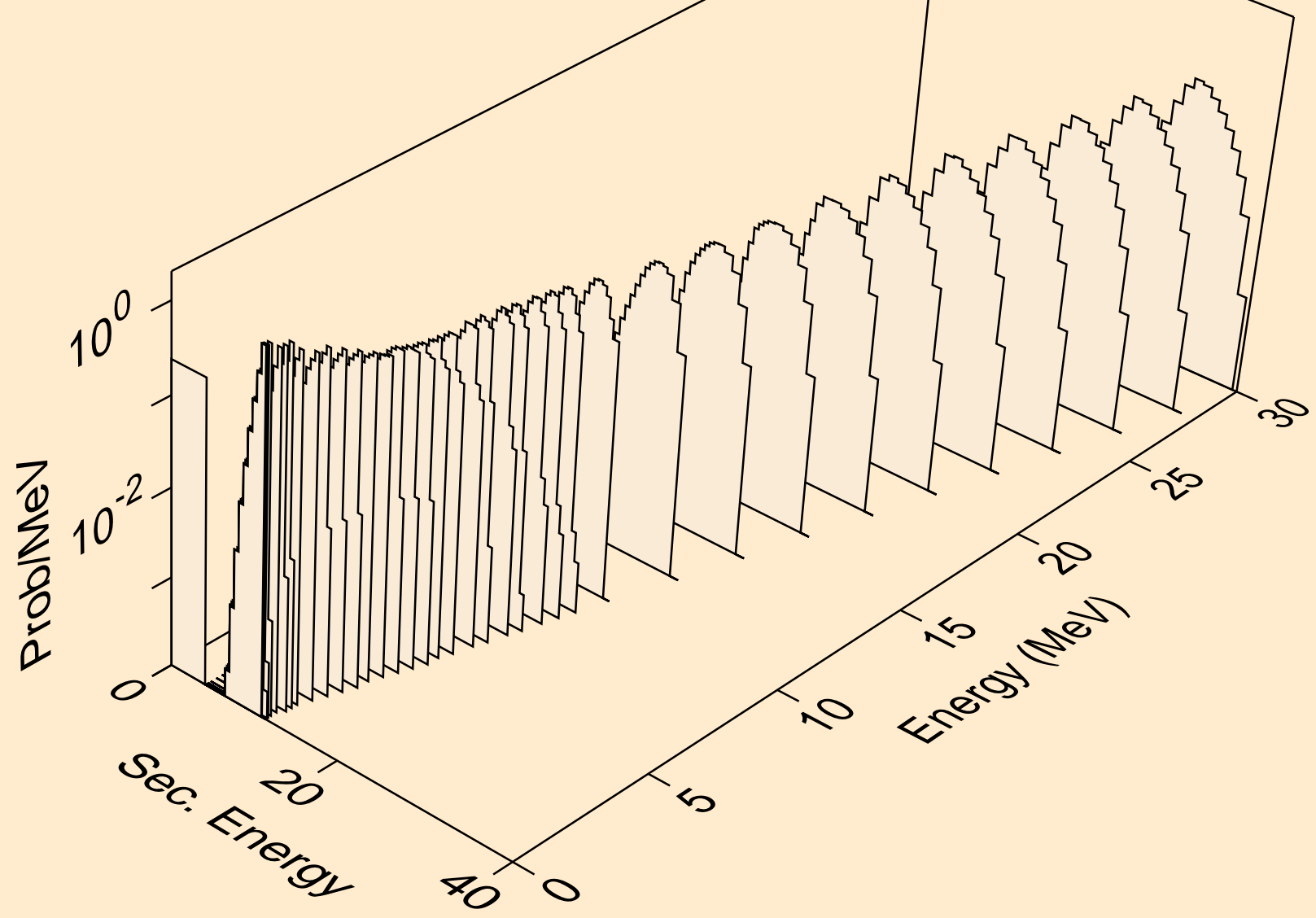

TM162 NEUTRON ACER TENDL-2019 LIBRARY; T=293.16K
alphas from (n,2a)

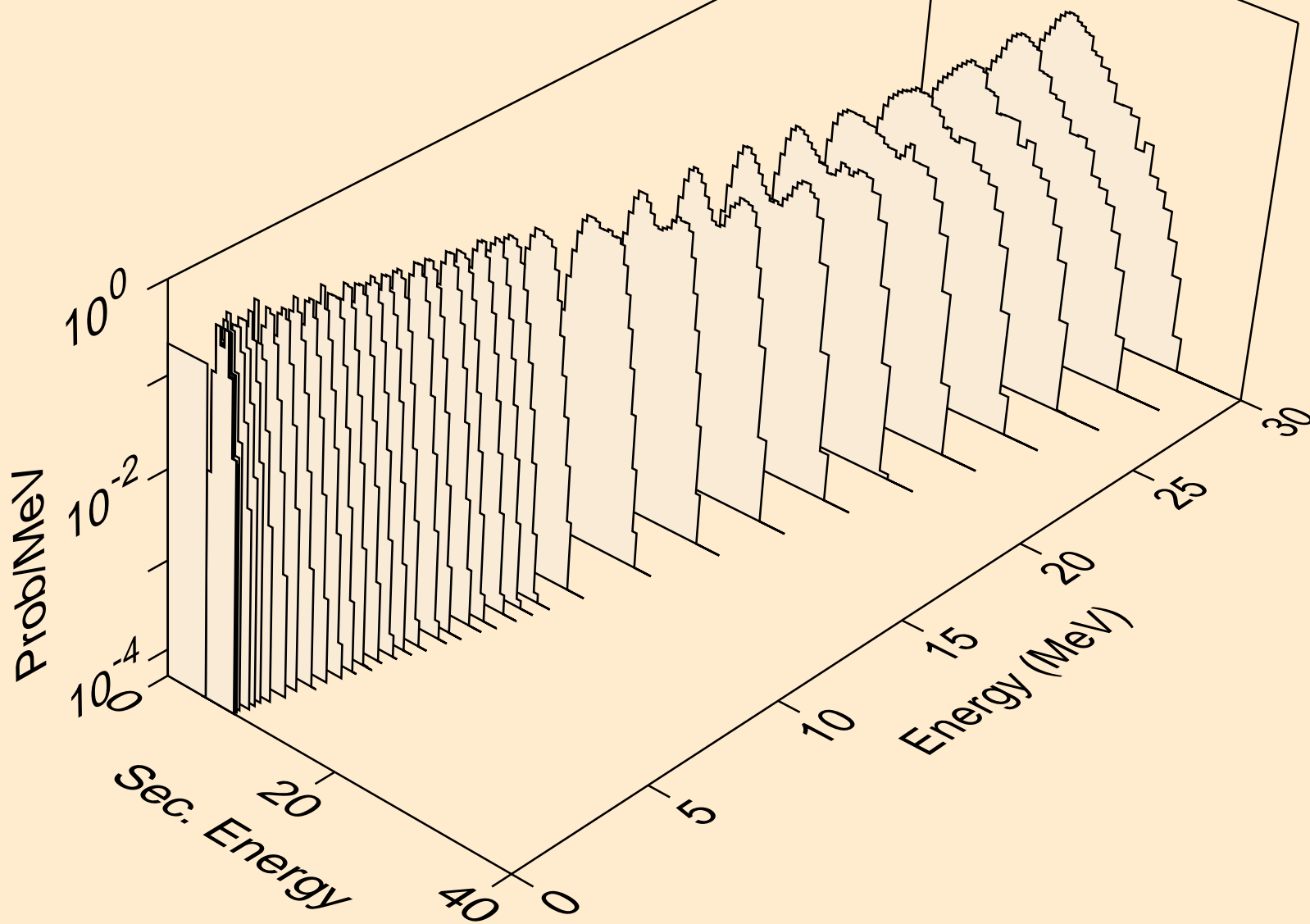

TM162 NEUTRON ACER TENDL-2019 LIBRARY; T=293.16K
alphas from (n,pa)

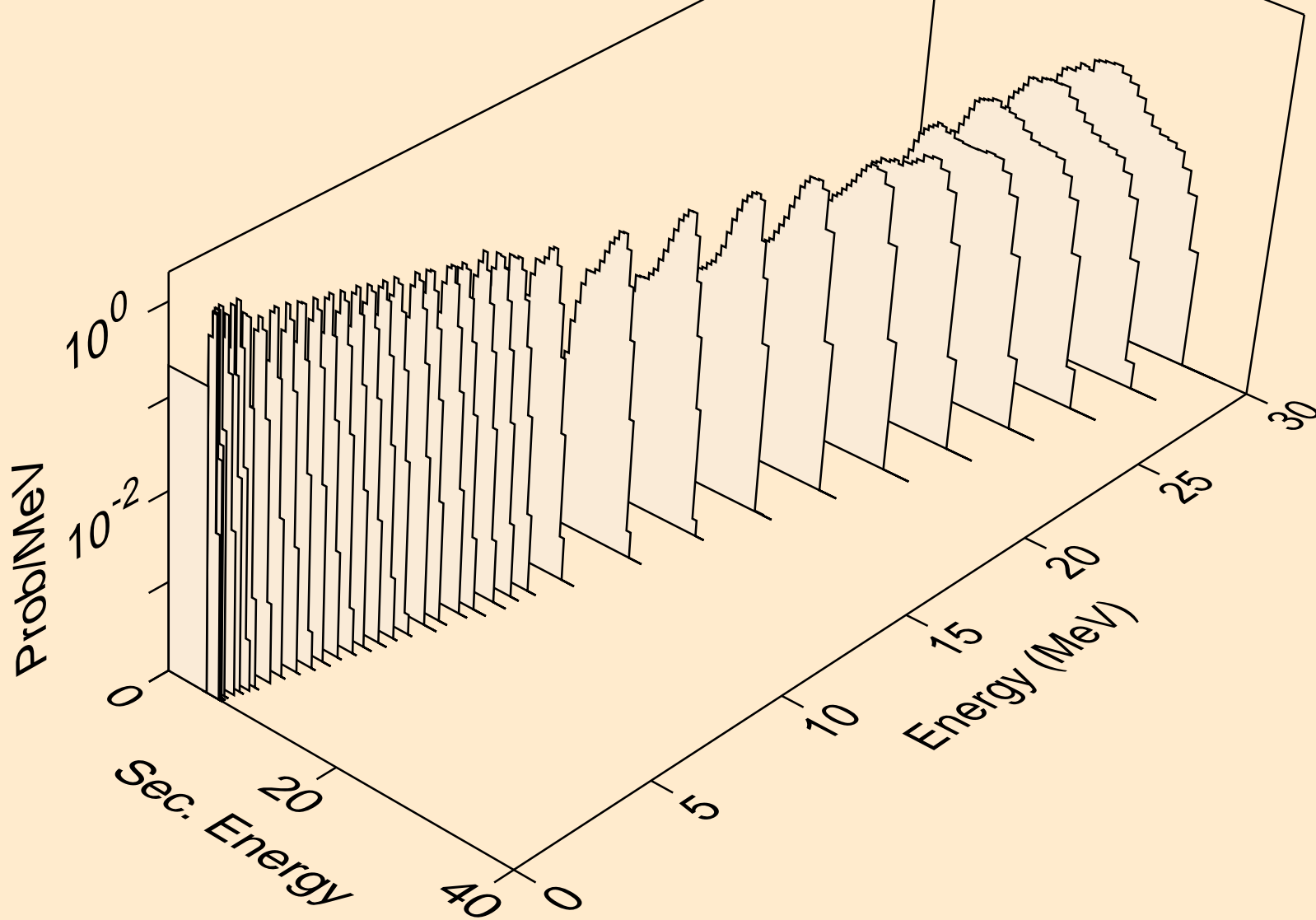

TM162 NEUTRON ACER TENDL-2019 LIBRARY; T=293.16K
alphas from (n,da)

