

U227 NEUTRON ACER TENDL-2019 LIBRARY; T=293.16K
Principal cross sections

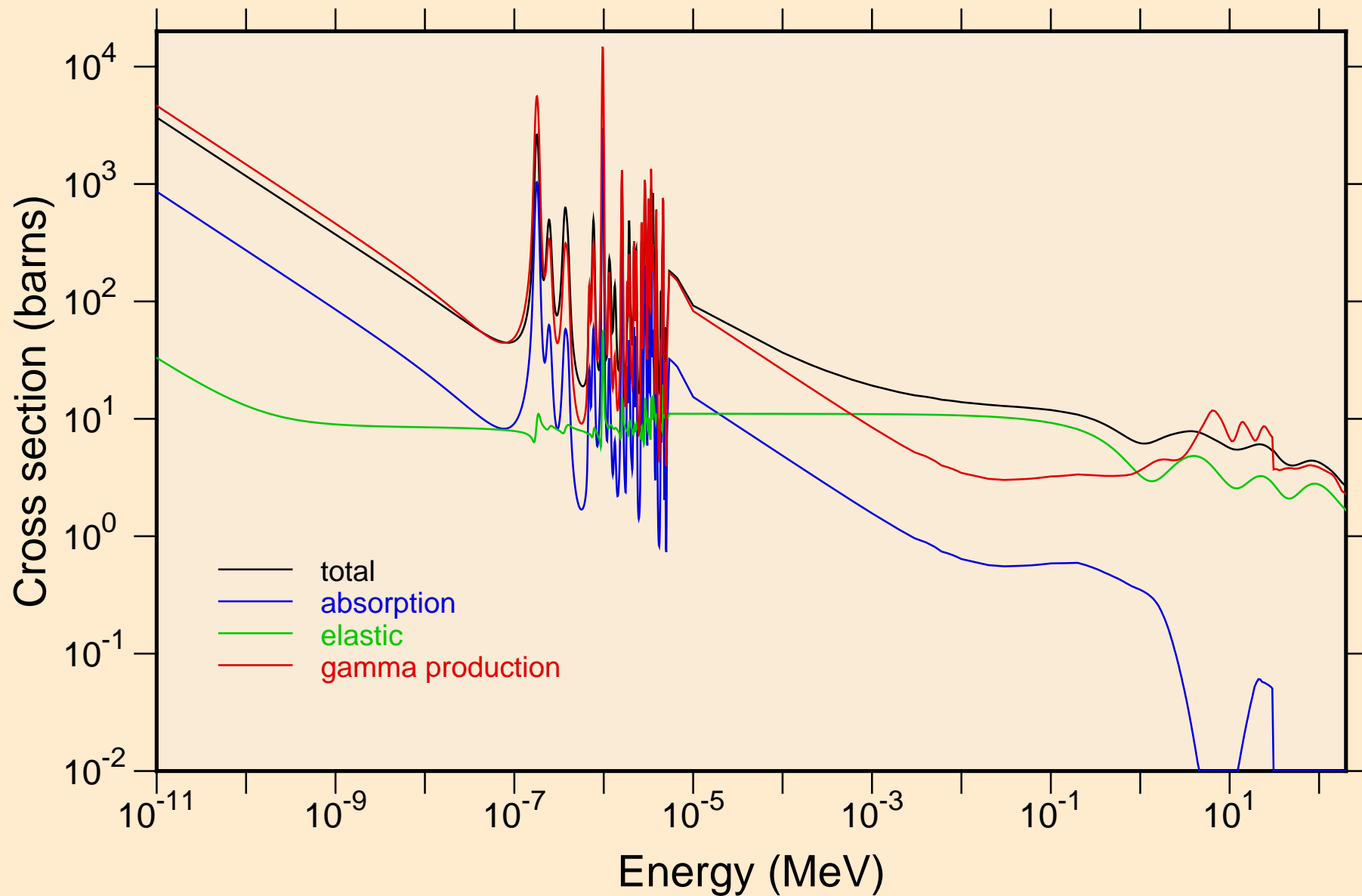

U227 NEUTRON ACER TENDL-2019 LIBRARY; T=293.16K
resonance total cross section

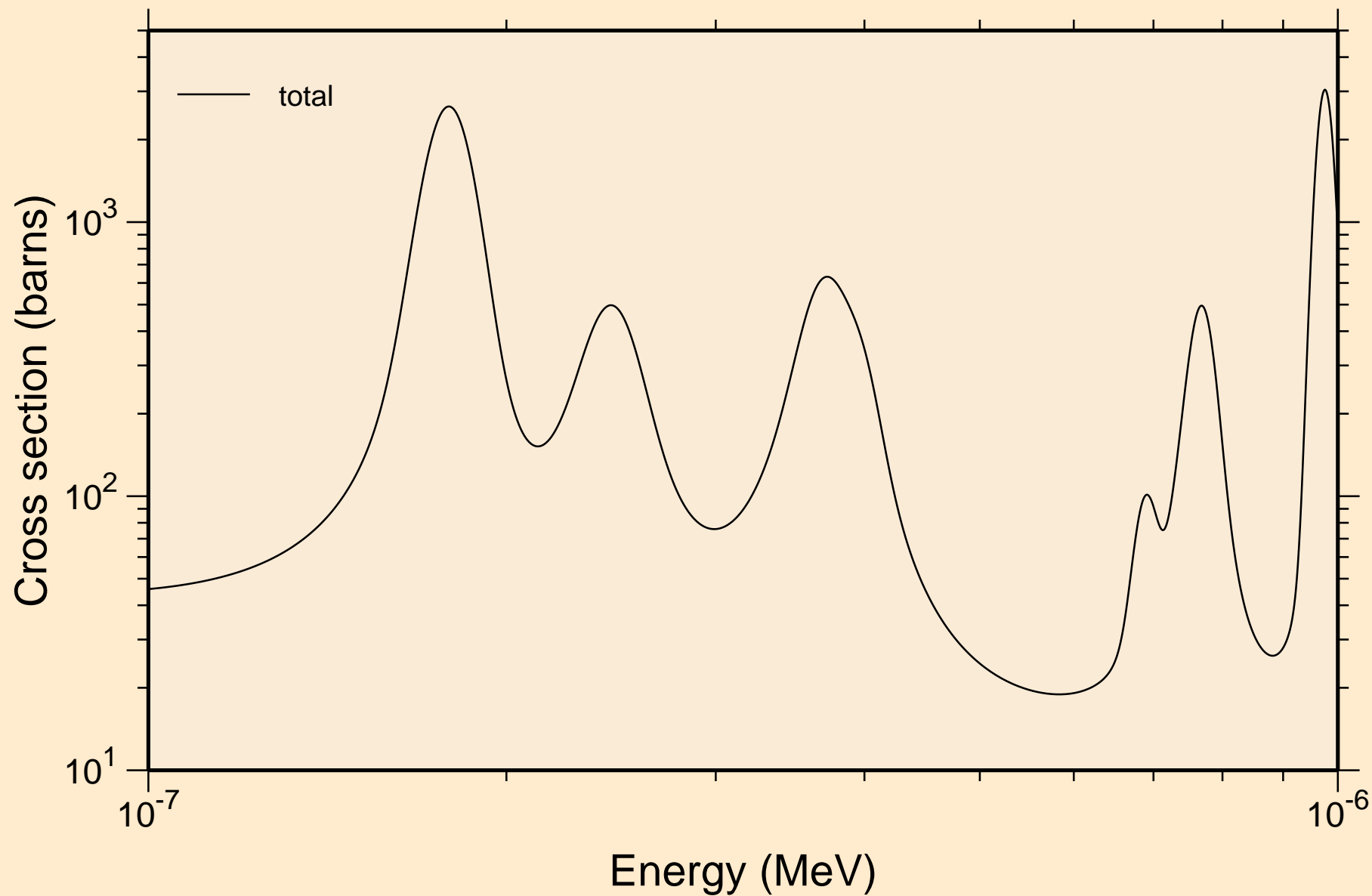

U227 NEUTRON ACER TENDL-2019 LIBRARY; T=293.16K
resonance total cross section

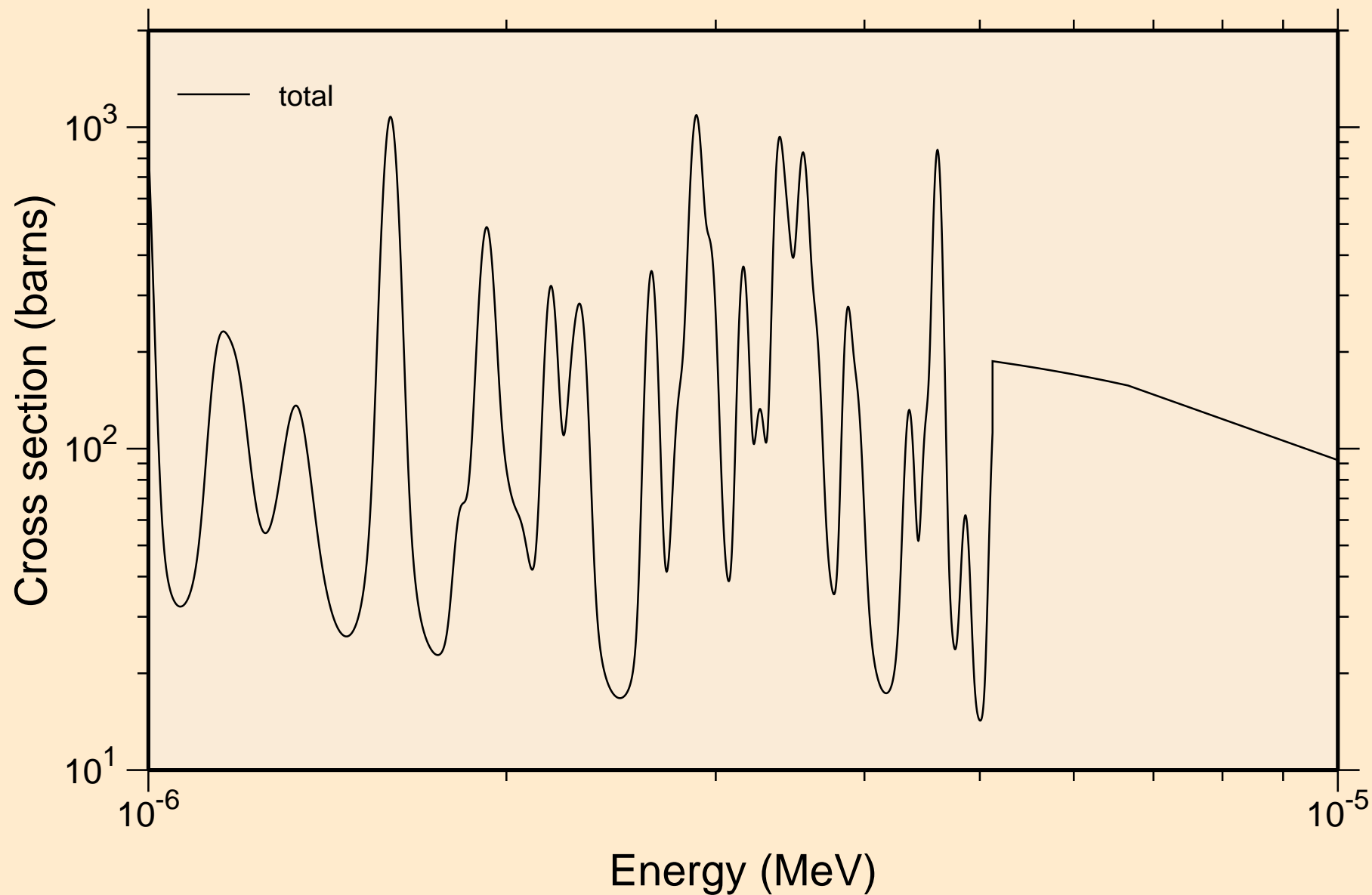

U227 NEUTRON ACER TENDL-2019 LIBRARY; T=293.16K
resonance total cross section

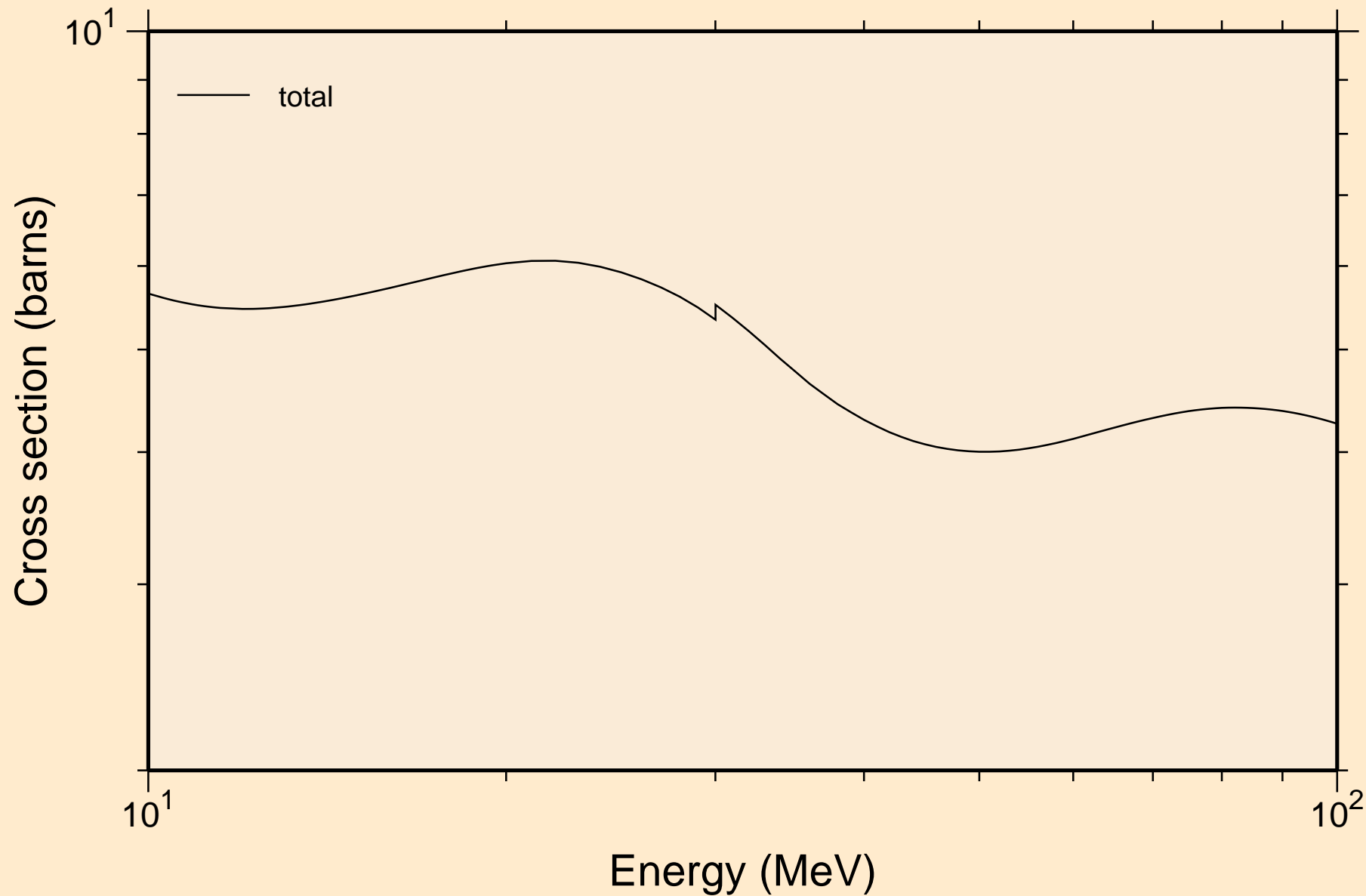

U227 NEUTRON ACER TENDL-2019 LIBRARY; T=293.16K
resonance absorption cross sections

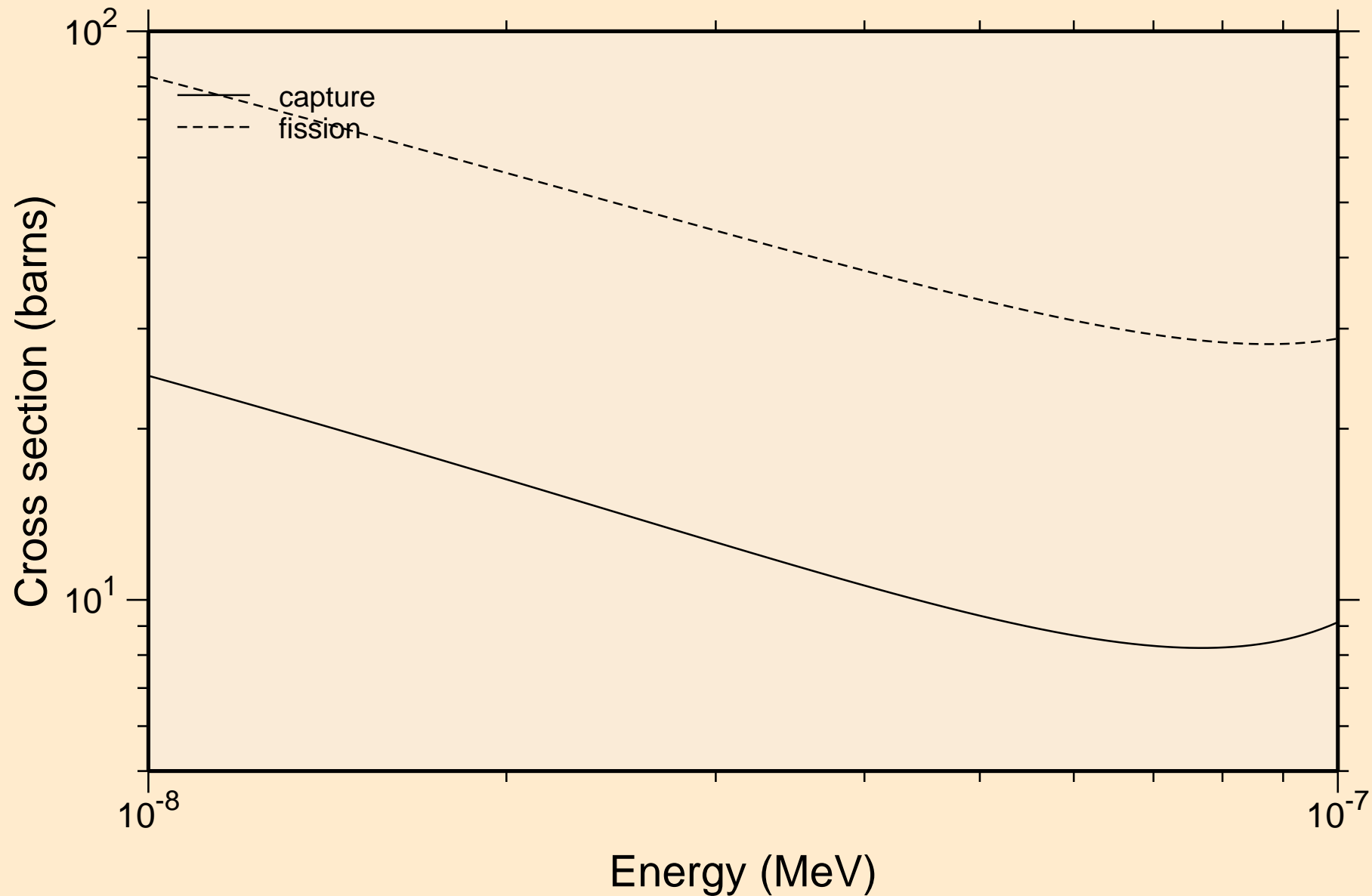

U227 NEUTRON ACER TENDL-2019 LIBRARY; T=293.16K
resonance absorption cross sections

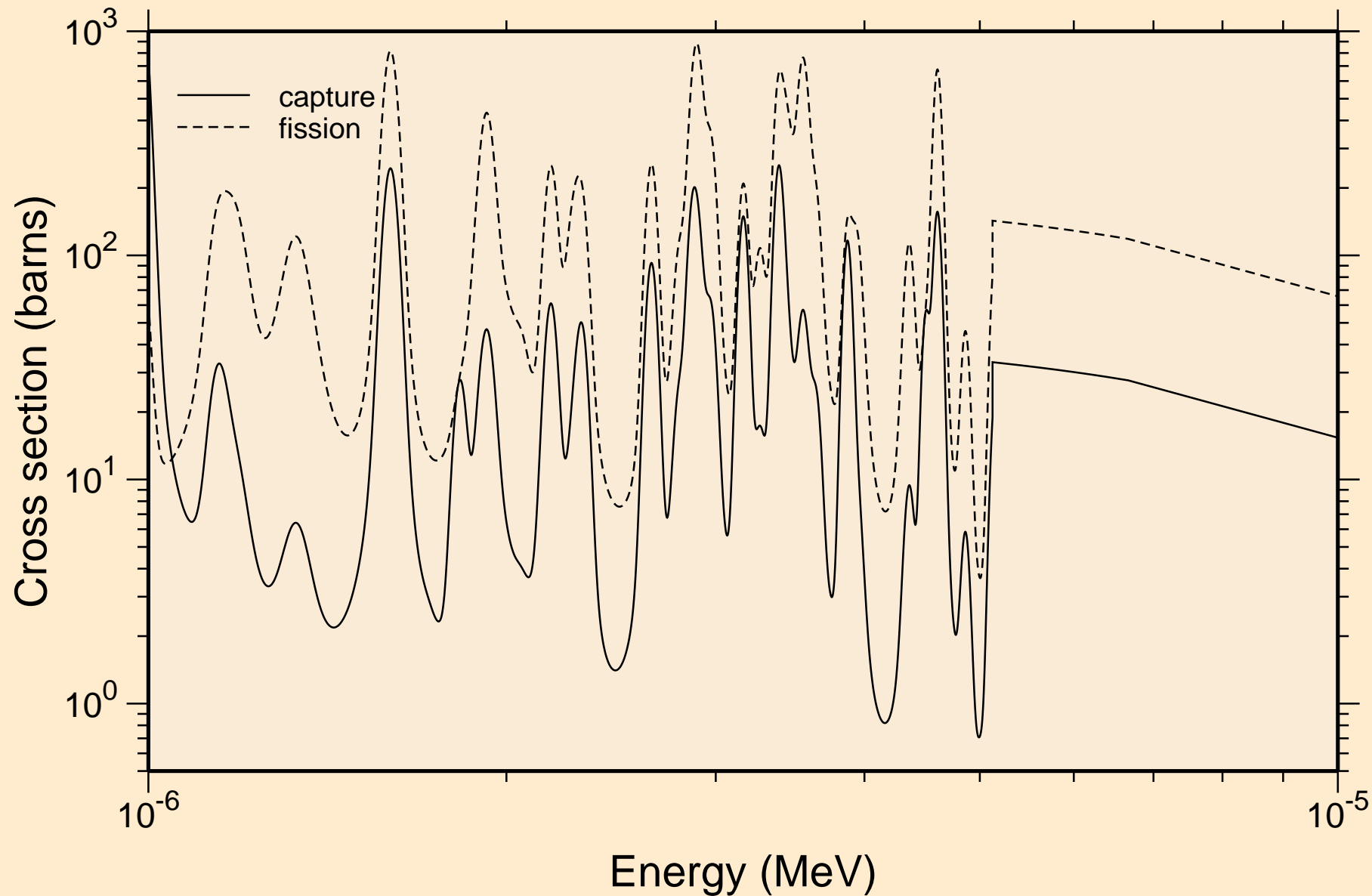

U227 NEUTRON ACER TENDL-2019 LIBRARY; T=293.16K
resonance absorption cross sections

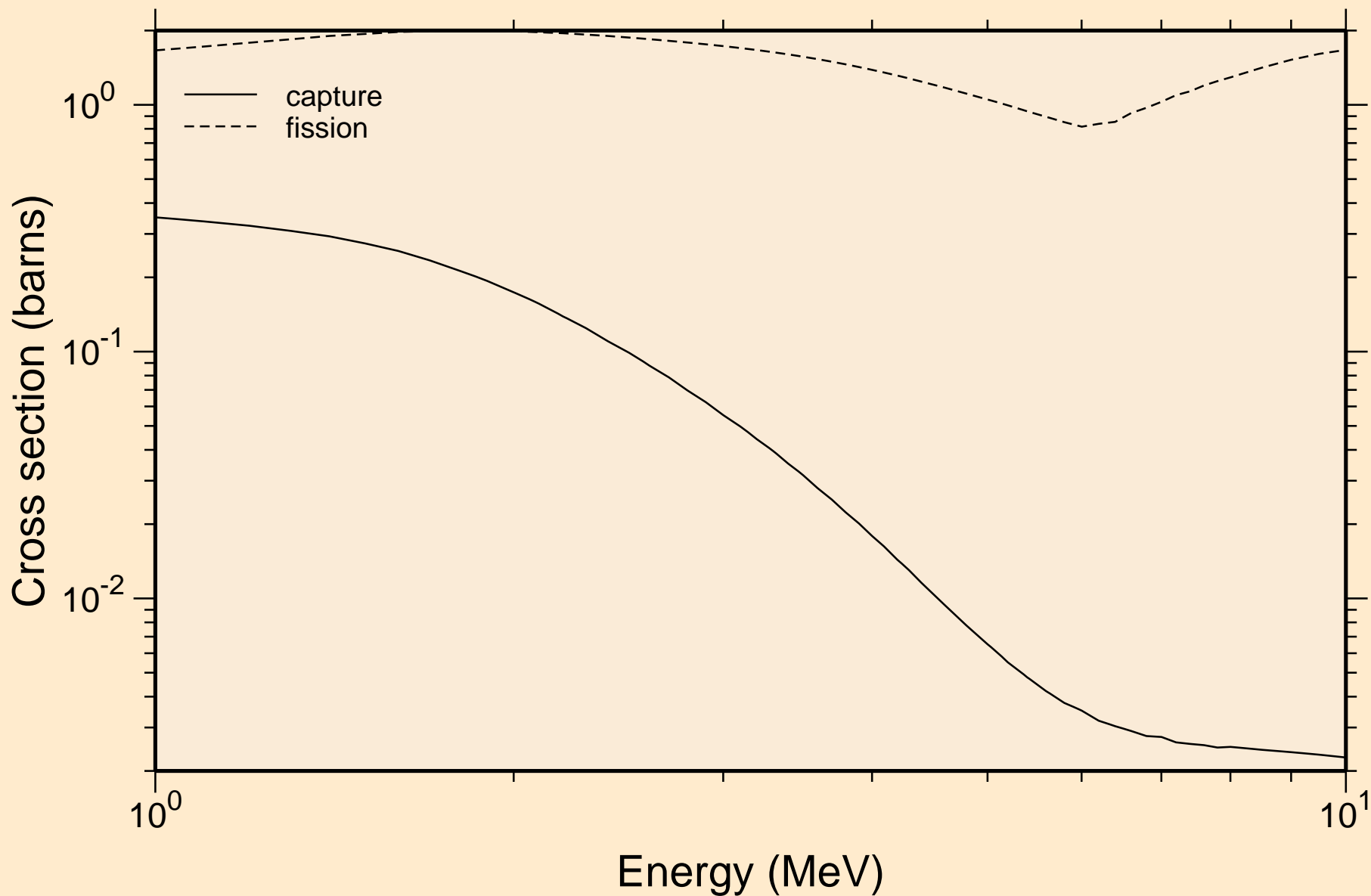

U227 NEUTRON ACER TENDL-2019 LIBRARY; T=293.16K
Heating

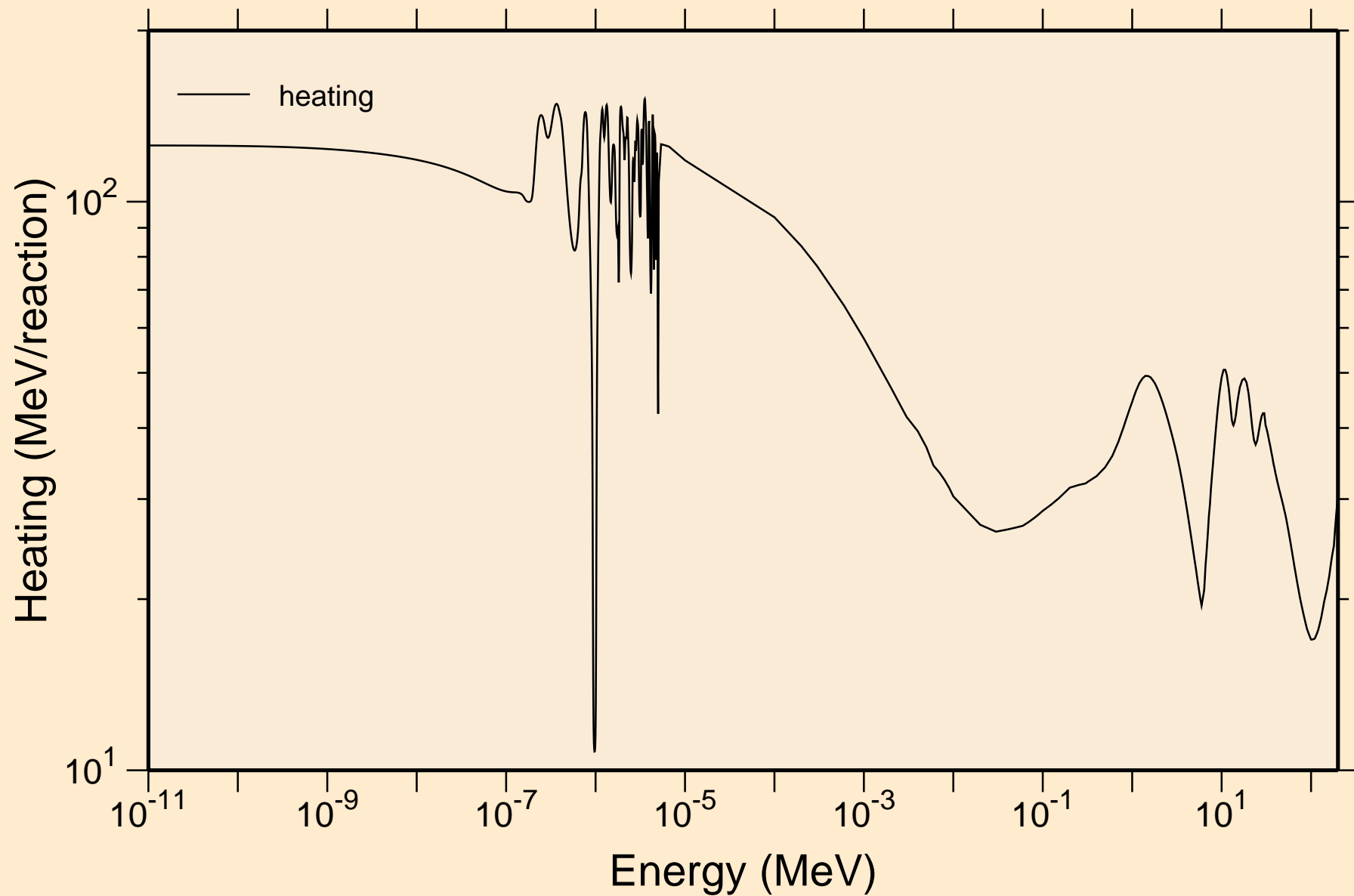

U227 NEUTRON ACER TENDL-2019 LIBRARY; T=293.16K
Damage

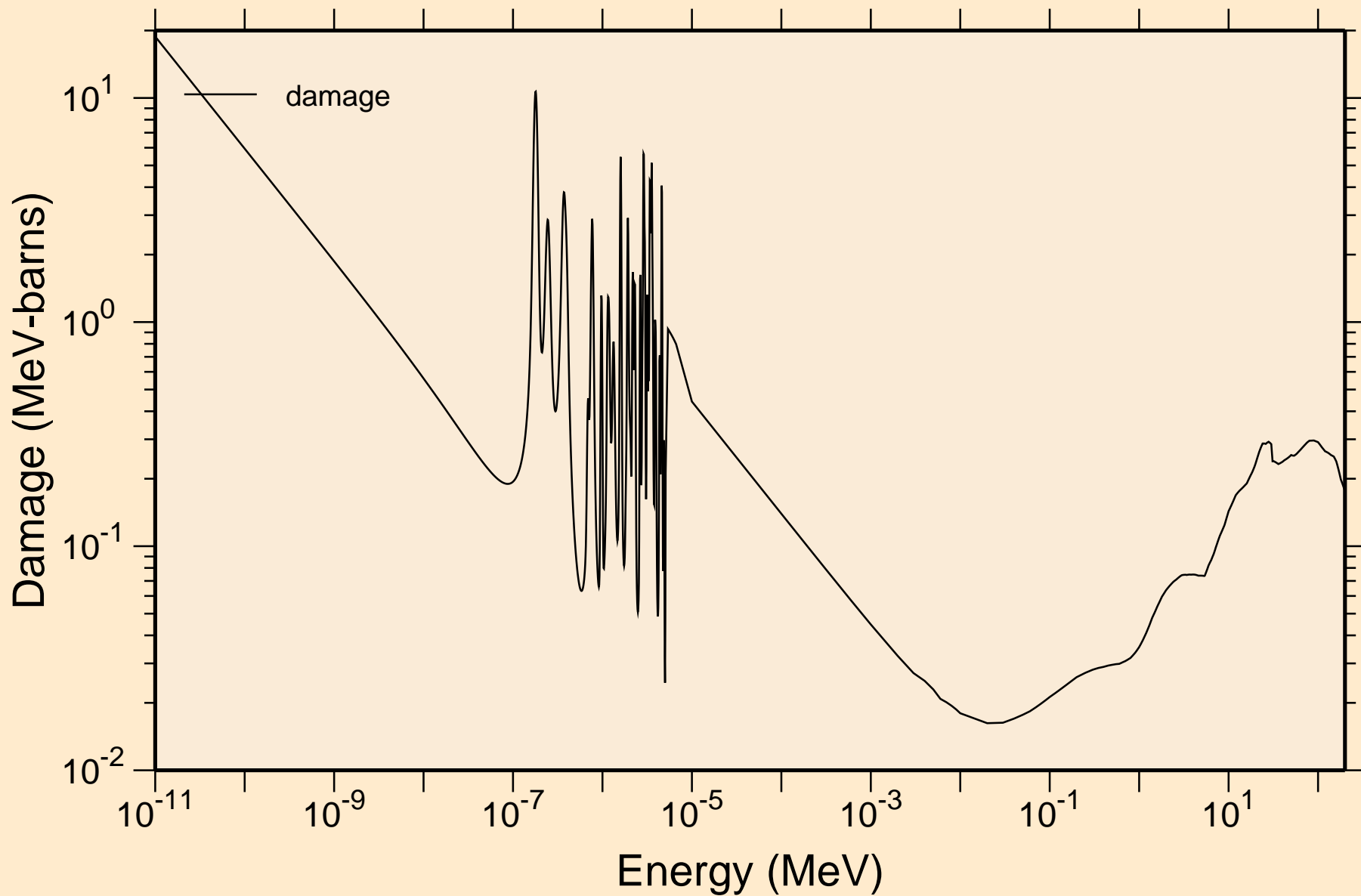

U227 NEUTRON ACER TENDL-2019 LIBRARY; T=293.16K
Non-threshold reactions

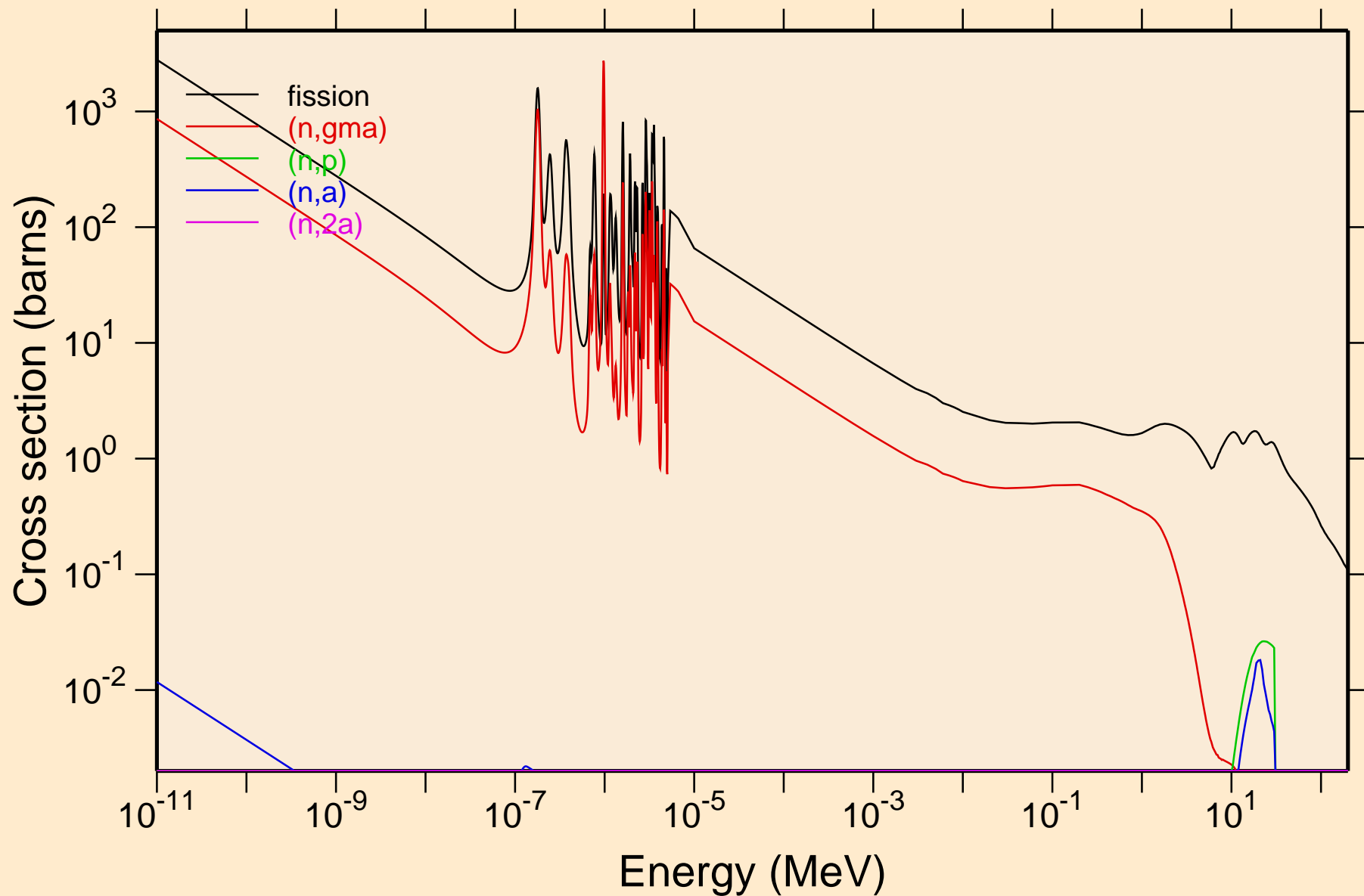

U227 NEUTRON ACER TENDL-2019 LIBRARY; T=293.16K
Non-threshold reactions

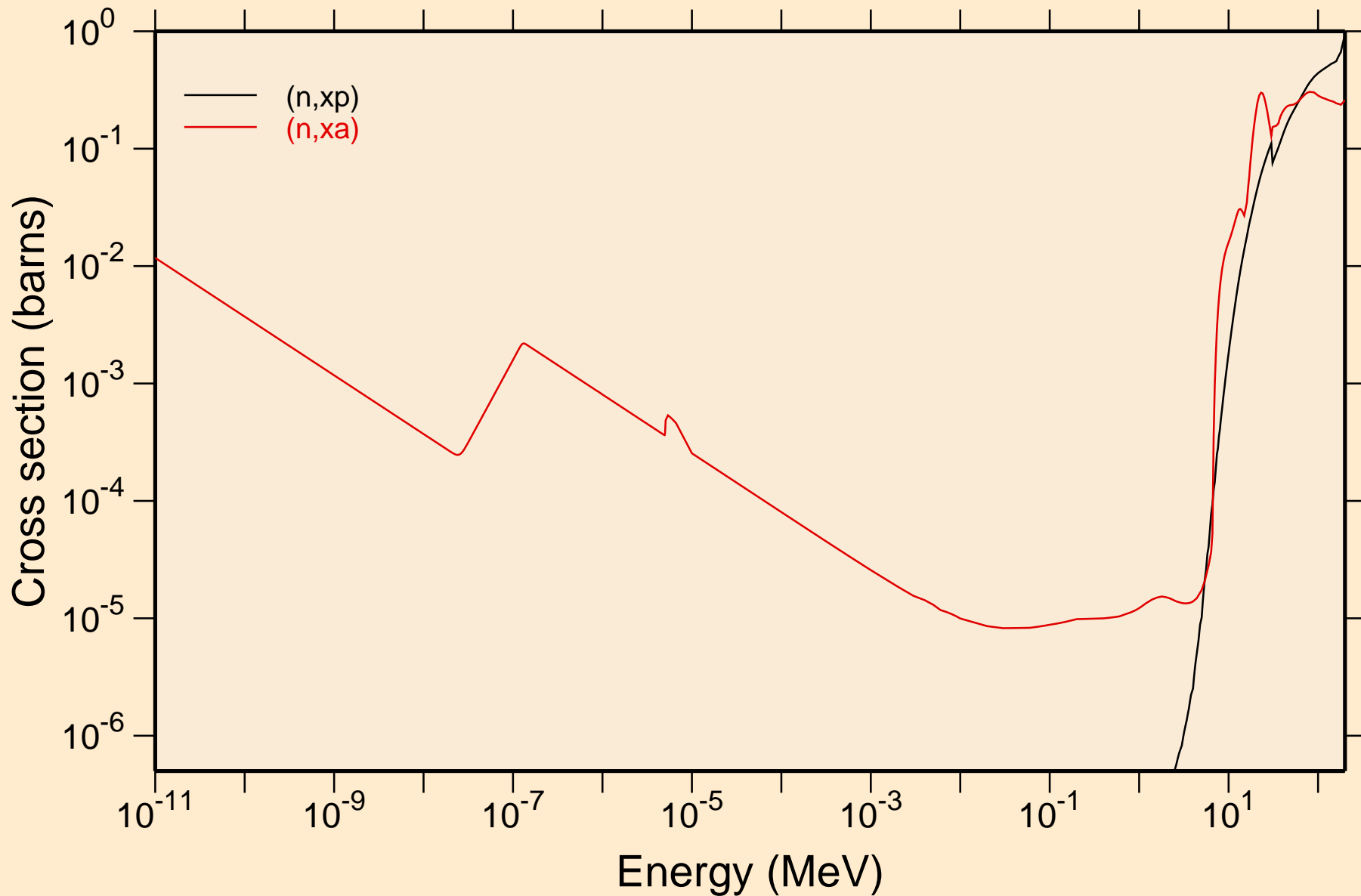

U227 NEUTRON ACER TENDL-2019 LIBRARY; T=293.16K
Principal cross sections

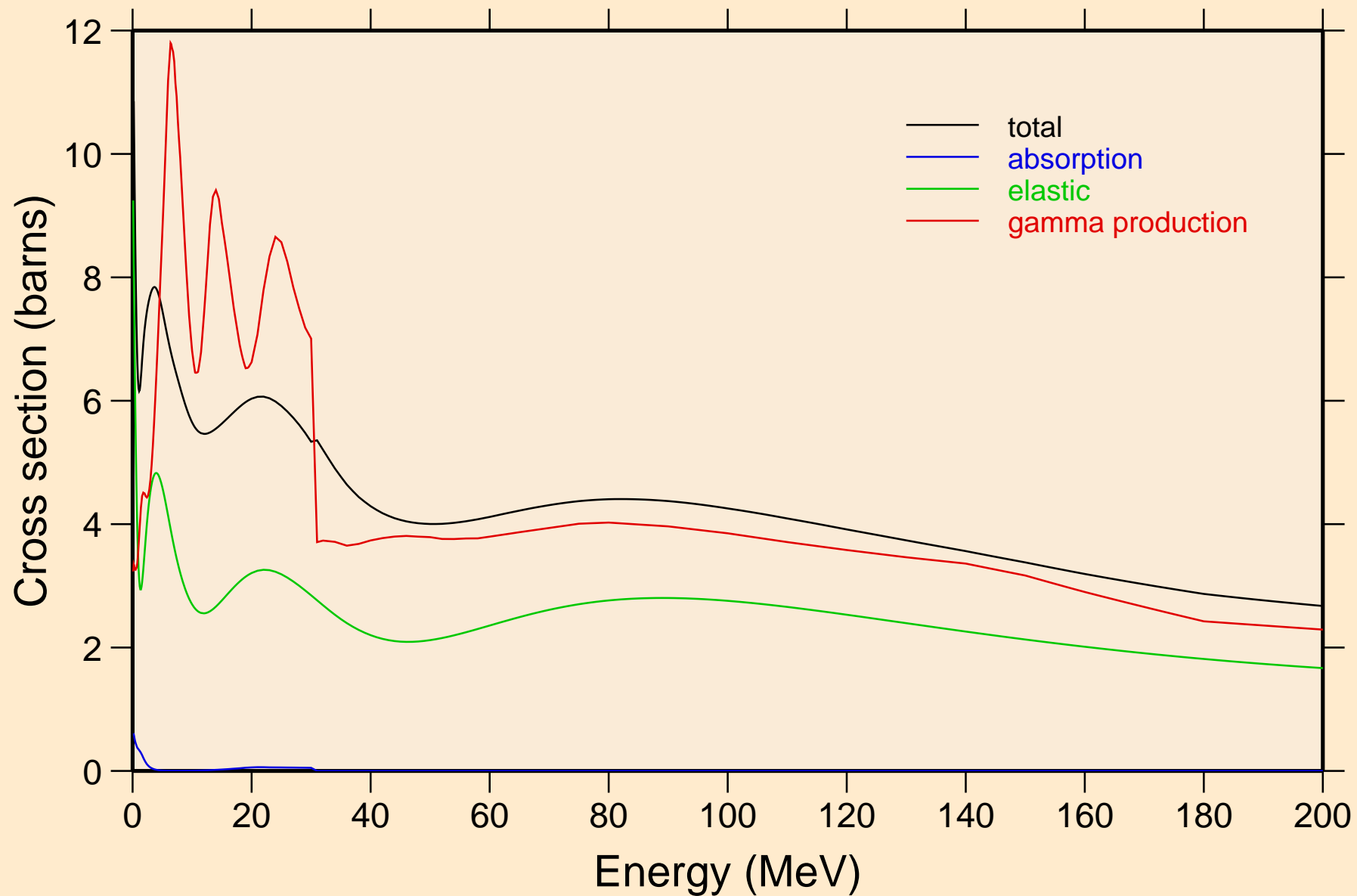

U227 NEUTRON ACER TENDL-2019 LIBRARY; T=293.16K
Heating

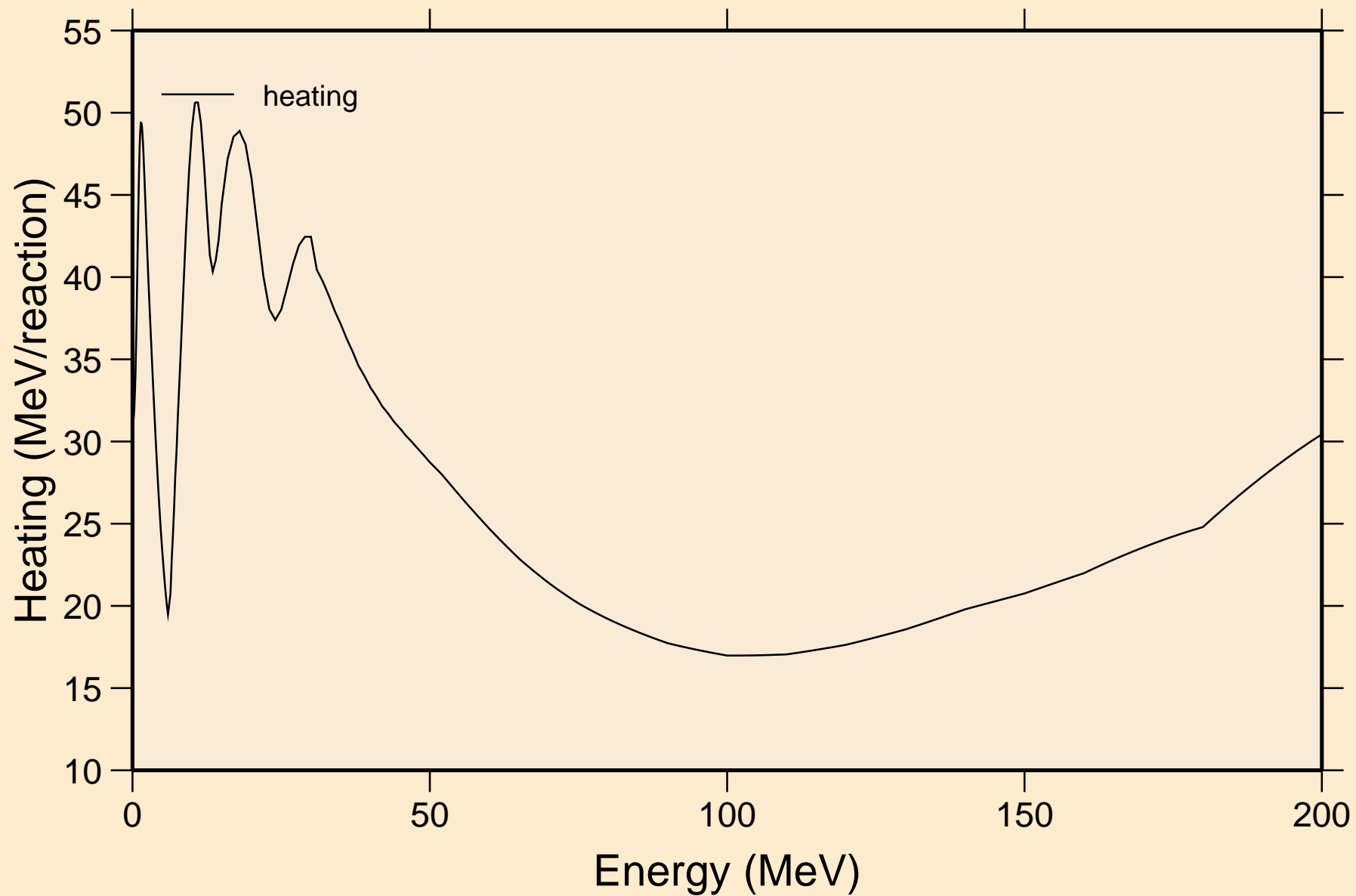

U227 NEUTRON ACER TENDL-2019 LIBRARY; T=293.16K
Damage

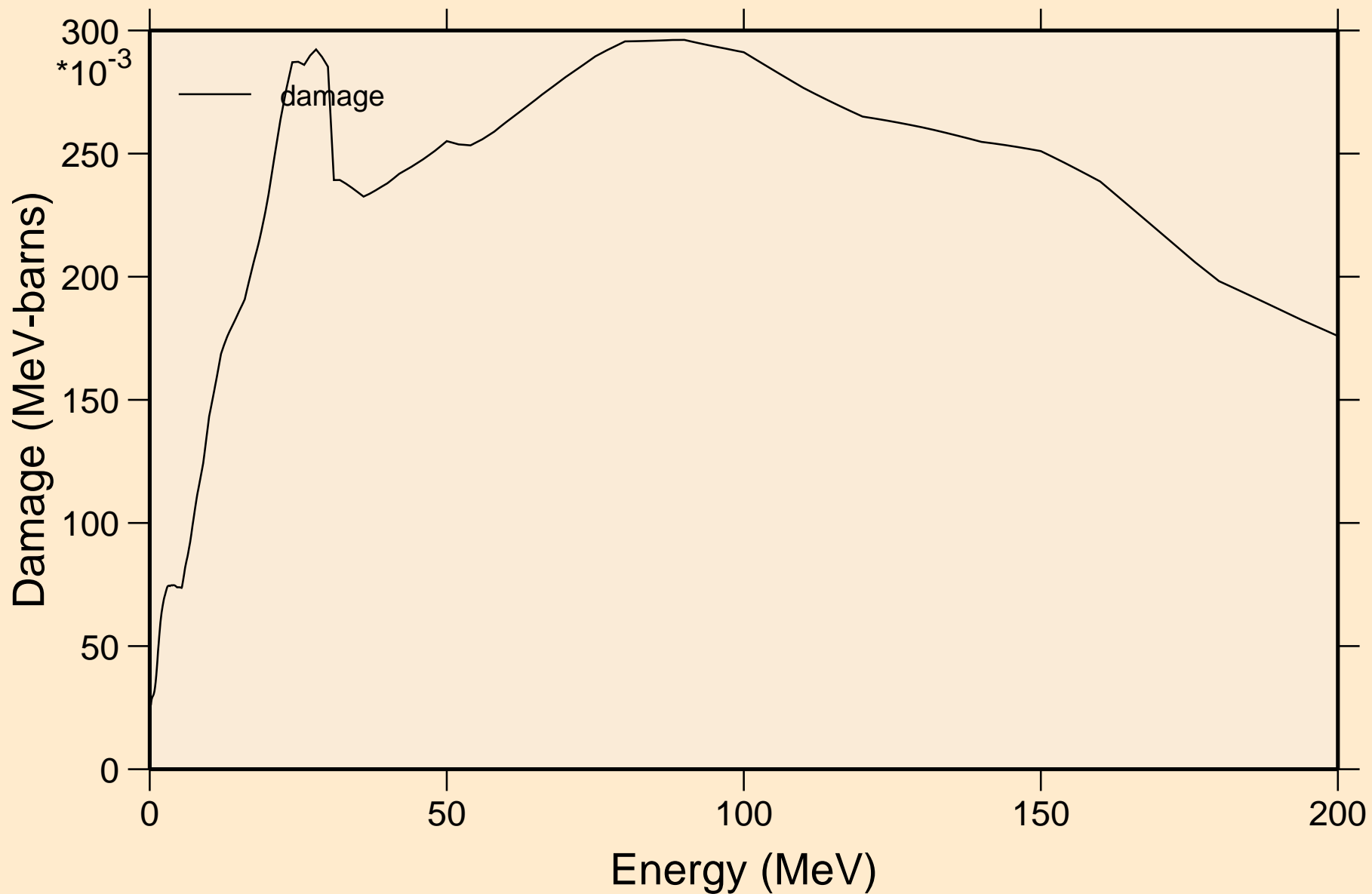

U227 NEUTRON ACER TENDL-2019 LIBRARY; T=293.16K
Non-threshold reactions

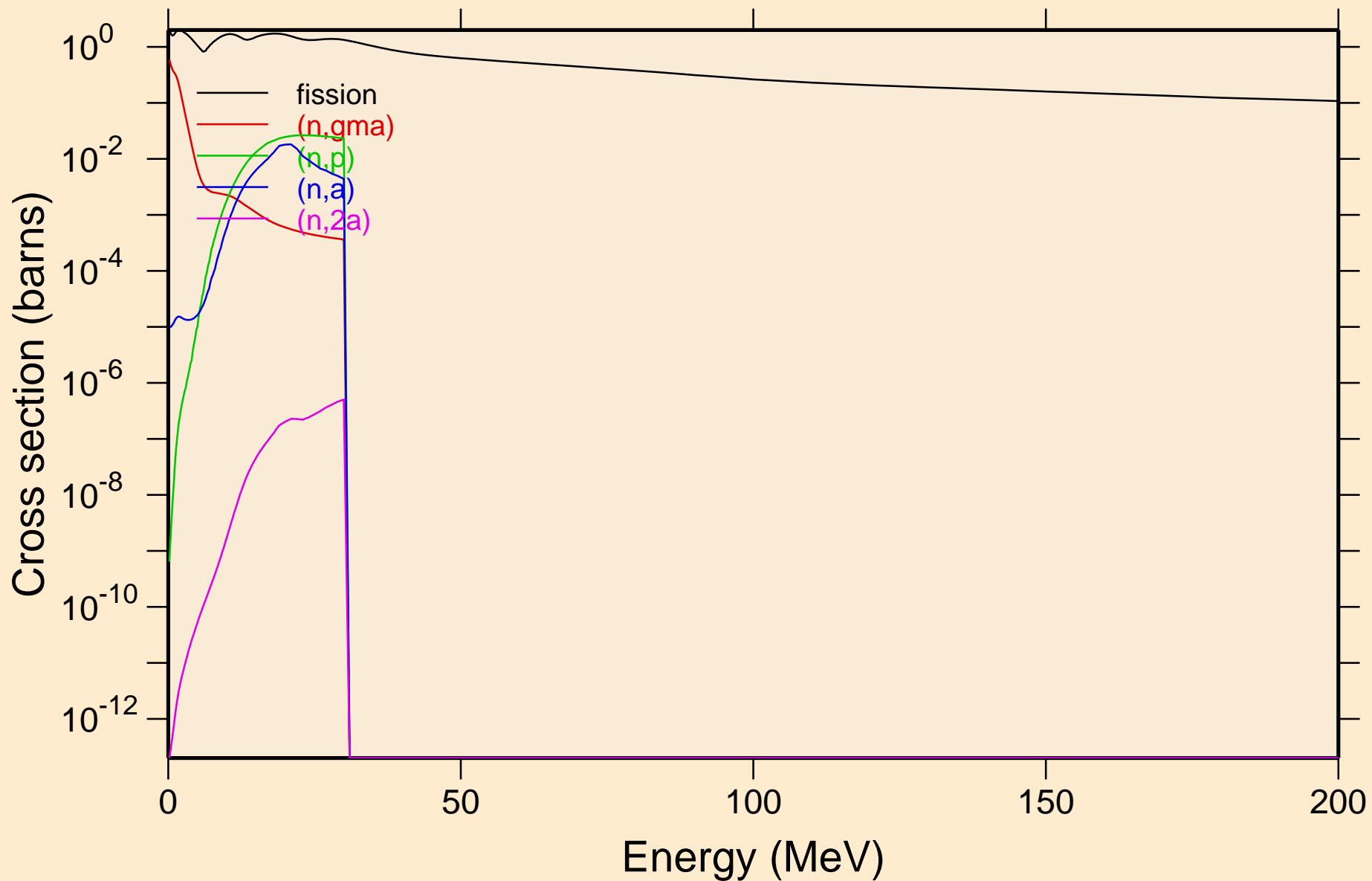

U227 NEUTRON ACER TENDL-2019 LIBRARY; T=293.16K
Non-threshold reactions

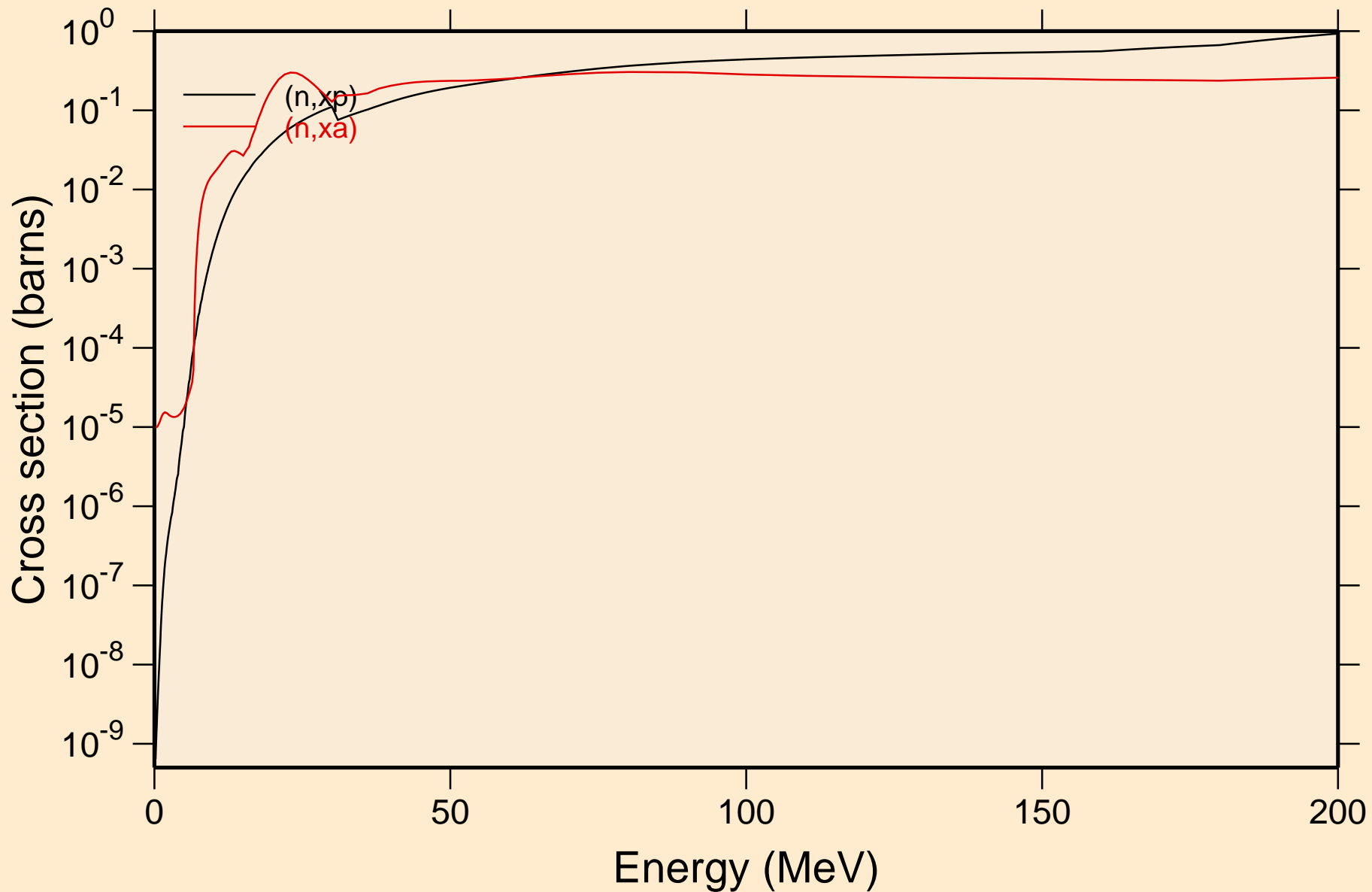

U227 NEUTRON ACER TENDL-2019 LIBRARY; T=293.16K
Inelastic levels

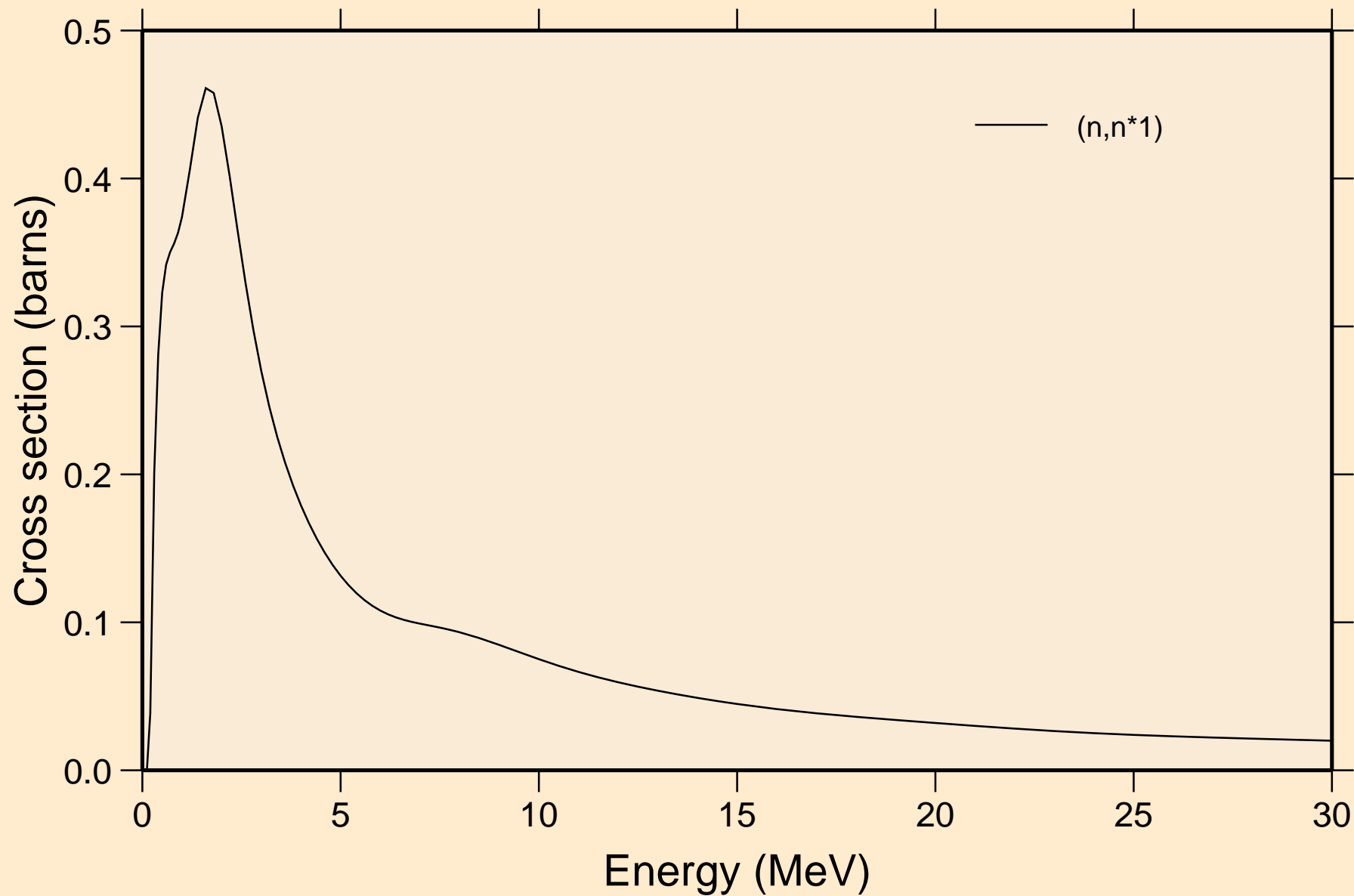

U227 NEUTRON ACER TENDL-2019 LIBRARY; T=293.16K
Threshold reactions

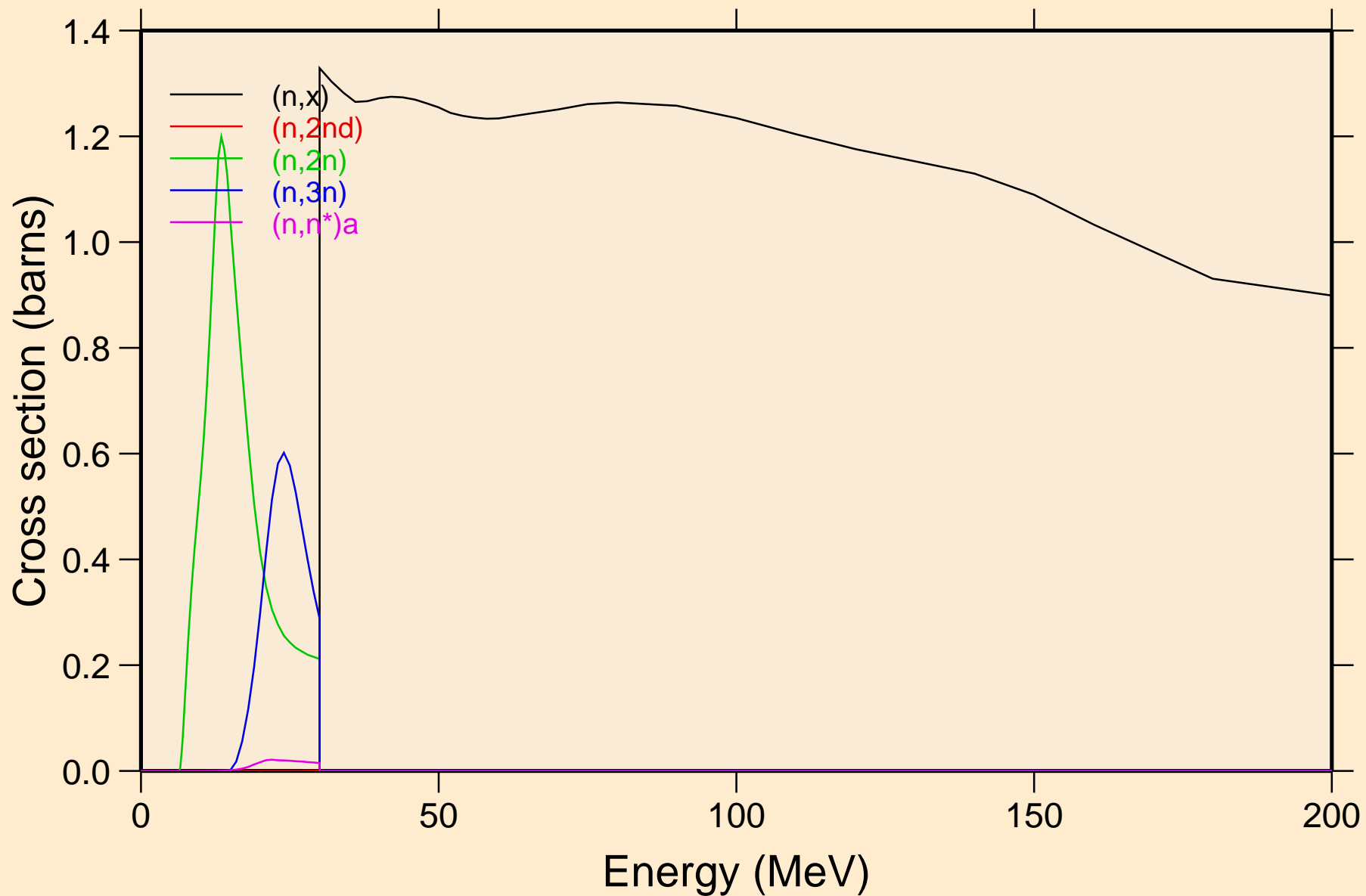

U227 NEUTRON ACER TENDL-2019 LIBRARY; T=293.16K
Threshold reactions

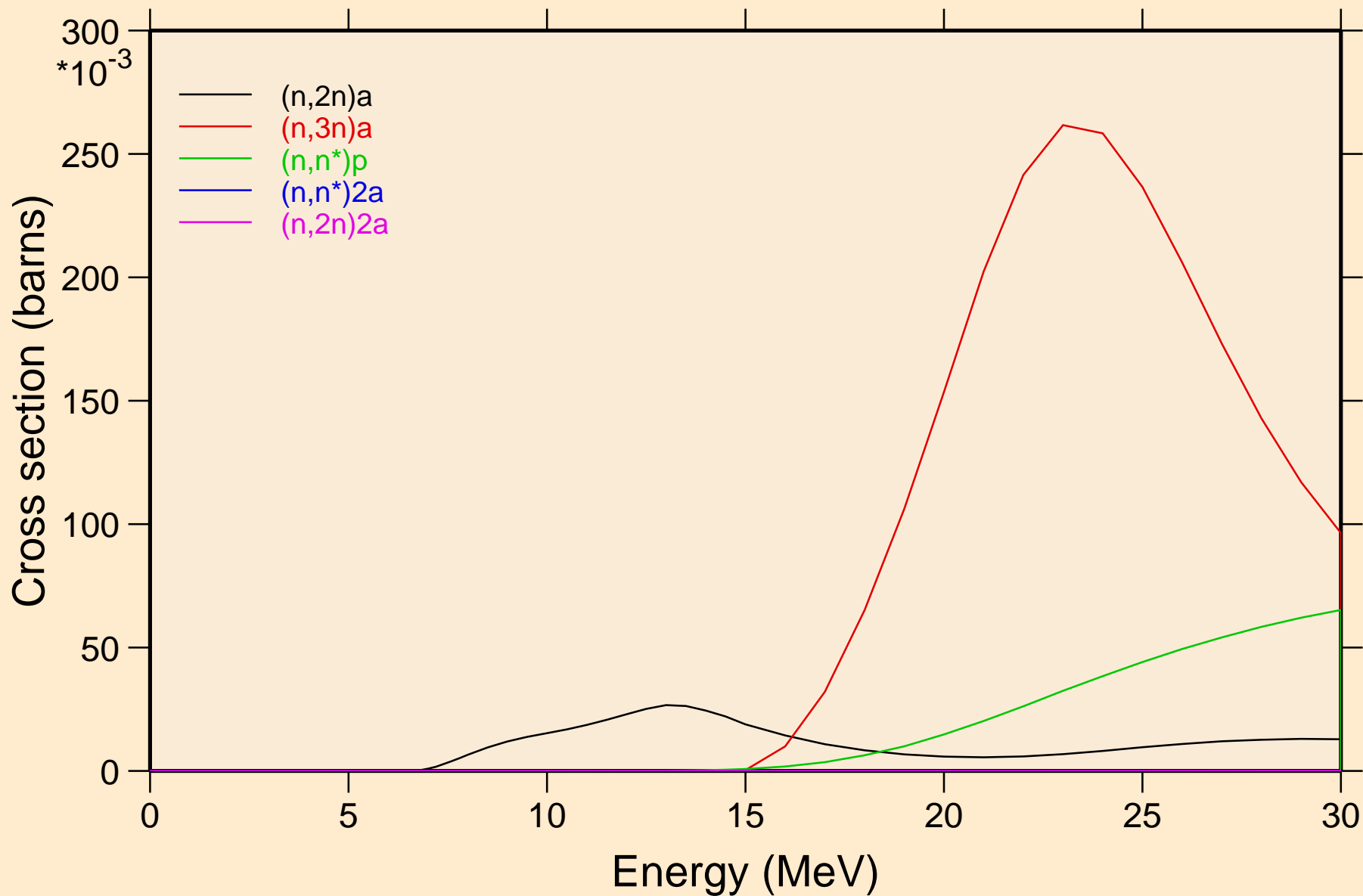

U227 NEUTRON ACER TENDL-2019 LIBRARY; T=293.16K
Threshold reactions

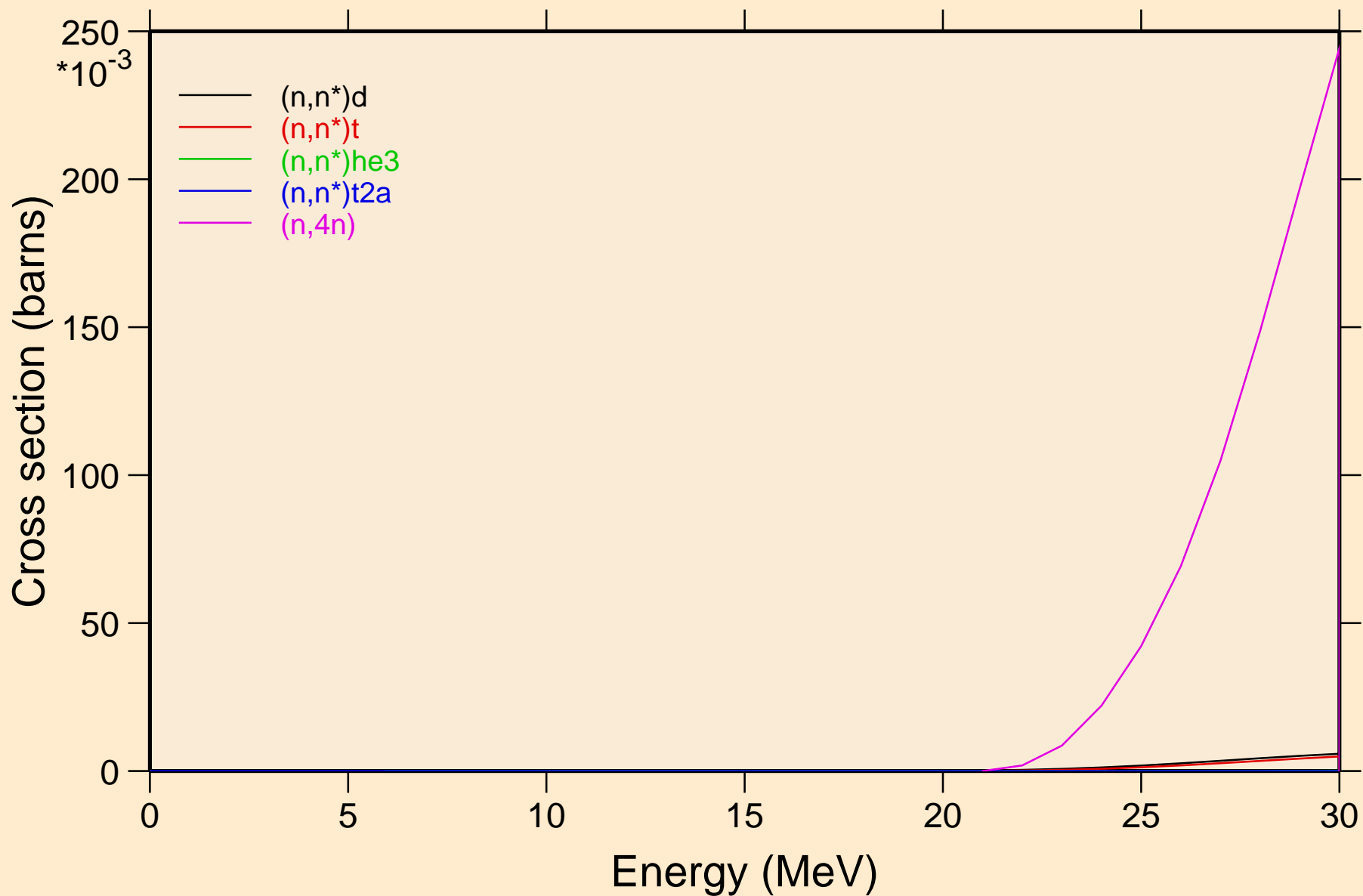

U227 NEUTRON ACER TENDL-2019 LIBRARY; T=293.16K
Threshold reactions

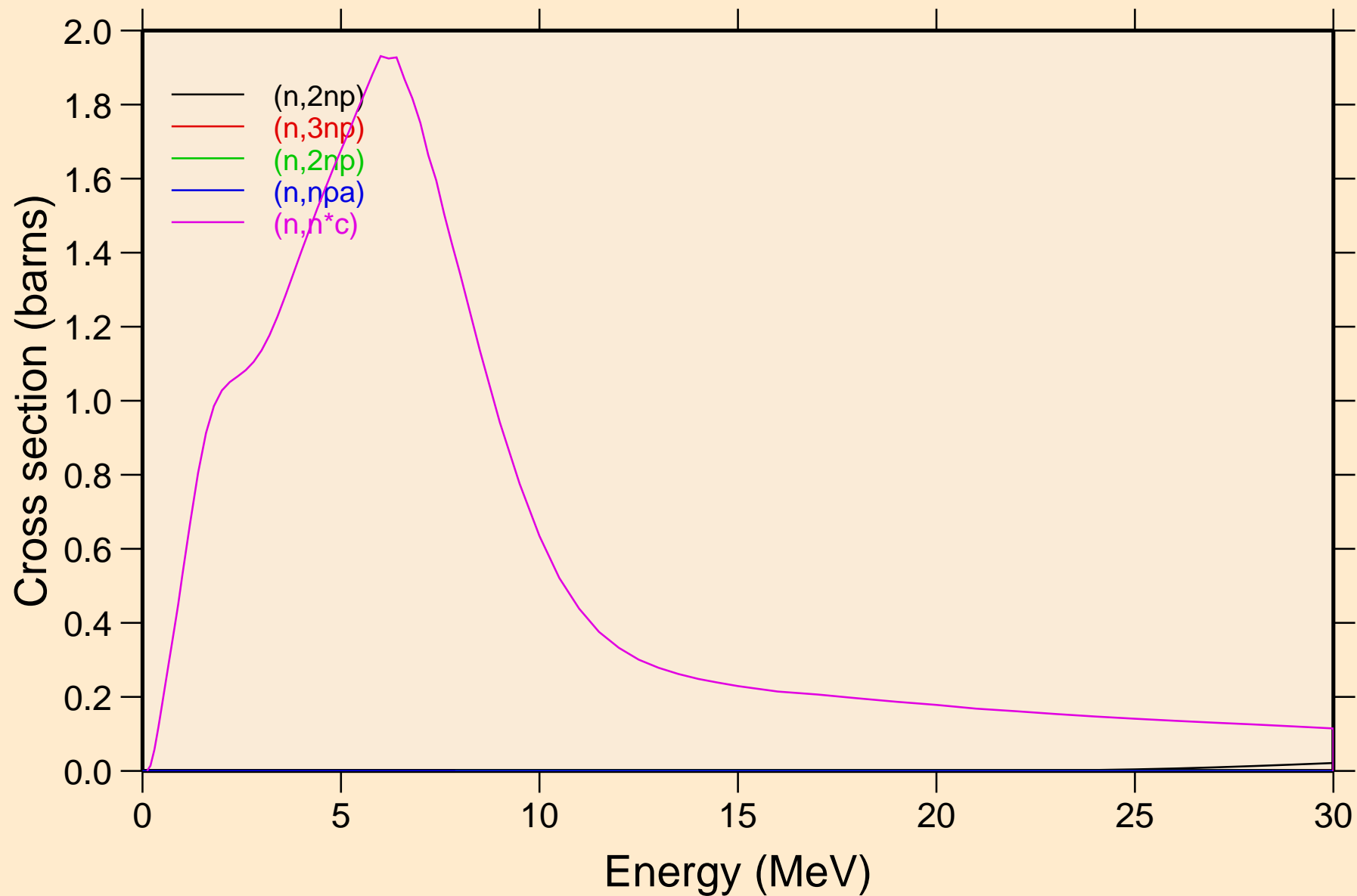

U227 NEUTRON ACER TENDL-2019 LIBRARY; T=293.16K
Threshold reactions

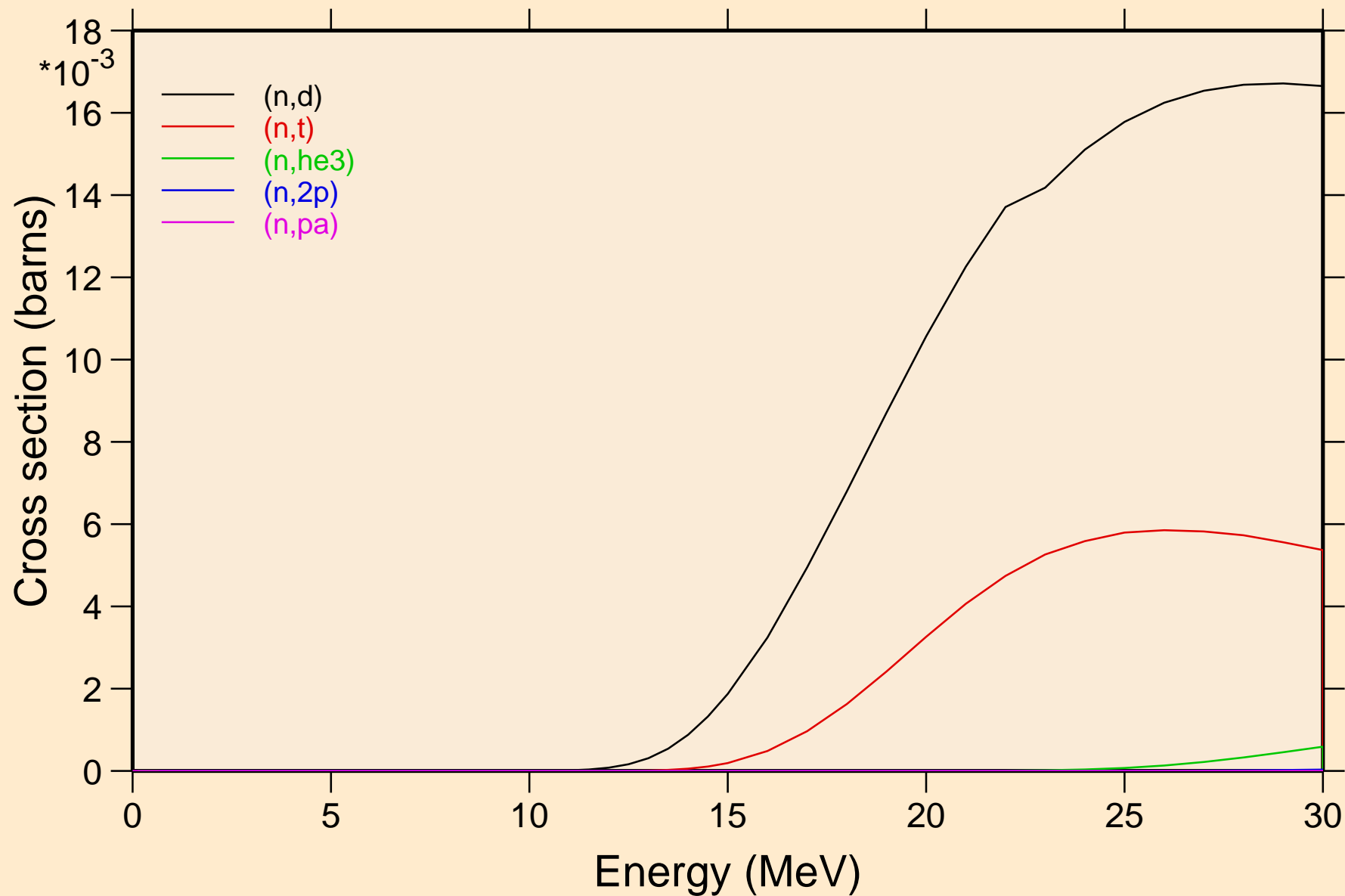

U227 NEUTRON ACER TENDL-2019 LIBRARY; T=293.16K
Threshold reactions

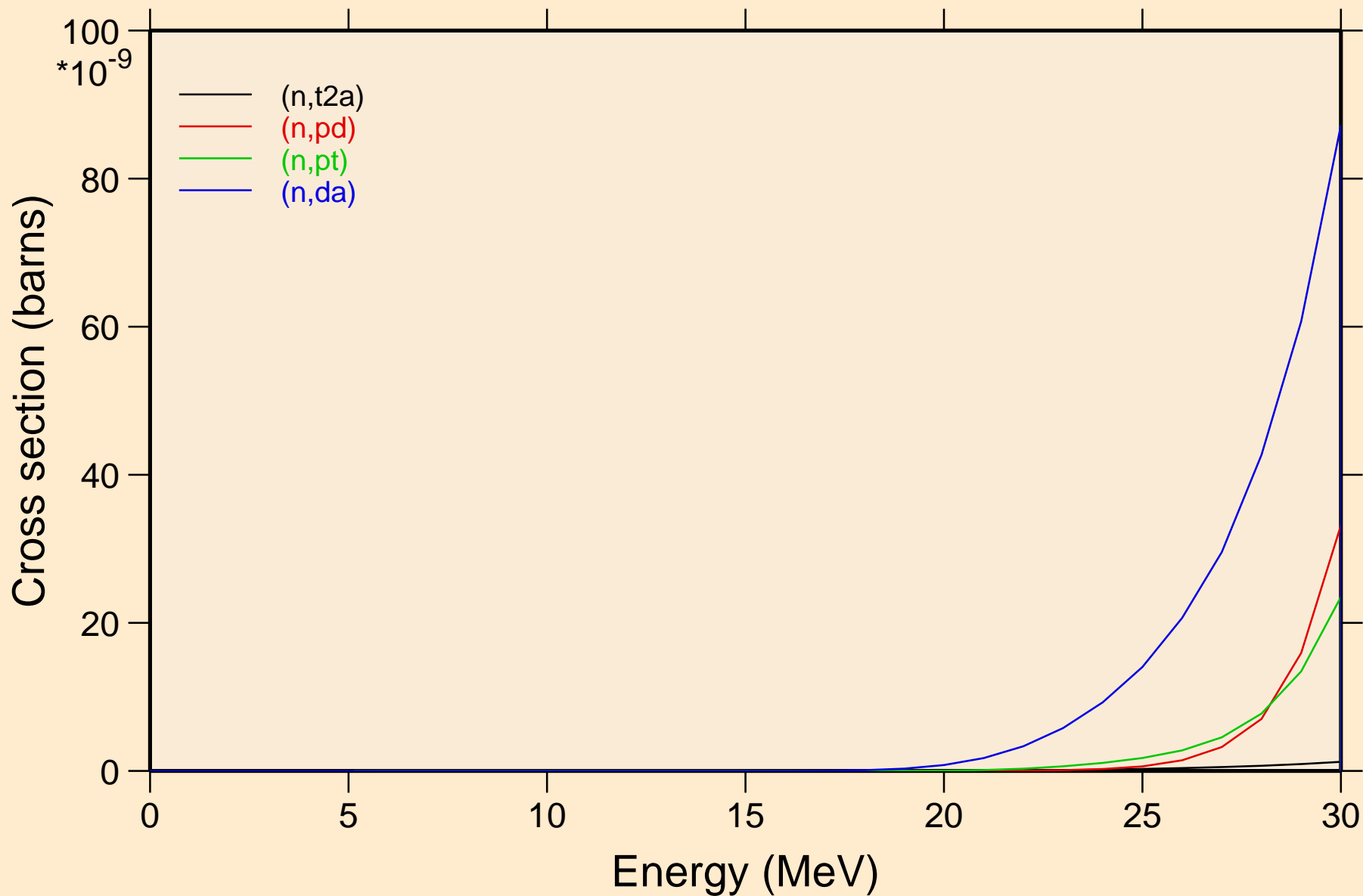

U227 NEUTRON ACER TENDL-2019 LIBRARY; T=293.16K

Threshold reactions

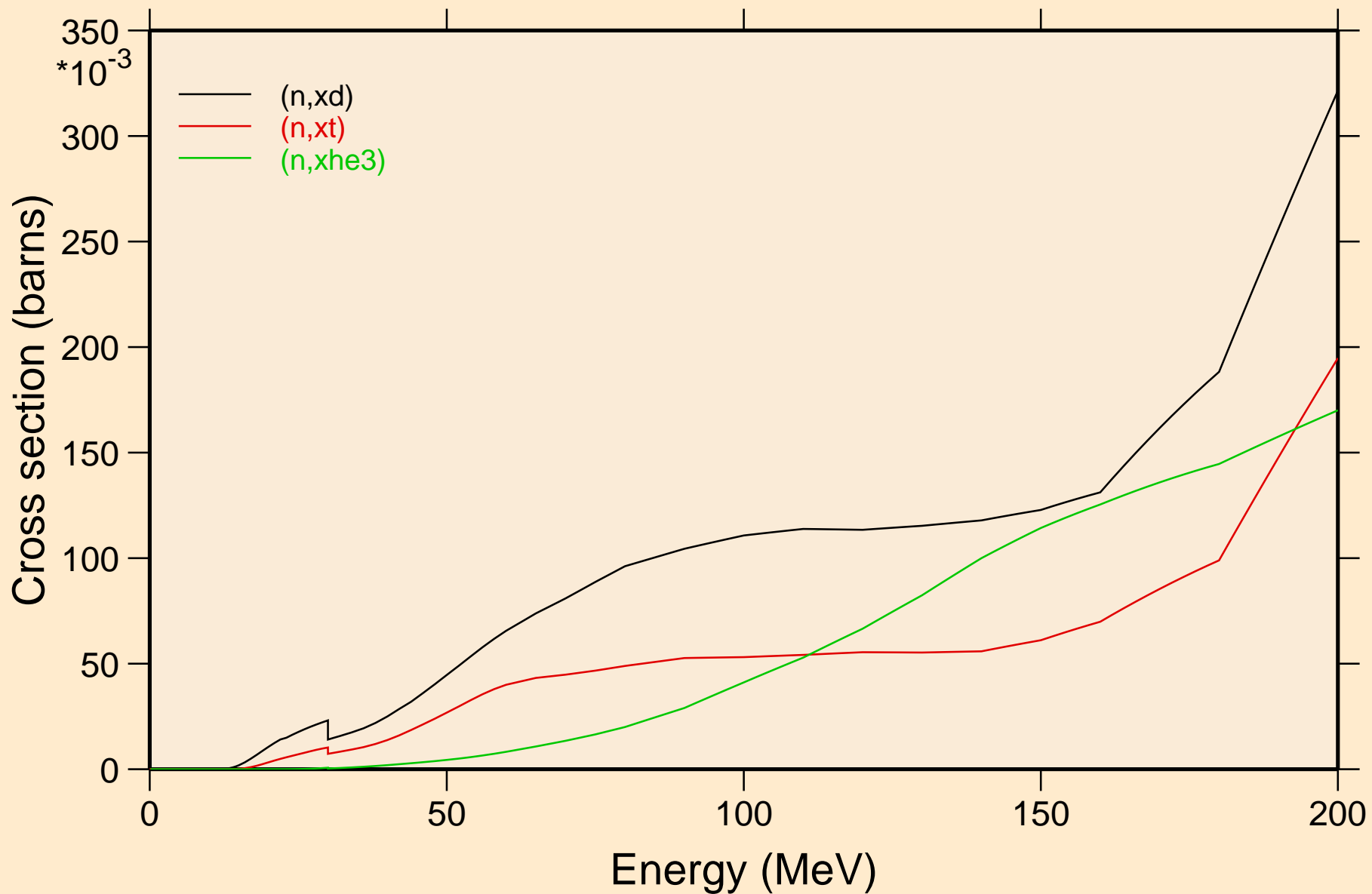

U227 NEUTRON ACER TENDL-2019 LIBRARY; T=293.16K
angular distribution for elastic

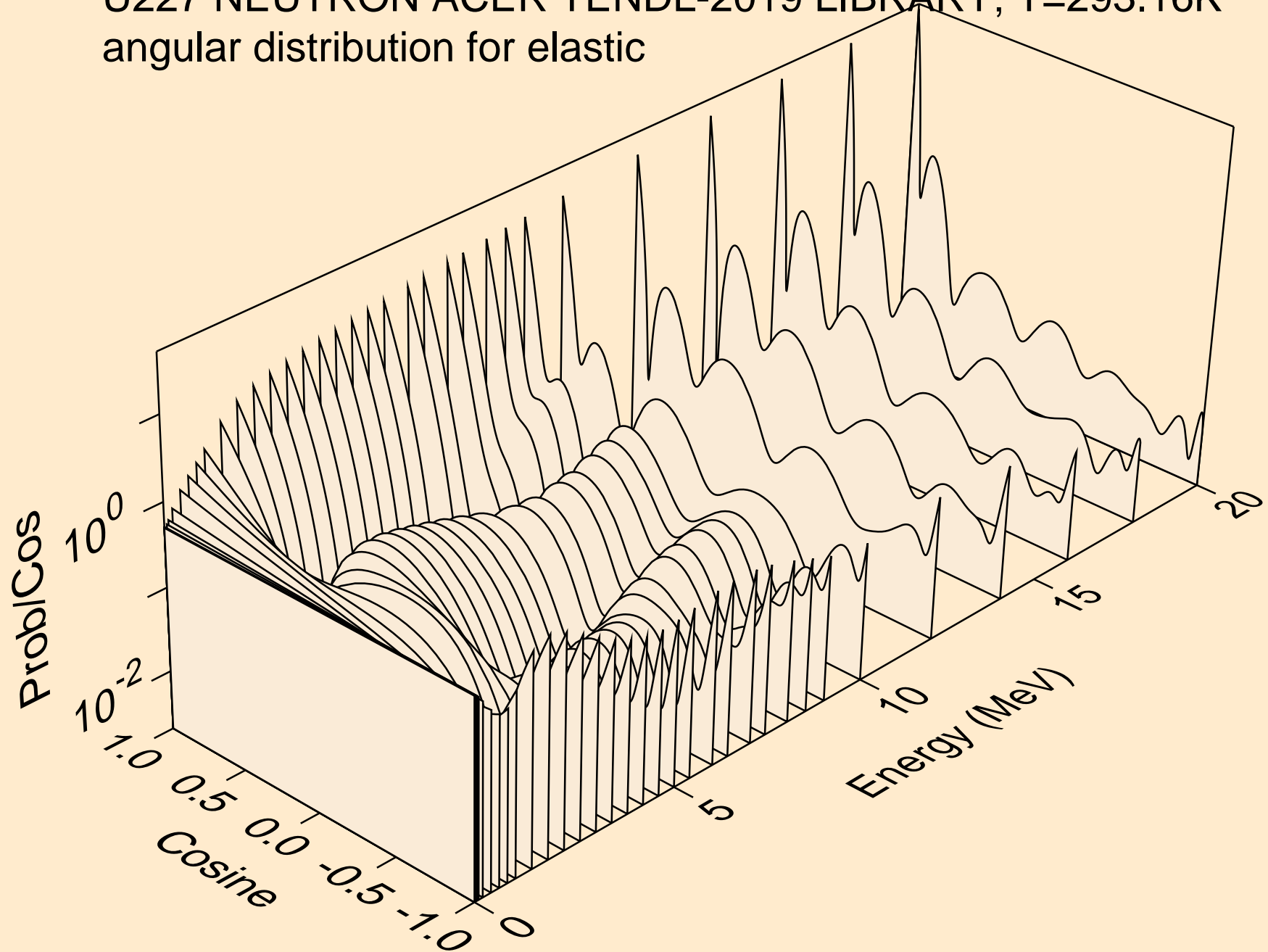

U227 NEUTRON ACER TENDL-2019 LIBRARY; T=293.16K
angular distribution for elastic

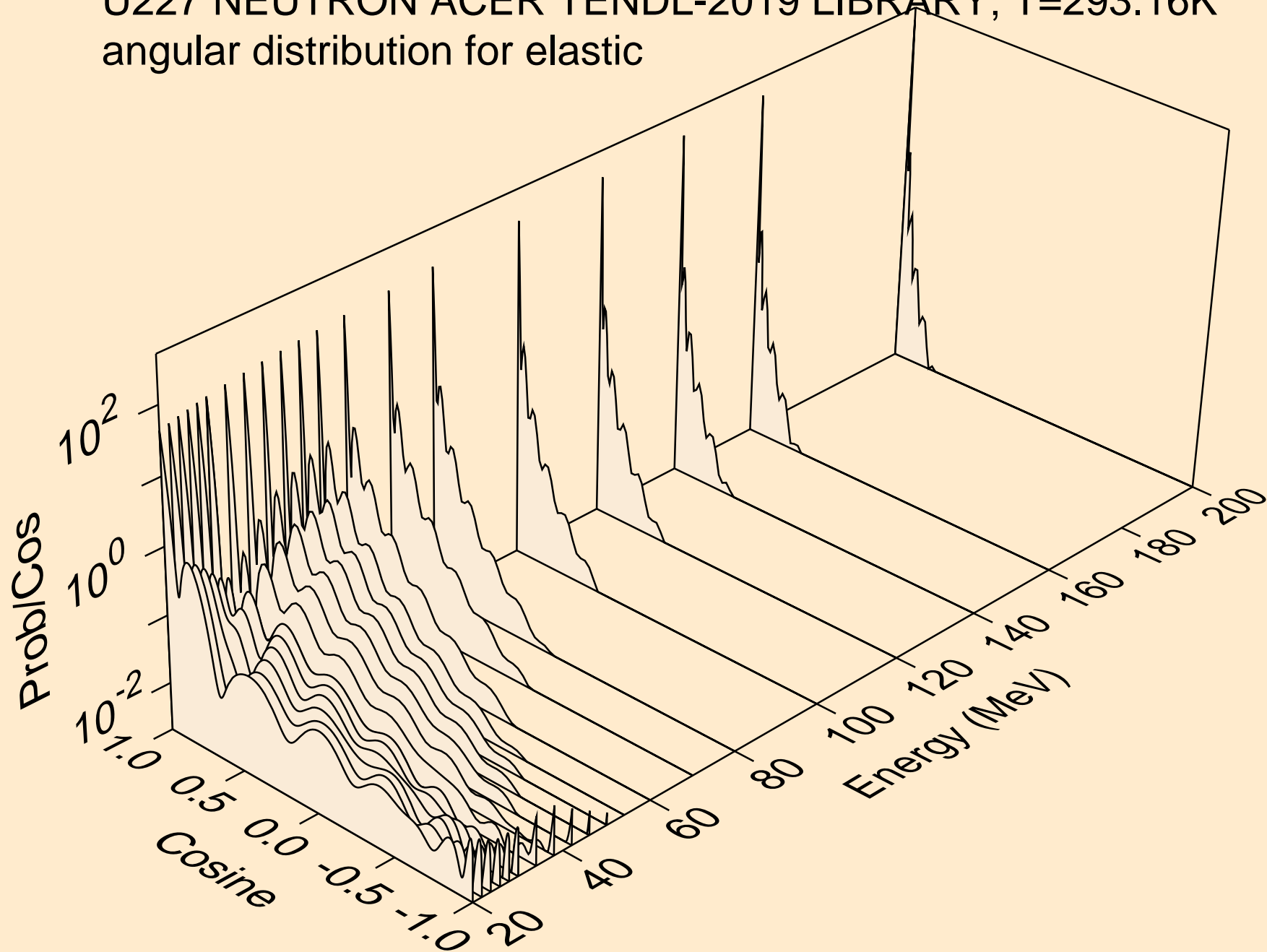

U227 NEUTRON ACER TENDL-2019 LIBRARY; T=293.16K
angular distribution for (n,n*1)

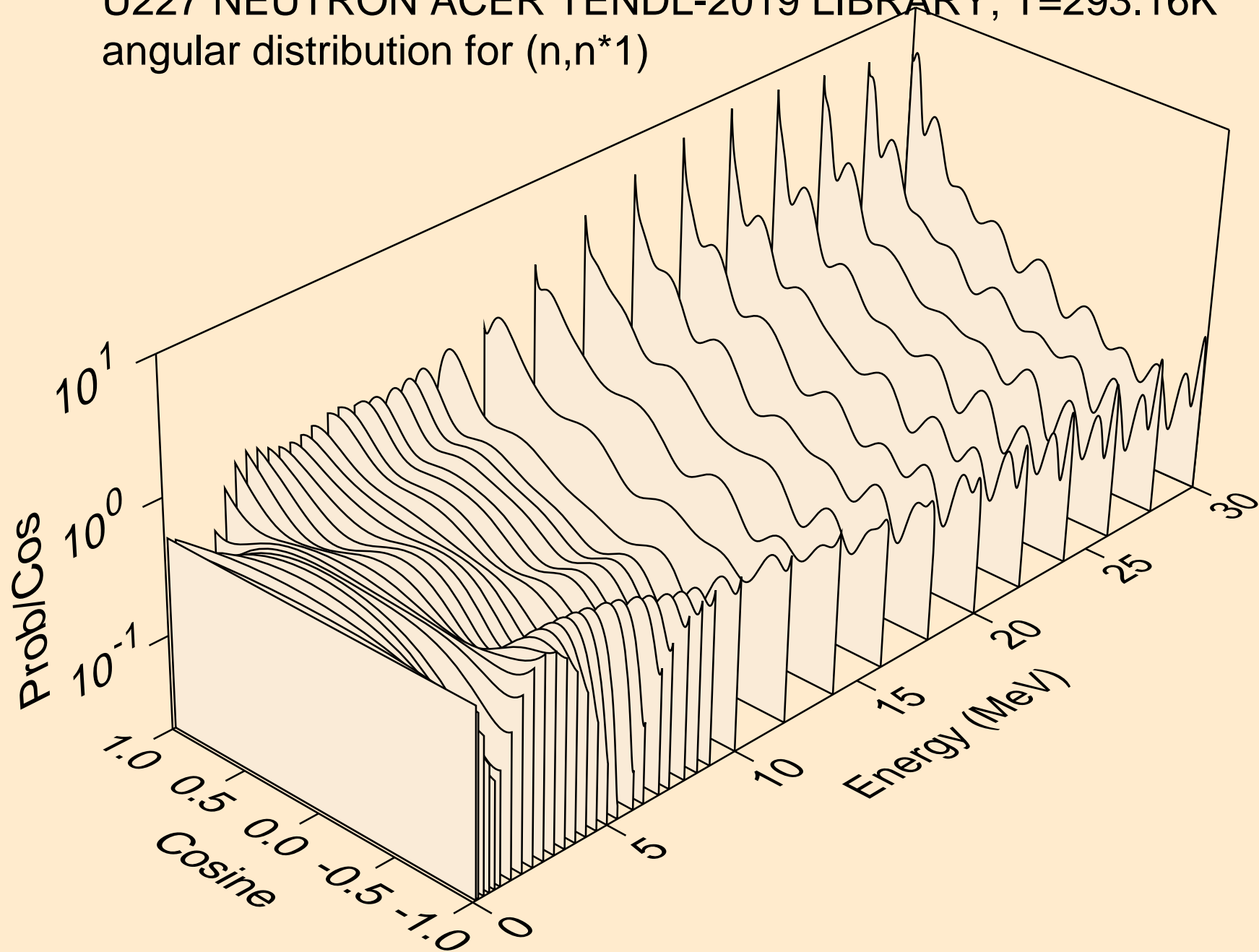

U227 NEUTRON ACER TENDL-2019 LIBRARY; T=293.16K
Total fission nubar

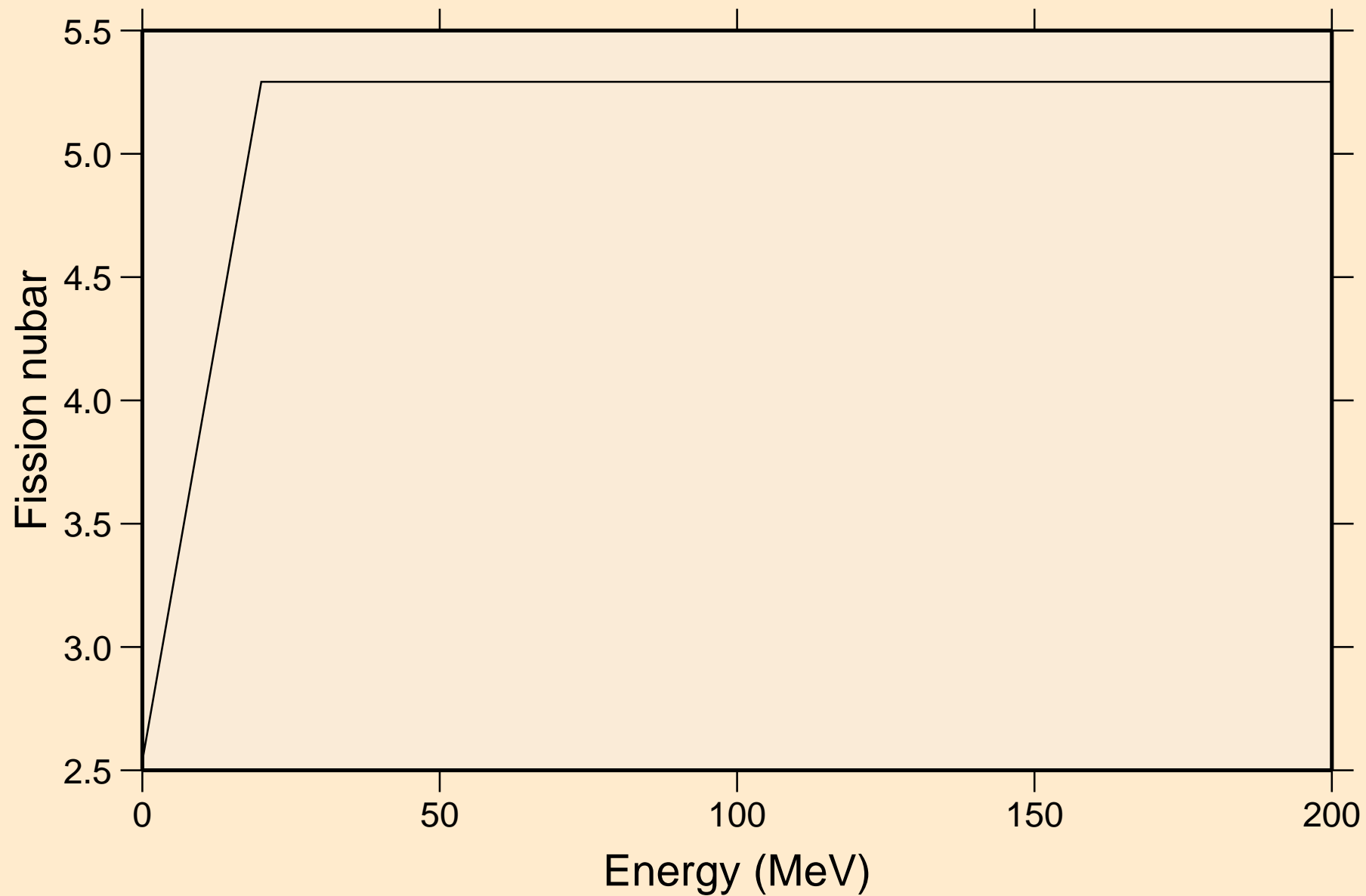

U227 NEUTRON ACER TENDL-2019 LIBRARY; T=293.16K
Neutron emission for (n,x)

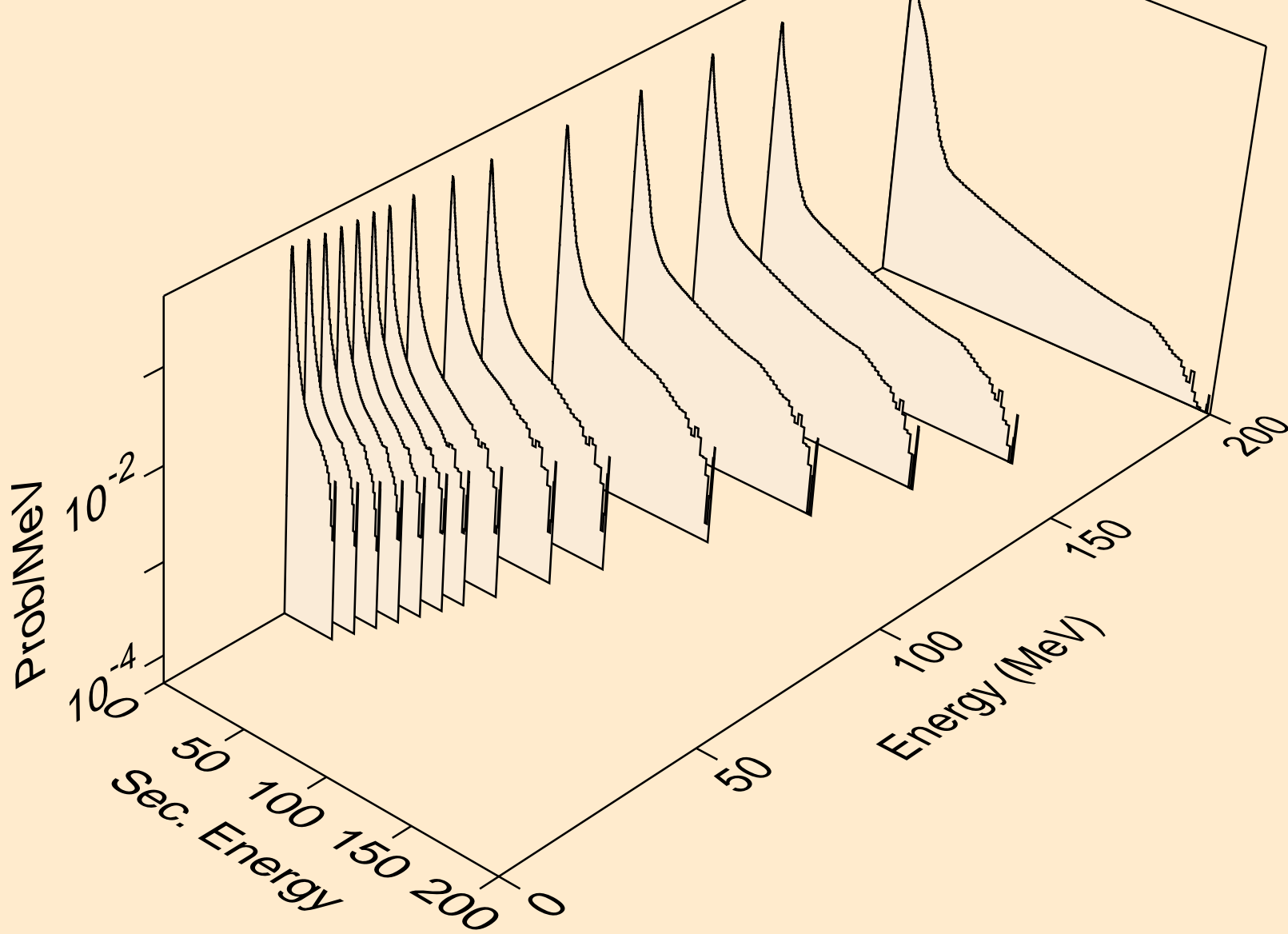

U227 NEUTRON ACER TENDL-2019 LIBRARY; T=293.16K
Neutron emission for (n,2nd)

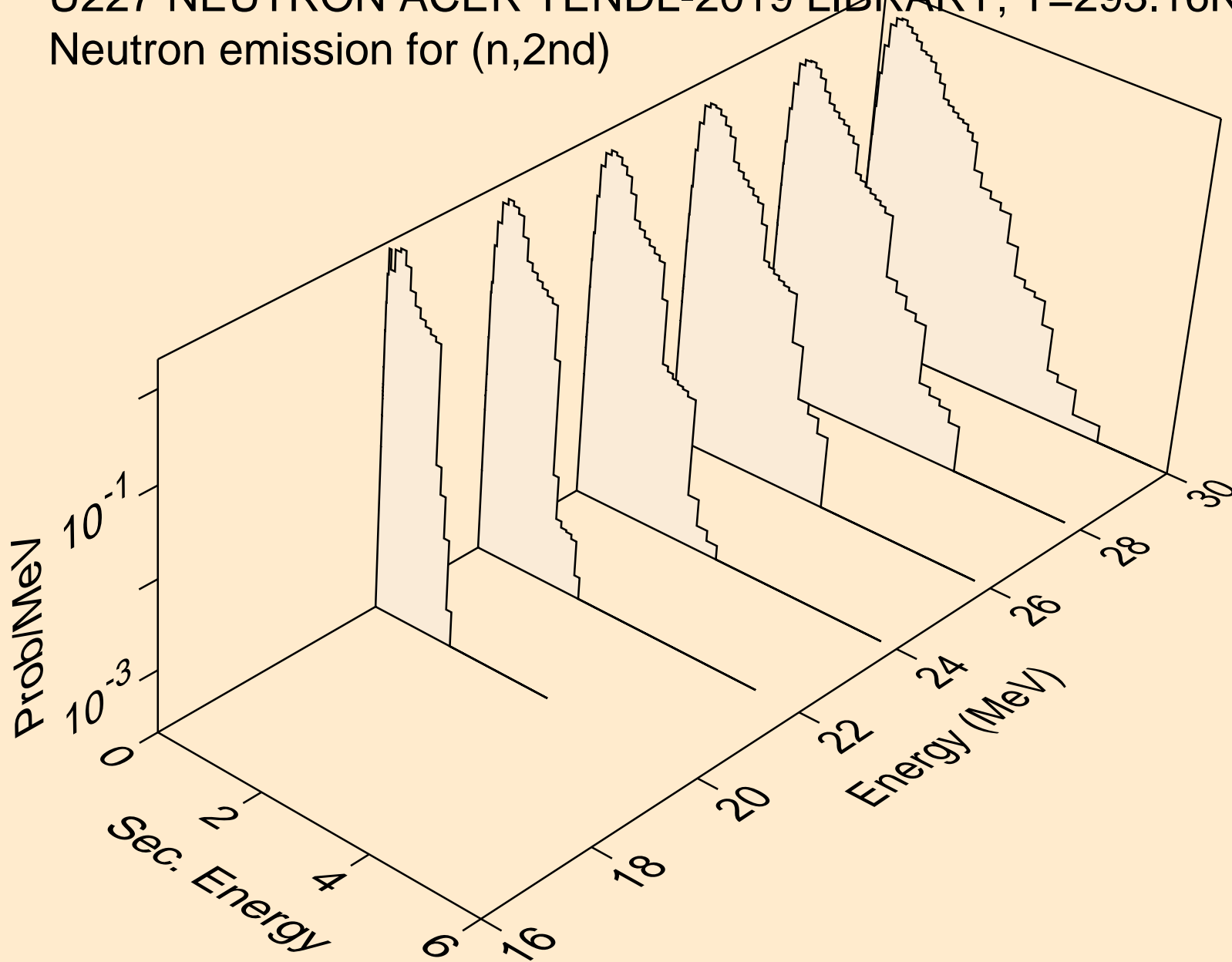

U227 NEUTRON ACER TENDL-2019 LIBRARY; T=293.16K
Neutron emission for (n,2n)

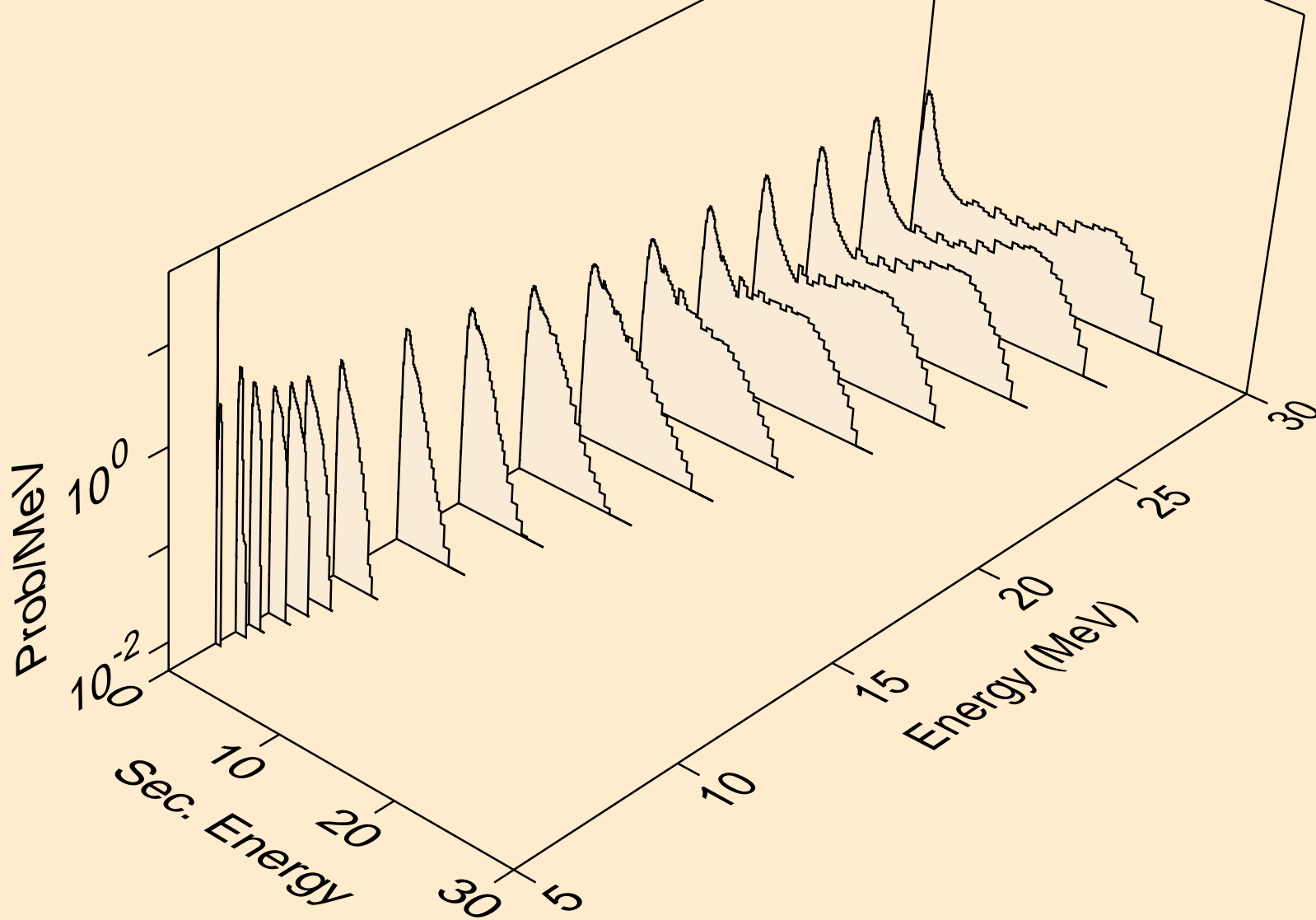

U227 NEUTRON ACER TENDL-2019 LIBRARY; T=293.16K
Neutron emission for (n,3n)

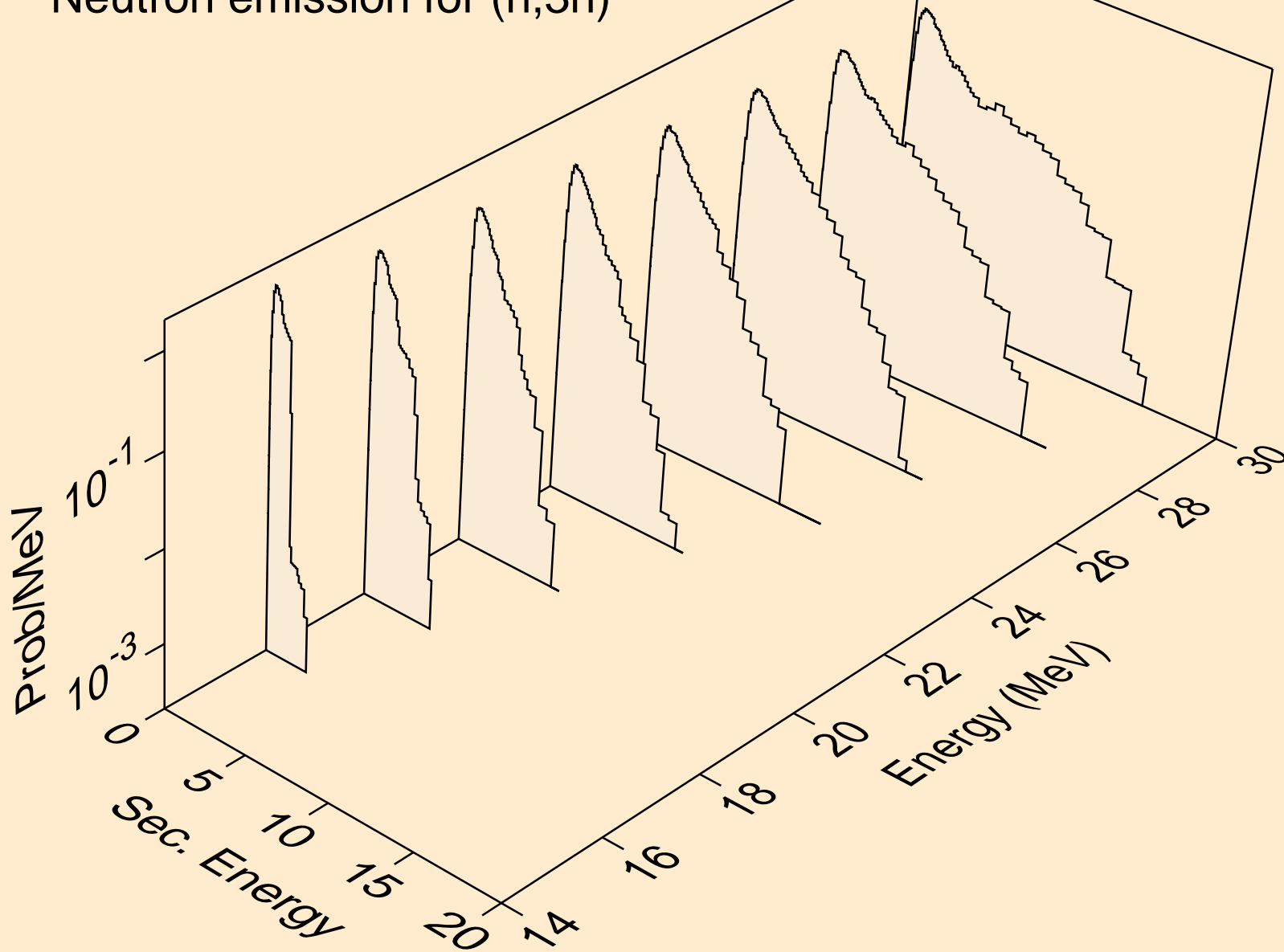

U227 NEUTRON ACER TENDL-2019 LIBRARY; T=293.16K
Neutron emission for fission

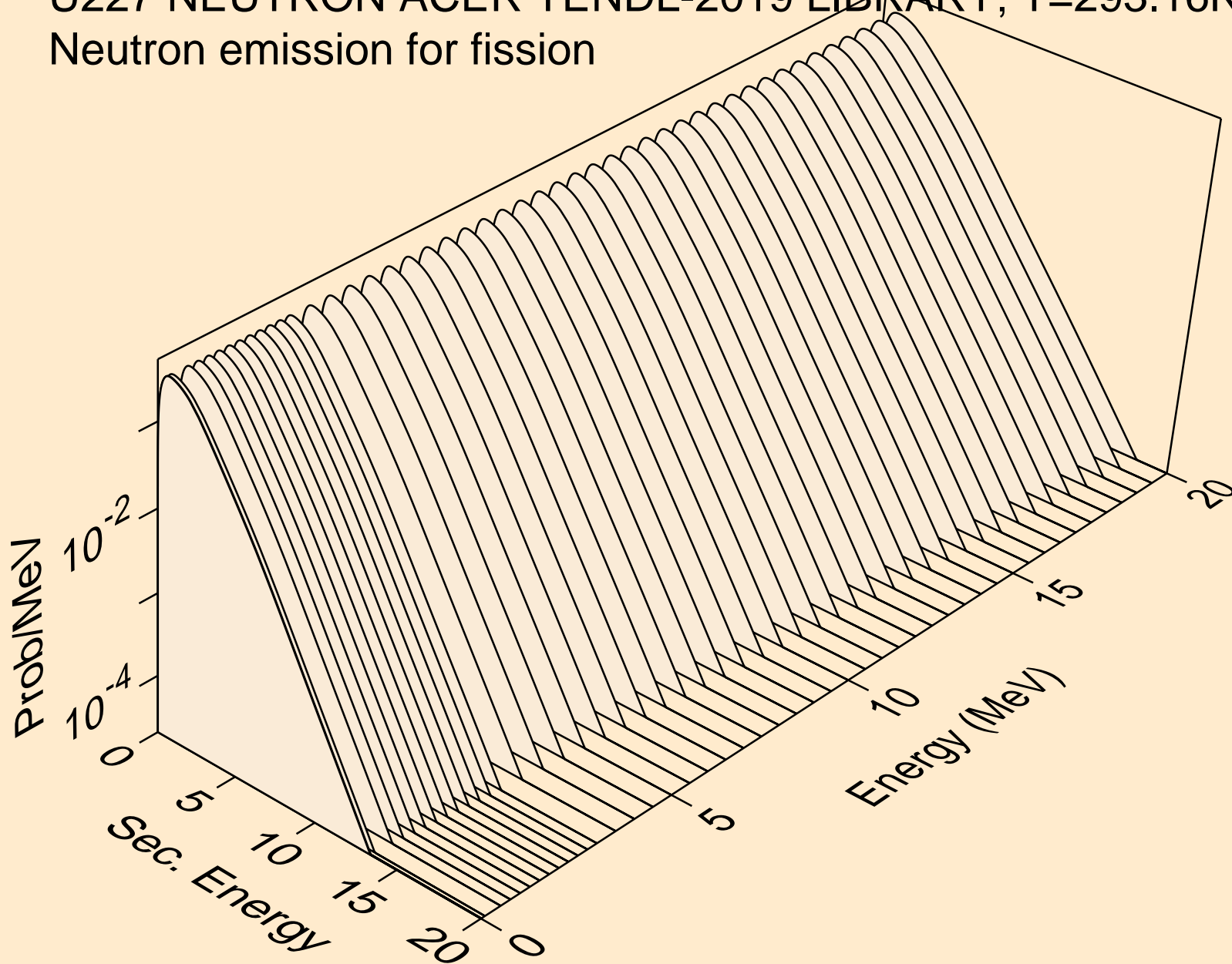

U227 NEUTRON ACER TENDL-2019 LIBRARY; T=293.16K
Neutron emission for (n,n*)a

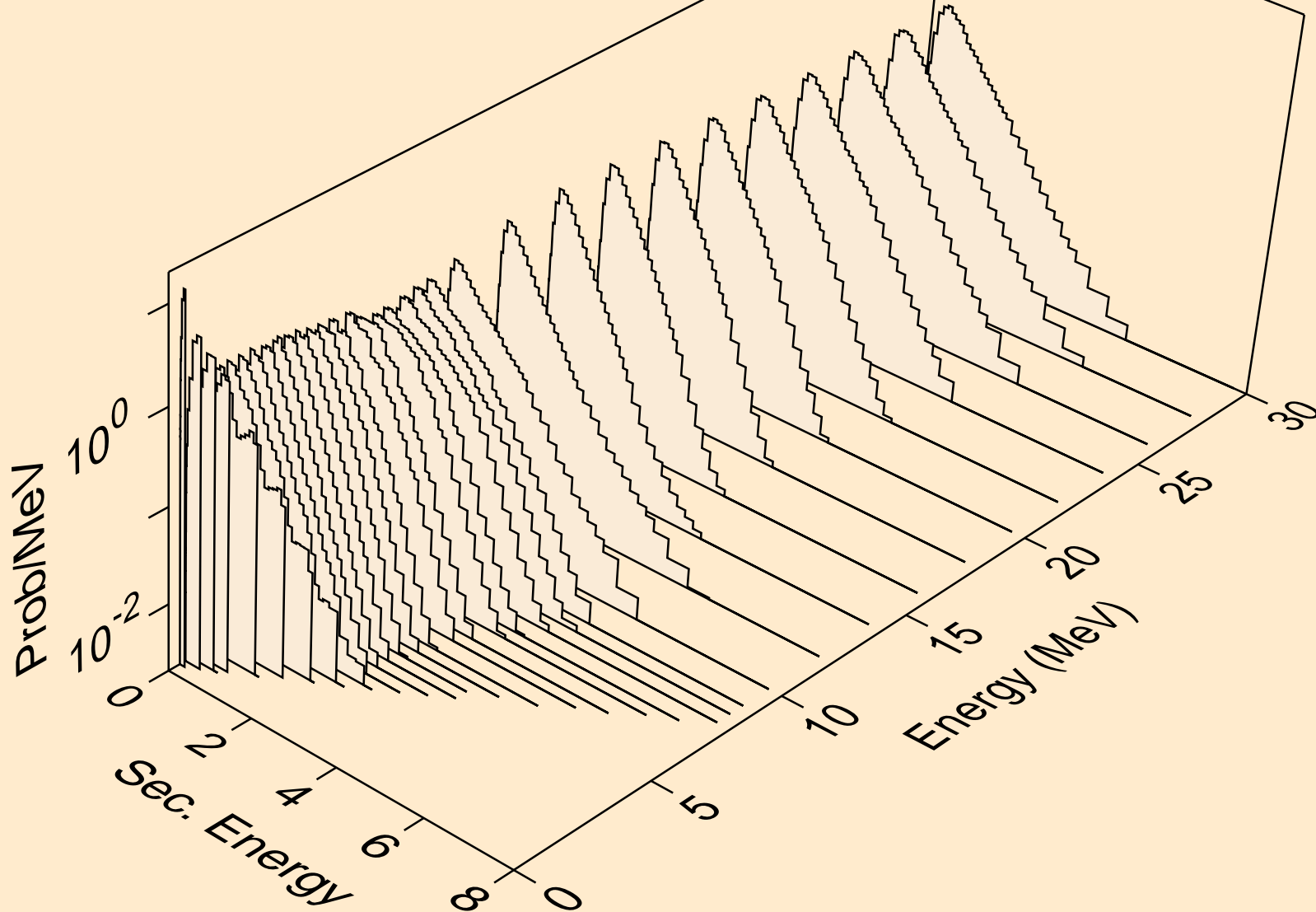

U227 NEUTRON ACER TENDL-2019 LIBRARY; T=293.16K
Neutron emission for (n,2n)a

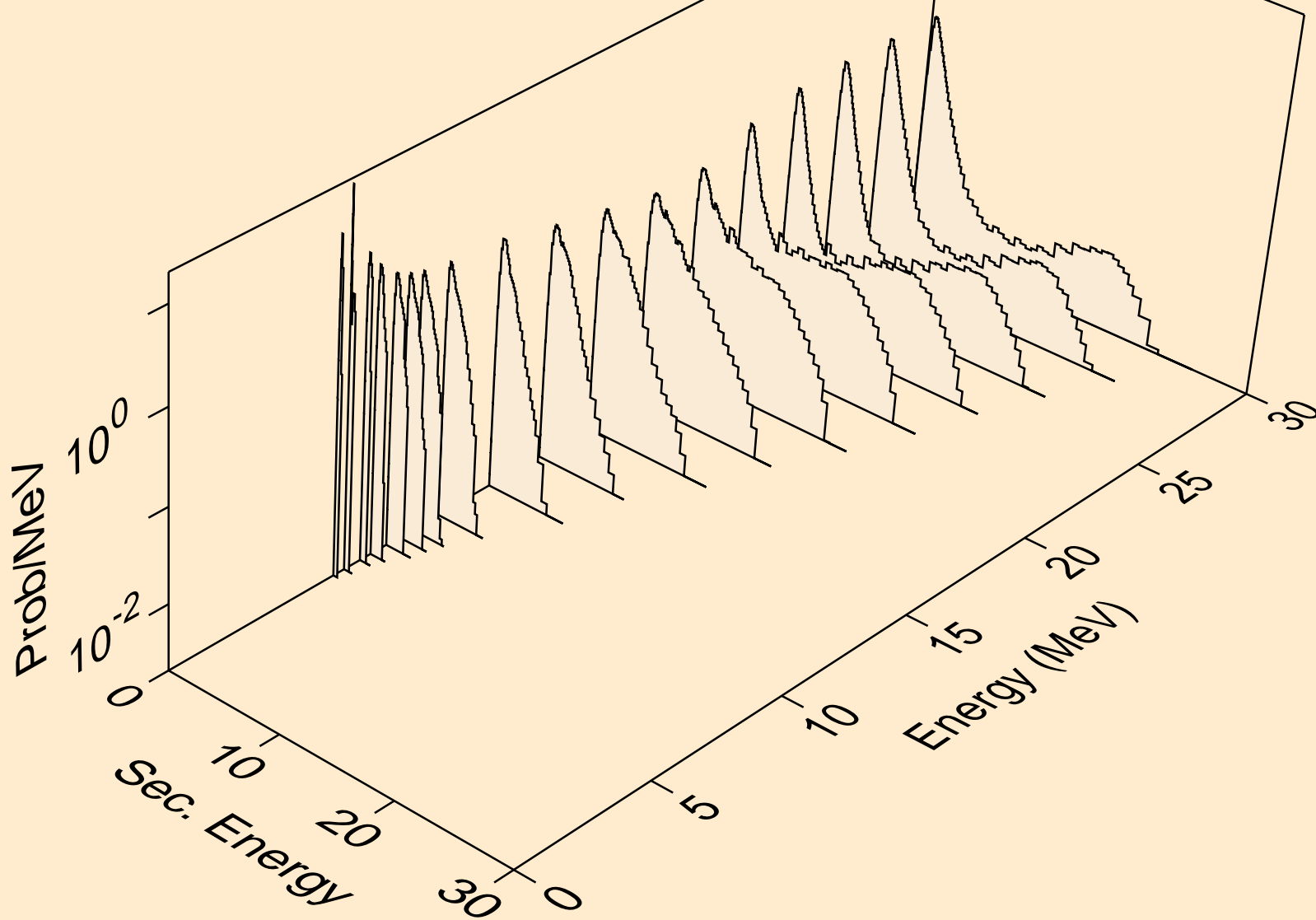

U227 NEUTRON ACER TENDL-2019 LIBRARY; T=293.16K
Neutron emission for (n,3n)a

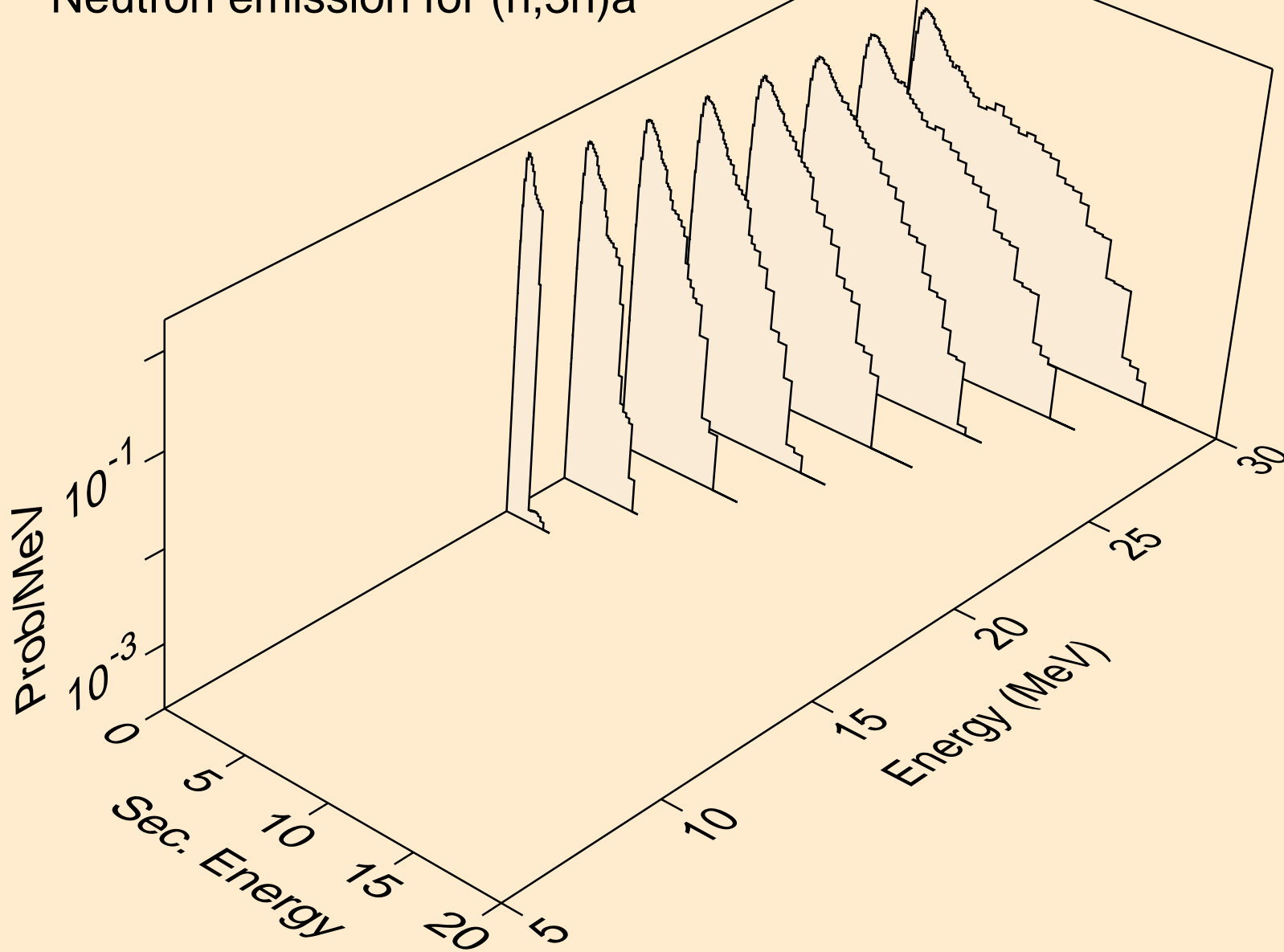

U227 NEUTRON ACER TENDL-2019 LIBRARY; T=293.16K
Neutron emission for (n,n*)p

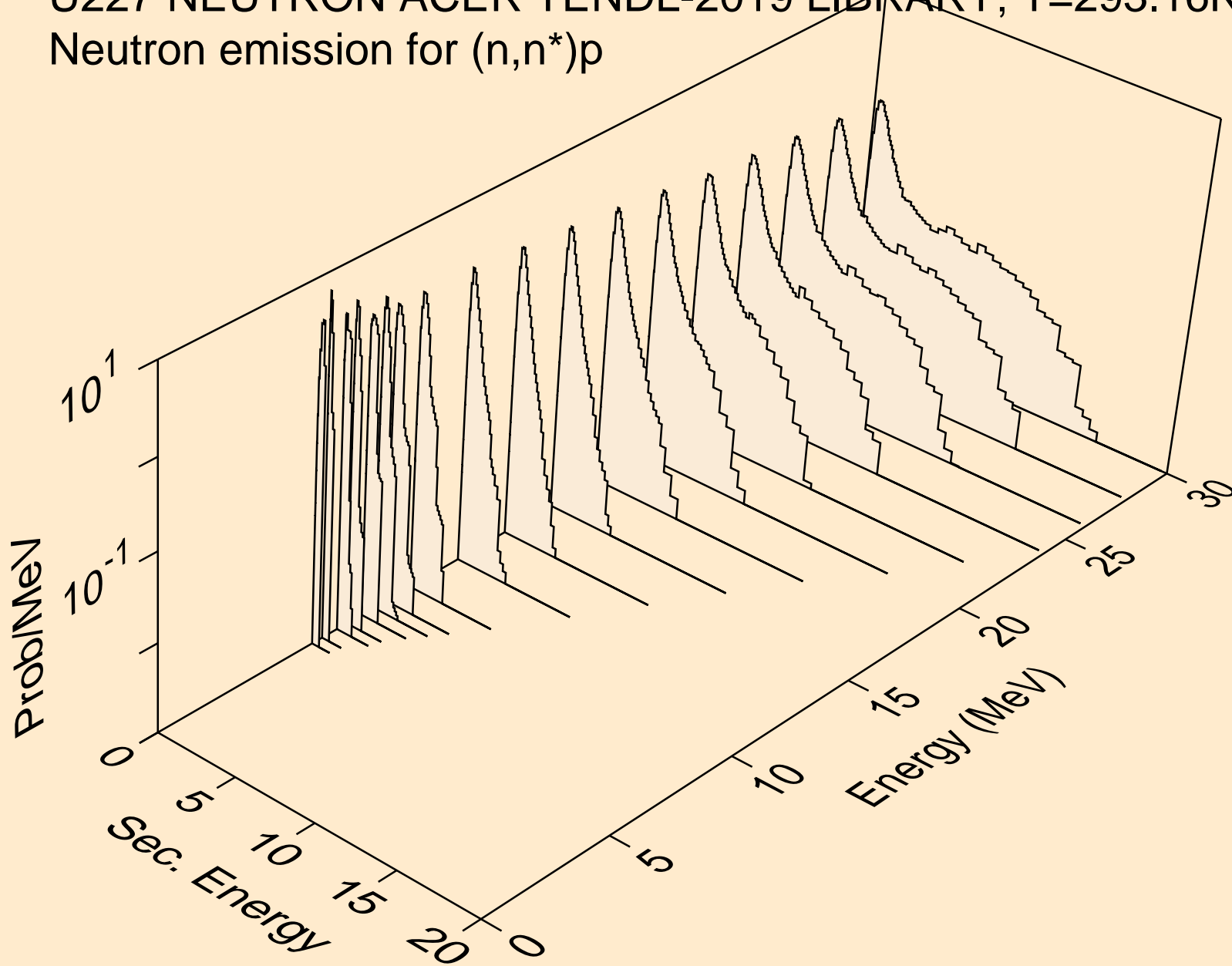

U227 NEUTRON ACER TENDL-2019 LIBRARY; T=293.16K
Neutron emission for (n,n*)2a

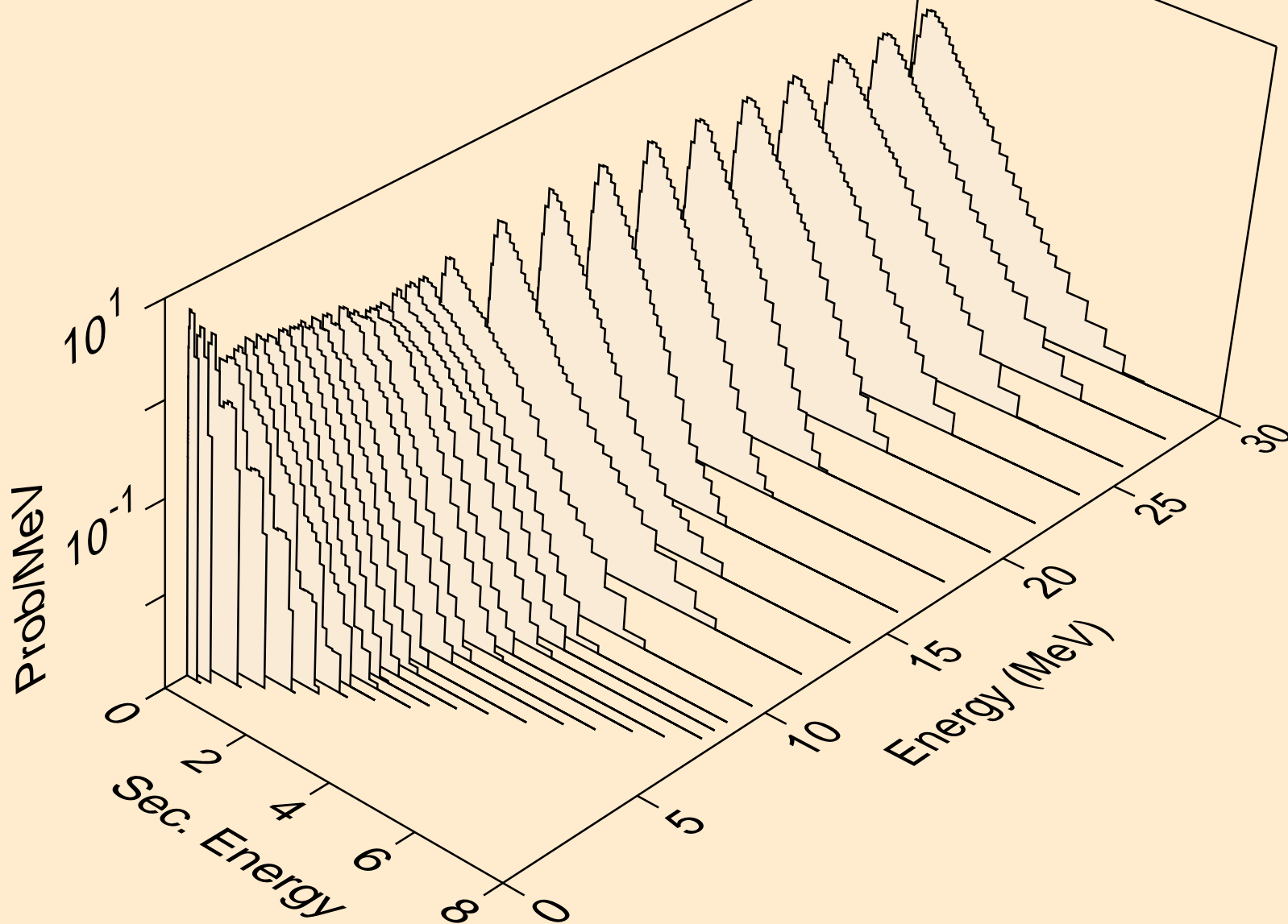

U227 NEUTRON ACER TENDL-2019 LIBRARY; T=293.16K
Neutron emission for (n,2n)2a

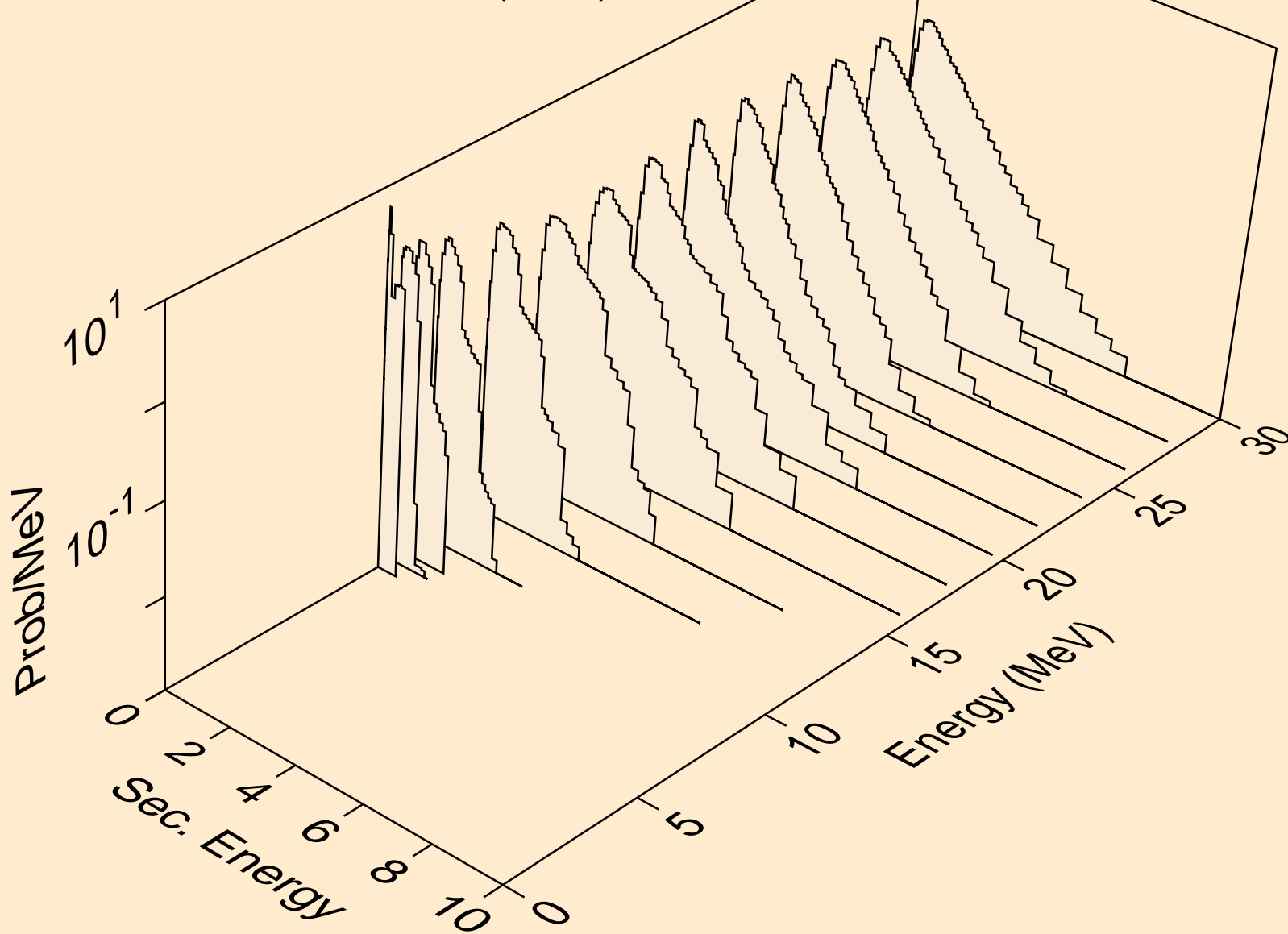

U227 NEUTRON ACER TENDL-2019 LIBRARY; T=293.16K
Neutron emission for (n,n*)d

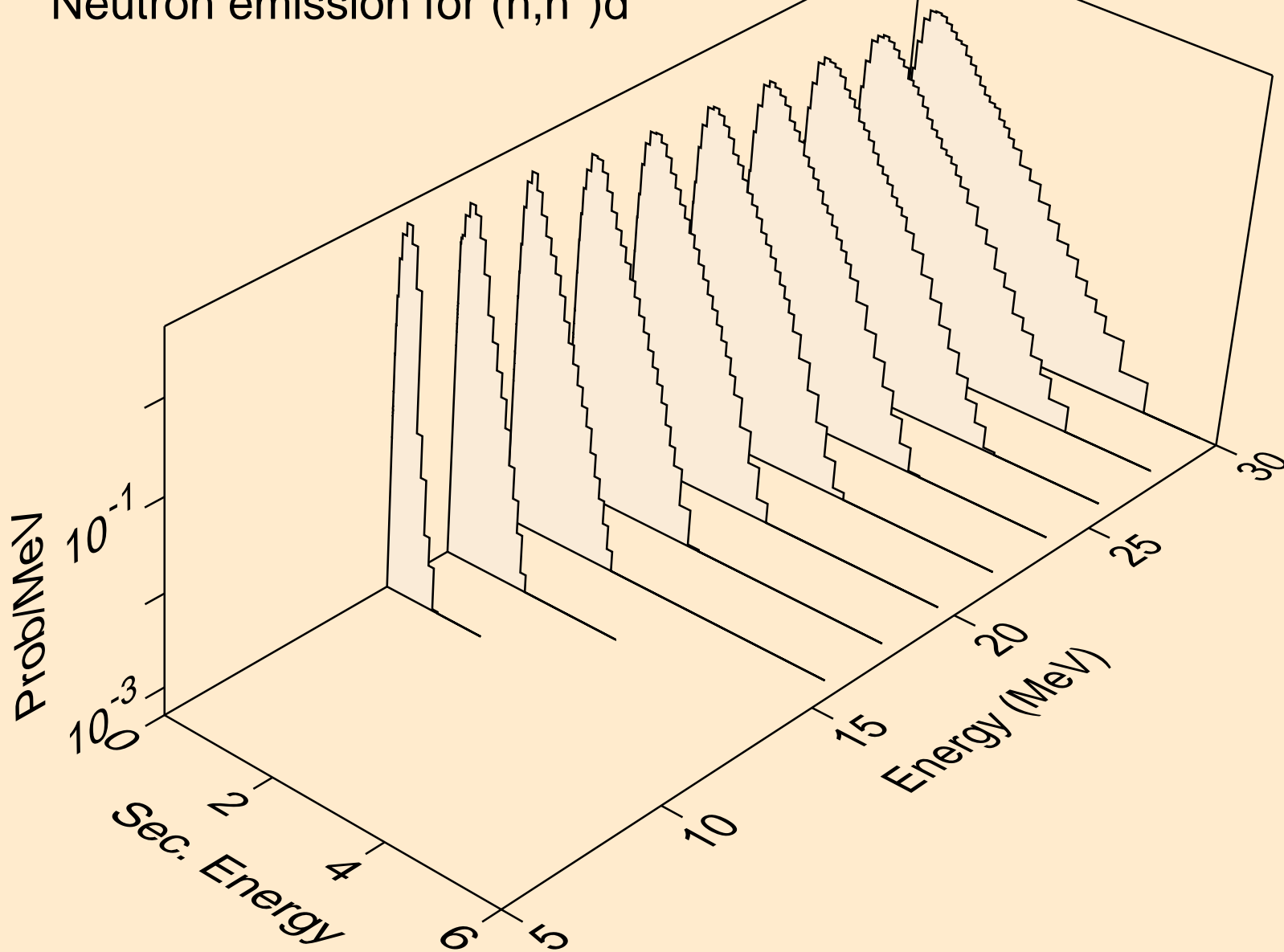

U227 NEUTRON ACER TENDL-2019 LIBRARY; T=293.16K
Neutron emission for (n,n*)t

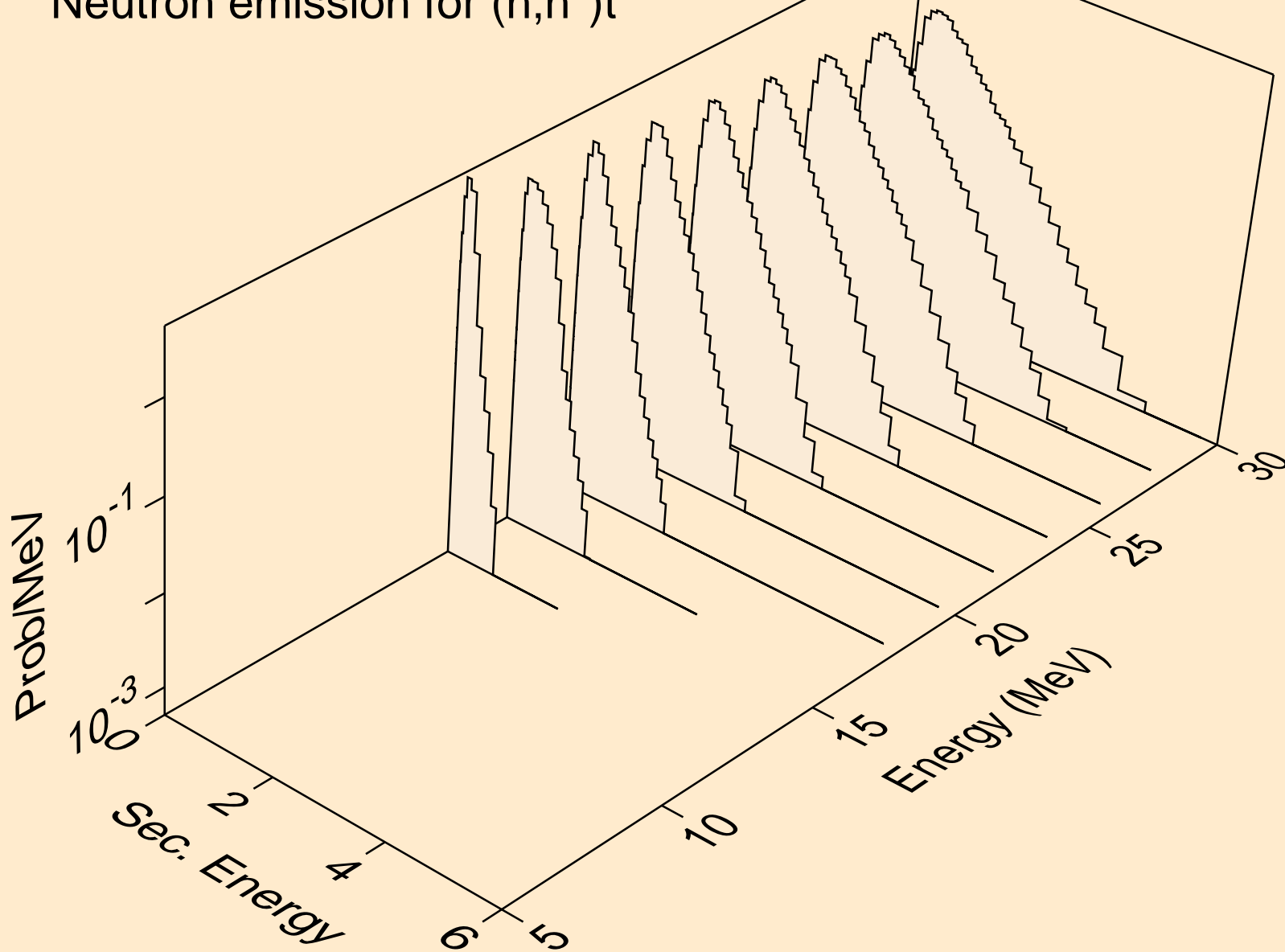

U227 NEUTRON ACER TENDL-2019 LIBRARY; T=293.16K
Neutron emission for (n,n*)he3

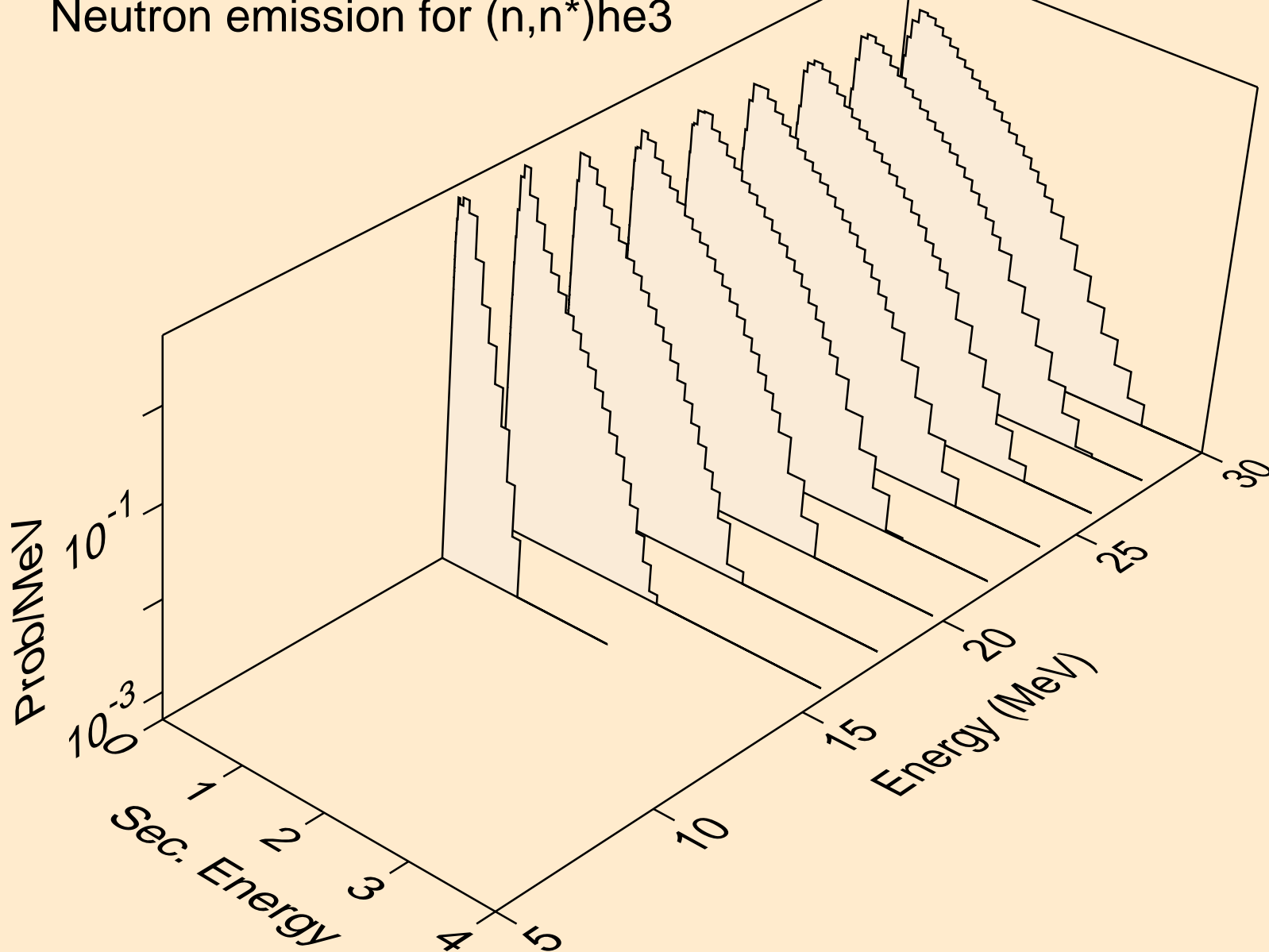

U227 NEUTRON ACER TENDL-2019 LIBRARY; T=293.16K
Neutron emission for (n,n*)t2a

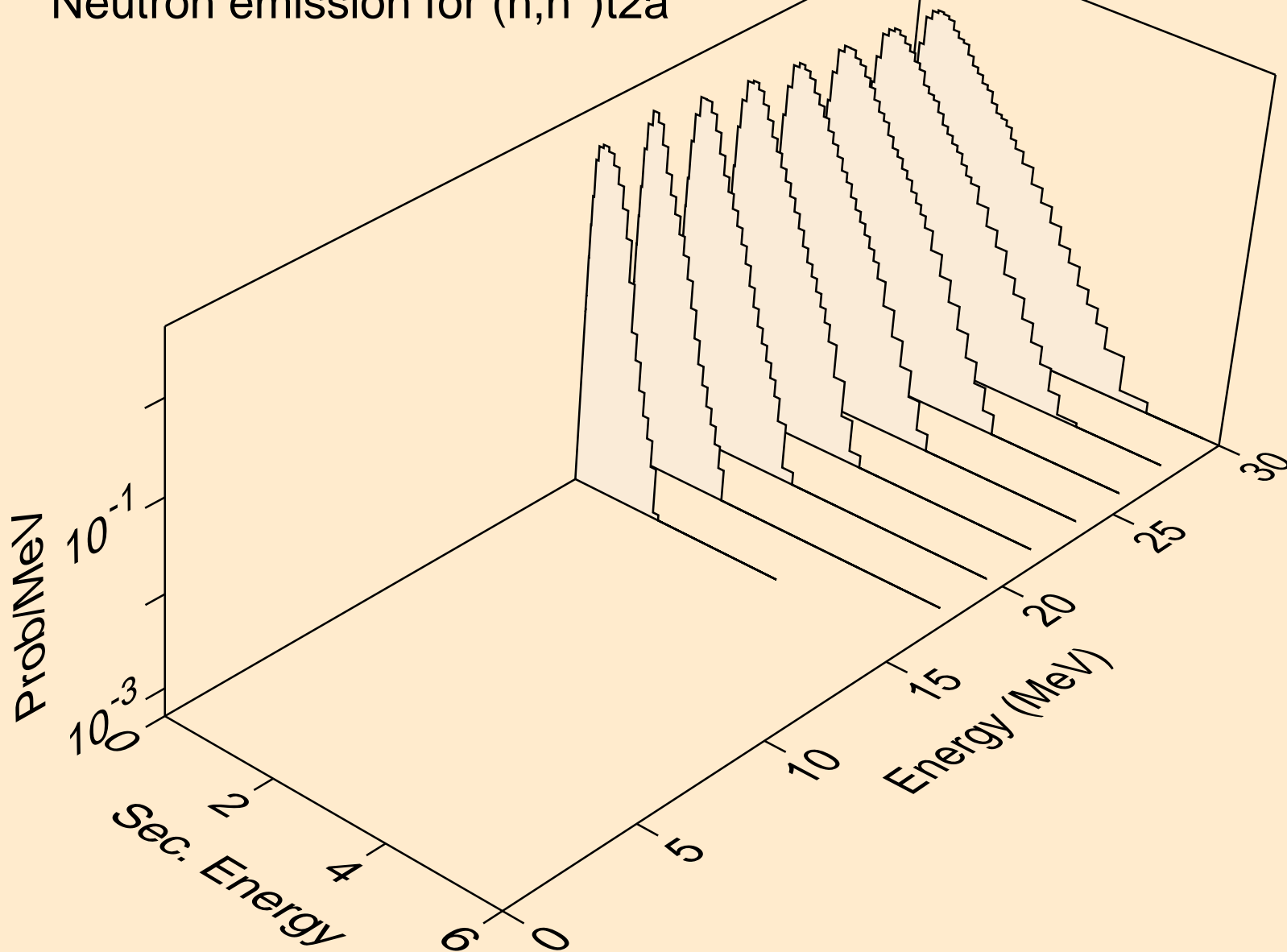

U227 NEUTRON ACER TENDL-2019 LIBRARY; T=293.16K
Neutron emission for (n,4n)

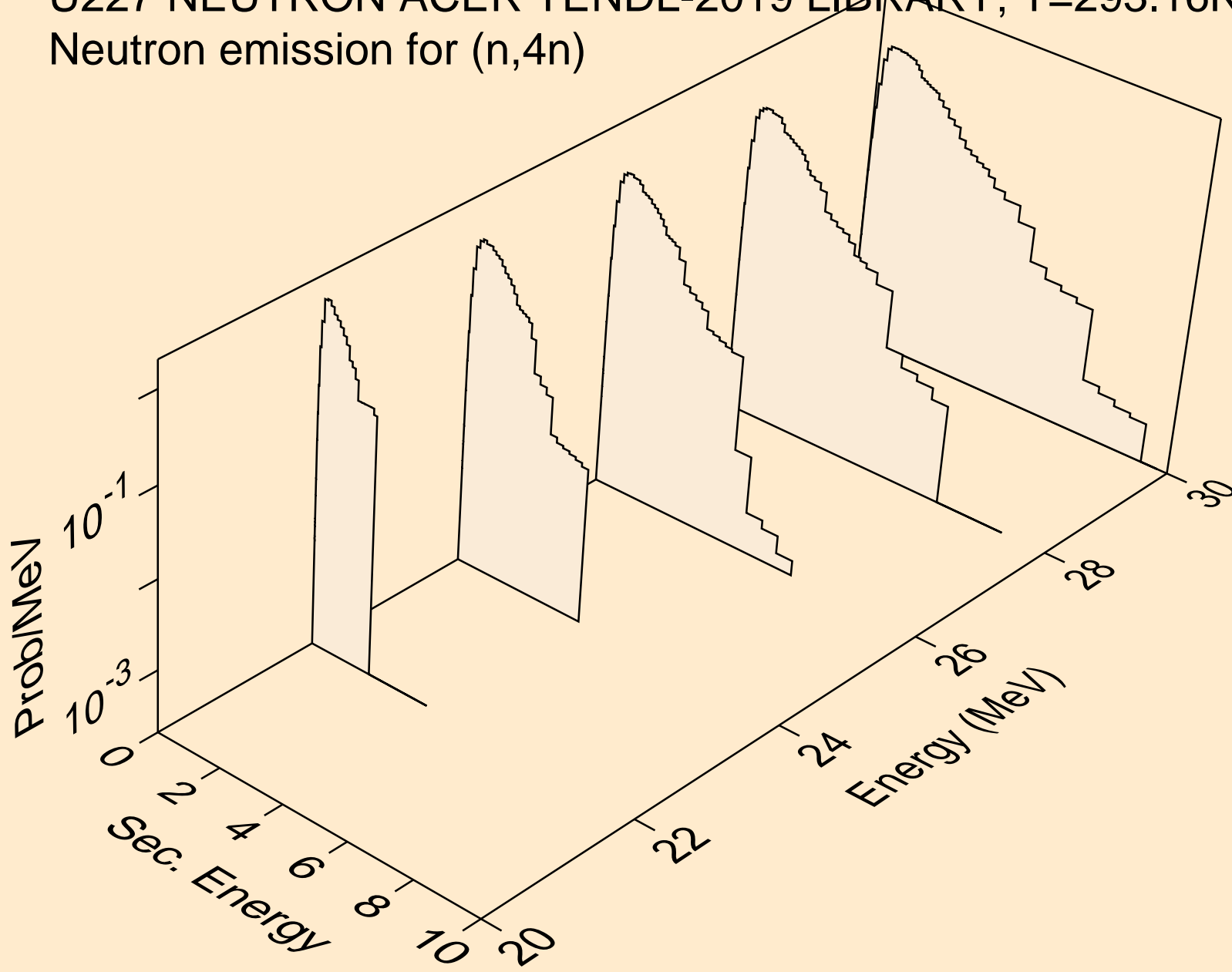

U227 NEUTRON ACER TENDL-2019 LIBRARY; T=293.16K
Neutron emission for (n,2np)

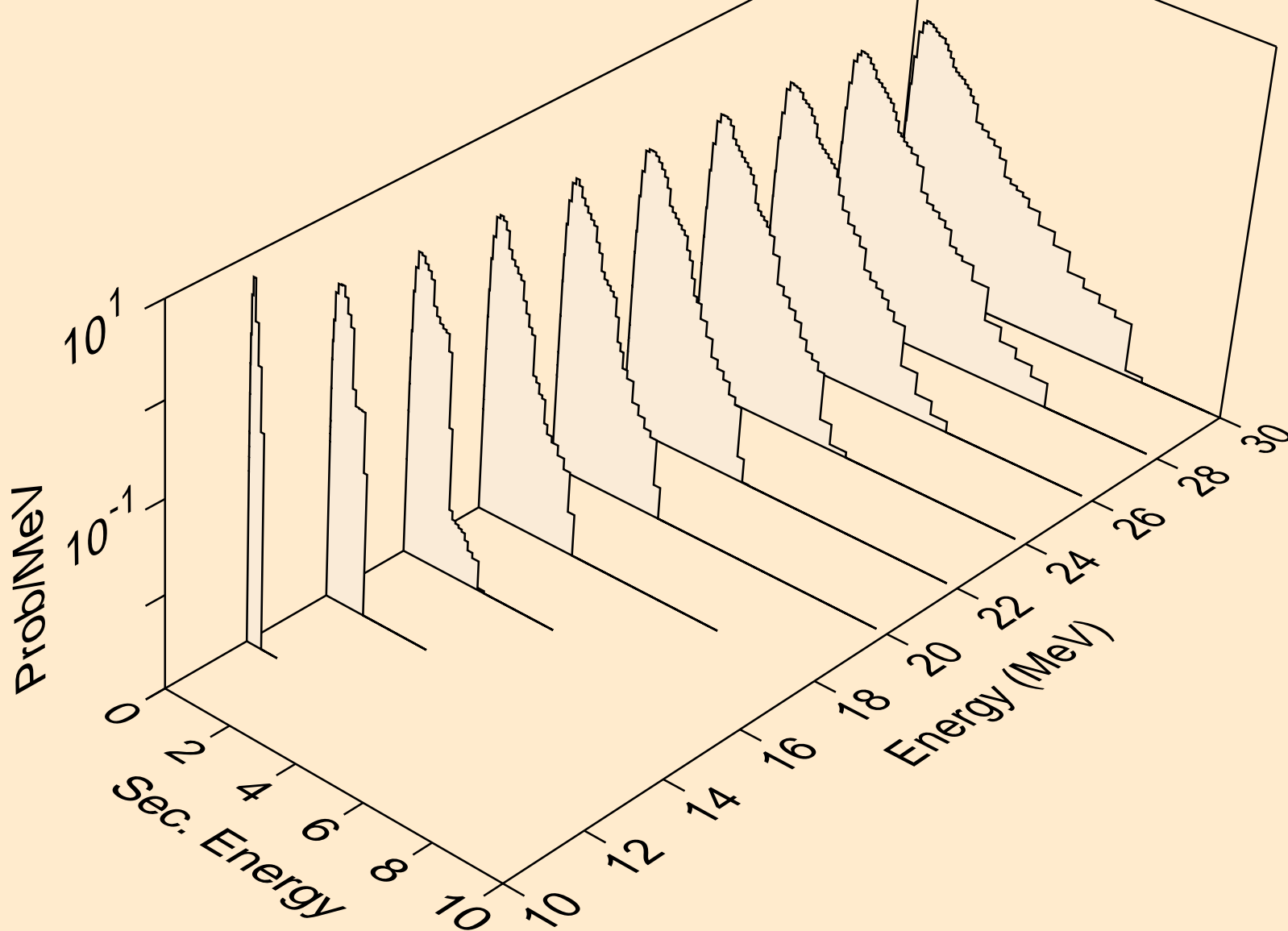

U227 NEUTRON ACER TENDL-2019 LIBRARY; T=293.16K
Neutron emission for (n,3np)

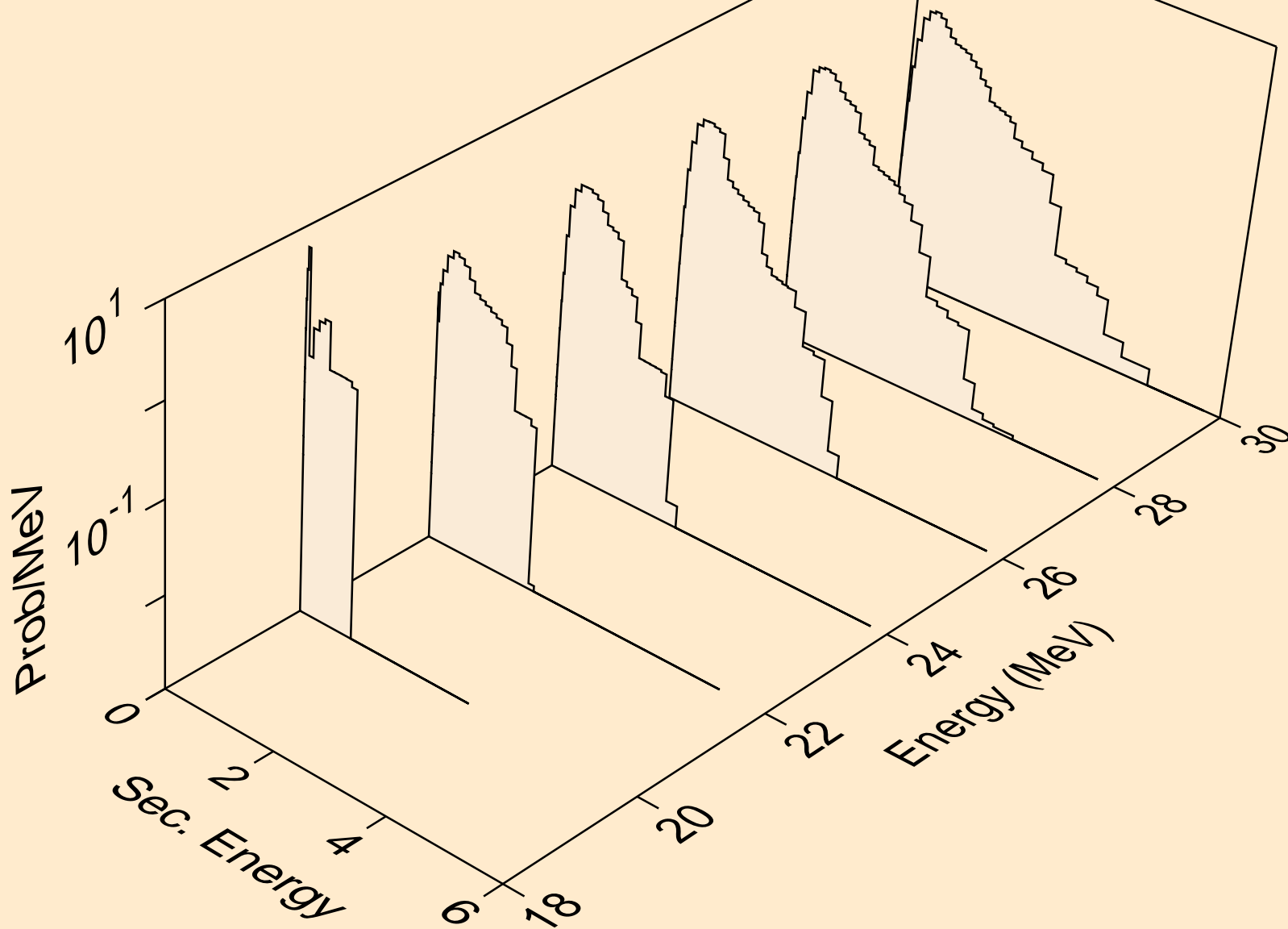

U227 NEUTRON ACER TENDL-2019 LIBRARY; T=293.16K
Neutron emission for (n,2np)

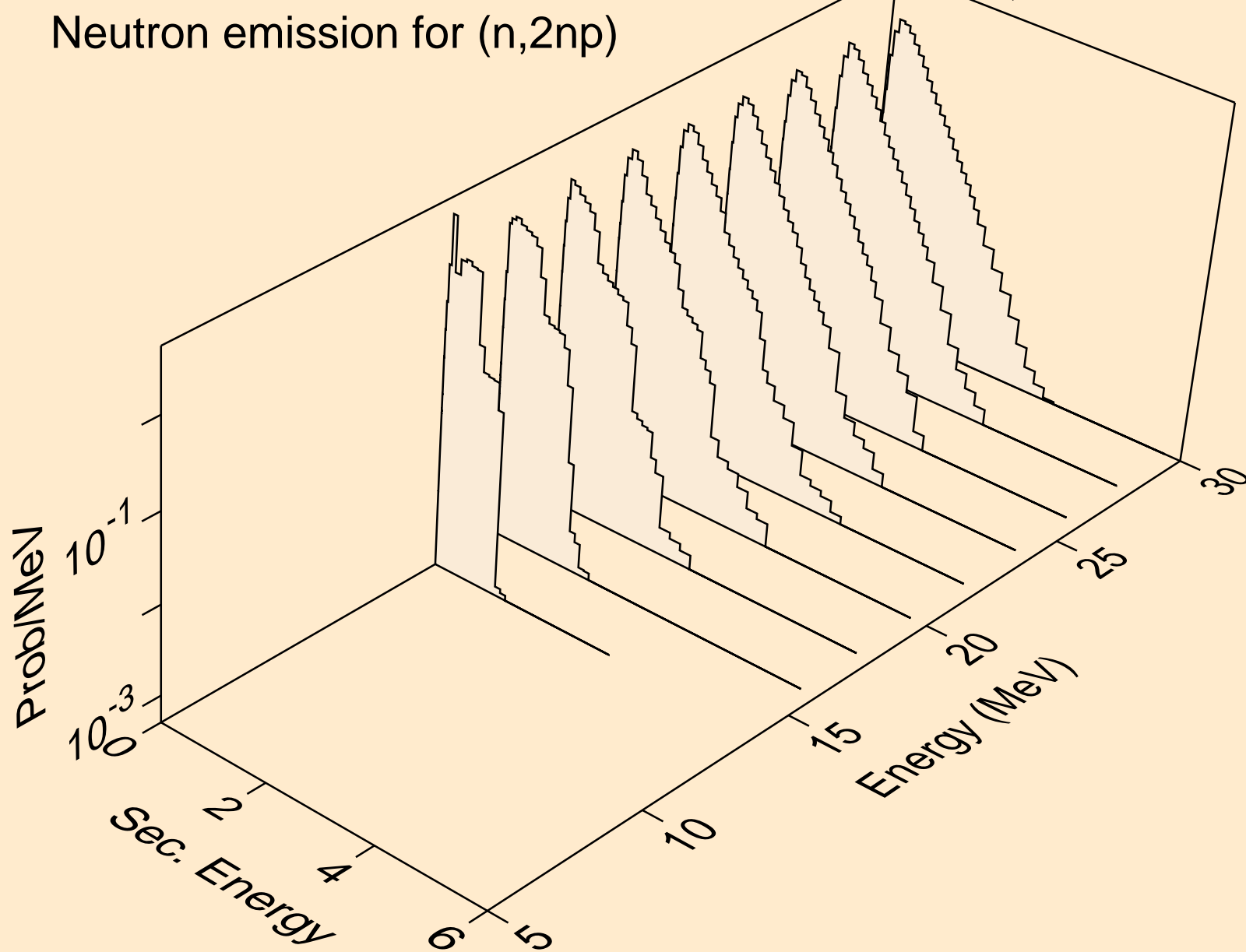

U227 NEUTRON ACER TENDL-2019 LIBRARY; T=293.16K
Neutron emission for (n,npa)

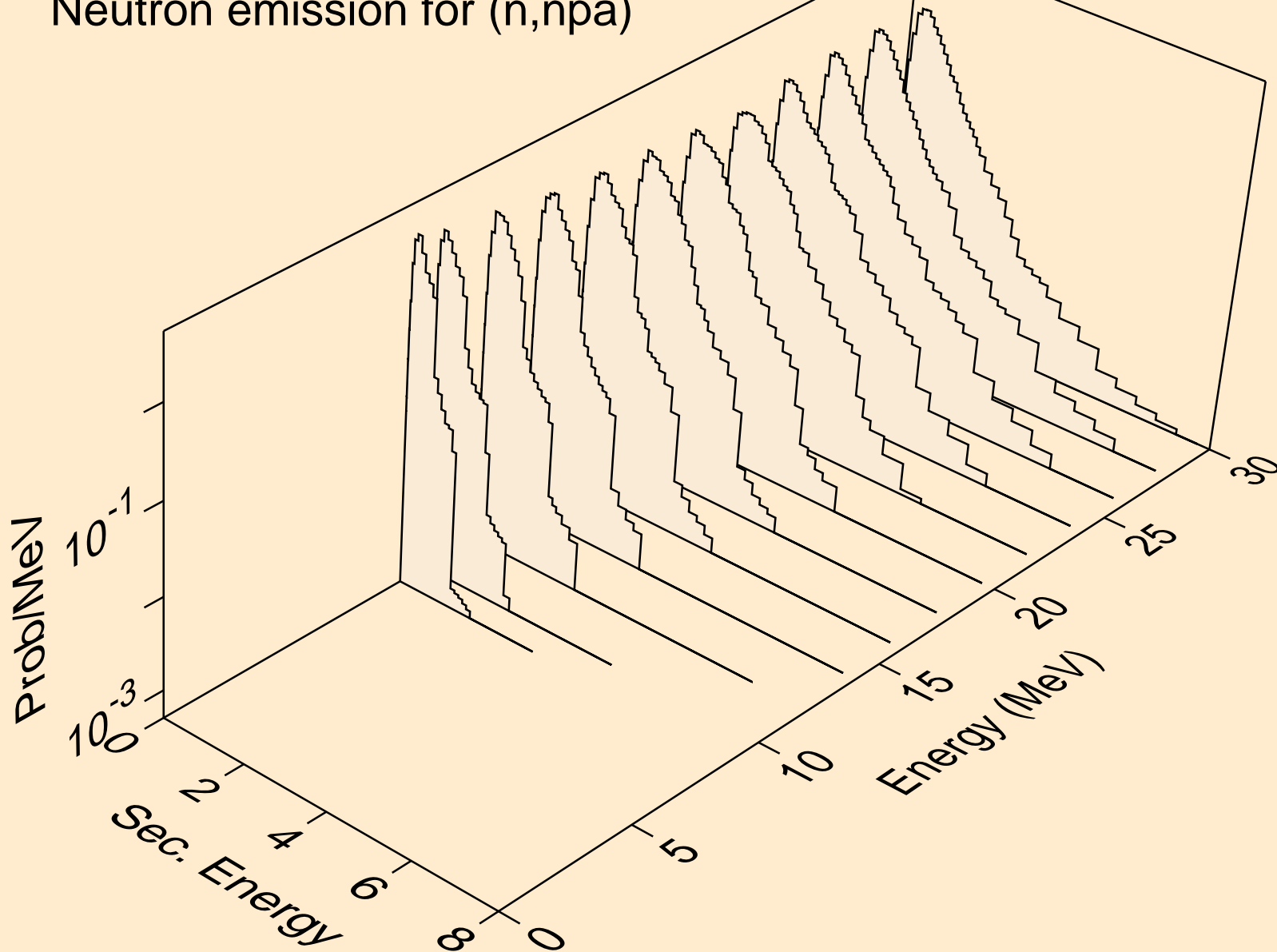

U227 NEUTRON ACER TENDL-2019 LIBRARY; T=293.16K
Neutron emission for (n,n*c)

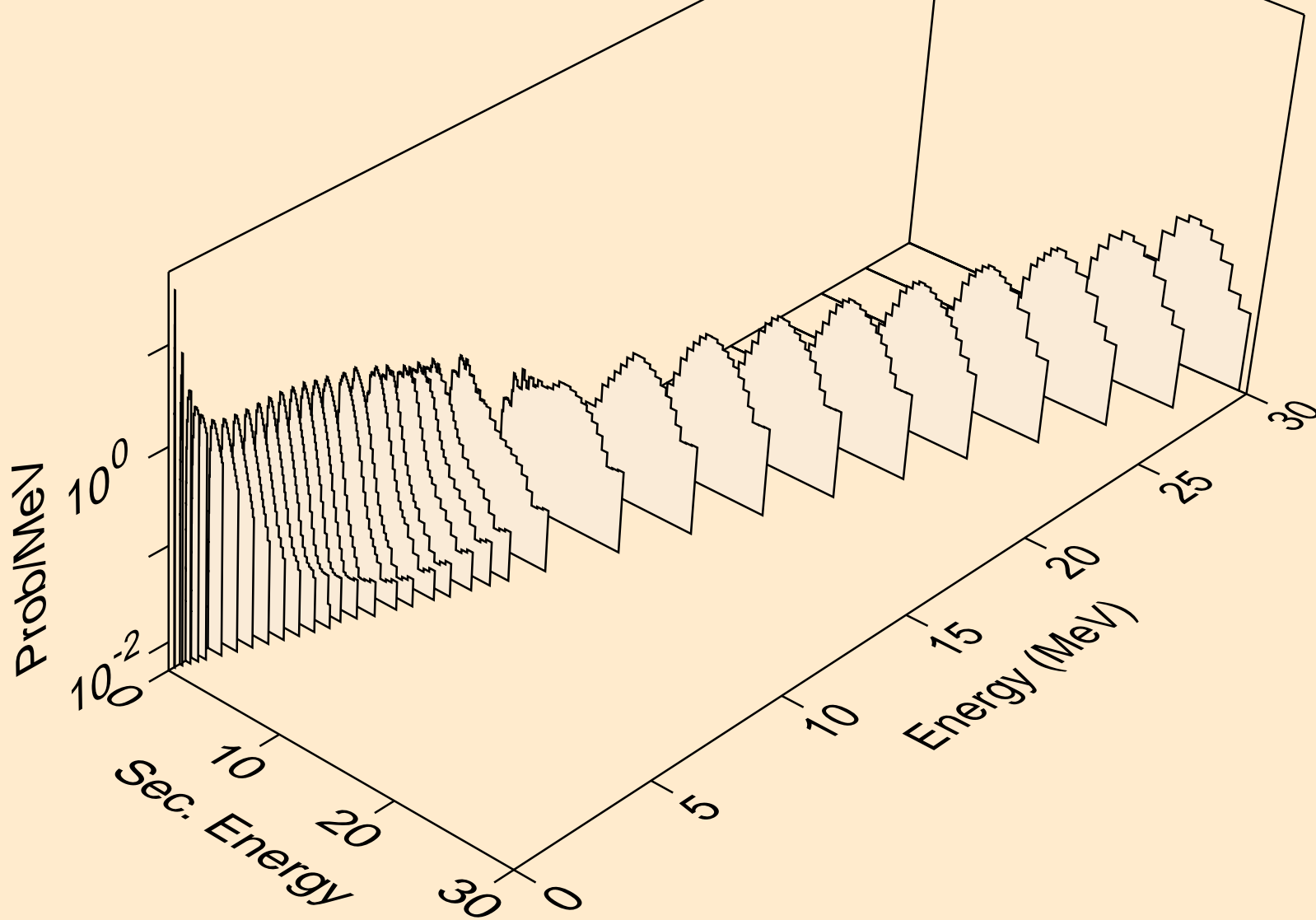

U227 NEUTRON ACER TENDL-2019 LIBRARY; T=293.16K
Delayed nubar

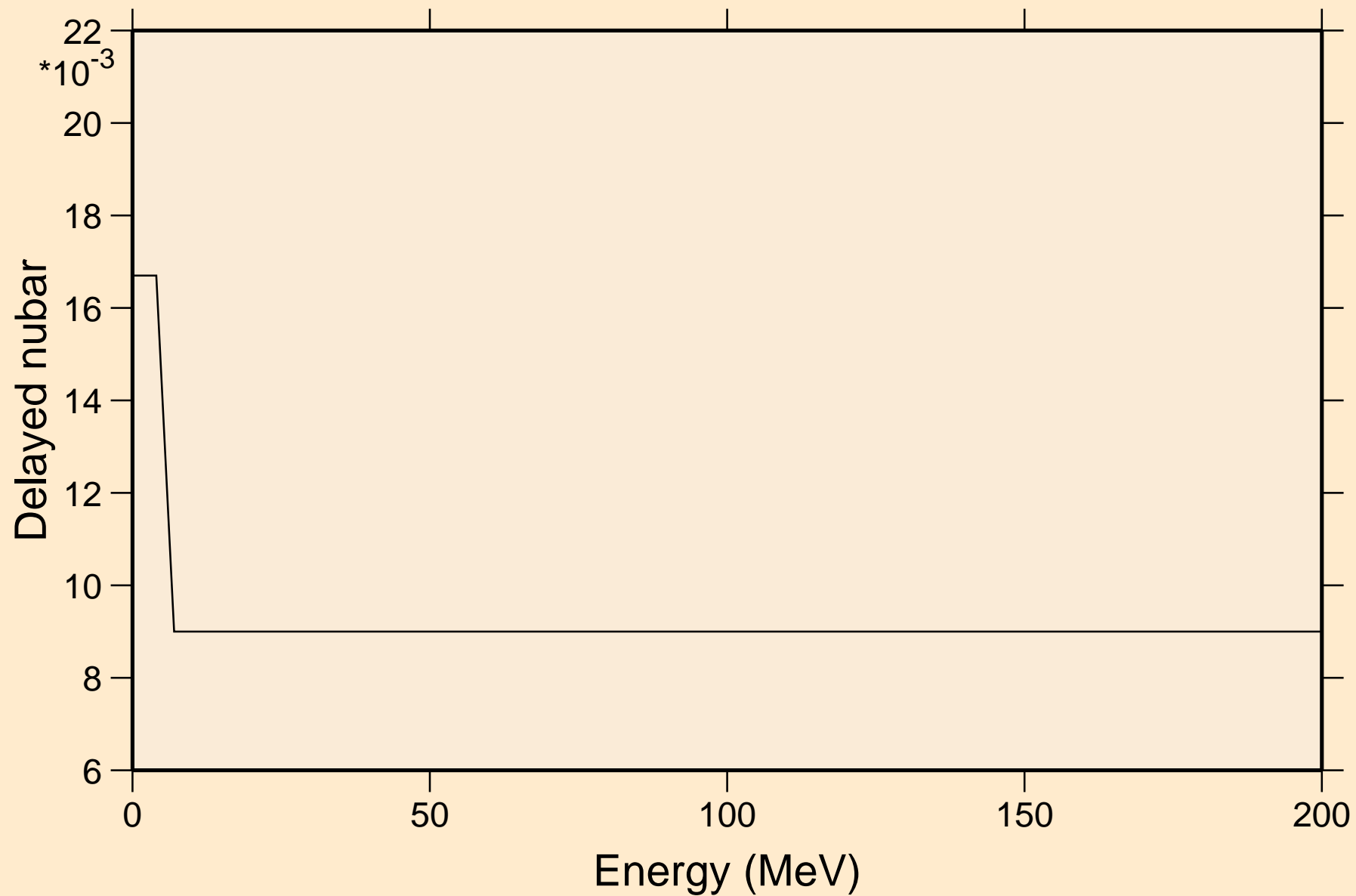

U227 NEUTRON ACER TENDL-2019 LIBRARY; T=293.16K

Delayed neutron spectra

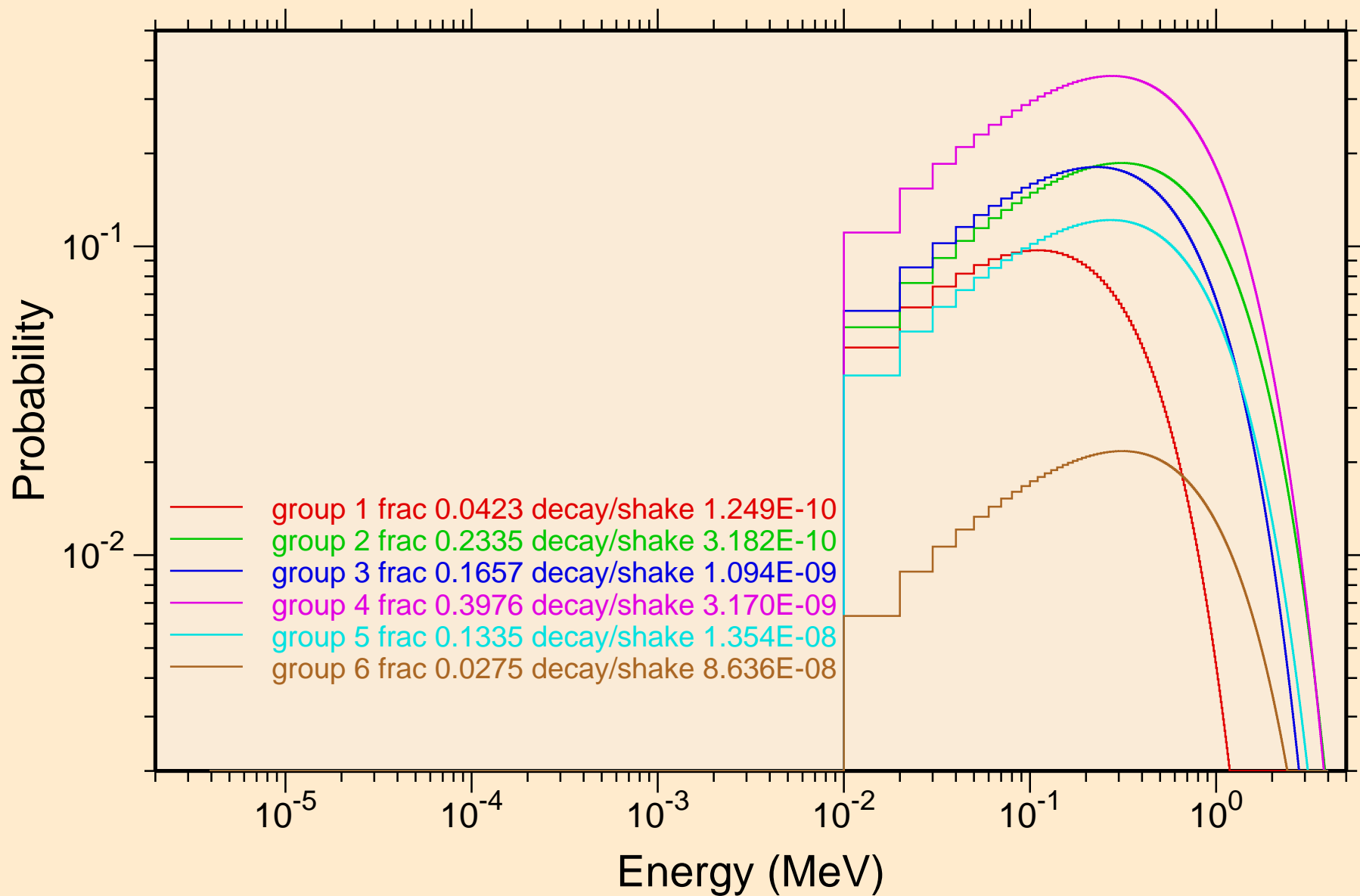

U227 NEUTRON ACER TENDL-2019 LIBRARY; T=293.16K
Photon emission for (n,x)

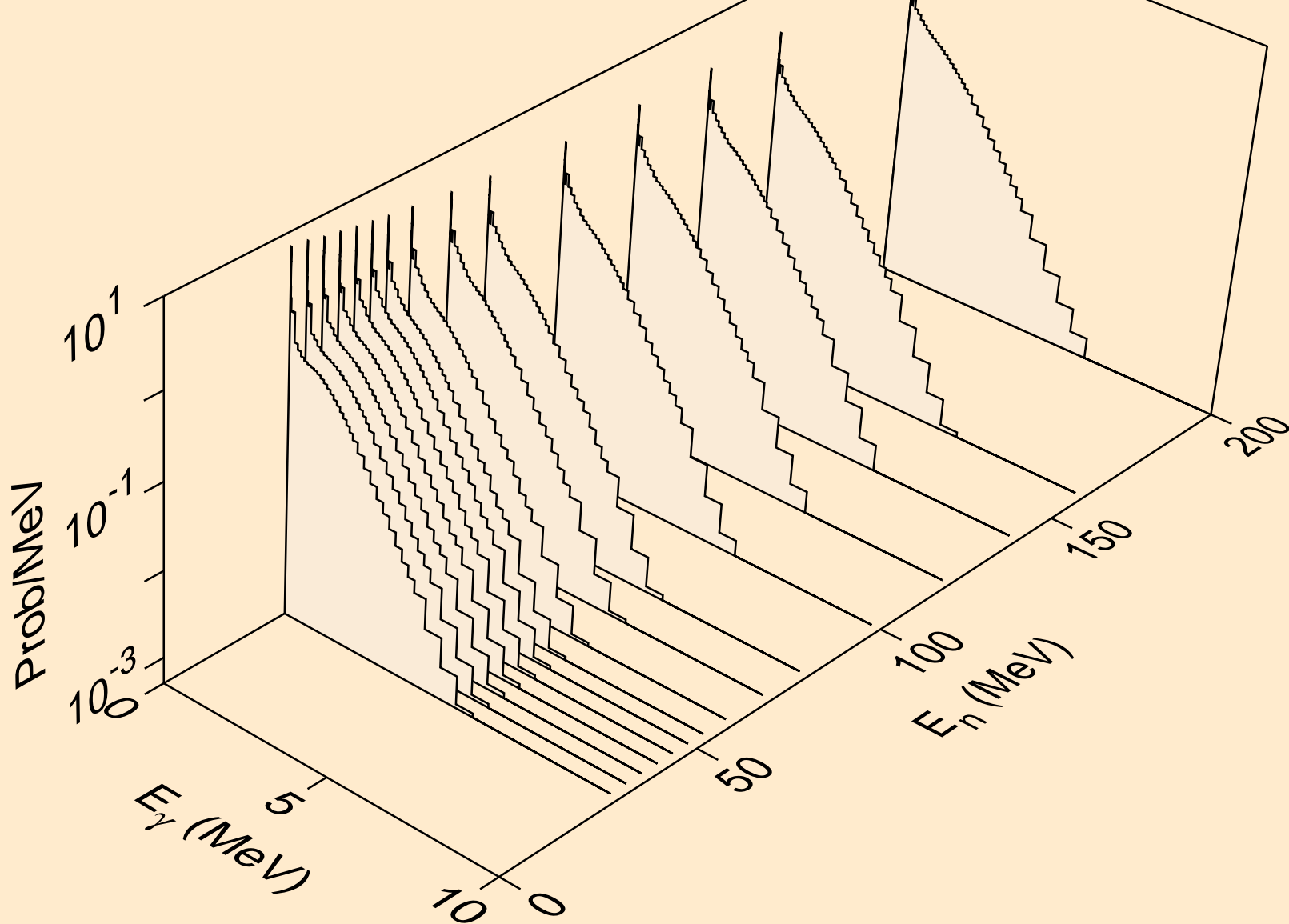

U227 NEUTRON ACER TENDL-2019 LIBRARY; T=293.16K
Photon emission for (n,2nd)

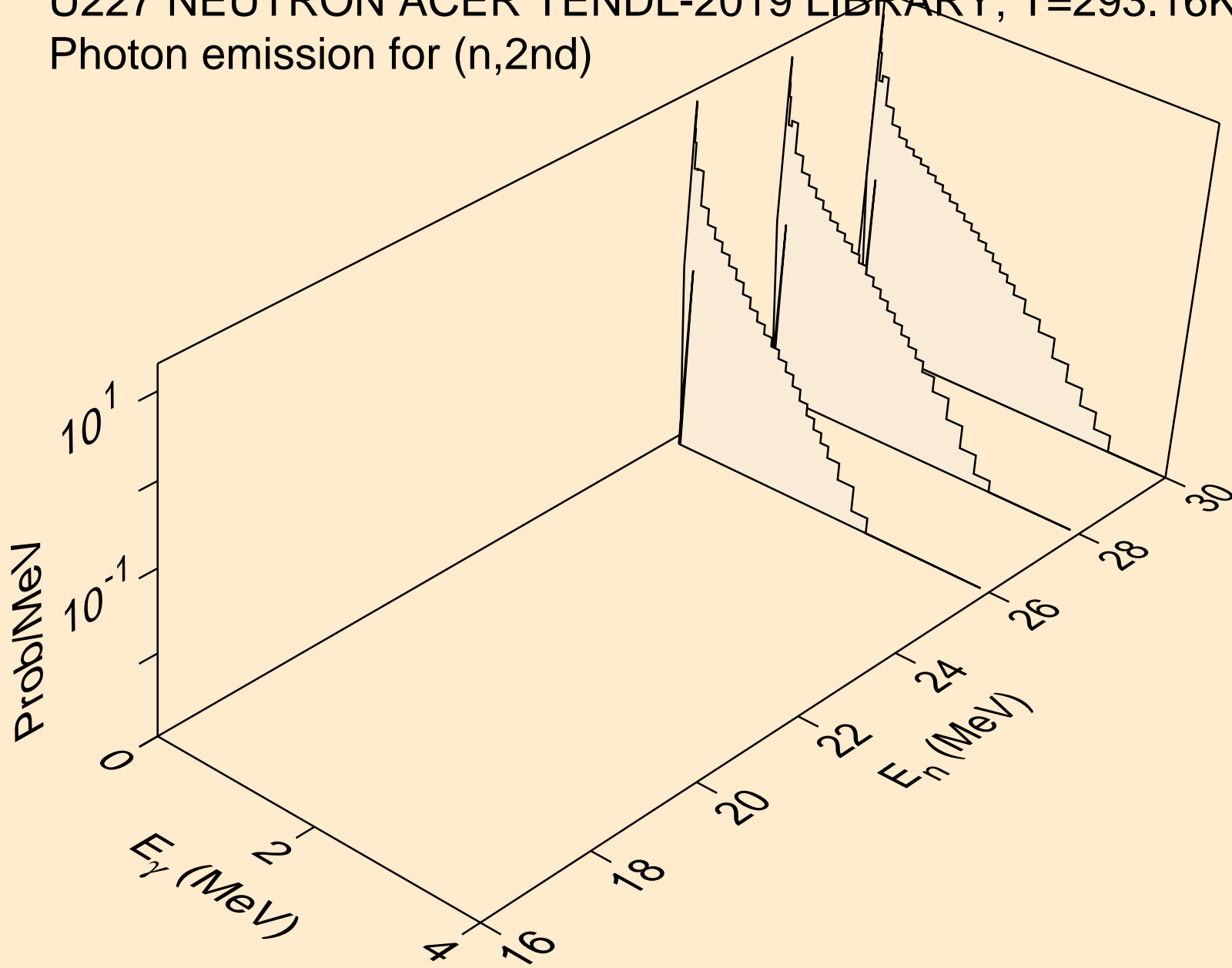

U227 NEUTRON ACER TENDL-2019 LIBRARY; T=293.16K
Photon emission for (n,2n)

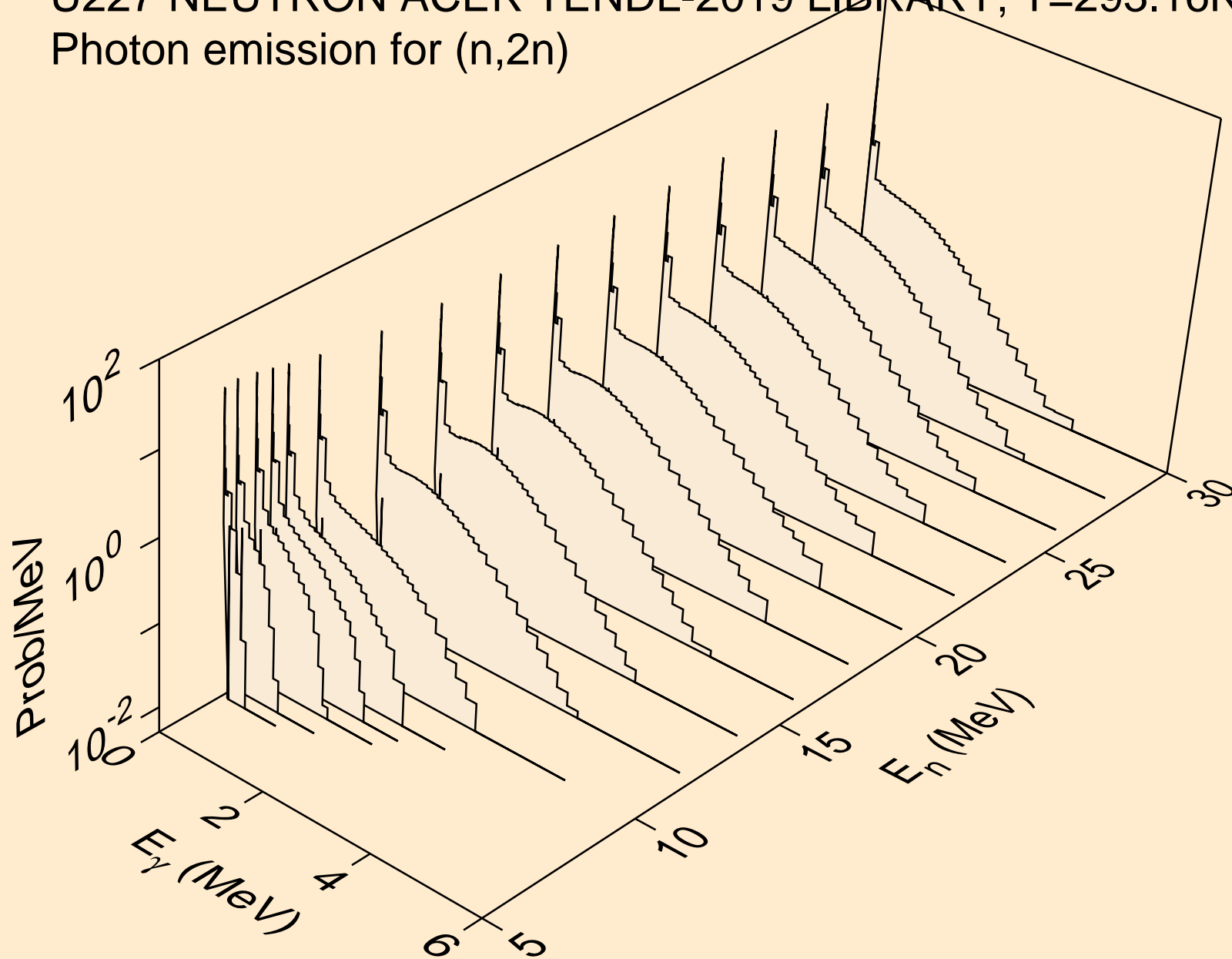

U227 NEUTRON ACER TENDL-2019 LIBRARY; T=293.16K
Photon emission for (n,3n)

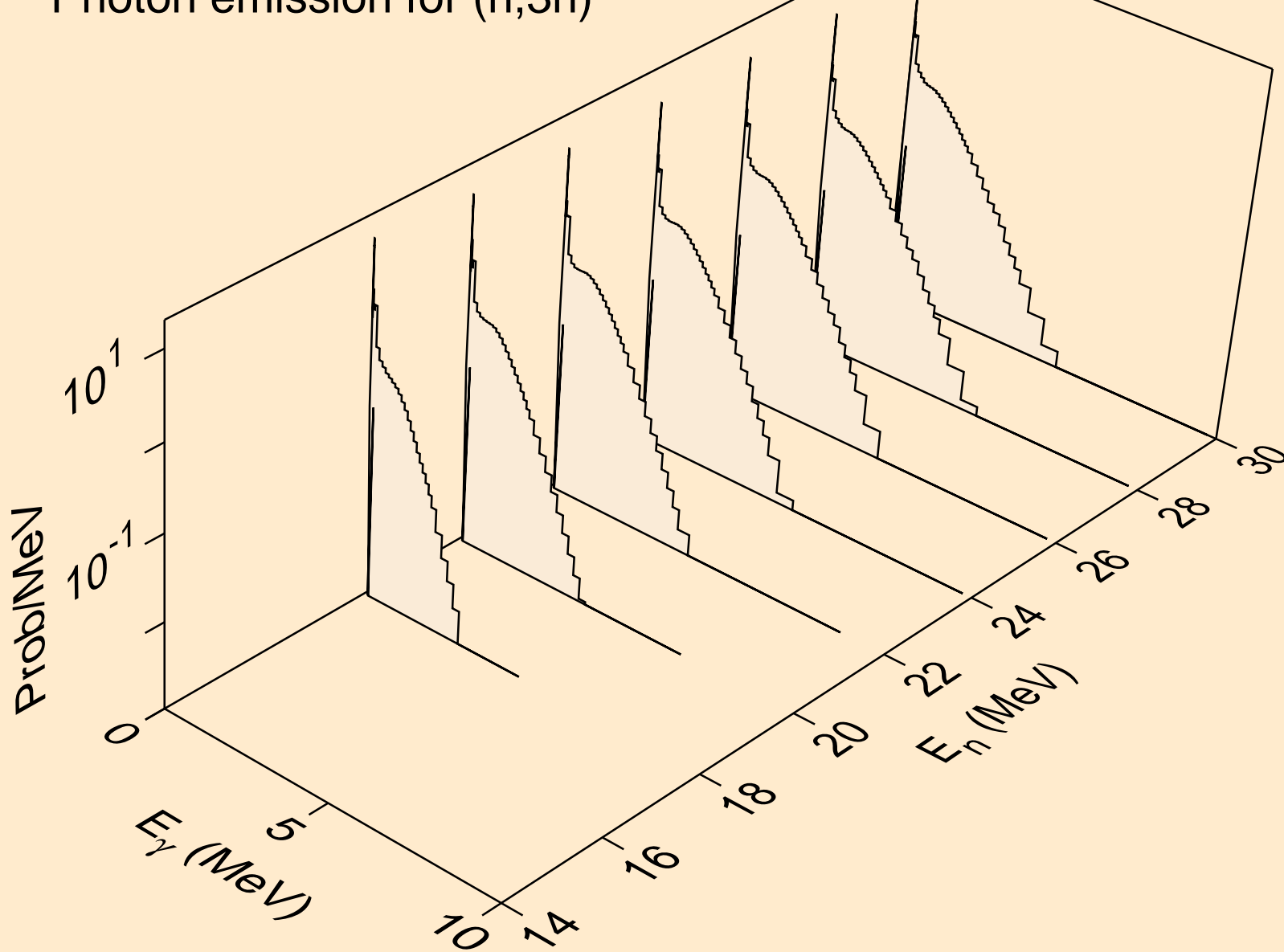

U227 NEUTRON ACER TENDL-2019 LIBRARY; T=293.16K
Photon emission for (n,n*)a

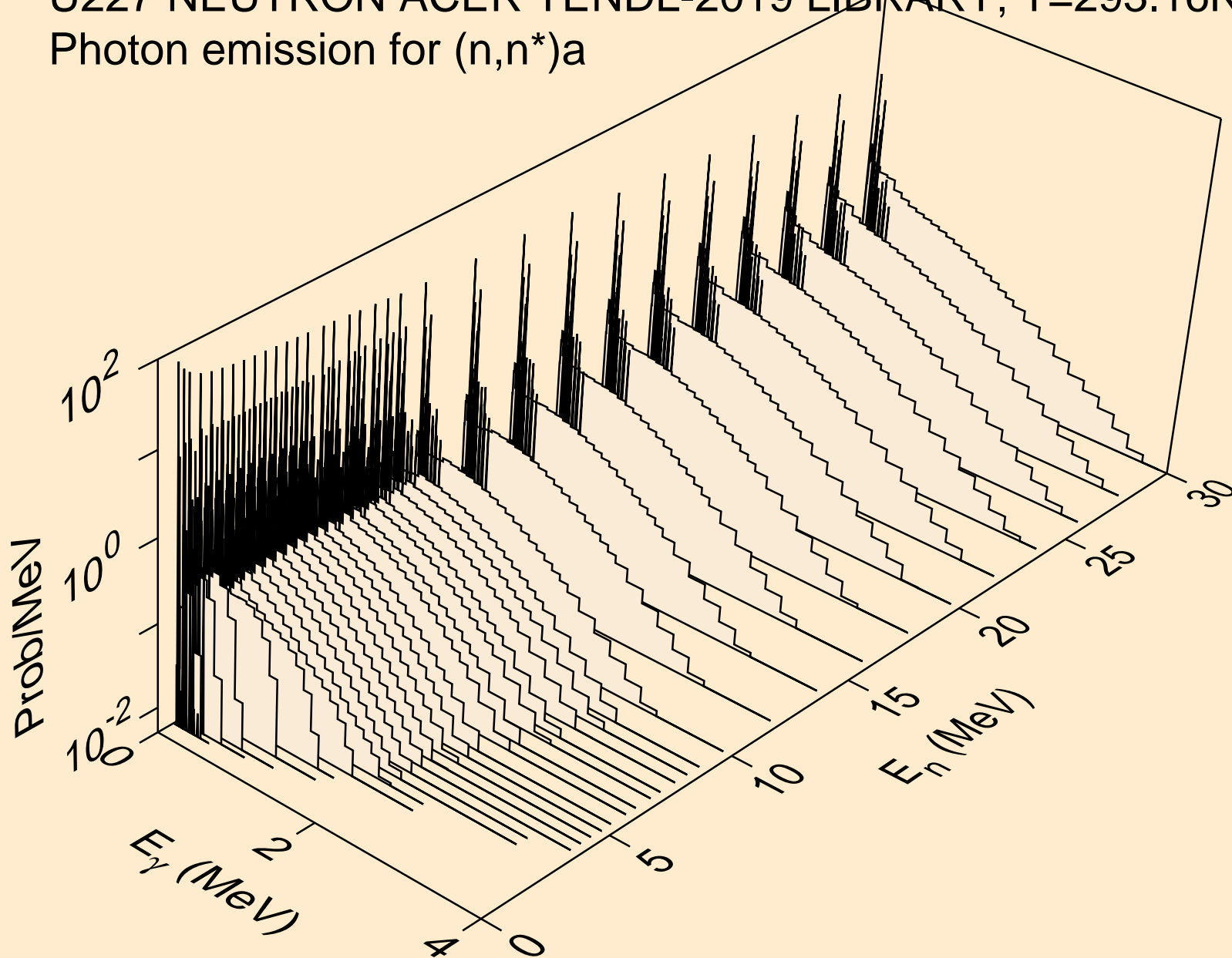

U227 NEUTRON ACER TENDL-2019 LIBRARY; T=293.16K
Photon emission for (n,2n)a

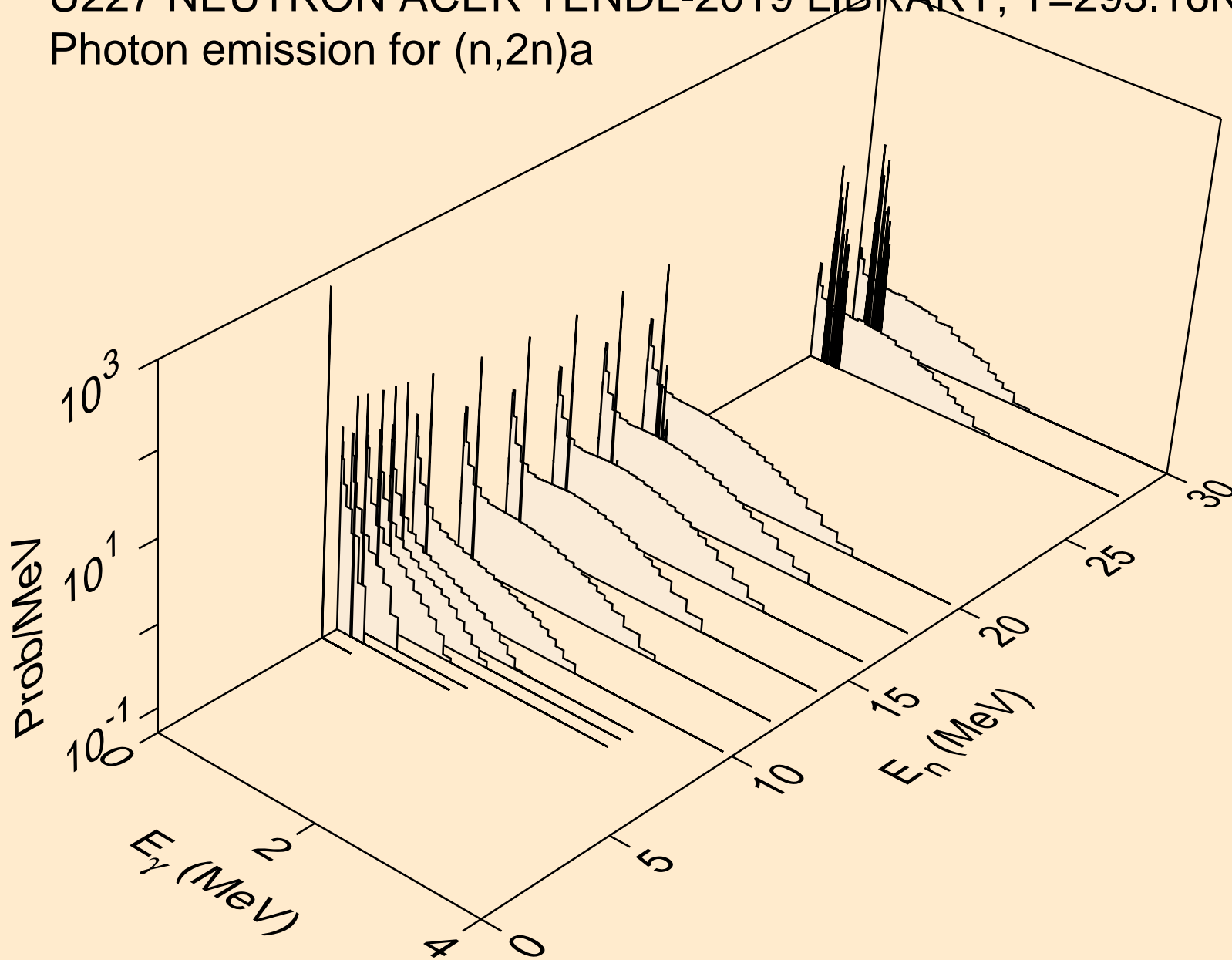

U227 NEUTRON ACER TENDL-2019 LIBRARY; T=293.16K
Photon emission for (n,3n)a

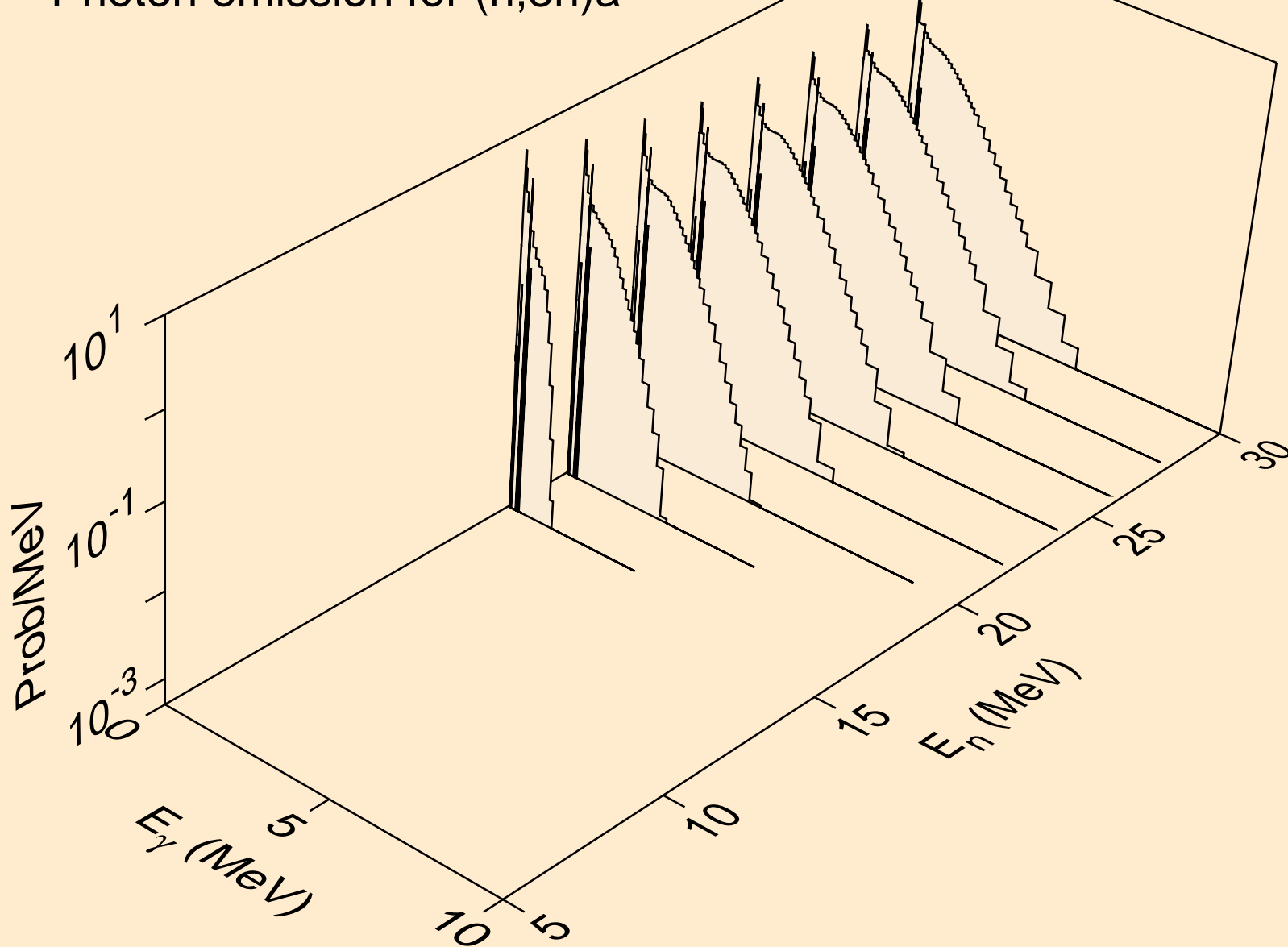

U227 NEUTRON ACER TENDL-2019 LIBRARY; T=293.16K
Photon emission for (n,n*)p

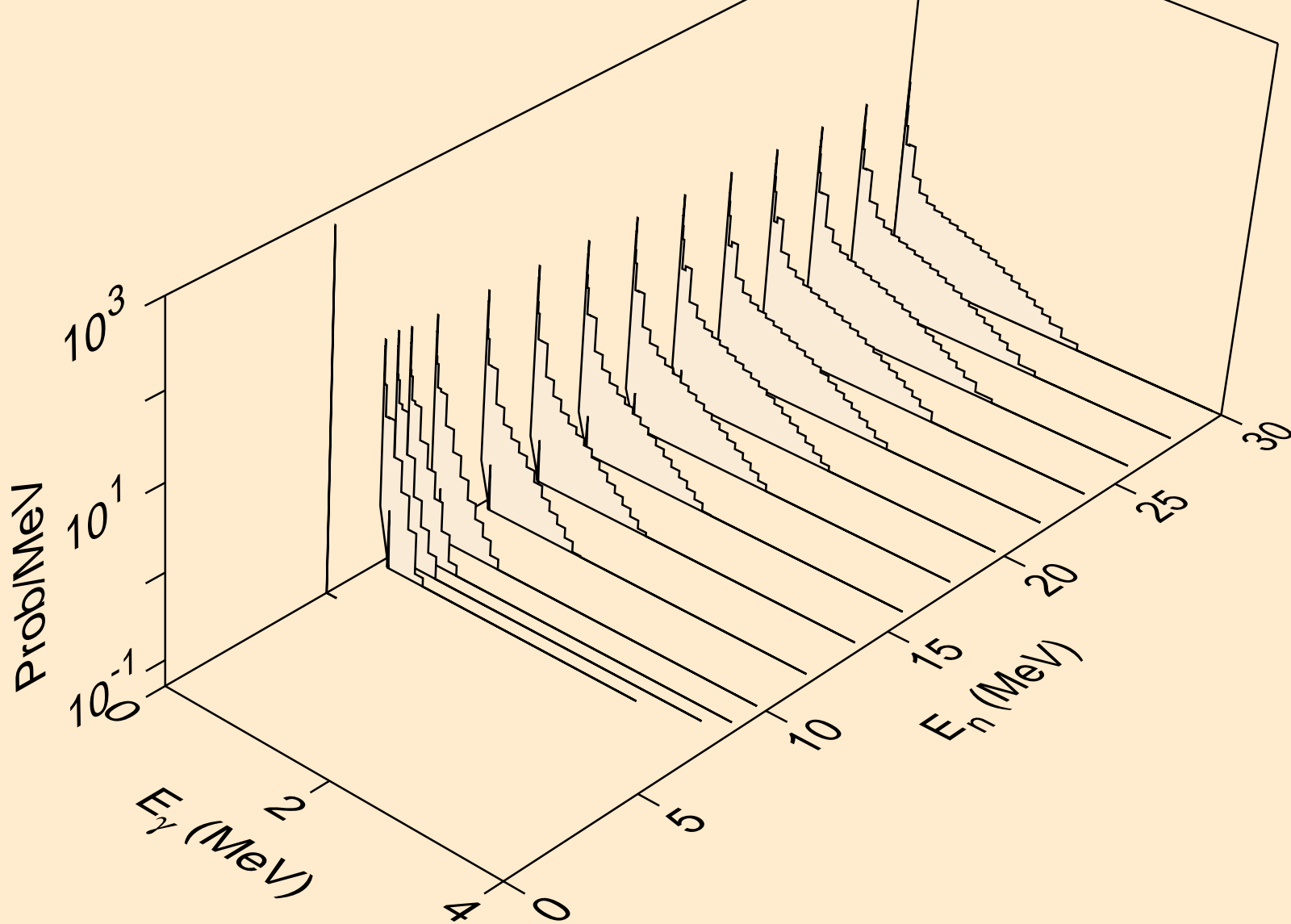

U227 NEUTRON ACER TENDL-2019 LIBRARY; T=293.16K
Photon emission for (n,n*)2a

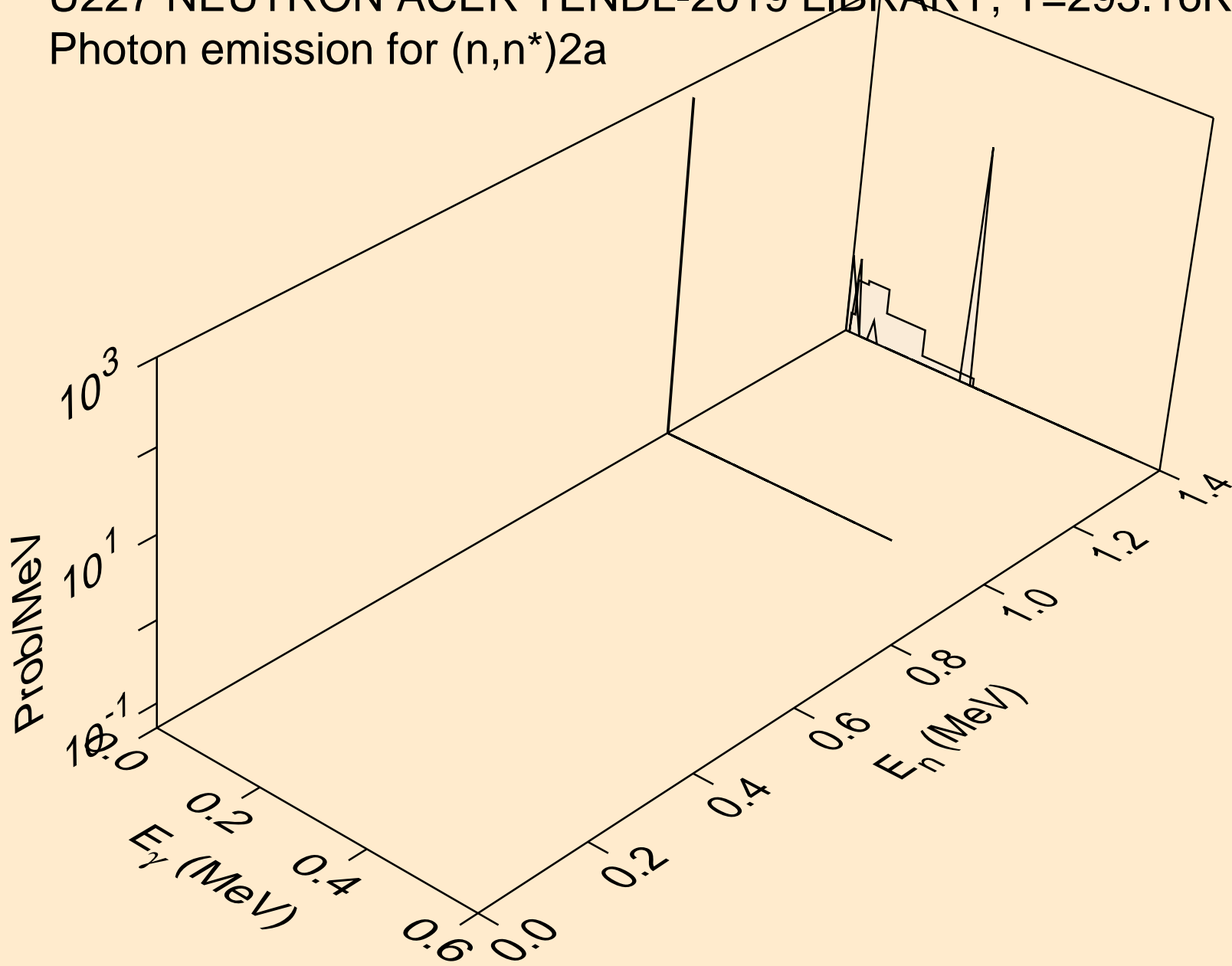

U227 NEUTRON ACER TENDL-2019 LIBRARY; T=293.16K
Photon emission for (n,2n)2a

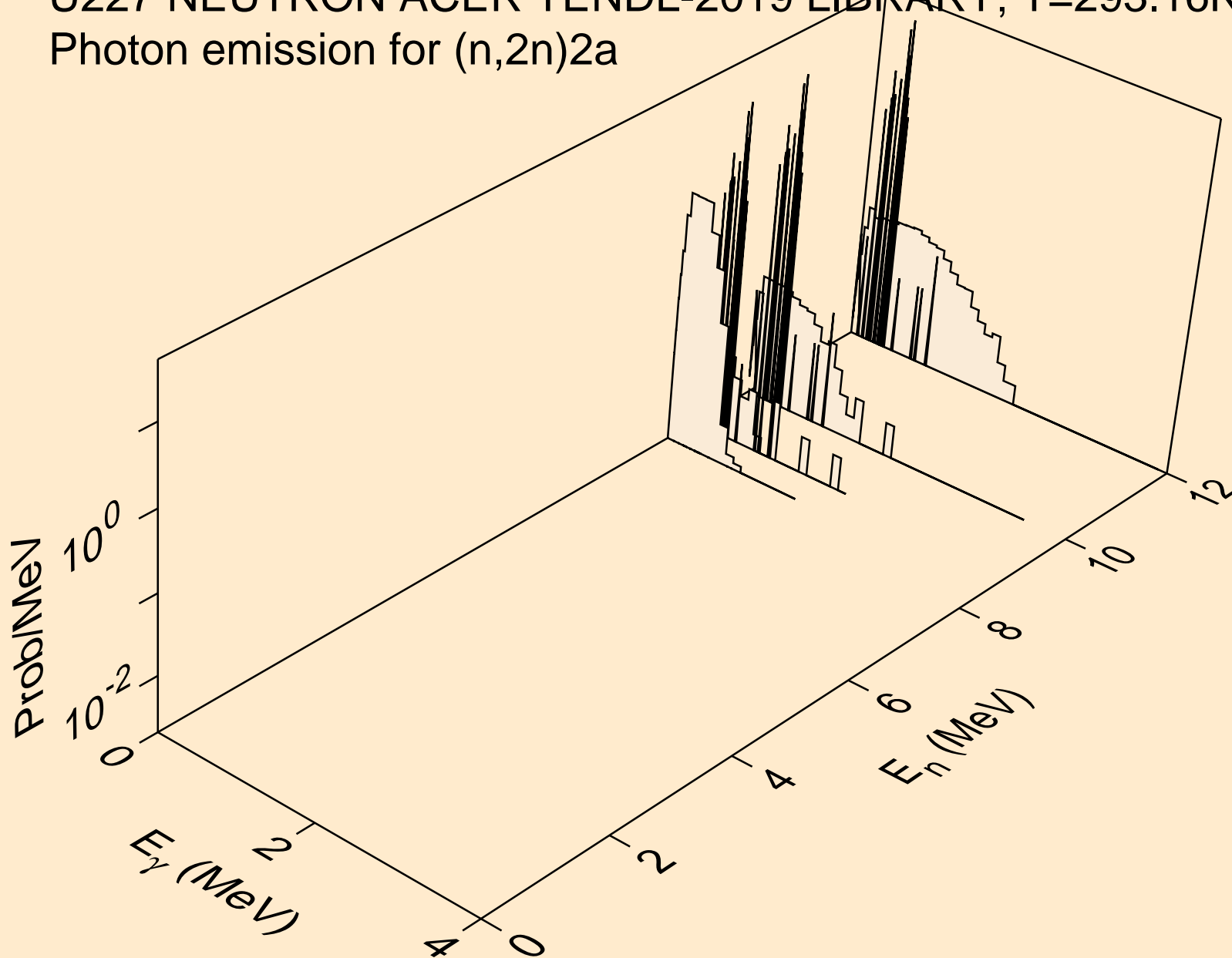

U227 NEUTRON ACER TENDL-2019 LIBRARY; T=293.16K
Photon emission for (n,n*)d

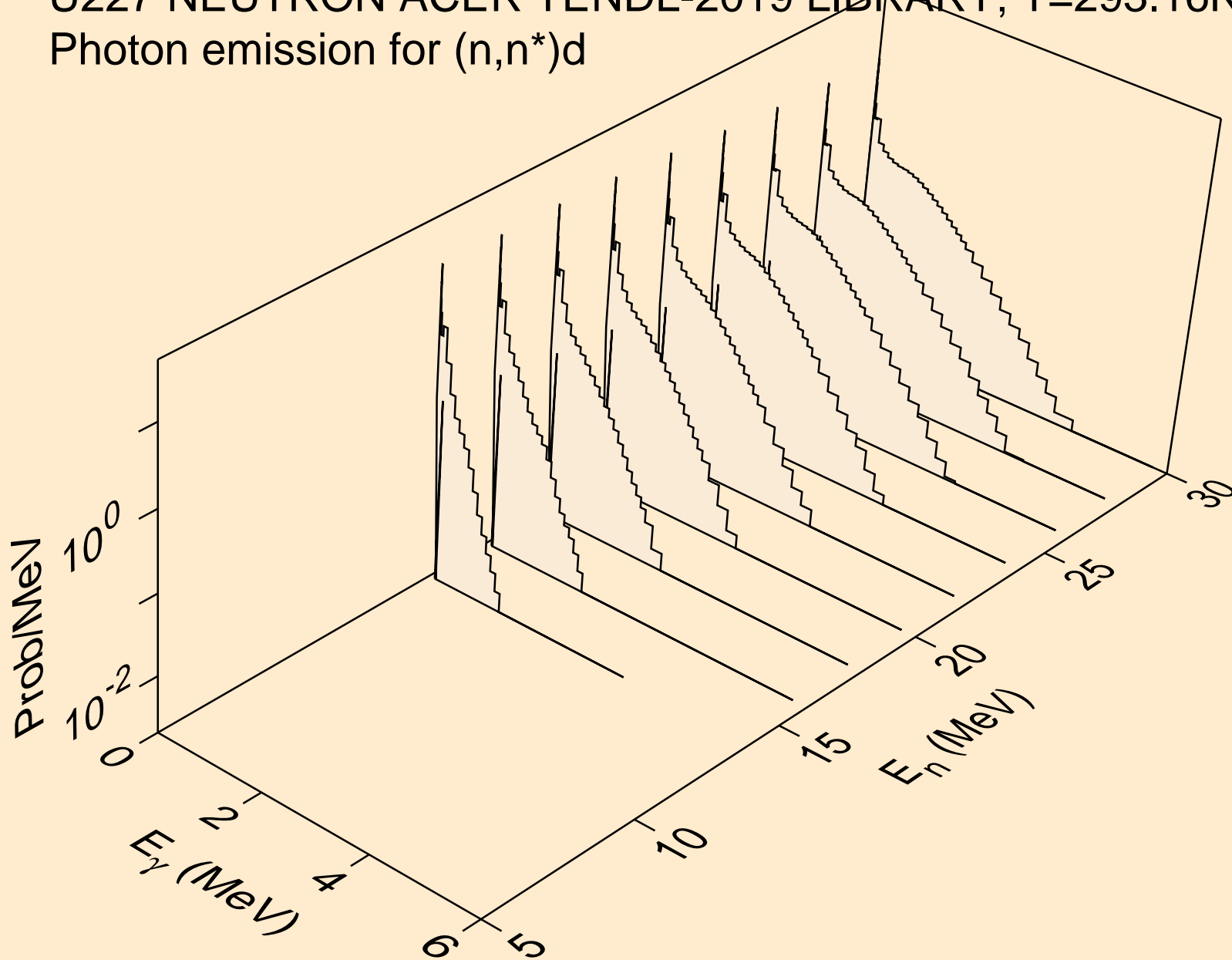

U227 NEUTRON ACER TENDL-2019 LIBRARY; T=293.16K
Photon emission for (n,n*)t

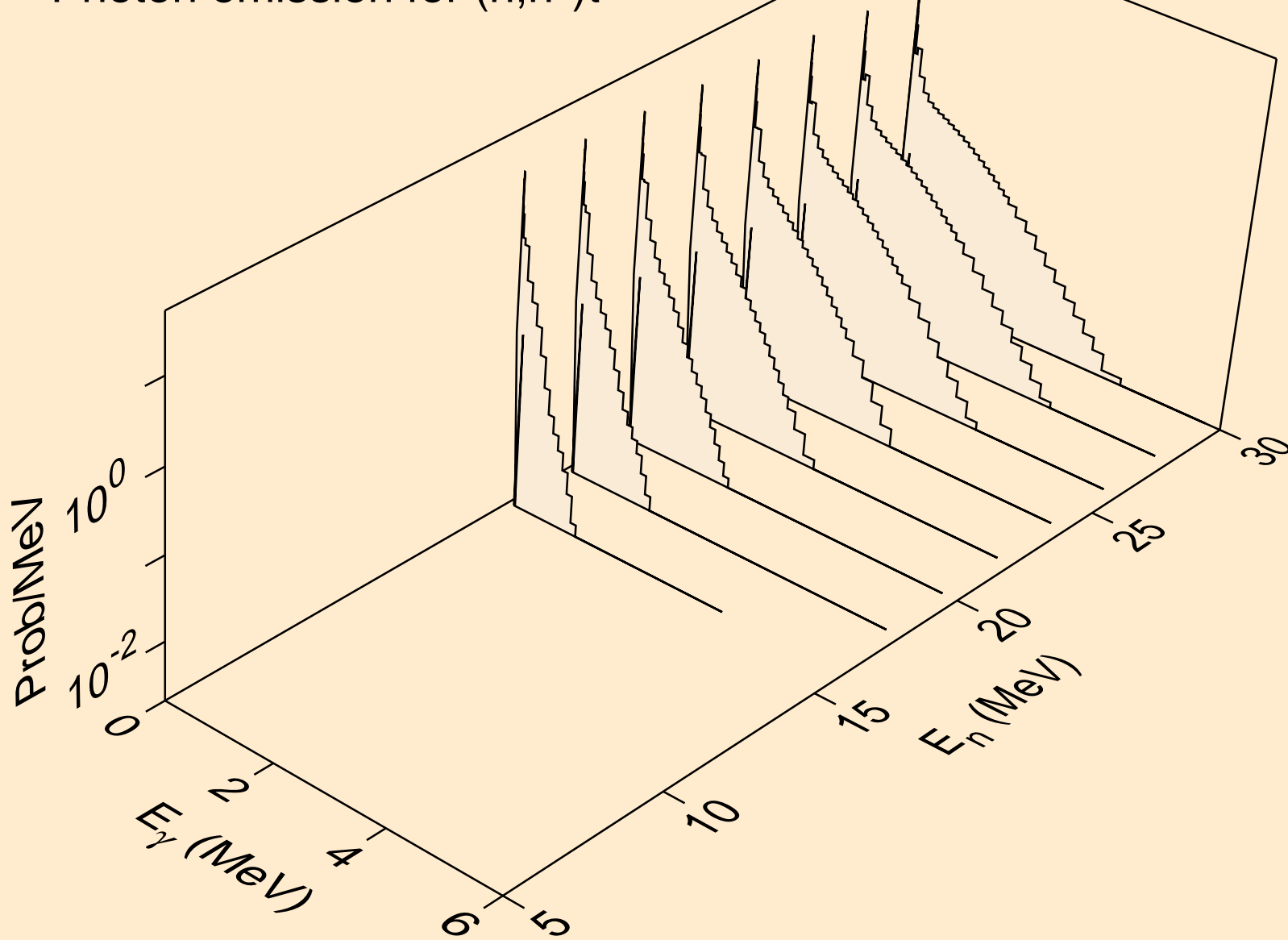

U227 NEUTRON ACER TENDL-2019 LIBRARY; T=293.16K
Photon emission for (n,n*)he3

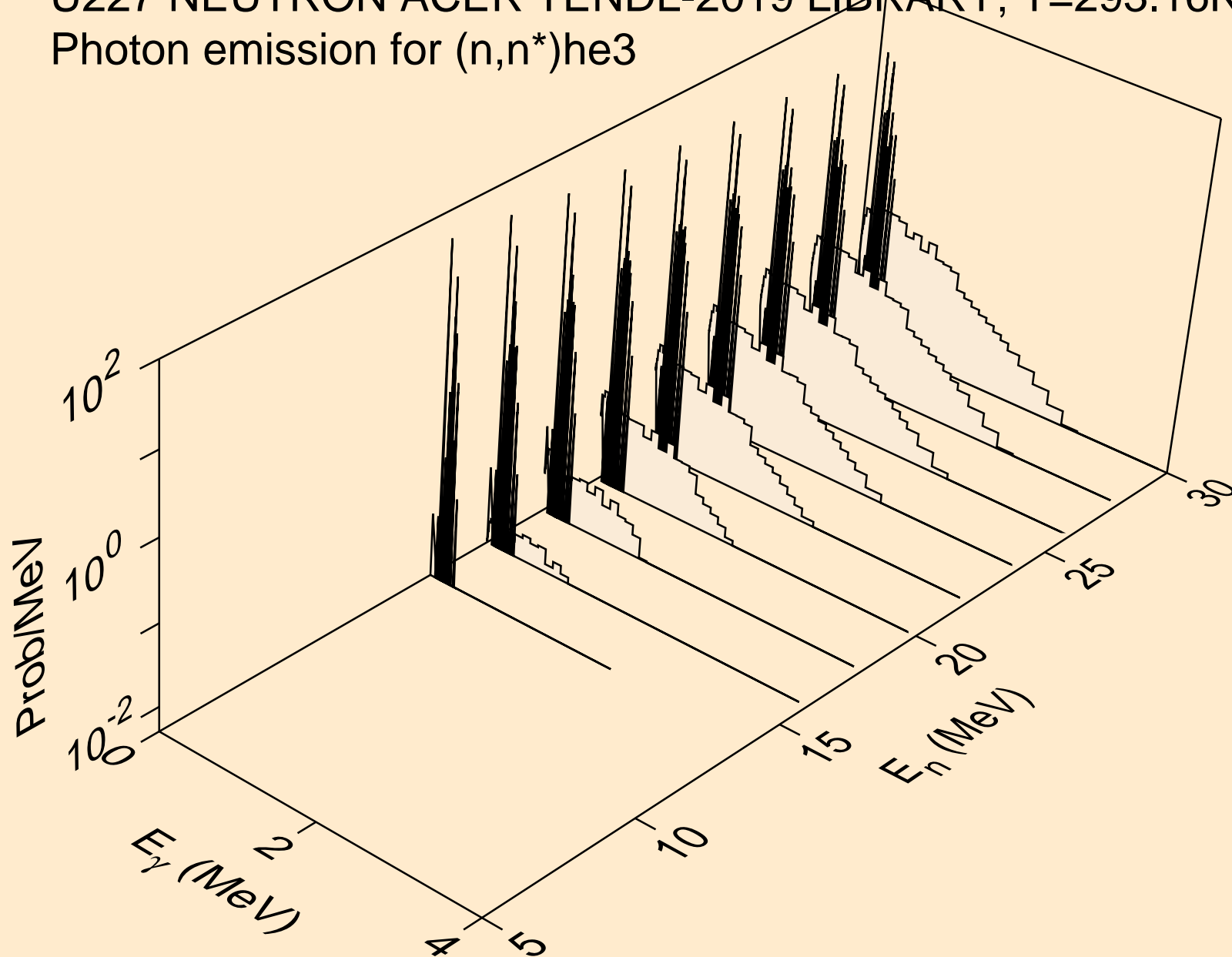

U227 NEUTRON ACER TENDL-2019 LIBRARY; T=293.16K
Photon emission for (n,n*)t2a

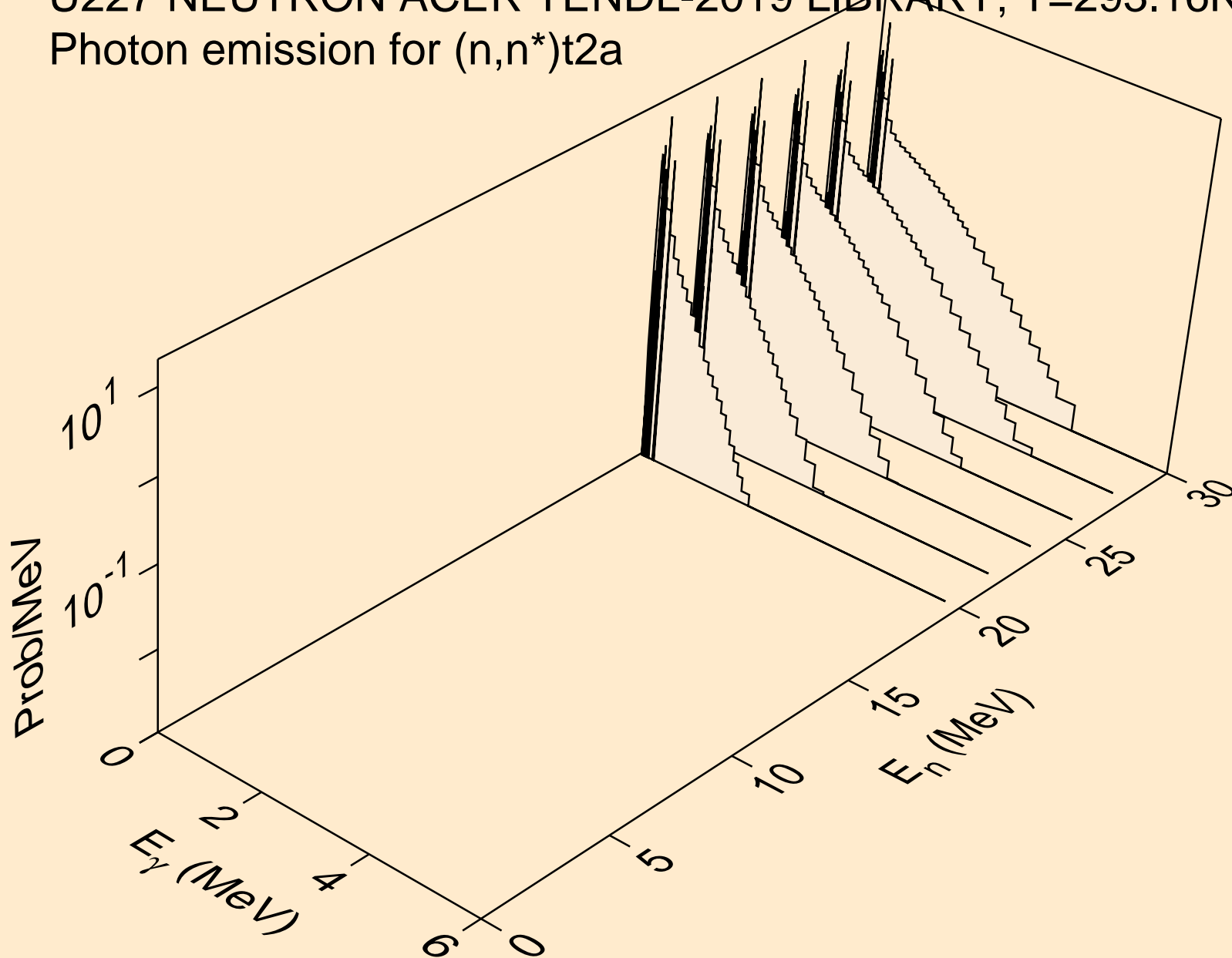

U227 NEUTRON ACER TENDL-2019 LIBRARY; T=293.16K
Photon emission for (n,4n)

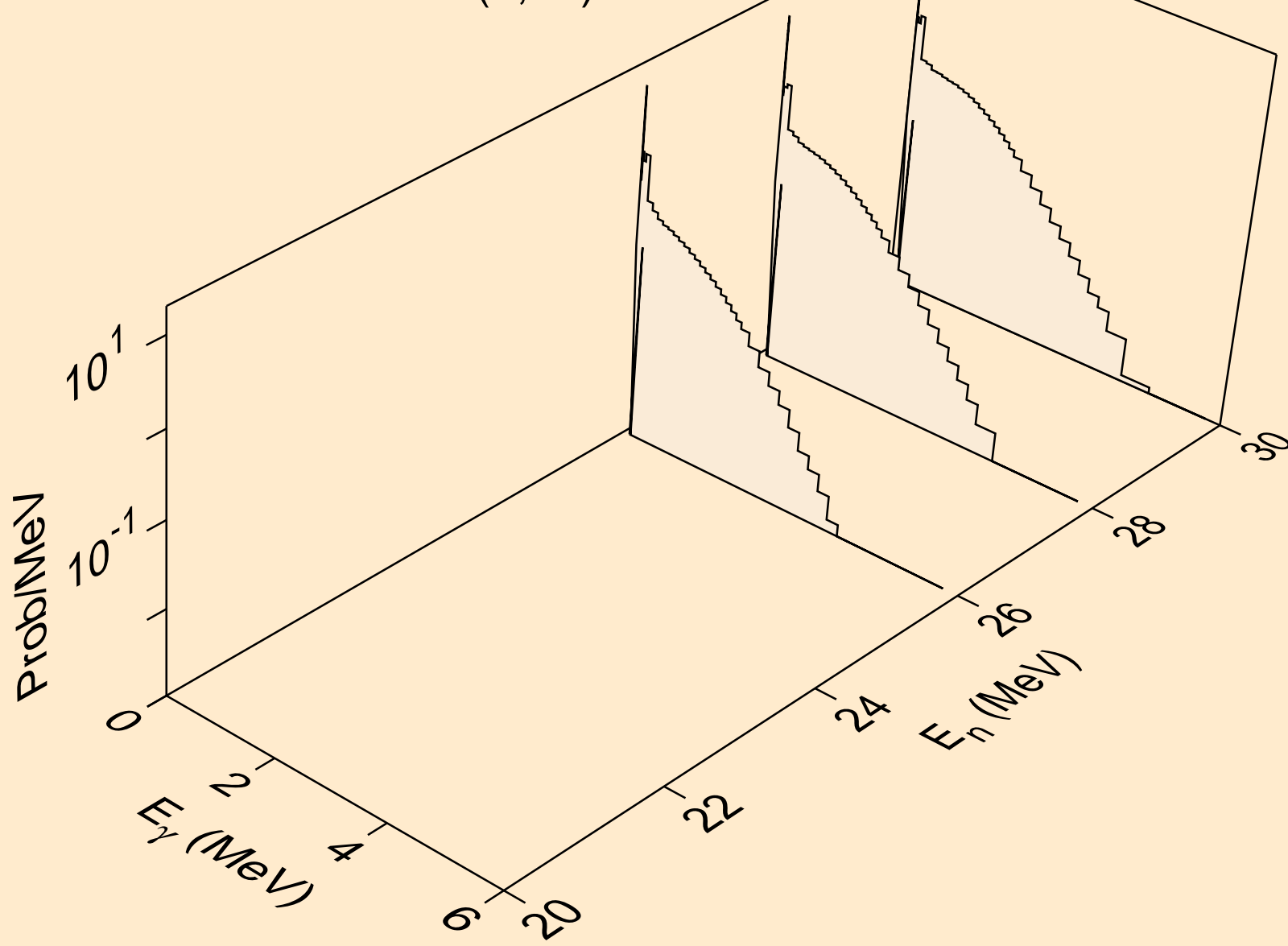

U227 NEUTRON ACER TENDL-2019 LIBRARY; T=293.16K
Photon emission for (n,2np)

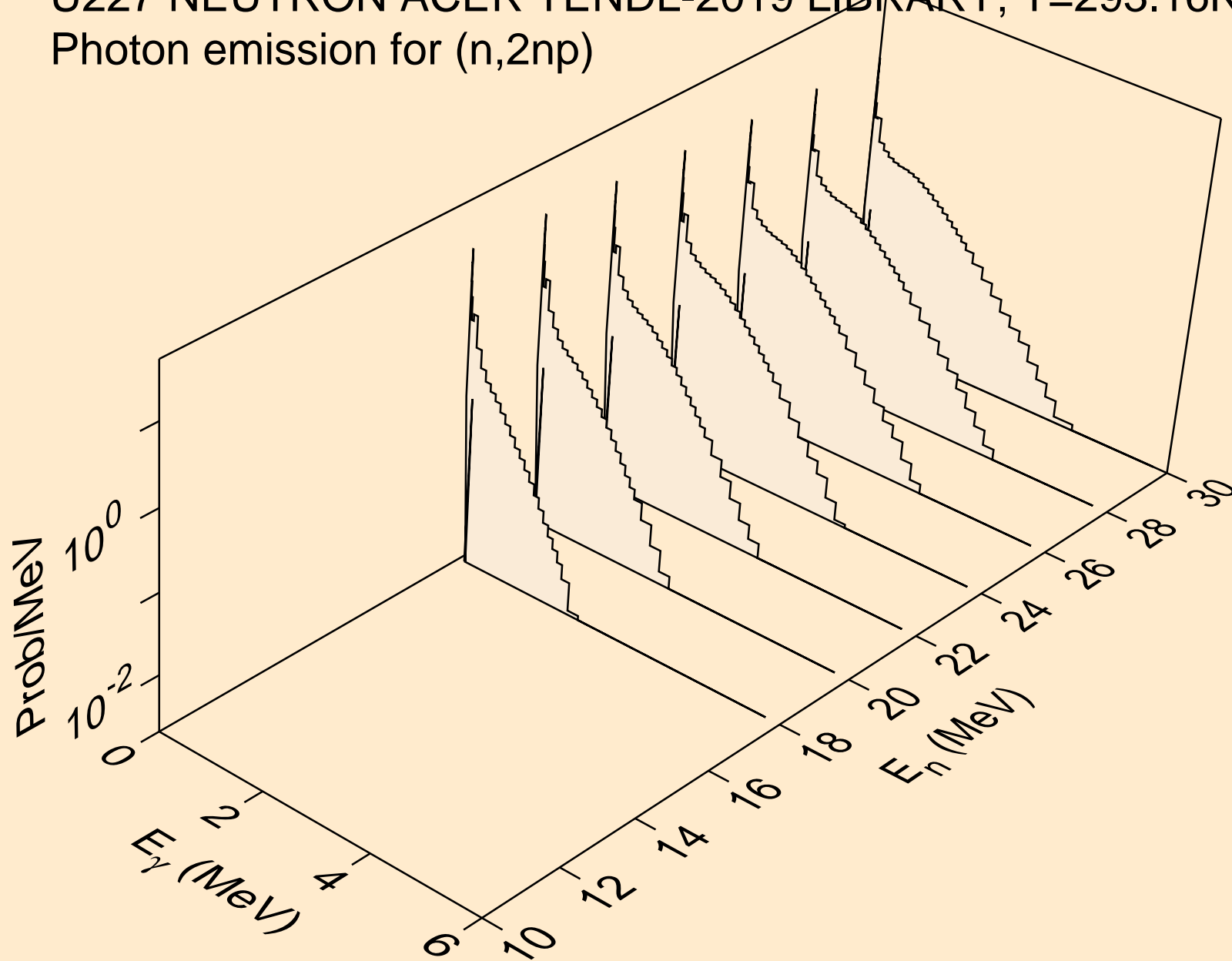

U227 NEUTRON ACER TENDL-2019 LIBRARY; T=293.16K
Photon emission for (n,3np)

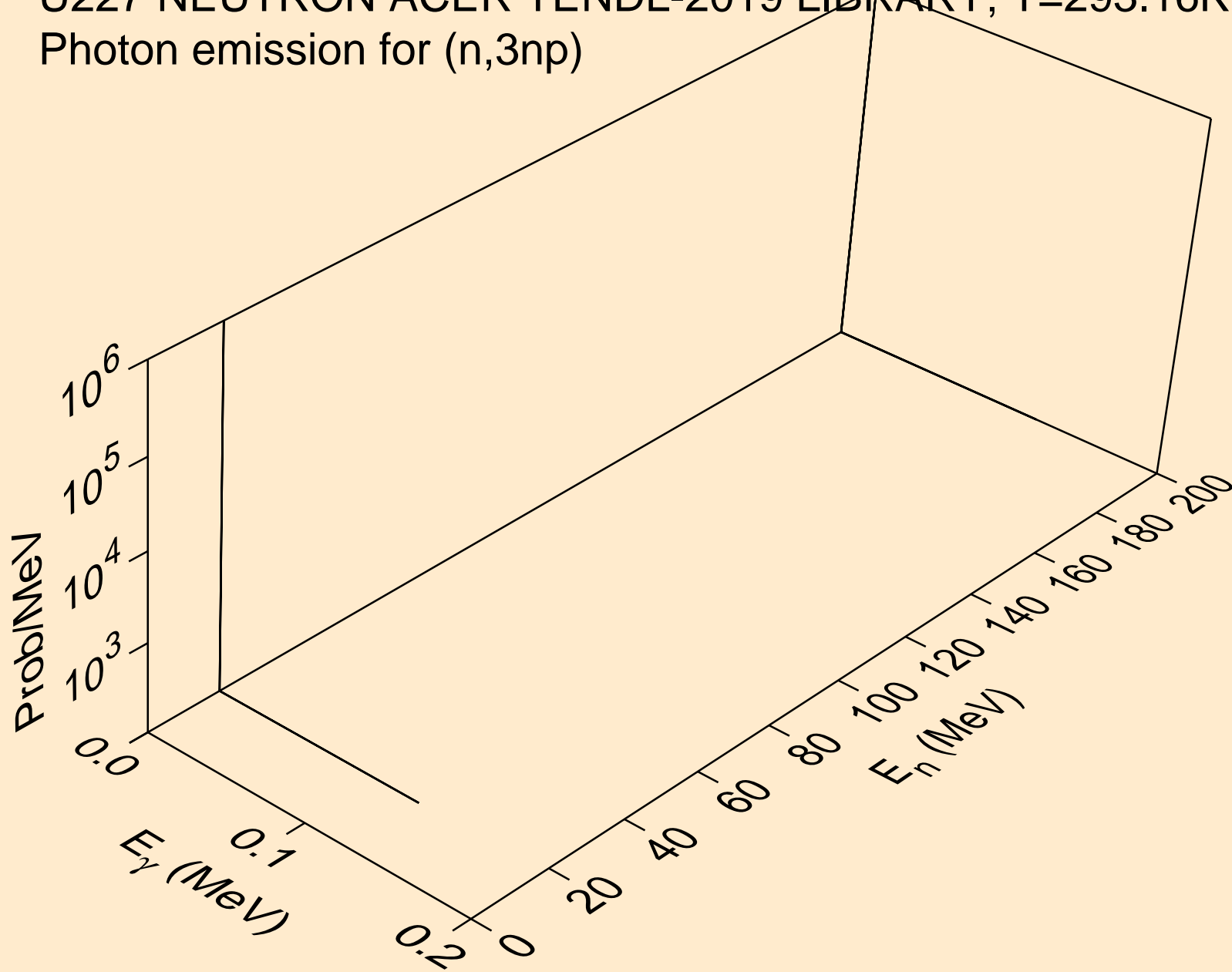

U227 NEUTRON ACER TENDL-2019 LIBRARY; T=293.16K
Photon emission for (n,2np)

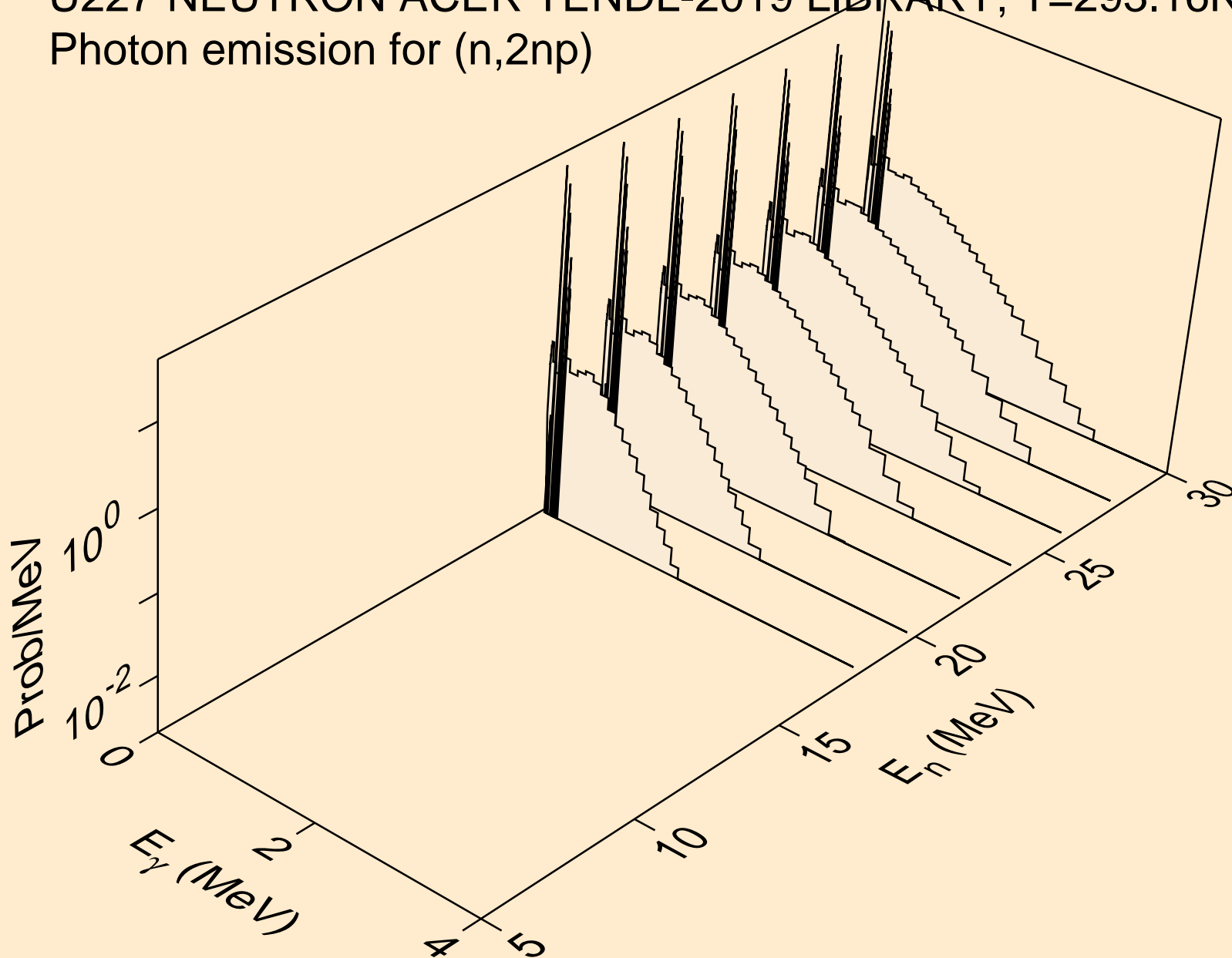

U227 NEUTRON ACER TENDL-2019 LIBRARY; T=293.16K
Photon emission for (n,npa)

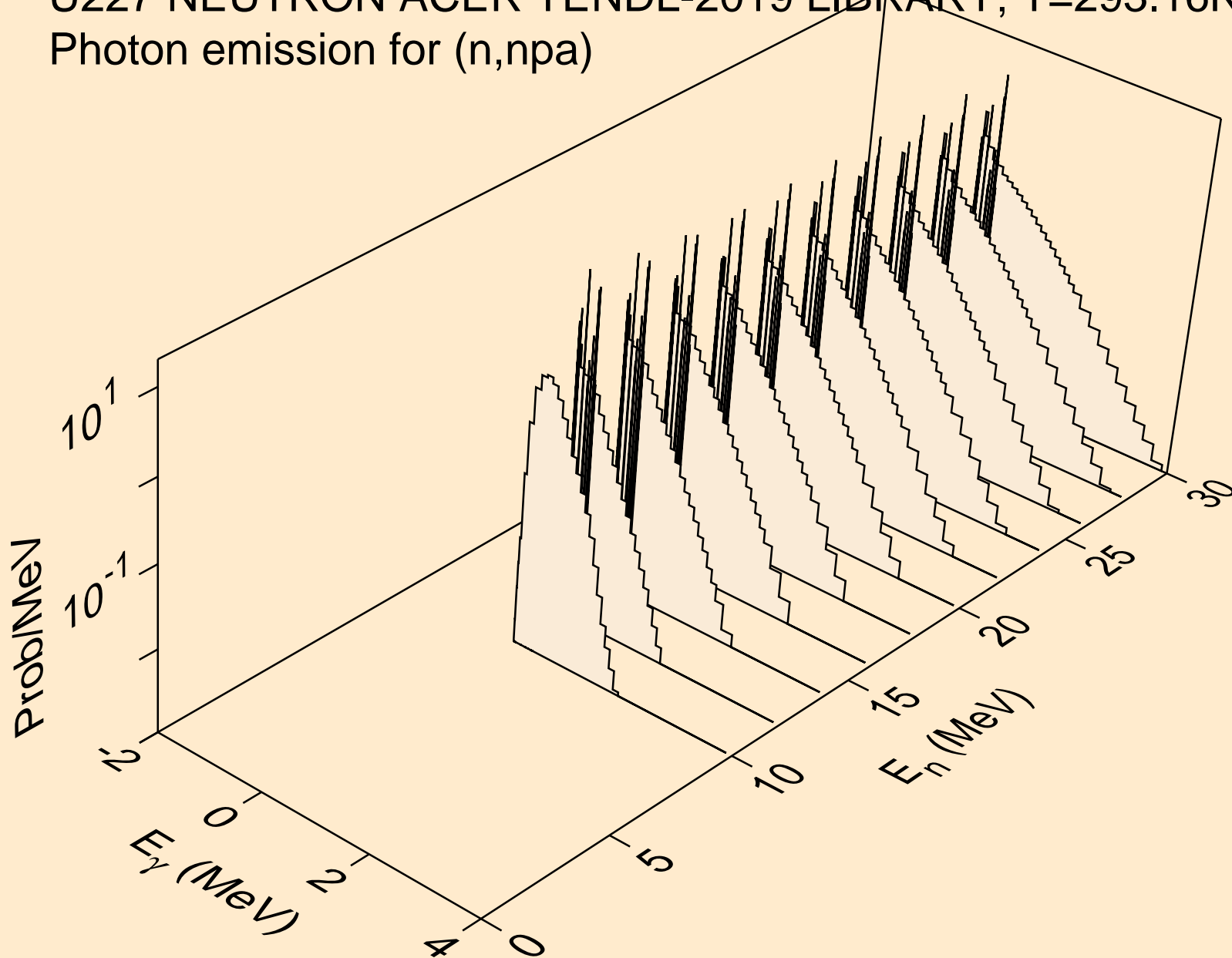

U227 NEUTRON ACER TENDL-2019 LIBRARY; T=293.16K
Photon emission for (n,n*c)

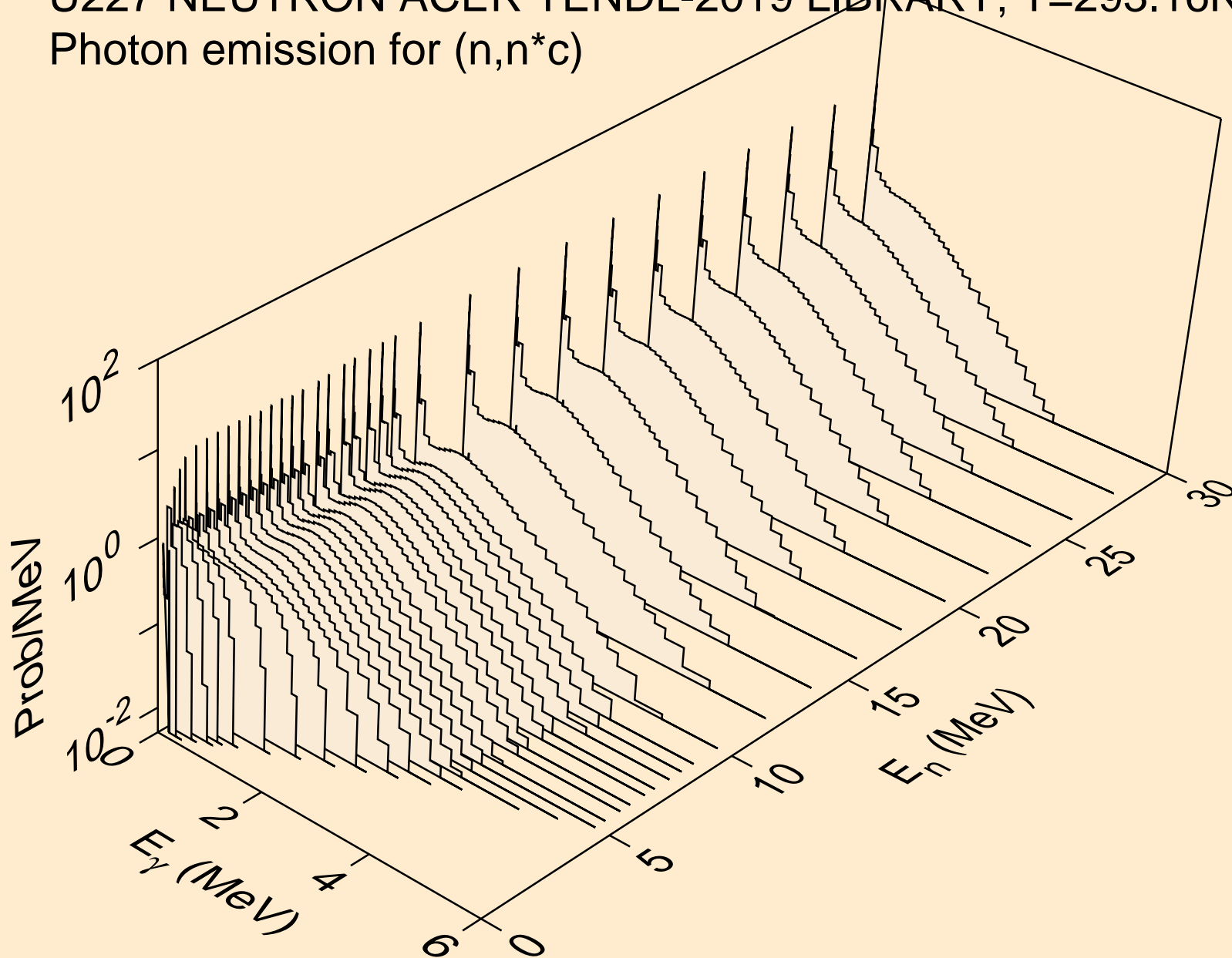

U227 NEUTRON ACER TENDL-2019 LIBRARY; T=293.16K
Photon emission for (n,gma)

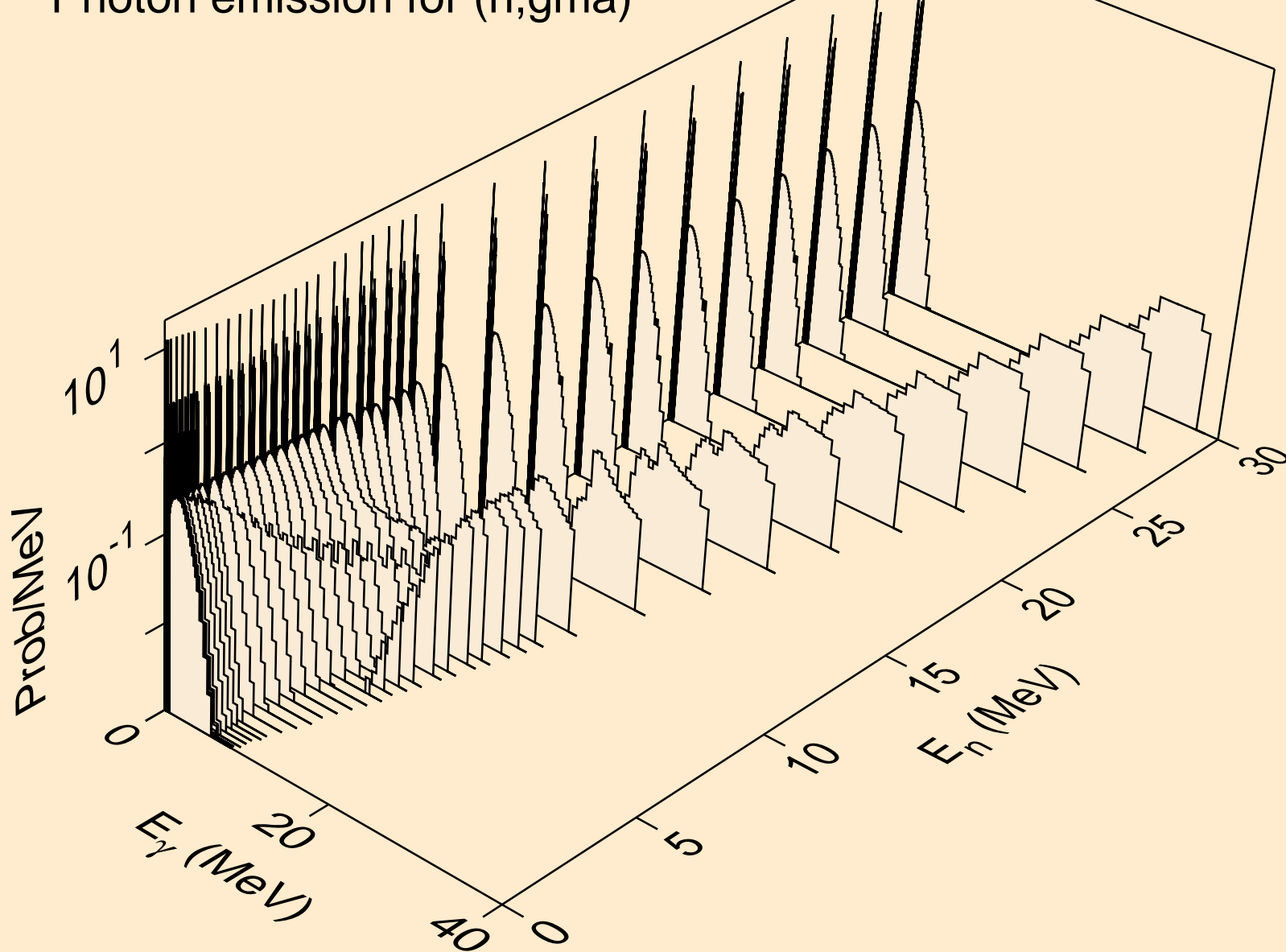

U227 NEUTRON ACER TENDL-2019 LIBRARY; T=293.16K
Photon emission for (n,p)

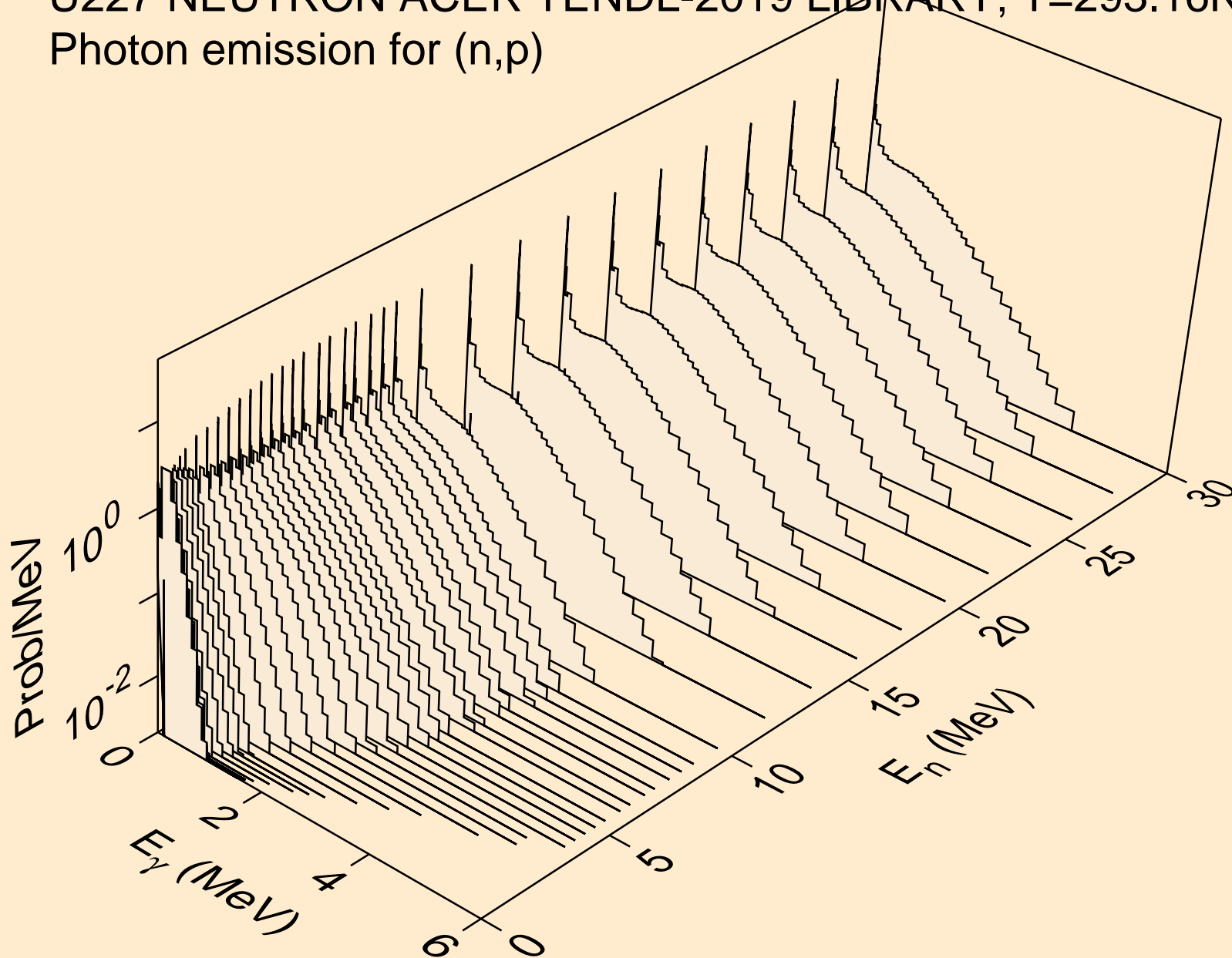

U227 NEUTRON ACER TENDL-2019 LIBRARY; T=293.16K
Photon emission for (n,d)

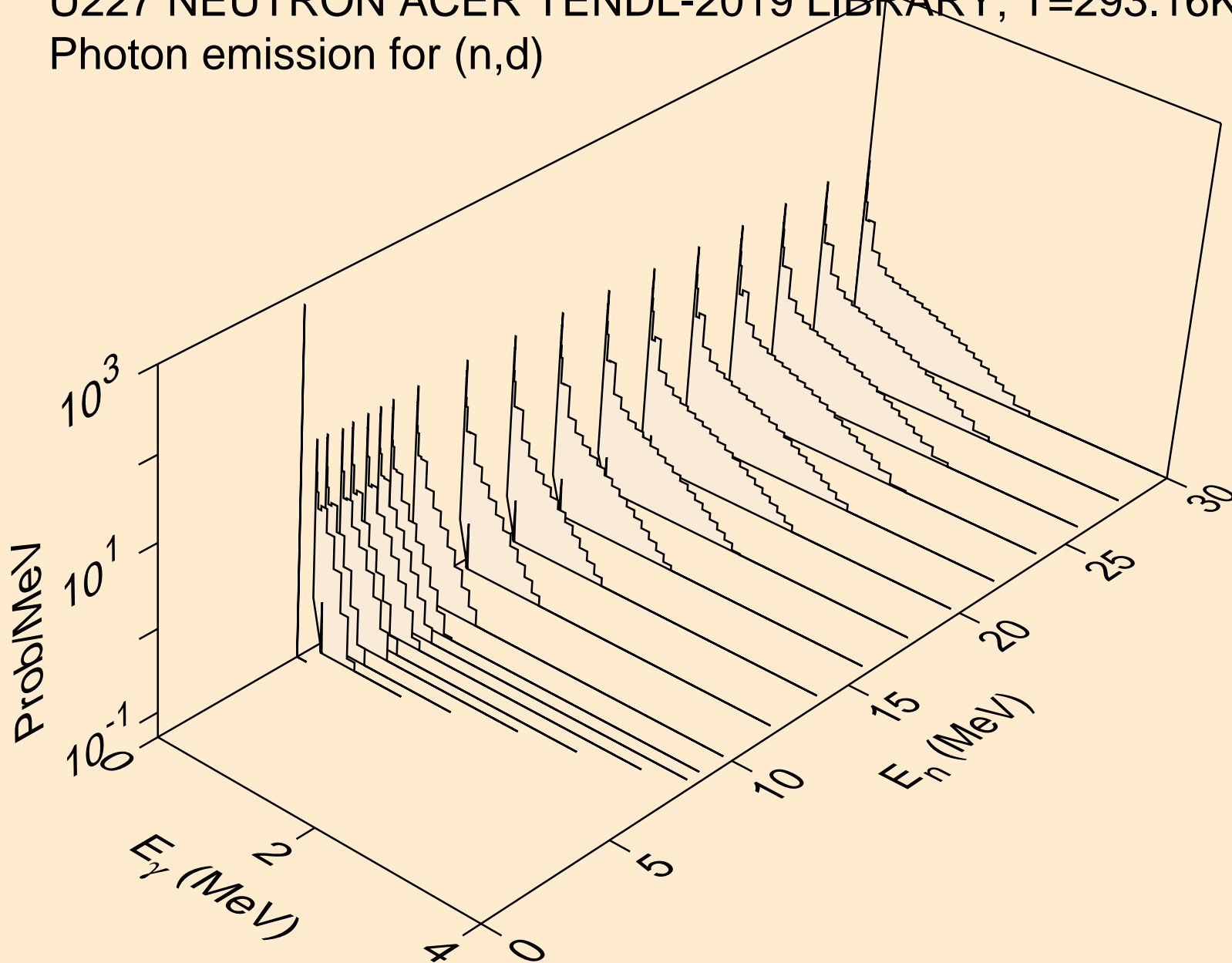

U227 NEUTRON ACER TENDL-2019 LIBRARY; T=293.16K
Photon emission for (n,t)

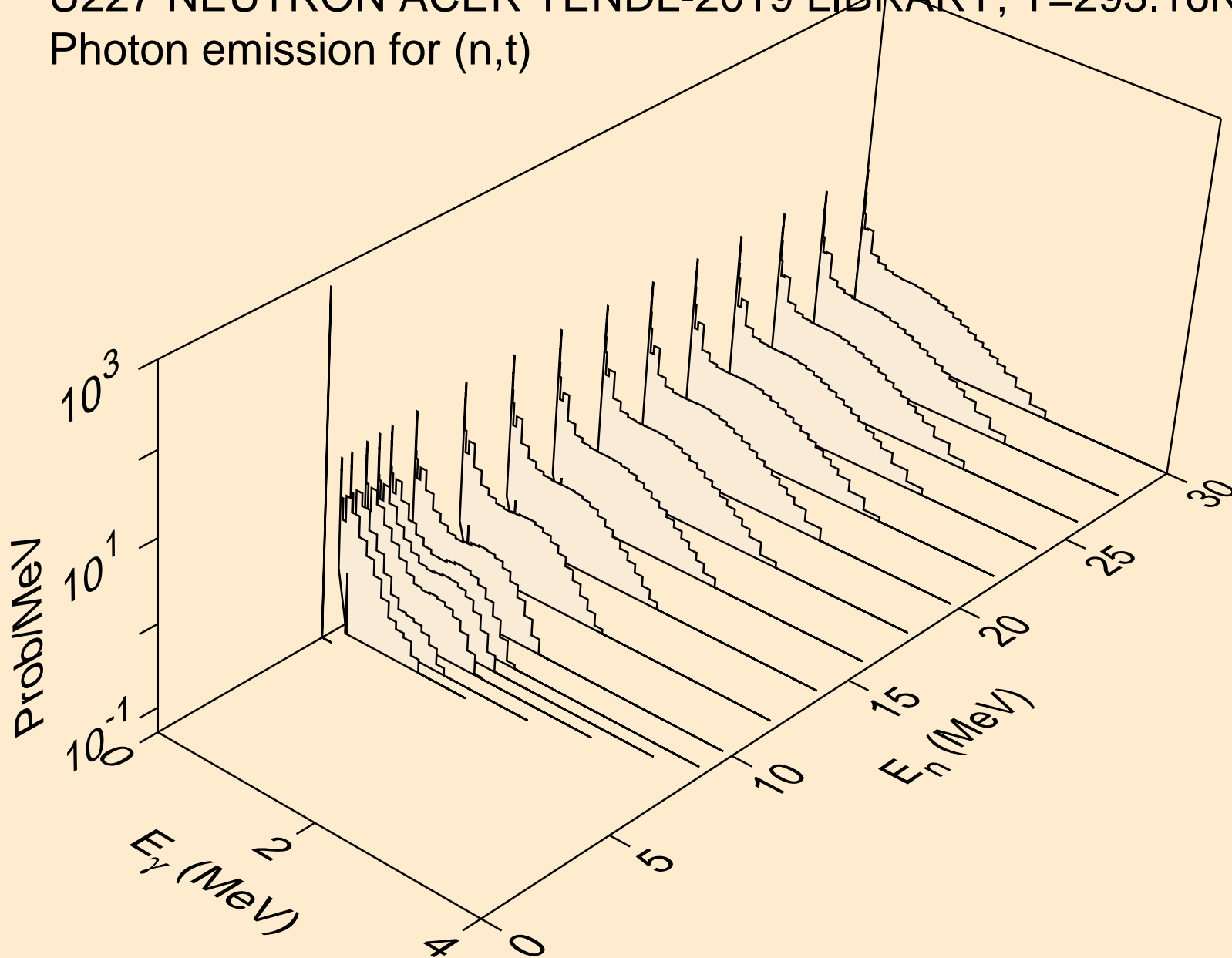

U227 NEUTRON ACER TENDL-2019 LIBRARY; T=293.16K
Photon emission for (n,he3)

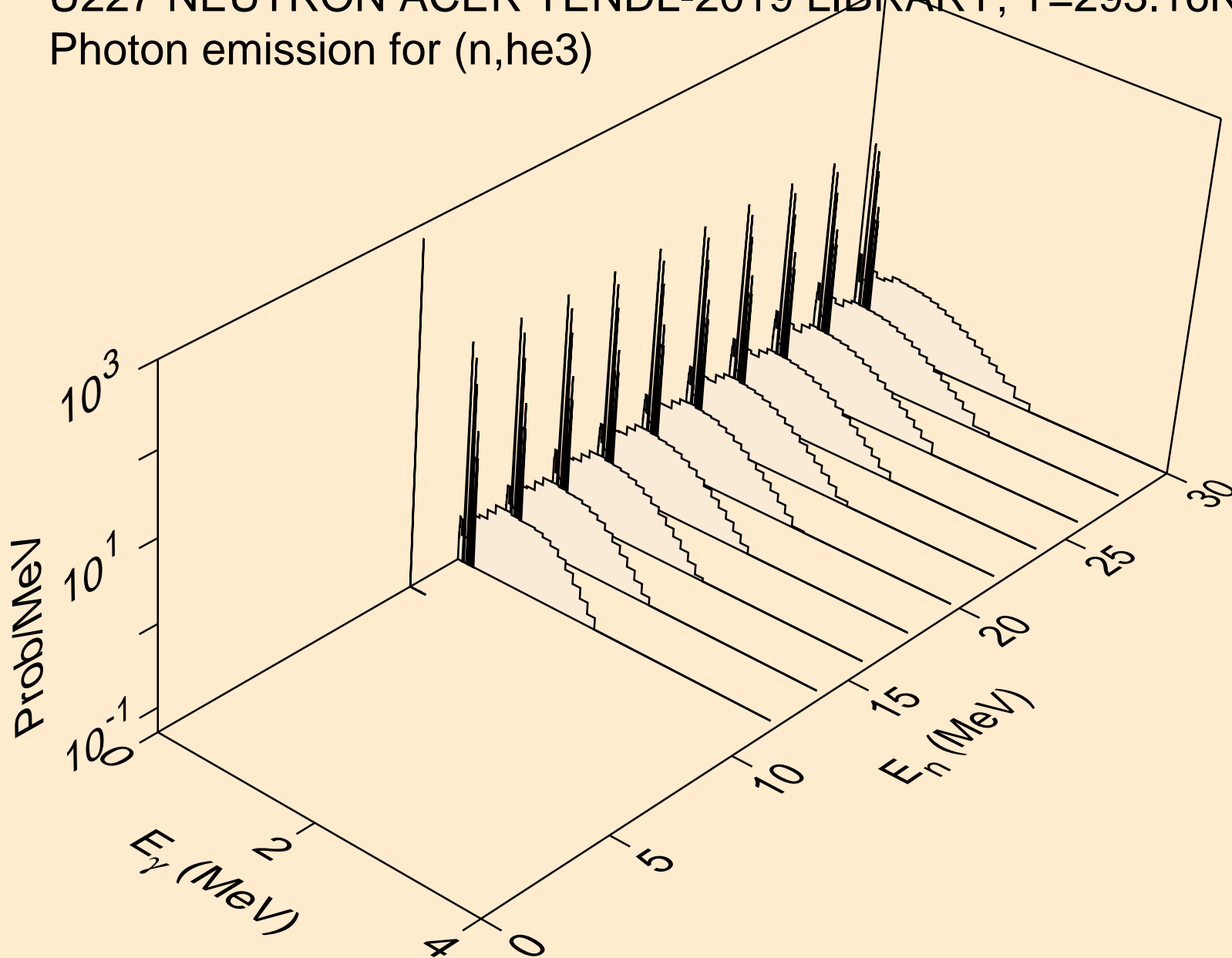

U227 NEUTRON ACER TENDL-2019 LIBRARY; T=293.16K
Photon emission for (n,a)

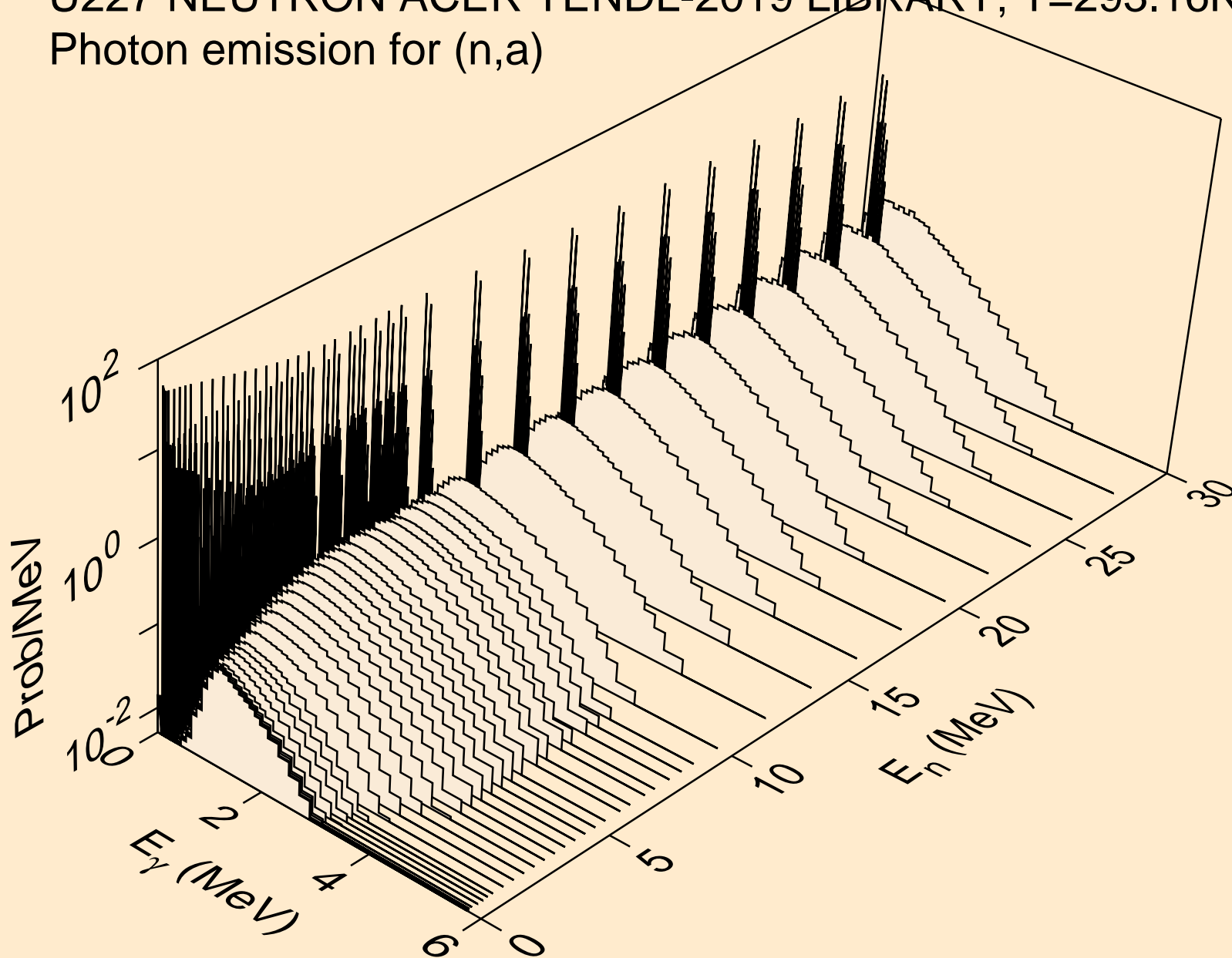

U227 NEUTRON ACER TENDL-2019 LIBRARY; T=293.16K
Photon emission for (n,2a)

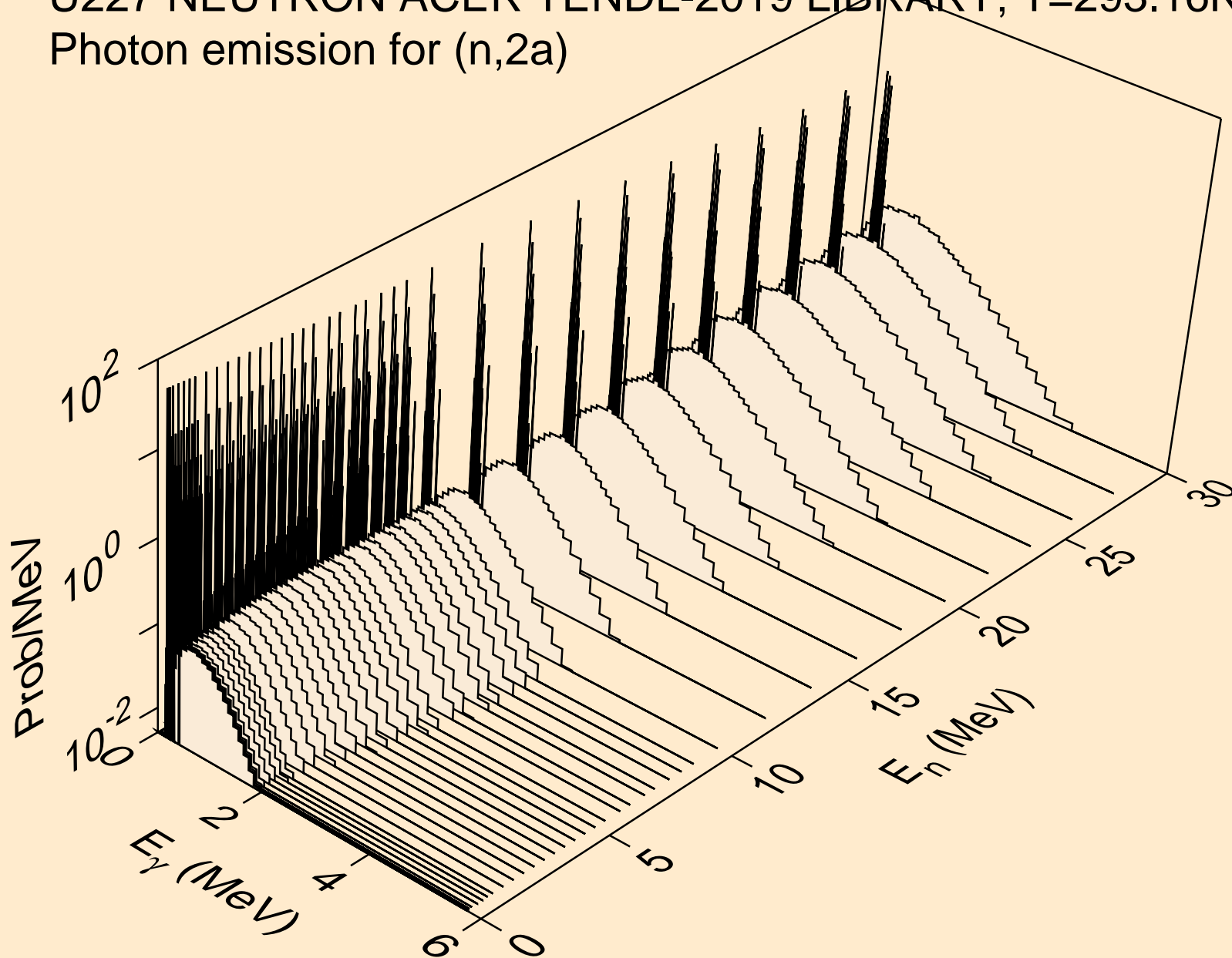

U227 NEUTRON ACER TENDL-2019 LIBRARY; T=293.16K
Photon emission for (n,2p)

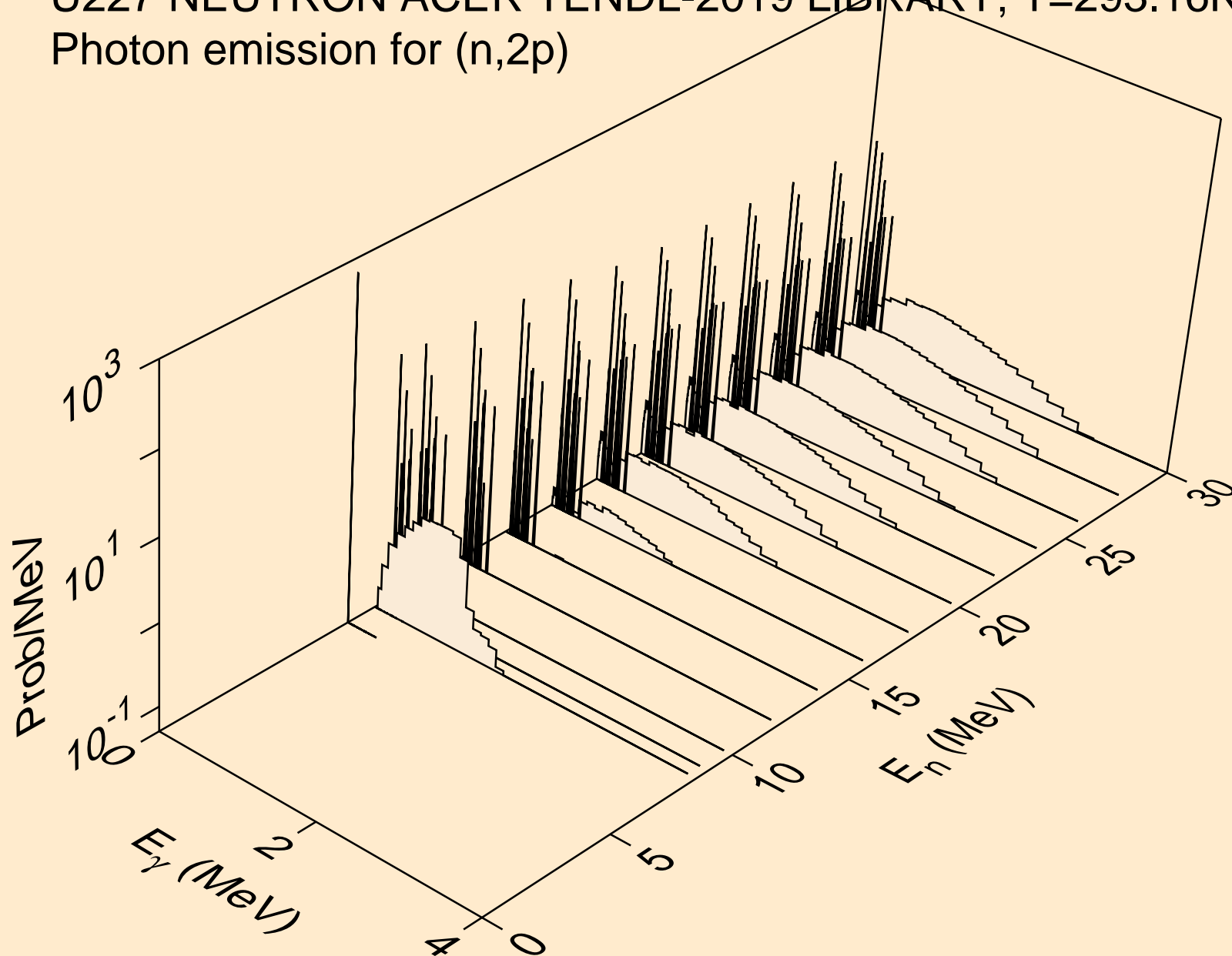

U227 NEUTRON ACER TENDL-2019 LIBRARY; T=293.16K
Photon emission for (n,p α)

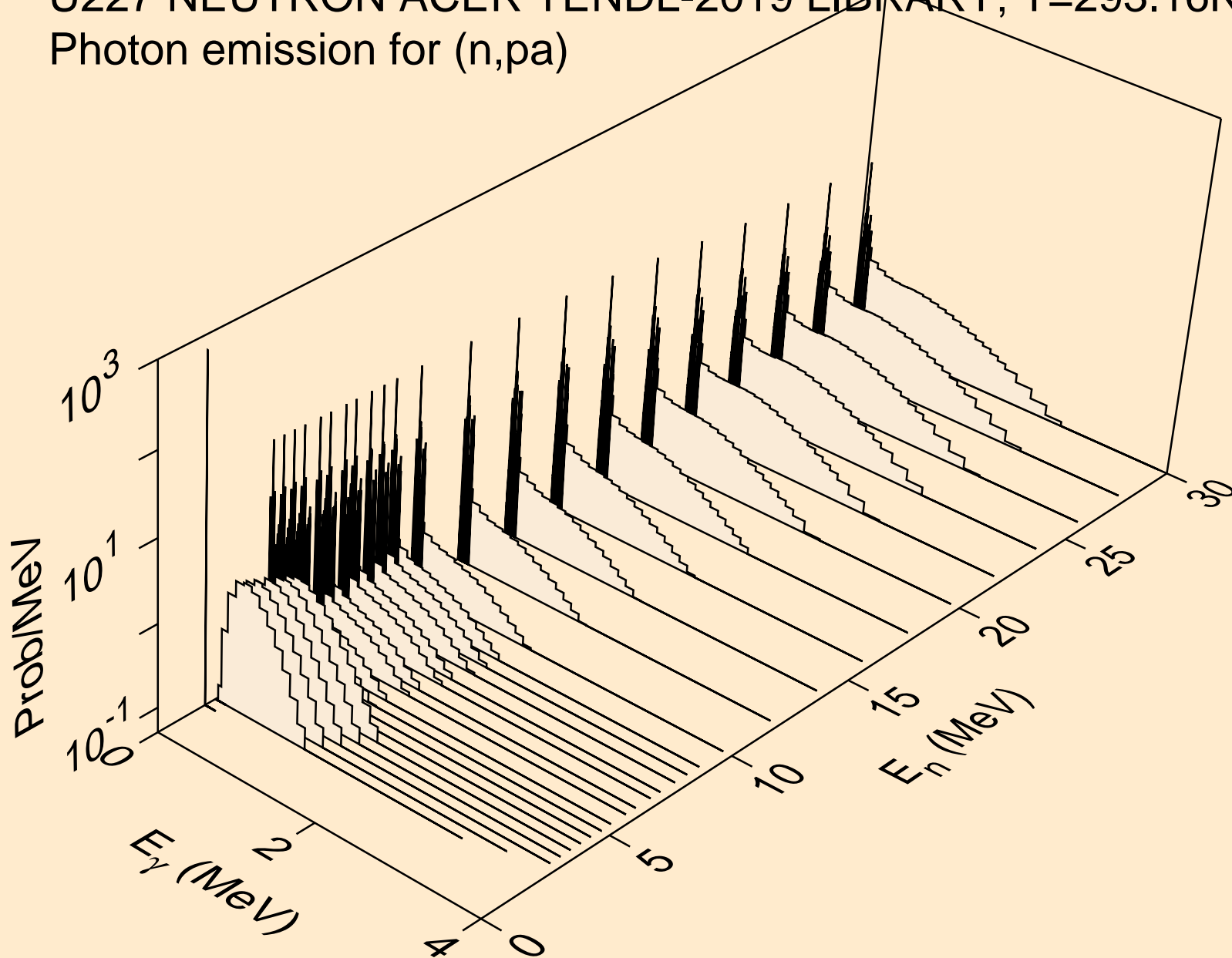

U227 NEUTRON ACER TENDL-2019 LIBRARY; T=293.16K
Photon emission for (n,t2a)

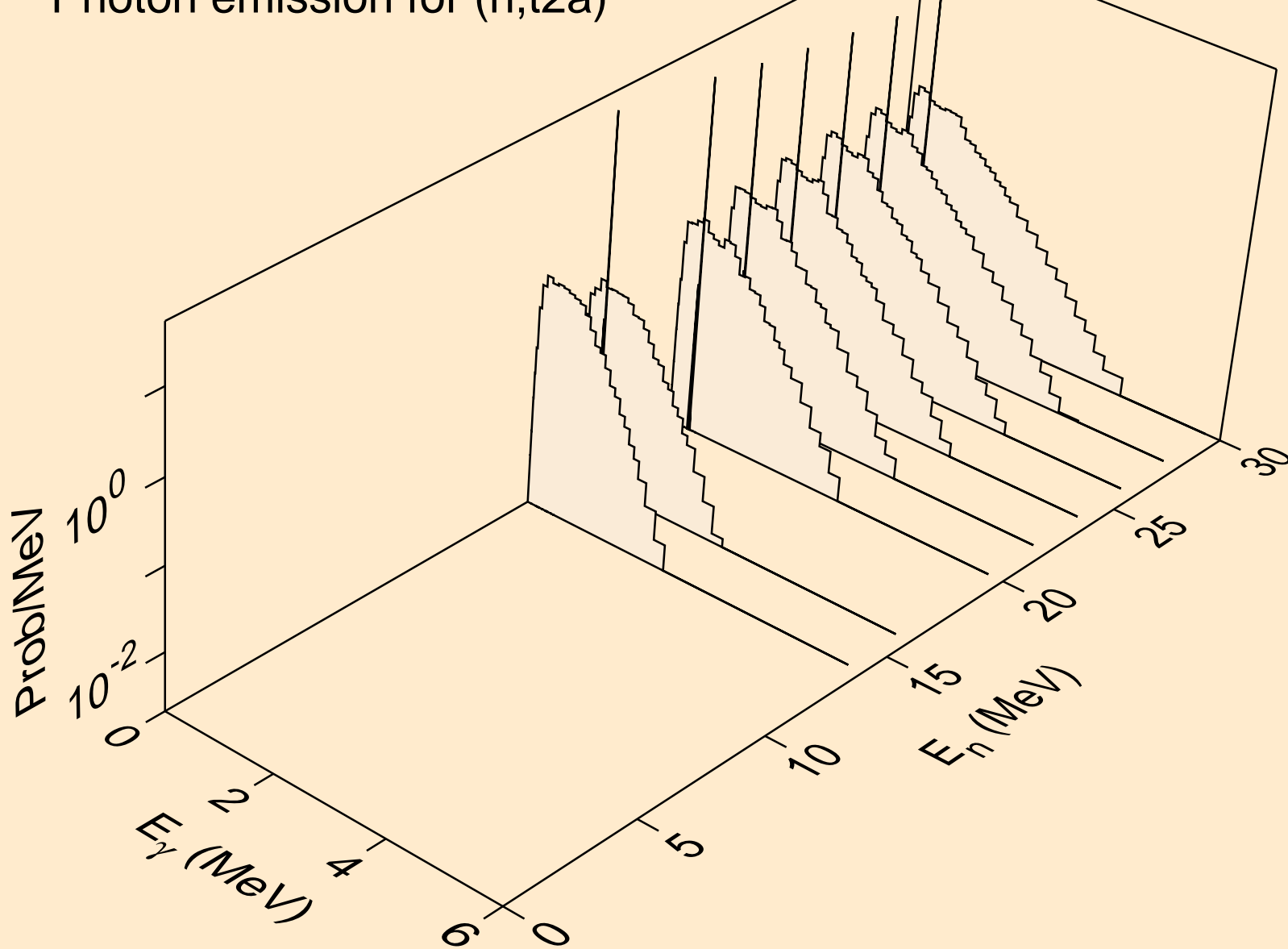

U227 NEUTRON ACER TENDL-2019 LIBRARY; T=293.16K
Photon emission for (n,pd)

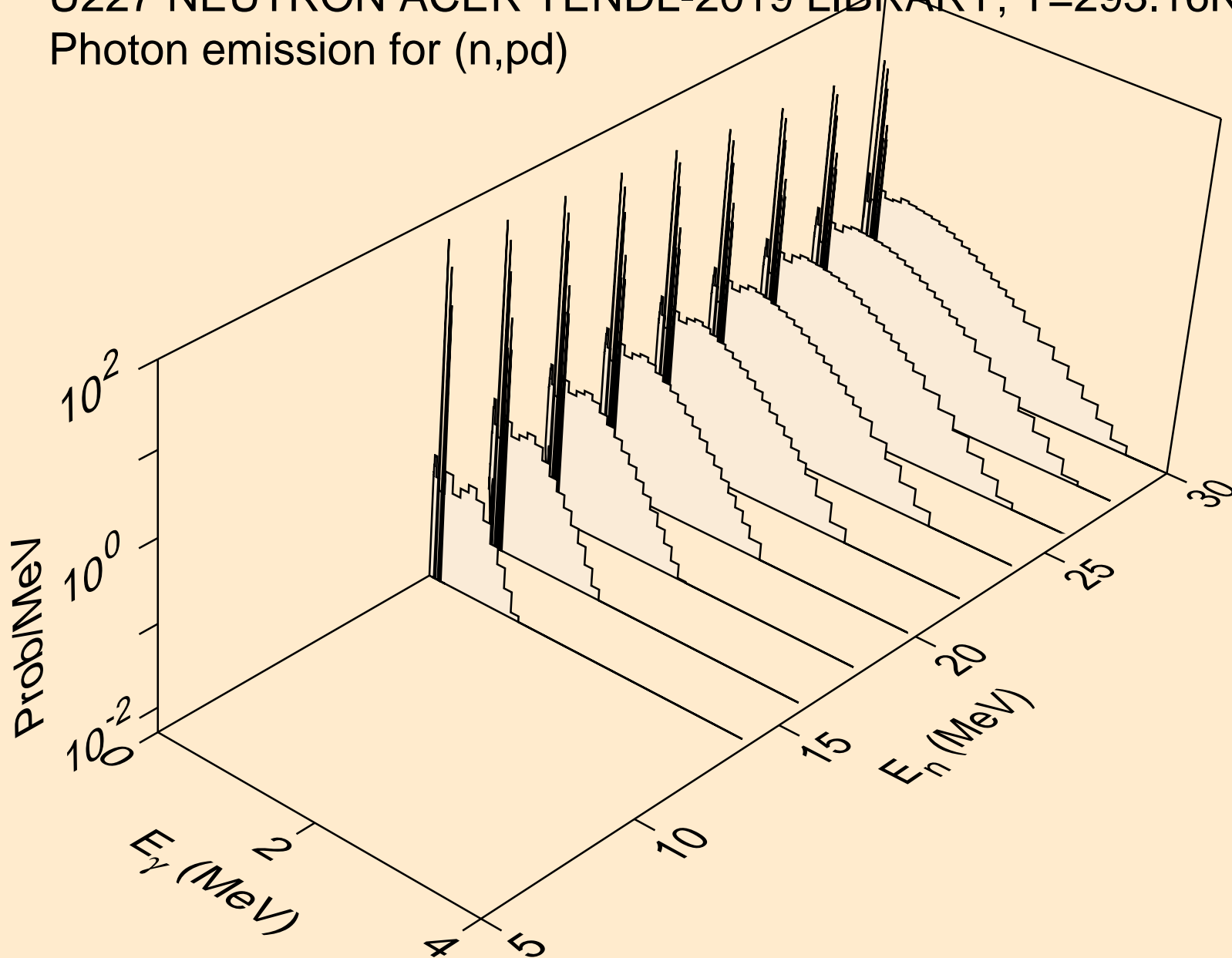

U227 NEUTRON ACER TENDL-2019 LIBRARY; T=293.16K
Photon emission for (n,pt)

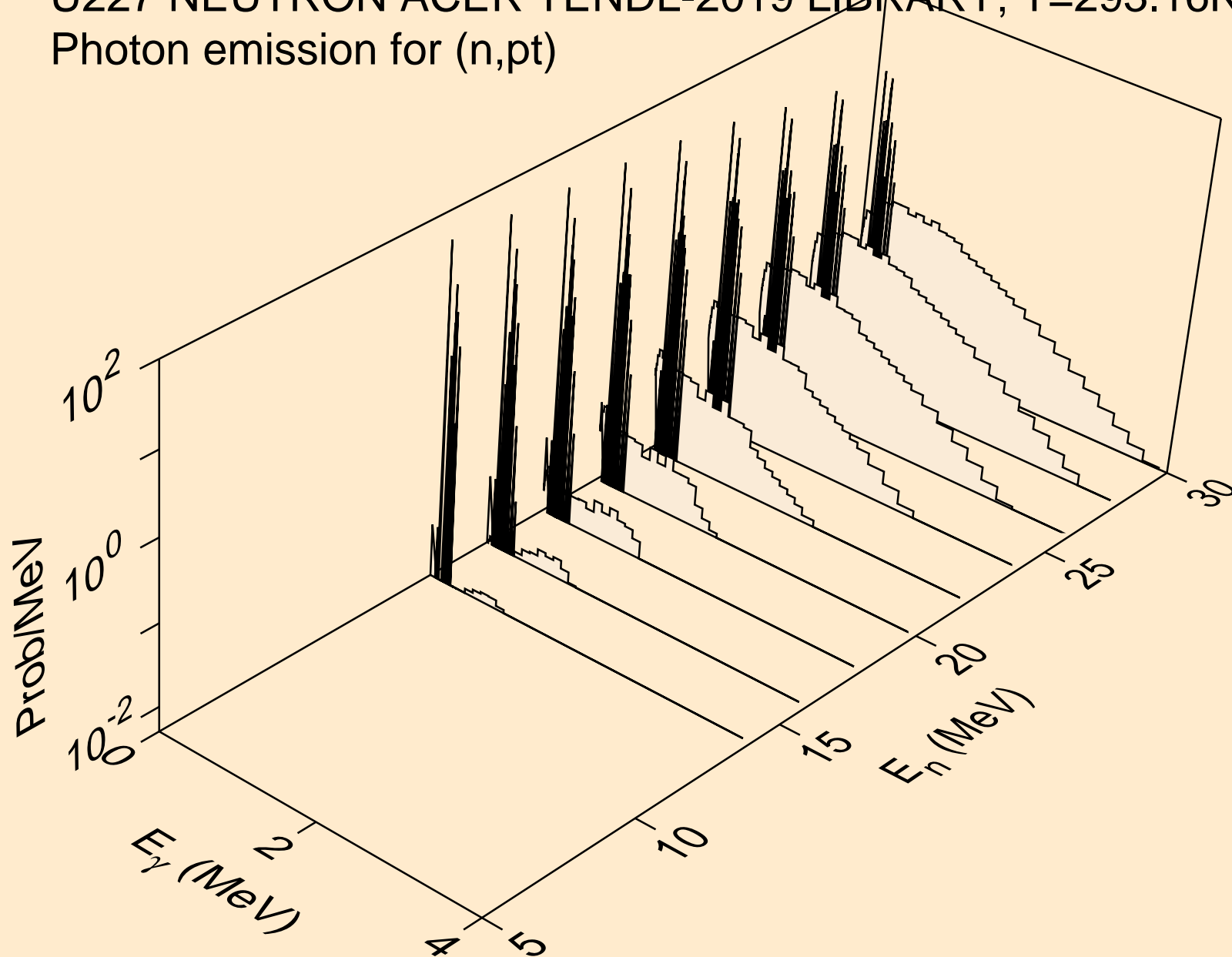

U227 NEUTRON ACER TENDL-2019 LIBRARY; T=293.16K
Photon emission for (n,da)

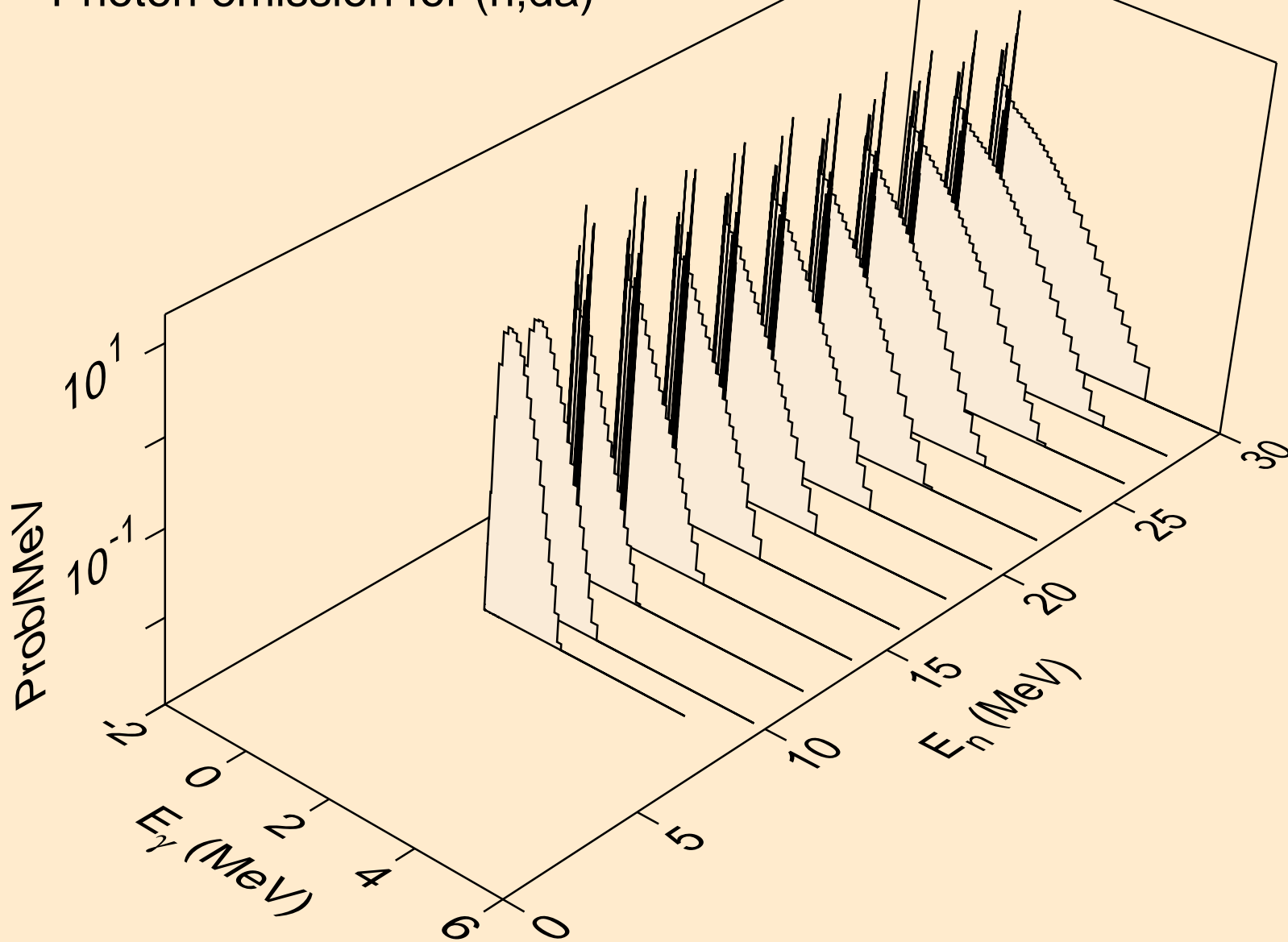

U227 NEUTRON ACER TENDL-2019 LIBRARY; T=293.16K
thermal capture photon spectrum

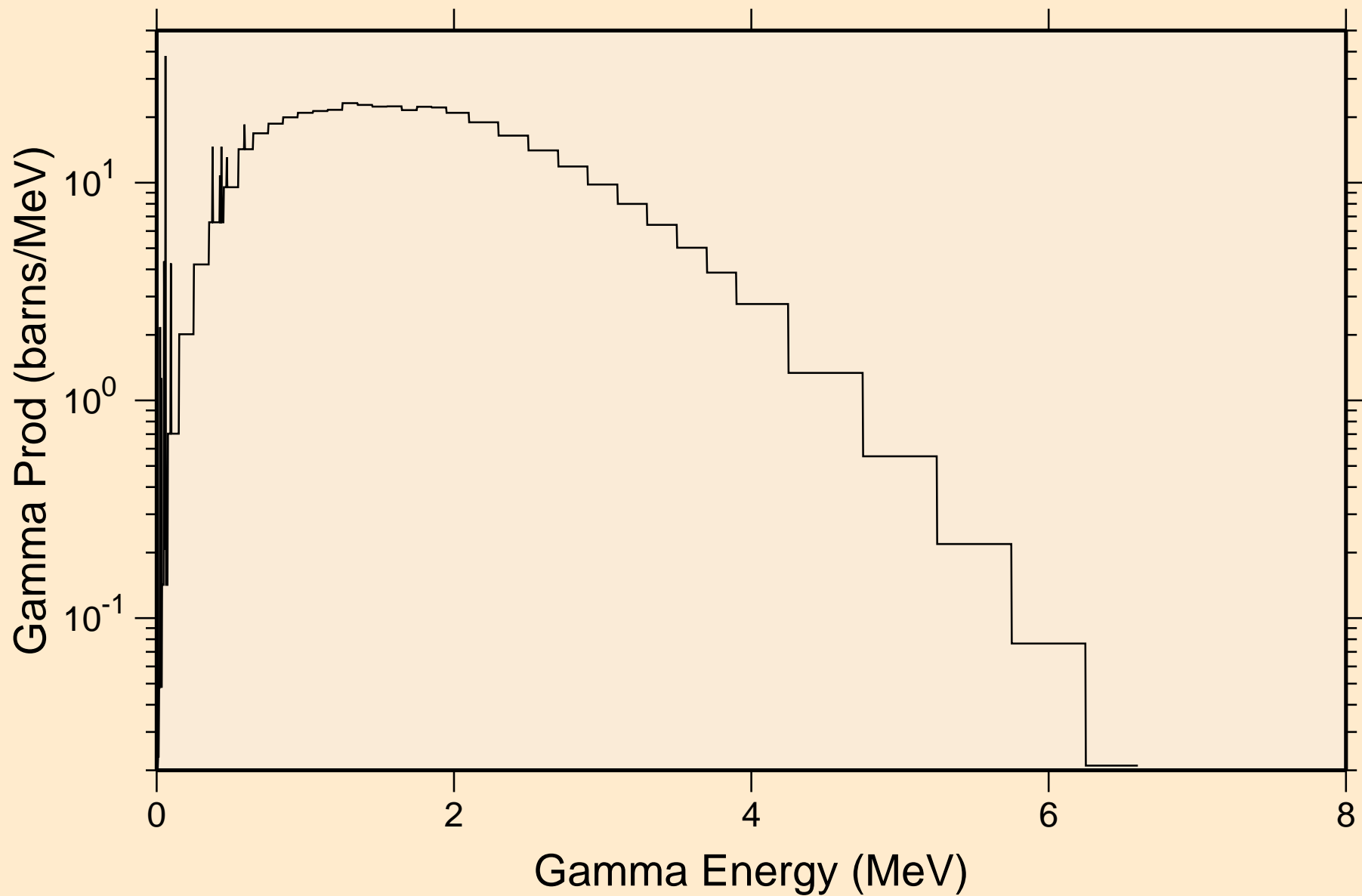

U227 NEUTRON ACER TENDL-2019 LIBRARY; T=293.16K
14 MeV photon spectrum

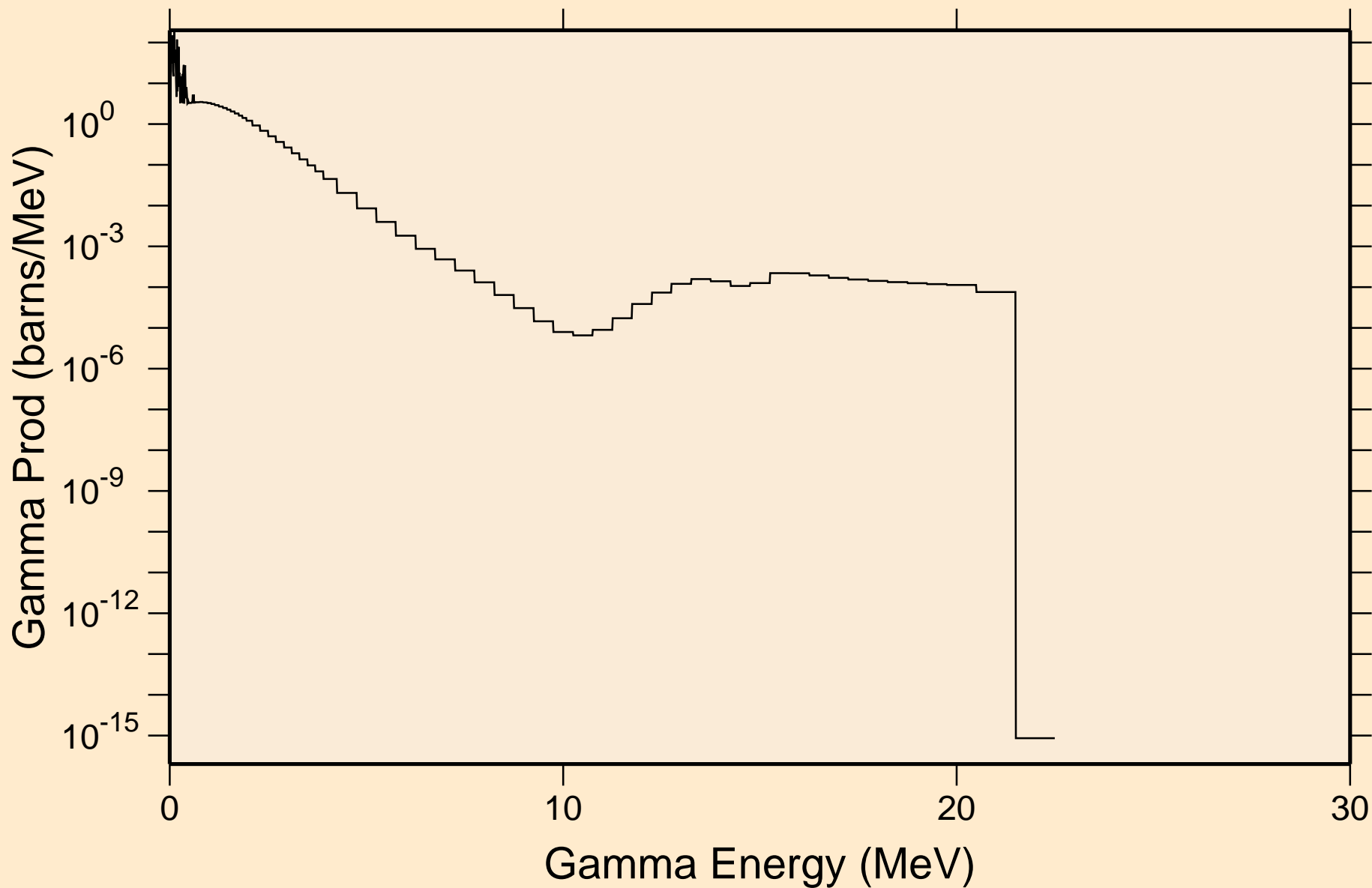

U227 NEUTRON ACER TENDL-2019 LIBRARY; T=293.16K
Particle heating contributions

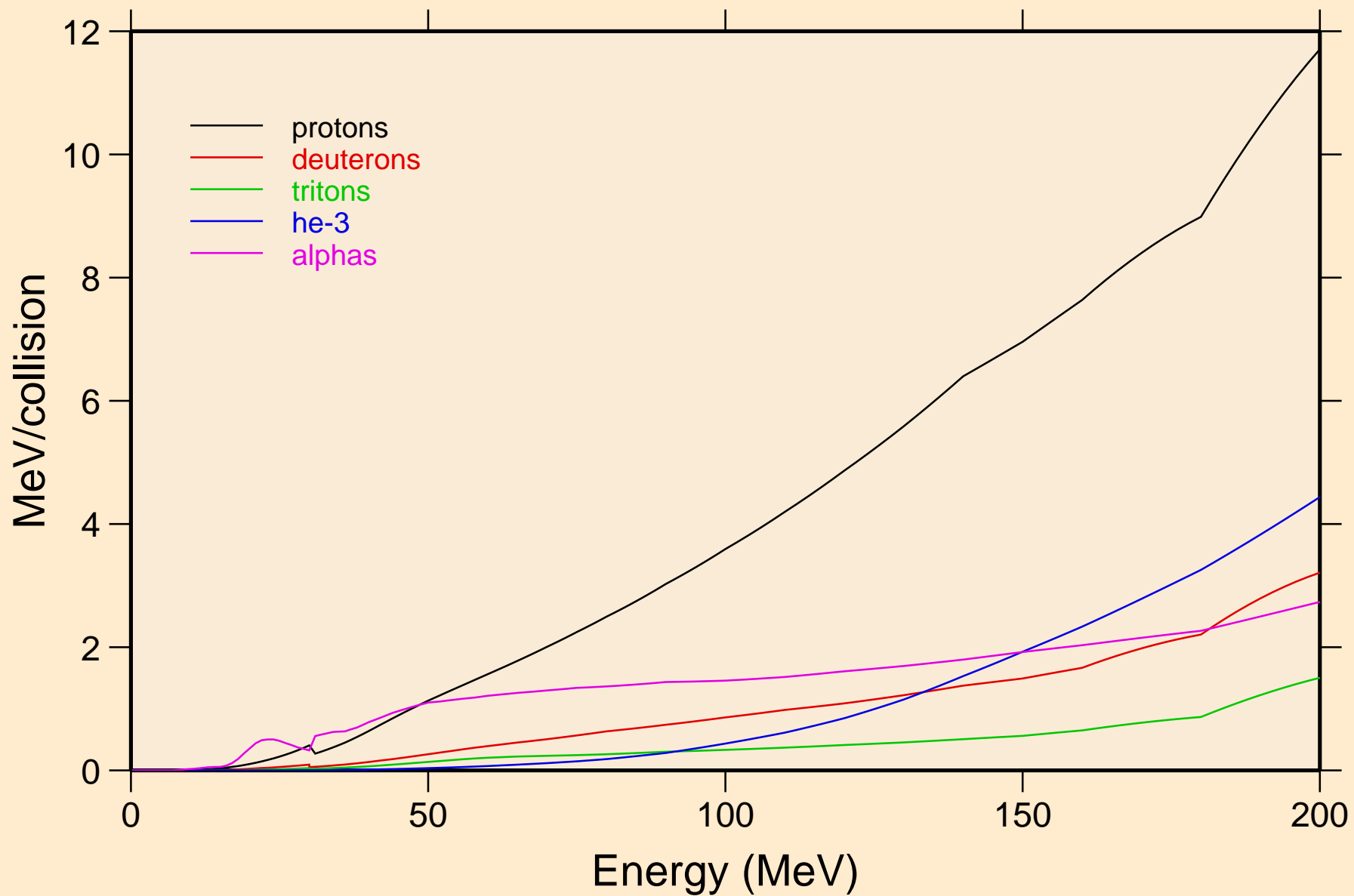

U227 NEUTRON ACER TENDL-2019 LIBRARY; T=293.16K
Recoil Heating

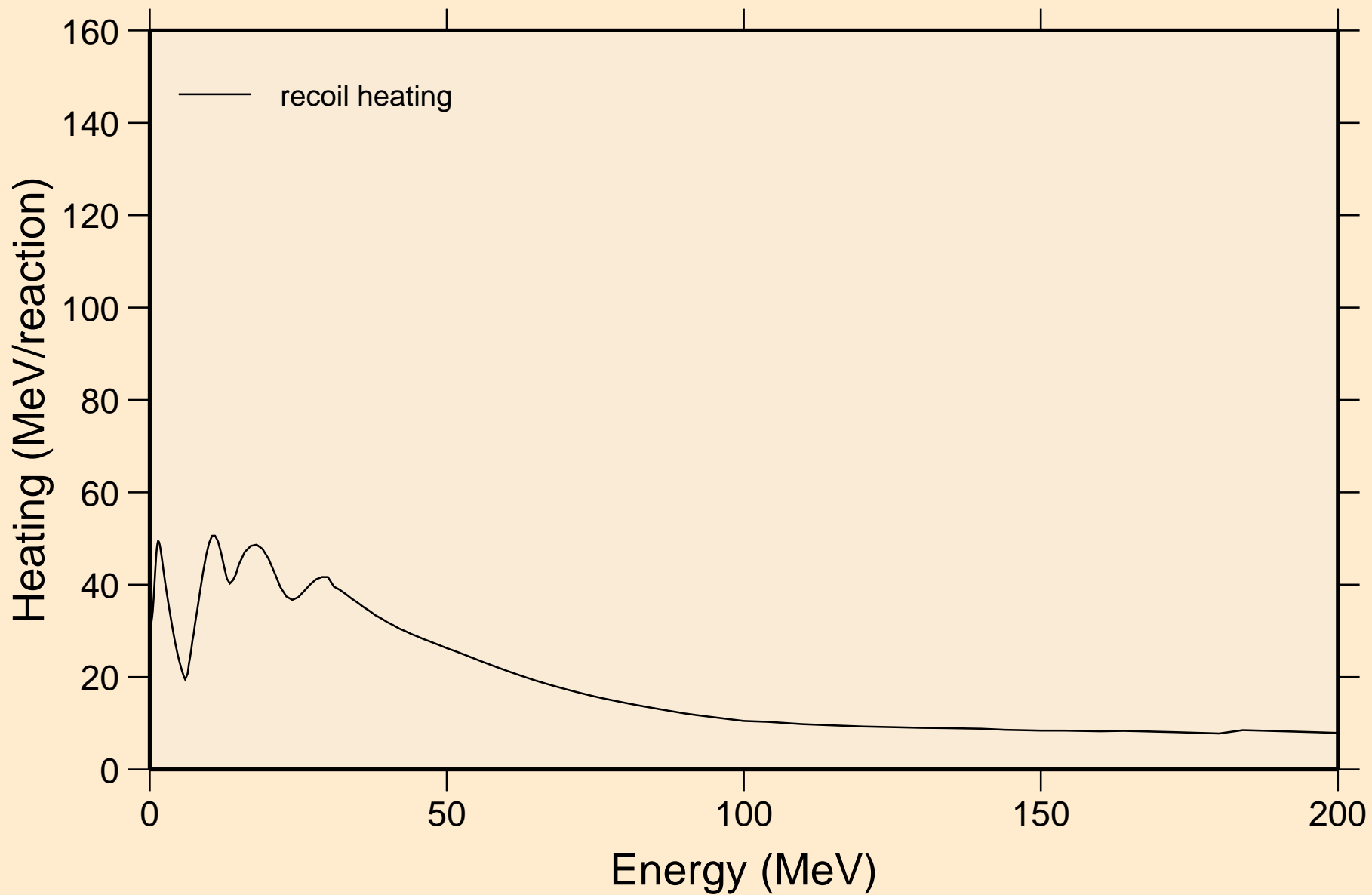

U227 NEUTRON ACER TENDL-2019 LIBRARY; T=293.16K

Particle production cross sections

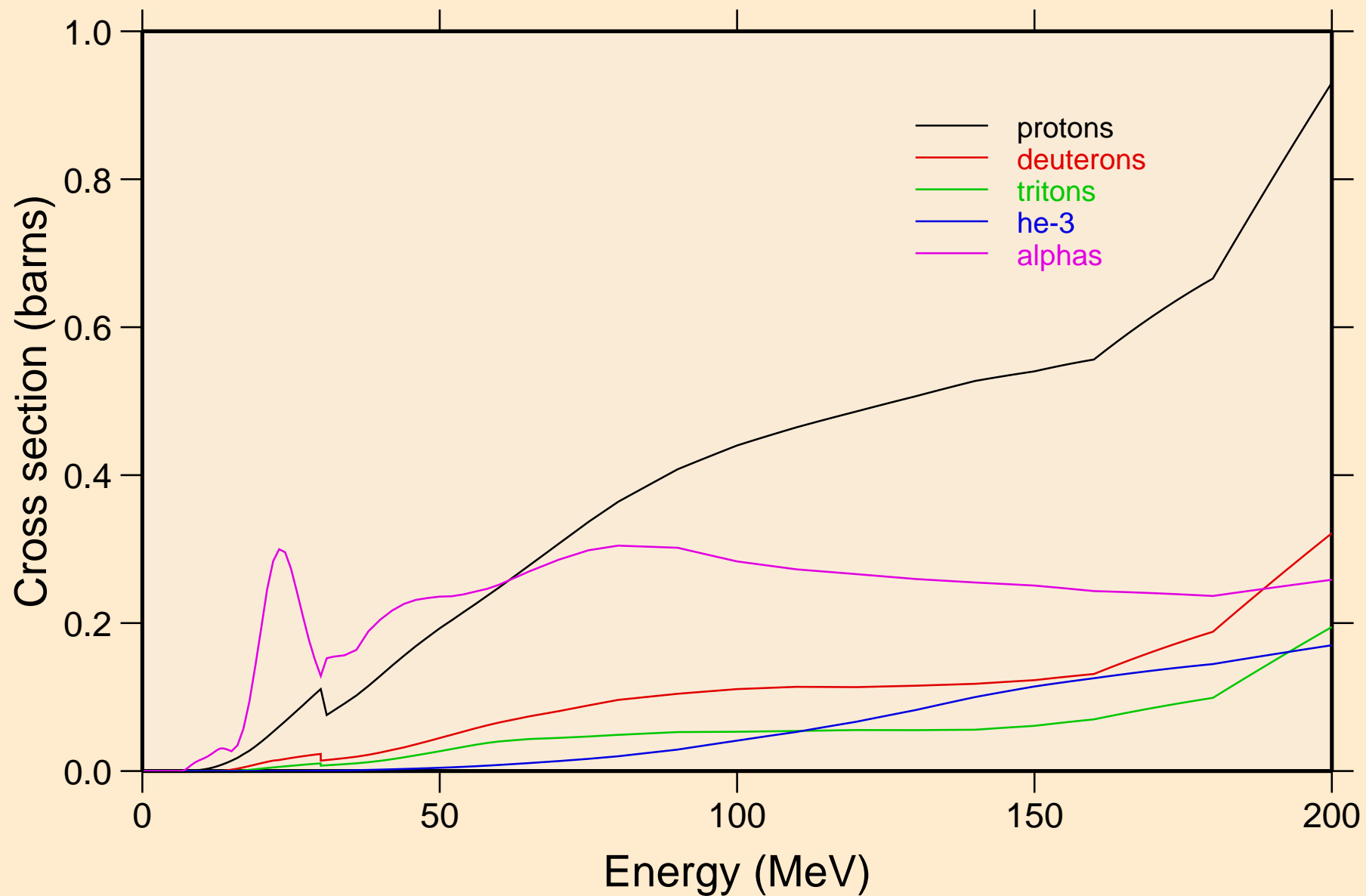

U227 NEUTRON ACER TENDL-2019 LIBRARY; T=293.16K
protons from (n,x)

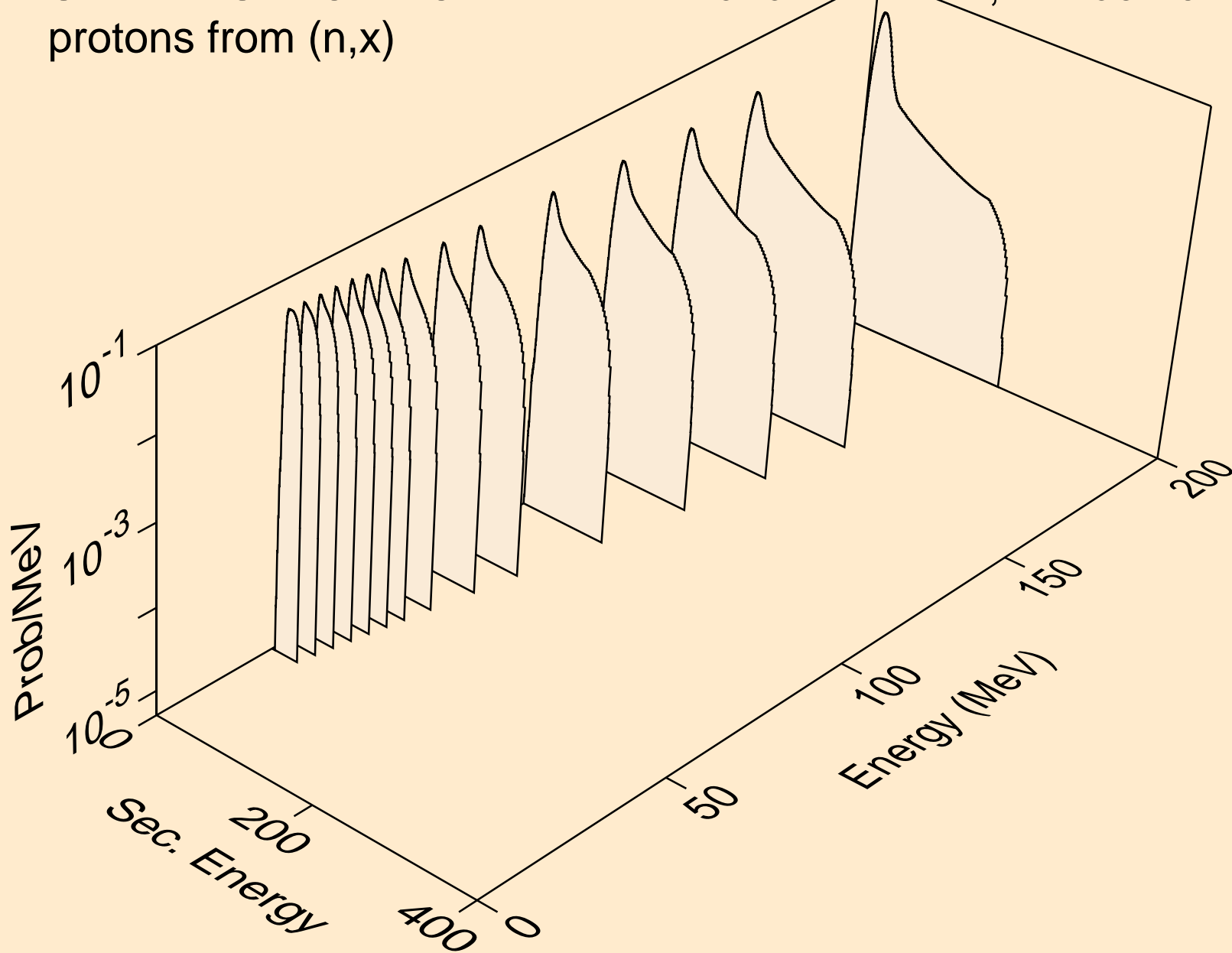

U227 NEUTRON ACER TENDL-2019 LIBRARY; T=293.16K
protons from (n,n*)p

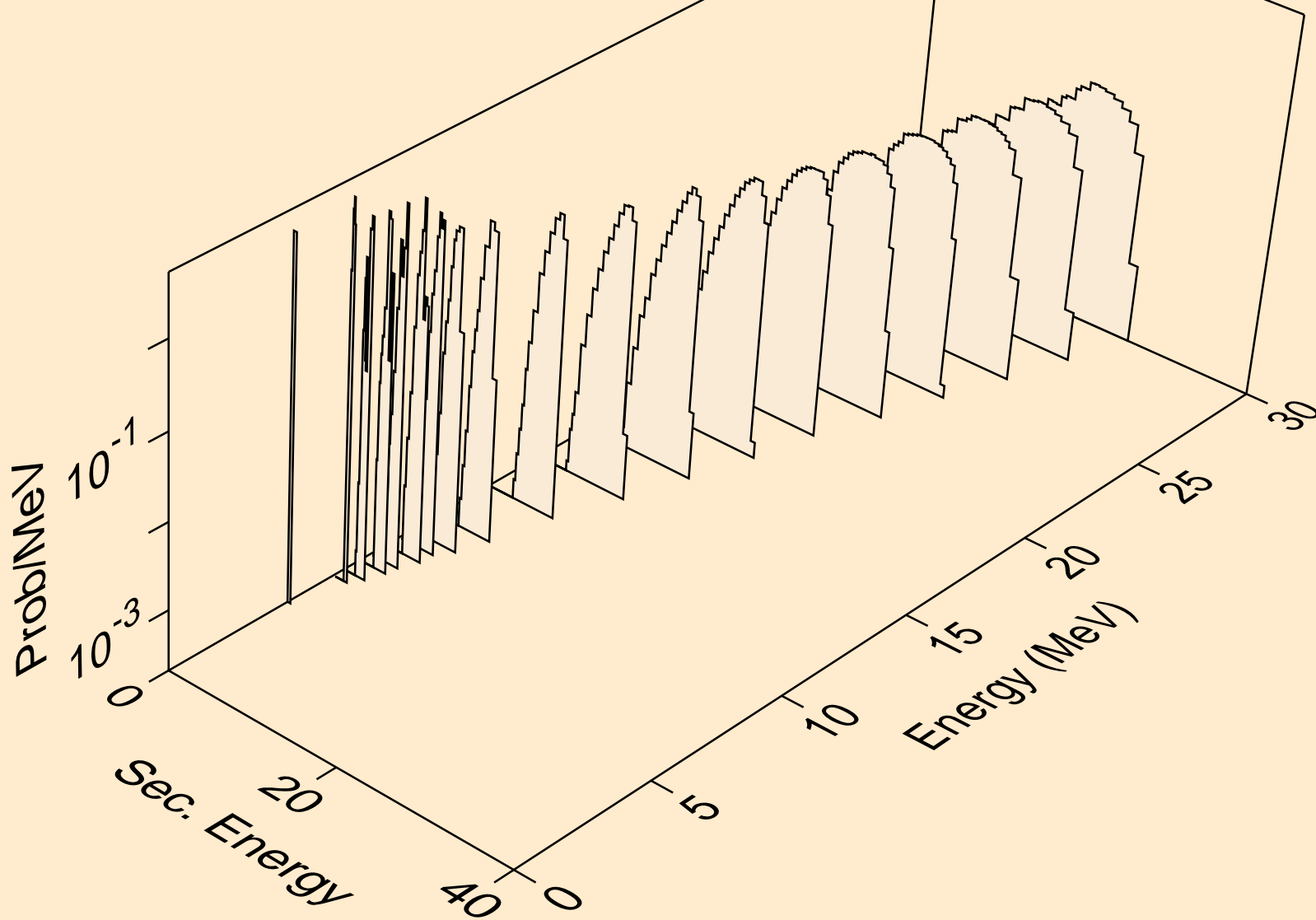

U227 NEUTRON ACER TENDL-2019 LIBRARY; T=293.16K
protons from (n,2np)

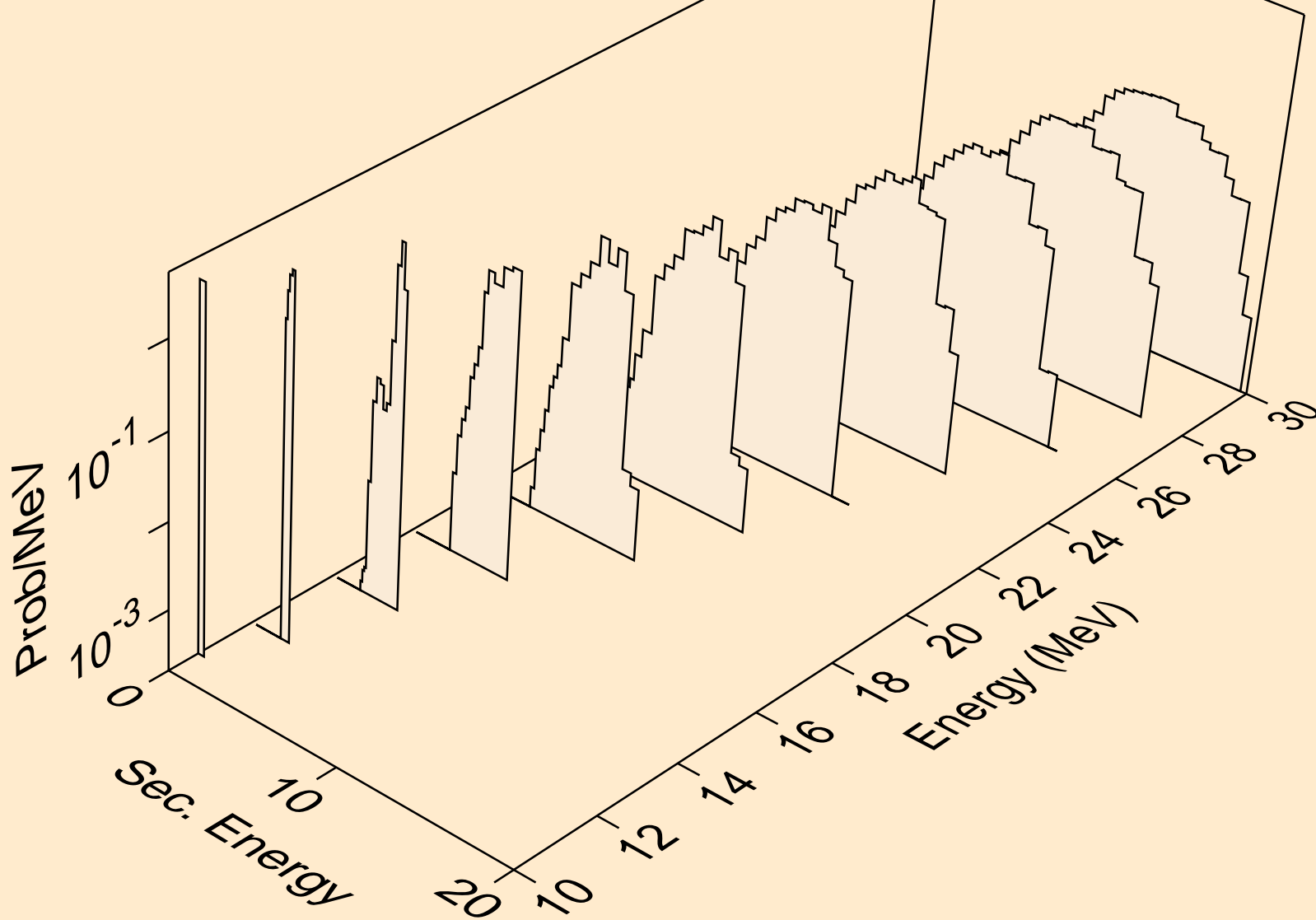

U227 NEUTRON ACER TENDL-2019 LIBRARY; T=293.16K
protons from (n,3np)

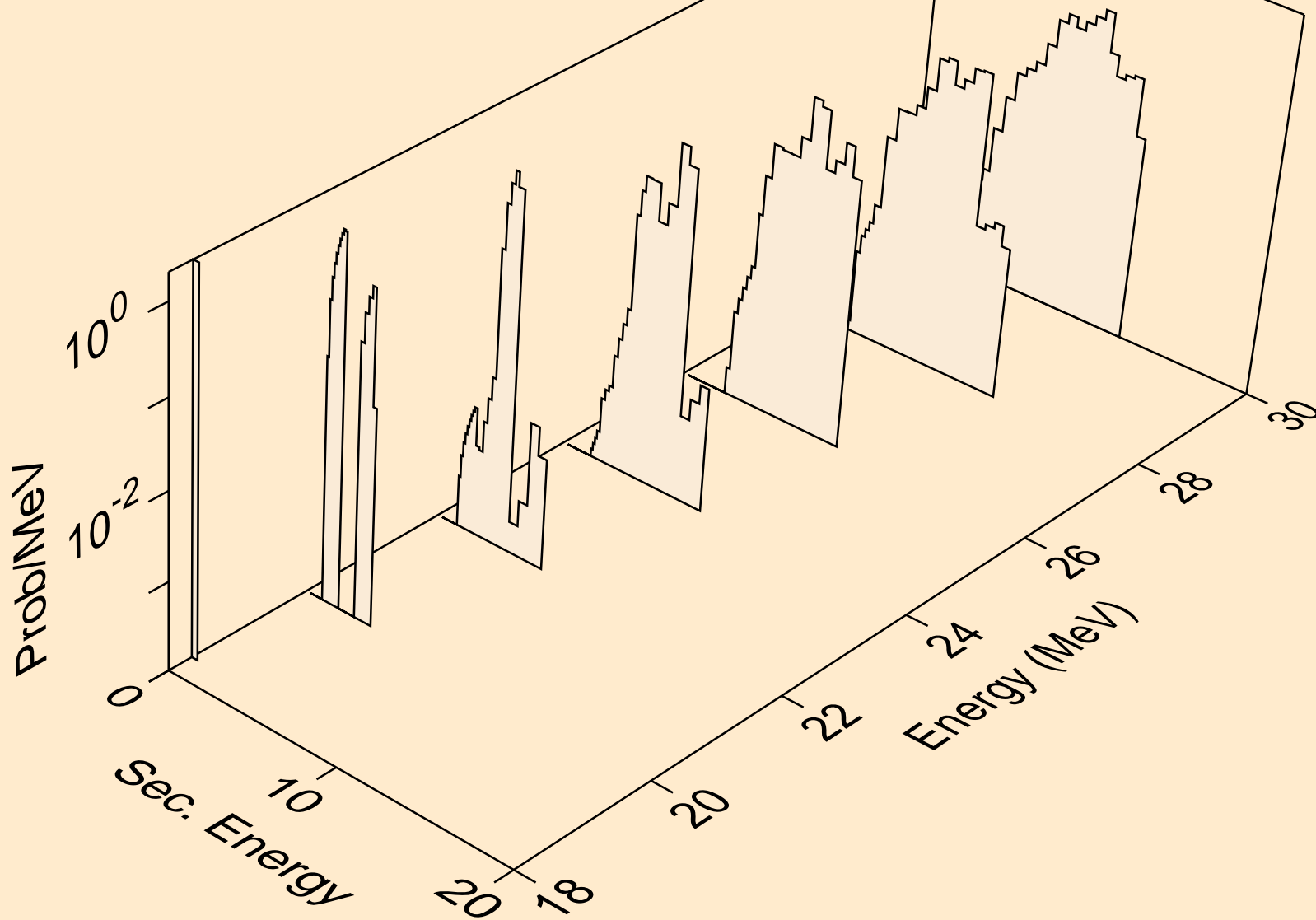

U227 NEUTRON ACER TENDL-2019 LIBRARY; T=293.16K
protons from (n,2np)

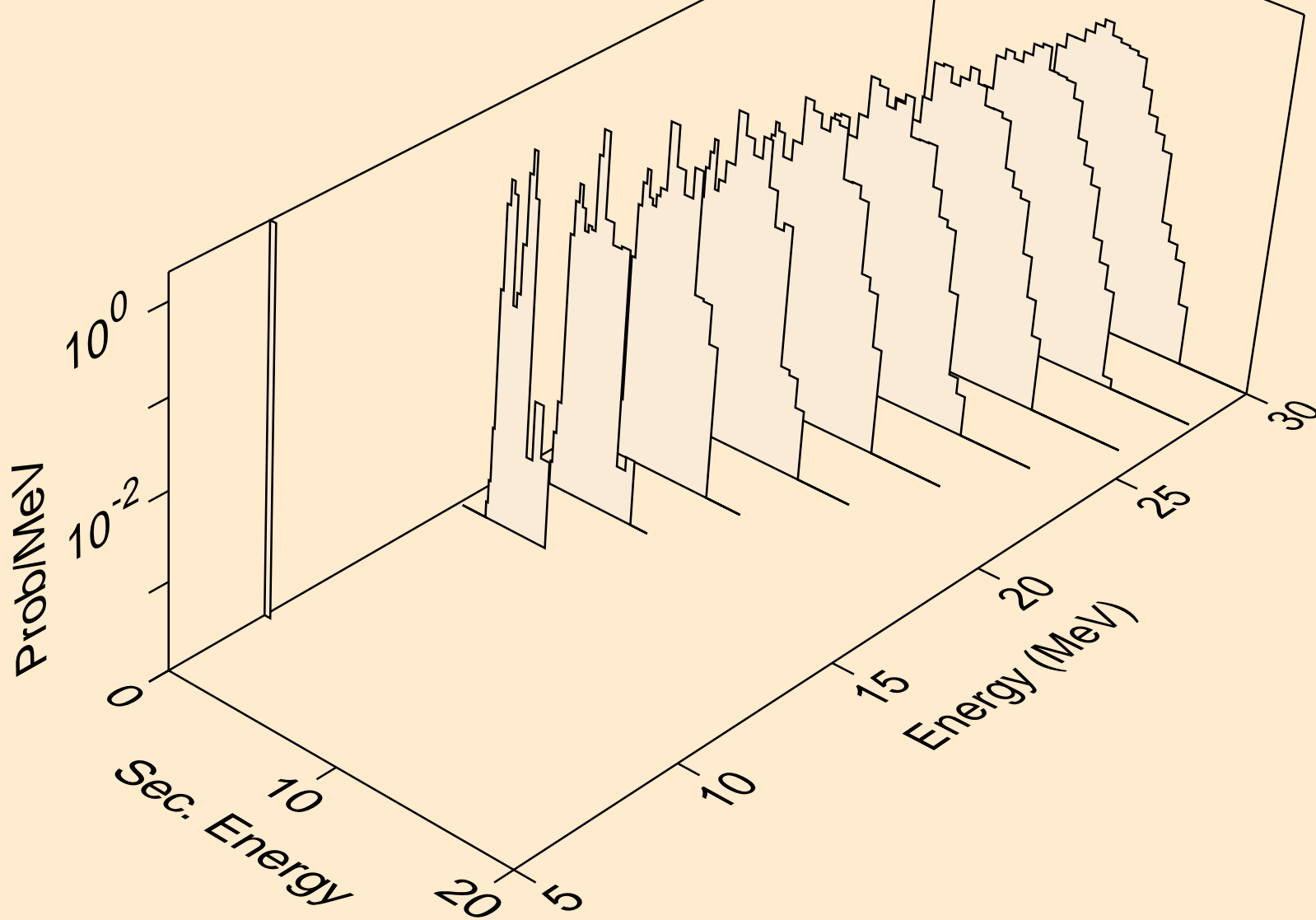

U227 NEUTRON ACER TENDL-2019 LIBRARY; T=293.16K
protons from (n,npa)

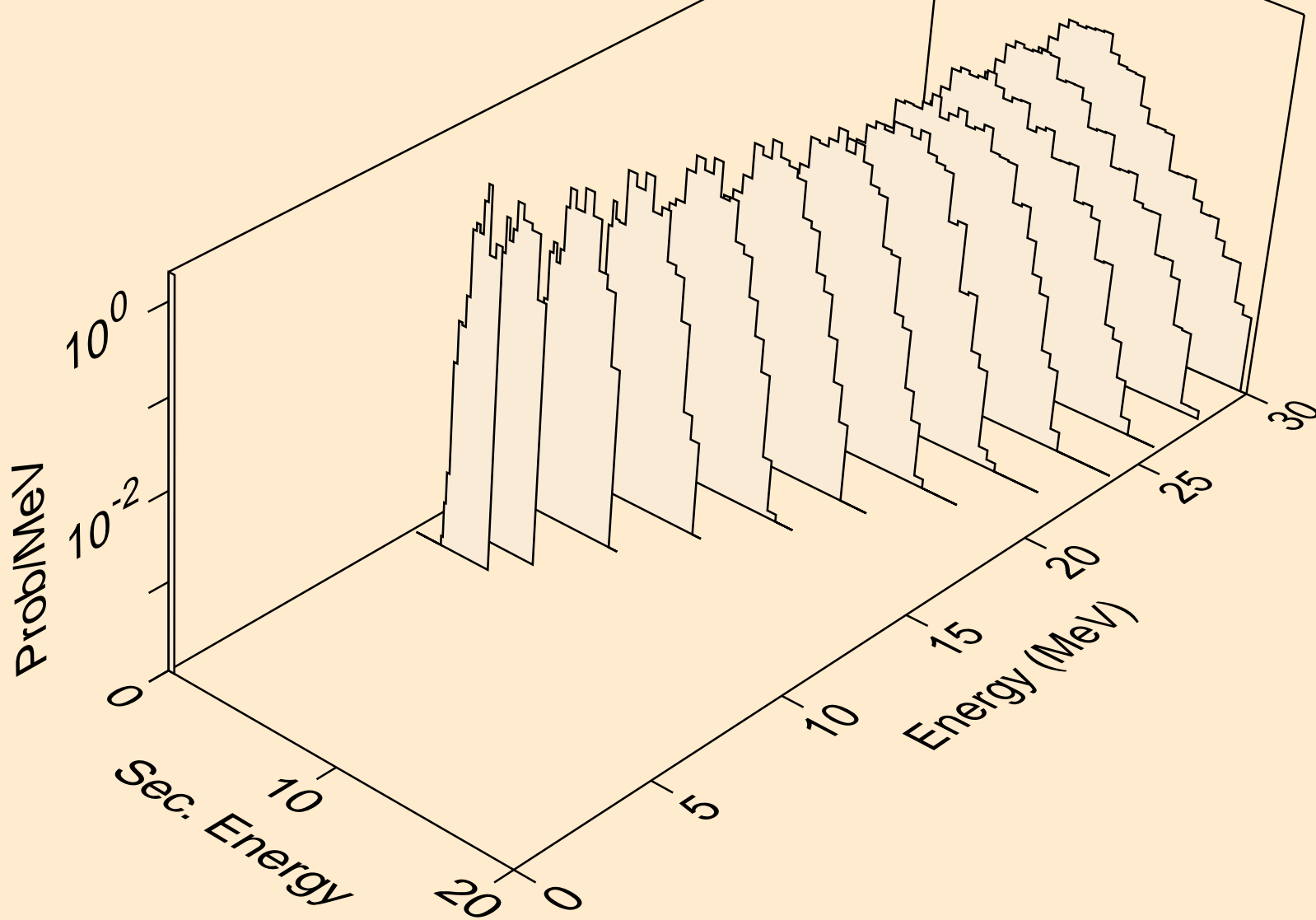

U227 NEUTRON ACER TENDL-2019 LIBRARY; T=293.16K
protons from (n,p)

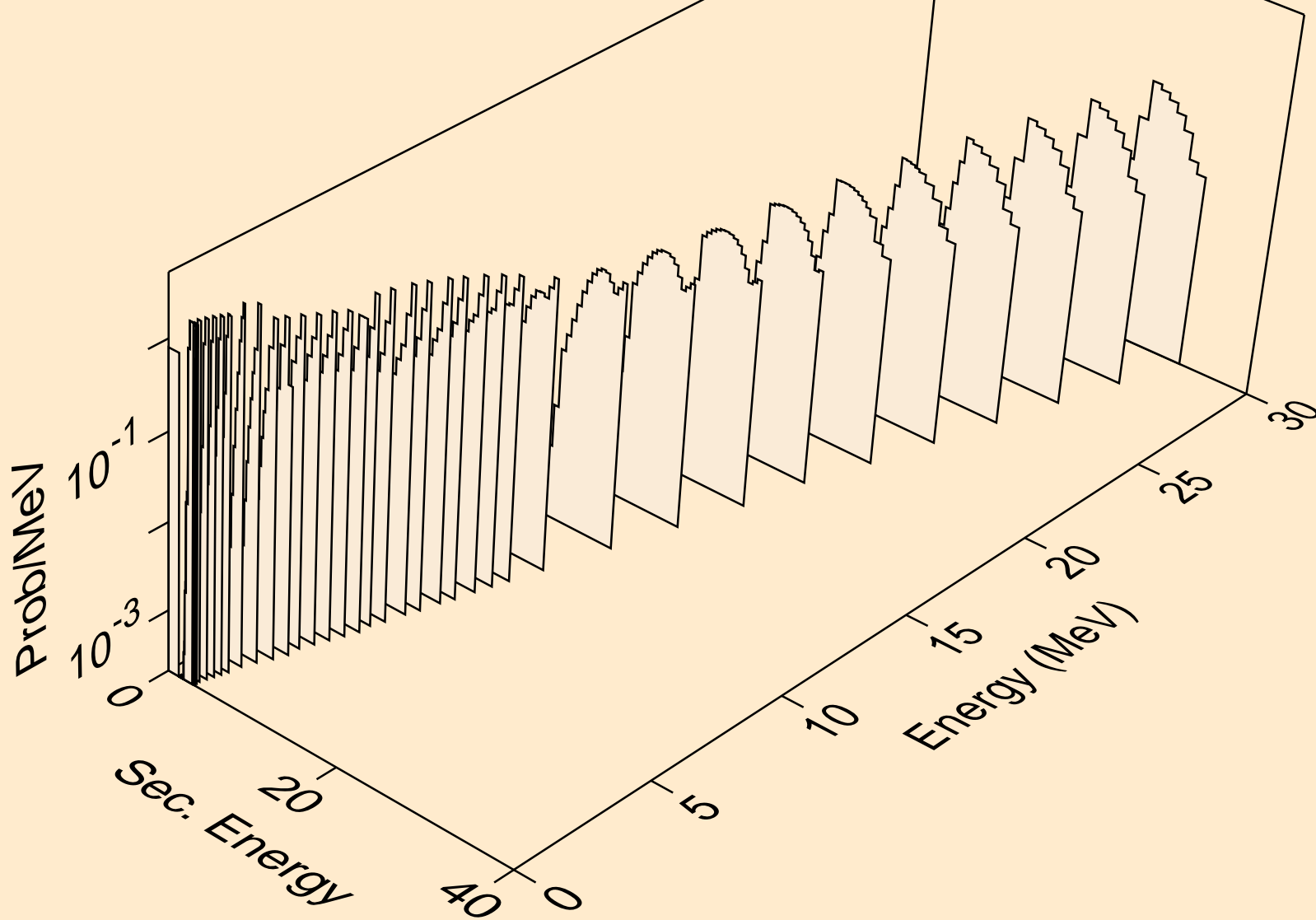

U227 NEUTRON ACER TENDL-2019 LIBRARY; T=293.16K
protons from (n,2p)

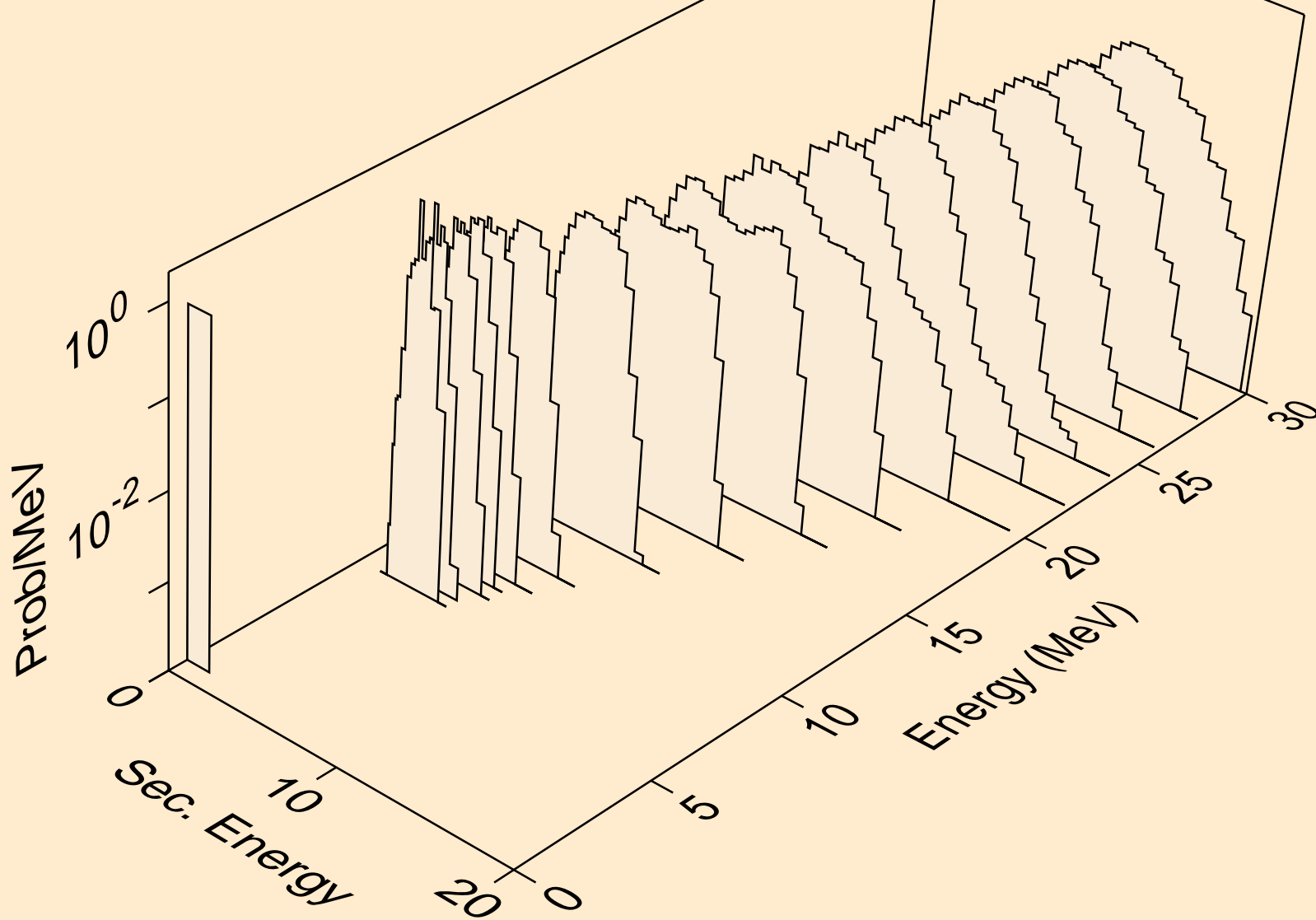

U227 NEUTRON ACER TENDL-2019 LIBRARY; T=293.16K
protons from (n,p)

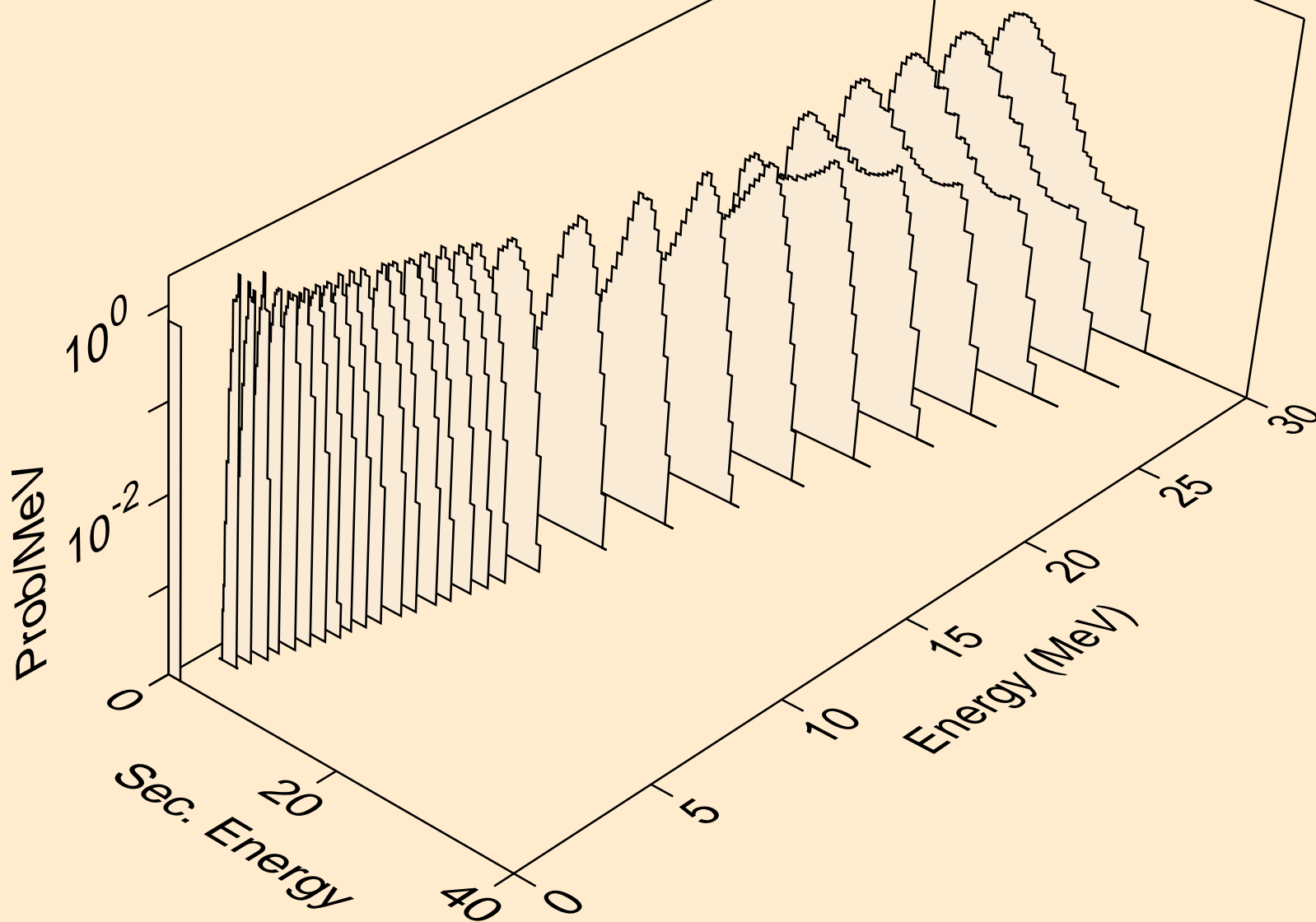

U227 NEUTRON ACER TENDL-2019 LIBRARY; T=293.16K
protons from (n,pd)

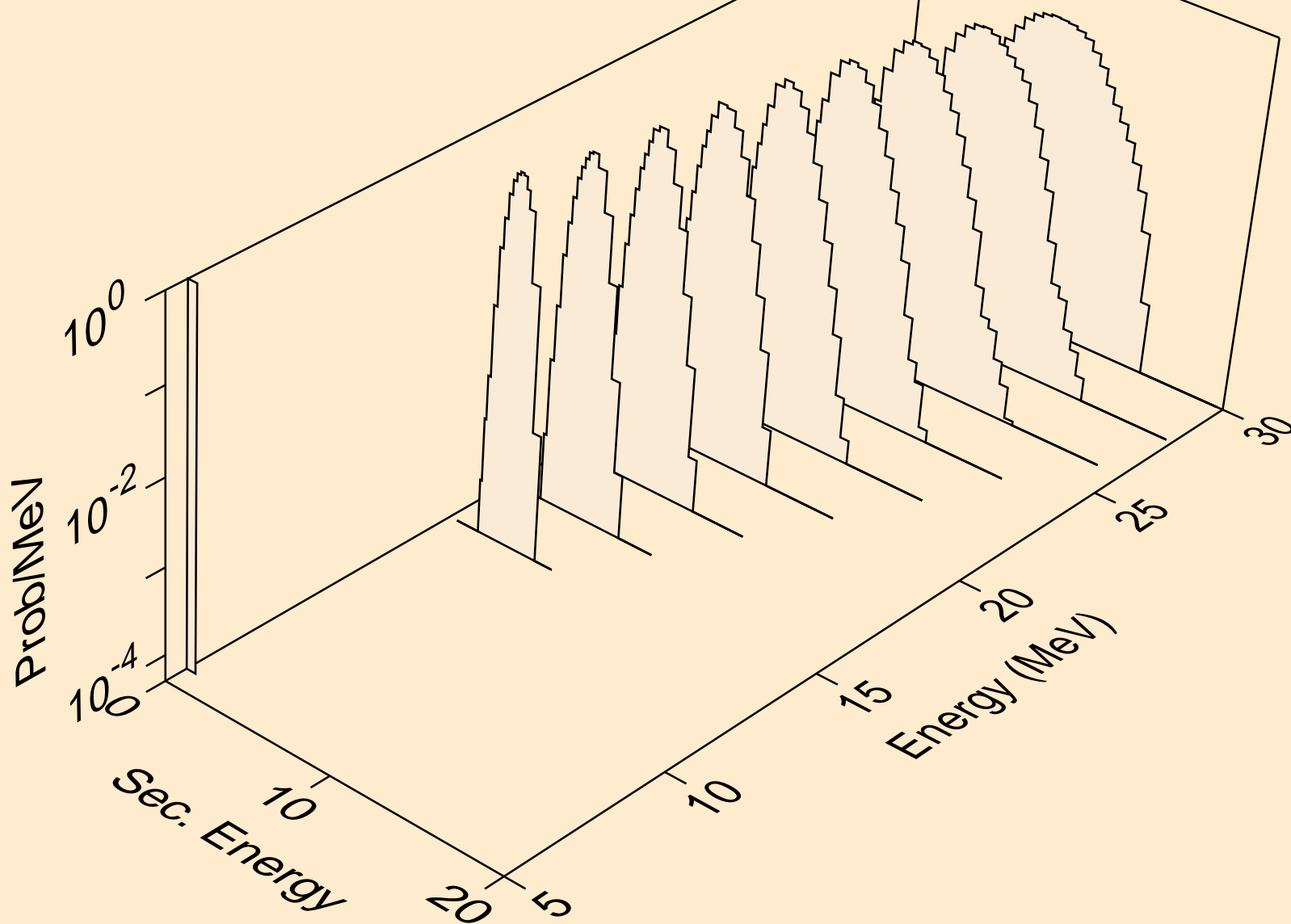

U227 NEUTRON ACER TENDL-2019 LIBRARY; T=293.16K
protons from (n,pt)

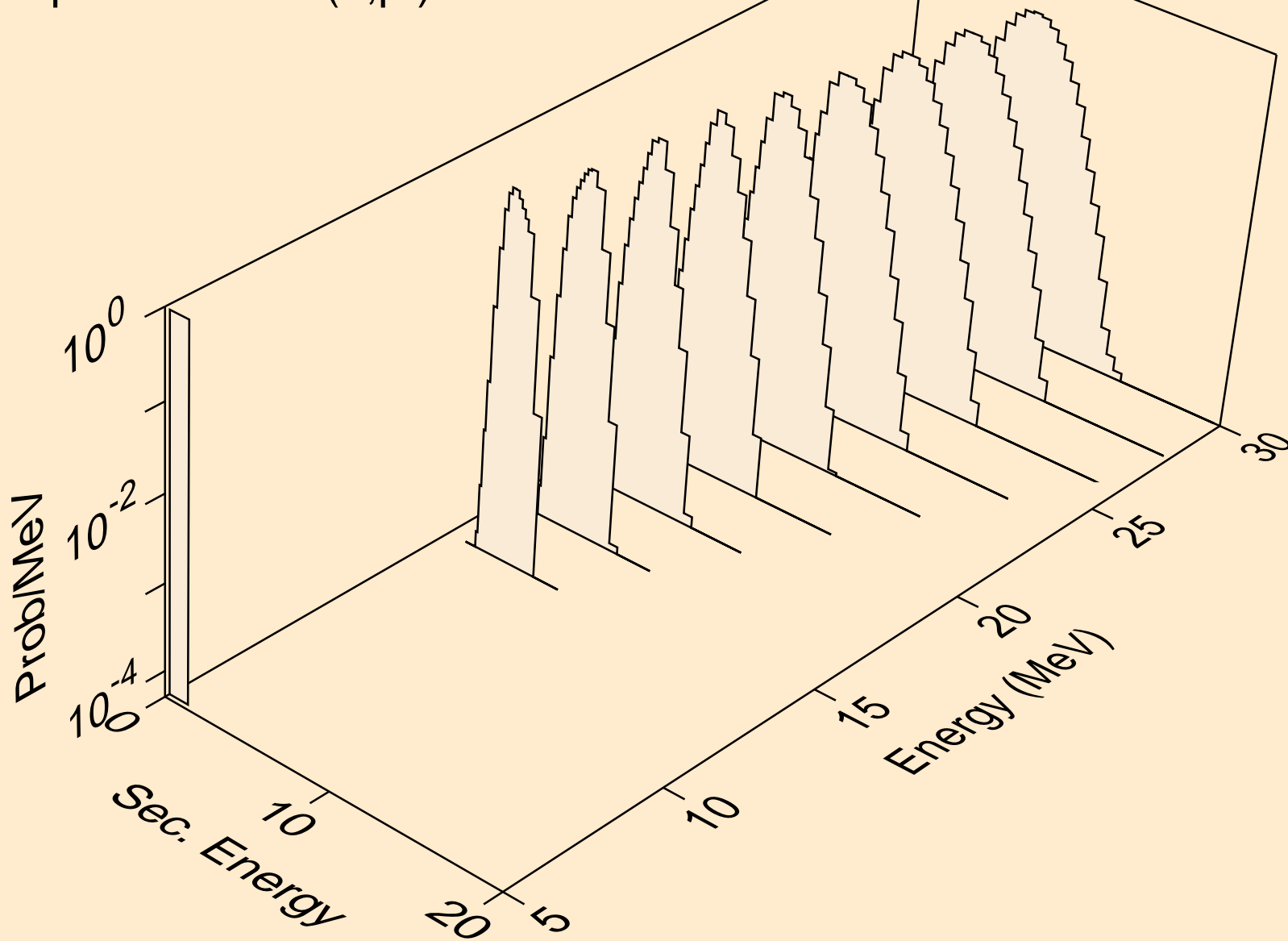

U227 NEUTRON ACER TENDL-2019 LIBRARY; T=293.16K
deuterons from (n,x)

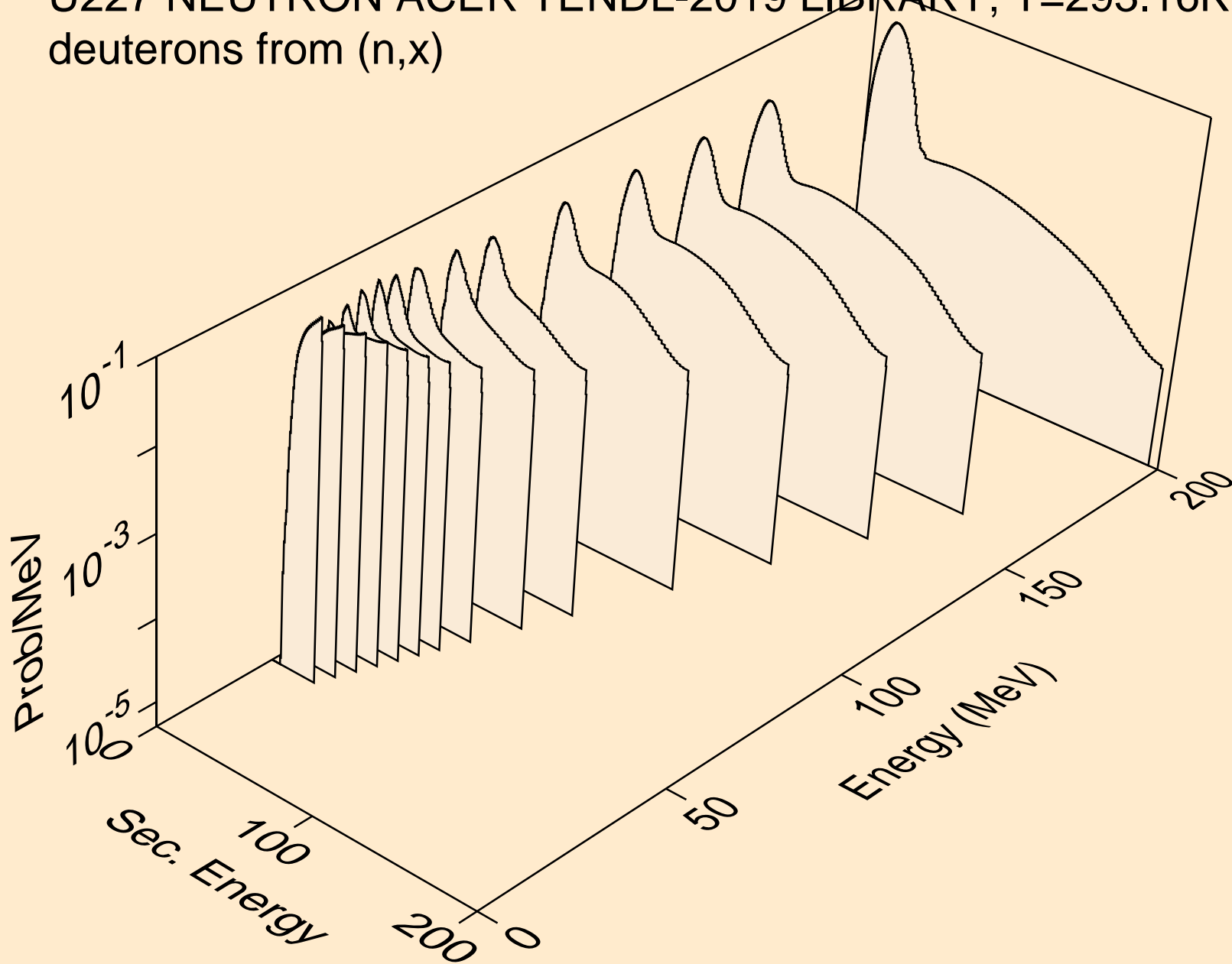

U227 NEUTRON ACER TENDL-2019 LIBRARY; T=293.16K
deuterons from (n,2nd)

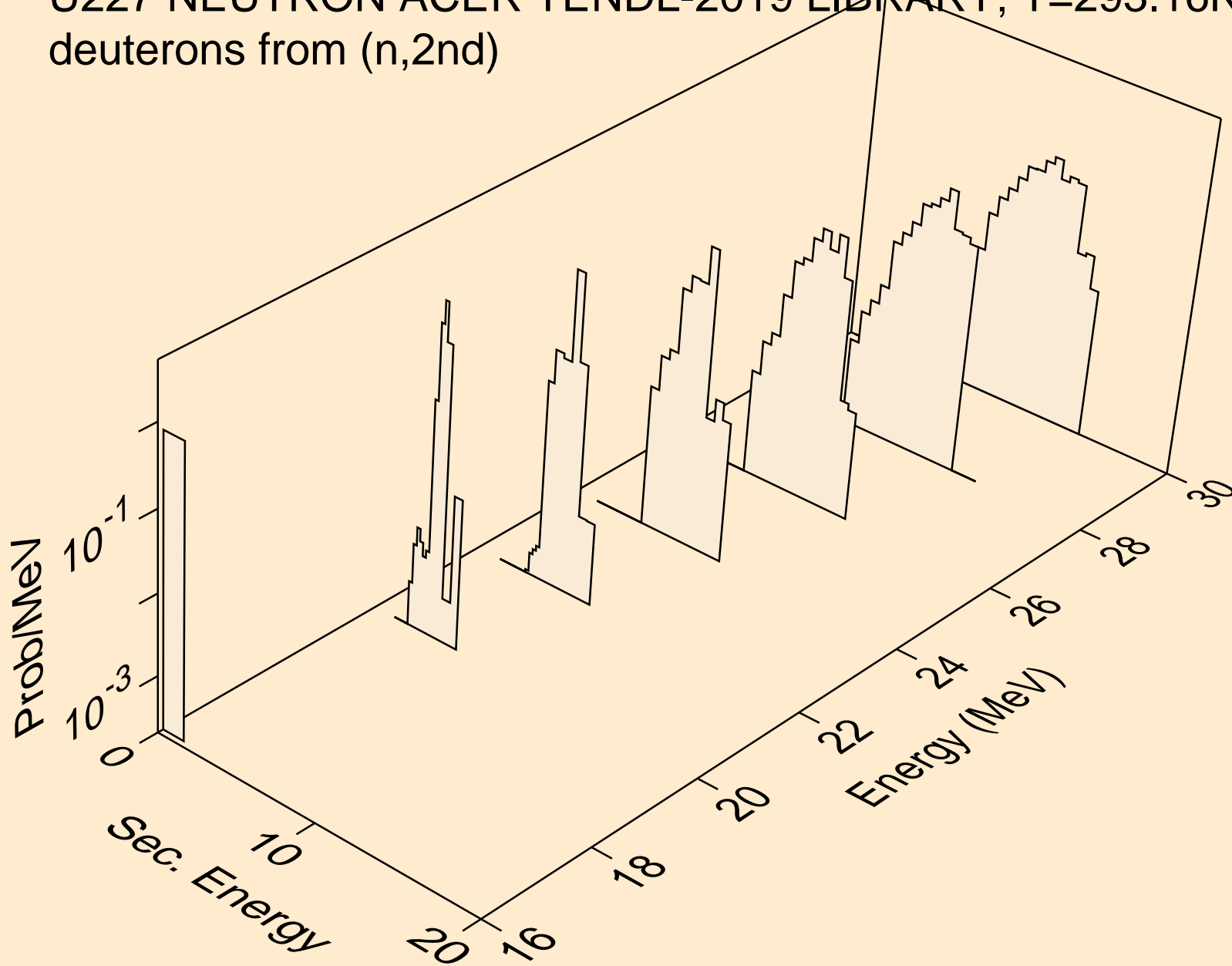

U227 NEUTRON ACER TENDL-2019 LIBRARY; T=293.16K
deuterons from (n,n*)d

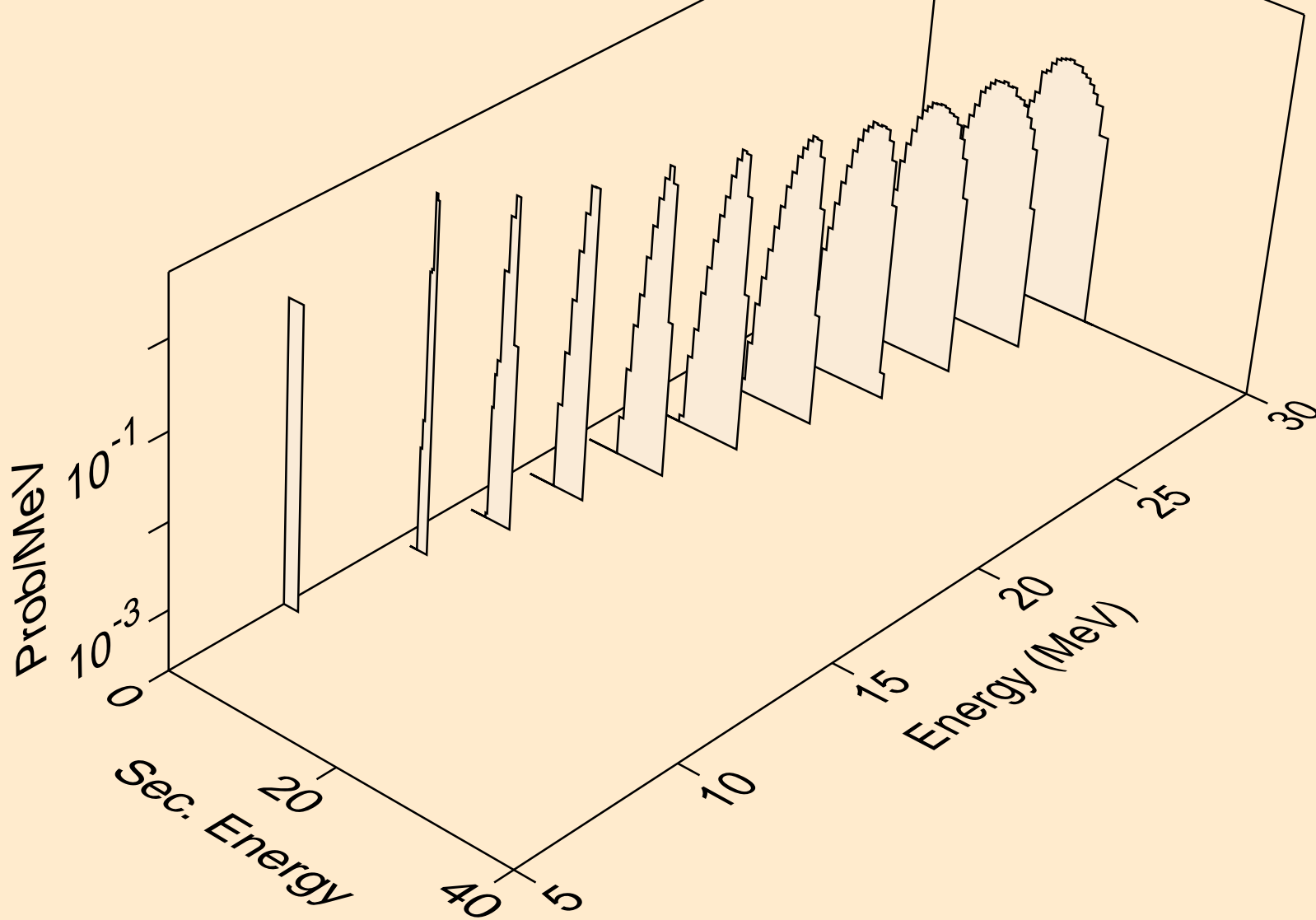

U227 NEUTRON ACER TENDL-2019 LIBRARY; T=293.16K
deuterons from (n,d)

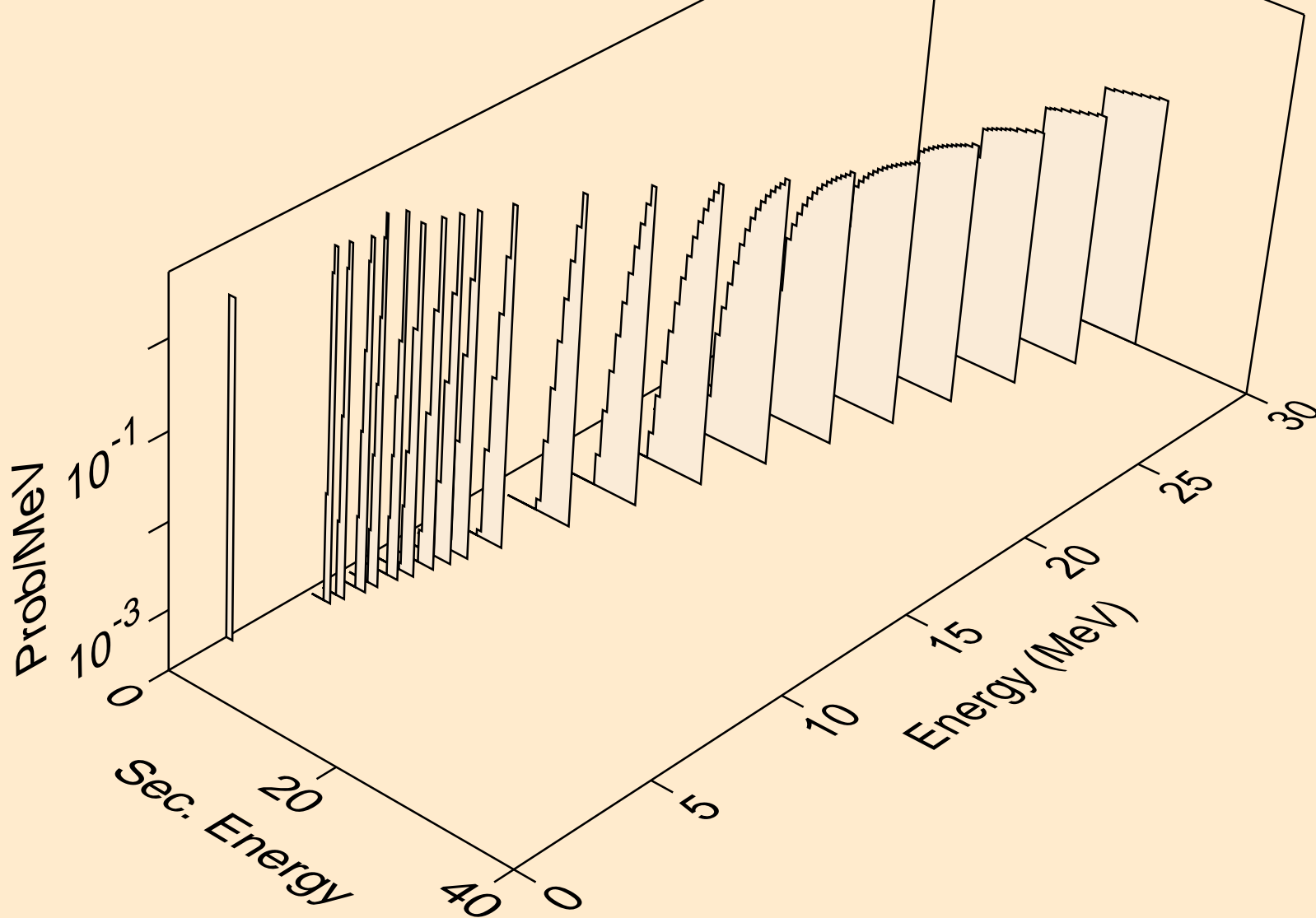

U227 NEUTRON ACER TENDL-2019 LIBRARY; T=293.16K
deuterons from (n,pd)

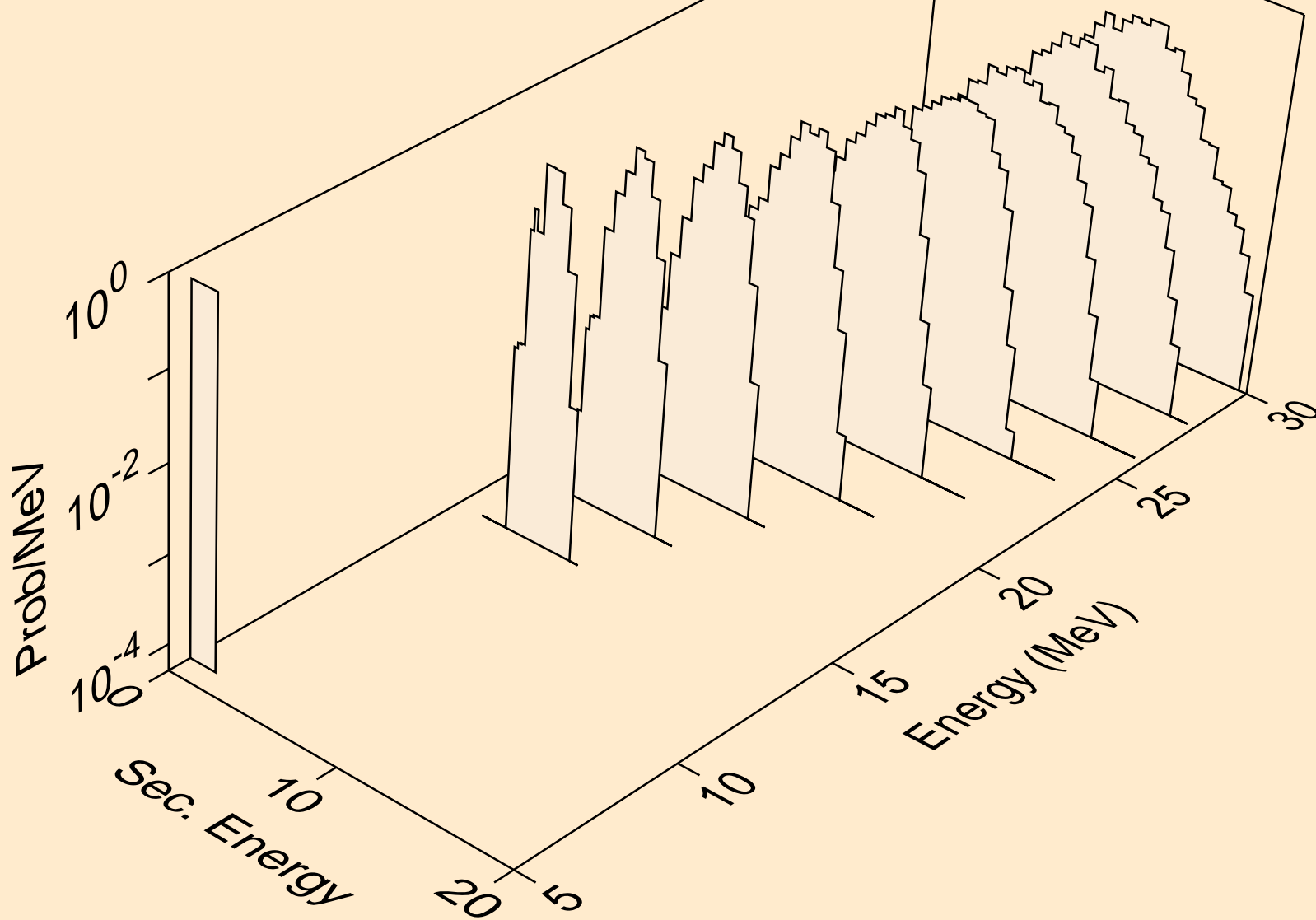

U227 NEUTRON ACER TENDL-2019 LIBRARY; T=293.16K
deuterons from (n,da)

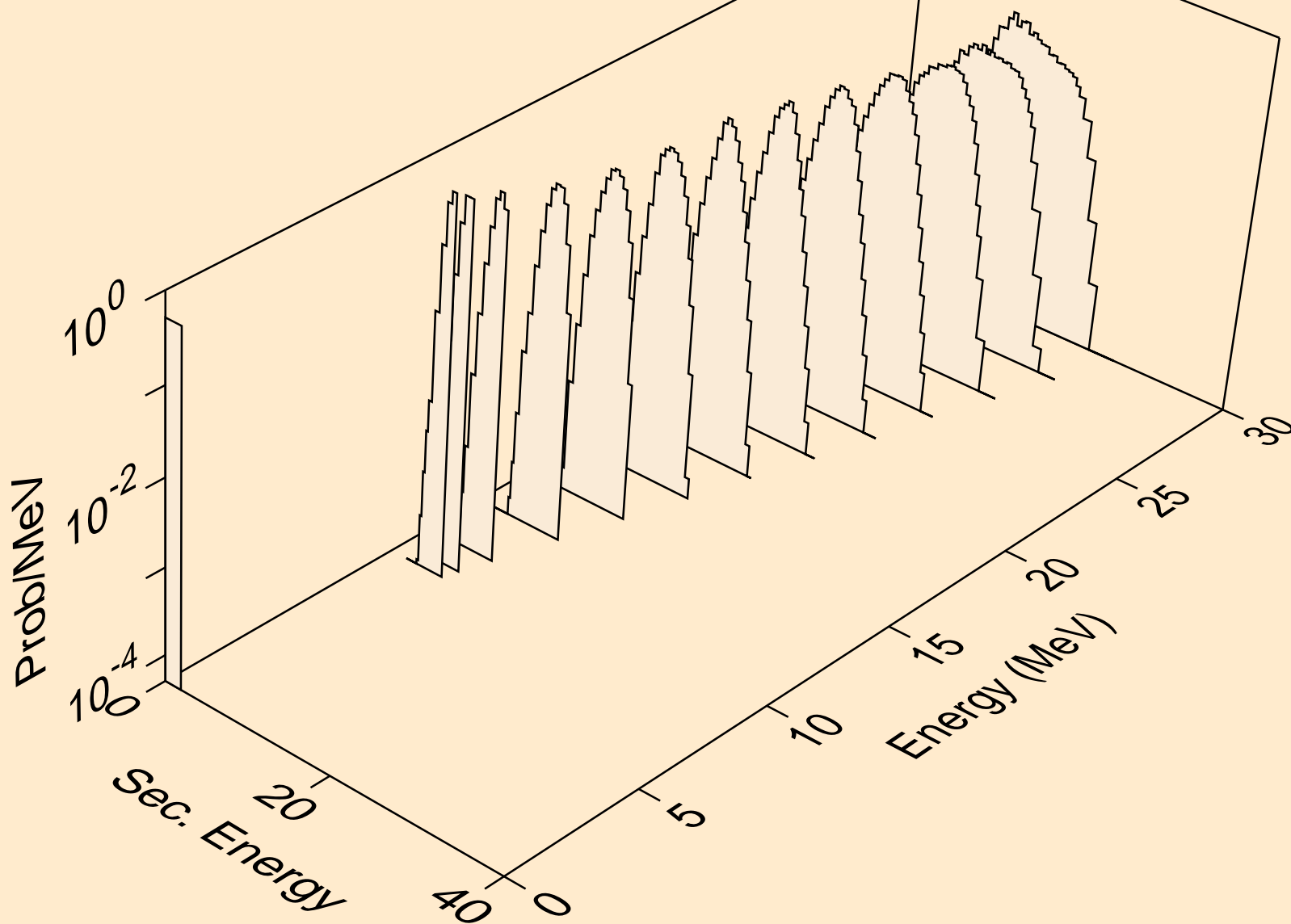

U227 NEUTRON ACER TENDL-2019 LIBRARY; T=293.16K
tritons from (n,x)

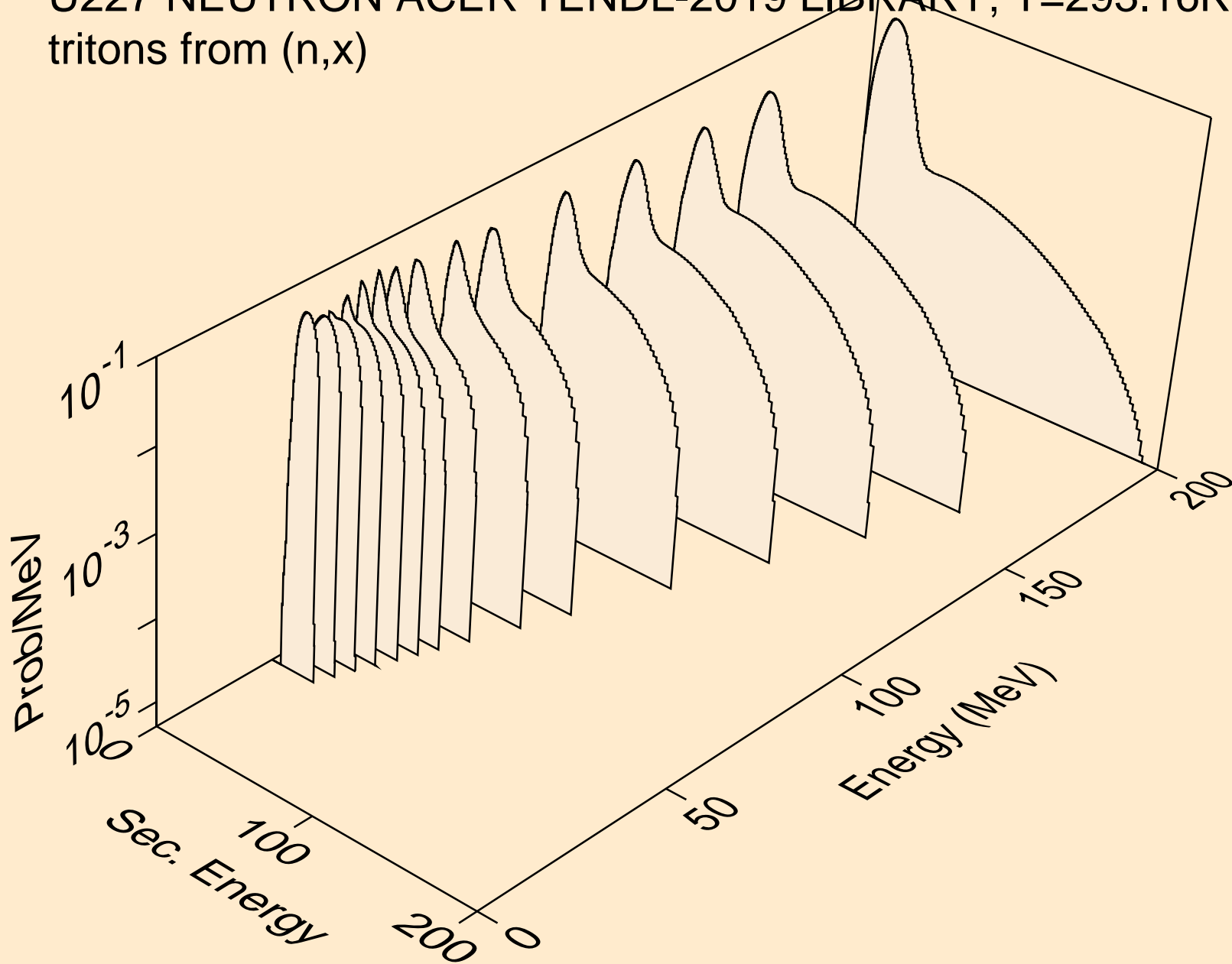

U227 NEUTRON ACER TENDL-2019 LIBRARY; T=293.16K
tritons from (n,n*)t

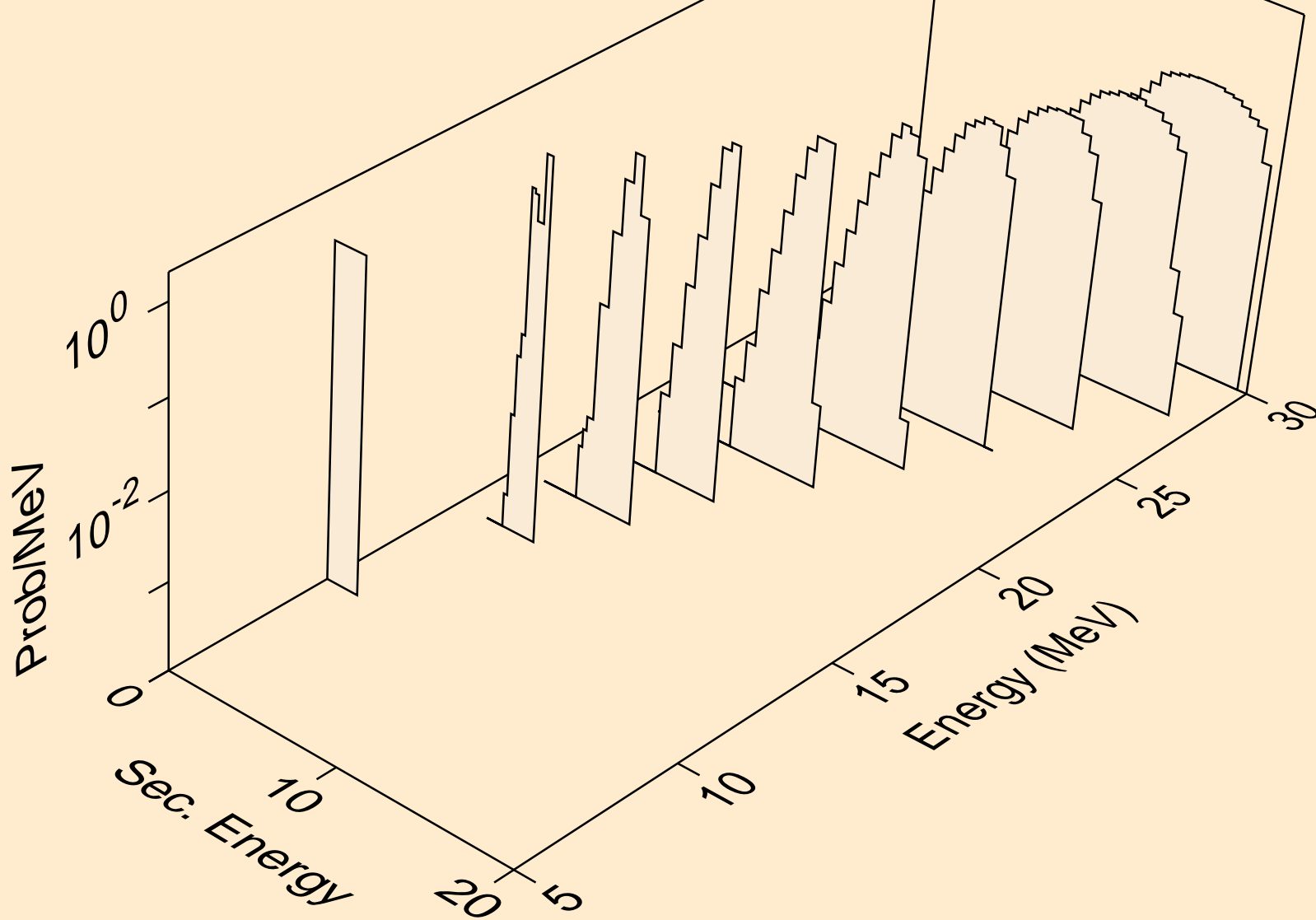

U227 NEUTRON ACER TENDL-2019 LIBRARY; T=293.16K
tritons from (n,n*)t2a

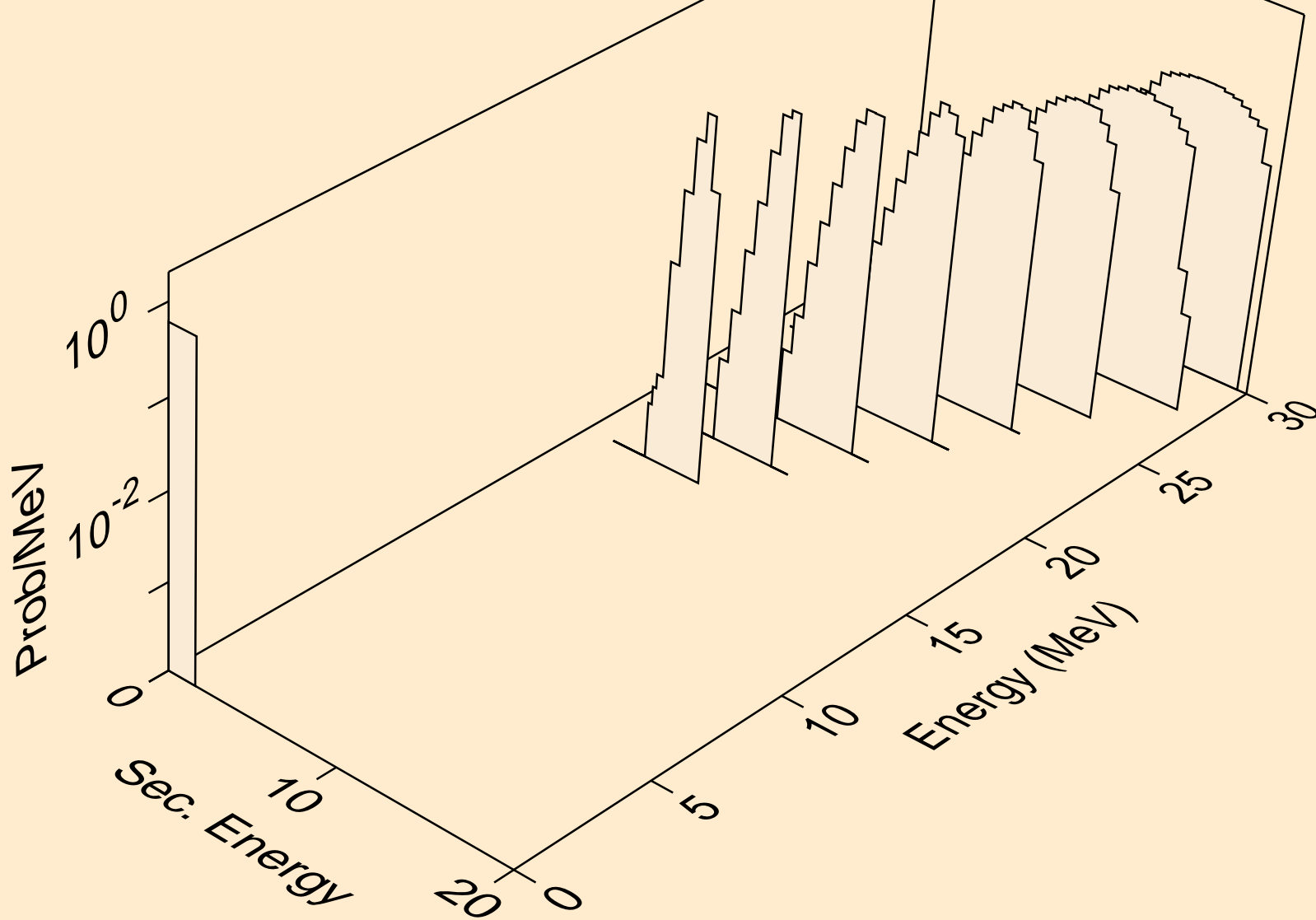

U227 NEUTRON ACER TENDL-2019 LIBRARY; T=293.16K
tritons from (n,t)

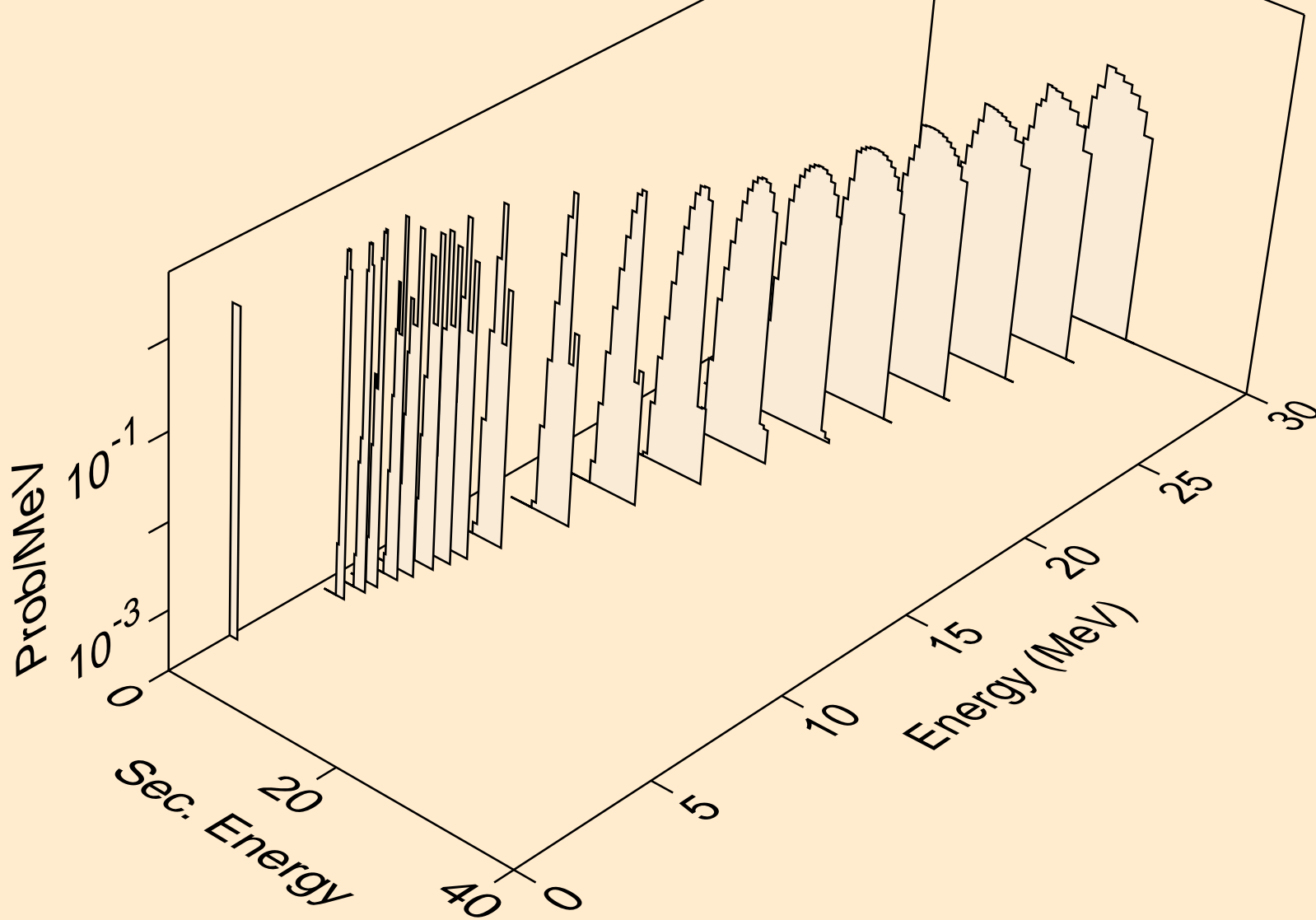

U227 NEUTRON ACER TENDL-2019 LIBRARY; T=293.16K
tritons from (n,t2a)

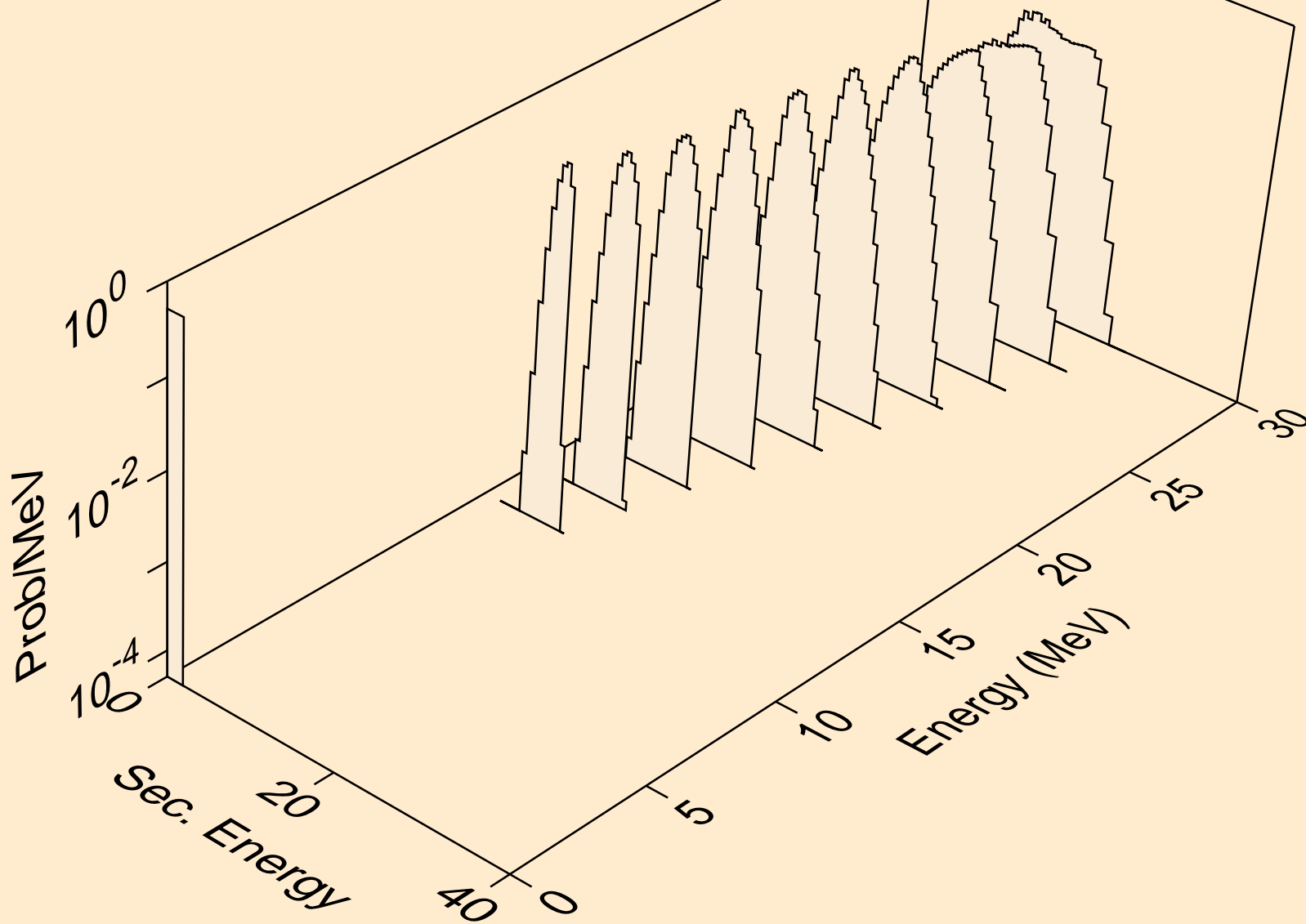

U227 NEUTRON ACER TENDL-2019 LIBRARY; T=293.16K
tritons from (n,pt)

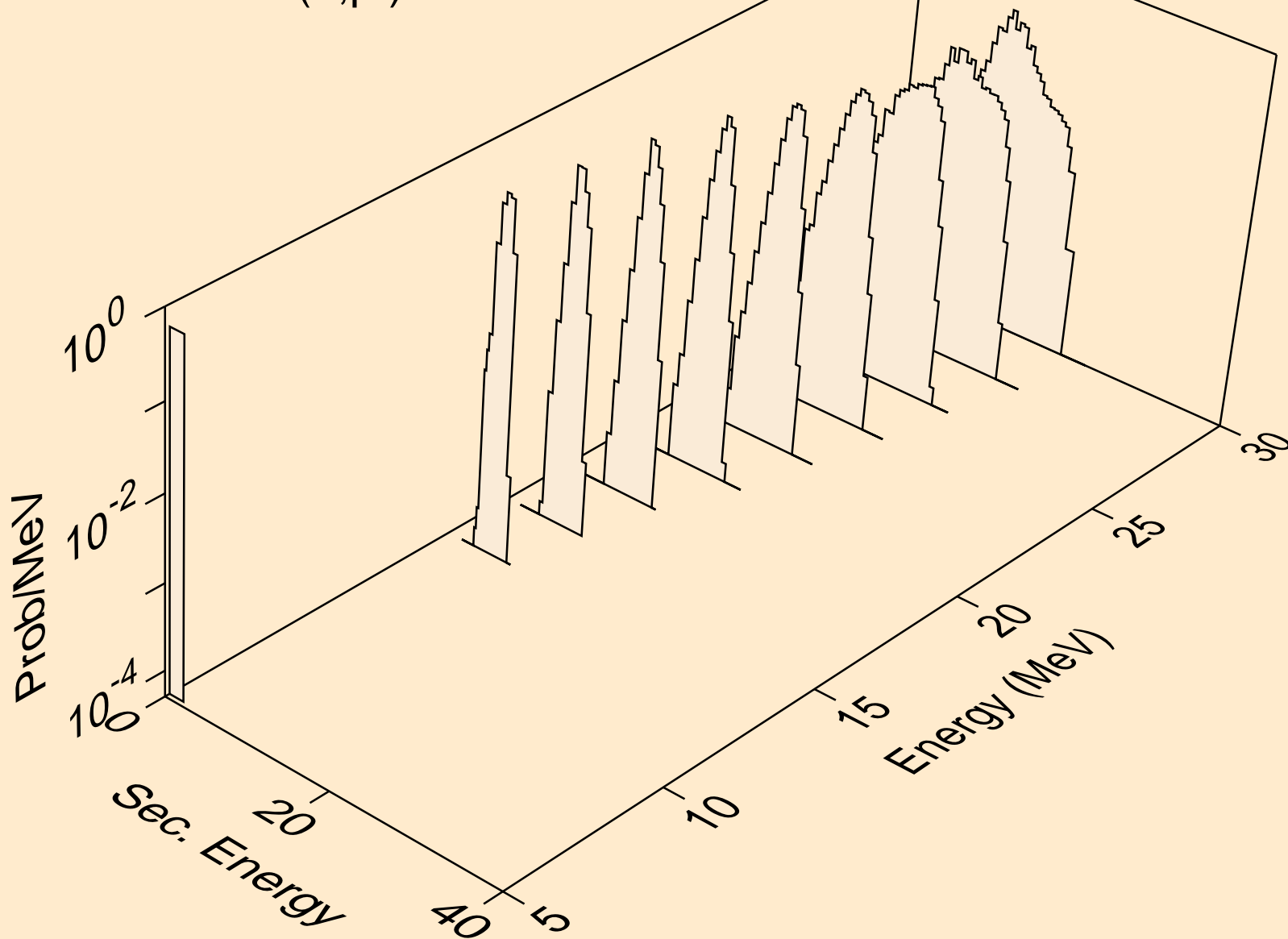

U227 NEUTRON ACER TENDL-2019 LIBRARY; T=293.16K
he3s from (n,x)

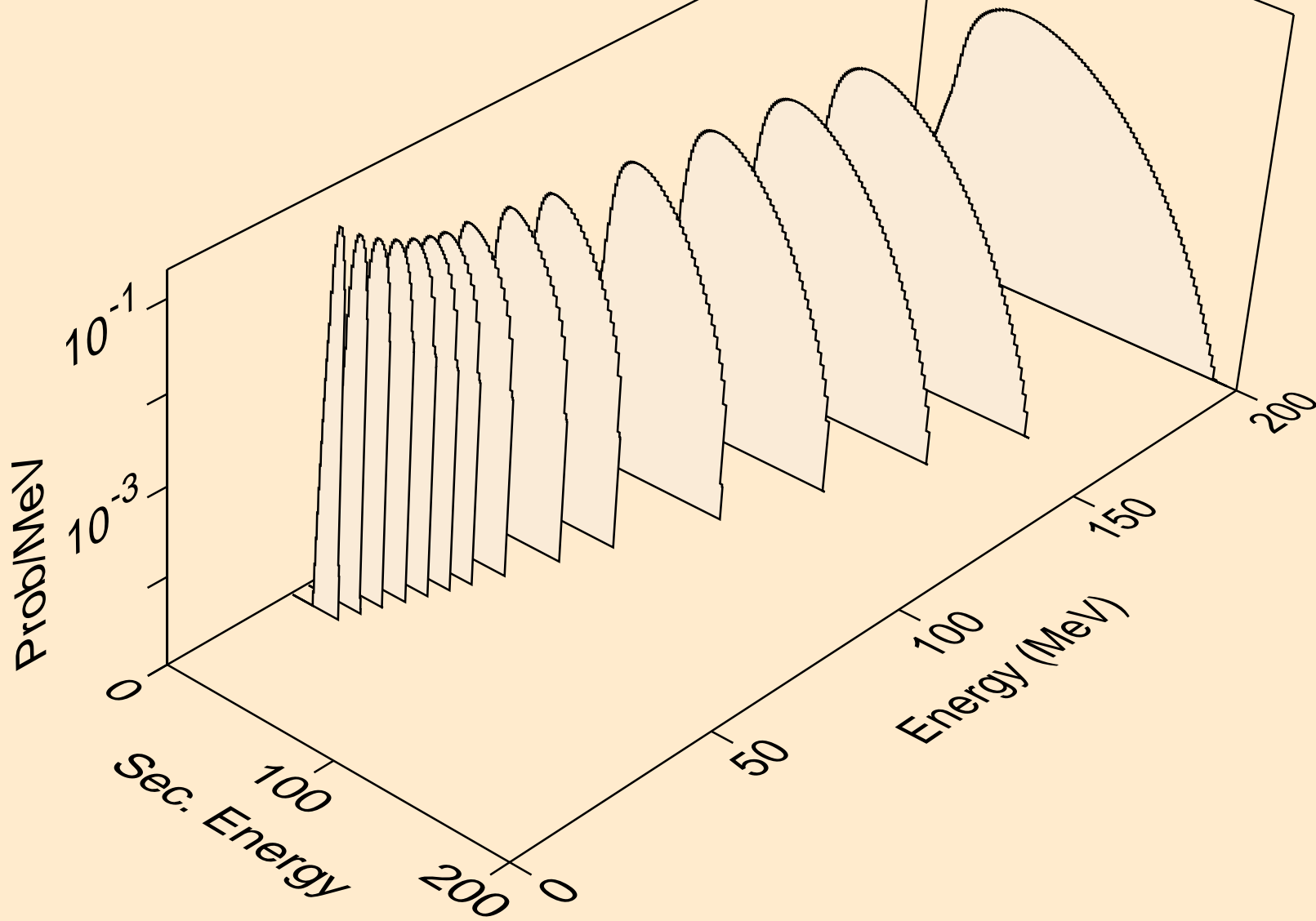

U227 NEUTRON ACER TENDL-2019 LIBRARY; T=293.16K
he3s from (n,n*)he3

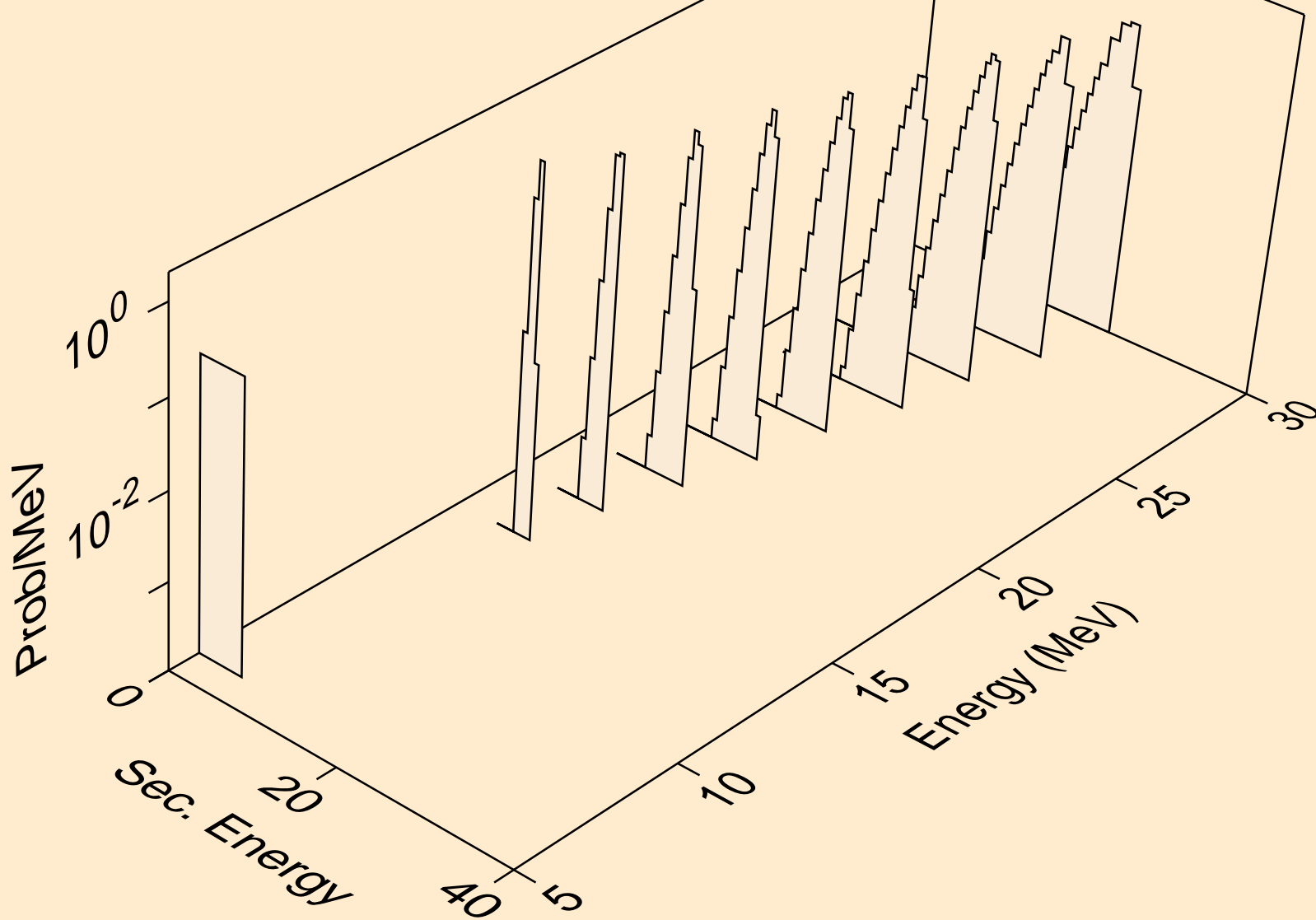

U227 NEUTRON ACER TENDL-2019 LIBRARY; T=293.16K
he3s from (n,he3)

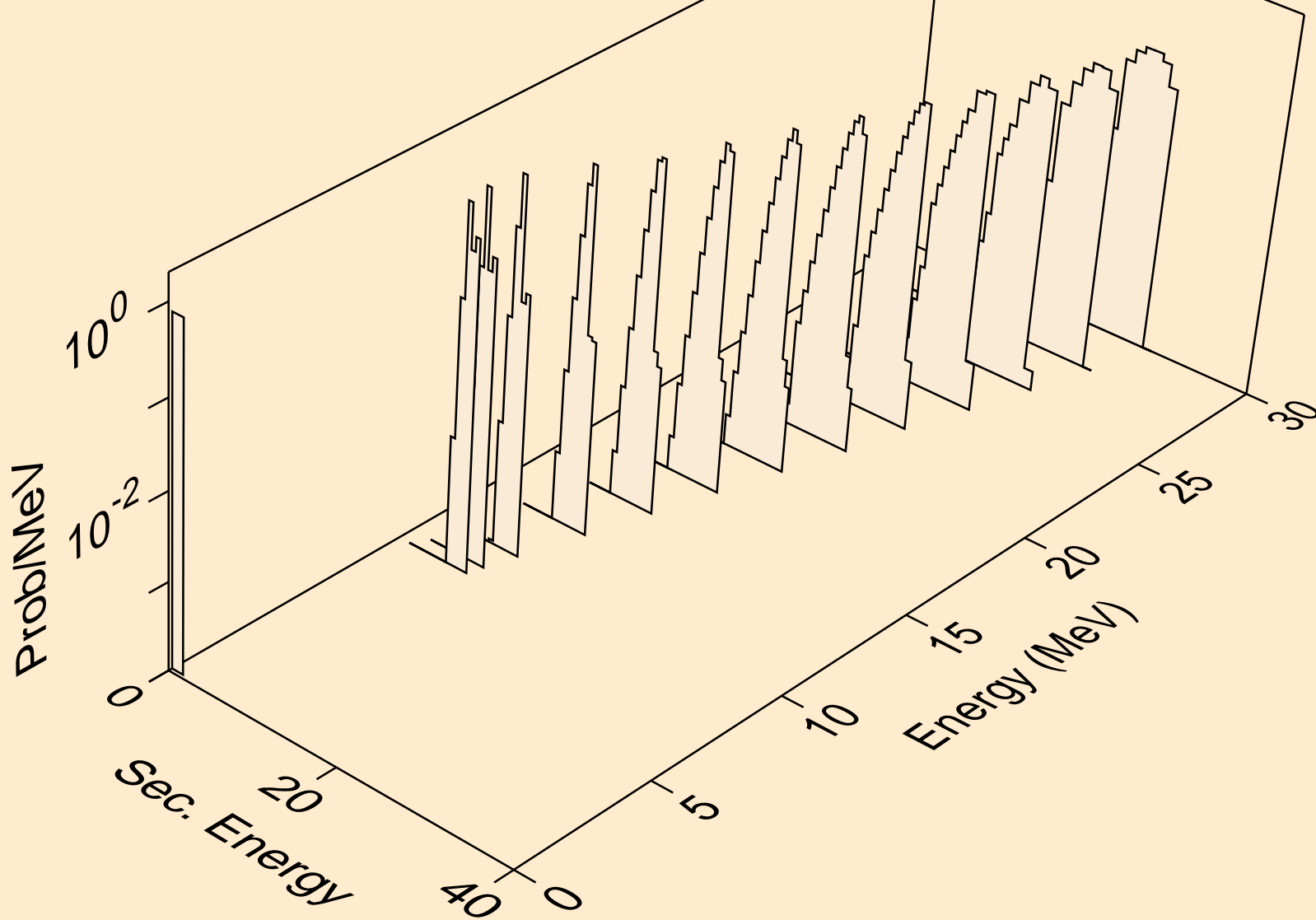

U227 NEUTRON ACER TENDL-2019 LIBRARY; T=293.16K
alphas from (n,x)

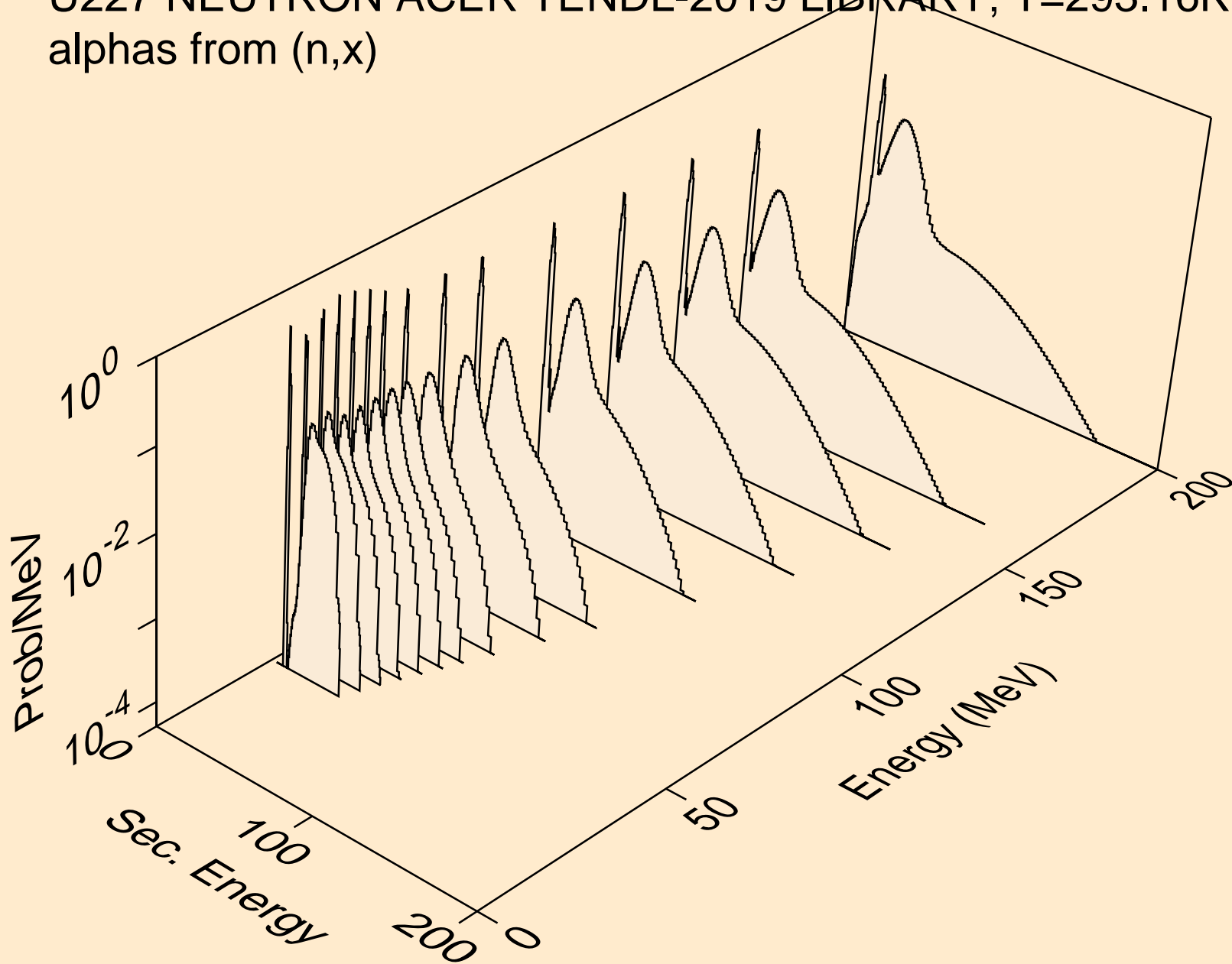

U227 NEUTRON ACER TENDL-2019 LIBRARY; T=293.16K
alphas from (n,n*)a

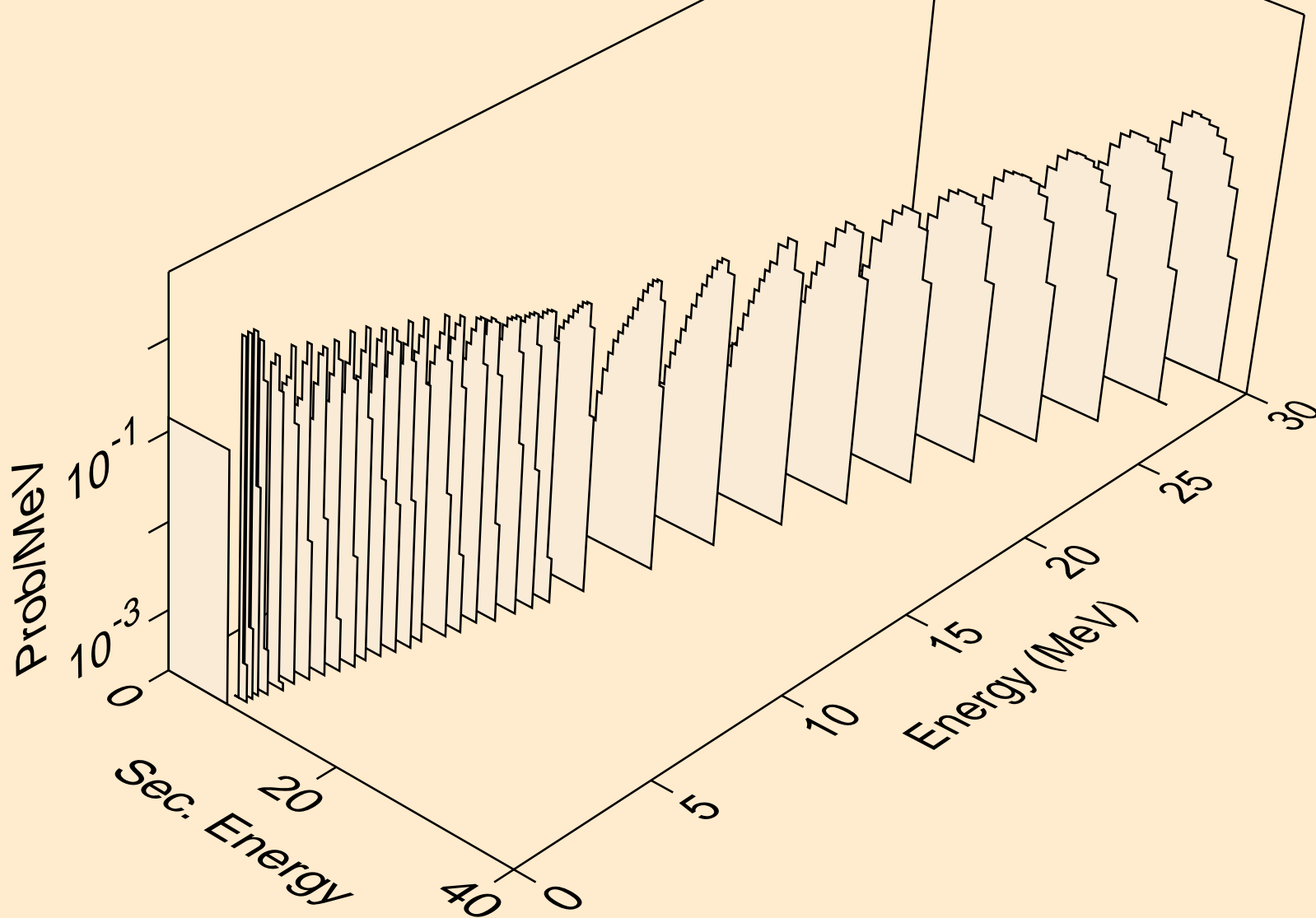

U227 NEUTRON ACER TENDL-2019 LIBRARY; T=293.16K
alphas from (n,2n)a

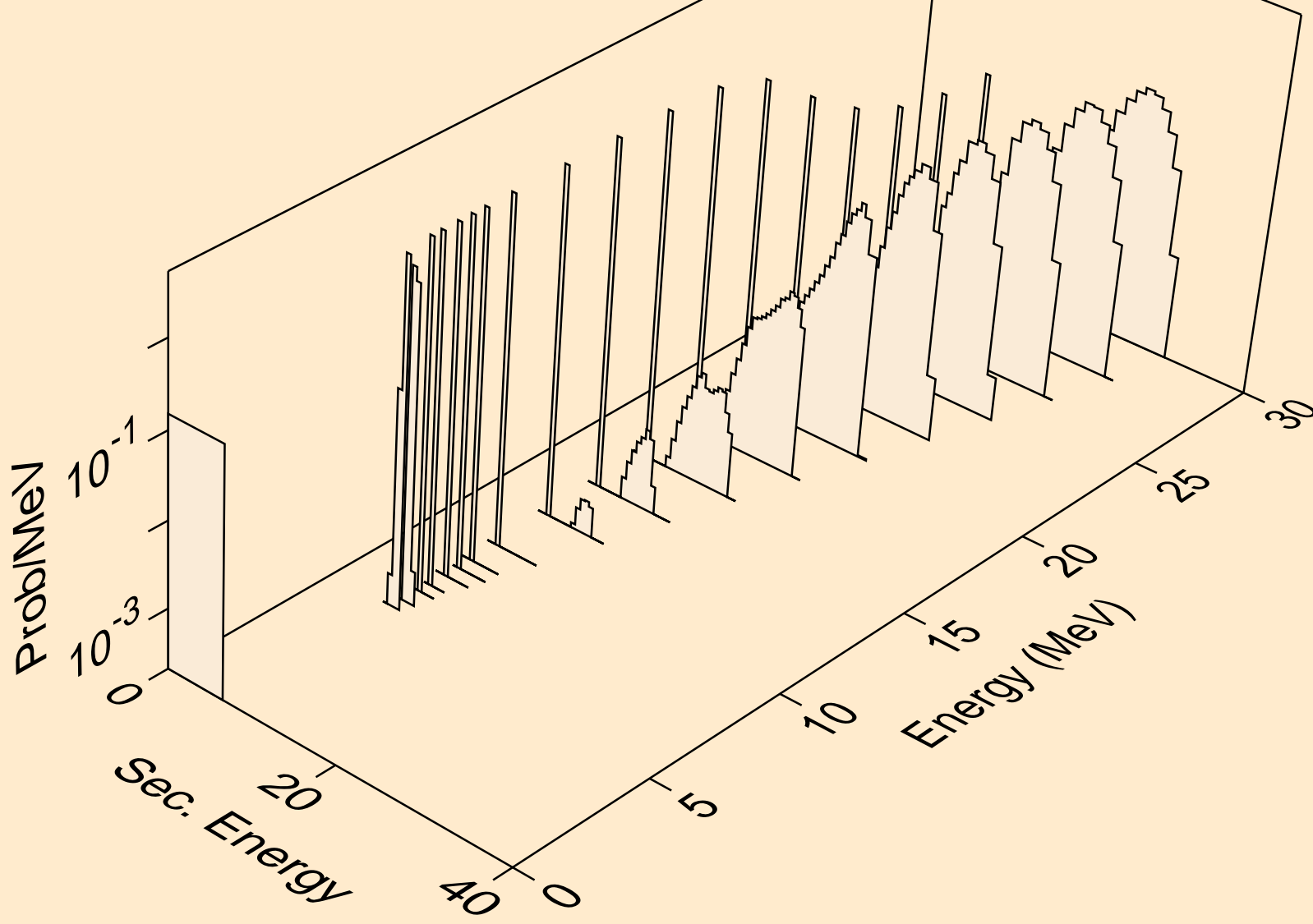

U227 NEUTRON ACER TENDL-2019 LIBRARY; T=293.16K
alphas from (n,3n)a

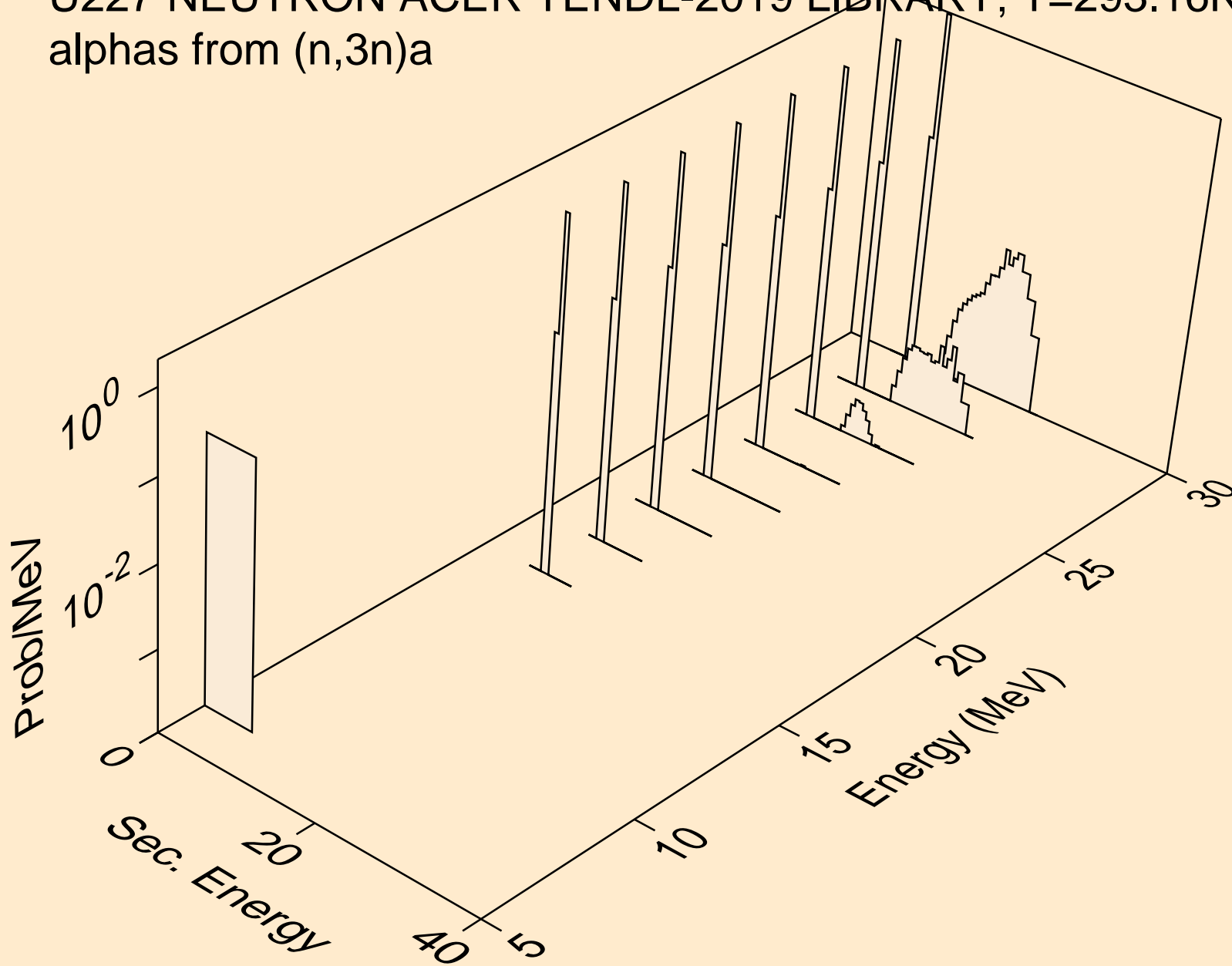

U227 NEUTRON ACER TENDL-2019 LIBRARY; T=293.16K
alphas from (n,n*)2a

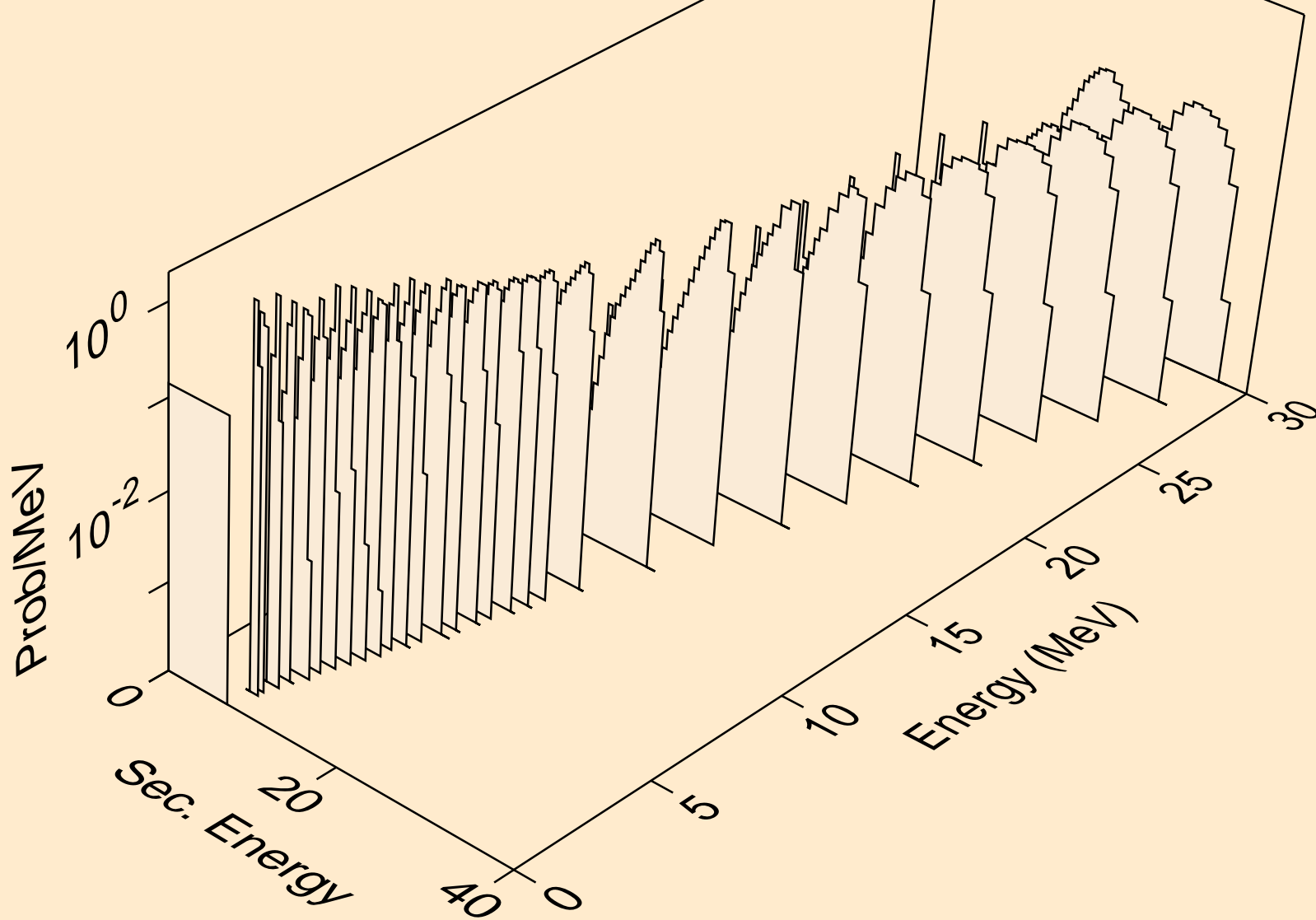

U227 NEUTRON ACER TENDL-2019 LIBRARY; T=293.16K
alphas from (n,2n)2a

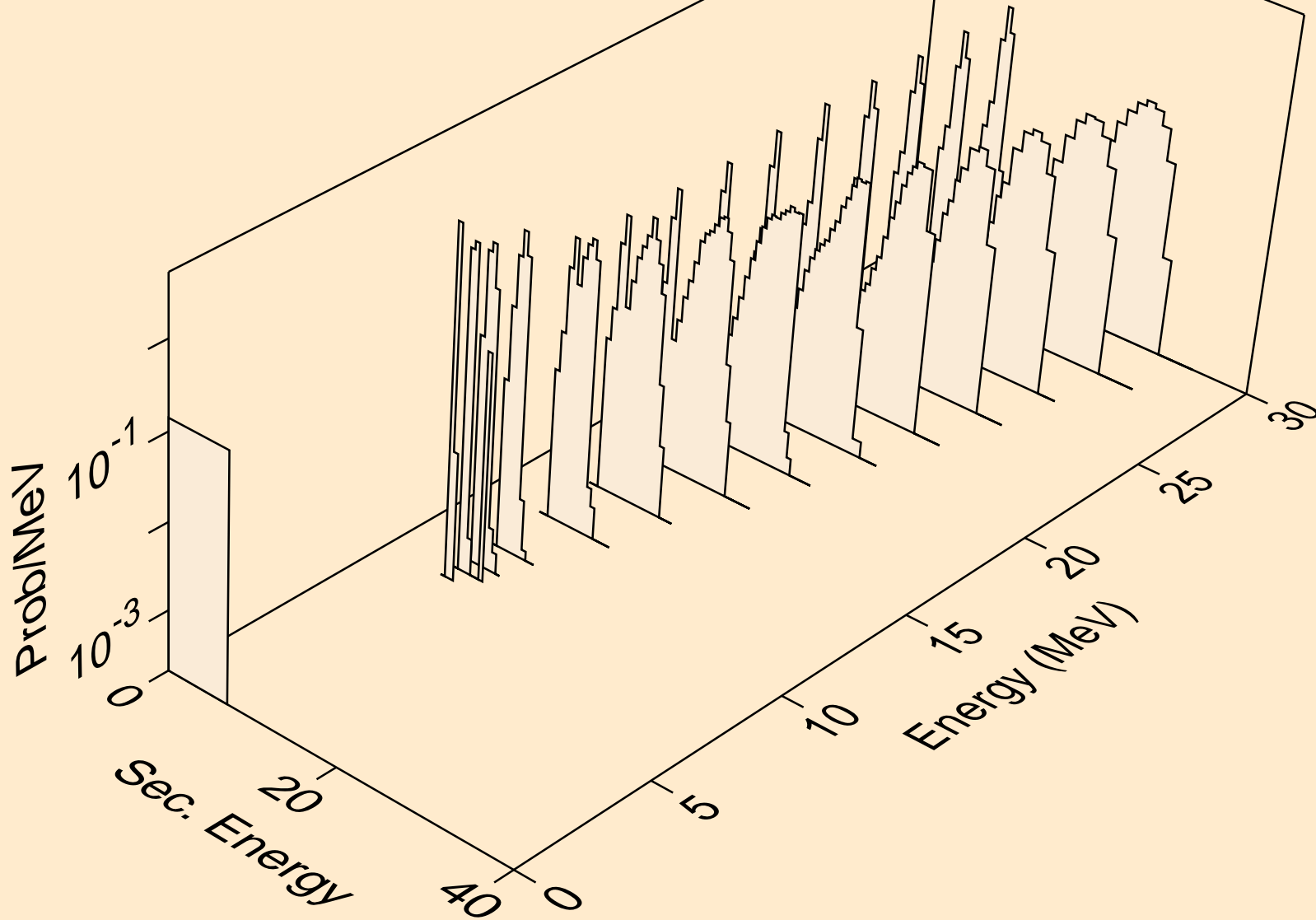

U227 NEUTRON ACER TENDL-2019 LIBRARY; T=293.16K
alphas from (n,n*)t2a

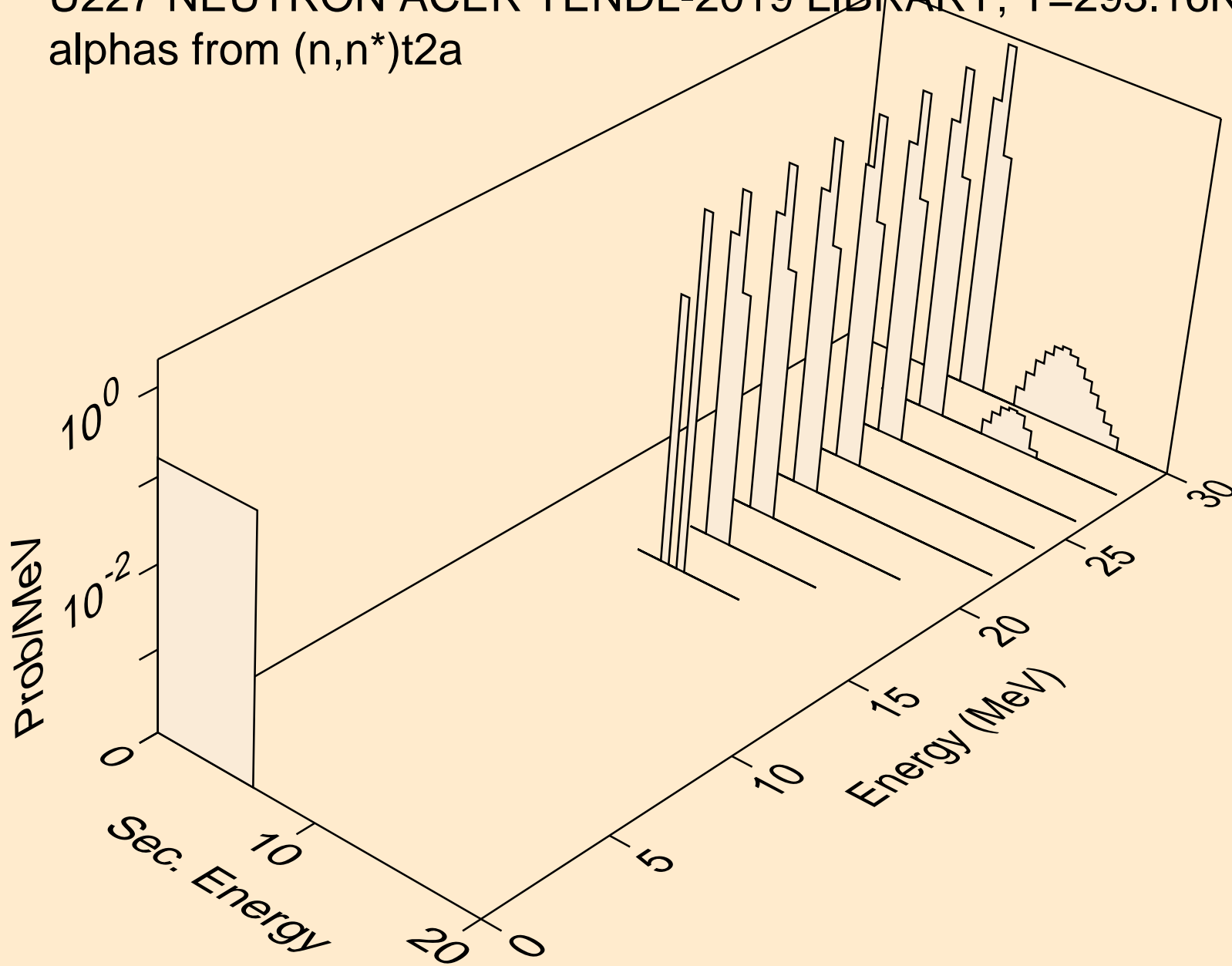

U227 NEUTRON ACER TENDL-2019 LIBRARY; T=293.16K
alphas from (n,a)

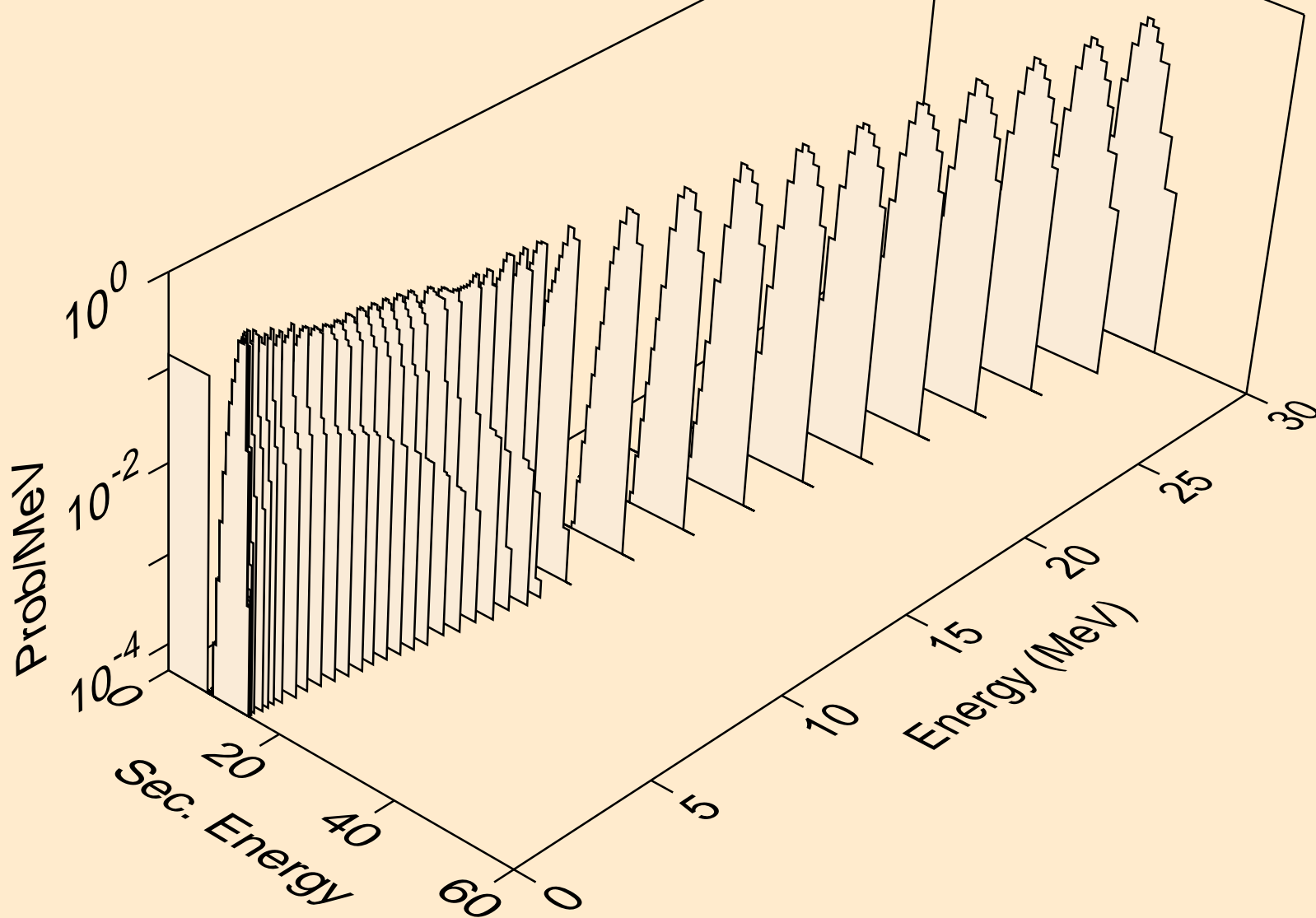

U227 NEUTRON ACER TENDL-2019 LIBRARY; T=293.16K
alphas from (n,2a)

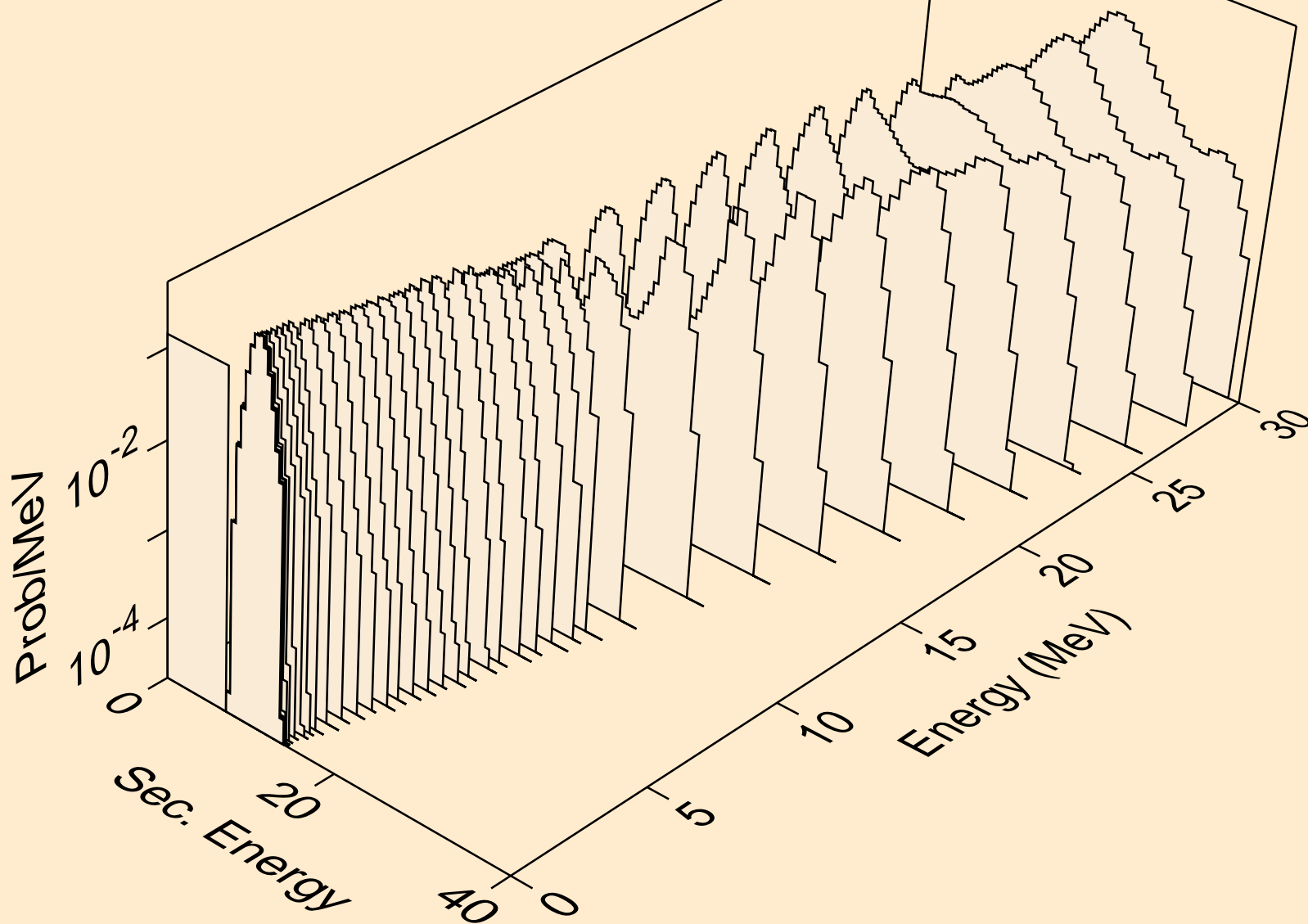

U227 NEUTRON ACER TENDL-2019 LIBRARY; T=293.16K
alphas from (n,pa)

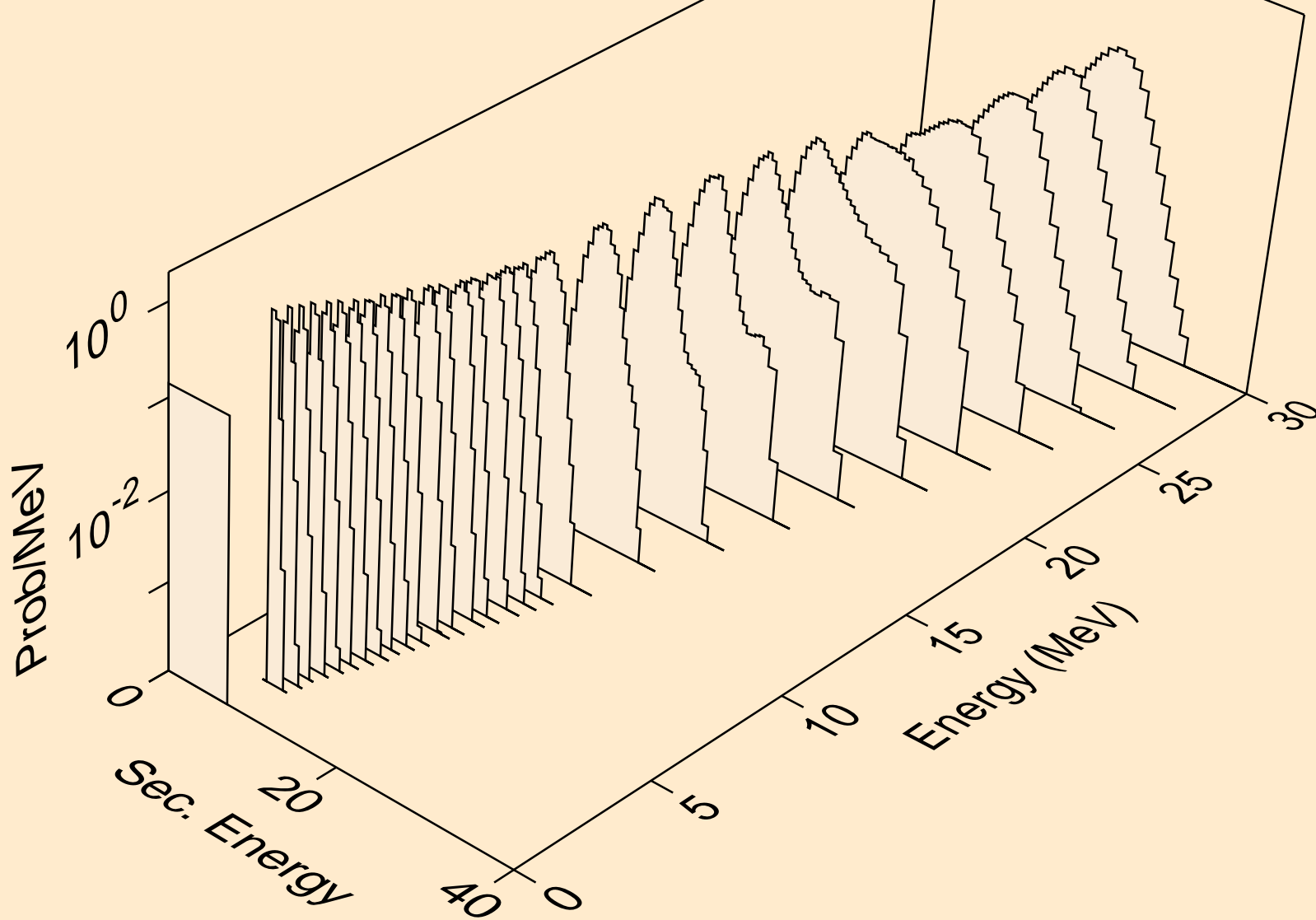

U227 NEUTRON ACER TENDL-2019 LIBRARY; T=293.16K
alphas from (n,t2a)

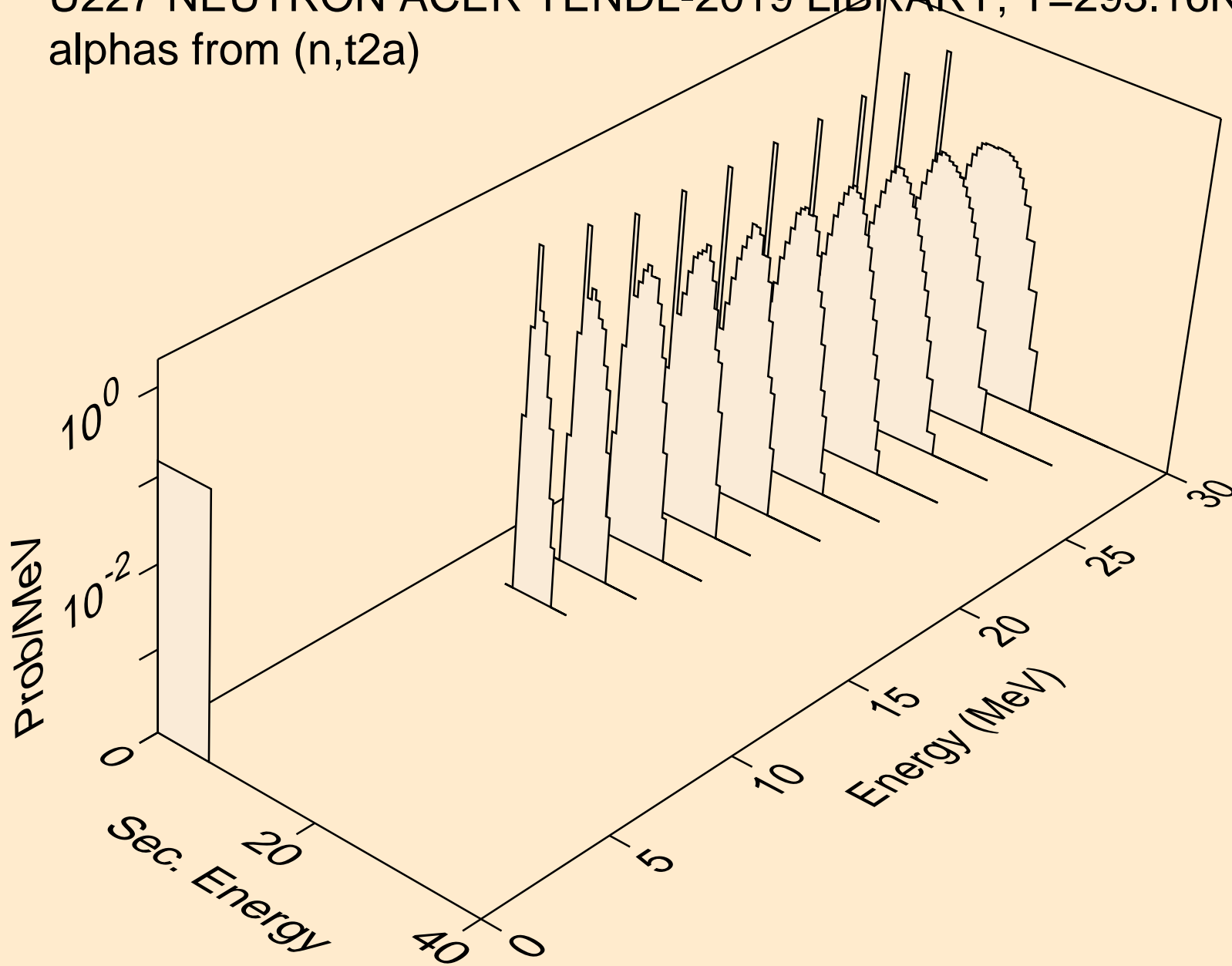

U227 NEUTRON ACER TENDL-2019 LIBRARY; T=293.16K
alphas from (n,da)

