

YB152 NEUTRON ACER TENDL-2019 LIBRARY; T=293.16K
Principal cross sections

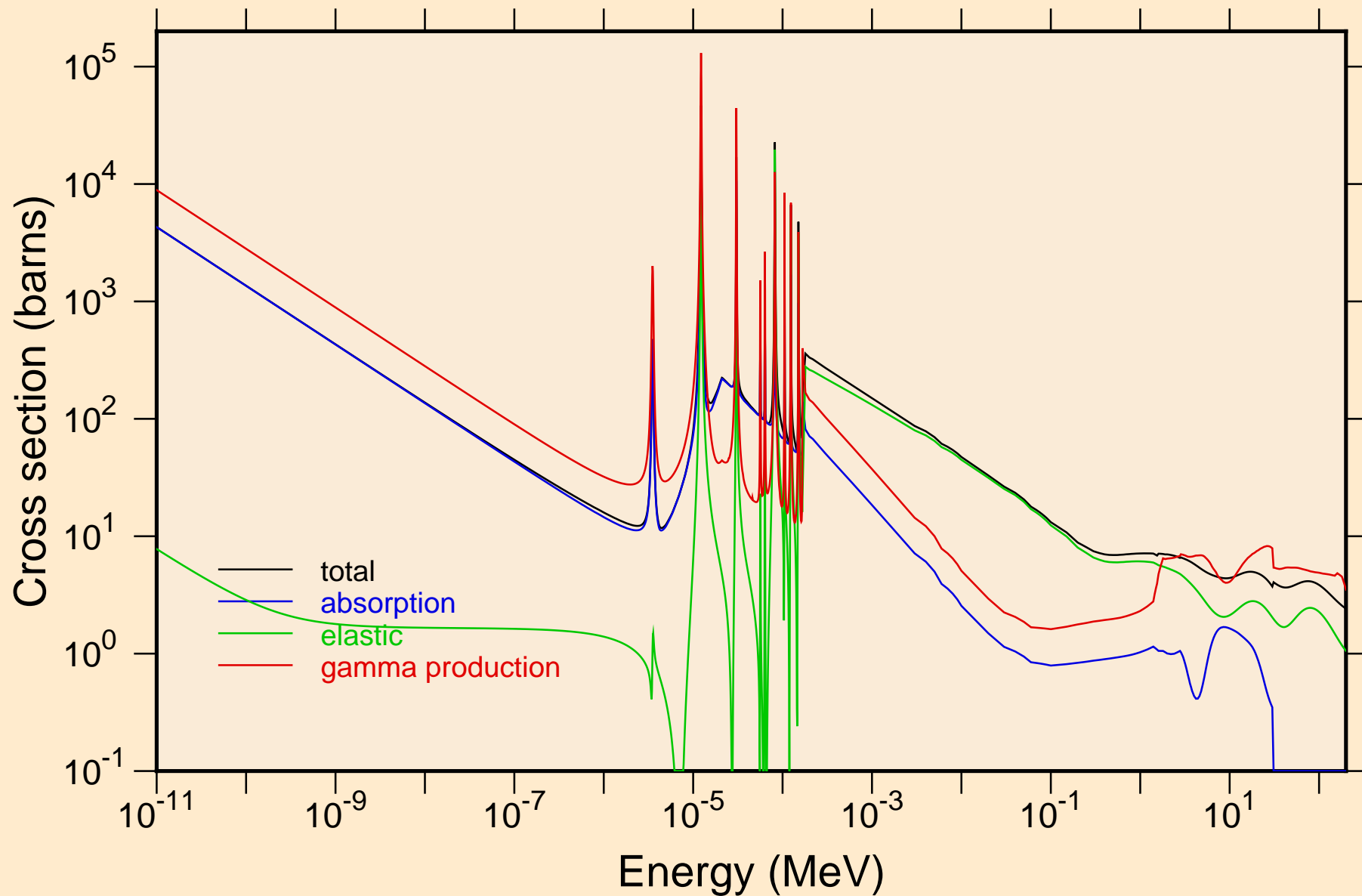

YB152 NEUTRON ACER TENDL-2019 LIBRARY; T=293.16K
resonance total cross section

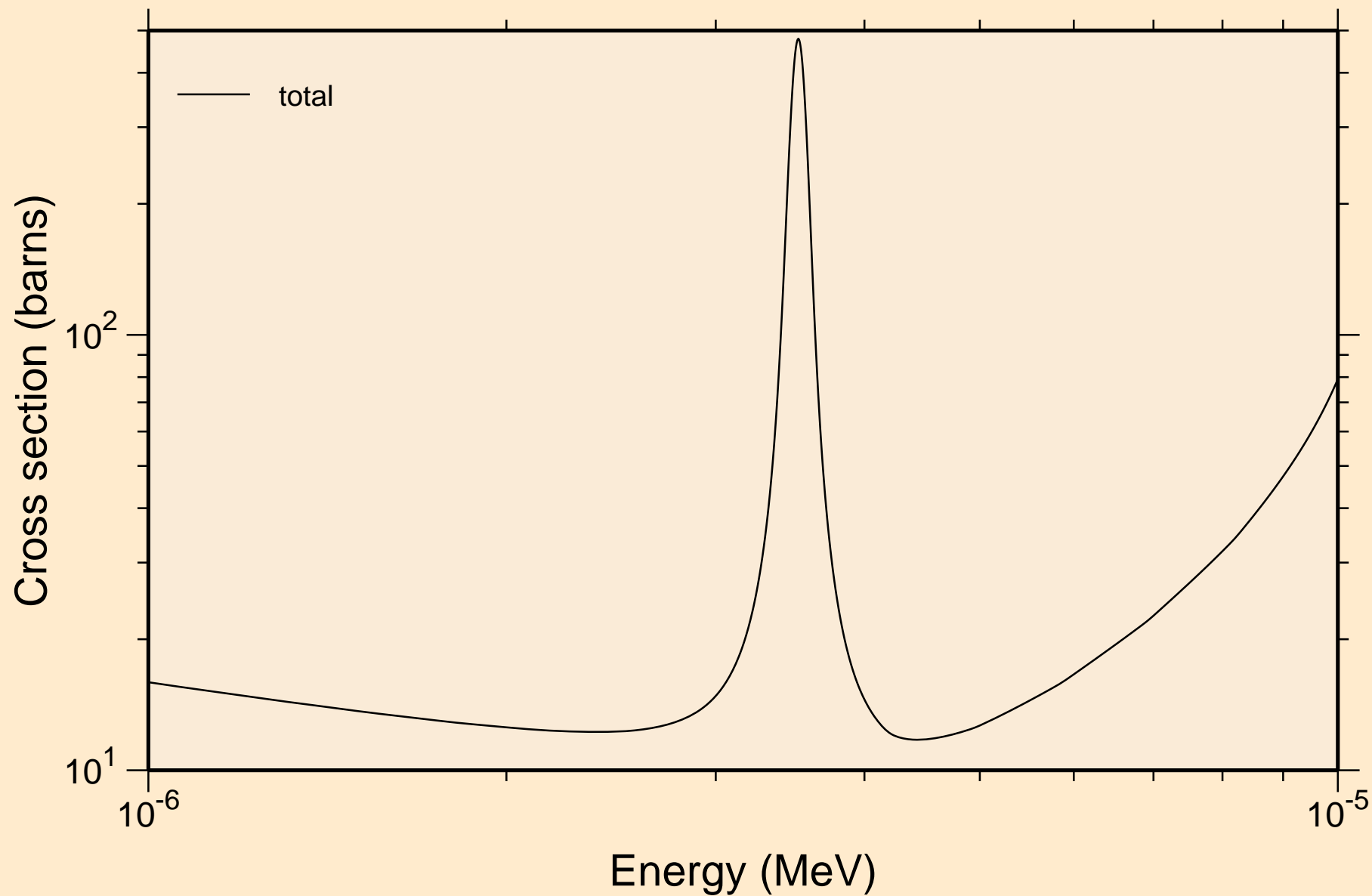

YB152 NEUTRON ACER TENDL-2019 LIBRARY; T=293.16K
resonance total cross section

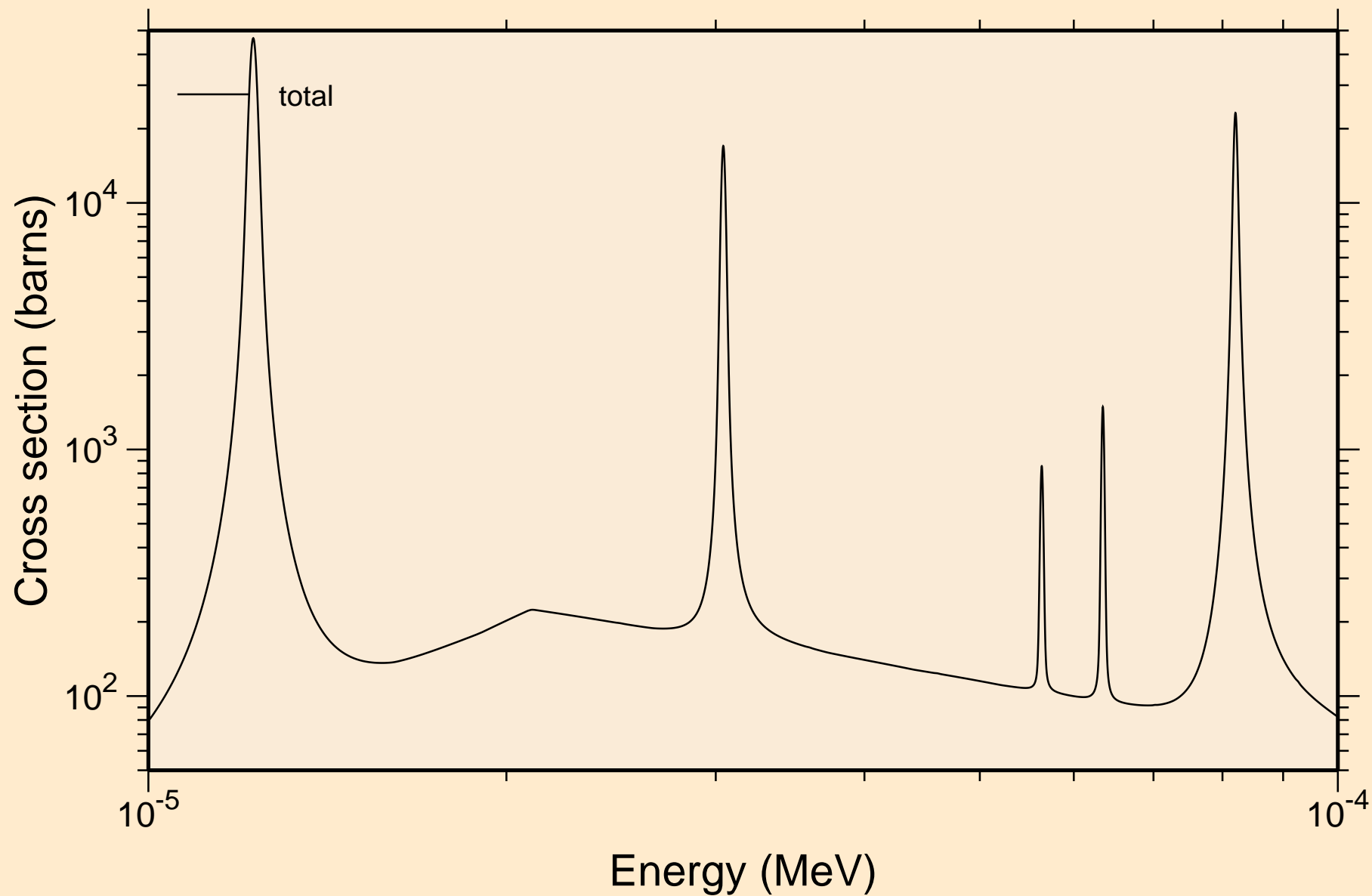

YB152 NEUTRON ACER TENDL-2019 LIBRARY; T=293.16K
resonance total cross section

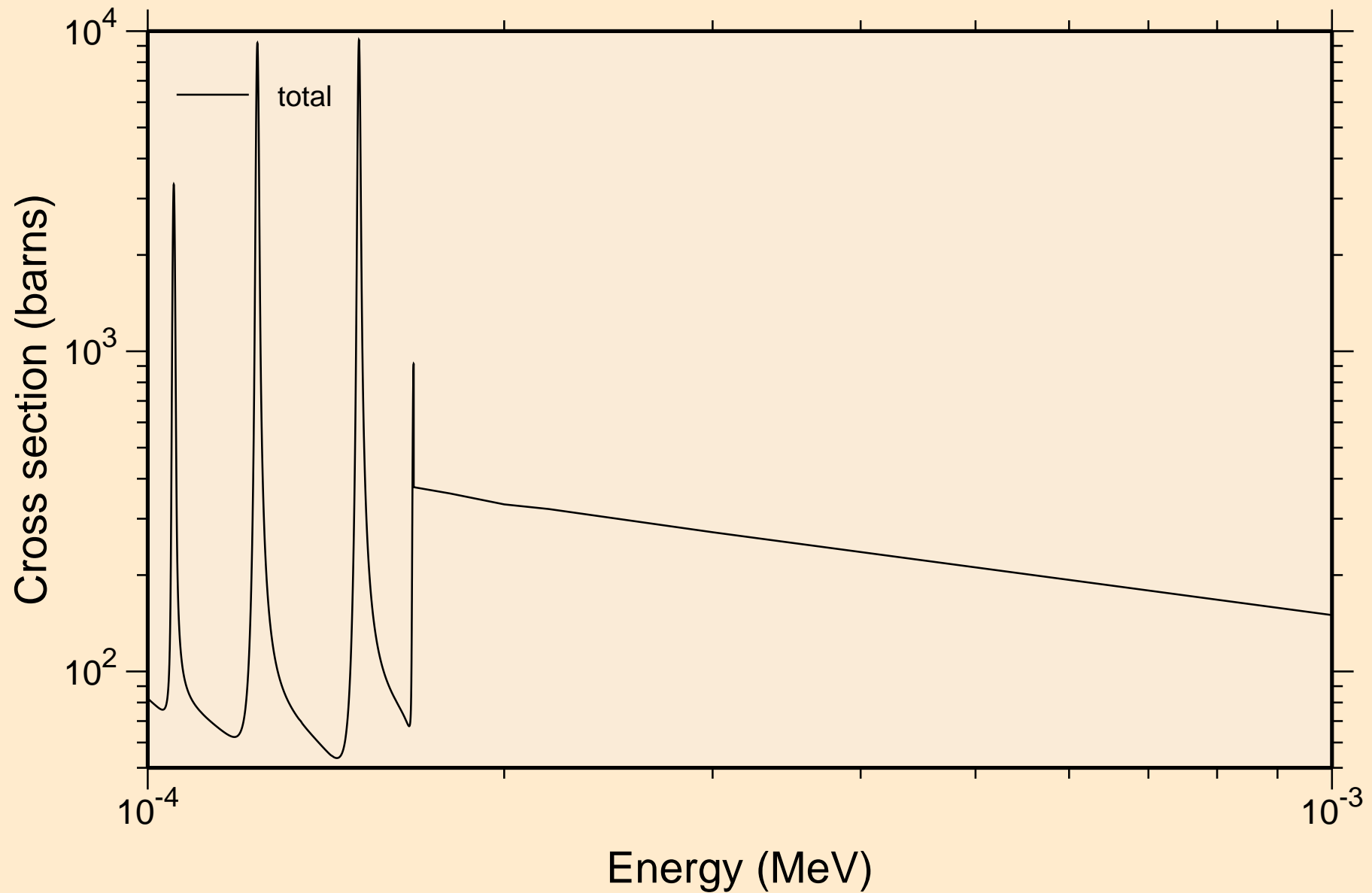

YB152 NEUTRON ACER TENDL-2019 LIBRARY; T=293.16K
resonance total cross section

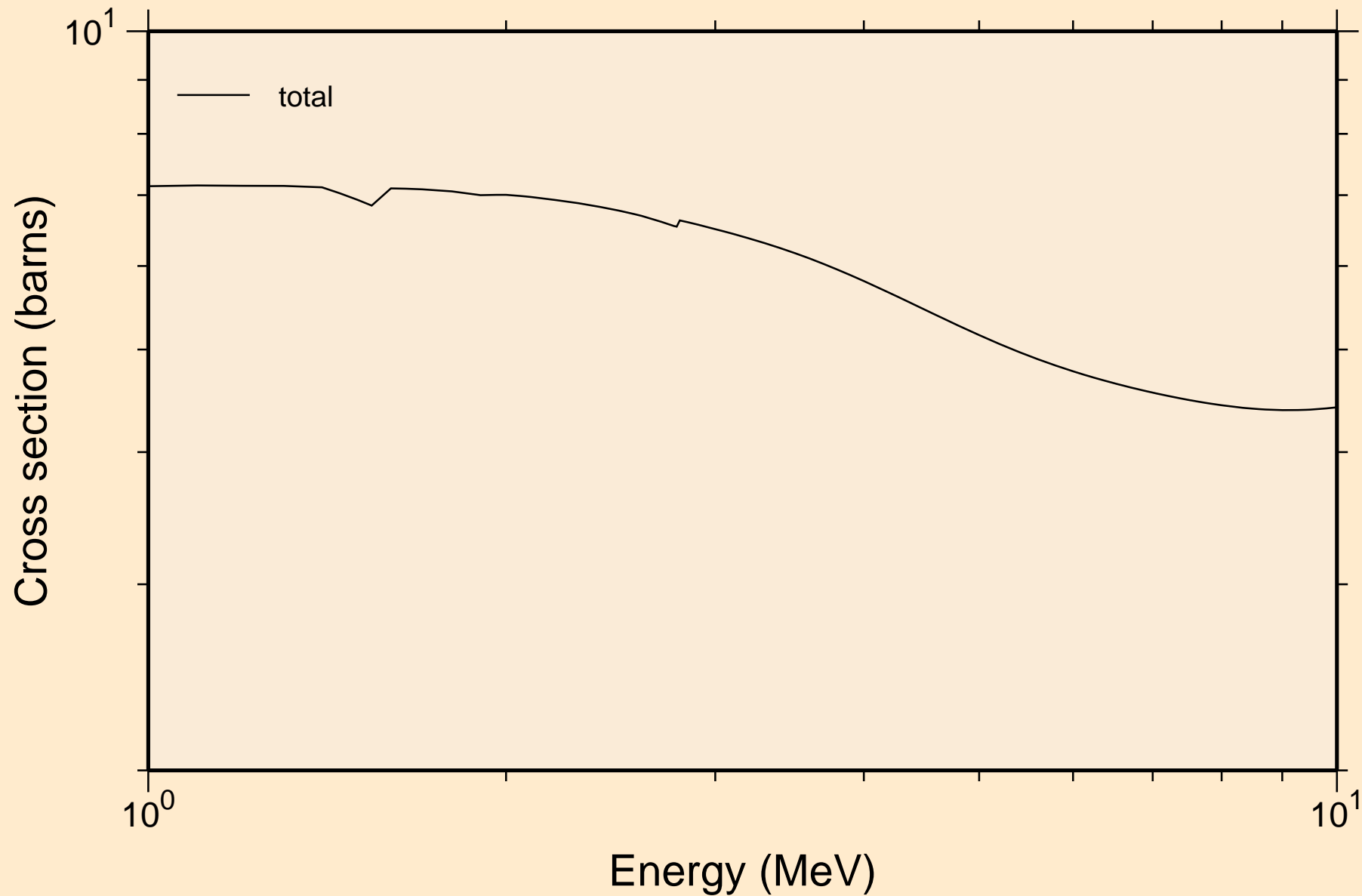

YB152 NEUTRON ACER TENDL-2019 LIBRARY; T=293.16K
resonance absorption cross sections

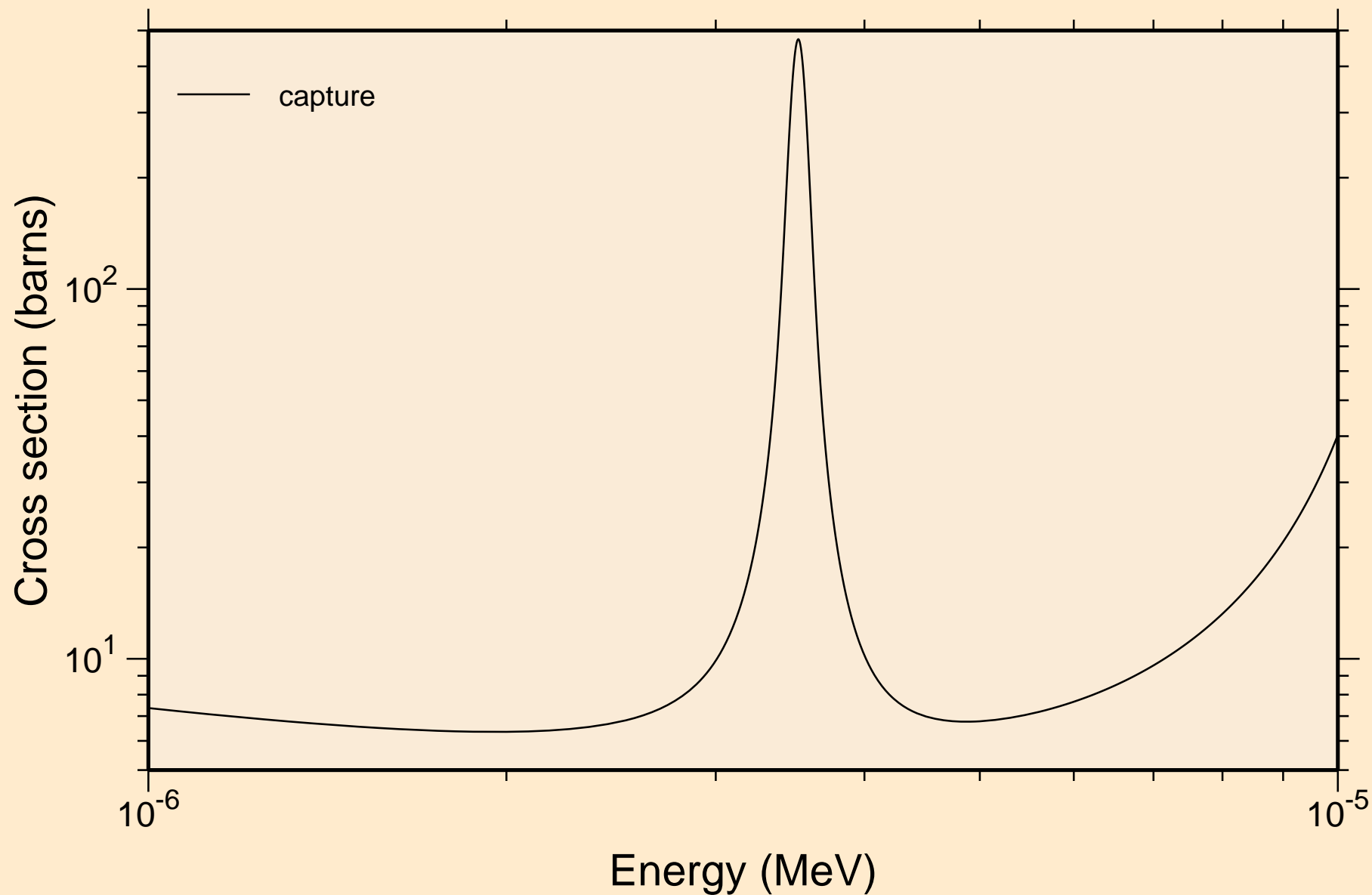

YB152 NEUTRON ACER TENDL-2019 LIBRARY; T=293.16K
resonance absorption cross sections

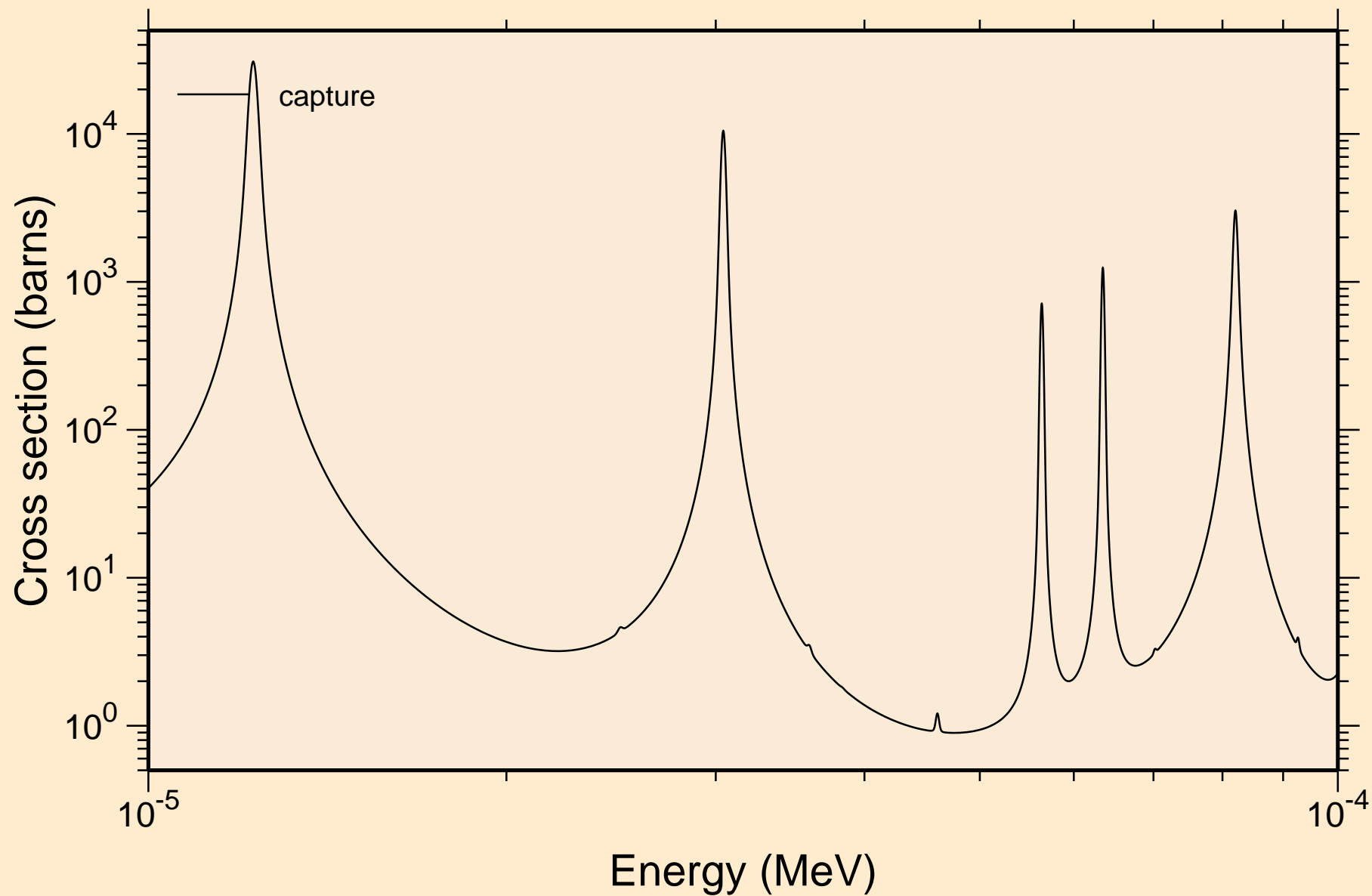

YB152 NEUTRON ACER TENDL-2019 LIBRARY; T=293.16K
resonance absorption cross sections

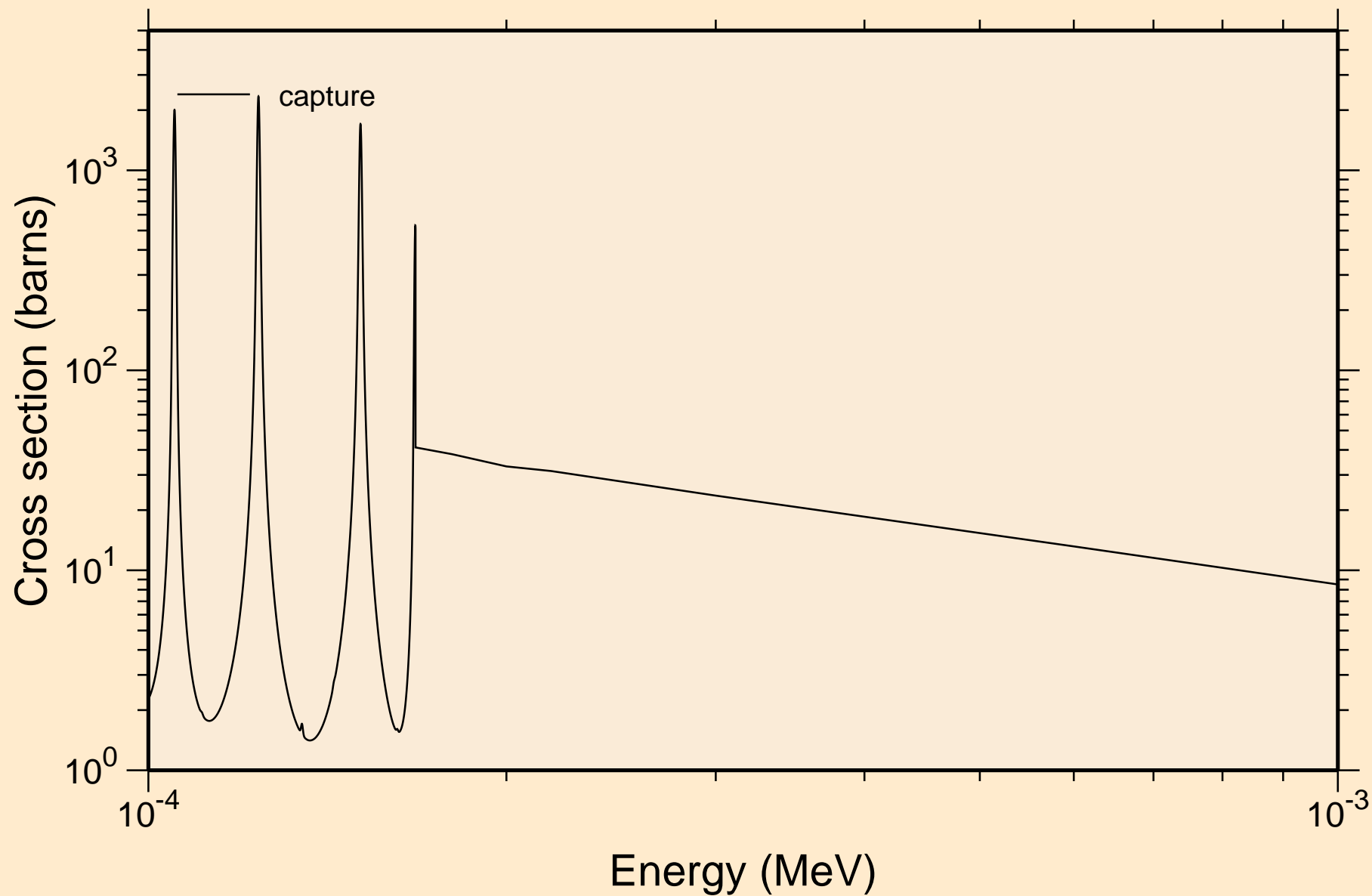

YB152 NEUTRON ACER TENDL-2019 LIBRARY; T=293.16K
resonance absorption cross sections

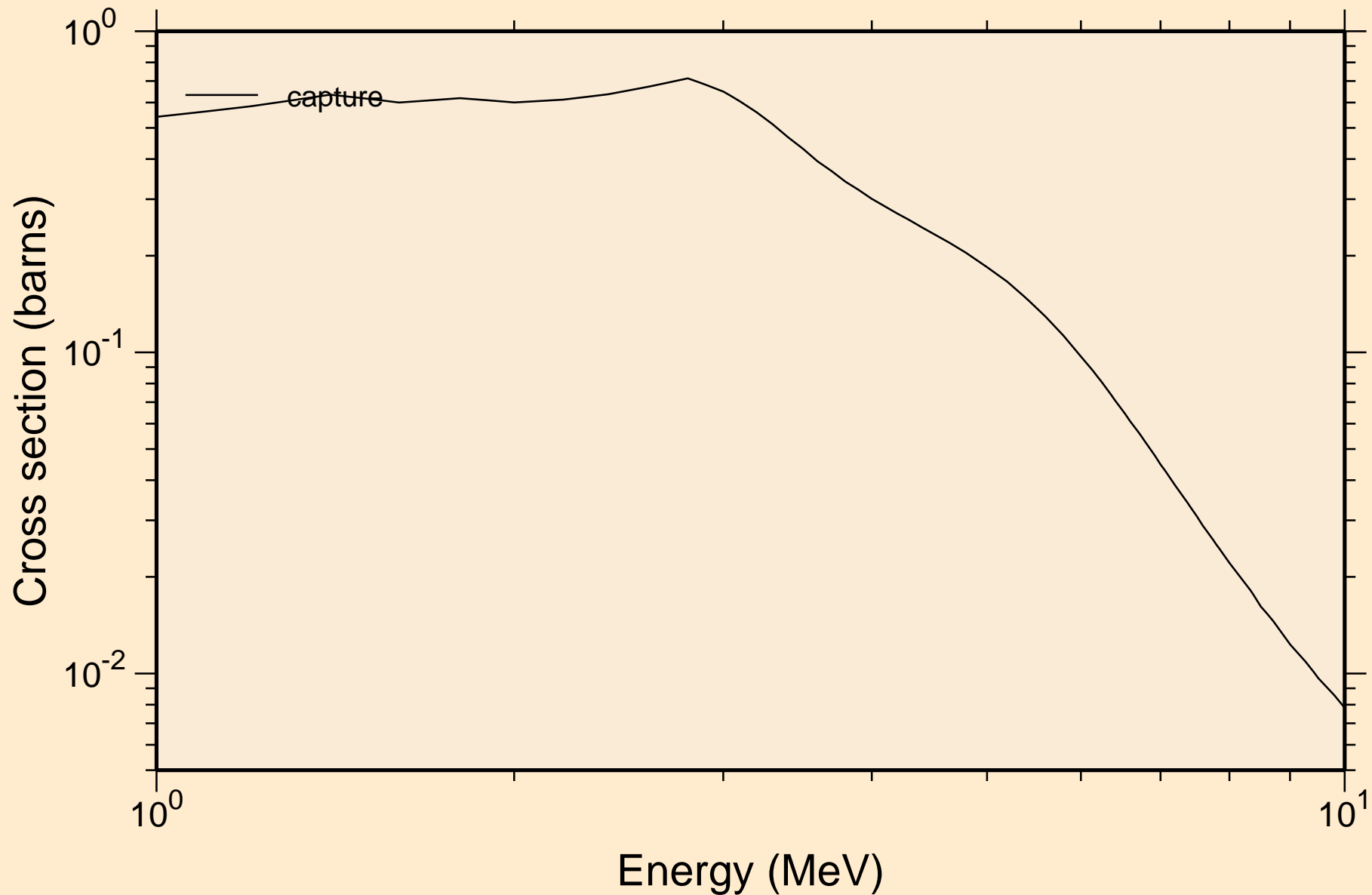

YB152 NEUTRON ACER TENDL-2019 LIBRARY; T=293.16K
Heating

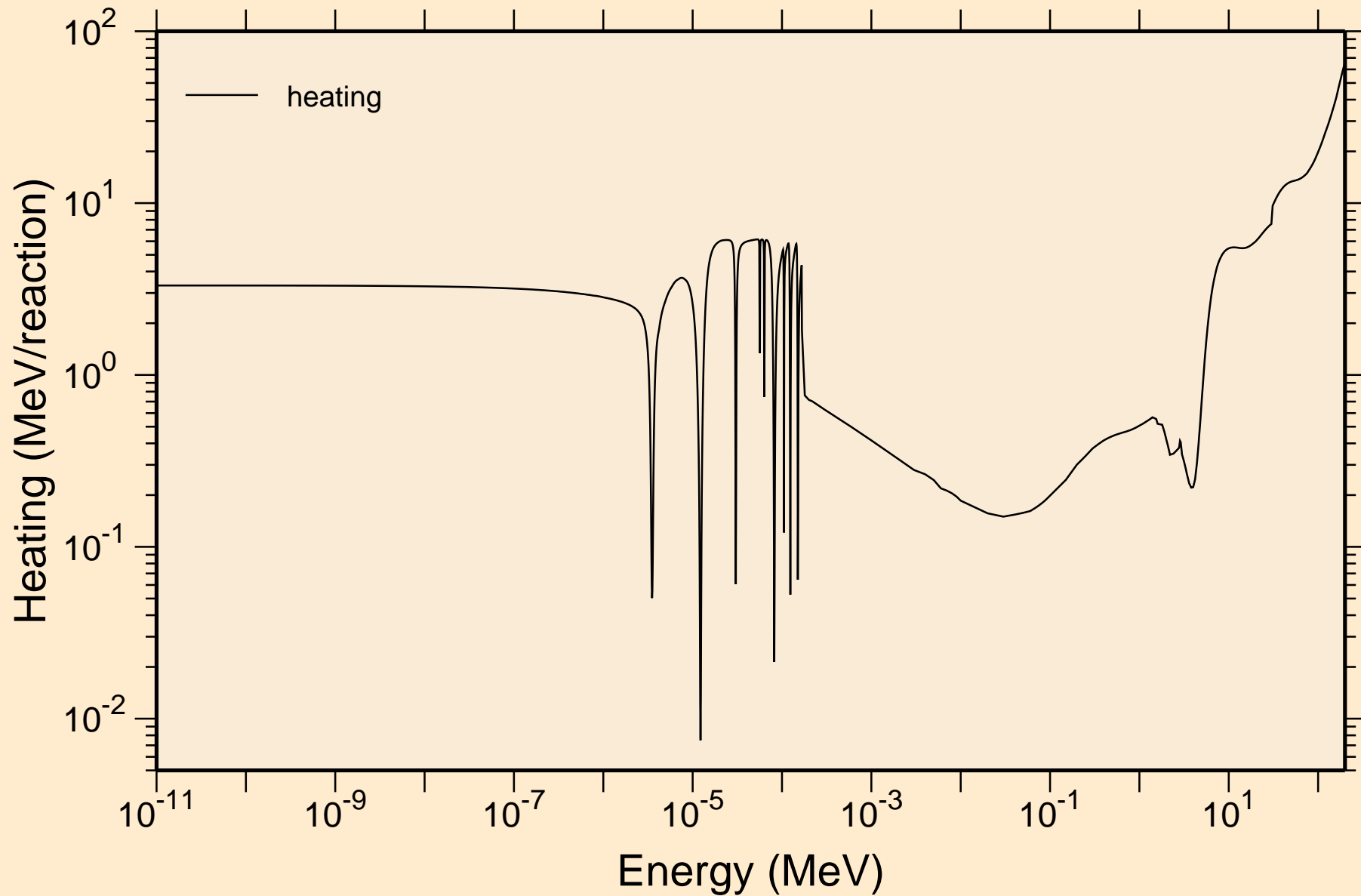

YB152 NEUTRON ACER TENDL-2019 LIBRARY; T=293.16K
Damage

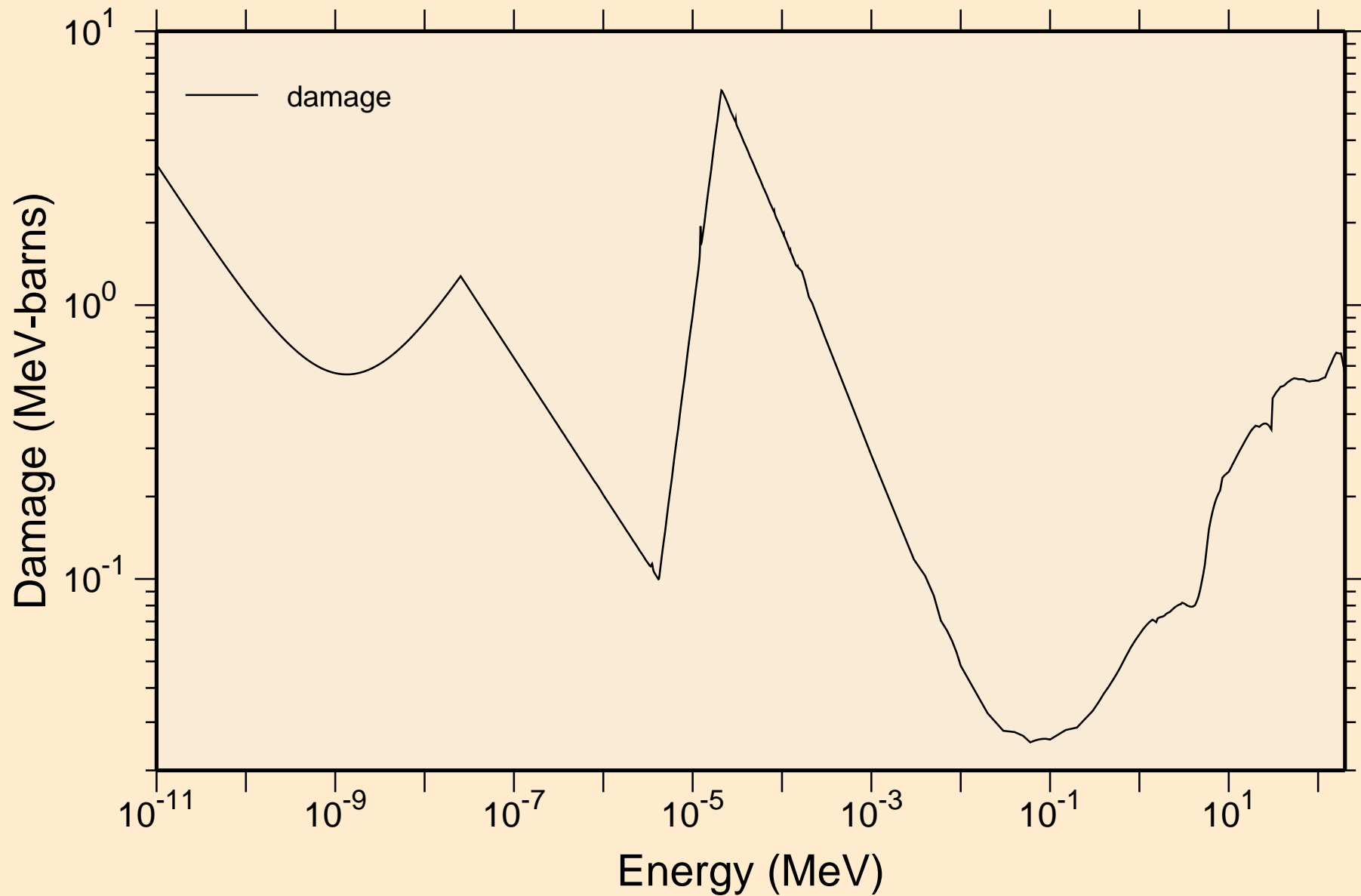

YB152 NEUTRON ACER TENDL-2019 LIBRARY; T=293.16K
Non-threshold reactions

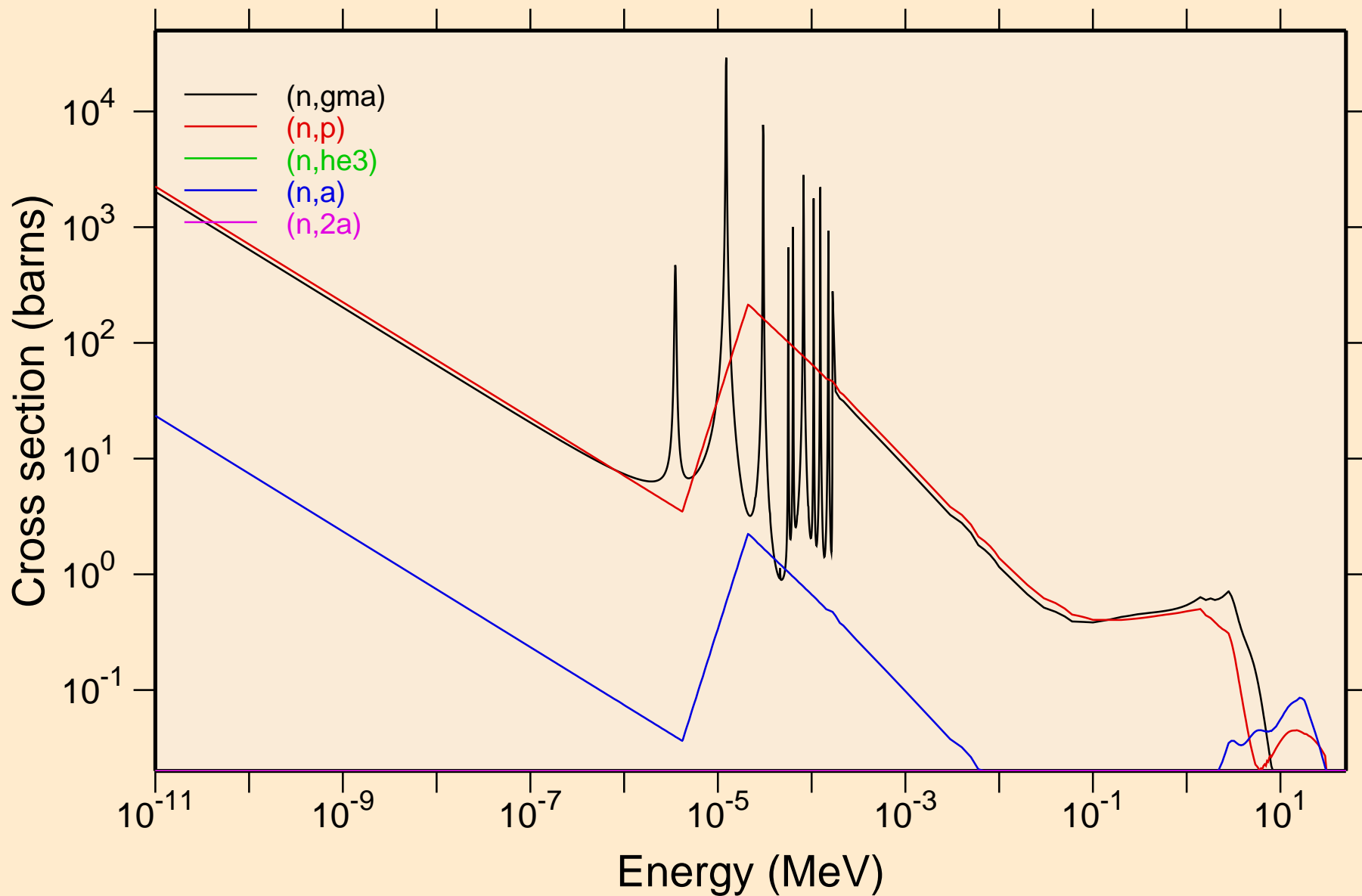

YB152 NEUTRON ACER TENDL-2019 LIBRARY; T=293.16K
Non-threshold reactions

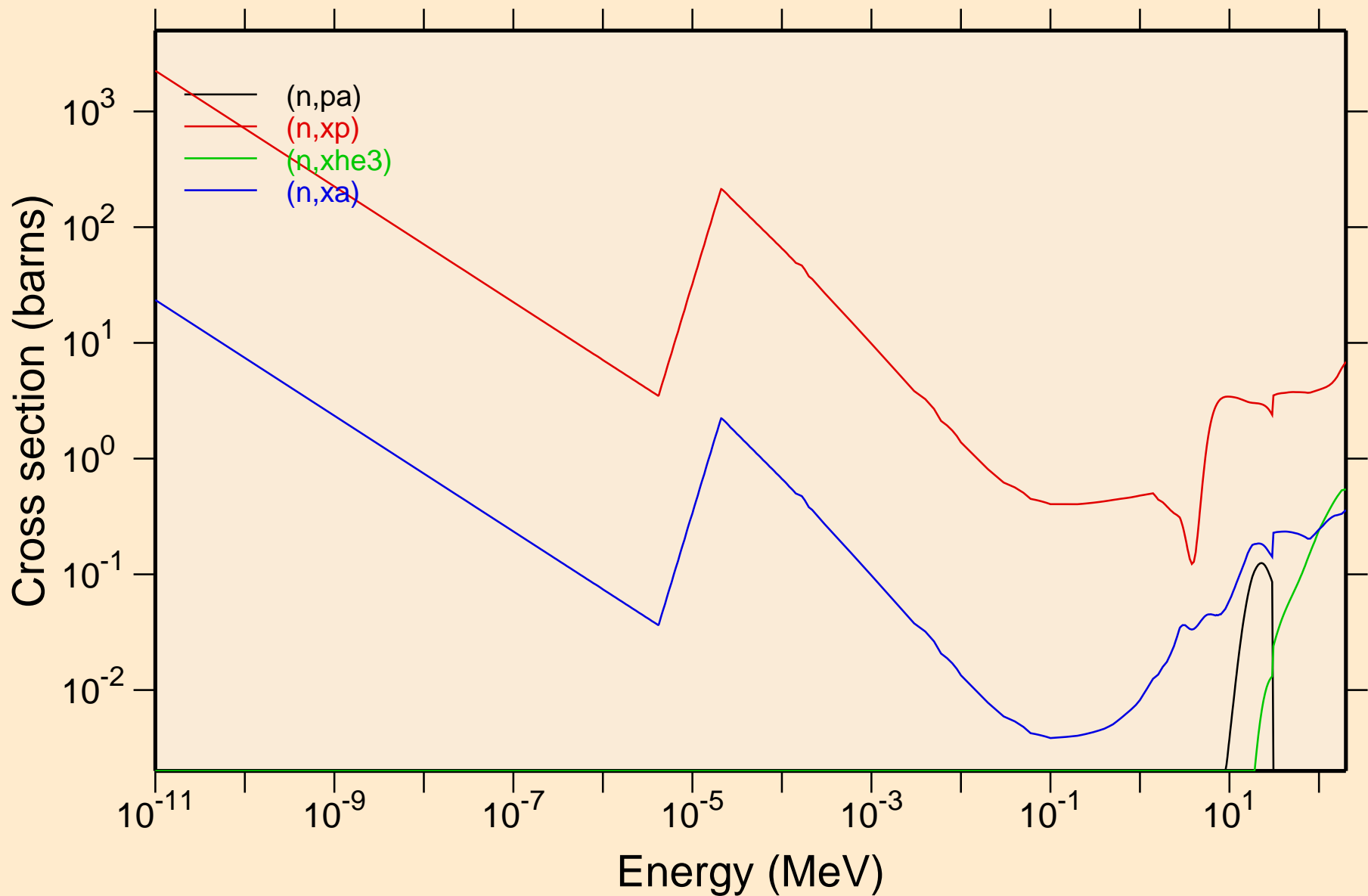

YB152 NEUTRON ACER TENDL-2019 LIBRARY; T=293.16K
Principal cross sections

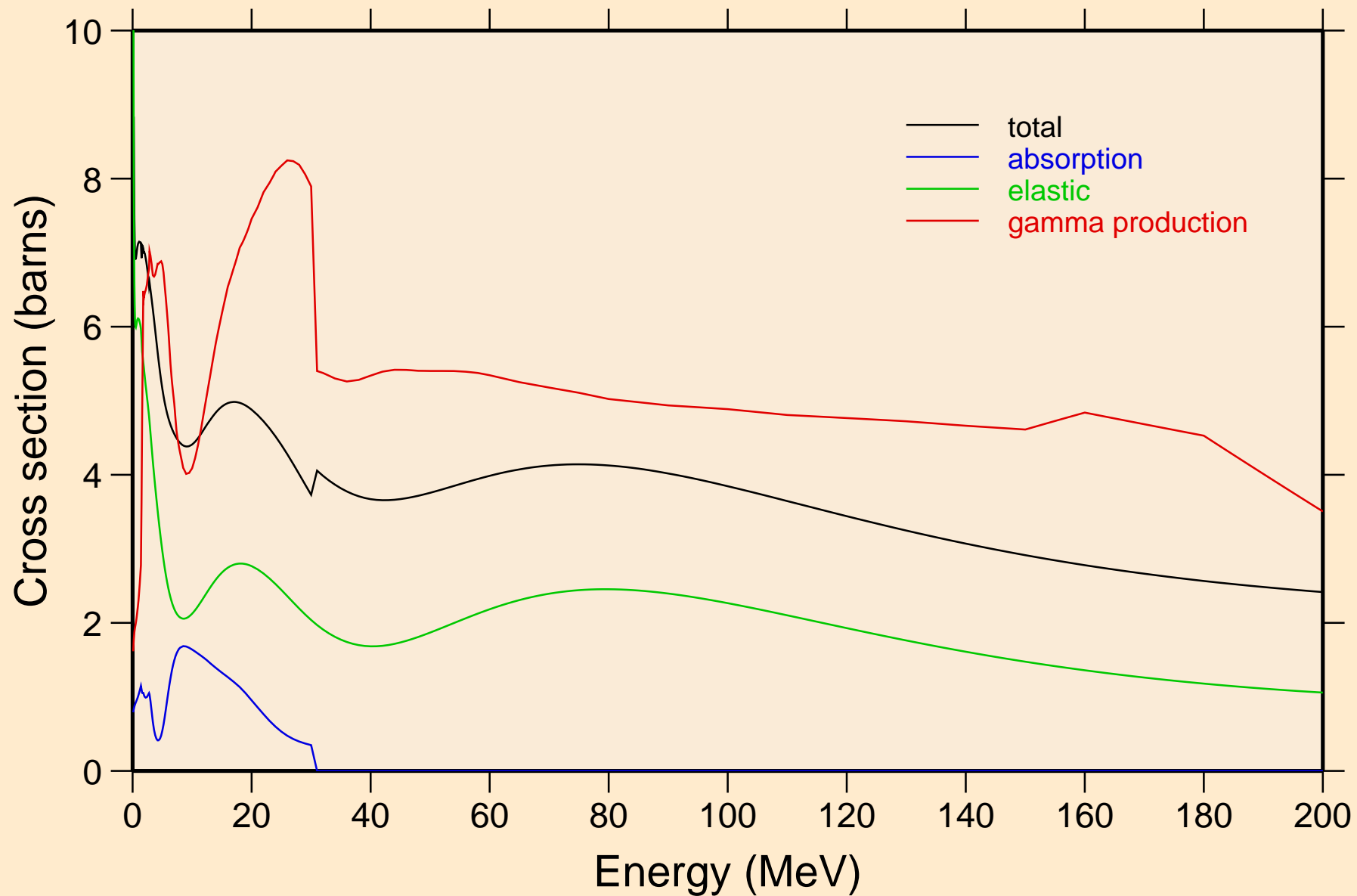

YB152 NEUTRON ACER TENDL-2019 LIBRARY; T=293.16K
Heating

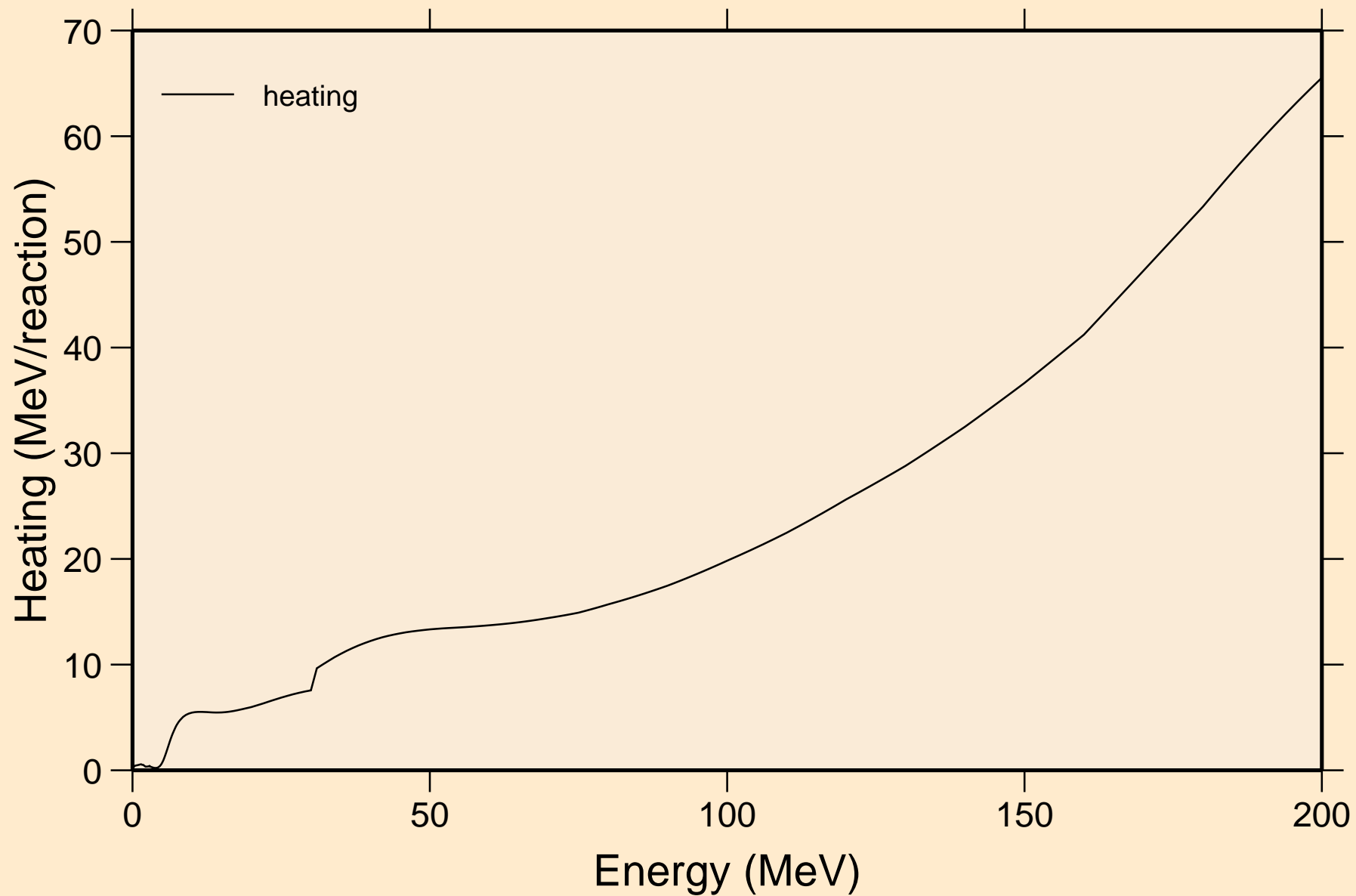

YB152 NEUTRON ACER TENDL-2019 LIBRARY; T=293.16K
Damage

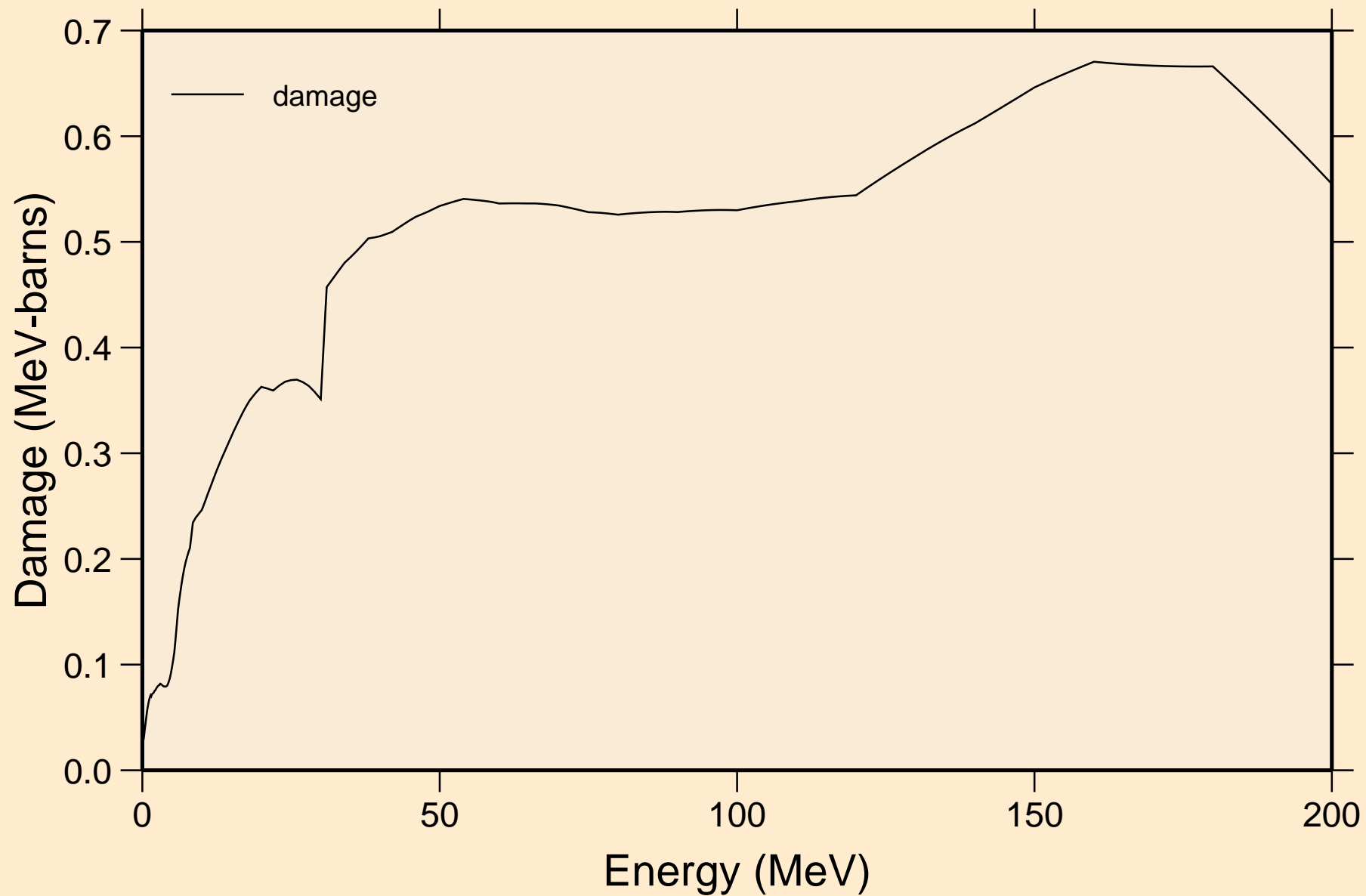

YB152 NEUTRON ACER TENDL-2019 LIBRARY; T=293.16K
Non-threshold reactions

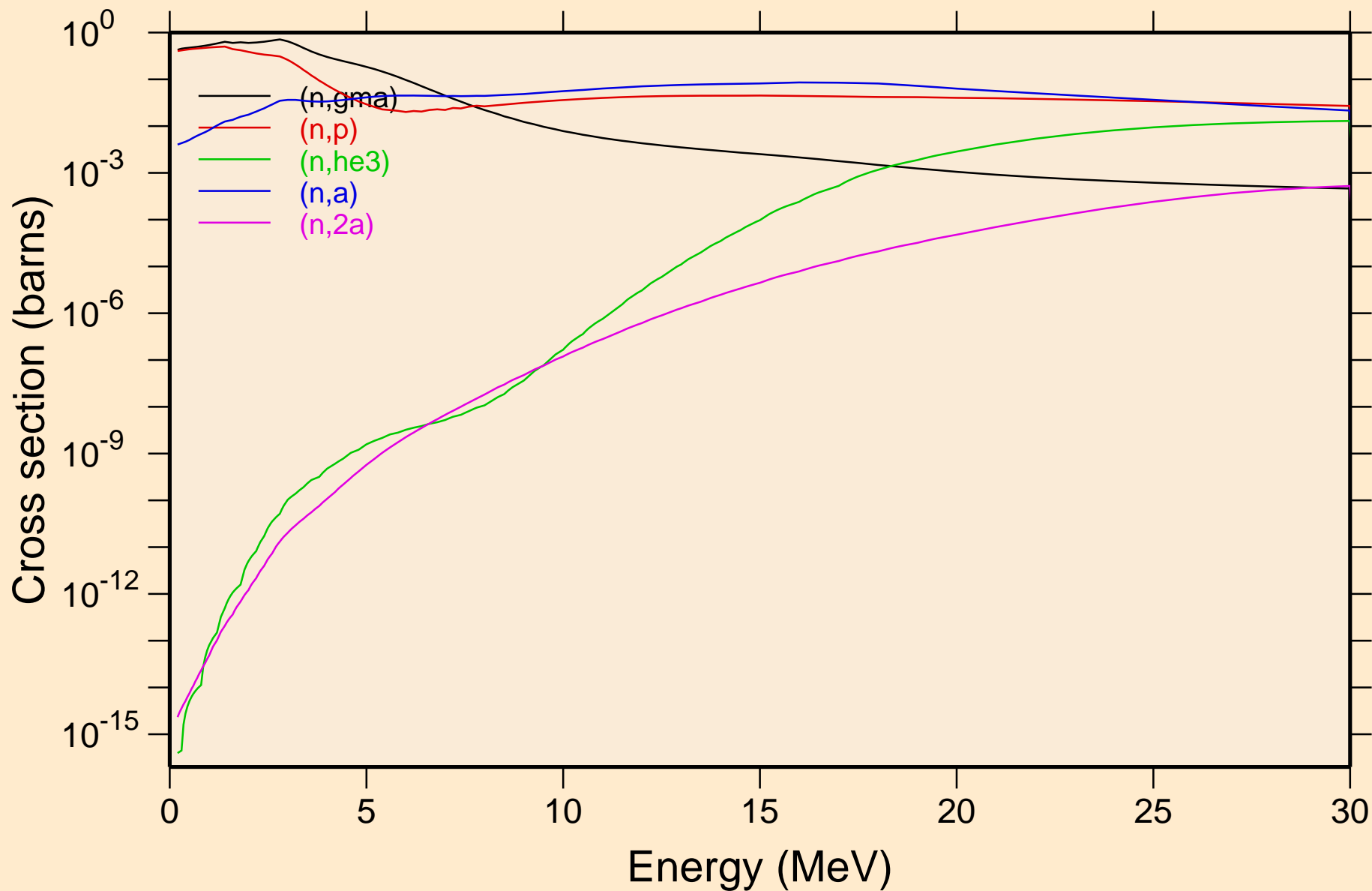

YB152 NEUTRON ACER TENDL-2019 LIBRARY; T=293.16K
Non-threshold reactions

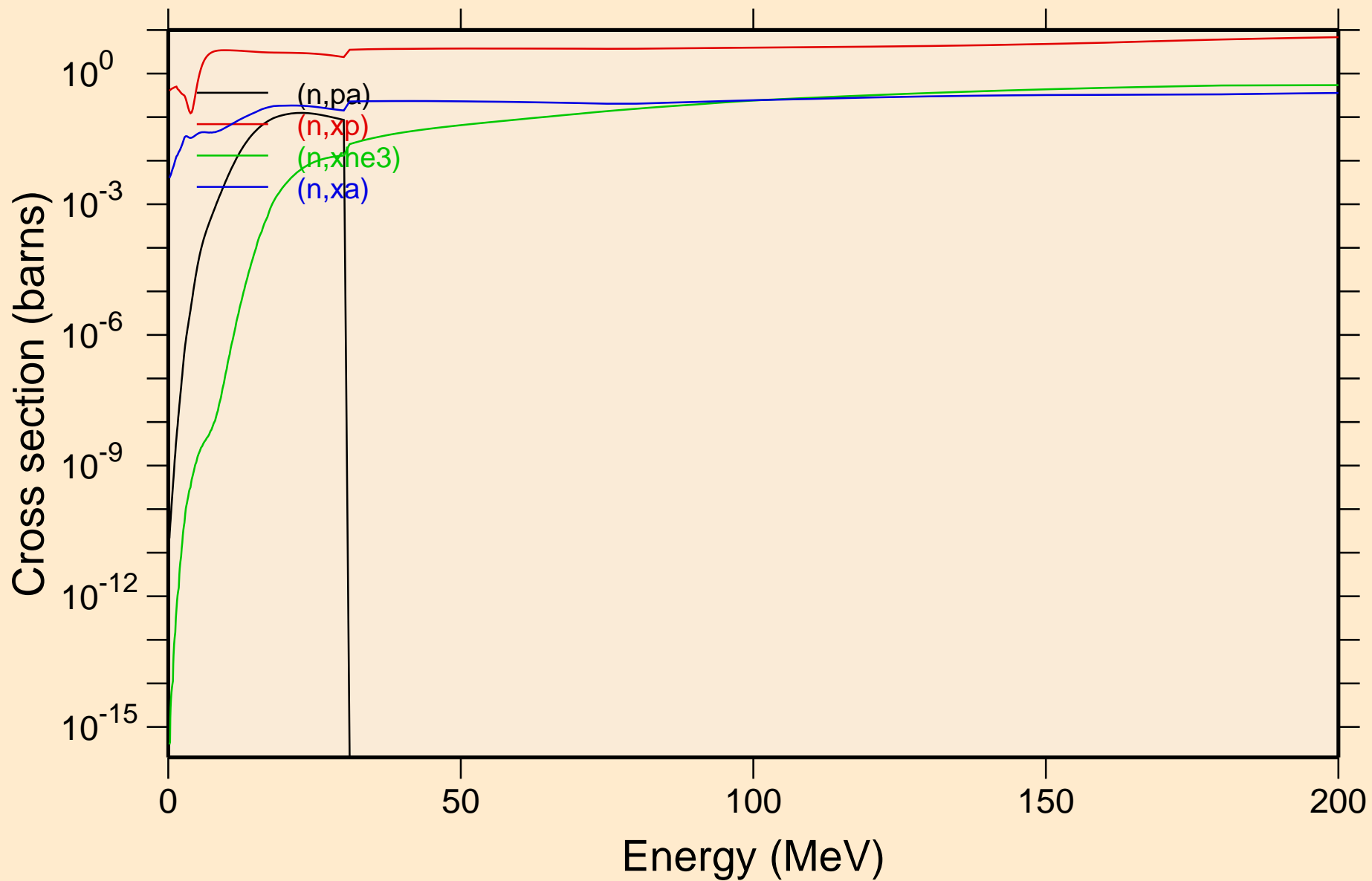

YB152 NEUTRON ACER TENDL-2019 LIBRARY; T=293.16K
Inelastic levels

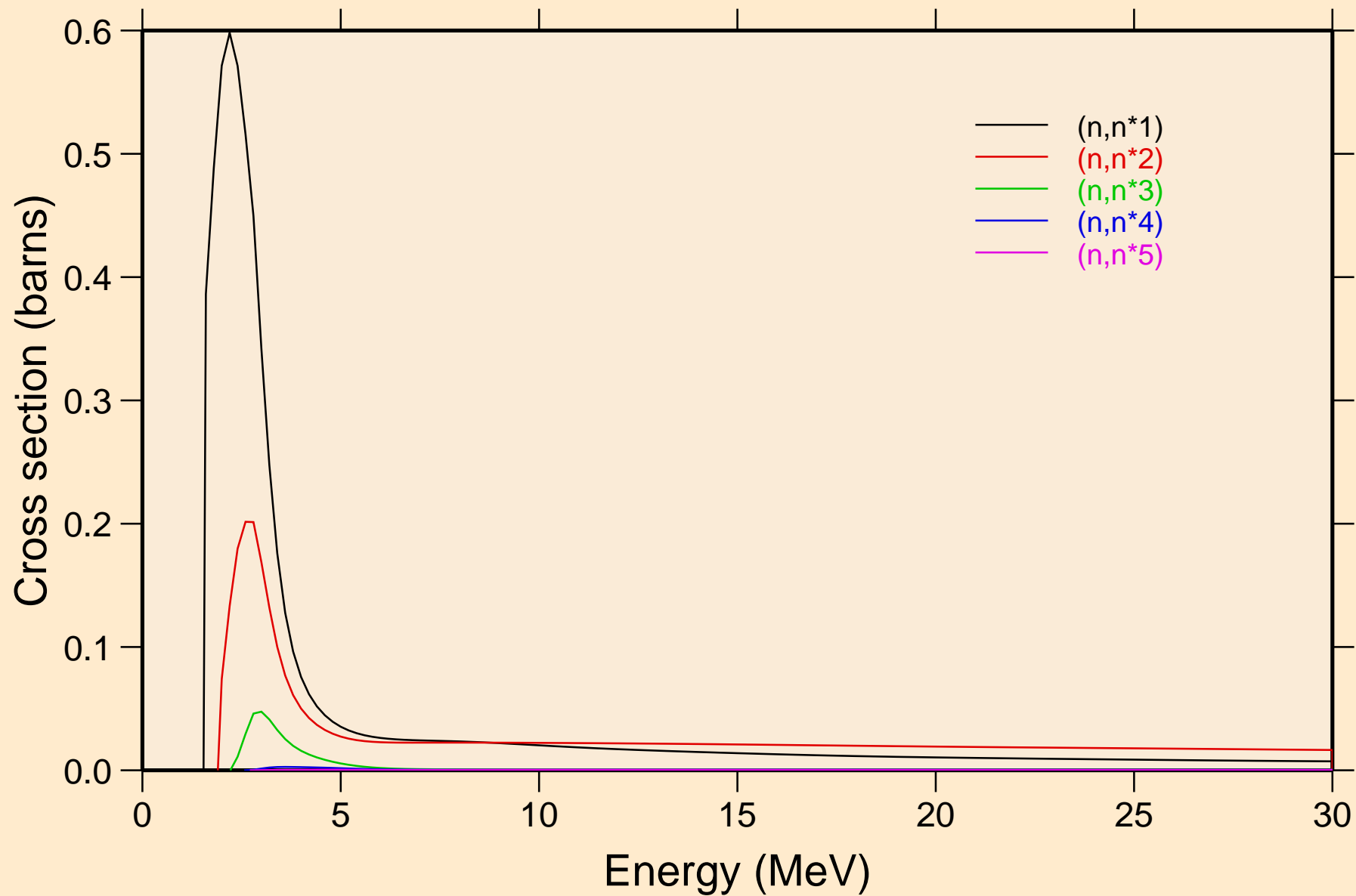

YB152 NEUTRON ACER TENDL-2019 LIBRARY; T=293.16K
Inelastic levels

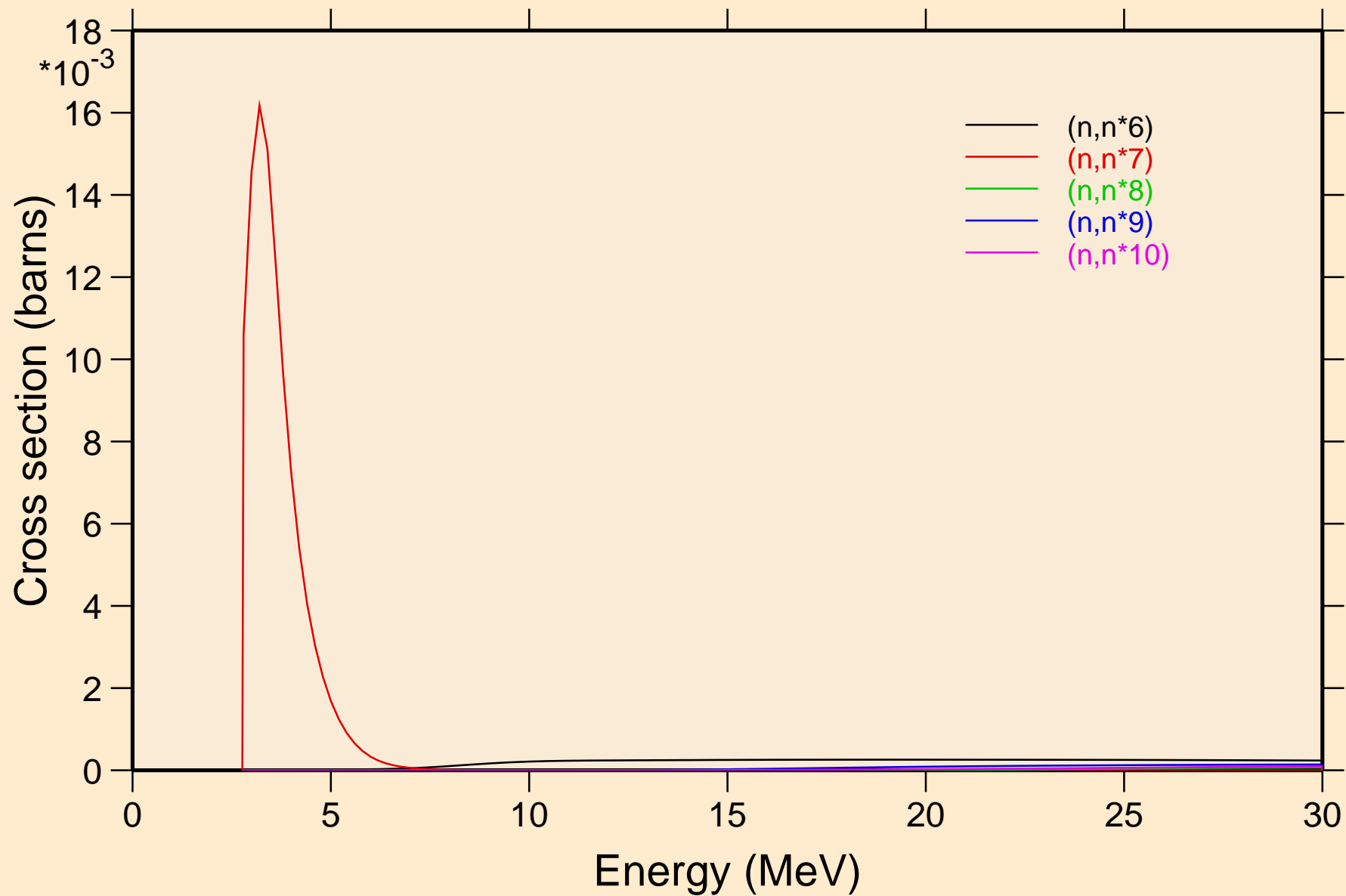

YB152 NEUTRON ACER TENDL-2019 LIBRARY; T=293.16K
Inelastic levels

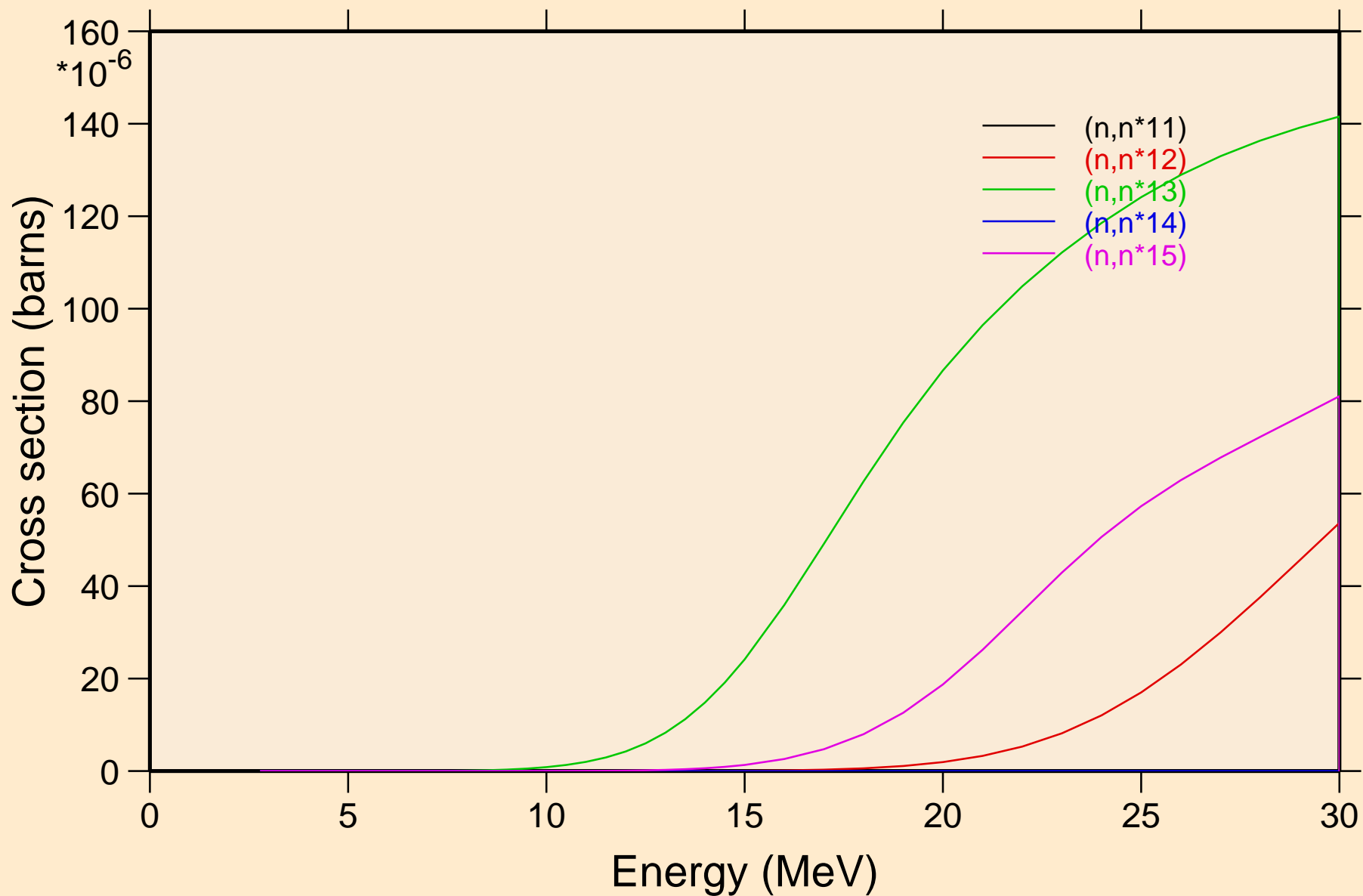

YB152 NEUTRON ACER TENDL-2019 LIBRARY; T=293.16K
Inelastic levels

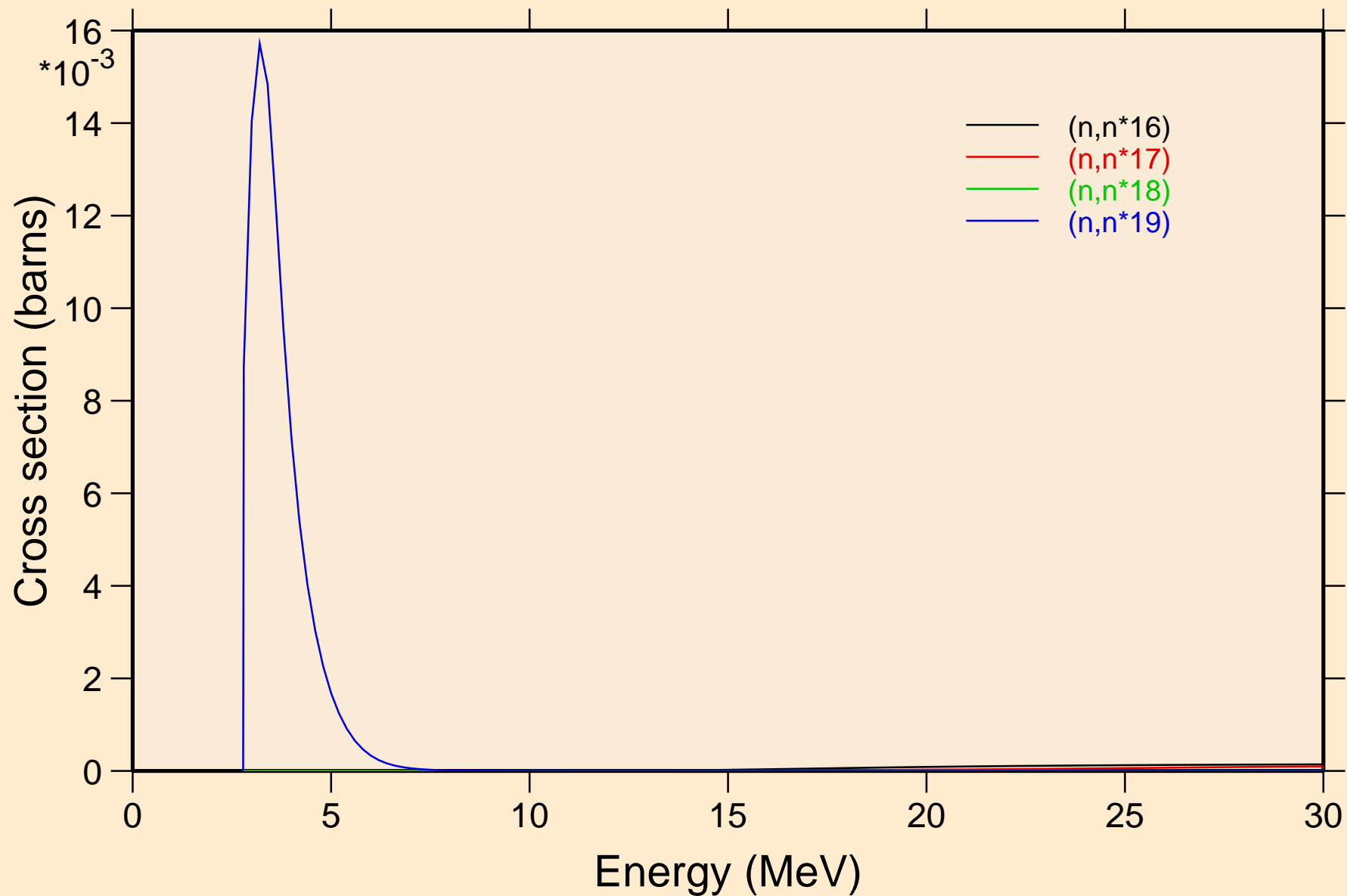

YB152 NEUTRON ACER TENDL-2019 LIBRARY; T=293.16K
Threshold reactions

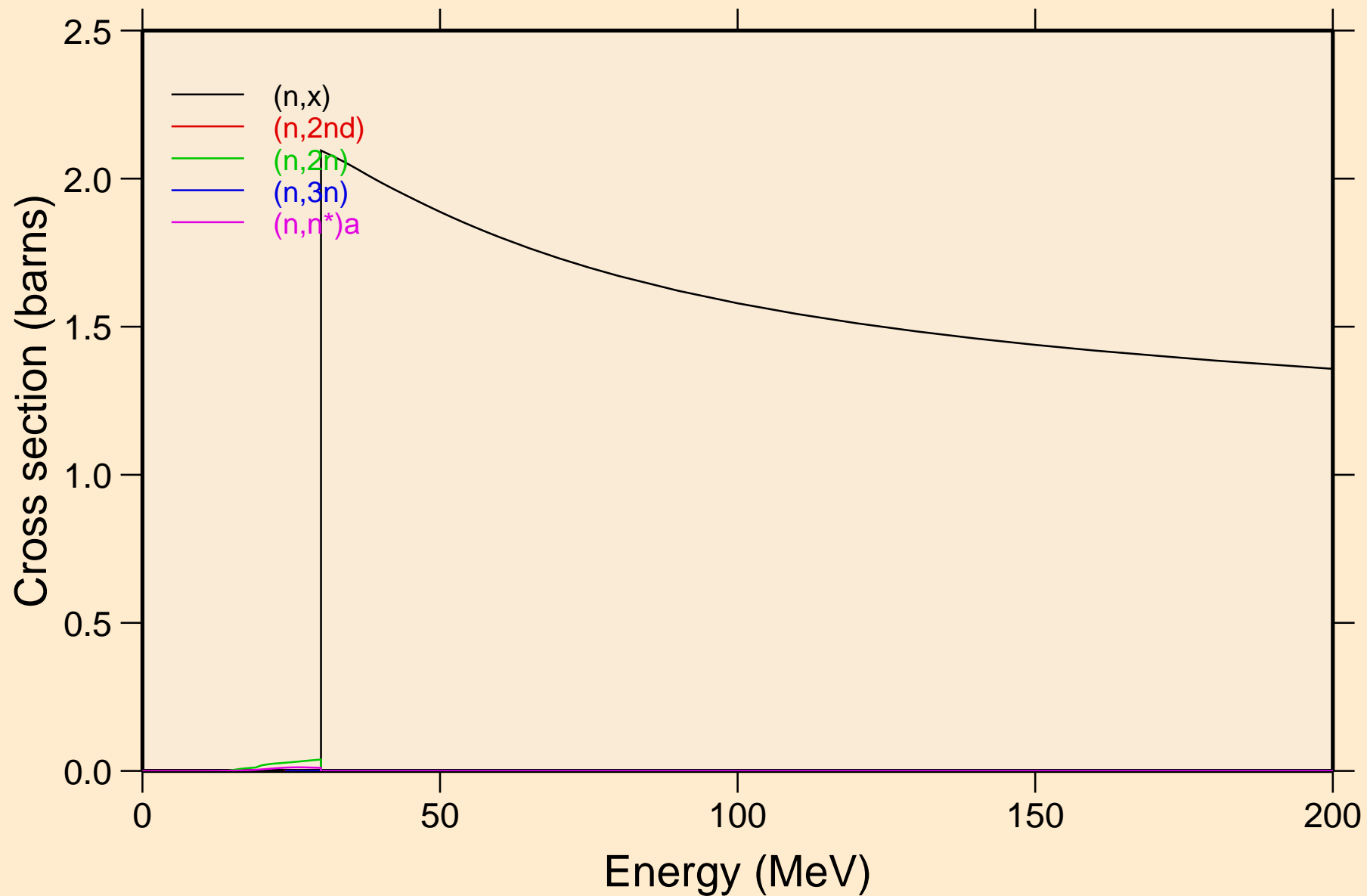

YB152 NEUTRON ACER TENDL-2019 LIBRARY; T=293.16K
Threshold reactions

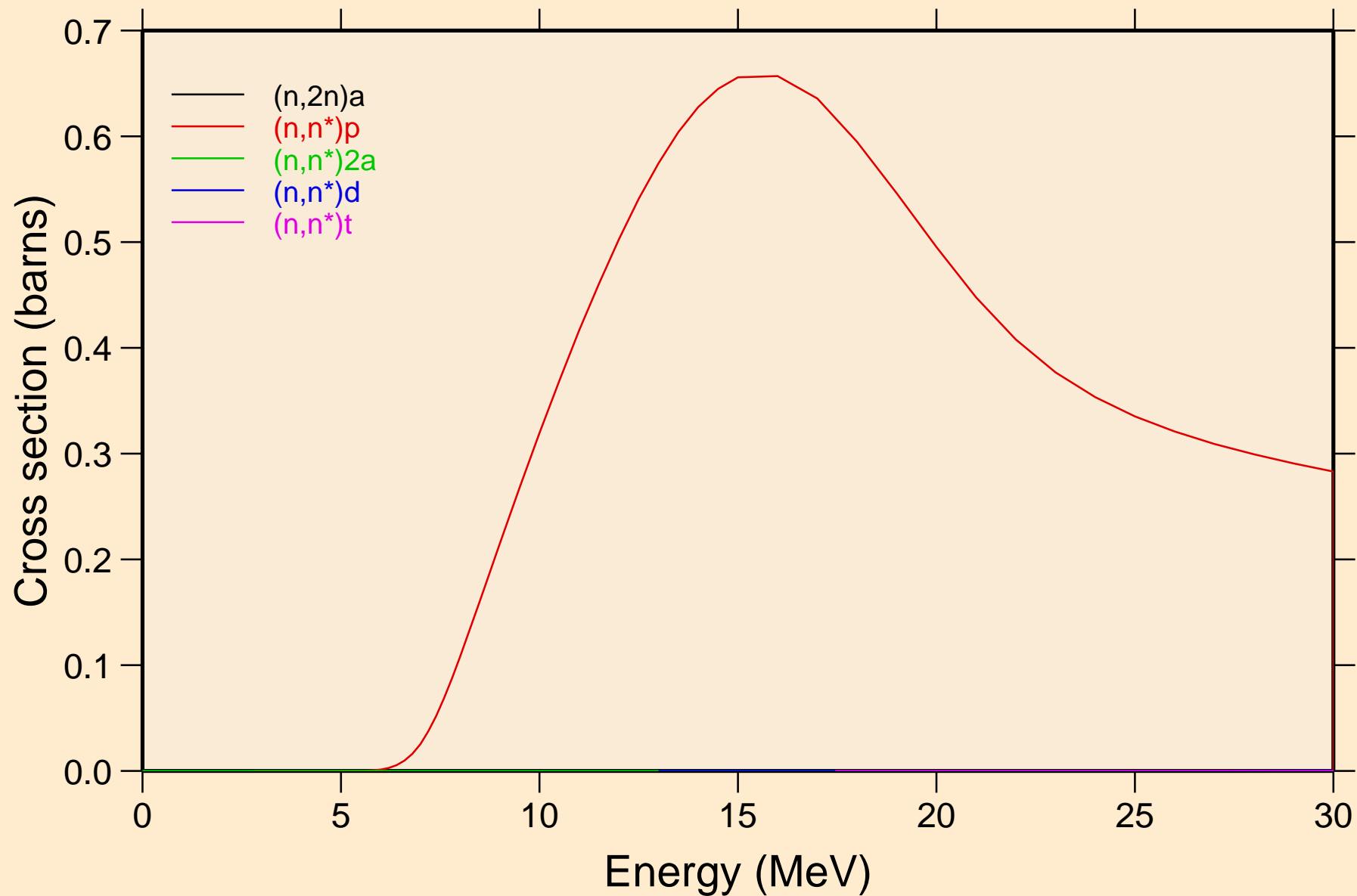

YB152 NEUTRON ACER TENDL-2019 LIBRARY; T=293.16K
Threshold reactions

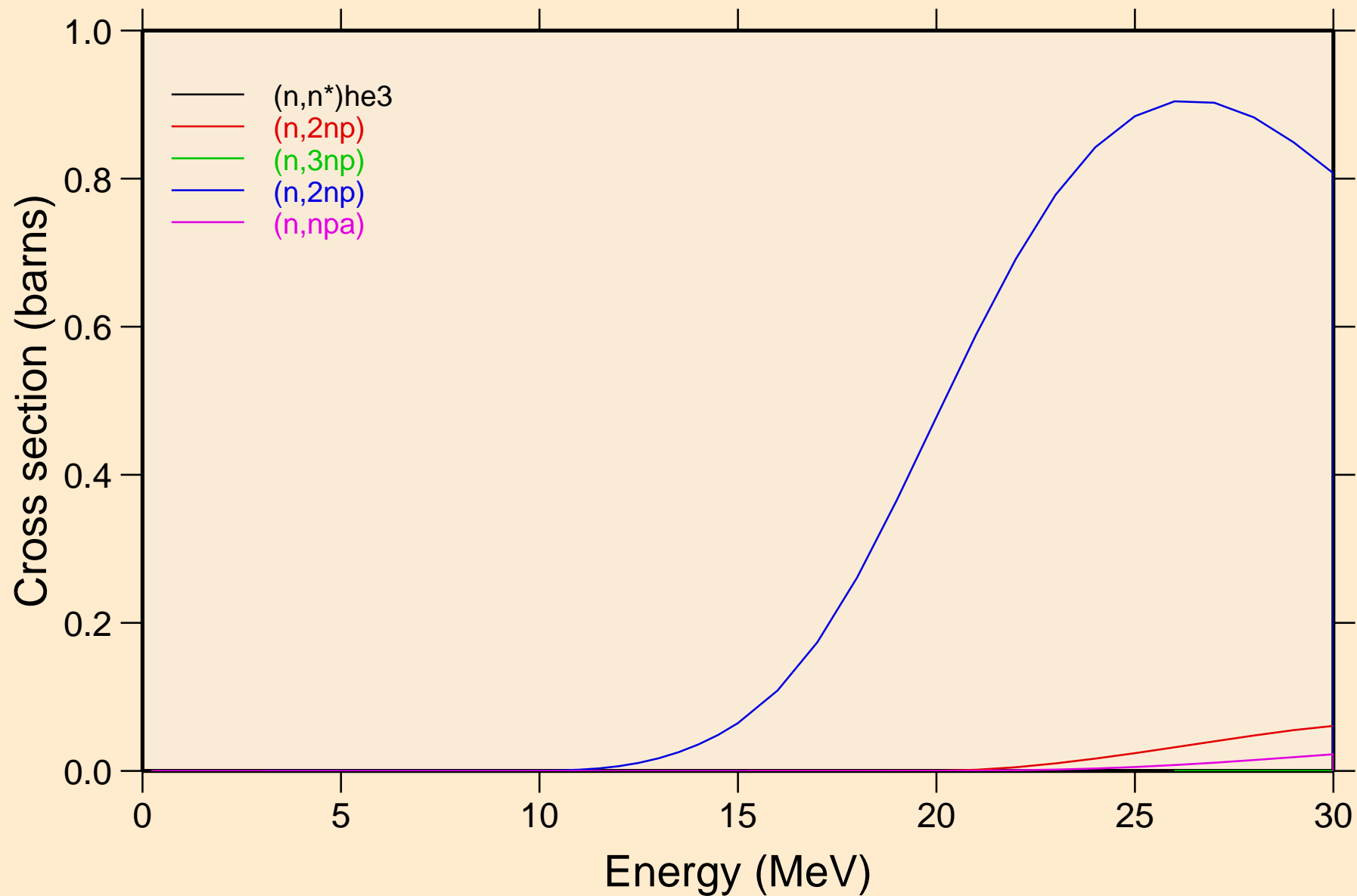

YB152 NEUTRON ACER TENDL-2019 LIBRARY; T=293.16K
Threshold reactions

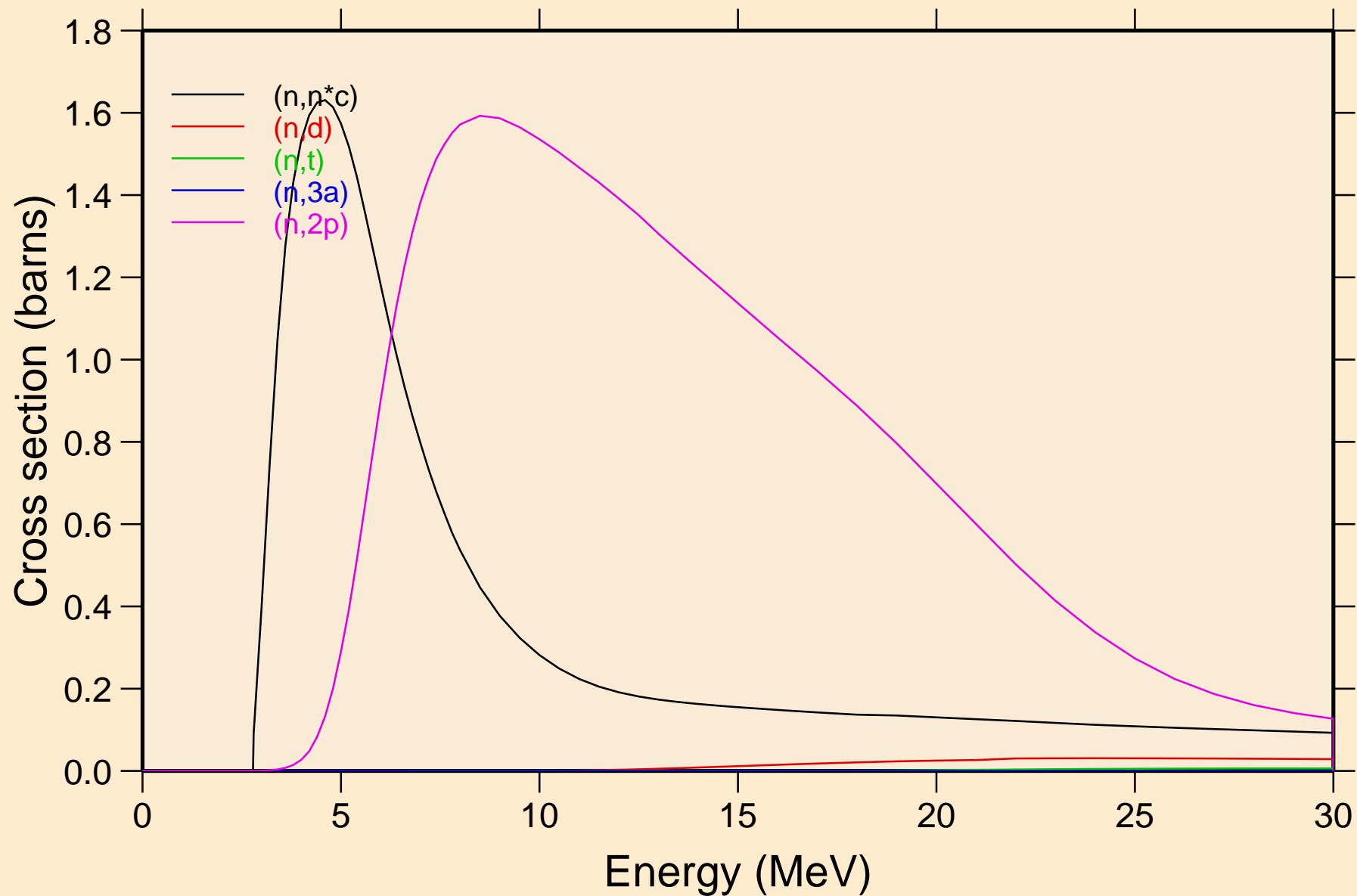

YB152 NEUTRON ACER TENDL-2019 LIBRARY; T=293.16K
Threshold reactions

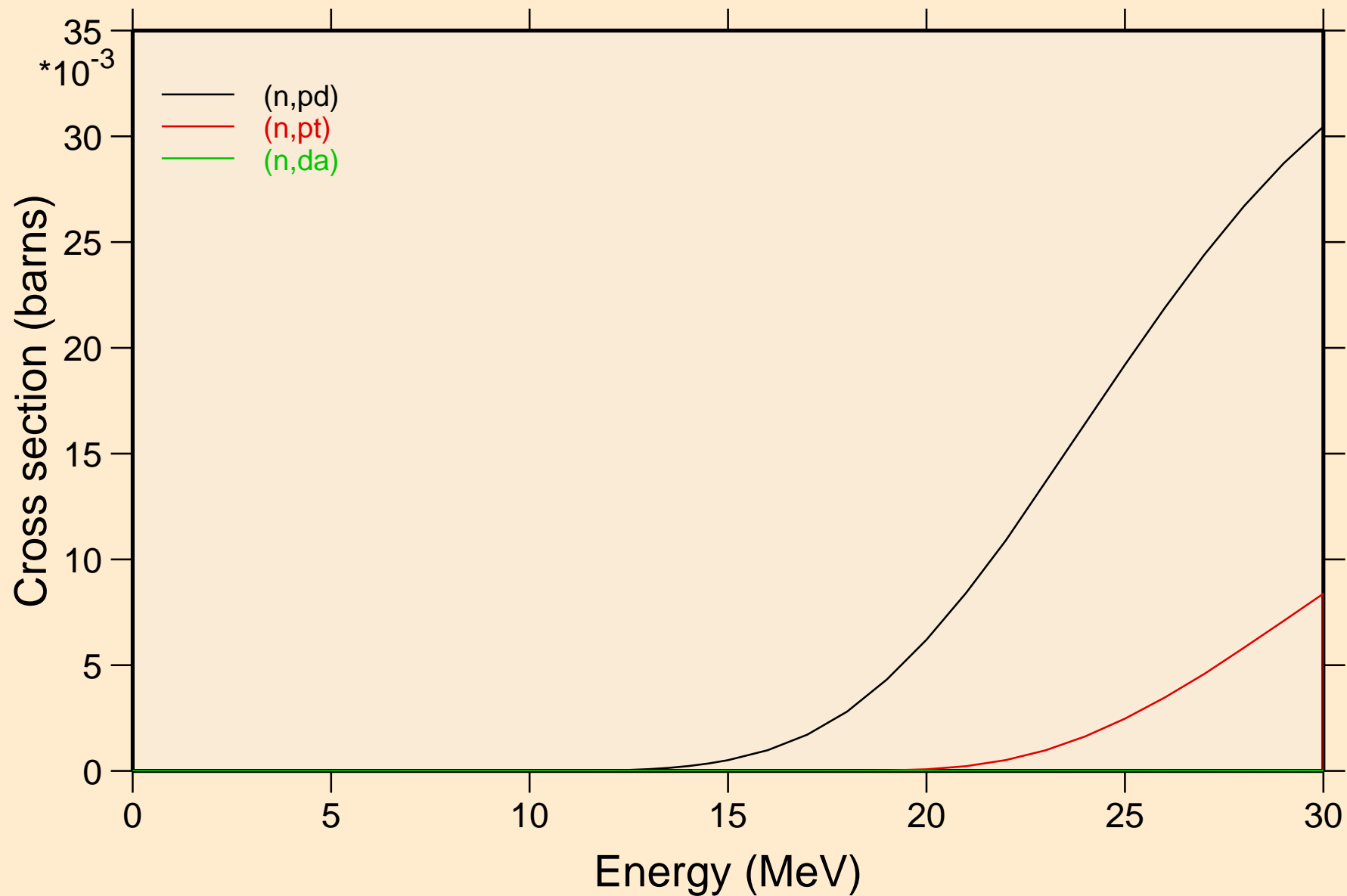

YB152 NEUTRON ACER TENDL-2019 LIBRARY; T=293.16K
Threshold reactions

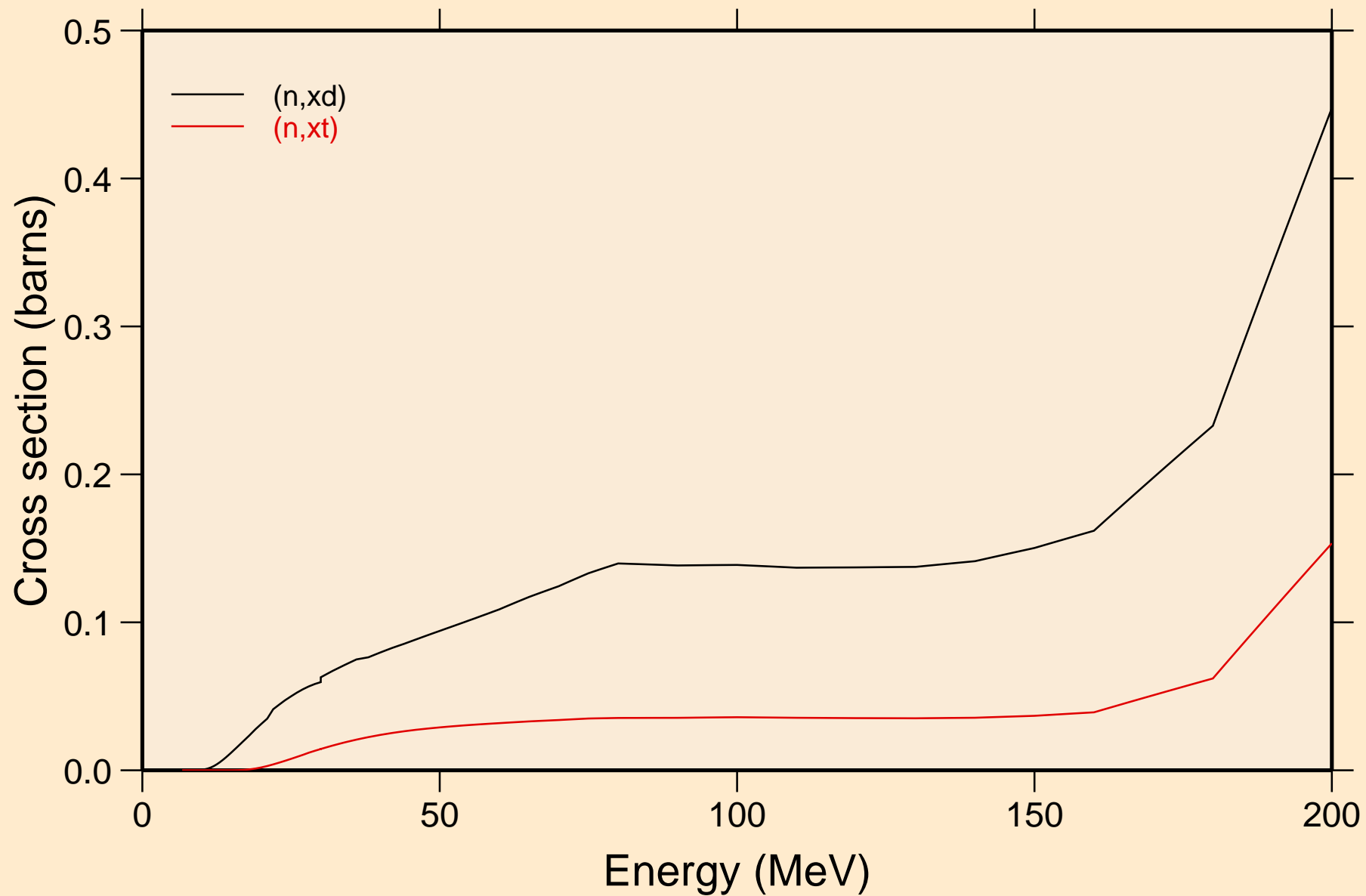

YB152 NEUTRON ACER TENDL-2019 LIBRARY; T=293.16K
angular distribution for elastic

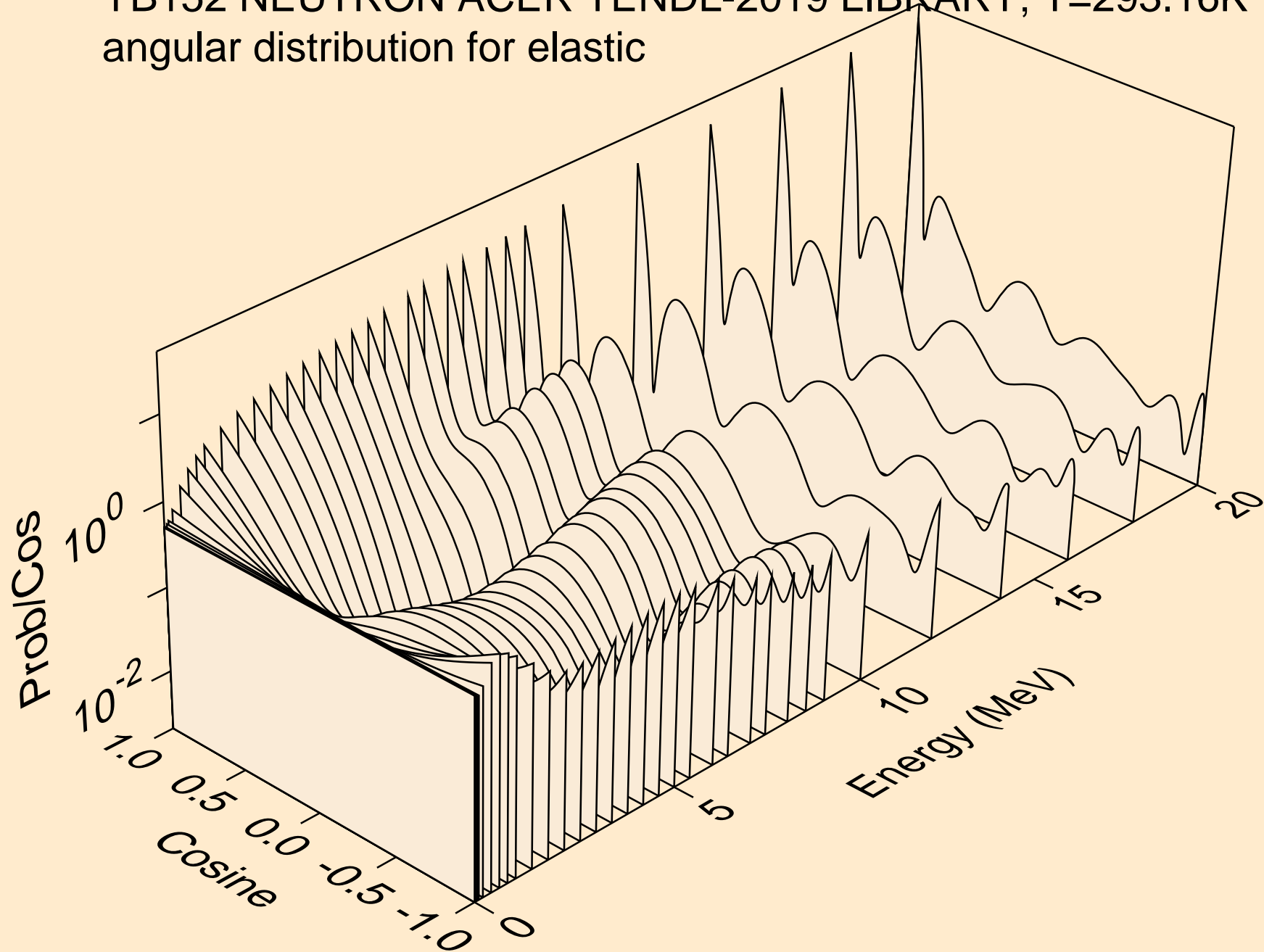

YB152 NEUTRON ACER TENDL-2019 LIBRARY; T=293.16K
angular distribution for elastic

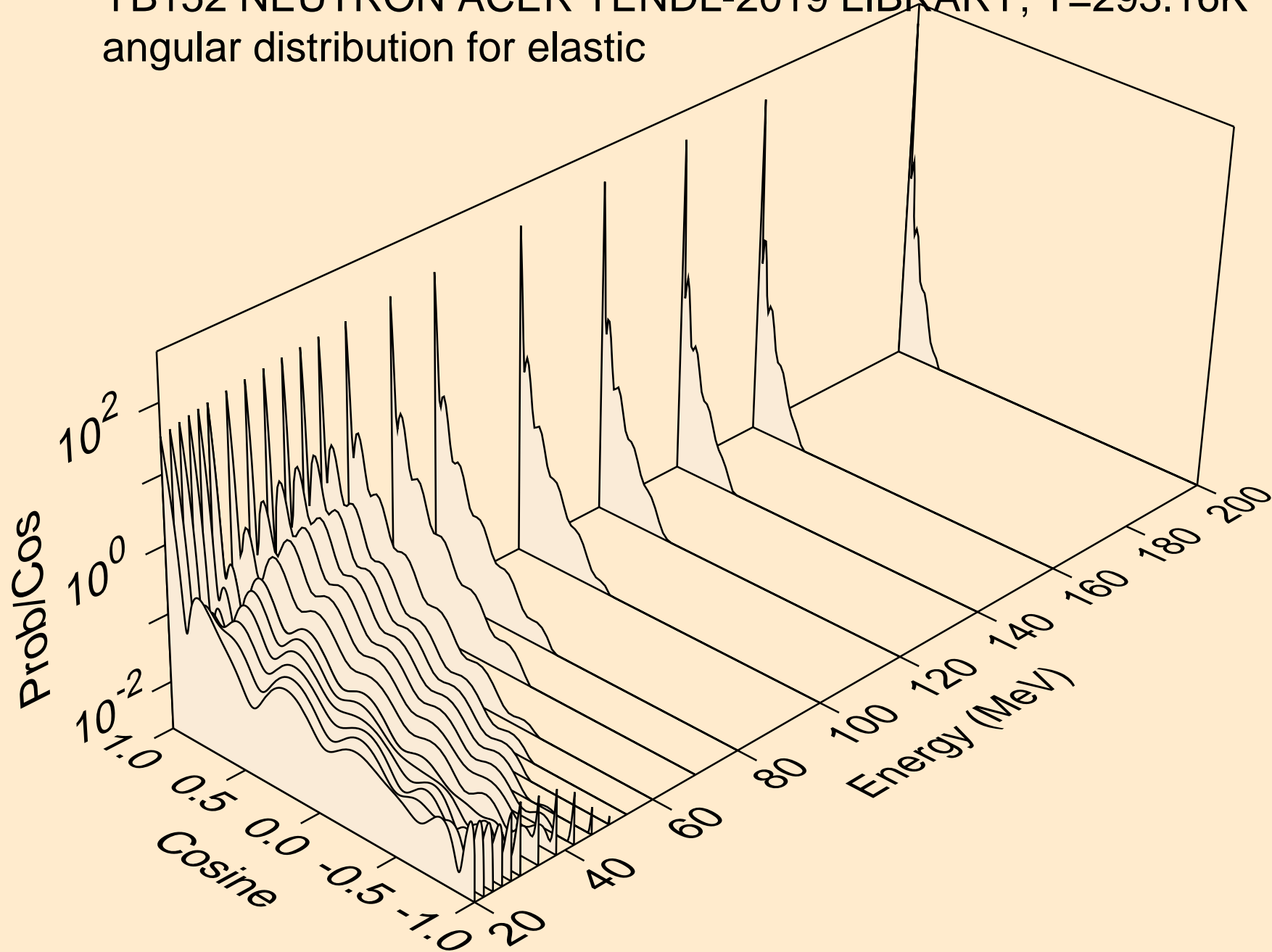

YB152 NEUTRON ACER TENDL-2019 LIBRARY; T=293.16K
angular distribution for (n,n*1)

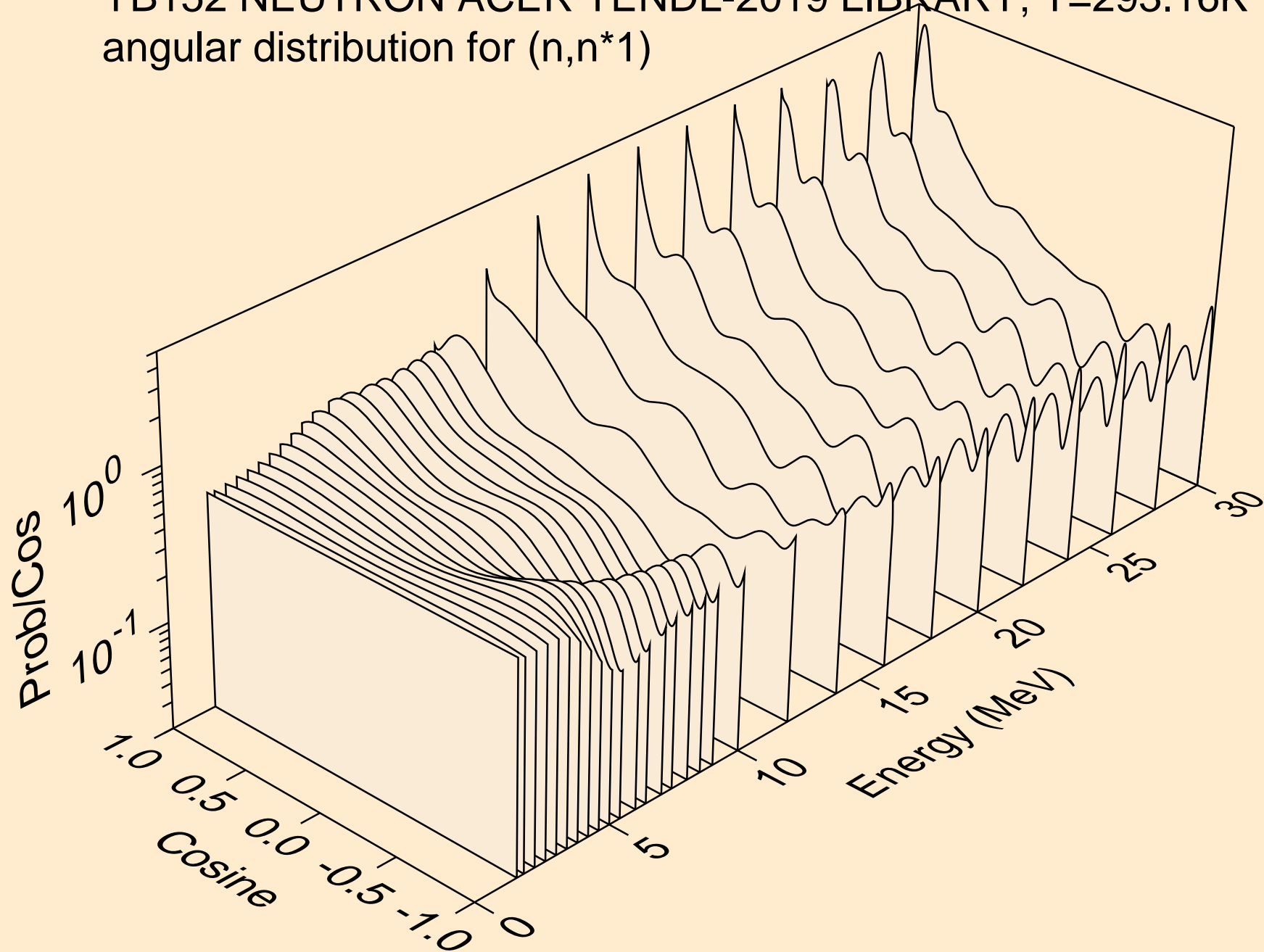

YB152 NEUTRON ACER TENDL-2019 LIBRARY; T=293.16K
angular distribution for (n,n*2)

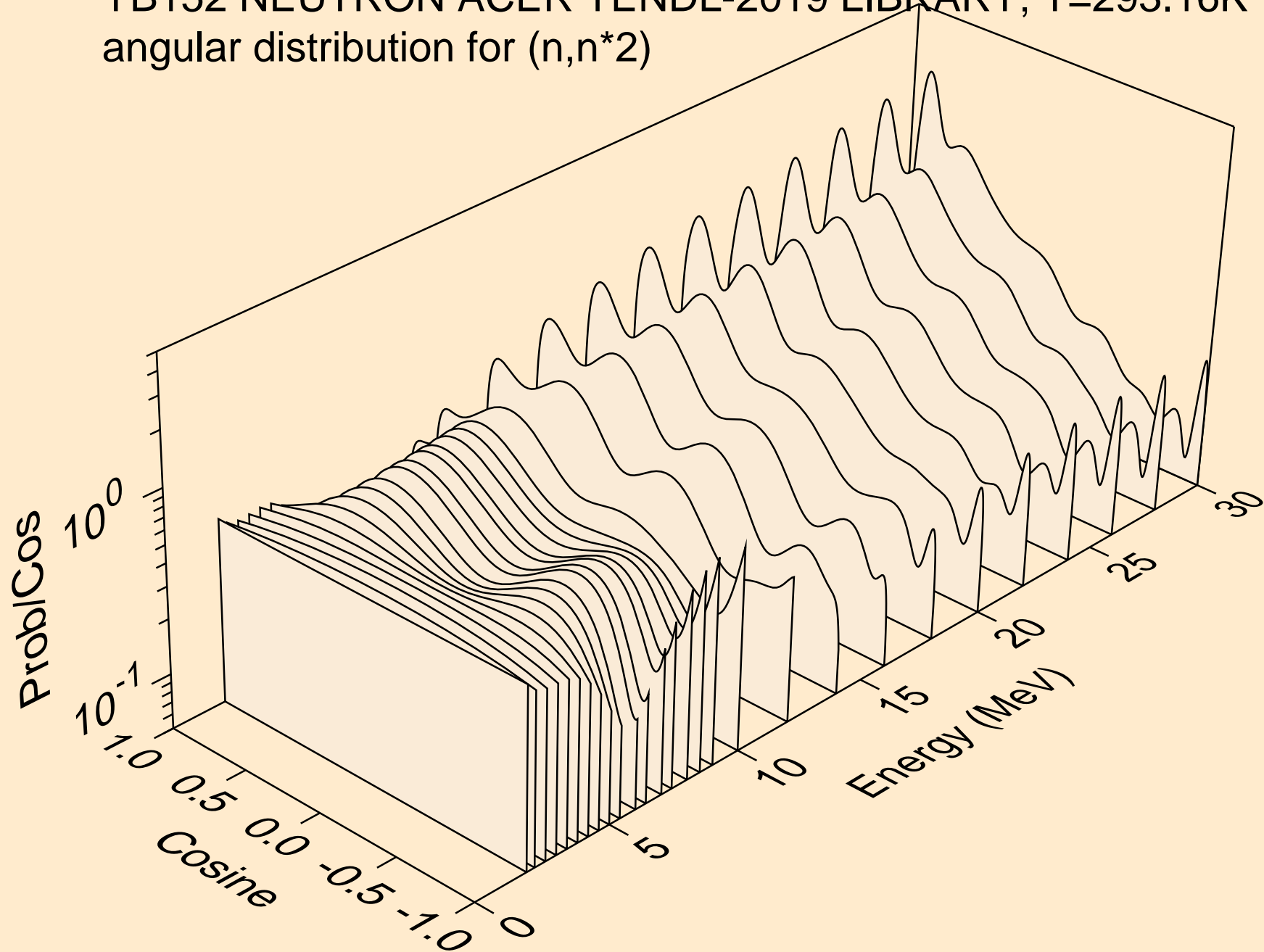

YB152 NEUTRON ACER TENDL-2019 LIBRARY; T=293.16K
angular distribution for (n,n*3)

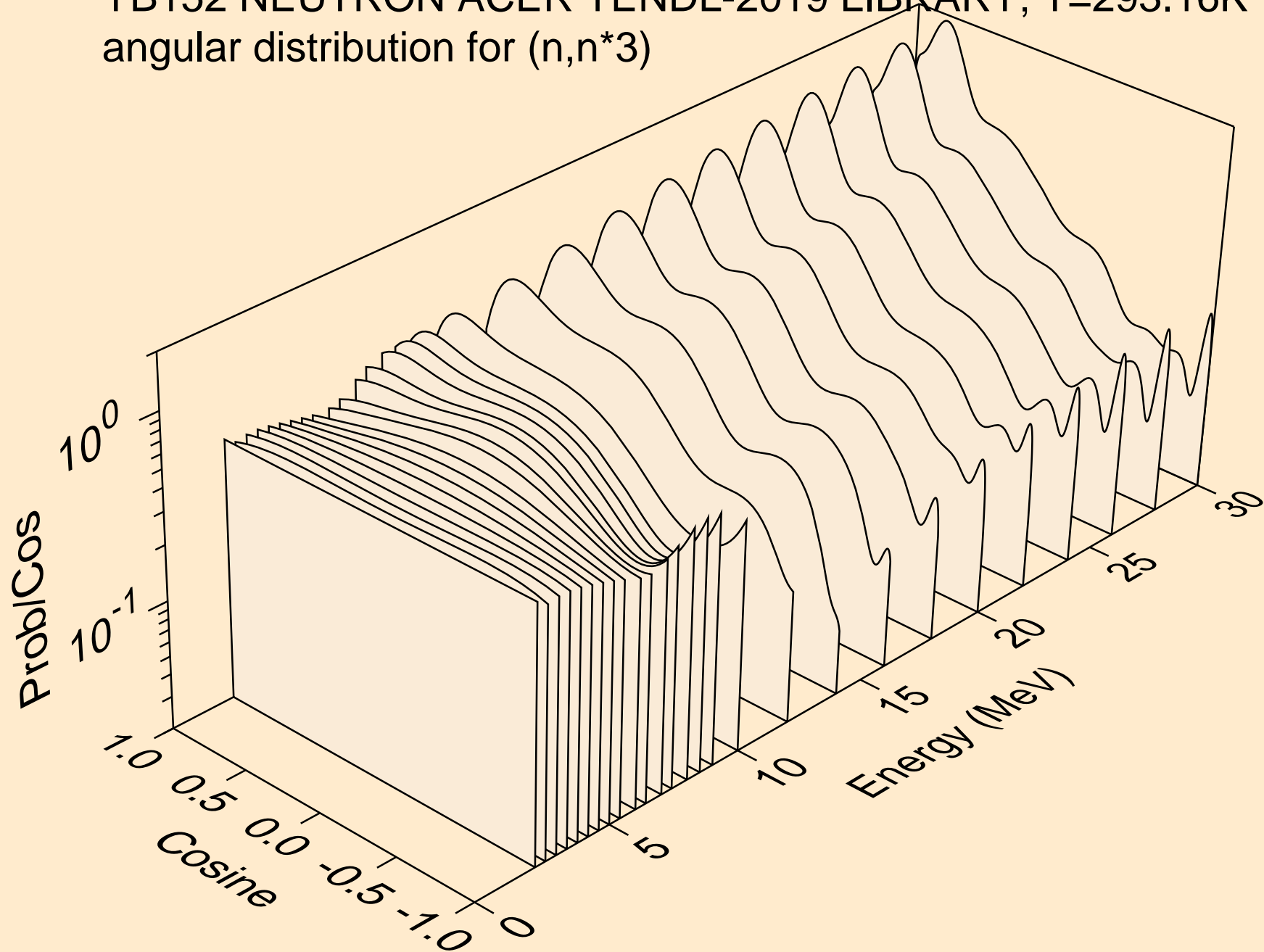

YB152 NEUTRON ACER TENDL-2019 LIBRARY; T=293.16K
angular distribution for (n,n*4)

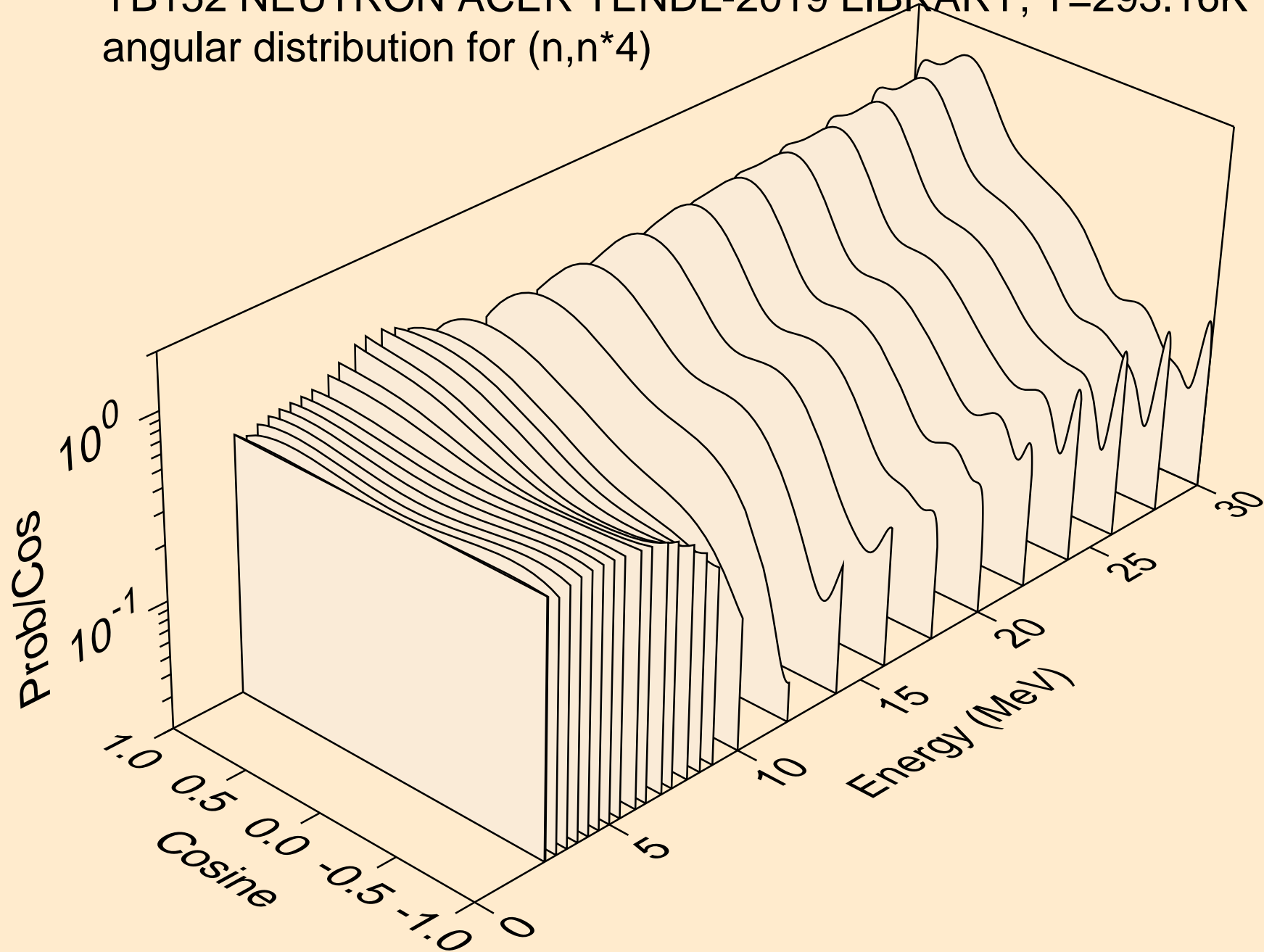

YB152 NEUTRON ACER TENDL-2019 LIBRARY; T=293.16K
angular distribution for (n,n*5)

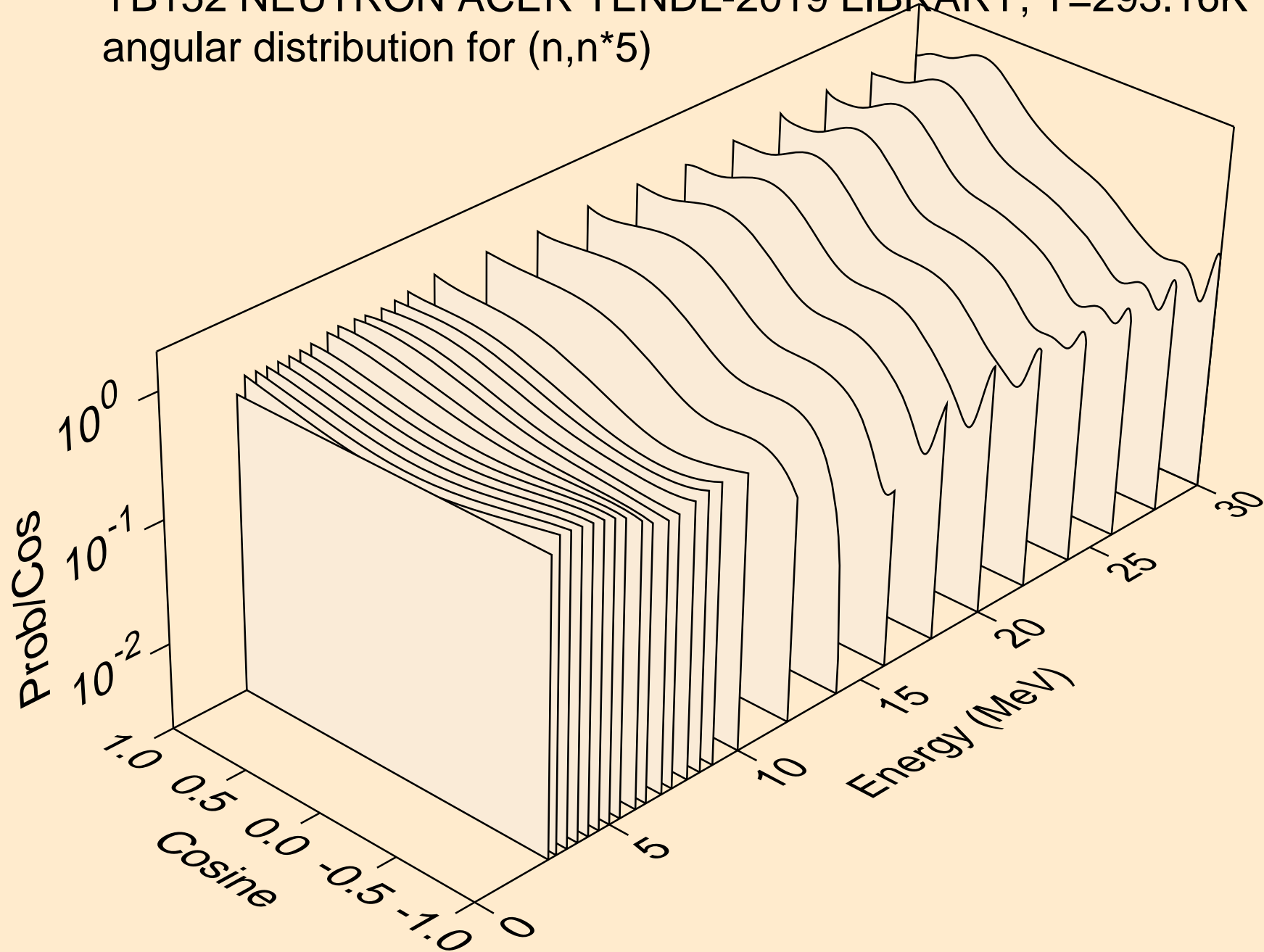

YB152 NEUTRON ACER TENDL-2019 LIBRARY; T=293.16K
angular distribution for (n,n*6)

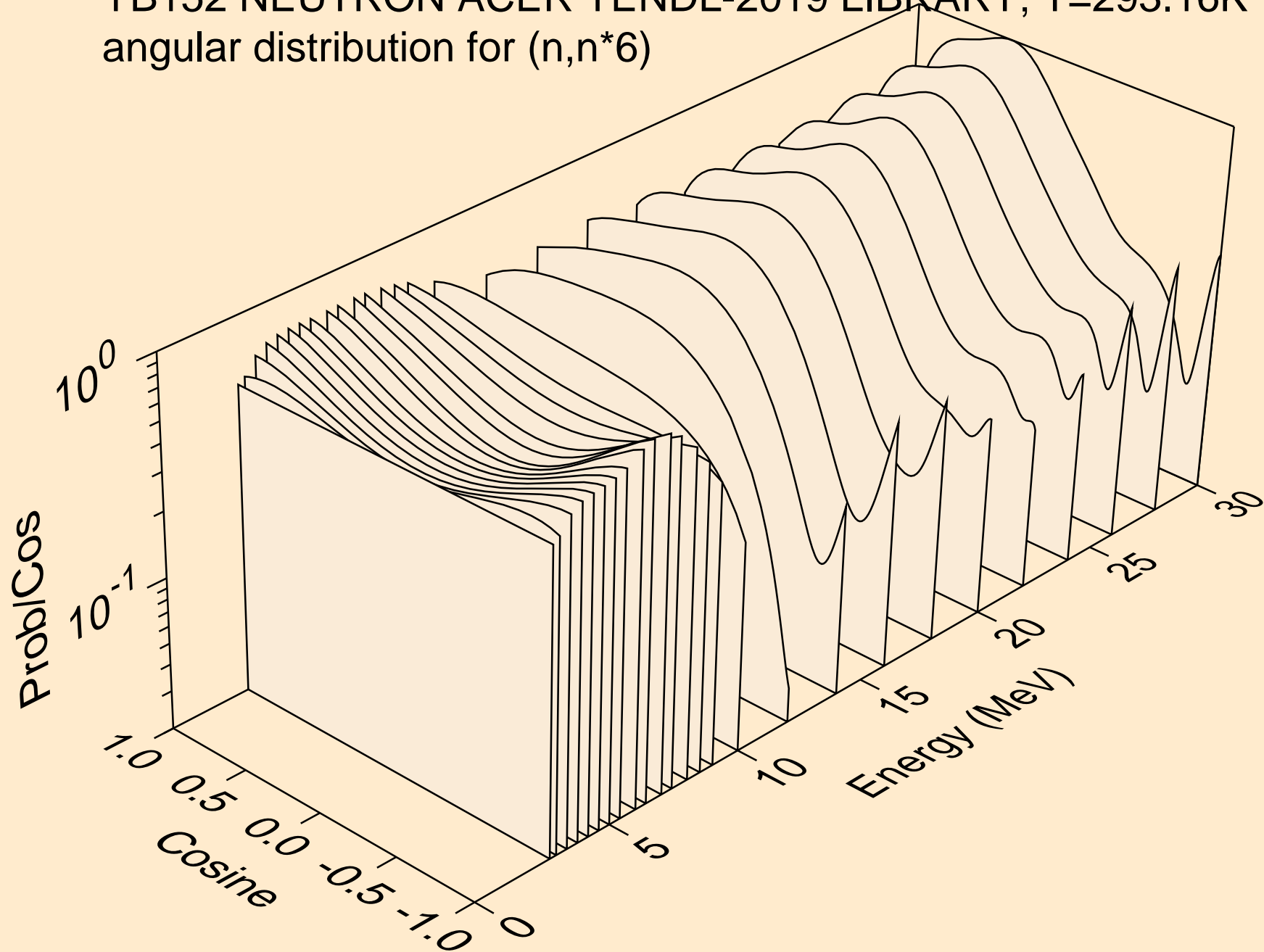

YB152 NEUTRON ACER TENDL-2019 LIBRARY; T=293.16K
angular distribution for (n,n*7)

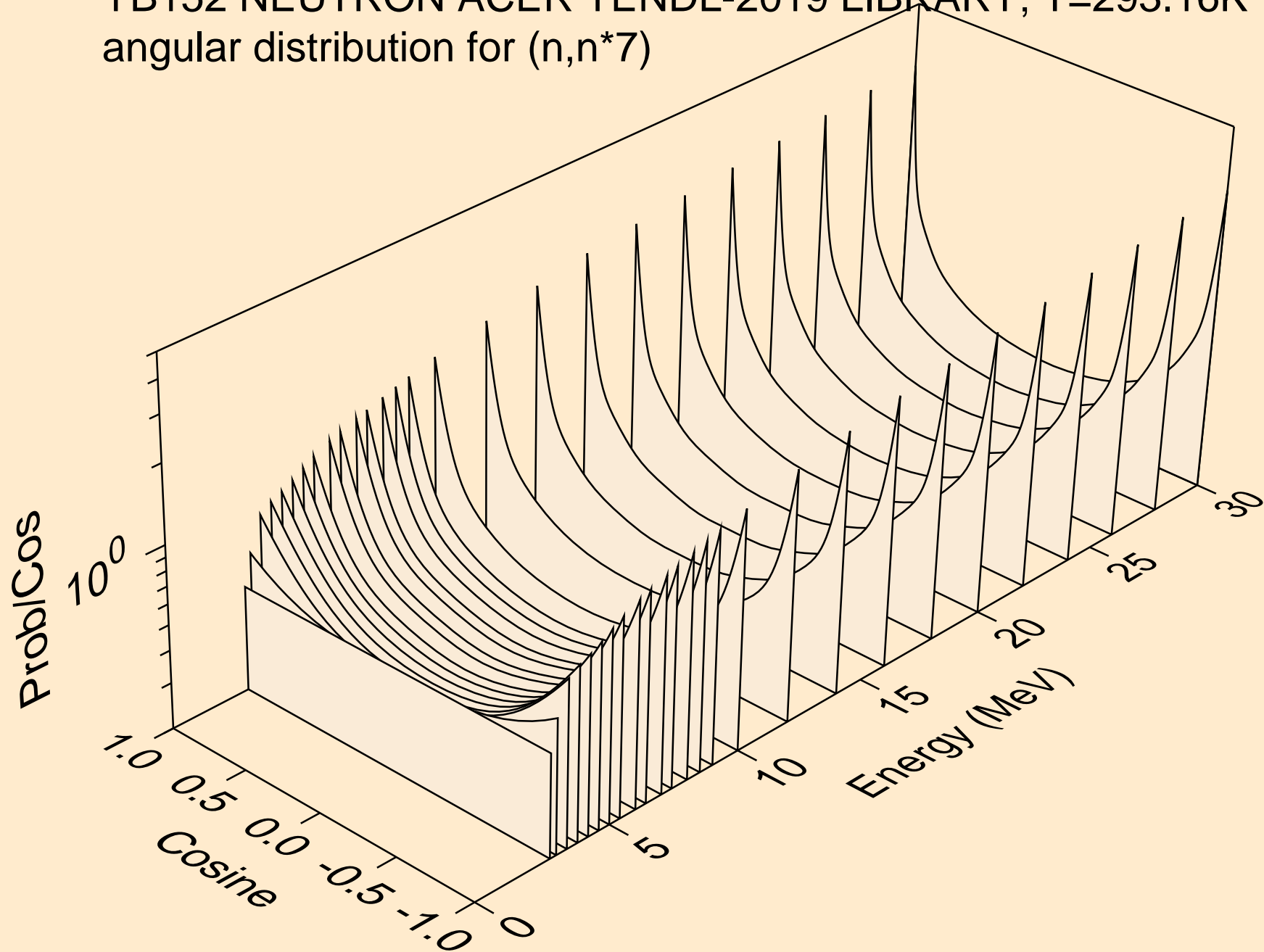

YB152 NEUTRON ACER TENDL-2019 LIBRARY; T=293.16K
angular distribution for (n,n*8)

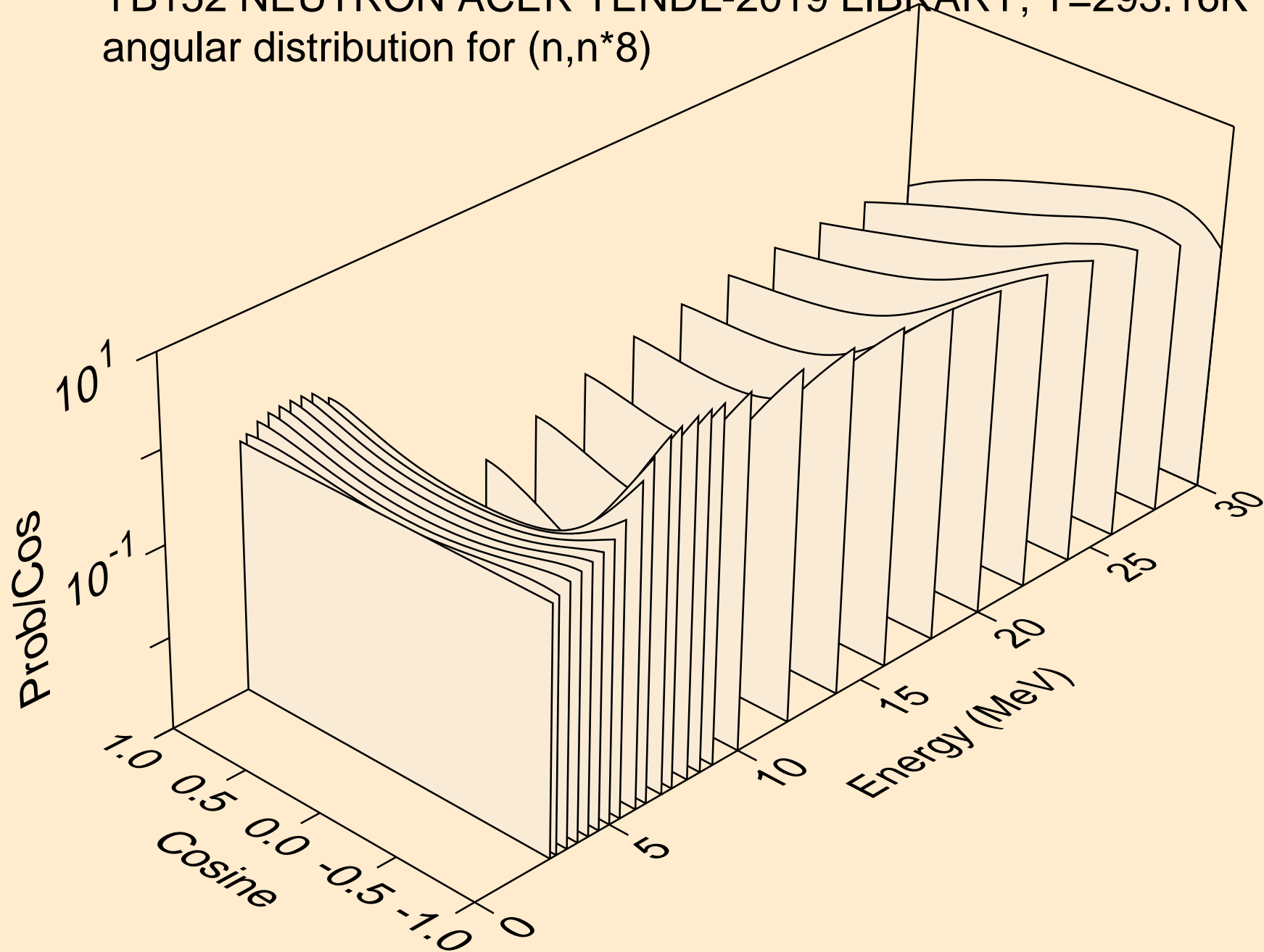

YB152 NEUTRON ACER TENDL-2019 LIBRARY; T=293.16K
angular distribution for (n,n*9)

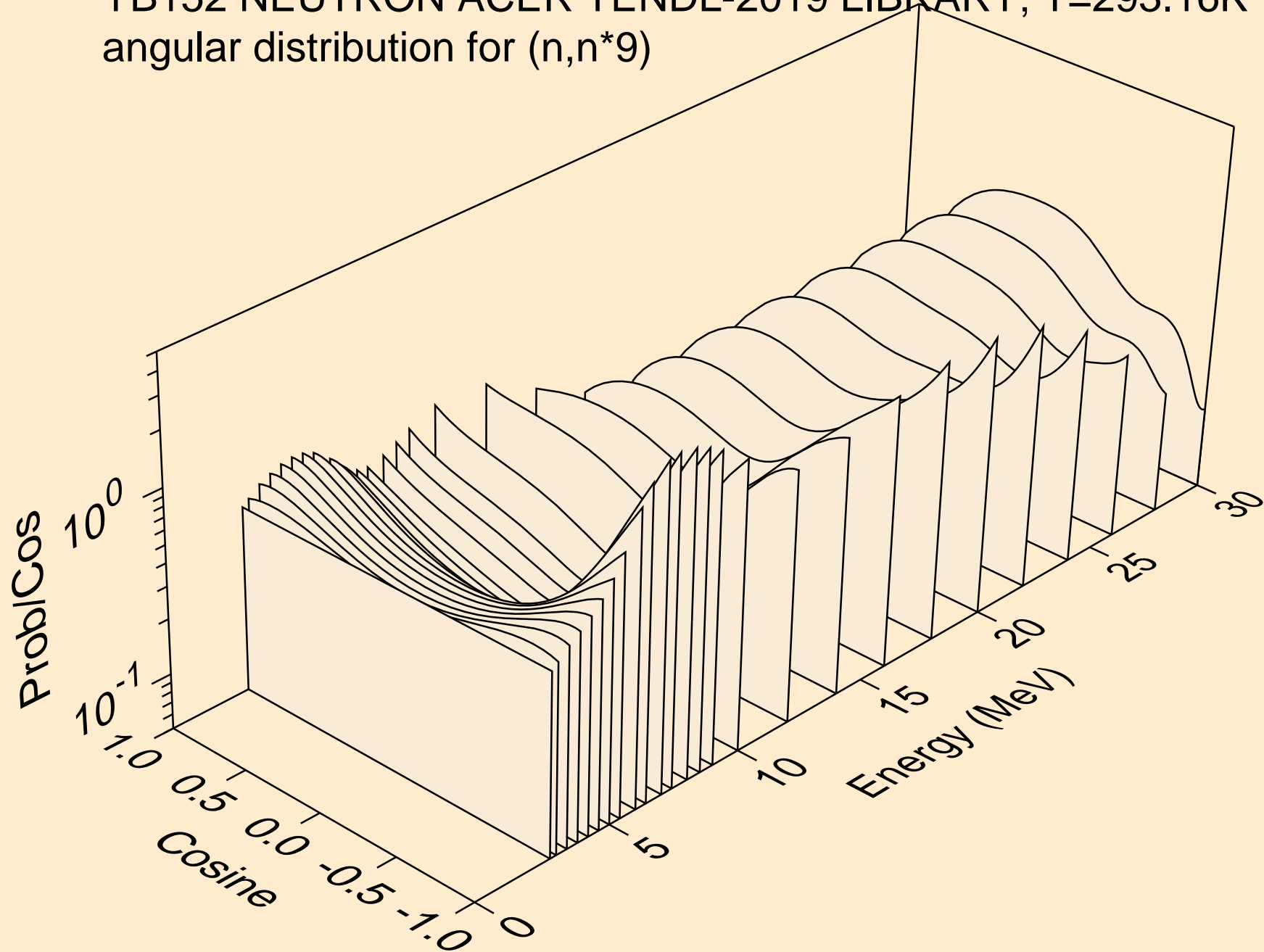

YB152 NEUTRON ACER TENDL-2019 LIBRARY; T=293.16K
angular distribution for (n,n*10)

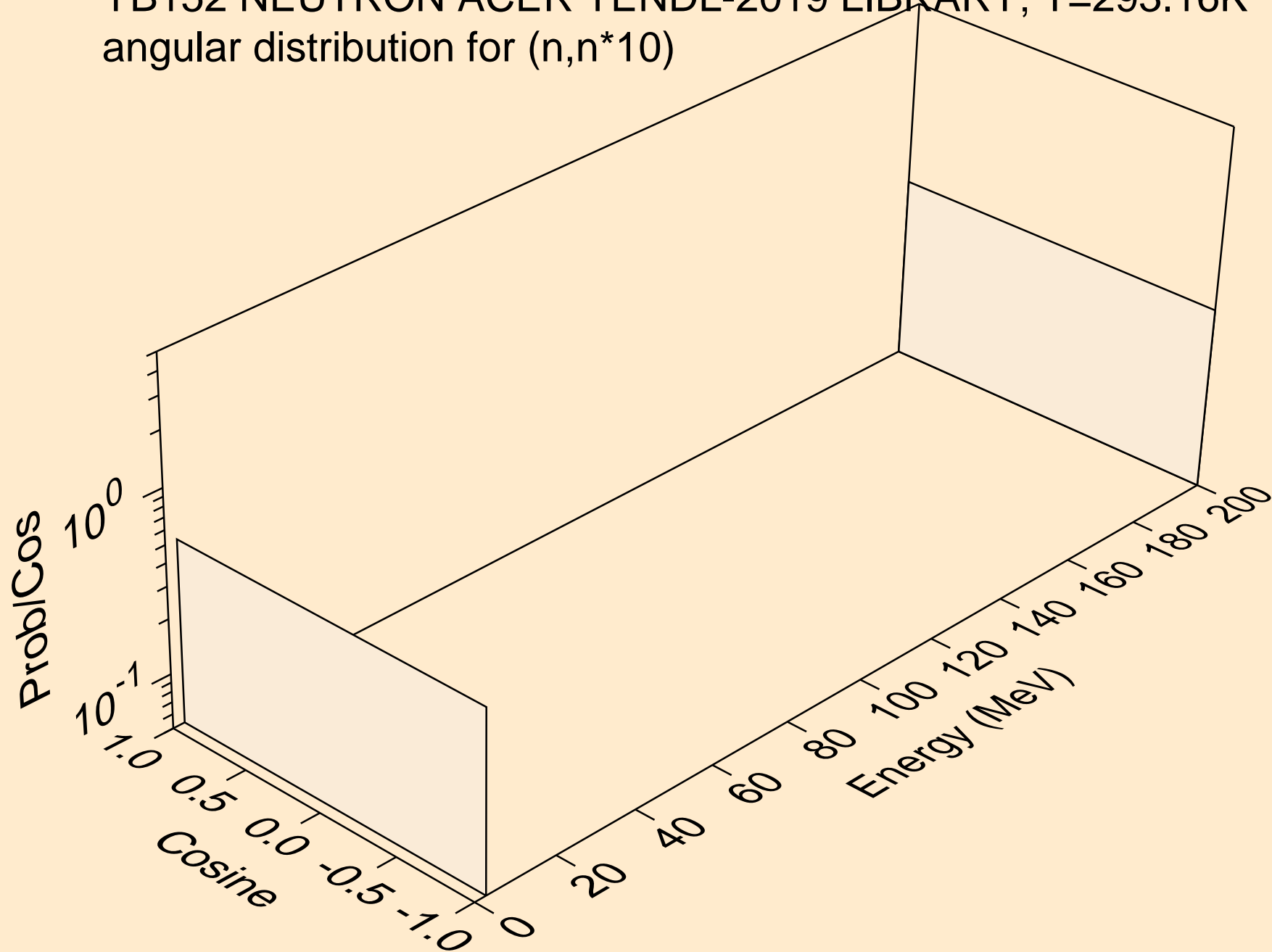

YB152 NEUTRON ACER TENDL-2019 LIBRARY; T=293.16K
angular distribution for (n,n*11)

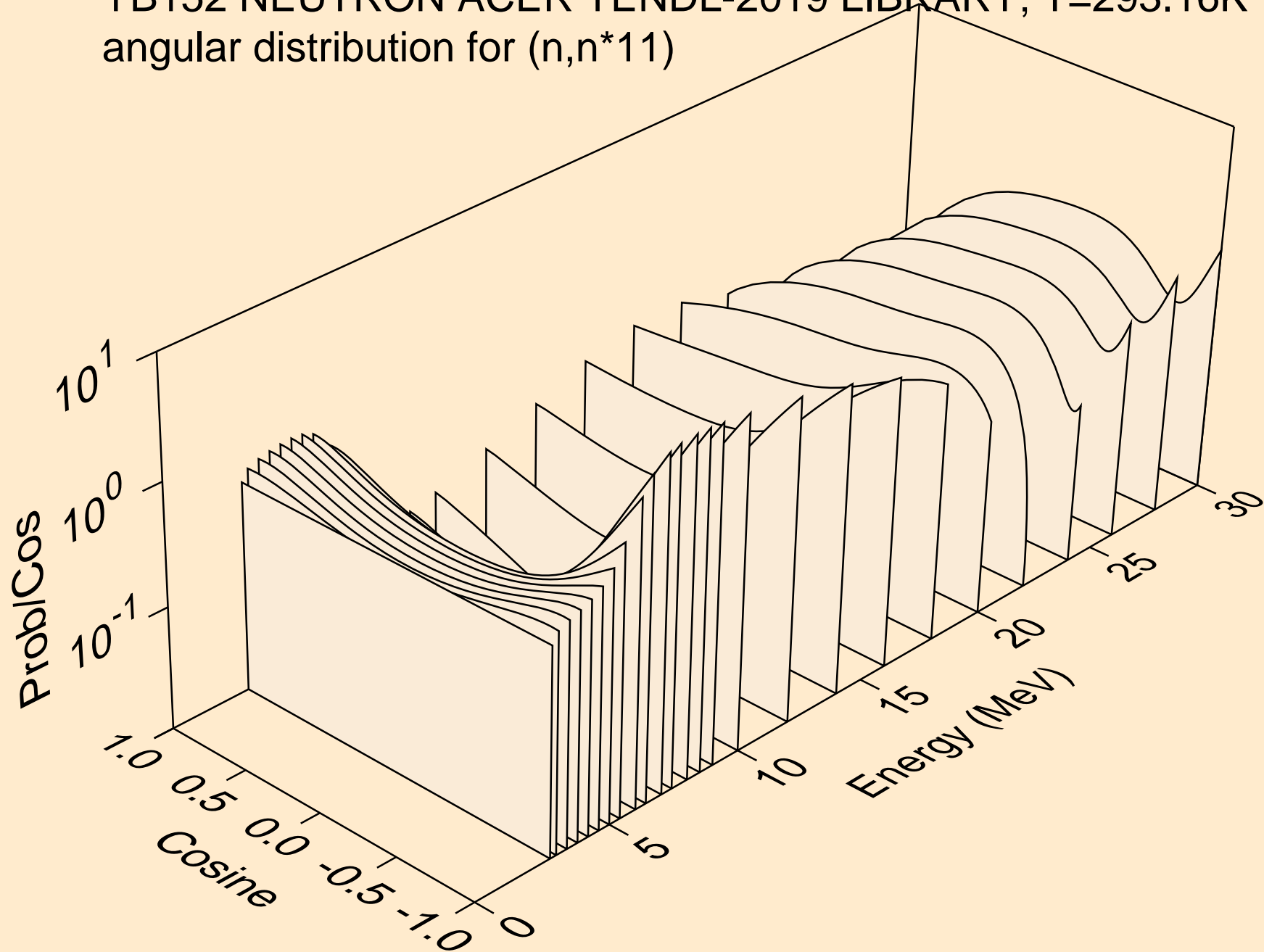

YB152 NEUTRON ACER TENDL-2019 LIBRARY; T=293.16K
angular distribution for (n,n*12)

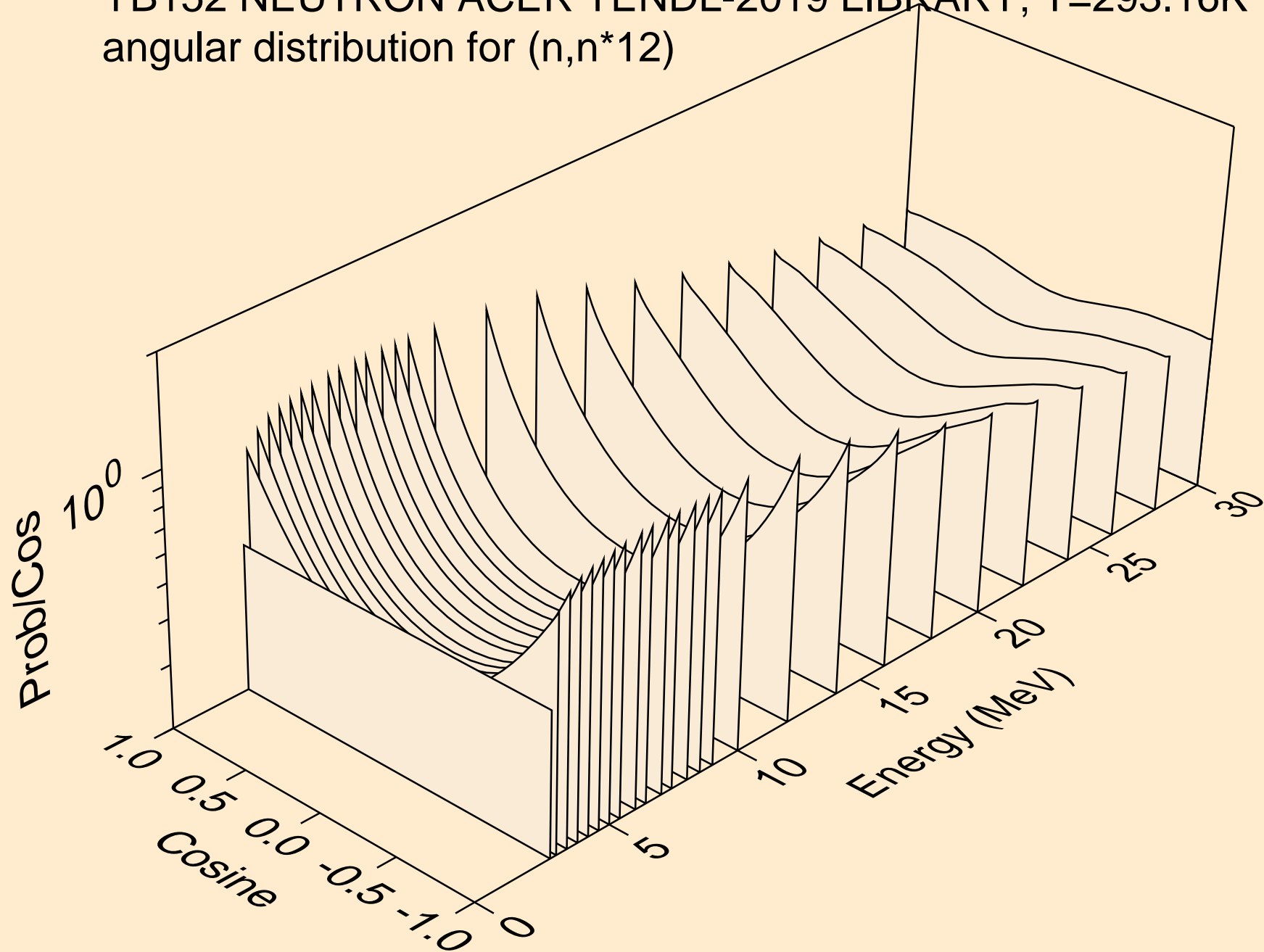

YB152 NEUTRON ACER TENDL-2019 LIBRARY; T=293.16K
angular distribution for (n,n*13)

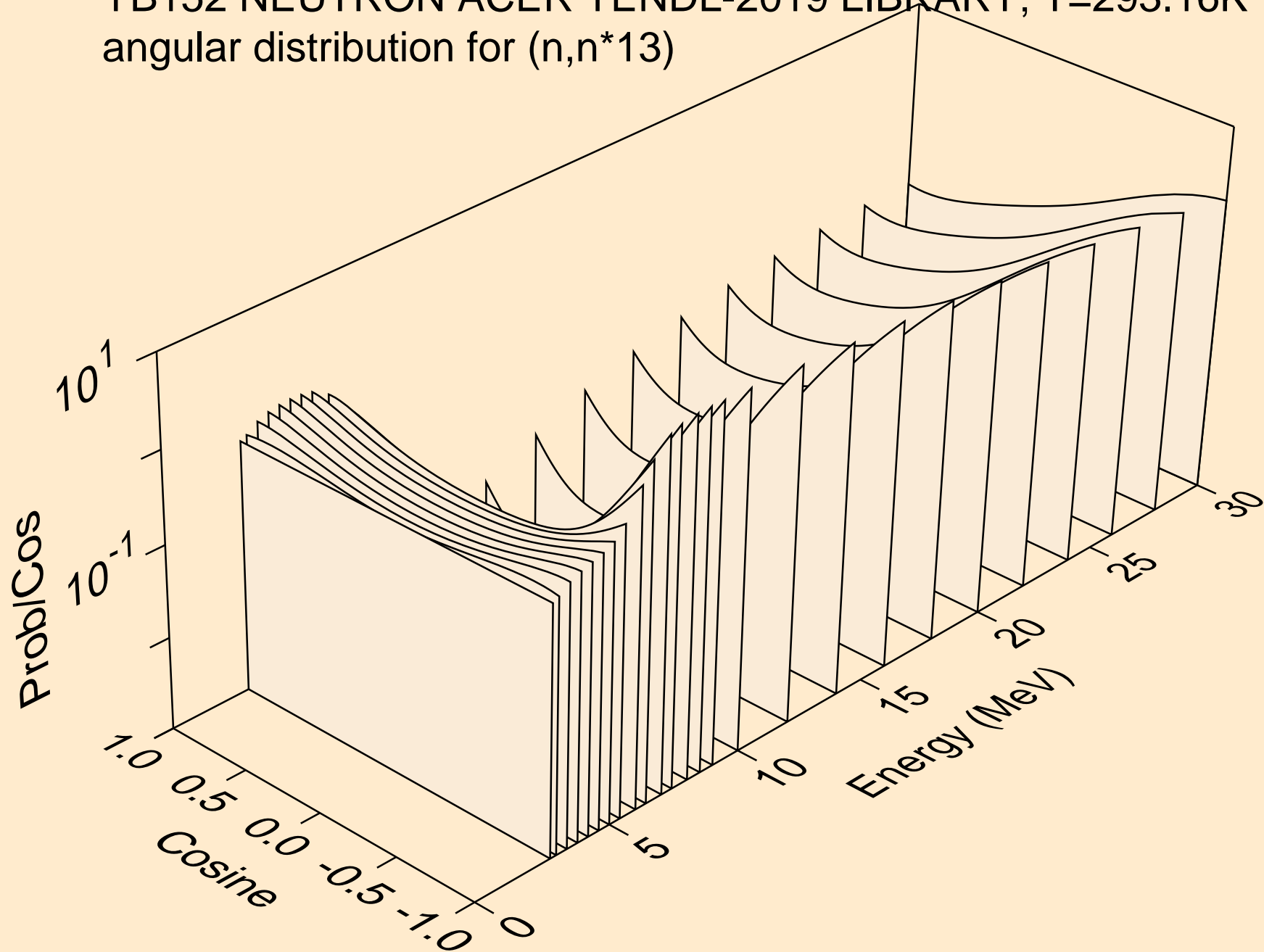

YB152 NEUTRON ACER TENDL-2019 LIBRARY; T=293.16K
angular distribution for (n,n*14)

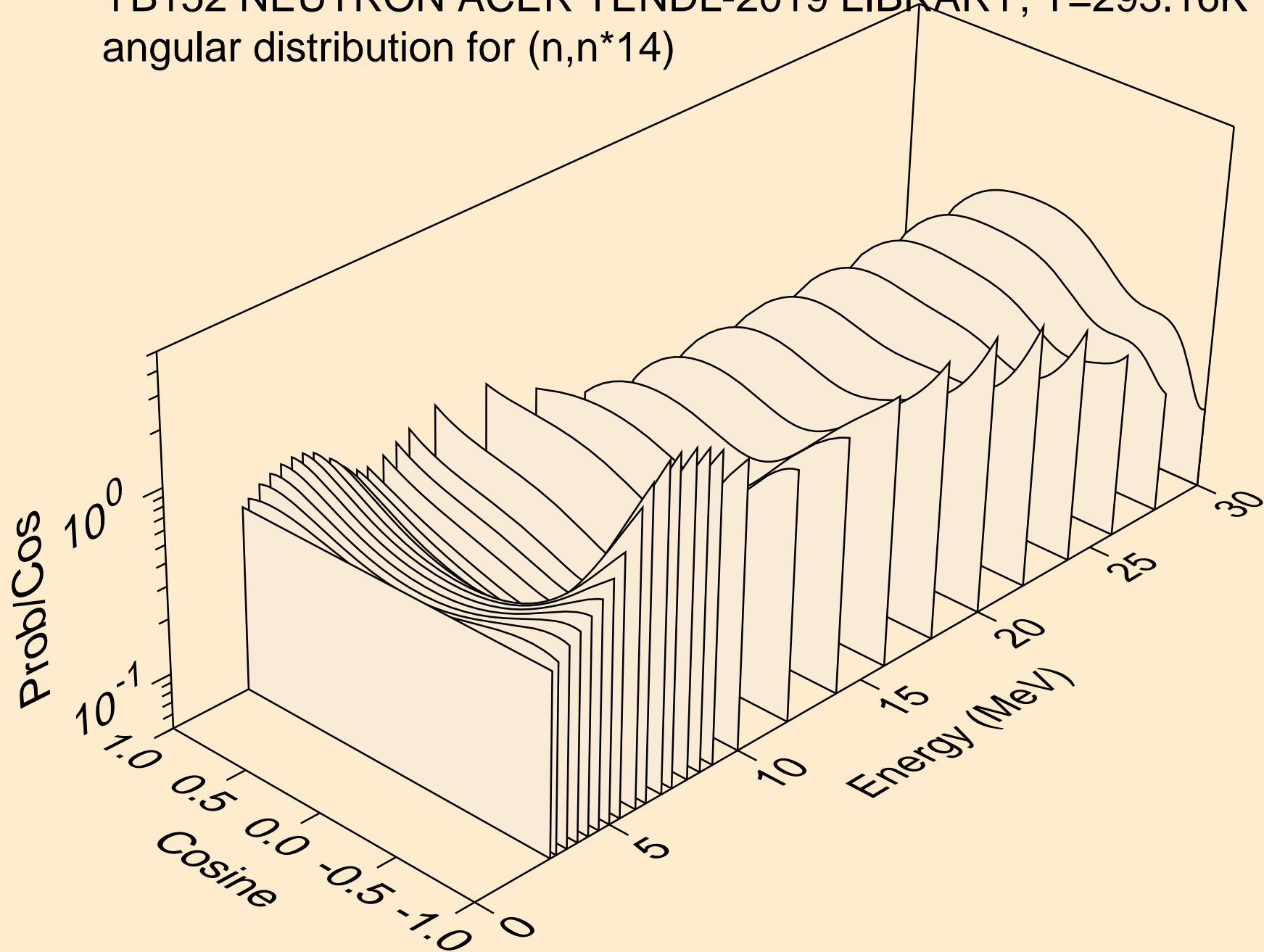

YB152 NEUTRON ACER TENDL-2019 LIBRARY; T=293.16K
angular distribution for (n,n*15)

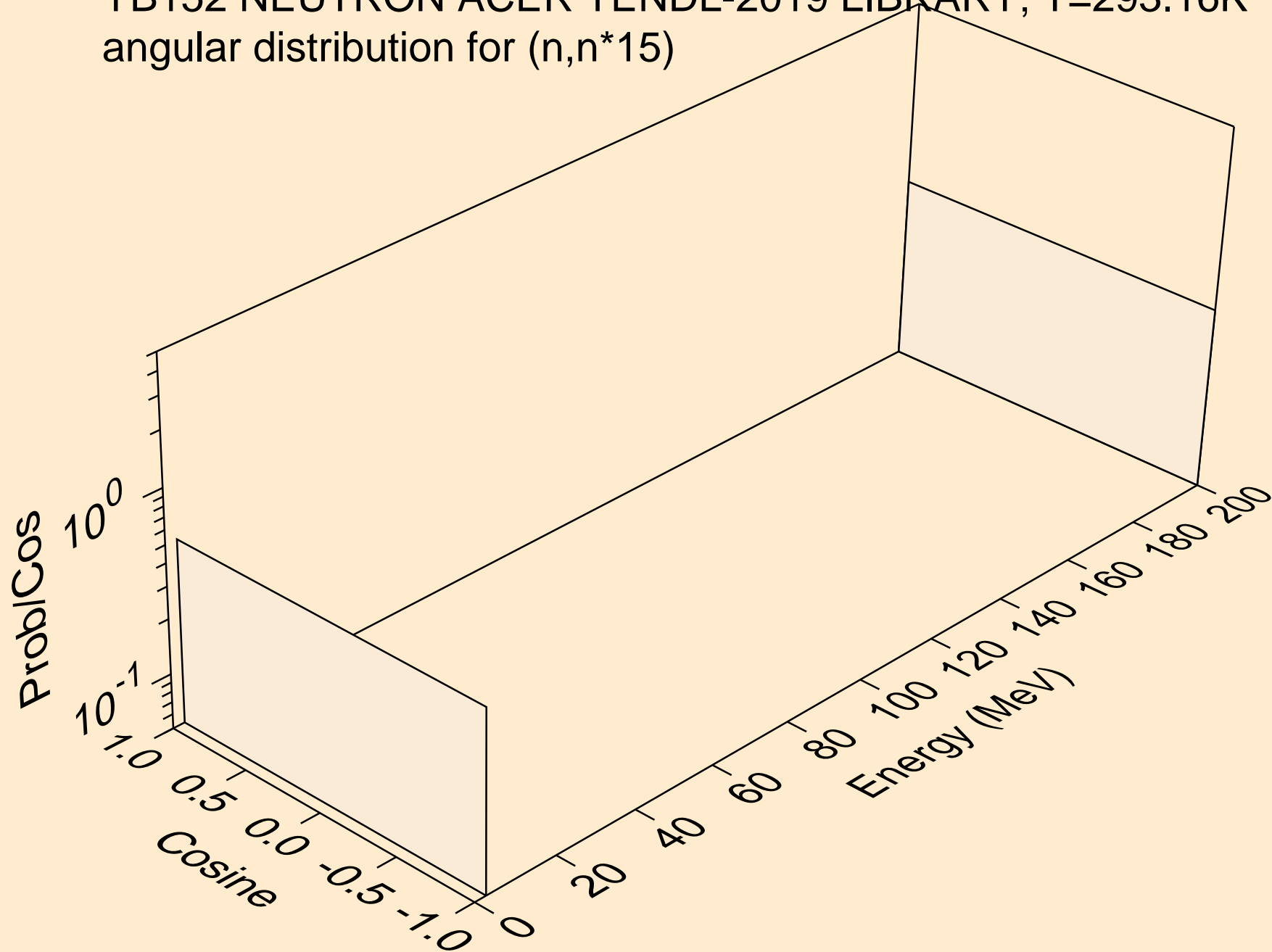

YB152 NEUTRON ACER TENDL-2019 LIBRARY; T=293.16K
angular distribution for (n,n*16)

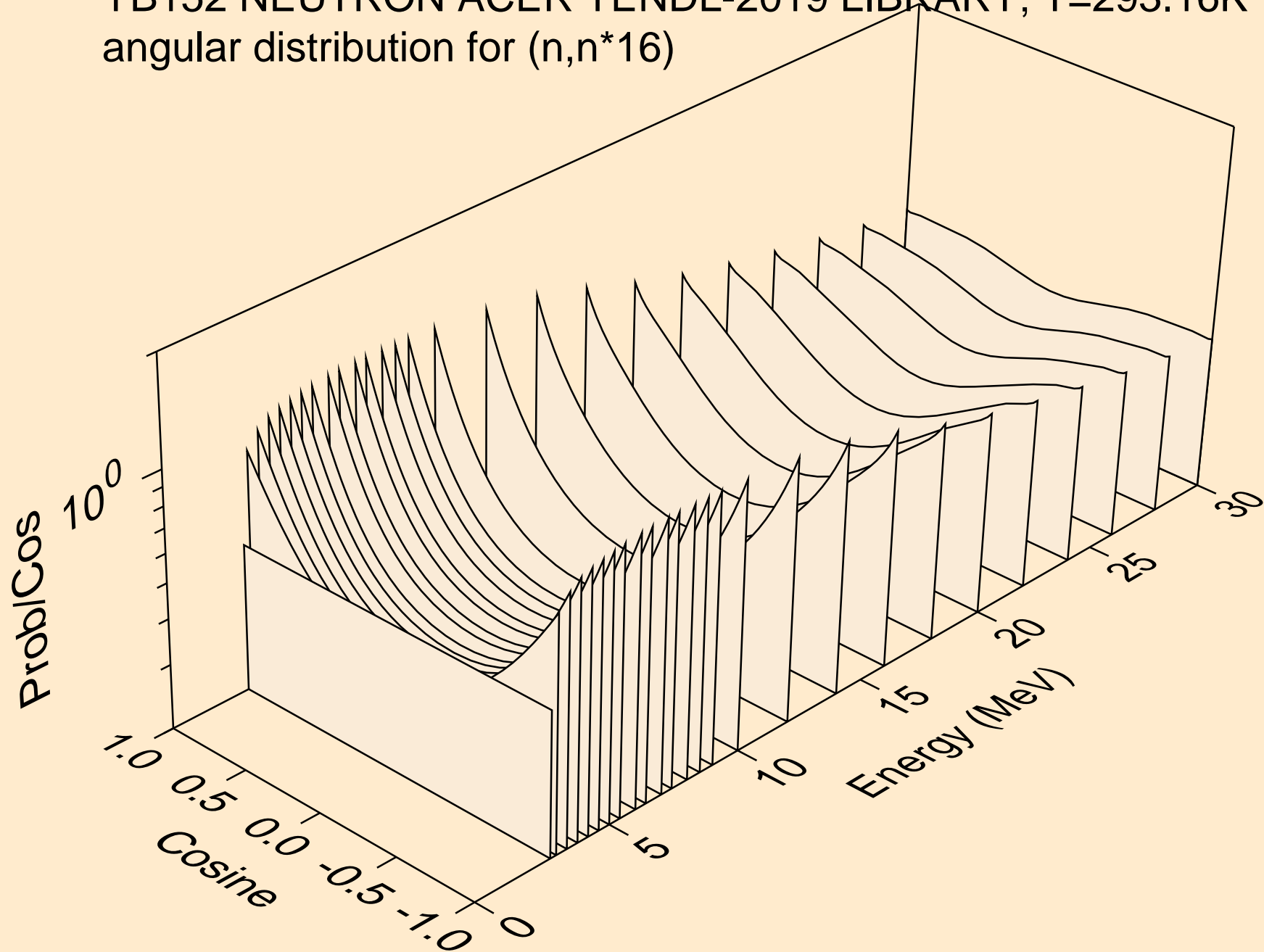

YB152 NEUTRON ACER TENDL-2019 LIBRARY; T=293.16K
angular distribution for (n,n*17)

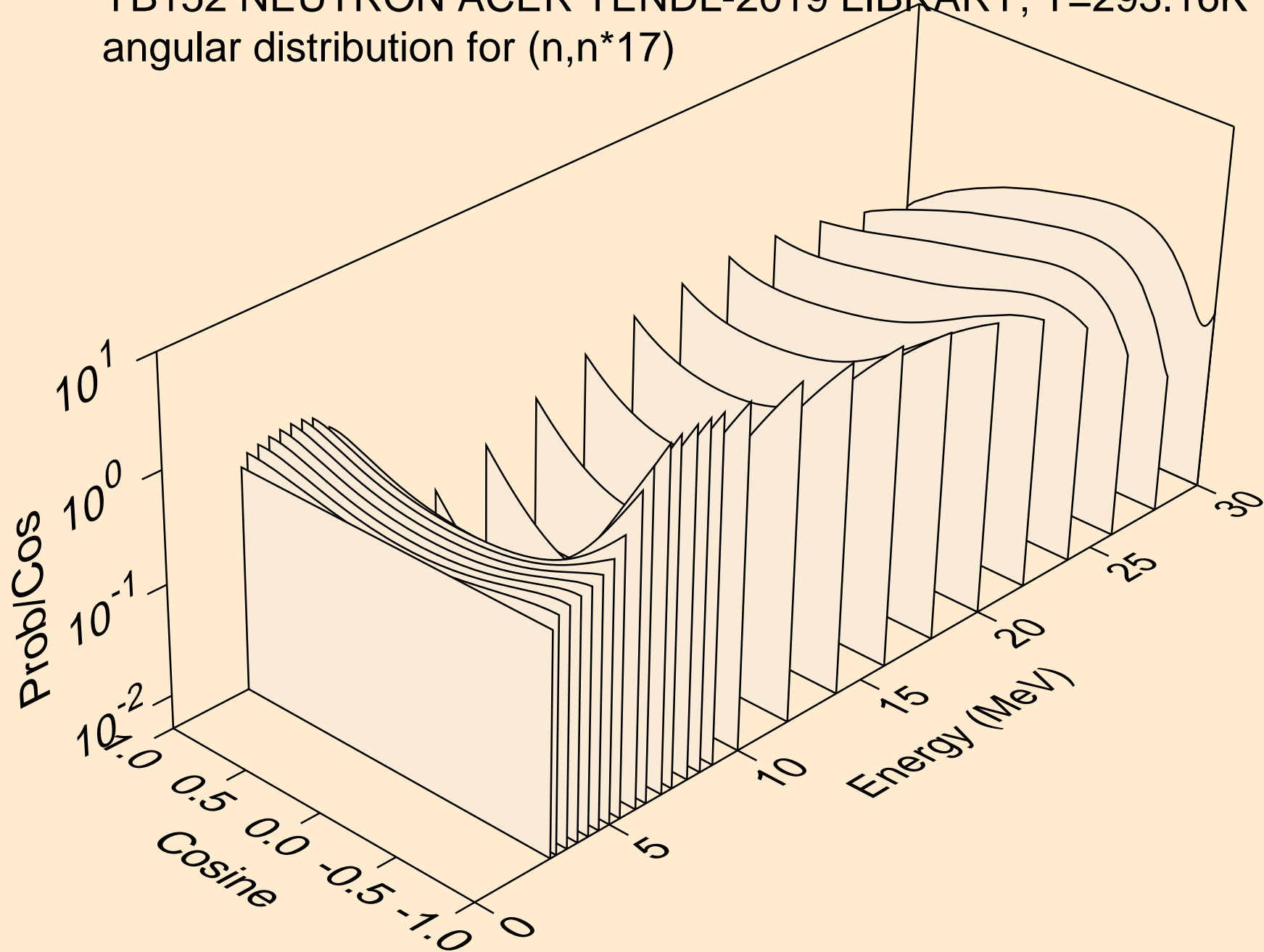

YB152 NEUTRON ACER TENDL-2019 LIBRARY; T=293.16K
angular distribution for (n,n*18)

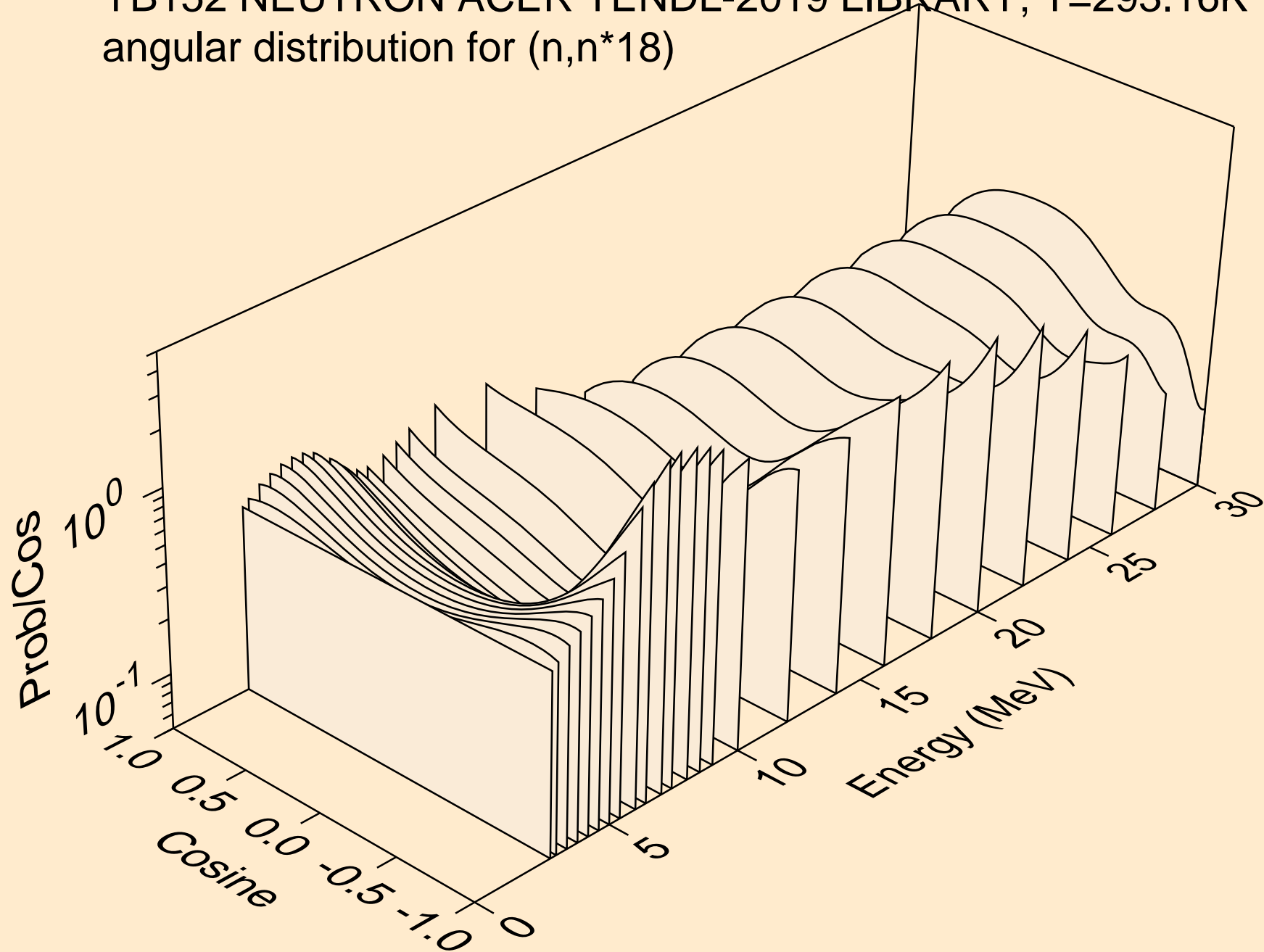

YB152 NEUTRON ACER TENDL-2019 LIBRARY; T=293.16K
angular distribution for (n,n*19)

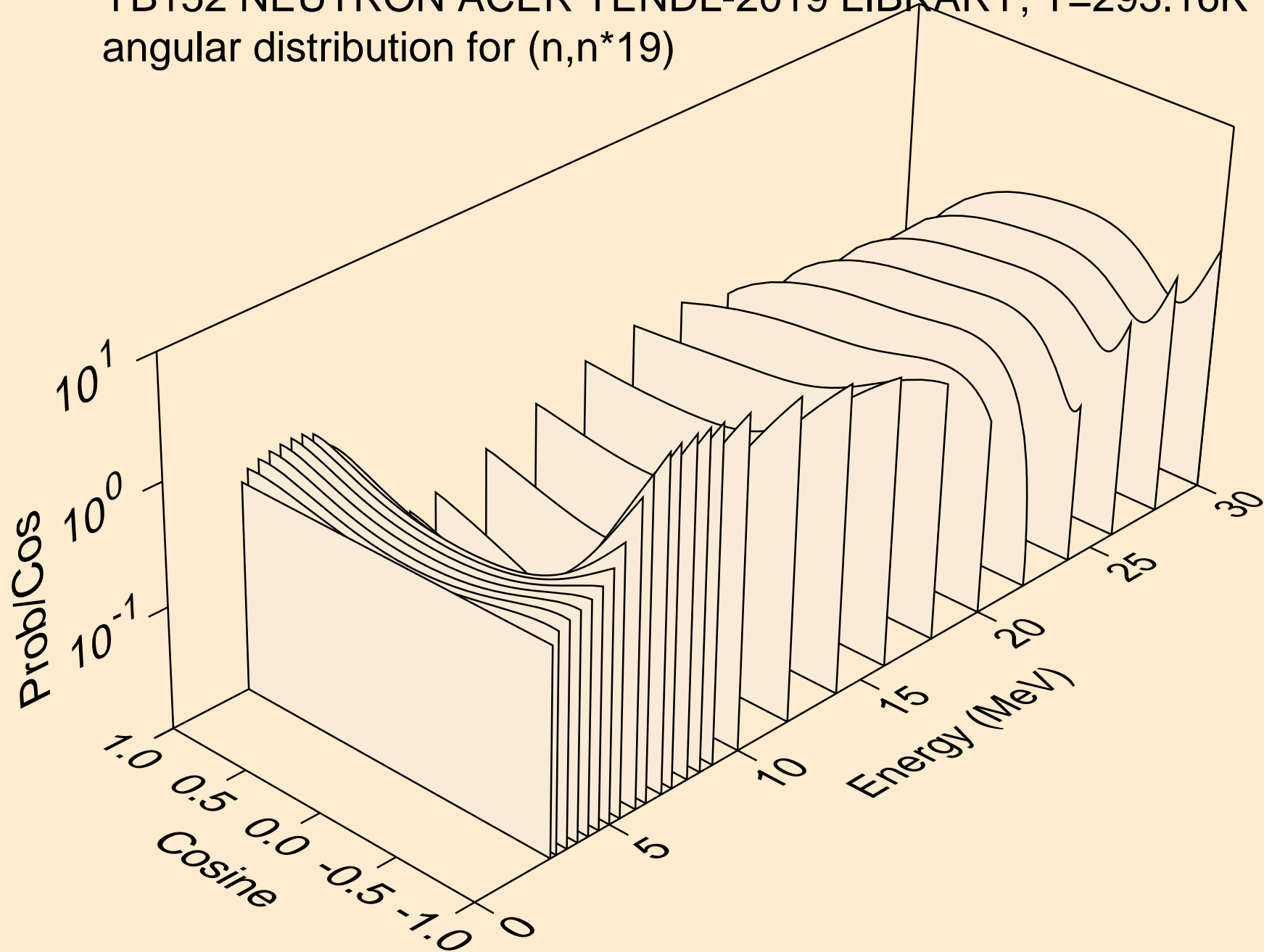

YB152 NEUTRON ACER TENDL-2019 LIBRARY; T=293.16K
Neutron emission for (n,x)

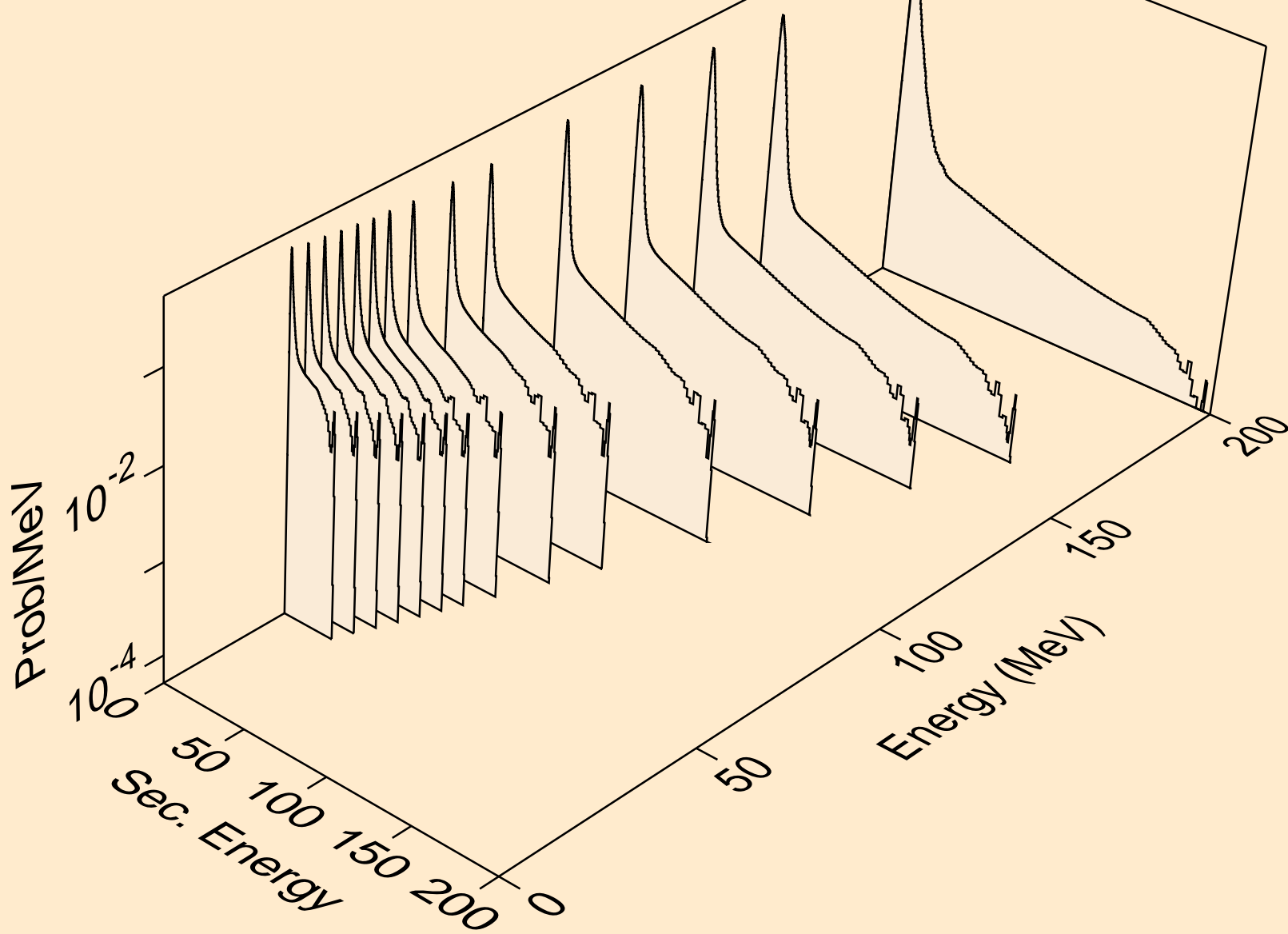

YB152 NEUTRON ACER TENDL-2019 LIBRARY; T=293.16K
Neutron emission for (n,2nd)

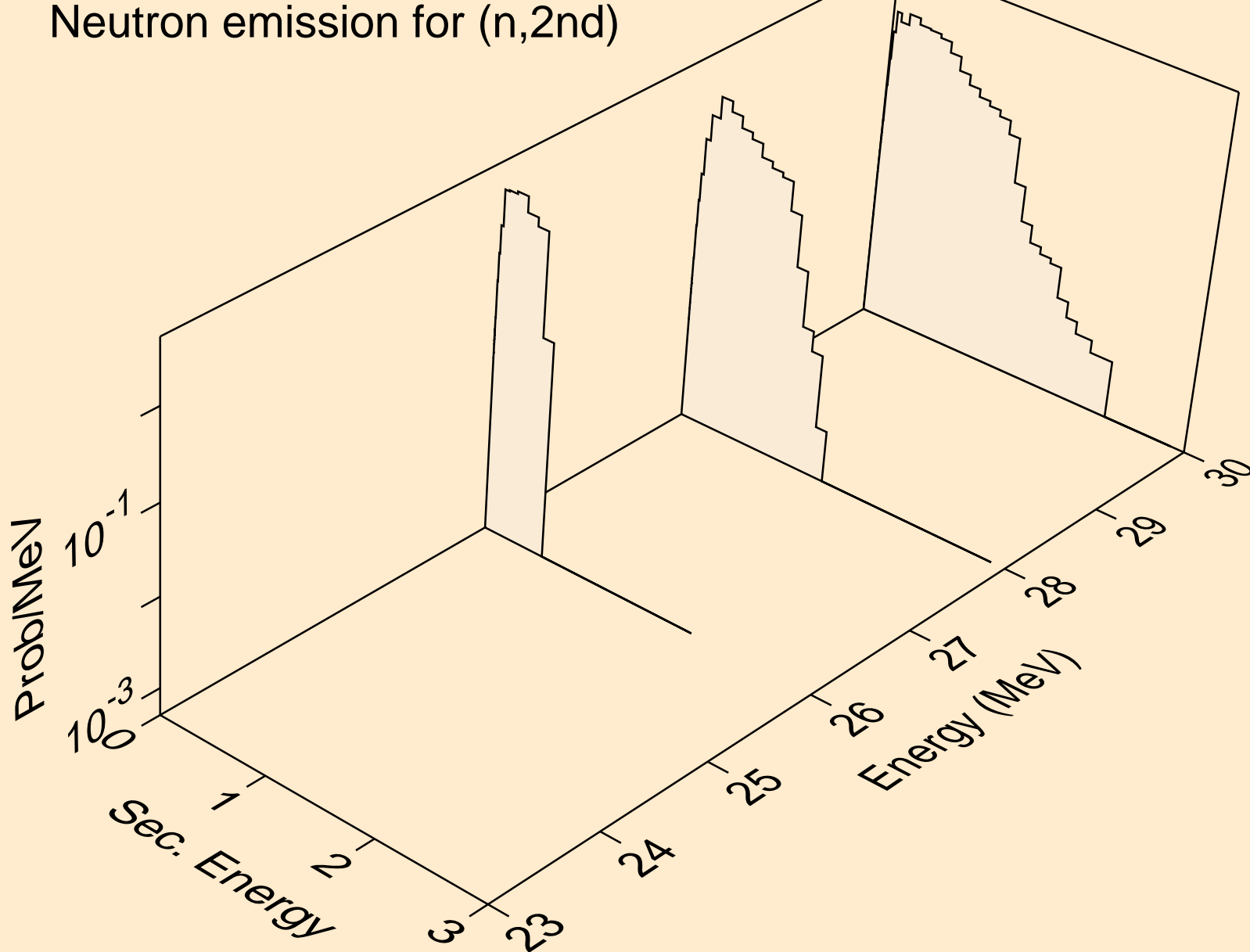

YB152 NEUTRON ACER TENDL-2019 LIBRARY; T=293.16K
Neutron emission for (n,2n)

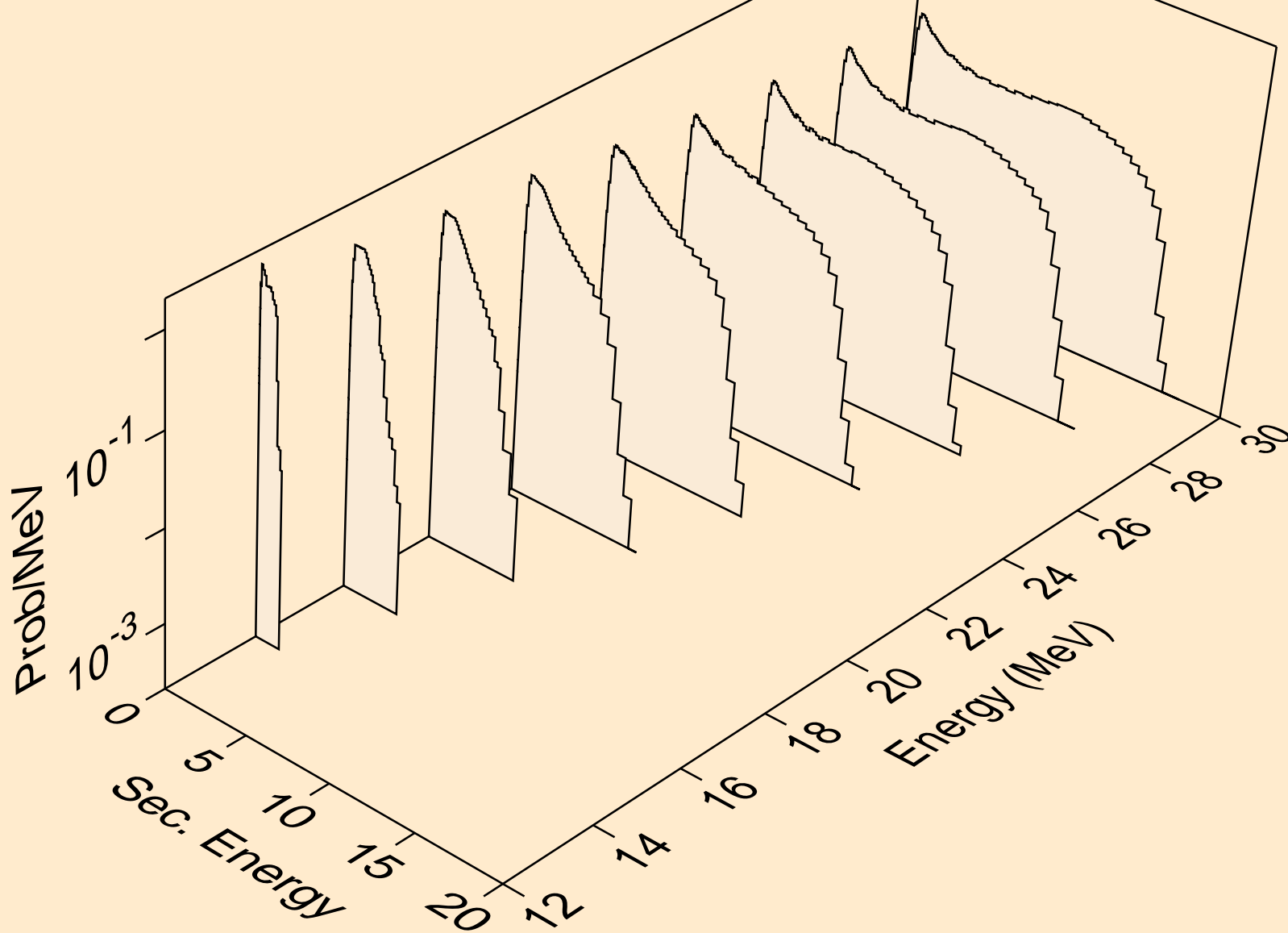

YB152 NEUTRON ACER TENDL-2019 LIBRARY; T=293.16K
Neutron emission for (n,3n)

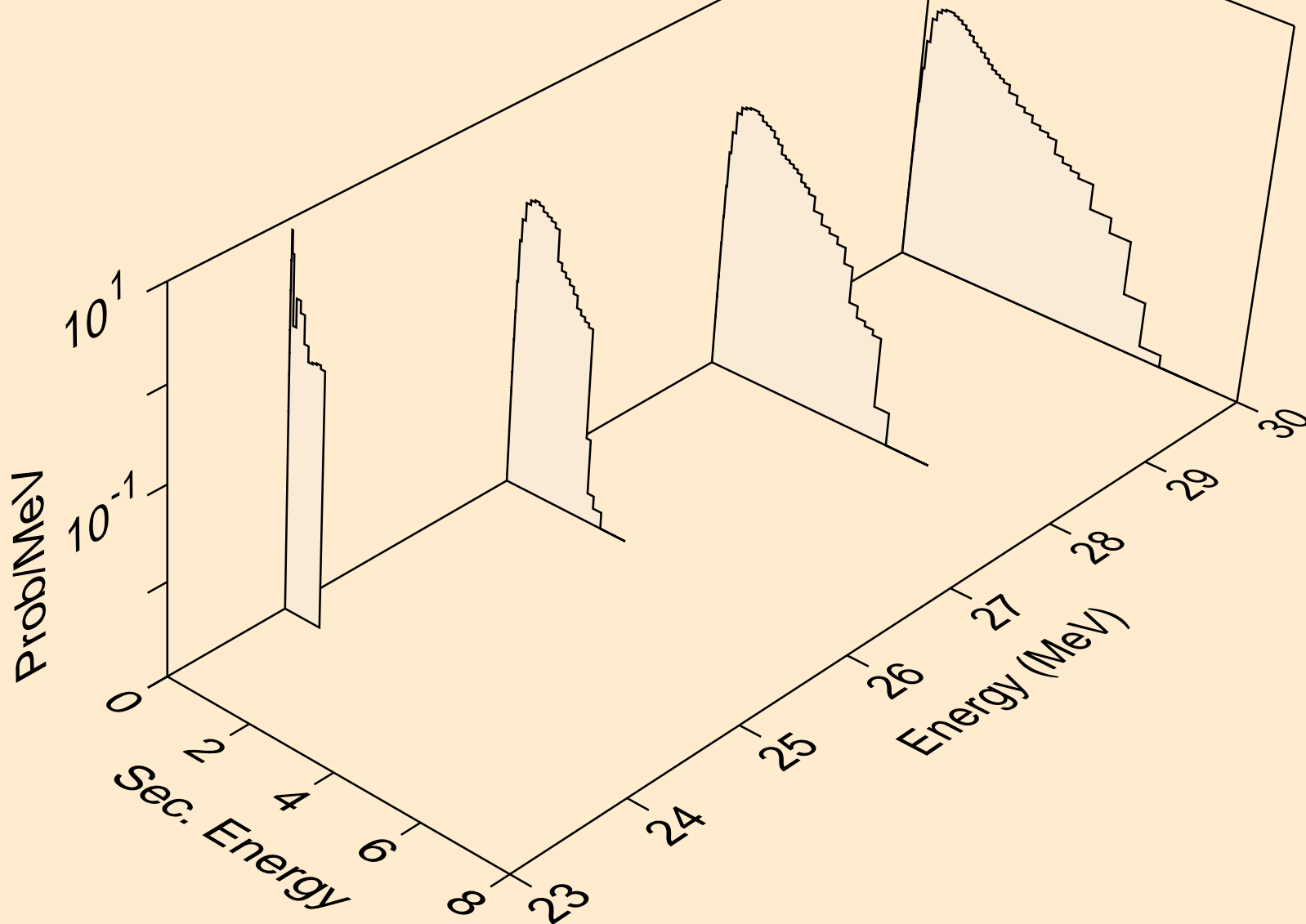

YB152 NEUTRON ACER TENDL-2019 LIBRARY; T=293.16K
Neutron emission for (n,n*)a

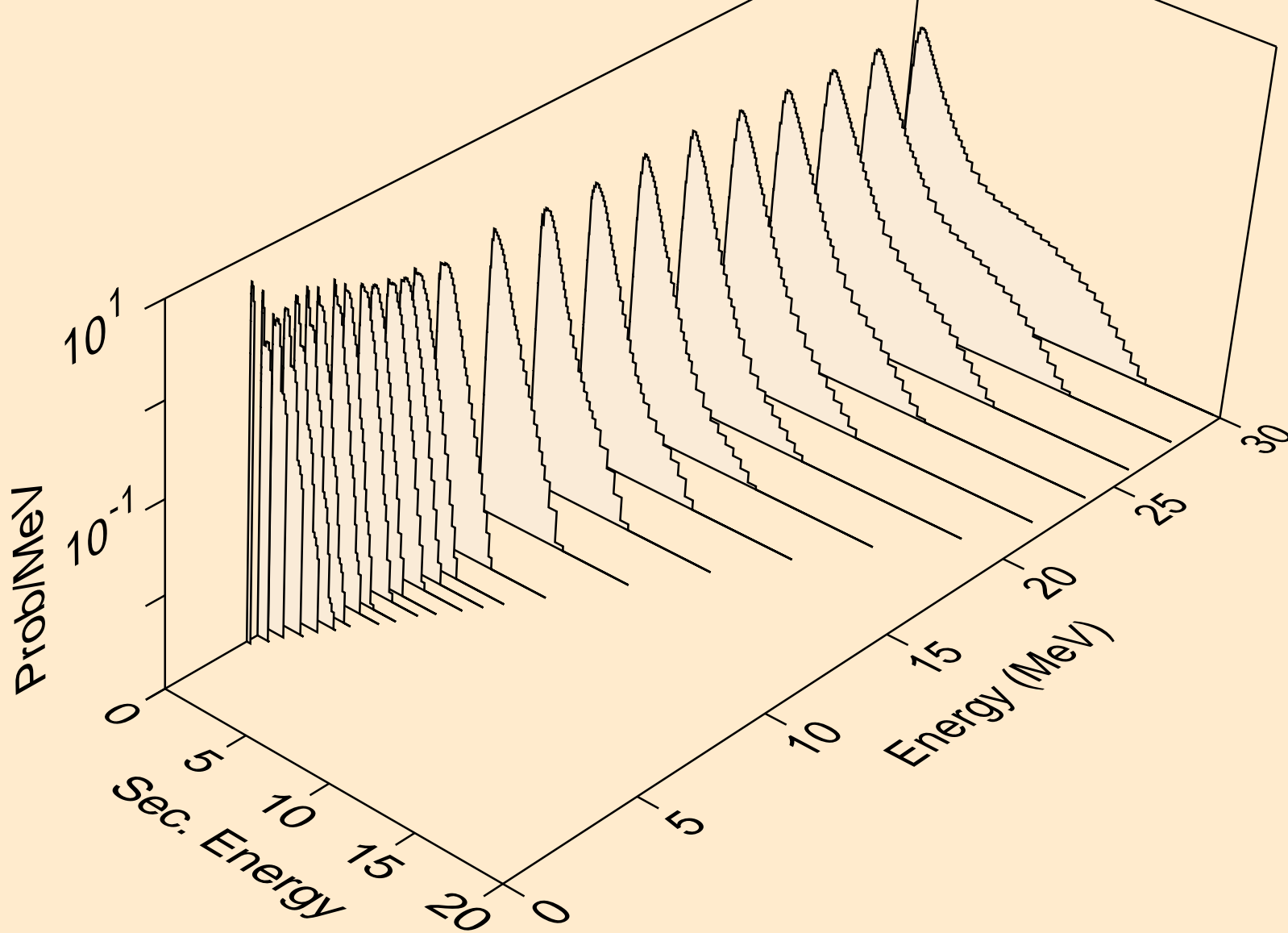

YB152 NEUTRON ACER TENDL-2019 LIBRARY; T=293.16K
Neutron emission for (n,2n)a

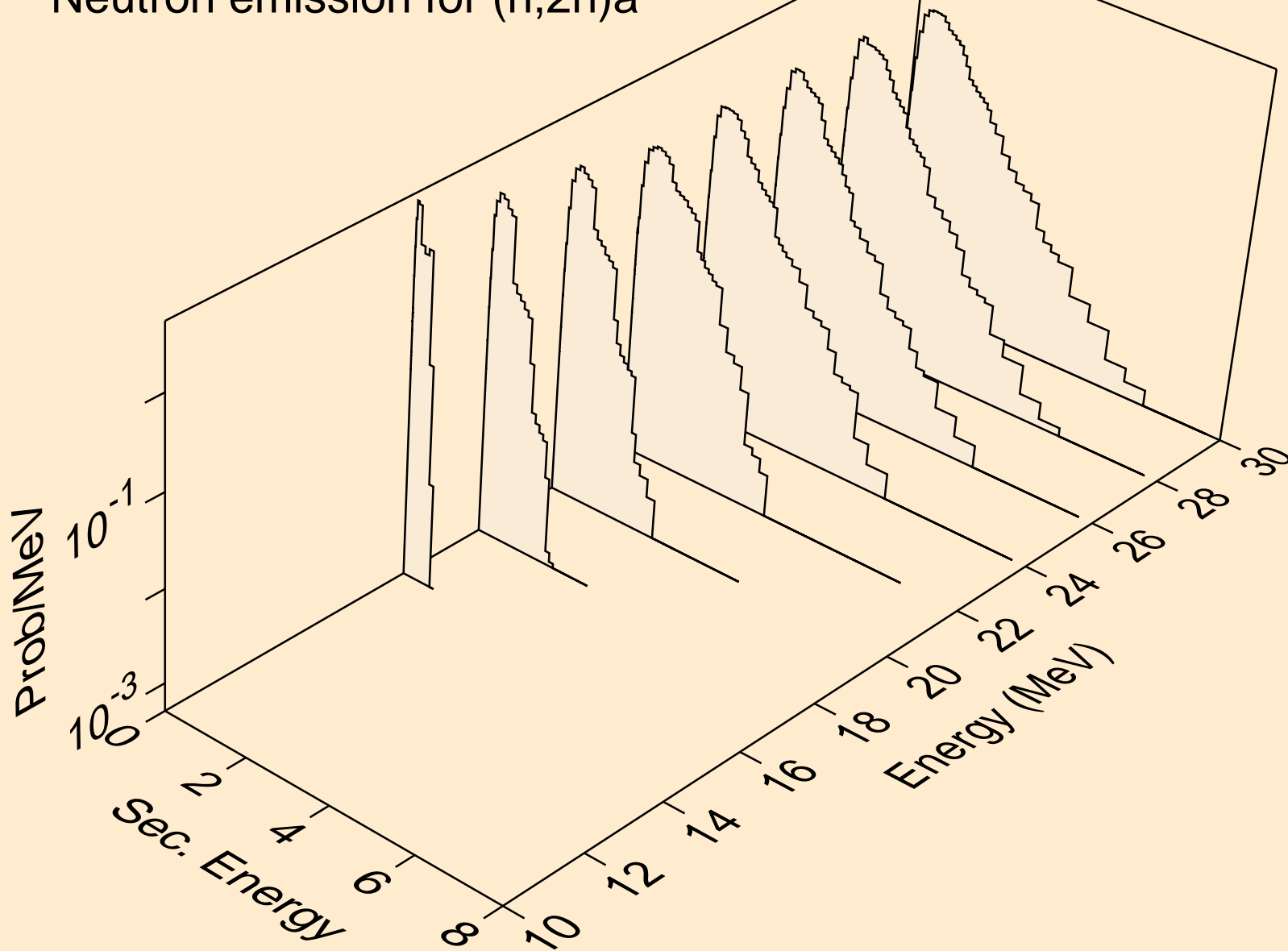

YB152 NEUTRON ACER TENDL-2019 LIBRARY; T=293.16K
Neutron emission for (n,n*)p

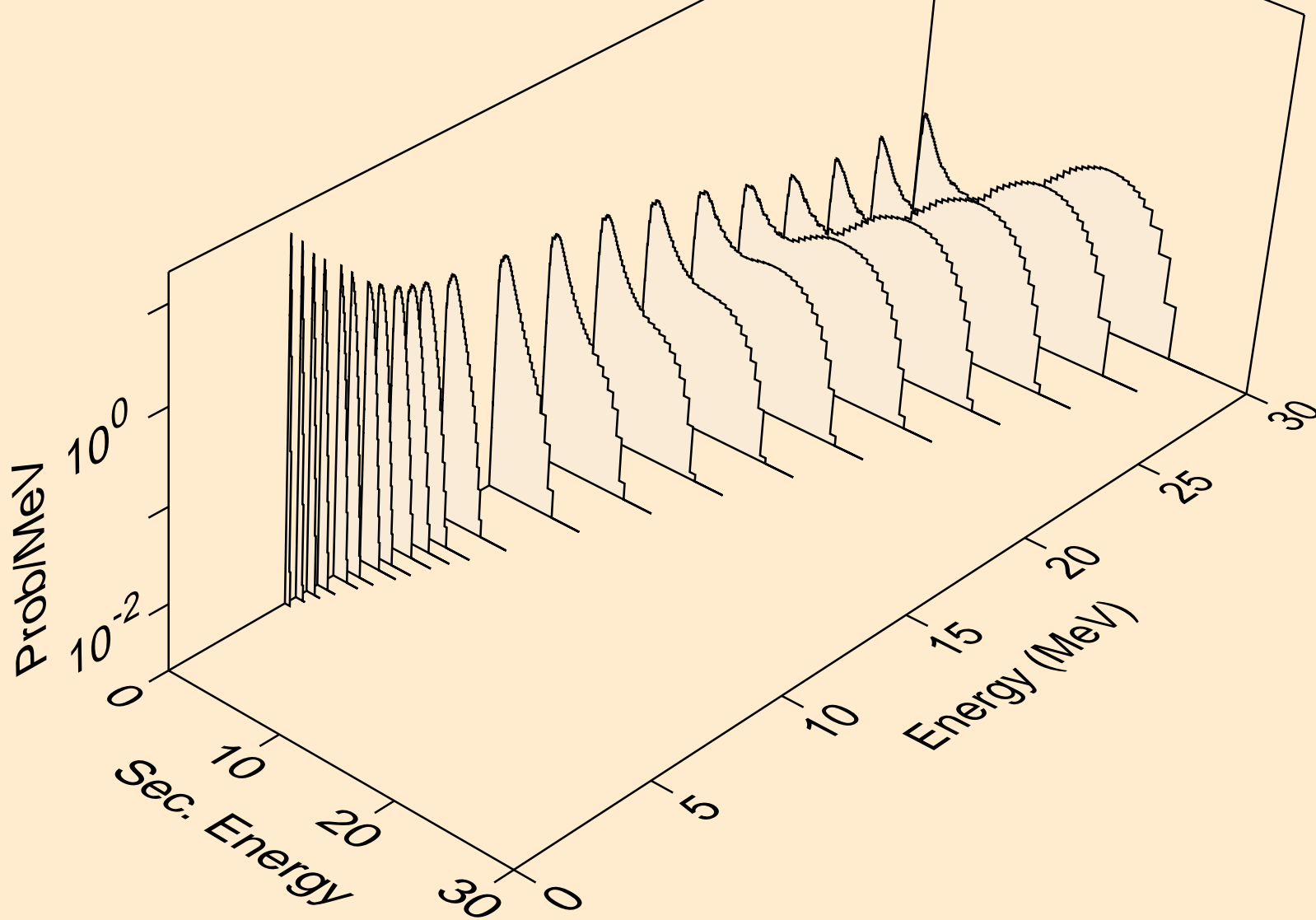

YB152 NEUTRON ACER TENDL-2019 LIBRARY; T=293.16K
Neutron emission for (n,n*)2a

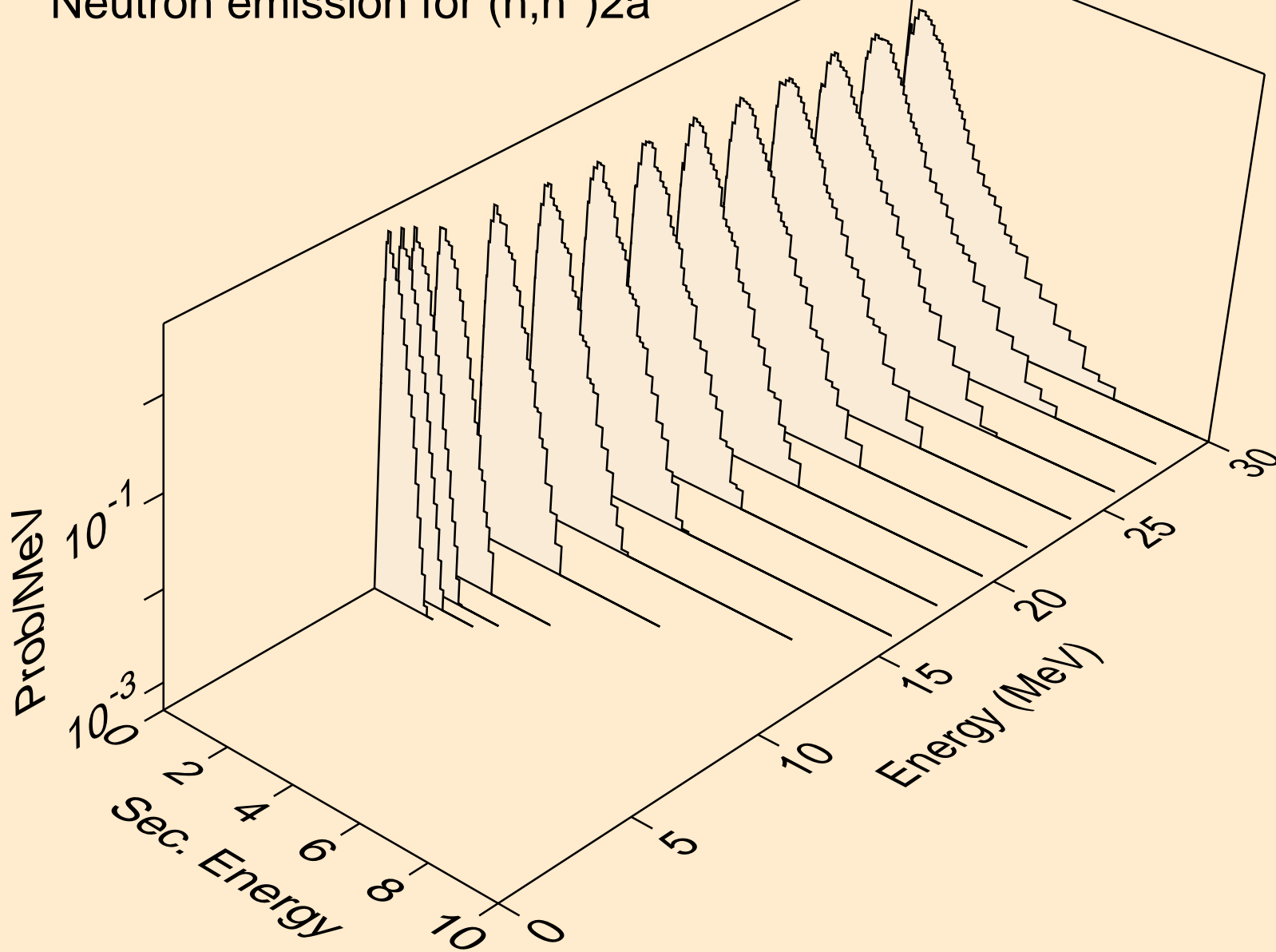

YB152 NEUTRON ACER TENDL-2019 LIBRARY; T=293.16K
Neutron emission for (n,n*)d

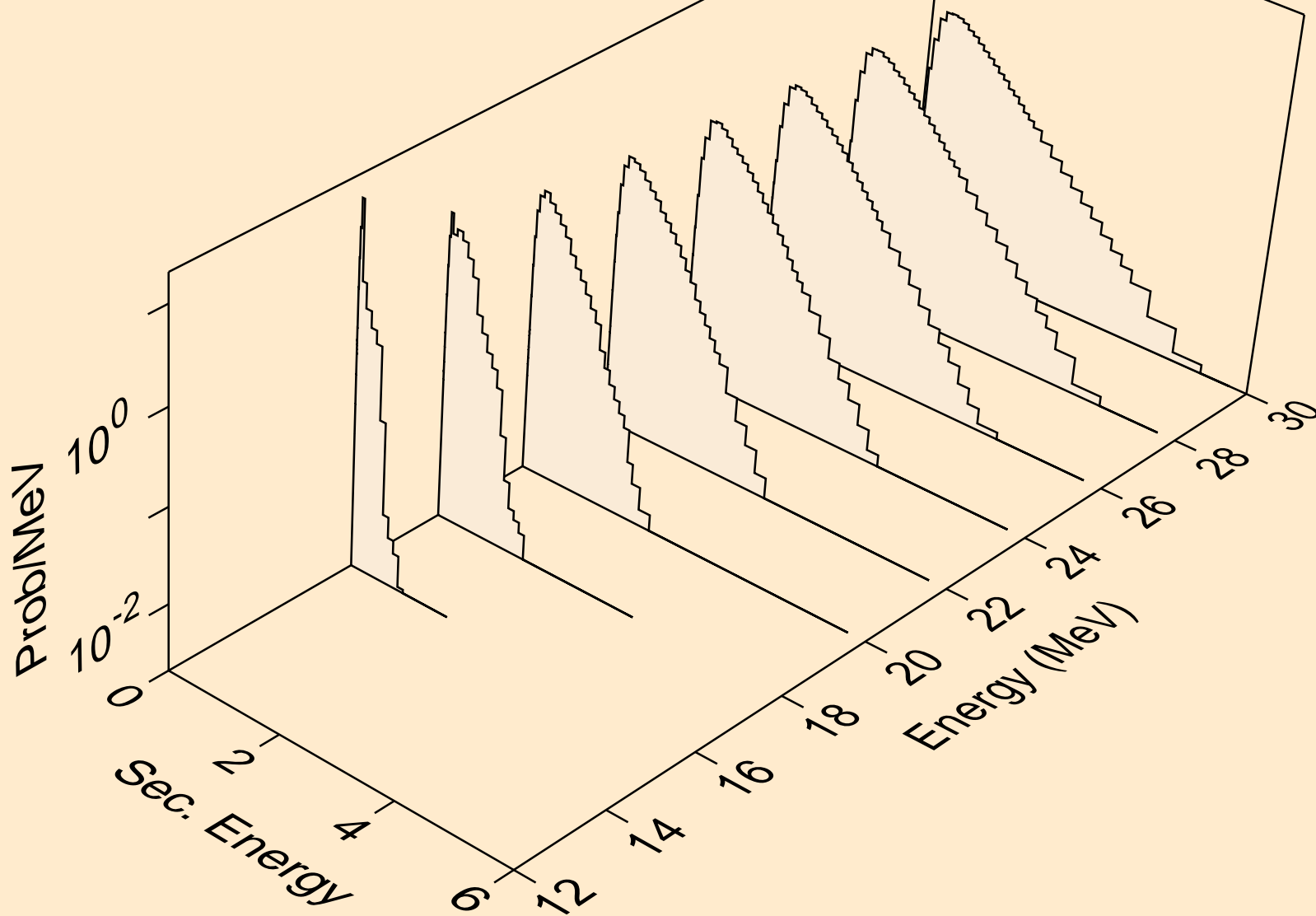

YB152 NEUTRON ACER TENDL-2019 LIBRARY; T=293.16K
Neutron emission for (n,n*)t

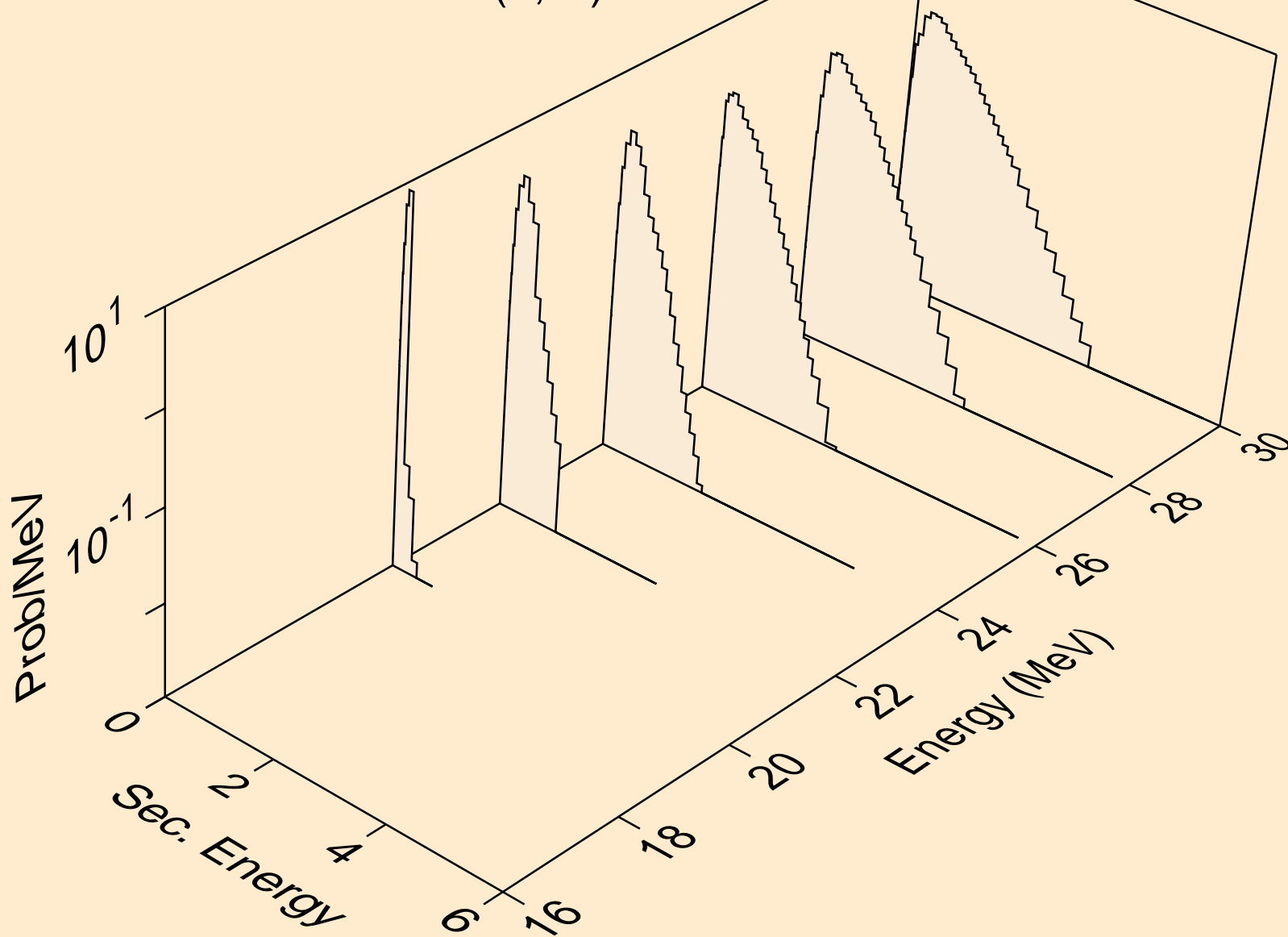

YB152 NEUTRON ACER TENDL-2019 LIBRARY; T=293.16K
Neutron emission for (n,n*)he3

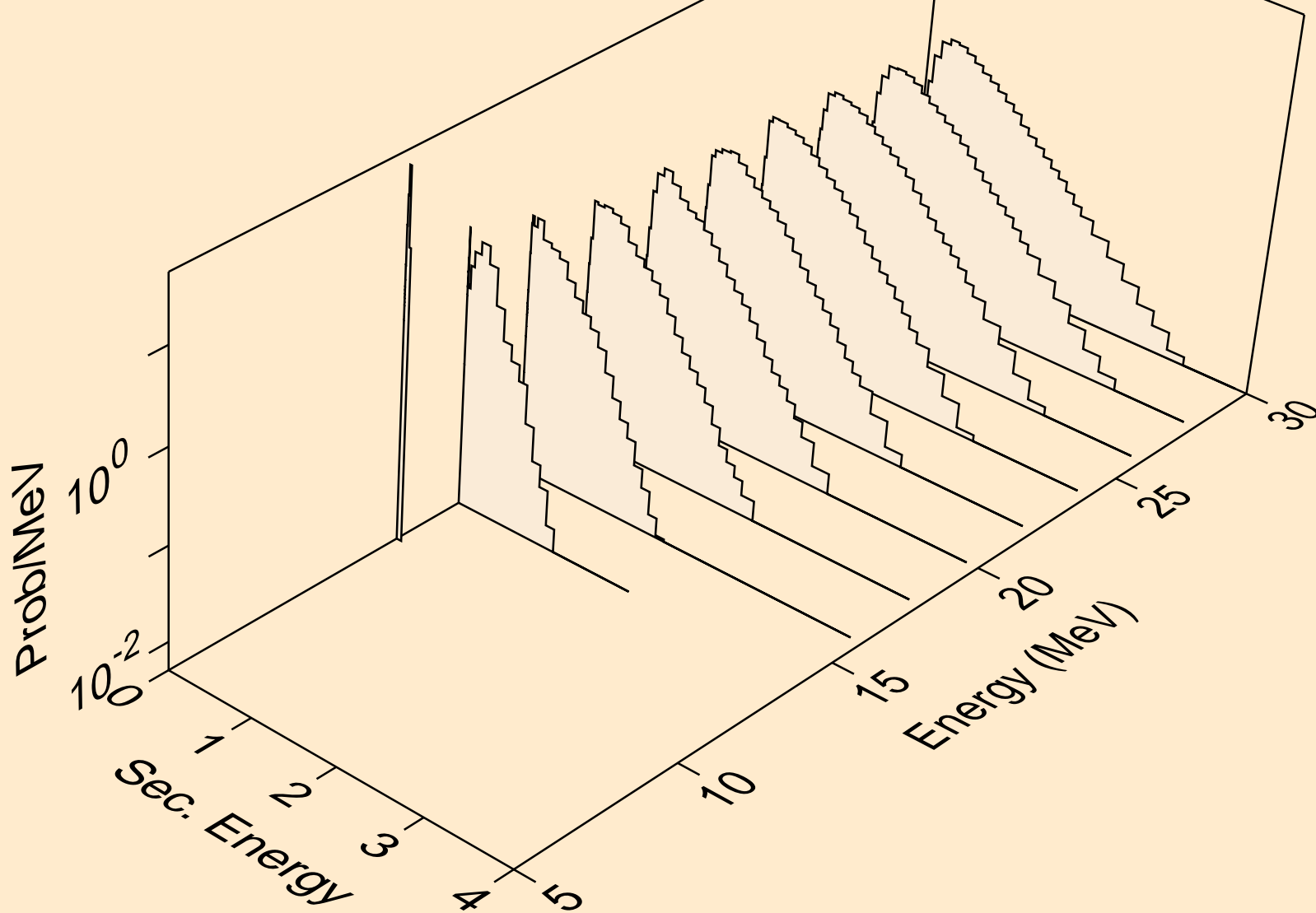

YB152 NEUTRON ACER TENDL-2019 LIBRARY; T=293.16K
Neutron emission for (n,2np)

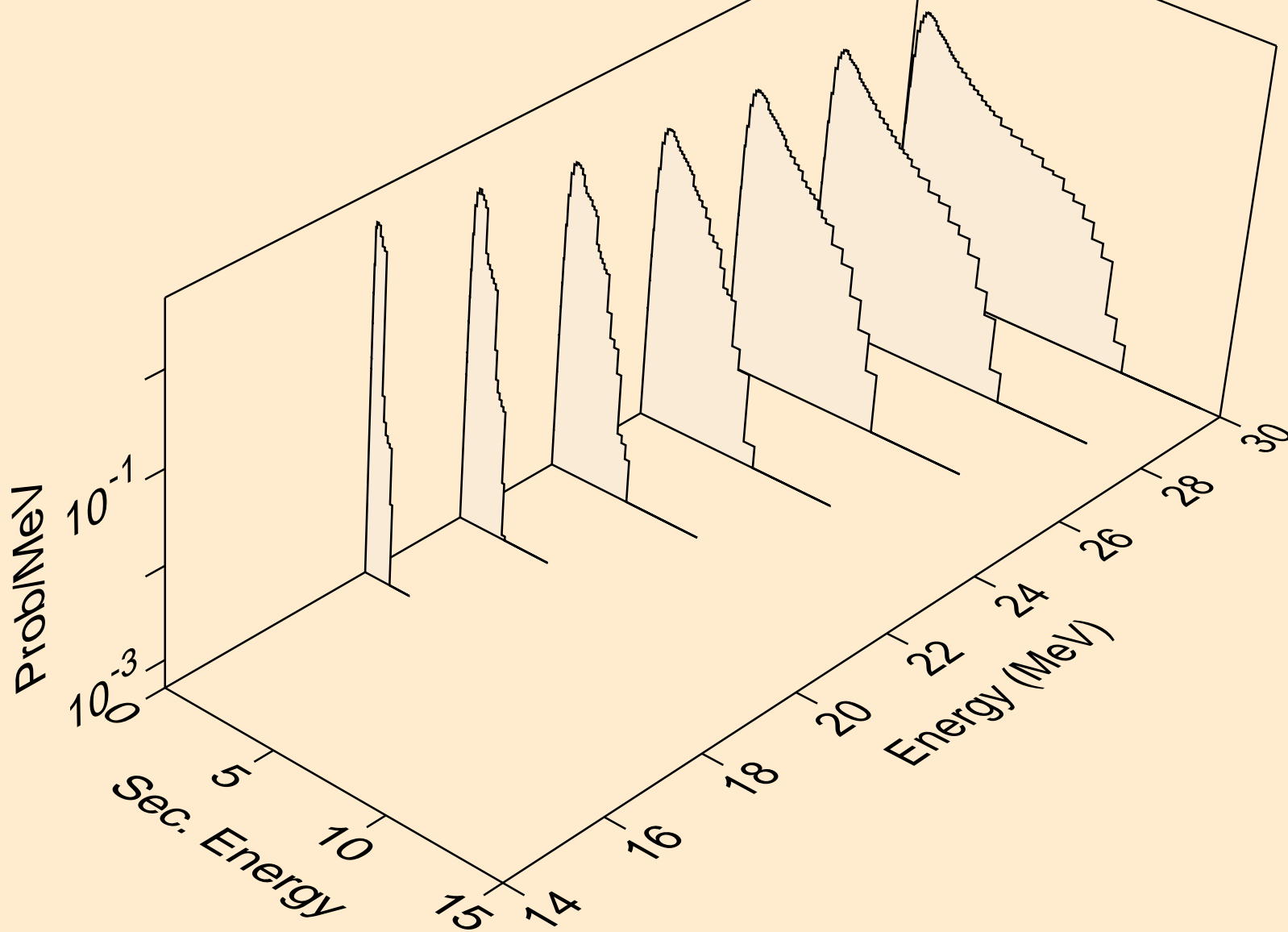

YB152 NEUTRON ACER TENDL-2019 LIBRARY; T=293.16K
Neutron emission for (n,3np)

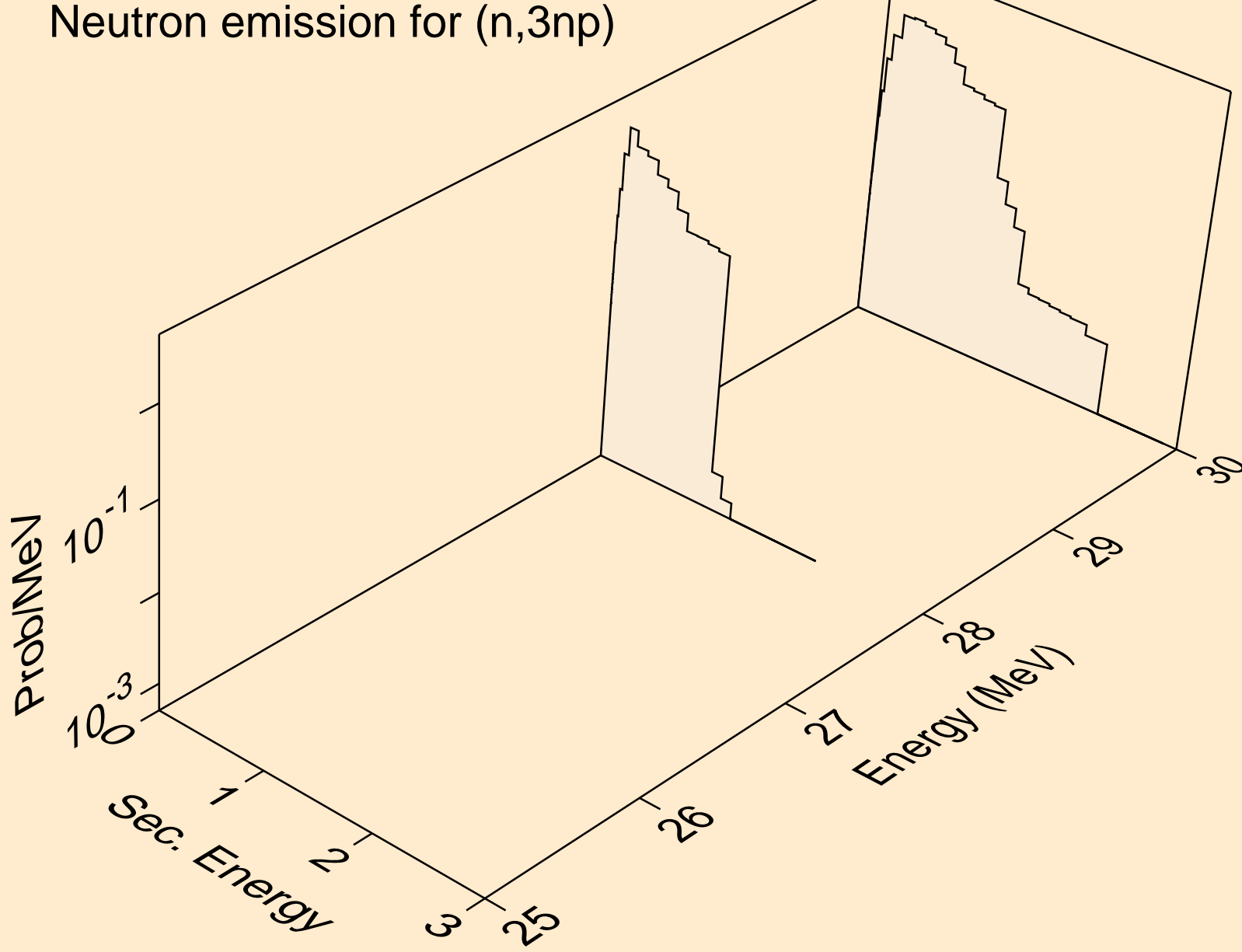

YB152 NEUTRON ACER TENDL-2019 LIBRARY; T=293.16K
Neutron emission for (n,2np)

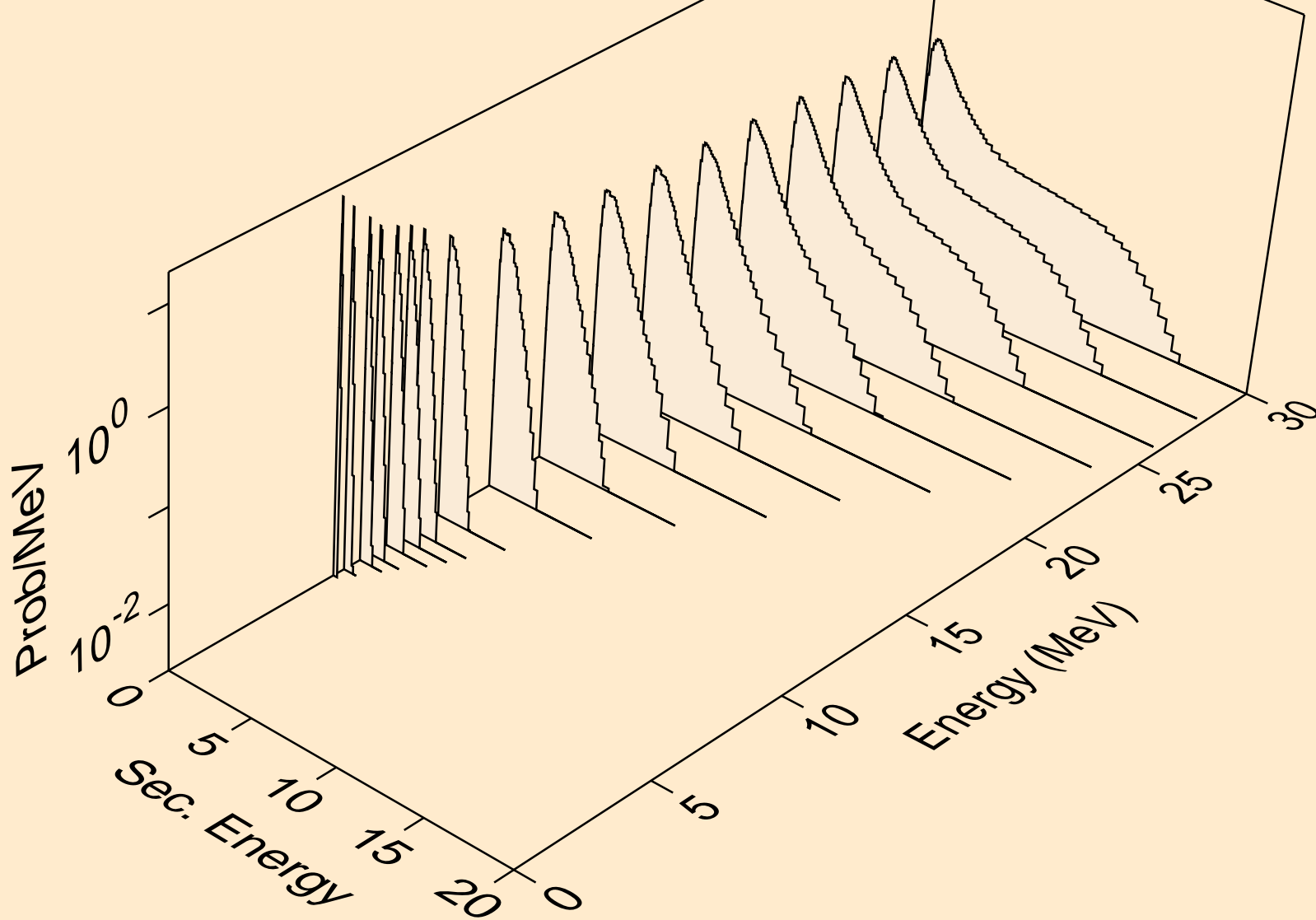

YB152 NEUTRON ACER TENDL-2019 LIBRARY; T=293.16K
Neutron emission for (n,npa)

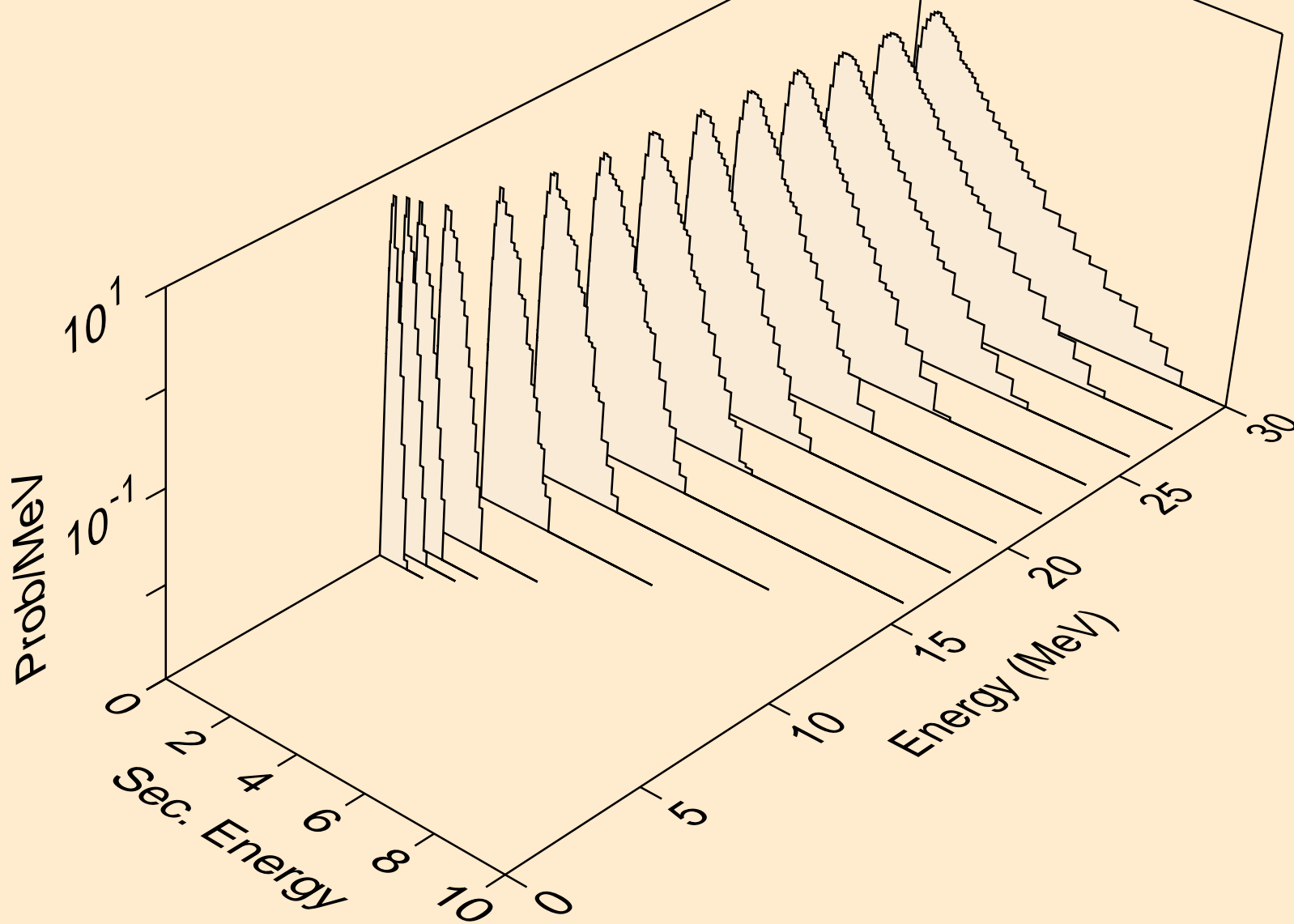

YB152 NEUTRON ACER TENDL-2019 LIBRARY; T=293.16K
Neutron emission for (n,n*c)

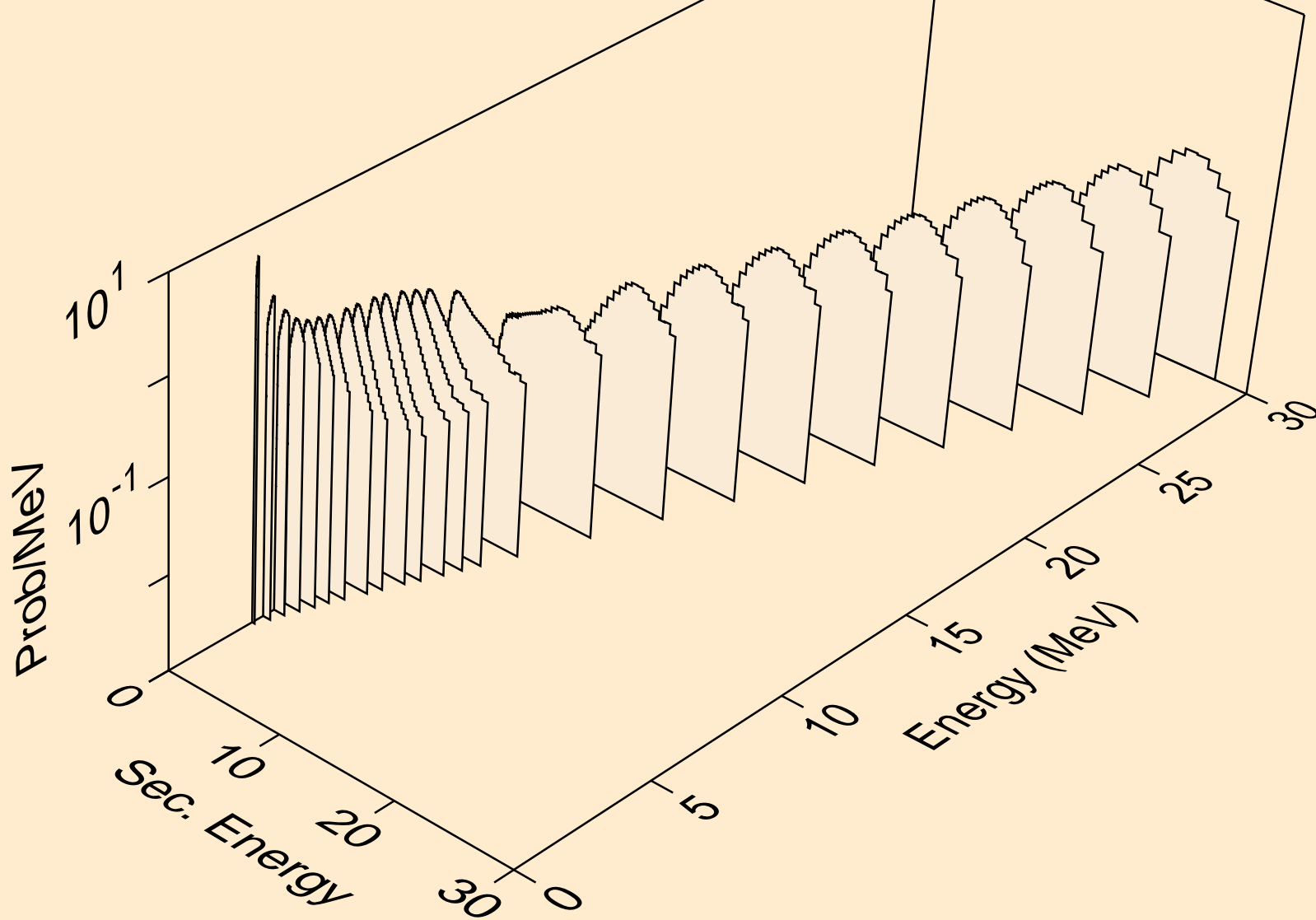

YB152 NEUTRON ACER TENDL-2019 LIBRARY; T=293.16K
Photon emission for (n,x)

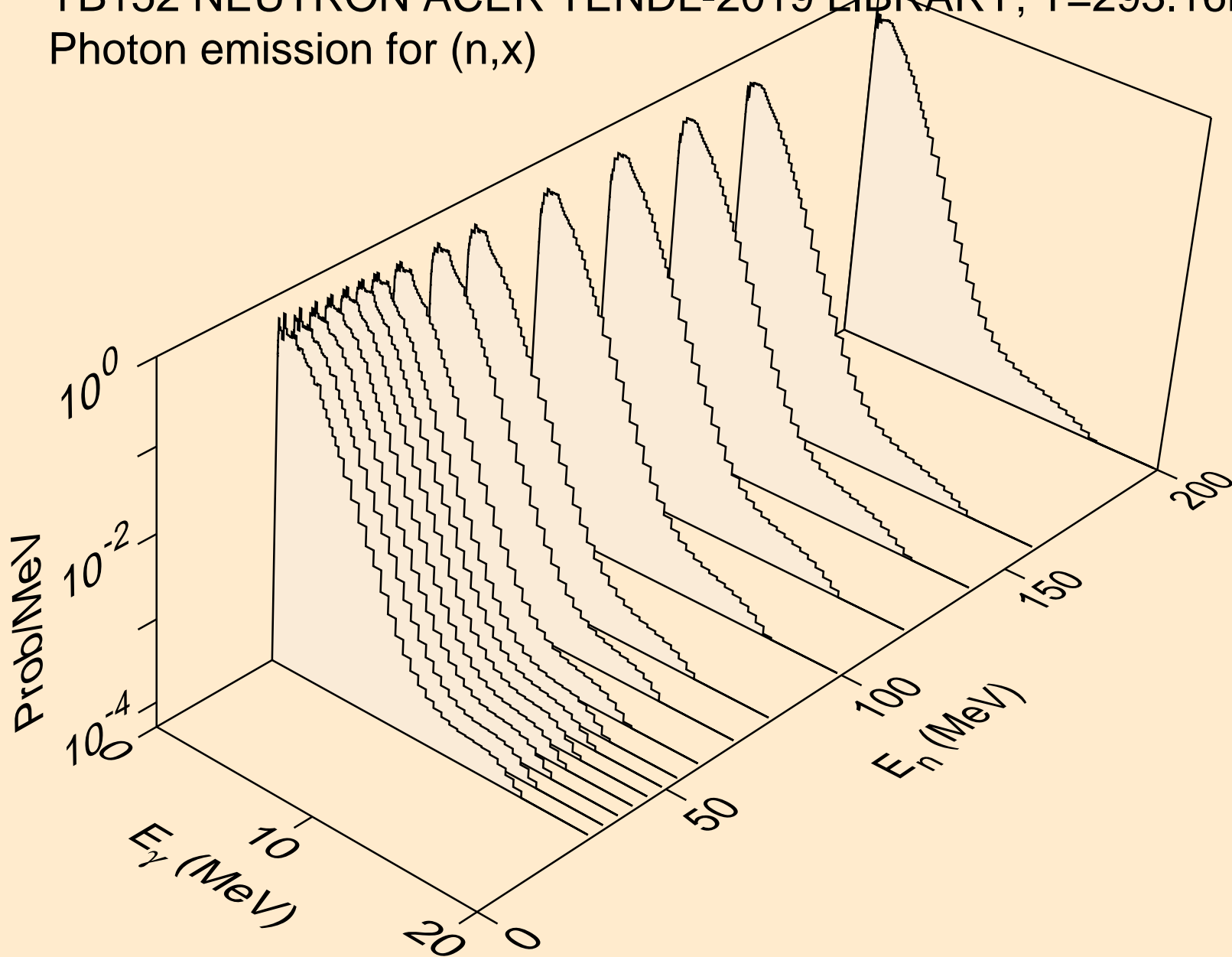

YB152 NEUTRON ACER TENDL-2019 LIBRARY; T=293.16K
Photon emission for (n,2nd)

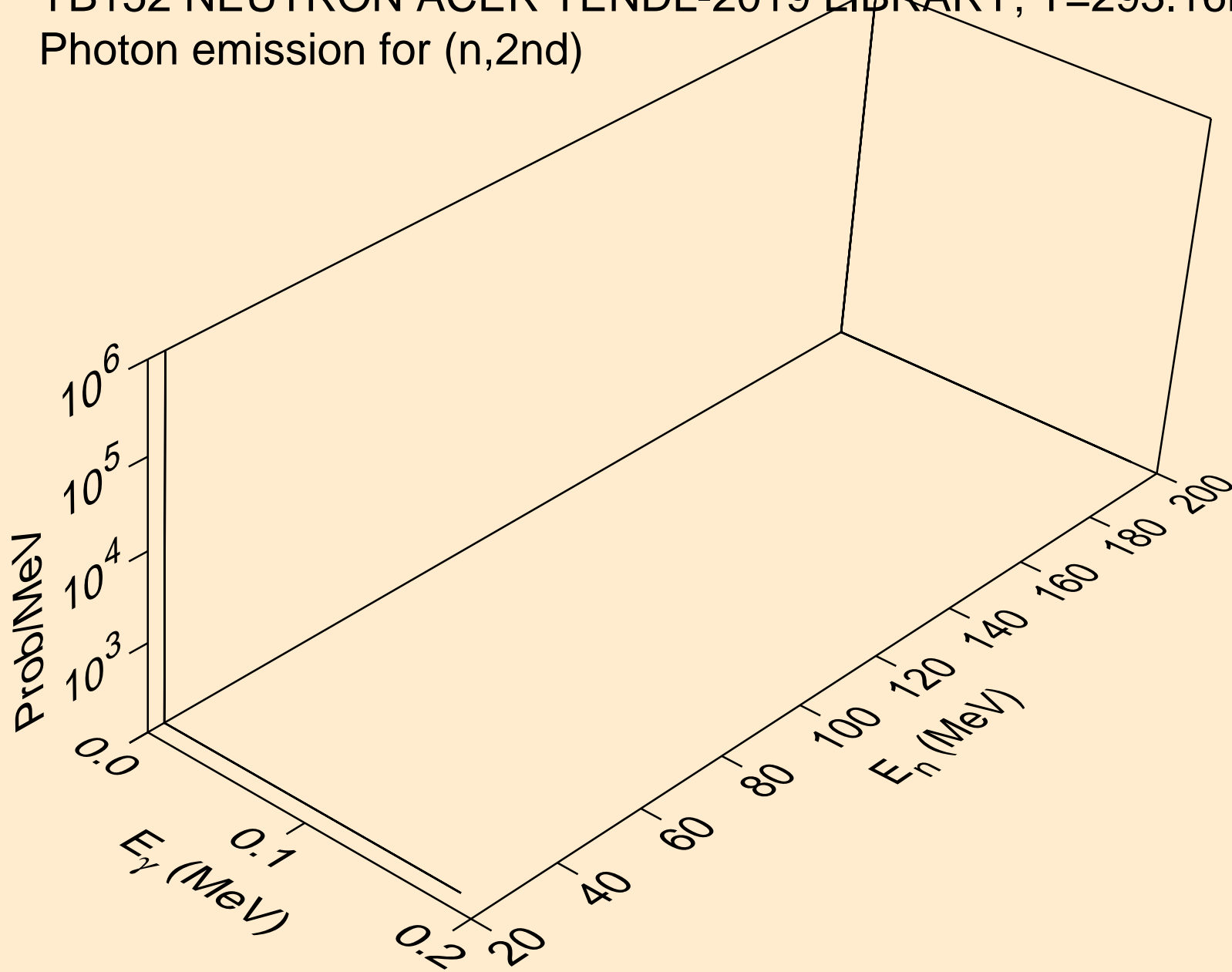

YB152 NEUTRON ACER TENDL-2019 LIBRARY; T=293.16K
Photon emission for (n,2n)

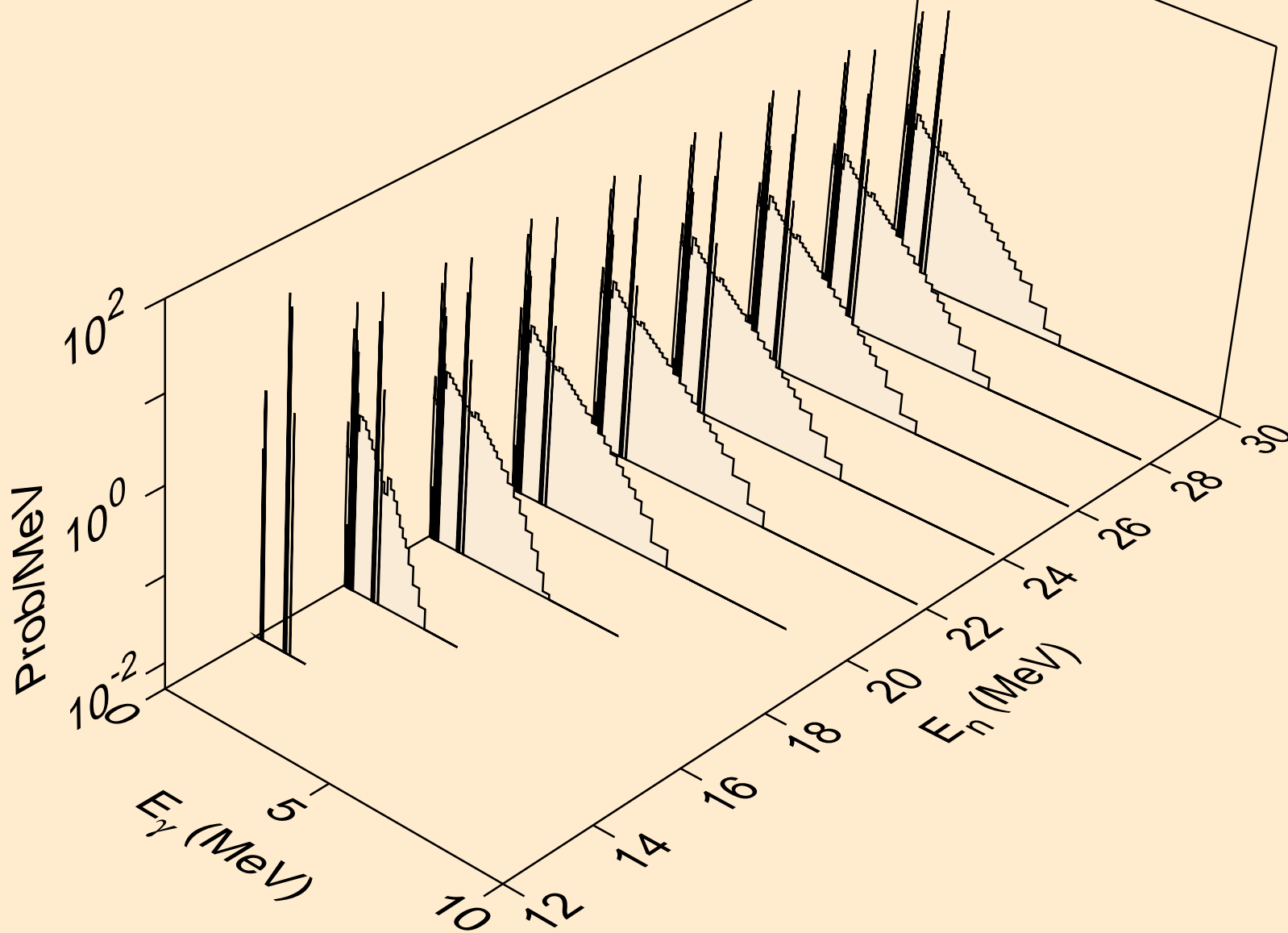

YB152 NEUTRON ACER TENDL-2019 LIBRARY; T=293.16K
Photon emission for (n,3n)

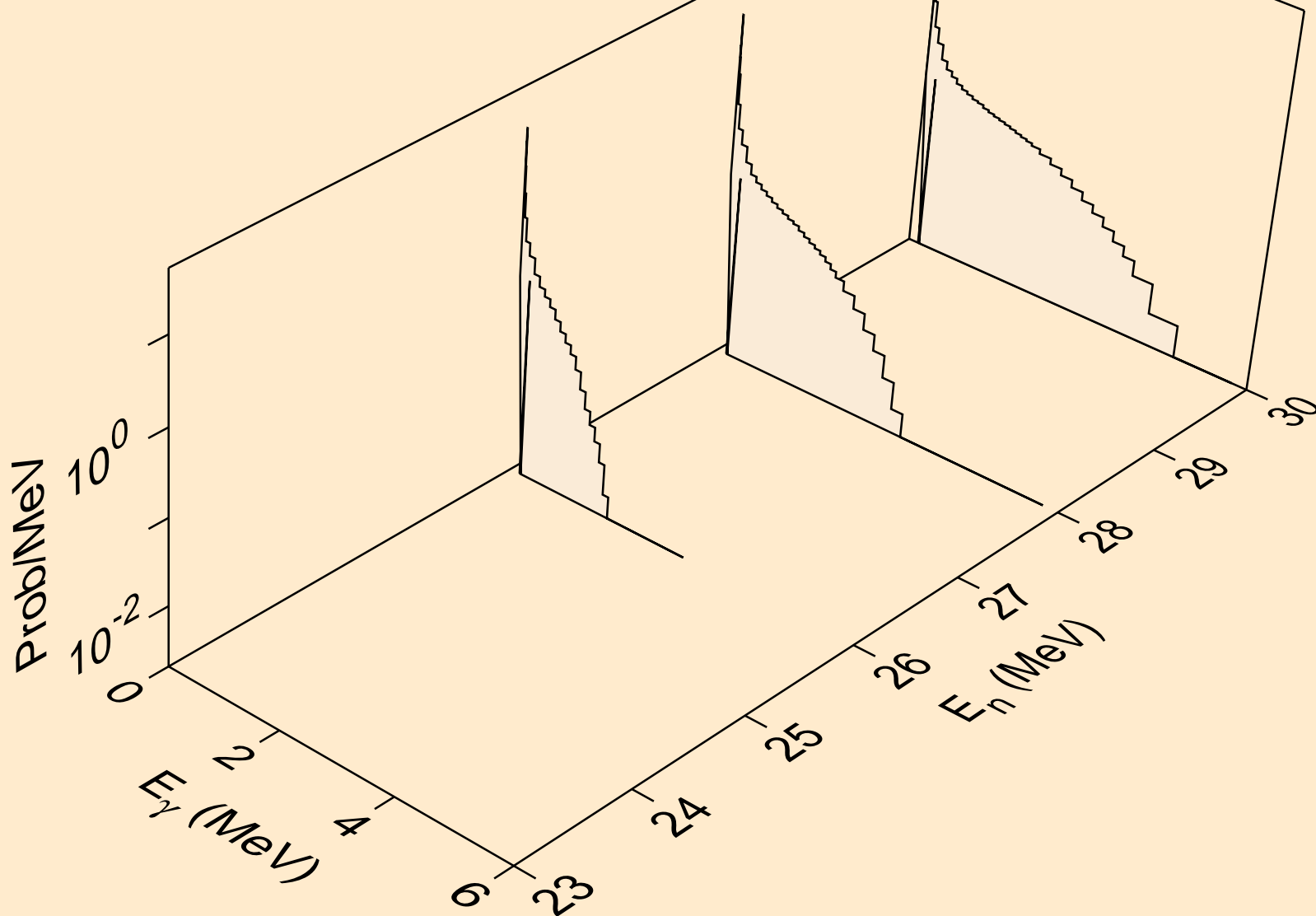

YB152 NEUTRON ACER TENDL-2019 LIBRARY; T=293.16K
Photon emission for (n,n*)a

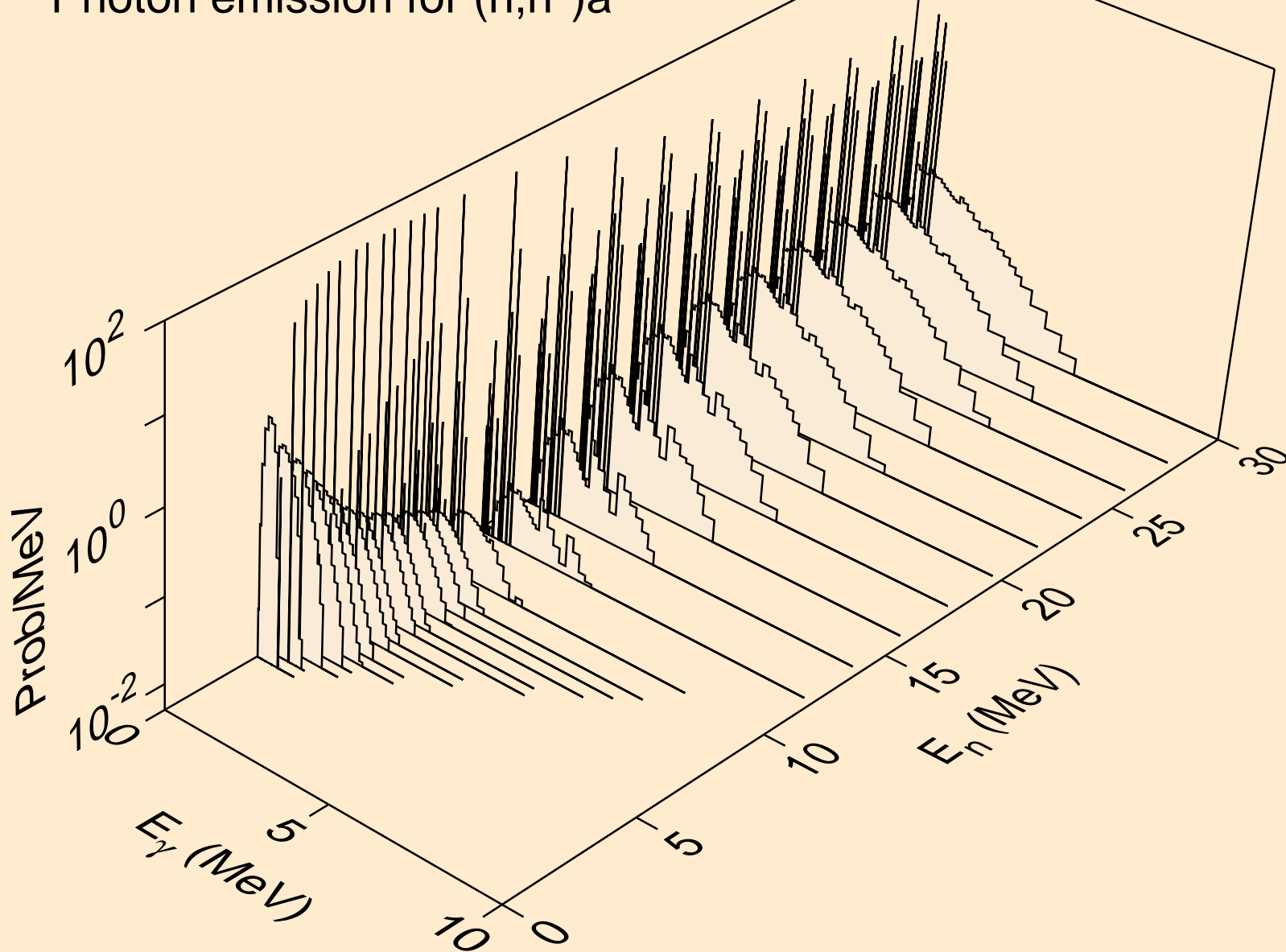

YB152 NEUTRON ACER TENDL-2019 LIBRARY; T=293.16K
Photon emission for (n,2n)a

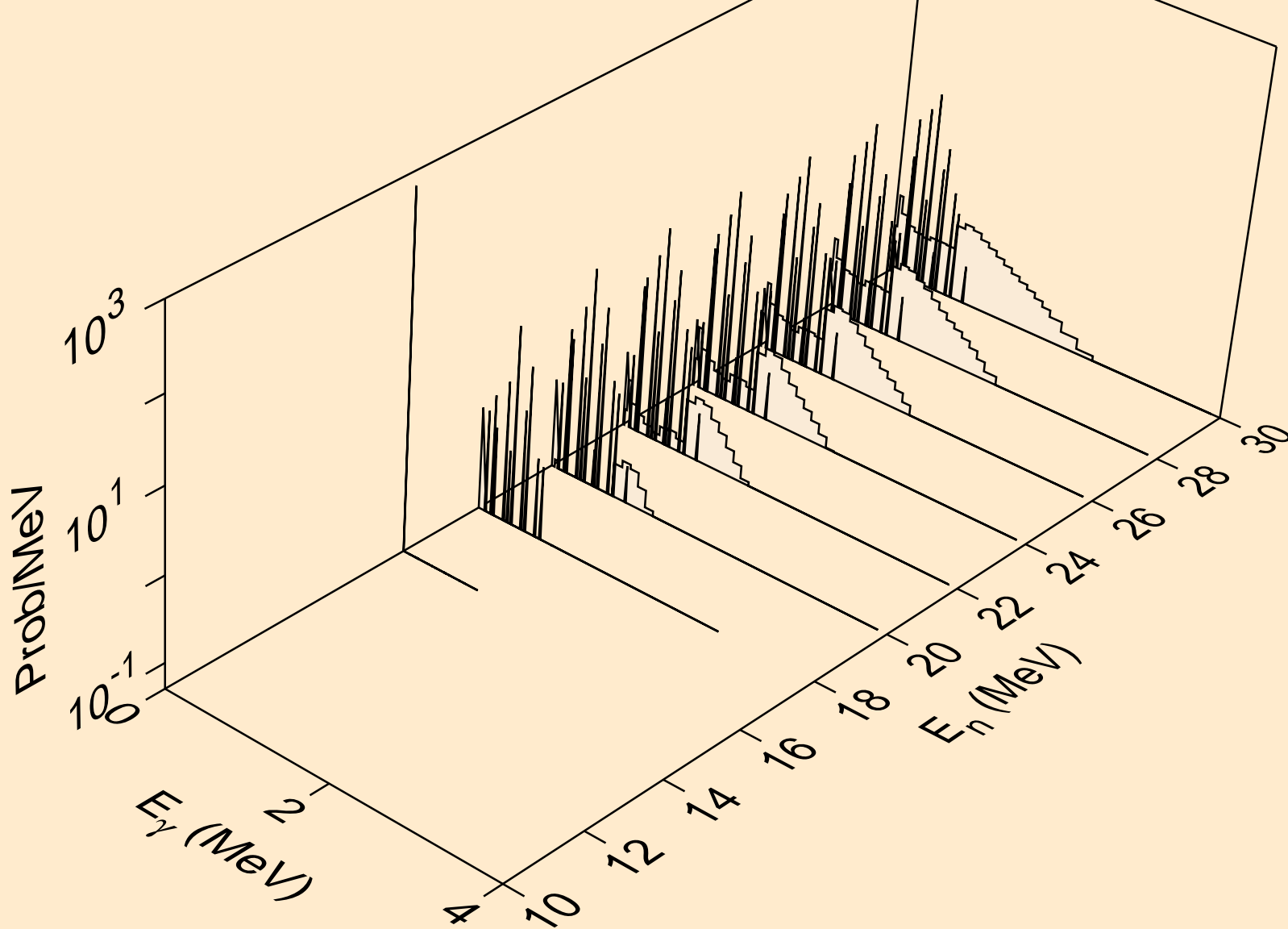

YB152 NEUTRON ACER TENDL-2019 LIBRARY; T=293.16K
Photon emission for (n,n*)p

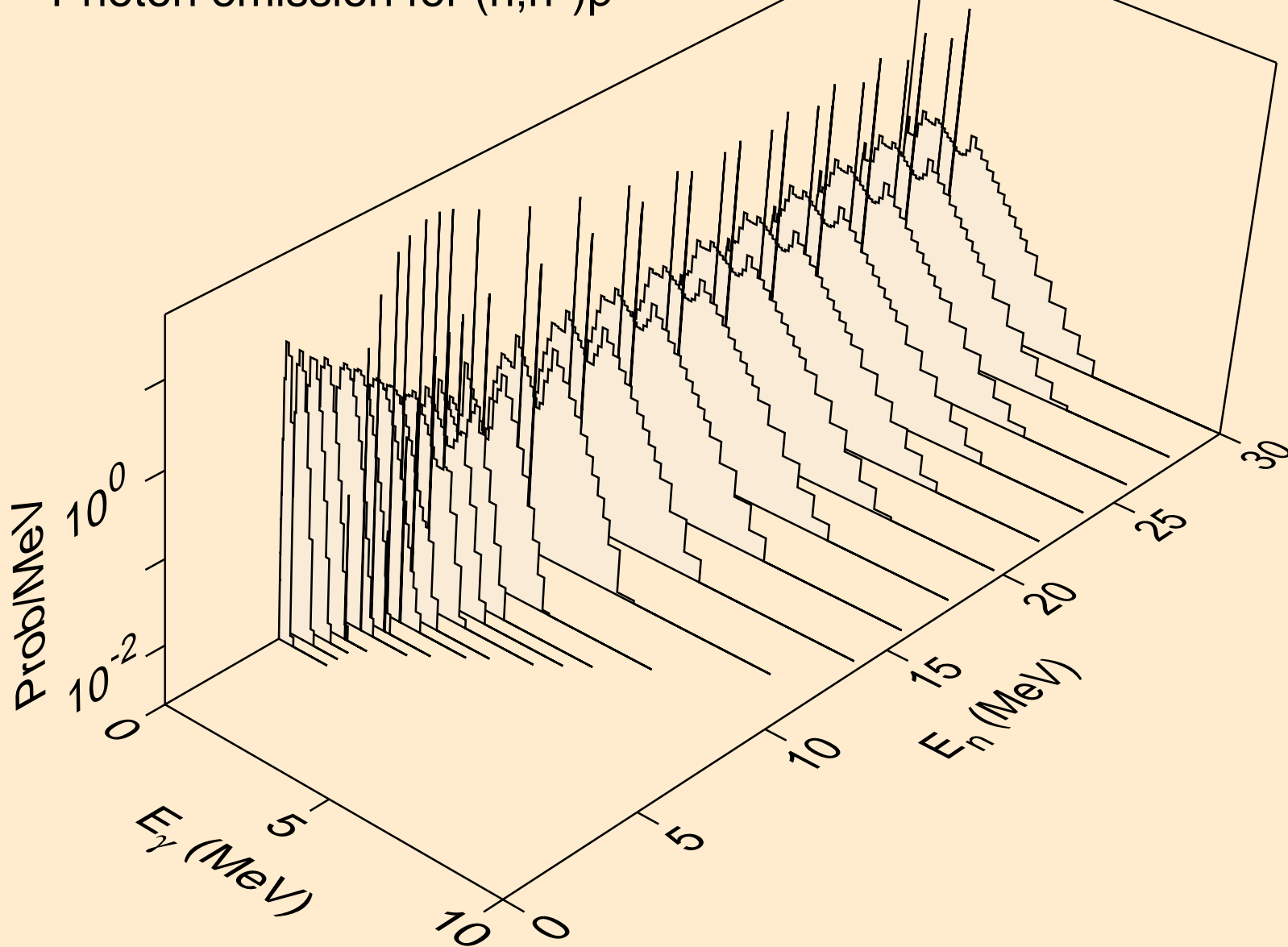

YB152 NEUTRON ACER TENDL-2019 LIBRARY; T=293.16K
Photon emission for (n,n*)2a

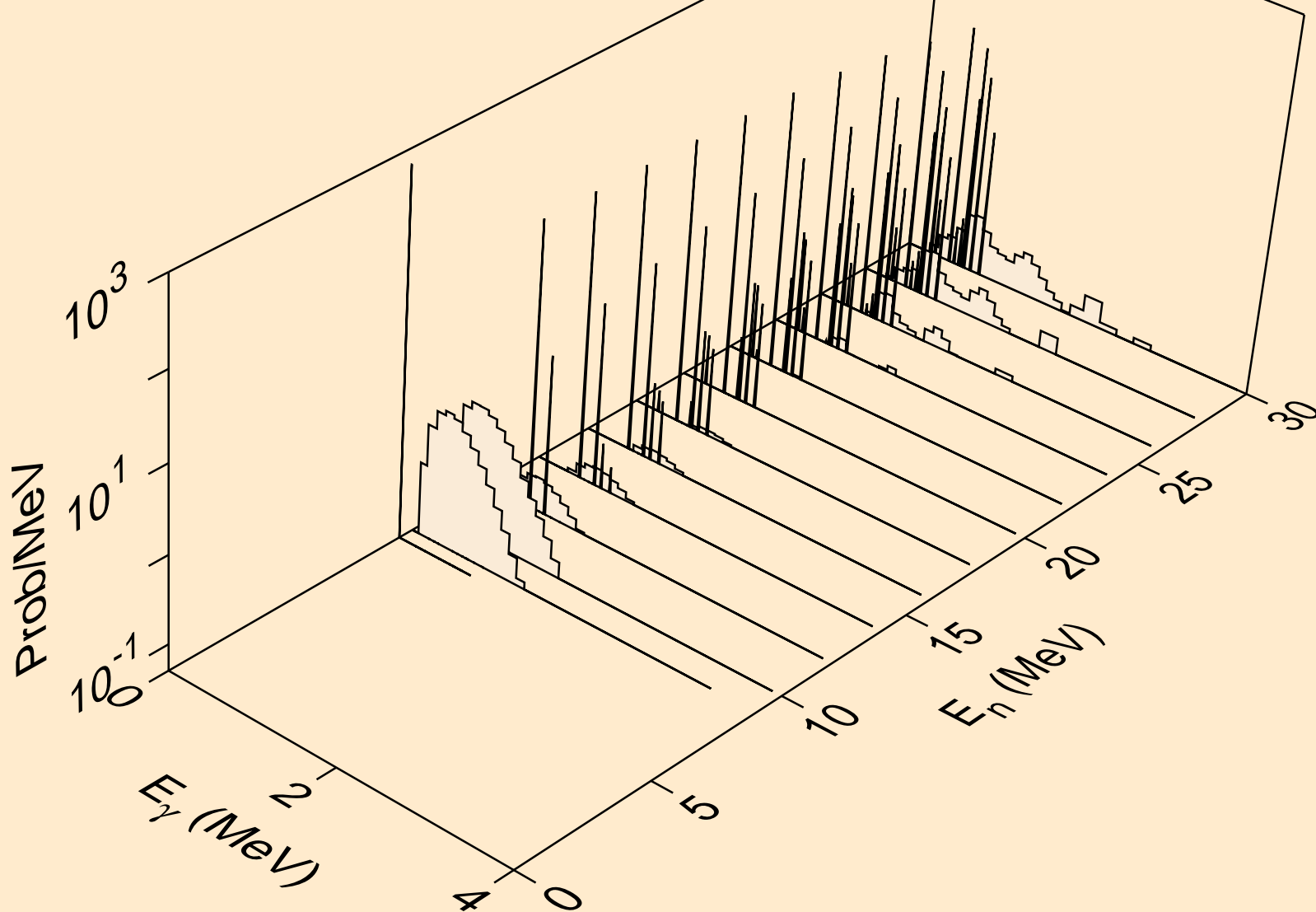

YB152 NEUTRON ACER TENDL-2019 LIBRARY; T=293.16K
Photon emission for (n,n*)d

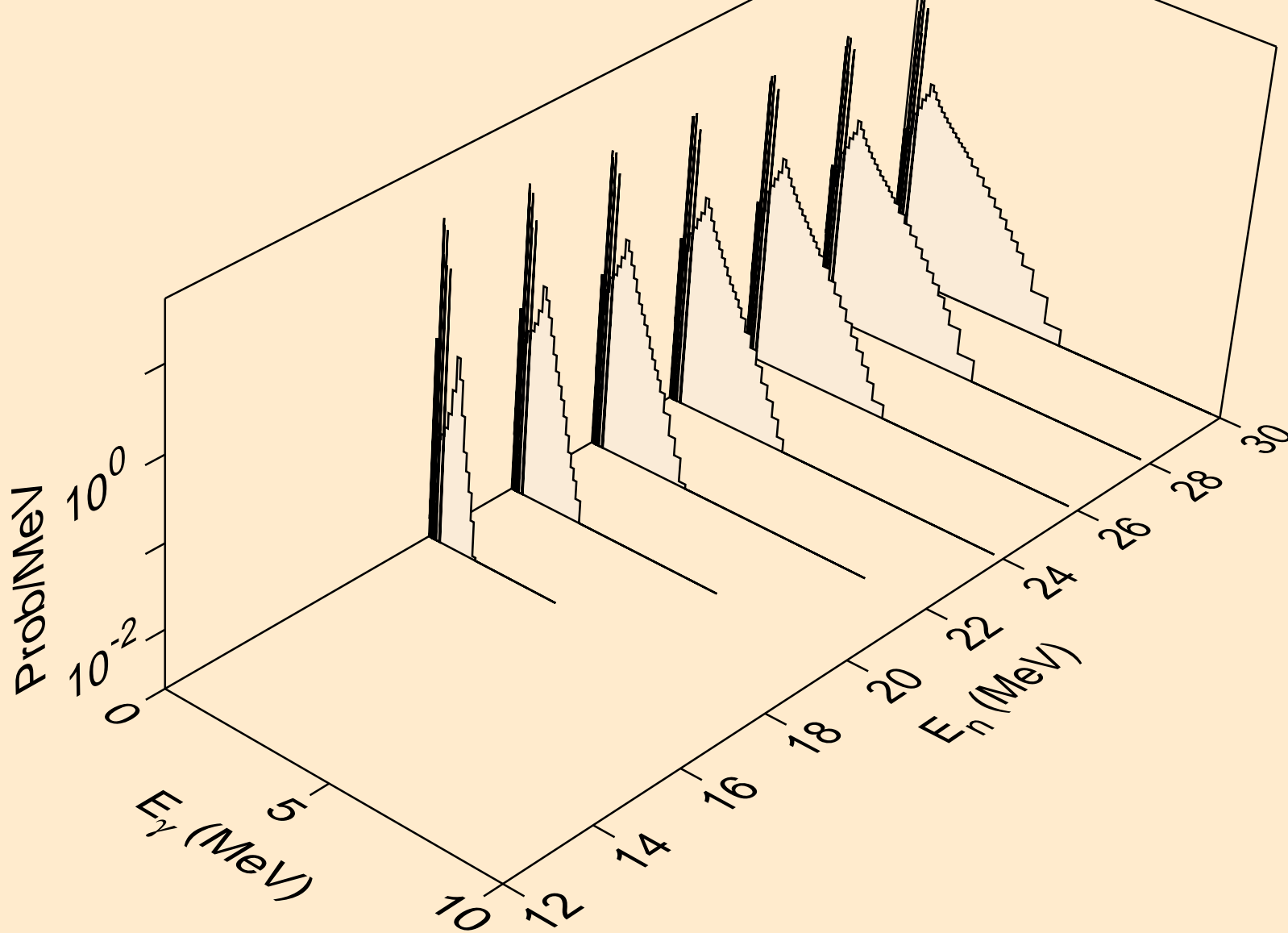

YB152 NEUTRON ACER TENDL-2019 LIBRARY; T=293.16K
Photon emission for (n,n*)t

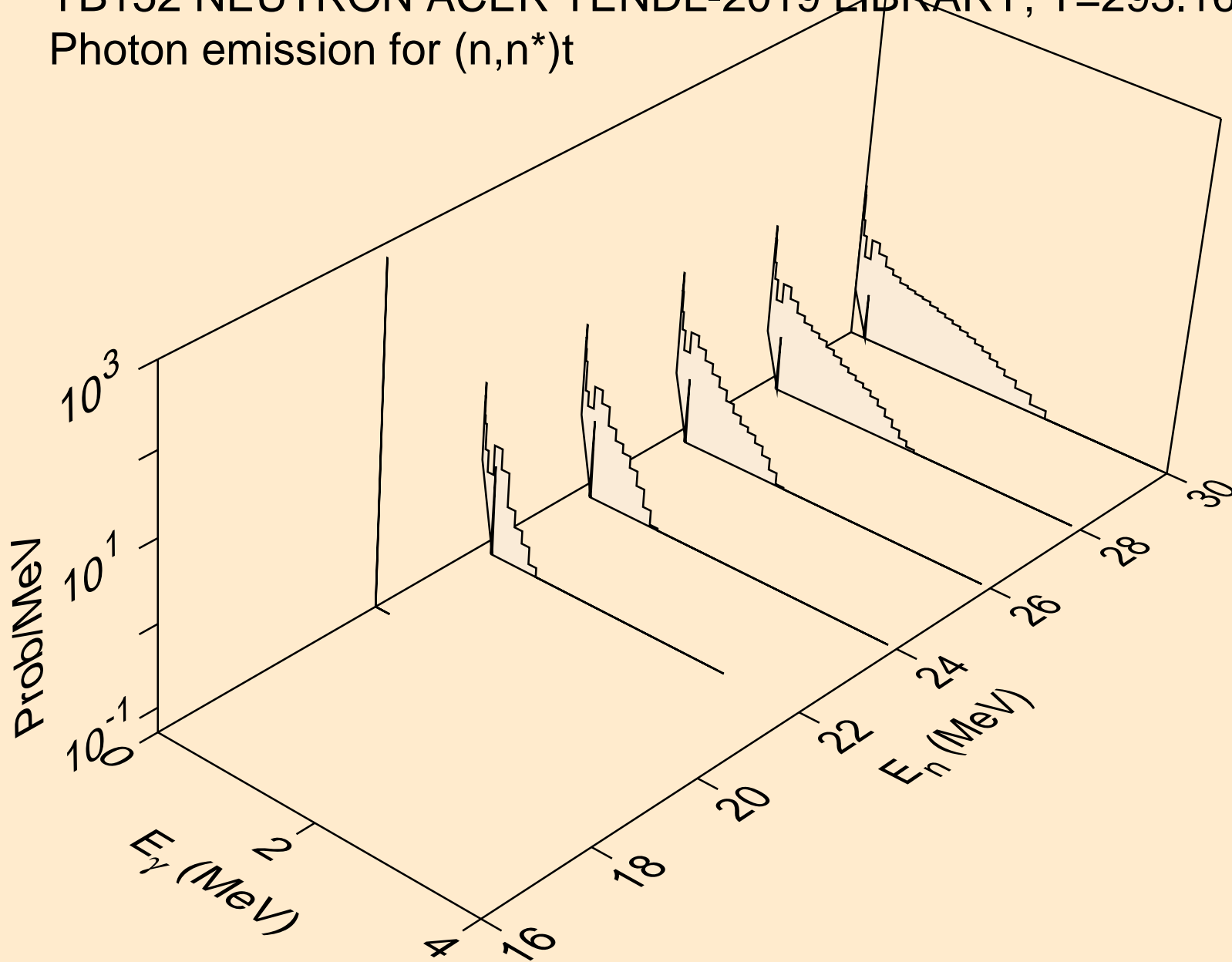

YB152 NEUTRON ACER TENDL-2019 LIBRARY; T=293.16K
Photon emission for (n,n*)he3

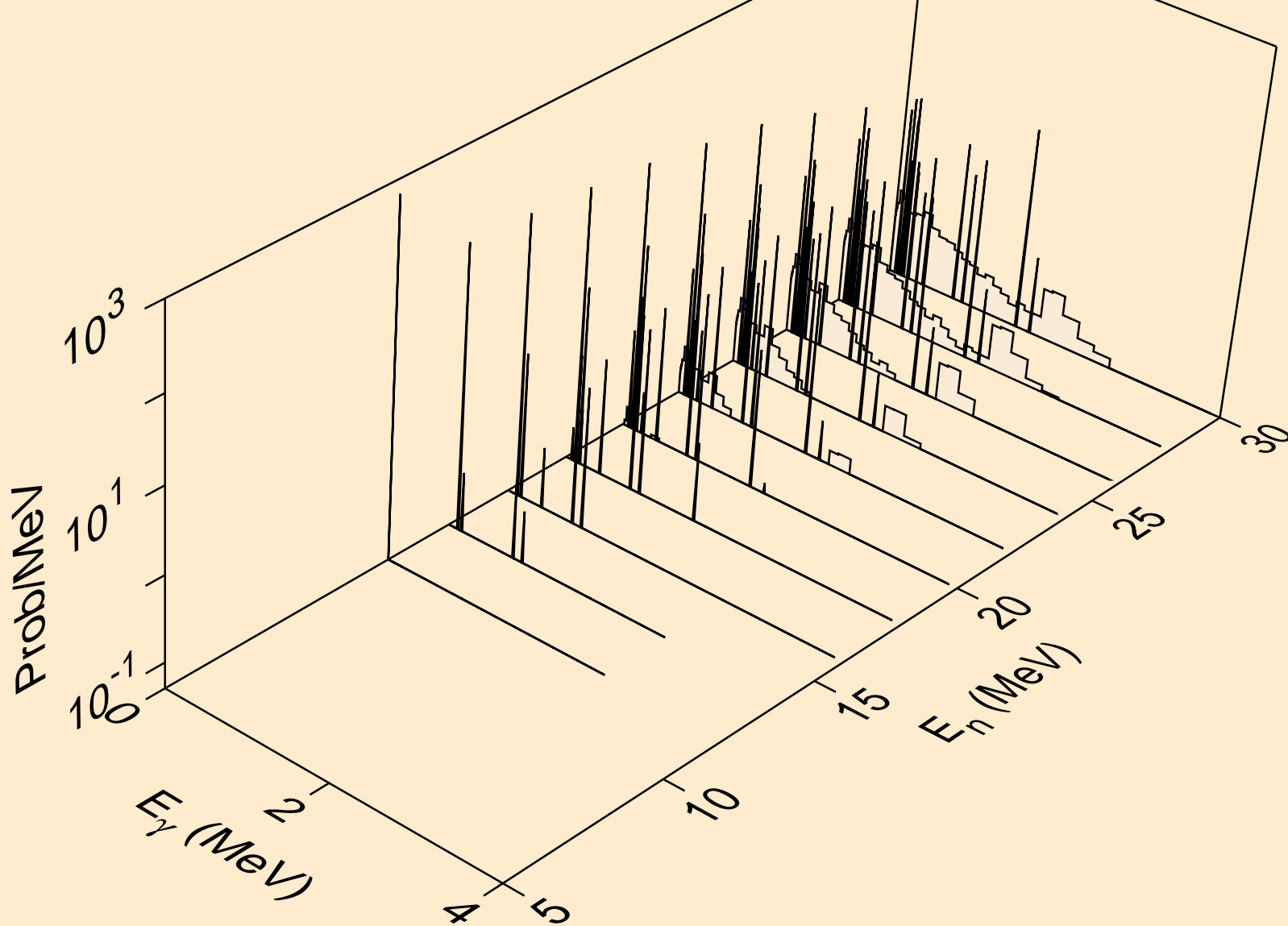

YB152 NEUTRON ACER TENDL-2019 LIBRARY; T=293.16K
Photon emission for (n,2np)

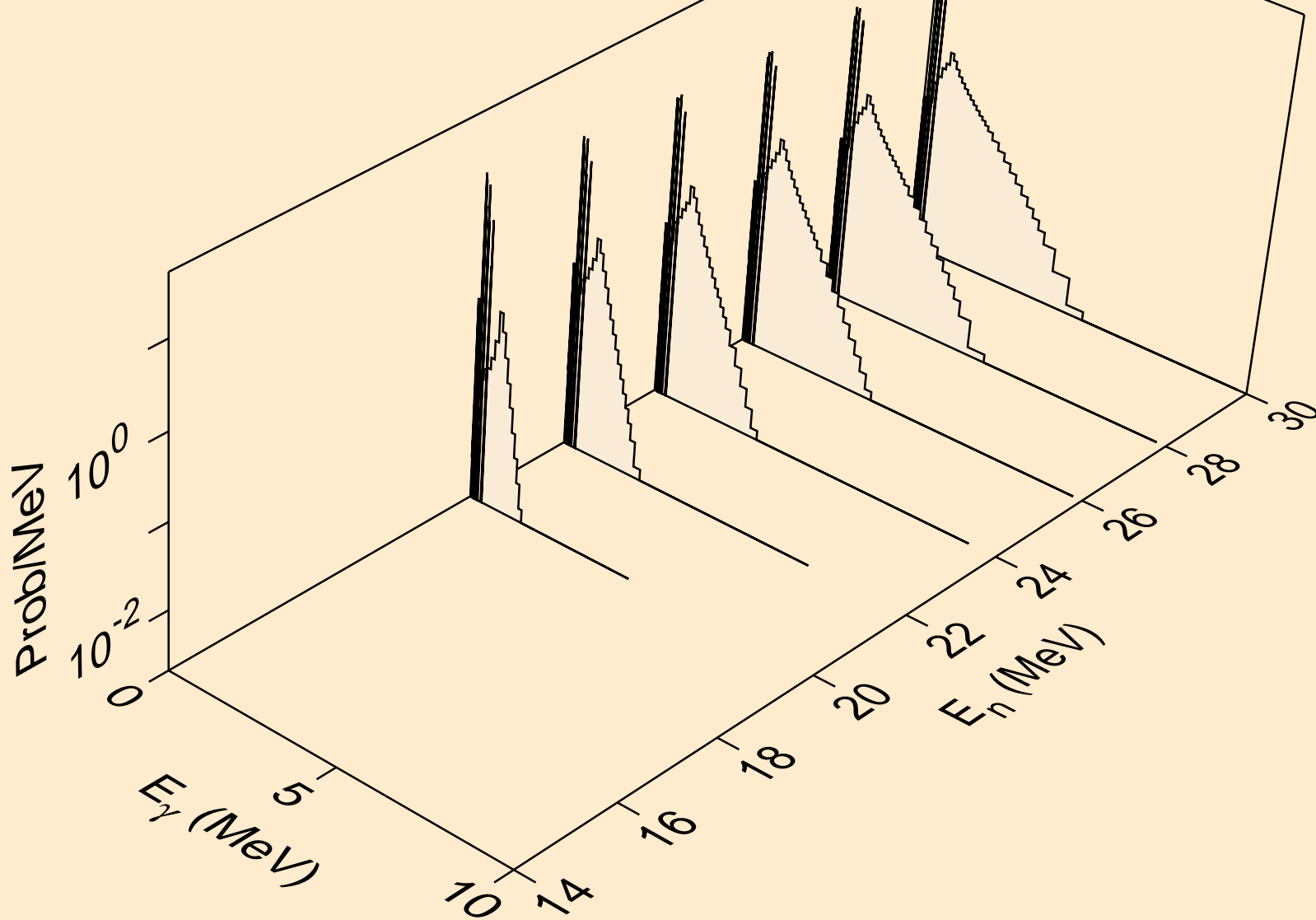

YB152 NEUTRON ACER TENDL-2019 LIBRARY; T=293.16K
Photon emission for (n,3np)

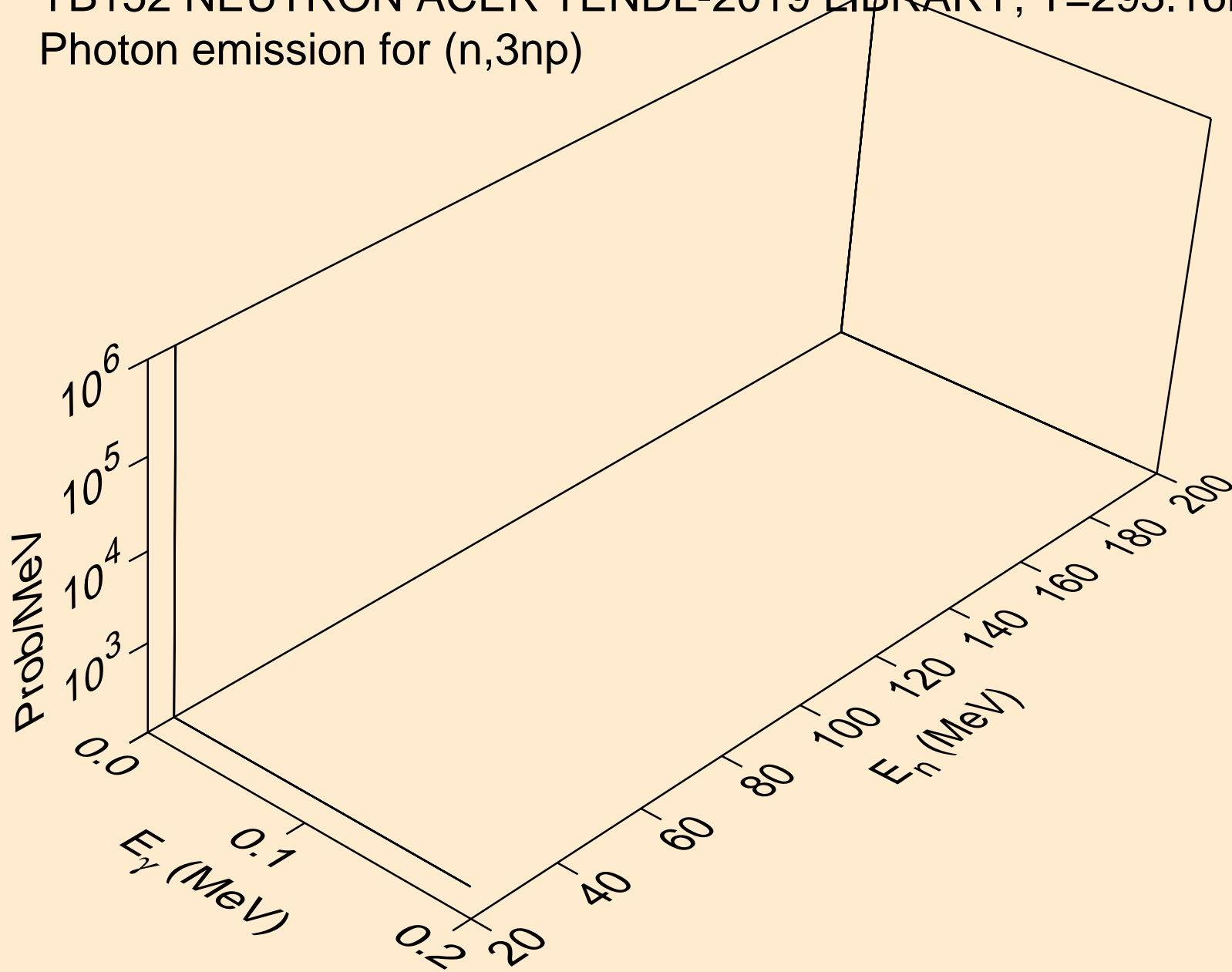

YB152 NEUTRON ACER TENDL-2019 LIBRARY; T=293.16K
Photon emission for (n,2np)

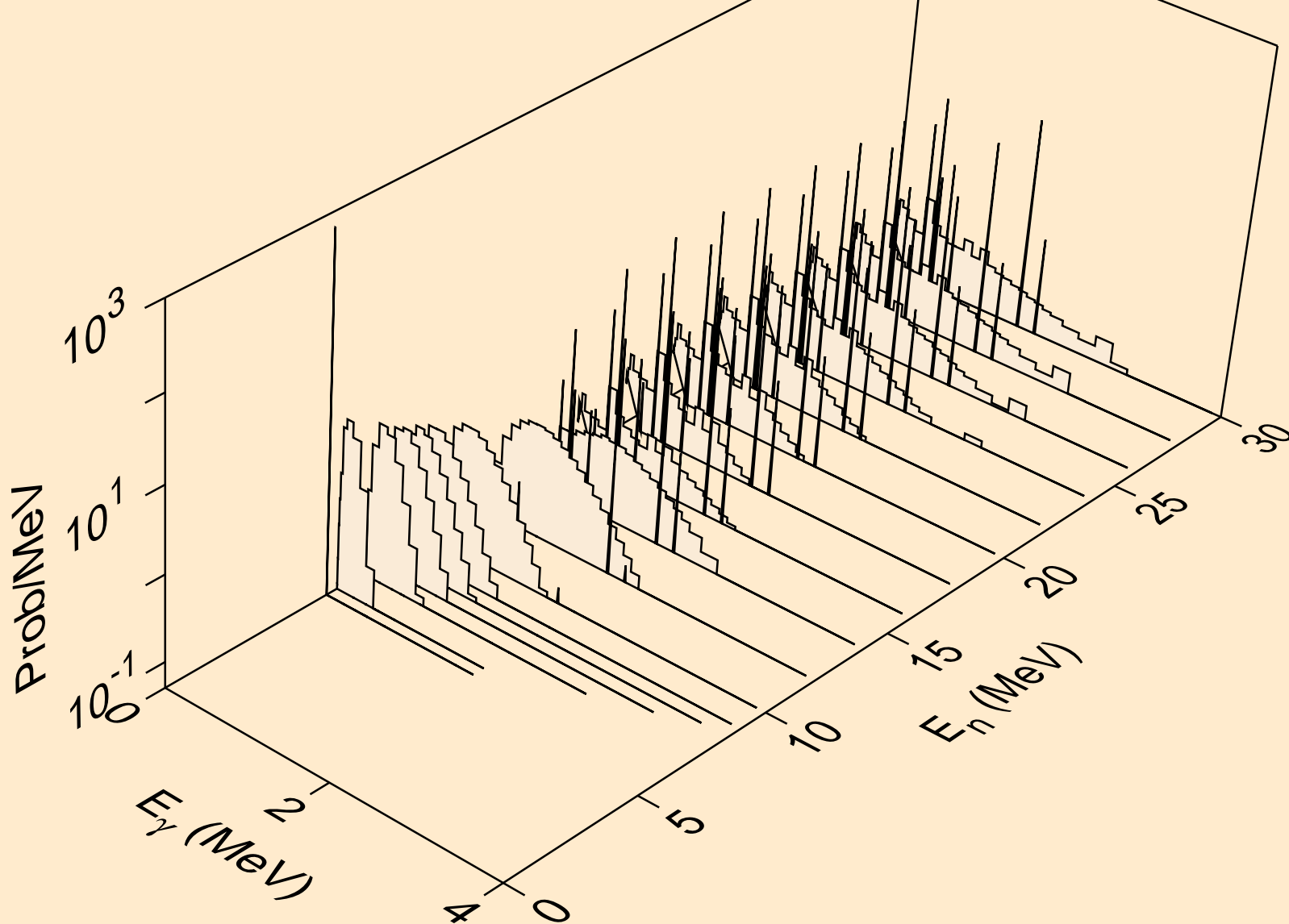

YB152 NEUTRON ACER TENDL-2019 LIBRARY; T=293.16K
Photon emission for (n,npa)

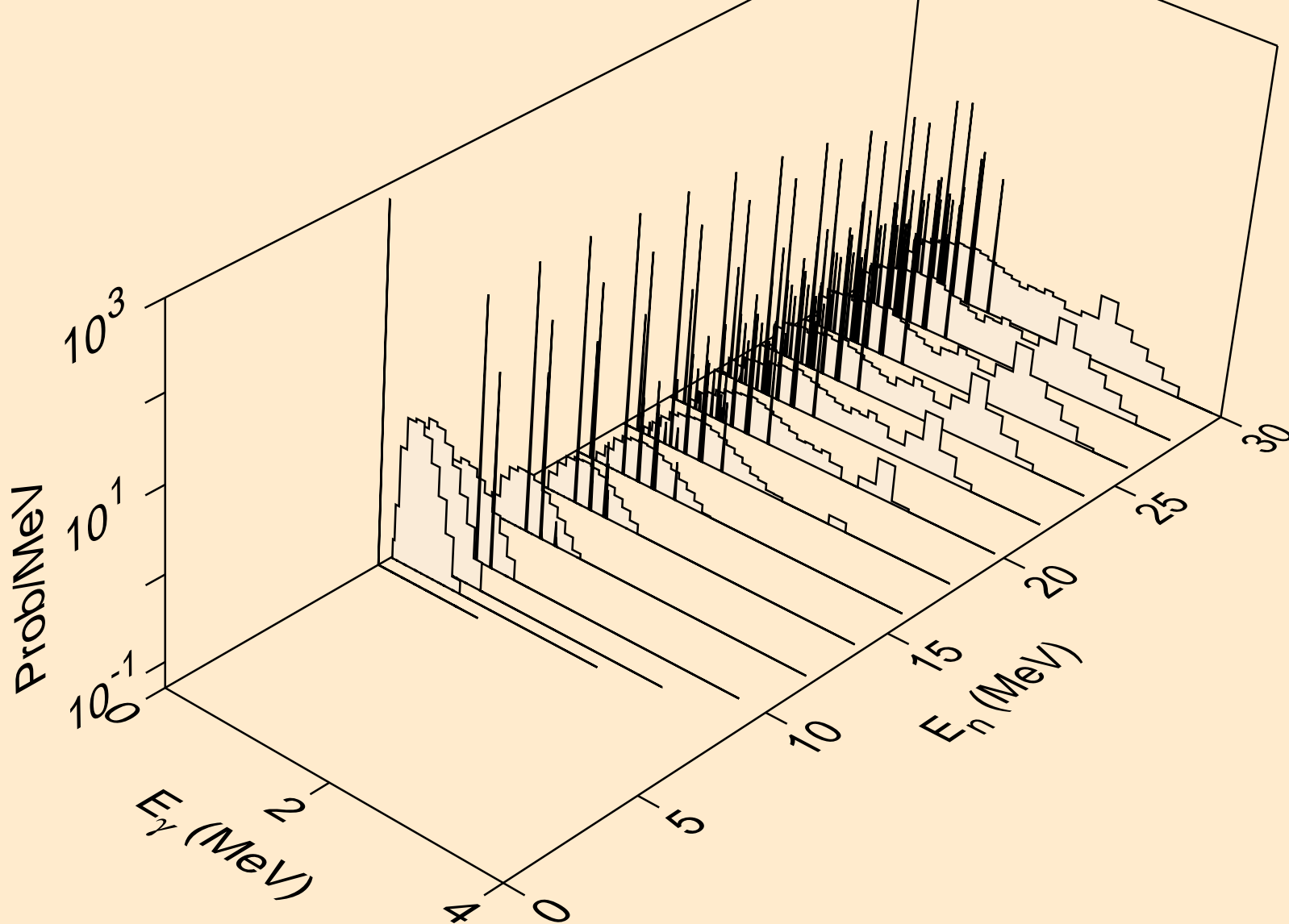

YB152 NEUTRON ACER TENDL-2019 LIBRARY; T=293.16K
Photon emission for (n,n*c)

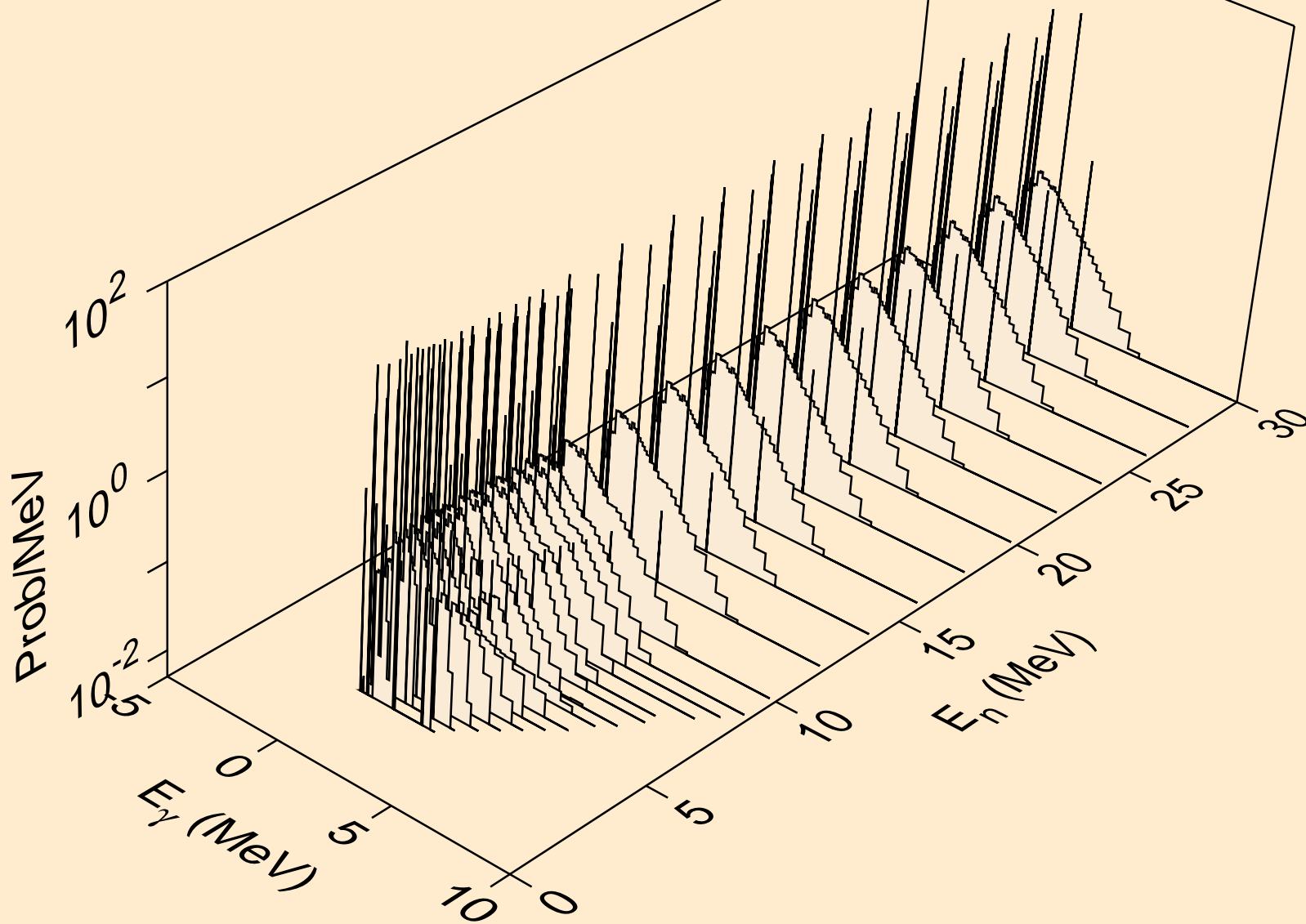

YB152 NEUTRON ACER TENDL-2019 LIBRARY; T=293.16K
Photon emission for (n,gma)

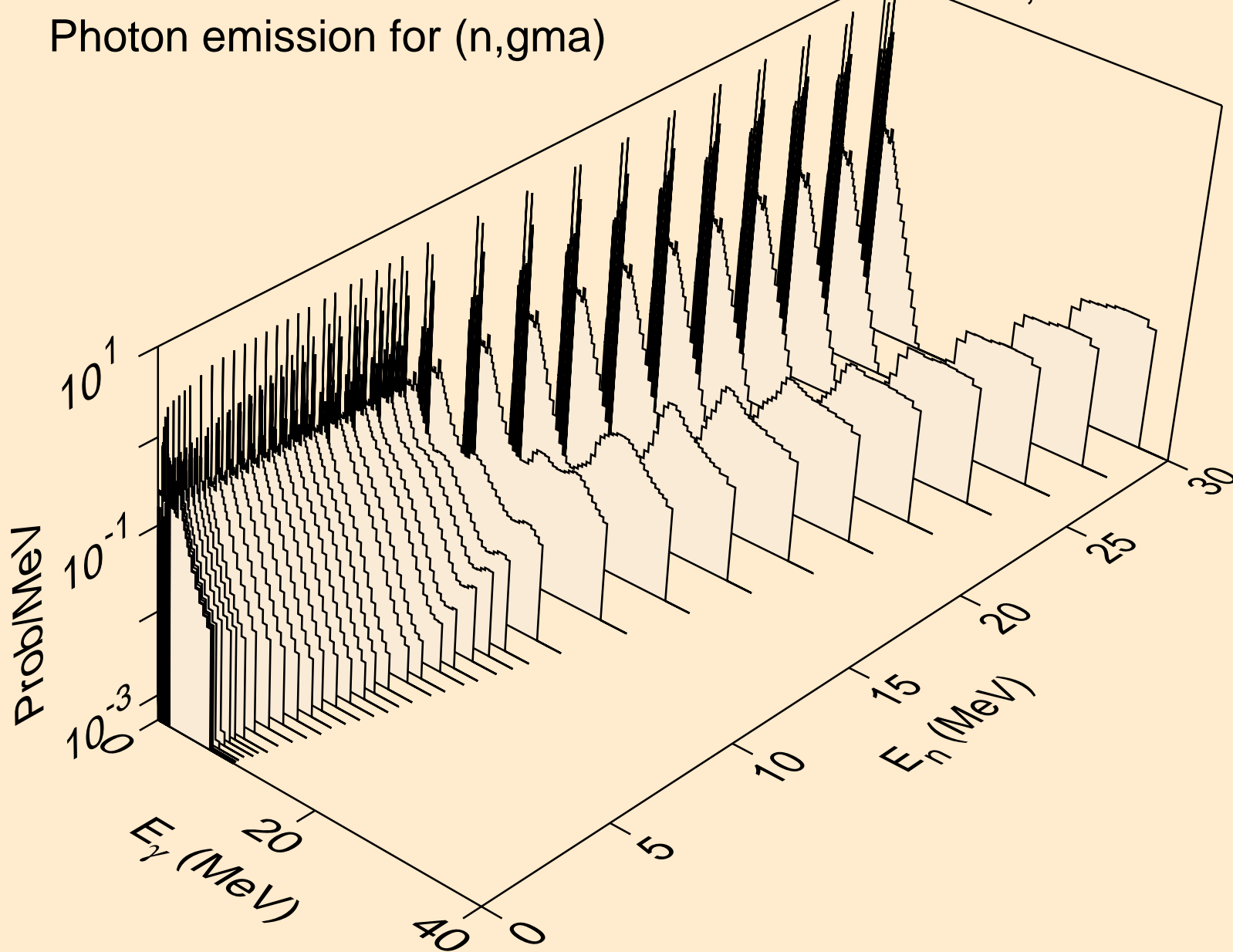

YB152 NEUTRON ACER TENDL-2019 LIBRARY; T=293.16K
Photon emission for (n,p)

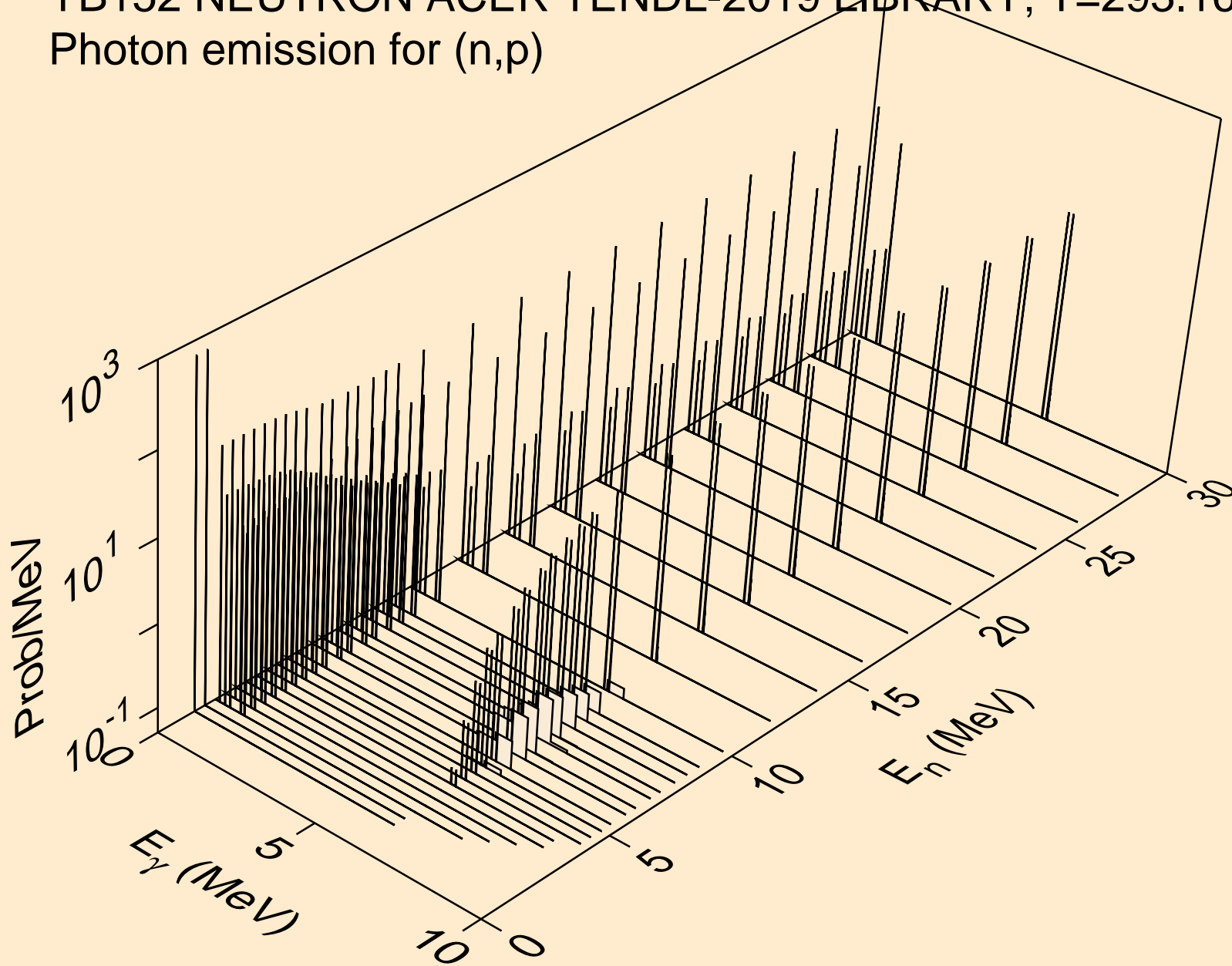

YB152 NEUTRON ACER TENDL-2019 LIBRARY; T=293.16K
Photon emission for (n,d)

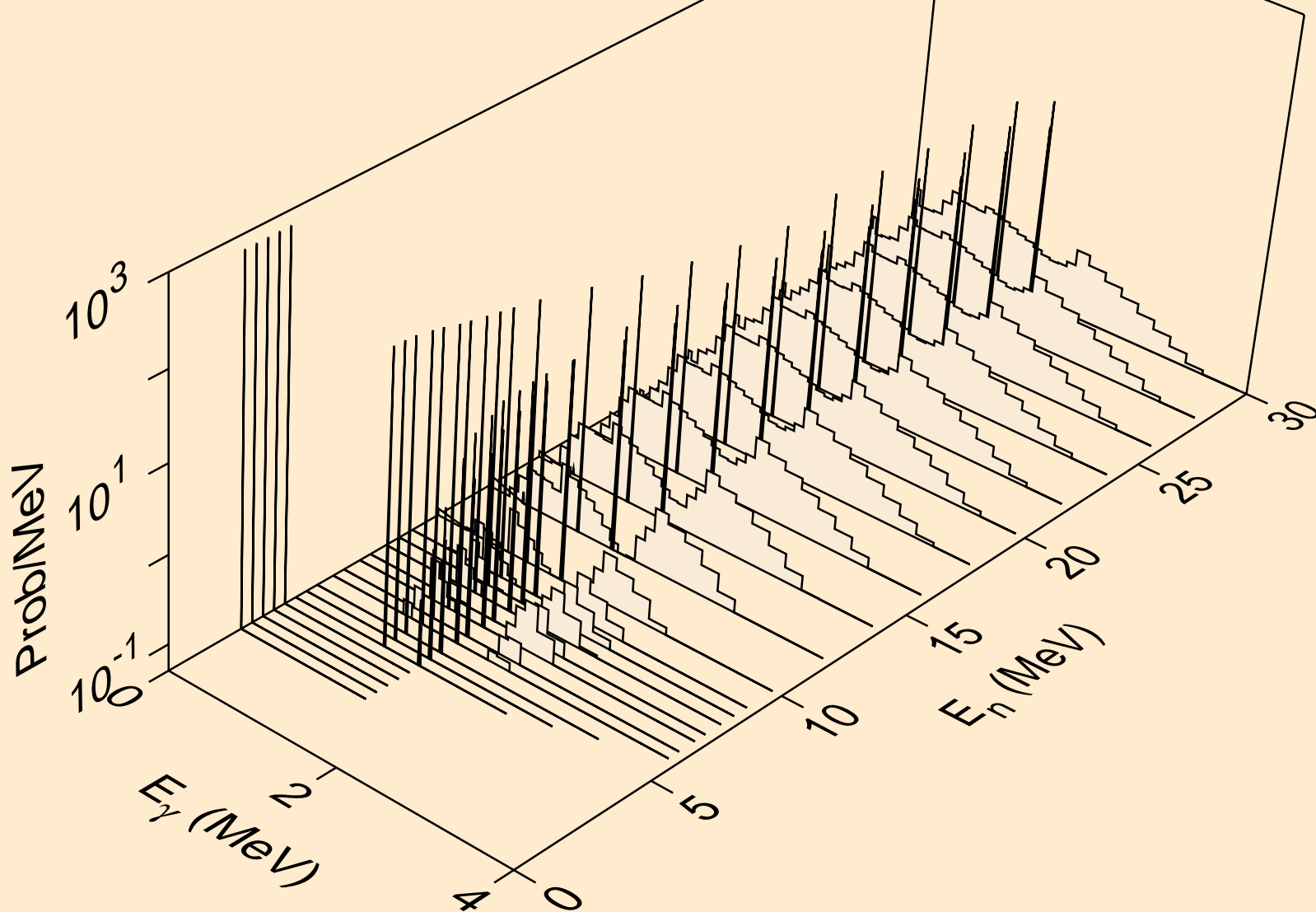

YB152 NEUTRON ACER TENDL-2019 LIBRARY; T=293.16K
Photon emission for (n,t)

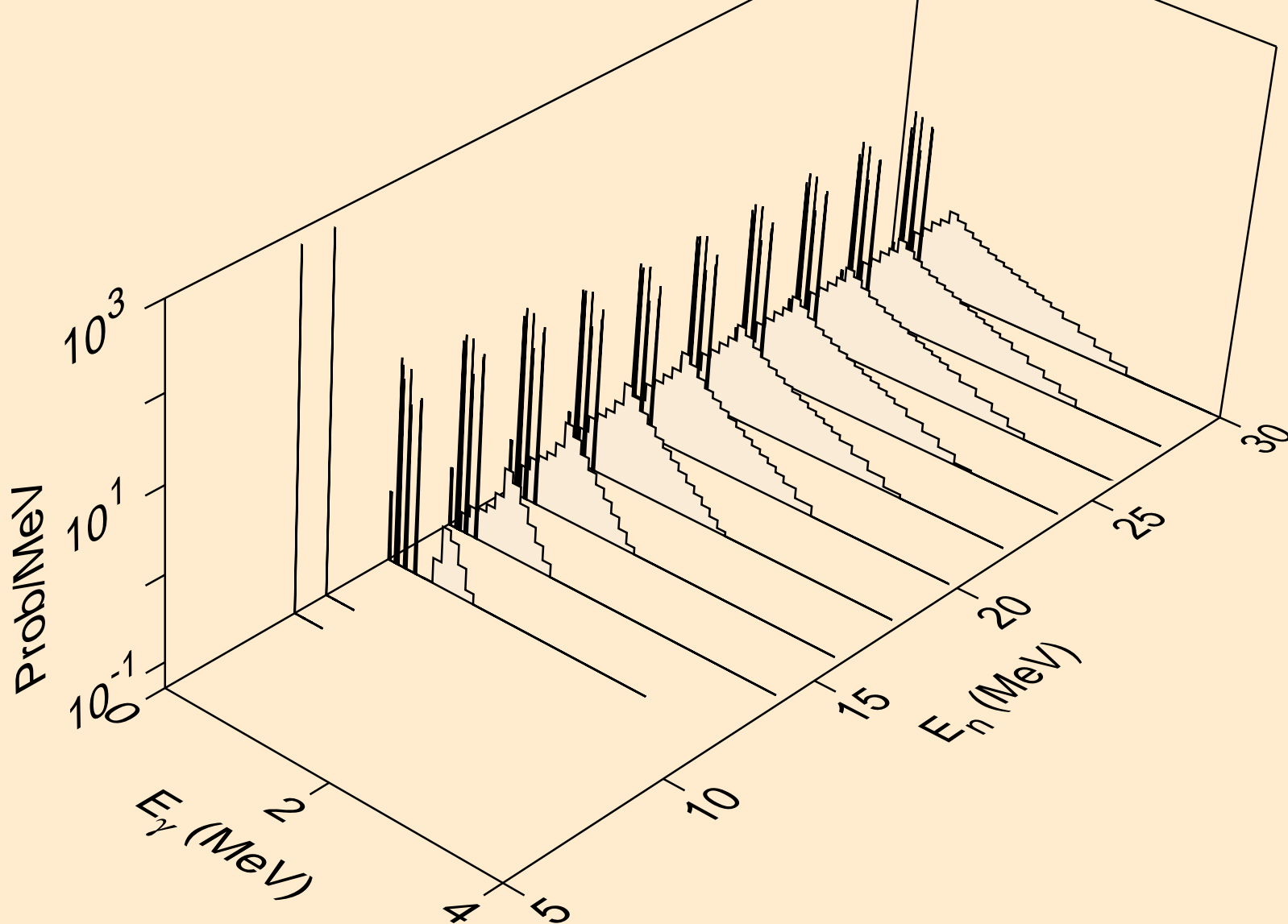

YB152 NEUTRON ACER TENDL-2019 LIBRARY; T=293.16K
Photon emission for (n,he3)

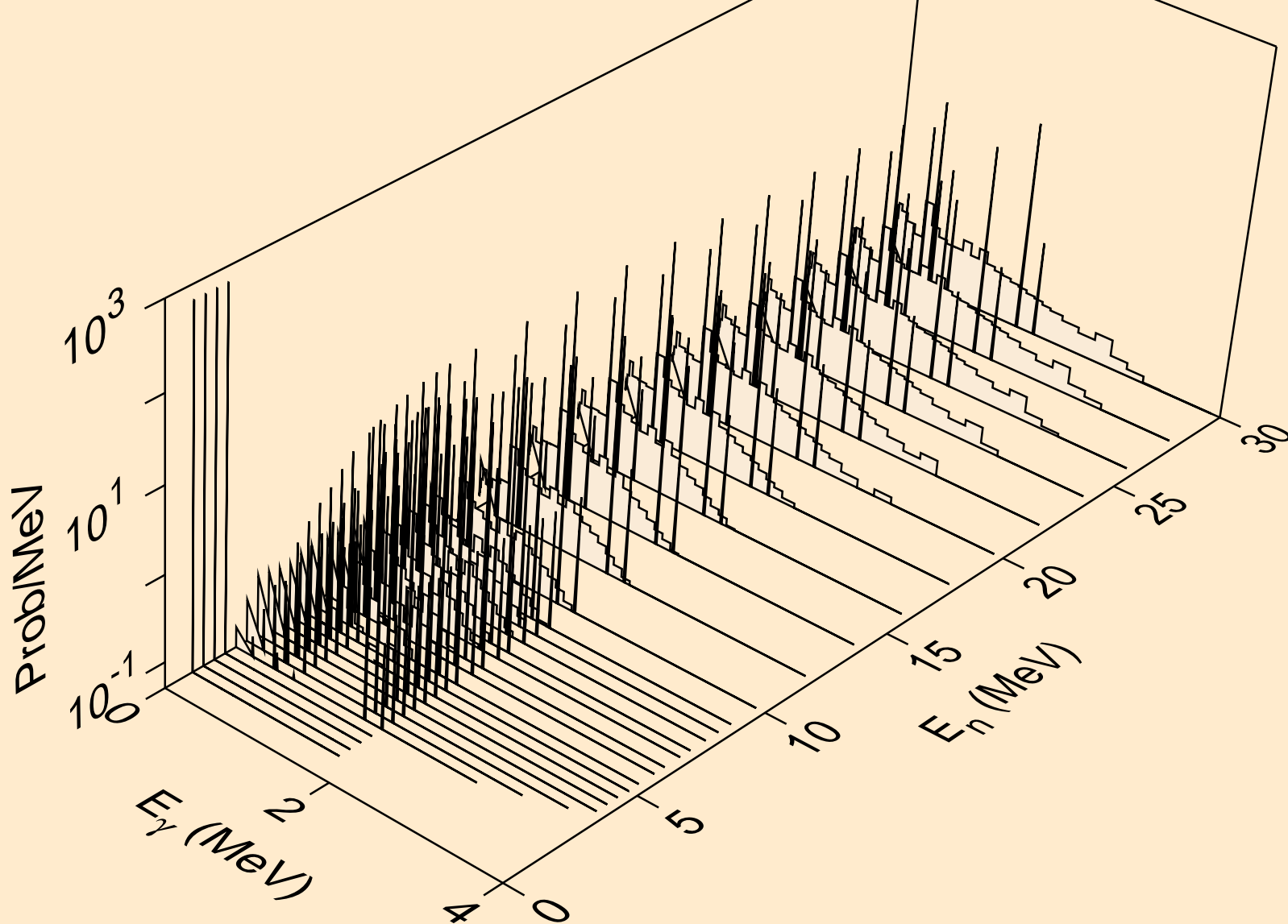

YB152 NEUTRON ACER TENDL-2019 LIBRARY; T=293.16K
Photon emission for (n,a)

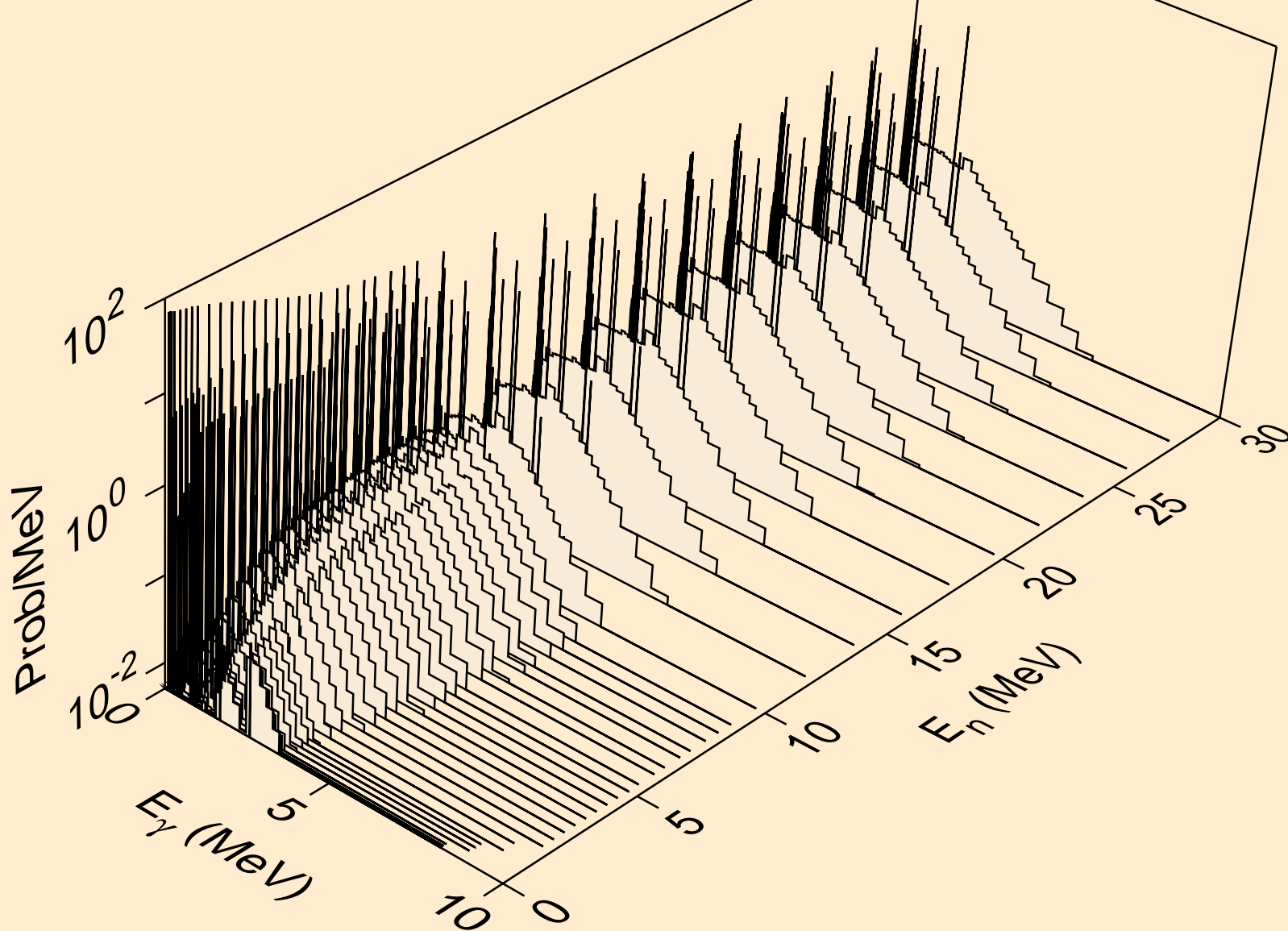

YB152 NEUTRON ACER TENDL-2019 LIBRARY; T=293.16K
Photon emission for (n,2a)

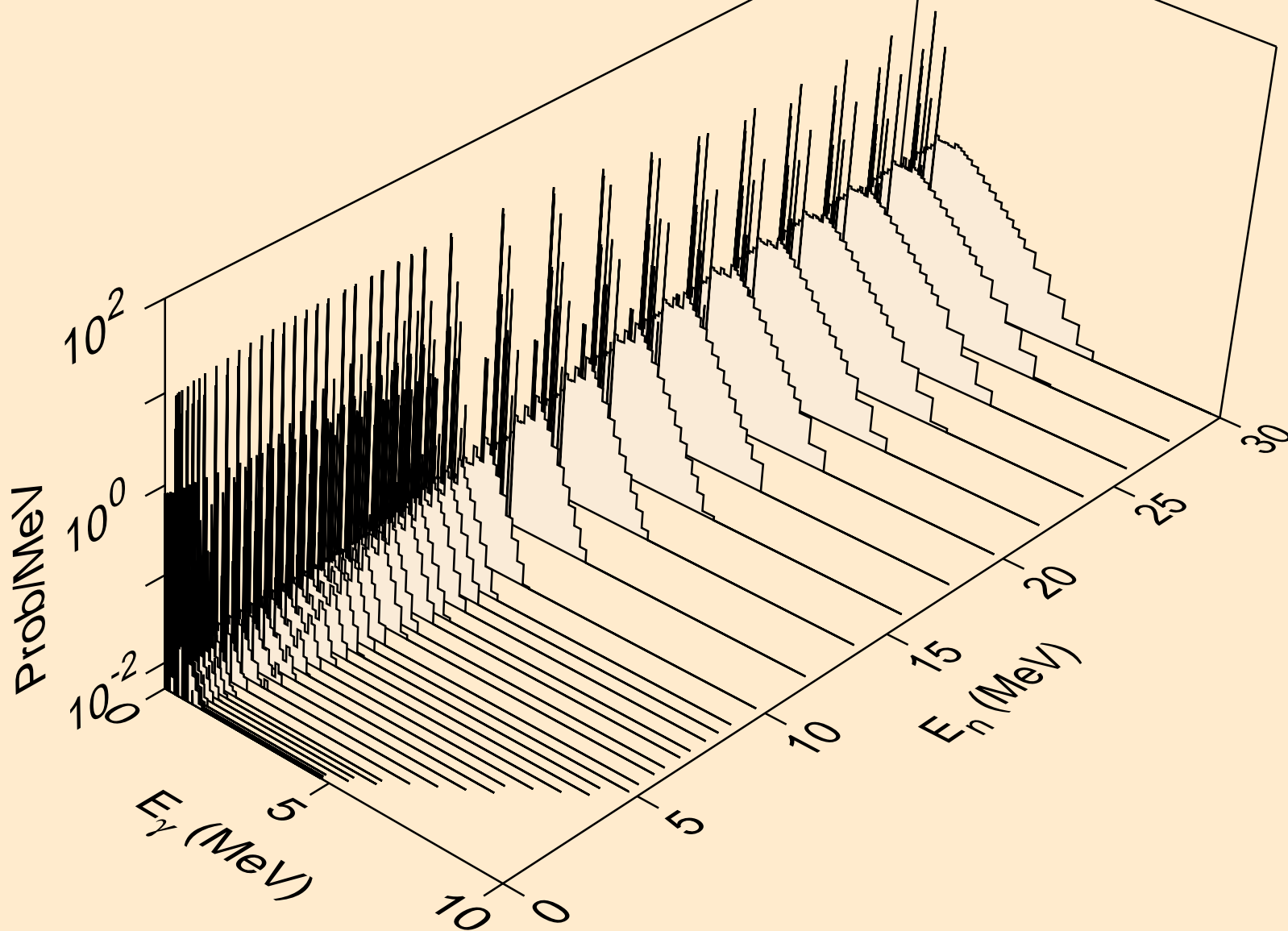

YB152 NEUTRON ACER TENDL-2019 LIBRARY; T=293.16K
Photon emission for (n,3a)

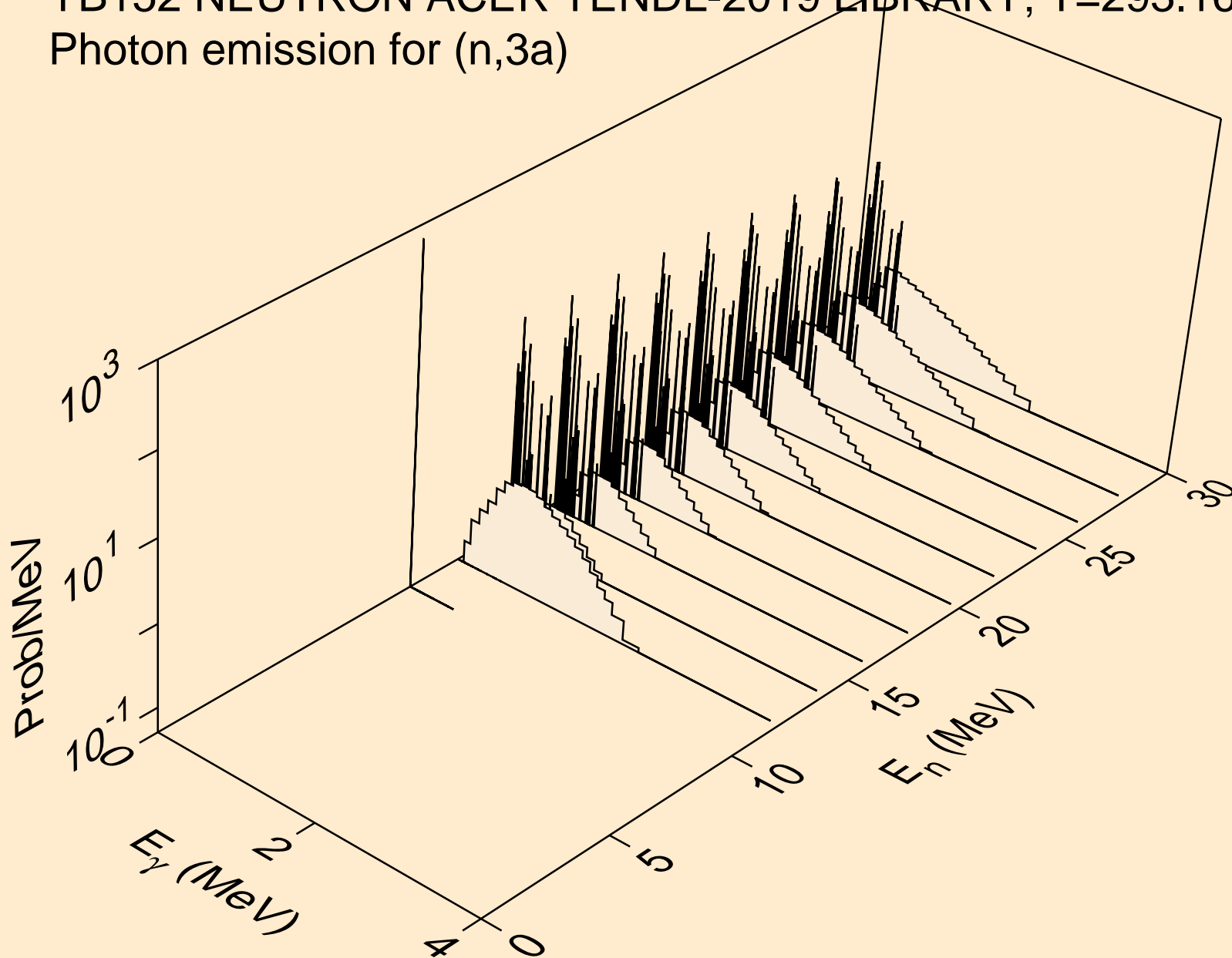

YB152 NEUTRON ACER TENDL-2019 LIBRARY; T=293.16K
Photon emission for (n,2p)

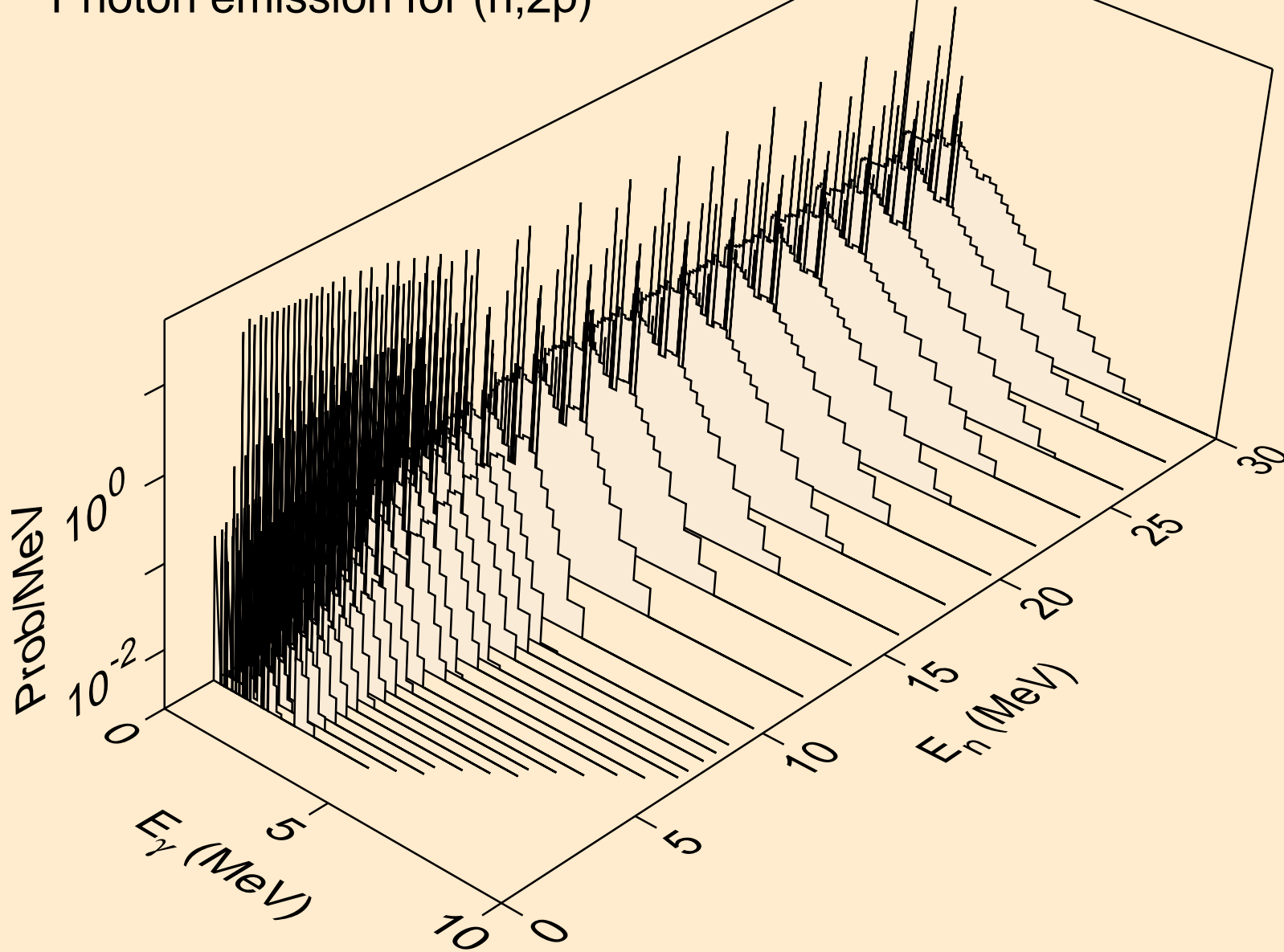

YB152 NEUTRON ACER TENDL-2019 LIBRARY; T=293.16K
Photon emission for (n,p α)

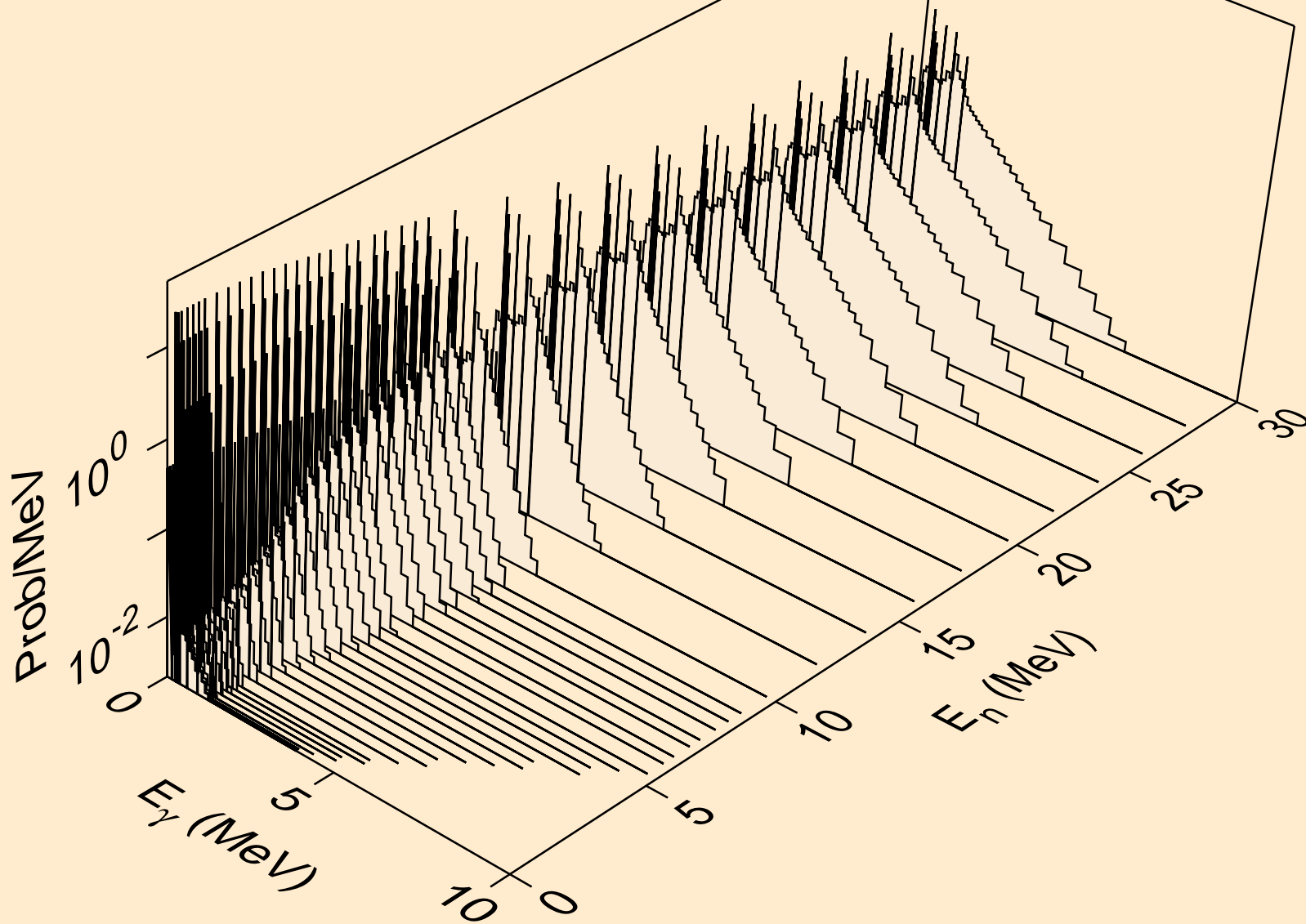

YB152 NEUTRON ACER TENDL-2019 LIBRARY; T=293.16K
Photon emission for (n,pd)

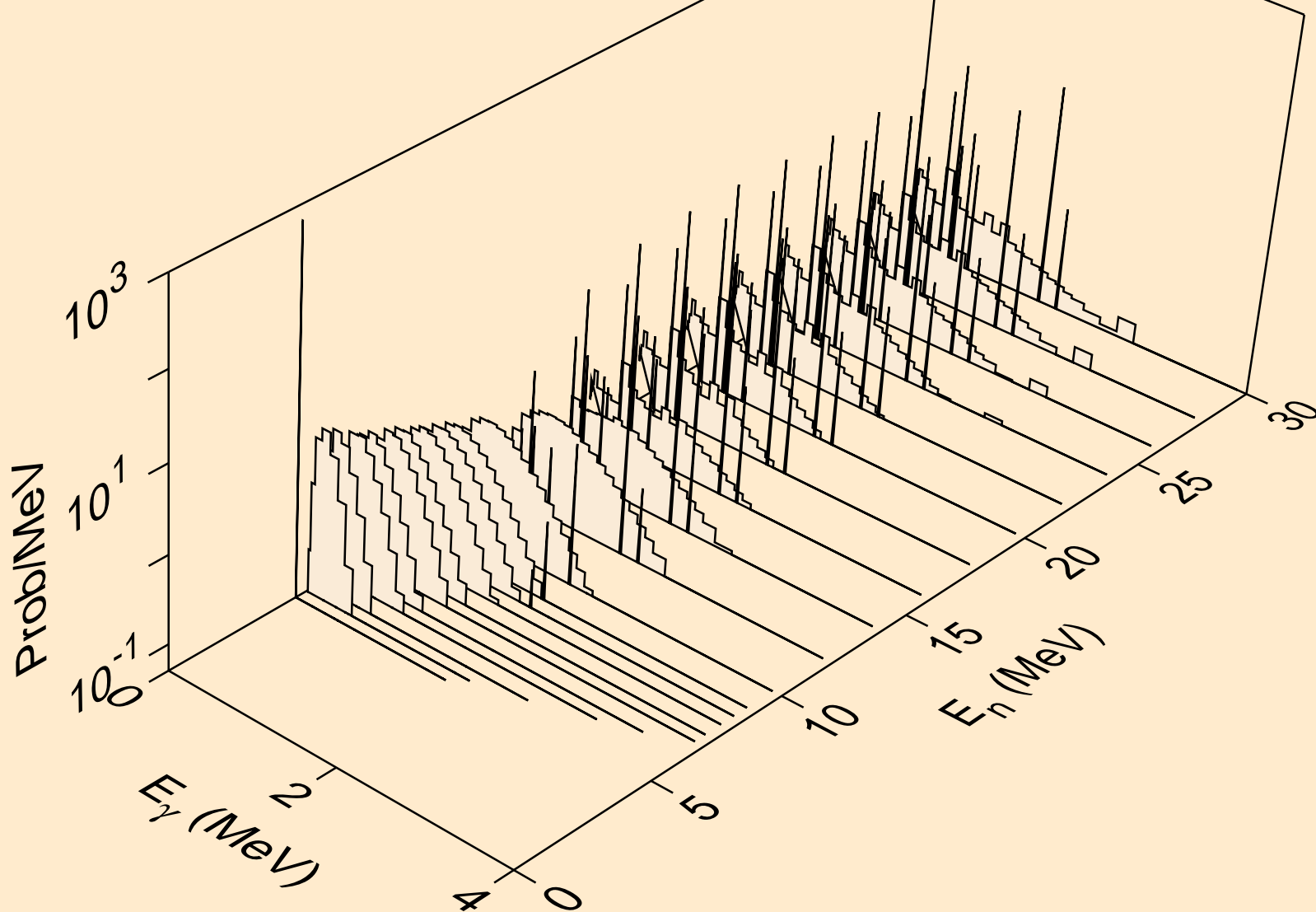

YB152 NEUTRON ACER TENDL-2019 LIBRARY; T=293.16K
Photon emission for (n,pt)

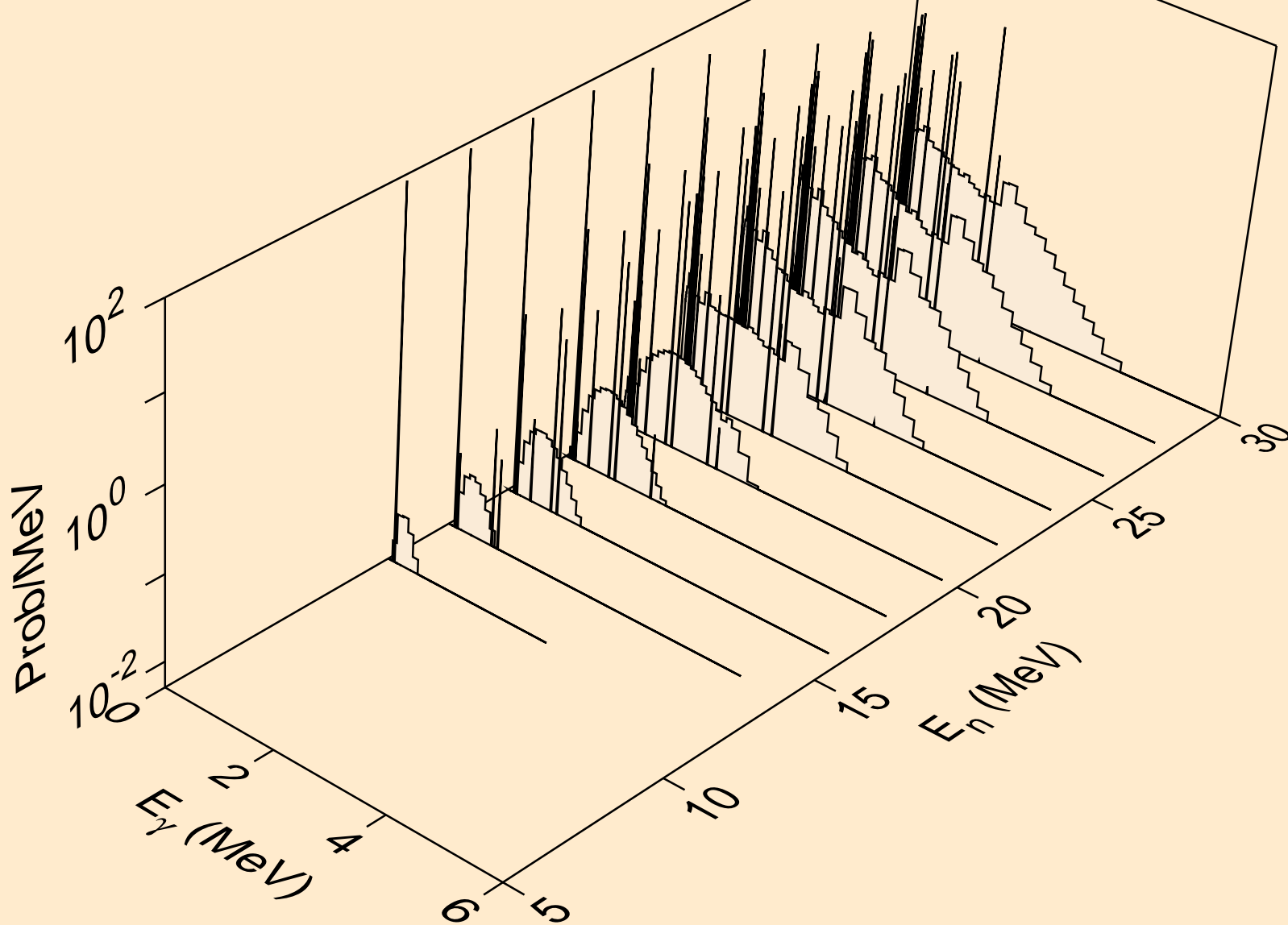

YB152 NEUTRON ACER TENDL-2019 LIBRARY; T=293.16K
Photon emission for (n,da)

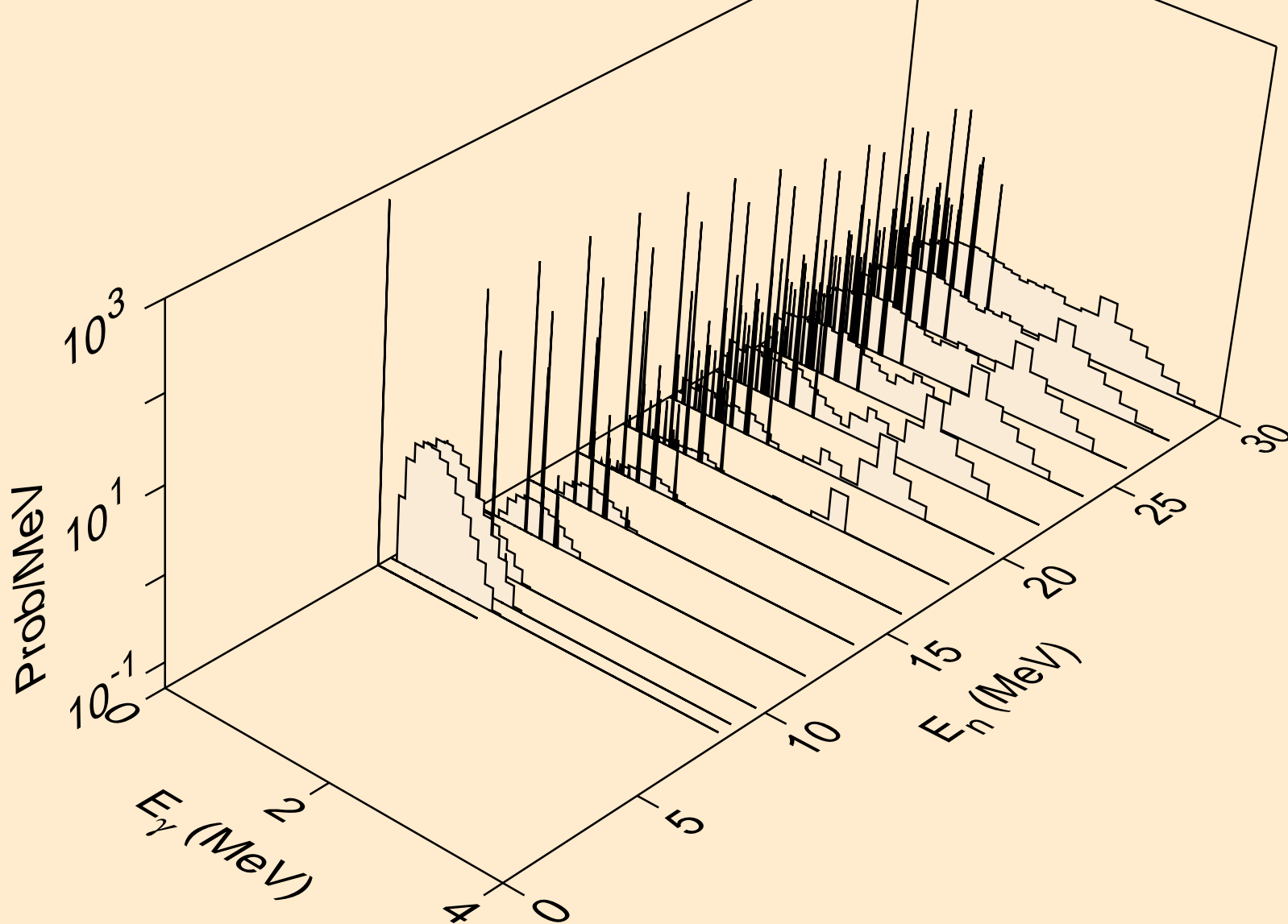

YB152 NEUTRON ACER TENDL-2019 LIBRARY; T=293.16K
thermal capture photon spectrum

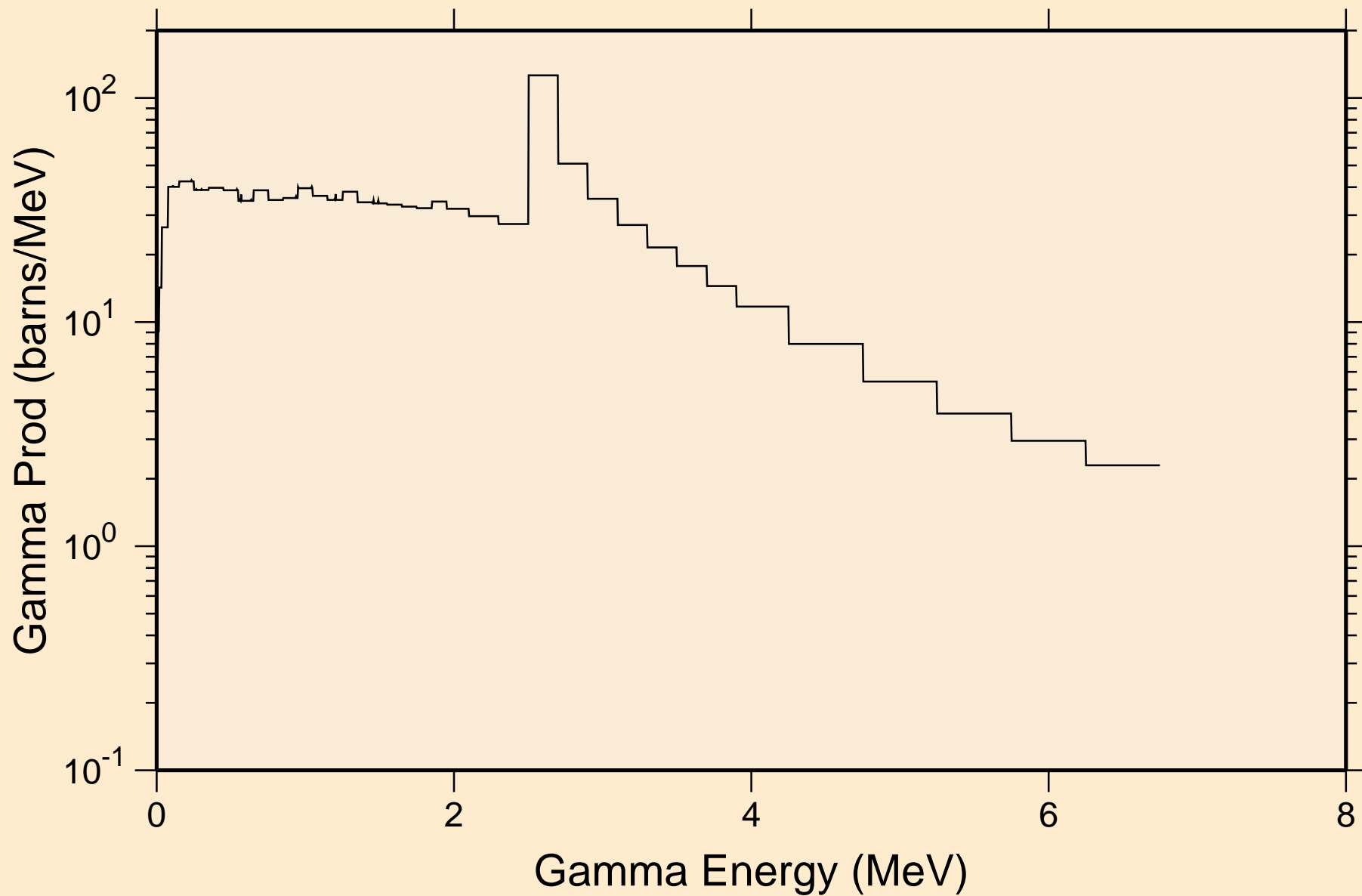

YB152 NEUTRON ACER TENDL-2019 LIBRARY; T=293.16K
14 MeV photon spectrum

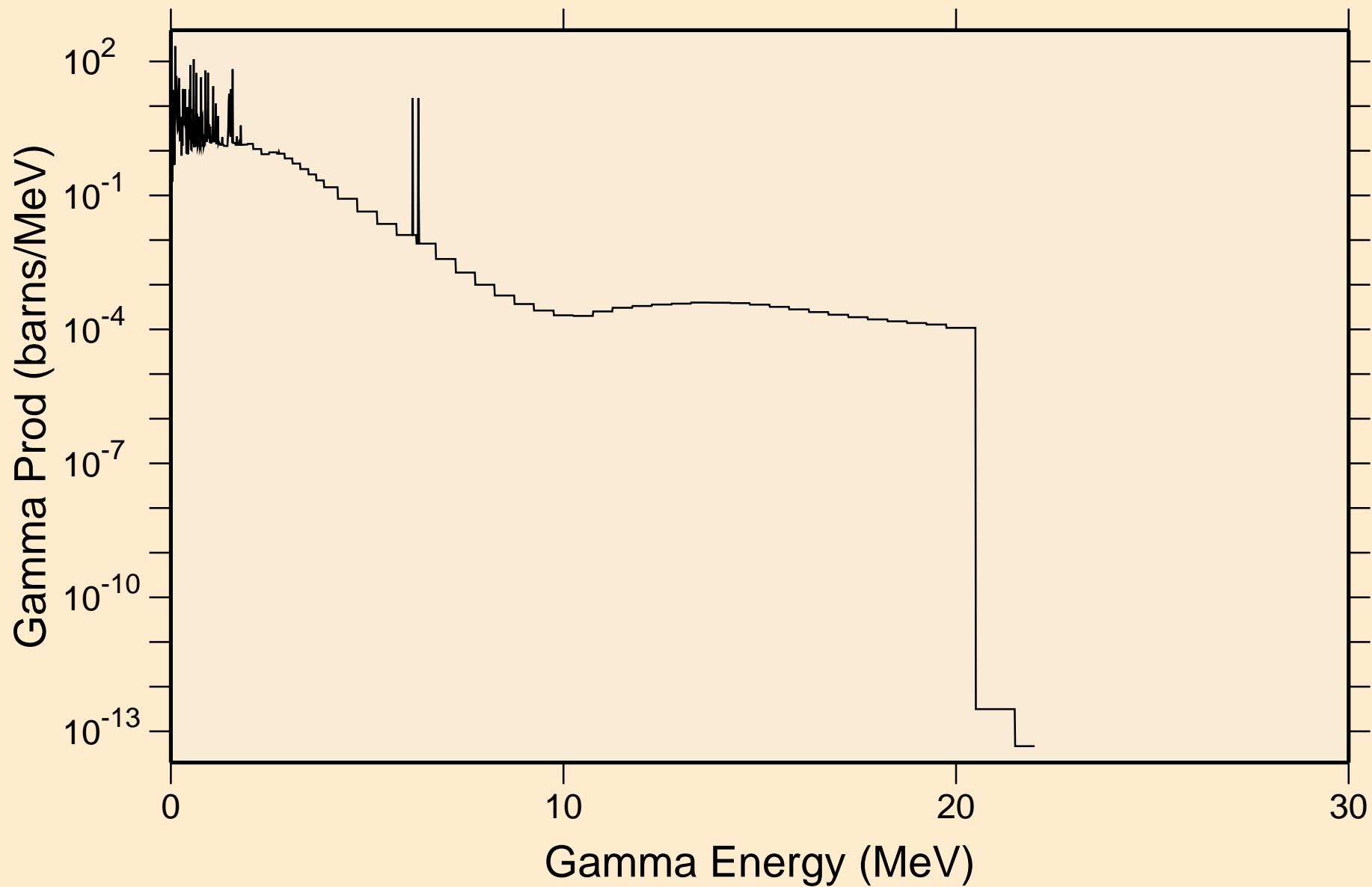

YB152 NEUTRON ACER TENDL-2019 LIBRARY; T=293.16K

Particle heating contributions

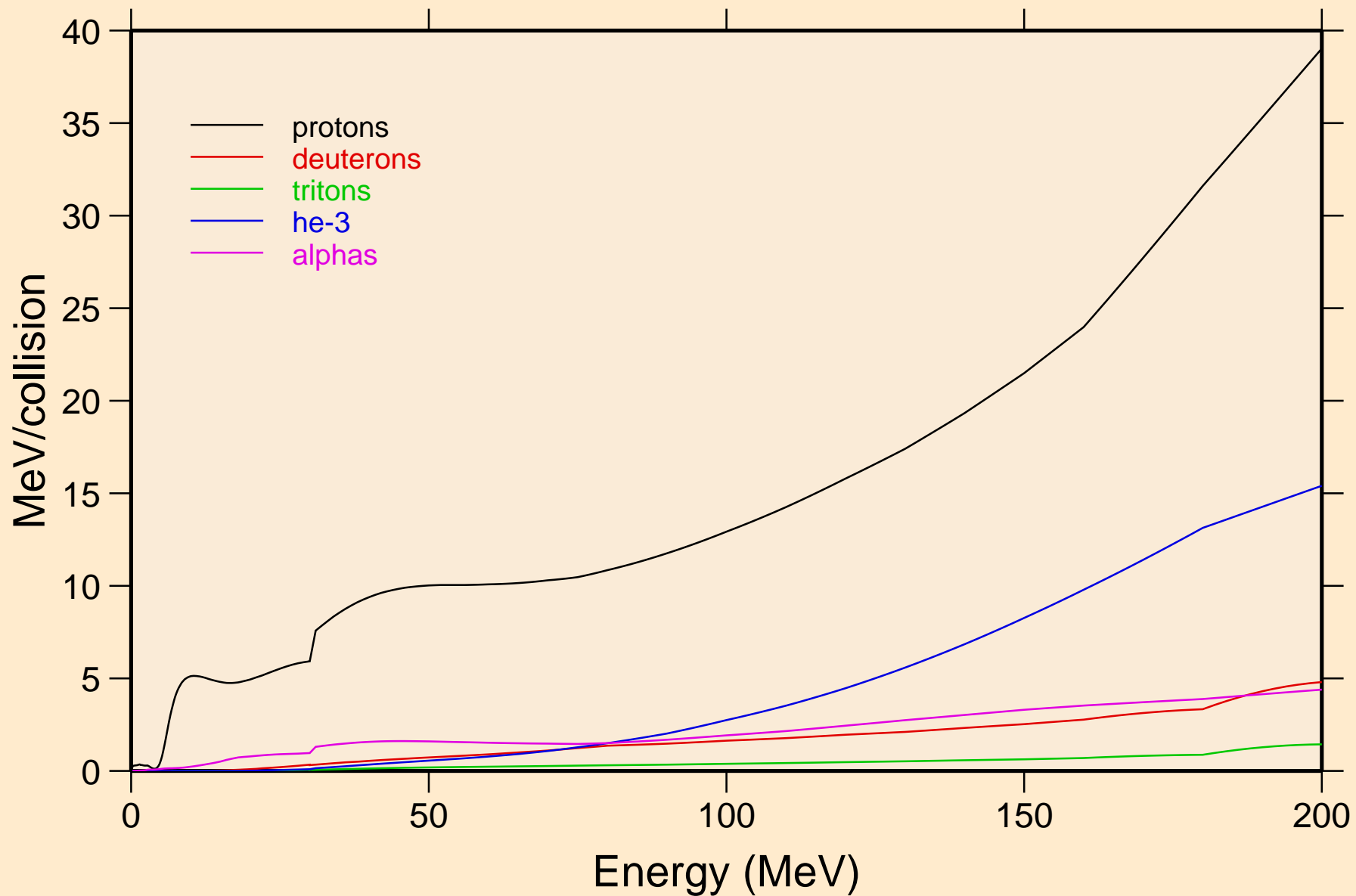

YB152 NEUTRON ACER TENDL-2019 LIBRARY; T=293.16K
Recoil Heating

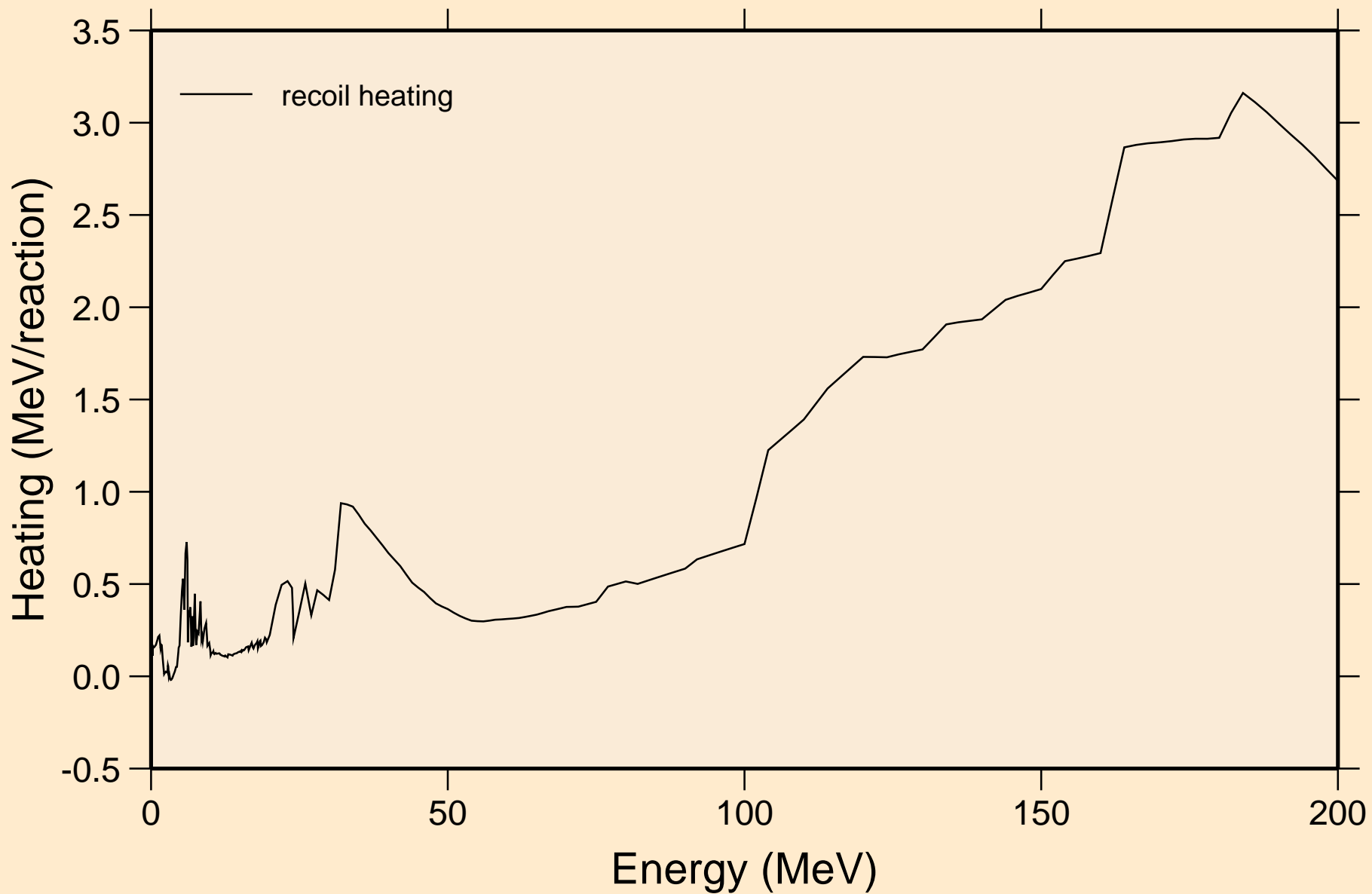

YB152 NEUTRON ACER TENDL-2019 LIBRARY; T=293.16K
Particle production cross sections

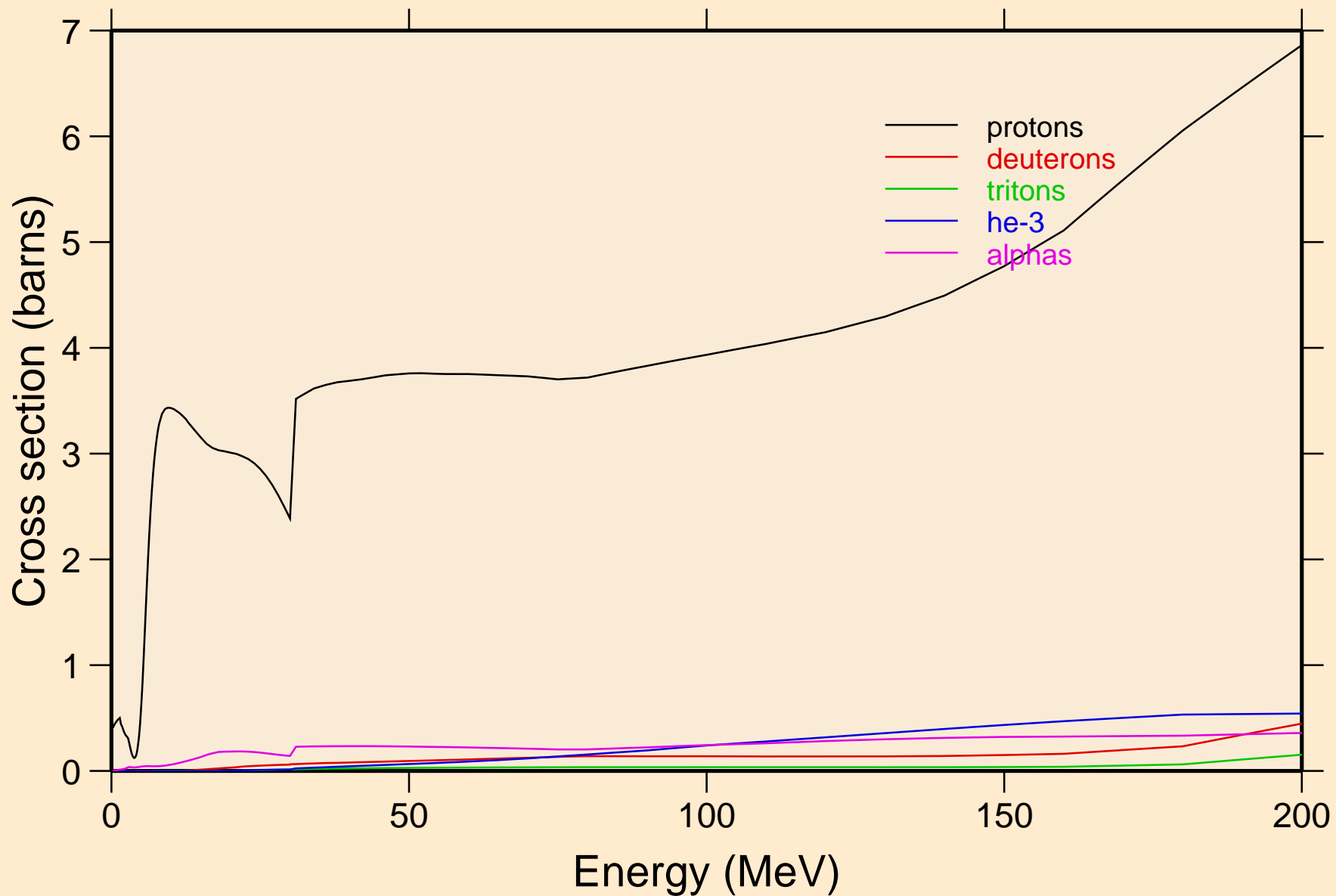

YB152 NEUTRON ACER TENDL-2019 LIBRARY; T=293.16K
protons from (n,x)

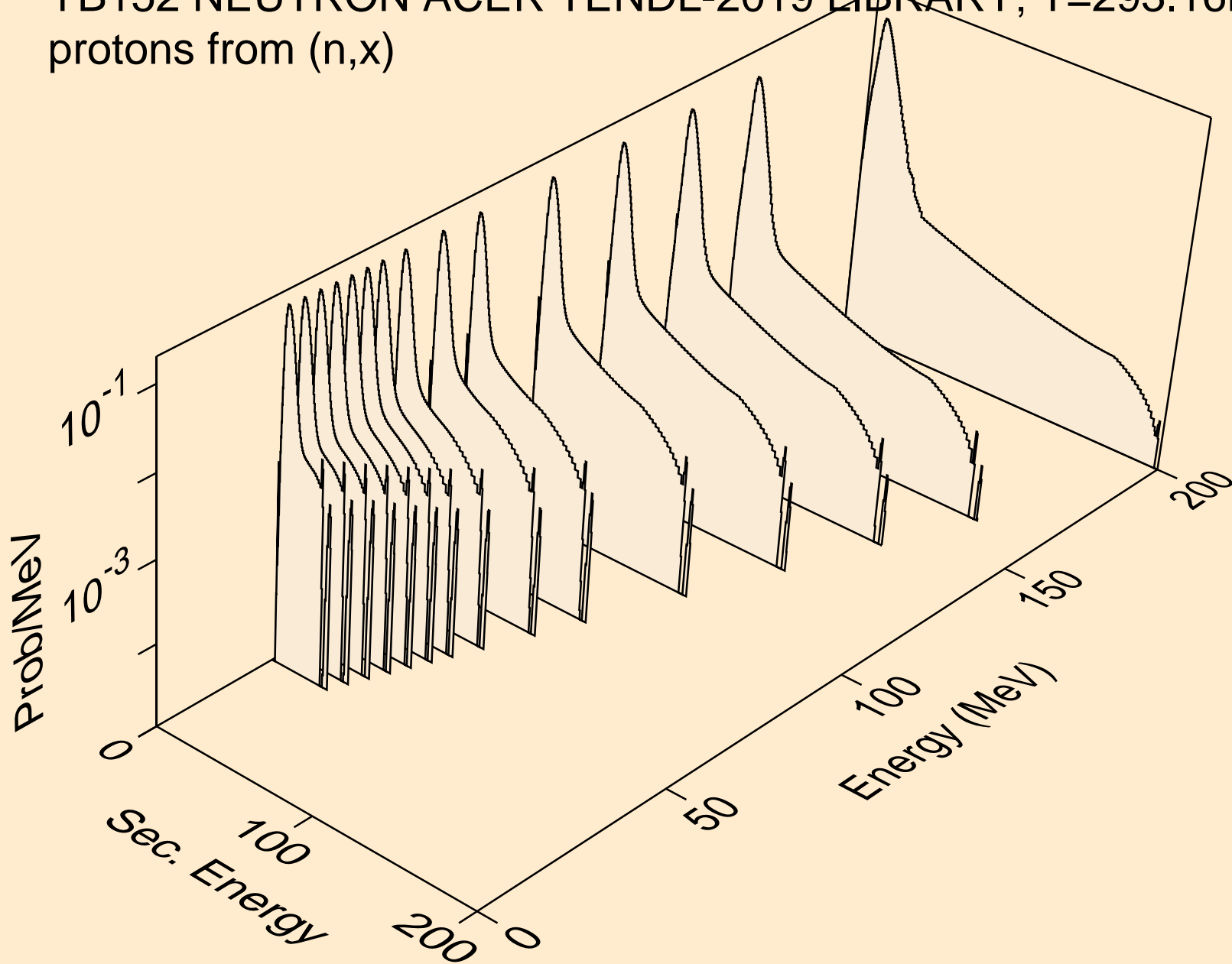

YB152 NEUTRON ACER TENDL-2019 LIBRARY; T=293.16K
protons from (n,n*)p

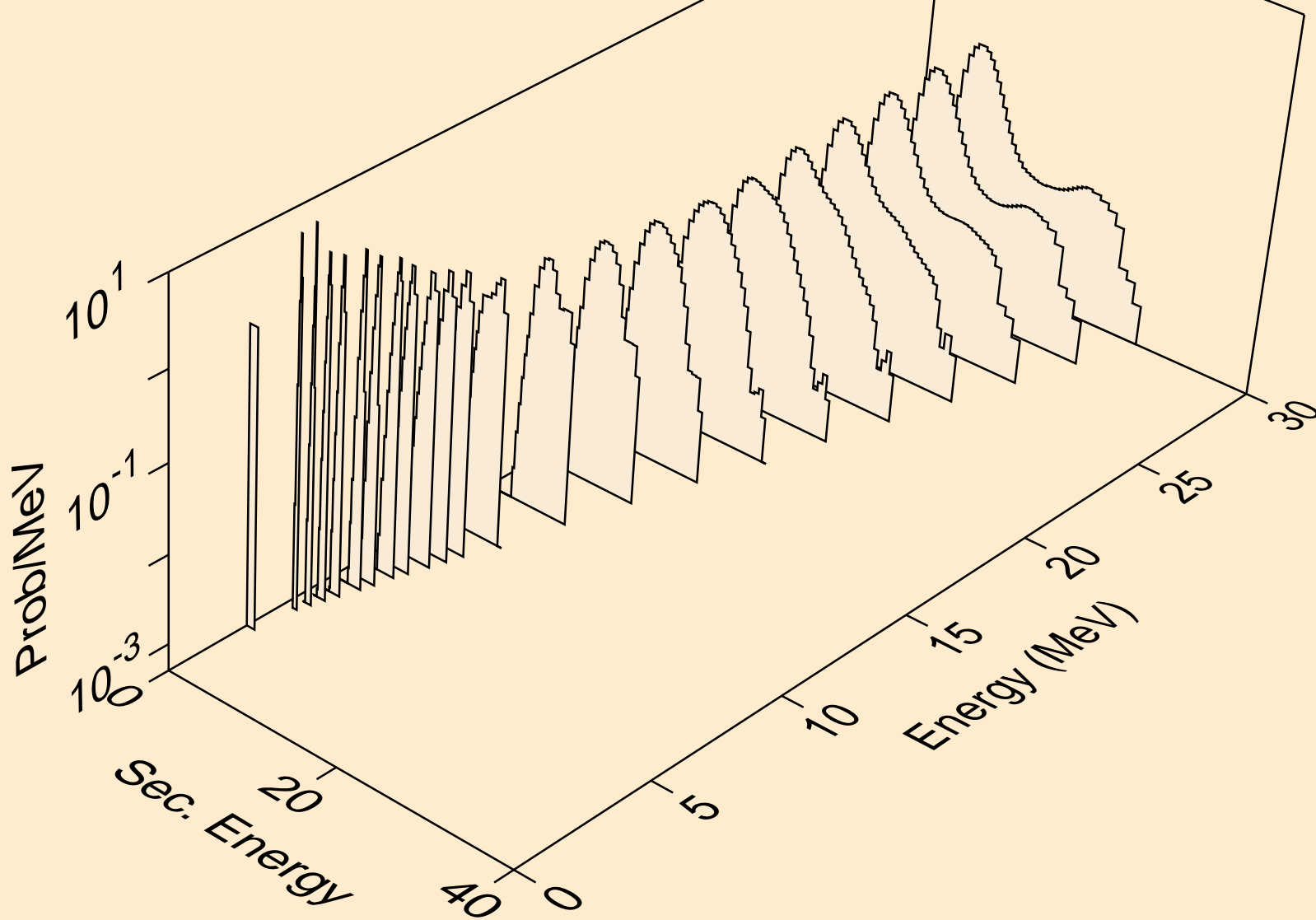

YB152 NEUTRON ACER TENDL-2019 LIBRARY; T=293.16K
protons from (n,2np)

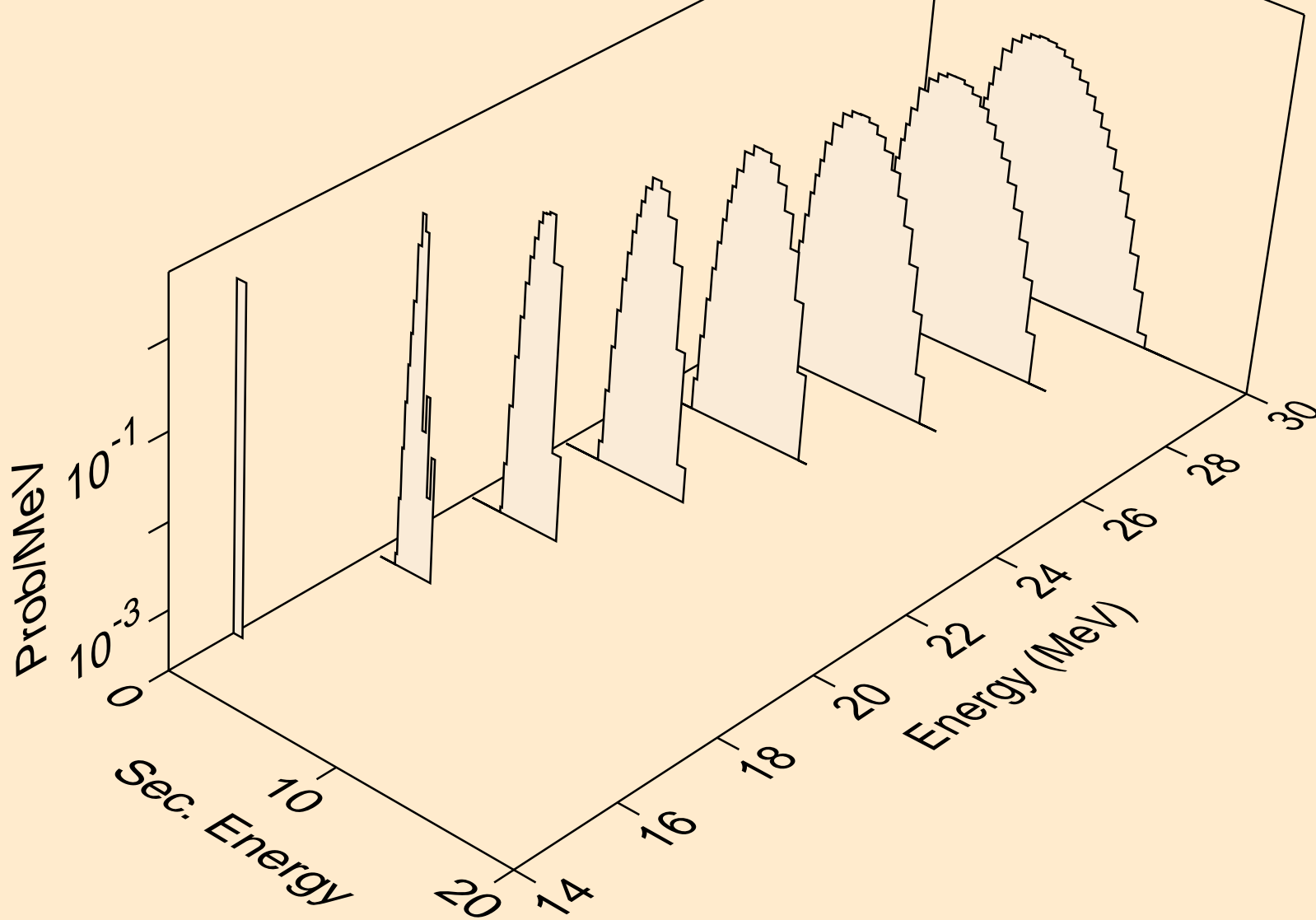

YB152 NEUTRON ACER TENDL-2019 LIBRARY; T=293.16K
protons from (n,3np)

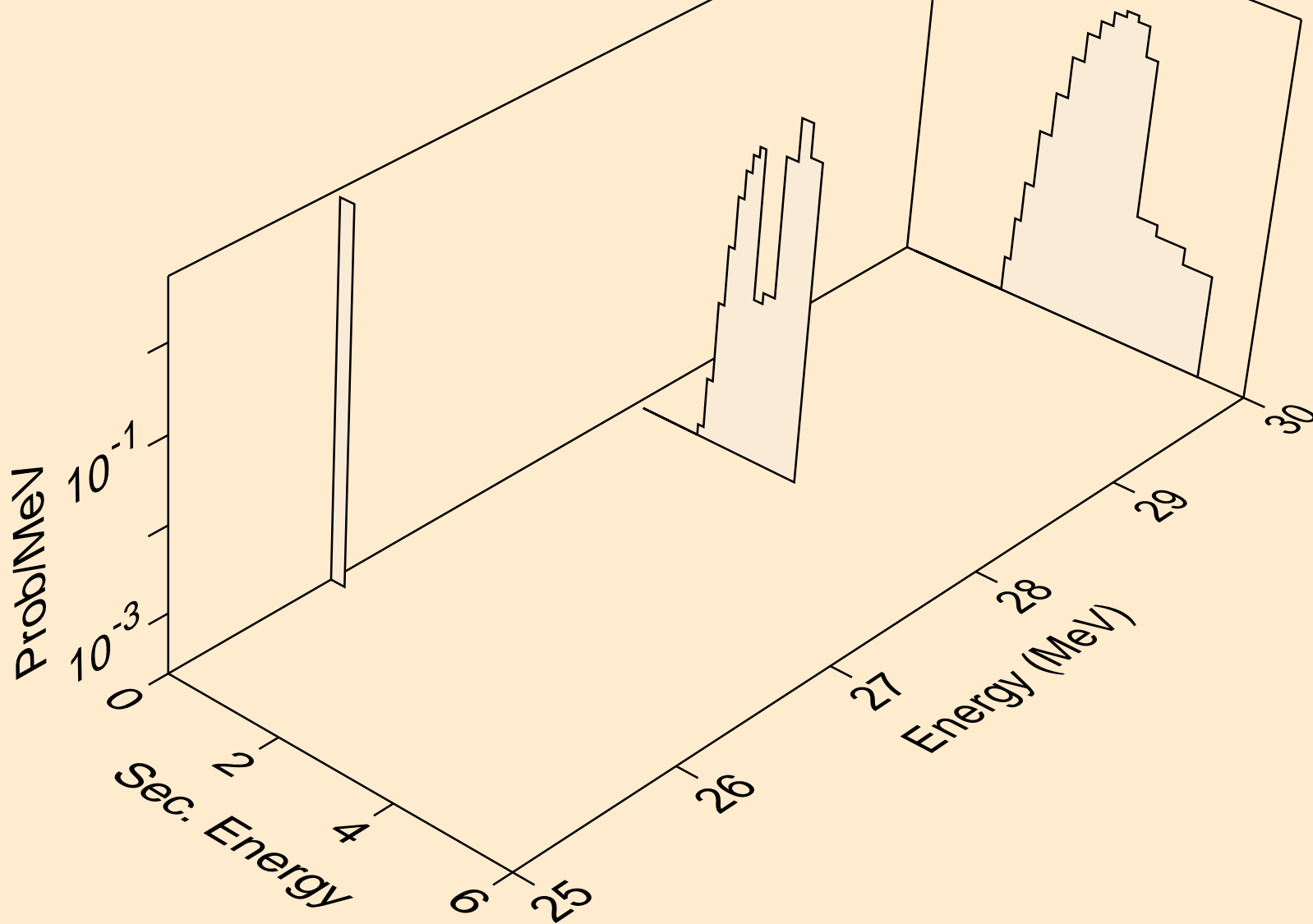

YB152 NEUTRON ACER TENDL-2019 LIBRARY; T=293.16K
protons from (n,2np)

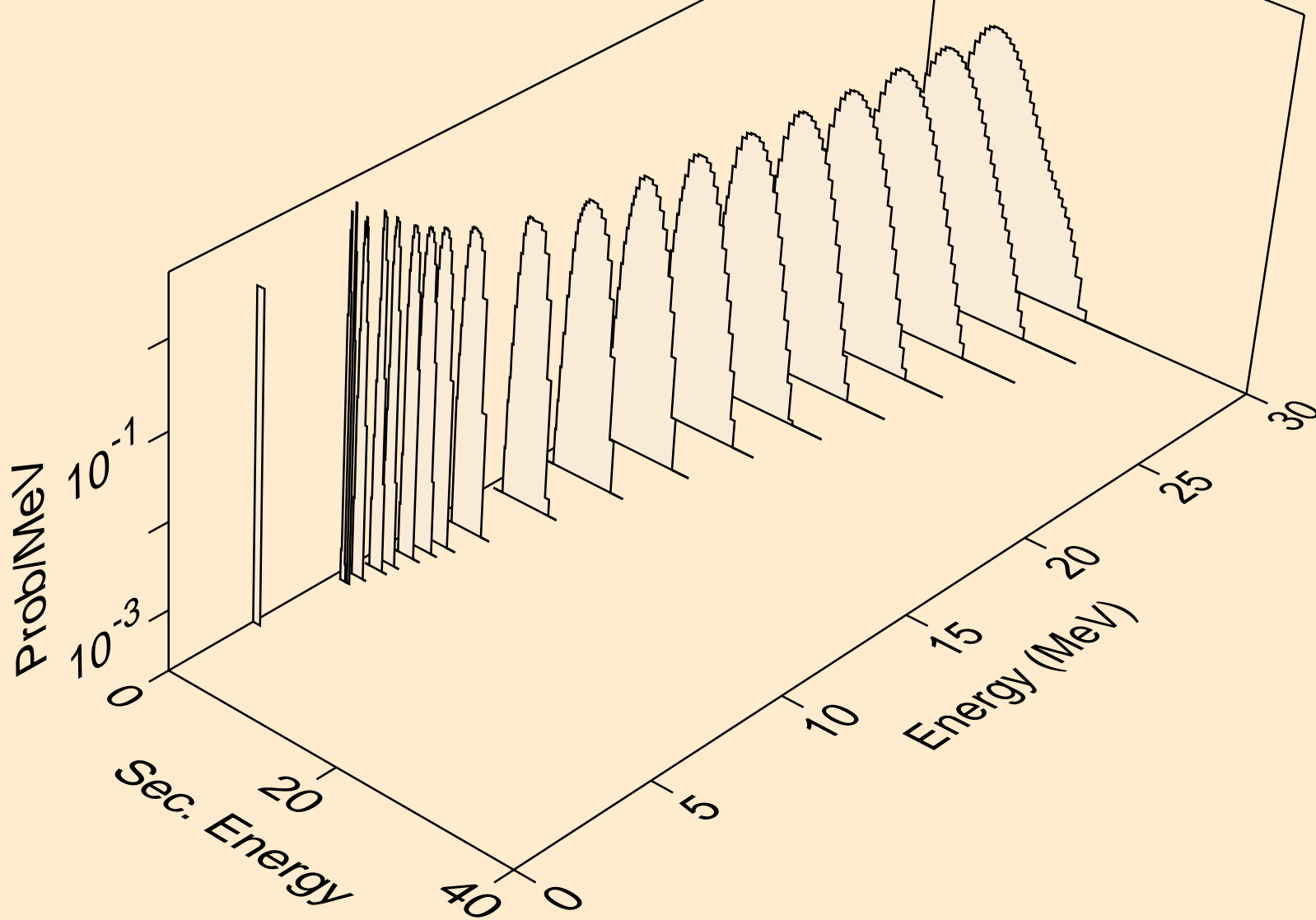

YB152 NEUTRON ACER TENDL-2019 LIBRARY; T=293.16K
protons from (n,npa)

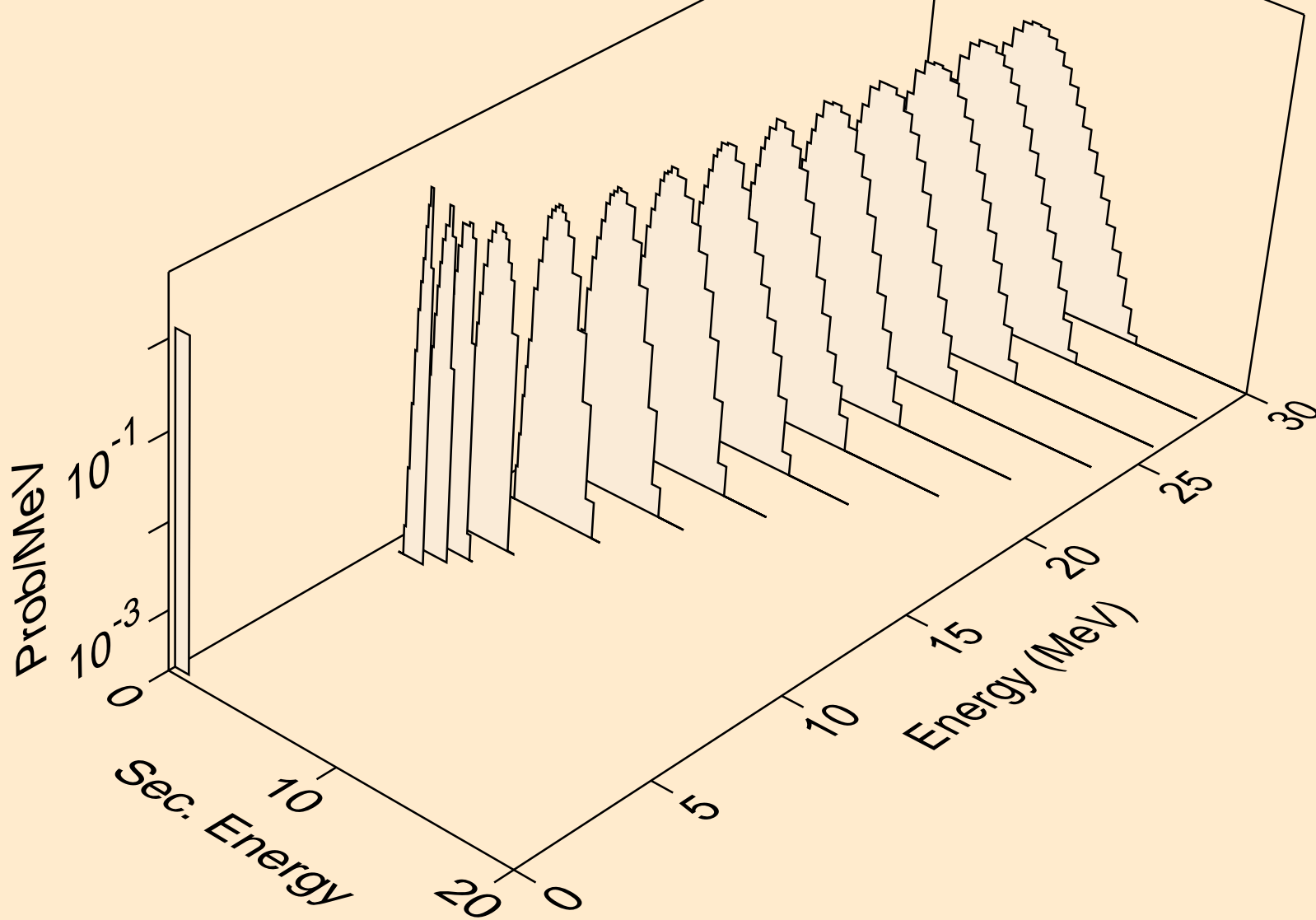

YB152 NEUTRON ACER TENDL-2019 LIBRARY; T=293.16K
protons from (n,p)

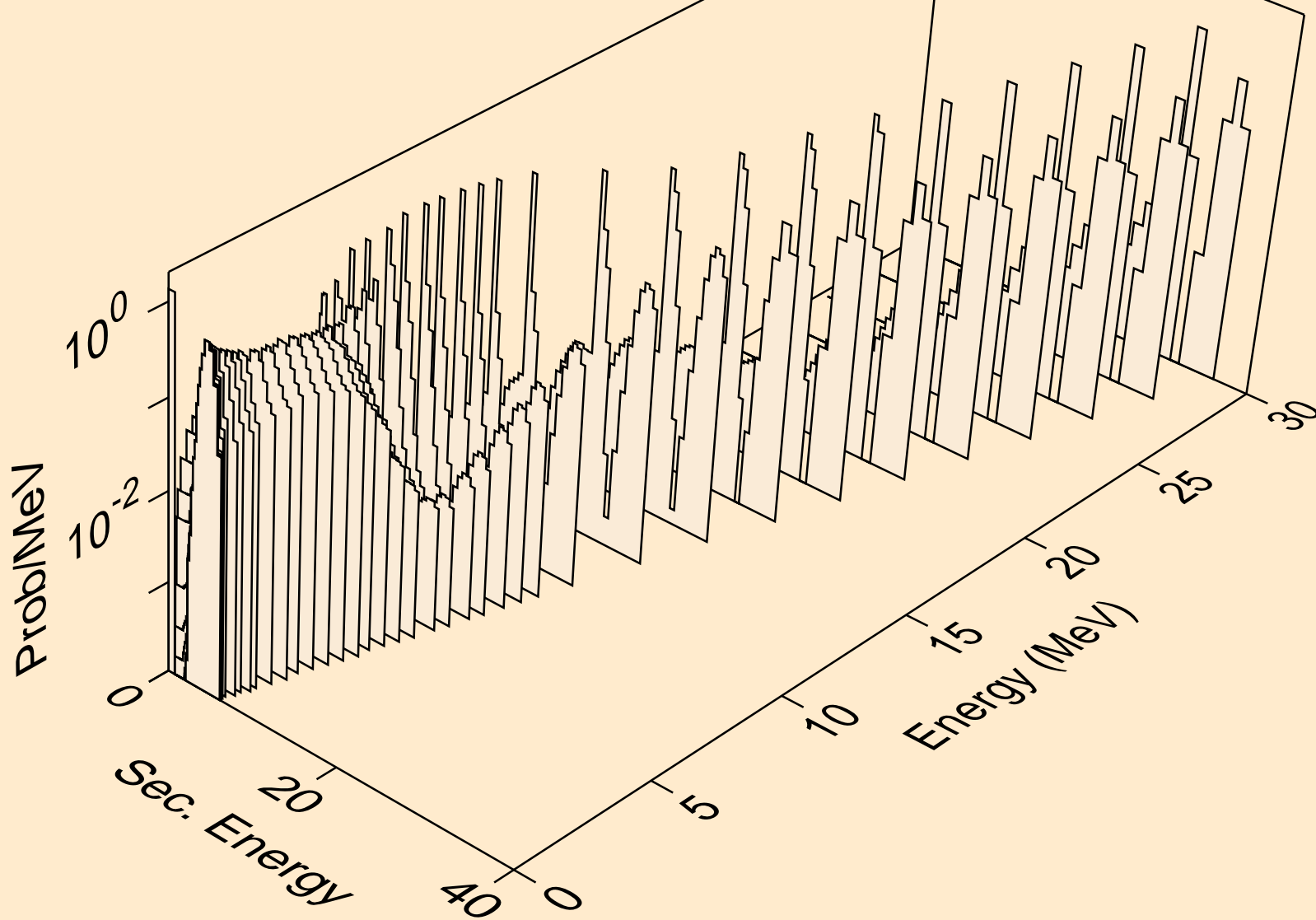

YB152 NEUTRON ACER TENDL-2019 LIBRARY; T=293.16K
protons from (n,2p)

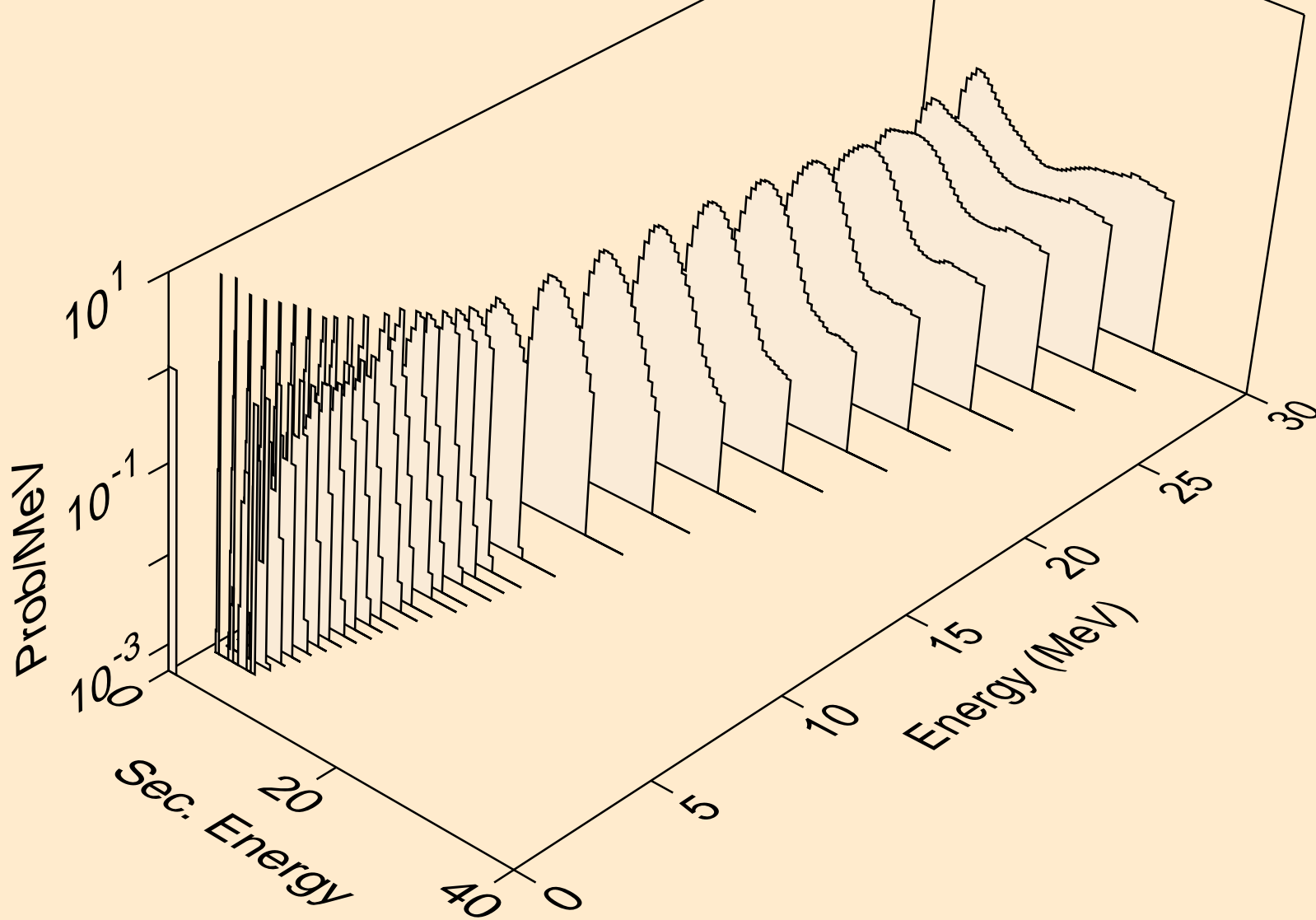

YB152 NEUTRON ACER TENDL-2019 LIBRARY; T=293.16K
protons from (n,p)

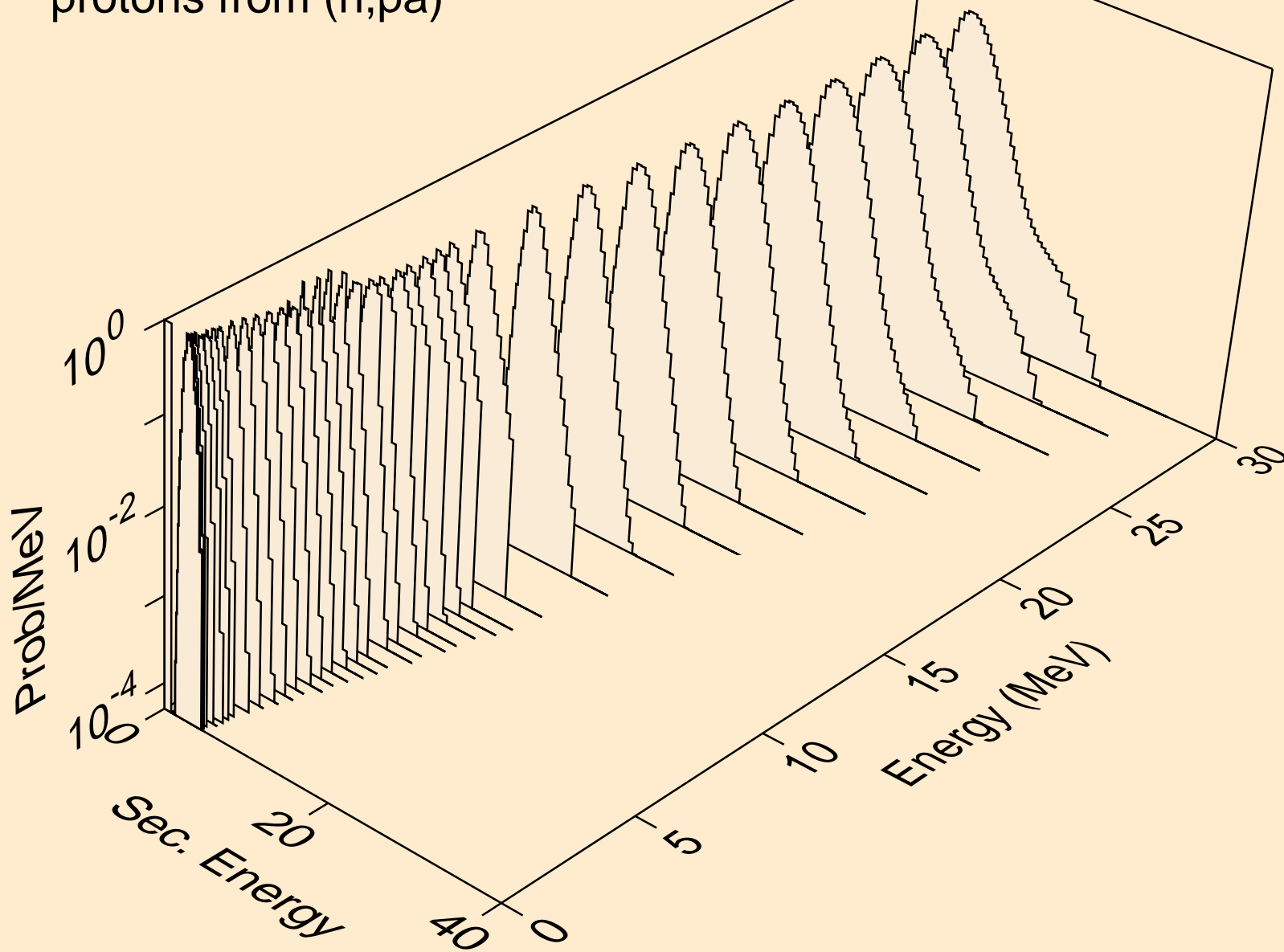

YB152 NEUTRON ACER TENDL-2019 LIBRARY; T=293.16K
protons from (n,pd)

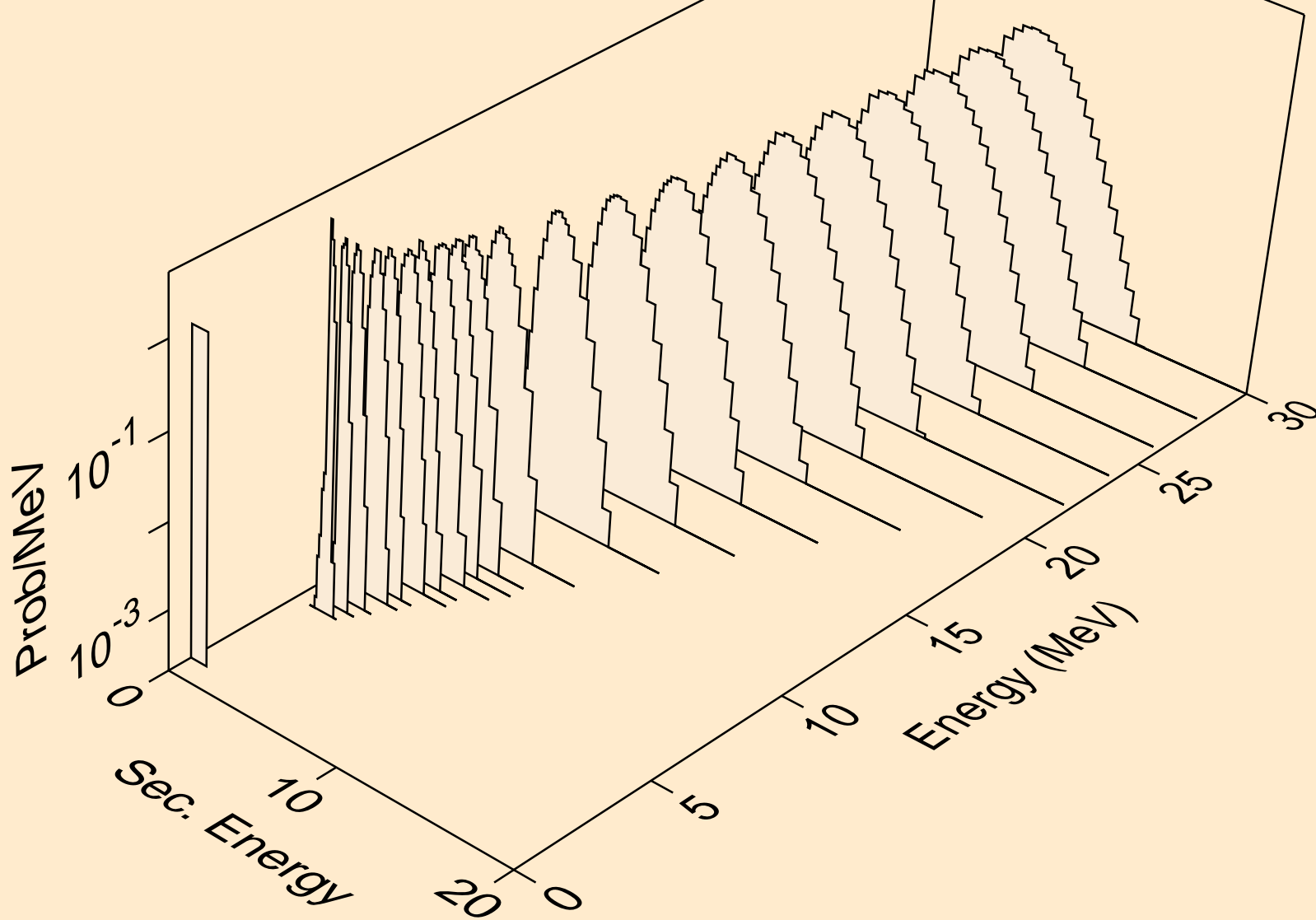

YB152 NEUTRON ACER TENDL-2019 LIBRARY; T=293.16K
protons from (n,pt)

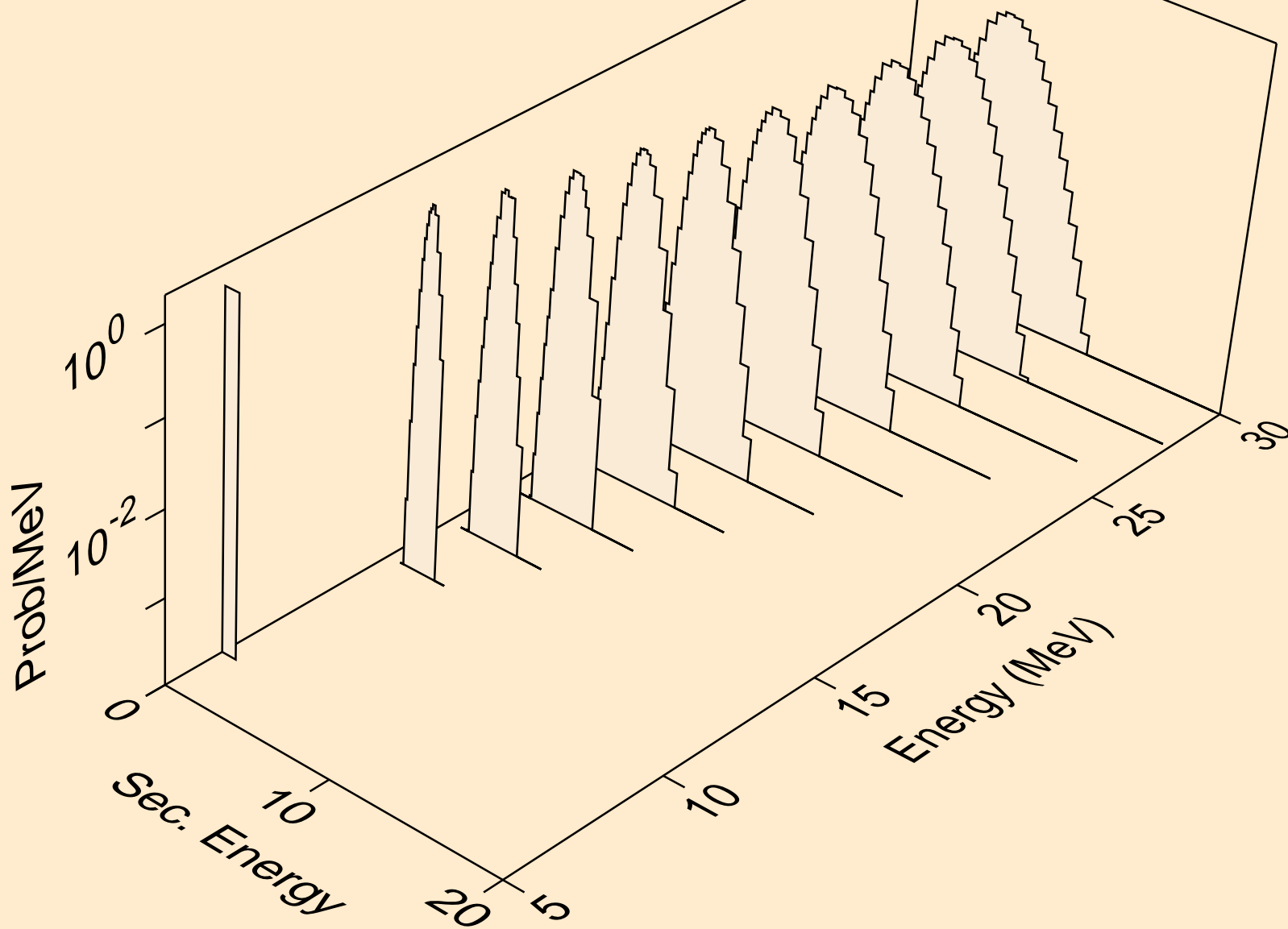

YB152 NEUTRON ACER TENDL-2019 LIBRARY; T=293.16K
deuterons from (n,x)

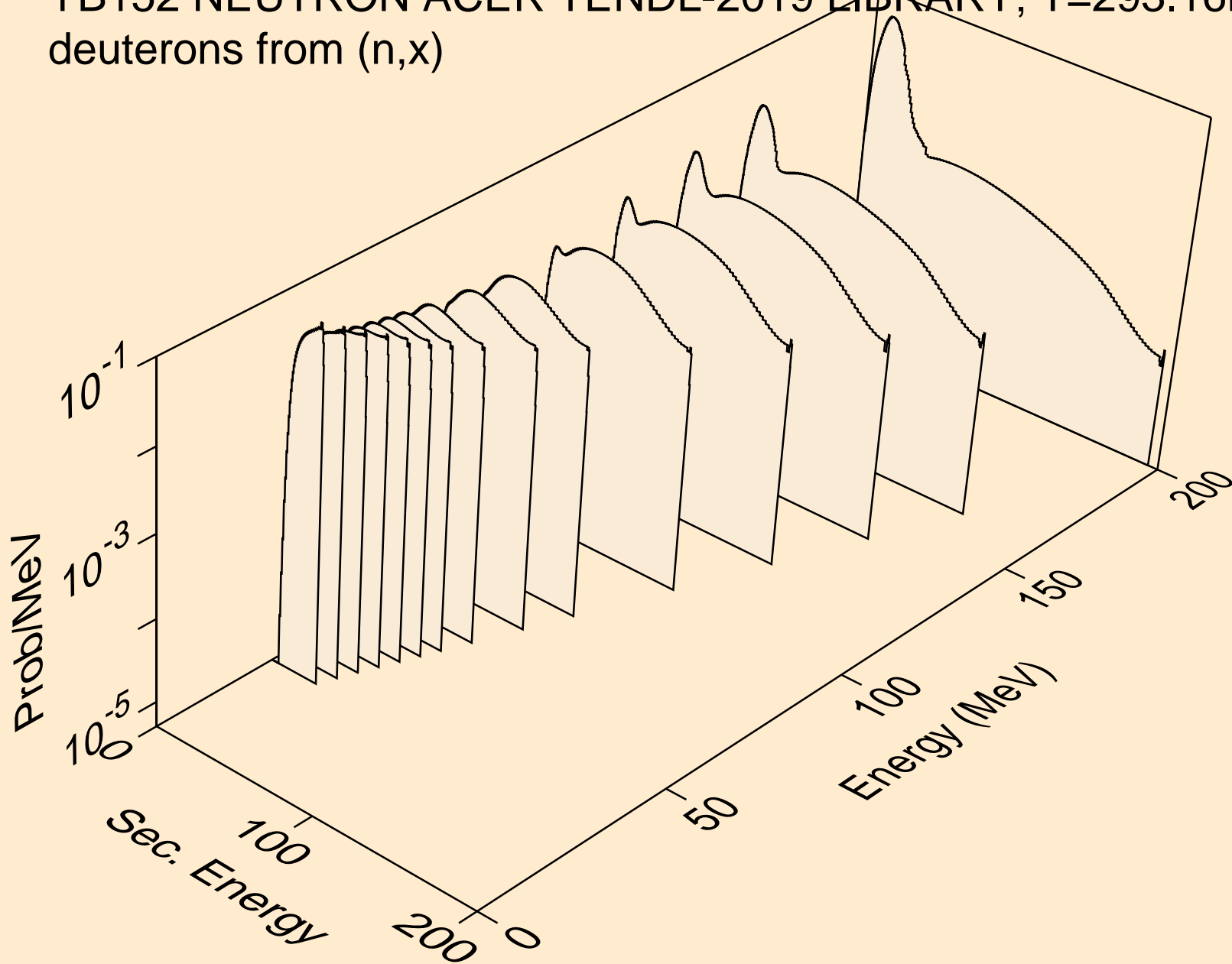

YB152 NEUTRON ACER TENDL-2019 LIBRARY; T=293.16K
deuterons from (n,2nd)

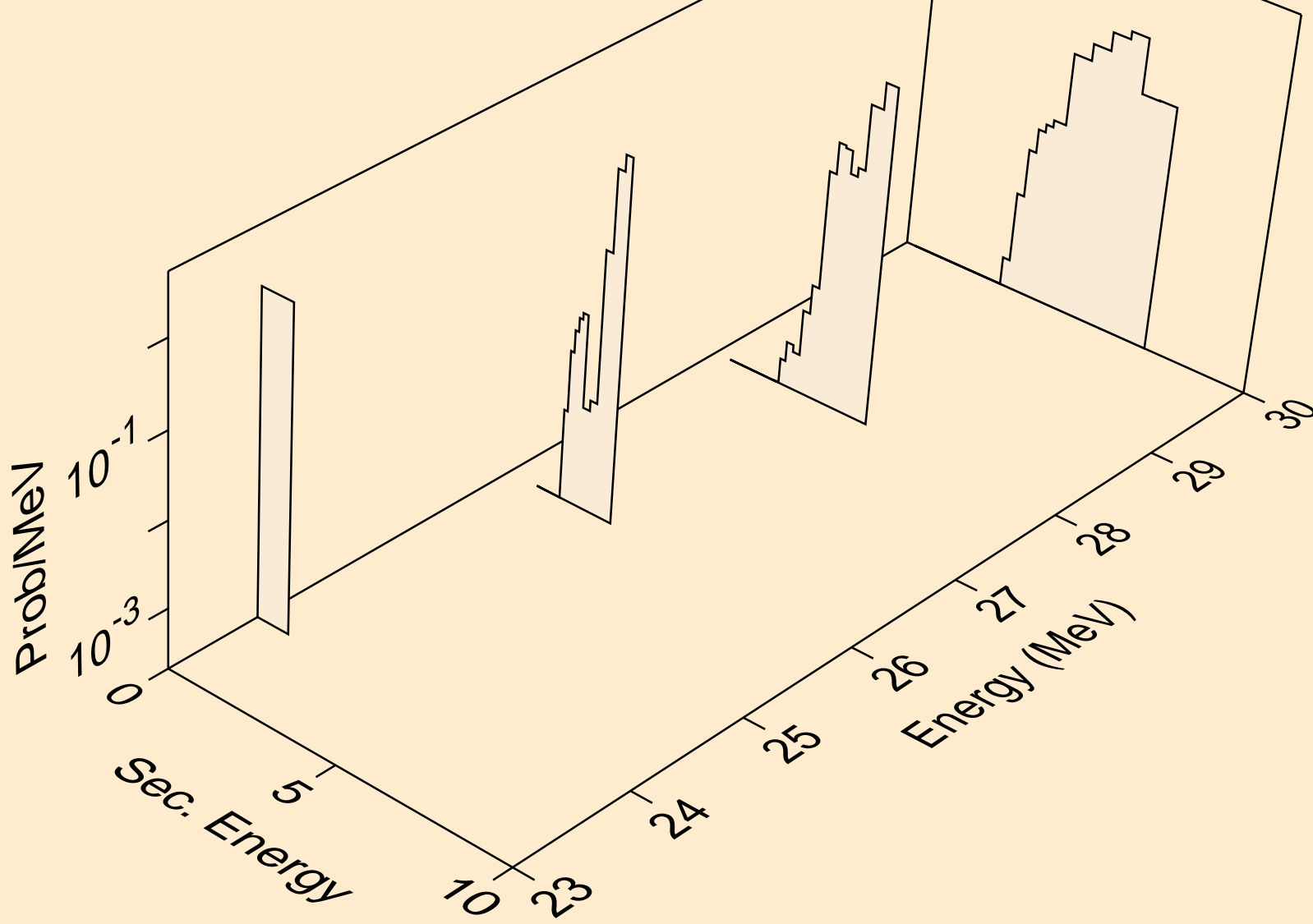

YB152 NEUTRON ACER TENDL-2019 LIBRARY; T=293.16K
deuterons from (n,n*)d

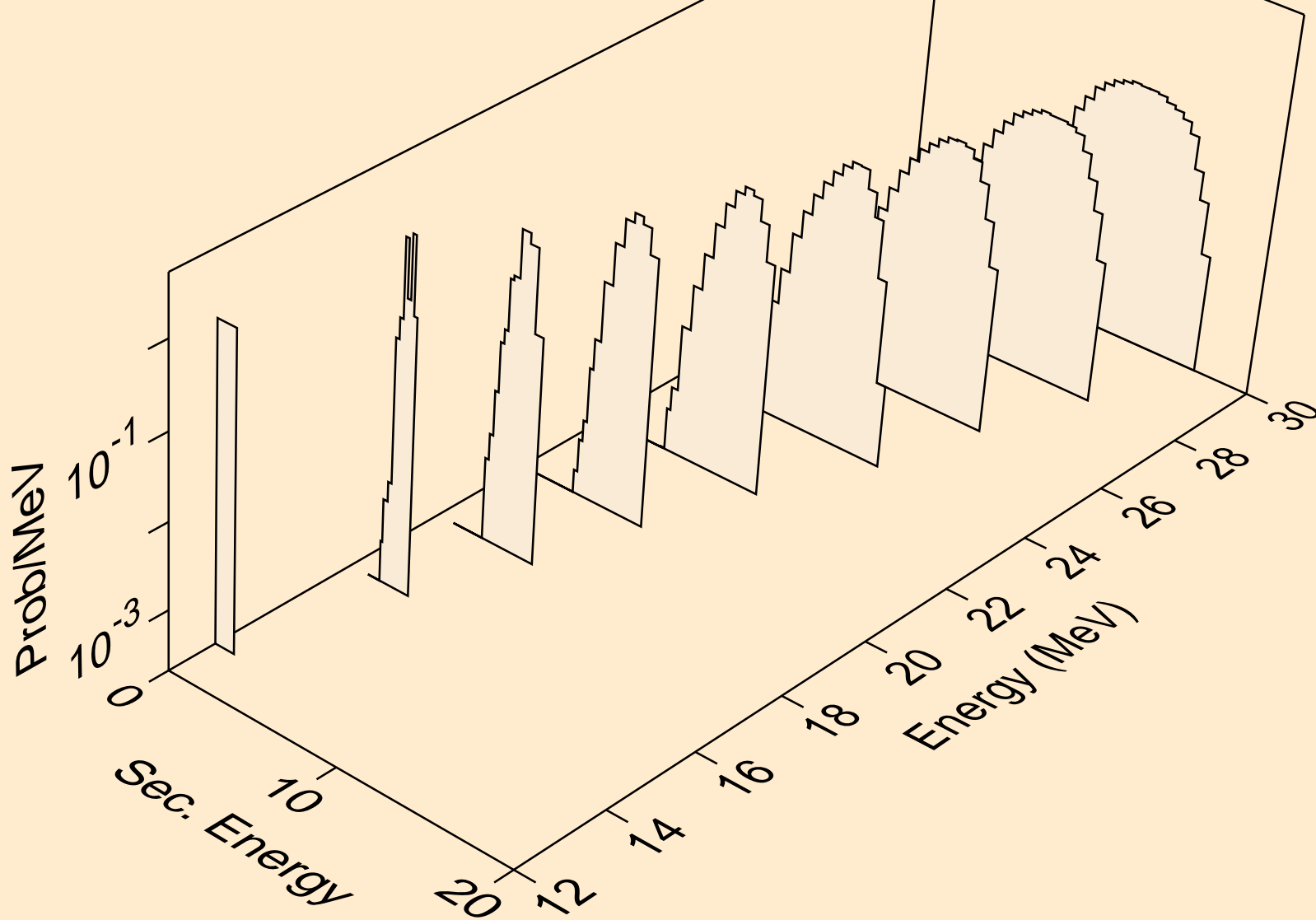

YB152 NEUTRON ACER TENDL-2019 LIBRARY; T=293.16K
deuterons from (n,d)

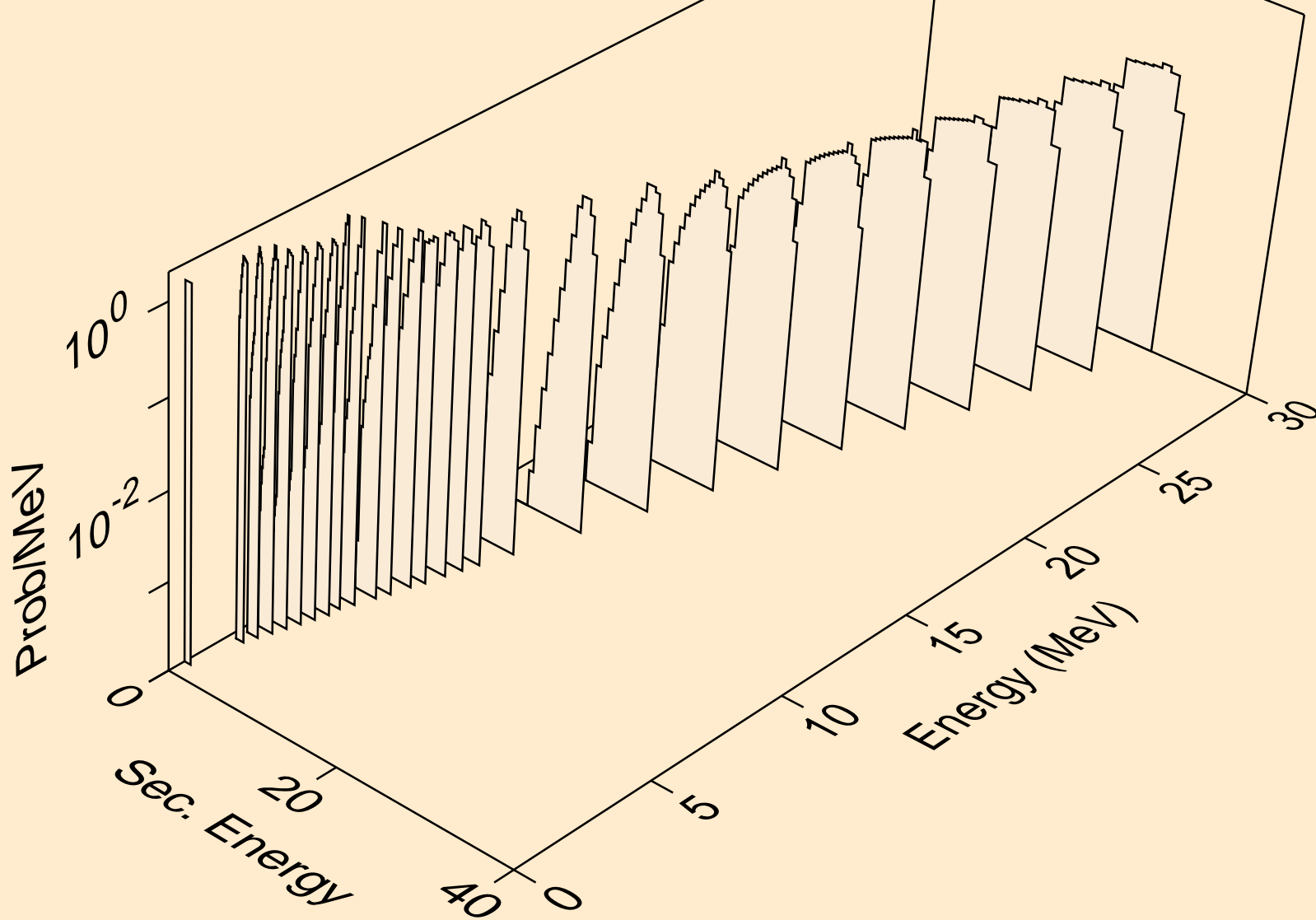

YB152 NEUTRON ACER TENDL-2019 LIBRARY; T=293.16K
deuterons from (n,pd)

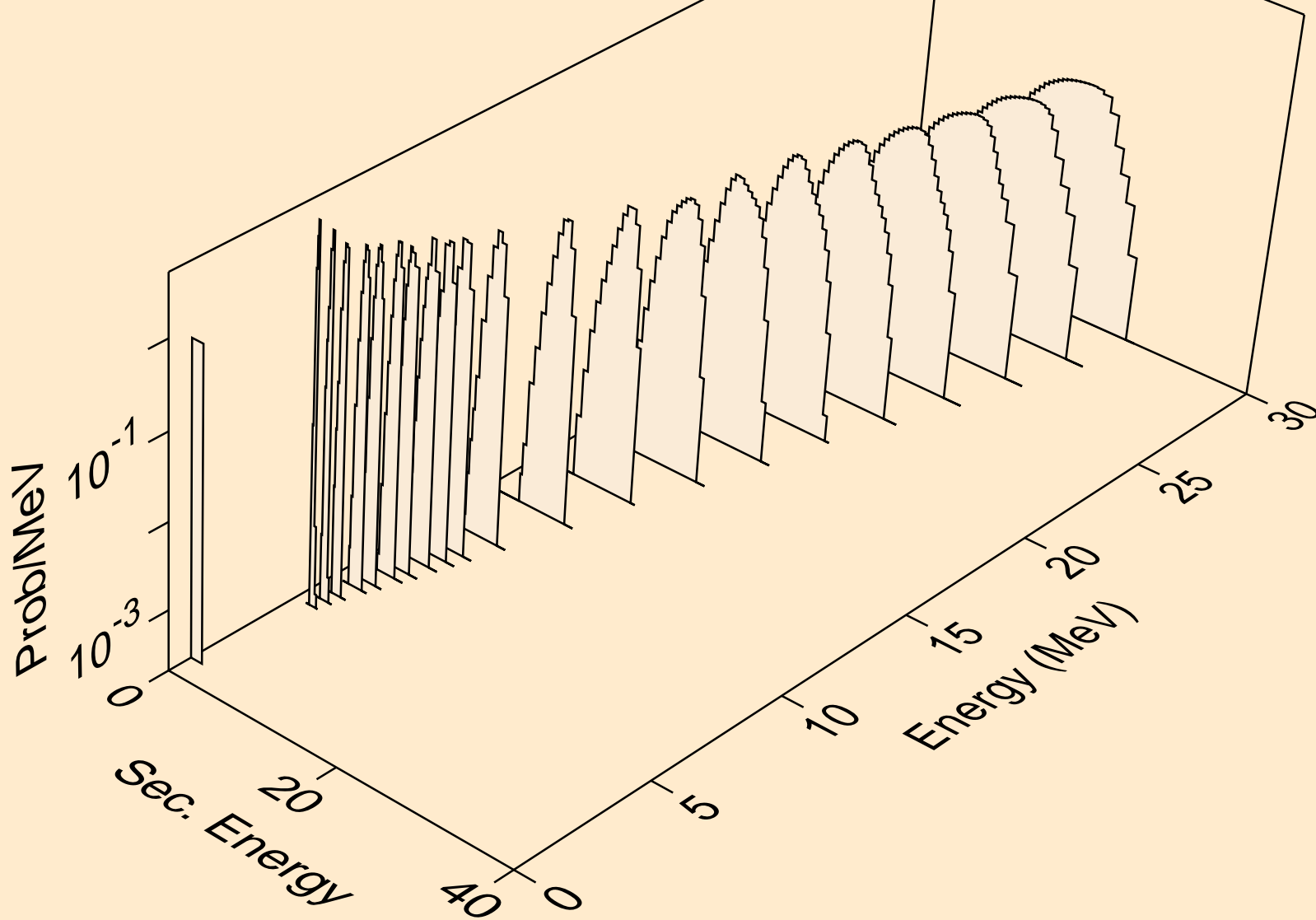

YB152 NEUTRON ACER TENDL-2019 LIBRARY; T=293.16K
deuterons from (n,da)

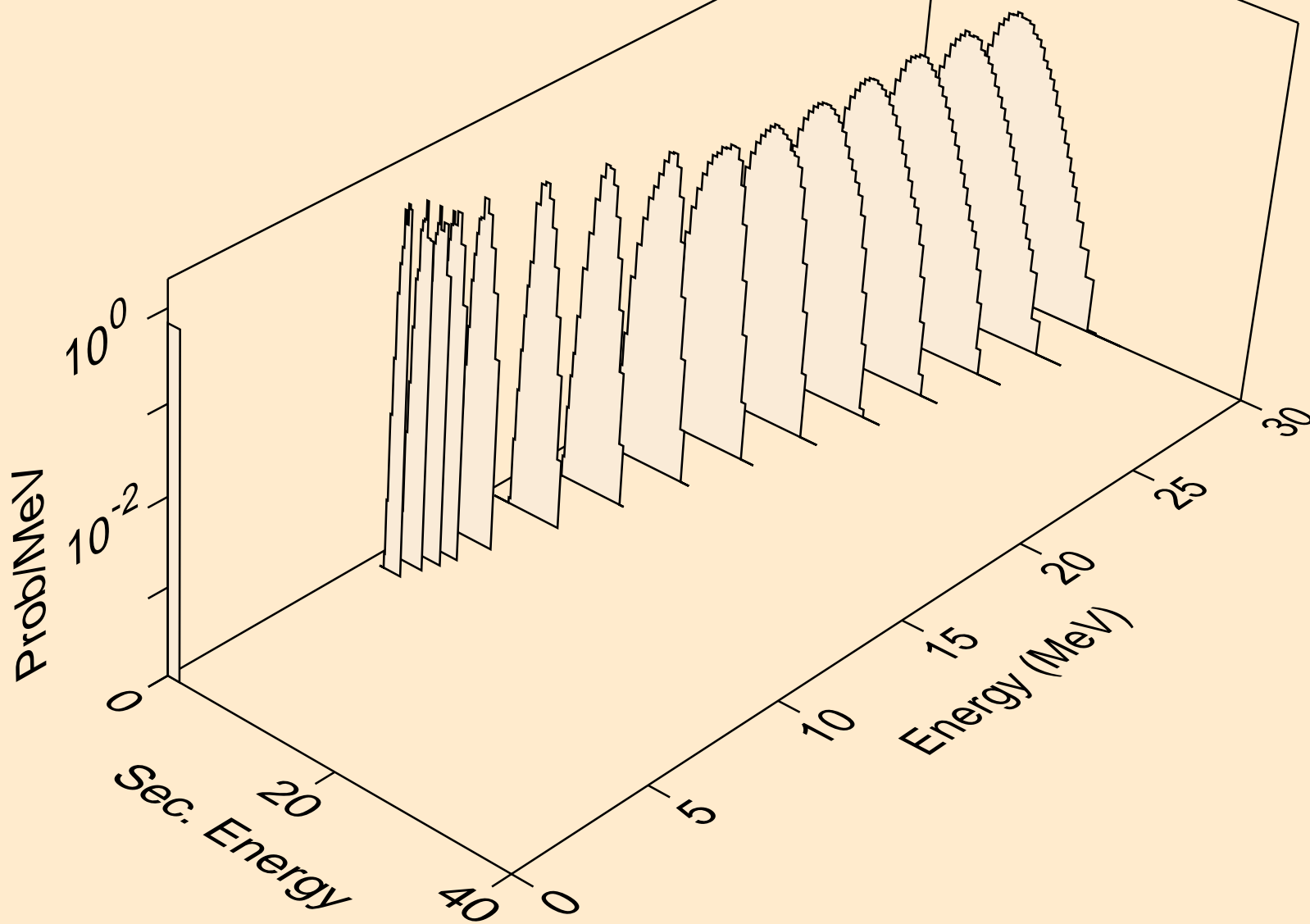

YB152 NEUTRON ACER TENDL-2019 LIBRARY; T=293.16K
tritons from (n,x)

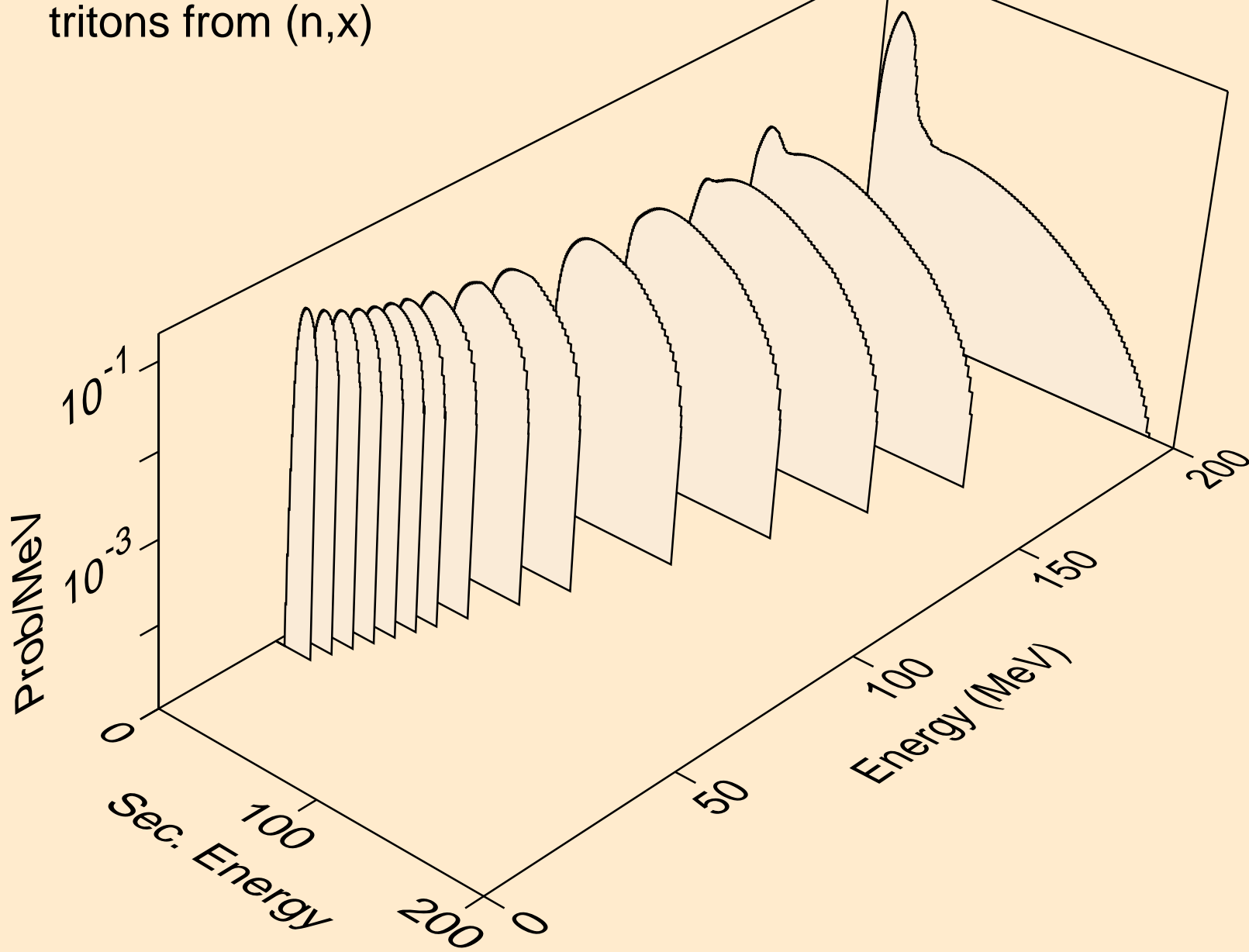

YB152 NEUTRON ACER TENDL-2019 LIBRARY; T=293.16K
tritons from (n,n*)t

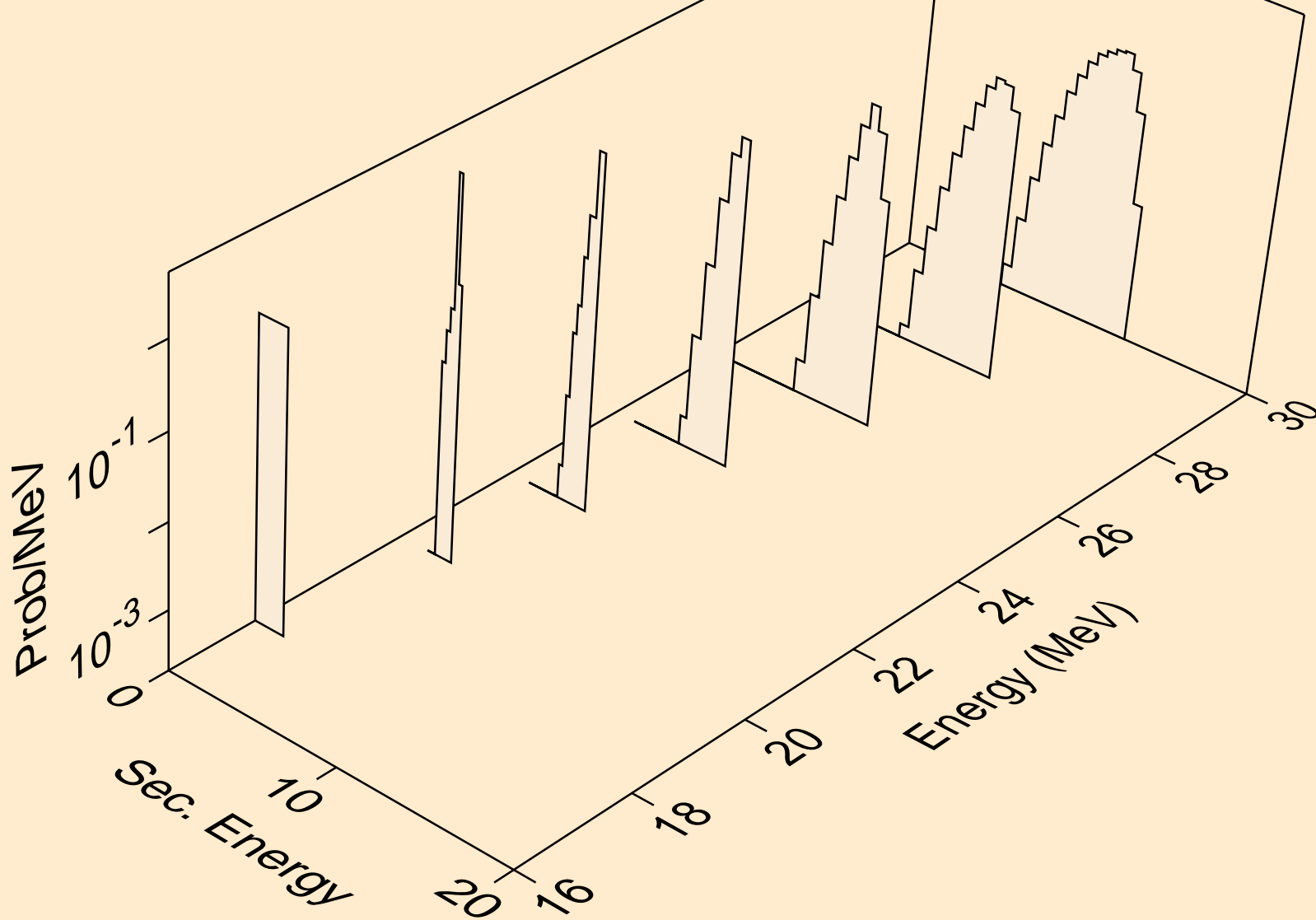

YB152 NEUTRON ACER TENDL-2019 LIBRARY; T=293.16K
tritons from (n,t)

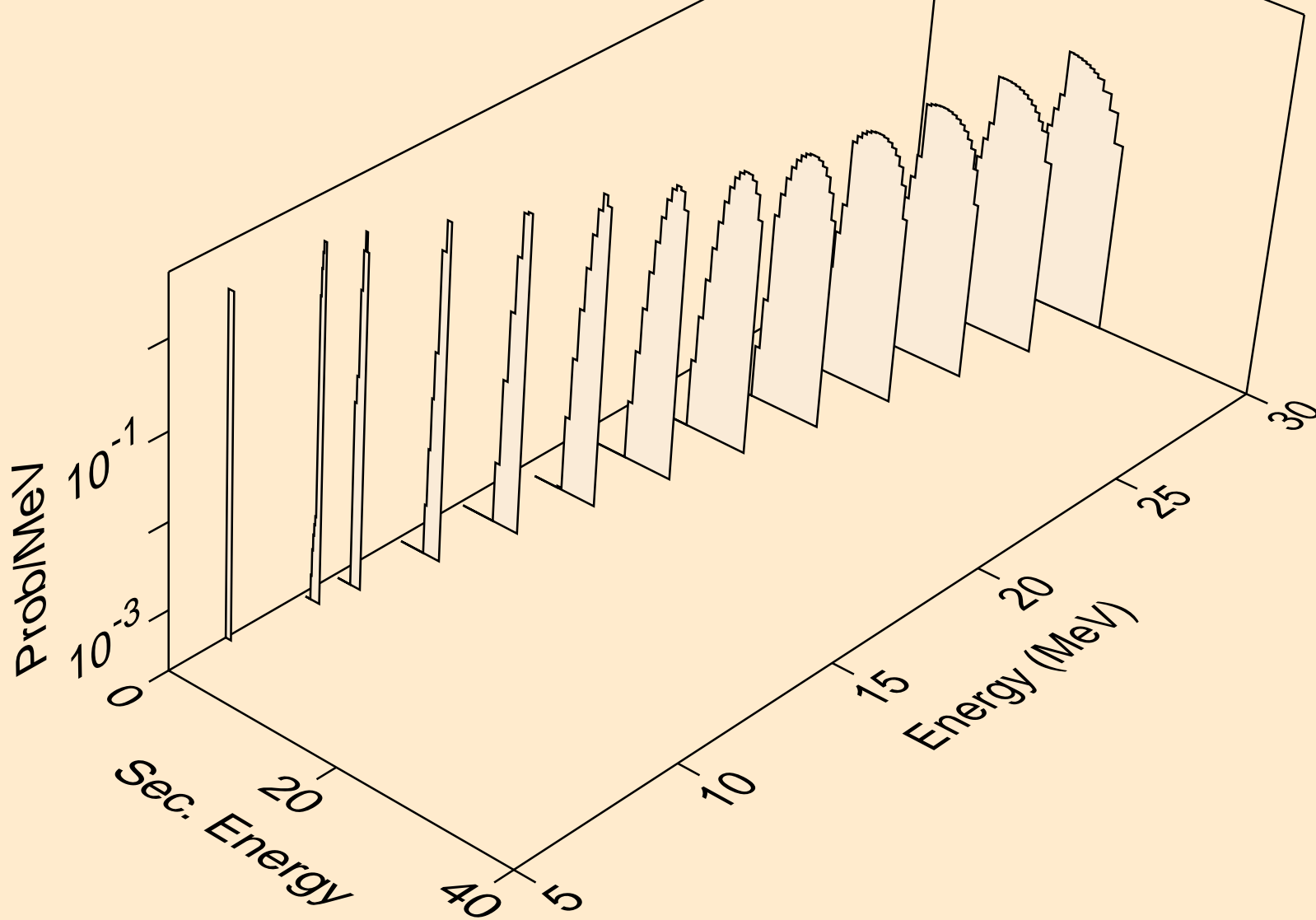

YB152 NEUTRON ACER TENDL-2019 LIBRARY; T=293.16K
tritons from (n,pt)

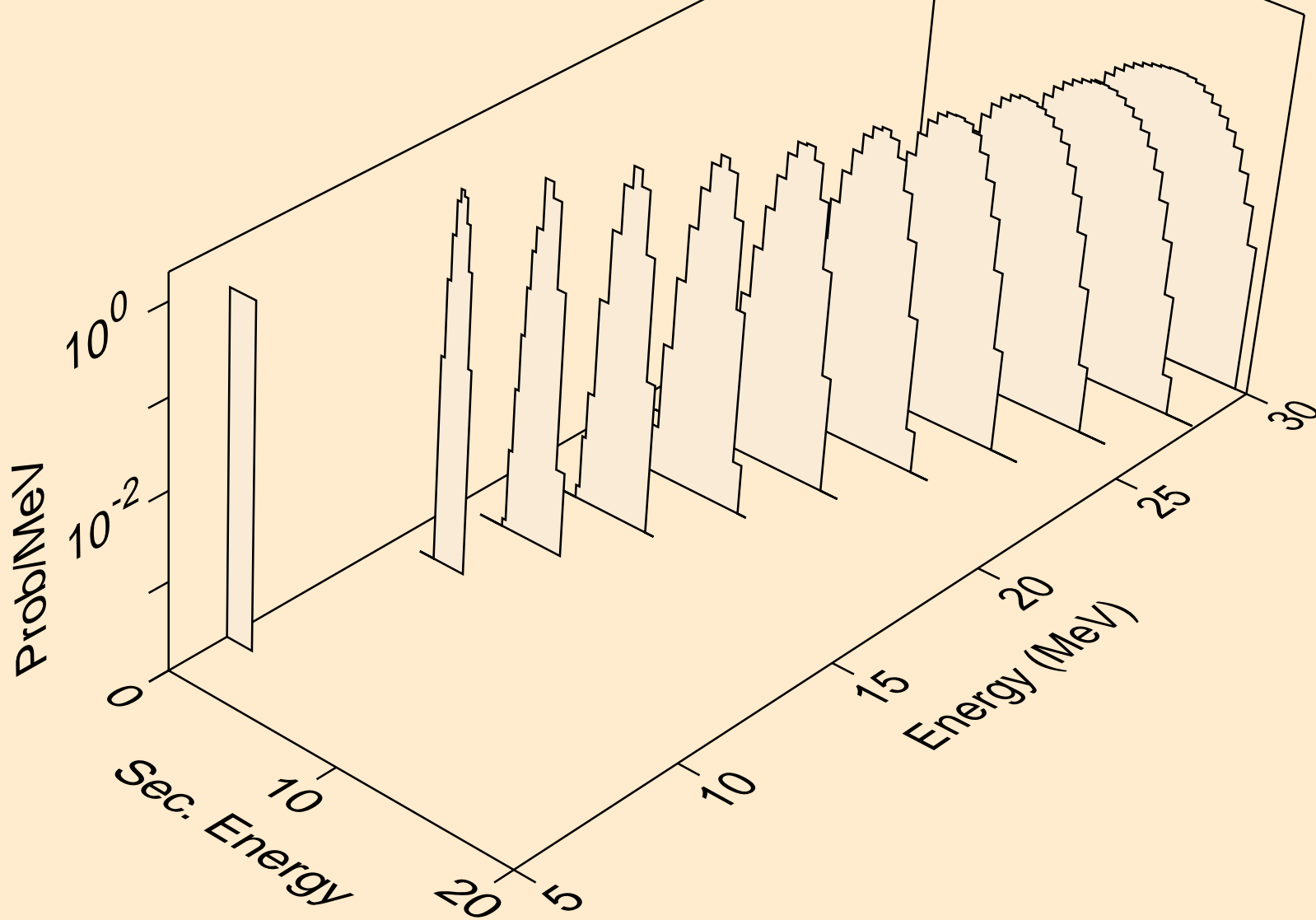

YB152 NEUTRON ACER TENDL-2019 LIBRARY; T=293.16K
he3s from (n,x)

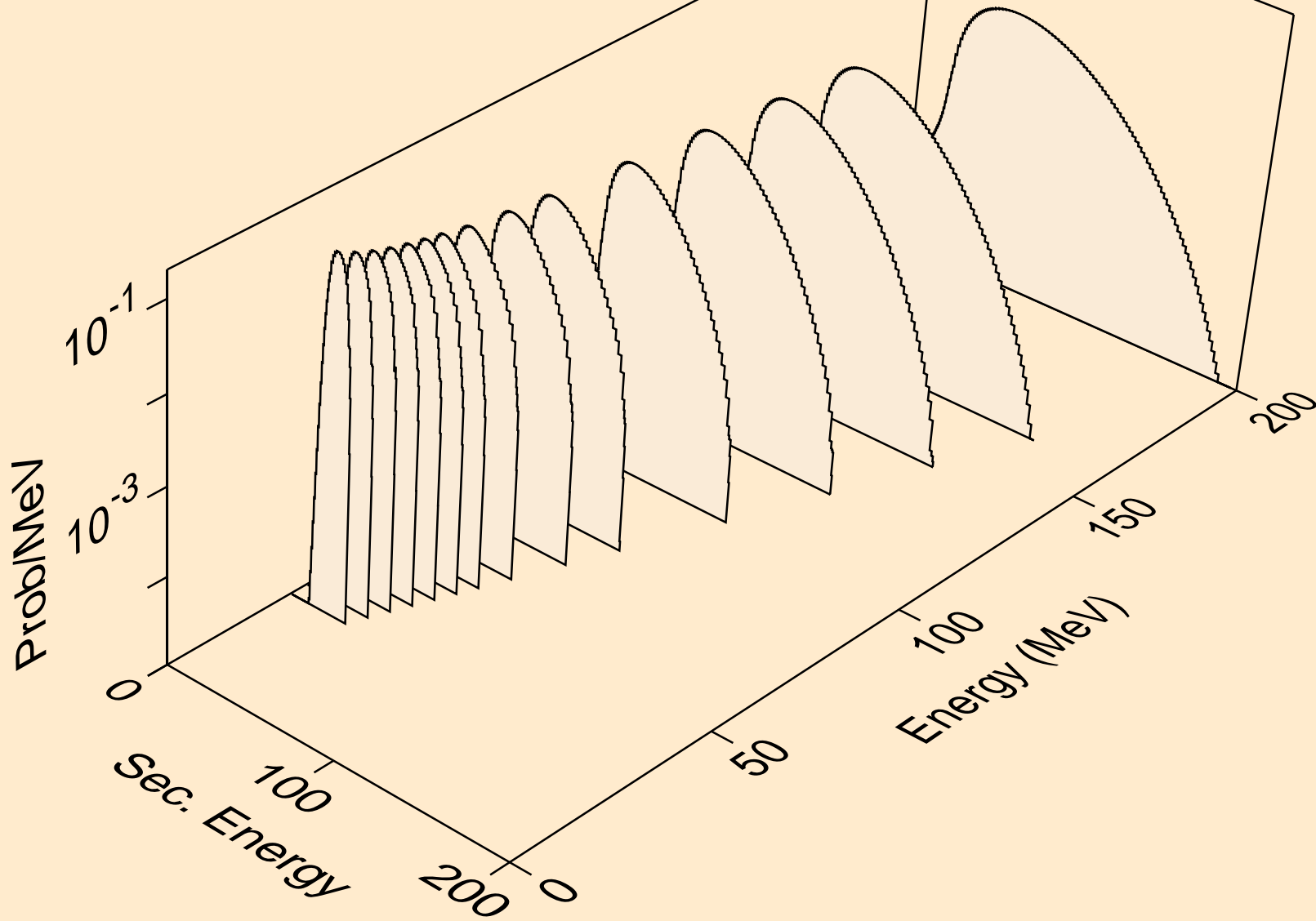

YB152 NEUTRON ACER TENDL-2019 LIBRARY; T=293.16K
he3s from (n,n*)he3

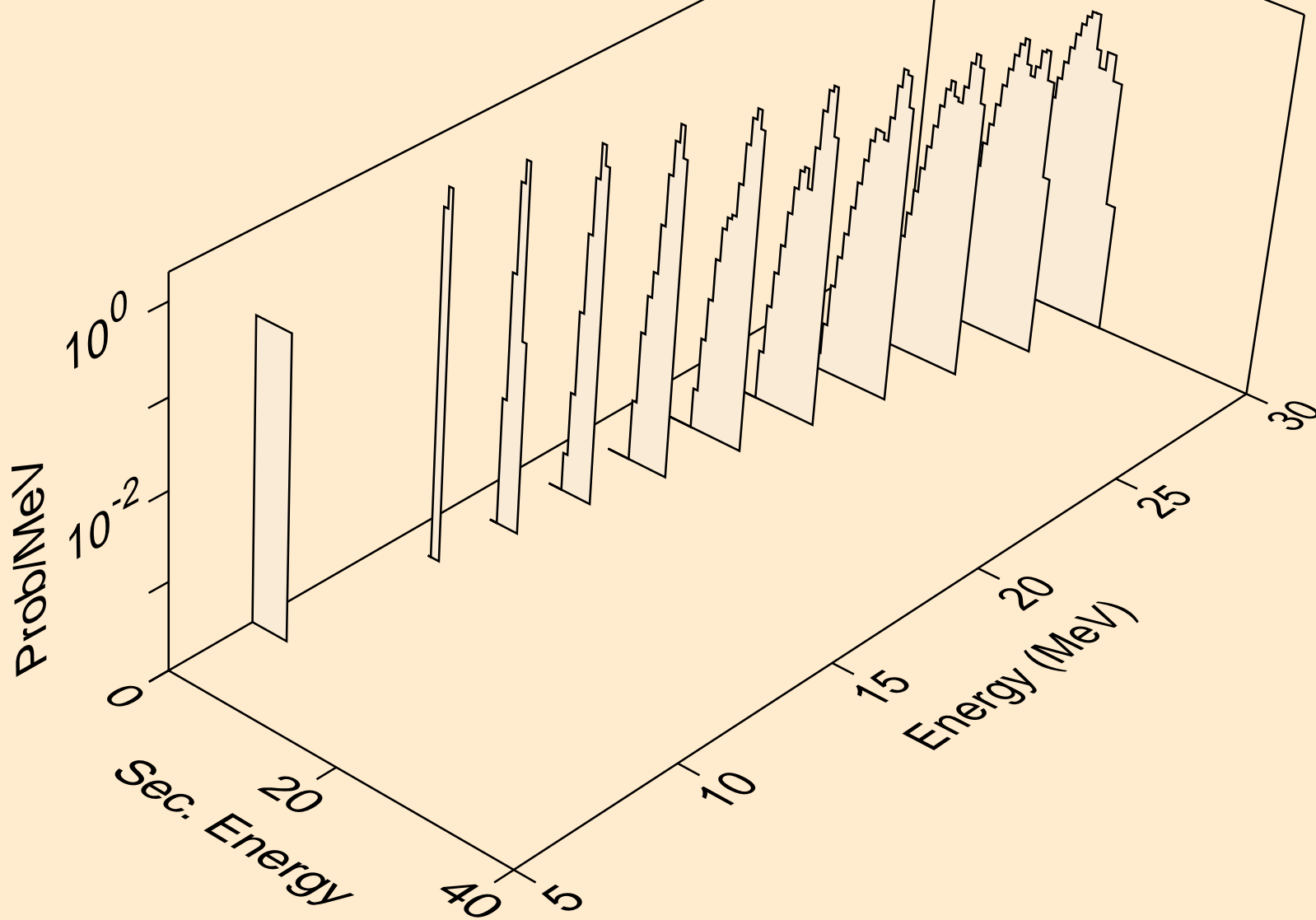

YB152 NEUTRON ACER TENDL-2019 LIBRARY; T=293.16K
he3s from (n,he3)

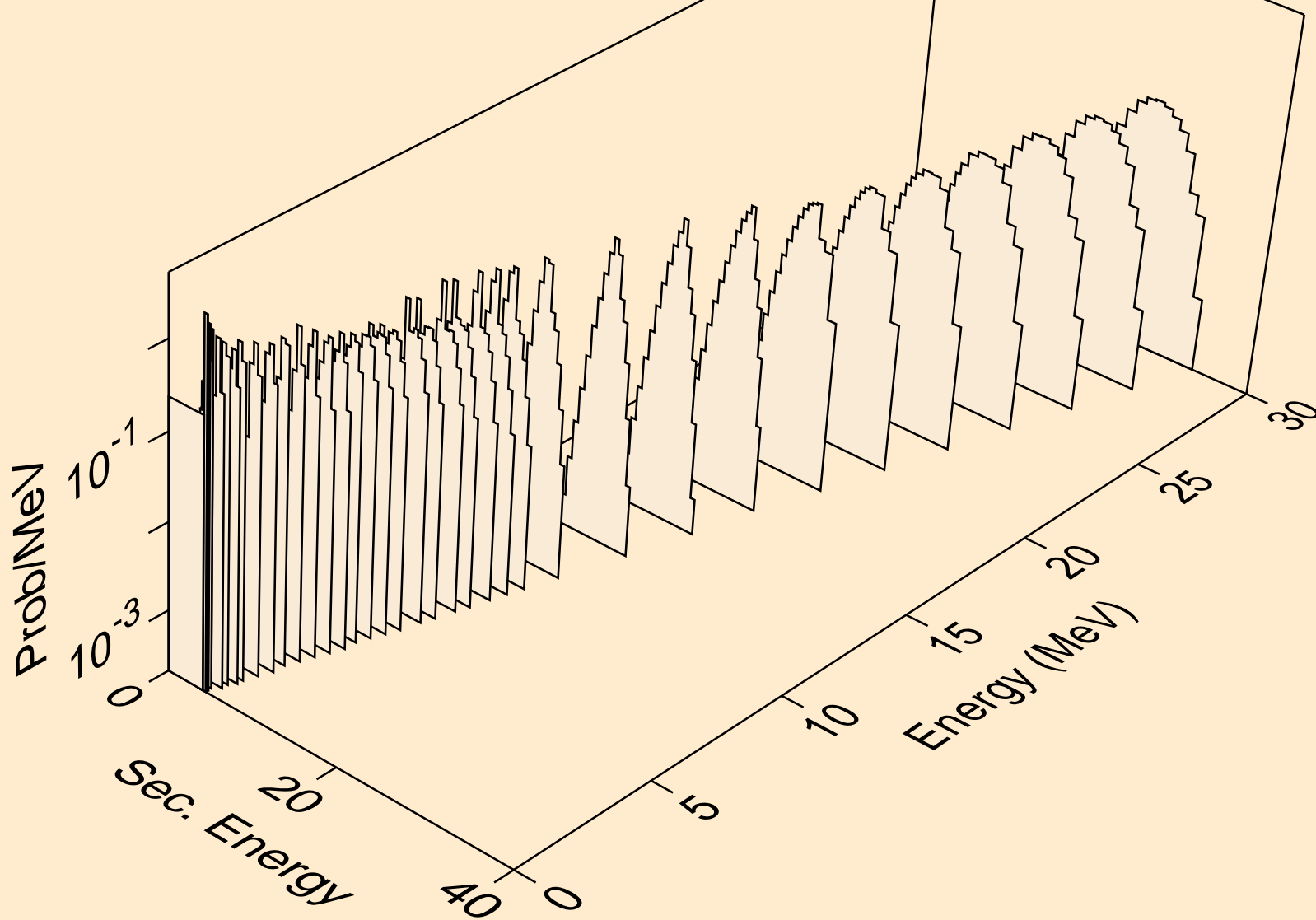

YB152 NEUTRON ACER TENDL-2019 LIBRARY; T=293.16K
alphas from (n,x)

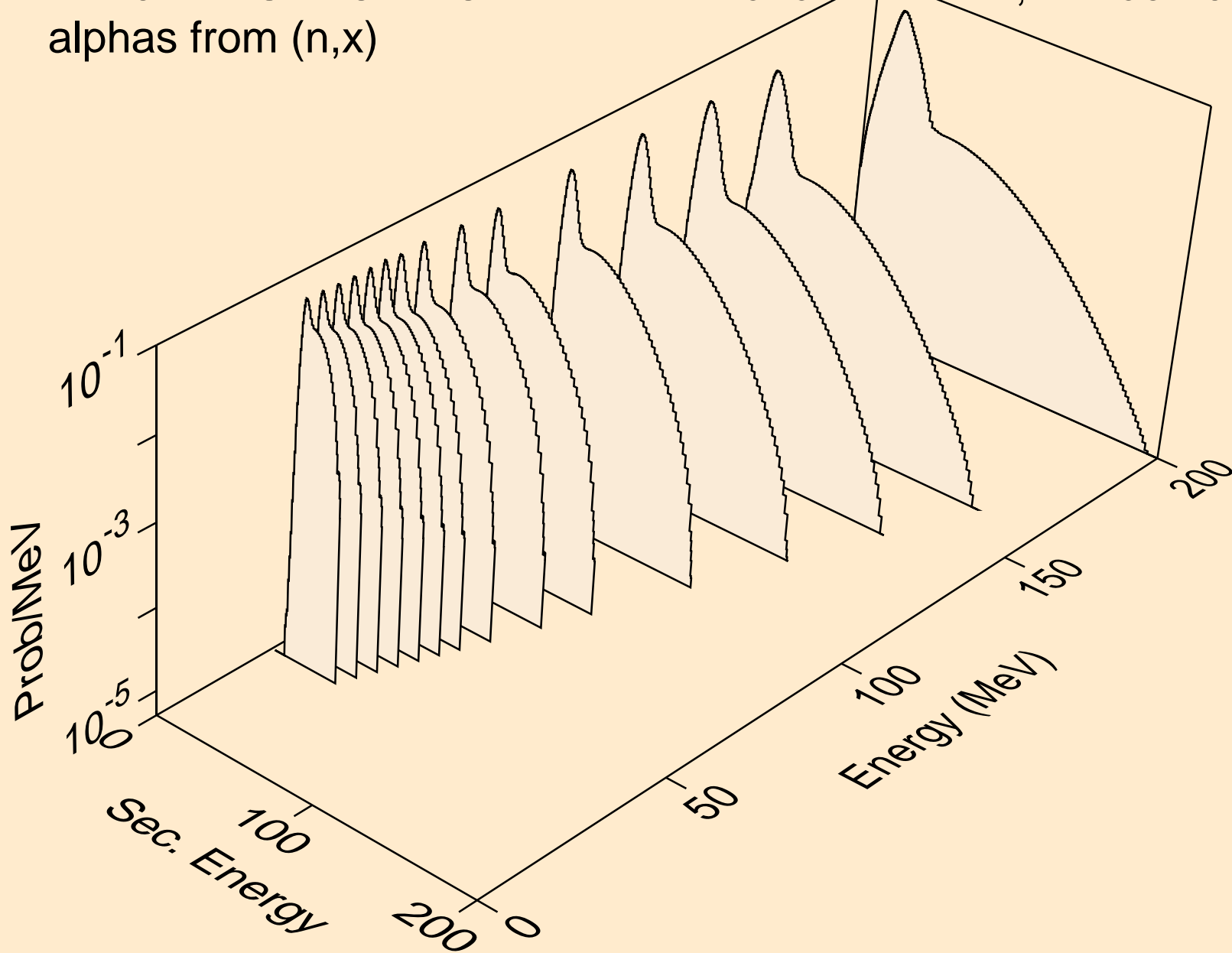

YB152 NEUTRON ACER TENDL-2019 LIBRARY; T=293.16K
alphas from (n,n*)a

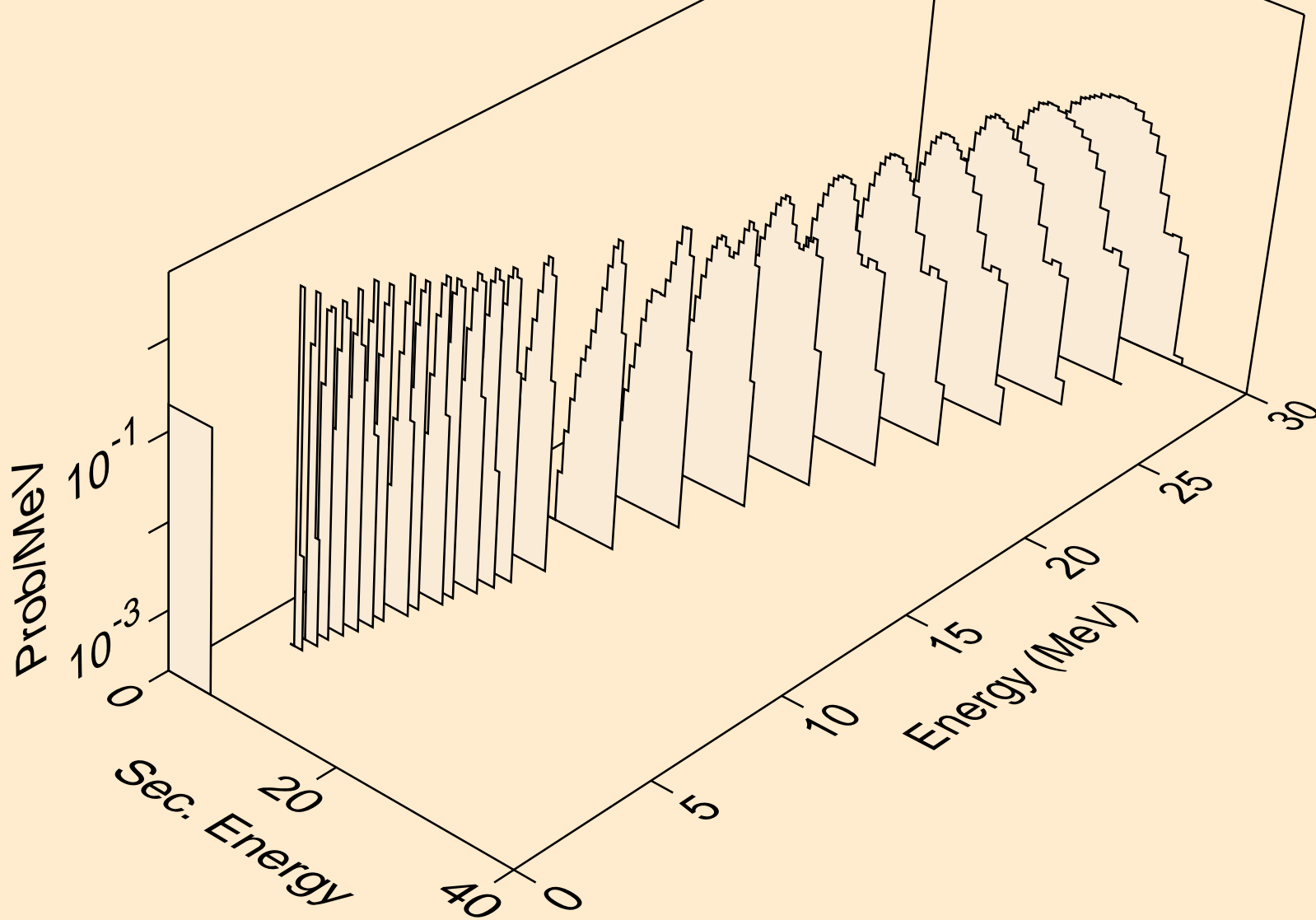

YB152 NEUTRON ACER TENDL-2019 LIBRARY; T=293.16K
alphas from (n,2n)a

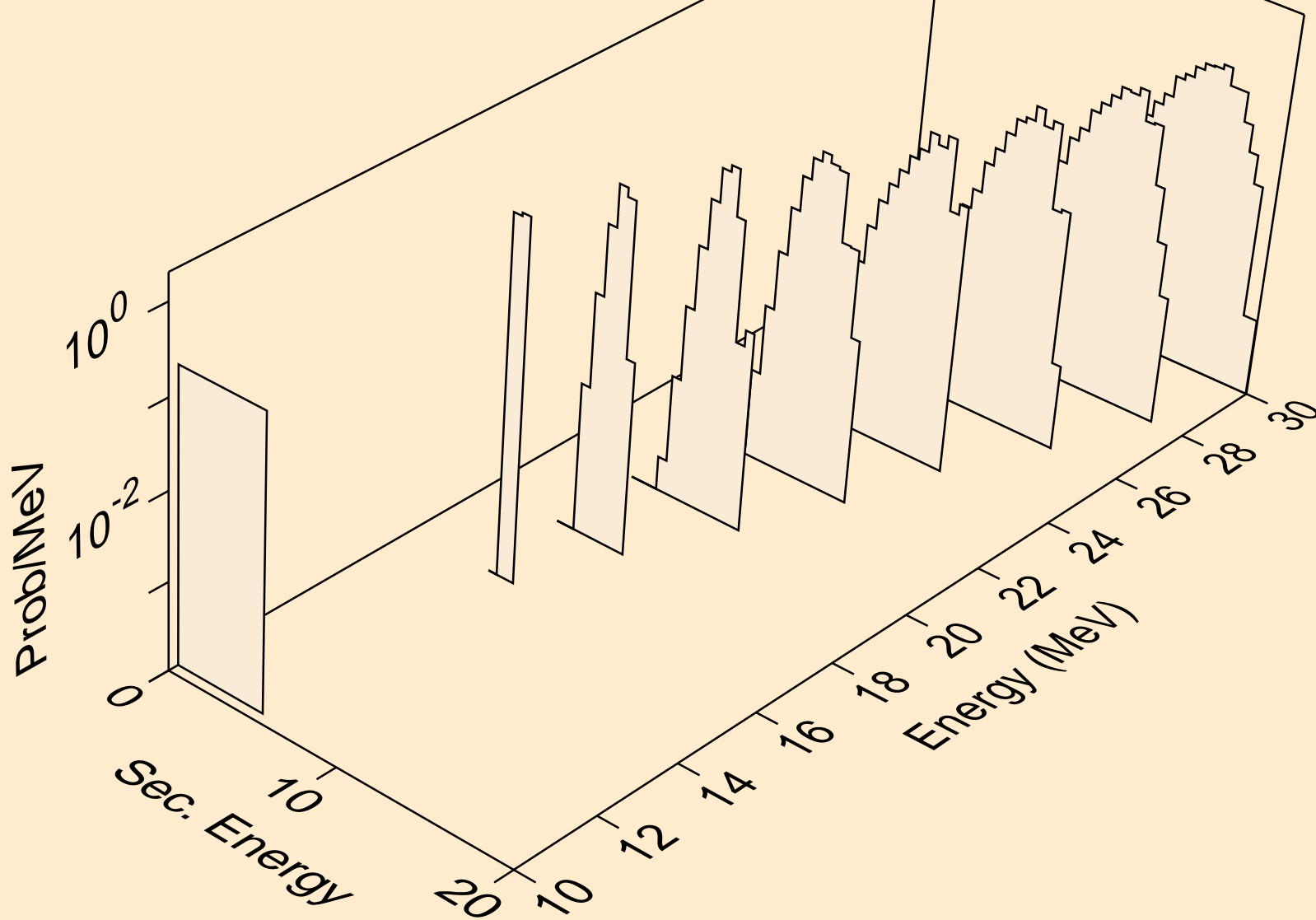

YB152 NEUTRON ACER TENDL-2019 LIBRARY; T=293.16K
alphas from (n,n*)2a

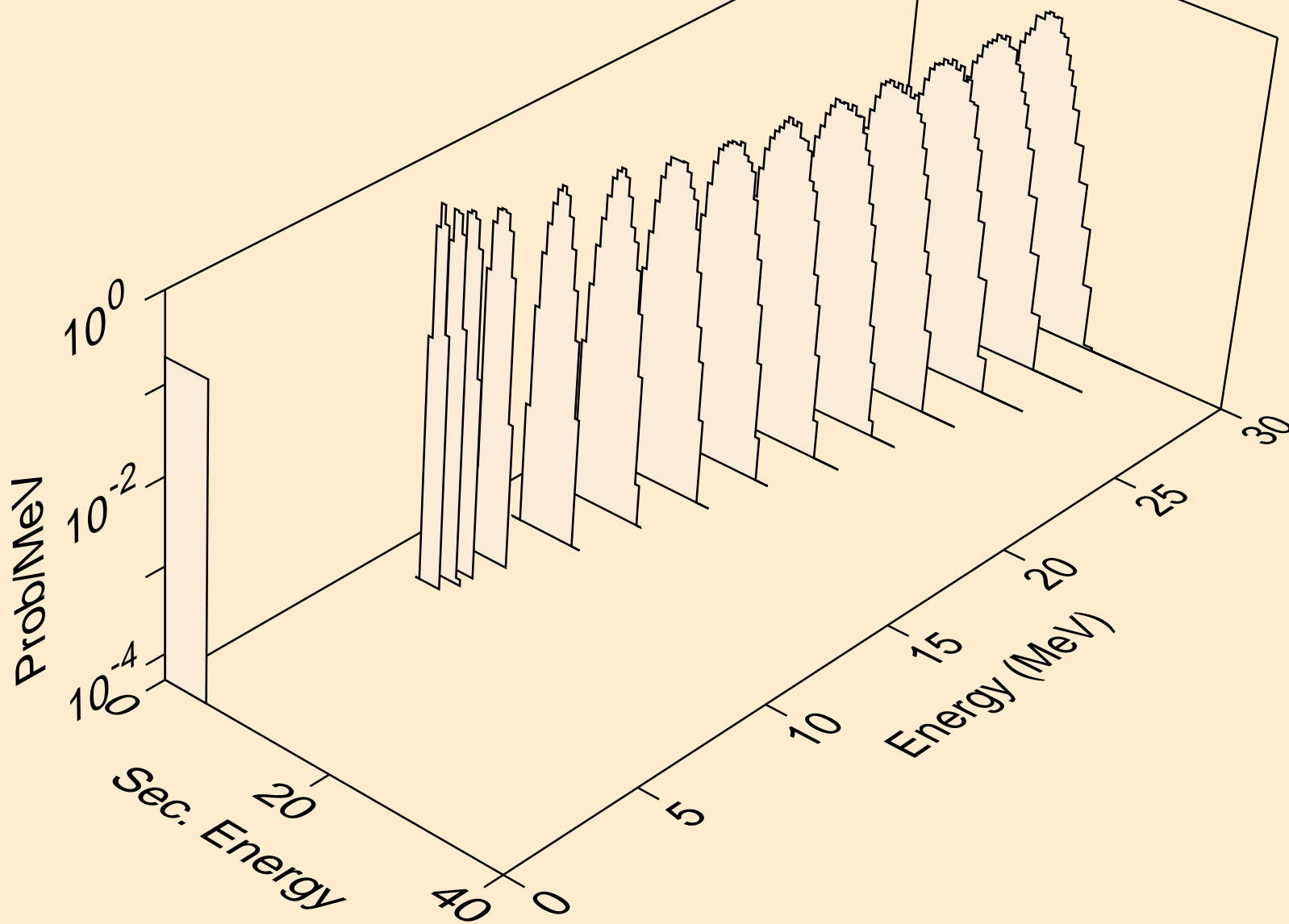

YB152 NEUTRON ACER TENDL-2019 LIBRARY; T=293.16K
alphas from (n,npa)

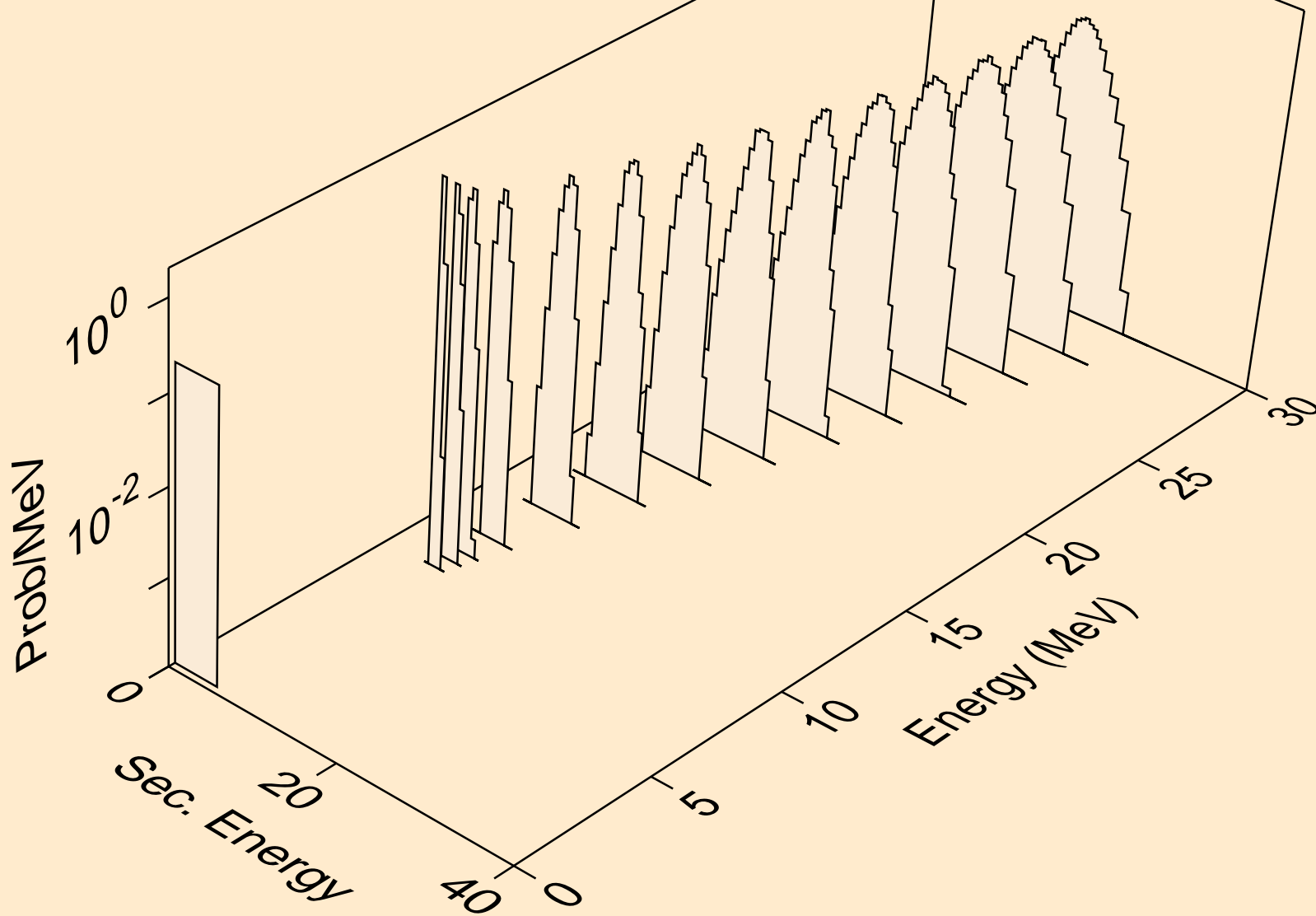

YB152 NEUTRON ACER TENDL-2019 LIBRARY; T=293.16K
alphas from (n,a)

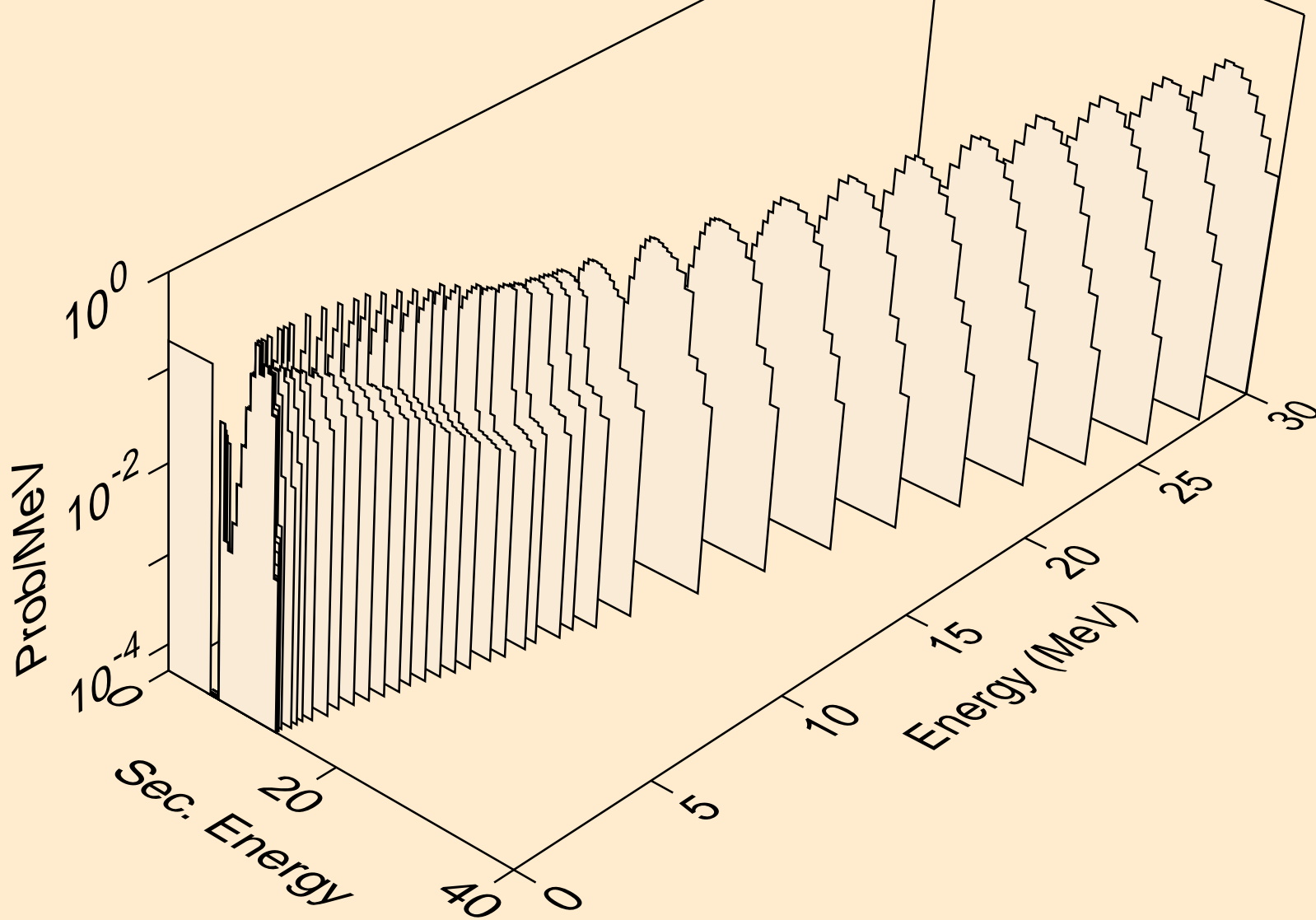

YB152 NEUTRON ACER TENDL-2019 LIBRARY; T=293.16K
alphas from (n,2a)

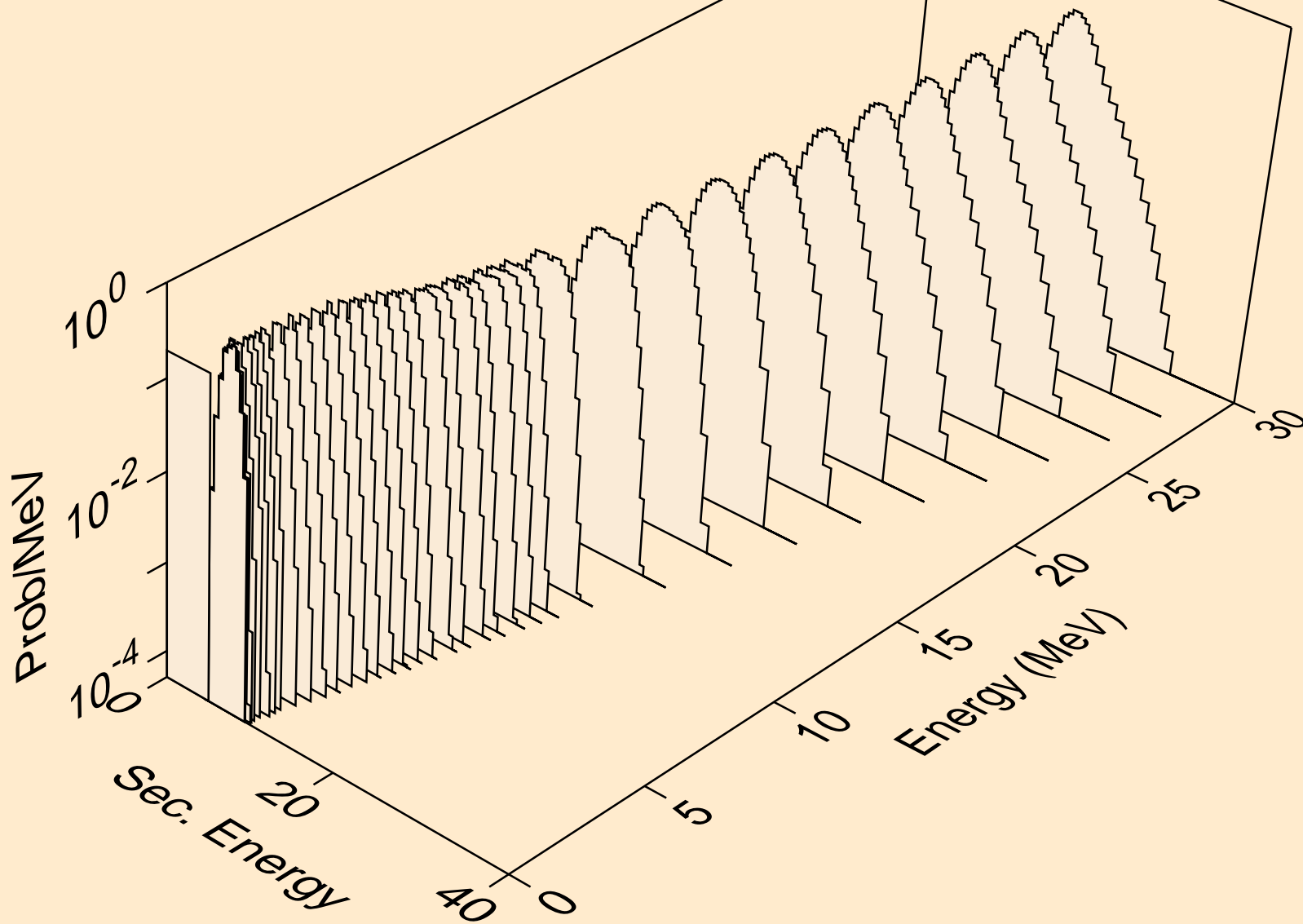

YB152 NEUTRON ACER TENDL-2019 LIBRARY; T=293.16K
alphas from (n,3a)

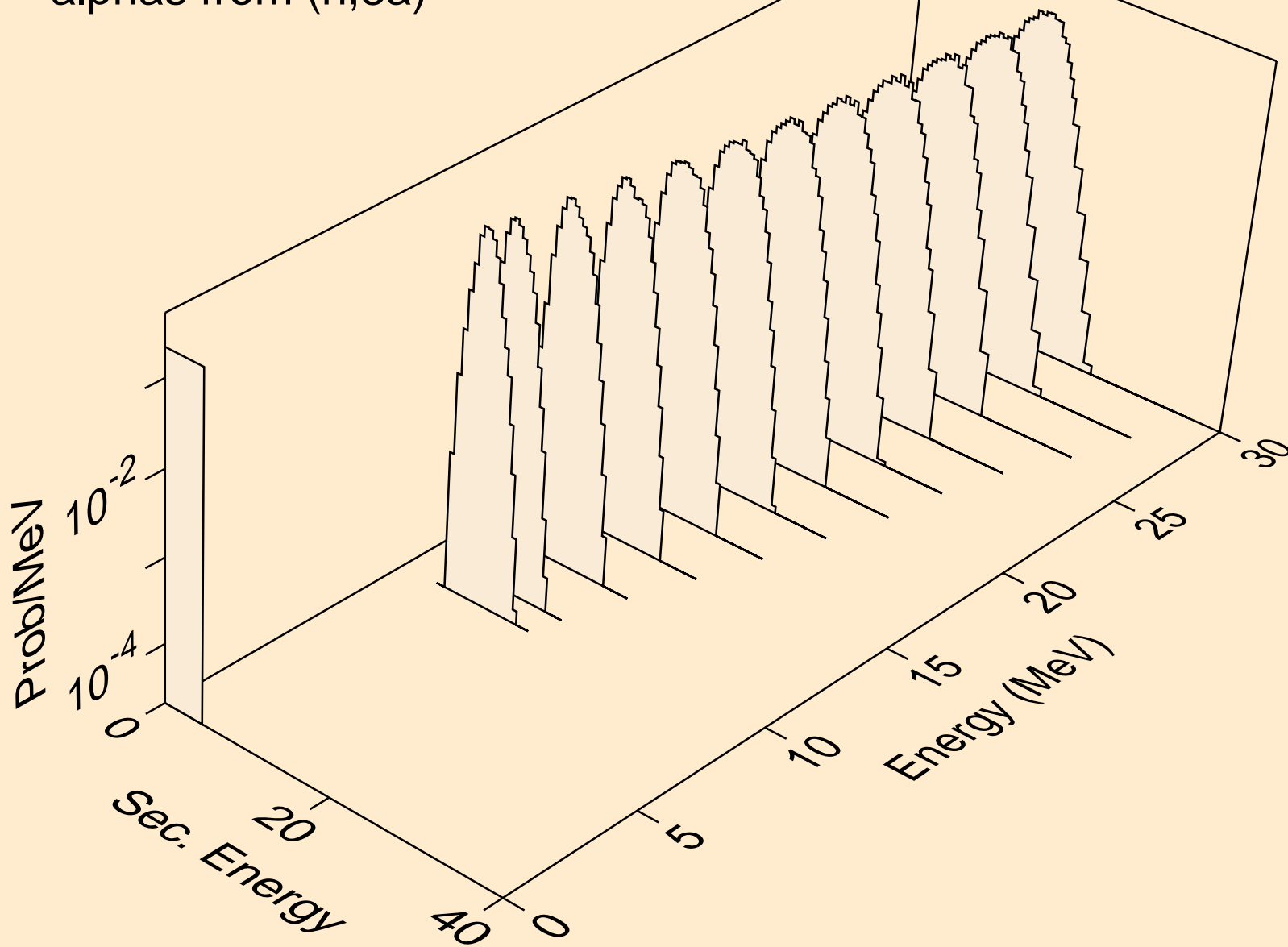

YB152 NEUTRON ACER TENDL-2019 LIBRARY; T=293.16K
alphas from (n,pa)

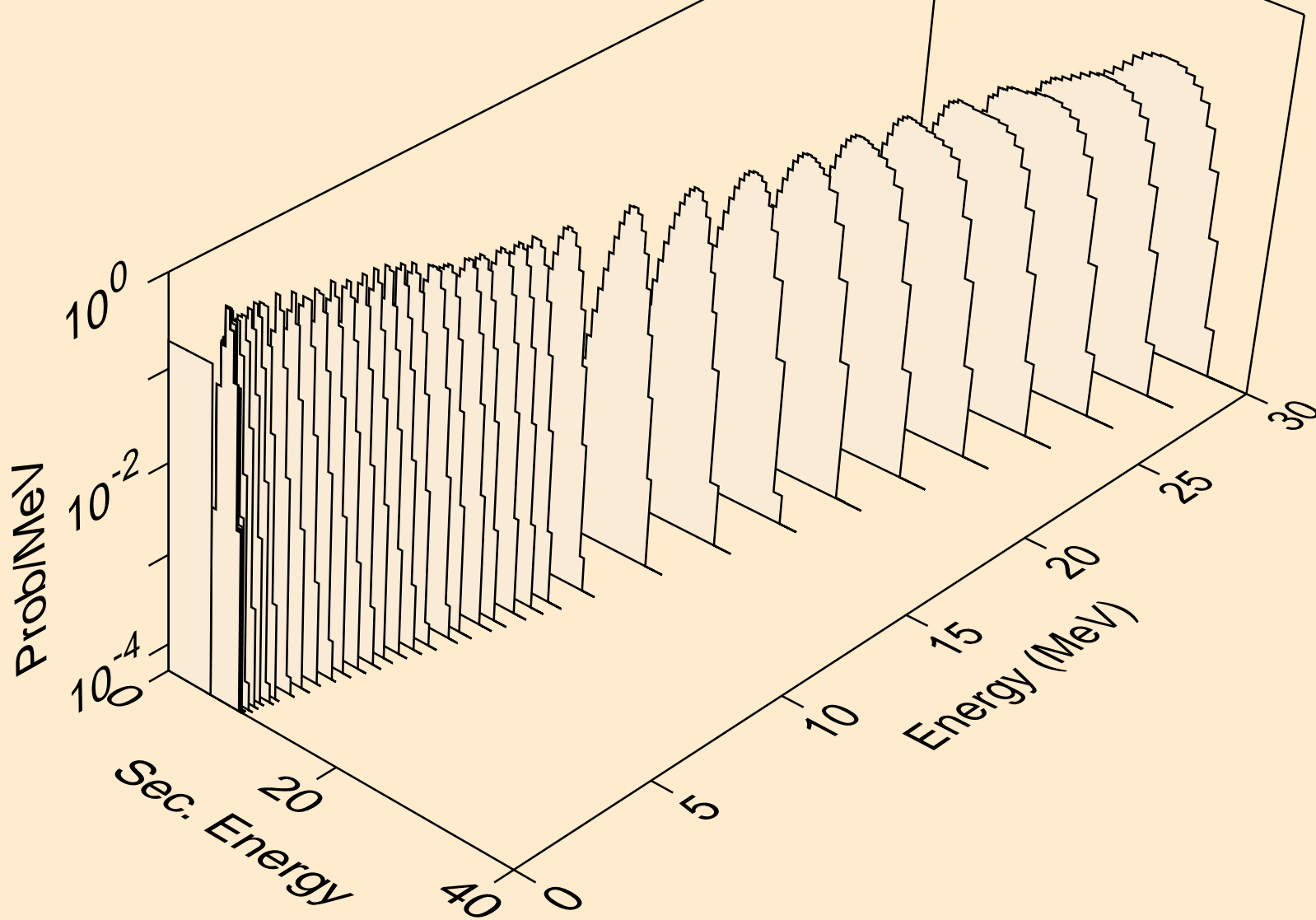

YB152 NEUTRON ACER TENDL-2019 LIBRARY; T=293.16K
alphas from (n,da)

