

YB165 NEUTRON ACER TENDL-2019 LIBRARY; T=293.16K
Principal cross sections

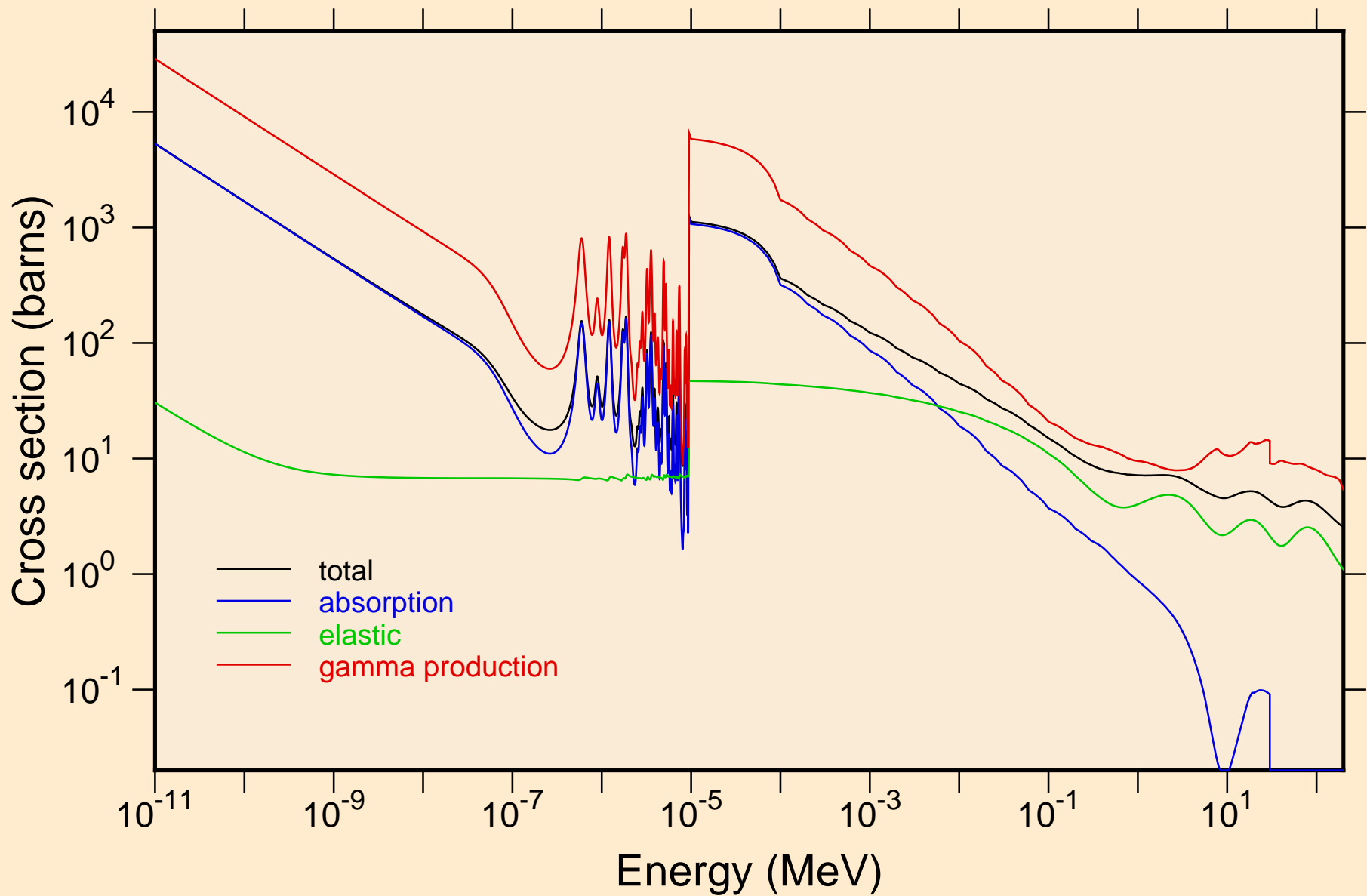

YB165 NEUTRON ACER TENDL-2019 LIBRARY; T=293.16K
resonance total cross section

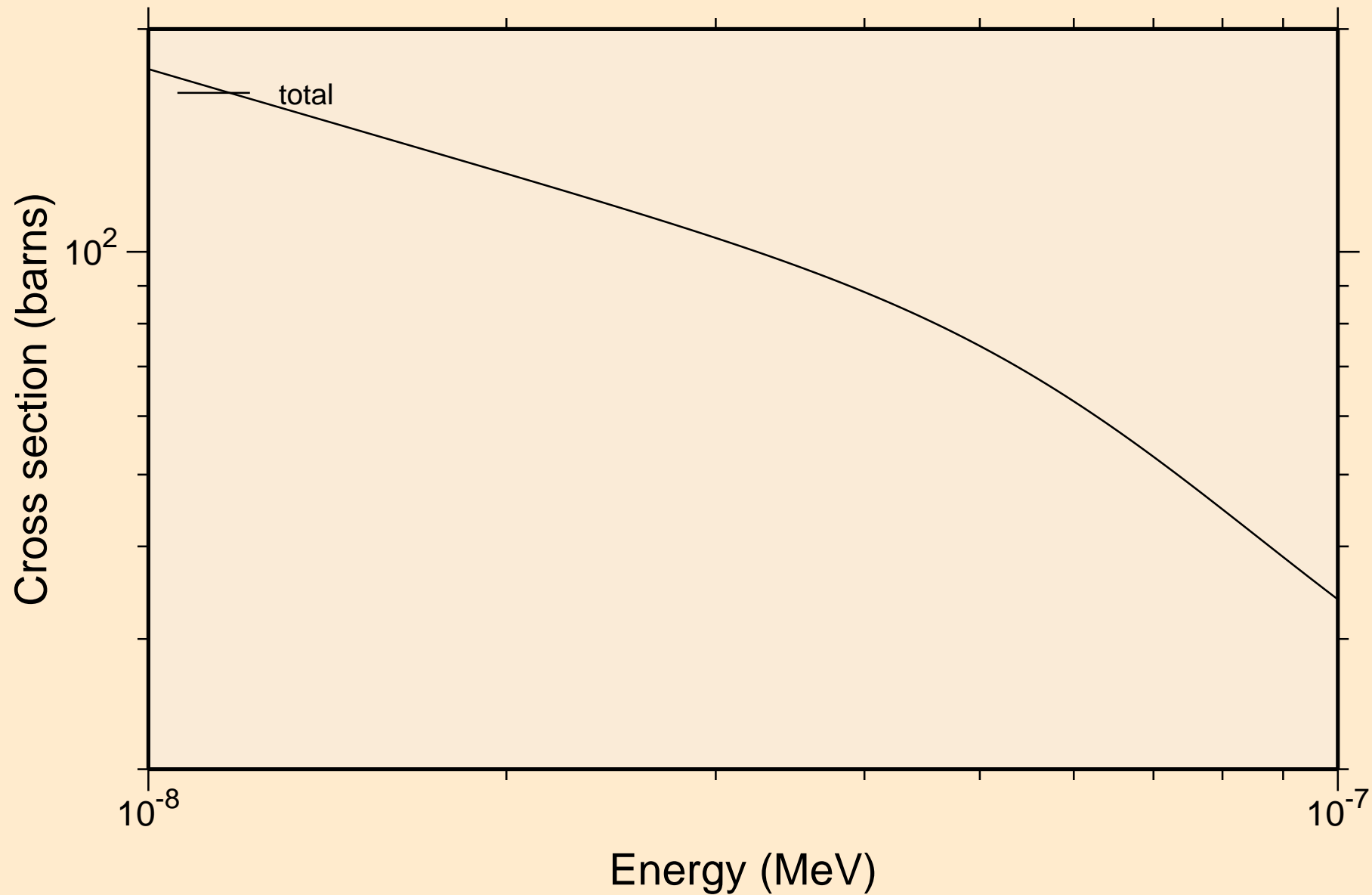

YB165 NEUTRON ACER TENDL-2019 LIBRARY; T=293.16K
resonance total cross section

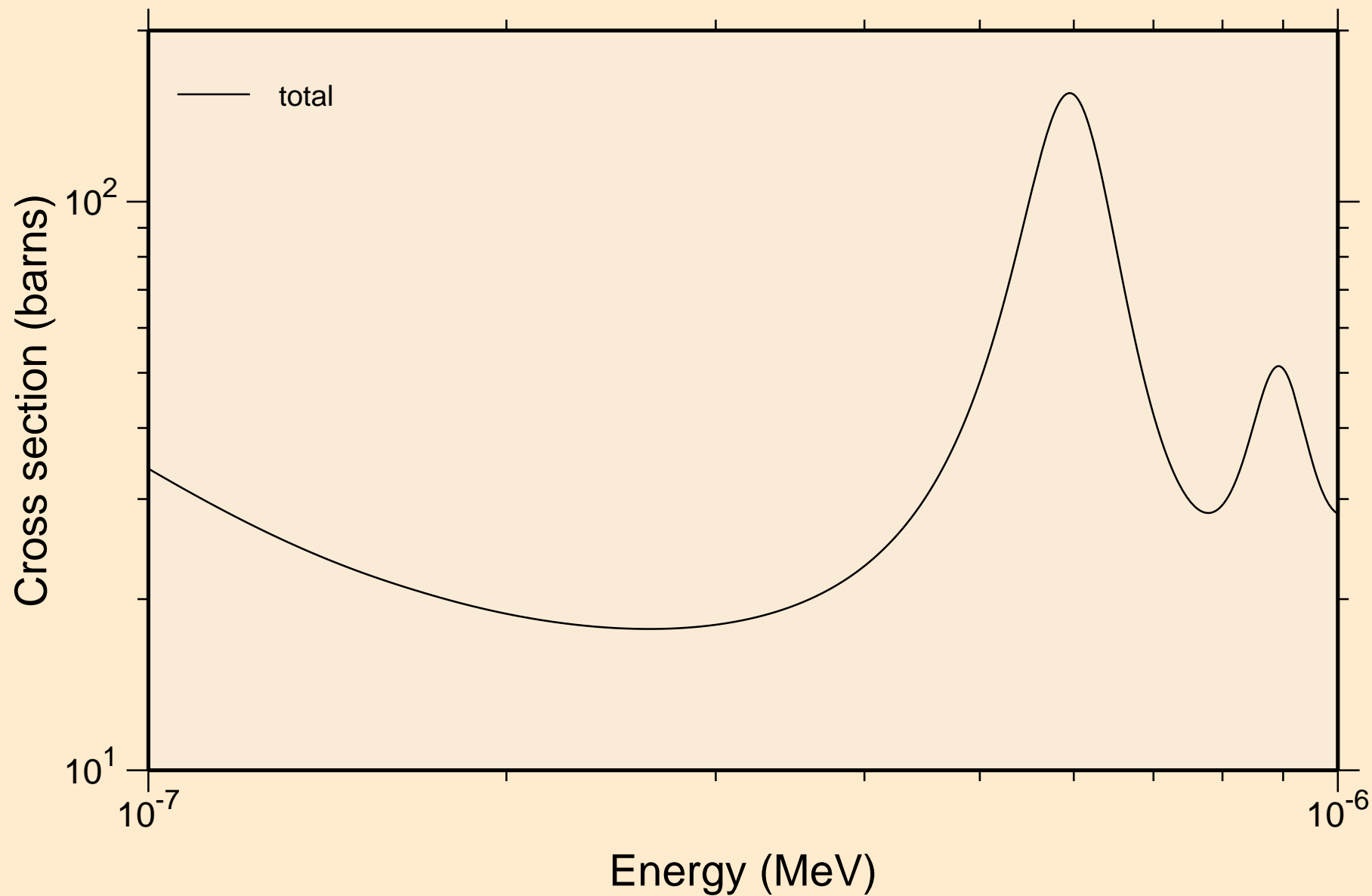

YB165 NEUTRON ACER TENDL-2019 LIBRARY; T=293.16K
resonance total cross section

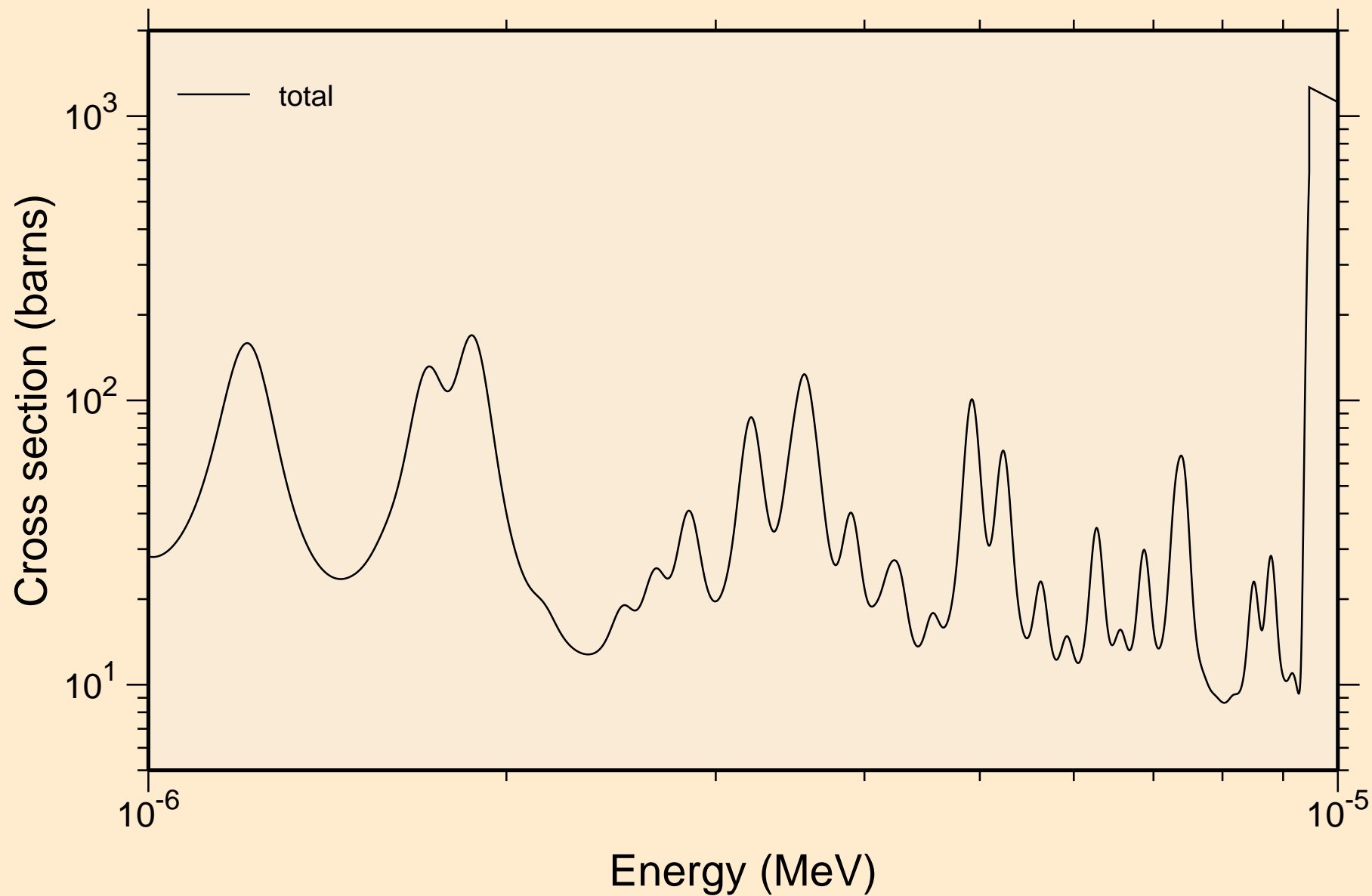

YB165 NEUTRON ACER TENDL-2019 LIBRARY; T=293.16K
resonance total cross section

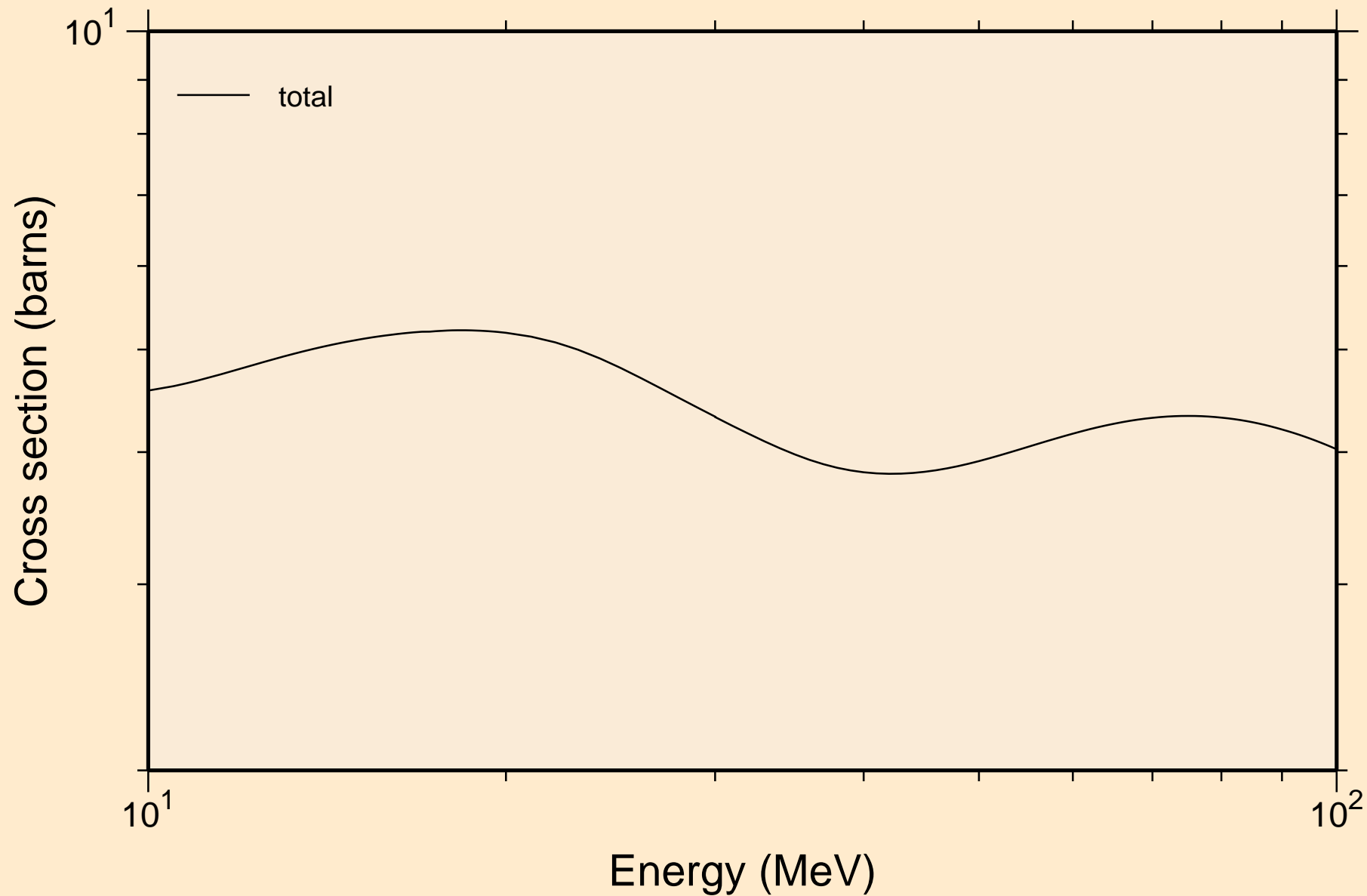

YB165 NEUTRON ACER TENDL-2019 LIBRARY; T=293.16K
resonance absorption cross sections

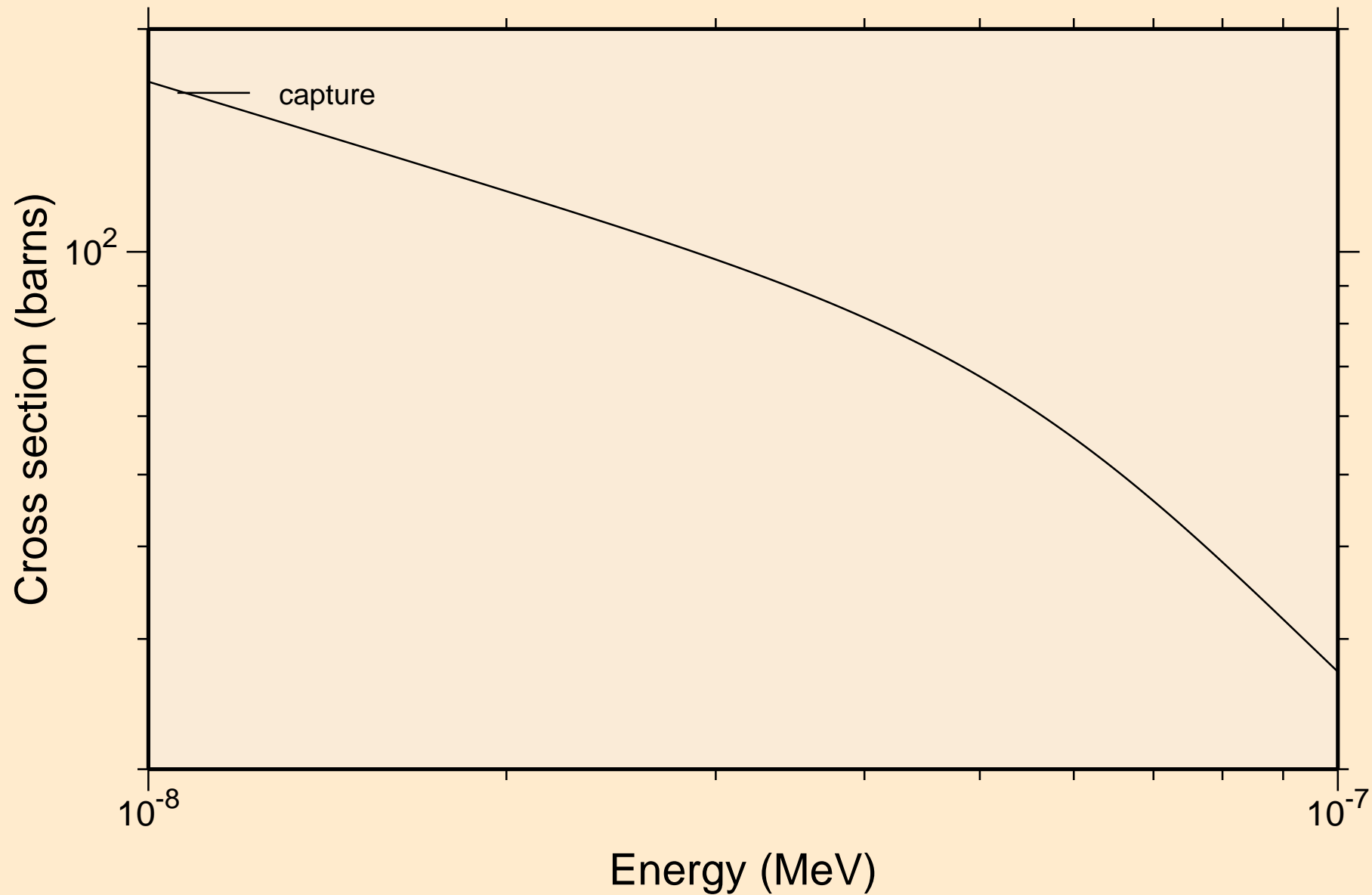

YB165 NEUTRON ACER TENDL-2019 LIBRARY; T=293.16K
resonance absorption cross sections

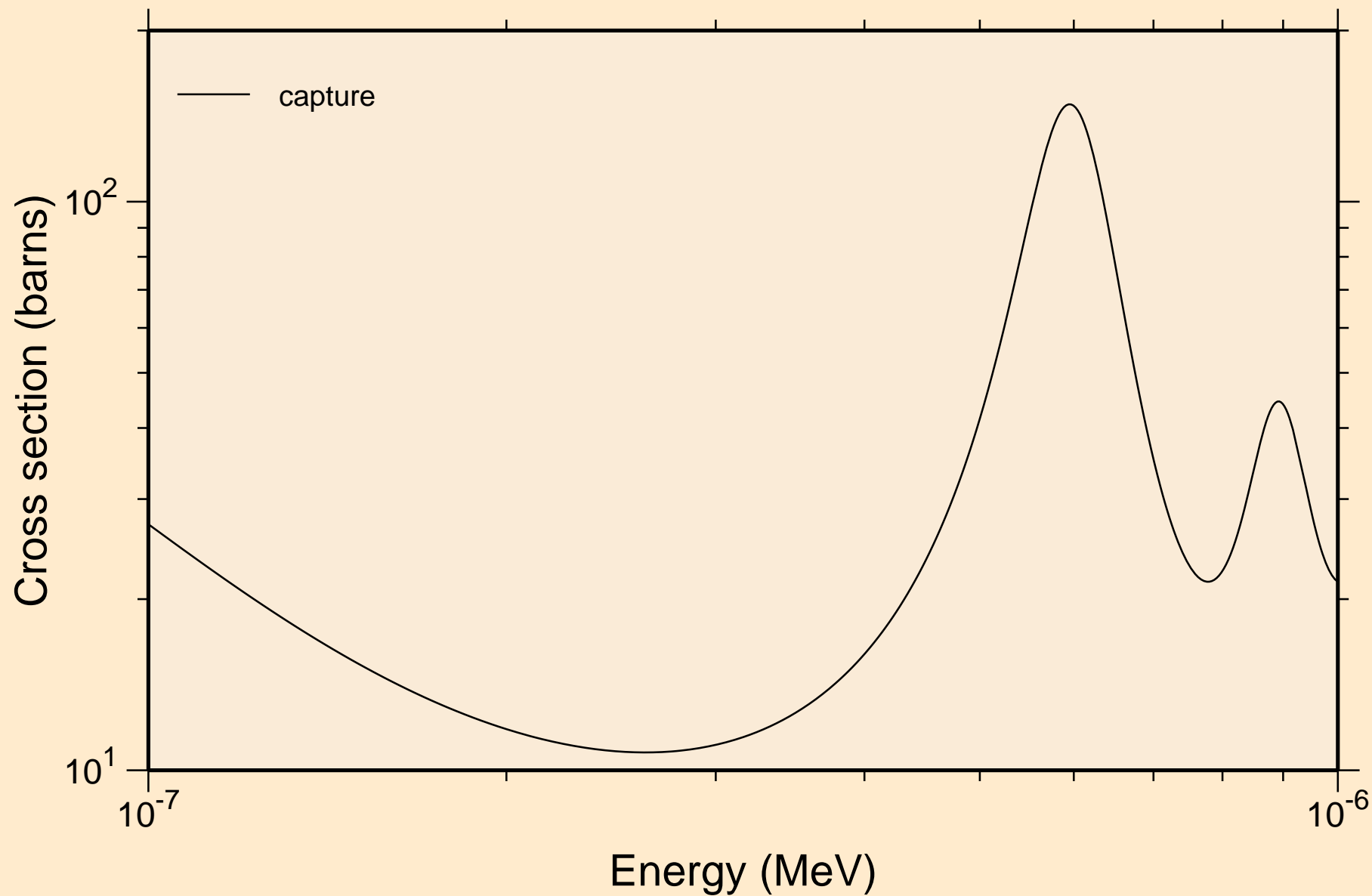

YB165 NEUTRON ACER TENDL-2019 LIBRARY; T=293.16K
resonance absorption cross sections

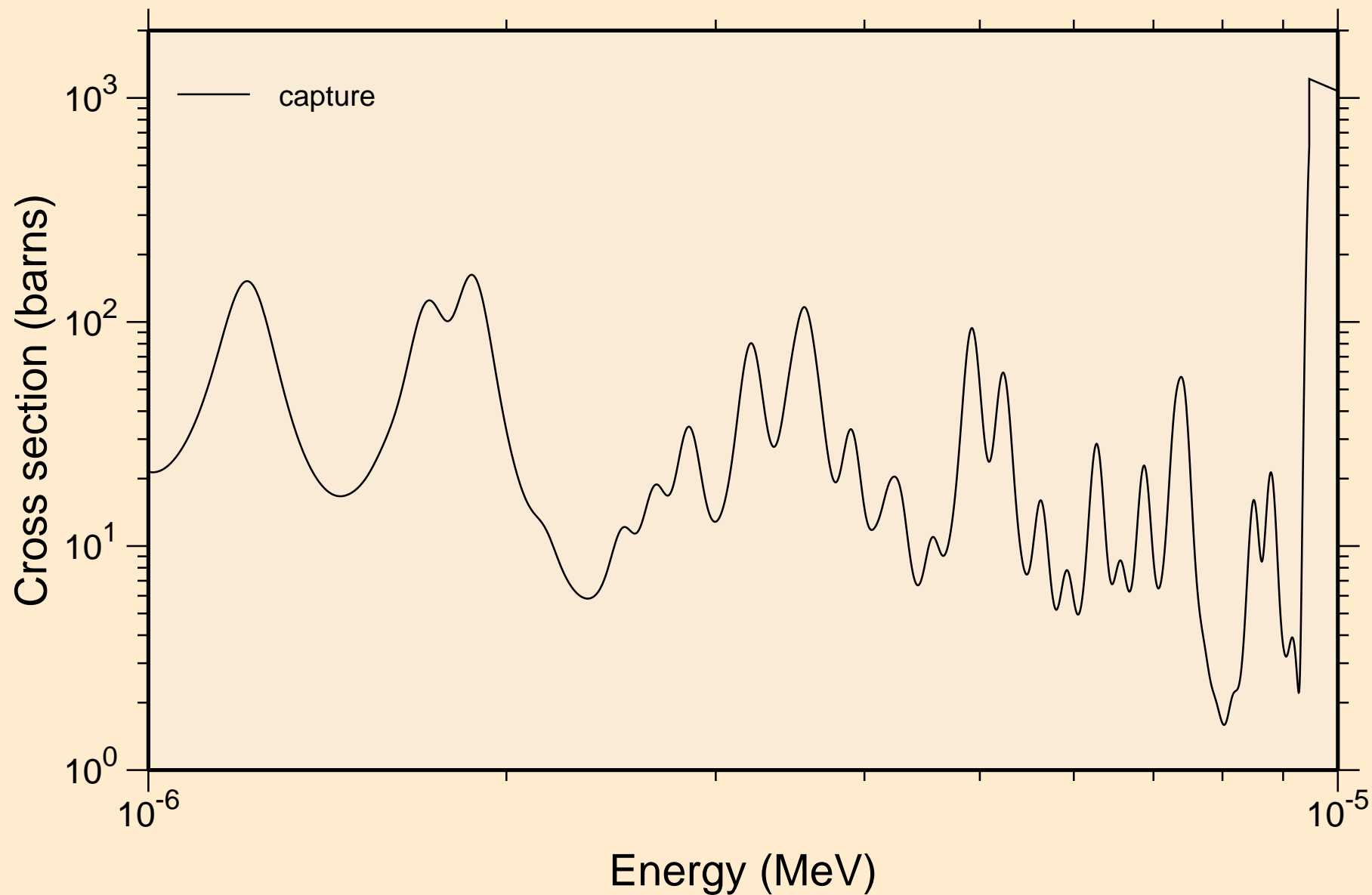

YB165 NEUTRON ACER TENDL-2019 LIBRARY; T=293.16K
resonance absorption cross sections

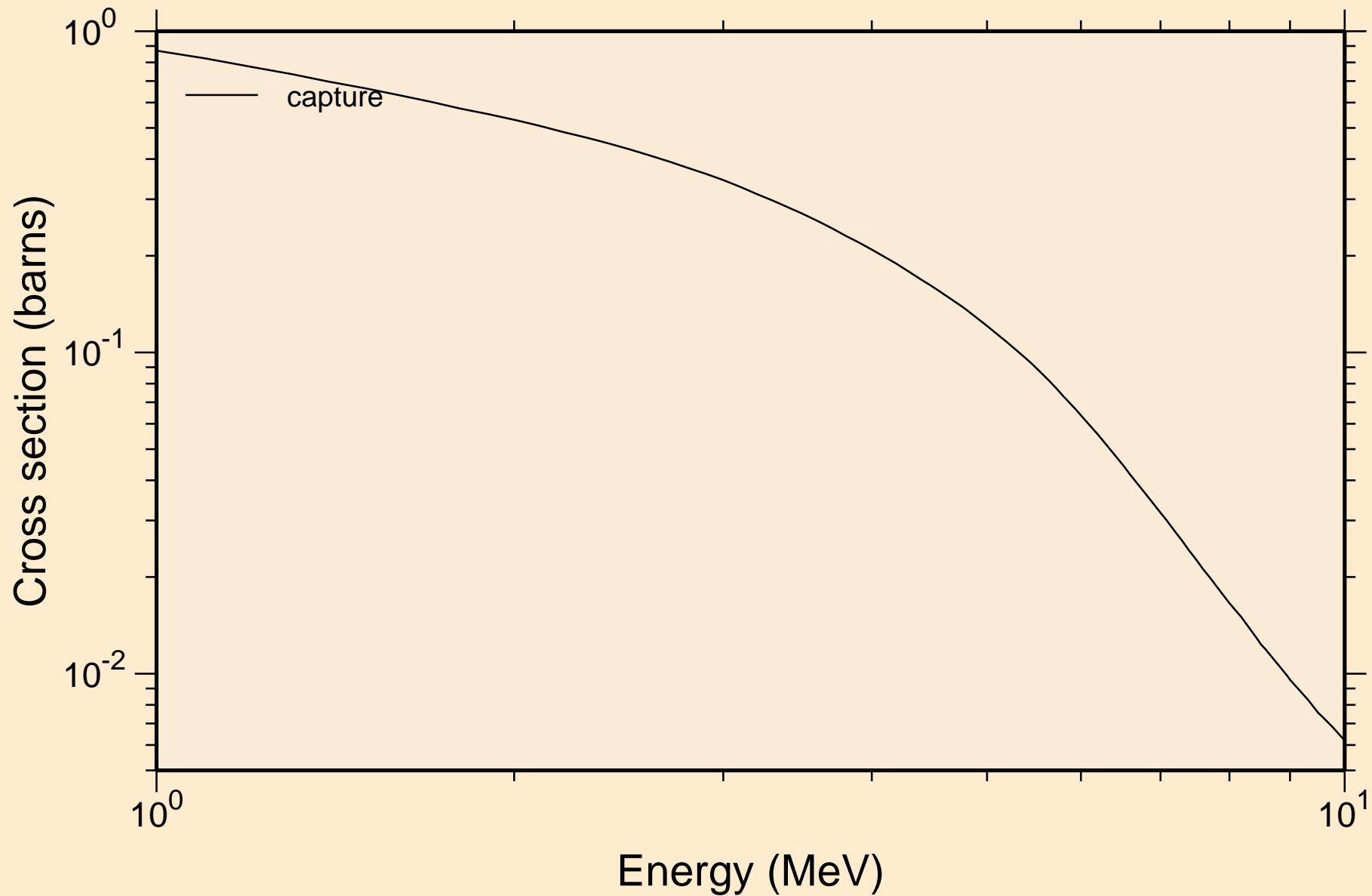

YB165 NEUTRON ACER TENDL-2019 LIBRARY; T=293.16K
Heating

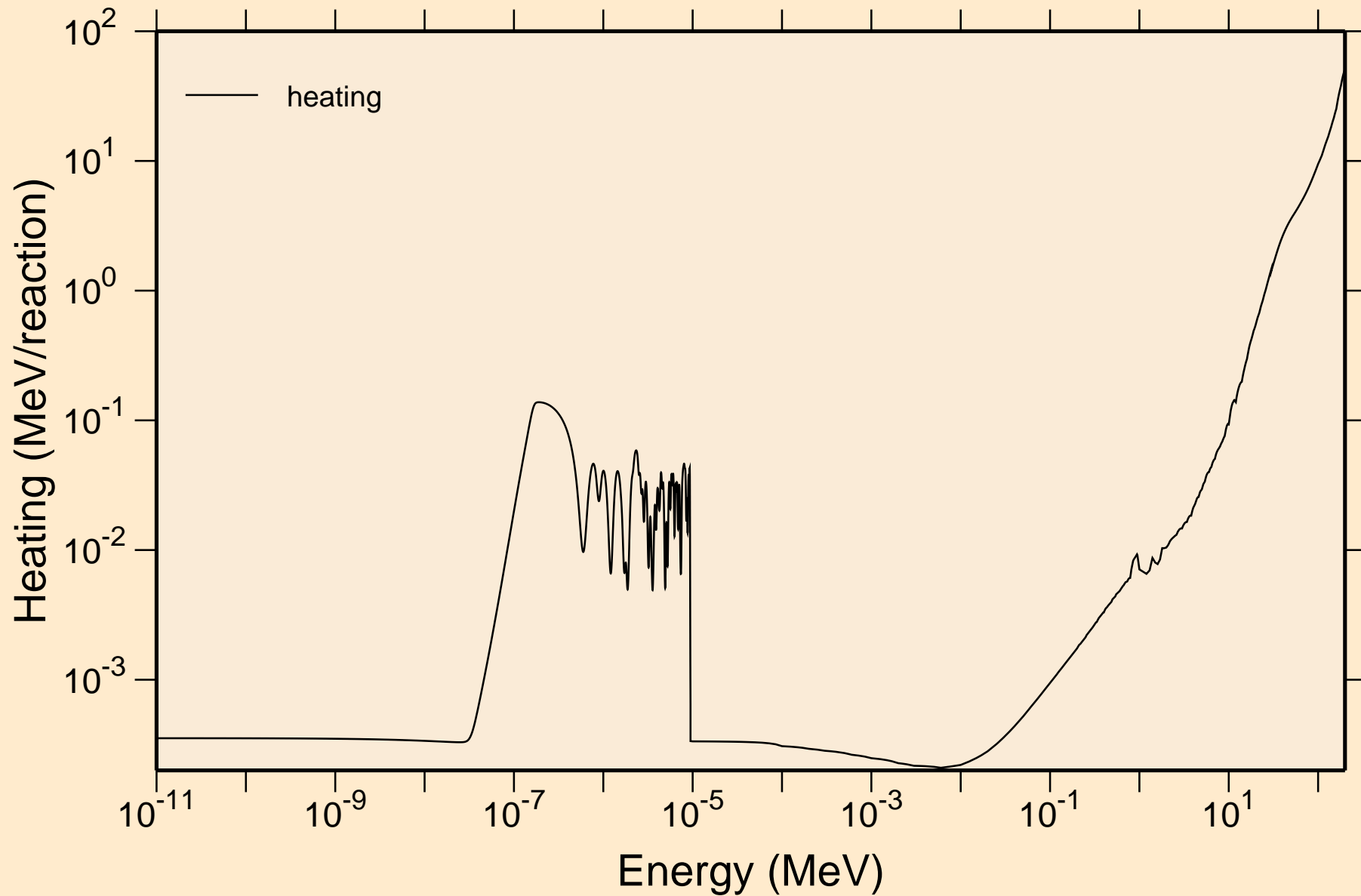

YB165 NEUTRON ACER TENDL-2019 LIBRARY; T=293.16K
Damage

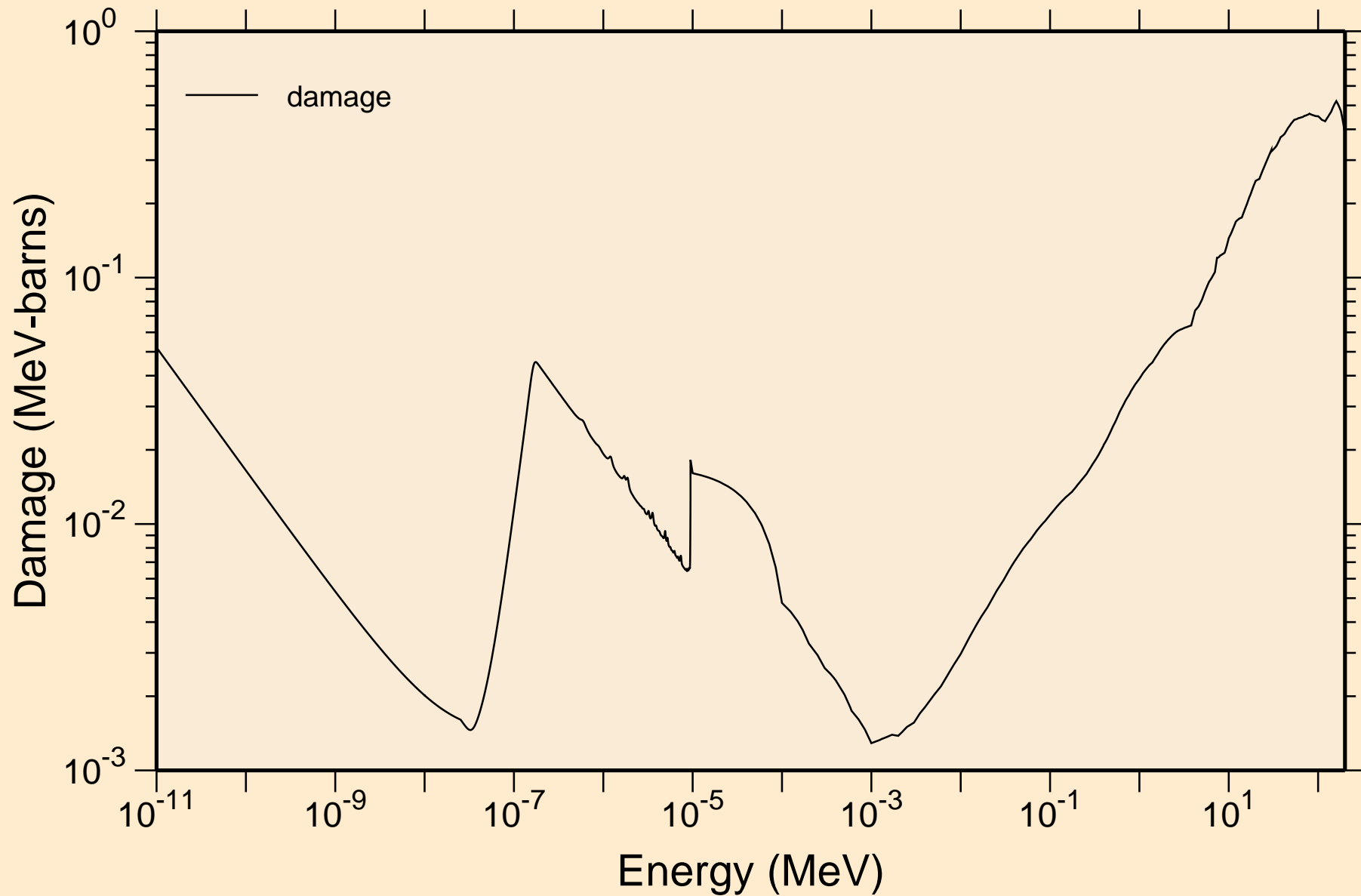

YB165 NEUTRON ACER TENDL-2019 LIBRARY; T=293.16K
Non-threshold reactions

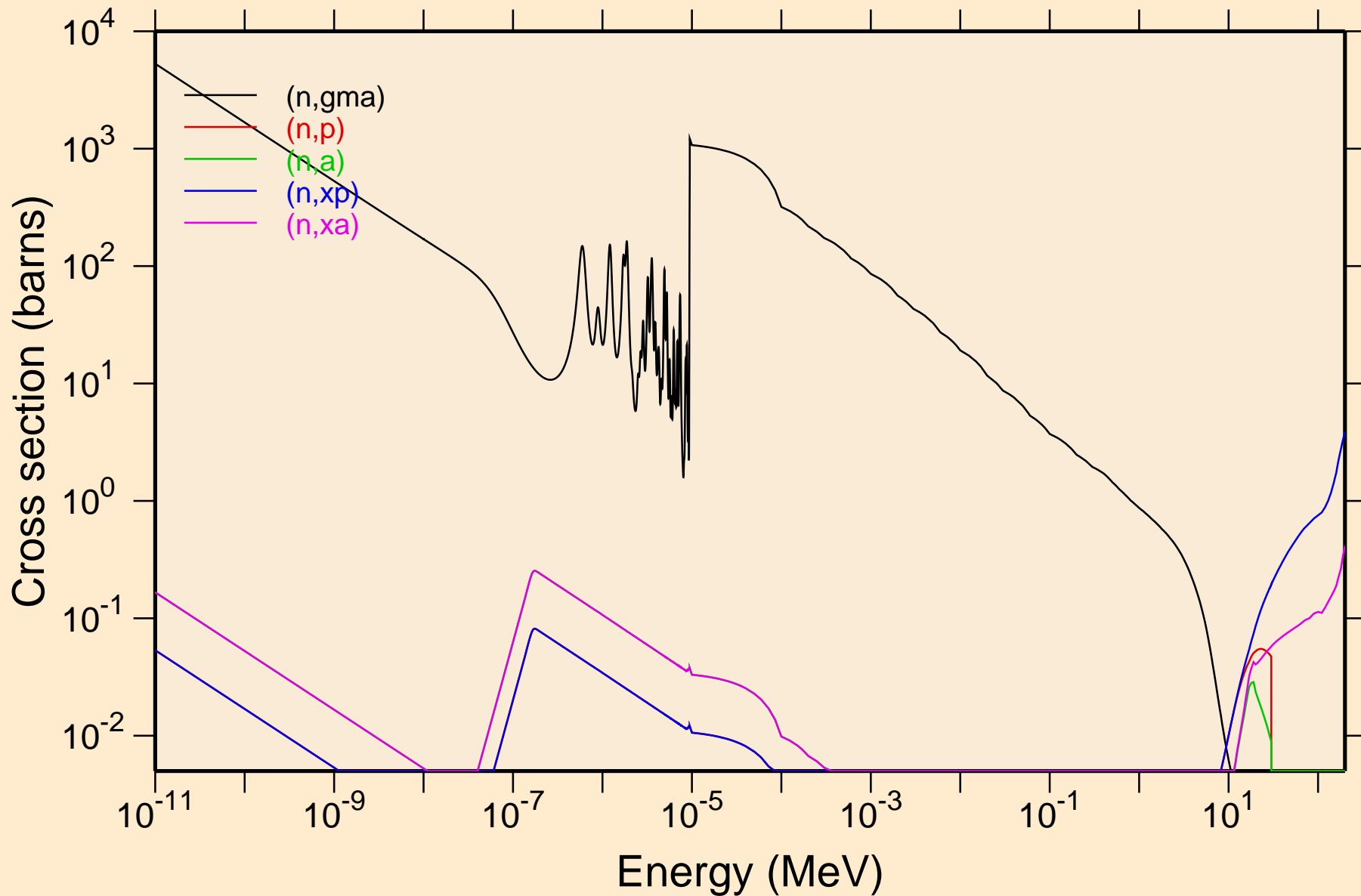

YB165 NEUTRON ACER TENDL-2019 LIBRARY; T=293.16K
Principal cross sections

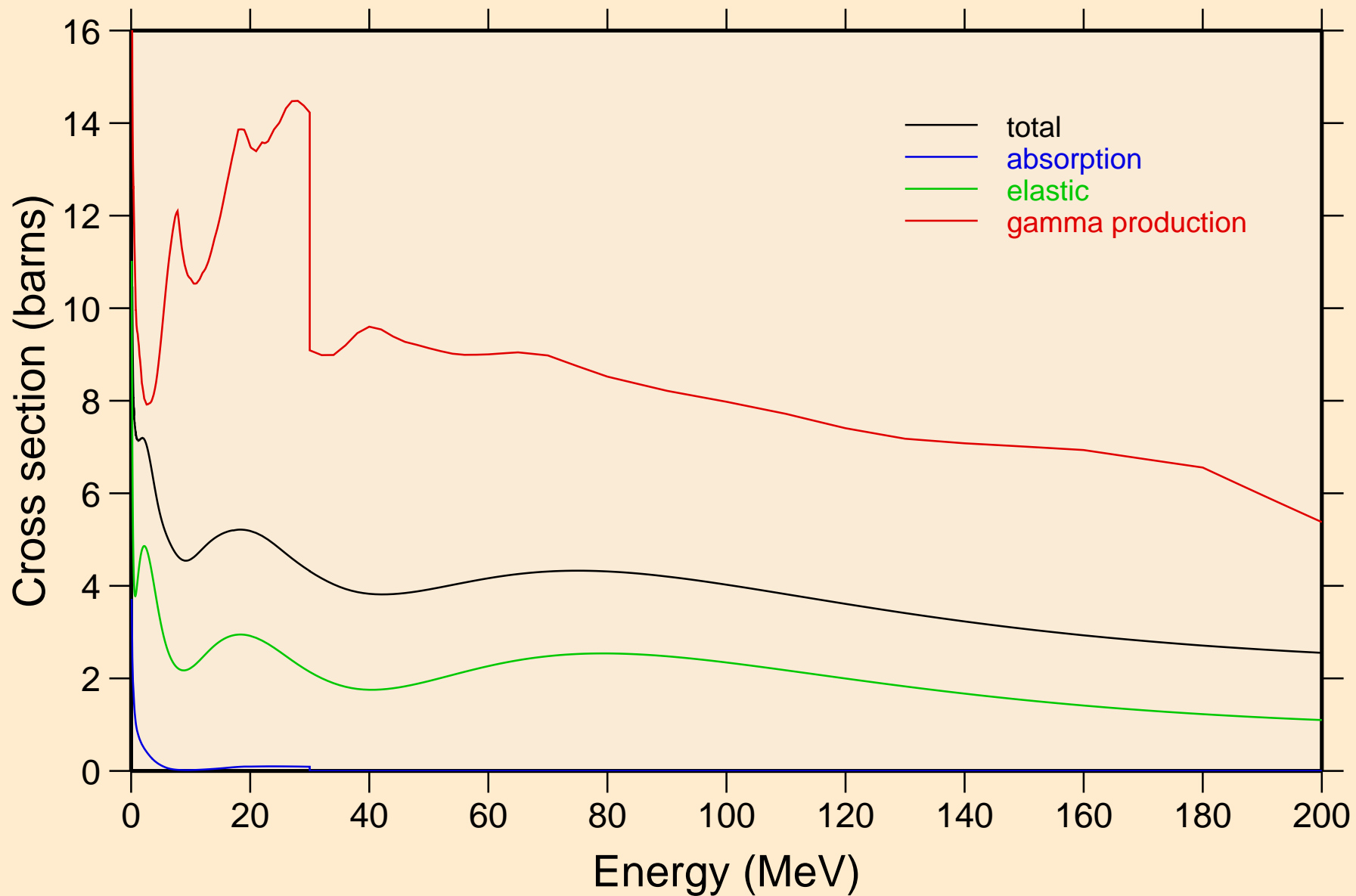

YB165 NEUTRON ACER TENDL-2019 LIBRARY; T=293.16K
Heating

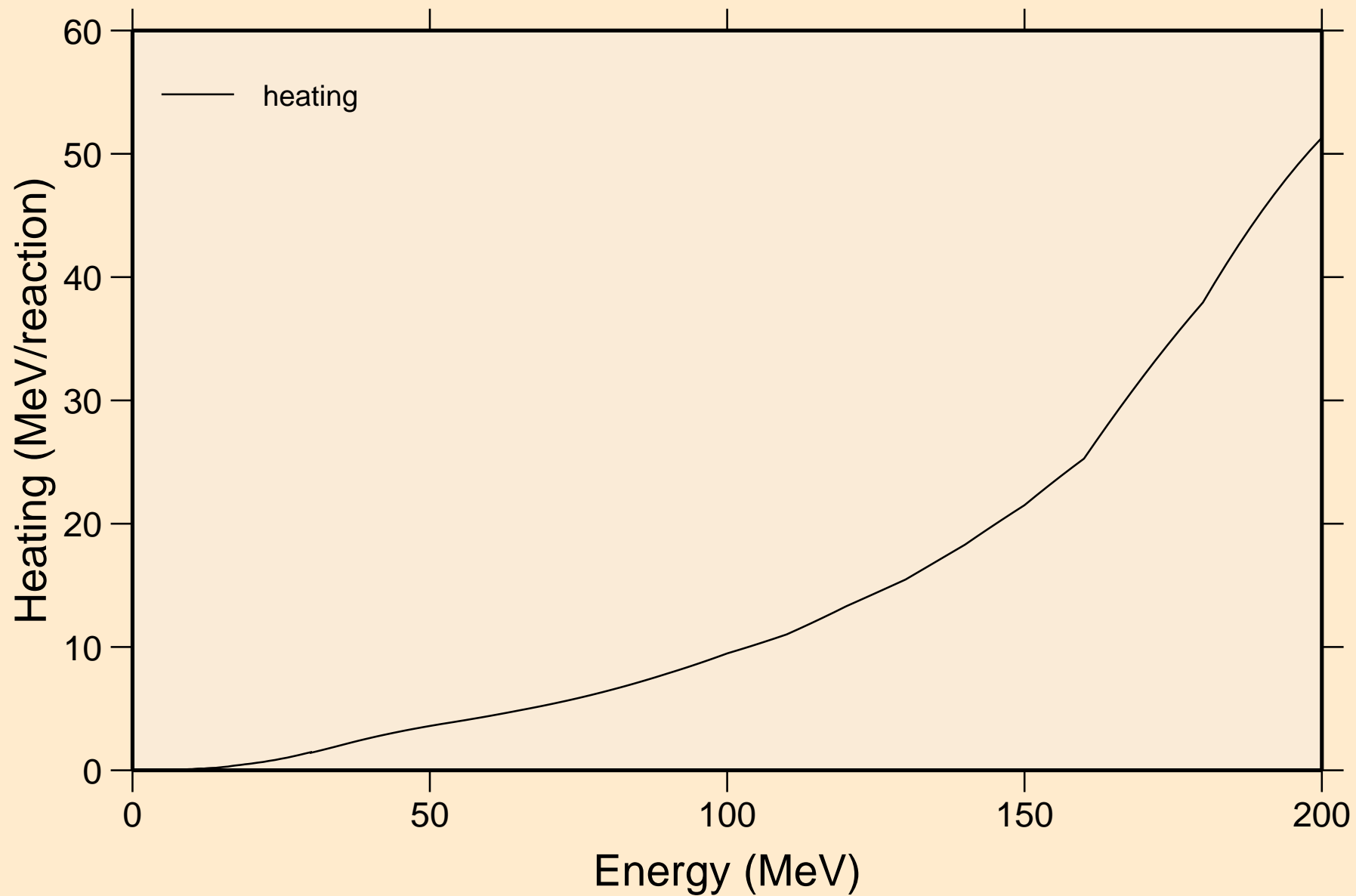

YB165 NEUTRON ACER TENDL-2019 LIBRARY; T=293.16K
Damage

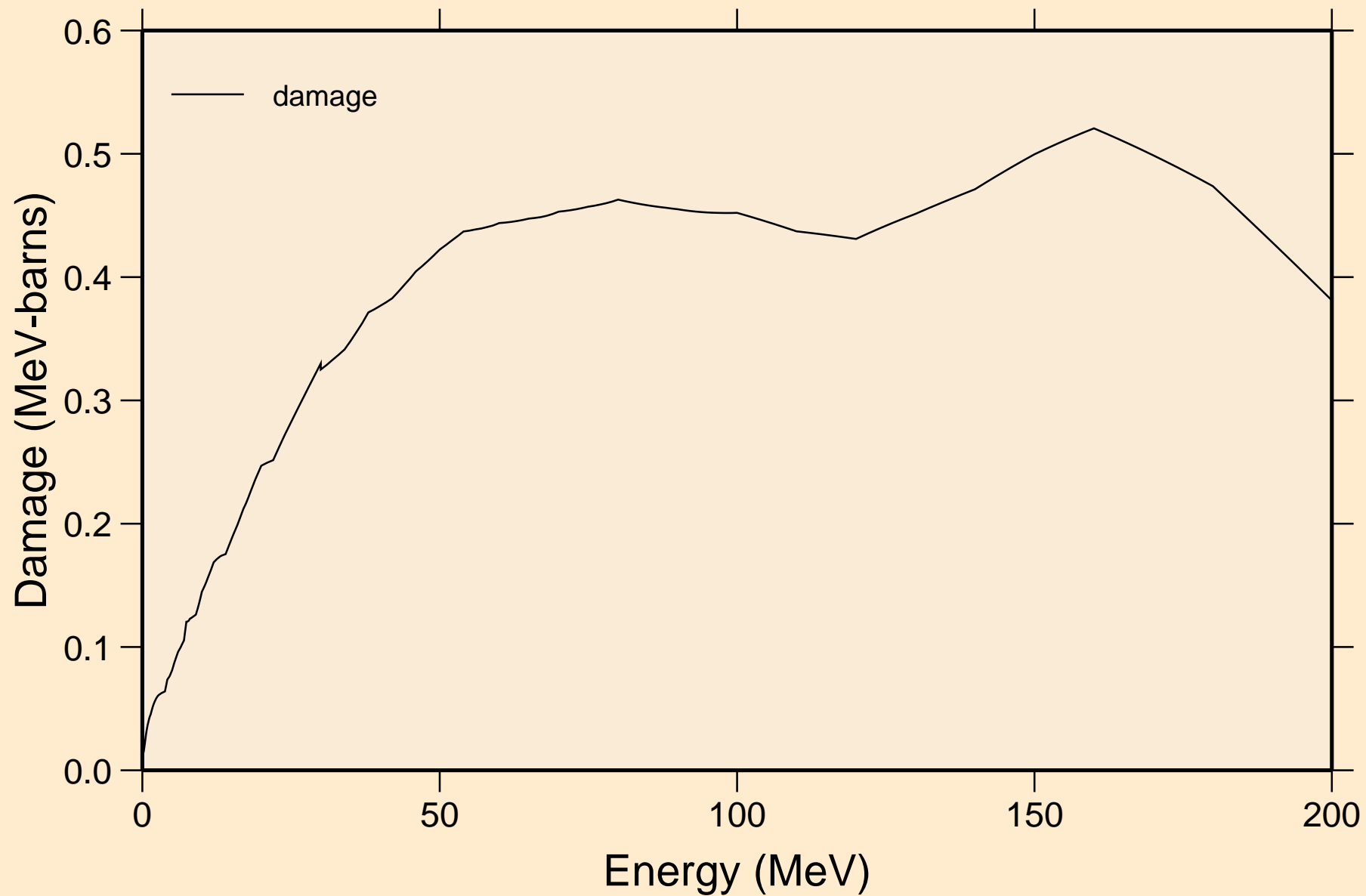

YB165 NEUTRON ACER TENDL-2019 LIBRARY; T=293.16K
Non-threshold reactions

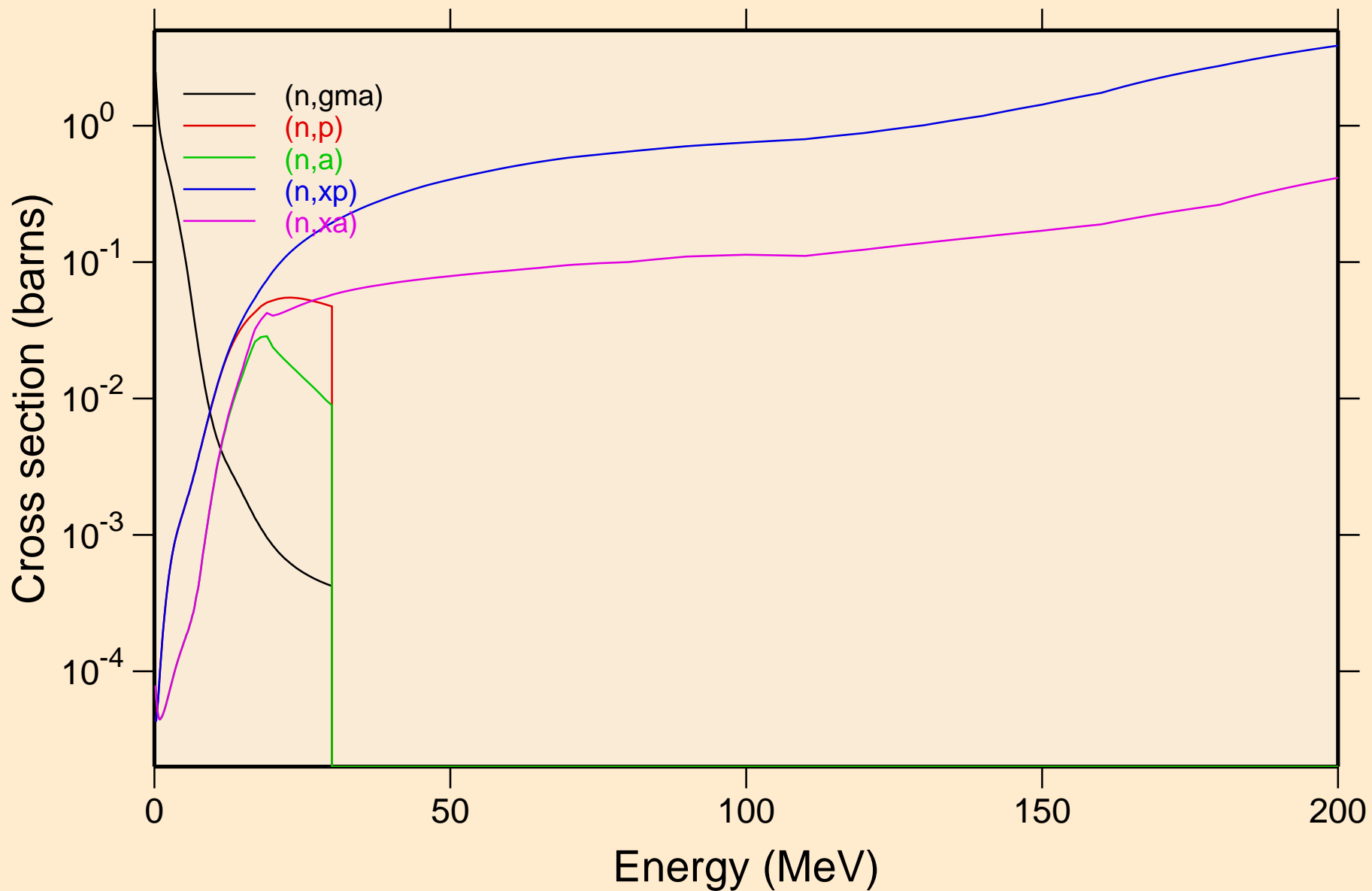

YB165 NEUTRON ACER TENDL-2019 LIBRARY; T=293.16K
Inelastic levels

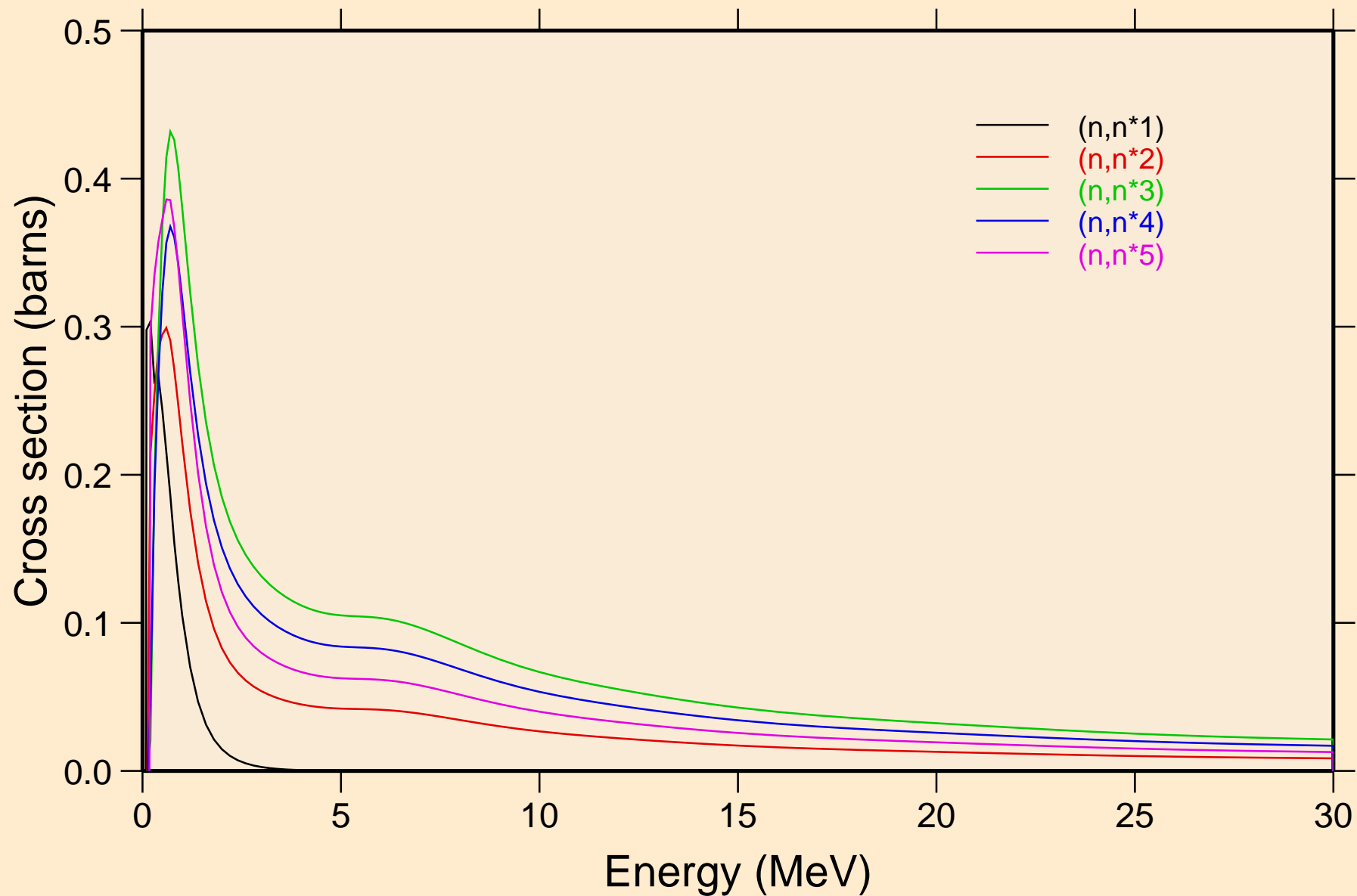

YB165 NEUTRON ACER TENDL-2019 LIBRARY; T=293.16K
Inelastic levels

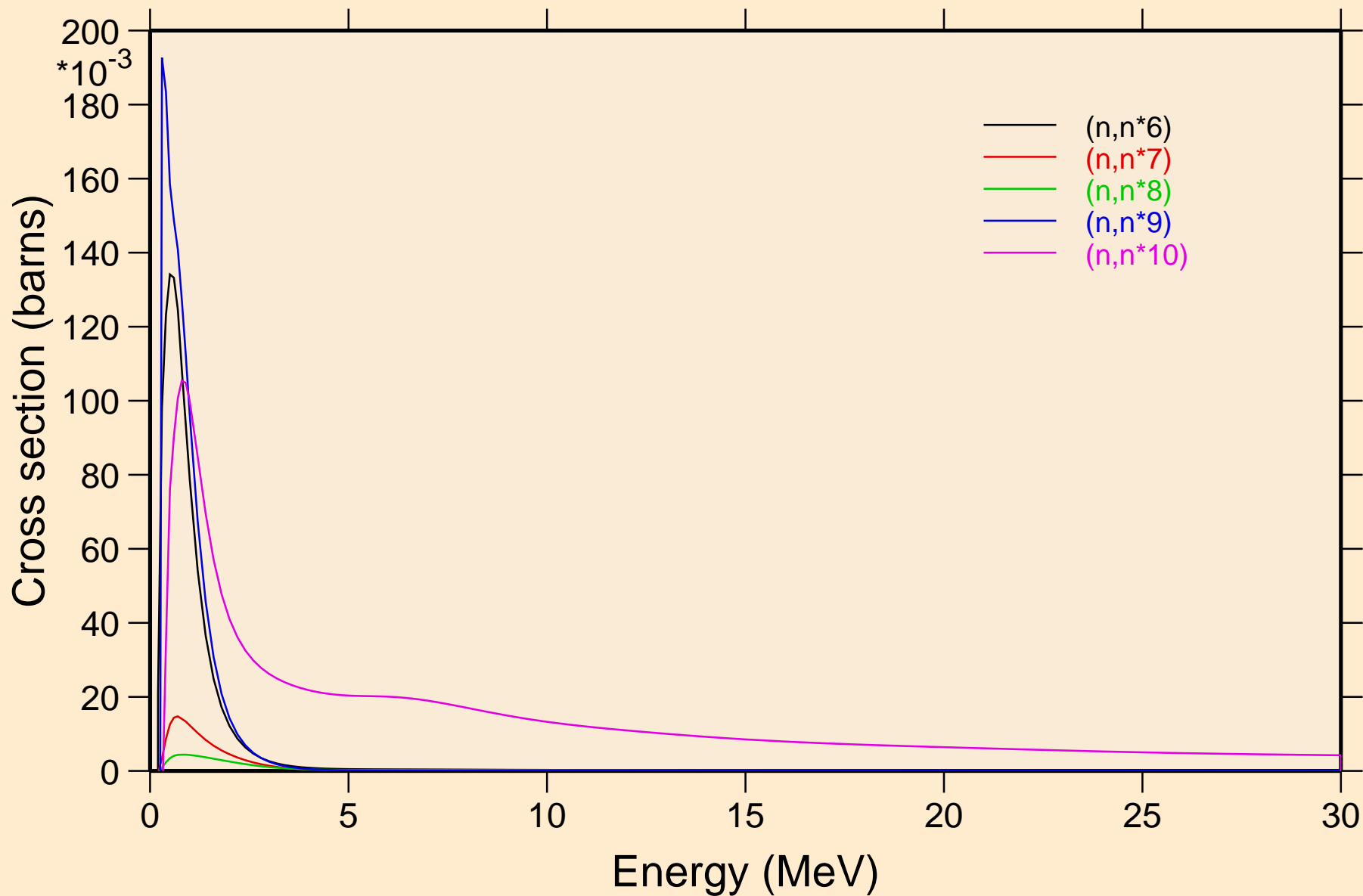

YB165 NEUTRON ACER TENDL-2019 LIBRARY; T=293.16K
Inelastic levels

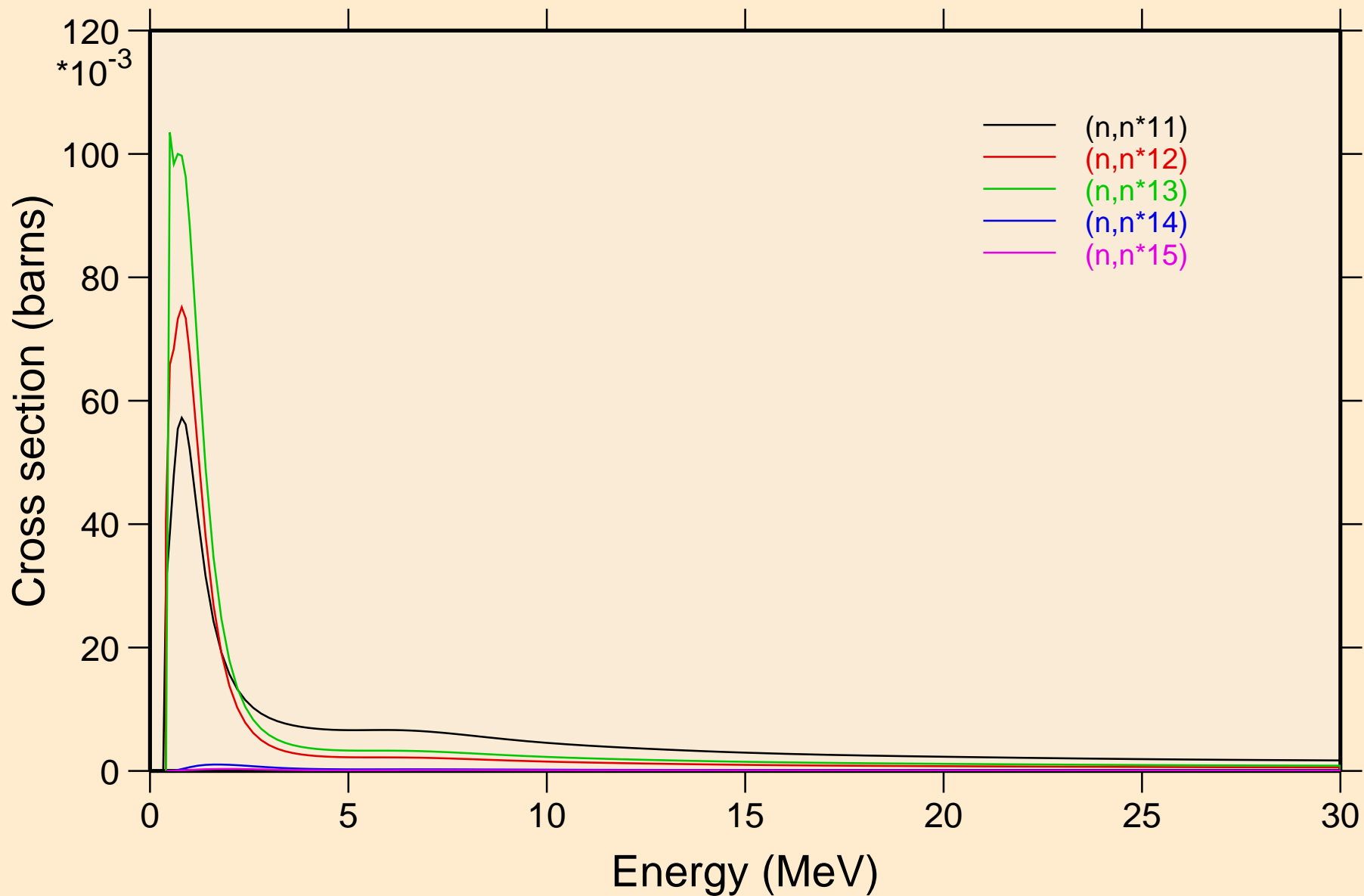

YB165 NEUTRON ACER TENDL-2019 LIBRARY; T=293.16K
Inelastic levels

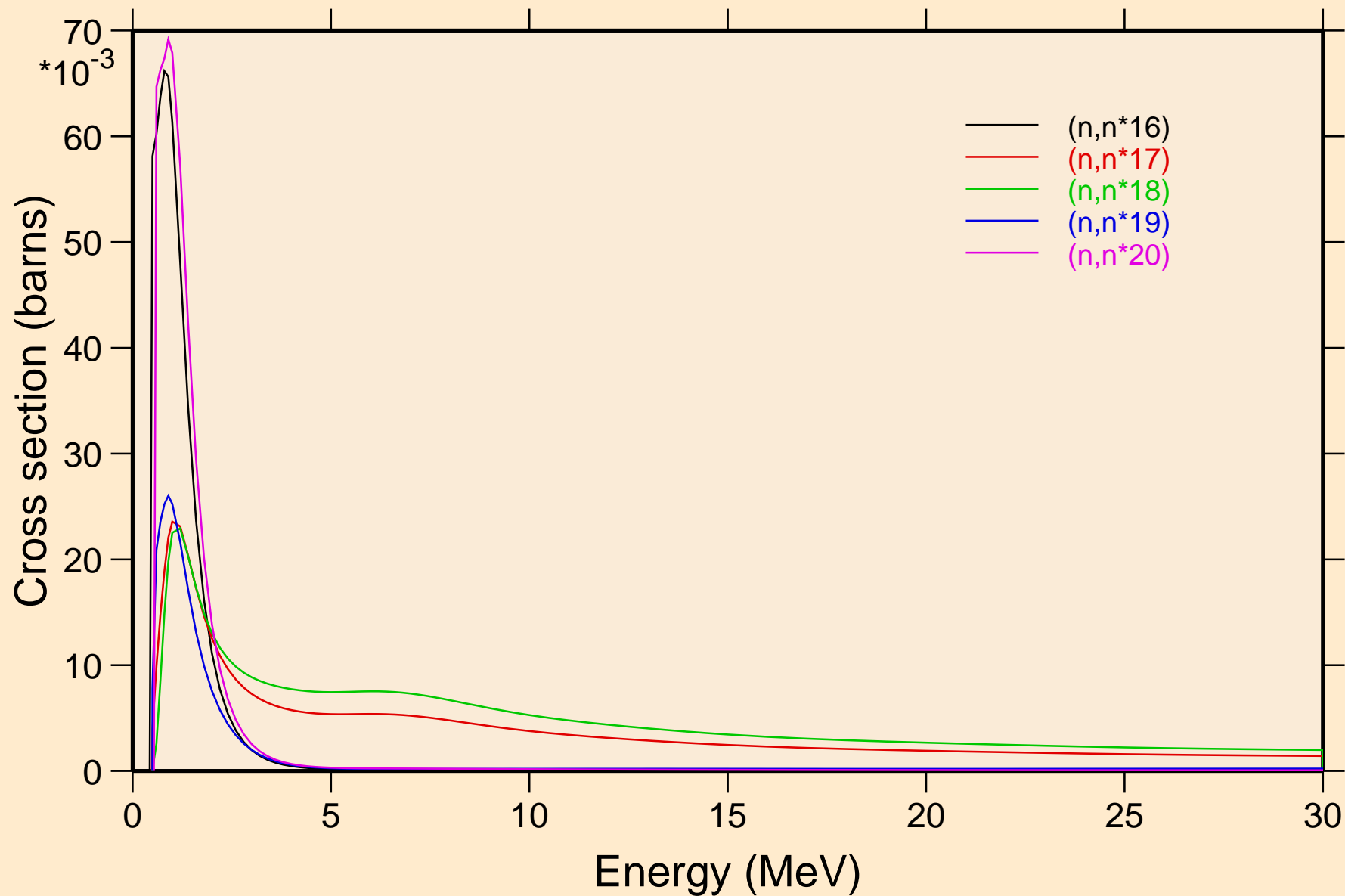

YB165 NEUTRON ACER TENDL-2019 LIBRARY; T=293.16K
Inelastic levels

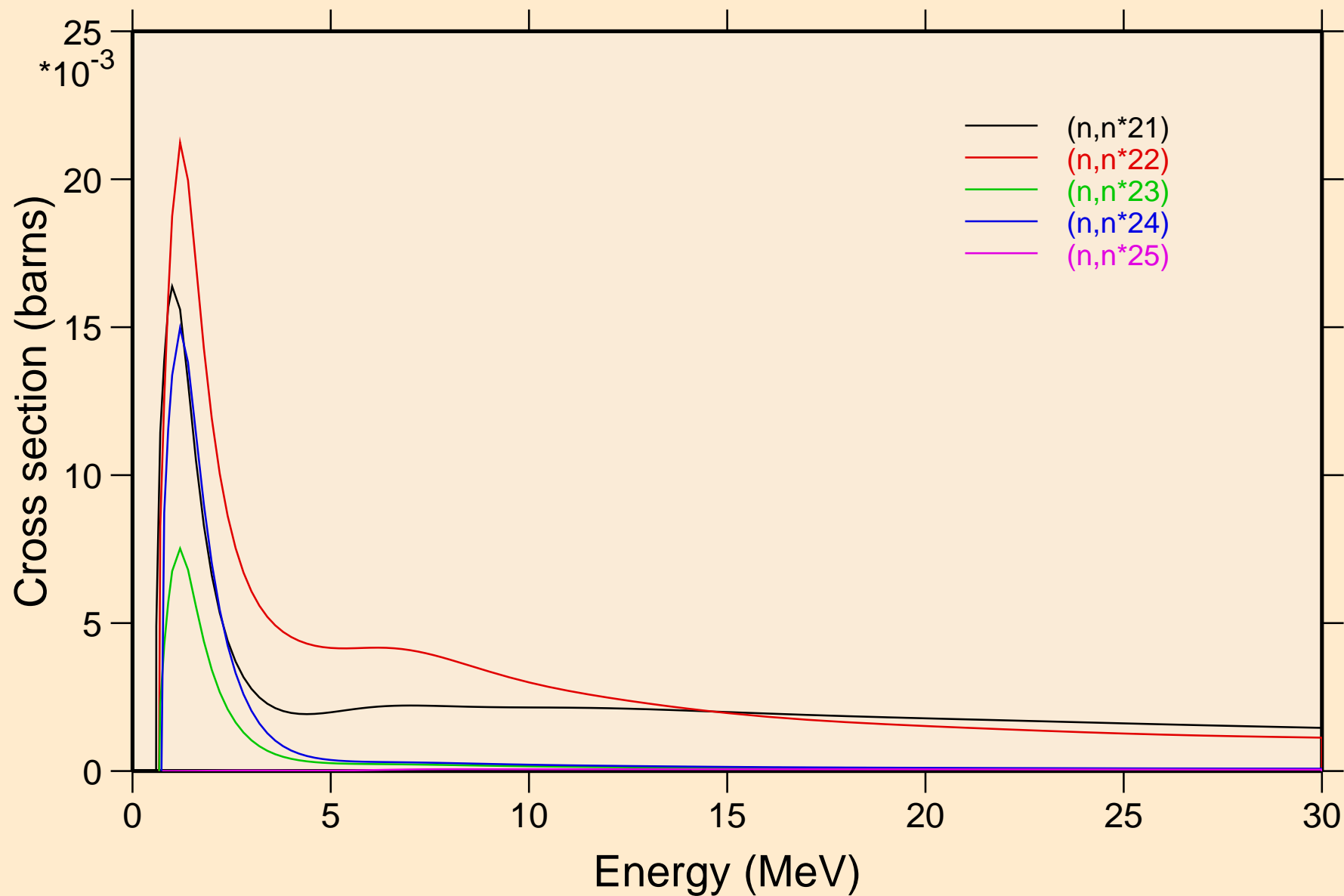

YB165 NEUTRON ACER TENDL-2019 LIBRARY; T=293.16K
Inelastic levels

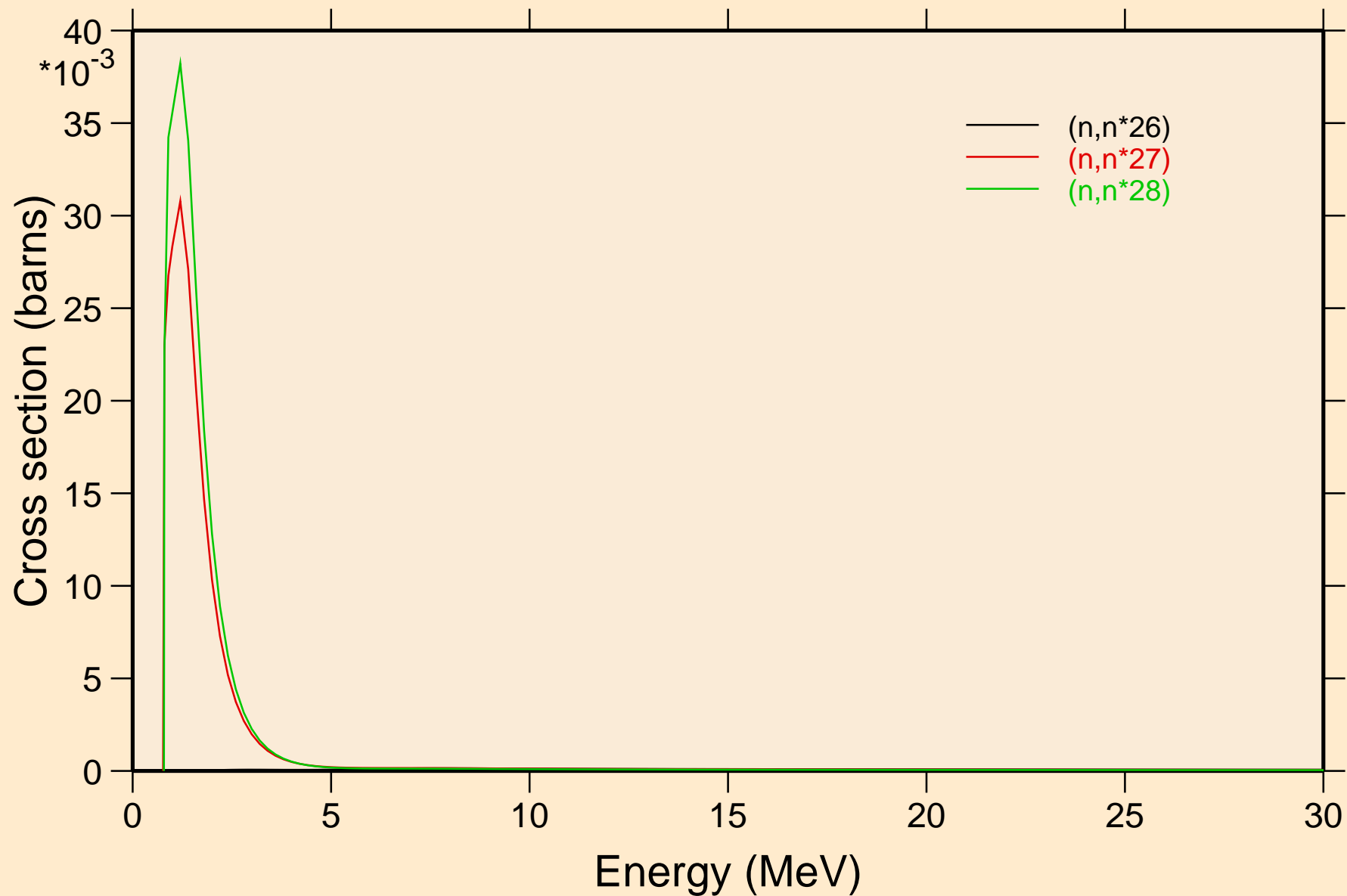

YB165 NEUTRON ACER TENDL-2019 LIBRARY; T=293.16K
Threshold reactions

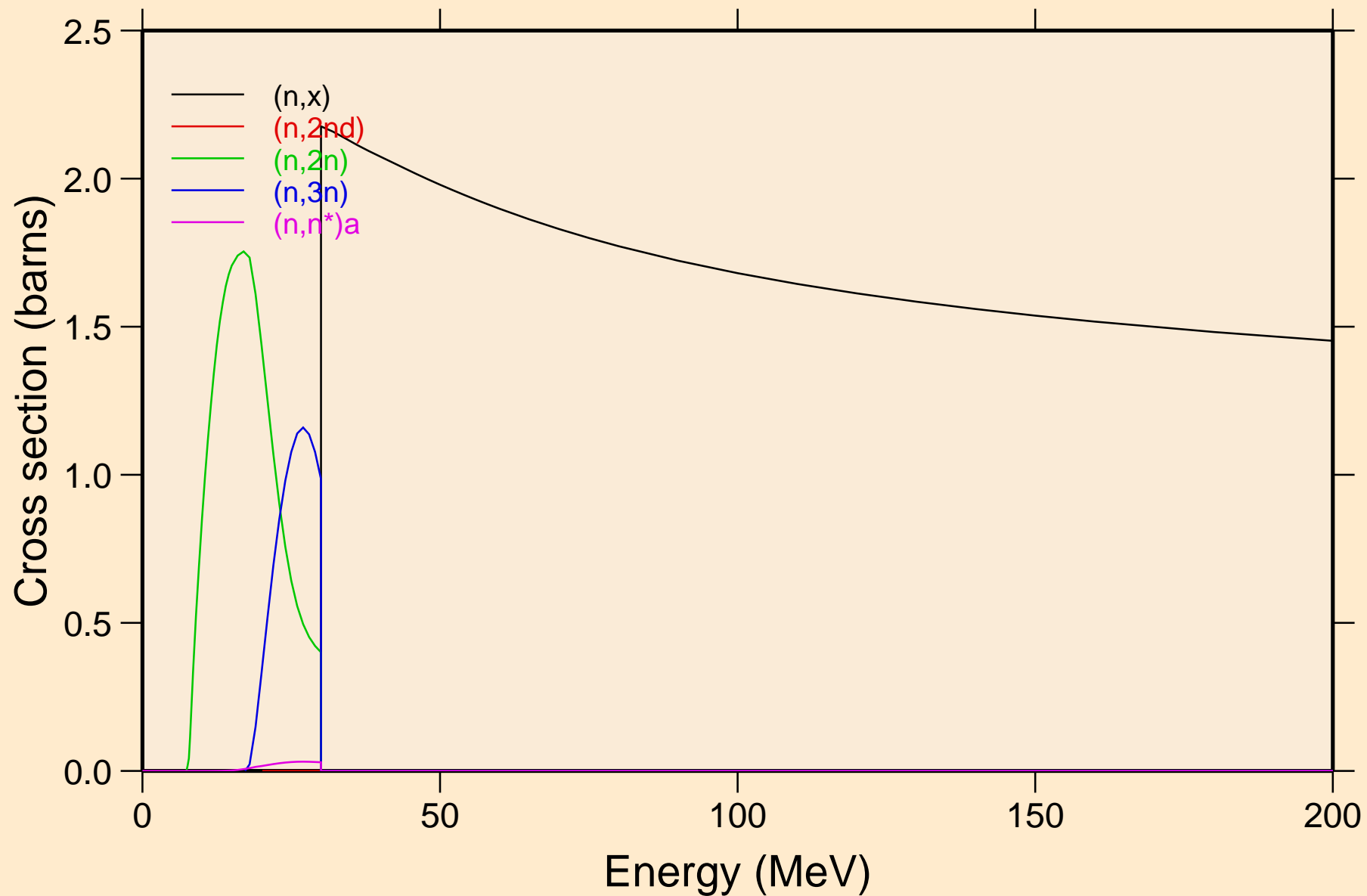

YB165 NEUTRON ACER TENDL-2019 LIBRARY; T=293.16K
Threshold reactions

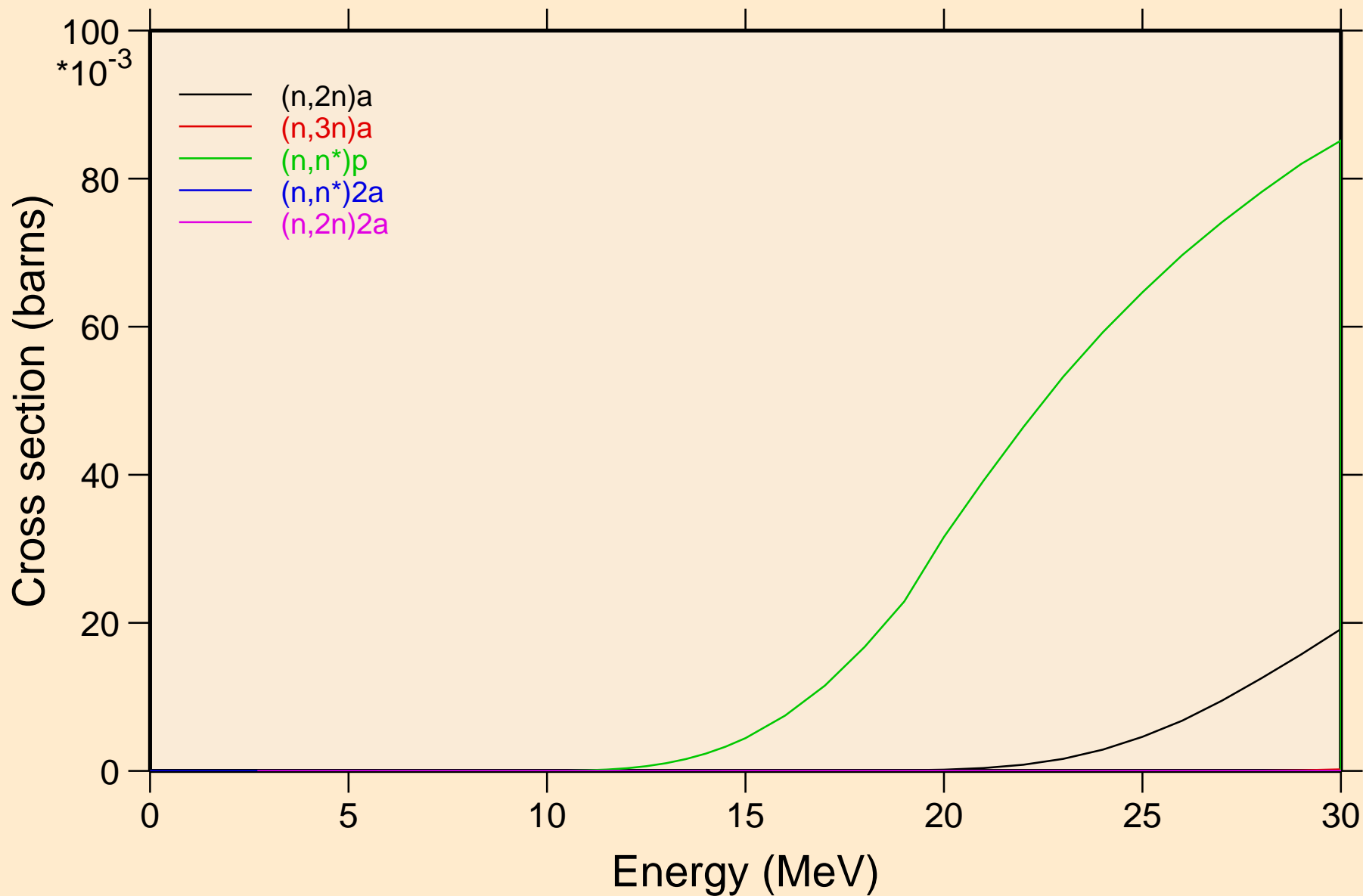

YB165 NEUTRON ACER TENDL-2019 LIBRARY; T=293.16K
Threshold reactions

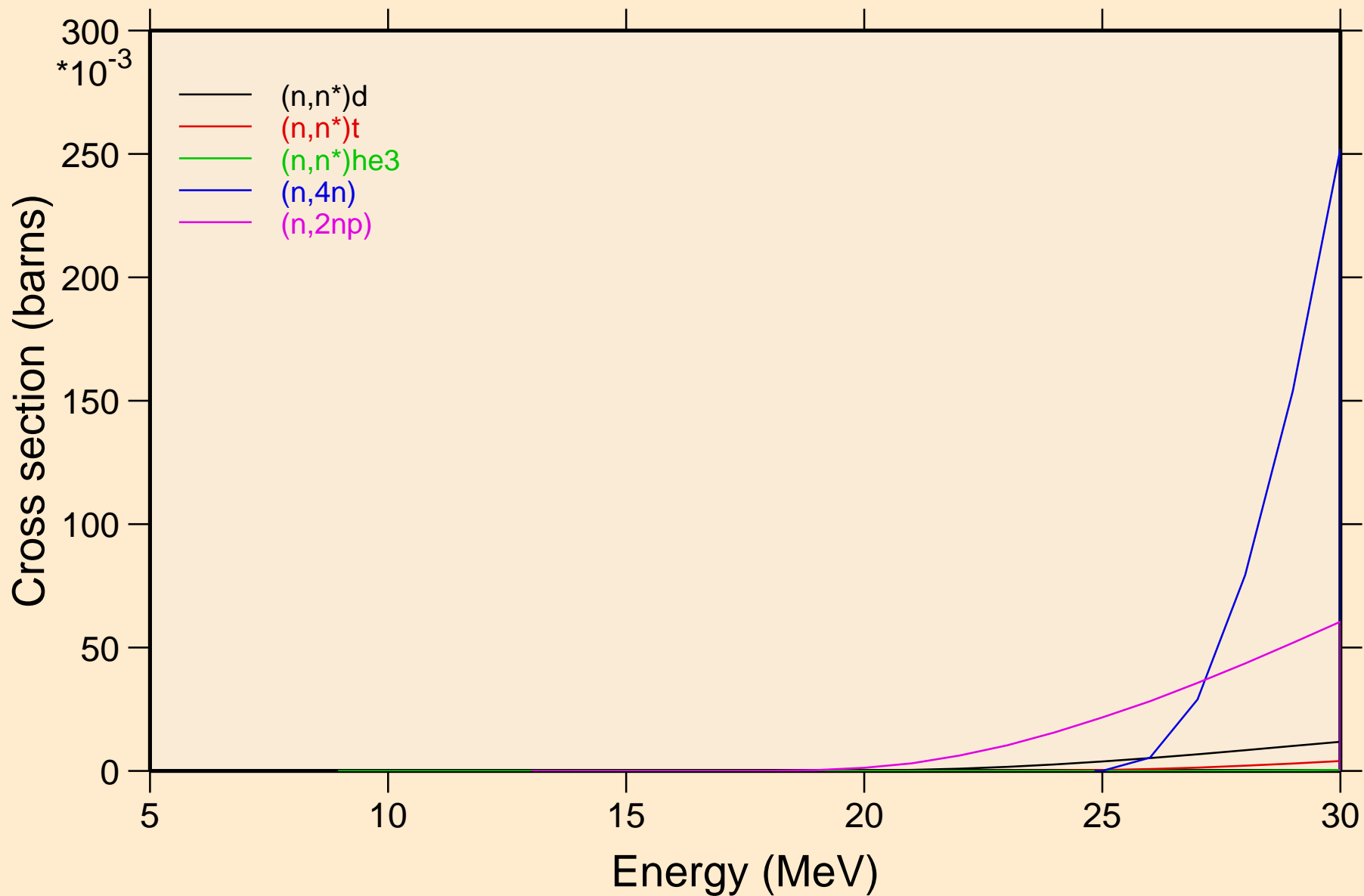

YB165 NEUTRON ACER TENDL-2019 LIBRARY; T=293.16K
Threshold reactions

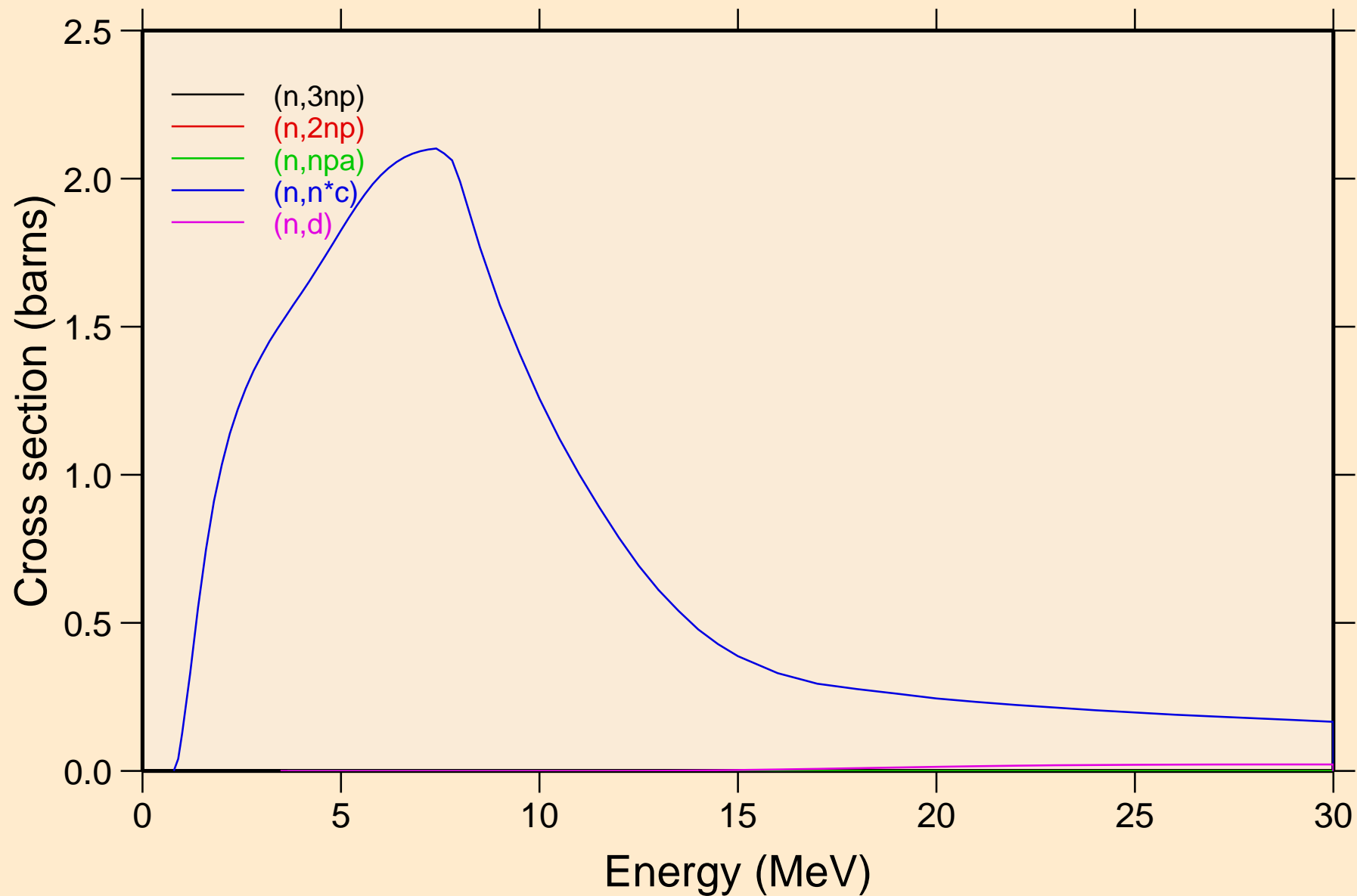

YB165 NEUTRON ACER TENDL-2019 LIBRARY; T=293.16K
Threshold reactions

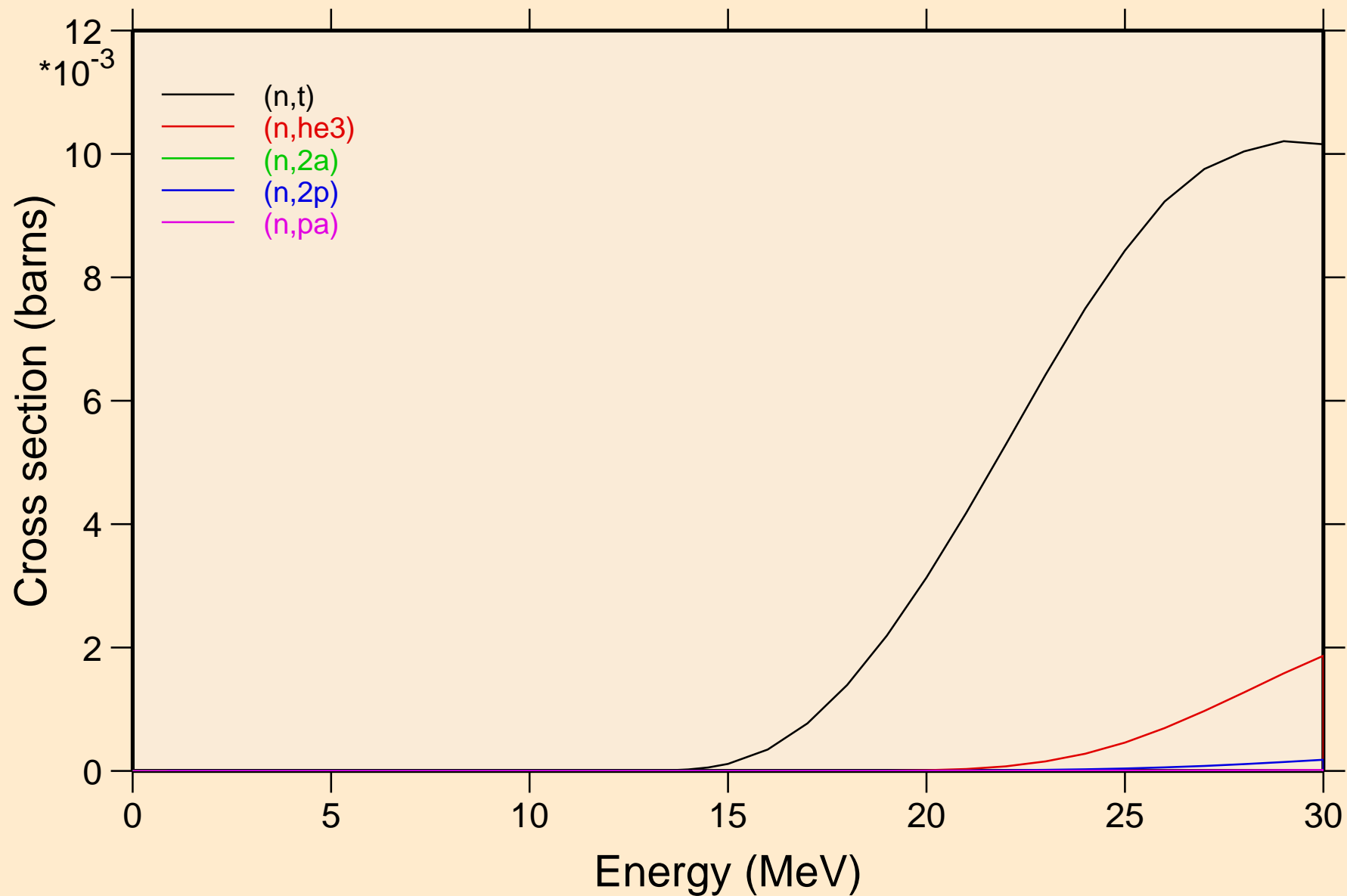

YB165 NEUTRON ACER TENDL-2019 LIBRARY; T=293.16K
Threshold reactions

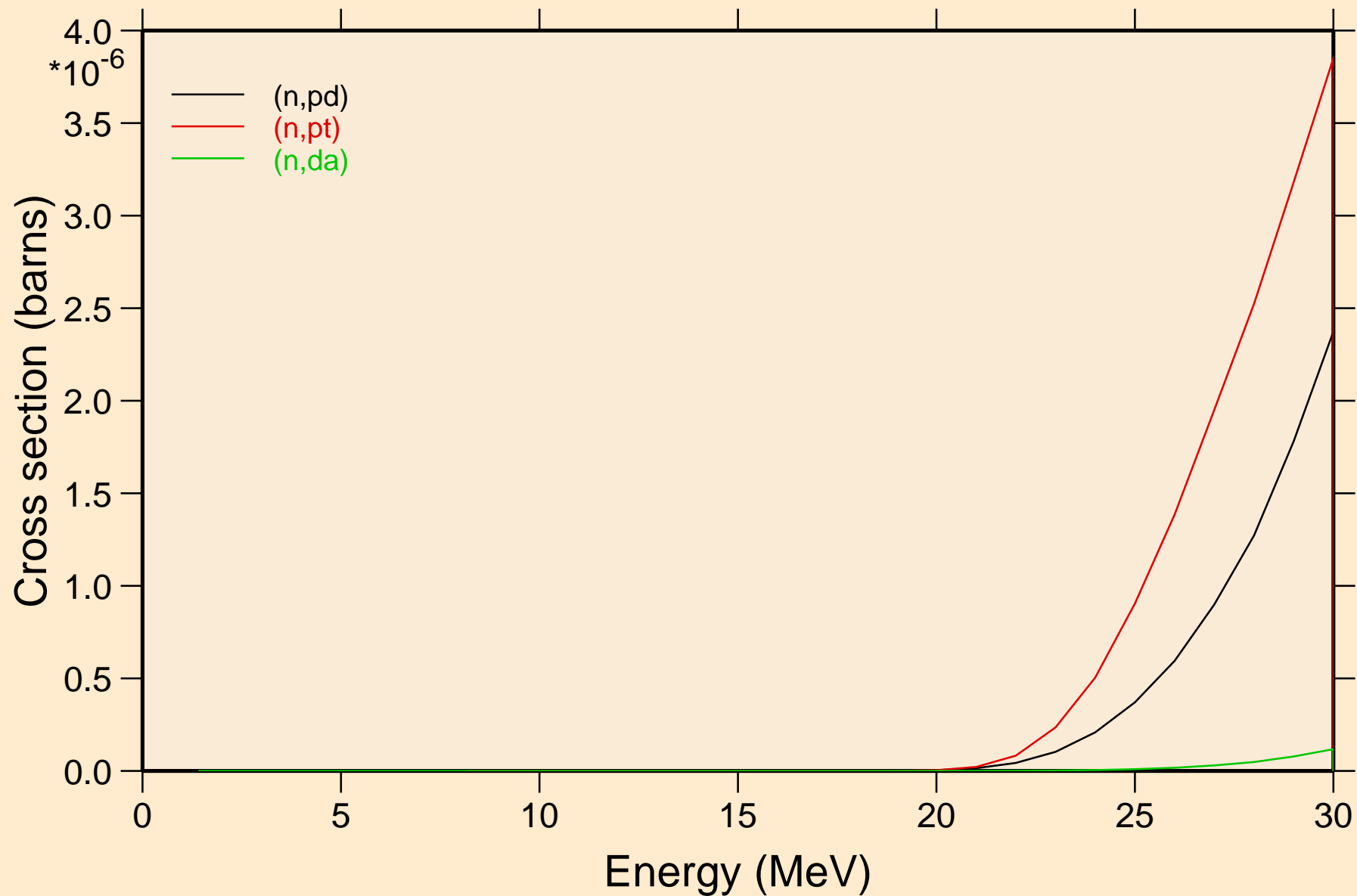

YB165 NEUTRON ACER TENDL-2019 LIBRARY; T=293.16K
Threshold reactions

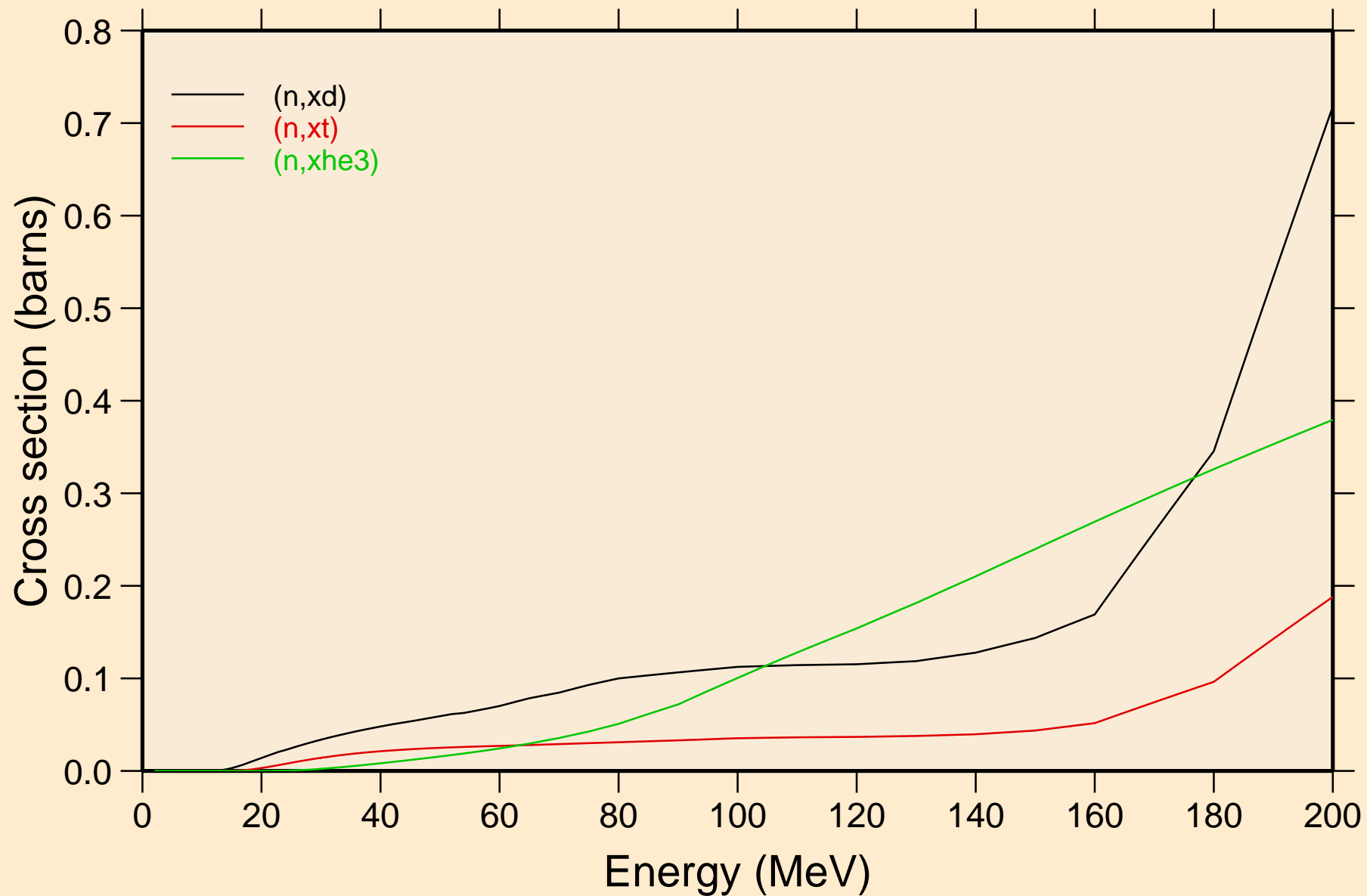

YB165 NEUTRON ACER TENDL-2019 LIBRARY; T=293.16K
angular distribution for elastic

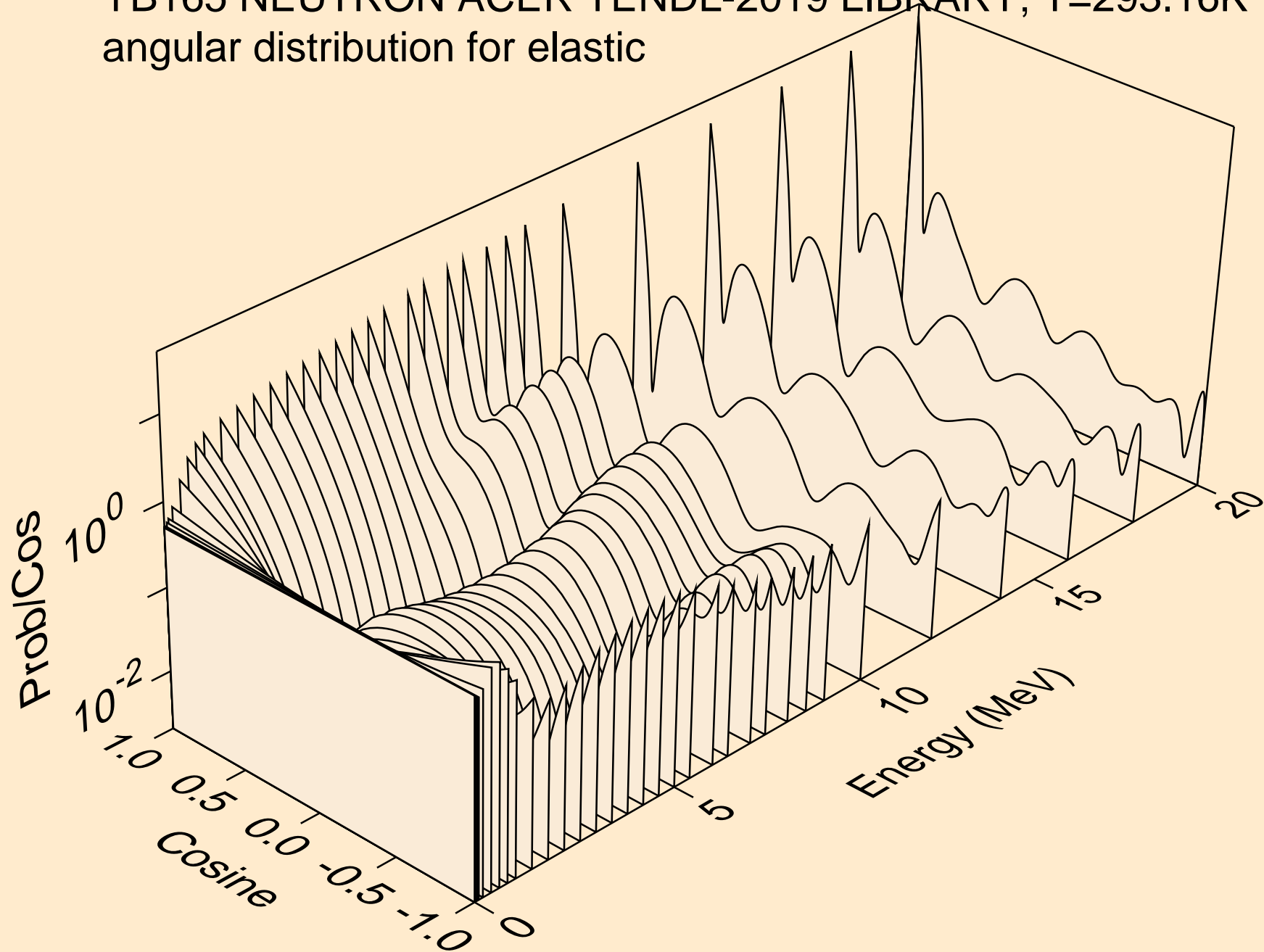

YB165 NEUTRON ACER TENDL-2019 LIBRARY; T=293.16K
angular distribution for elastic

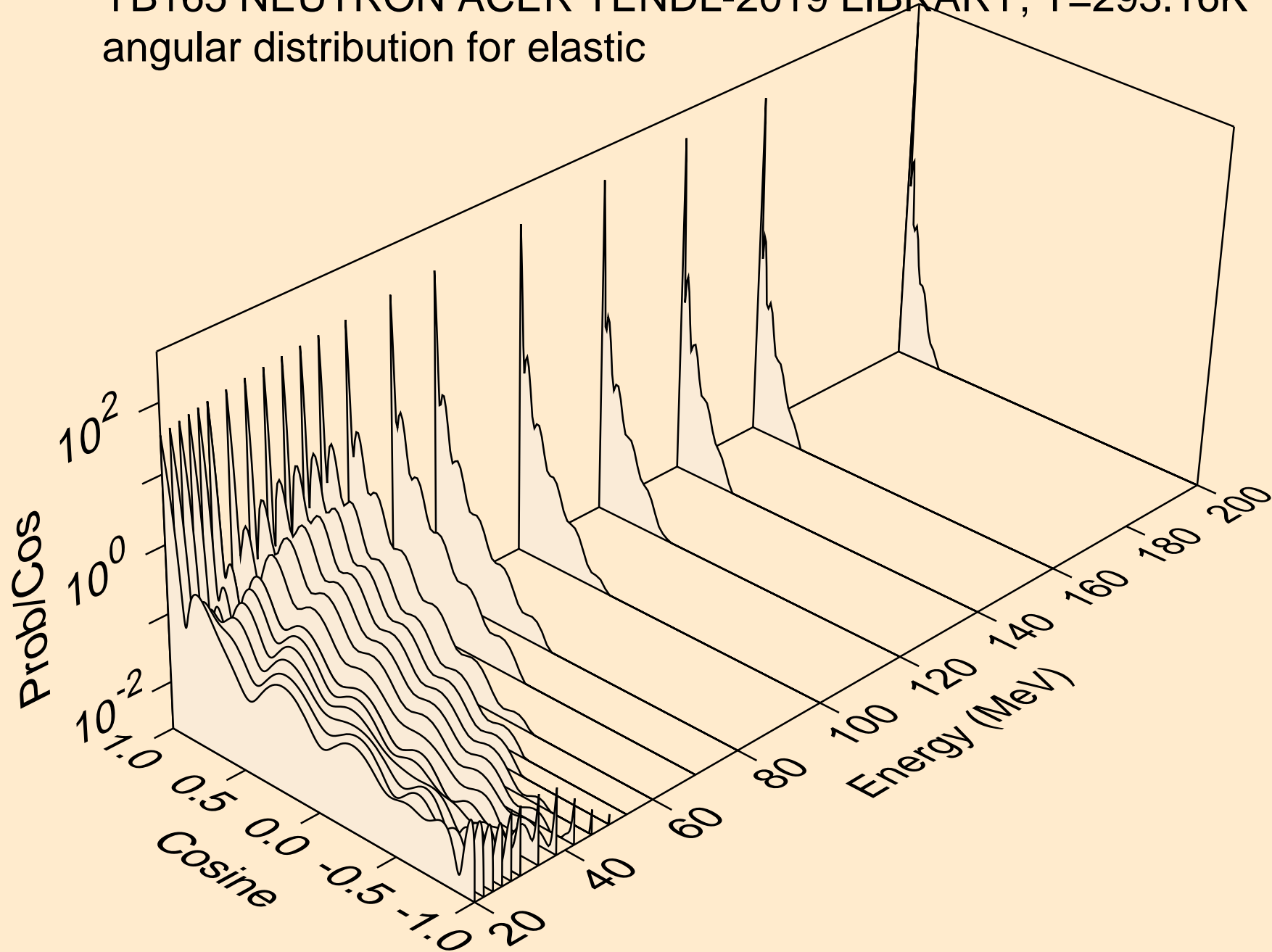

YB165 NEUTRON ACER TENDL-2019 LIBRARY; T=293.16K
angular distribution for (n,n*1)

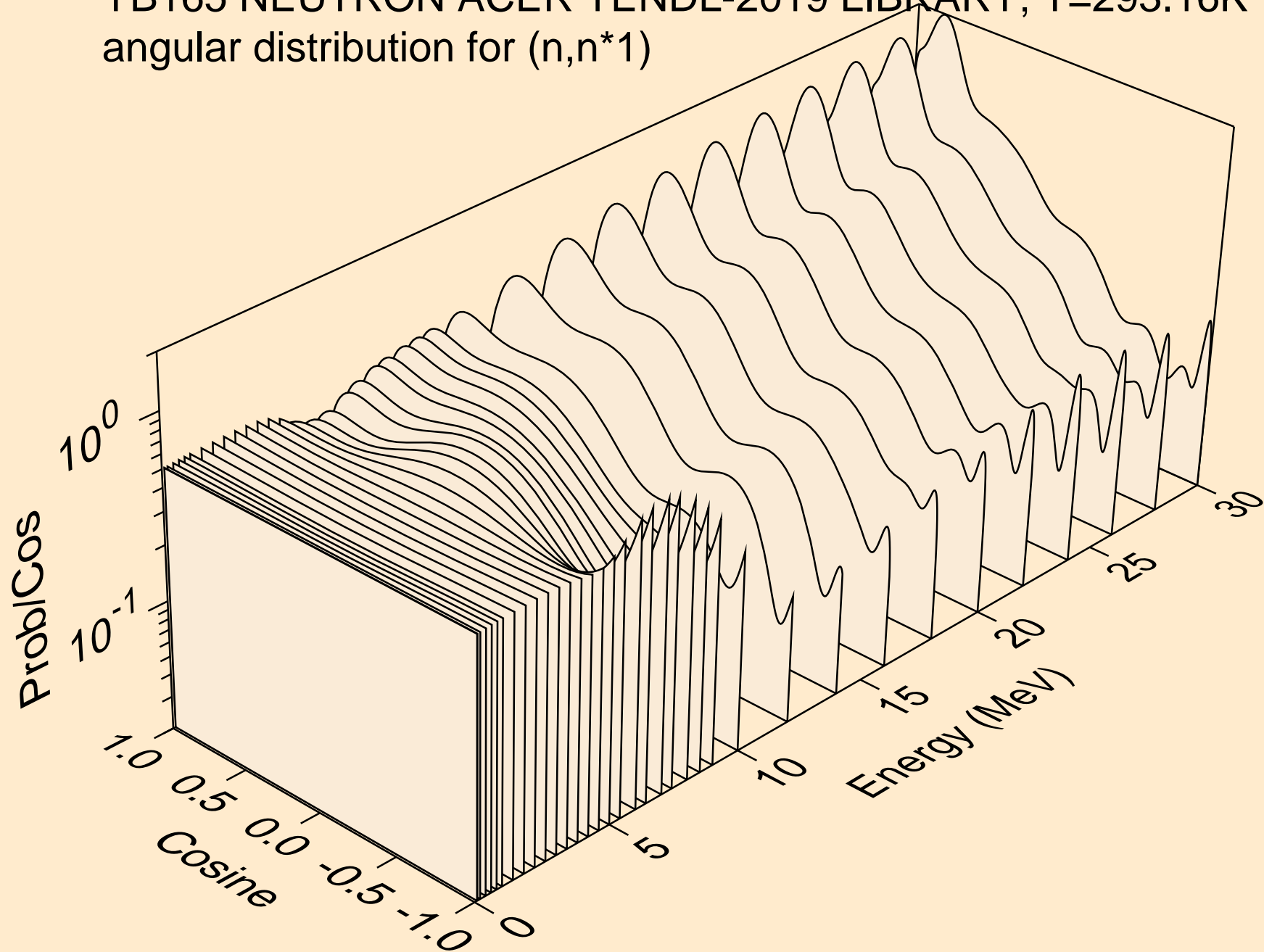

YB165 NEUTRON ACER TENDL-2019 LIBRARY; T=293.16K
angular distribution for (n,n*2)

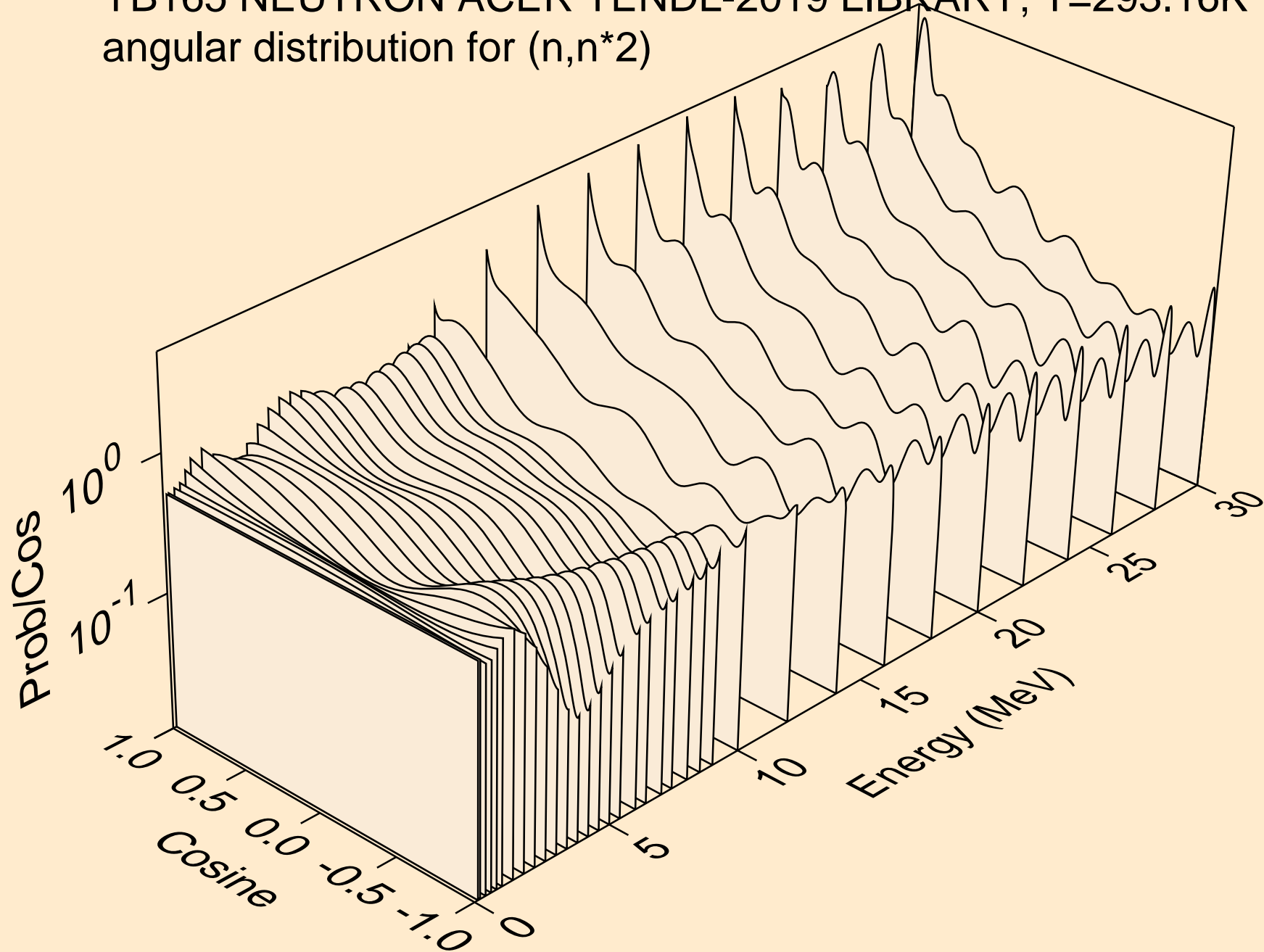

YB165 NEUTRON ACER TENDL-2019 LIBRARY; T=293.16K
angular distribution for (n,n*3)

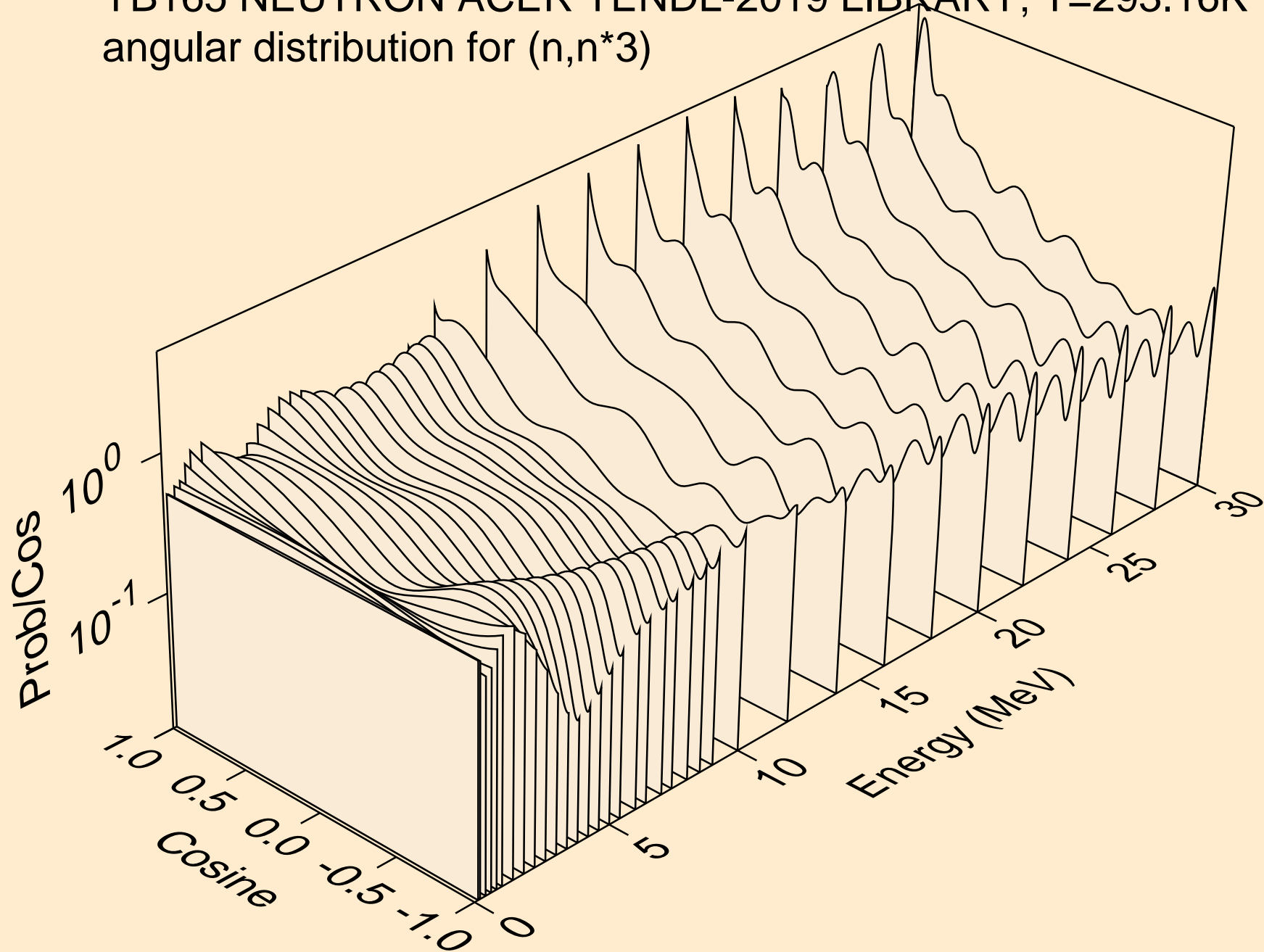

YB165 NEUTRON ACER TENDL-2019 LIBRARY; T=293.16K
angular distribution for (n,n*4)

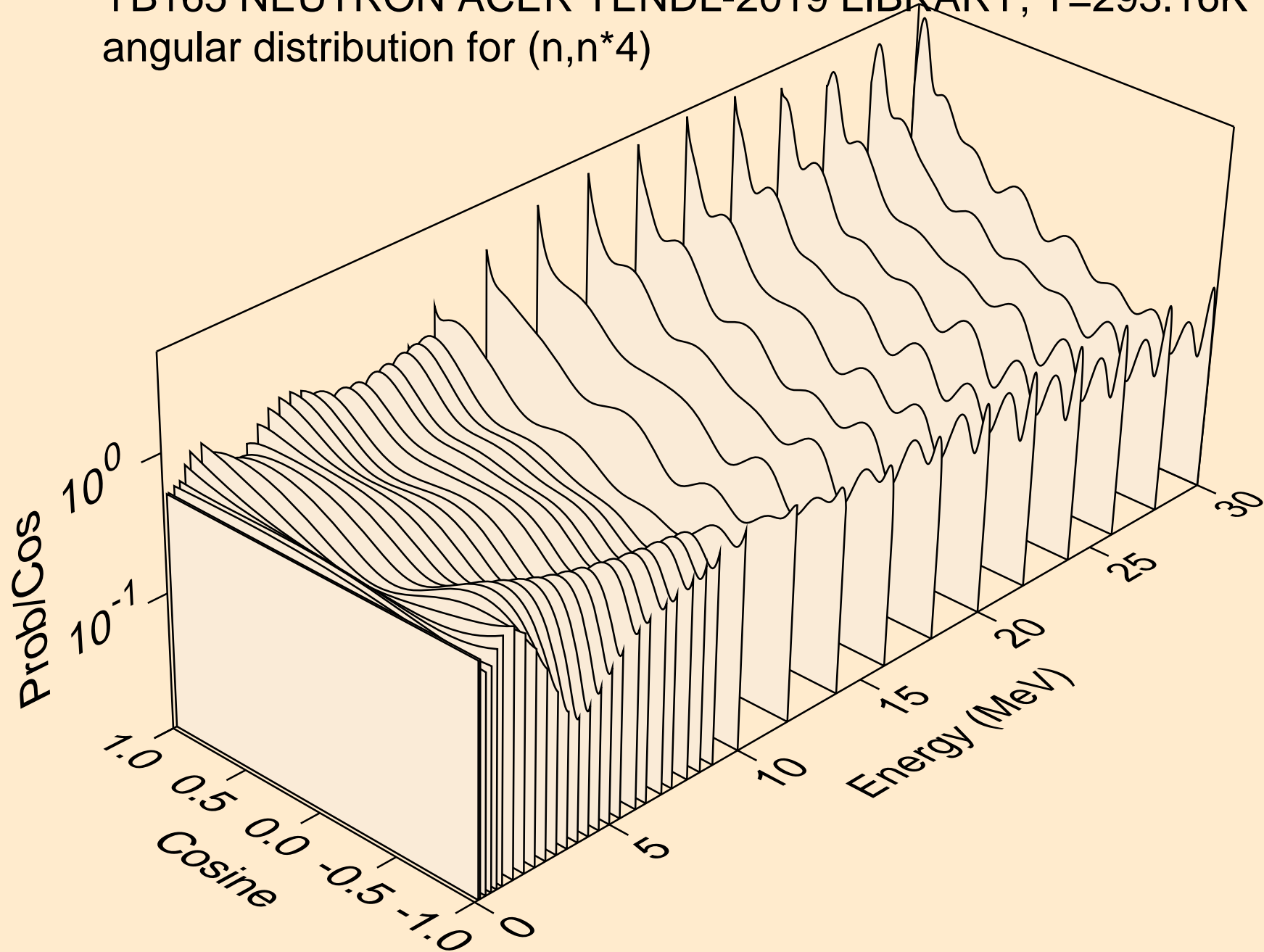

YB165 NEUTRON ACER TENDL-2019 LIBRARY; T=293.16K
angular distribution for (n,n*5)

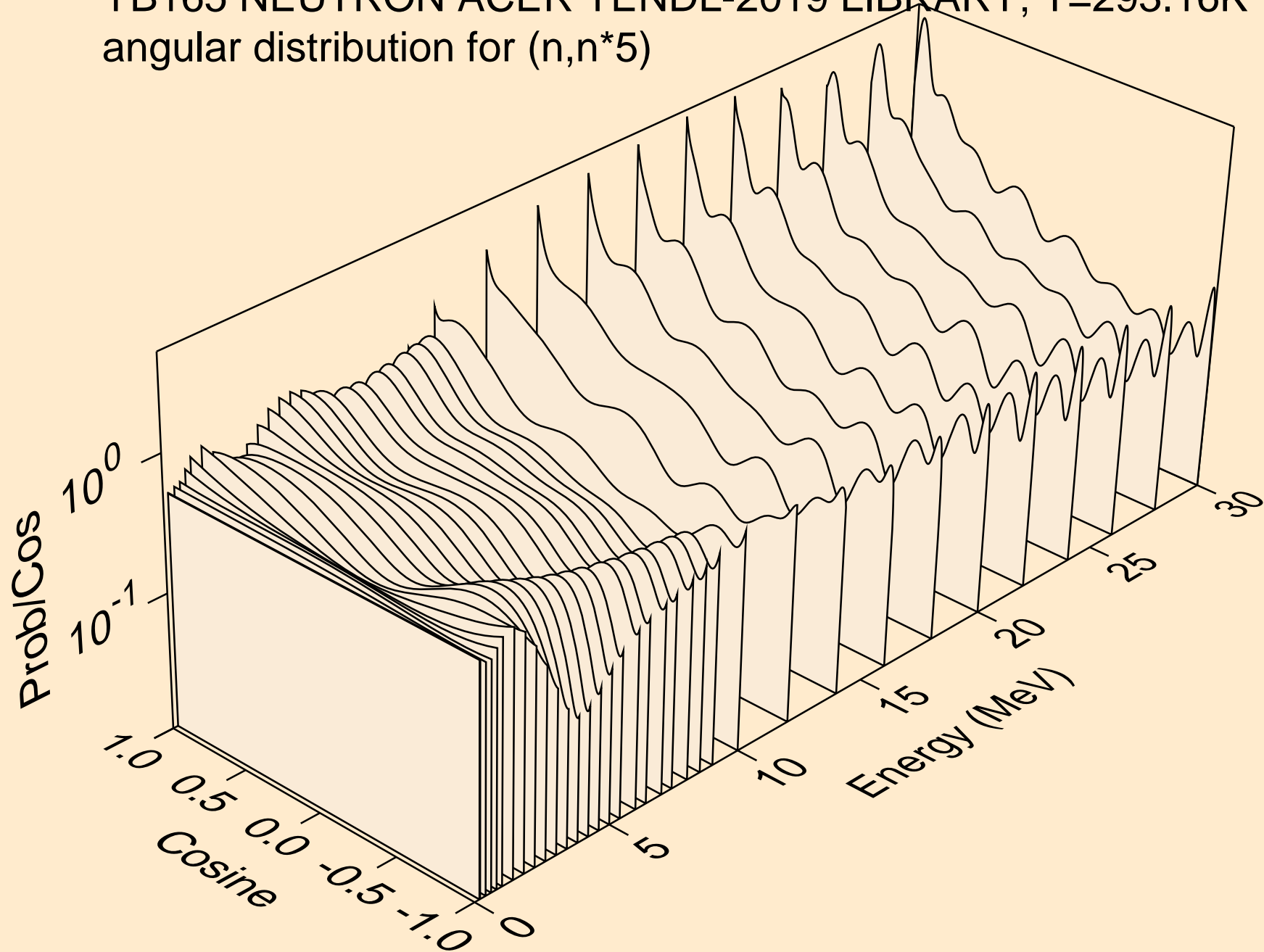

YB165 NEUTRON ACER TENDL-2019 LIBRARY; T=293.16K
angular distribution for (n,n*6)

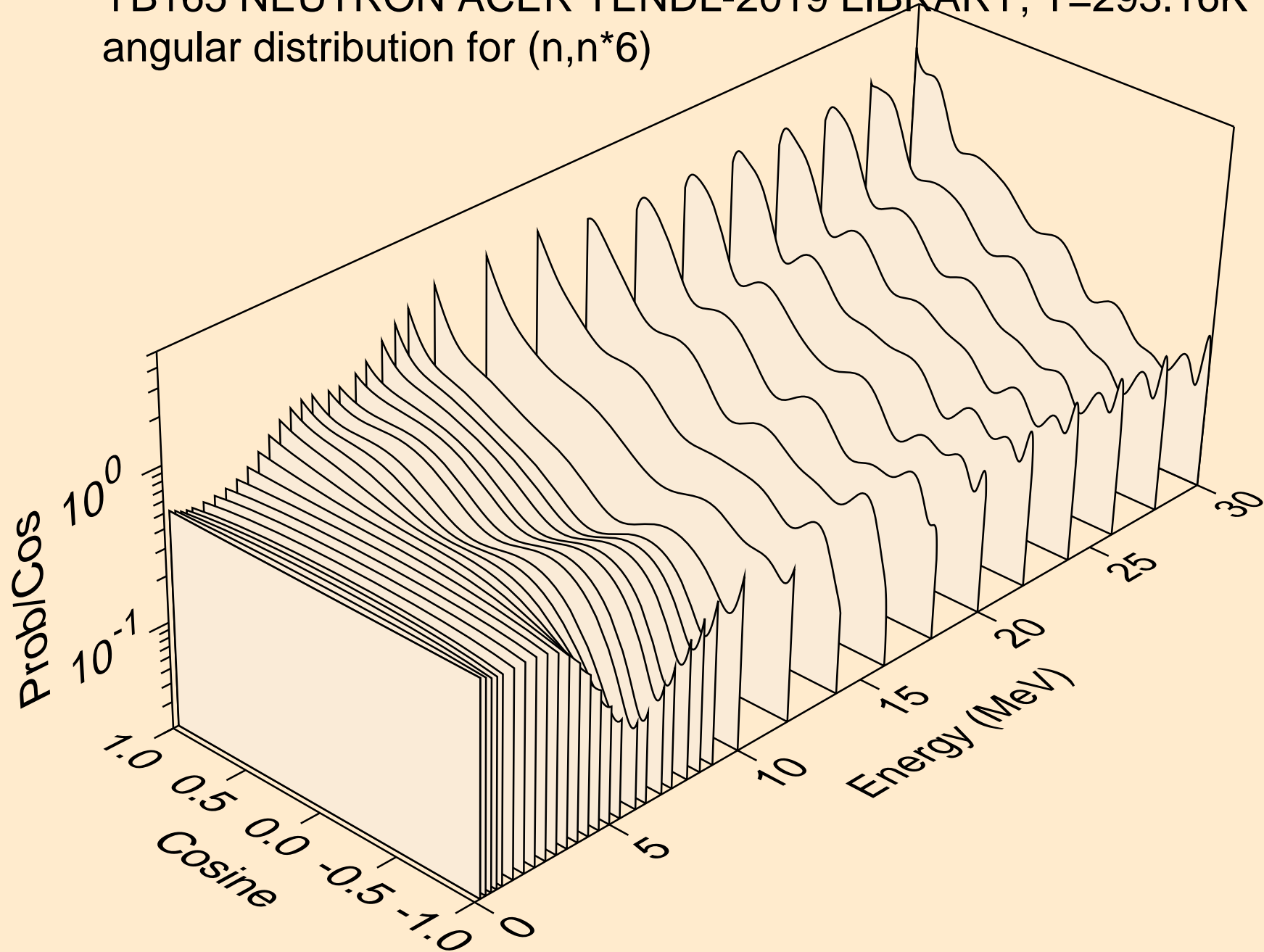

YB165 NEUTRON ACER TENDL-2019 LIBRARY; T=293.16K
angular distribution for (n,n*7)

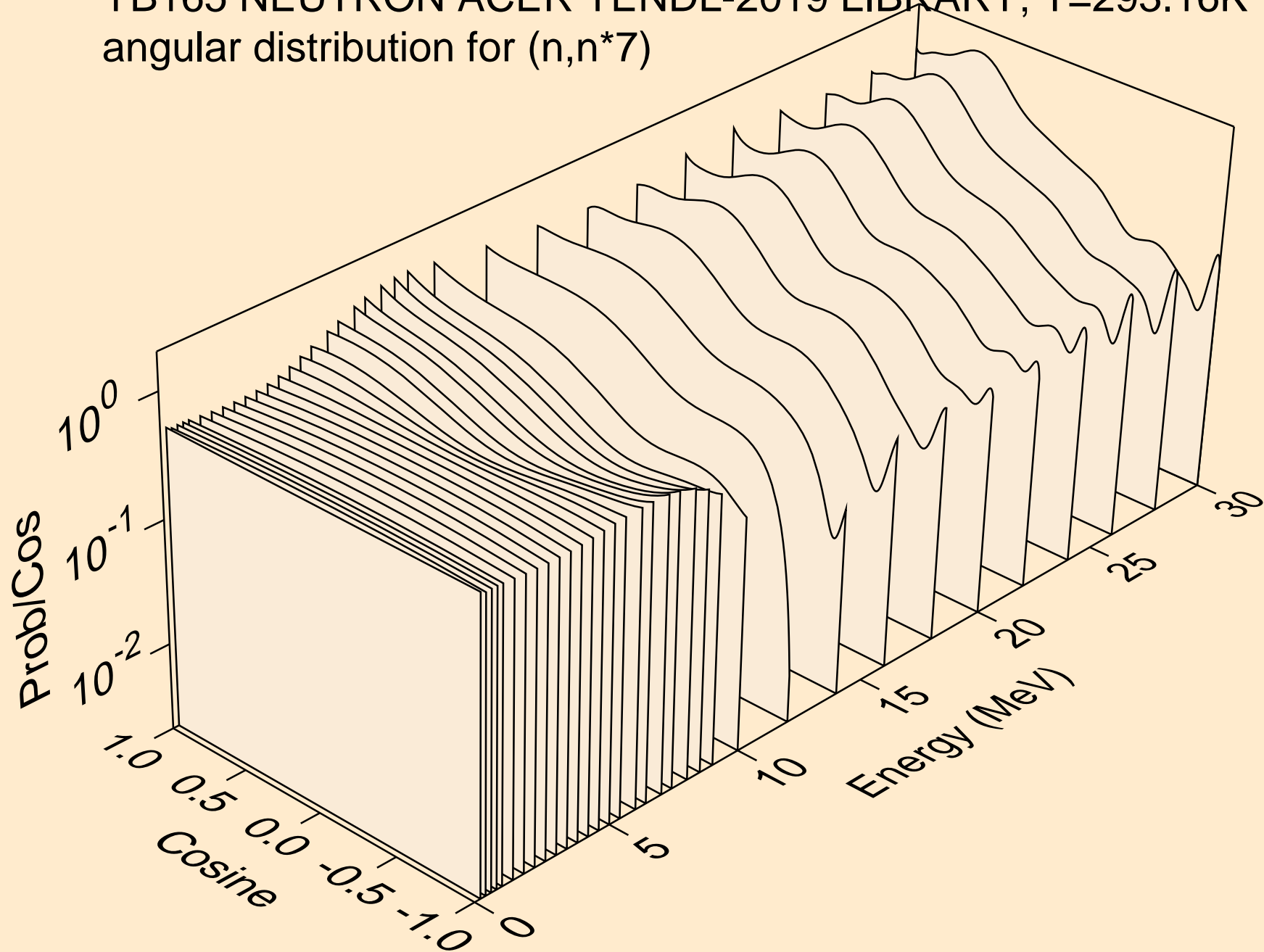

YB165 NEUTRON ACER TENDL-2019 LIBRARY; T=293.16K
angular distribution for (n,n*8)

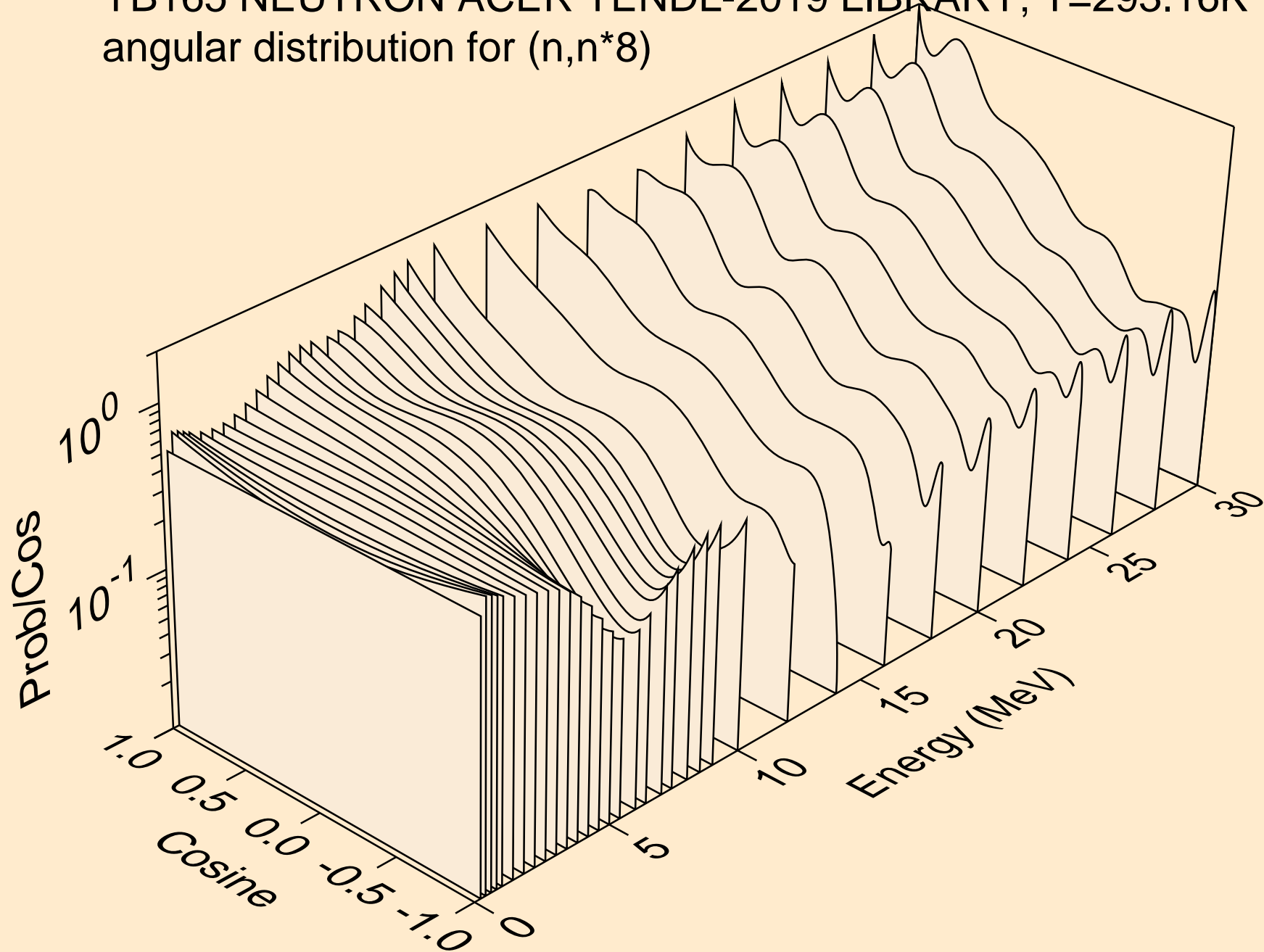

YB165 NEUTRON ACER TENDL-2019 LIBRARY; T=293.16K
angular distribution for (n,n*9)

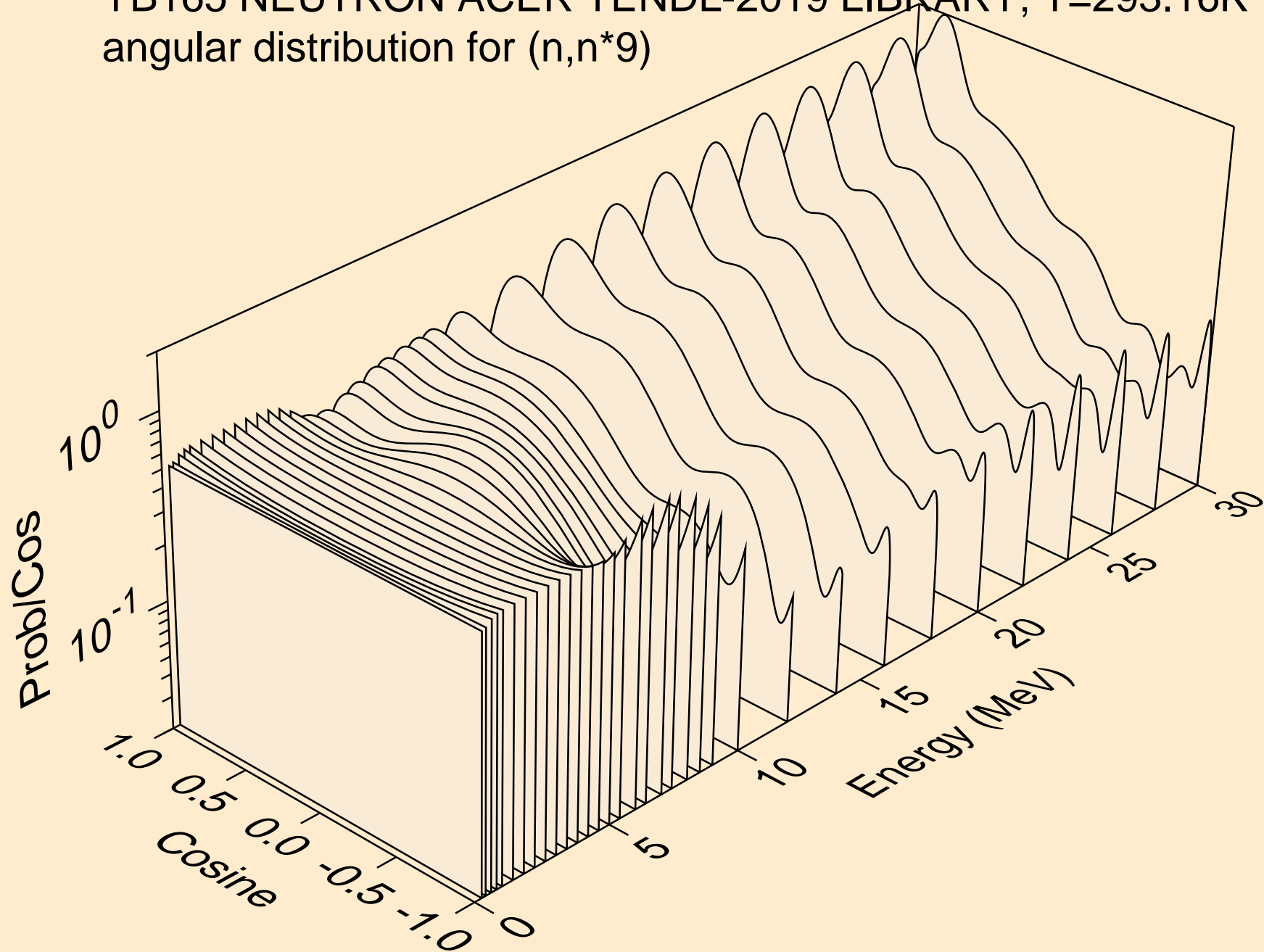

YB165 NEUTRON ACER TENDL-2019 LIBRARY; T=293.16K
angular distribution for (n,n*10)

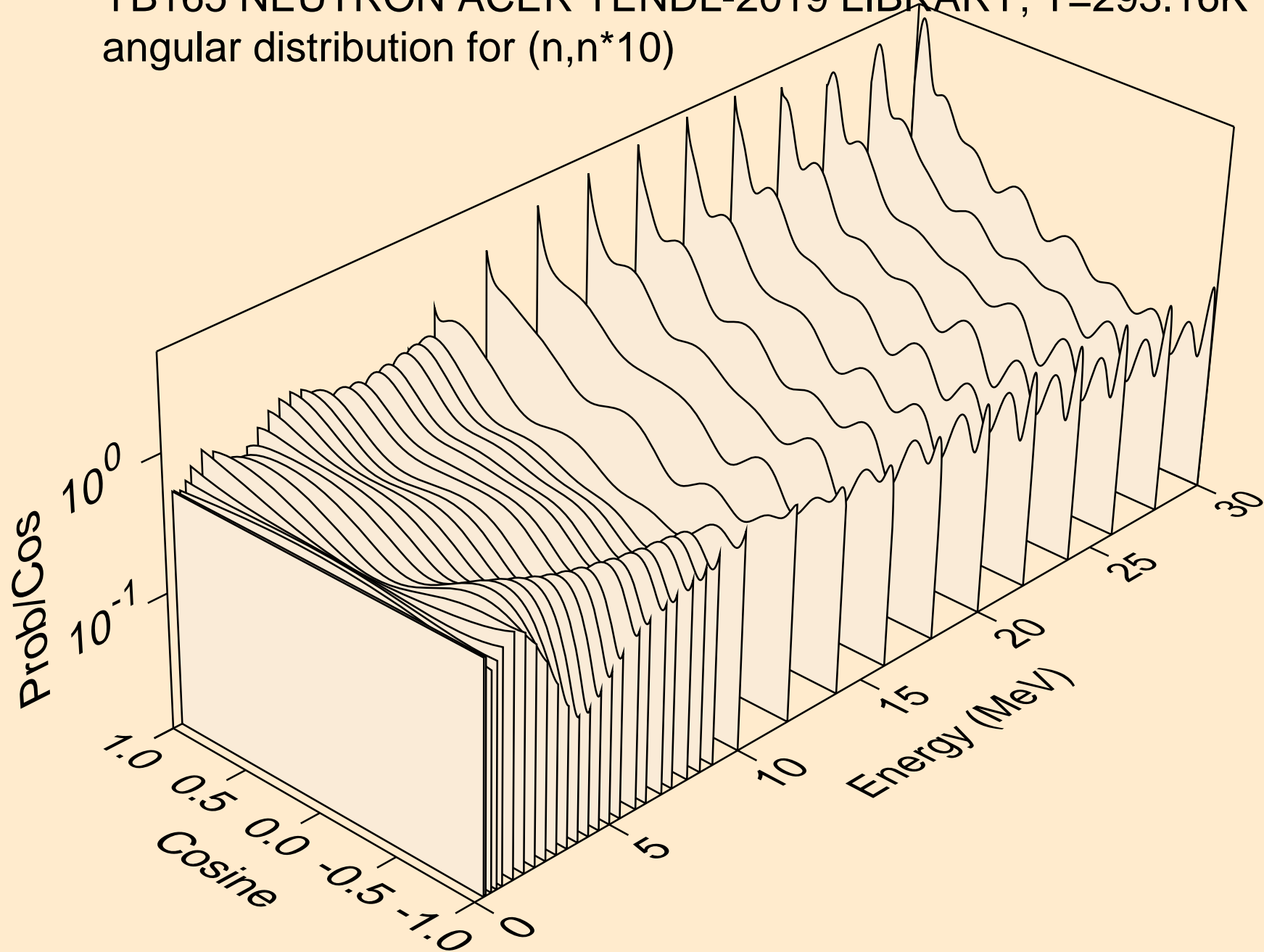

YB165 NEUTRON ACER TENDL-2019 LIBRARY; T=293.16K
angular distribution for (n,n*11)

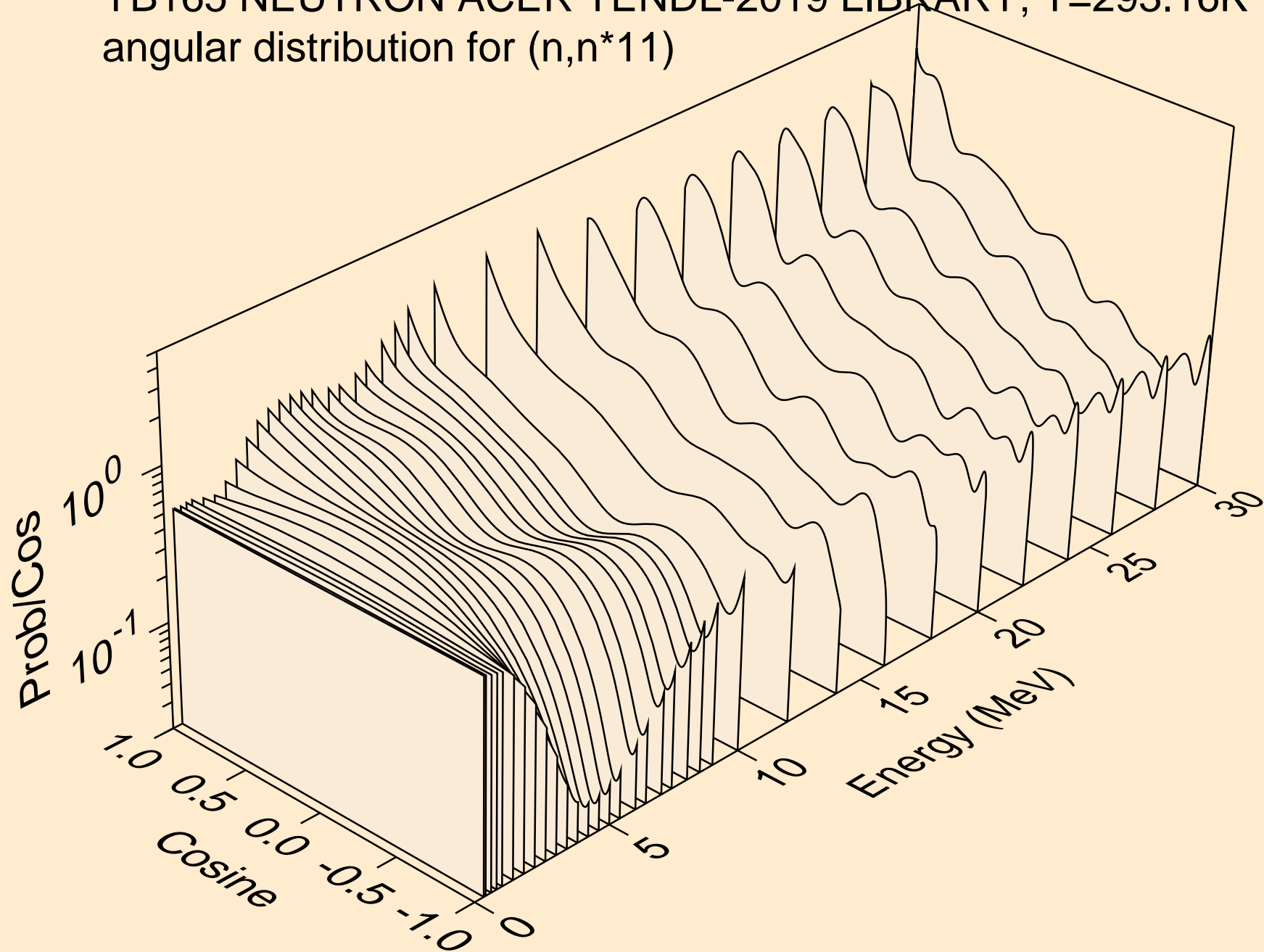

YB165 NEUTRON ACER TENDL-2019 LIBRARY; T=293.16K
angular distribution for (n,n*12)

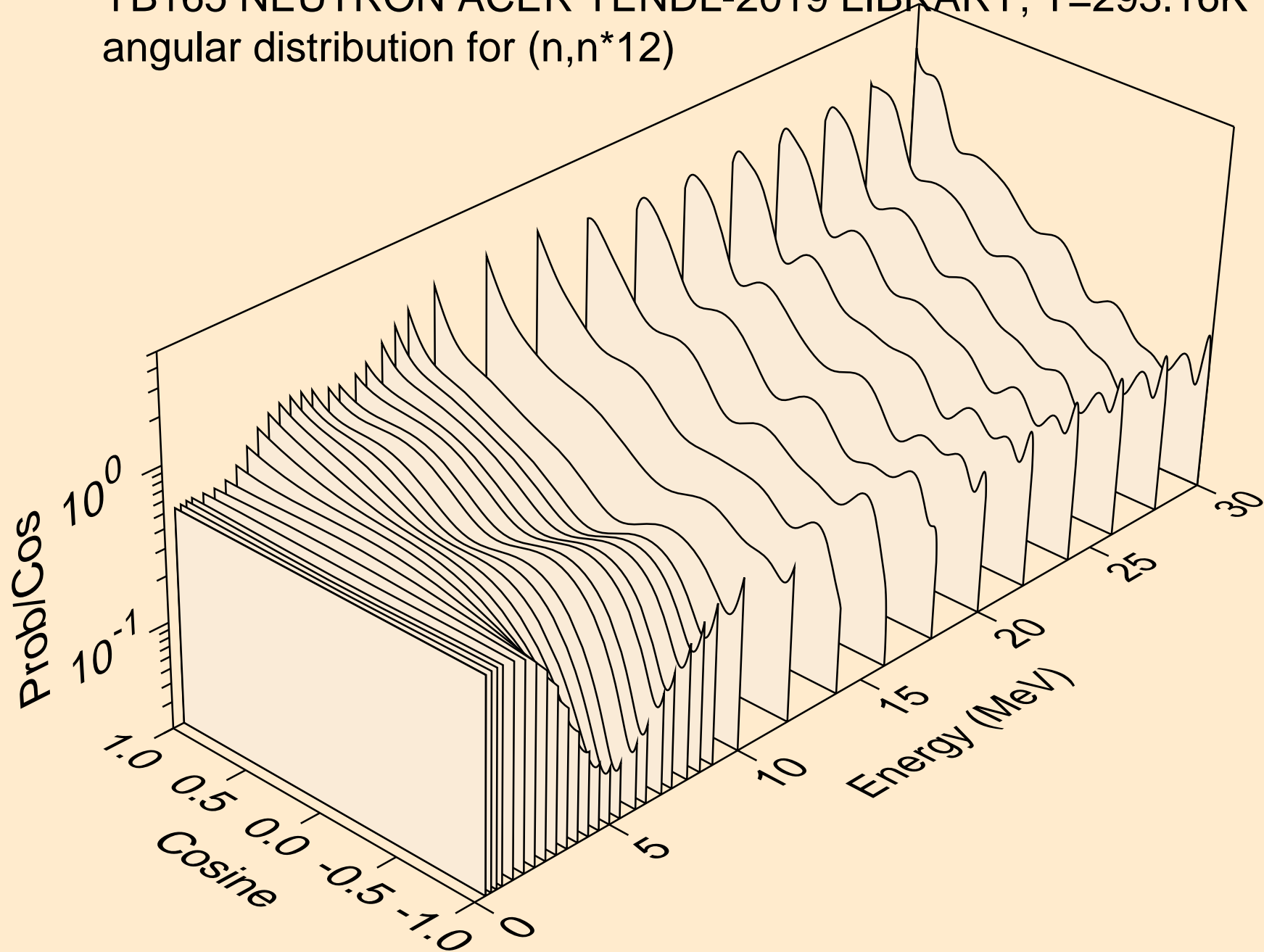

YB165 NEUTRON ACER TENDL-2019 LIBRARY; T=293.16K
angular distribution for (n,n*13)

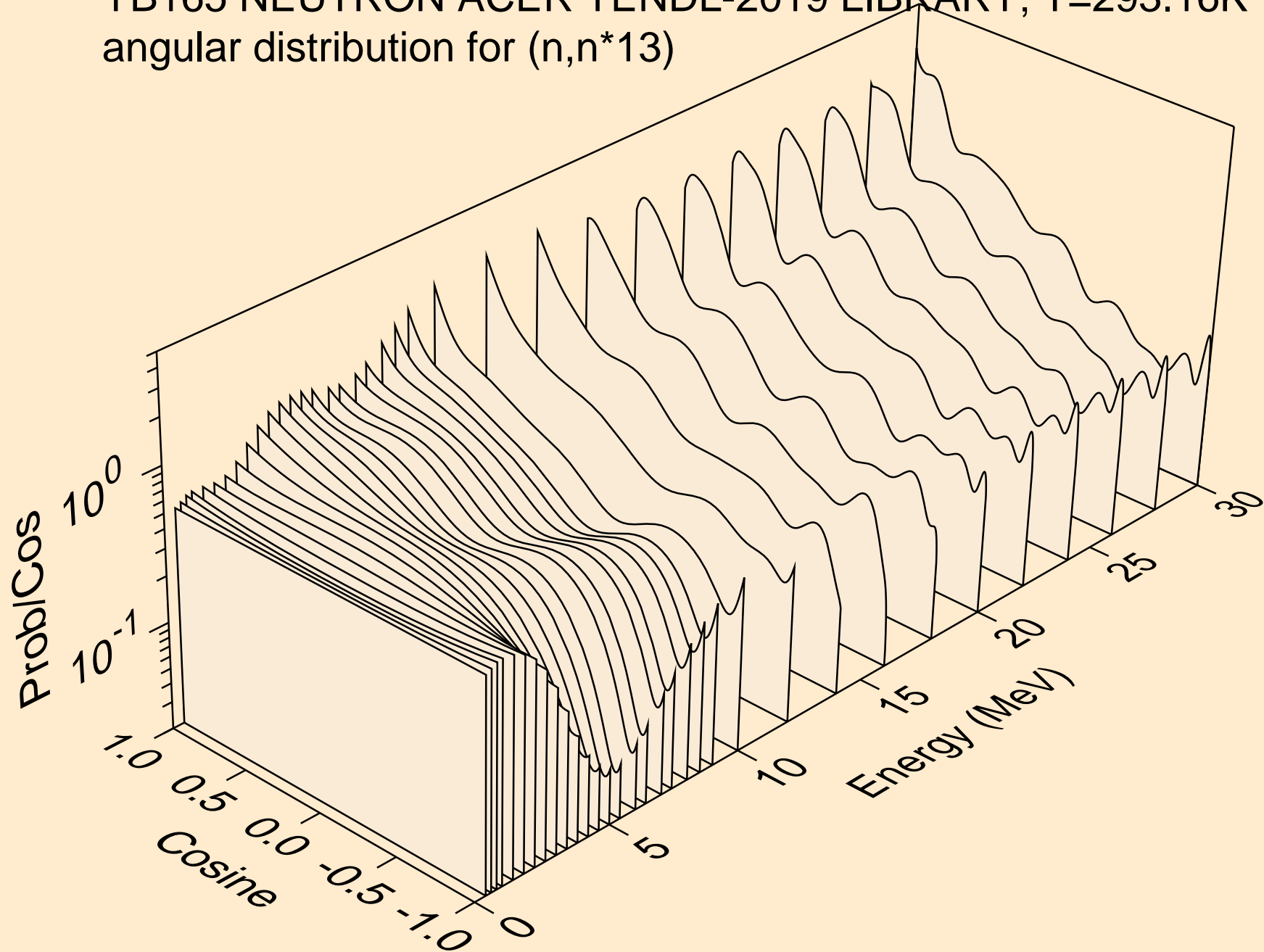

YB165 NEUTRON ACER TENDL-2019 LIBRARY; T=293.16K
angular distribution for (n,n*14)

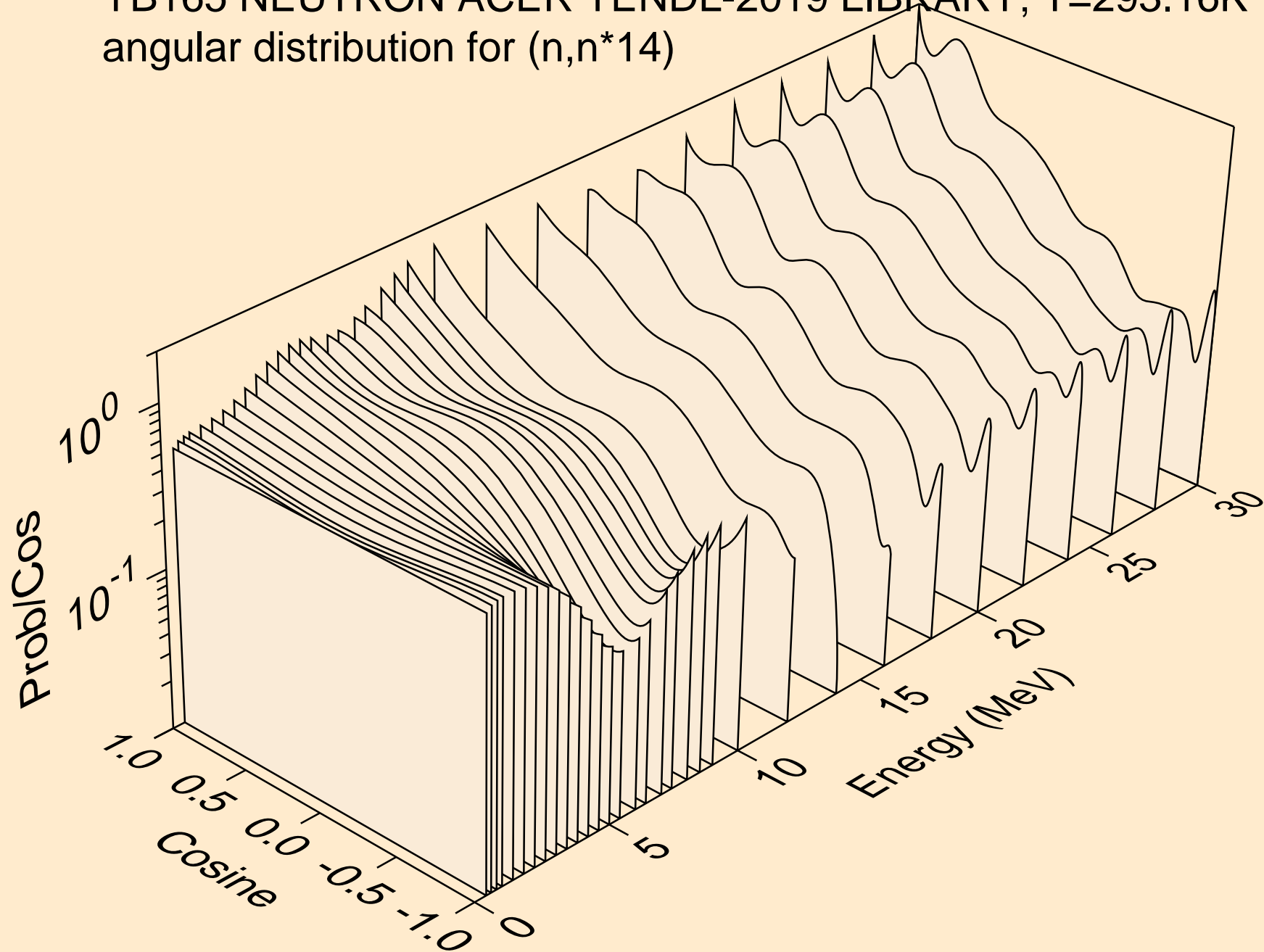

YB165 NEUTRON ACER TENDL-2019 LIBRARY; T=293.16K
angular distribution for (n,n*15)

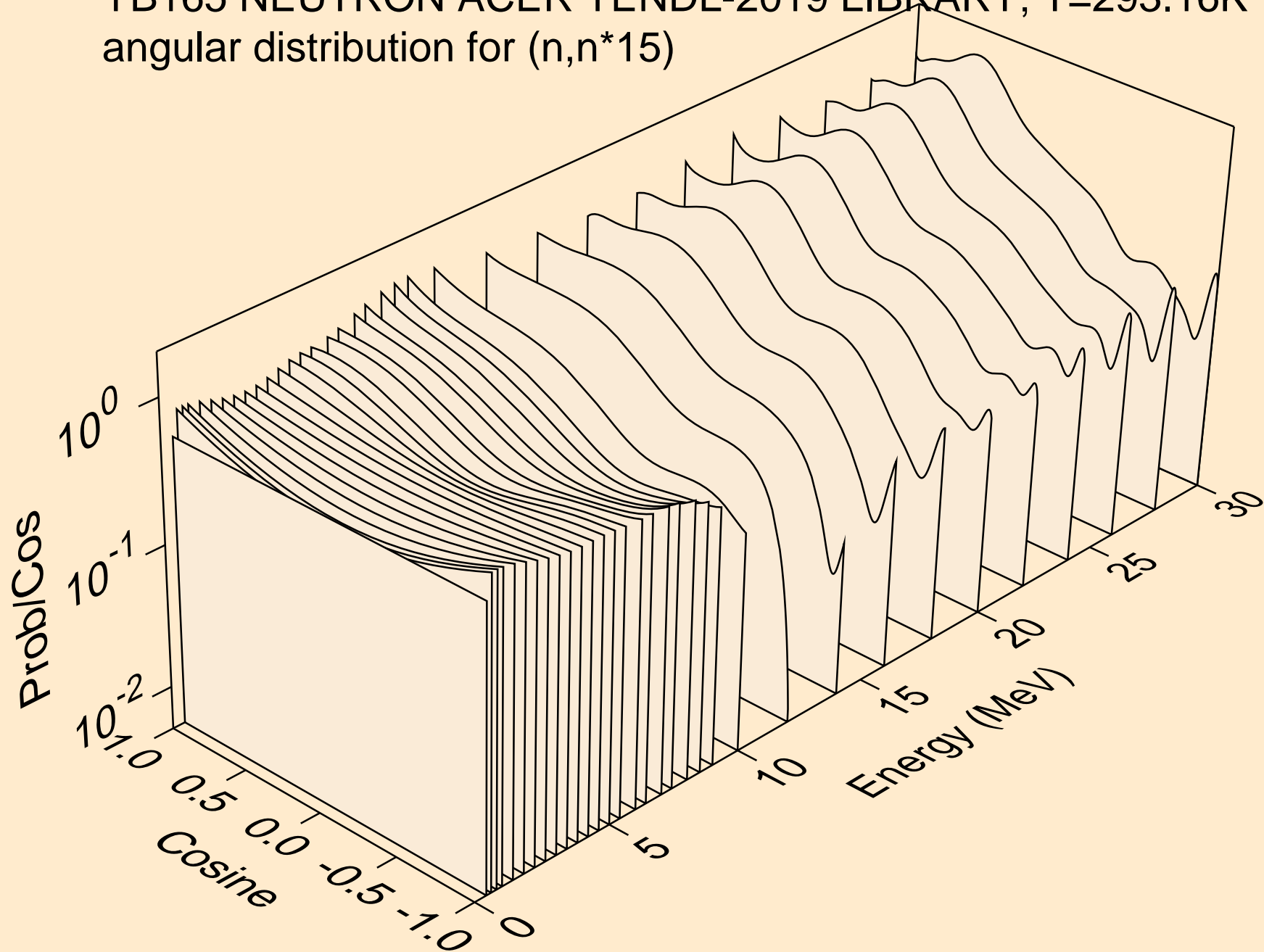

YB165 NEUTRON ACER TENDL-2019 LIBRARY; T=293.16K
angular distribution for (n,n*16)

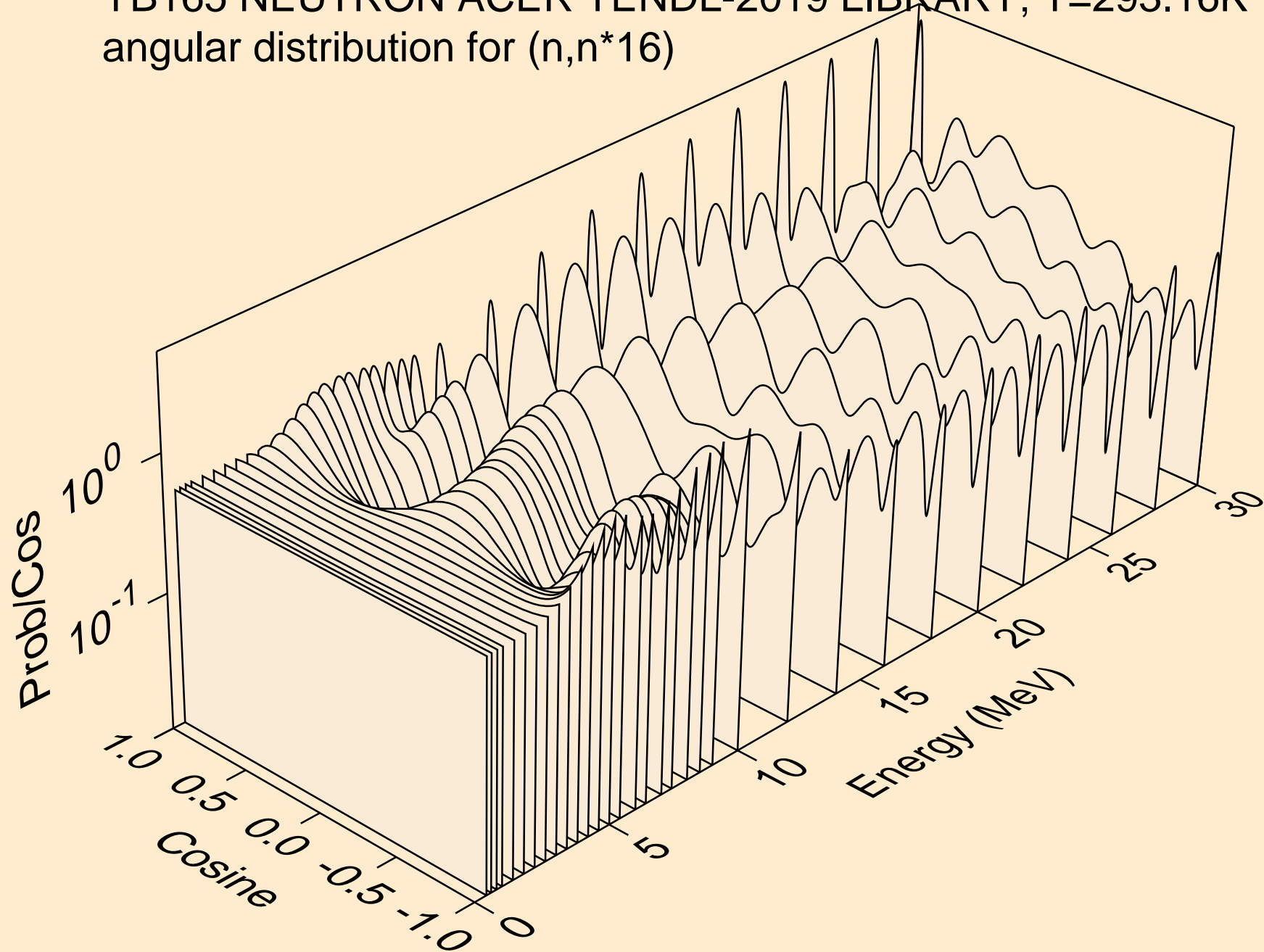

YB165 NEUTRON ACER TENDL-2019 LIBRARY; T=293.16K
angular distribution for (n,n*17)

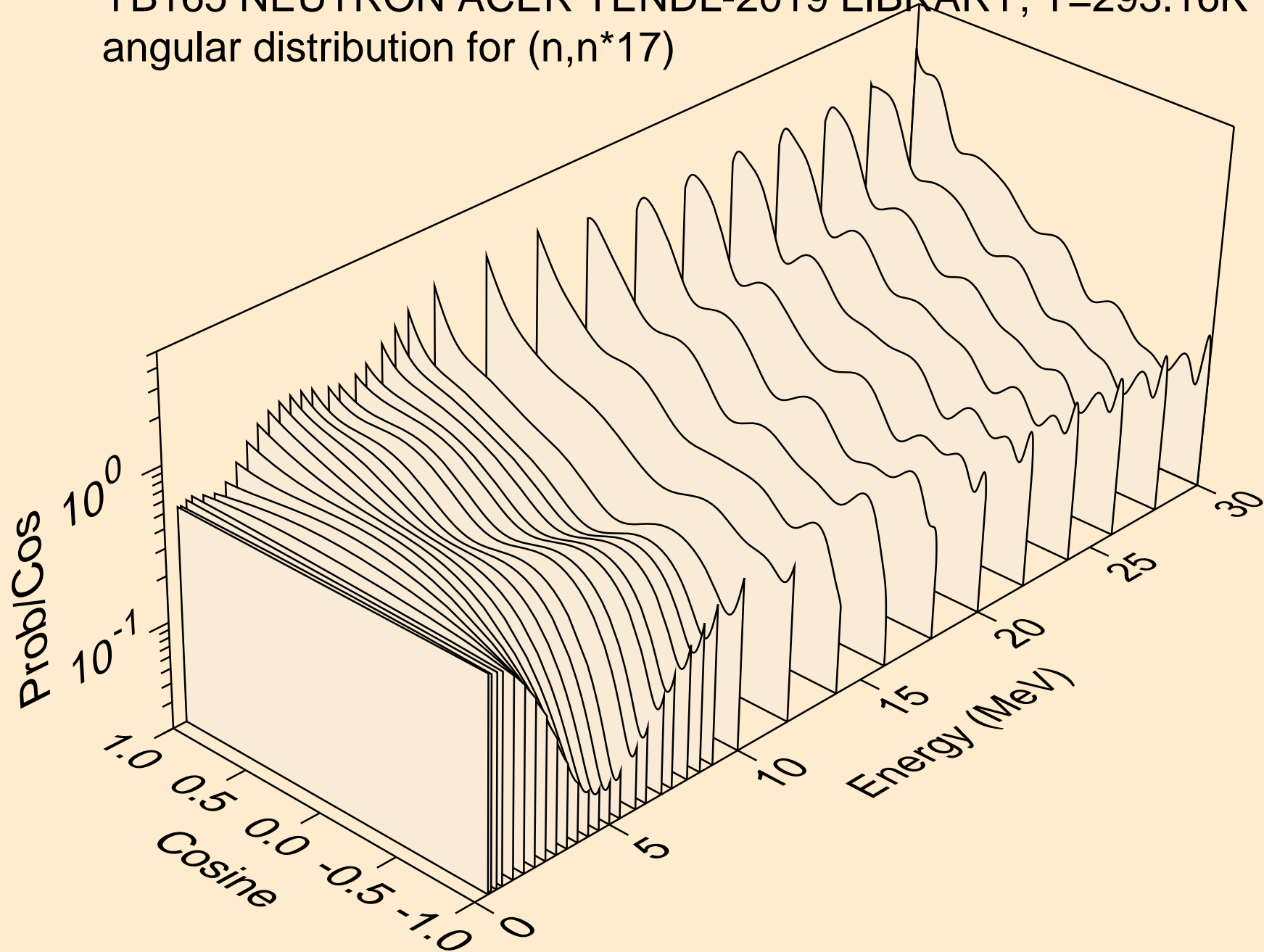

YB165 NEUTRON ACER TENDL-2019 LIBRARY; T=293.16K
angular distribution for (n,n*18)

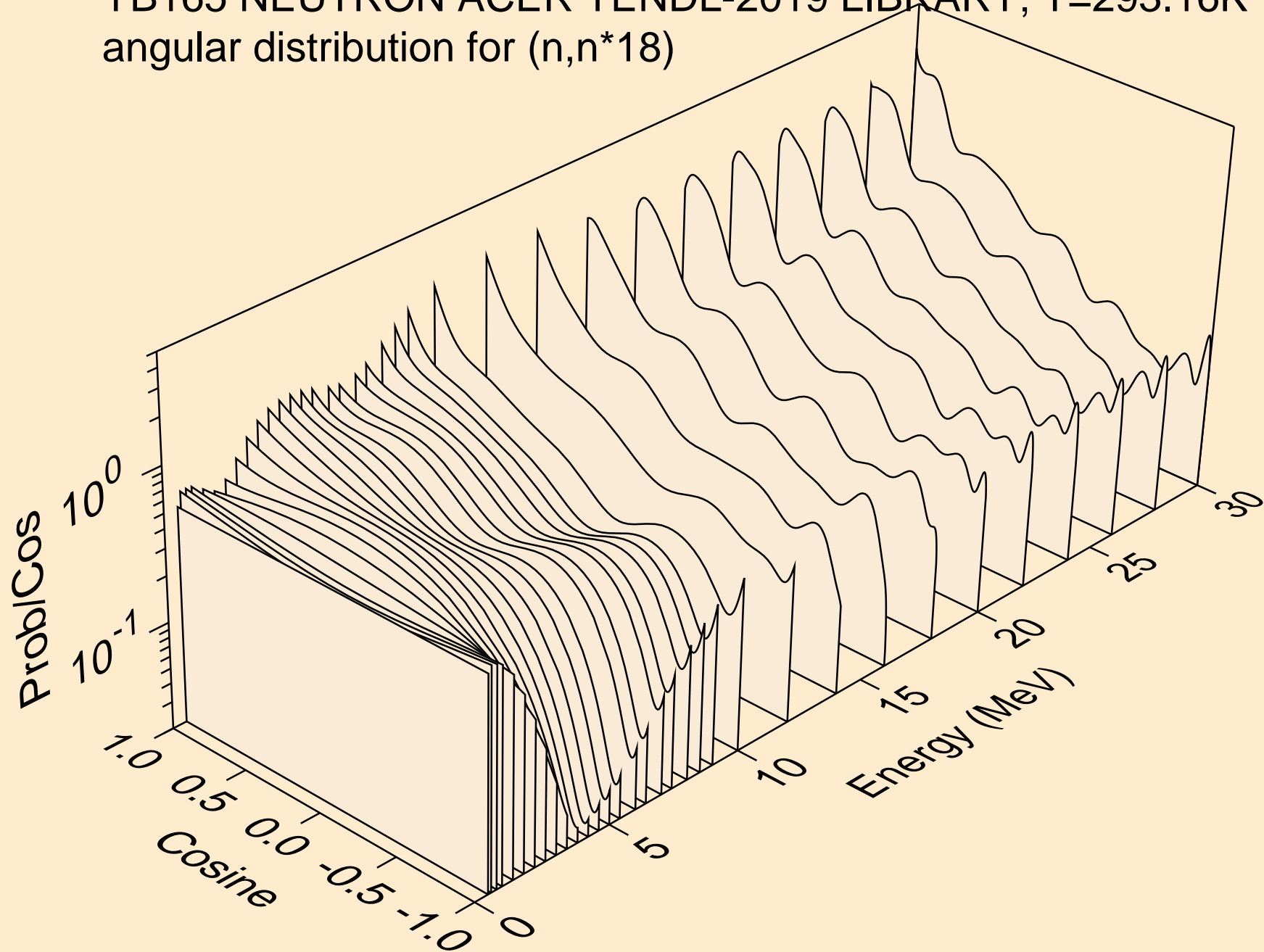

YB165 NEUTRON ACER TENDL-2019 LIBRARY; T=293.16K
angular distribution for (n,n*19)

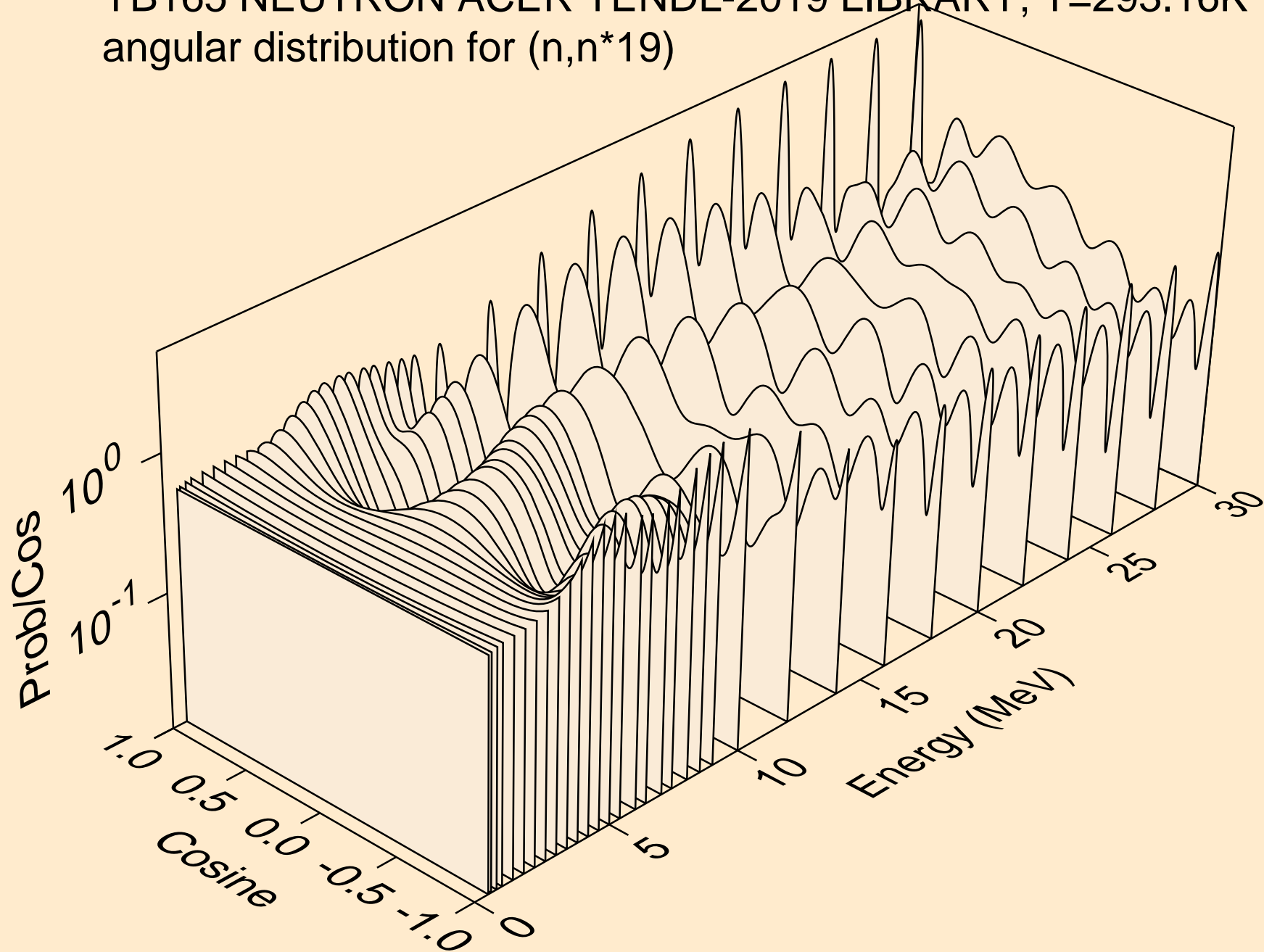

YB165 NEUTRON ACER TENDL-2019 LIBRARY; T=293.16K
angular distribution for (n,n*20)

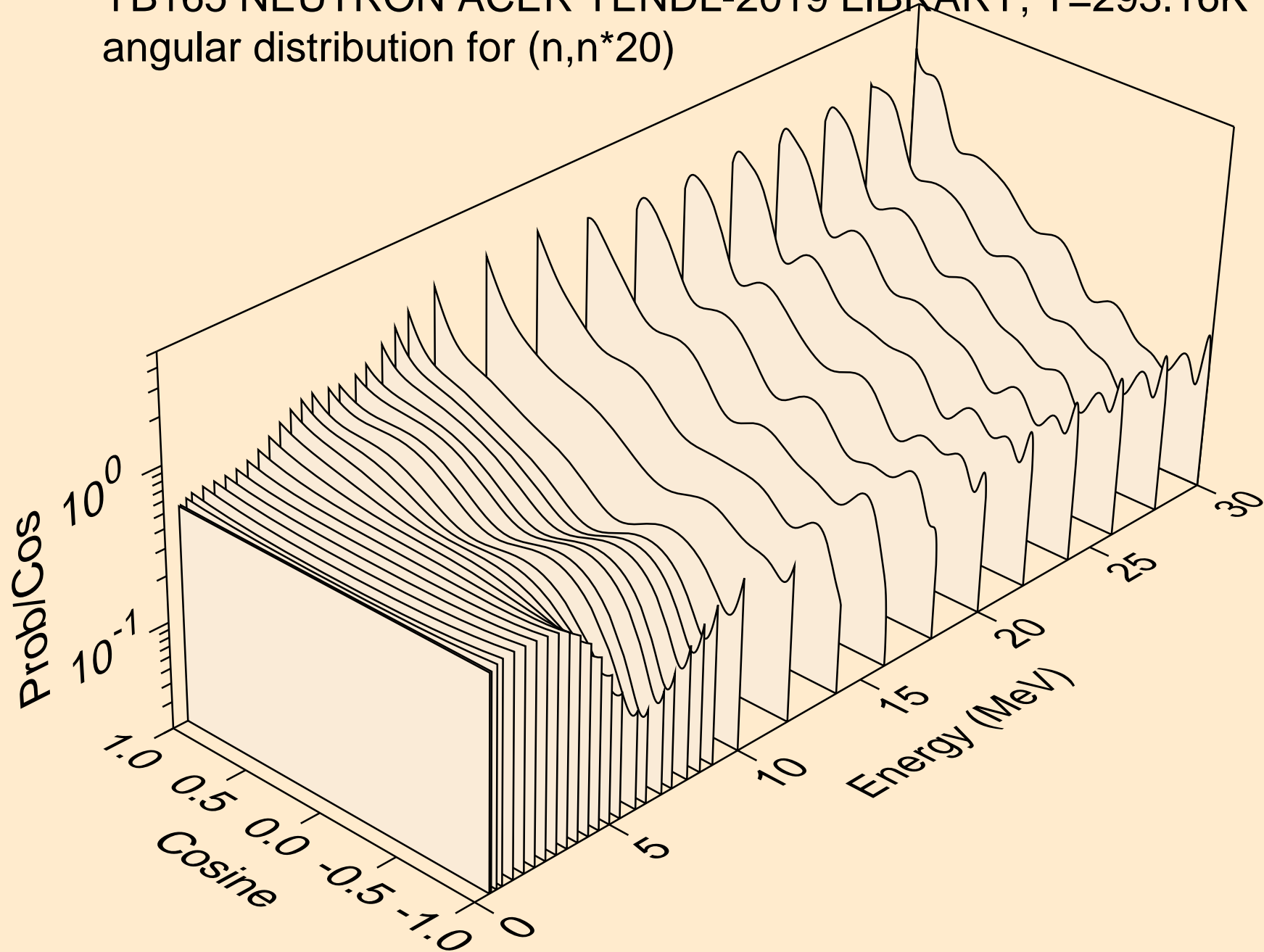

YB165 NEUTRON ACER TENDL-2019 LIBRARY; T=293.16K
angular distribution for (n,n*21)

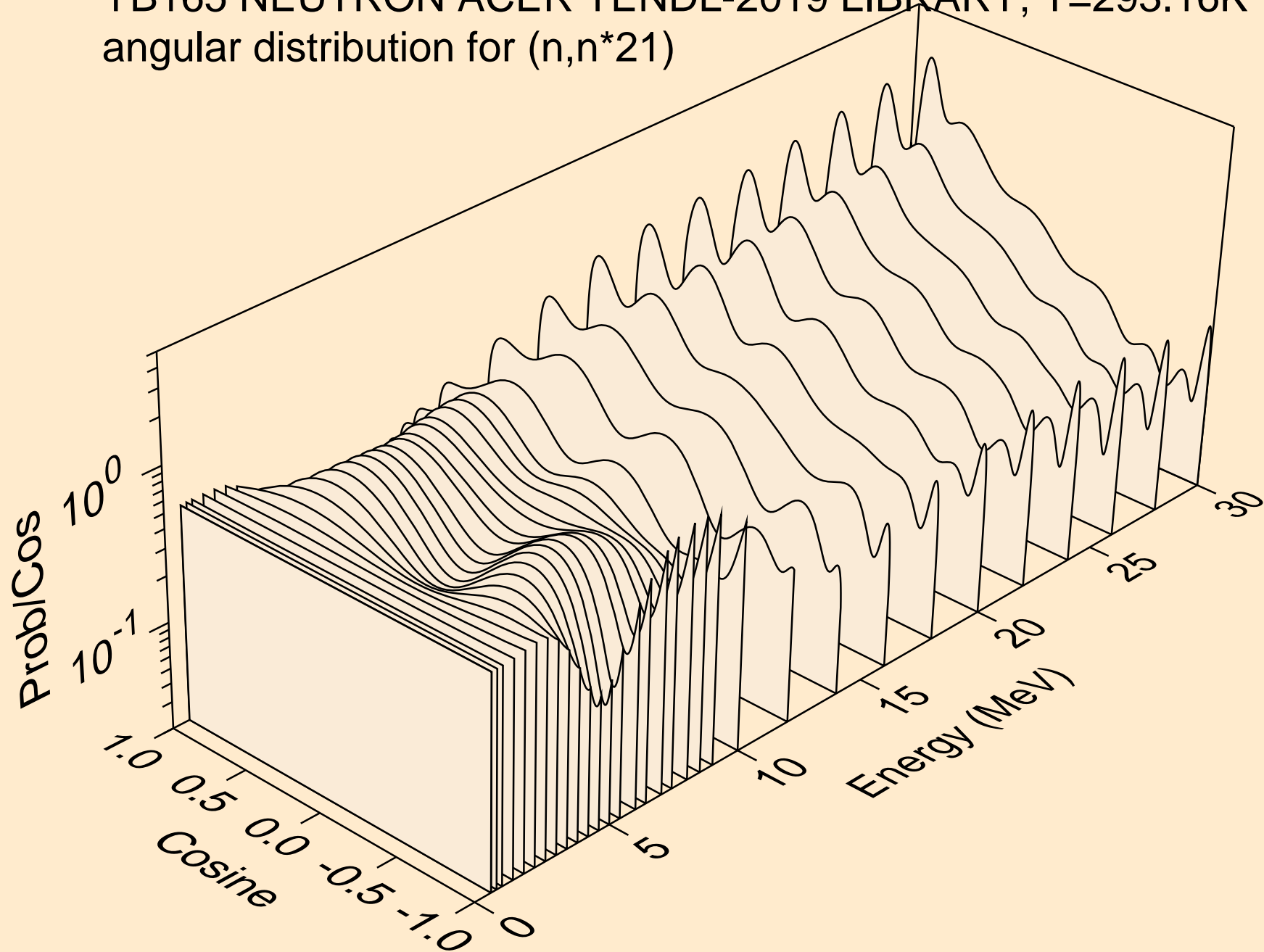

YB165 NEUTRON ACER TENDL-2019 LIBRARY; T=293.16K
angular distribution for (n,n*22)

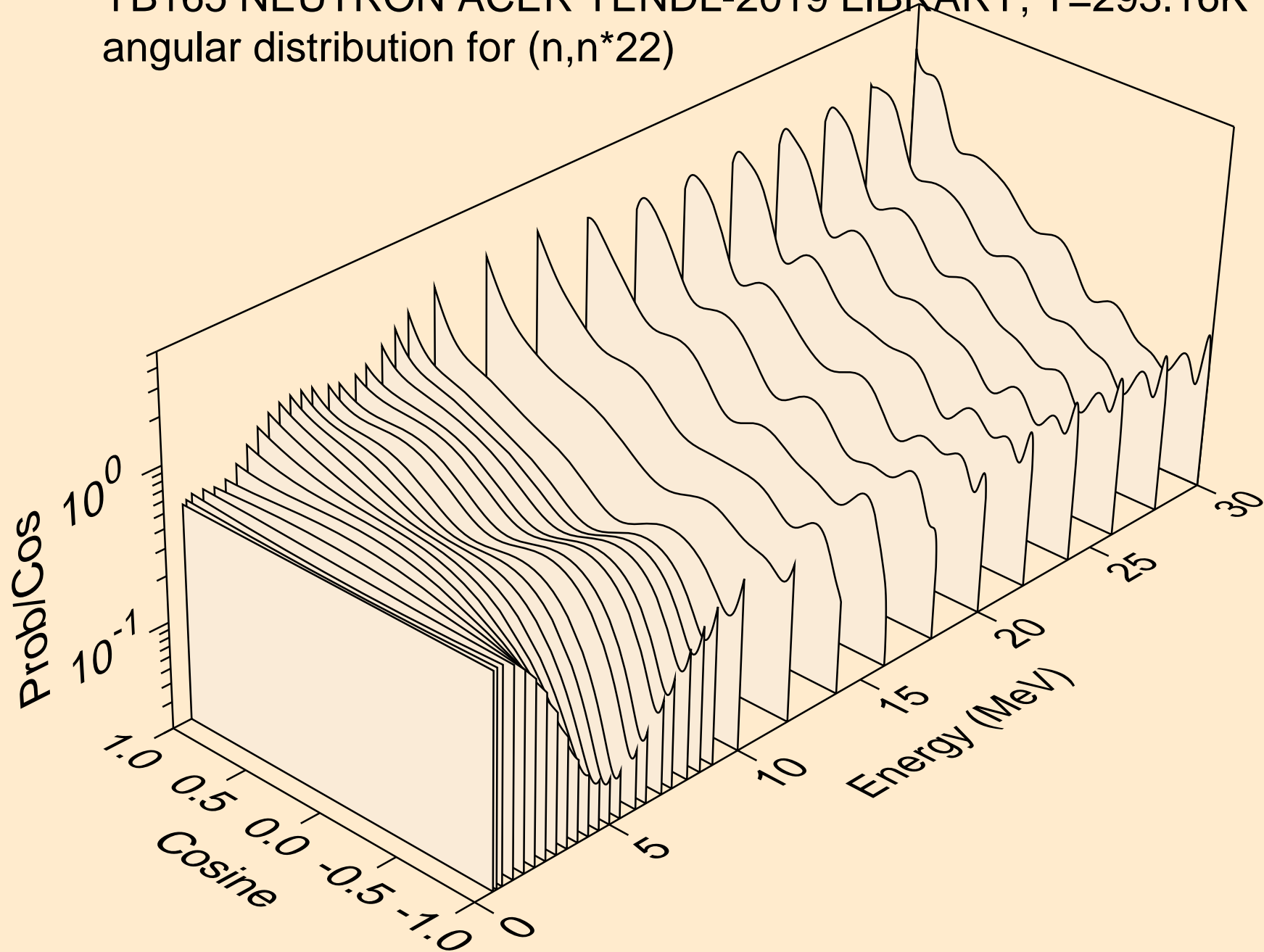

YB165 NEUTRON ACER TENDL-2019 LIBRARY; T=293.16K
angular distribution for (n,n*23)

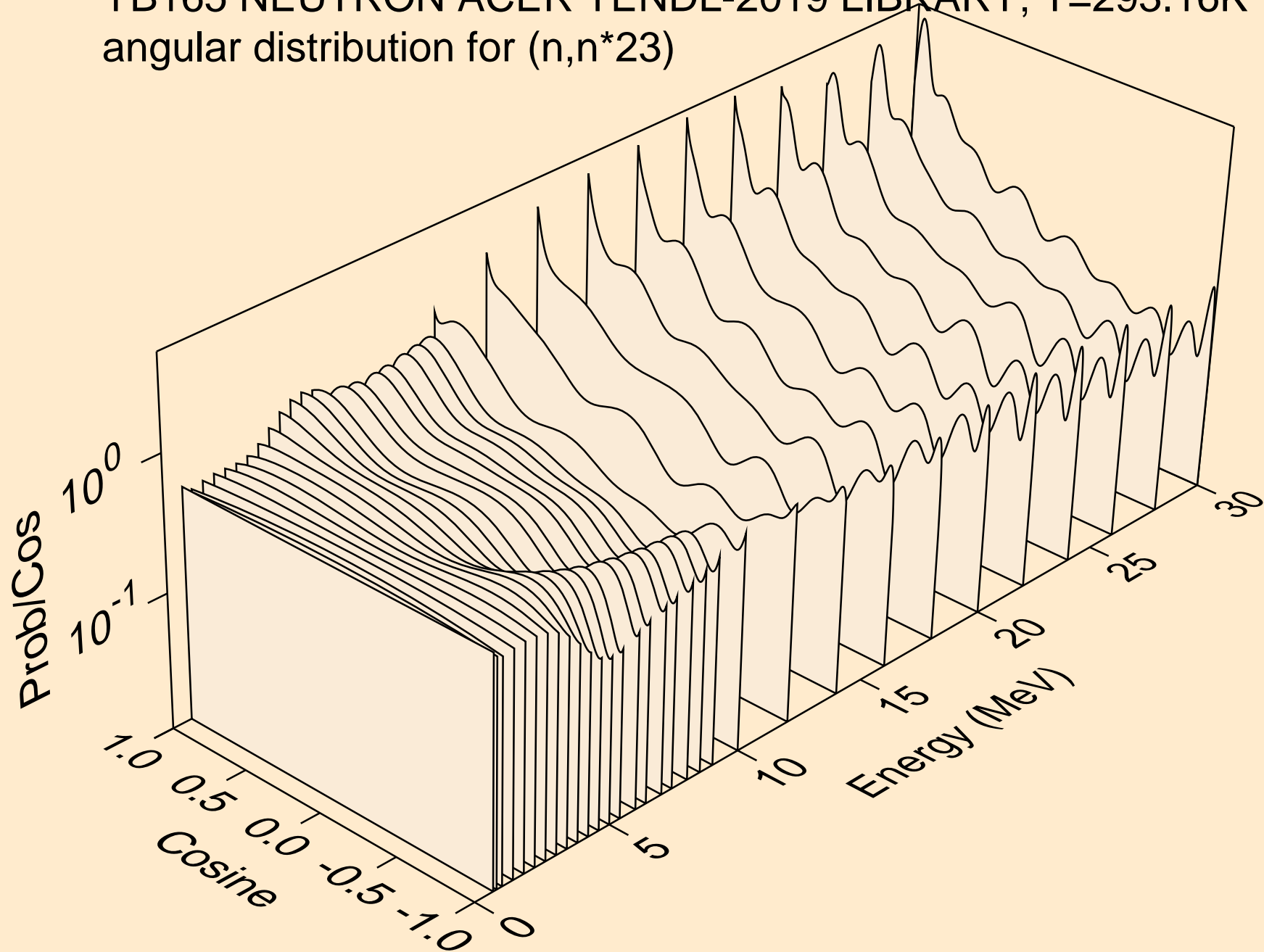

YB165 NEUTRON ACER TENDL-2019 LIBRARY; T=293.16K
angular distribution for (n,n*24)

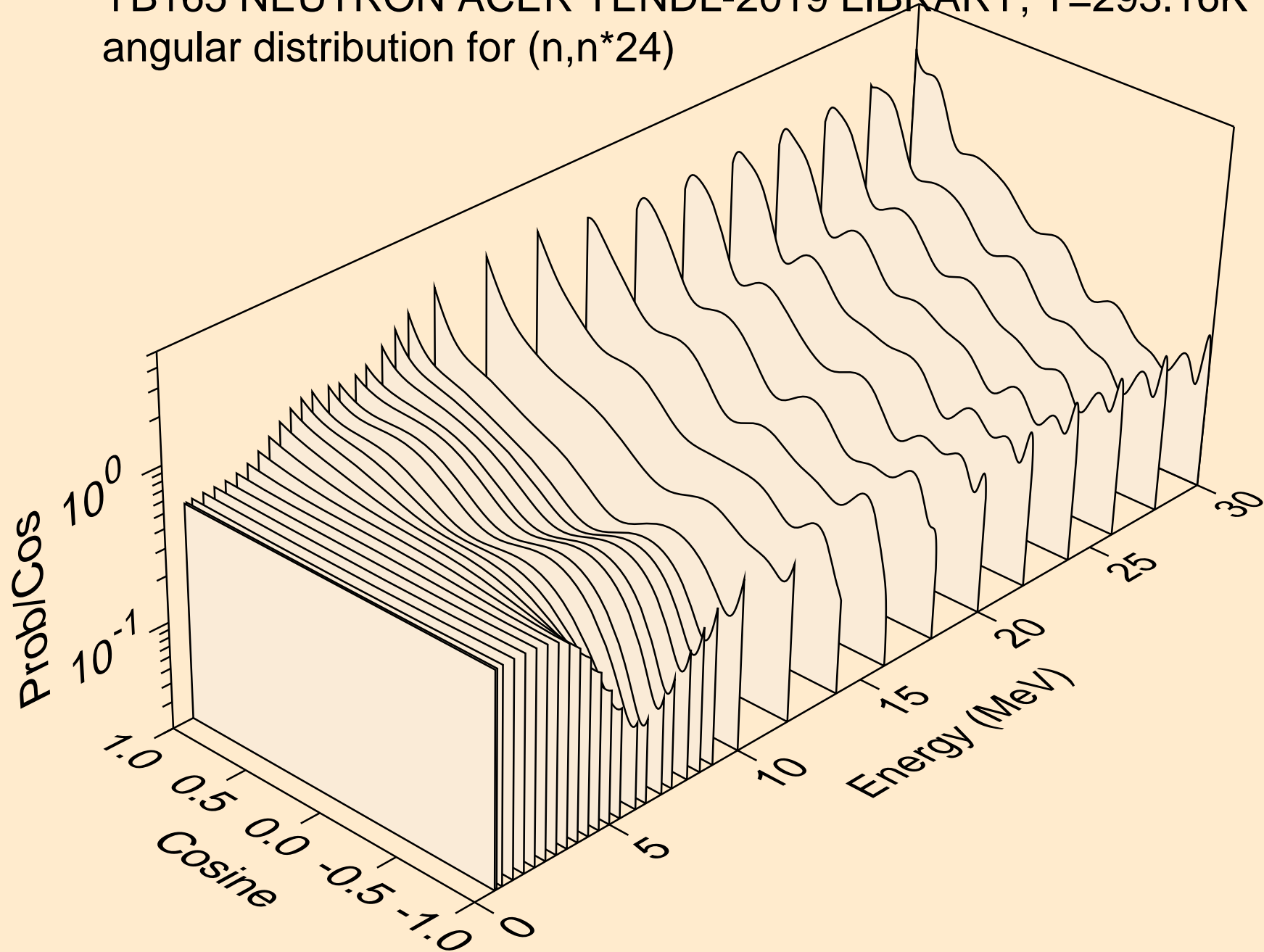

YB165 NEUTRON ACER TENDL-2019 LIBRARY; T=293.16K
angular distribution for (n,n*25)

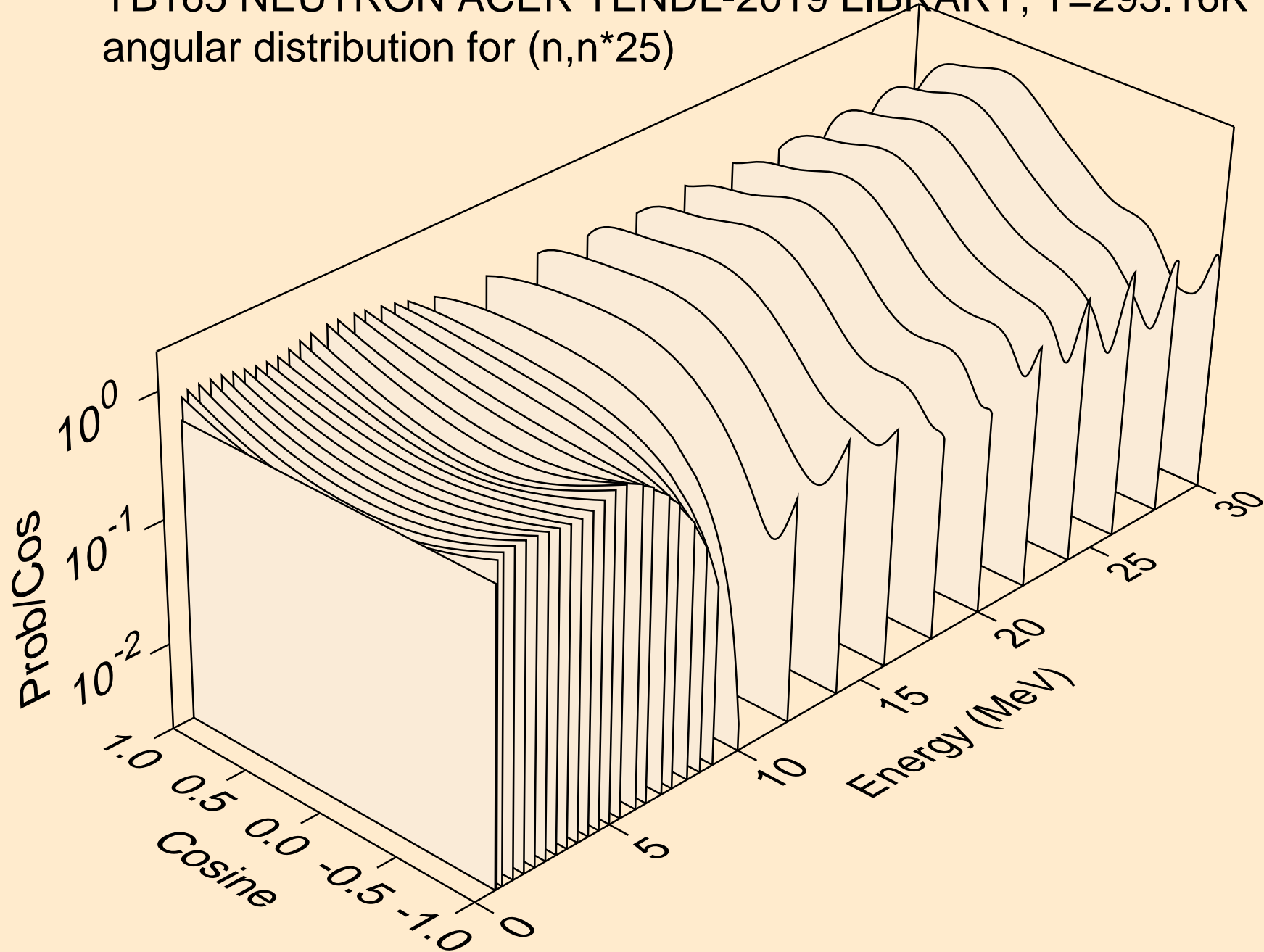

YB165 NEUTRON ACER TENDL-2019 LIBRARY; T=293.16K
angular distribution for (n,n*26)

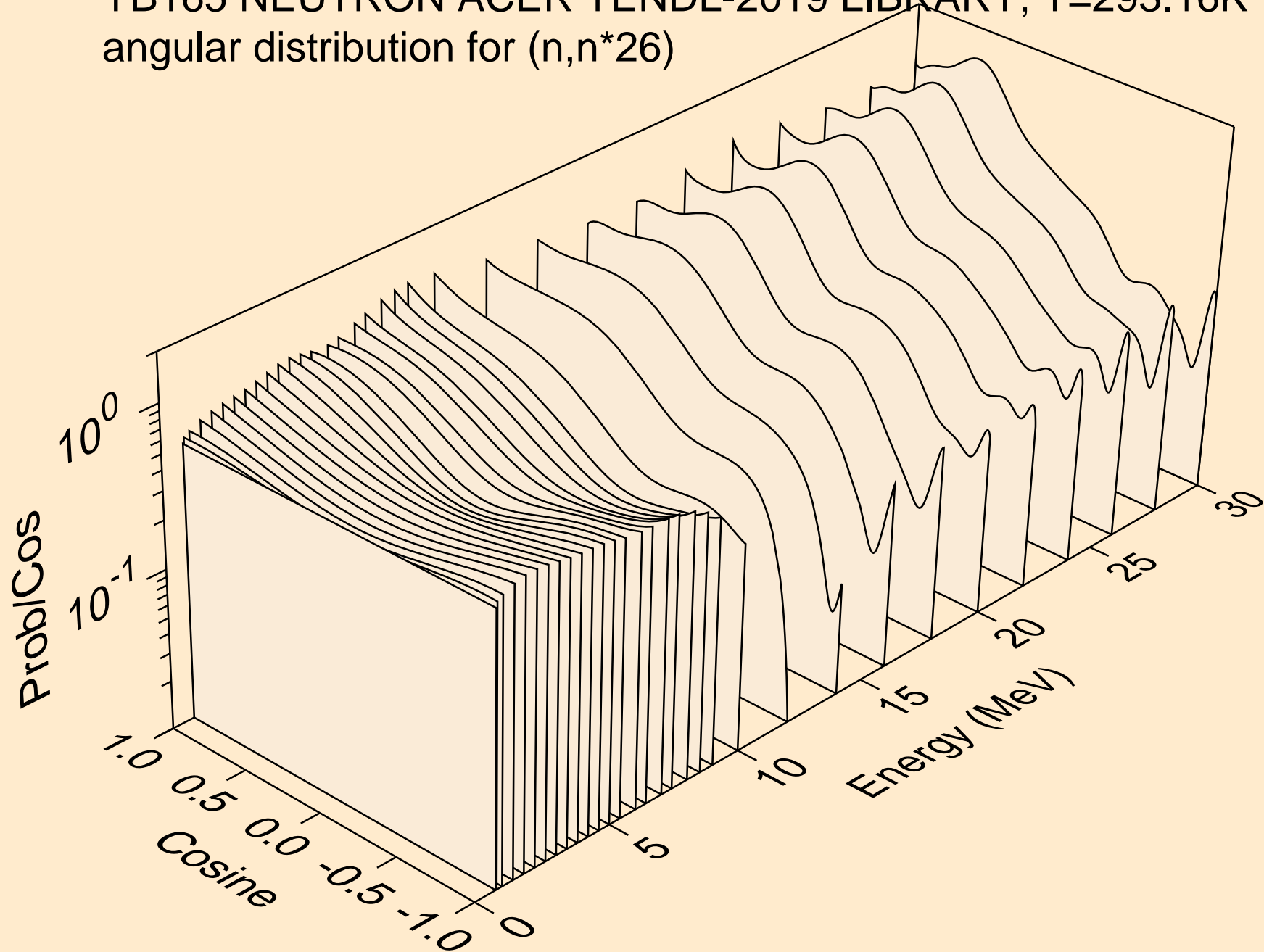

YB165 NEUTRON ACER TENDL-2019 LIBRARY; T=293.16K
angular distribution for (n,n*27)

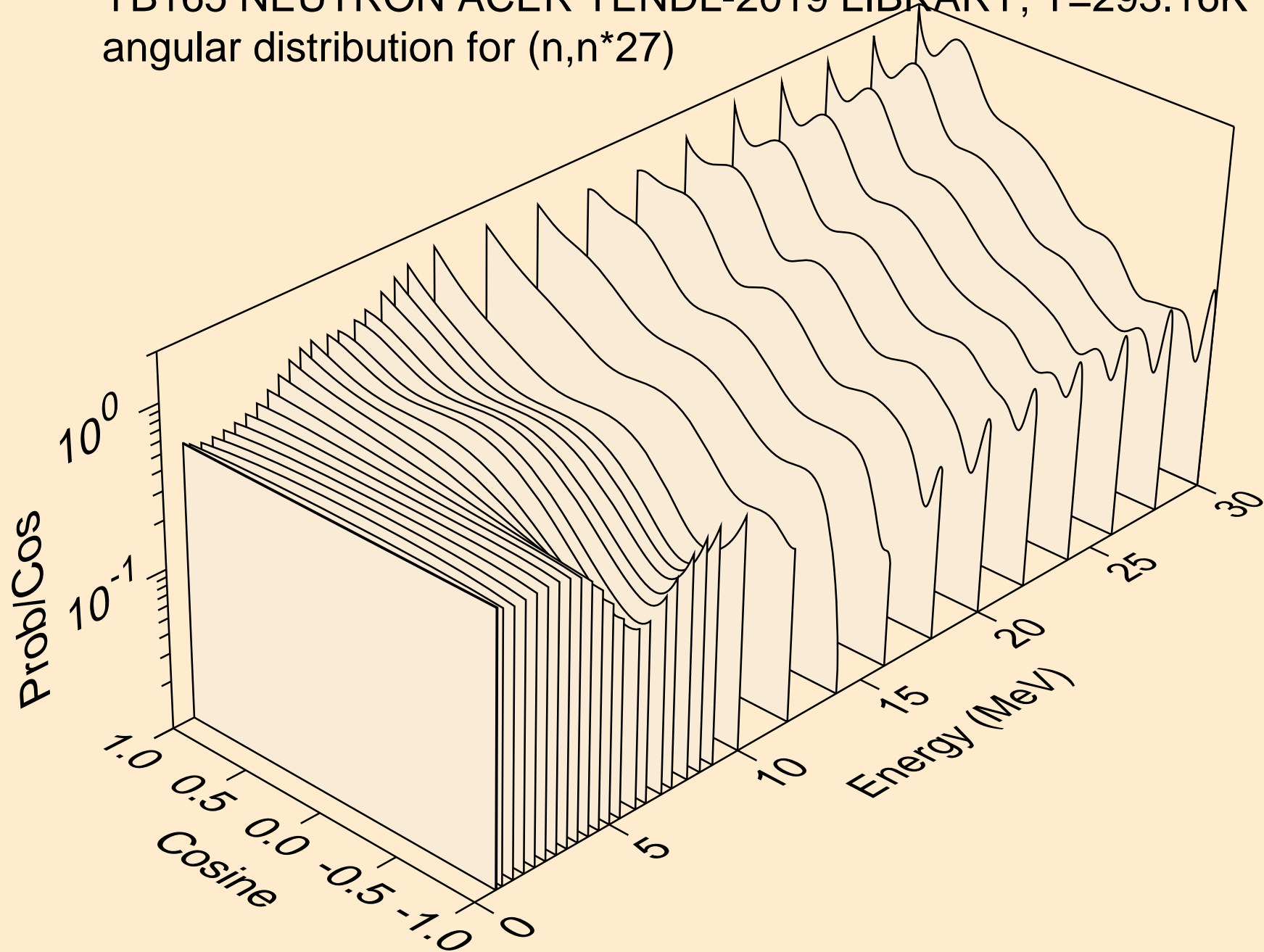

YB165 NEUTRON ACER TENDL-2019 LIBRARY; T=293.16K
angular distribution for (n,n*28)

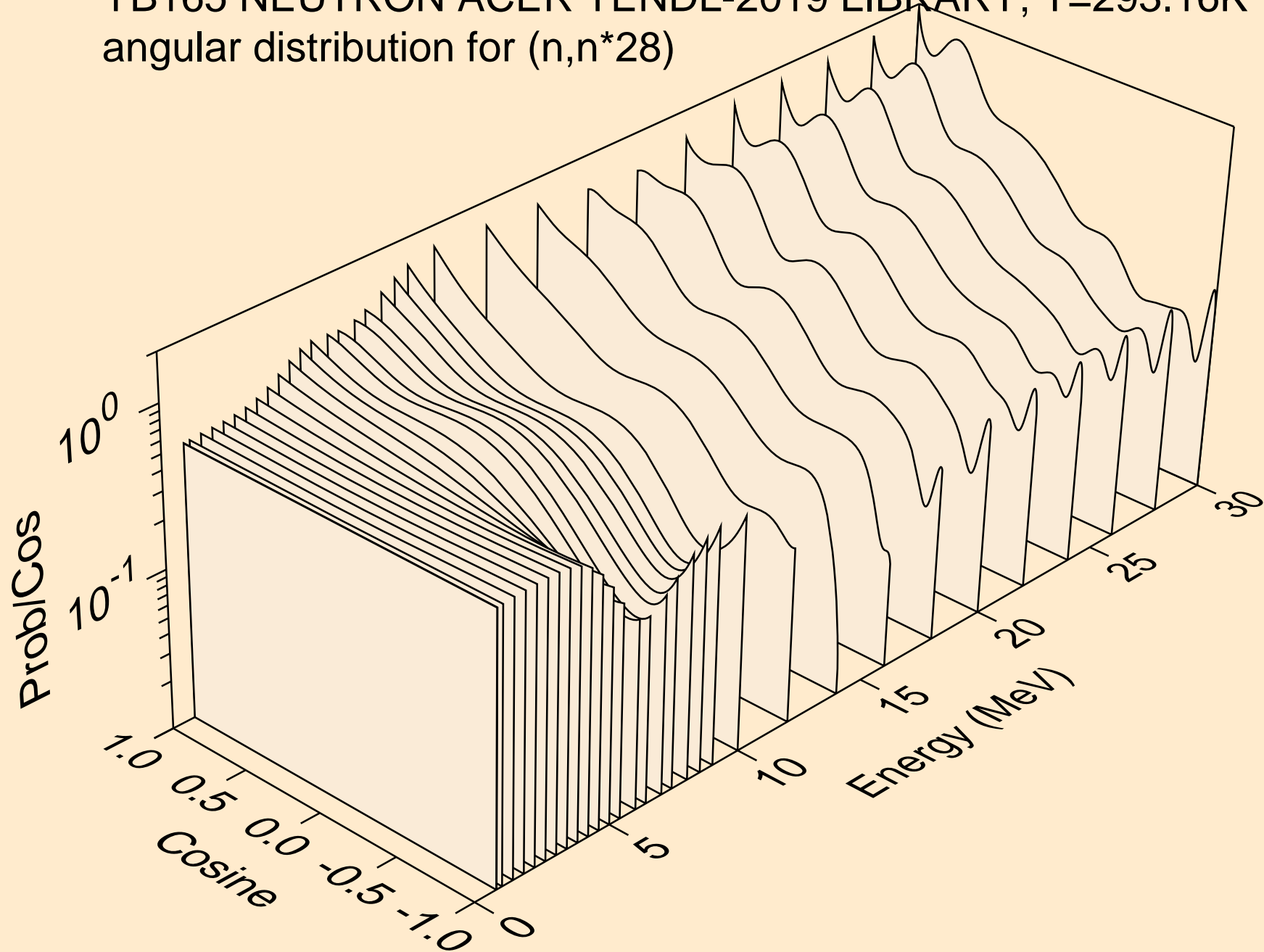

YB165 NEUTRON ACER TENDL-2019 LIBRARY; T=293.16K
Neutron emission for (n,x)

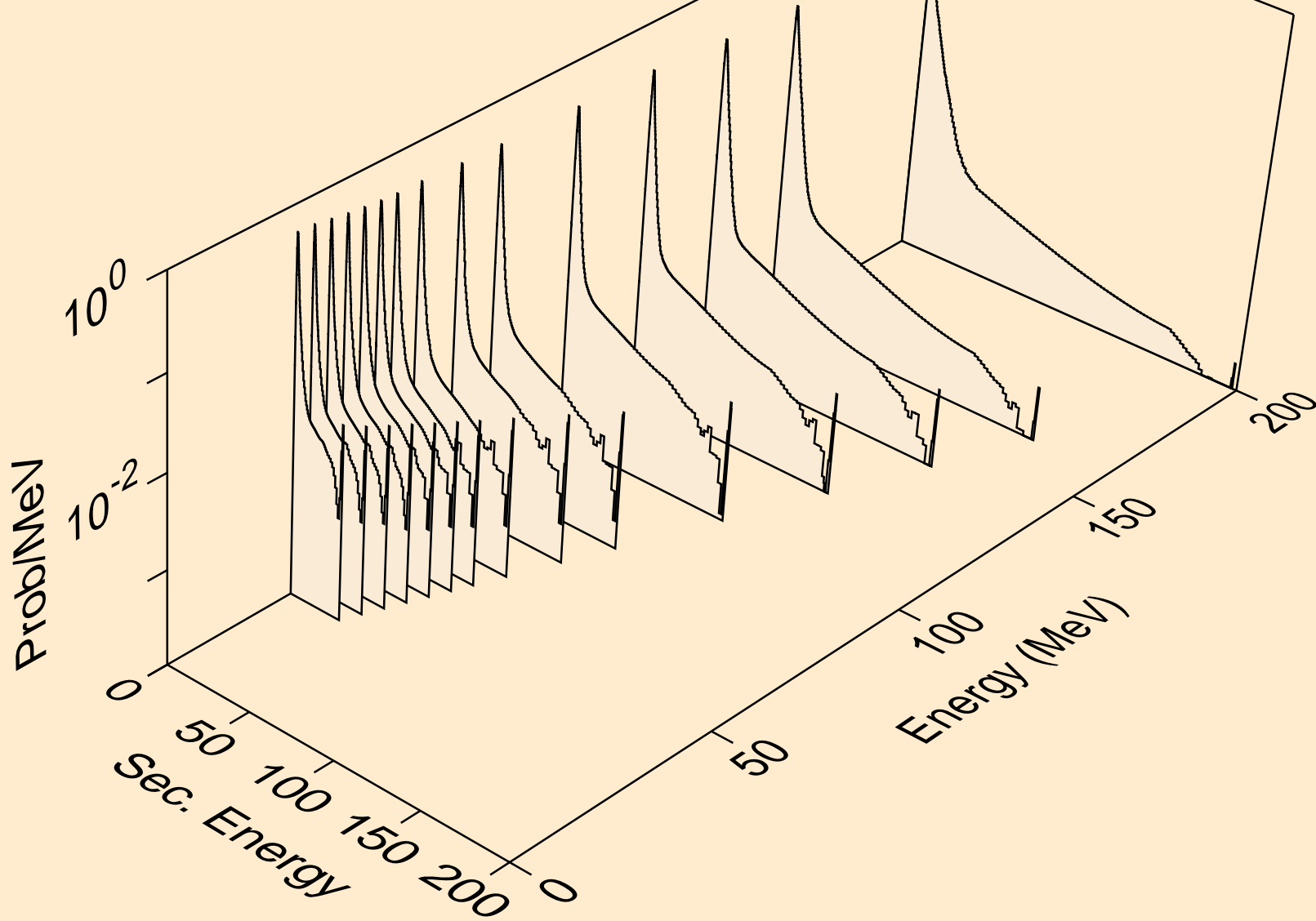

YB165 NEUTRON ACER TENDL-2019 LIBRARY; T=293.16K
Neutron emission for (n,2nd)

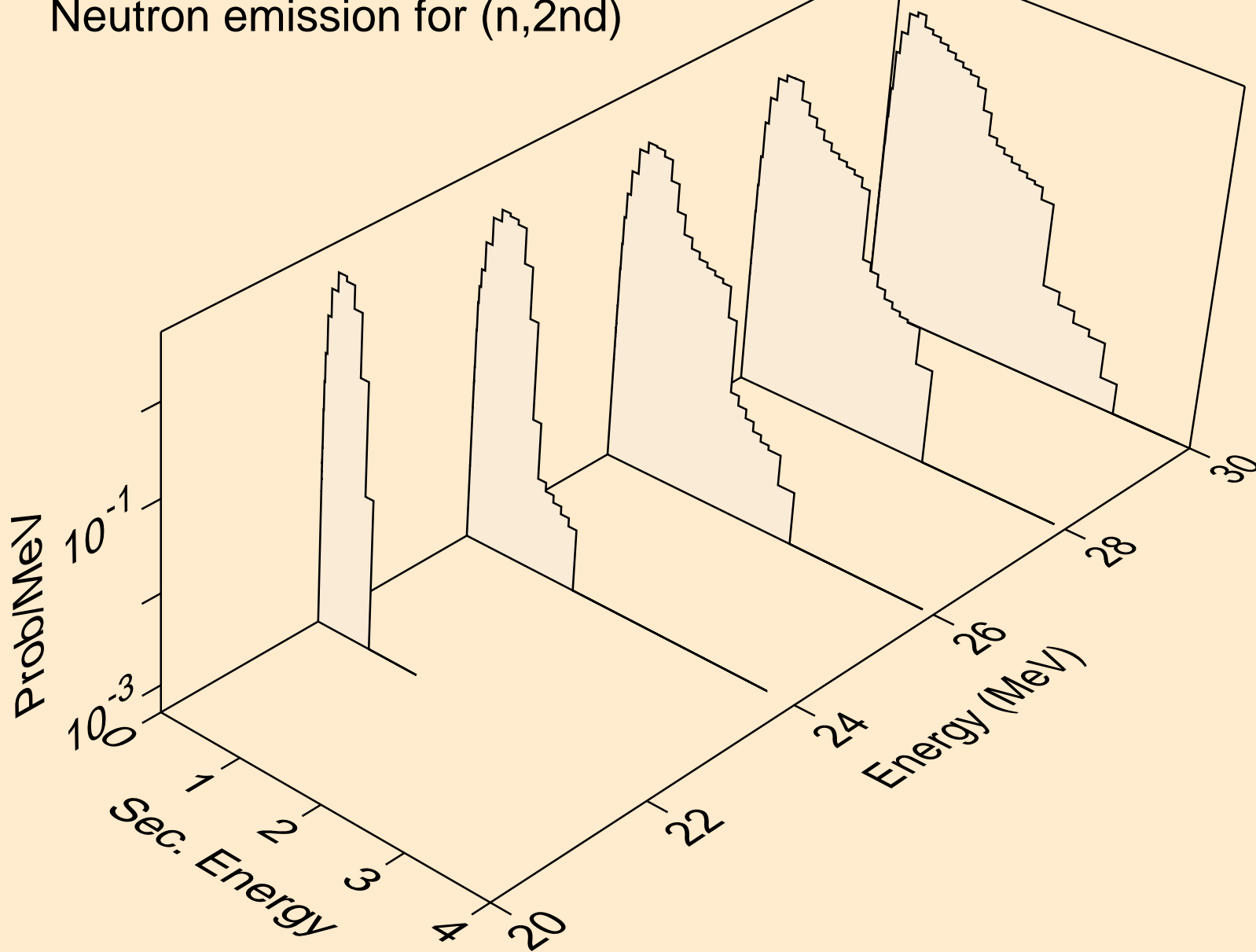

YB165 NEUTRON ACER TENDL-2019 LIBRARY; T=293.16K
Neutron emission for (n,2n)

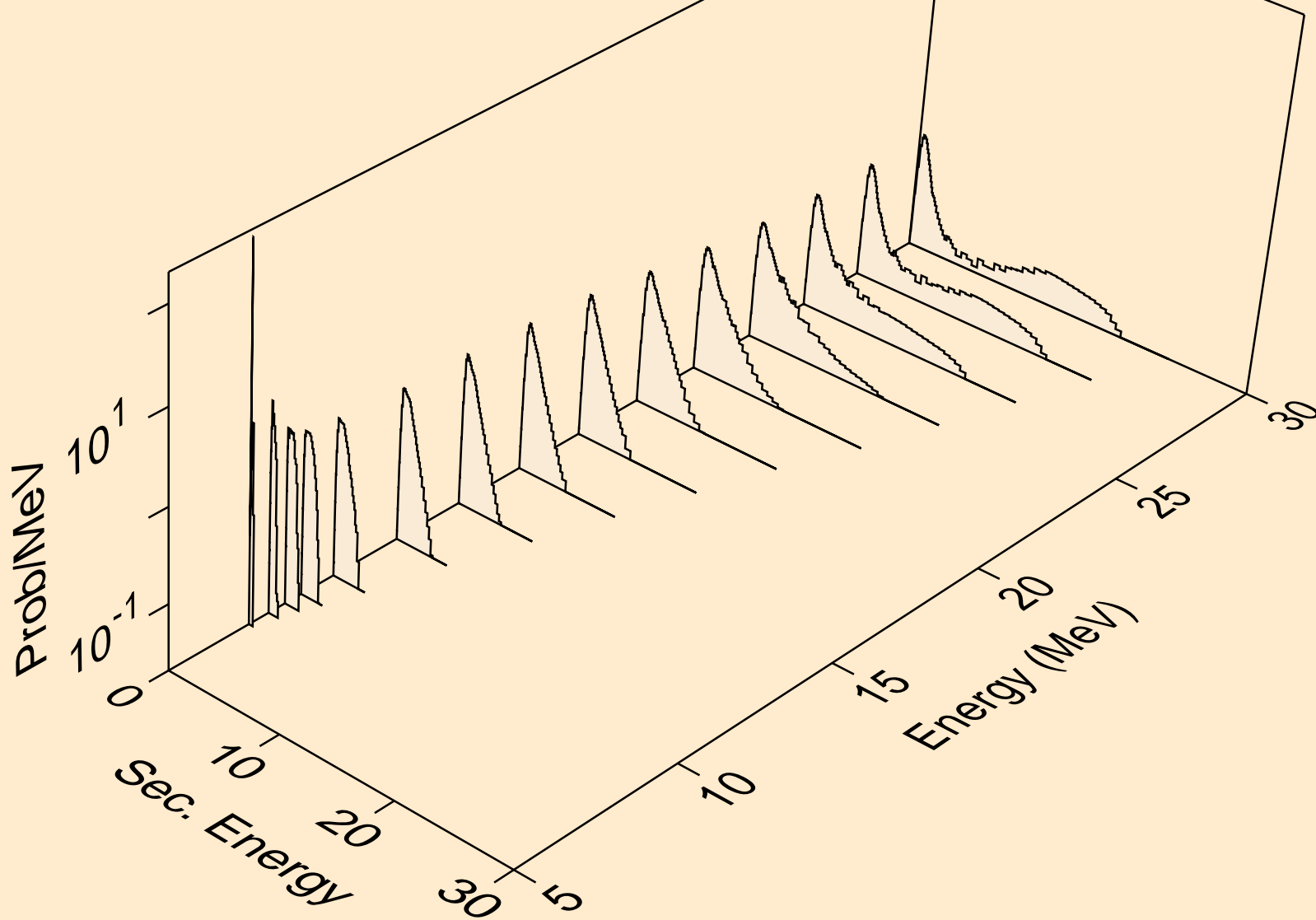

YB165 NEUTRON ACER TENDL-2019 LIBRARY; T=293.16K
Neutron emission for (n,3n)

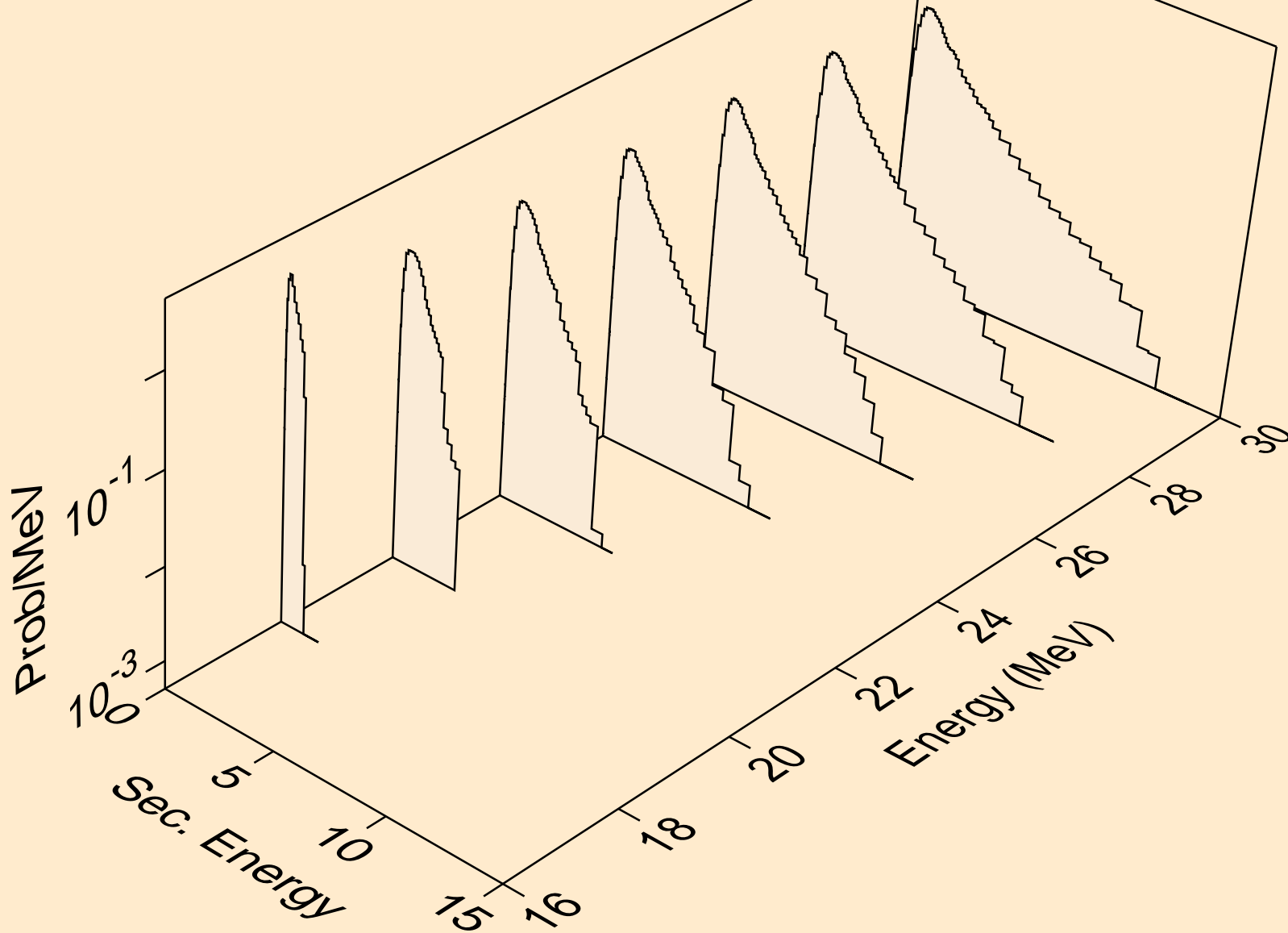

YB165 NEUTRON ACER TENDL-2019 LIBRARY; T=293.16K
Neutron emission for (n,n*)a

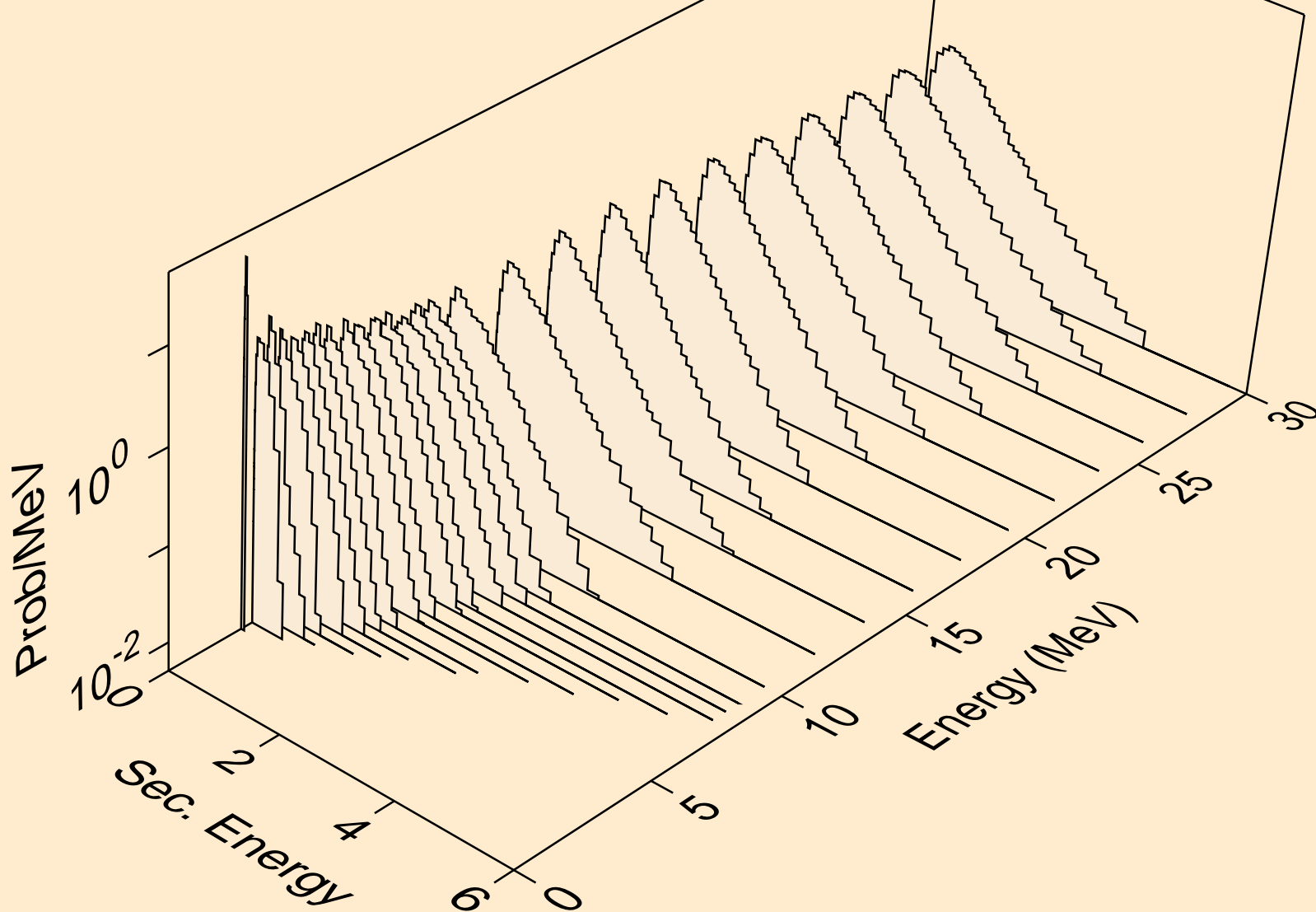

YB165 NEUTRON ACER TENDL-2019 LIBRARY; T=293.16K
Neutron emission for (n,2n)a

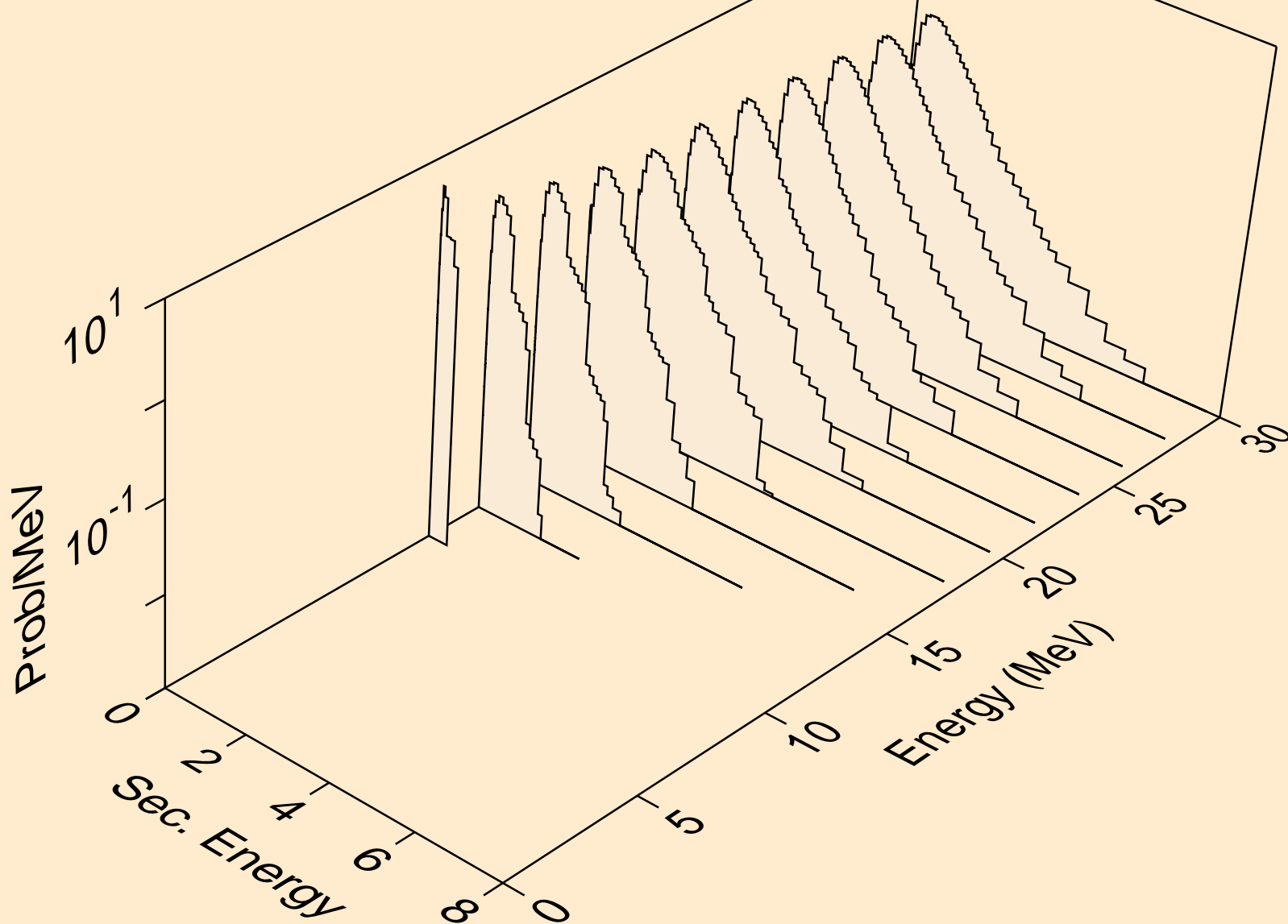

YB165 NEUTRON ACER TENDL-2019 LIBRARY; T=293.16K
Neutron emission for (n,3n)a

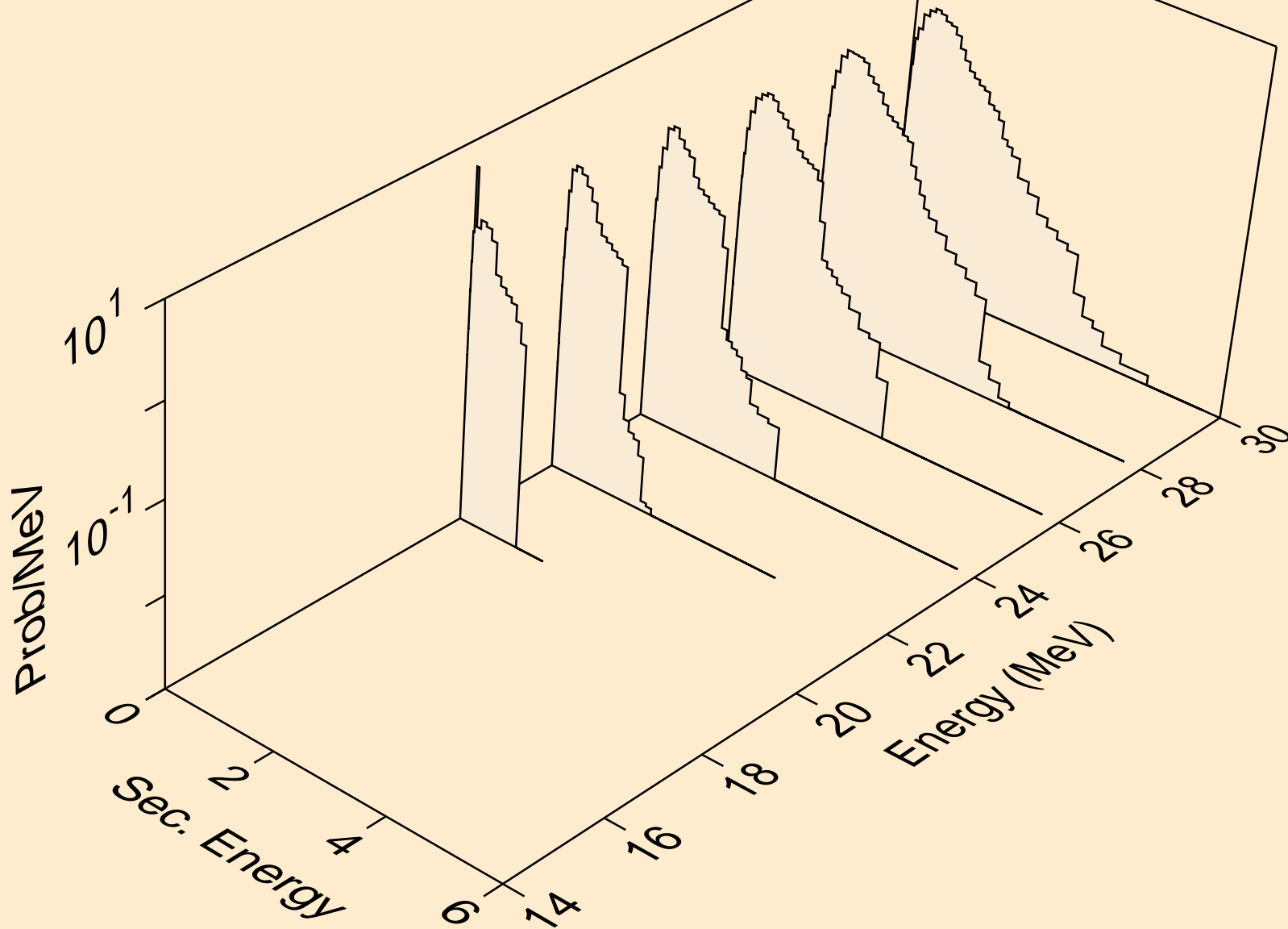

YB165 NEUTRON ACER TENDL-2019 LIBRARY; T=293.16K
Neutron emission for (n,n*)p

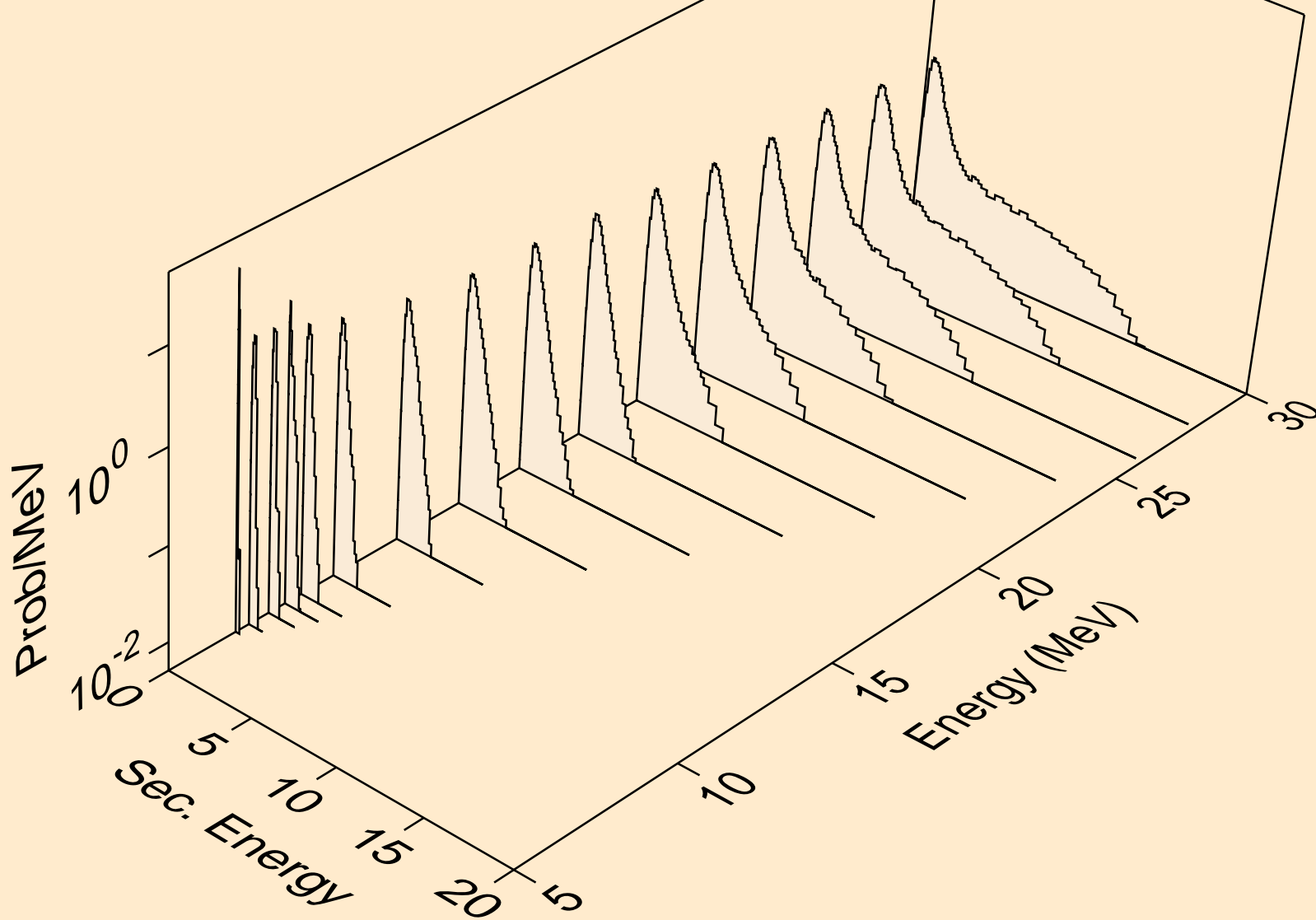

YB165 NEUTRON ACER TENDL-2019 LIBRARY; T=293.16K
Neutron emission for (n,n*)2a

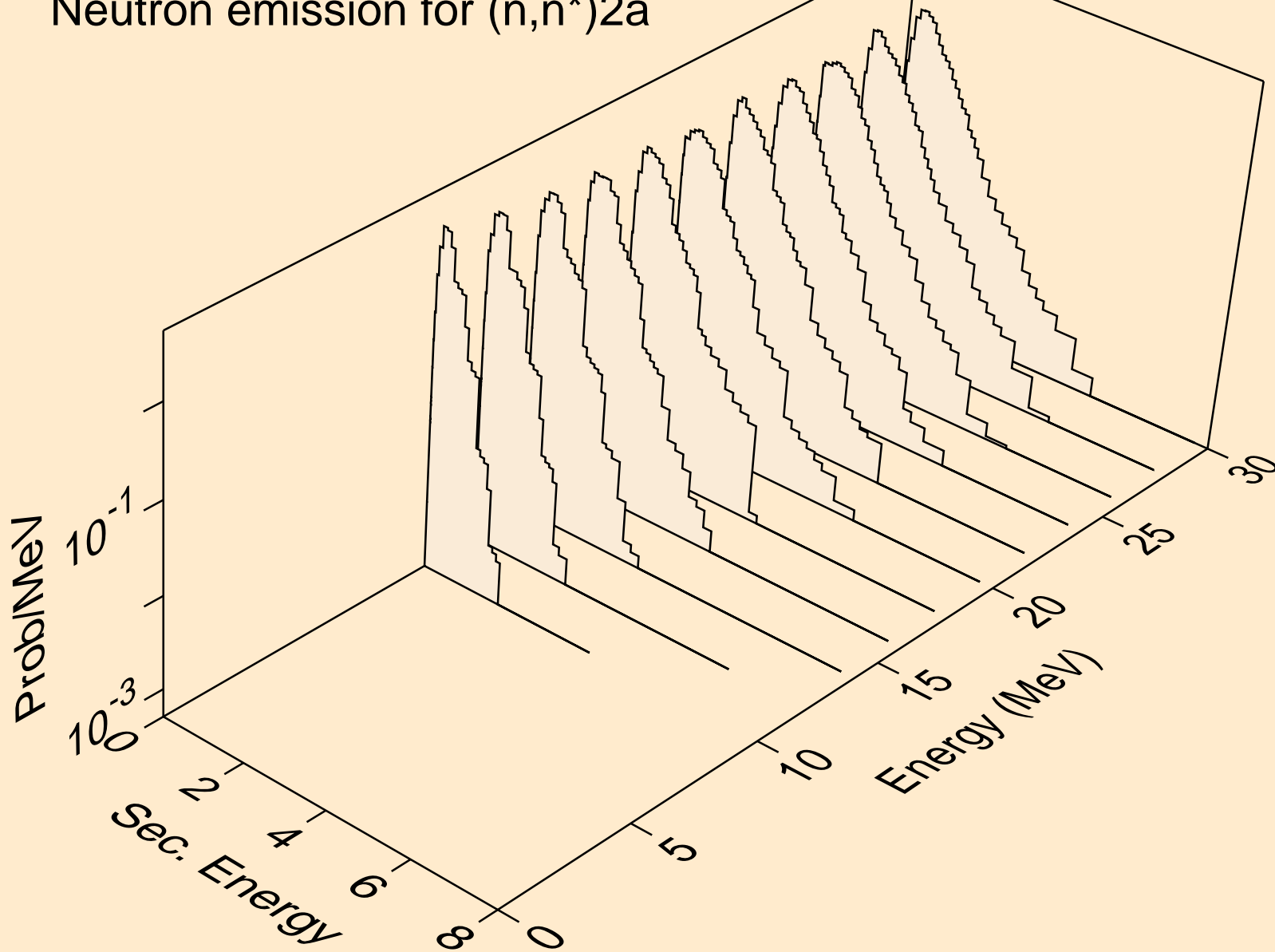

YB165 NEUTRON ACER TENDL-2019 LIBRARY; T=293.16K
Neutron emission for (n,2n)2a

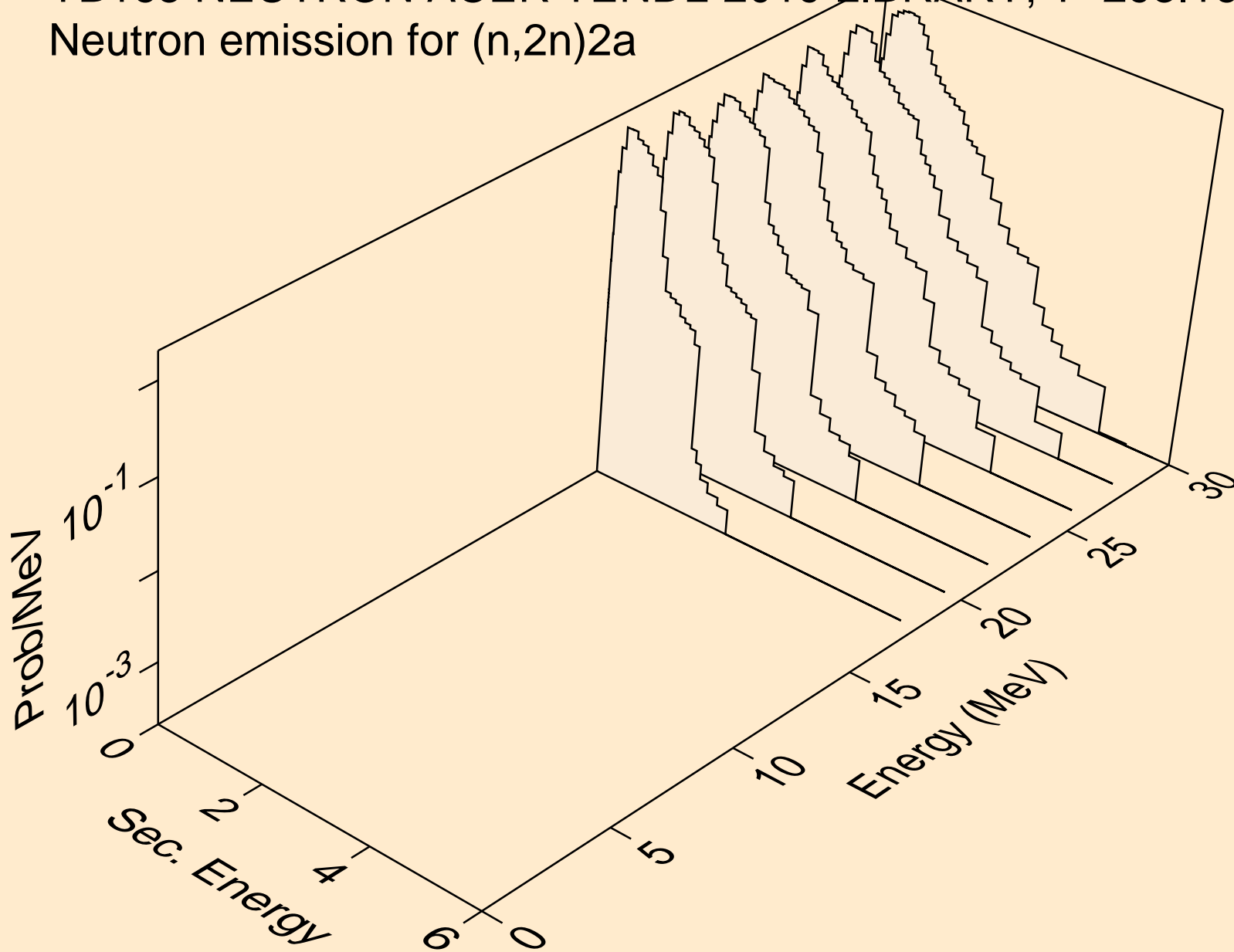

YB165 NEUTRON ACER TENDL-2019 LIBRARY; T=293.16K
Neutron emission for (n,n*)d

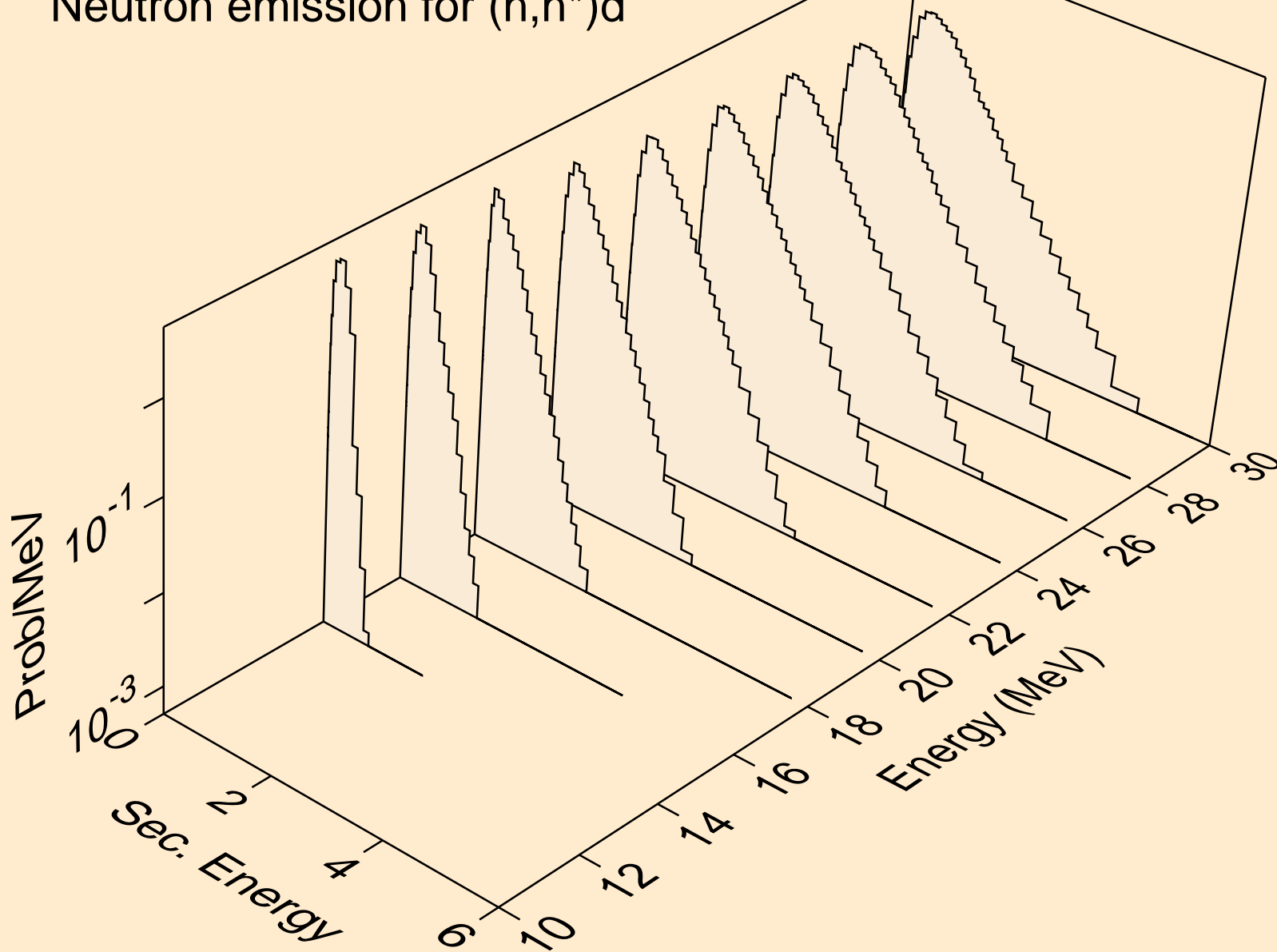

YB165 NEUTRON ACER TENDL-2019 LIBRARY; T=293.16K
Neutron emission for (n,n*)t

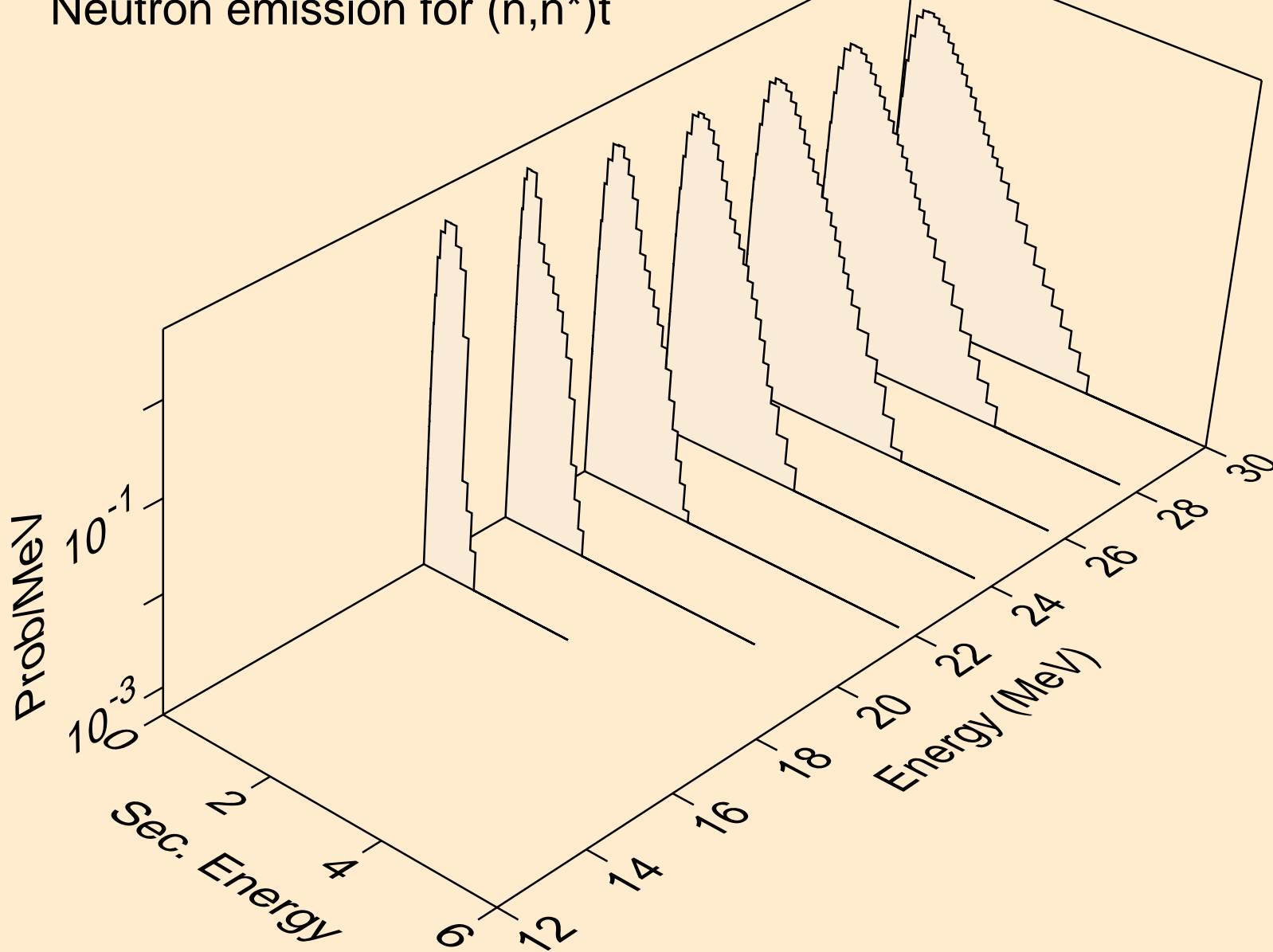

YB165 NEUTRON ACER TENDL-2019 LIBRARY; T=293.16K
Neutron emission for (n,n*)he3

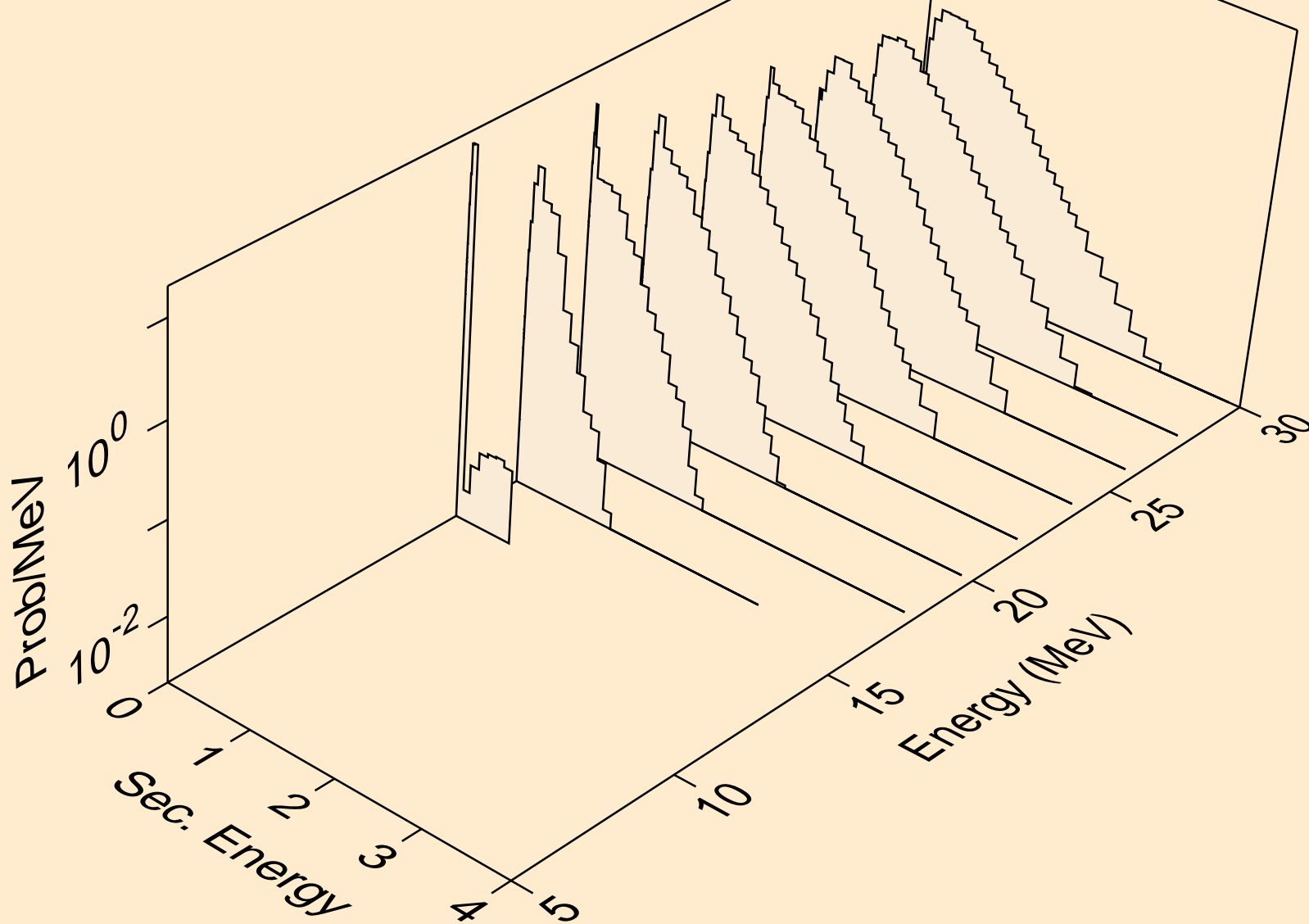

YB165 NEUTRON ACER TENDL-2019 LIBRARY; T=293.16K
Neutron emission for (n,4n)

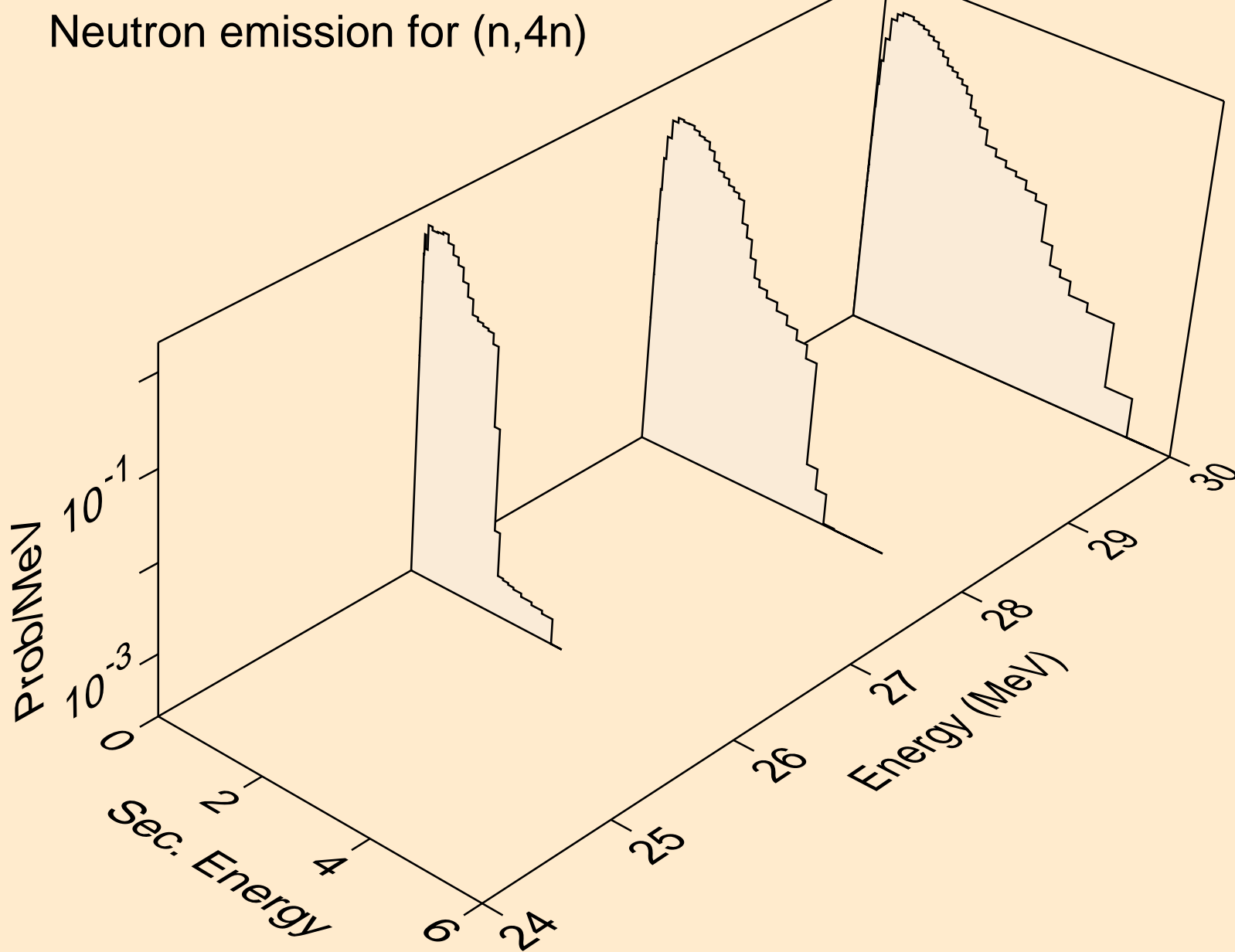

YB165 NEUTRON ACER TENDL-2019 LIBRARY; T=293.16K
Neutron emission for (n,2np)

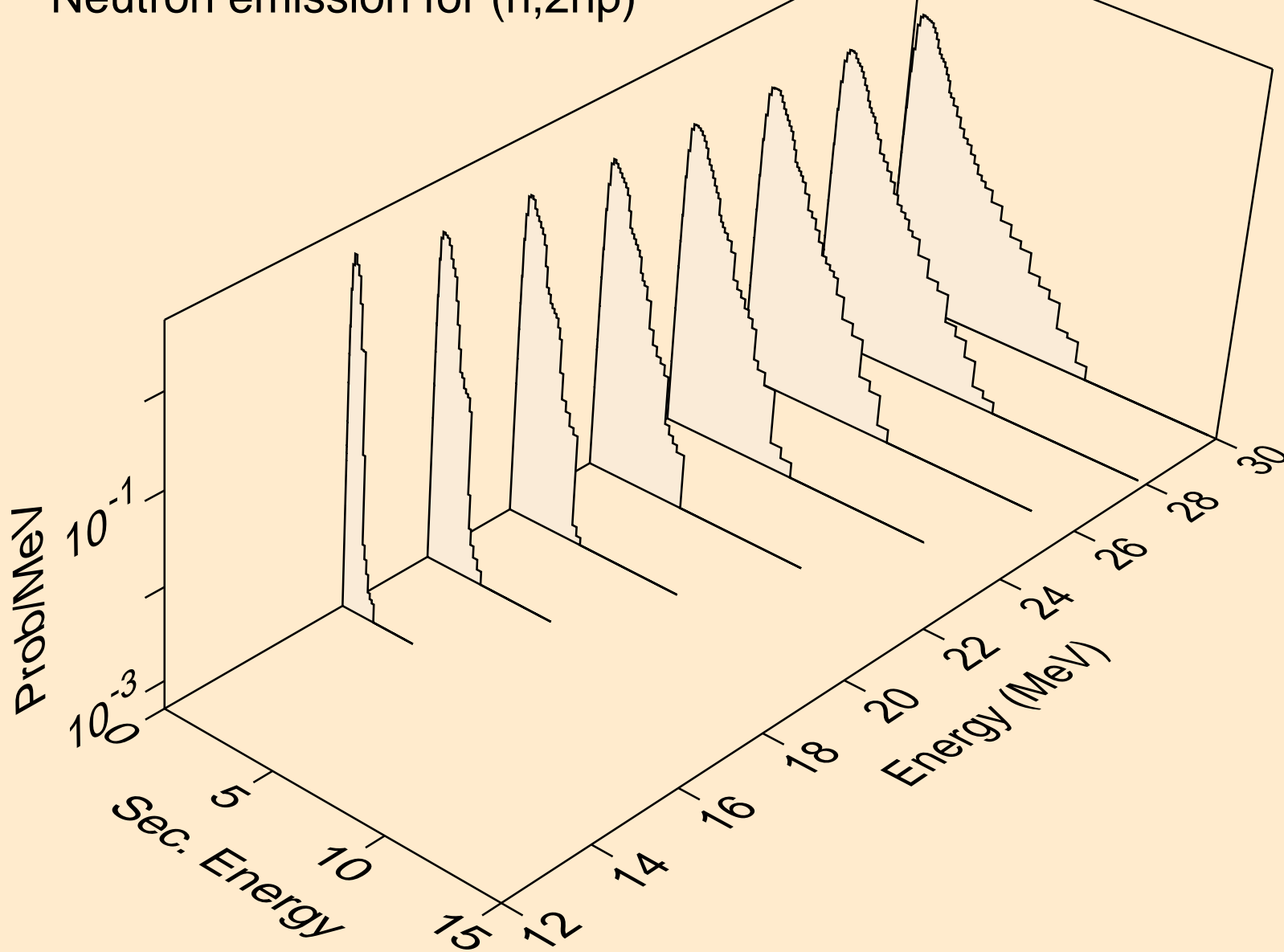

YB165 NEUTRON ACER TENDL-2019 LIBRARY; T=293.16K
Neutron emission for (n,3np)

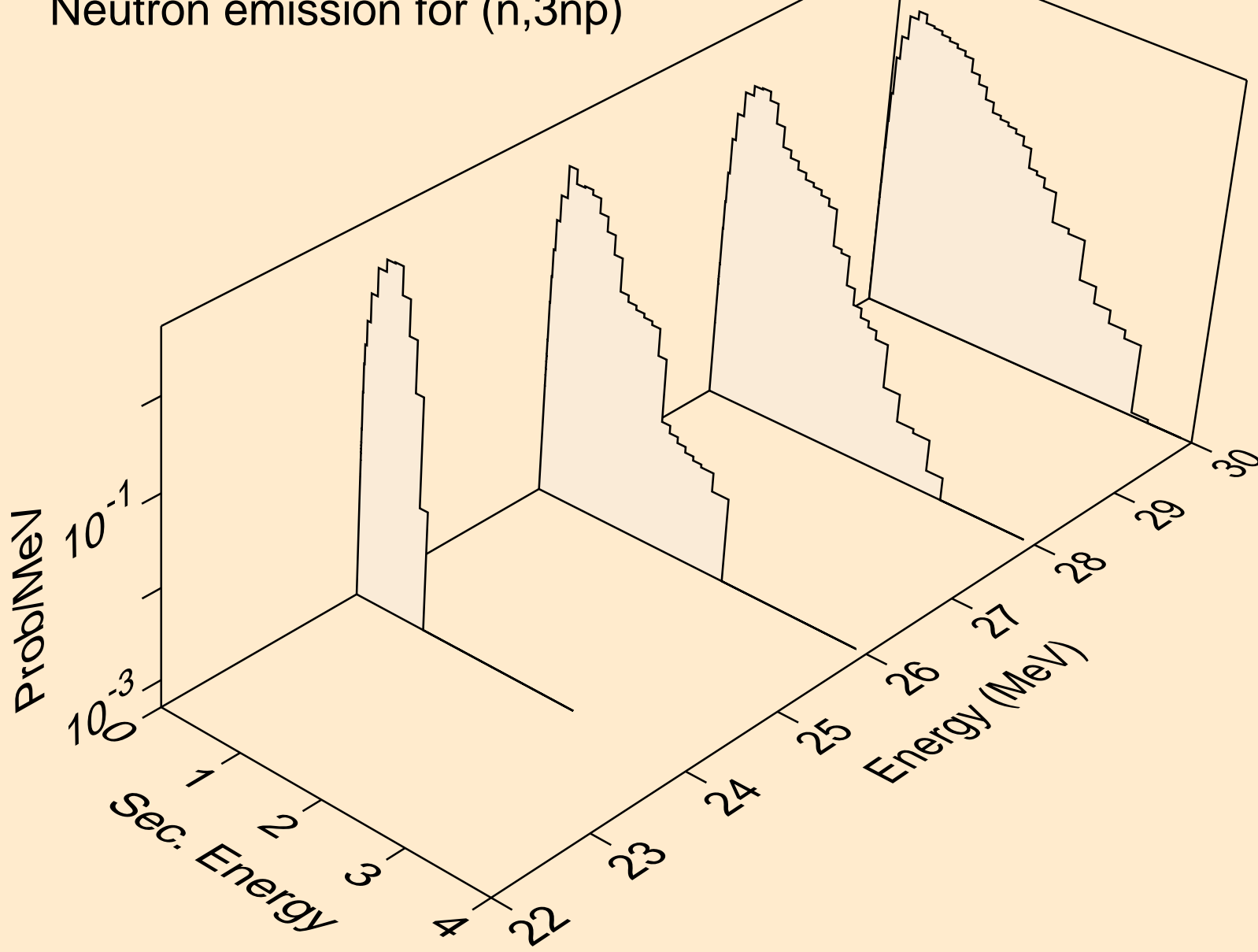

YB165 NEUTRON ACER TENDL-2019 LIBRARY; T=293.16K
Neutron emission for (n,2np)

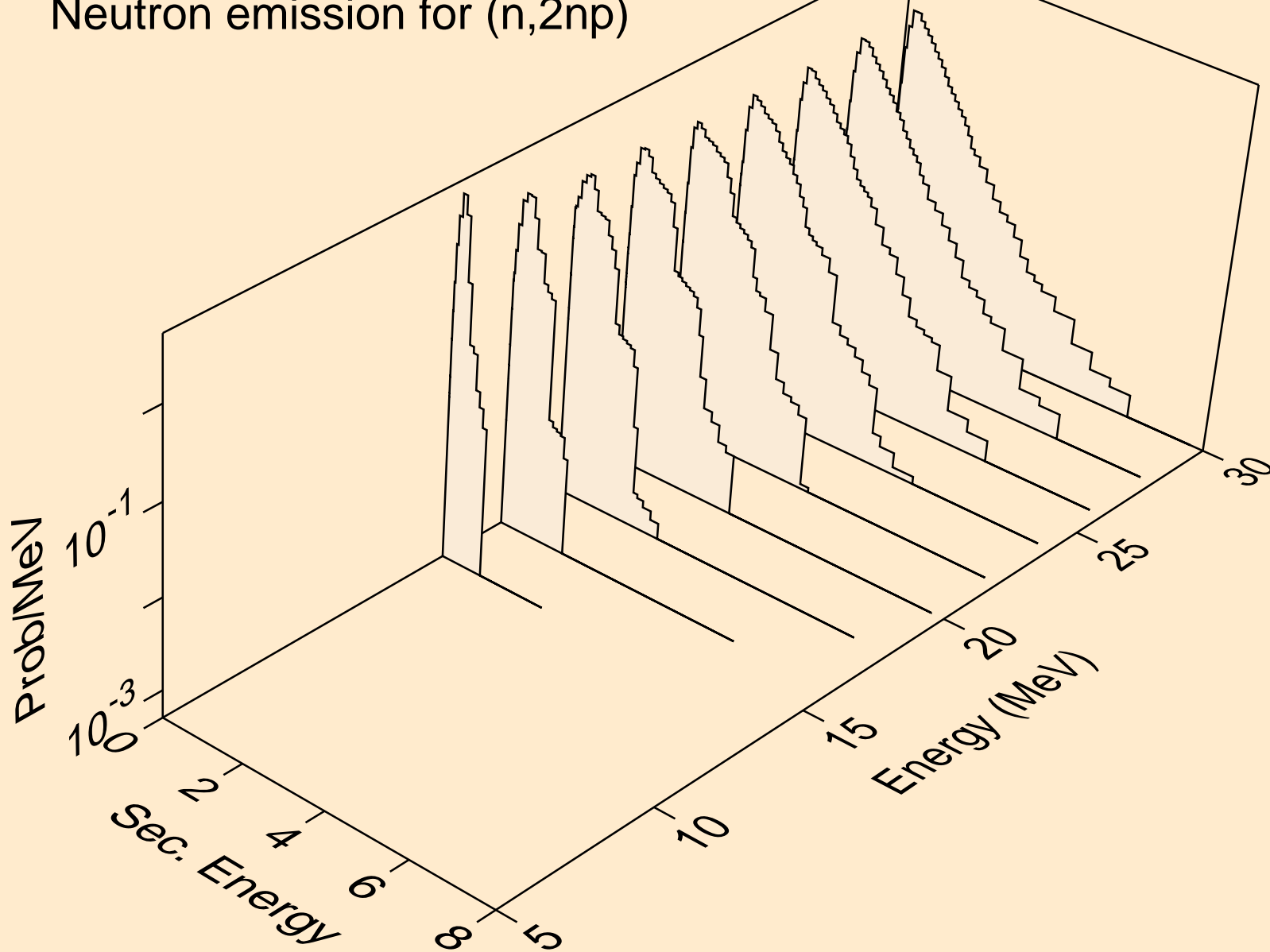

YB165 NEUTRON ACER TENDL-2019 LIBRARY; T=293.16K
Neutron emission for (n,npa)

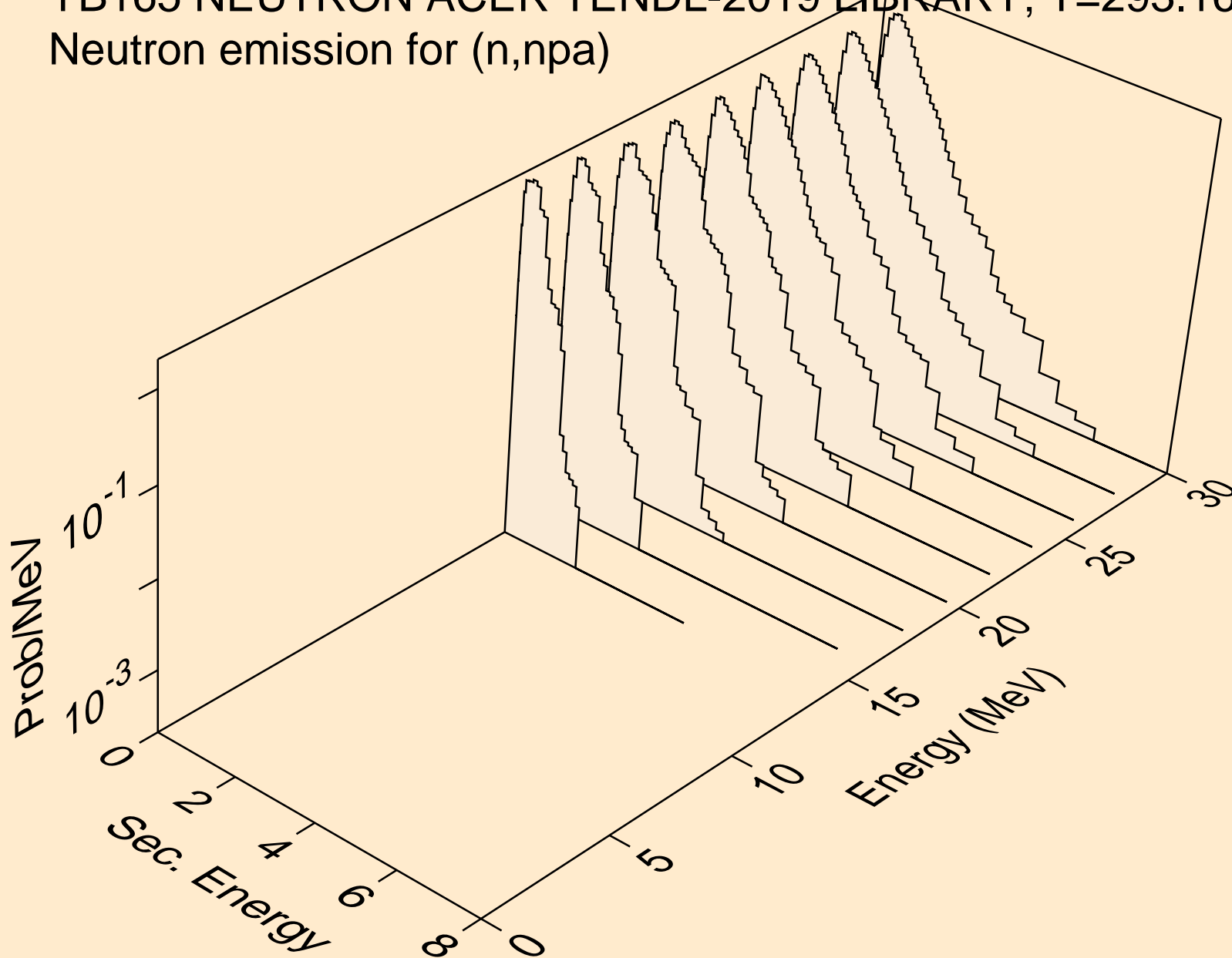

YB165 NEUTRON ACER TENDL-2019 LIBRARY; T=293.16K
Neutron emission for (n,n*c)

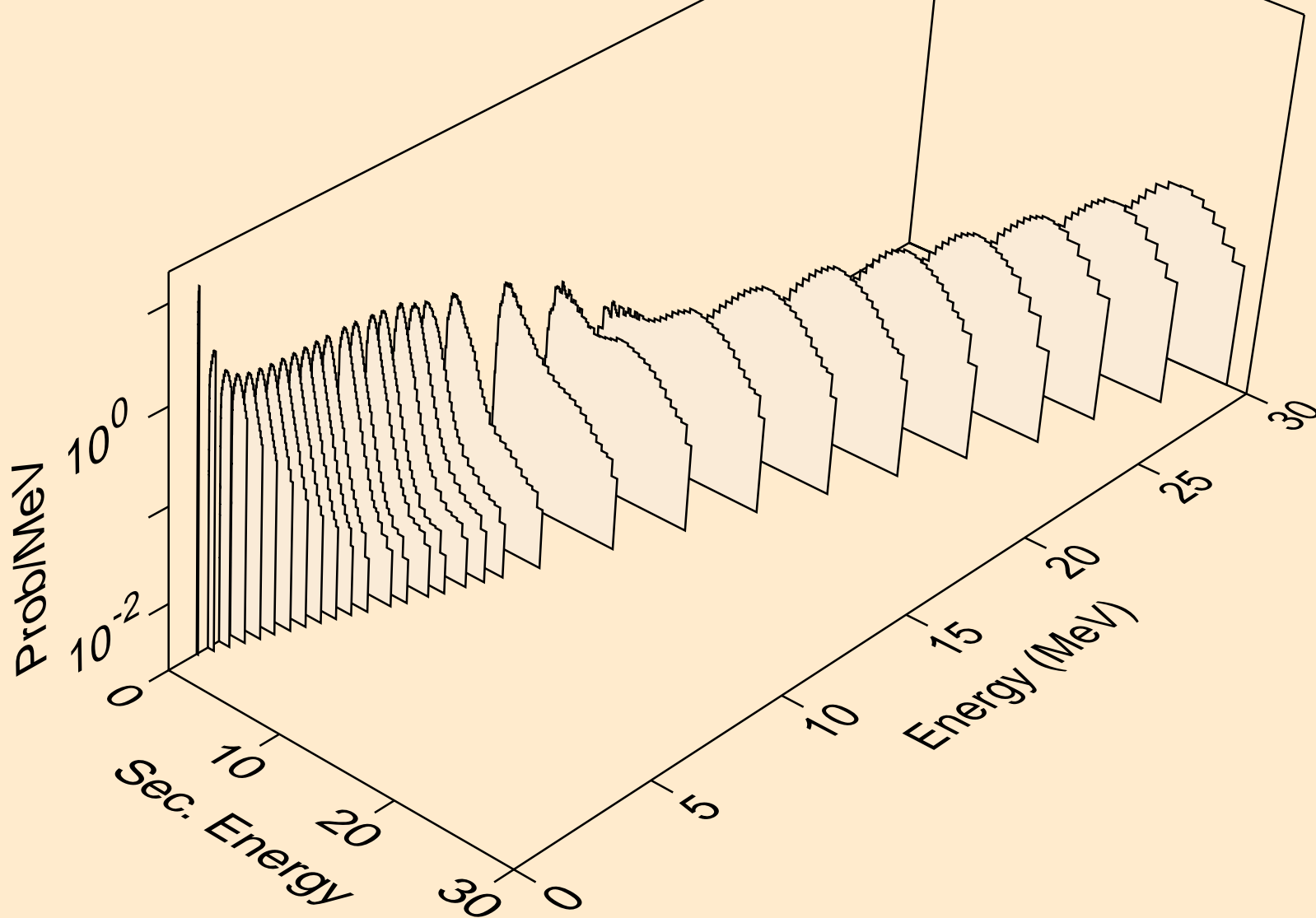

YB165 NEUTRON ACER TENDL-2019 LIBRARY; T=293.16K
Photon emission for (n,x)

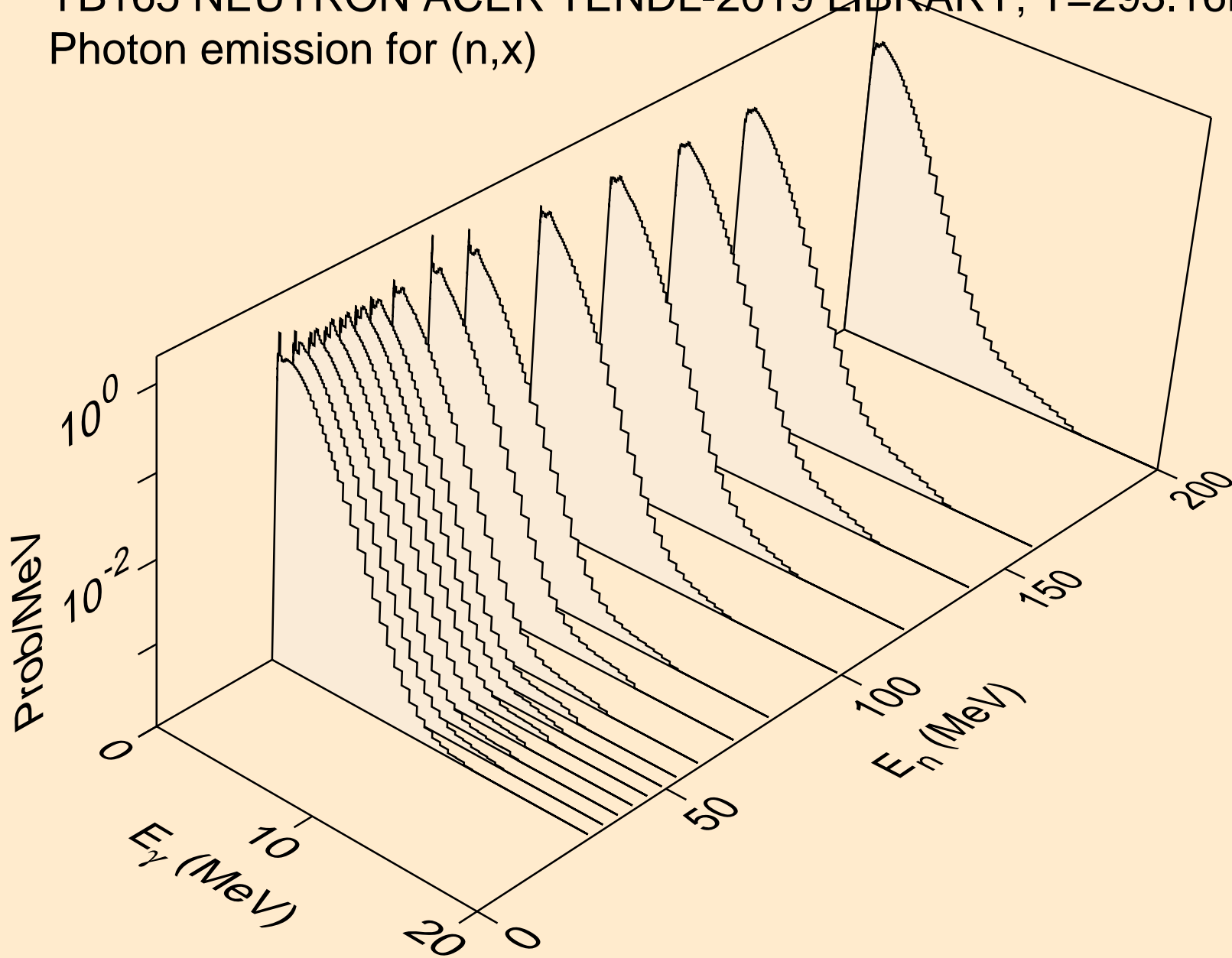

YB165 NEUTRON ACER TENDL-2019 LIBRARY; T=293.16K
Photon emission for (n,2nd)

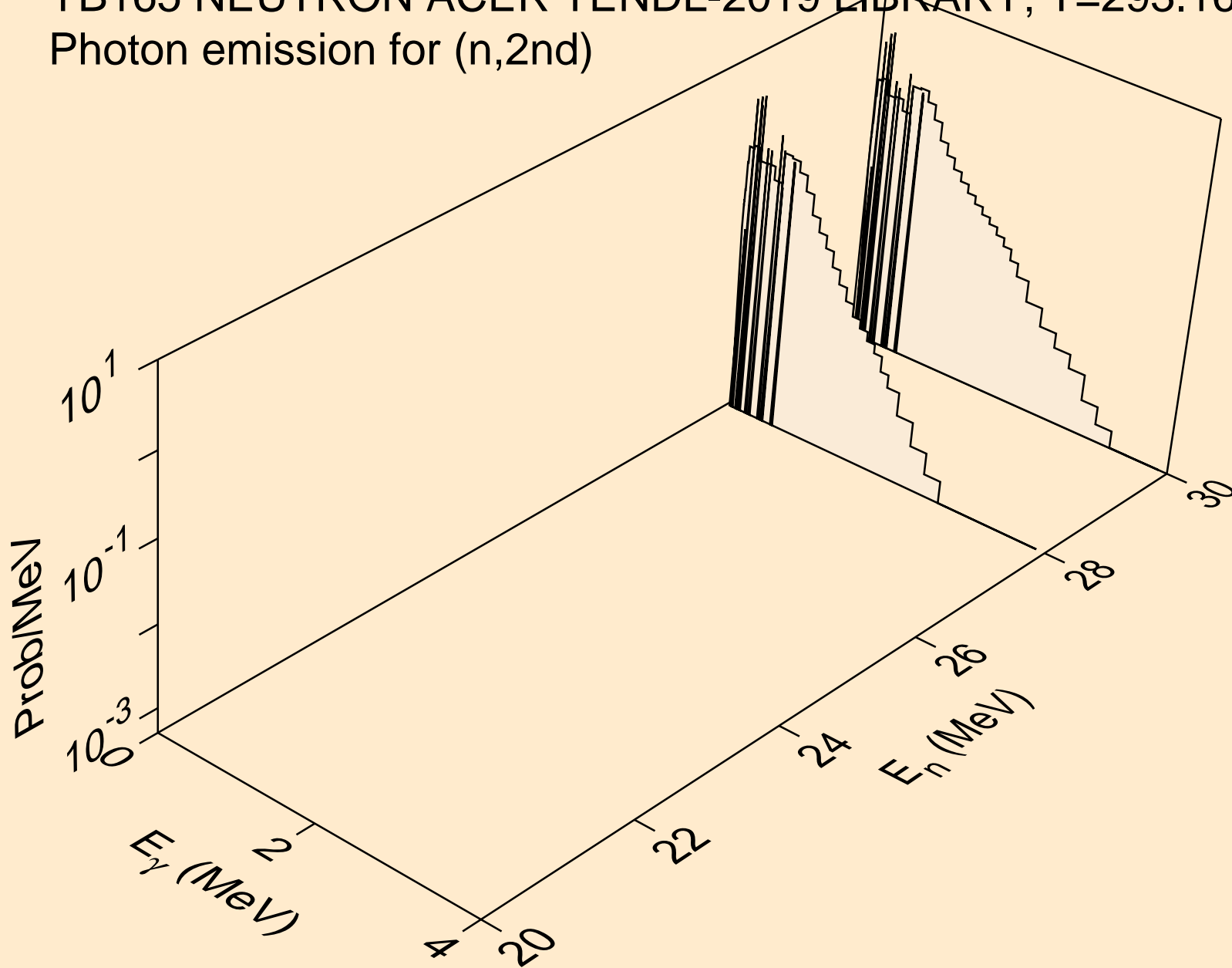

YB165 NEUTRON ACER TENDL-2019 LIBRARY; T=293.16K
Photon emission for (n,2n)

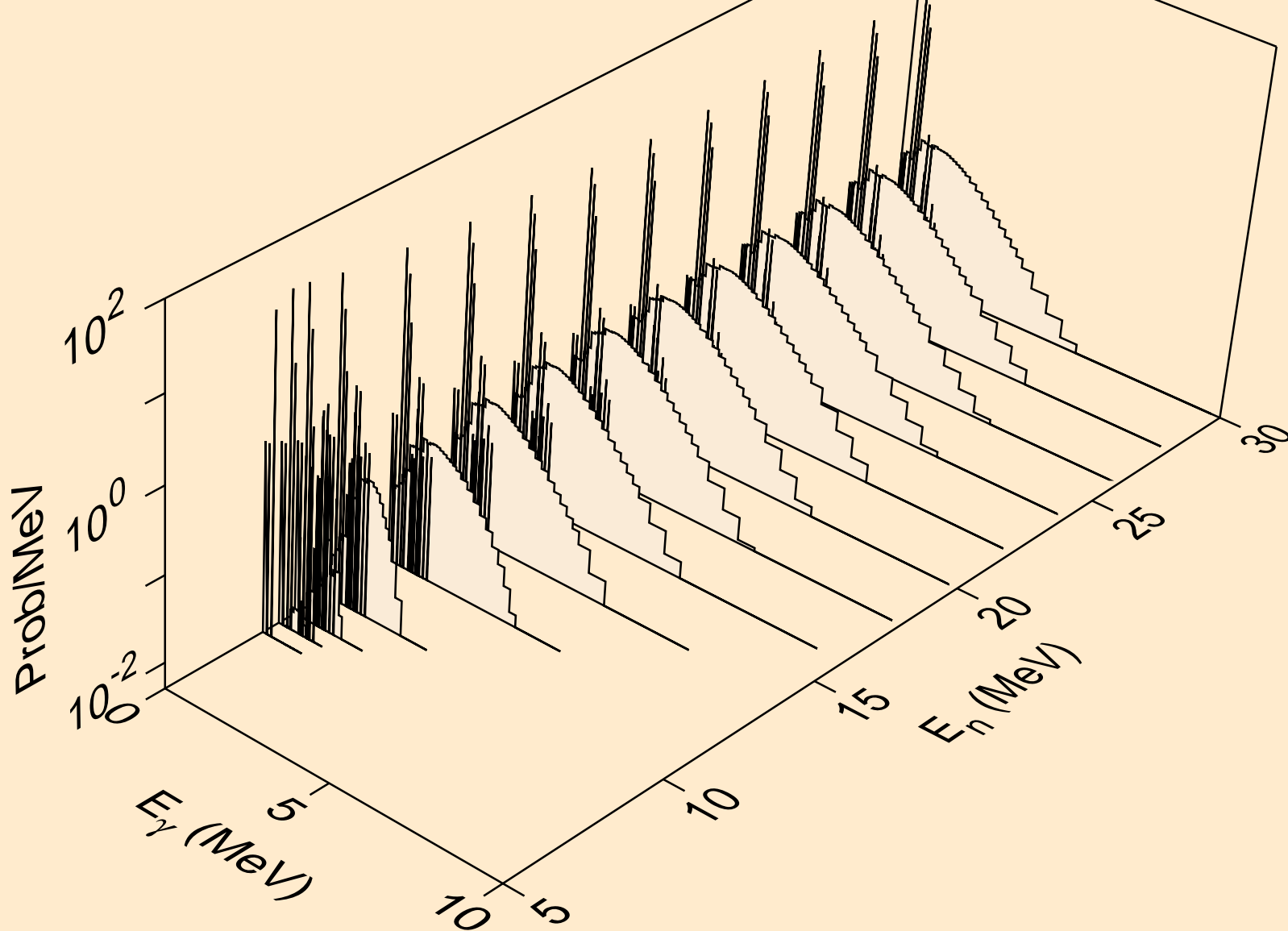

YB165 NEUTRON ACER TENDL-2019 LIBRARY; T=293.16K
Photon emission for (n,3n)

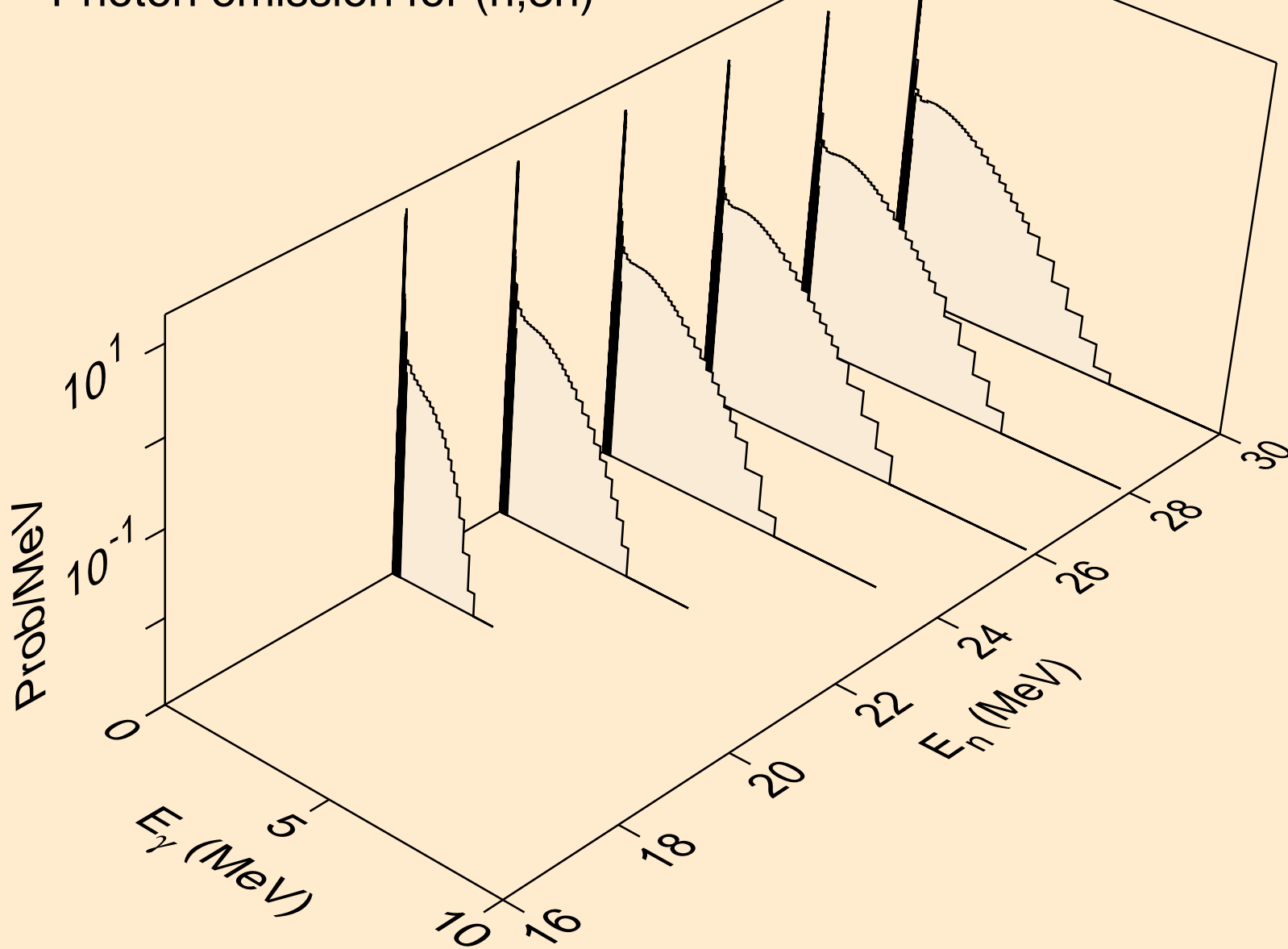

YB165 NEUTRON ACER TENDL-2019 LIBRARY; T=293.16K
Photon emission for (n,n*)a

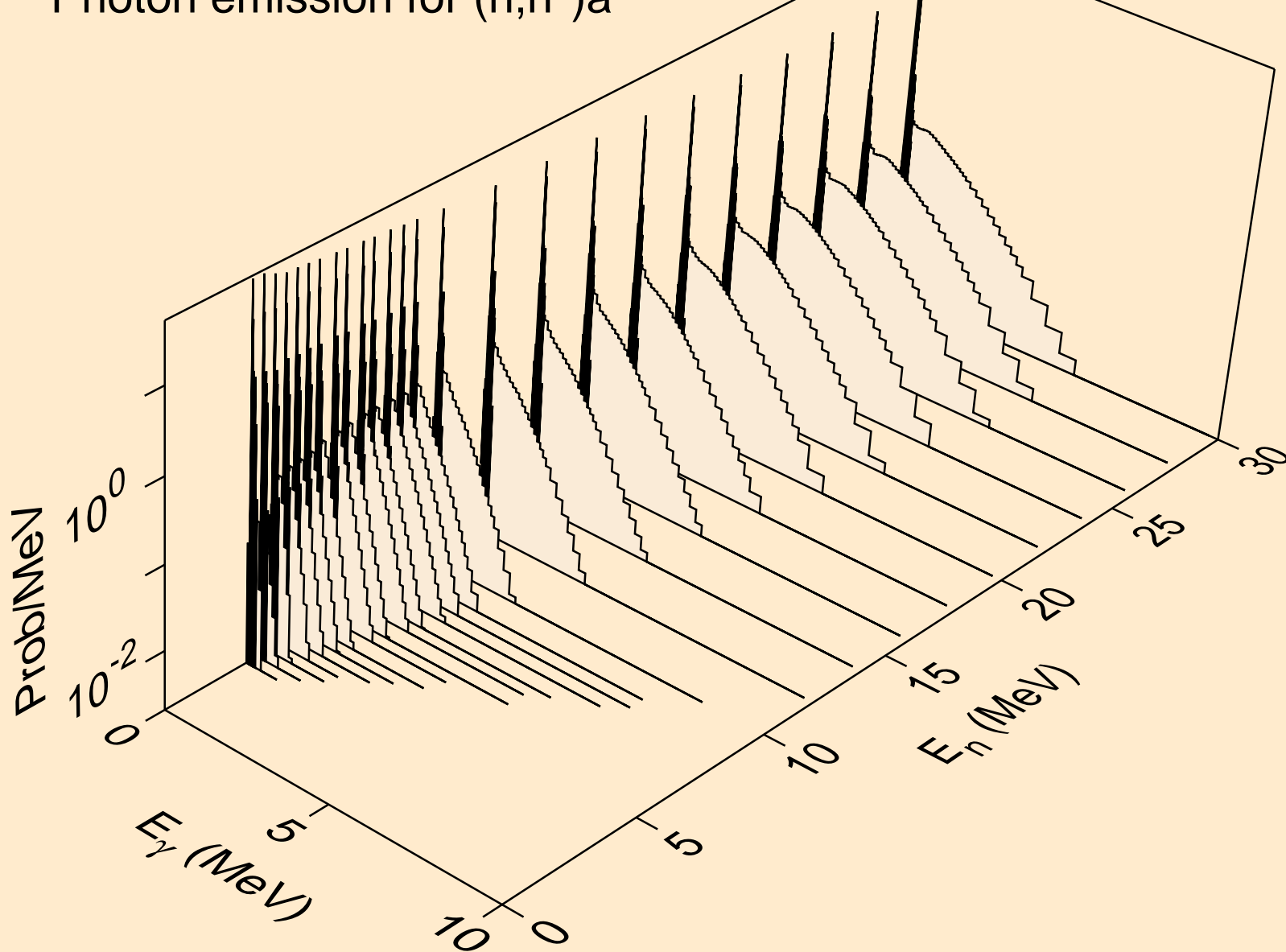

YB165 NEUTRON ACER TENDL-2019 LIBRARY; T=293.16K
Photon emission for (n,2n) α

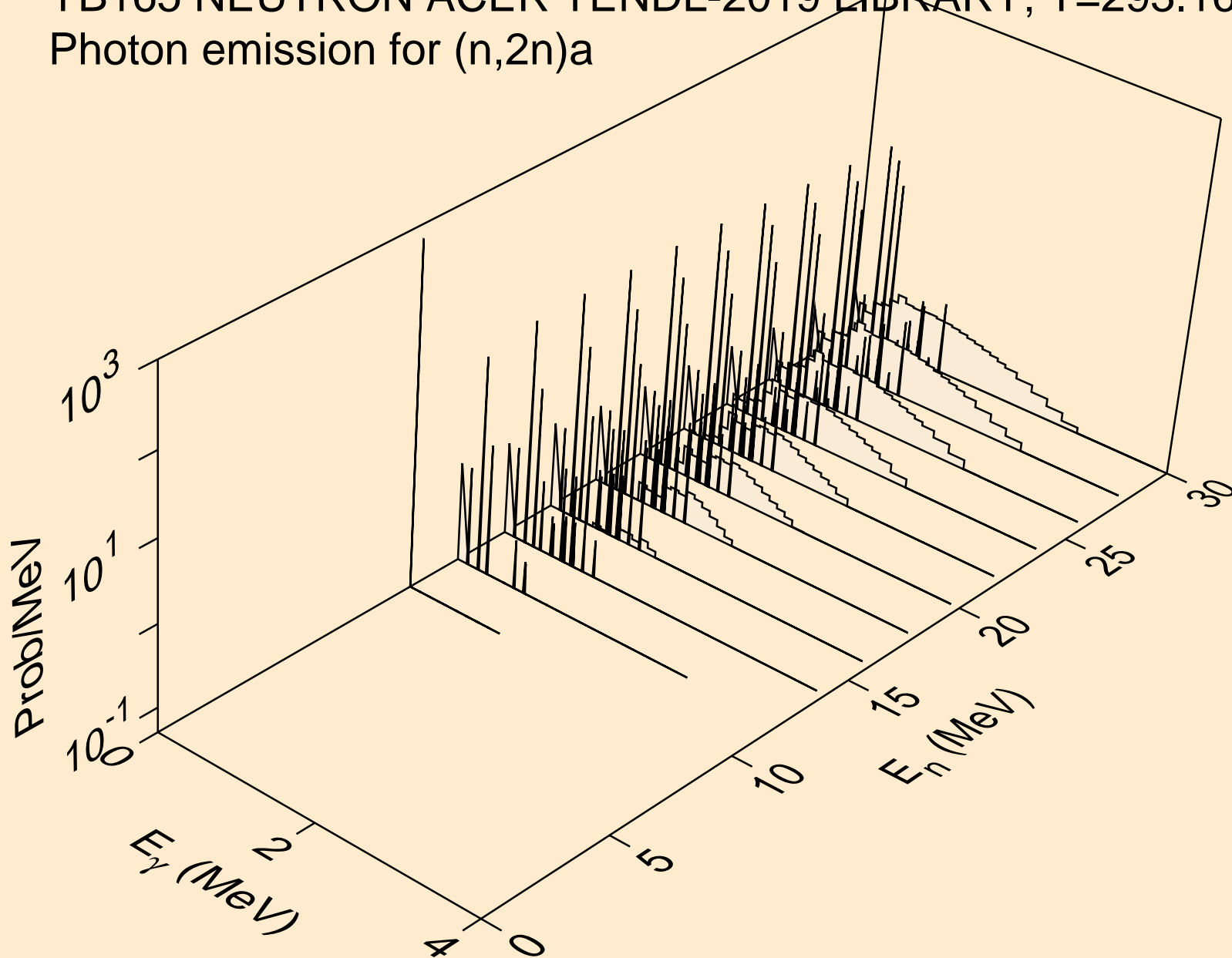

YB165 NEUTRON ACER TENDL-2019 LIBRARY; T=293.16K
Photon emission for (n,3n)a

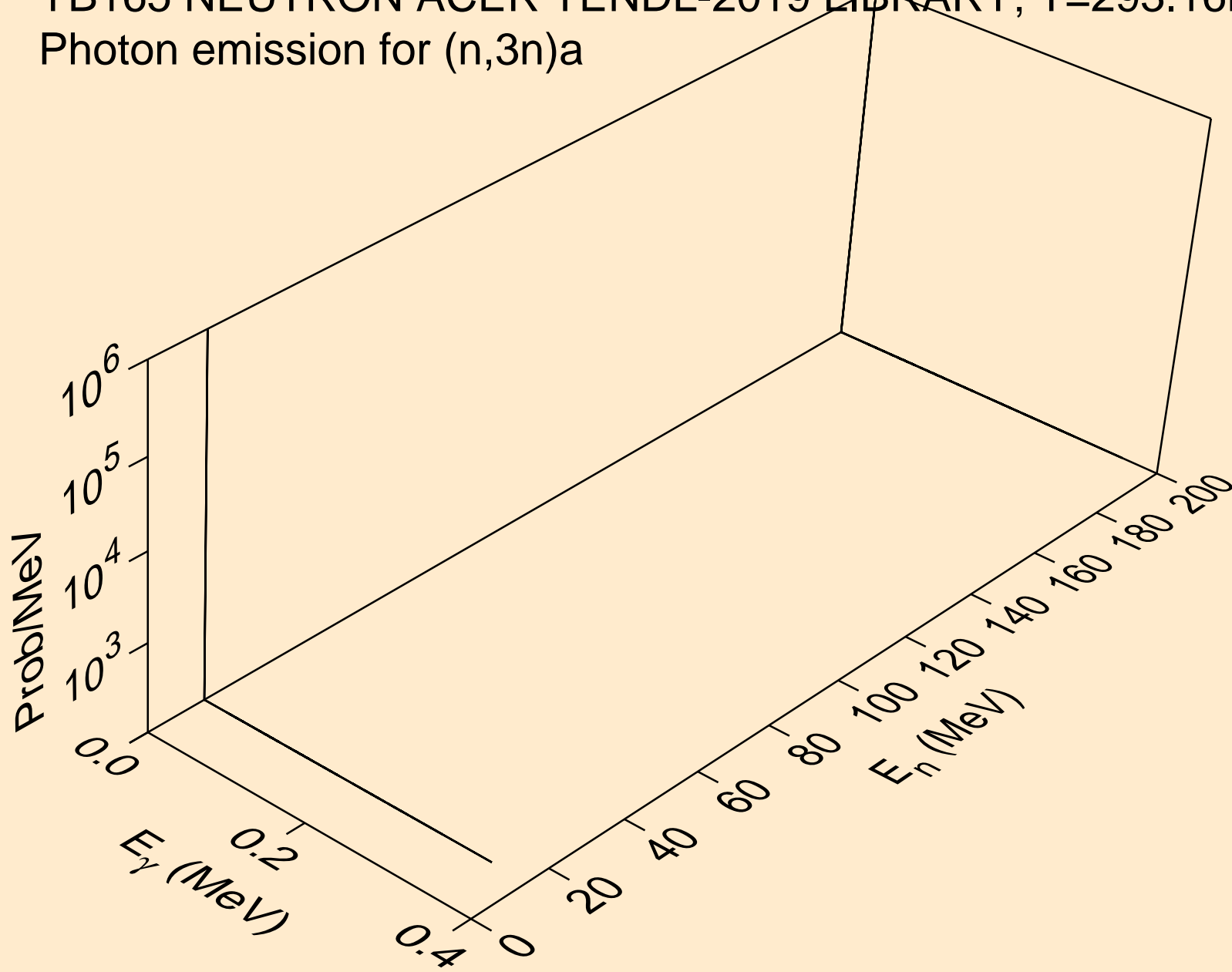

YB165 NEUTRON ACER TENDL-2019 LIBRARY; T=293.16K
Photon emission for (n,n*)p

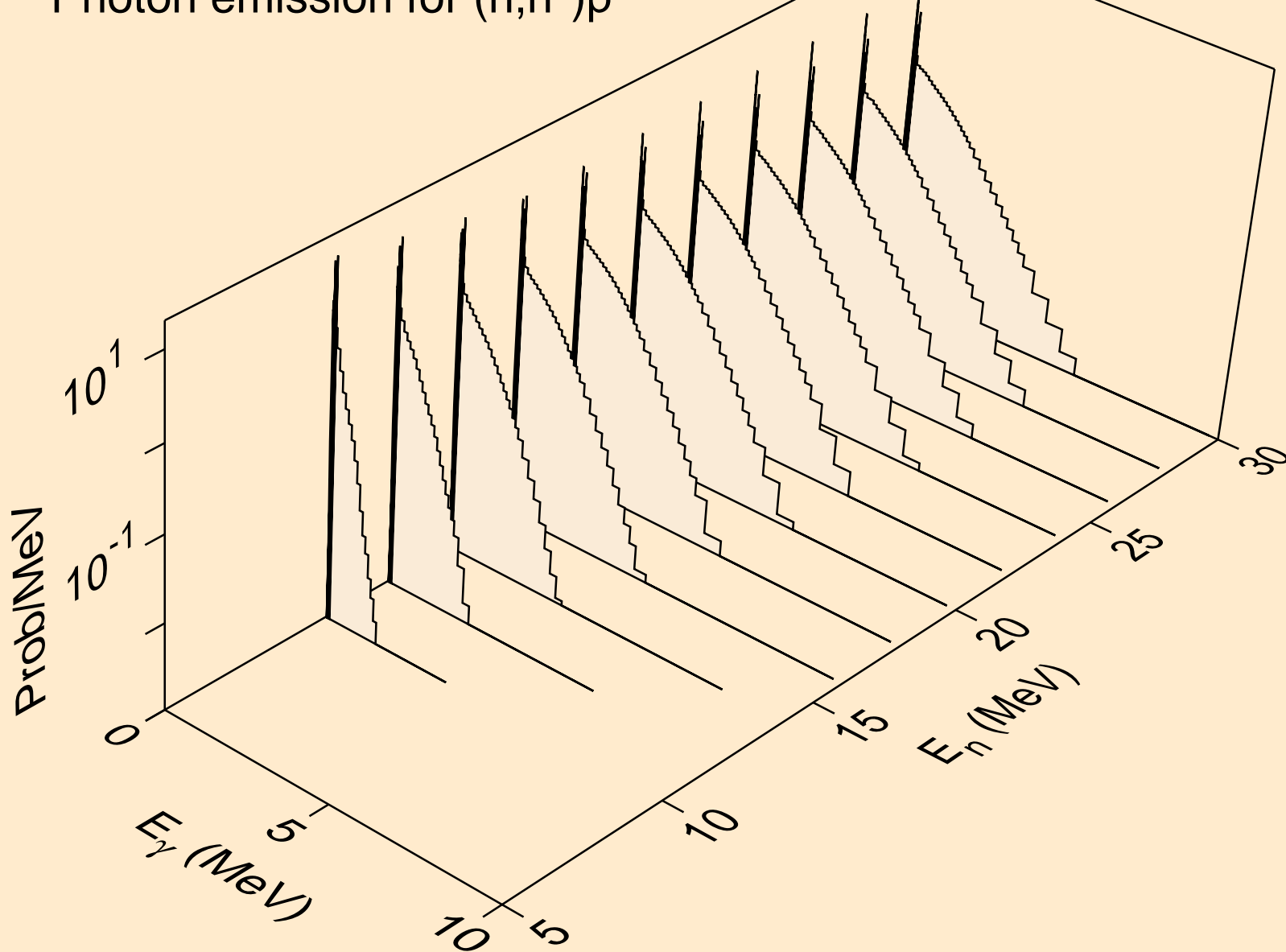

YB165 NEUTRON ACER TENDL-2019 LIBRARY; T=293.16K
Photon emission for (n,n*)2a

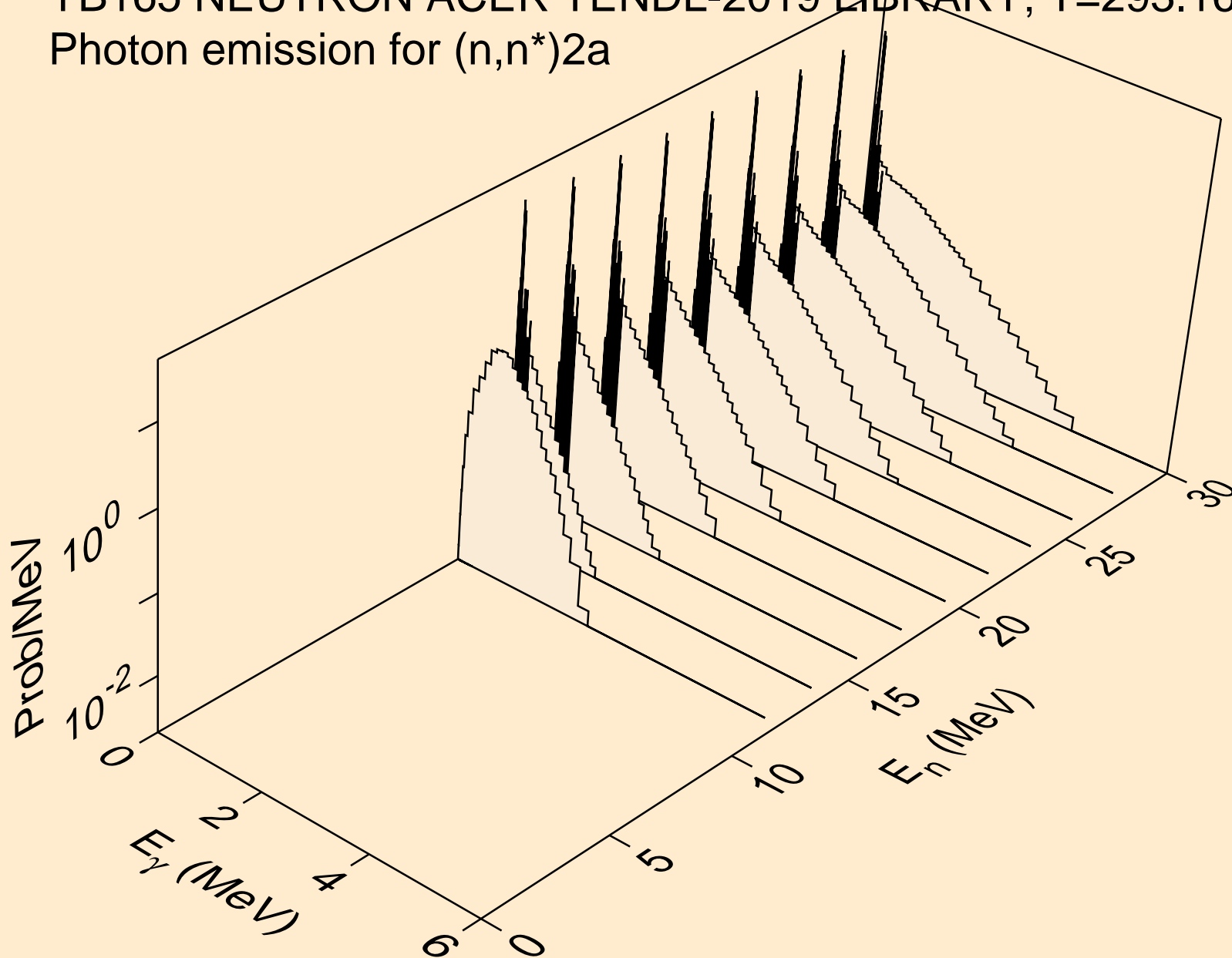

YB165 NEUTRON ACER TENDL-2019 LIBRARY; T=293.16K
Photon emission for (n,2n)2a

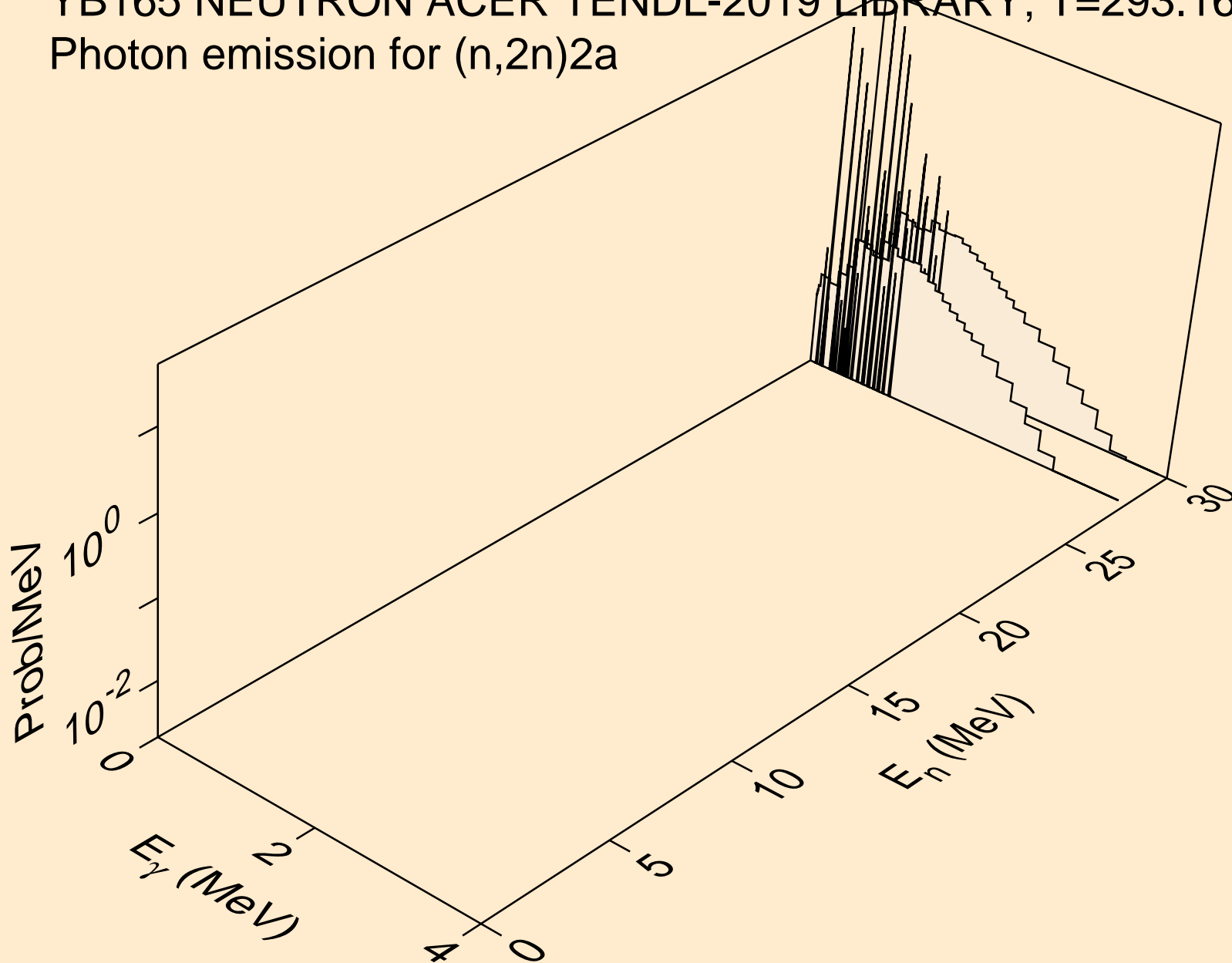

YB165 NEUTRON ACER TENDL-2019 LIBRARY; T=293.16K
Photon emission for (n,n*)d

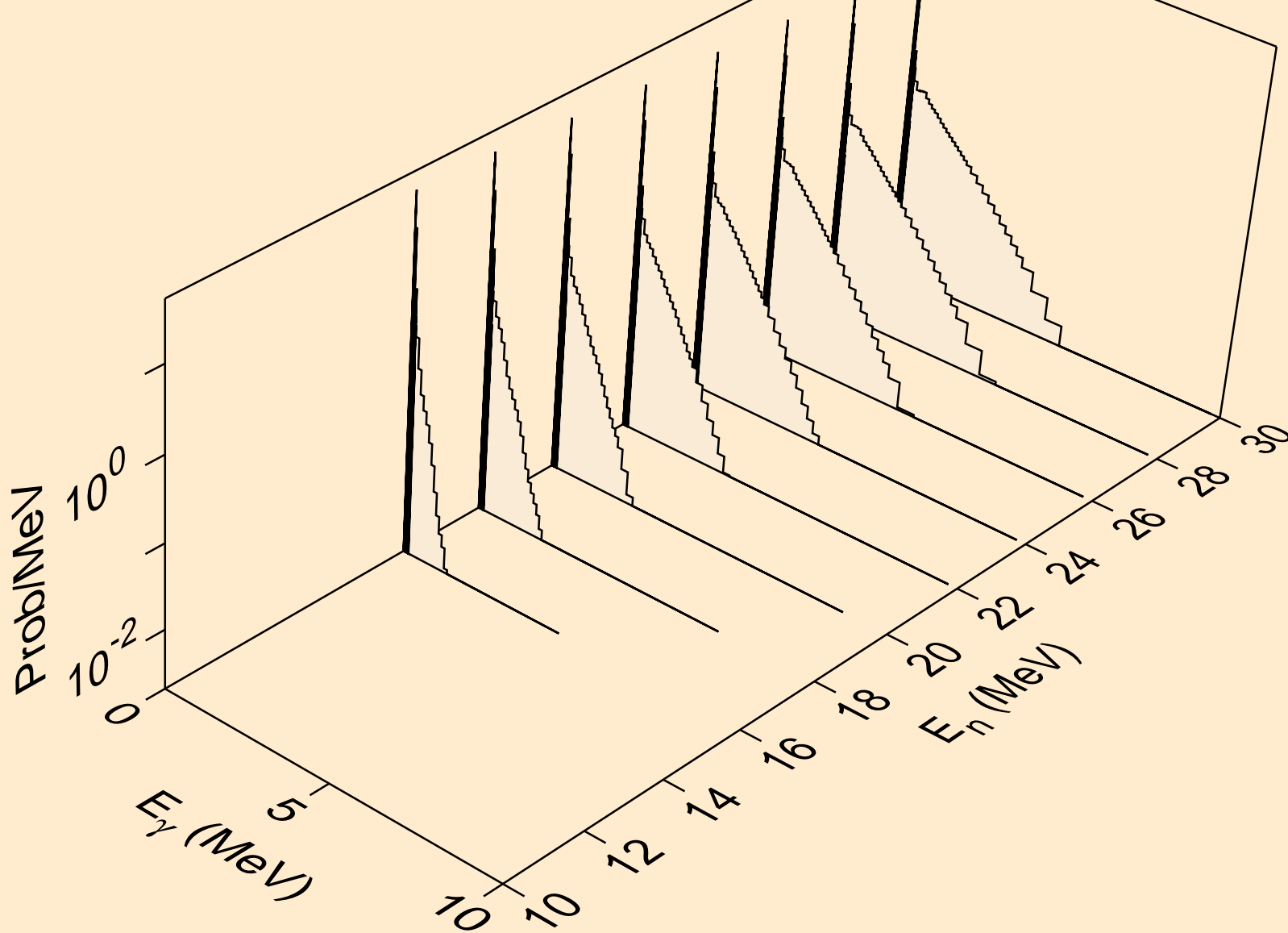

YB165 NEUTRON ACER TENDL-2019 LIBRARY; T=293.16K
Photon emission for (n,n*)t

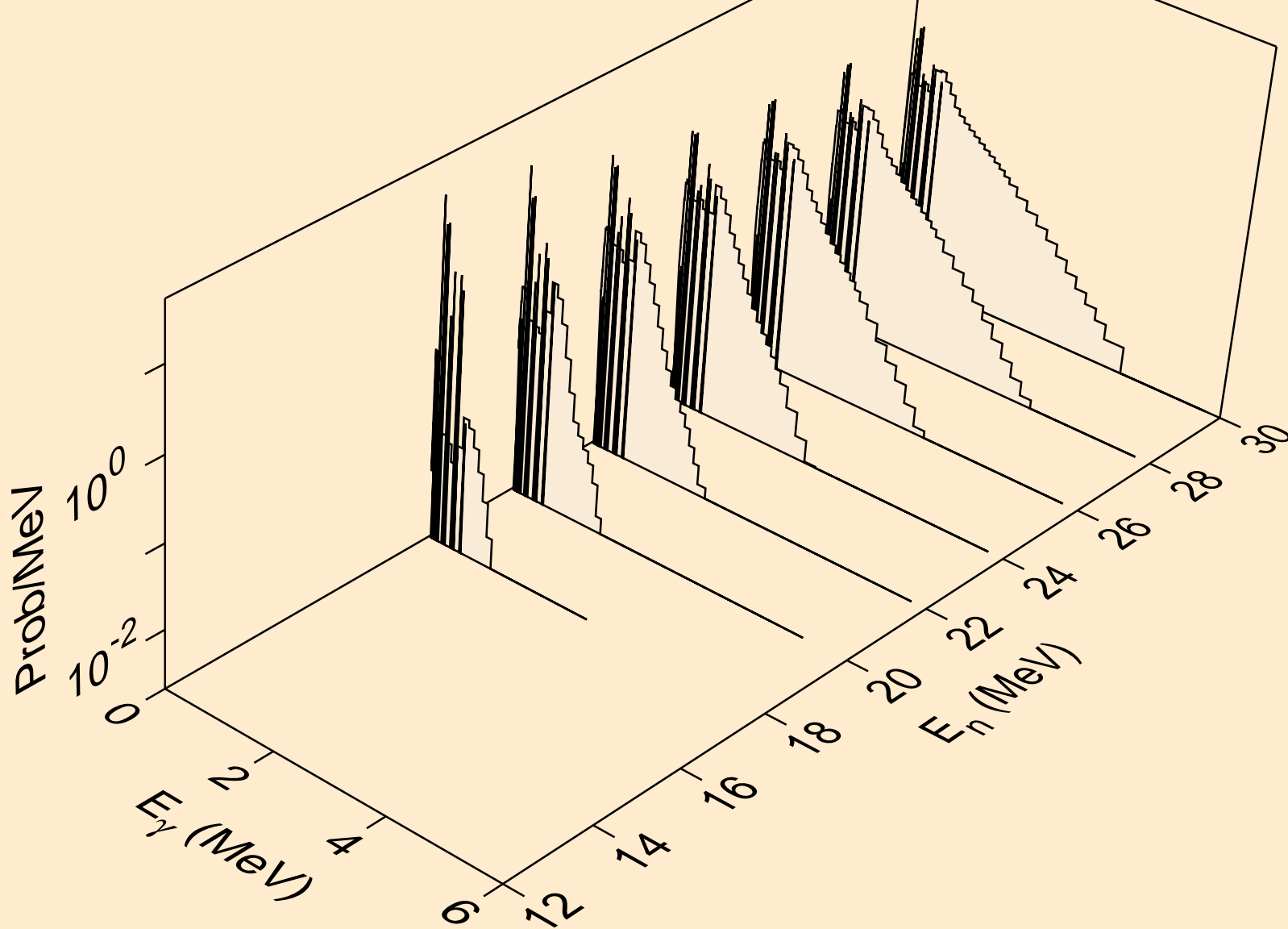

YB165 NEUTRON ACER TENDL-2019 LIBRARY; T=293.16K
Photon emission for (n,n*)he3

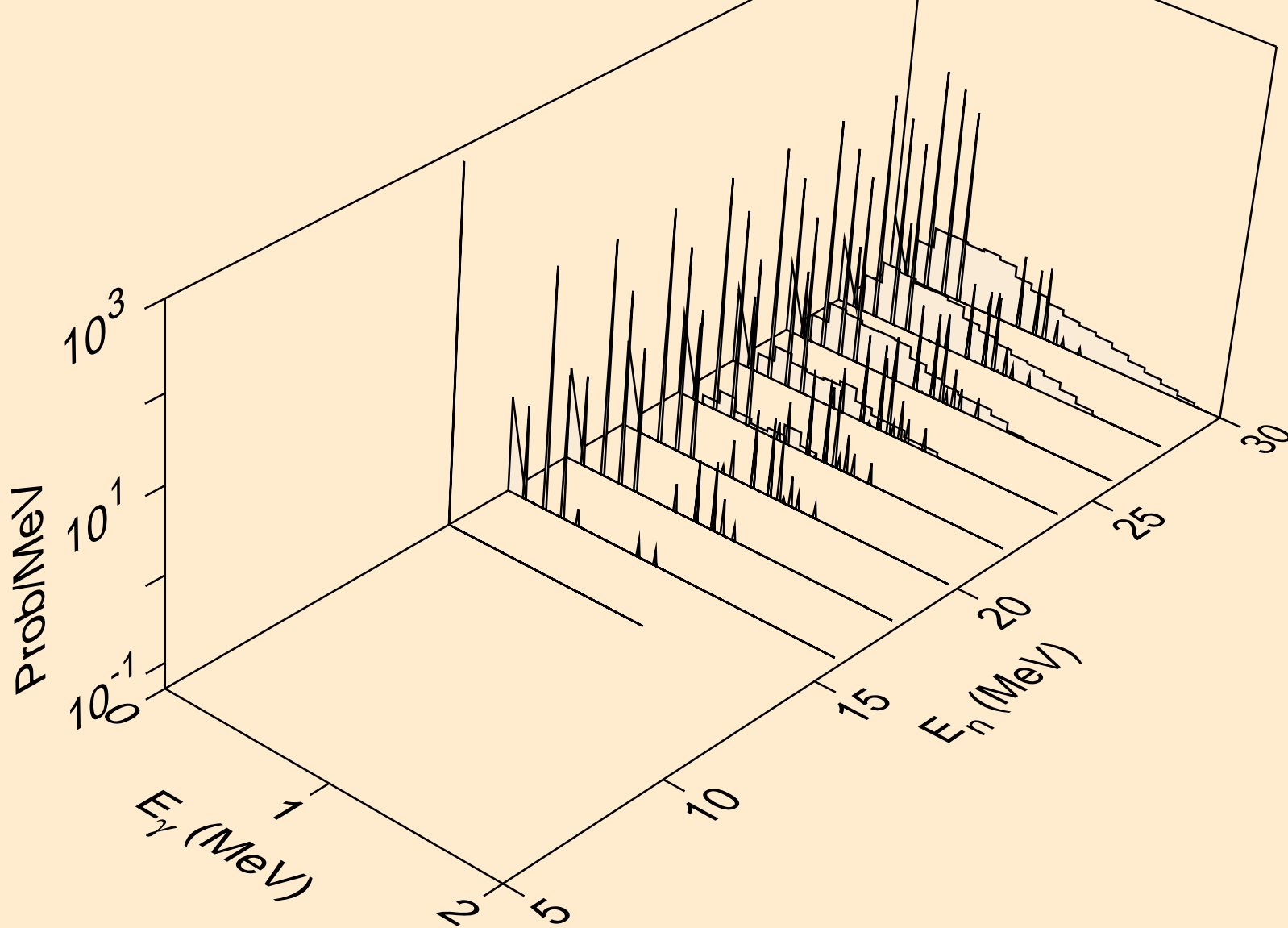

YB165 NEUTRON ACER TENDL-2019 LIBRARY; T=293.16K
Photon emission for (n,4n)

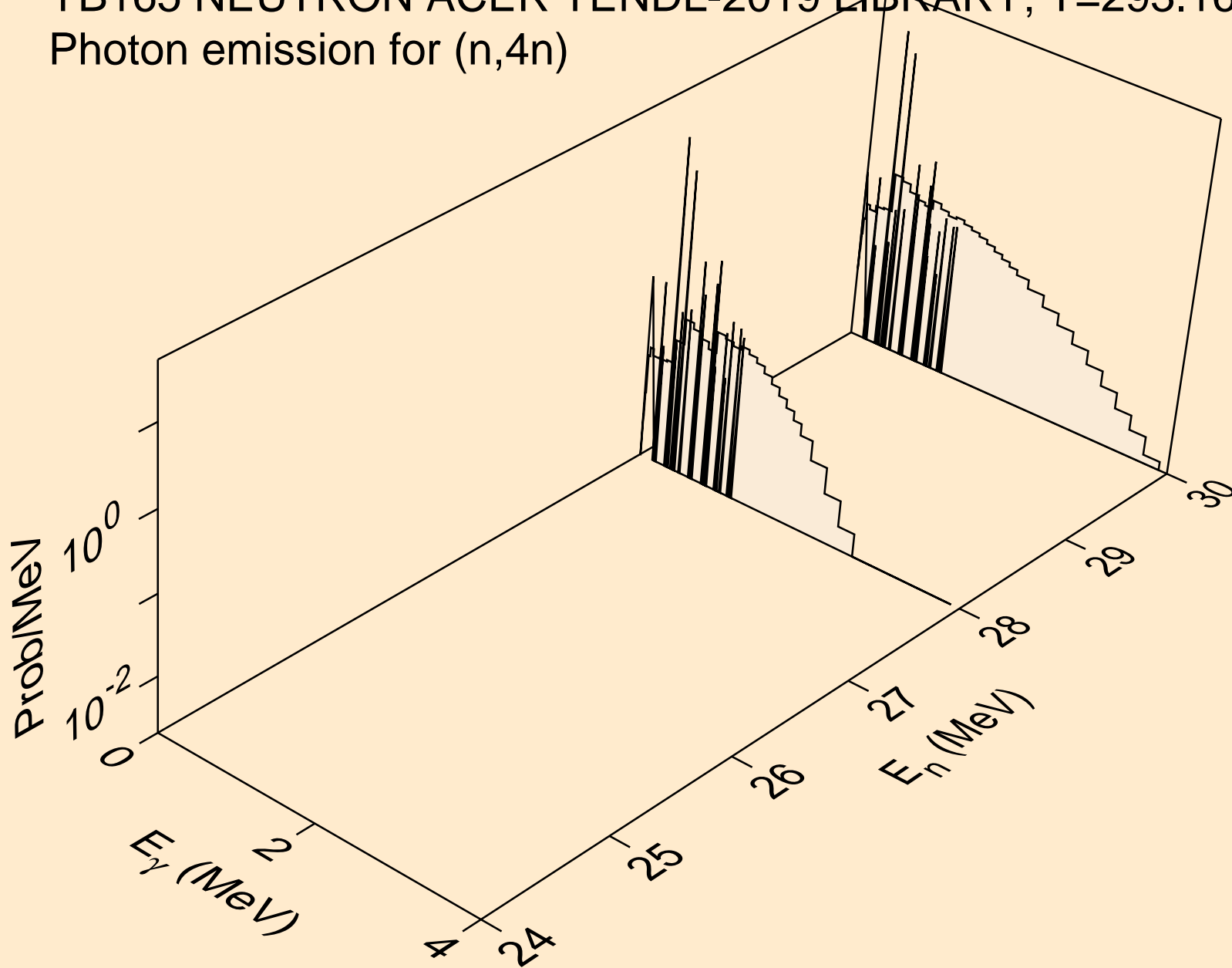

YB165 NEUTRON ACER TENDL-2019 LIBRARY; T=293.16K
Photon emission for (n,2np)

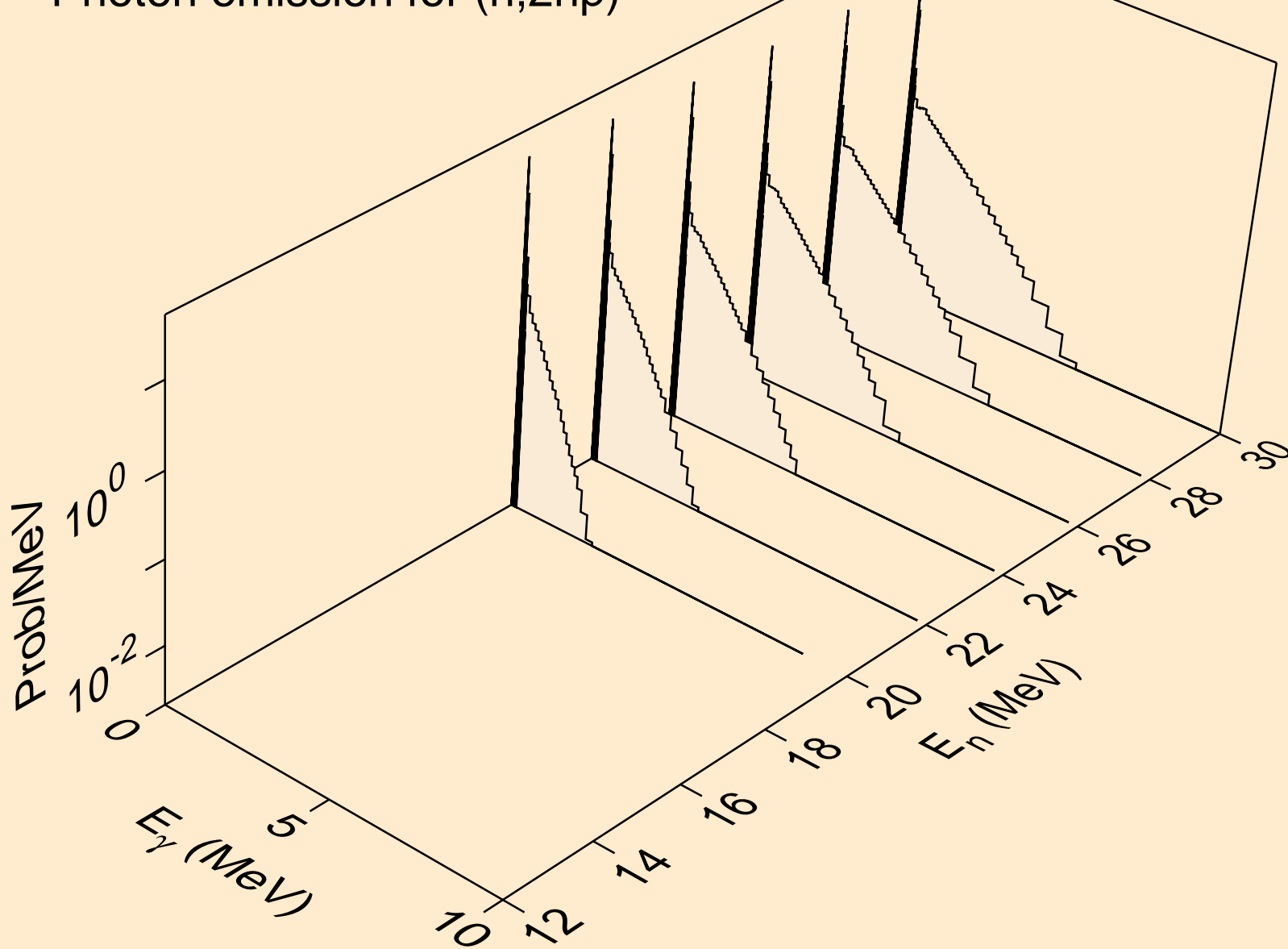

YB165 NEUTRON ACER TENDL-2019 LIBRARY; T=293.16K
Photon emission for (n,3np)

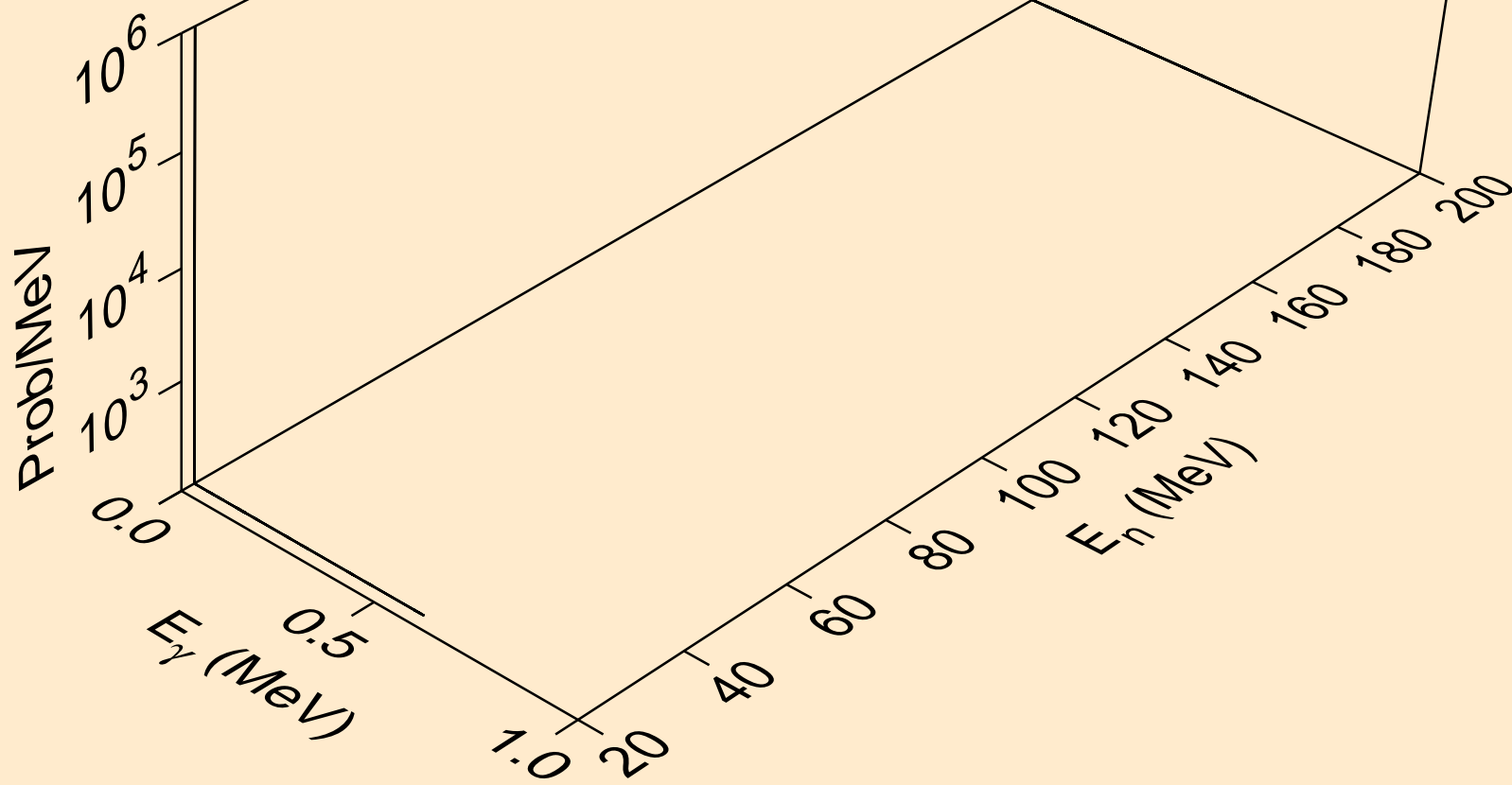

YB165 NEUTRON ACER TENDL-2019 LIBRARY; T=293.16K
Photon emission for (n,2np)

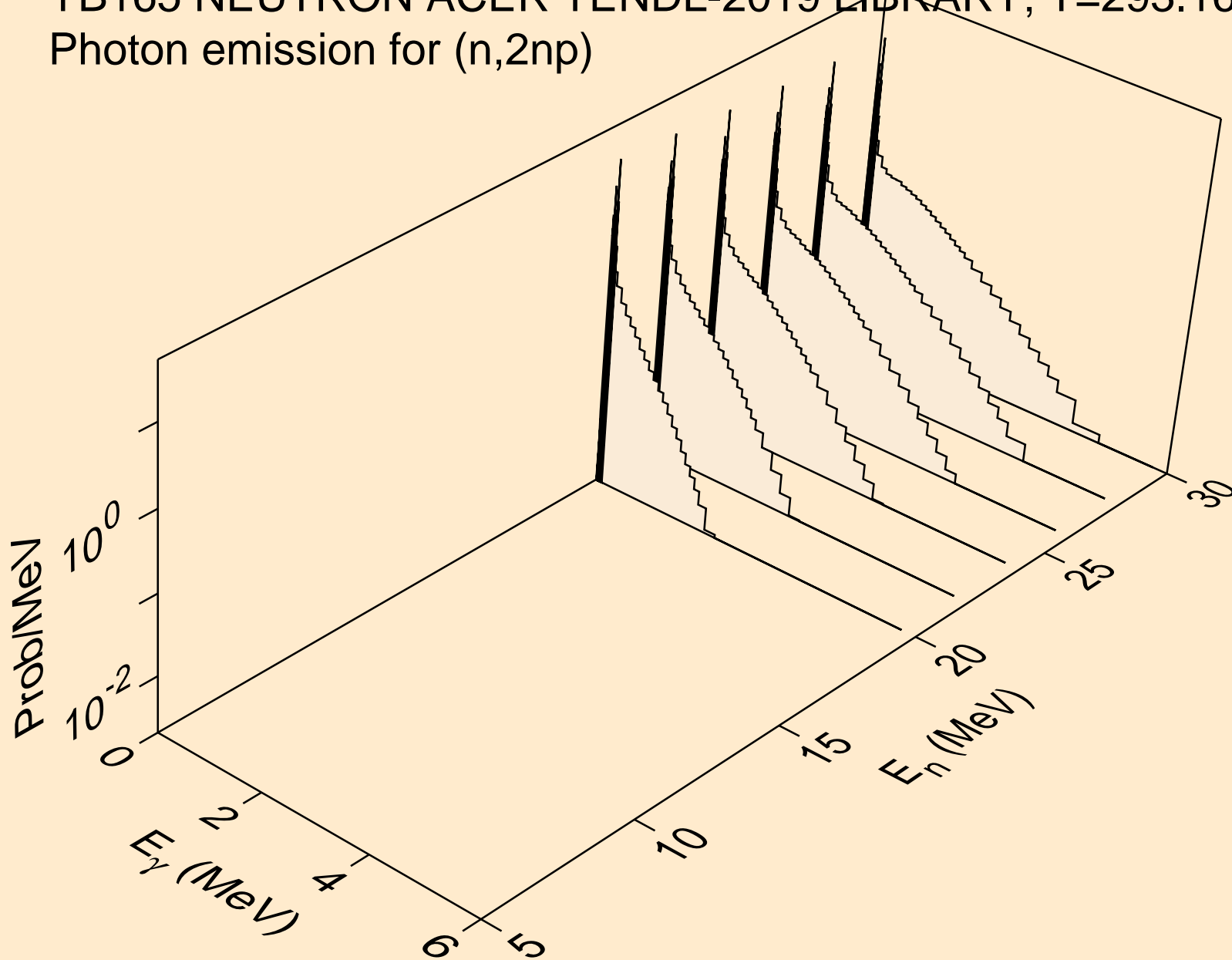

YB165 NEUTRON ACER TENDL-2019 LIBRARY; T=293.16K
Photon emission for (n,npa)

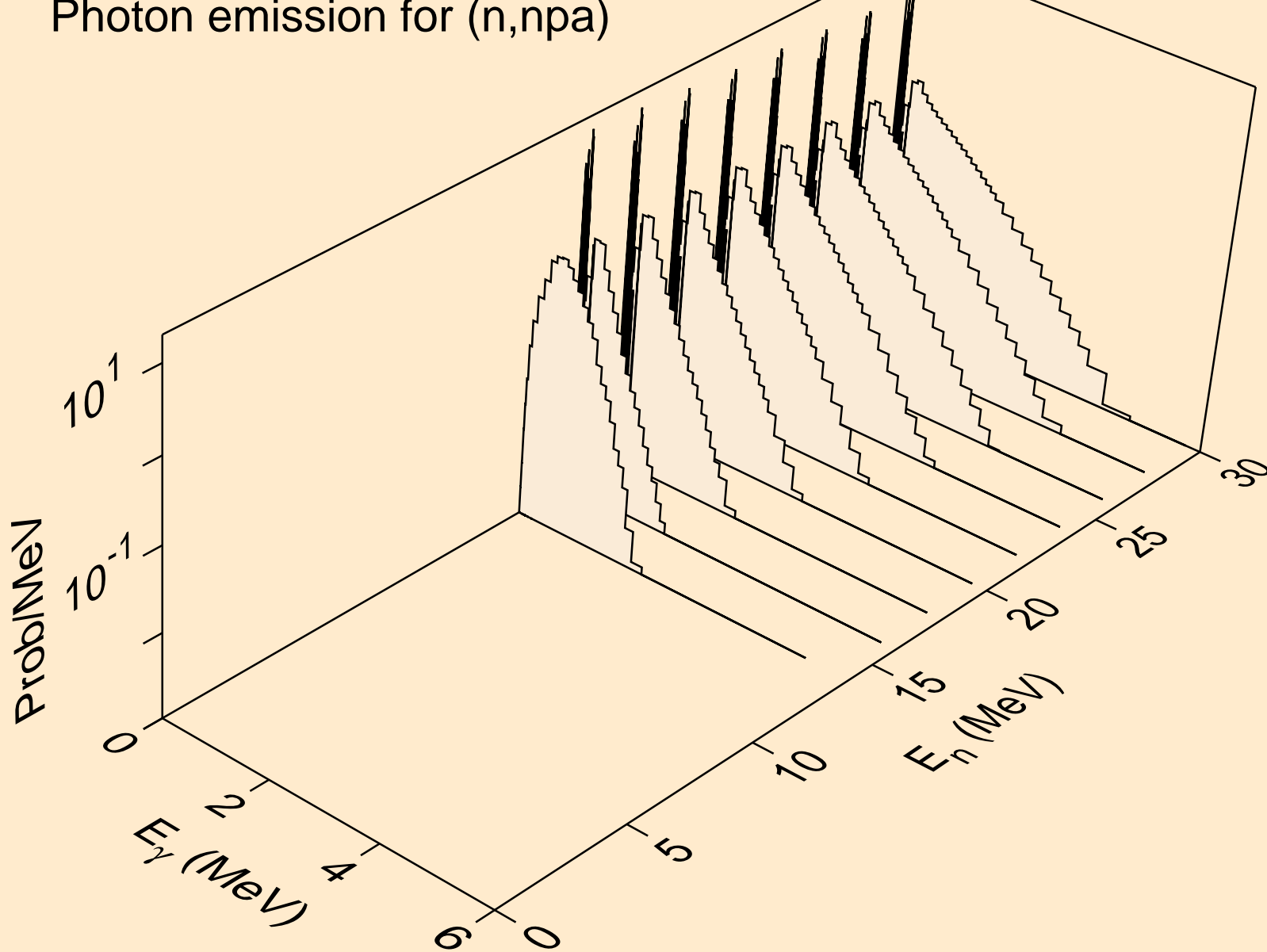

YB165 NEUTRON ACER TENDL-2019 LIBRARY; T=293.16K
Photon emission for (n,n*c)

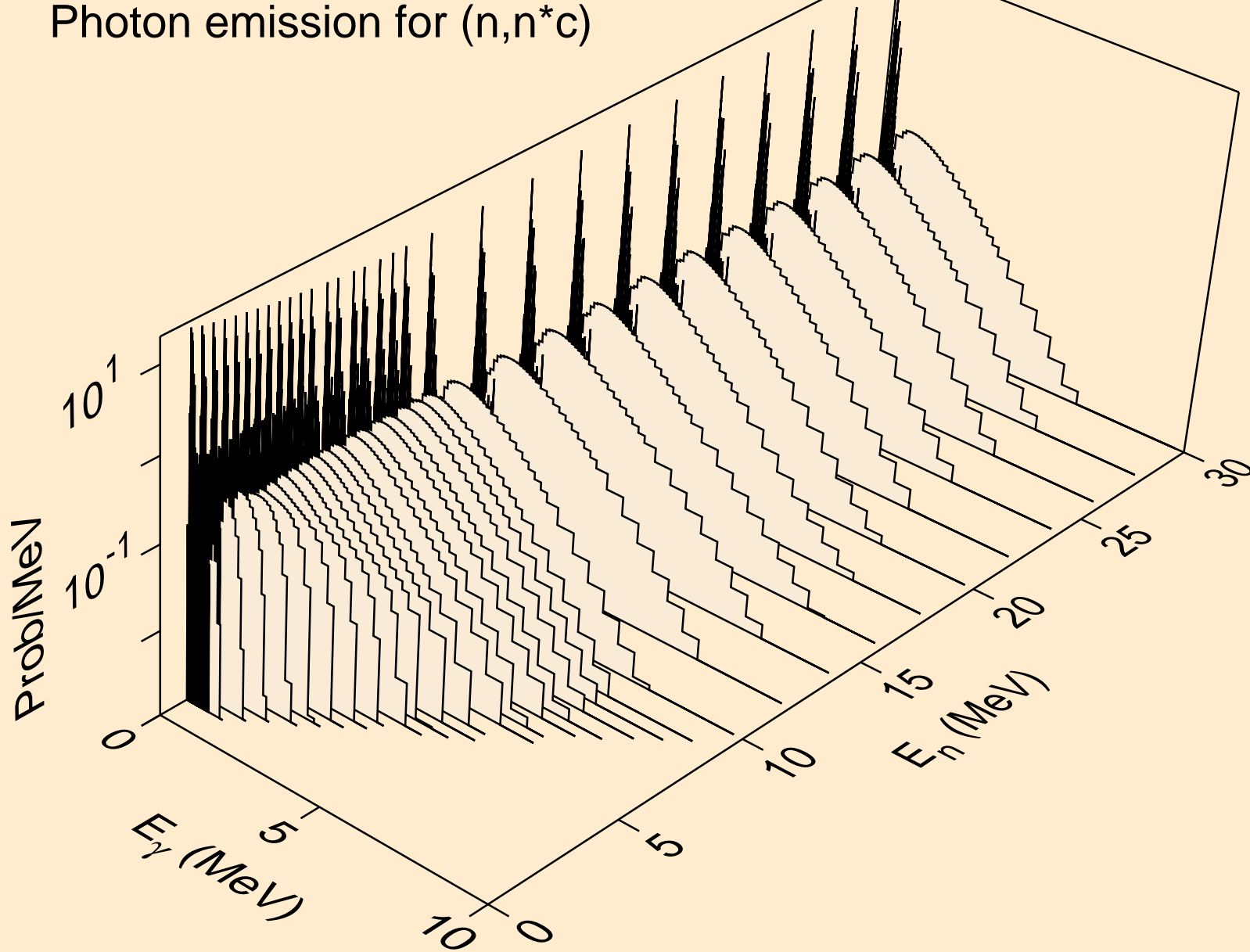

YB165 NEUTRON ACER TENDL-2019 LIBRARY; T=293.16K
Photon emission for (n,gma)

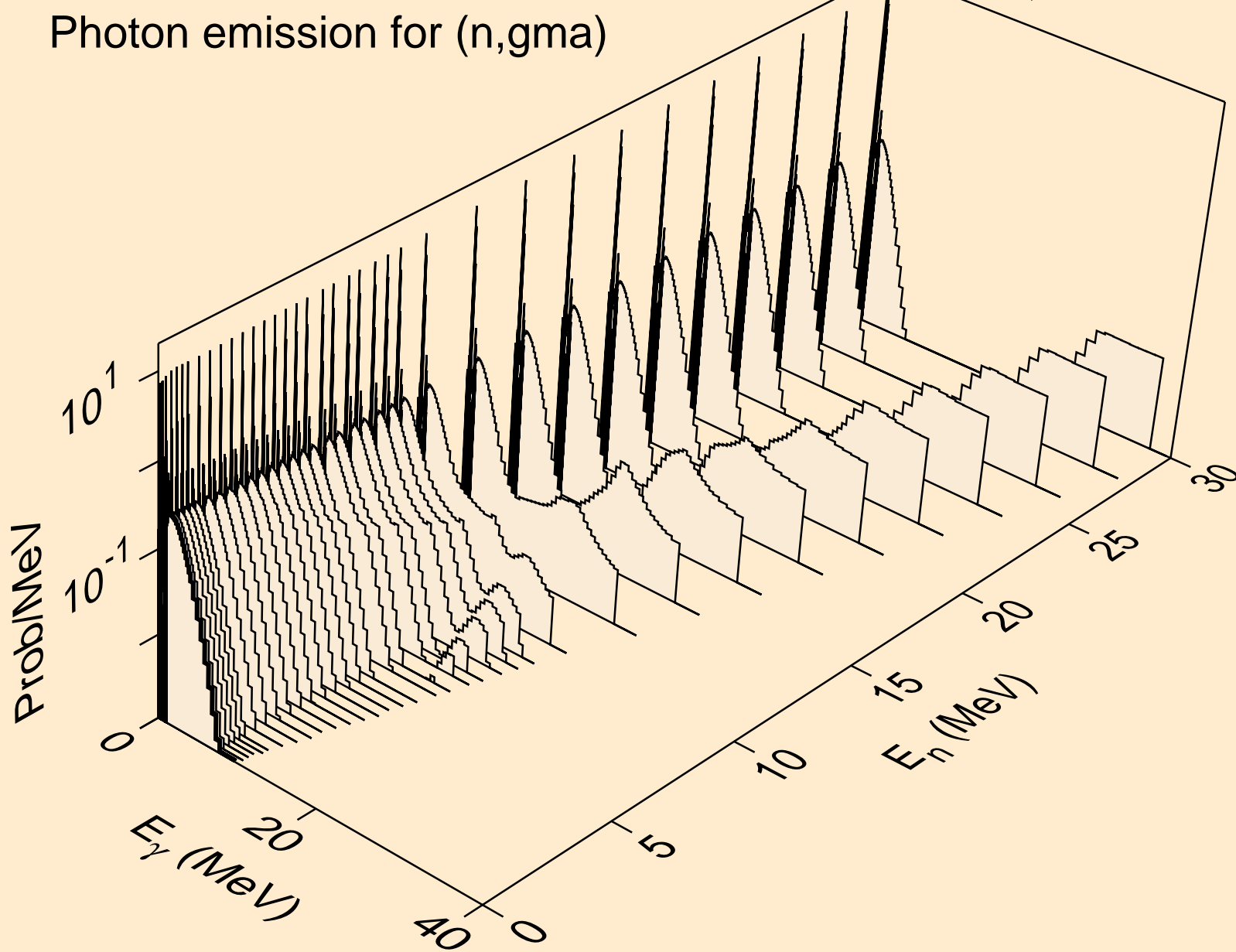

YB165 NEUTRON ACER TENDL-2019 LIBRARY; T=293.16K
Photon emission for (n,p)

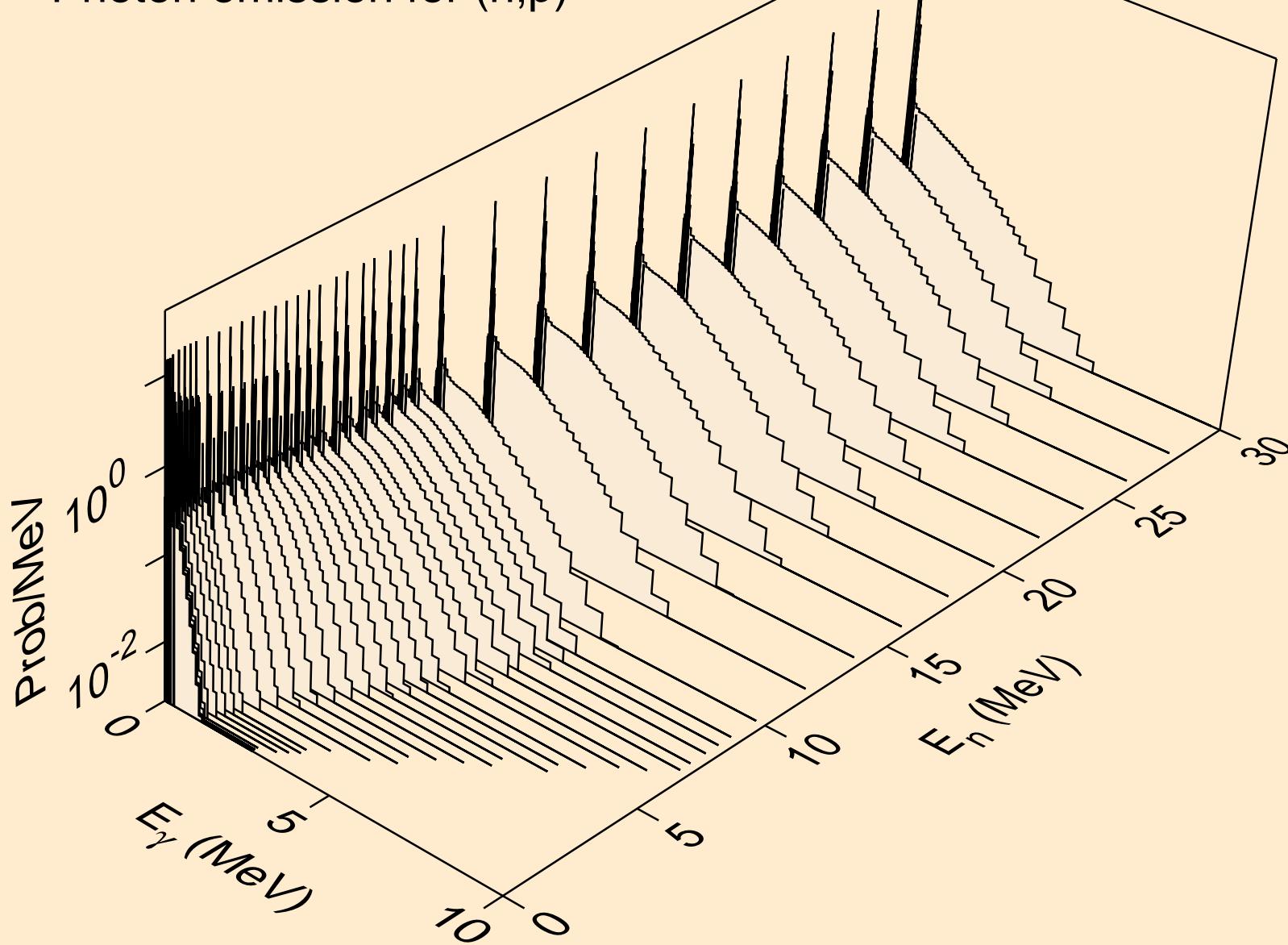

YB165 NEUTRON ACER TENDL-2019 LIBRARY; T=293.16K
Photon emission for (n,d)

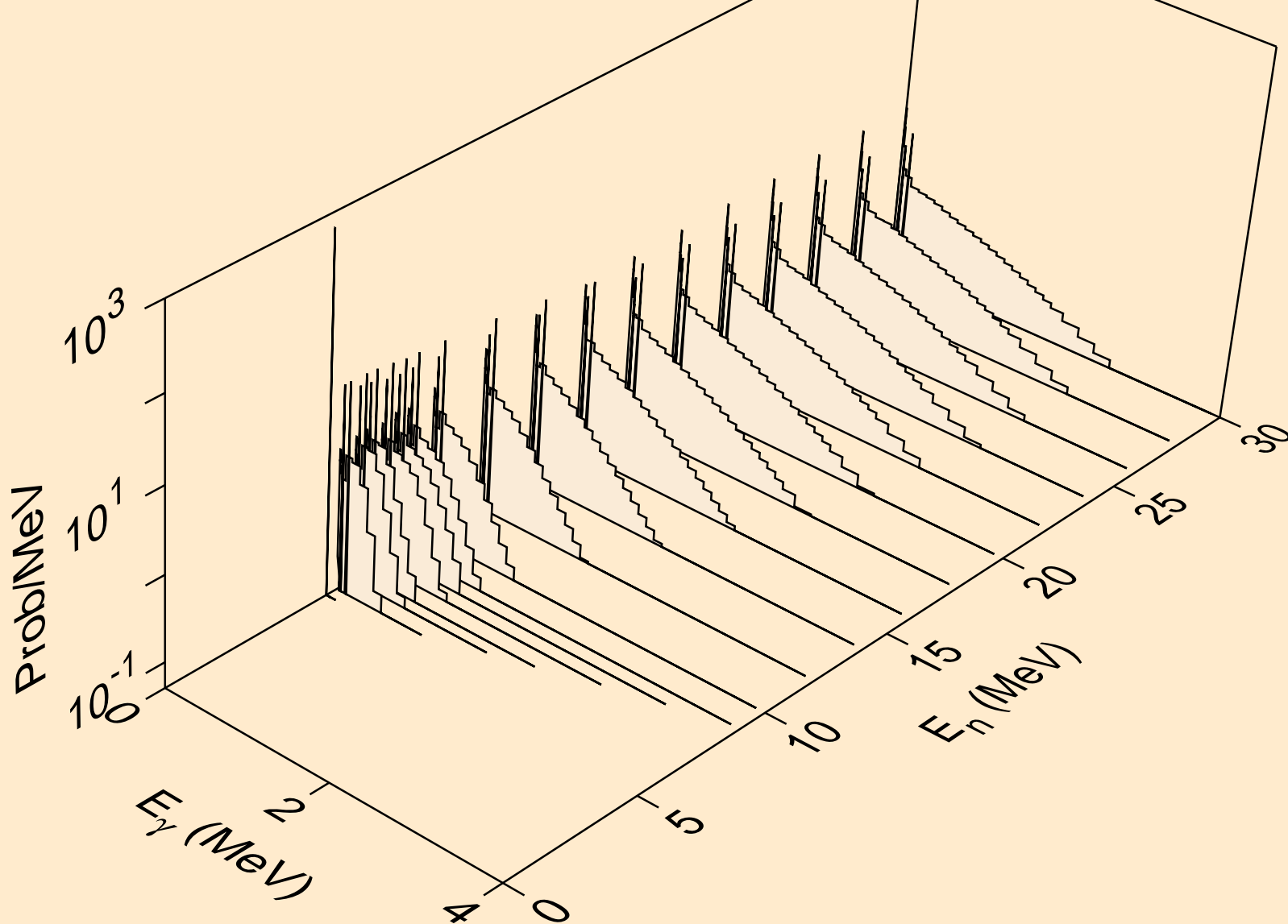

YB165 NEUTRON ACER TENDL-2019 LIBRARY; T=293.16K
Photon emission for (n,t)

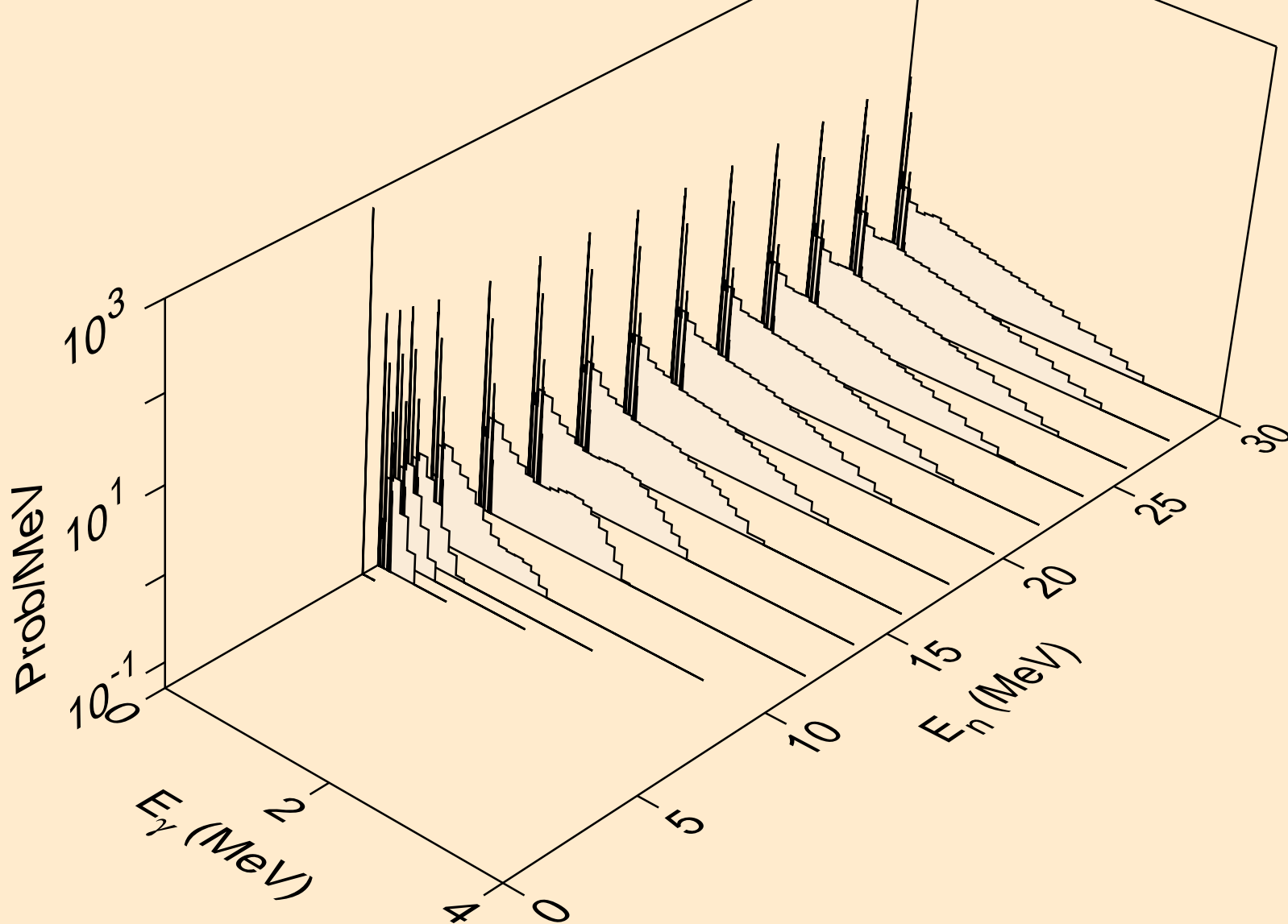

YB165 NEUTRON ACER TENDL-2019 LIBRARY; T=293.16K
Photon emission for (n,he3)

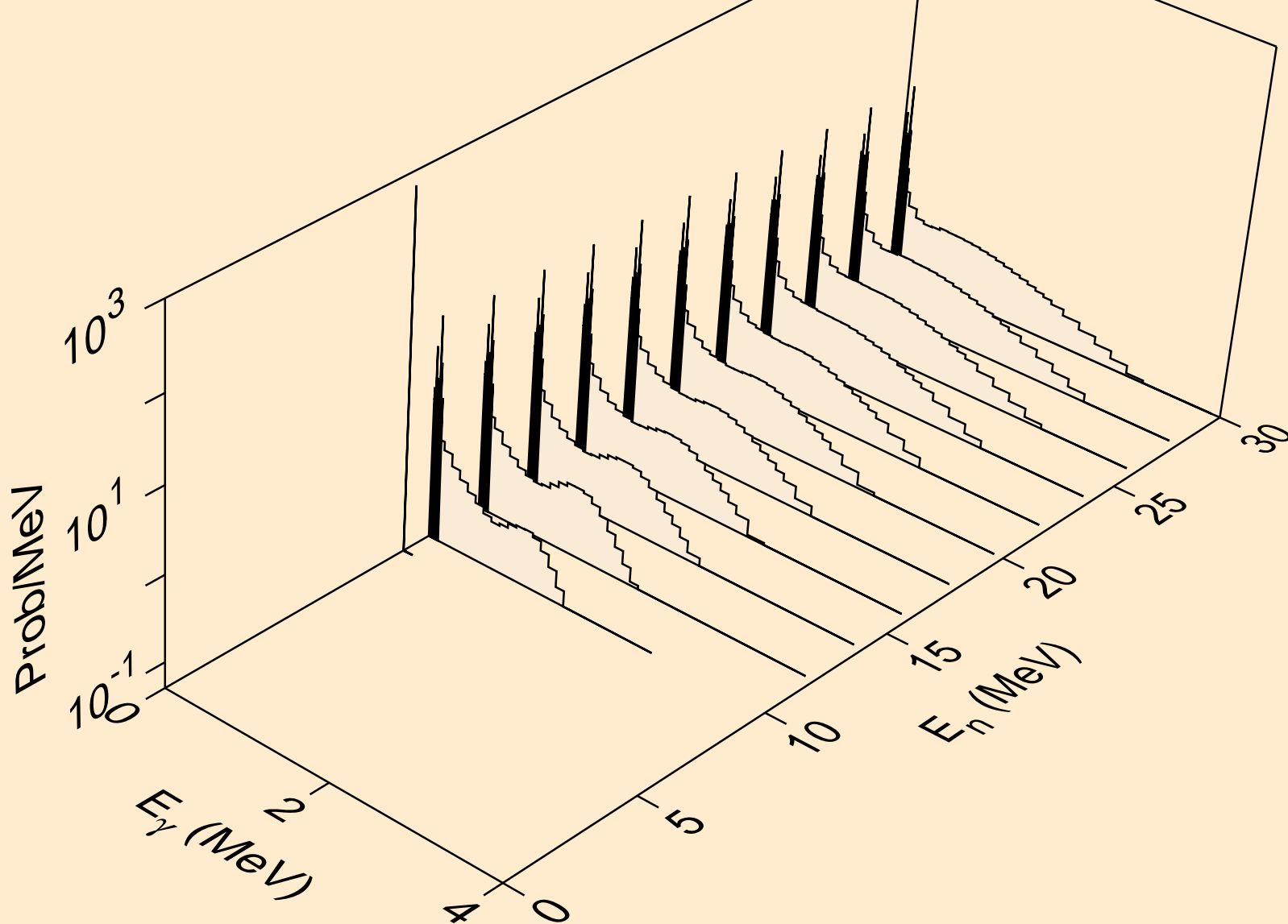

YB165 NEUTRON ACER TENDL-2019 LIBRARY; T=293.16K
Photon emission for (n,a)

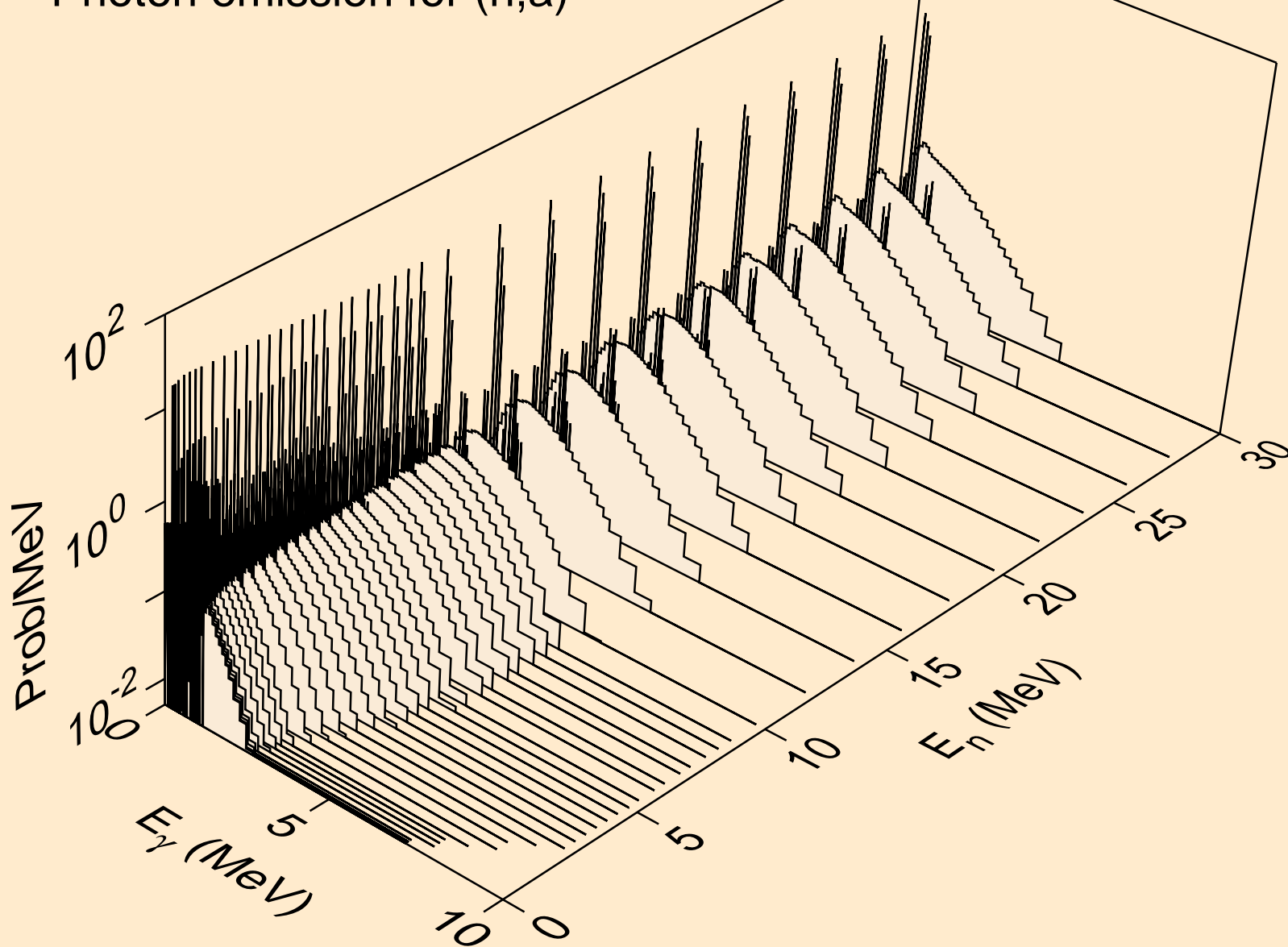

YB165 NEUTRON ACER TENDL-2019 LIBRARY; T=293.16K
Photon emission for (n,2a)

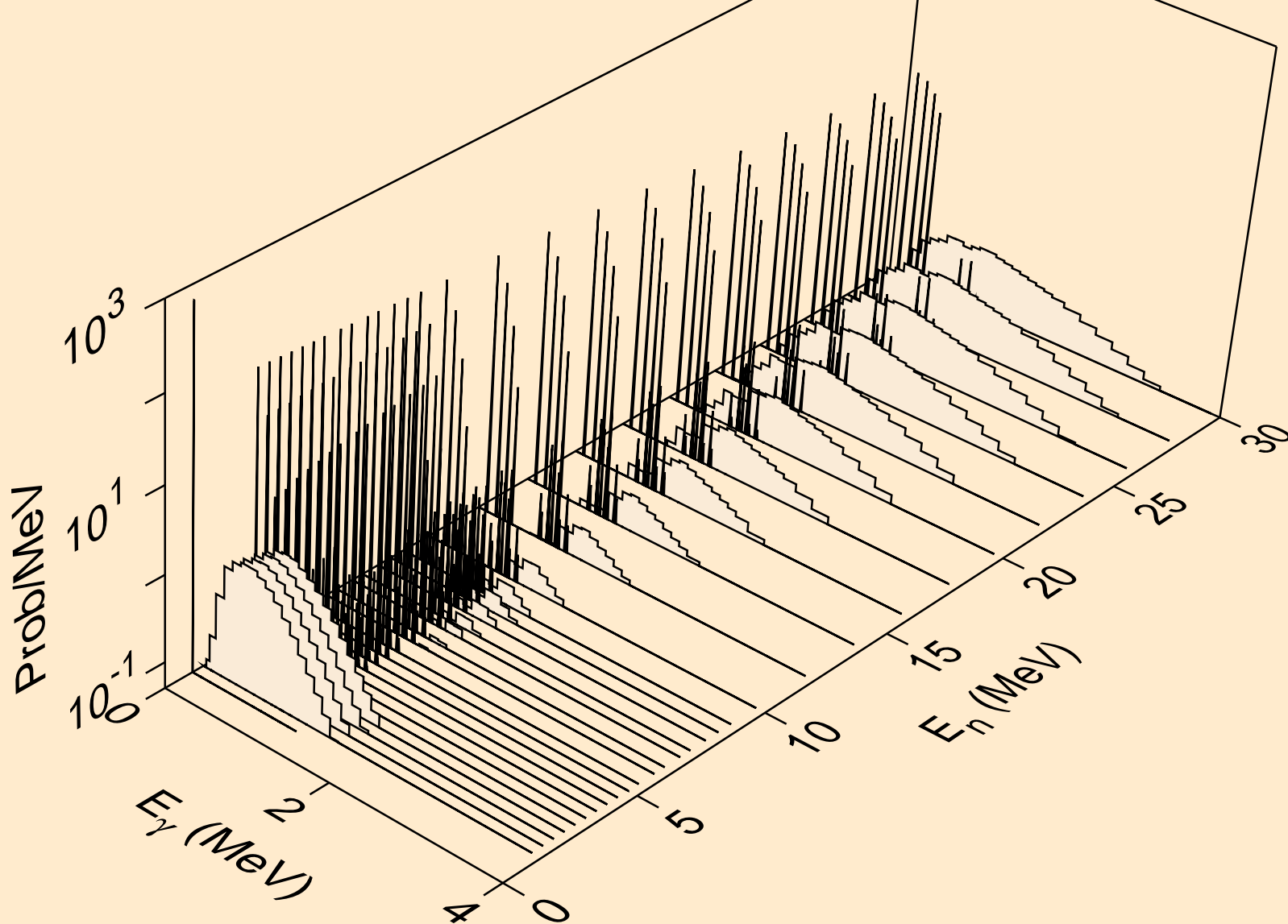

YB165 NEUTRON ACER TENDL-2019 LIBRARY; T=293.16K
Photon emission for (n,2p)

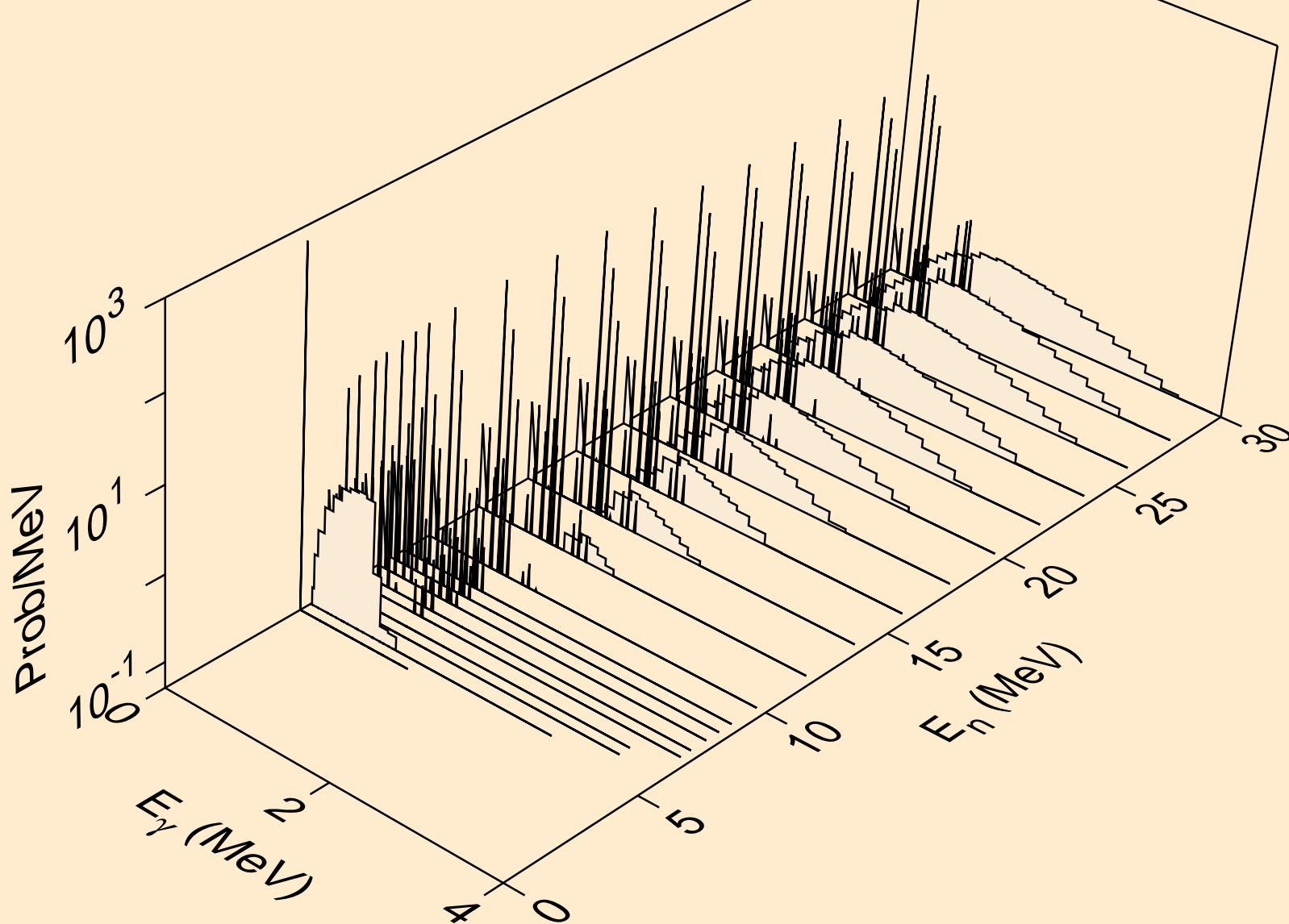

YB165 NEUTRON ACER TENDL-2019 LIBRARY; T=293.16K
Photon emission for (n,p α)

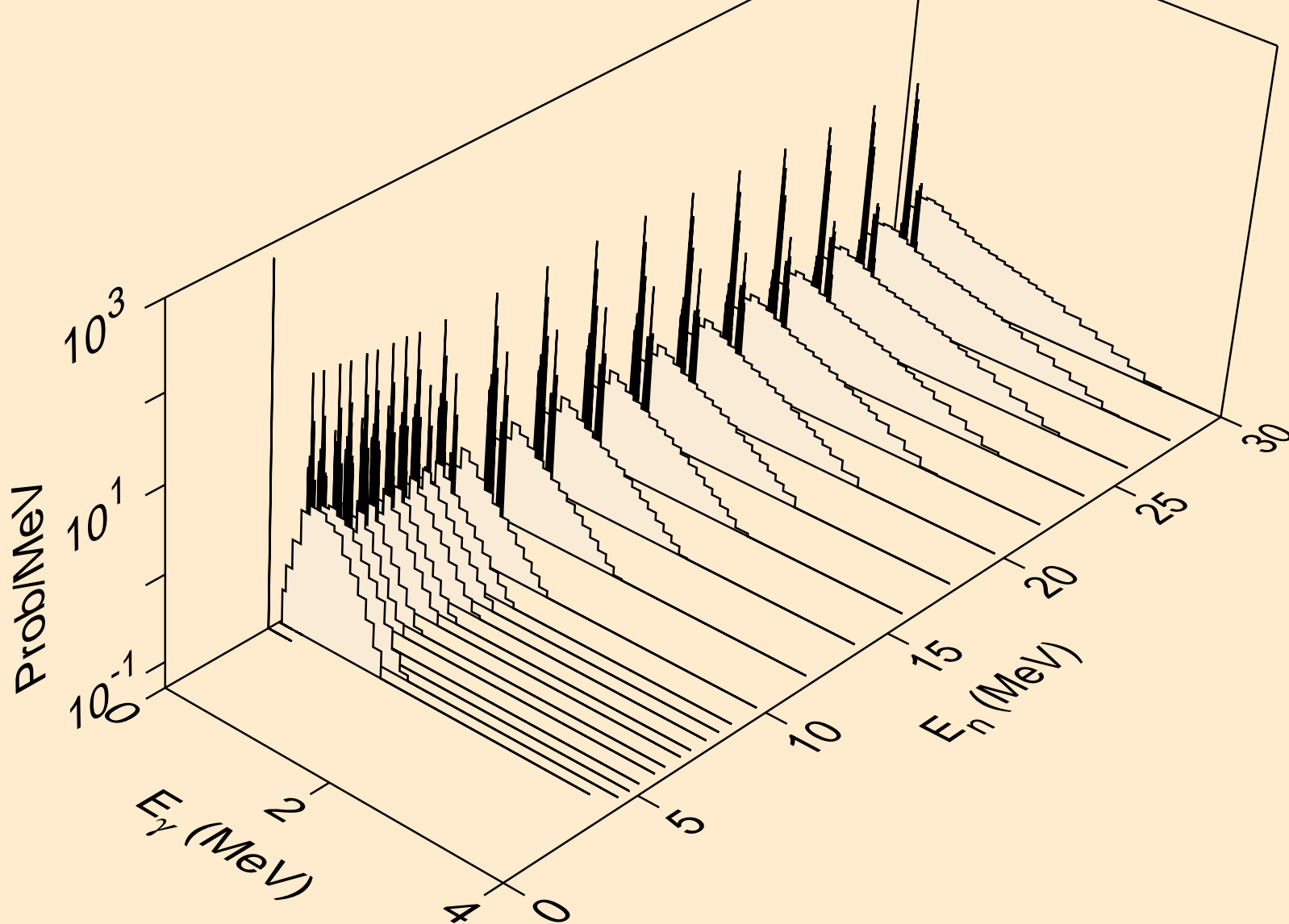

YB165 NEUTRON ACER TENDL-2019 LIBRARY; T=293.16K
Photon emission for (n,pd)

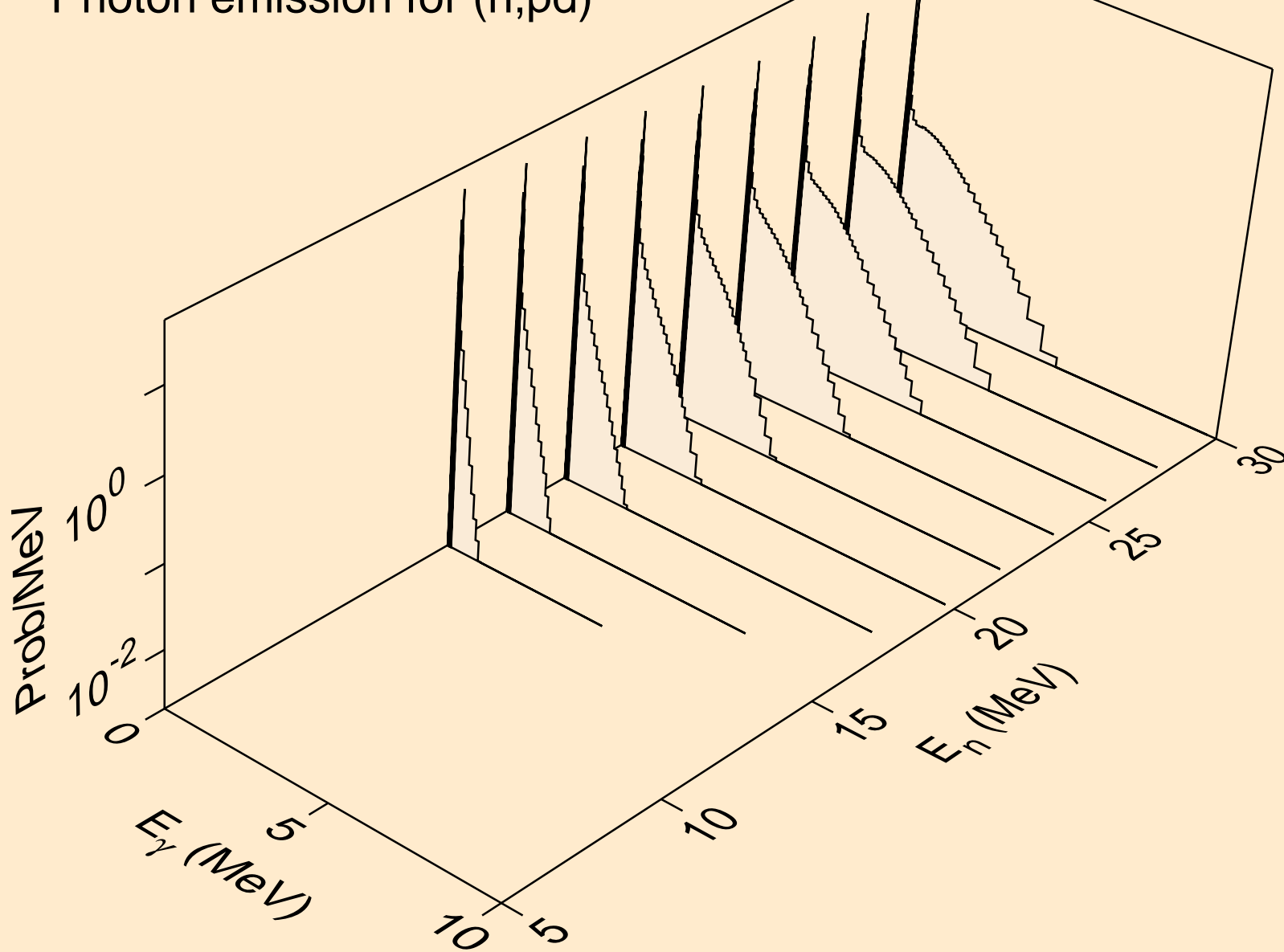

YB165 NEUTRON ACER TENDL-2019 LIBRARY; T=293.16K
Photon emission for (n,pt)

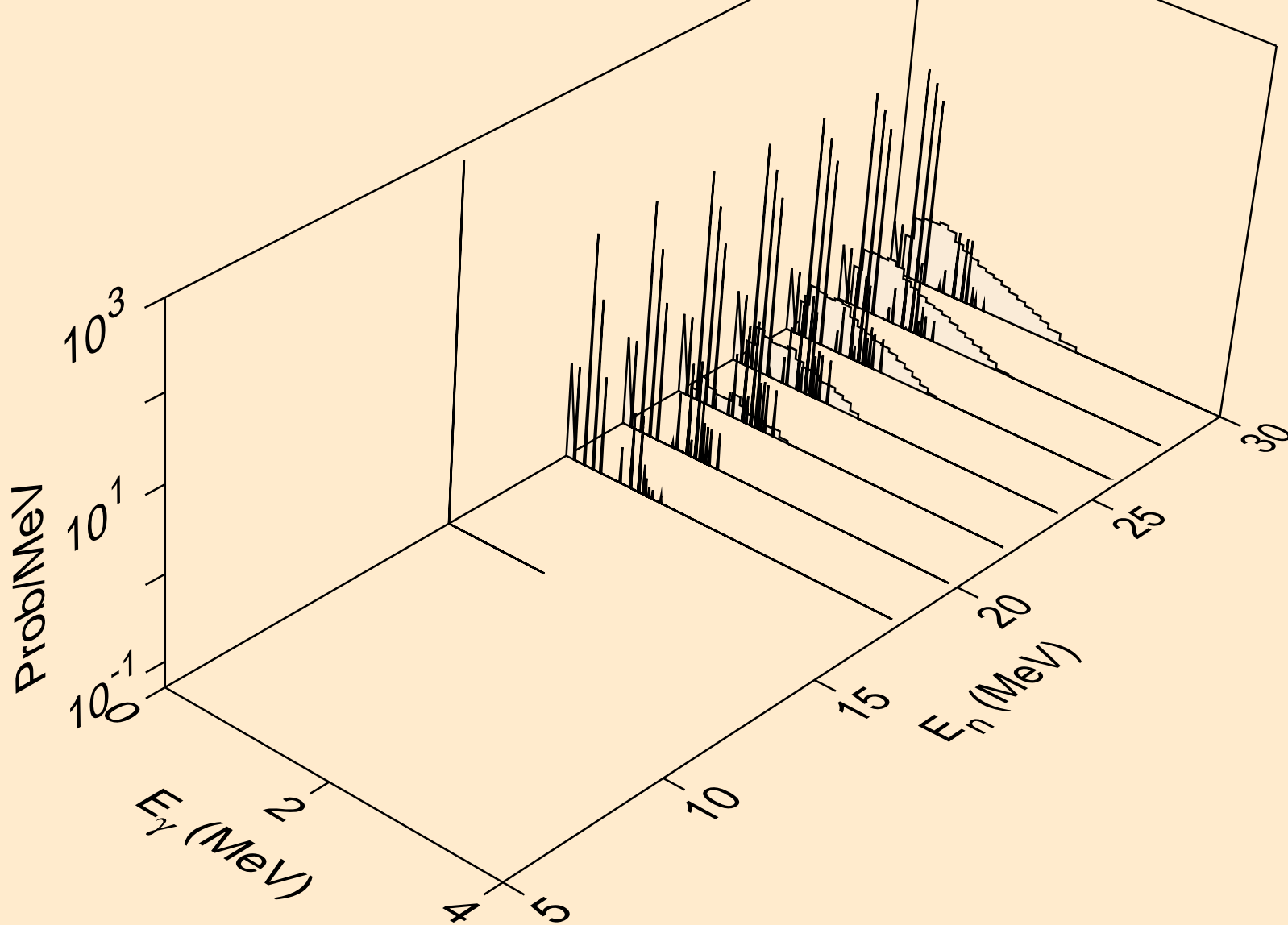

YB165 NEUTRON ACER TENDL-2019 LIBRARY; T=293.16K
Photon emission for (n,da)

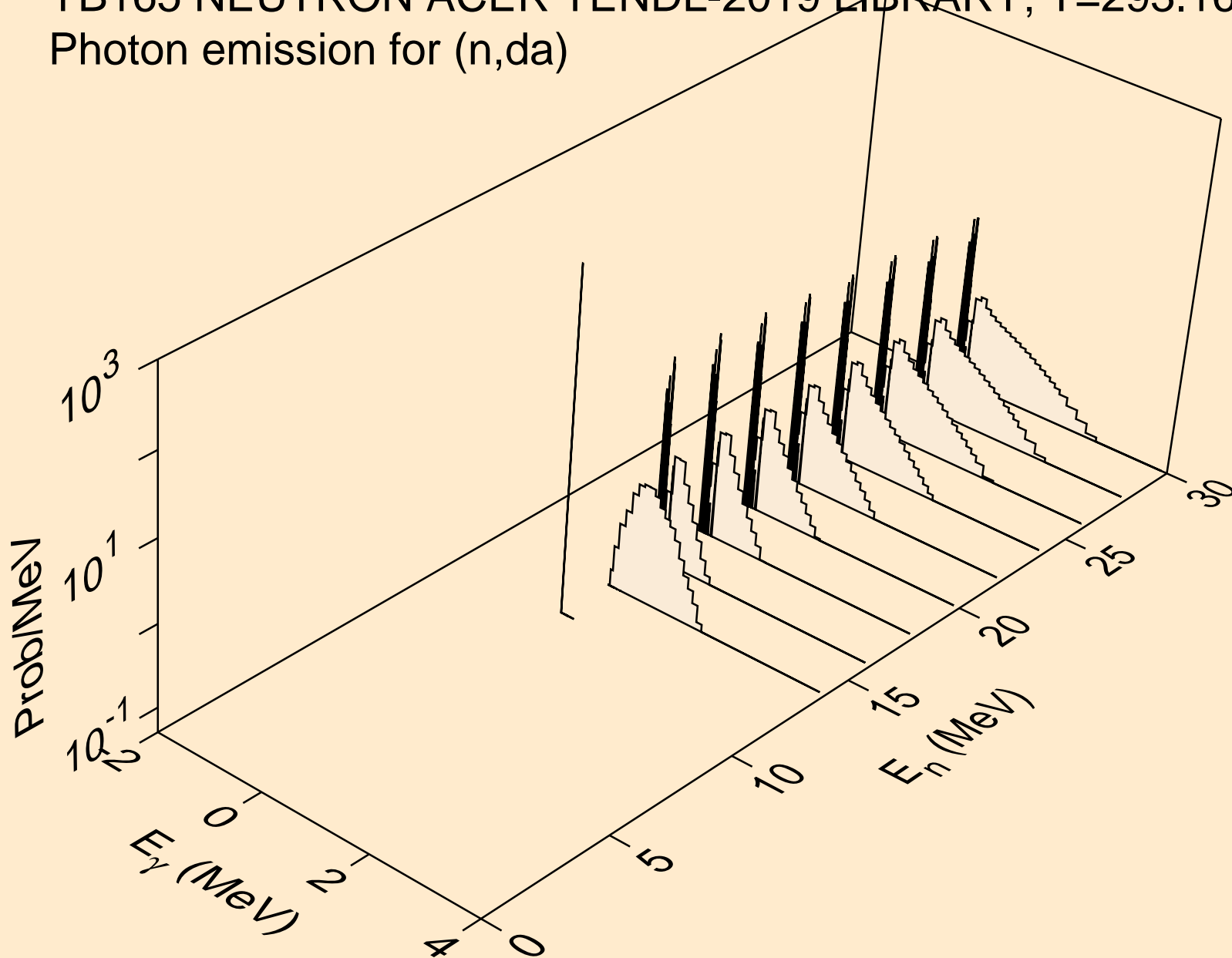

YB165 NEUTRON ACER TENDL-2019 LIBRARY; T=293.16K
thermal capture photon spectrum

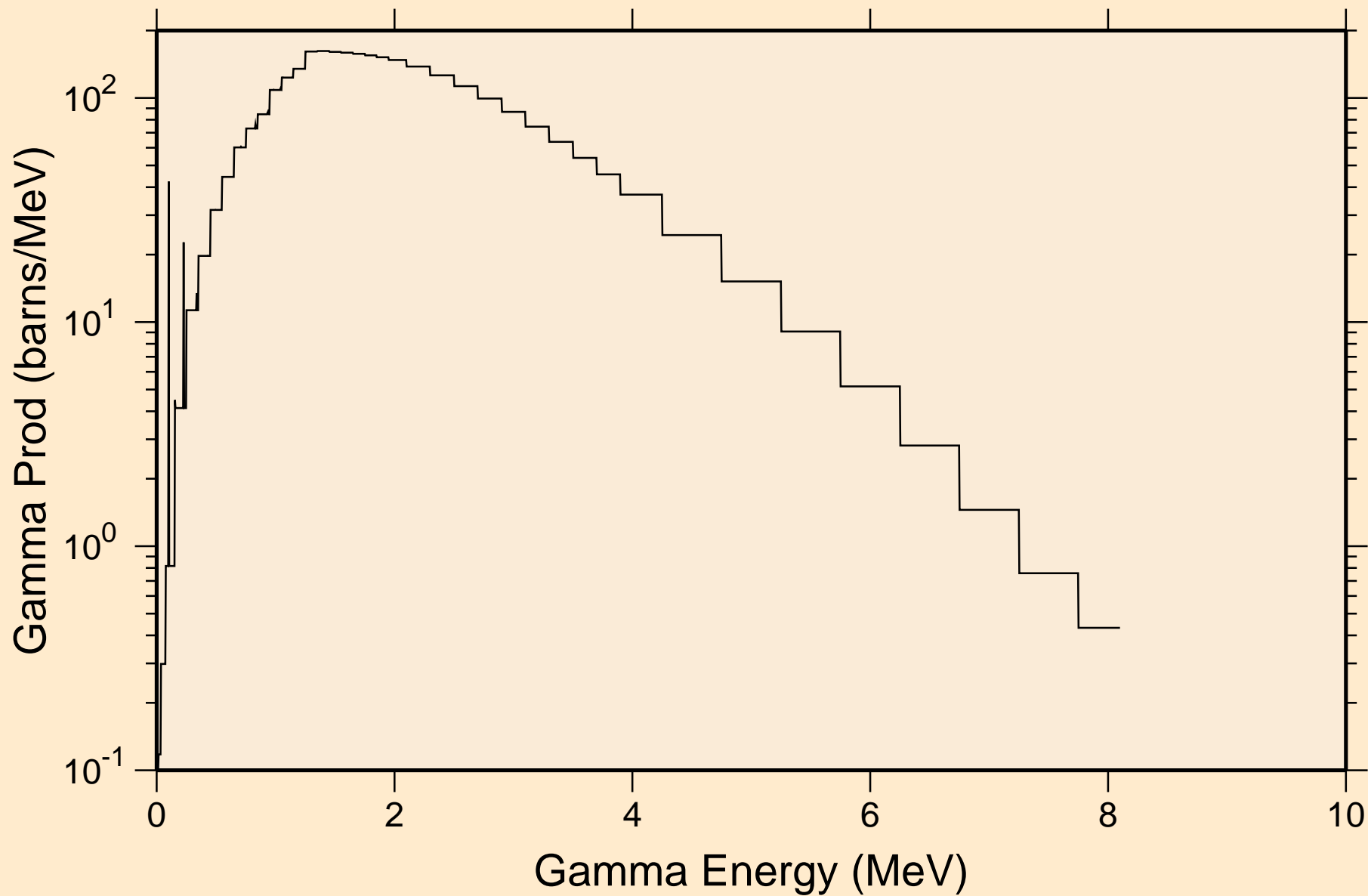

YB165 NEUTRON ACER TENDL-2019 LIBRARY; T=293.16K
14 MeV photon spectrum

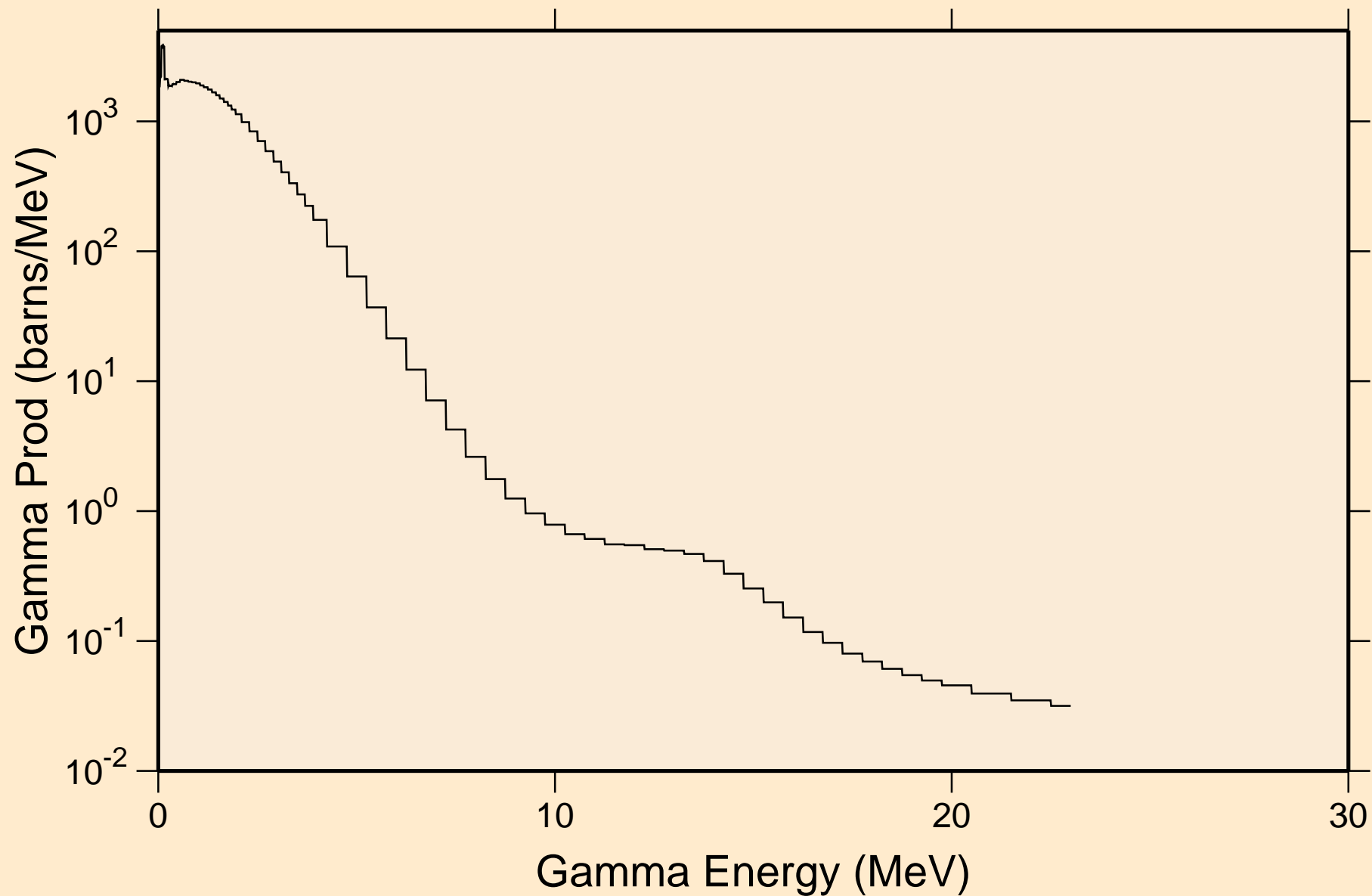

YB165 NEUTRON ACER TENDL-2019 LIBRARY; T=293.16K
Particle heating contributions

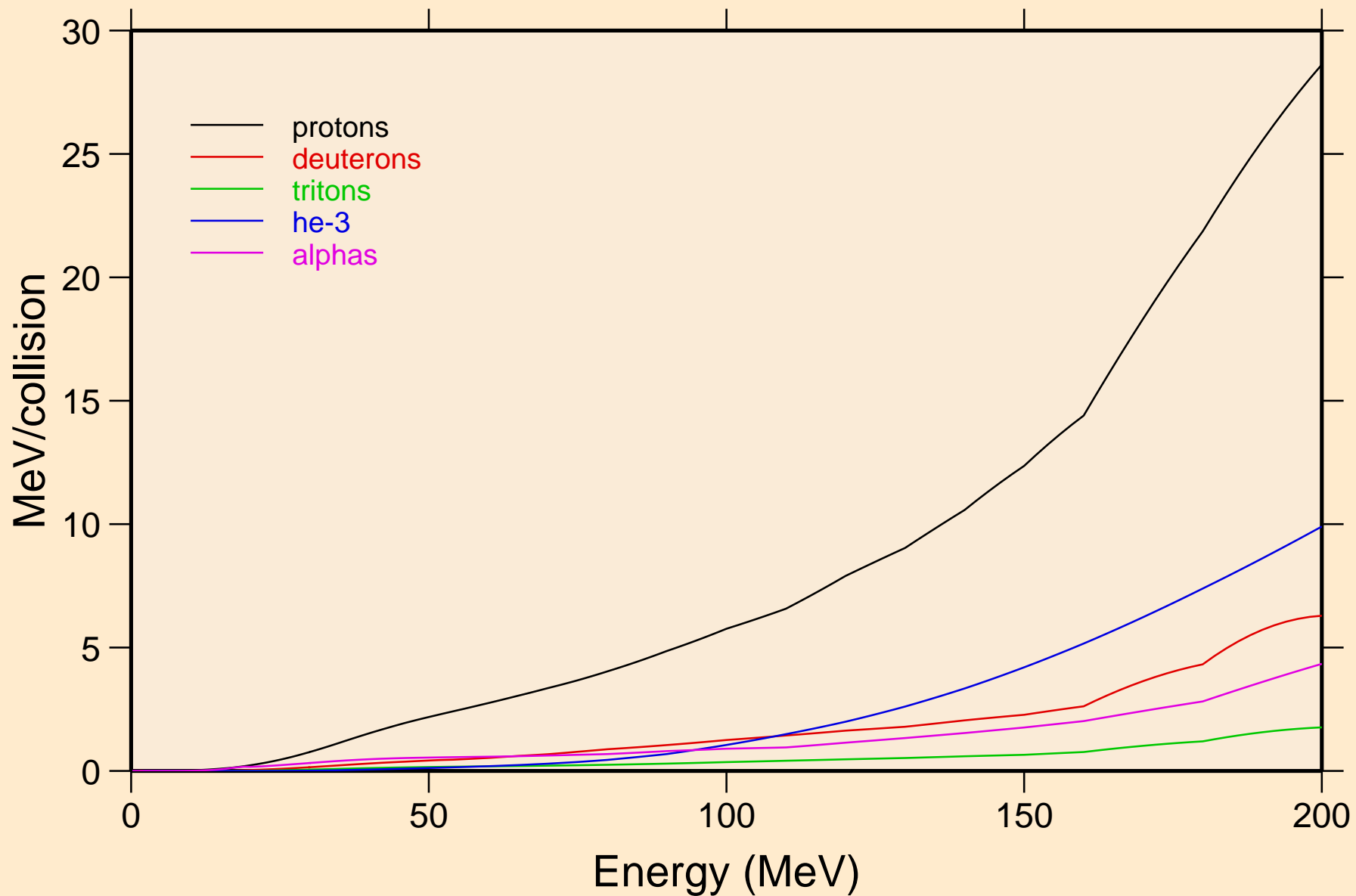

YB165 NEUTRON ACER TENDL-2019 LIBRARY; T=293.16K
Recoil Heating

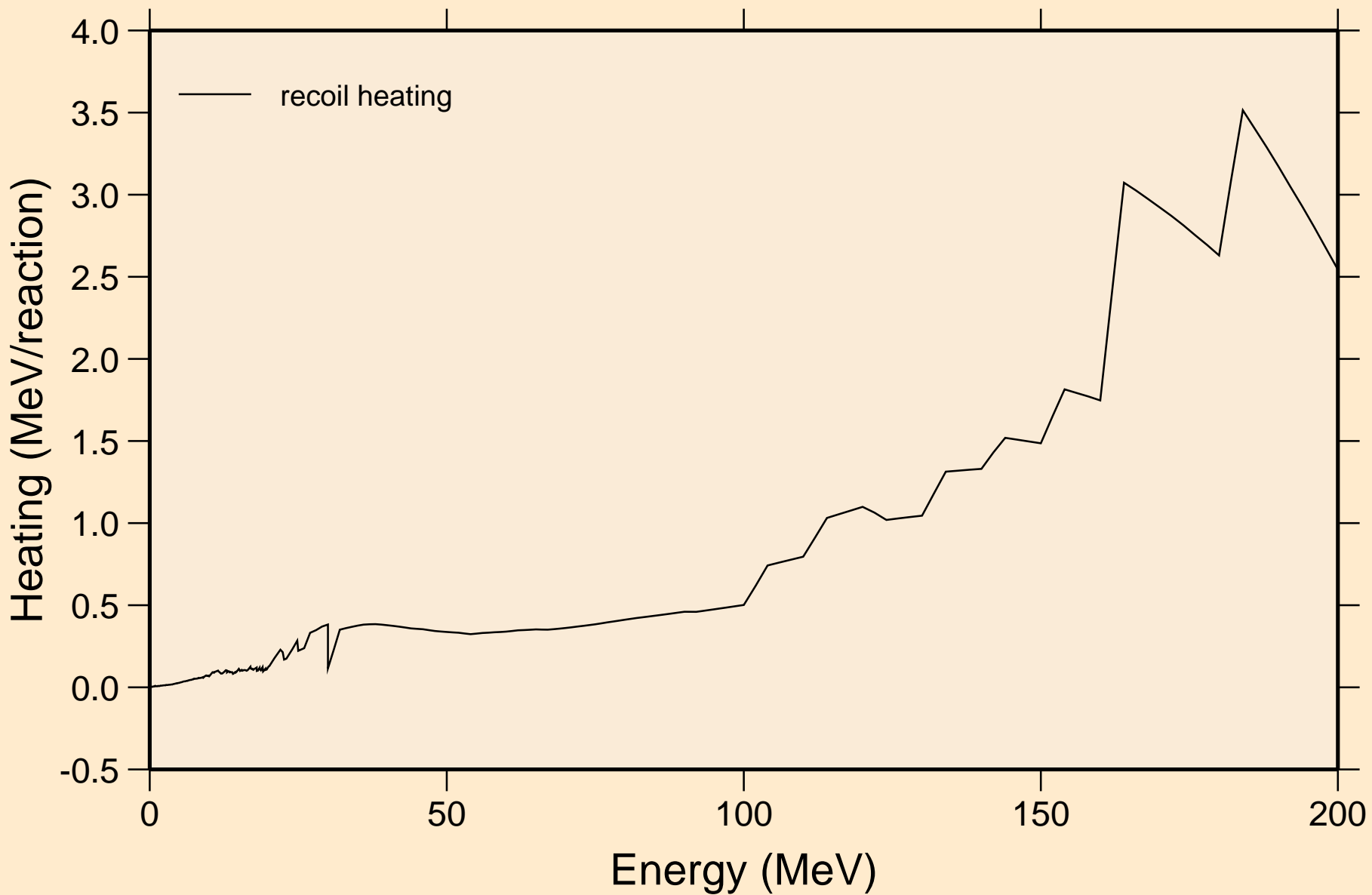

YB165 NEUTRON ACER TENDL-2019 LIBRARY; T=293.16K
Particle production cross sections

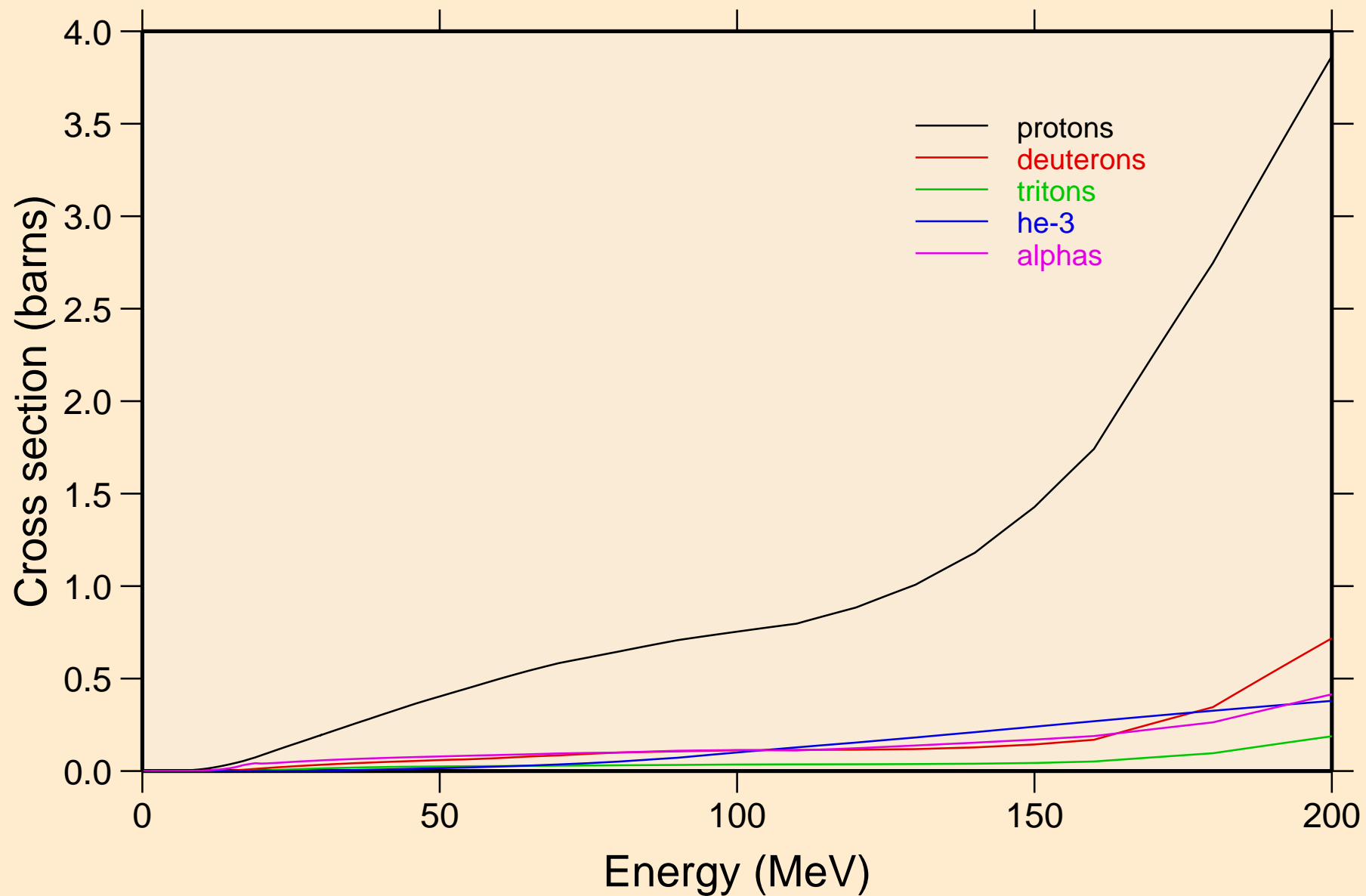

YB165 NEUTRON ACER TENDL-2019 LIBRARY; T=293.16K
protons from (n,x)

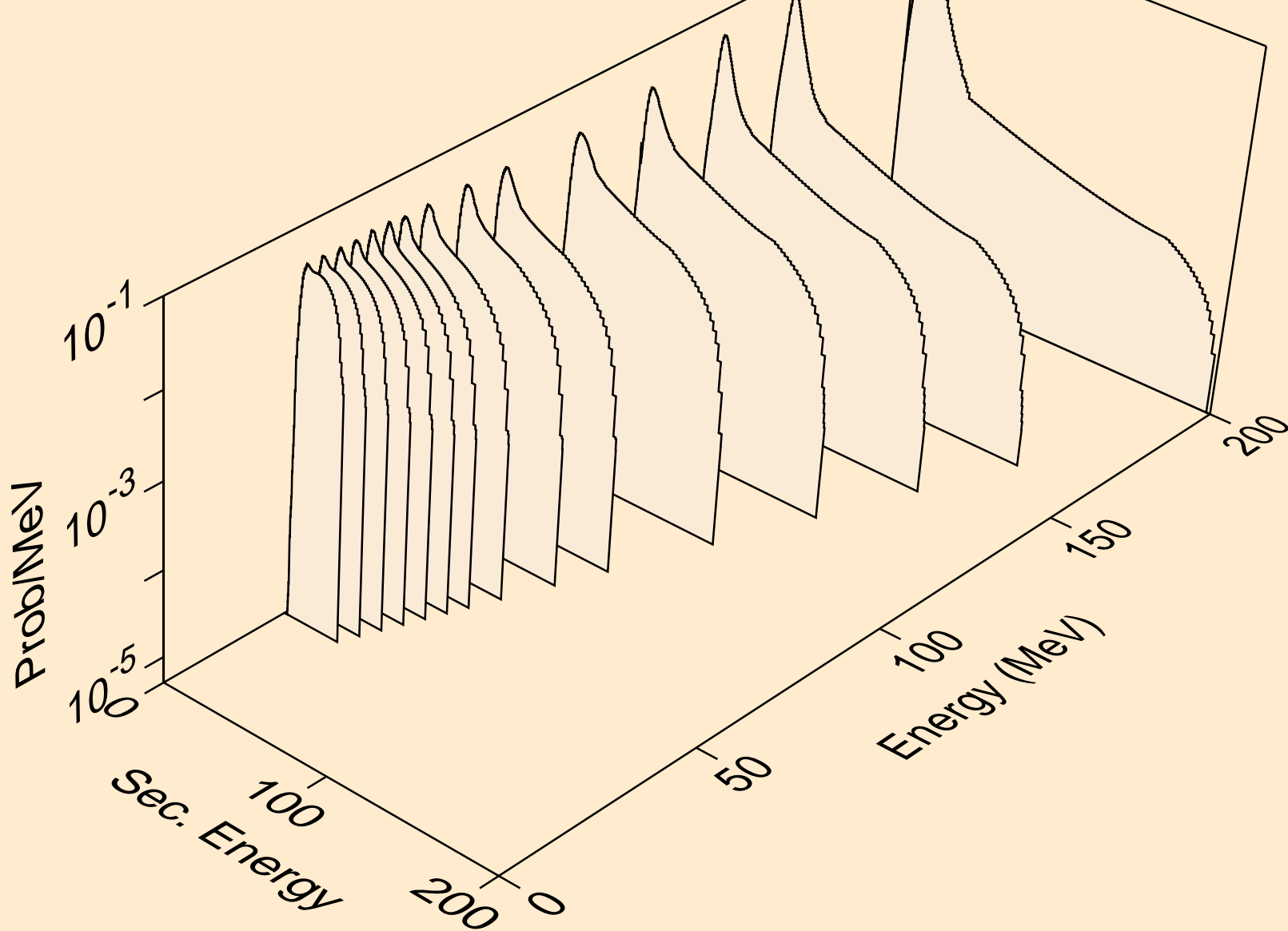

YB165 NEUTRON ACER TENDL-2019 LIBRARY; T=293.16K
protons from (n,n*)p

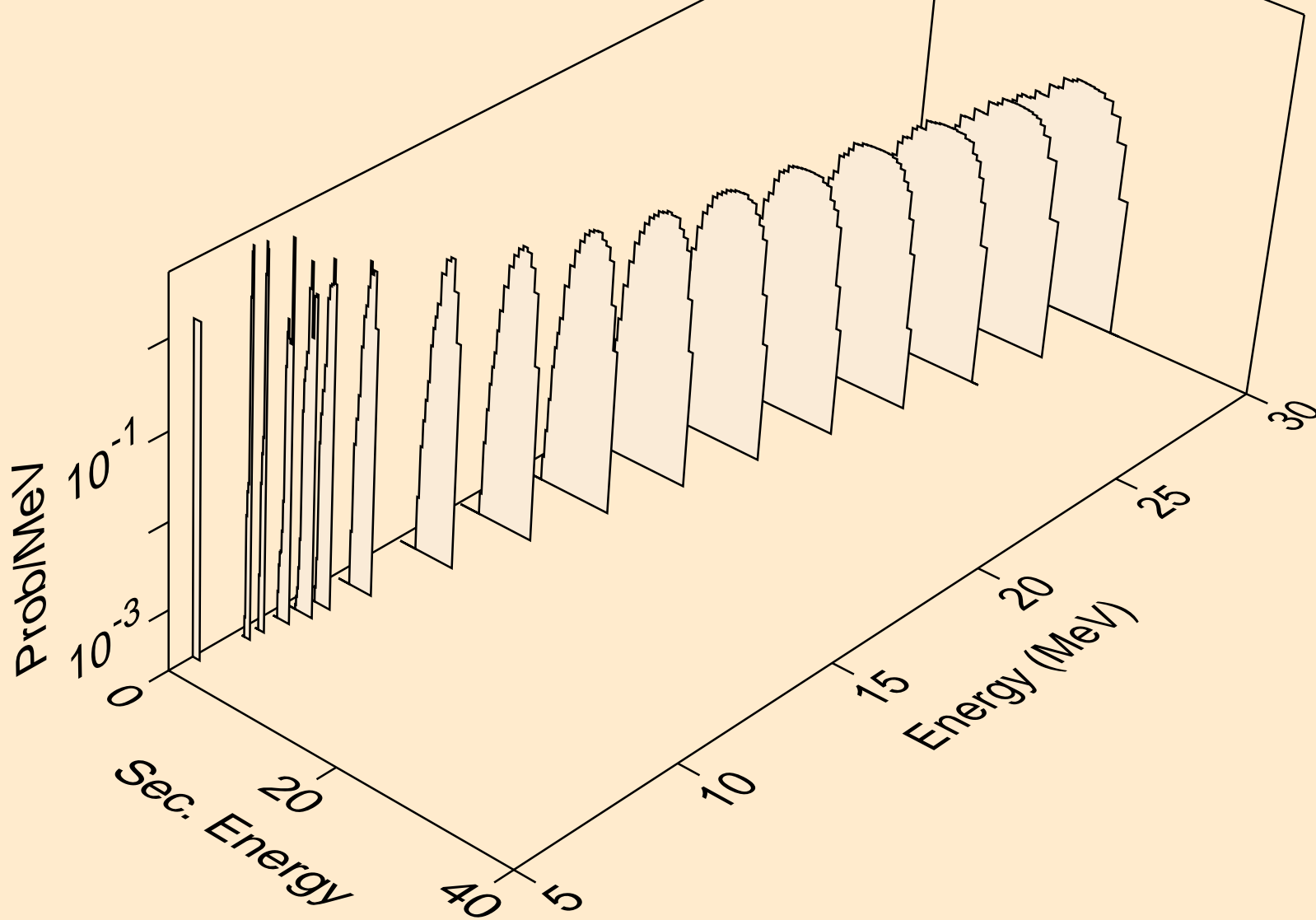

YB165 NEUTRON ACER TENDL-2019 LIBRARY; T=293.16K
protons from (n,2np)

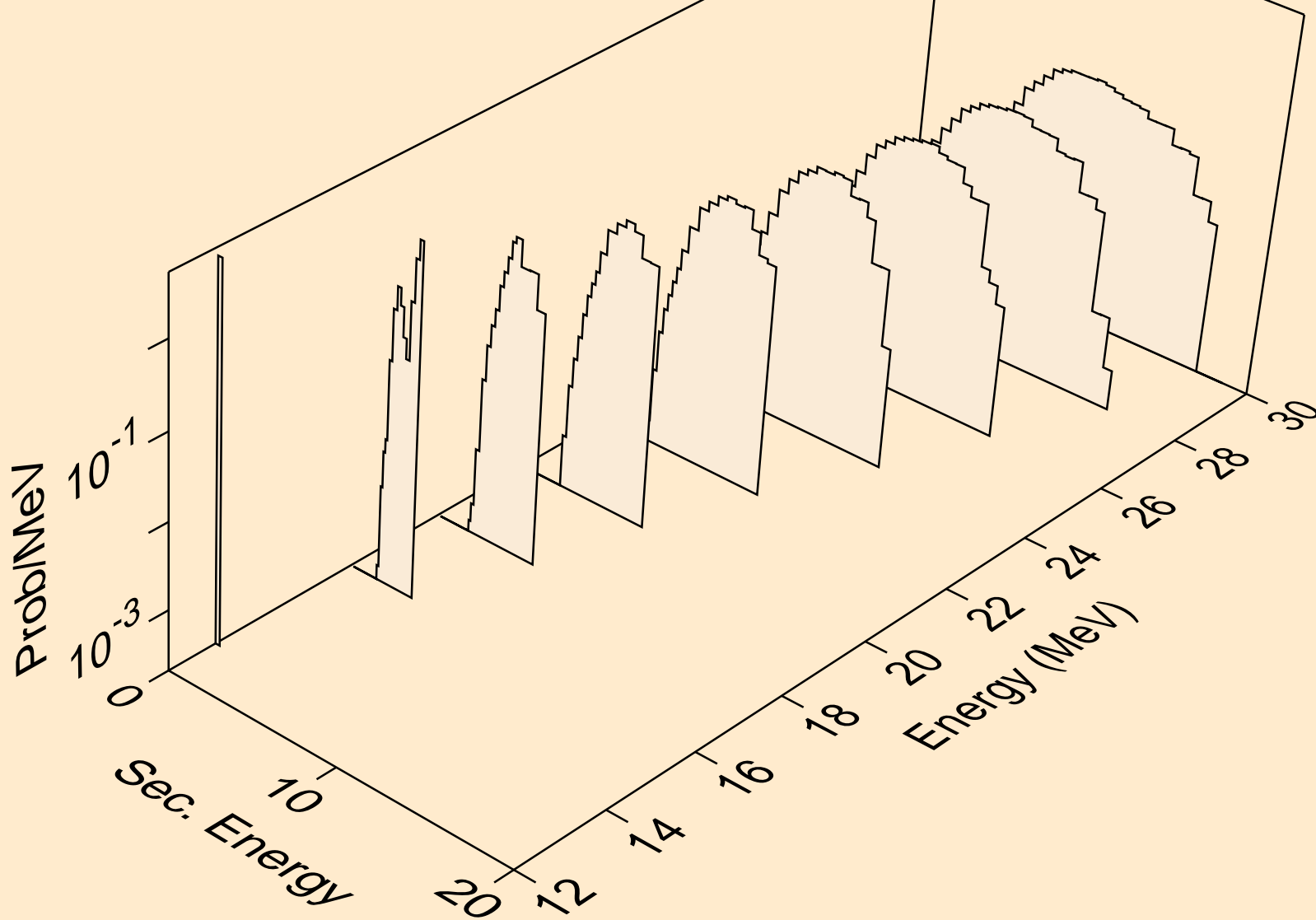

YB165 NEUTRON ACER TENDL-2019 LIBRARY; T=293.16K
protons from (n,3np)

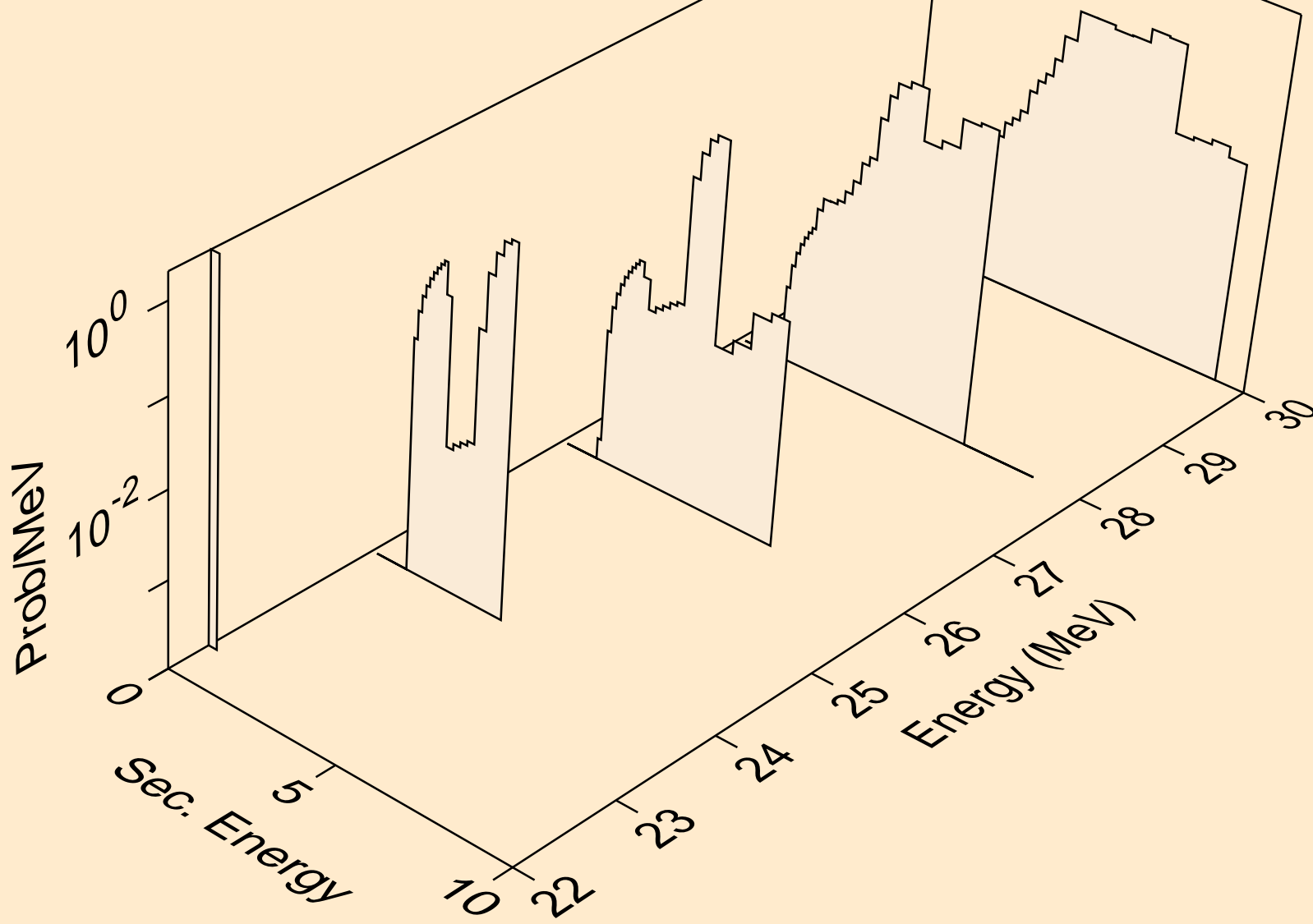

YB165 NEUTRON ACER TENDL-2019 LIBRARY; T=293.16K
protons from (n,2np)

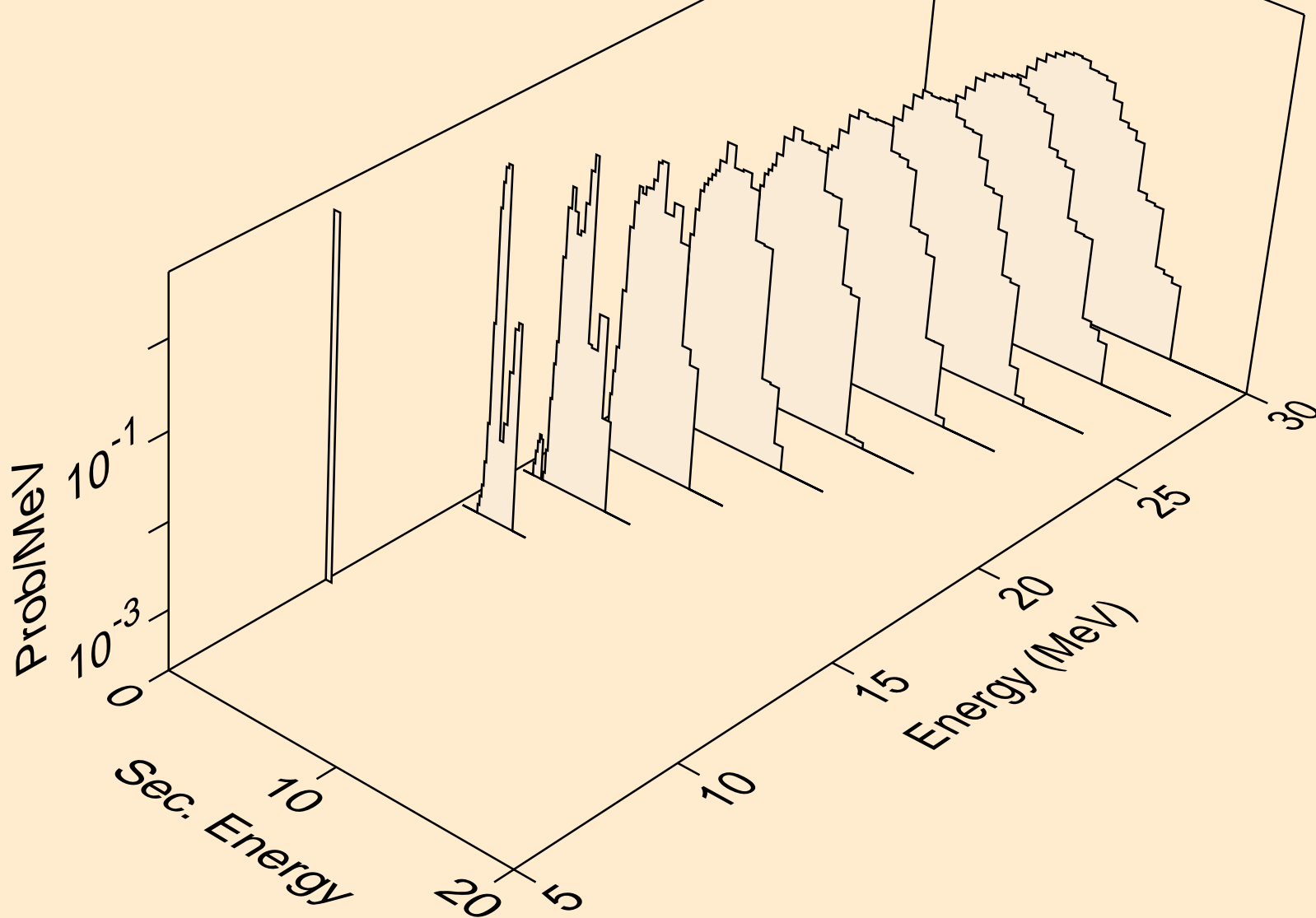

YB165 NEUTRON ACER TENDL-2019 LIBRARY; T=293.16K
protons from (n,npa)

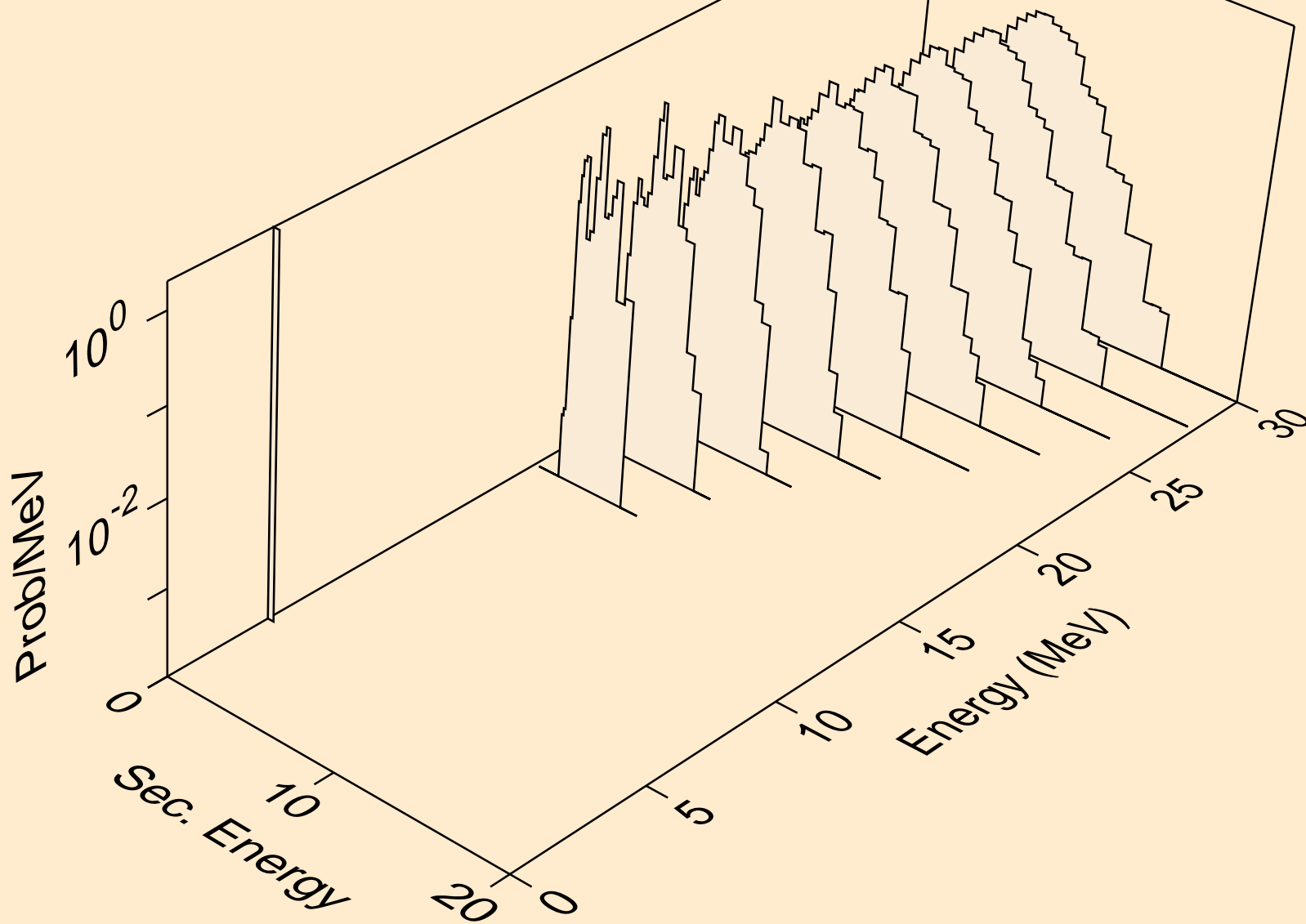

YB165 NEUTRON ACER TENDL-2019 LIBRARY; T=293.16K
protons from (n,p)

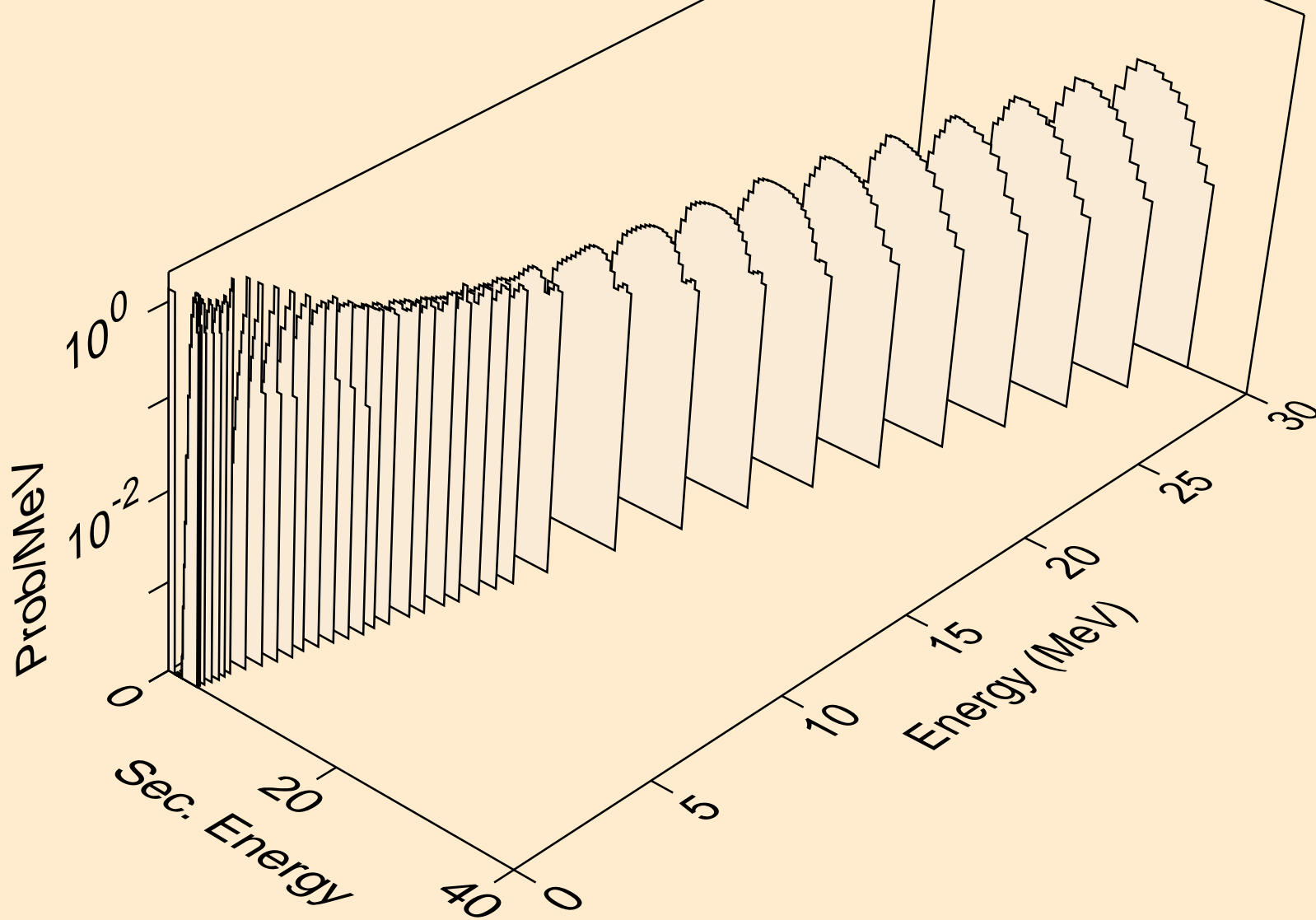

YB165 NEUTRON ACER TENDL-2019 LIBRARY; T=293.16K
protons from (n,2p)

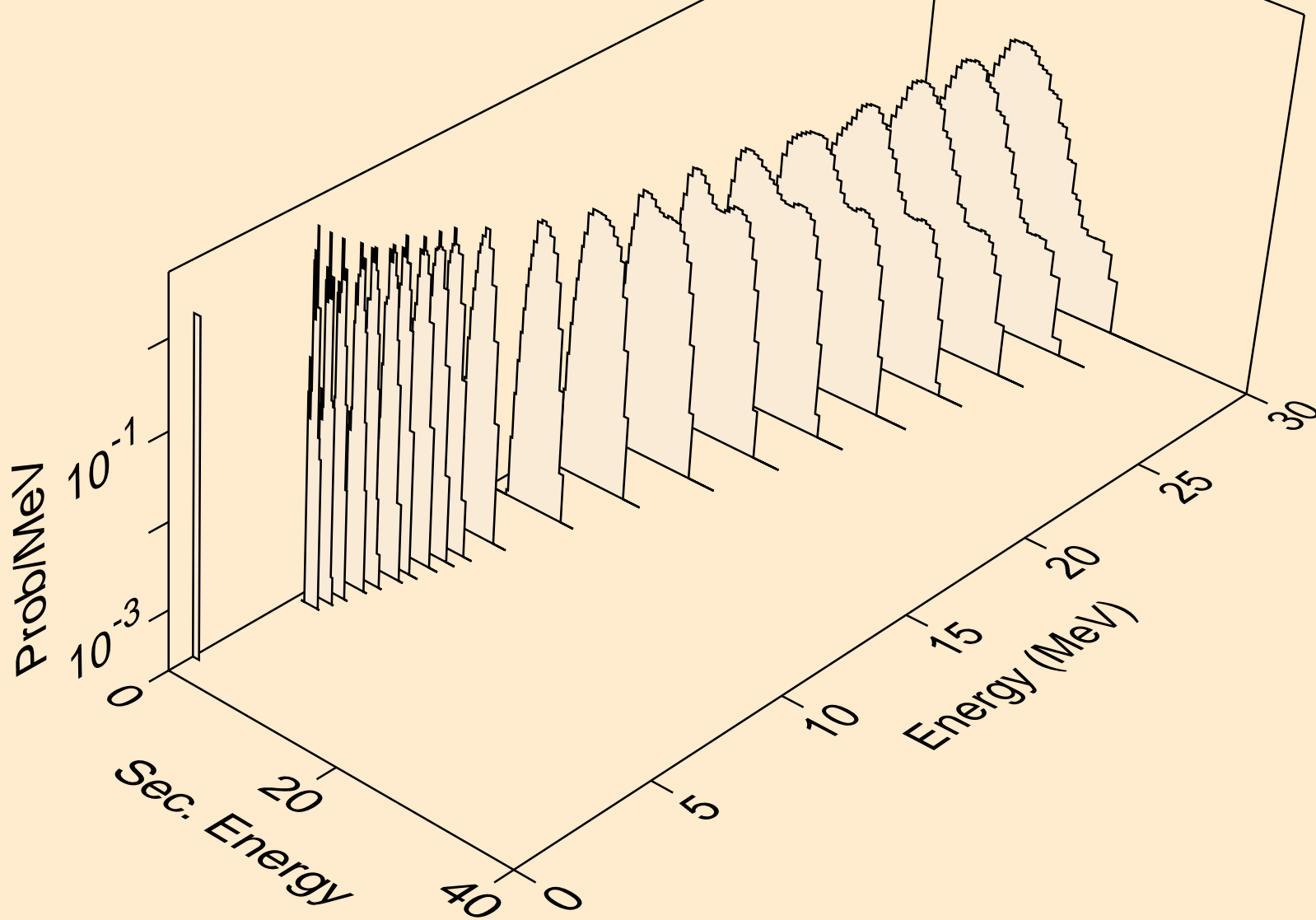

YB165 NEUTRON ACER TENDL-2019 LIBRARY; T=293.16K
protons from (n,p)

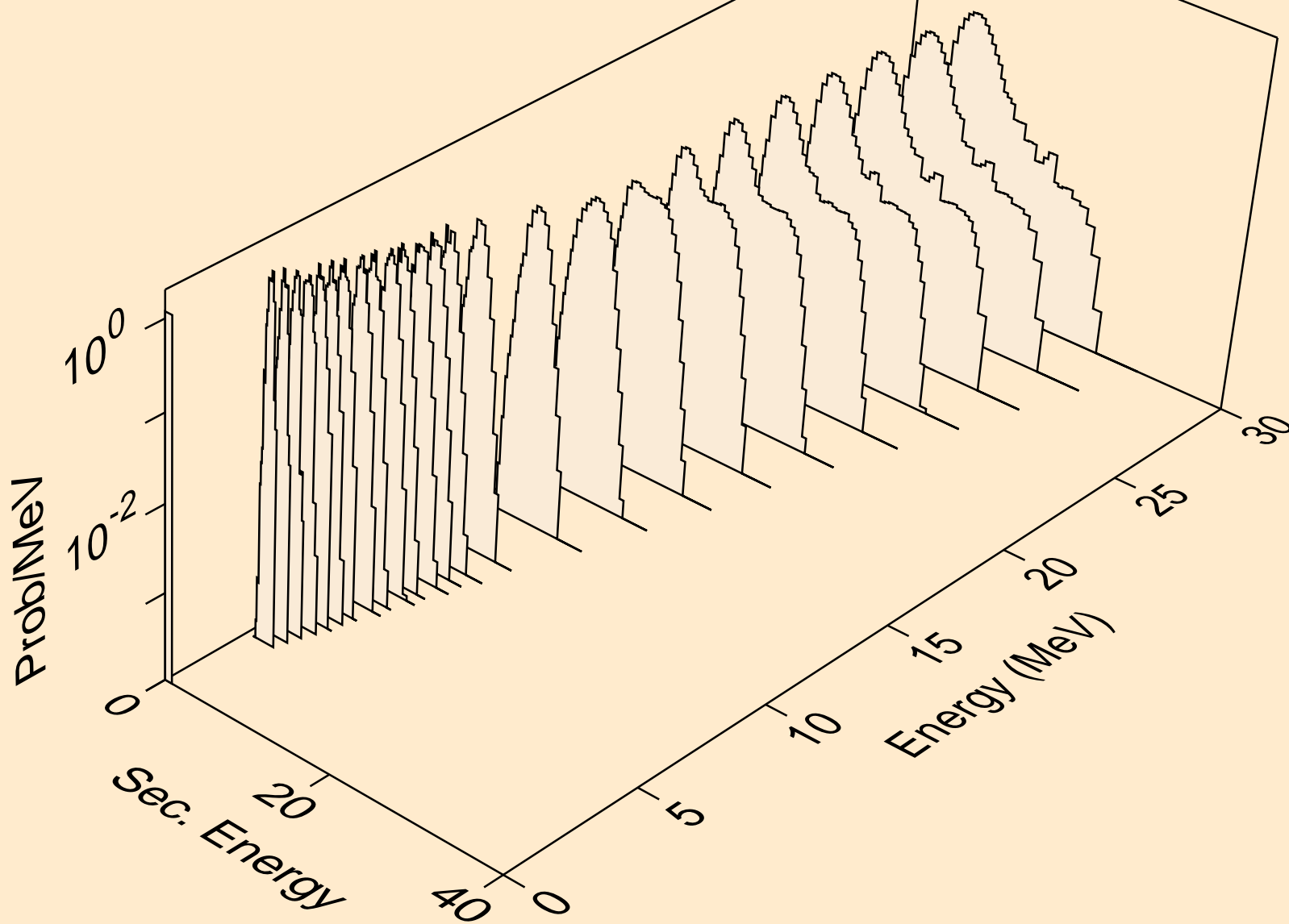

YB165 NEUTRON ACER TENDL-2019 LIBRARY; T=293.16K
protons from (n,pd)

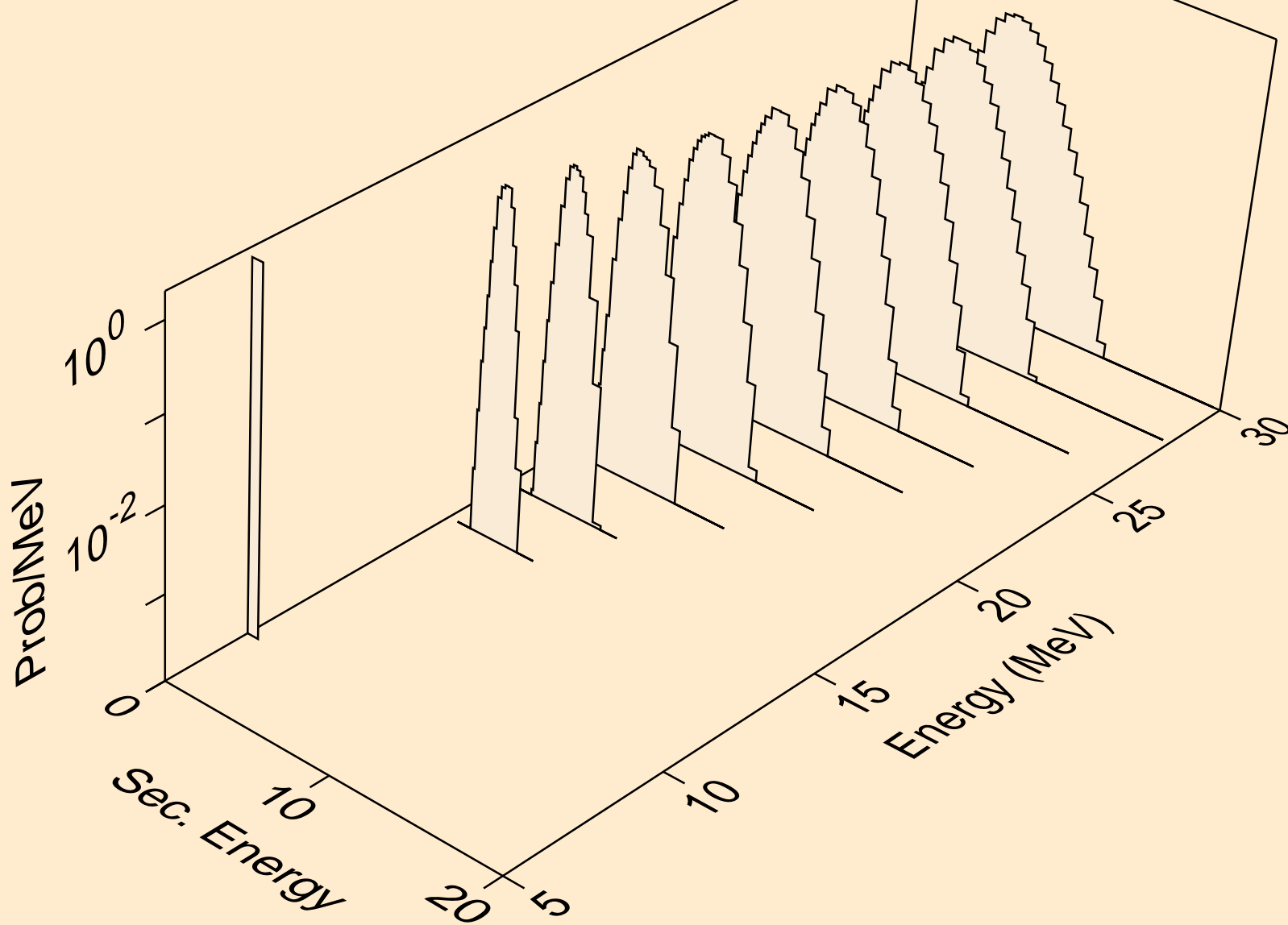

YB165 NEUTRON ACER TENDL-2019 LIBRARY; T=293.16K
protons from (n,pt)

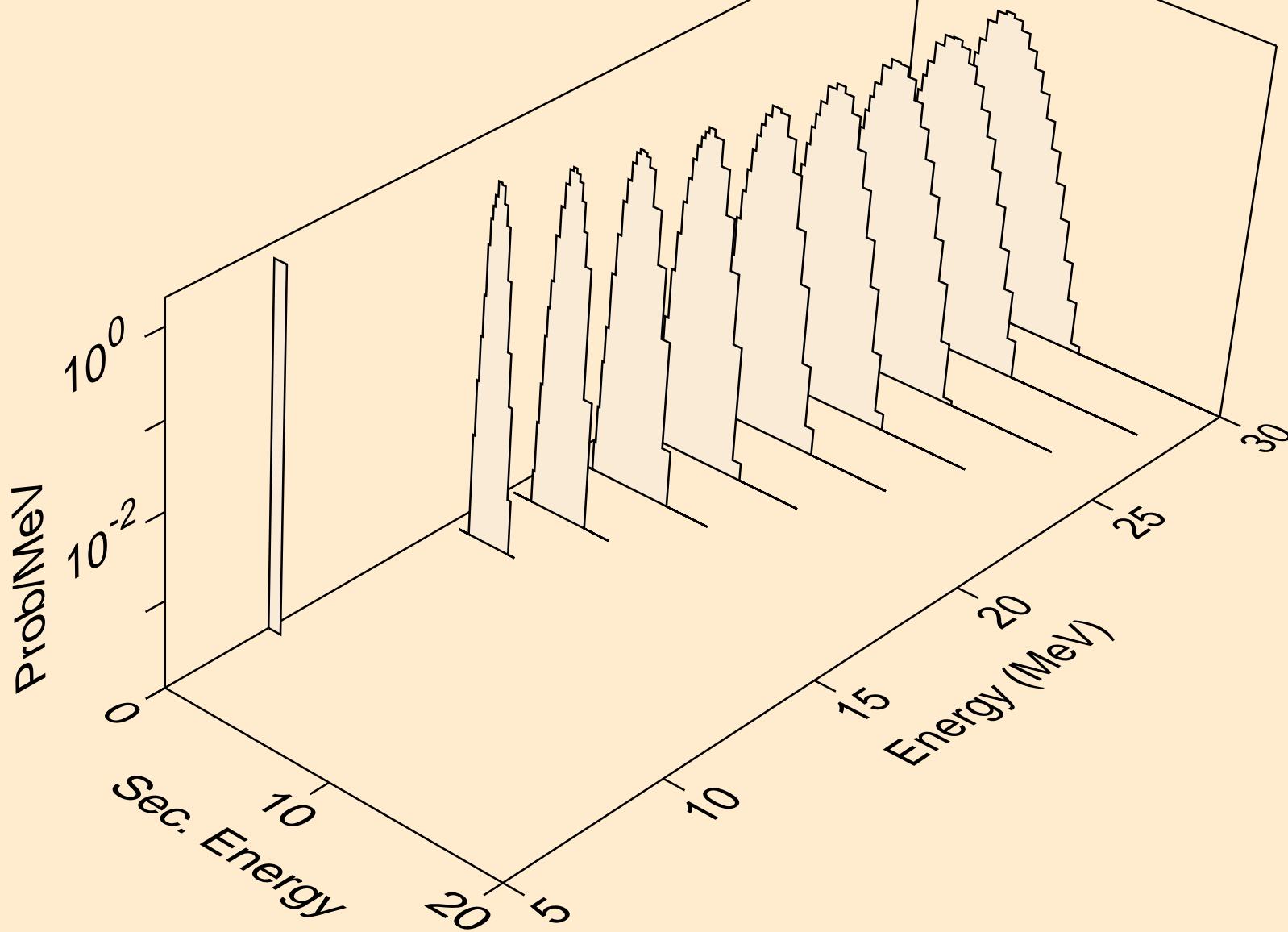

YB165 NEUTRON ACER TENDL-2019 LIBRARY; T=293.16K
deuterons from (n,x)

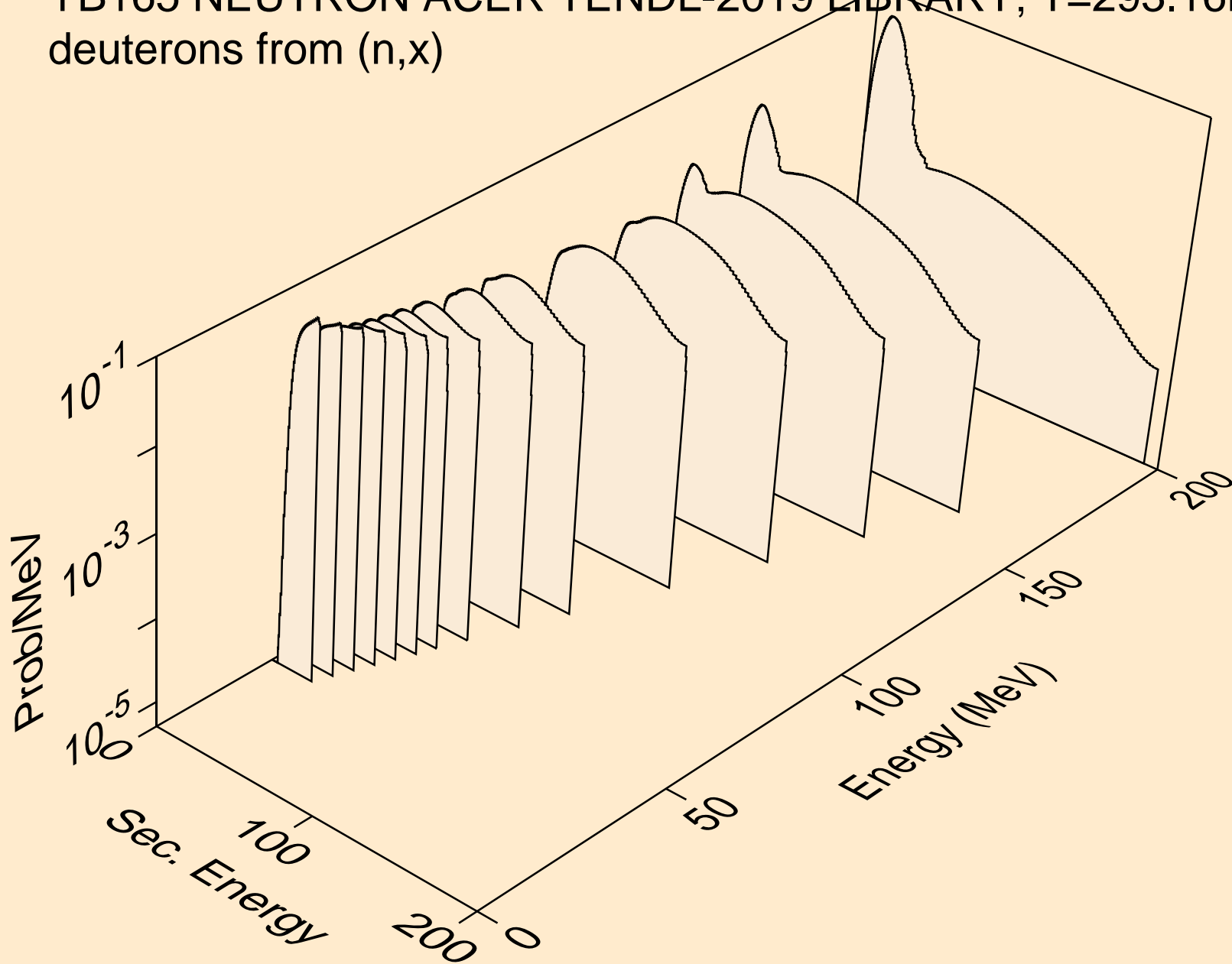

YB165 NEUTRON ACER TENDL-2019 LIBRARY; T=293.16K
deuterons from (n,2nd)

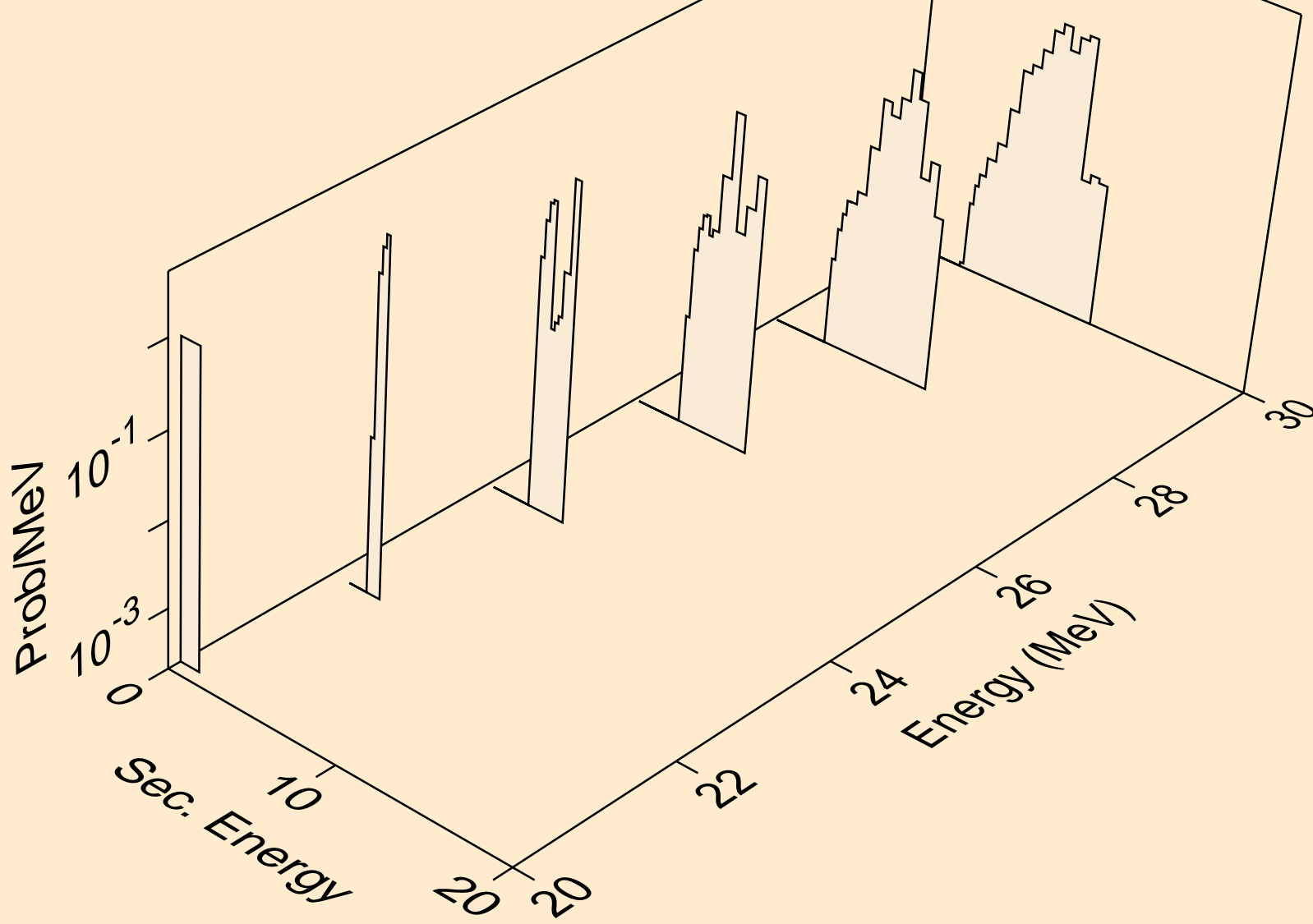

YB165 NEUTRON ACER TENDL-2019 LIBRARY; T=293.16K
deuterons from (n,n*)d

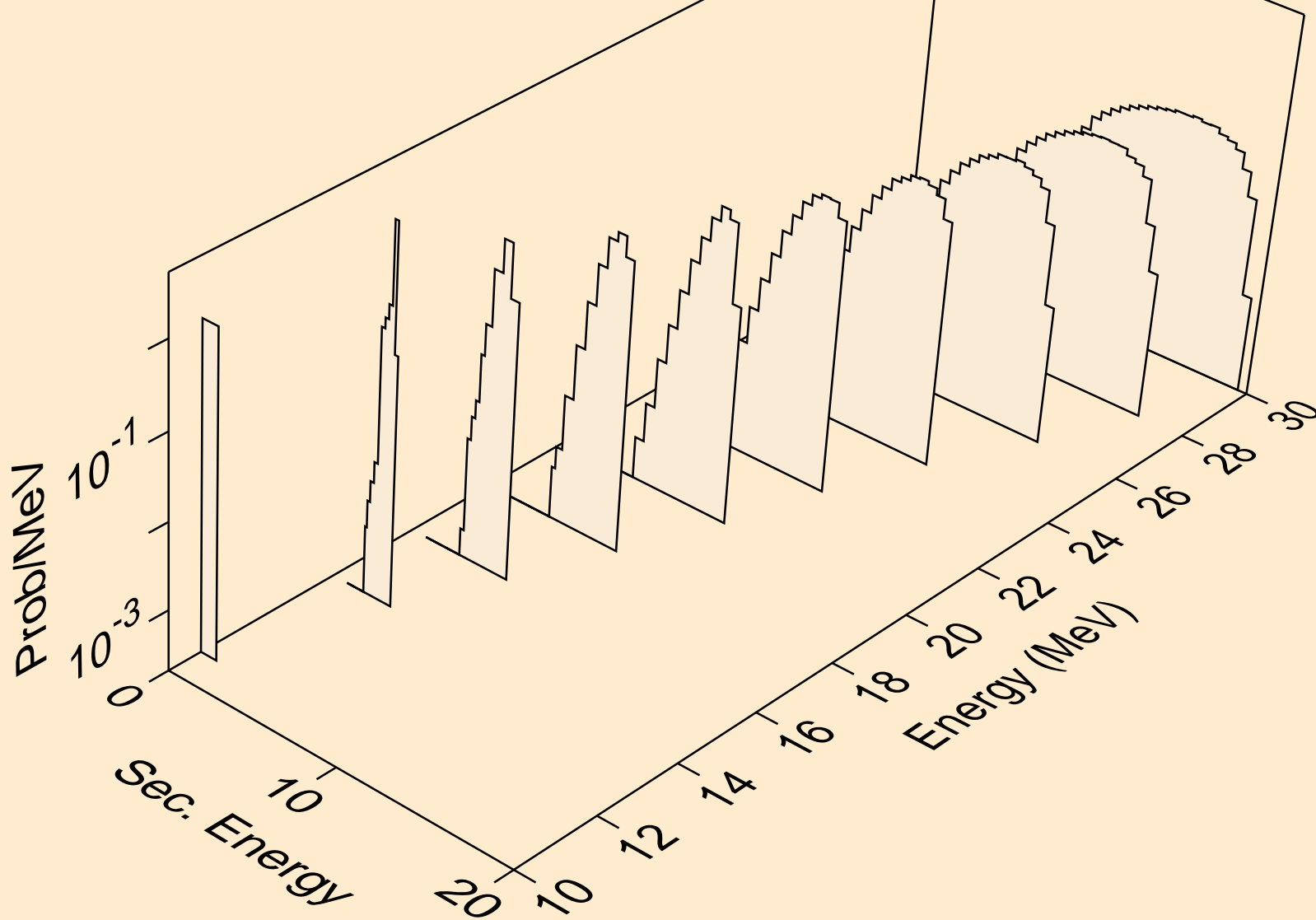

YB165 NEUTRON ACER TENDL-2019 LIBRARY; T=293.16K
deuterons from (n,d)

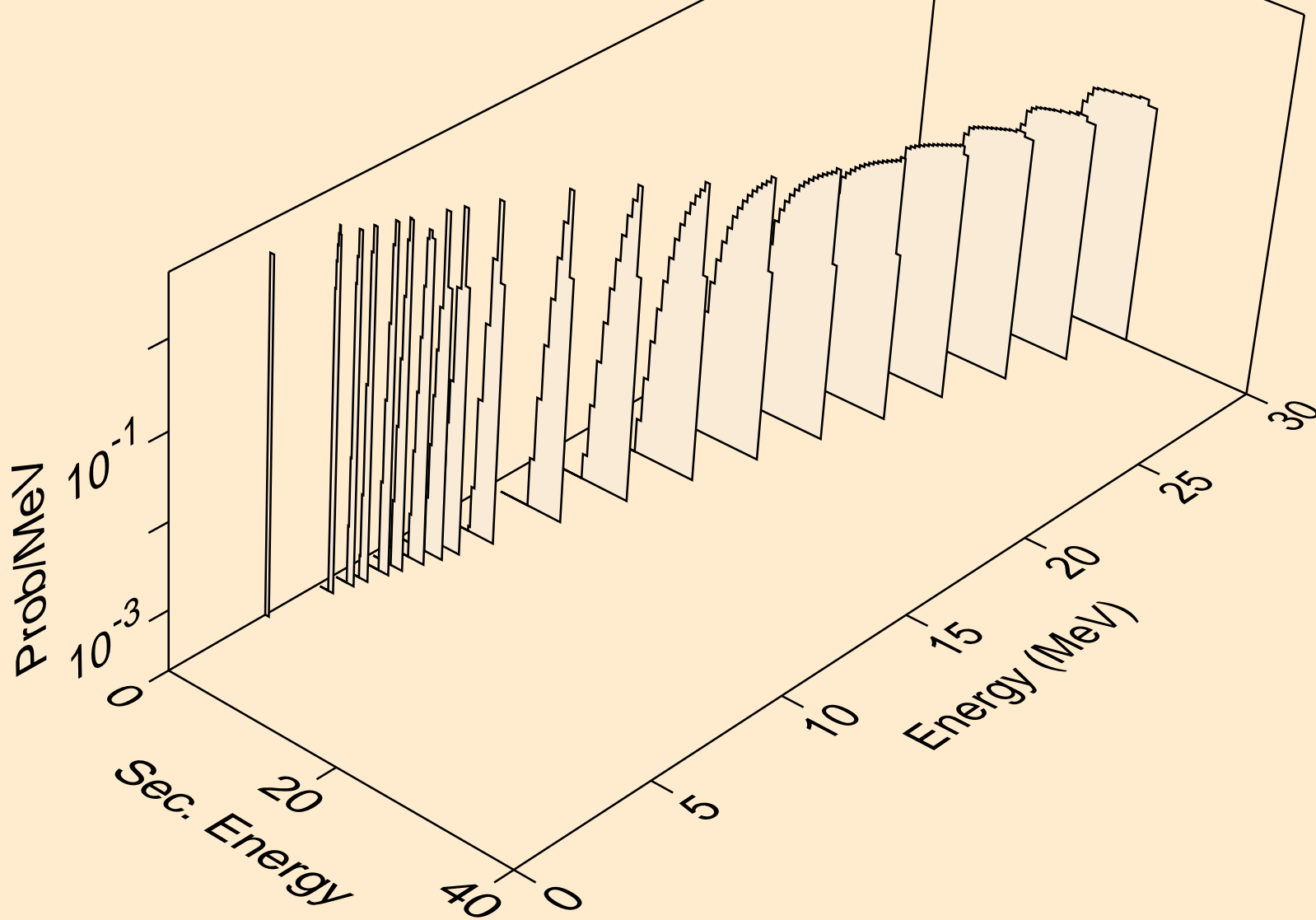

YB165 NEUTRON ACER TENDL-2019 LIBRARY; T=293.16K
deuterons from (n,pd)

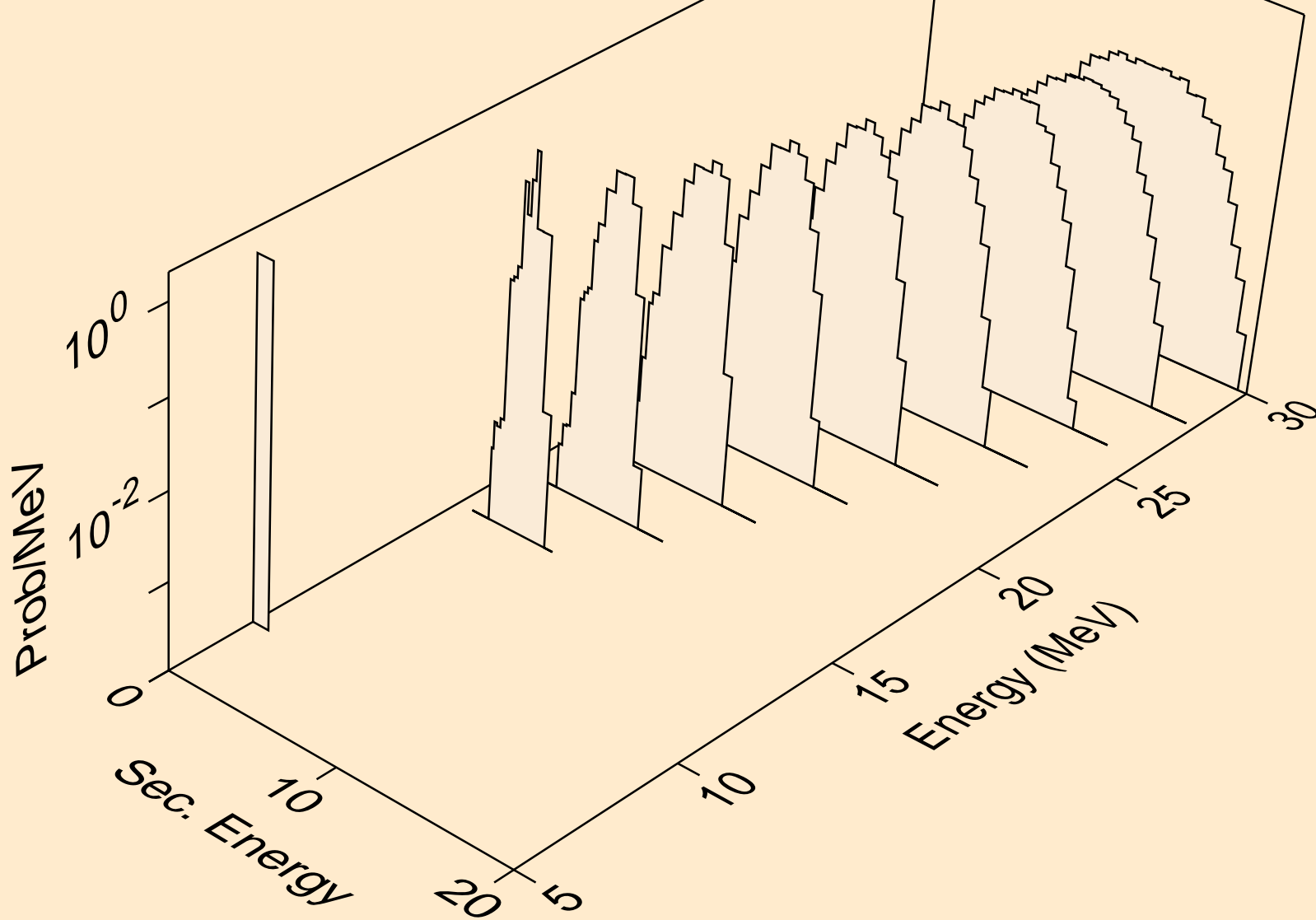

YB165 NEUTRON ACER TENDL-2019 LIBRARY; T=293.16K
deuterons from (n,da)

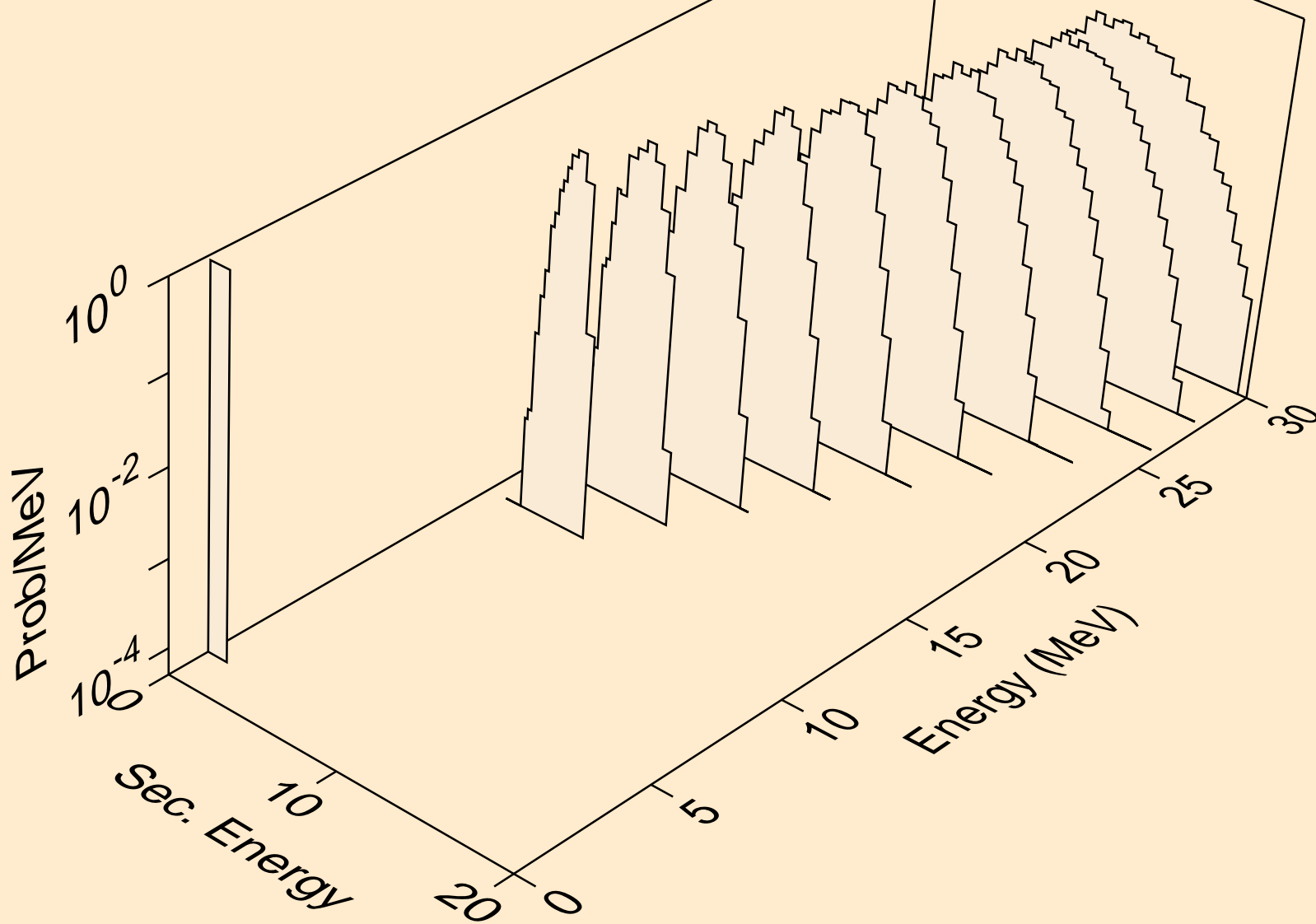

YB165 NEUTRON ACER TENDL-2019 LIBRARY; T=293.16K
tritons from (n,x)

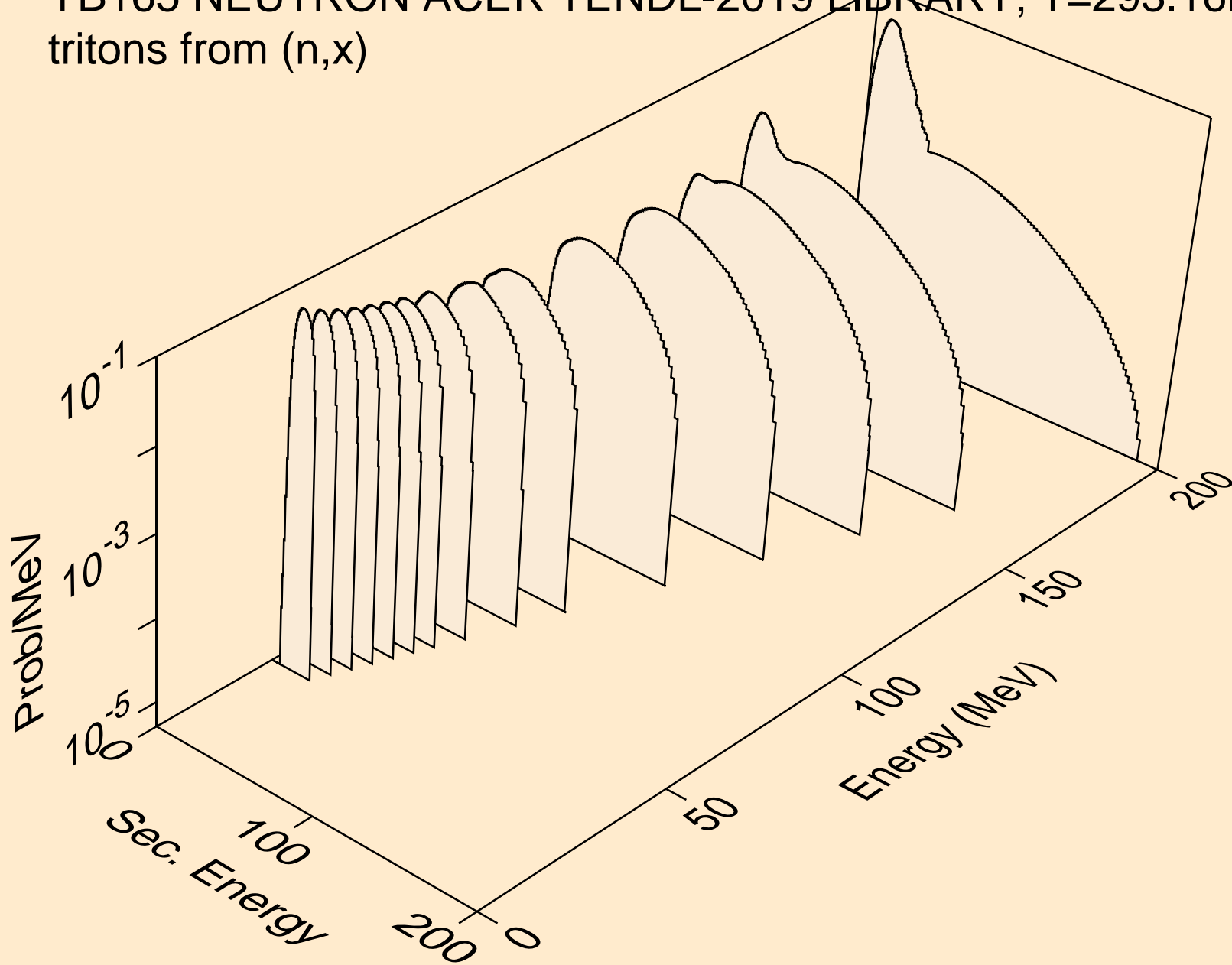

YB165 NEUTRON ACER TENDL-2019 LIBRARY; T=293.16K
tritons from (n,n*)t

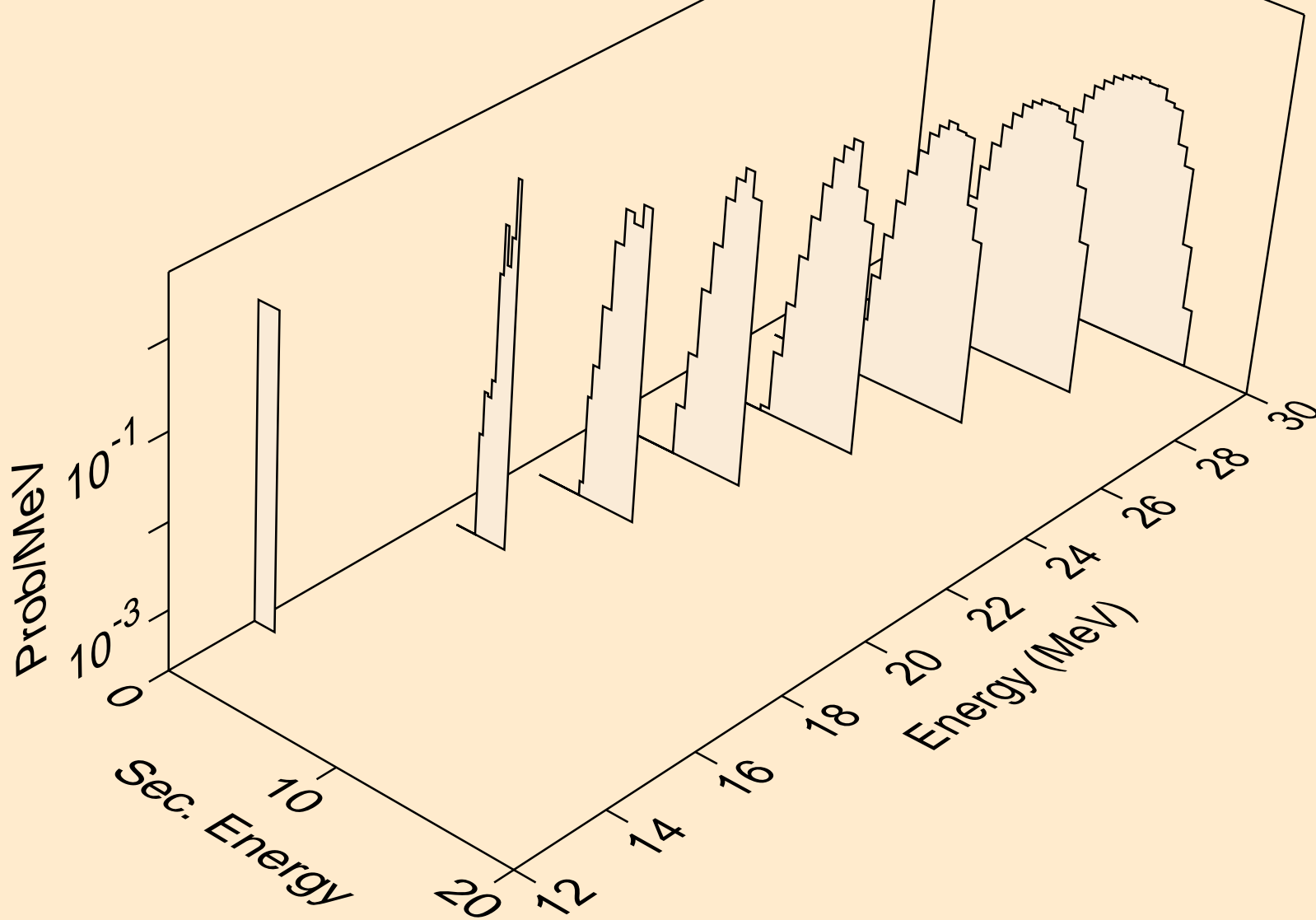

YB165 NEUTRON ACER TENDL-2019 LIBRARY; T=293.16K
tritons from (n,t)

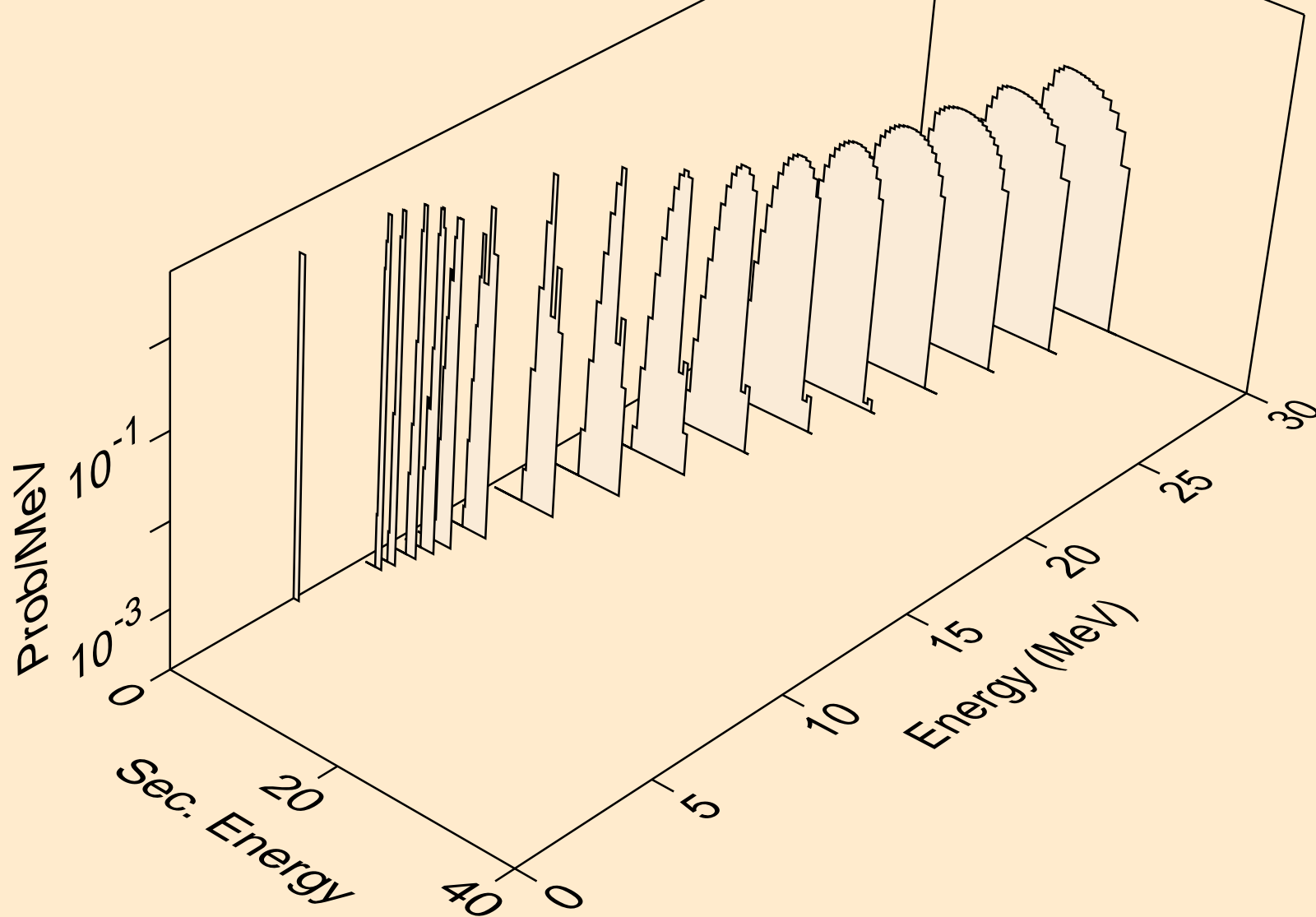

YB165 NEUTRON ACER TENDL-2019 LIBRARY; T=293.16K
tritons from (n,pt)

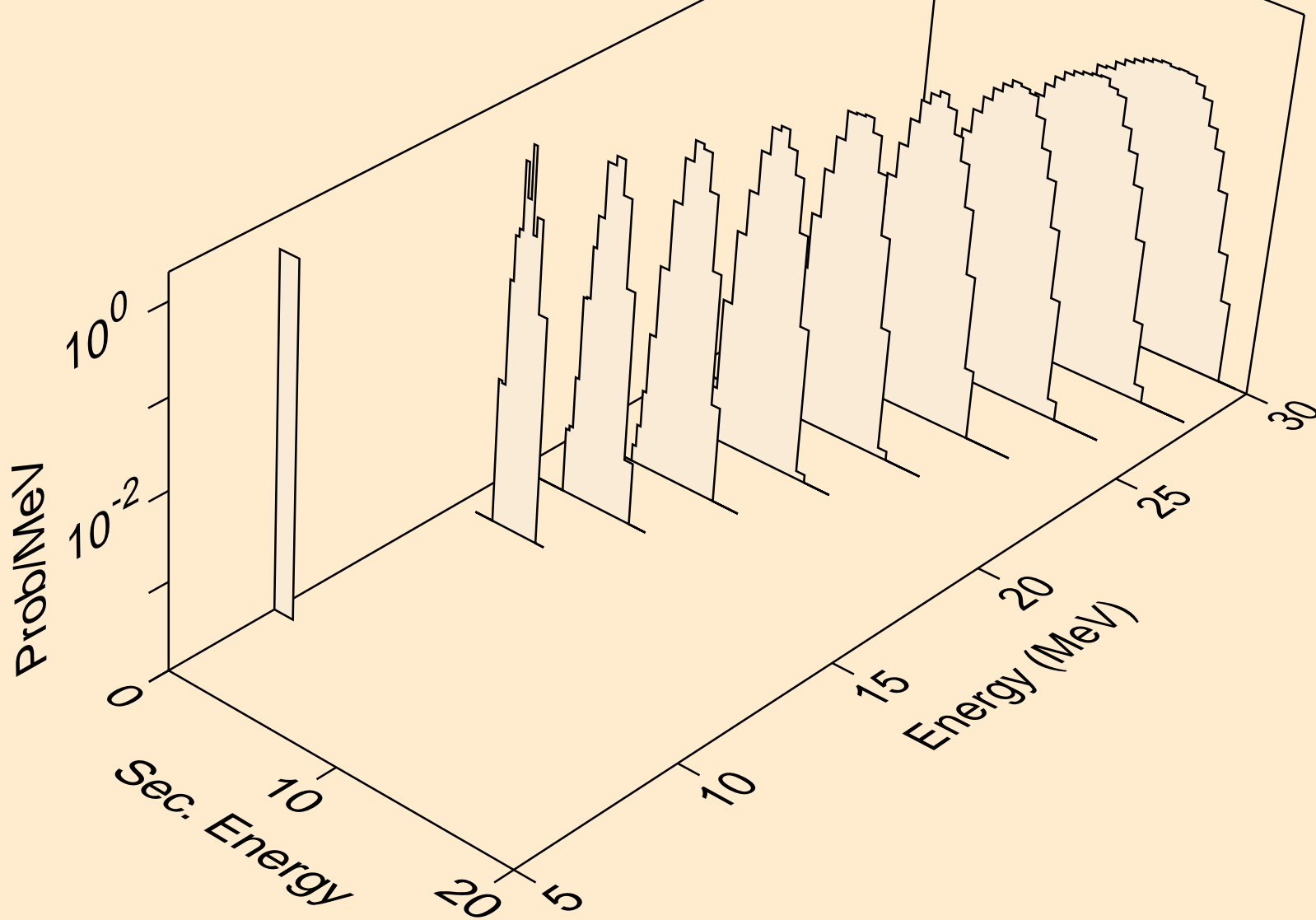

YB165 NEUTRON ACER TENDL-2019 LIBRARY; T=293.16K
he3s from (n,x)

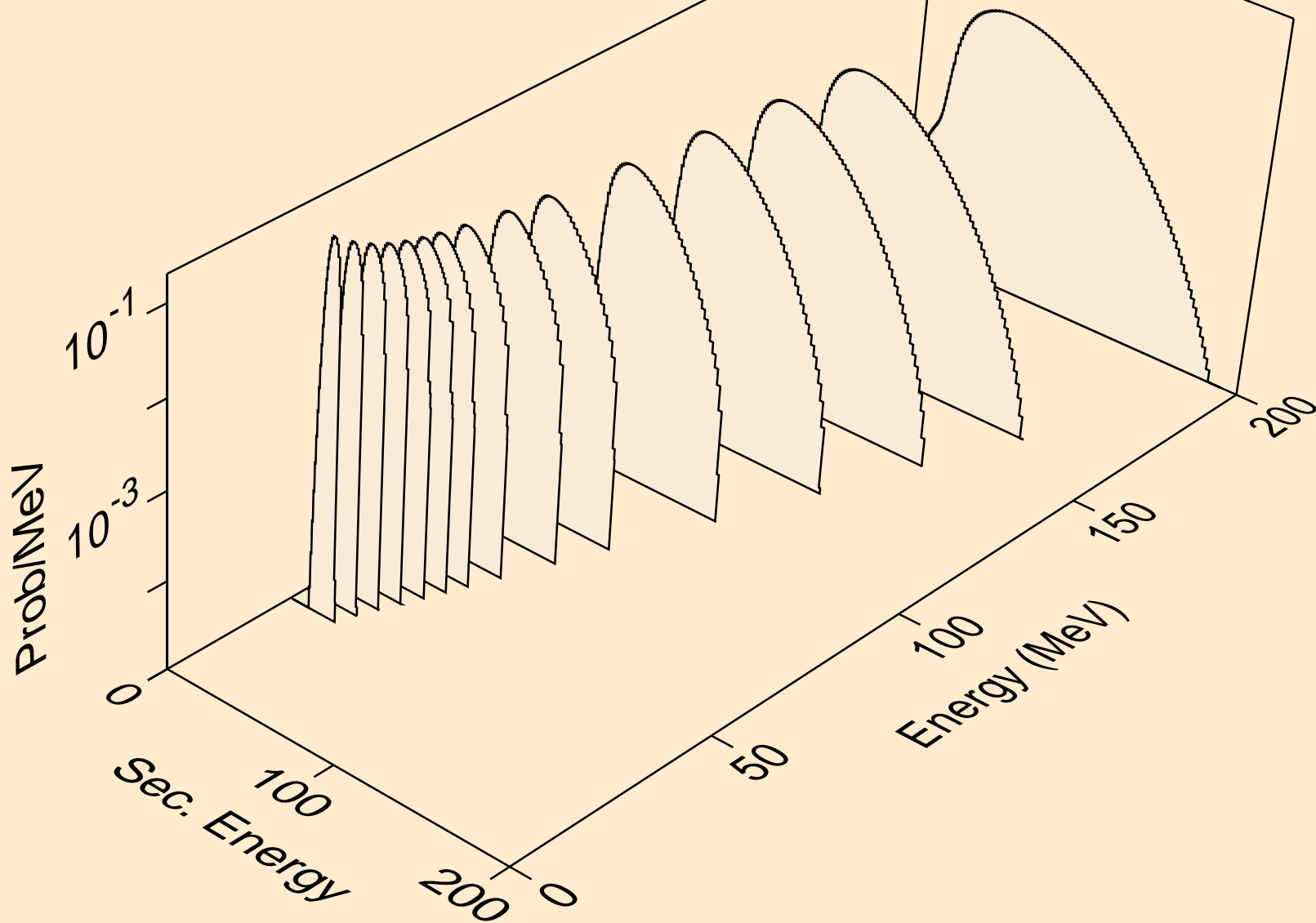

YB165 NEUTRON ACER TENDL-2019 LIBRARY; T=293.16K
he3s from (n,n*)he3

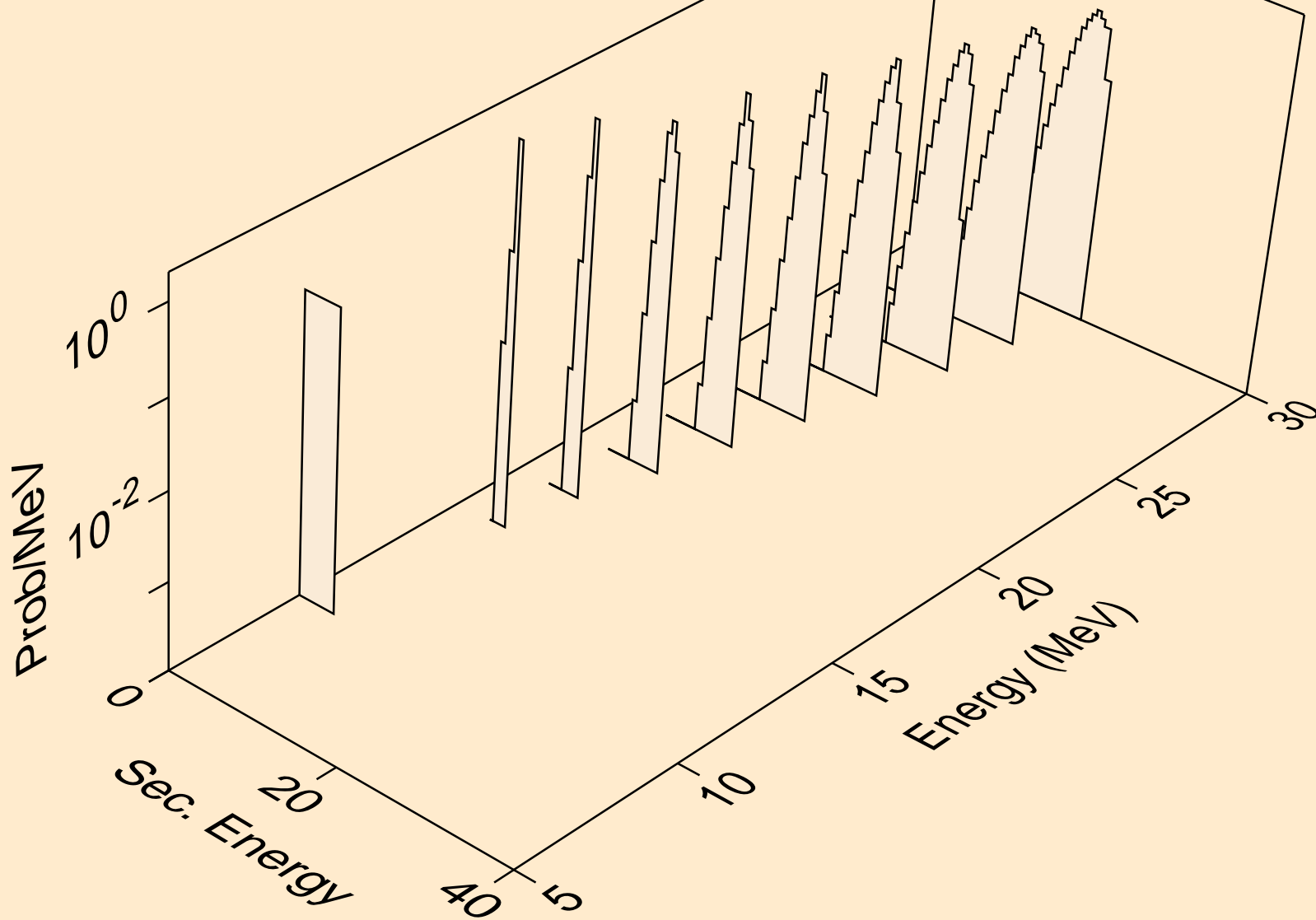

YB165 NEUTRON ACER TENDL-2019 LIBRARY; T=293.16K
he3s from (n,he3)

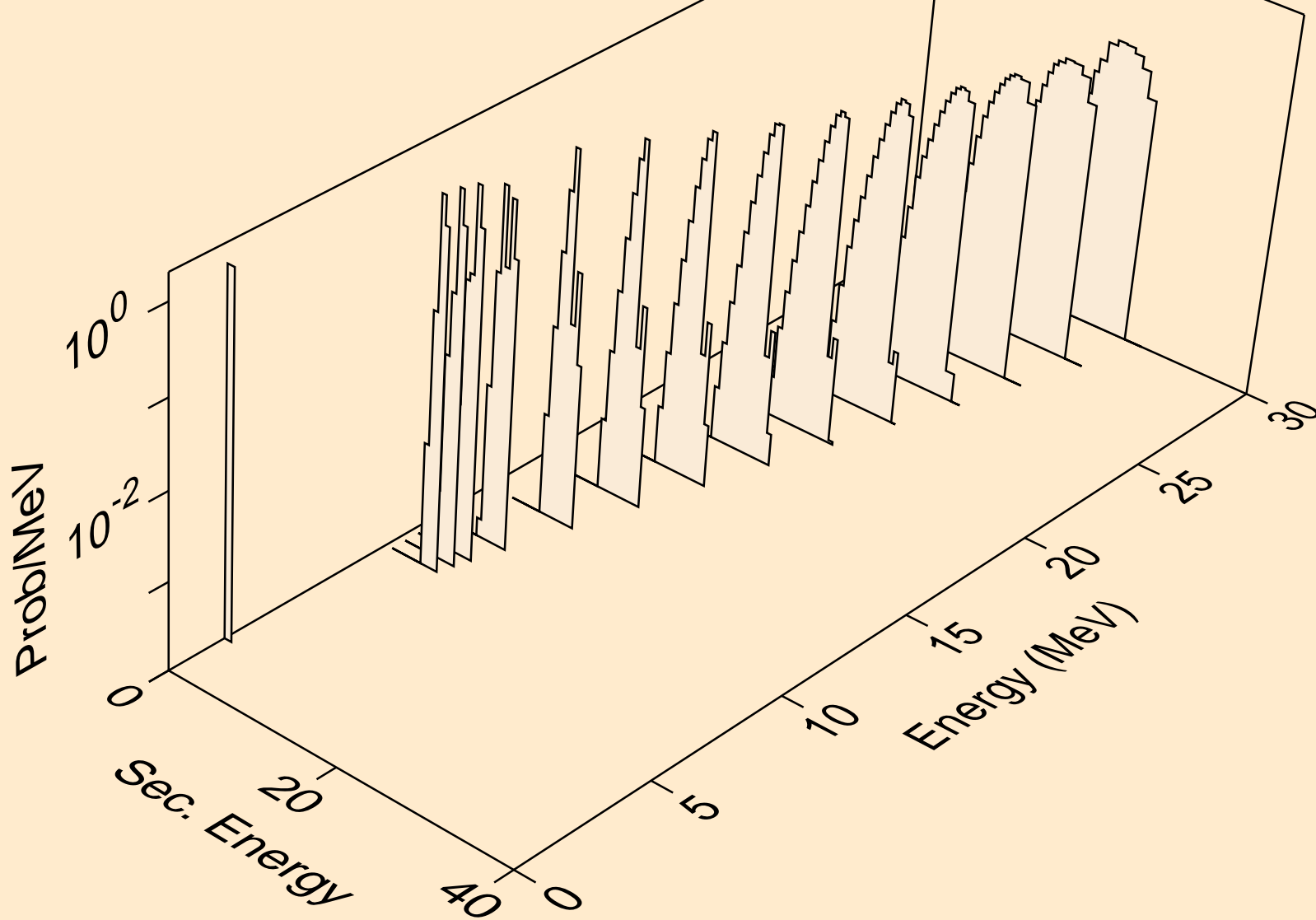

YB165 NEUTRON ACER TENDL-2019 LIBRARY; T=293.16K
alphas from (n,x)

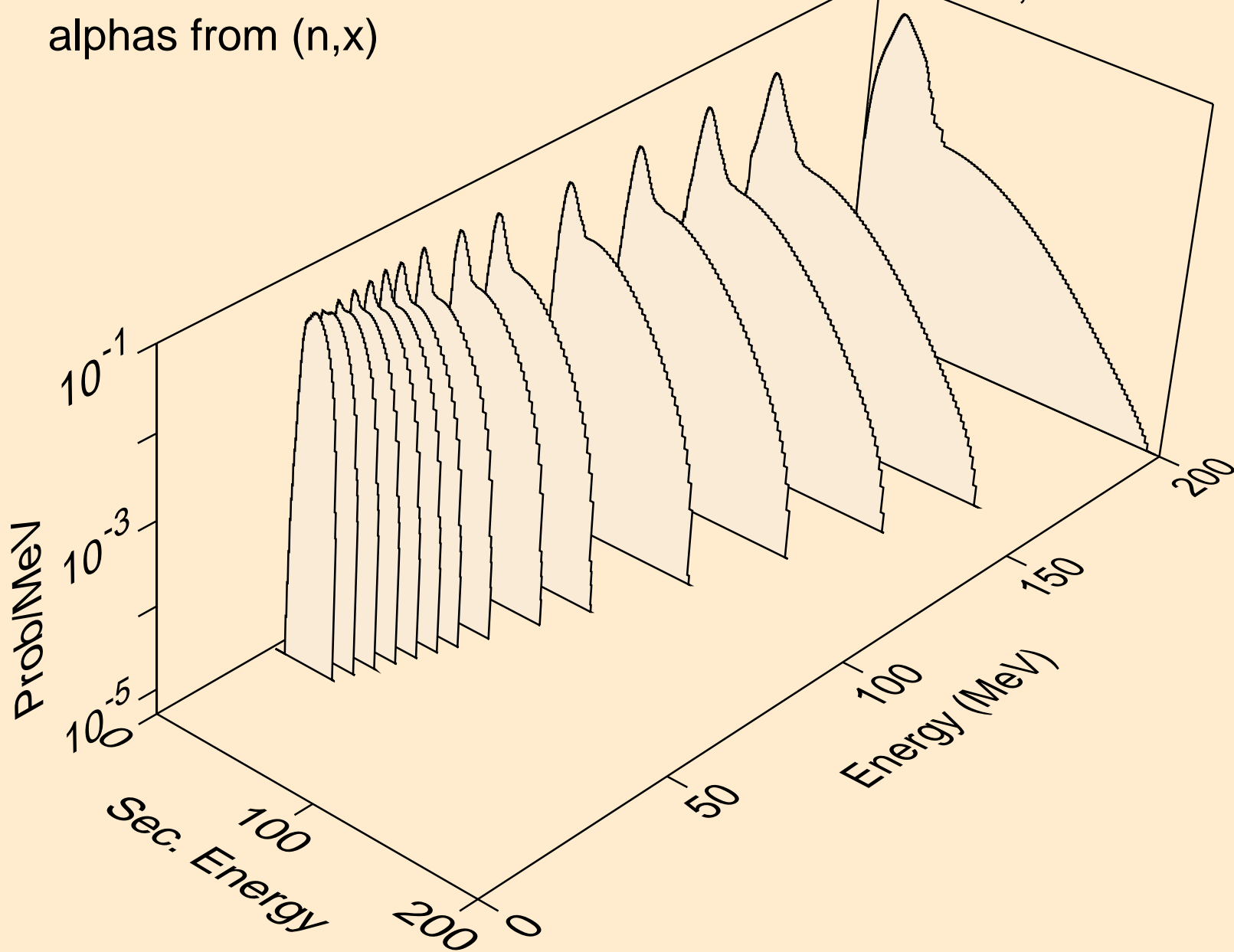

YB165 NEUTRON ACER TENDL-2019 LIBRARY; T=293.16K
alphas from (n,n*)a

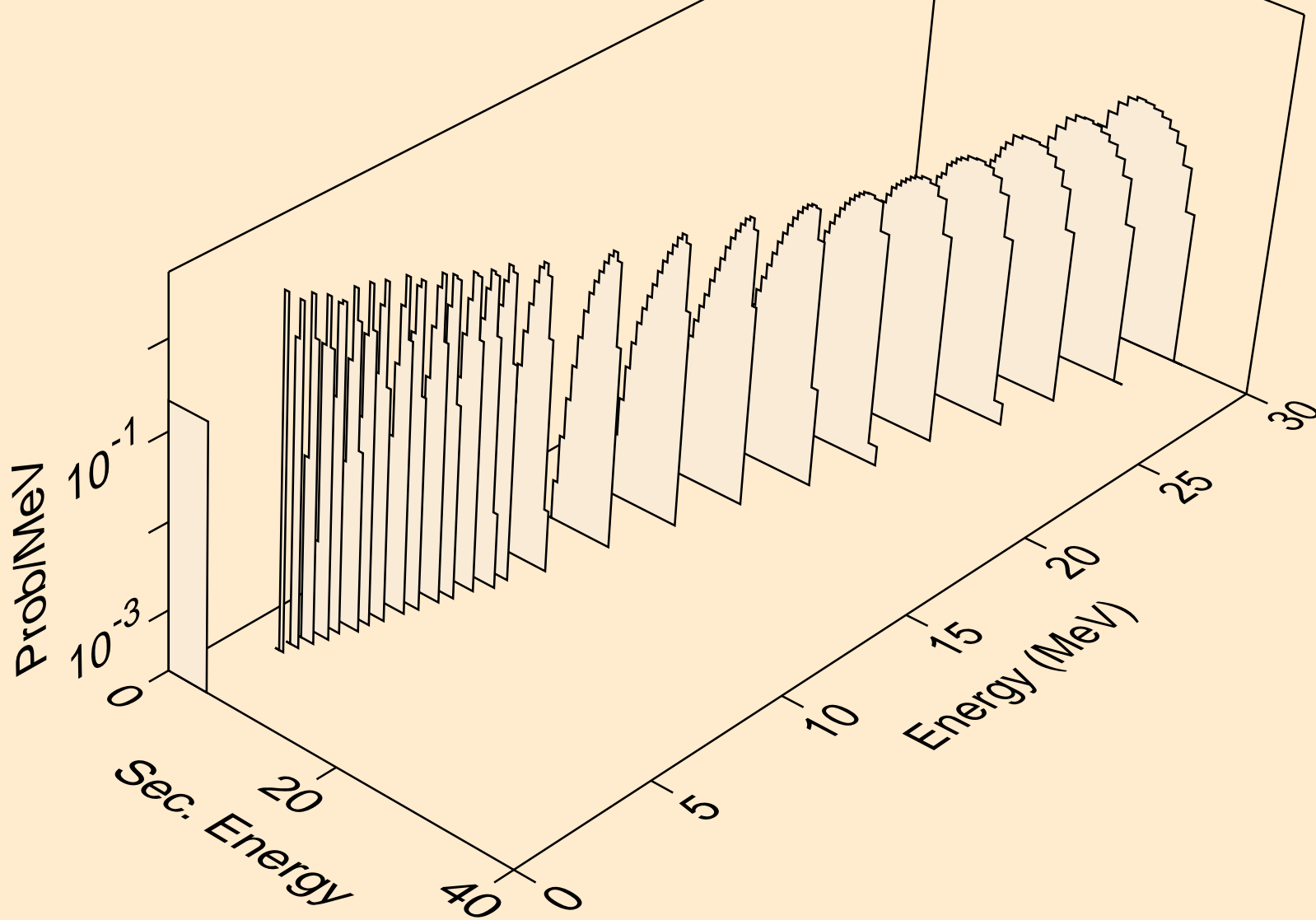

YB165 NEUTRON ACER TENDL-2019 LIBRARY; T=293.16K
alphas from (n,2n)a

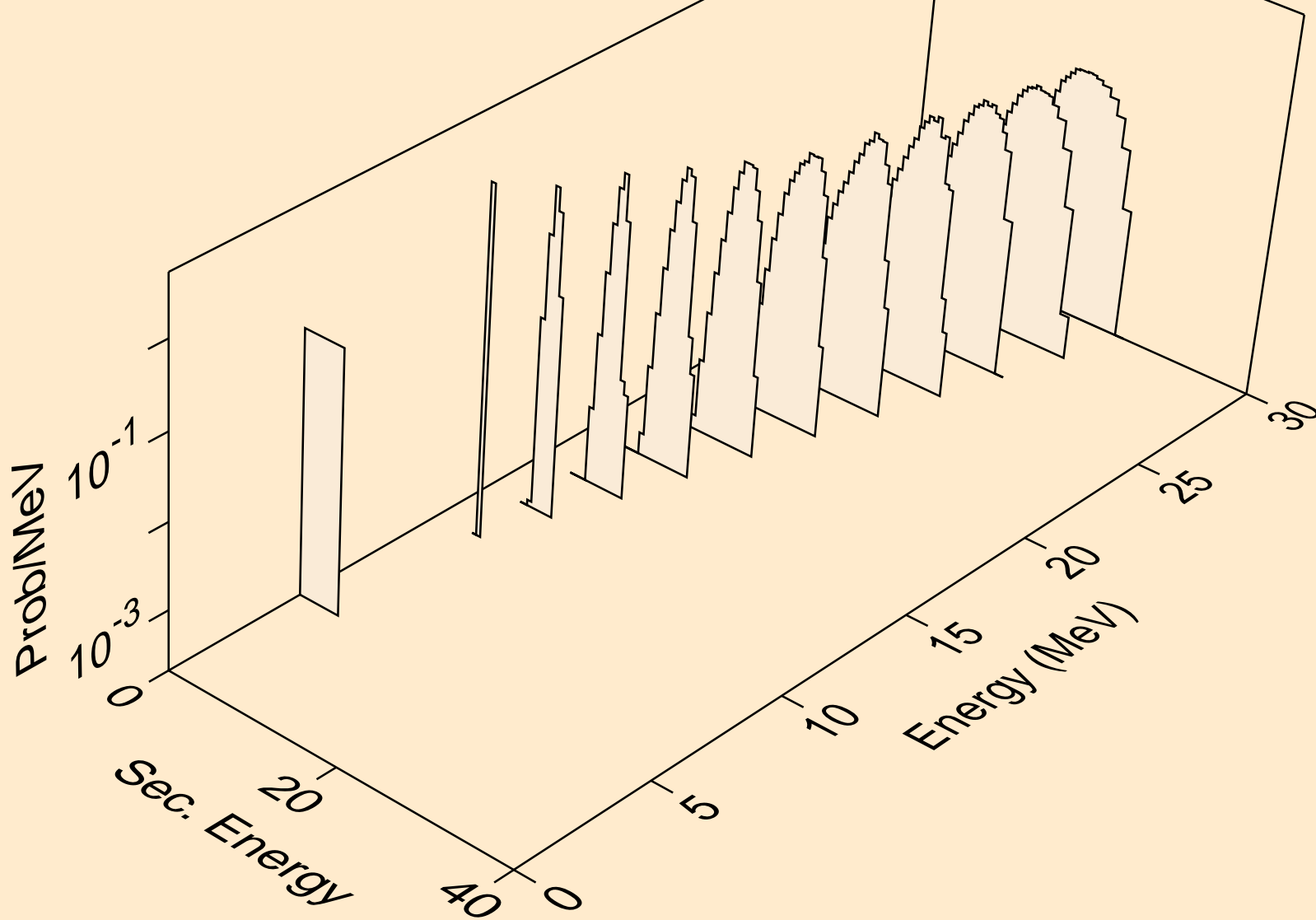

YB165 NEUTRON ACER TENDL-2019 LIBRARY; T=293.16K
alphas from (n,3n)a

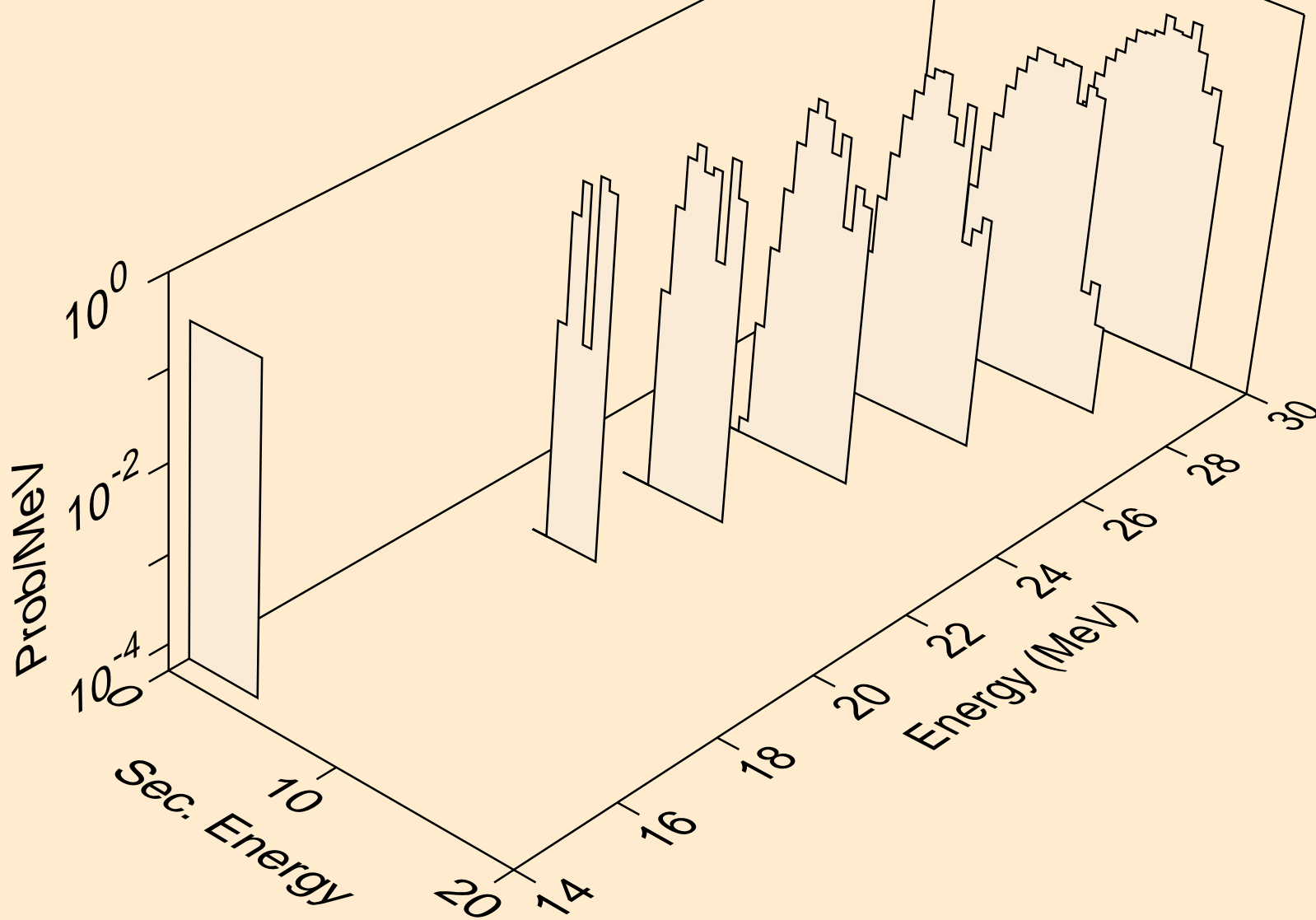

YB165 NEUTRON ACER TENDL-2019 LIBRARY; T=293.16K
alphas from (n,n*)2a

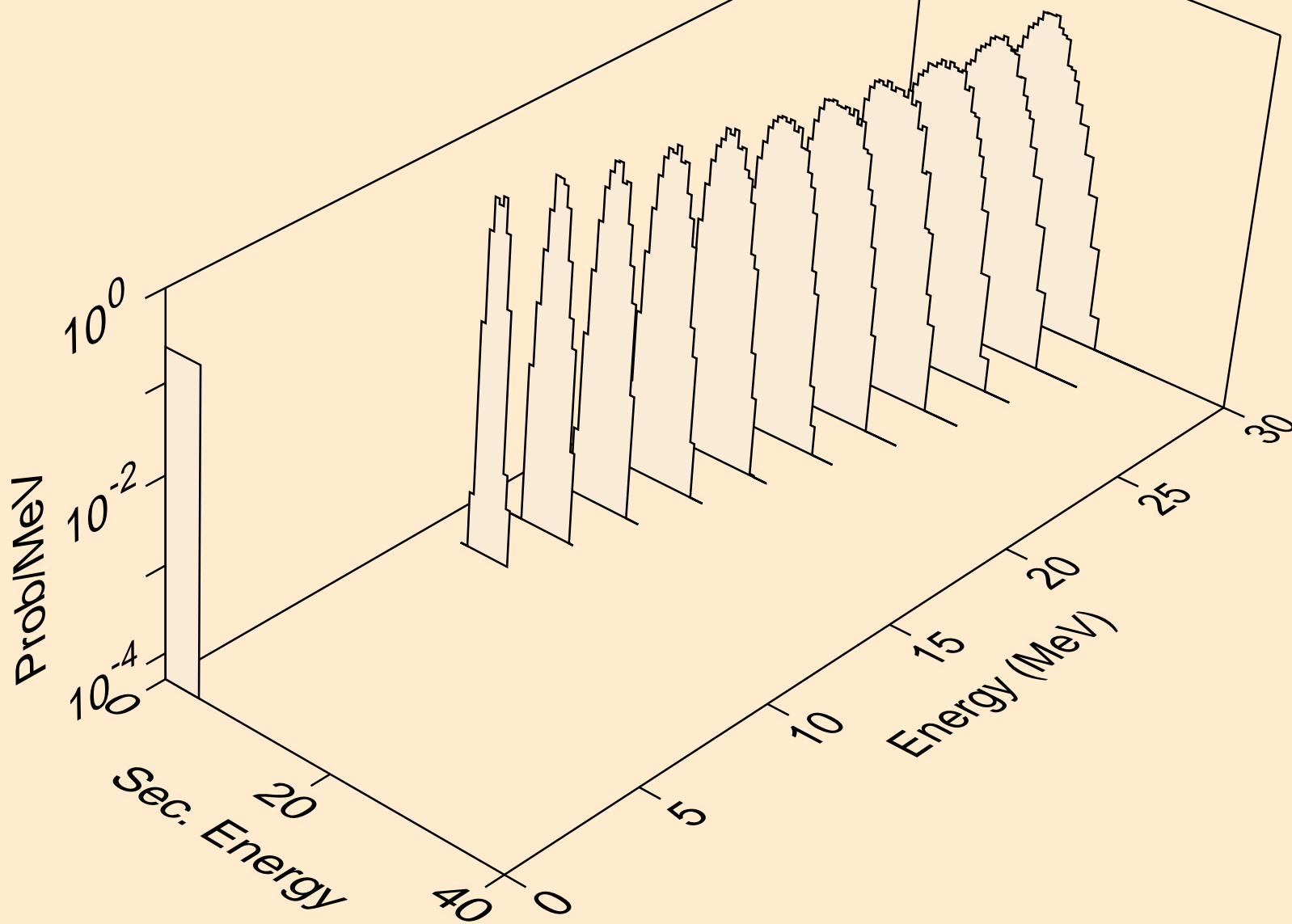

YB165 NEUTRON ACER TENDL-2019 LIBRARY; T=293.16K
alphas from (n,2n)2a

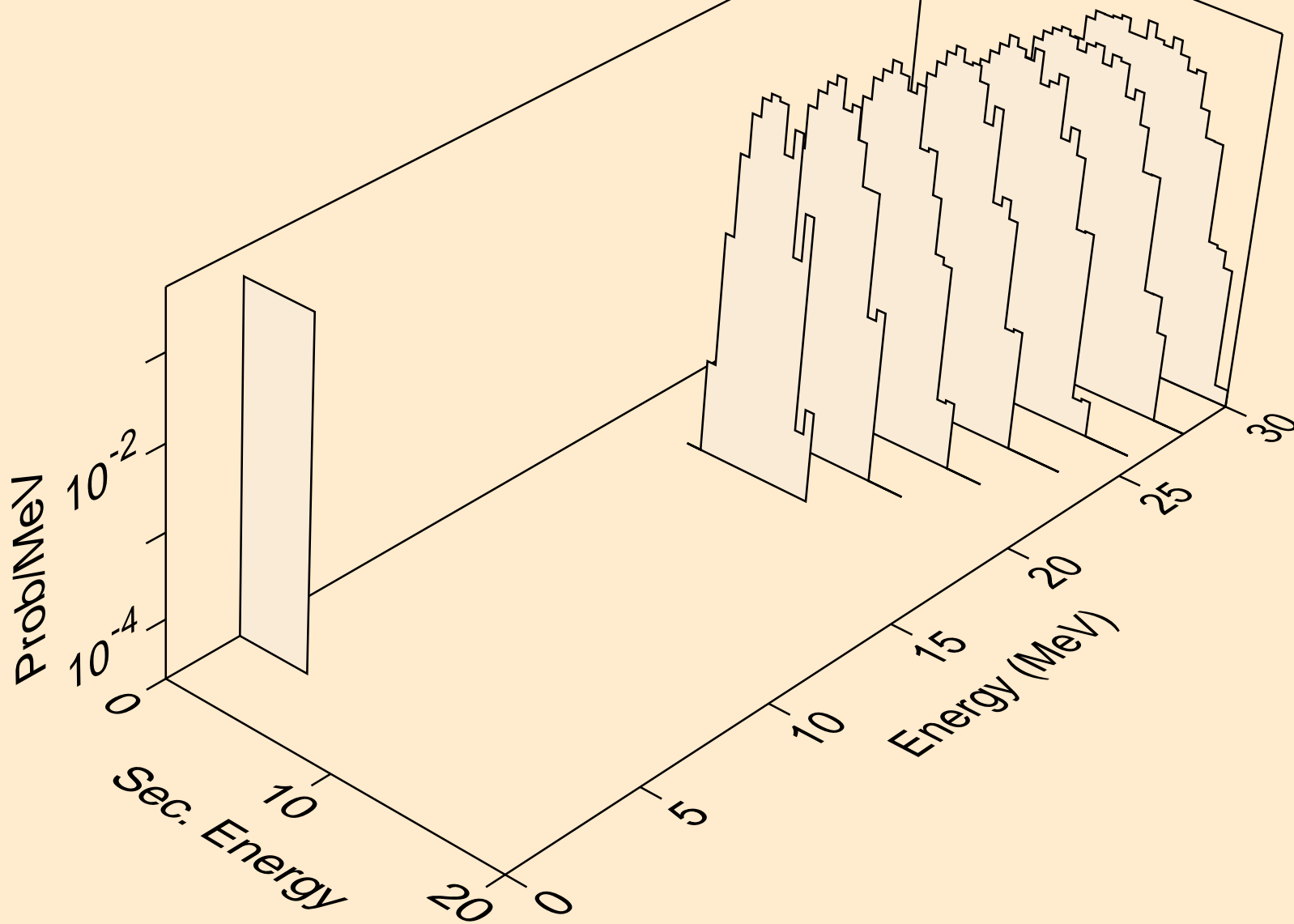

YB165 NEUTRON ACER TENDL-2019 LIBRARY; T=293.16K
alphas from (n,npa)

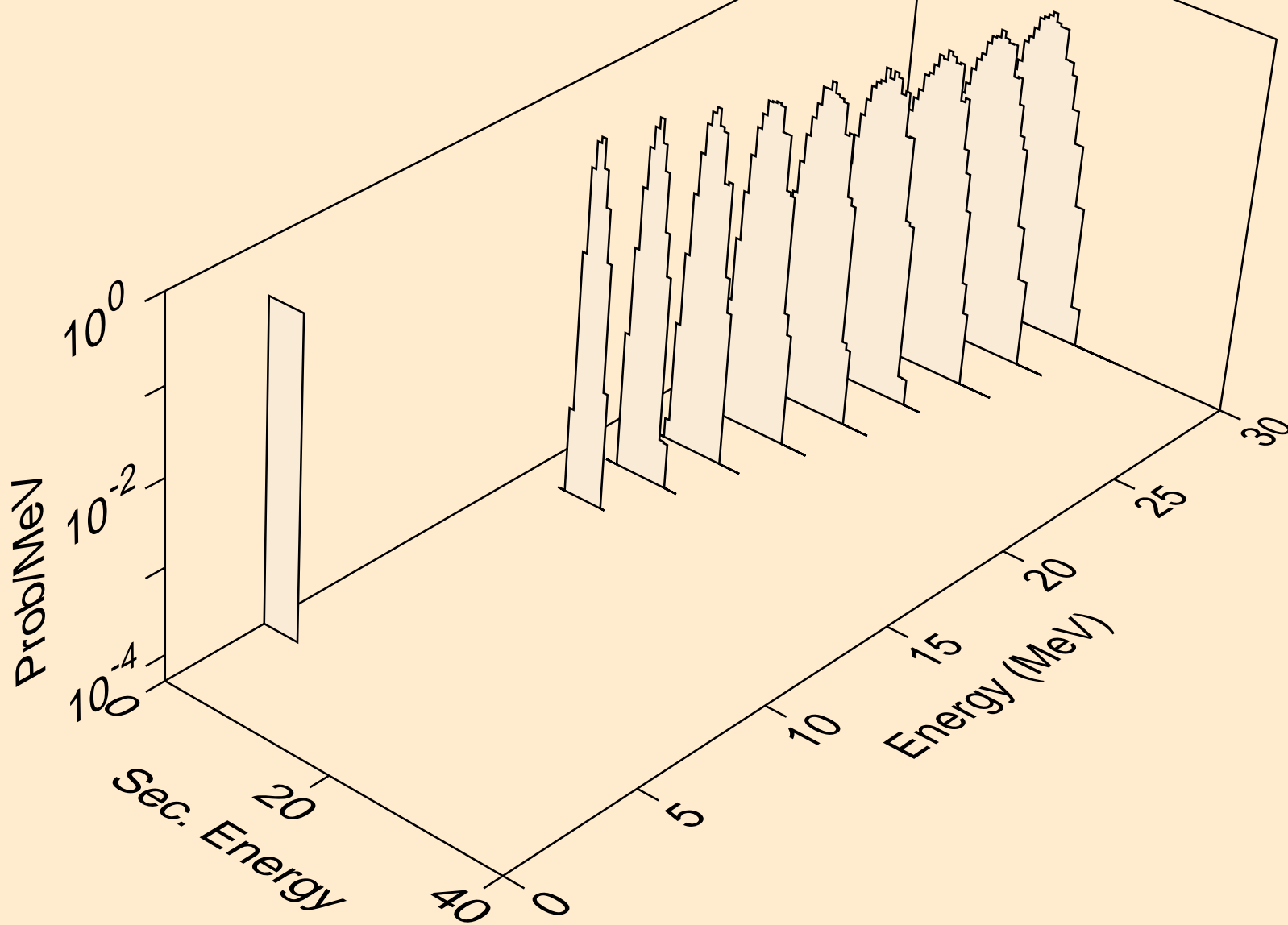

YB165 NEUTRON ACER TENDL-2019 LIBRARY; T=293.16K
alphas from (n,a)

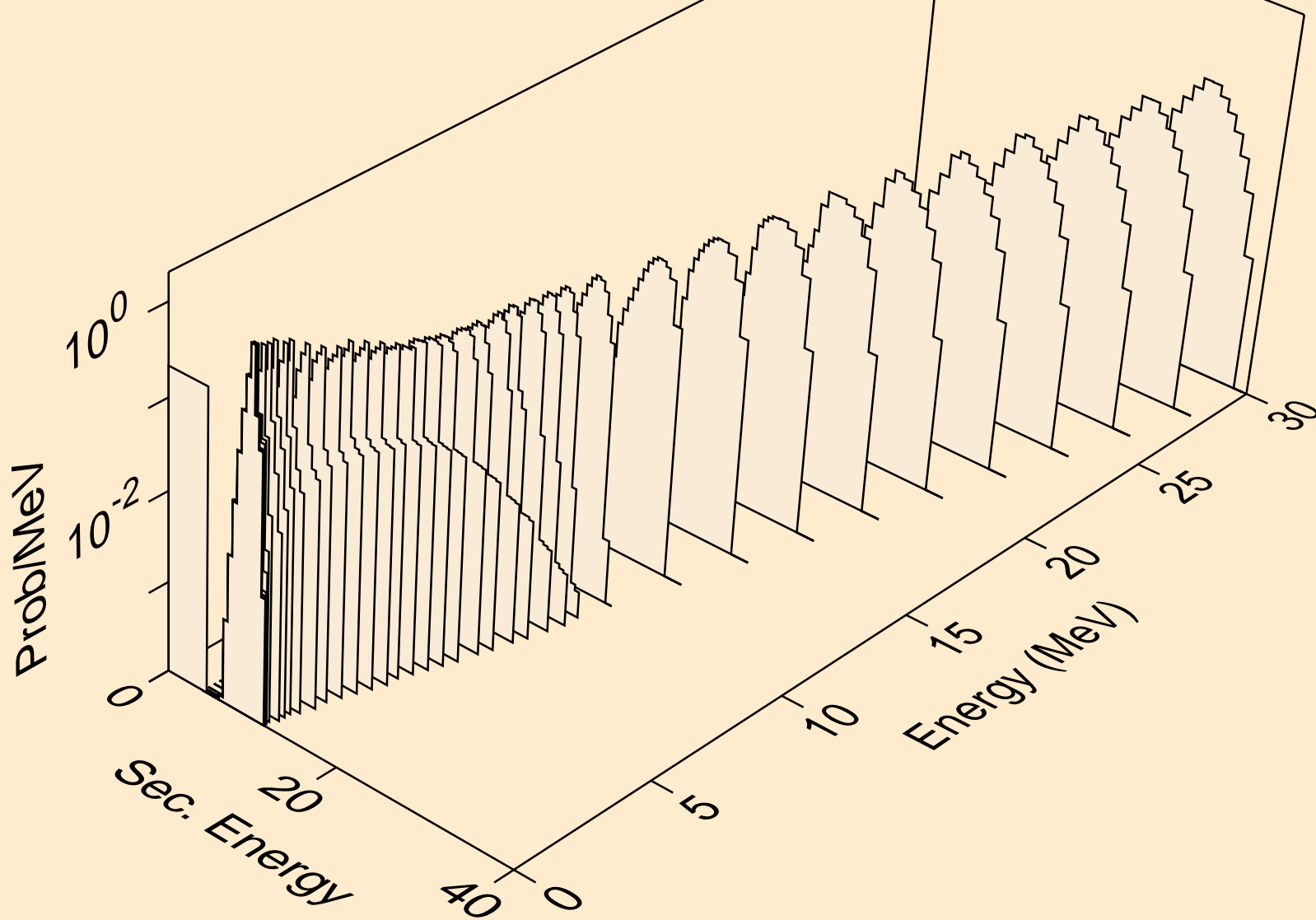

YB165 NEUTRON ACER TENDL-2019 LIBRARY; T=293.16K
alphas from (n,2a)

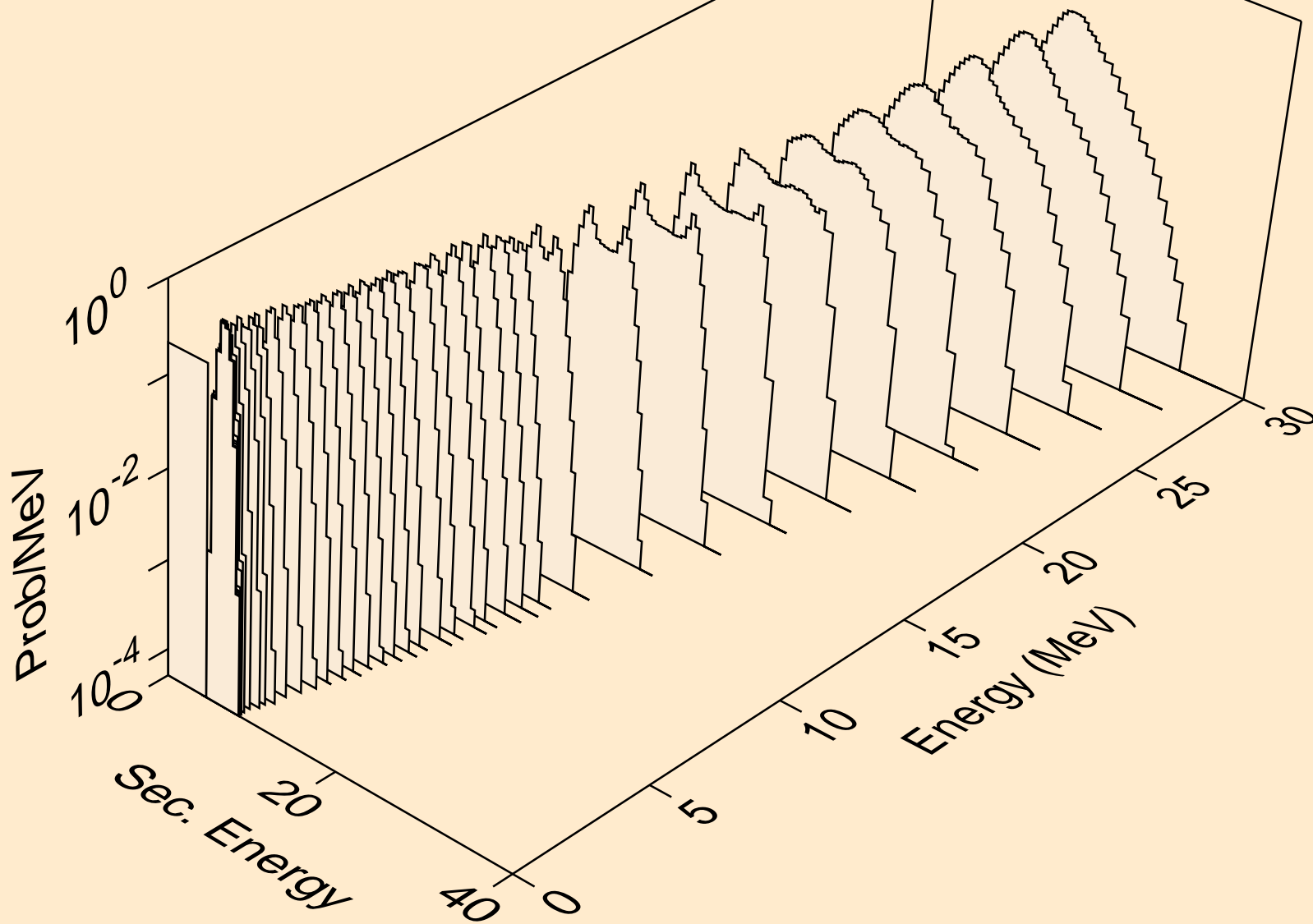

YB165 NEUTRON ACER TENDL-2019 LIBRARY; T=293.16K
alphas from (n,pa)

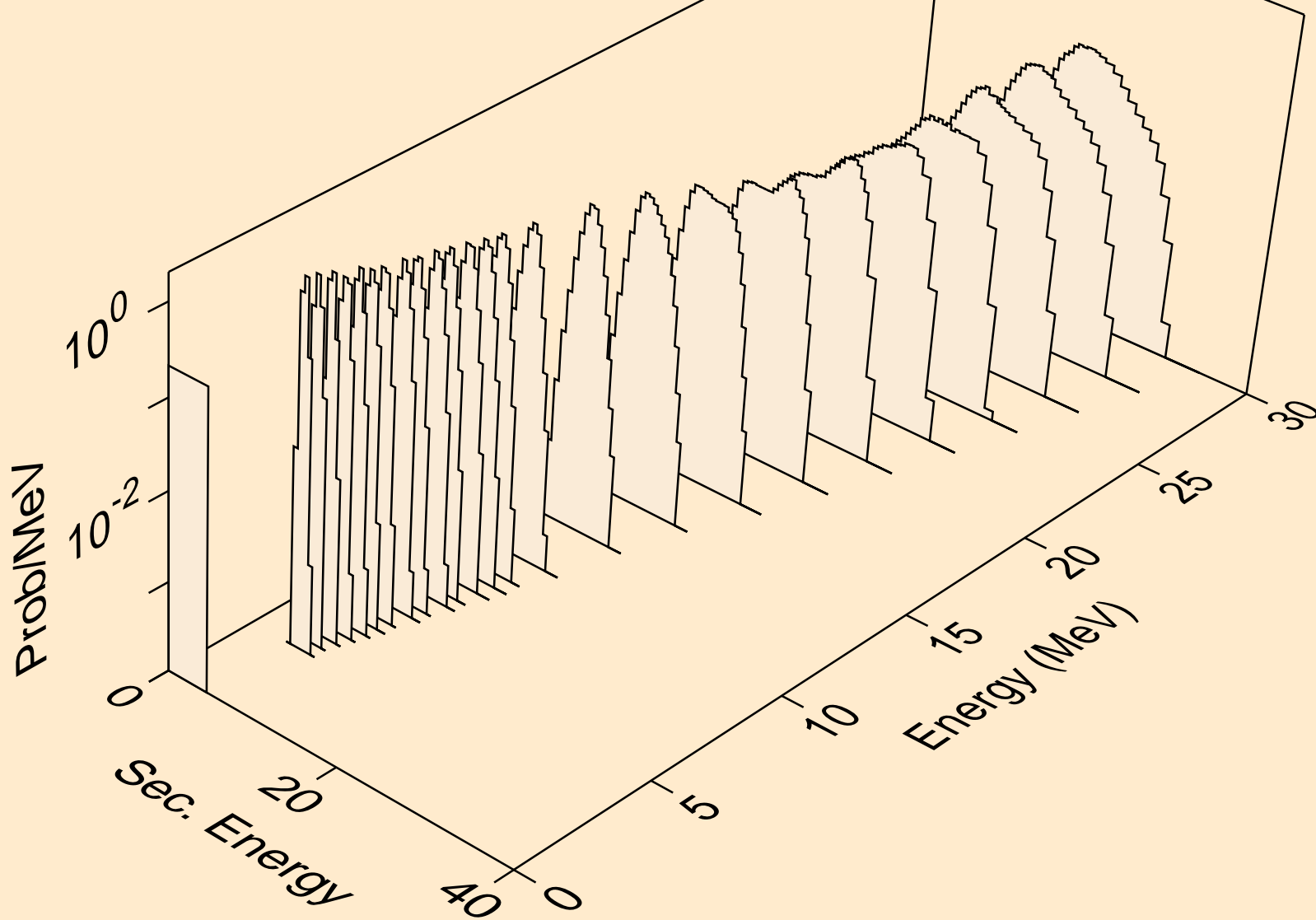

YB165 NEUTRON ACER TENDL-2019 LIBRARY; T=293.16K
alphas from (n,da)

