

YB168 NEUTRON ACER TENDL-2019 LIBRARY; T=293.16K
Principal cross sections

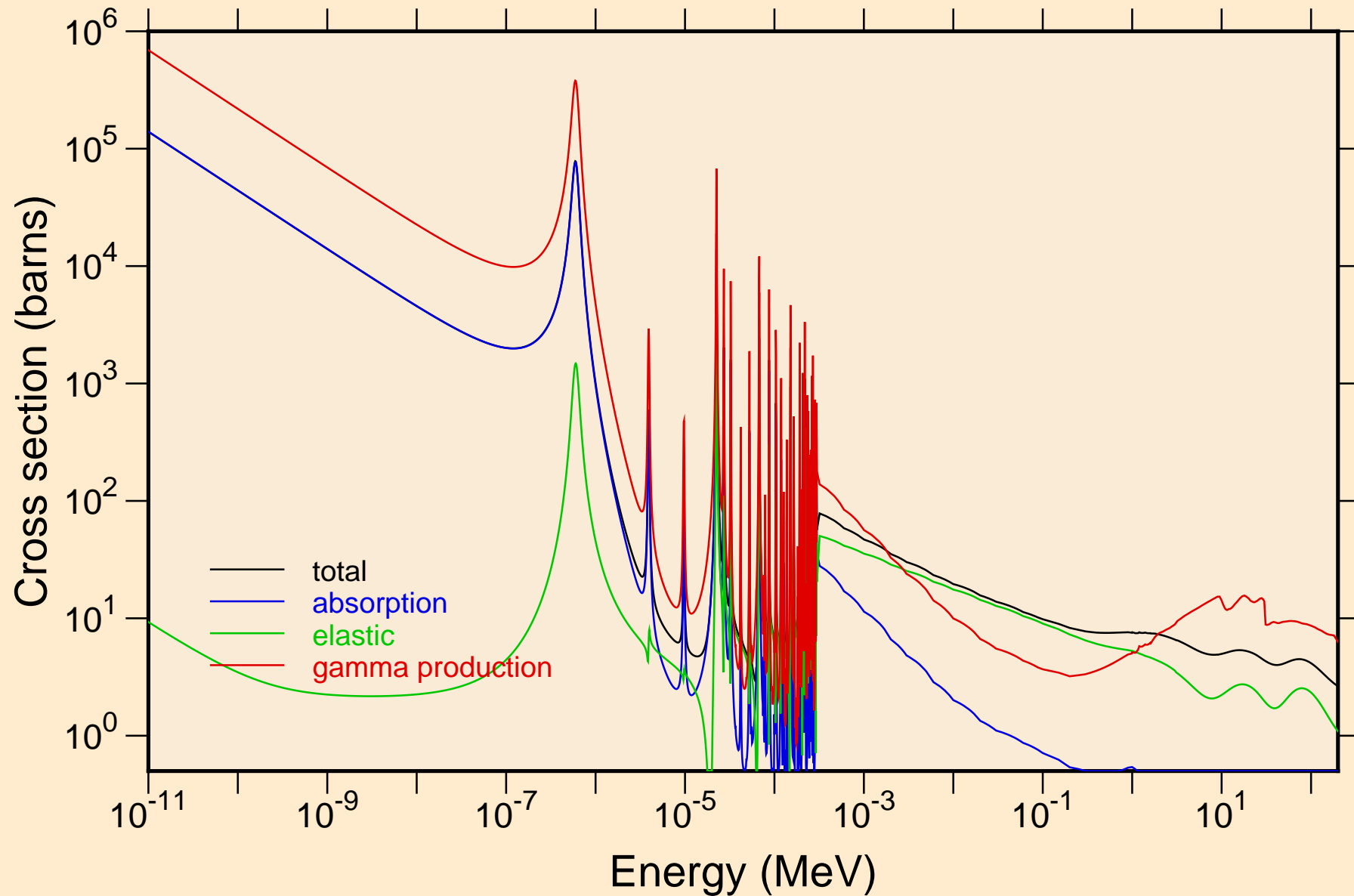

YB168 NEUTRON ACER TENDL-2019 LIBRARY; T=293.16K
resonance total cross section

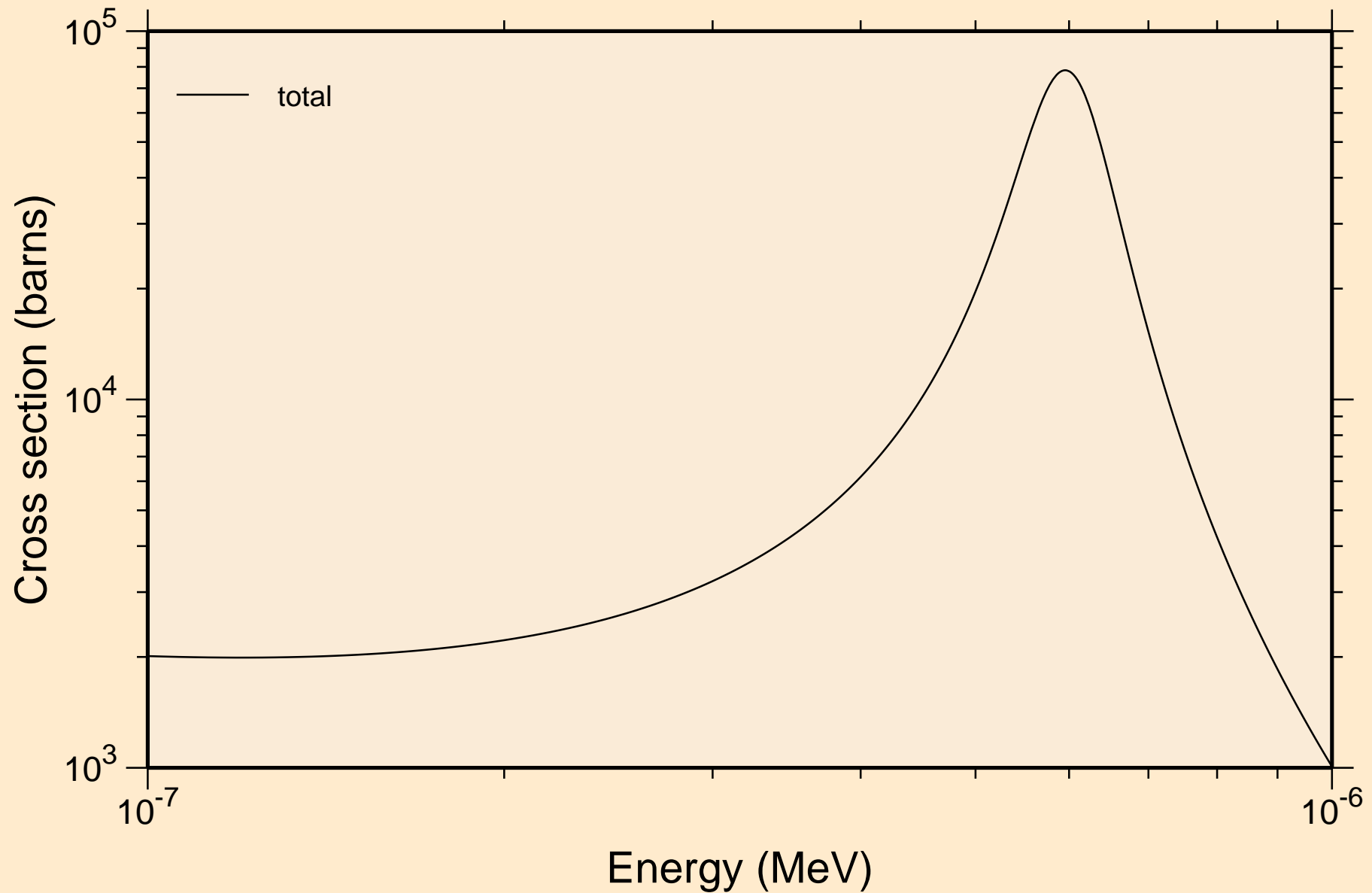

YB168 NEUTRON ACER TENDL-2019 LIBRARY; T=293.16K
resonance total cross section

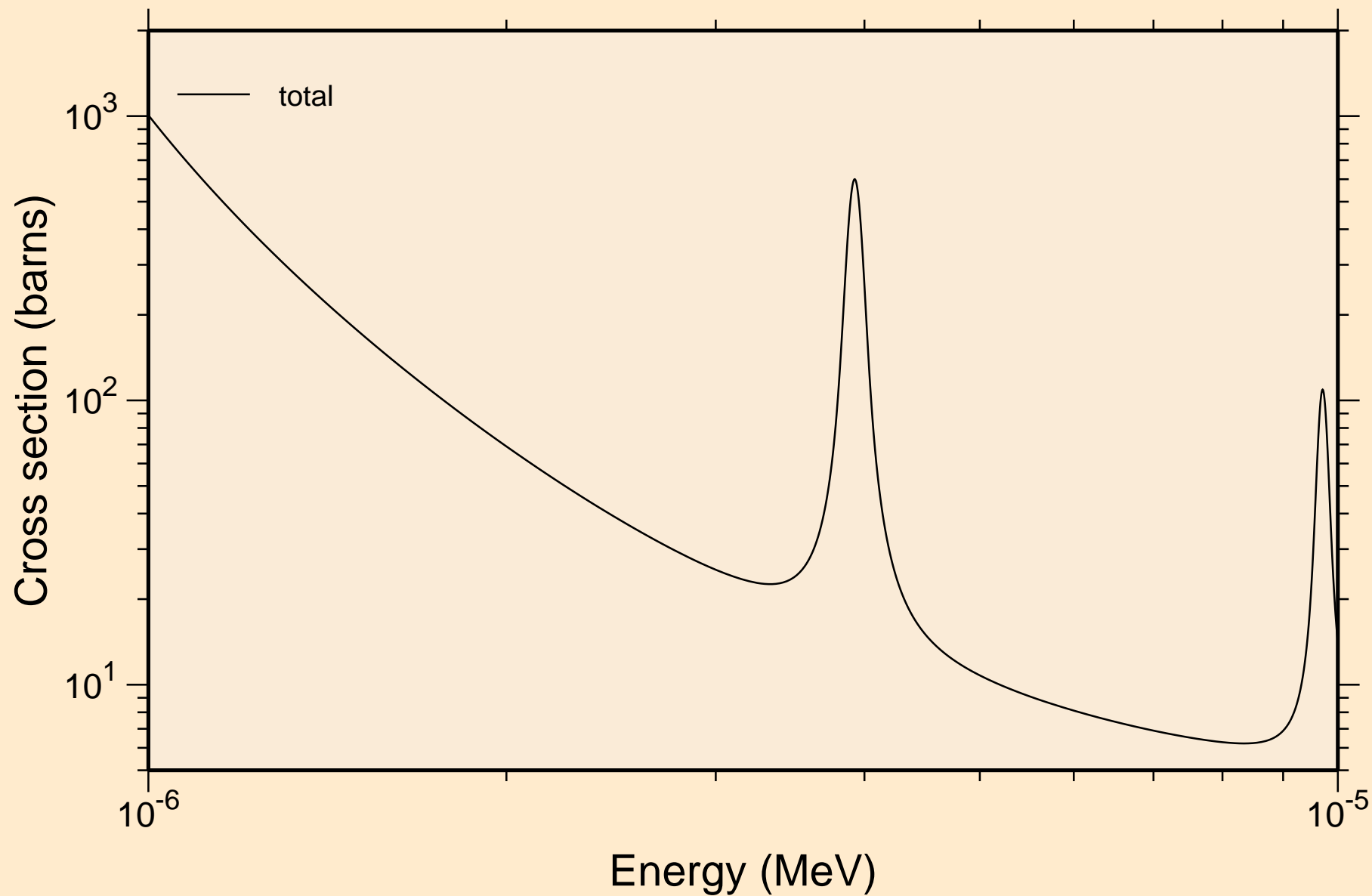

YB168 NEUTRON ACER TENDL-2019 LIBRARY; T=293.16K
resonance total cross section

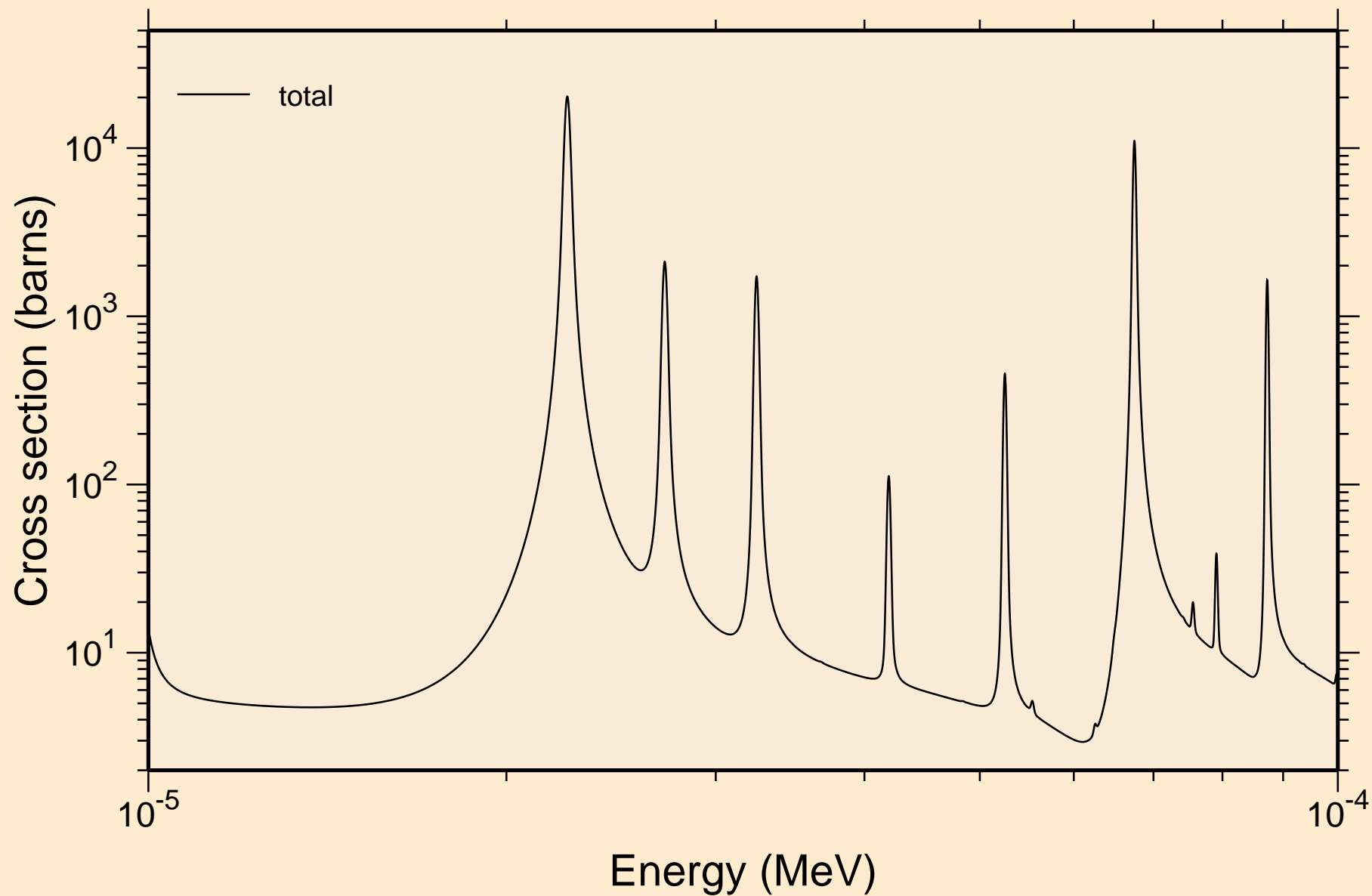

YB168 NEUTRON ACER TENDL-2019 LIBRARY; T=293.16K
resonance total cross section

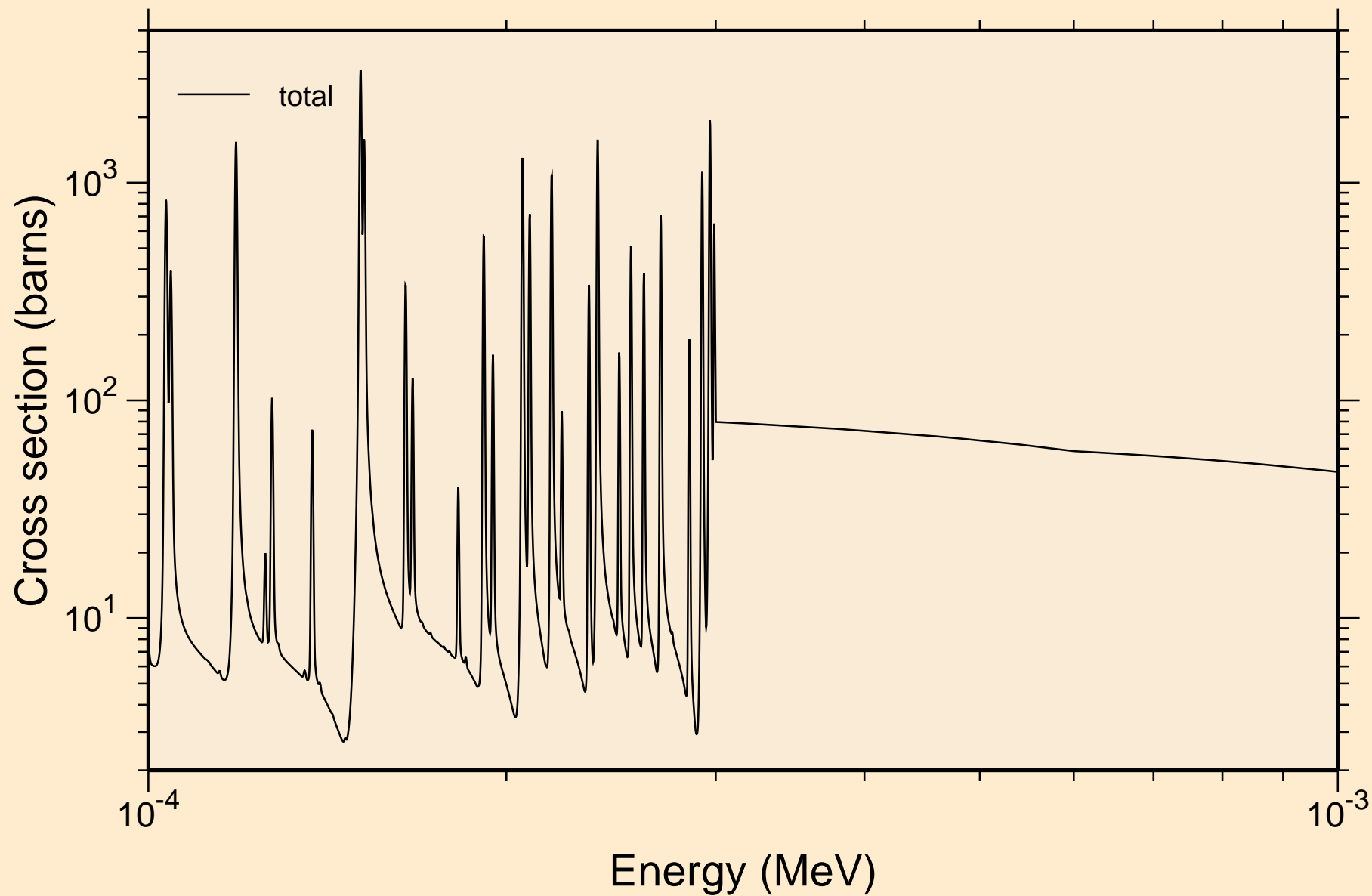

YB168 NEUTRON ACER TENDL-2019 LIBRARY; T=293.16K
resonance total cross section

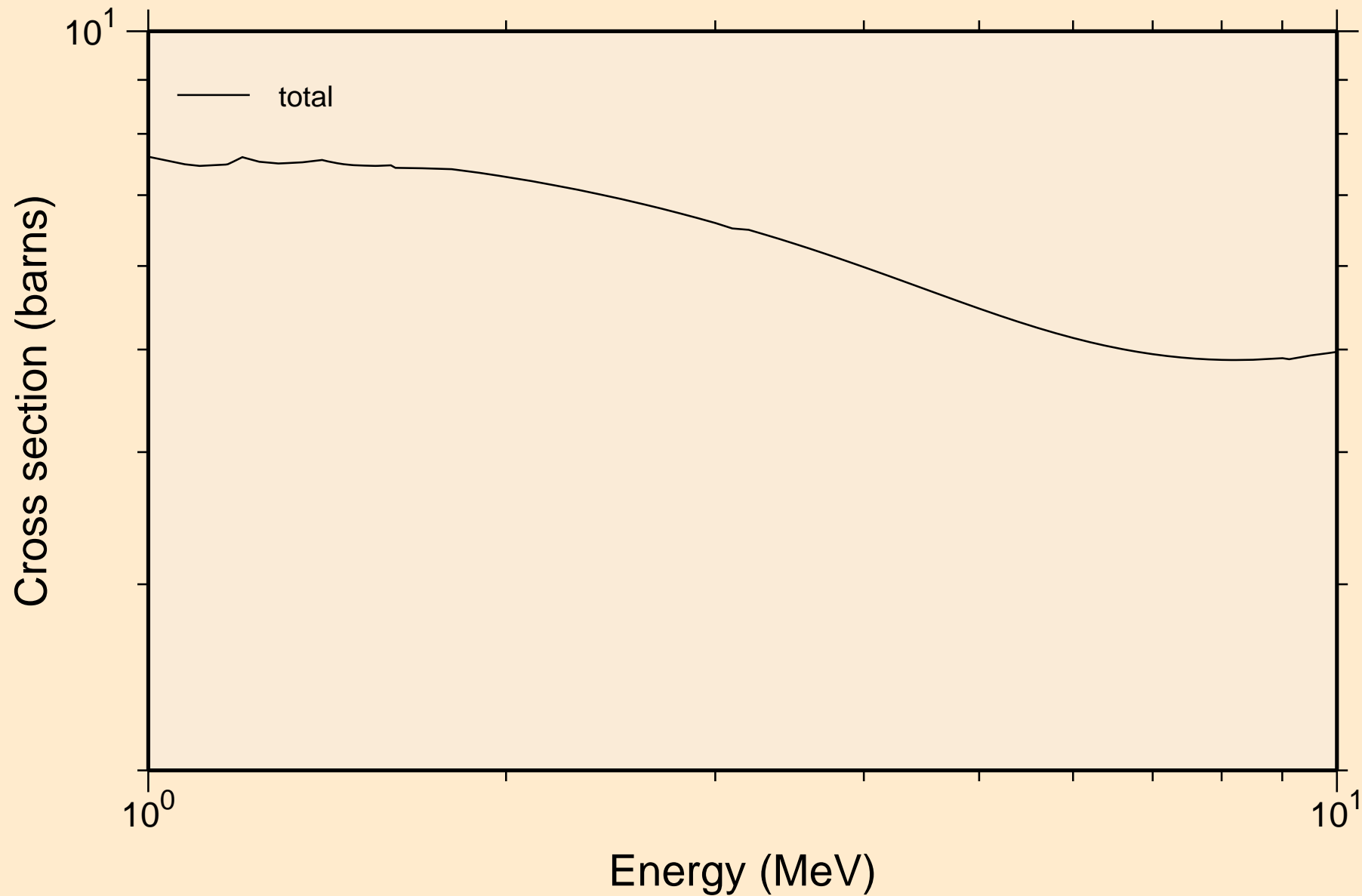

YB168 NEUTRON ACER TENDL-2019 LIBRARY; T=293.16K
resonance absorption cross sections

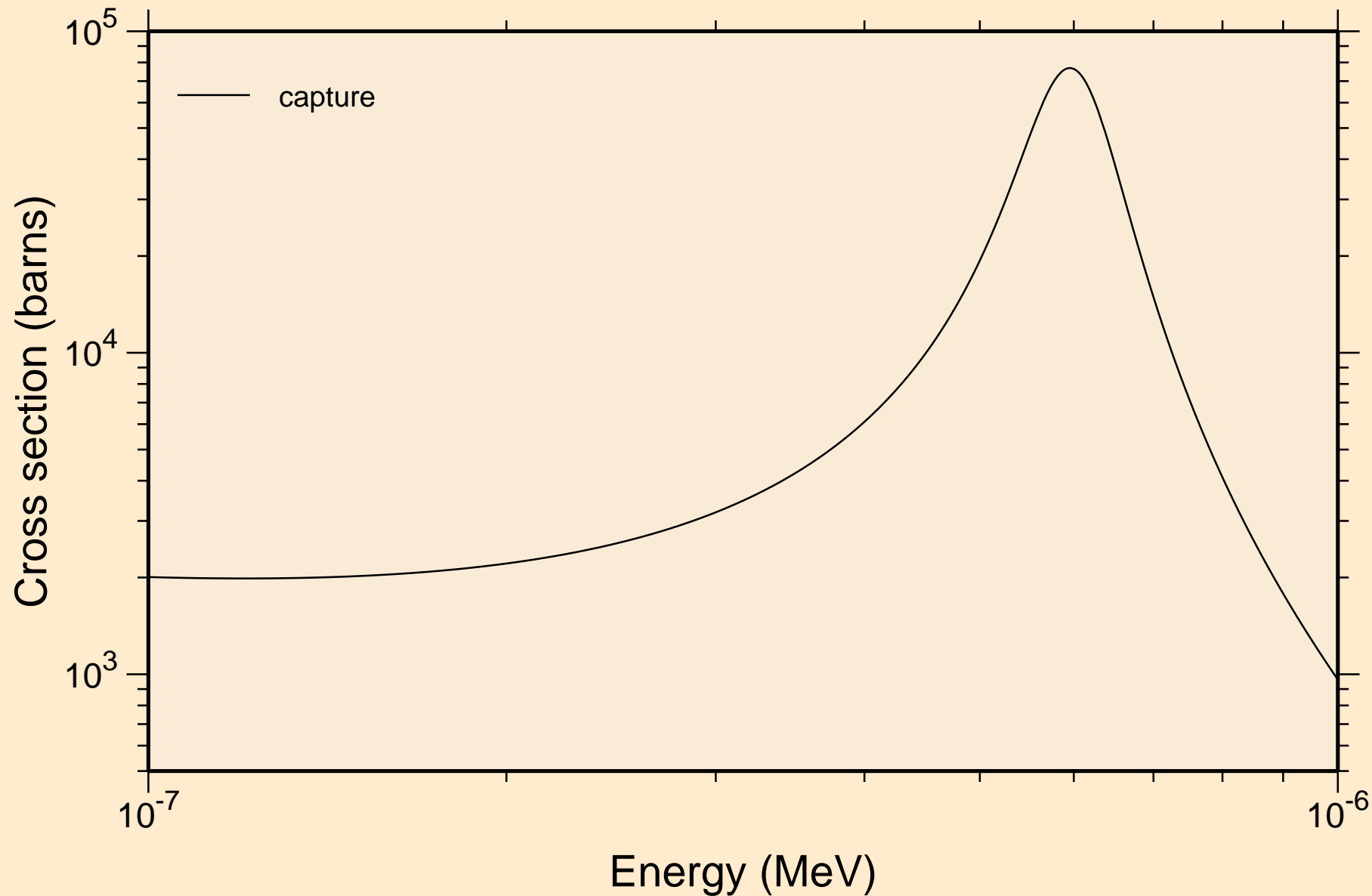

YB168 NEUTRON ACER TENDL-2019 LIBRARY; T=293.16K
resonance absorption cross sections

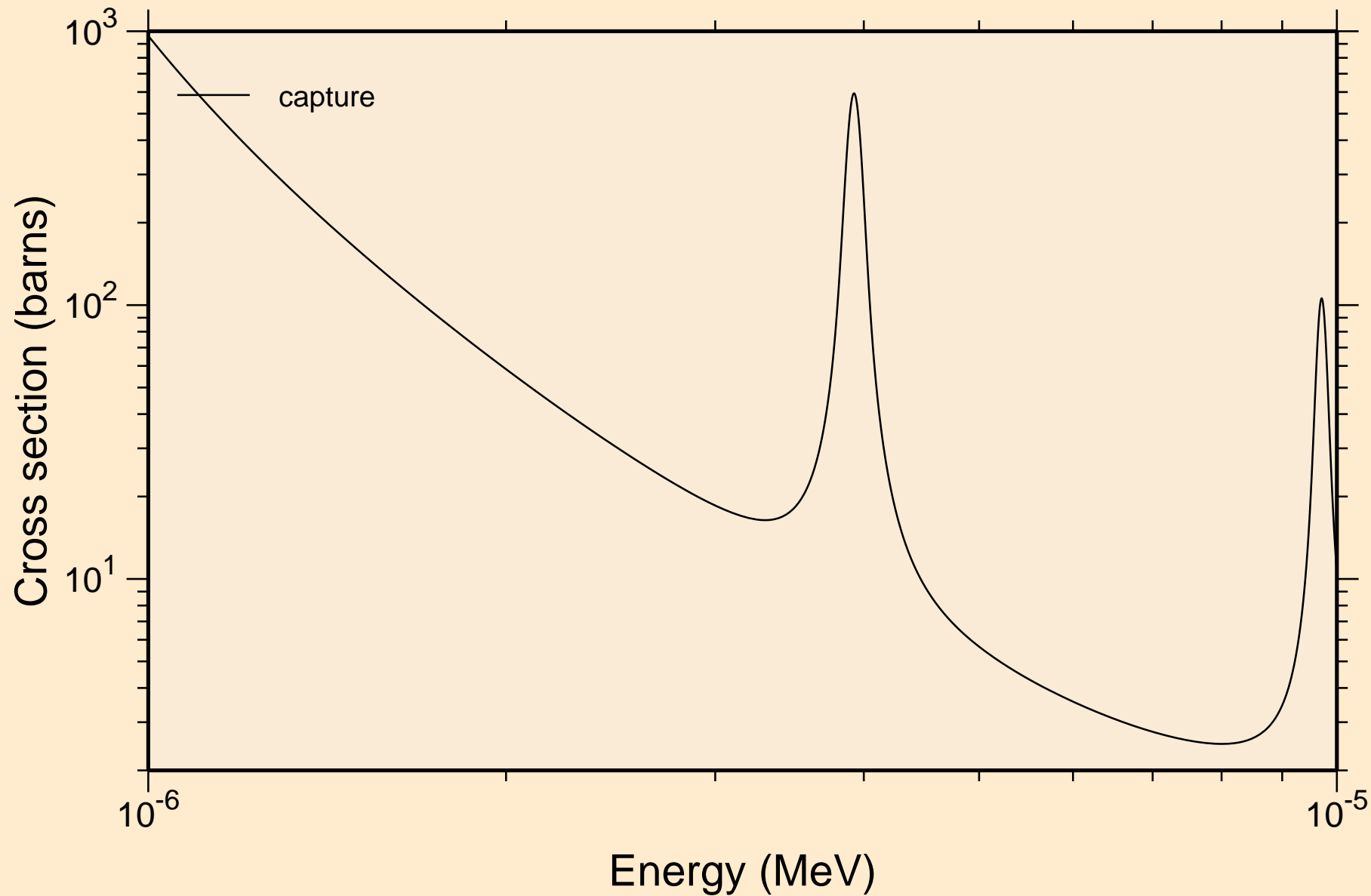

YB168 NEUTRON ACER TENDL-2019 LIBRARY; T=293.16K
resonance absorption cross sections

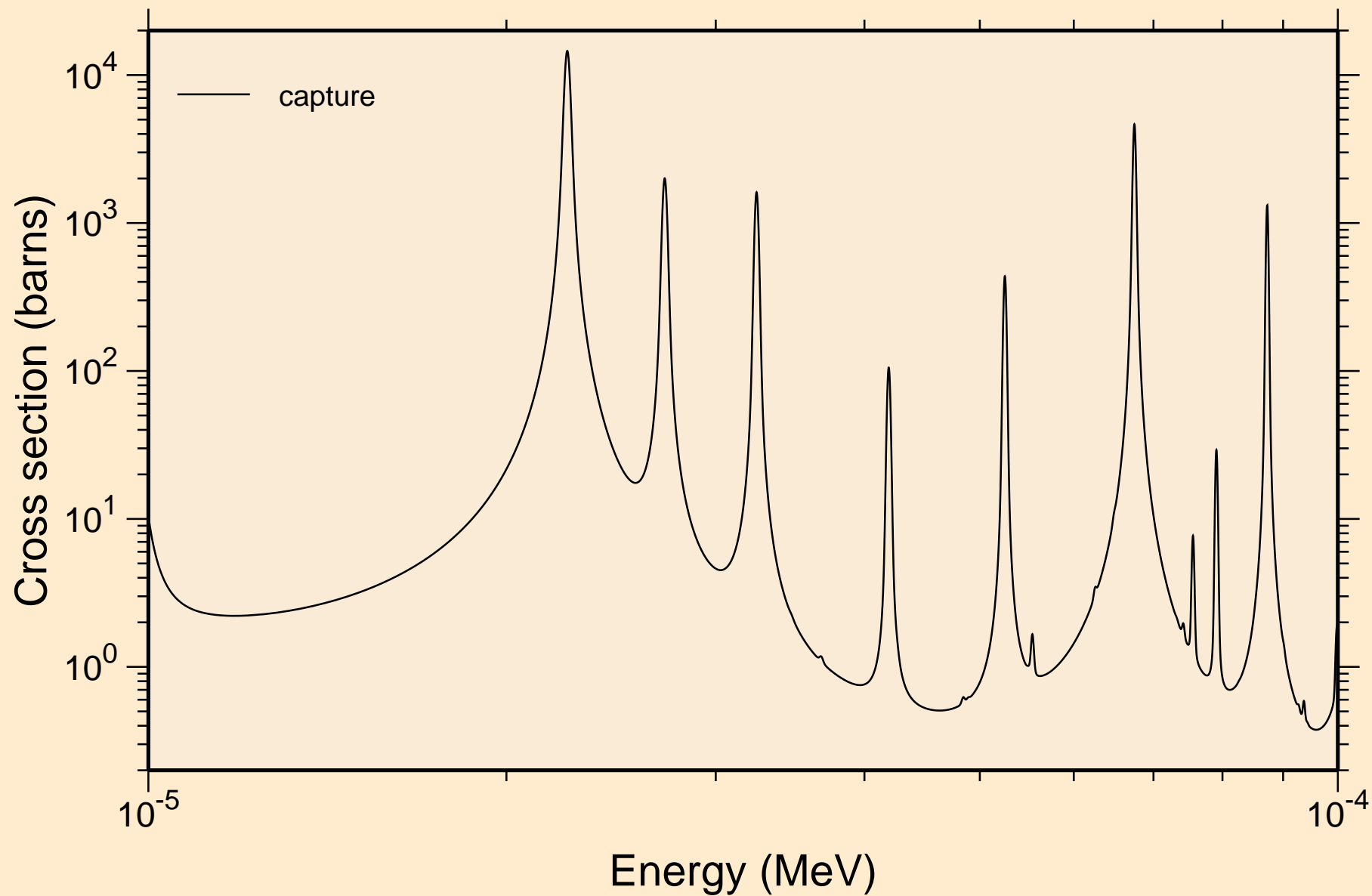

YB168 NEUTRON ACER TENDL-2019 LIBRARY; T=293.16K
resonance absorption cross sections

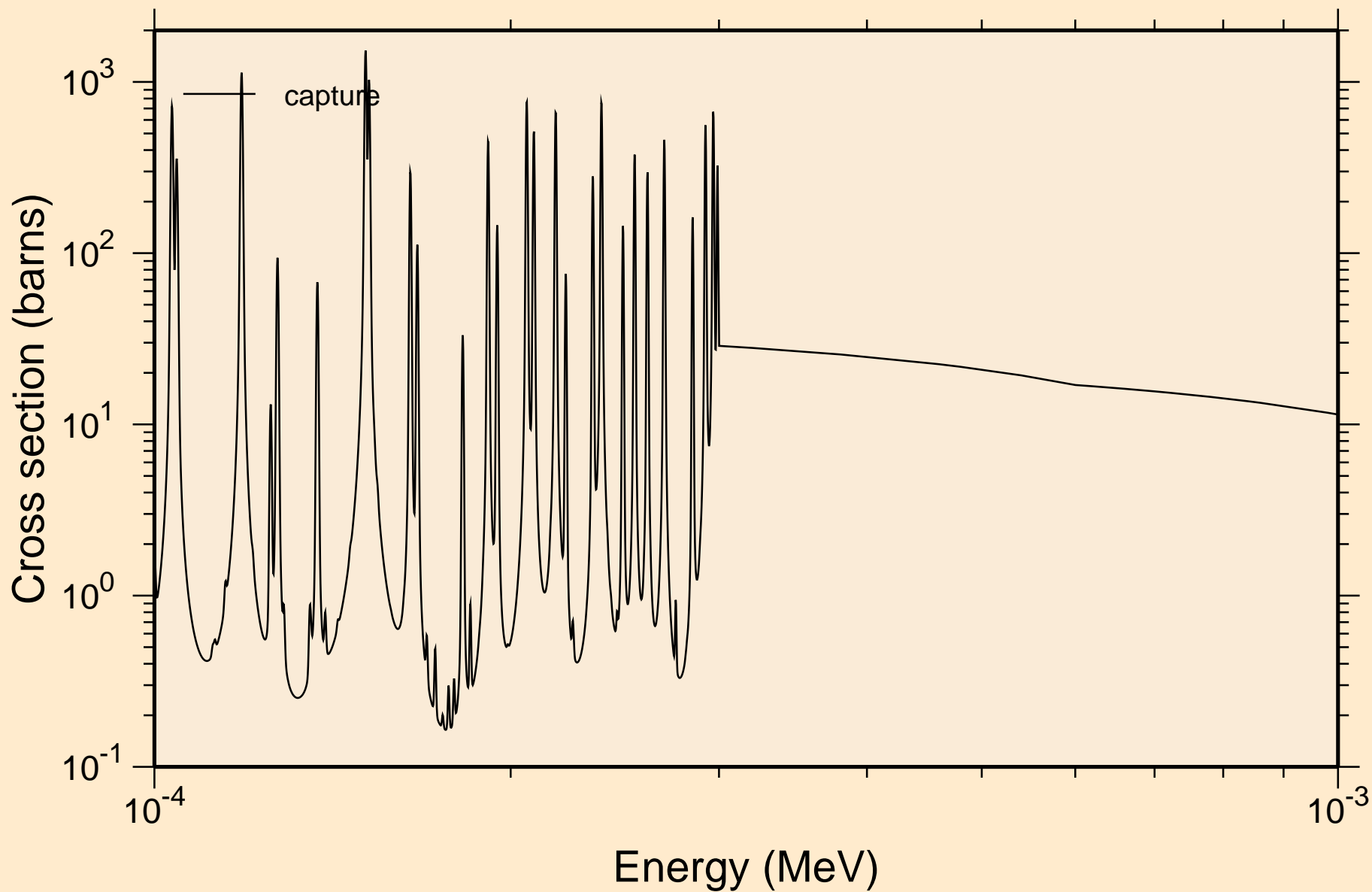

YB168 NEUTRON ACER TENDL-2019 LIBRARY; T=293.16K
resonance absorption cross sections

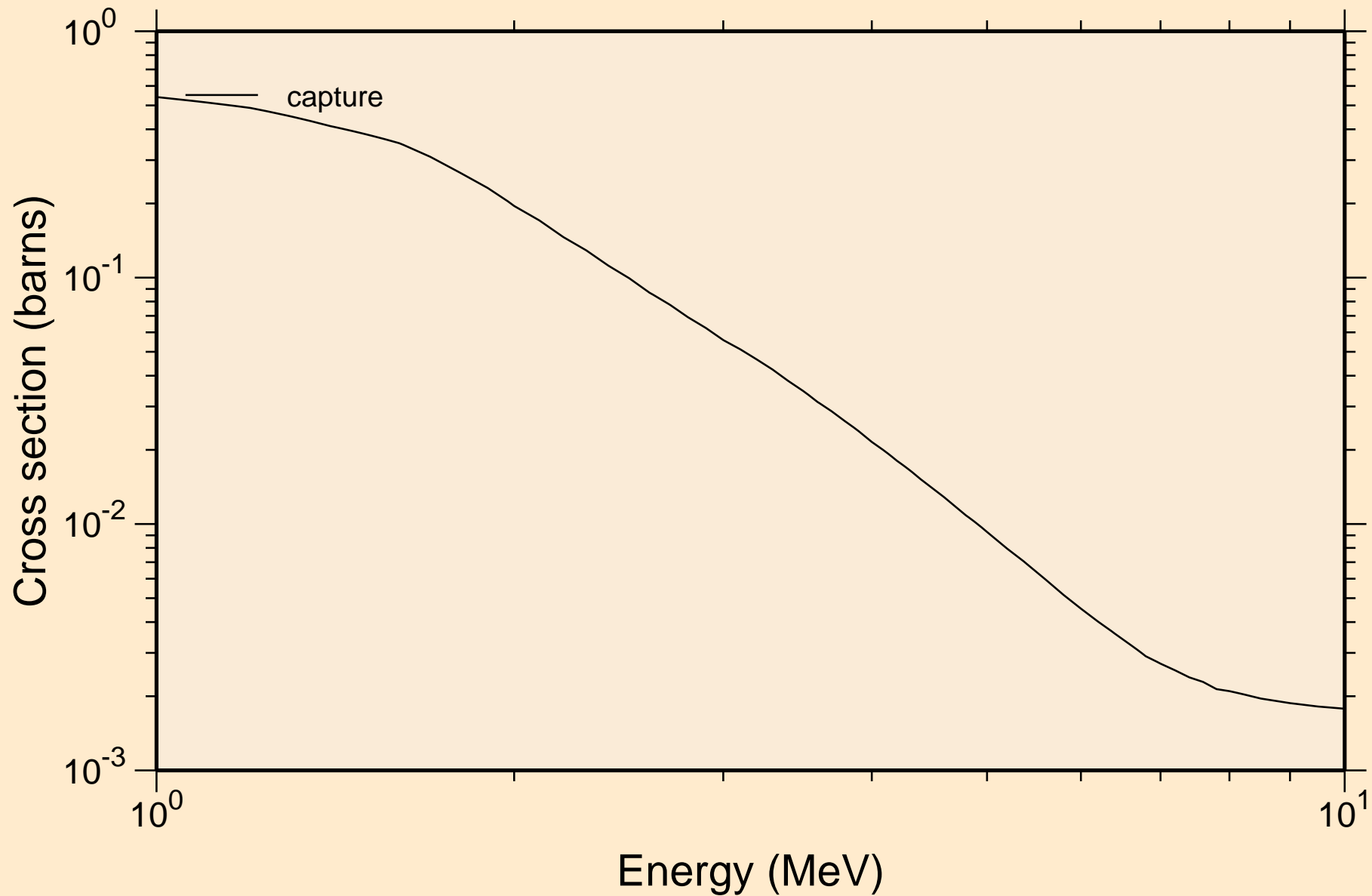

YB168 NEUTRON ACER TENDL-2019 LIBRARY; T=293.16K
Heating

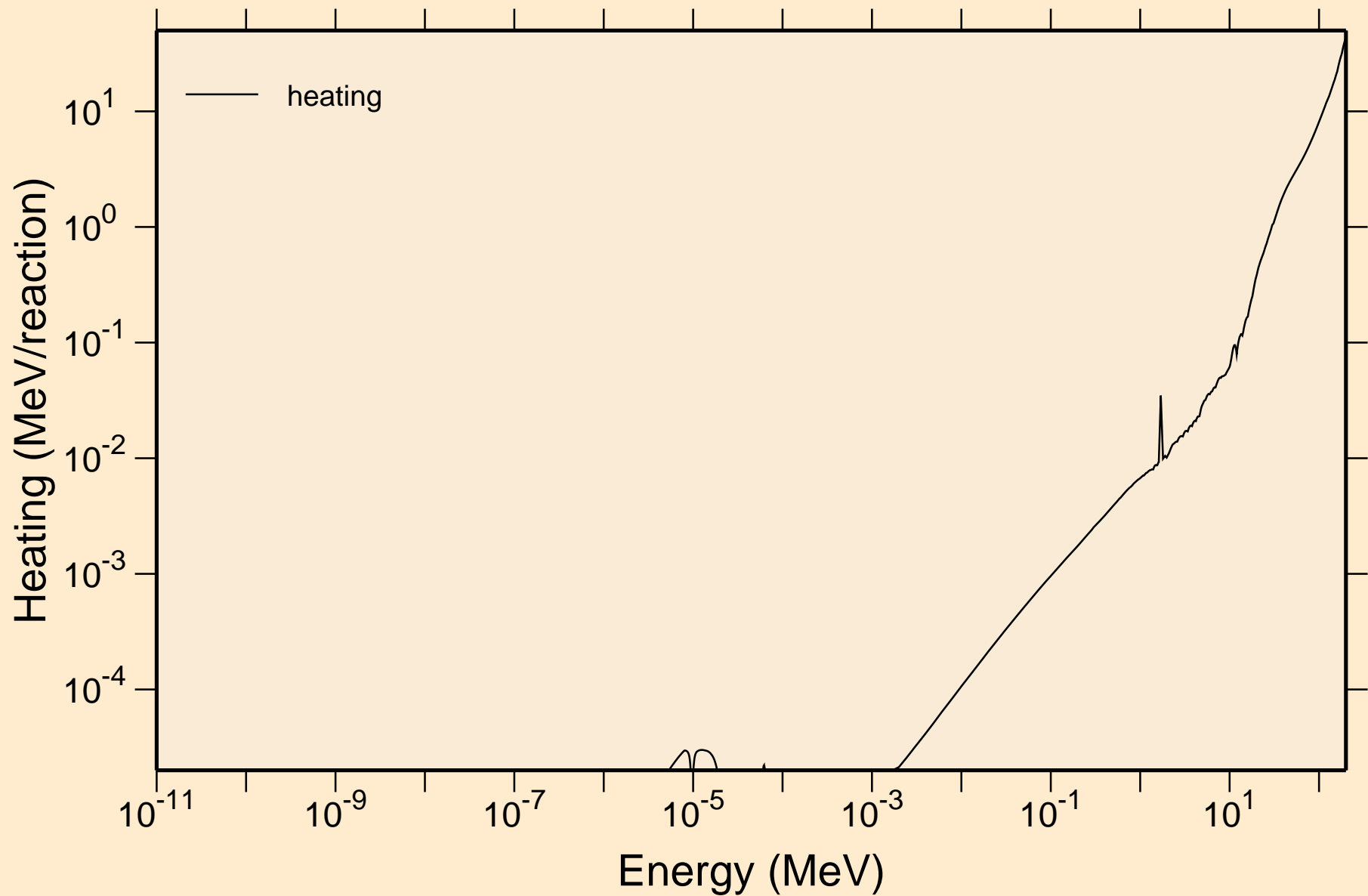

YB168 NEUTRON ACER TENDL-2019 LIBRARY; T=293.16K
Damage

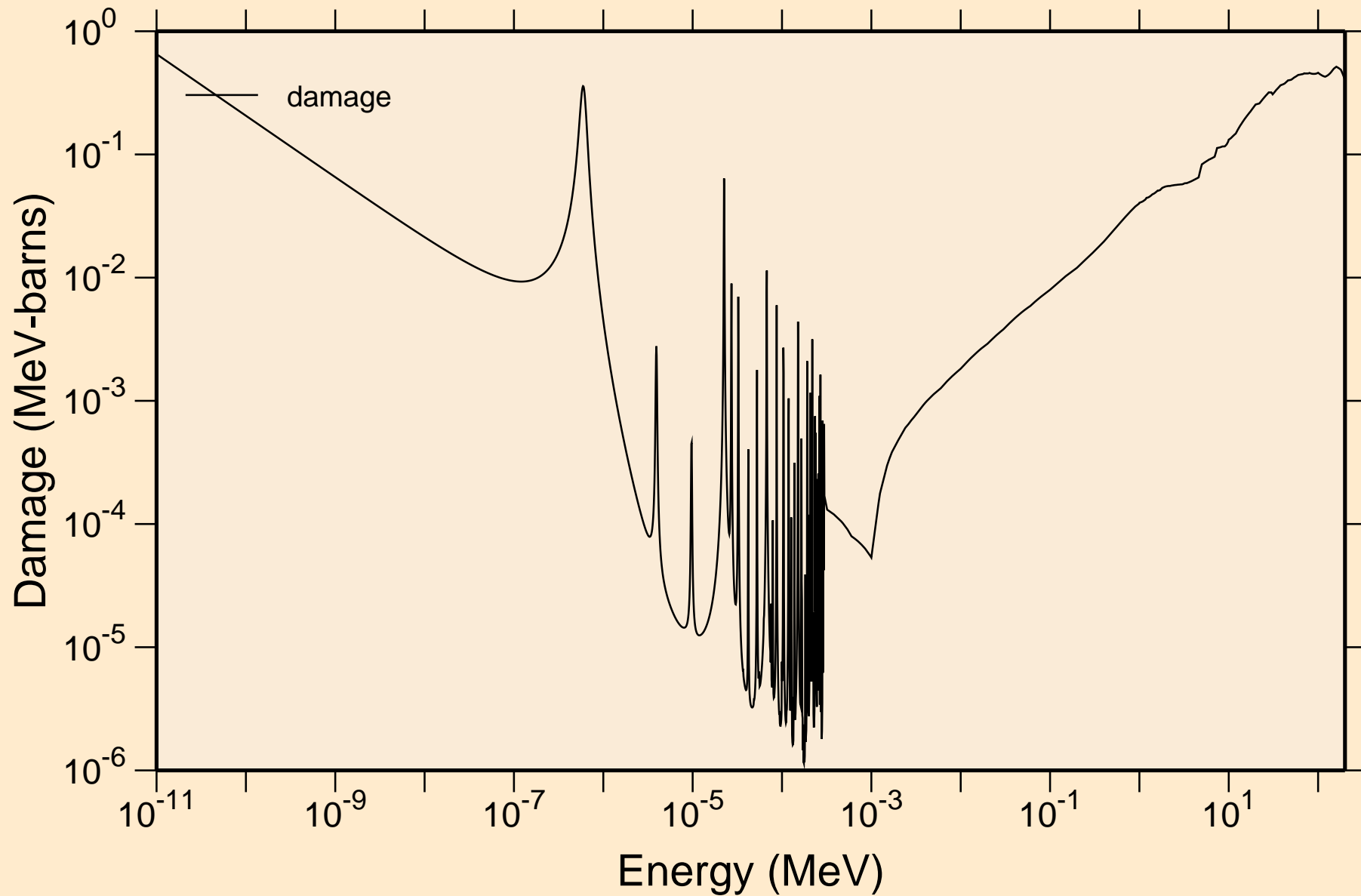

YB168 NEUTRON ACER TENDL-2019 LIBRARY; T=293.16K
Non-threshold reactions

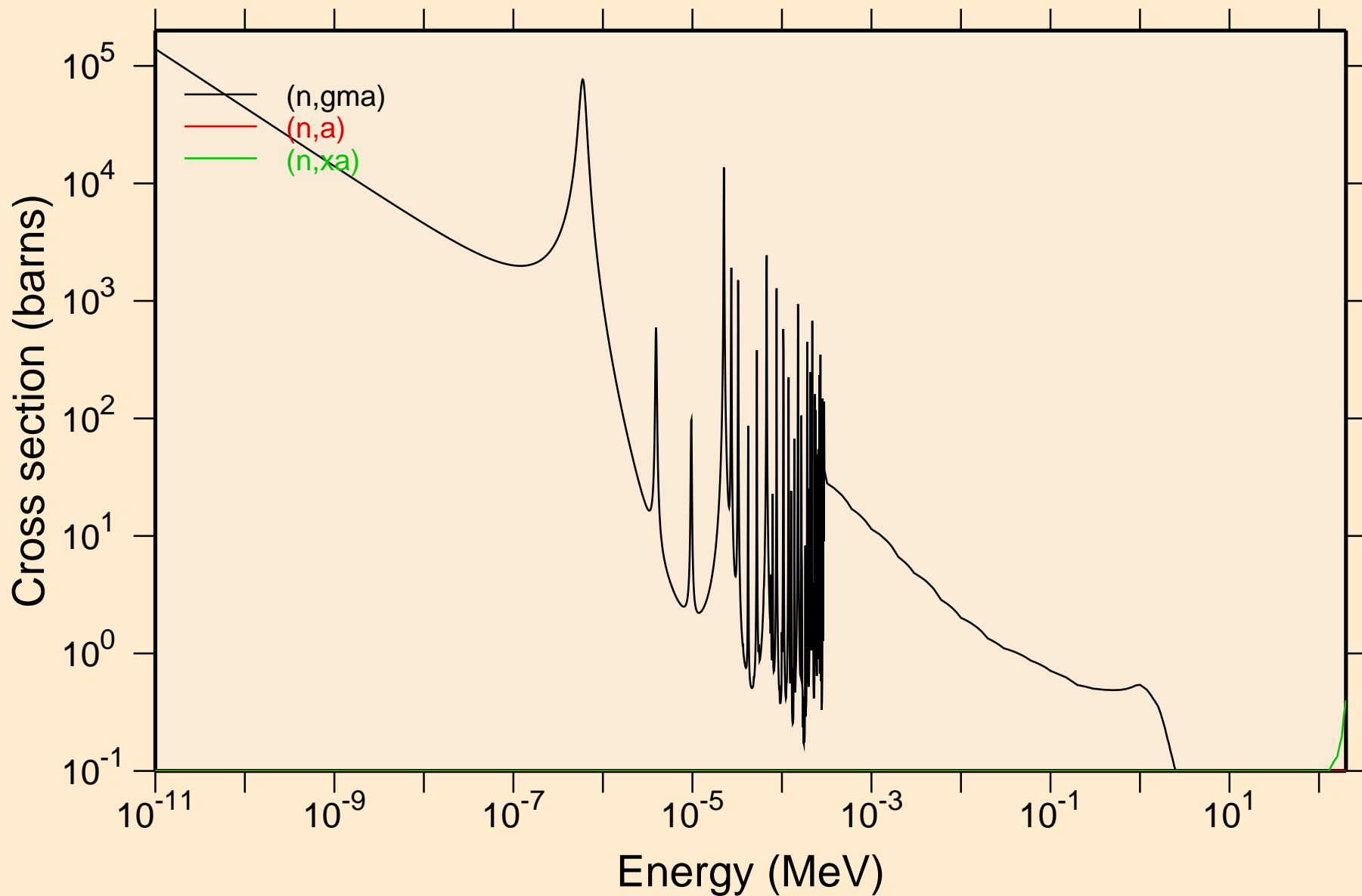

YB168 NEUTRON ACER TENDL-2019 LIBRARY; T=293.16K
Principal cross sections

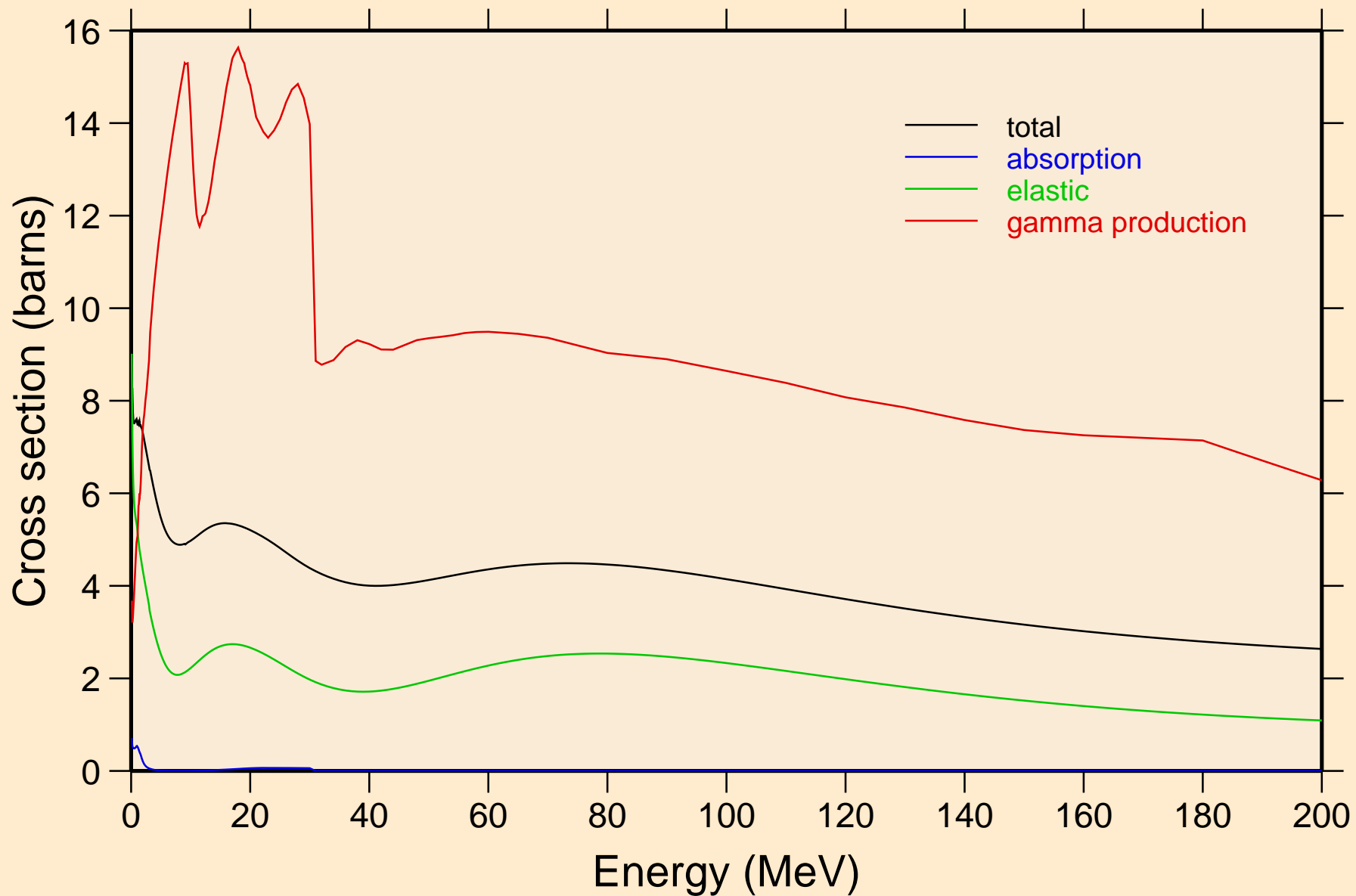

YB168 NEUTRON ACER TENDL-2019 LIBRARY; T=293.16K
Heating

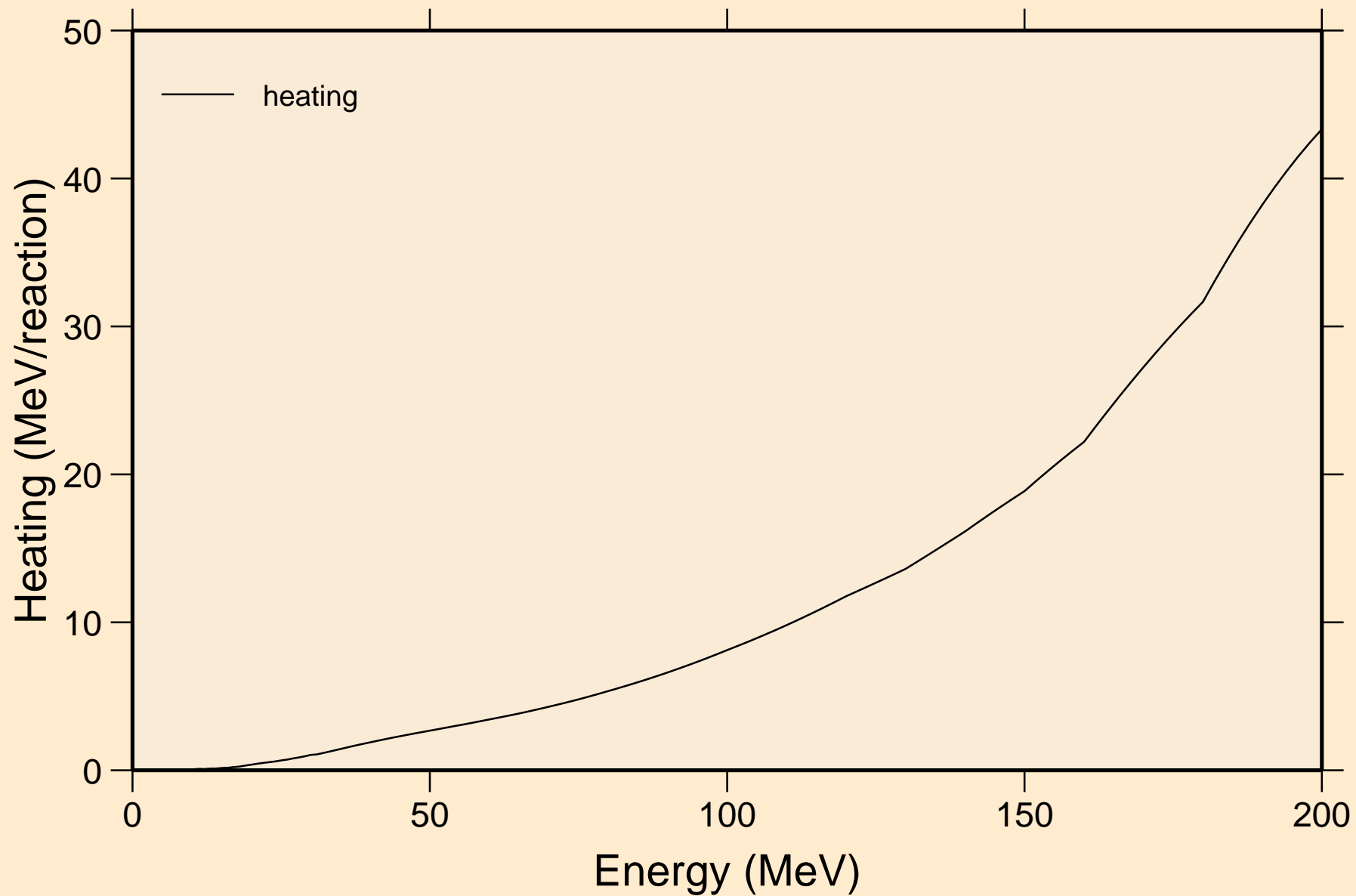

YB168 NEUTRON ACER TENDL-2019 LIBRARY; T=293.16K
Damage

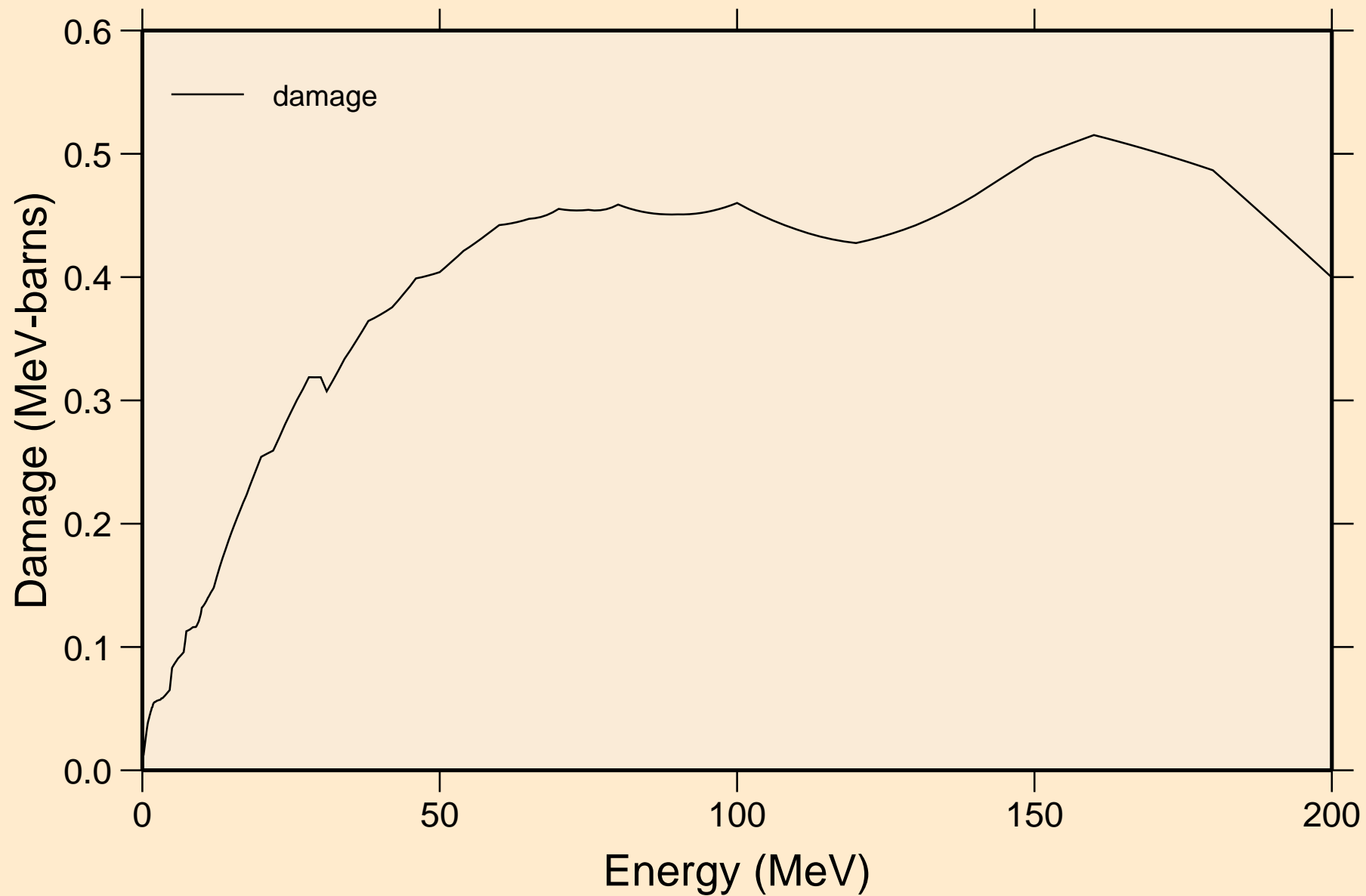

YB168 NEUTRON ACER TENDL-2019 LIBRARY; T=293.16K
Non-threshold reactions

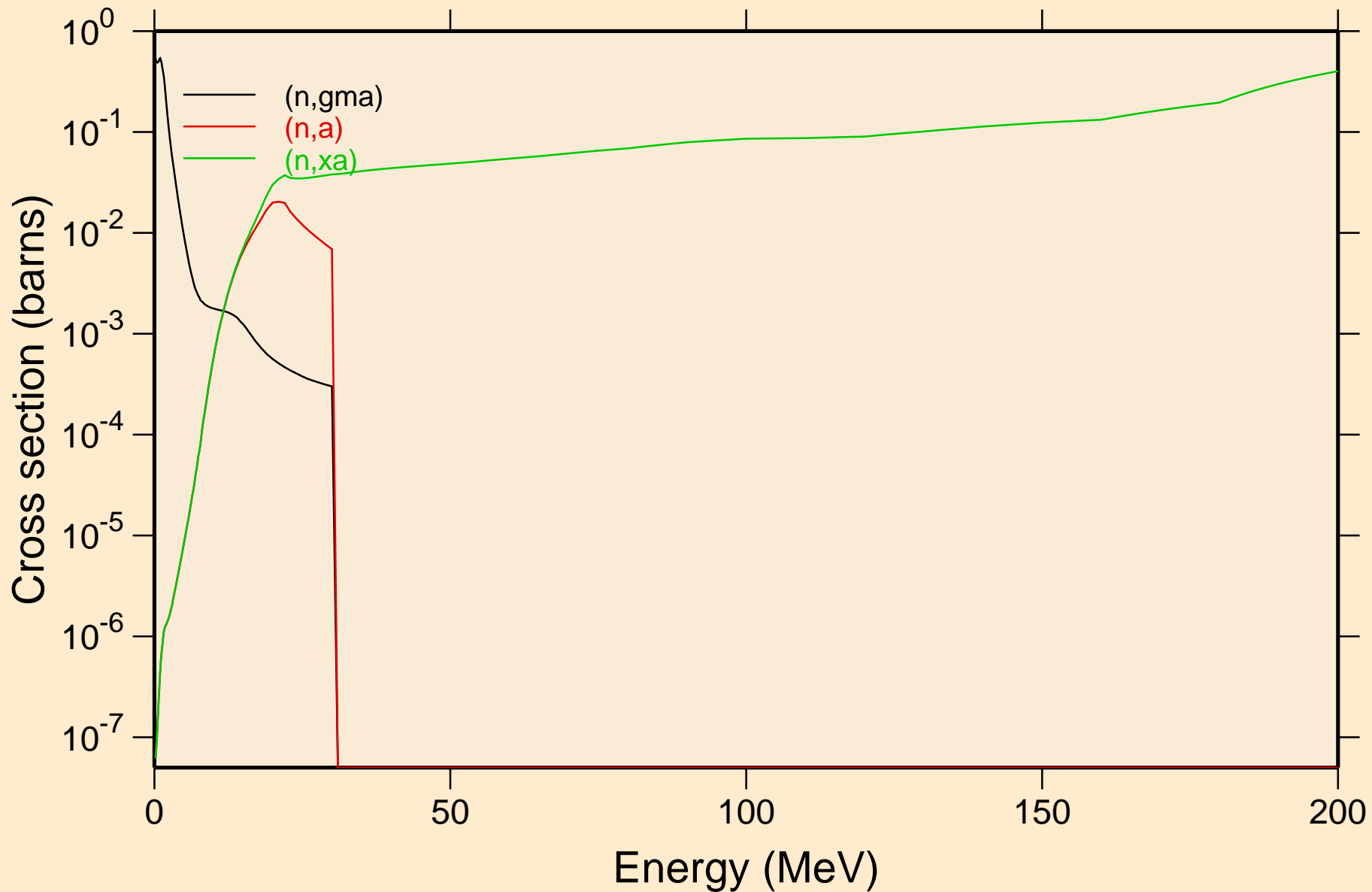

YB168 NEUTRON ACER TENDL-2019 LIBRARY; T=293.16K
Inelastic levels

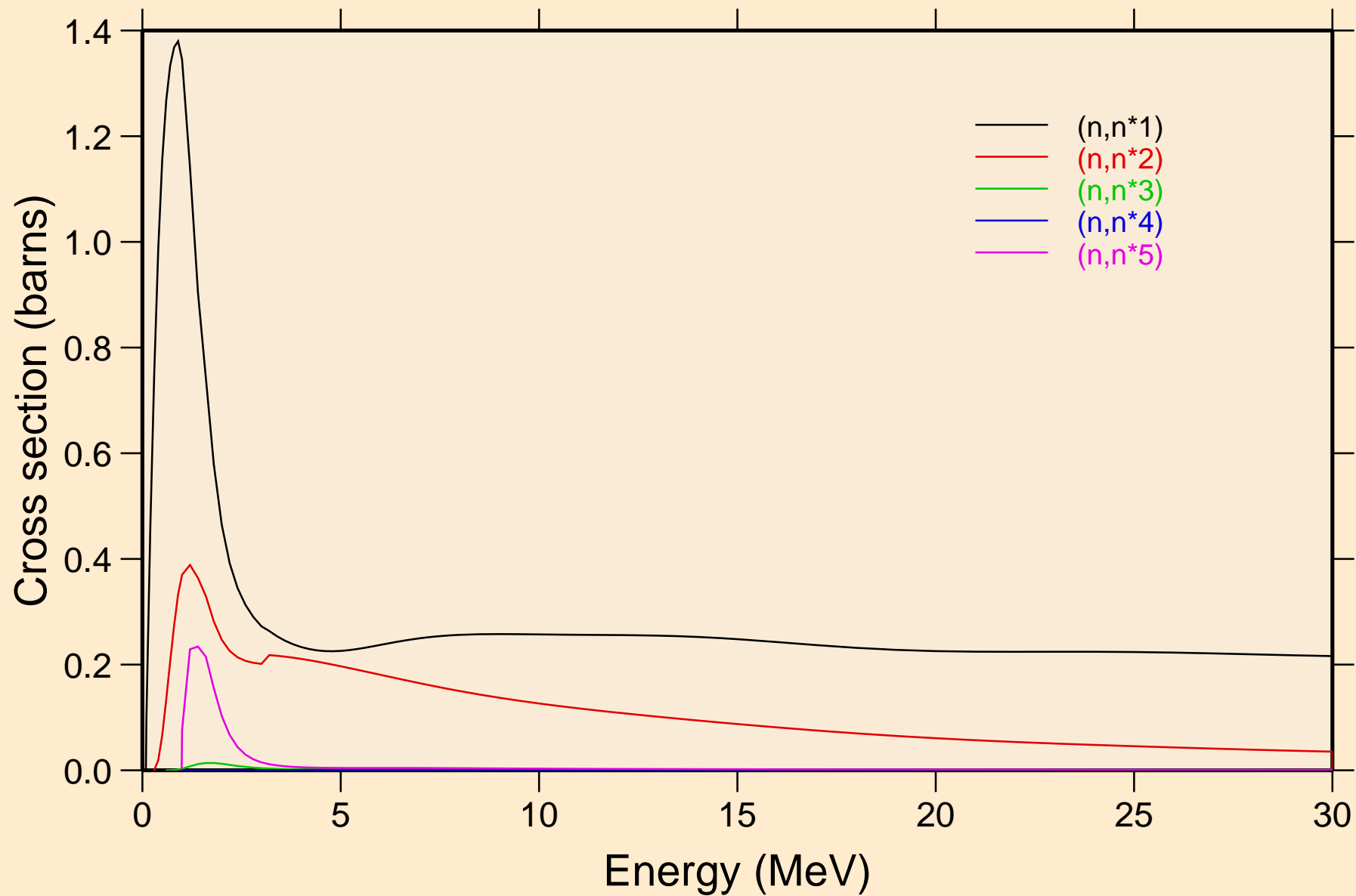

YB168 NEUTRON ACER TENDL-2019 LIBRARY; T=293.16K
Inelastic levels

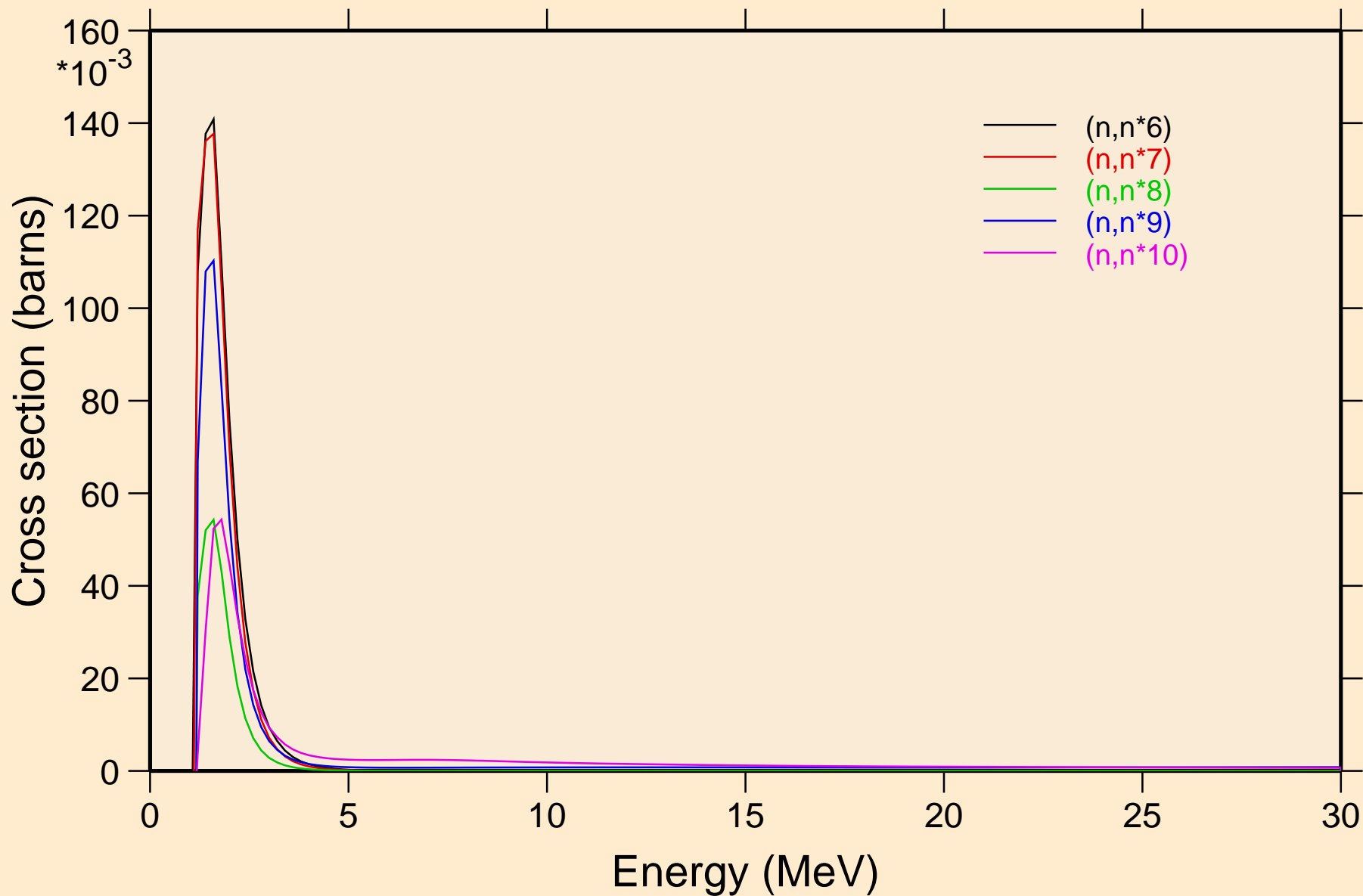

YB168 NEUTRON ACER TENDL-2019 LIBRARY; T=293.16K
Inelastic levels

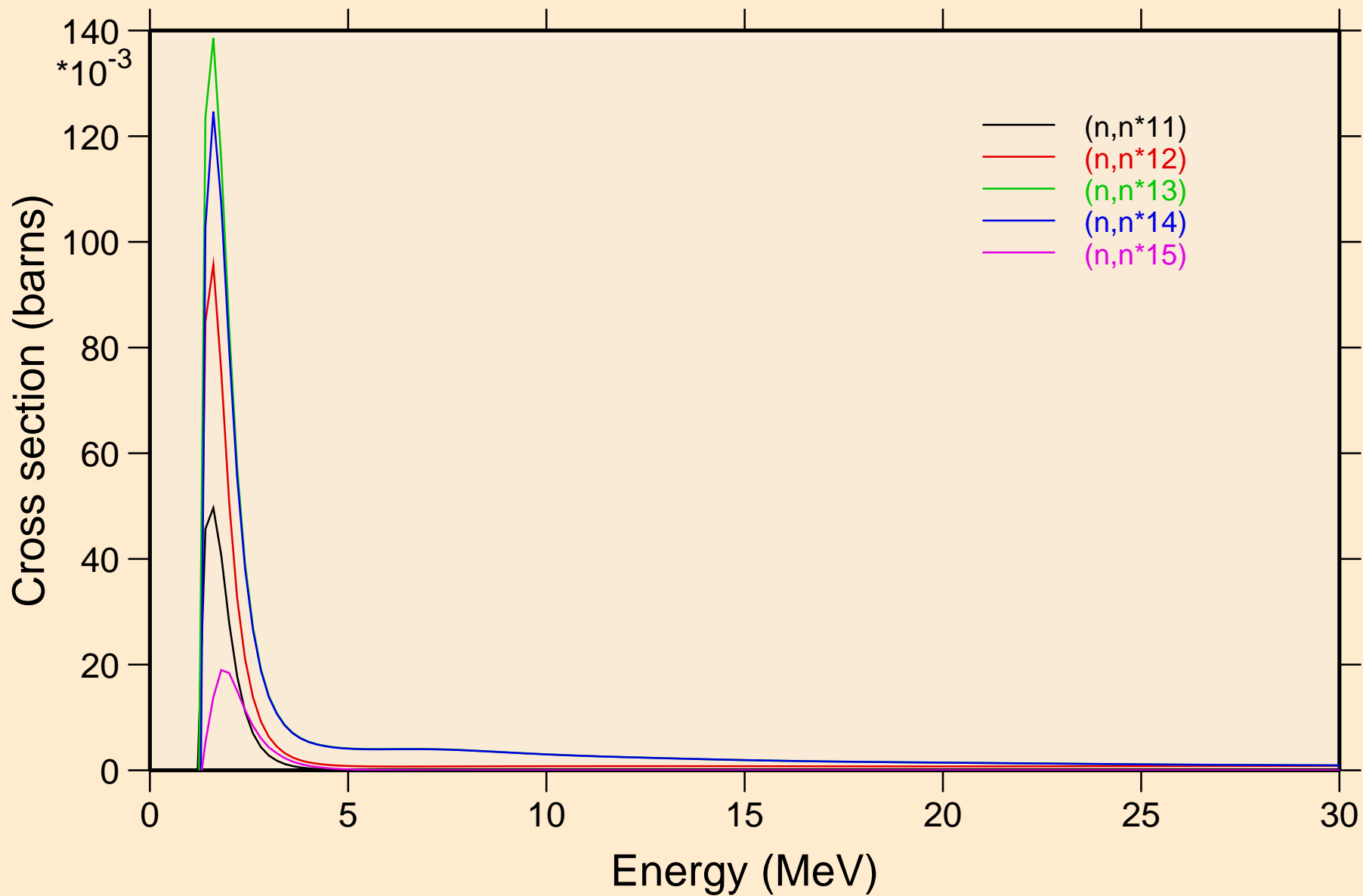

YB168 NEUTRON ACER TENDL-2019 LIBRARY; T=293.16K
Inelastic levels

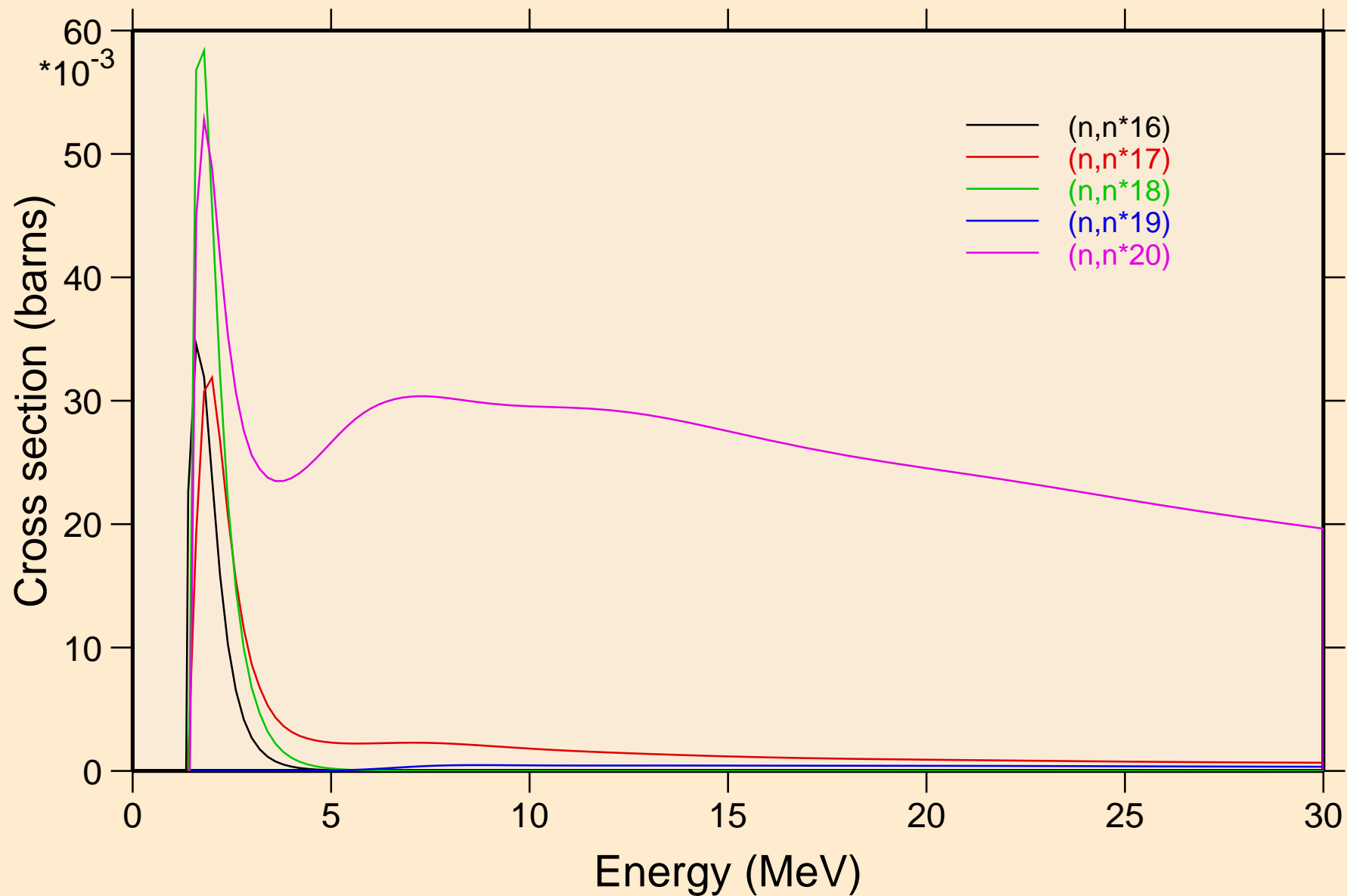

YB168 NEUTRON ACER TENDL-2019 LIBRARY; T=293.16K
Inelastic levels

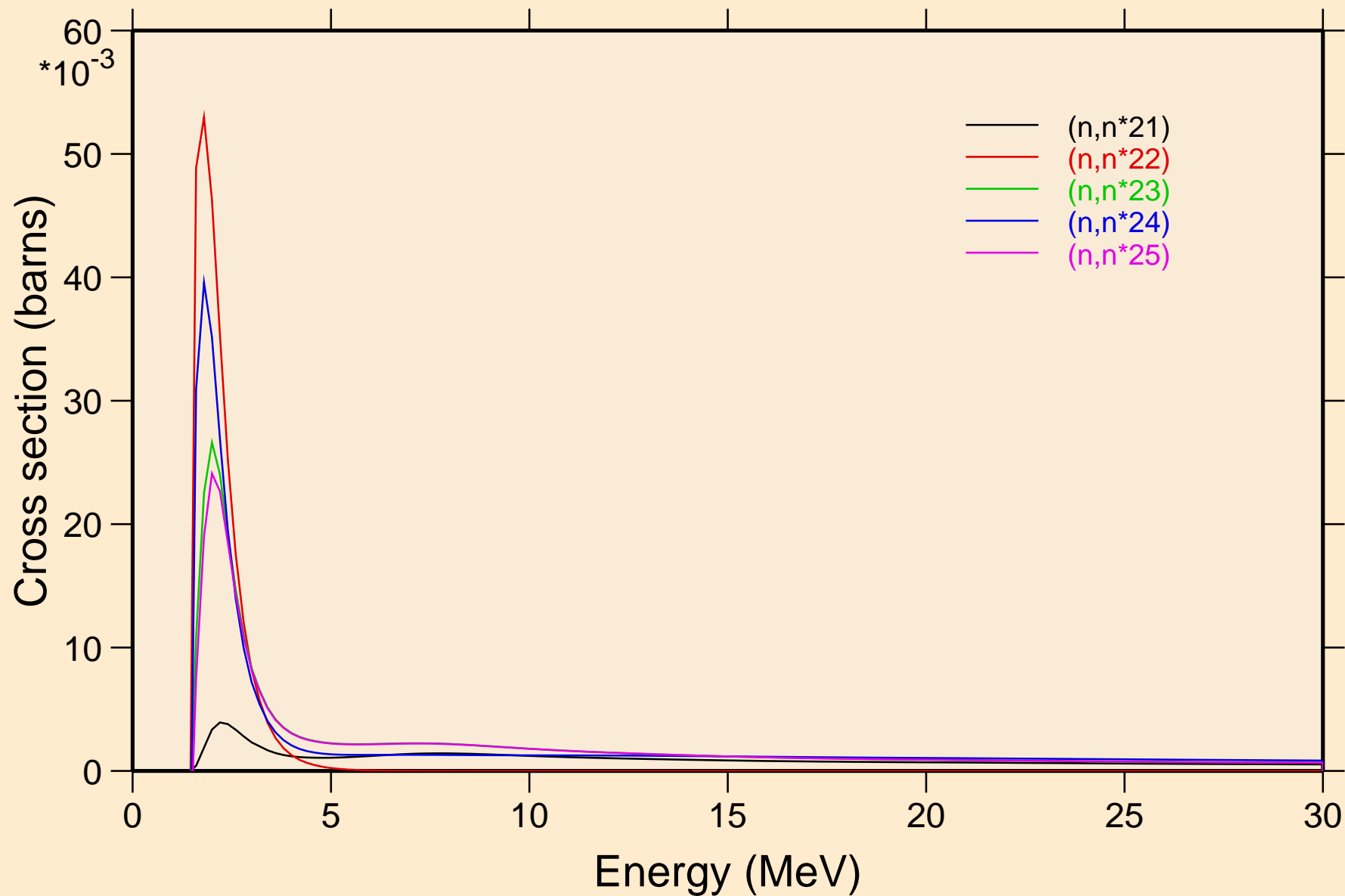

YB168 NEUTRON ACER TENDL-2019 LIBRARY; T=293.16K
Inelastic levels

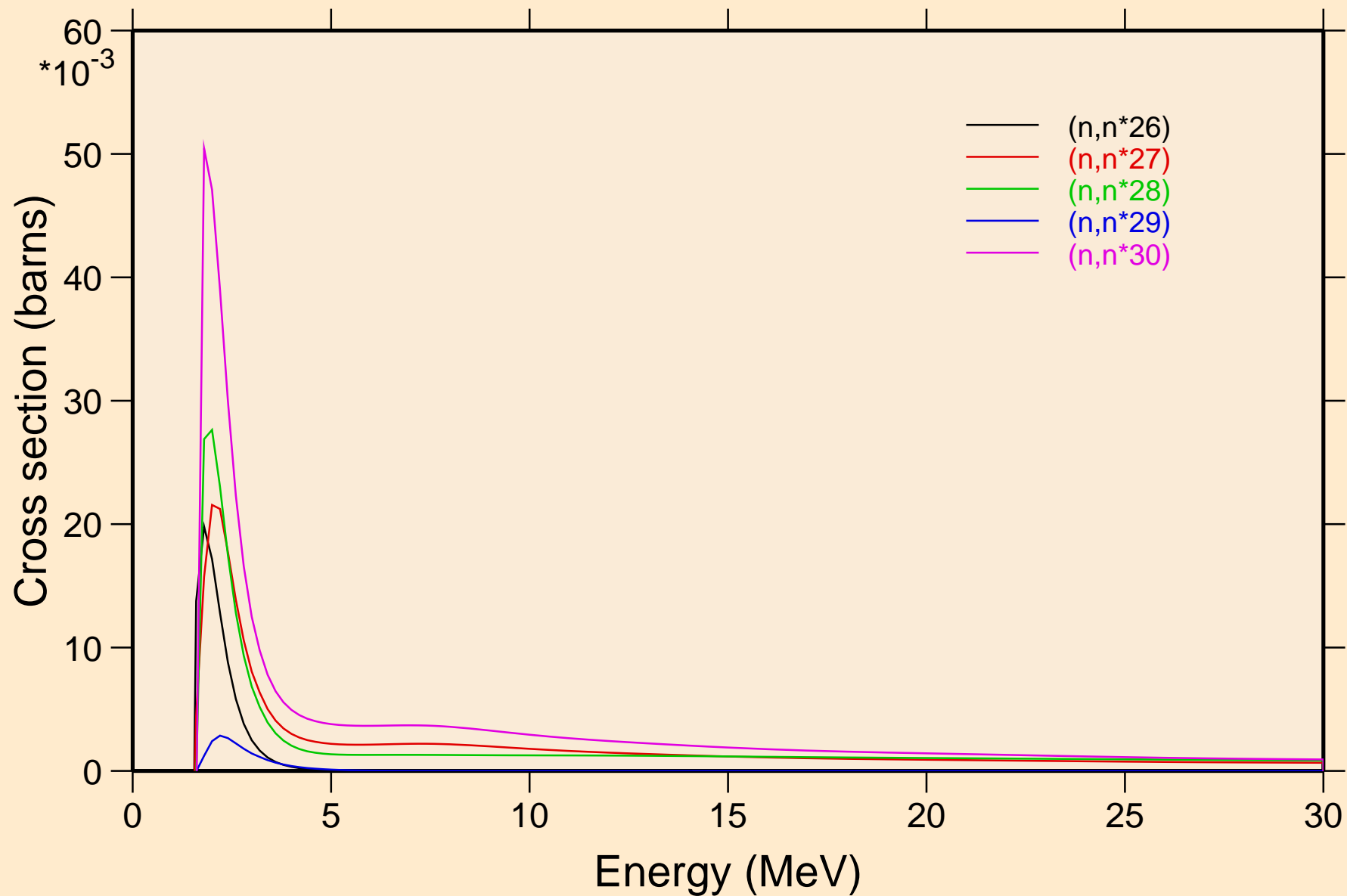

YB168 NEUTRON ACER TENDL-2019 LIBRARY; T=293.16K
Threshold reactions

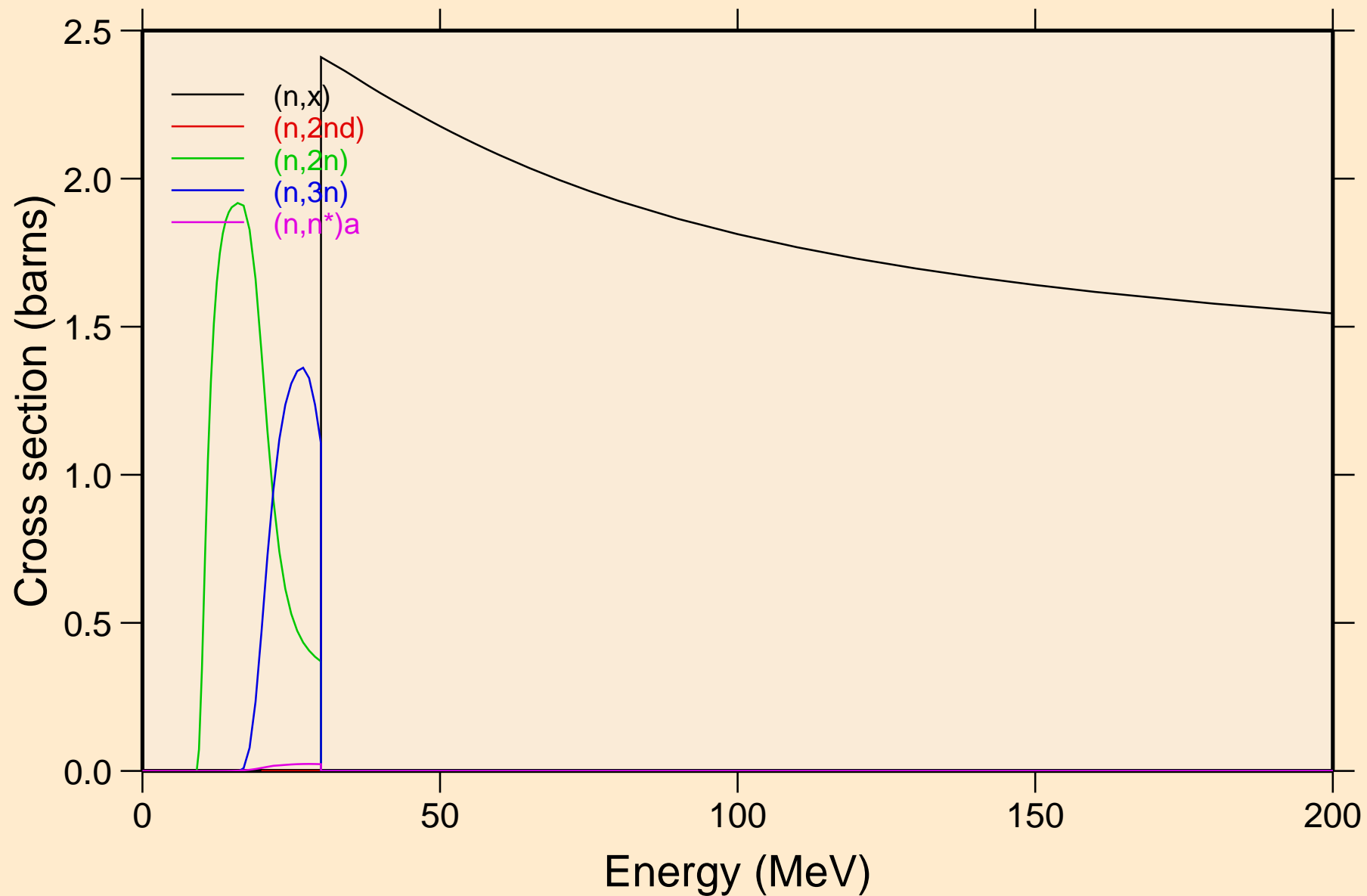

YB168 NEUTRON ACER TENDL-2019 LIBRARY; T=293.16K
Threshold reactions

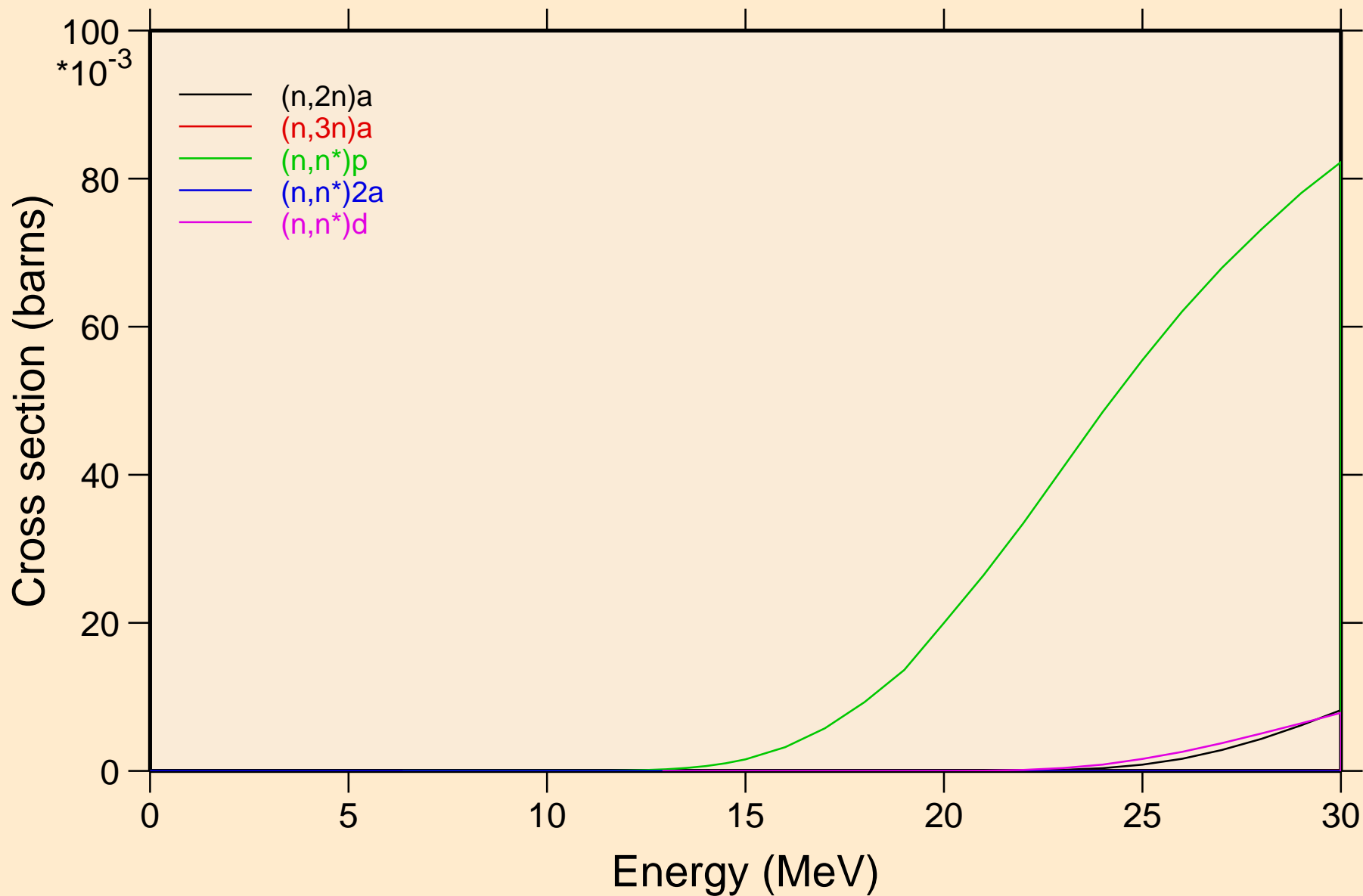

YB168 NEUTRON ACER TENDL-2019 LIBRARY; T=293.16K
Threshold reactions

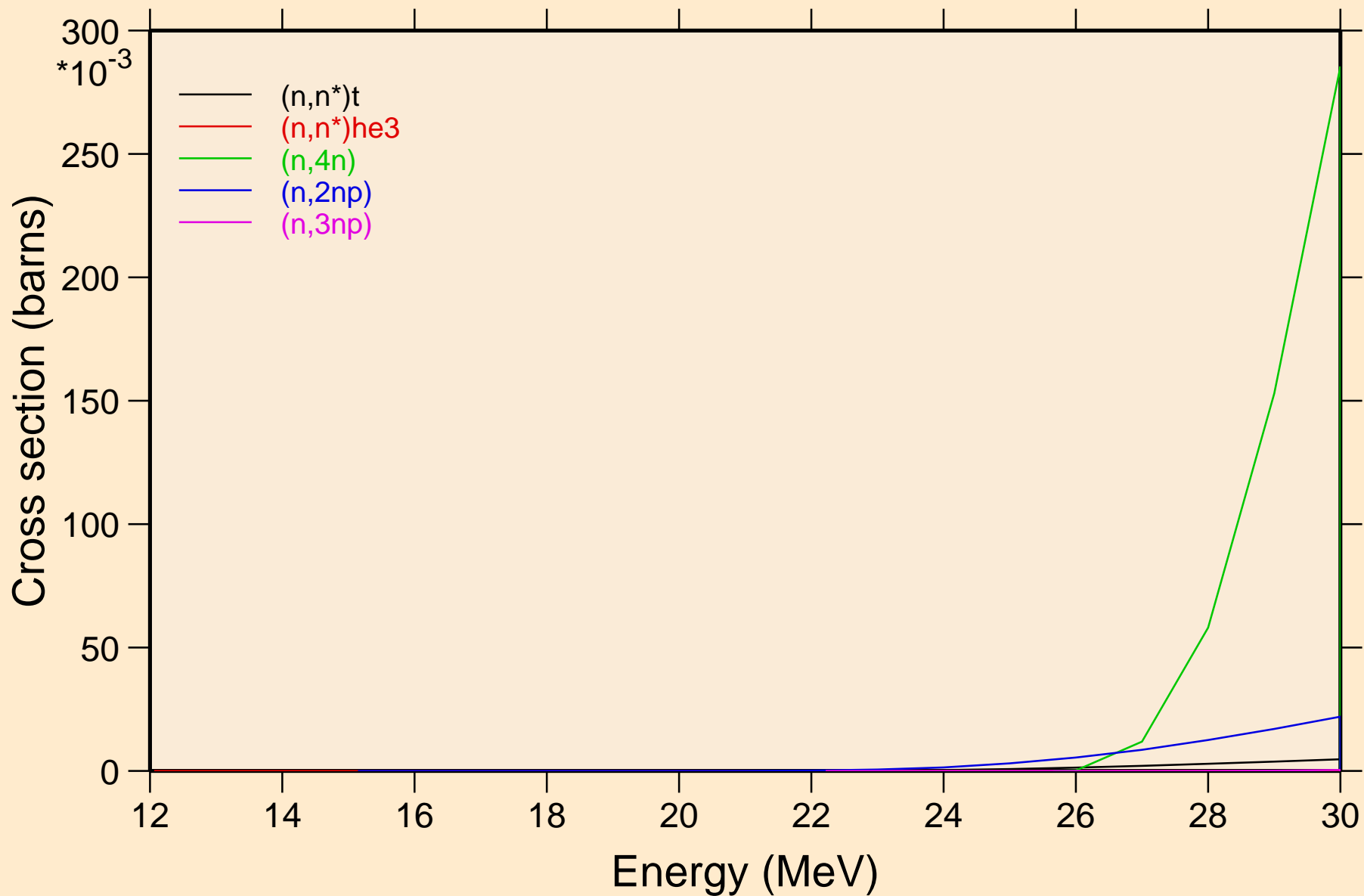

YB168 NEUTRON ACER TENDL-2019 LIBRARY; T=293.16K
Threshold reactions

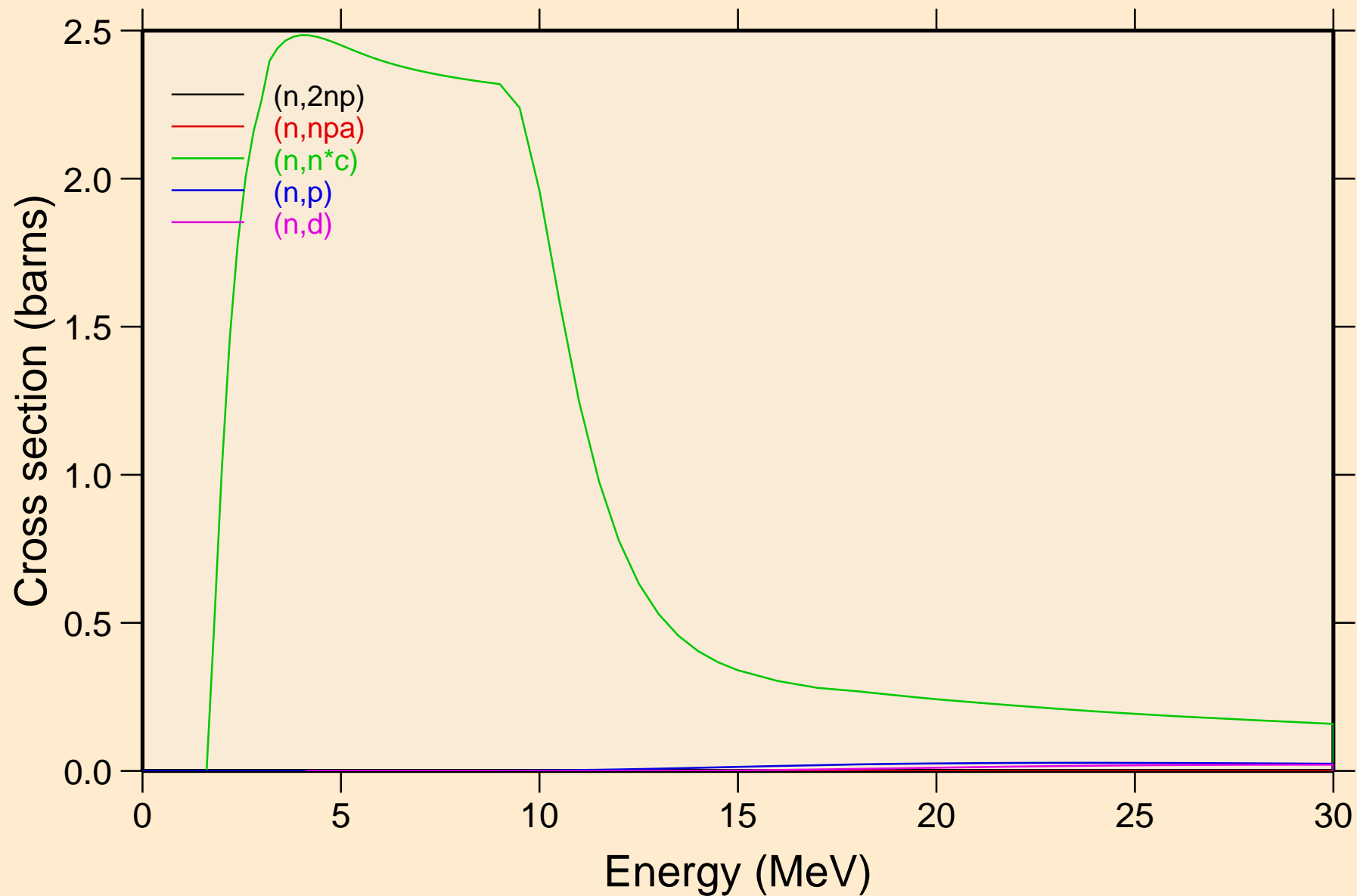

YB168 NEUTRON ACER TENDL-2019 LIBRARY; T=293.16K
Threshold reactions

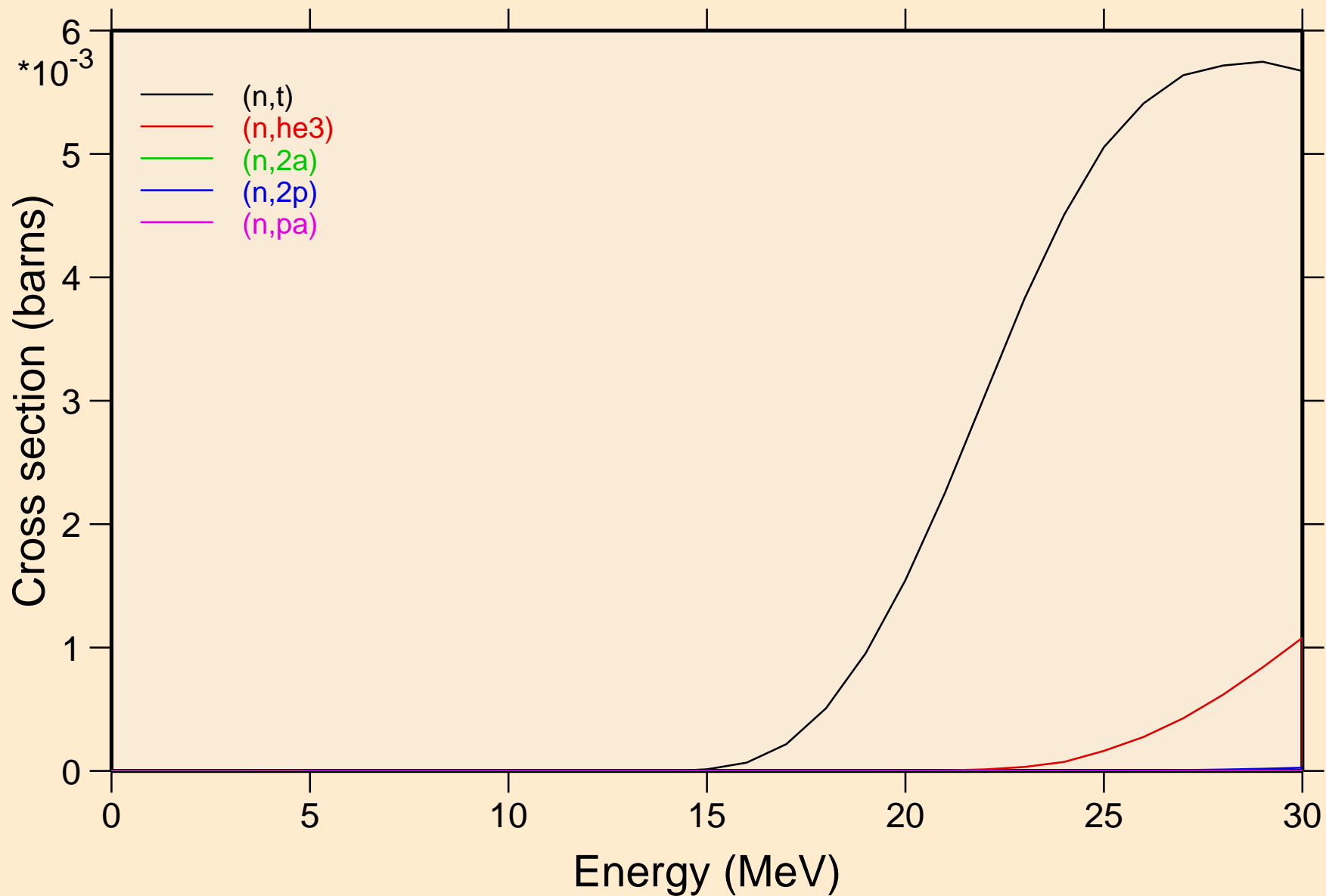

YB168 NEUTRON ACER TENDL-2019 LIBRARY; T=293.16K
Threshold reactions

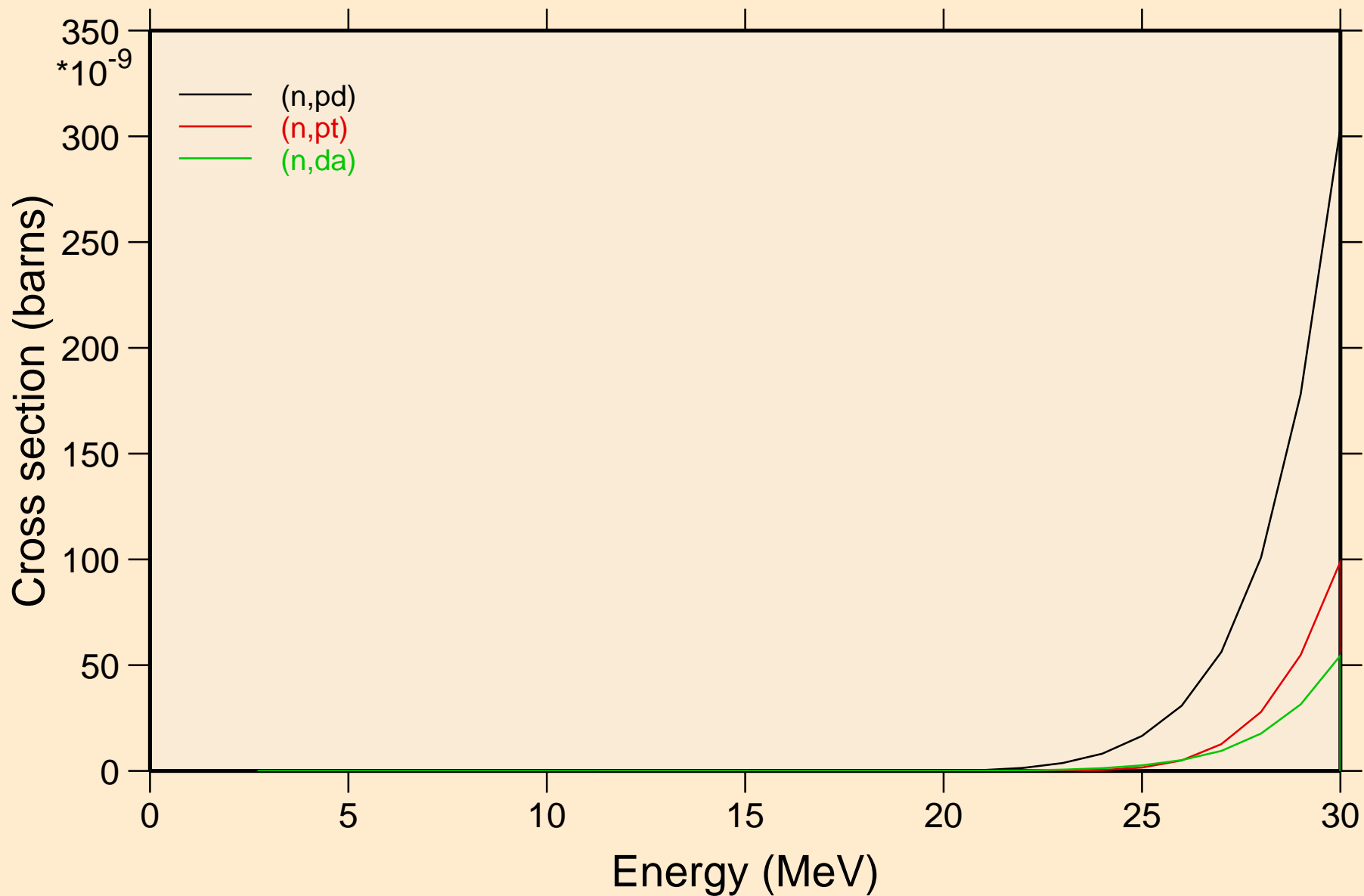

YB168 NEUTRON ACER TENDL-2019 LIBRARY; T=293.16K
Threshold reactions

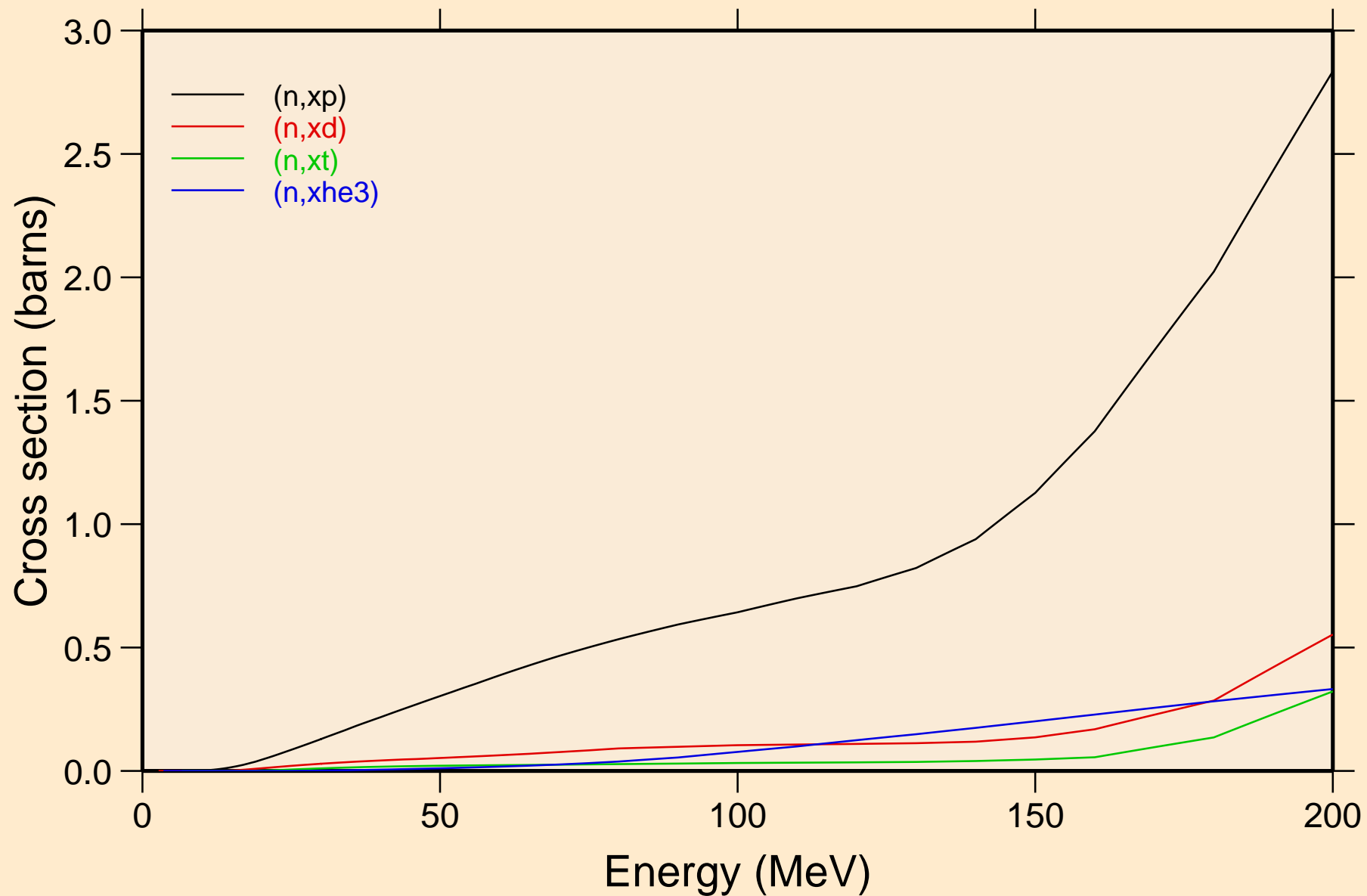

YB168 NEUTRON ACER TENDL-2019 LIBRARY; T=293.16K
angular distribution for elastic

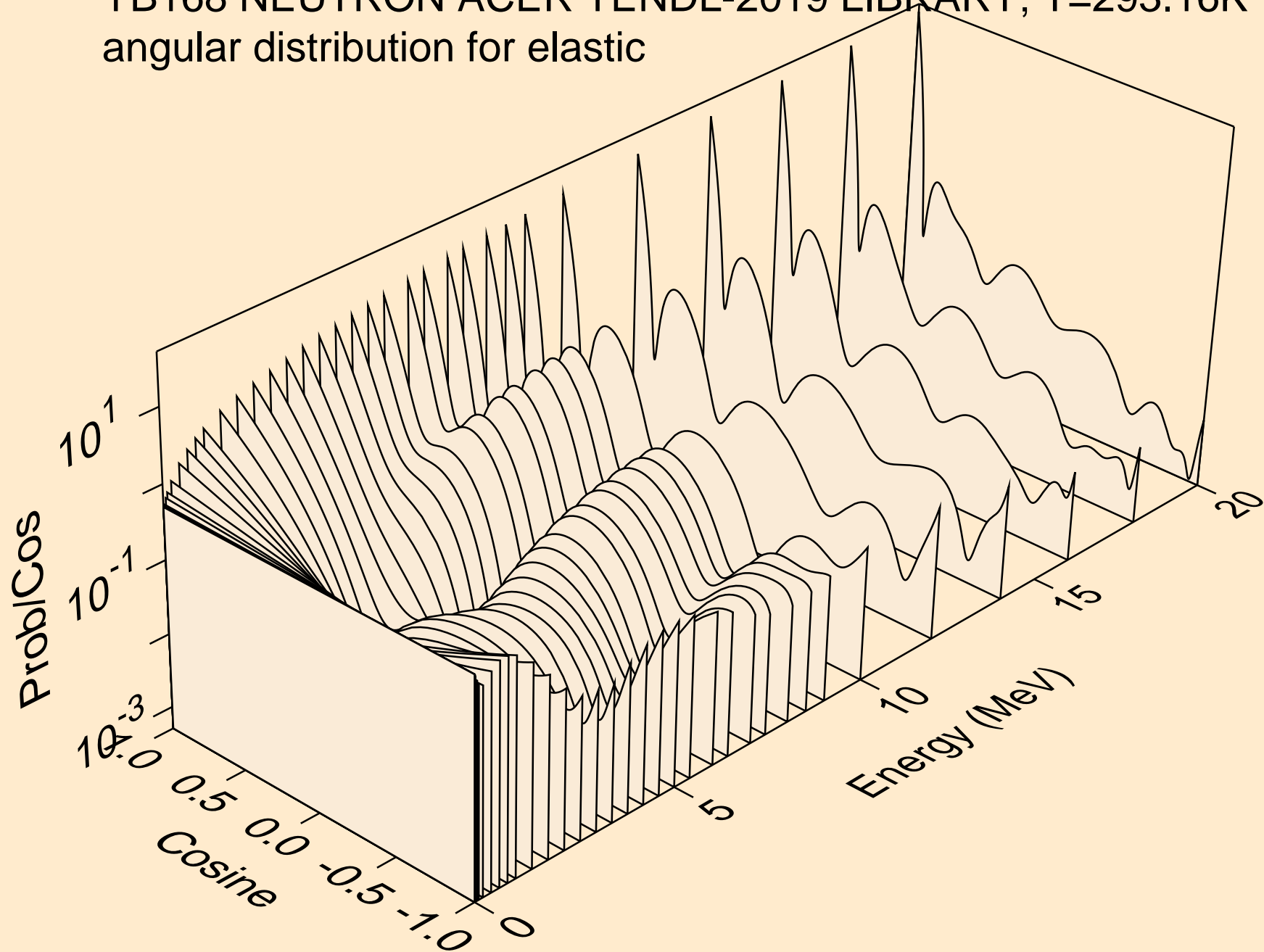

YB168 NEUTRON ACER TENDL-2019 LIBRARY; T=293.16K
angular distribution for elastic

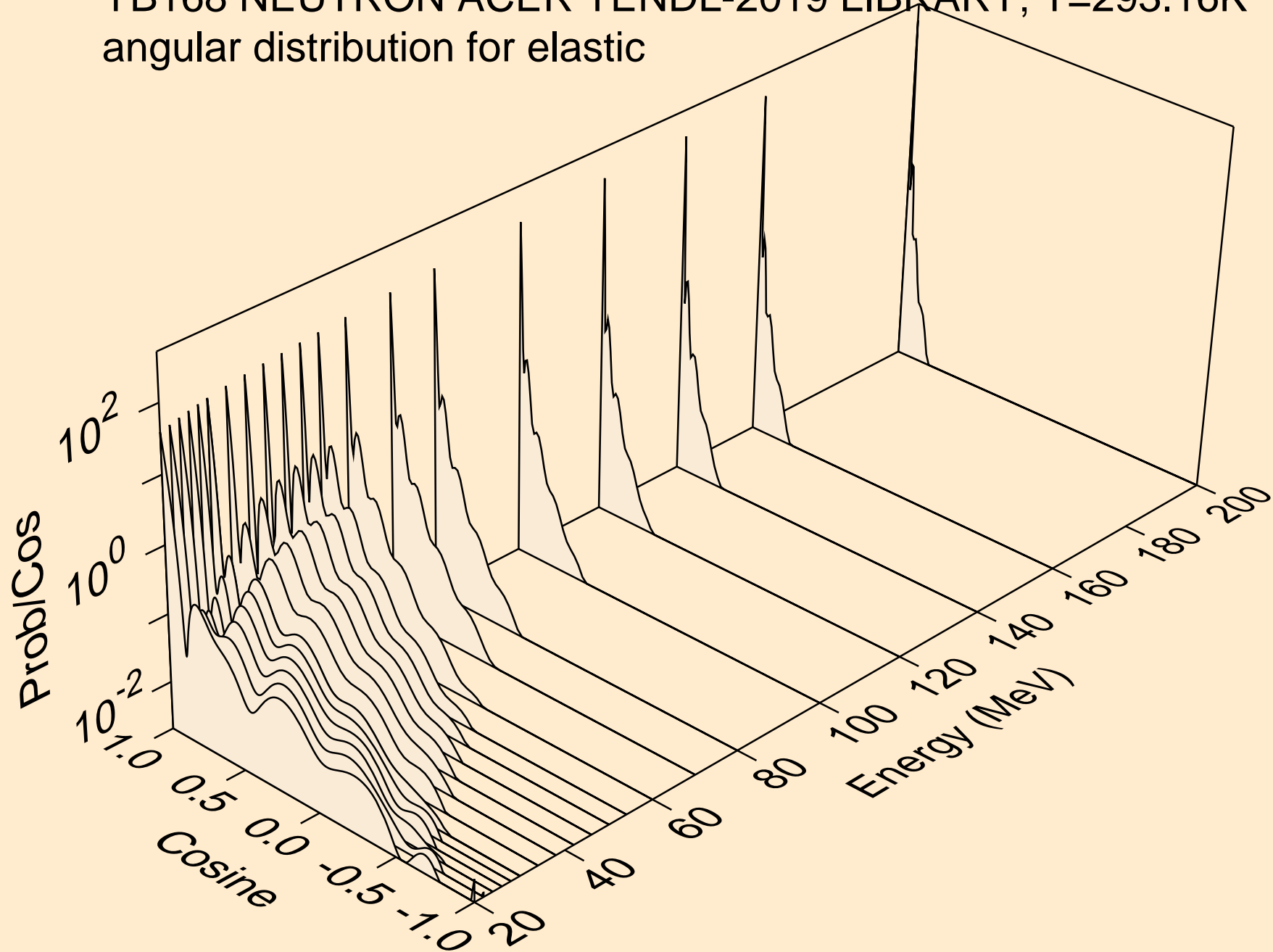

YB168 NEUTRON ACER TENDL-2019 LIBRARY; T=293.16K
angular distribution for (n,n*1)

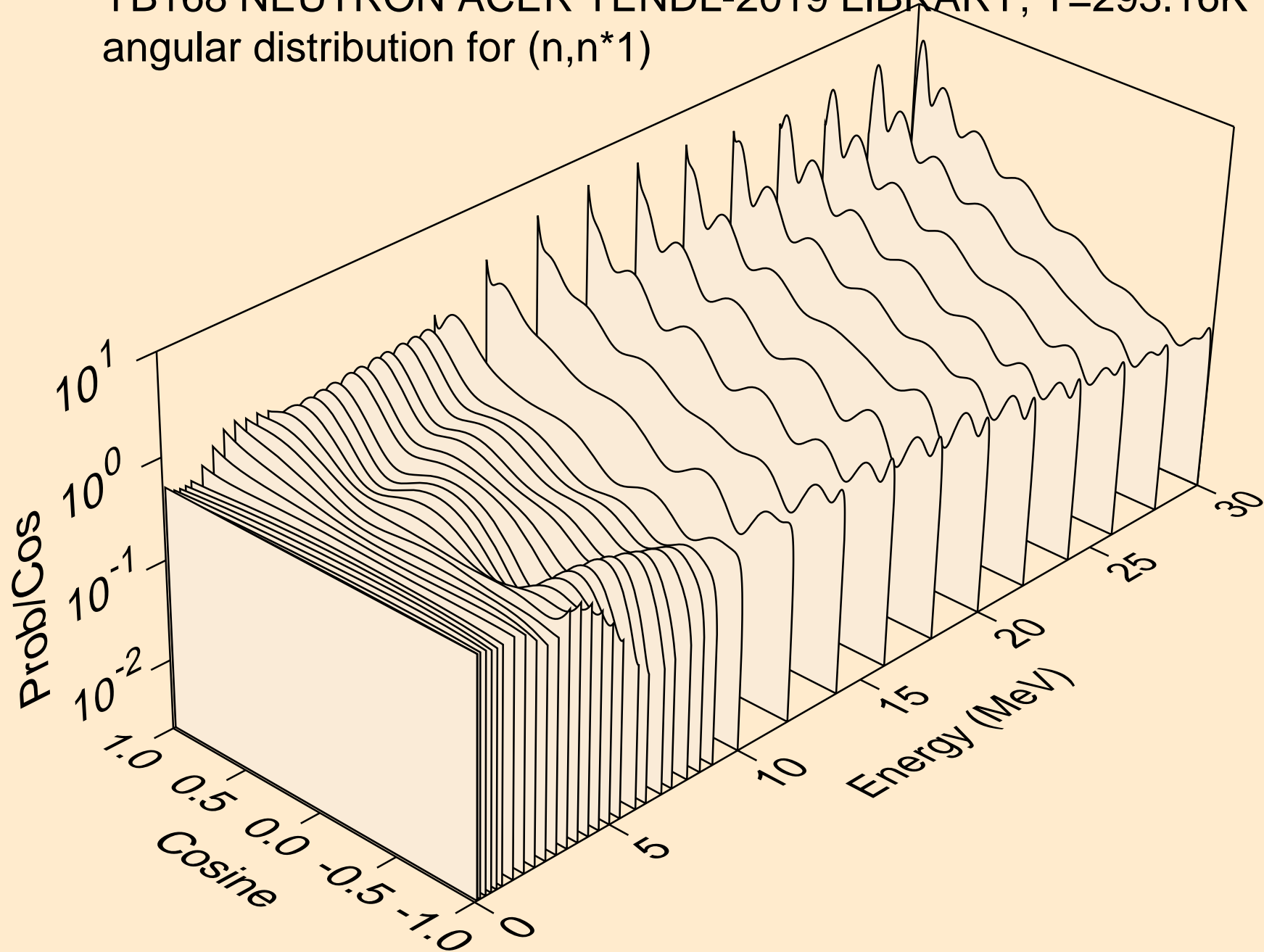

YB168 NEUTRON ACER TENDL-2019 LIBRARY; T=293.16K
angular distribution for (n,n*2)

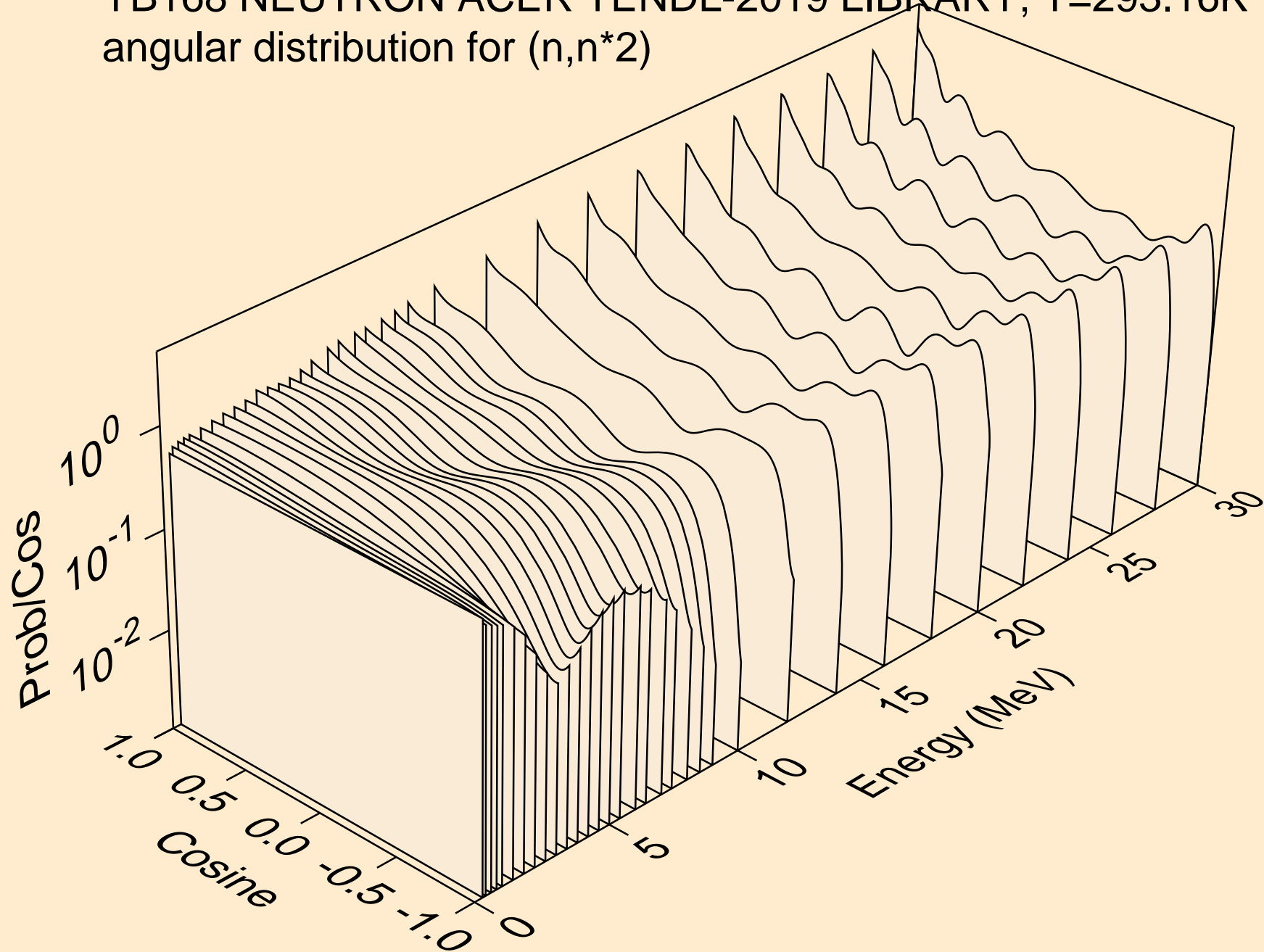

YB168 NEUTRON ACER TENDL-2019 LIBRARY; T=293.16K
angular distribution for (n,n*3)

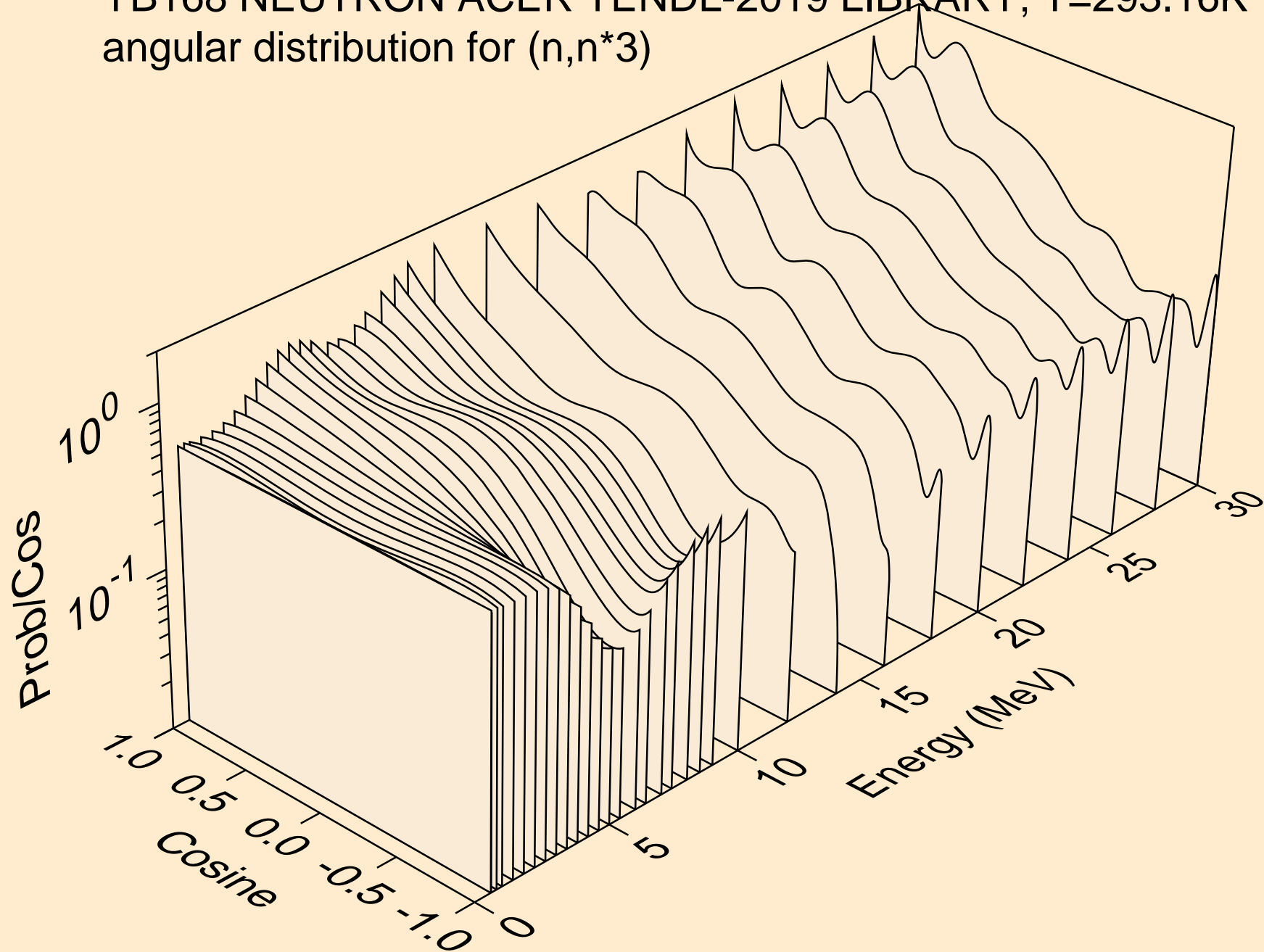

YB168 NEUTRON ACER TENDL-2019 LIBRARY; T=293.16K
angular distribution for (n,n*4)

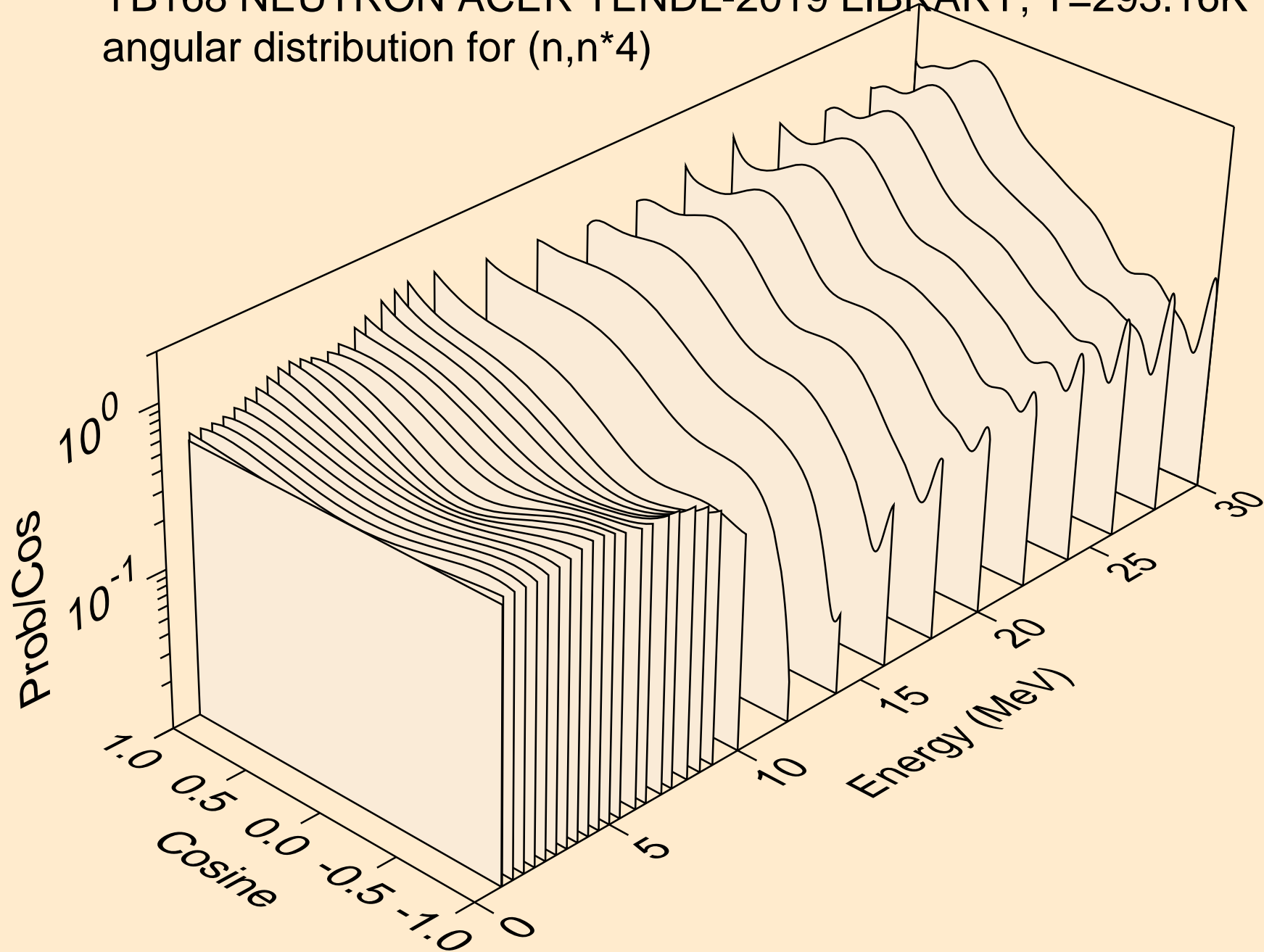

YB168 NEUTRON ACER TENDL-2019 LIBRARY; T=293.16K
angular distribution for (n,n*5)

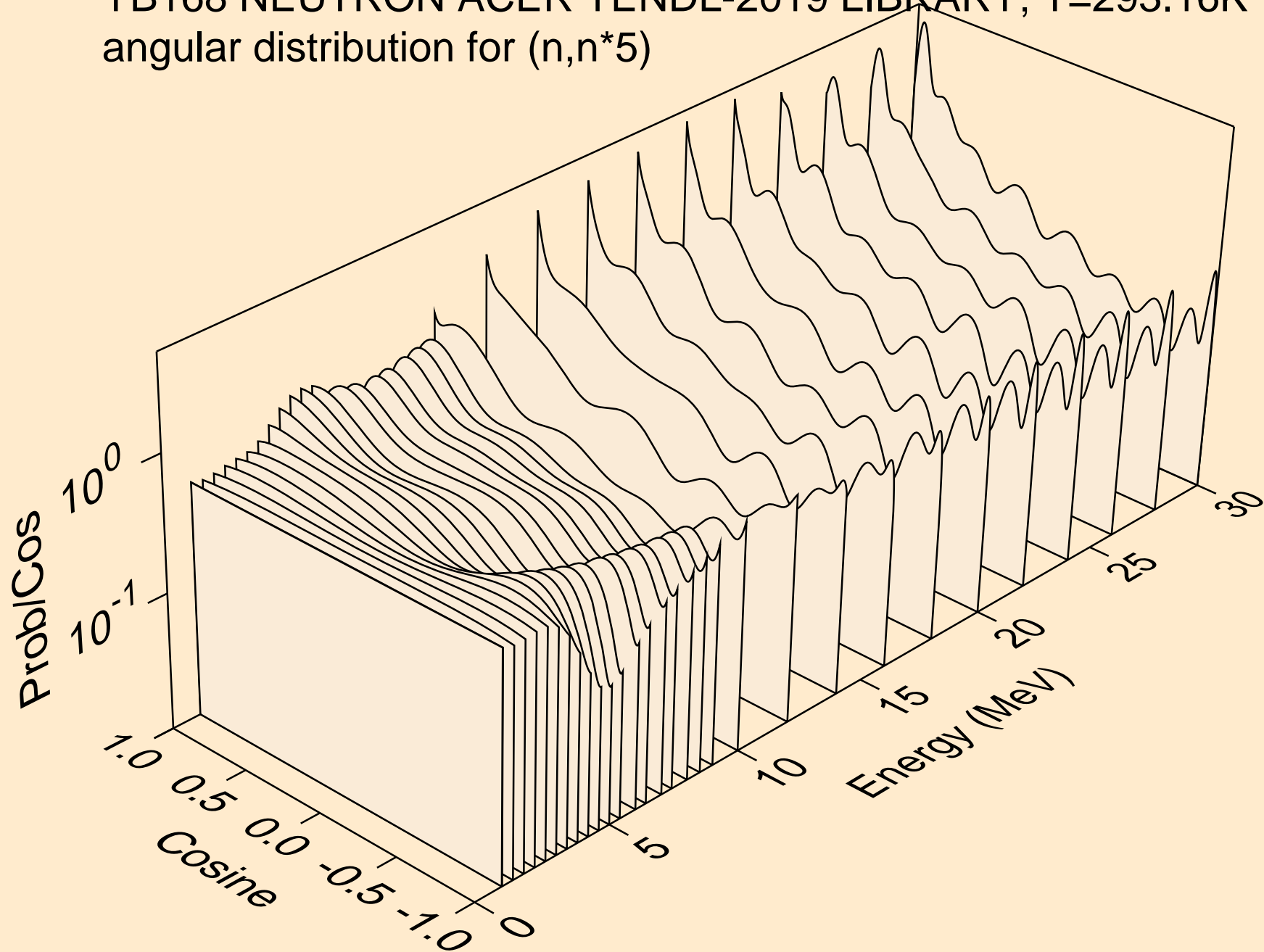

YB168 NEUTRON ACER TENDL-2019 LIBRARY; T=293.16K
angular distribution for (n,n*6)

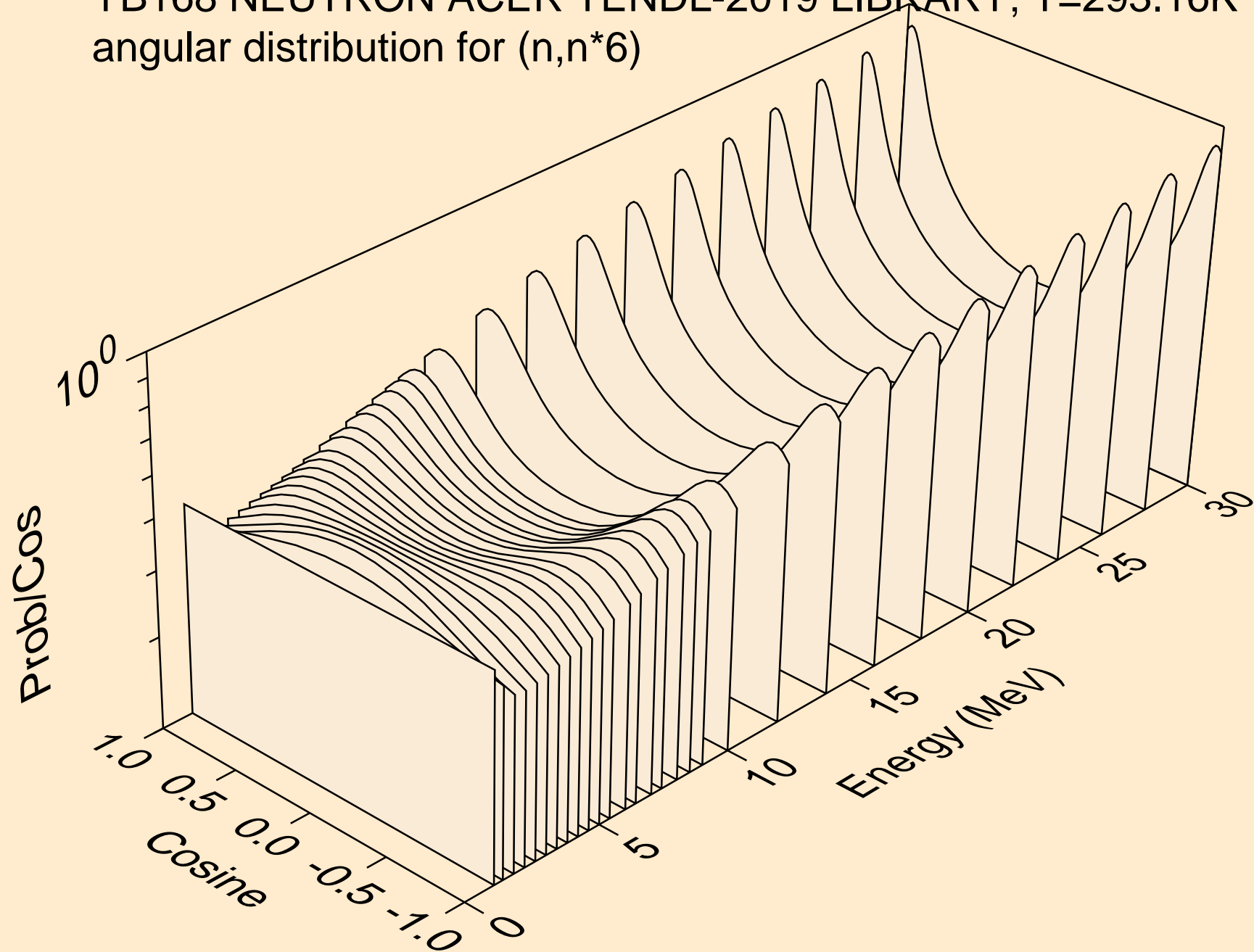

YB168 NEUTRON ACER TENDL-2019 LIBRARY; T=293.16K
angular distribution for (n,n*7)

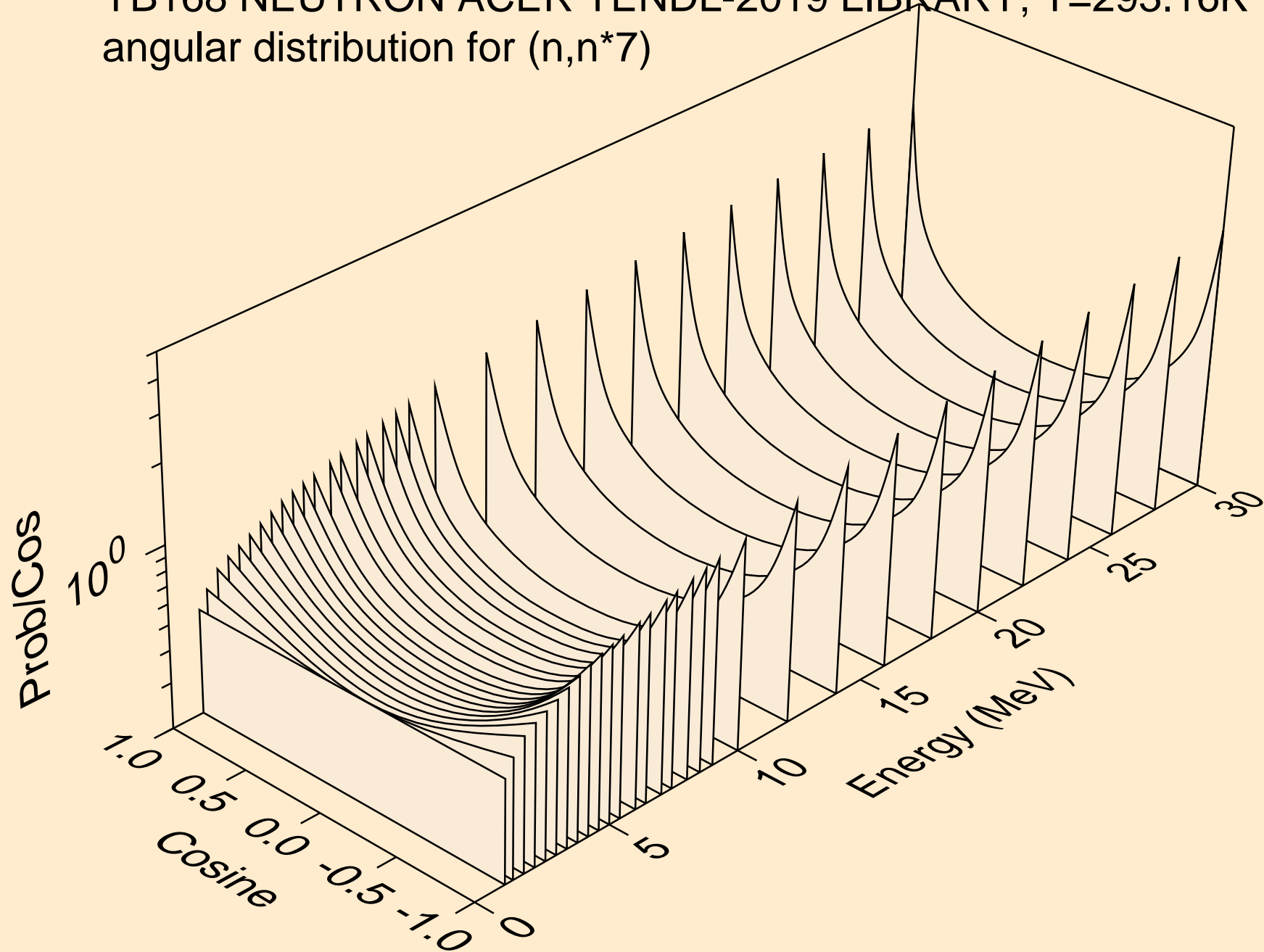

YB168 NEUTRON ACER TENDL-2019 LIBRARY; T=293.16K
angular distribution for (n,n*8)

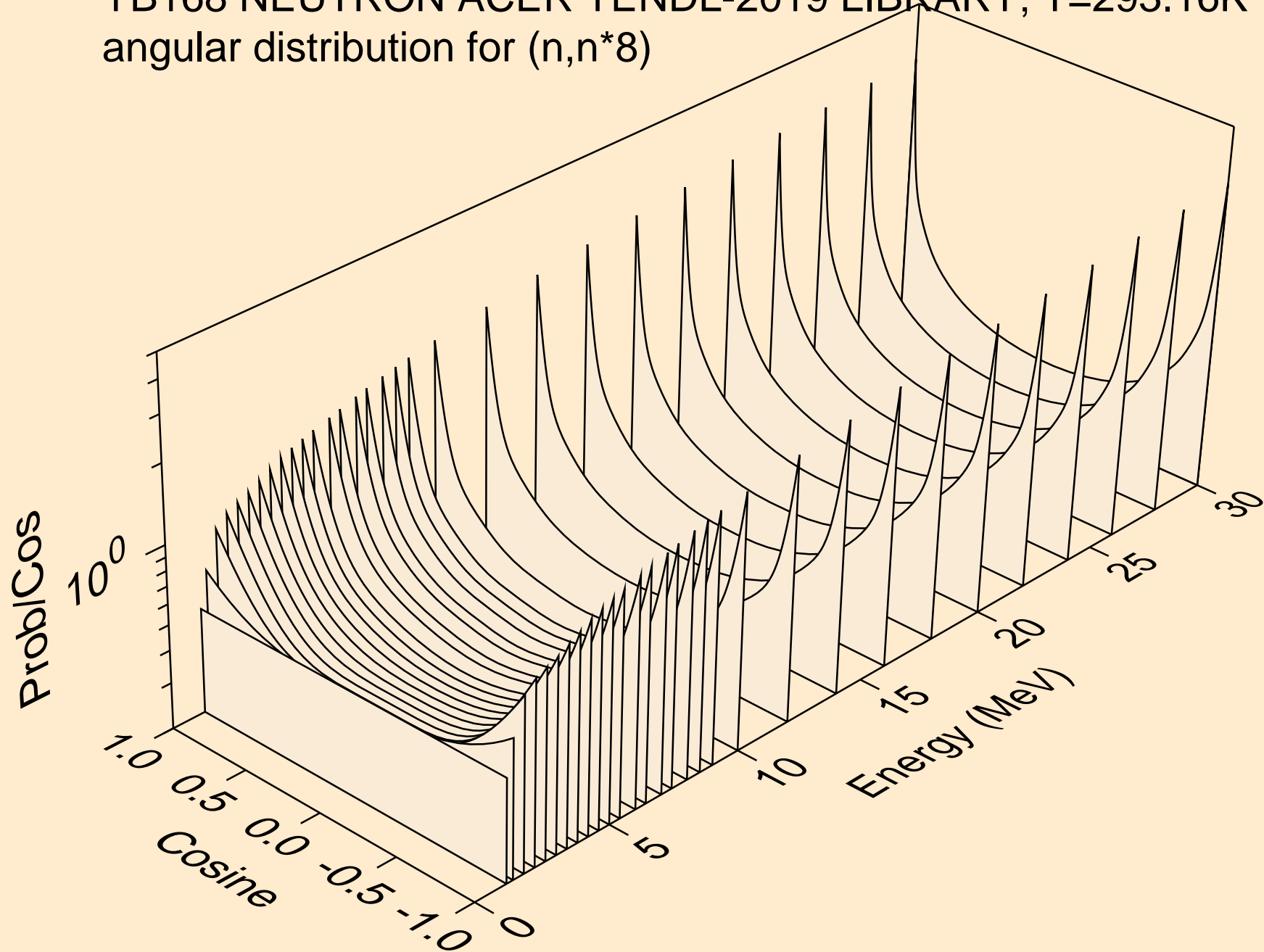

YB168 NEUTRON ACER TENDL-2019 LIBRARY; T=293.16K
angular distribution for (n,n*9)

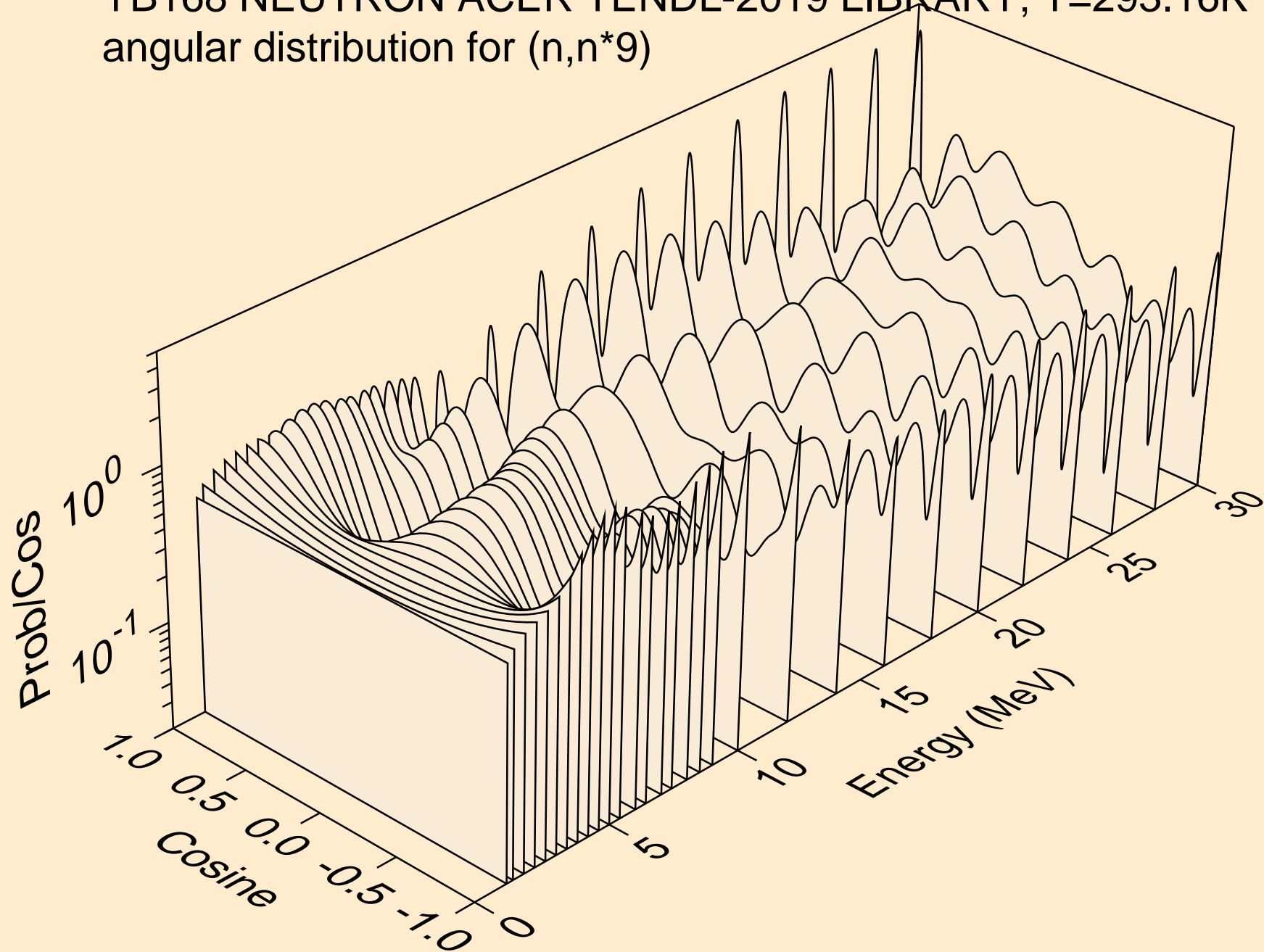

YB168 NEUTRON ACER TENDL-2019 LIBRARY; T=293.16K
angular distribution for (n,n*10)

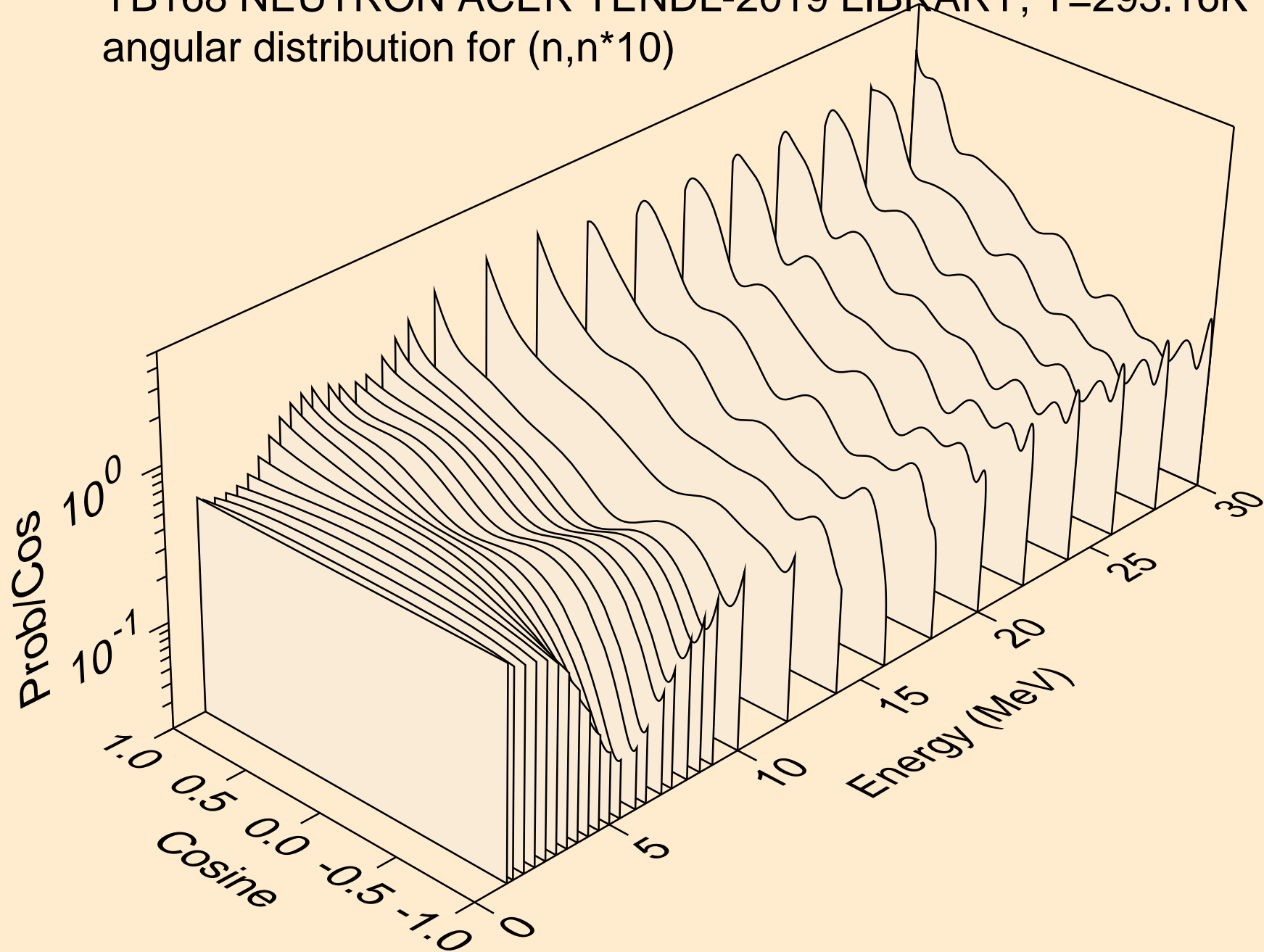

YB168 NEUTRON ACER TENDL-2019 LIBRARY; T=293.16K
angular distribution for (n,n*11)

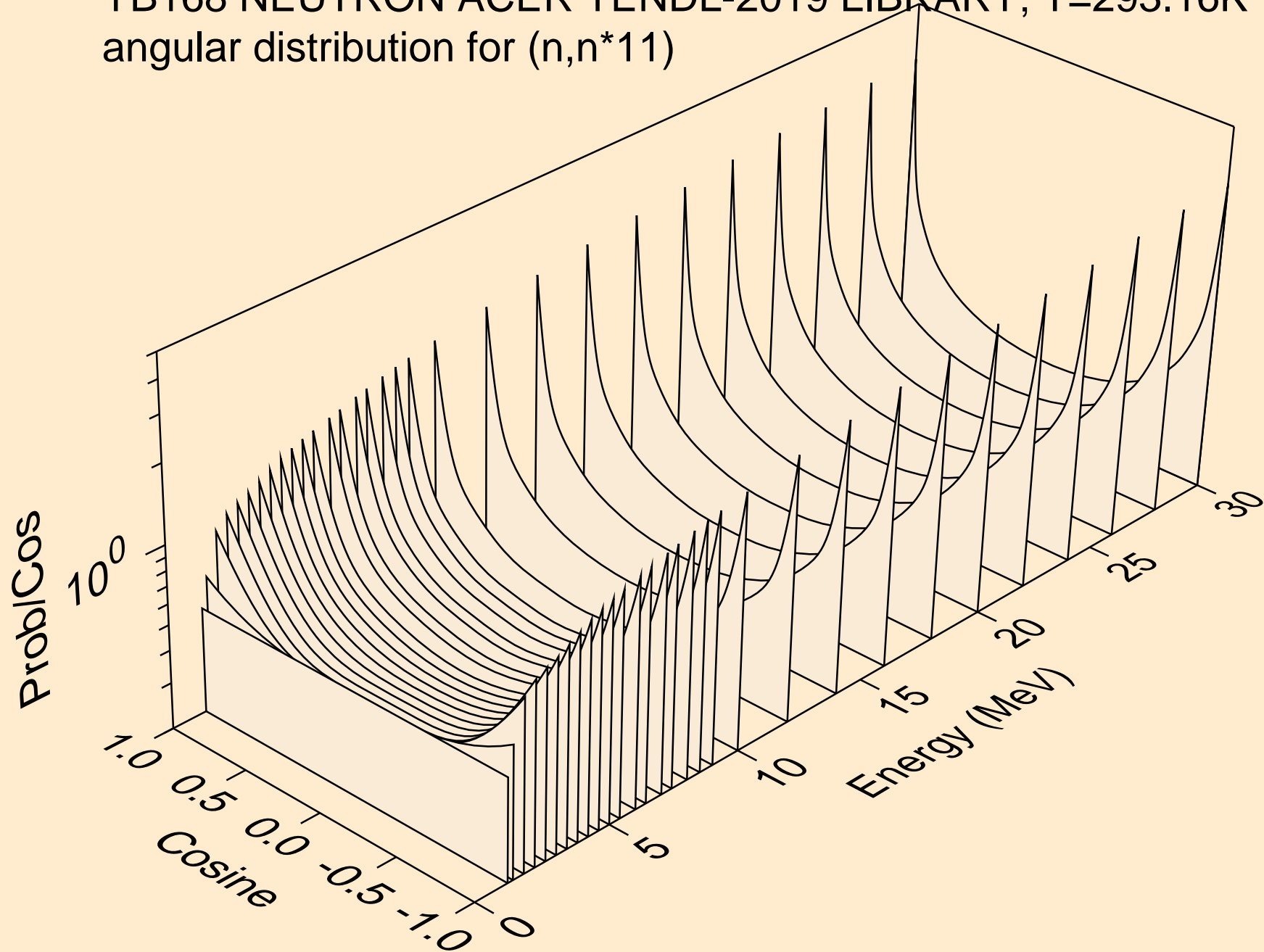

YB168 NEUTRON ACER TENDL-2019 LIBRARY; T=293.16K
angular distribution for (n,n*12)

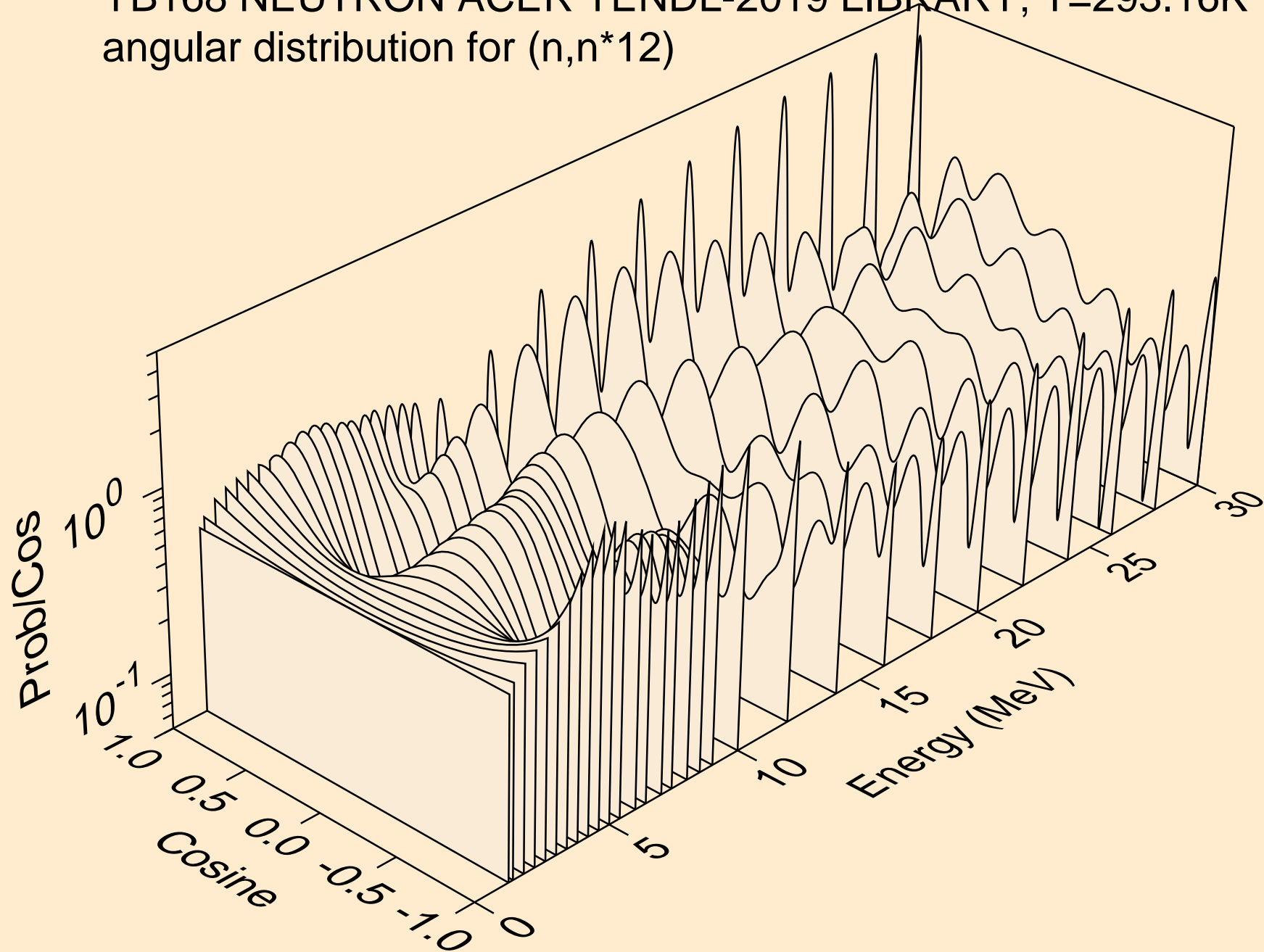

YB168 NEUTRON ACER TENDL-2019 LIBRARY; T=293.16K
angular distribution for (n,n*13)

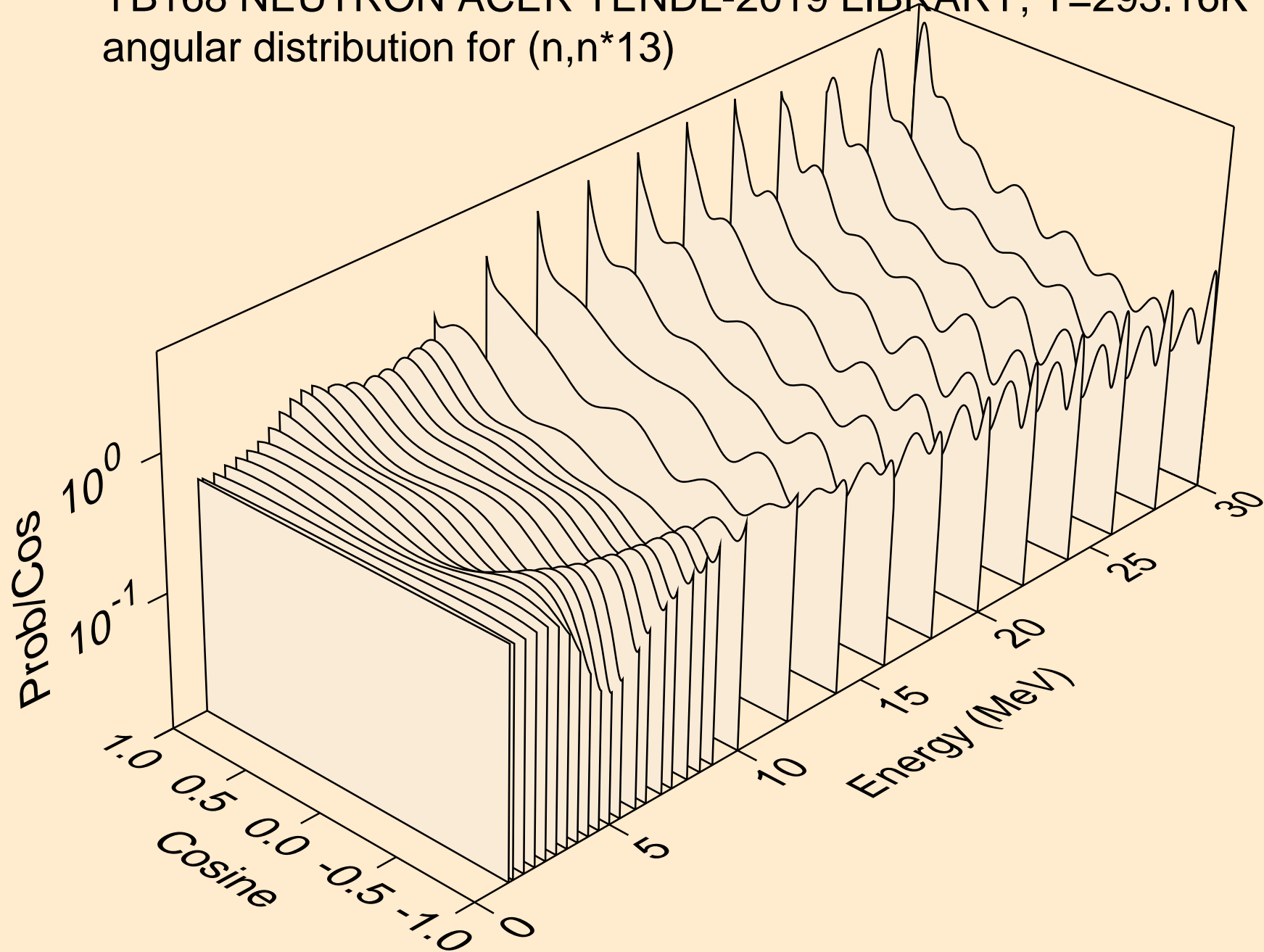

YB168 NEUTRON ACER TENDL-2019 LIBRARY; T=293.16K
angular distribution for (n,n*14)

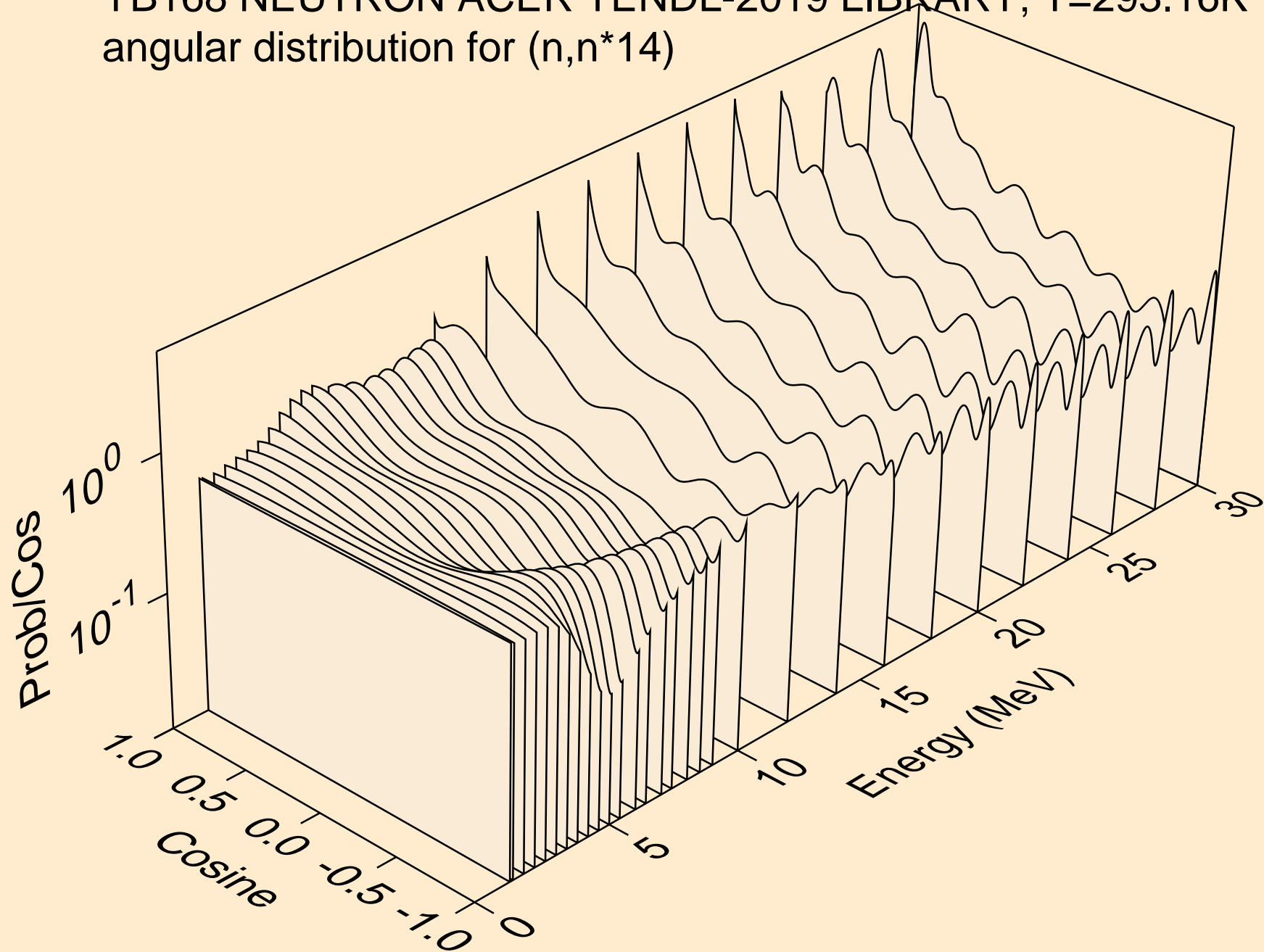

YB168 NEUTRON ACER TENDL-2019 LIBRARY; T=293.16K
angular distribution for (n,n*15)

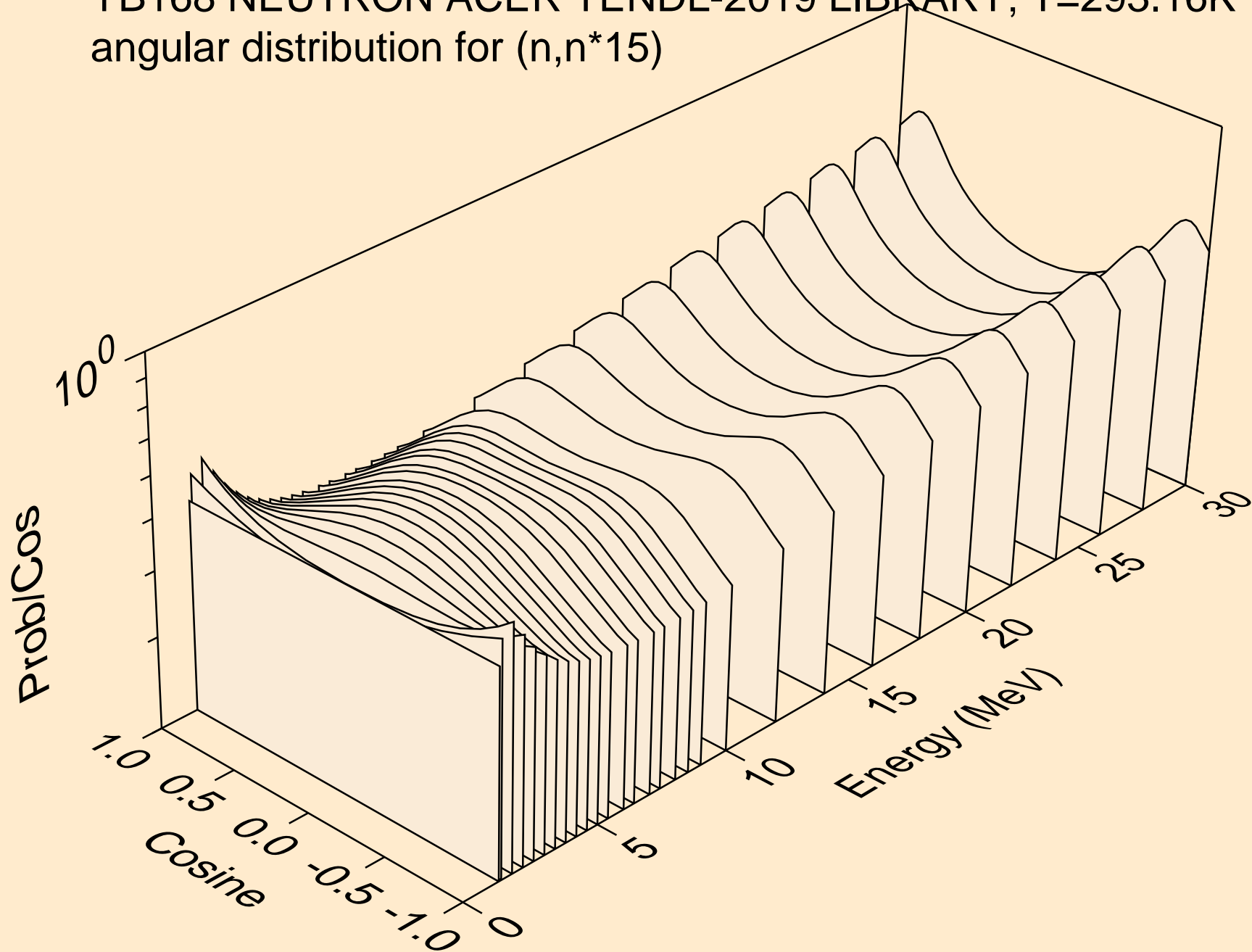

YB168 NEUTRON ACER TENDL-2019 LIBRARY; T=293.16K
angular distribution for (n,n*16)

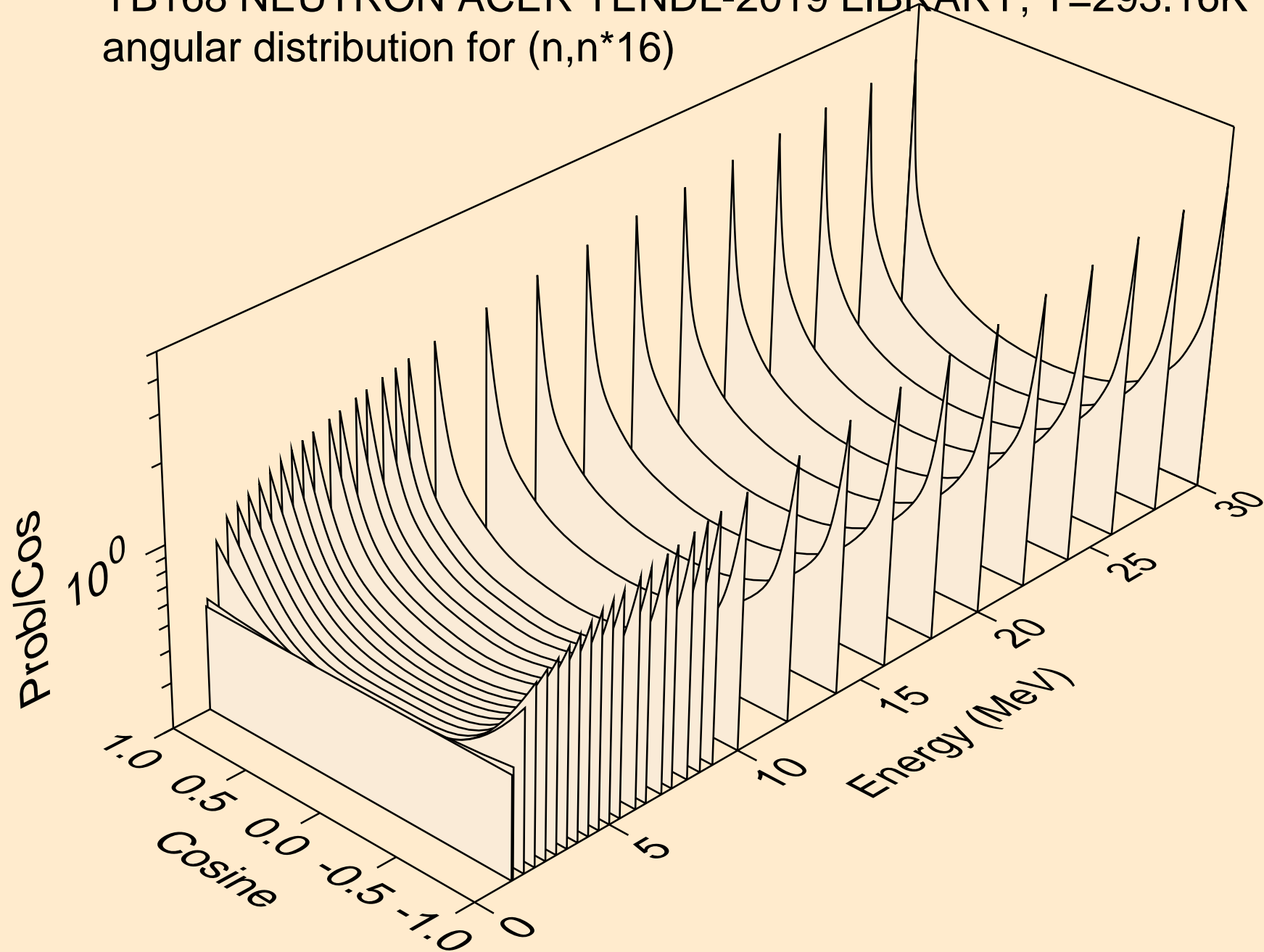

YB168 NEUTRON ACER TENDL-2019 LIBRARY; T=293.16K
angular distribution for (n,n*17)

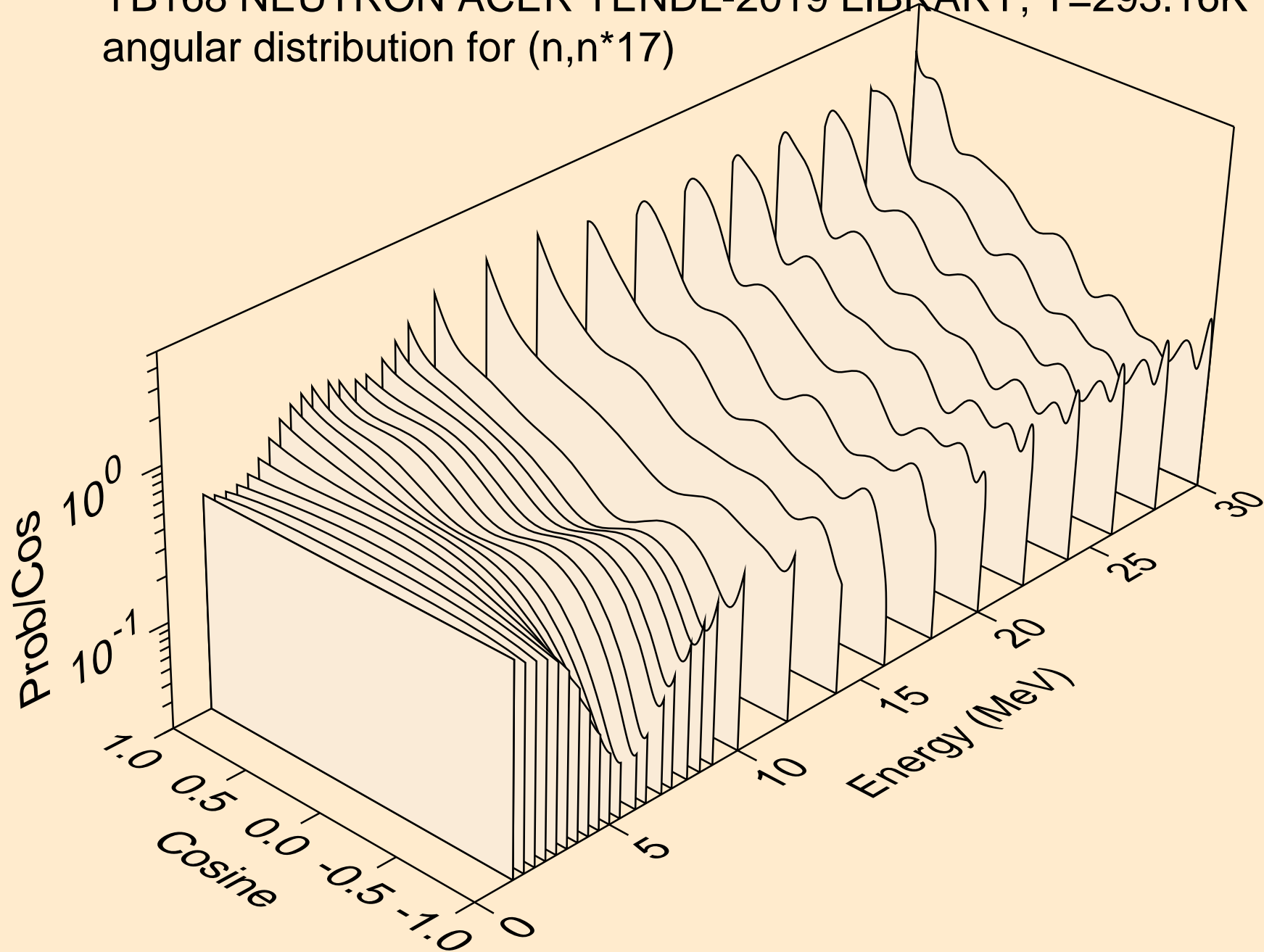

YB168 NEUTRON ACER TENDL-2019 LIBRARY; T=293.16K
angular distribution for (n,n*18)

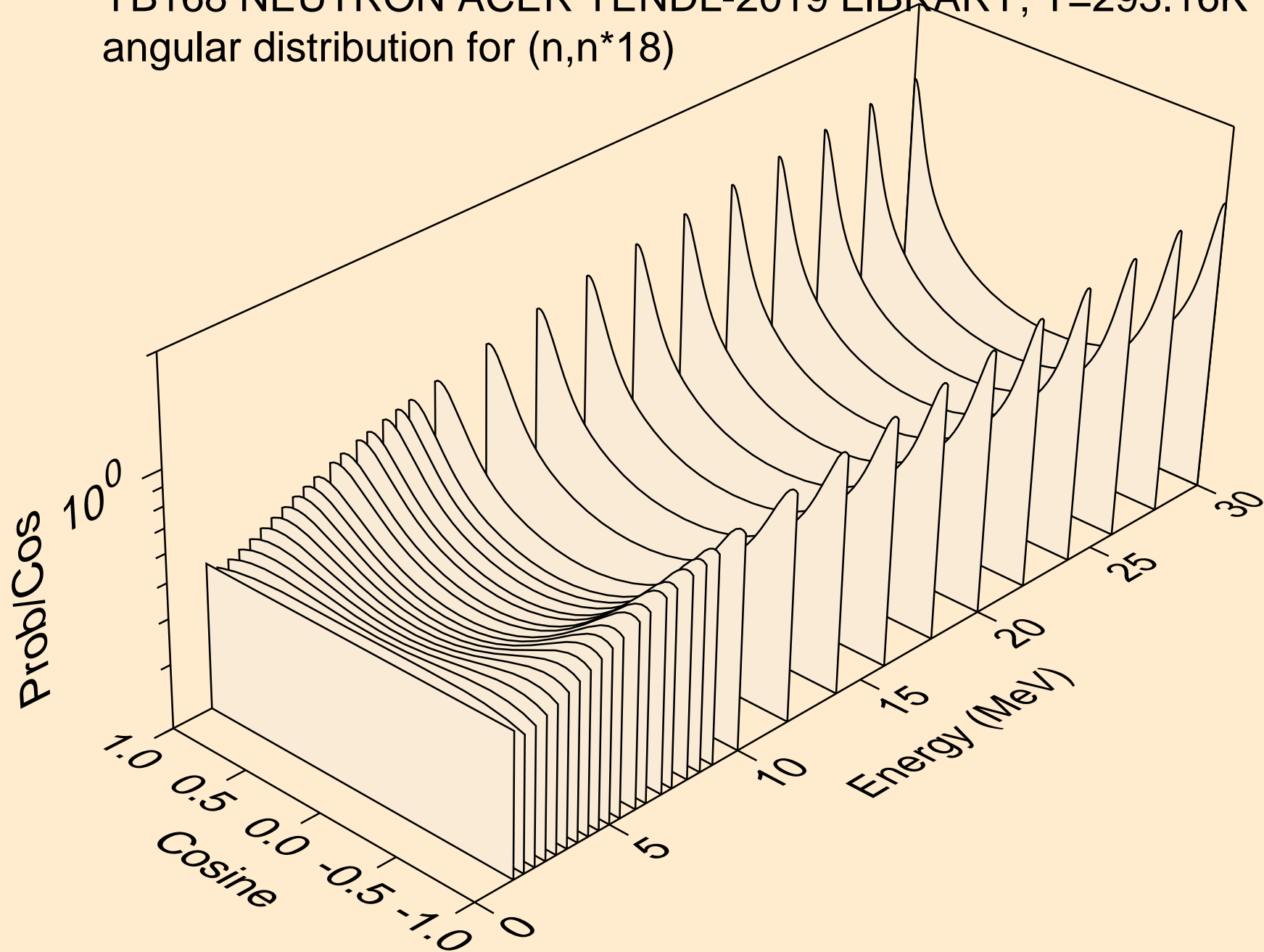

YB168 NEUTRON ACER TENDL-2019 LIBRARY; T=293.16K
angular distribution for (n,n*19)

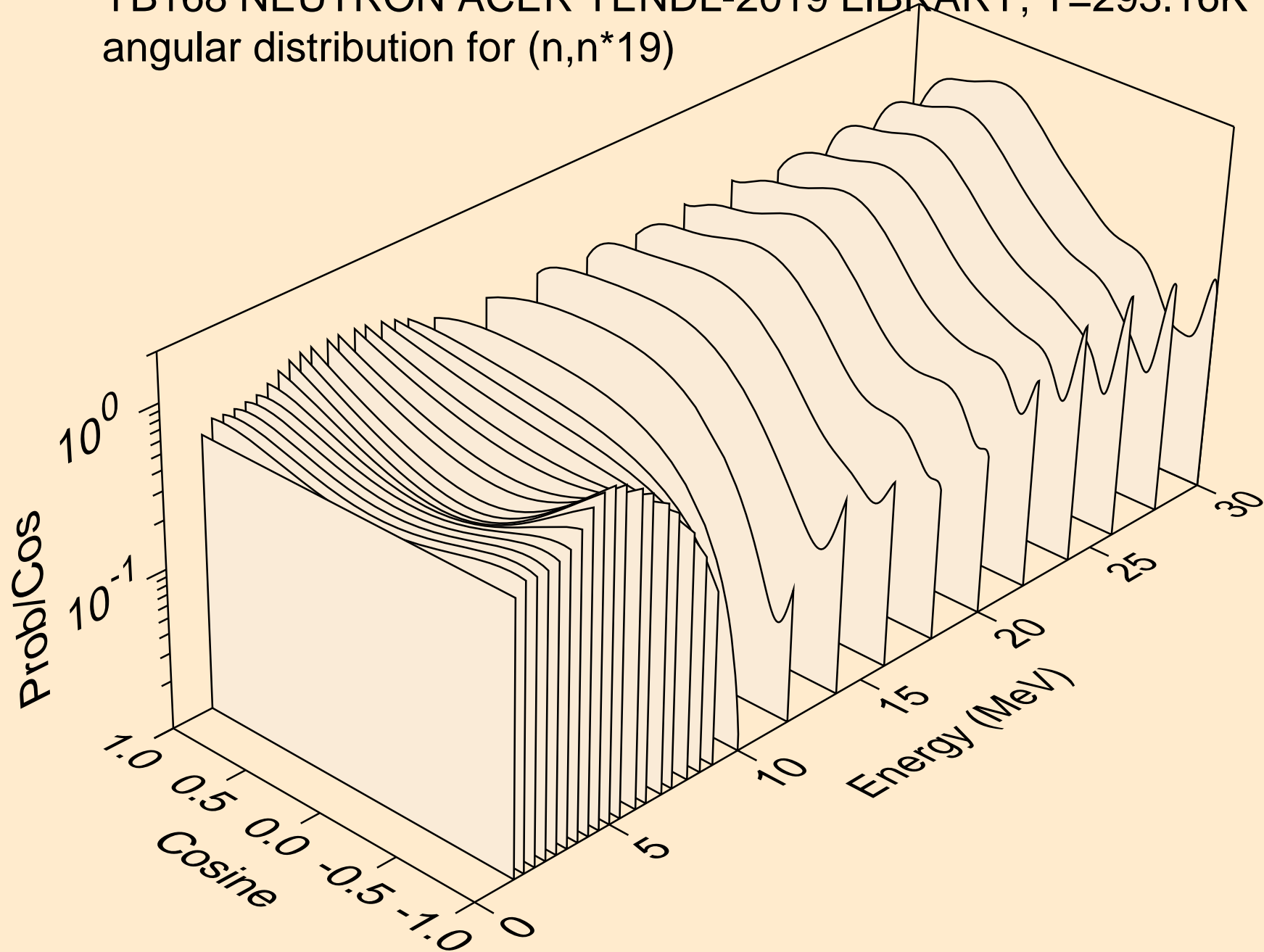

YB168 NEUTRON ACER TENDL-2019 LIBRARY; T=293.16K
angular distribution for (n,n*20)

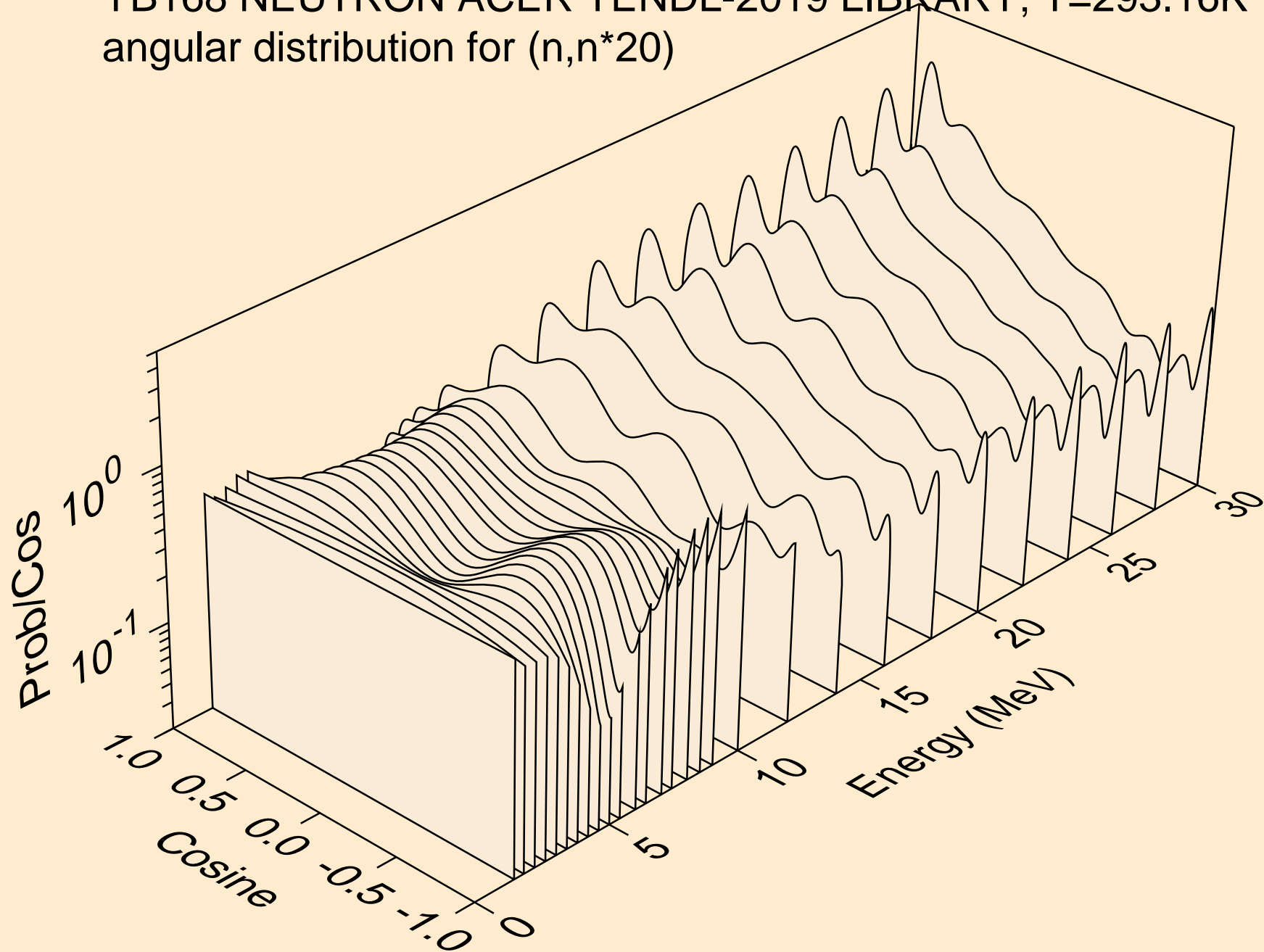

YB168 NEUTRON ACER TENDL-2019 LIBRARY; T=293.16K
angular distribution for (n,n*21)

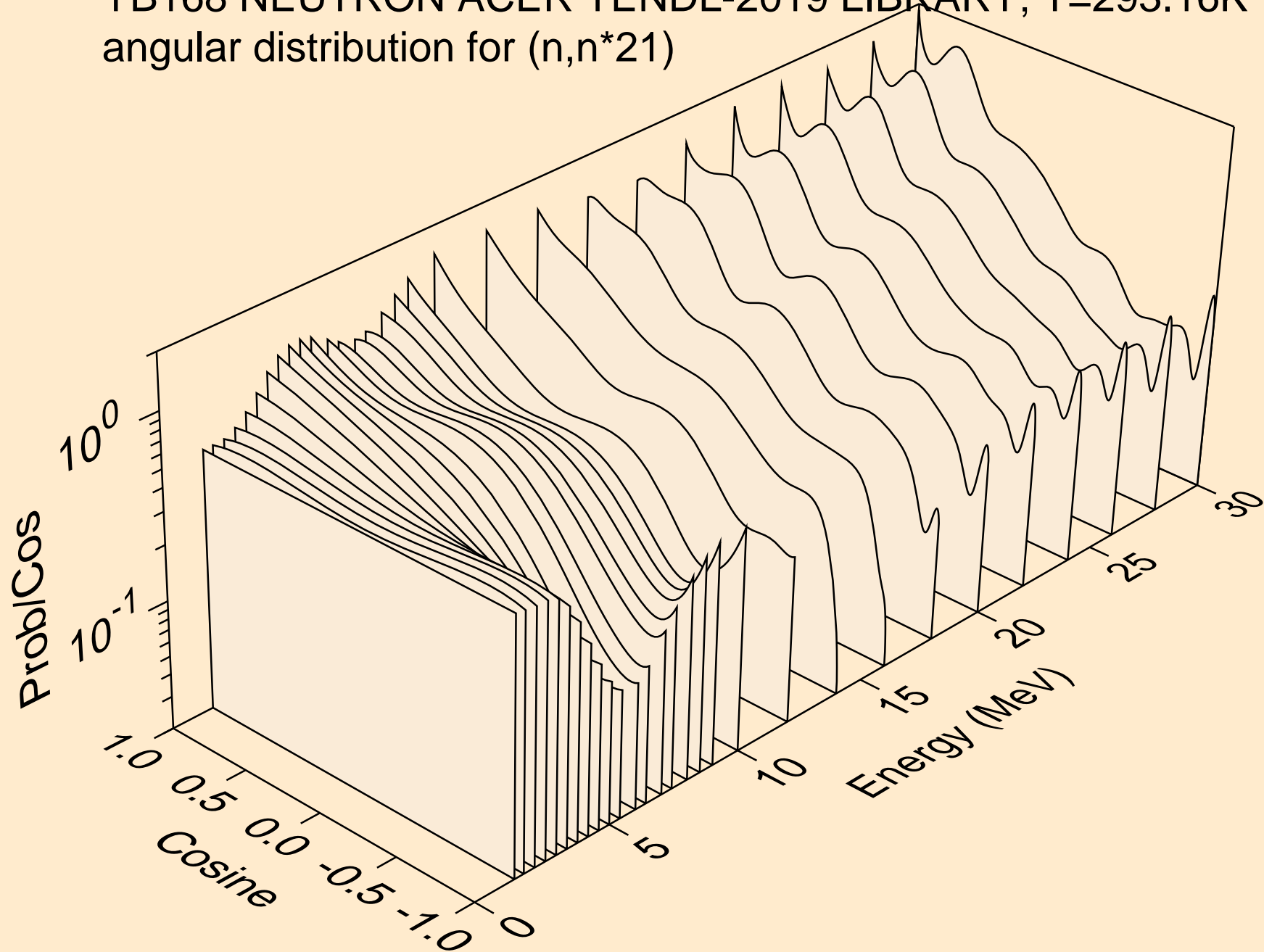

YB168 NEUTRON ACER TENDL-2019 LIBRARY; T=293.16K
angular distribution for (n,n*22)

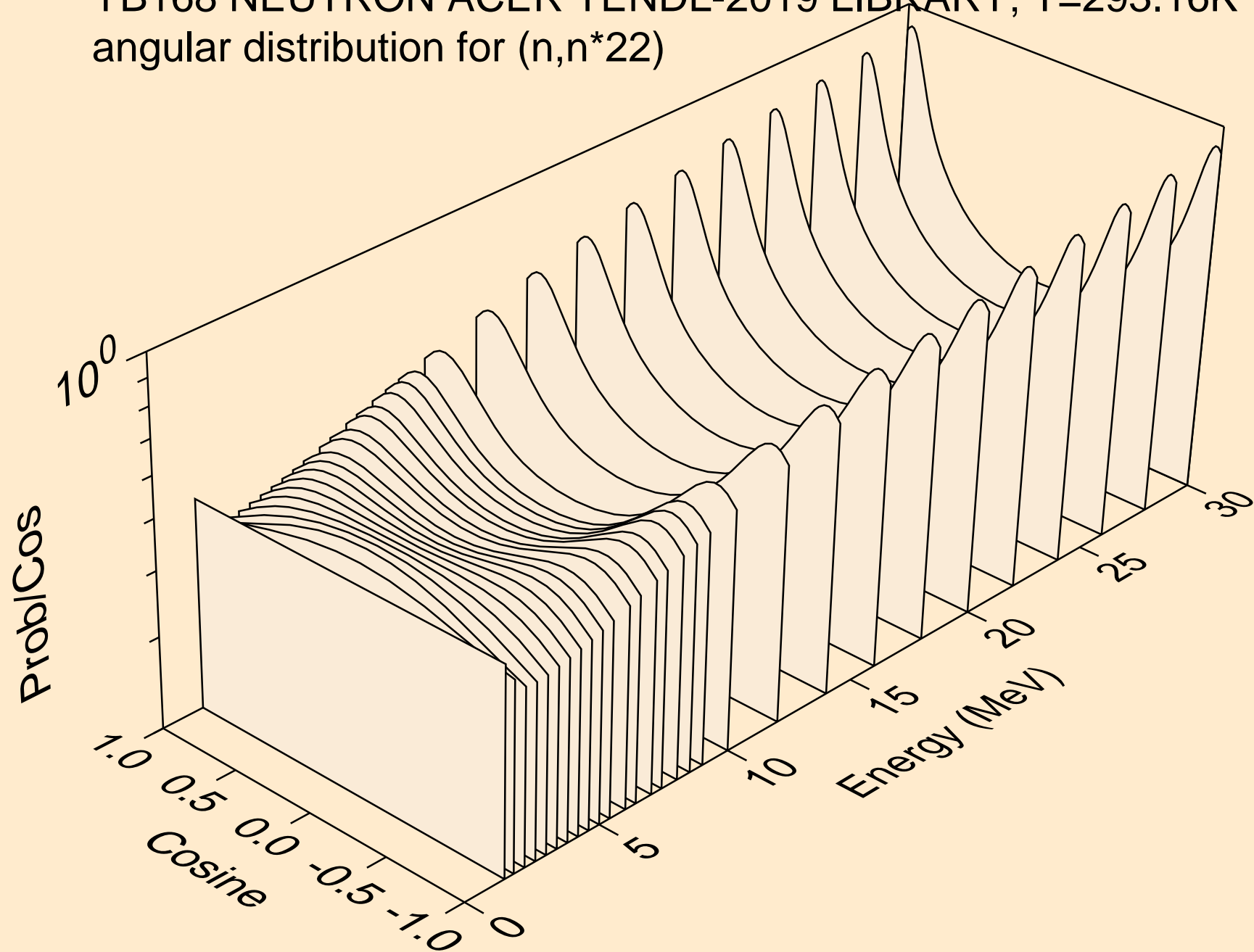

YB168 NEUTRON ACER TENDL-2019 LIBRARY; T=293.16K
angular distribution for (n,n*23)

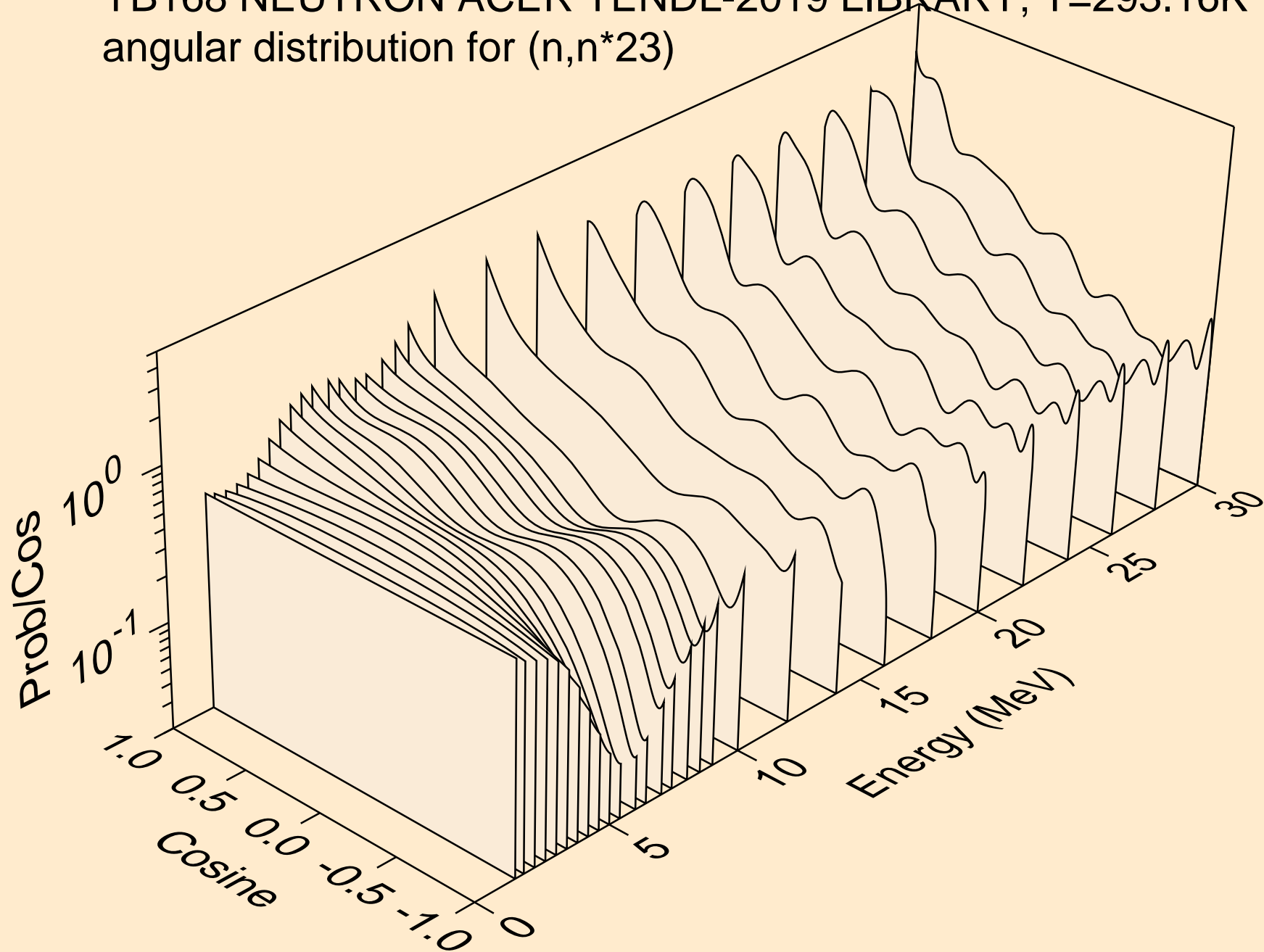

YB168 NEUTRON ACER TENDL-2019 LIBRARY; T=293.16K
angular distribution for (n,n*24)

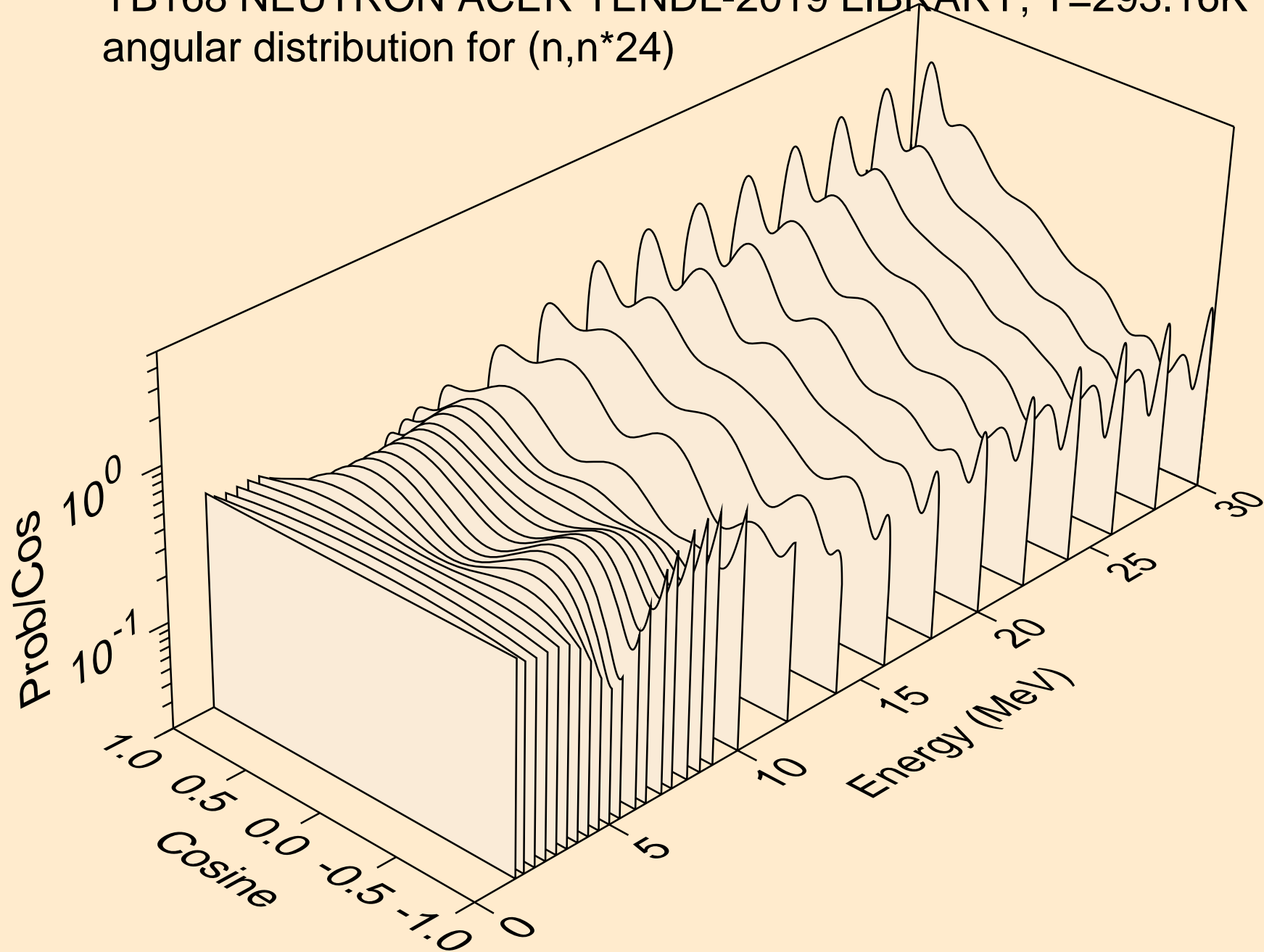

YB168 NEUTRON ACER TENDL-2019 LIBRARY; T=293.16K
angular distribution for (n,n*25)

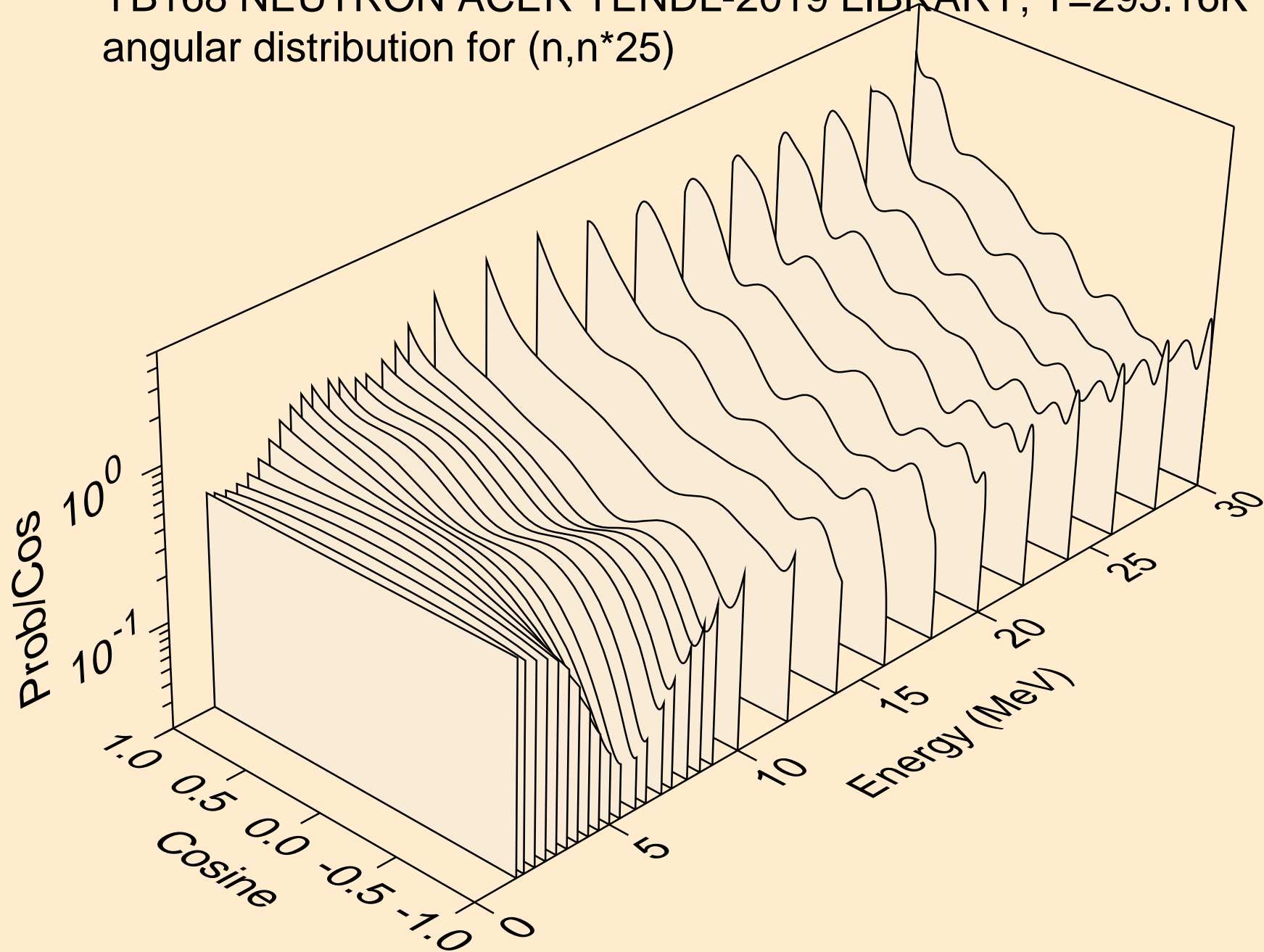

YB168 NEUTRON ACER TENDL-2019 LIBRARY; T=293.16K
angular distribution for (n,n*26)

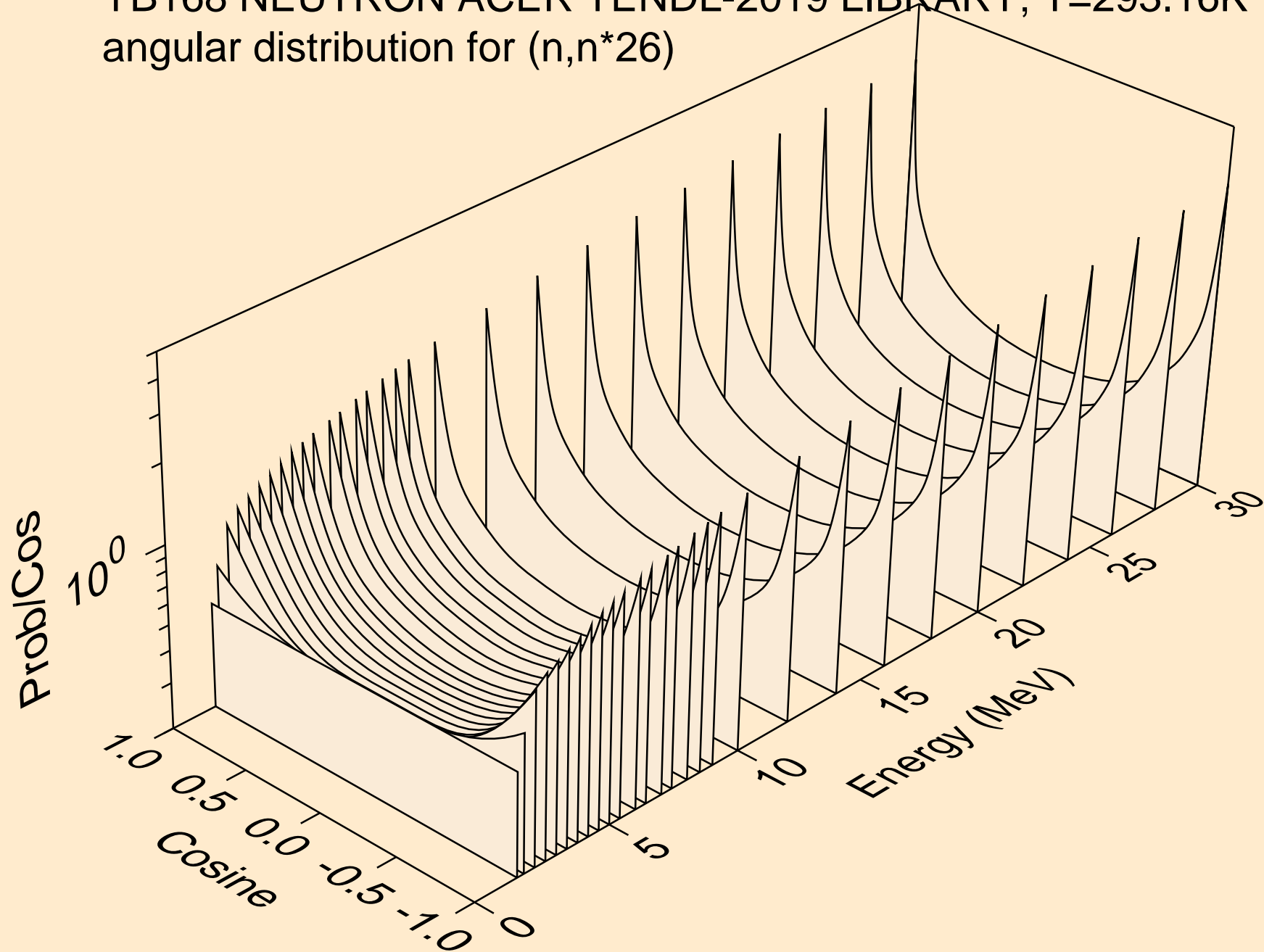

YB168 NEUTRON ACER TENDL-2019 LIBRARY; T=293.16K
angular distribution for (n,n*27)

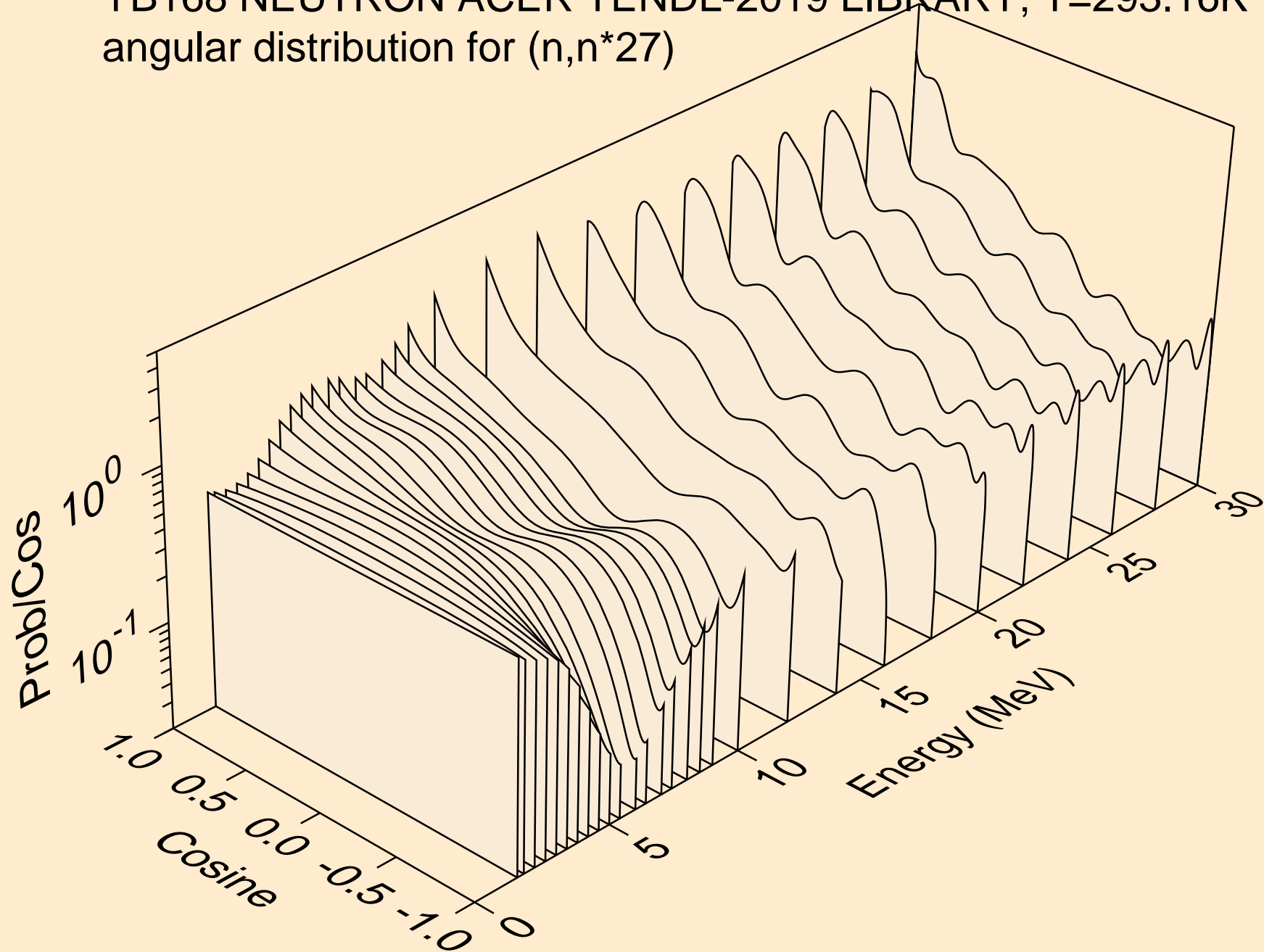

YB168 NEUTRON ACER TENDL-2019 LIBRARY; T=293.16K
angular distribution for (n,n*28)

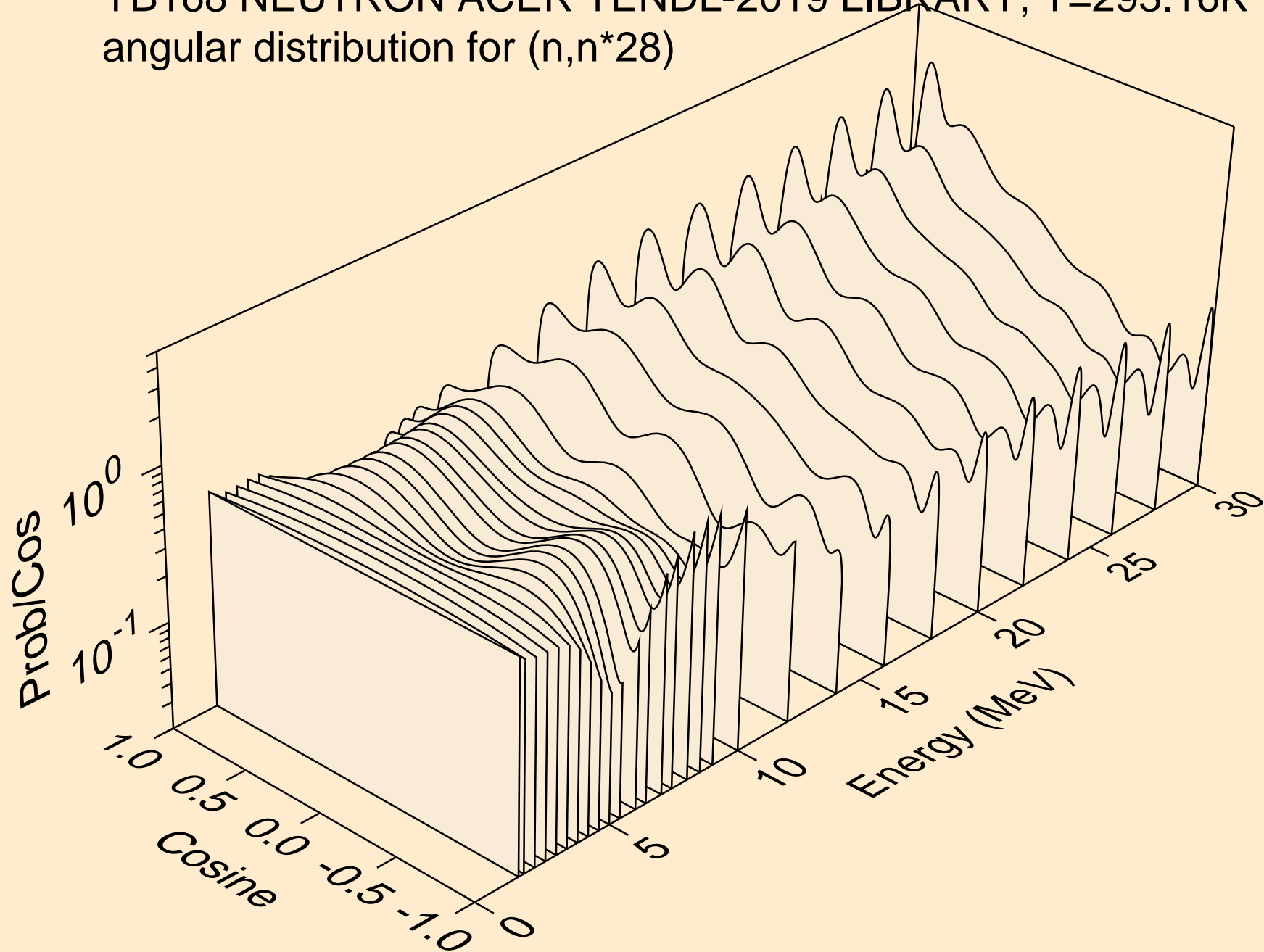

YB168 NEUTRON ACER TENDL-2019 LIBRARY; T=293.16K
angular distribution for (n,n*29)

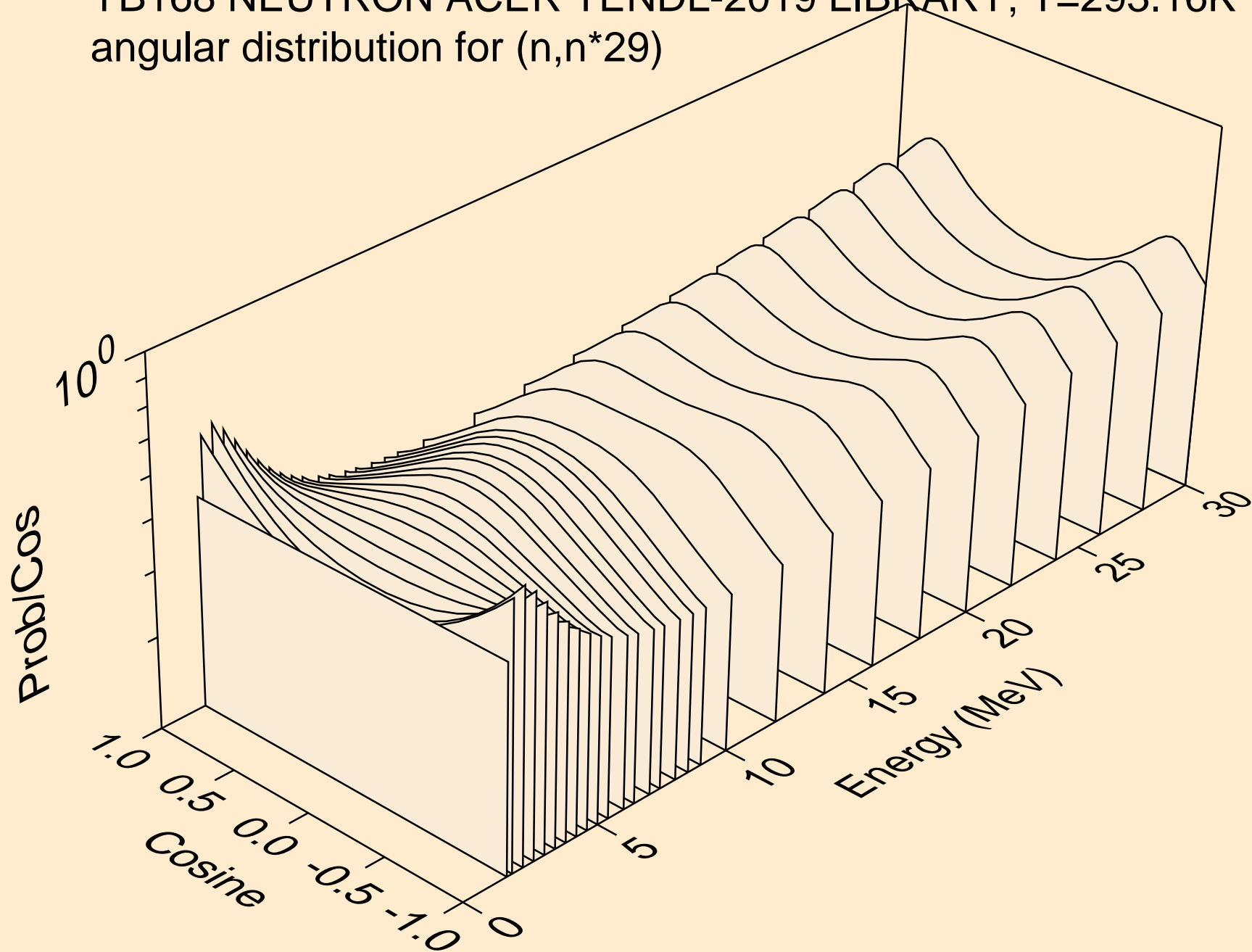

YB168 NEUTRON ACER TENDL-2019 LIBRARY; T=293.16K
angular distribution for (n,n*30)

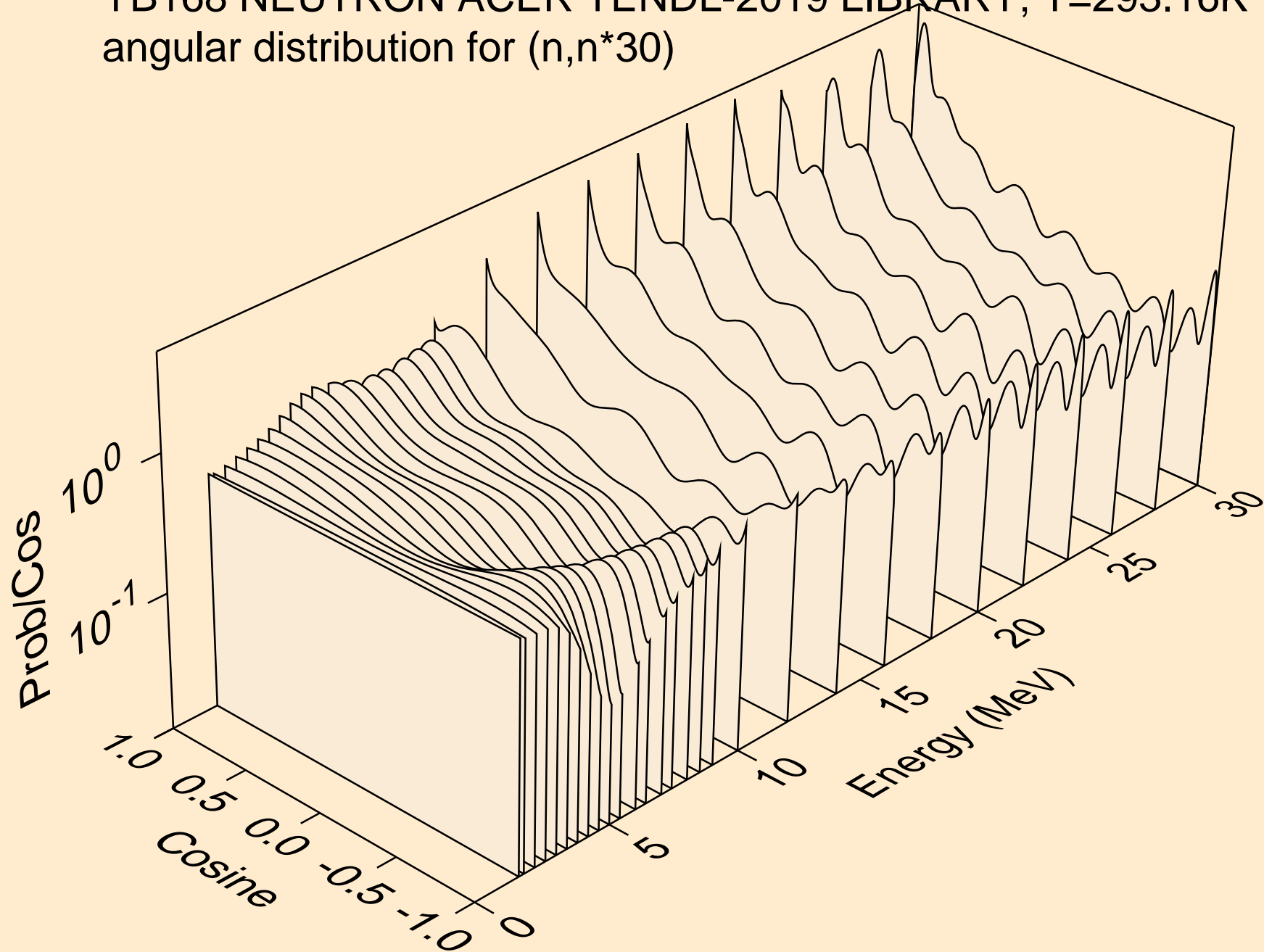

YB168 NEUTRON ACER TENDL-2019 LIBRARY; T=293.16K
Neutron emission for (n,x)

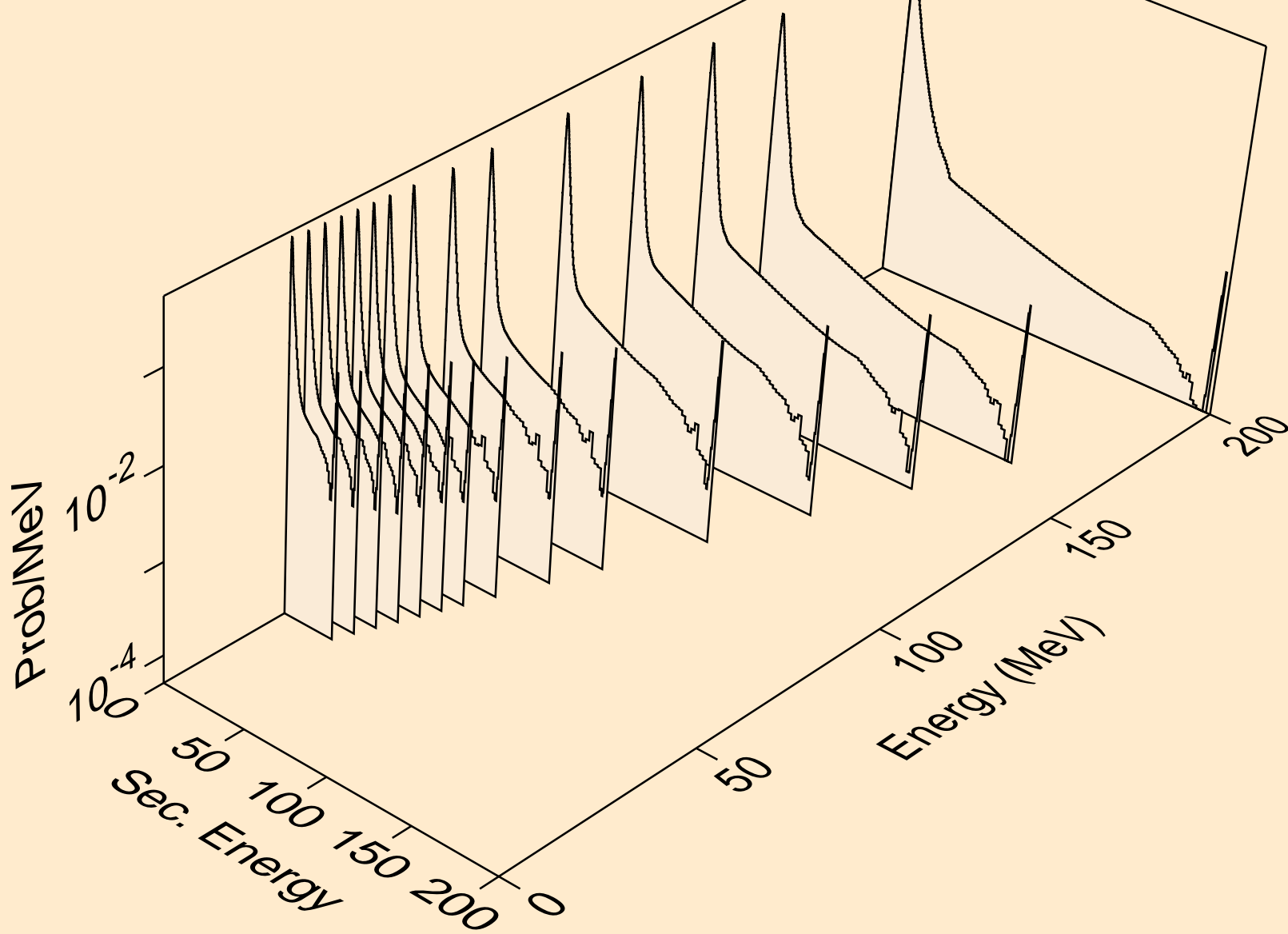

YB168 NEUTRON ACER TENDL-2019 LIBRARY; T=293.16K
Neutron emission for (n,2nd)

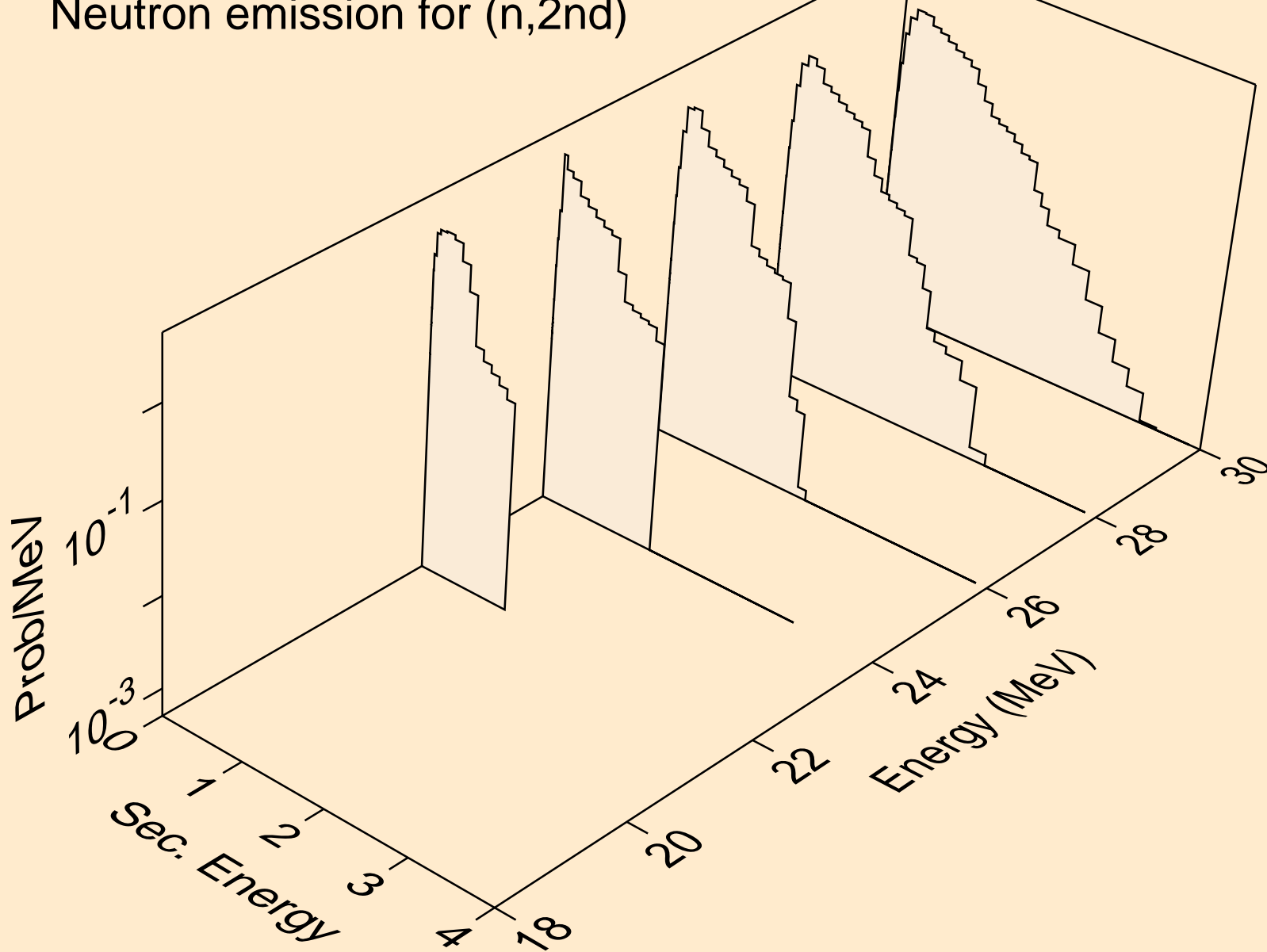

YB168 NEUTRON ACER TENDL-2019 LIBRARY; T=293.16K
Neutron emission for (n,2n)

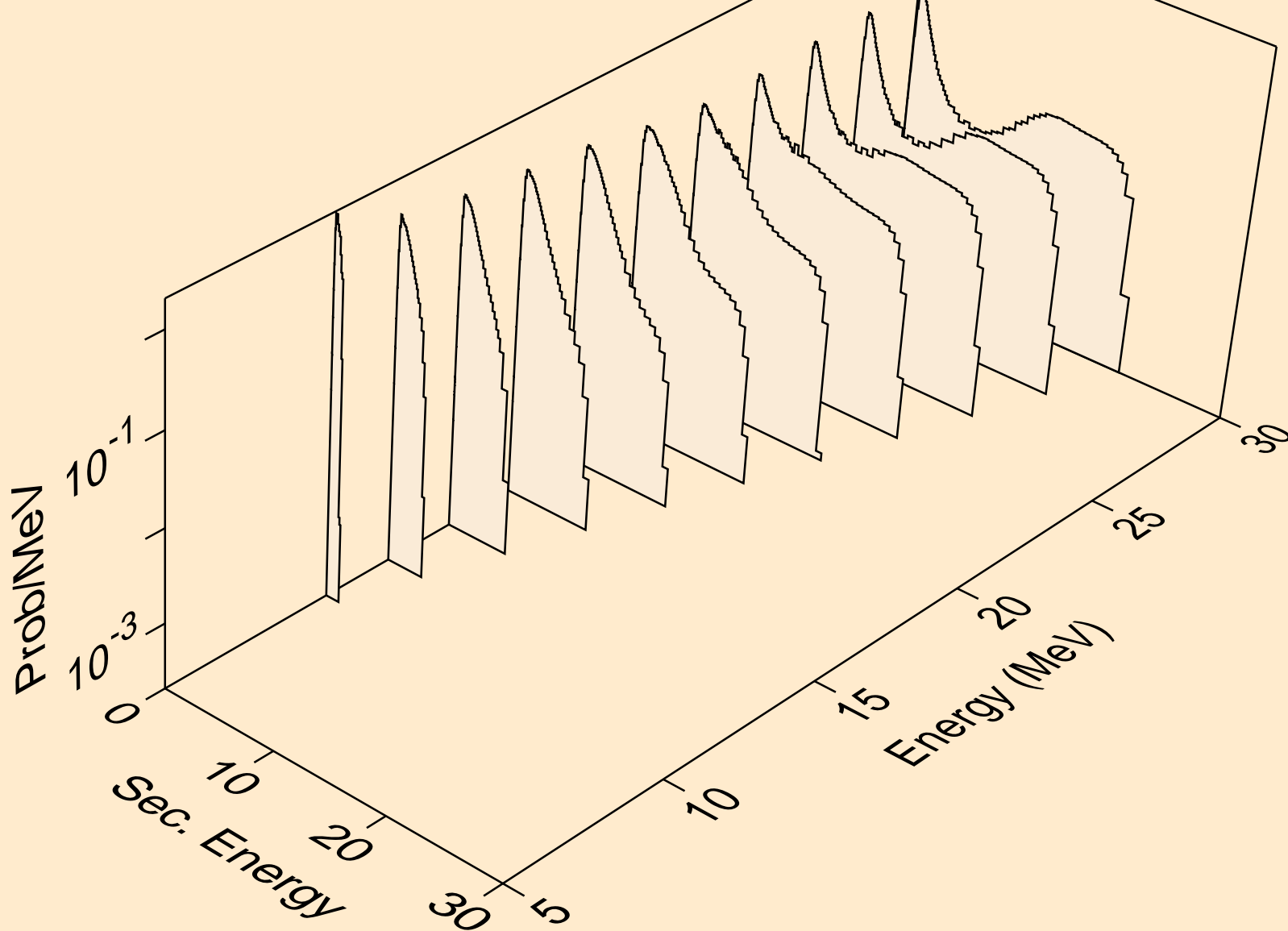

YB168 NEUTRON ACER TENDL-2019 LIBRARY; T=293.16K
Neutron emission for (n,3n)

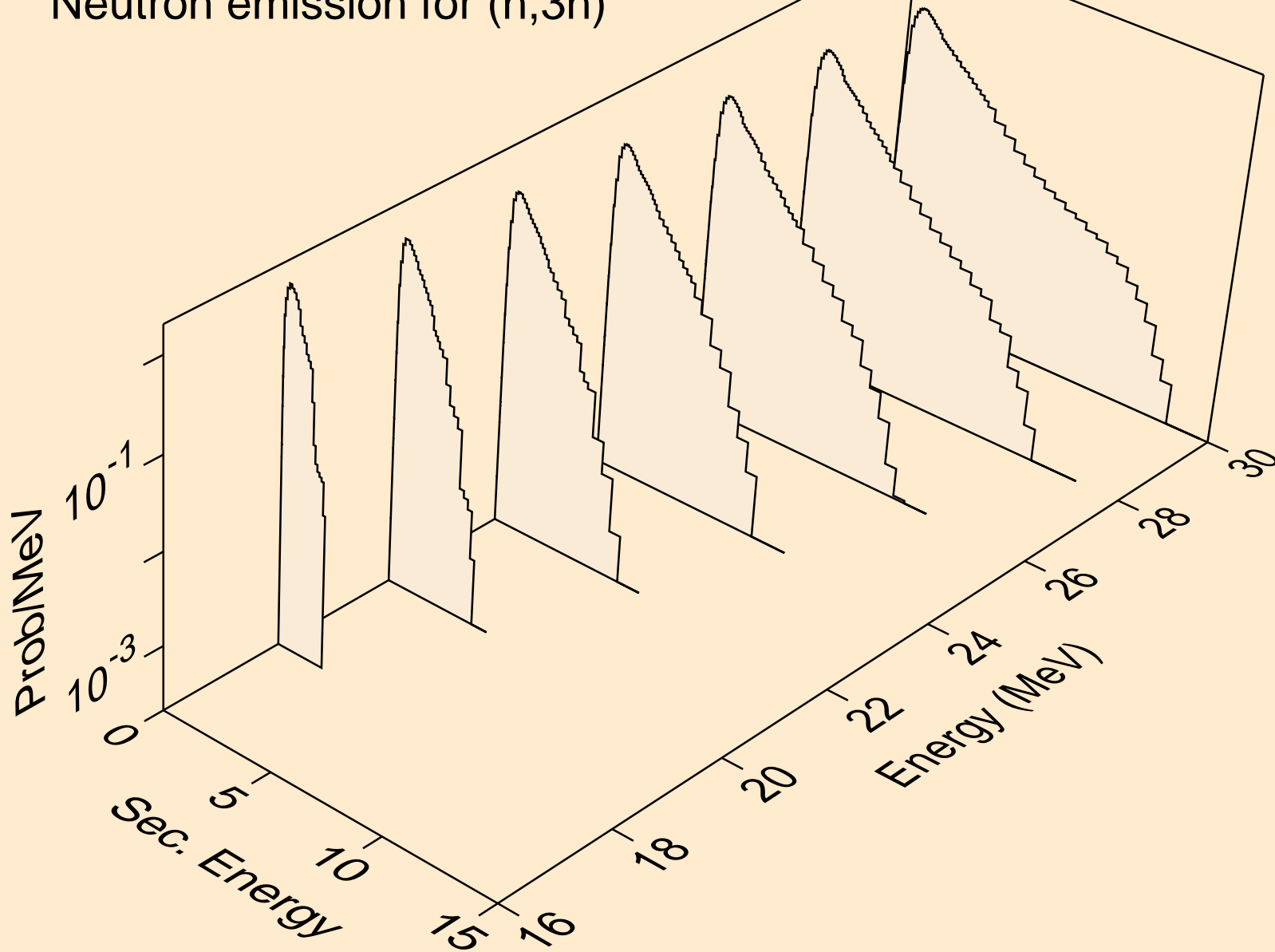

YB168 NEUTRON ACER TENDL-2019 LIBRARY; T=293.16K
Neutron emission for (n,n*)a

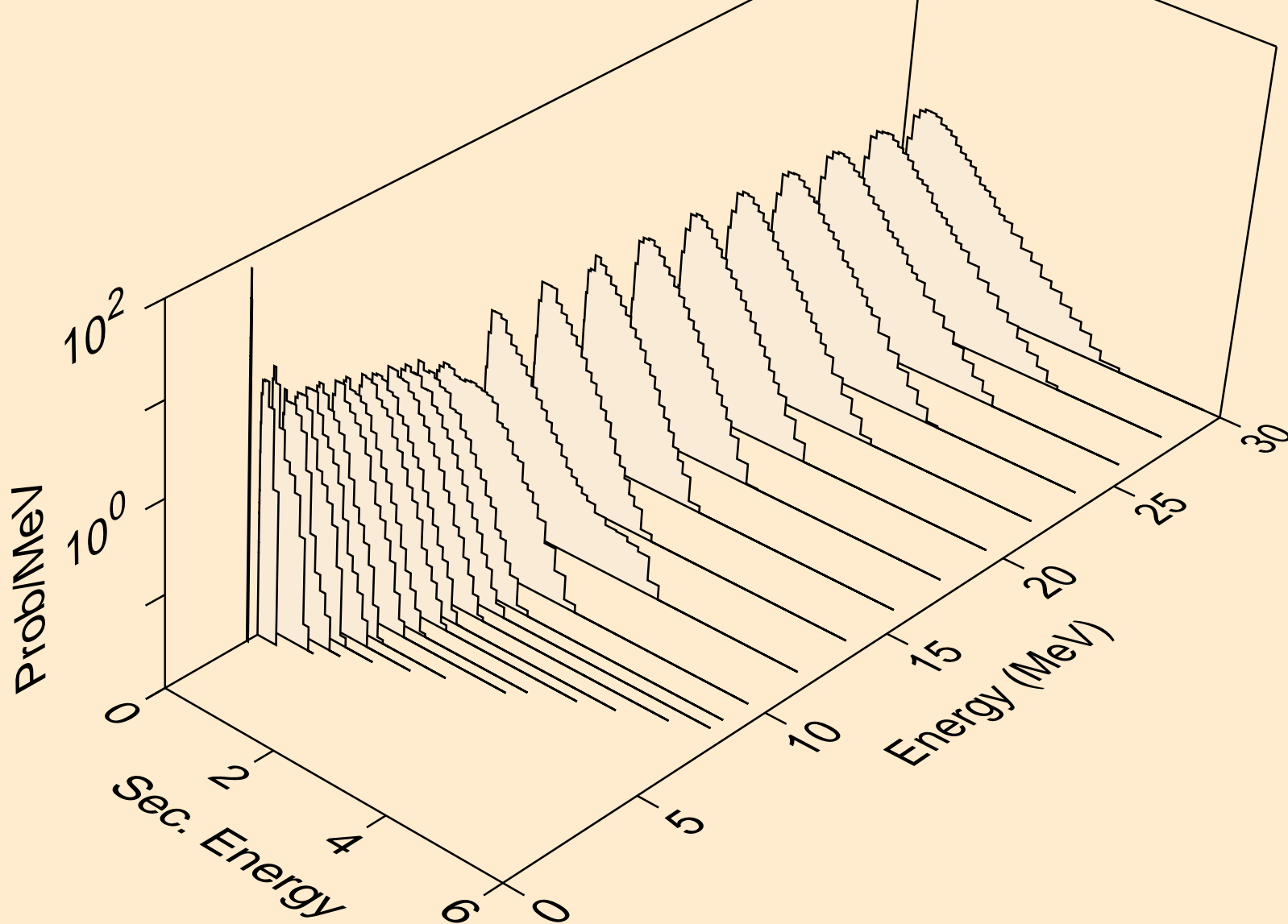

YB168 NEUTRON ACER TENDL-2019 LIBRARY; T=293.16K
Neutron emission for (n,2n)a

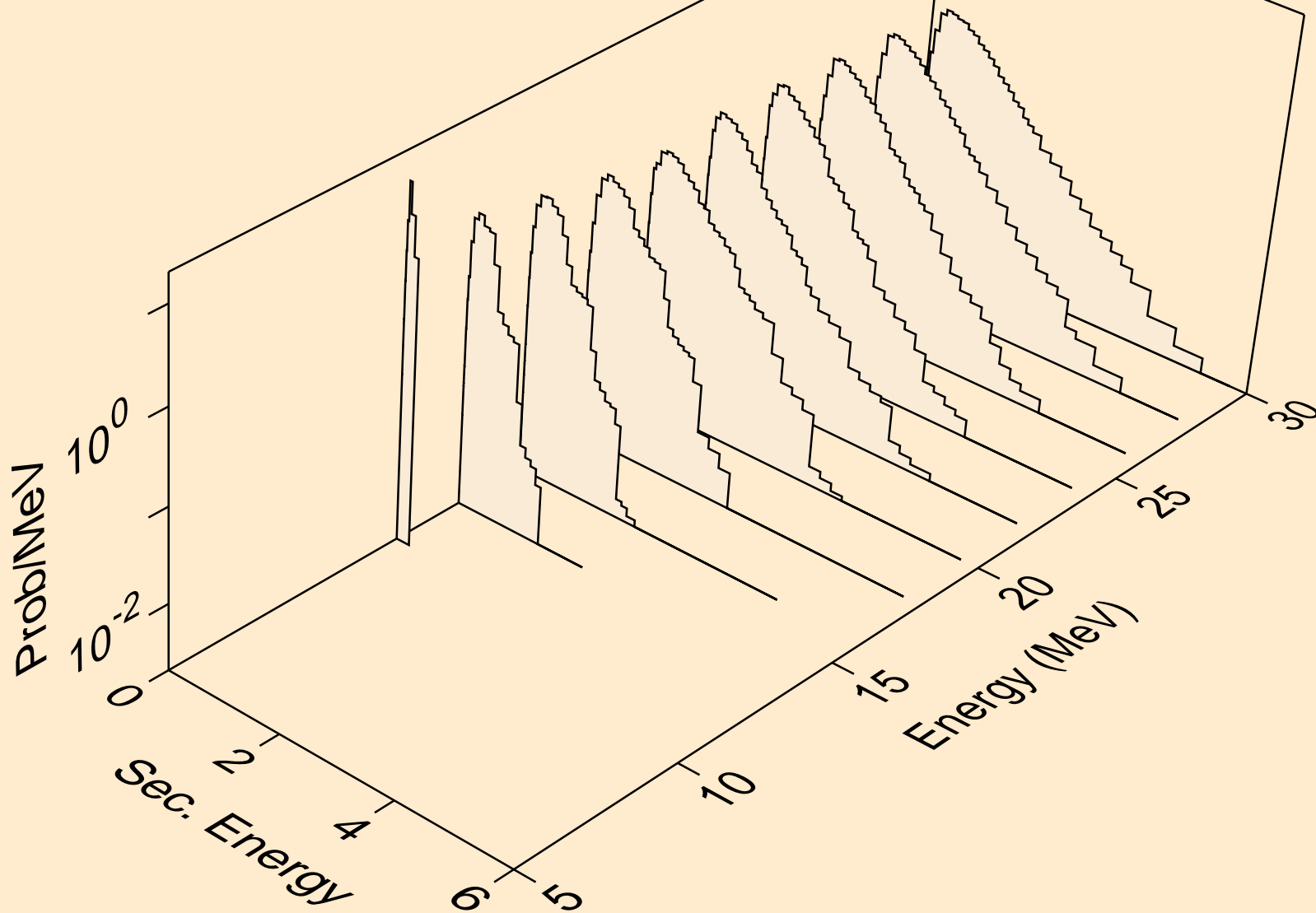

YB168 NEUTRON ACER TENDL-2019 LIBRARY; T=293.16K
Neutron emission for (n,3n)a

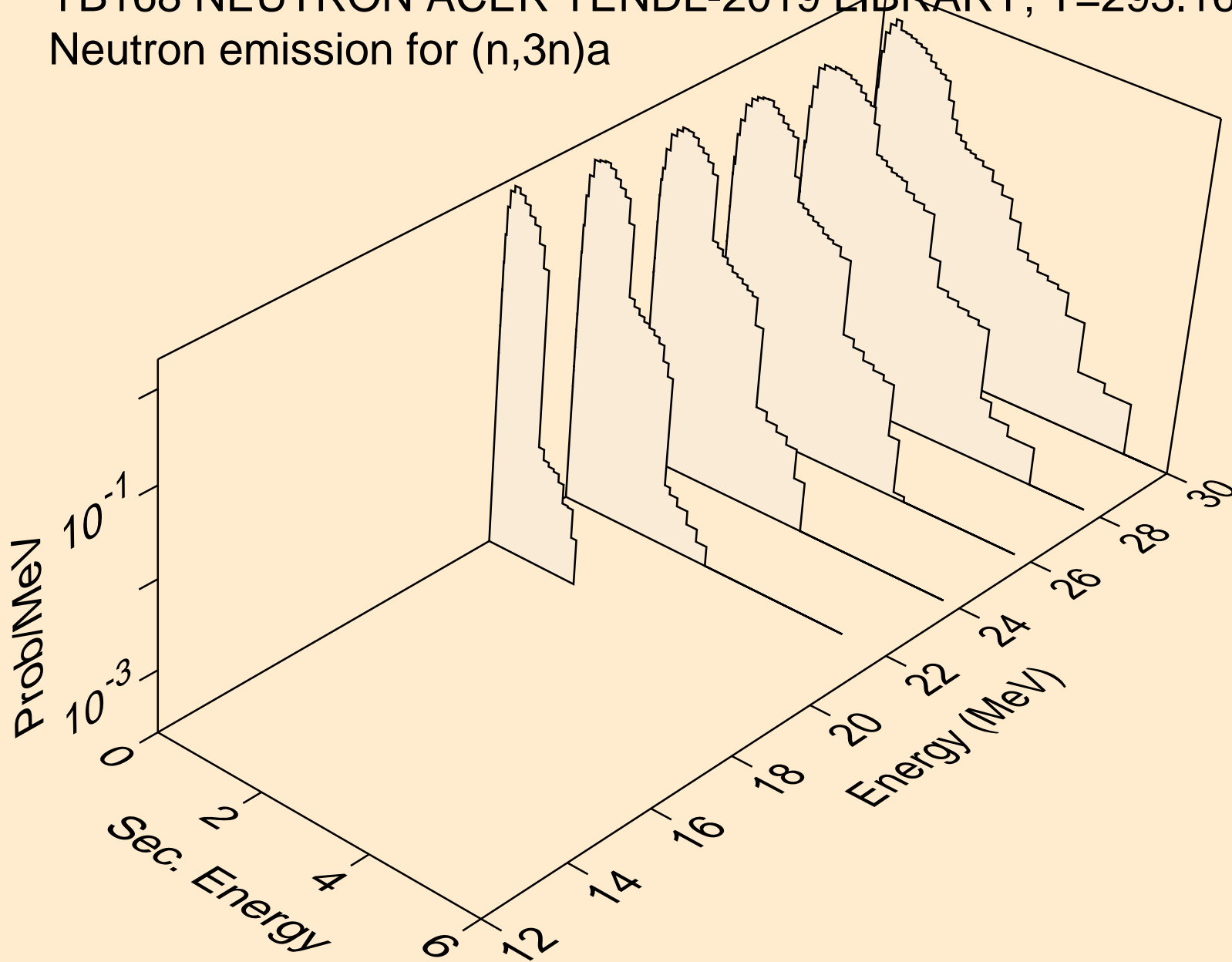

YB168 NEUTRON ACER TENDL-2019 LIBRARY; T=293.16K
Neutron emission for (n,n*)p

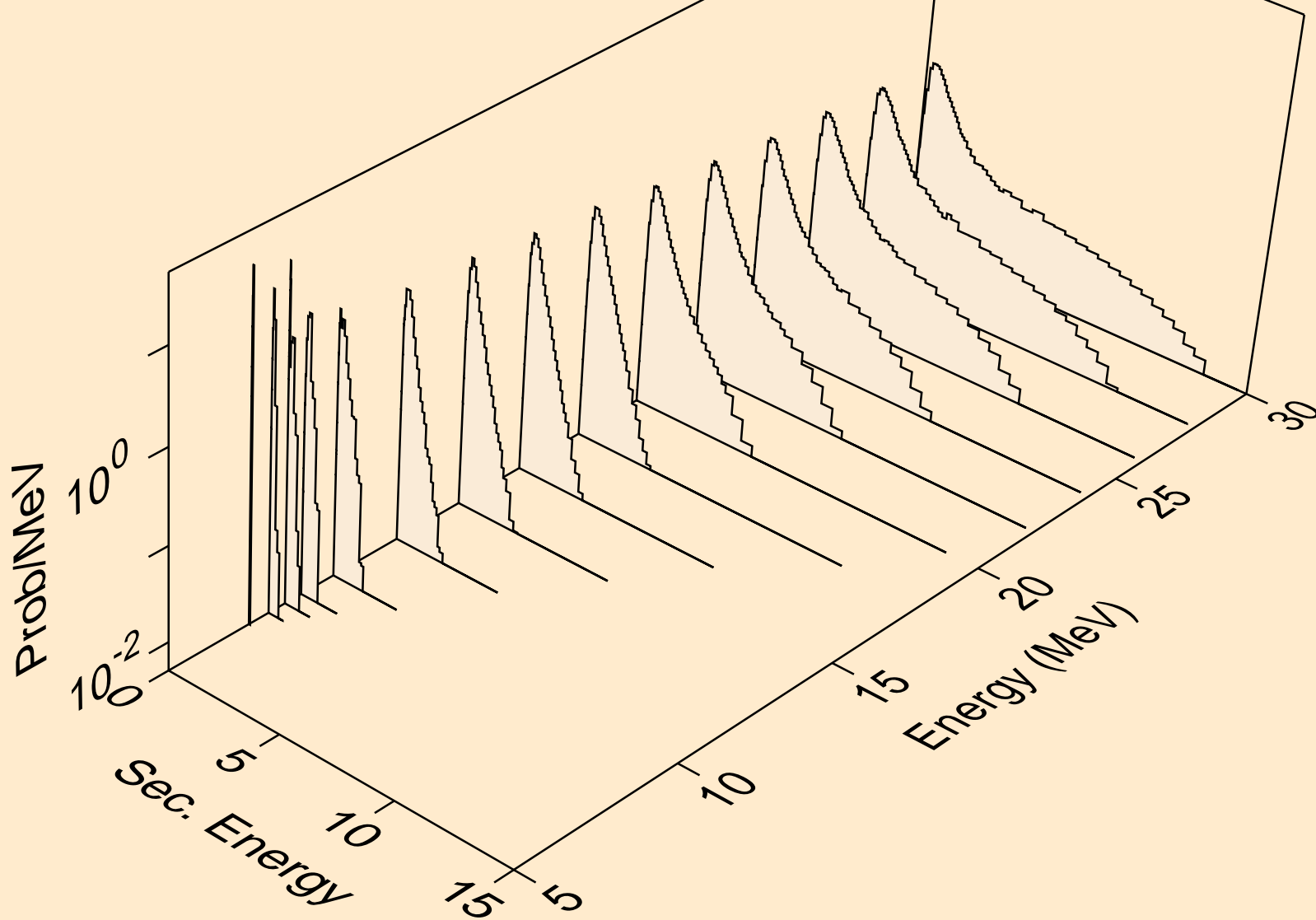

YB168 NEUTRON ACER TENDL-2019 LIBRARY; T=293.16K
Neutron emission for (n,n*)2a

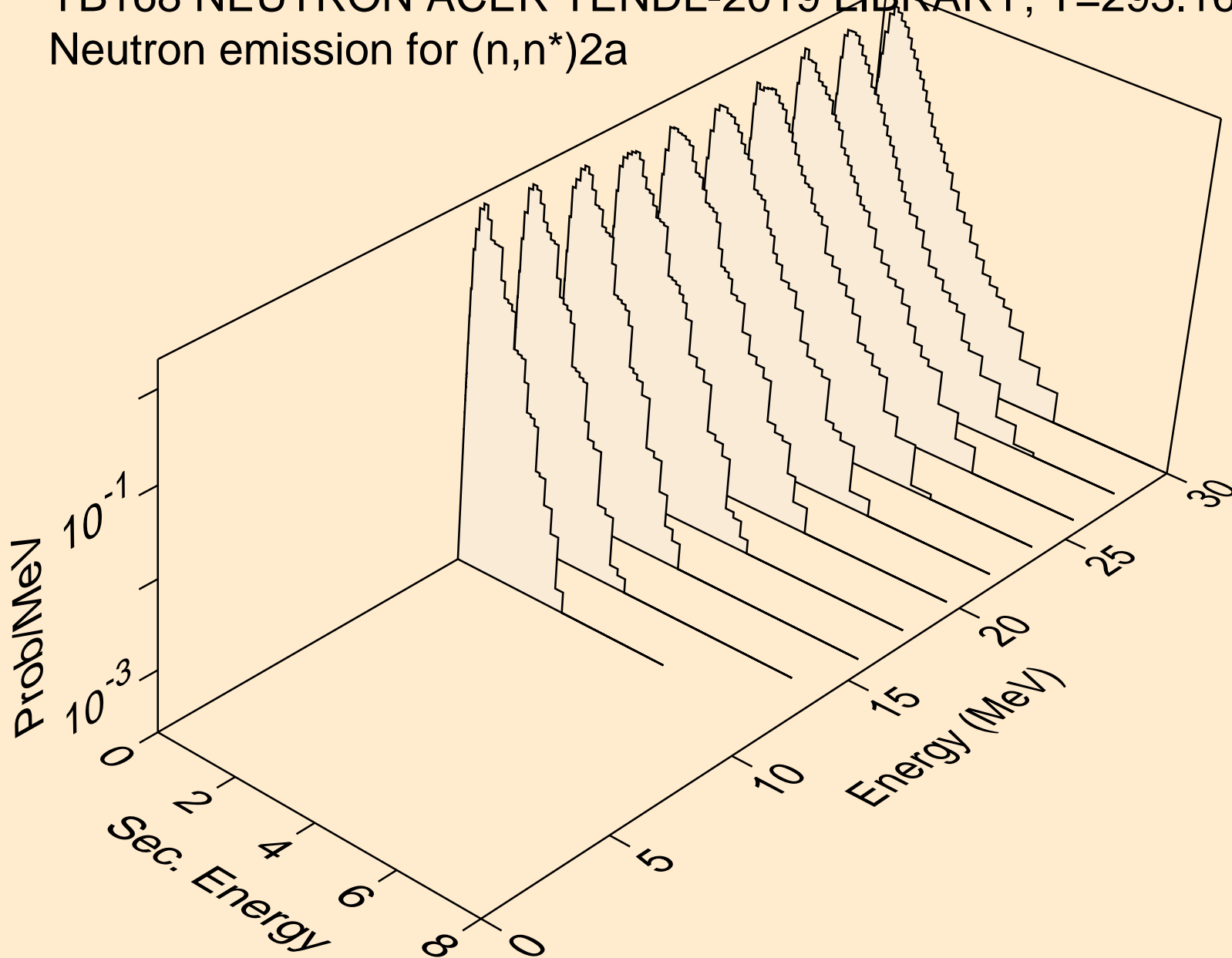

YB168 NEUTRON ACER TENDL-2019 LIBRARY; T=293.16K
Neutron emission for (n,n*)d

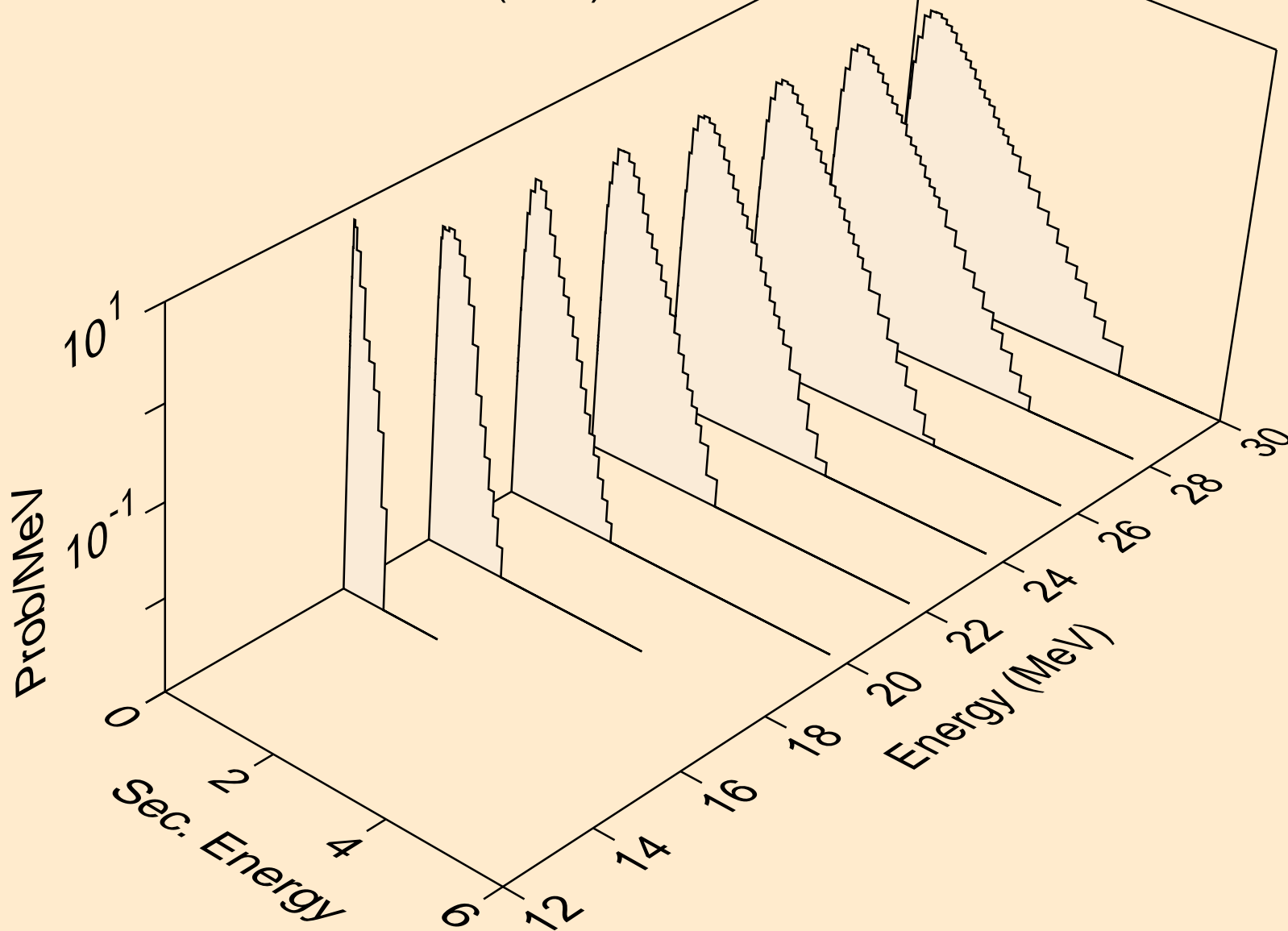

YB168 NEUTRON ACER TENDL-2019 LIBRARY; T=293.16K
Neutron emission for (n,n*)t

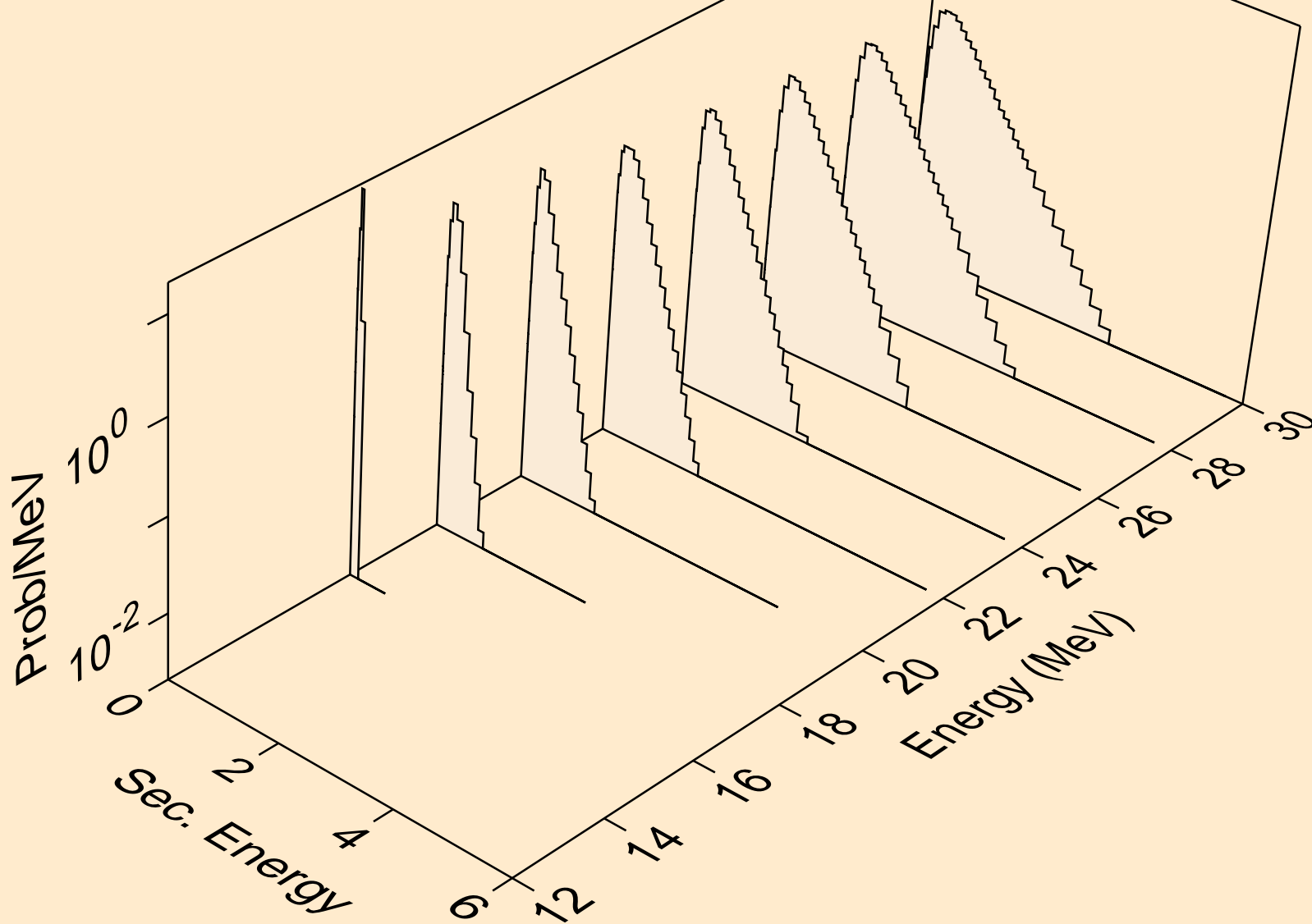

YB168 NEUTRON ACER TENDL-2019 LIBRARY; T=293.16K
Neutron emission for (n,n*)he3

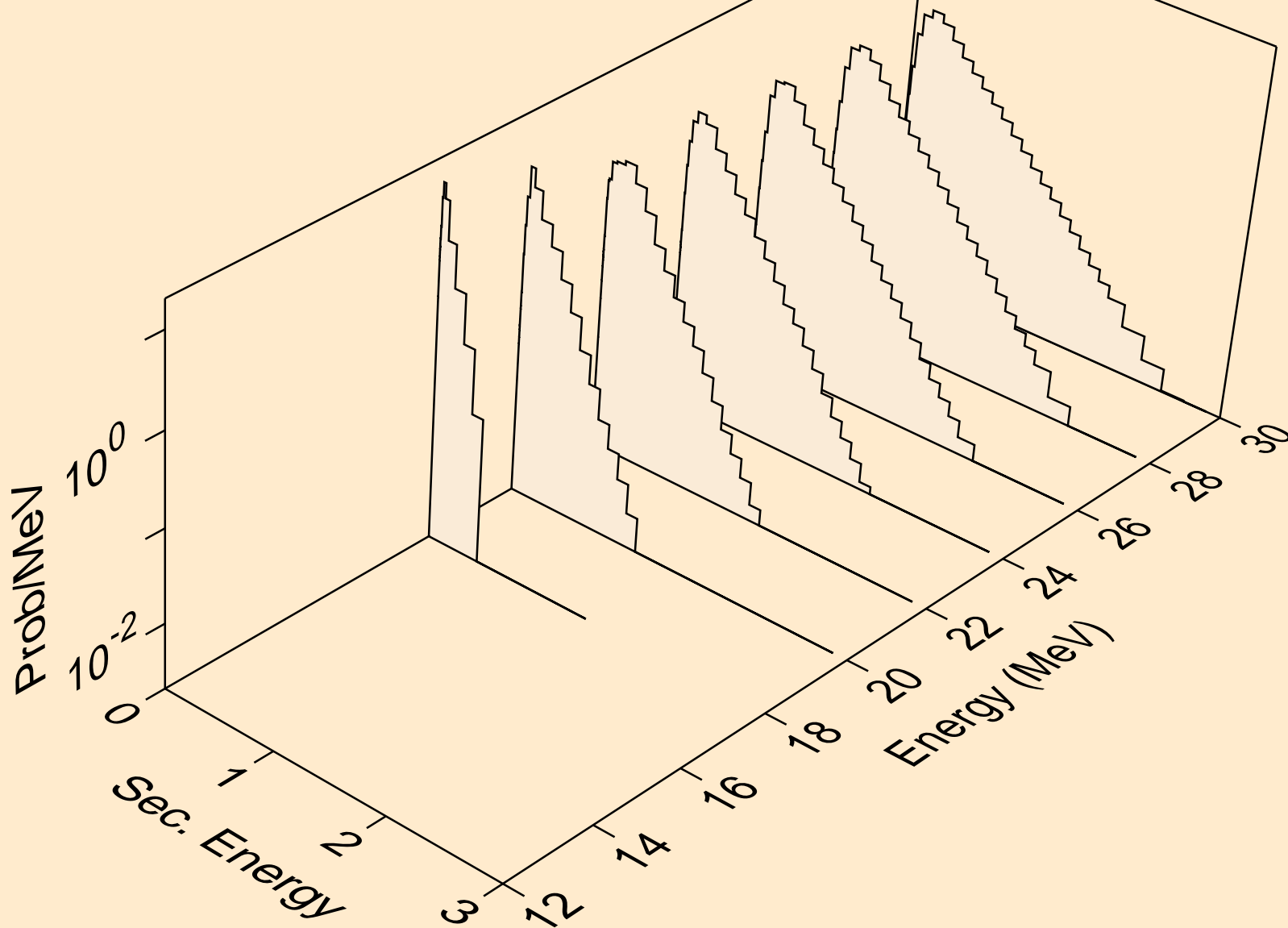

YB168 NEUTRON ACER TENDL-2019 LIBRARY; T=293.16K
Neutron emission for (n,4n)

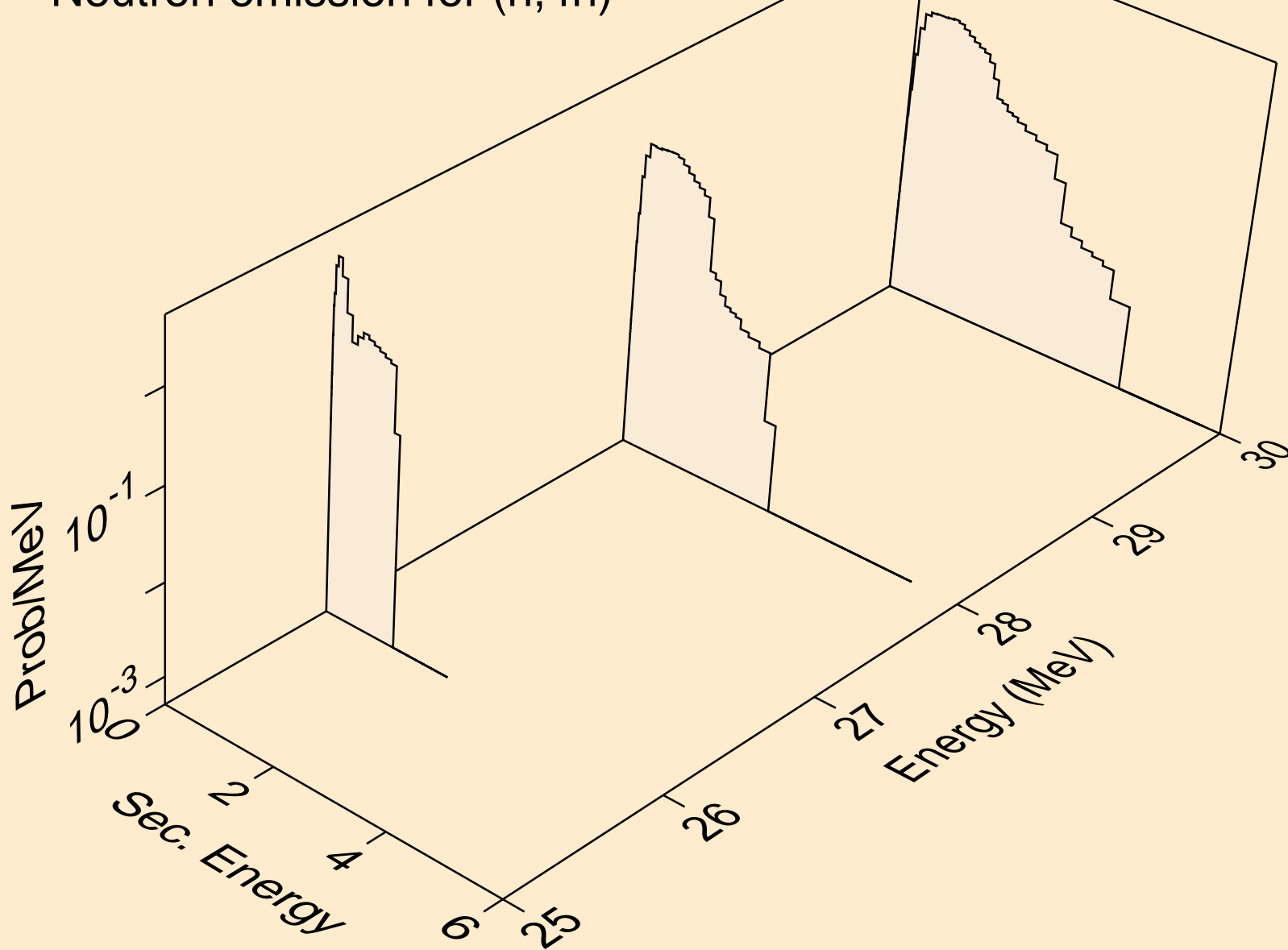

YB168 NEUTRON ACER TENDL-2019 LIBRARY; T=293.16K
Neutron emission for (n,2np)

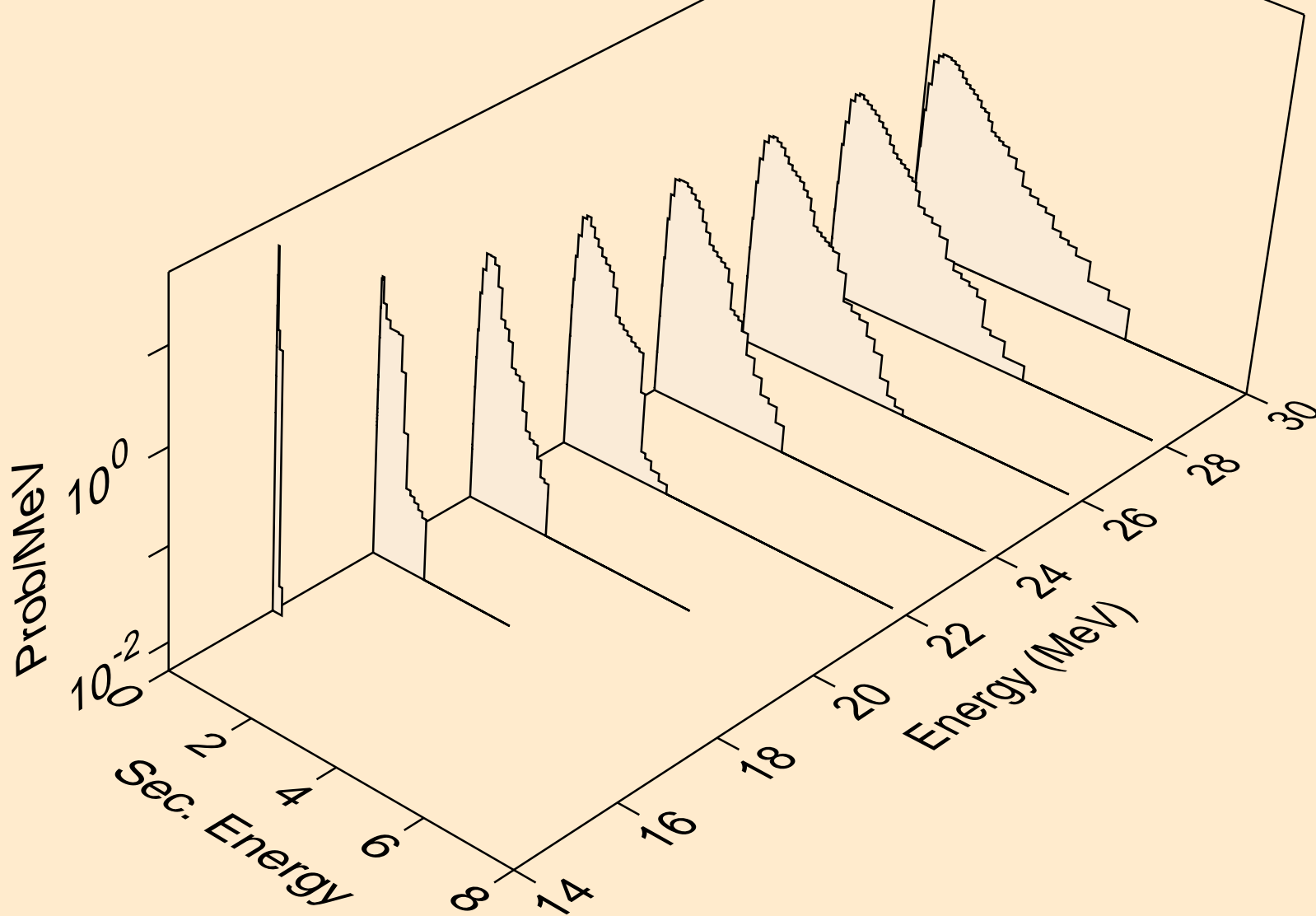

YB168 NEUTRON ACER TENDL-2019 LIBRARY; T=293.16K
Neutron emission for (n,3np)

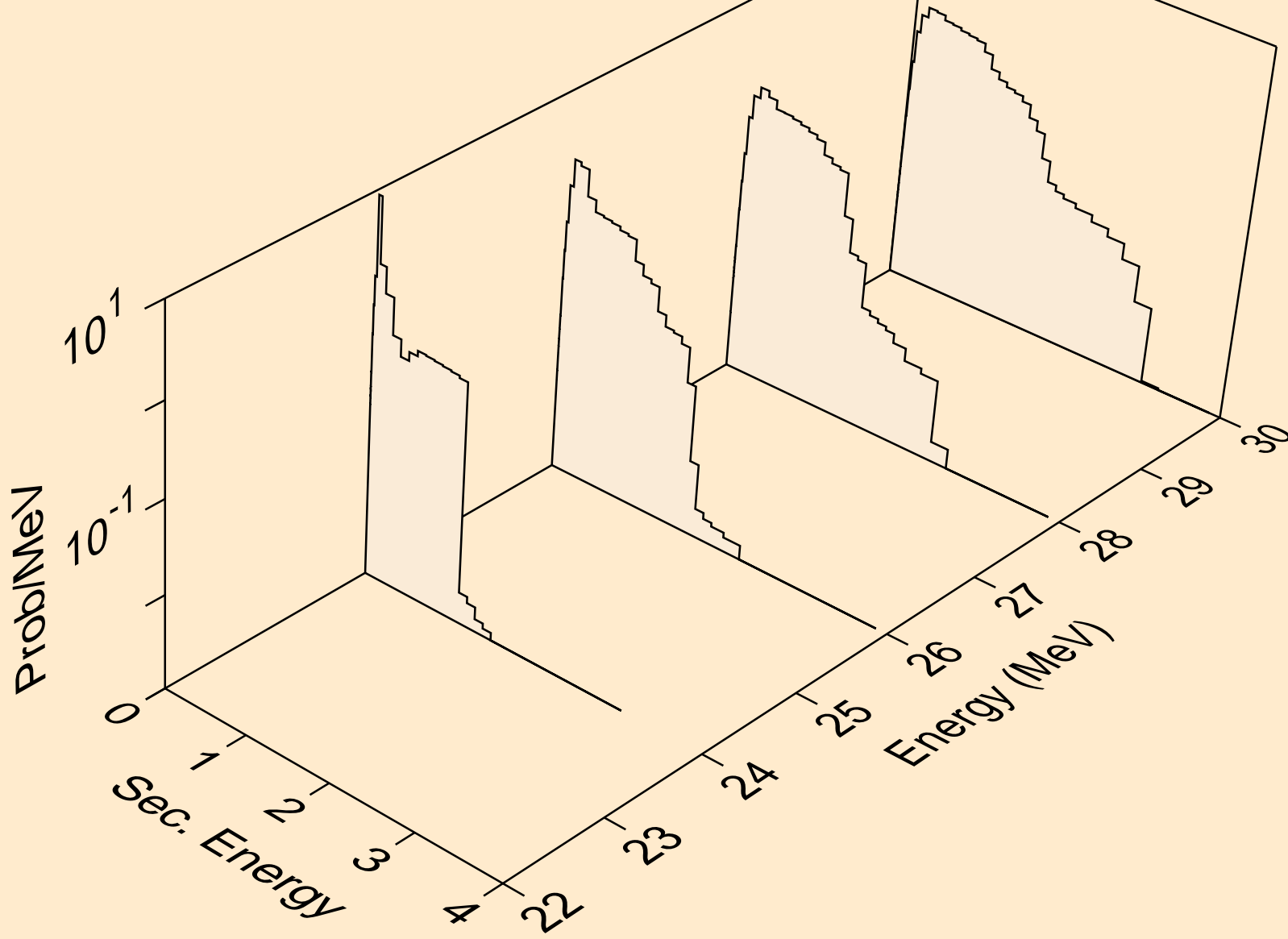

YB168 NEUTRON ACER TENDL-2019 LIBRARY; T=293.16K
Neutron emission for (n,2np)

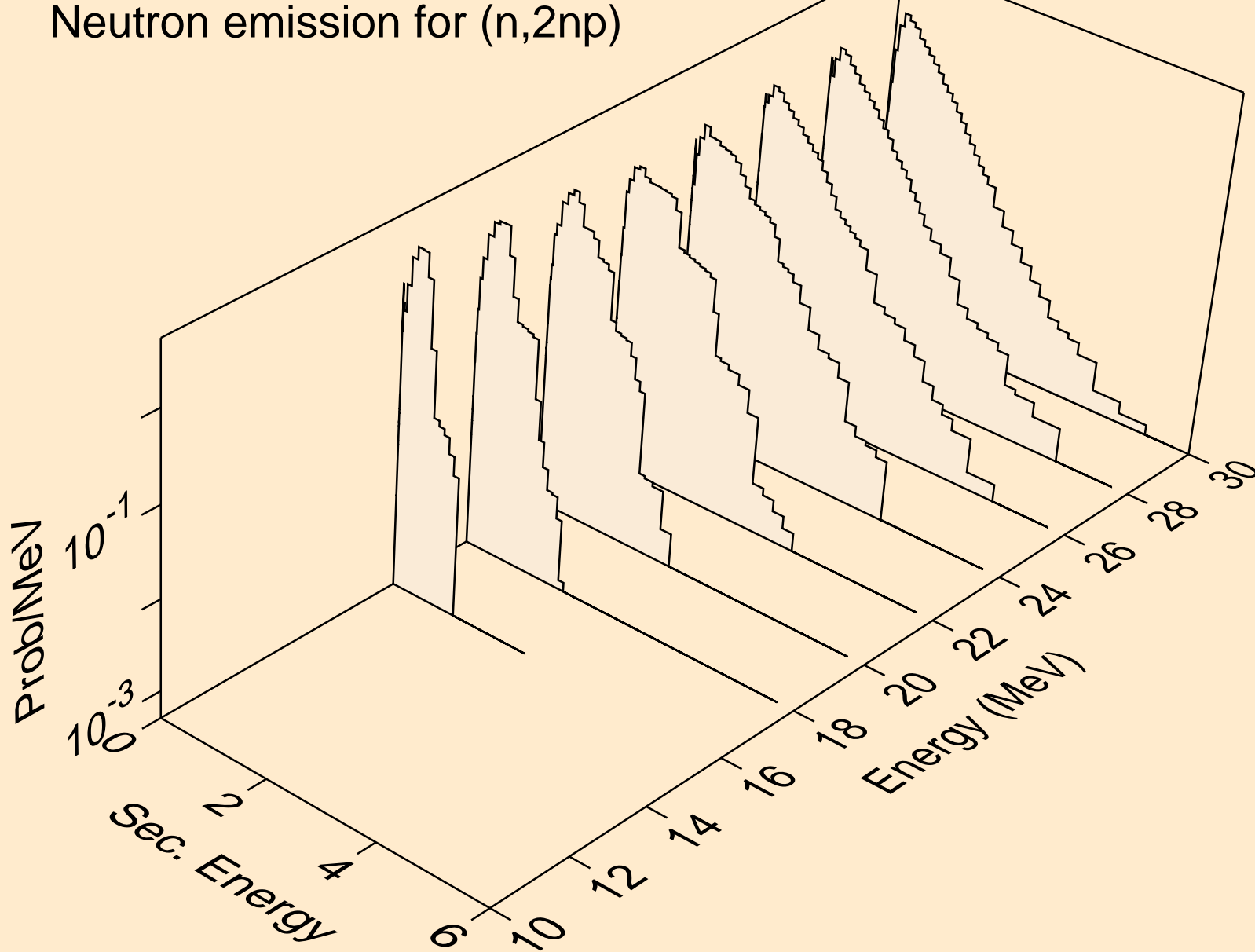

YB168 NEUTRON ACER TENDL-2019 LIBRARY; T=293.16K
Neutron emission for (n,npa)

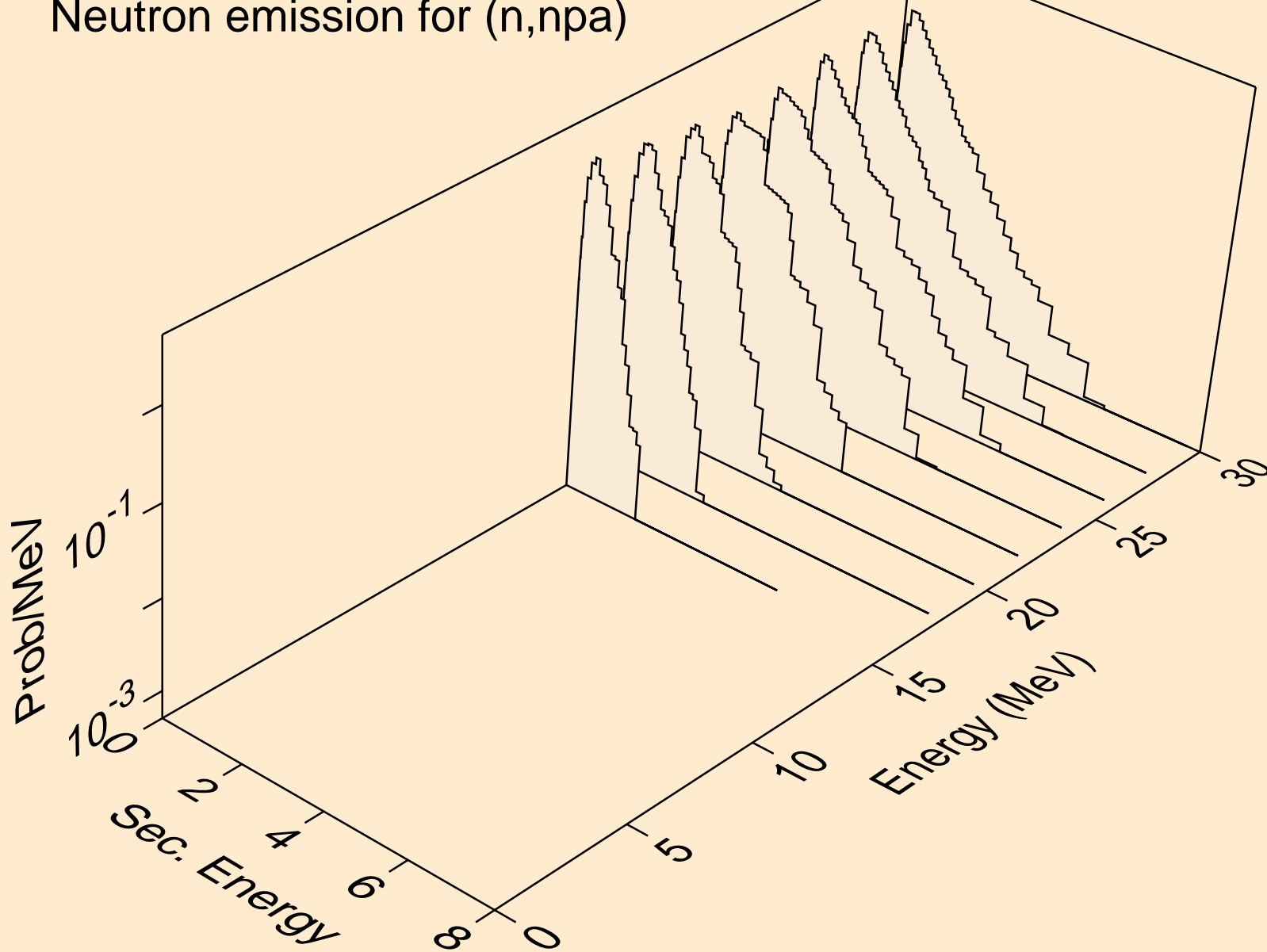

YB168 NEUTRON ACER TENDL-2019 LIBRARY; T=293.16K
Neutron emission for (n,n*c)

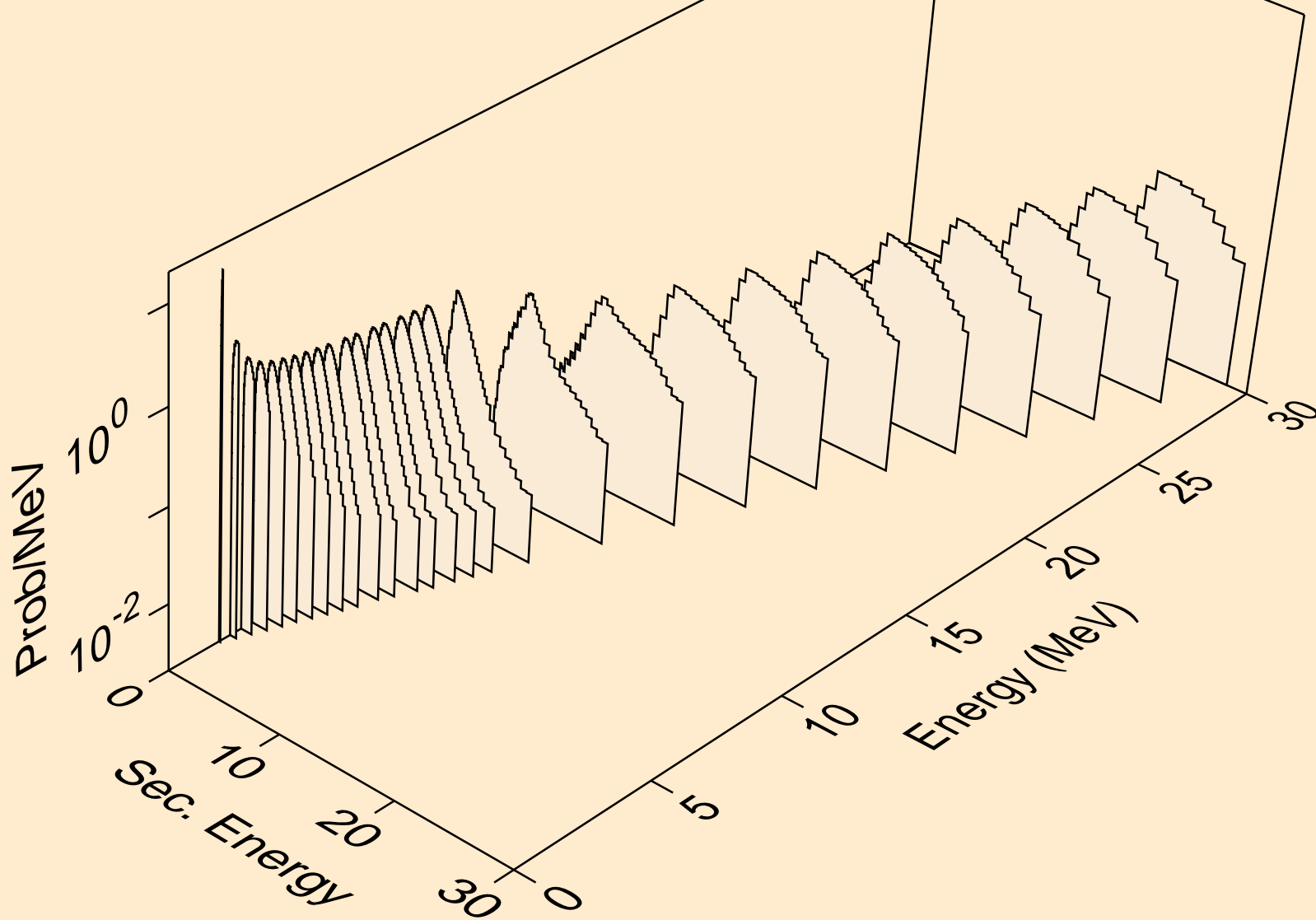

YB168 NEUTRON ACER TENDL-2019 LIBRARY; T=293.16K
Photon emission for (n,x)

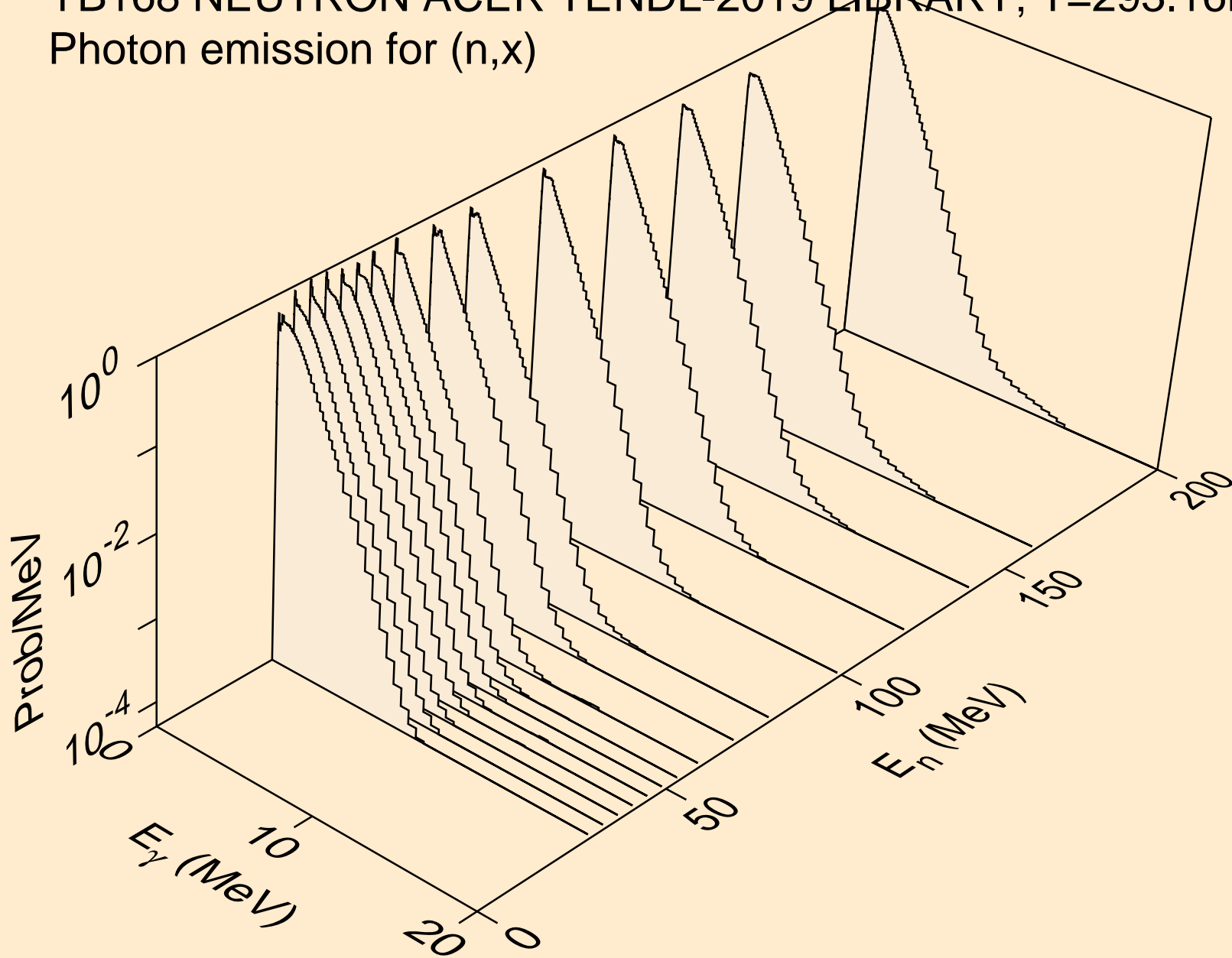

YB168 NEUTRON ACER TENDL-2019 LIBRARY; T=293.16K
Photon emission for (n,2nd)

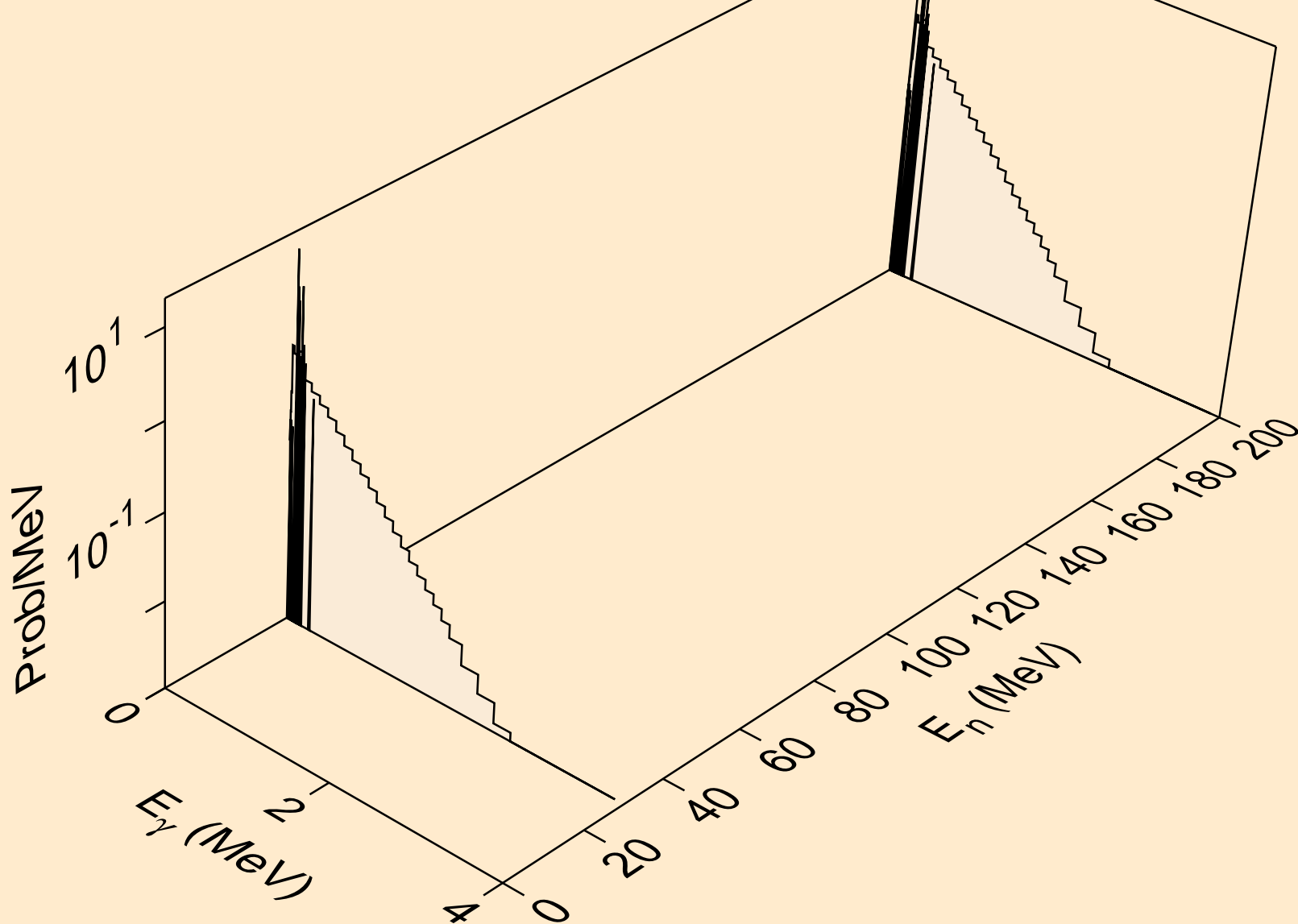

YB168 NEUTRON ACER TENDL-2019 LIBRARY; T=293.16K
Photon emission for (n,2n)

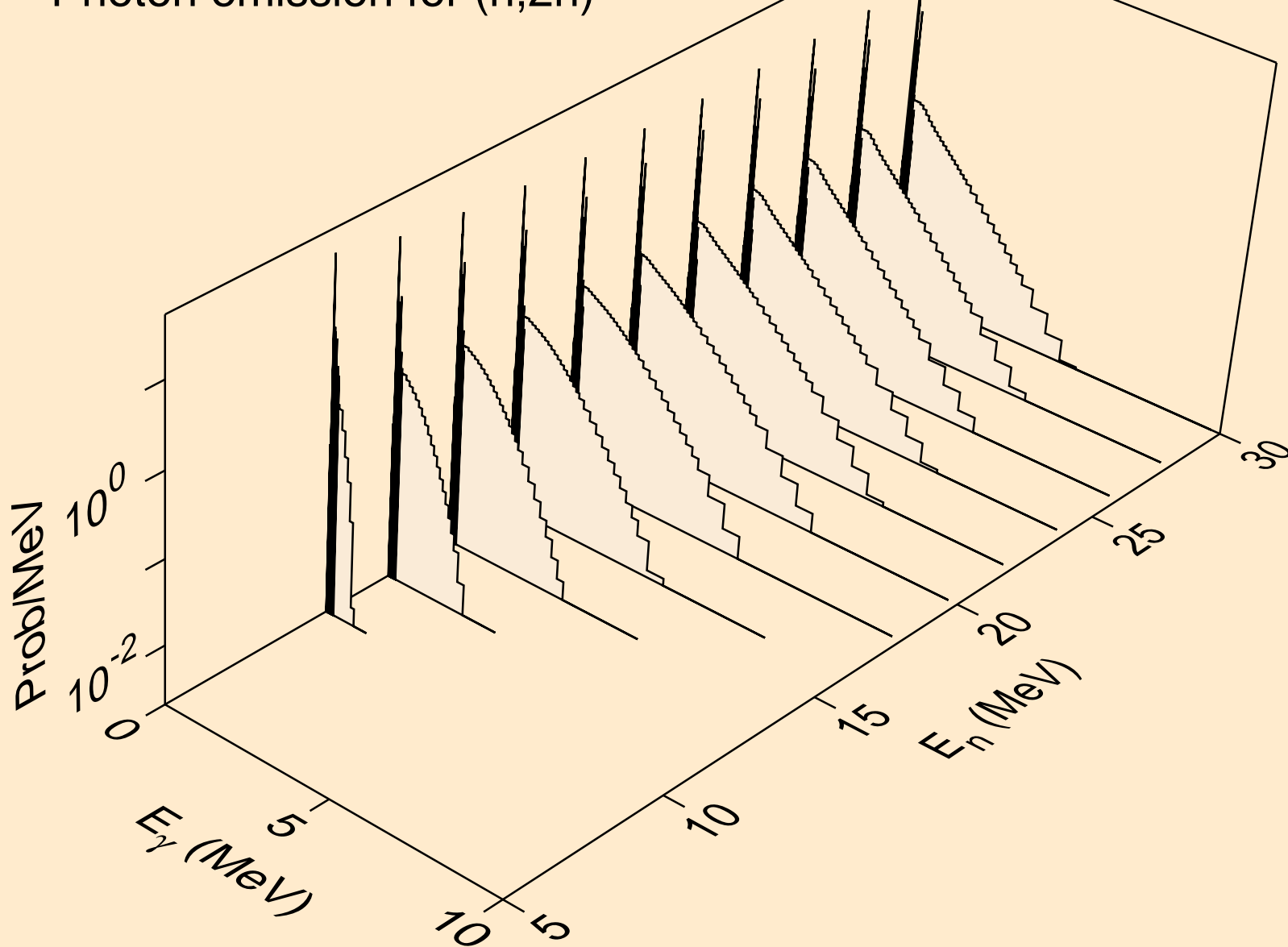

YB168 NEUTRON ACER TENDL-2019 LIBRARY; T=293.16K
Photon emission for (n,3n)

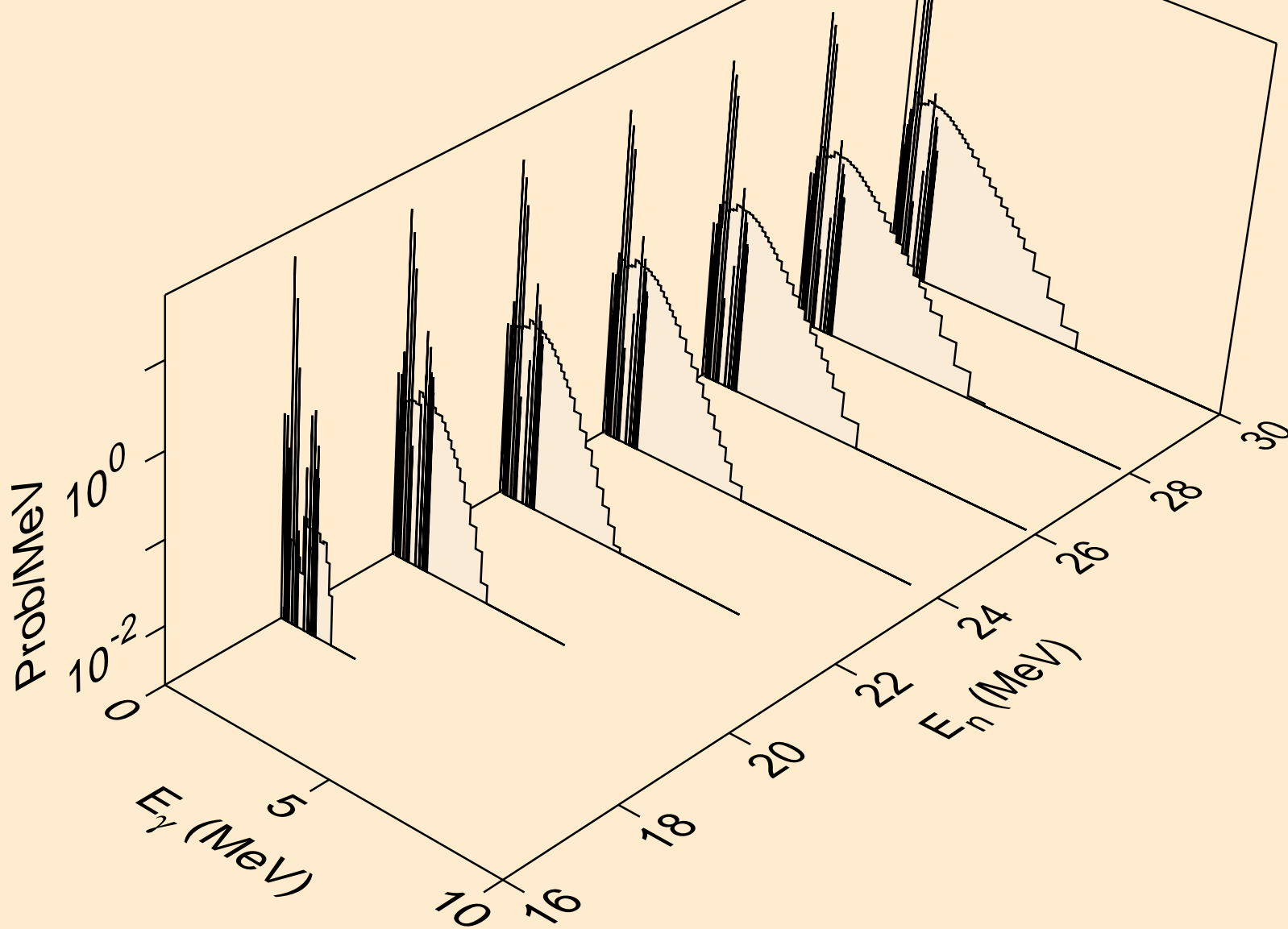

YB168 NEUTRON ACER TENDL-2019 LIBRARY; T=293.16K
Photon emission for (n,n*)a

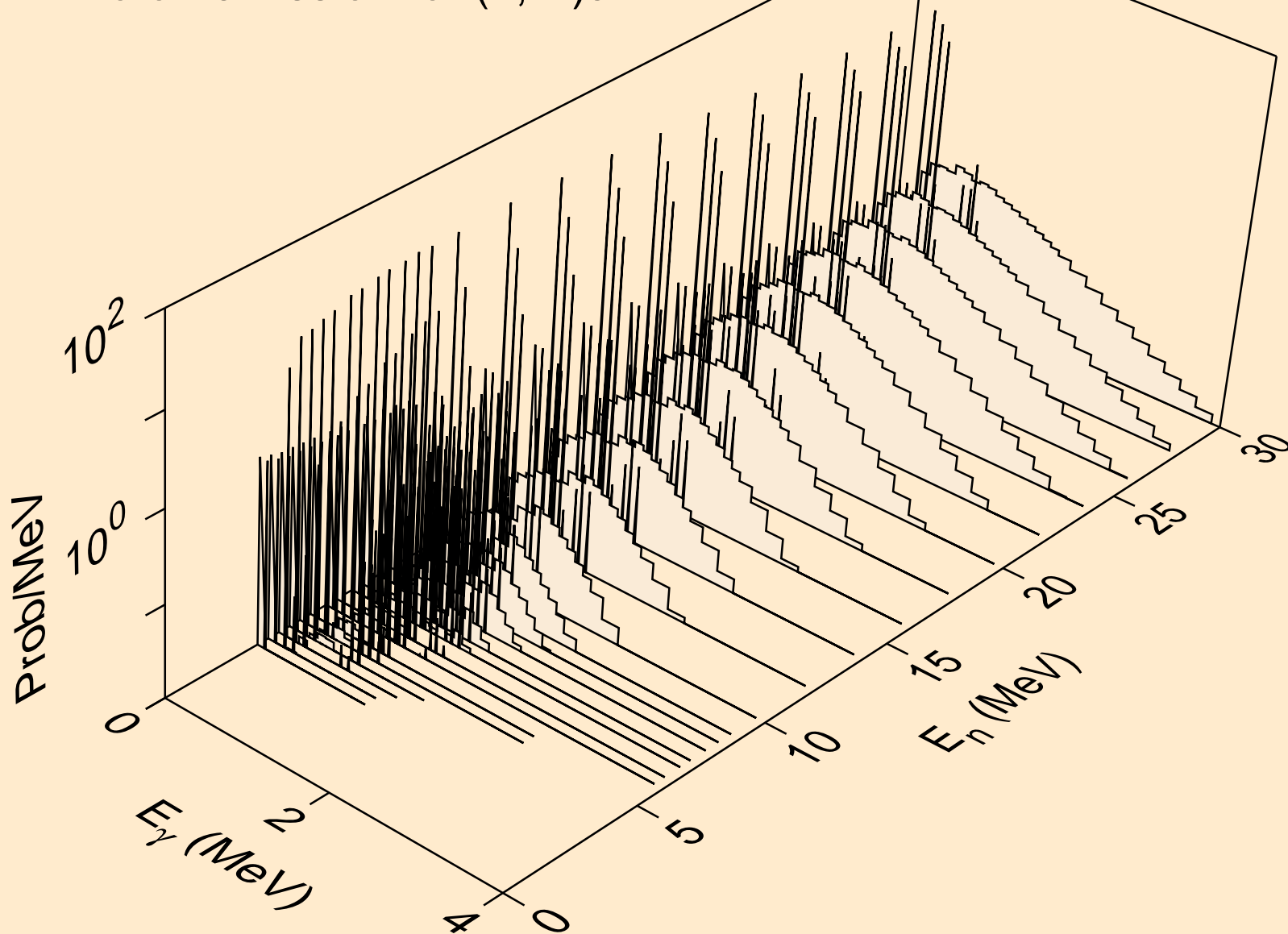

YB168 NEUTRON ACER TENDL-2019 LIBRARY; T=293.16K
Photon emission for (n,2n)a

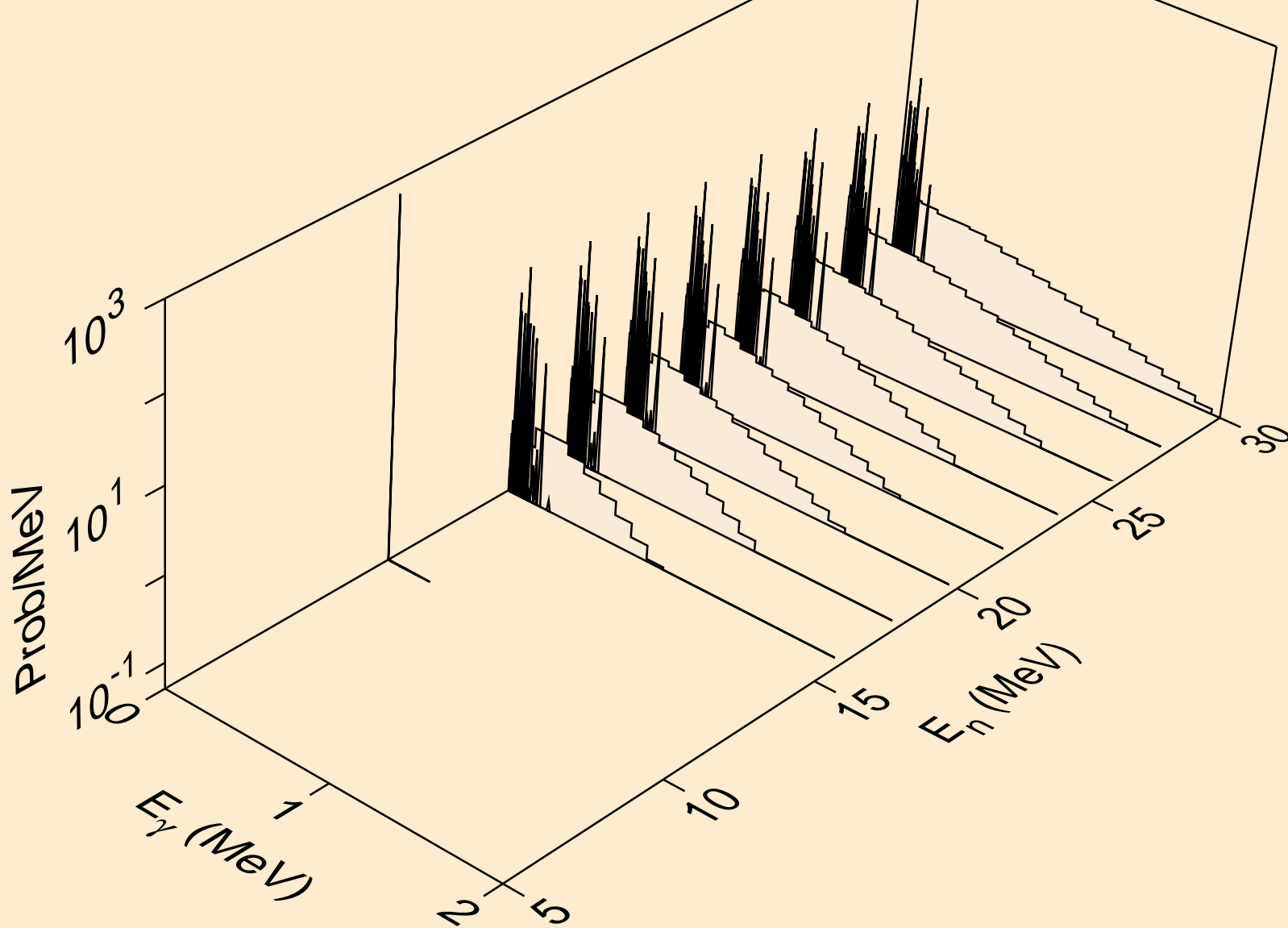

YB168 NEUTRON ACER TENDL-2019 LIBRARY; T=293.16K
Photon emission for (n,3n)a

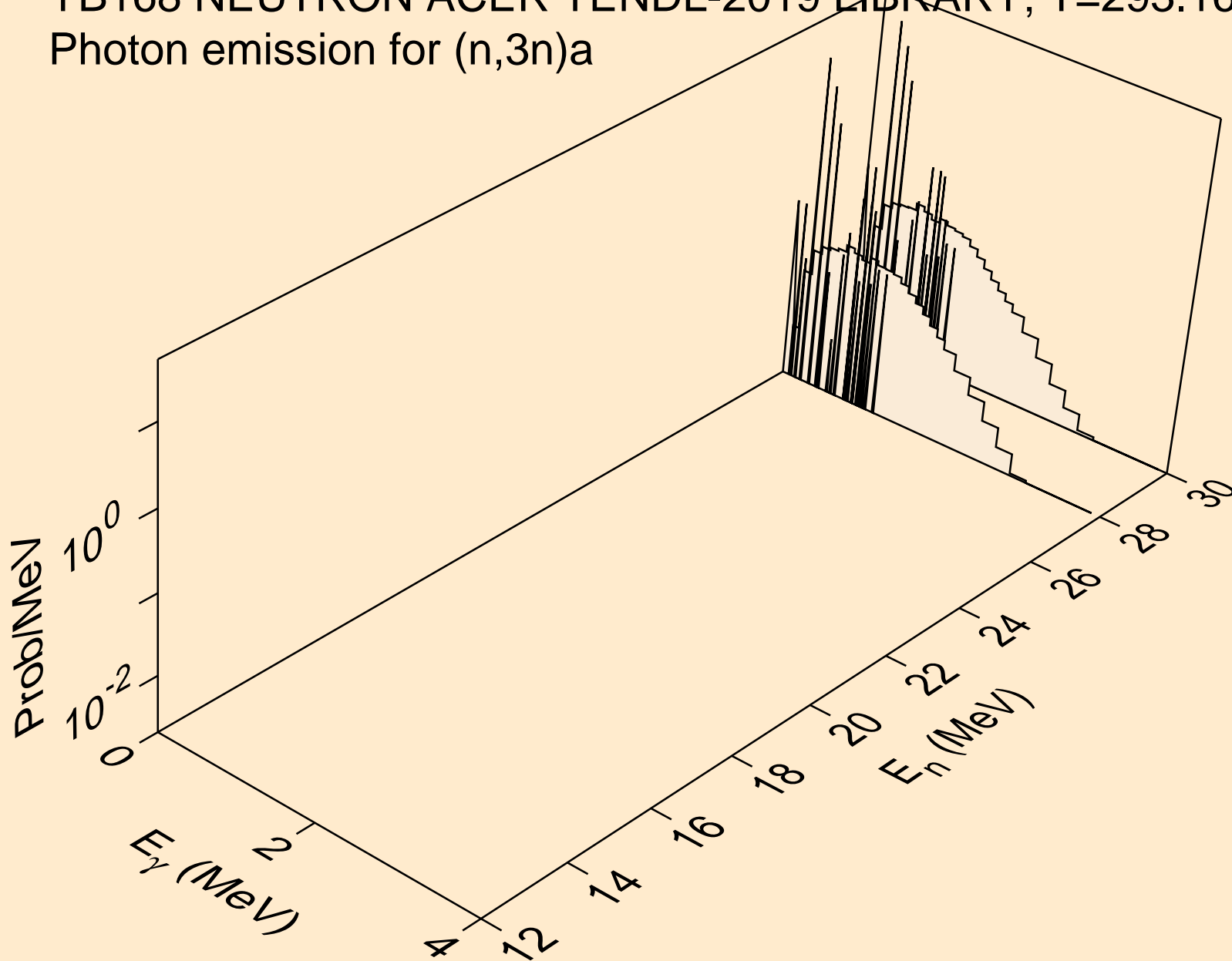

YB168 NEUTRON ACER TENDL-2019 LIBRARY; T=293.16K
Photon emission for (n,n*)p

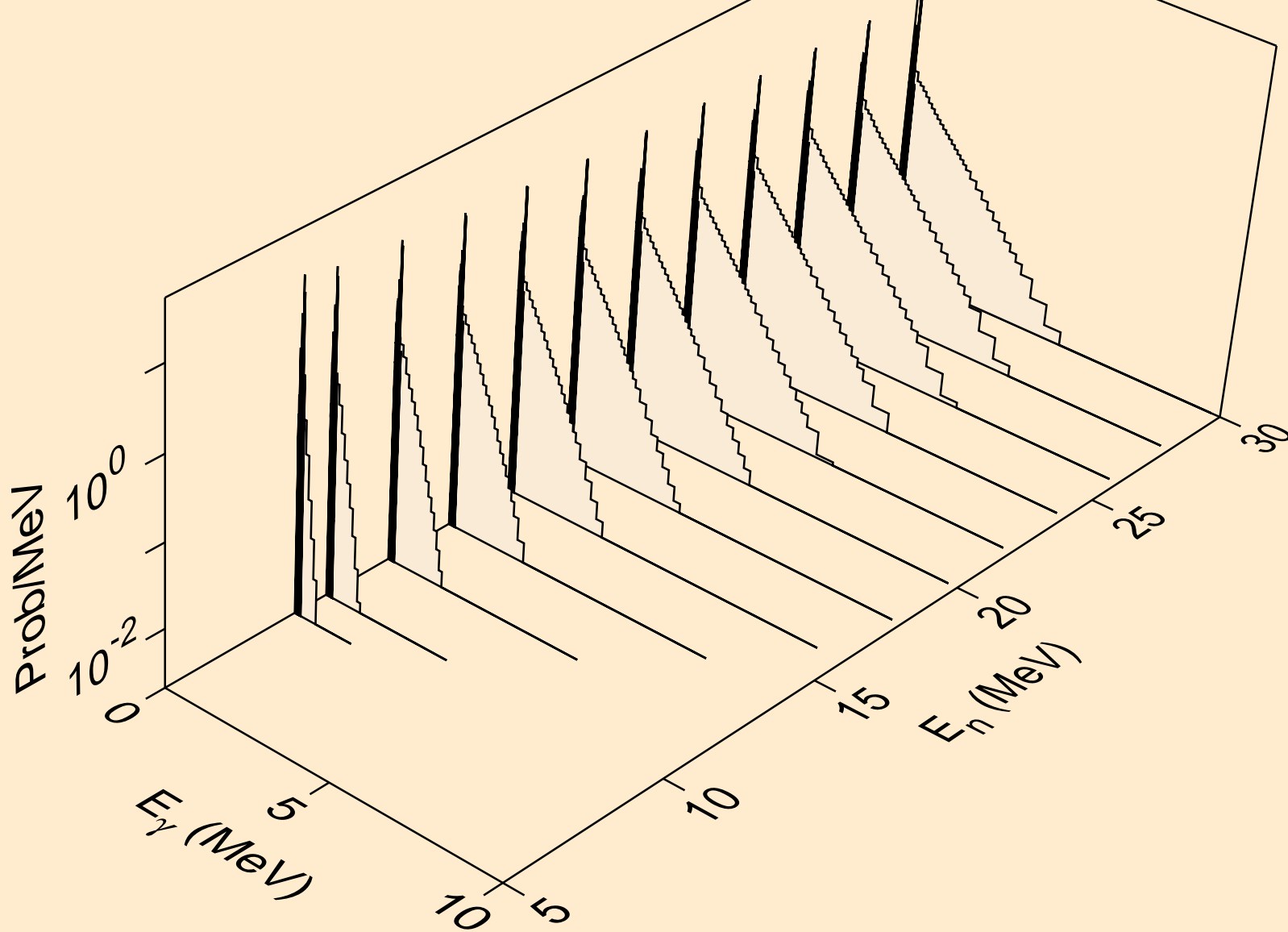

YB168 NEUTRON ACER TENDL-2019 LIBRARY; T=293.16K
Photon emission for (n,n*)2a

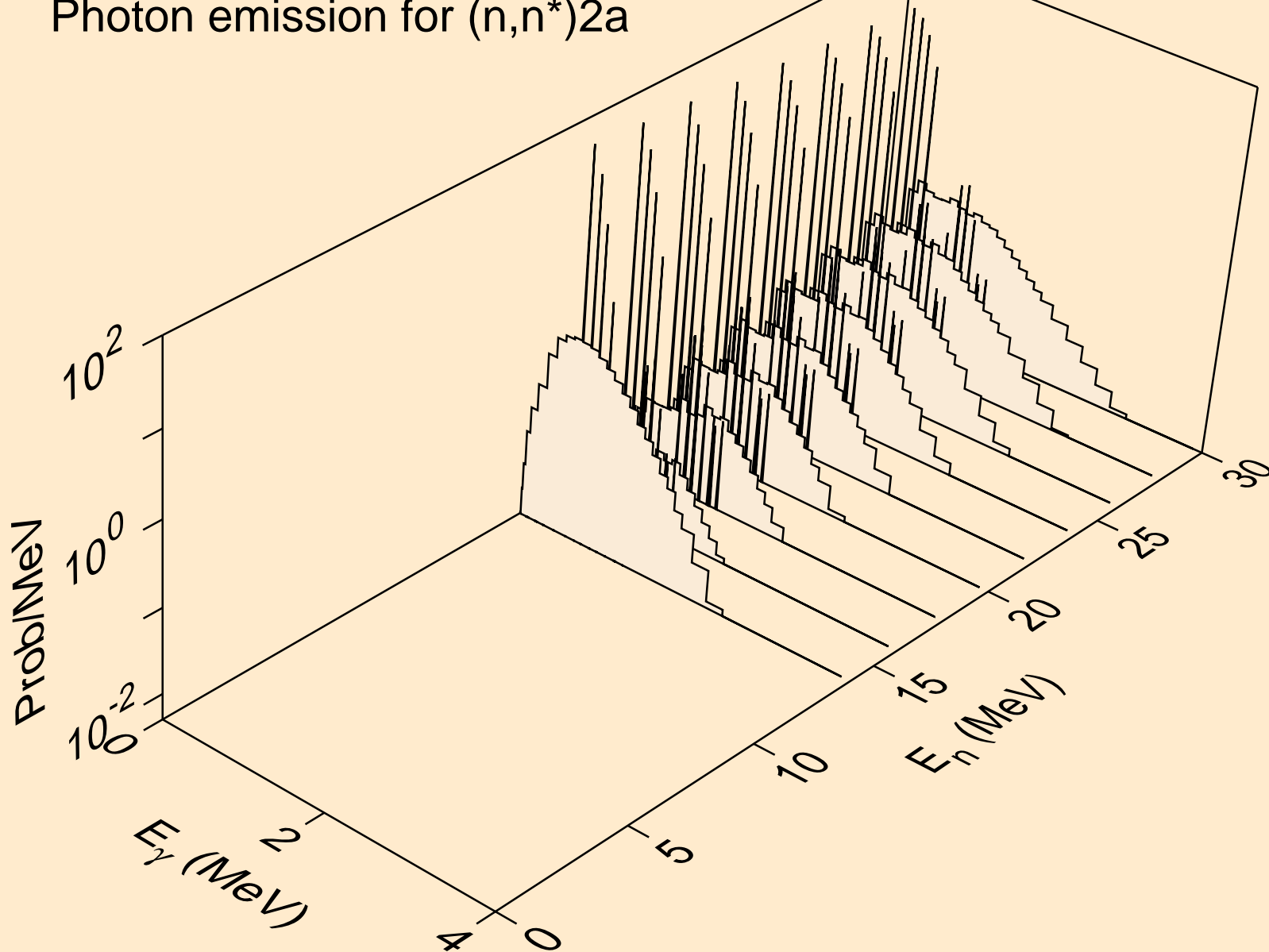

YB168 NEUTRON ACER TENDL-2019 LIBRARY; T=293.16K
Photon emission for (n,n*)d

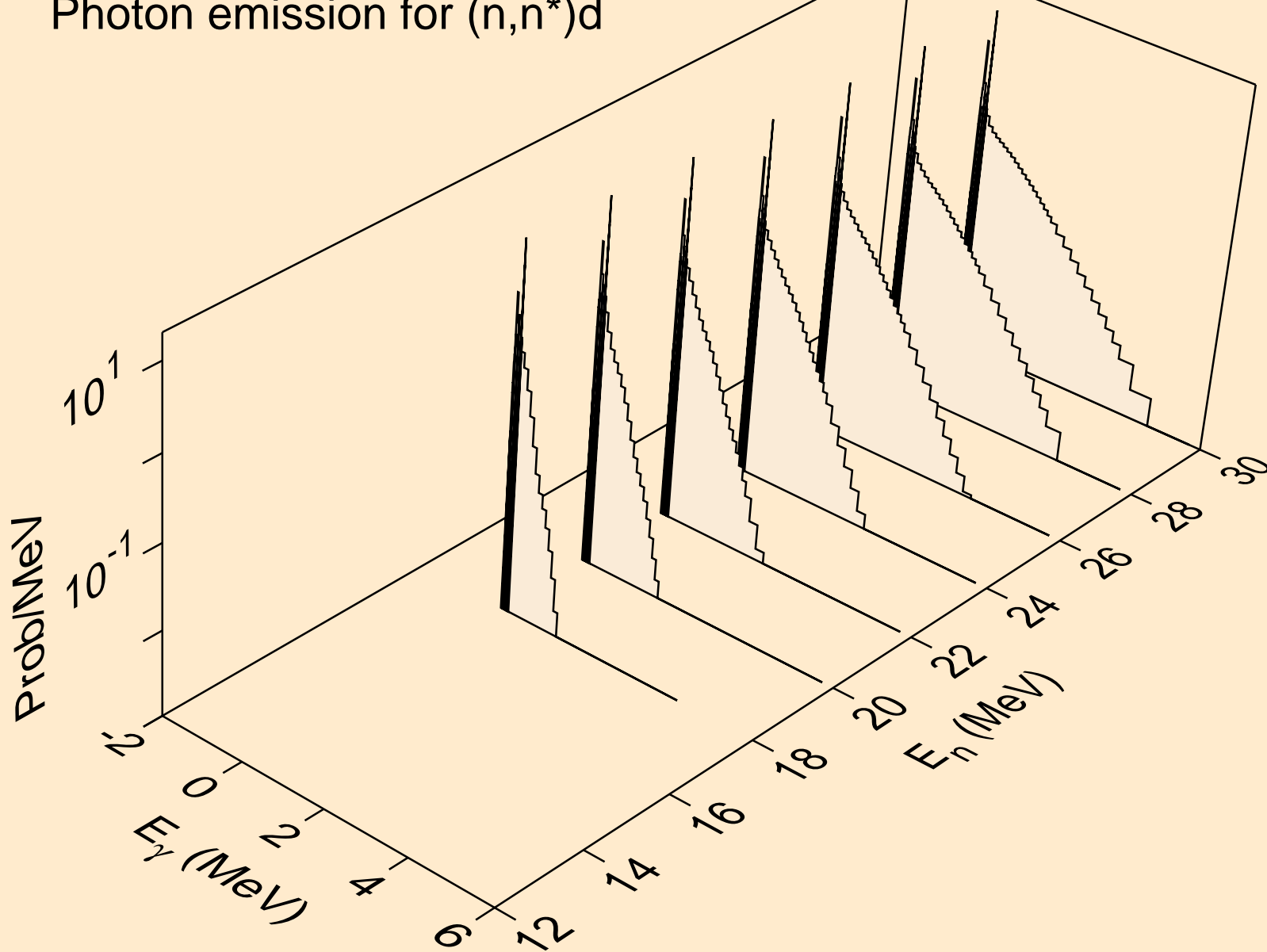

YB168 NEUTRON ACER TENDL-2019 LIBRARY; T=293.16K
Photon emission for (n,n*)t

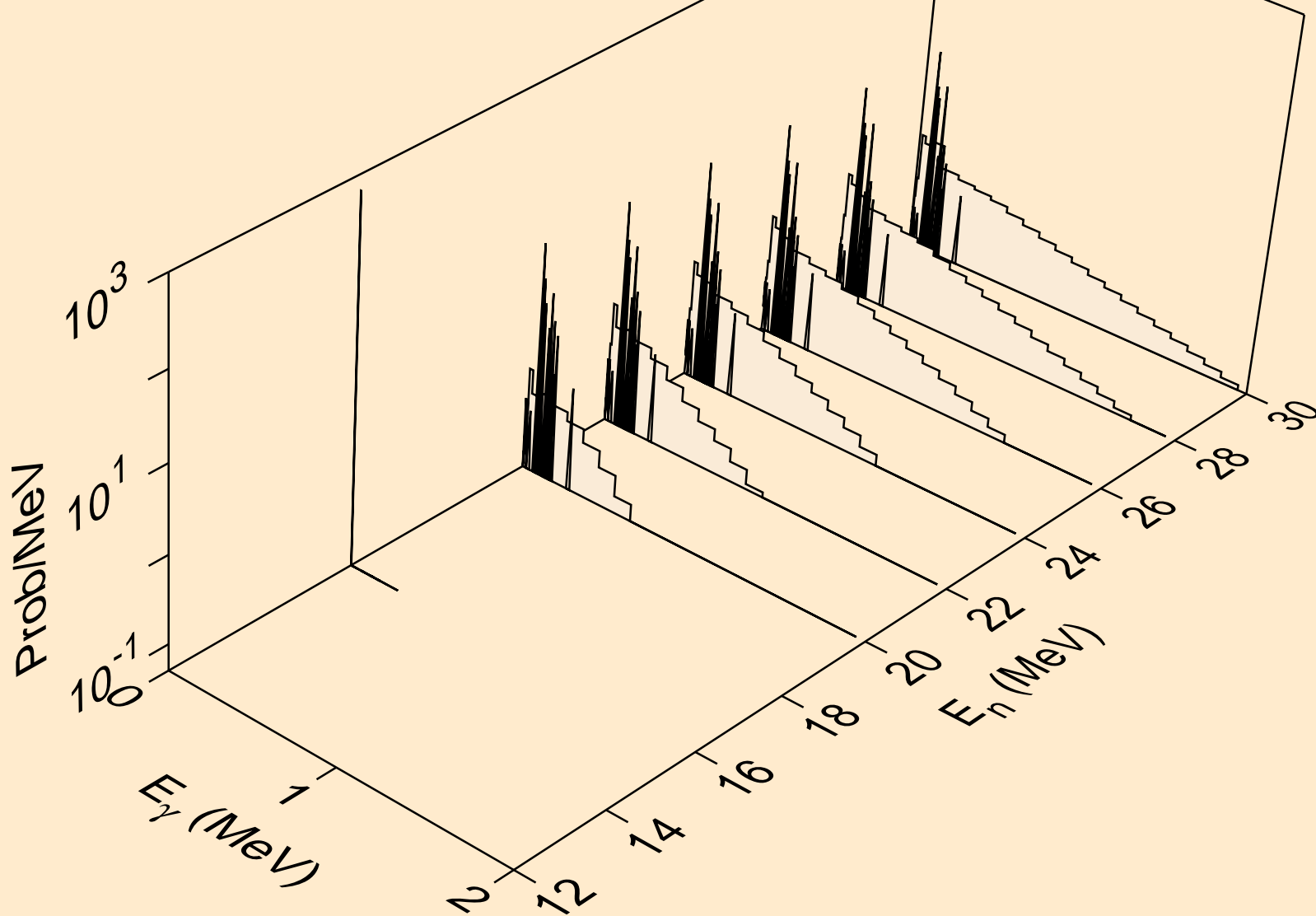

YB168 NEUTRON ACER TENDL-2019 LIBRARY; T=293.16K
Photon emission for (n,n*)he3

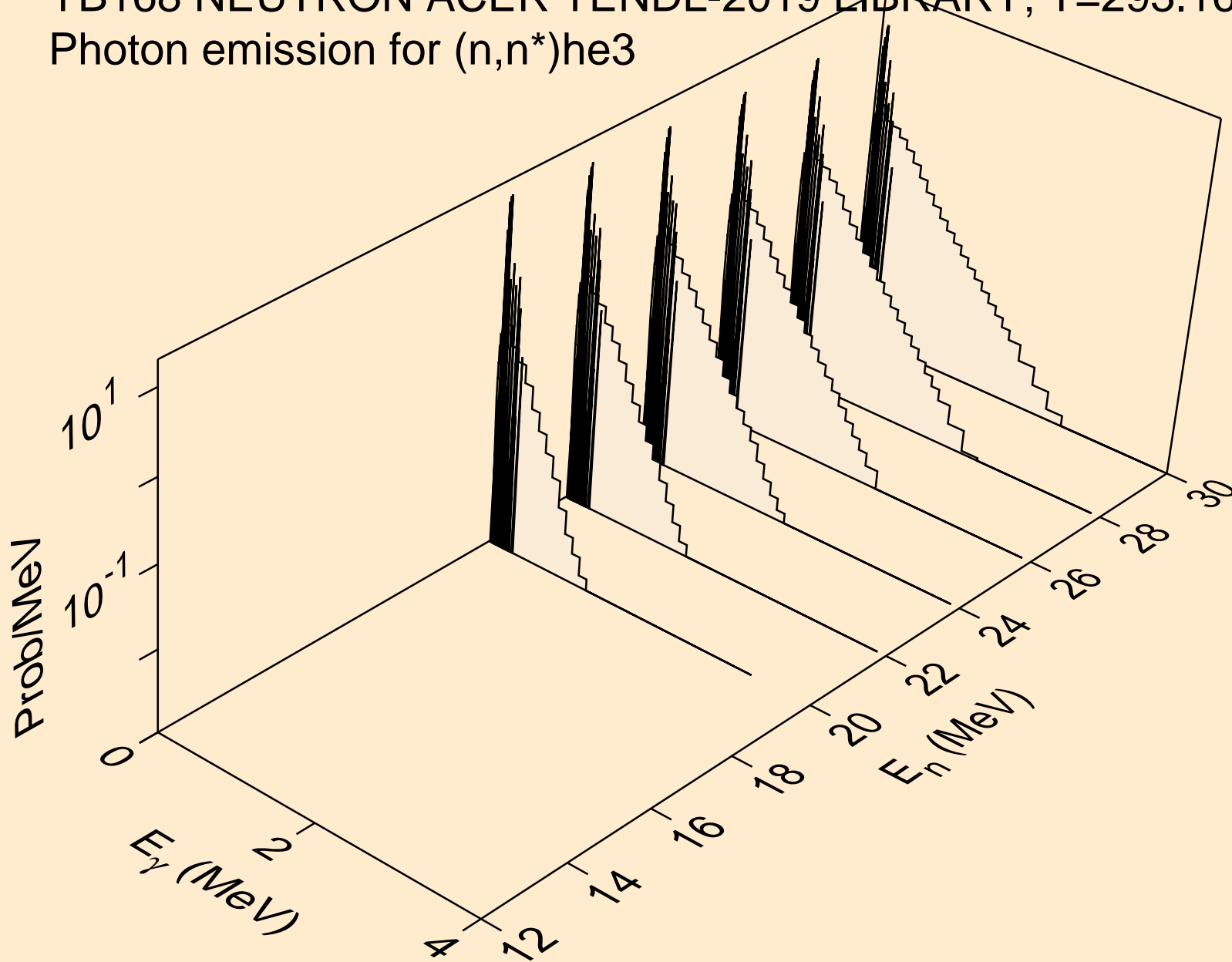

YB168 NEUTRON ACER TENDL-2019 LIBRARY; T=293.16K
Photon emission for (n,4n)

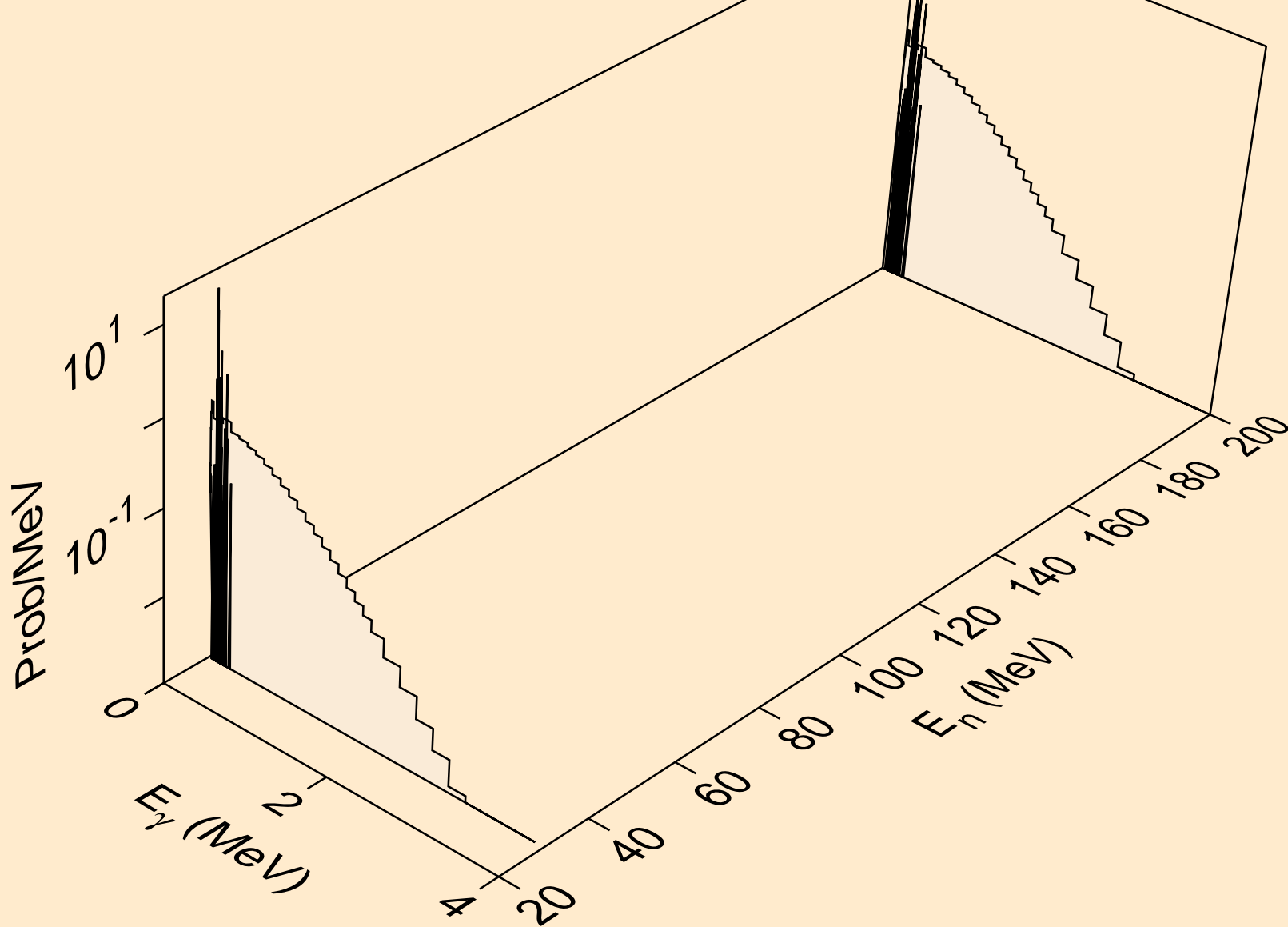

YB168 NEUTRON ACER TENDL-2019 LIBRARY; T=293.16K
Photon emission for (n,2np)

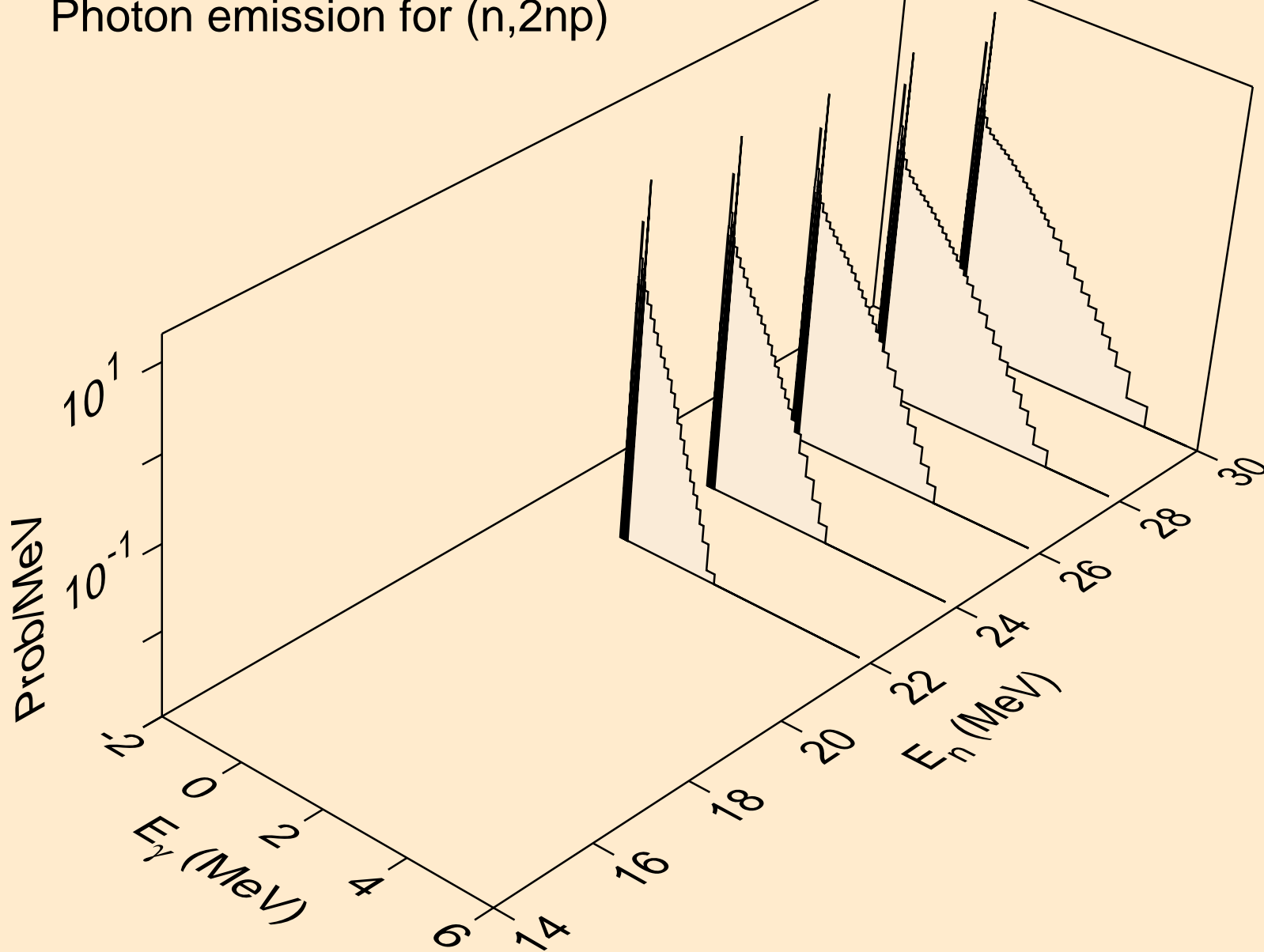

YB168 NEUTRON ACER TENDL-2019 LIBRARY; T=293.16K
Photon emission for (n,3np)

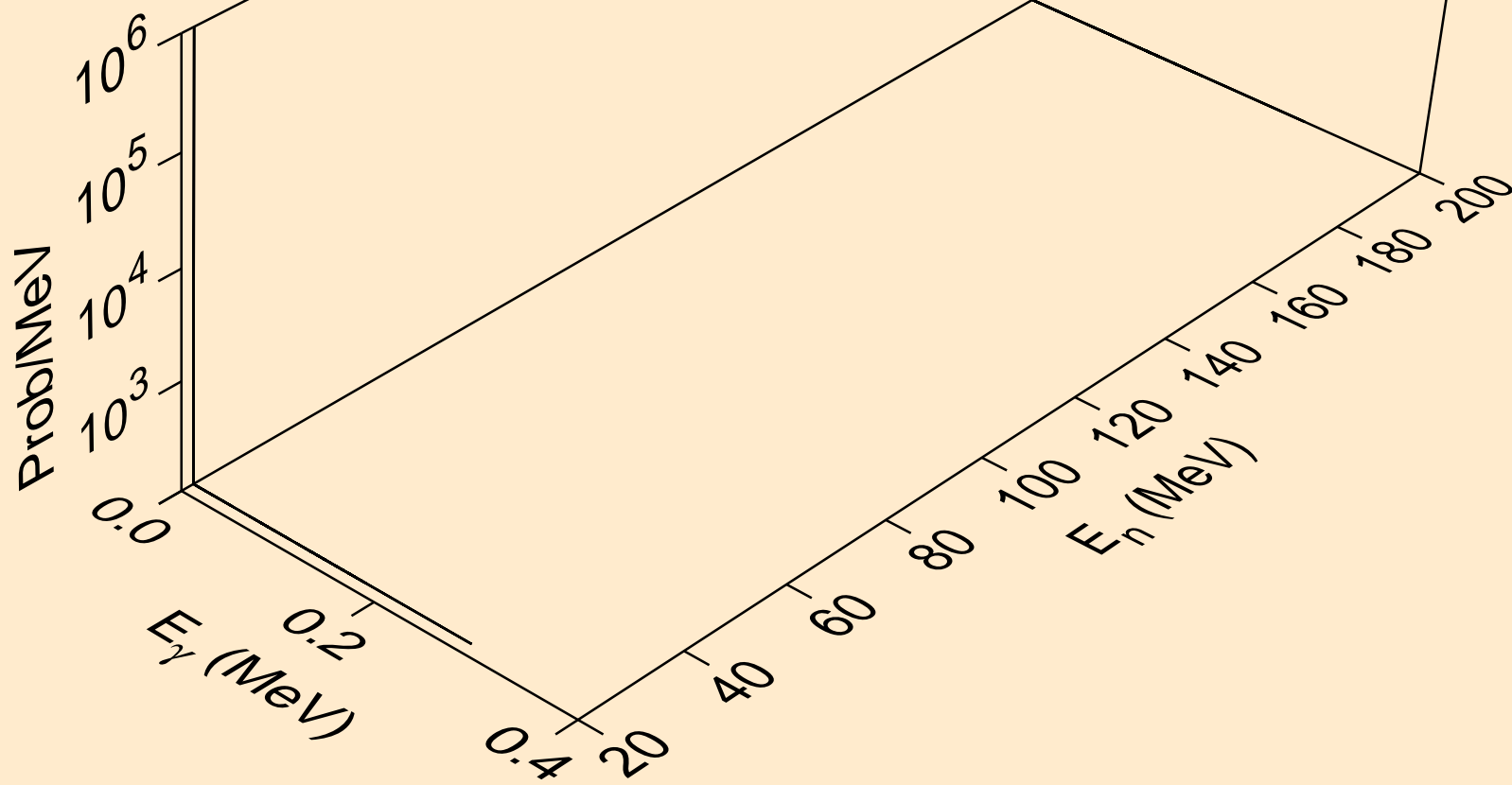

YB168 NEUTRON ACER TENDL-2019 LIBRARY; T=293.16K
Photon emission for (n,2np)

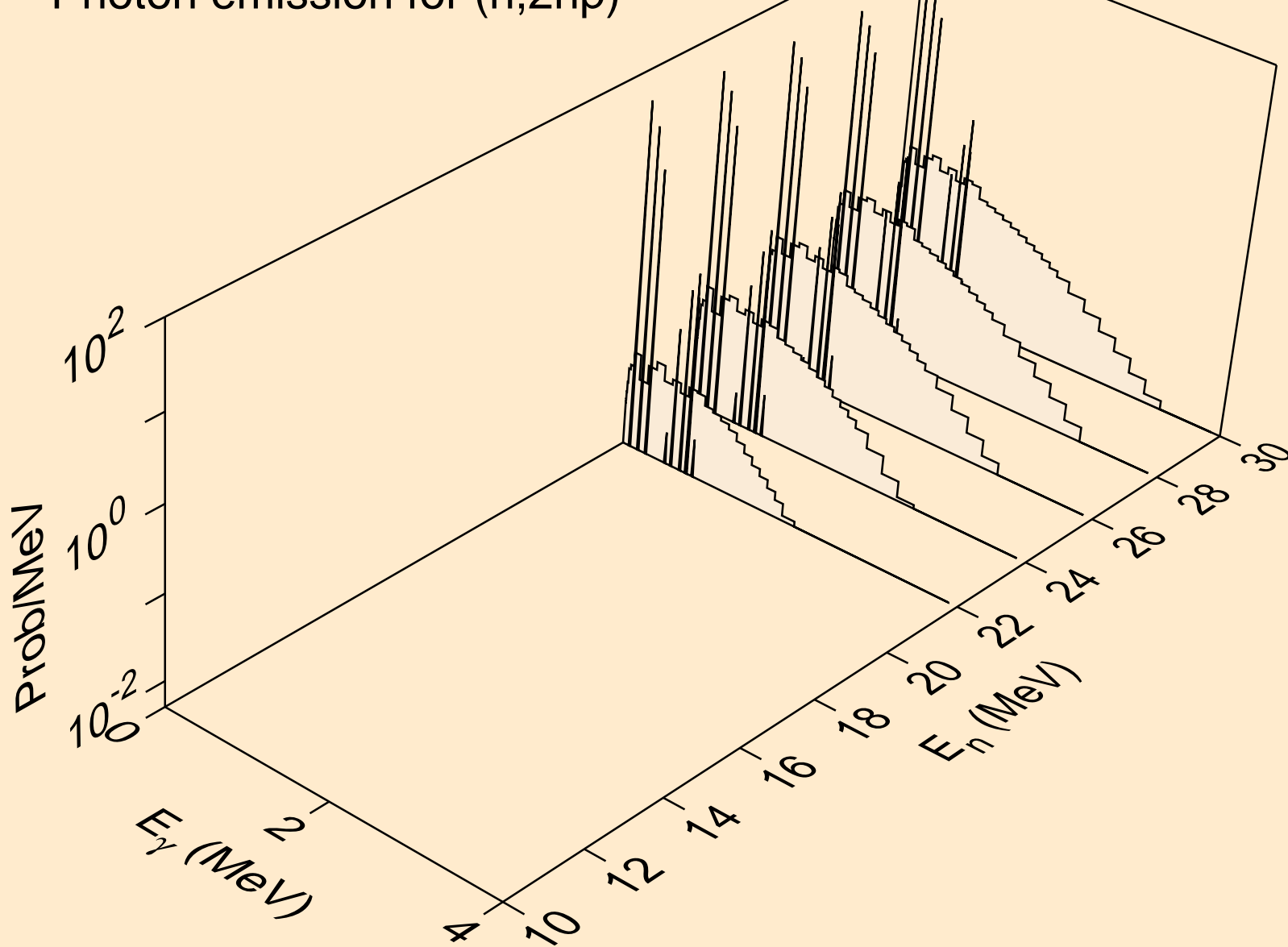

YB168 NEUTRON ACER TENDL-2019 LIBRARY; T=293.16K
Photon emission for (n,npa)

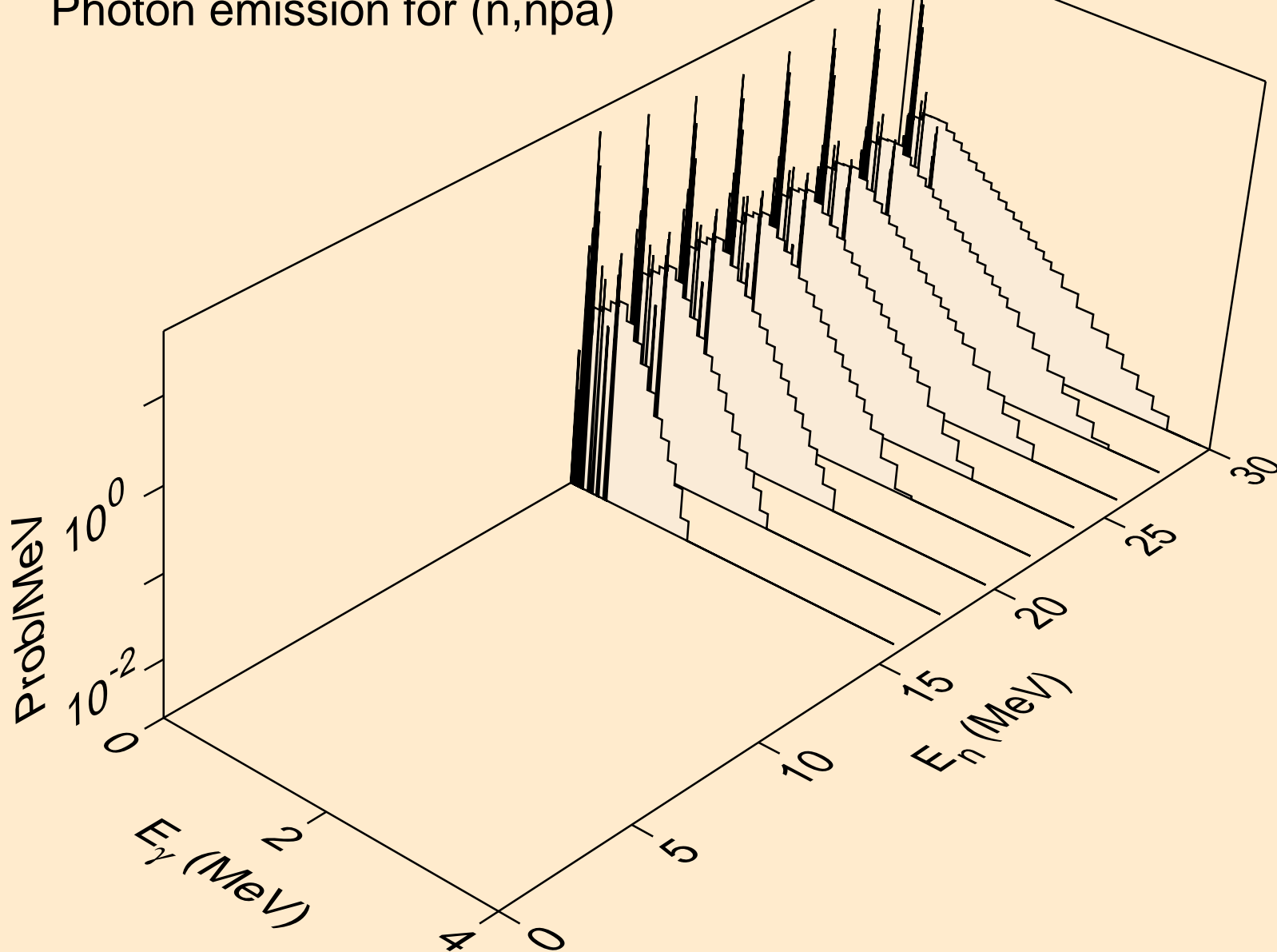

YB168 NEUTRON ACER TENDL-2019 LIBRARY; T=293.16K
Photon emission for (n,n*c)

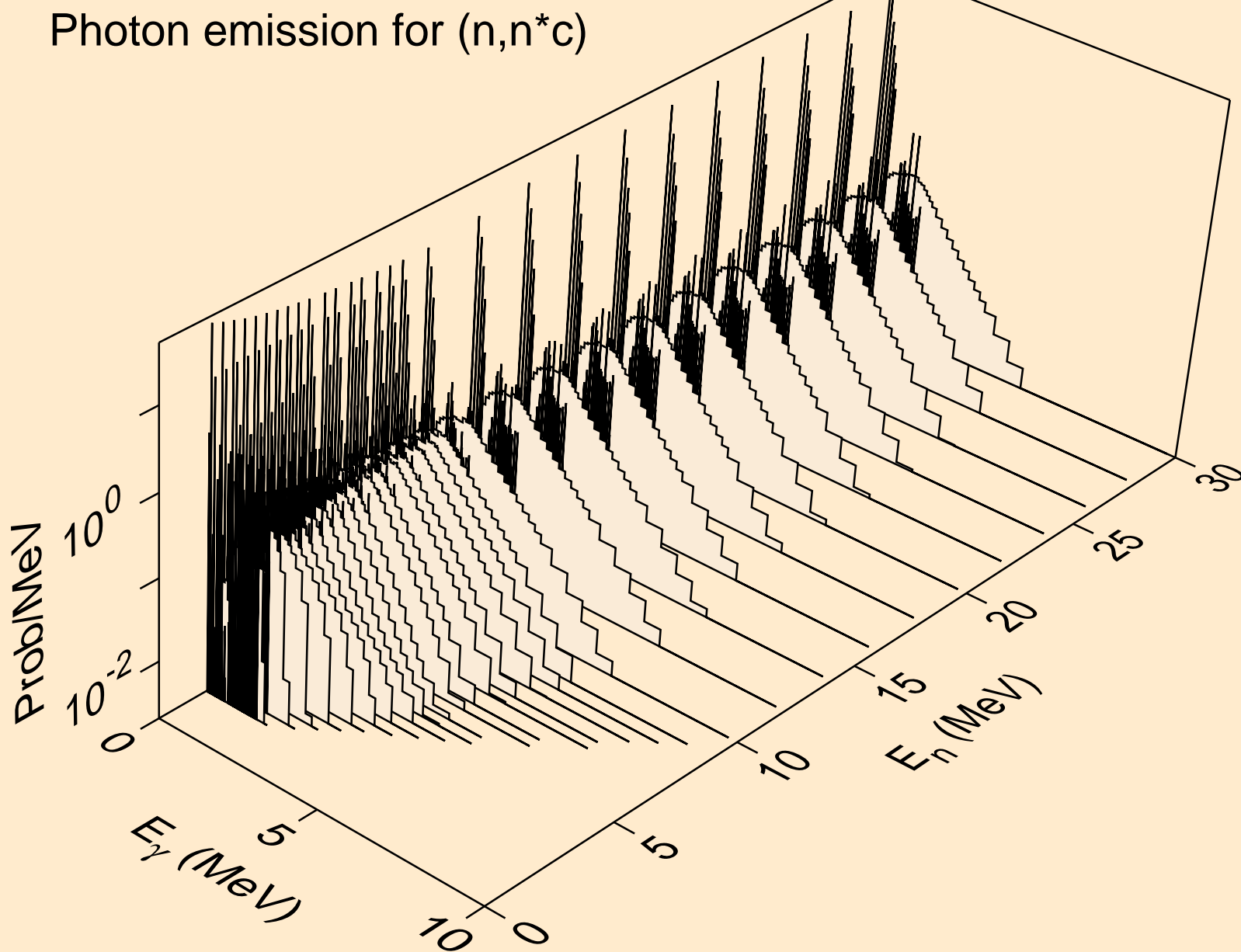

YB168 NEUTRON ACER TENDL-2019 LIBRARY; T=293.16K
Photon emission for (n,gma)

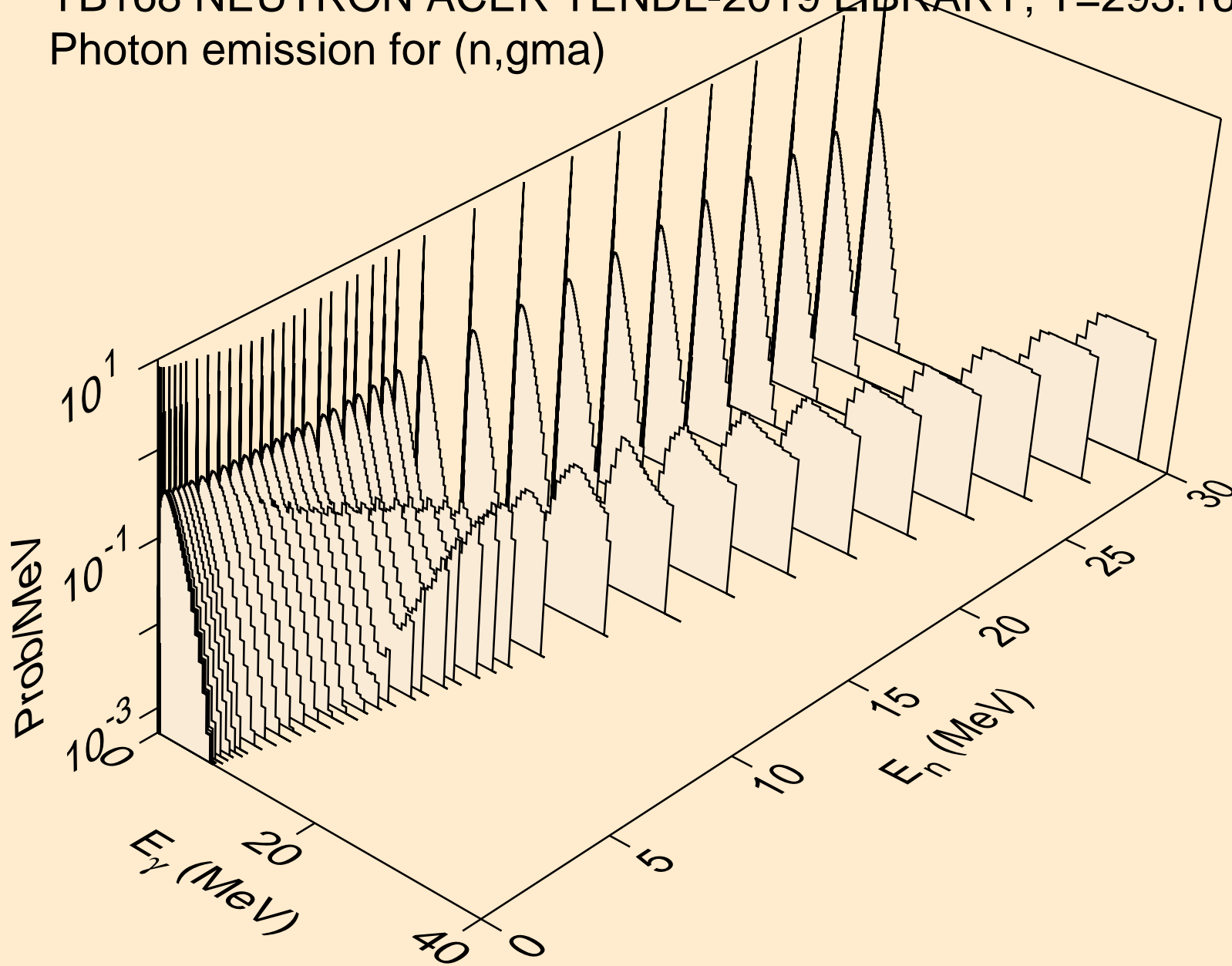

YB168 NEUTRON ACER TENDL-2019 LIBRARY; T=293.16K
Photon emission for (n,p)

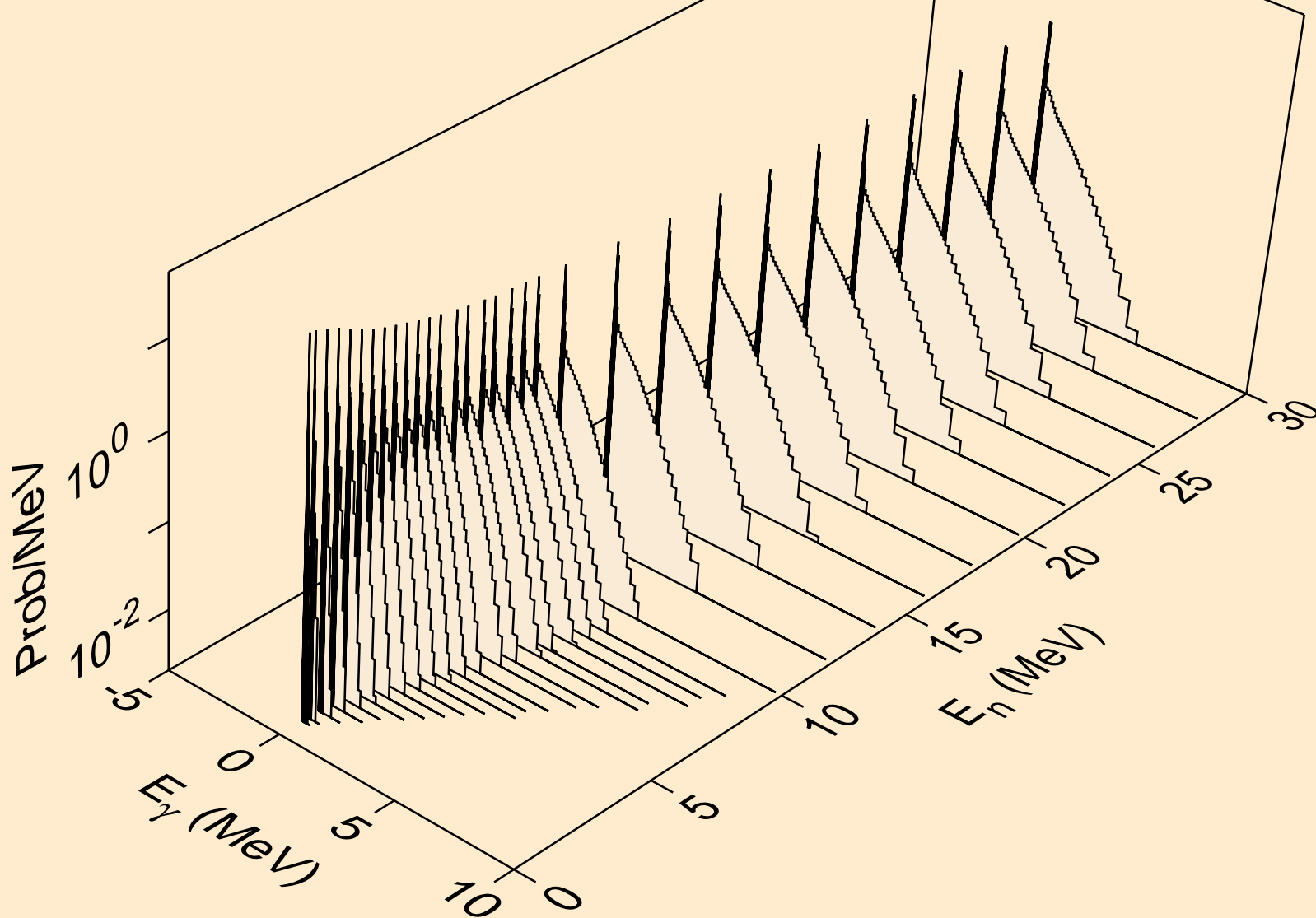

YB168 NEUTRON ACER TENDL-2019 LIBRARY; T=293.16K
Photon emission for (n,d)

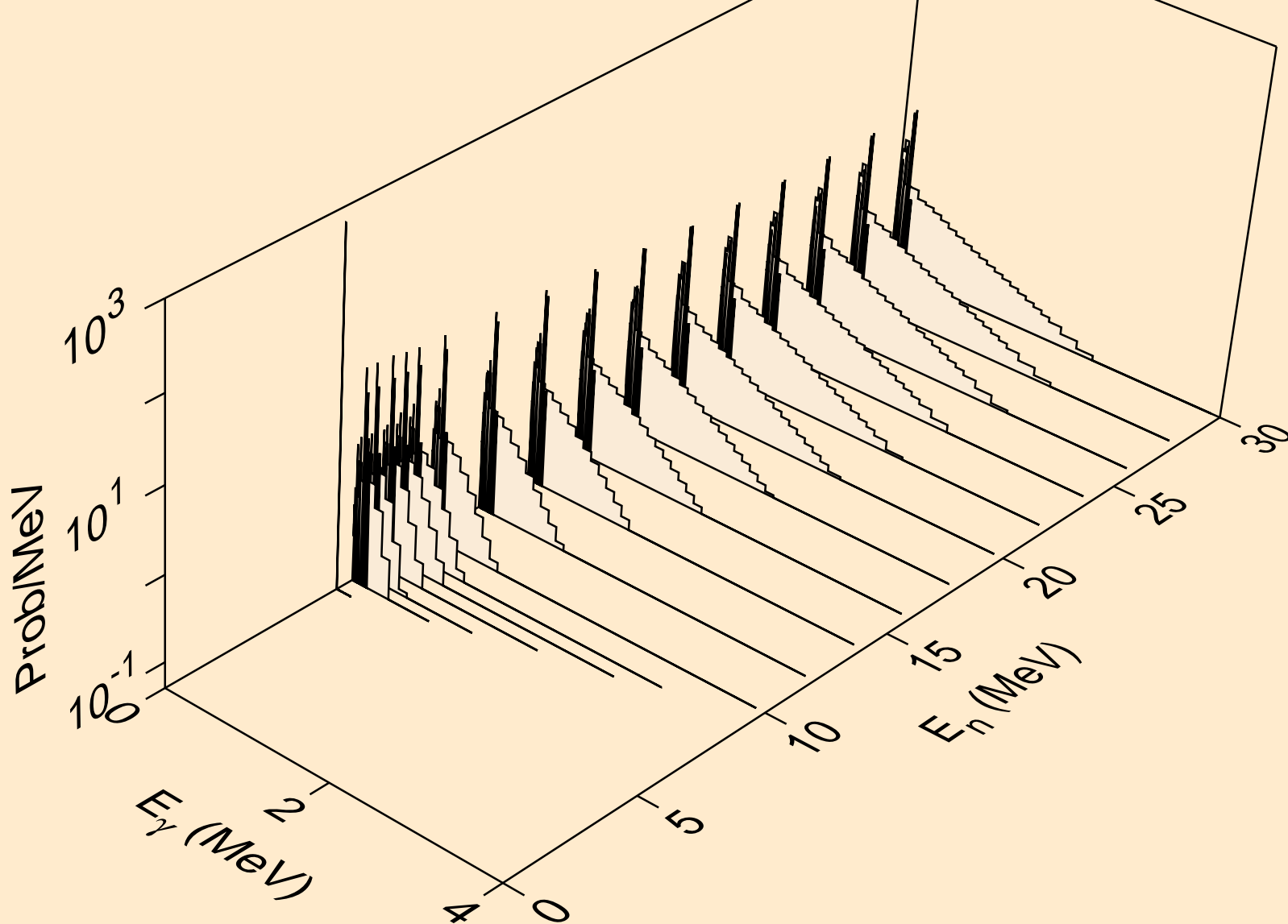

YB168 NEUTRON ACER TENDL-2019 LIBRARY; T=293.16K
Photon emission for (n,t)

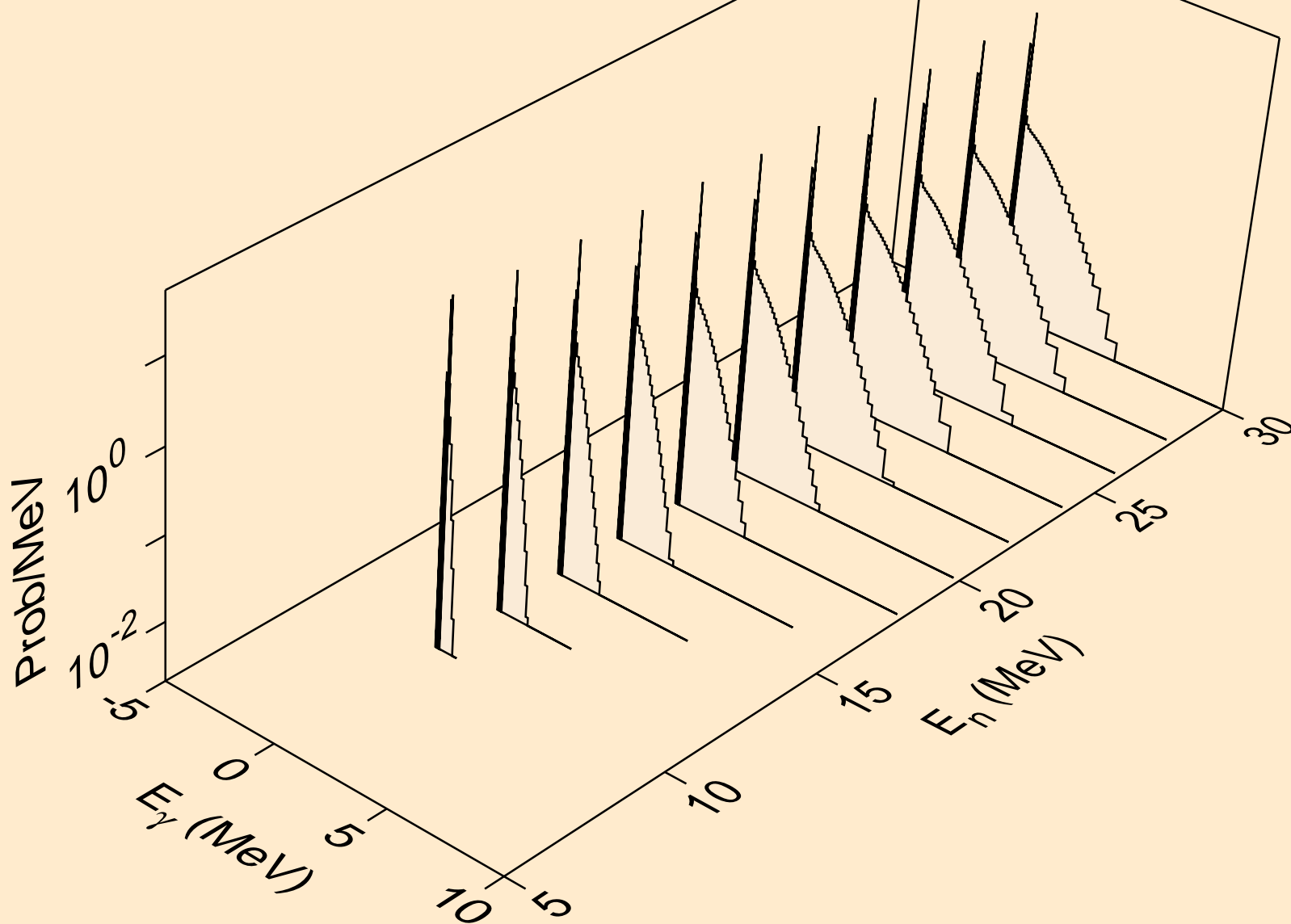

YB168 NEUTRON ACER TENDL-2019 LIBRARY; T=293.16K
Photon emission for (n,he3)

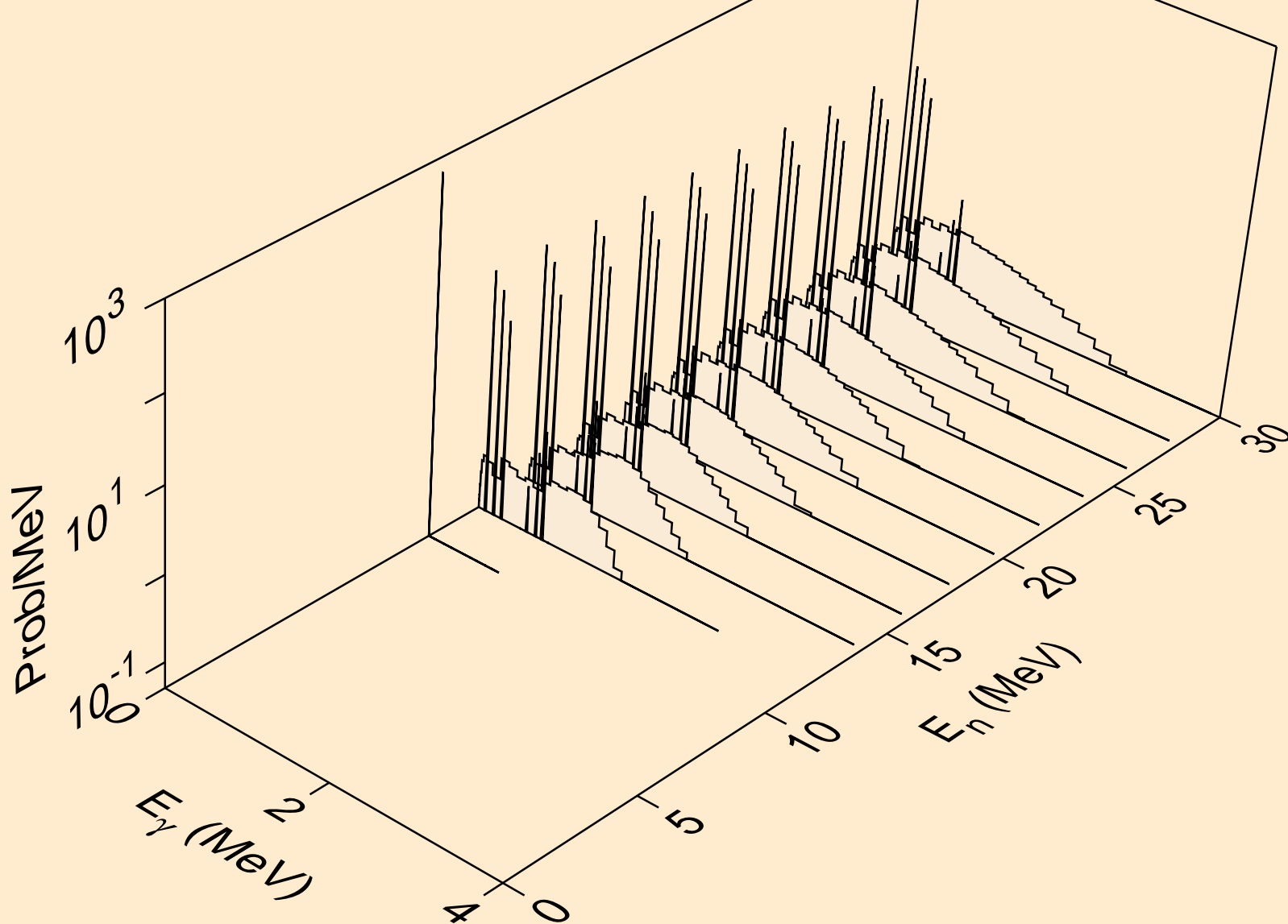

YB168 NEUTRON ACER TENDL-2019 LIBRARY; T=293.16K
Photon emission for (n,a)

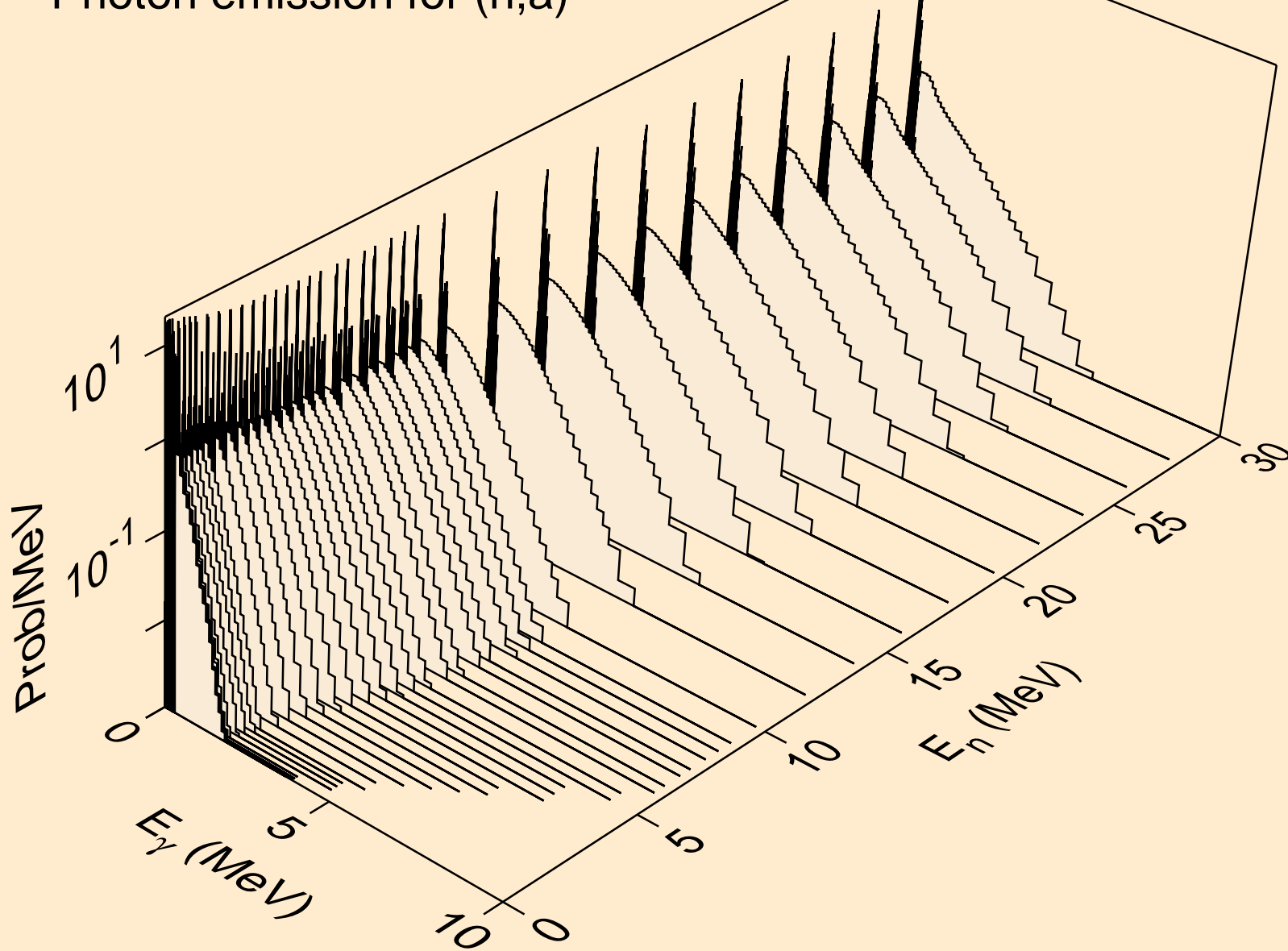

YB168 NEUTRON ACER TENDL-2019 LIBRARY; T=293.16K
Photon emission for (n,2a)

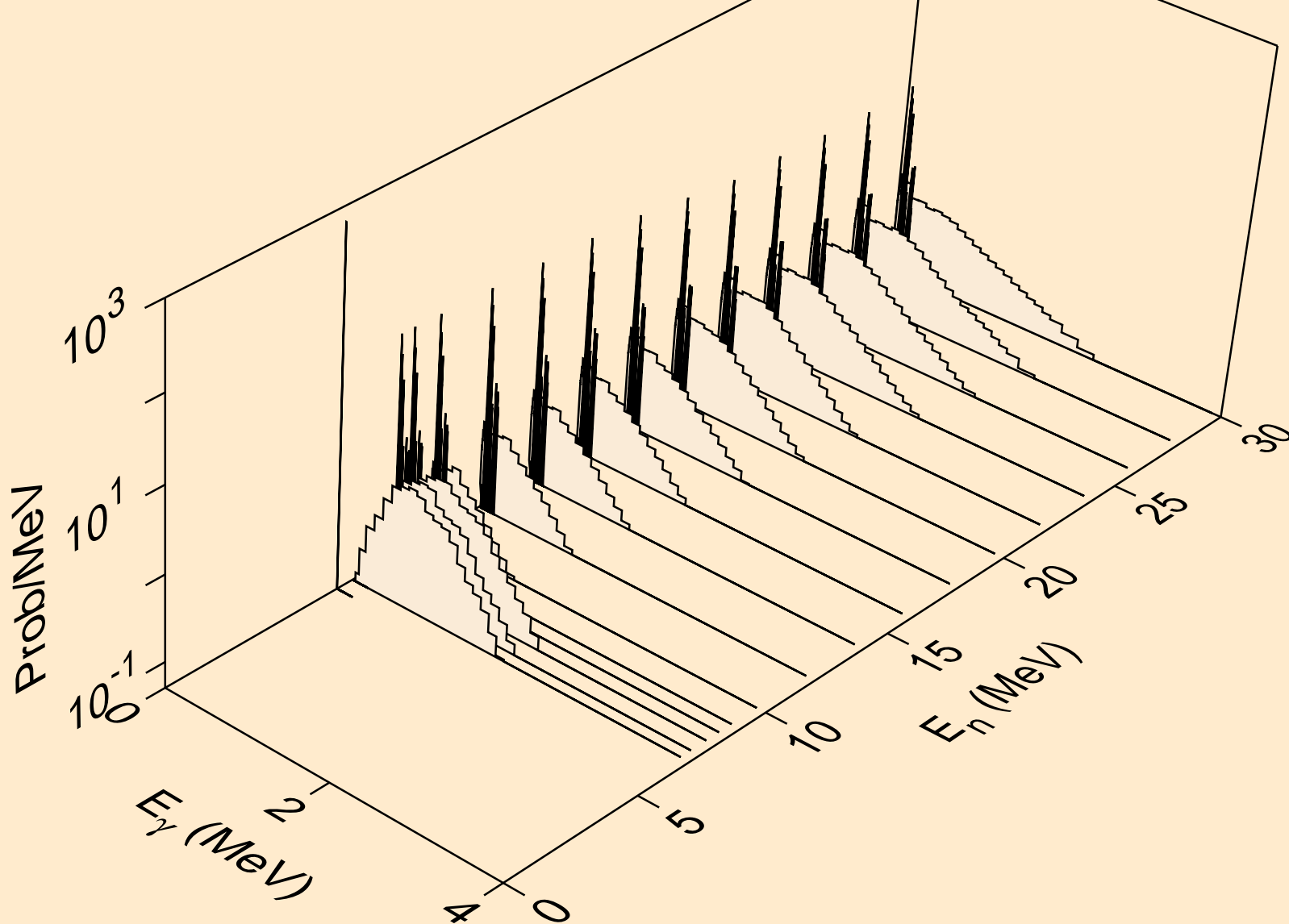

YB168 NEUTRON ACER TENDL-2019 LIBRARY; T=293.16K
Photon emission for (n,2p)

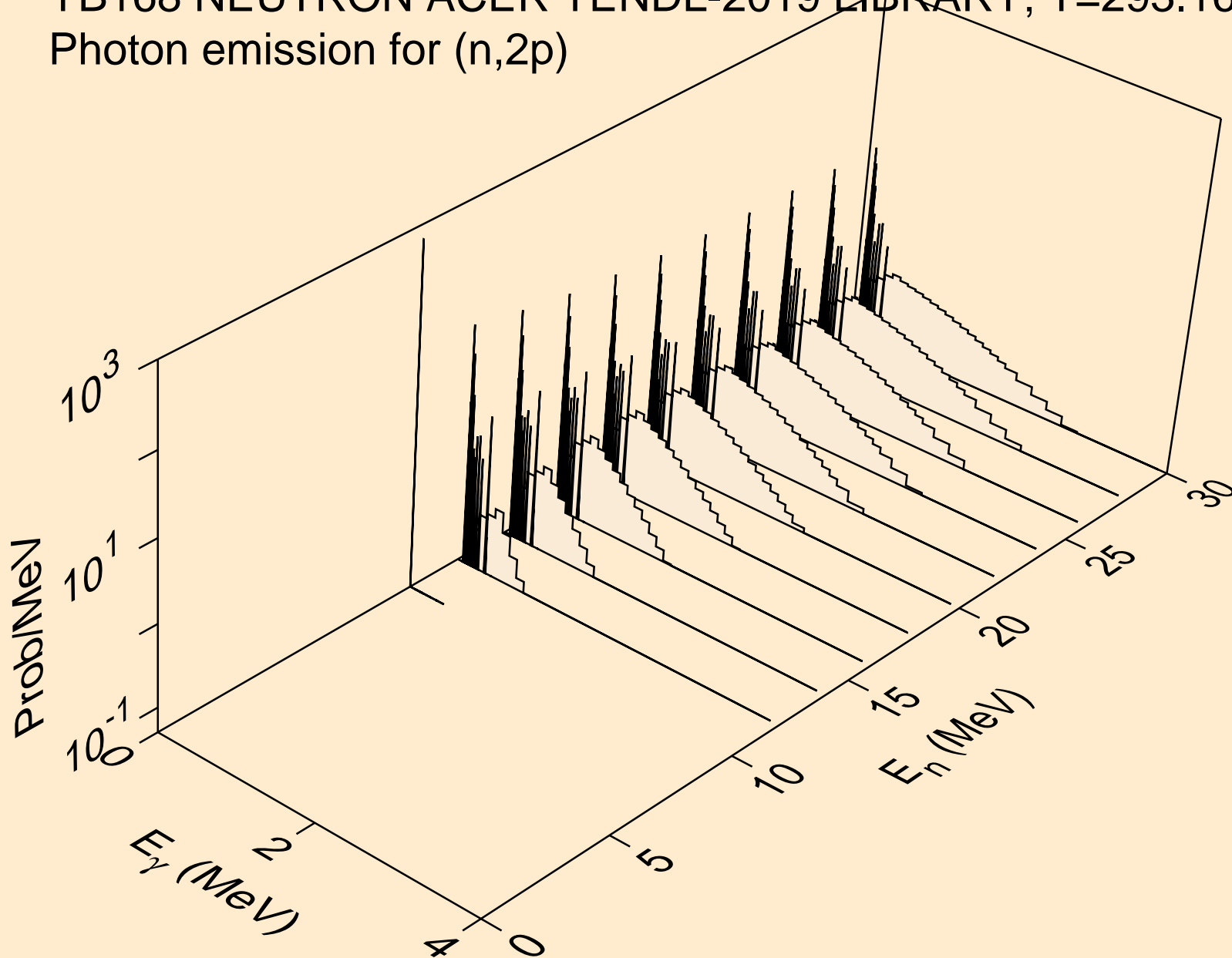

YB168 NEUTRON ACER TENDL-2019 LIBRARY; T=293.16K
Photon emission for (n,p α)

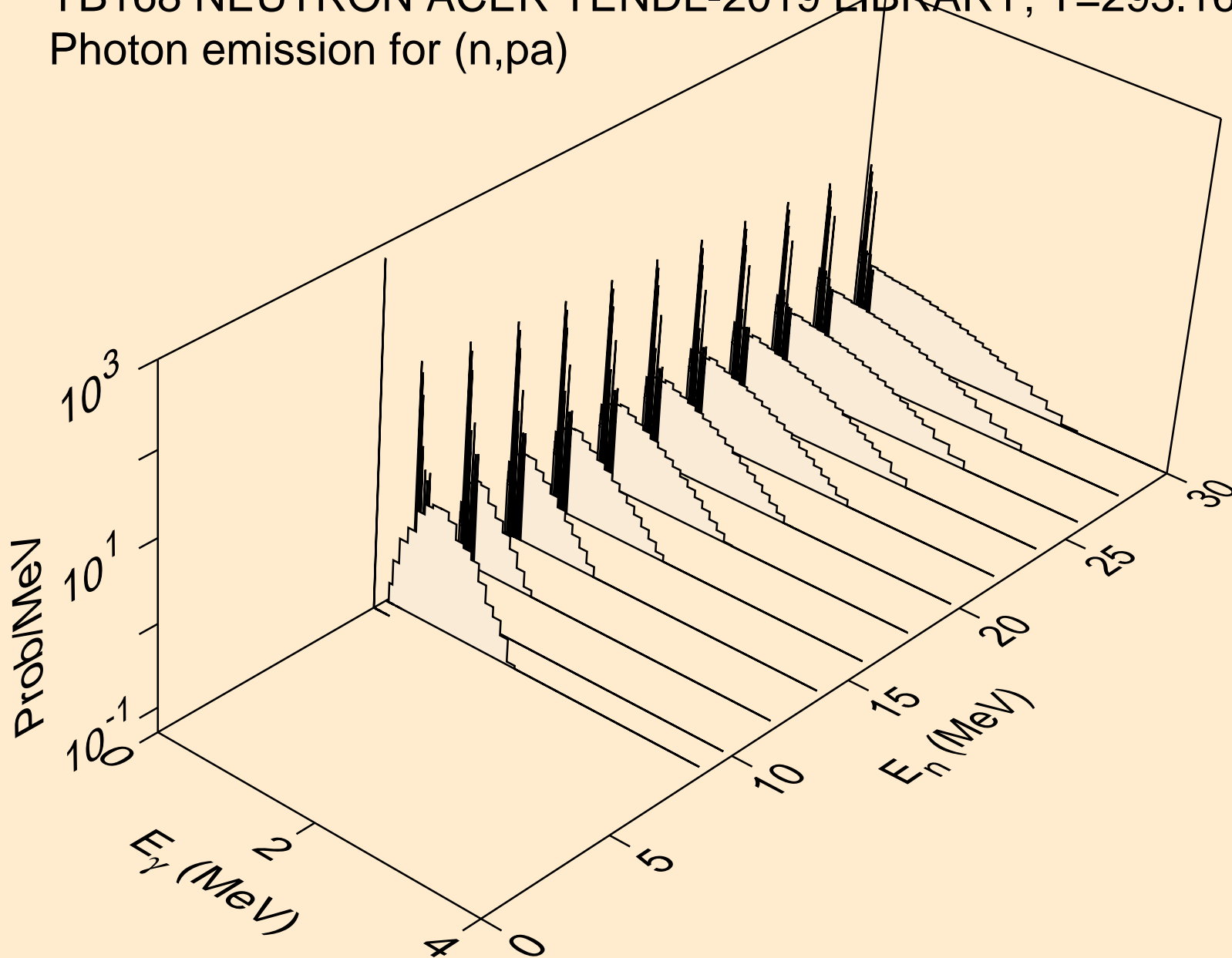

YB168 NEUTRON ACER TENDL-2019 LIBRARY; T=293.16K
Photon emission for (n,pd)

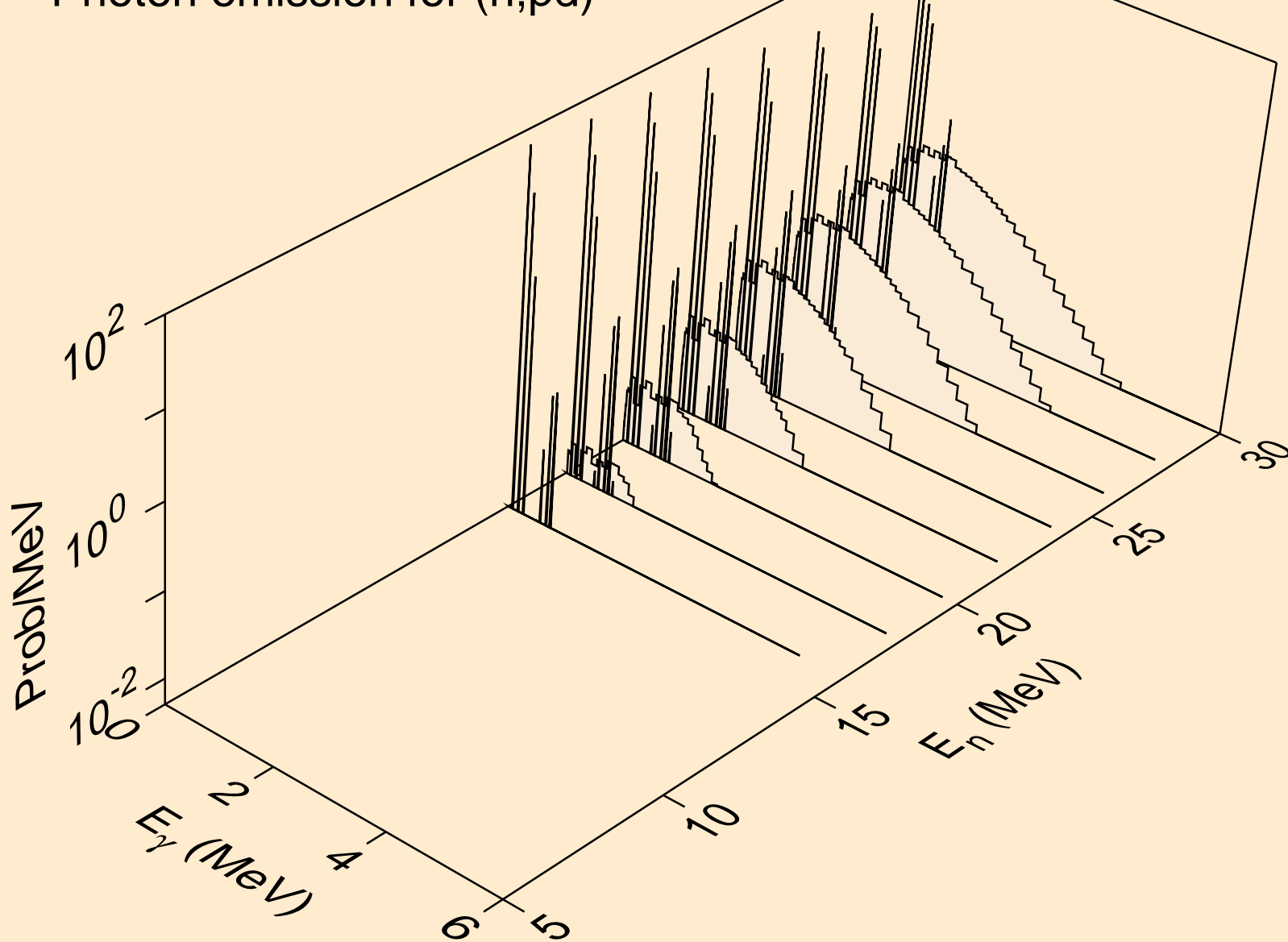

YB168 NEUTRON ACER TENDL-2019 LIBRARY; T=293.16K
Photon emission for (n,pt)

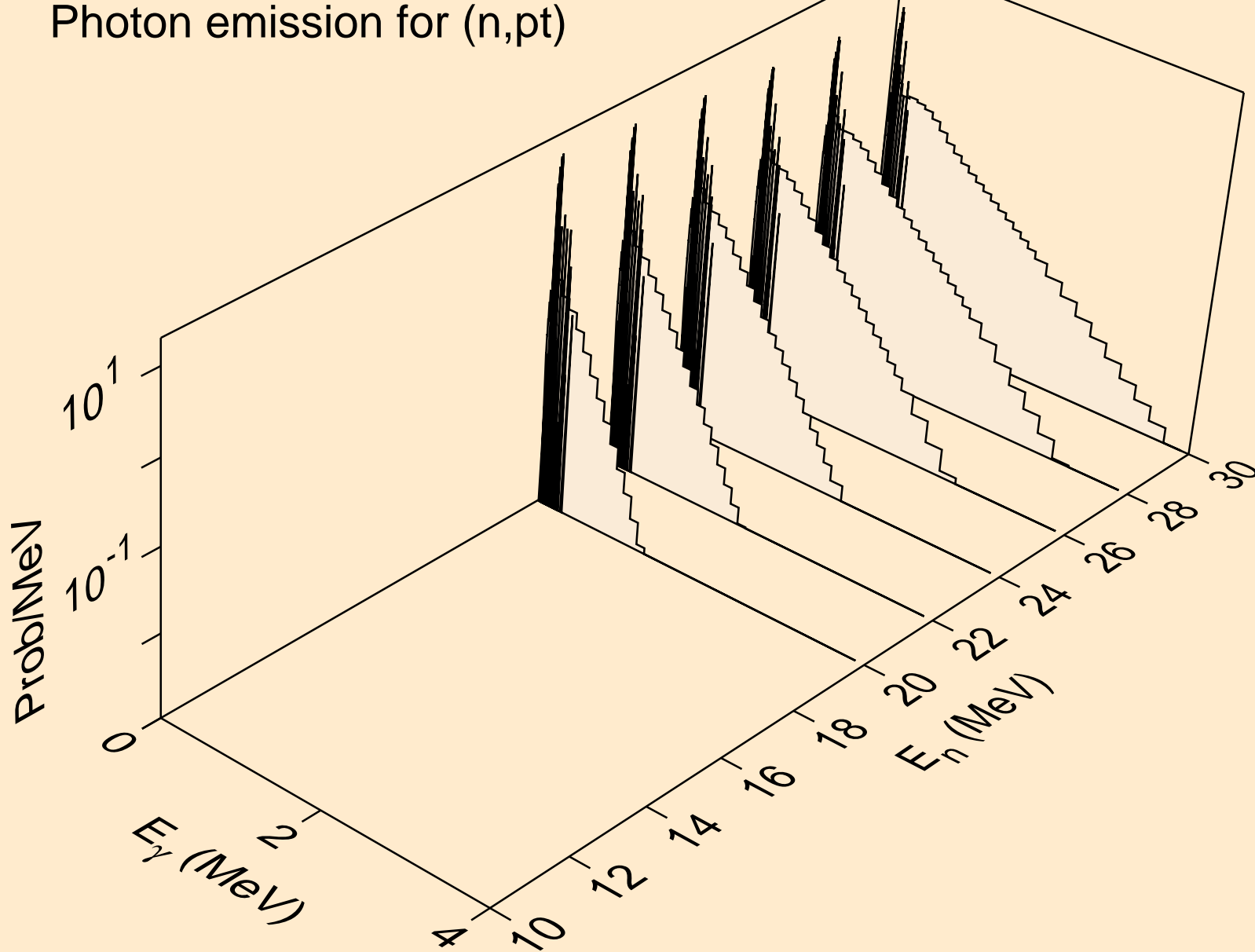

YB168 NEUTRON ACER TENDL-2019 LIBRARY; T=293.16K
Photon emission for (n,da)

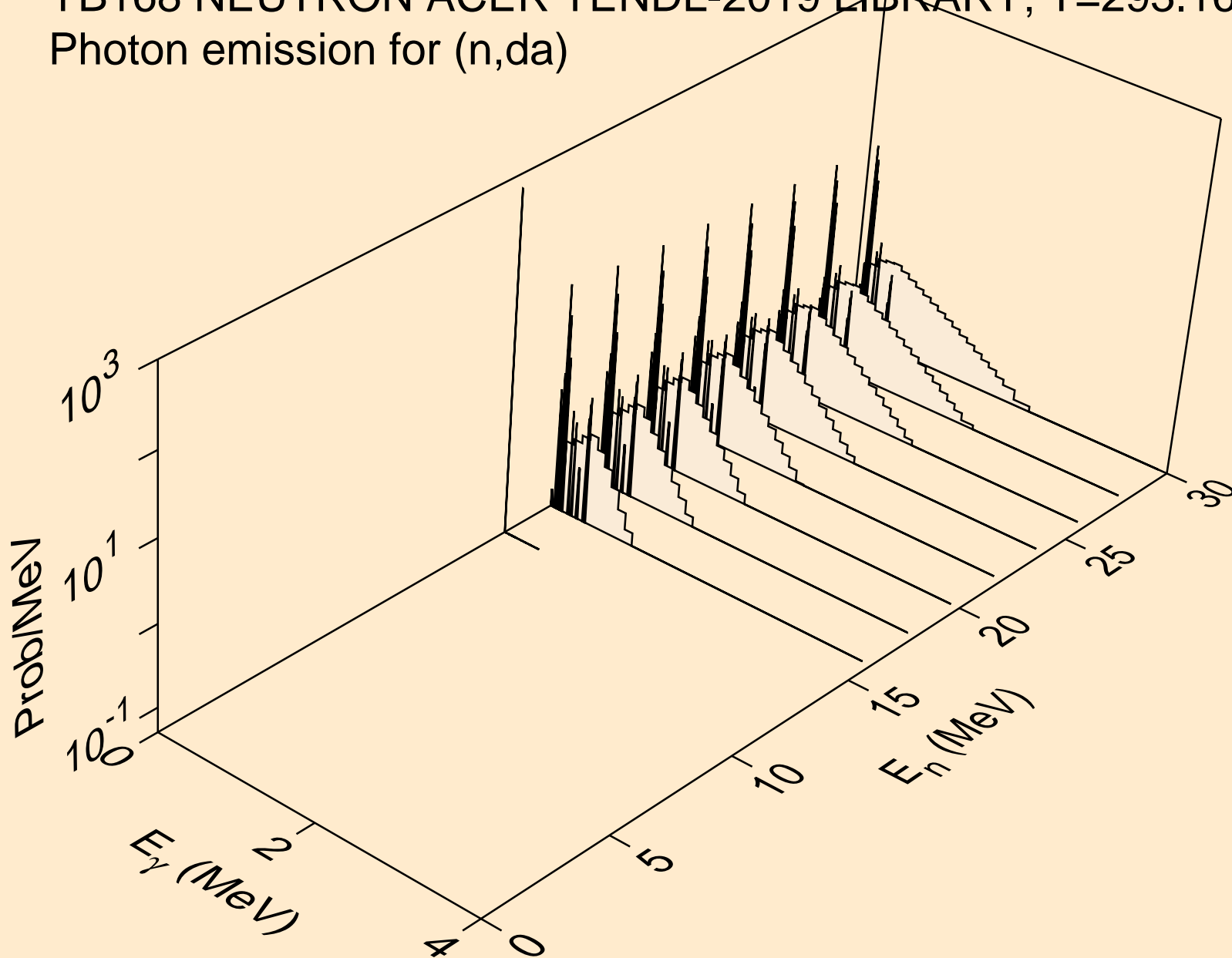

YB168 NEUTRON ACER TENDL-2019 LIBRARY; T=293.16K
thermal capture photon spectrum

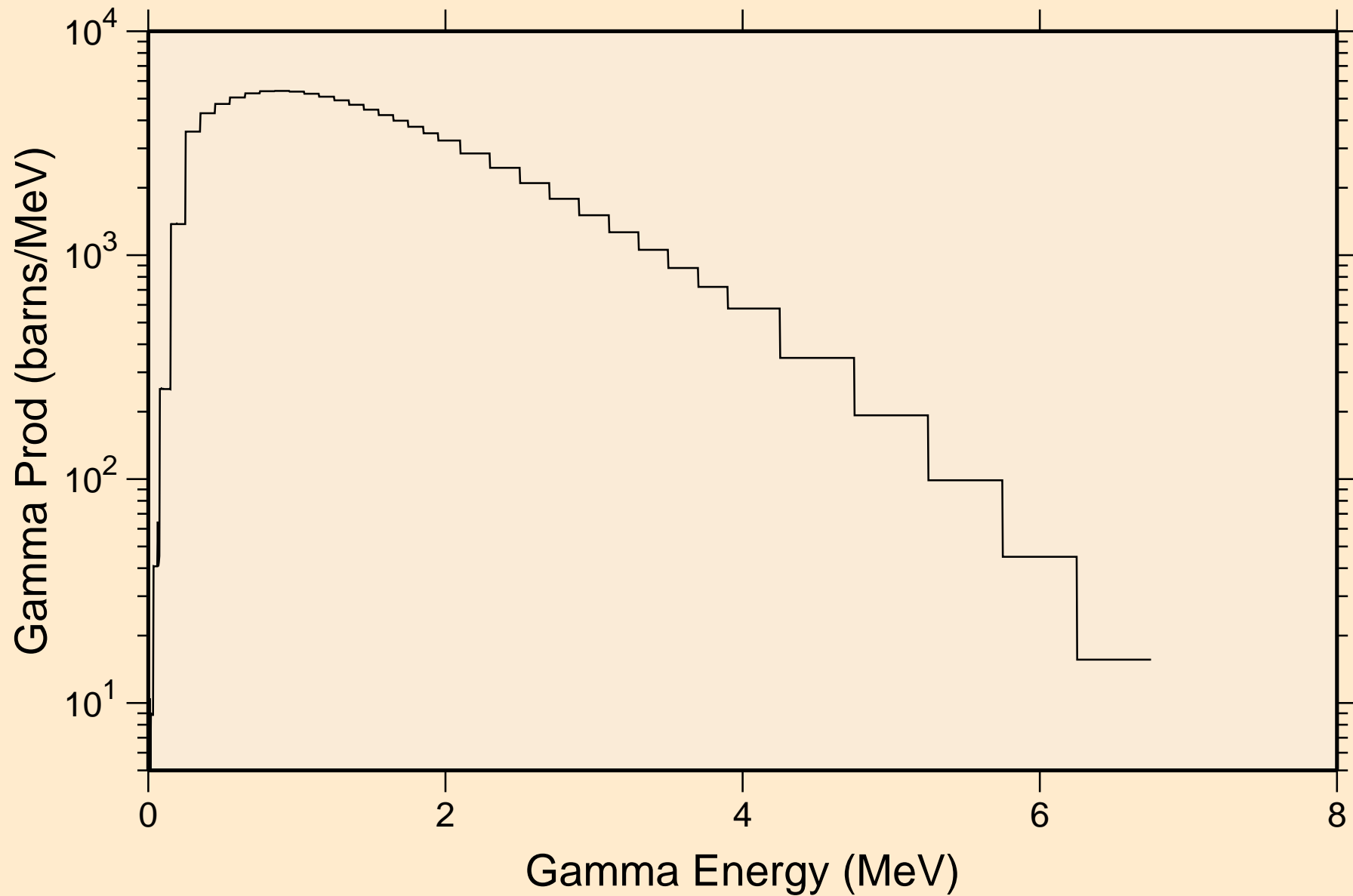

YB168 NEUTRON ACER TENDL-2019 LIBRARY; T=293.16K
14 MeV photon spectrum

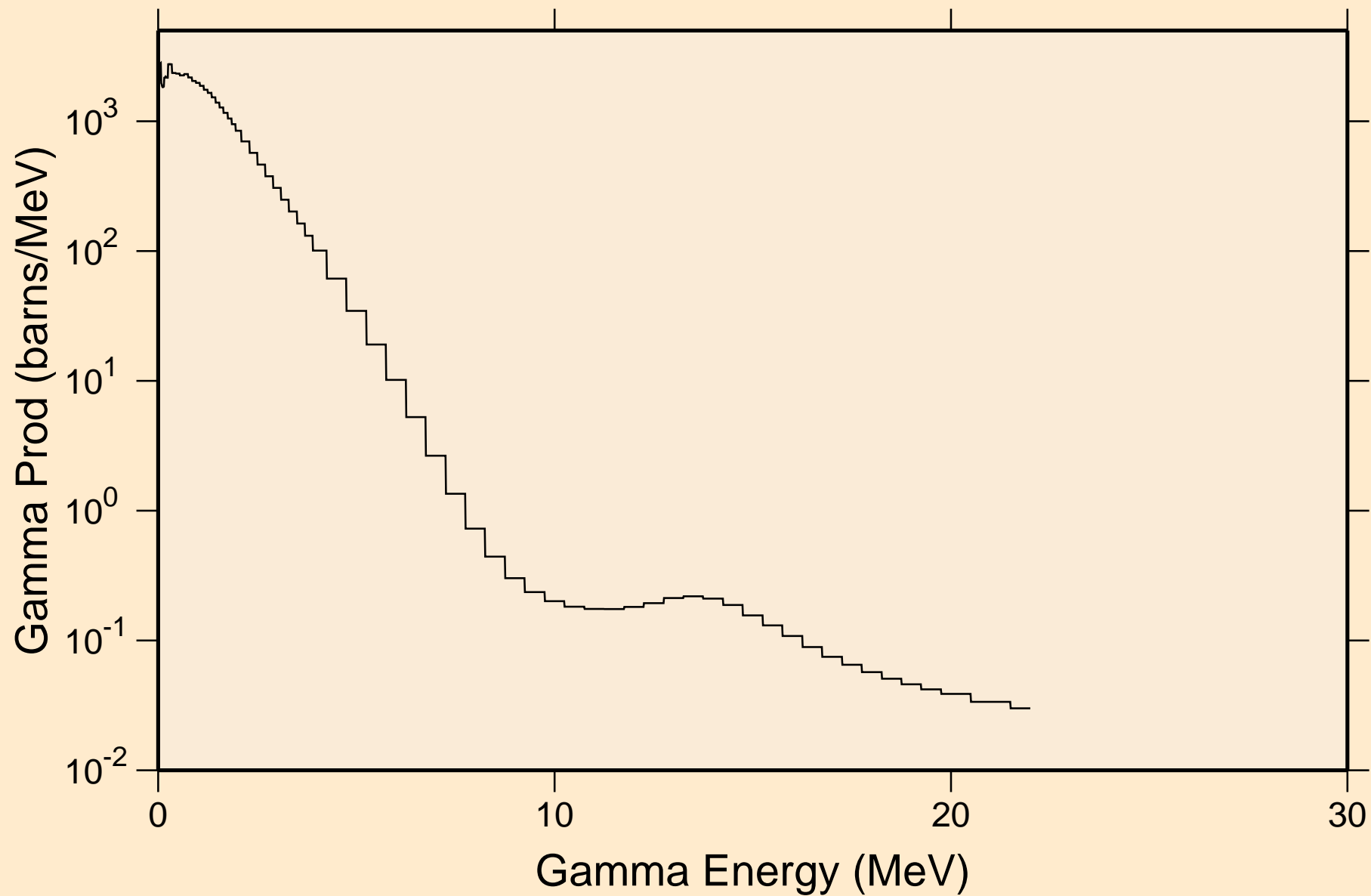

YB168 NEUTRON ACER TENDL-2019 LIBRARY; T=293.16K
Particle heating contributions

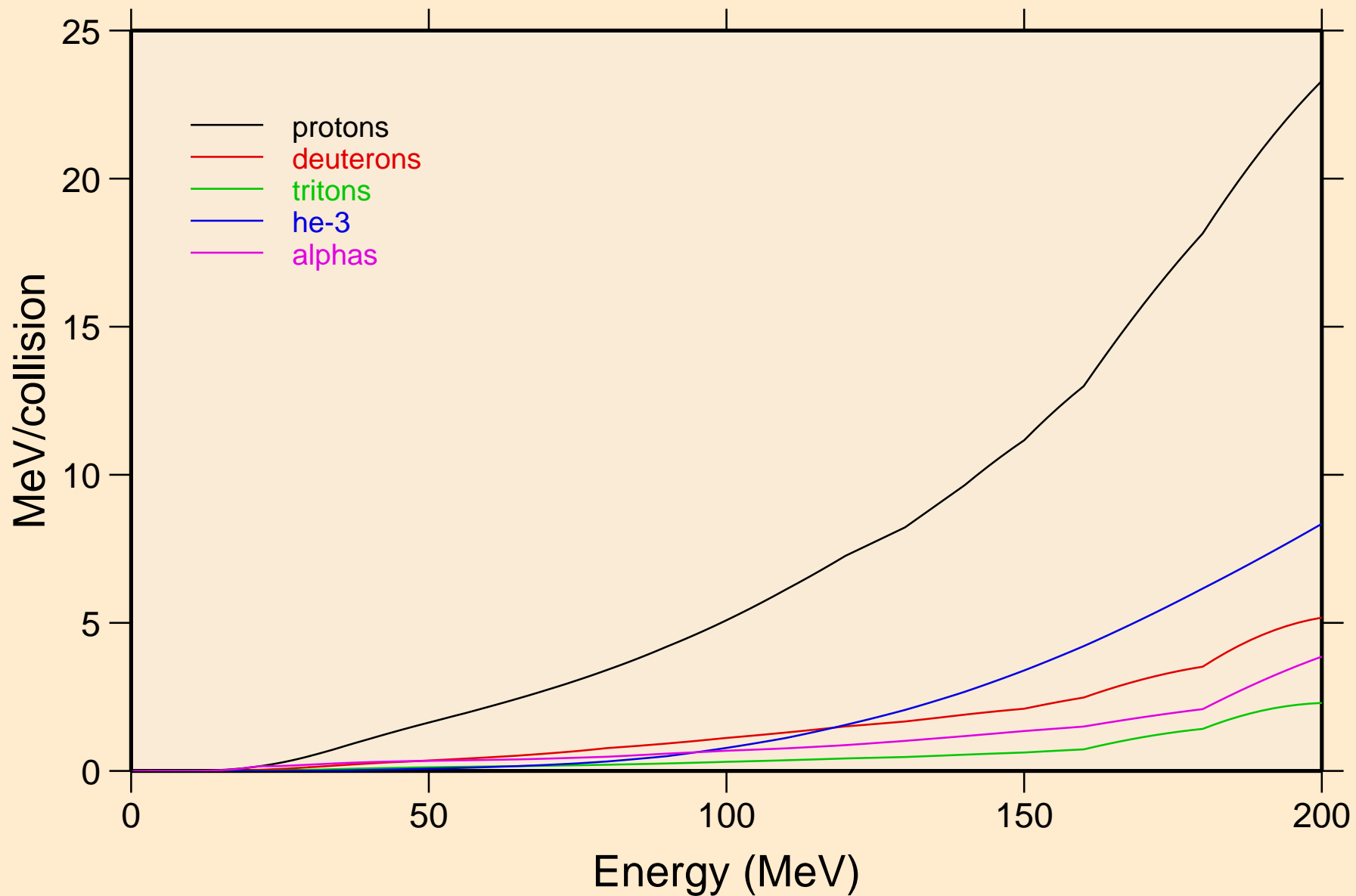

YB168 NEUTRON ACER TENDL-2019 LIBRARY; T=293.16K
Recoil Heating

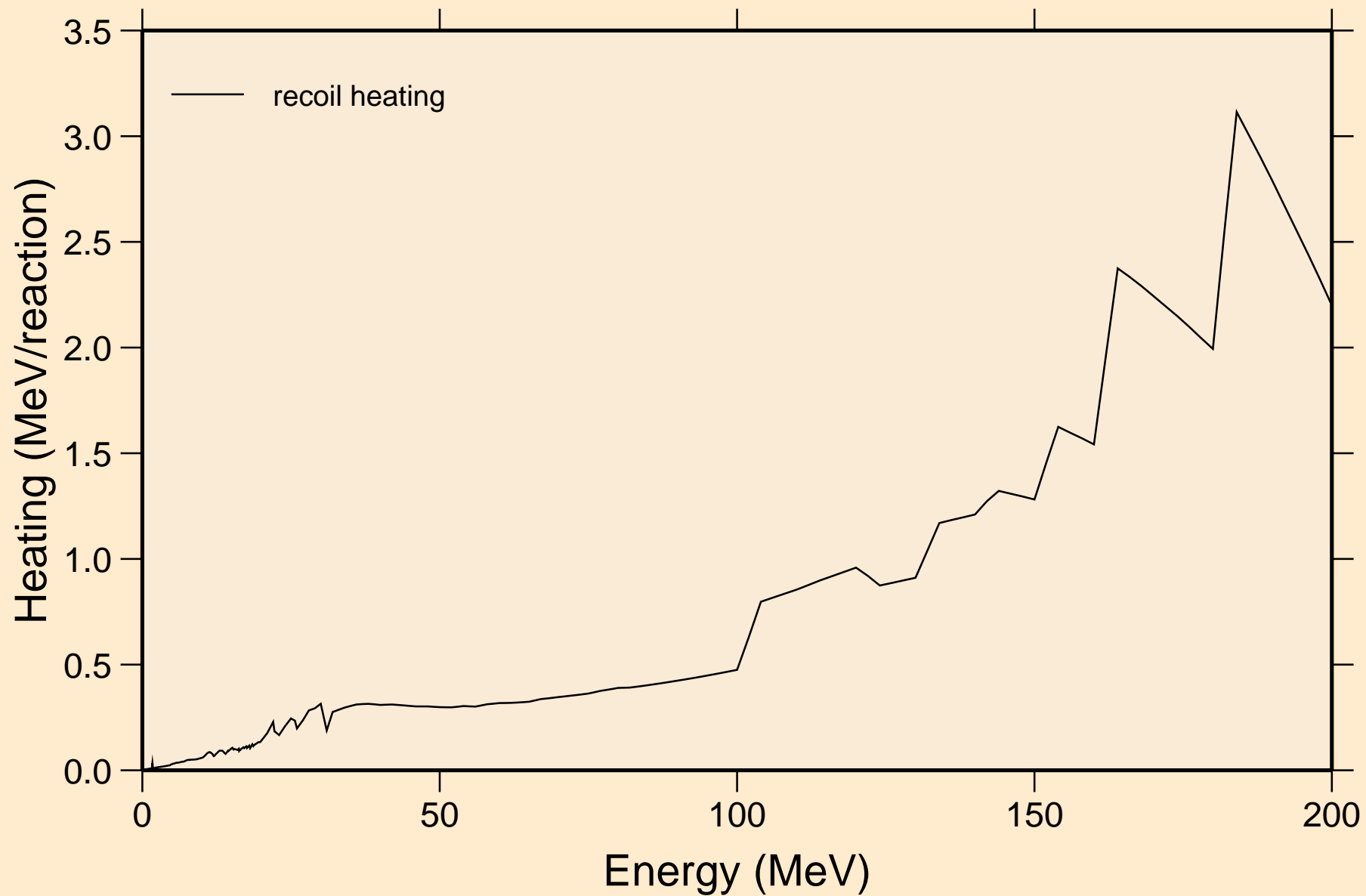

YB168 NEUTRON ACER TENDL-2019 LIBRARY; T=293.16K

Particle production cross sections

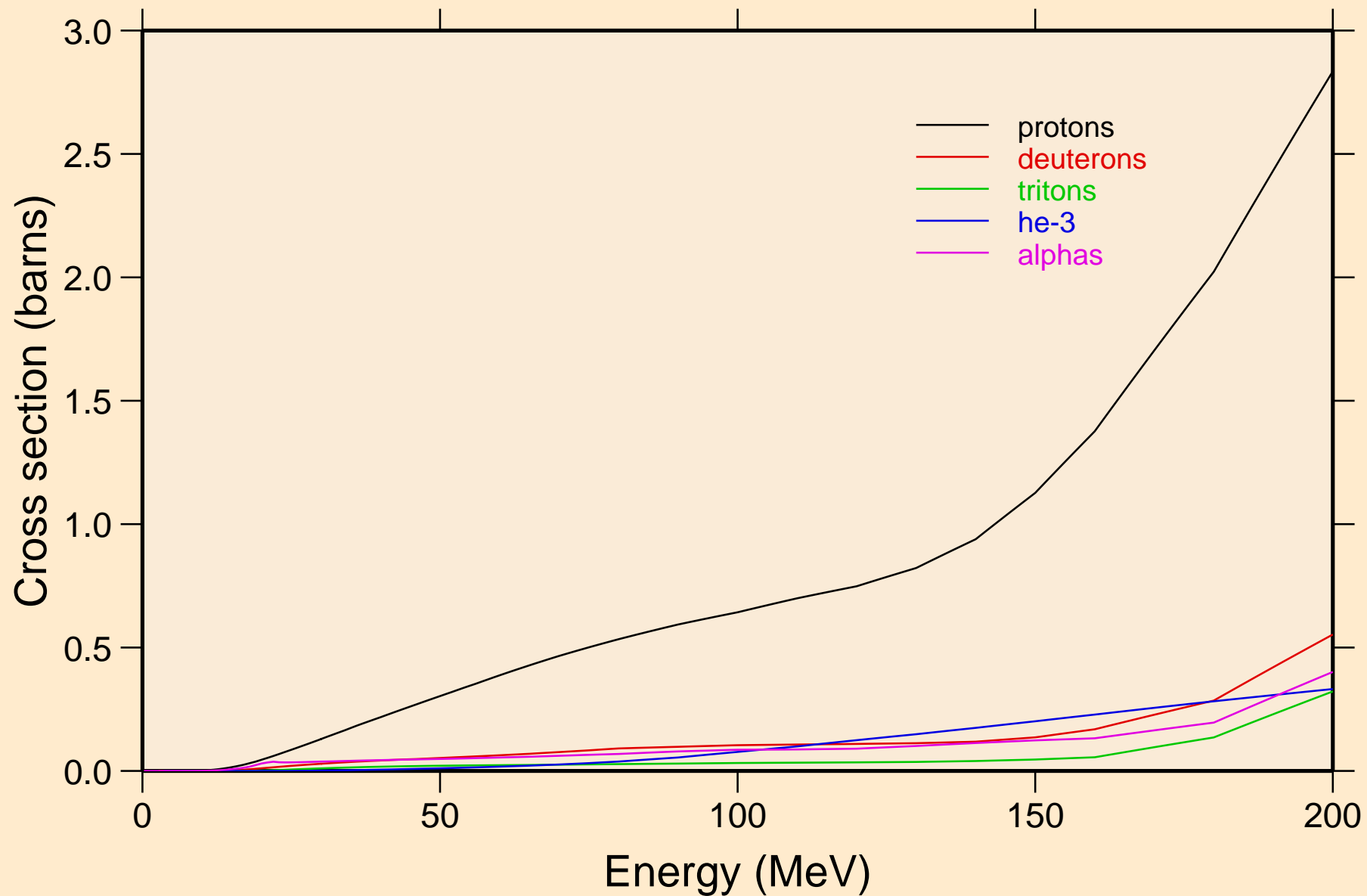

YB168 NEUTRON ACER TENDL-2019 LIBRARY; T=293.16K
protons from (n,x)

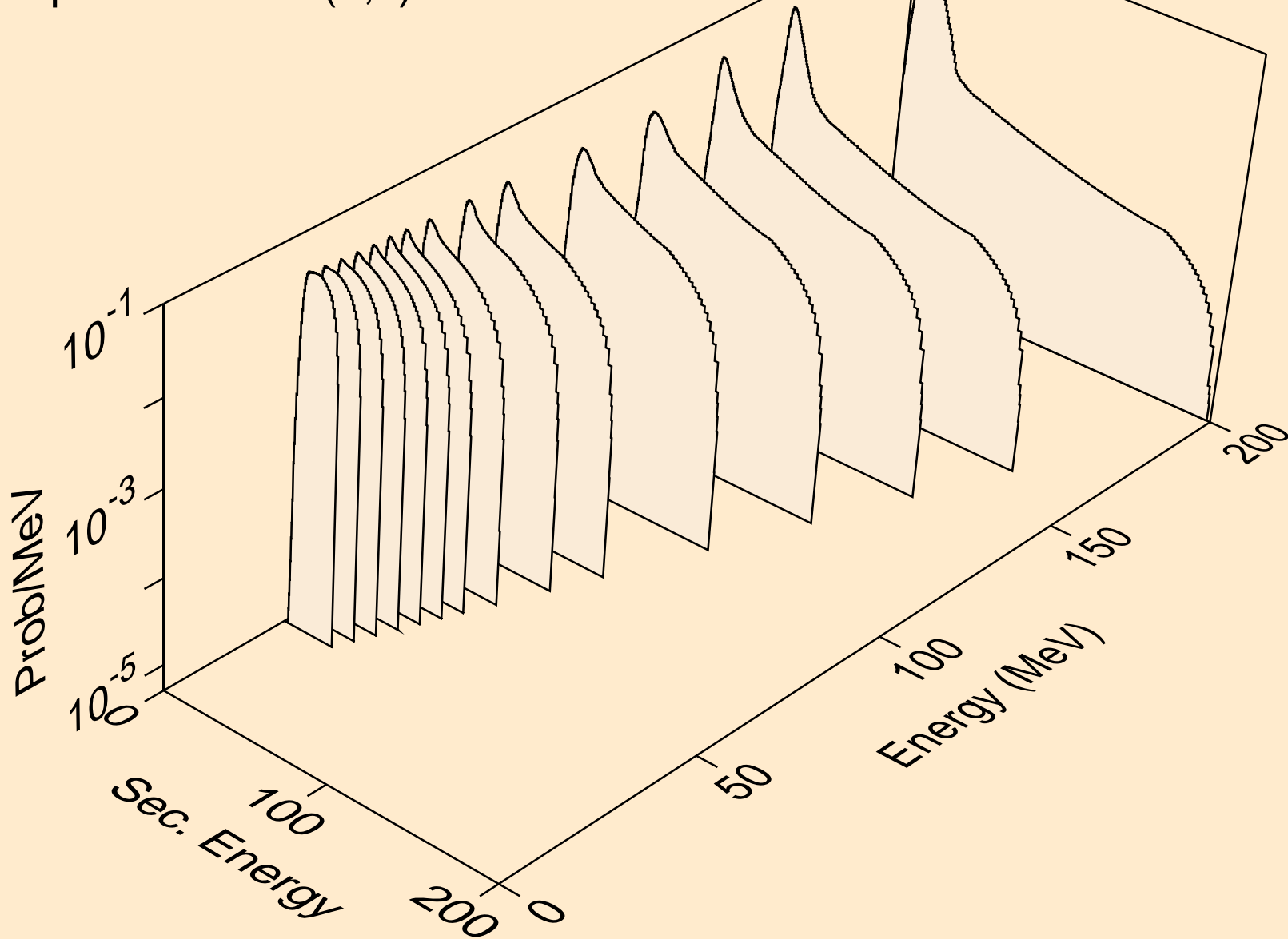

YB168 NEUTRON ACER TENDL-2019 LIBRARY; T=293.16K
protons from (n,n*)p

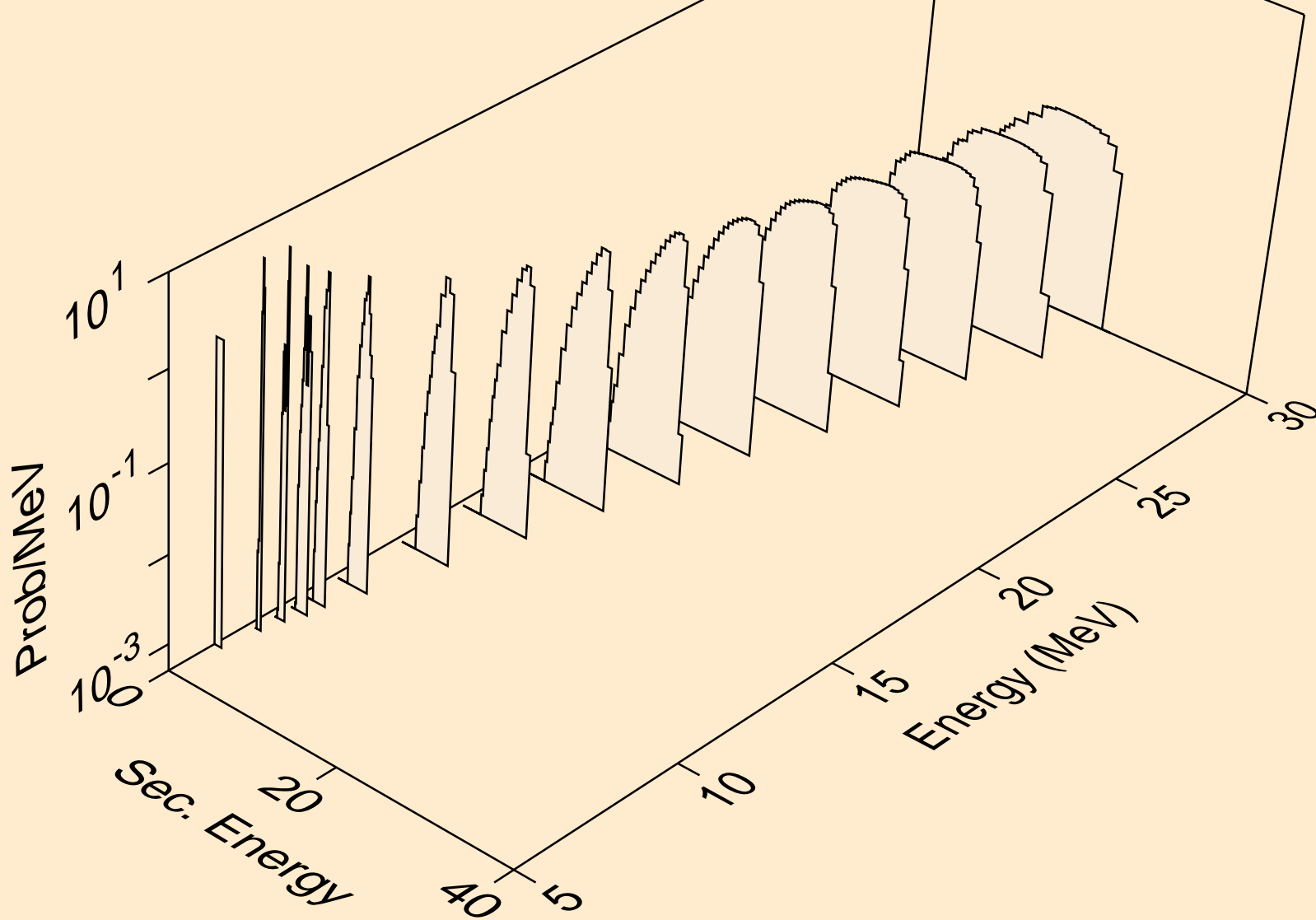

YB168 NEUTRON ACER TENDL-2019 LIBRARY; T=293.16K
protons from (n,2np)

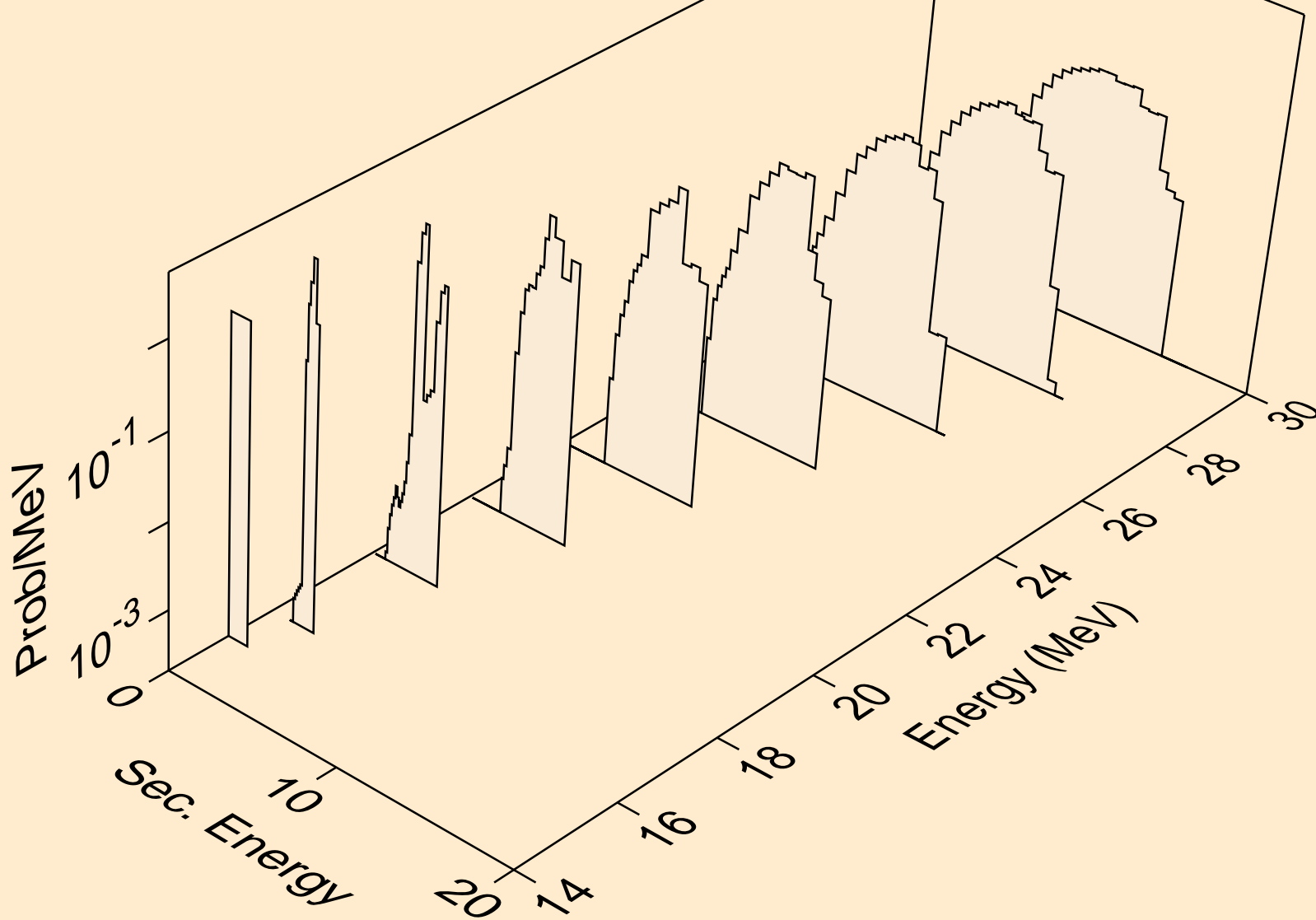

YB168 NEUTRON ACER TENDL-2019 LIBRARY; T=293.16K
protons from (n,3np)

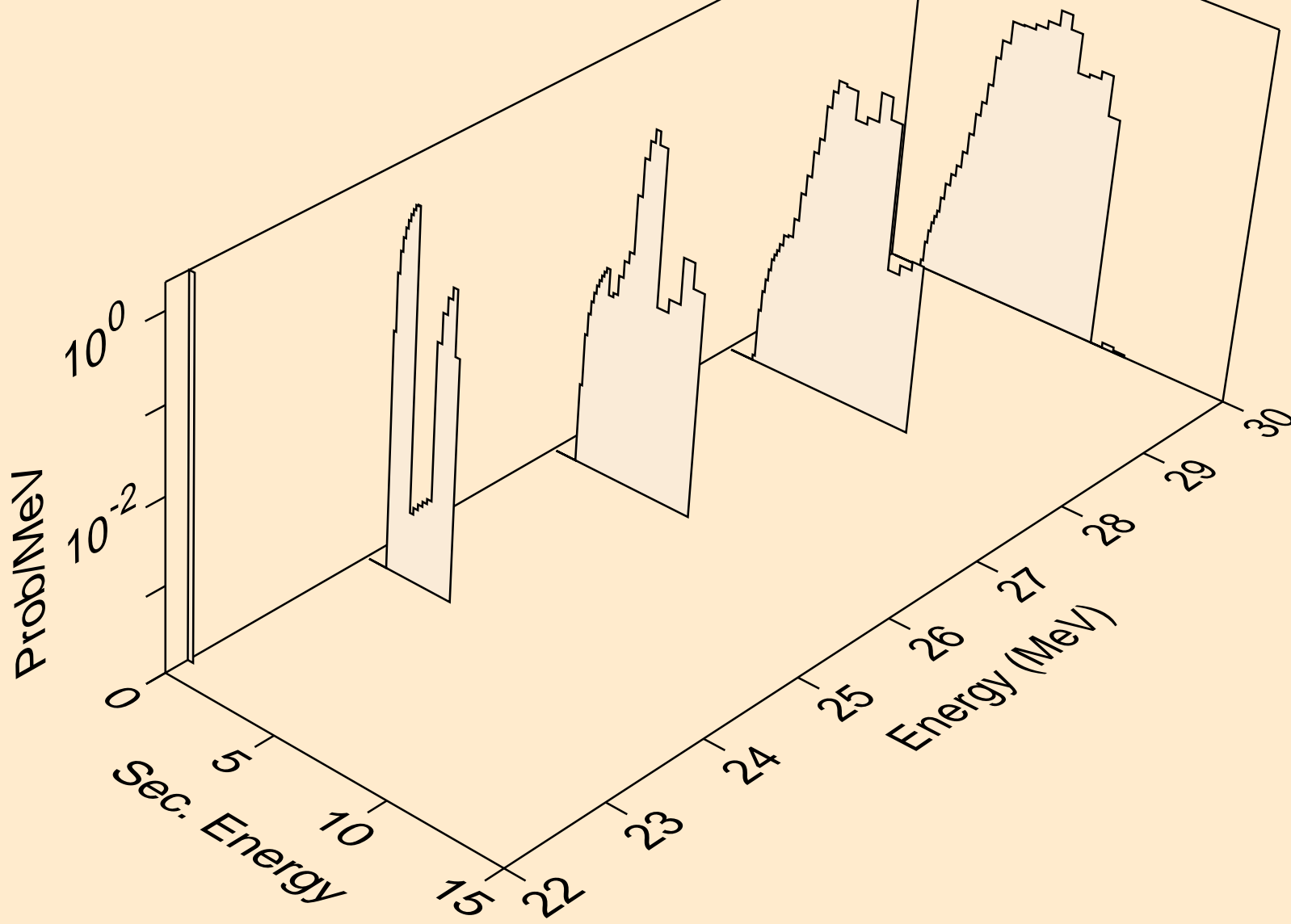

YB168 NEUTRON ACER TENDL-2019 LIBRARY; T=293.16K
protons from (n,2np)

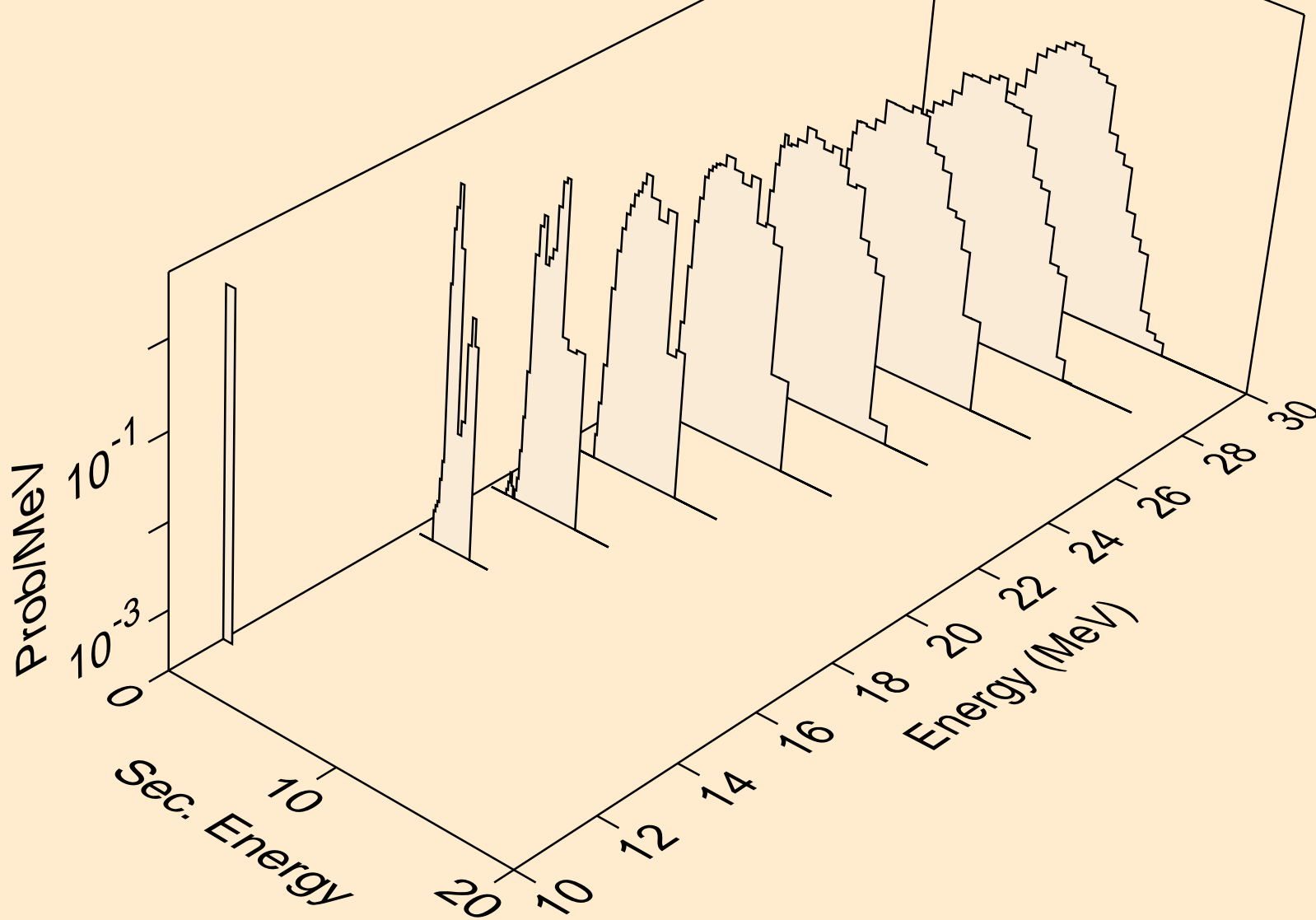

YB168 NEUTRON ACER TENDL-2019 LIBRARY; T=293.16K
protons from (n,npa)

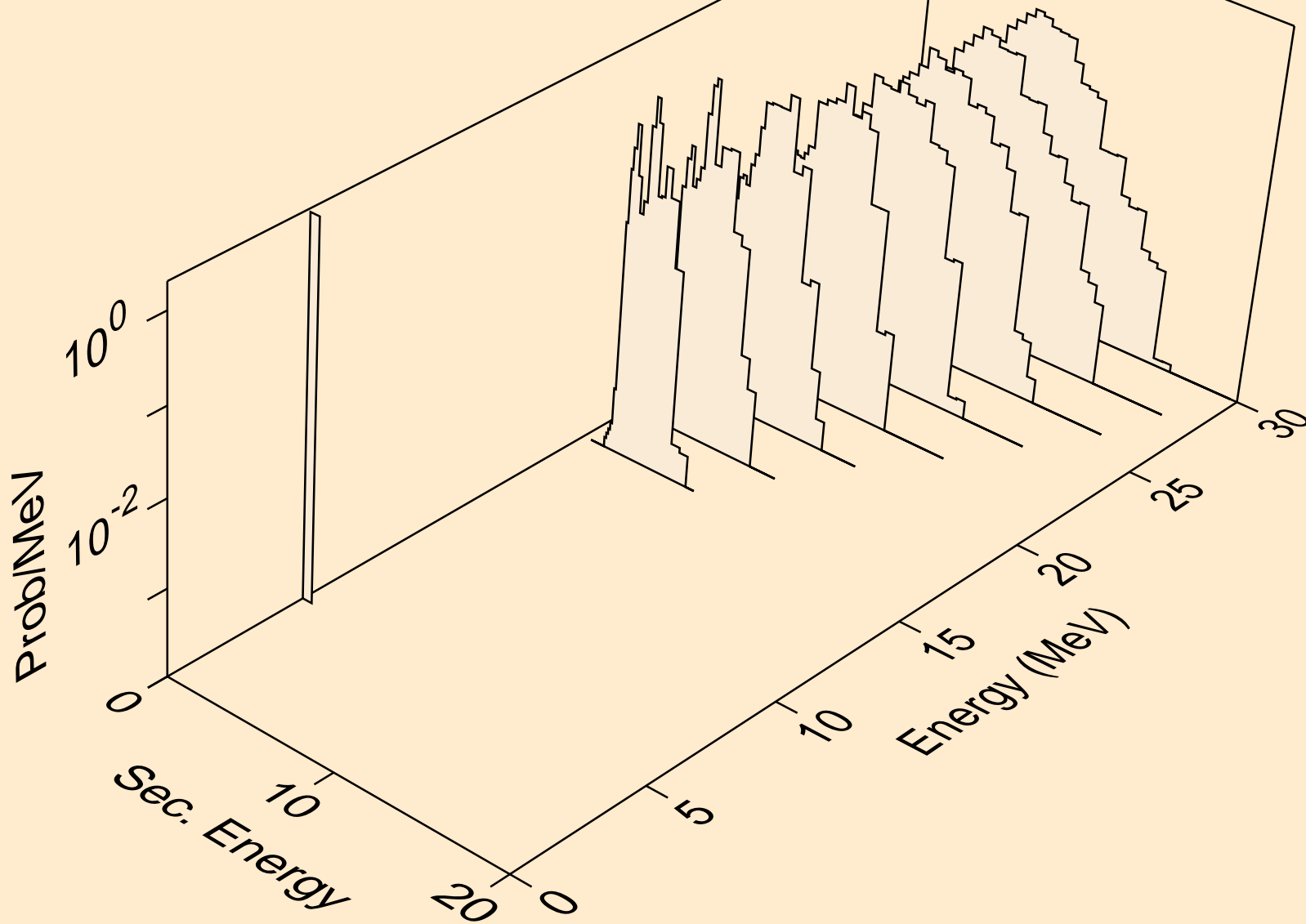

YB168 NEUTRON ACER TENDL-2019 LIBRARY; T=293.16K
protons from (n,p)

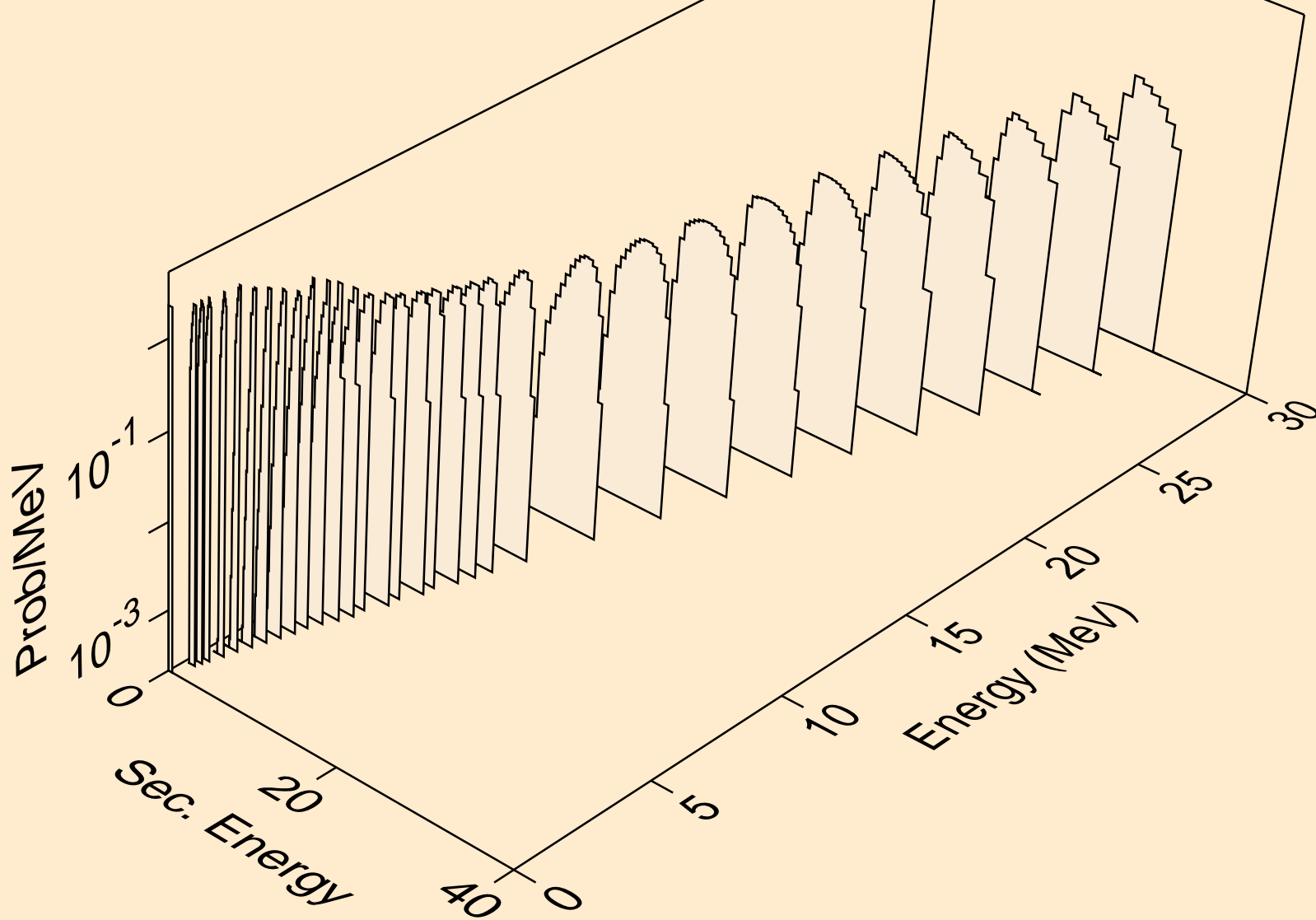

YB168 NEUTRON ACER TENDL-2019 LIBRARY; T=293.16K
protons from (n,2p)

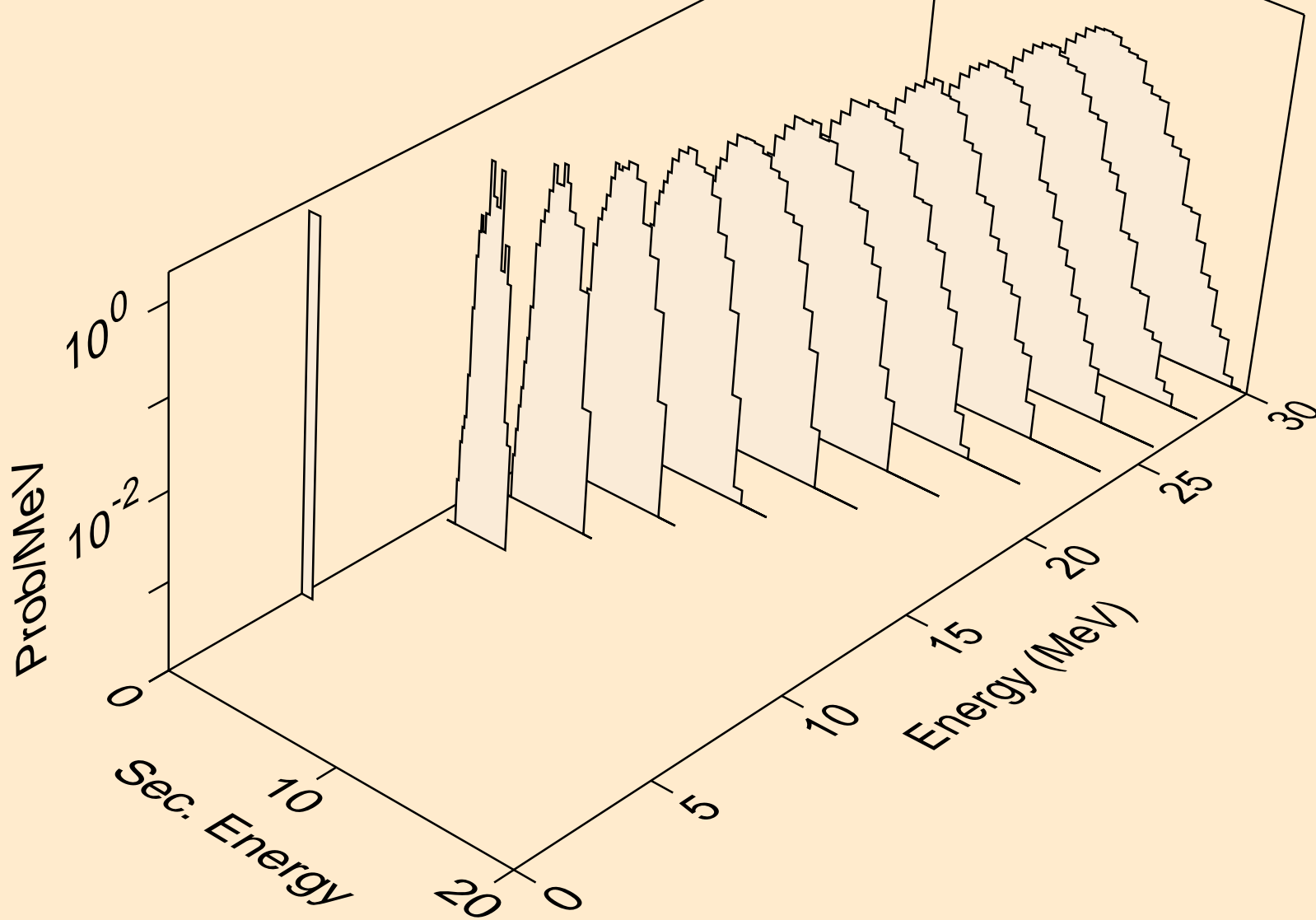

YB168 NEUTRON ACER TENDL-2019 LIBRARY; T=293.16K
protons from (n,p)

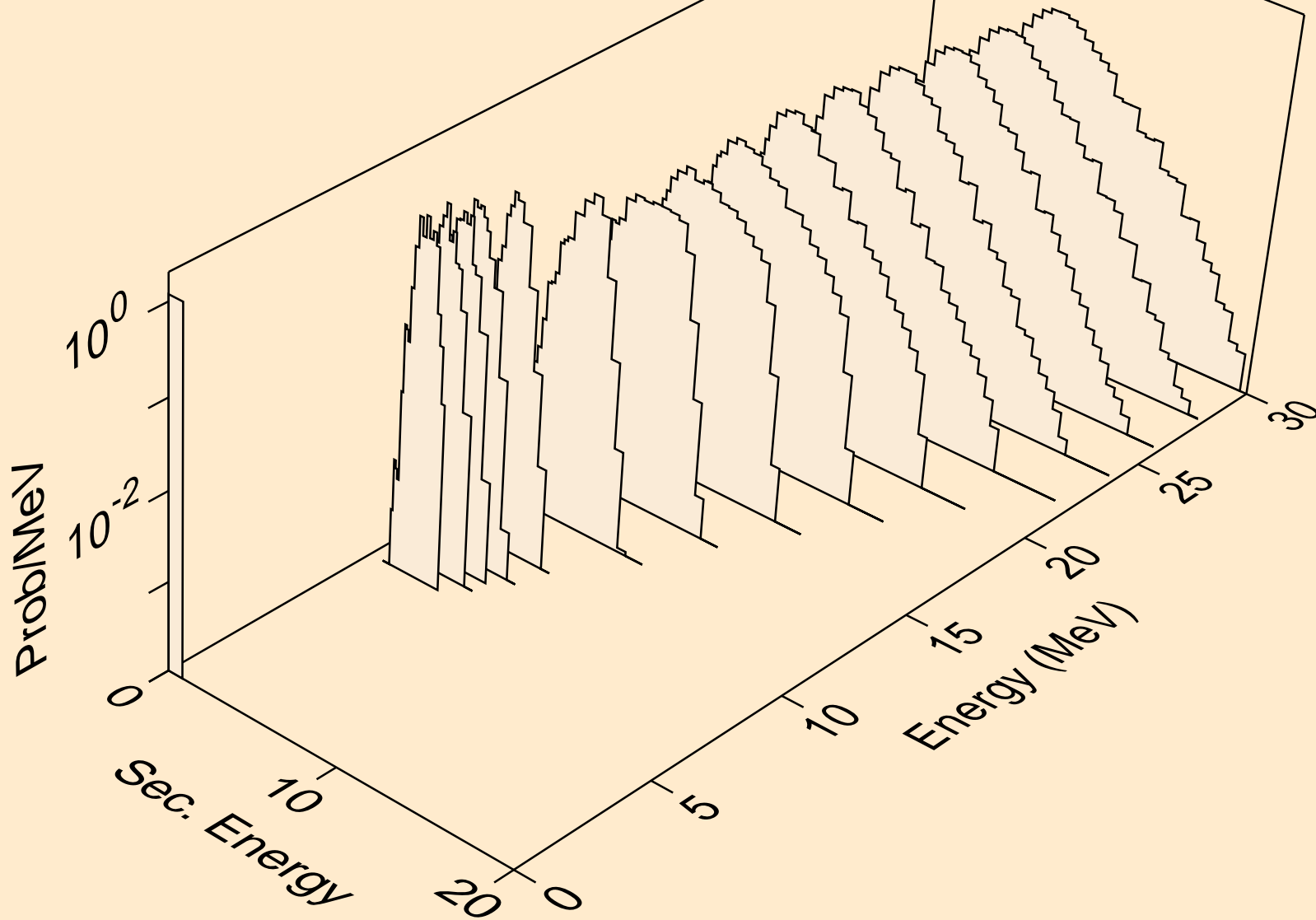

YB168 NEUTRON ACER TENDL-2019 LIBRARY; T=293.16K
protons from (n,pd)

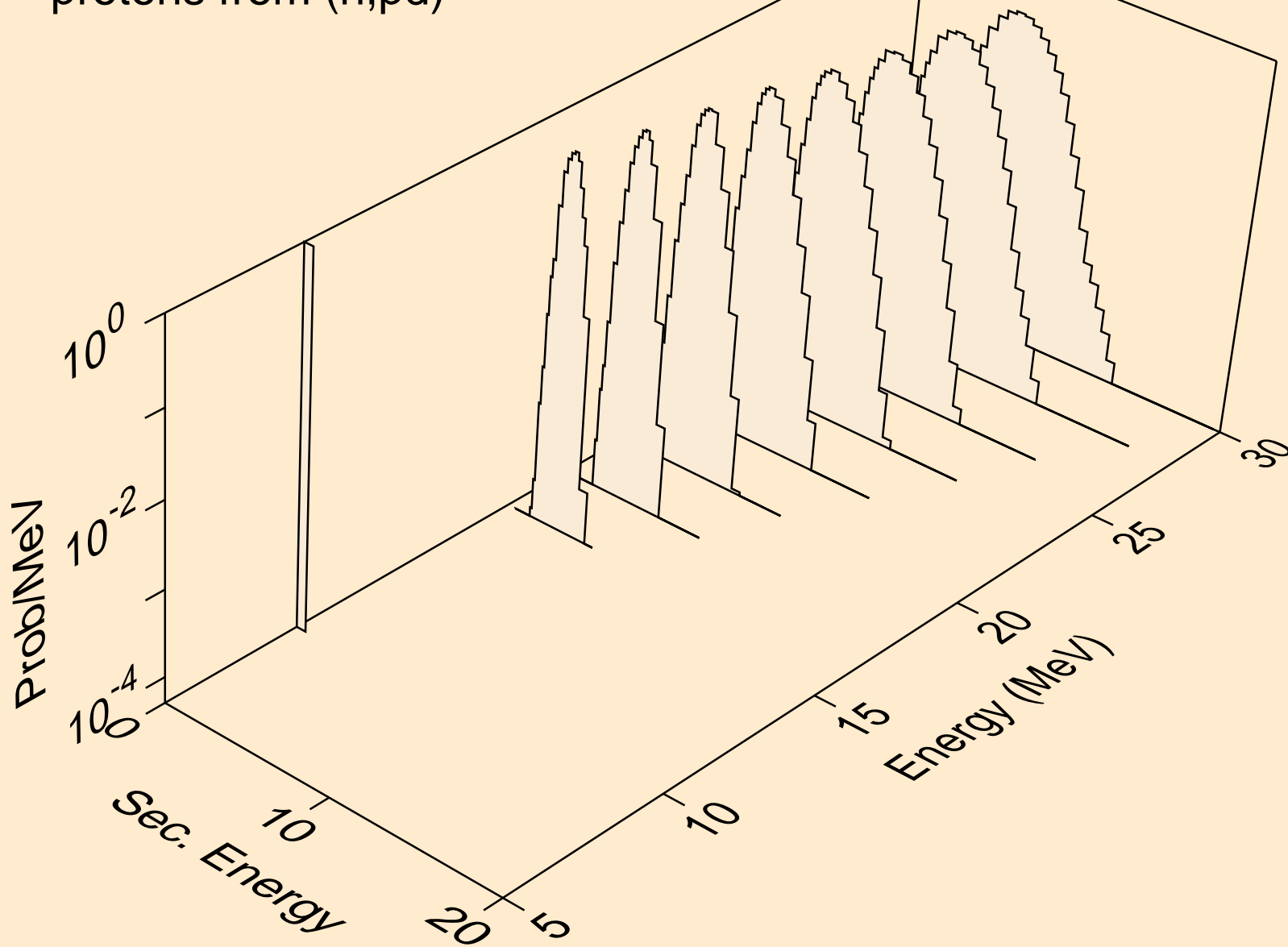

YB168 NEUTRON ACER TENDL-2019 LIBRARY; T=293.16K
protons from (n,pt)

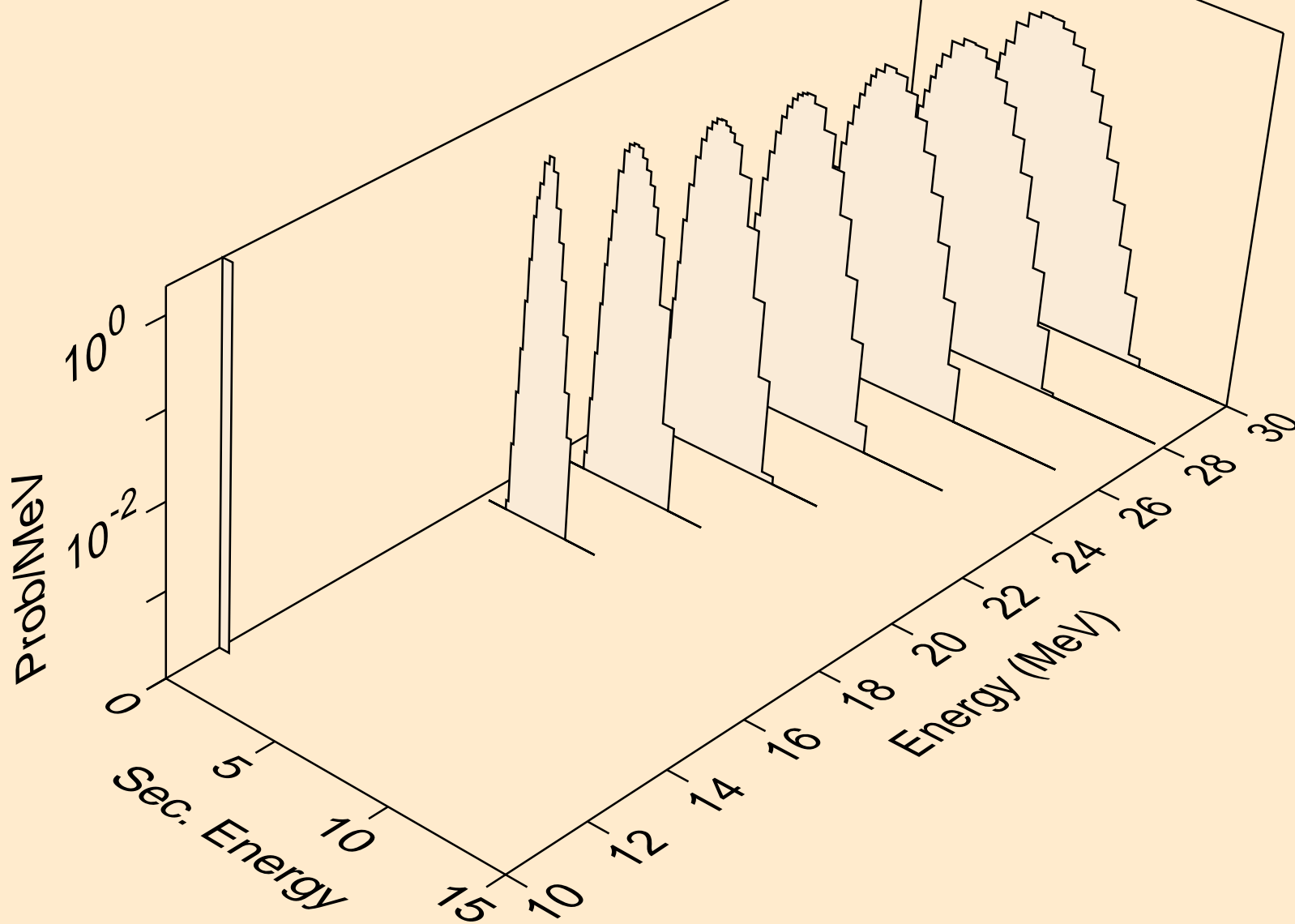

YB168 NEUTRON ACER TENDL-2019 LIBRARY; T=293.16K
deuterons from (n,x)

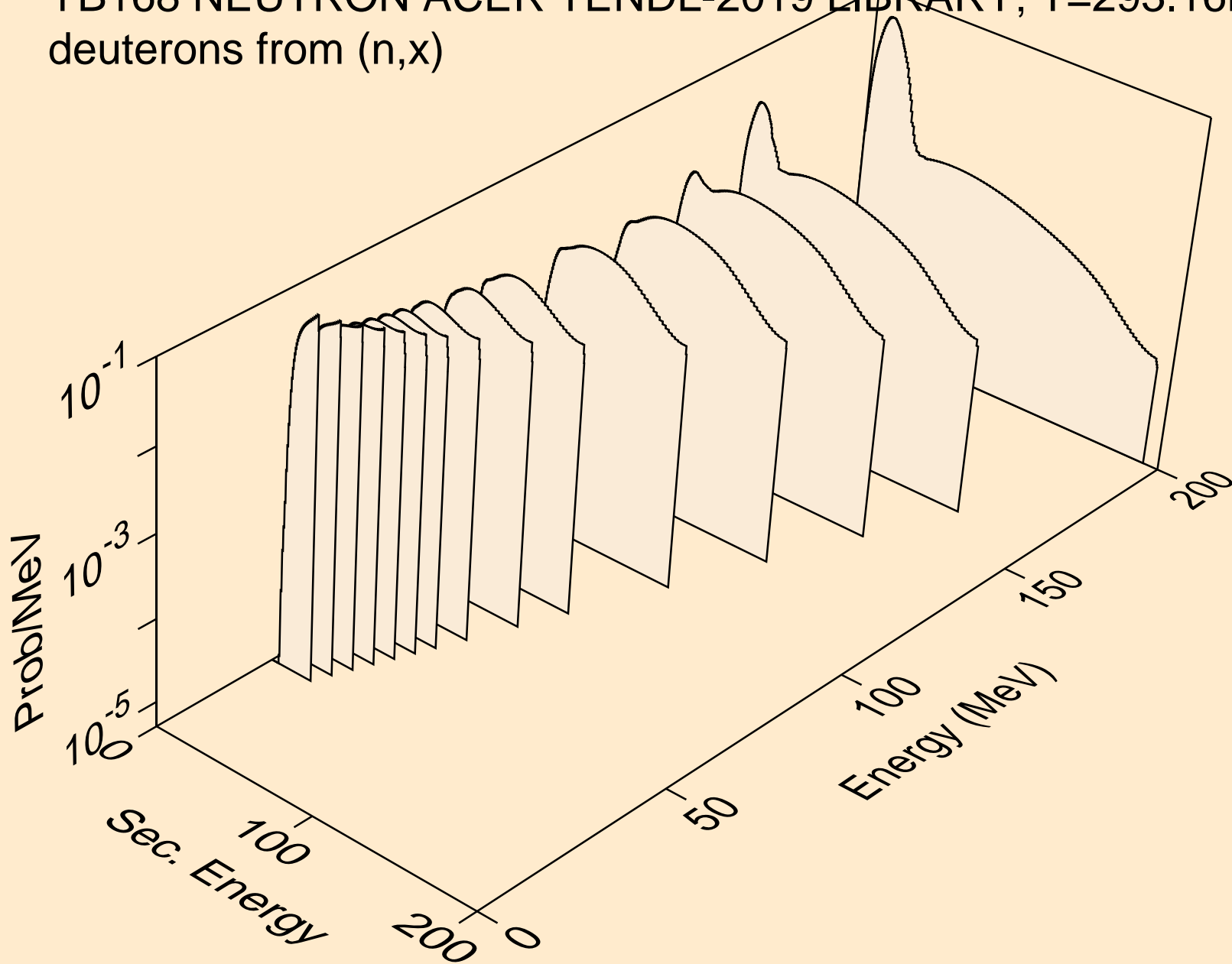

YB168 NEUTRON ACER TENDL-2019 LIBRARY; T=293.16K
deuterons from (n,2nd)

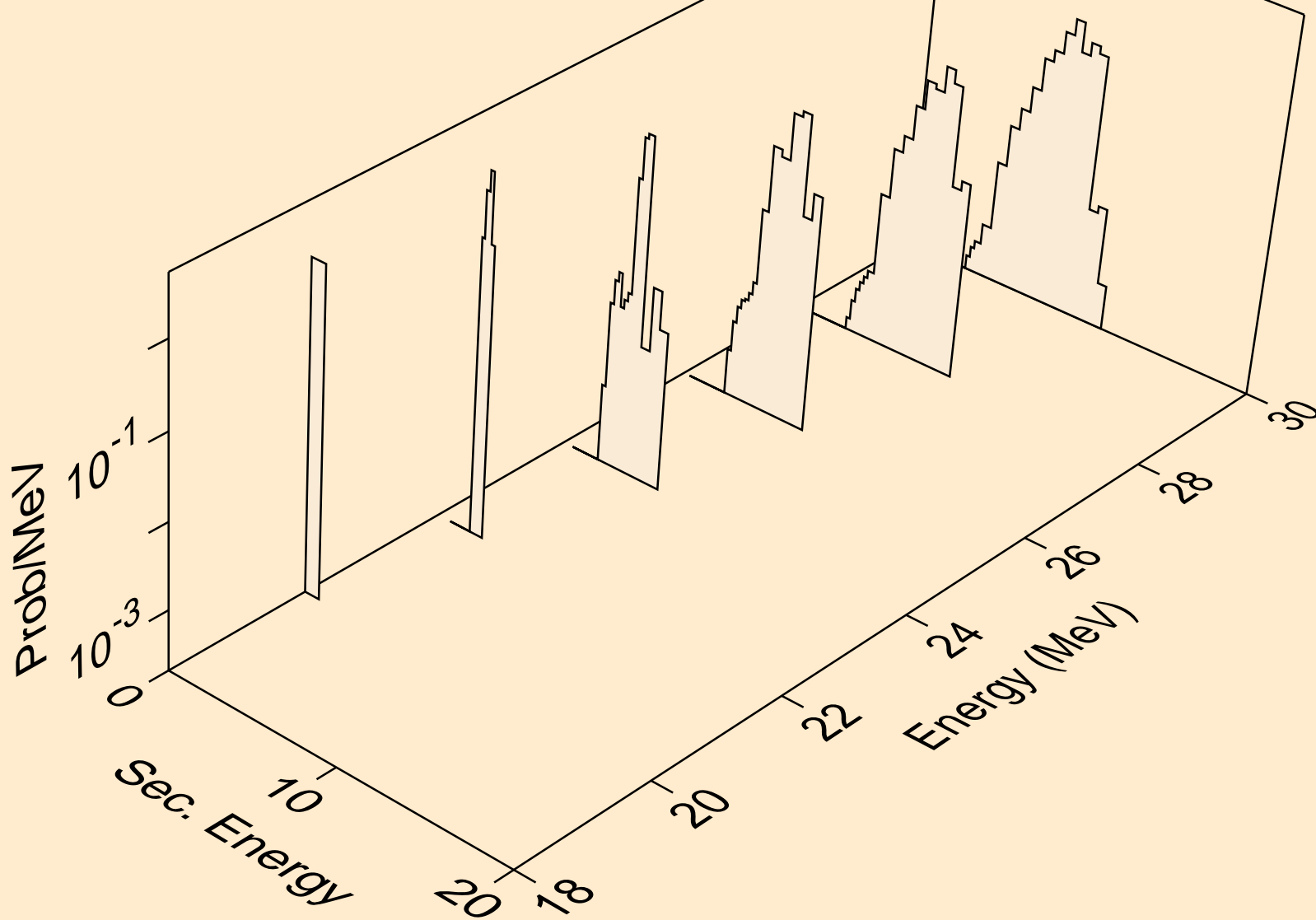

YB168 NEUTRON ACER TENDL-2019 LIBRARY; T=293.16K
deuterons from (n,n*)d

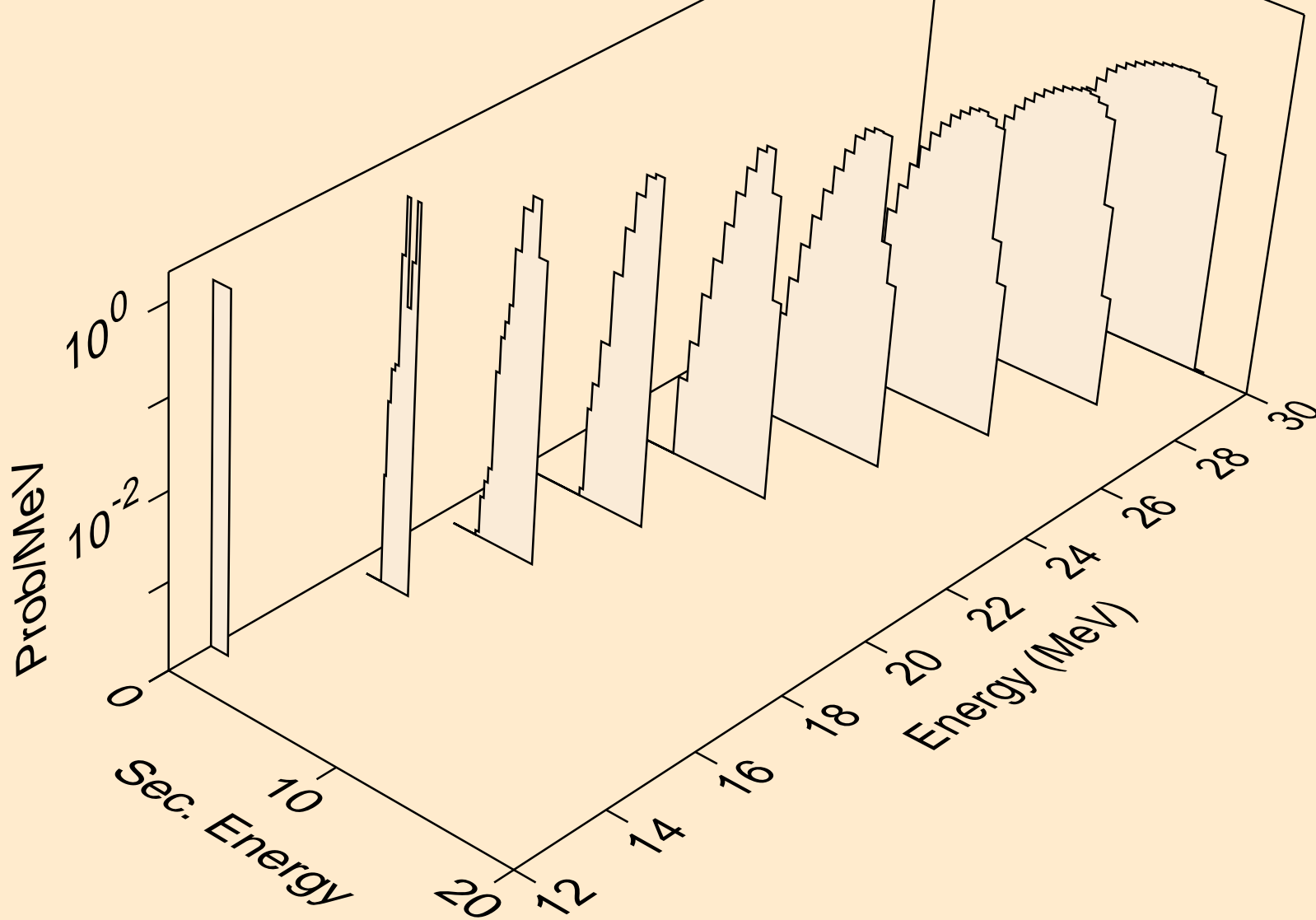

YB168 NEUTRON ACER TENDL-2019 LIBRARY; T=293.16K
deuterons from (n,d)

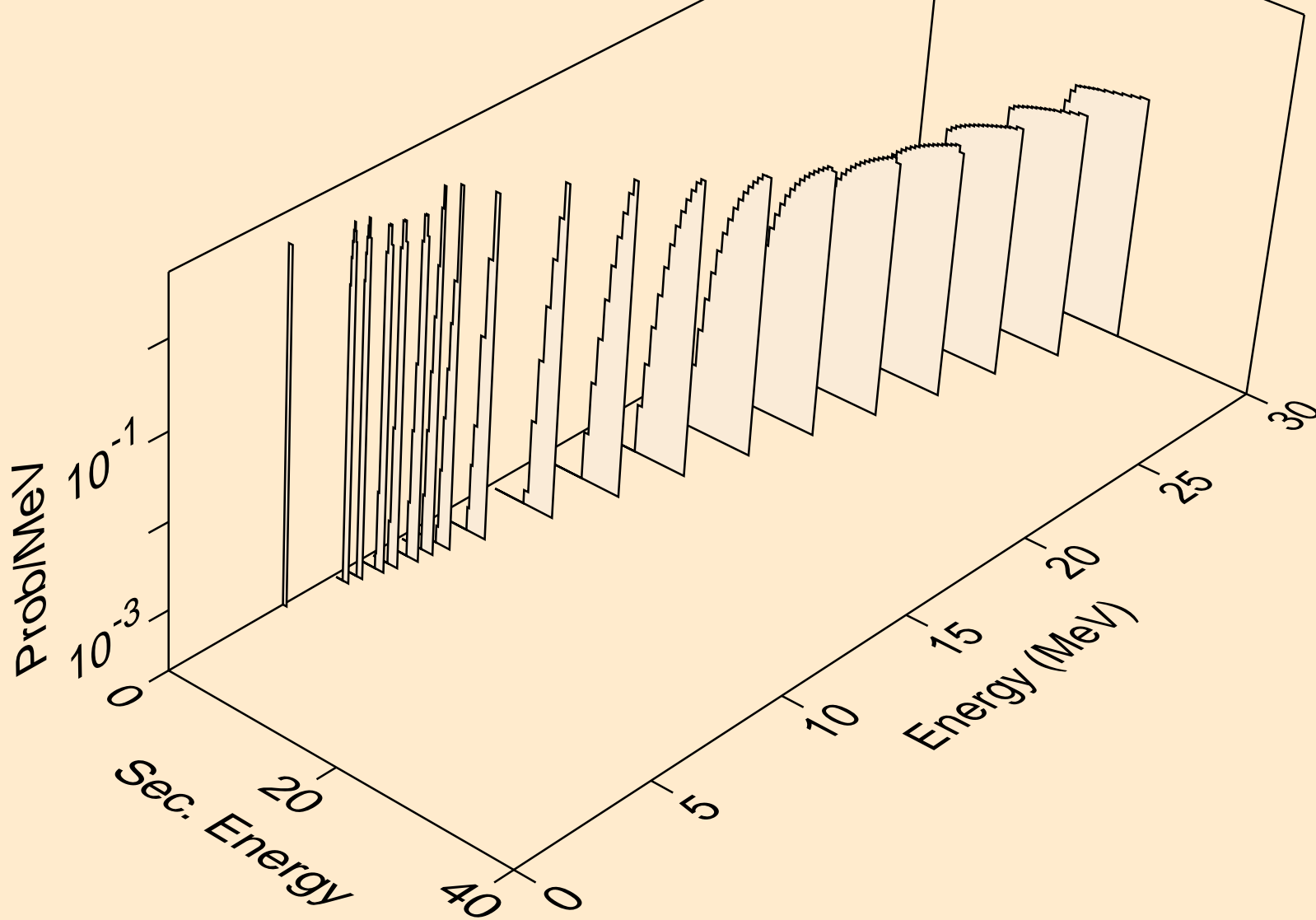

YB168 NEUTRON ACER TENDL-2019 LIBRARY; T=293.16K
deuterons from (n,pd)

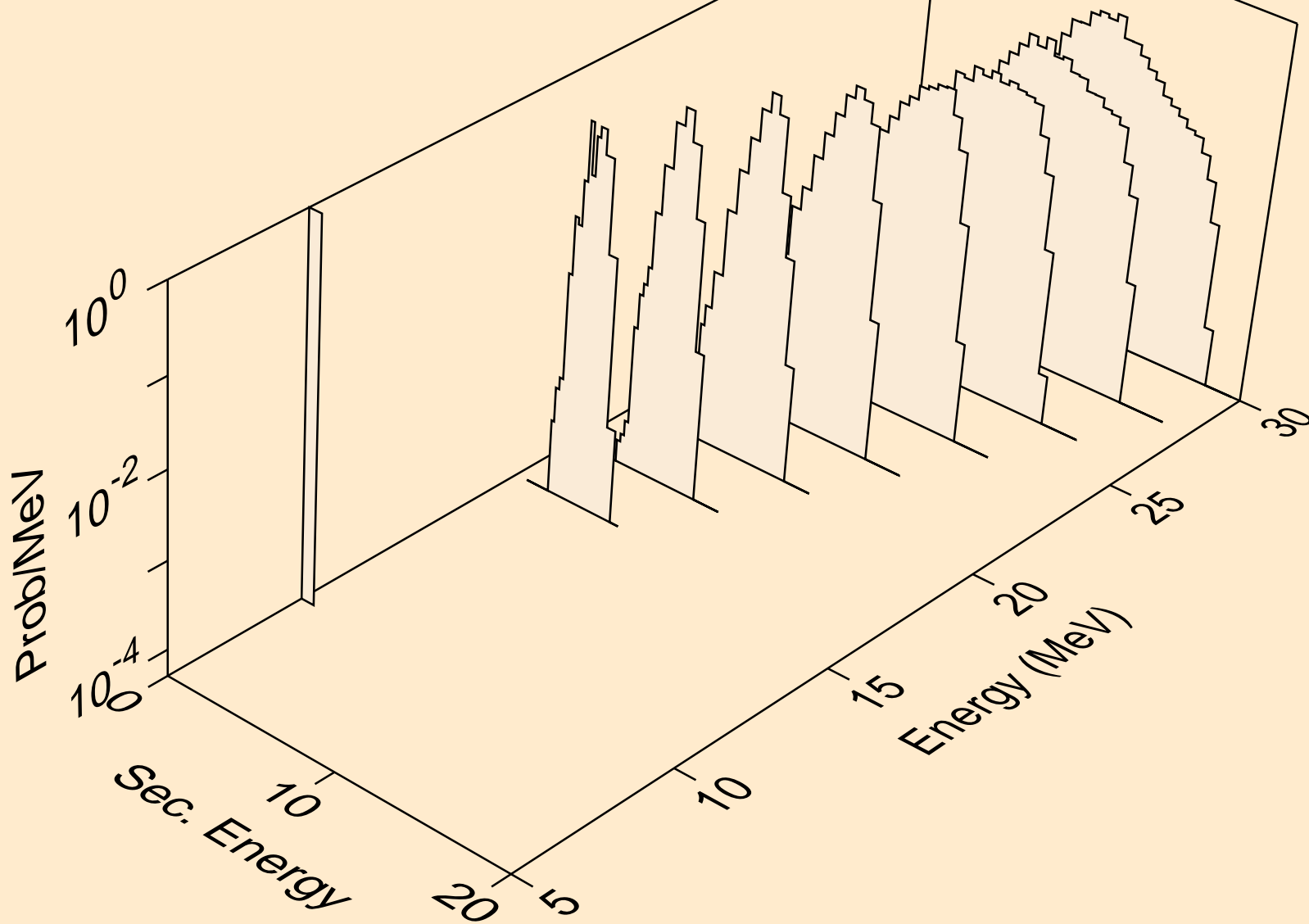

YB168 NEUTRON ACER TENDL-2019 LIBRARY; T=293.16K
deuterons from (n,da)

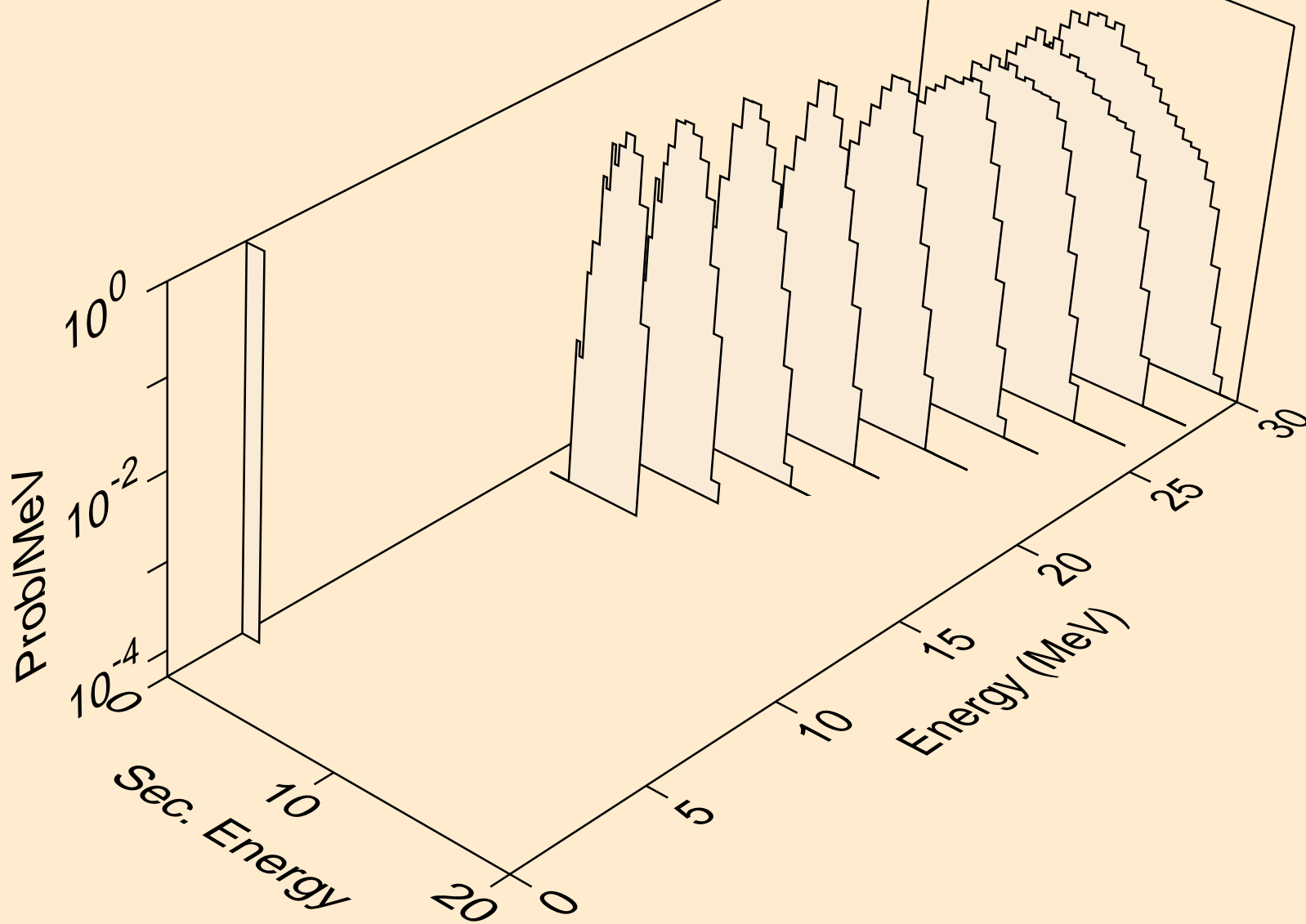

YB168 NEUTRON ACER TENDL-2019 LIBRARY; T=293.16K
tritons from (n,x)

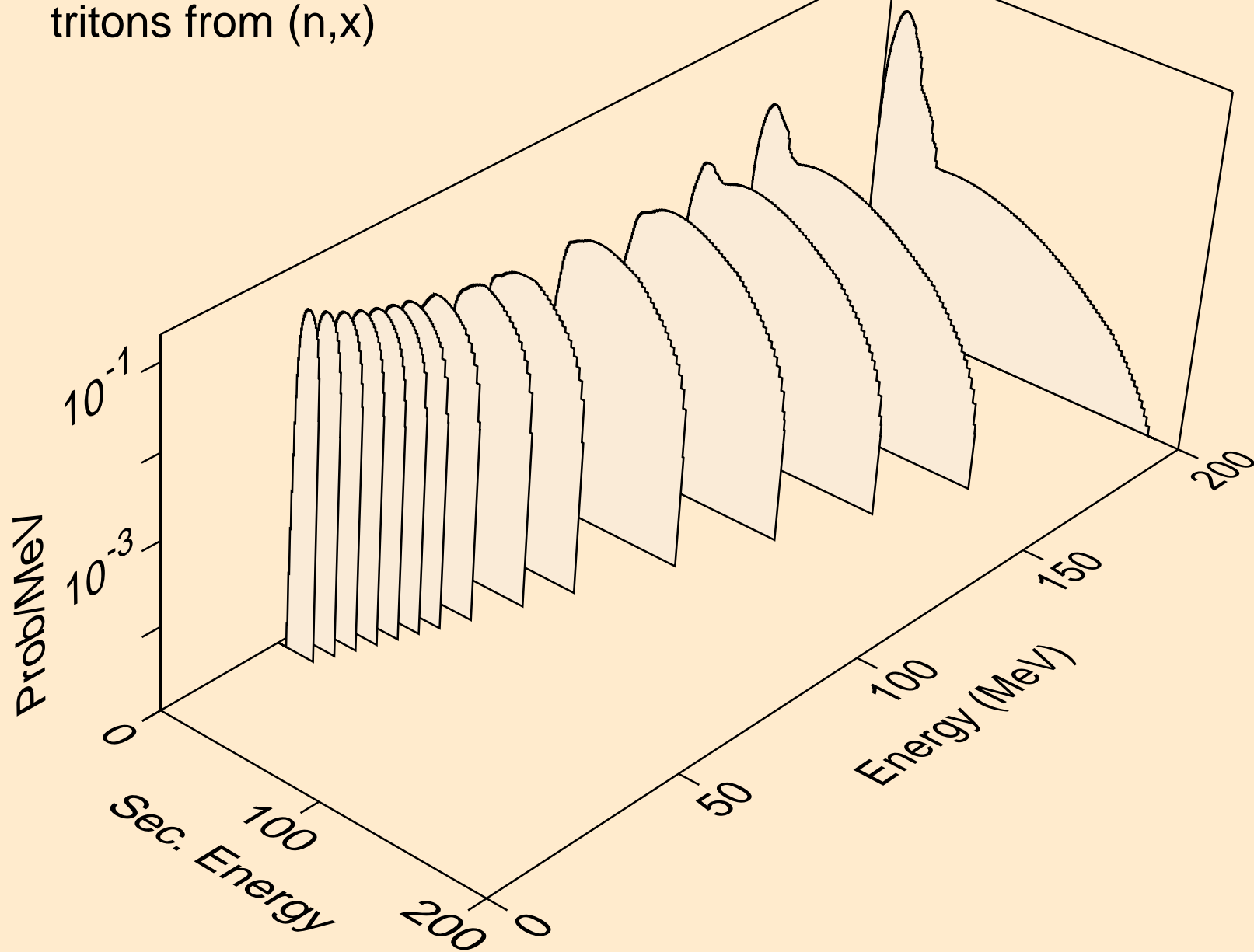

YB168 NEUTRON ACER TENDL-2019 LIBRARY; T=293.16K
tritons from (n,n*)t

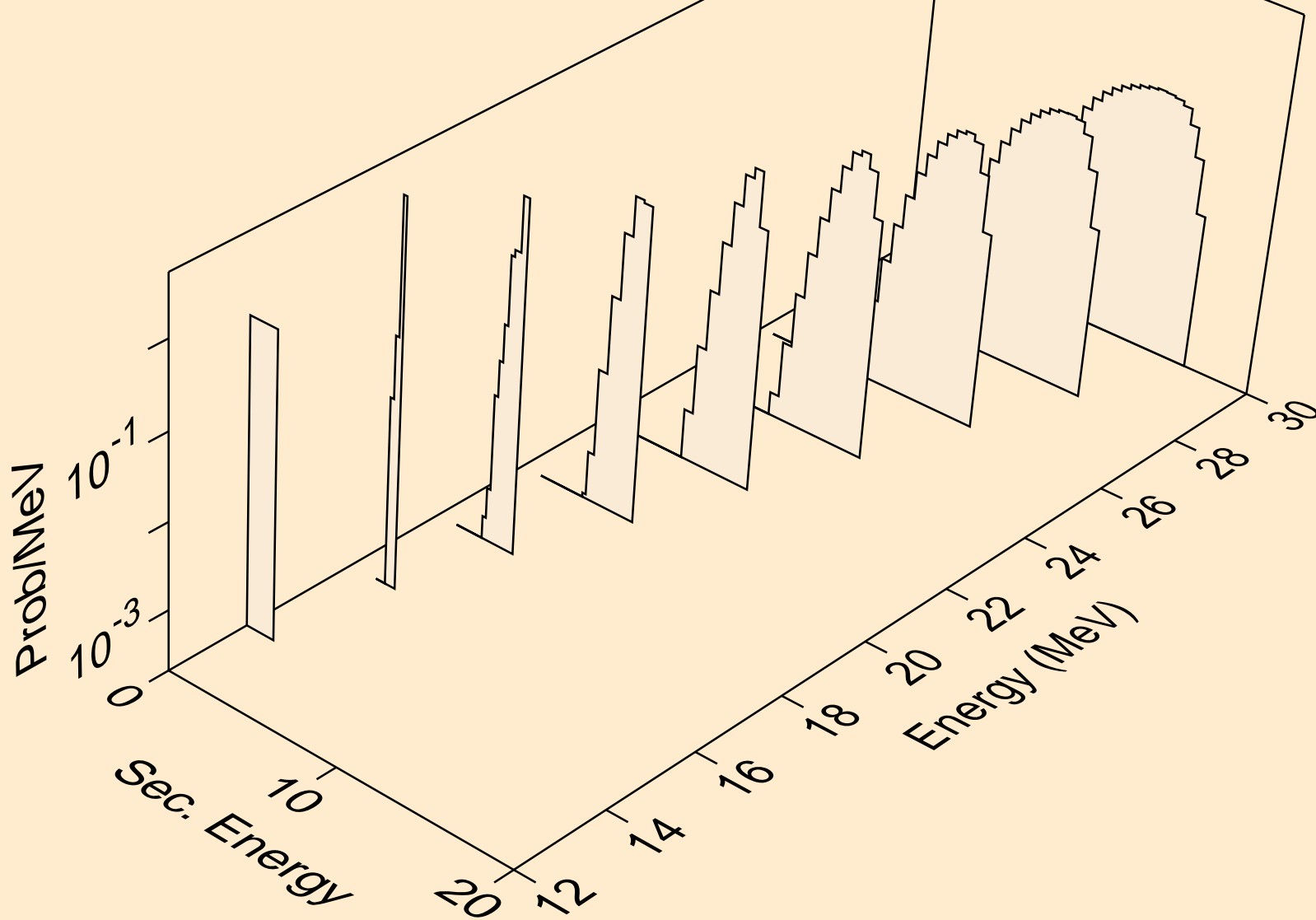

YB168 NEUTRON ACER TENDL-2019 LIBRARY; T=293.16K
tritons from (n,t)

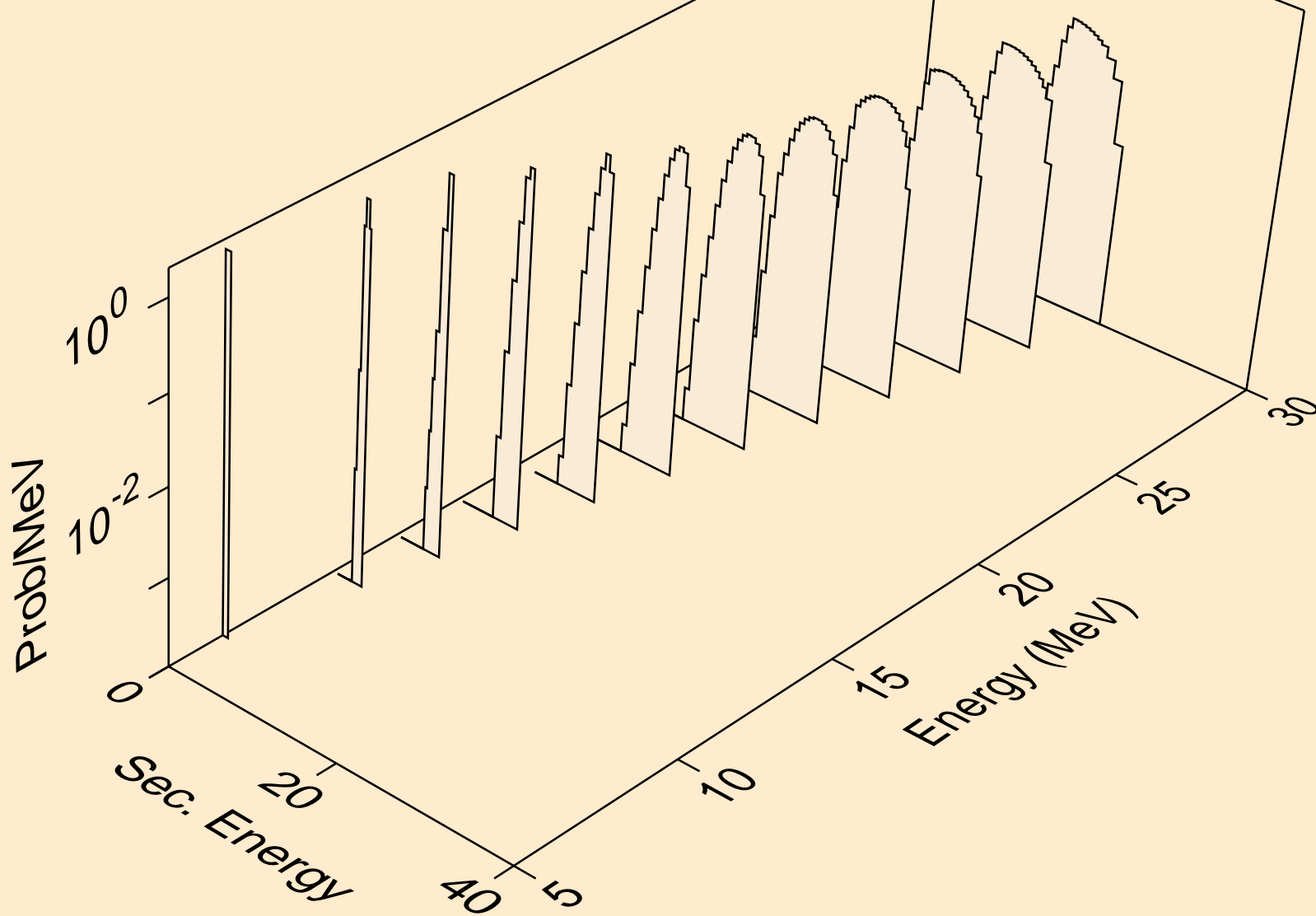

YB168 NEUTRON ACER TENDL-2019 LIBRARY; T=293.16K
tritons from (n,pt)

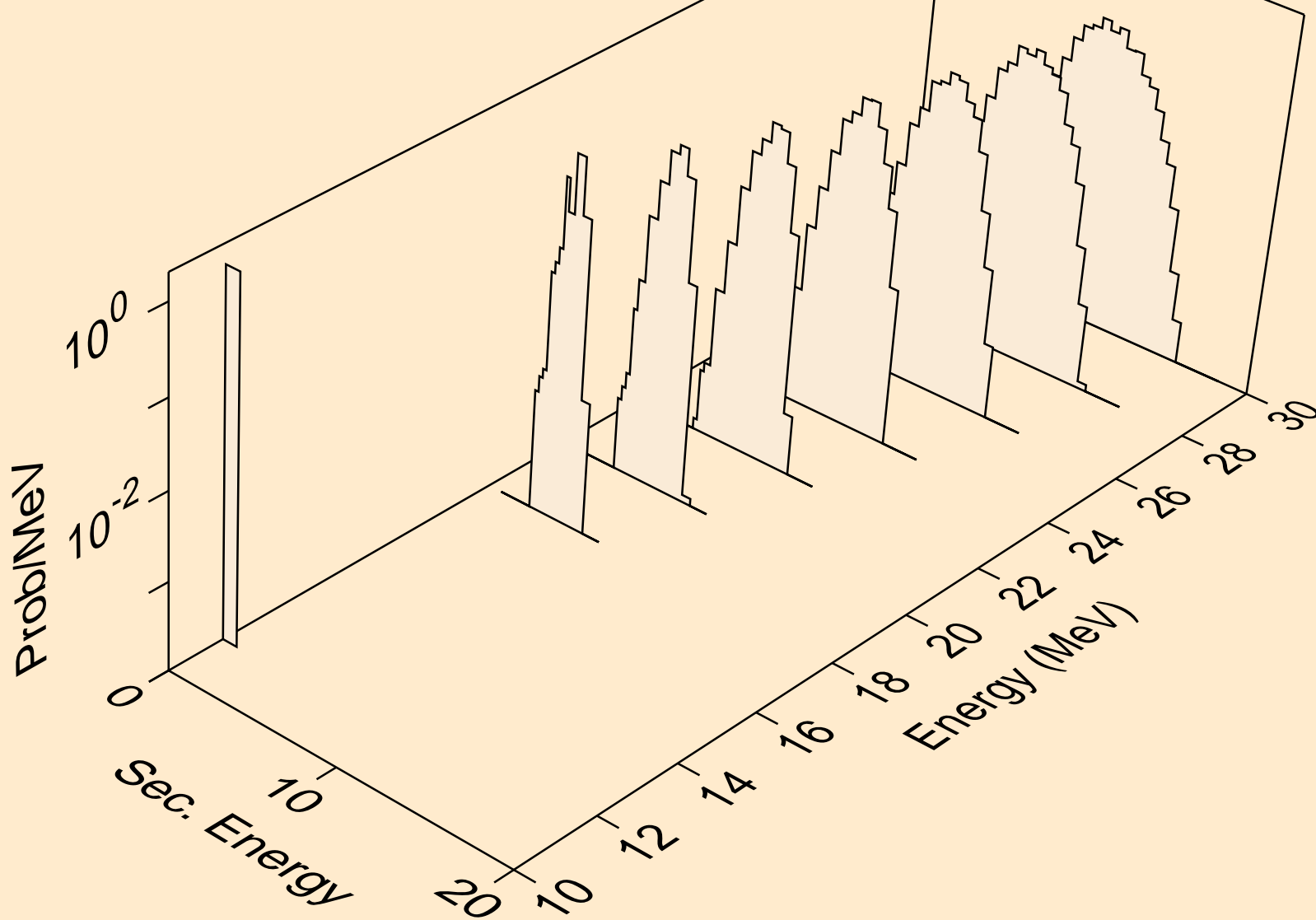

YB168 NEUTRON ACER TENDL-2019 LIBRARY; T=293.16K
he3s from (n,x)

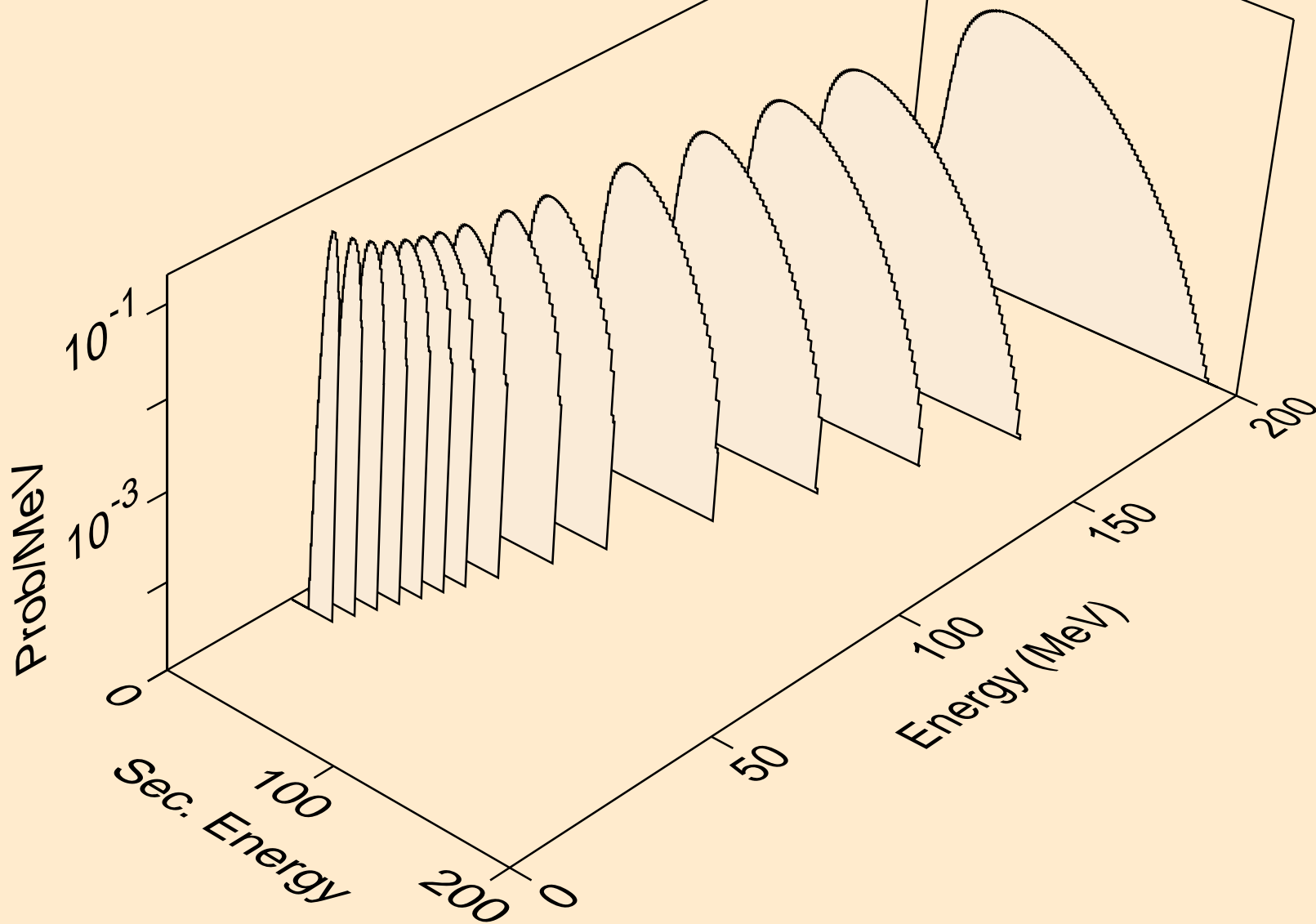

YB168 NEUTRON ACER TENDL-2019 LIBRARY; T=293.16K
he3s from (n,n*)he3

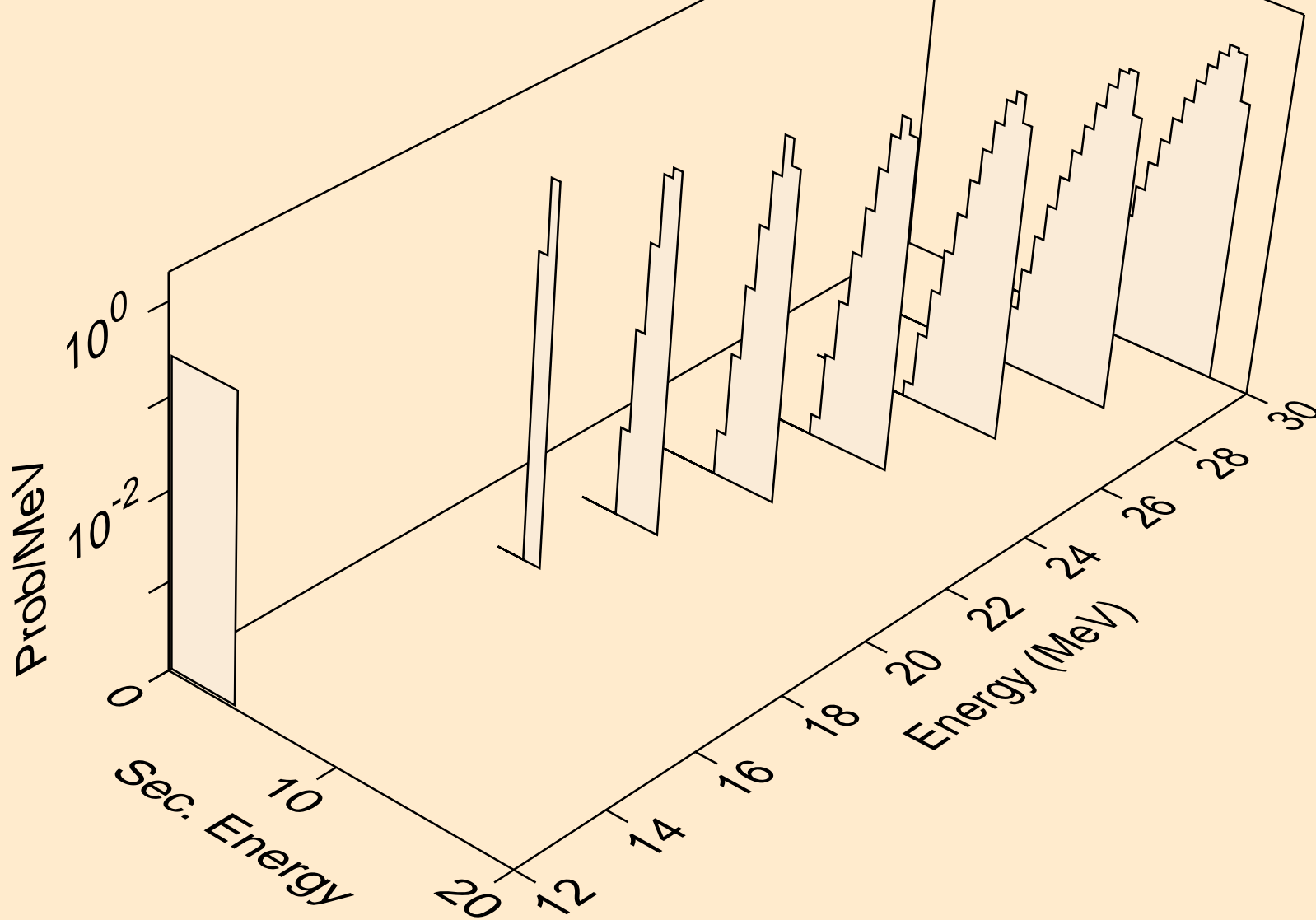

YB168 NEUTRON ACER TENDL-2019 LIBRARY; T=293.16K
he3s from (n,he3)

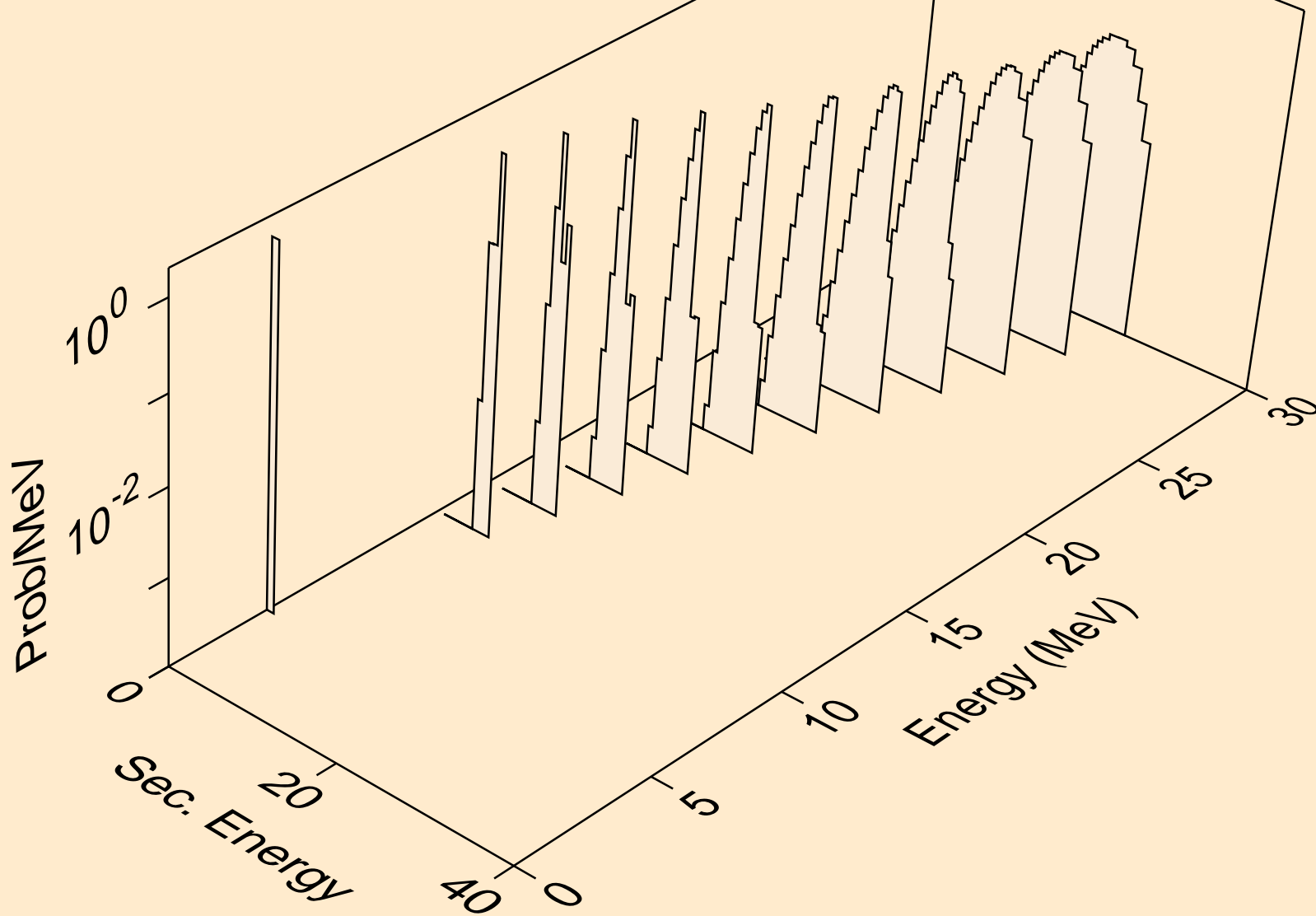

YB168 NEUTRON ACER TENDL-2019 LIBRARY; T=293.16K
alphas from (n,x)

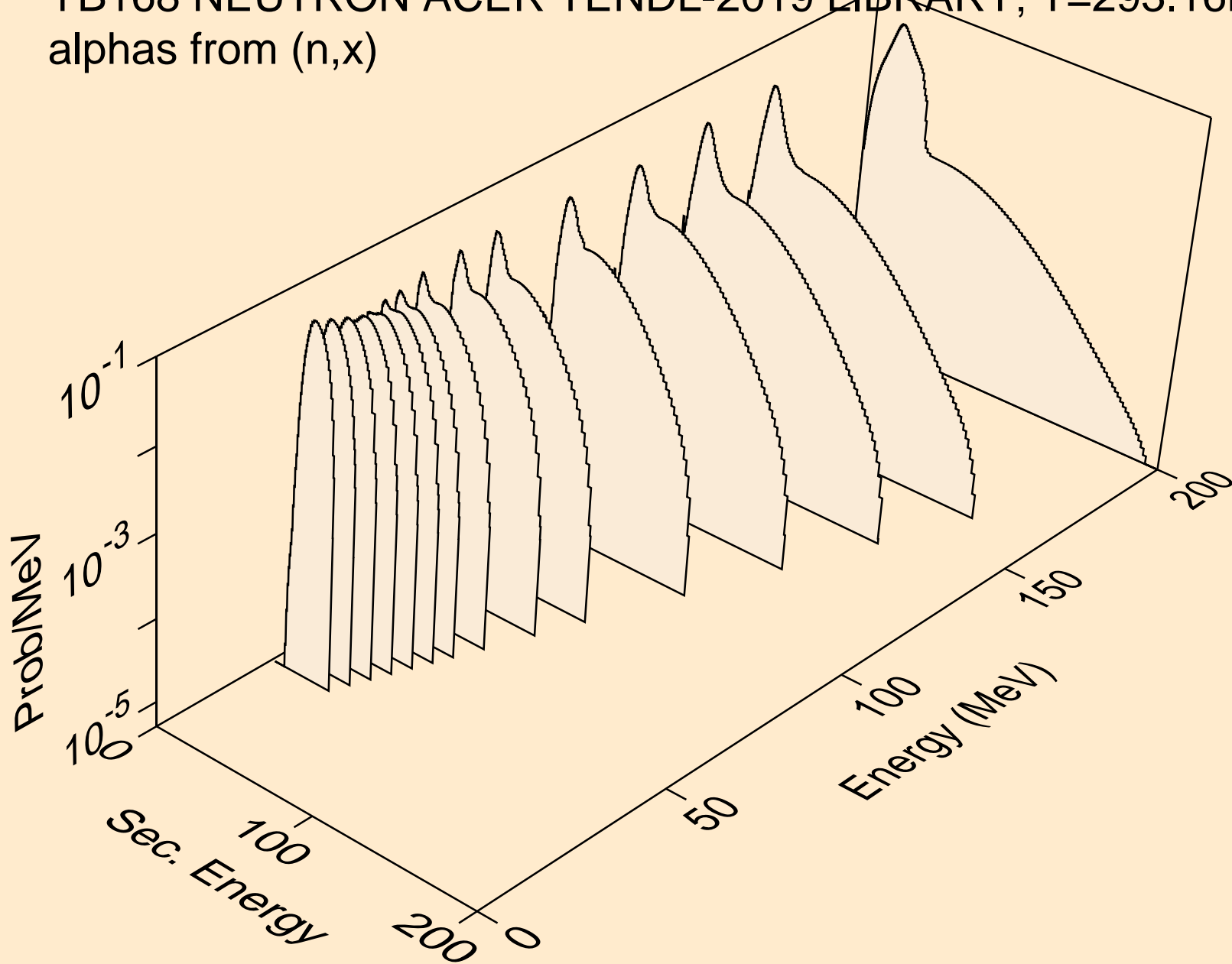

YB168 NEUTRON ACER TENDL-2019 LIBRARY; T=293.16K
alphas from (n,n*)a

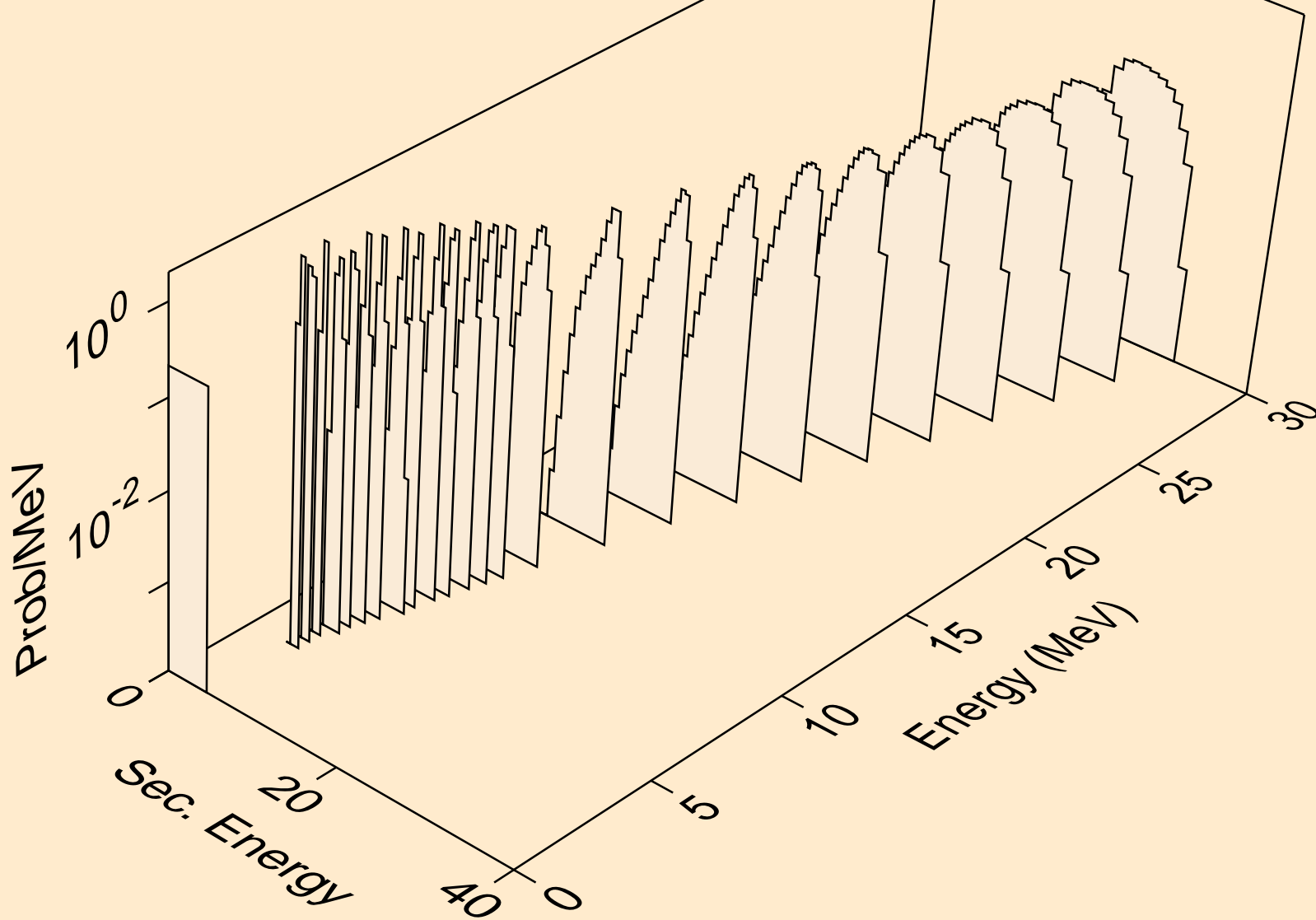

YB168 NEUTRON ACER TENDL-2019 LIBRARY; T=293.16K
alphas from (n,2n)a

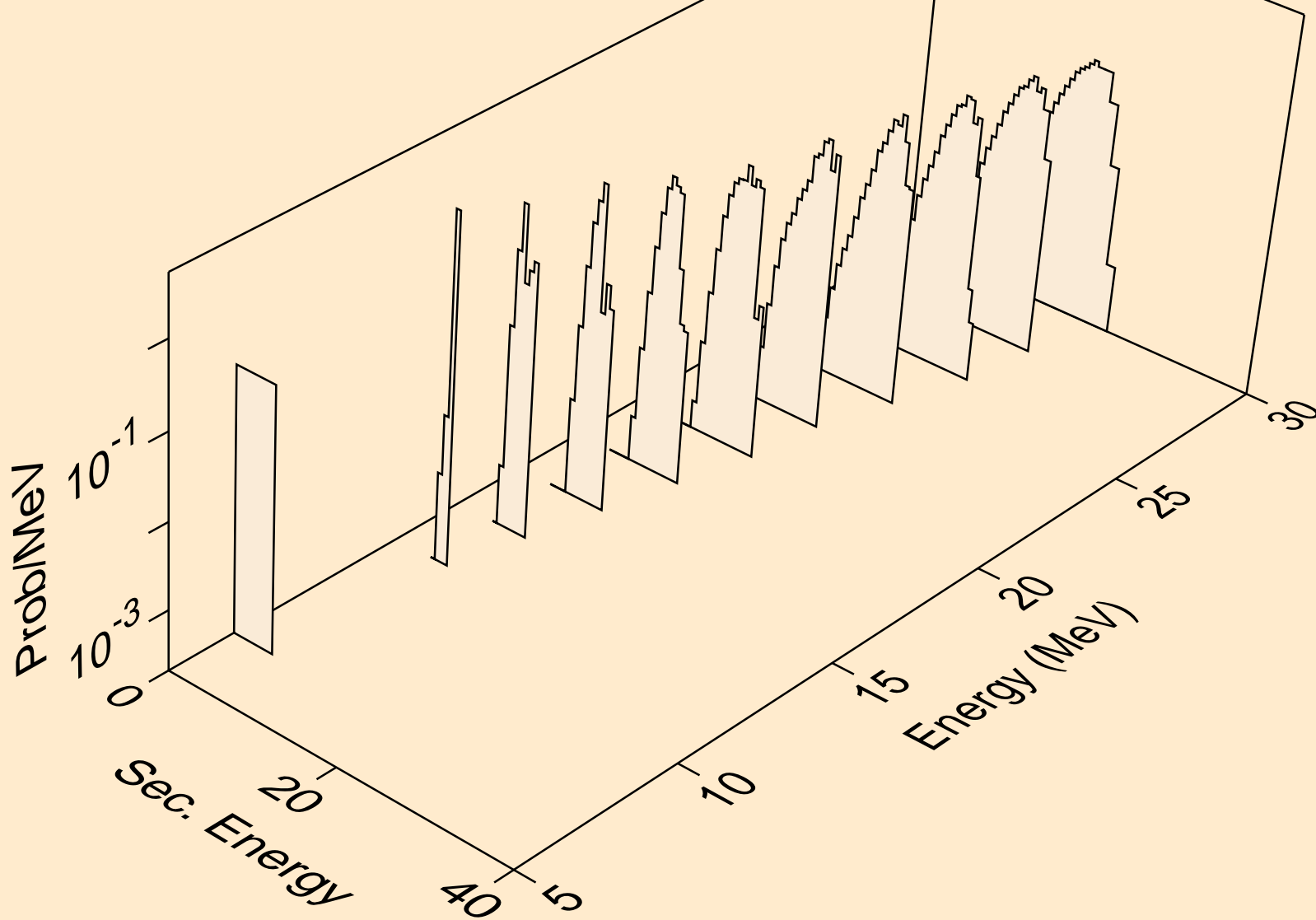

YB168 NEUTRON ACER TENDL-2019 LIBRARY; T=293.16K
alphas from (n,3n)a

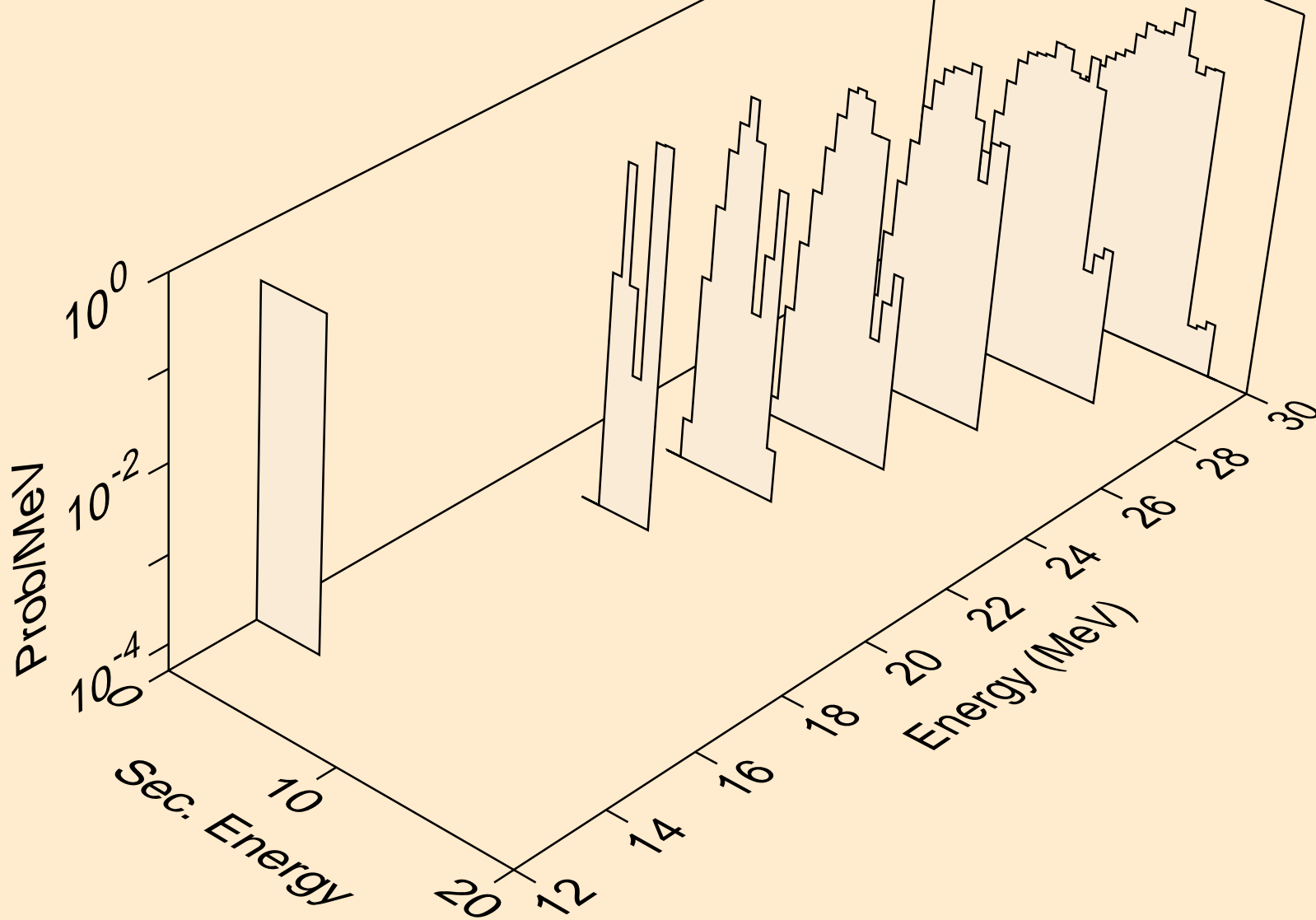

YB168 NEUTRON ACER TENDL-2019 LIBRARY; T=293.16K
alphas from (n,n*)2a

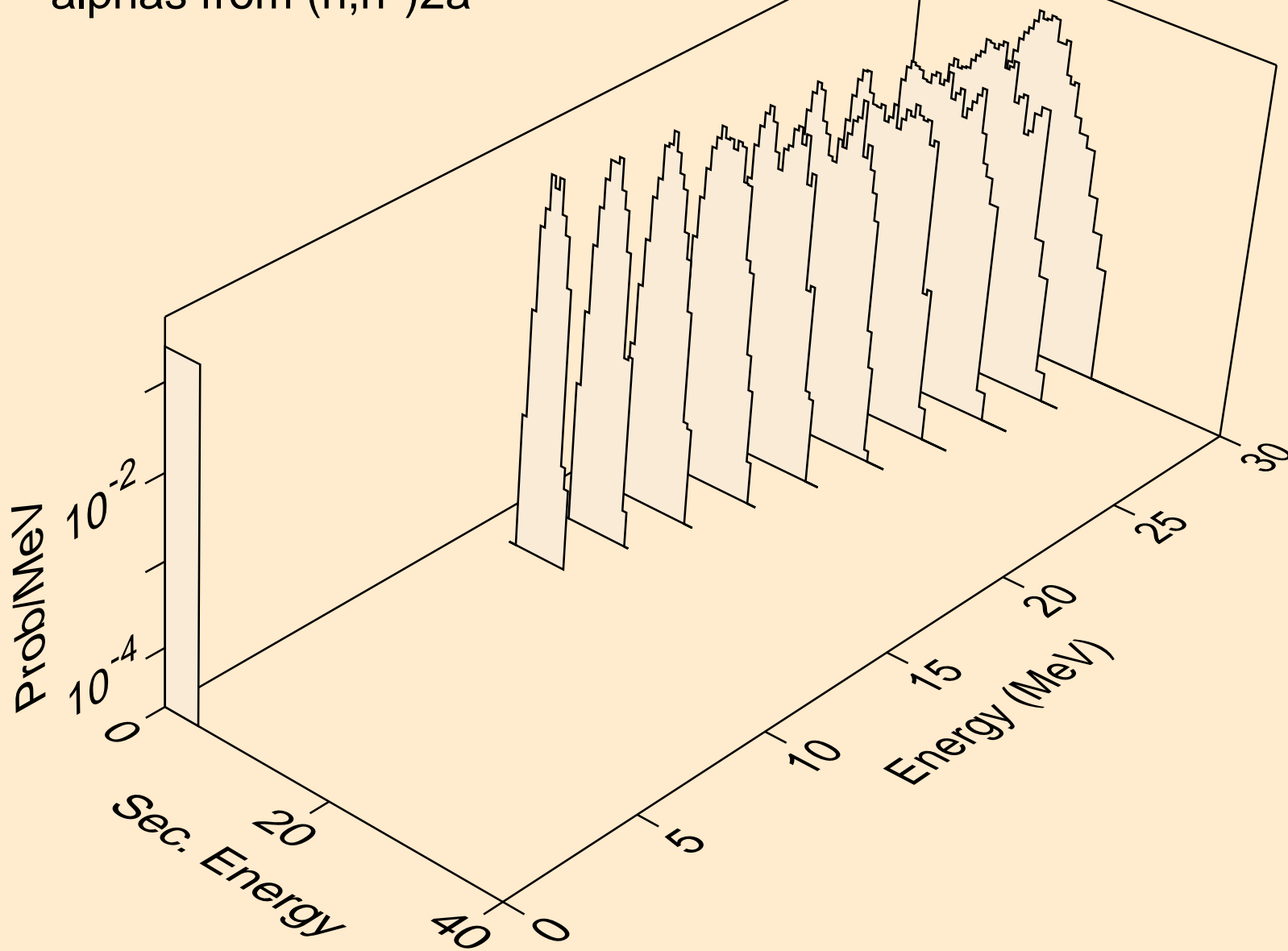

YB168 NEUTRON ACER TENDL-2019 LIBRARY; T=293.16K
alphas from (n,npa)

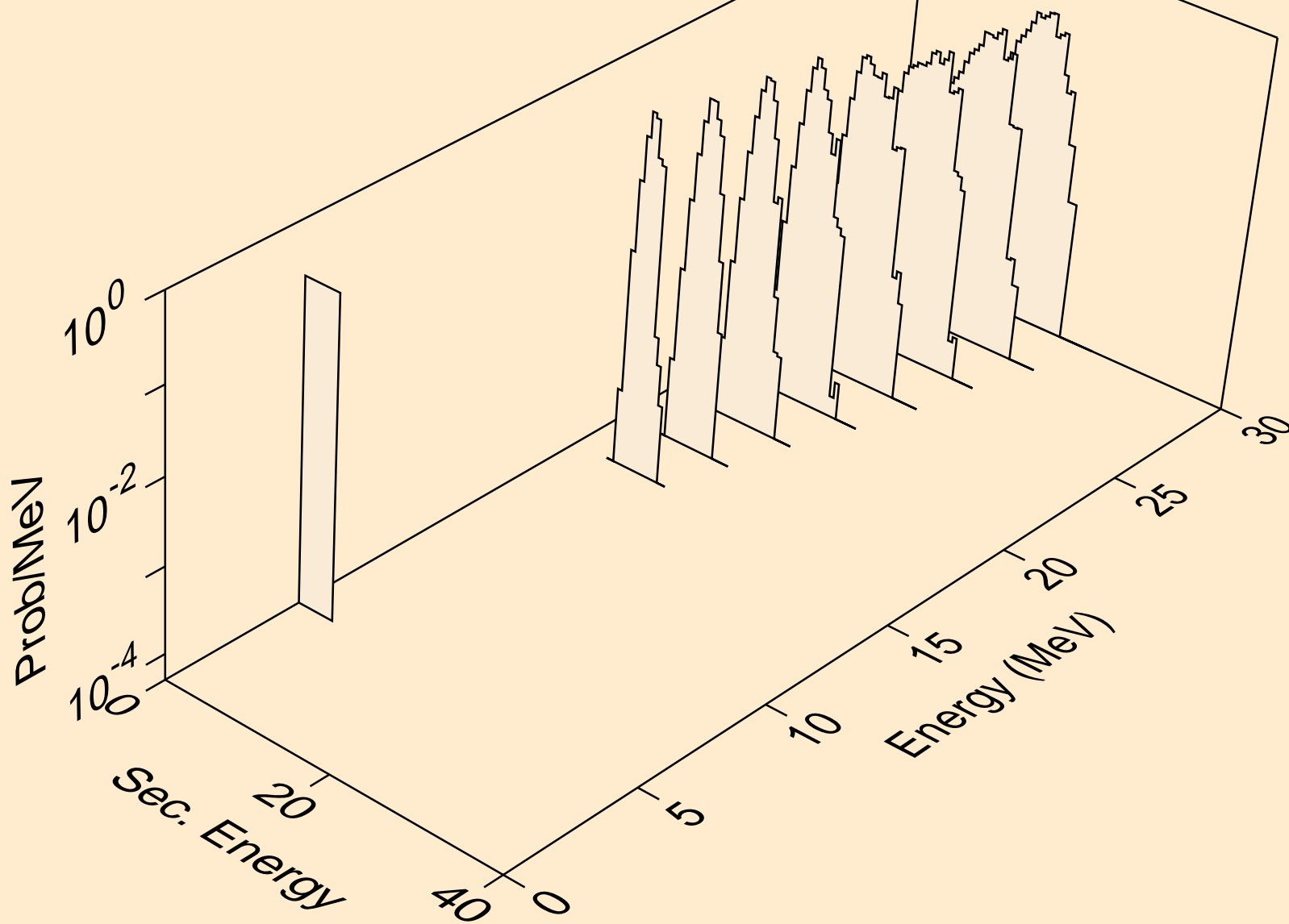

YB168 NEUTRON ACER TENDL-2019 LIBRARY; T=293.16K
alphas from (n,a)

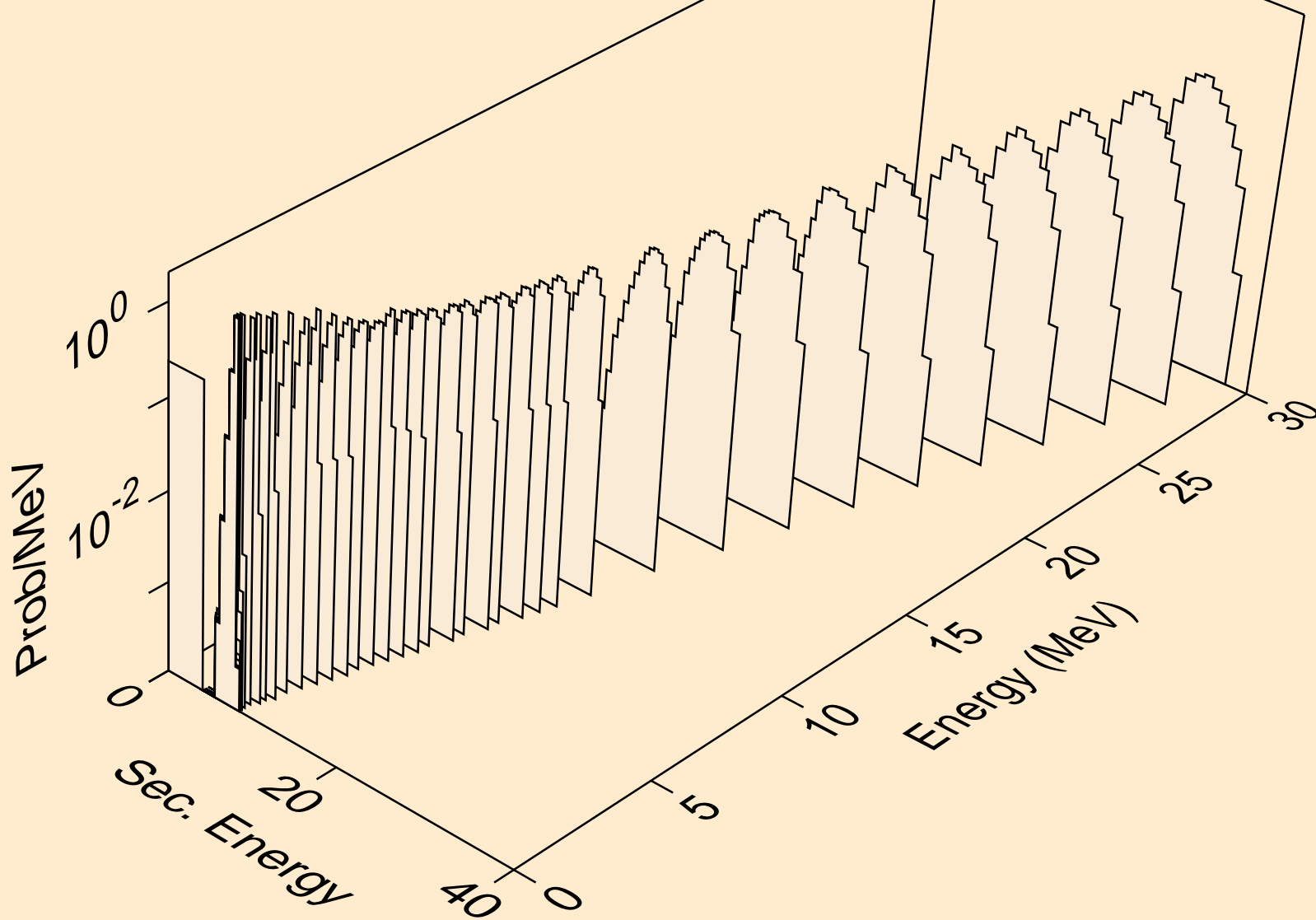

YB168 NEUTRON ACER TENDL-2019 LIBRARY; T=293.16K
alphas from (n,2a)

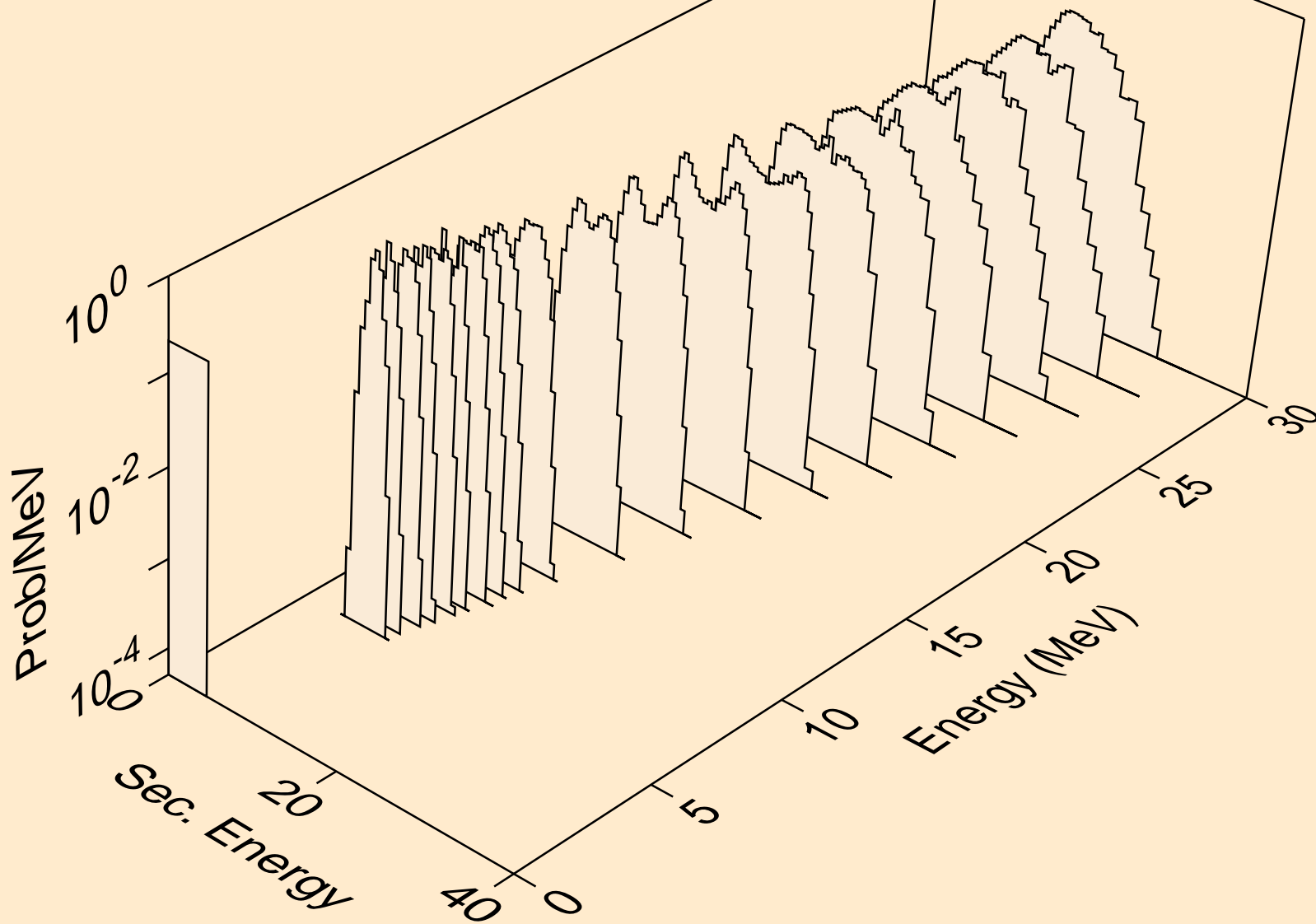

YB168 NEUTRON ACER TENDL-2019 LIBRARY; T=293.16K
alphas from (n,pa)

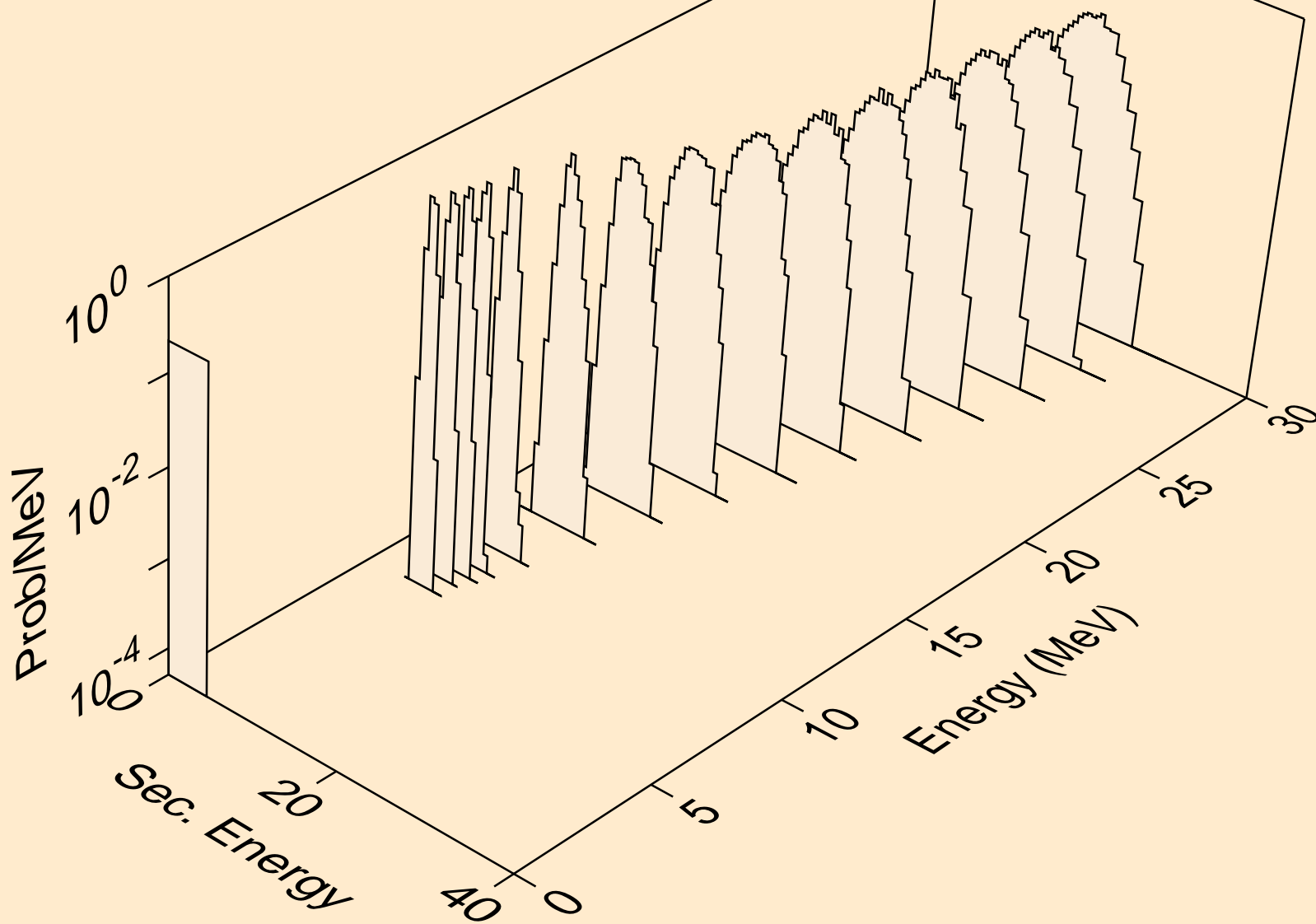

YB168 NEUTRON ACER TENDL-2019 LIBRARY; T=293.16K
alphas from (n,da)

