

YB172 NEUTRON ACER TENDL-2019 LIBRARY; T=293.16K  
Principal cross sections

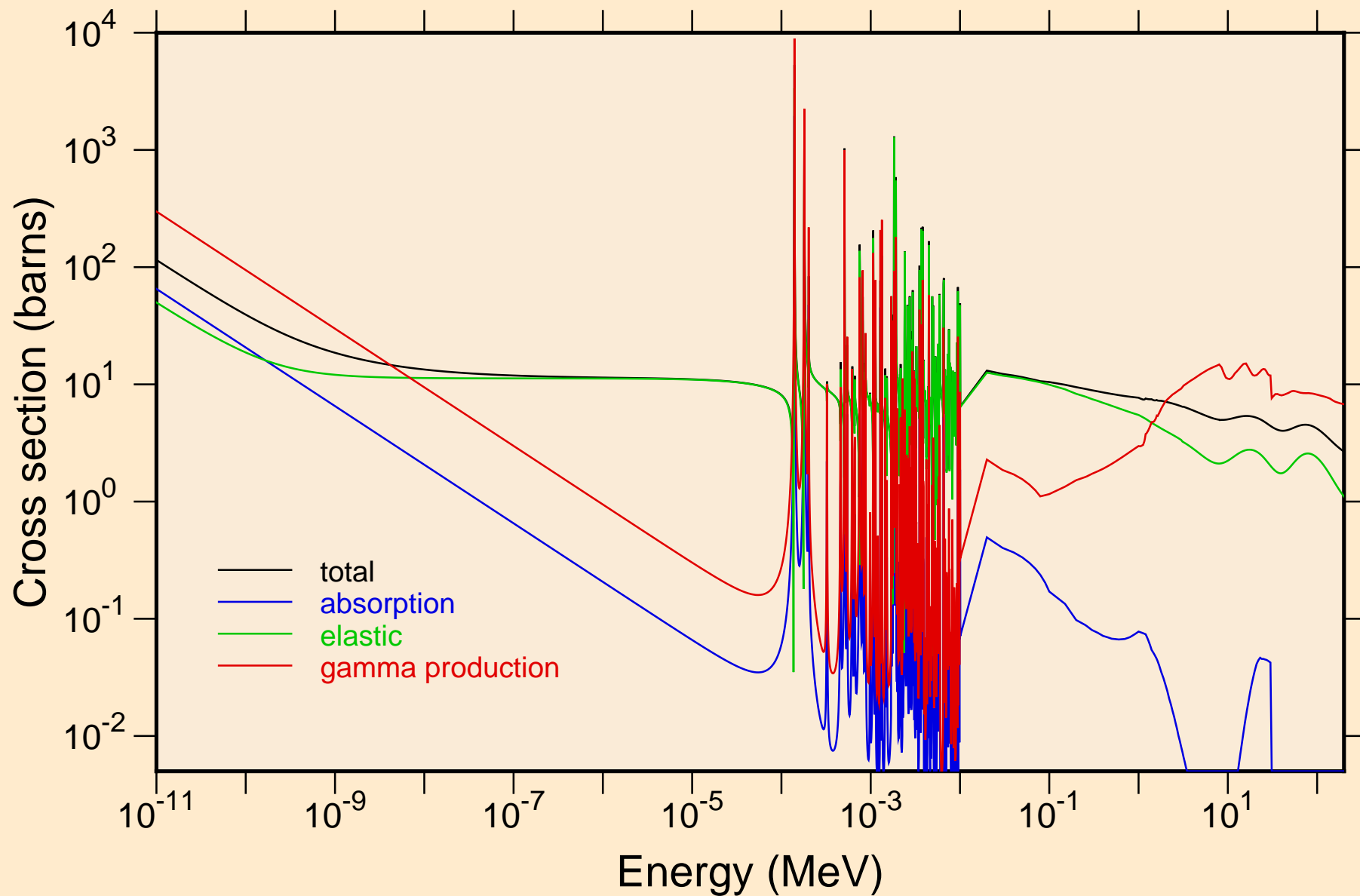

YB172 NEUTRON ACER TENDL-2019 LIBRARY; T=293.16K  
resonance total cross section

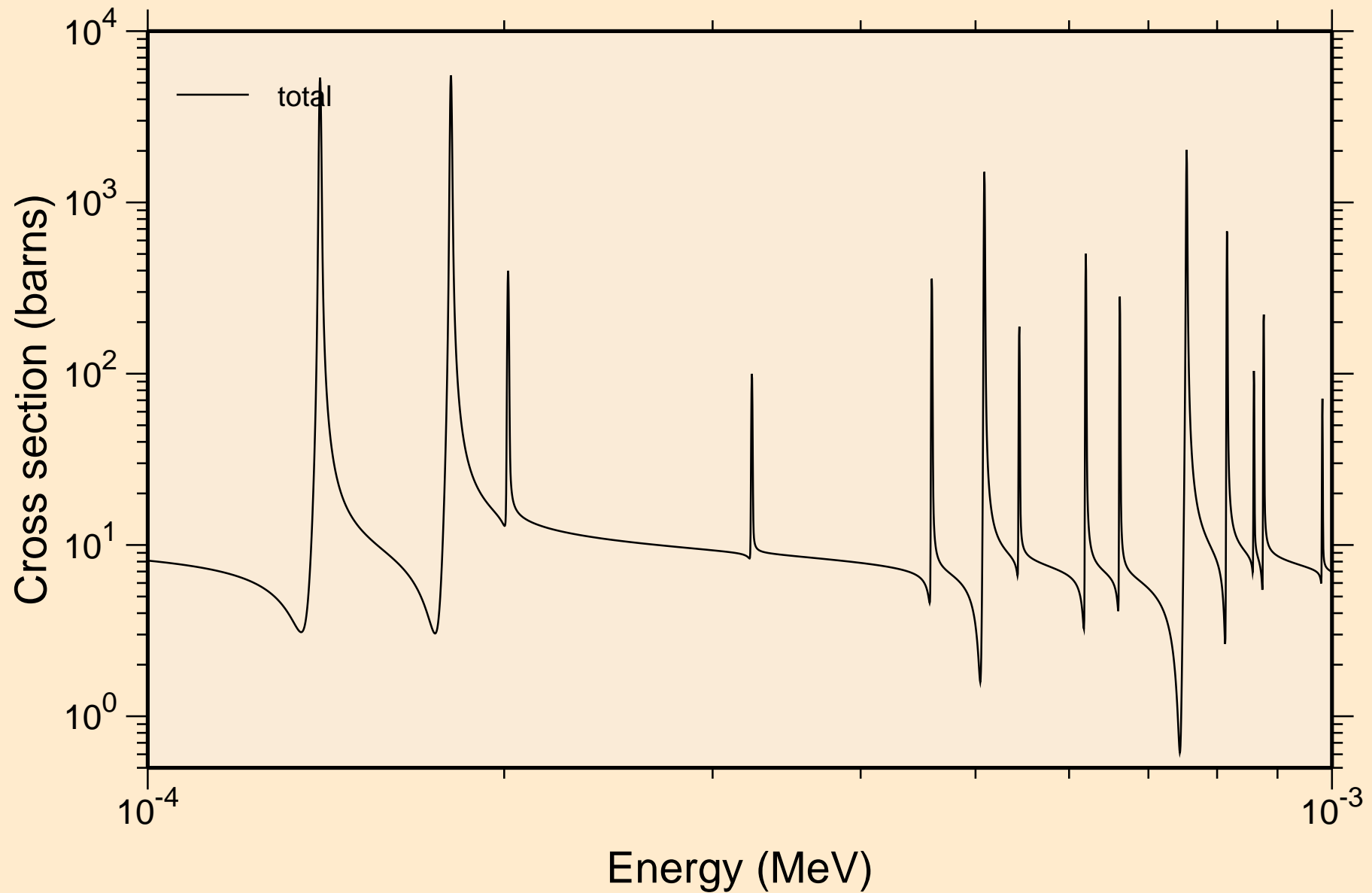

YB172 NEUTRON ACER TENDL-2019 LIBRARY; T=293.16K  
resonance total cross section

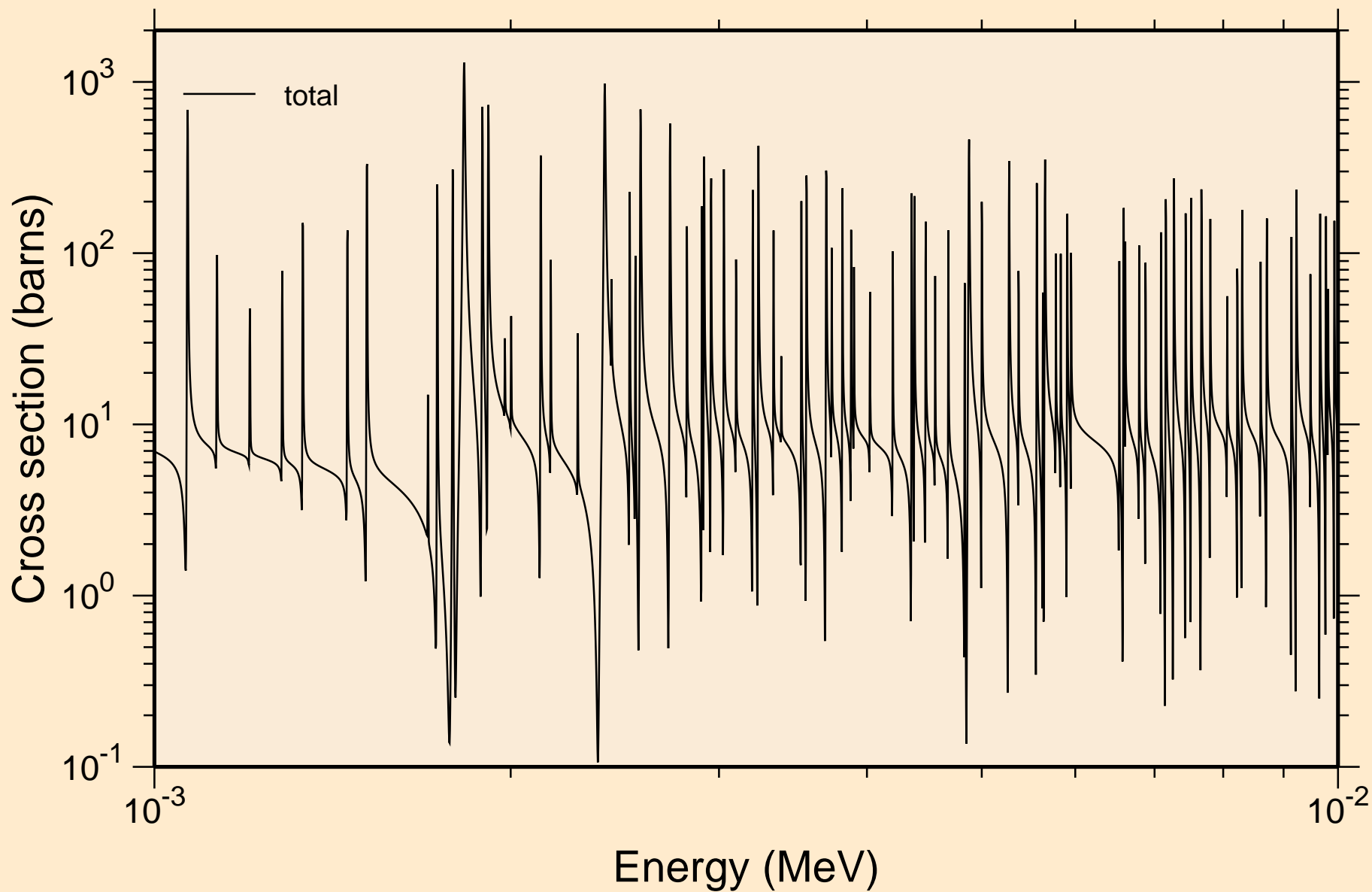

YB172 NEUTRON ACER TENDL-2019 LIBRARY; T=293.16K  
resonance total cross section

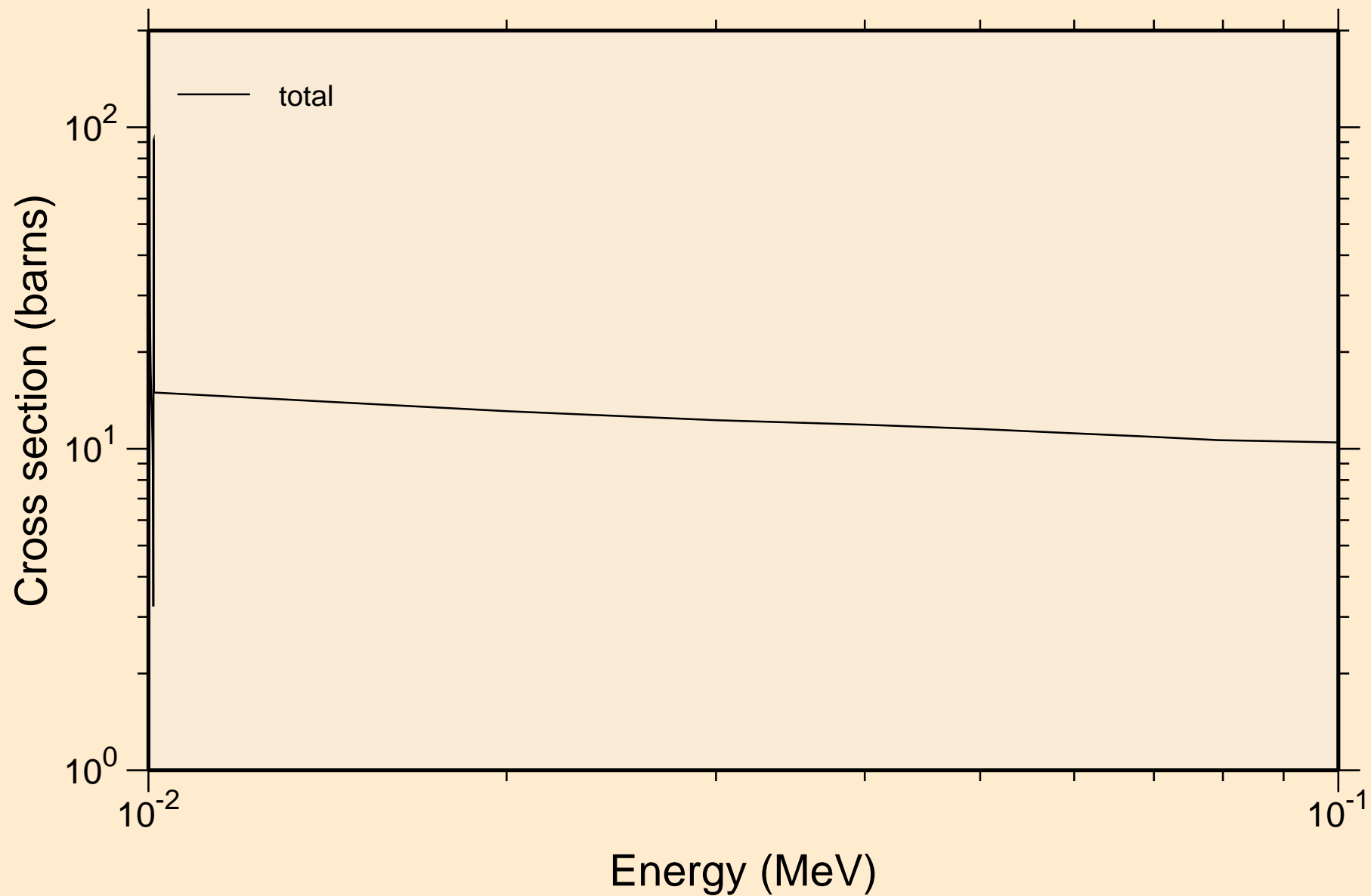

YB172 NEUTRON ACER TENDL-2019 LIBRARY; T=293.16K  
resonance total cross section

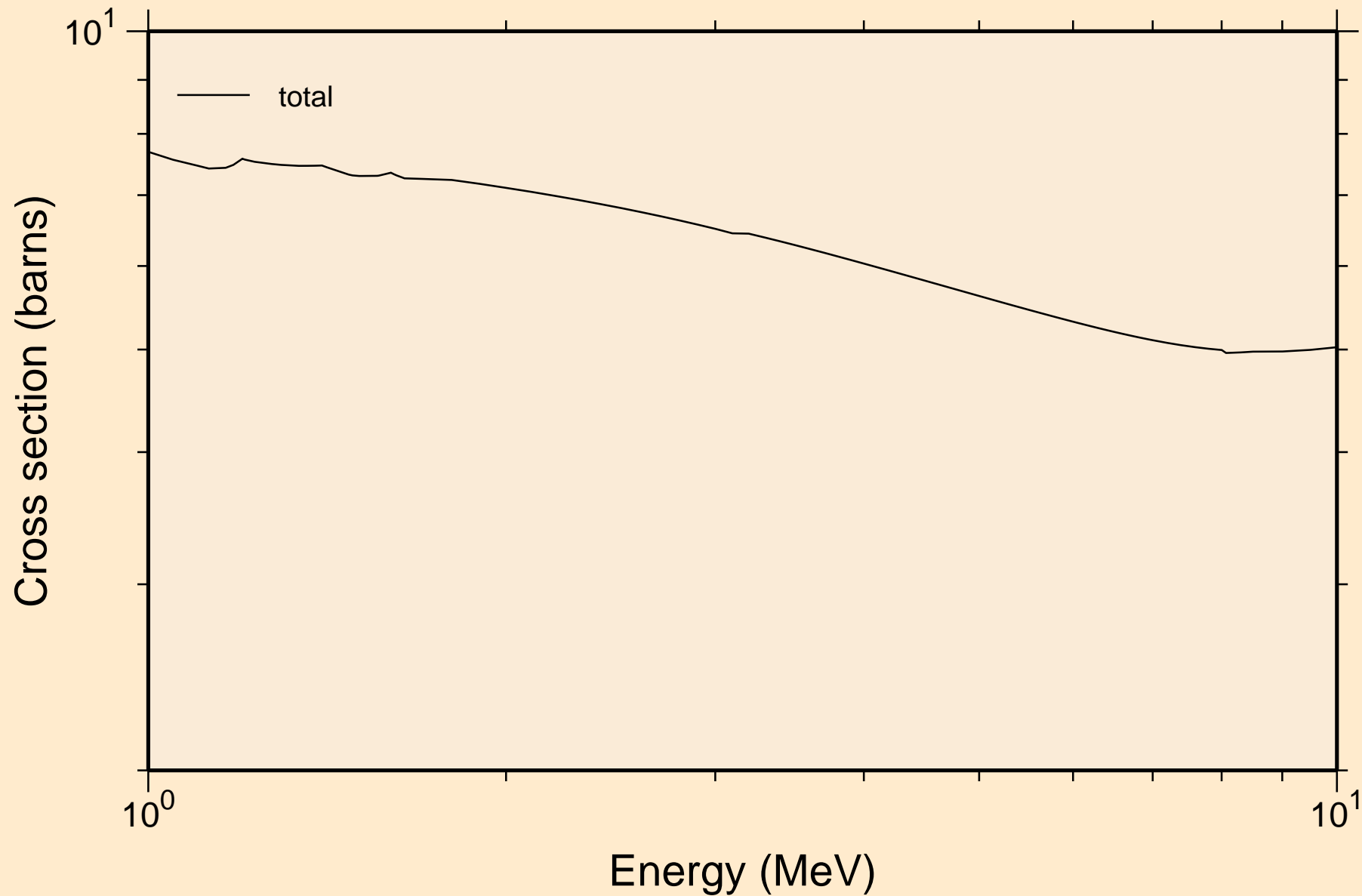

YB172 NEUTRON ACER TENDL-2019 LIBRARY; T=293.16K  
resonance absorption cross sections

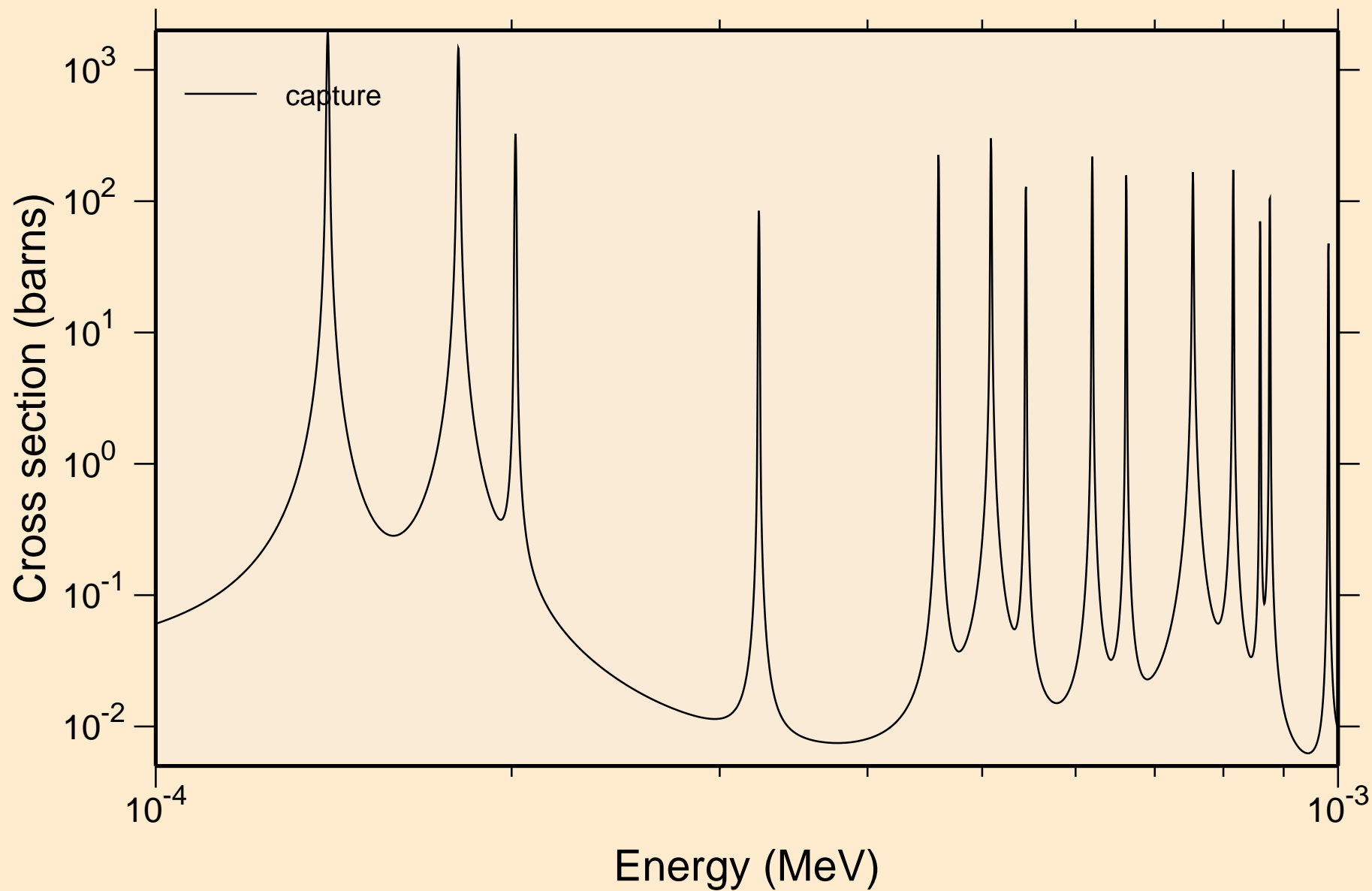

YB172 NEUTRON ACER TENDL-2019 LIBRARY; T=293.16K  
resonance absorption cross sections

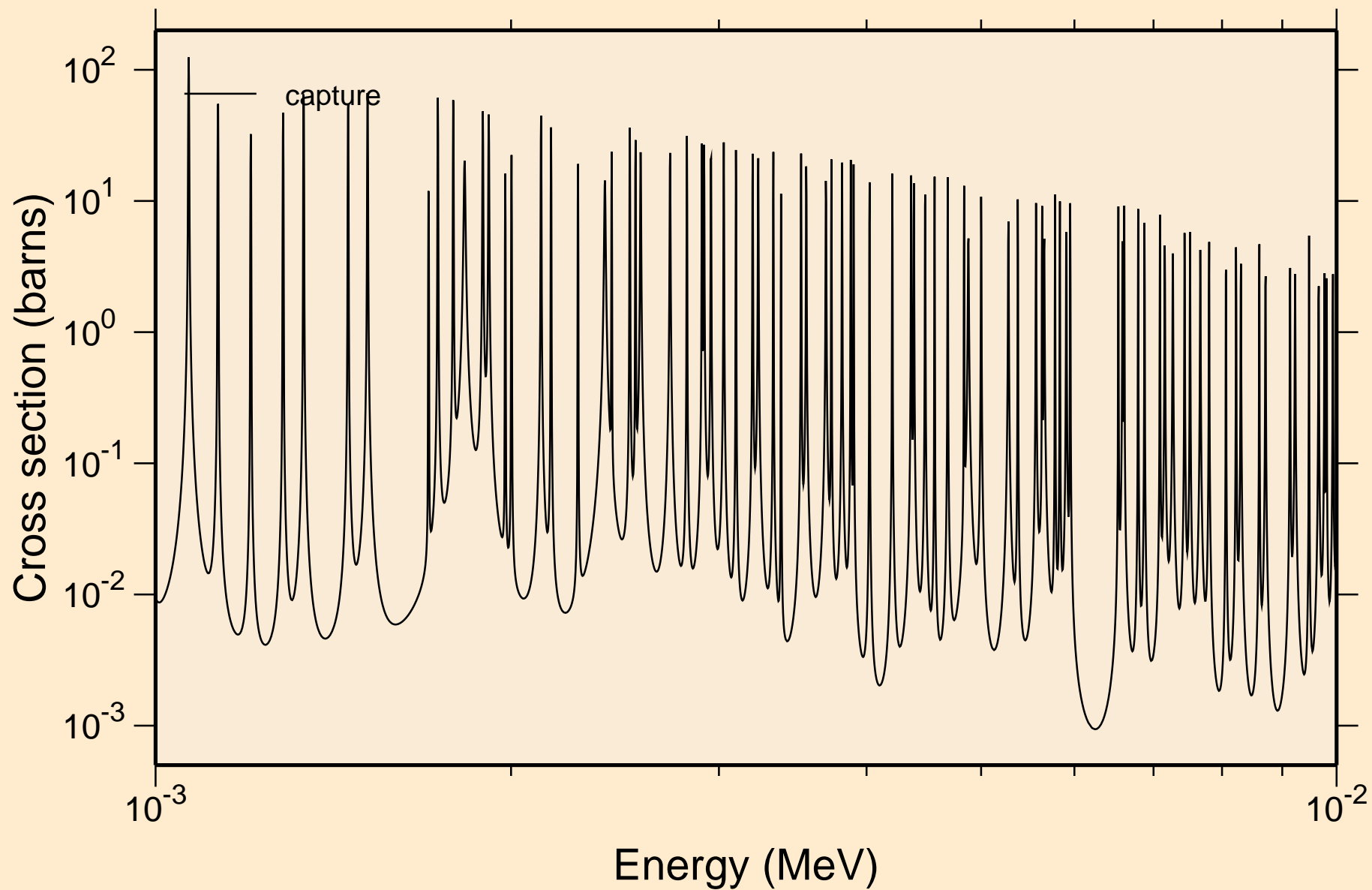

YB172 NEUTRON ACER TENDL-2019 LIBRARY; T=293.16K  
resonance absorption cross sections

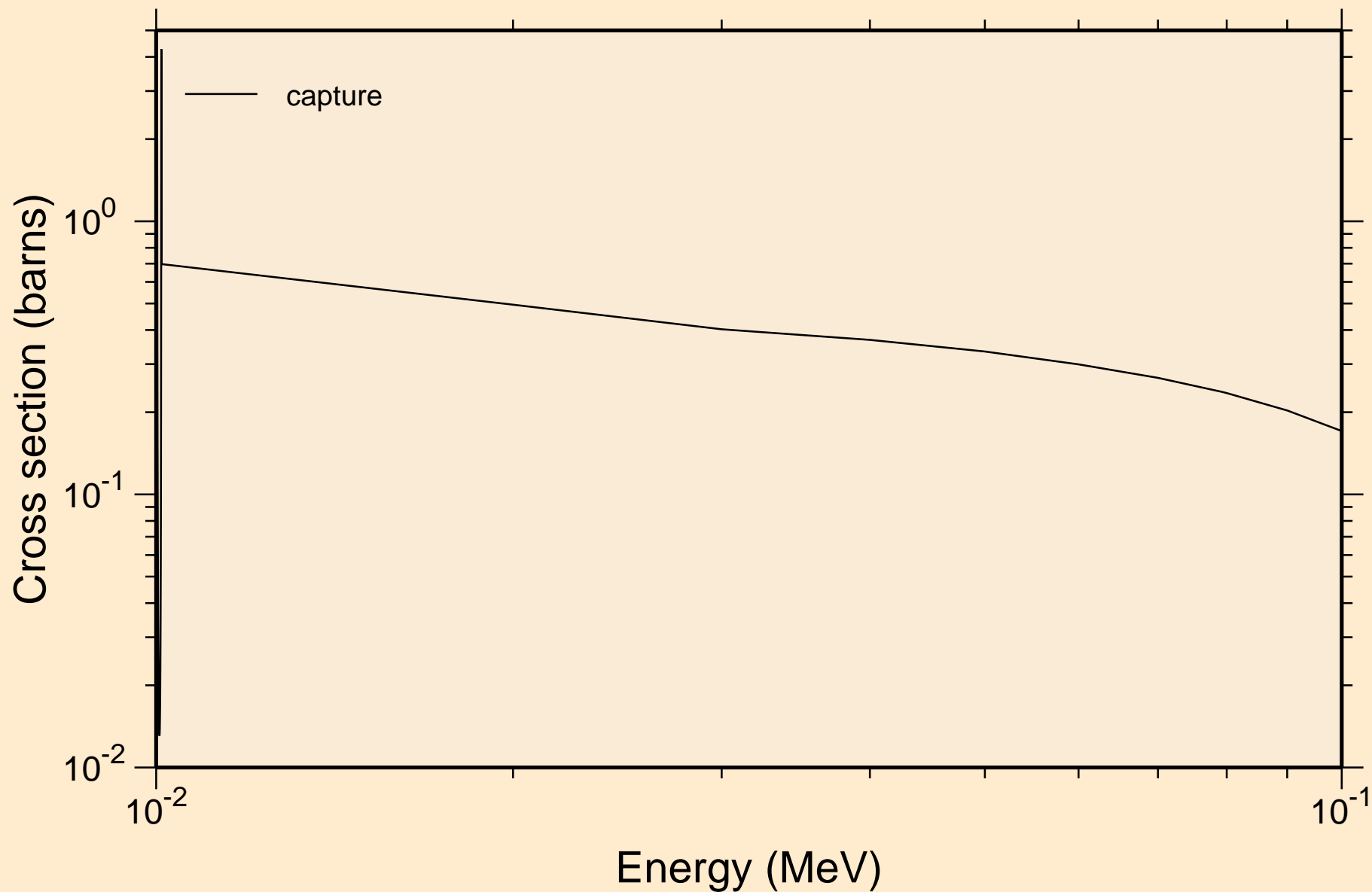



YB172 NEUTRON ACER TENDL-2019 LIBRARY; T=293.16K  
resonance absorption cross sections

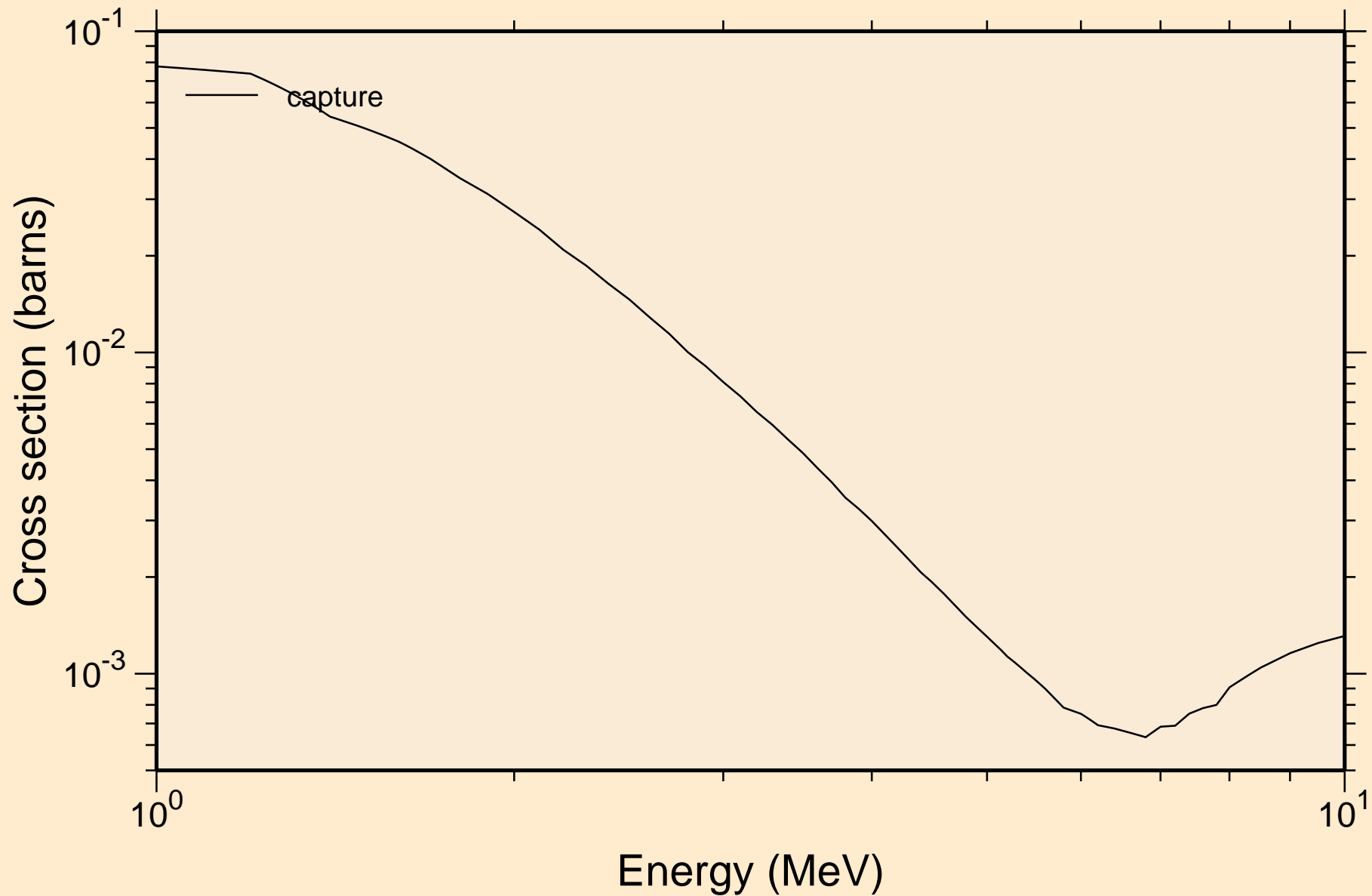

YB172 NEUTRON ACER TENDL-2019 LIBRARY; T=293.16K  
Heating

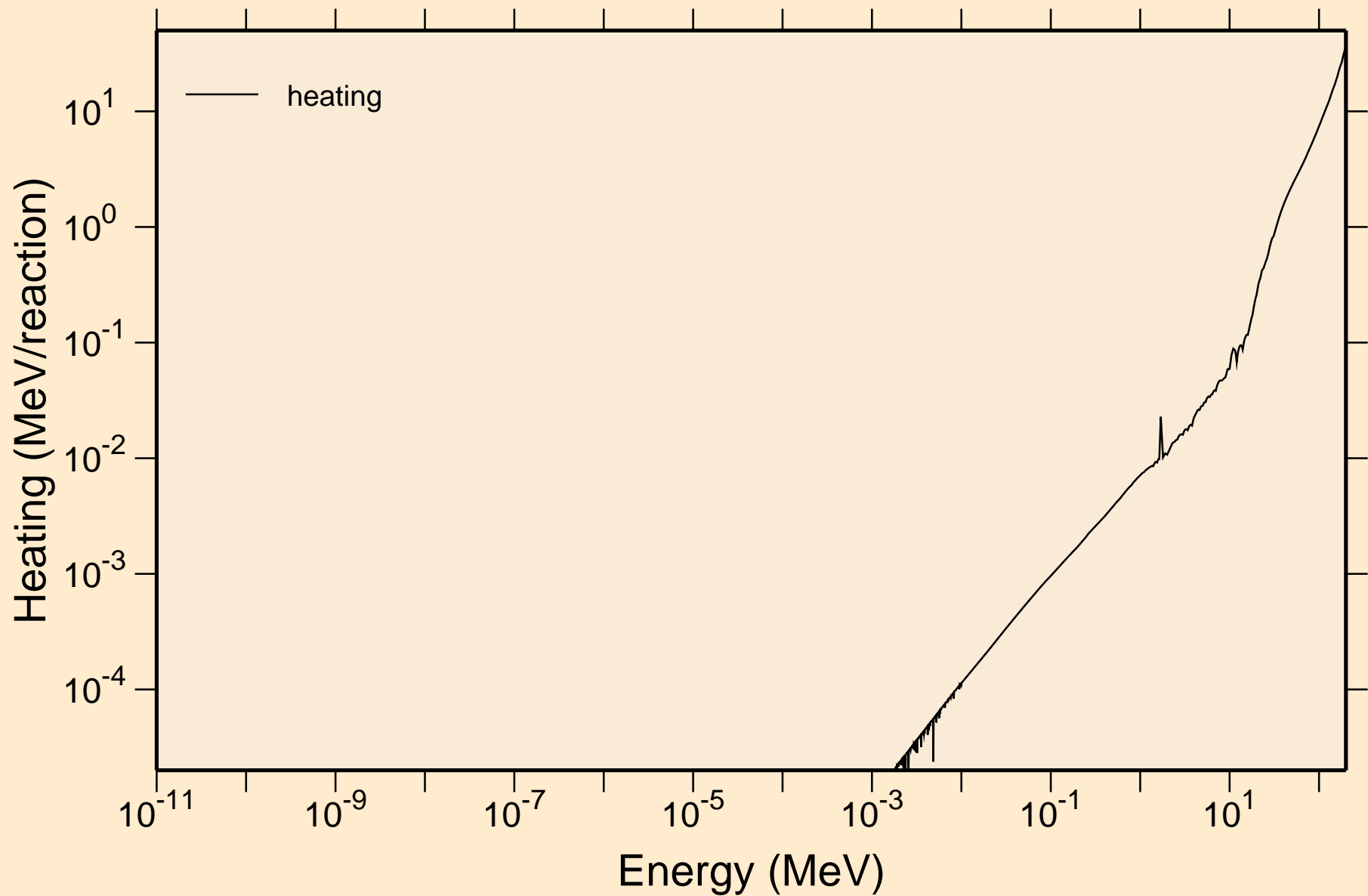

YB172 NEUTRON ACER TENDL-2019 LIBRARY; T=293.16K  
Damage

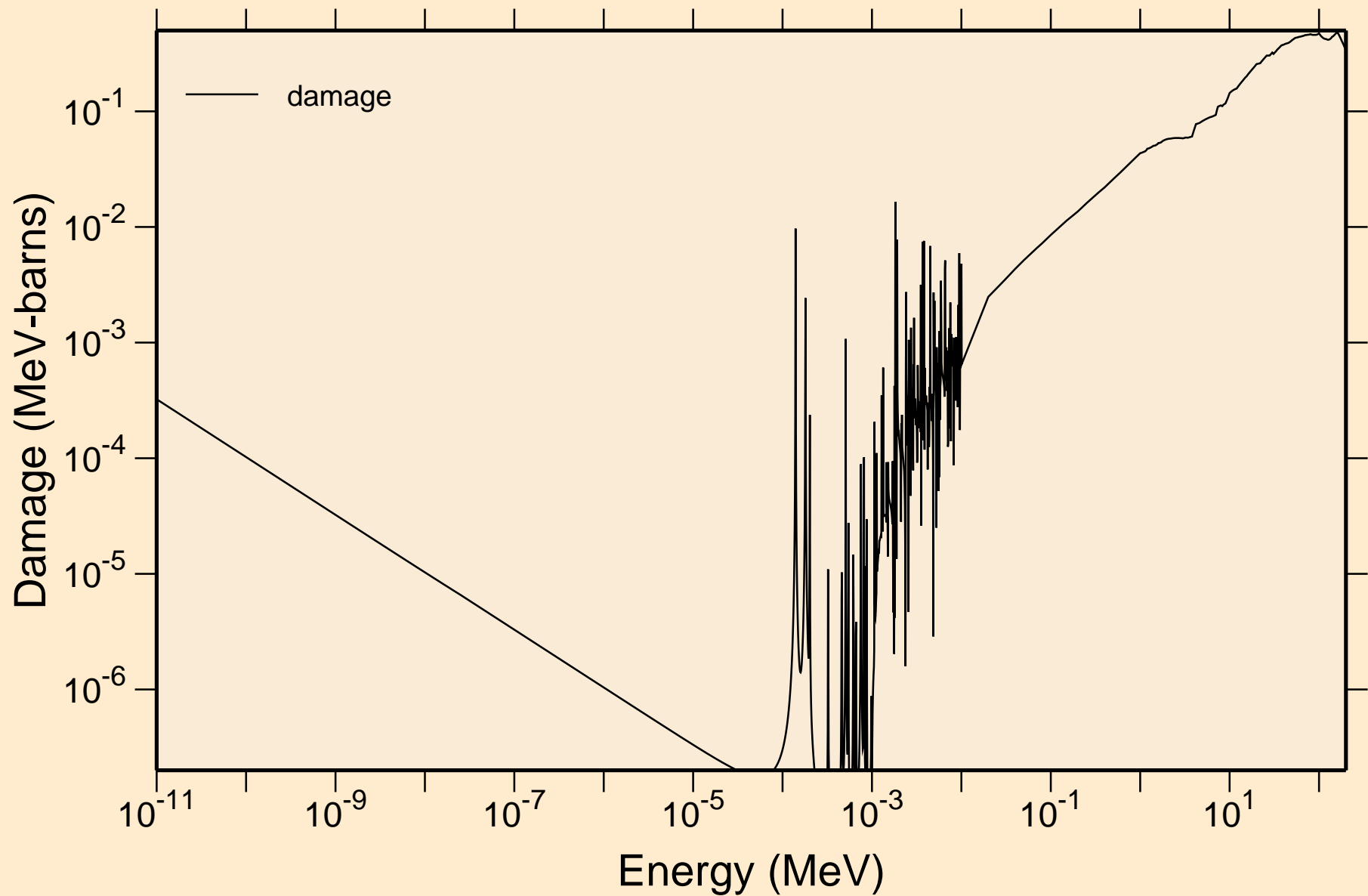

YB172 NEUTRON ACER TENDL-2019 LIBRARY; T=293.16K  
Non-threshold reactions

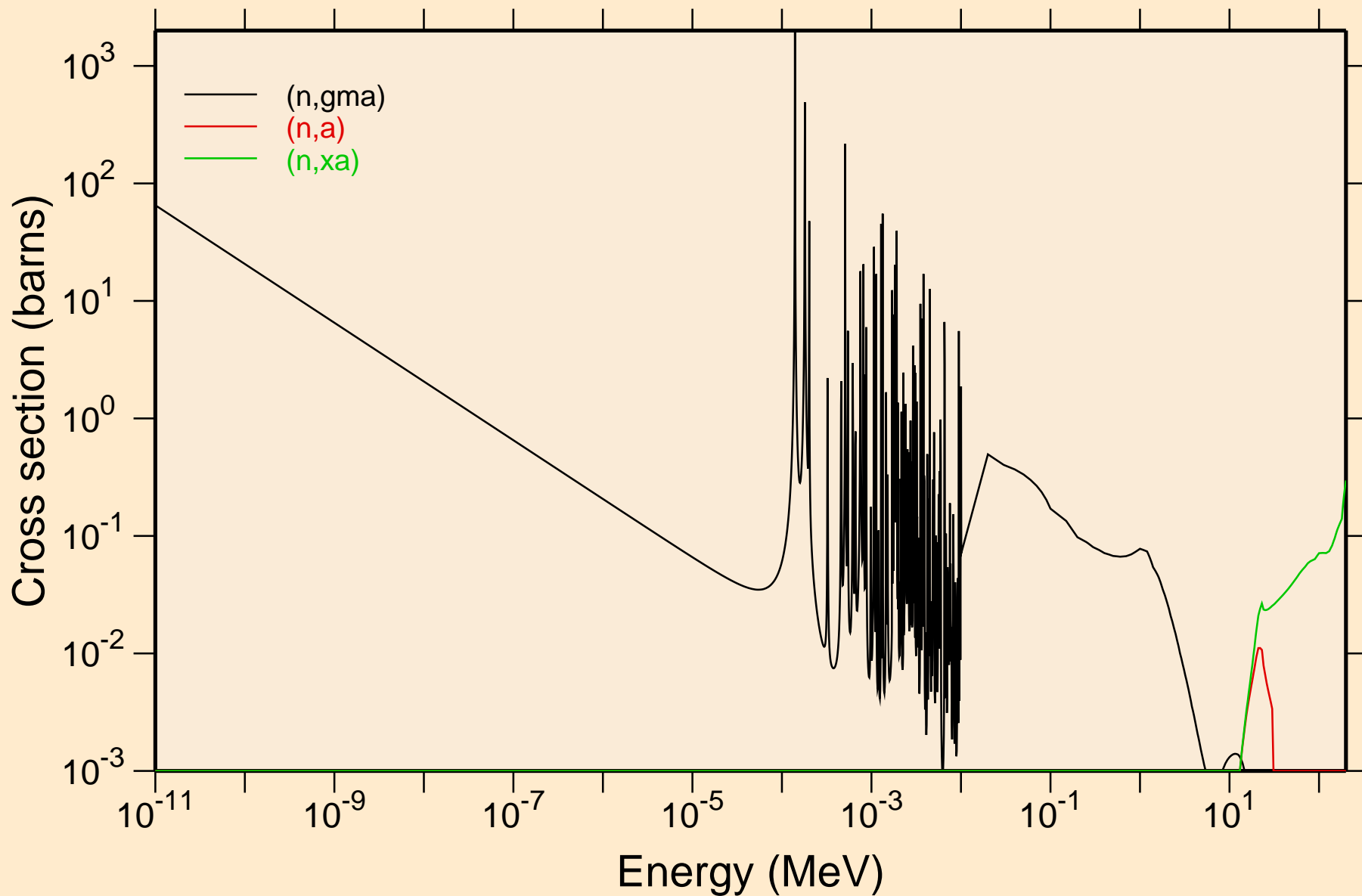

YB172 NEUTRON ACER TENDL-2019 LIBRARY; T=293.16K  
Principal cross sections

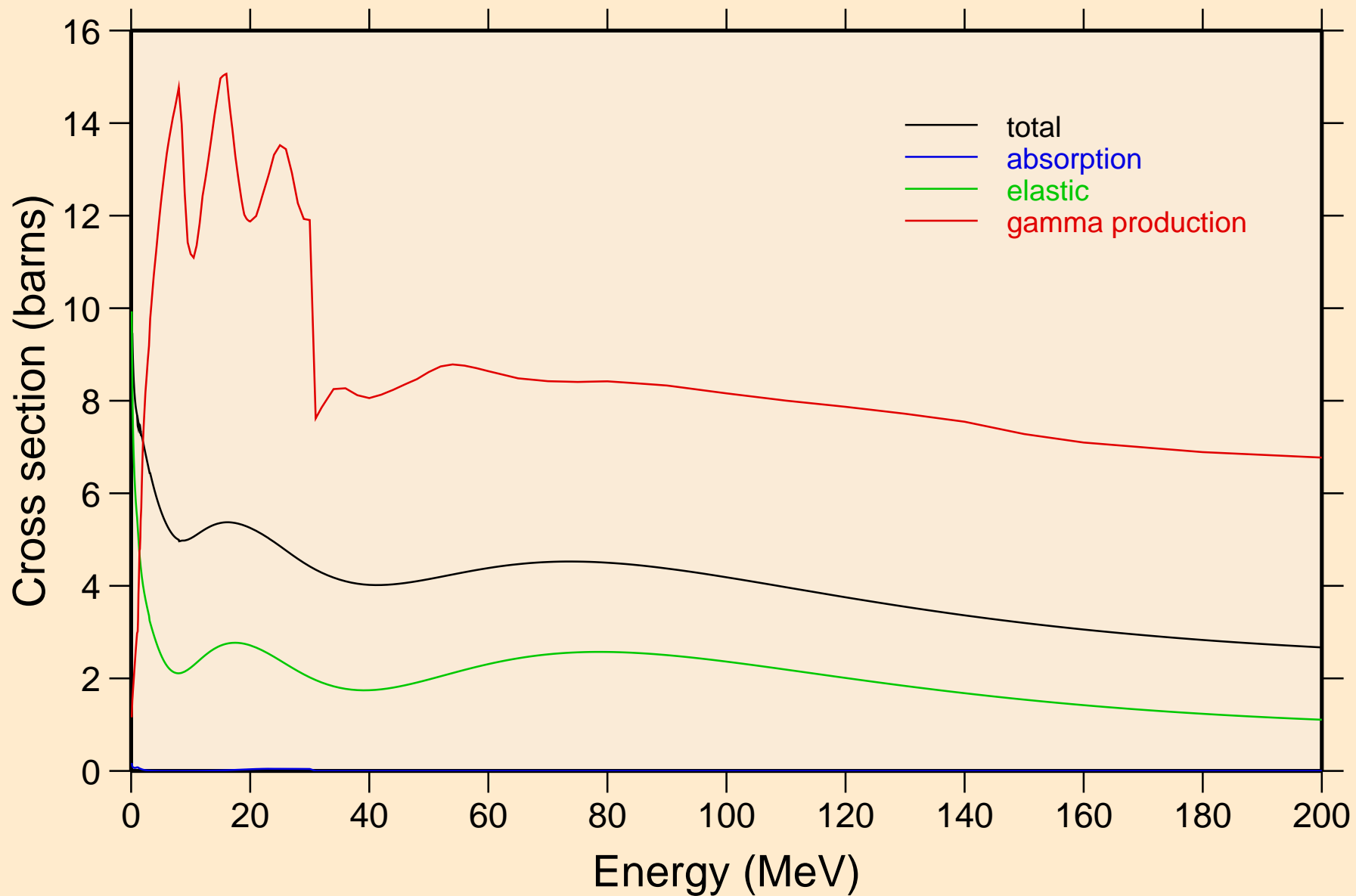

YB172 NEUTRON ACER TENDL-2019 LIBRARY; T=293.16K  
Heating

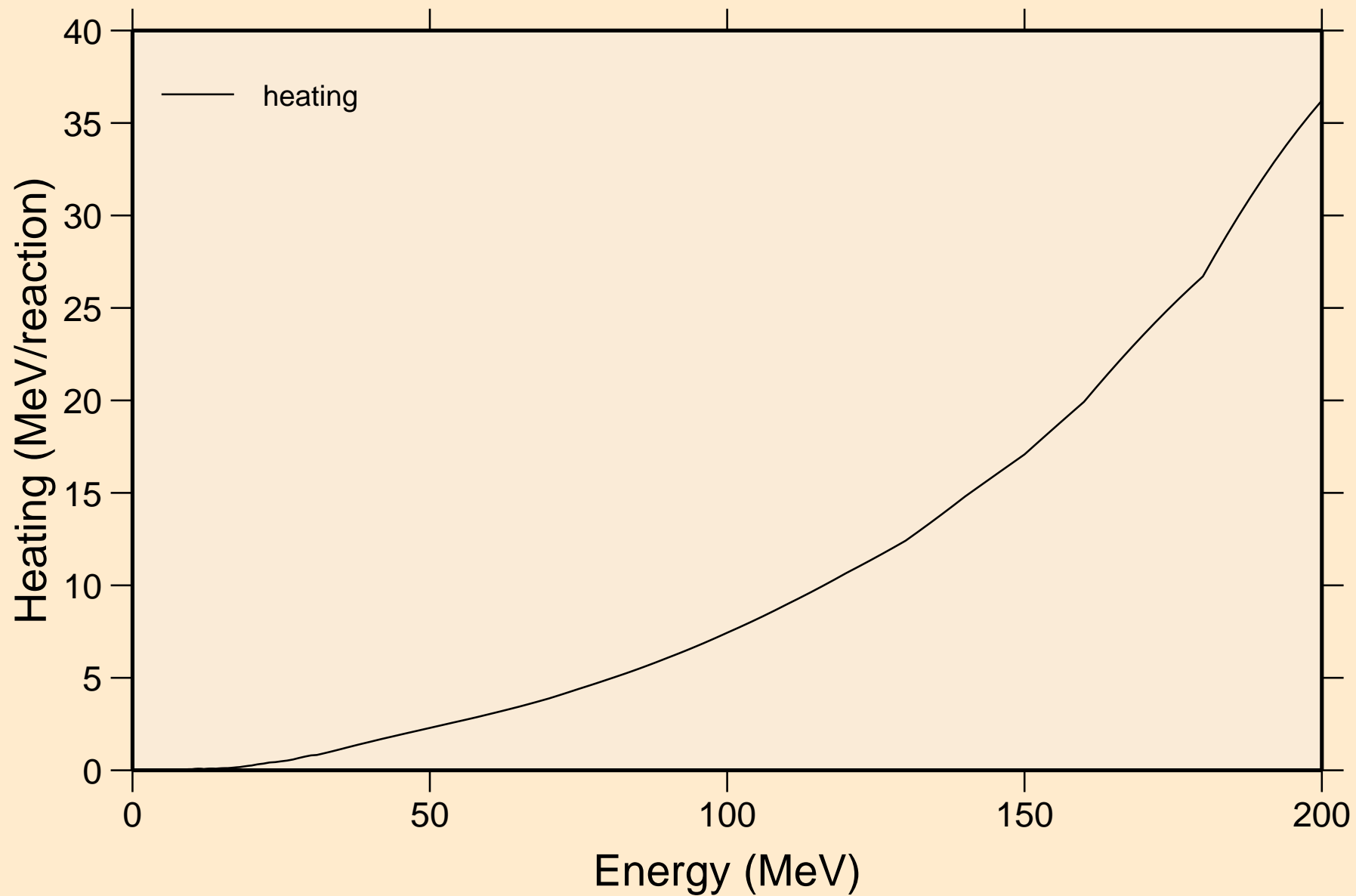

YB172 NEUTRON ACER TENDL-2019 LIBRARY; T=293.16K  
Damage

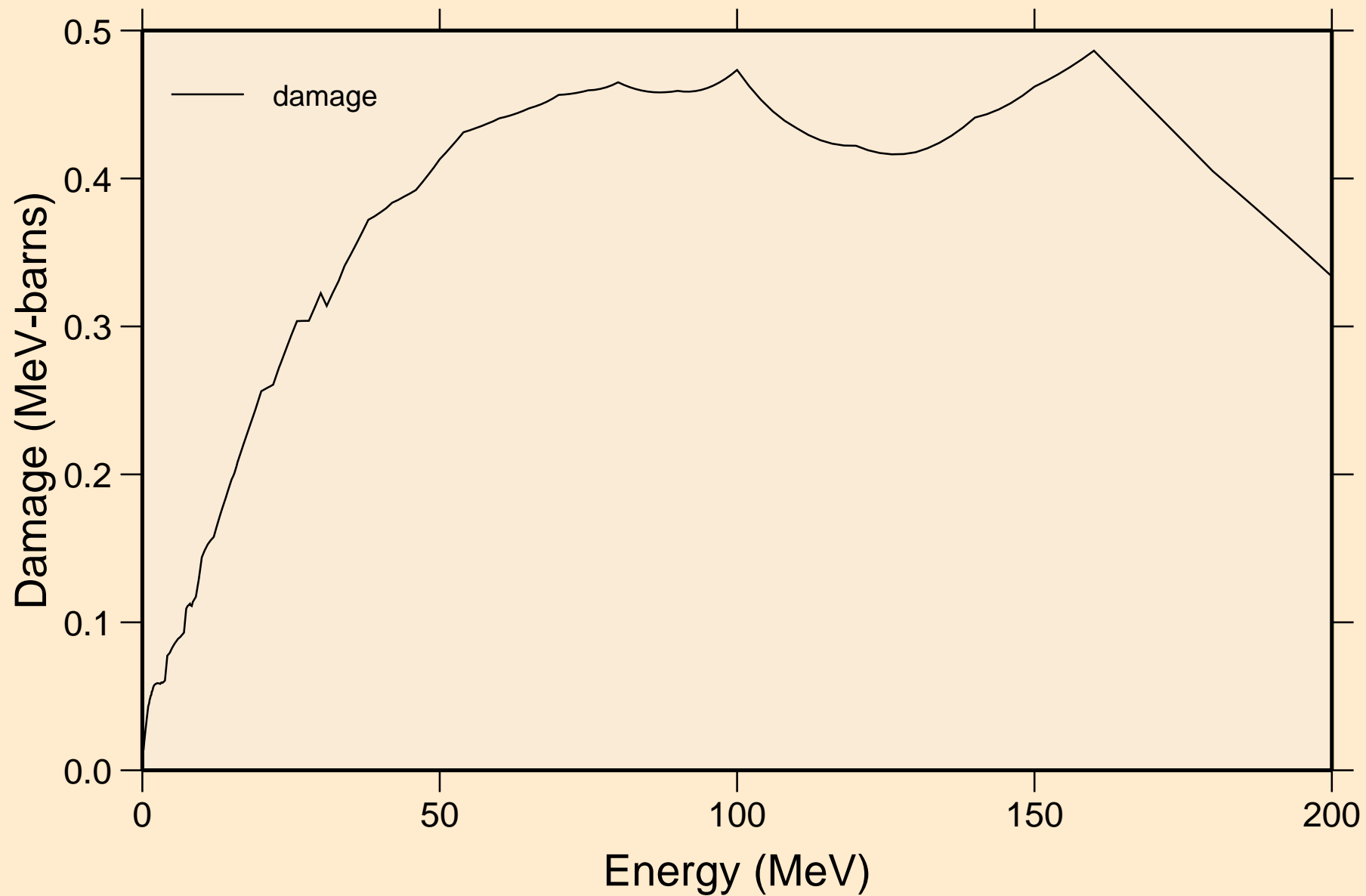

YB172 NEUTRON ACER TENDL-2019 LIBRARY; T=293.16K  
Non-threshold reactions

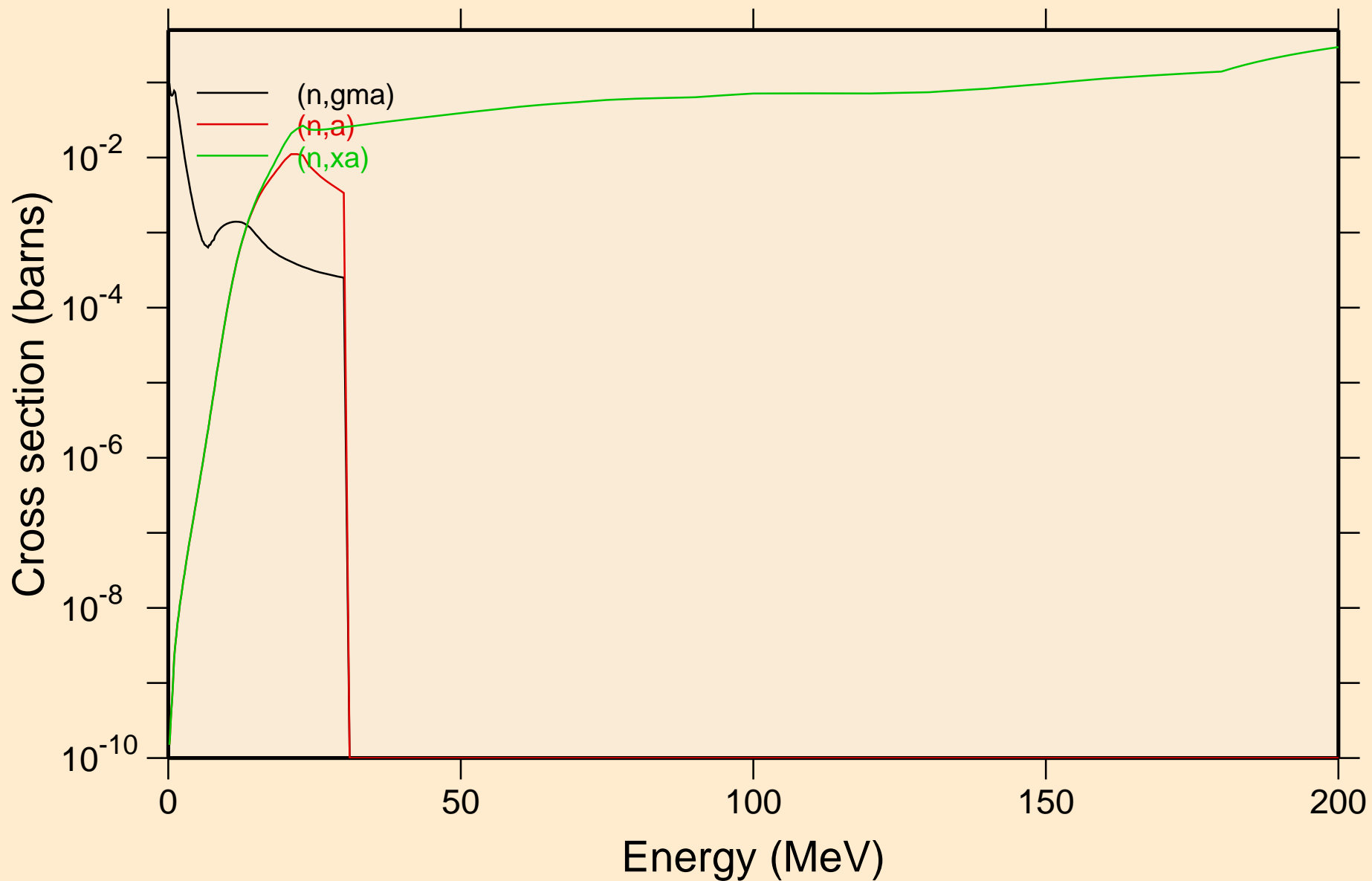



YB172 NEUTRON ACER TENDL-2019 LIBRARY; T=293.16K  
Inelastic levels

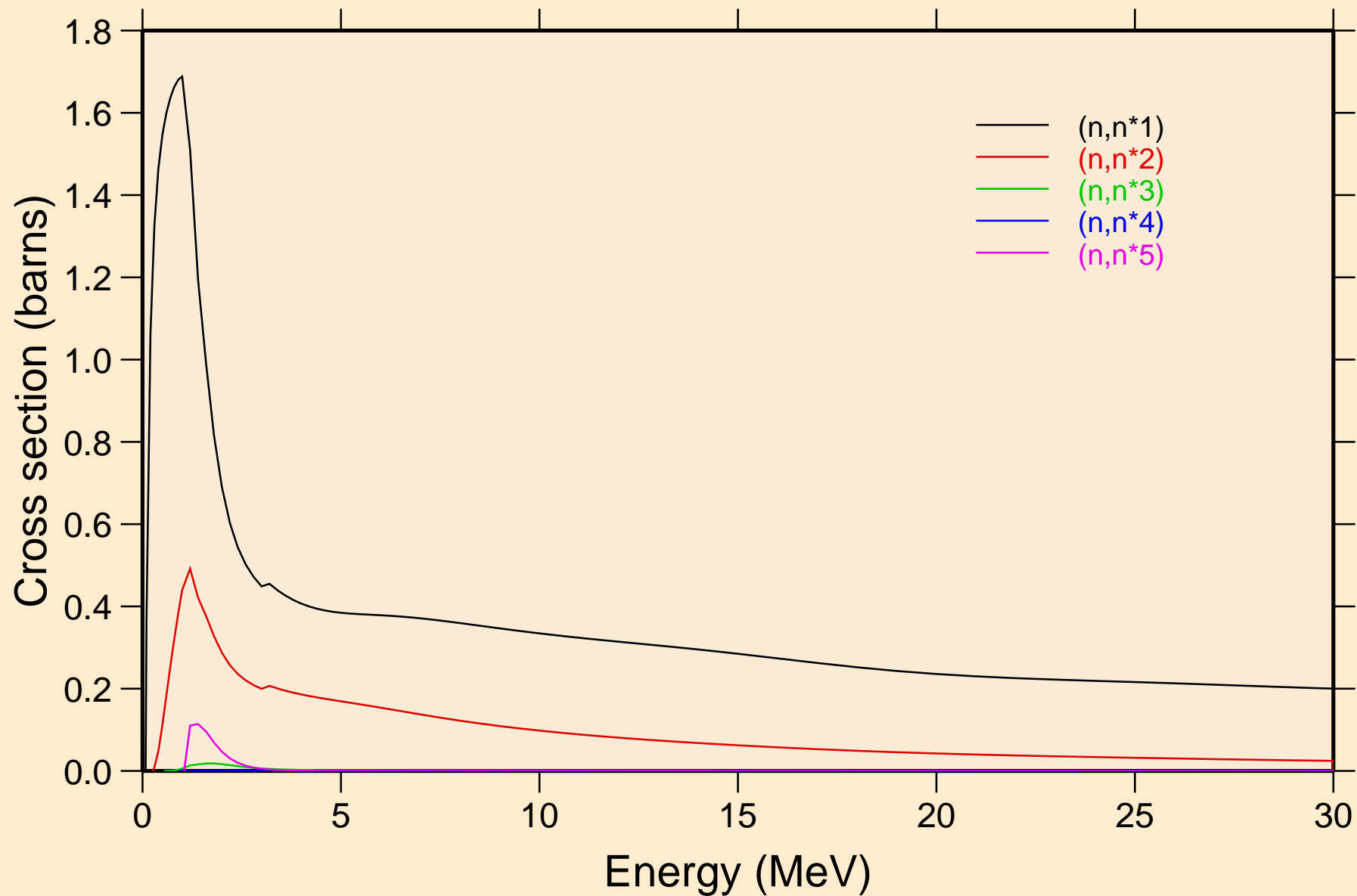

YB172 NEUTRON ACER TENDL-2019 LIBRARY; T=293.16K  
Inelastic levels

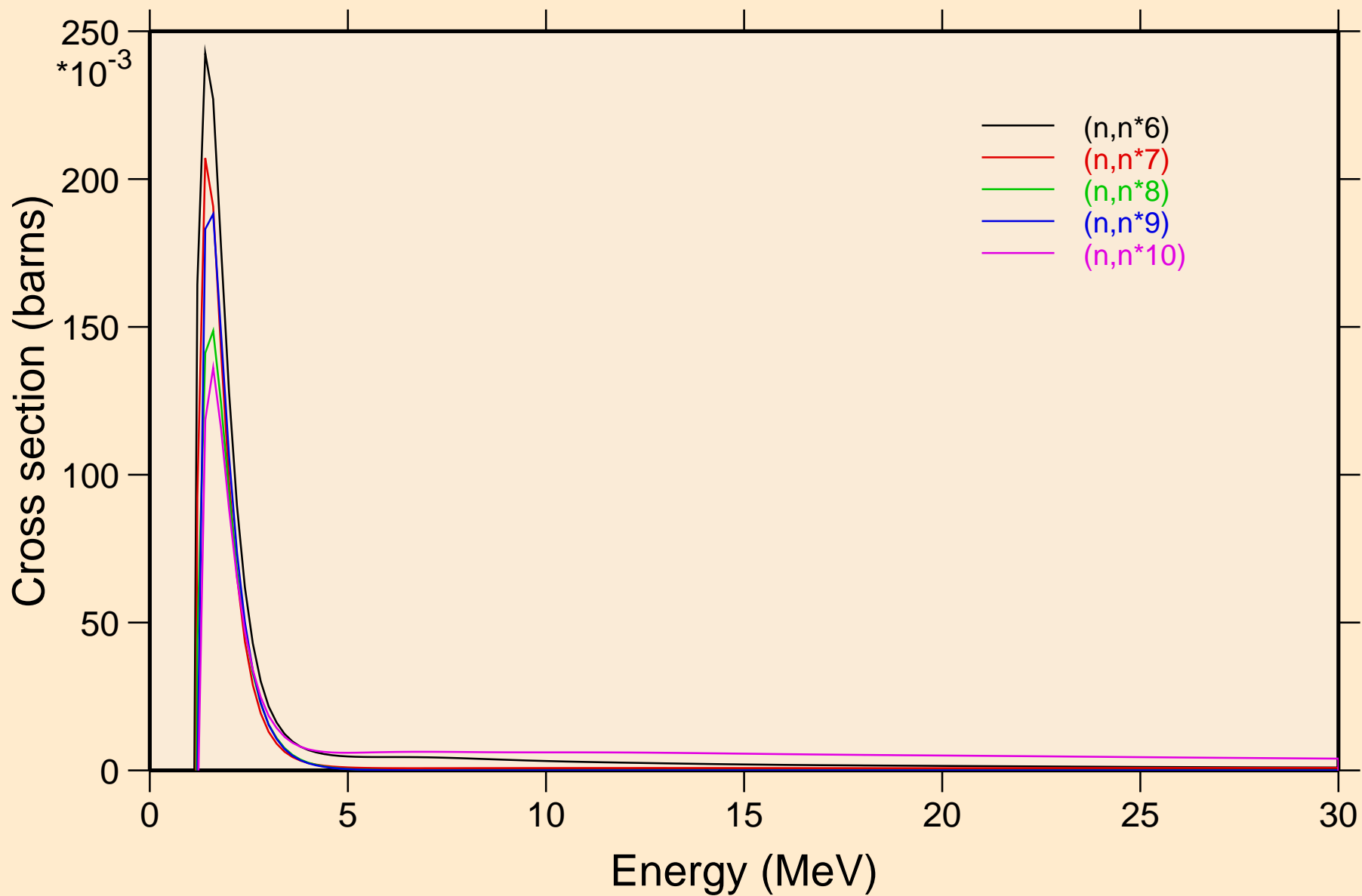

YB172 NEUTRON ACER TENDL-2019 LIBRARY; T=293.16K  
Inelastic levels

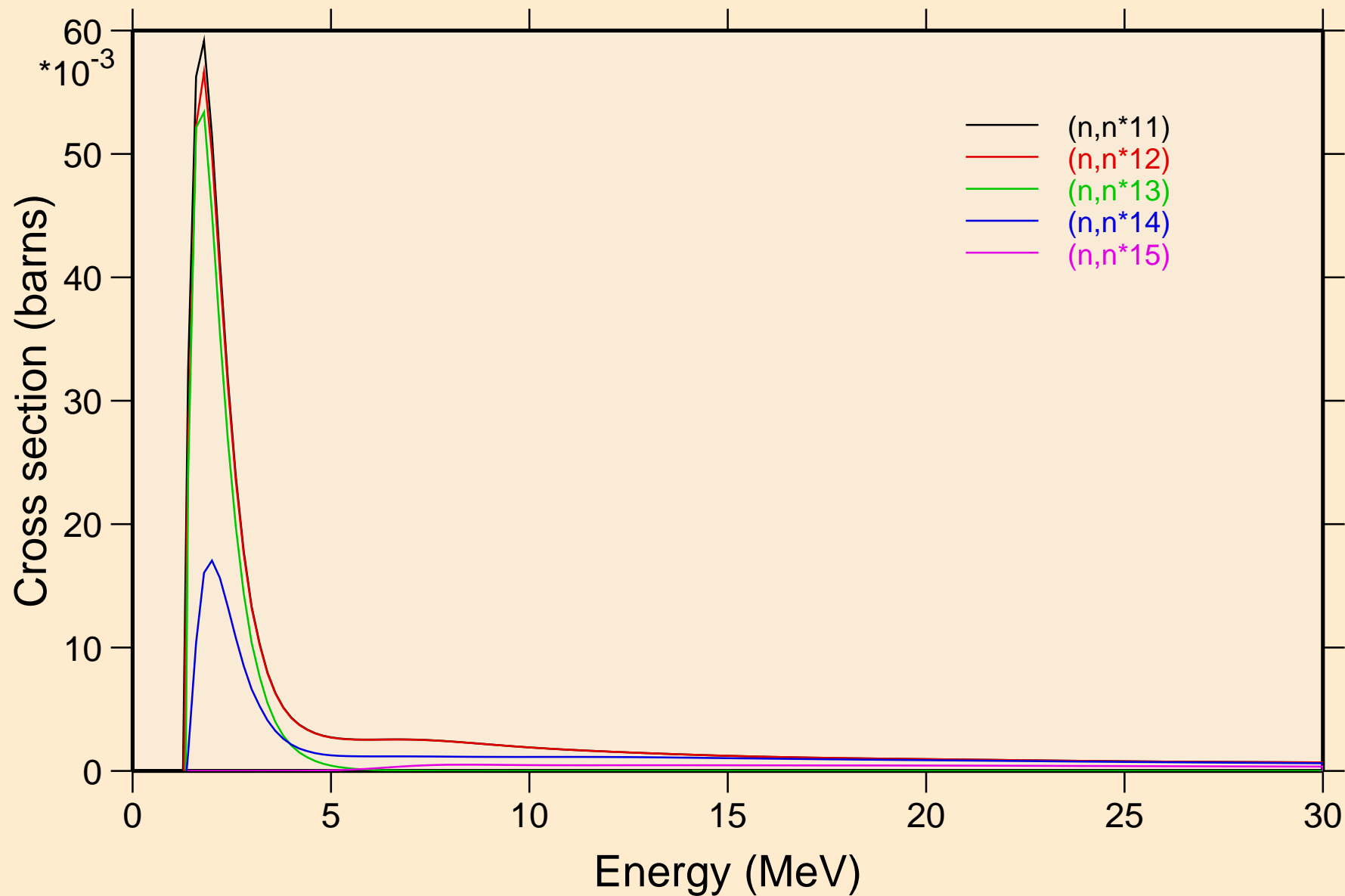

YB172 NEUTRON ACER TENDL-2019 LIBRARY; T=293.16K  
Inelastic levels

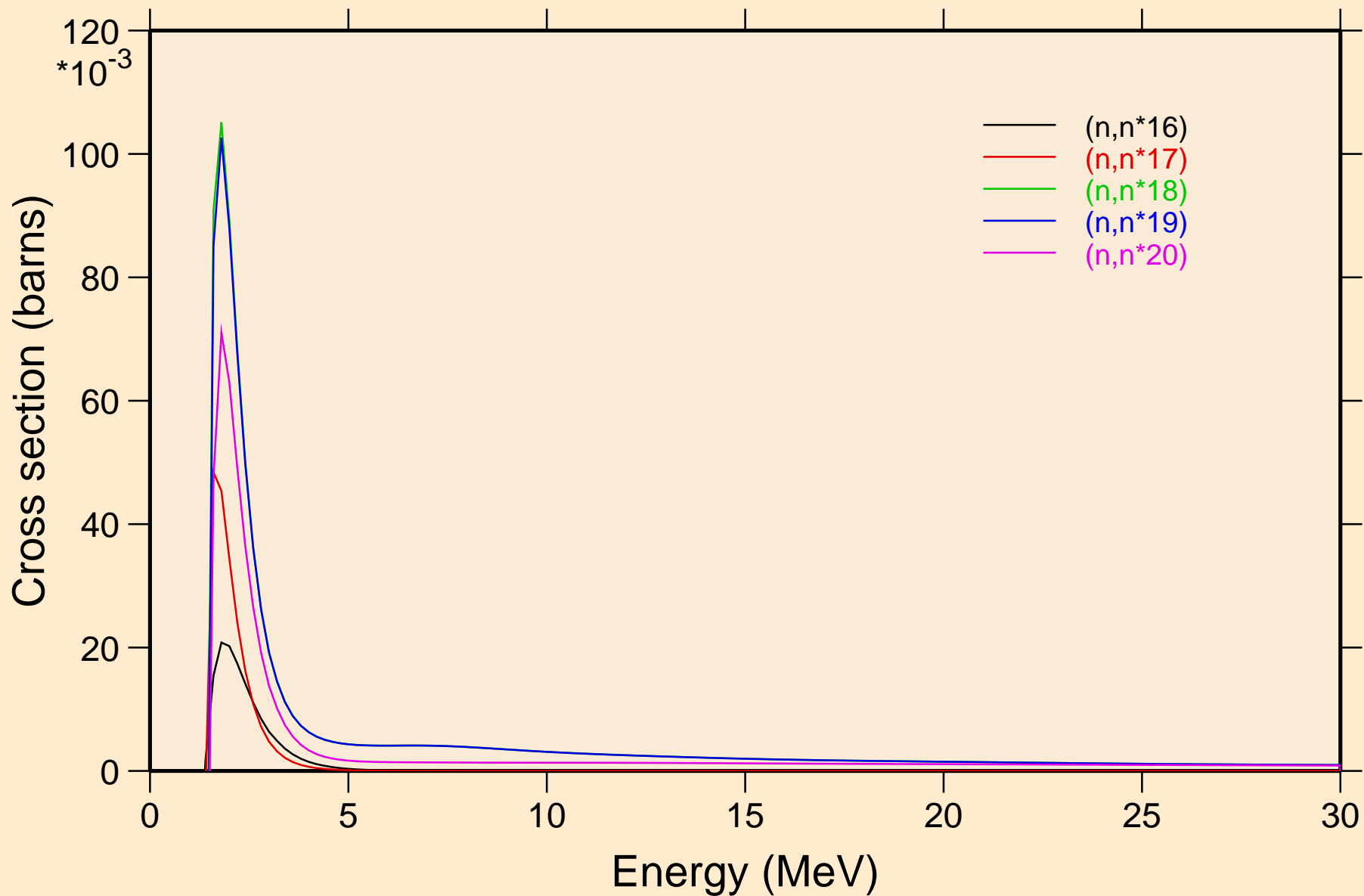

YB172 NEUTRON ACER TENDL-2019 LIBRARY; T=293.16K  
Inelastic levels

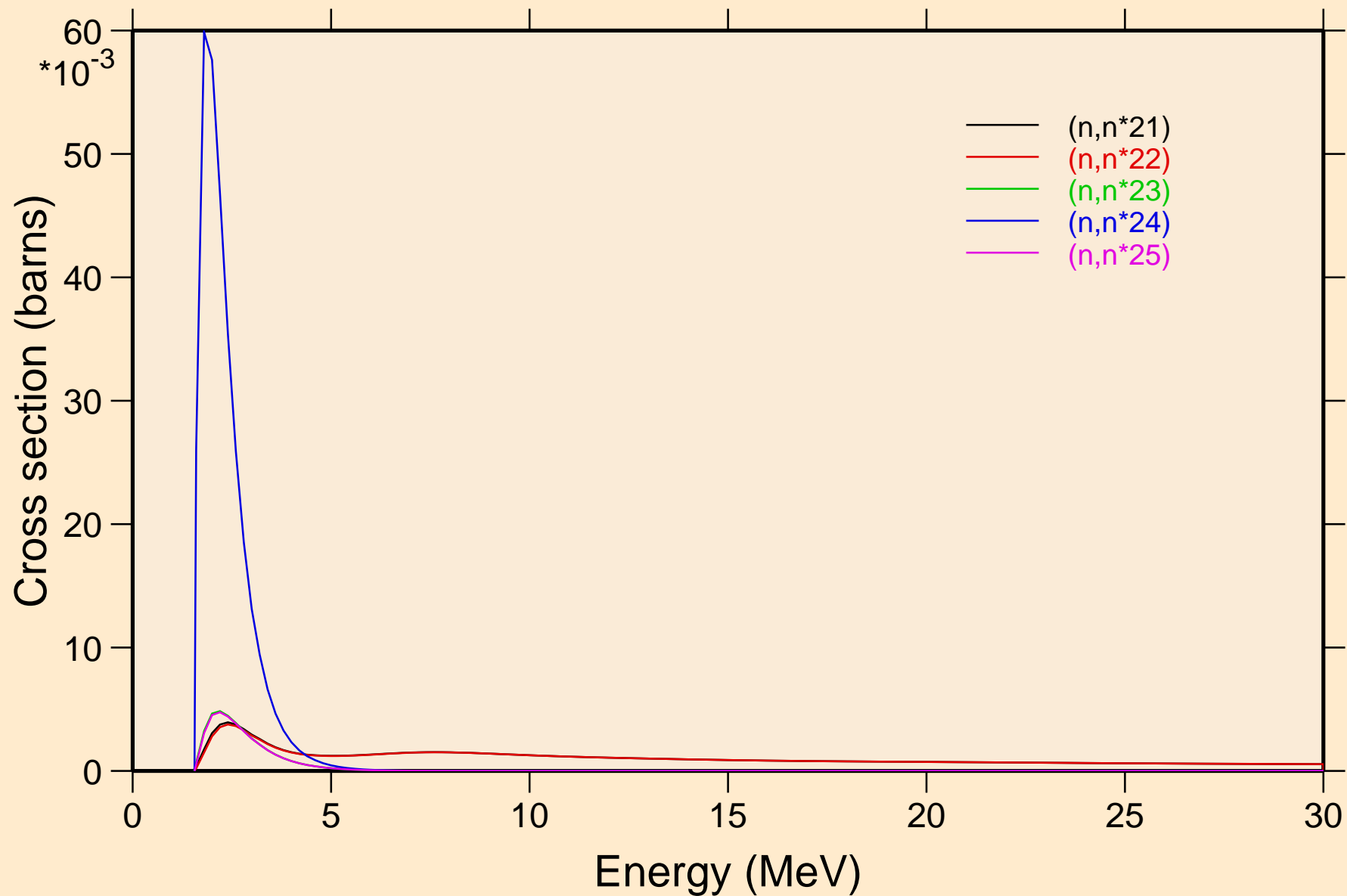

YB172 NEUTRON ACER TENDL-2019 LIBRARY; T=293.16K  
Inelastic levels

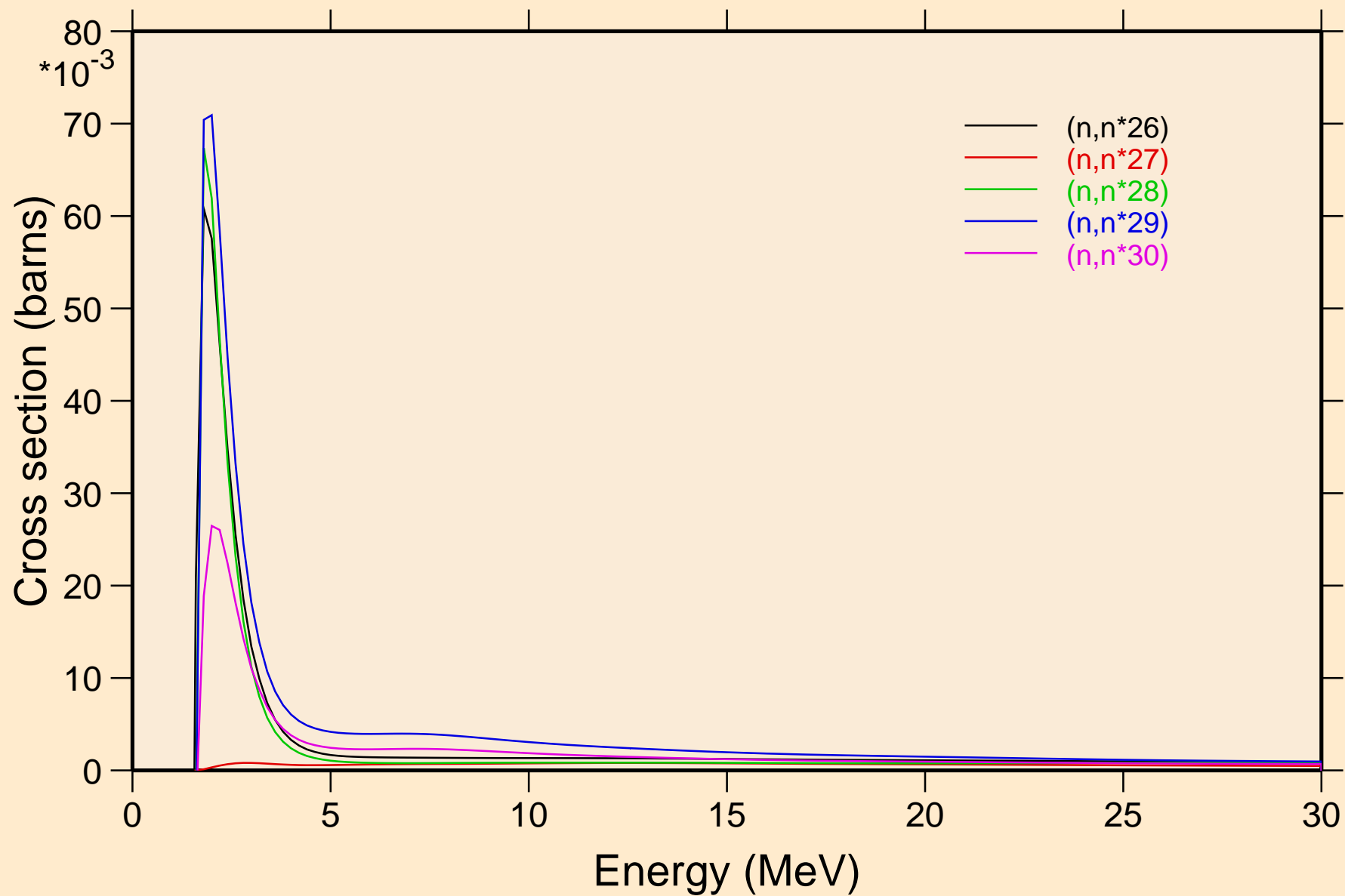

# YB172 NEUTRON ACER TENDL-2019 LIBRARY; T=293.16K

## Threshold reactions

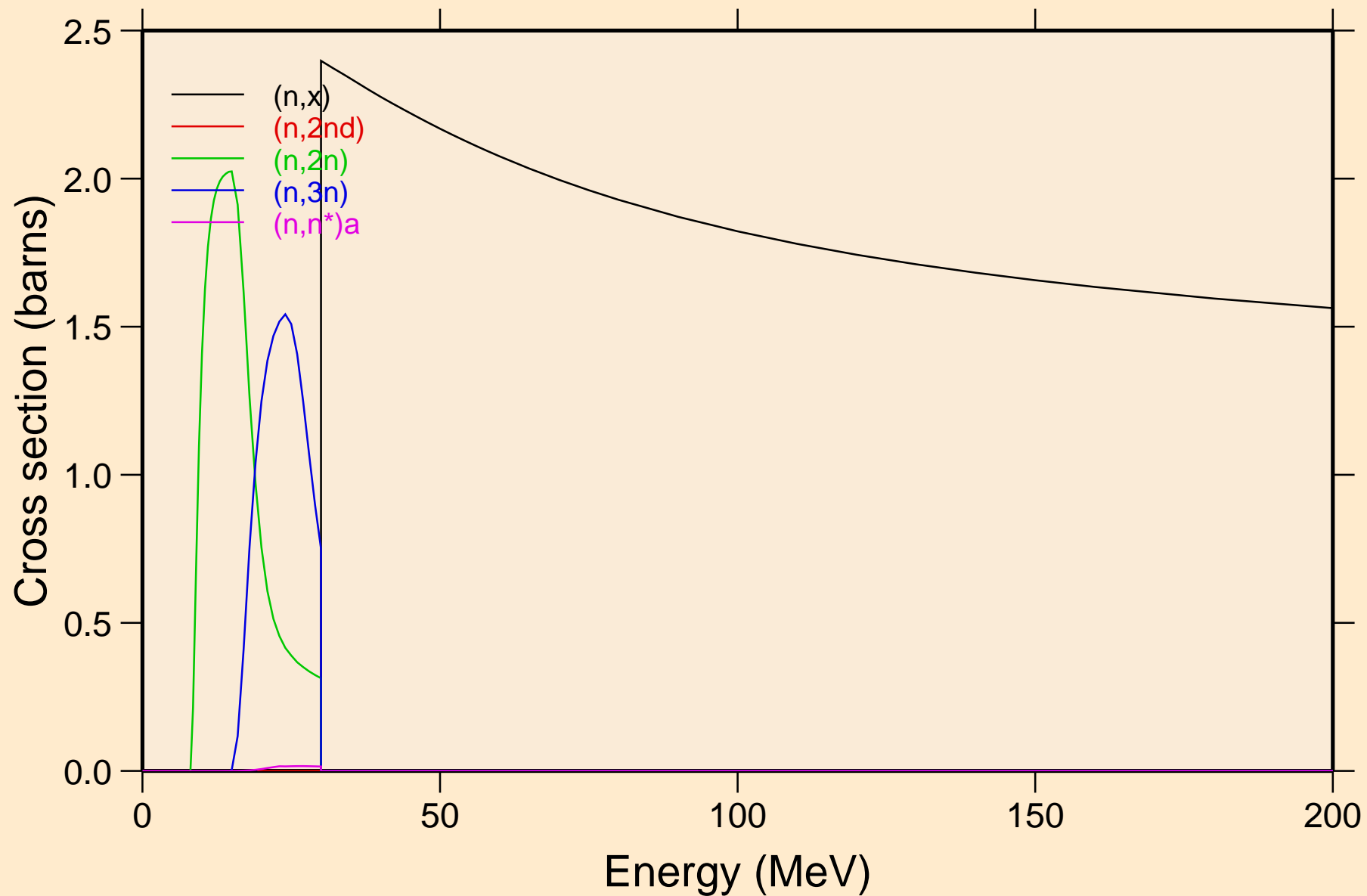

YB172 NEUTRON ACER TENDL-2019 LIBRARY; T=293.16K  
Threshold reactions

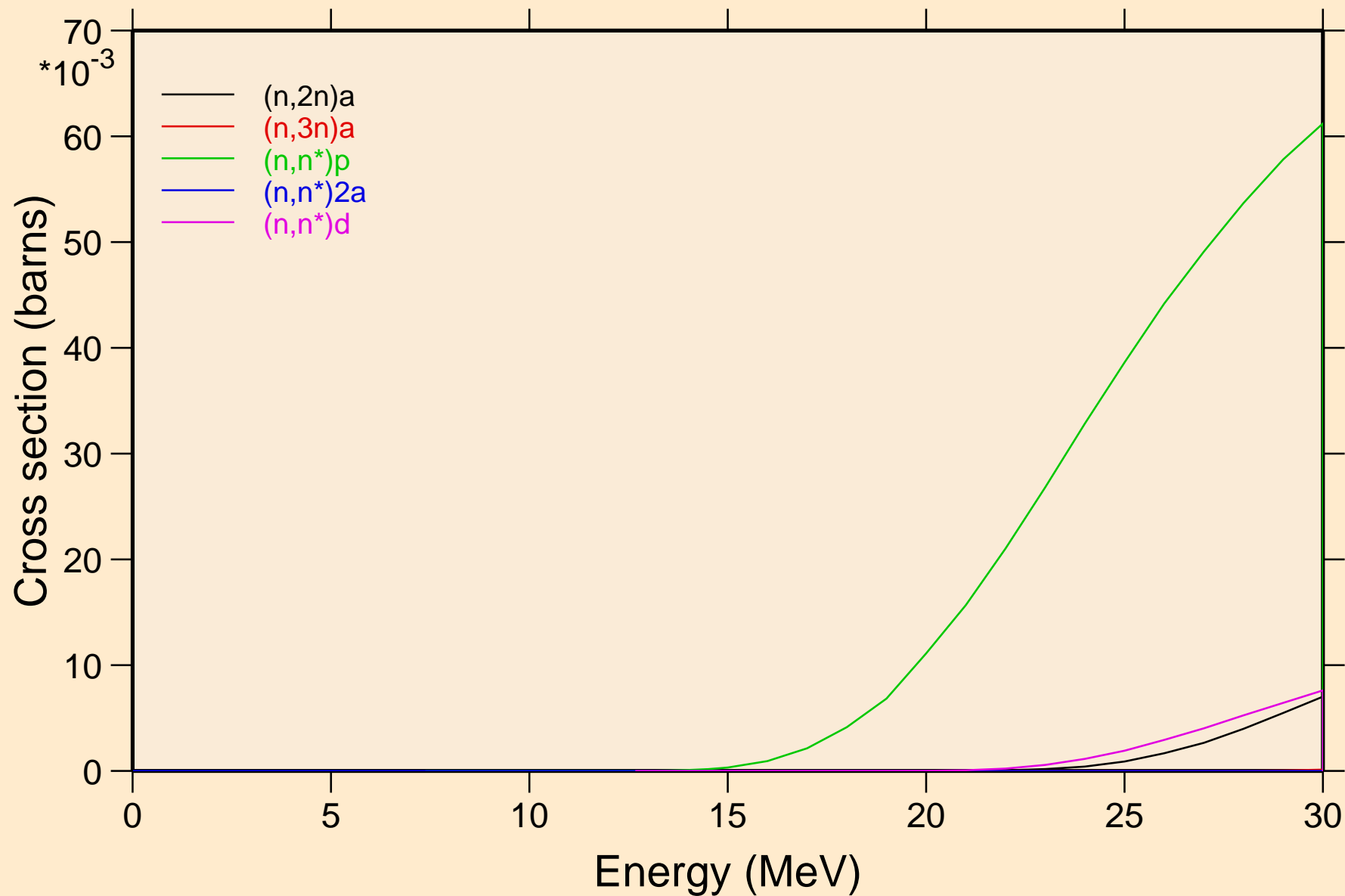



YB172 NEUTRON ACER TENDL-2019 LIBRARY; T=293.16K  
Threshold reactions

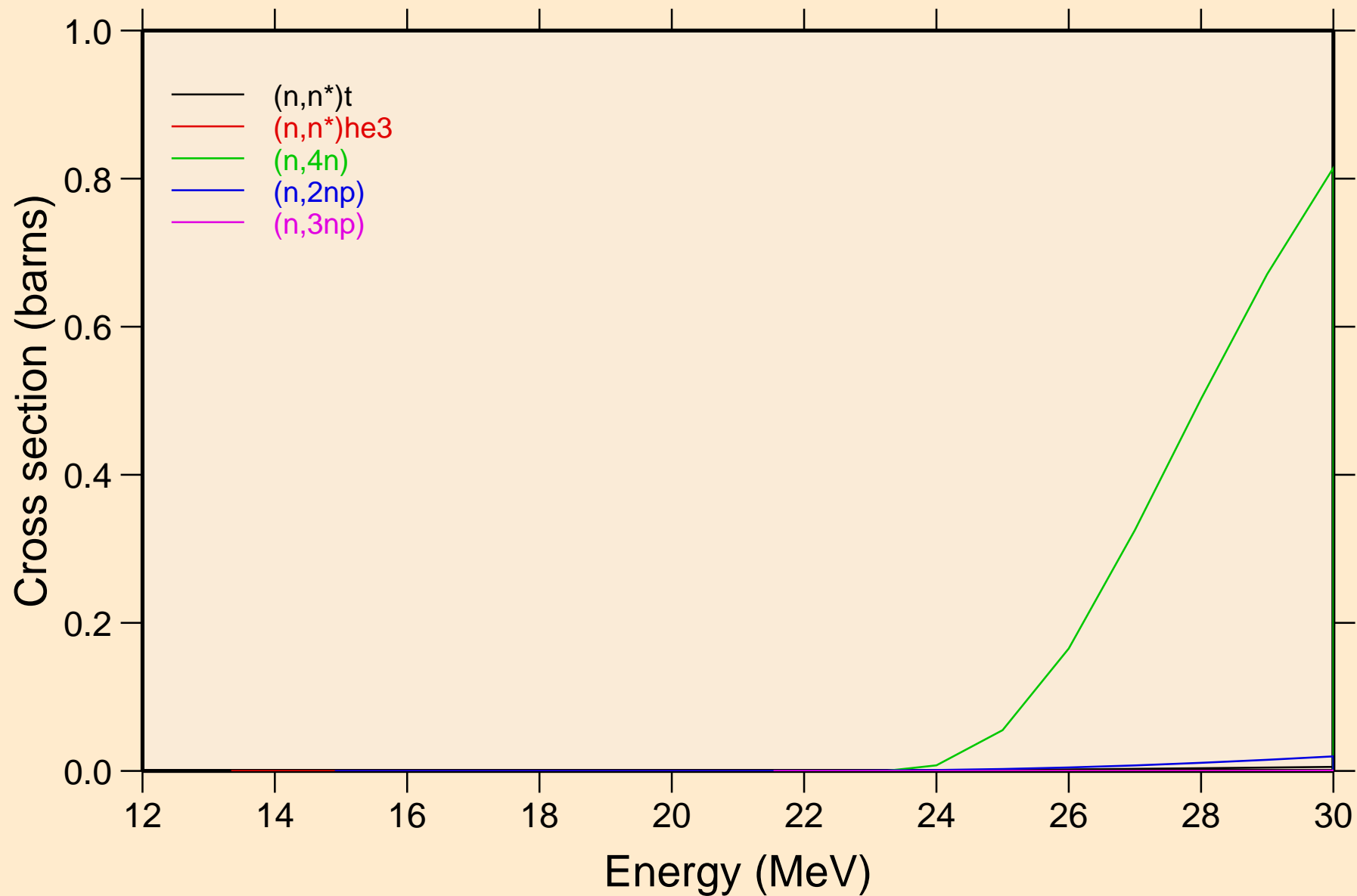

YB172 NEUTRON ACER TENDL-2019 LIBRARY; T=293.16K  
Threshold reactions

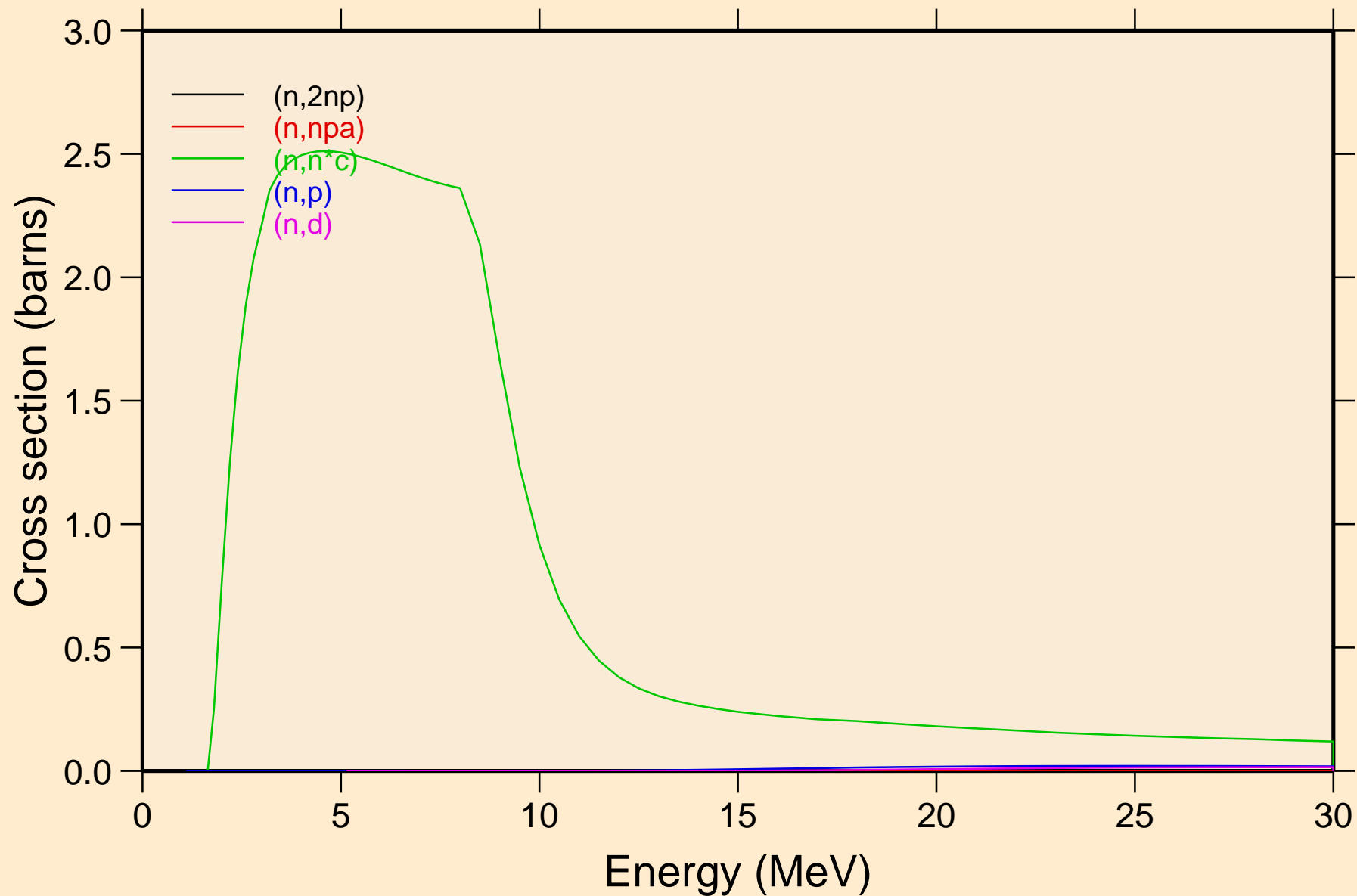

YB172 NEUTRON ACER TENDL-2019 LIBRARY; T=293.16K  
Threshold reactions

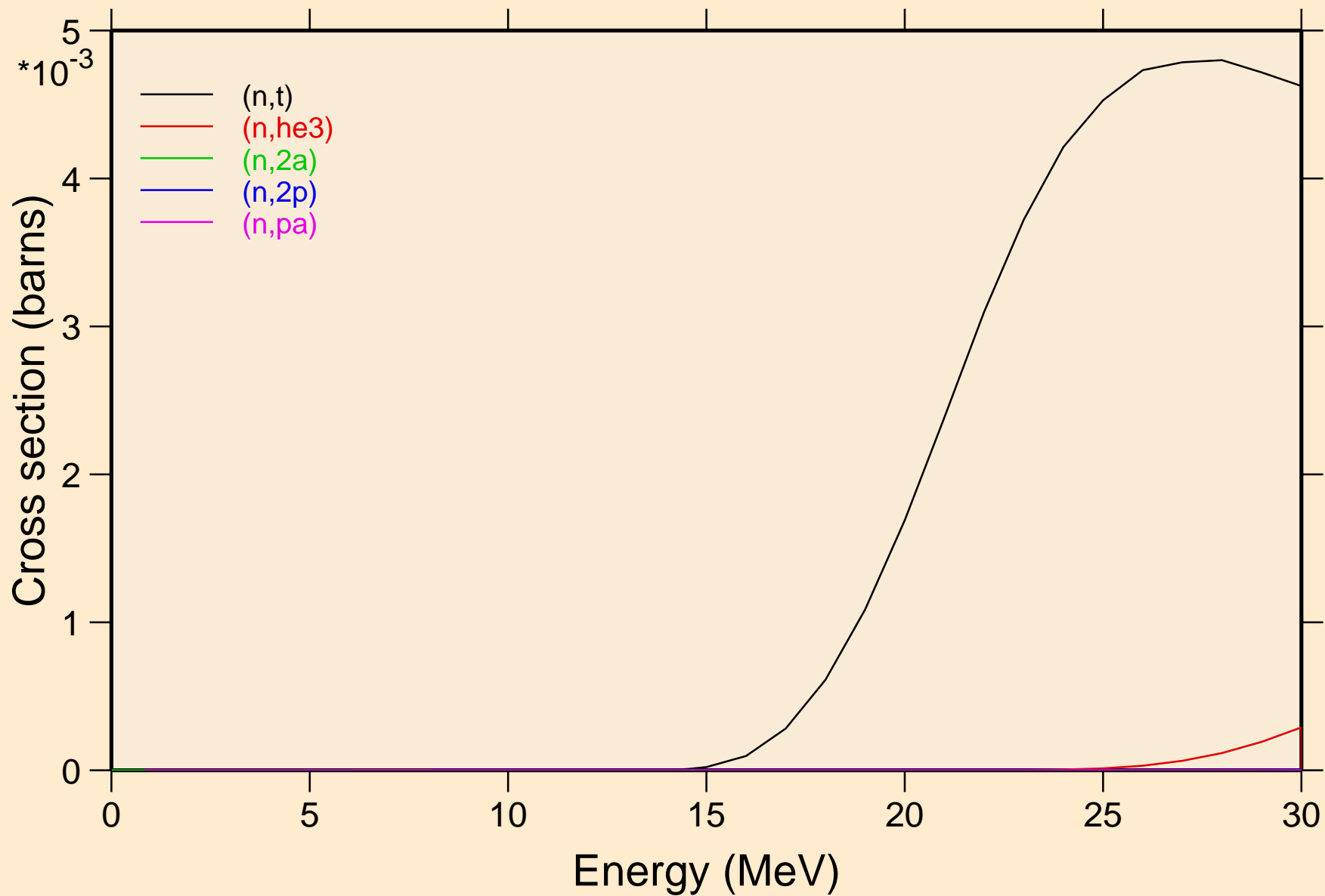

YB172 NEUTRON ACER TENDL-2019 LIBRARY; T=293.16K  
Threshold reactions

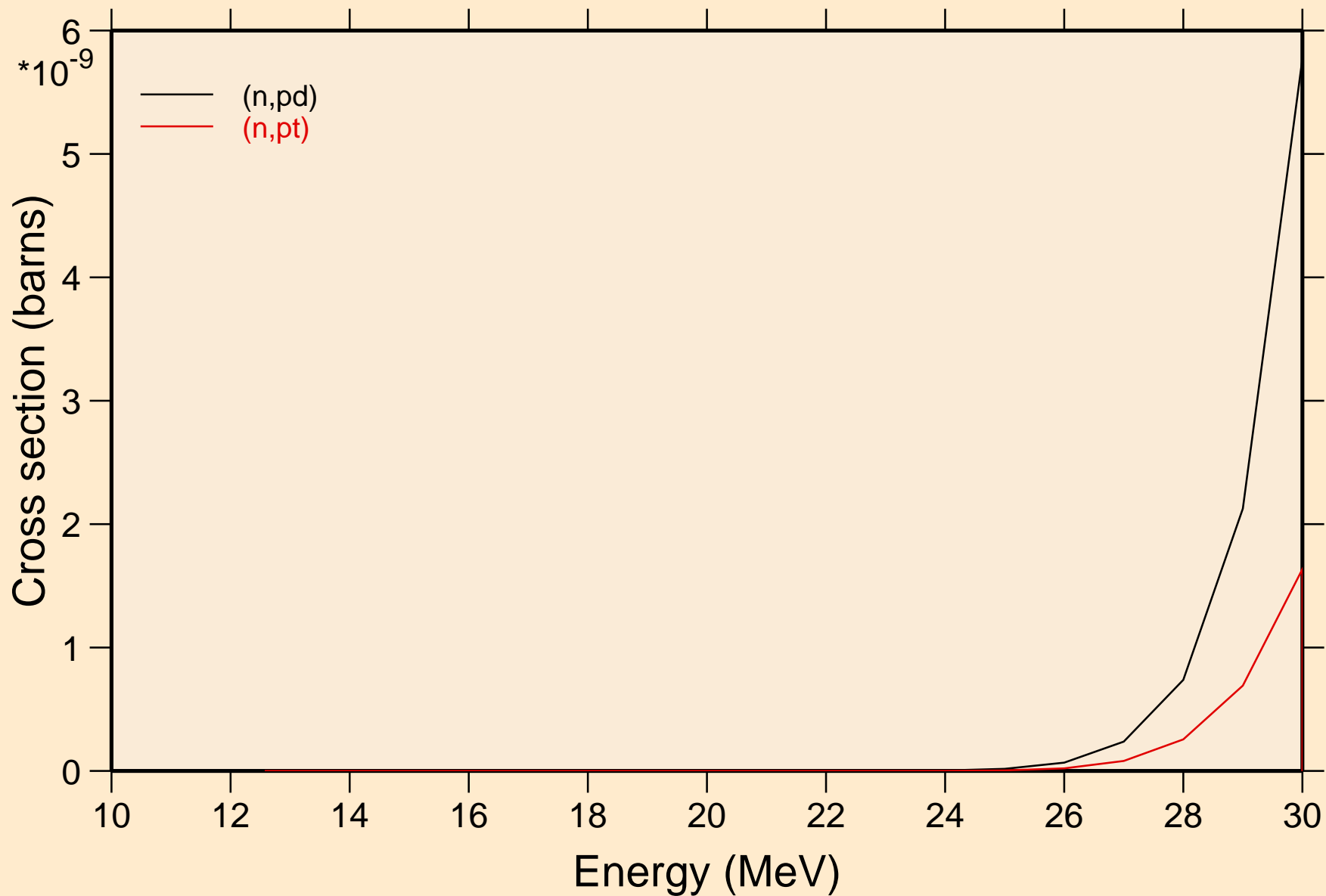

YB172 NEUTRON ACER TENDL-2019 LIBRARY; T=293.16K  
Threshold reactions

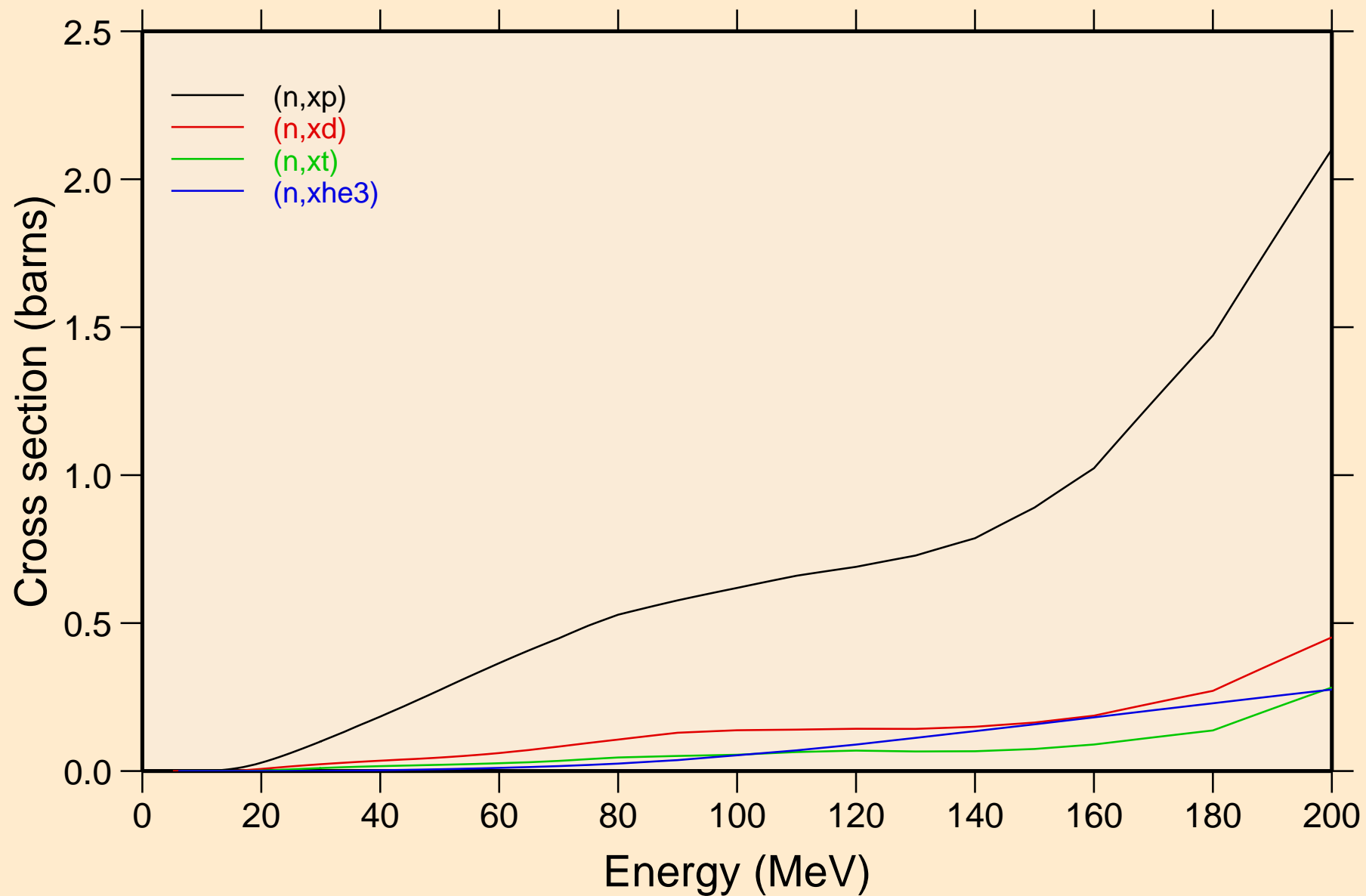

YB172 NEUTRON ACER TENDL-2019 LIBRARY; T=293.16K  
angular distribution for elastic

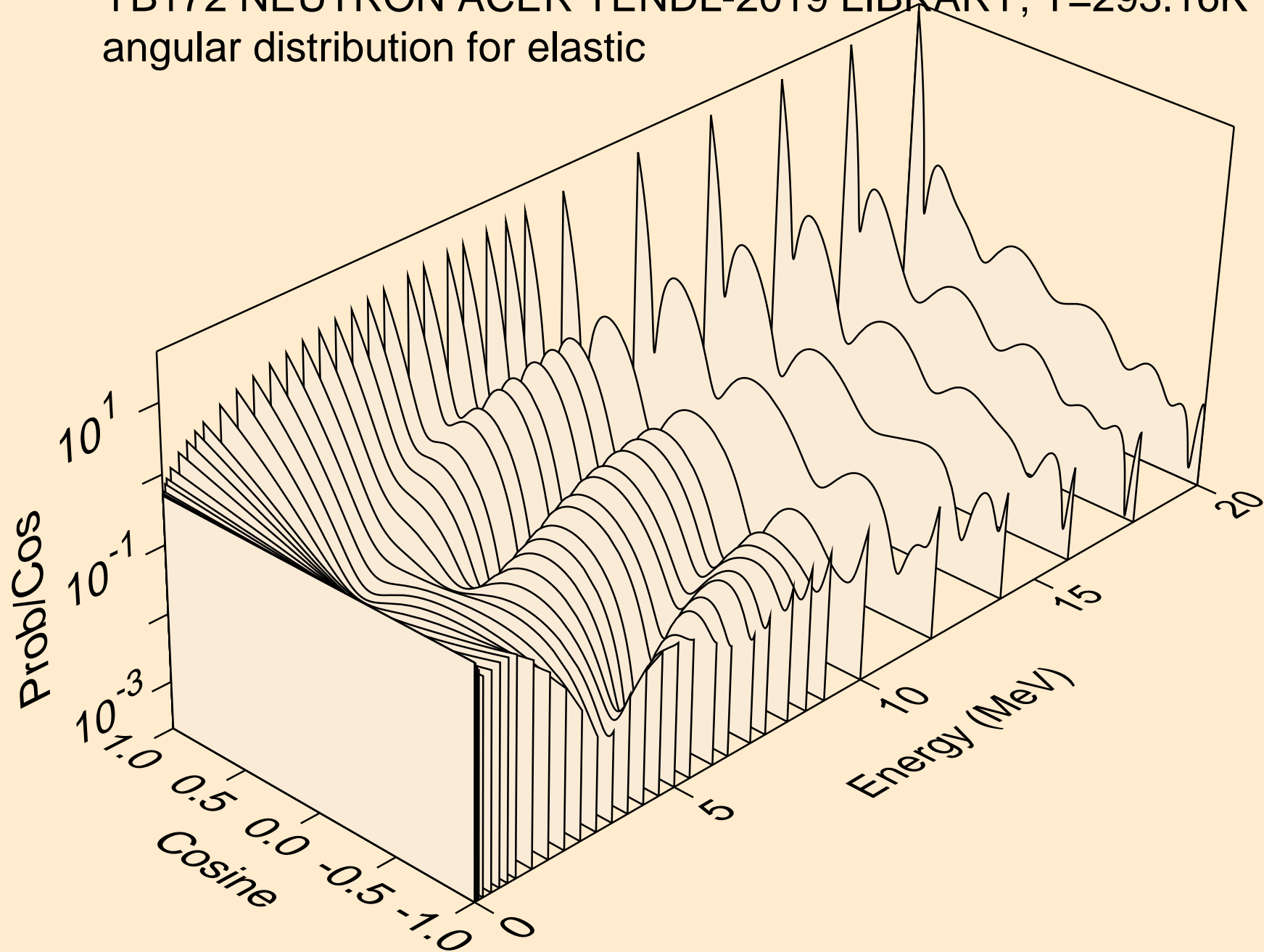

YB172 NEUTRON ACER TENDL-2019 LIBRARY; T=293.16K  
angular distribution for elastic

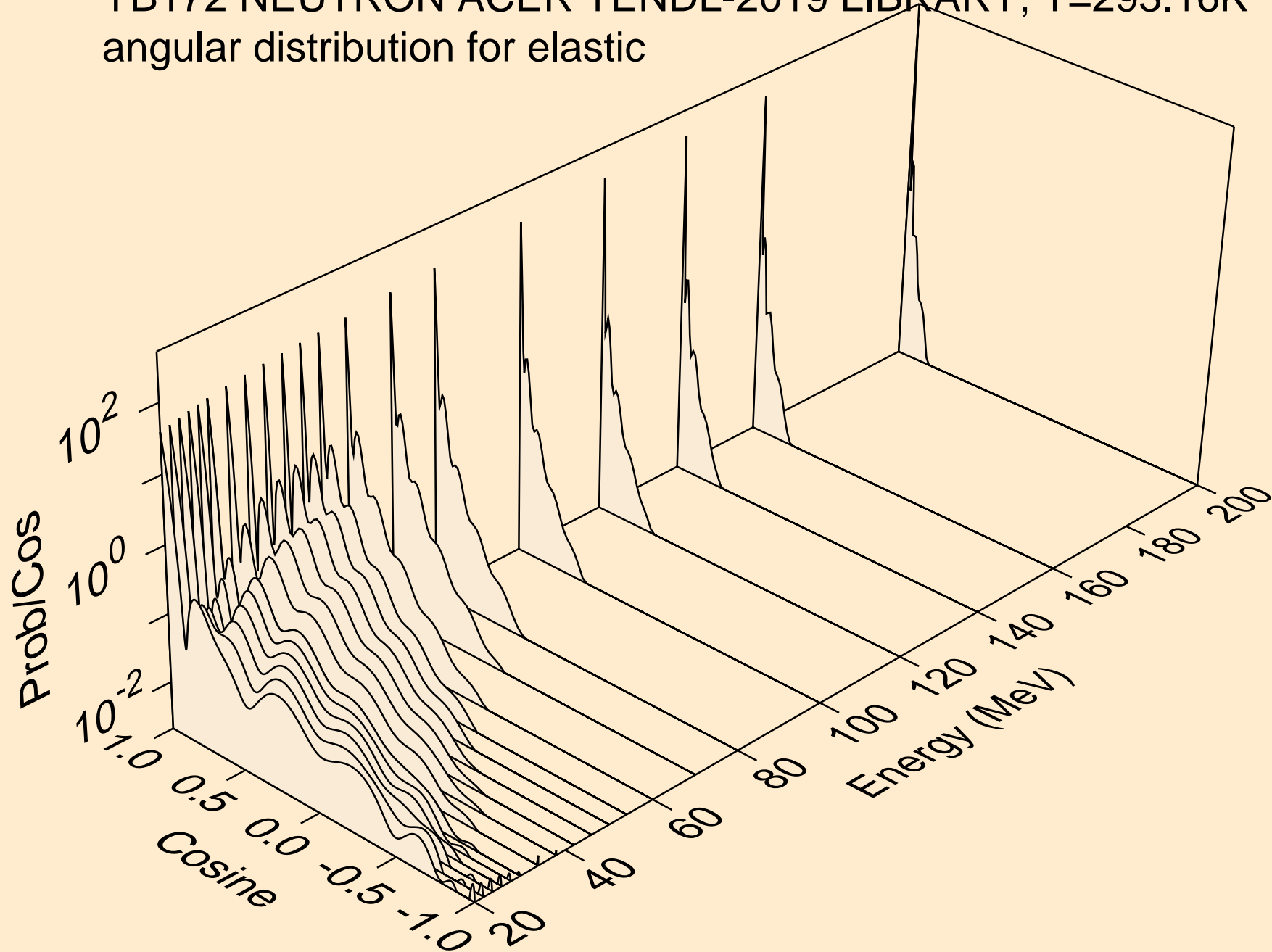

YB172 NEUTRON ACER TENDL-2019 LIBRARY; T=293.16K  
angular distribution for (n,n\*1)

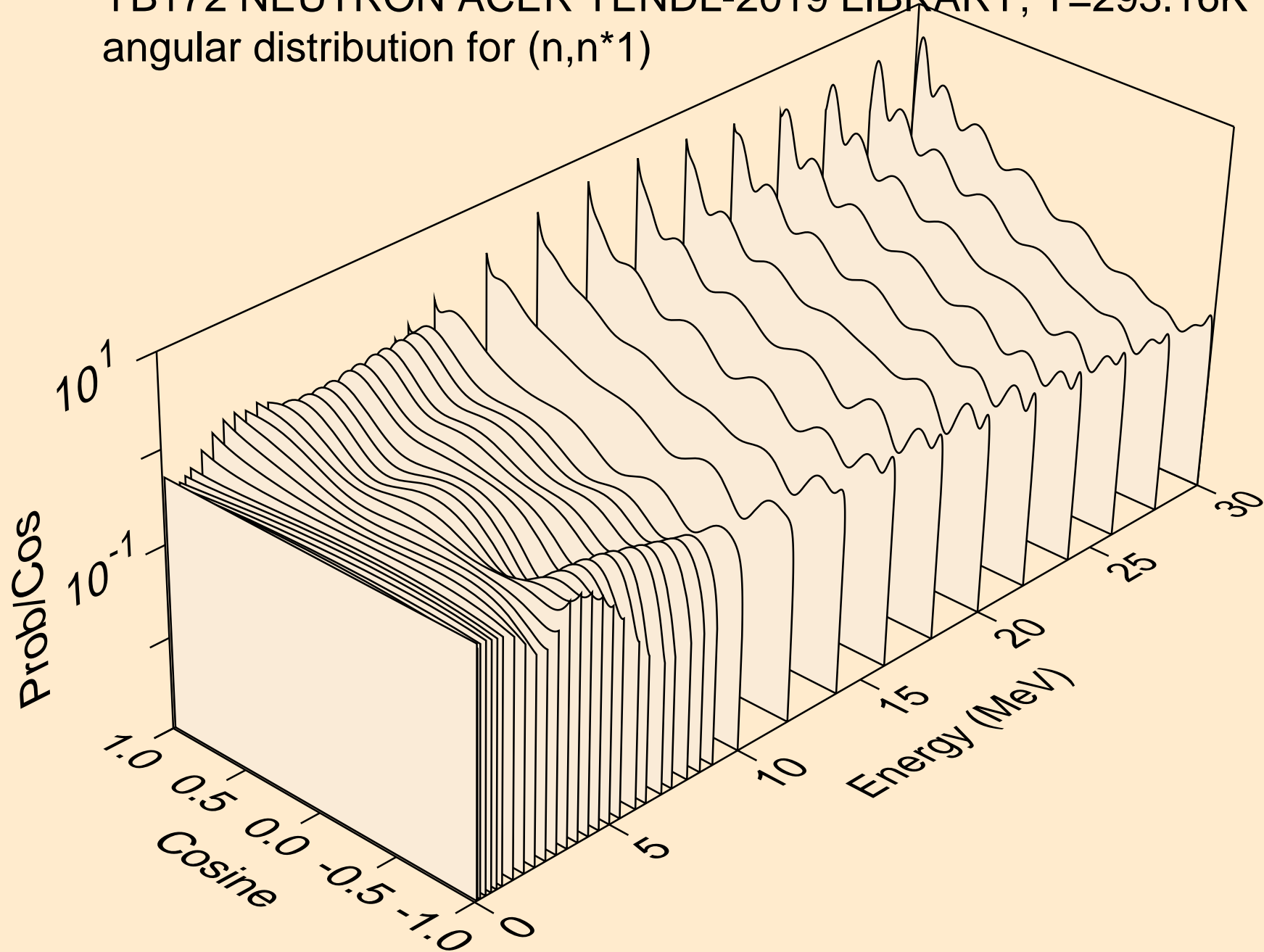



YB172 NEUTRON ACER TENDL-2019 LIBRARY; T=293.16K  
angular distribution for (n,n\*2)

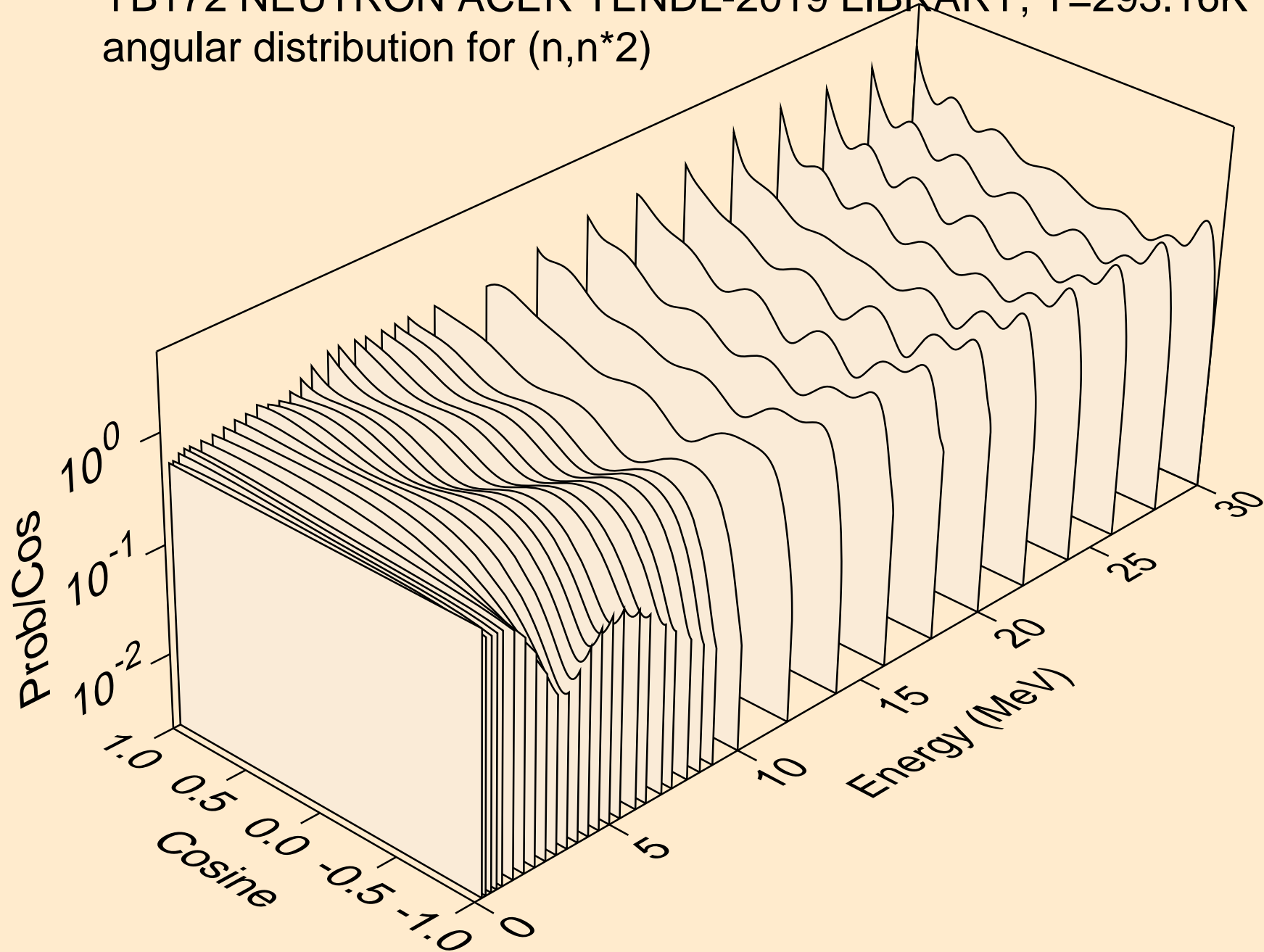

YB172 NEUTRON ACER TENDL-2019 LIBRARY; T=293.16K  
angular distribution for (n,n\*3)

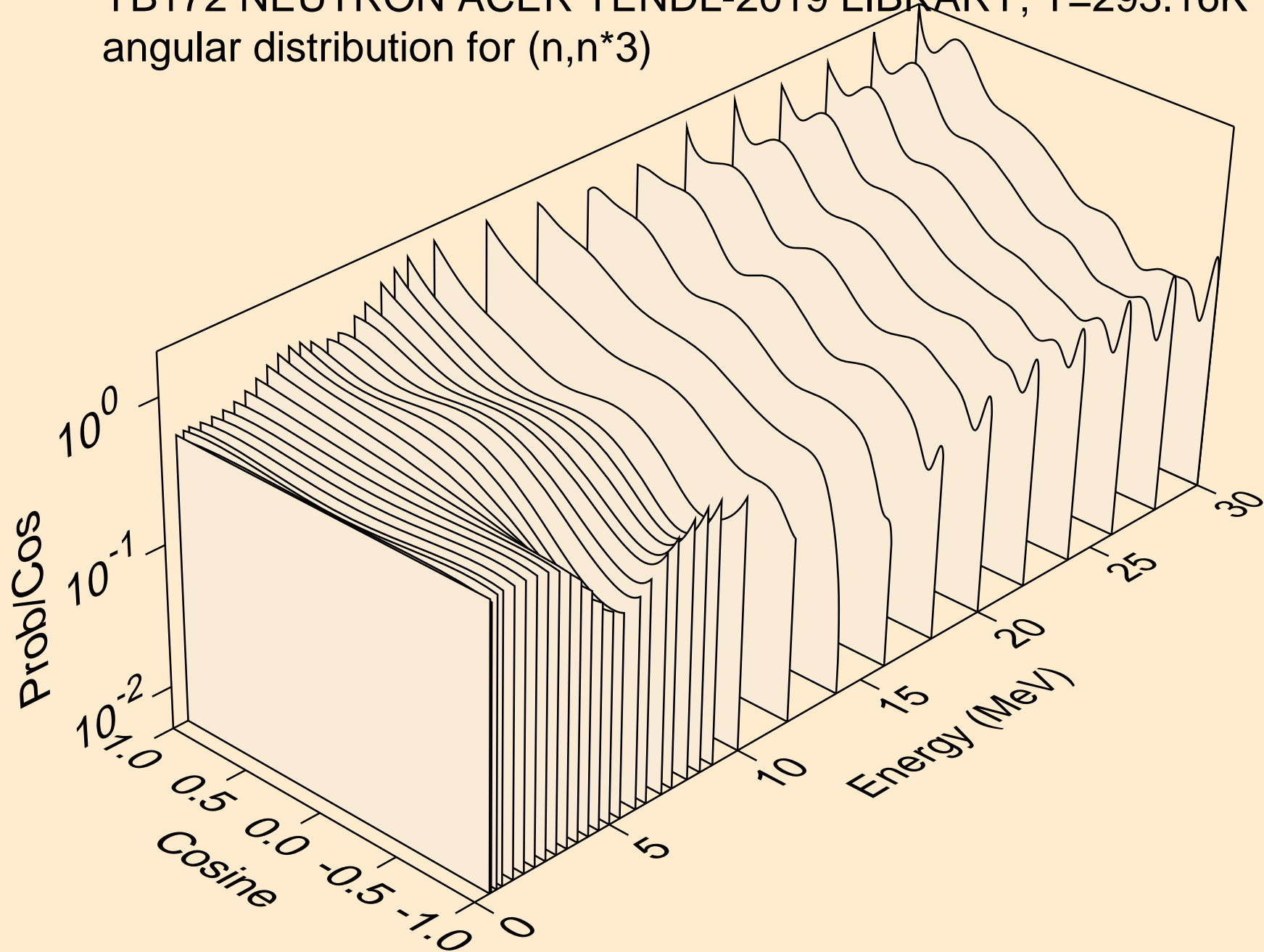

YB172 NEUTRON ACER TENDL-2019 LIBRARY; T=293.16K  
angular distribution for (n,n\*4)

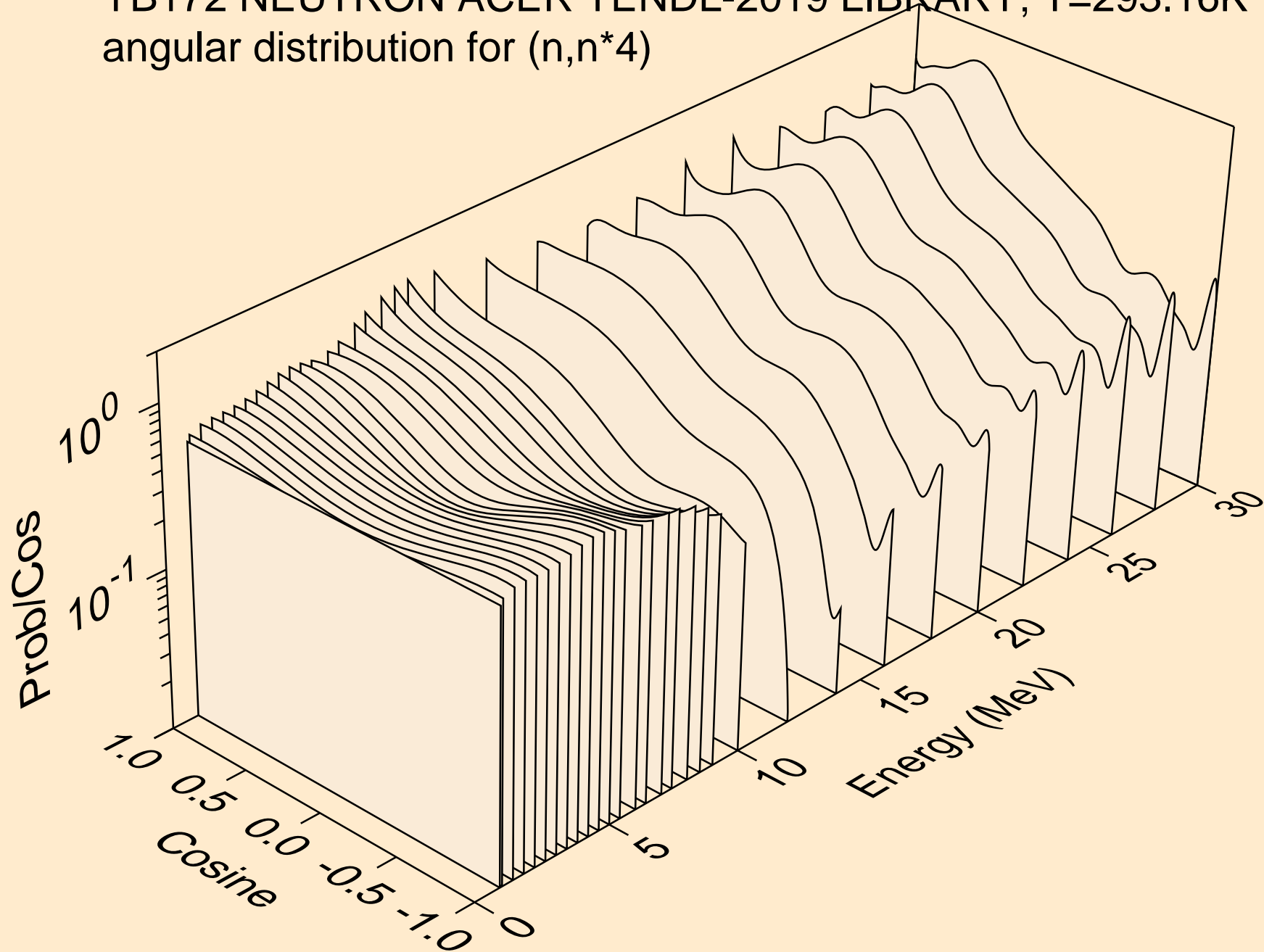

YB172 NEUTRON ACER TENDL-2019 LIBRARY; T=293.16K  
angular distribution for (n,n\*5)

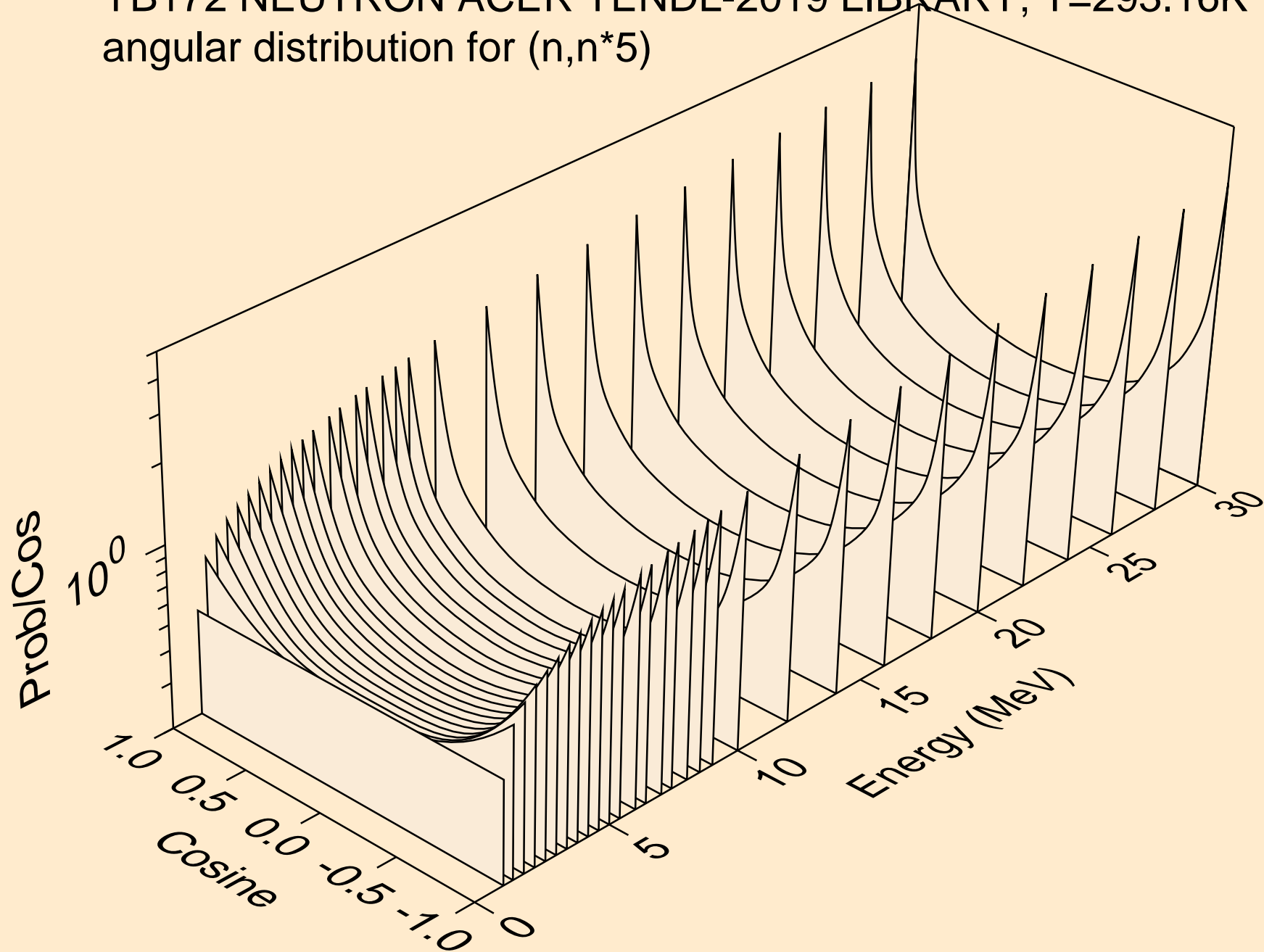

YB172 NEUTRON ACER TENDL-2019 LIBRARY; T=293.16K  
angular distribution for (n,n\*6)

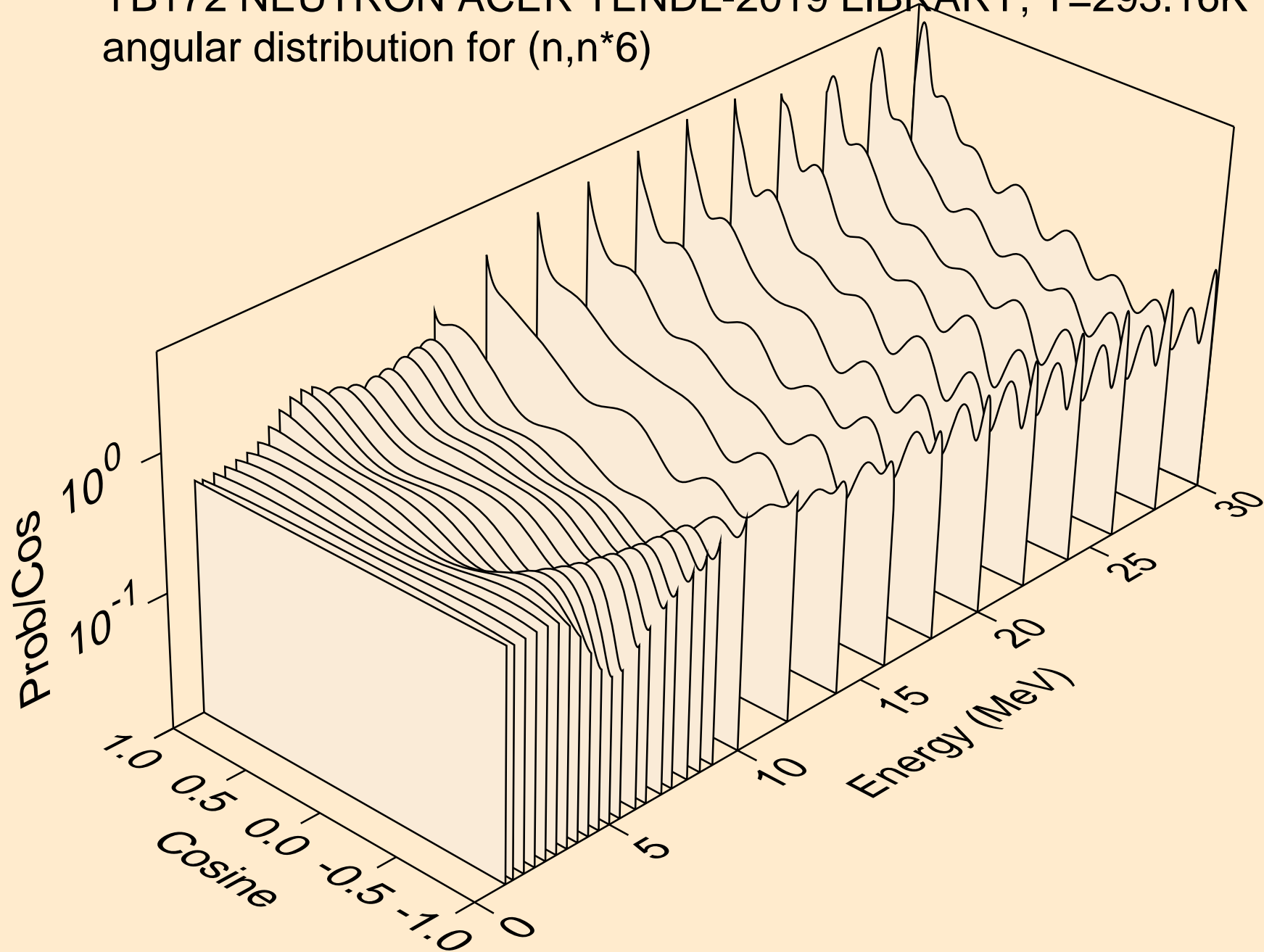

YB172 NEUTRON ACER TENDL-2019 LIBRARY; T=293.16K  
angular distribution for (n,n\*7)

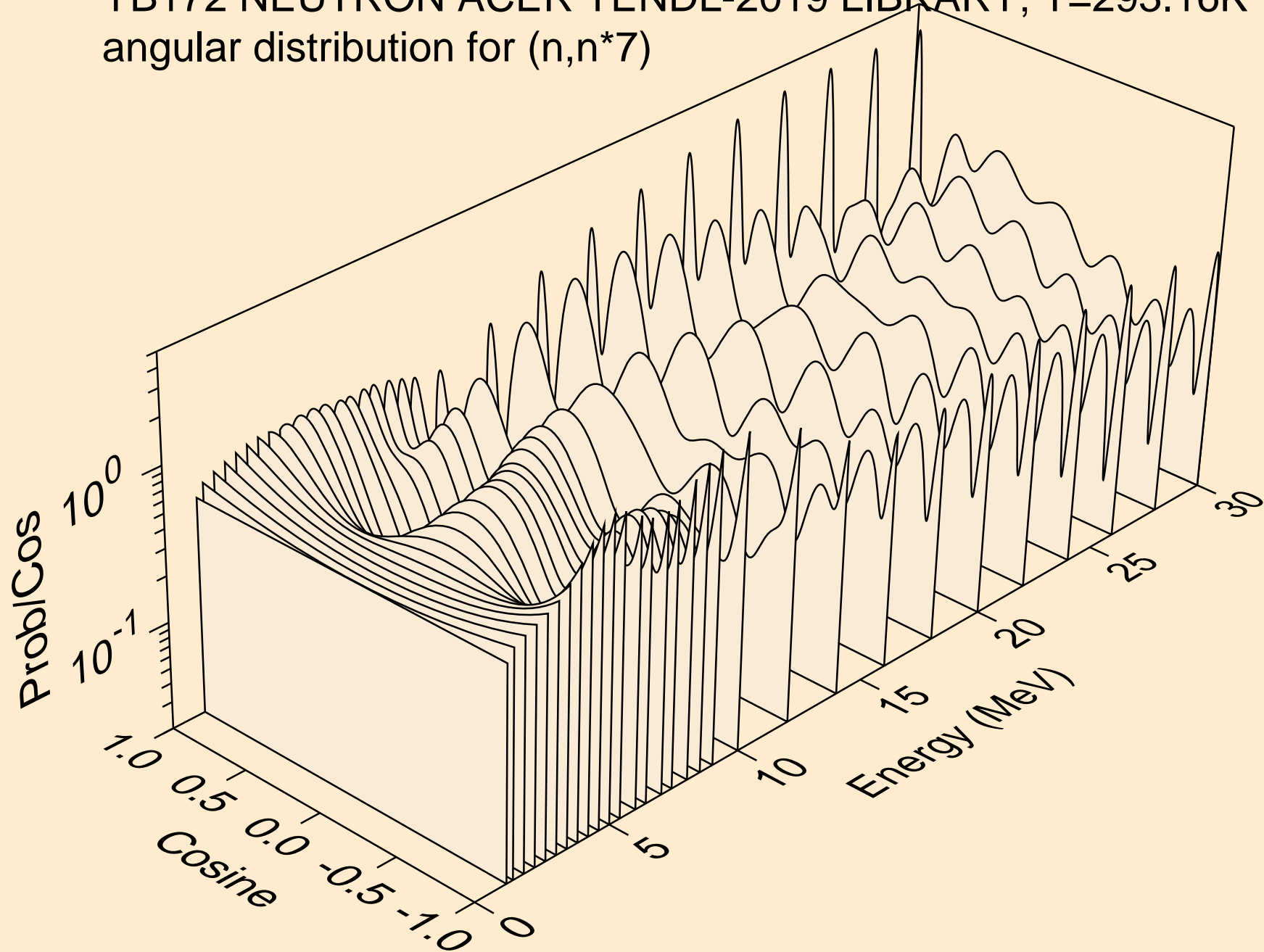

YB172 NEUTRON ACER TENDL-2019 LIBRARY; T=293.16K  
angular distribution for (n,n\*8)

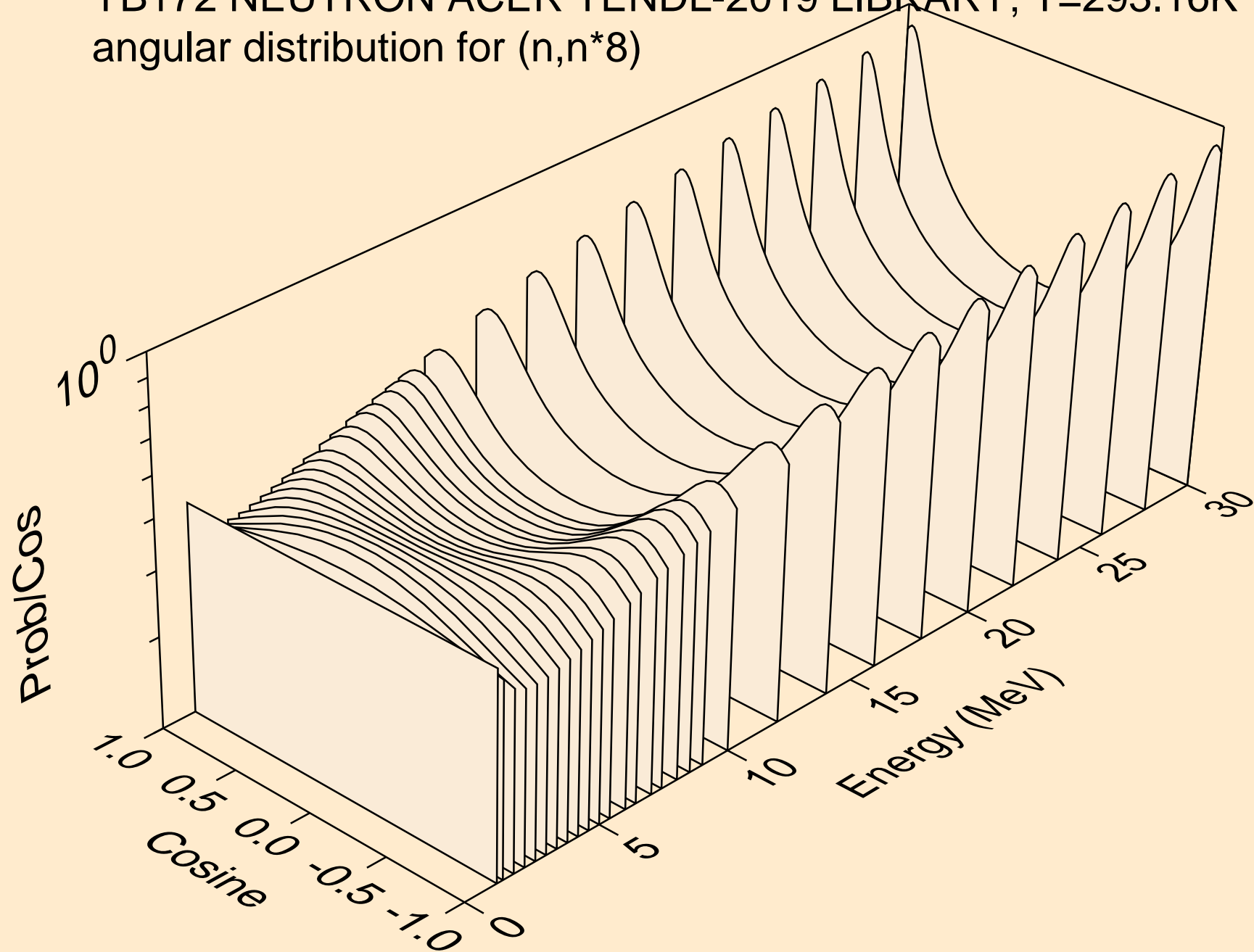

YB172 NEUTRON ACER TENDL-2019 LIBRARY; T=293.16K  
angular distribution for (n,n\*9)

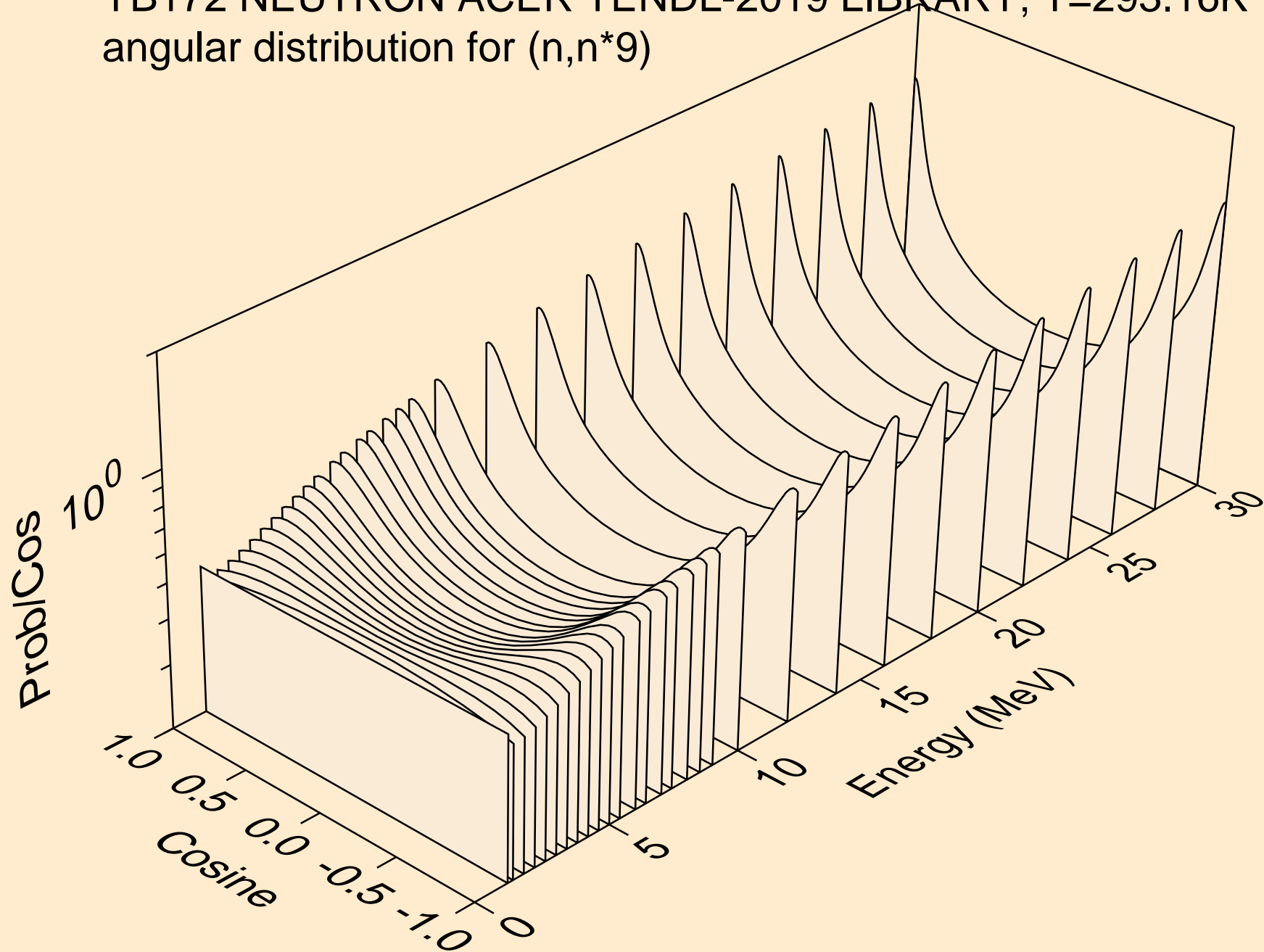



YB172 NEUTRON ACER TENDL-2019 LIBRARY; T=293.16K  
angular distribution for (n,n\*10)

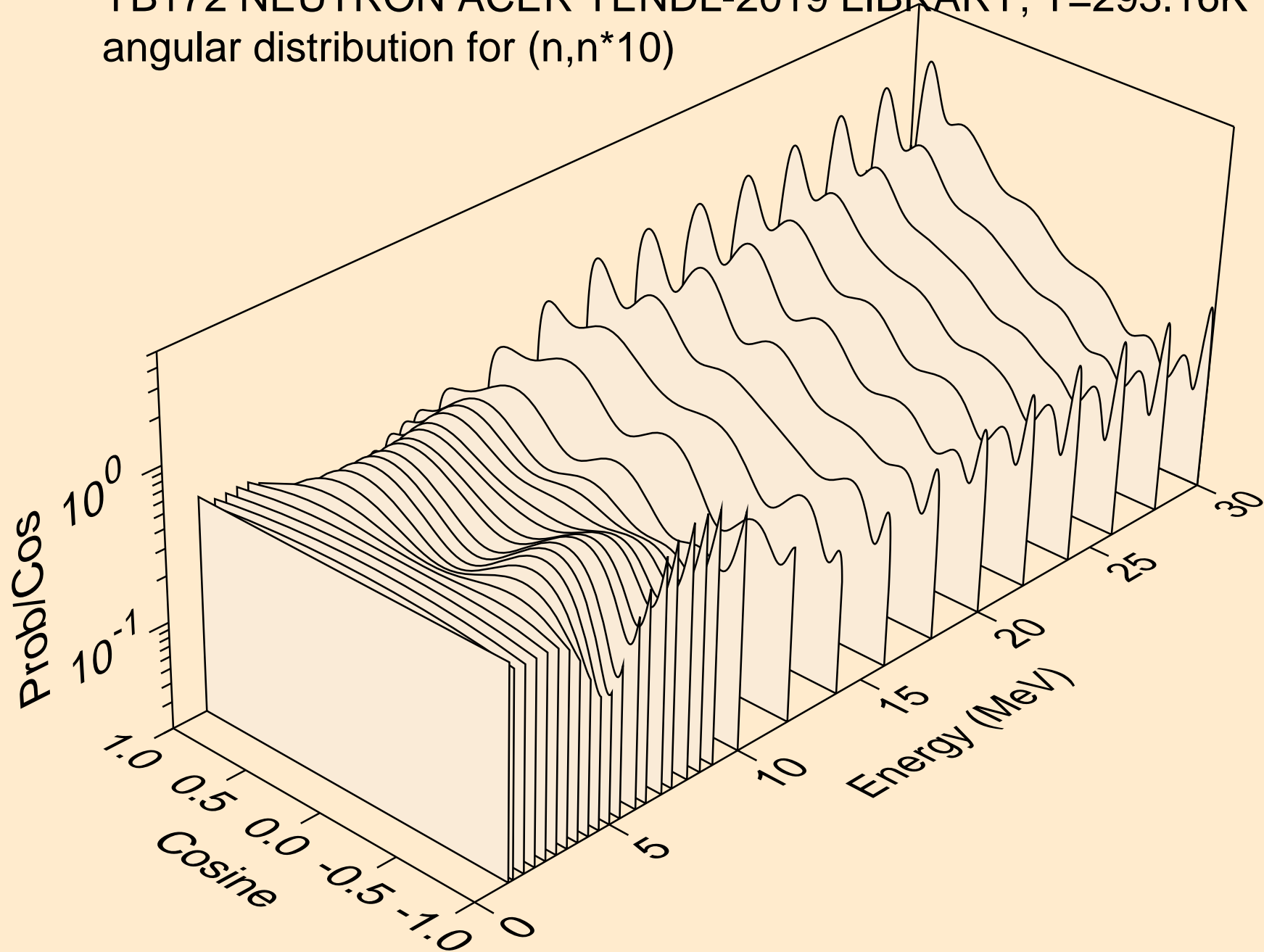

YB172 NEUTRON ACER TENDL-2019 LIBRARY; T=293.16K  
angular distribution for (n,n\*11)

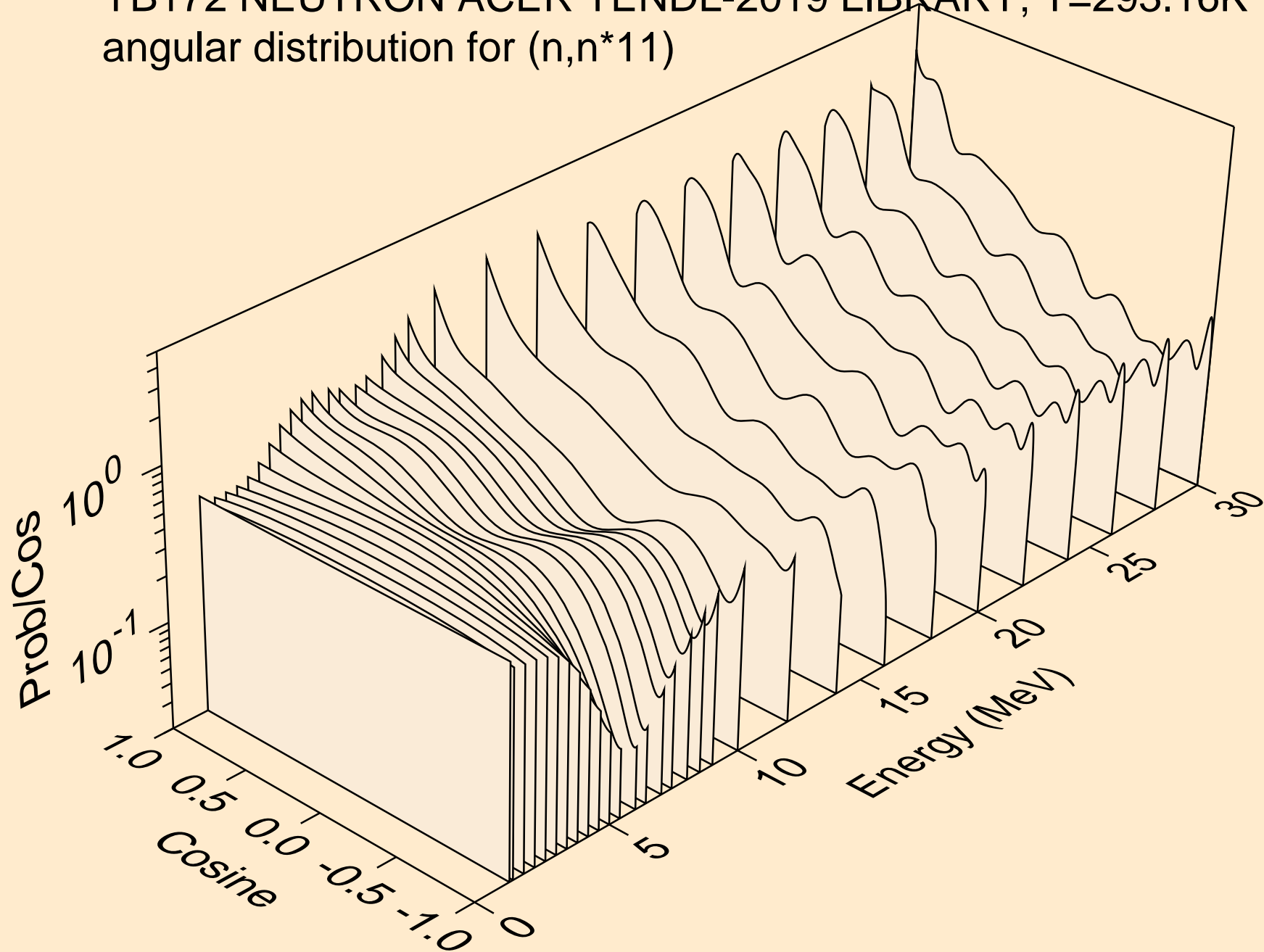

YB172 NEUTRON ACER TENDL-2019 LIBRARY; T=293.16K  
angular distribution for (n,n\*12)

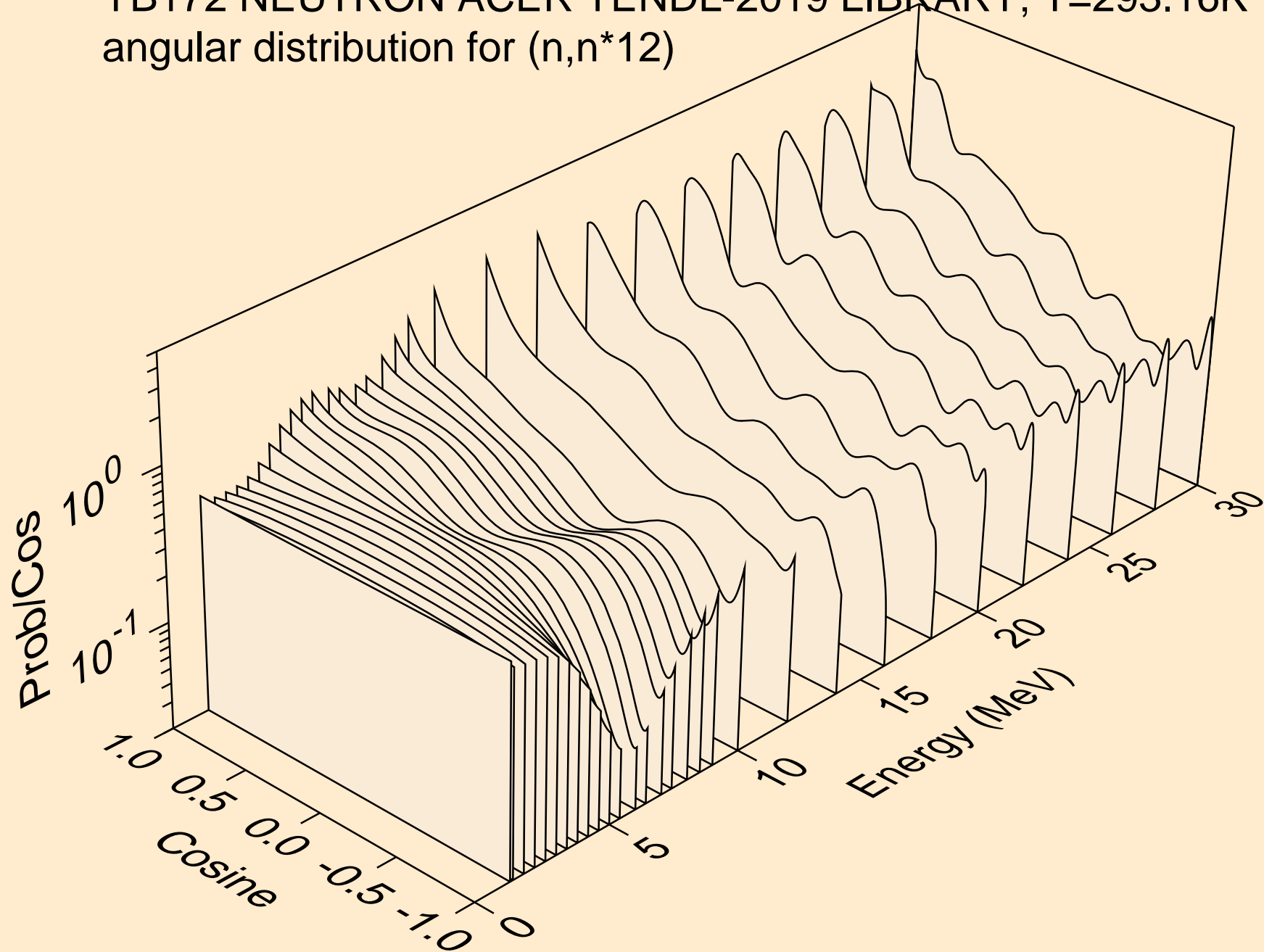

YB172 NEUTRON ACER TENDL-2019 LIBRARY; T=293.16K  
angular distribution for (n,n\*13)

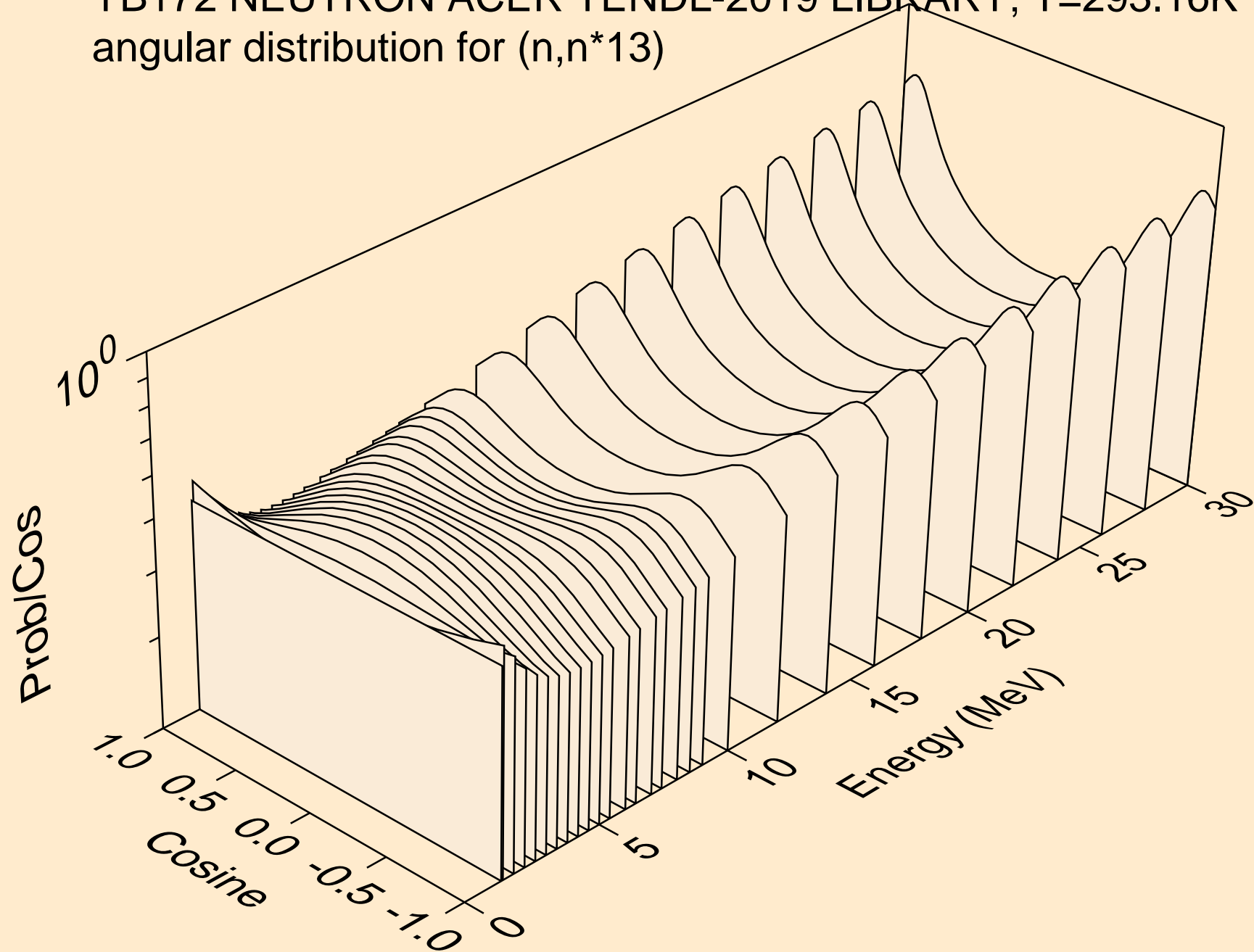

YB172 NEUTRON ACER TENDL-2019 LIBRARY; T=293.16K  
angular distribution for (n,n\*14)

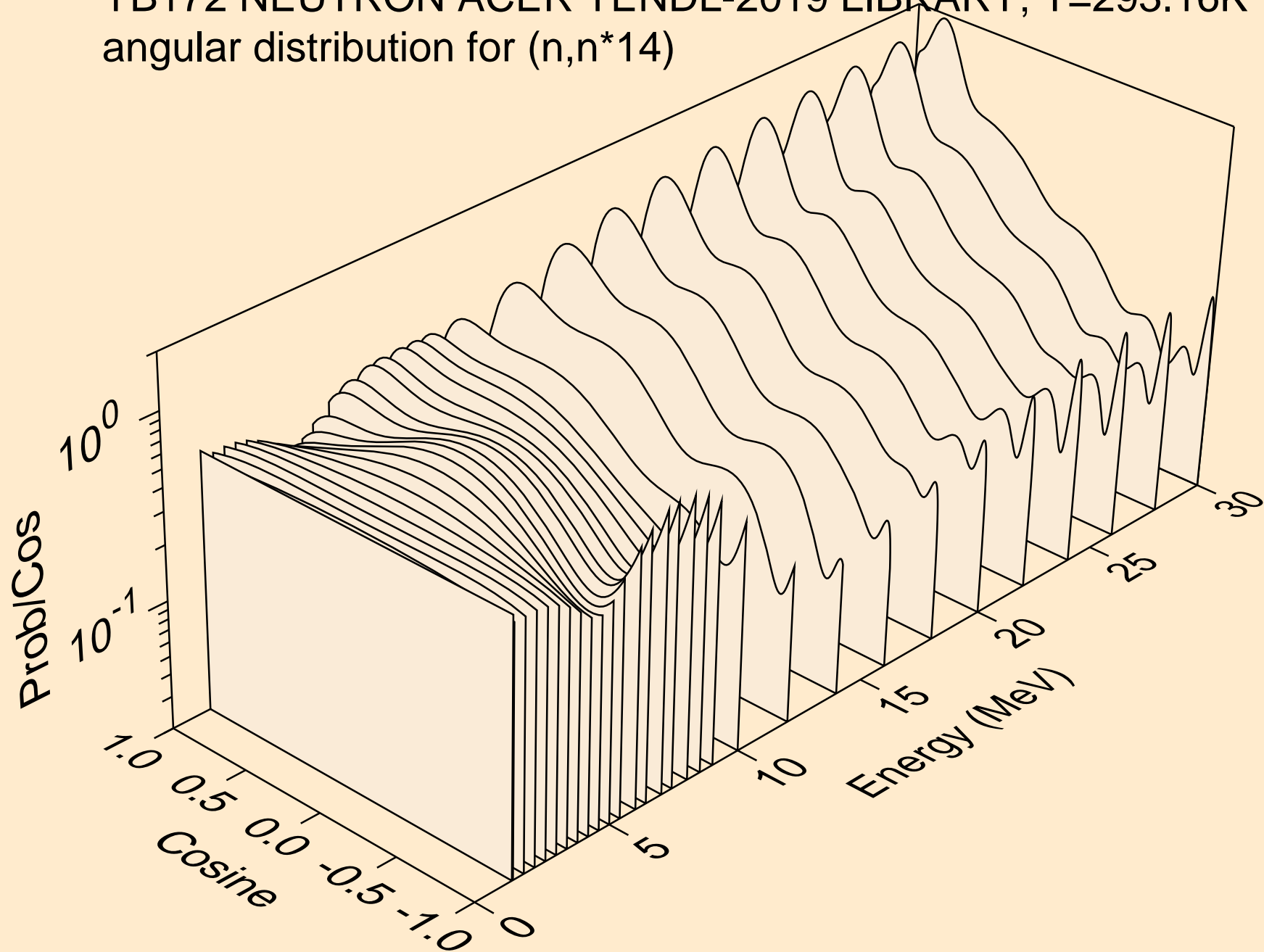

YB172 NEUTRON ACER TENDL-2019 LIBRARY; T=293.16K  
angular distribution for (n,n\*15)

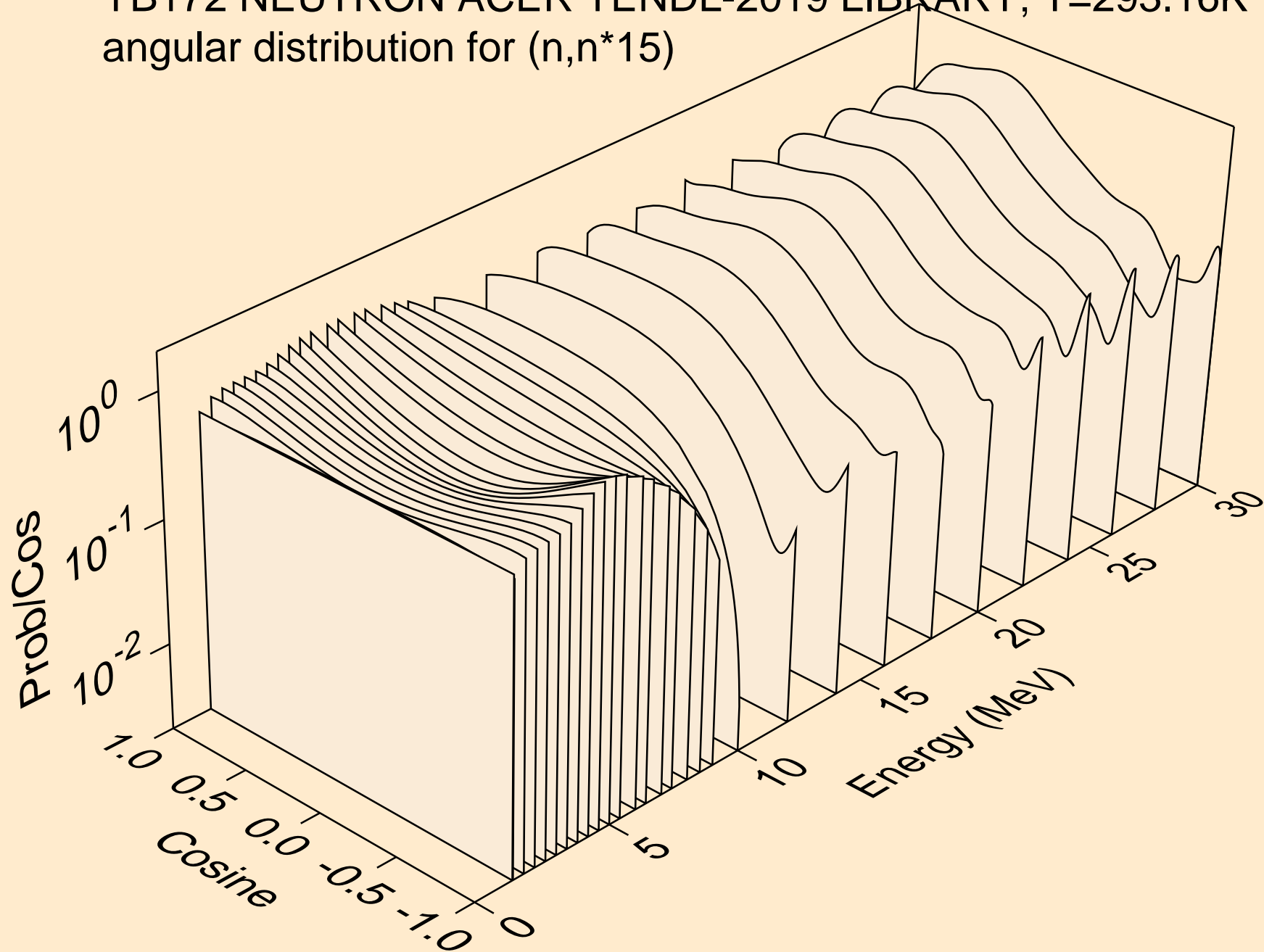

YB172 NEUTRON ACER TENDL-2019 LIBRARY; T=293.16K  
angular distribution for (n,n\*16)

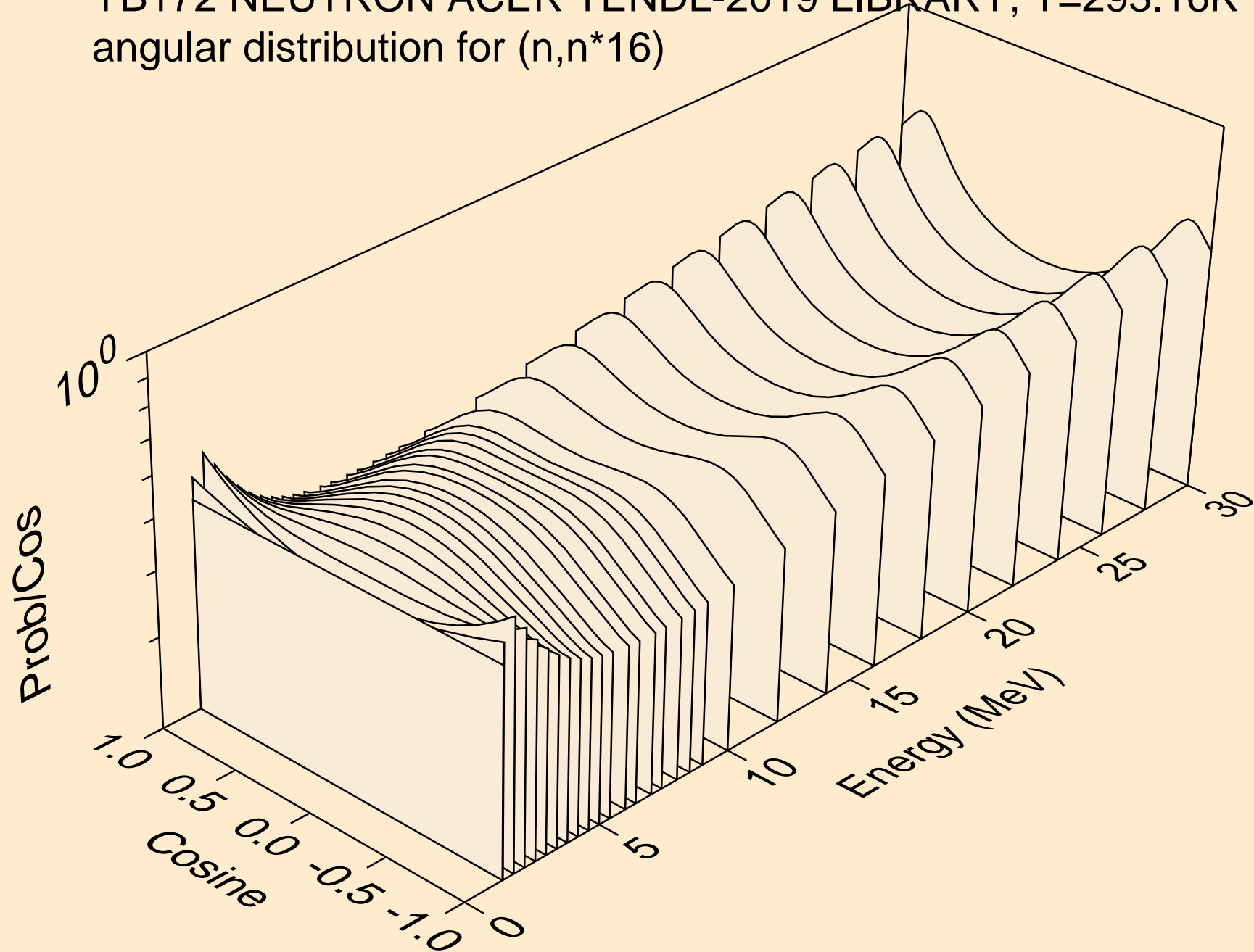

YB172 NEUTRON ACER TENDL-2019 LIBRARY; T=293.16K  
angular distribution for (n,n\*17)

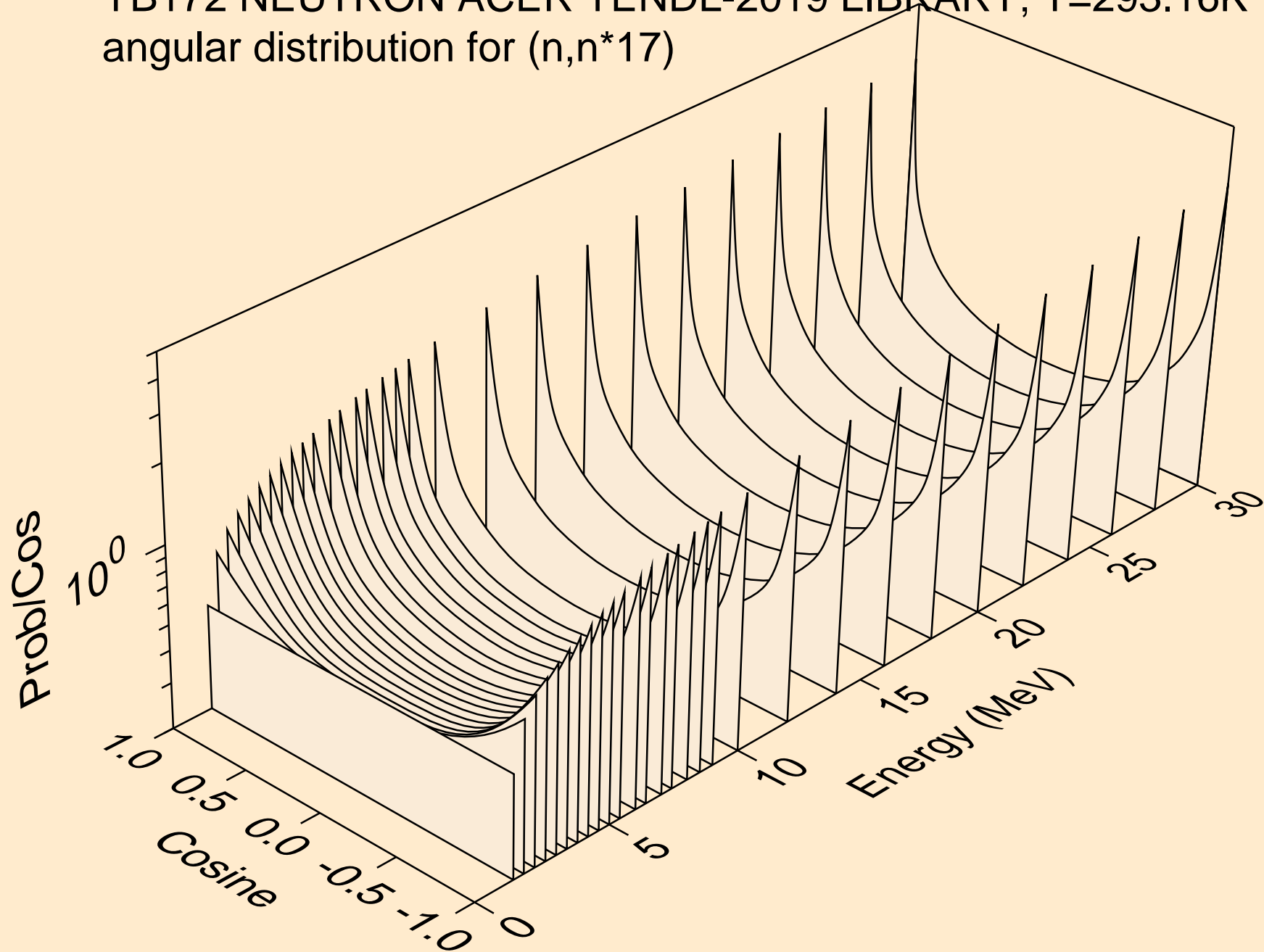



YB172 NEUTRON ACER TENDL-2019 LIBRARY; T=293.16K  
angular distribution for (n,n\*18)

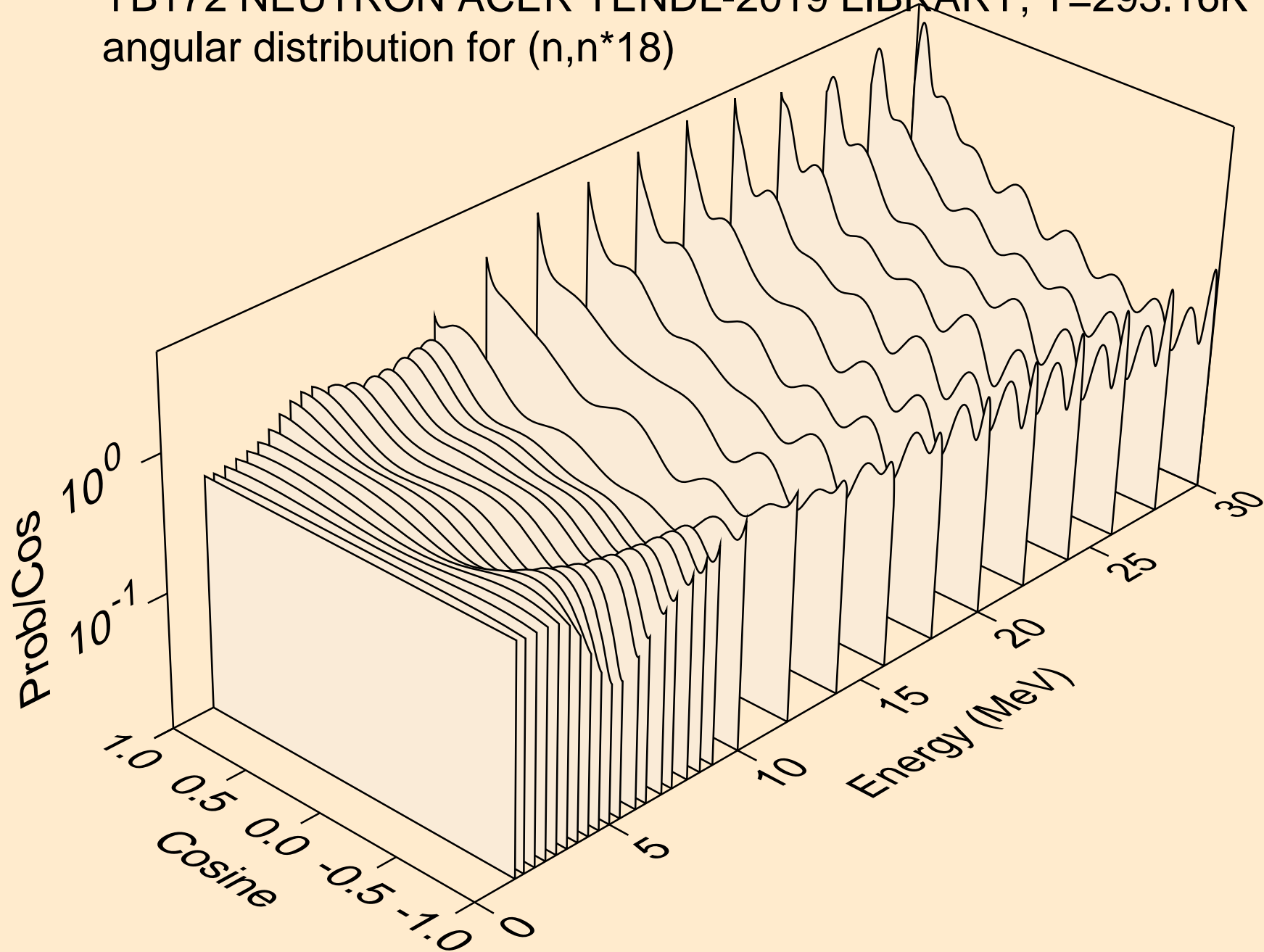

YB172 NEUTRON ACER TENDL-2019 LIBRARY; T=293.16K  
angular distribution for (n,n\*19)

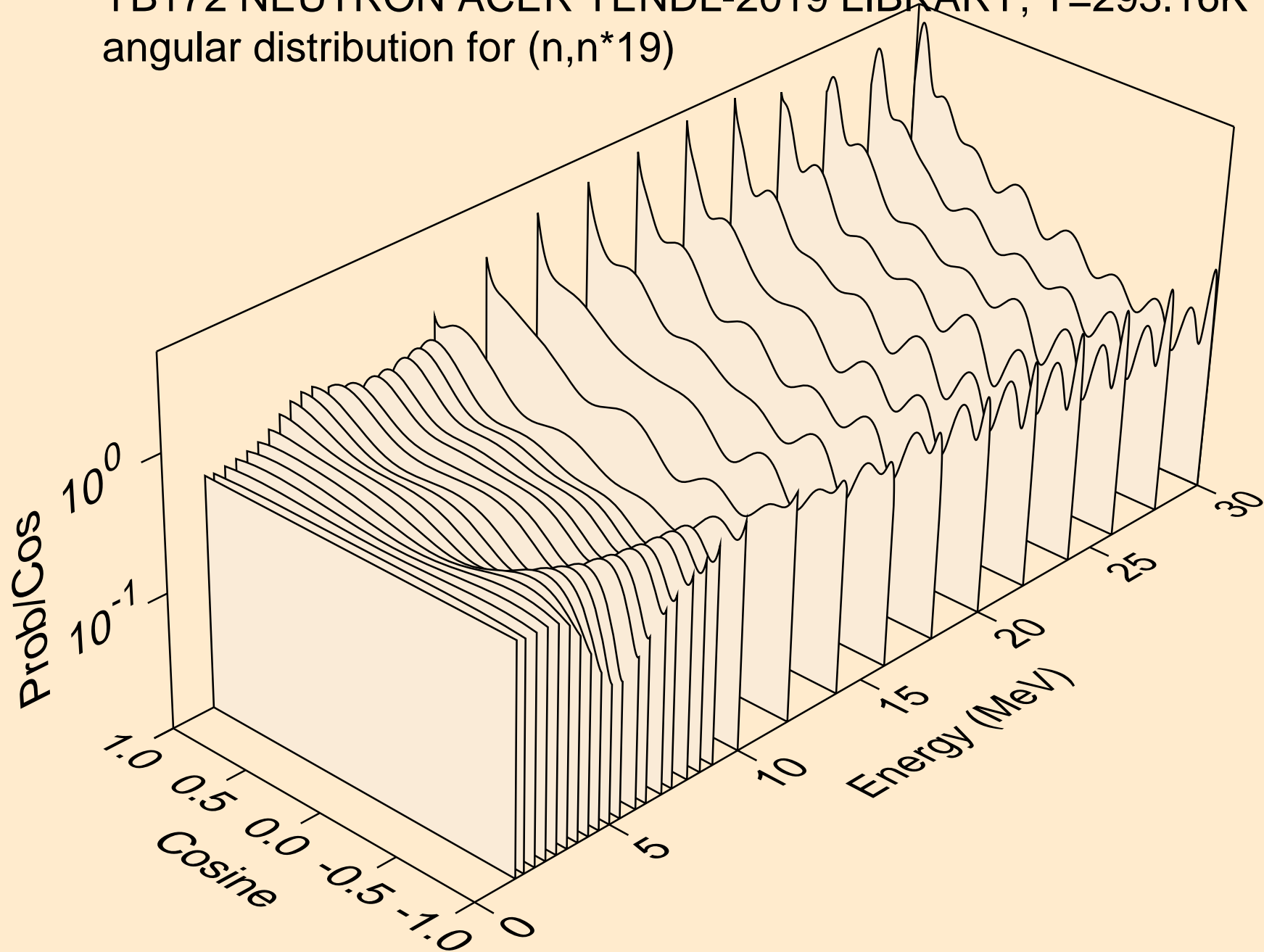

YB172 NEUTRON ACER TENDL-2019 LIBRARY; T=293.16K  
angular distribution for (n,n\*20)

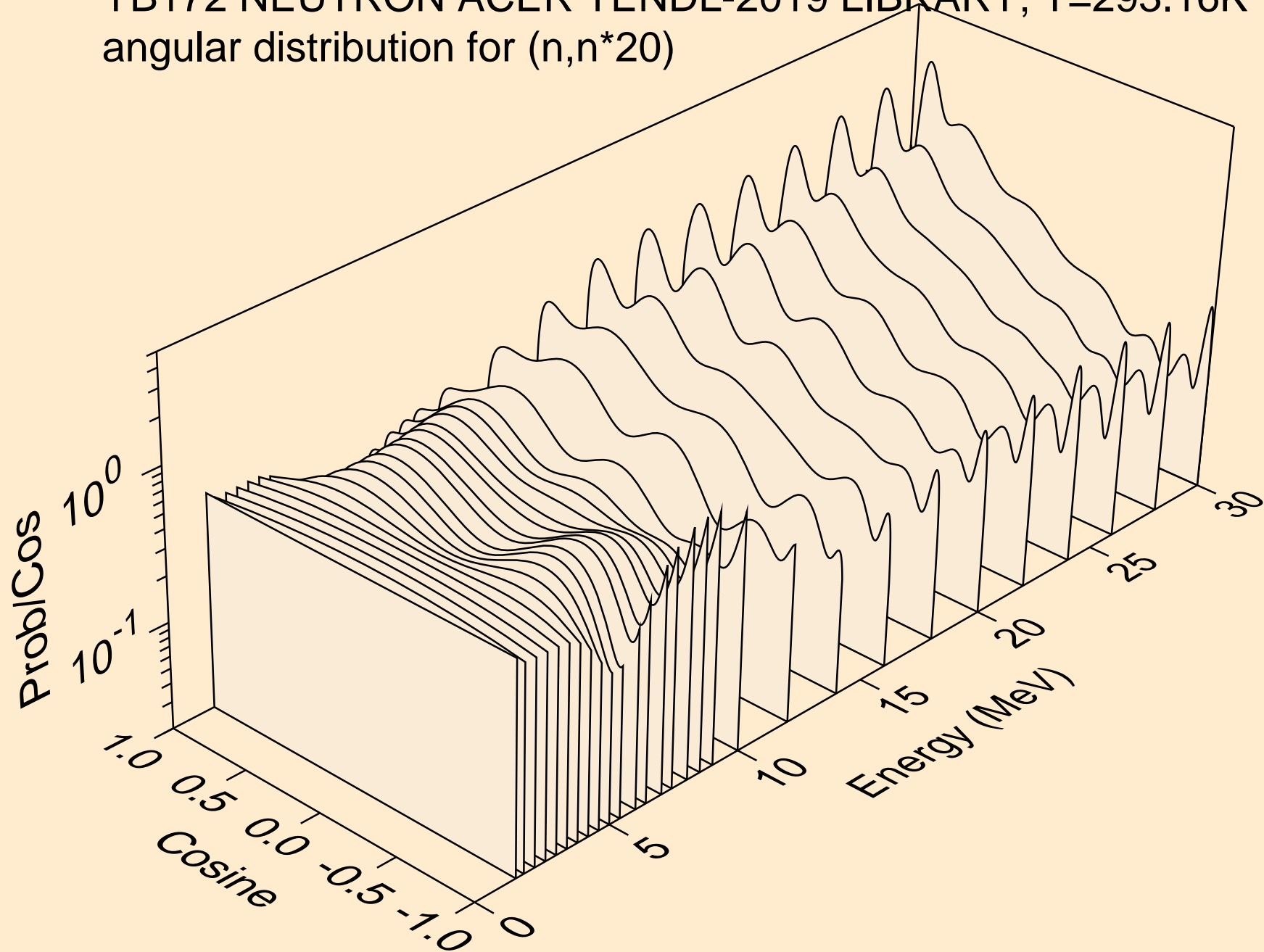

YB172 NEUTRON ACER TENDL-2019 LIBRARY; T=293.16K  
angular distribution for (n,n\*21)

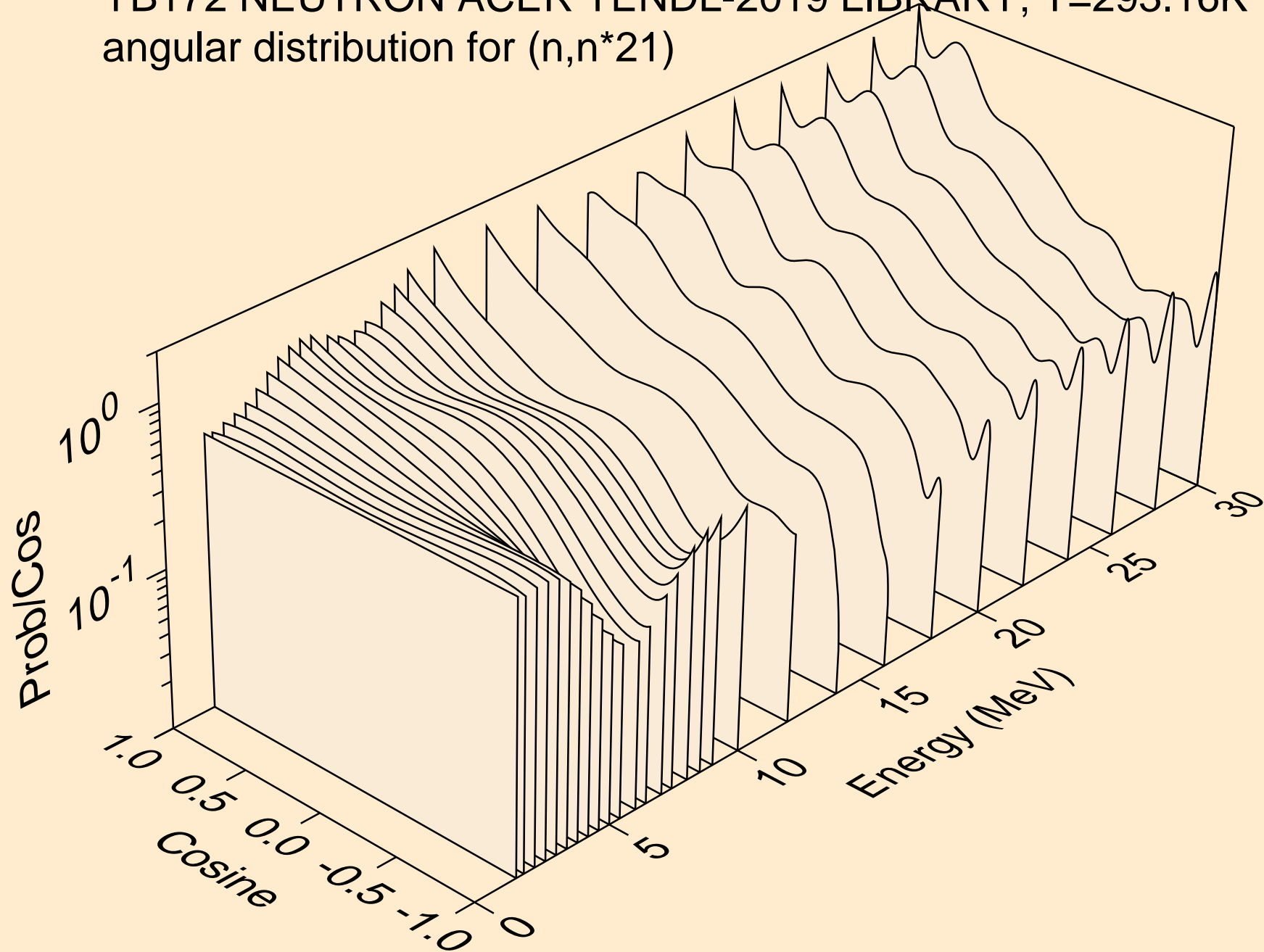

YB172 NEUTRON ACER TENDL-2019 LIBRARY; T=293.16K  
angular distribution for (n,n\*22)

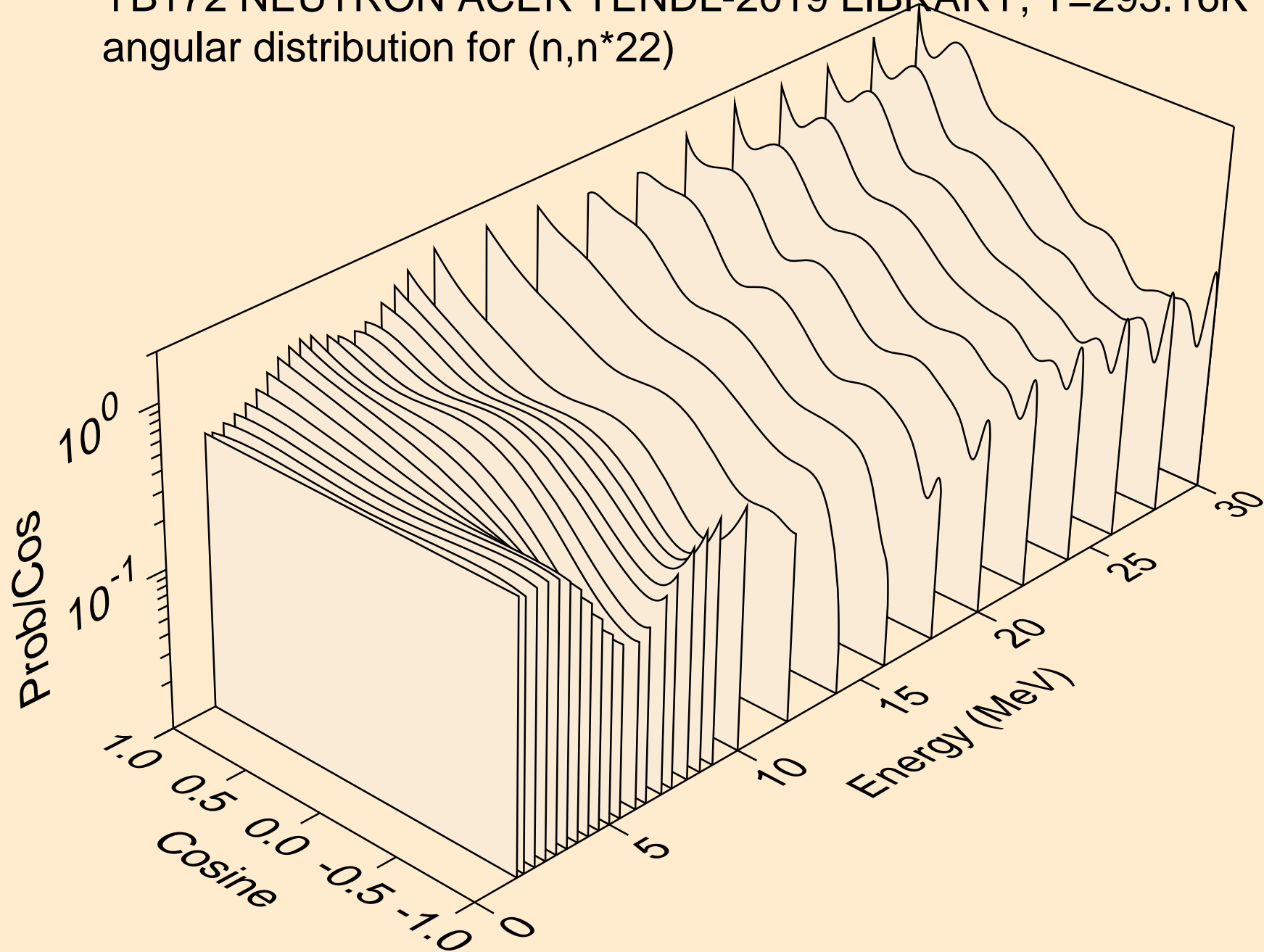

YB172 NEUTRON ACER TENDL-2019 LIBRARY; T=293.16K  
angular distribution for (n,n\*23)

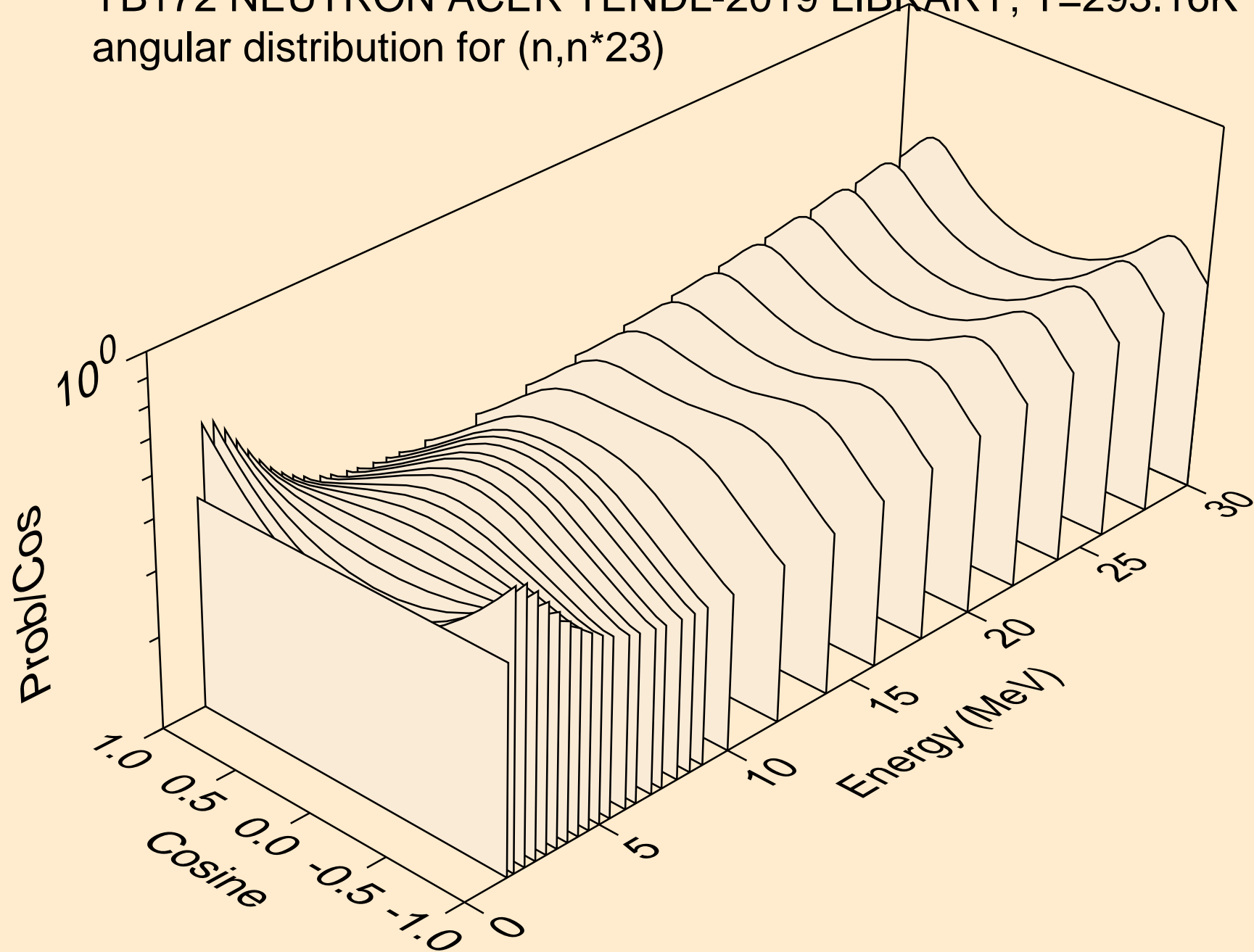

YB172 NEUTRON ACER TENDL-2019 LIBRARY; T=293.16K  
angular distribution for (n,n\*24)

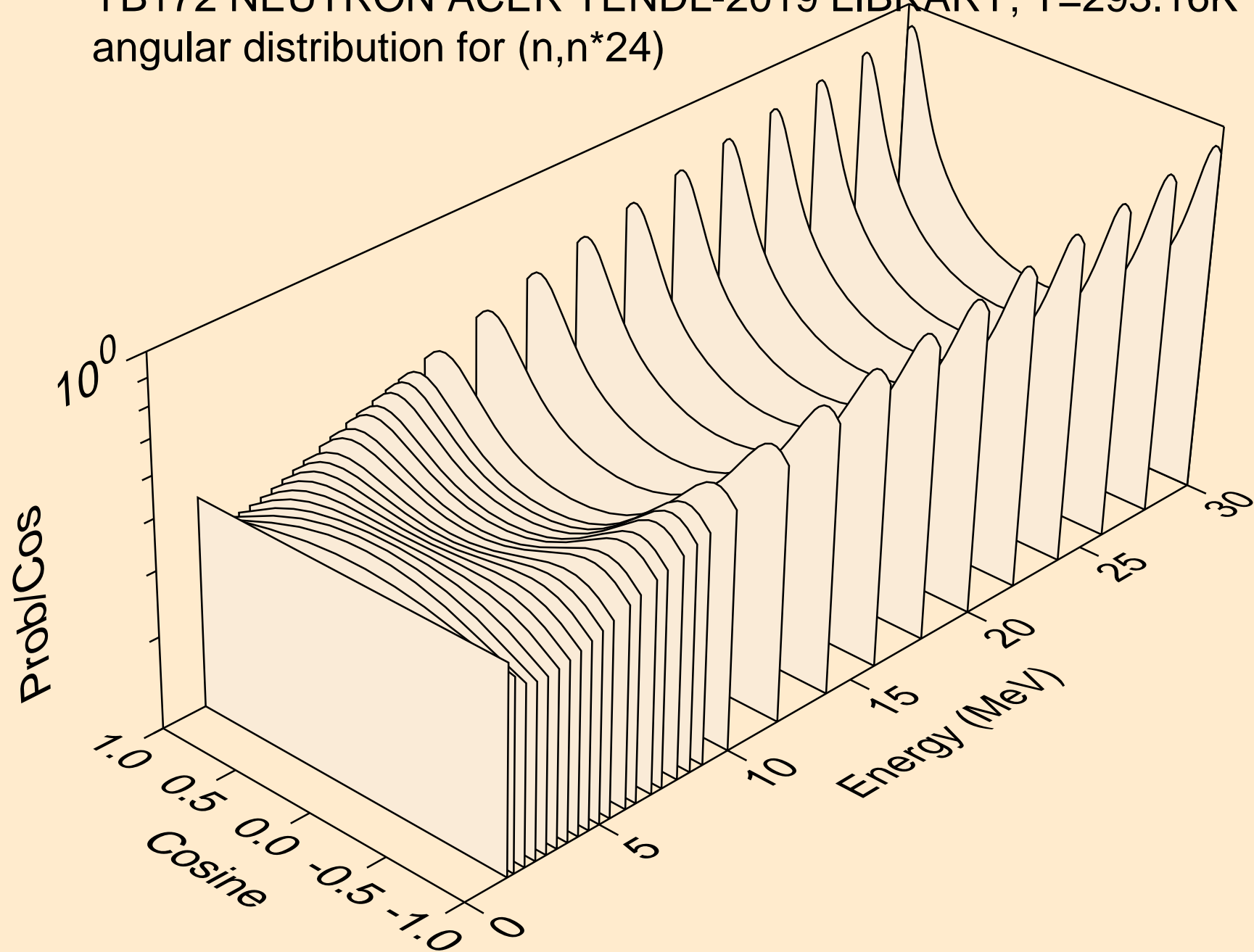

YB172 NEUTRON ACER TENDL-2019 LIBRARY; T=293.16K  
angular distribution for (n,n\*25)

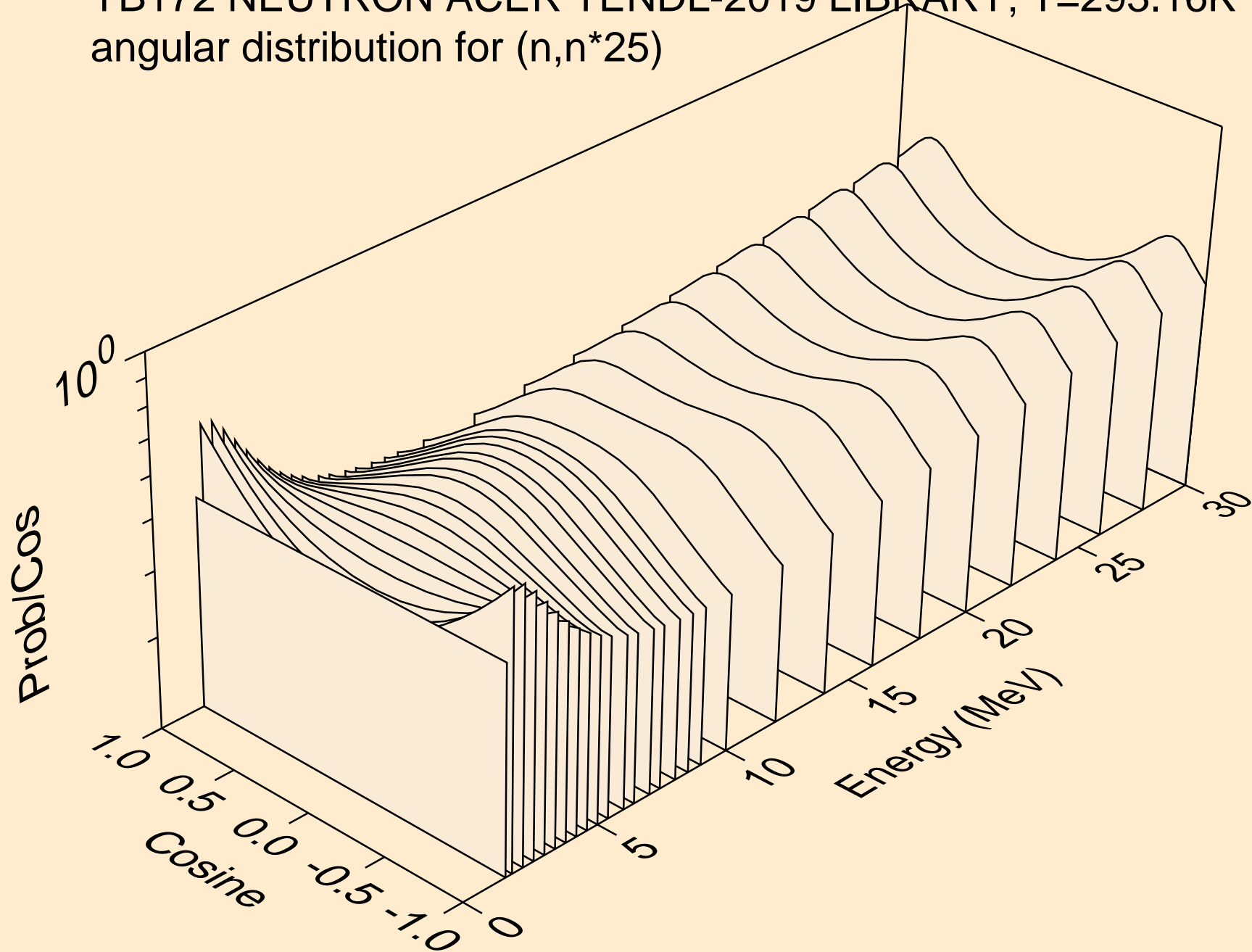



YB172 NEUTRON ACER TENDL-2019 LIBRARY; T=293.16K  
angular distribution for (n,n\*26)

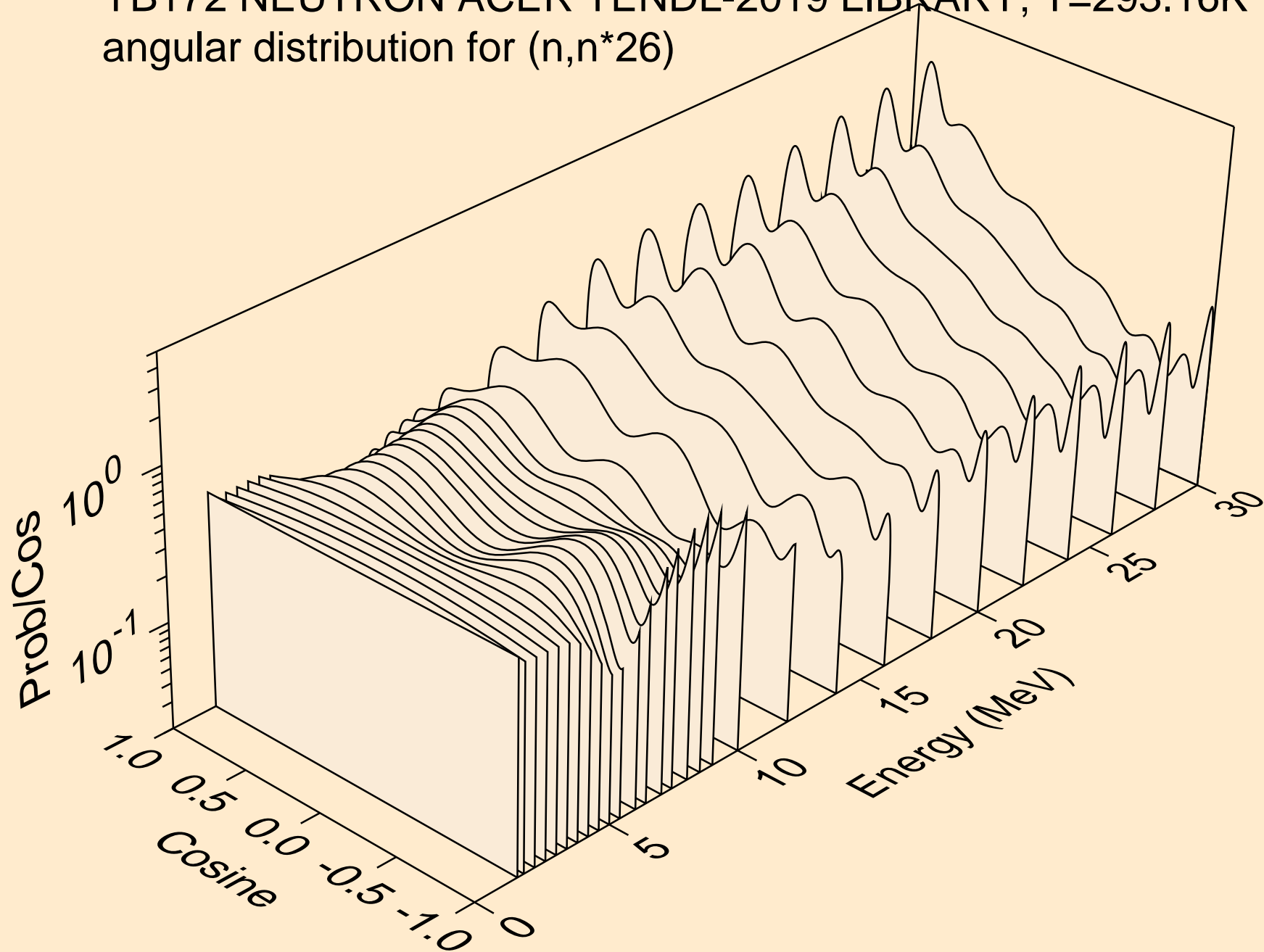

YB172 NEUTRON ACER TENDL-2019 LIBRARY; T=293.16K  
angular distribution for (n,n\*27)

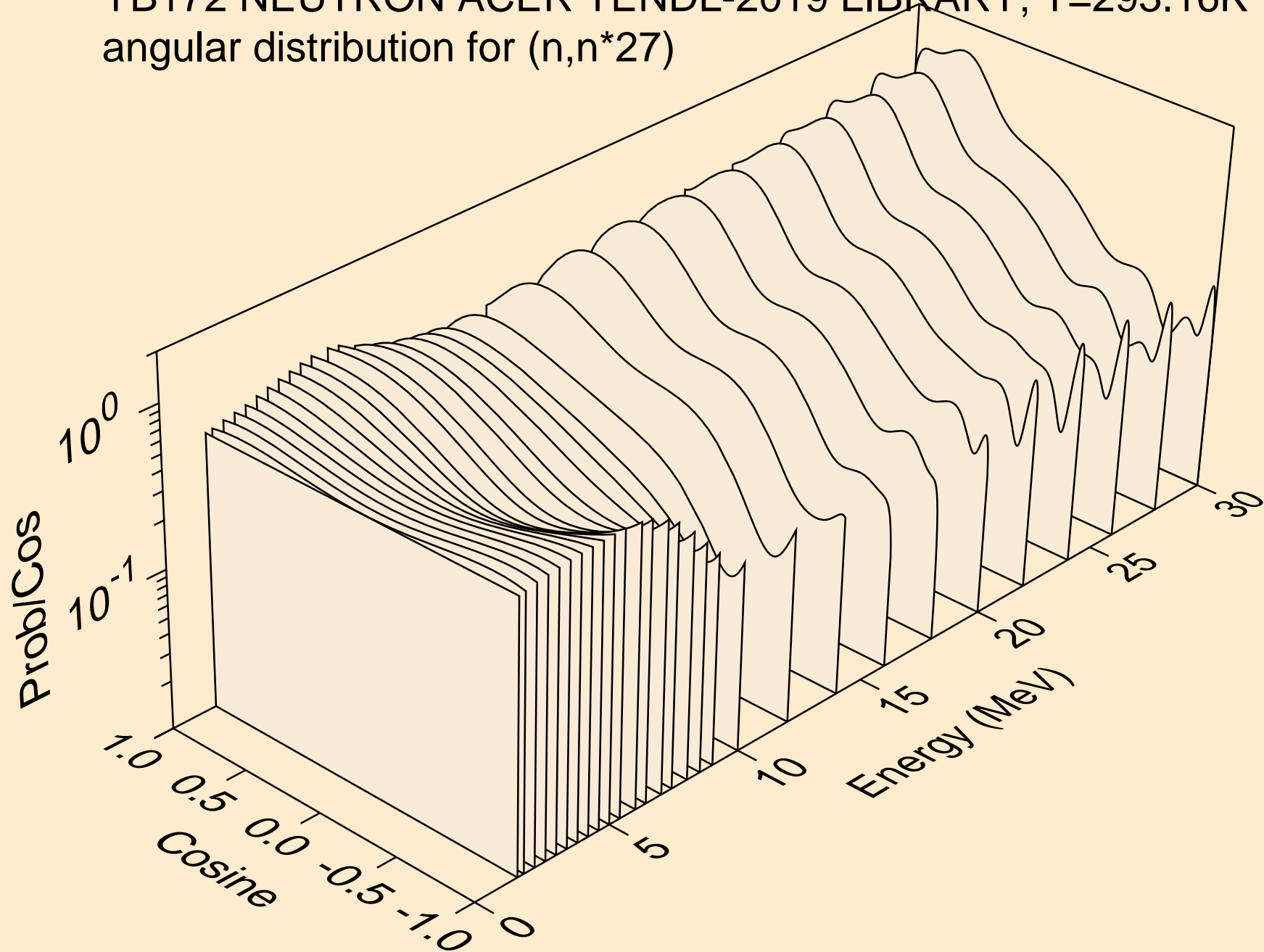

YB172 NEUTRON ACER TENDL-2019 LIBRARY; T=293.16K  
angular distribution for (n,n\*28)

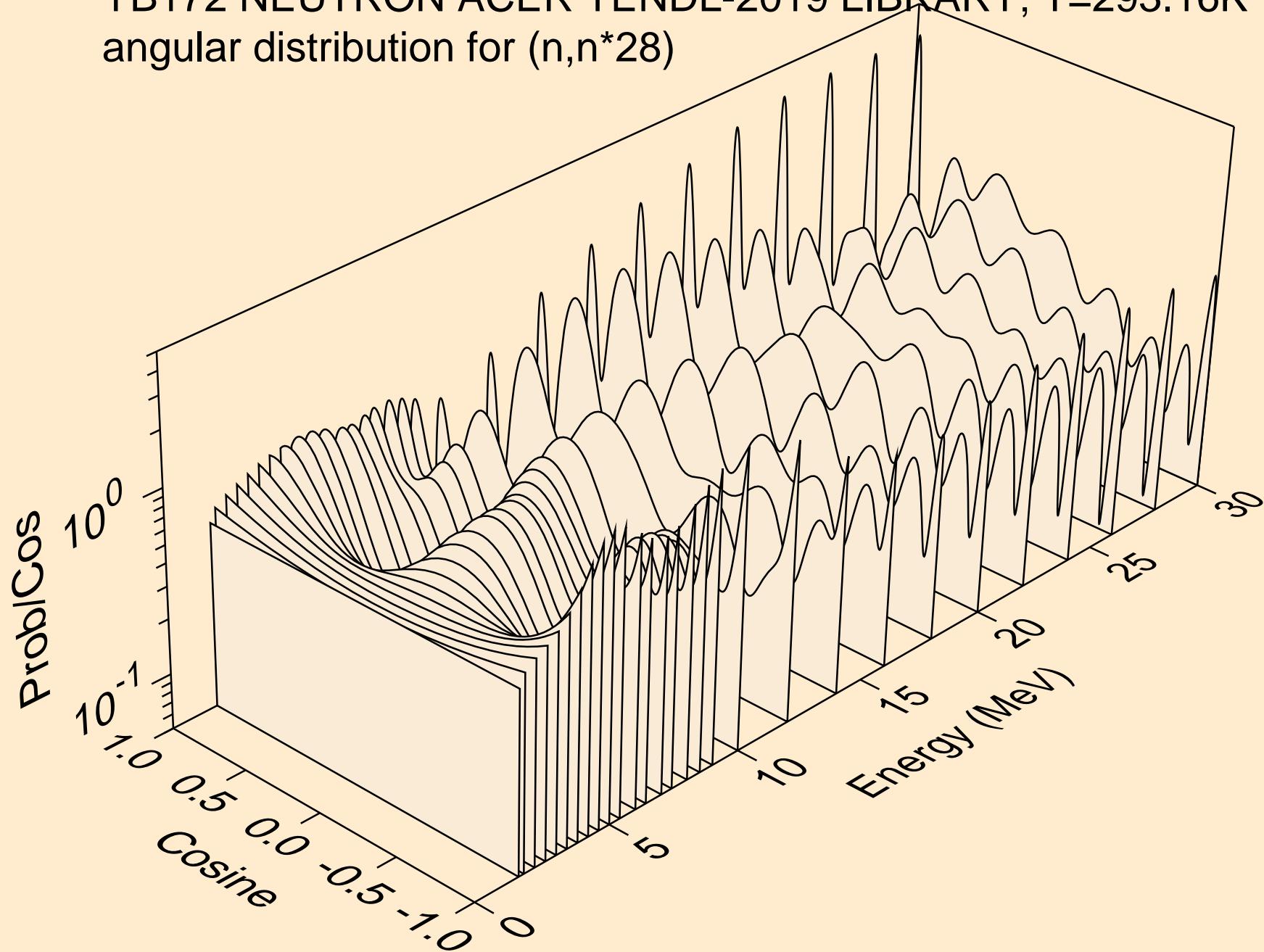

YB172 NEUTRON ACER TENDL-2019 LIBRARY; T=293.16K  
angular distribution for (n,n\*29)

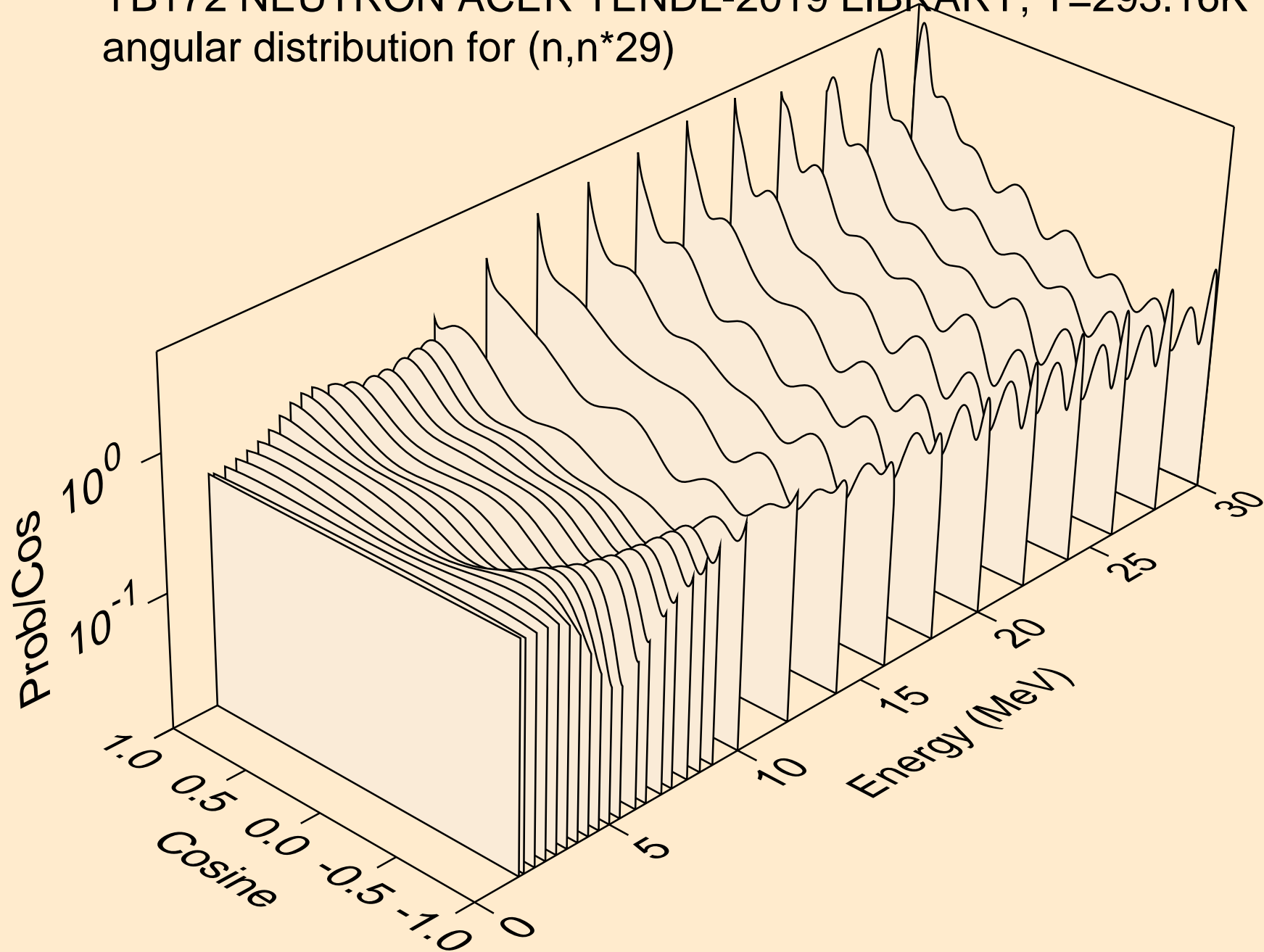

YB172 NEUTRON ACER TENDL-2019 LIBRARY; T=293.16K  
angular distribution for (n,n\*30)

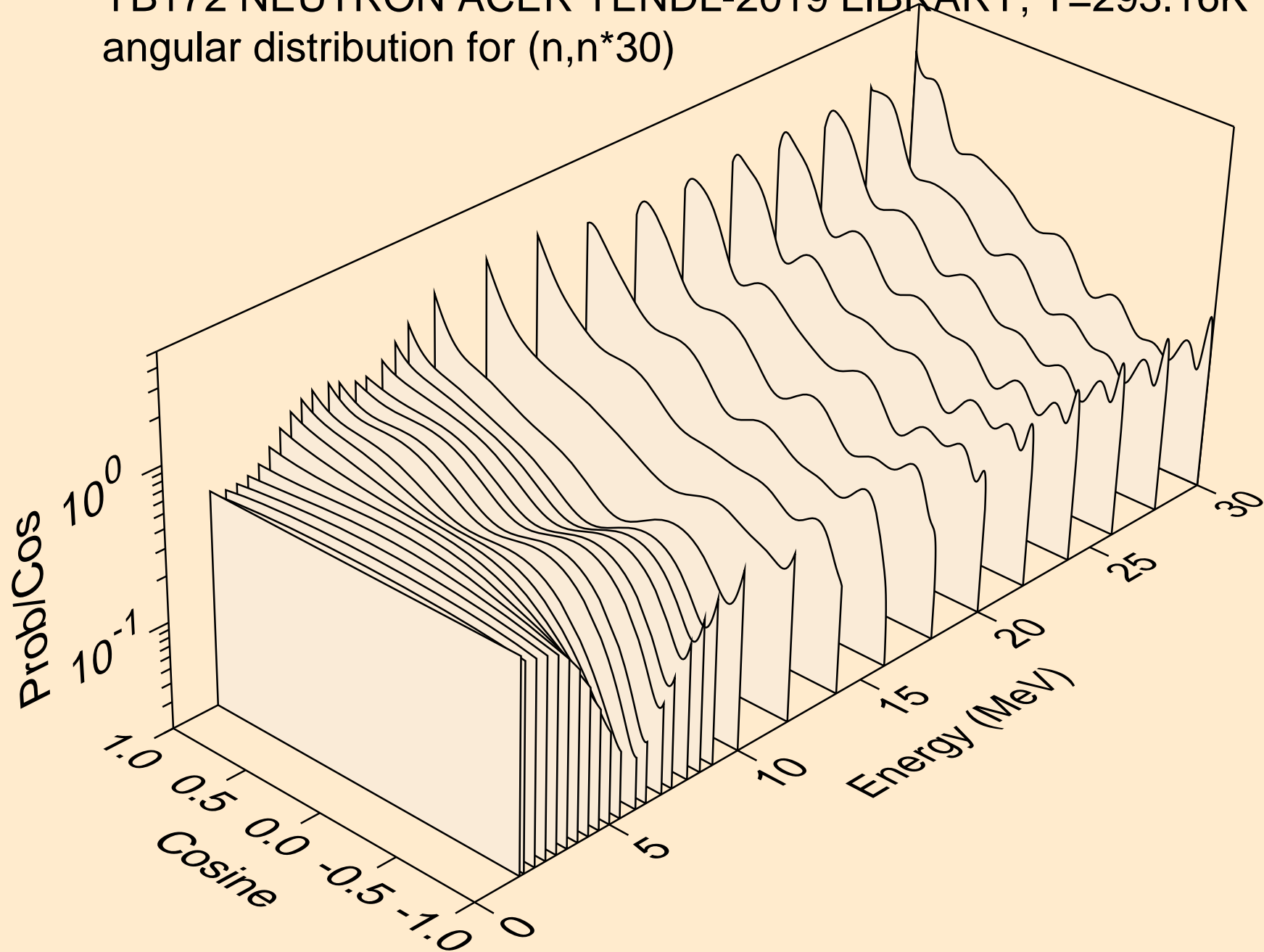

YB172 NEUTRON ACER TENDL-2019 LIBRARY; T=293.16K  
Neutron emission for (n,x)

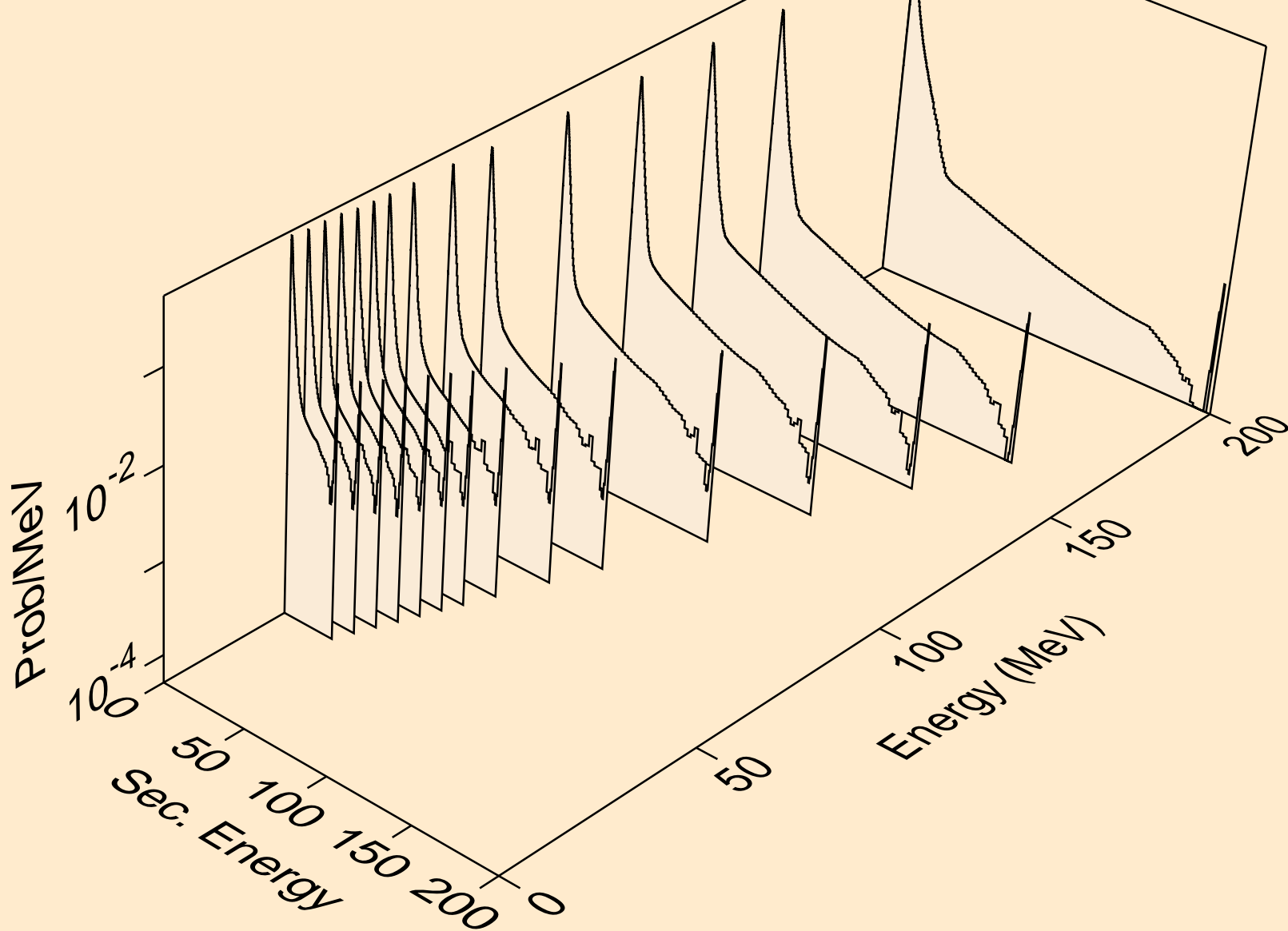

YB172 NEUTRON ACER TENDL-2019 LIBRARY; T=293.16K  
Neutron emission for (n,2nd)

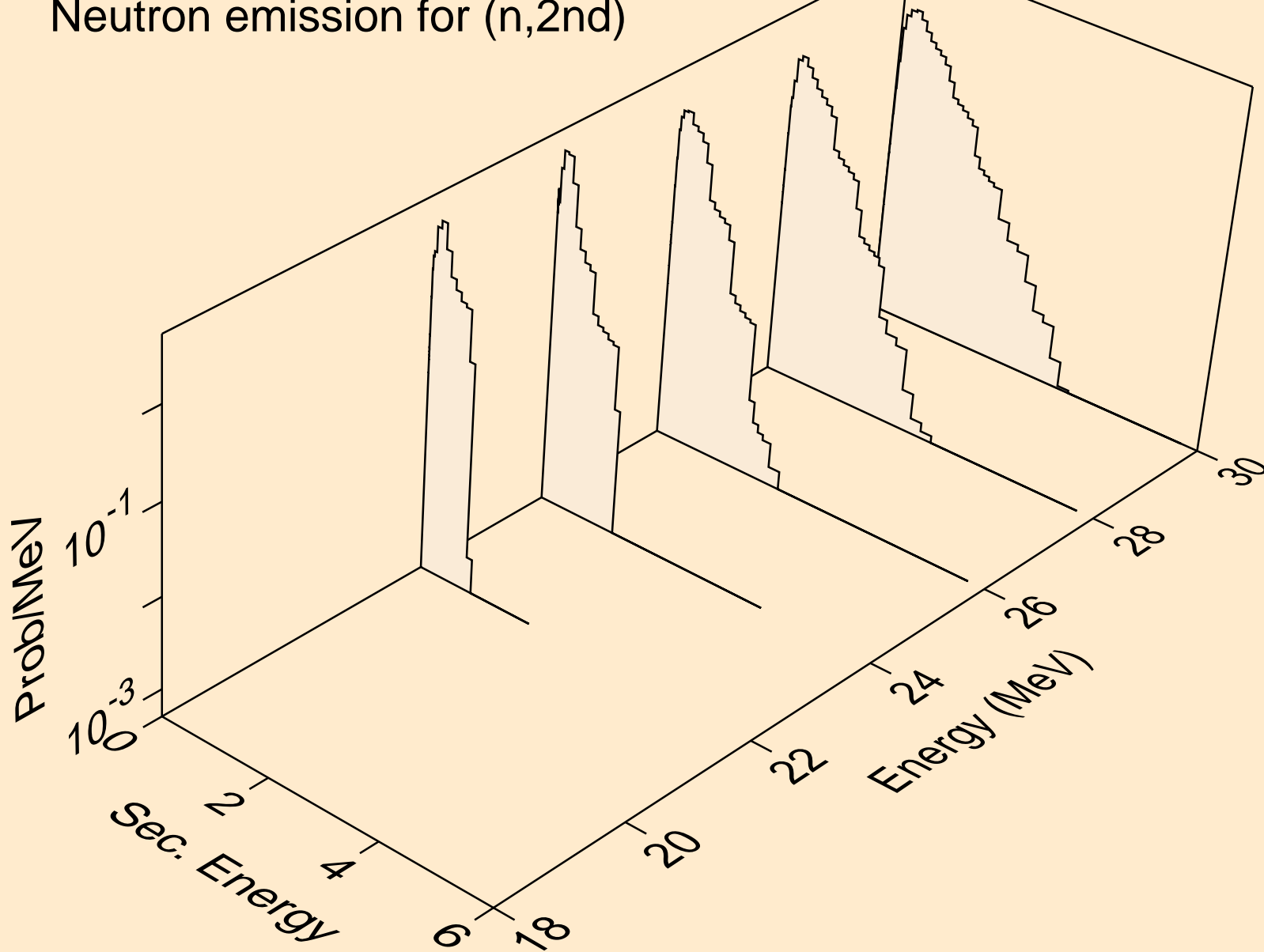

YB172 NEUTRON ACER TENDL-2019 LIBRARY; T=293.16K  
Neutron emission for (n,2n)

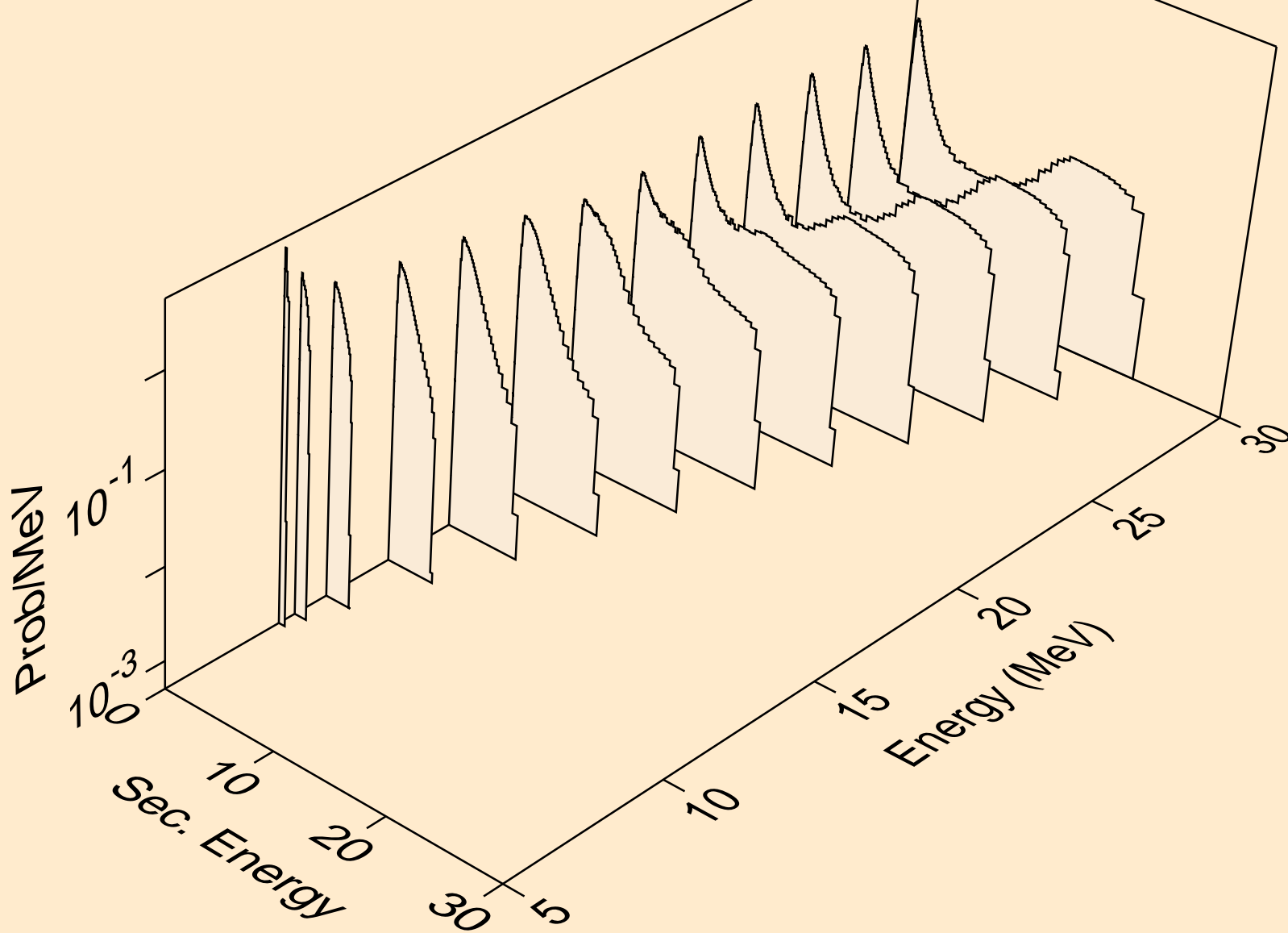



YB172 NEUTRON ACER TENDL-2019 LIBRARY; T=293.16K  
Neutron emission for (n,3n)

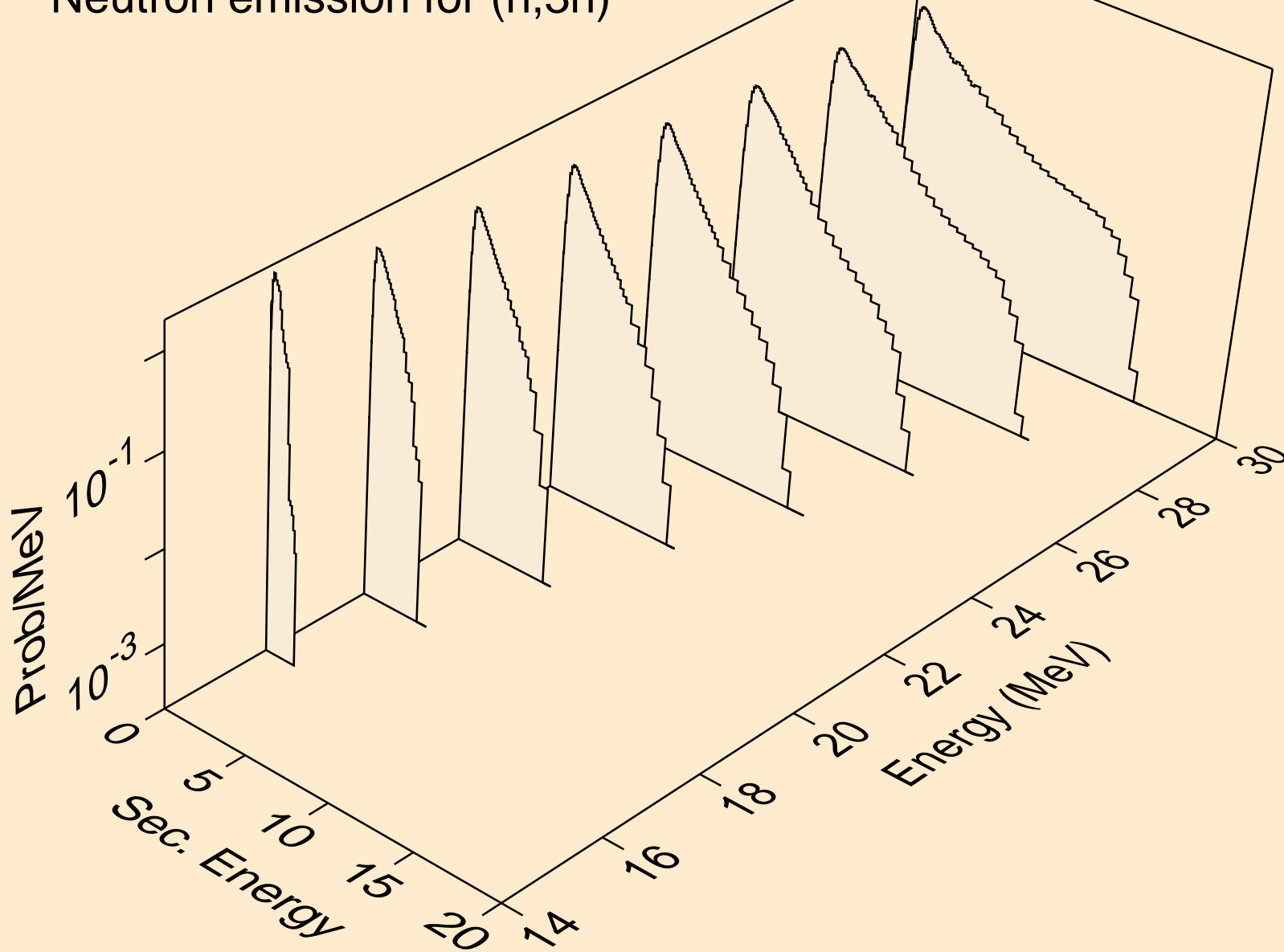

YB172 NEUTRON ACER TENDL-2019 LIBRARY; T=293.16K  
Neutron emission for (n,n\*)a

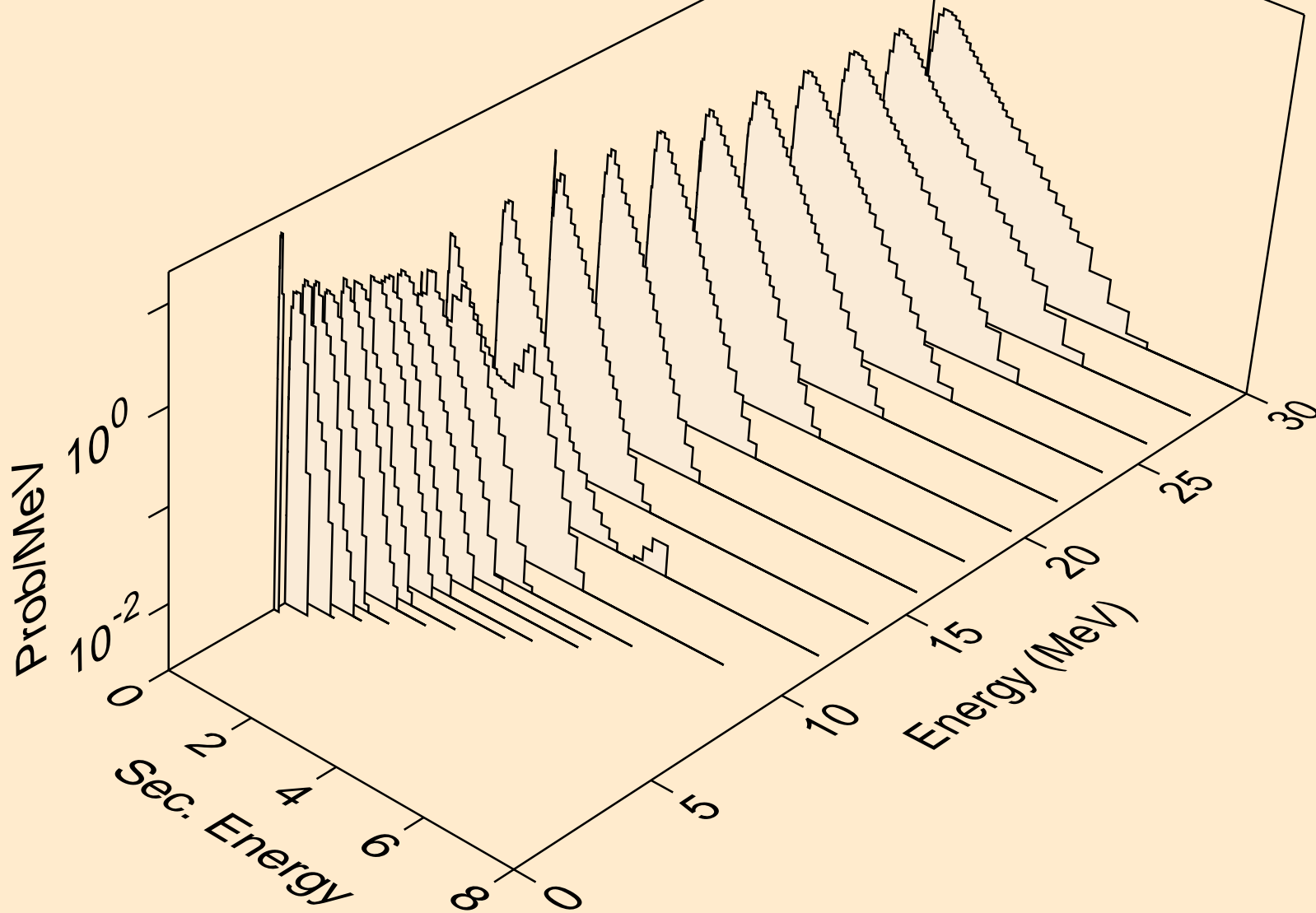

YB172 NEUTRON ACER TENDL-2019 LIBRARY; T=293.16K  
Neutron emission for (n,2n)a

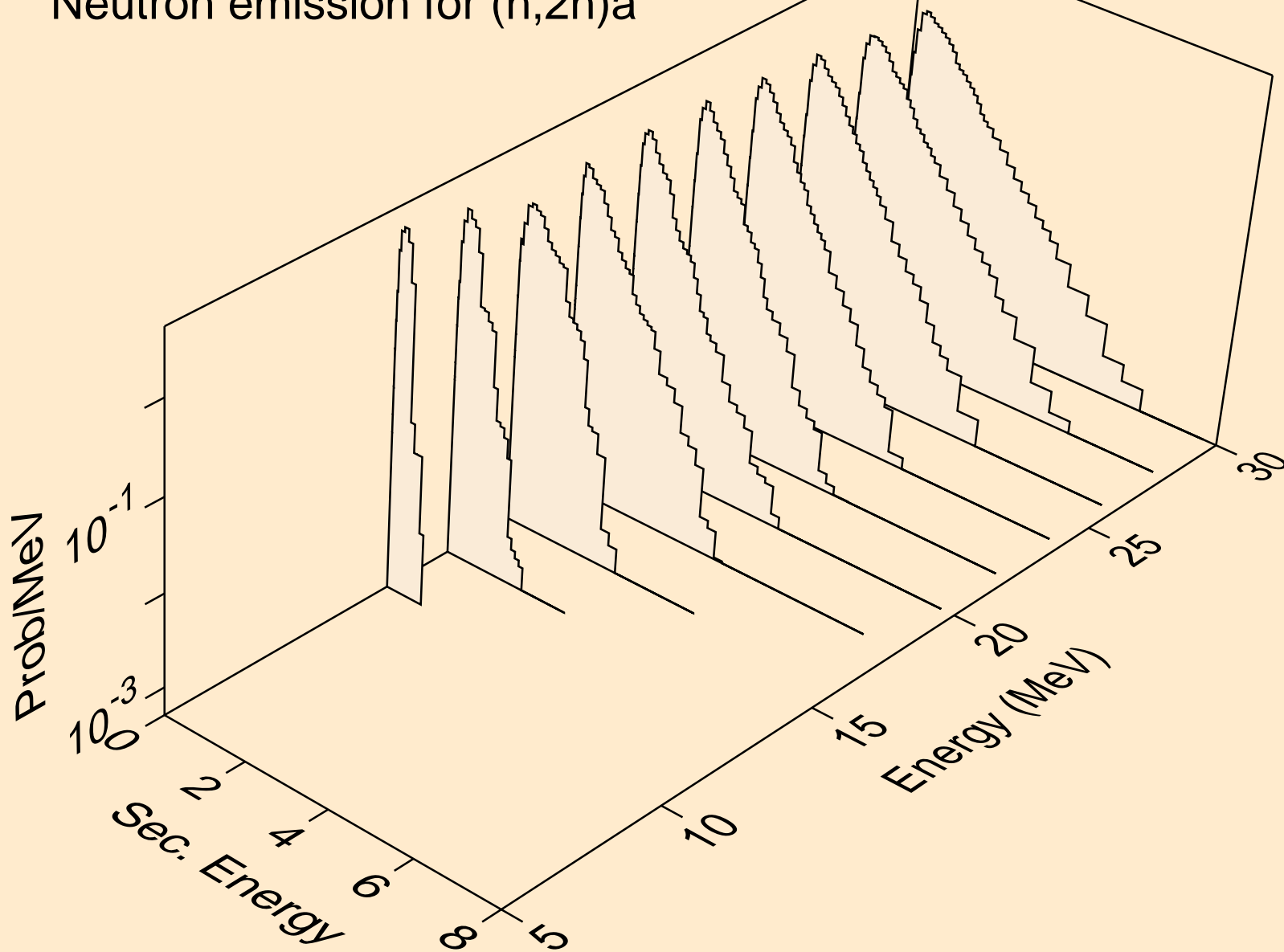

YB172 NEUTRON ACER TENDL-2019 LIBRARY; T=293.16K  
Neutron emission for (n,3n)a

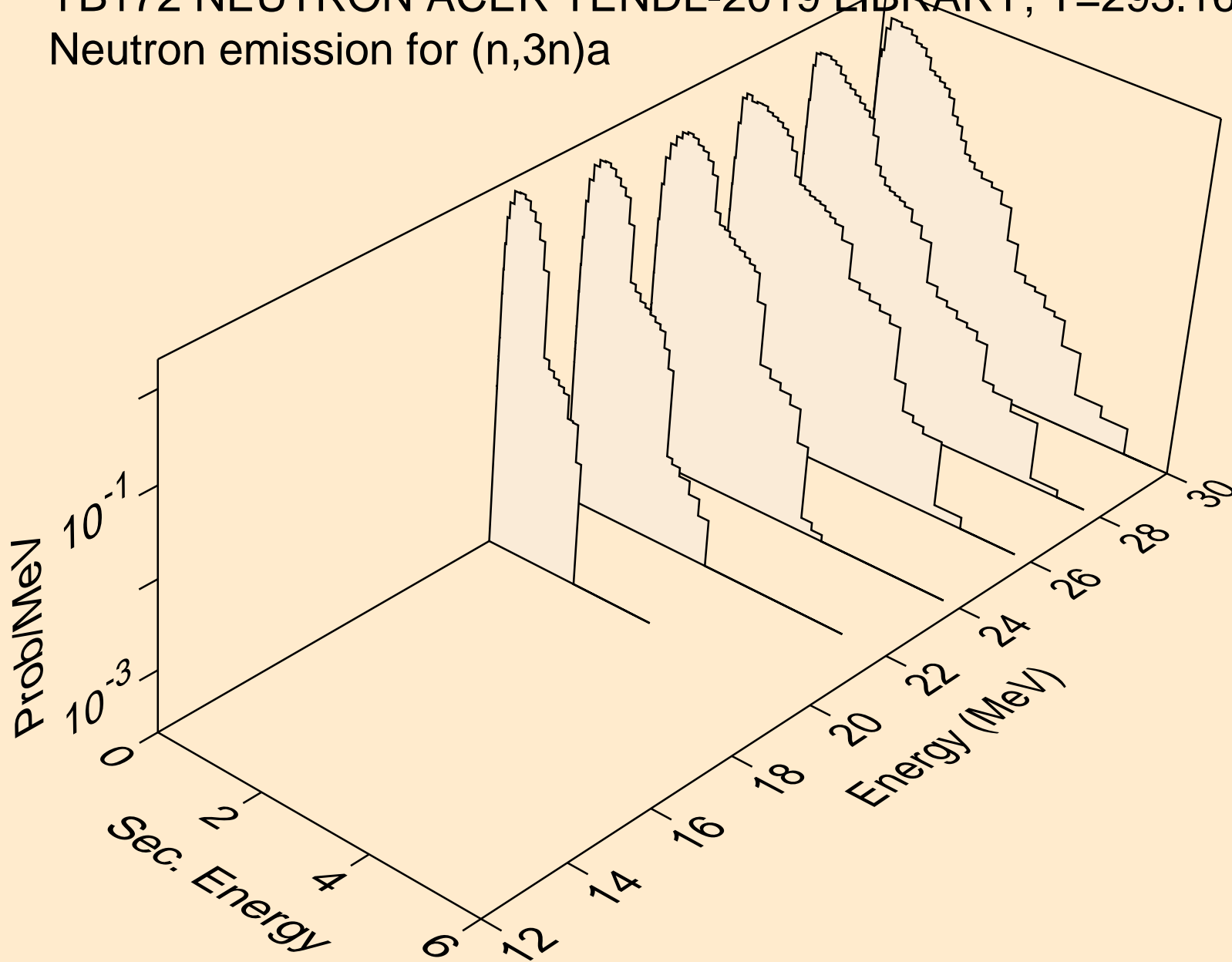

YB172 NEUTRON ACER TENDL-2019 LIBRARY; T=293.16K  
Neutron emission for (n,n\*)p

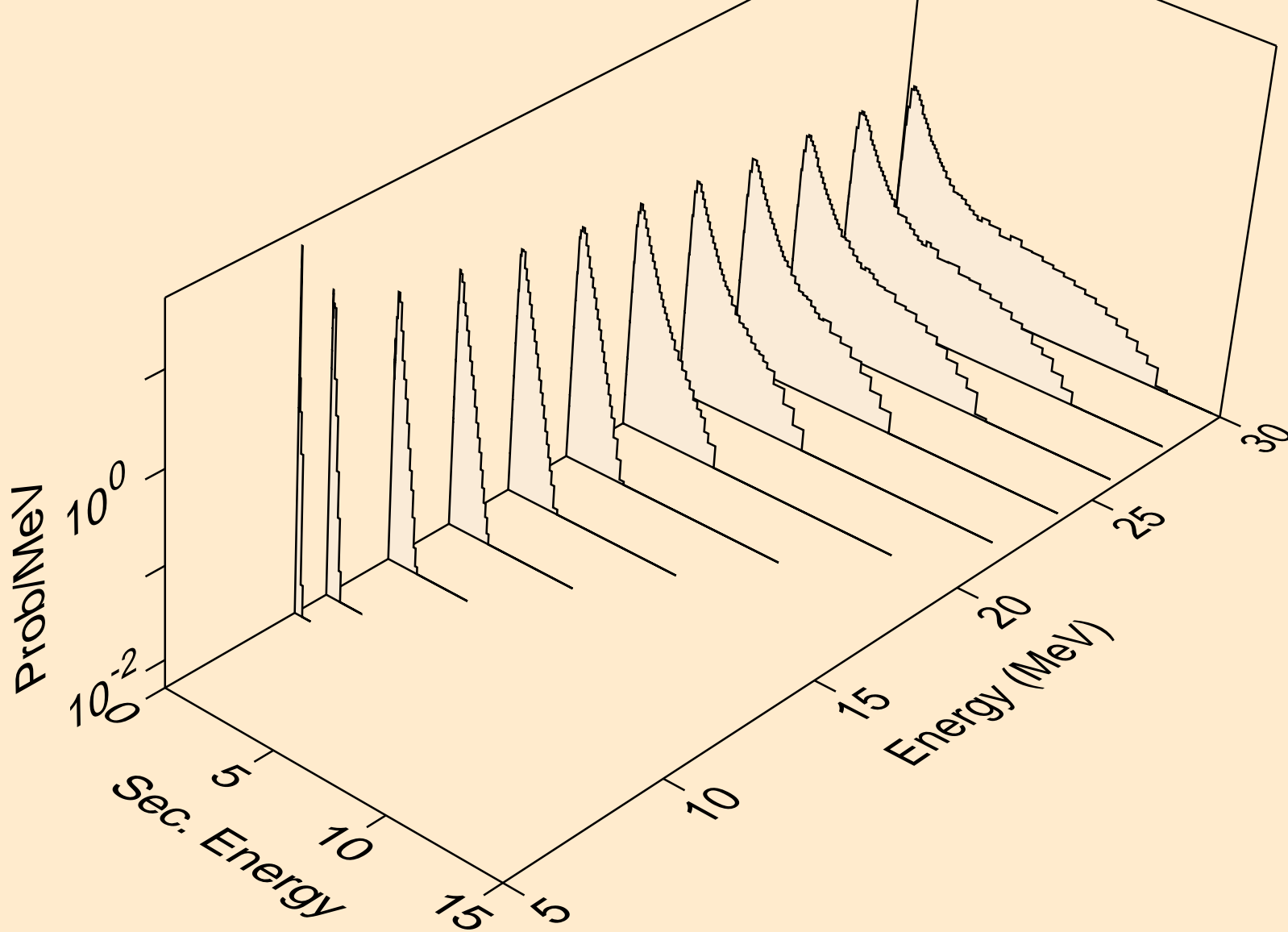

YB172 NEUTRON ACER TENDL-2019 LIBRARY; T=293.16K  
Neutron emission for (n,n\*)2a

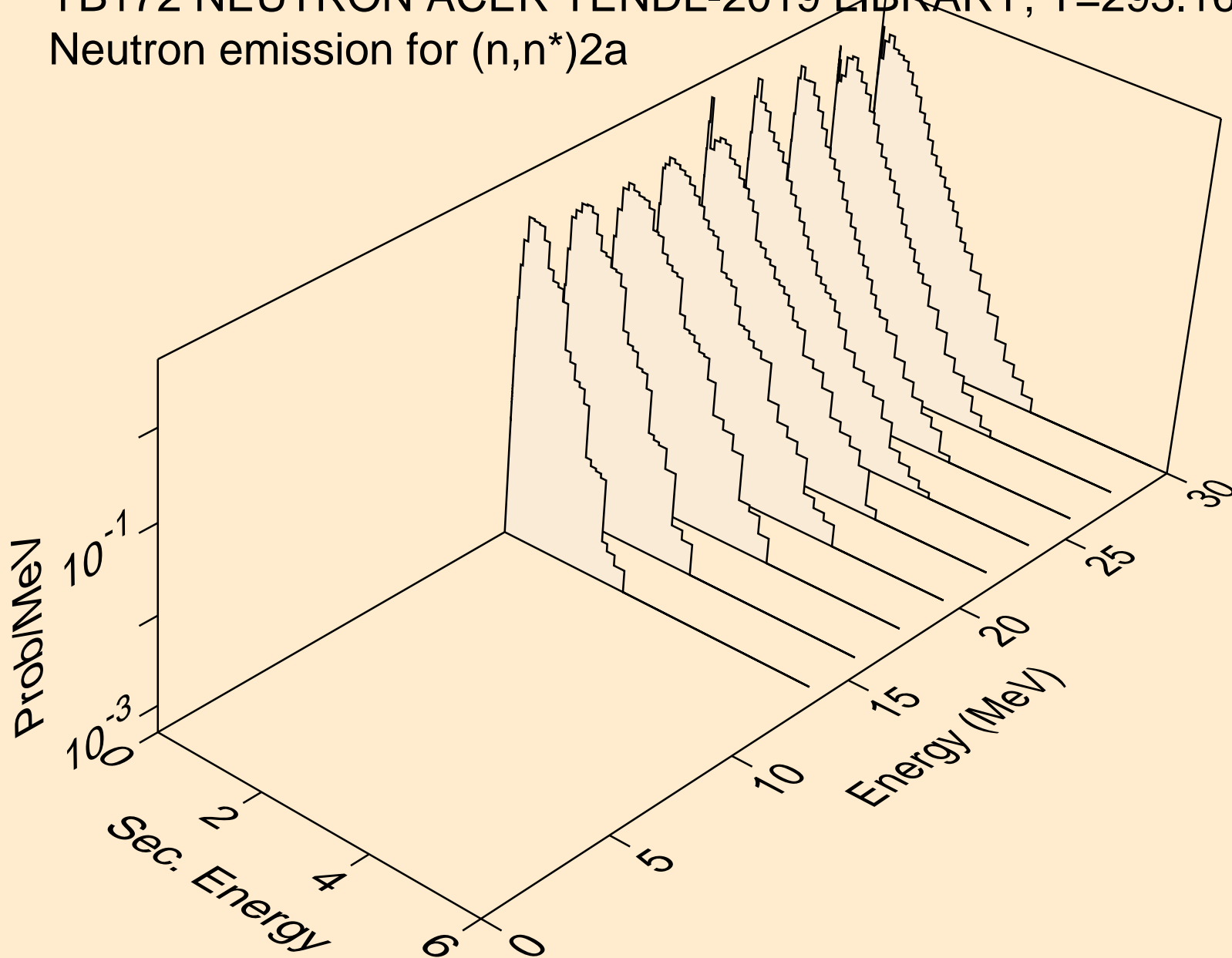

YB172 NEUTRON ACER TENDL-2019 LIBRARY; T=293.16K  
Neutron emission for (n,n\*)d

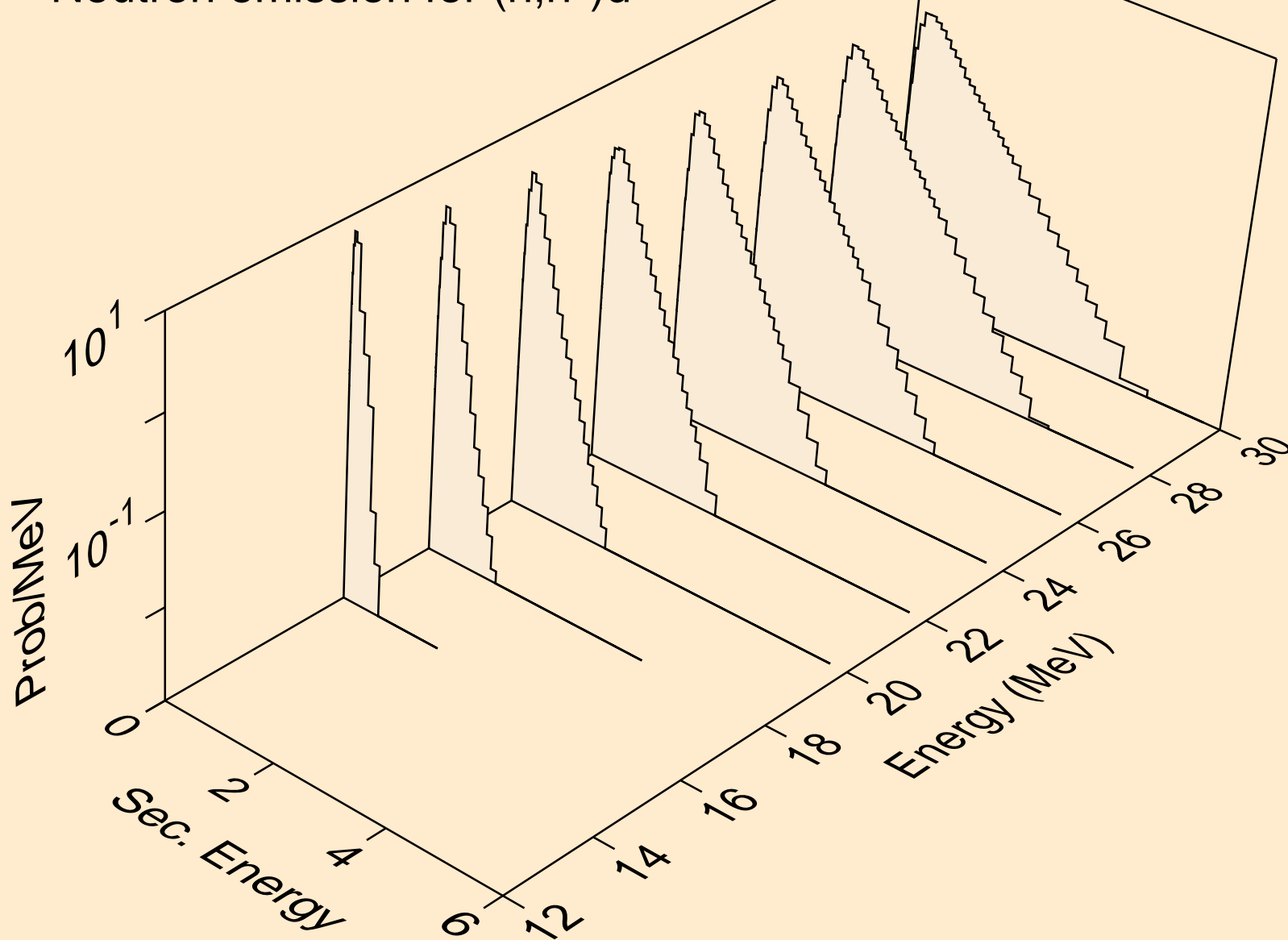

YB172 NEUTRON ACER TENDL-2019 LIBRARY; T=293.16K  
Neutron emission for (n,n\*)t

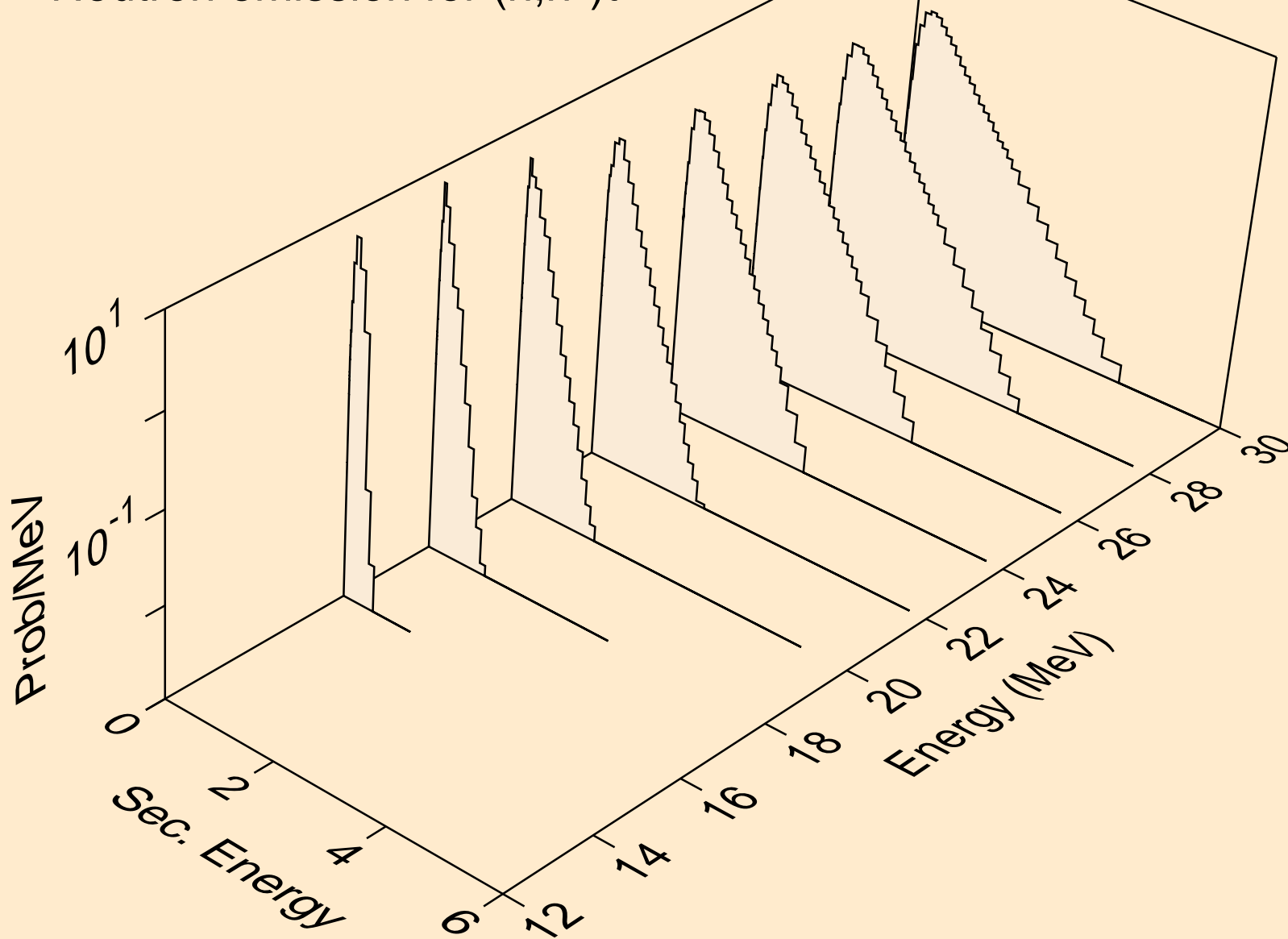



YB172 NEUTRON ACER TENDL-2019 LIBRARY; T=293.16K  
Neutron emission for (n,n\*)he3

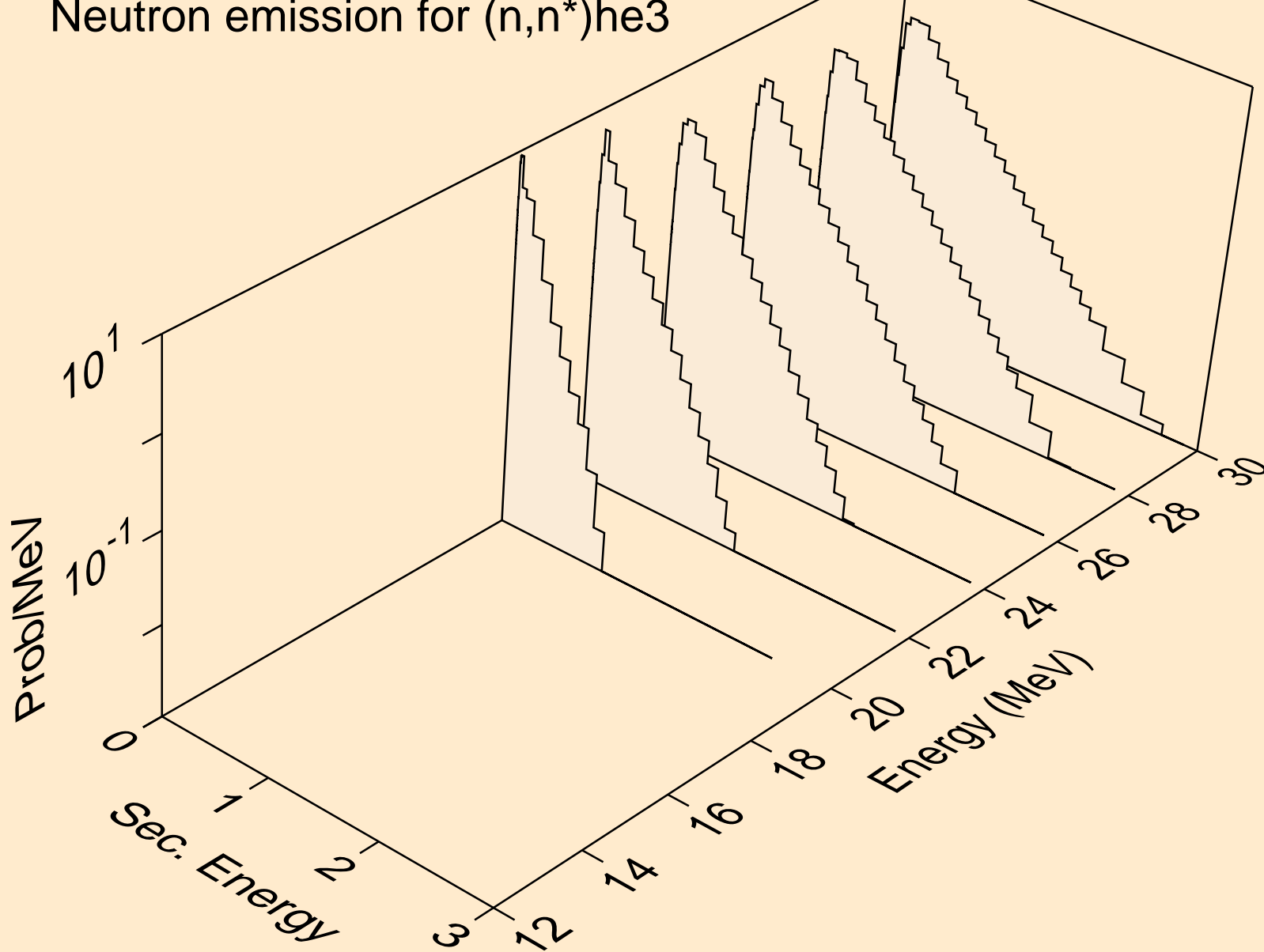

YB172 NEUTRON ACER TENDL-2019 LIBRARY; T=293.16K  
Neutron emission for (n,4n)

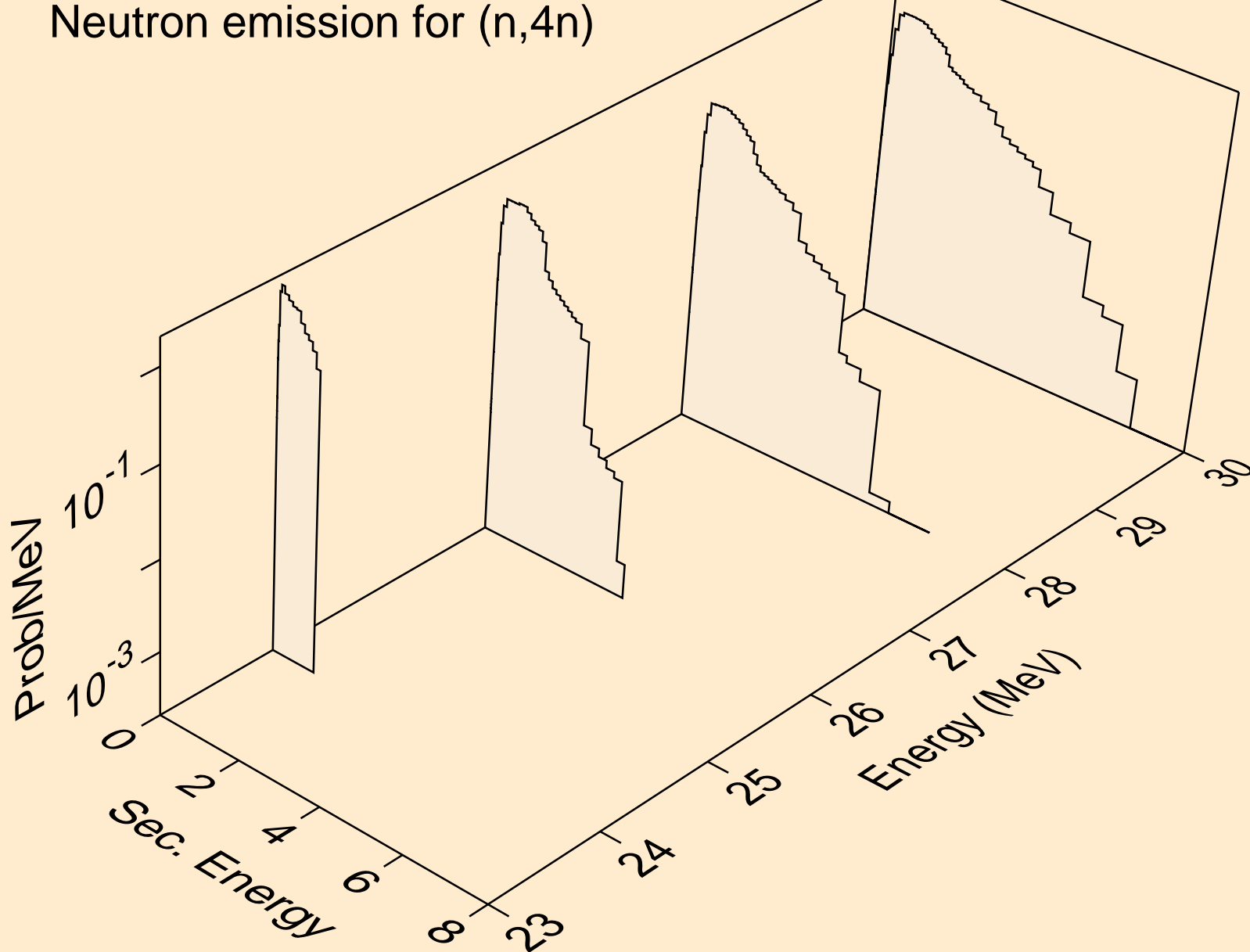

YB172 NEUTRON ACER TENDL-2019 LIBRARY; T=293.16K  
Neutron emission for (n,2np)

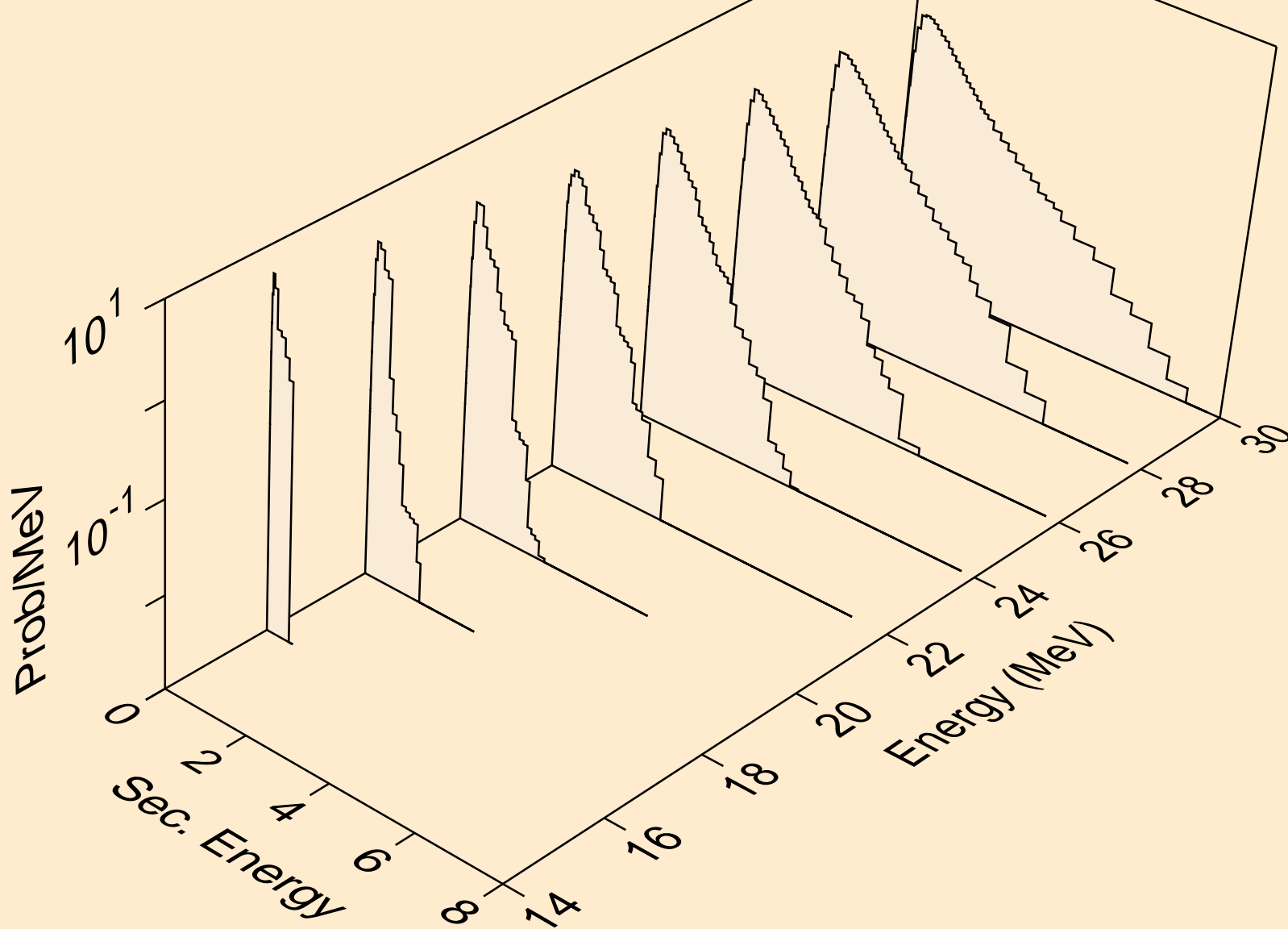

YB172 NEUTRON ACER TENDL-2019 LIBRARY; T=293.16K  
Neutron emission for (n,3np)

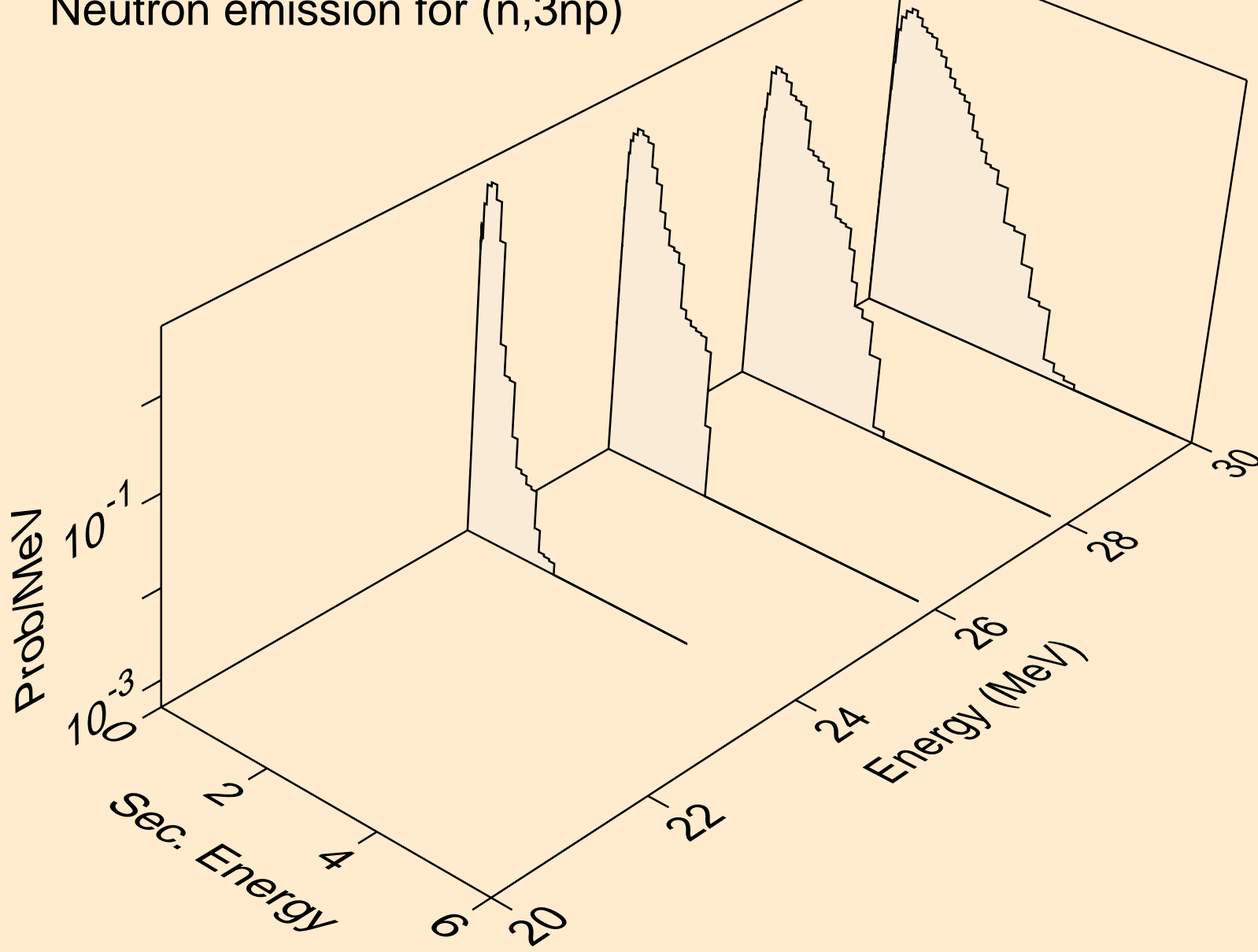

YB172 NEUTRON ACER TENDL-2019 LIBRARY; T=293.16K  
Neutron emission for (n,2np)

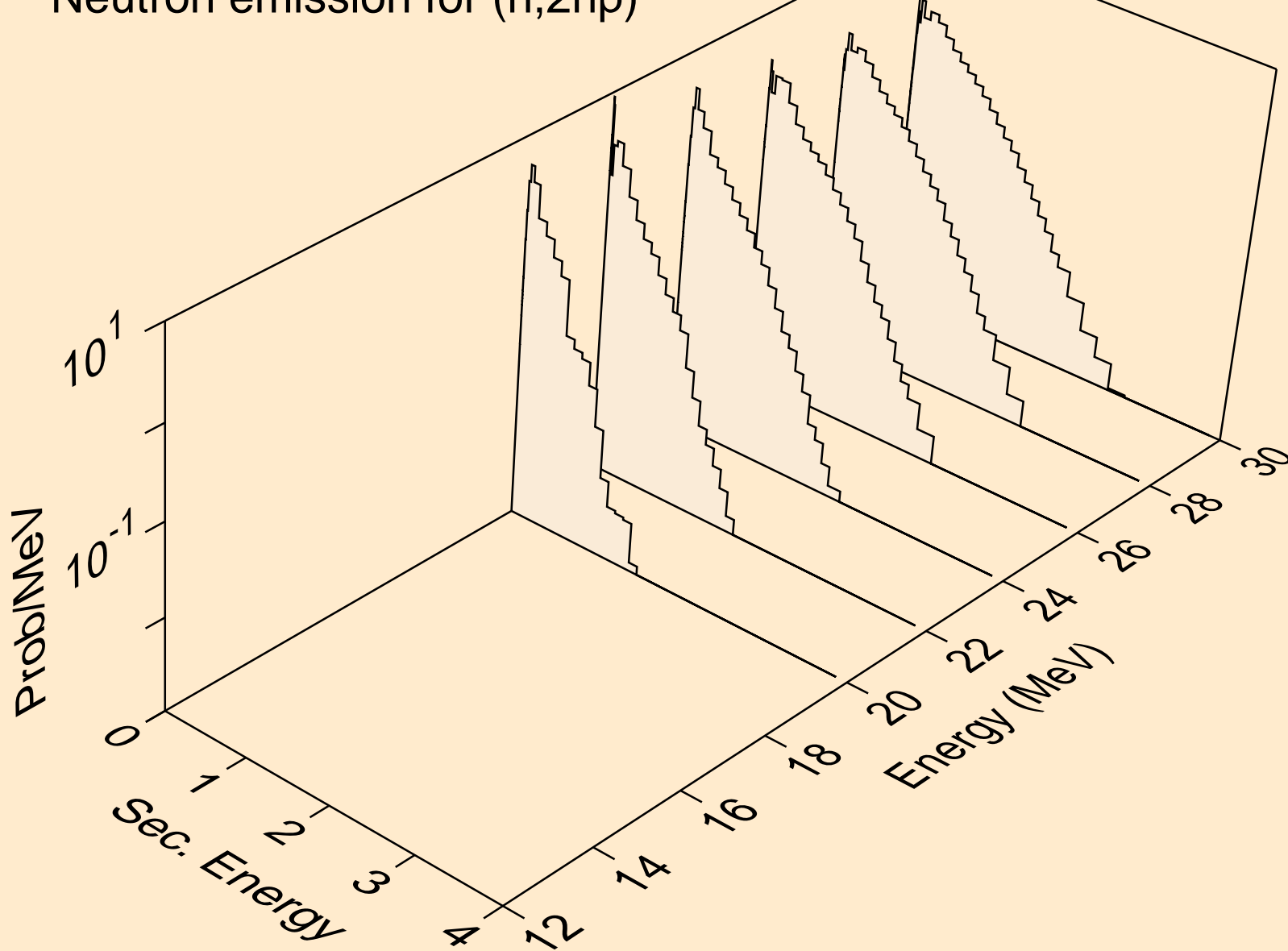

YB172 NEUTRON ACER TENDL-2019 LIBRARY; T=293.16K  
Neutron emission for (n,npa)

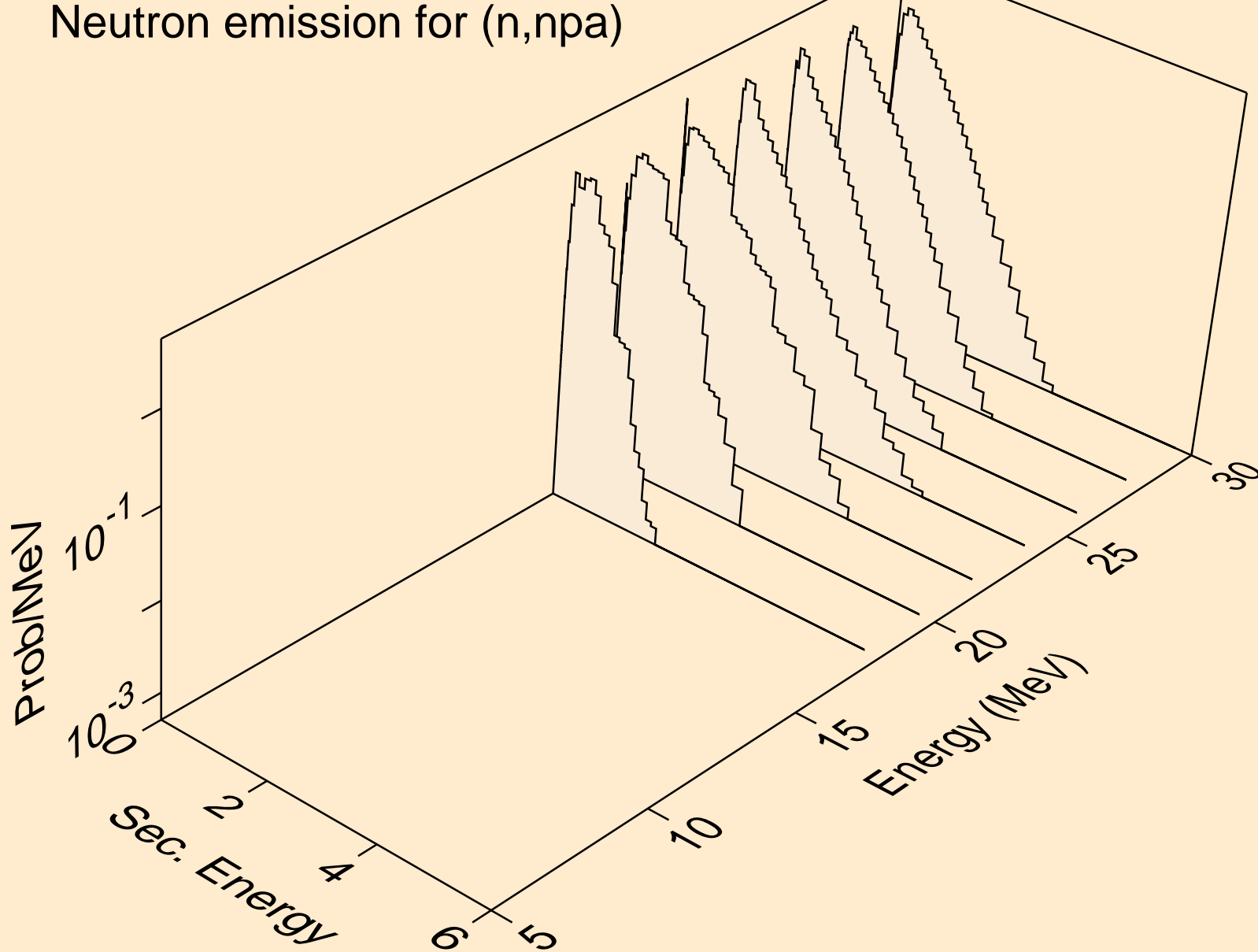

YB172 NEUTRON ACER TENDL-2019 LIBRARY; T=293.16K  
Neutron emission for (n,n\*c)

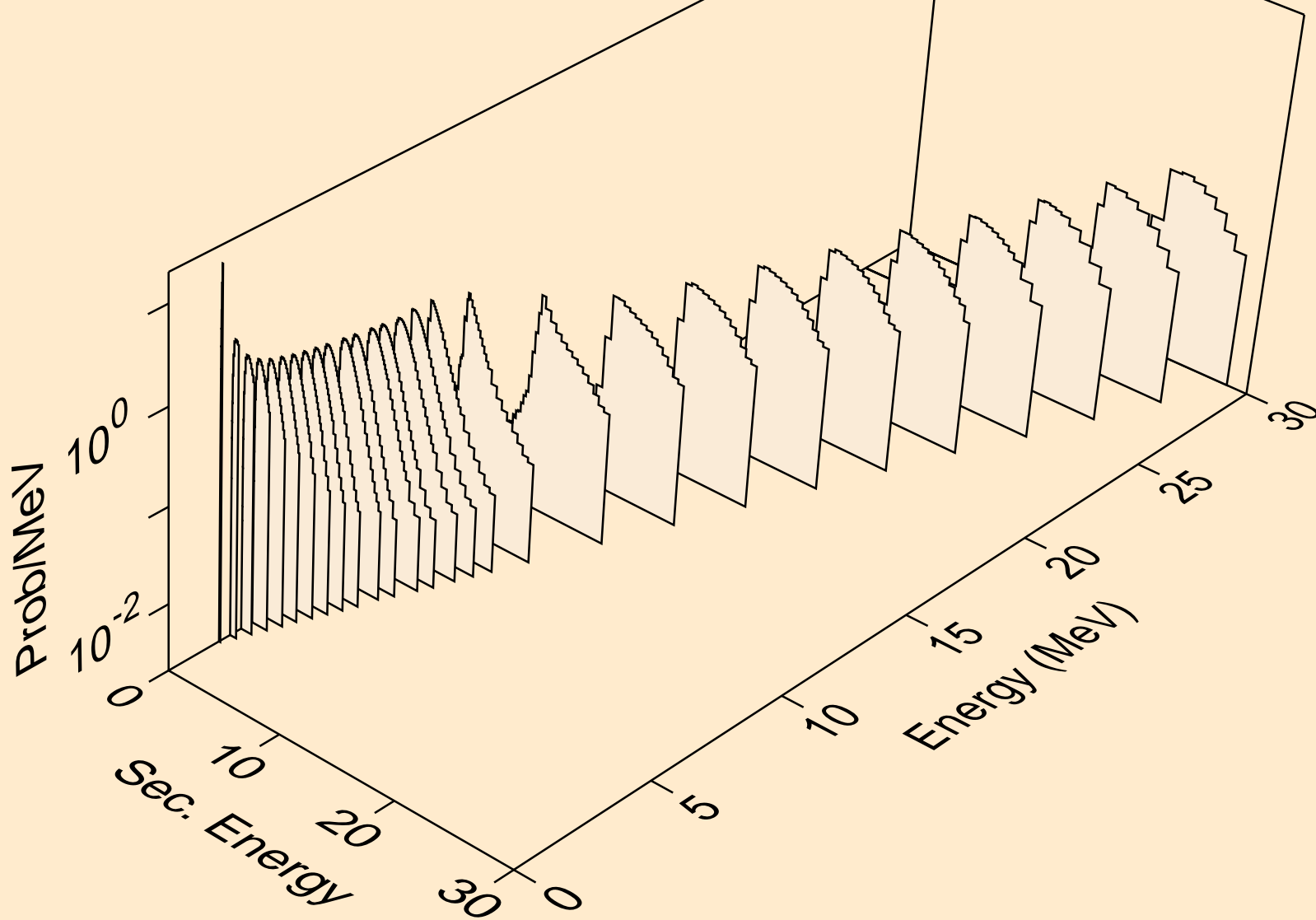

YB172 NEUTRON ACER TENDL-2019 LIBRARY; T=293.16K  
Photon emission for (n,x)

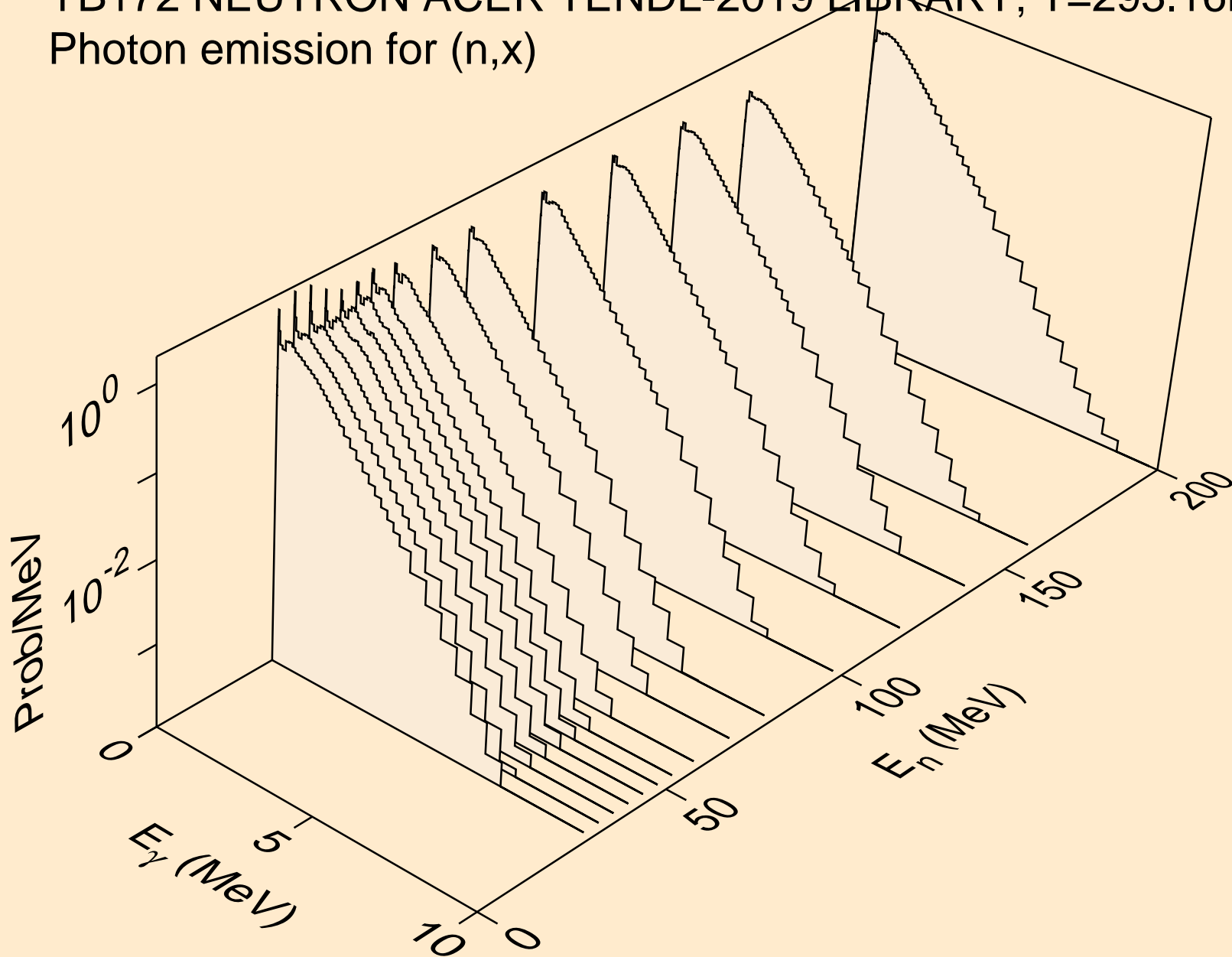



YB172 NEUTRON ACER TENDL-2019 LIBRARY; T=293.16K  
Photon emission for (n,2nd)

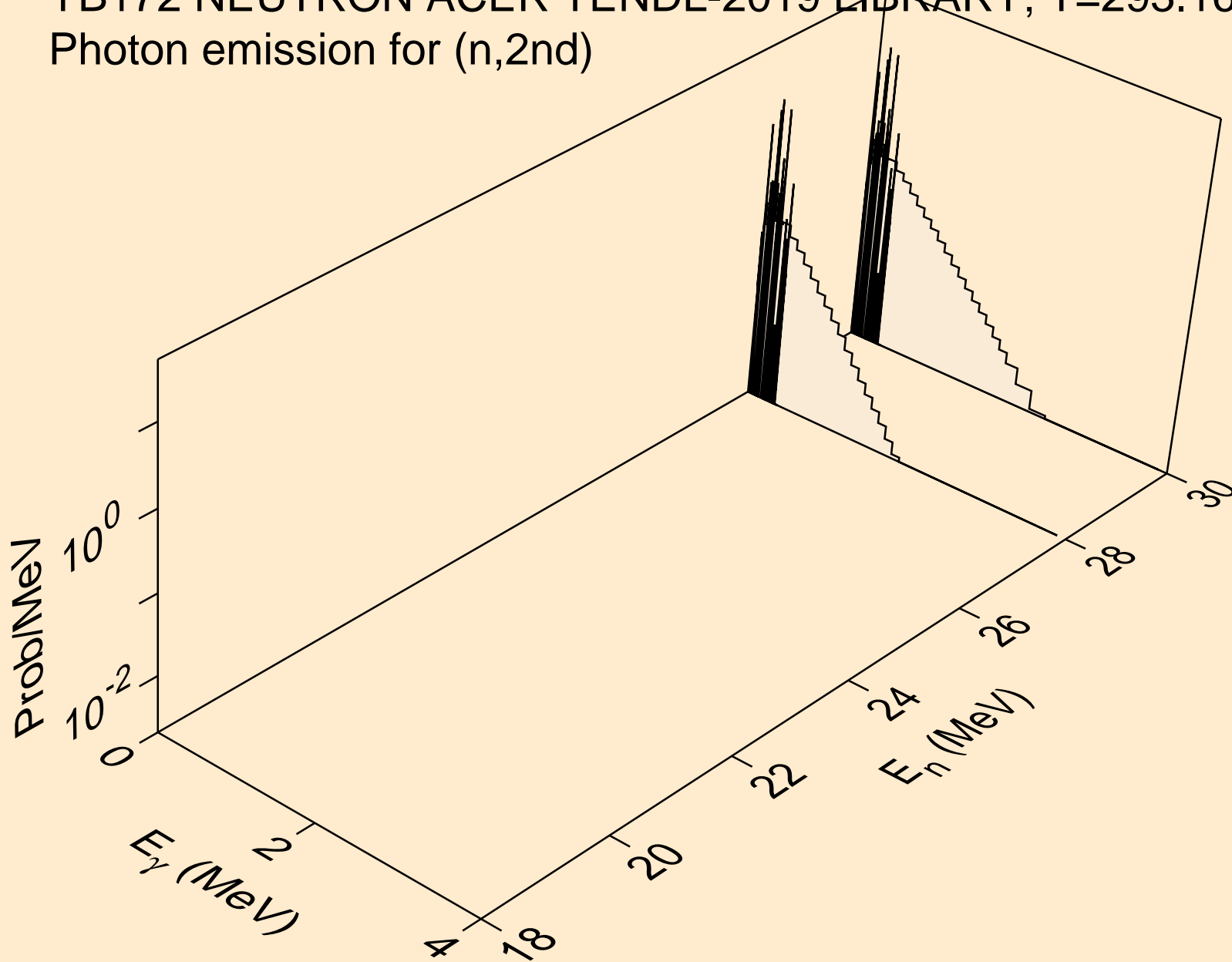

YB172 NEUTRON ACER TENDL-2019 LIBRARY; T=293.16K  
Photon emission for (n,2n)

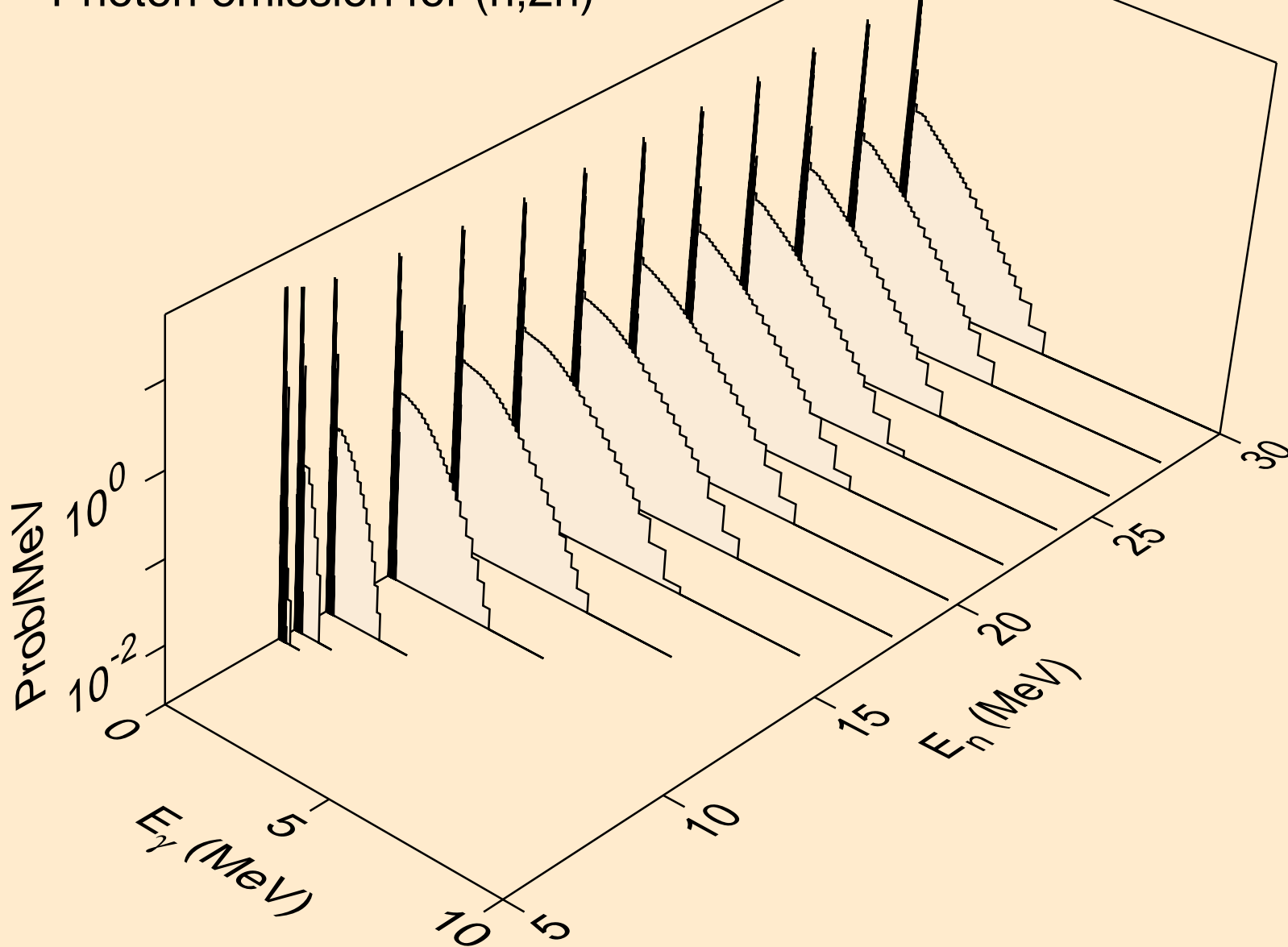

YB172 NEUTRON ACER TENDL-2019 LIBRARY; T=293.16K  
Photon emission for (n,3n)

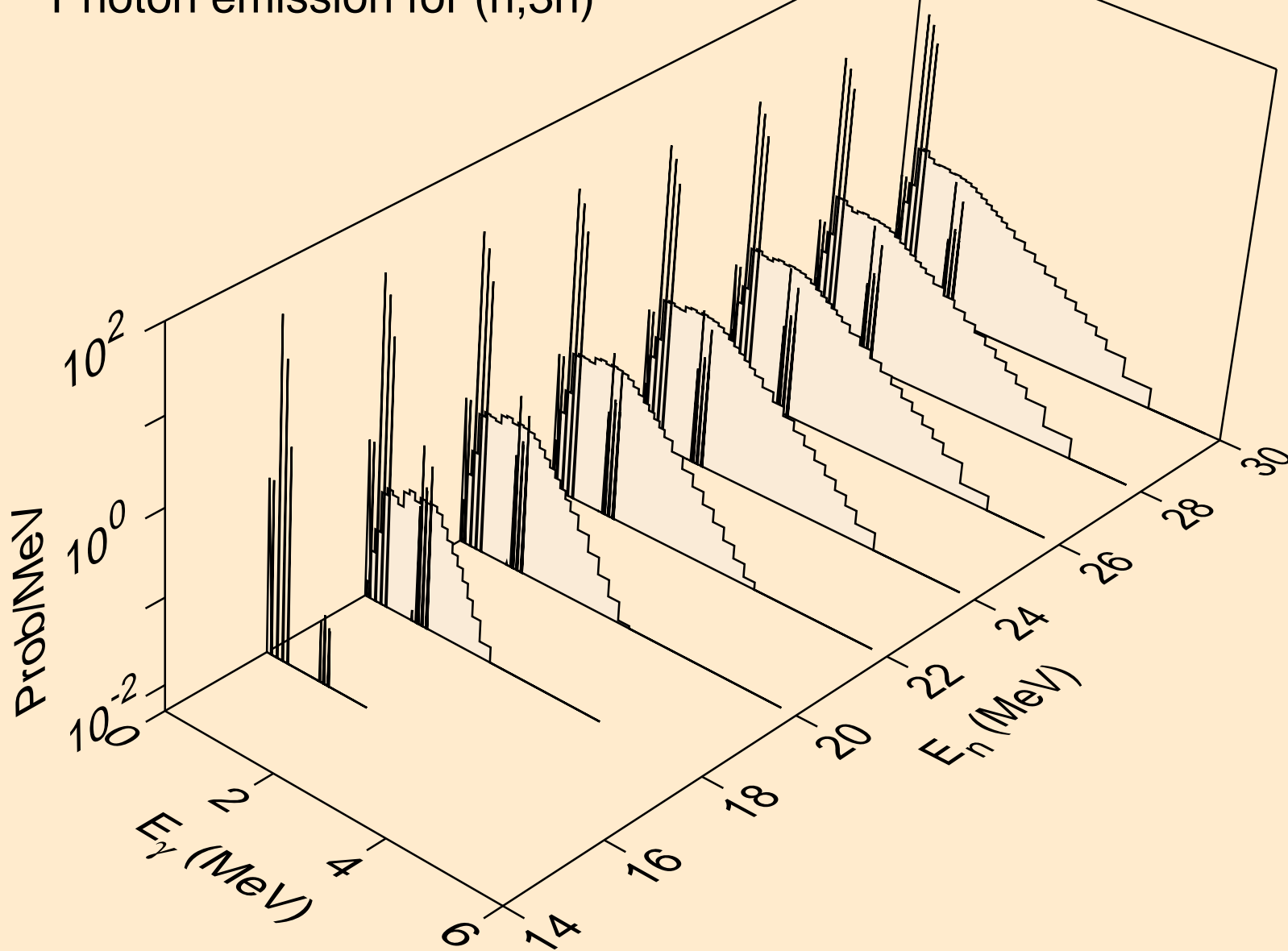

YB172 NEUTRON ACER TENDL-2019 LIBRARY; T=293.16K  
Photon emission for (n,n\*)a

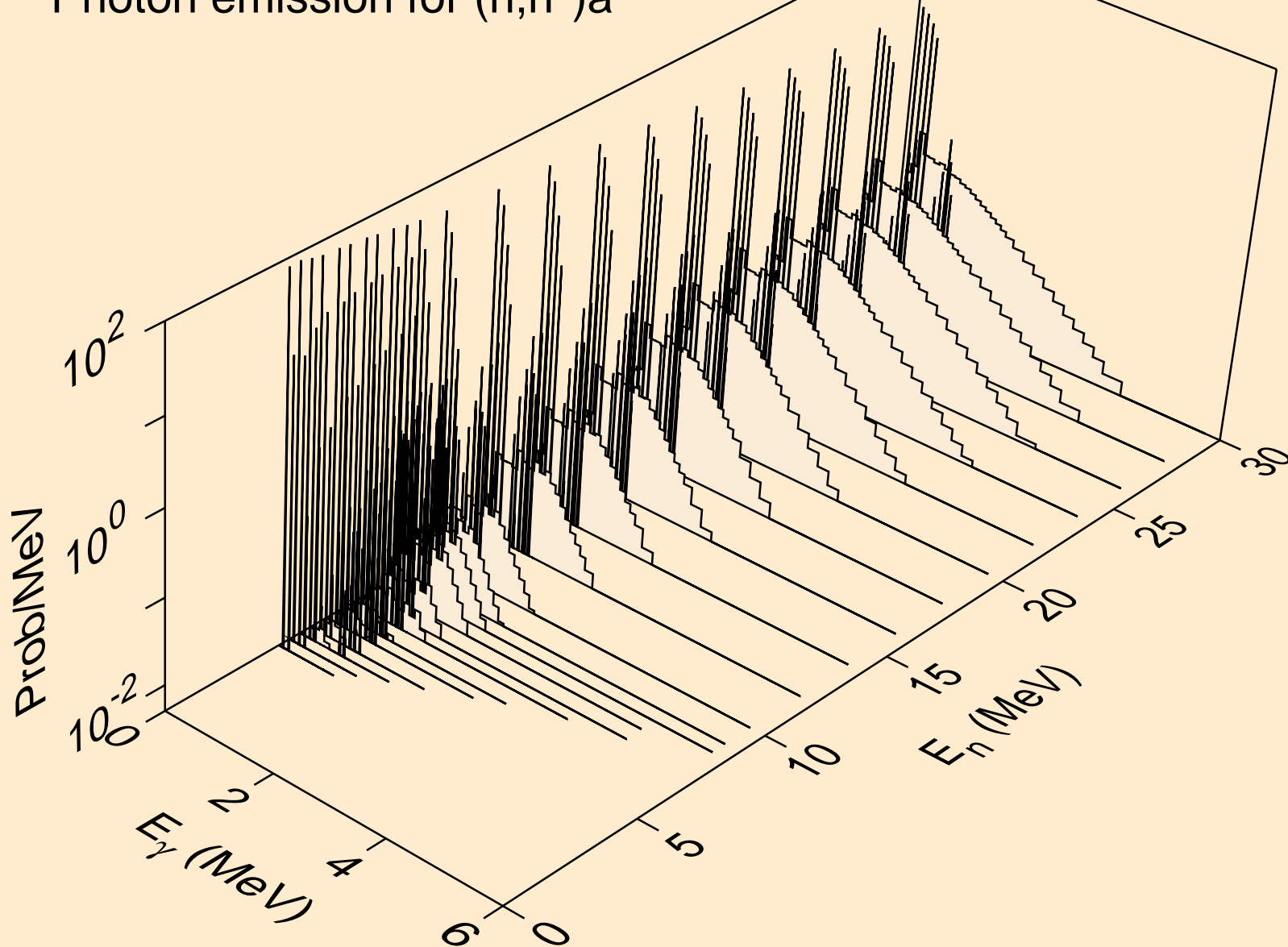

YB172 NEUTRON ACER TENDL-2019 LIBRARY; T=293.16K  
Photon emission for (n,2n)a

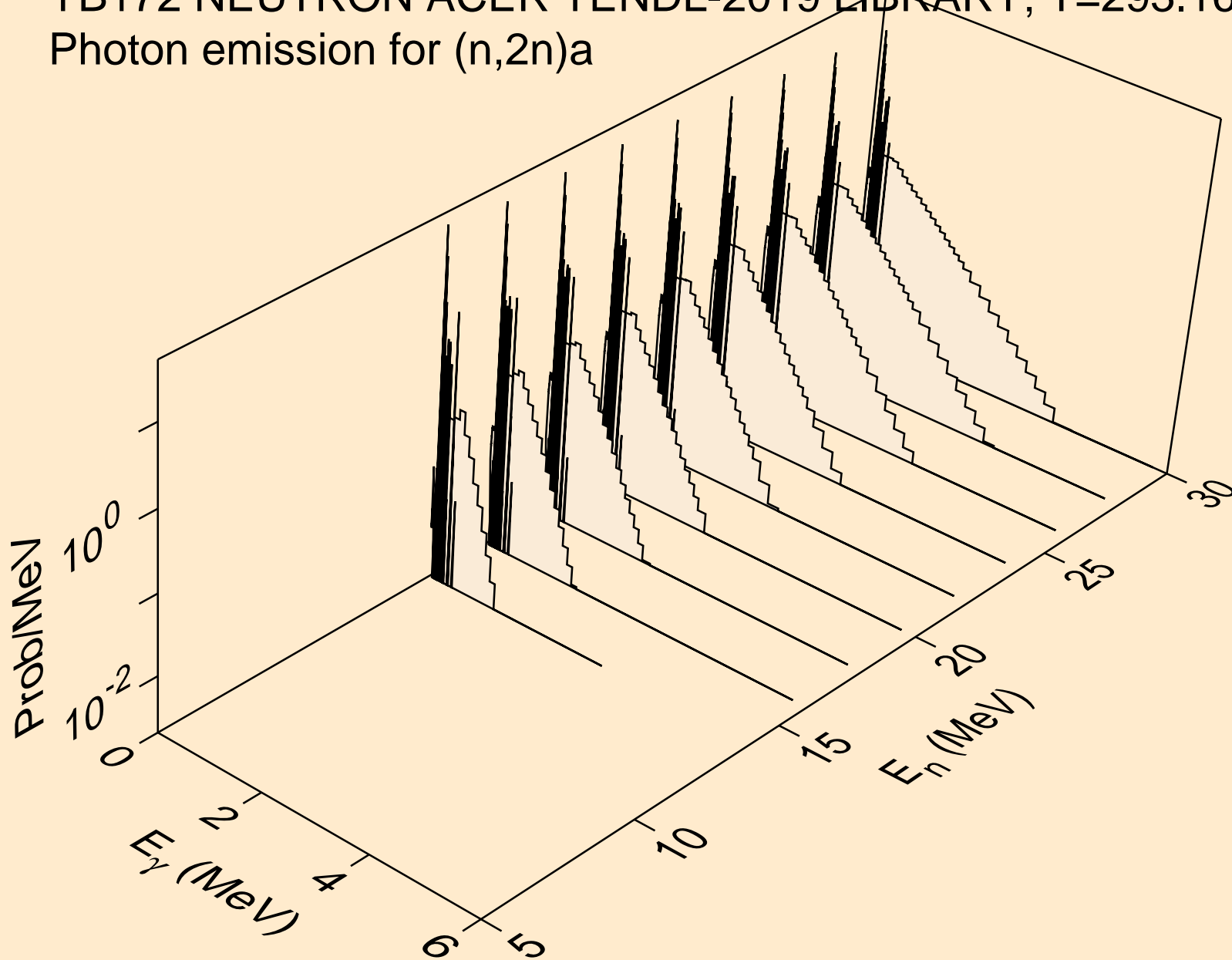

YB172 NEUTRON ACER TENDL-2019 LIBRARY; T=293.16K  
Photon emission for (n,3n)a

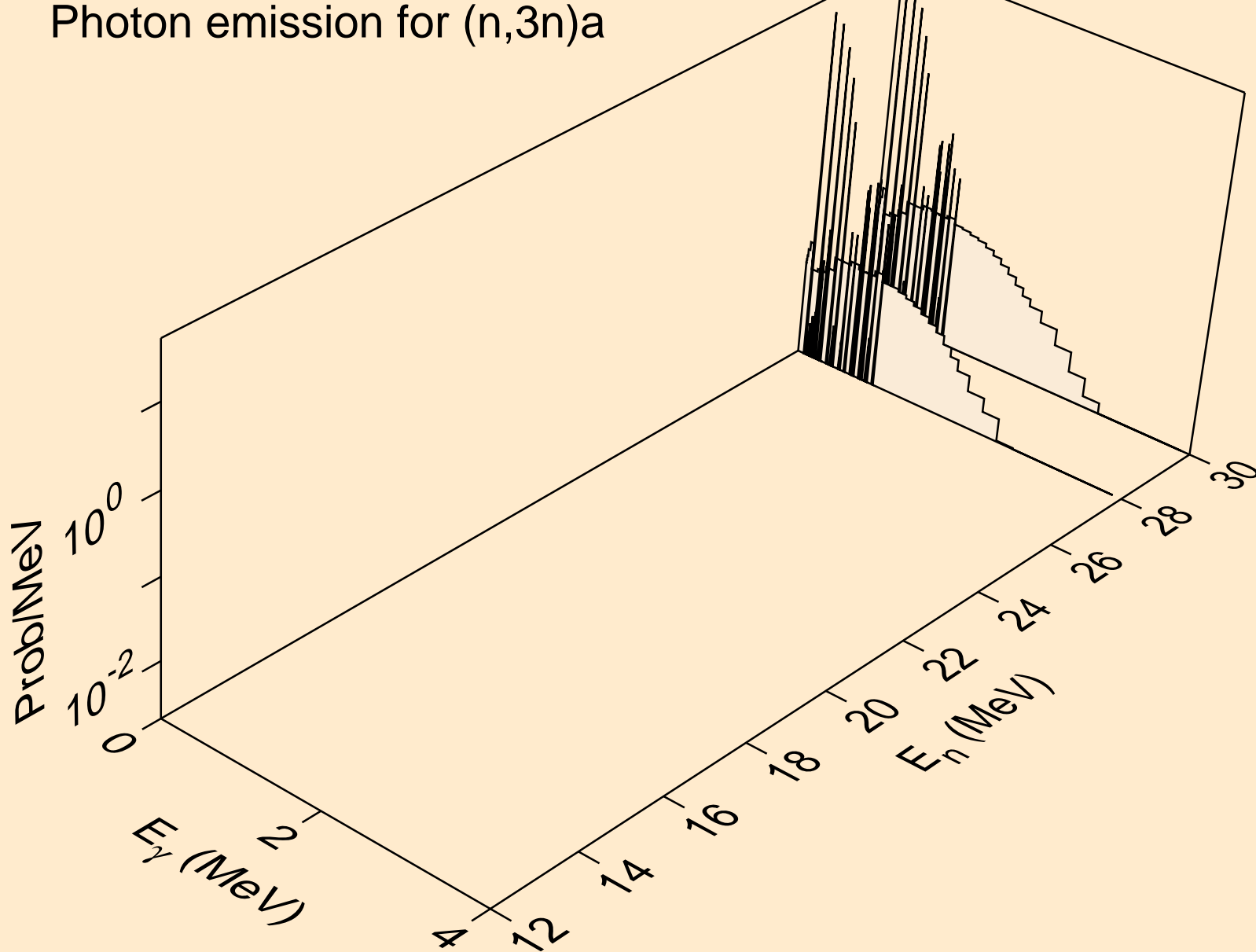

YB172 NEUTRON ACER TENDL-2019 LIBRARY; T=293.16K  
Photon emission for (n,n\*)p

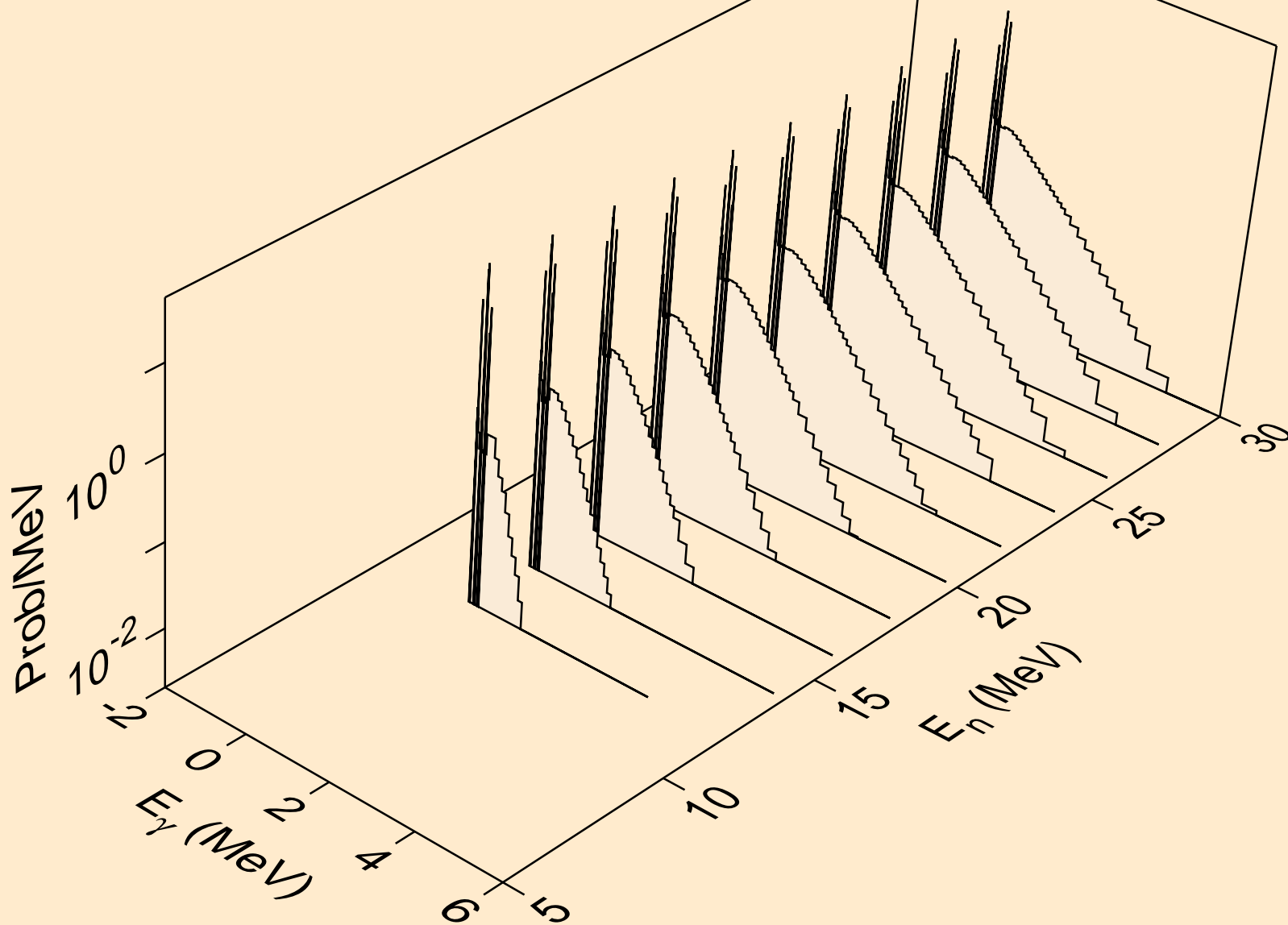

YB172 NEUTRON ACER TENDL-2019 LIBRARY; T=293.16K  
Photon emission for (n,n\*)2a

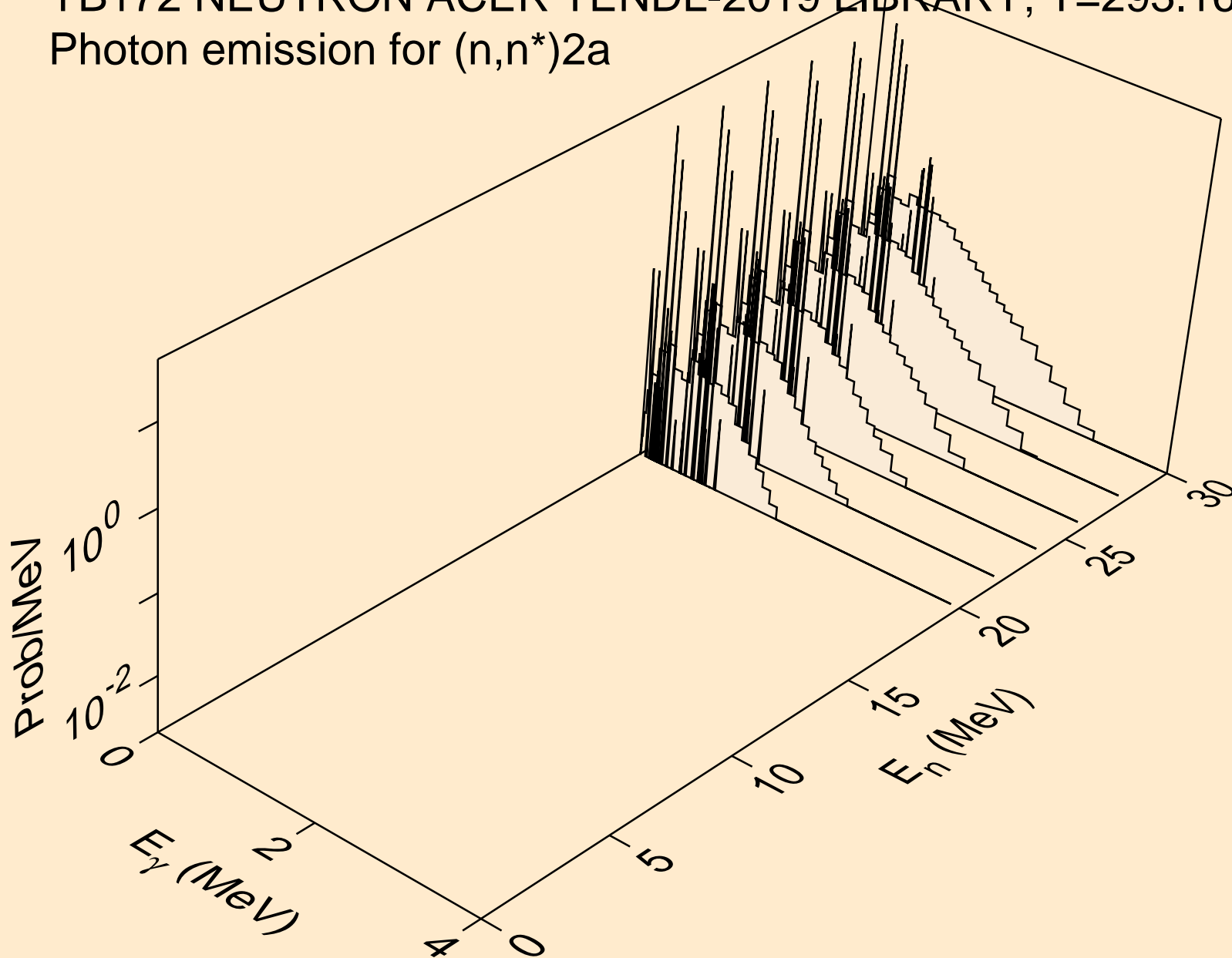



YB172 NEUTRON ACER TENDL-2019 LIBRARY; T=293.16K  
Photon emission for (n,n\*)d

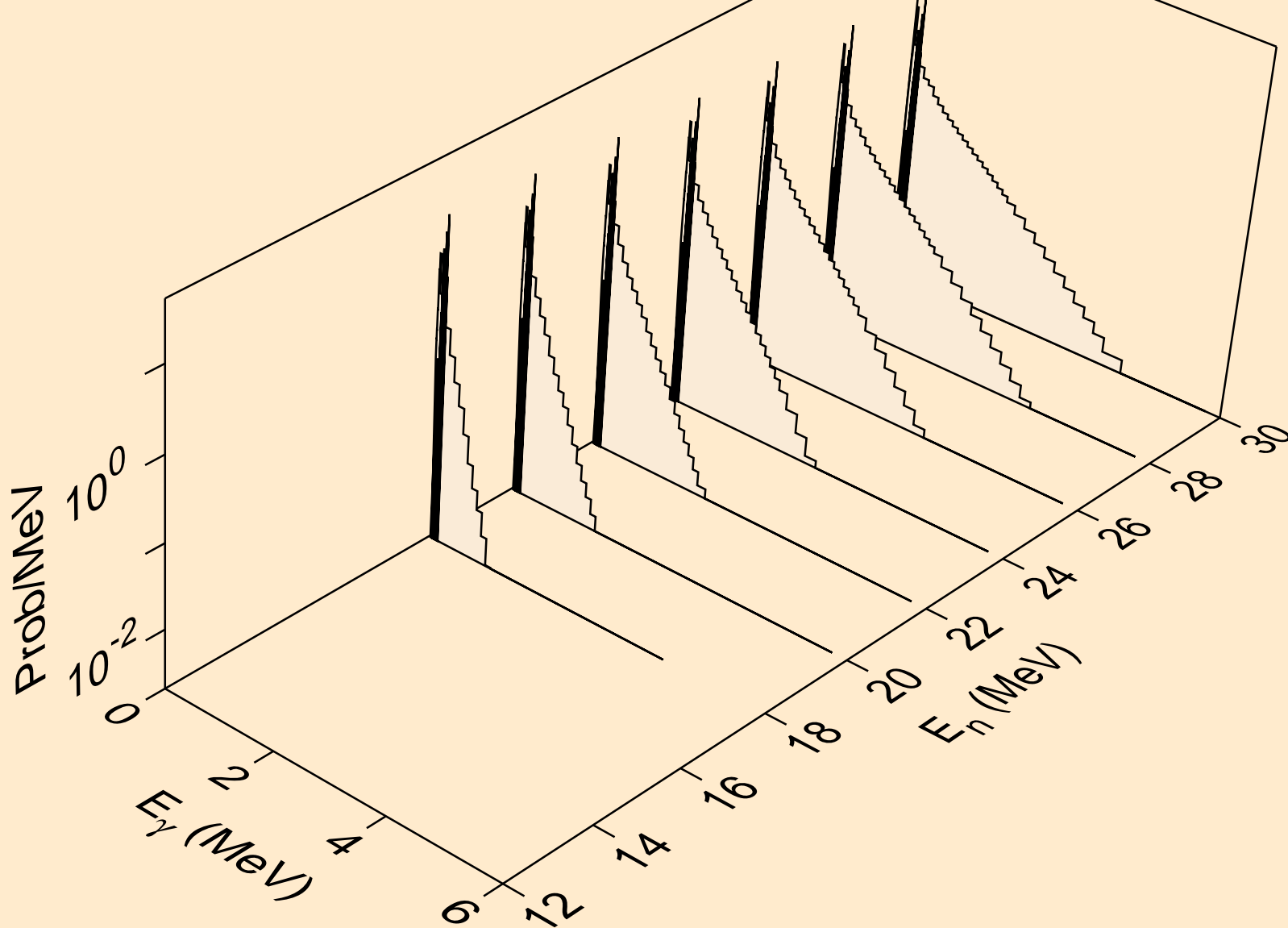

YB172 NEUTRON ACER TENDL-2019 LIBRARY; T=293.16K  
Photon emission for (n,n\*)t

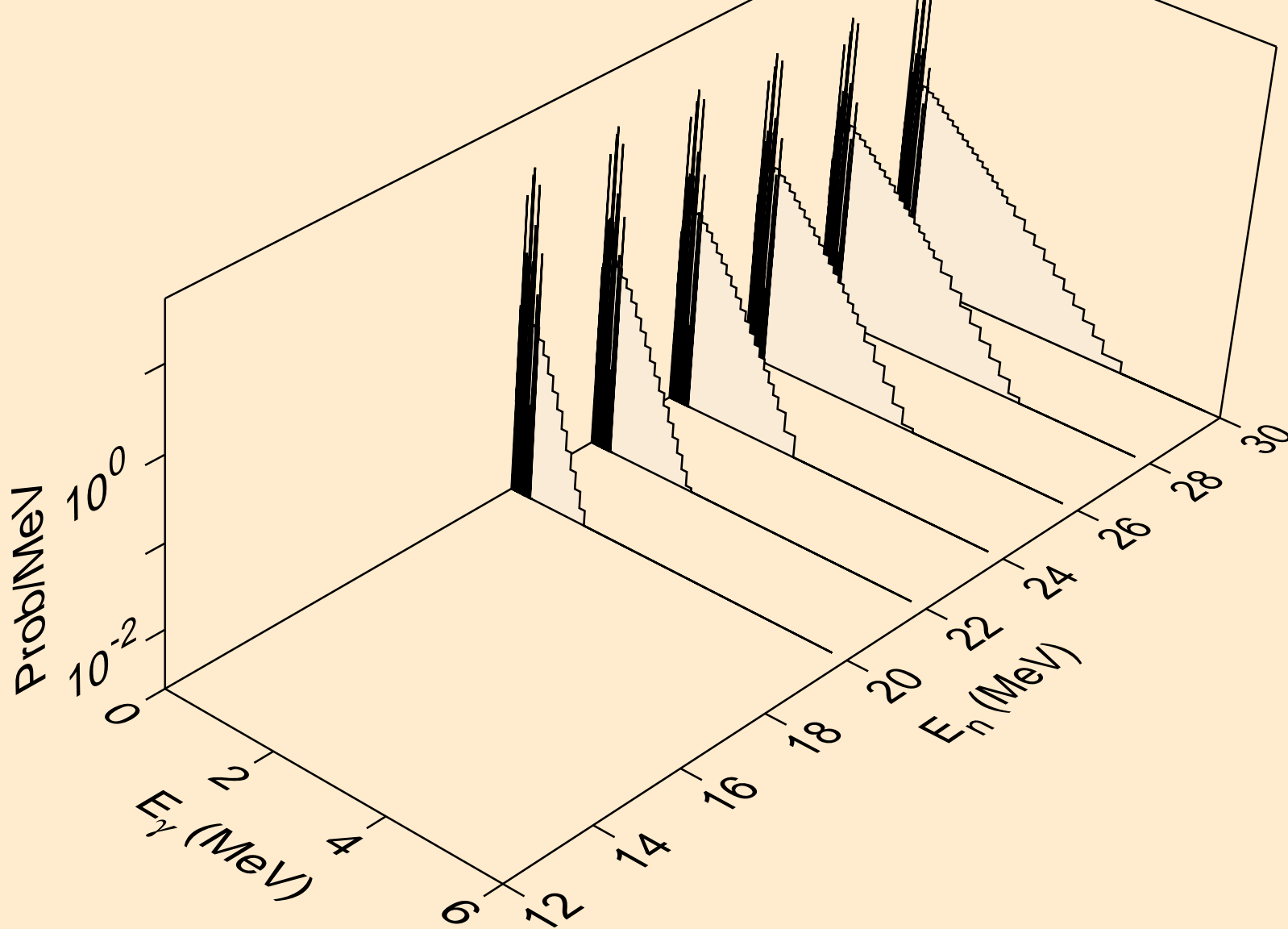

YB172 NEUTRON ACER TENDL-2019 LIBRARY; T=293.16K  
Photon emission for (n,n\*)he3

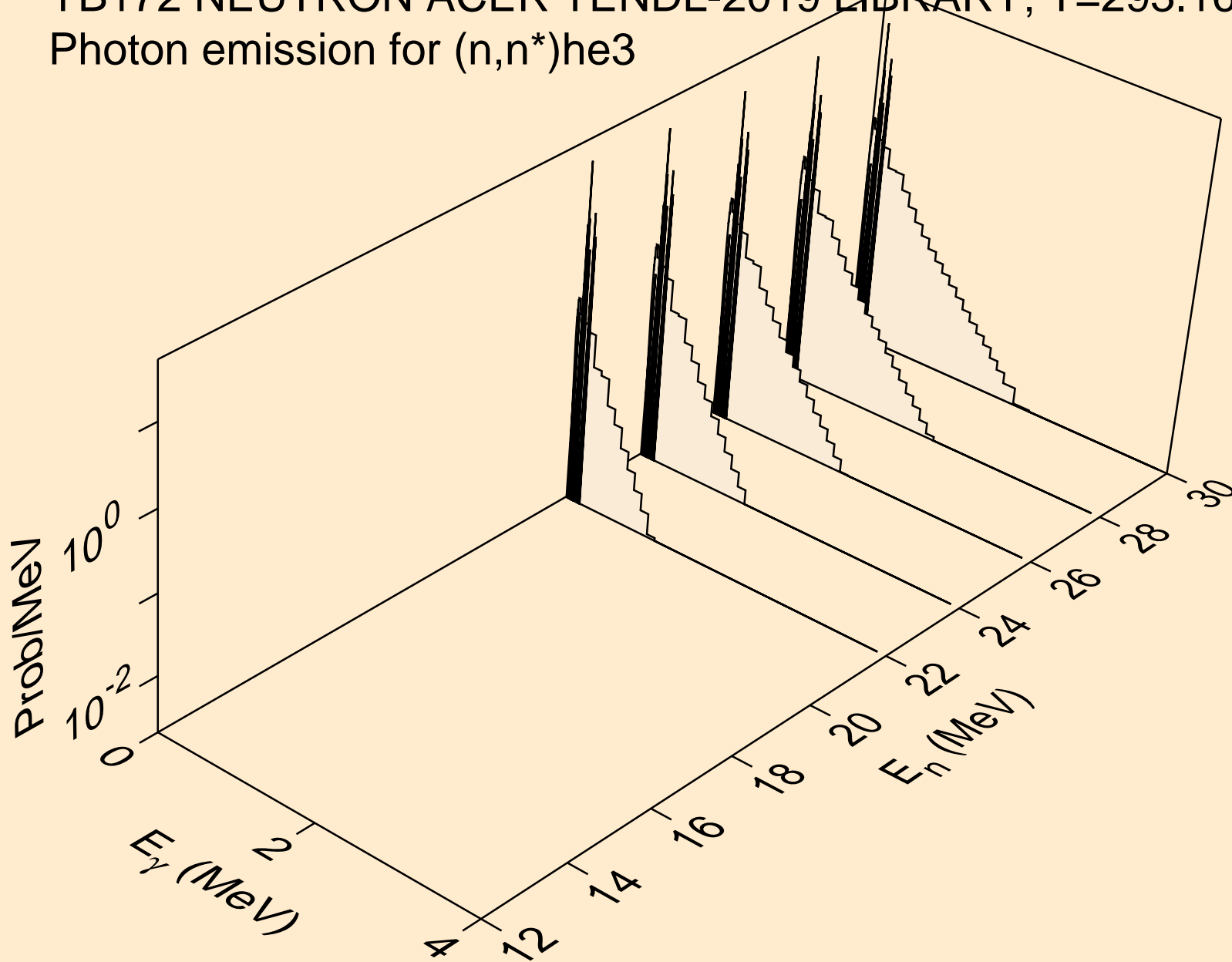

YB172 NEUTRON ACER TENDL-2019 LIBRARY; T=293.16K  
Photon emission for (n,4n)

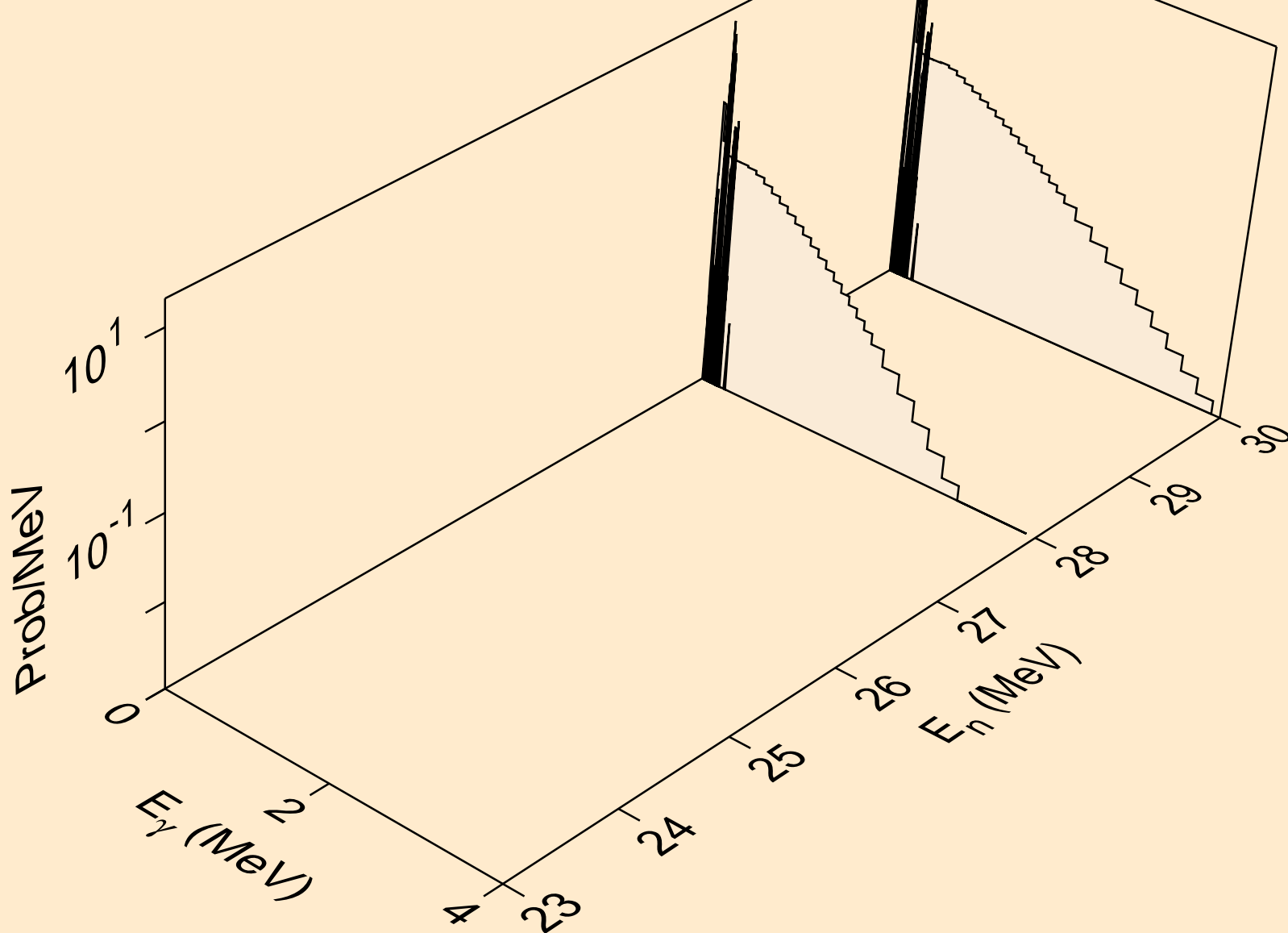

YB172 NEUTRON ACER TENDL-2019 LIBRARY; T=293.16K  
Photon emission for (n,2np)

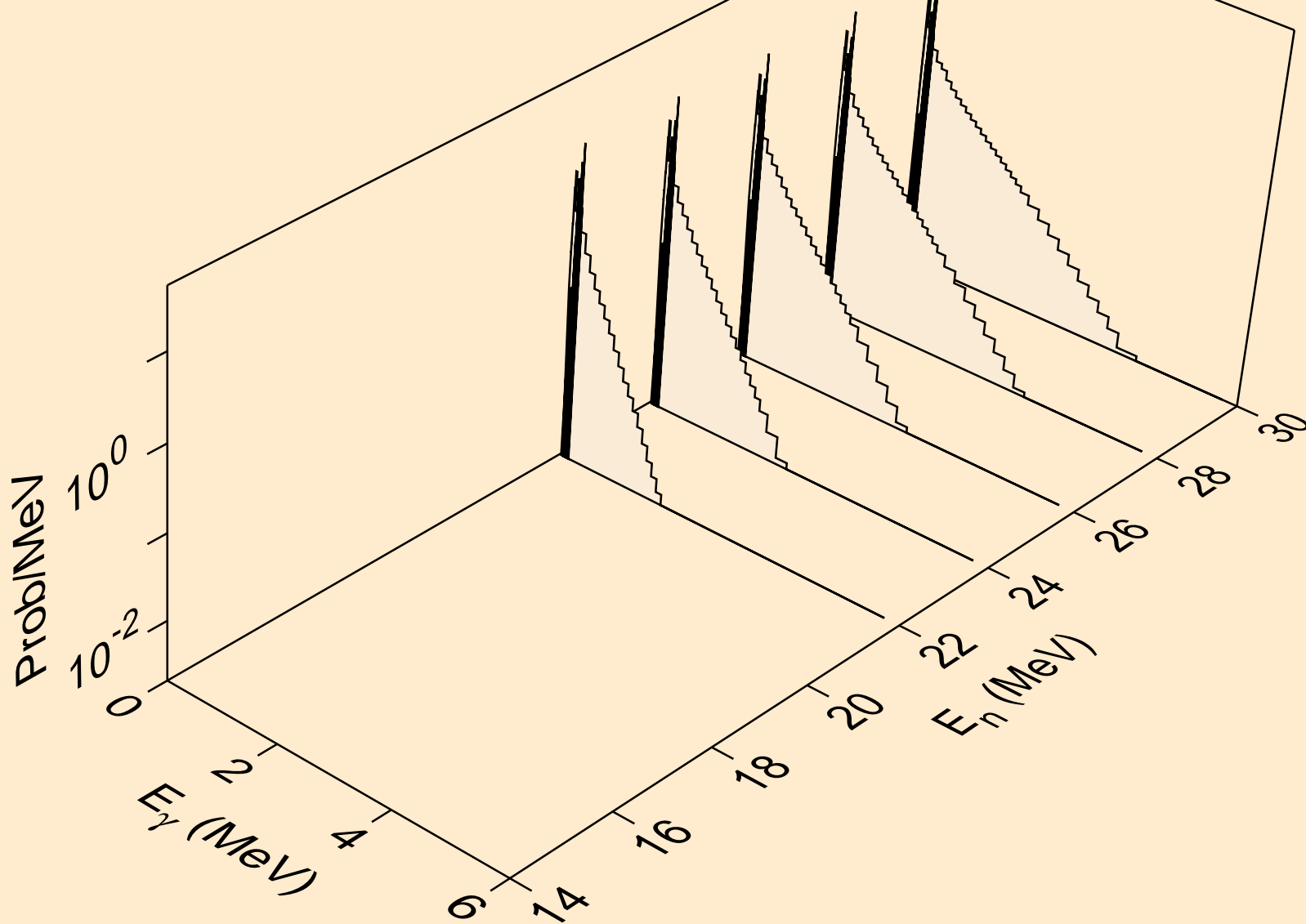

YB172 NEUTRON ACER TENDL-2019 LIBRARY; T=293.16K  
Photon emission for (n,3np)

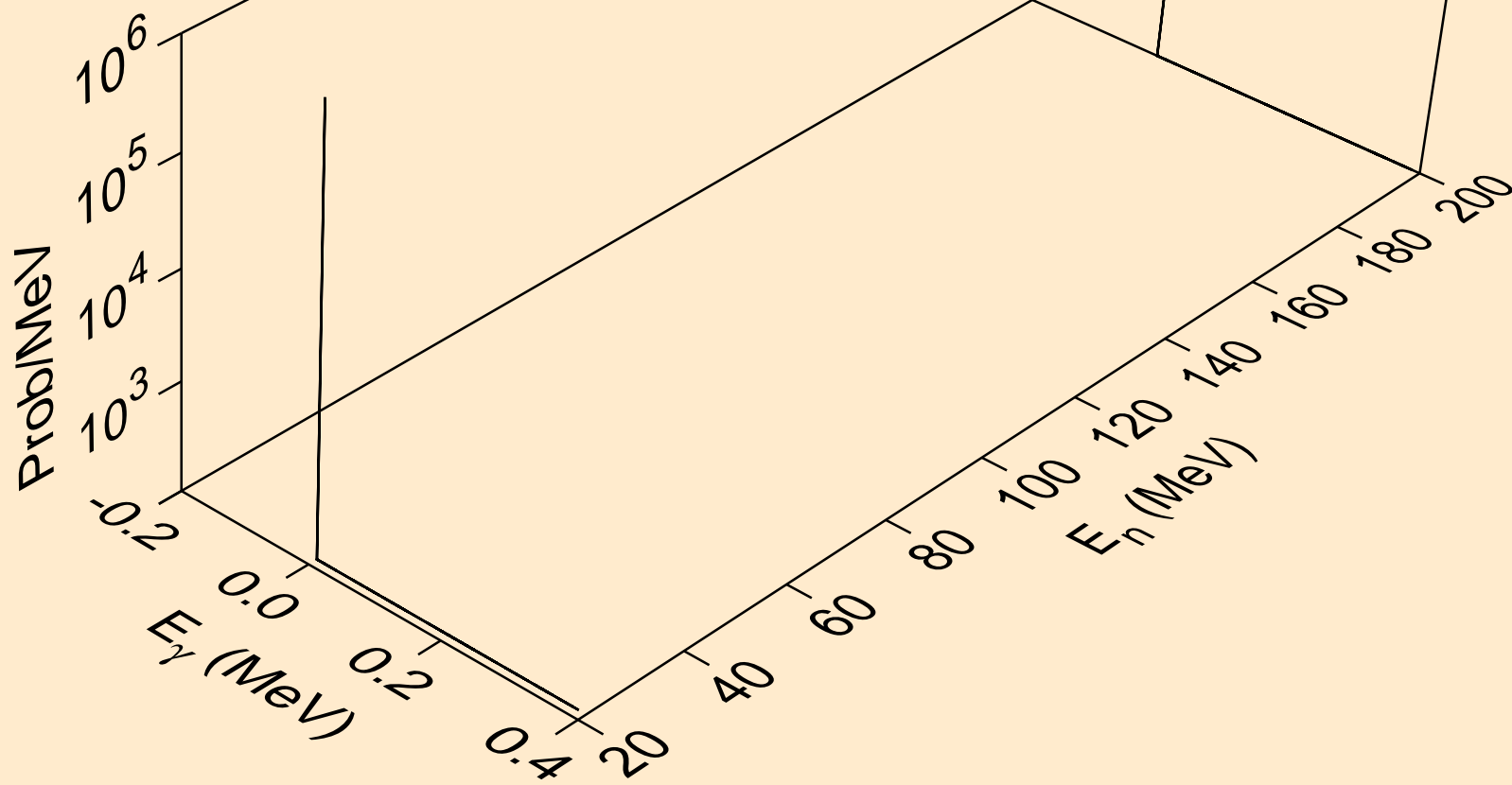

YB172 NEUTRON ACER TENDL-2019 LIBRARY; T=293.16K  
Photon emission for (n,2np)

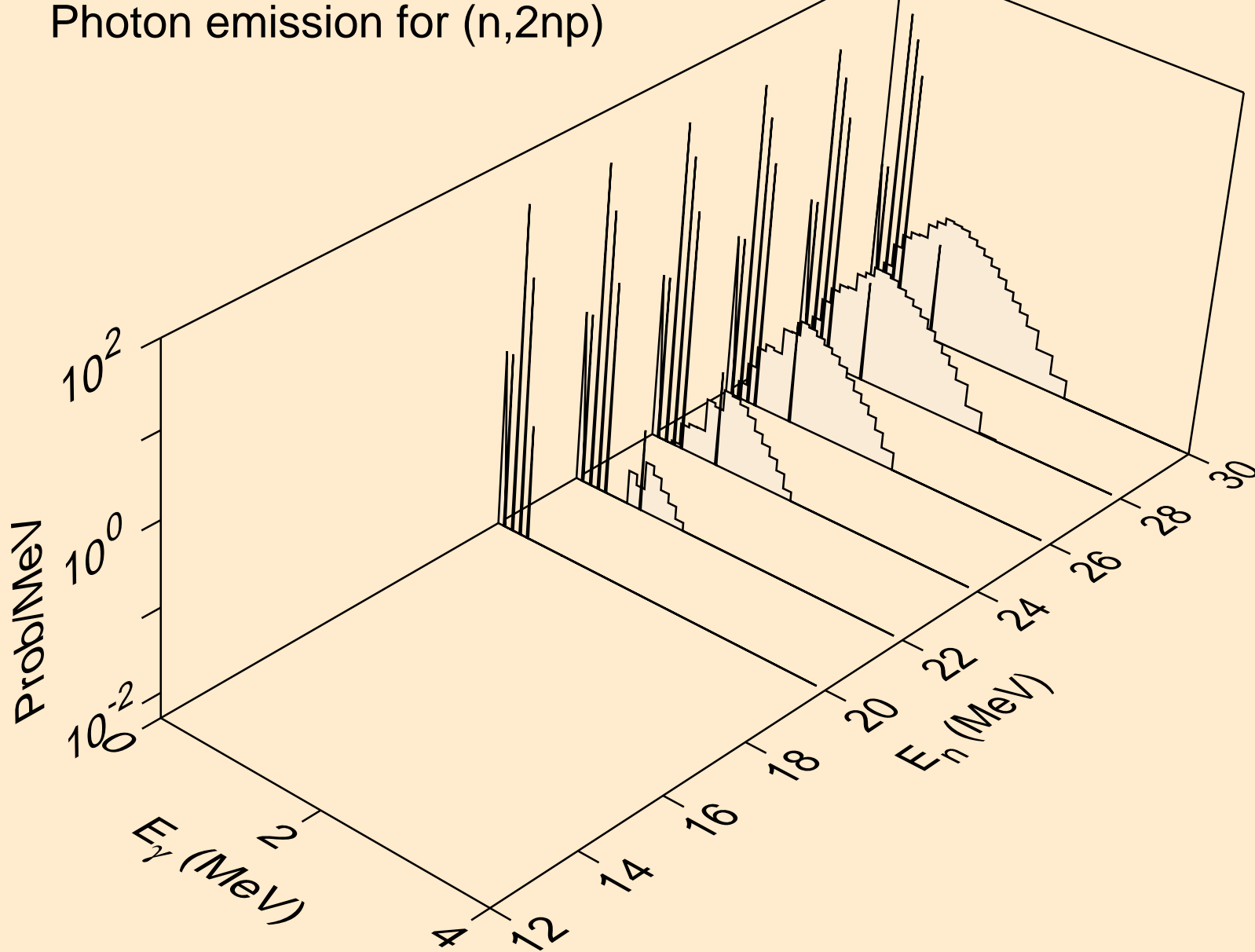

YB172 NEUTRON ACER TENDL-2019 LIBRARY; T=293.16K  
Photon emission for (n,npa)

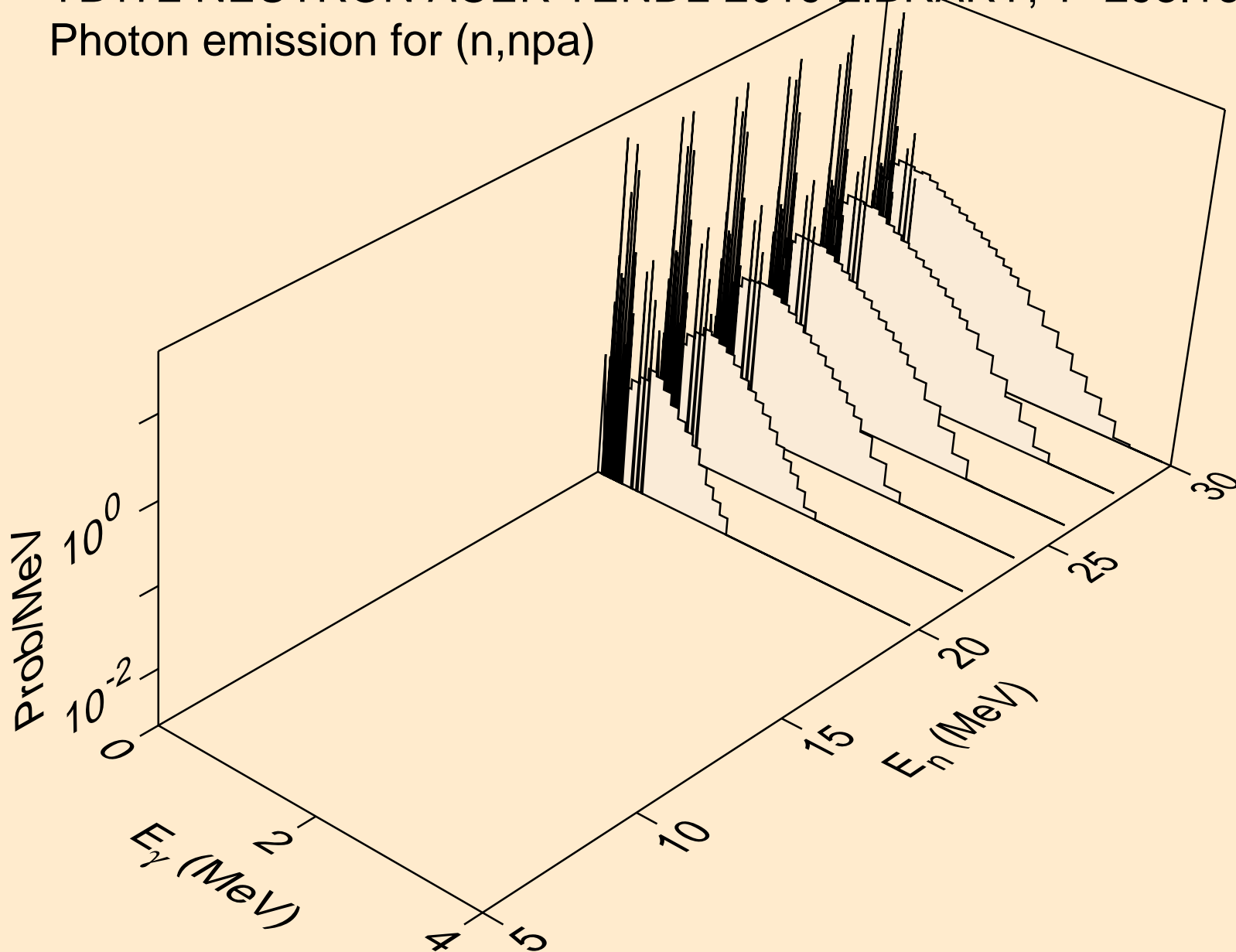



YB172 NEUTRON ACER TENDL-2019 LIBRARY; T=293.16K  
Photon emission for (n,n\*c)

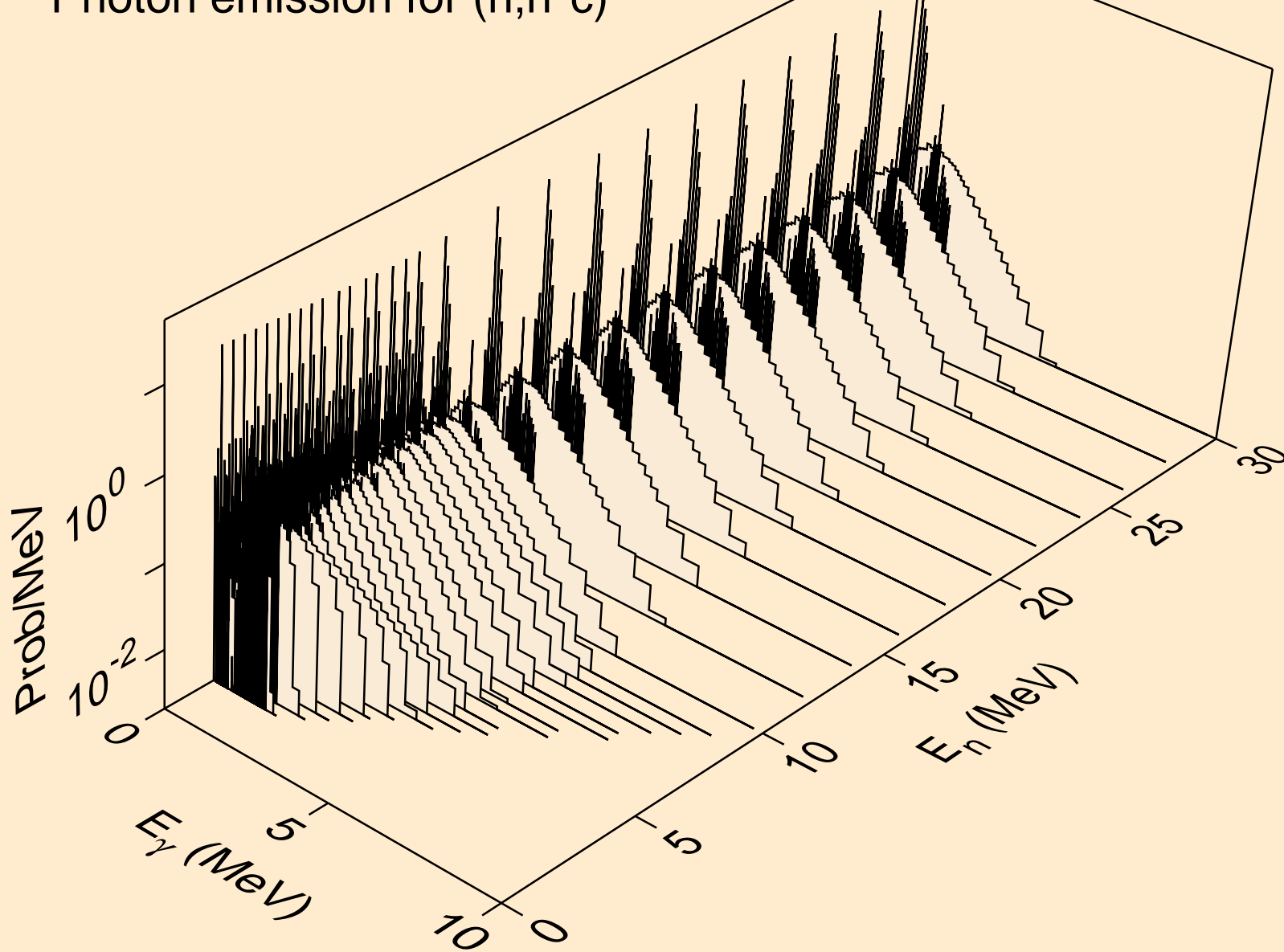

YB172 NEUTRON ACER TENDL-2019 LIBRARY; T=293.16K  
Photon emission for (n,gma)

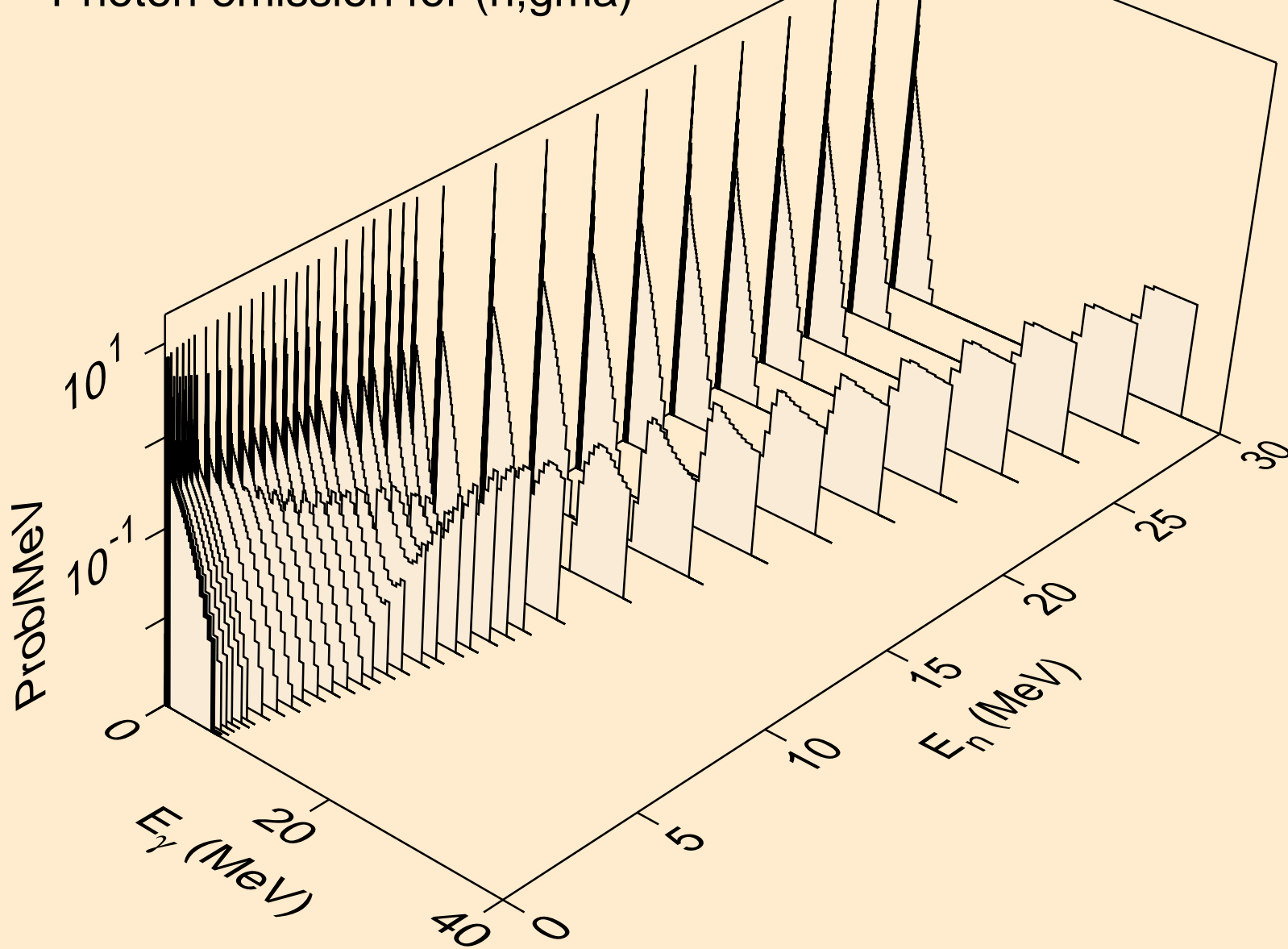

YB172 NEUTRON ACER TENDL-2019 LIBRARY; T=293.16K  
Photon emission for (n,p)

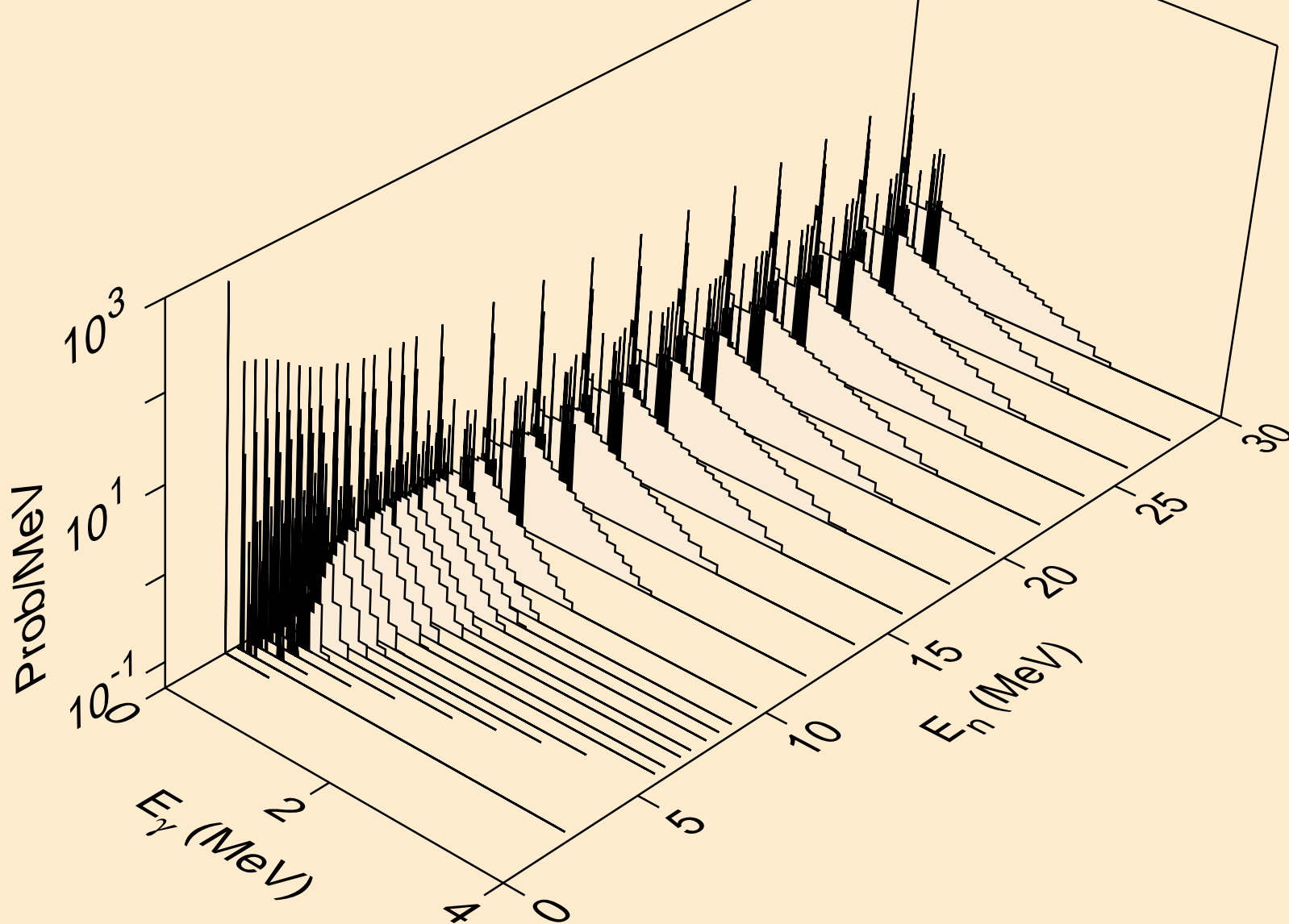

YB172 NEUTRON ACER TENDL-2019 LIBRARY; T=293.16K  
Photon emission for (n,d)

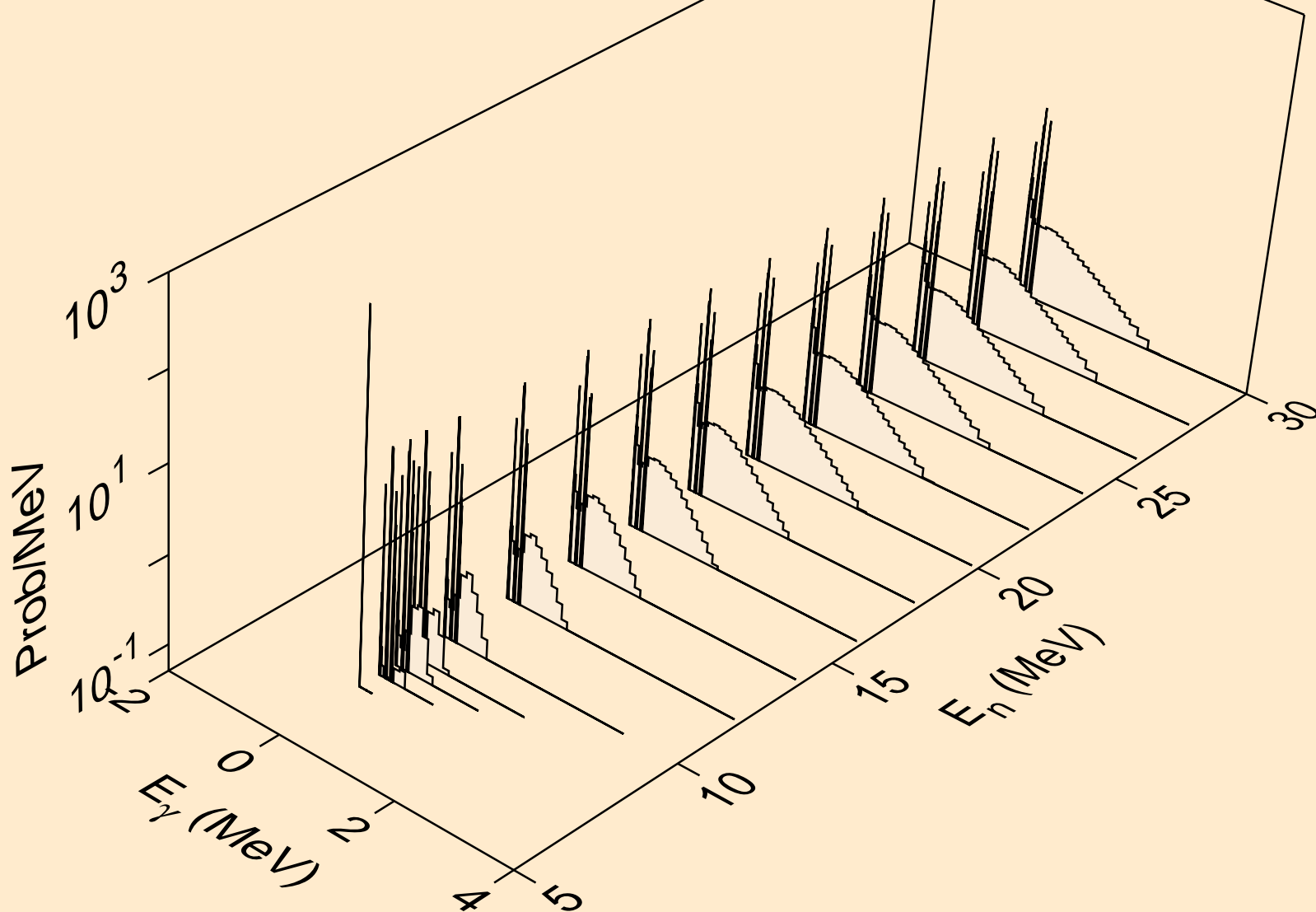

YB172 NEUTRON ACER TENDL-2019 LIBRARY; T=293.16K  
Photon emission for (n,t)

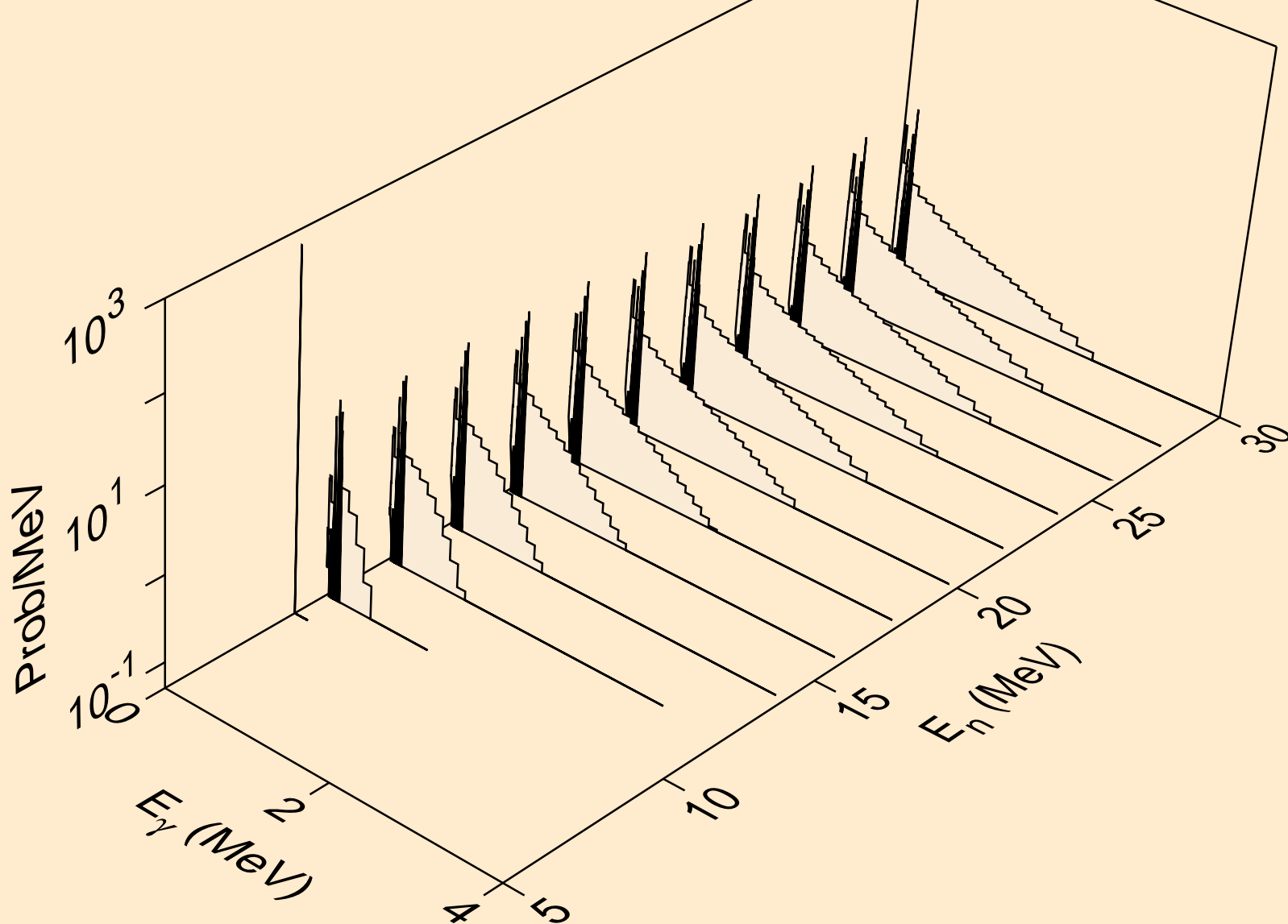

YB172 NEUTRON ACER TENDL-2019 LIBRARY; T=293.16K  
Photon emission for (n,he3)

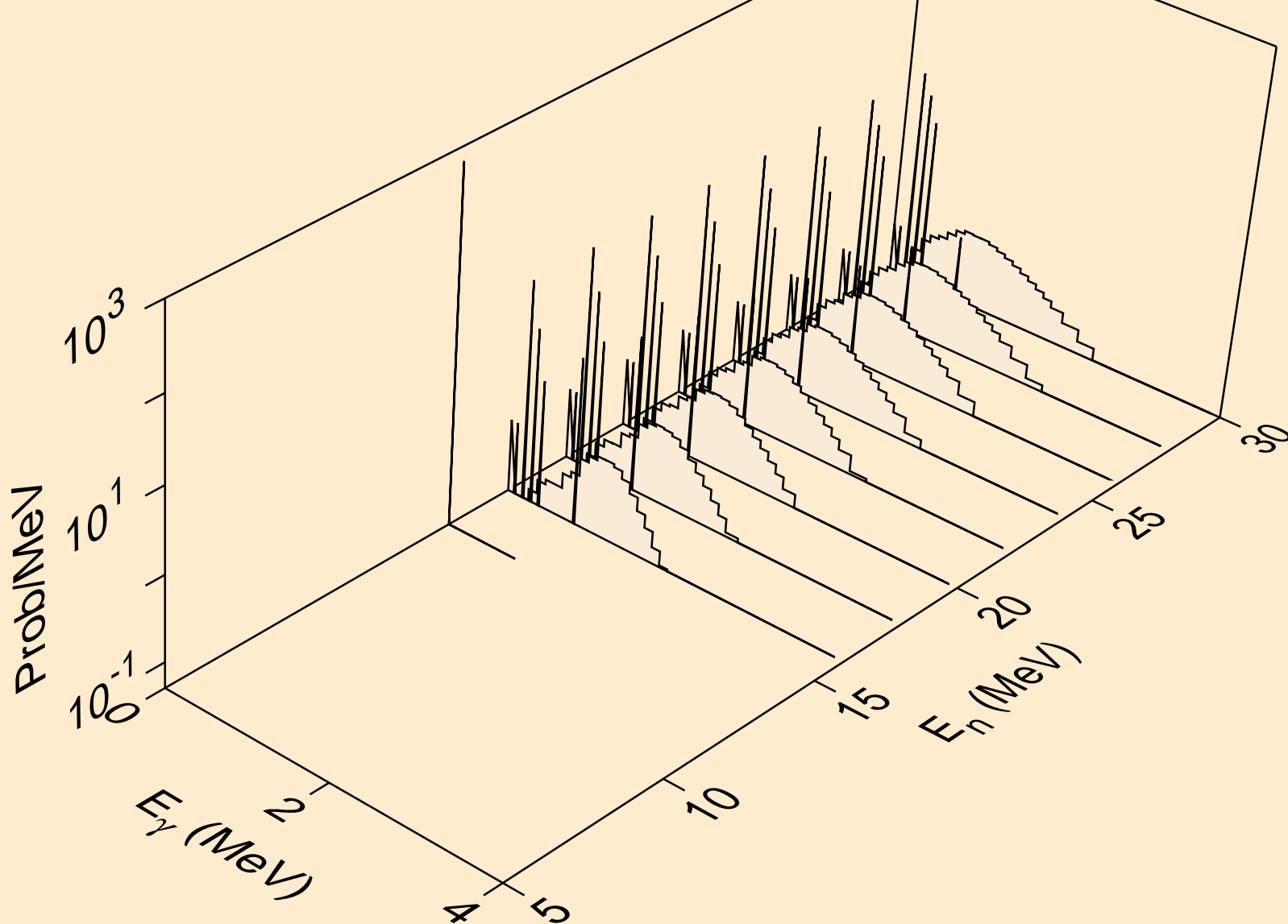

YB172 NEUTRON ACER TENDL-2019 LIBRARY; T=293.16K  
Photon emission for (n,a)

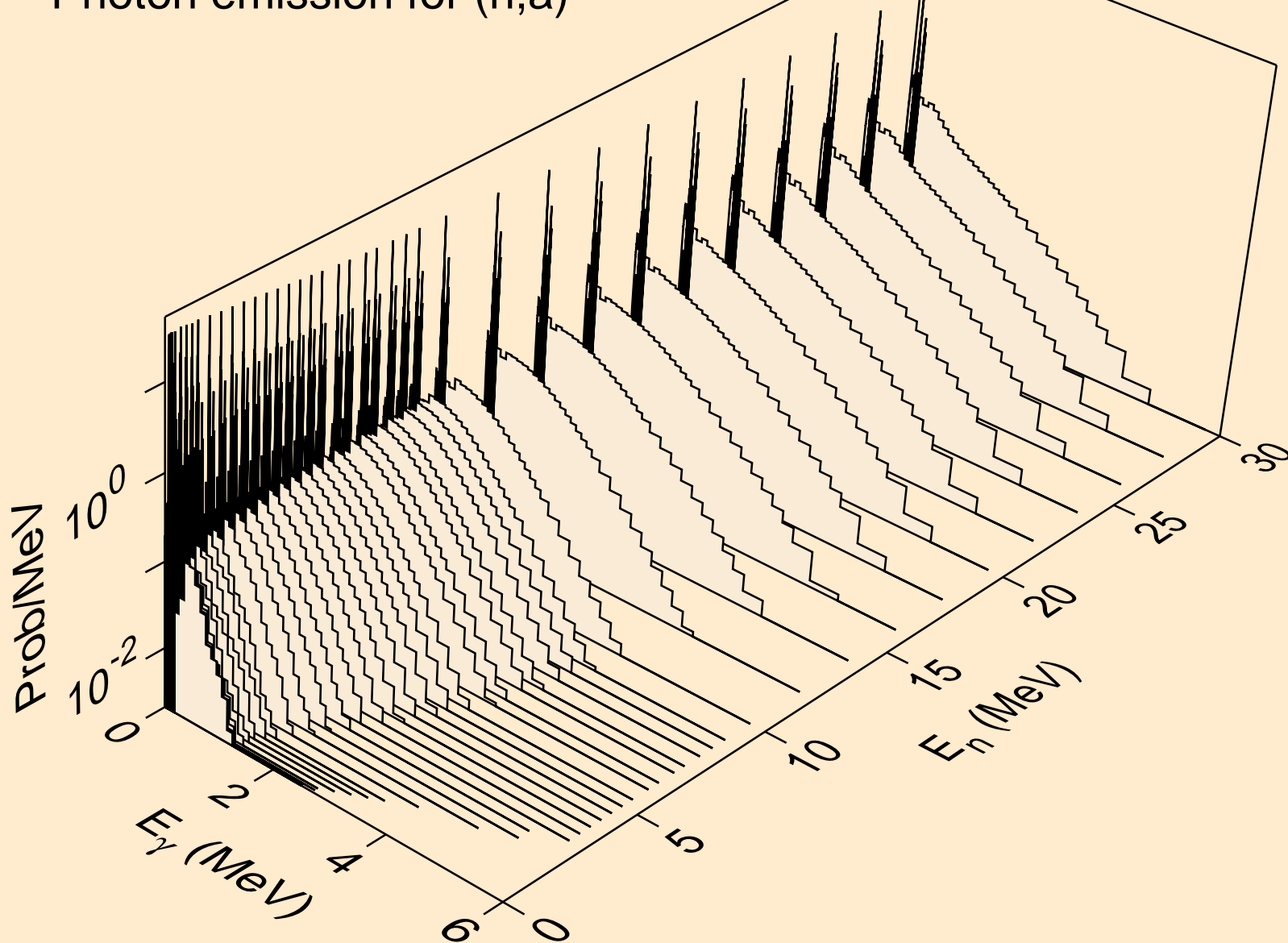

YB172 NEUTRON ACER TENDL-2019 LIBRARY; T=293.16K  
Photon emission for (n,2a)

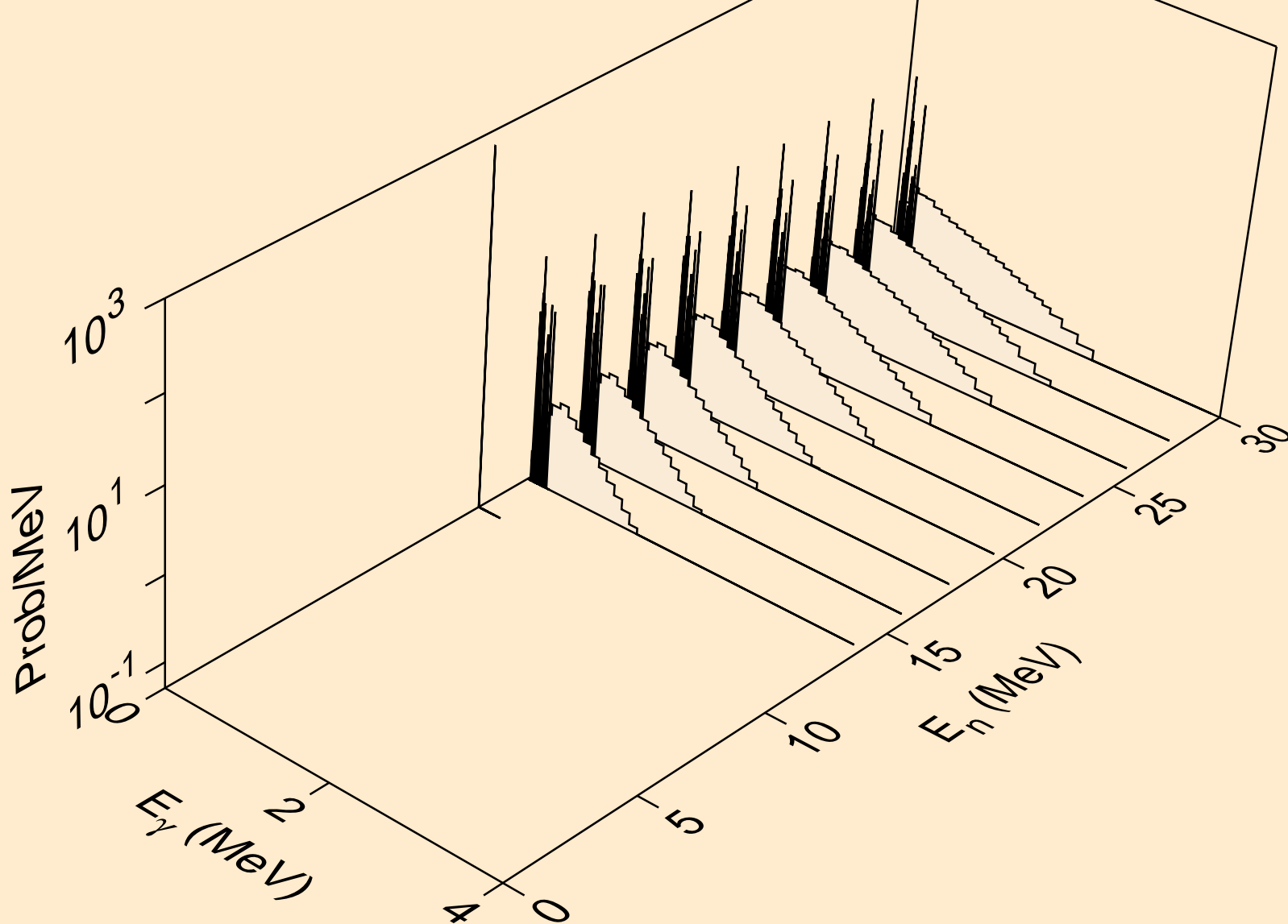



YB172 NEUTRON ACER TENDL-2019 LIBRARY; T=293.16K  
Photon emission for (n,2p)

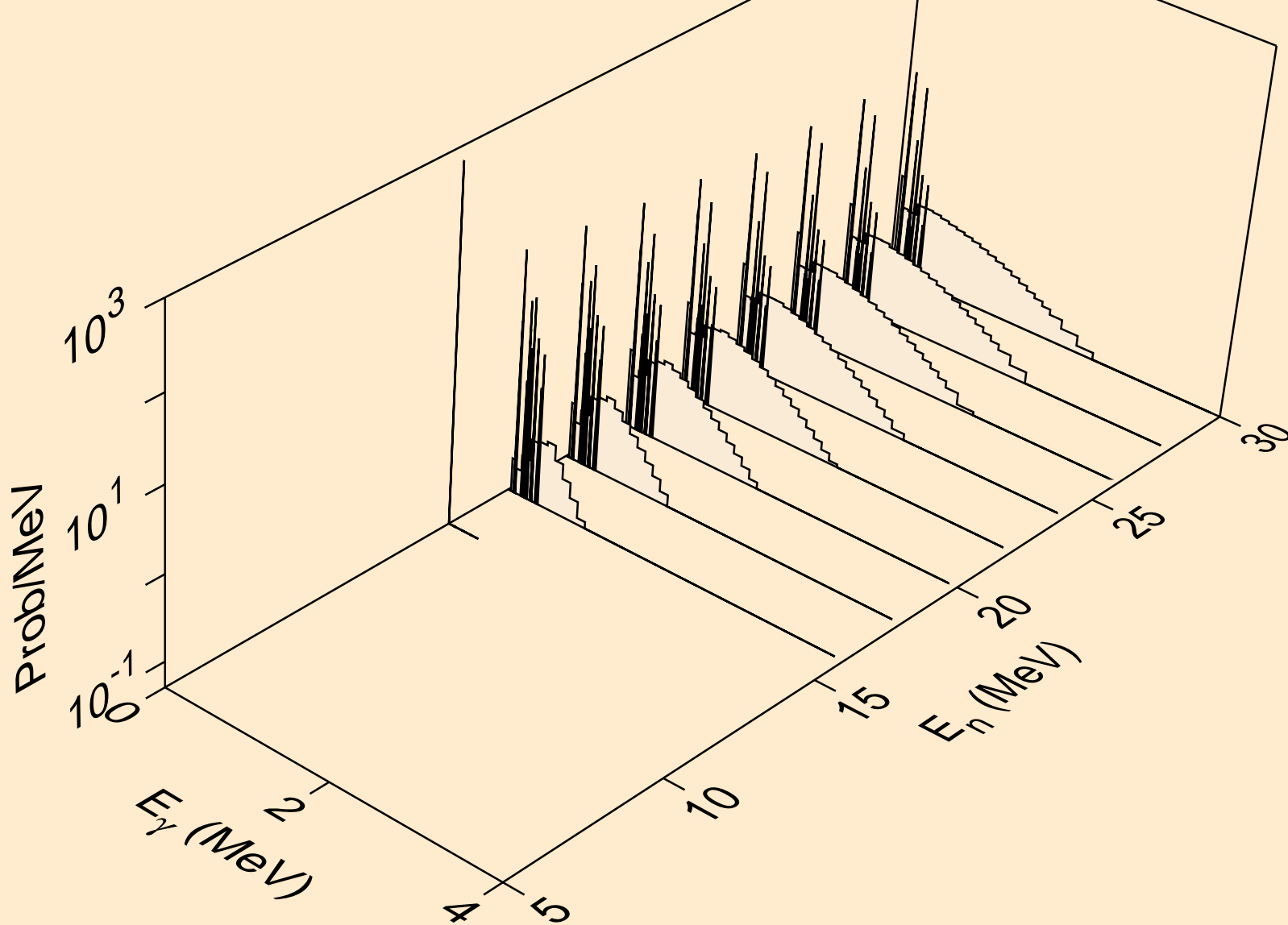

YB172 NEUTRON ACER TENDL-2019 LIBRARY; T=293.16K  
Photon emission for (n,p $\alpha$ )

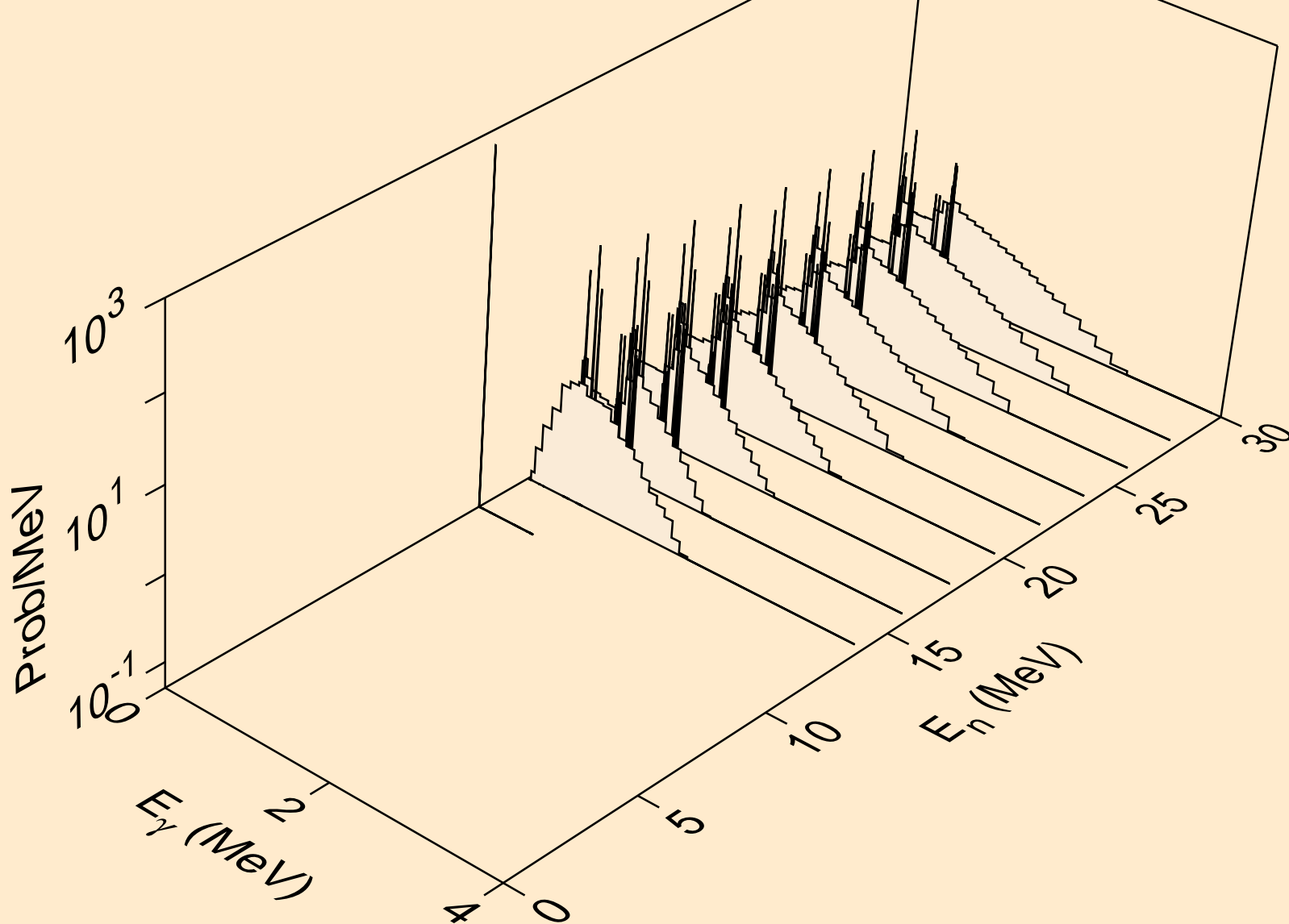

YB172 NEUTRON ACER TENDL-2019 LIBRARY; T=293.16K  
Photon emission for (n,pd)

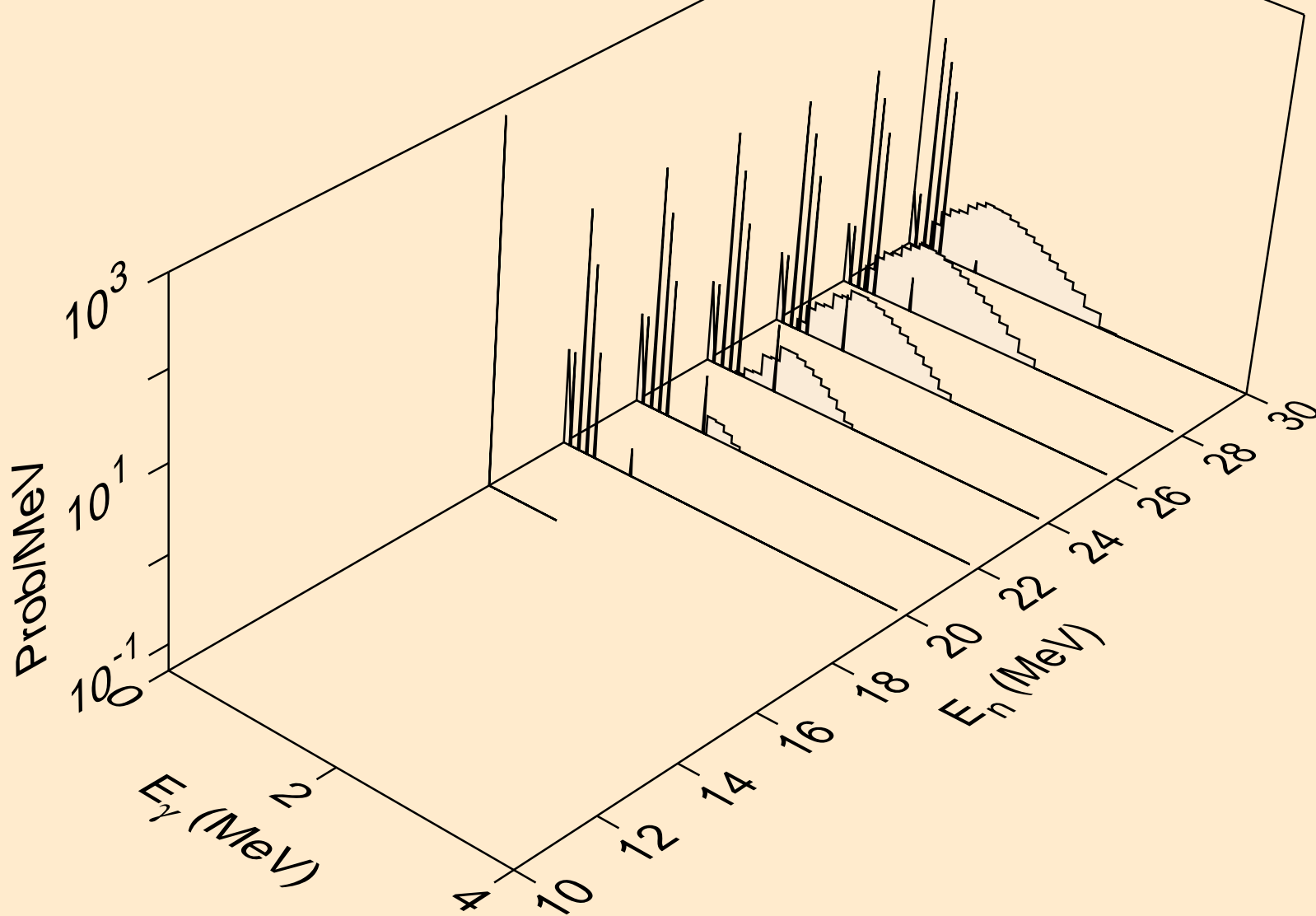

YB172 NEUTRON ACER TENDL-2019 LIBRARY; T=293.16K  
Photon emission for (n,pt)

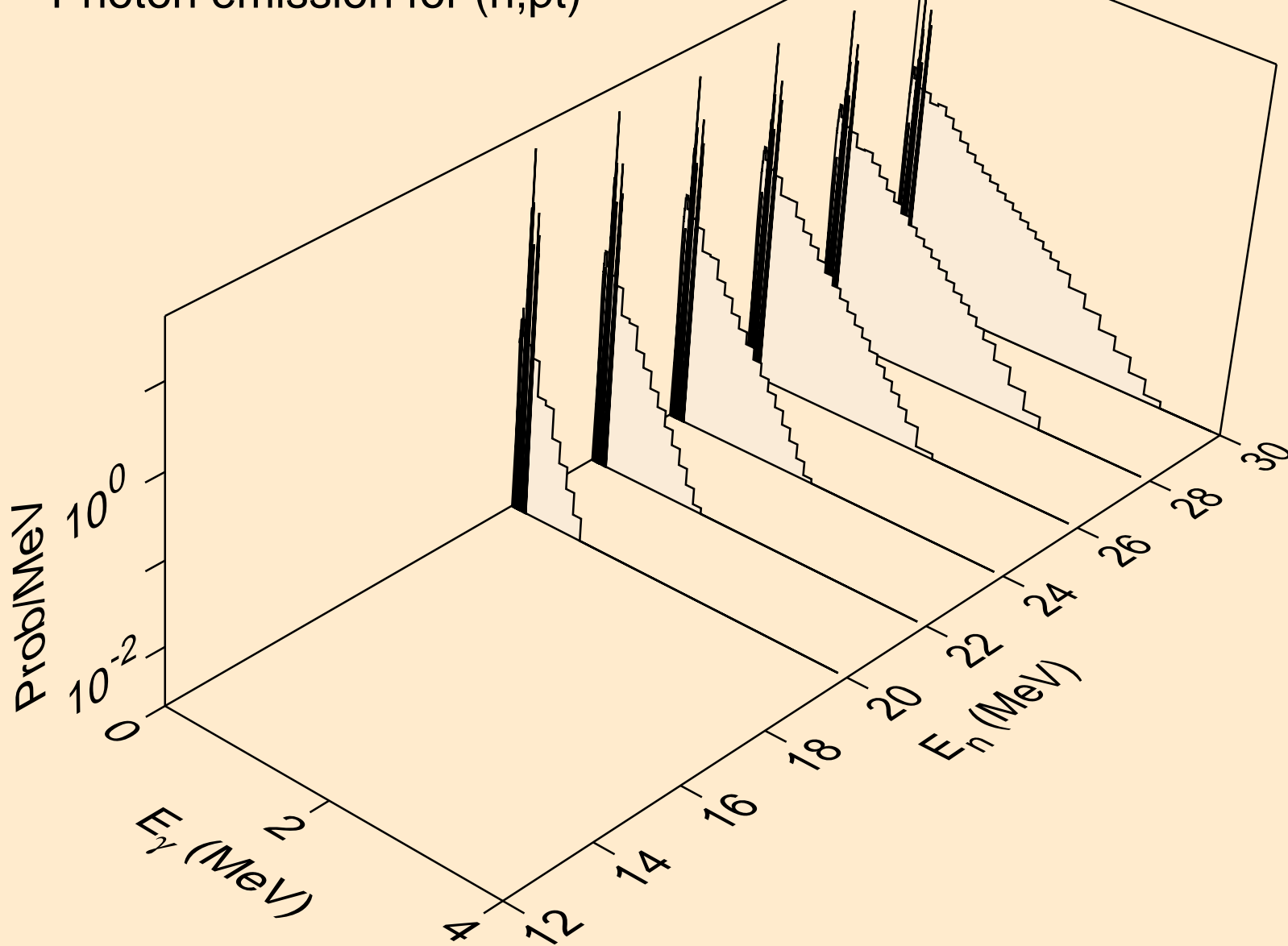

YB172 NEUTRON ACER TENDL-2019 LIBRARY; T=293.16K  
thermal capture photon spectrum

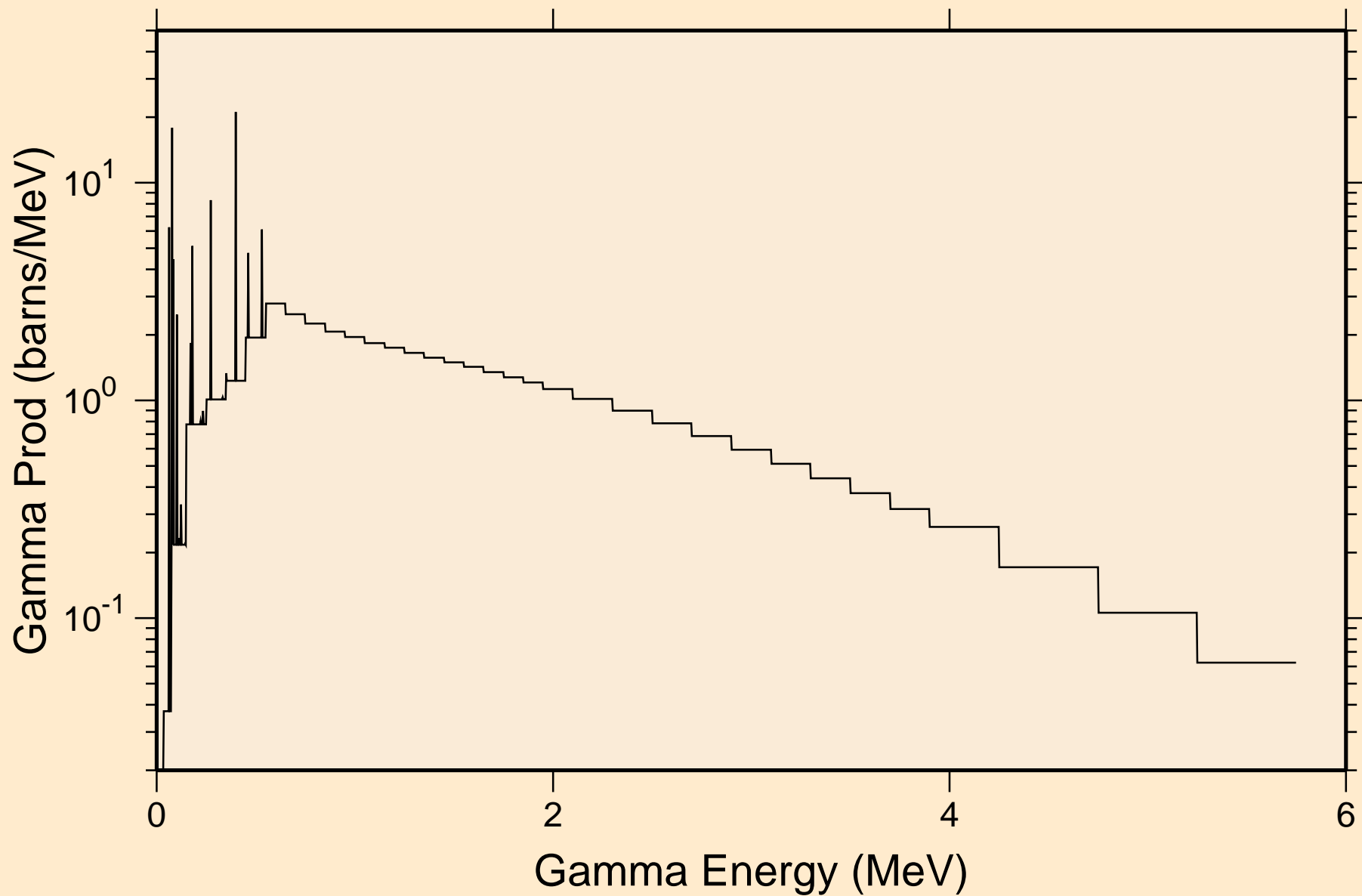

YB172 NEUTRON ACER TENDL-2019 LIBRARY; T=293.16K  
14 MeV photon spectrum

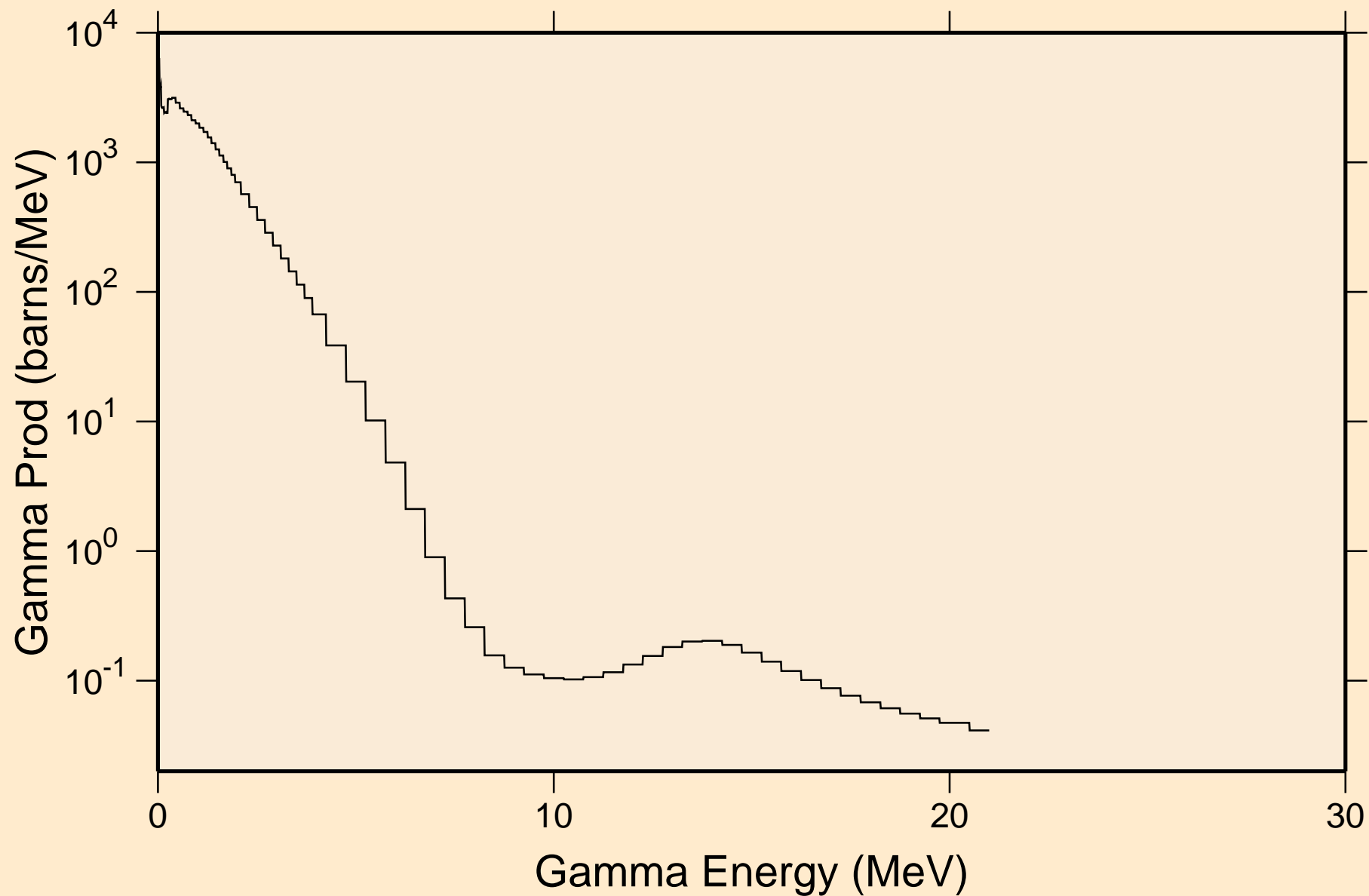

# YB172 NEUTRON ACER TENDL-2019 LIBRARY; T=293.16K

## Particle heating contributions

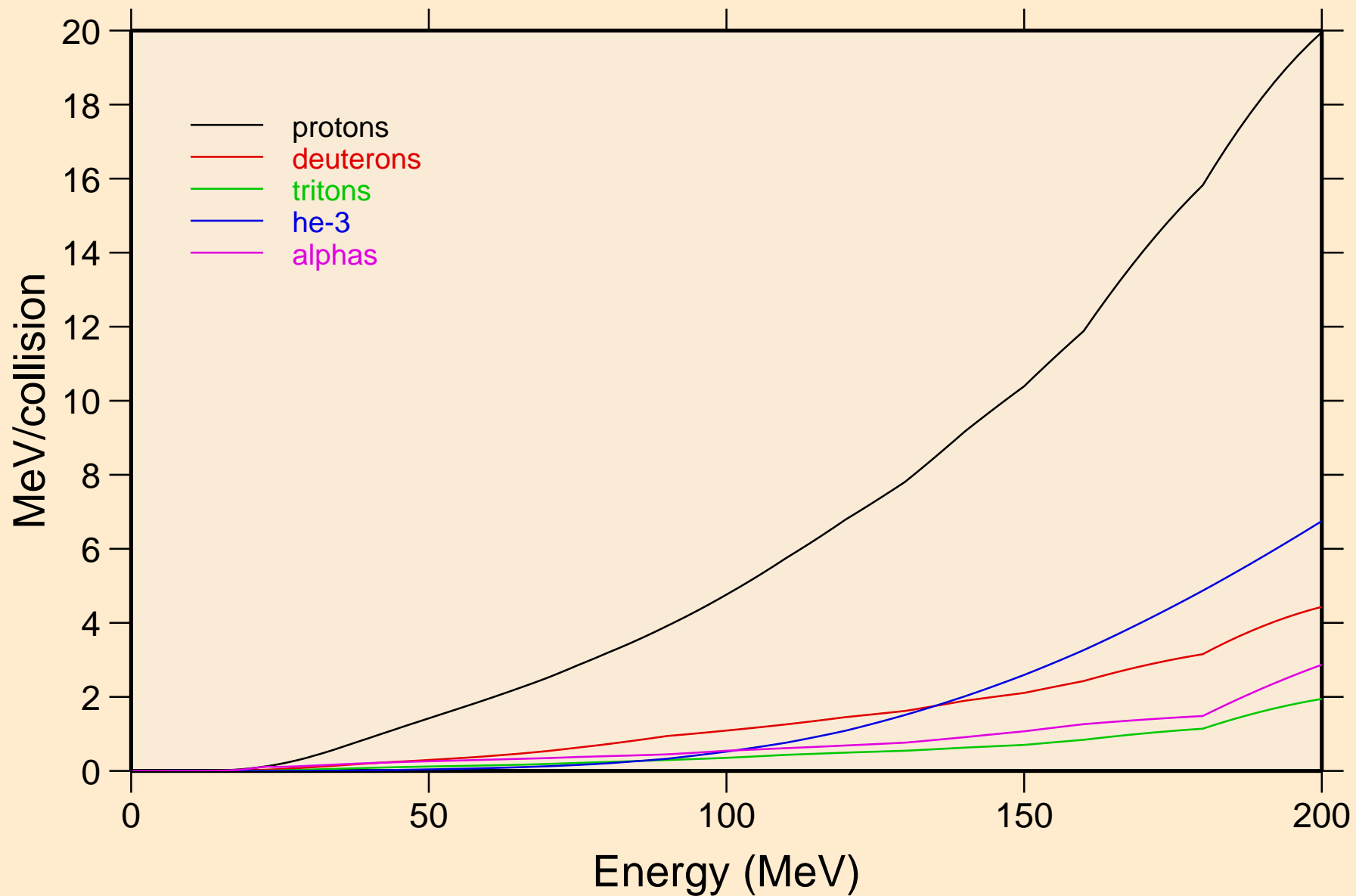

YB172 NEUTRON ACER TENDL-2019 LIBRARY; T=293.16K  
Recoil Heating

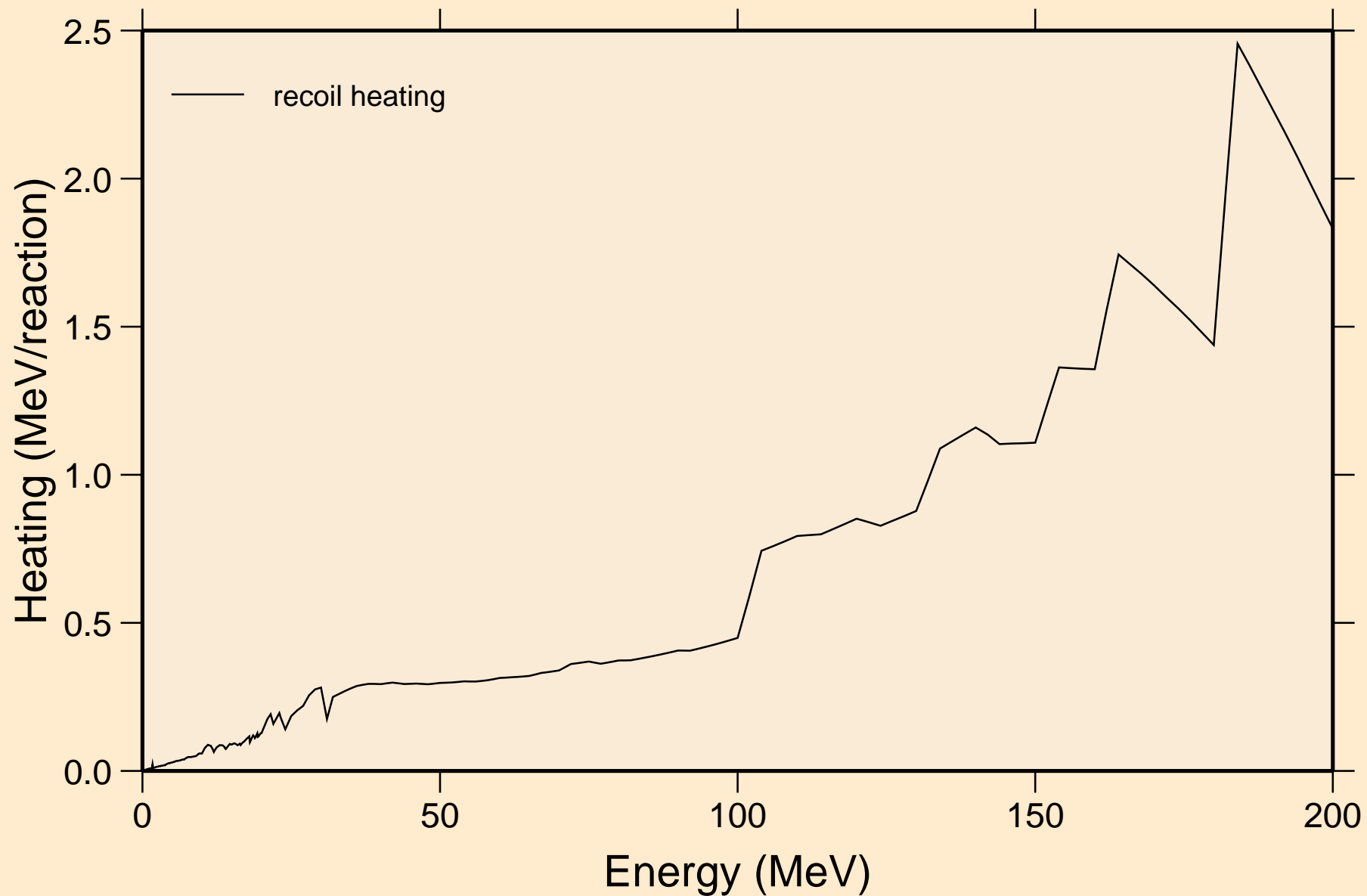



YB172 NEUTRON ACER TENDL-2019 LIBRARY; T=293.16K  
Particle production cross sections

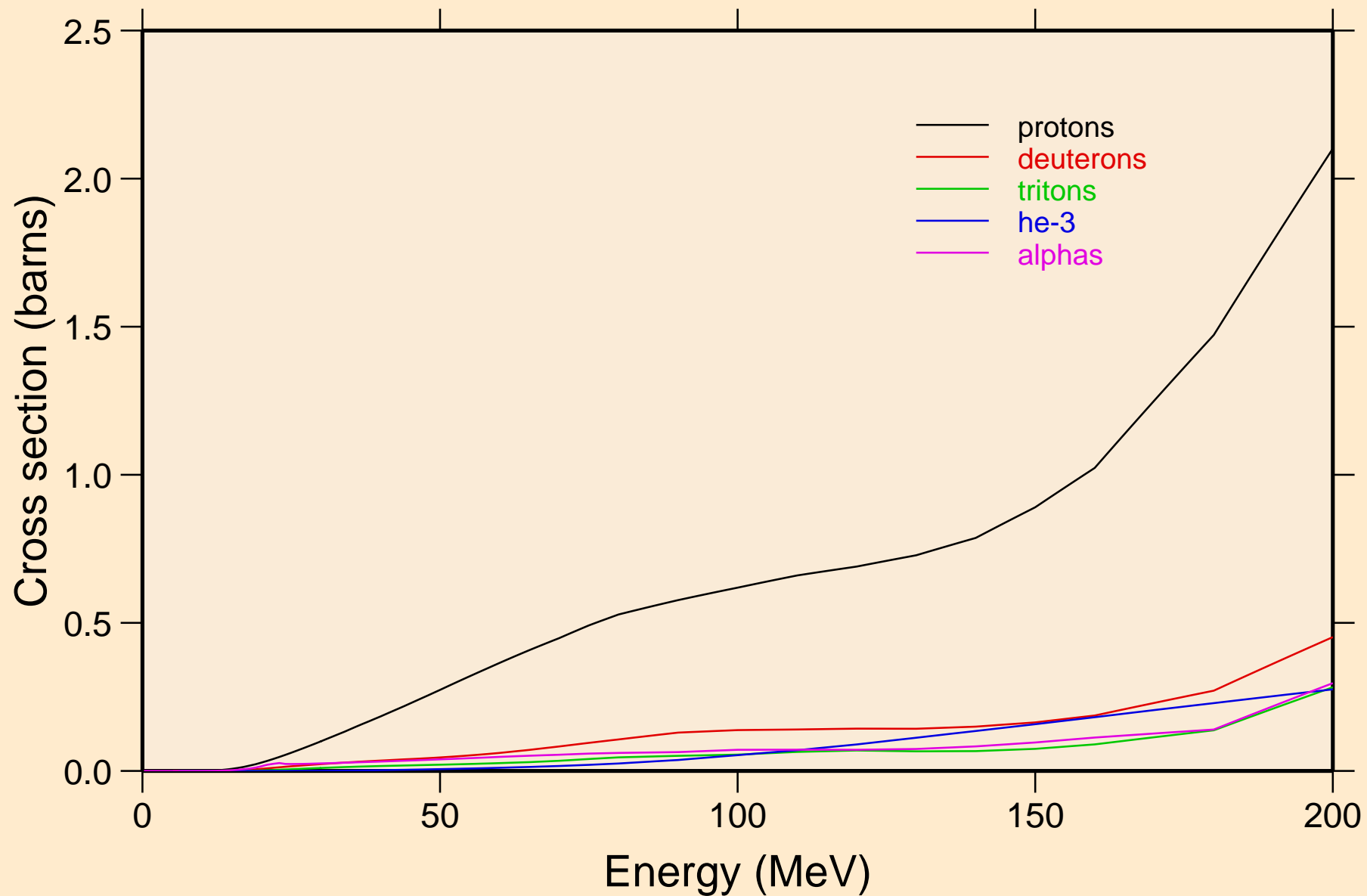

YB172 NEUTRON ACER TENDL-2019 LIBRARY; T=293.16K  
protons from (n,x)

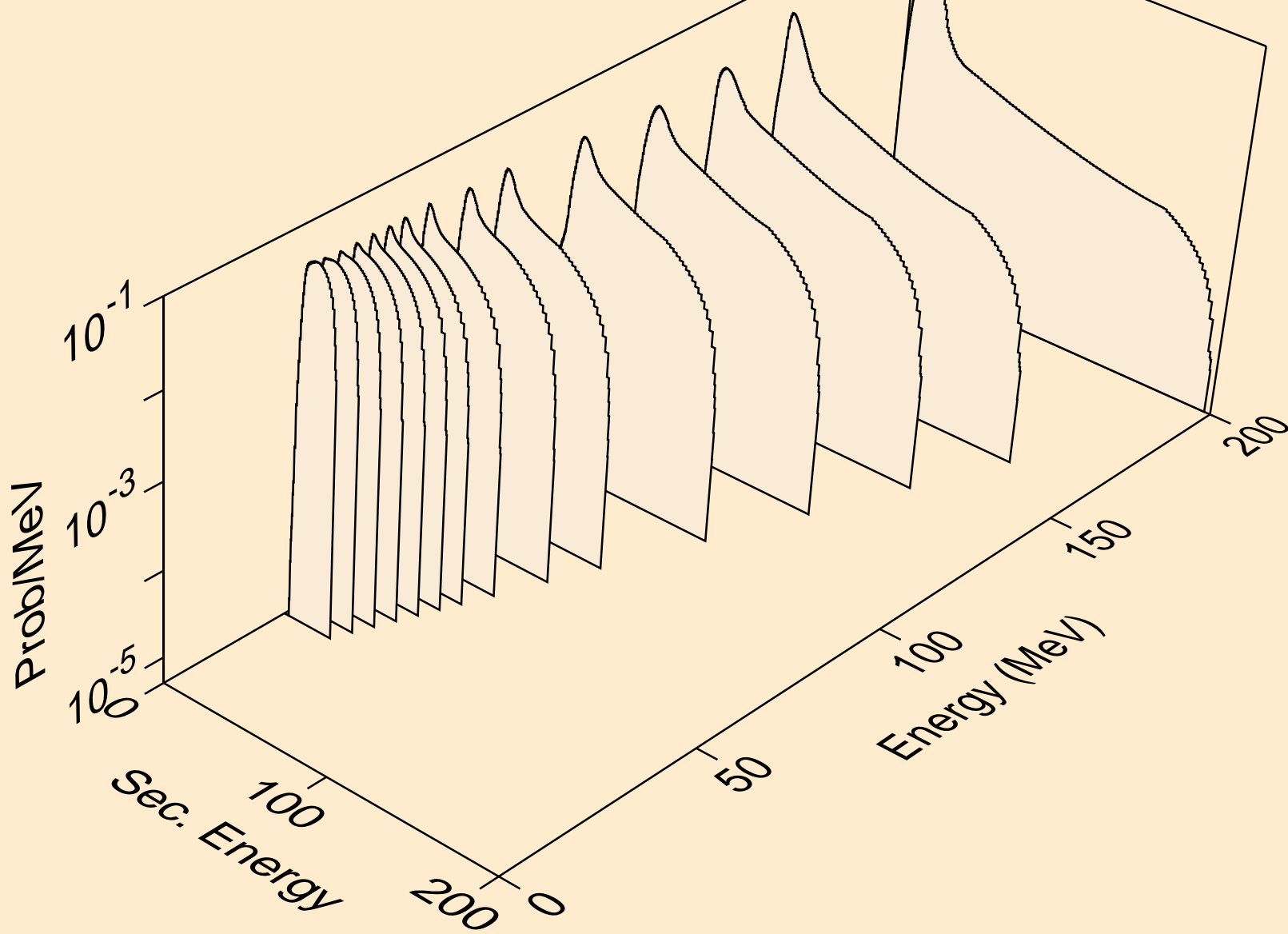

YB172 NEUTRON ACER TENDL-2019 LIBRARY; T=293.16K  
protons from (n,n\*)p

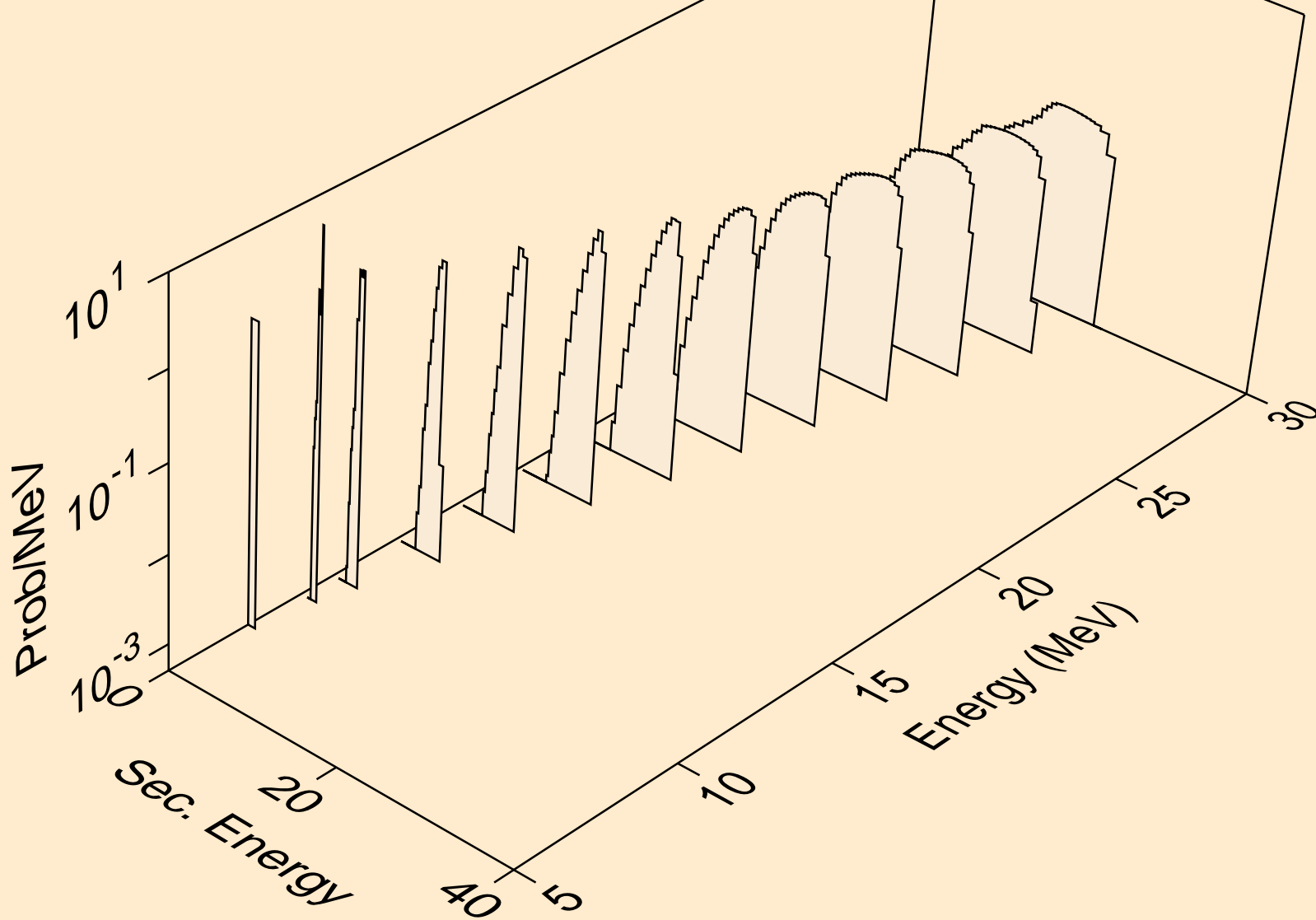

YB172 NEUTRON ACER TENDL-2019 LIBRARY; T=293.16K  
protons from (n,2np)

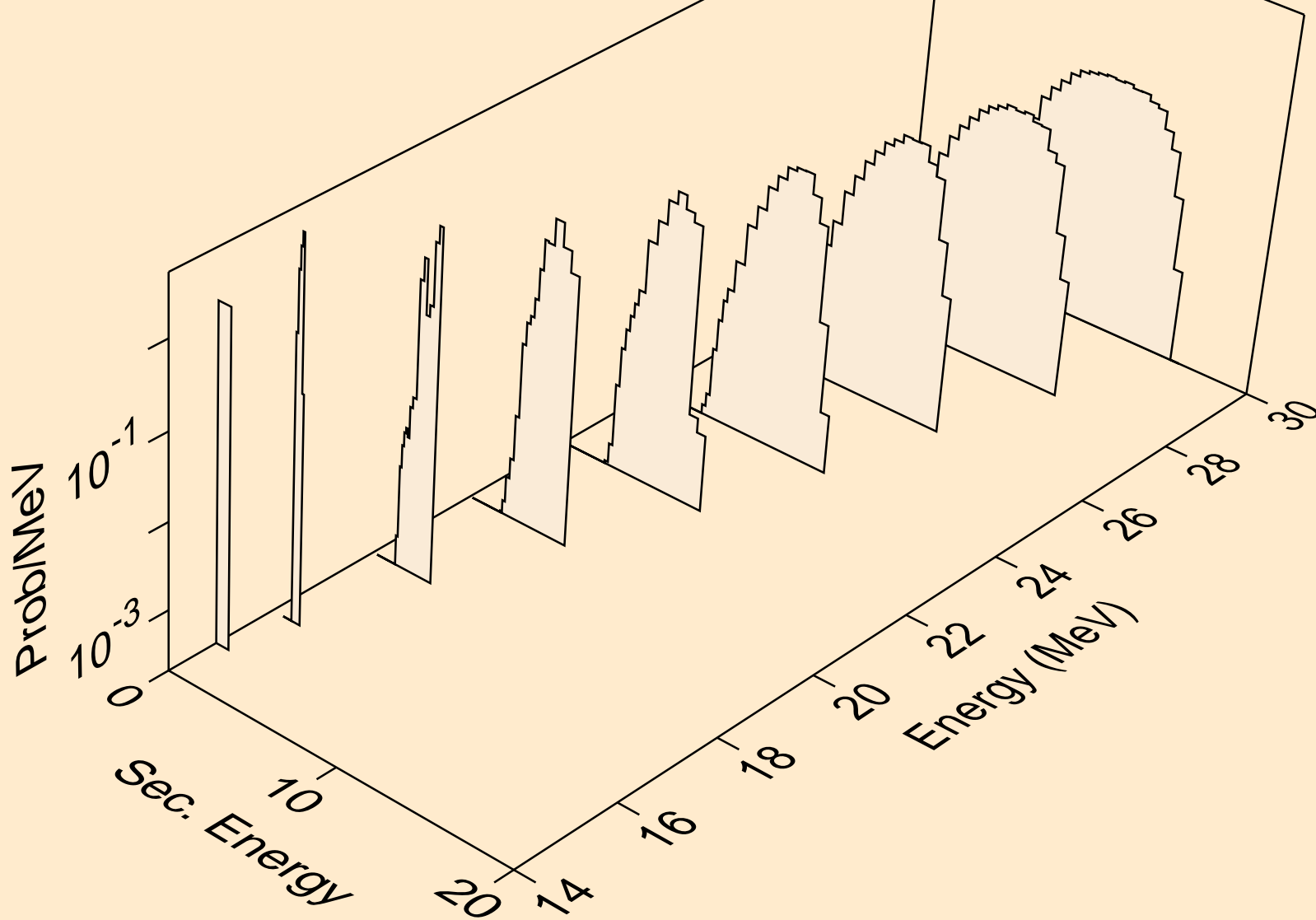

YB172 NEUTRON ACER TENDL-2019 LIBRARY; T=293.16K  
protons from (n,3np)

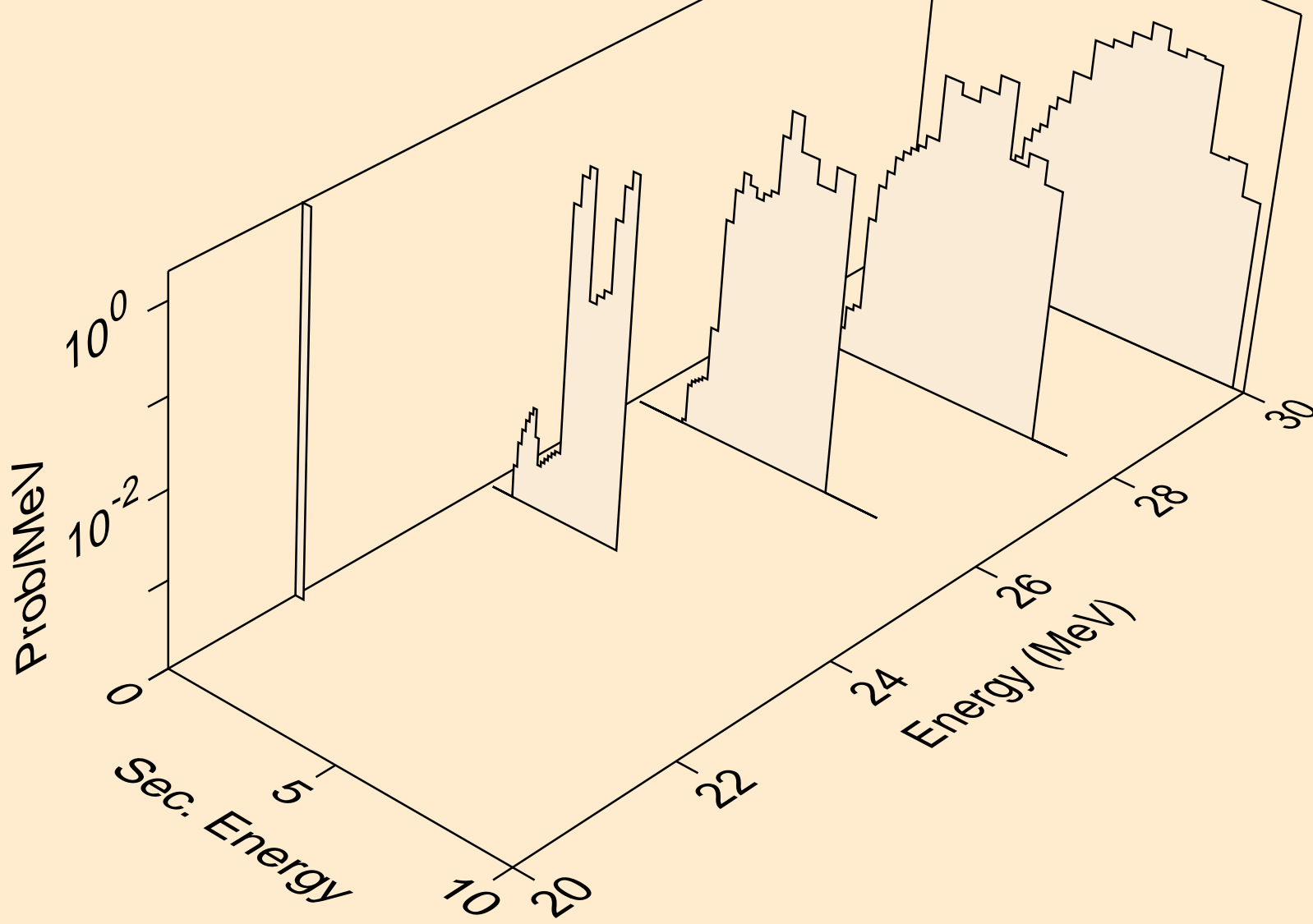

YB172 NEUTRON ACER TENDL-2019 LIBRARY; T=293.16K  
protons from (n,2np)

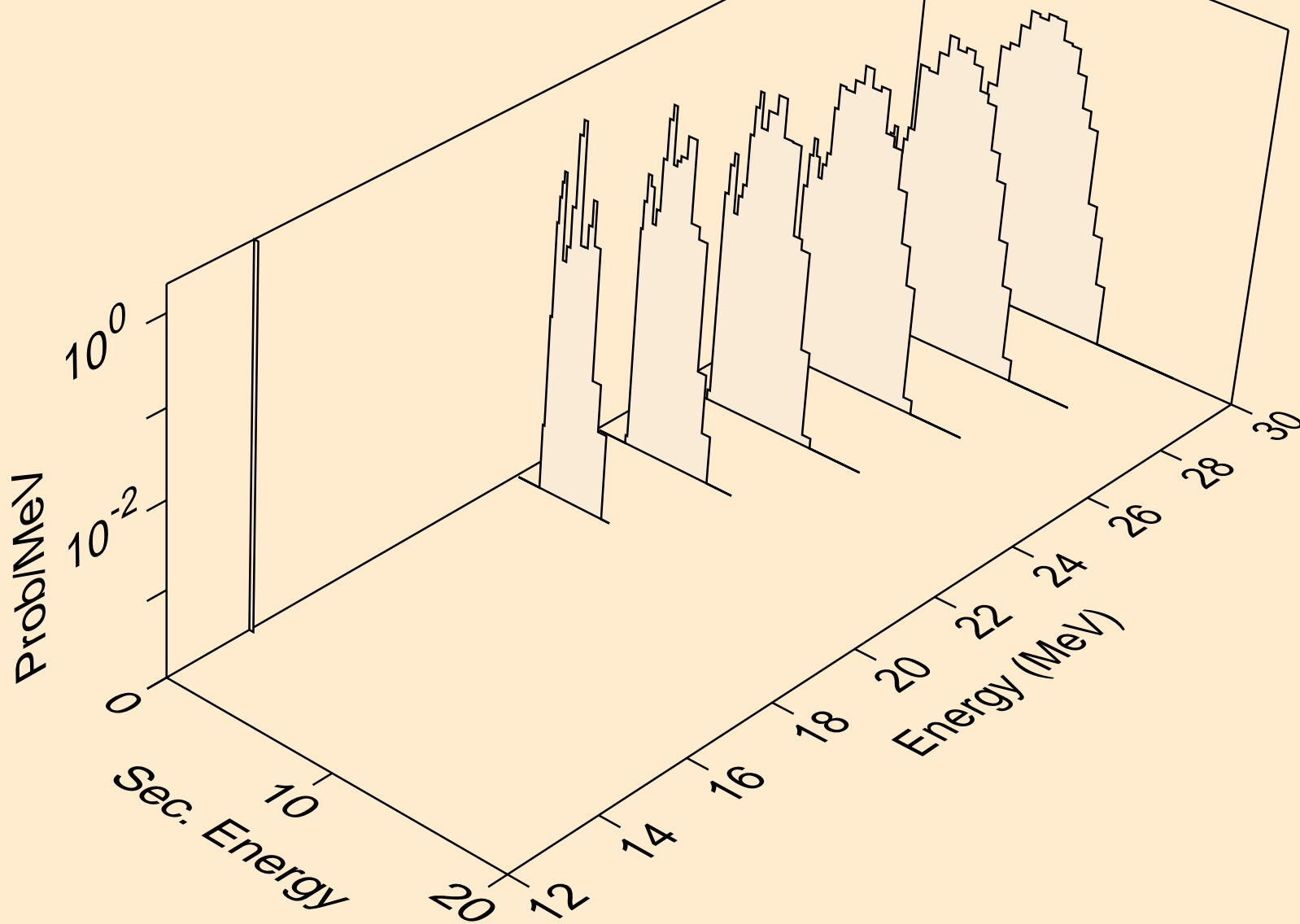

YB172 NEUTRON ACER TENDL-2019 LIBRARY; T=293.16K  
protons from (n,npa)

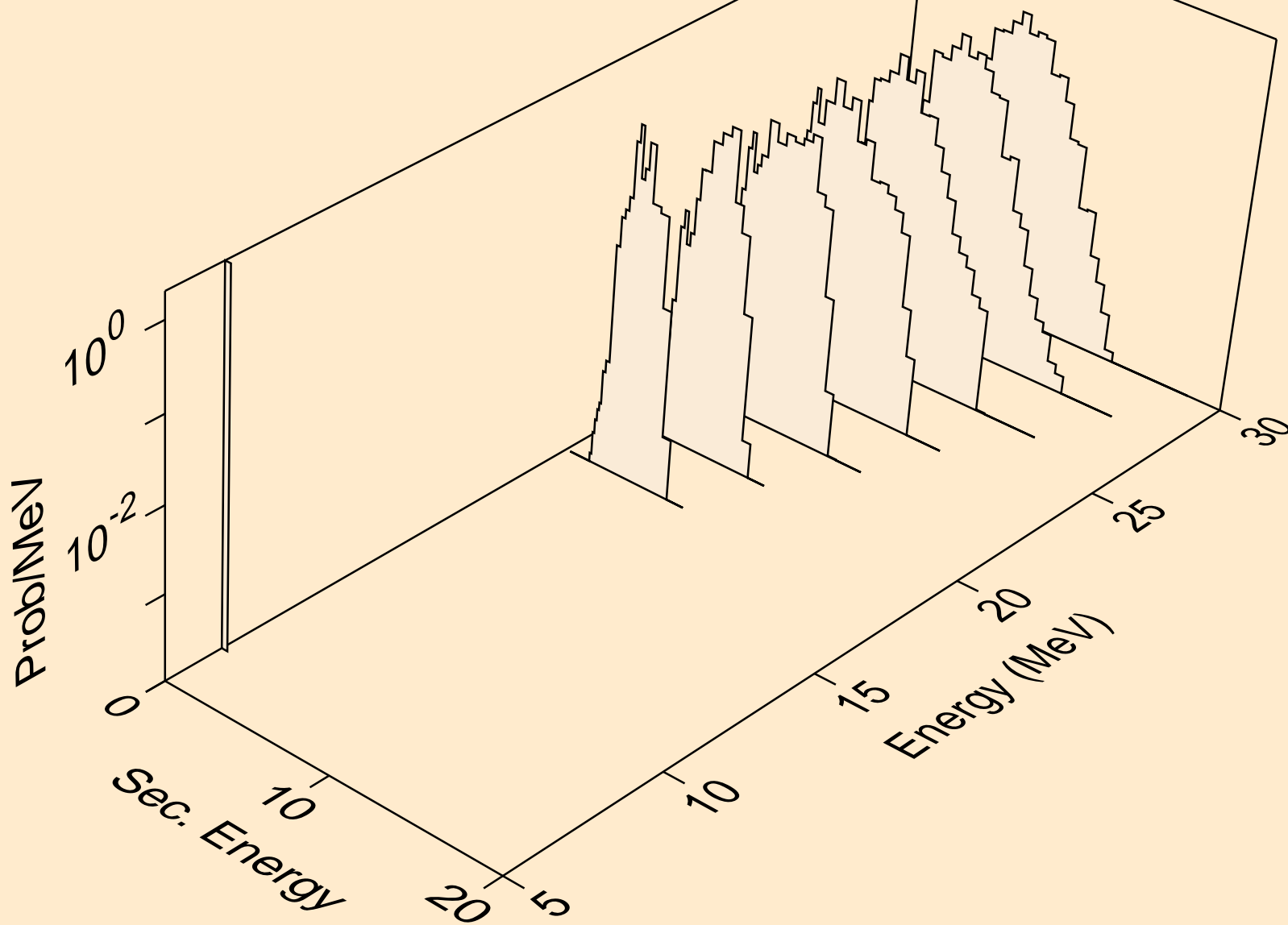

YB172 NEUTRON ACER TENDL-2019 LIBRARY; T=293.16K  
protons from (n,p)

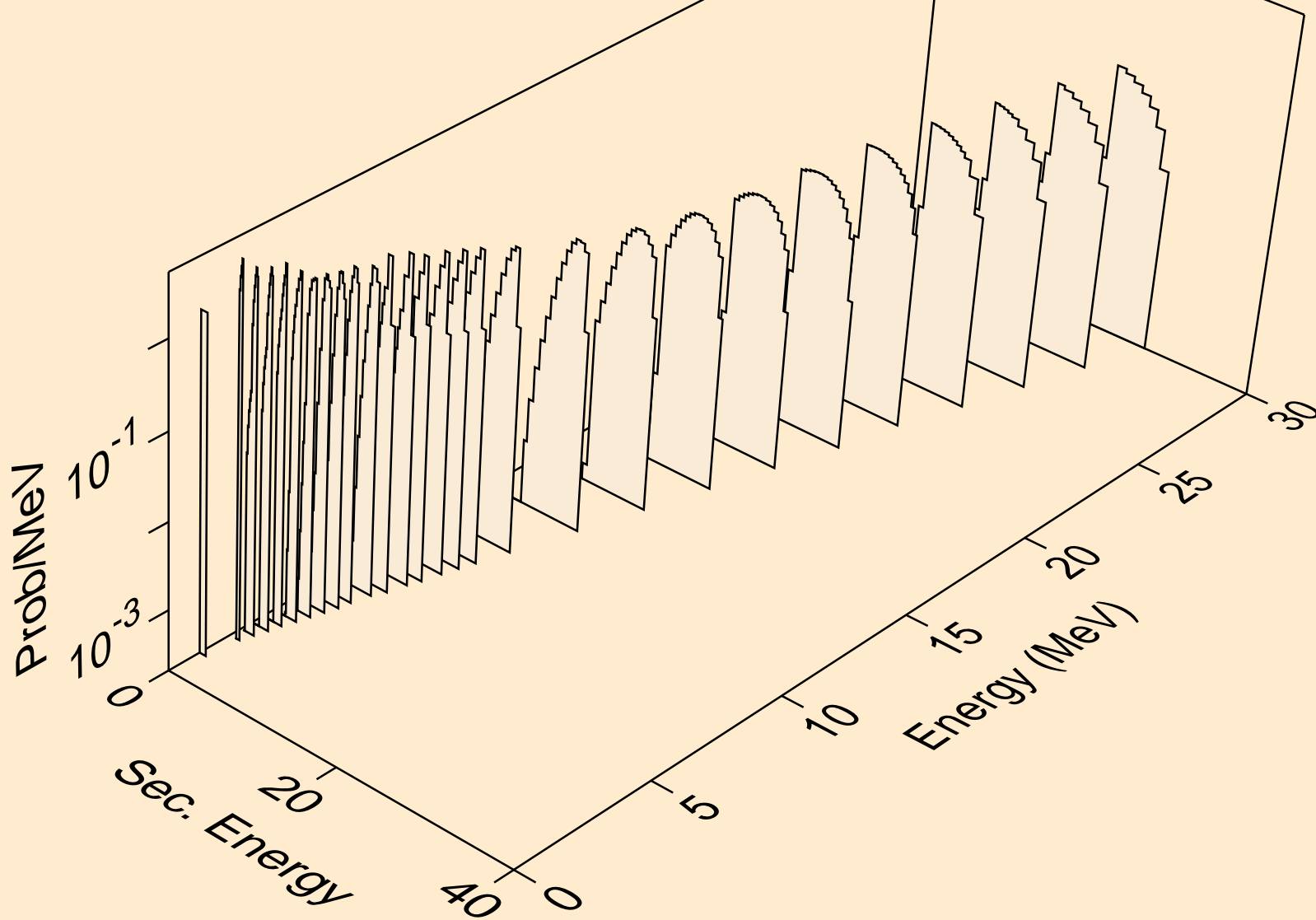



YB172 NEUTRON ACER TENDL-2019 LIBRARY; T=293.16K  
protons from (n,2p)

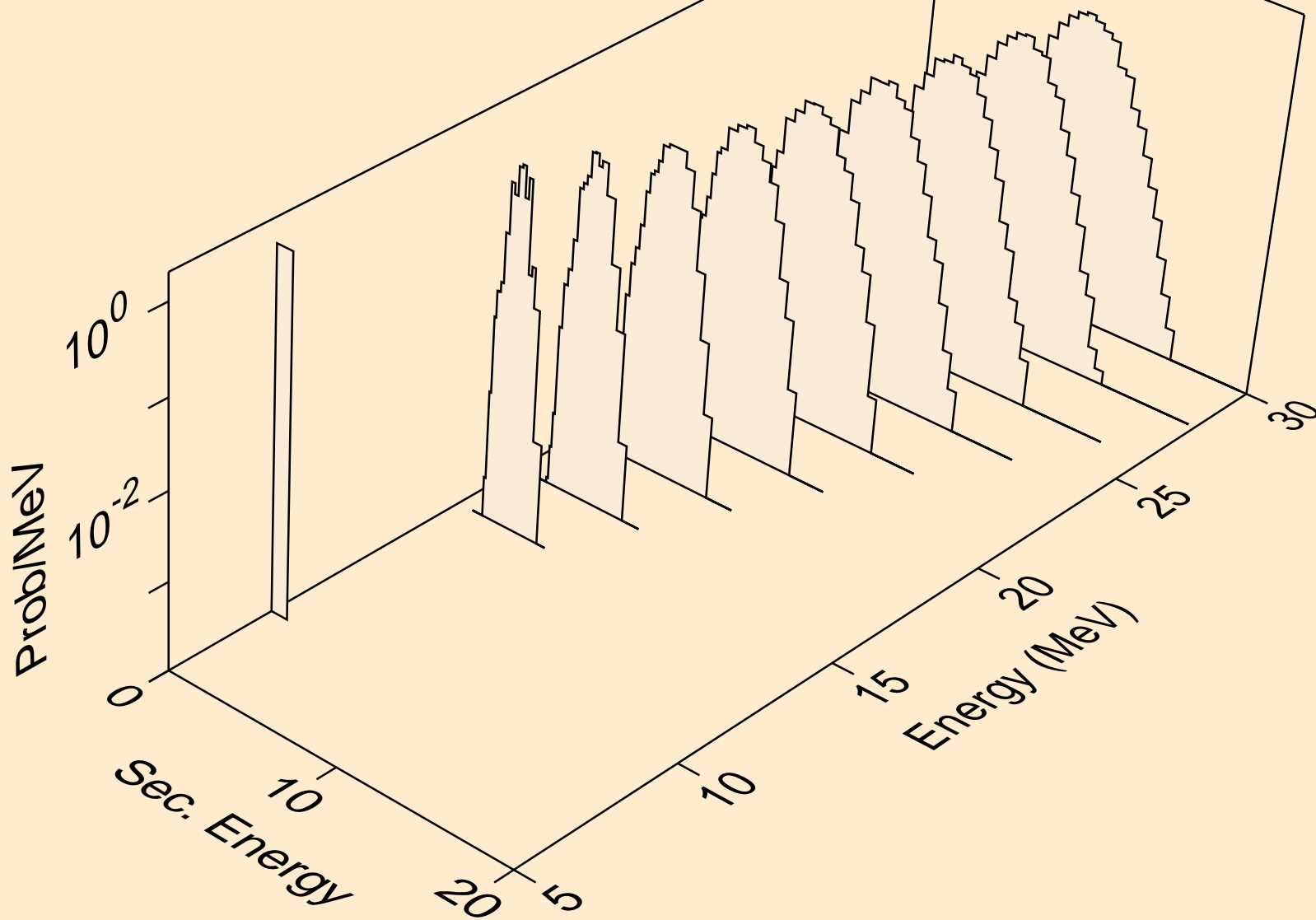

YB172 NEUTRON ACER TENDL-2019 LIBRARY; T=293.16K  
protons from (n,p)

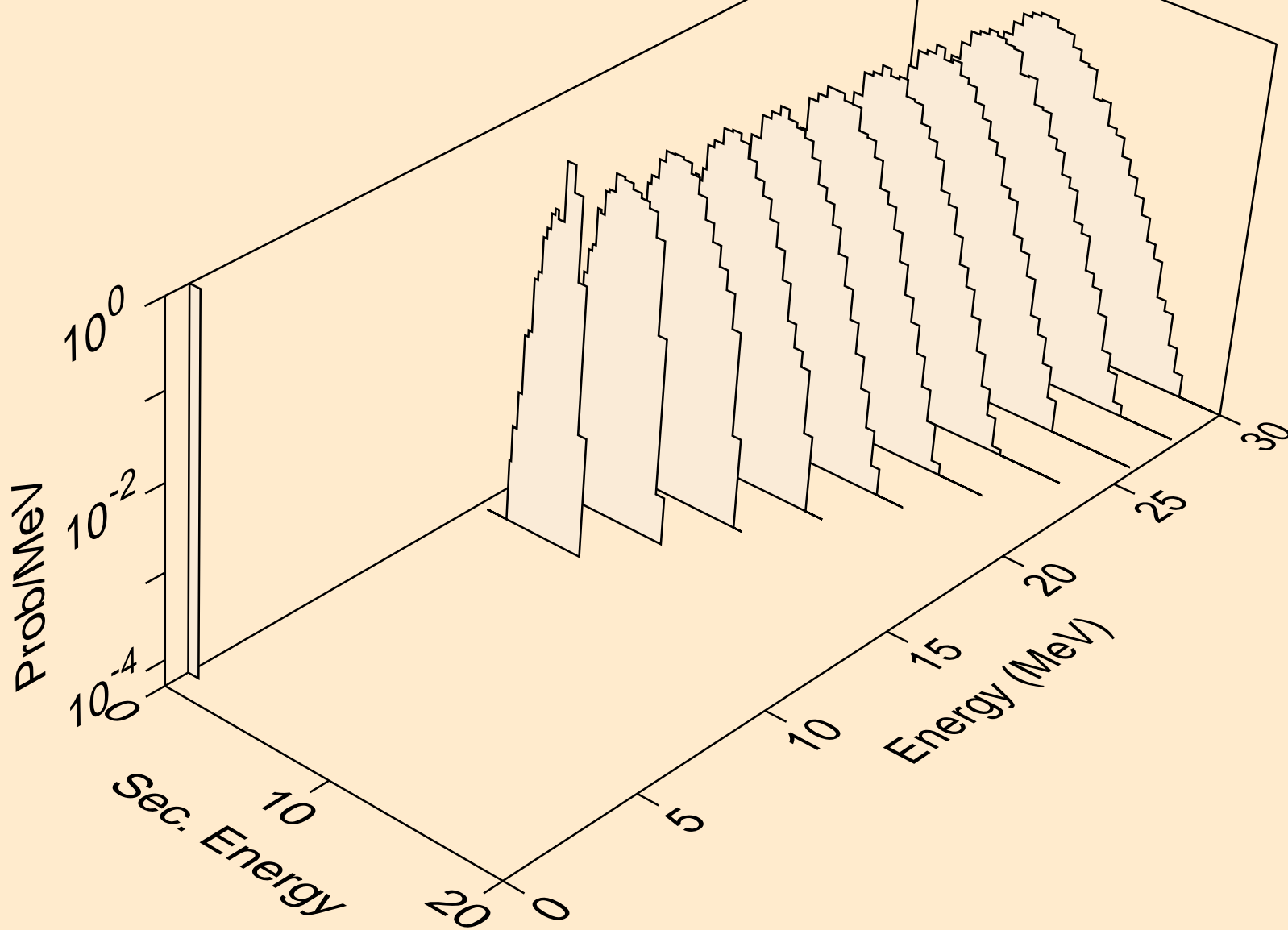

YB172 NEUTRON ACER TENDL-2019 LIBRARY; T=293.16K  
protons from (n,pd)

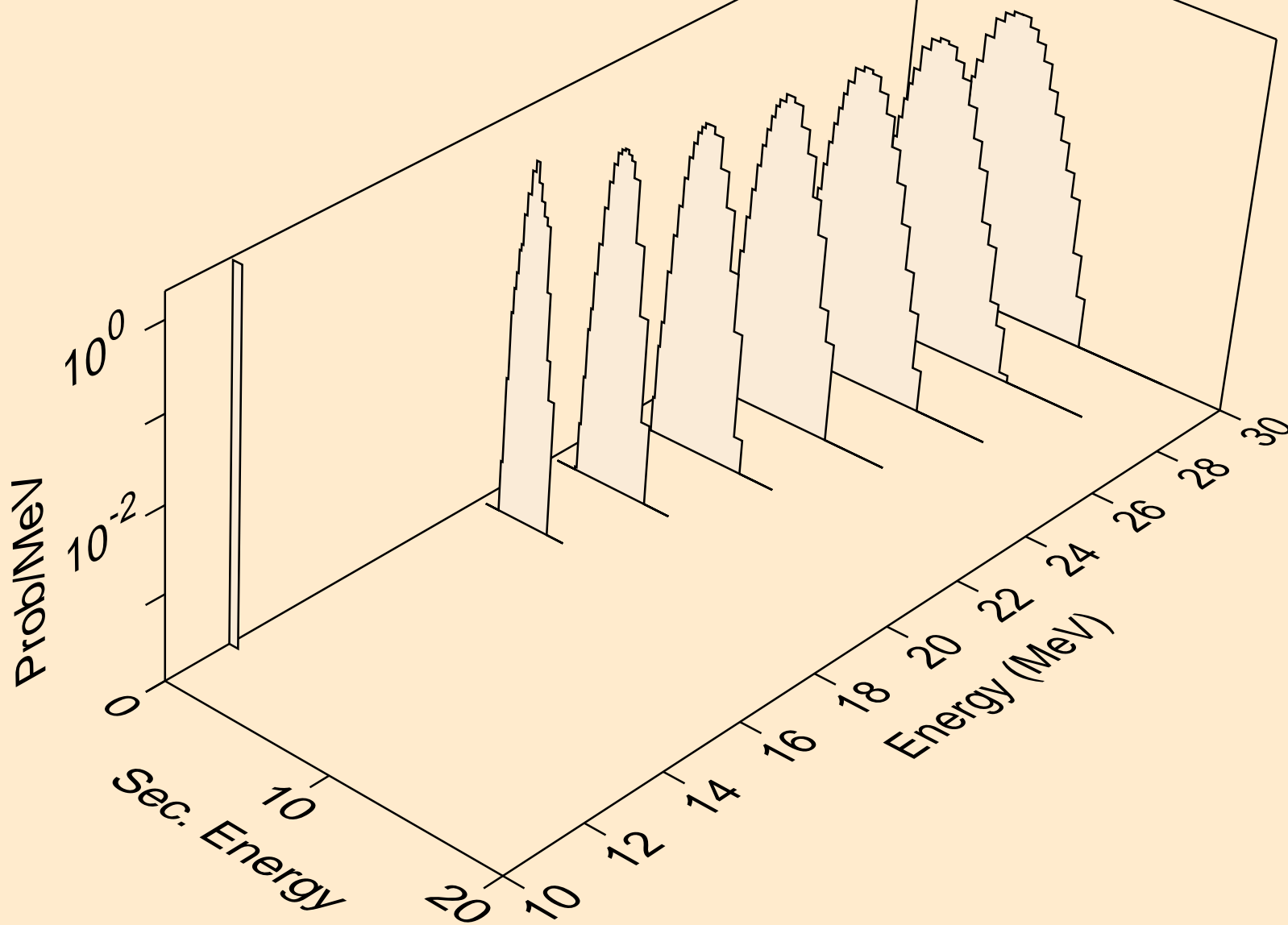

YB172 NEUTRON ACER TENDL-2019 LIBRARY; T=293.16K  
protons from (n,pt)

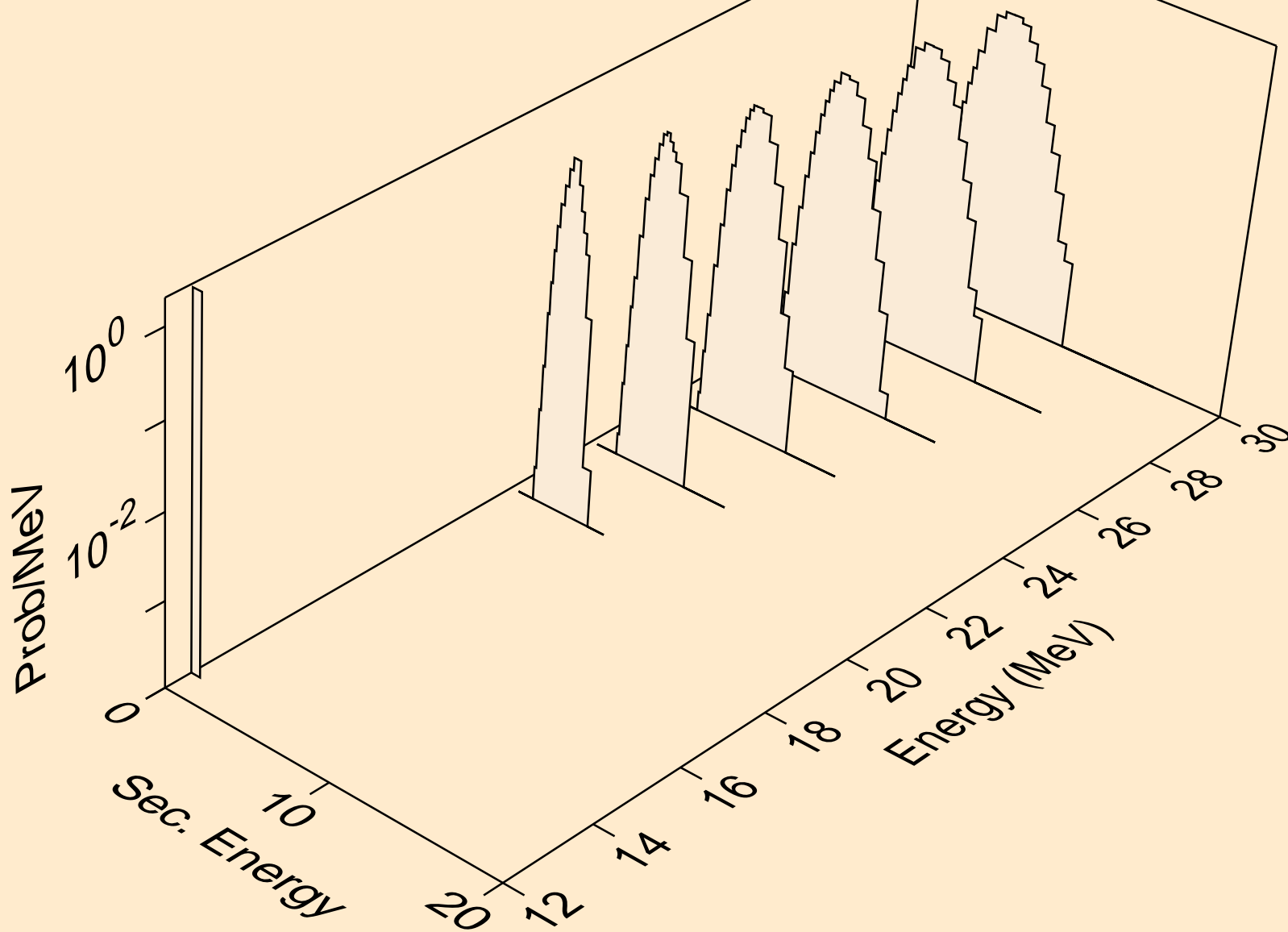

YB172 NEUTRON ACER TENDL-2019 LIBRARY; T=293.16K  
deuterons from (n,x)

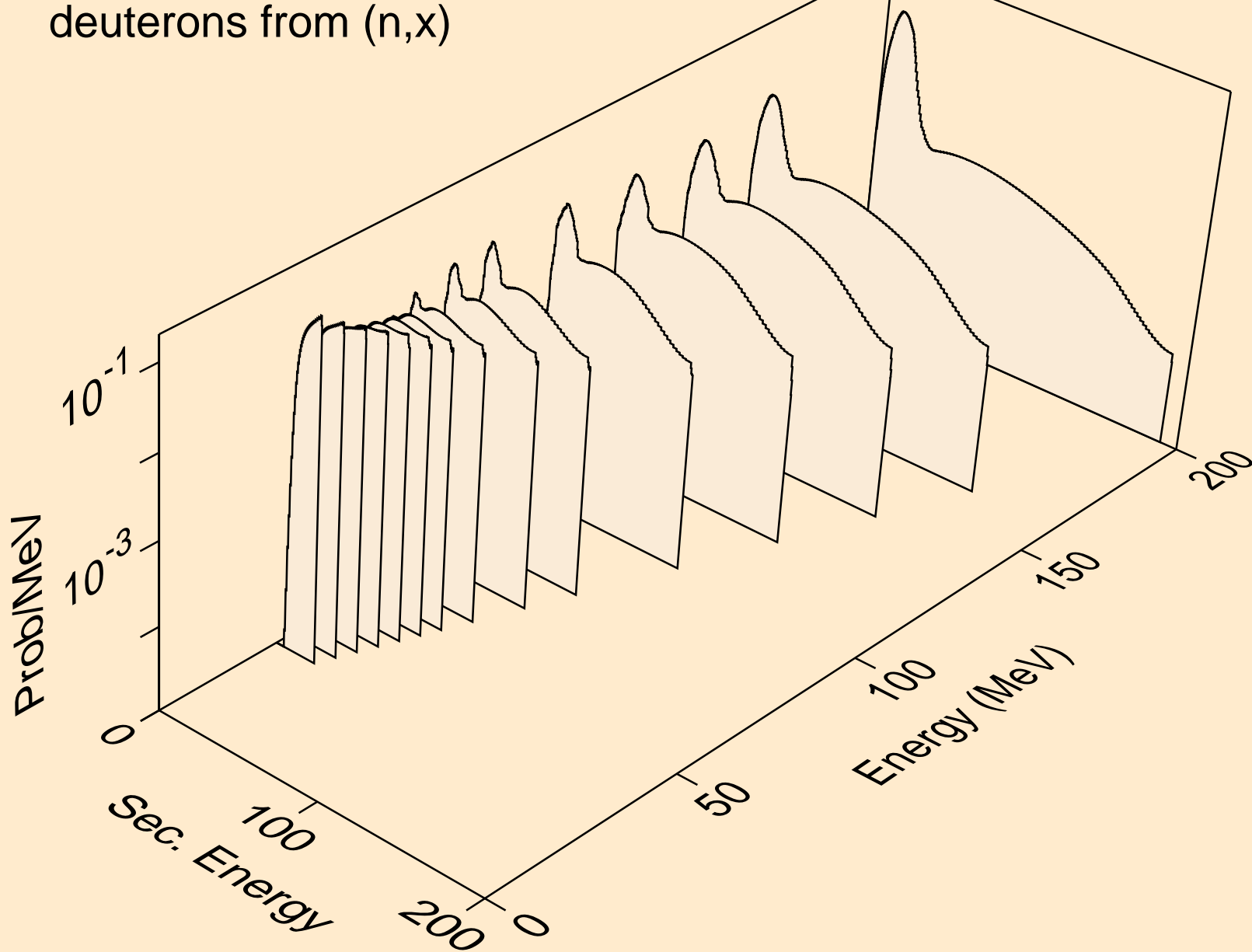

YB172 NEUTRON ACER TENDL-2019 LIBRARY; T=293.16K  
deuterons from (n,2nd)

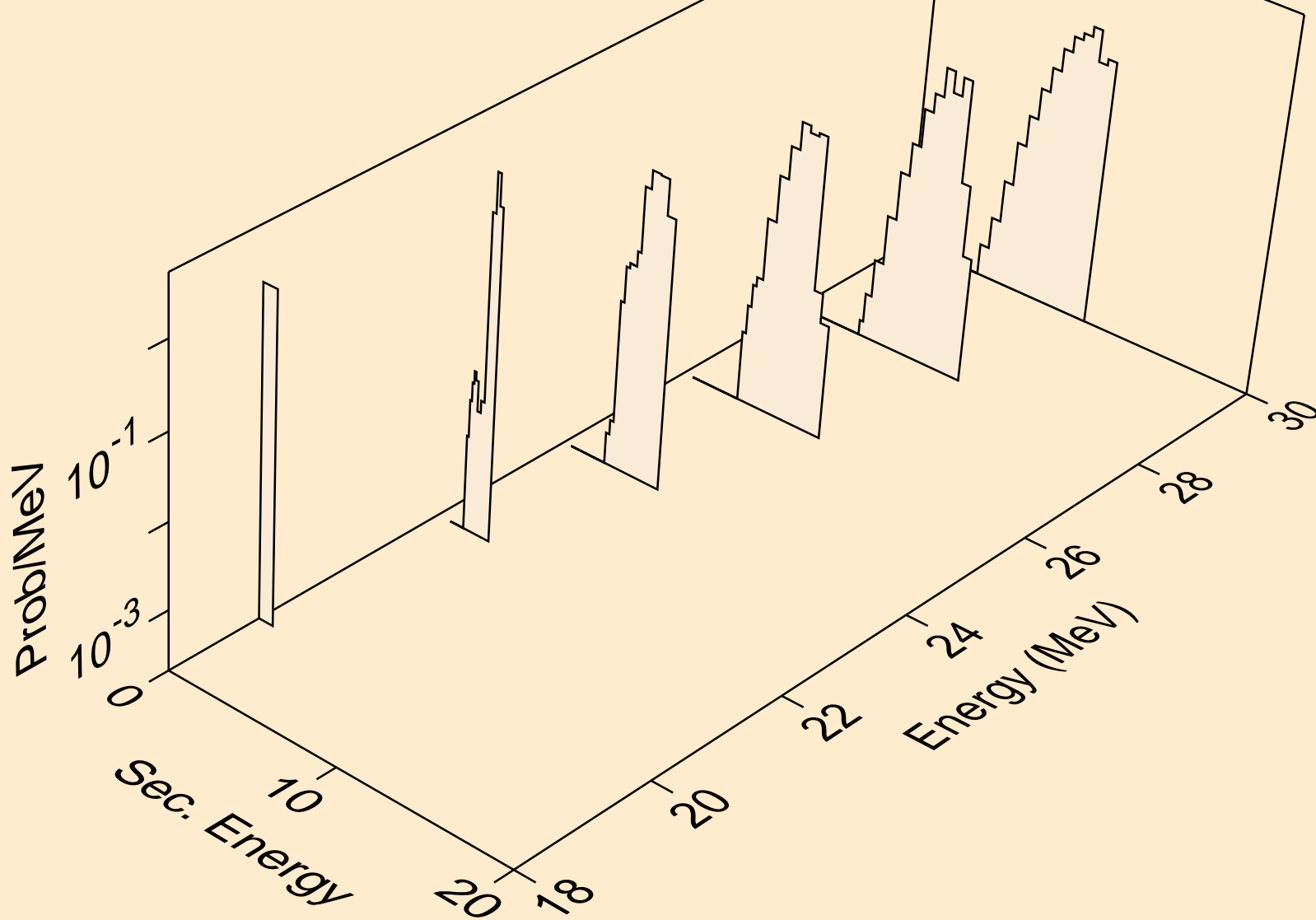

YB172 NEUTRON ACER TENDL-2019 LIBRARY; T=293.16K  
deuterons from (n,n\*)d

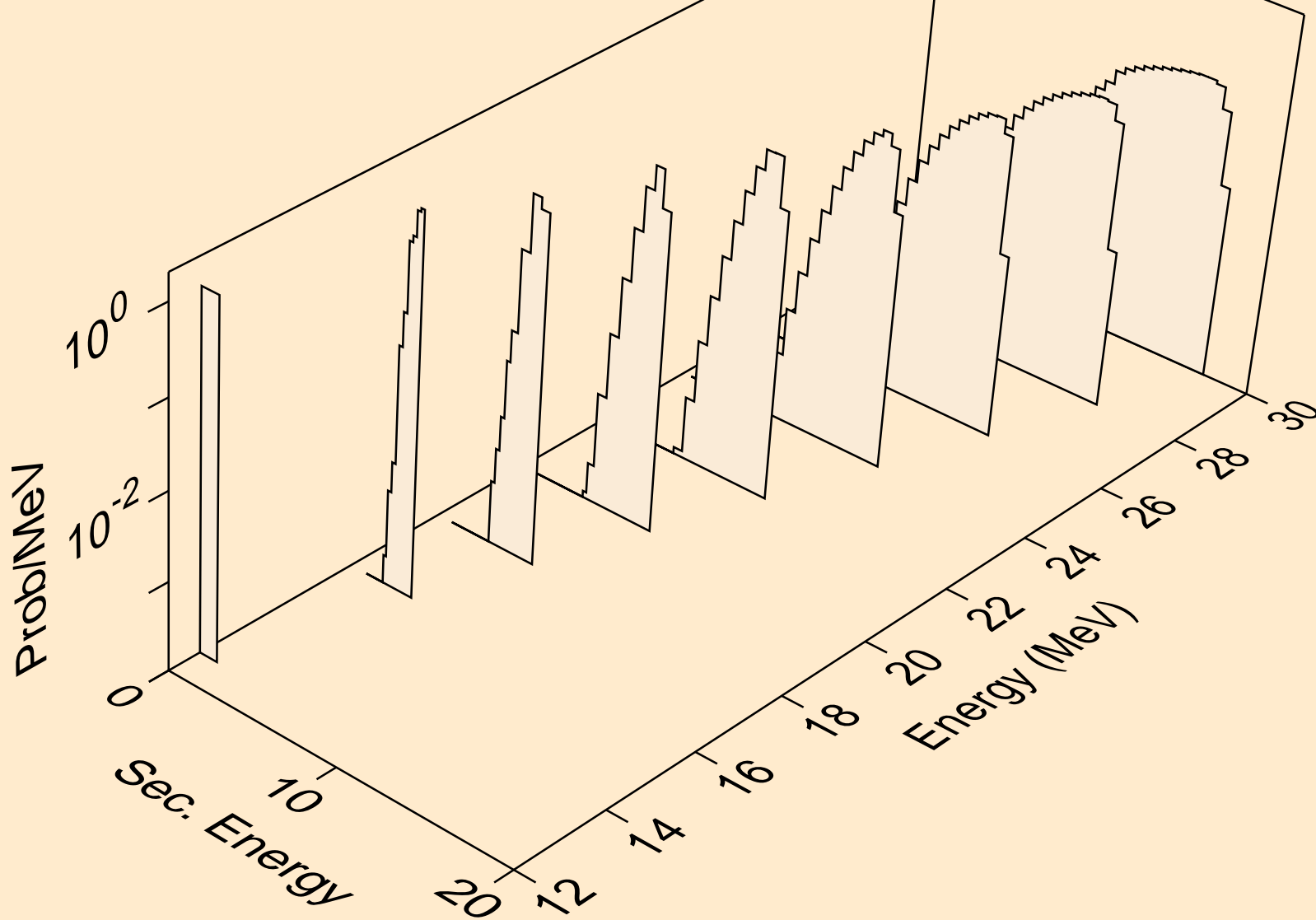

YB172 NEUTRON ACER TENDL-2019 LIBRARY; T=293.16K  
deuterons from (n,d)

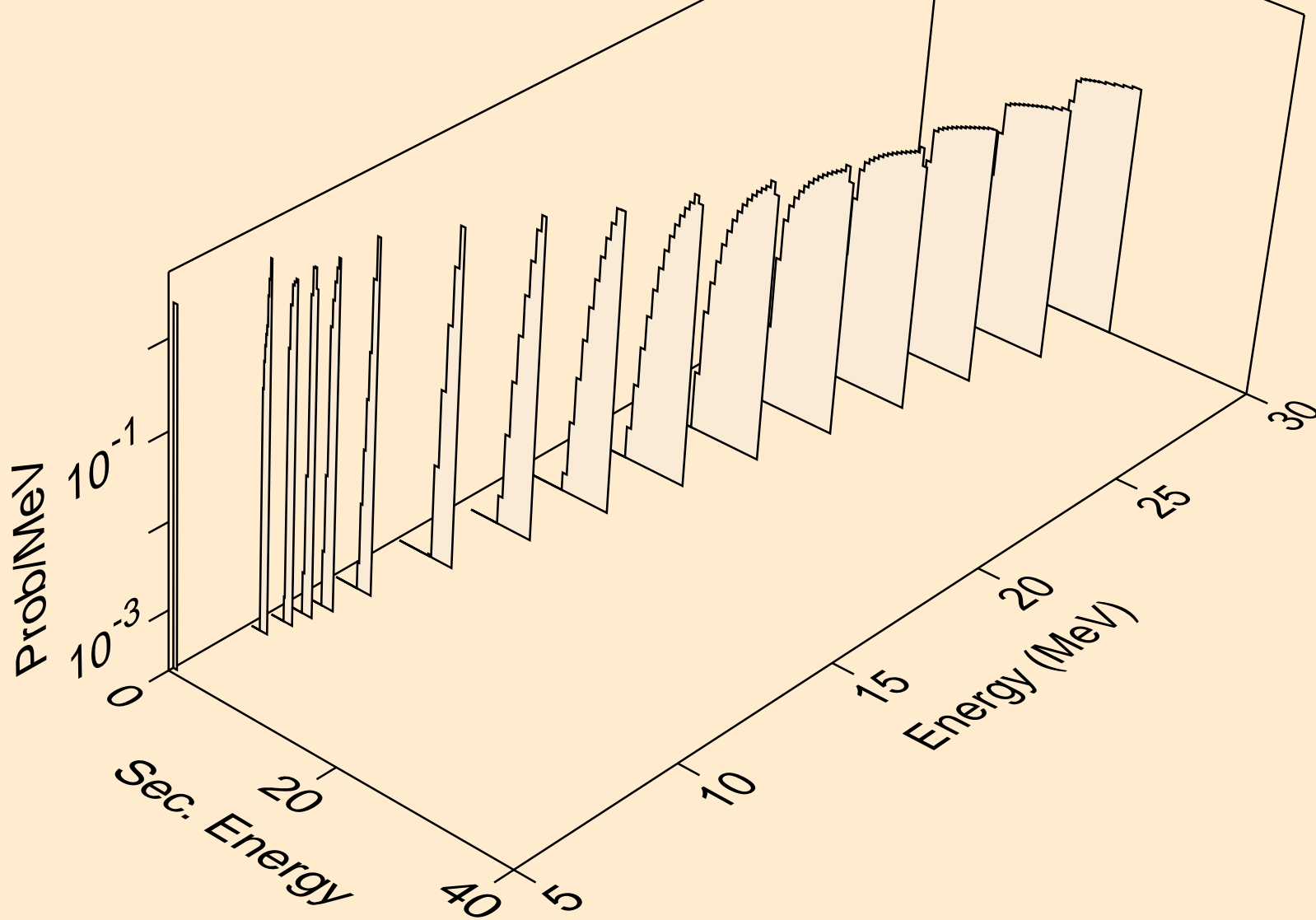



YB172 NEUTRON ACER TENDL-2019 LIBRARY; T=293.16K  
deuterons from (n,pd)

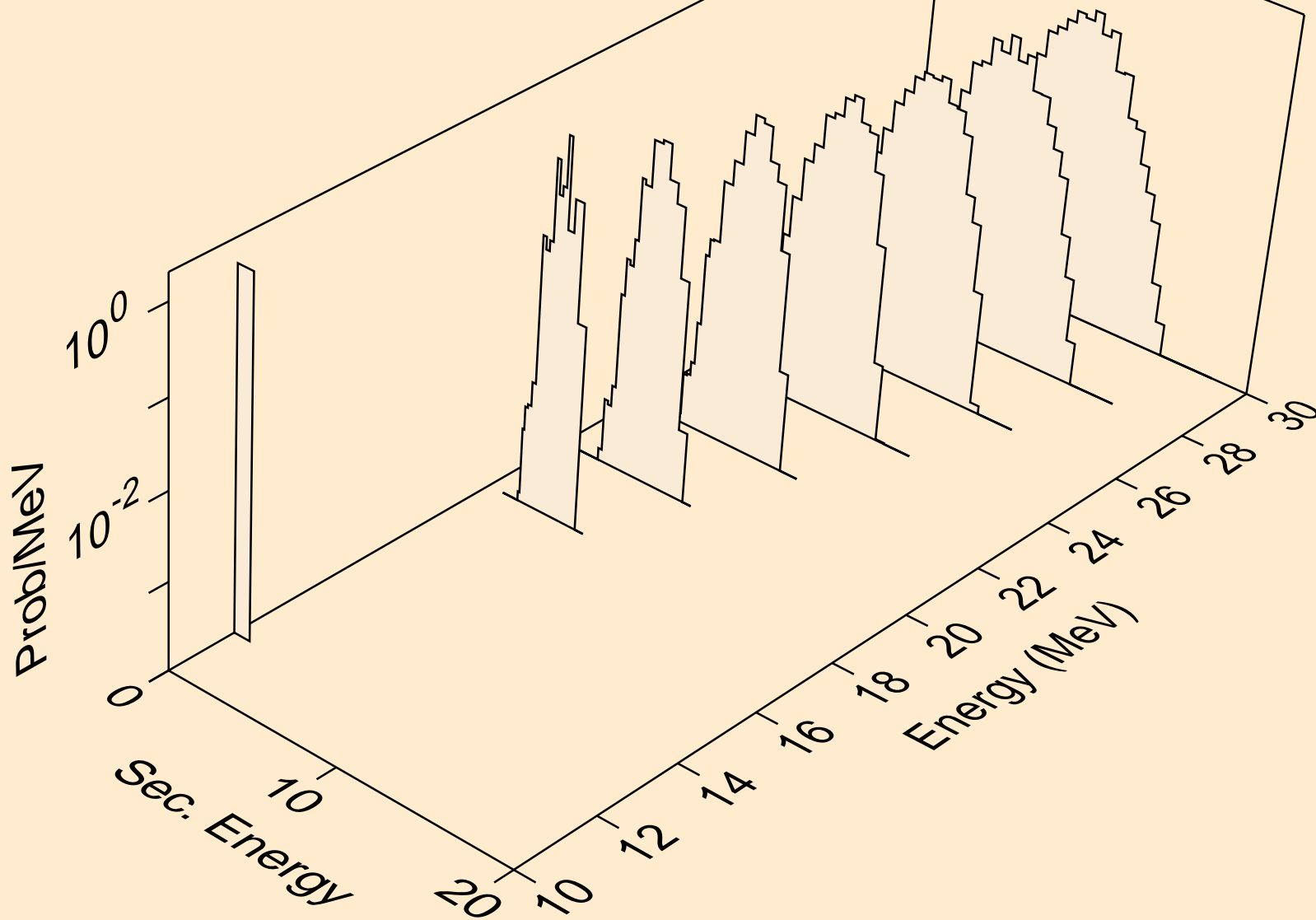

YB172 NEUTRON ACER TENDL-2019 LIBRARY; T=293.16K  
tritons from (n,x)

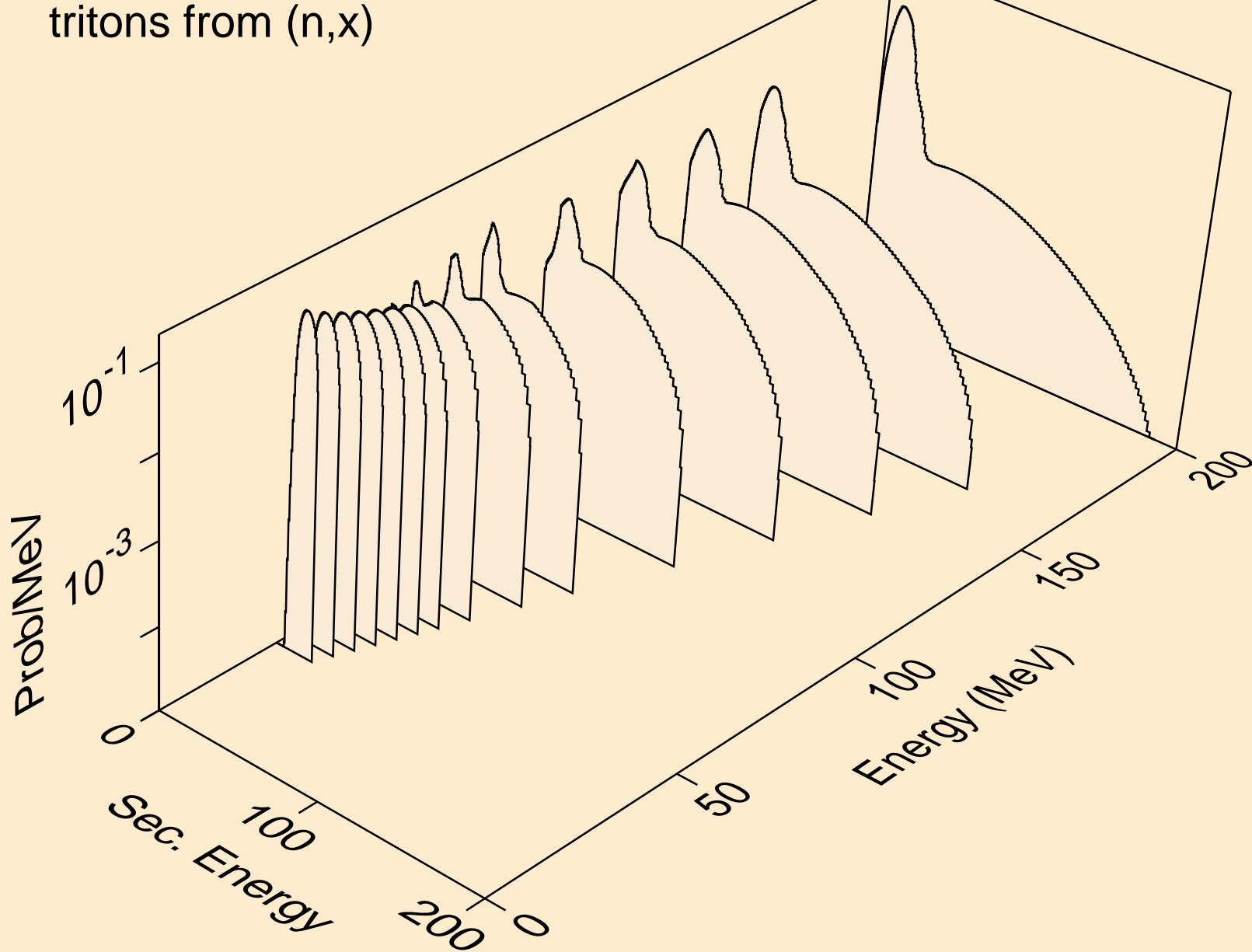

YB172 NEUTRON ACER TENDL-2019 LIBRARY; T=293.16K  
tritons from (n,n\*)t

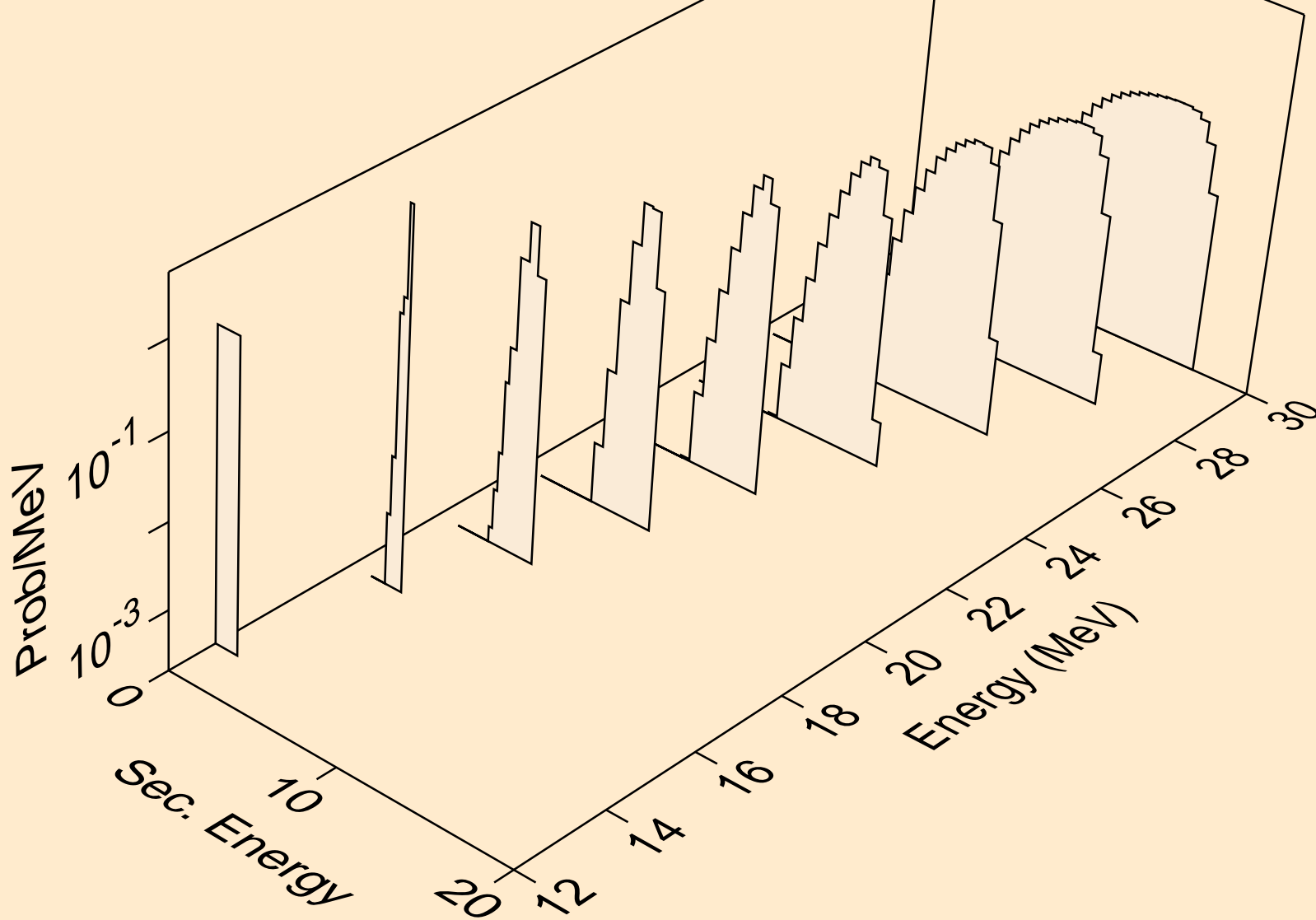

YB172 NEUTRON ACER TENDL-2019 LIBRARY; T=293.16K  
tritons from (n,t)

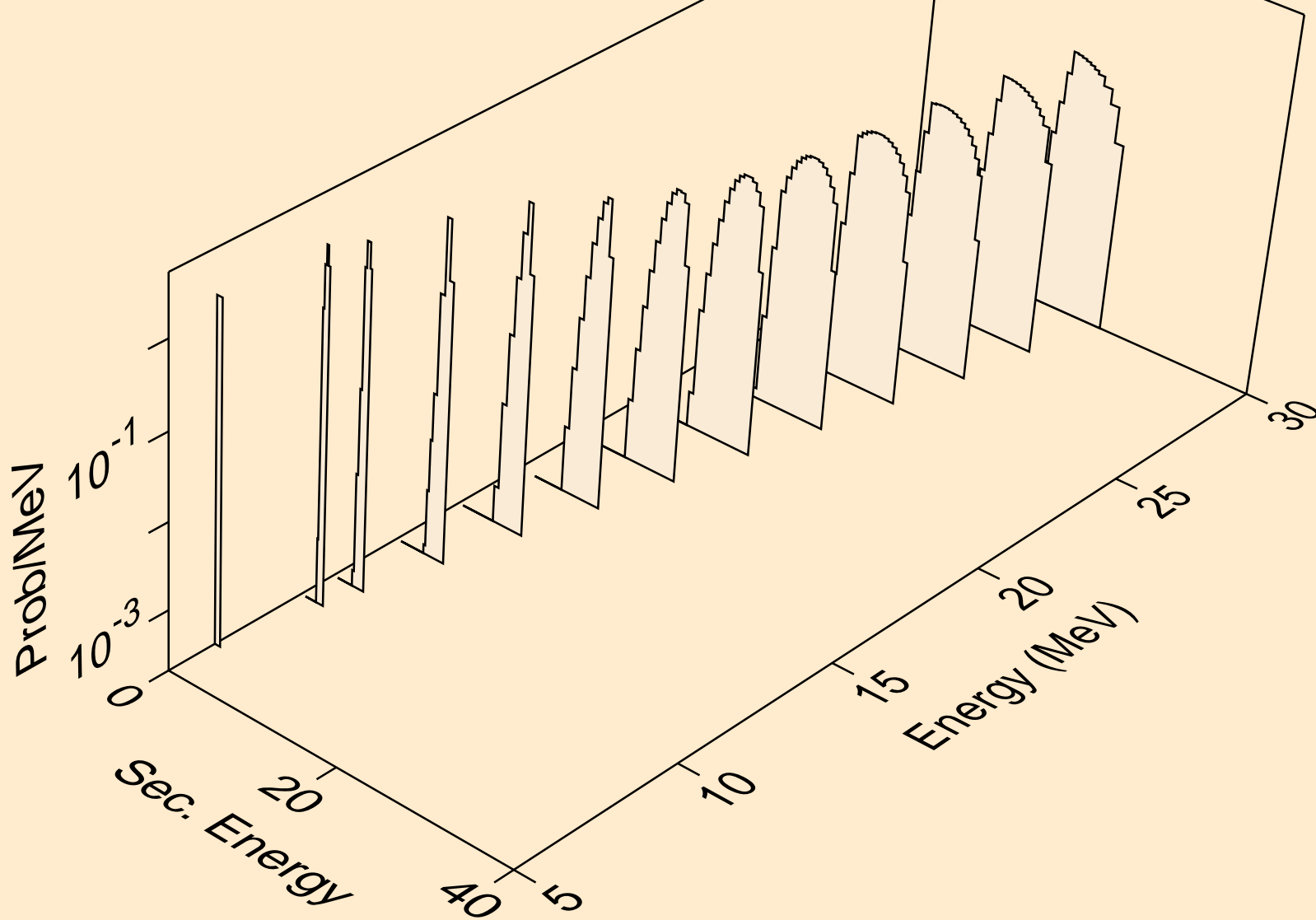

YB172 NEUTRON ACER TENDL-2019 LIBRARY; T=293.16K  
tritons from (n,pt)

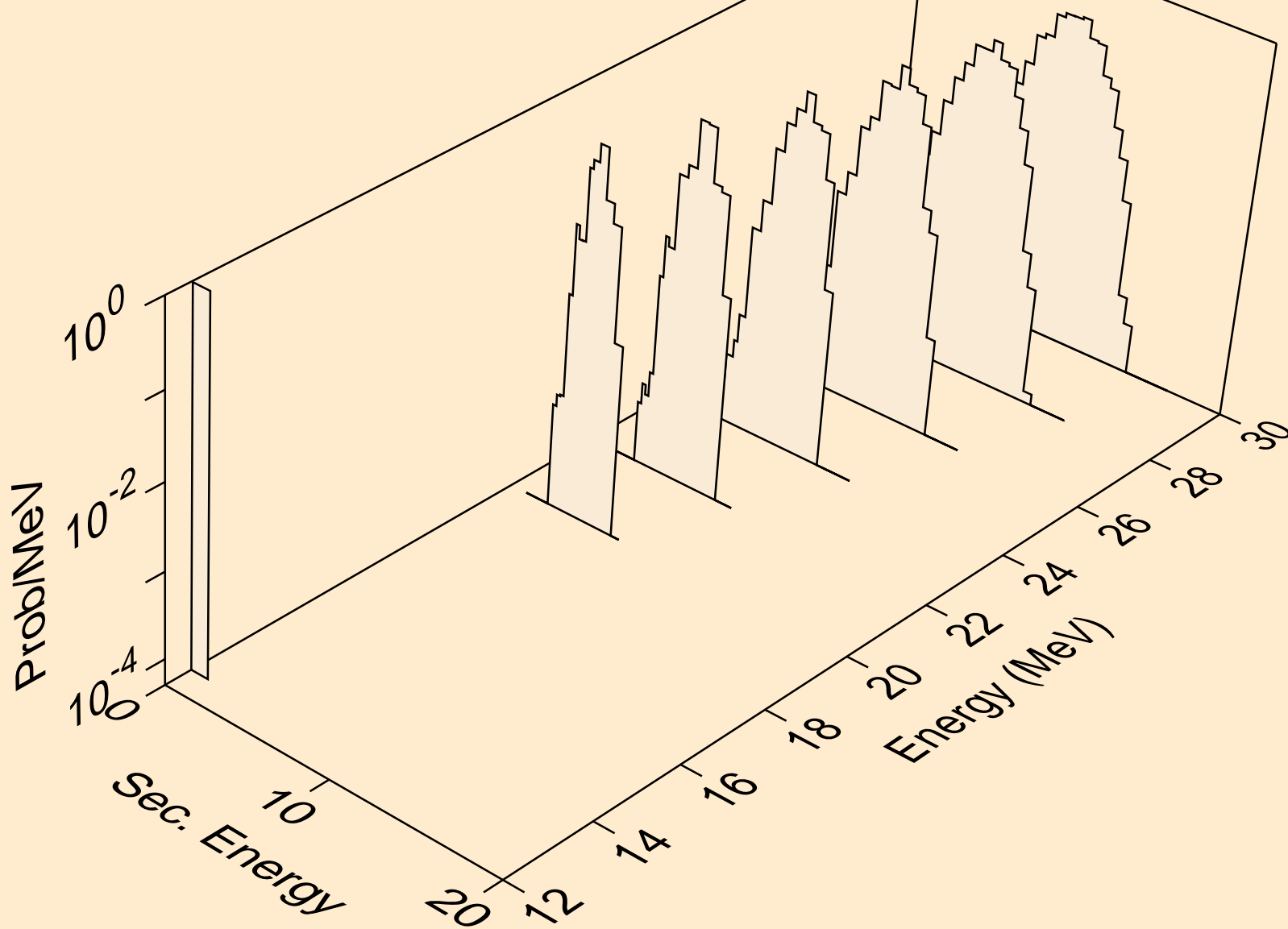

YB172 NEUTRON ACER TENDL-2019 LIBRARY; T=293.16K  
he3s from (n,x)

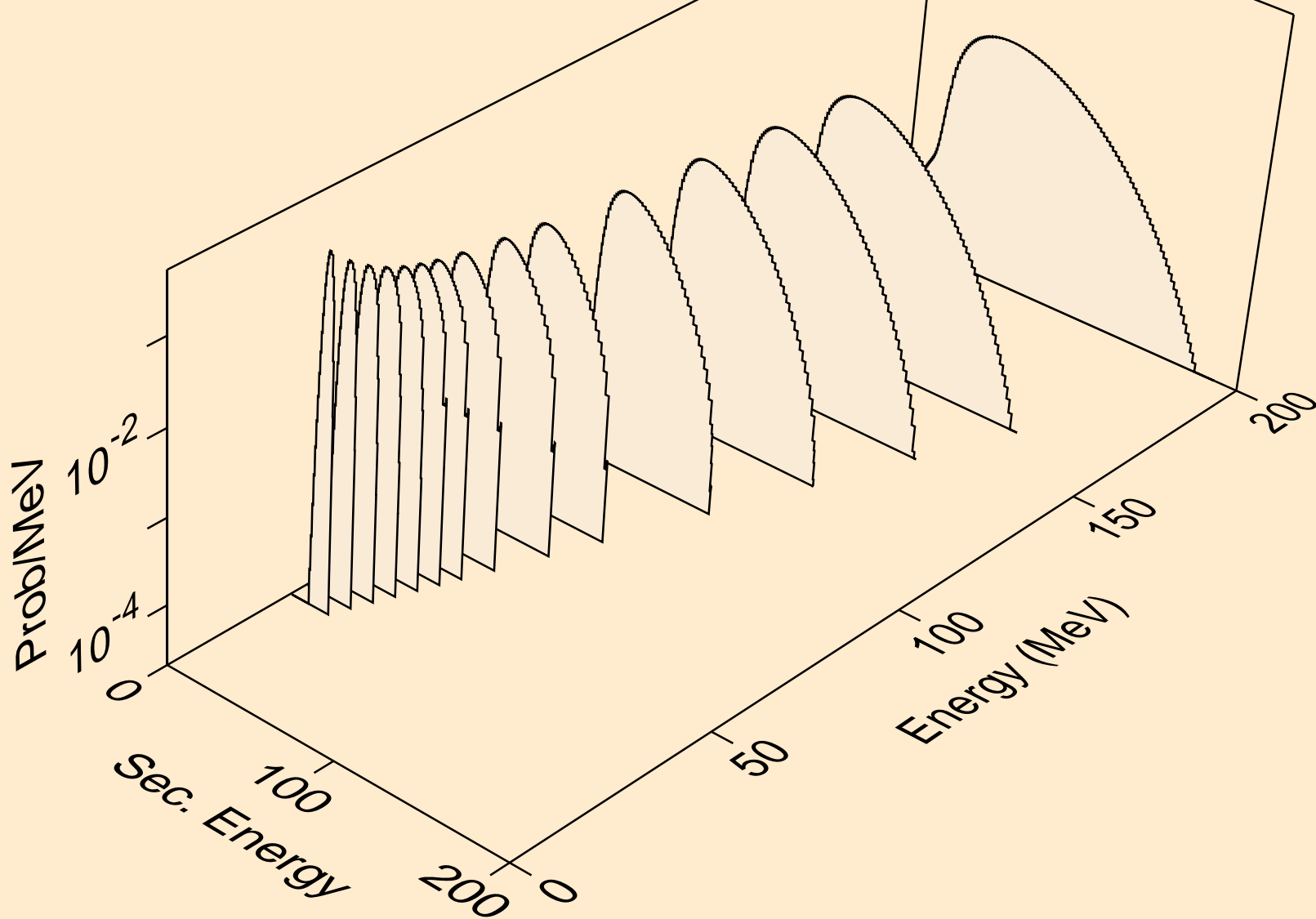

YB172 NEUTRON ACER TENDL-2019 LIBRARY; T=293.16K  
he3s from (n,n\*)he3

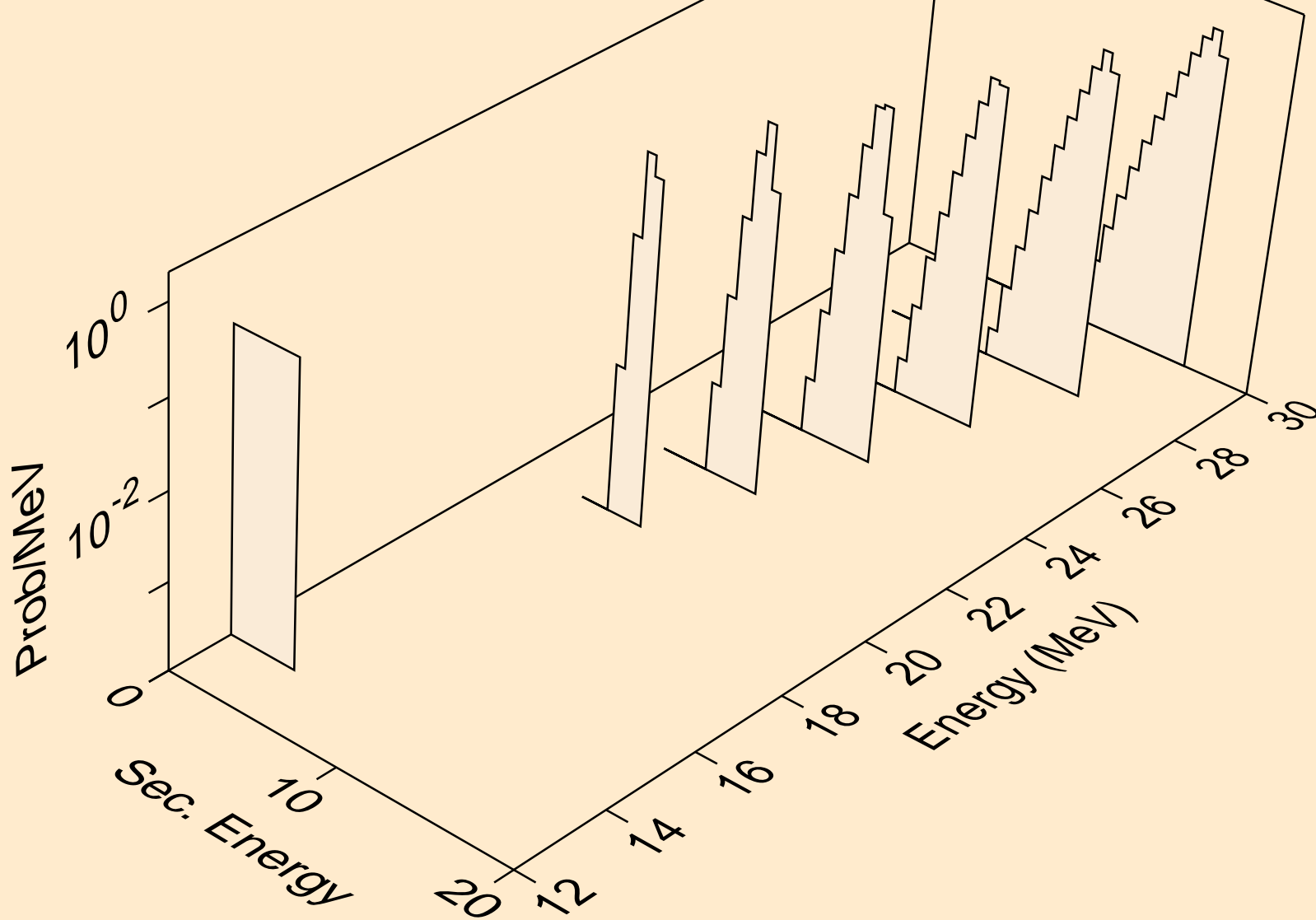

YB172 NEUTRON ACER TENDL-2019 LIBRARY; T=293.16K  
he3s from (n,he3)

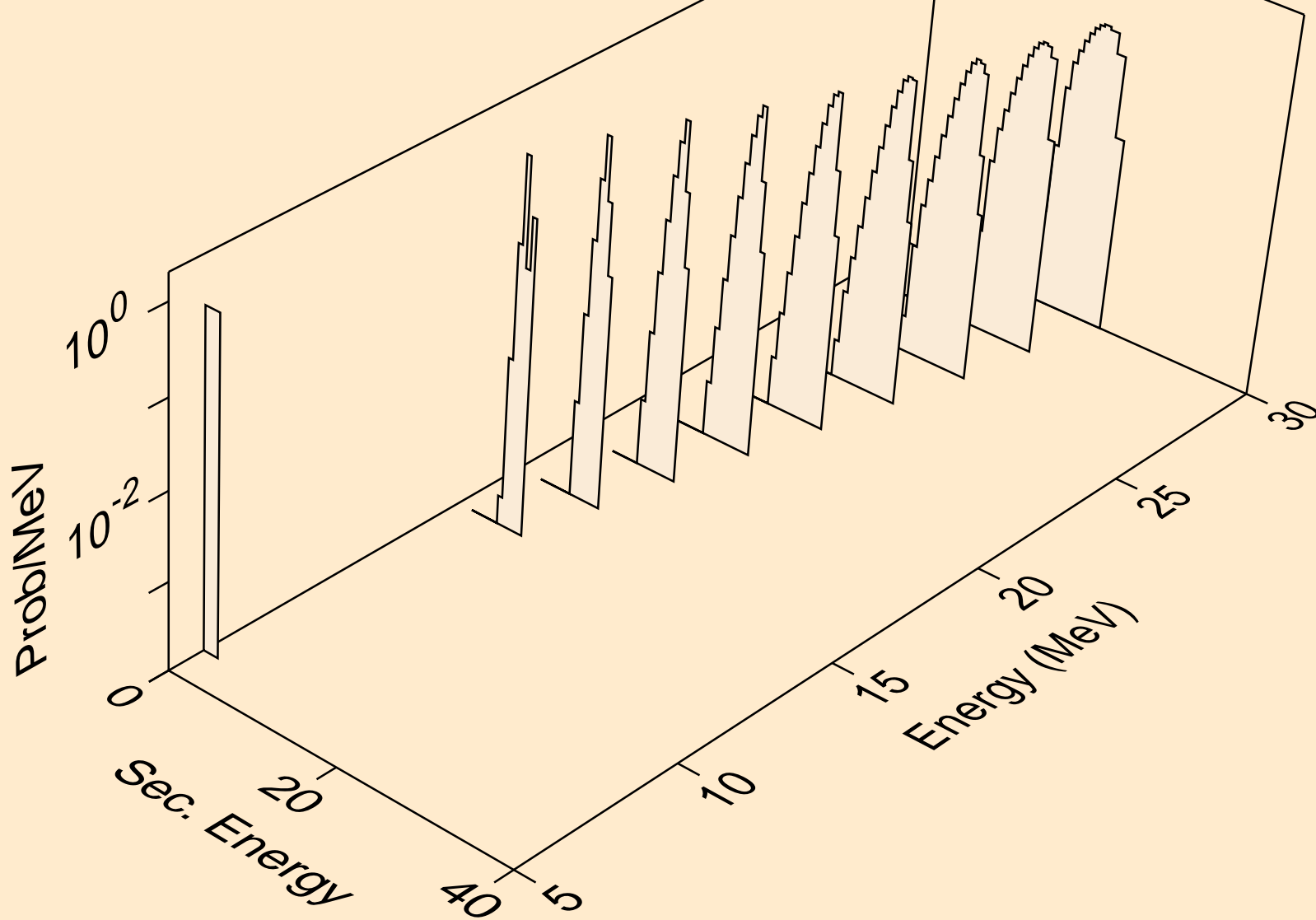



YB172 NEUTRON ACER TENDL-2019 LIBRARY; T=293.16K  
alphas from (n,x)

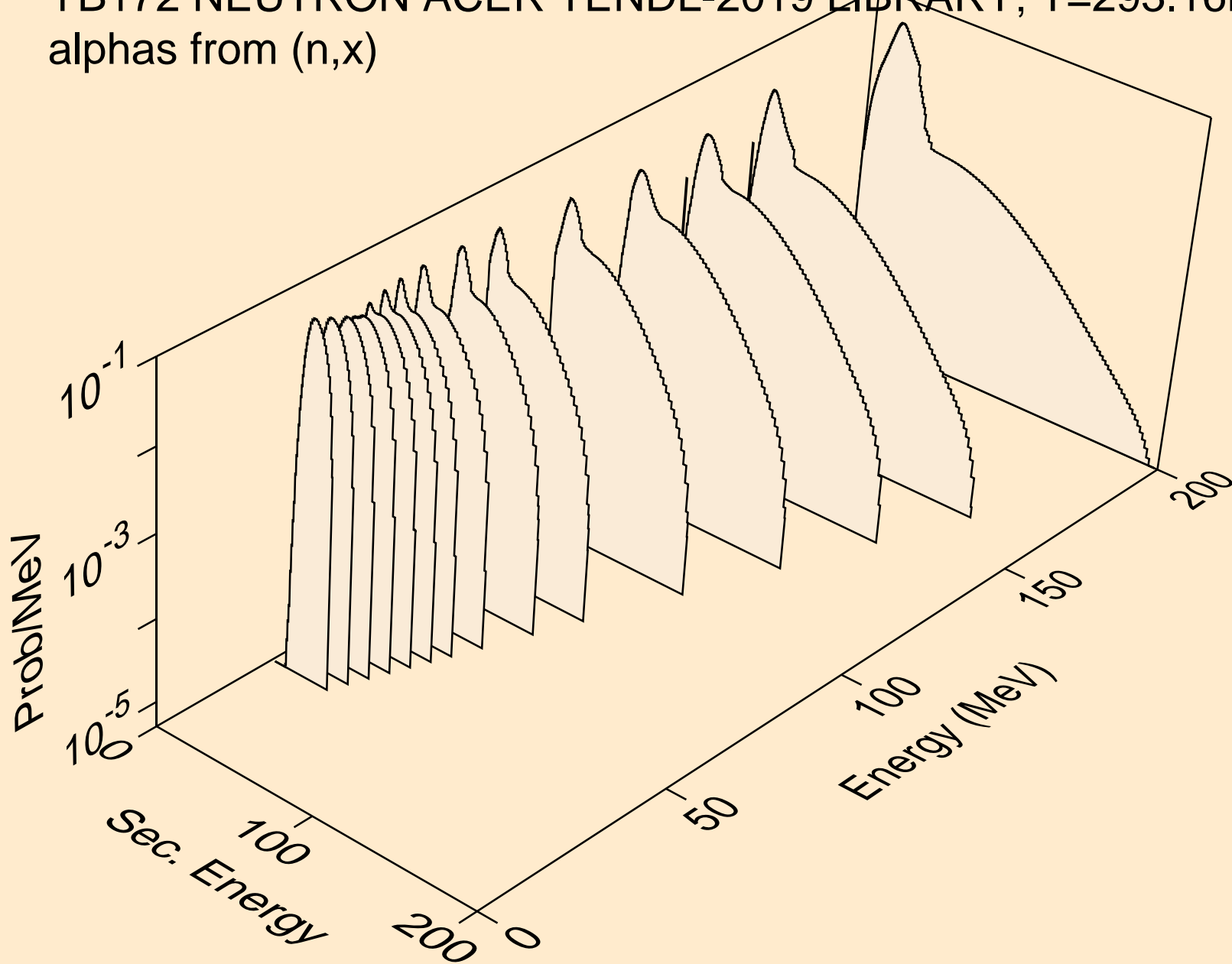

YB172 NEUTRON ACER TENDL-2019 LIBRARY; T=293.16K  
alphas from (n,n\*)a

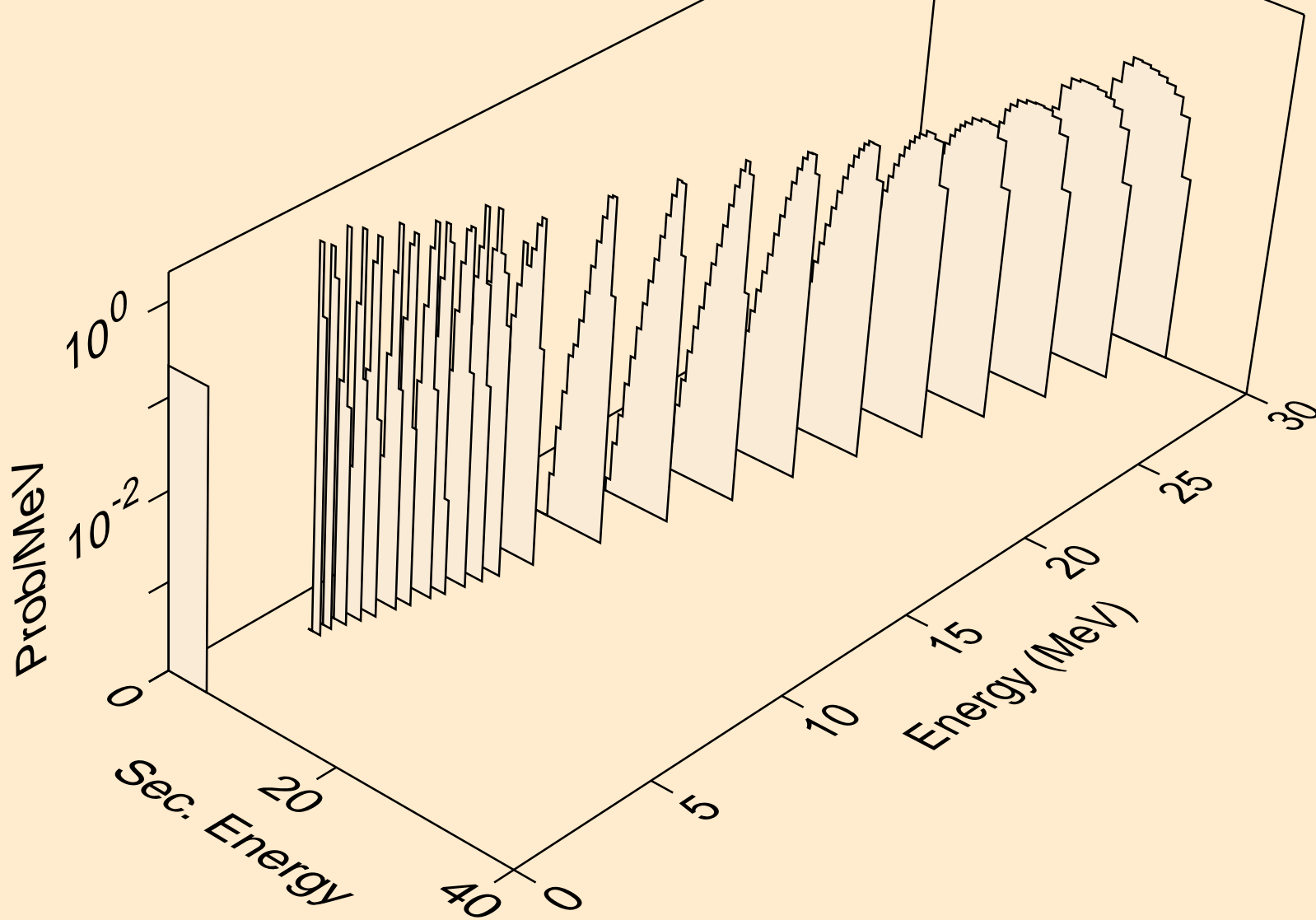

YB172 NEUTRON ACER TENDL-2019 LIBRARY; T=293.16K  
alphas from (n,2n)a

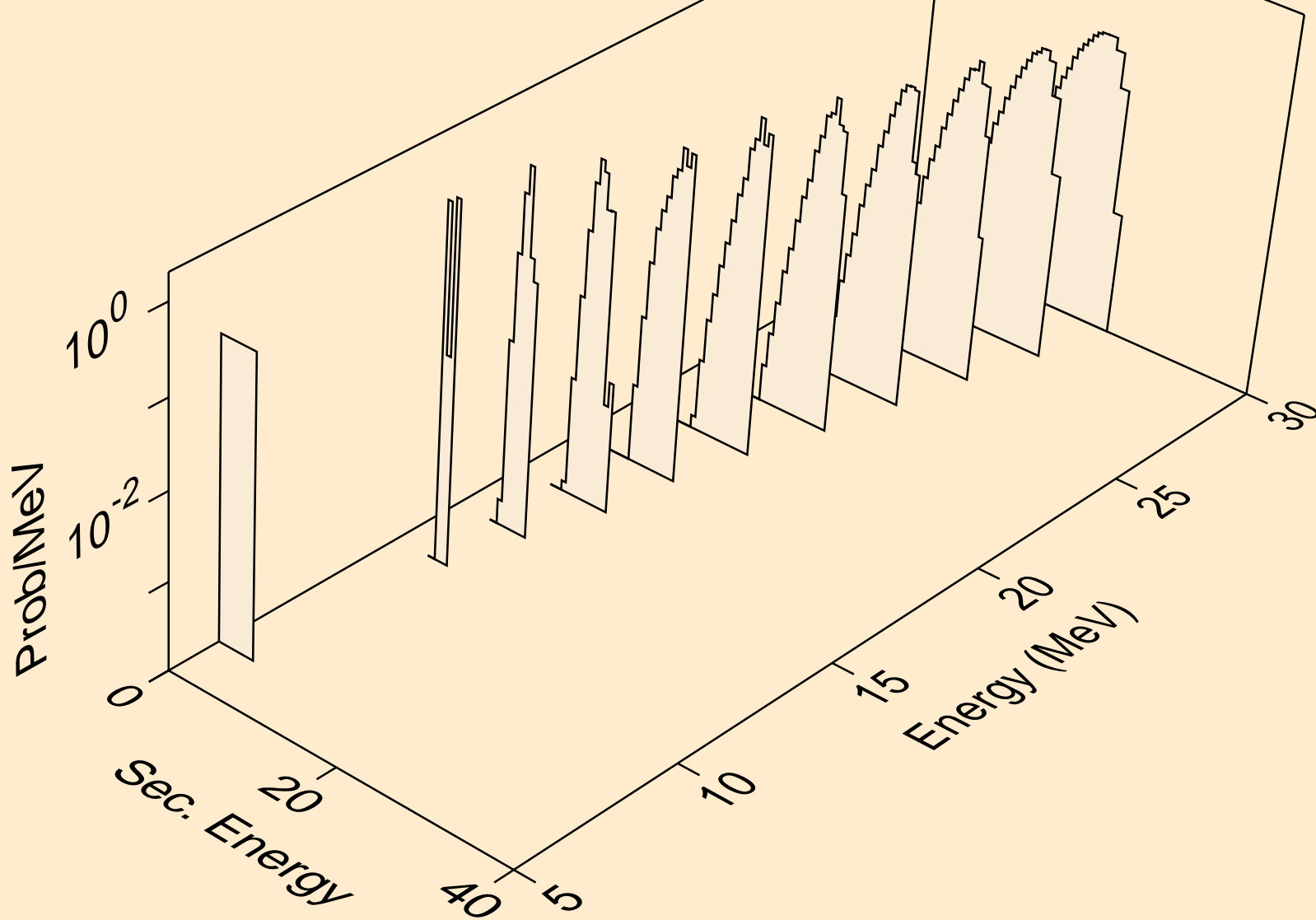

YB172 NEUTRON ACER TENDL-2019 LIBRARY; T=293.16K  
alphas from (n,3n)a

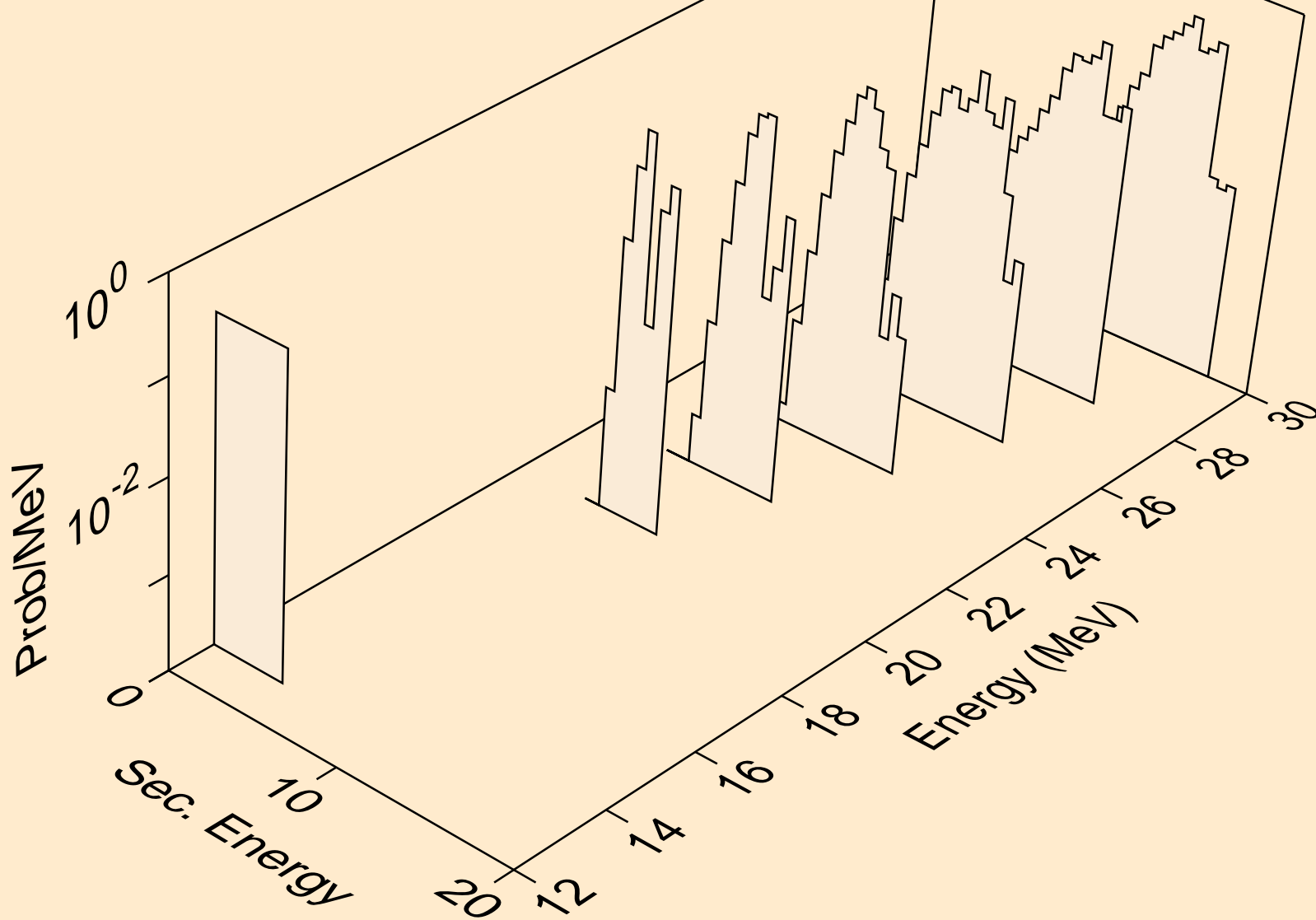

YB172 NEUTRON ACER TENDL-2019 LIBRARY; T=293.16K  
alphas from (n,n\*)2a

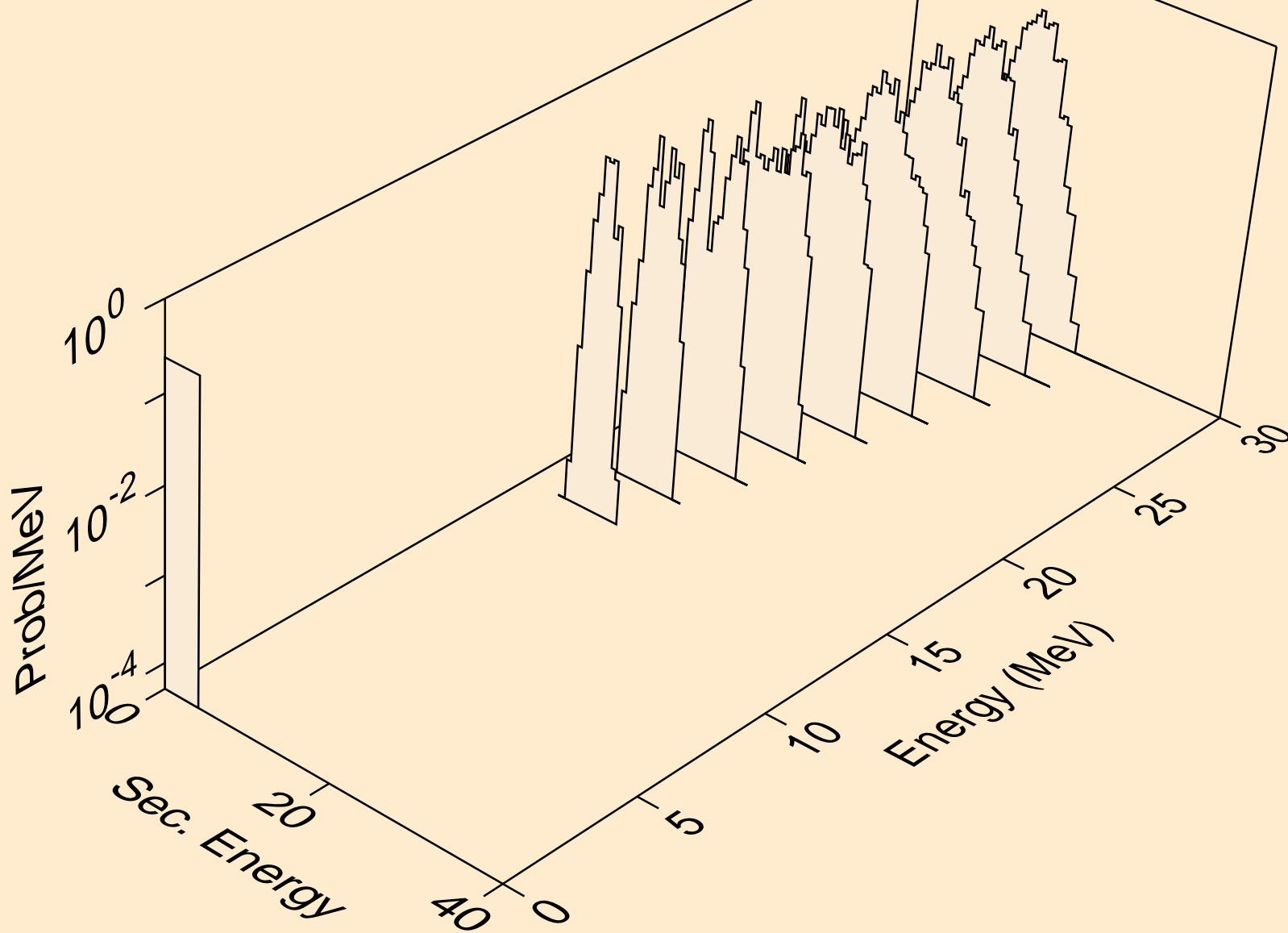

YB172 NEUTRON ACER TENDL-2019 LIBRARY; T=293.16K  
alphas from (n,npa)

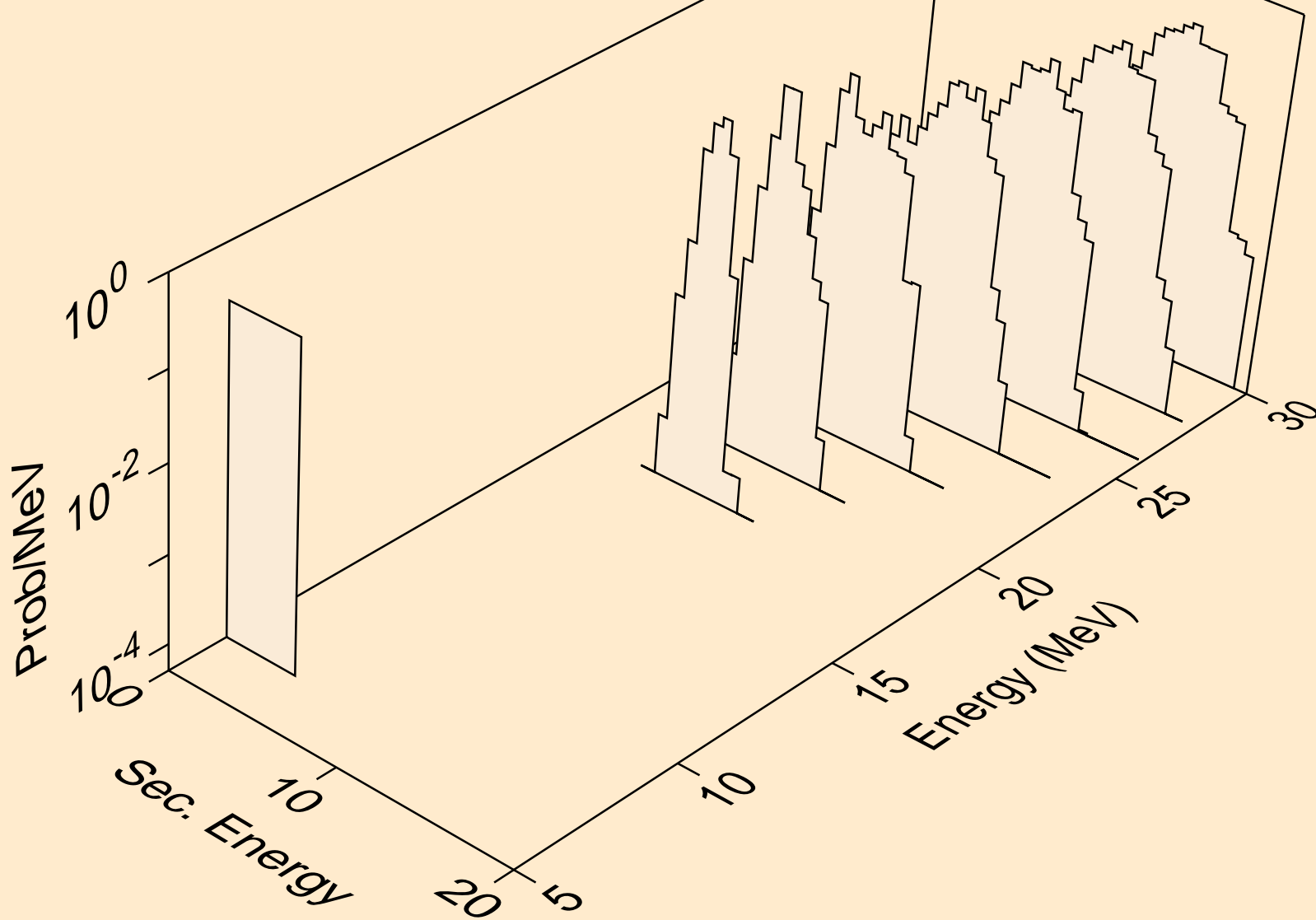

YB172 NEUTRON ACER TENDL-2019 LIBRARY; T=293.16K  
alphas from (n,a)

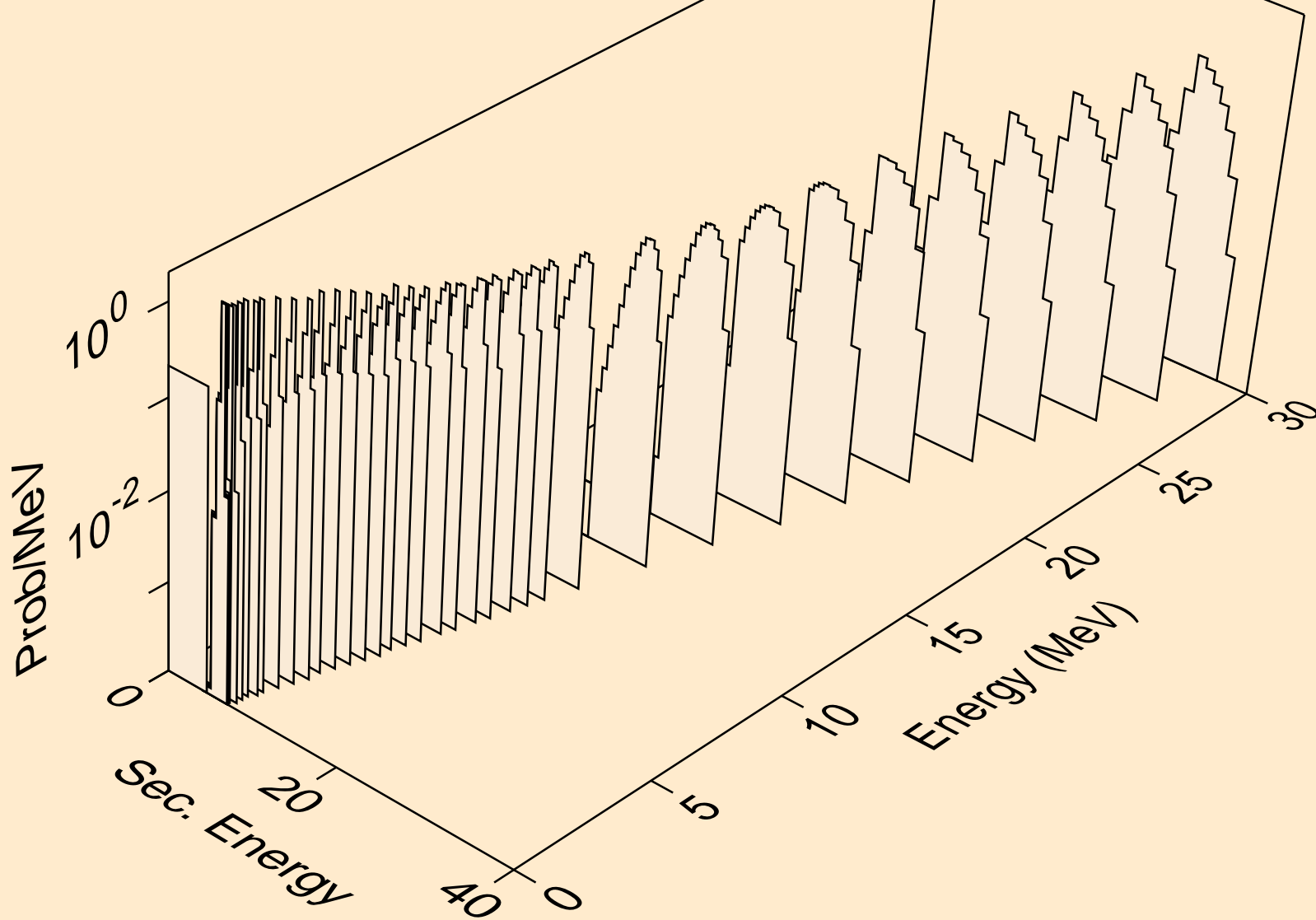

YB172 NEUTRON ACER TENDL-2019 LIBRARY; T=293.16K  
alphas from (n,2a)

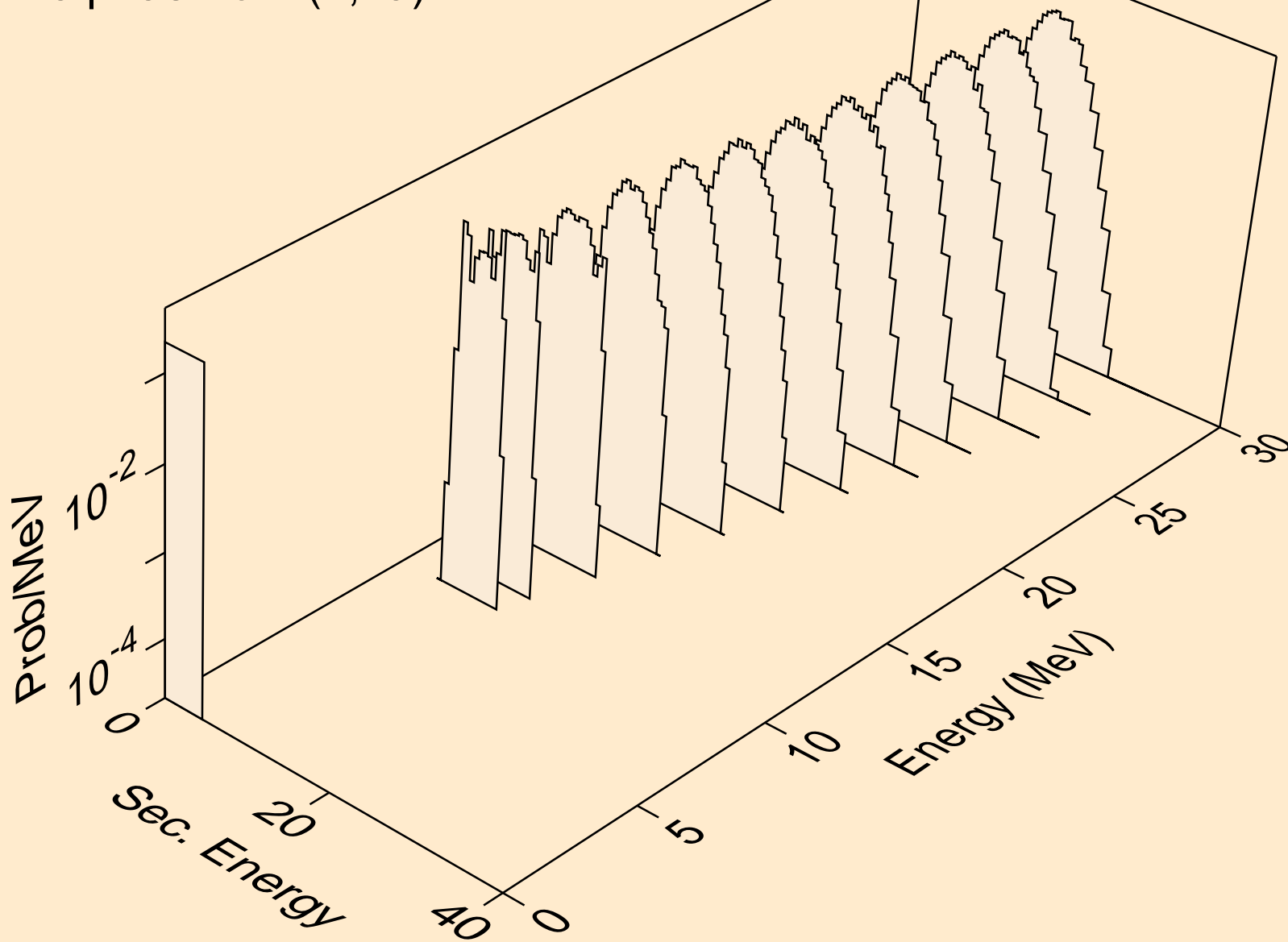



YB172 NEUTRON ACER TENDL-2019 LIBRARY; T=293.16K  
alphas from (n,pa)

