

YB176M NEUTRON ACER TENDL-2019 LIBRARY; T=293.16K
Principal cross sections

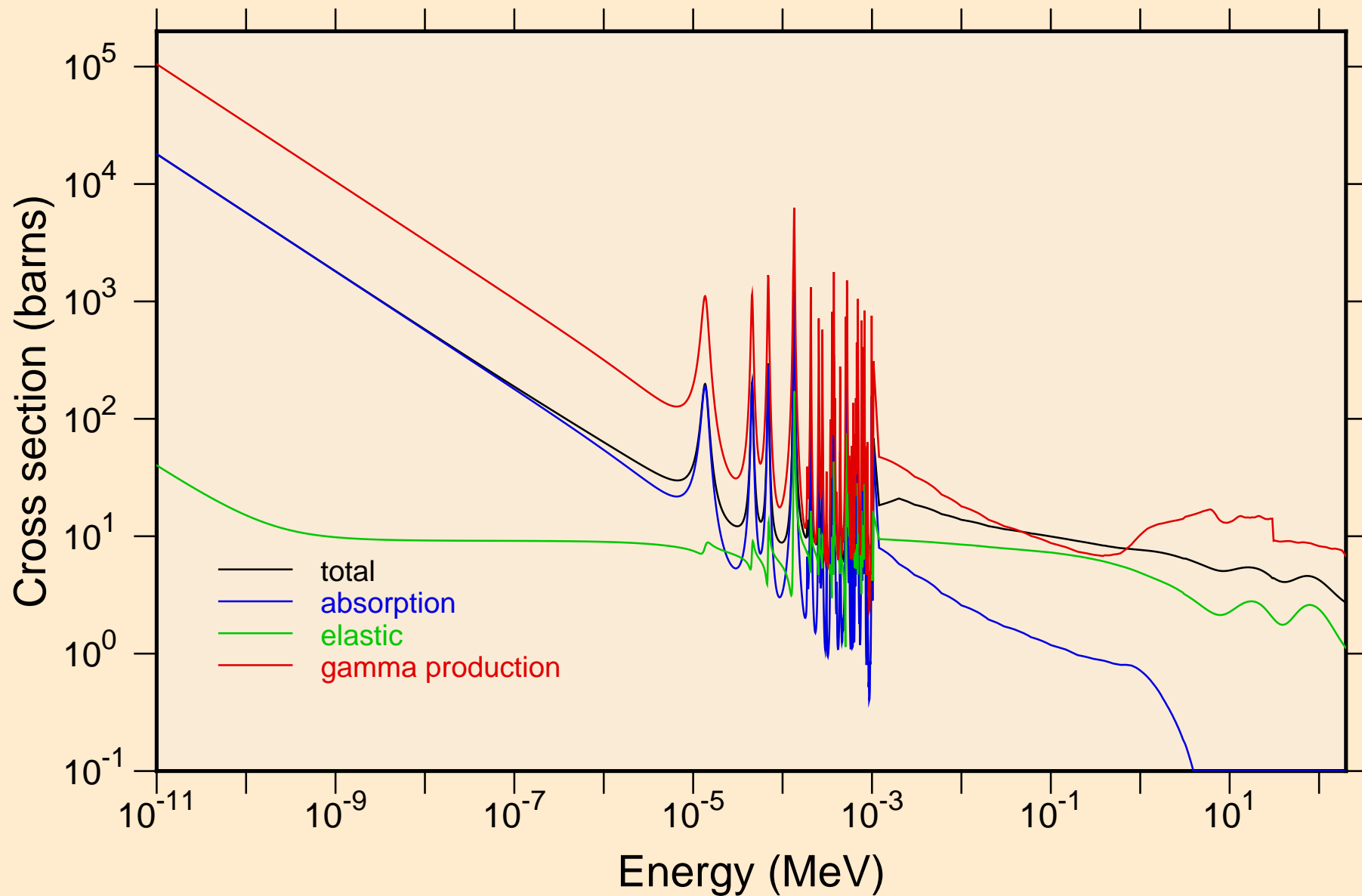

YB176M NEUTRON ACER TENDL-2019 LIBRARY; T=293.16K
resonance total cross section

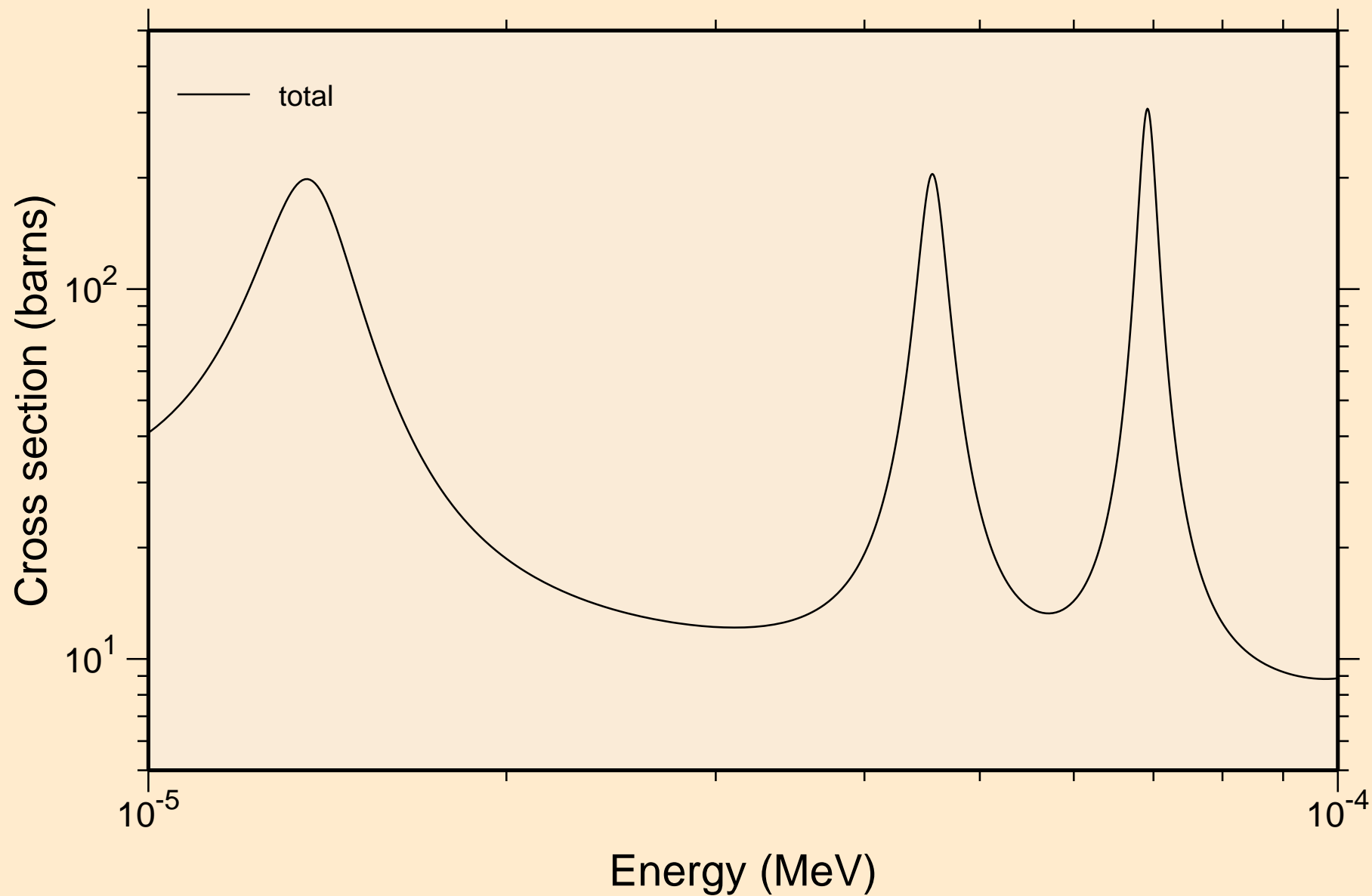

YB176M NEUTRON ACER TENDL-2019 LIBRARY; T=293.16K
resonance total cross section

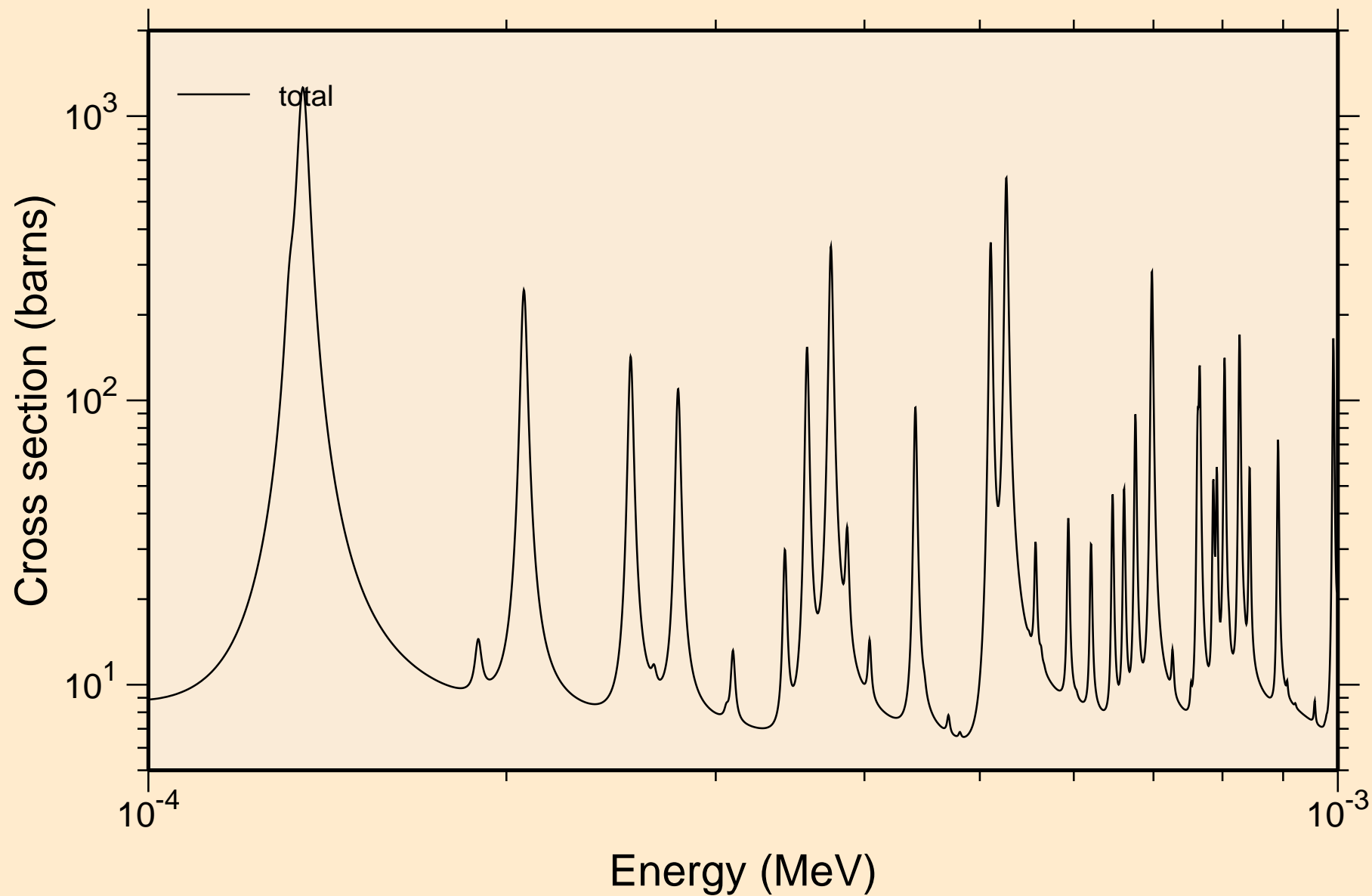

YB176M NEUTRON ACER TENDL-2019 LIBRARY; T=293.16K
resonance total cross section

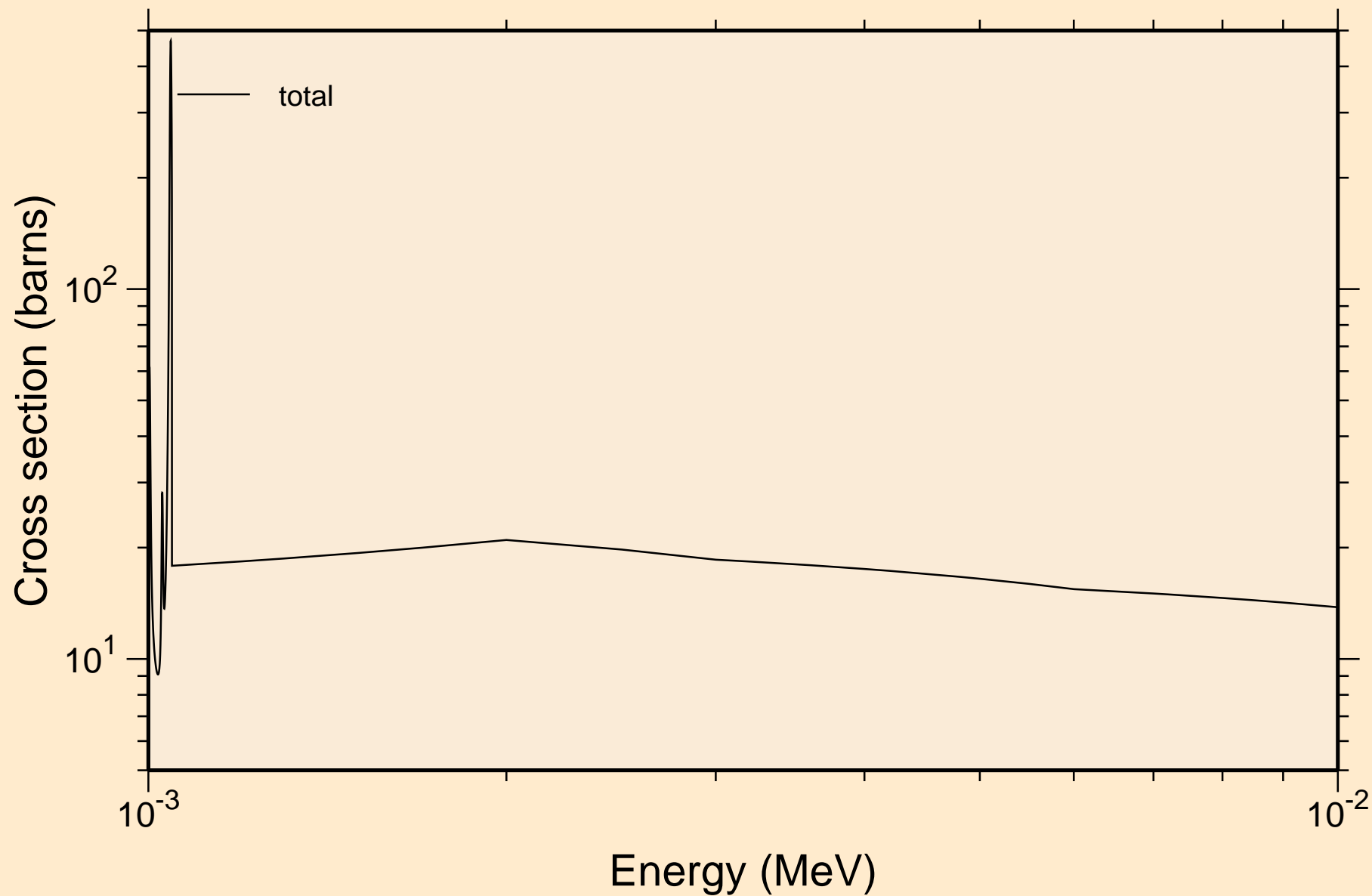

YB176M NEUTRON ACER TENDL-2019 LIBRARY; T=293.16K
resonance total cross section

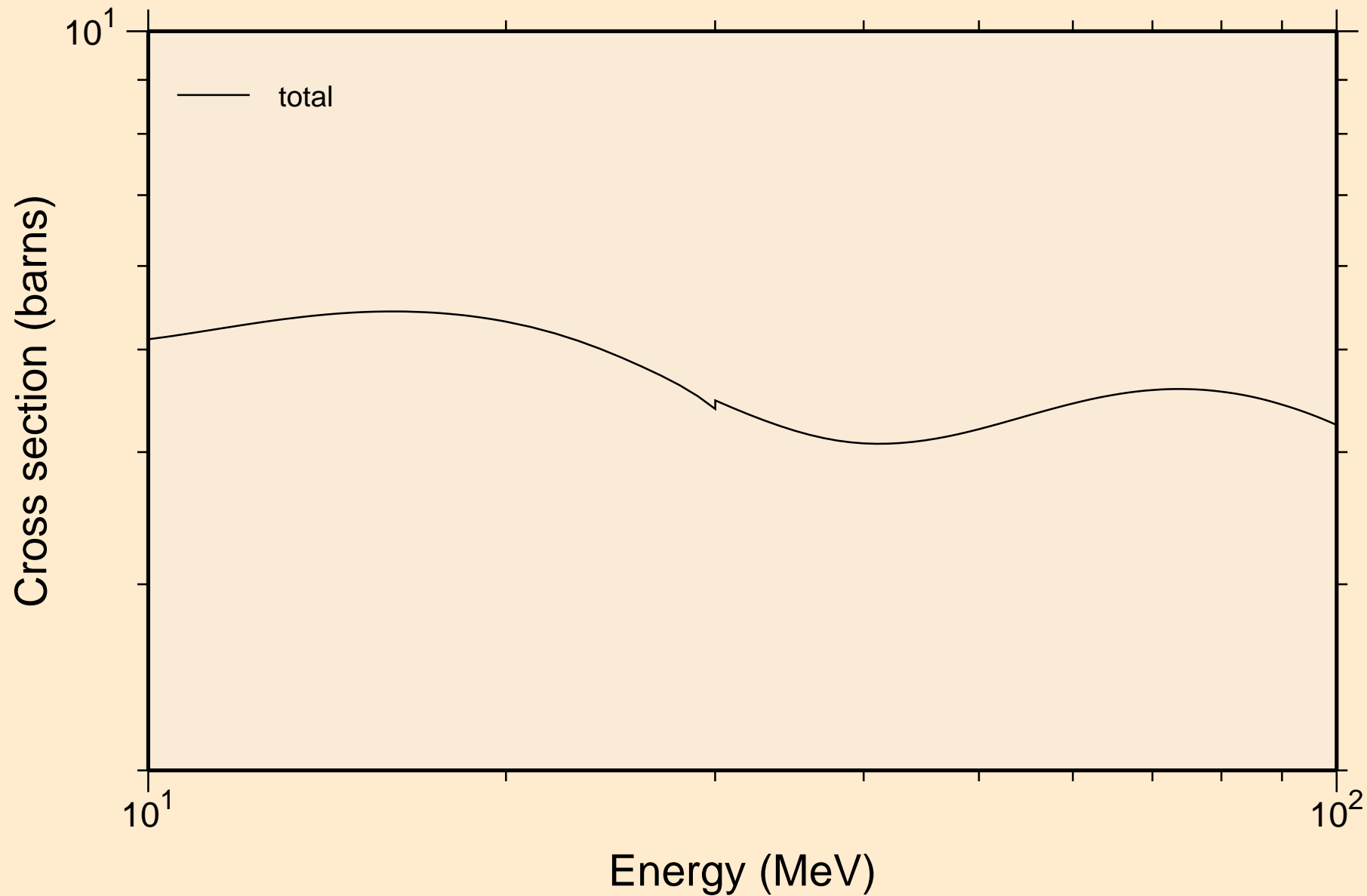

YB176M NEUTRON ACER TENDL-2019 LIBRARY; T=293.16K
resonance absorption cross sections

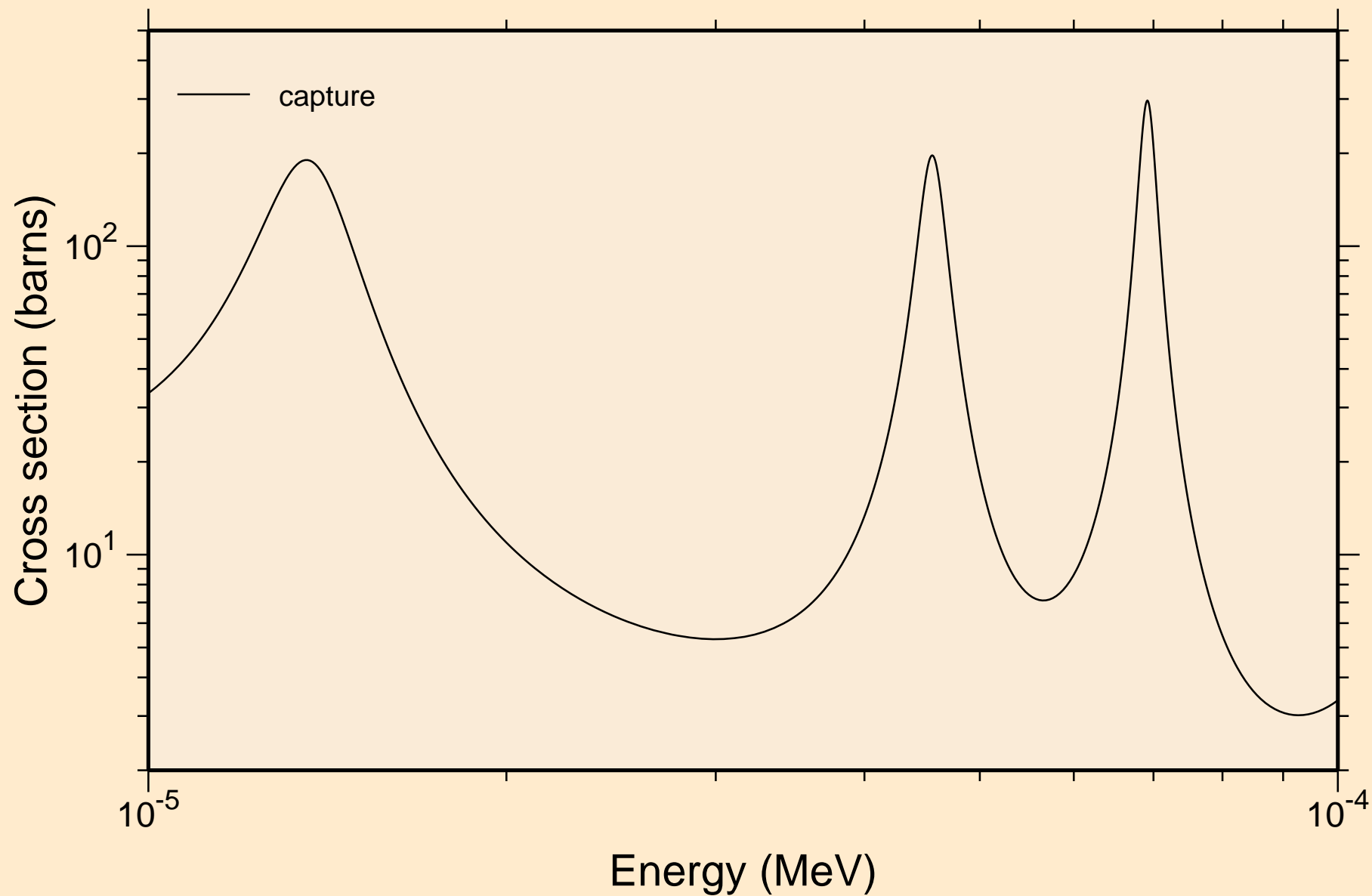

YB176M NEUTRON ACER TENDL-2019 LIBRARY; T=293.16K
resonance absorption cross sections

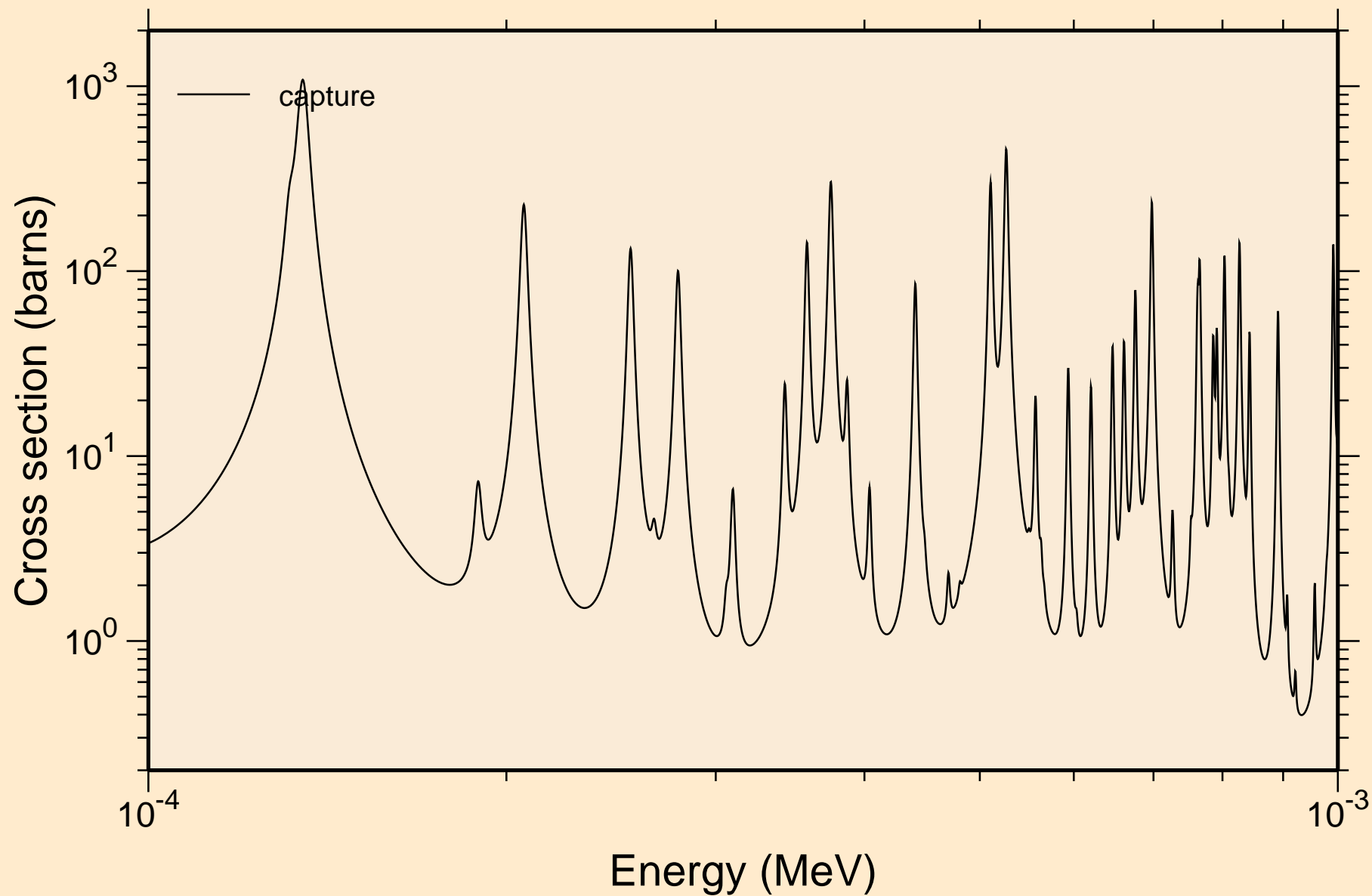

YB176M NEUTRON ACER TENDL-2019 LIBRARY; T=293.16K
resonance absorption cross sections

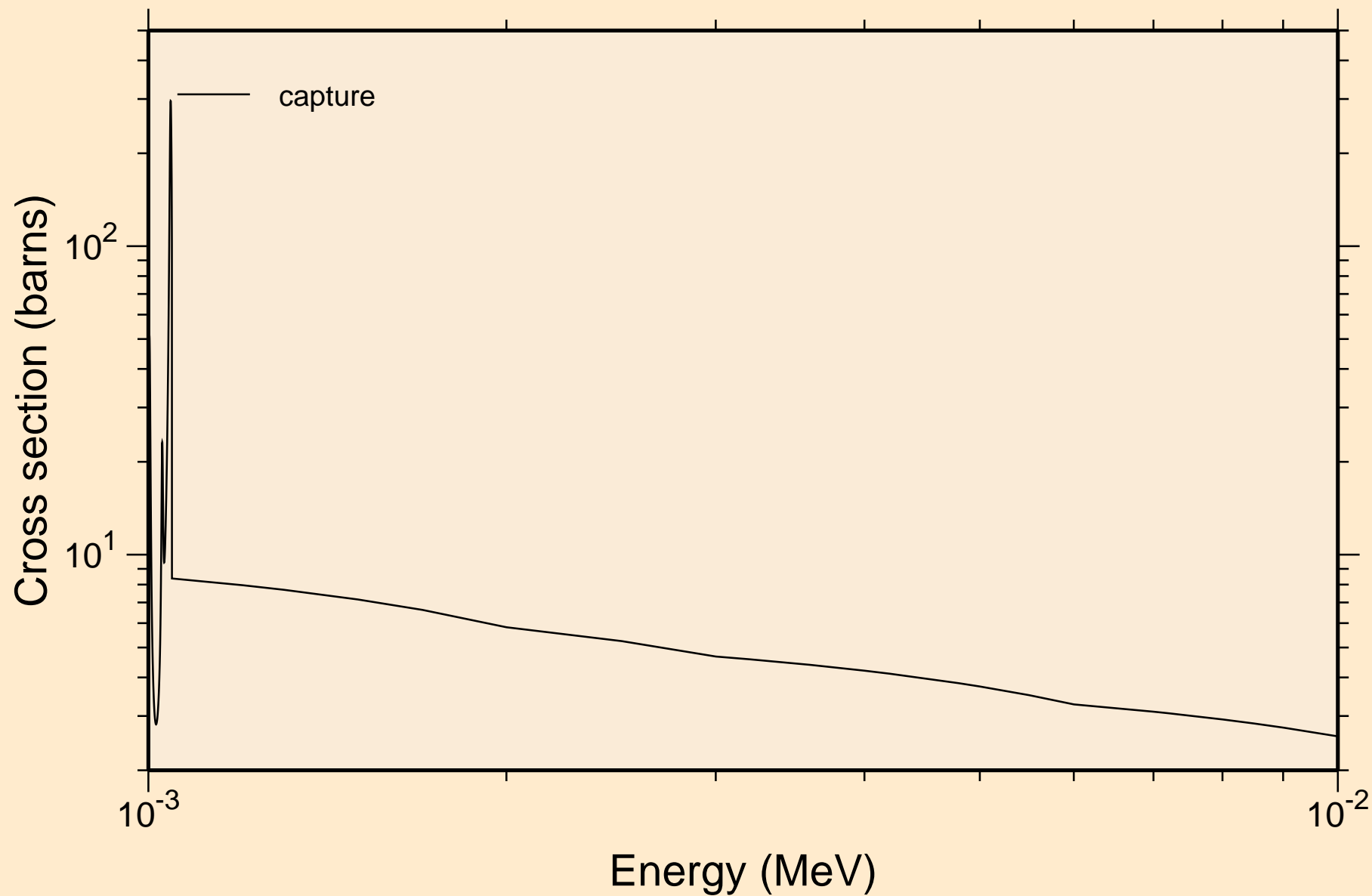

YB176M NEUTRON ACER TENDL-2019 LIBRARY; T=293.16K
resonance absorption cross sections

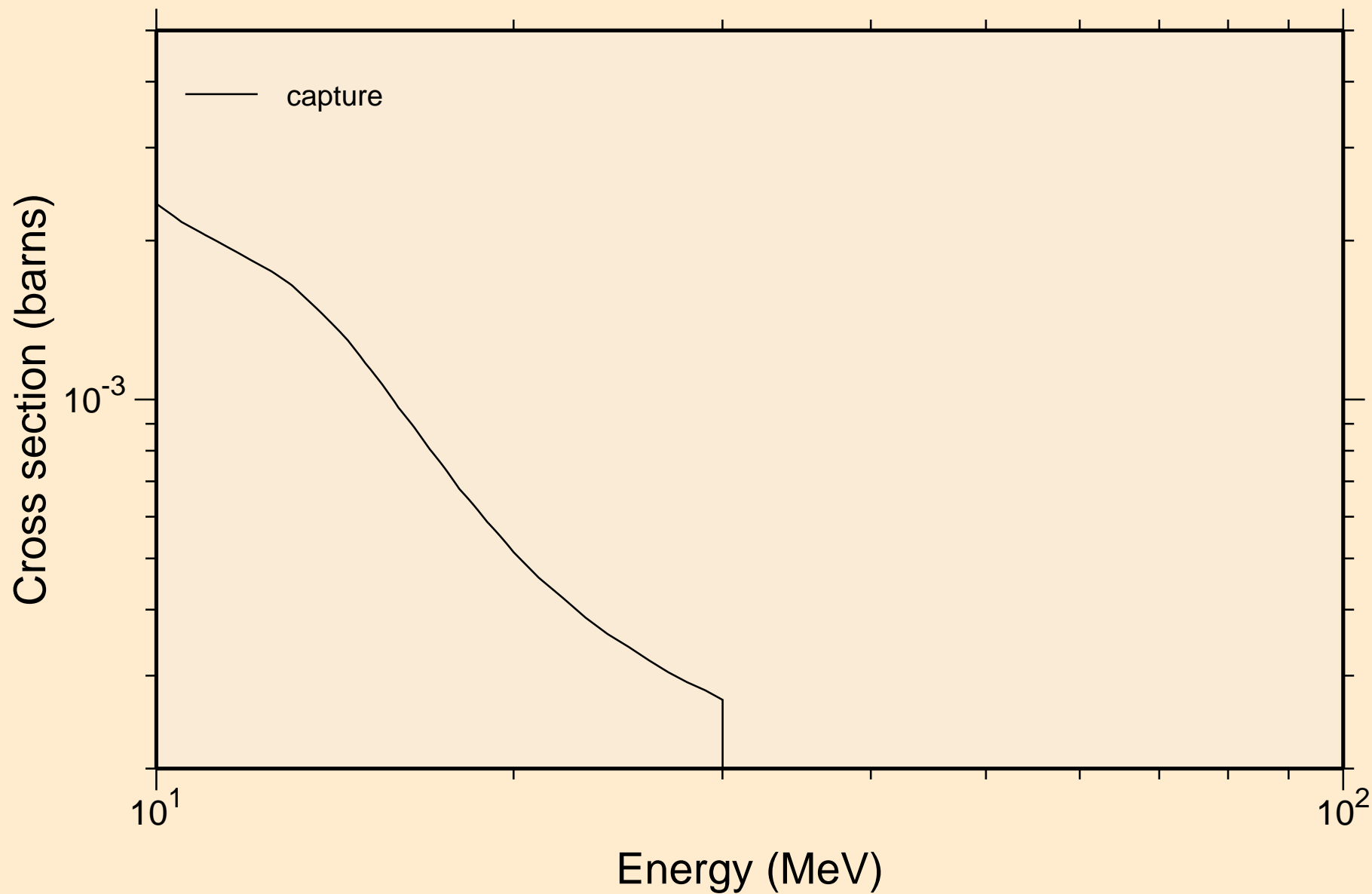

YB176M NEUTRON ACER TENDL-2019 LIBRARY; T=293.16K
Heating

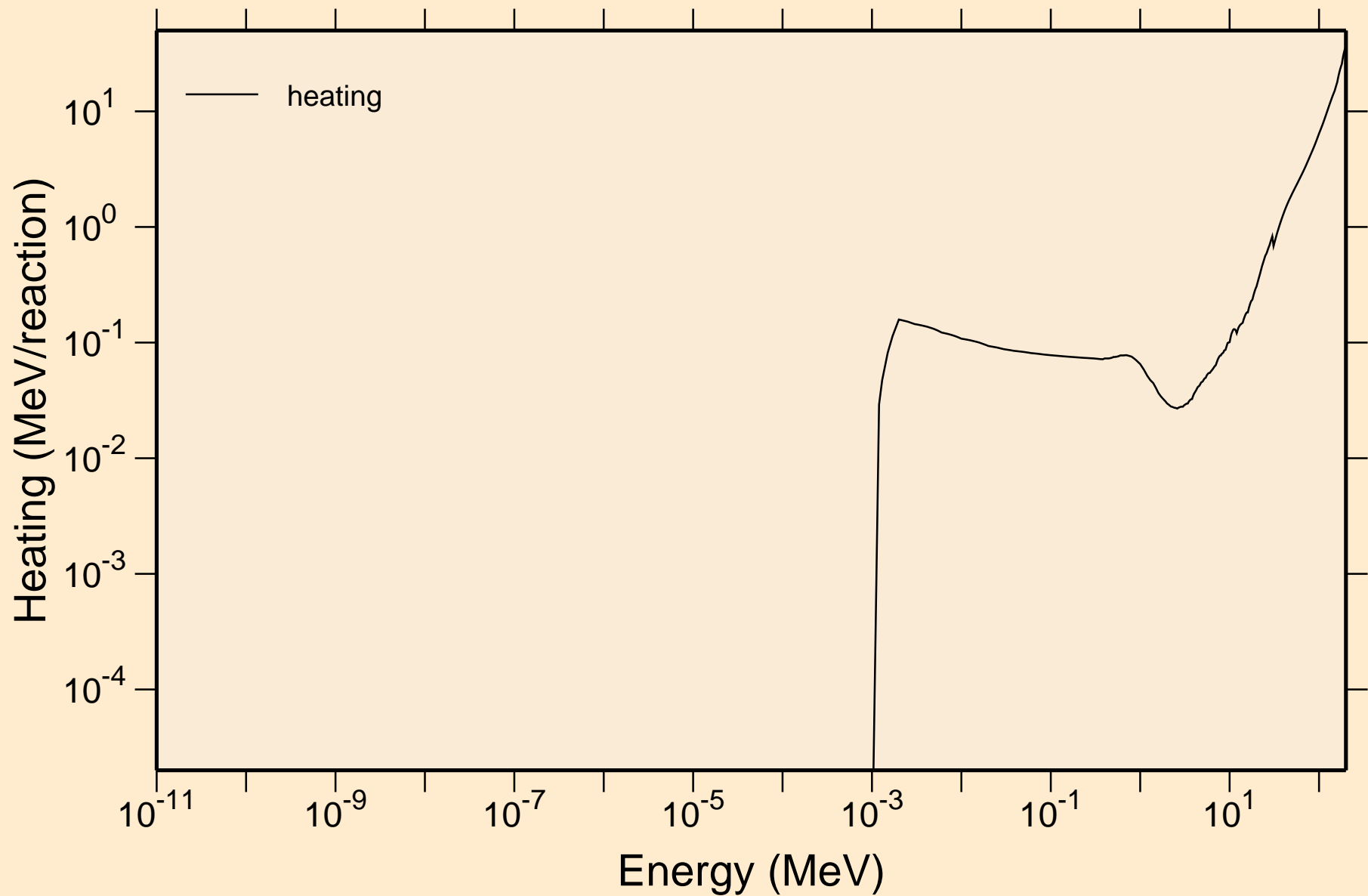

YB176M NEUTRON ACER TENDL-2019 LIBRARY; T=293.16K
Damage

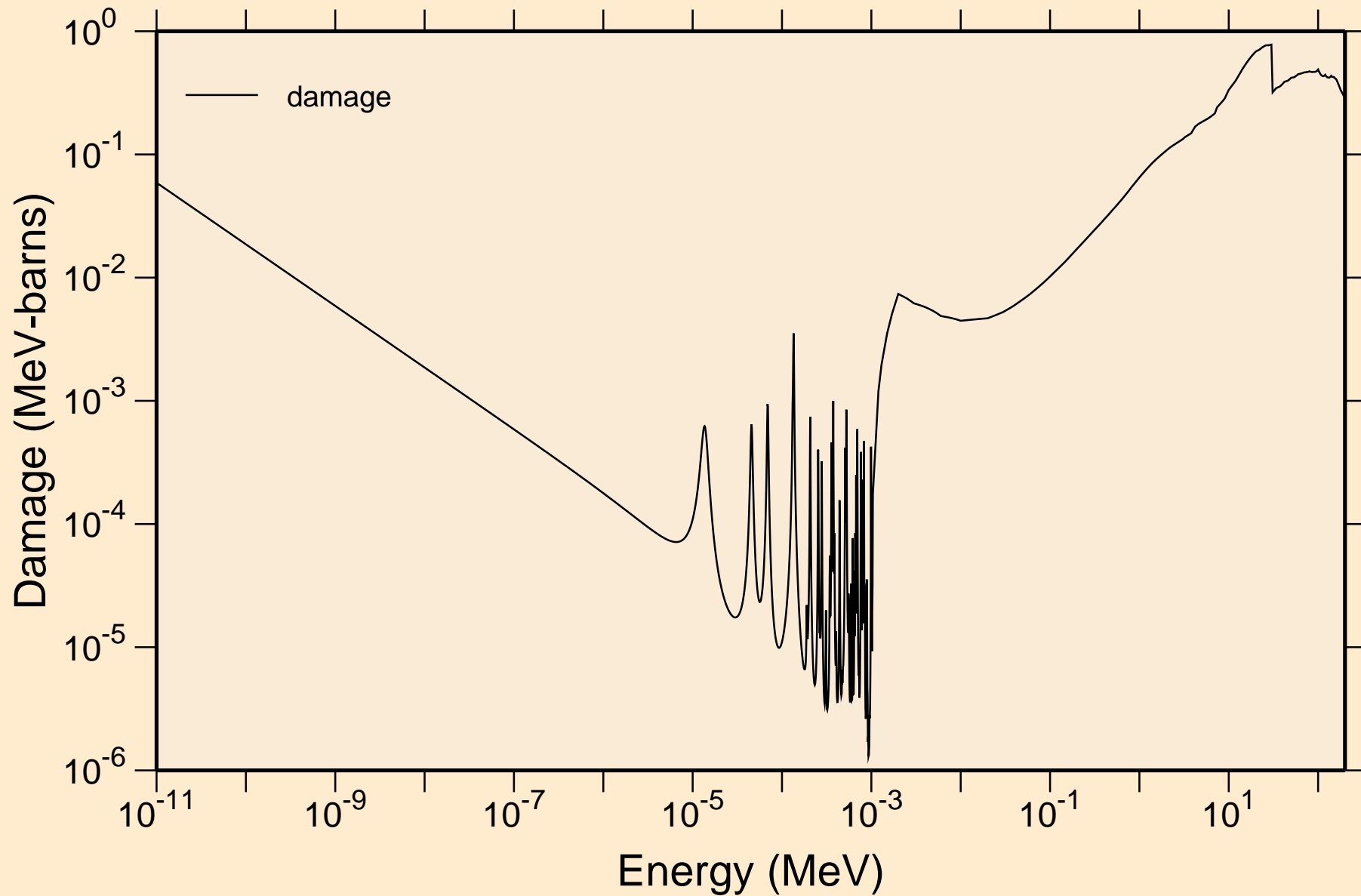

YB176M NEUTRON ACER TENDL-2019 LIBRARY; T=293.16K
Non-threshold reactions

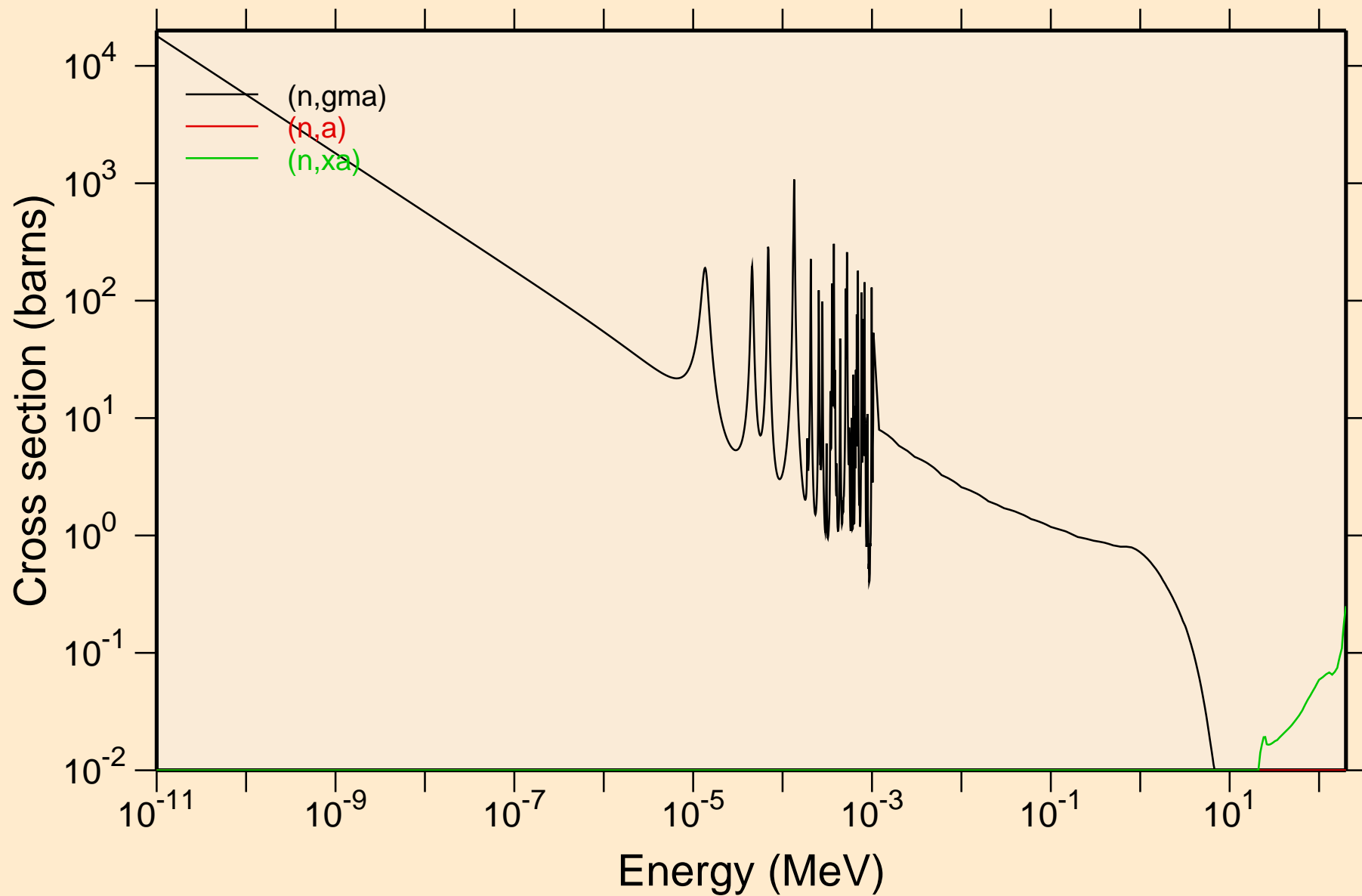

YB176M NEUTRON ACER TENDL-2019 LIBRARY; T=293.16K
Principal cross sections

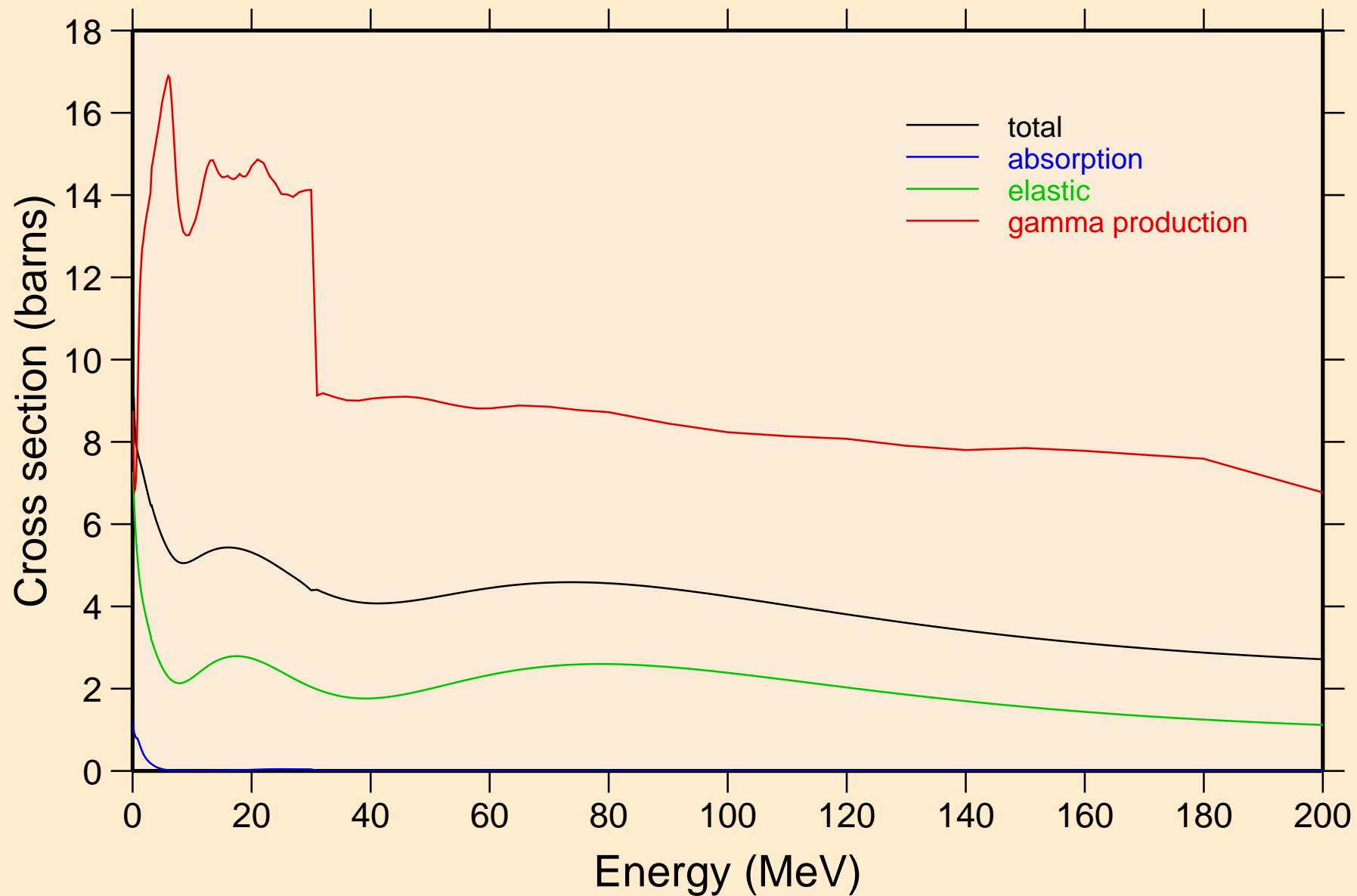

YB176M NEUTRON ACER TENDL-2019 LIBRARY; T=293.16K
Heating

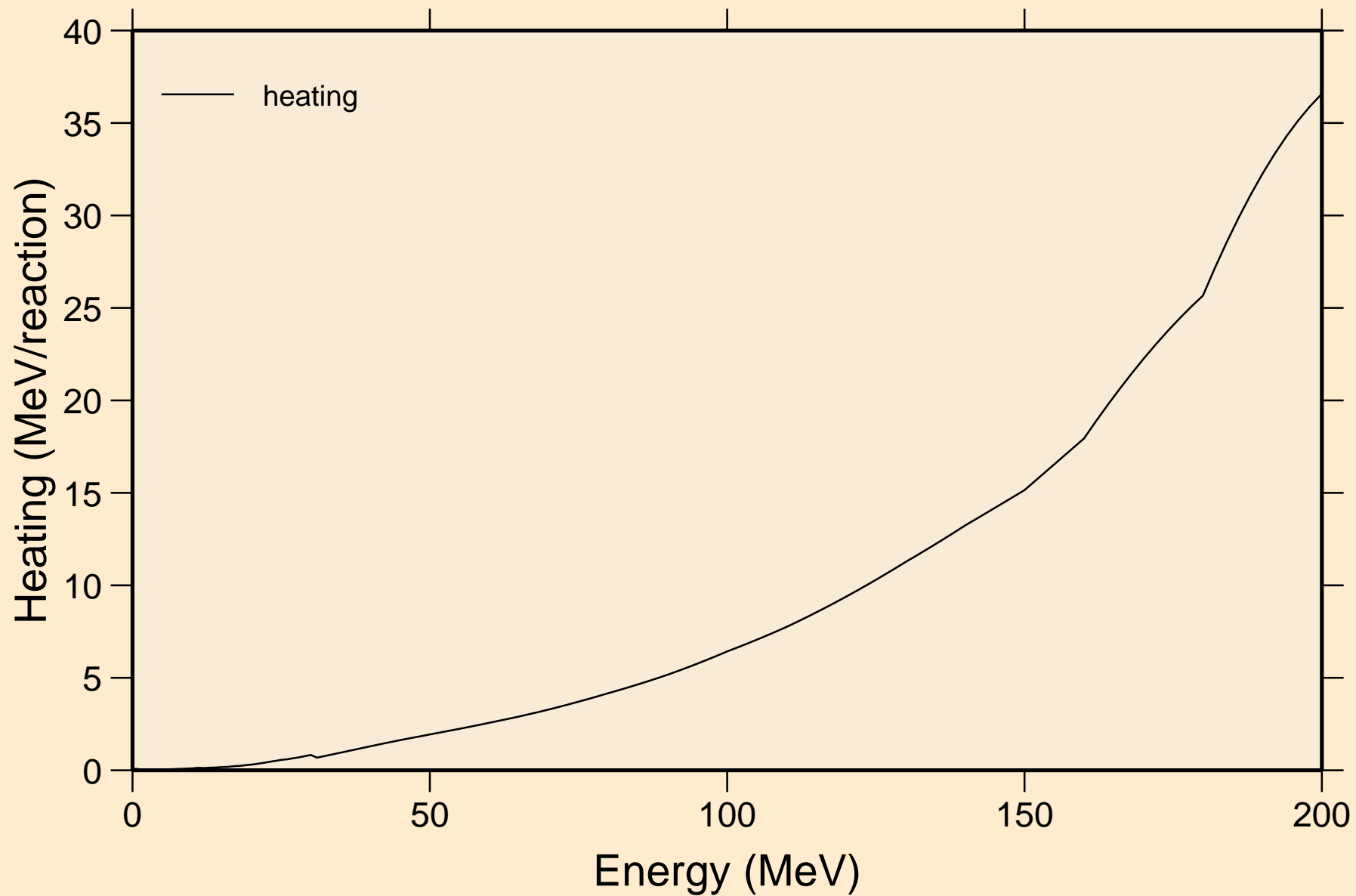

YB176M NEUTRON ACER TENDL-2019 LIBRARY; T=293.16K
Damage

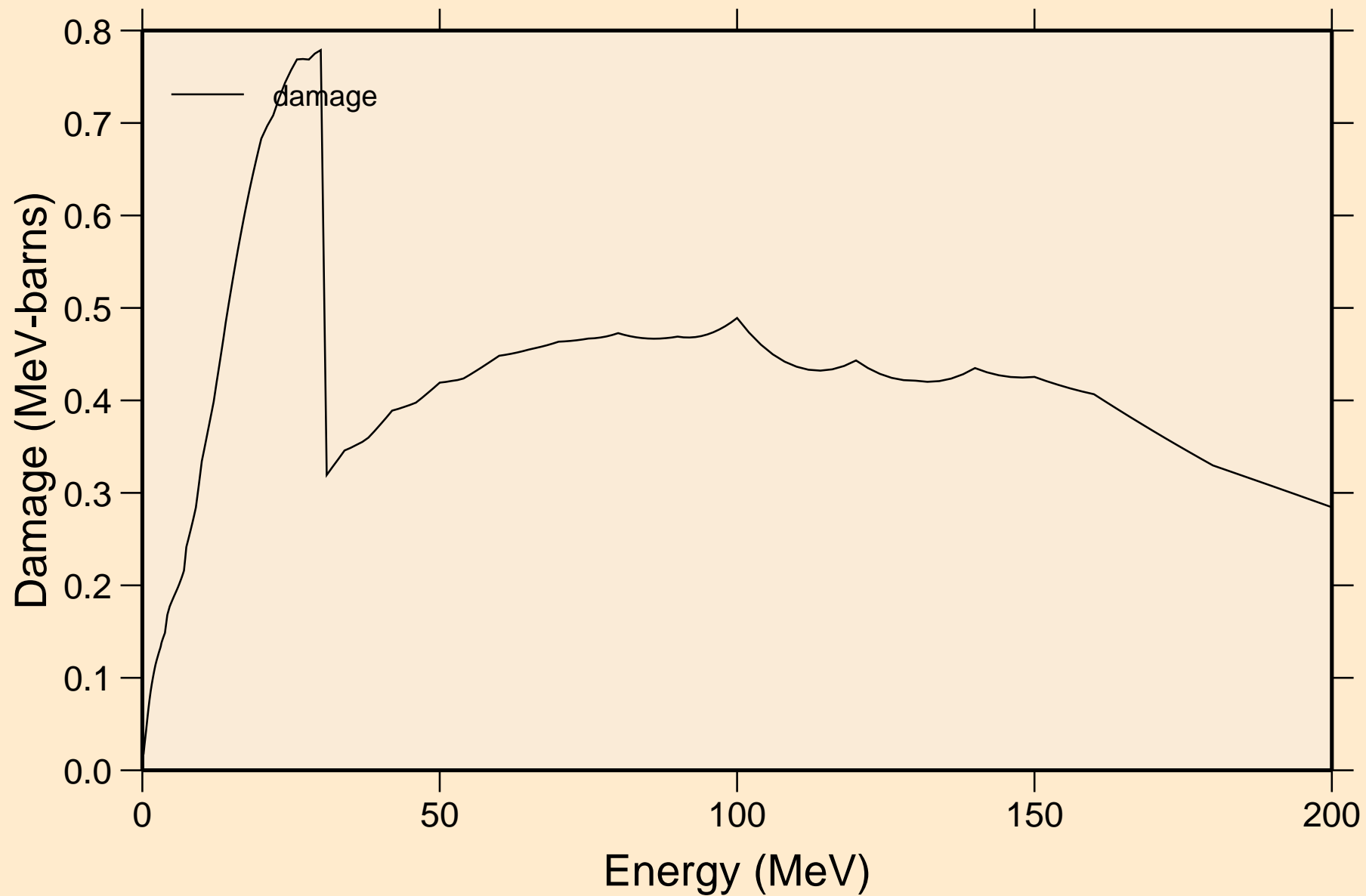

YB176M NEUTRON ACER TENDL-2019 LIBRARY; T=293.16K
Non-threshold reactions

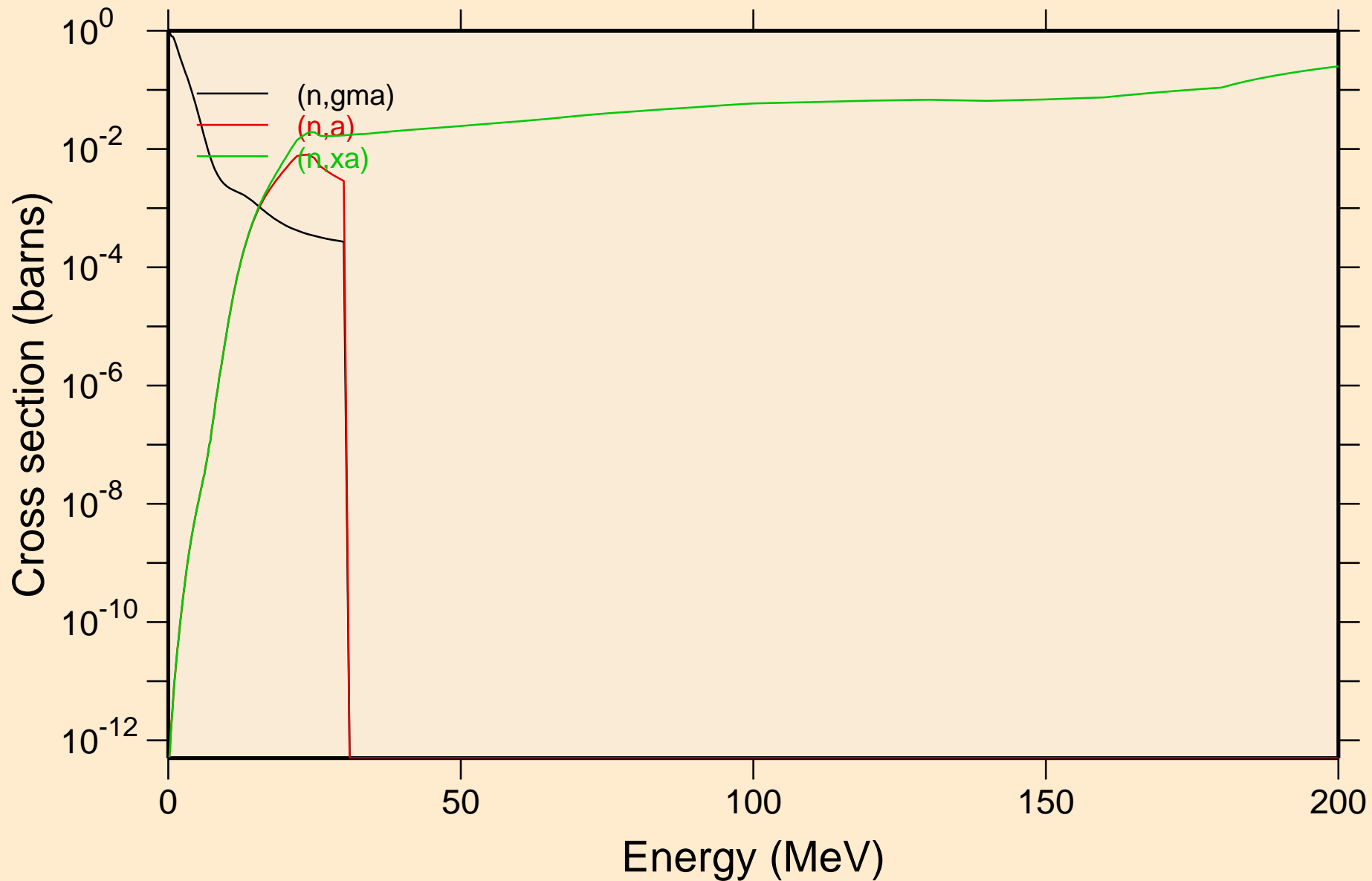

YB176M NEUTRON ACER TENDL-2019 LIBRARY; T=293.16K
Inelastic levels

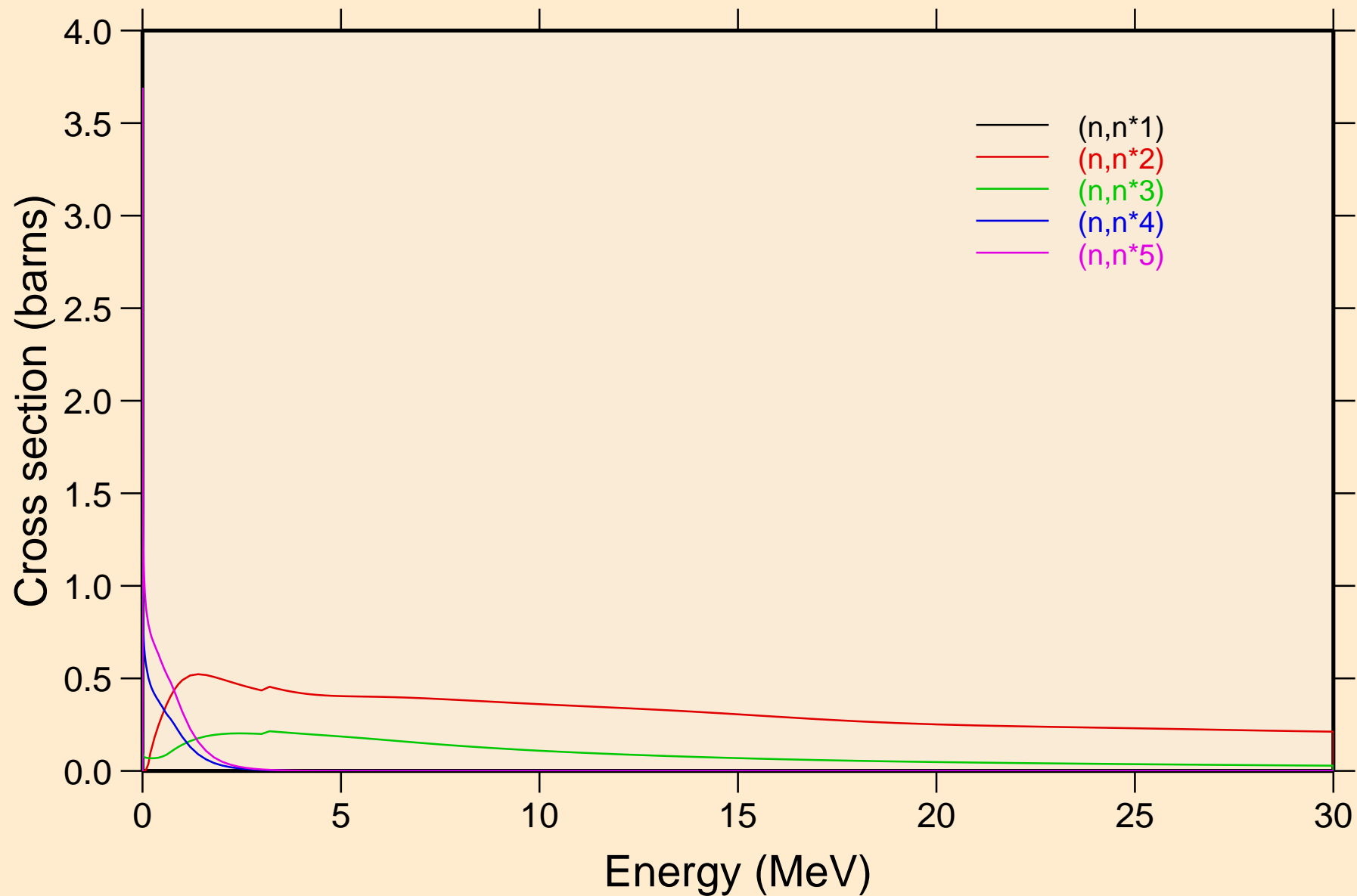

YB176M NEUTRON ACER TENDL-2019 LIBRARY; T=293.16K
Inelastic levels

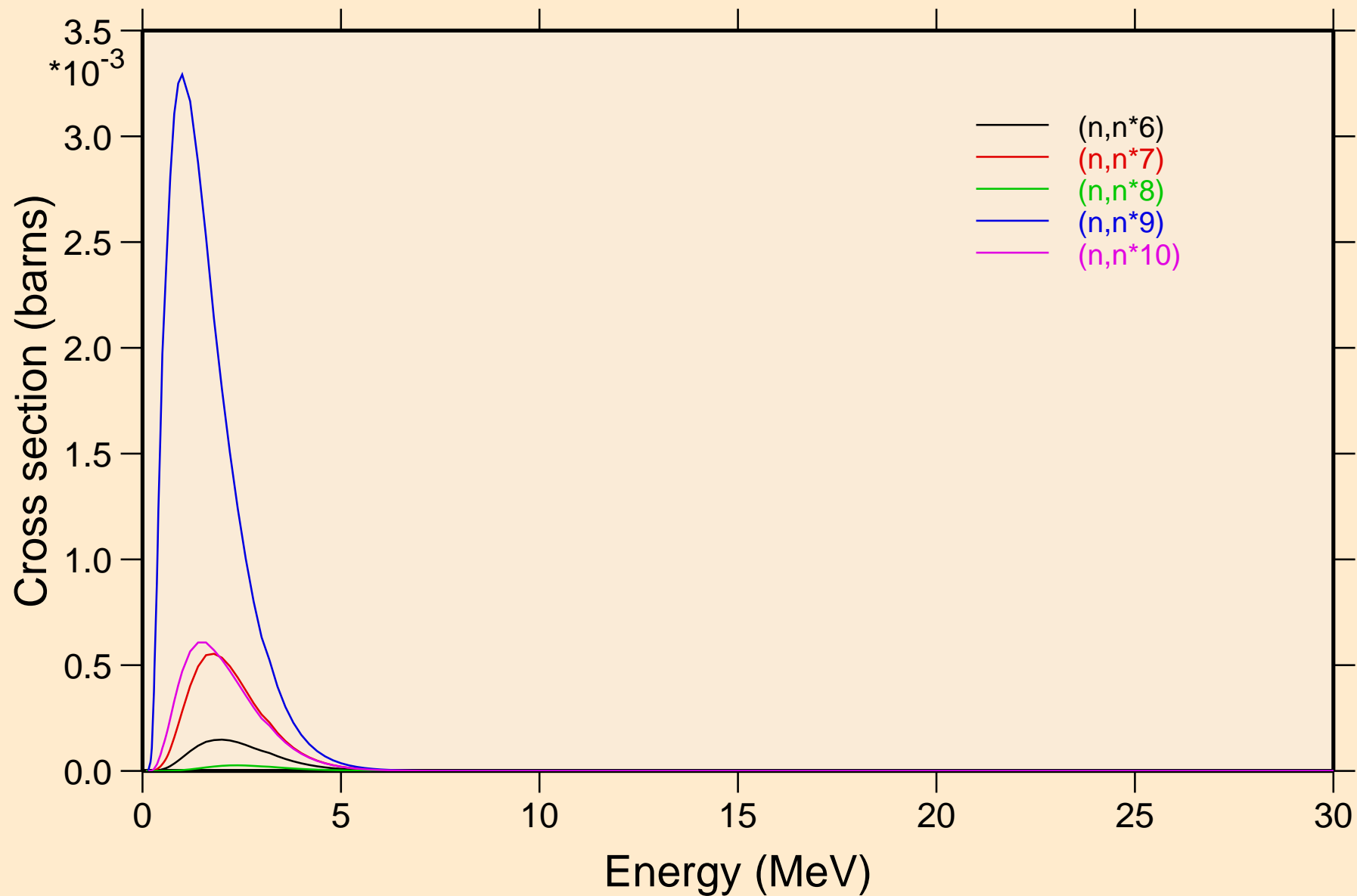

YB176M NEUTRON ACER TENDL-2019 LIBRARY; T=293.16K
Inelastic levels

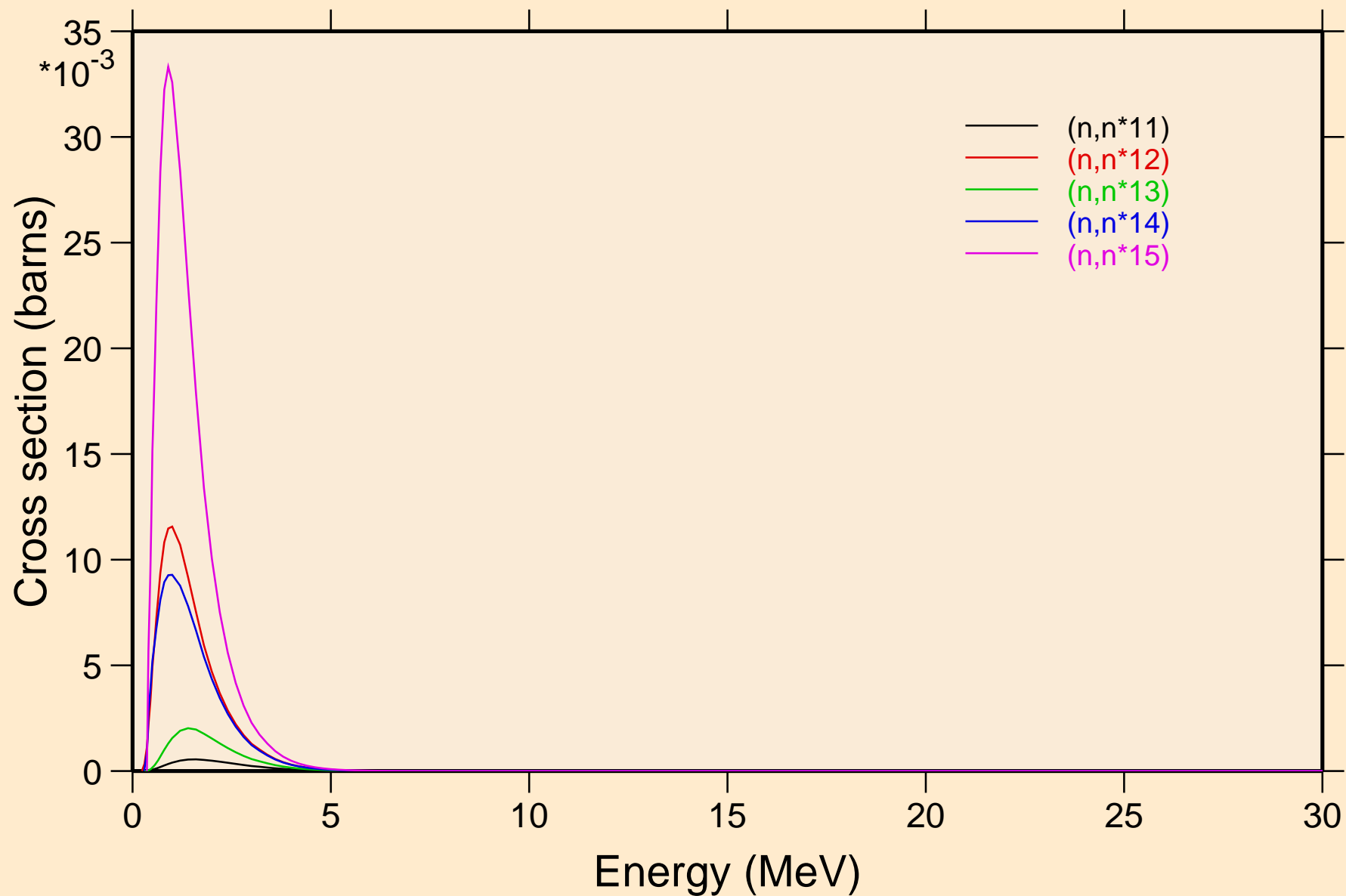

YB176M NEUTRON ACER TENDL-2019 LIBRARY; T=293.16K
Inelastic levels

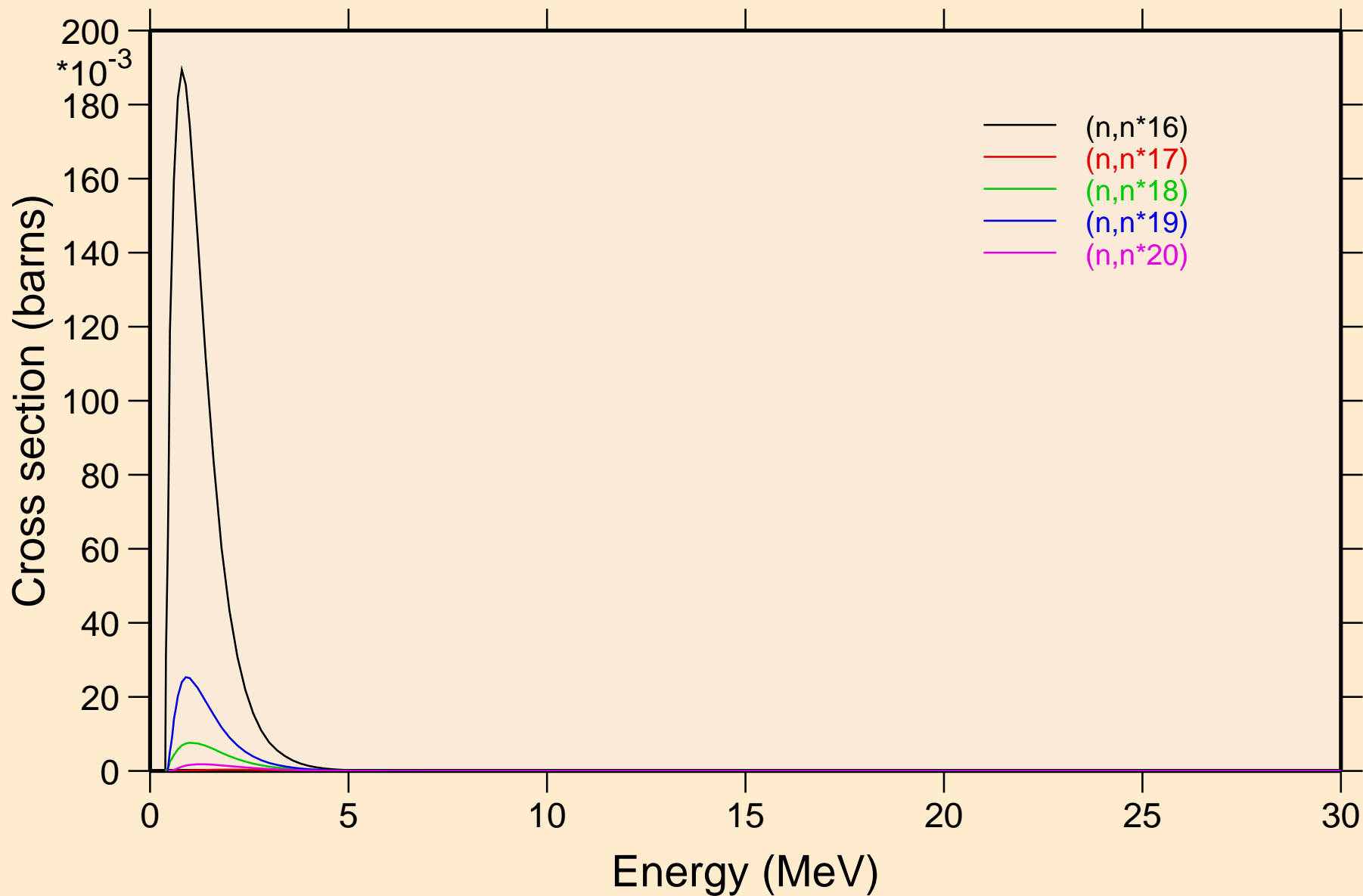

YB176M NEUTRON ACER TENDL-2019 LIBRARY; T=293.16K
Inelastic levels

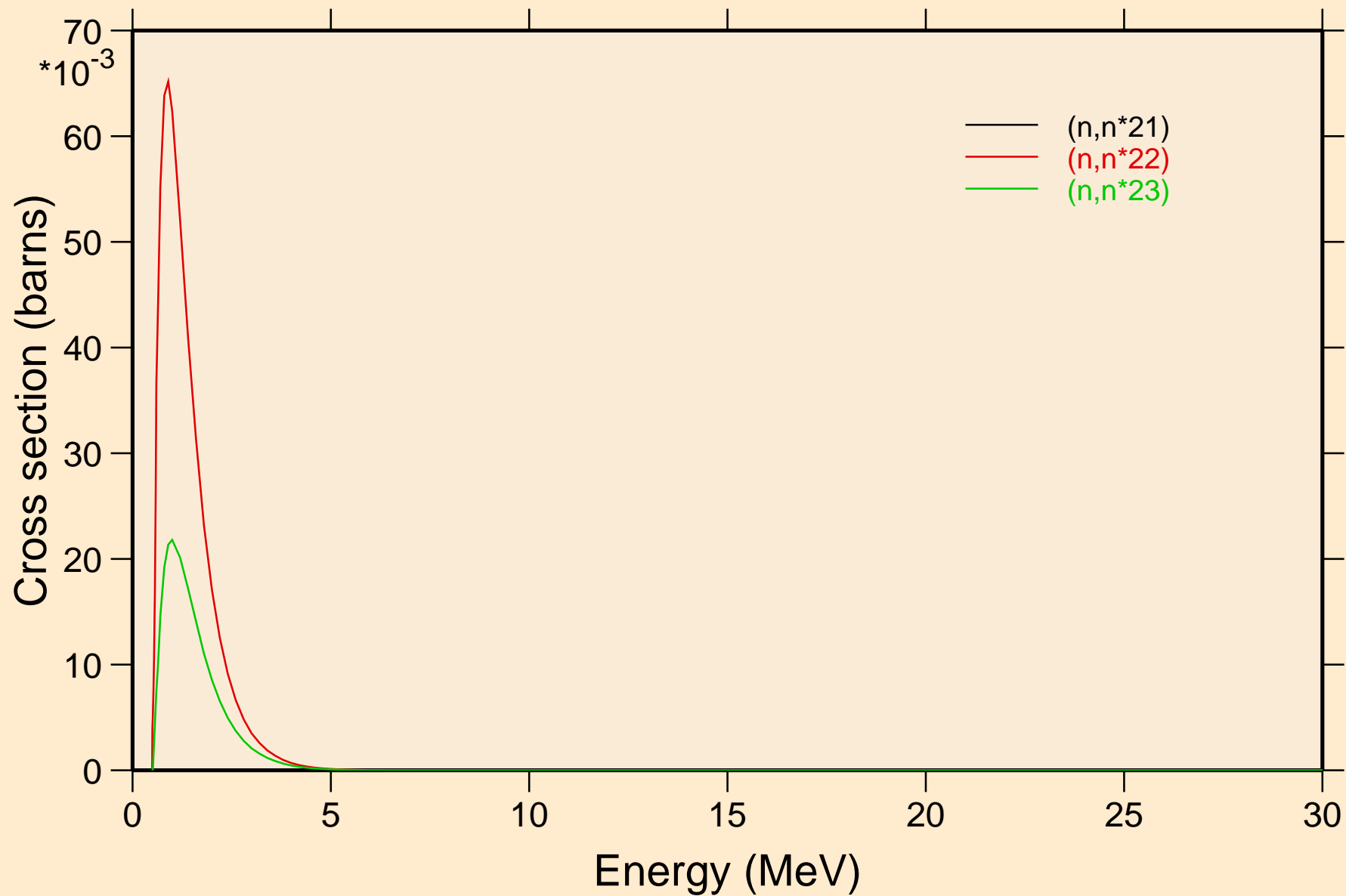

YB176M NEUTRON ACER TENDL-2019 LIBRARY; T=293.16K
Threshold reactions

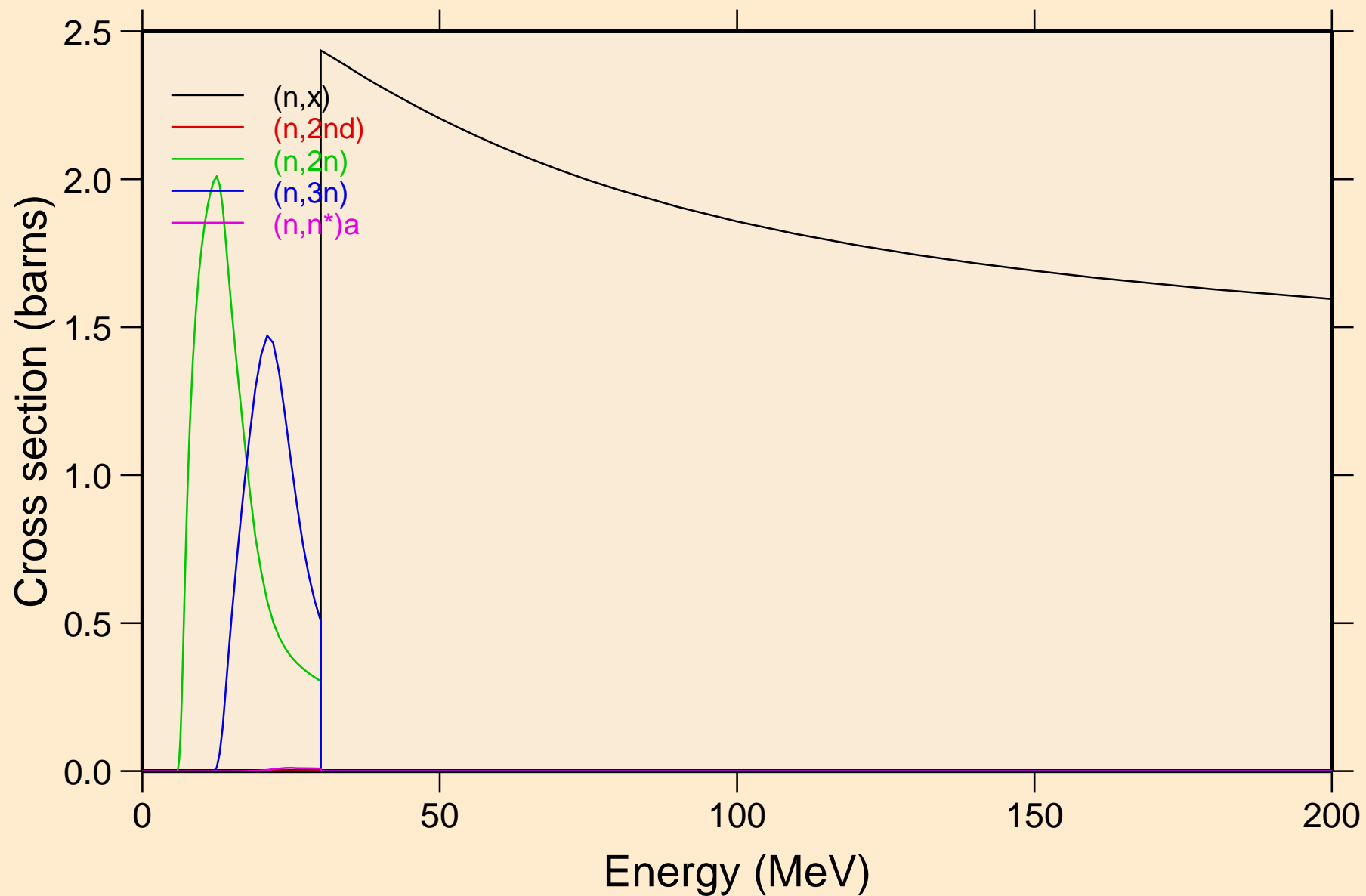

YB176M NEUTRON ACER TENDL-2019 LIBRARY; T=293.16K
Threshold reactions

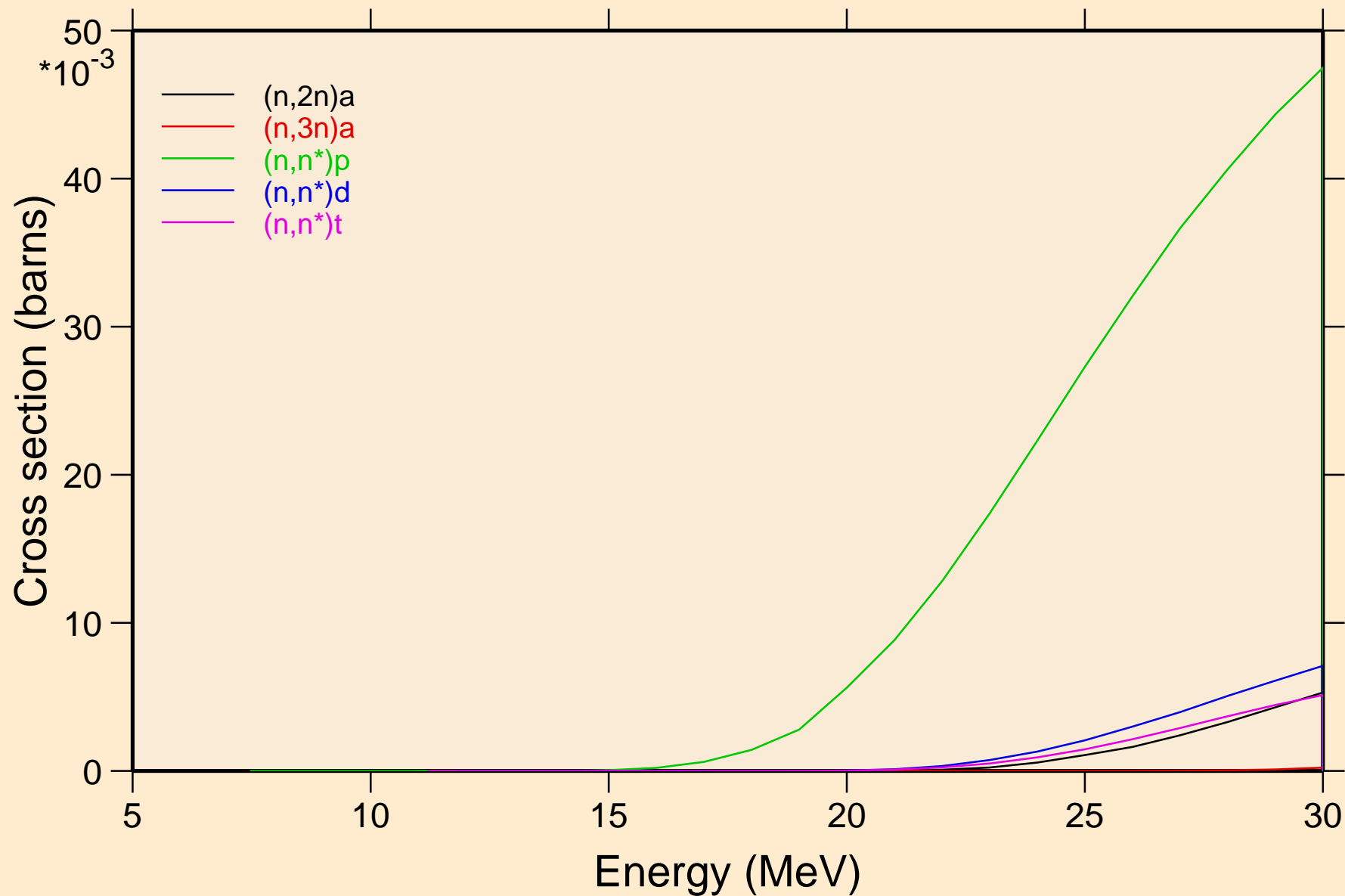

YB176M NEUTRON ACER TENDL-2019 LIBRARY; T=293.16K
Threshold reactions

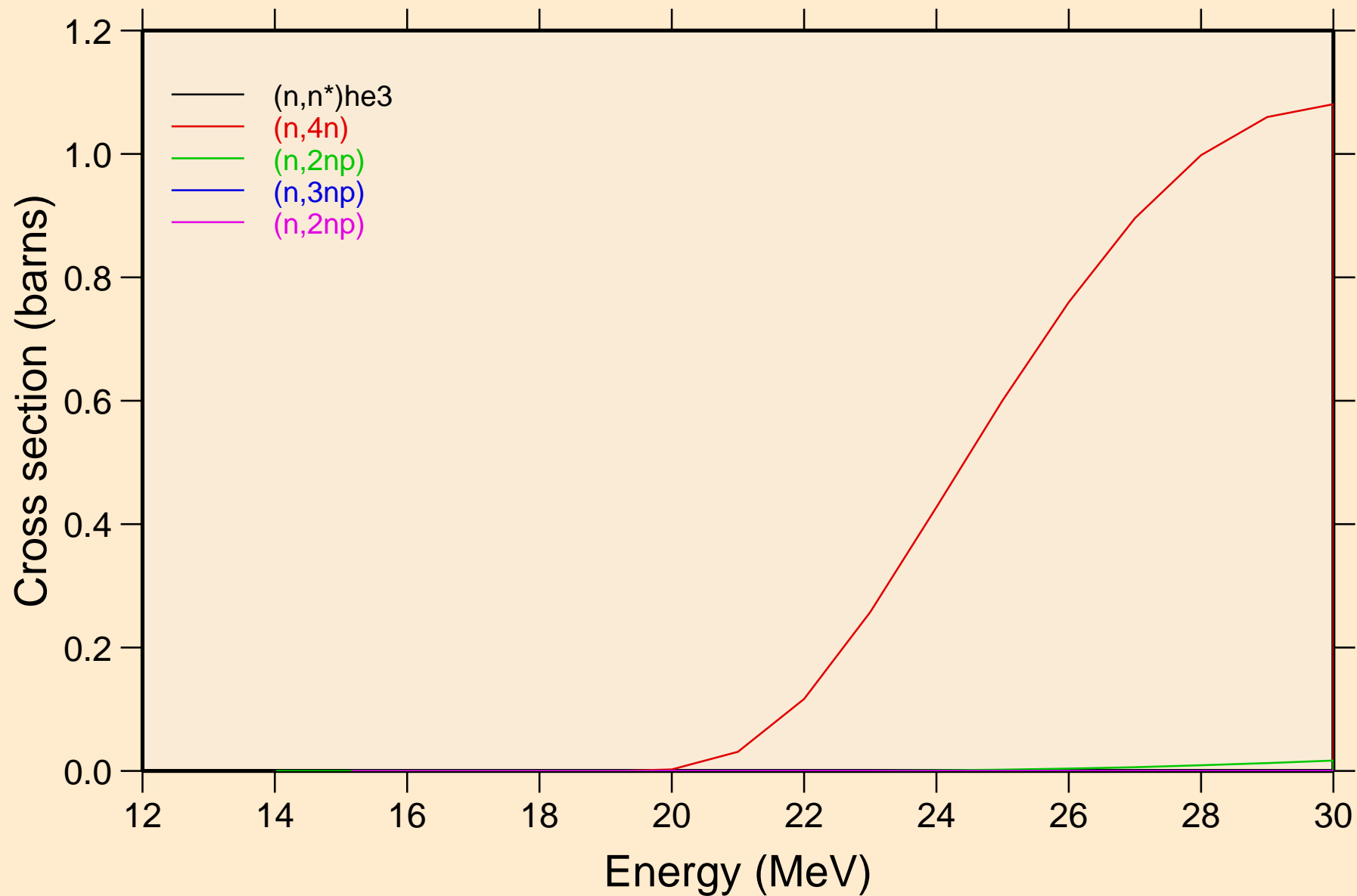

YB176M NEUTRON ACER TENDL-2019 LIBRARY; T=293.16K
Threshold reactions

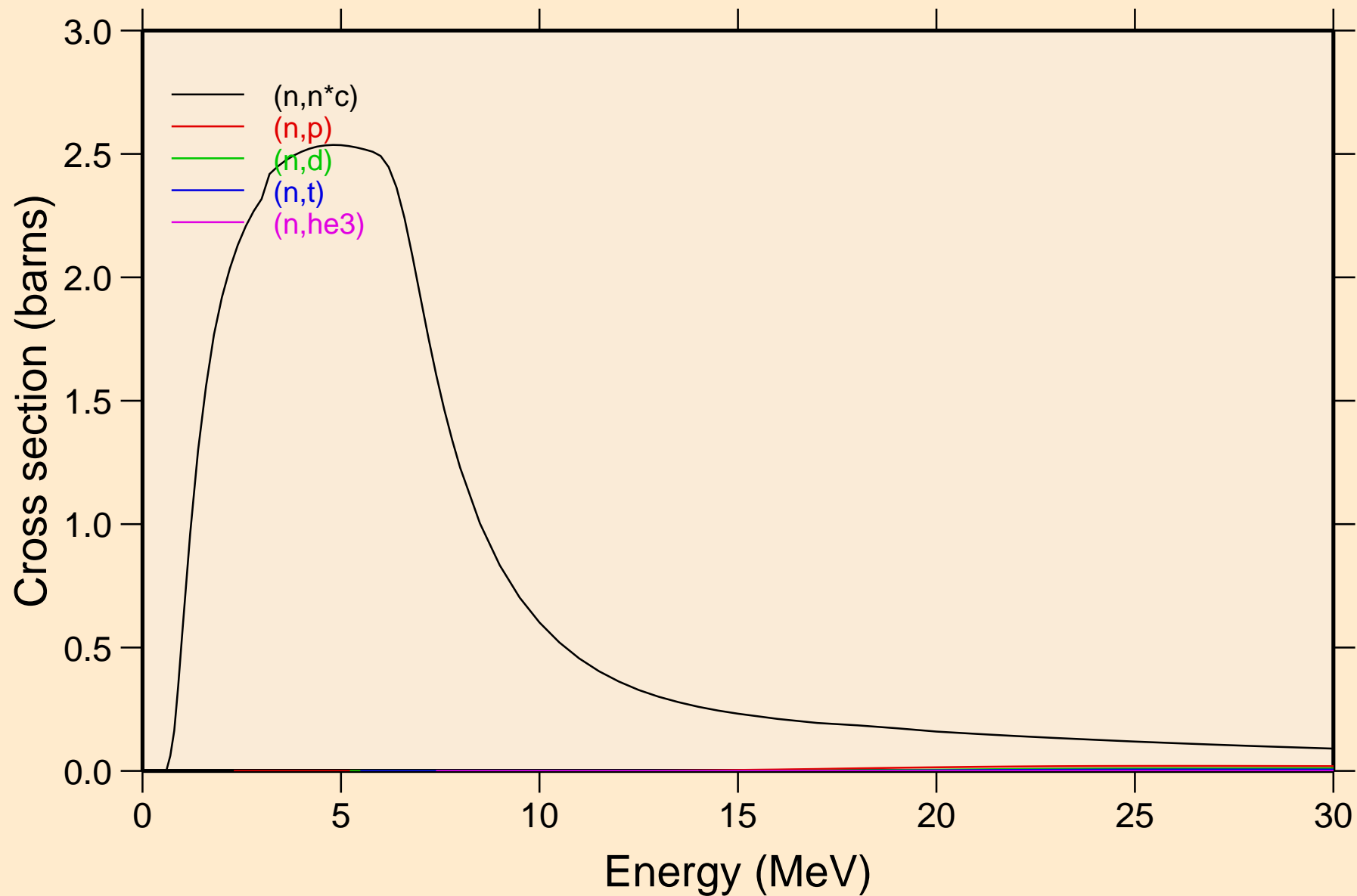

YB176M NEUTRON ACER TENDL-2019 LIBRARY; T=293.16K
Threshold reactions

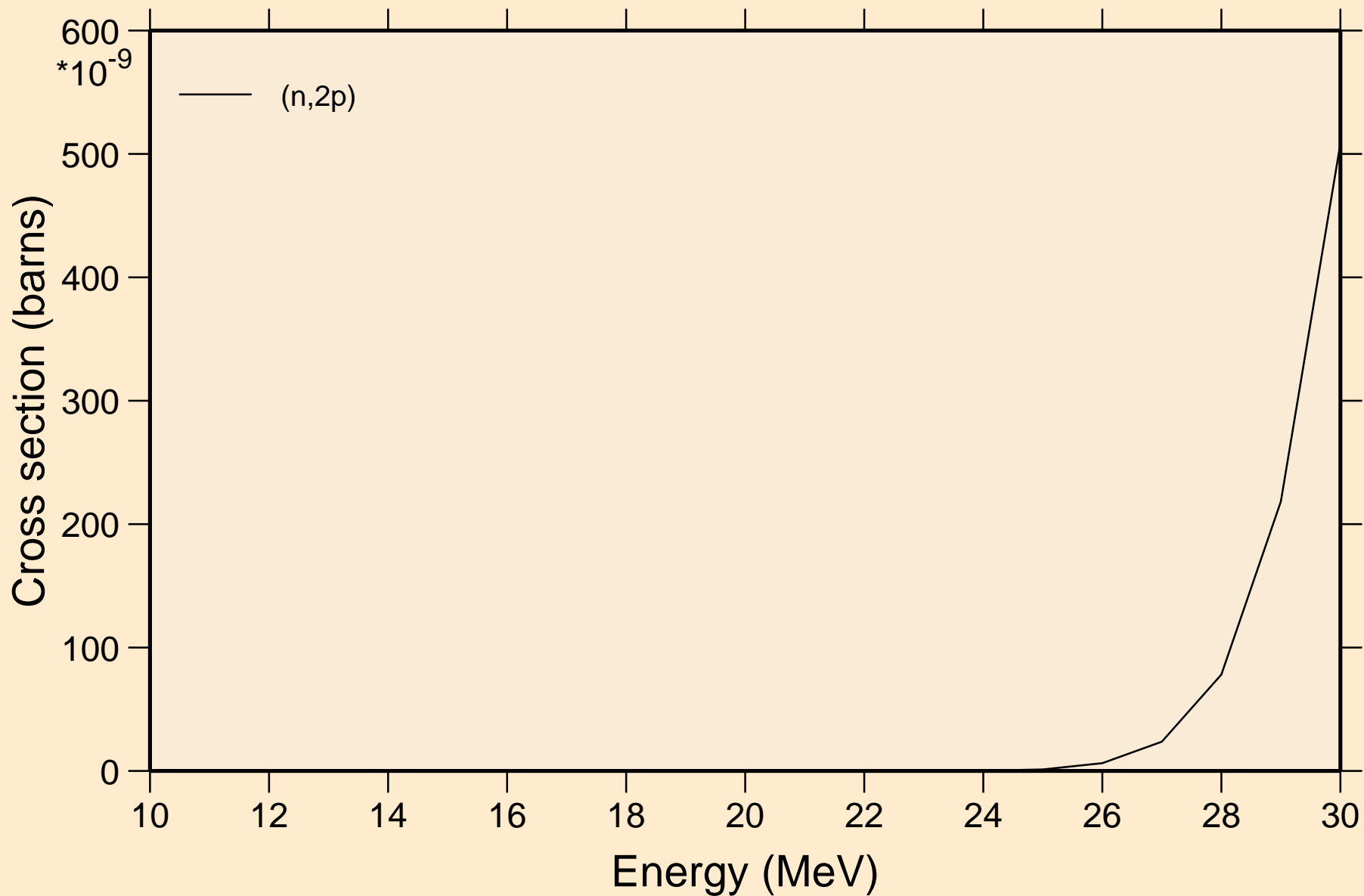

YB176M NEUTRON ACER TENDL-2019 LIBRARY; T=293.16K
Threshold reactions

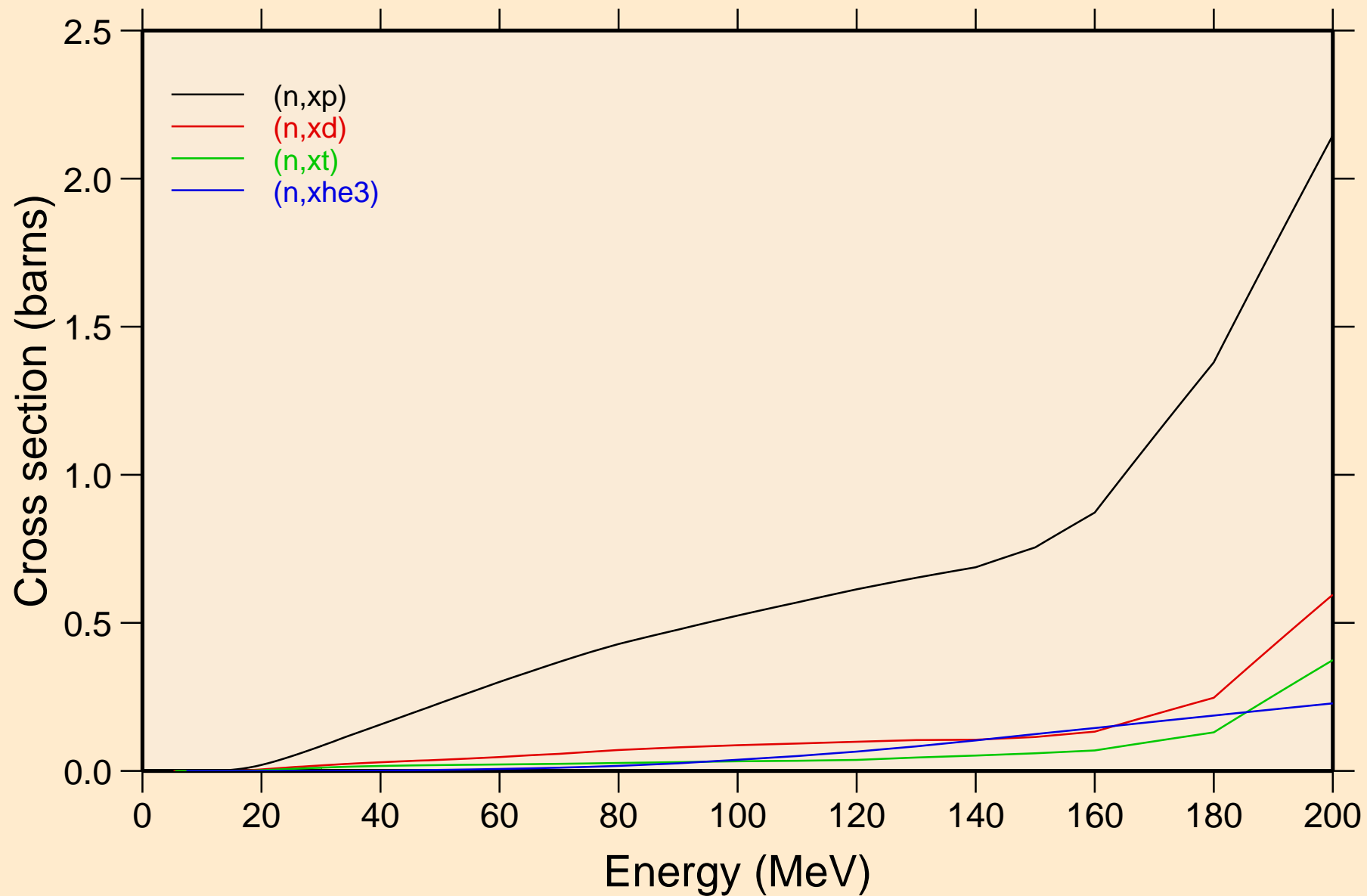

YB176M NEUTRON ACER TENDL-2019 LIBRARY; T=293.16K
angular distribution for elastic

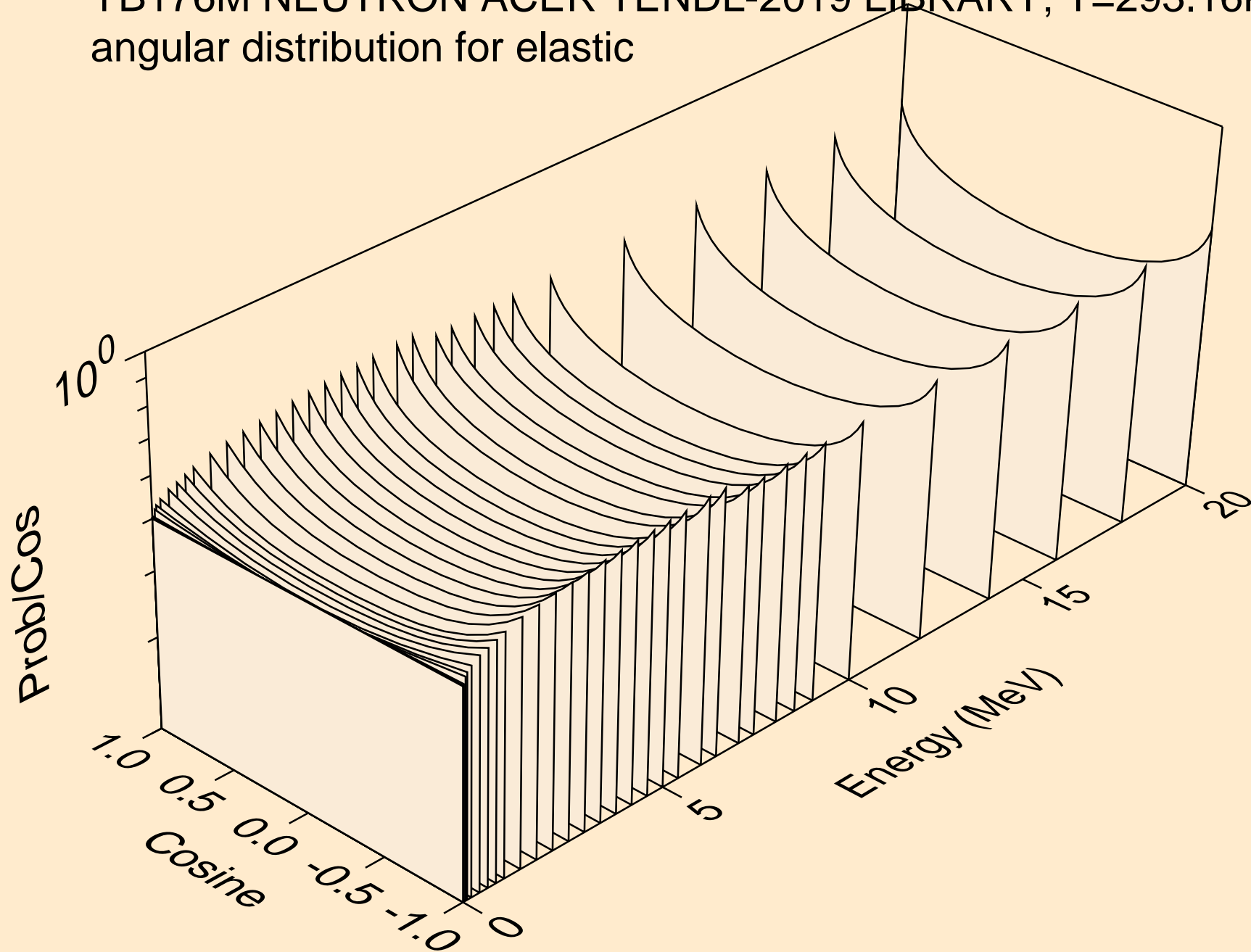

YB176M NEUTRON ACER TENDL-2019 LIBRARY; T=293.16K
angular distribution for elastic

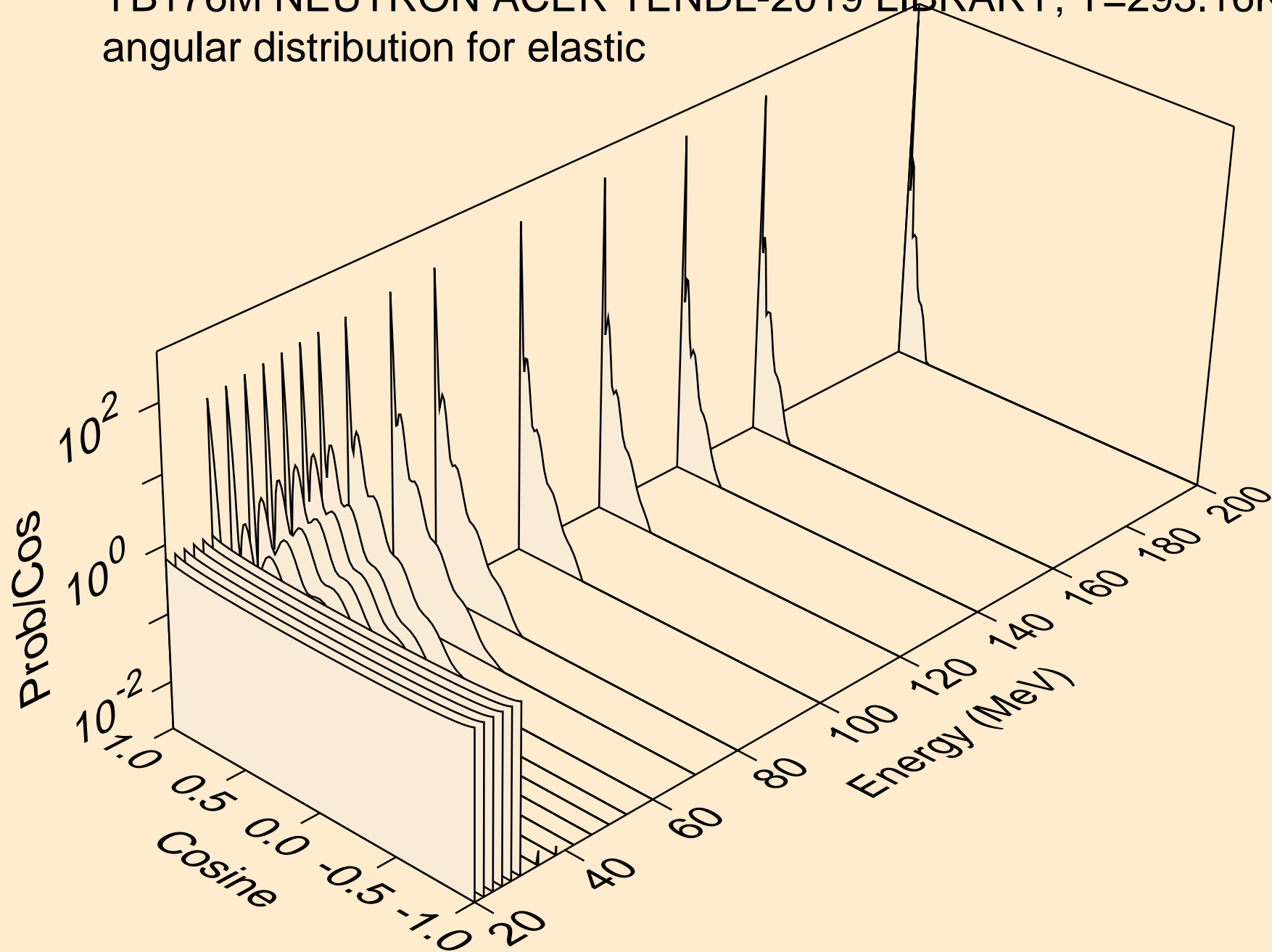

YB176M NEUTRON ACER TENDL-2019 LIBRARY; T=293.16K
angular distribution for (n,n*1)

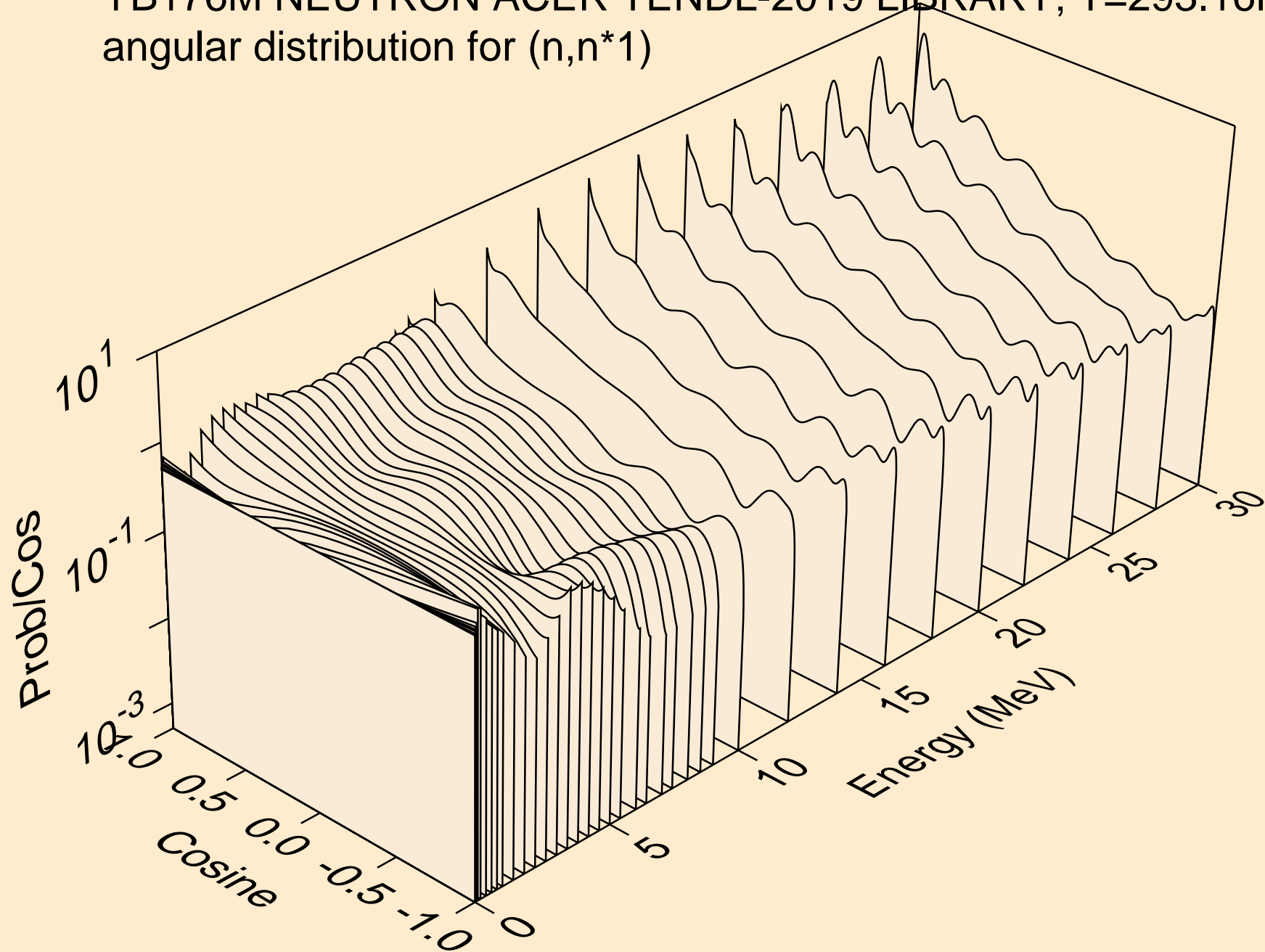

YB176M NEUTRON ACER TENDL-2019 LIBRARY; T=293.16K
angular distribution for (n,n*2)

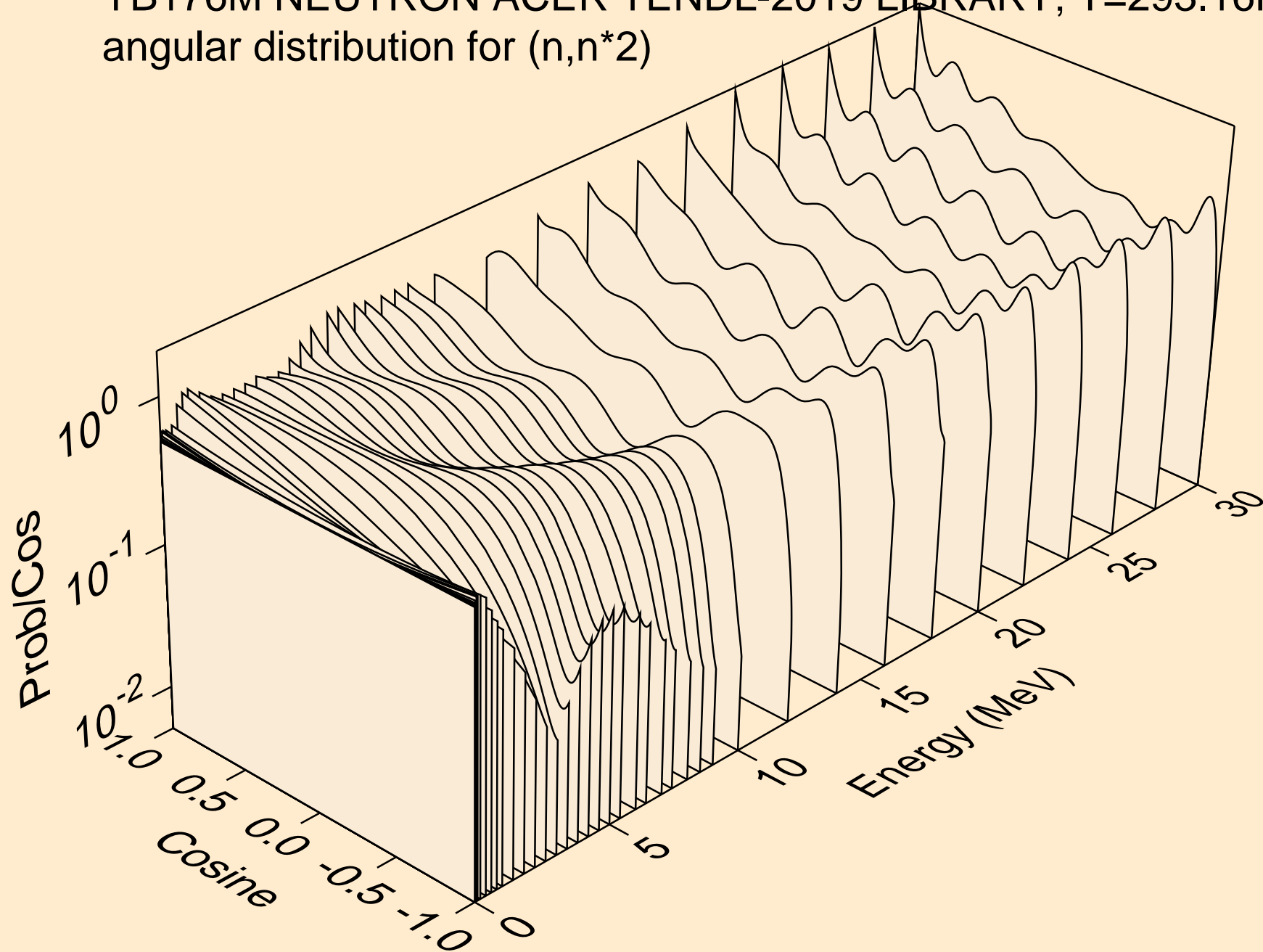

YB176M NEUTRON ACER TENDL-2019 LIBRARY; T=293.16K
angular distribution for (n,n*3)

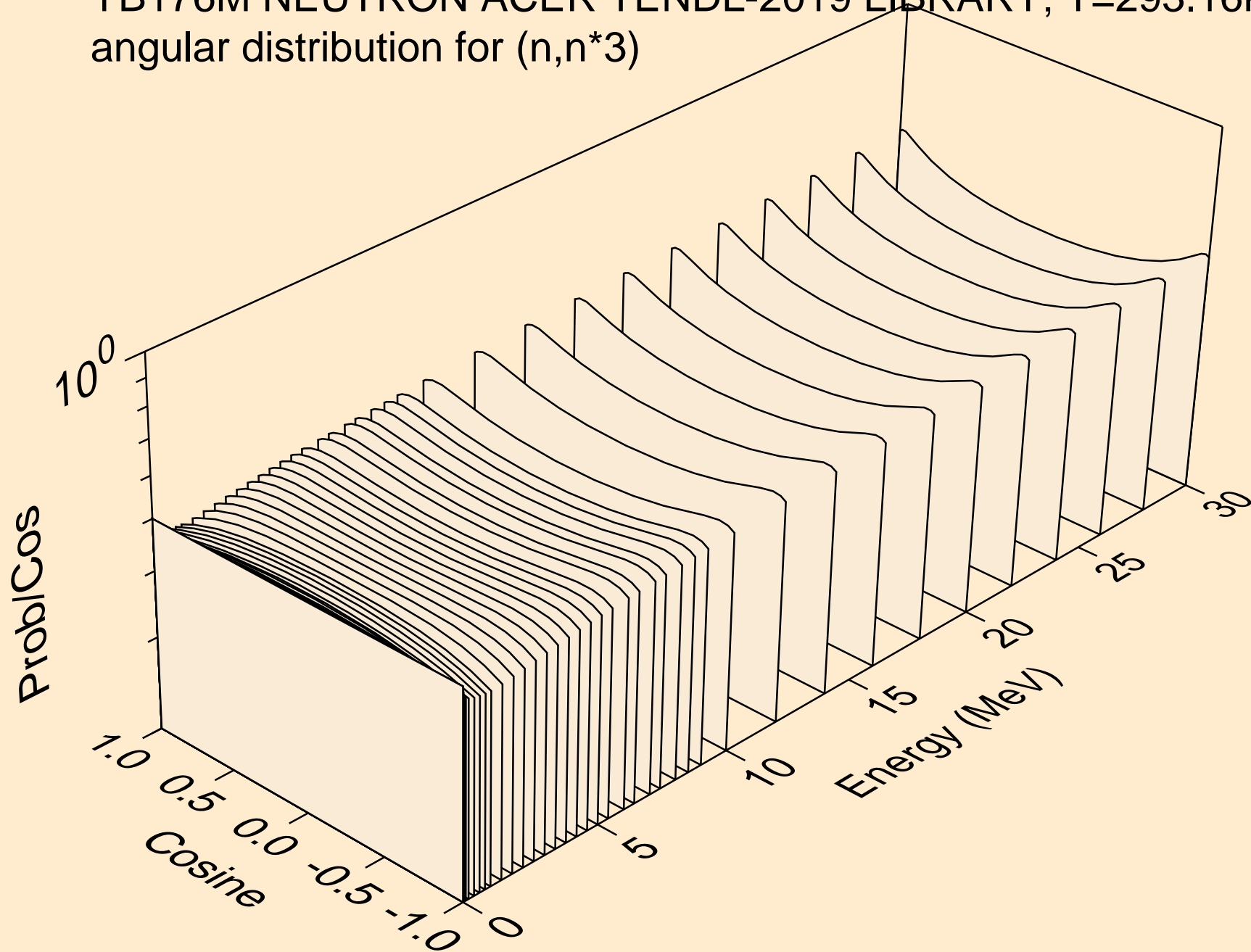

YB176M NEUTRON ACER TENDL-2019 LIBRARY; T=293.16K
angular distribution for (n,n*4)

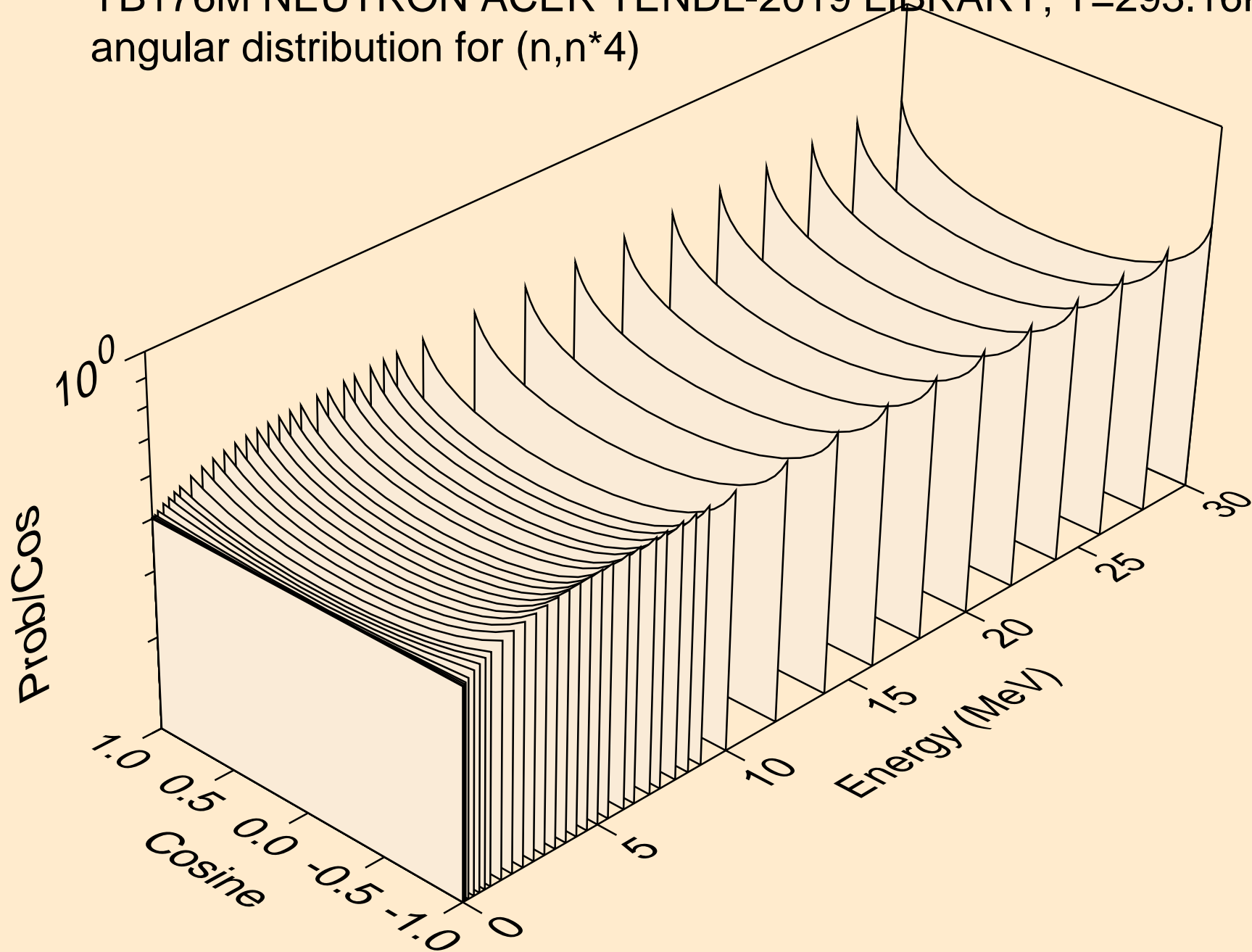

YB176M NEUTRON ACER TENDL-2019 LIBRARY; T=293.16K
angular distribution for (n,n*5)

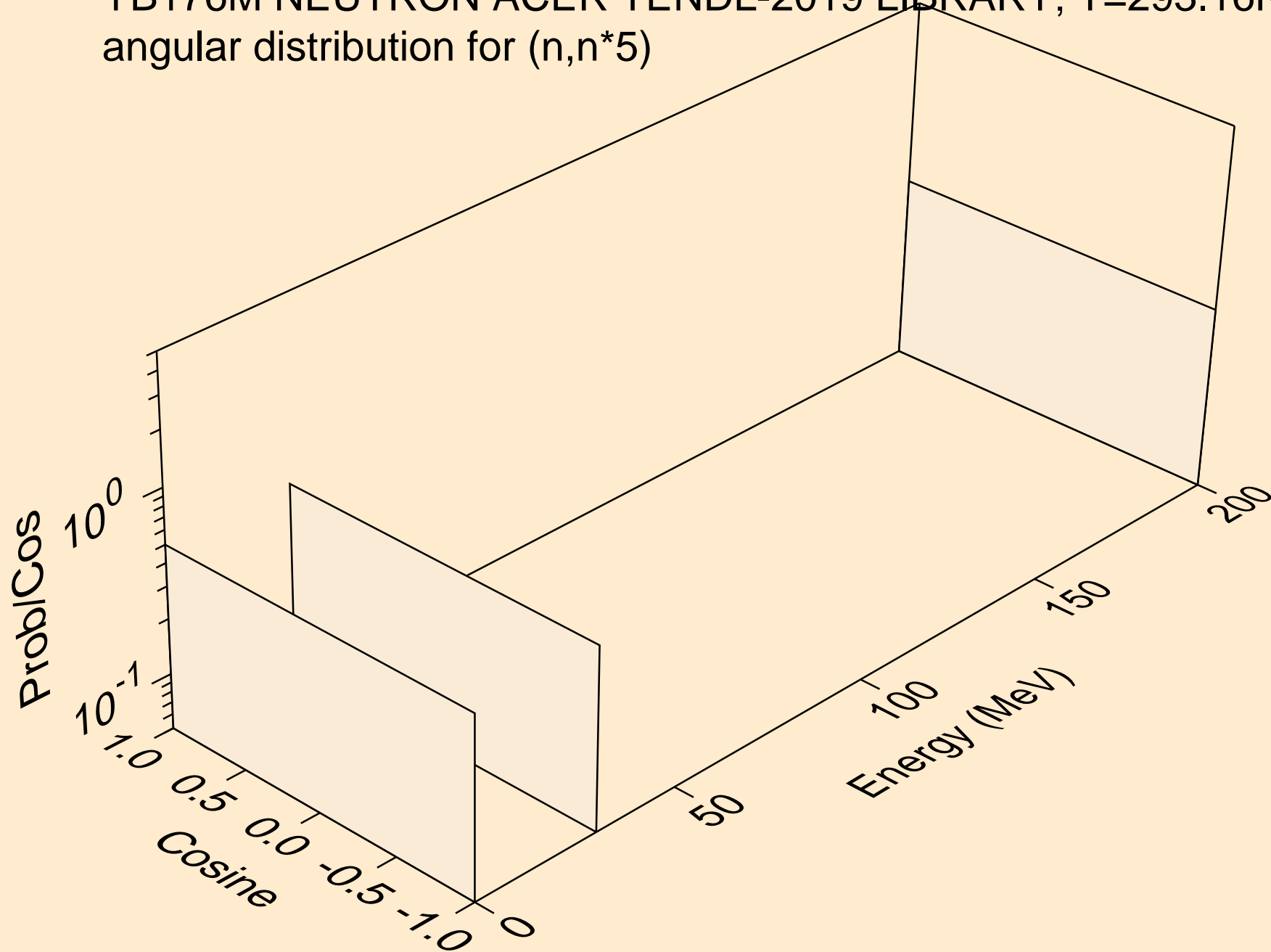

YB176M NEUTRON ACER TENDL-2019 LIBRARY; T=293.16K
angular distribution for (n,n*6)

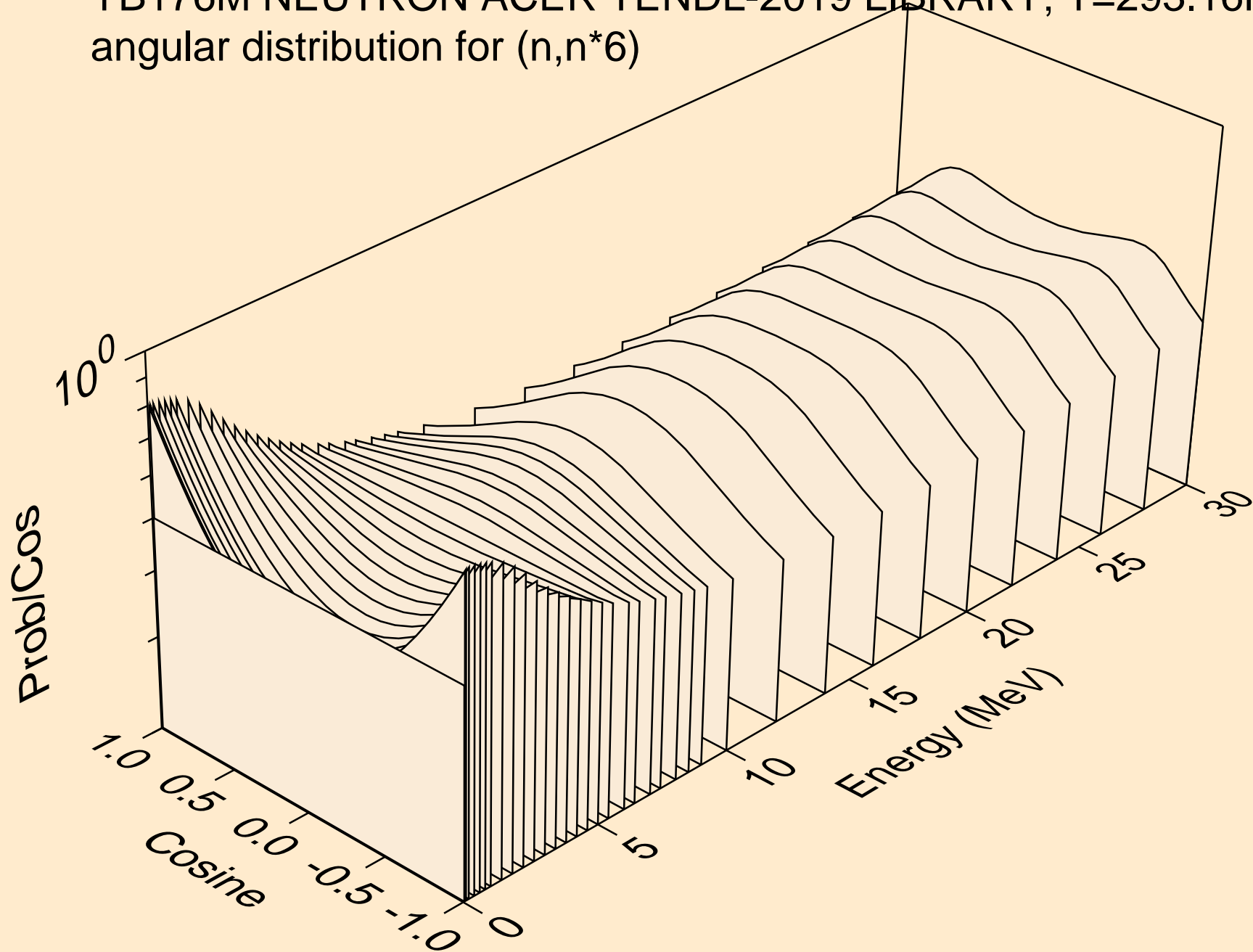

YB176M NEUTRON ACER TENDL-2019 LIBRARY; T=293.16K
angular distribution for (n,n*7)

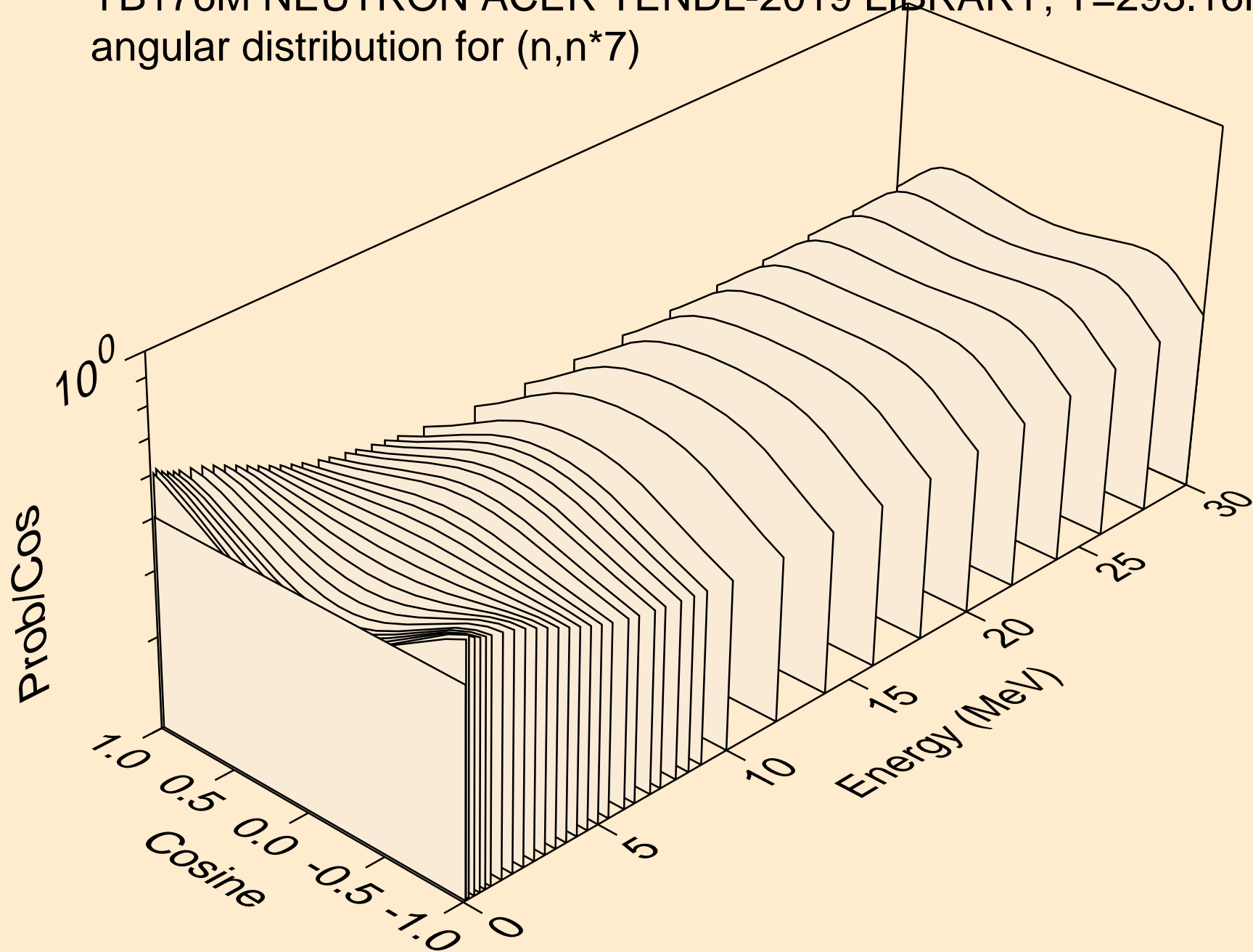

YB176M NEUTRON ACER TENDL-2019 LIBRARY; T=293.16K
angular distribution for (n,n*8)

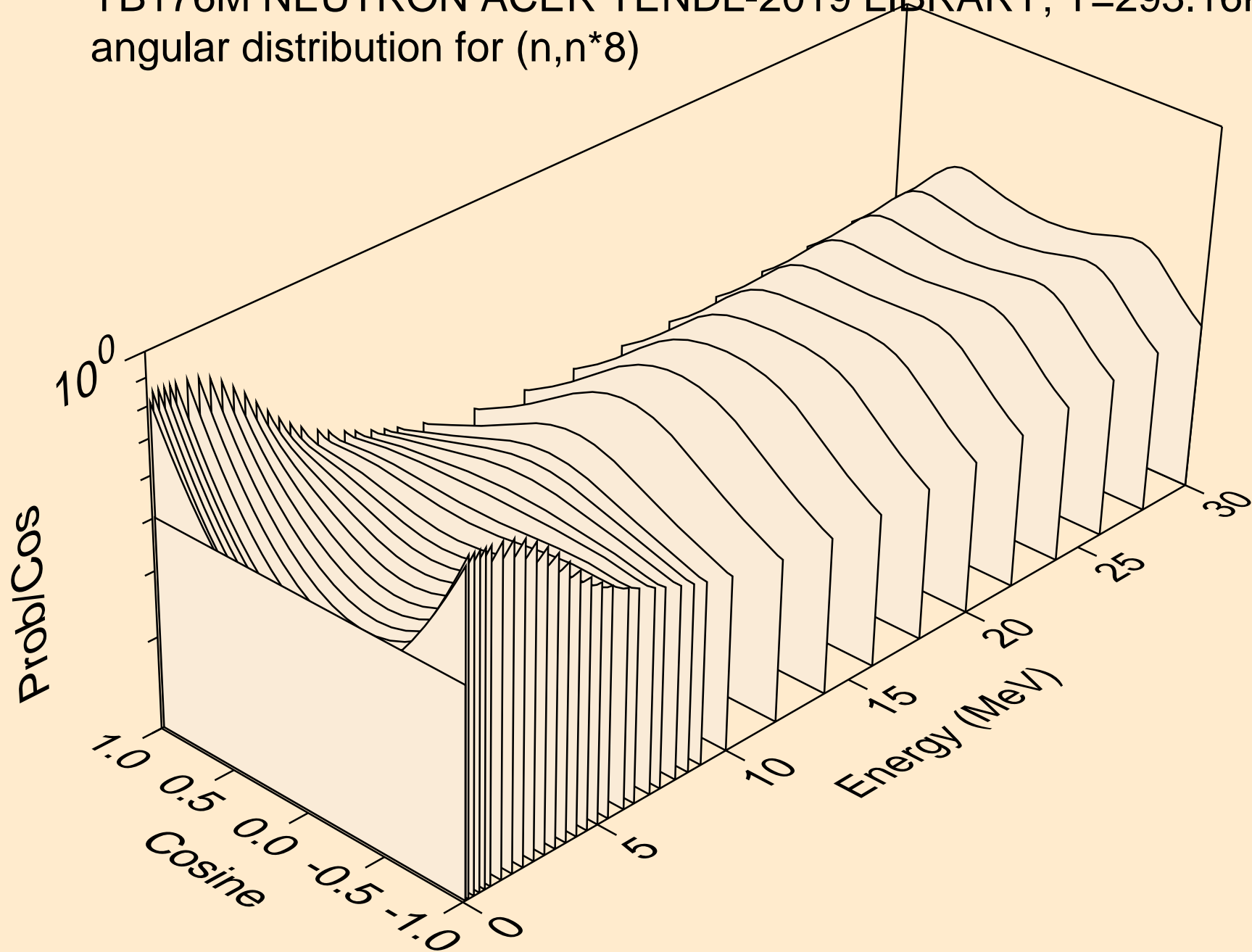

YB176M NEUTRON ACER TENDL-2019 LIBRARY; T=293.16K
angular distribution for (n,n*9)

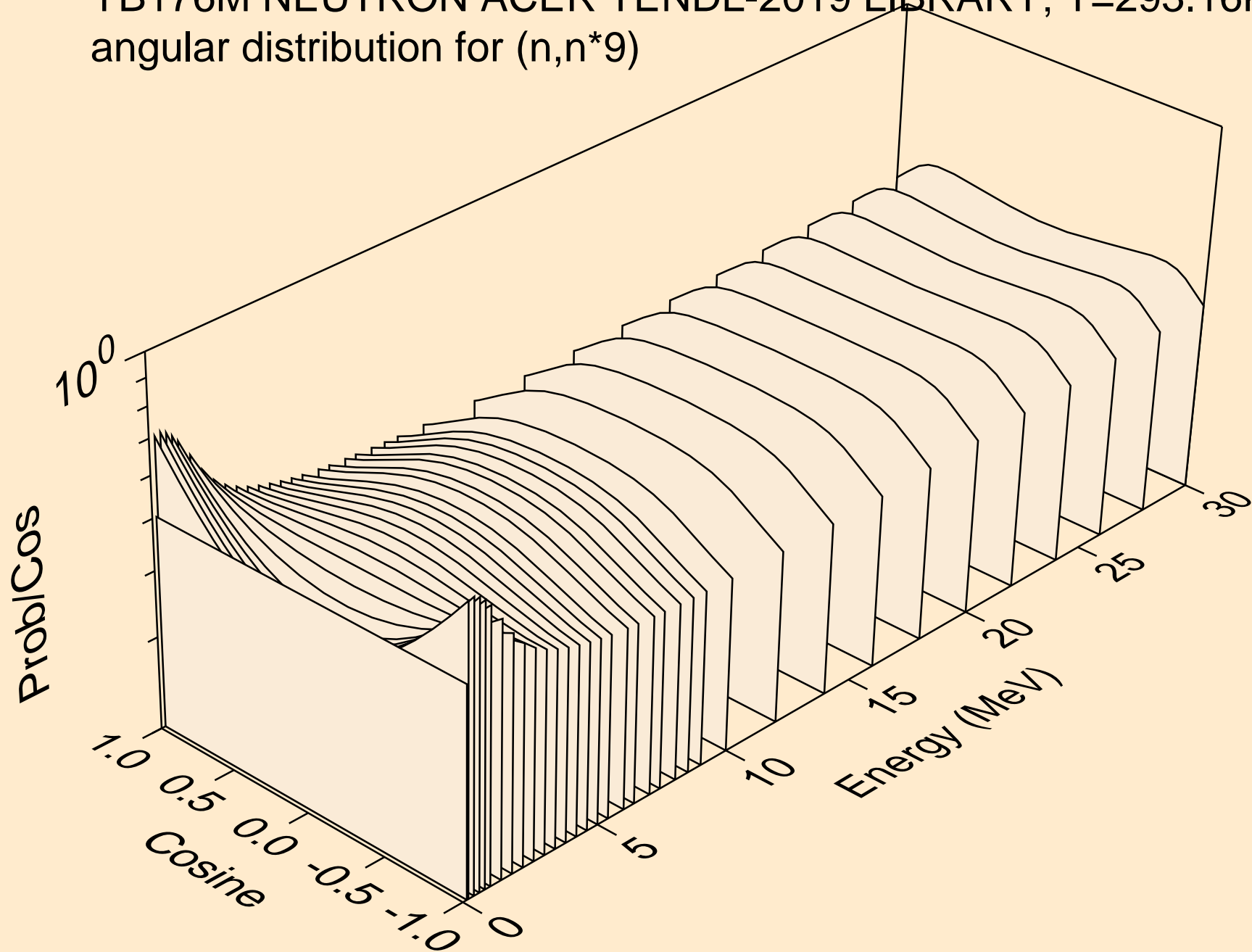

YB176M NEUTRON ACER TENDL-2019 LIBRARY; T=293.16K
angular distribution for (n,n*10)

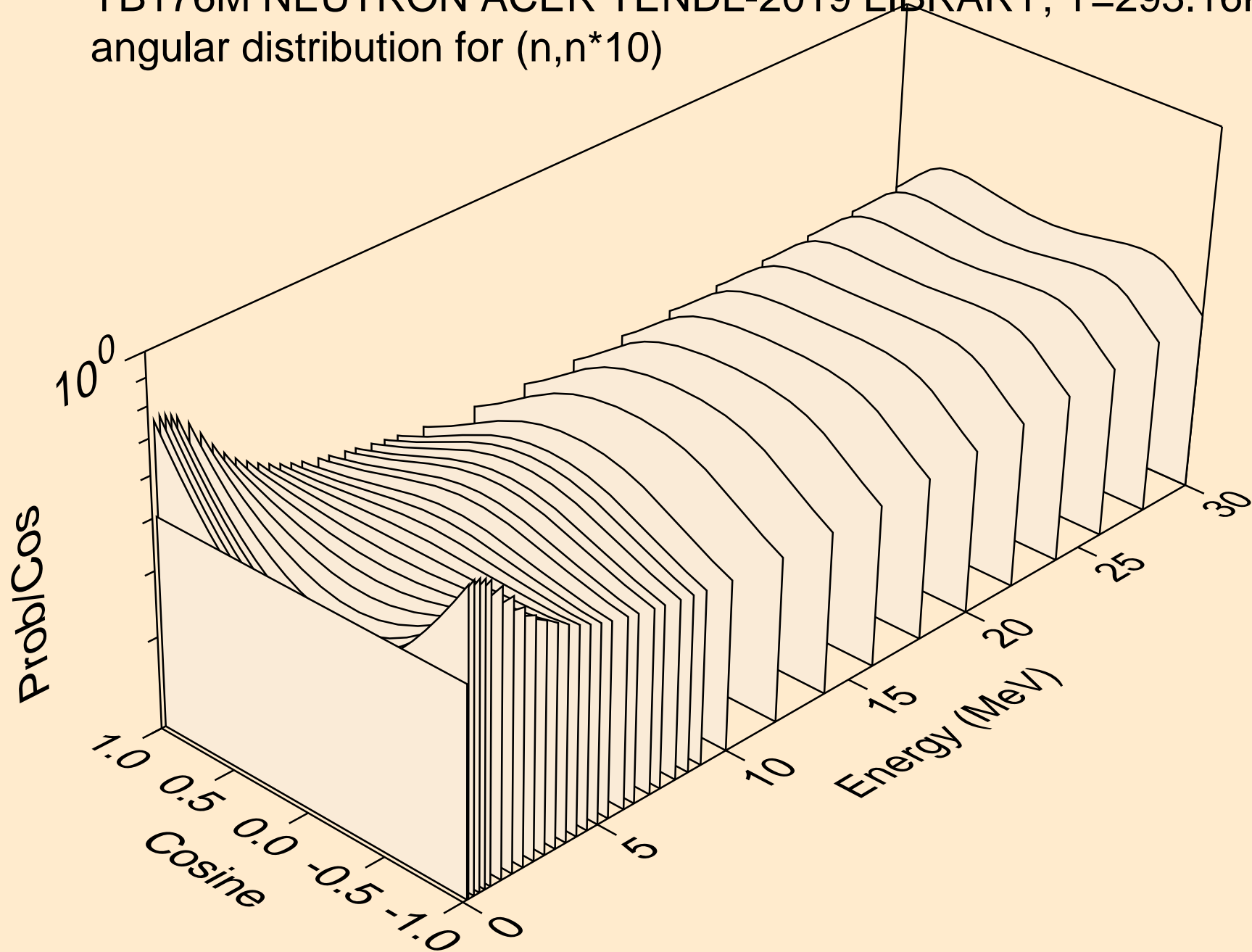

YB176M NEUTRON ACER TENDL-2019 LIBRARY; T=293.16K
angular distribution for (n,n*11)

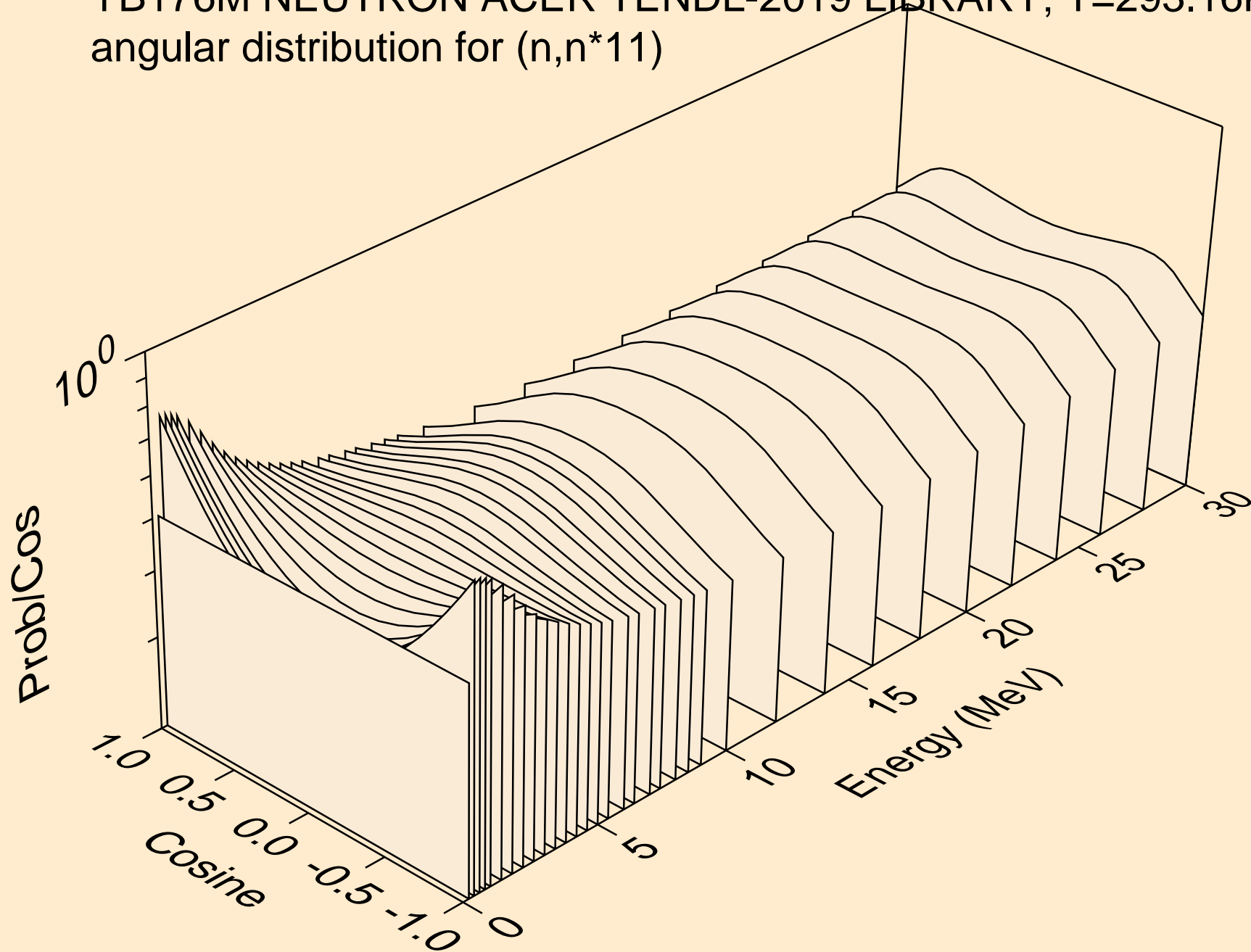

YB176M NEUTRON ACER TENDL-2019 LIBRARY; T=293.16K
angular distribution for (n,n*12)

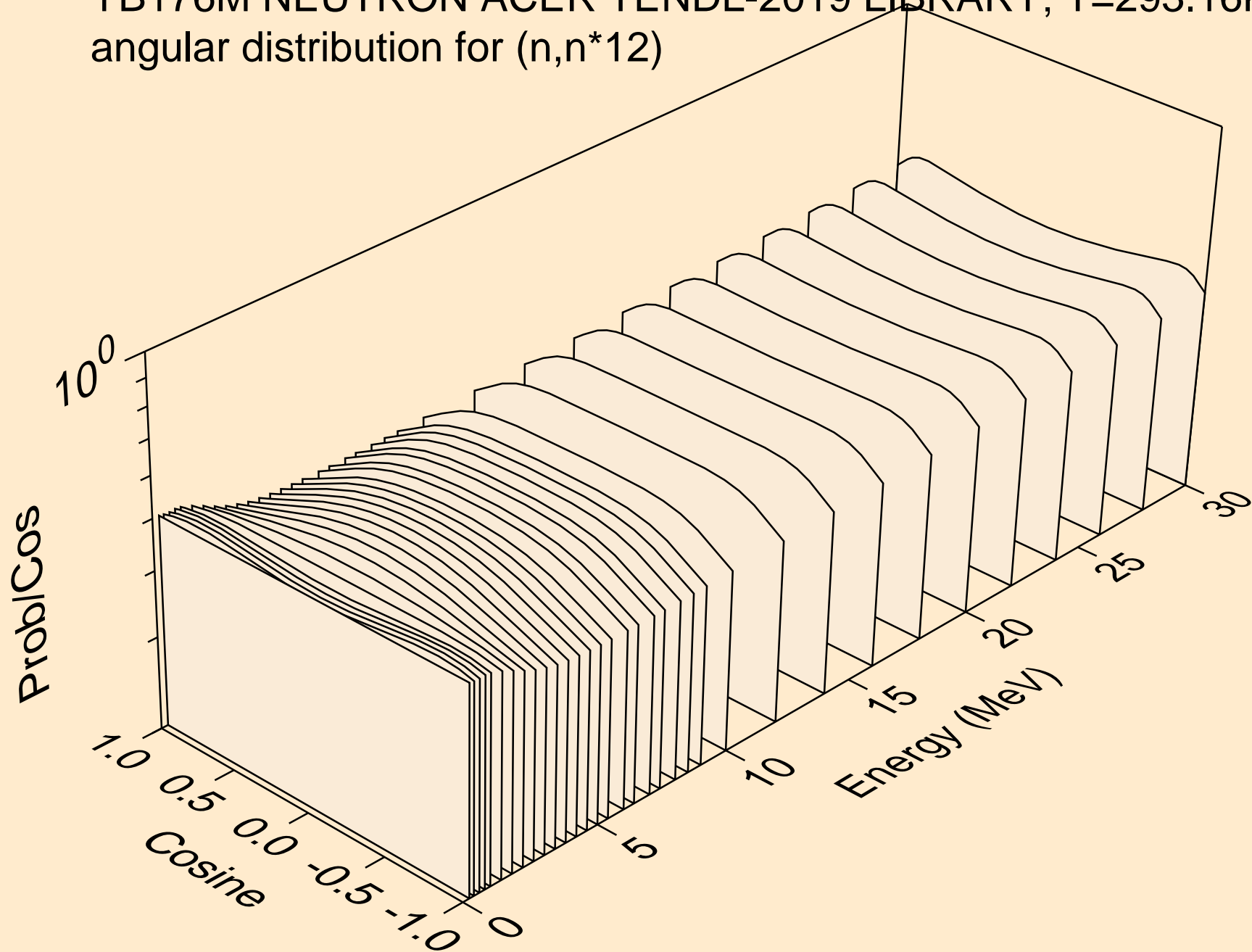

YB176M NEUTRON ACER TENDL-2019 LIBRARY; T=293.16K
angular distribution for (n,n*13)

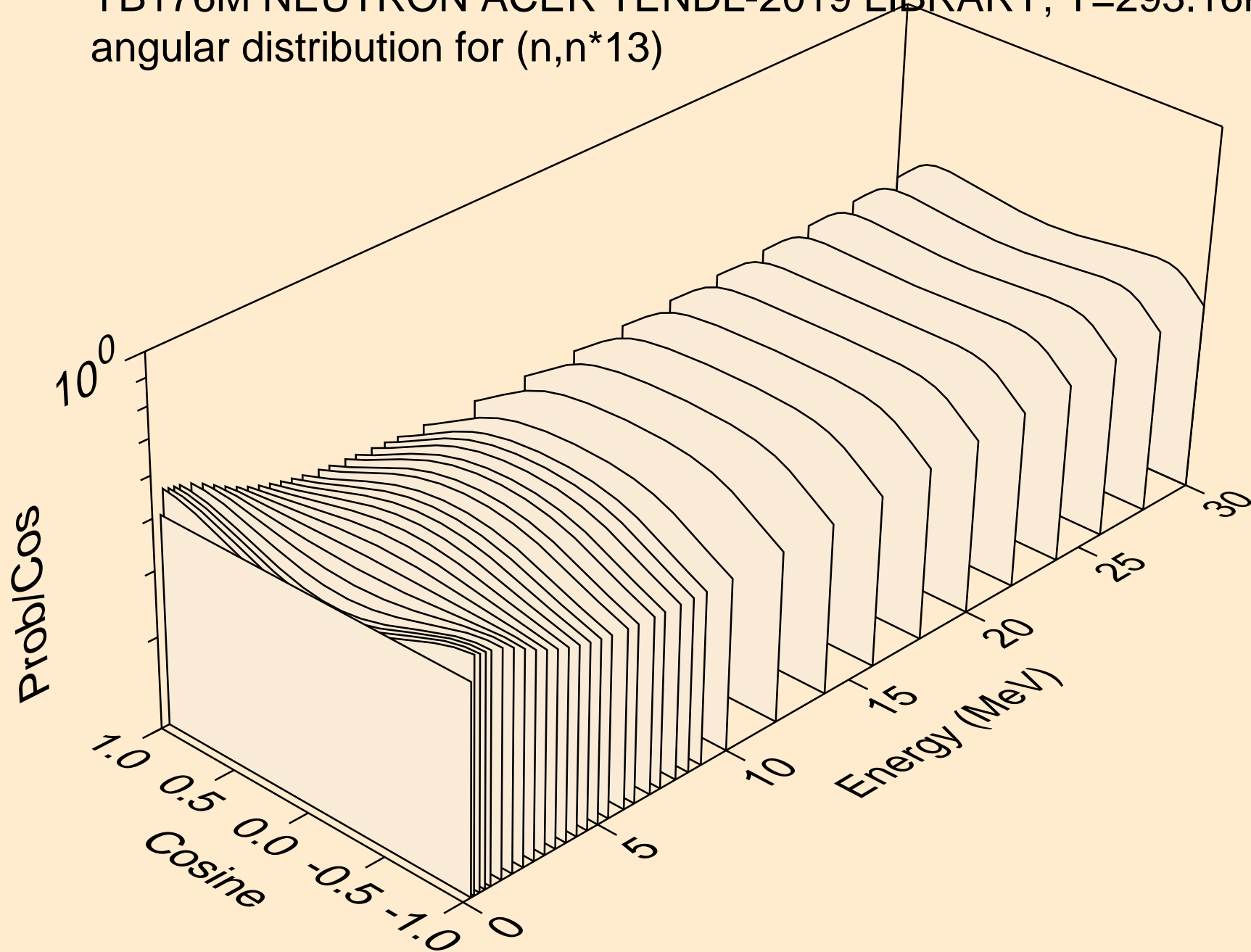

YB176M NEUTRON ACER TENDL-2019 LIBRARY; T=293.16K
angular distribution for (n,n*14)

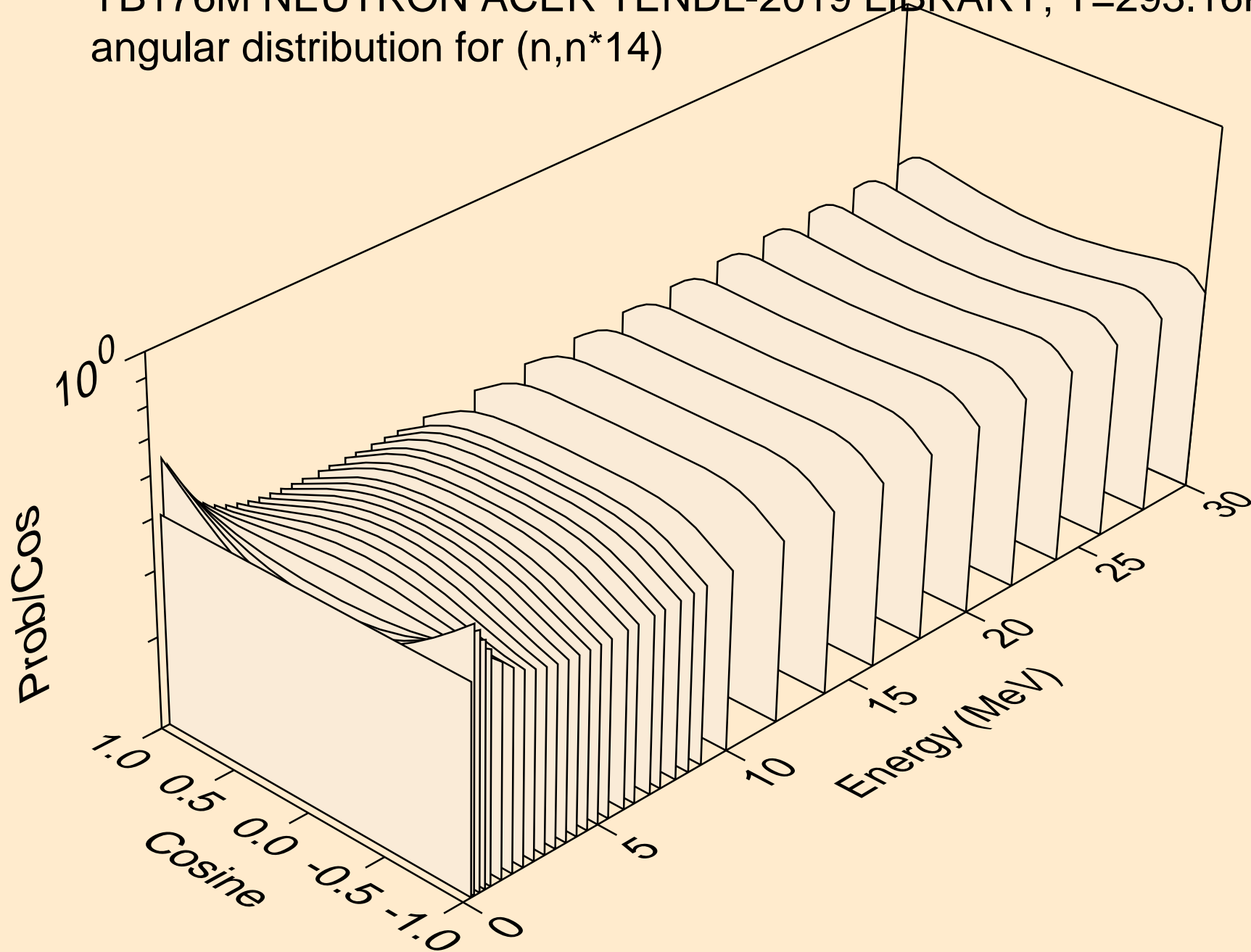

YB176M NEUTRON ACER TENDL-2019 LIBRARY; T=293.16K
angular distribution for (n,n*15)

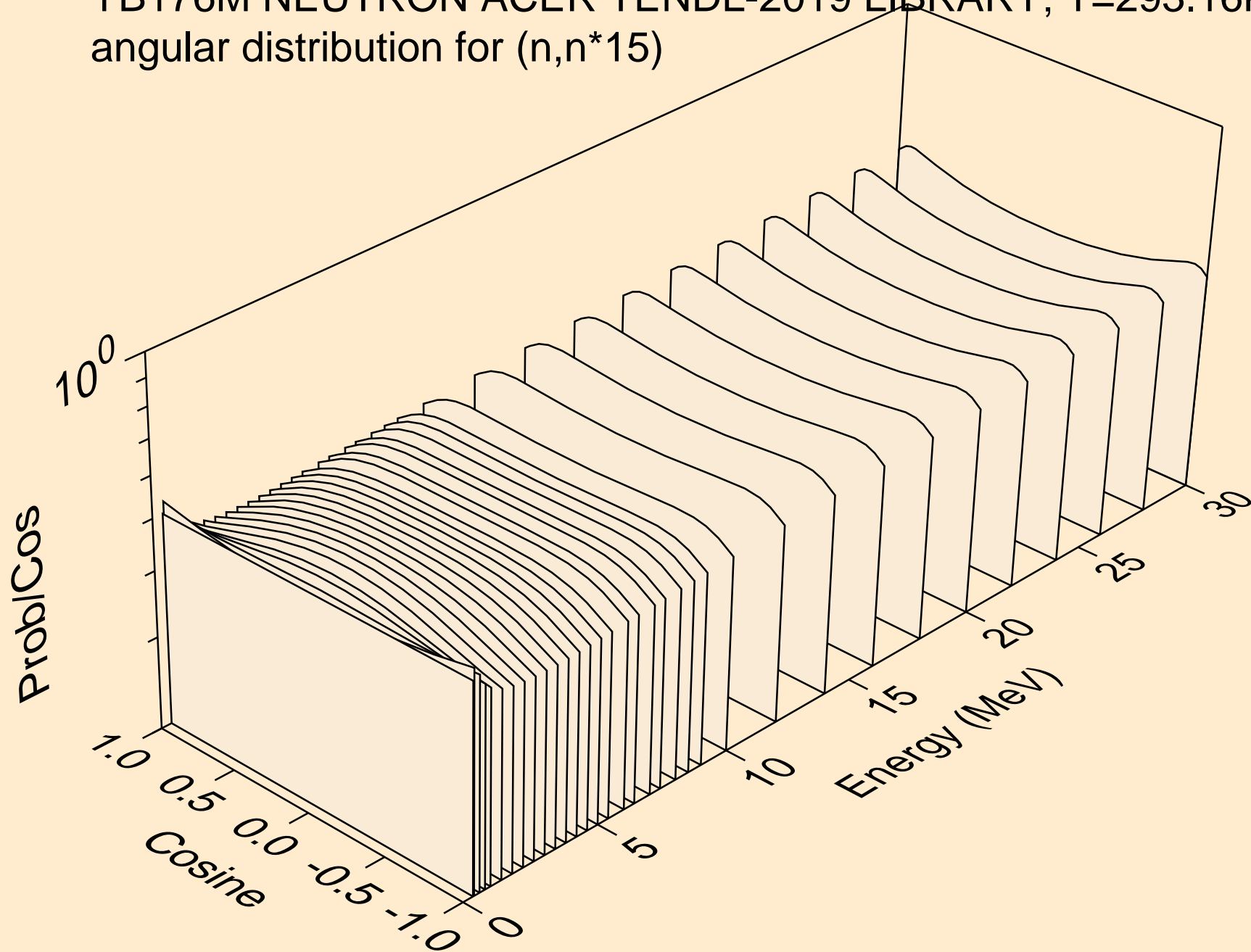

YB176M NEUTRON ACER TENDL-2019 LIBRARY; T=293.16K
angular distribution for (n,n*16)

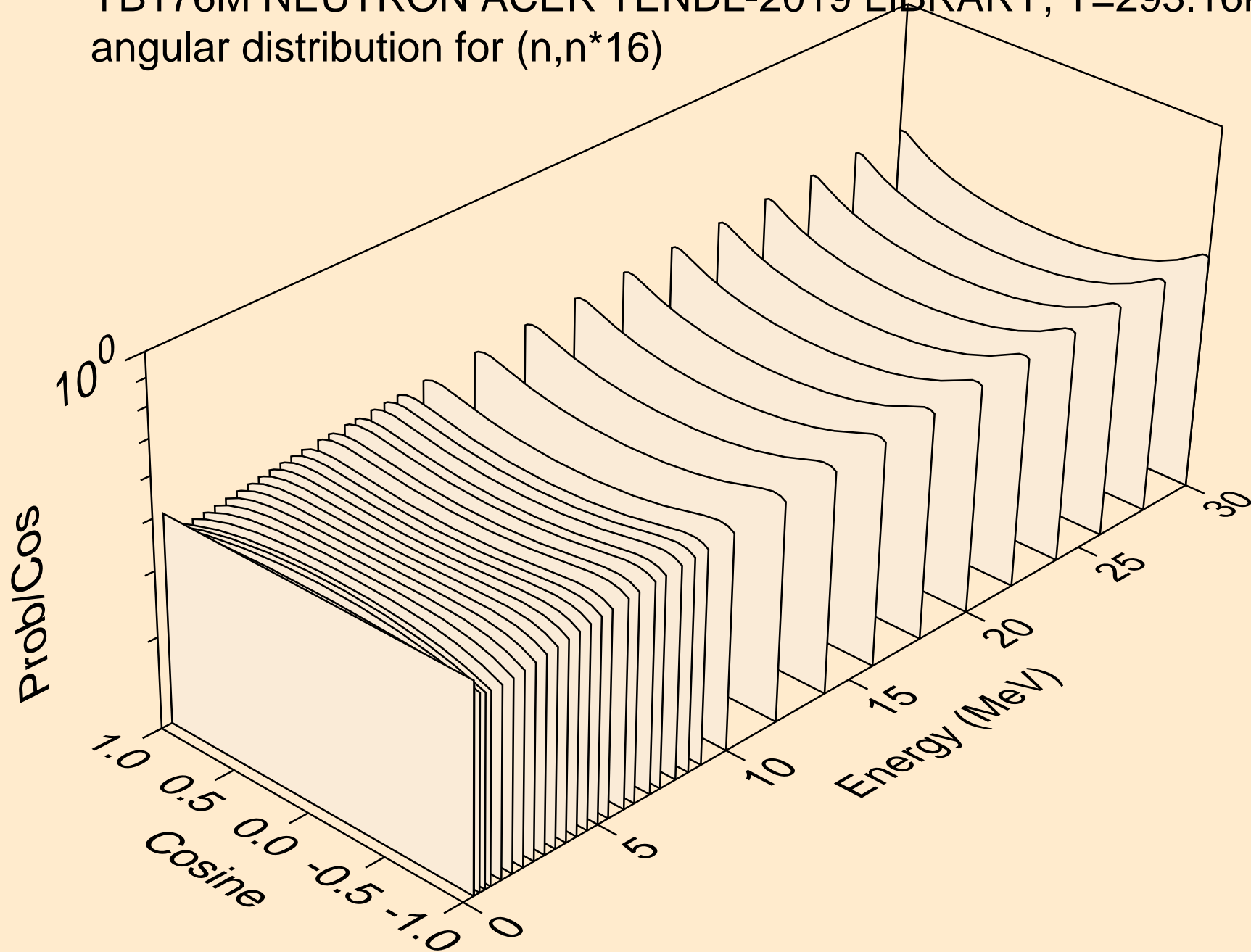

YB176M NEUTRON ACER TENDL-2019 LIBRARY; T=293.16K
angular distribution for (n,n*17)

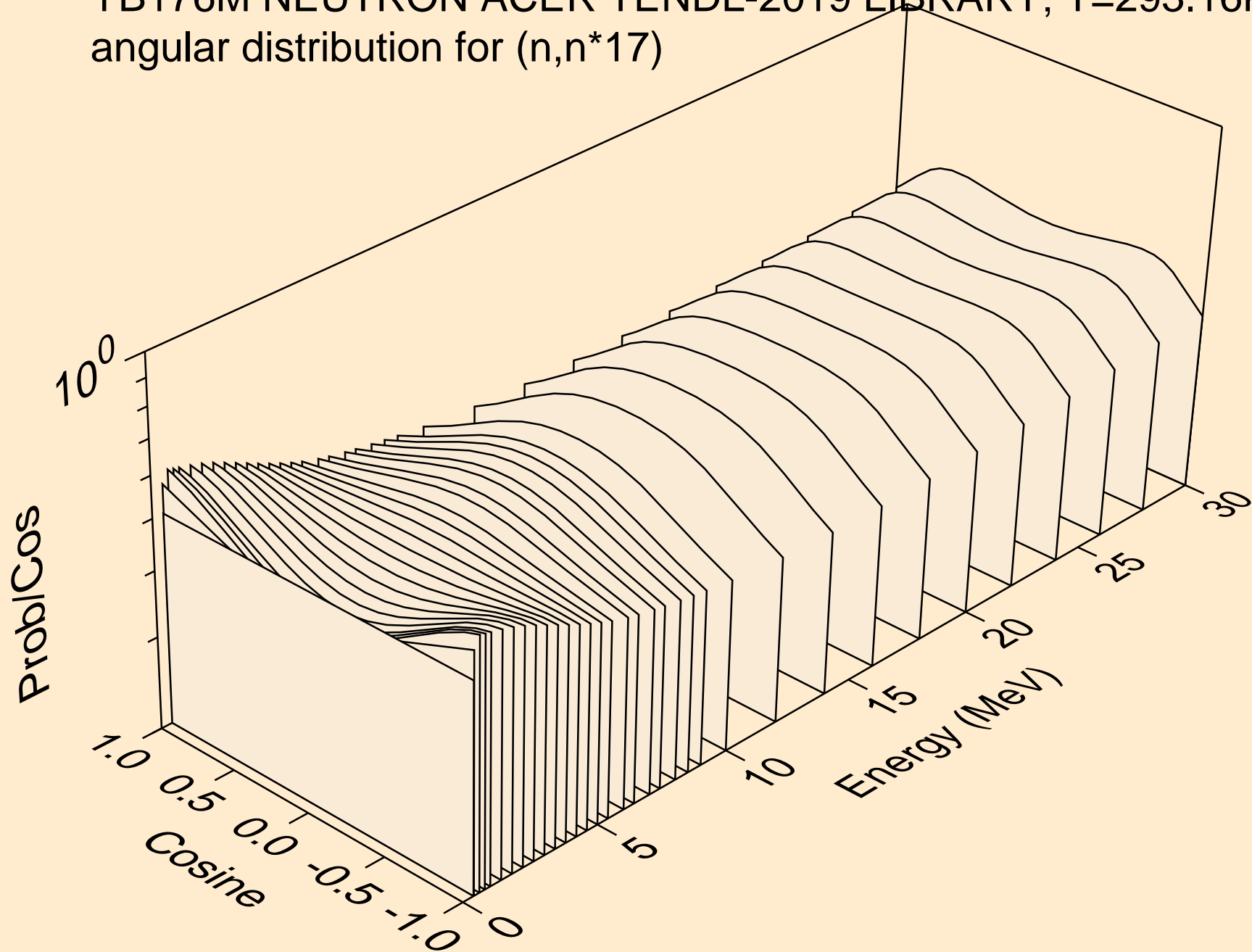

YB176M NEUTRON ACER TENDL-2019 LIBRARY; T=293.16K
angular distribution for (n,n*18)

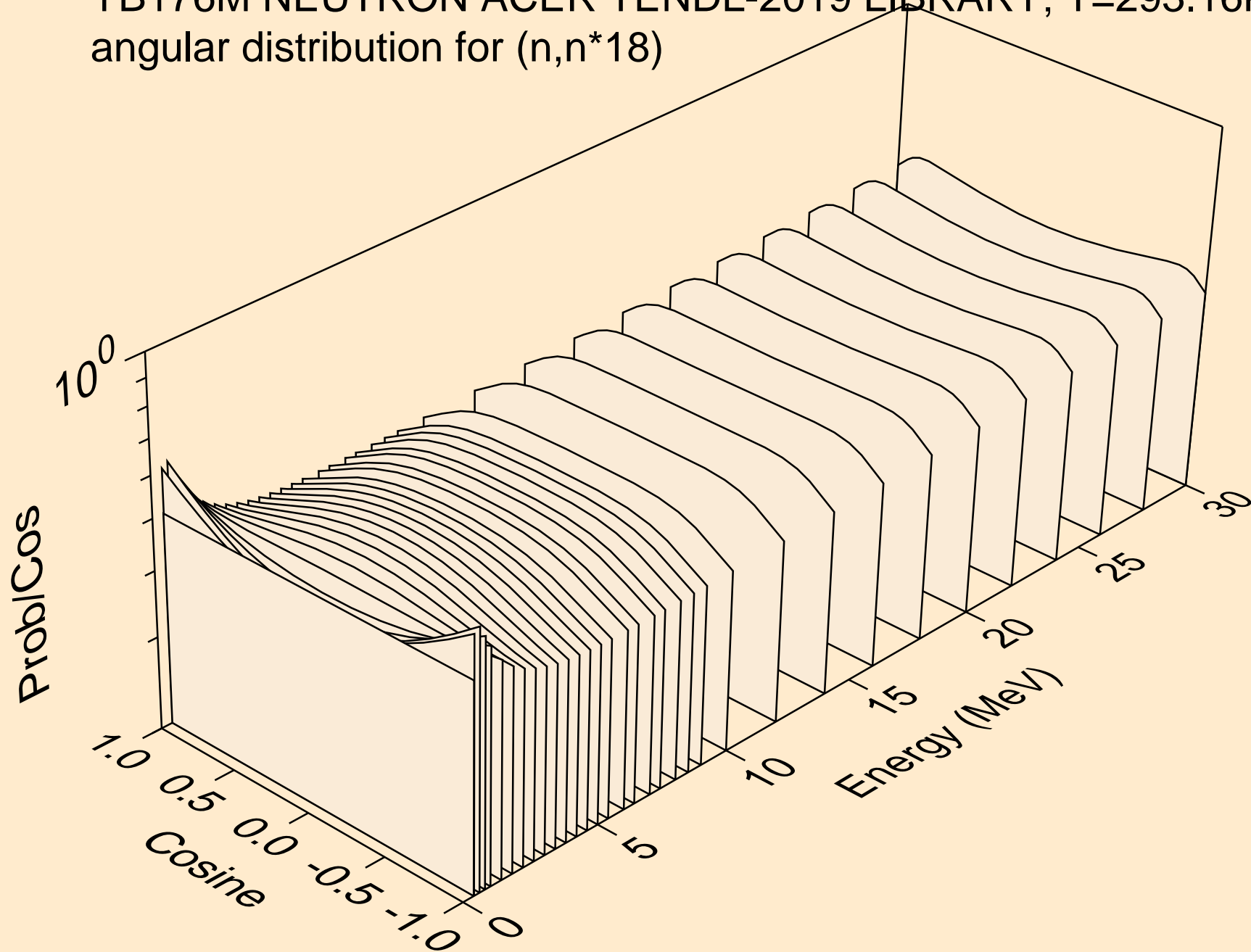

YB176M NEUTRON ACER TENDL-2019 LIBRARY; T=293.16K
angular distribution for (n,n*19)

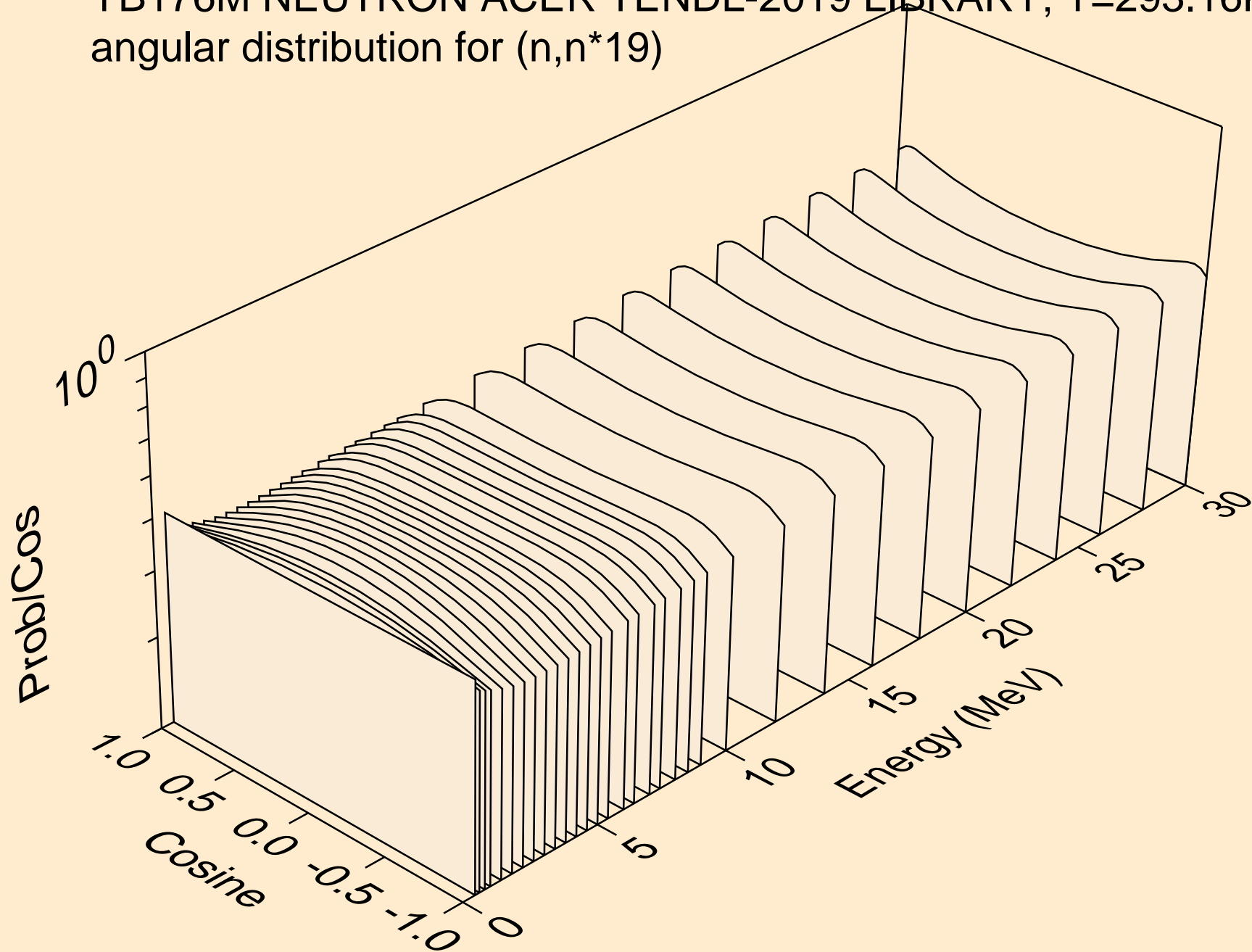

YB176M NEUTRON ACER TENDL-2019 LIBRARY; T=293.16K
angular distribution for (n,n*20)

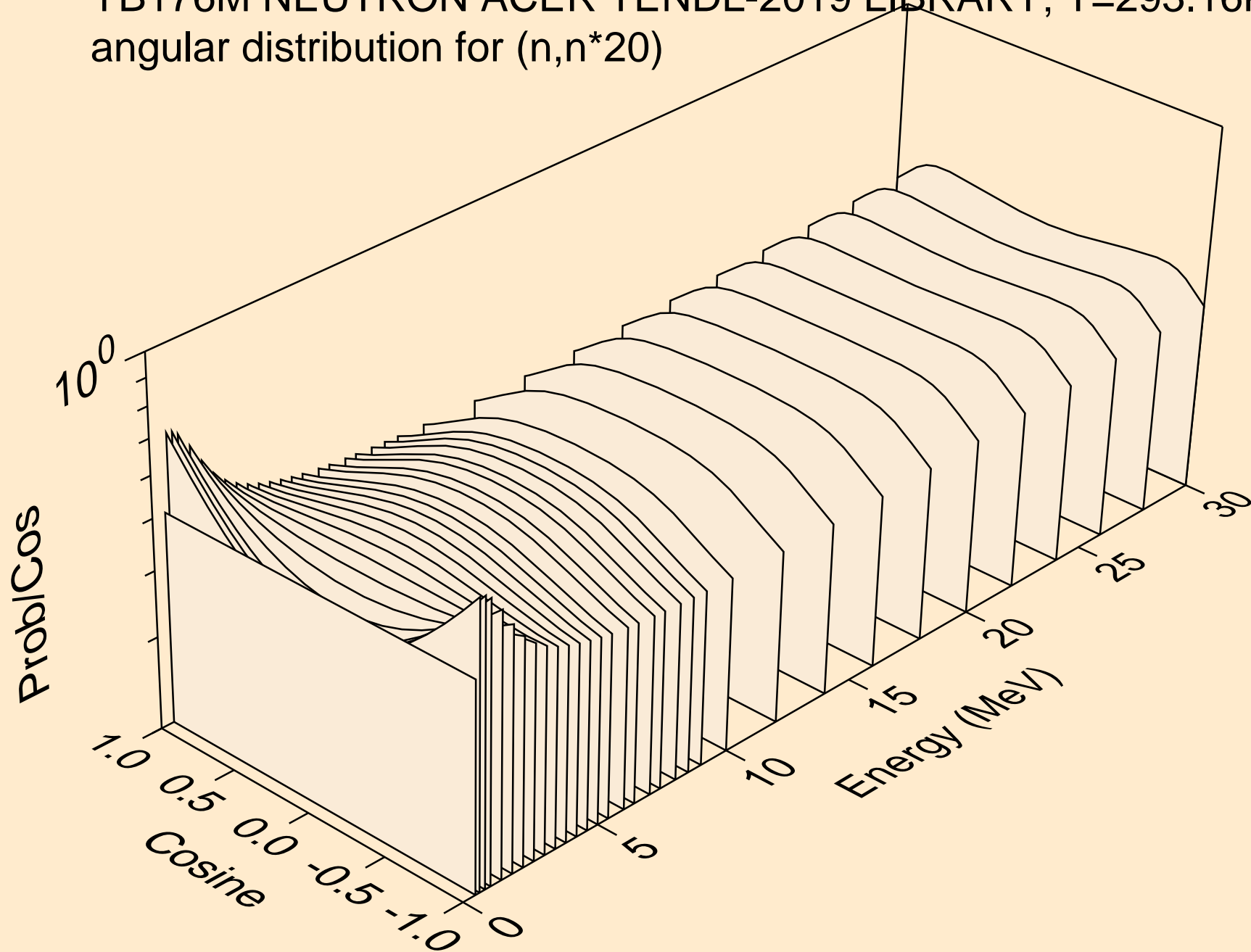

YB176M NEUTRON ACER TENDL-2019 LIBRARY; T=293.16K
angular distribution for (n,n*21)

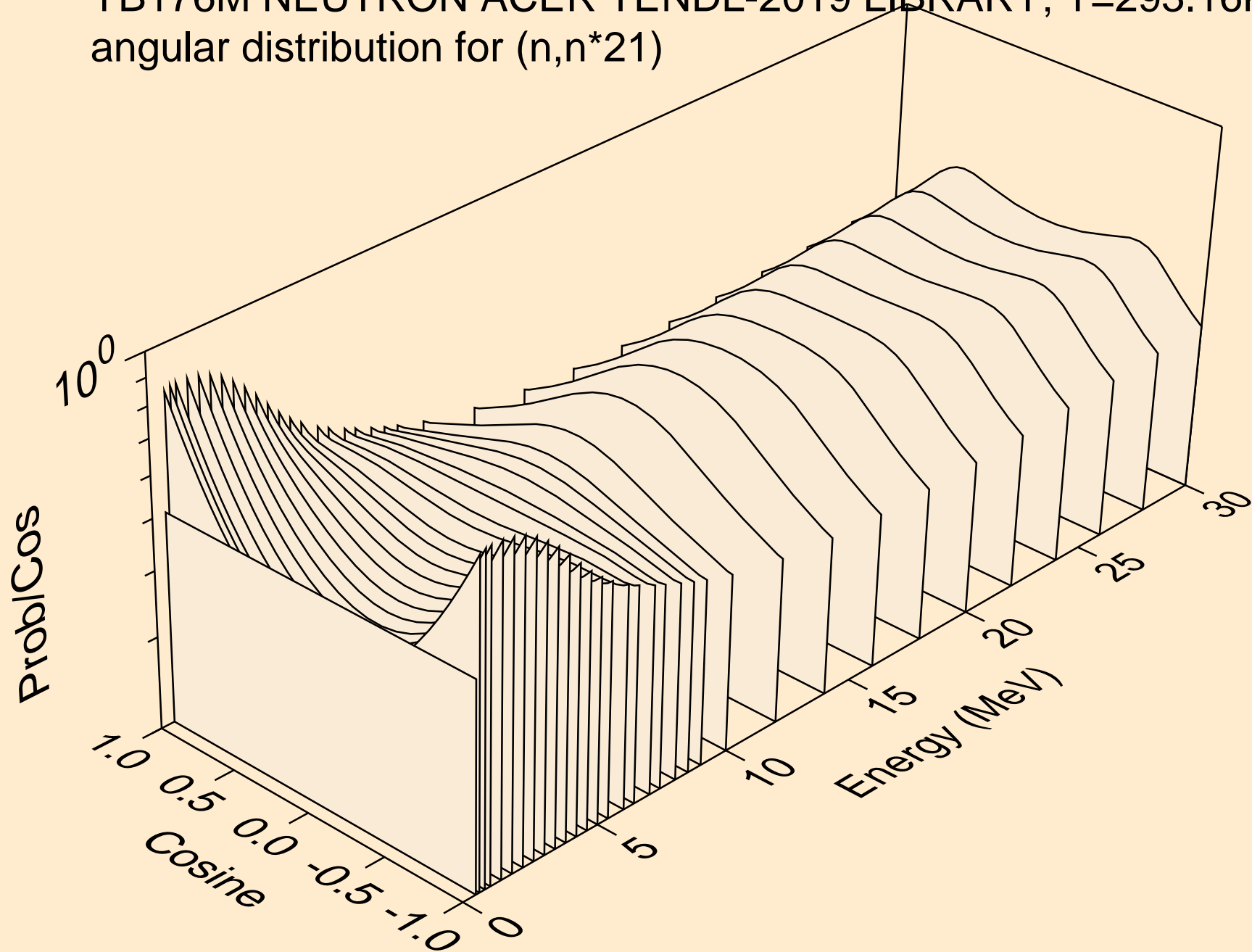

YB176M NEUTRON ACER TENDL-2019 LIBRARY; T=293.16K
angular distribution for (n,n*22)

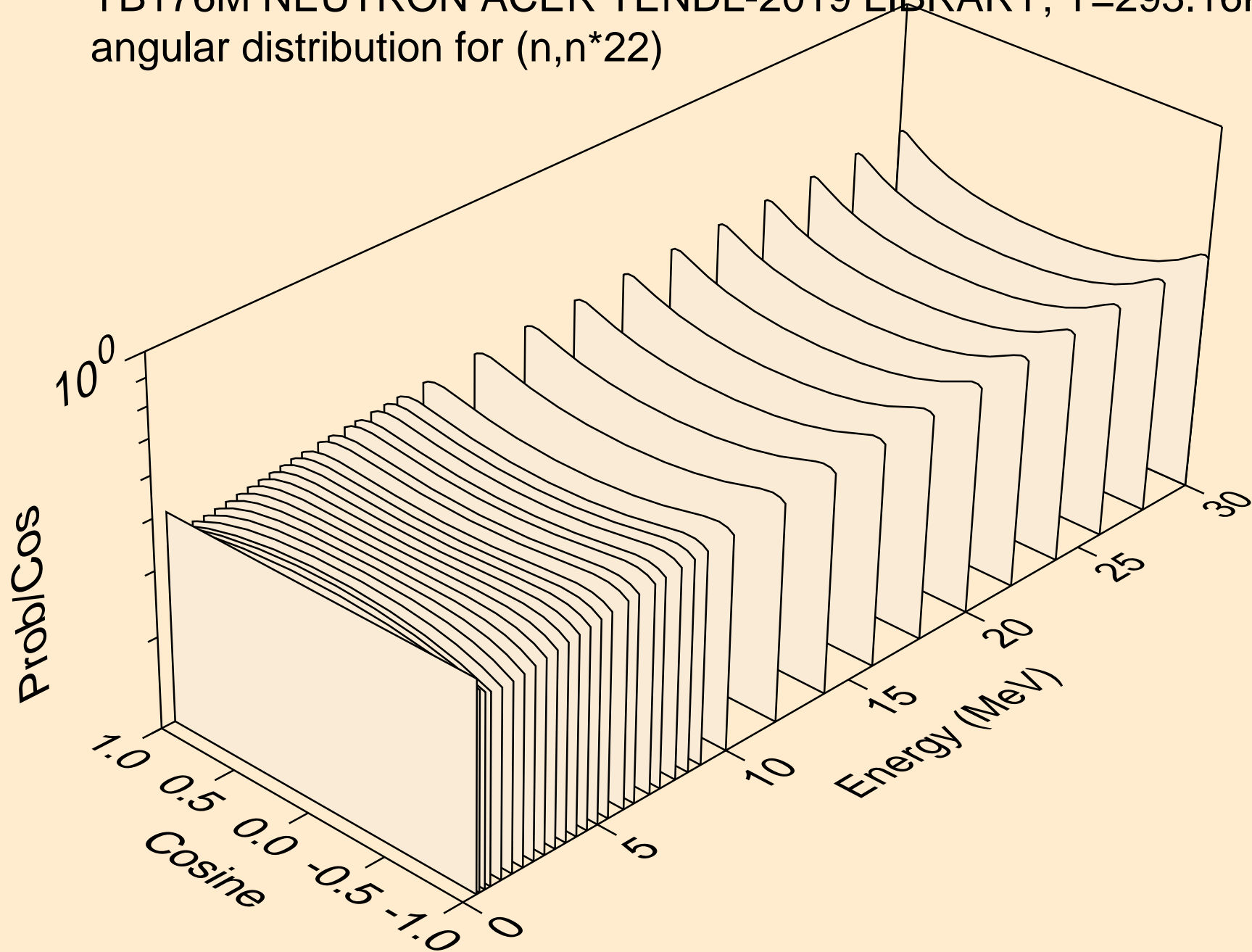

YB176M NEUTRON ACER TENDL-2019 LIBRARY; T=293.16K
angular distribution for (n,n*23)

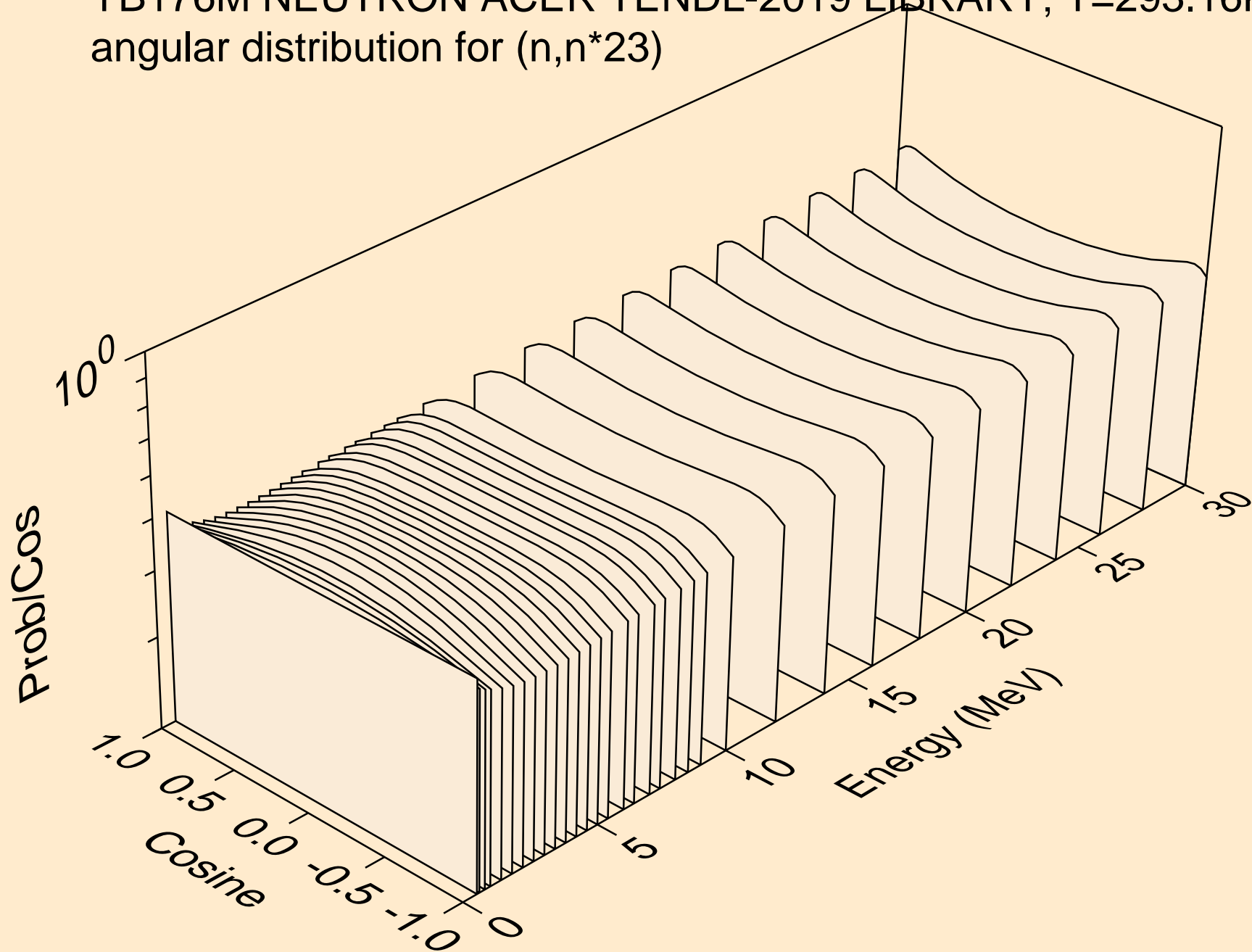

YB176M NEUTRON ACER TENDL-2019 LIBRARY; T=293.16K
Neutron emission for (n,x)

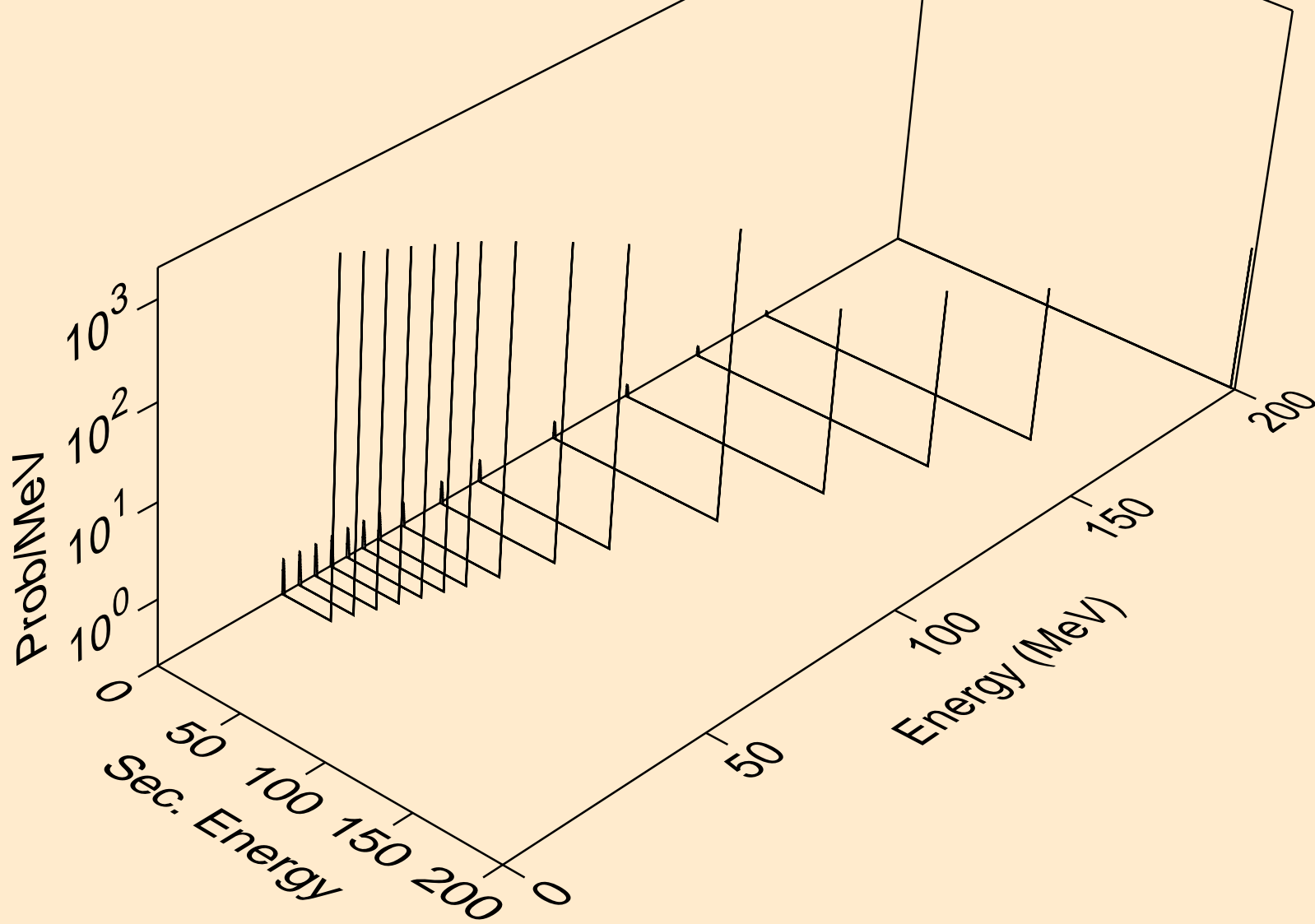

YB176M NEUTRON ACER TENDL-2019 LIBRARY; T=293.16K
Neutron emission for (n,2nd)

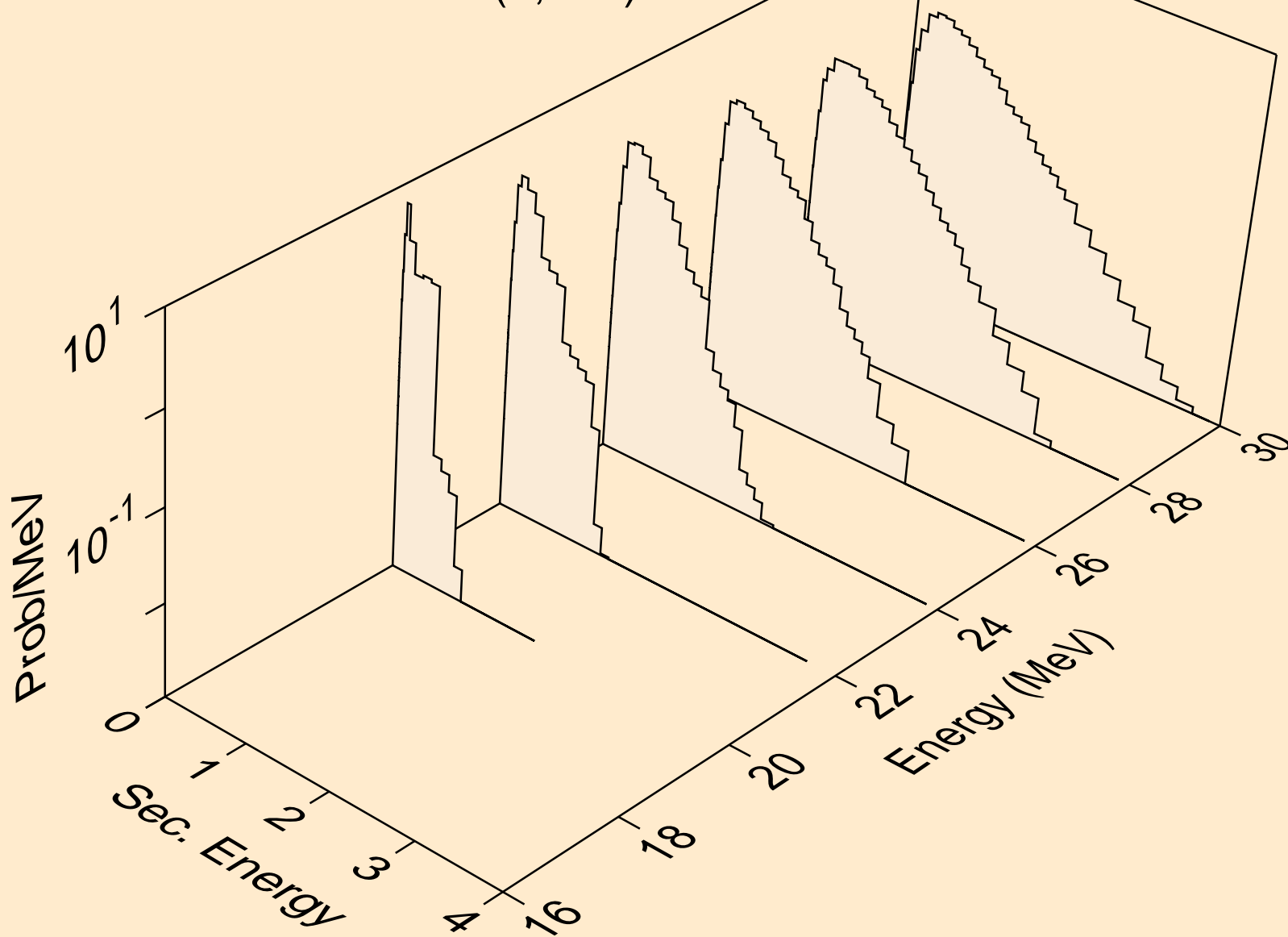

YB176M NEUTRON ACER TENDL-2019 LIBRARY; T=293.16K
Neutron emission for (n,2n)

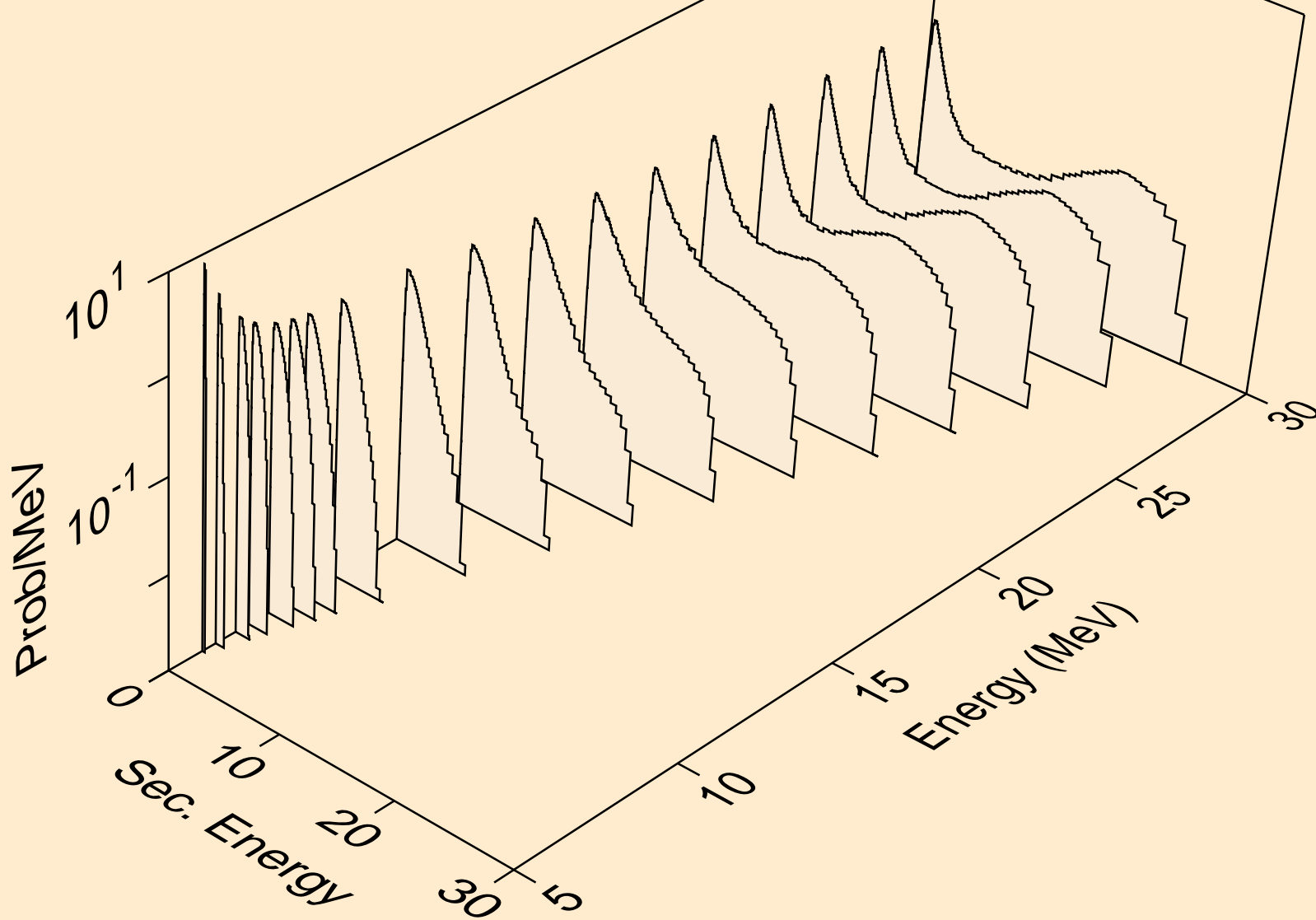

YB176M NEUTRON ACER TENDL-2019 LIBRARY; T=293.16K
Neutron emission for (n,3n)

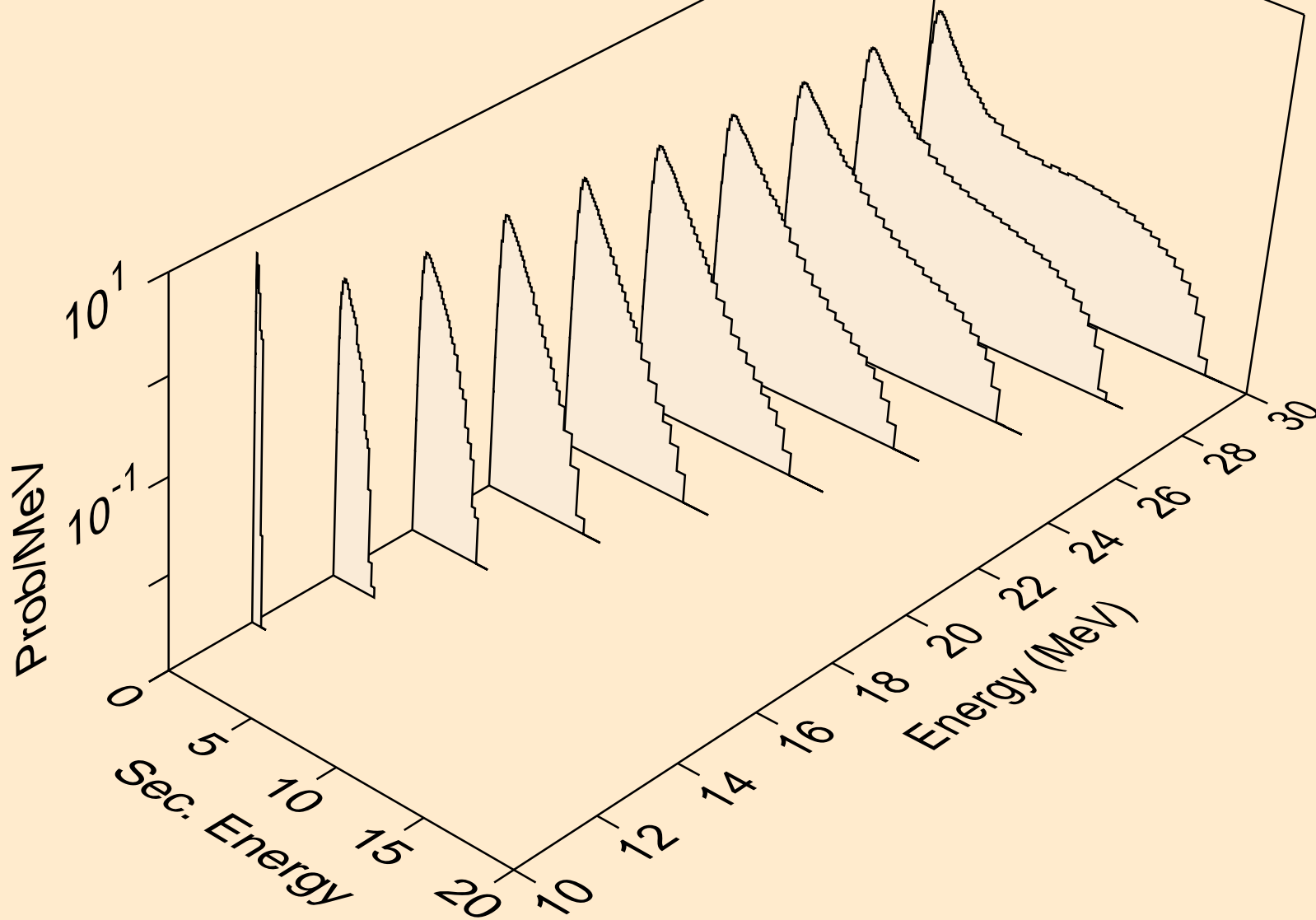

YB176M NEUTRON ACER TENDL-2019 LIBRARY; T=293.16K
Neutron emission for (n,n*)a

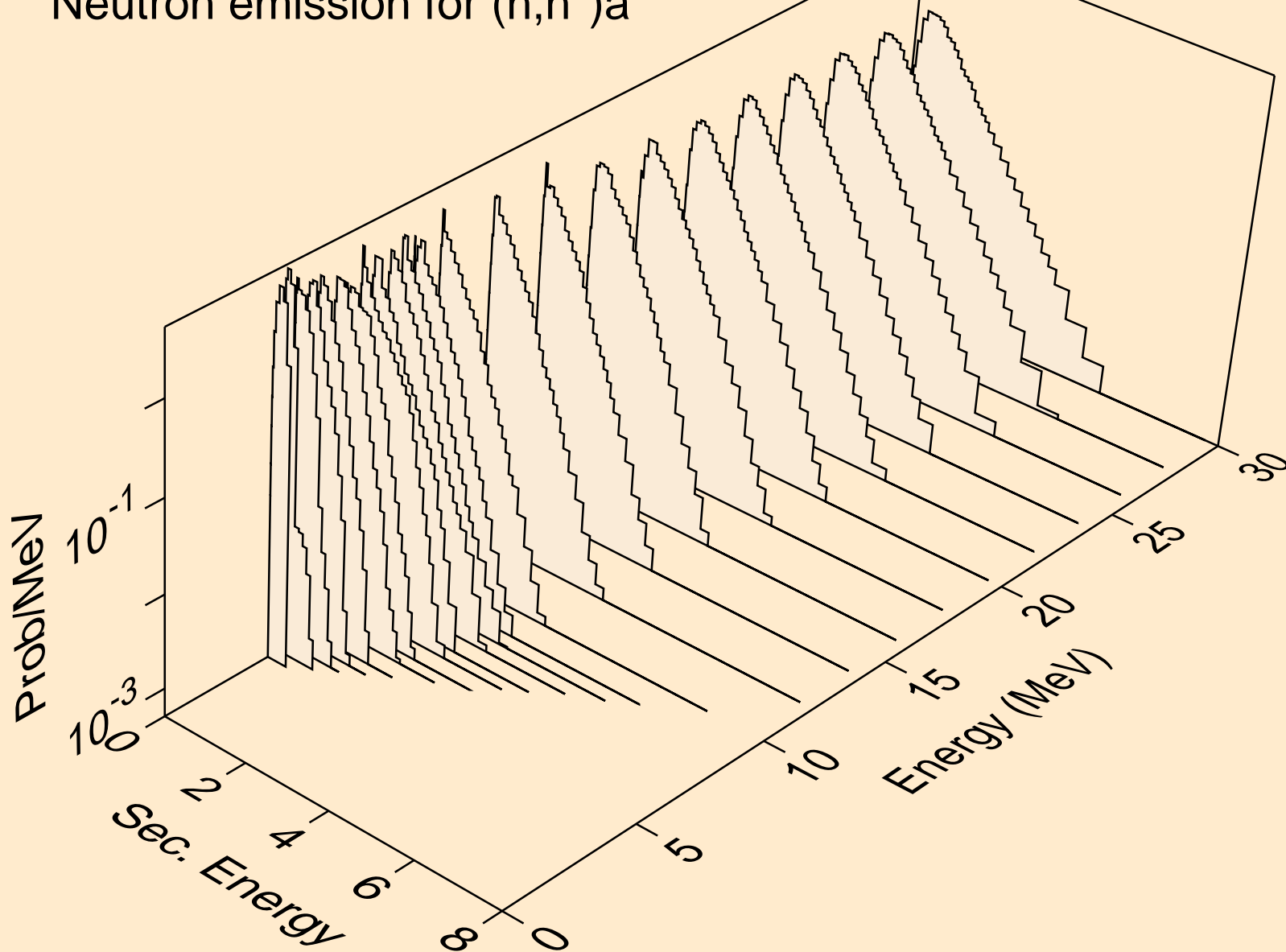

YB176M NEUTRON ACER TENDL-2019 LIBRARY; T=293.16K
Neutron emission for (n,2n)a

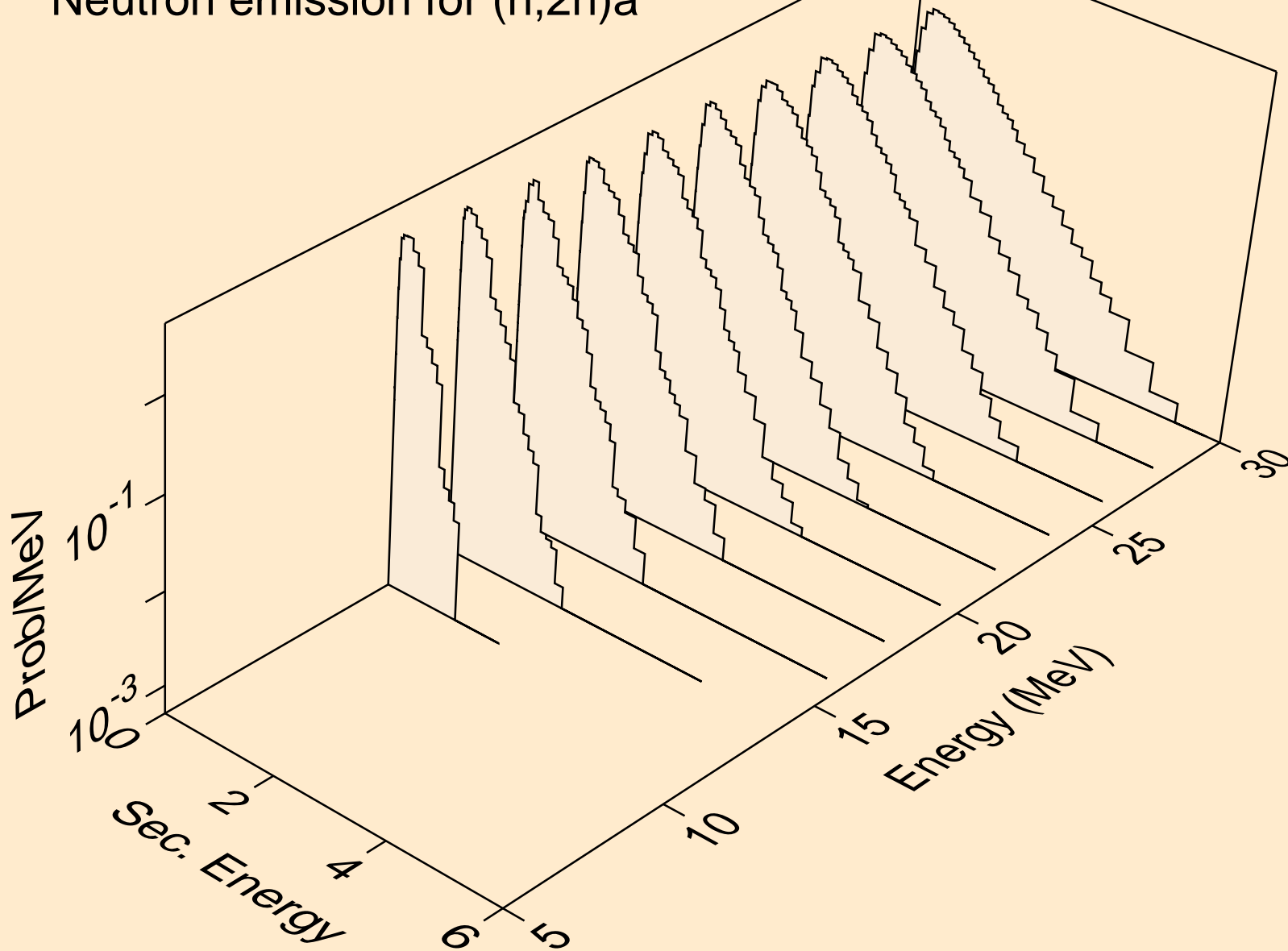

YB176M NEUTRON ACER TENDL-2019 LIBRARY; T=293.16K
Neutron emission for (n,3n)a

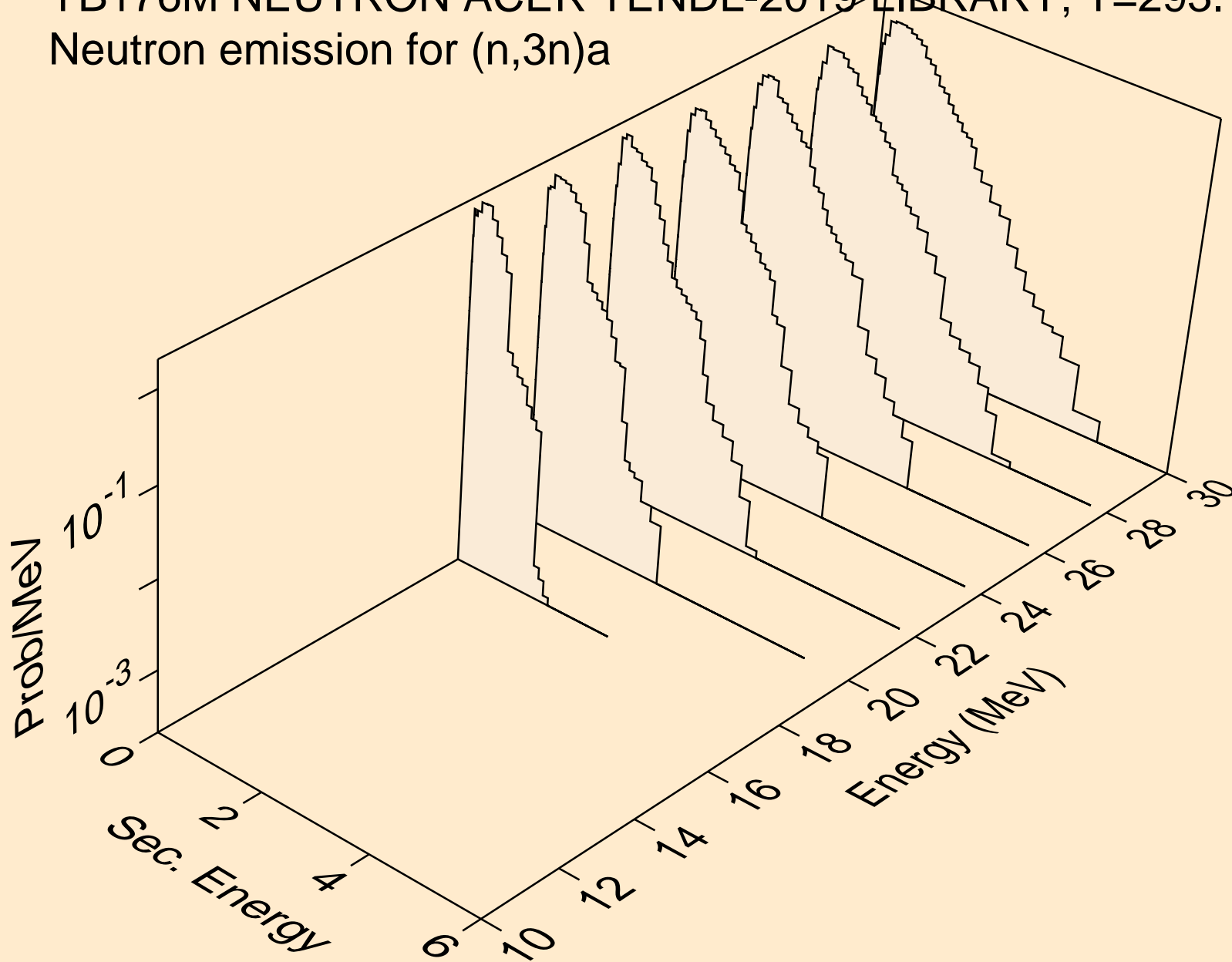

YB176M NEUTRON ACER TENDL-2019 LIBRARY; T=293.16K
Neutron emission for (n,n*)p

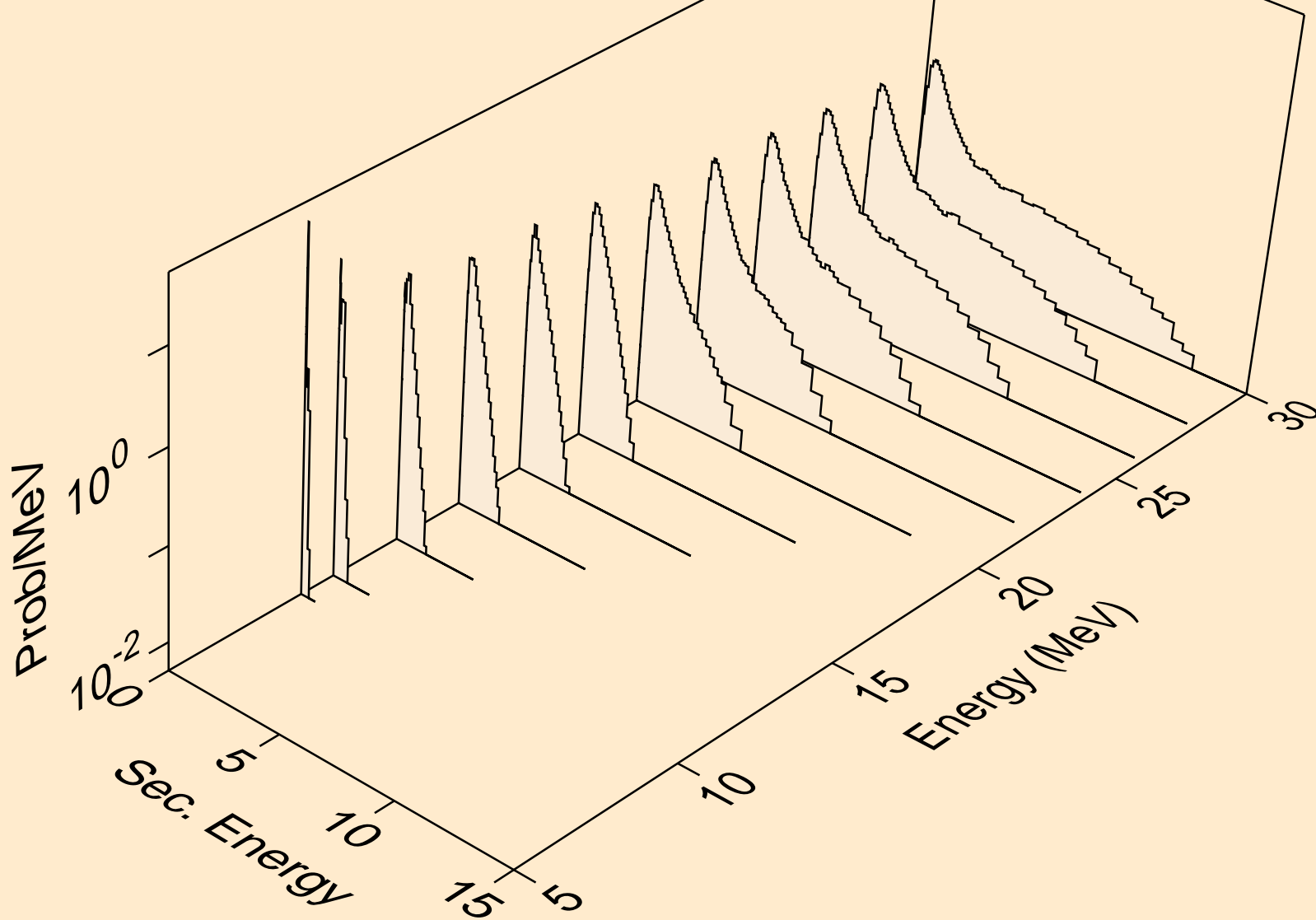

YB176M NEUTRON ACER TENDL-2019 LIBRARY; T=293.16K
Neutron emission for (n,n*)d

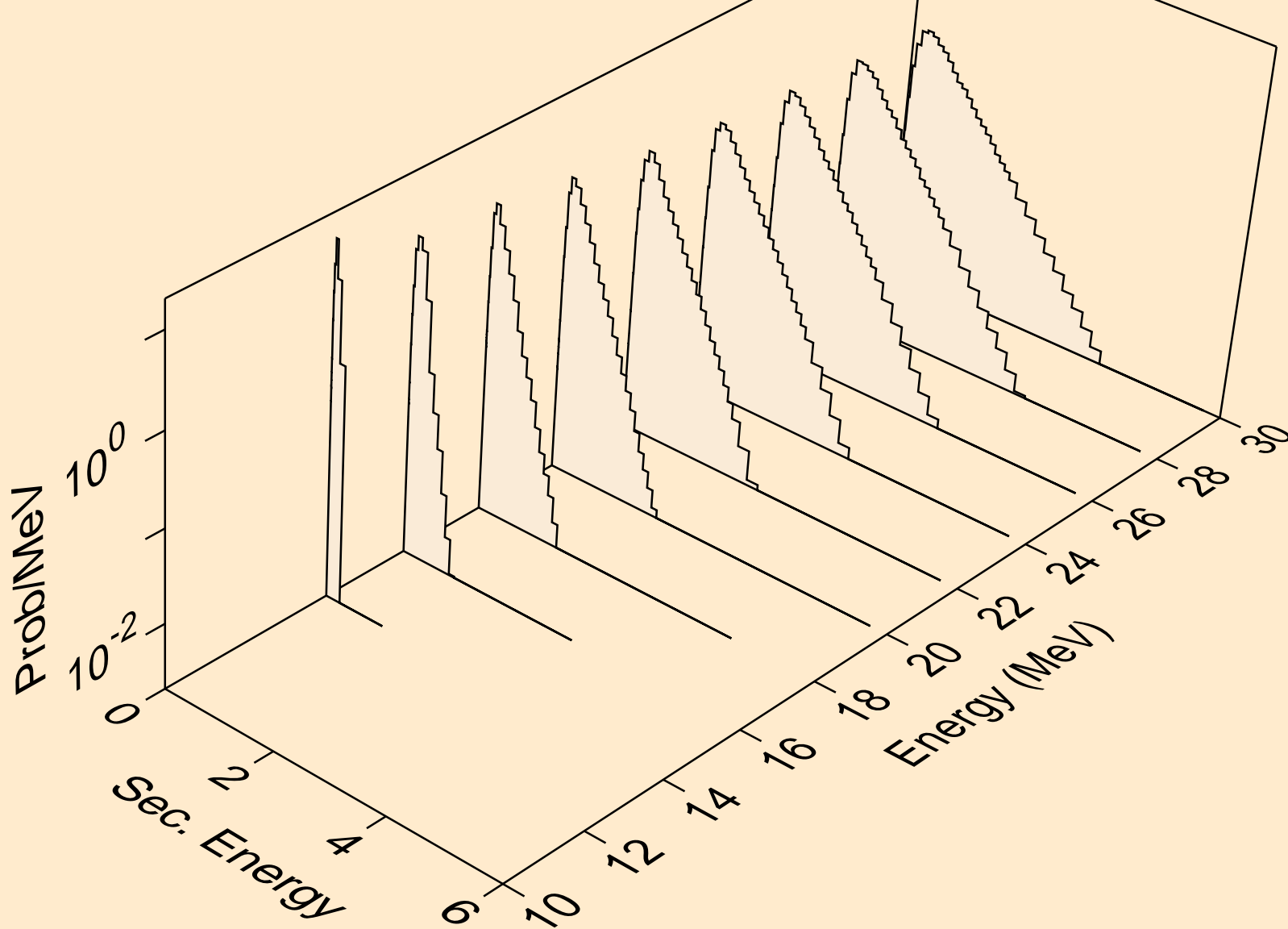

YB176M NEUTRON ACER TENDL-2019 LIBRARY; T=293.16K
Neutron emission for (n,n*)t

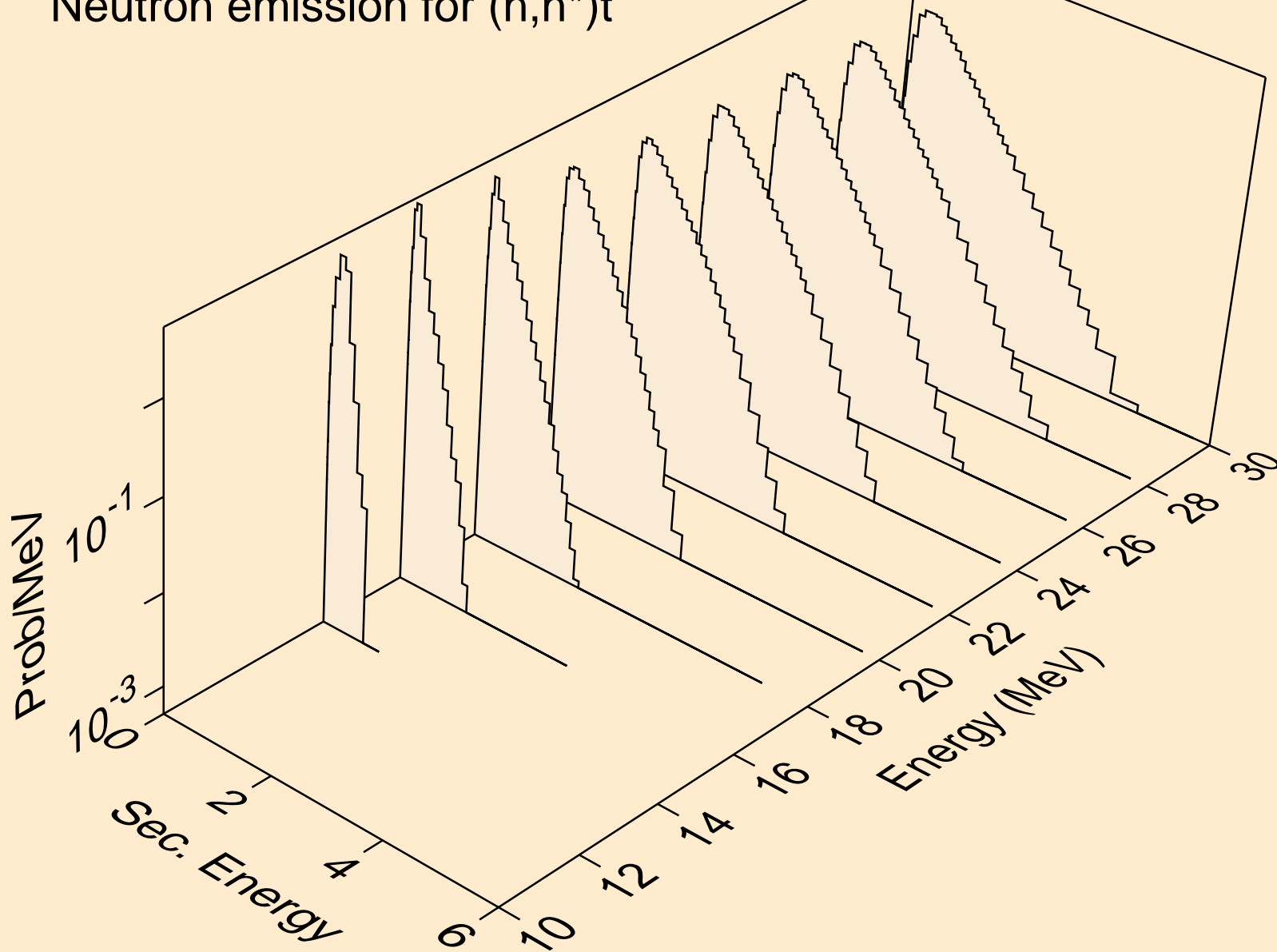

YB176M NEUTRON ACER TENDL-2019 LIBRARY; T=293.16K
Neutron emission for (n,n*)he3

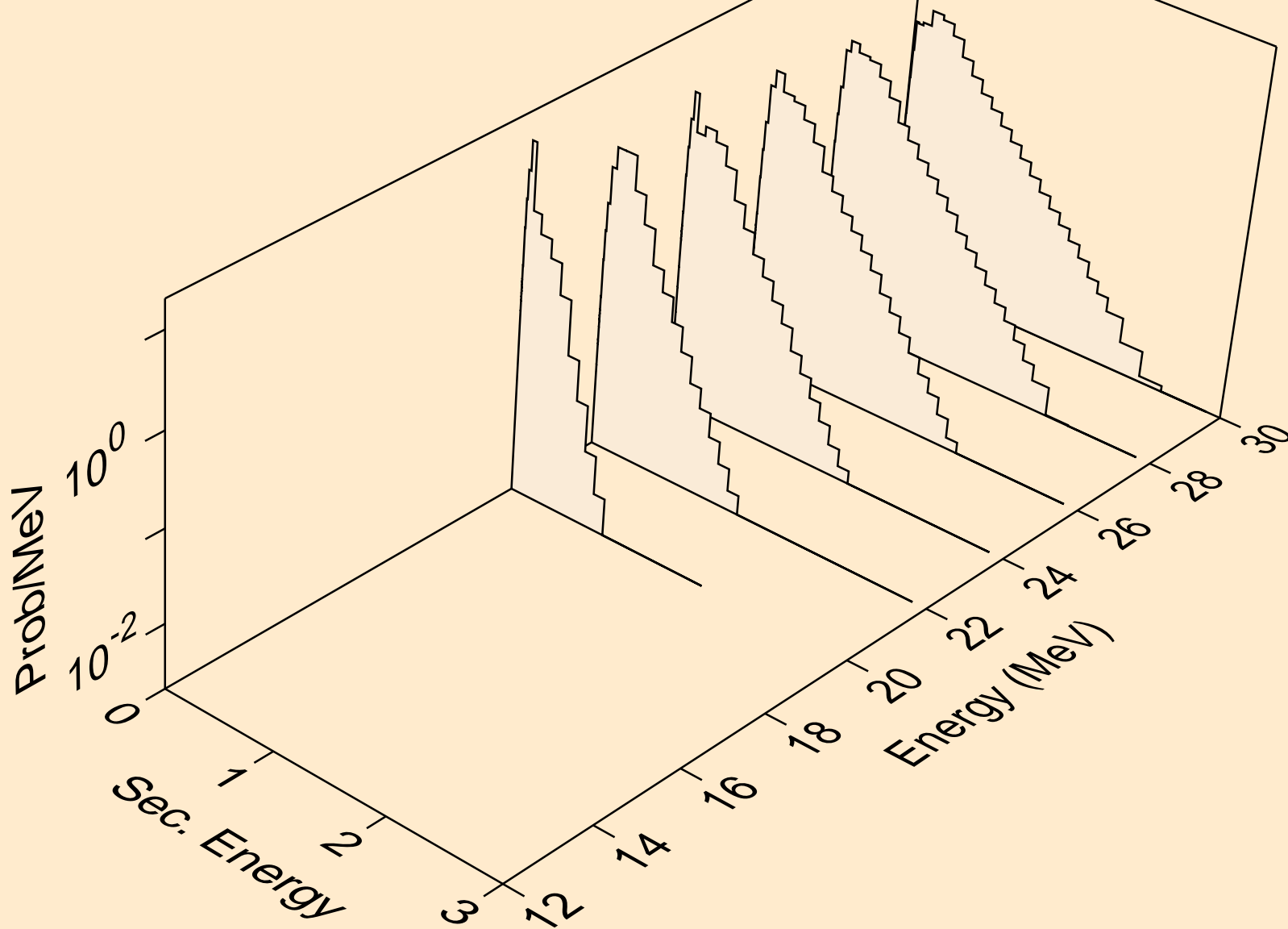

YB176M NEUTRON ACER TENDL-2019 LIBRARY; T=293.16K
Neutron emission for (n,4n)

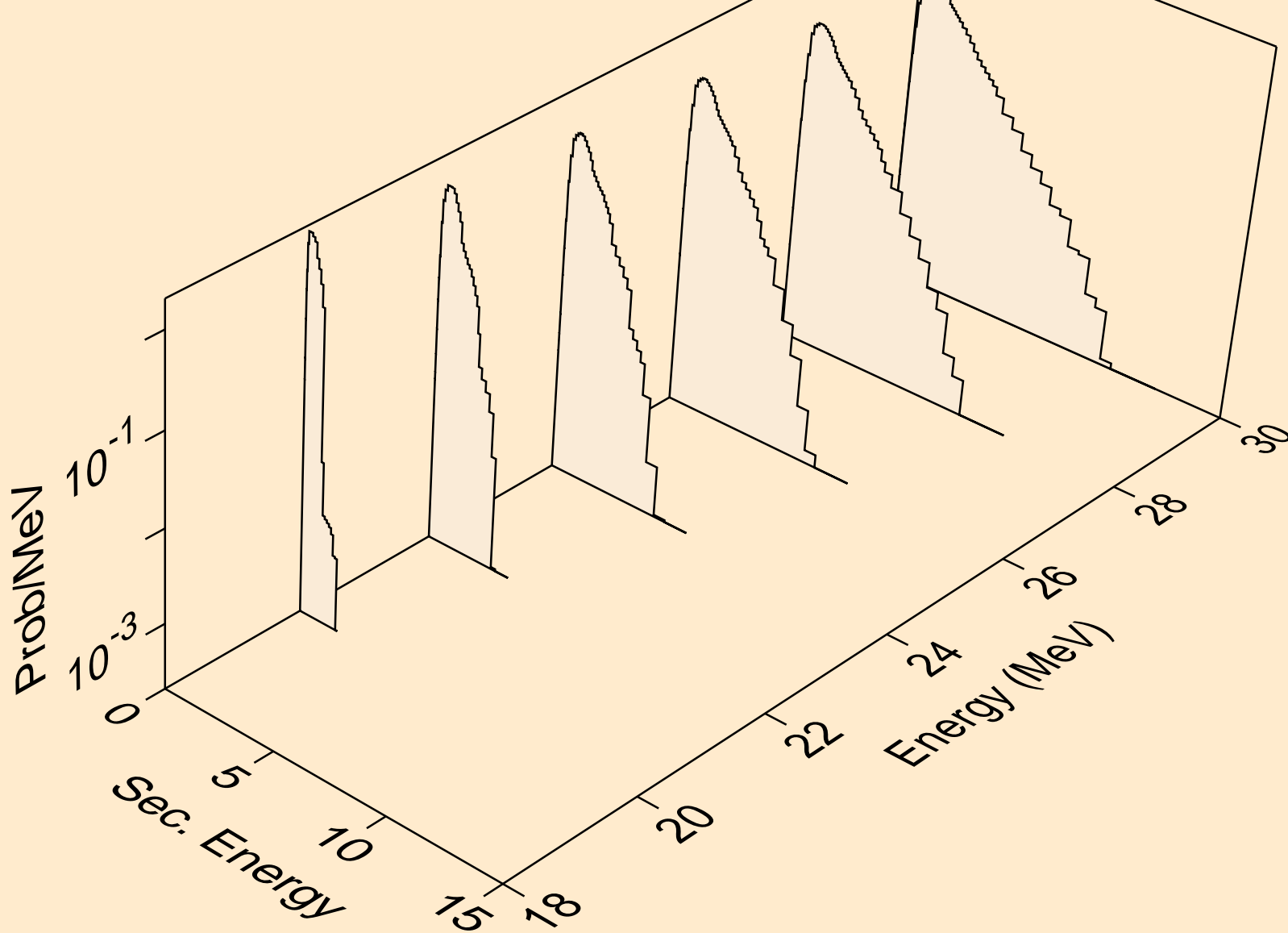

YB176M NEUTRON ACER TENDL-2019 LIBRARY; T=293.16K
Neutron emission for (n,2np)

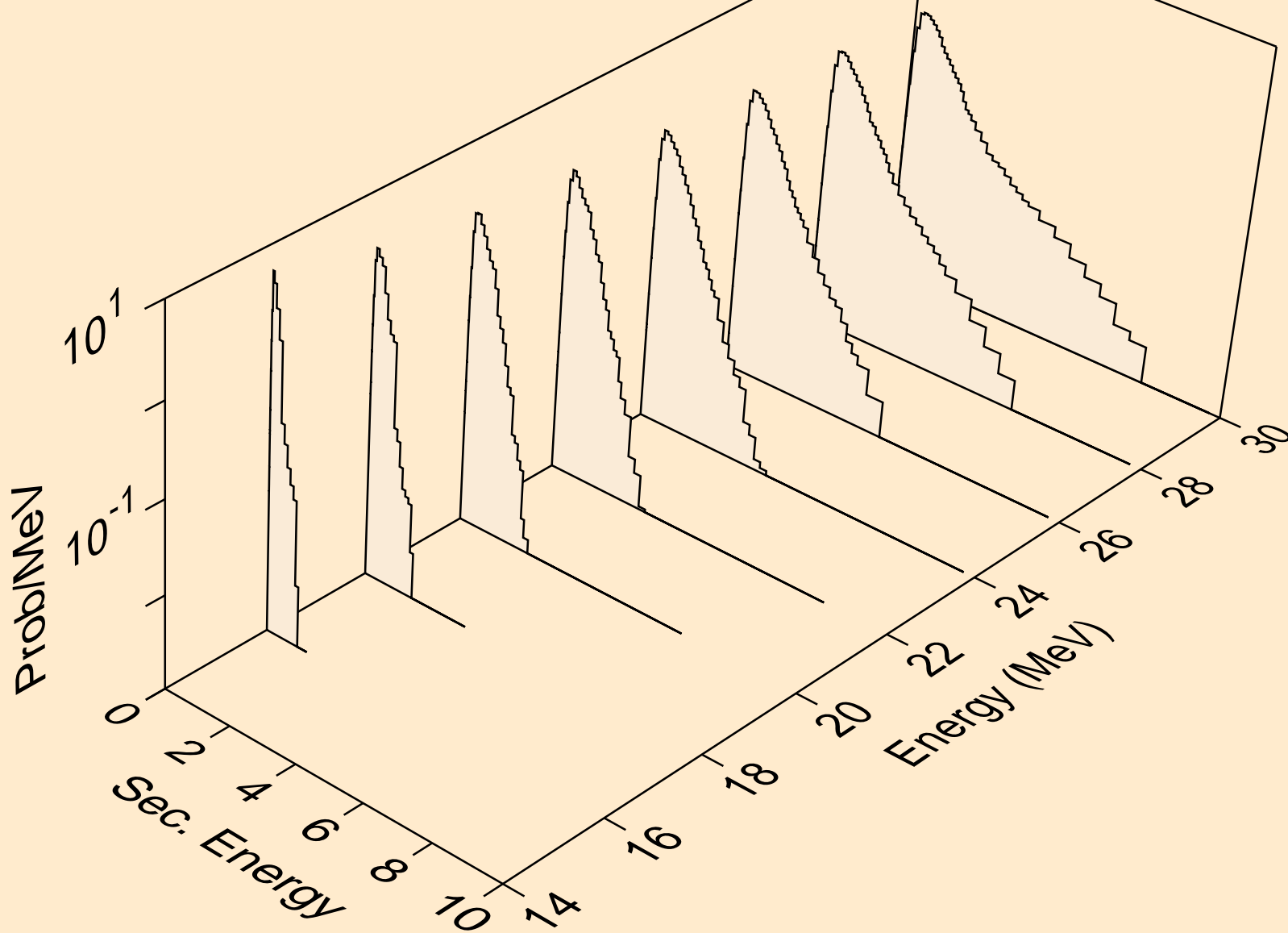

YB176M NEUTRON ACER TENDL-2019 LIBRARY; T=293.16K
Neutron emission for (n,3np)

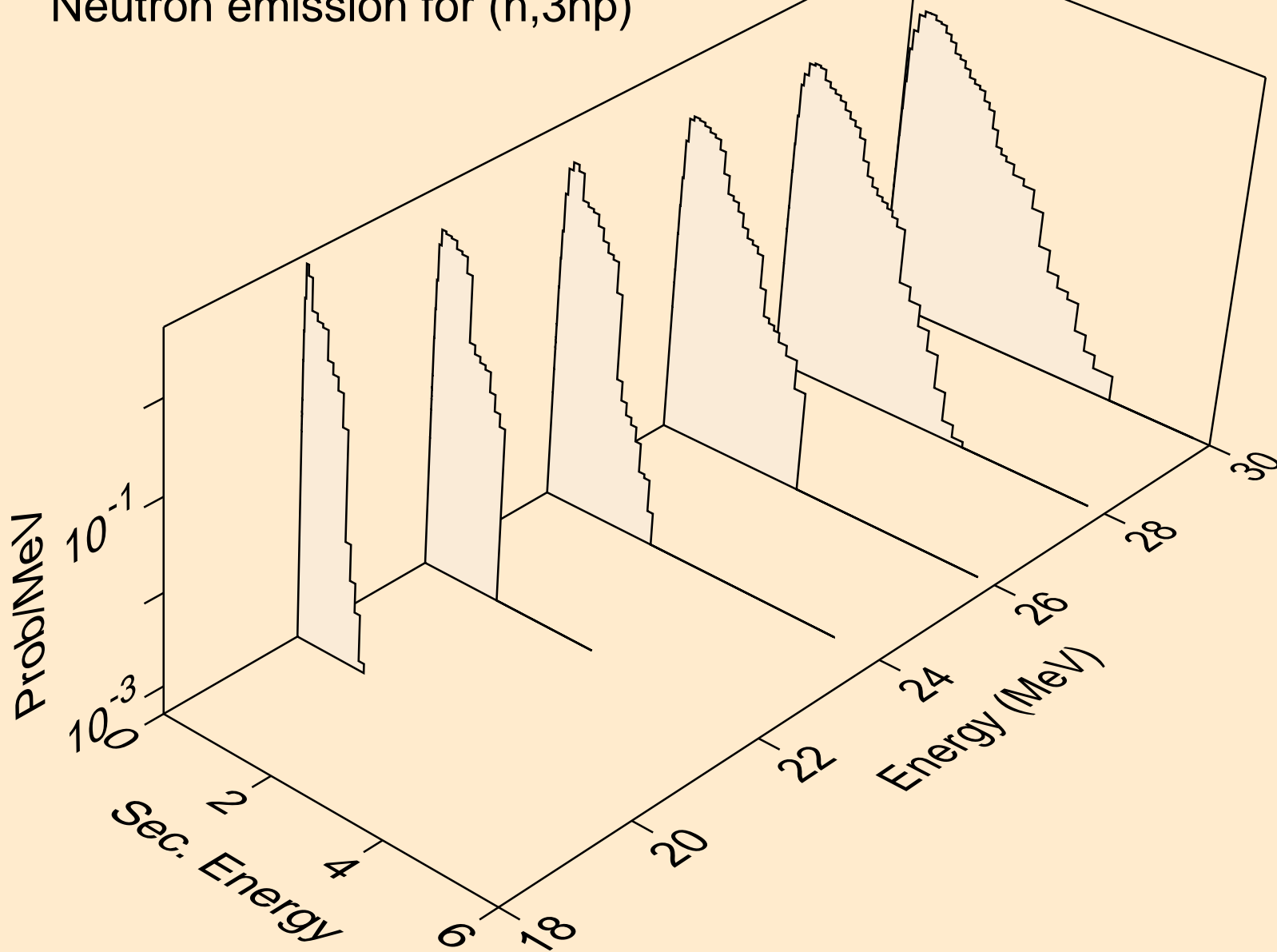

YB176M NEUTRON ACER TENDL-2019 LIBRARY; T=293.16K
Neutron emission for (n,2np)

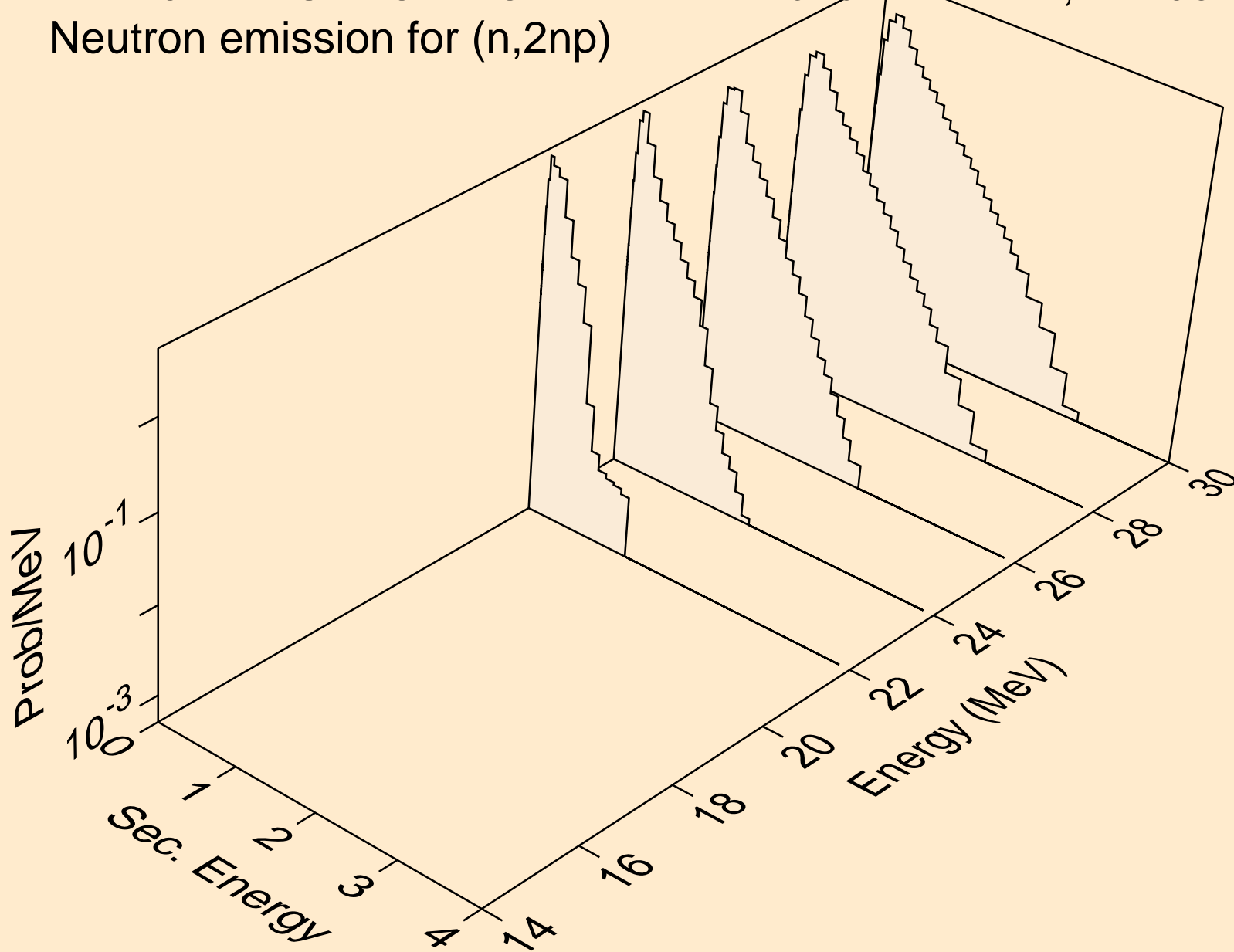

YB176M NEUTRON ACER TENDL-2019 LIBRARY; T=293.16K
Neutron emission for (n,n*c)

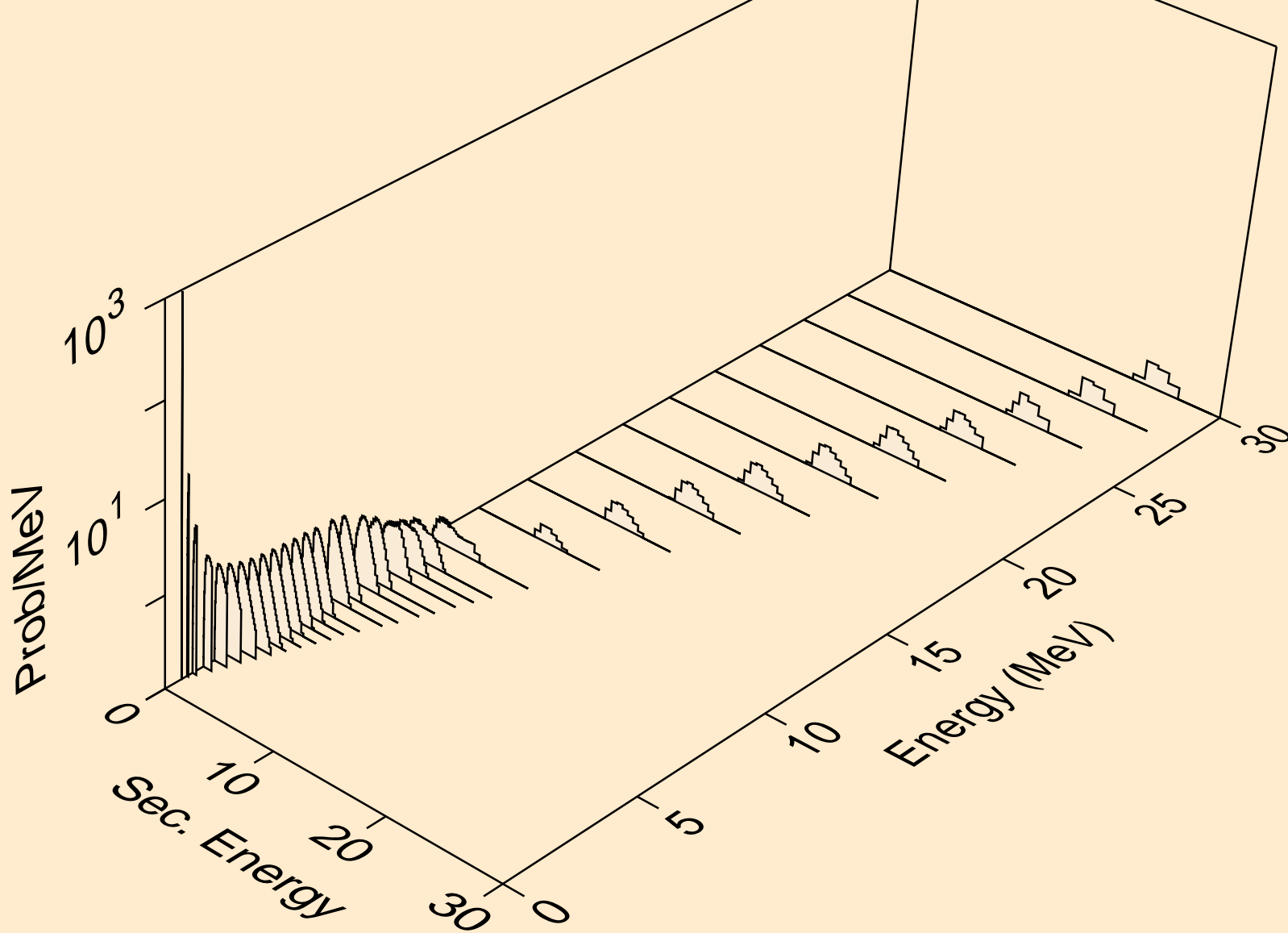

YB176M NEUTRON ACER TENDL-2019 LIBRARY; T=293.16K
Photon emission for (n,x)

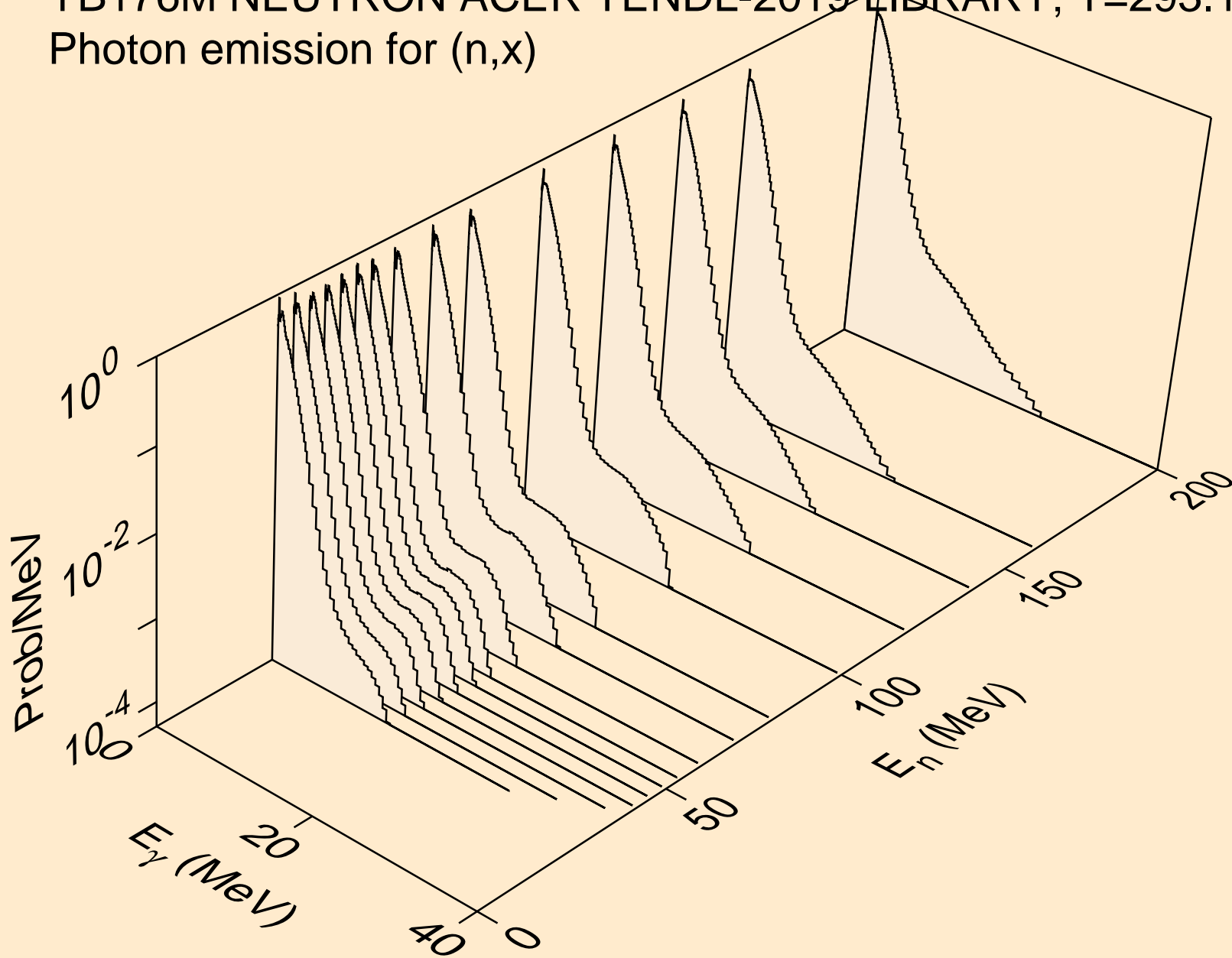

YB176M NEUTRON ACER TENDL-2019 LIBRARY; T=293.16K
Photon emission for (n,2nd)

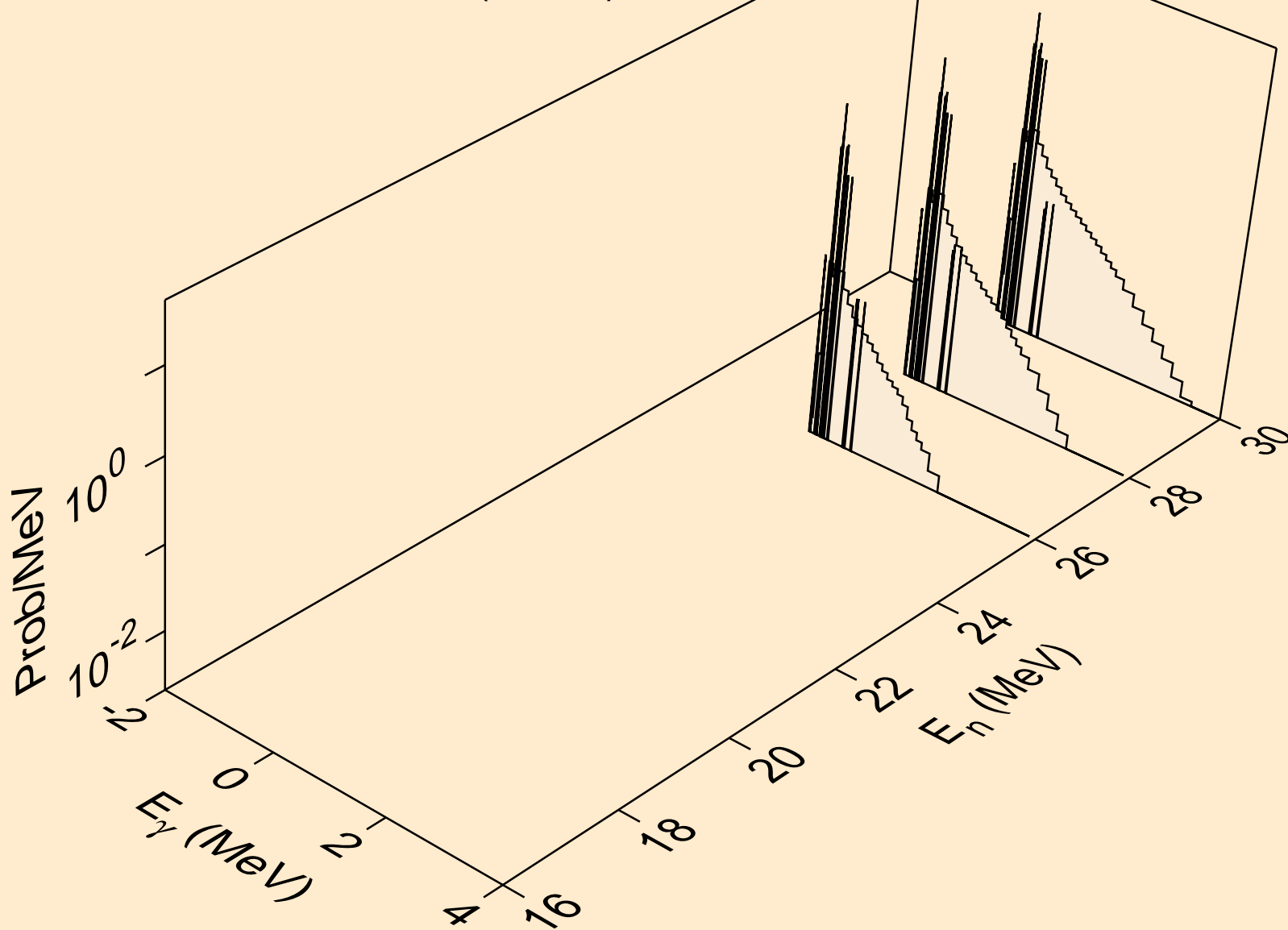

YB176M NEUTRON ACER TENDL-2019 LIBRARY; T=293.16K
Photon emission for (n,2n)

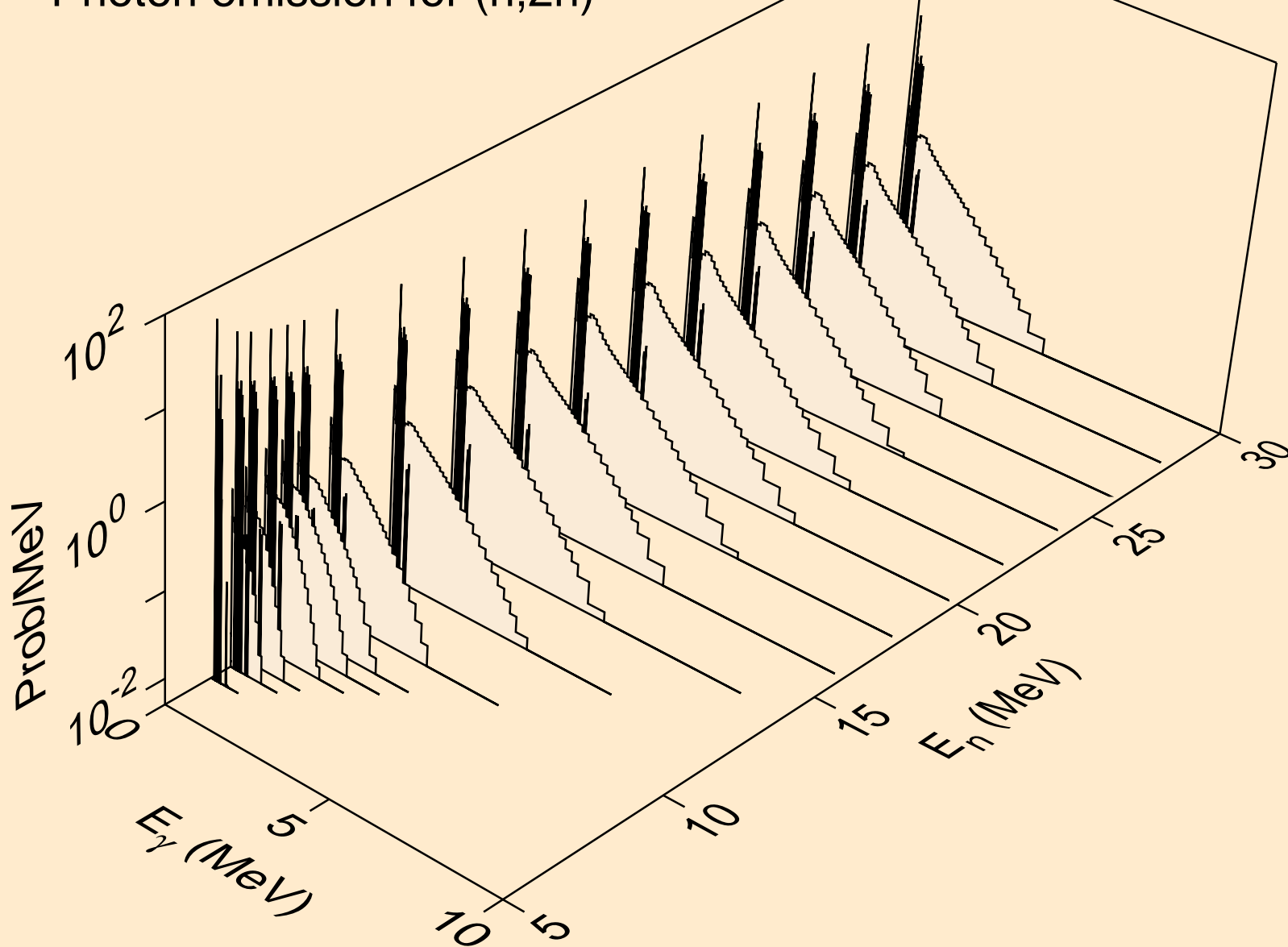

YB176M NEUTRON ACER TENDL-2019 LIBRARY; T=293.16K
Photon emission for (n,3n)

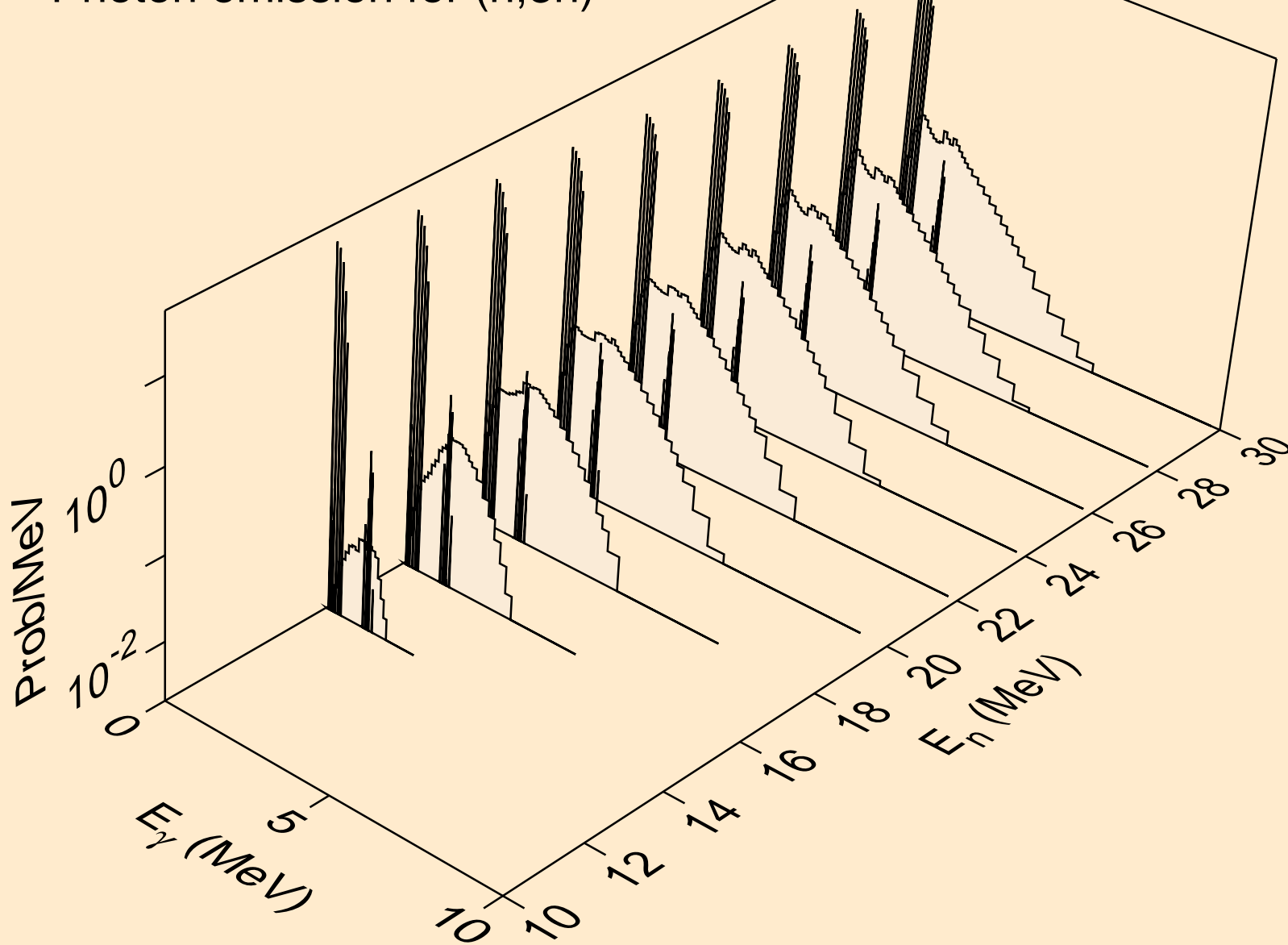

YB176M NEUTRON ACER TENDL-2019 LIBRARY; T=293.16K
Photon emission for (n,n*)a

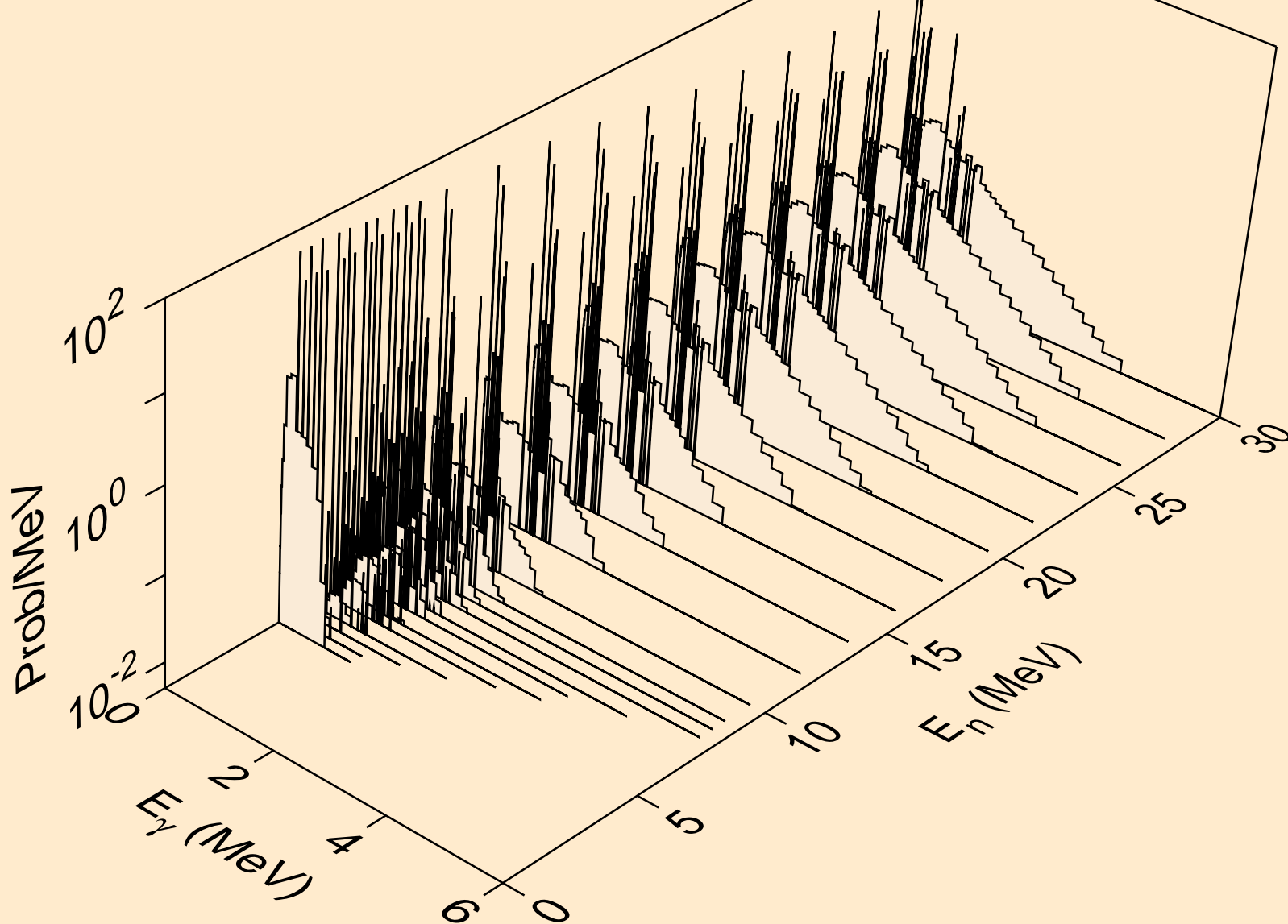

YB176M NEUTRON ACER TENDL-2019 LIBRARY; T=293.16K
Photon emission for (n,2n)a

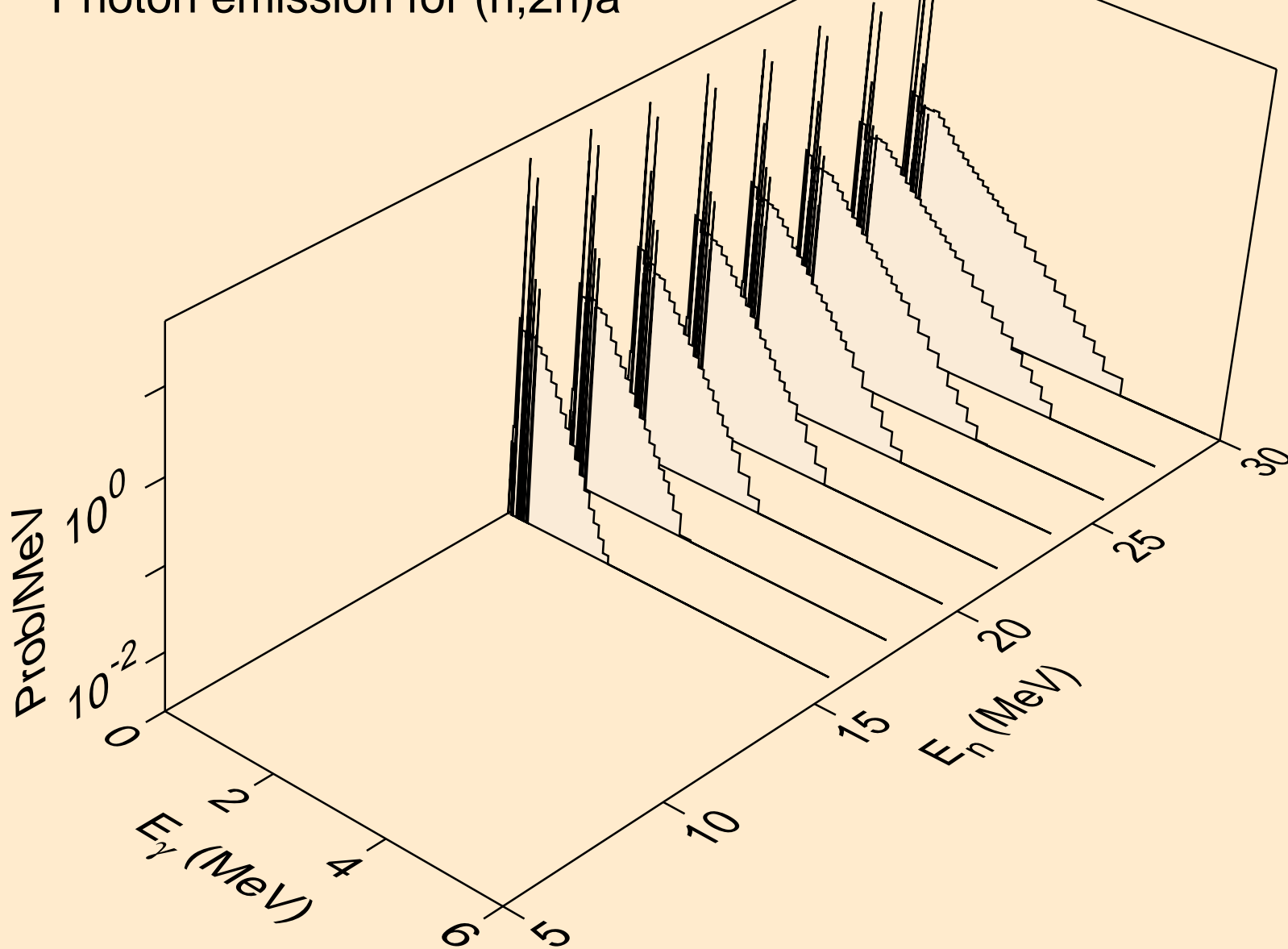

YB176M NEUTRON ACER TENDL-2019 LIBRARY; T=293.16K
Photon emission for (n,3n)a

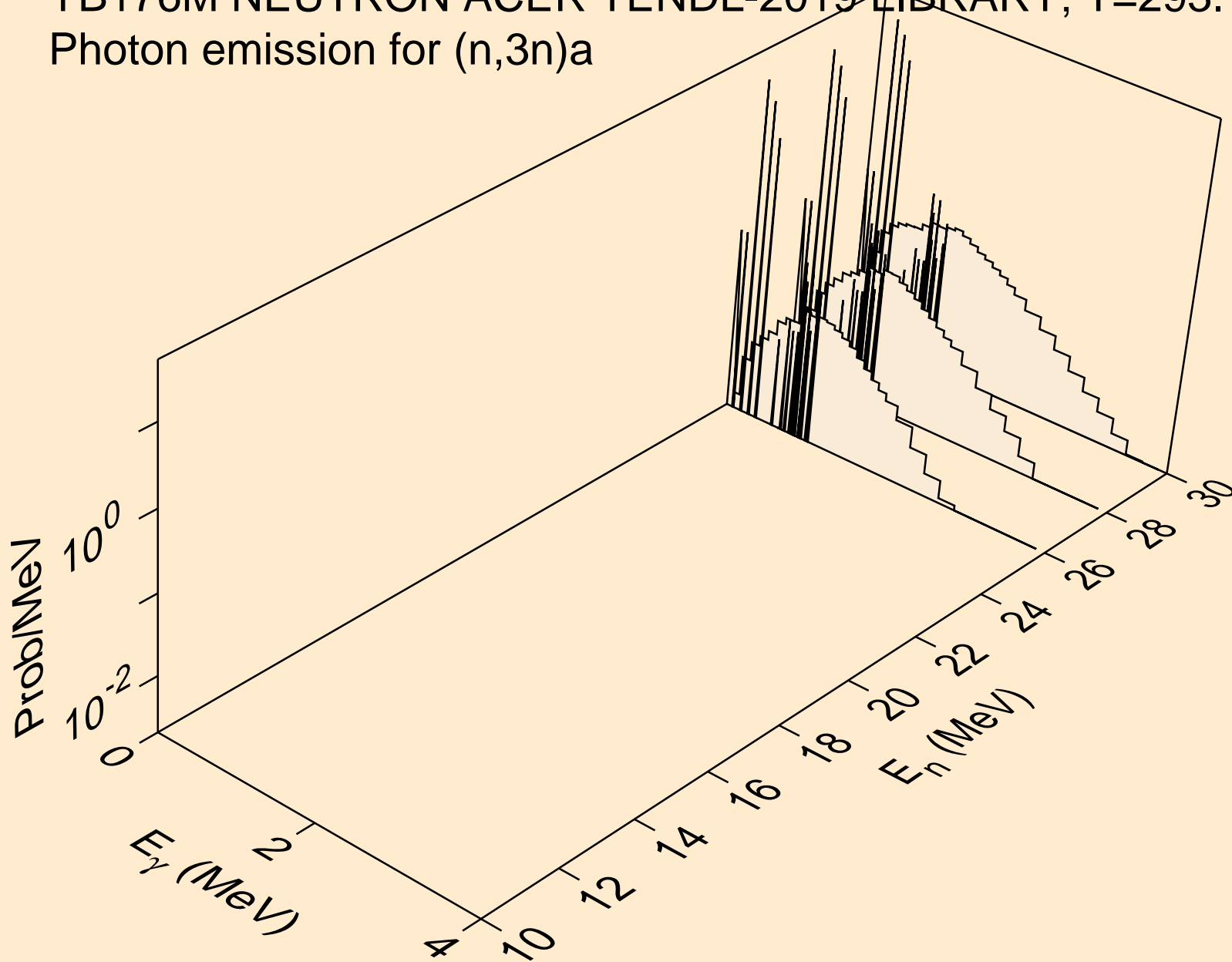

YB176M NEUTRON ACER TENDL-2019 LIBRARY; T=293.16K
Photon emission for (n,n*)p

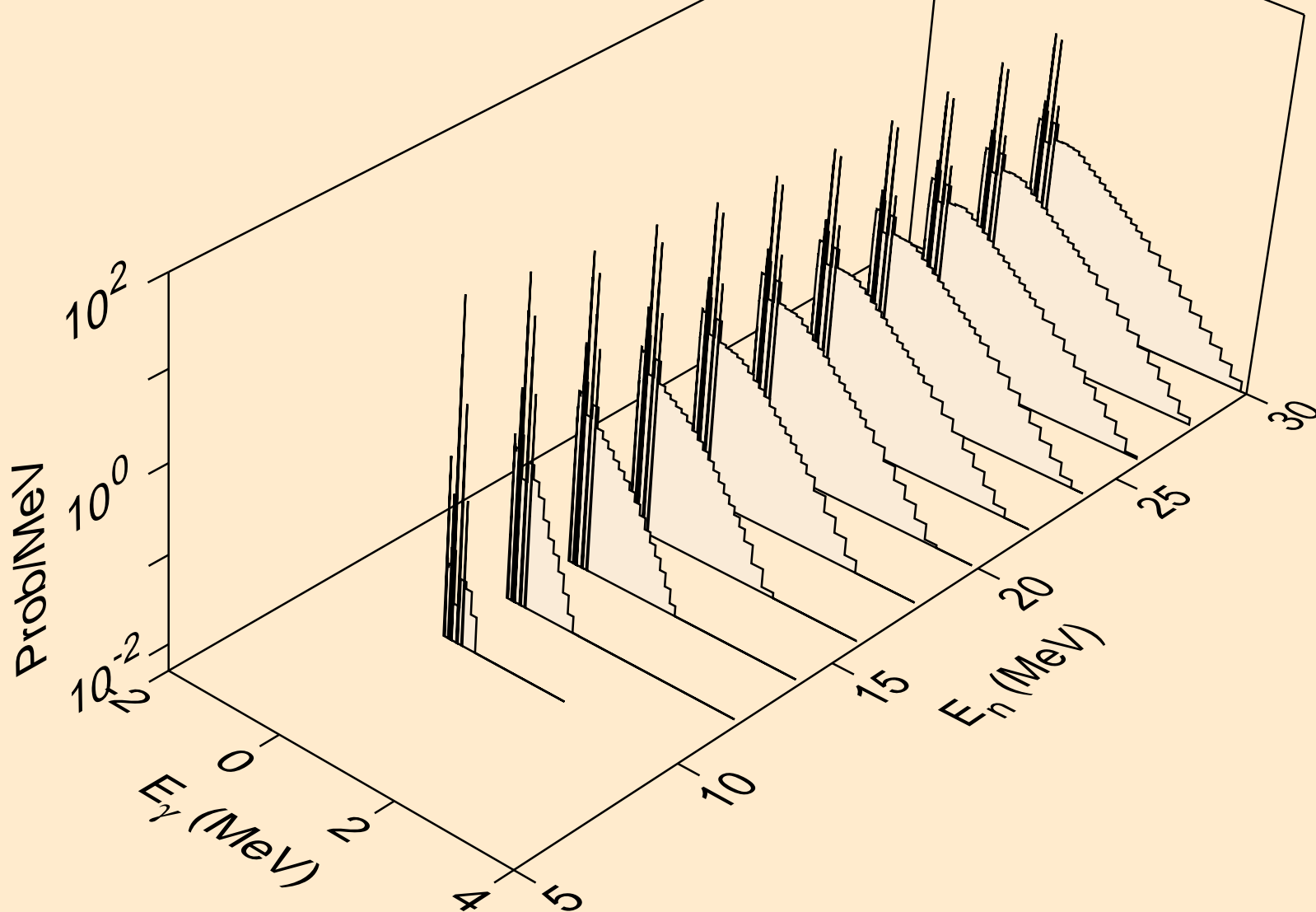

YB176M NEUTRON ACER TENDL-2019 LIBRARY; T=293.16K
Photon emission for (n,n*)d

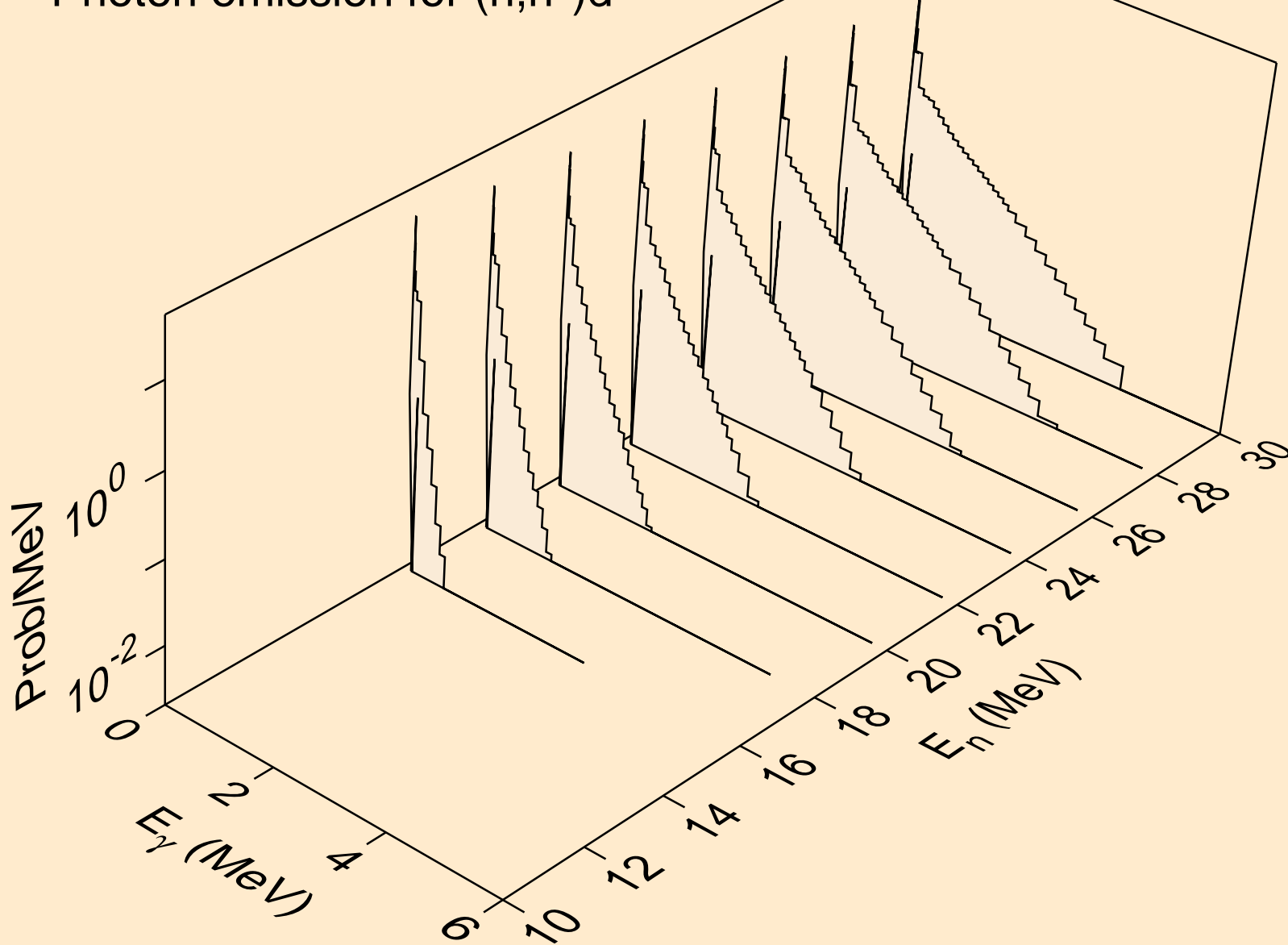

YB176M NEUTRON ACER TENDL-2019 LIBRARY; T=293.16K
Photon emission for (n,n*)t

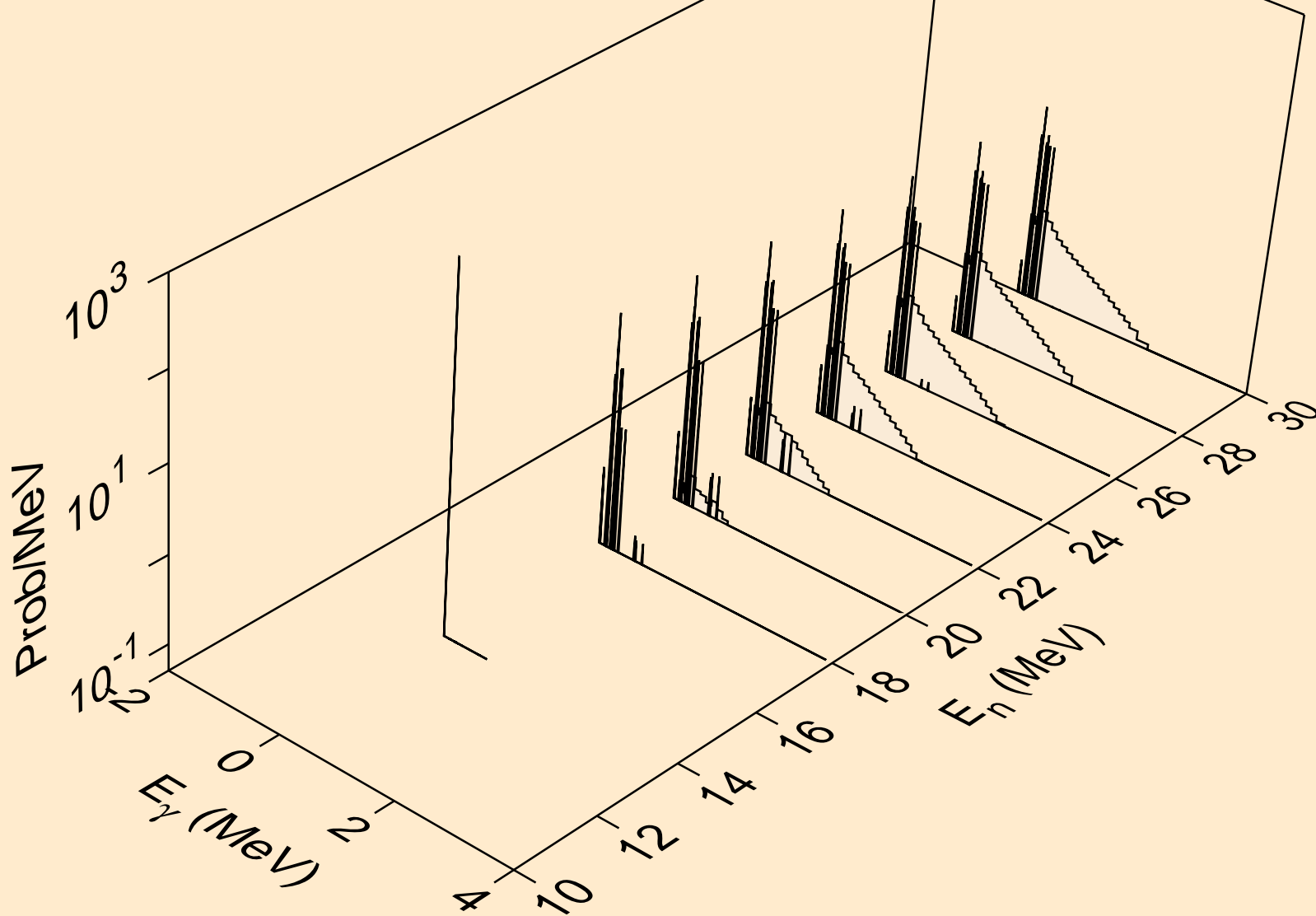

YB176M NEUTRON ACER TENDL-2019 LIBRARY; T=293.16K
Photon emission for (n,n*)he3

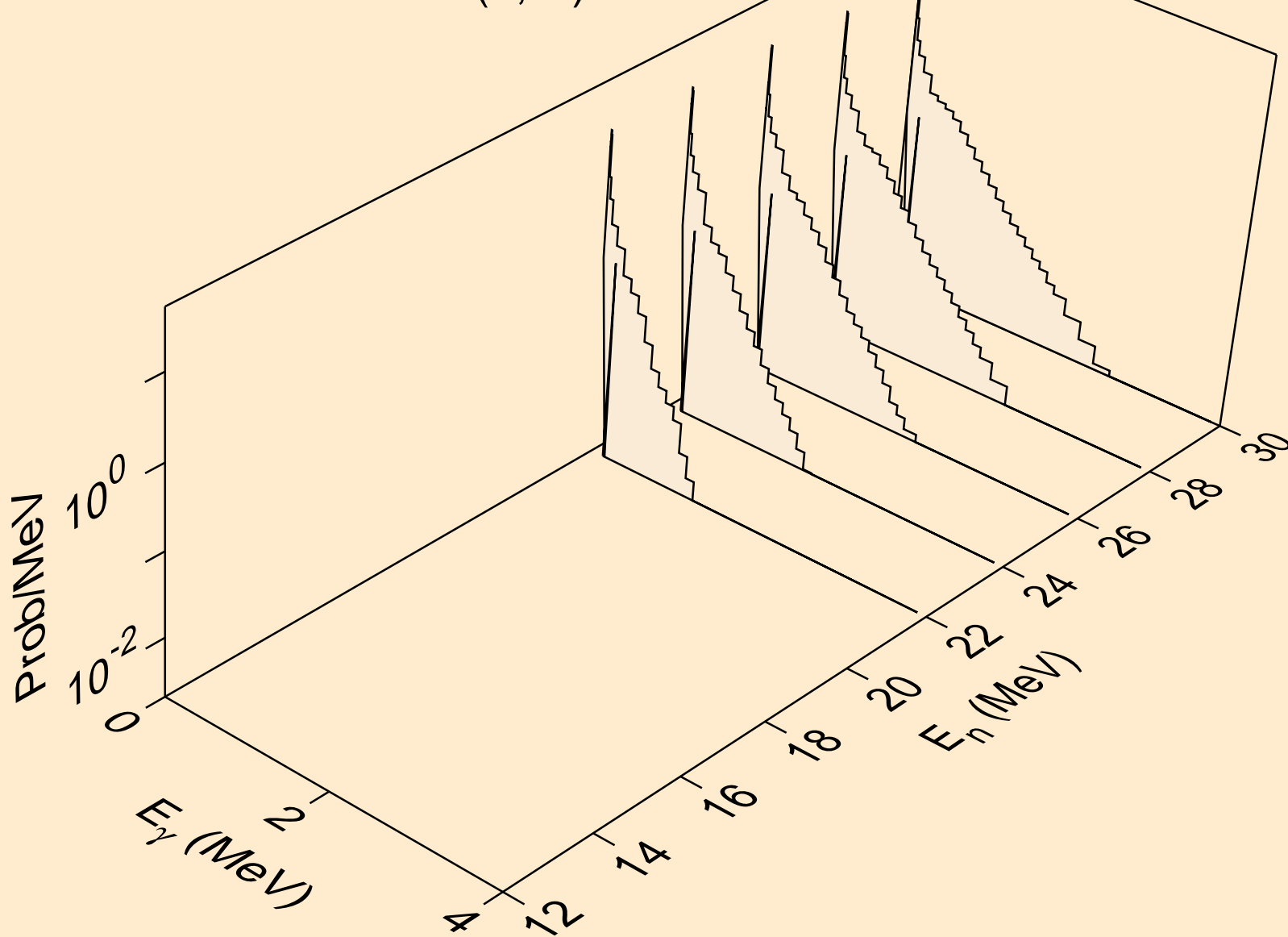

YB176M NEUTRON ACER TENDL-2019 LIBRARY; T=293.16K
Photon emission for (n,4n)

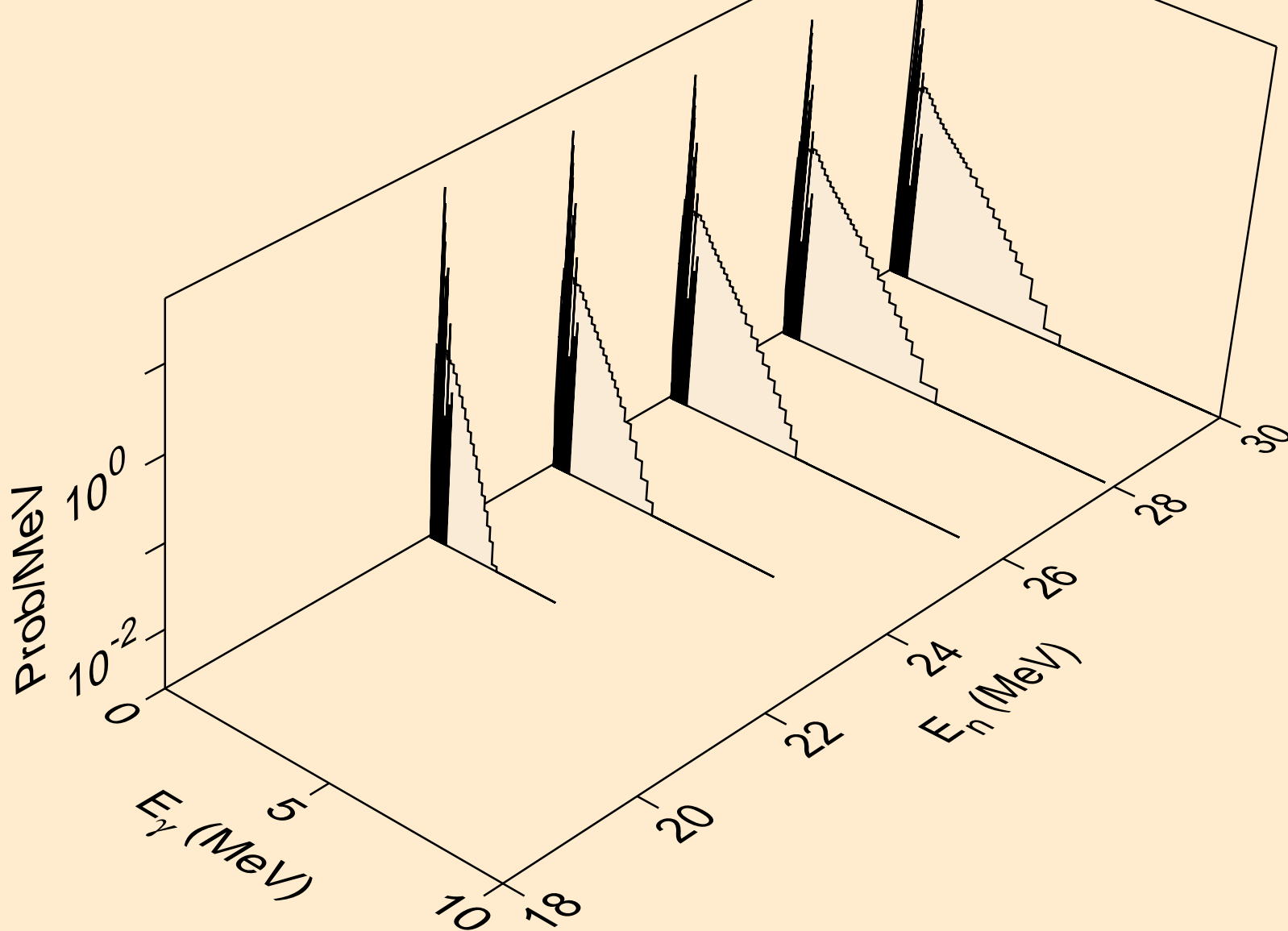

YB176M NEUTRON ACER TENDL-2019 LIBRARY; T=293.16K
Photon emission for (n,2np)

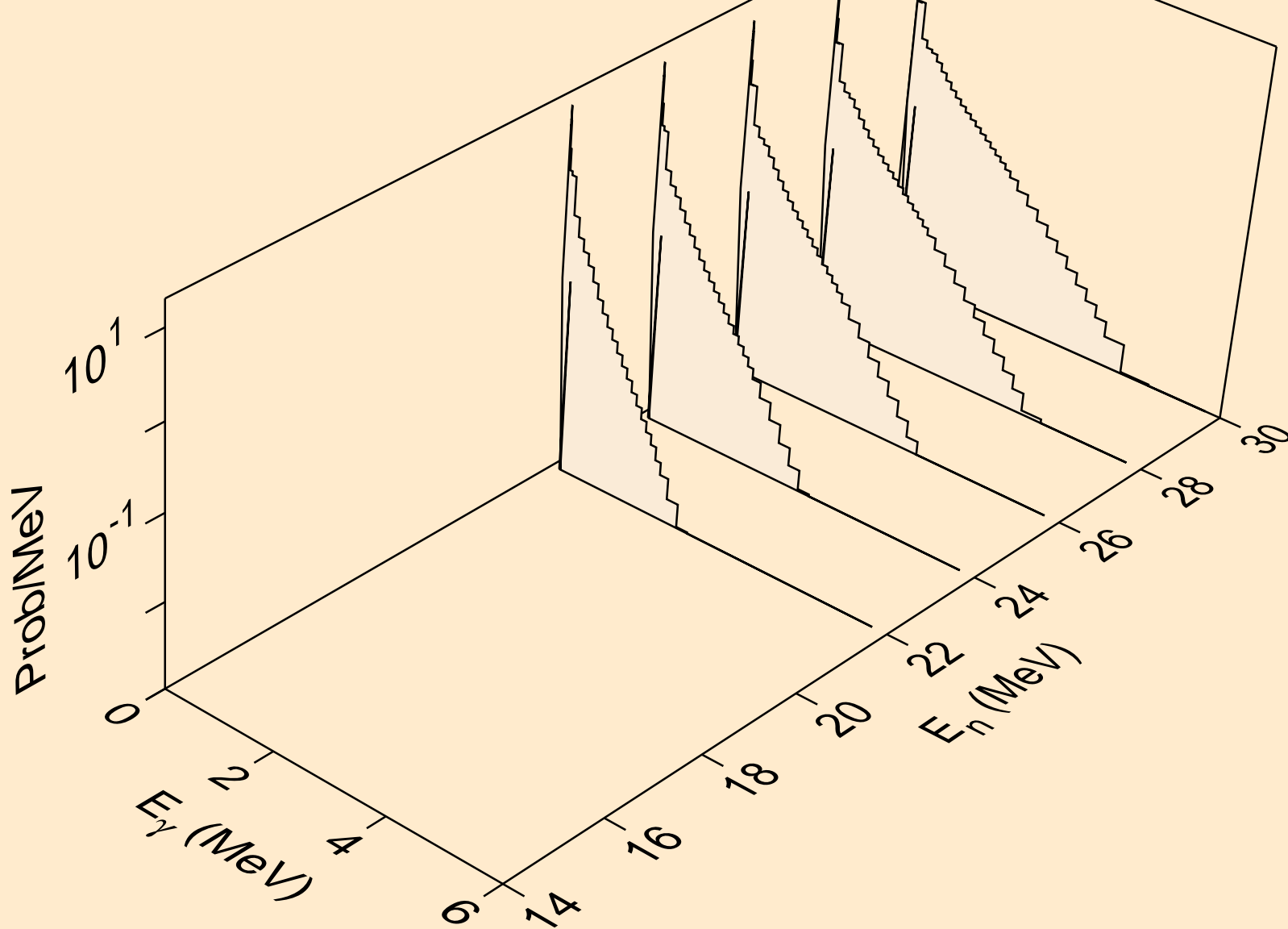

YB176M NEUTRON ACER TENDL-2019 LIBRARY; T=293.16K
Photon emission for (n,3np)

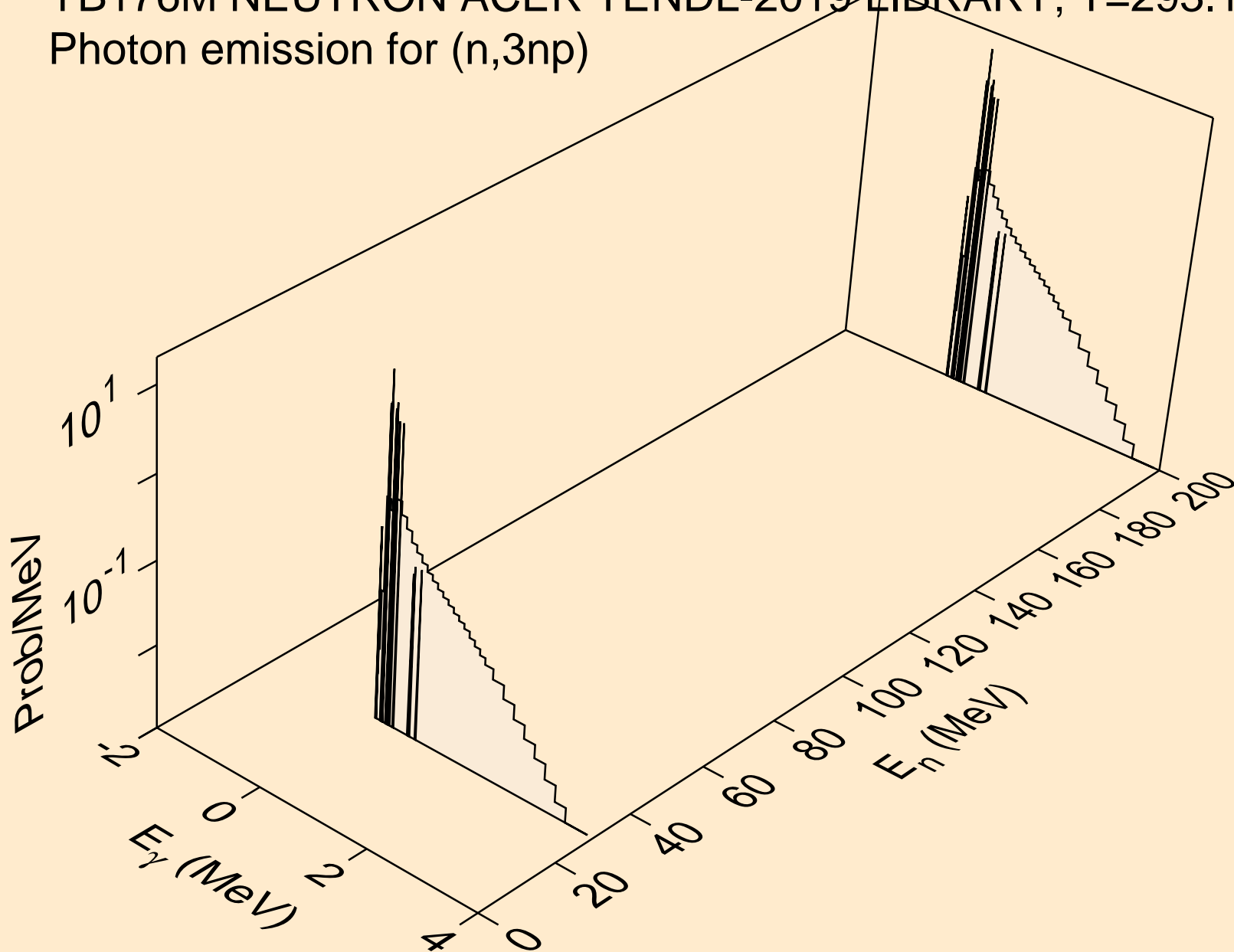

YB176M NEUTRON ACER TENDL-2019 LIBRARY; T=293.16K
Photon emission for (n,2np)

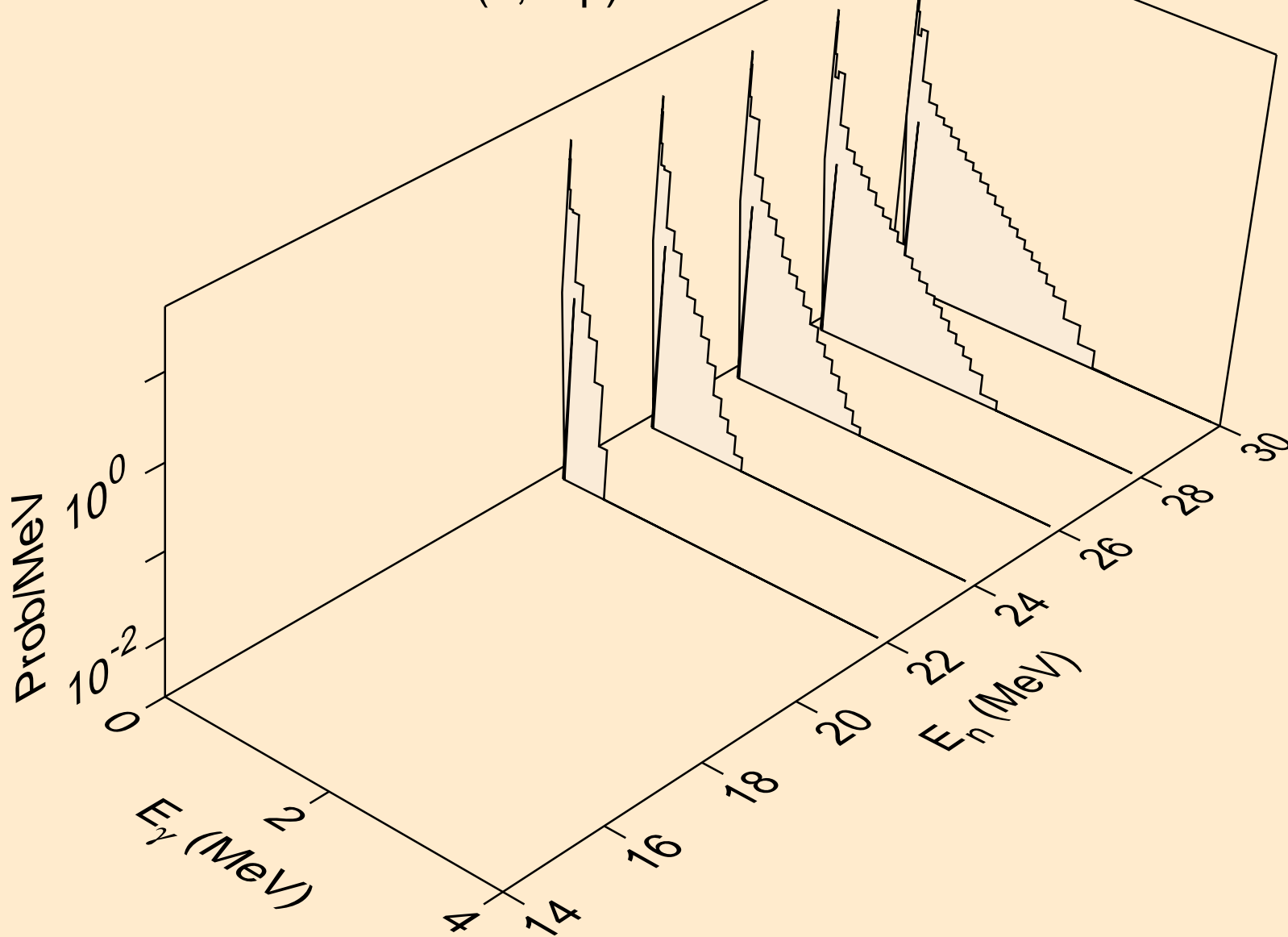

YB176M NEUTRON ACER TENDL-2019 LIBRARY; T=293.16K
Photon emission for (n,n*1)

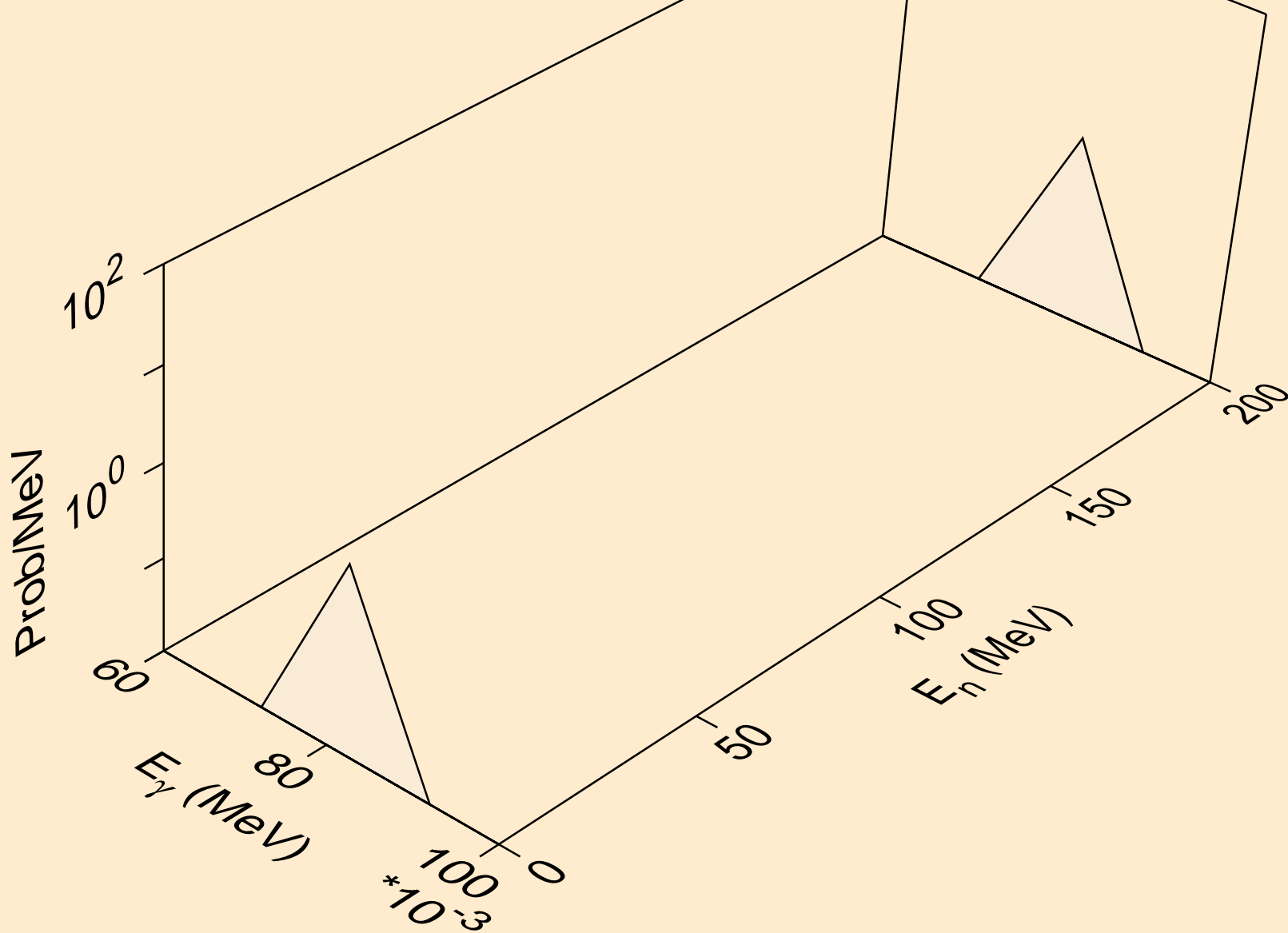

YB176M NEUTRON ACER TENDL-2019 LIBRARY; T=293.16K
Photon emission for (n,n*2)

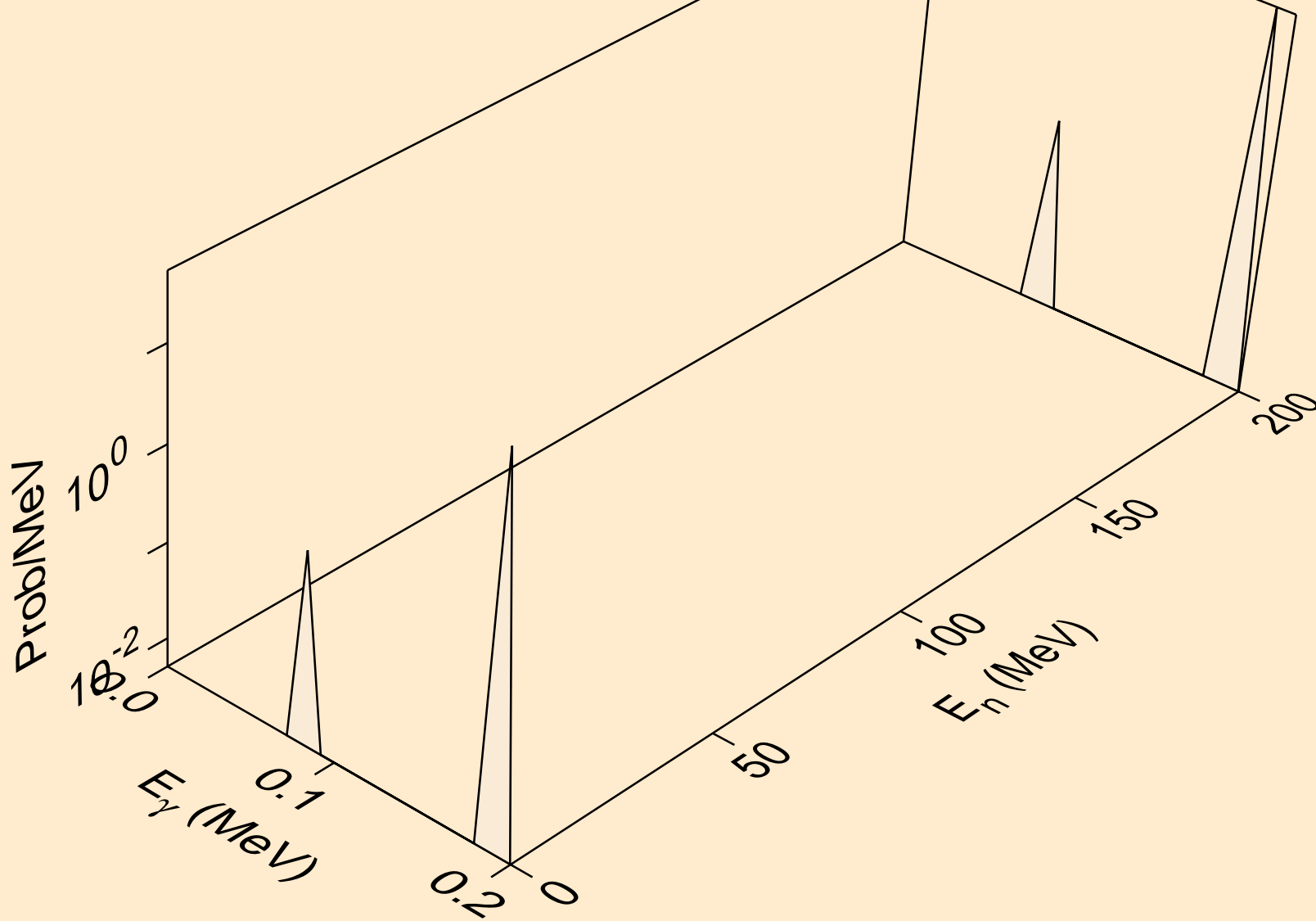

YB176M NEUTRON ACER TENDL-2019 LIBRARY; T=293.16K
Photon emission for (n,n*3)

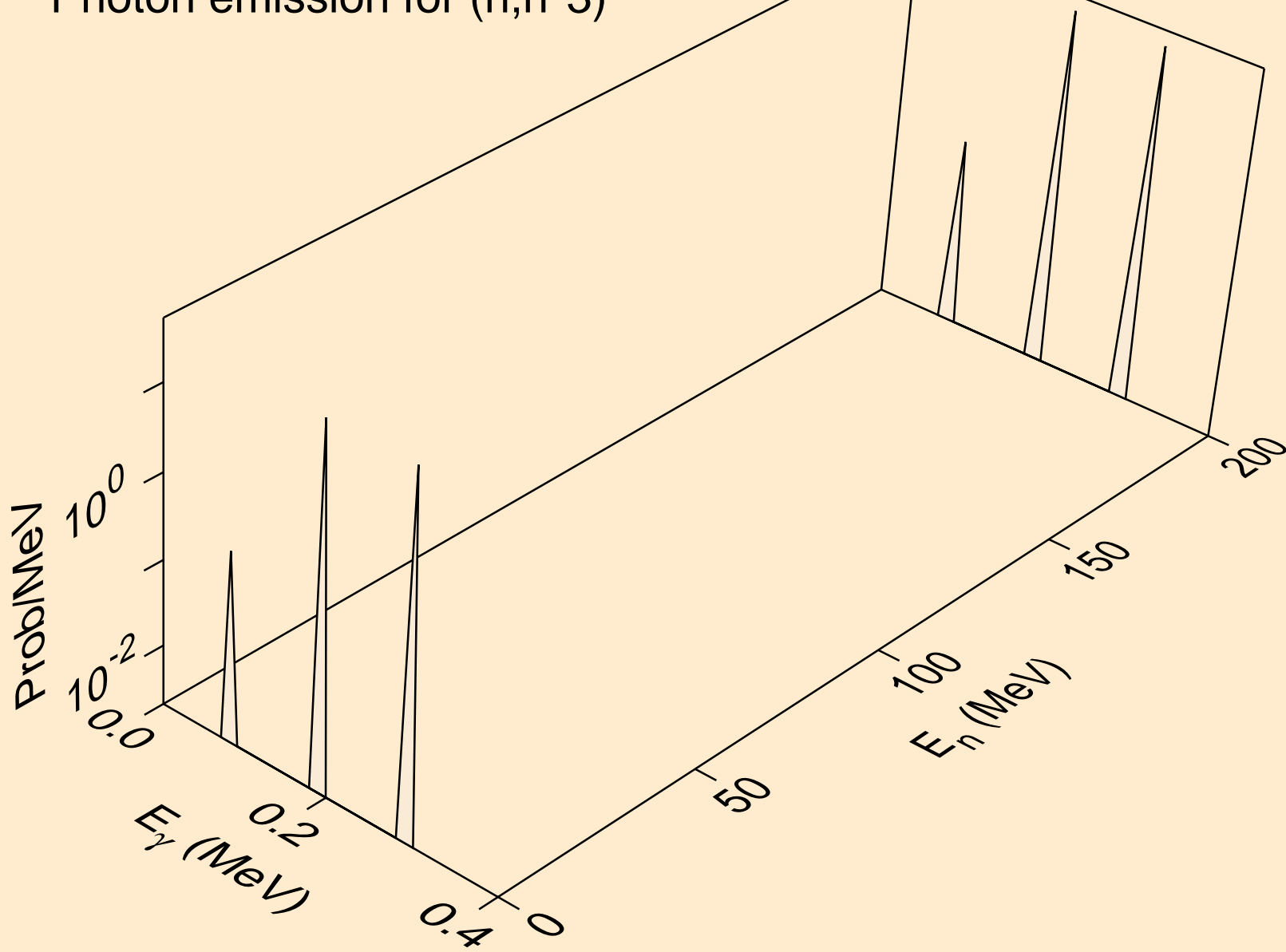

YB176M NEUTRON ACER TENDL-2019 LIBRARY; T=293.16K
Photon emission for (n,n*4)

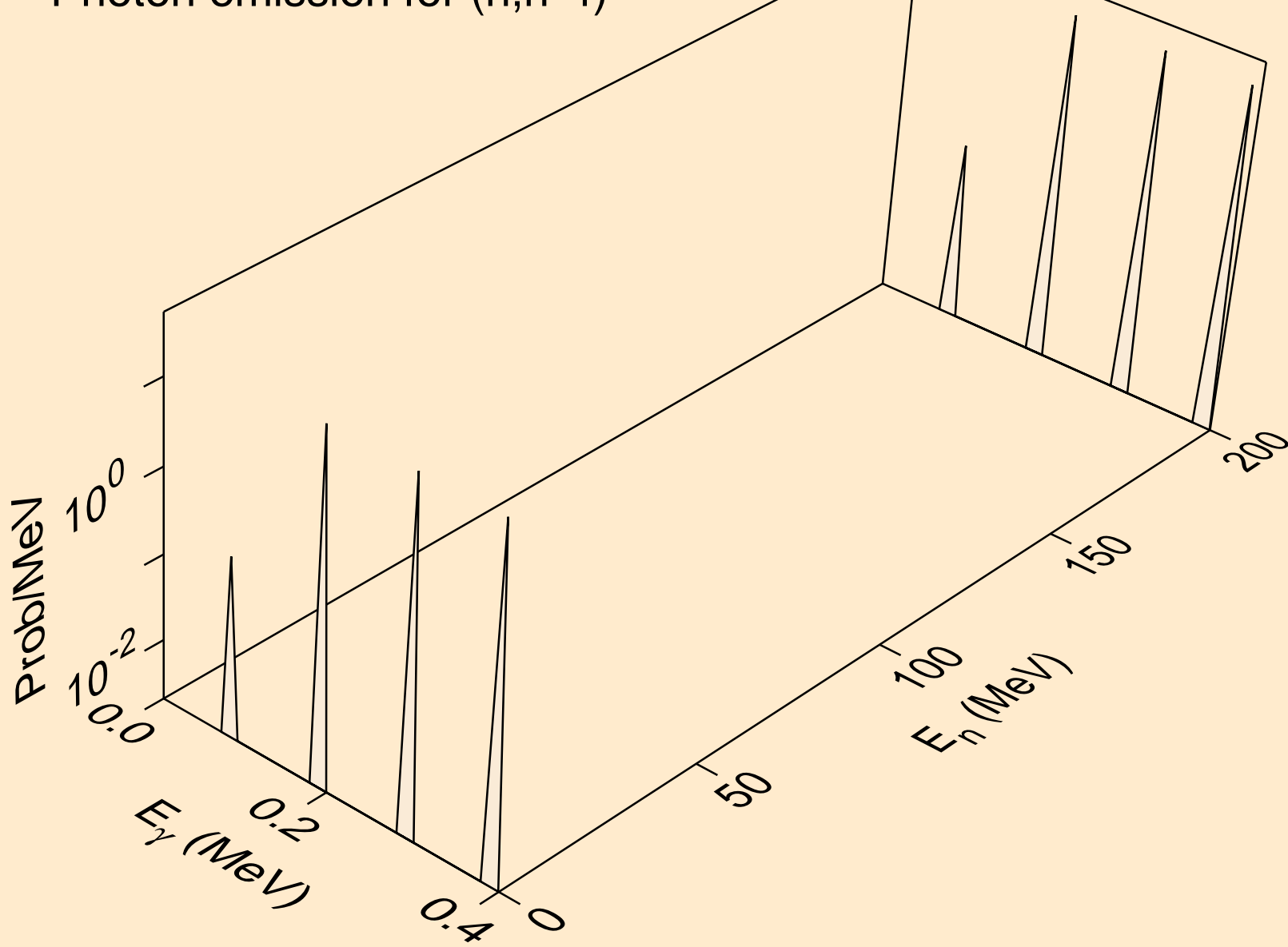

YB176M NEUTRON ACER TENDL-2019 LIBRARY; T=293.16K
Photon emission for (n,n*6)

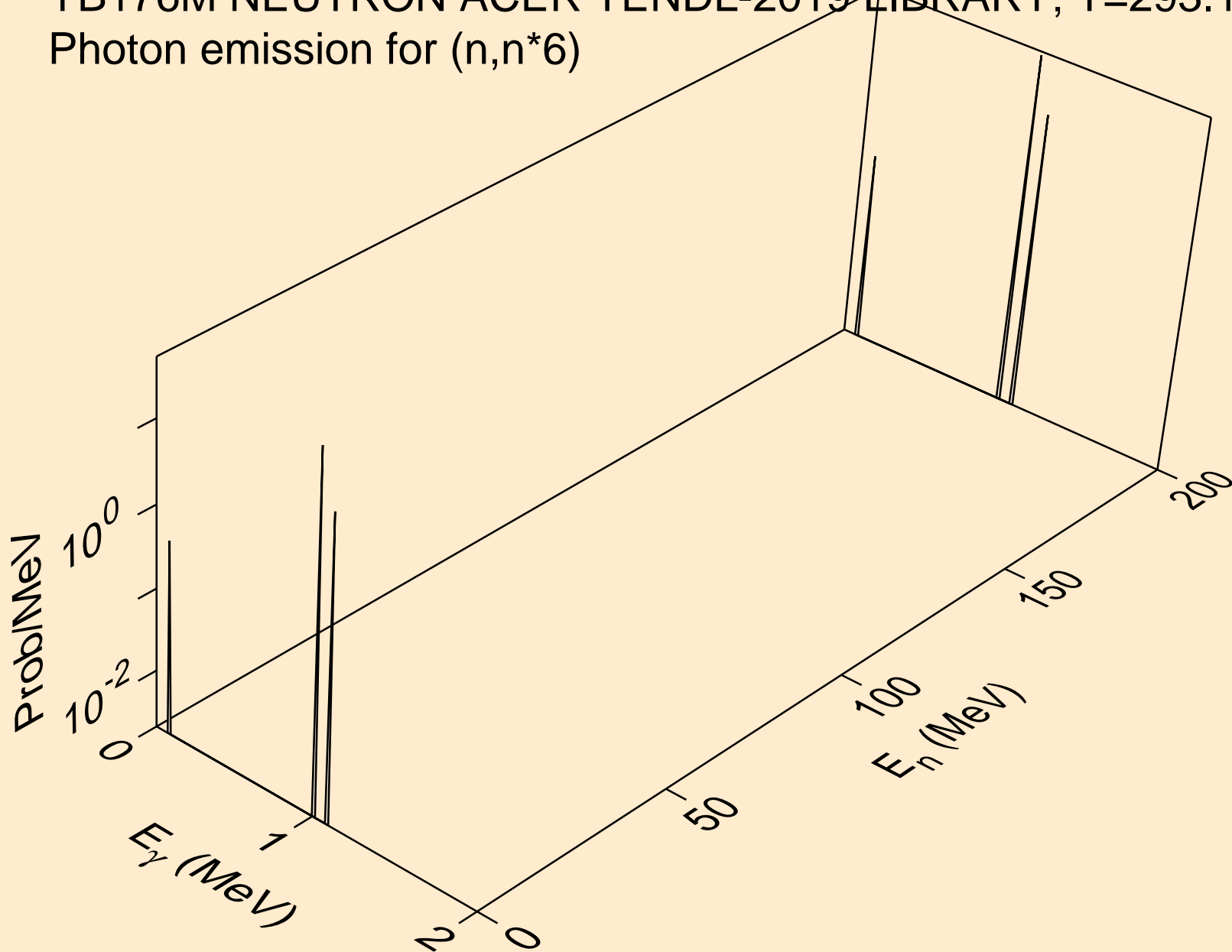

YB176M NEUTRON ACER TENDL-2019 LIBRARY; T=293.16K
Photon emission for (n,n*7)

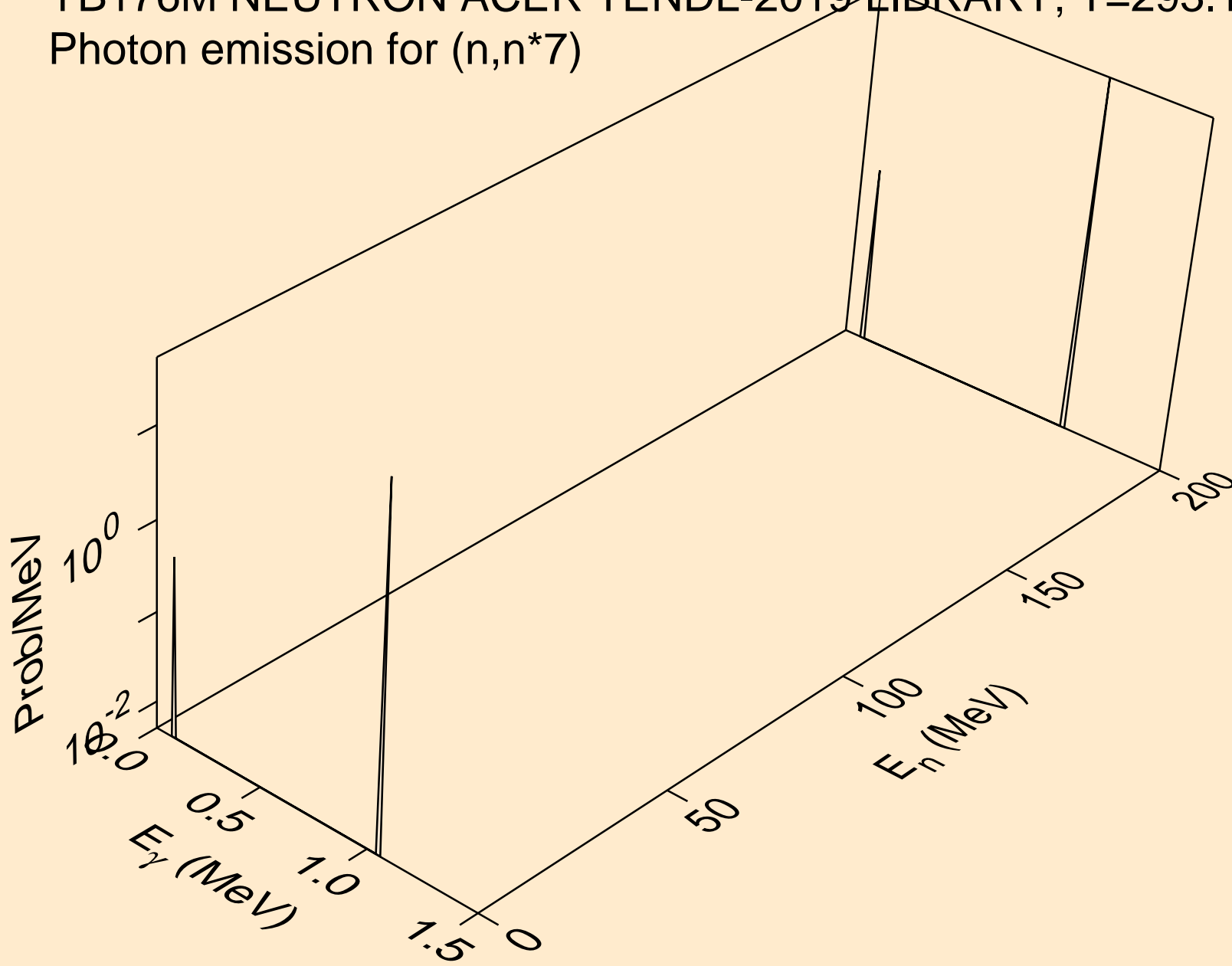

YB176M NEUTRON ACER TENDL-2019 LIBRARY; T=293.16K
Photon emission for (n,n*8)

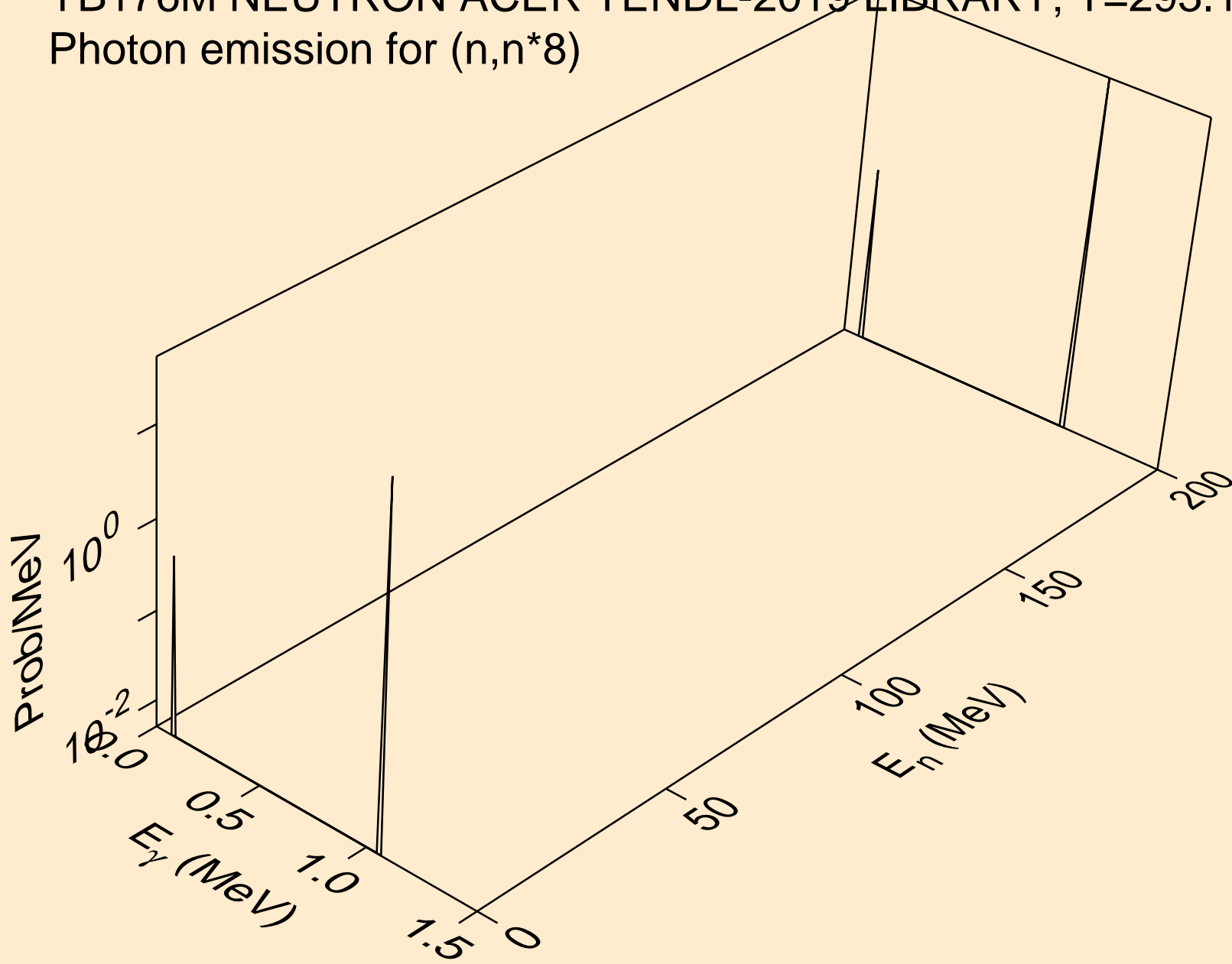

YB176M NEUTRON ACER TENDL-2019 LIBRARY; T=293.16K
Photon emission for (n,n*9)

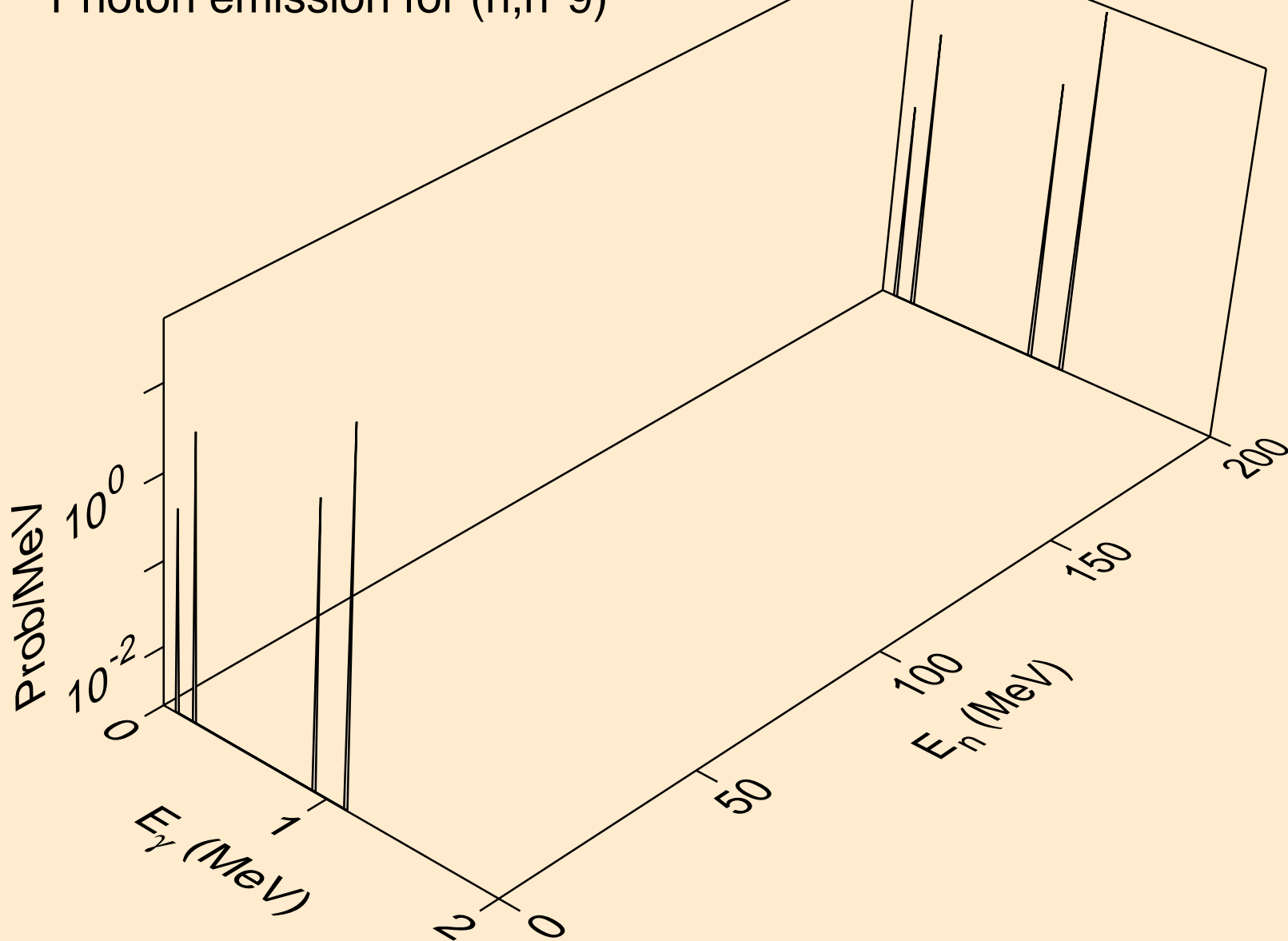

YB176M NEUTRON ACER TENDL-2019 LIBRARY; T=293.16K
Photon emission for (n,n*10)

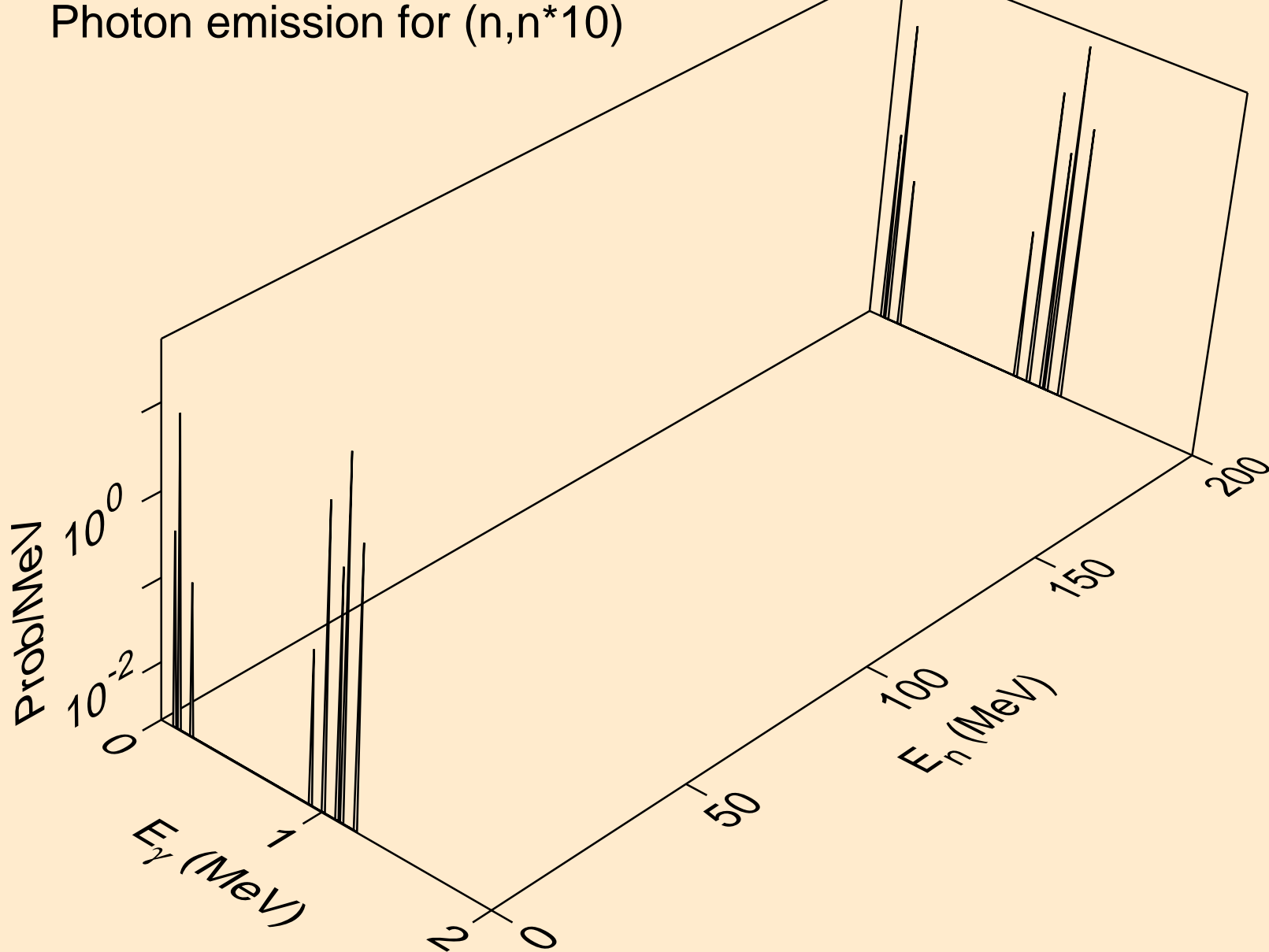

YB176M NEUTRON ACER TENDL-2019 LIBRARY; T=293.16K
Photon emission for (n,n*11)

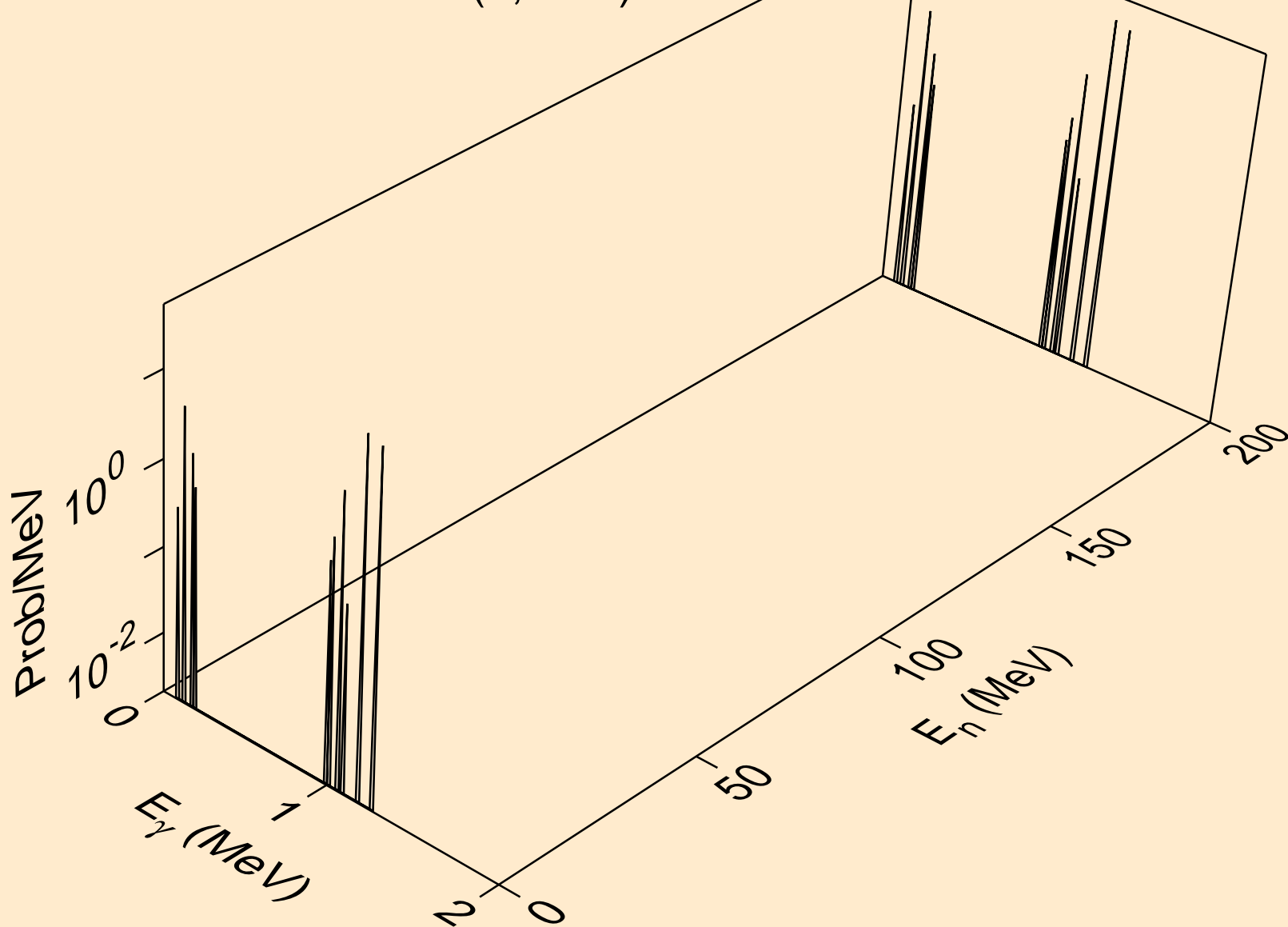

YB176M NEUTRON ACER TENDL-2019 LIBRARY; T=293.16K
Photon emission for (n,n*12)

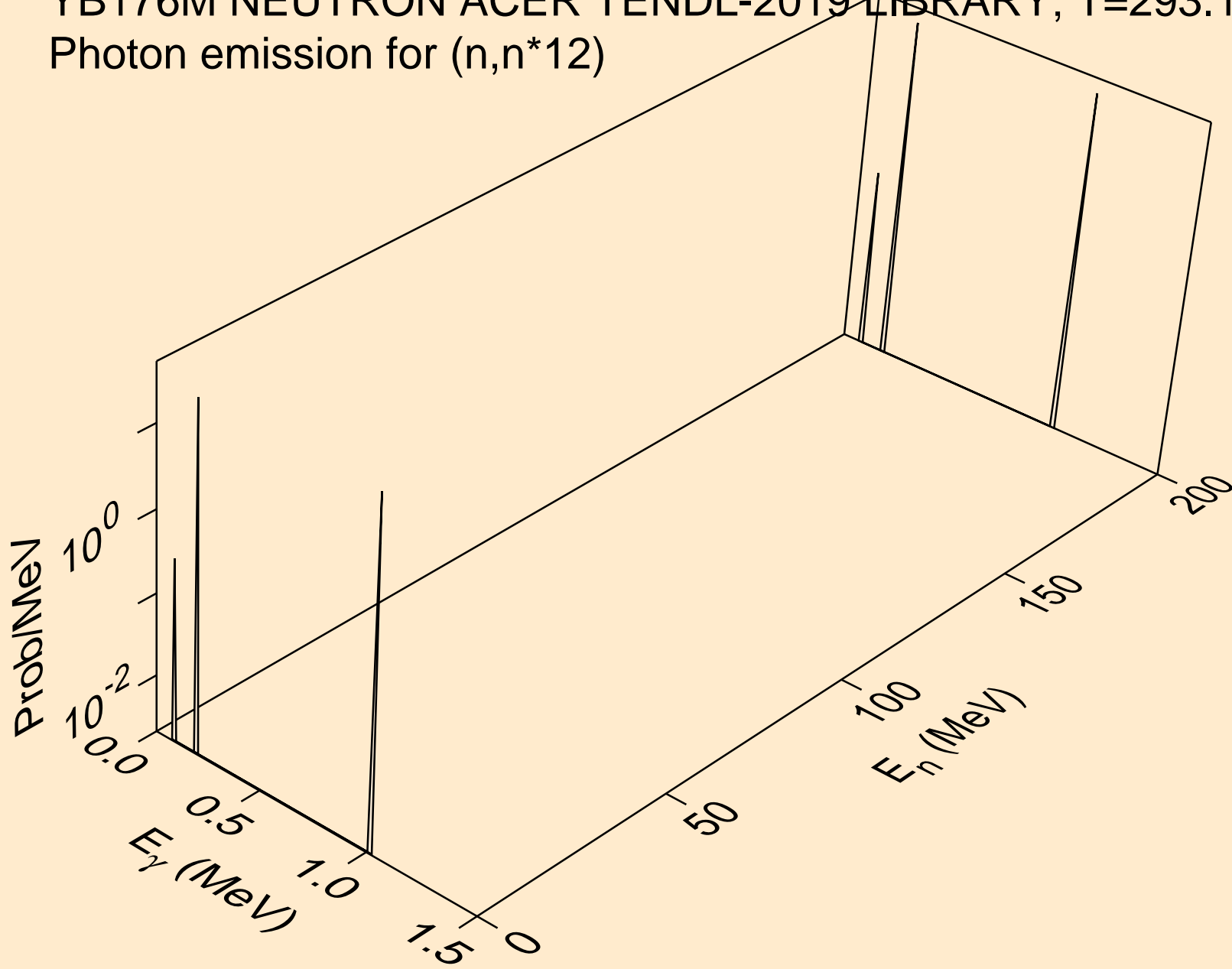

YB176M NEUTRON ACER TENDL-2019 LIBRARY; T=293.16K
Photon emission for (n,n*13)

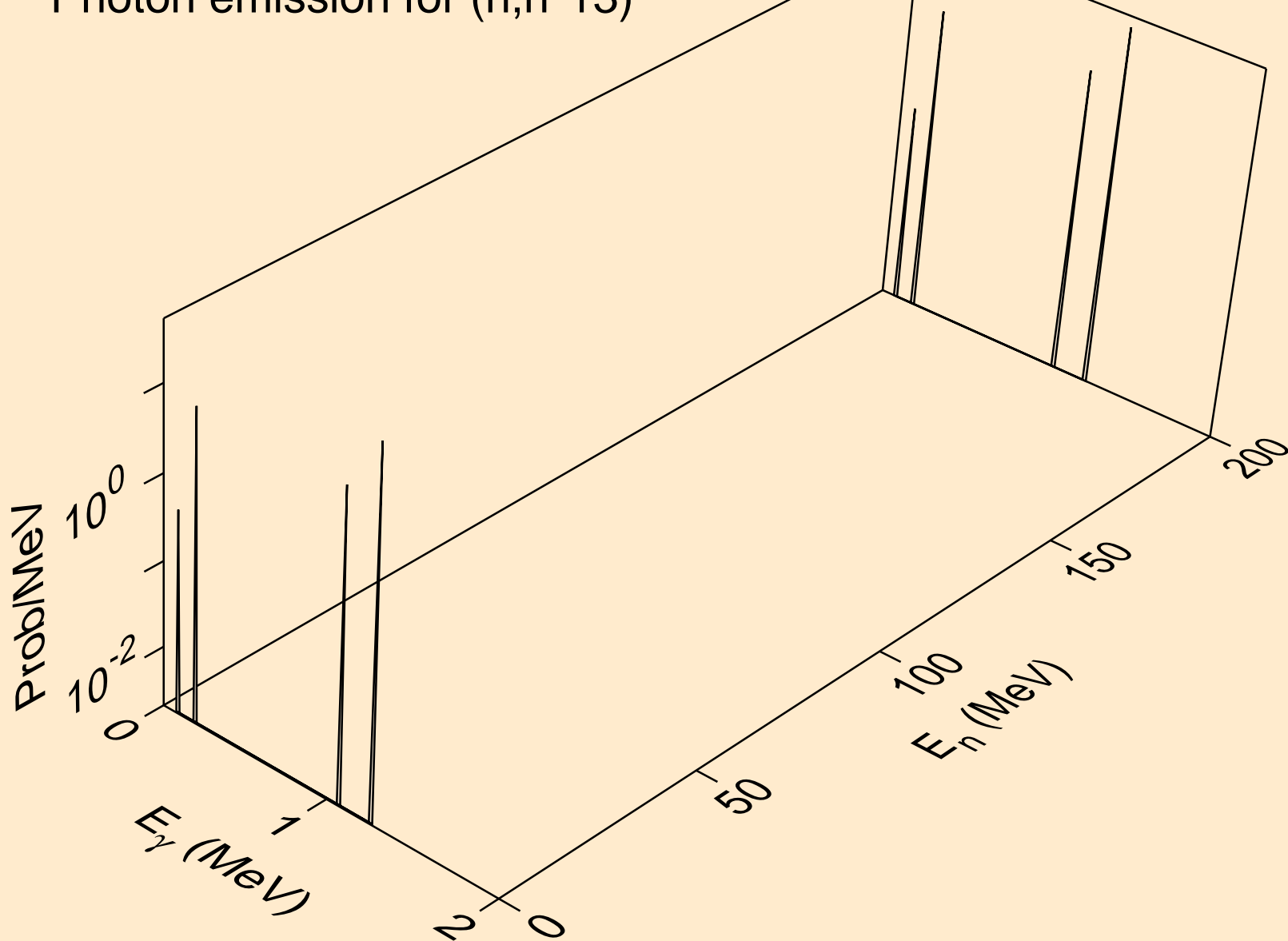

YB176M NEUTRON ACER TENDL-2019 LIBRARY; T=293.16K
Photon emission for (n,n*14)

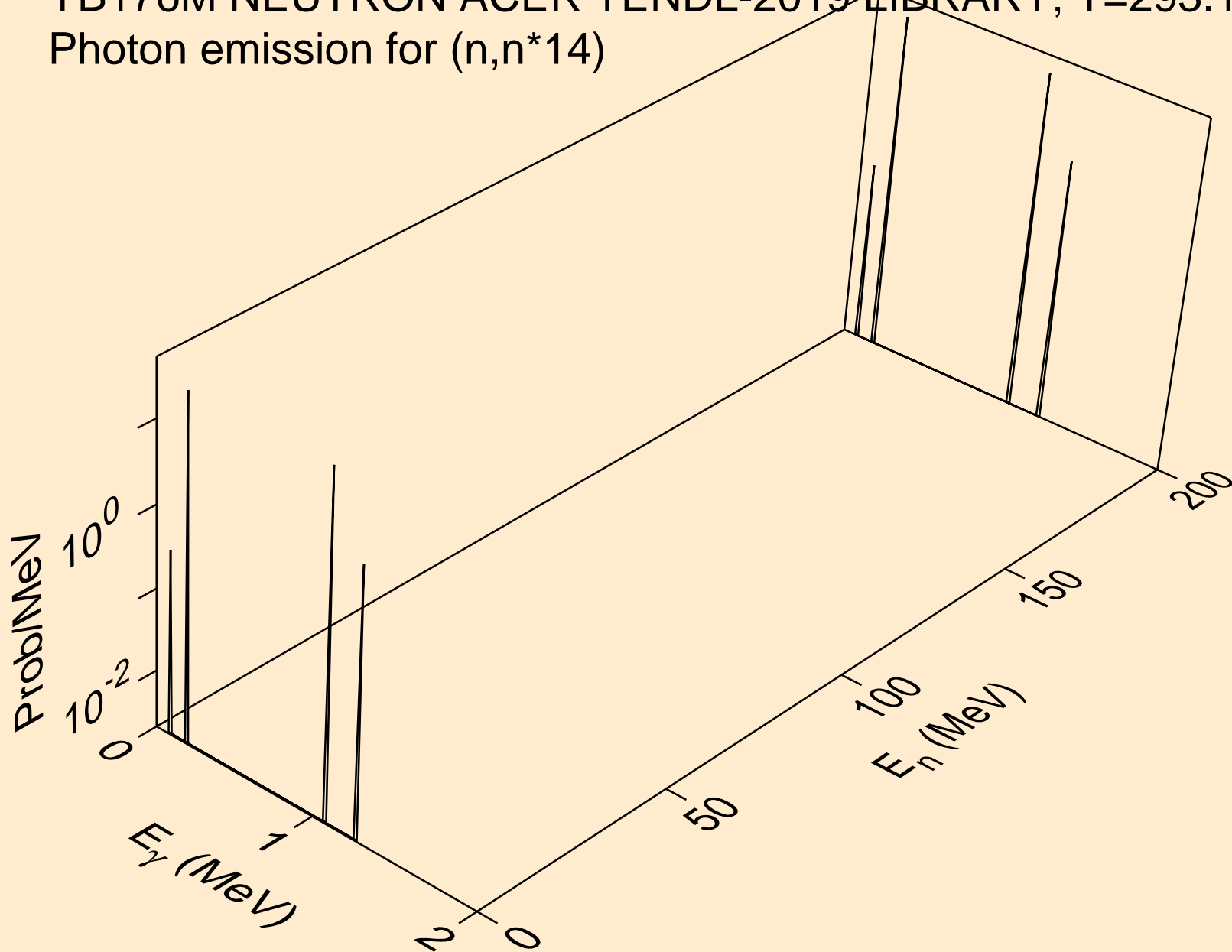

YB176M NEUTRON ACER TENDL-2019 LIBRARY; T=293.16K
Photon emission for (n,n*15)

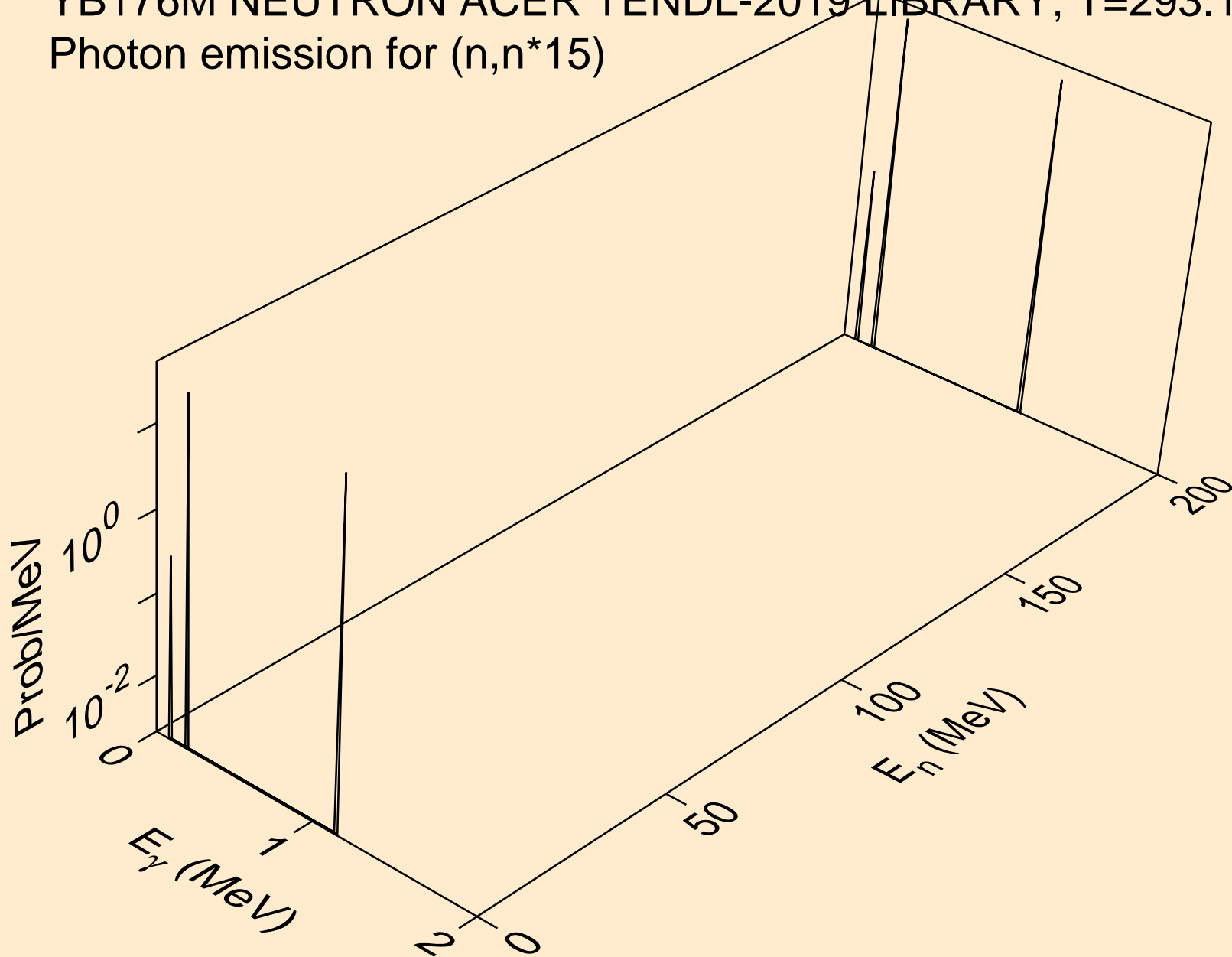

YB176M NEUTRON ACER TENDL-2019 LIBRARY; T=293.16K
Photon emission for (n,n*16)

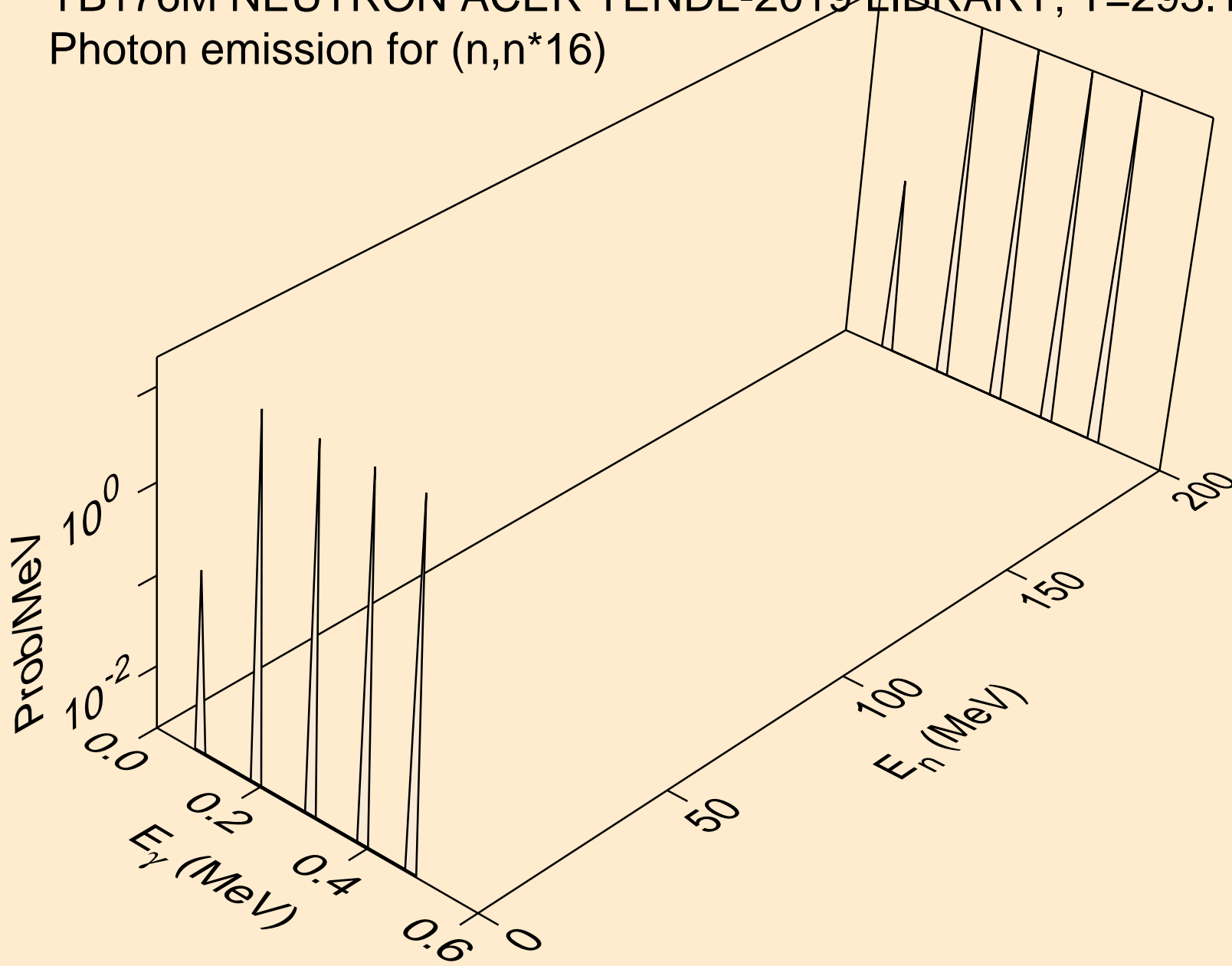

YB176M NEUTRON ACER TENDL-2019 LIBRARY; T=293.16K
Photon emission for (n,n*17)

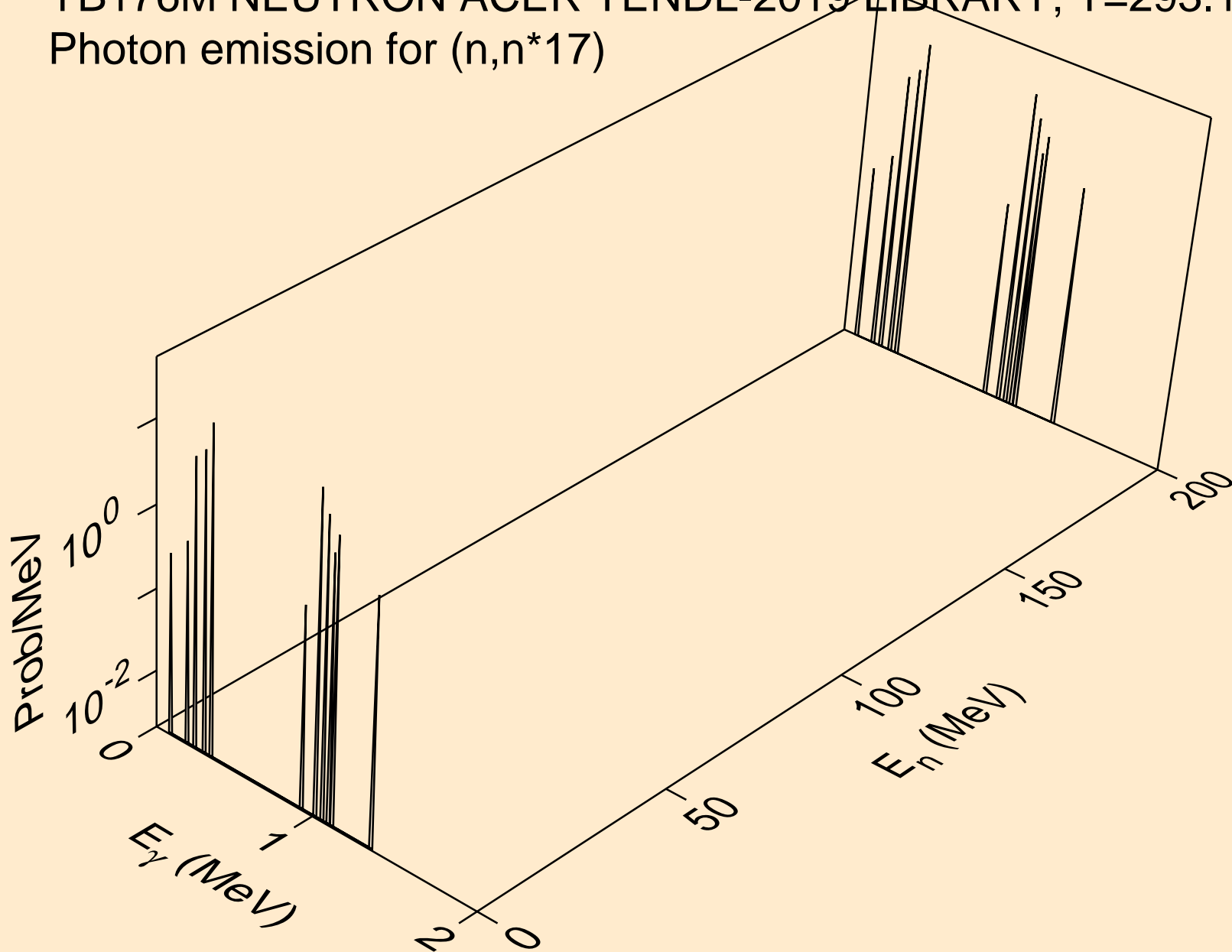

YB176M NEUTRON ACER TENDL-2019 LIBRARY; T=293.16K
Photon emission for (n,n*18)

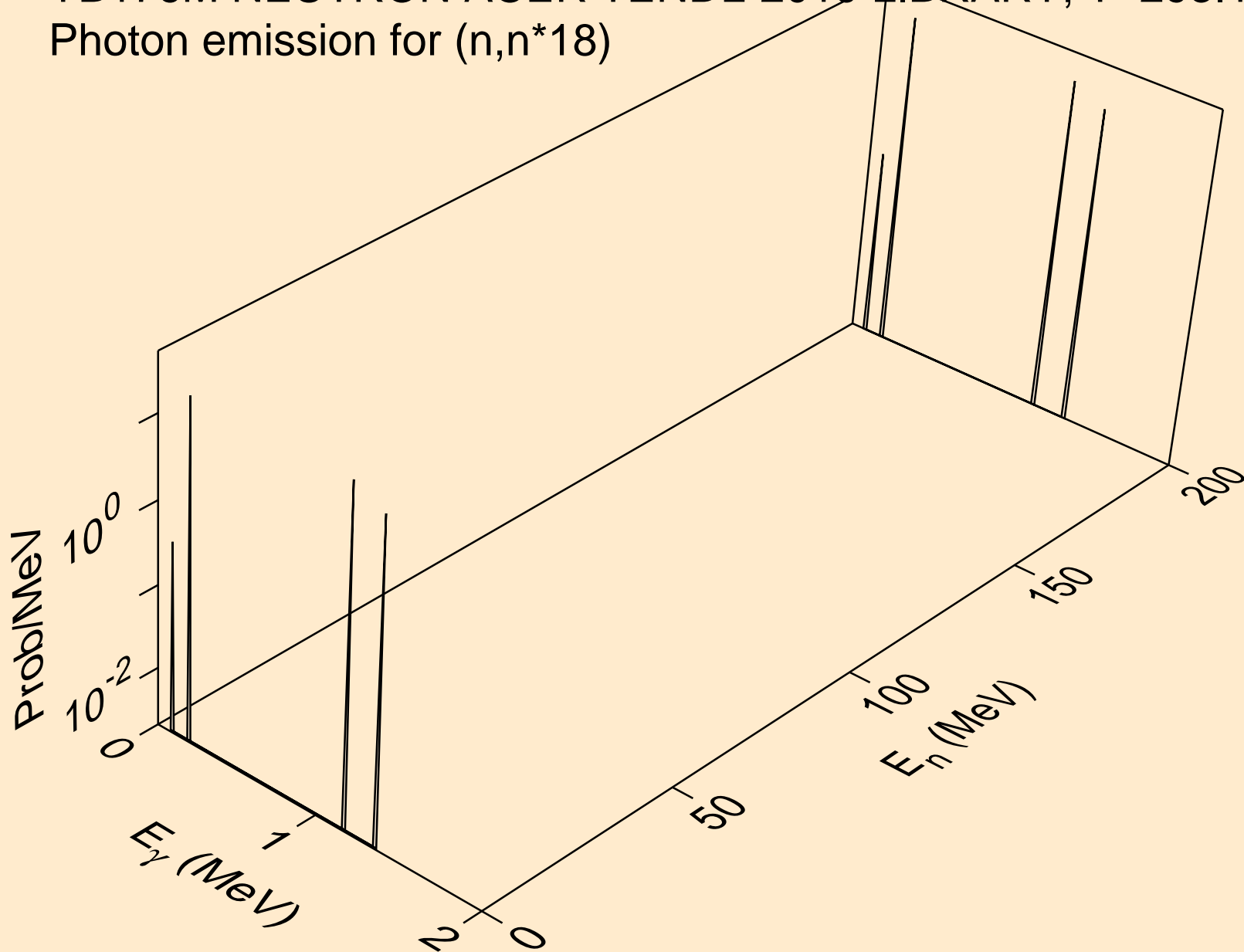

YB176M NEUTRON ACER TENDL-2019 LIBRARY; T=293.16K
Photon emission for (n,n*19)

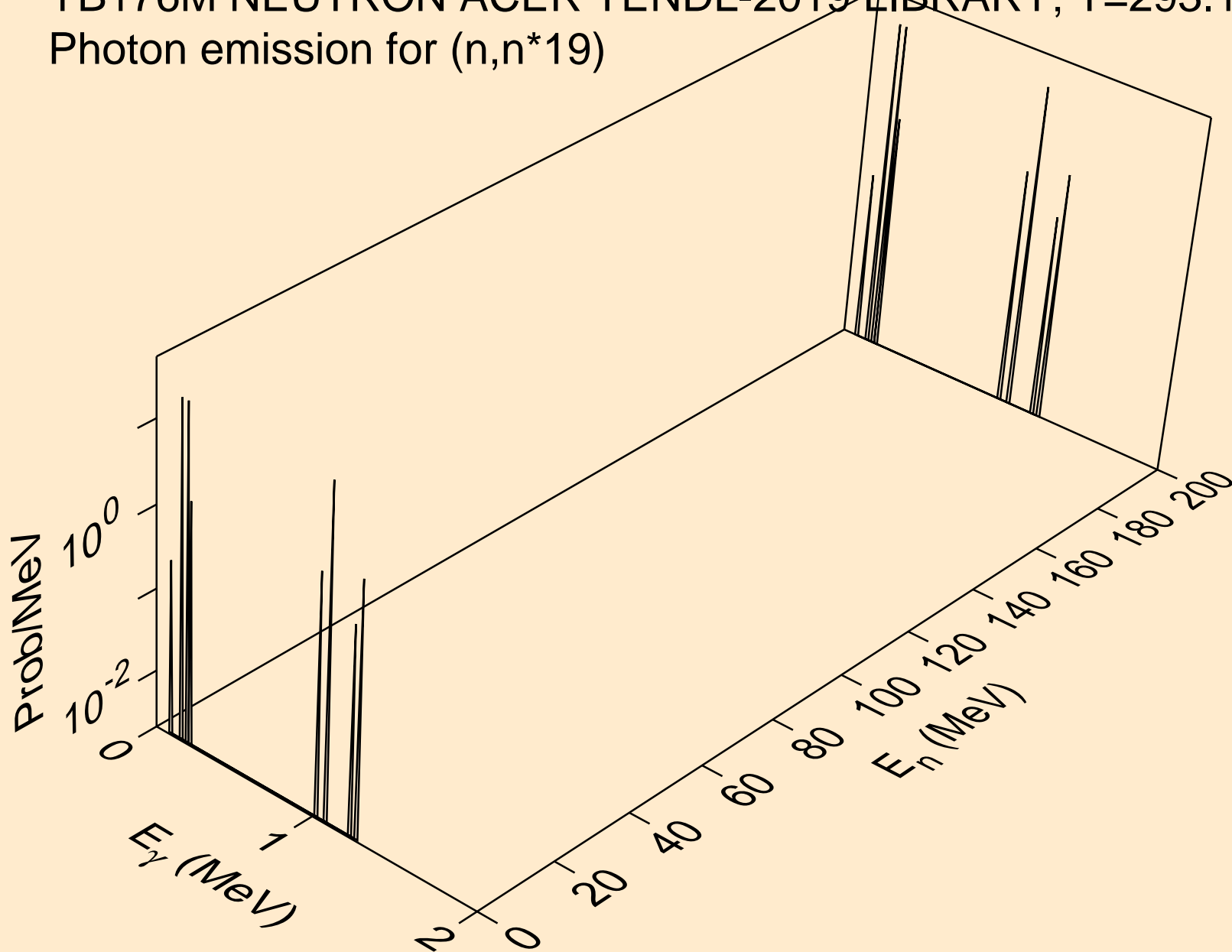

YB176M NEUTRON ACER TENDL-2019 LIBRARY; T=293.16K
Photon emission for (n,n*20)

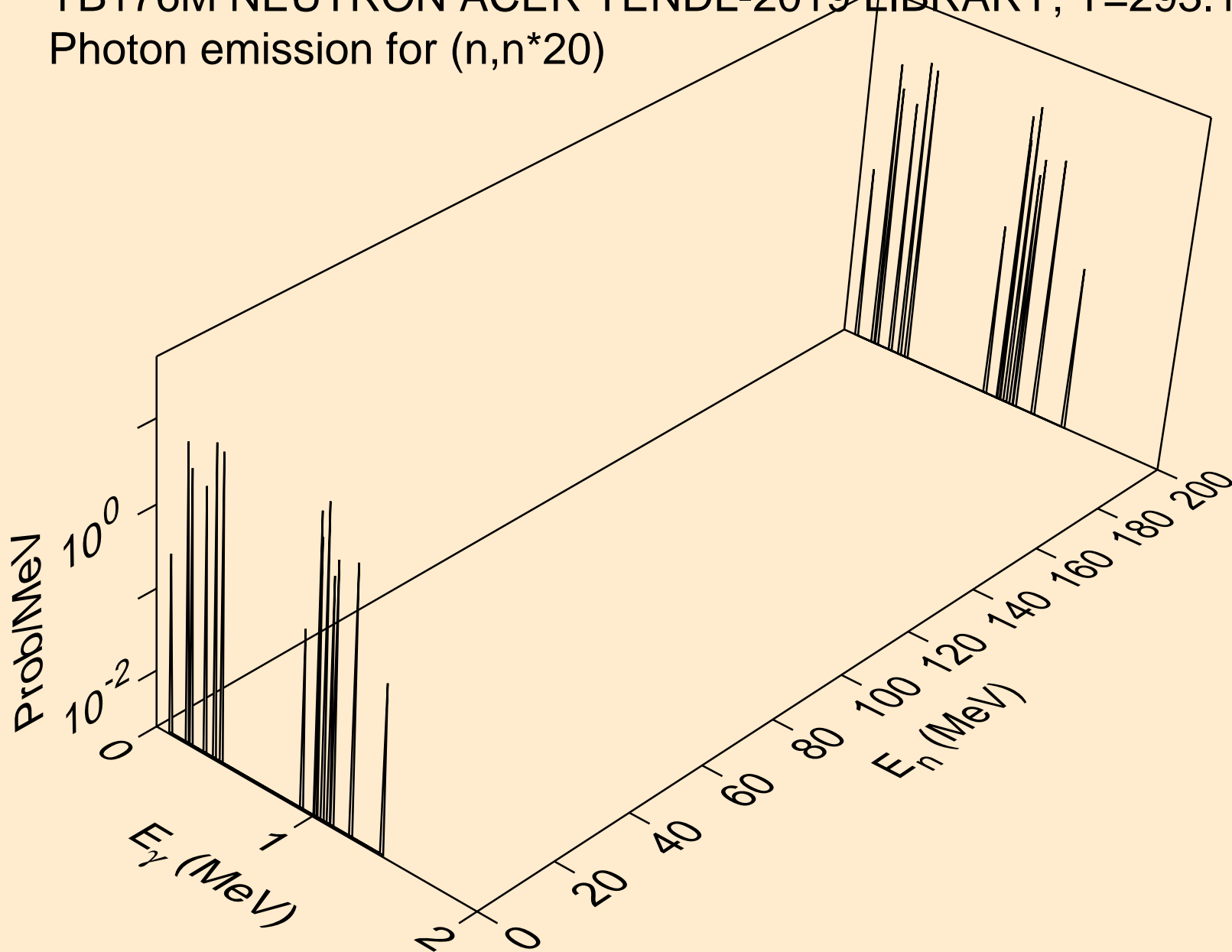

YB176M NEUTRON ACER TENDL-2019 LIBRARY; T=293.16K
Photon emission for (n,n*21)

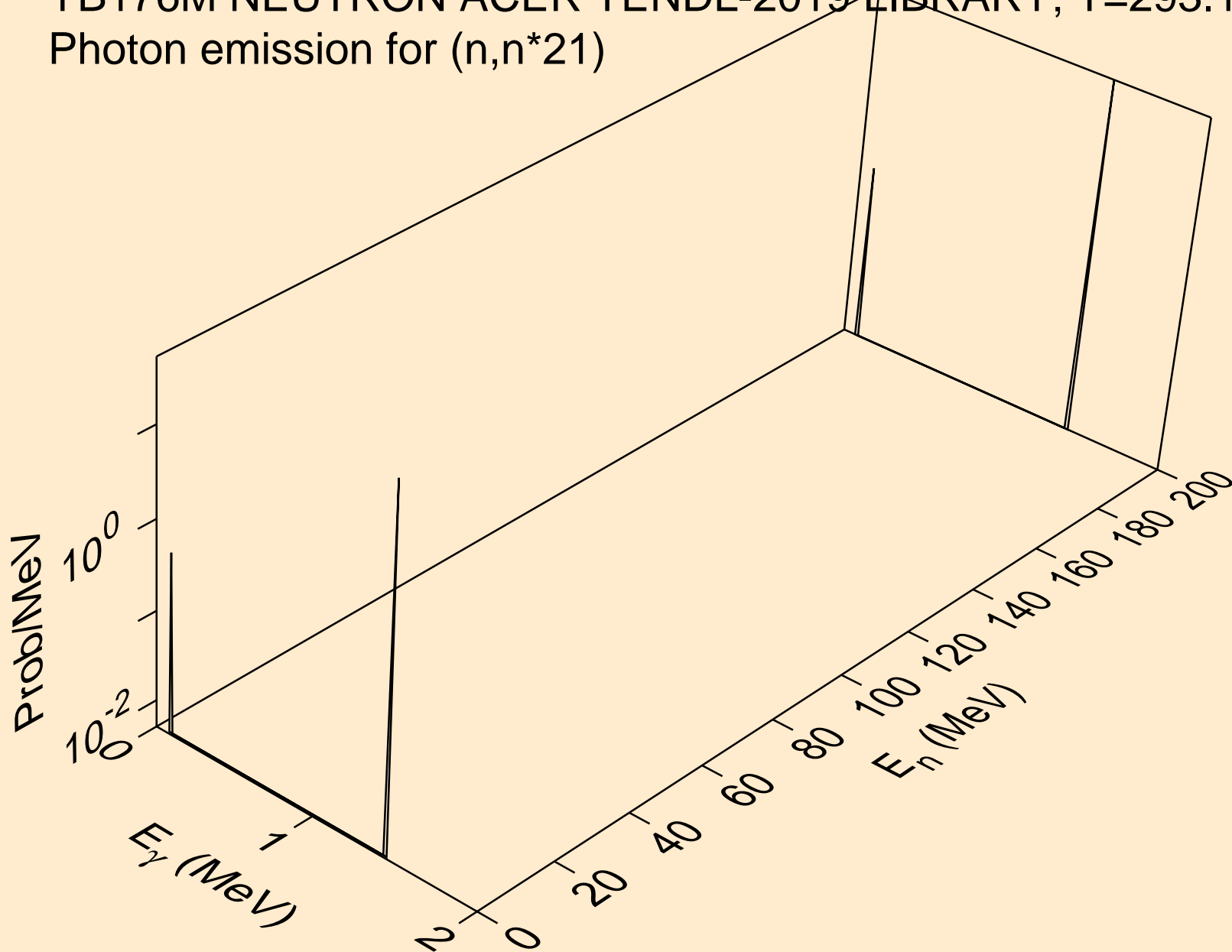

YB176M NEUTRON ACER TENDL-2019 LIBRARY; T=293.16K
Photon emission for (n,n*22)

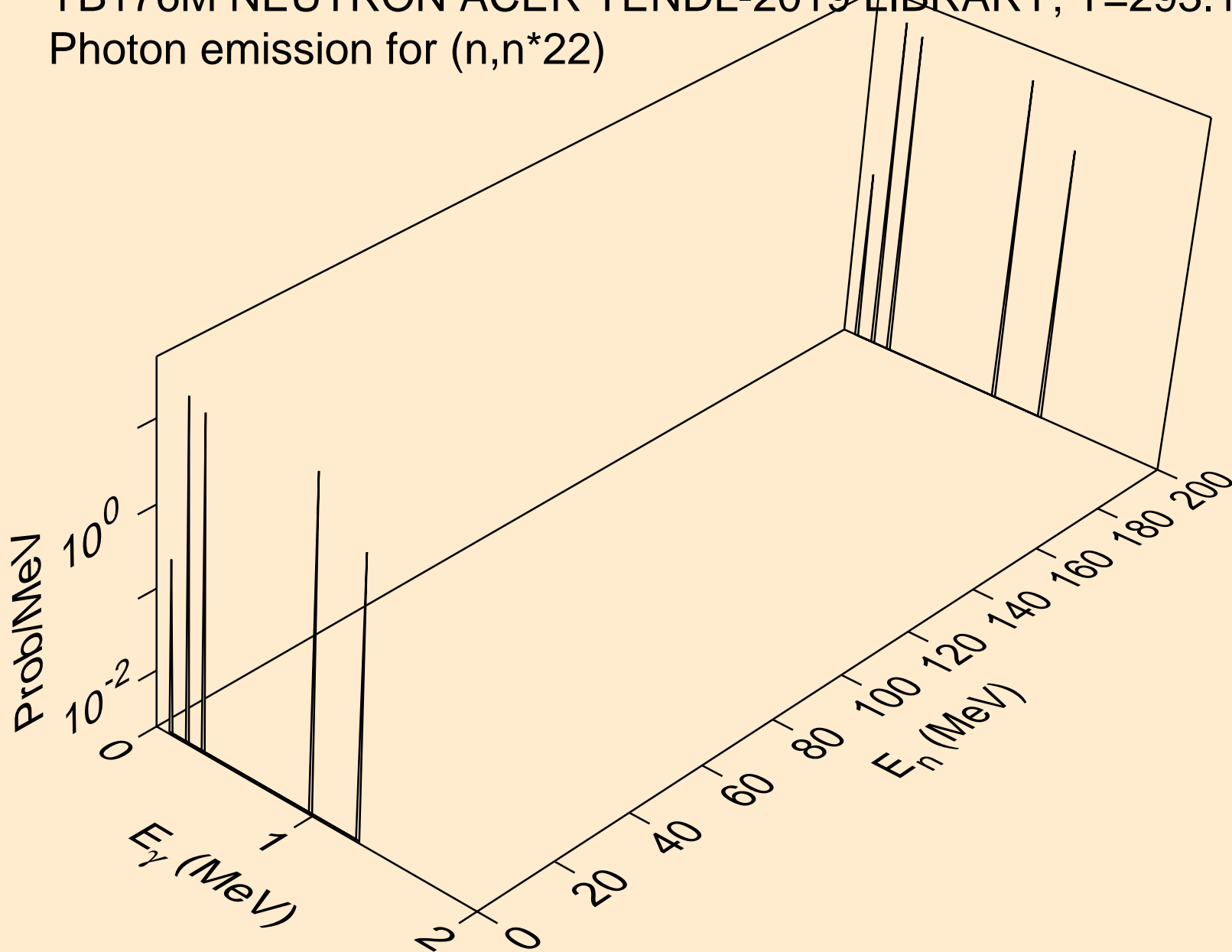

YB176M NEUTRON ACER TENDL-2019 LIBRARY; T=293.16K
Photon emission for (n,n*23)

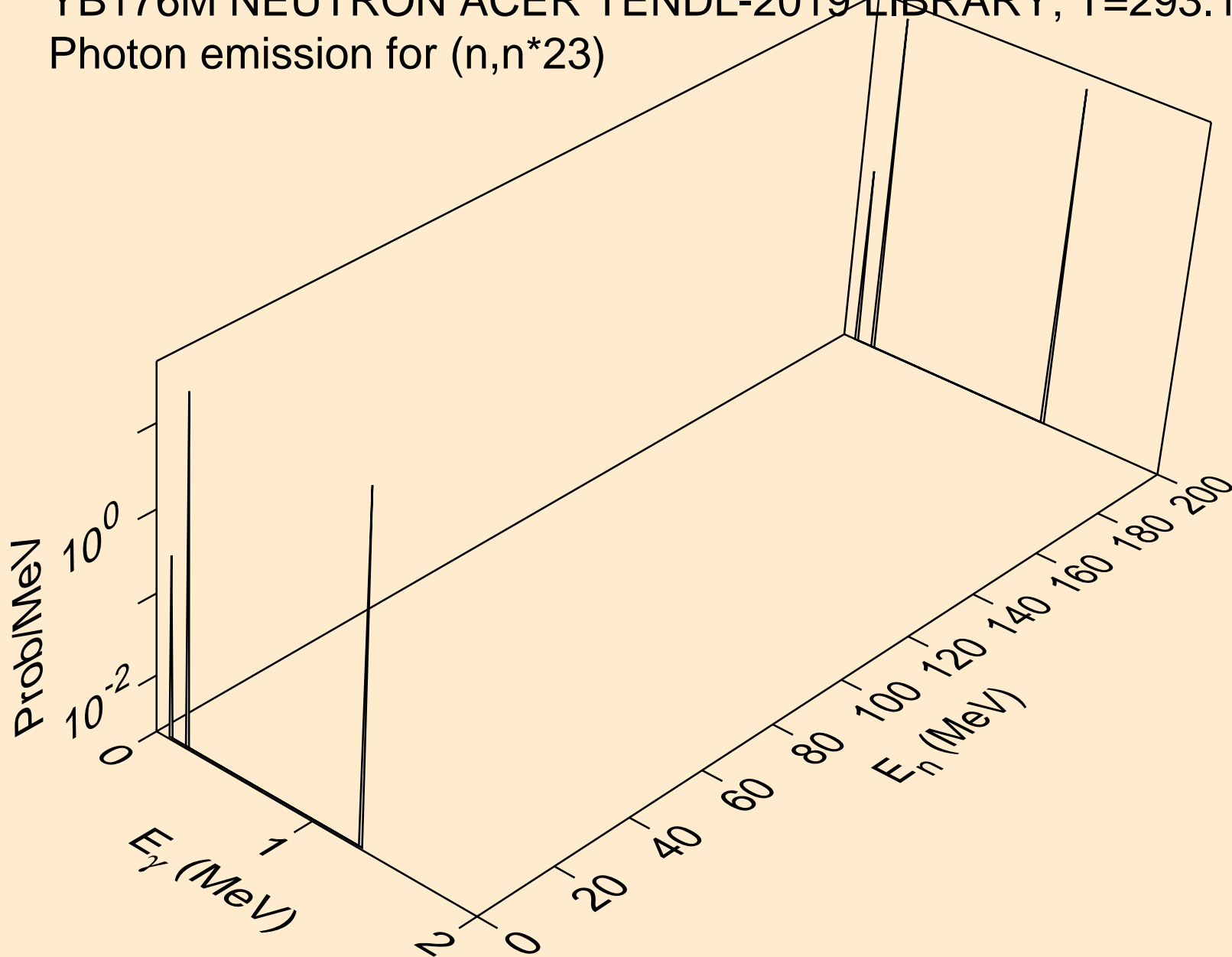

YB176M NEUTRON ACER TENDL-2019 LIBRARY; T=293.16K
Photon emission for (n,n*c)

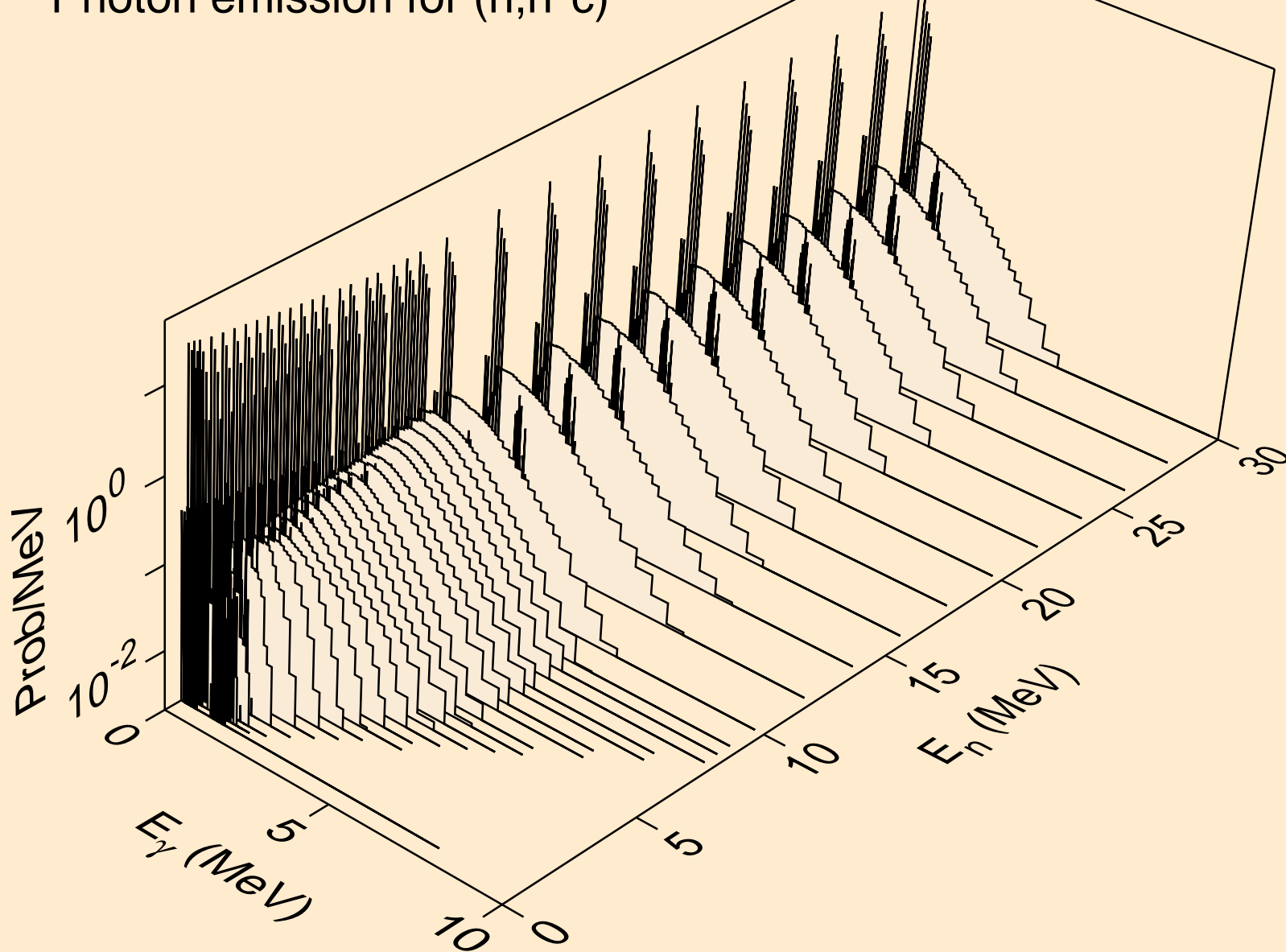

YB176M NEUTRON ACER TENDL-2019 LIBRARY; T=293.16K
Photon emission for (n,gma)

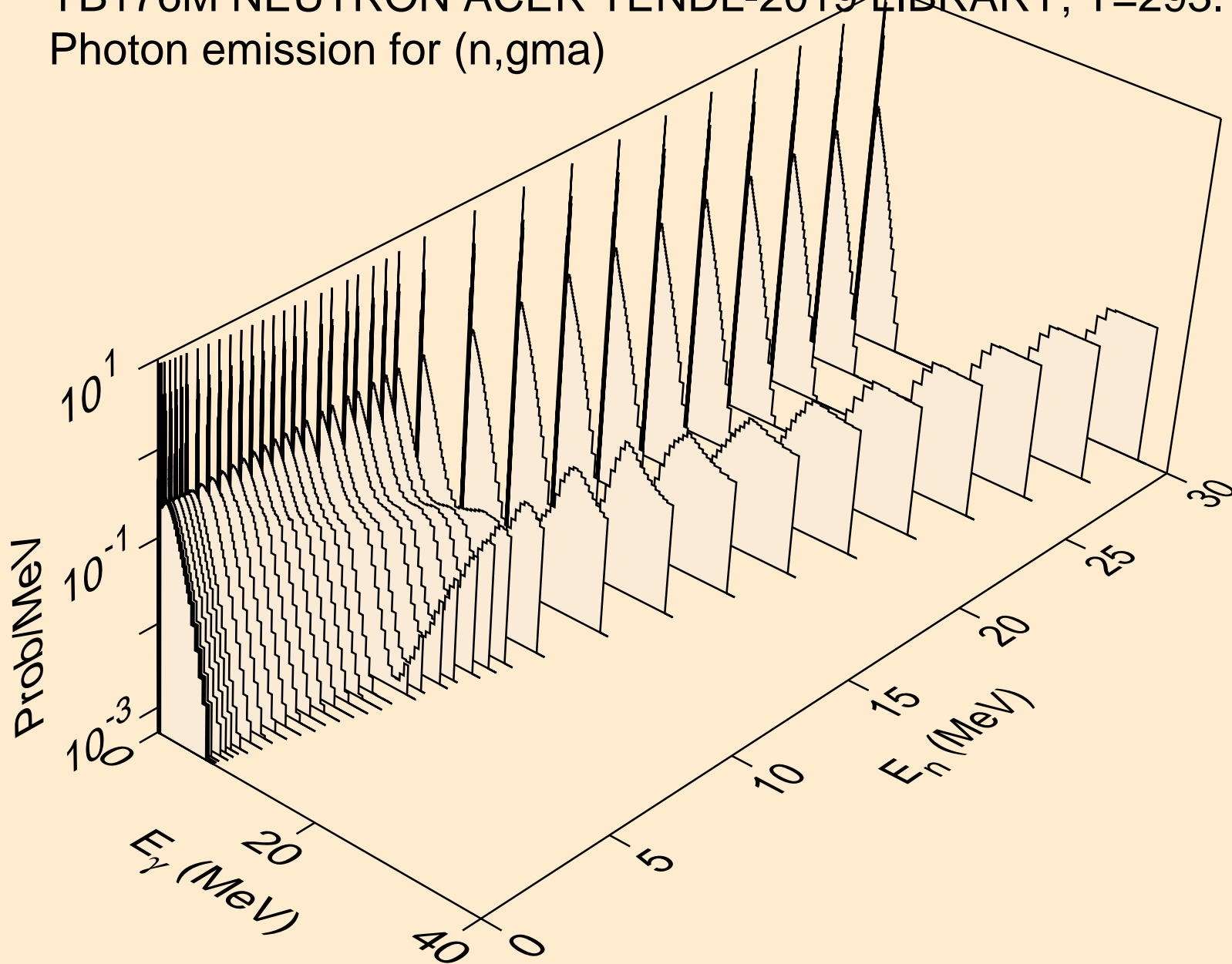

YB176M NEUTRON ACER TENDL-2019 LIBRARY; T=293.16K
Photon emission for (n,p)

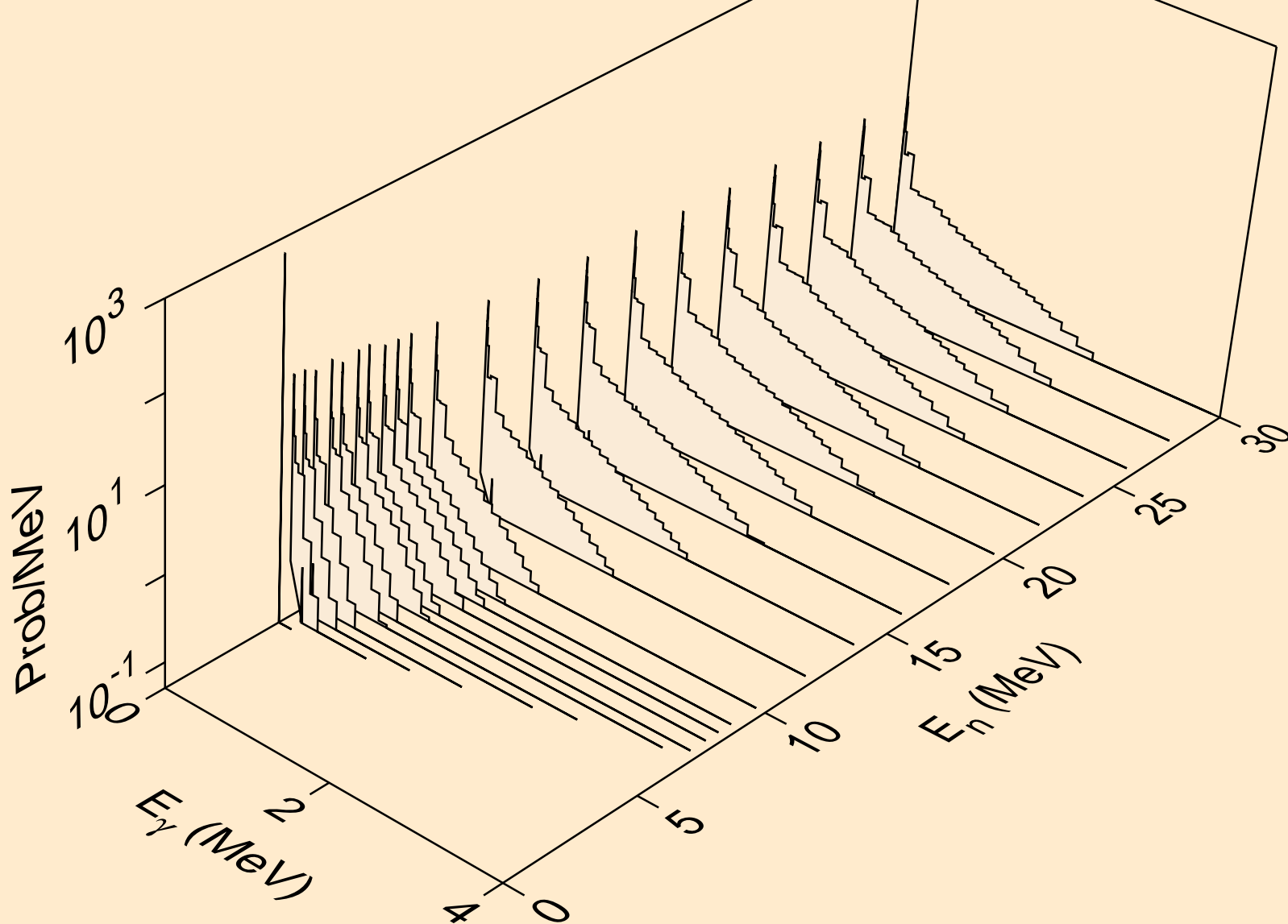

YB176M NEUTRON ACER TENDL-2019 LIBRARY; T=293.16K
Photon emission for (n,d)

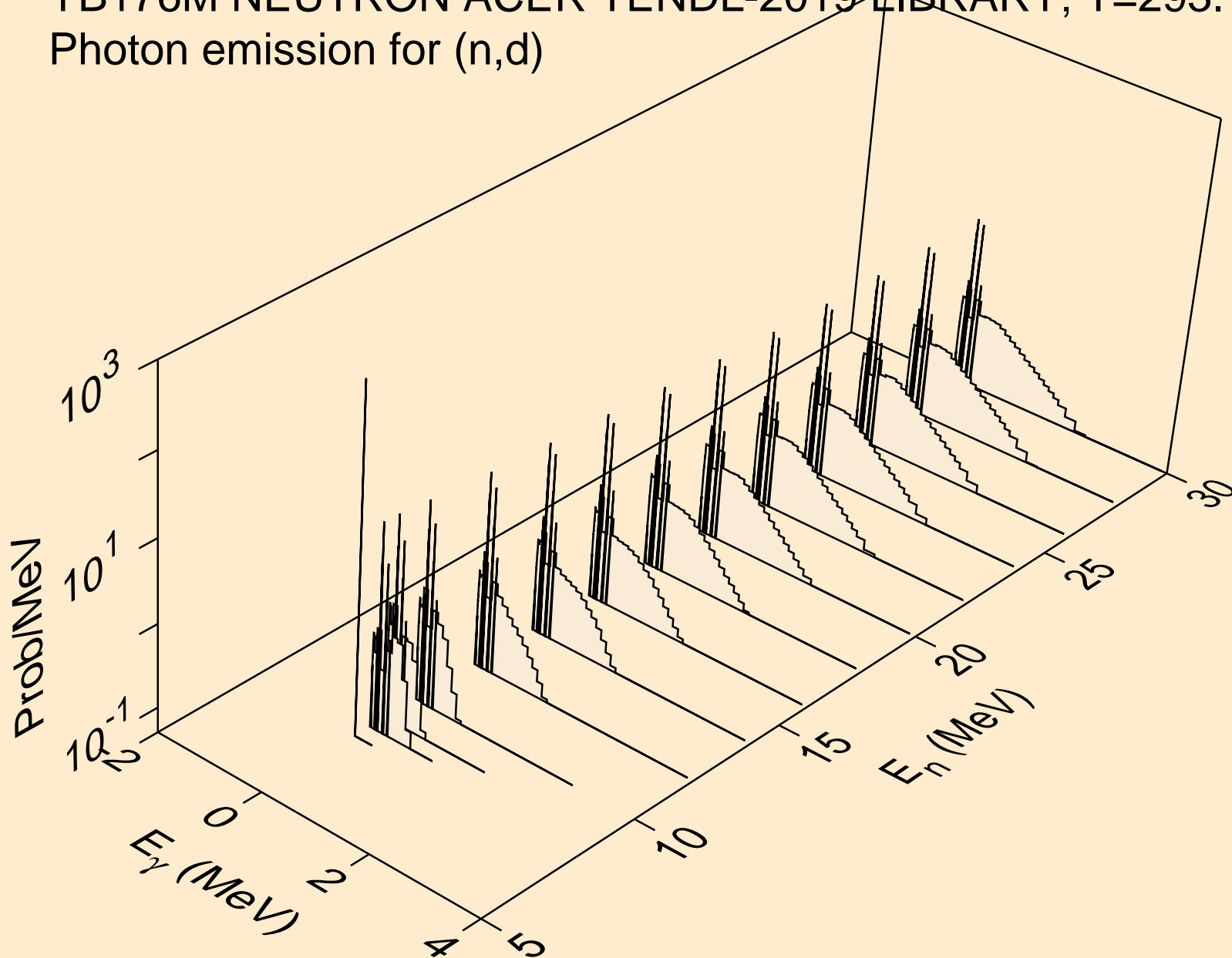

YB176M NEUTRON ACER TENDL-2019 LIBRARY; T=293.16K
Photon emission for (n,t)

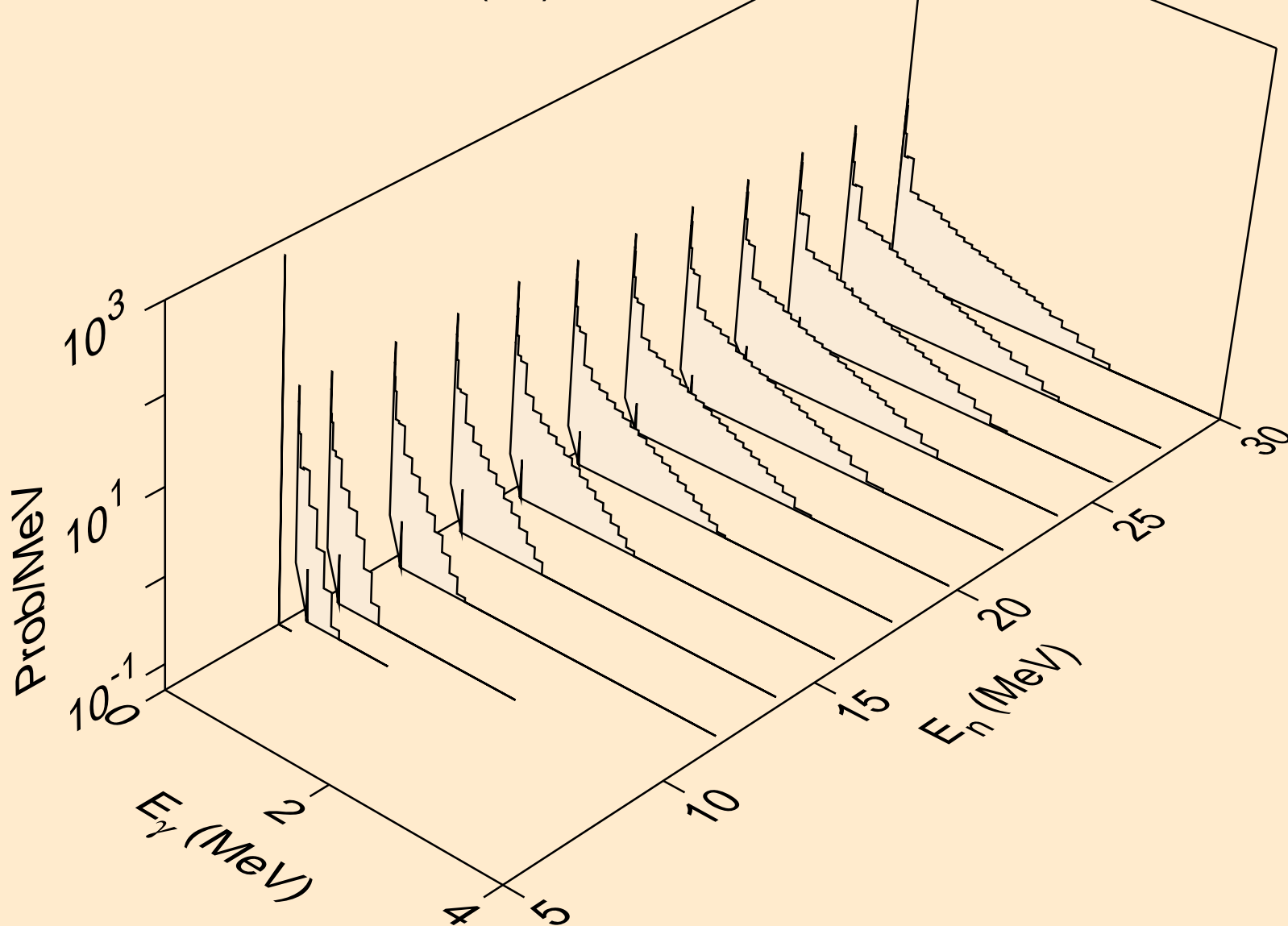

YB176M NEUTRON ACER TENDL-2019 LIBRARY; T=293.16K
Photon emission for (n,he3)

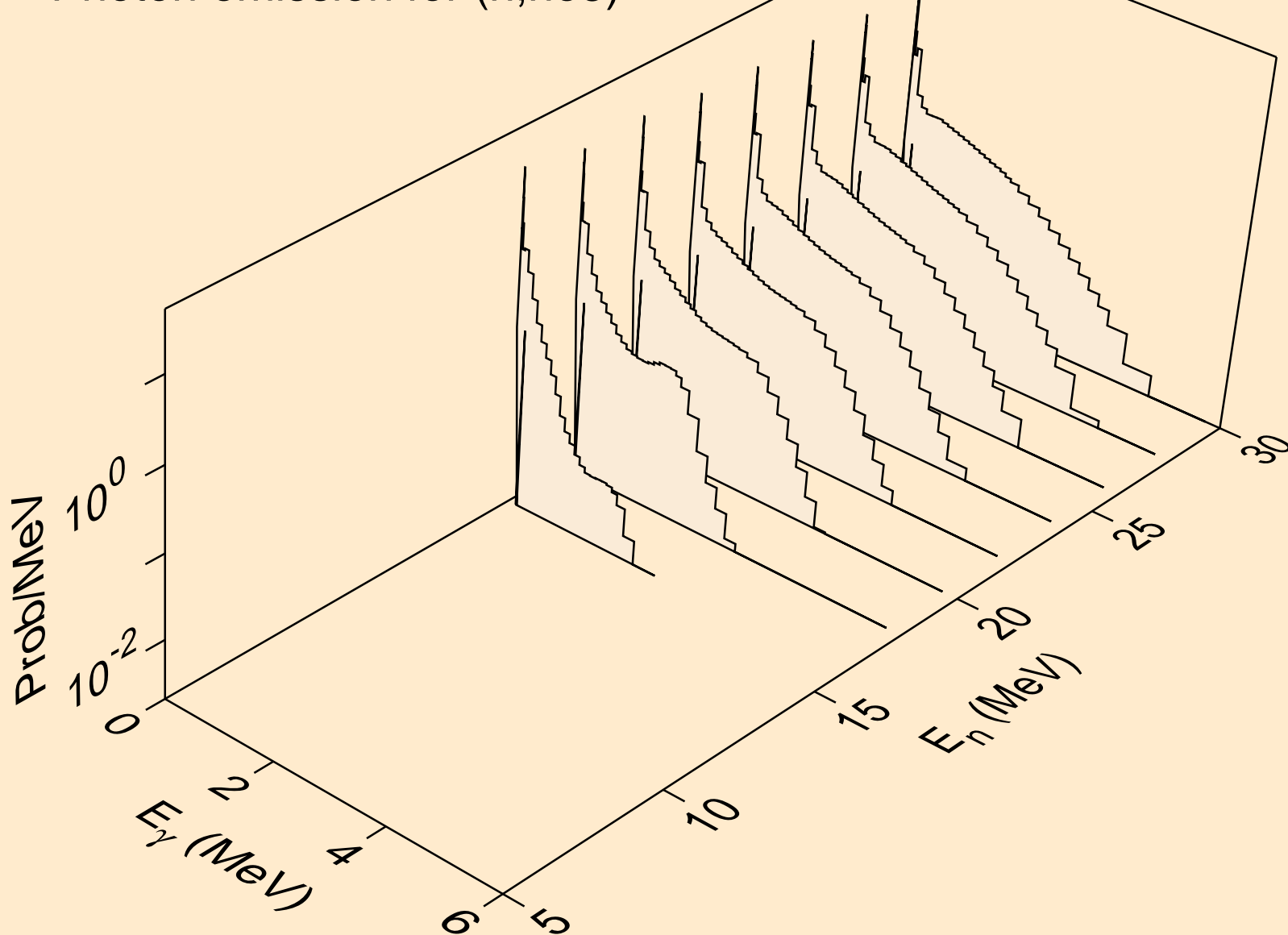

YB176M NEUTRON ACER TENDL-2019 LIBRARY; T=293.16K
Photon emission for (n,a)

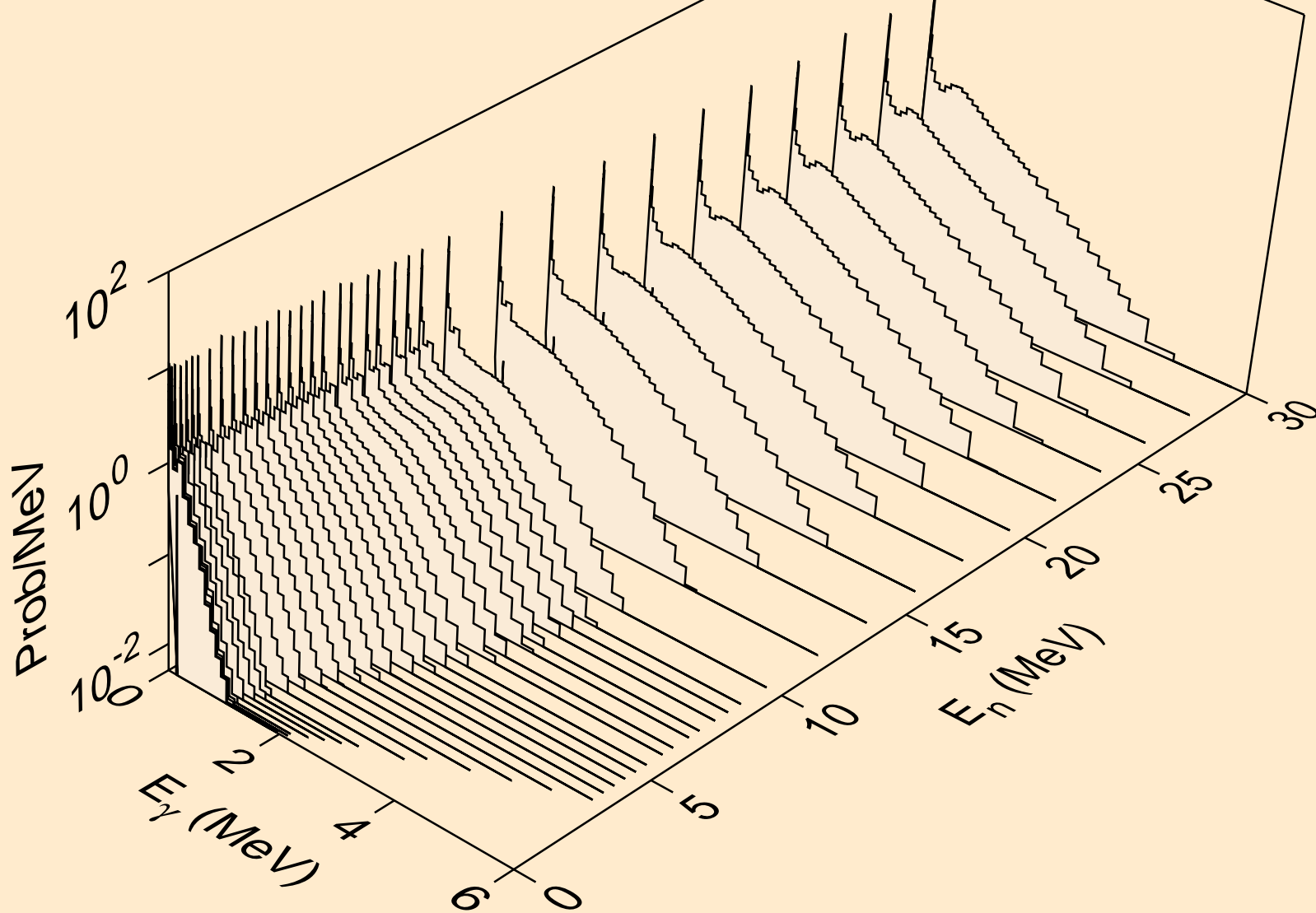

YB176M NEUTRON ACER TENDL-2019 LIBRARY; T=293.16K
Photon emission for (n,2p)

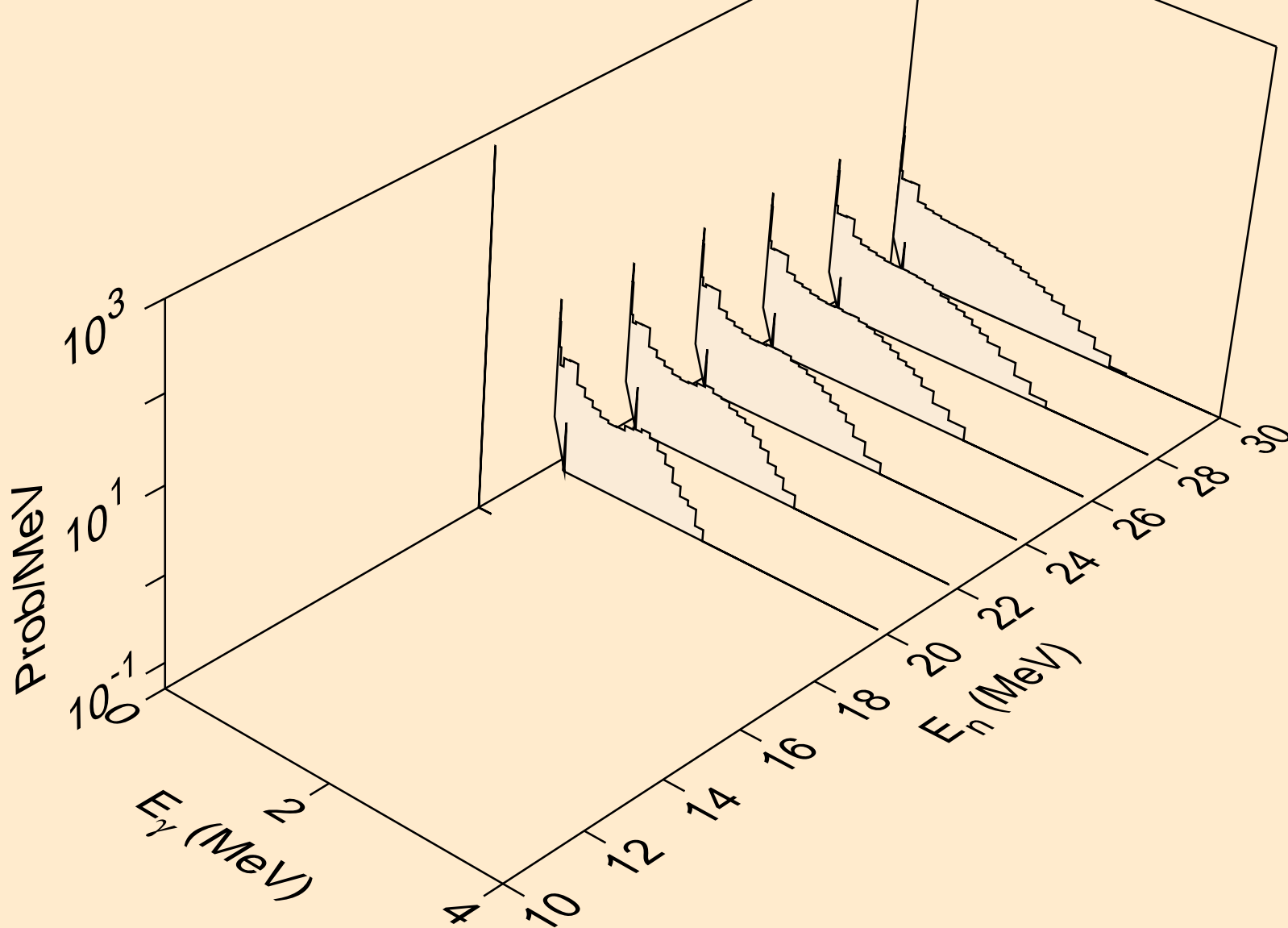

YB176M NEUTRON ACER TENDL-2019 LIBRARY; T=293.16K
thermal capture photon spectrum

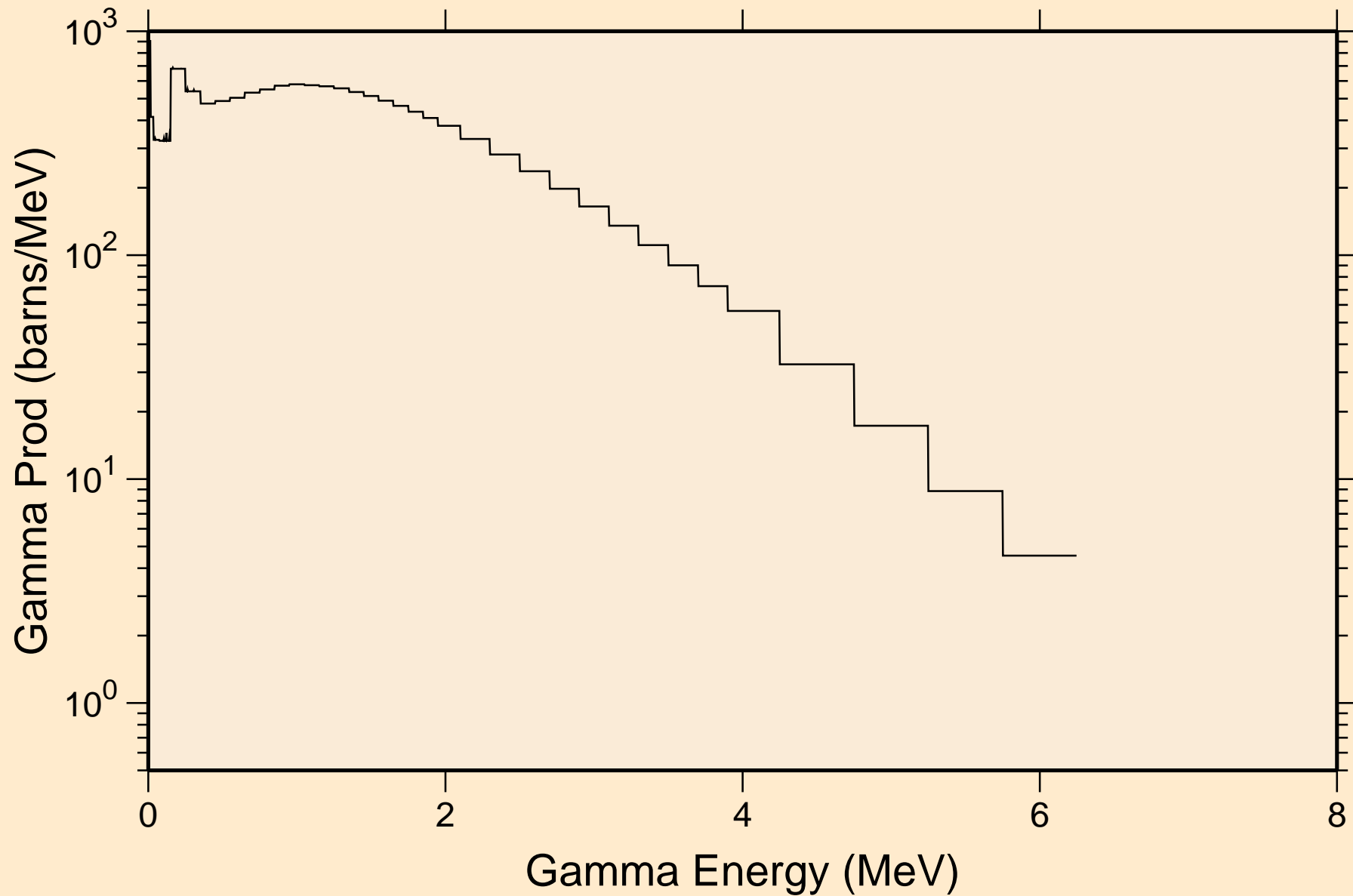

YB176M NEUTRON ACER TENDL-2019 LIBRARY; T=293.16K
14 MeV photon spectrum

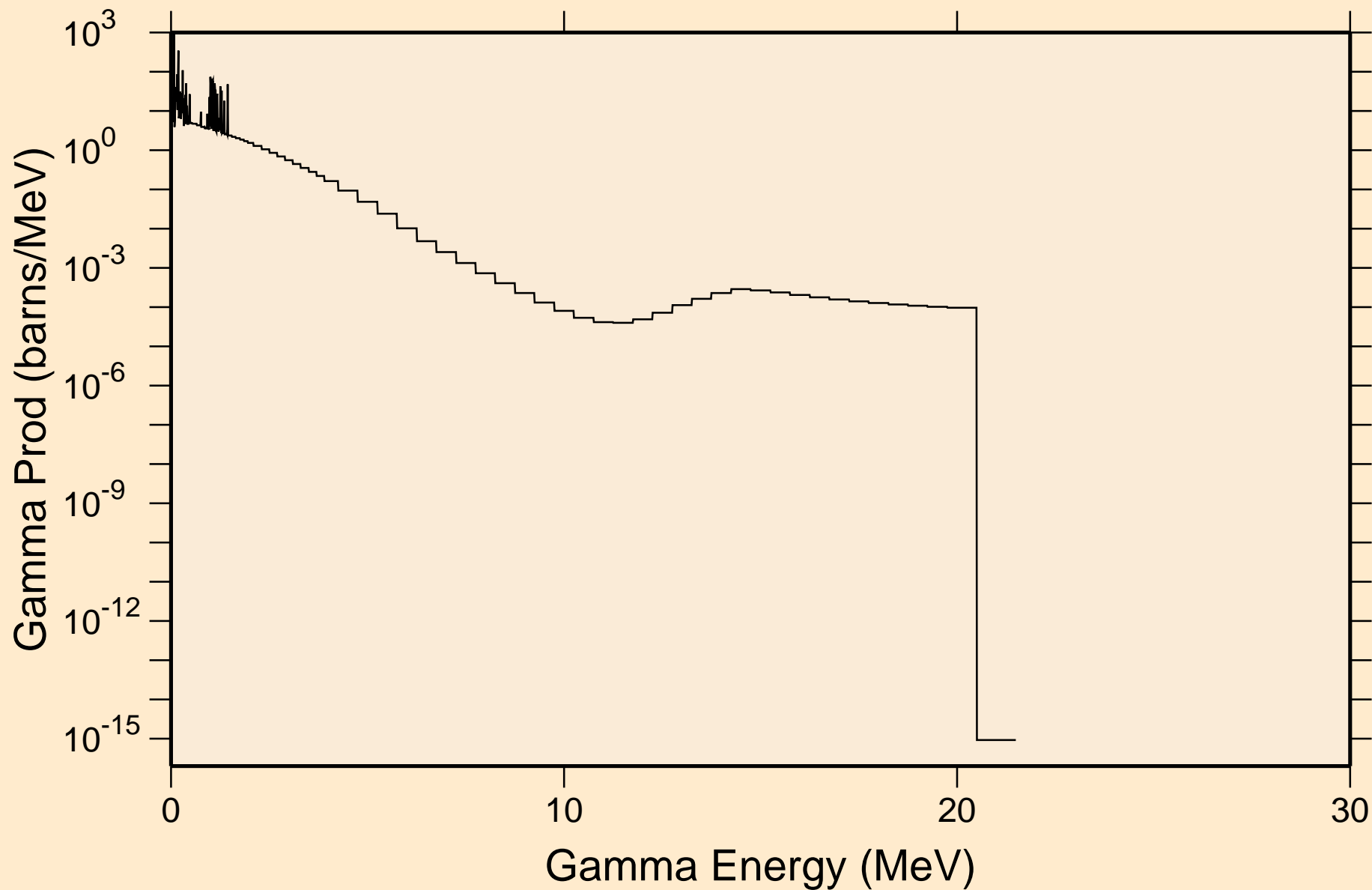

YB176M NEUTRON ACER TENDL-2019 LIBRARY; T=293.16K

Particle heating contributions

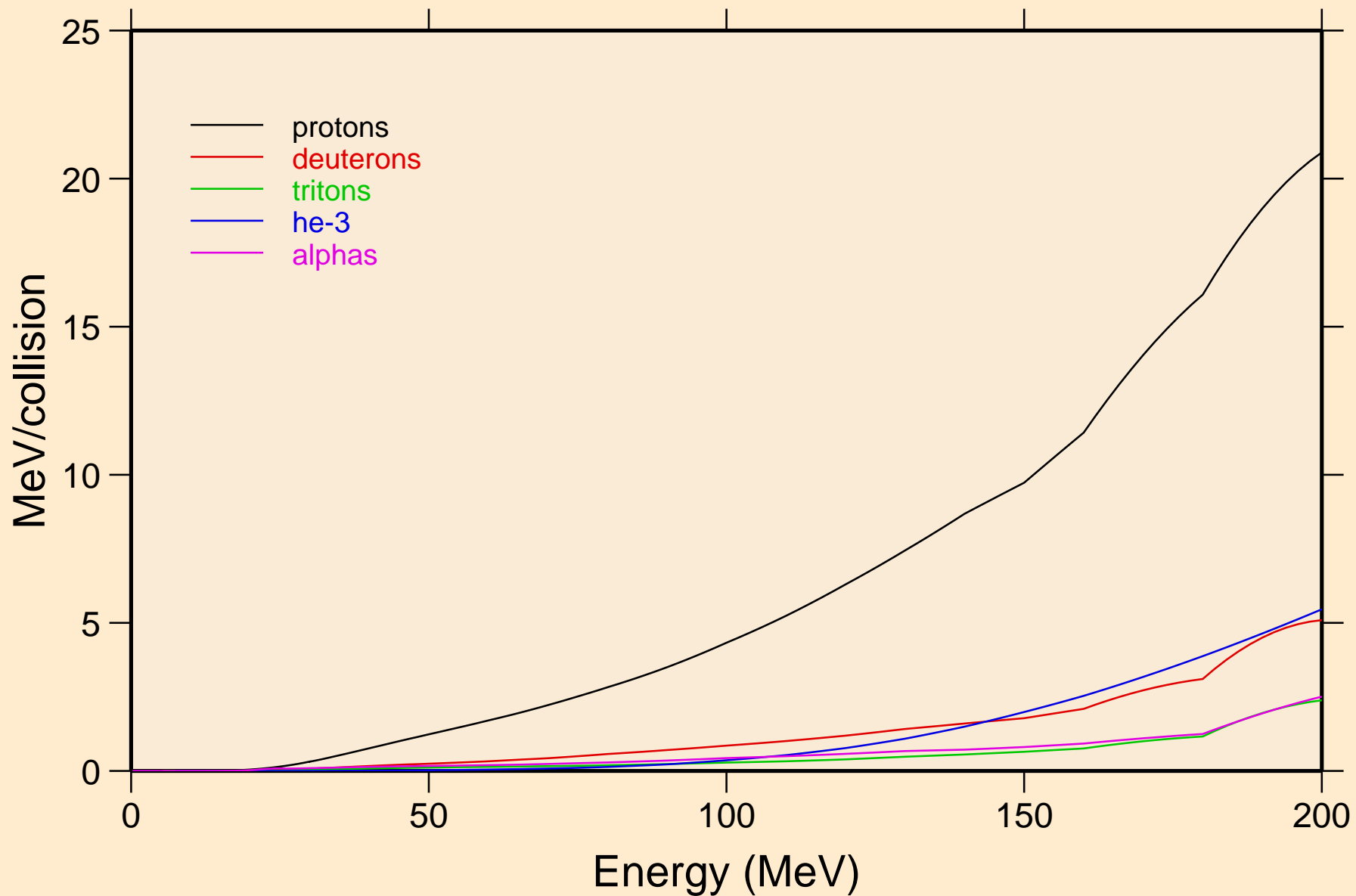

YB176M NEUTRON ACER TENDL-2019 LIBRARY; T=293.16K
Recoil Heating

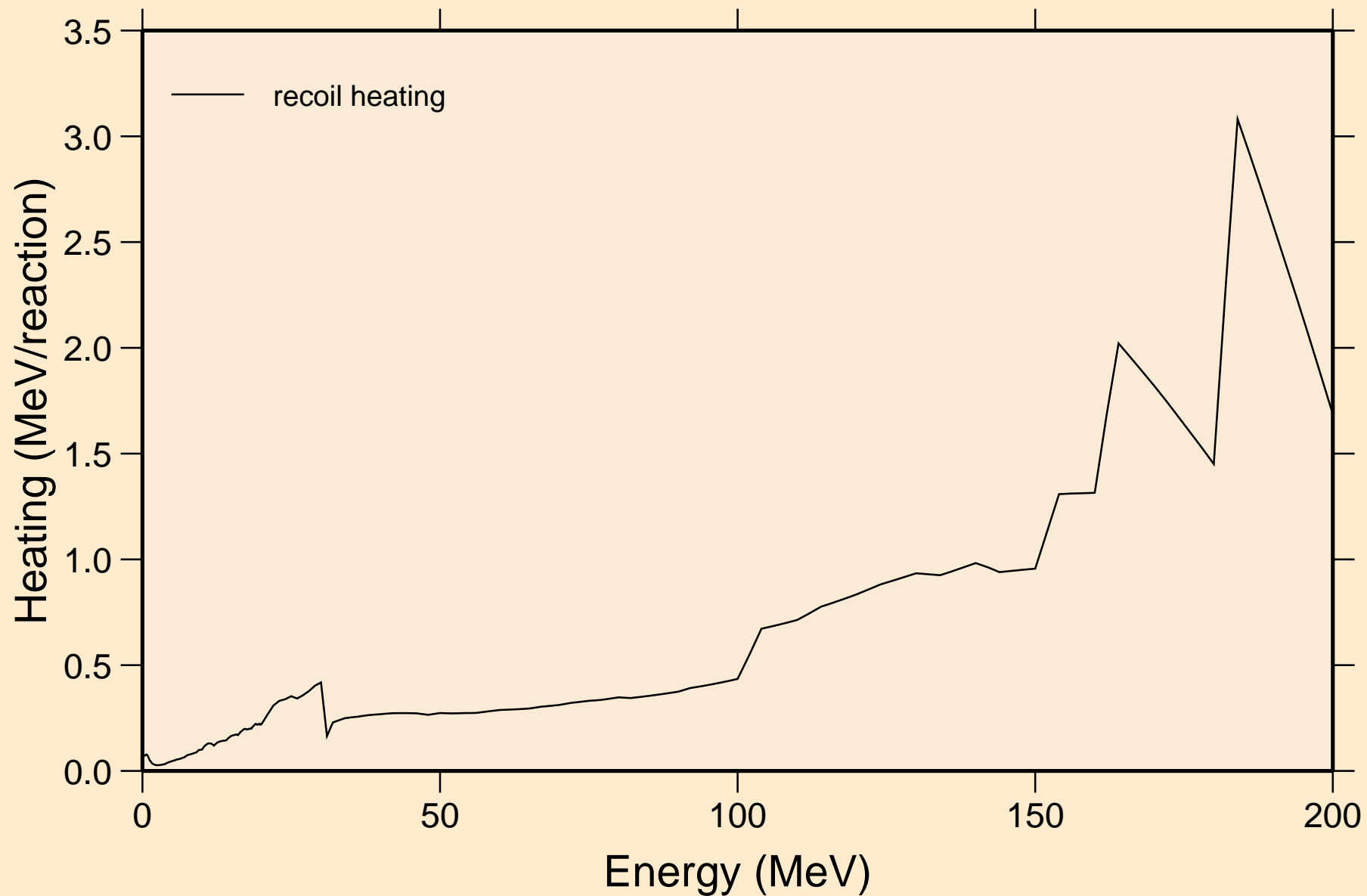

YB176M NEUTRON ACER TENDL-2019 LIBRARY; T=293.16K
Particle production cross sections

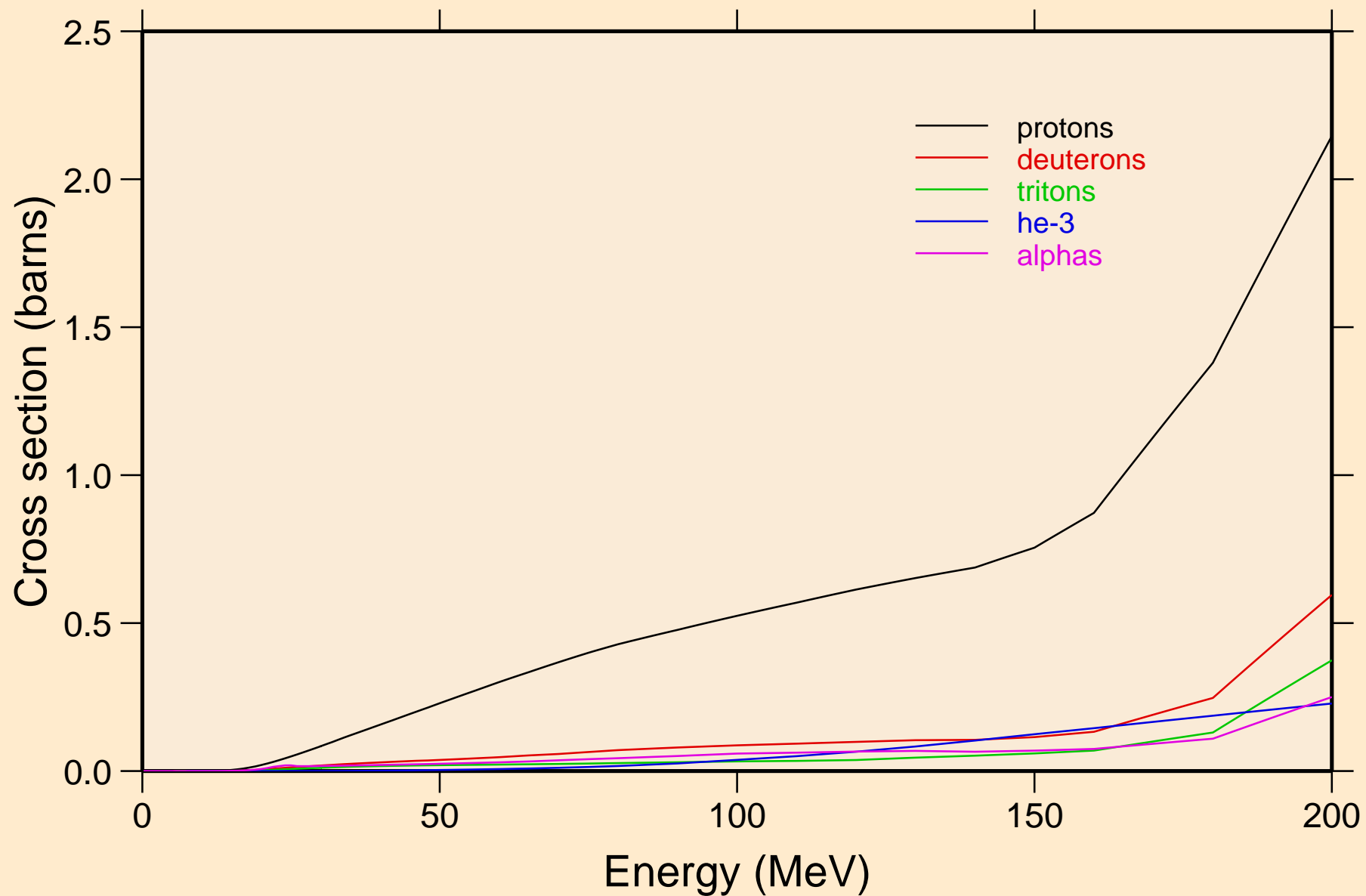

YB176M NEUTRON ACER TENDL-2019 LIBRARY; T=293.16K
protons from (n,x)

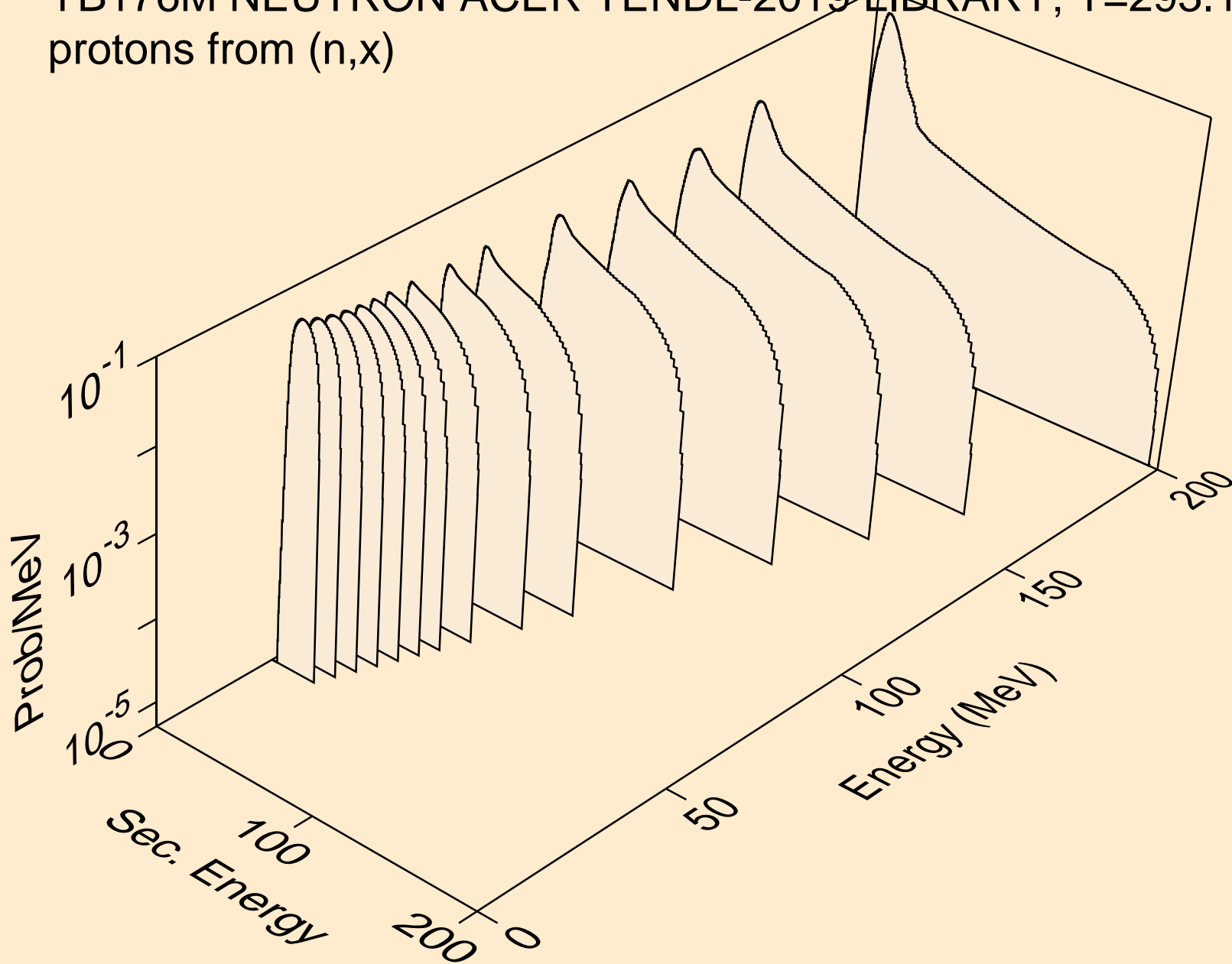

YB176M NEUTRON ACER TENDL-2019 LIBRARY; T=293.16K
protons from (n,n*)p

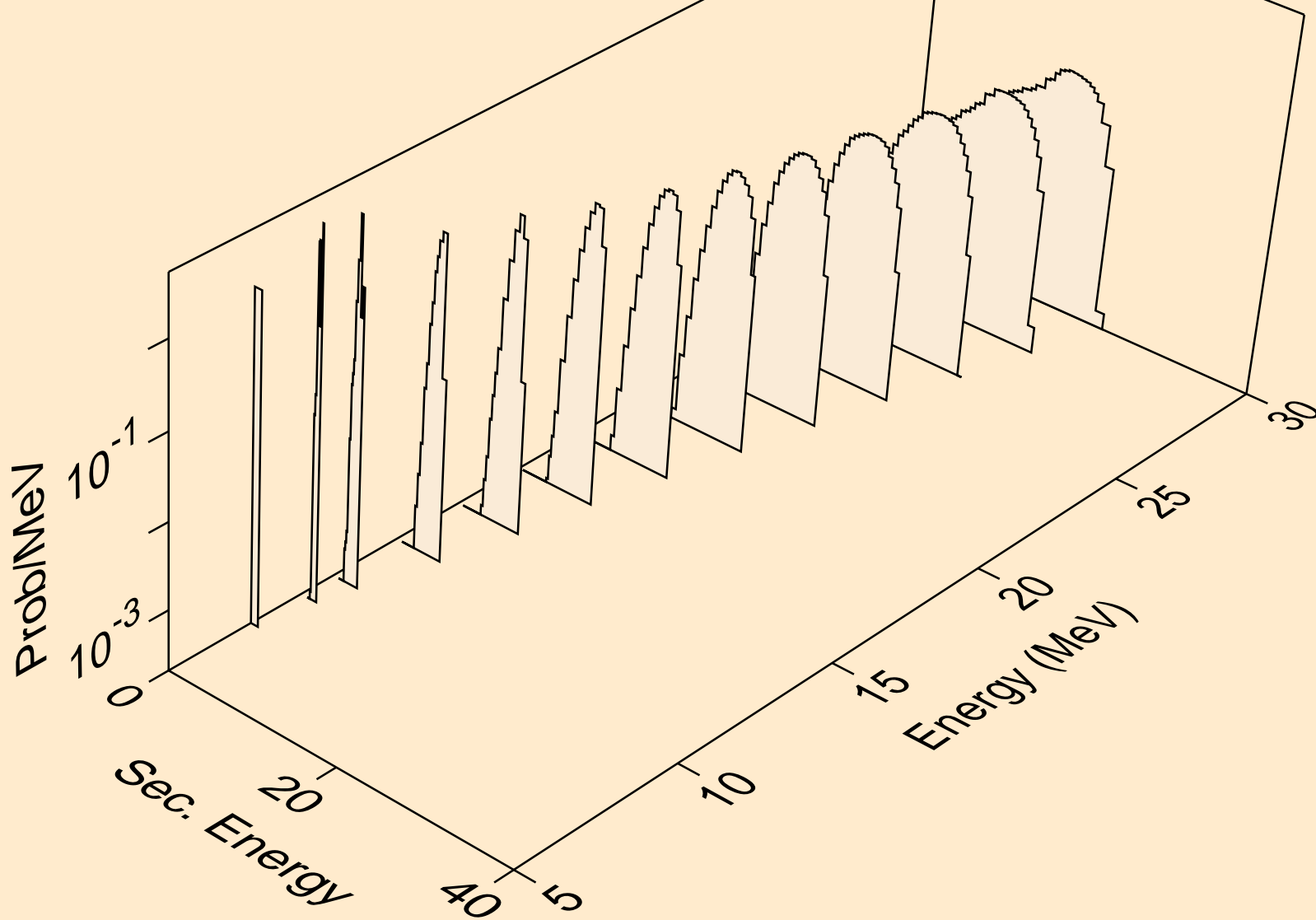

YB176M NEUTRON ACER TENDL-2019 LIBRARY; T=293.16K
protons from (n,2np)

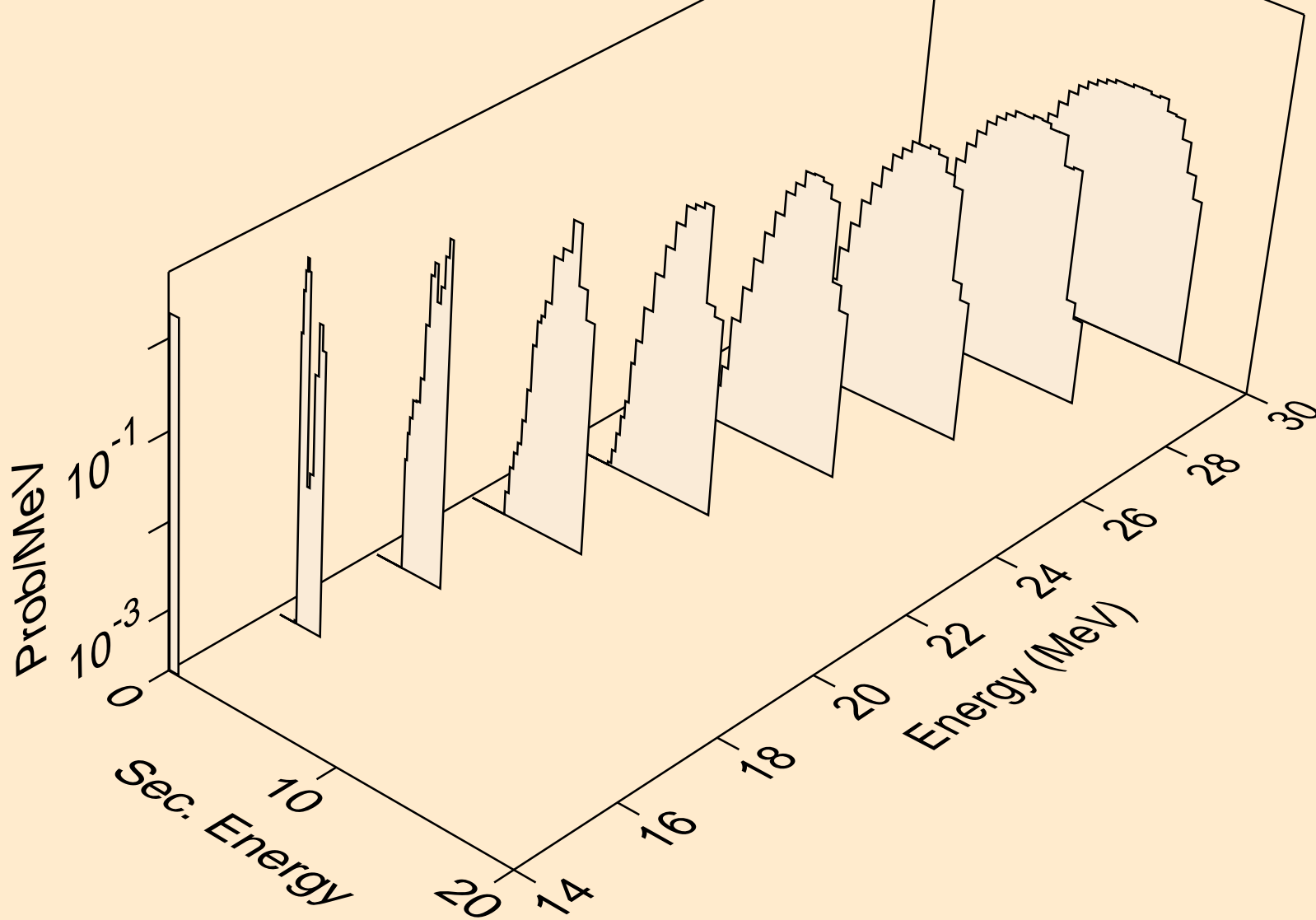

YB176M NEUTRON ACER TENDL-2019 LIBRARY; T=293.16K
protons from (n,3np)

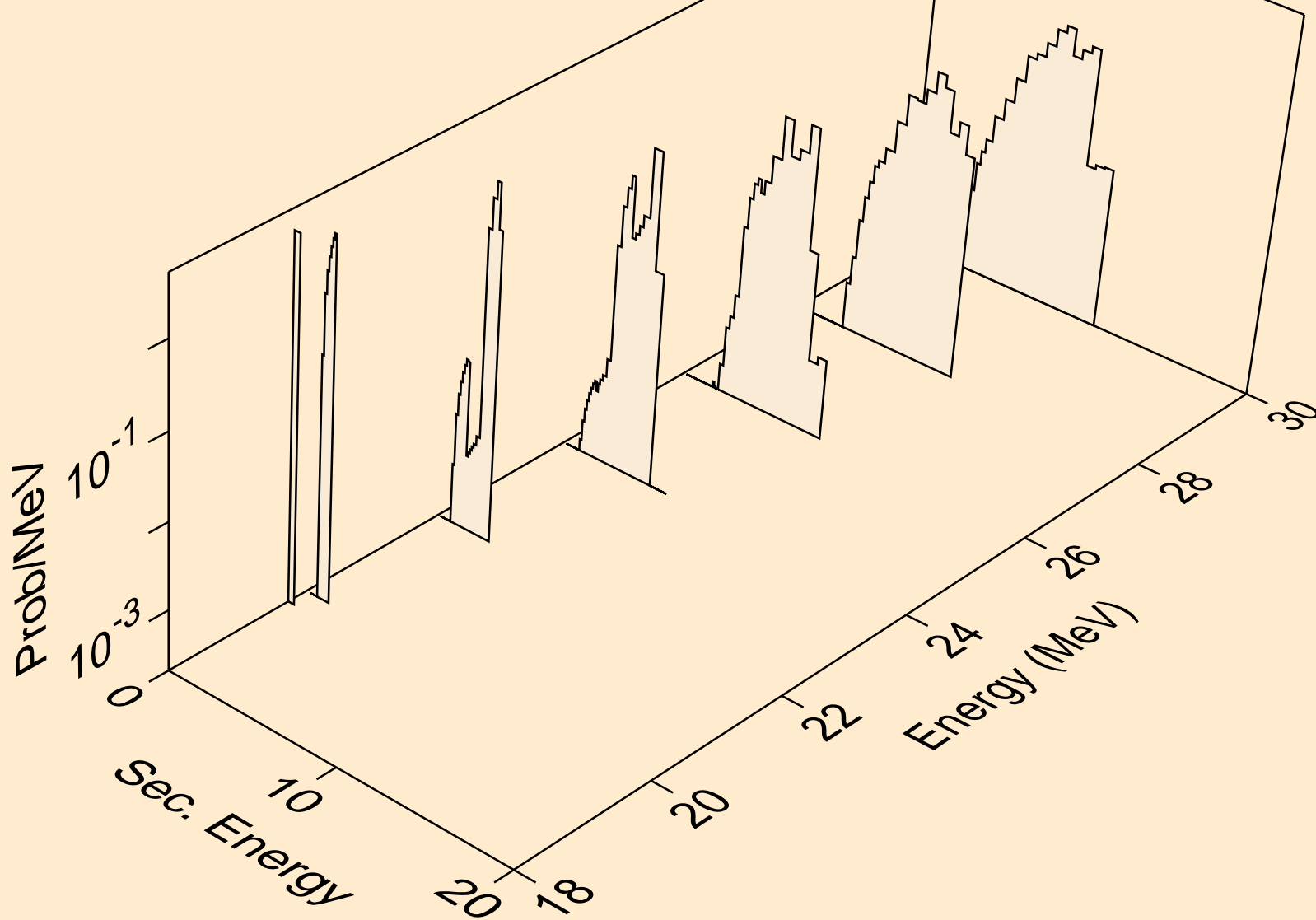

YB176M NEUTRON ACER TENDL-2019 LIBRARY; T=293.16K
protons from (n,2np)

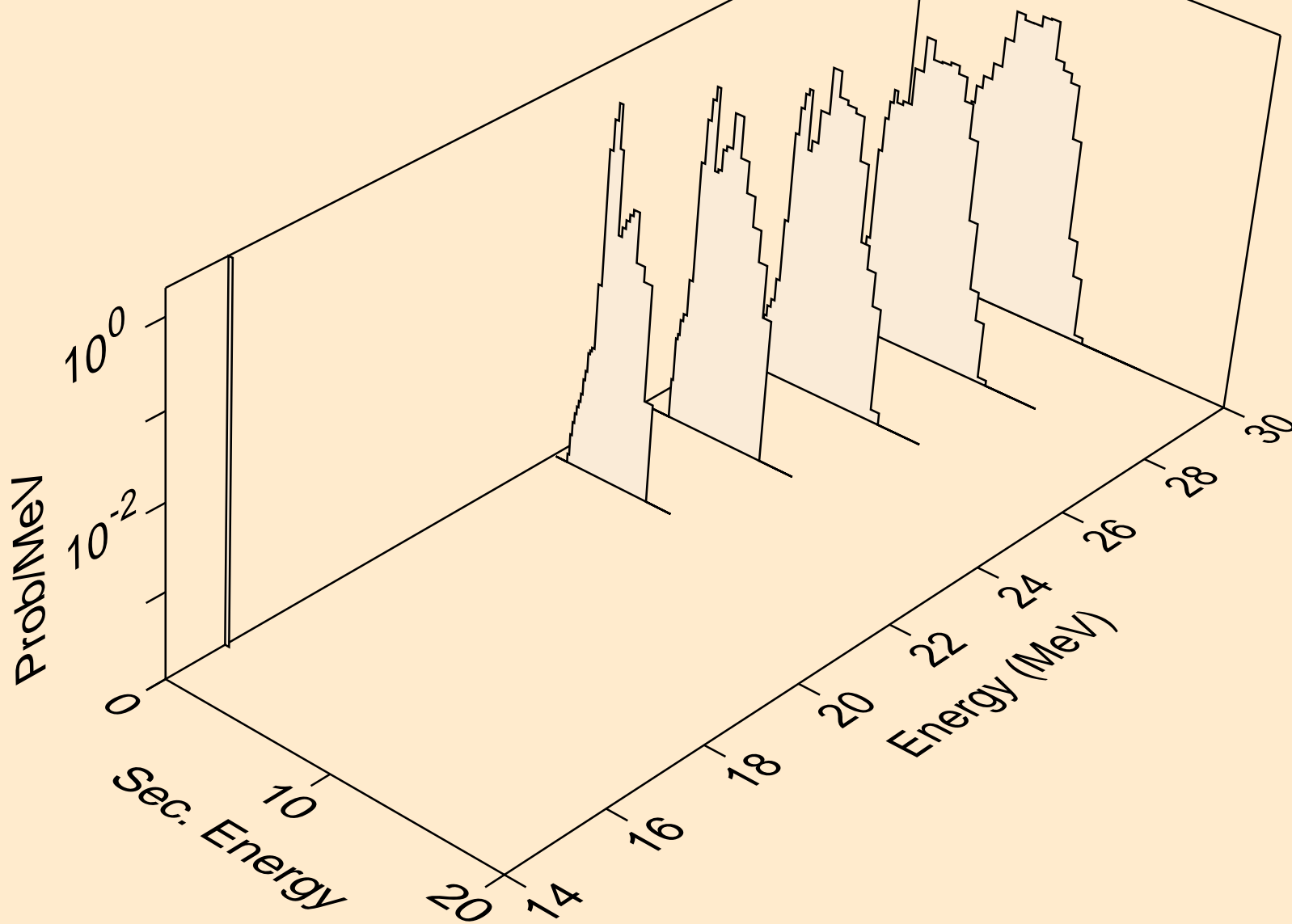

YB176M NEUTRON ACER TENDL-2019 LIBRARY; T=293.16K
protons from (n,p)

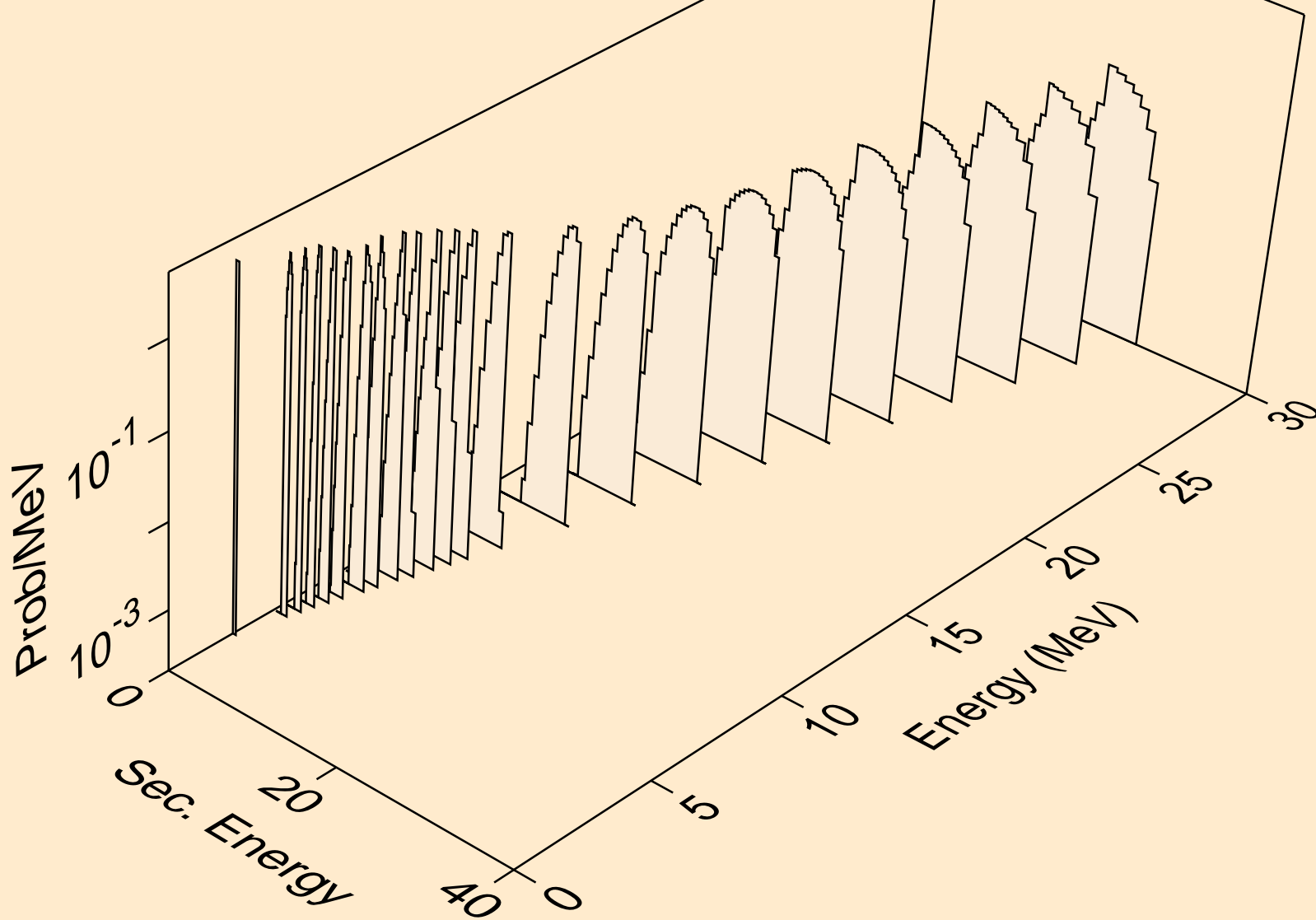

YB176M NEUTRON ACER TENDL-2019 LIBRARY; T=293.16K
protons from (n,2p)

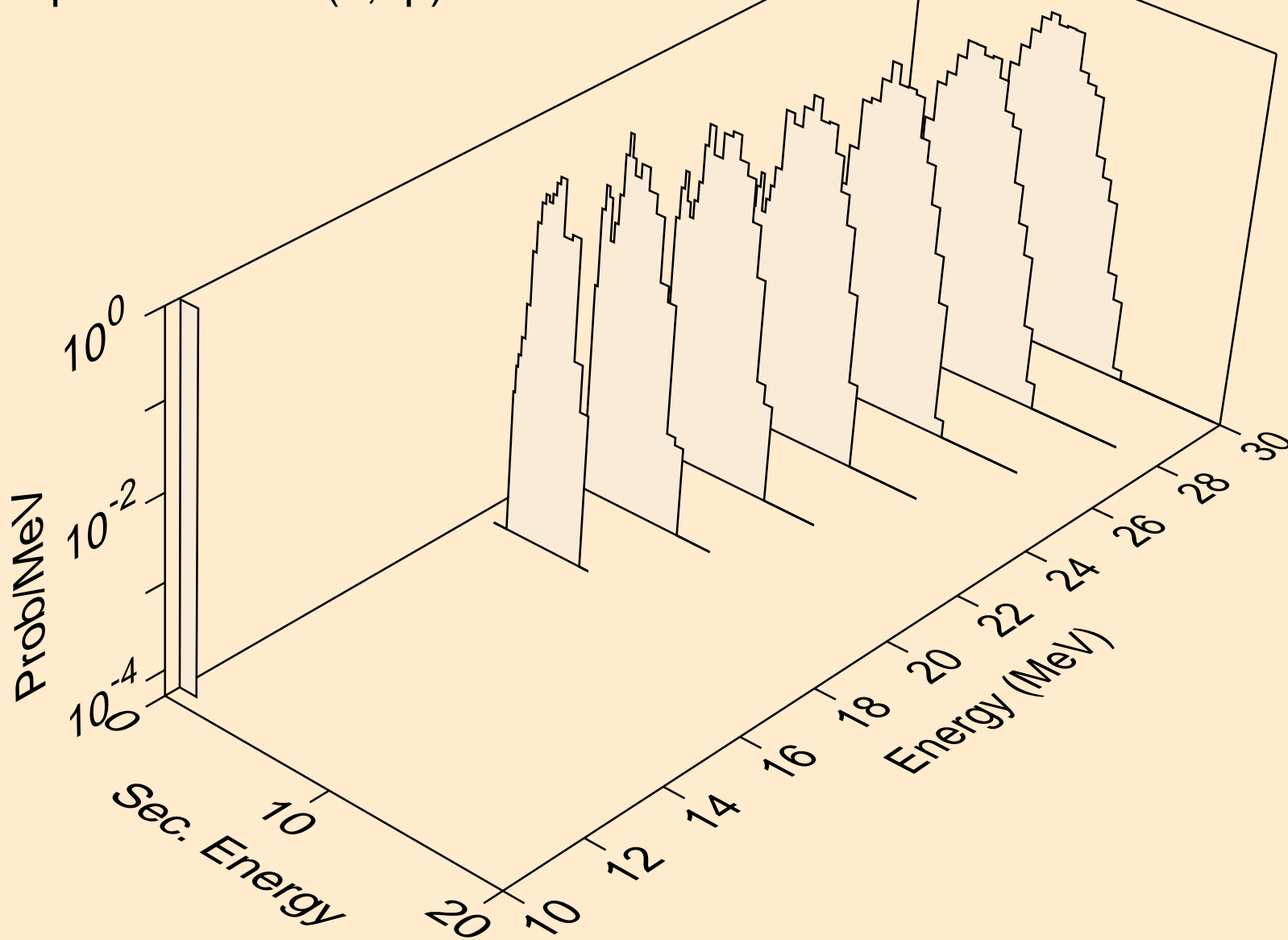

YB176M NEUTRON ACER TENDL-2019 LIBRARY; T=293.16K
deuterons from (n,x)

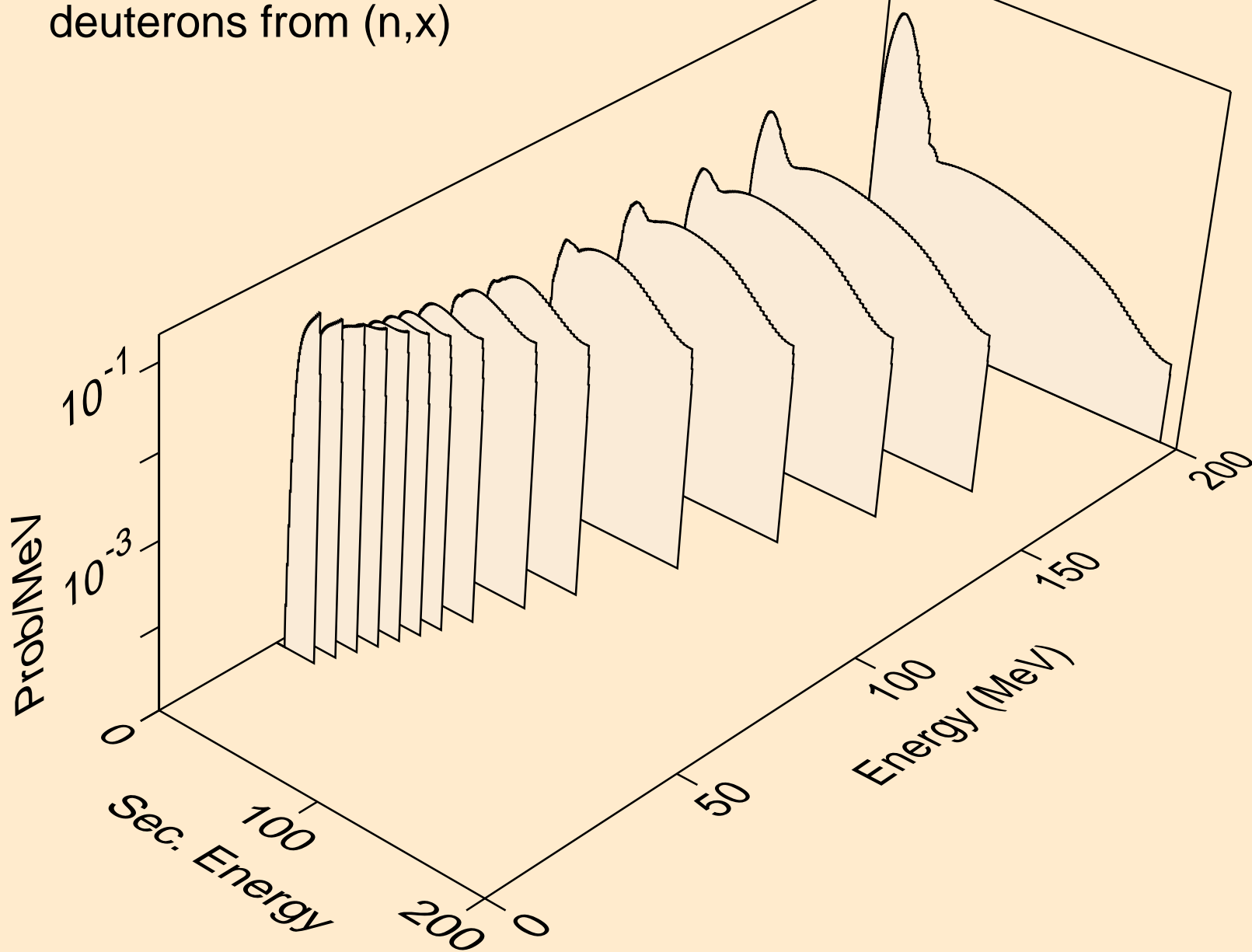

YB176M NEUTRON ACER TENDL-2019 LIBRARY; T=293.16K
deuterons from (n,2nd)

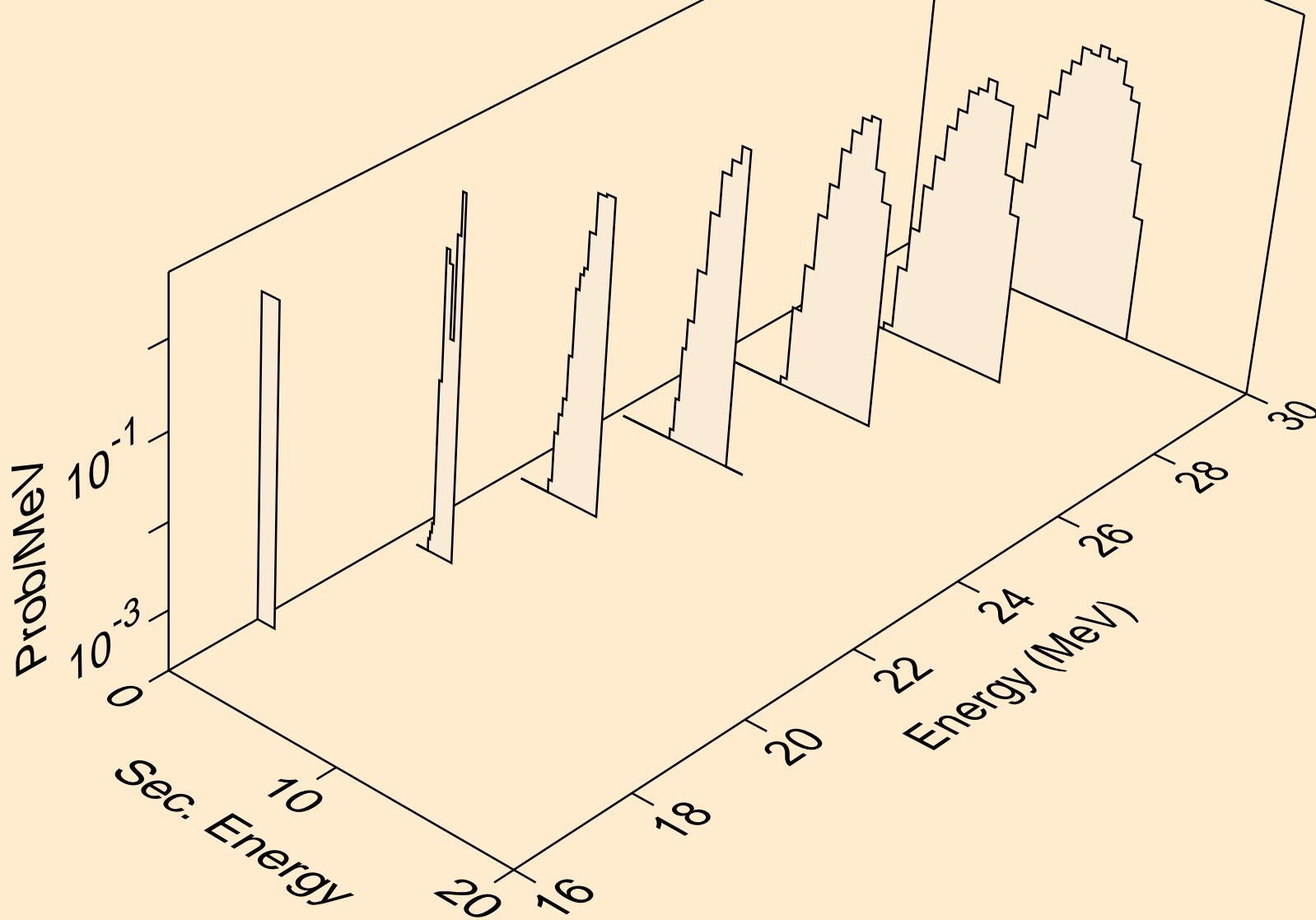

YB176M NEUTRON ACER TENDL-2019 LIBRARY; T=293.16K
deuterons from (n,n*)d

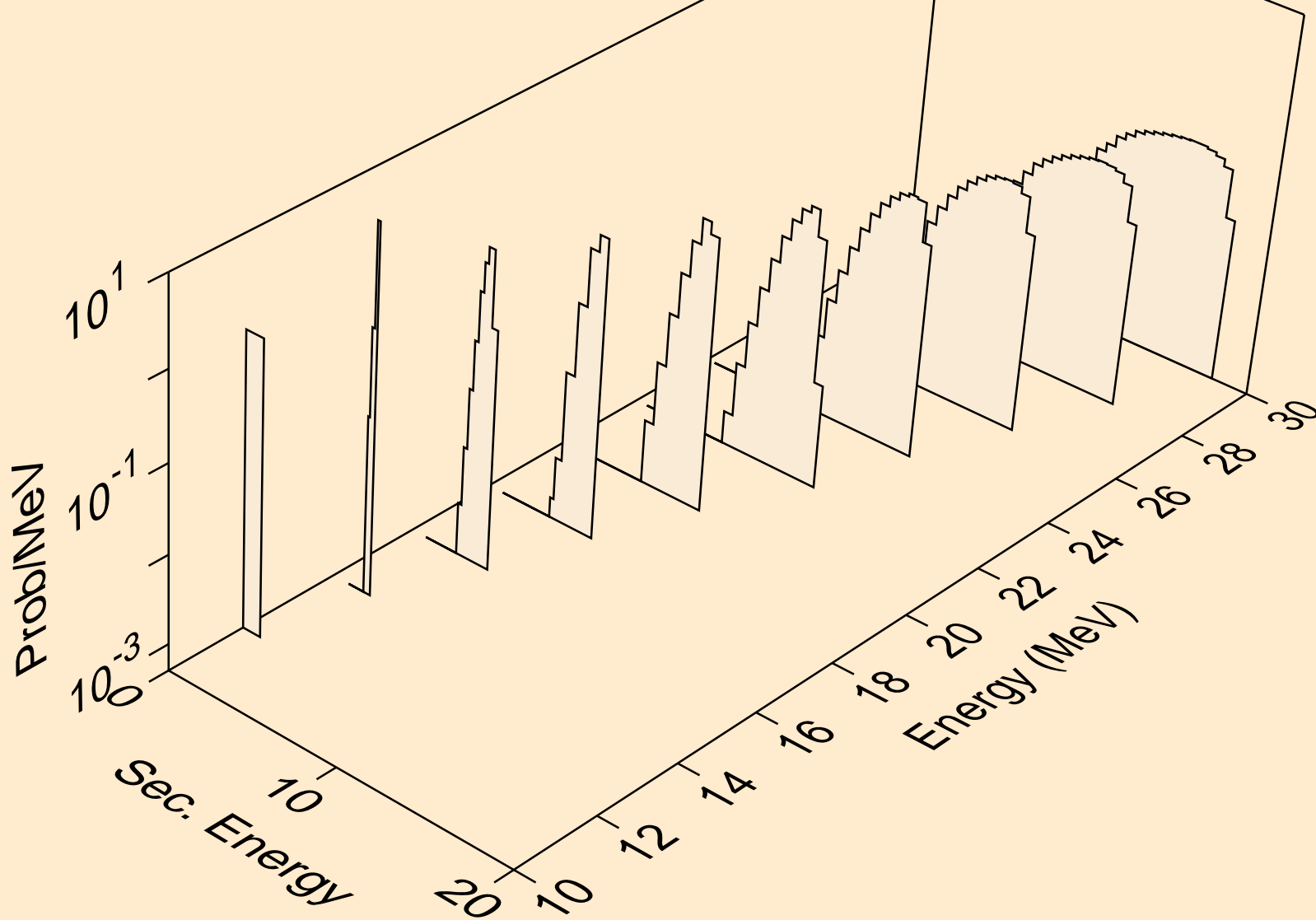

YB176M NEUTRON ACER TENDL-2019 LIBRARY; T=293.16K
deuterons from (n,d)

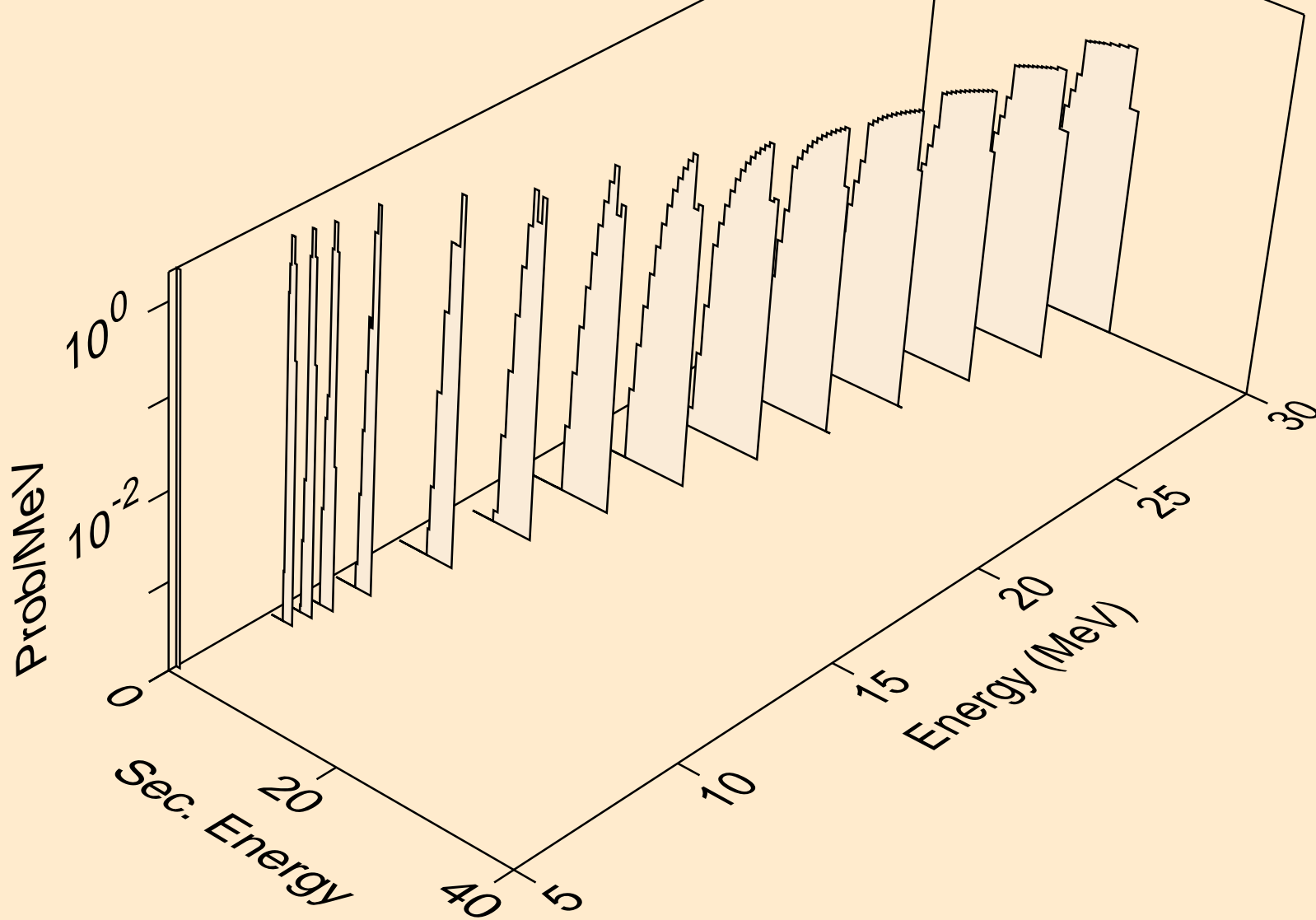

YB176M NEUTRON ACER TENDL-2019 LIBRARY; T=293.16K
tritons from (n,x)

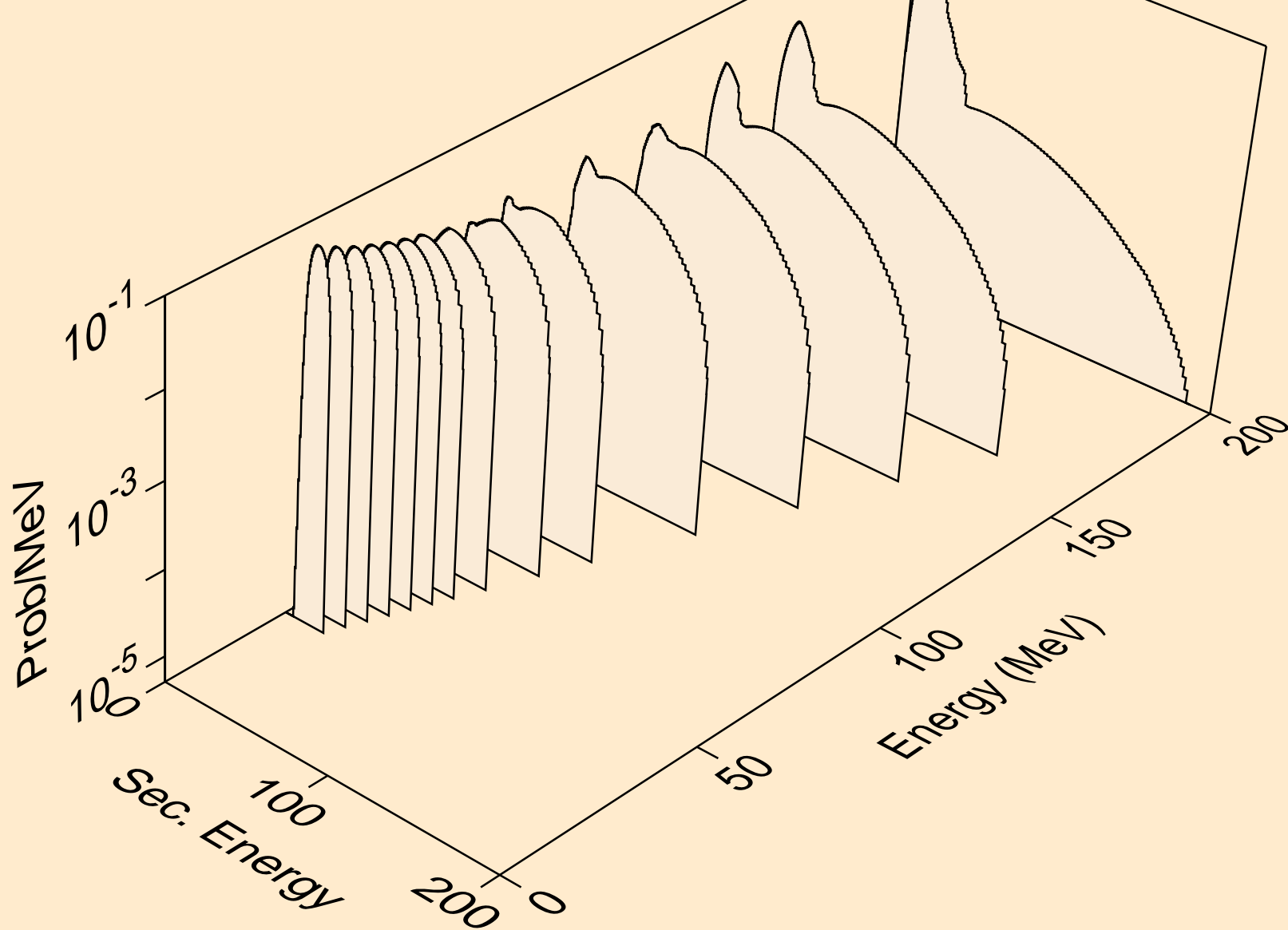

YB176M NEUTRON ACER TENDL-2019 LIBRARY; T=293.16K
tritons from (n,n*)t

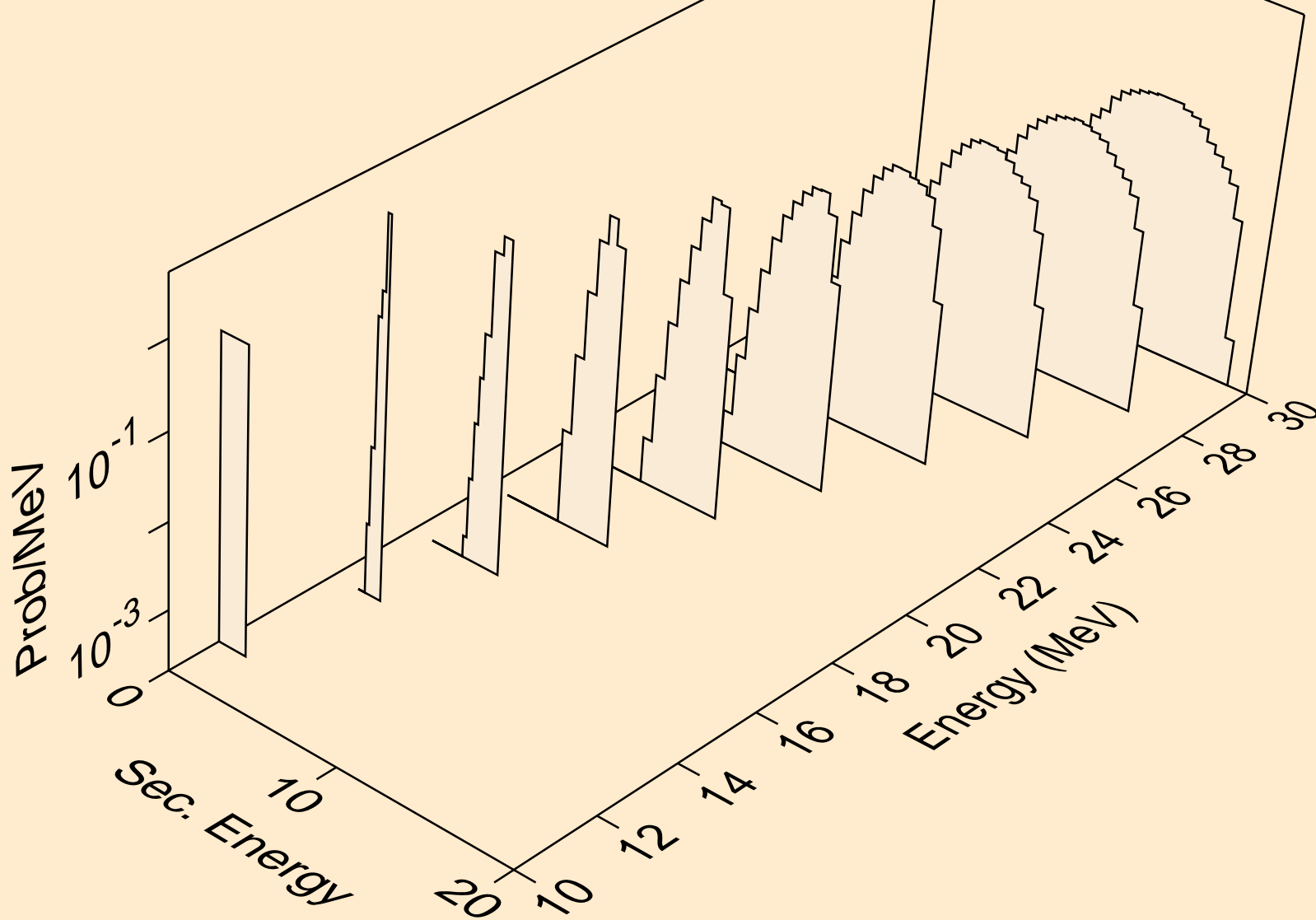

YB176M NEUTRON ACER TENDL-2019 LIBRARY; T=293.16K
tritons from (n,t)

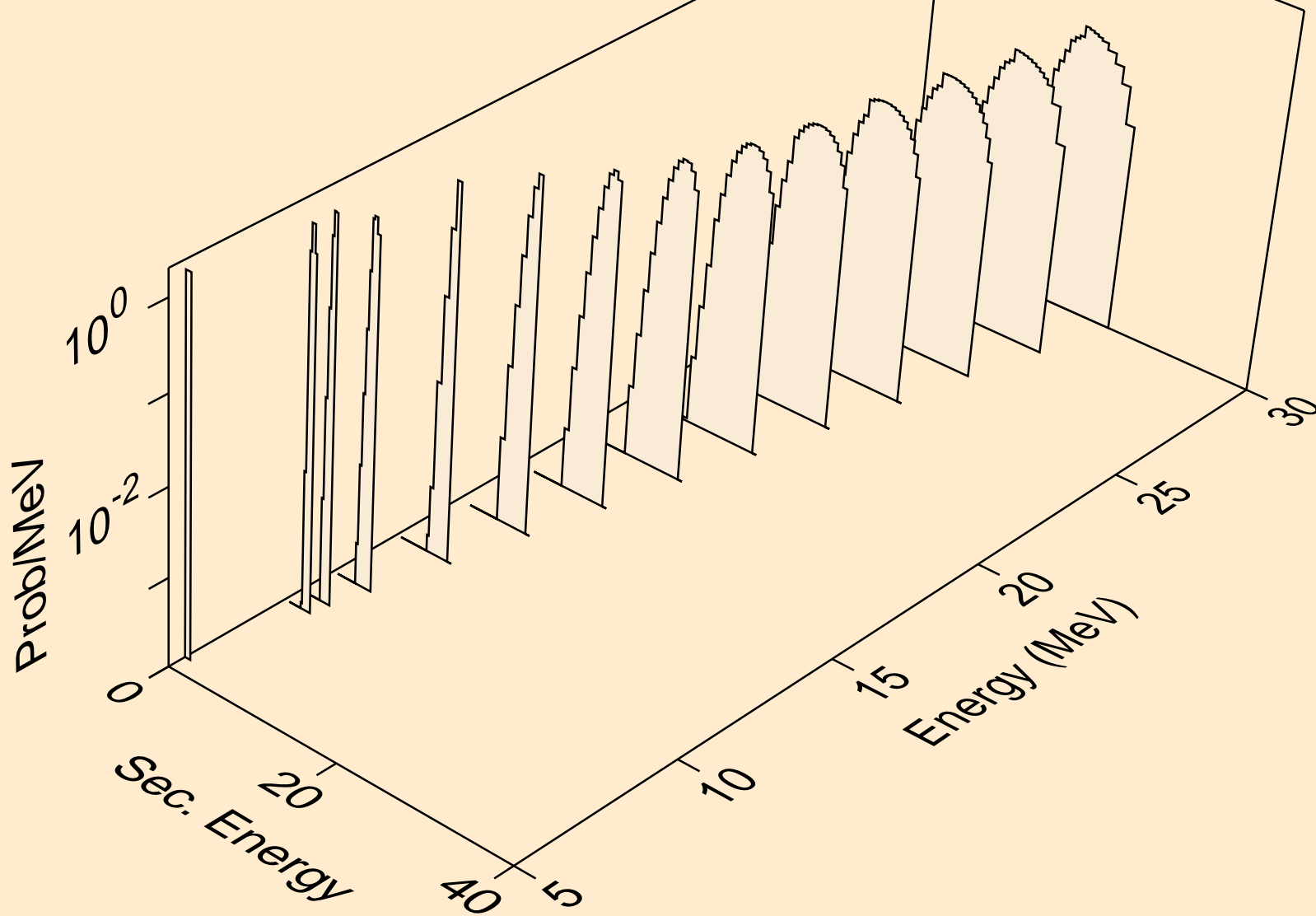

YB176M NEUTRON ACER TENDL-2019 LIBRARY; T=293.16K
he3s from (n,x)

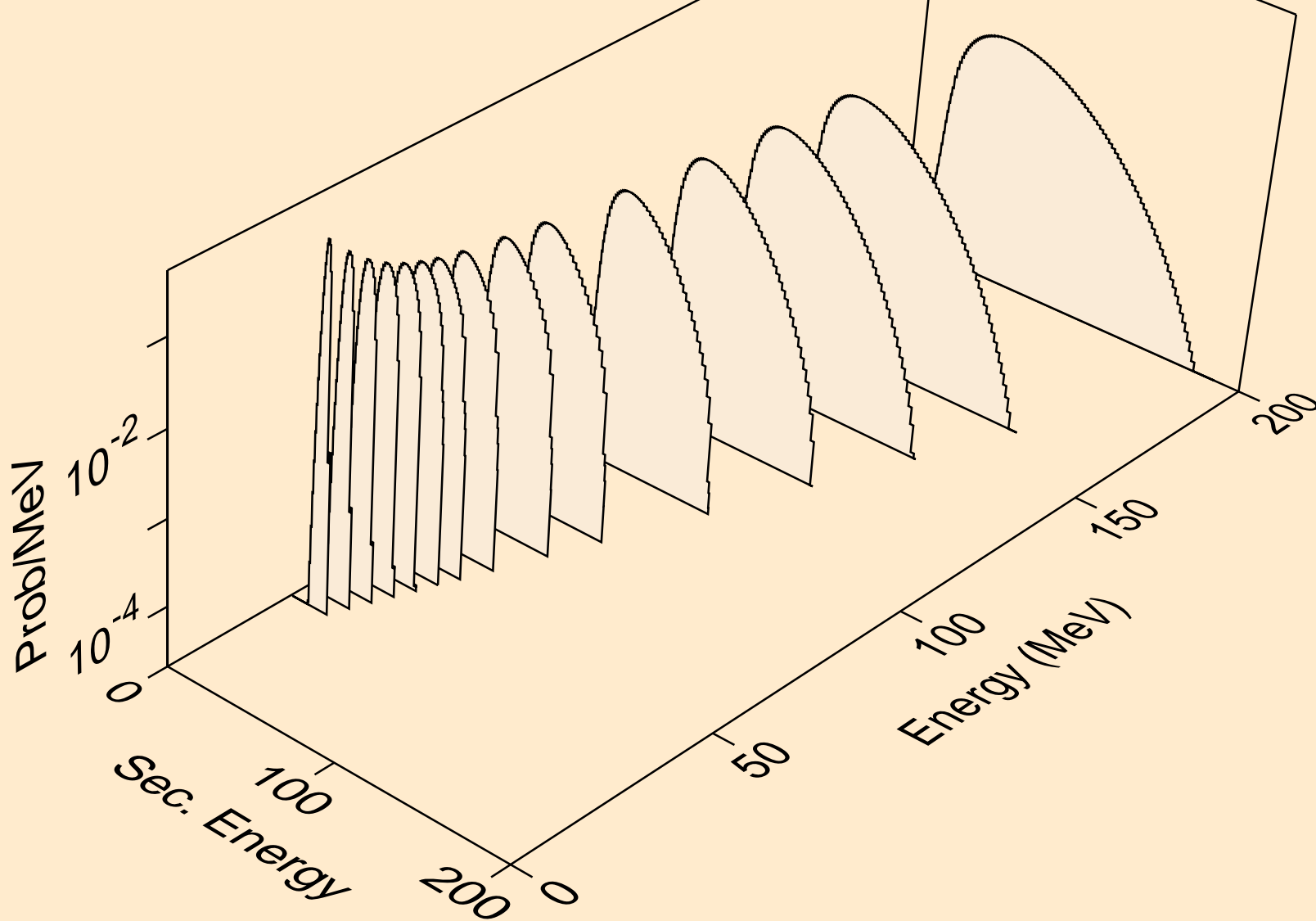

YB176M NEUTRON ACER TENDL-2019 LIBRARY; T=293.16K
he3s from (n,n*)he3

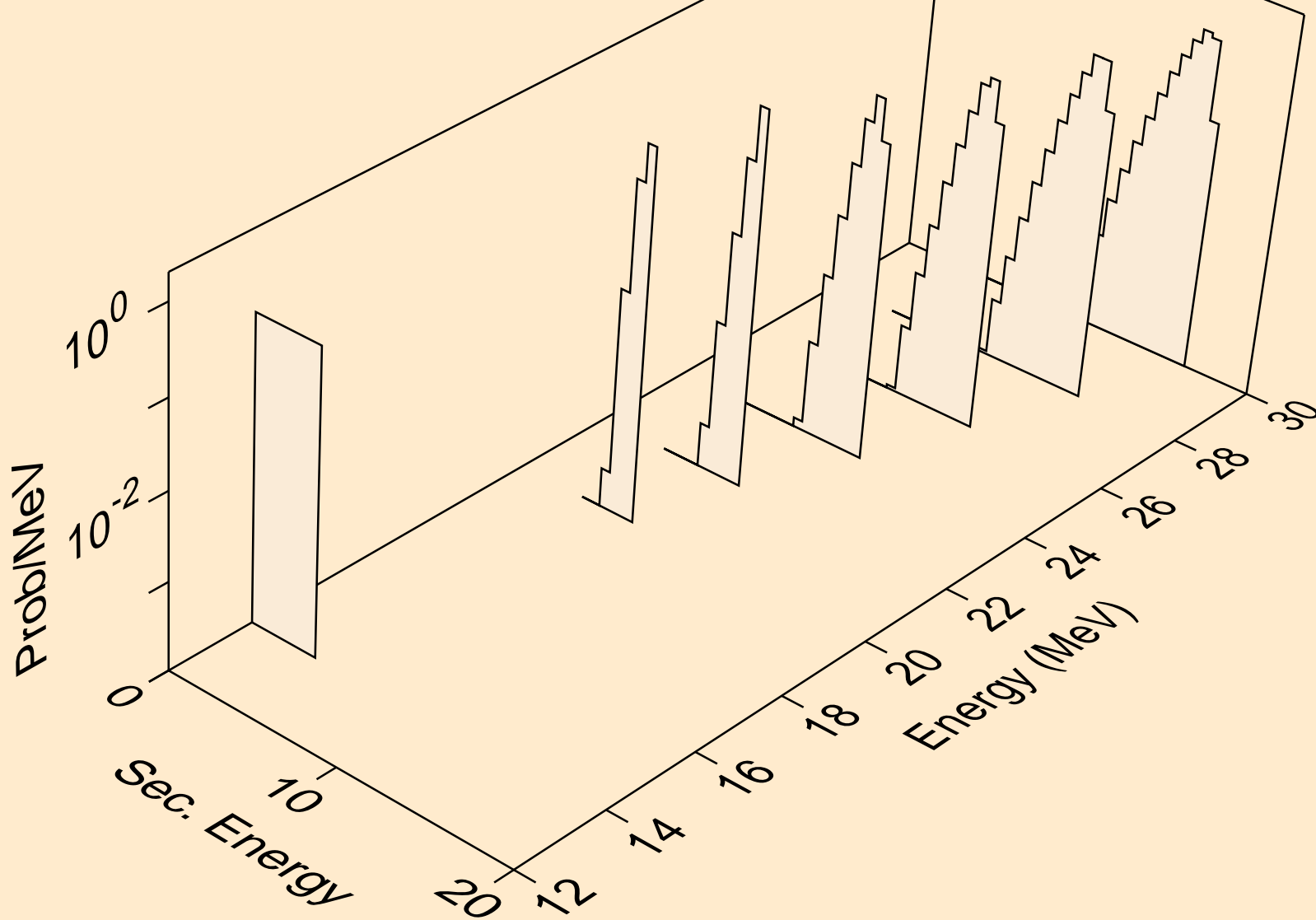

YB176M NEUTRON ACER TENDL-2019 LIBRARY; T=293.16K
he3s from (n,he3)

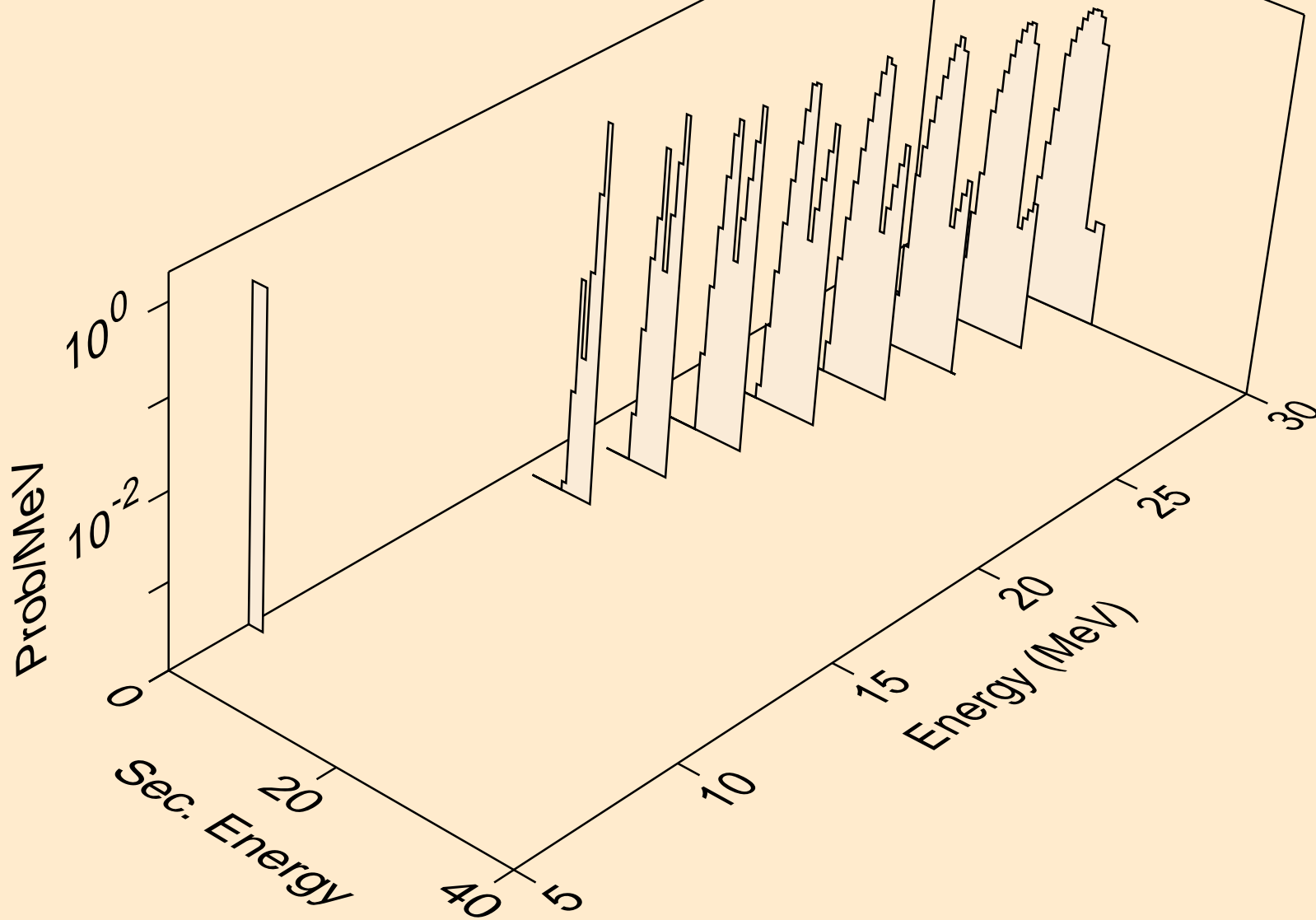

YB176M NEUTRON ACER TENDL-2019 LIBRARY; T=293.16K
alphas from (n,x)

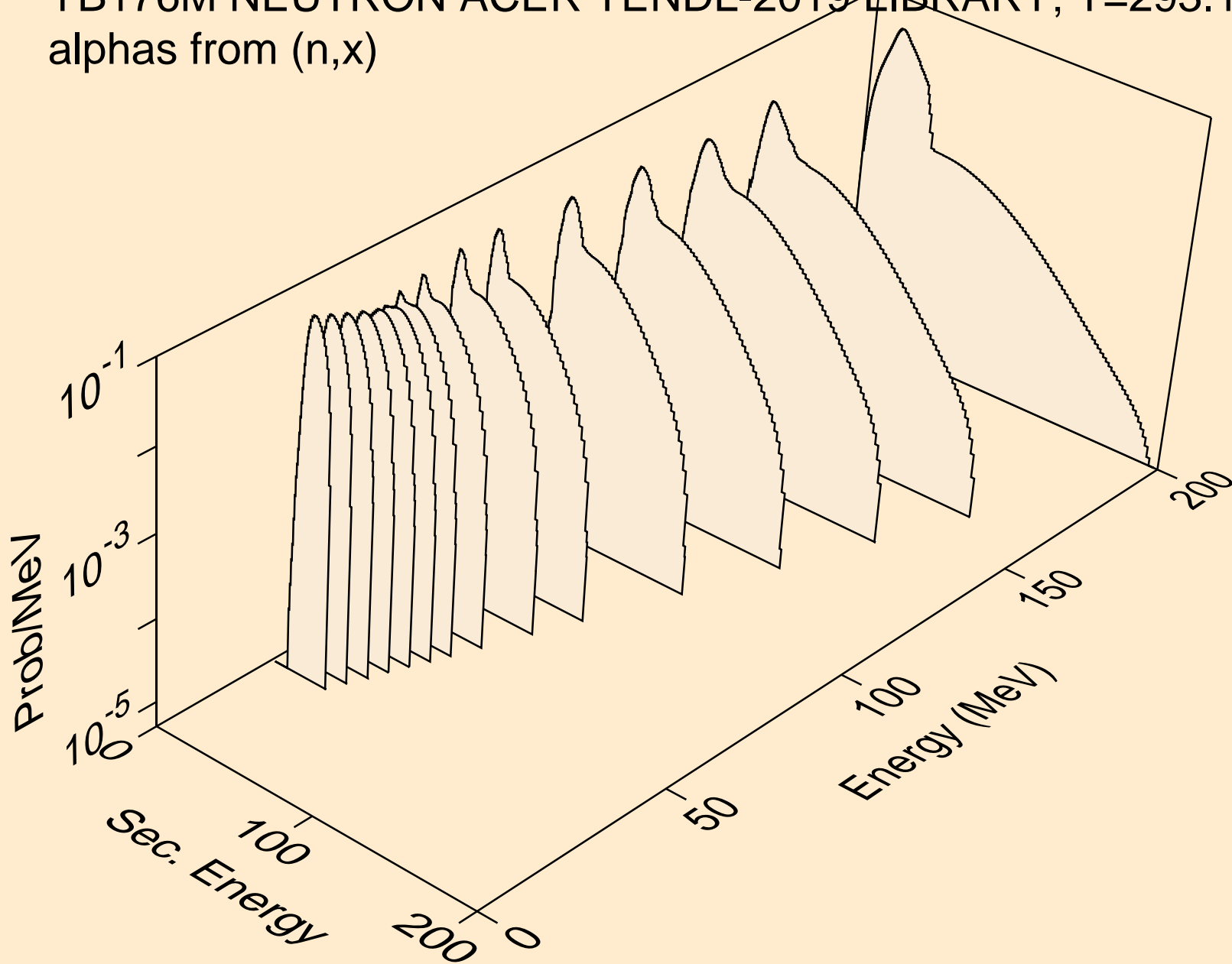

YB176M NEUTRON ACER TENDL-2019 LIBRARY; T=293.16K
alphas from (n,n*)a

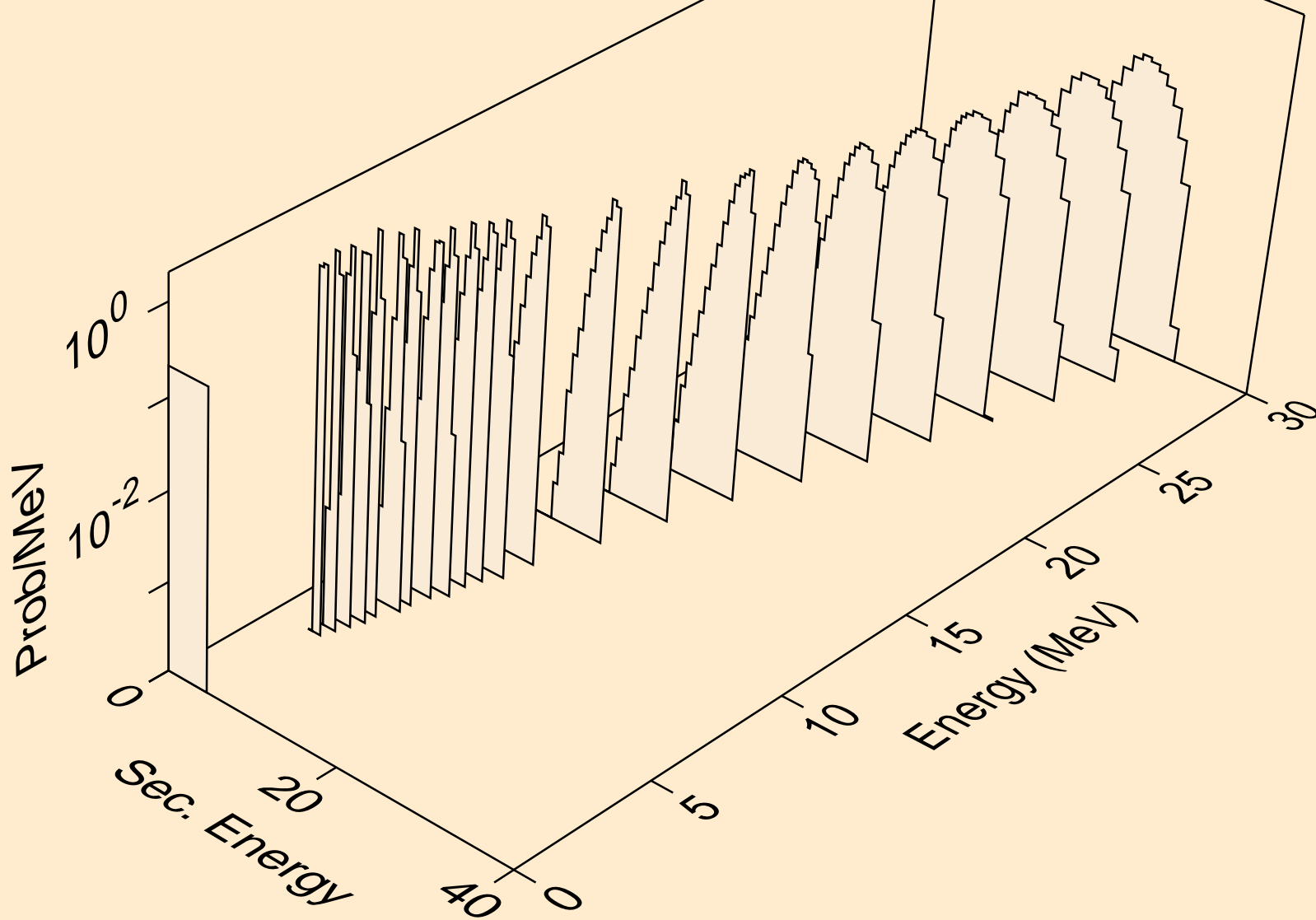

YB176M NEUTRON ACER TENDL-2019 LIBRARY; T=293.16K
alphas from (n,2n)a

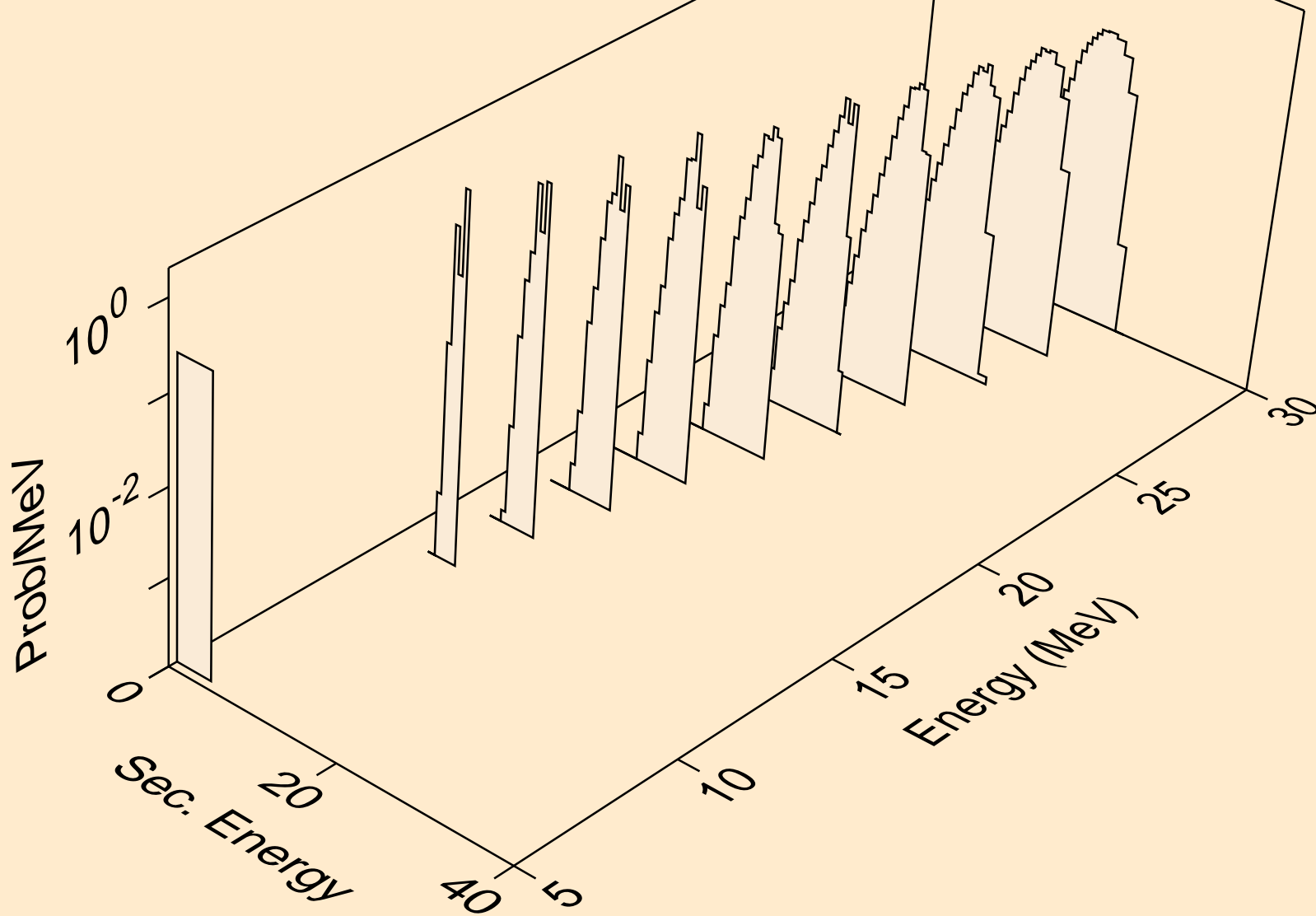

YB176M NEUTRON ACER TENDL-2019 LIBRARY; T=293.16K
alphas from (n,3n)a

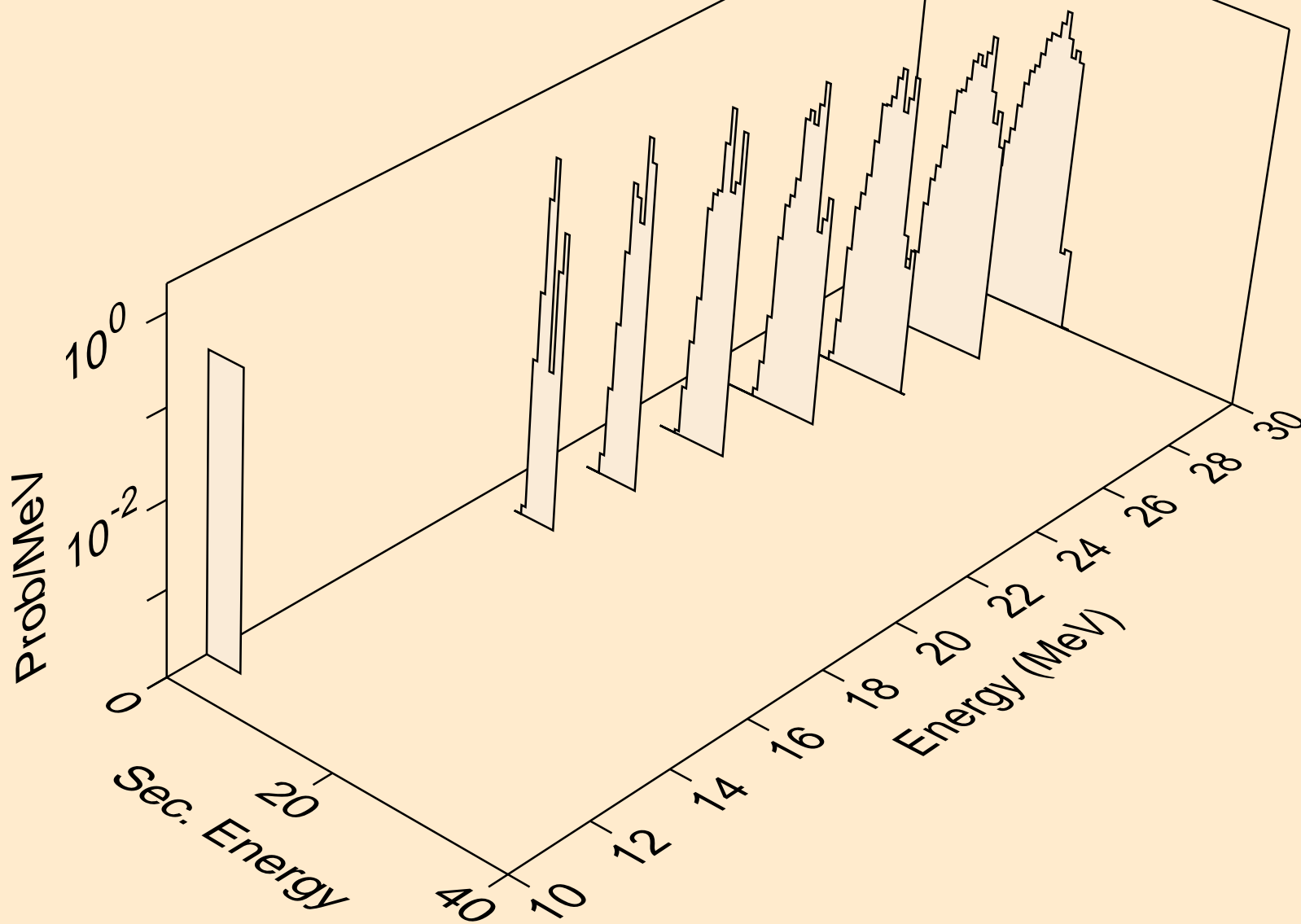

YB176M NEUTRON ACER TENDL-2019 LIBRARY; T=293.16K
alphas from (n,a)

