

AC236 ALPHA ACER TENDL-2021 LIBRARY; T=0.K  
Principal cross sections

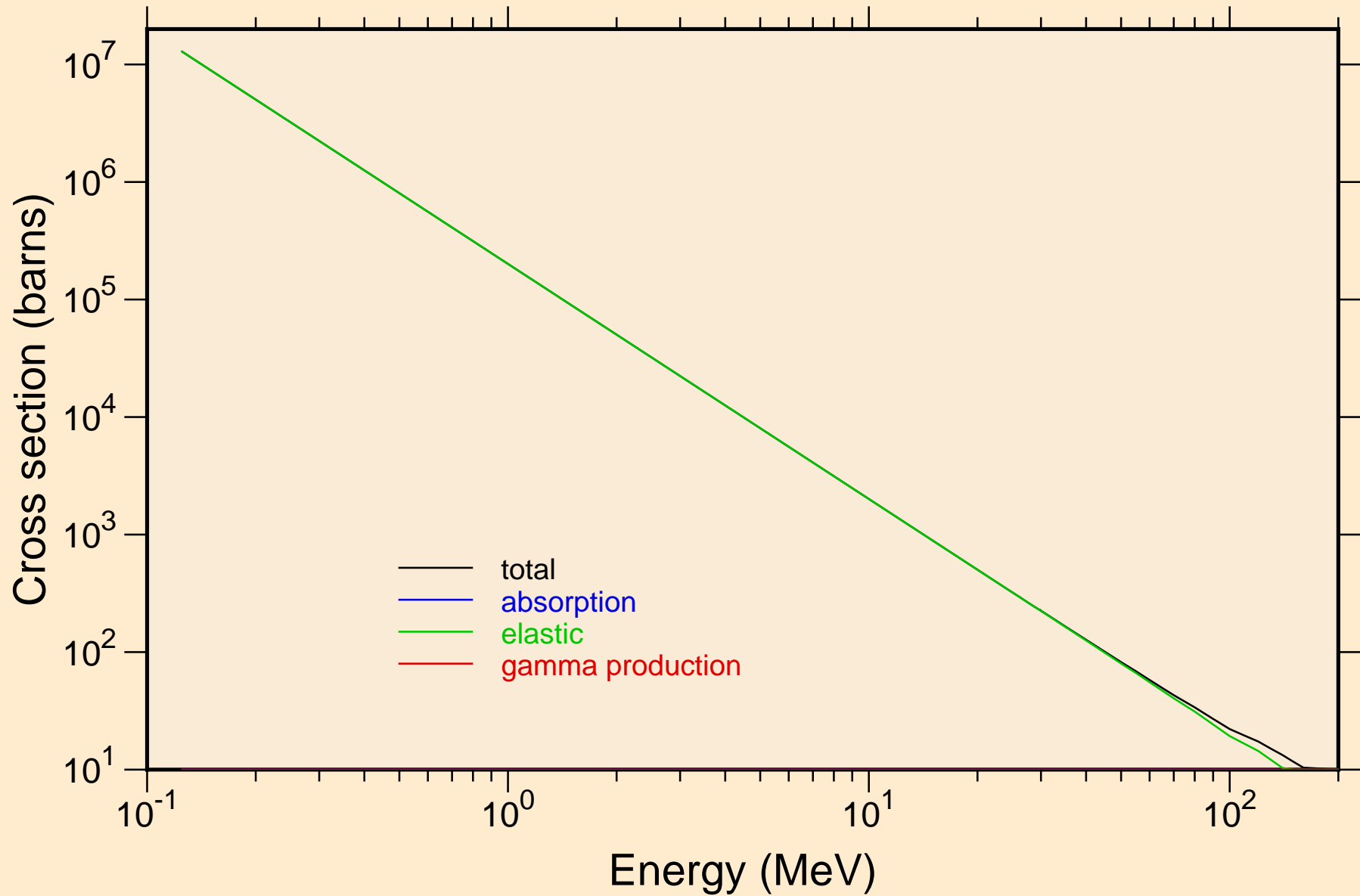

AC236 ALPHA ACER TENDL-2021 LIBRARY; T=0.K  
Heating

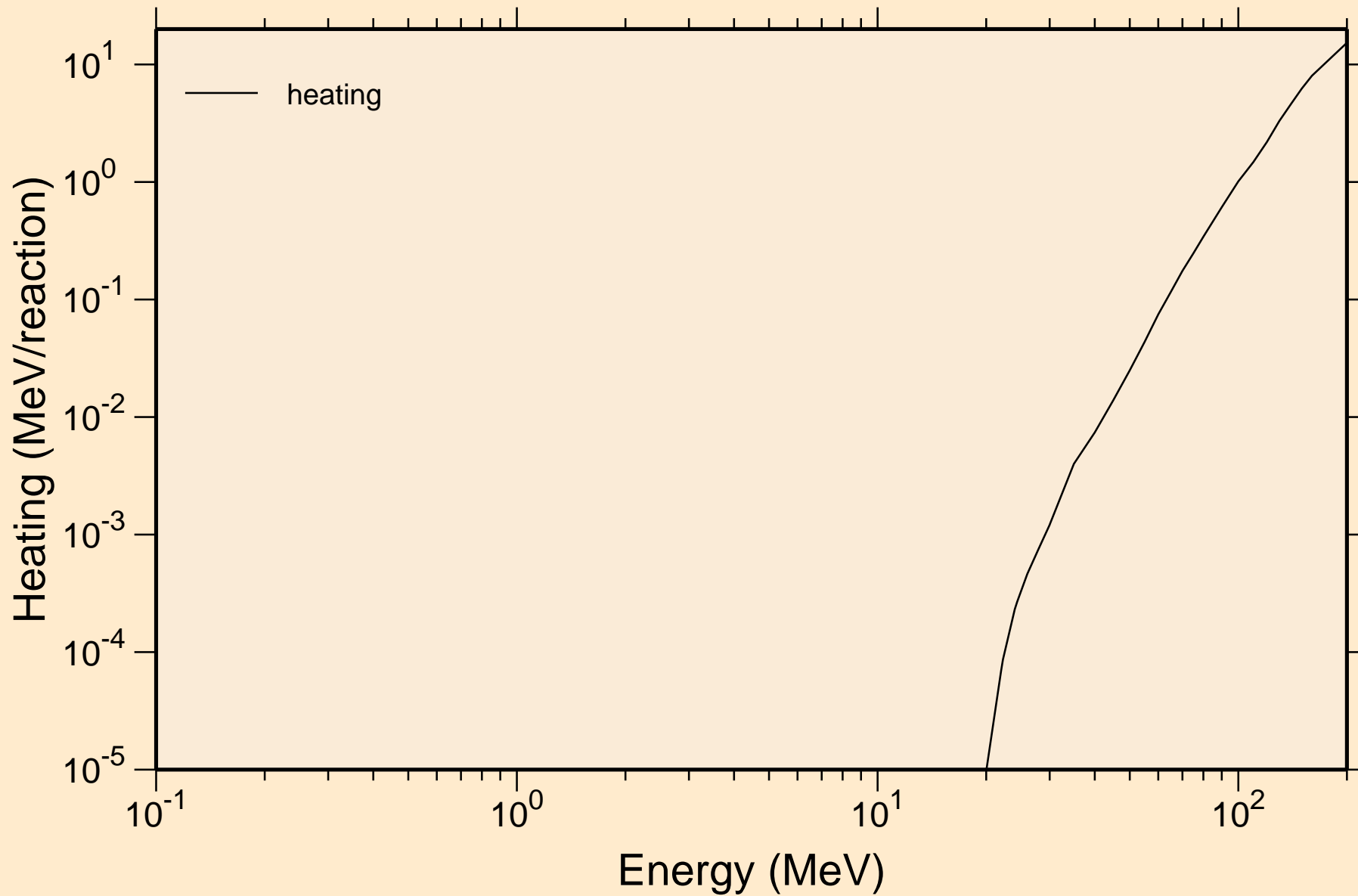

# AC236 ALPHA ACER TENDL-2021 LIBRARY; T=0.K

## Principal cross sections

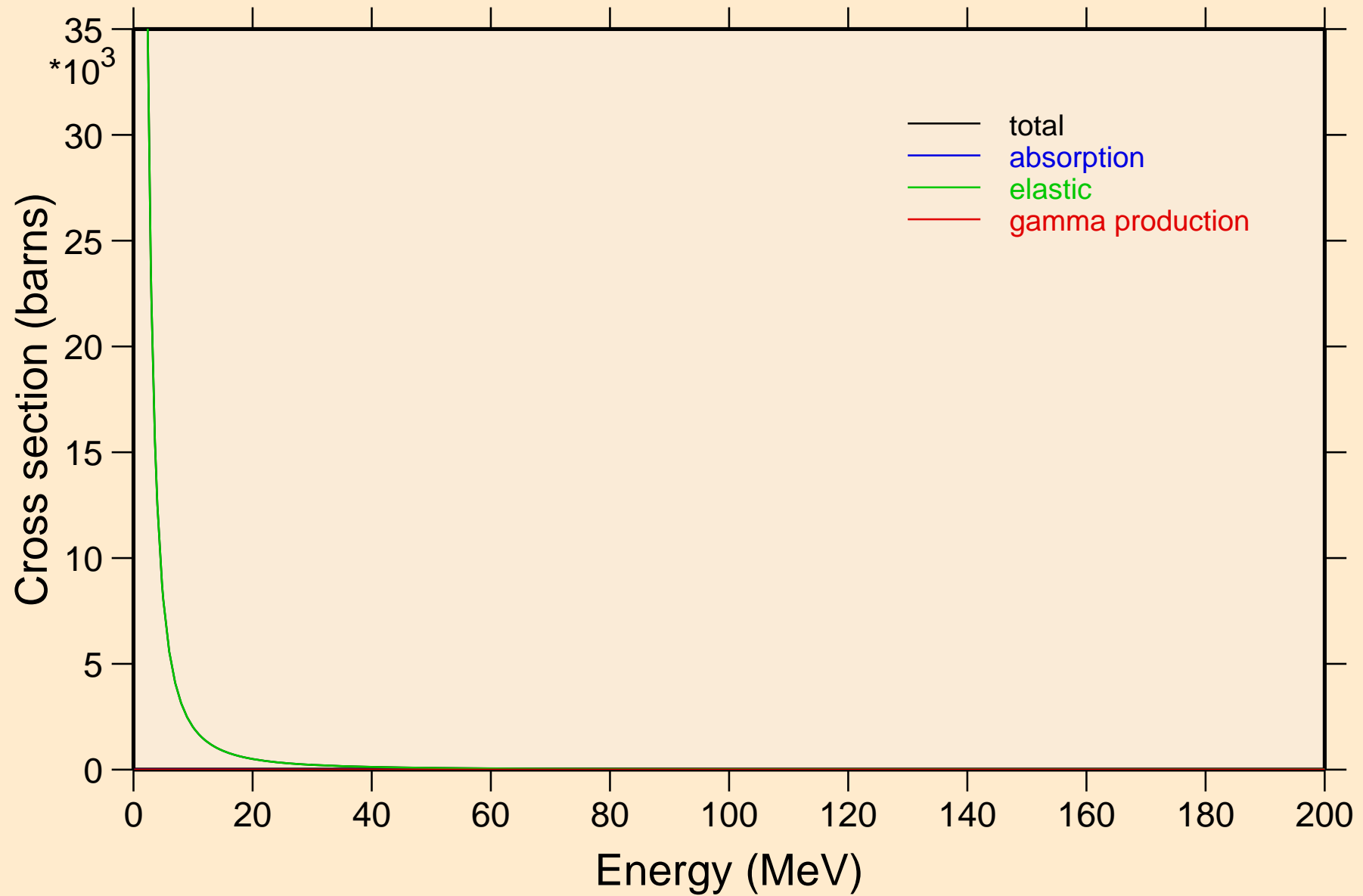

AC236 ALPHA ACER TENDL-2021 LIBRARY; T=0.K

Heating

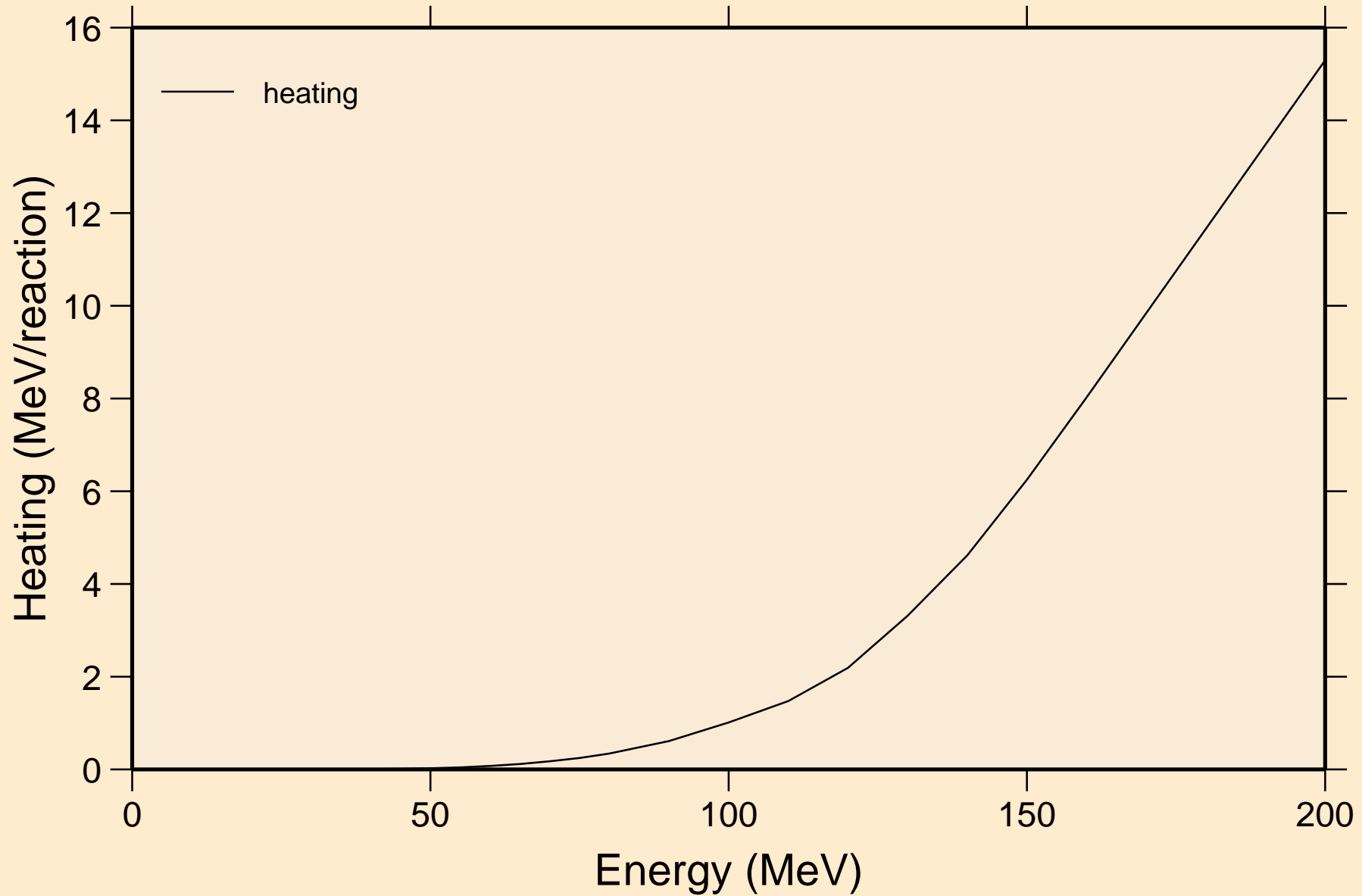

AC236 ALPHA ACER TENDL-2021 LIBRARY; T=0.K  
Threshold reactions

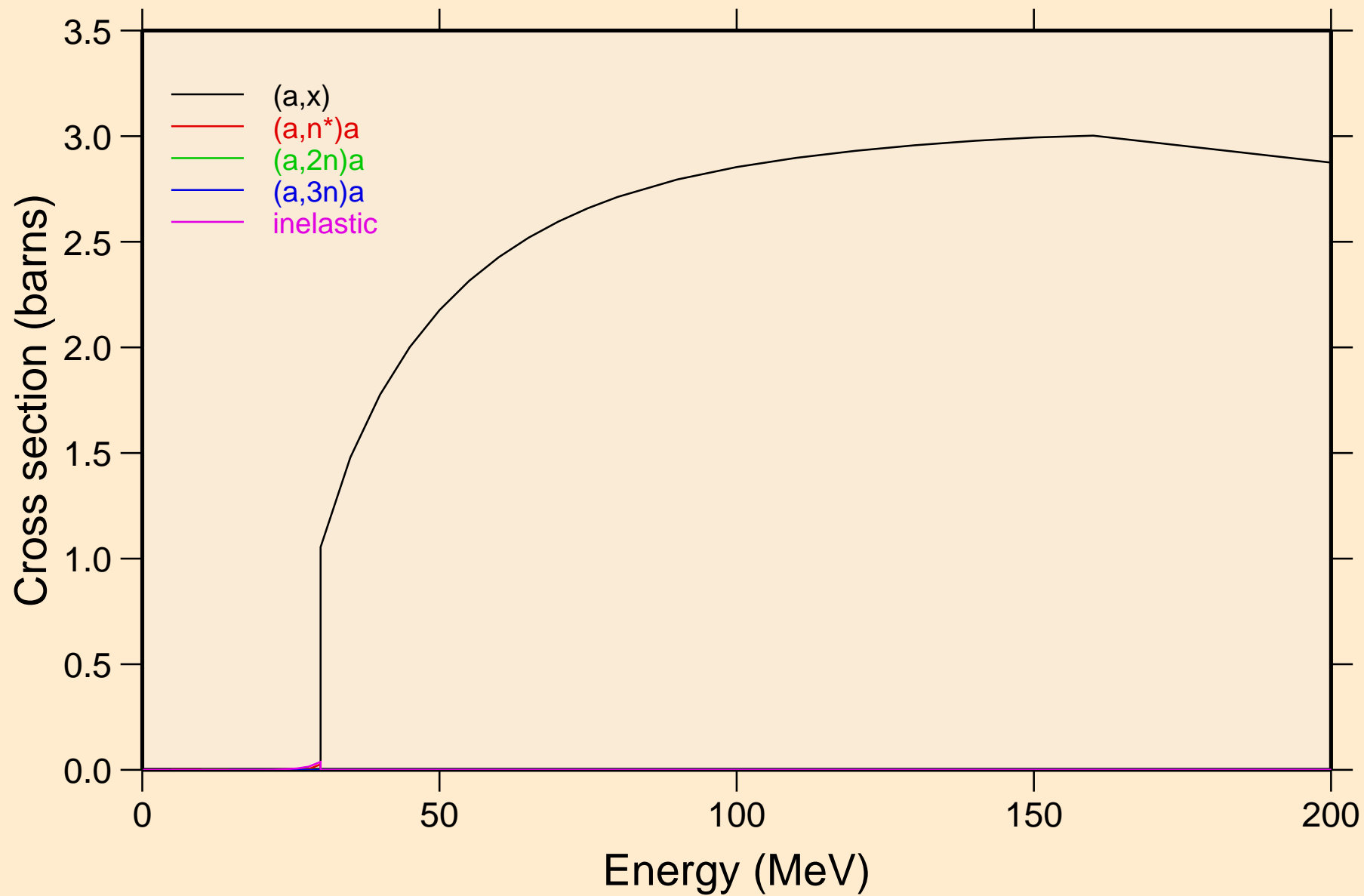

AC236 ALPHA ACER TENDL-2021 LIBRARY; T=0.K  
angular distribution for elastic

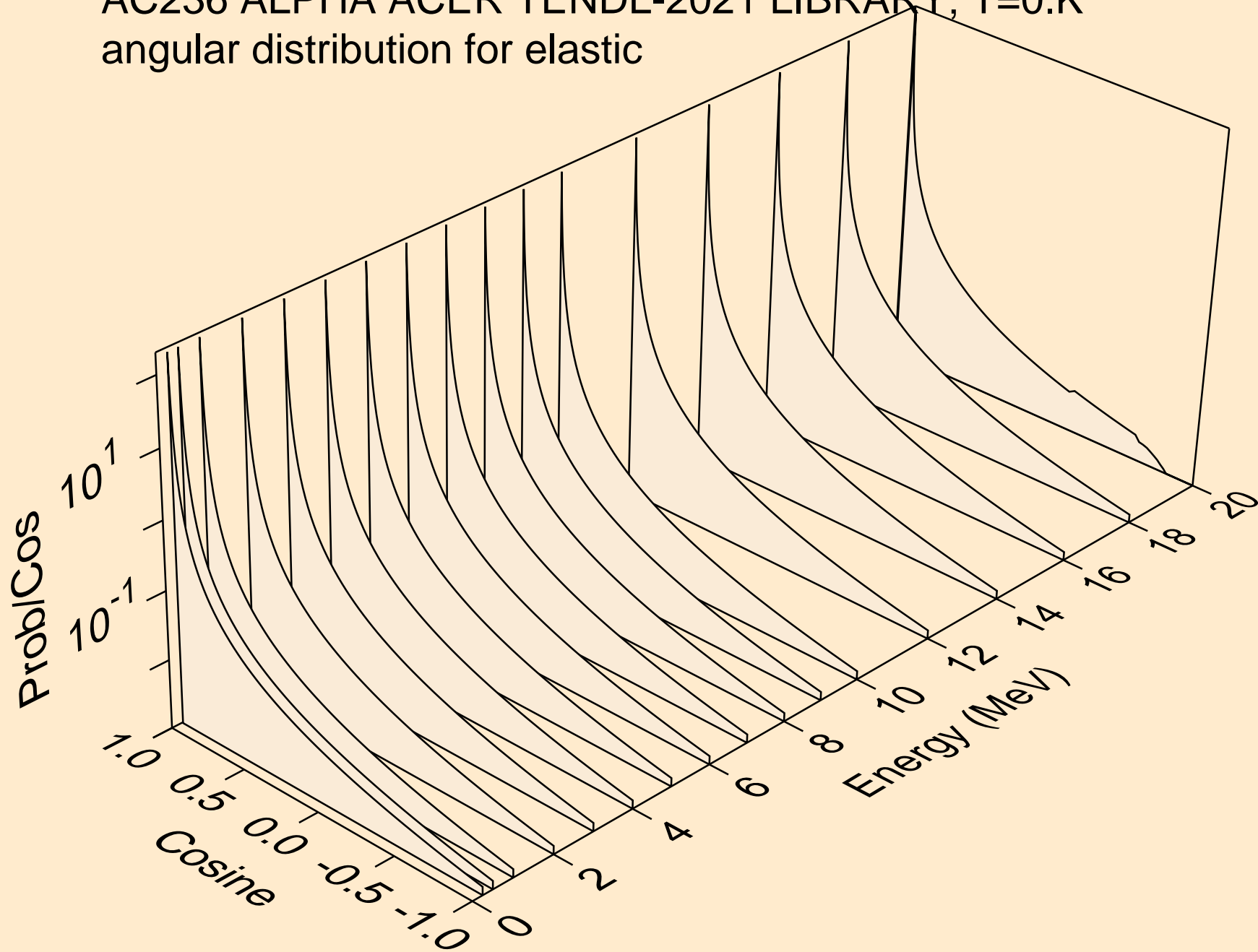

AC236 ALPHA ACER TENDL-2021 LIBRARY; T=0.K  
angular distribution for elastic

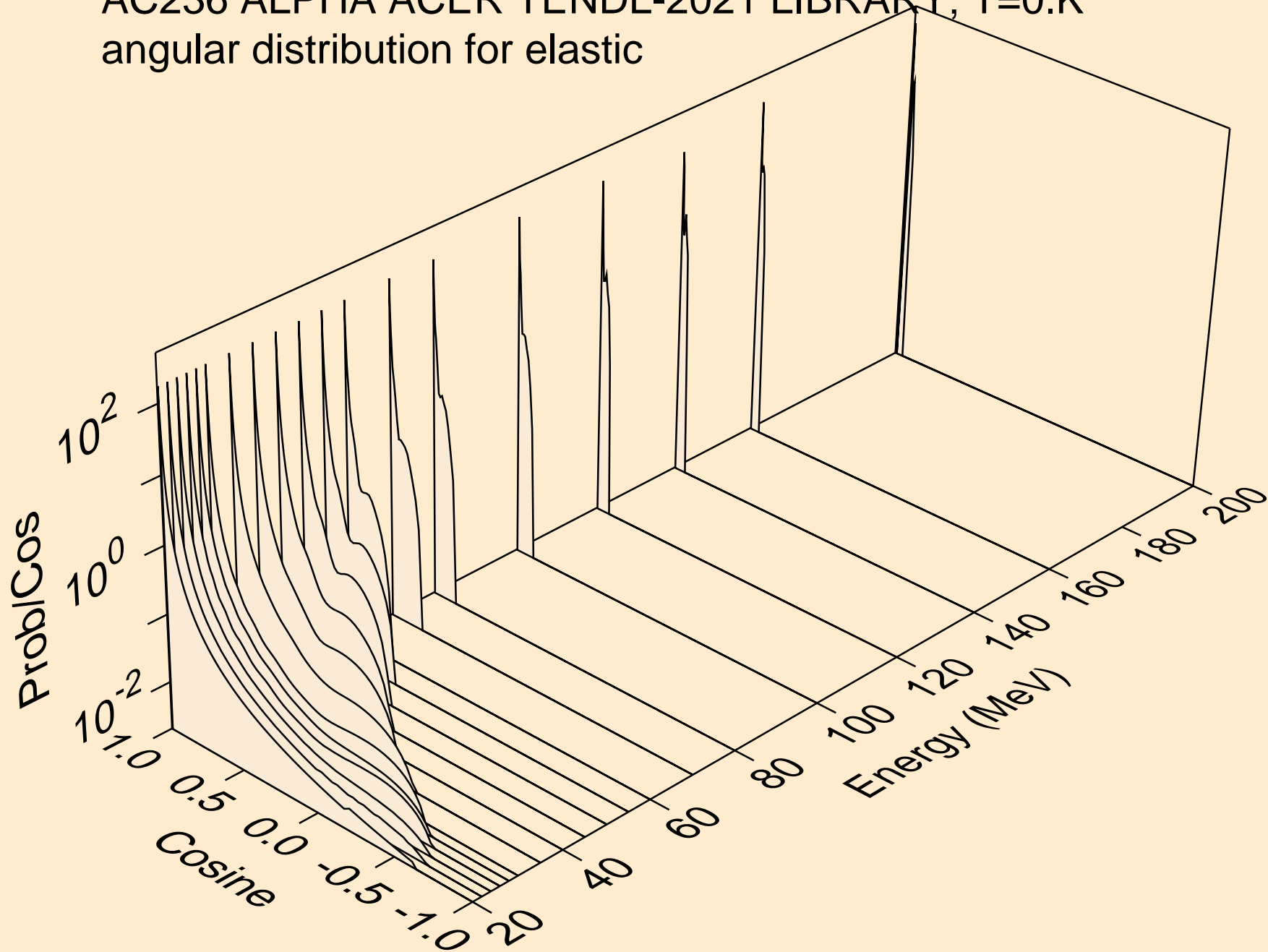

AC236 ALPHA ACER TENDL-2021 LIBRARY; T=0.K  
Alpha emission for (a,x)

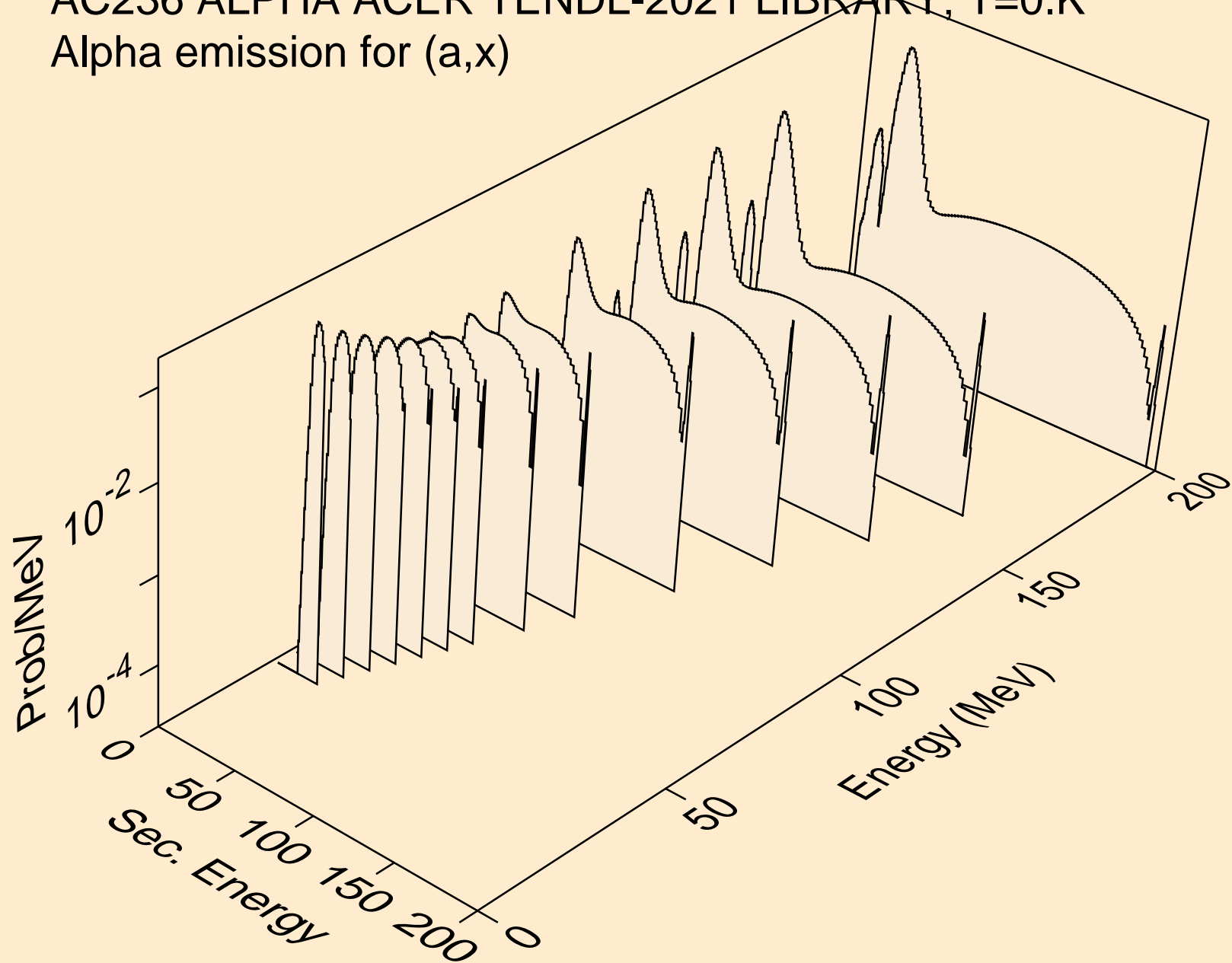



AC236 ALPHA ACER TENDL-2021 LIBRARY; T=0.K  
Alpha emission for (a,n\*)a

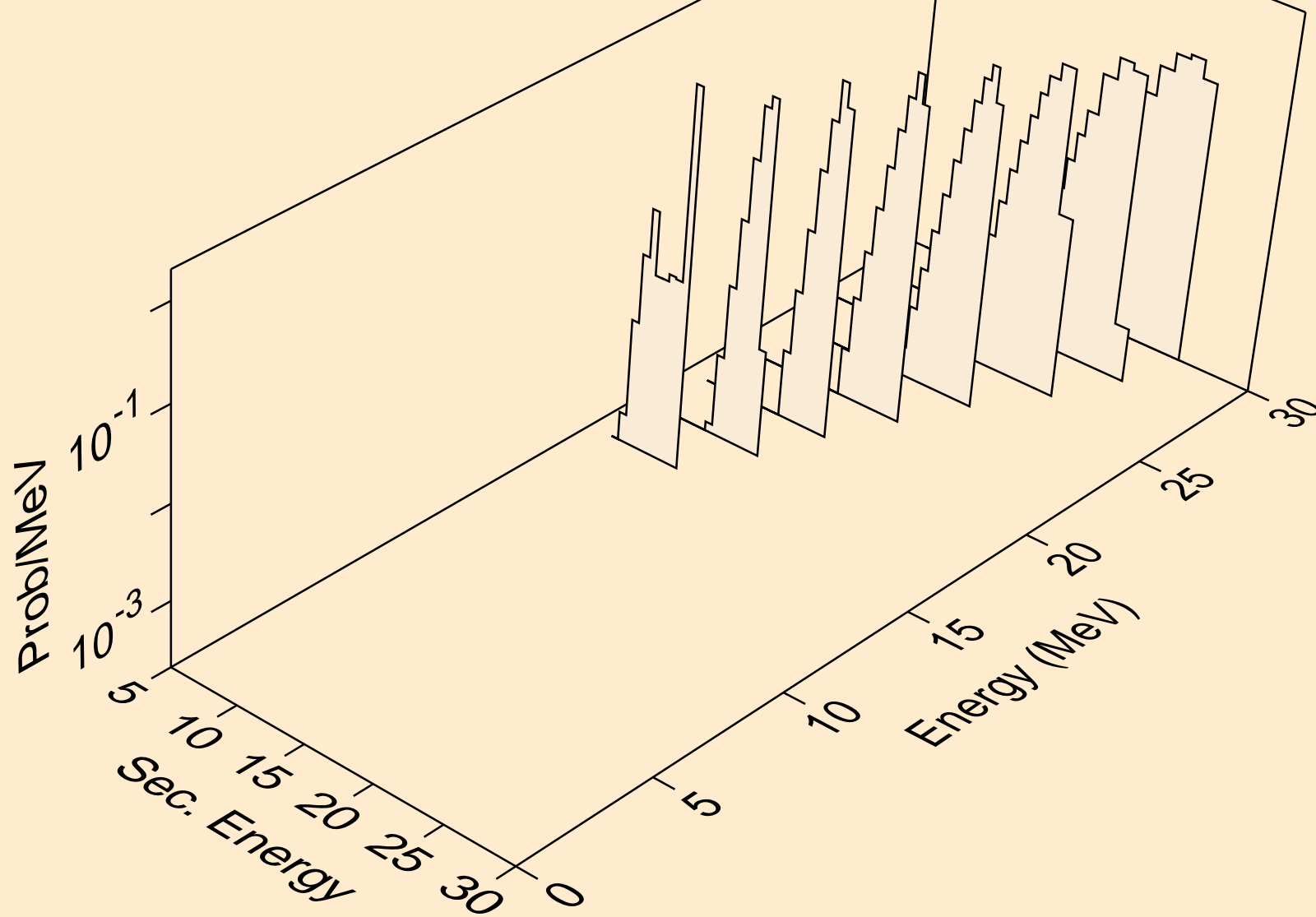

AC236 ALPHA ACER TENDL-2021 LIBRARY; T=0.K  
Alpha emission for (a,2n)a

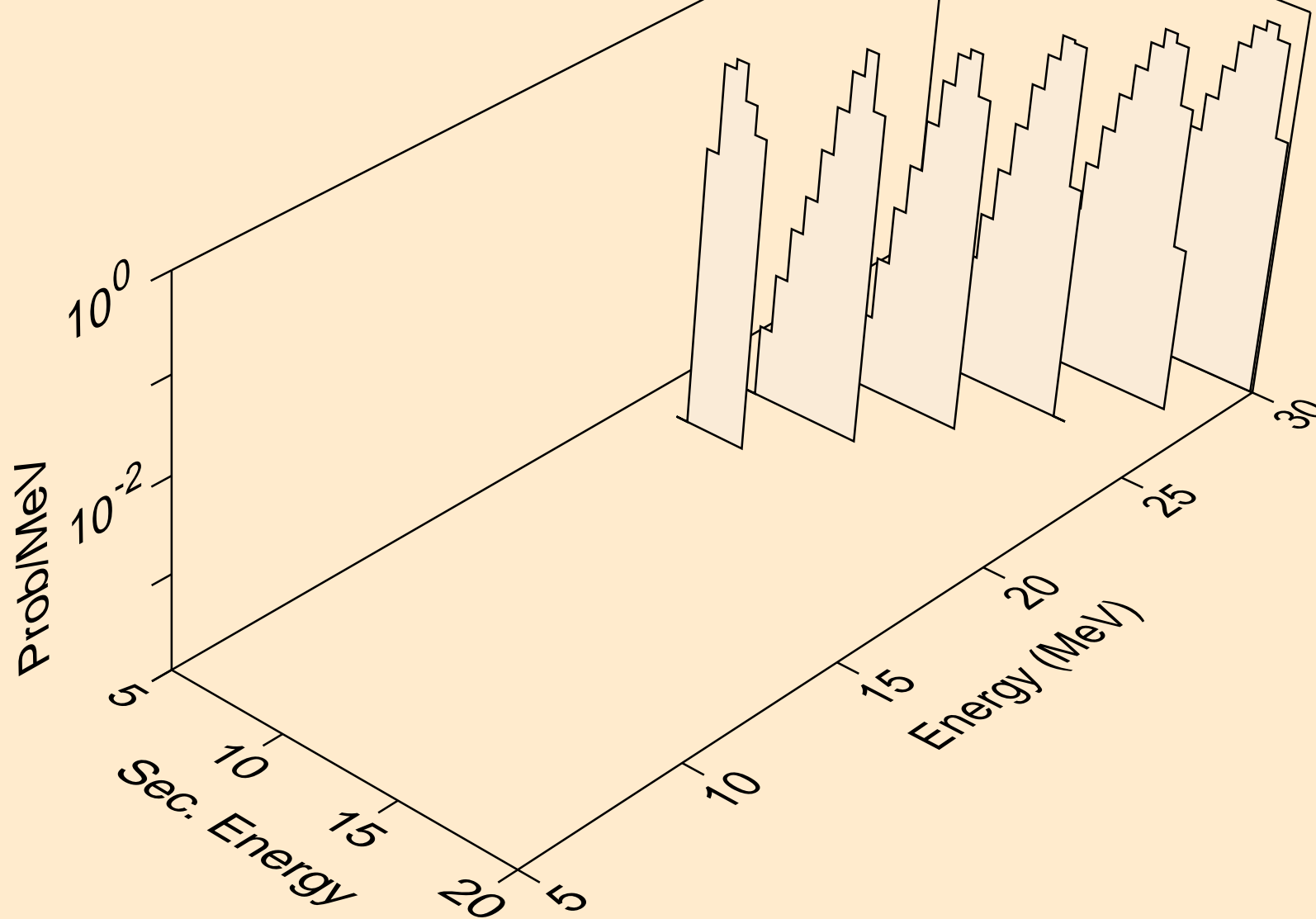

AC236 ALPHA ACER TENDL-2021 LIBRARY; T=0.K  
Alpha emission for (a,3n)a

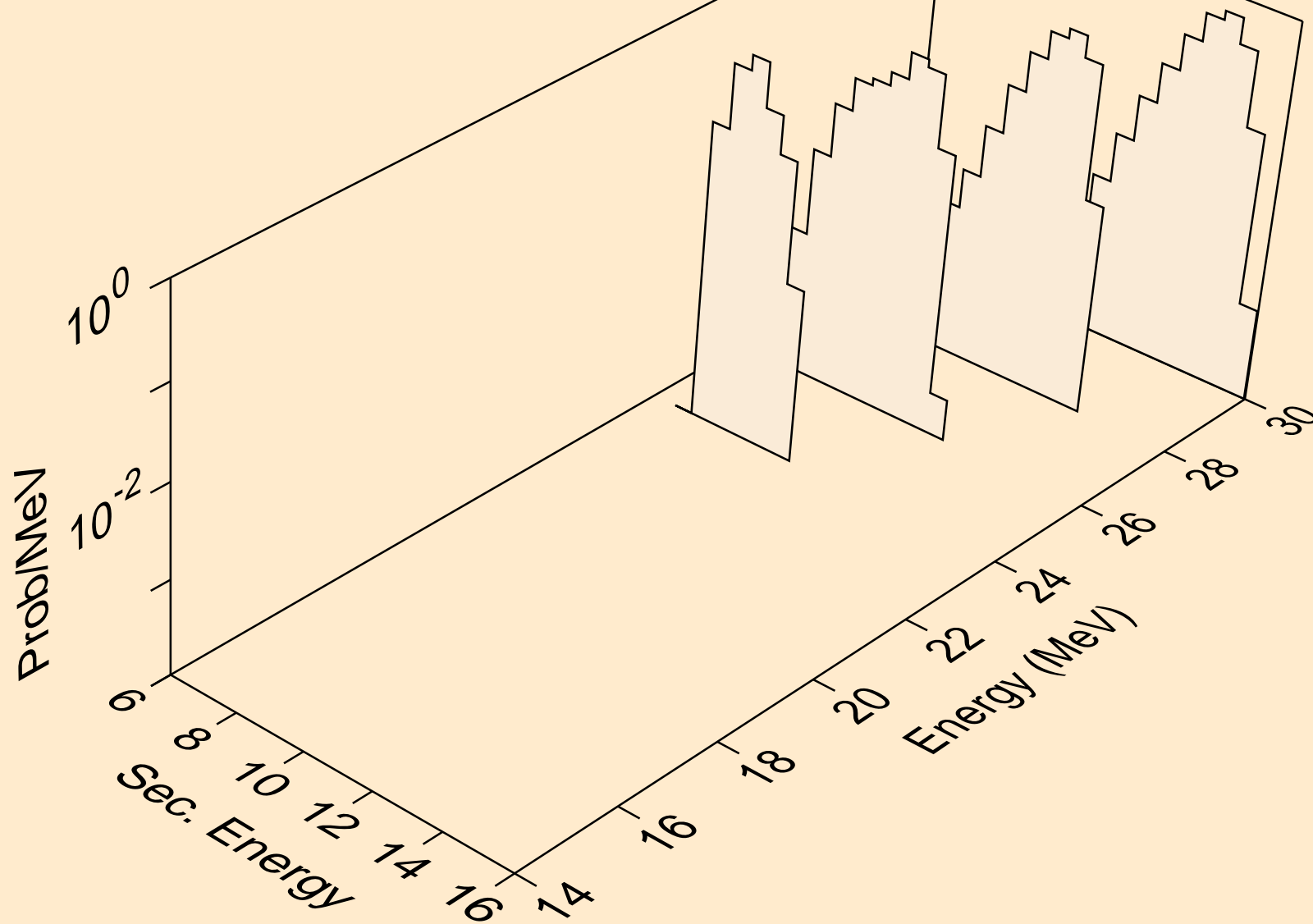

AC236 ALPHA ACER TENDL-2021 LIBRARY; T=0.K  
Alpha emission for inelastic

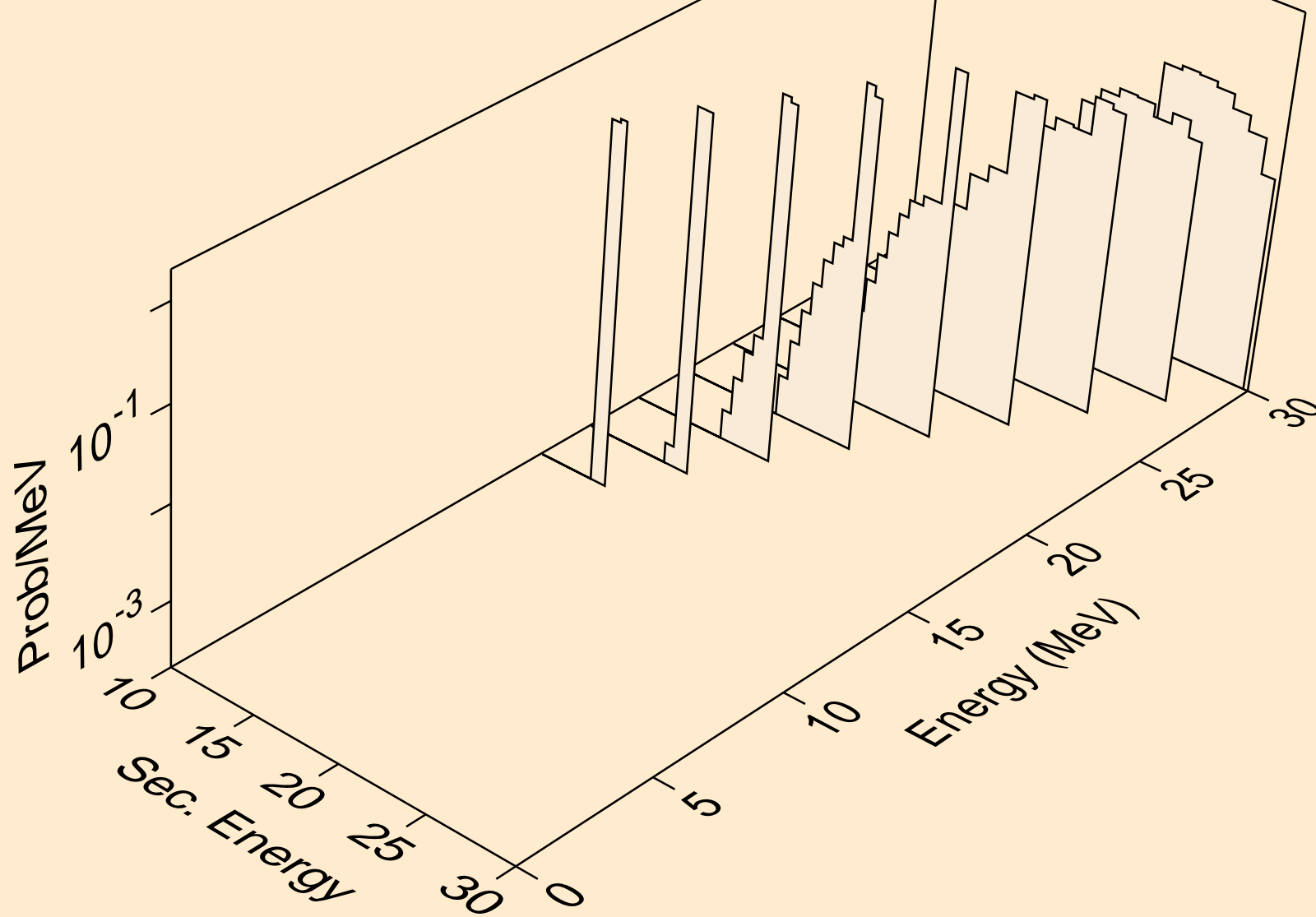

AC236 ALPHA ACER TENDL-2021 LIBRARY; T=0.K  
Photon emission for (z,n)

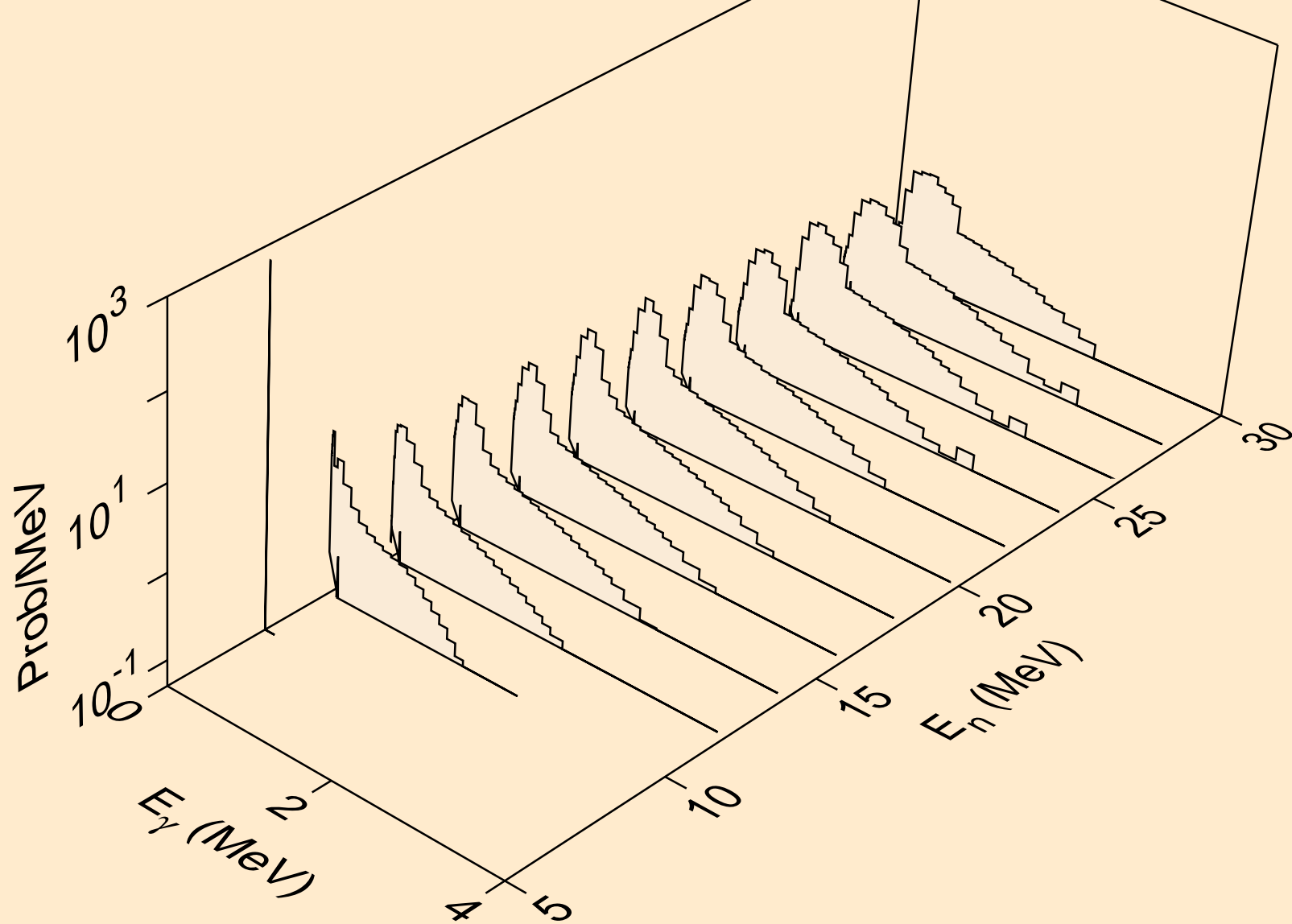

AC236 ALPHA ACER TENDL-2021 LIBRARY; T=0.K  
Photon emission for (n,x)

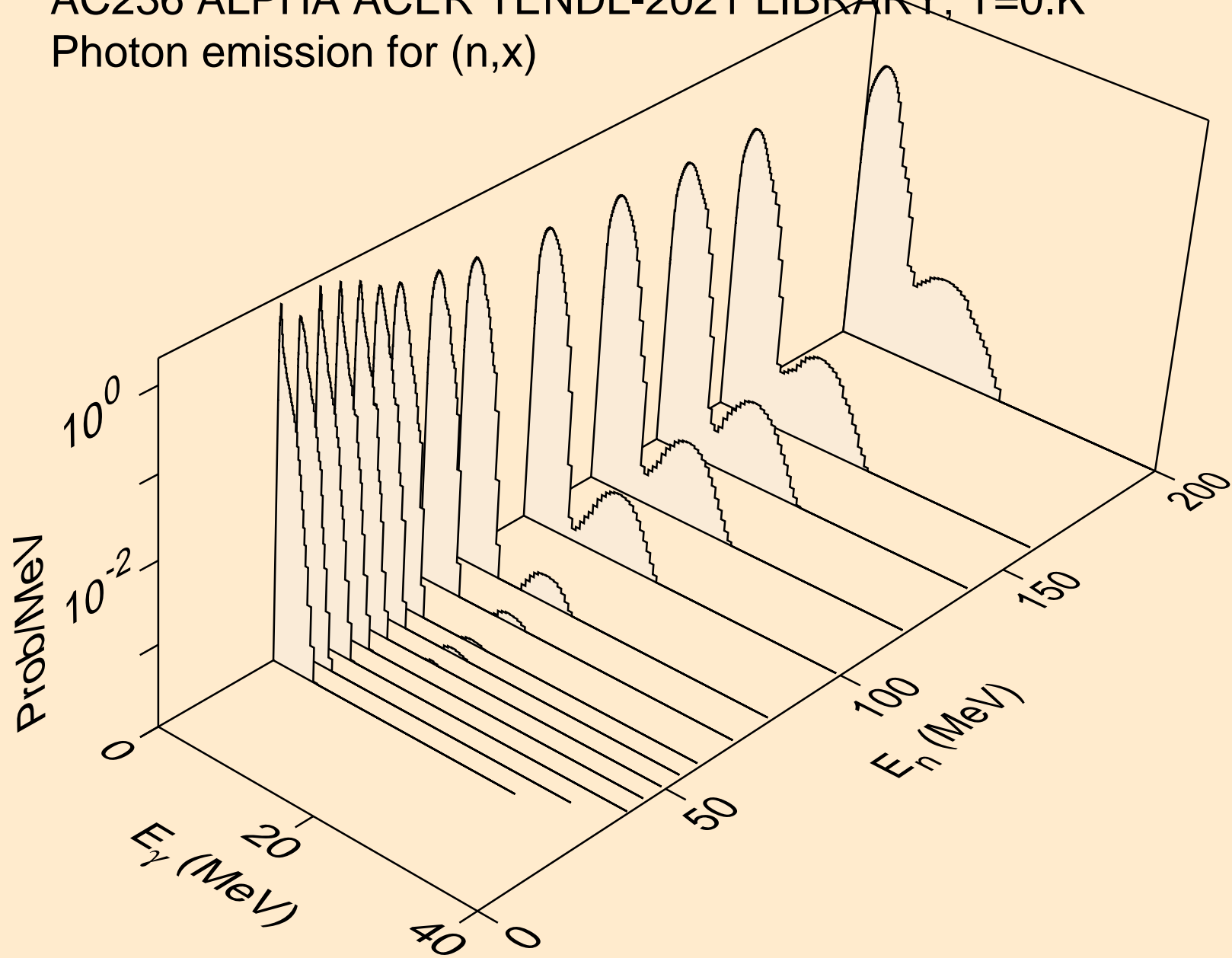

AC236 ALPHA ACER TENDL-2021 LIBRARY; T=0.K  
Photon emission for (n,2nd)

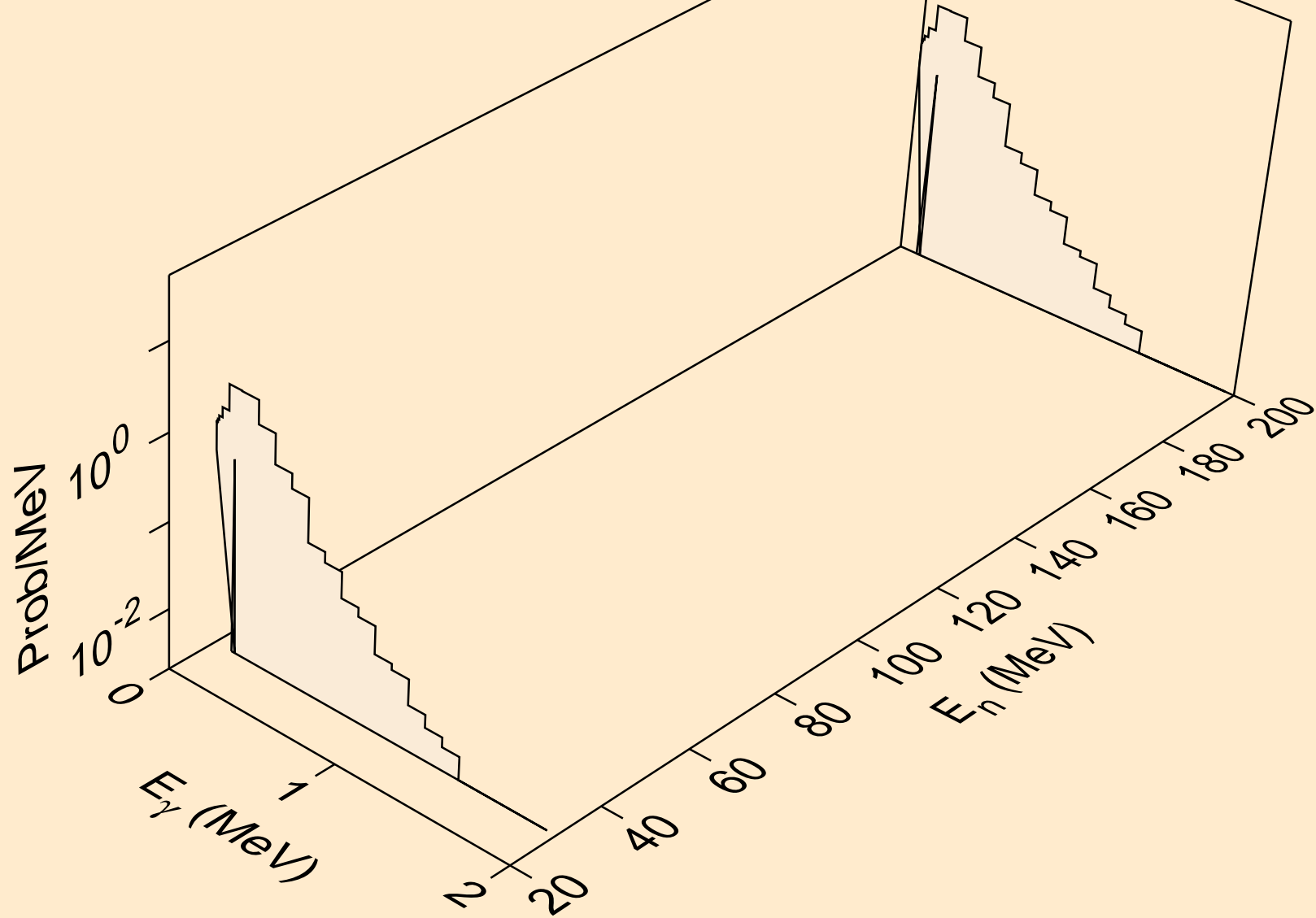

AC236 ALPHA ACER TENDL-2021 LIBRARY; T=0.K  
Photon emission for (n,2n)

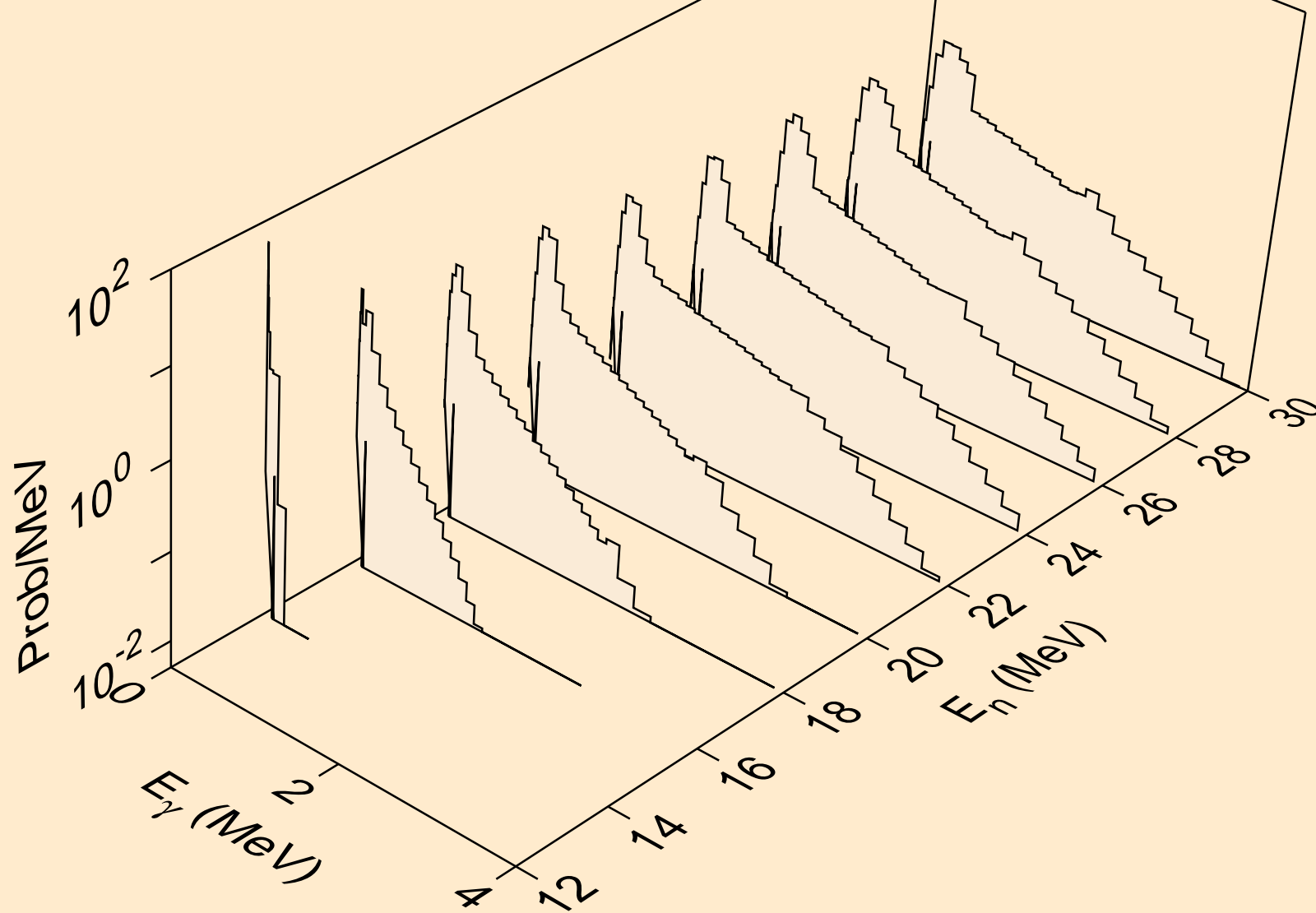



AC236 ALPHA ACER TENDL-2021 LIBRARY; T=0.K  
Photon emission for (n,3n)

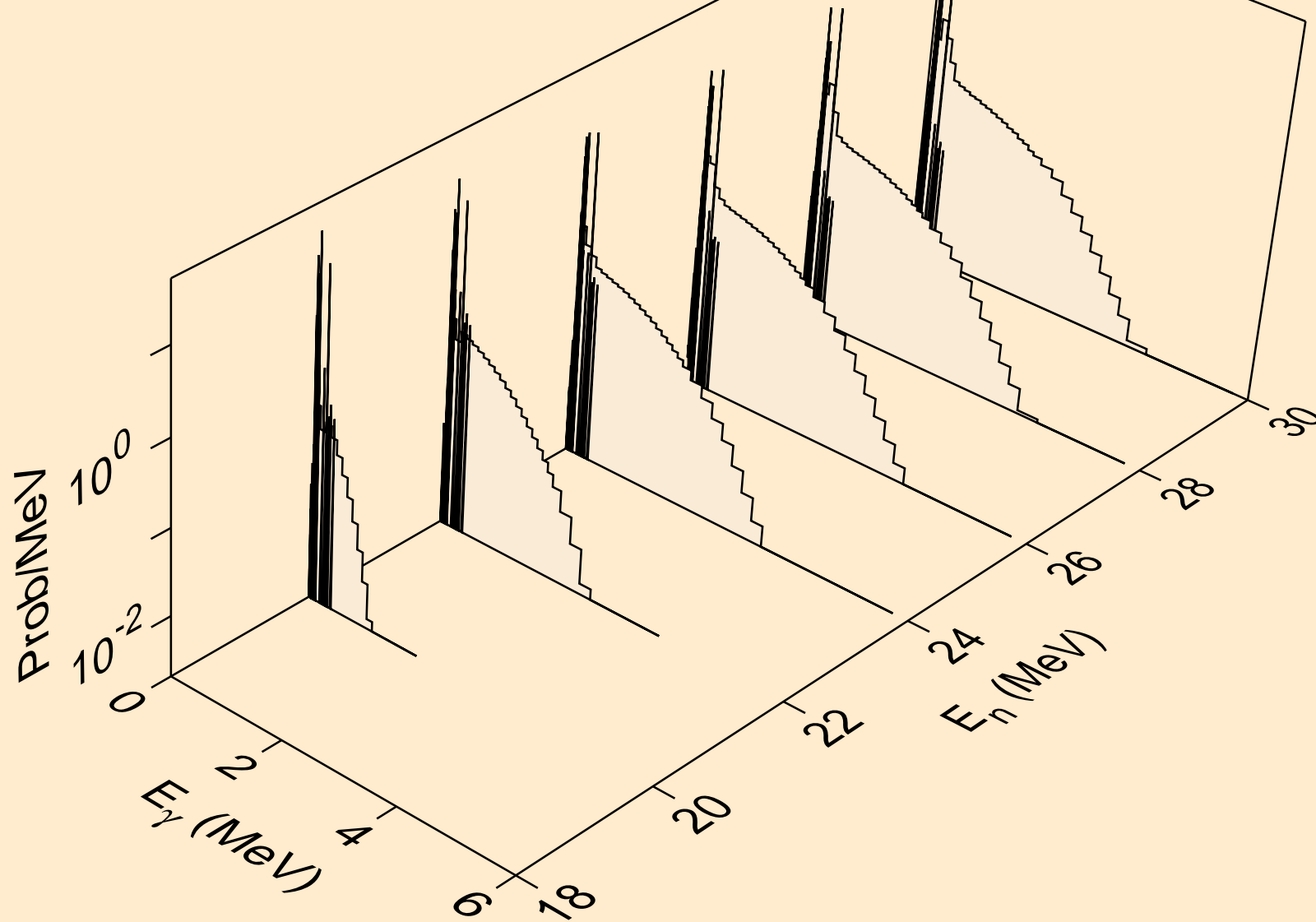

AC236 ALPHA ACER TENDL-2021 LIBRARY; T=0.K  
Photon emission for (n,n\*)a

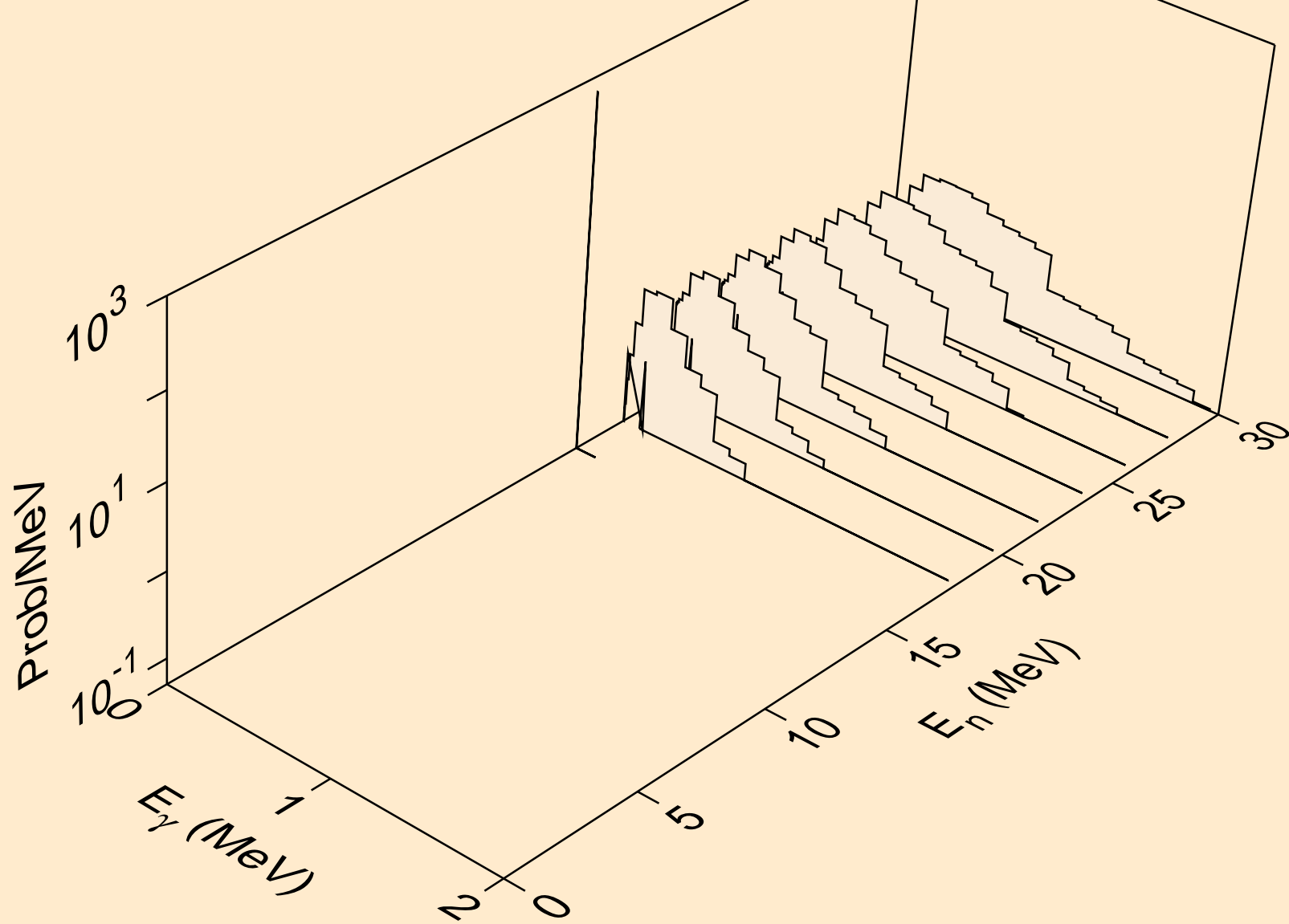

AC236 ALPHA ACER TENDL-2021 LIBRARY; T=0.K  
Photon emission for (n,2n)a

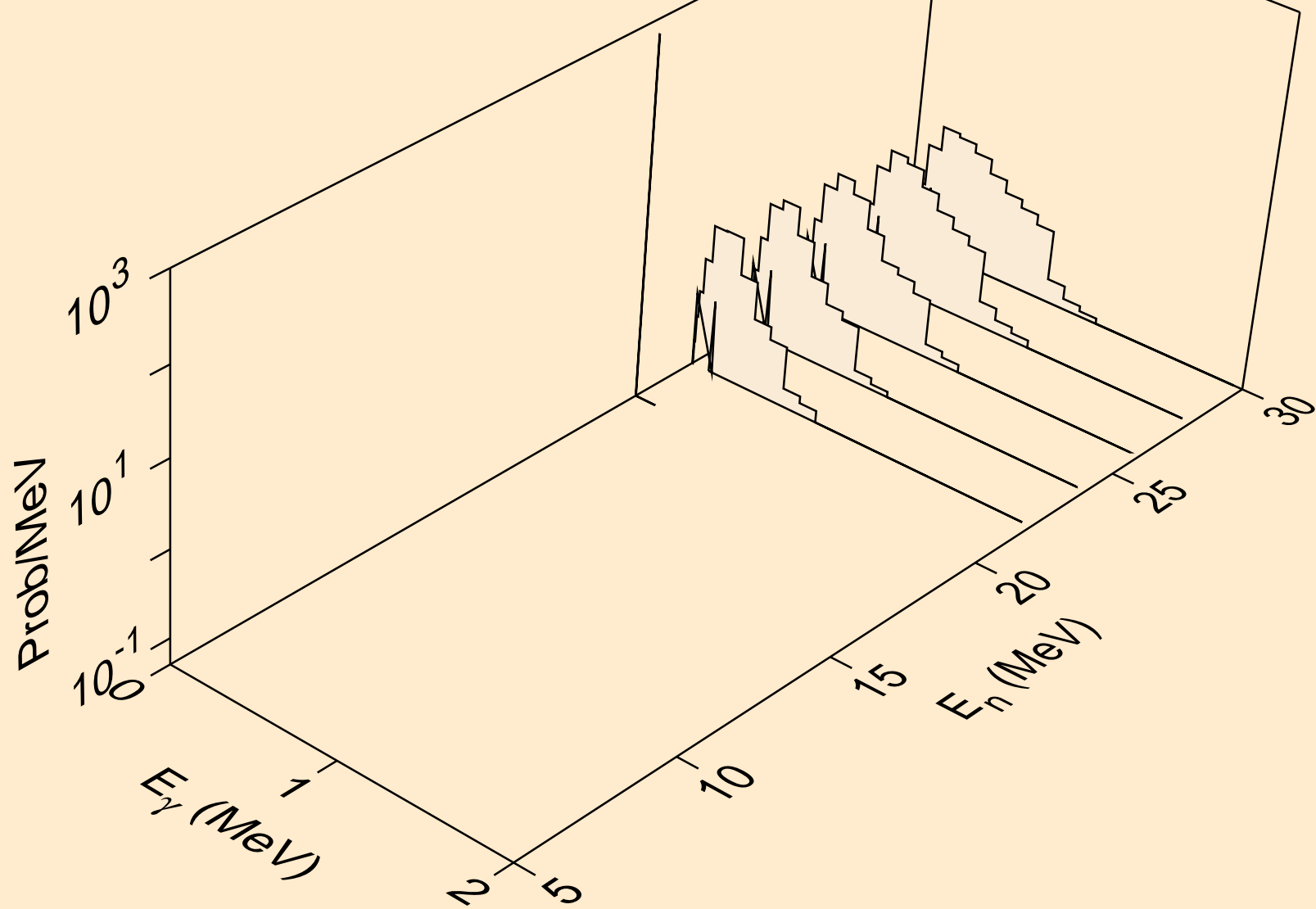

AC236 ALPHA ACER TENDL-2021 LIBRARY; T=0.K  
Photon emission for (n,3n)a

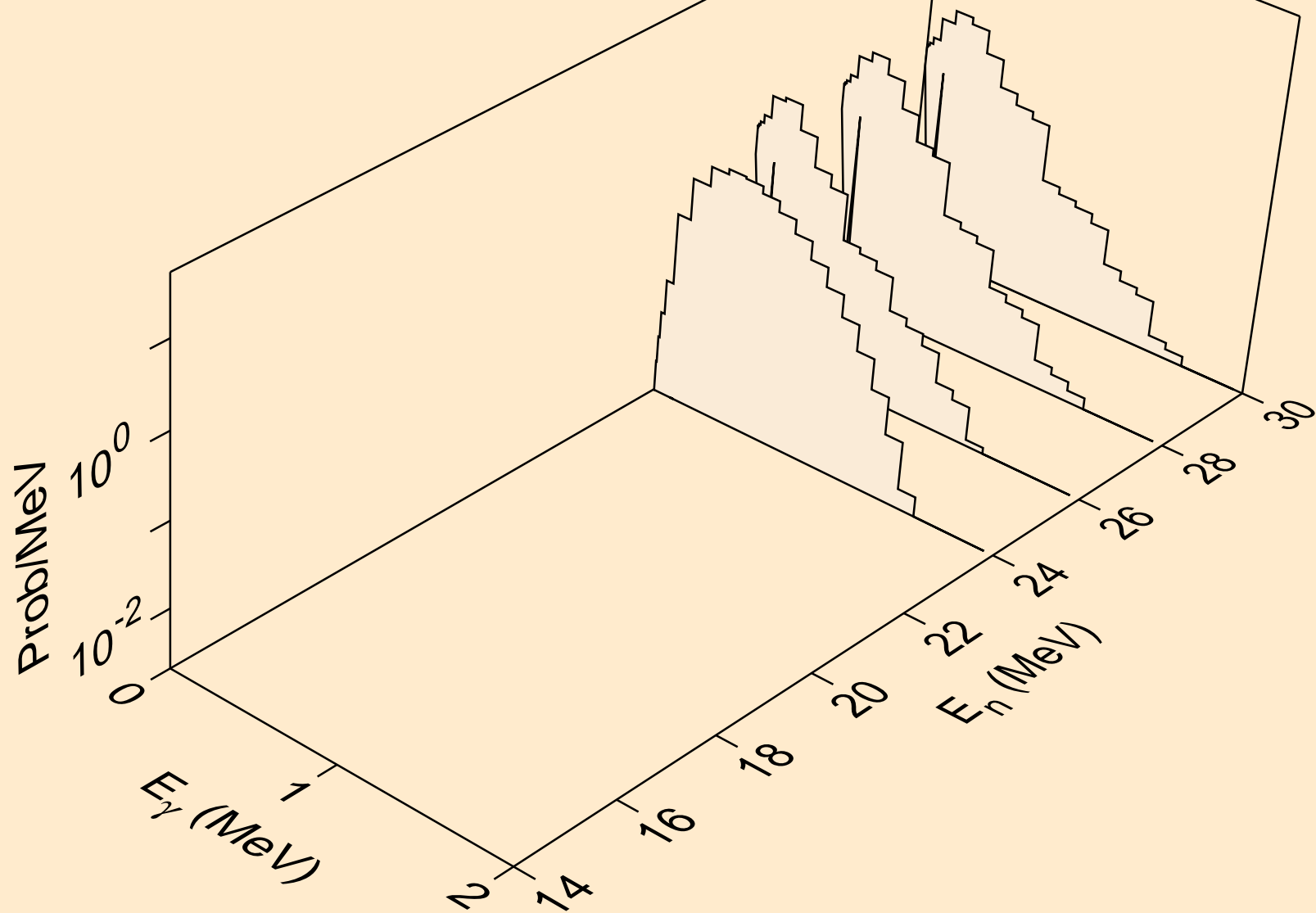

AC236 ALPHA ACER TENDL-2021 LIBRARY; T=0.K  
Photon emission for (n,n\*)p

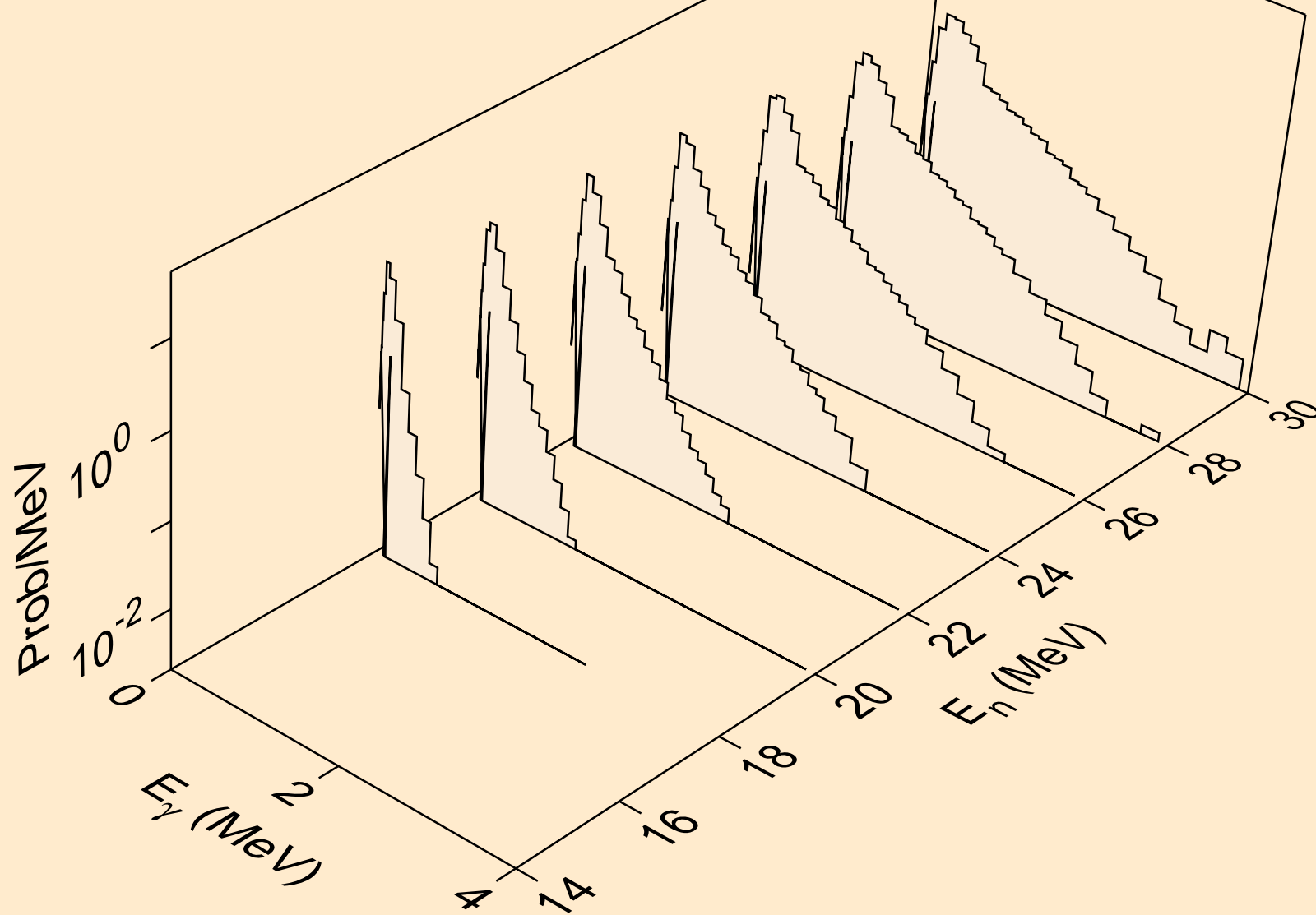

AC236 ALPHA ACER TENDL-2021 LIBRARY; T=0.K  
Photon emission for (n,n\*)d

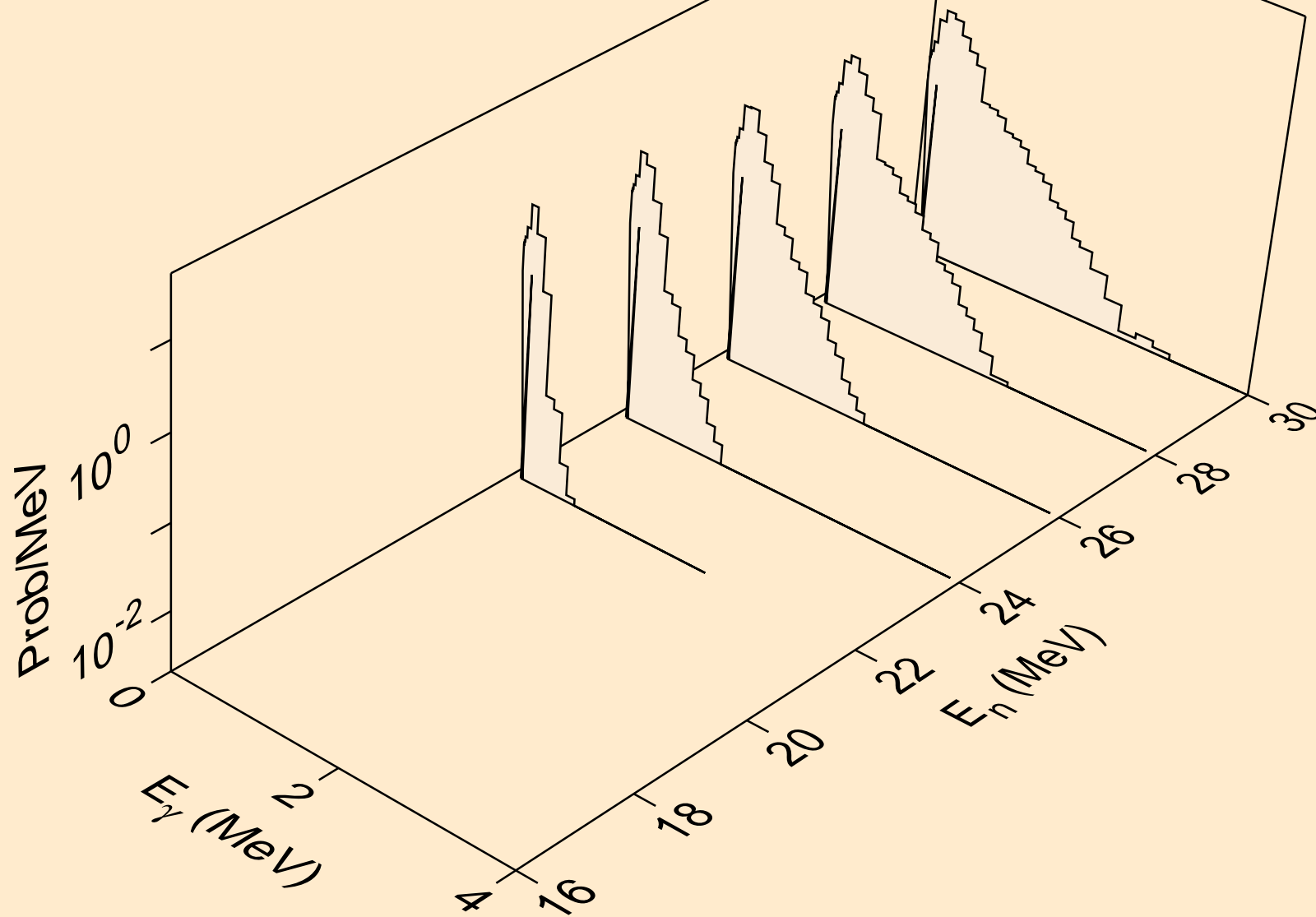

AC236 ALPHA ACER TENDL-2021 LIBRARY; T=0.K  
Photon emission for (n,n\*)t

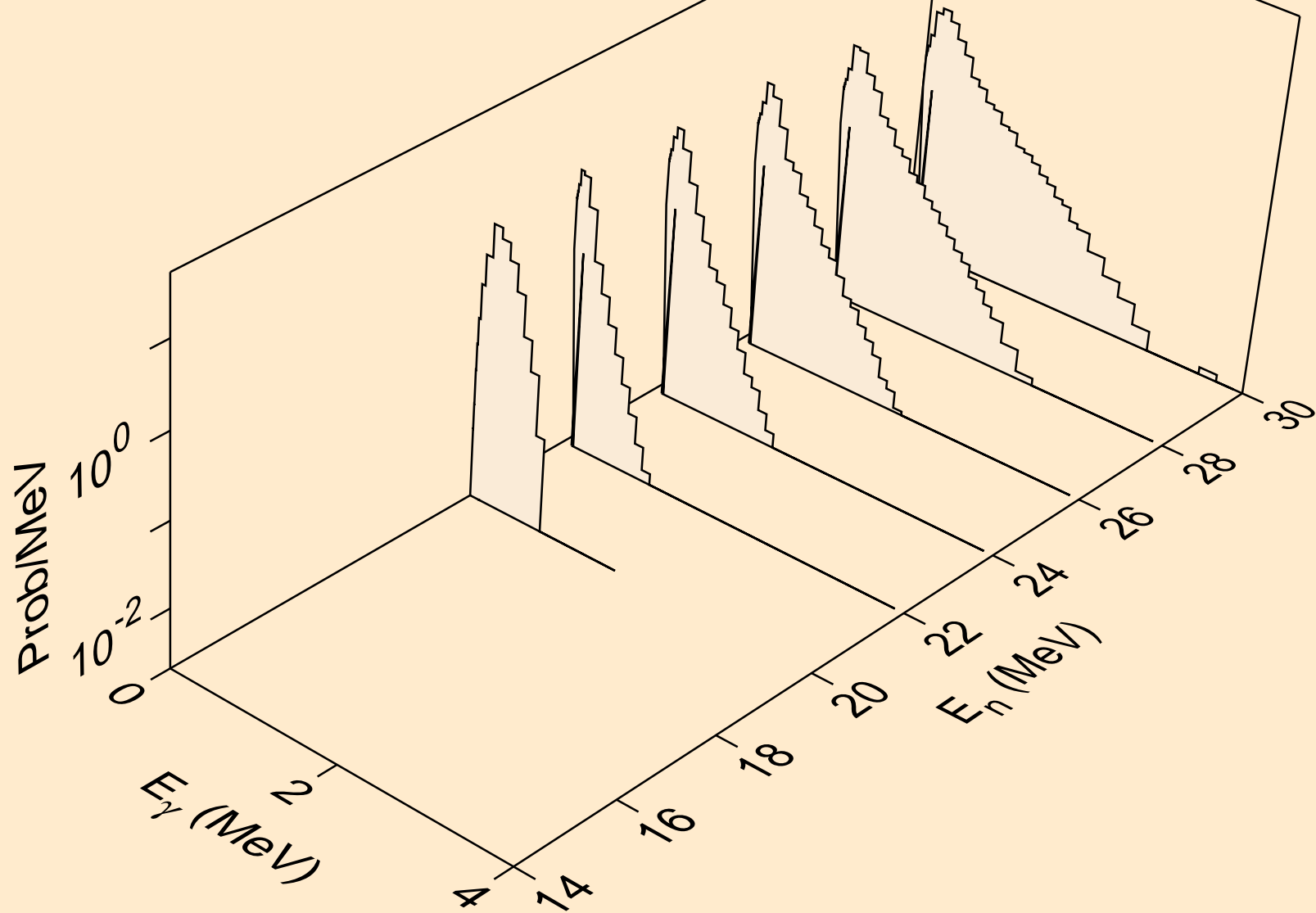

AC236 ALPHA ACER TENDL-2021 LIBRARY; T=0.K  
Photon emission for (n,4n)

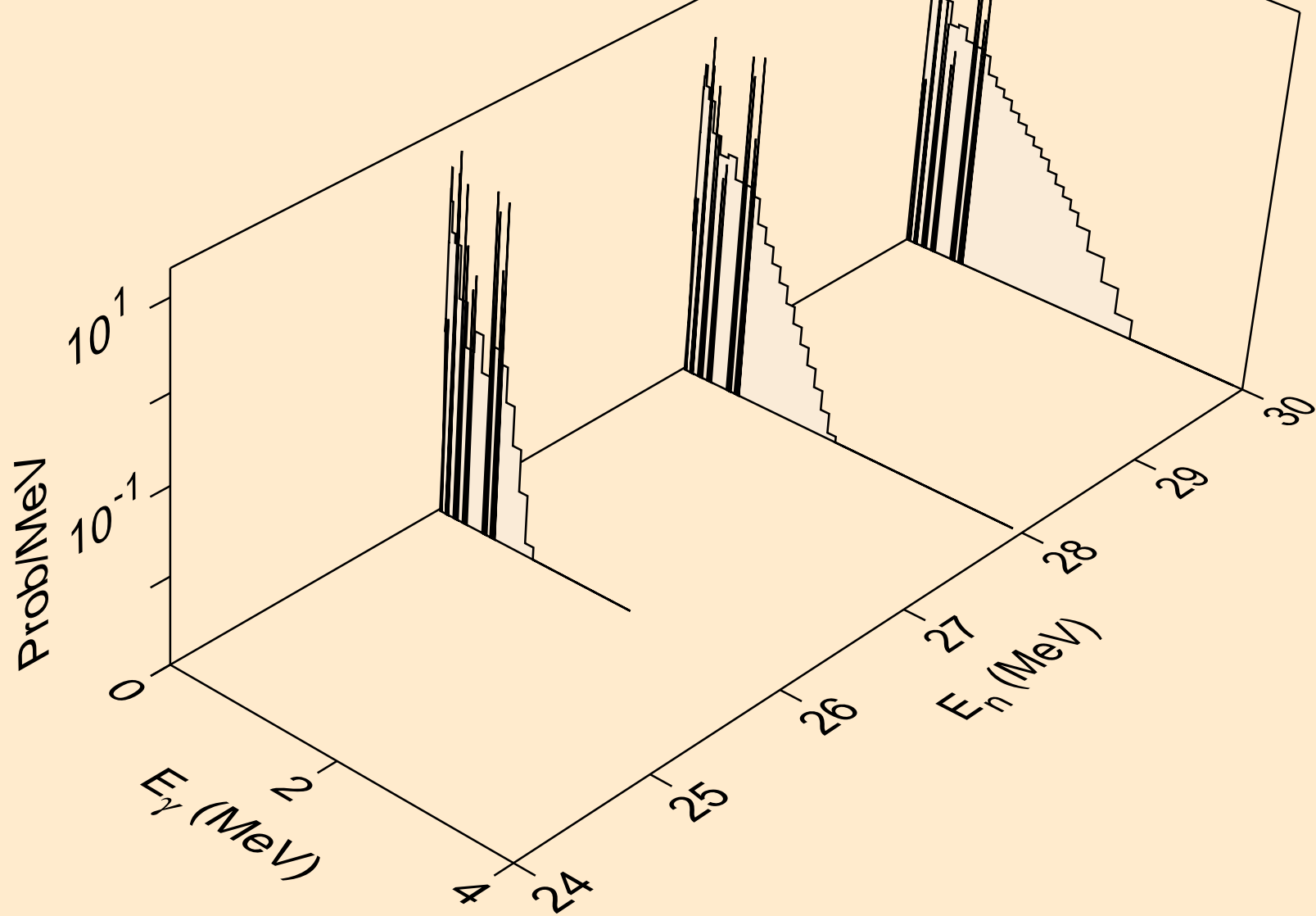



AC236 ALPHA ACER TENDL-2021 LIBRARY; T=0.K  
Photon emission for (n,2np)

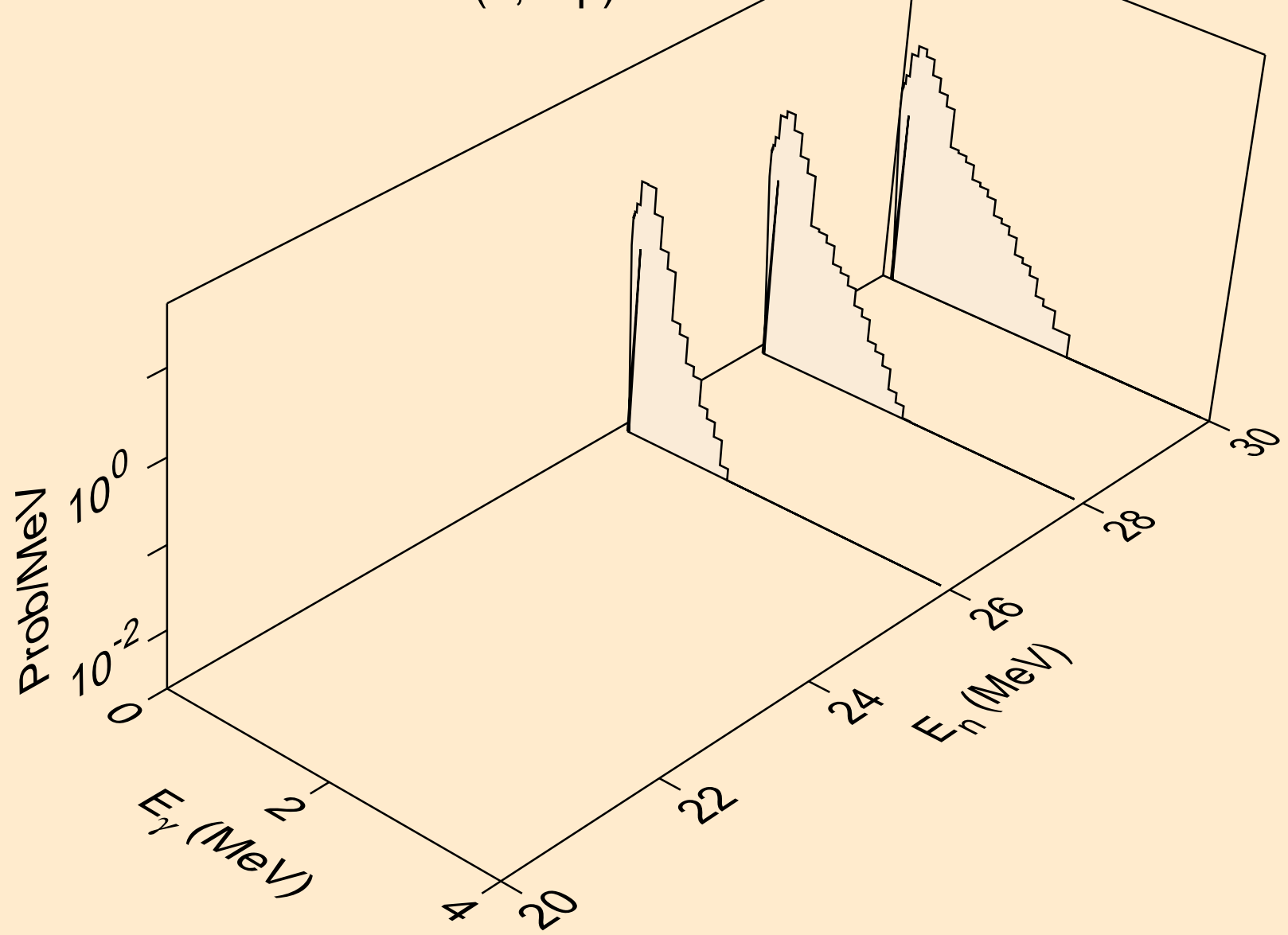

AC236 ALPHA ACER TENDL-2021 LIBRARY; T=0.K  
Photon emission for (n,gma)

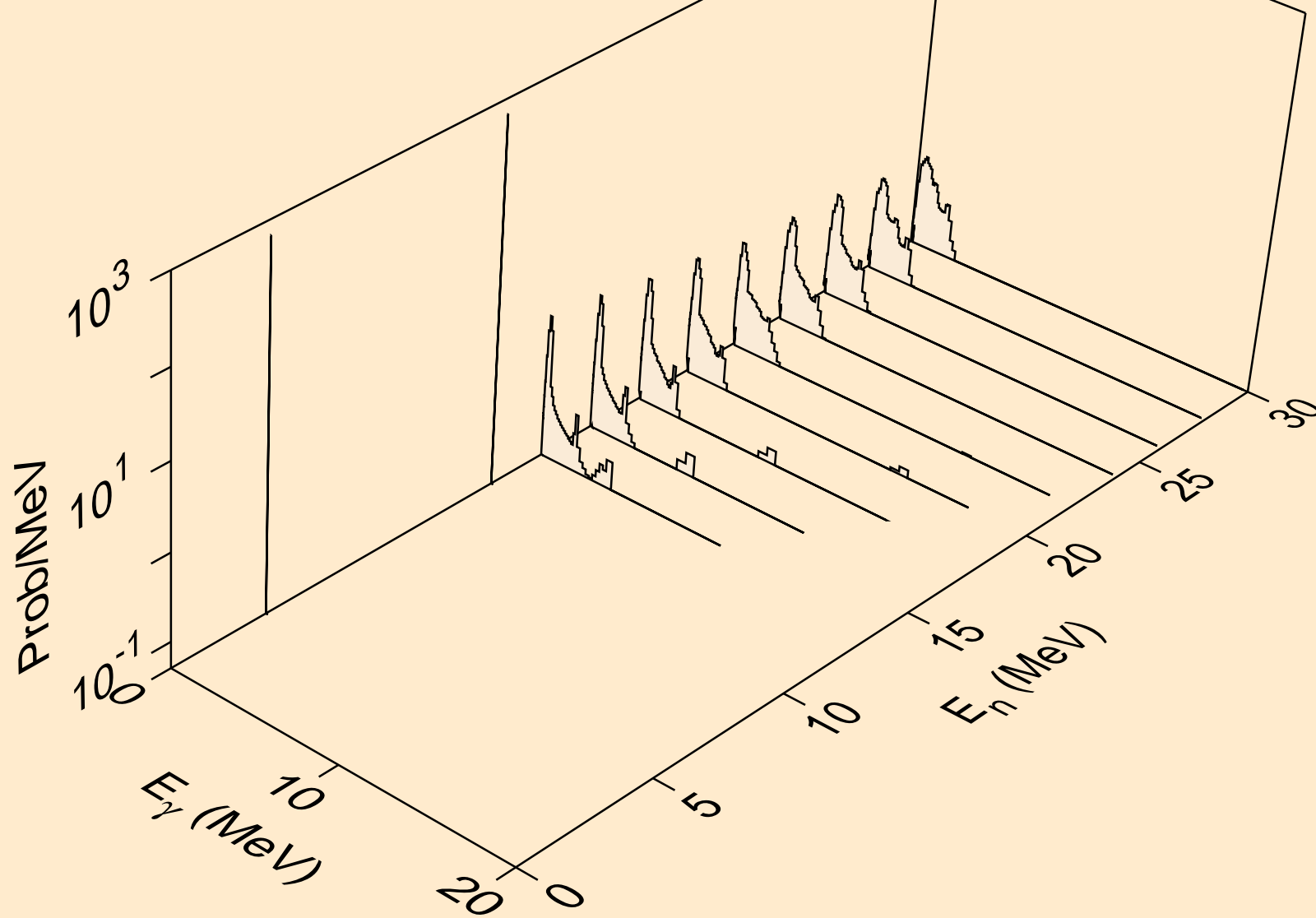

AC236 ALPHA ACER TENDL-2021 LIBRARY; T=0.K  
Photon emission for (n,p)

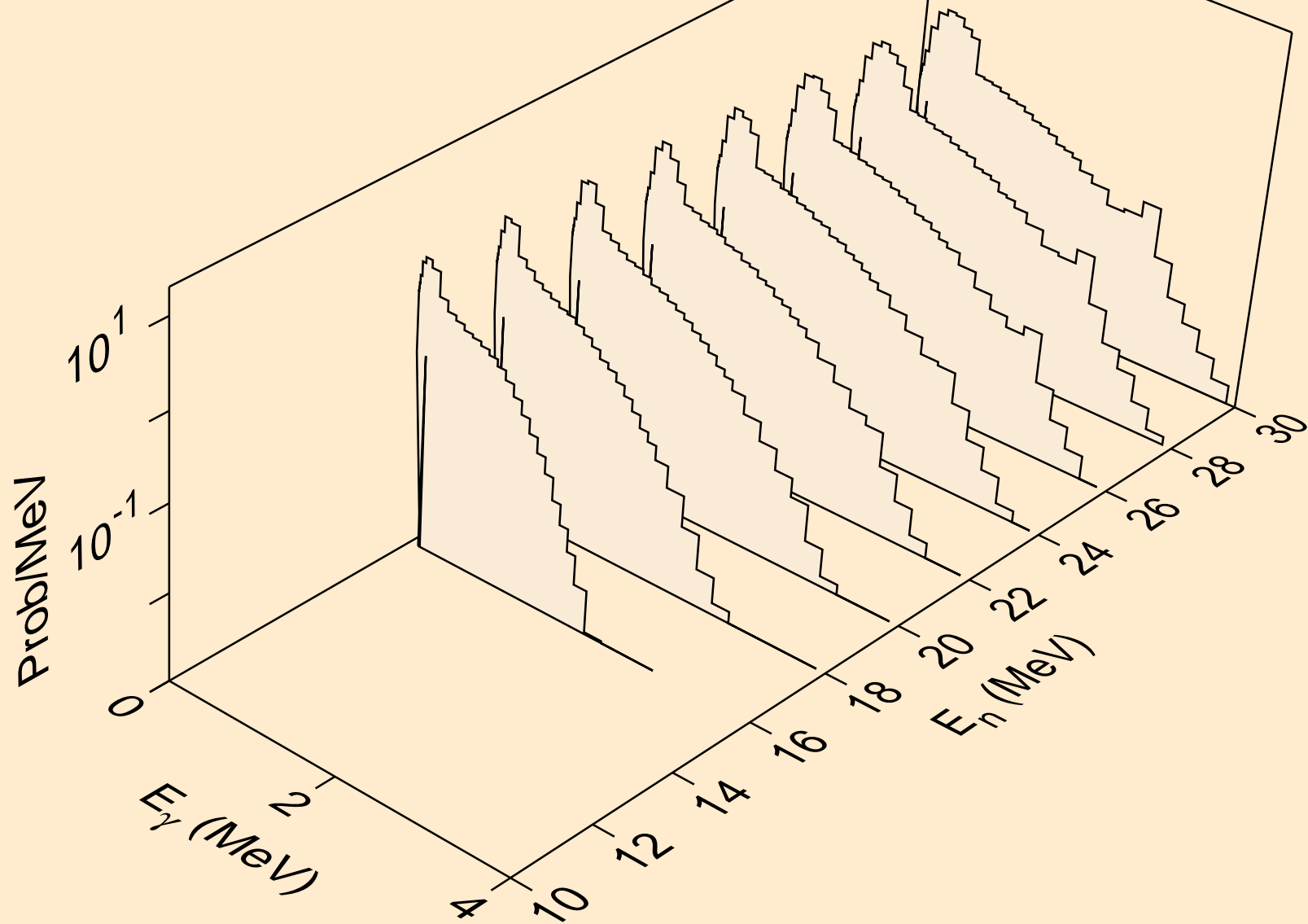

AC236 ALPHA ACER TENDL-2021 LIBRARY; T=0.K  
Photon emission for (n,d)

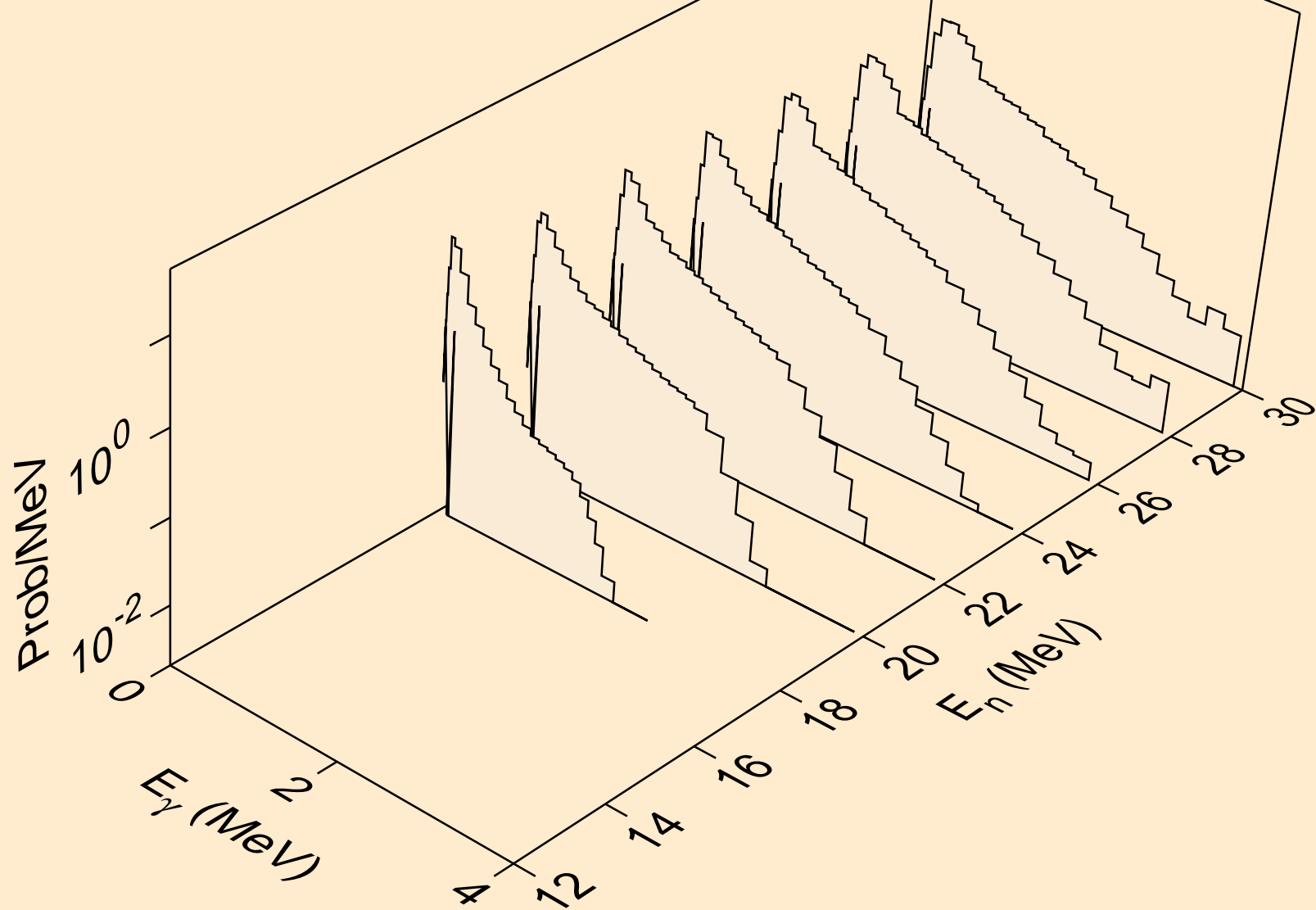

AC236 ALPHA ACER TENDL-2021 LIBRARY; T=0.K  
Photon emission for (n,t)

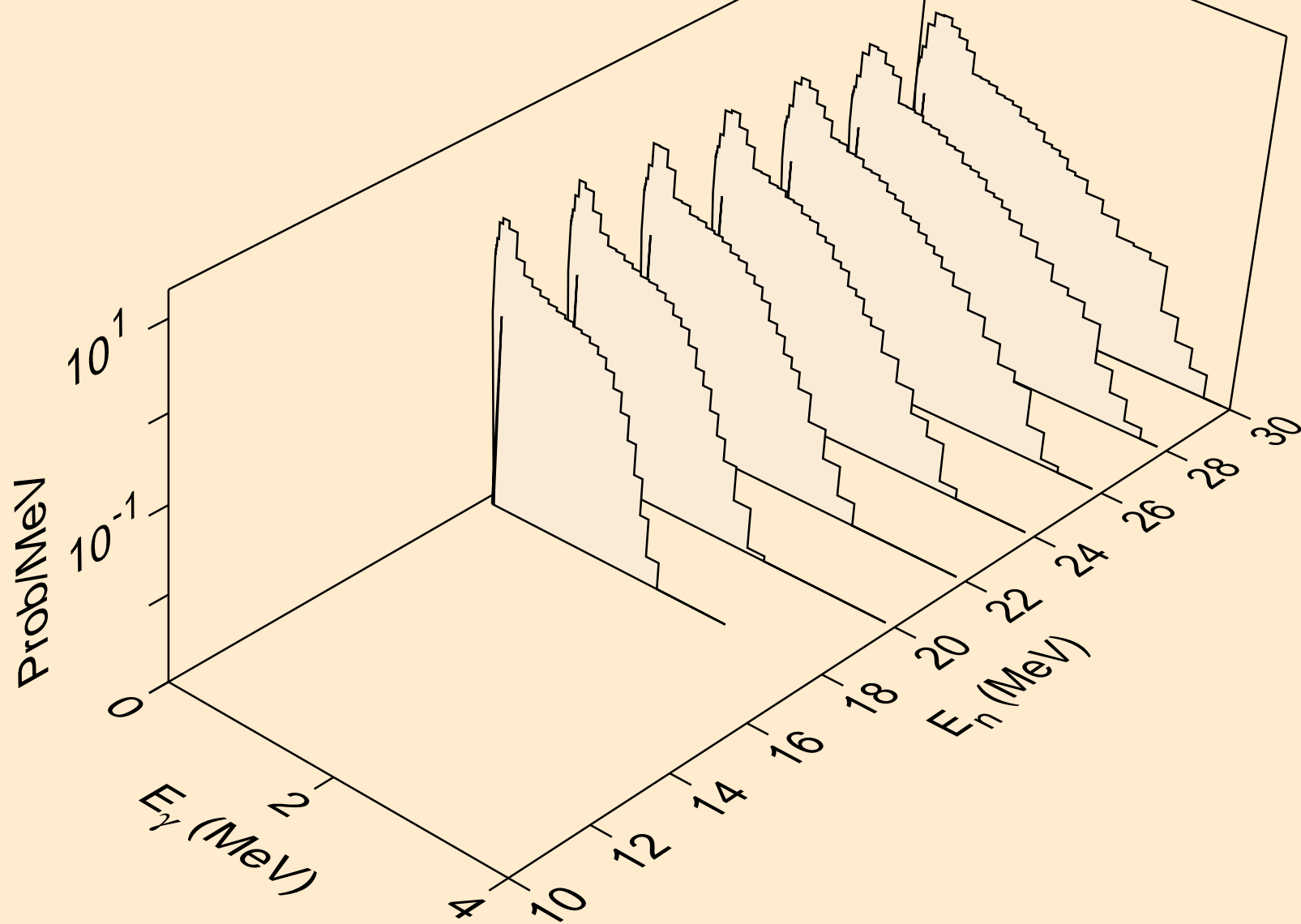

AC236 ALPHA ACER TENDL-2021 LIBRARY; T=0.K  
Photon emission for inelastic

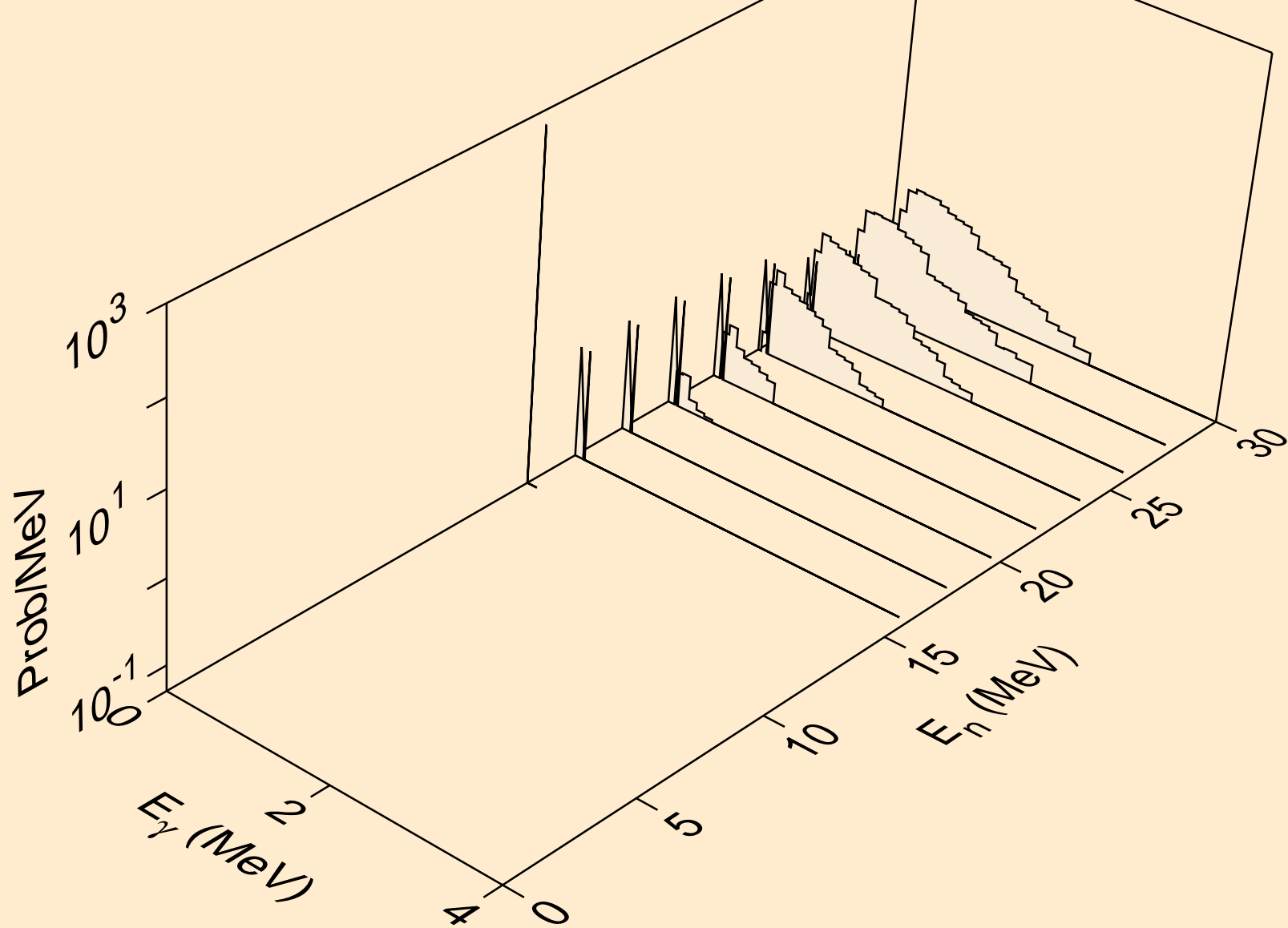

AC236 ALPHA ACER TENDL-2021 LIBRARY; T=0.K  
Particle heating contributions

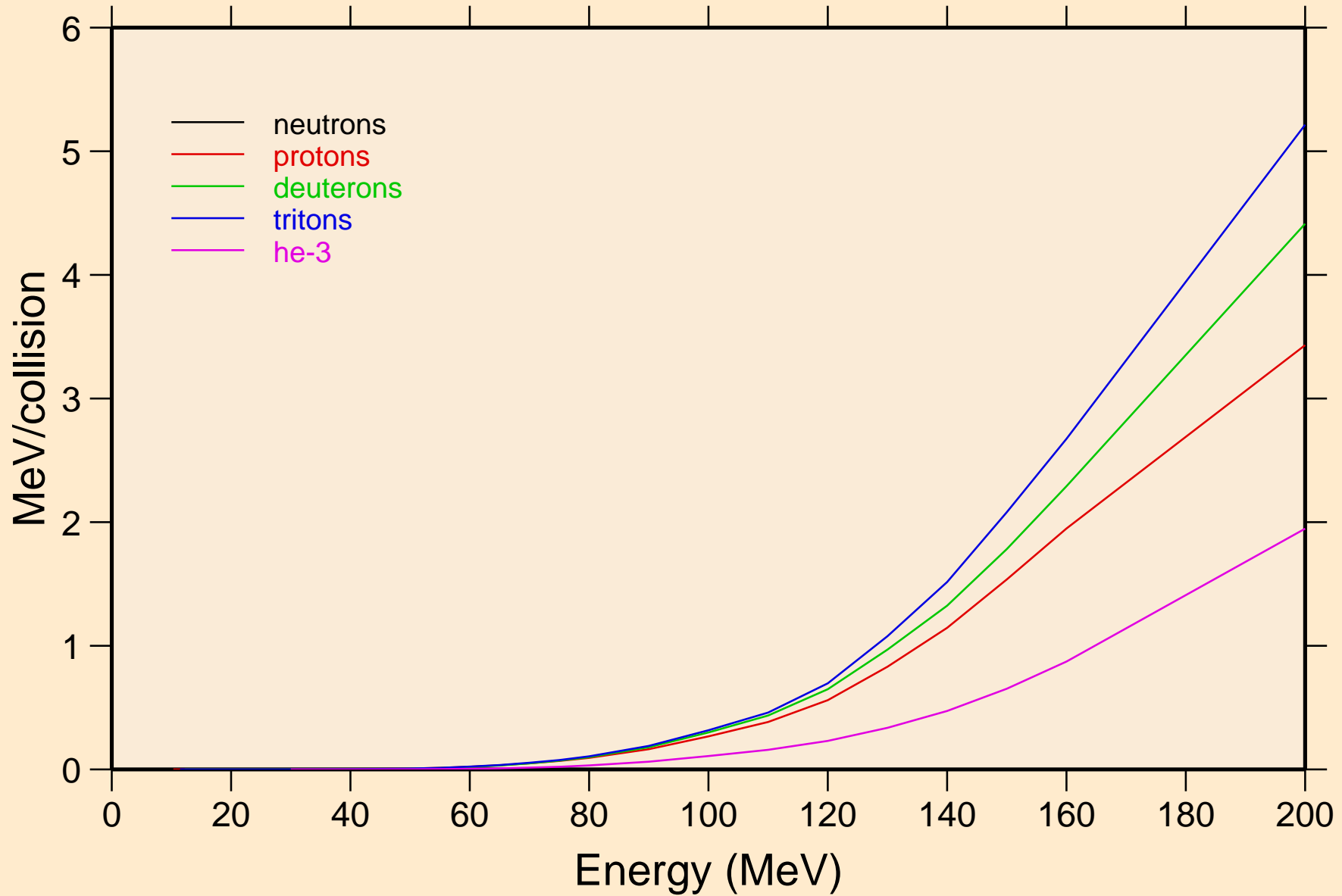

AC236 ALPHA ACER TENDL-2021 LIBRARY; T=0.K  
Recoil Heating

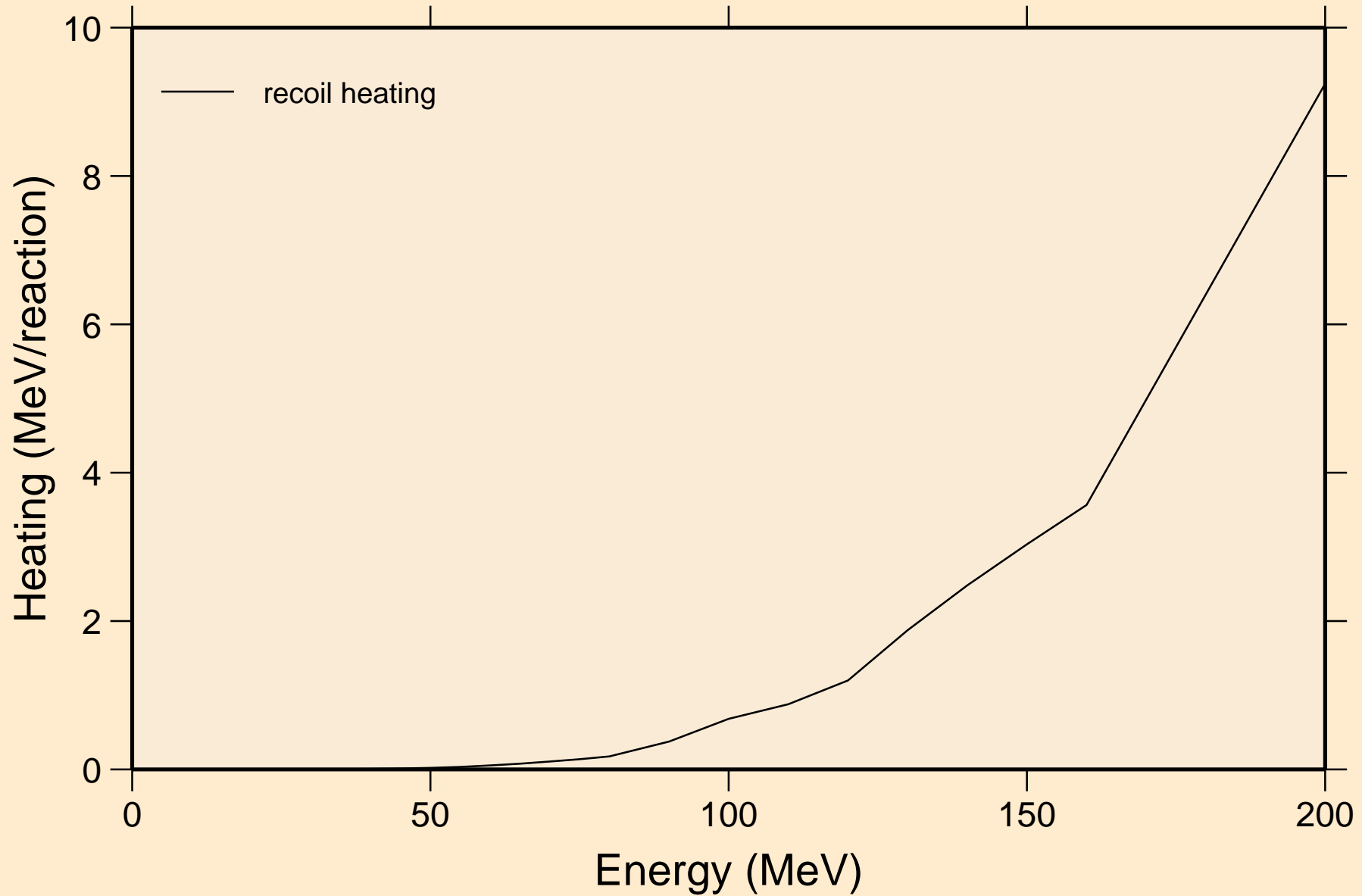



AC236 ALPHA ACER TENDL-2021 LIBRARY; T=0.K  
Particle production cross sections

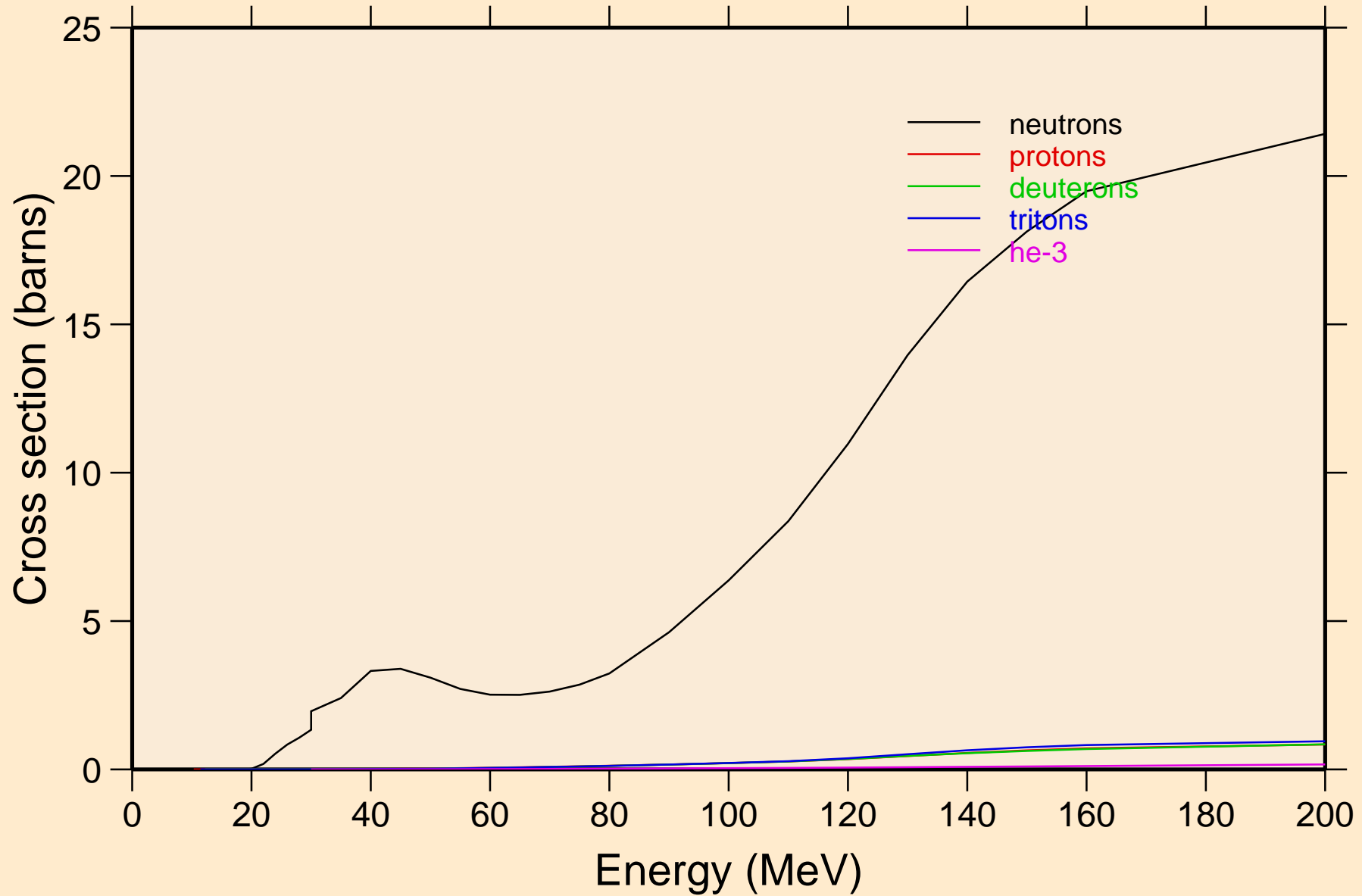

AC236 ALPHA ACER TENDL-2021 LIBRARY; T=0.K  
neutrons from (a,n)

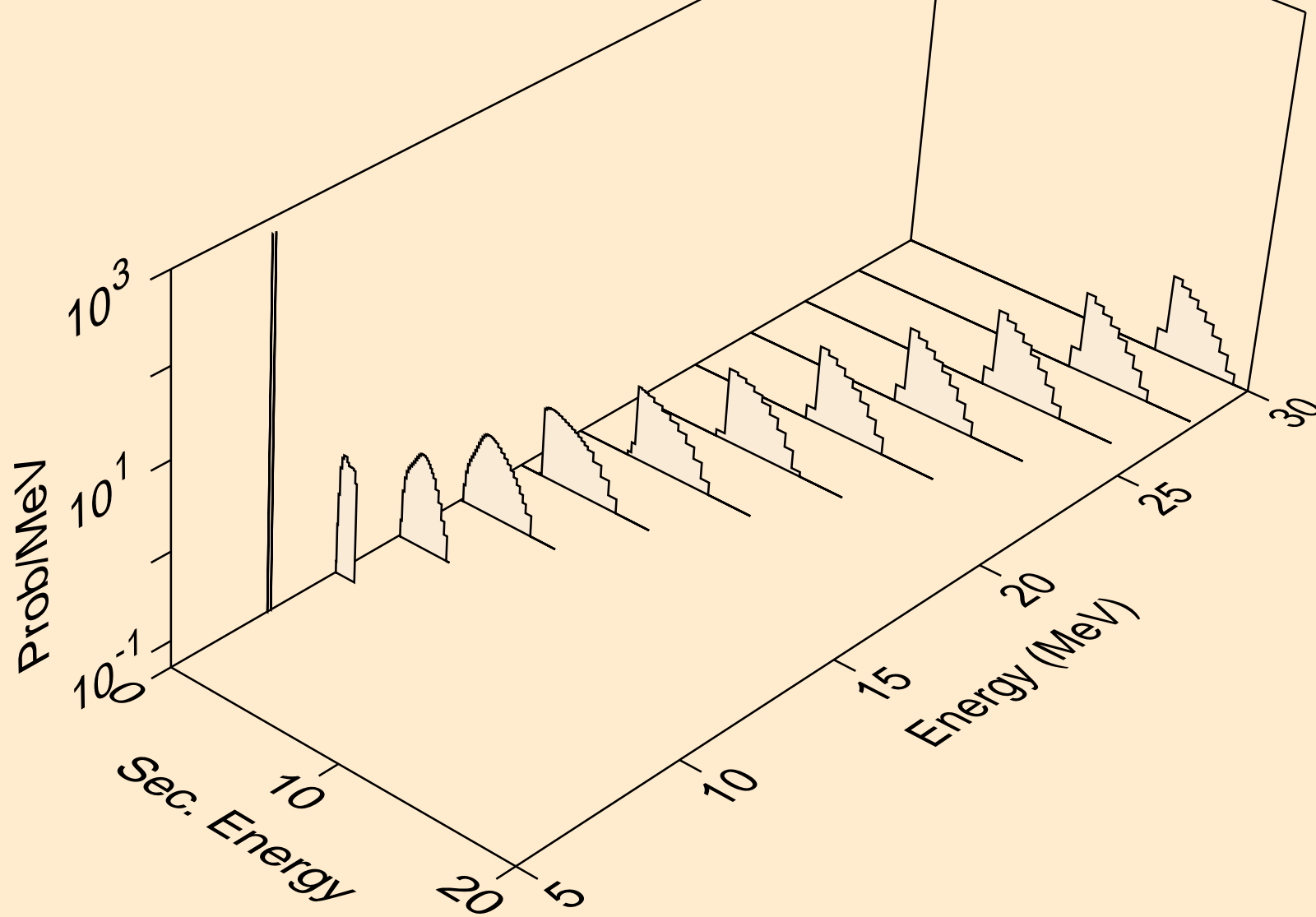

AC236 ALPHA ACER TENDL-2021 LIBRARY; T=0.K  
neutrons from (a,x)

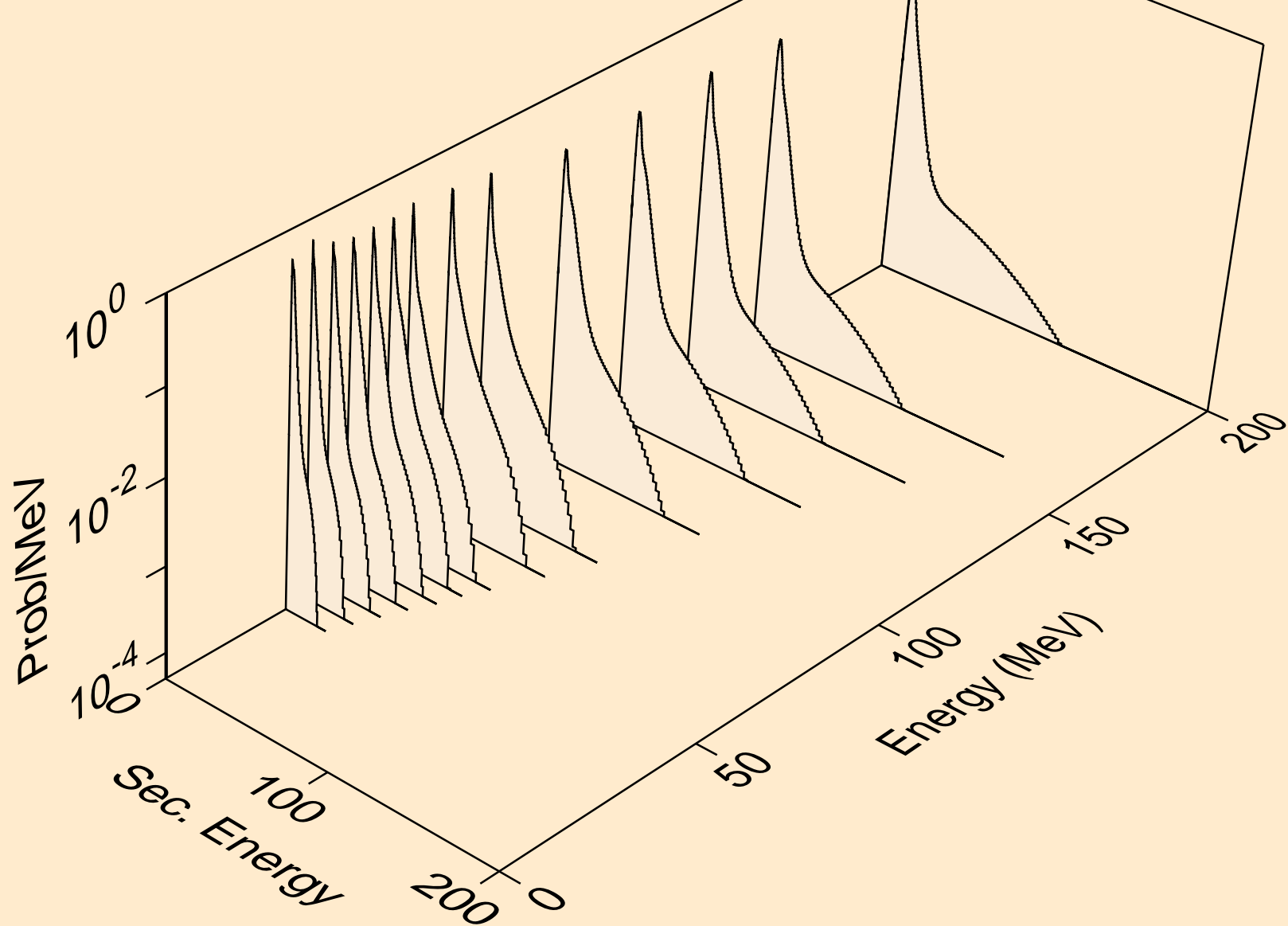

AC236 ALPHA ACER TENDL-2021 LIBRARY; T=0.K  
neutrons from (a,2nd)

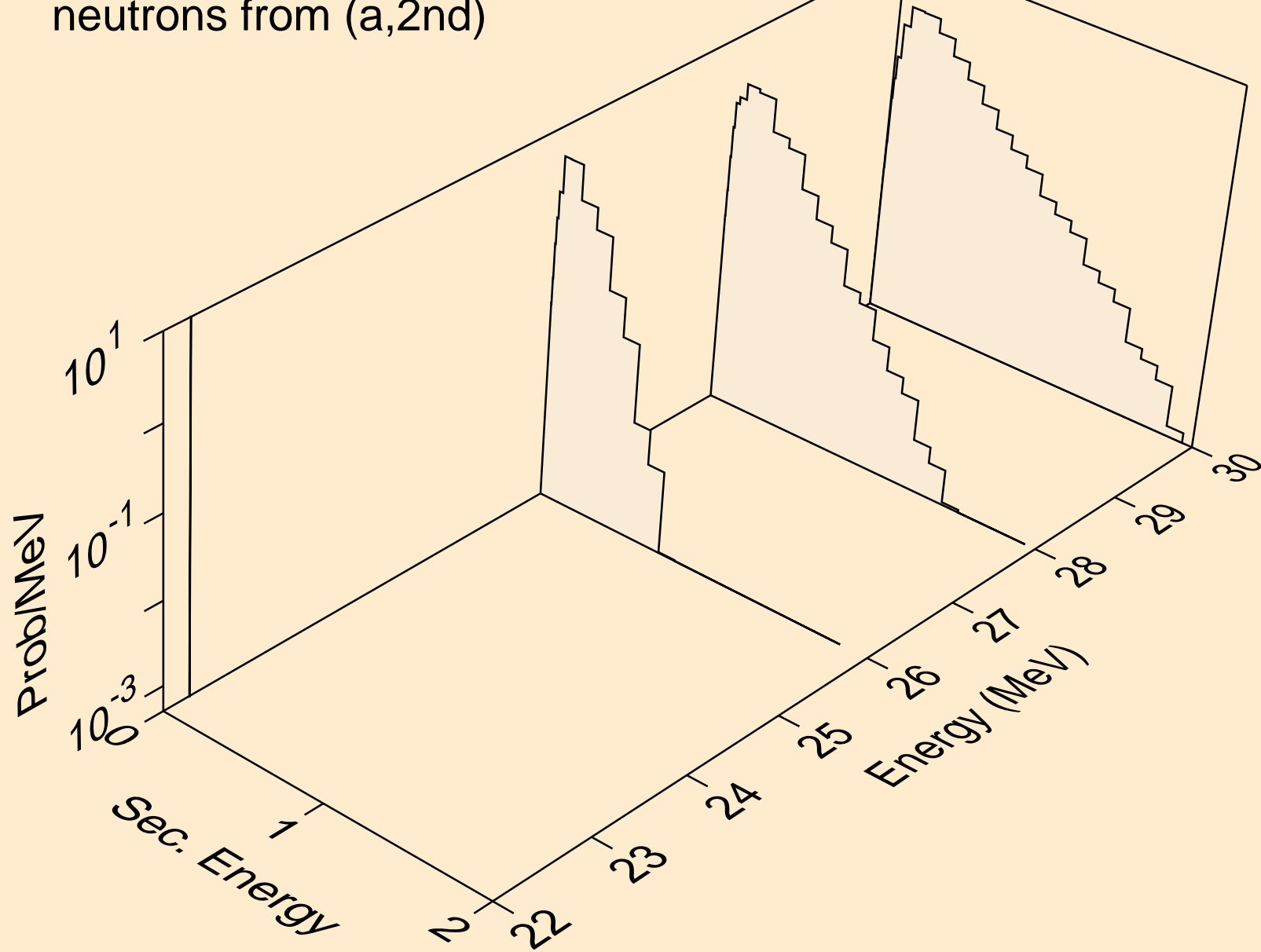

AC236 ALPHA ACER TENDL-2021 LIBRARY; T=0.K  
neutrons from (a,2n)

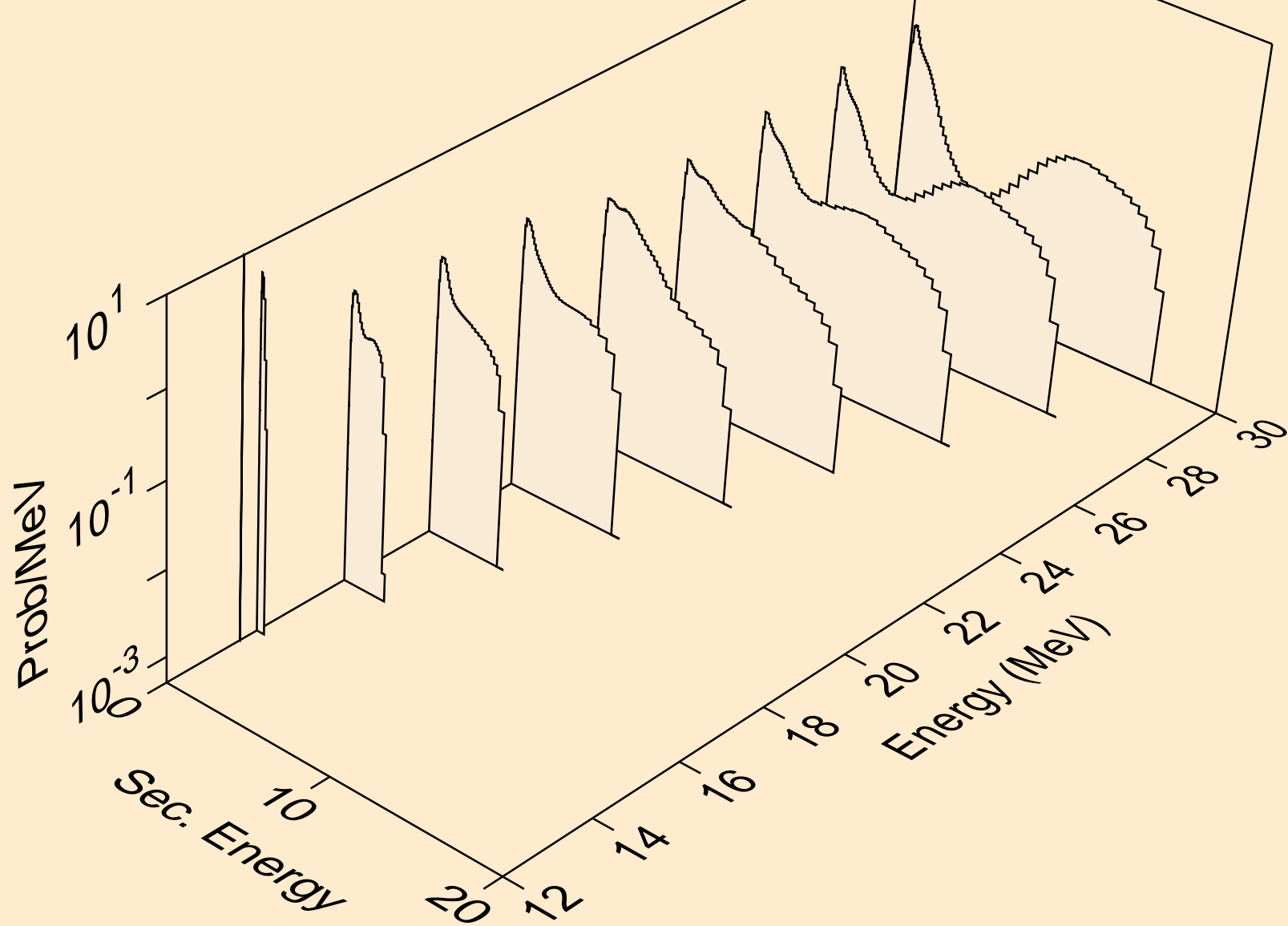

AC236 ALPHA ACER TENDL-2021 LIBRARY; T=0.K  
neutrons from (a,3n)

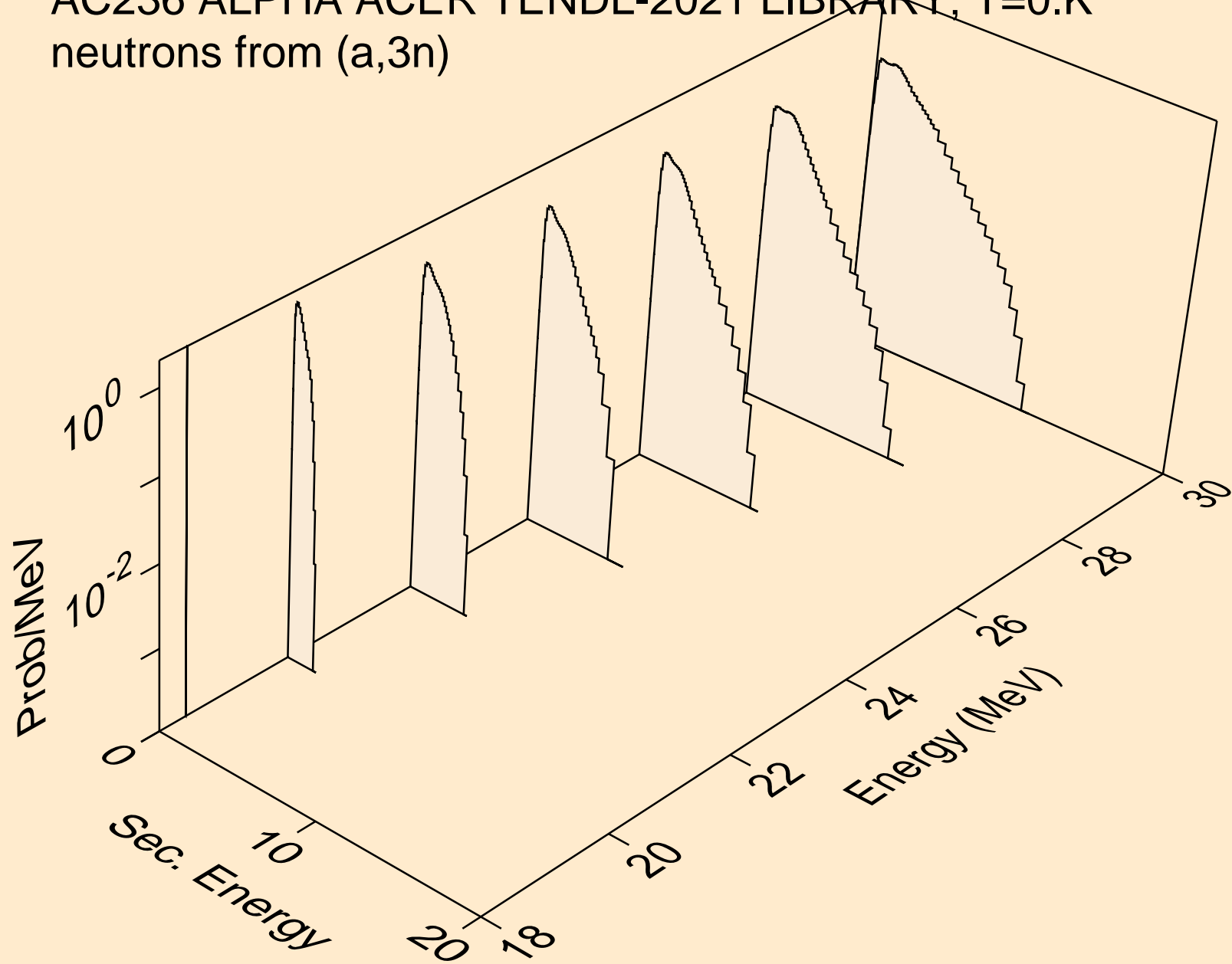

AC236 ALPHA ACER TENDL-2021 LIBRARY; T=0.K  
neutrons from (a,n\*)a

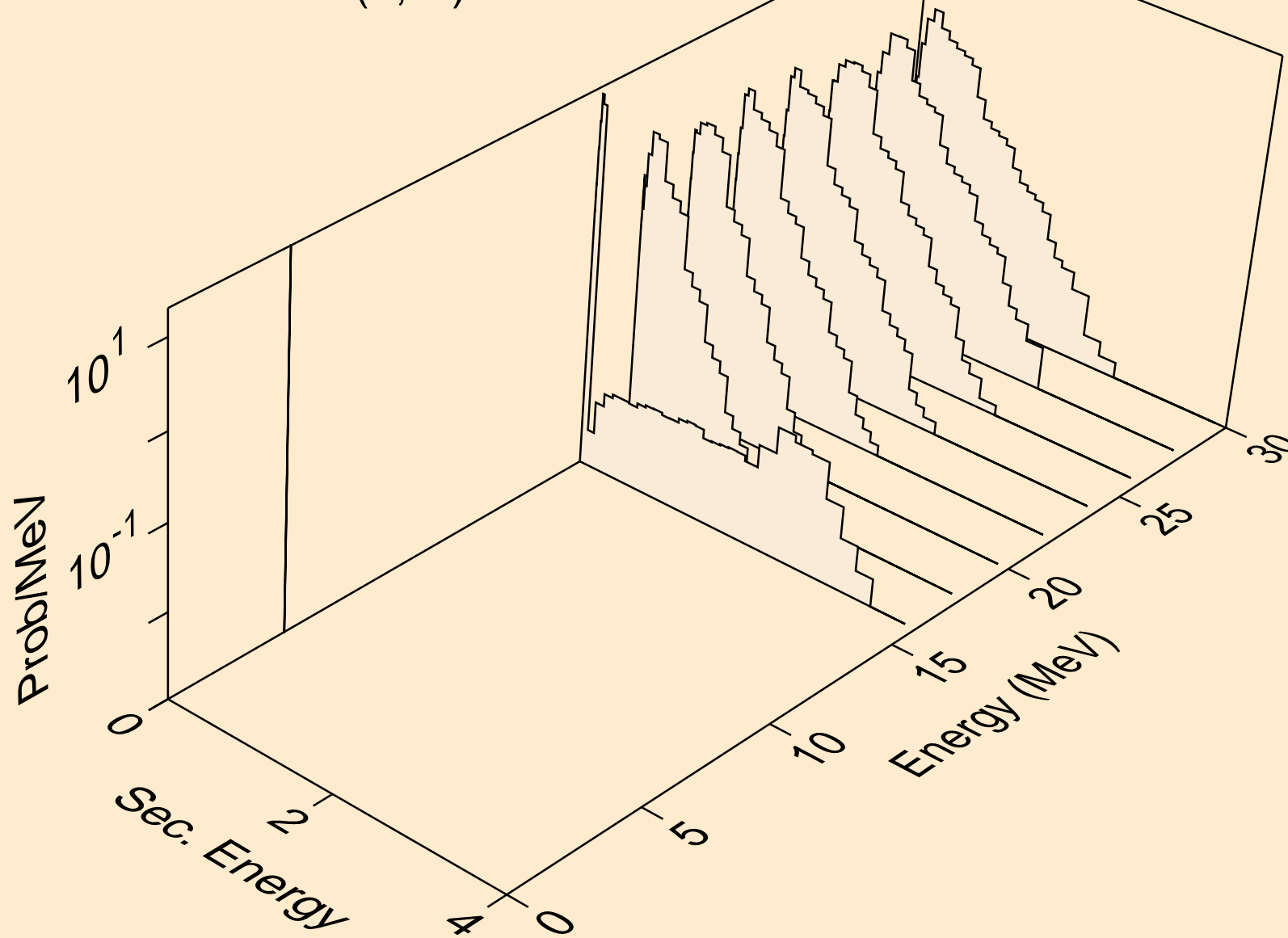

AC236 ALPHA ACER TENDL-2021 LIBRARY; T=0.K  
neutrons from (a,2n)a

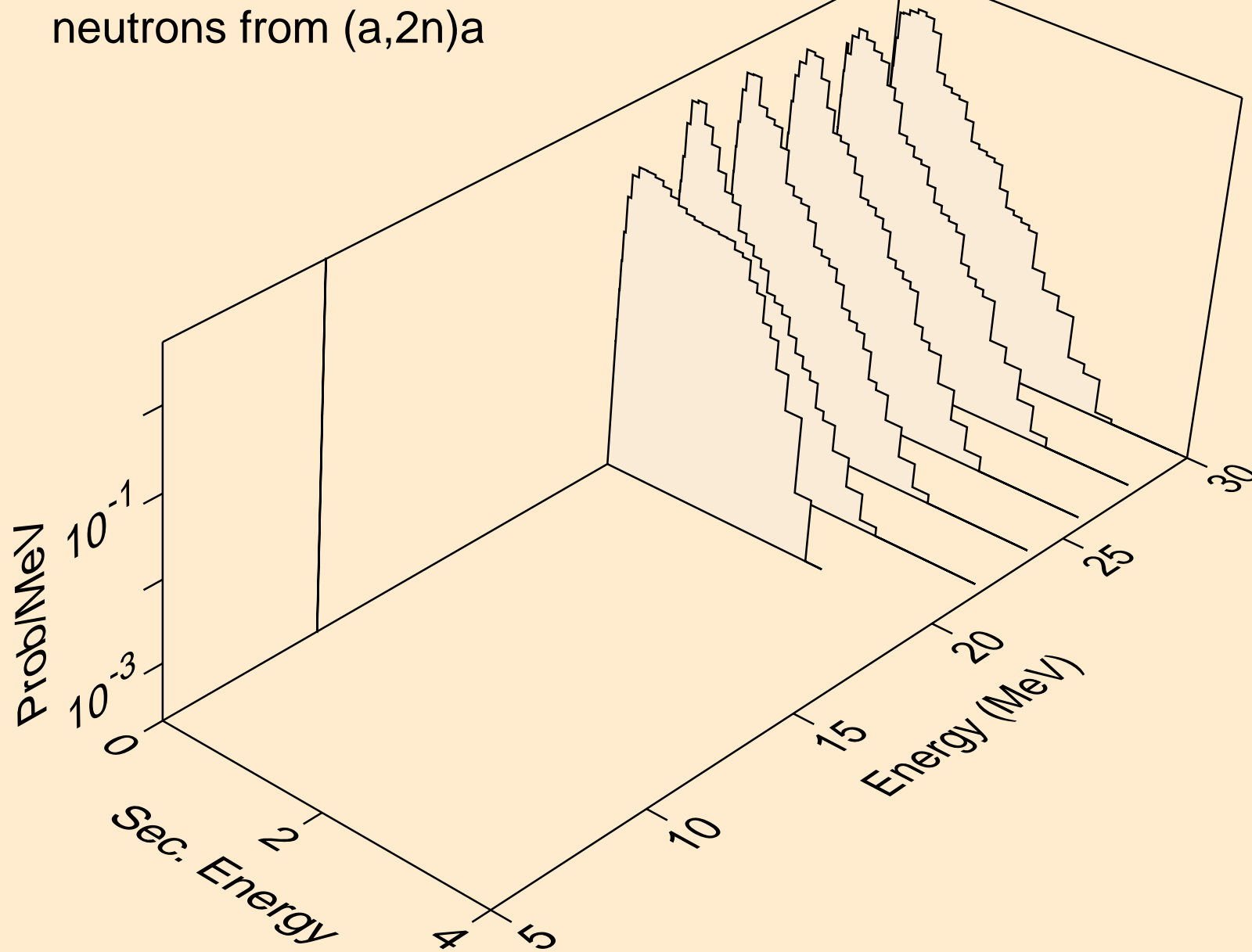



AC236 ALPHA ACER TENDL-2021 LIBRARY; T=0.K  
neutrons from (a,3n)a

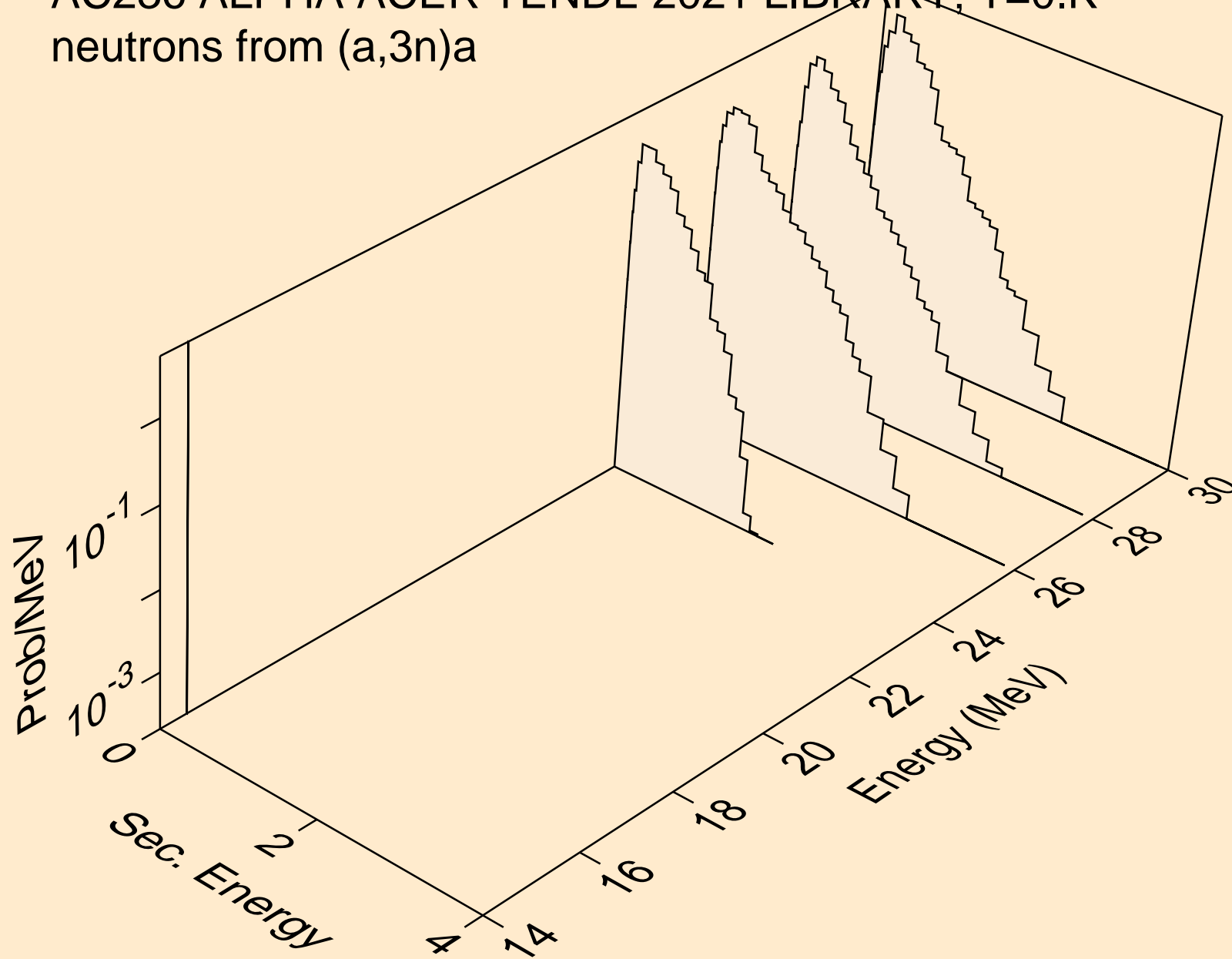

AC236 ALPHA ACER TENDL-2021 LIBRARY; T=0.K  
neutrons from (a,n\*)p

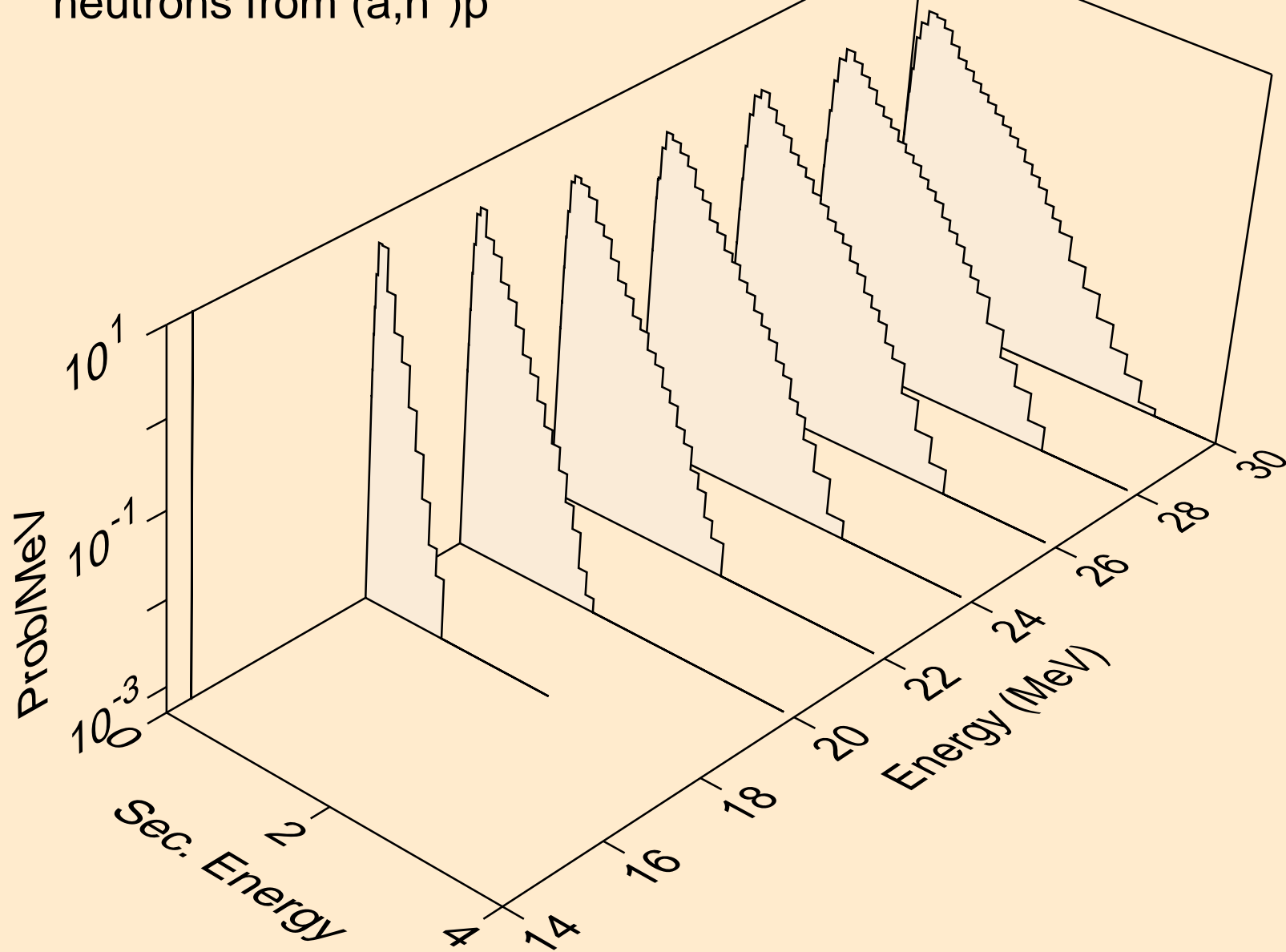

AC236 ALPHA ACER TENDL-2021 LIBRARY; T=0.K  
neutrons from (a,n\*)d

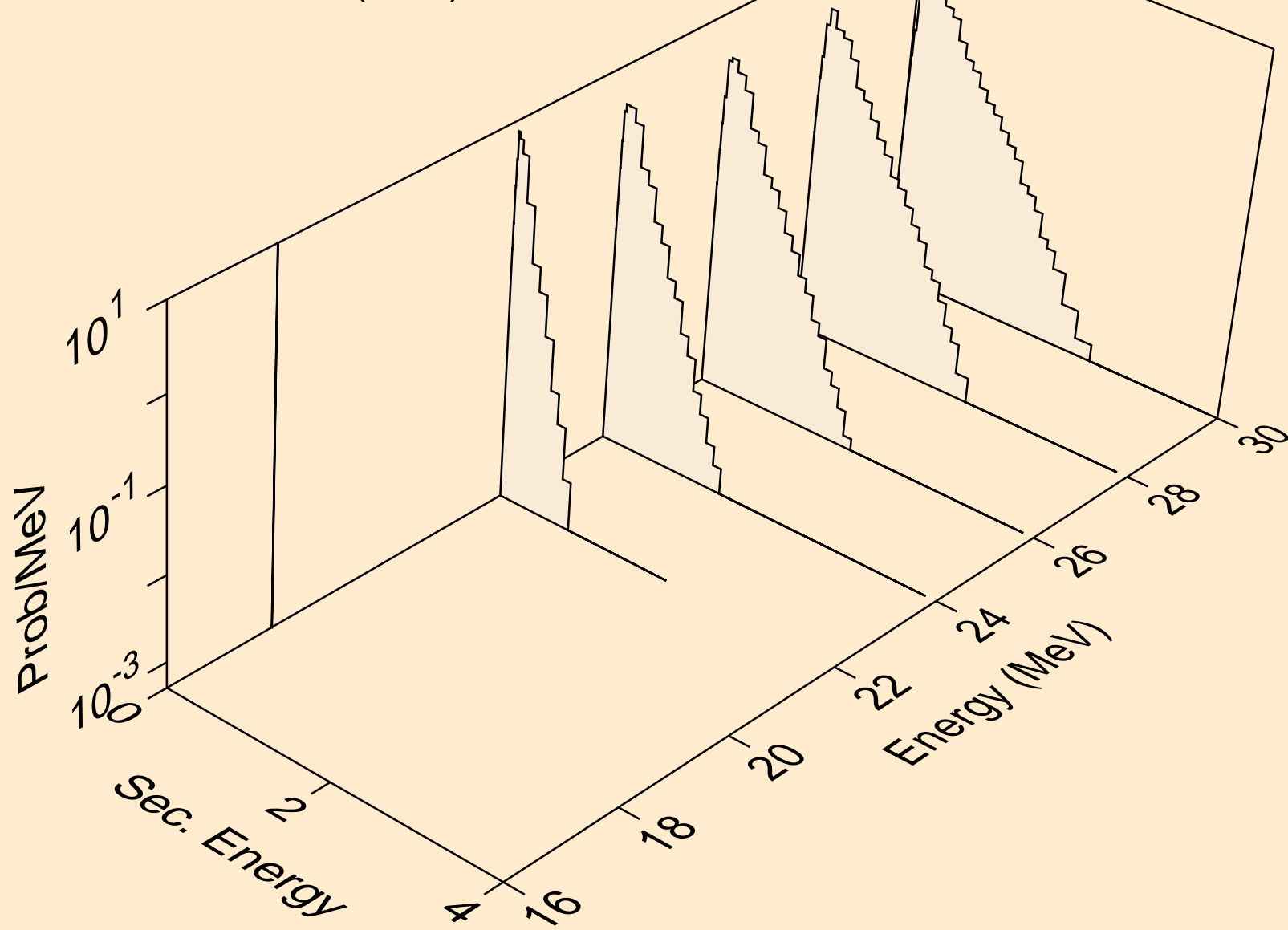

AC236 ALPHA ACER TENDL-2021 LIBRARY; T=0.K  
neutrons from (a,n\*)t

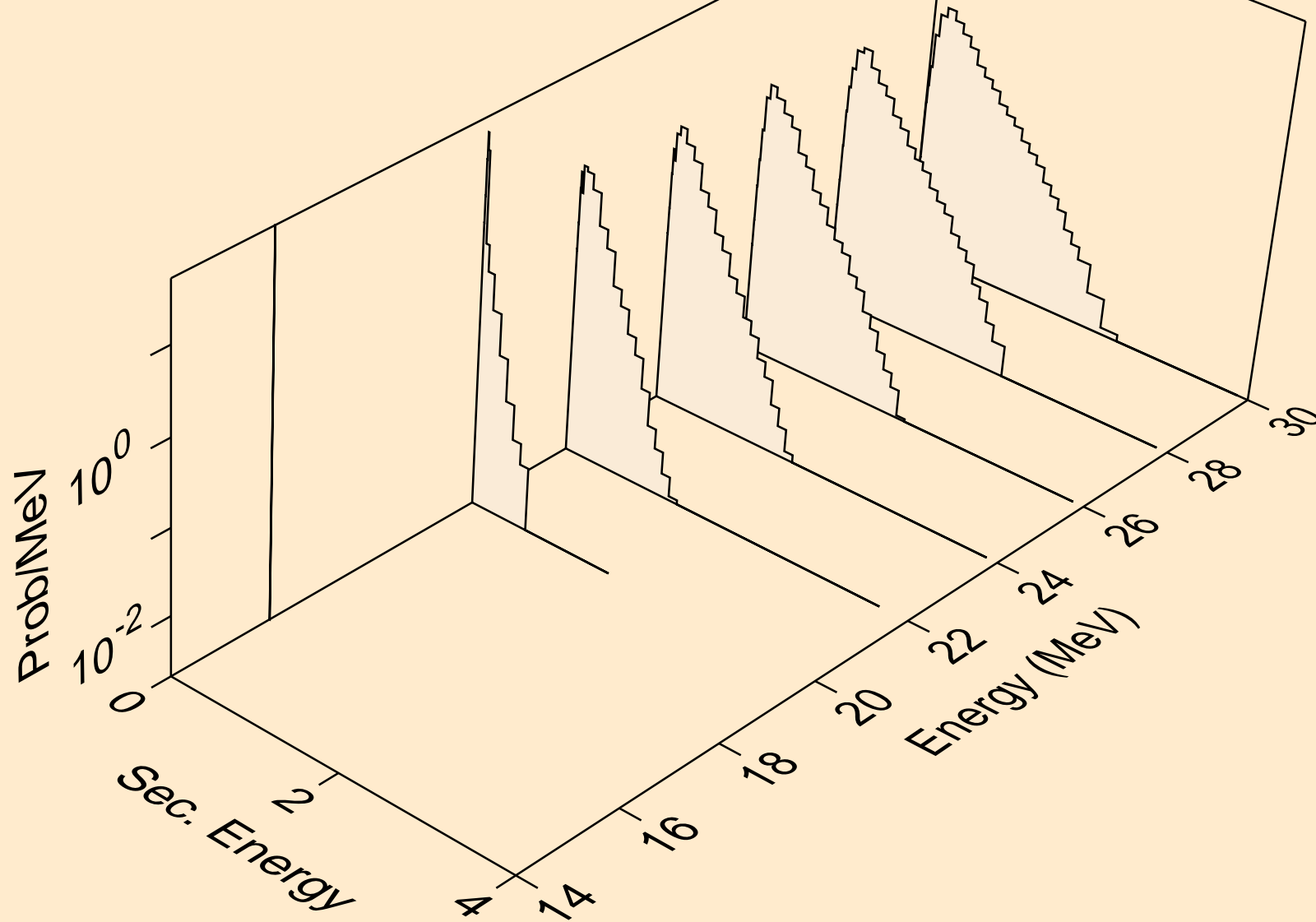

AC236 ALPHA ACER TENDL-2021 LIBRARY; T=0.K  
neutrons from (a,4n)

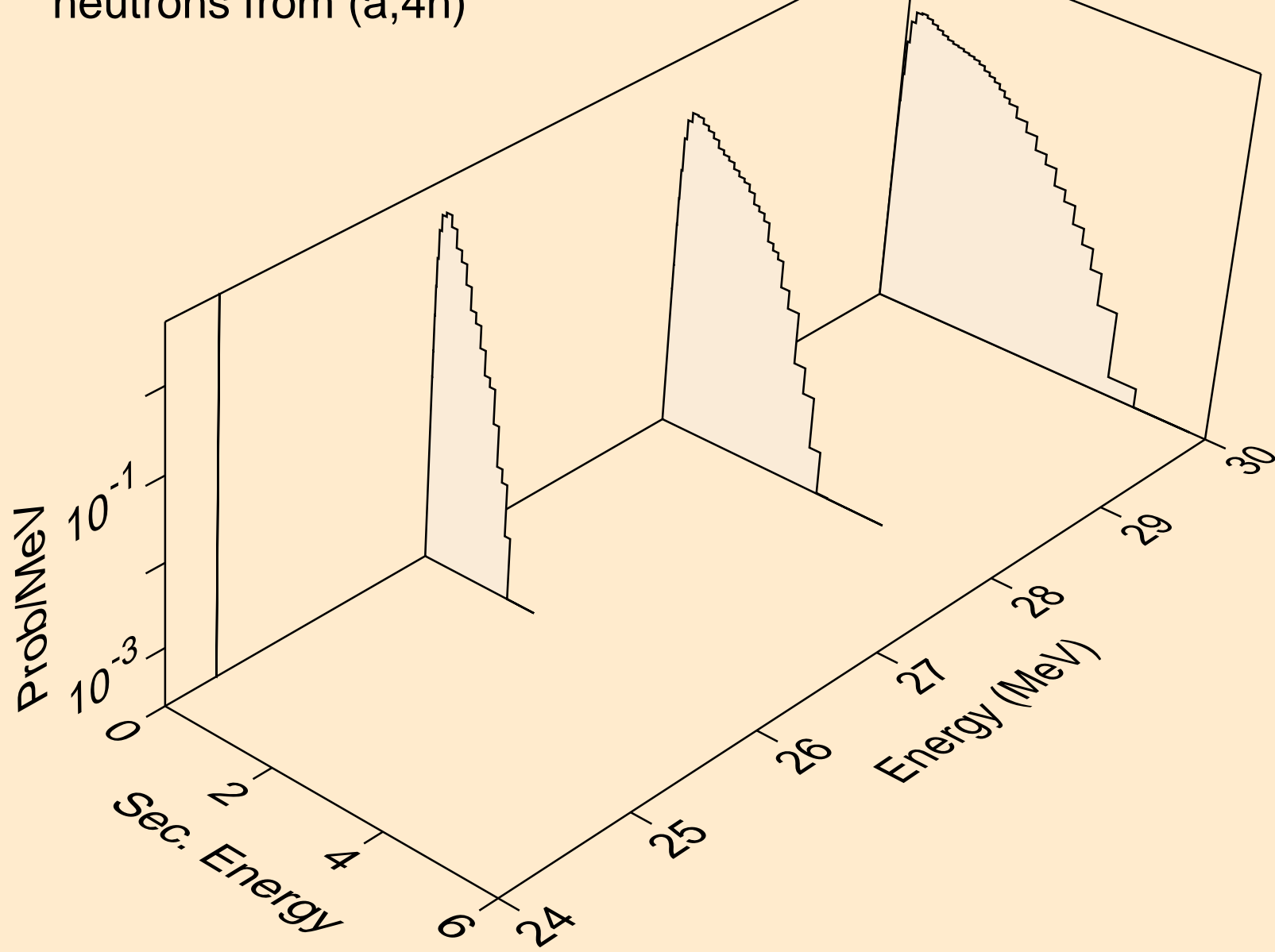

AC236 ALPHA ACER TENDL-2021 LIBRARY; T=0.K  
neutrons from (a,2np)

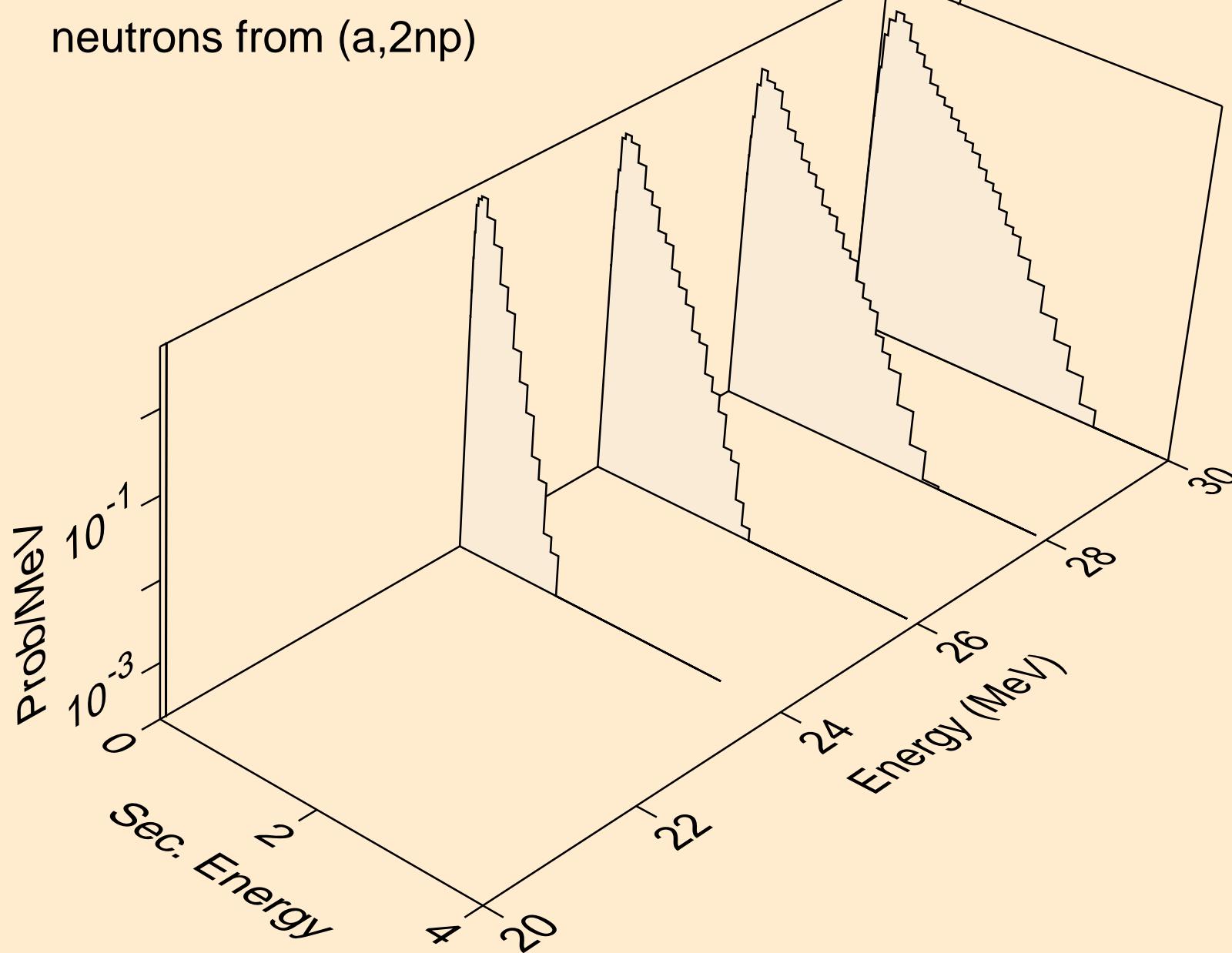

AC236 ALPHA ACER TENDL-2021 LIBRARY; T=0.K  
protons from (a,x)

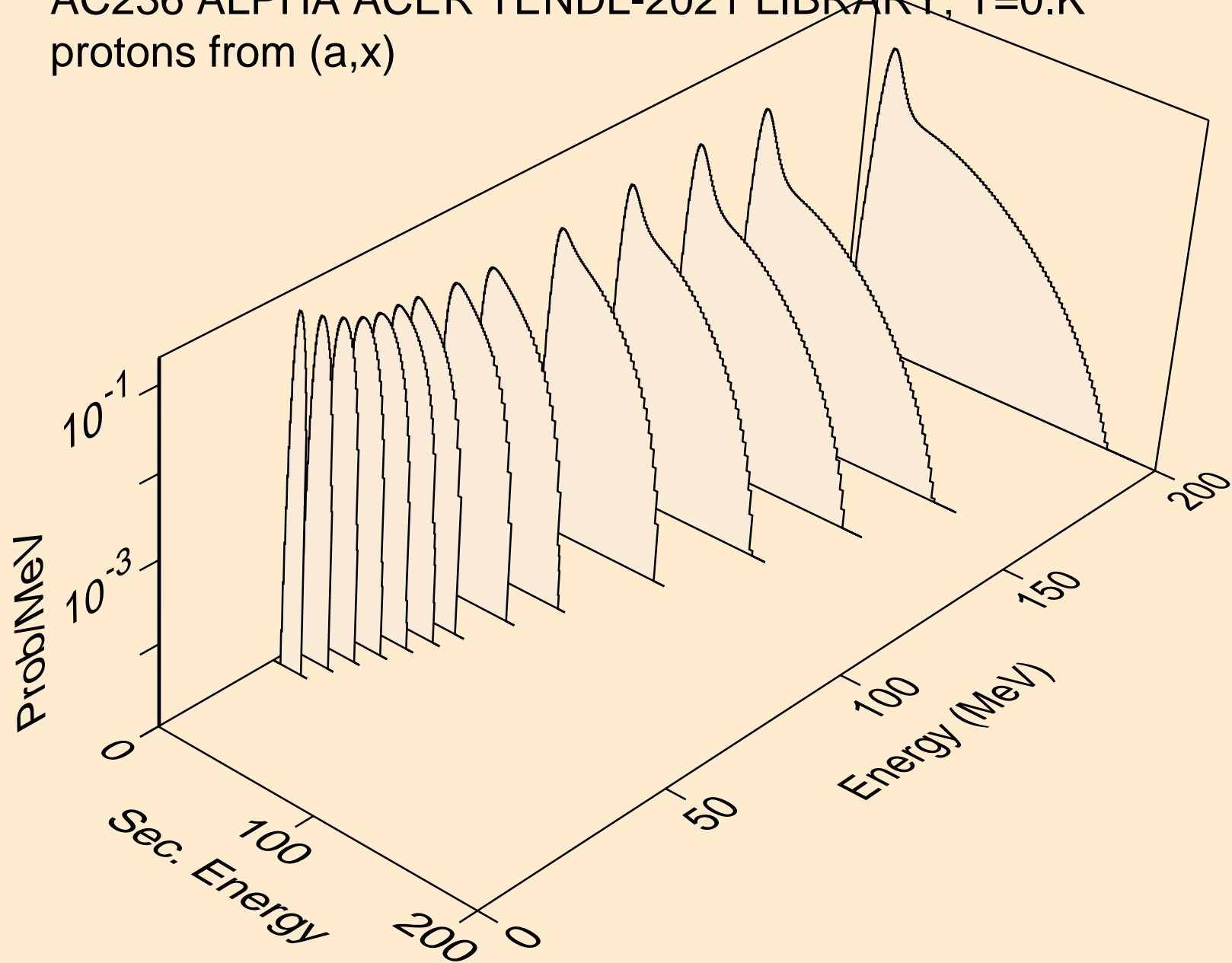

AC236 ALPHA ACER TENDL-2021 LIBRARY; T=0.K  
protons from (a,n\*)p

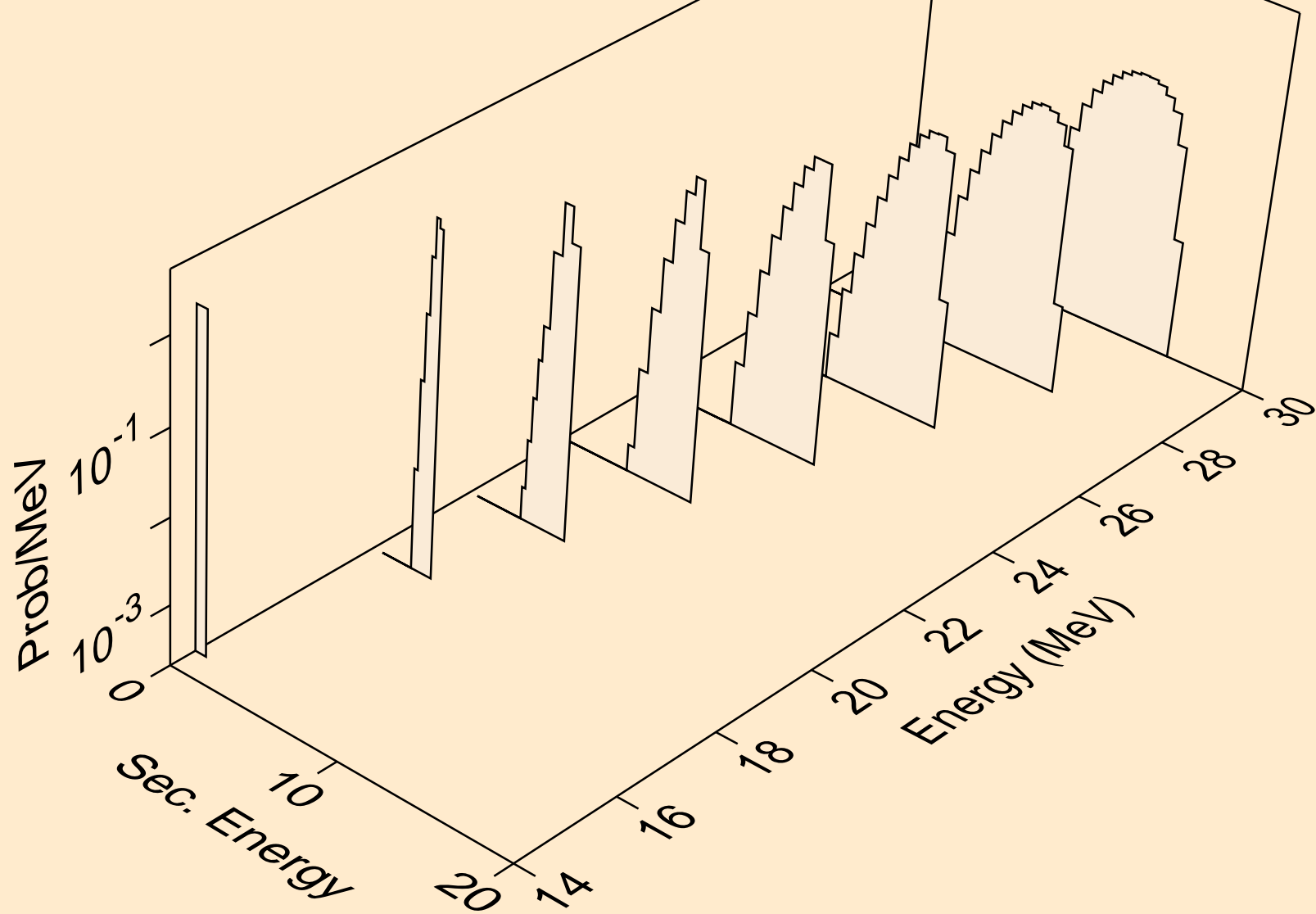



AC236 ALPHA ACER TENDL-2021 LIBRARY; T=0.K  
protons from (a,2np)

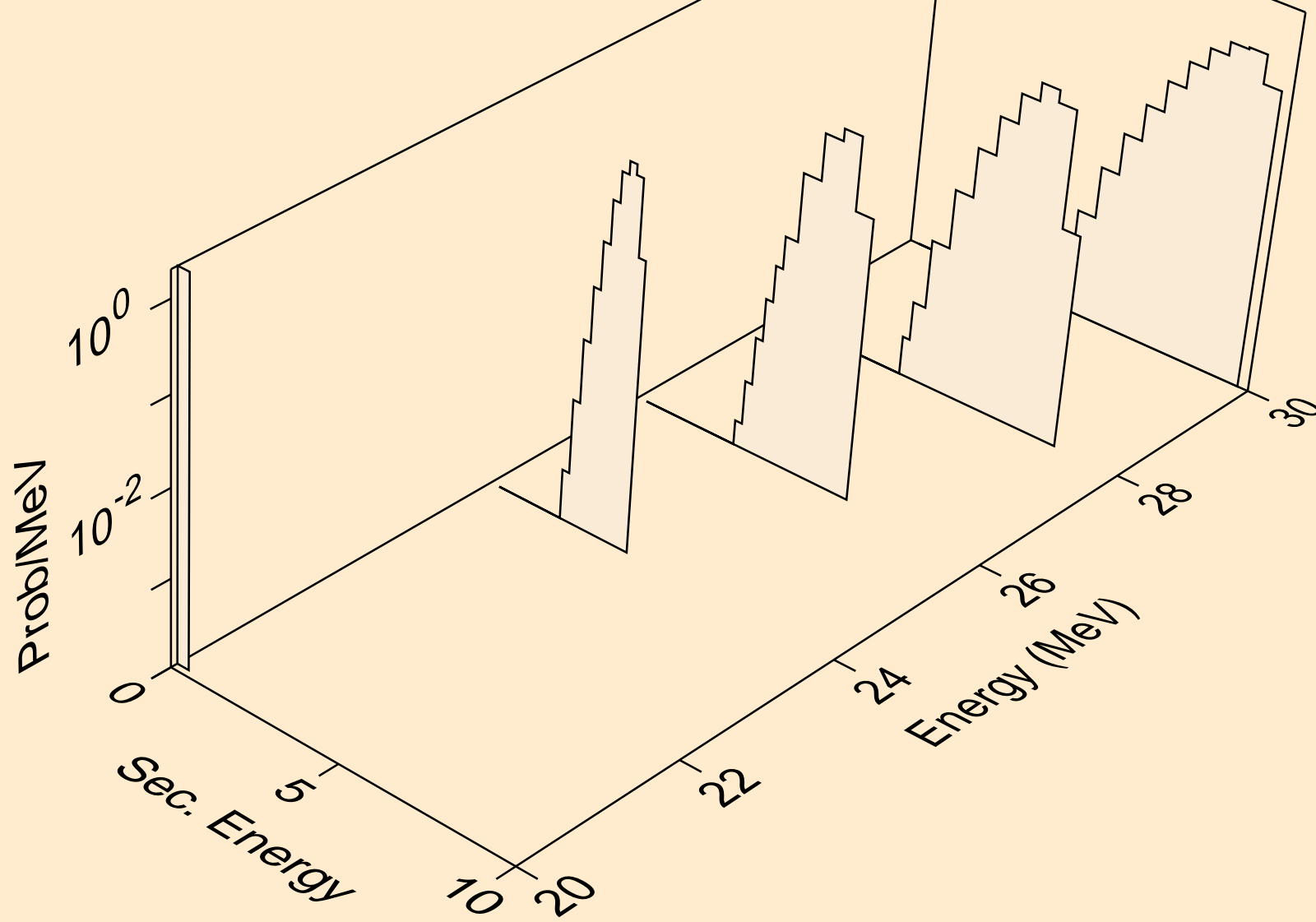

AC236 ALPHA ACER TENDL-2021 LIBRARY; T=0.K  
protons from (a,p)

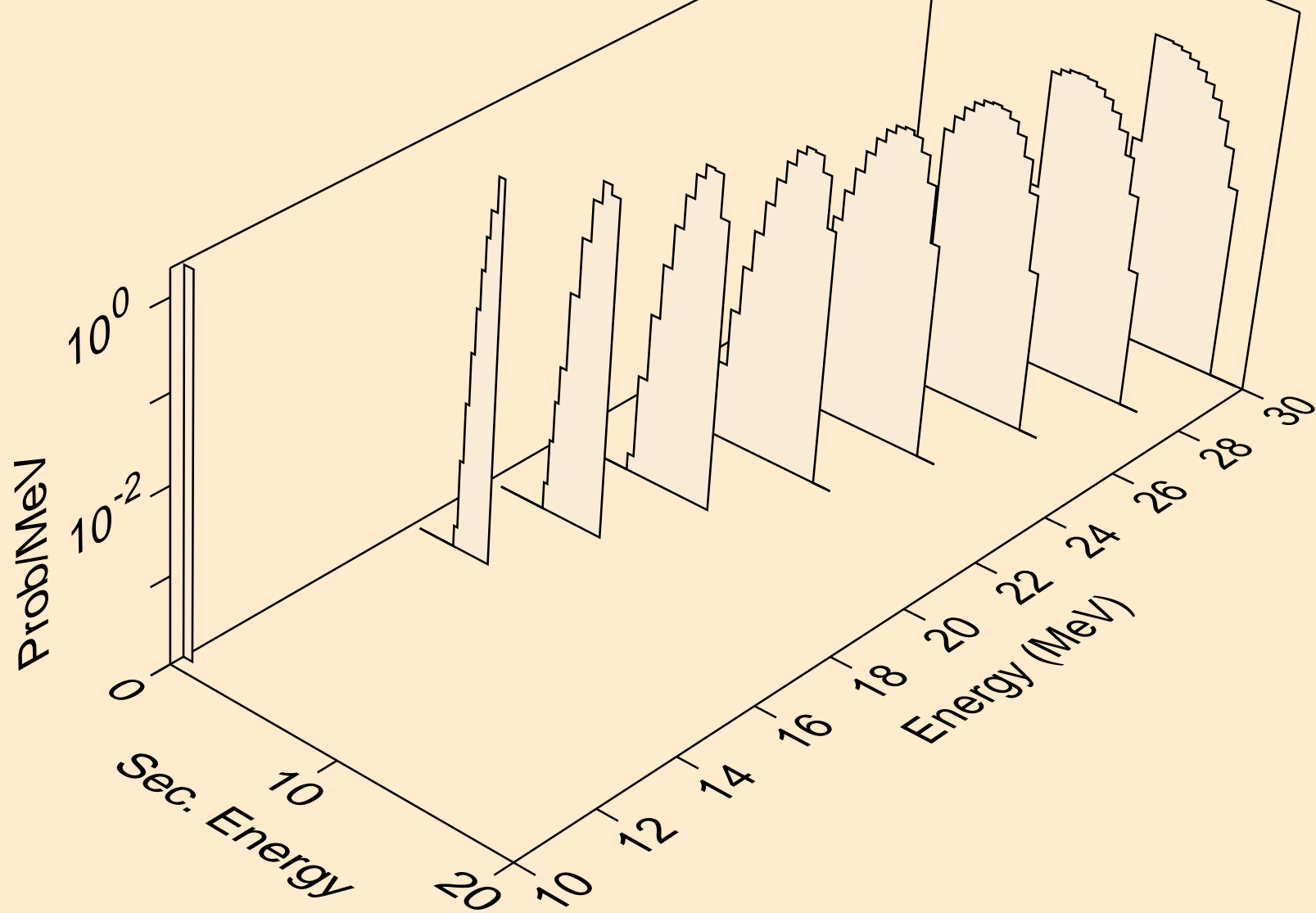

AC236 ALPHA ACER TENDL-2021 LIBRARY; T=0.K  
deuterons from (a,x)

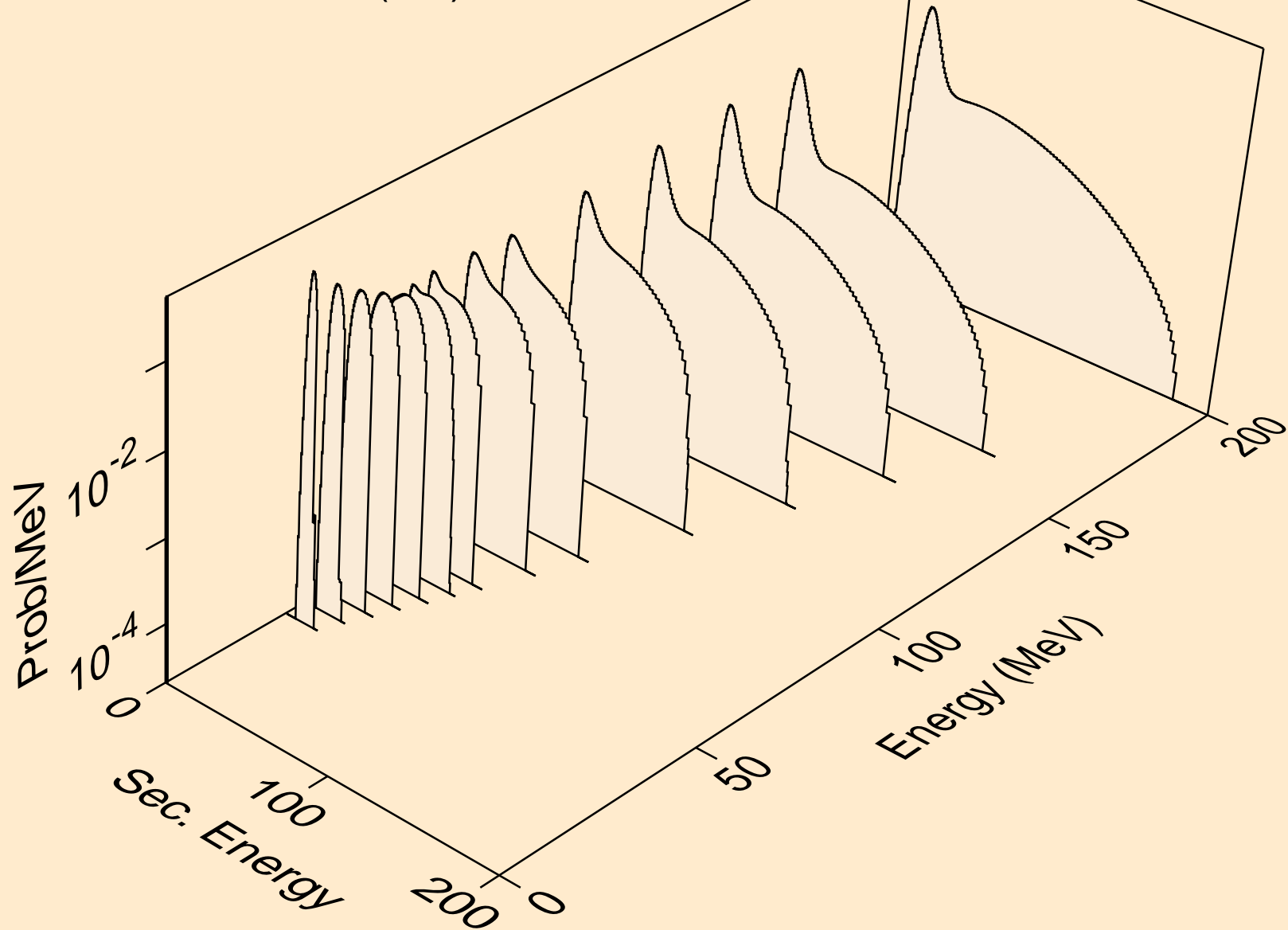

AC236 ALPHA ACER TENDL-2021 LIBRARY; T=0.K  
deuterons from (a,2nd)

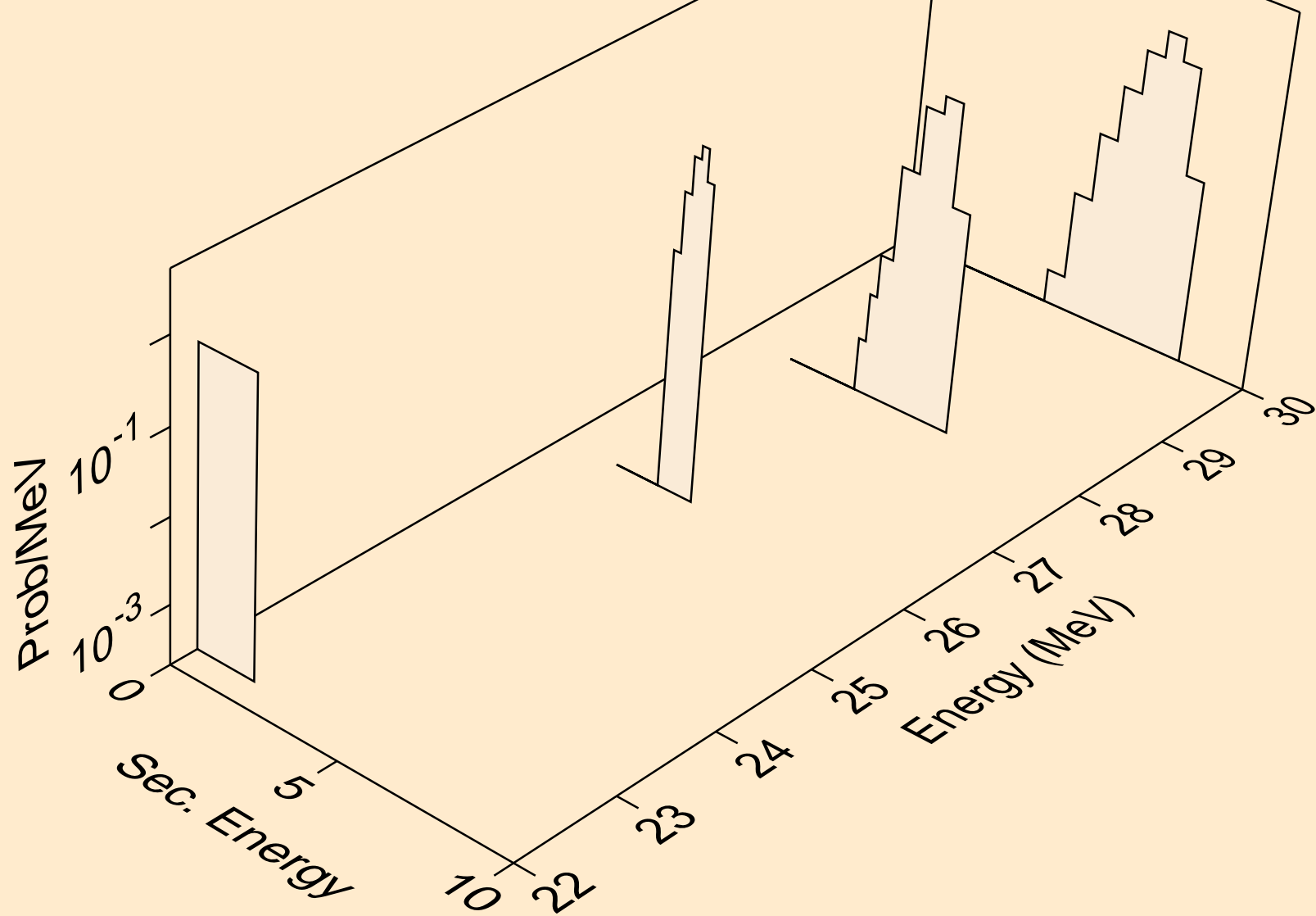

AC236 ALPHA ACER TENDL-2021 LIBRARY; T=0.K  
deuterons from (a,n\*)d

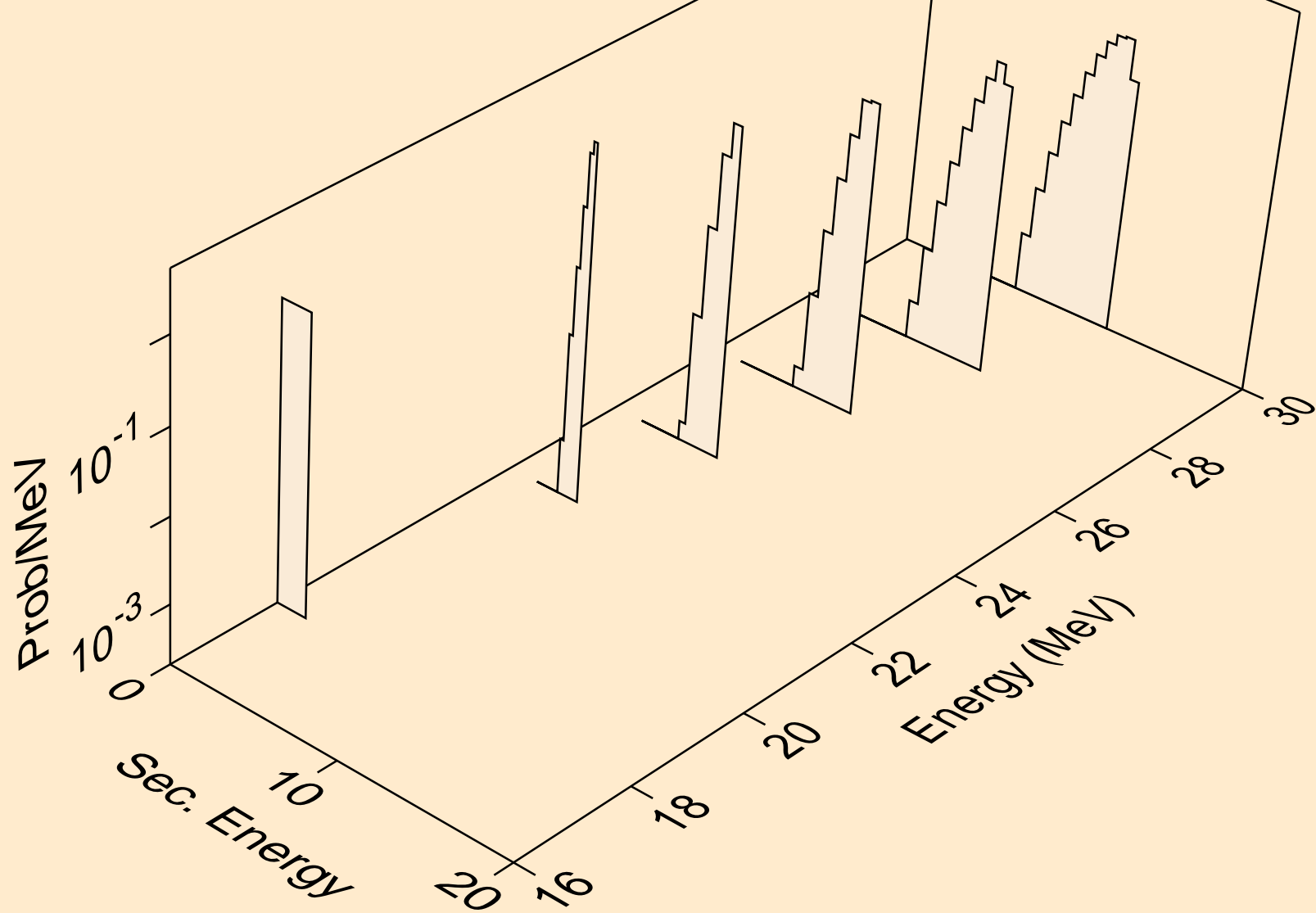

AC236 ALPHA ACER TENDL-2021 LIBRARY; T=0.K  
deuterons from (a,d)

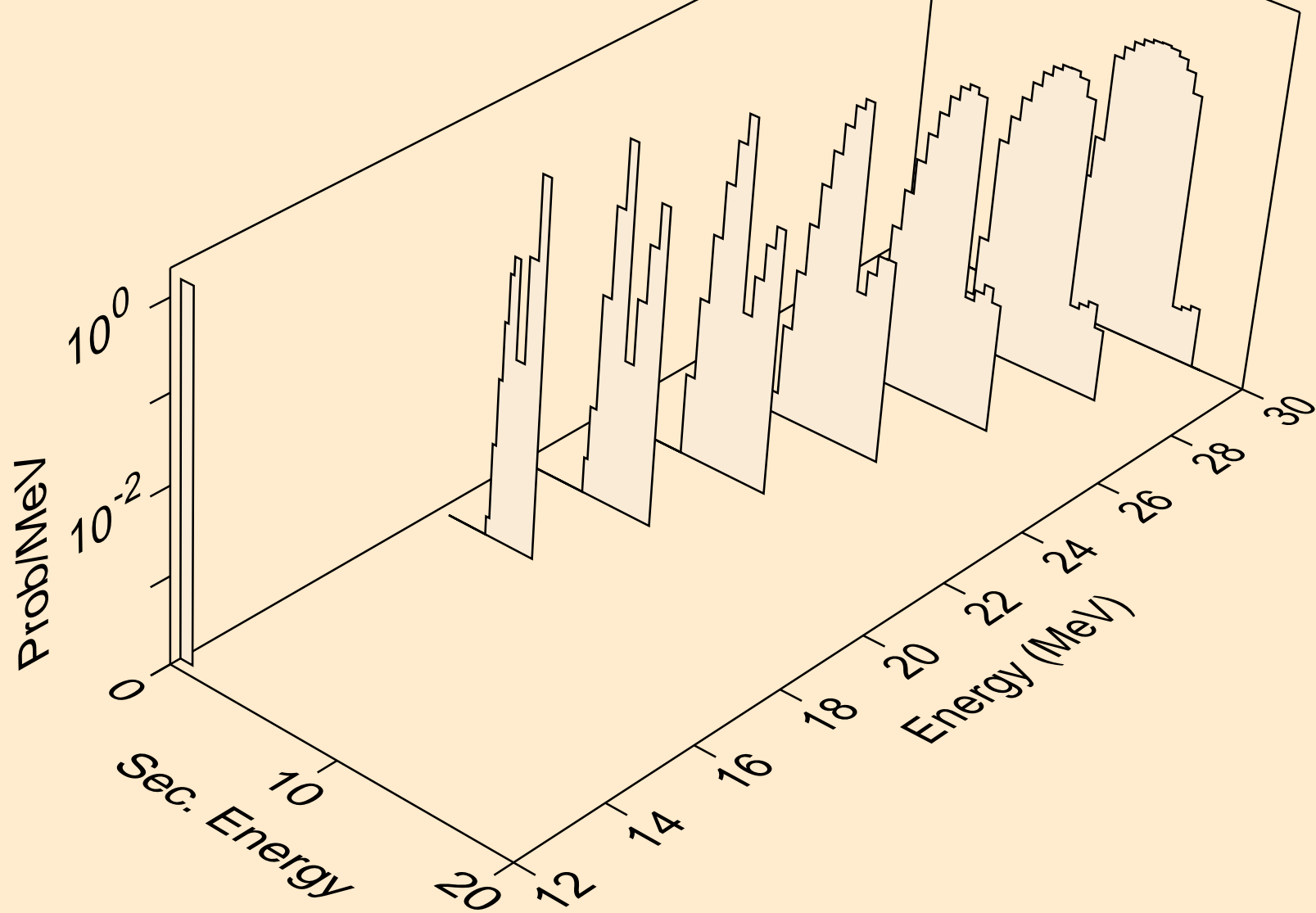

AC236 ALPHA ACER TENDL-2021 LIBRARY; T=0.K  
tritons from (a,x)

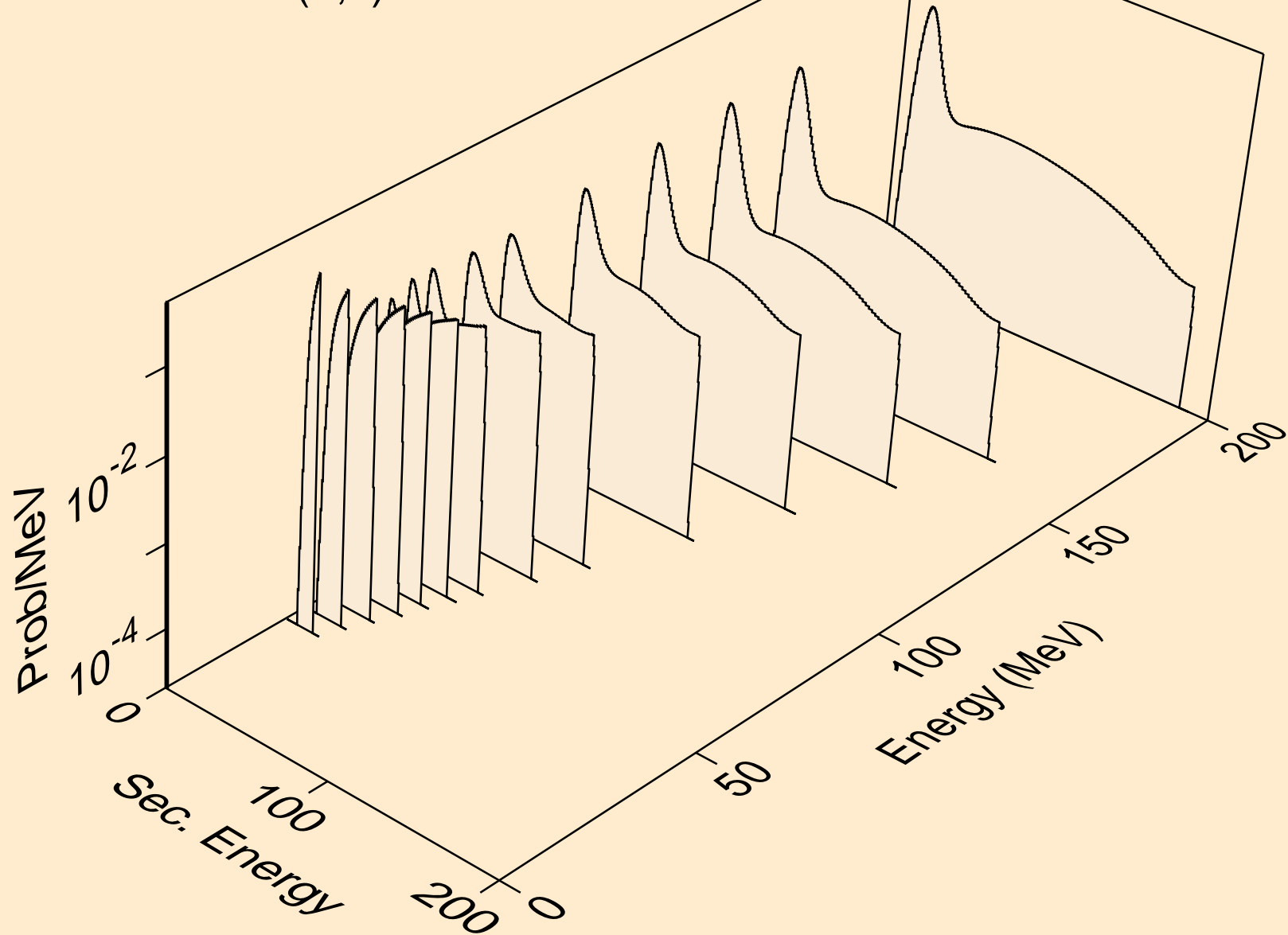

AC236 ALPHA ACER TENDL-2021 LIBRARY; T=0.K  
tritons from (a,n\*)t

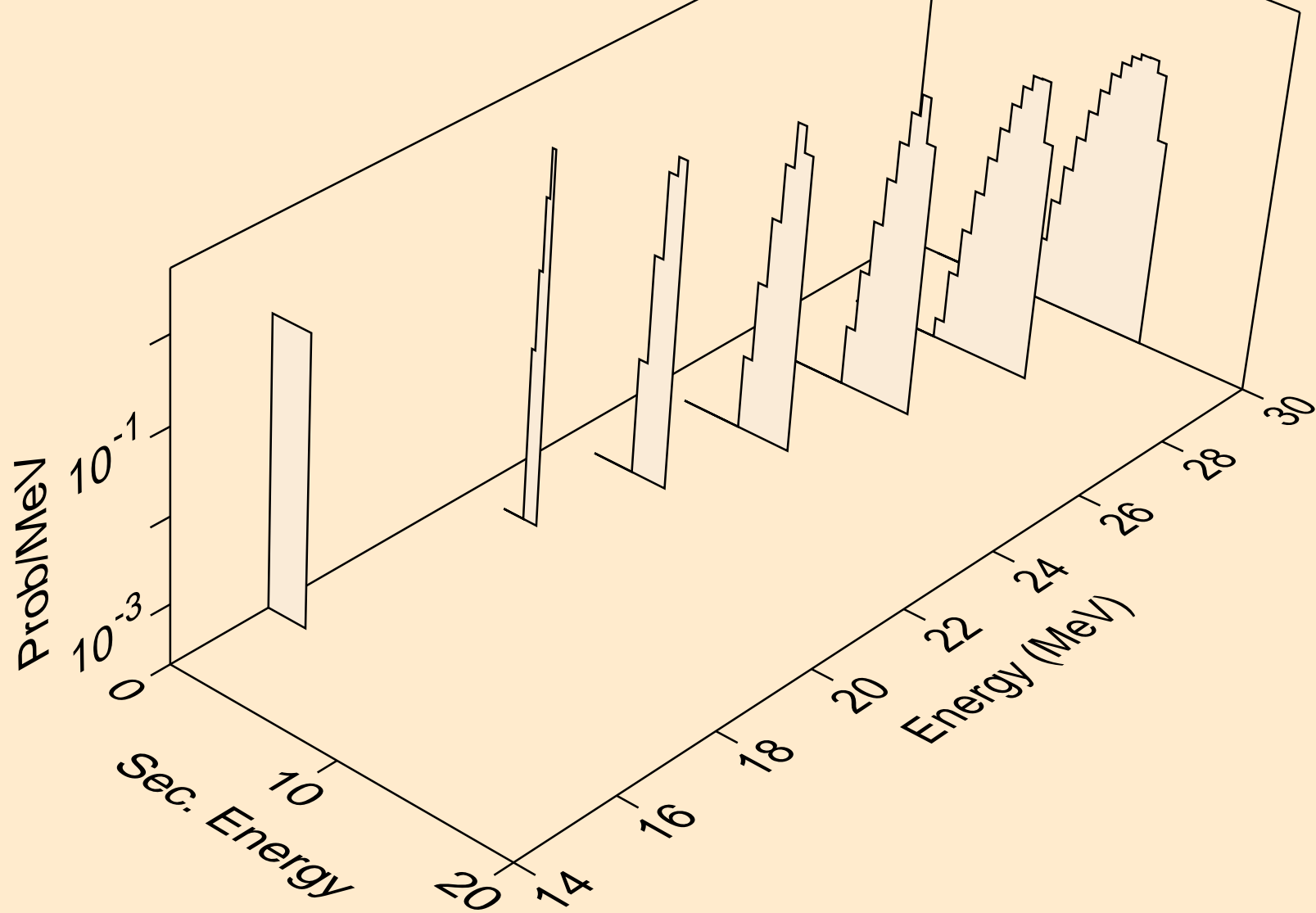



AC236 ALPHA ACER TENDL-2021 LIBRARY; T=0.K  
tritons from (a,t)

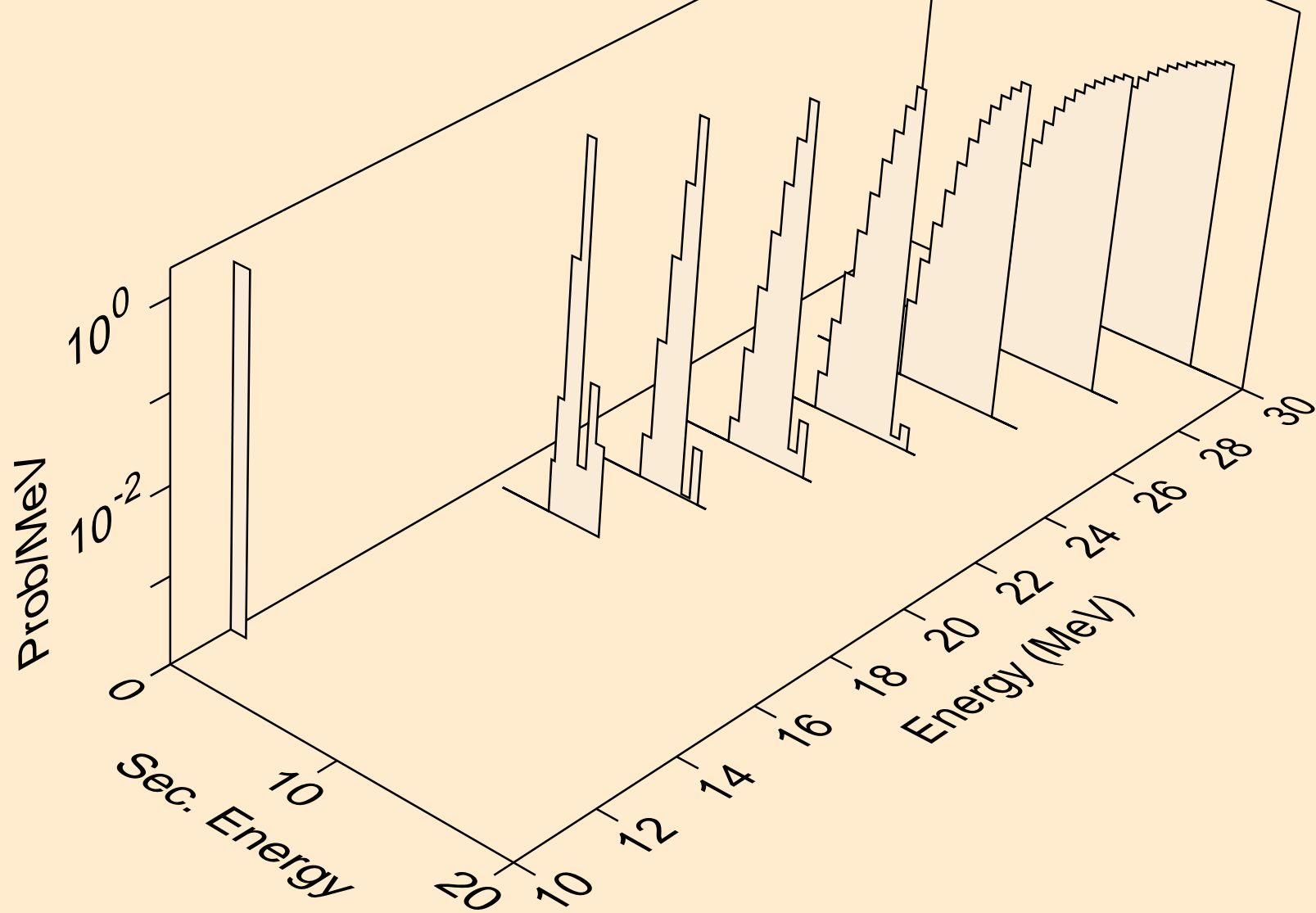

AC236 ALPHA ACER TENDL-2021 LIBRARY; T=0.K  
he3s from (a,x)

