

AC237 ALPHA ACER TENDL-2021 LIBRARY; T=0.K
Principal cross sections

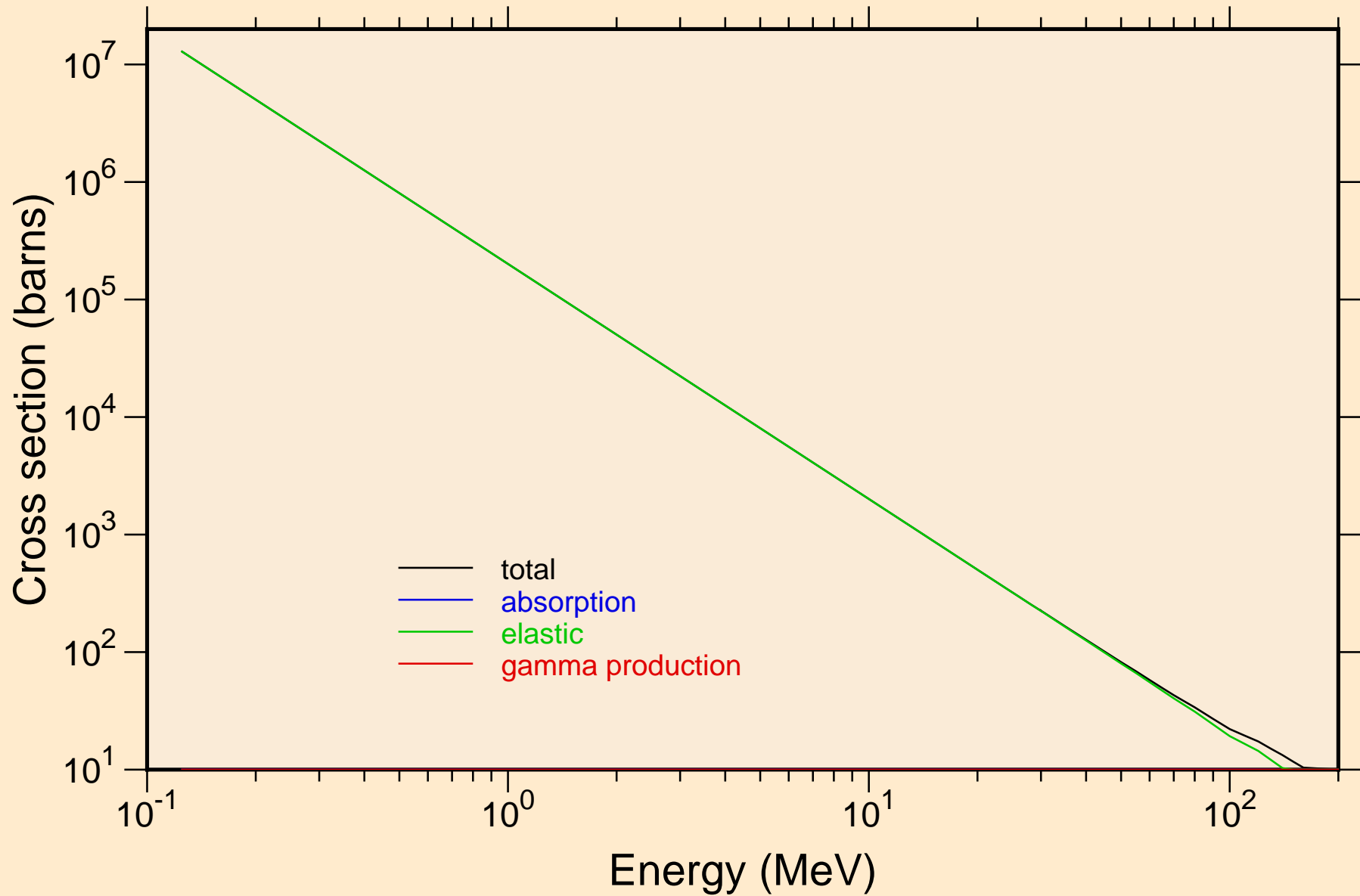

AC237 ALPHA ACER TENDL-2021 LIBRARY; T=0.K

Heating

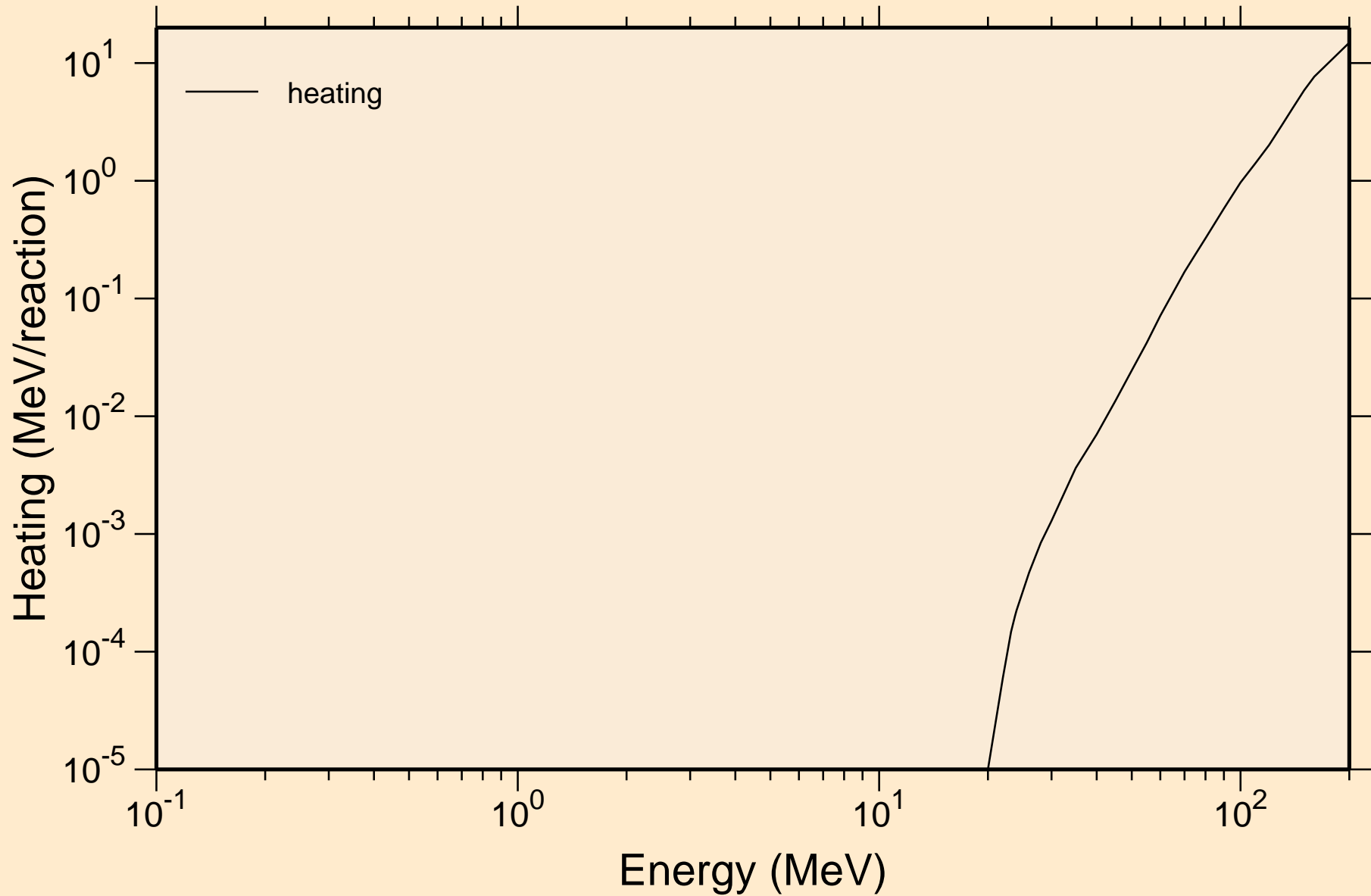

AC237 ALPHA ACER TENDL-2021 LIBRARY; T=0.K

Principal cross sections

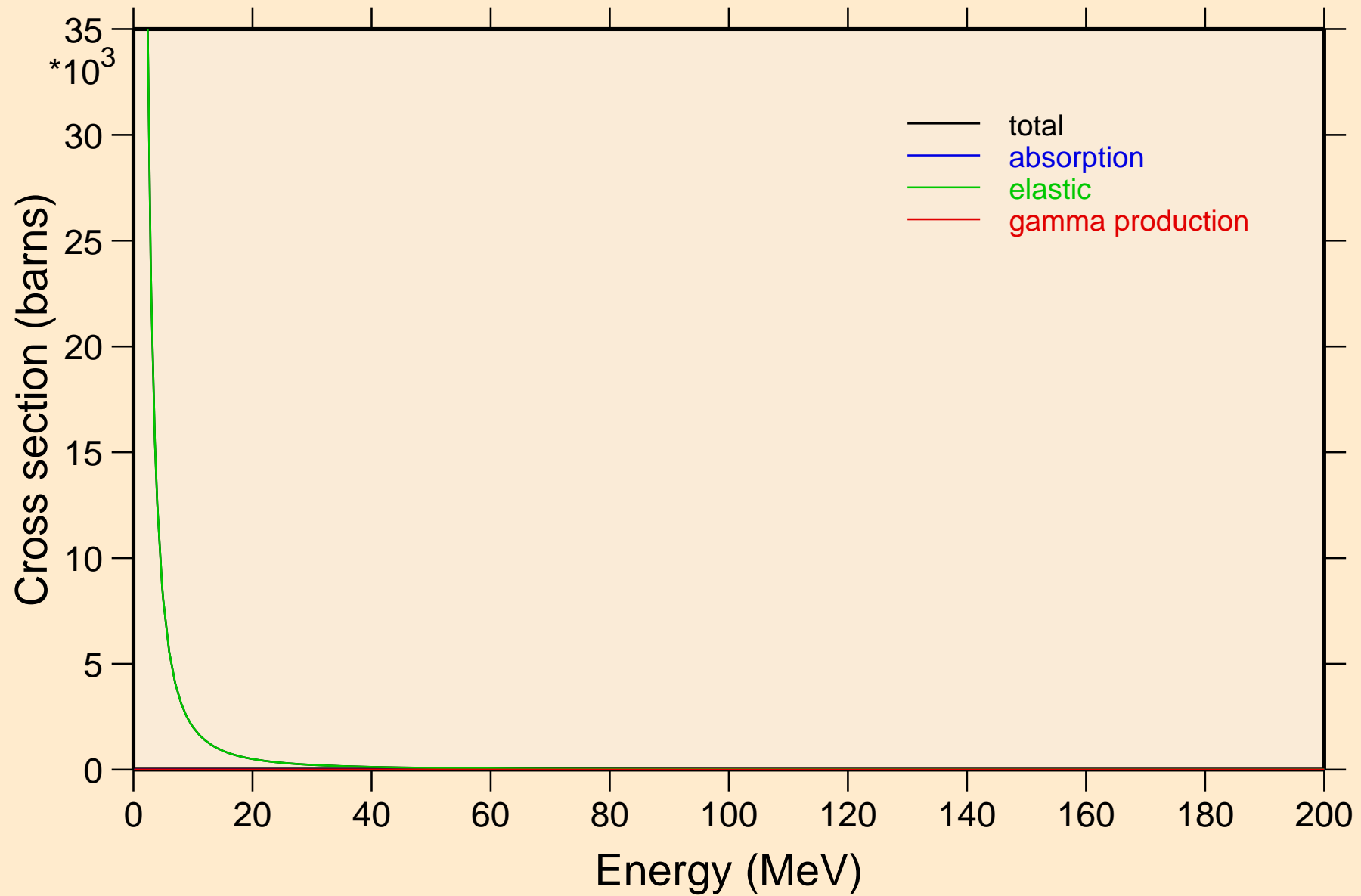

AC237 ALPHA ACER TENDL-2021 LIBRARY; T=0.K

Heating

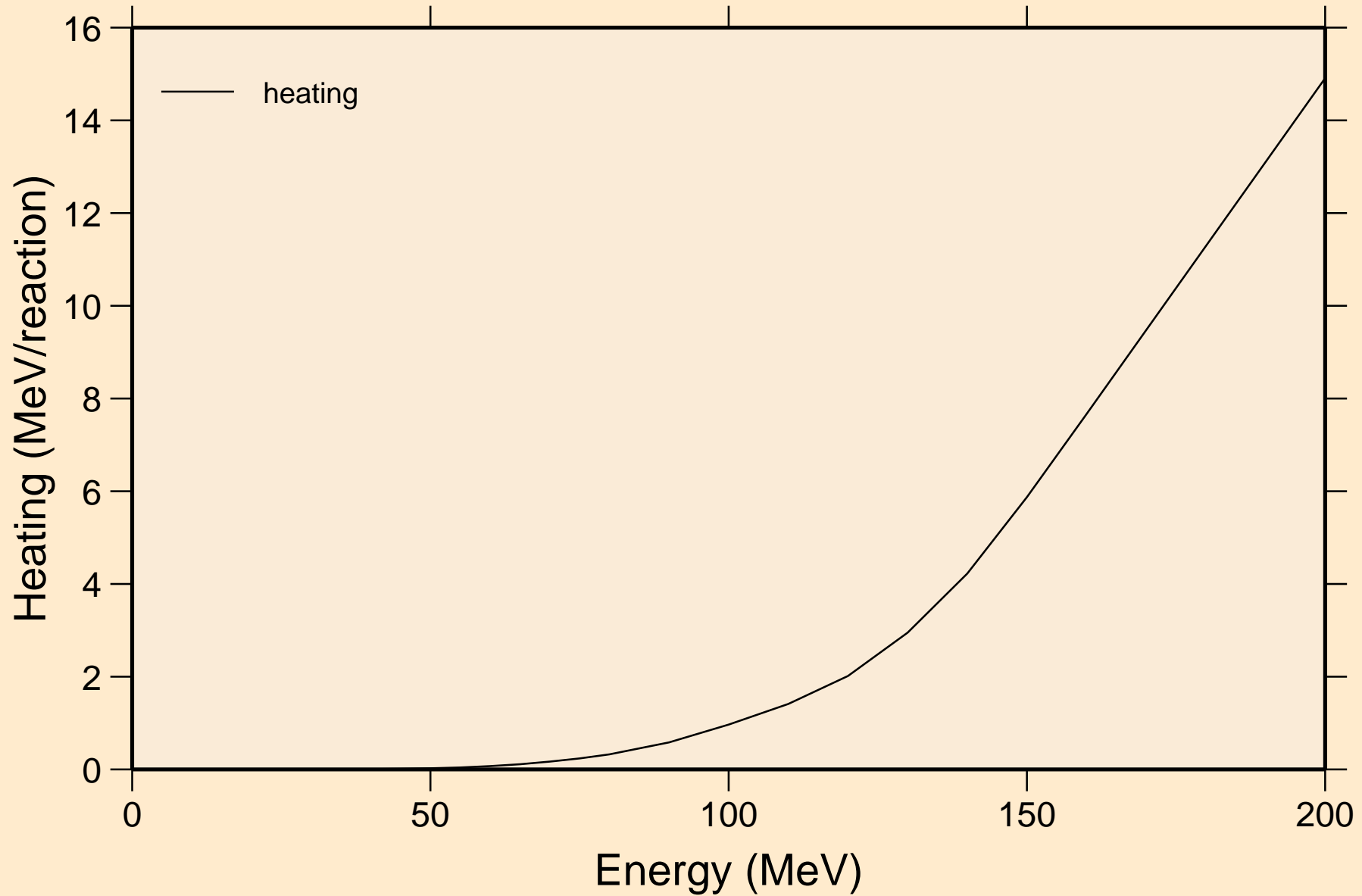

AC237 ALPHA ACER TENDL-2021 LIBRARY; T=0.K
Threshold reactions

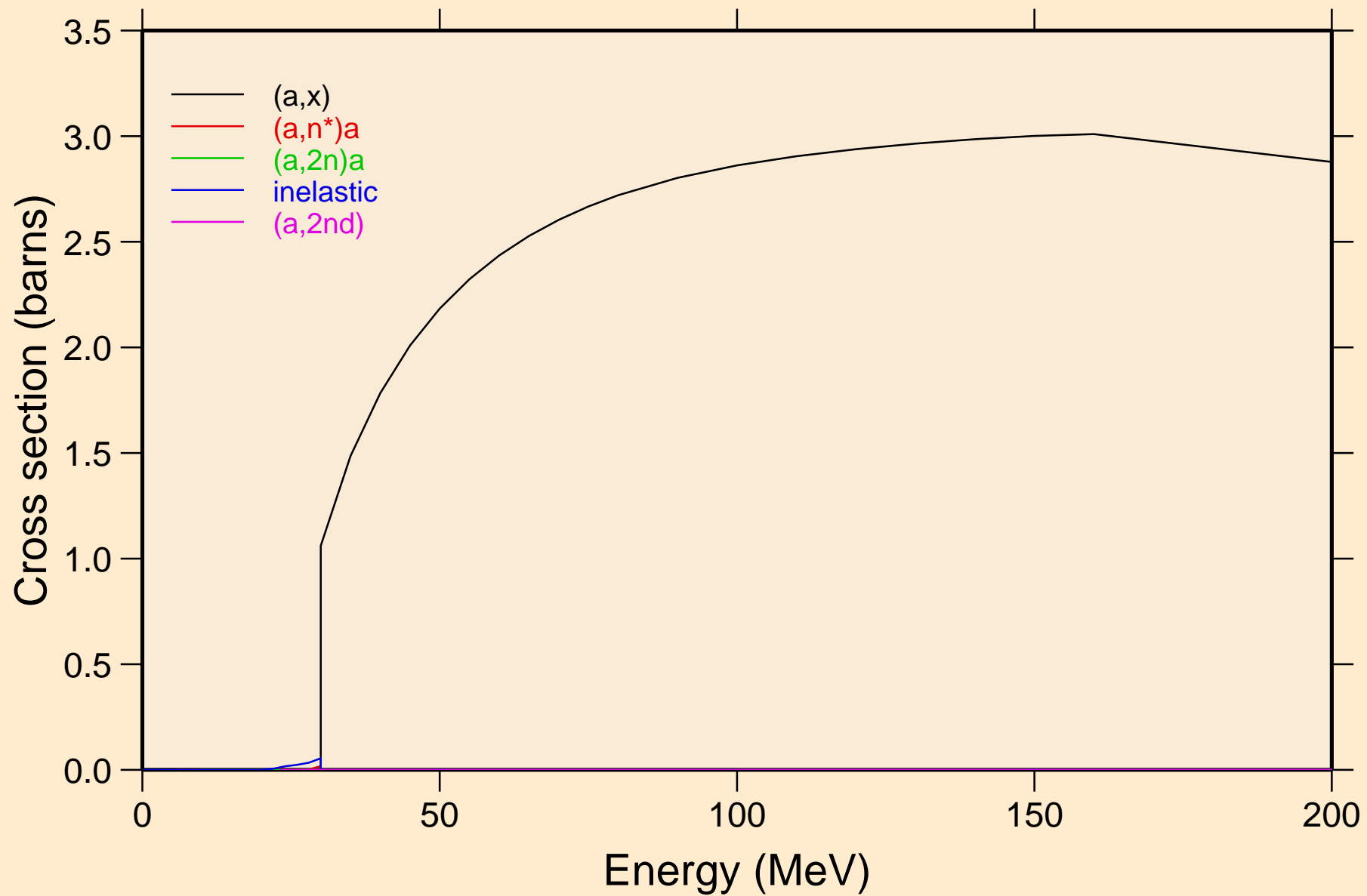

AC237 ALPHA ACER TENDL-2021 LIBRARY; T=0.K
Threshold reactions

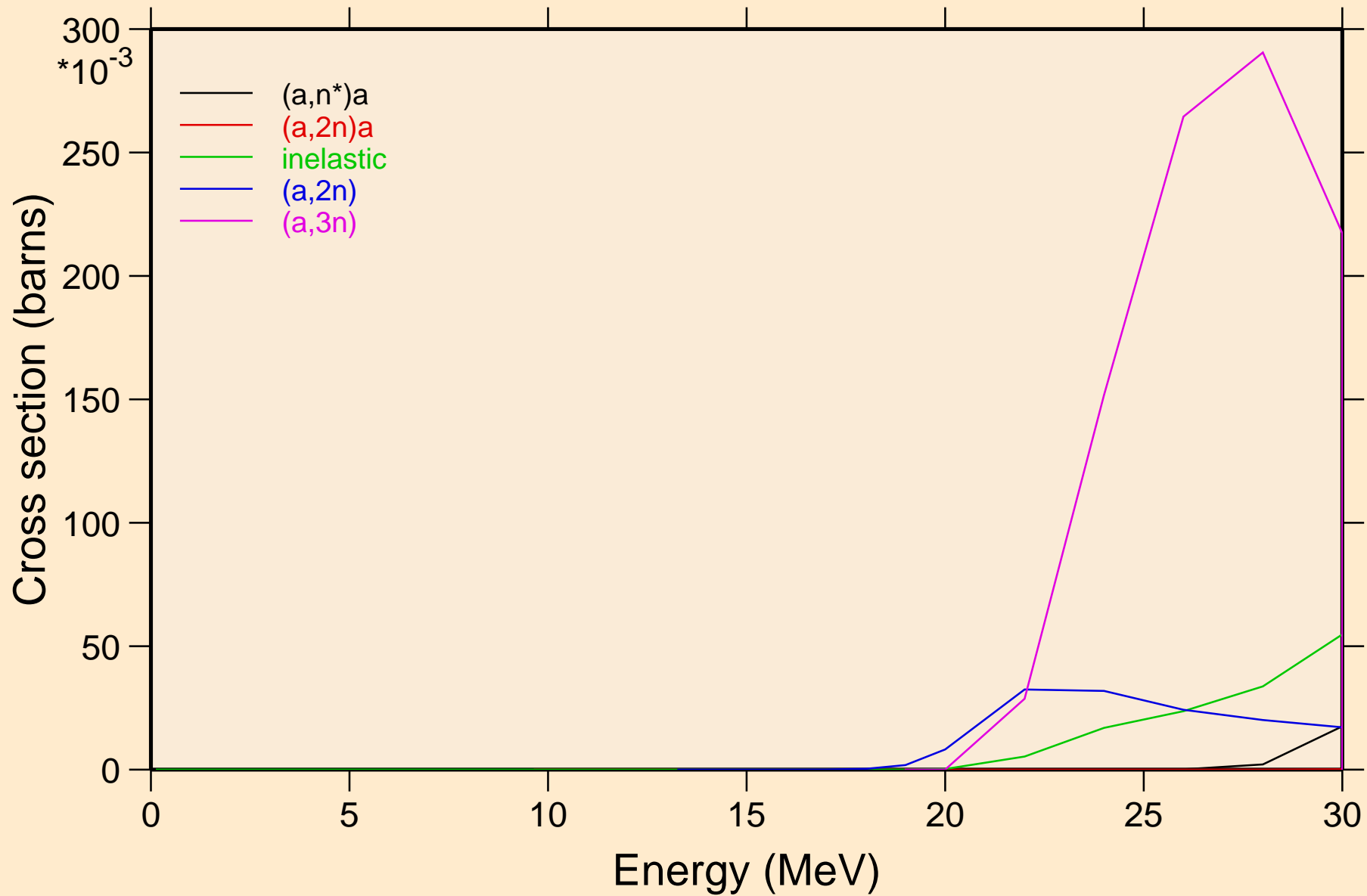

AC237 ALPHA ACER TENDL-2021 LIBRARY; T=0.K
Threshold reactions

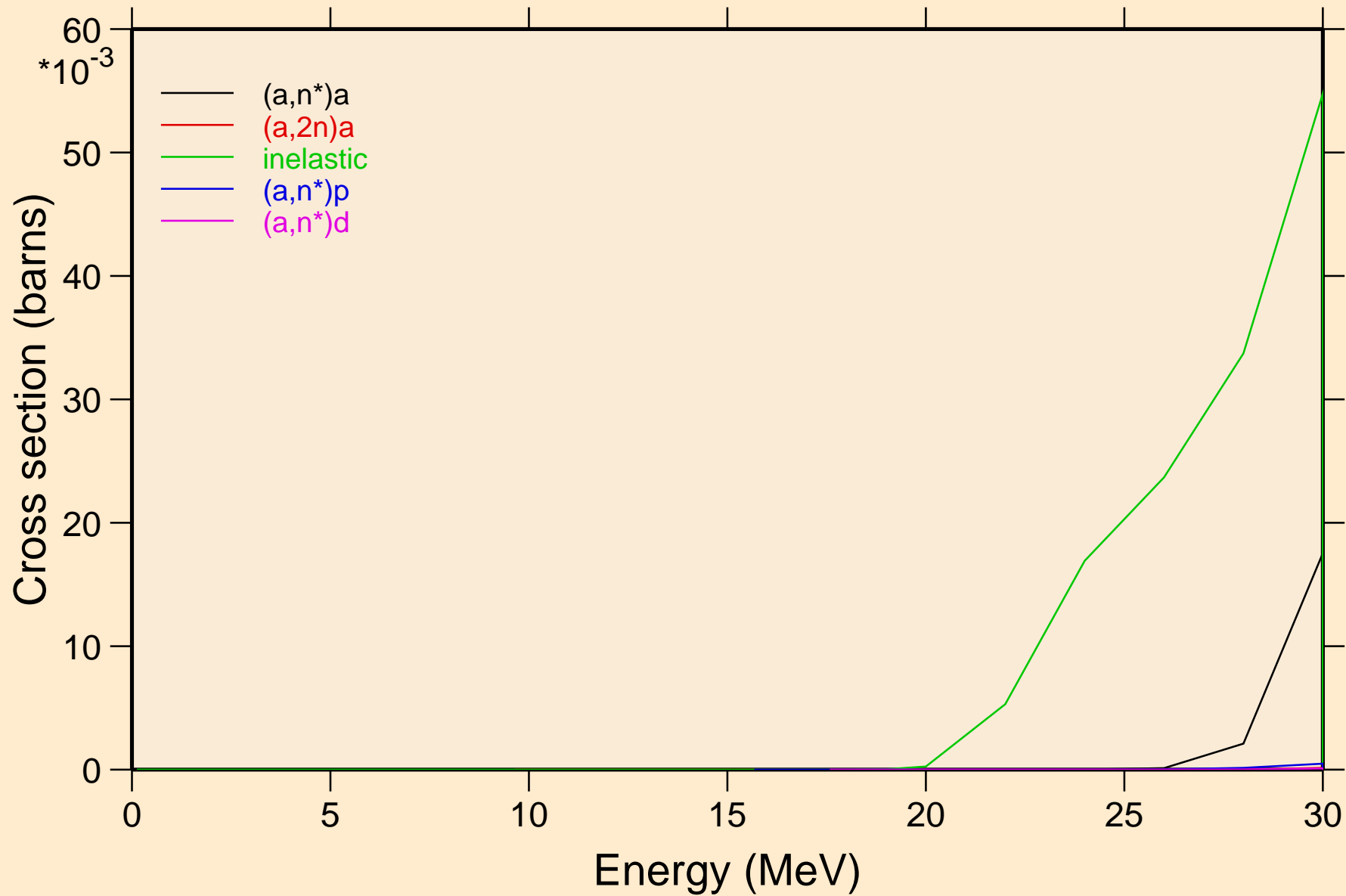

AC237 ALPHA ACER TENDL-2021 LIBRARY; T=0.K
Threshold reactions

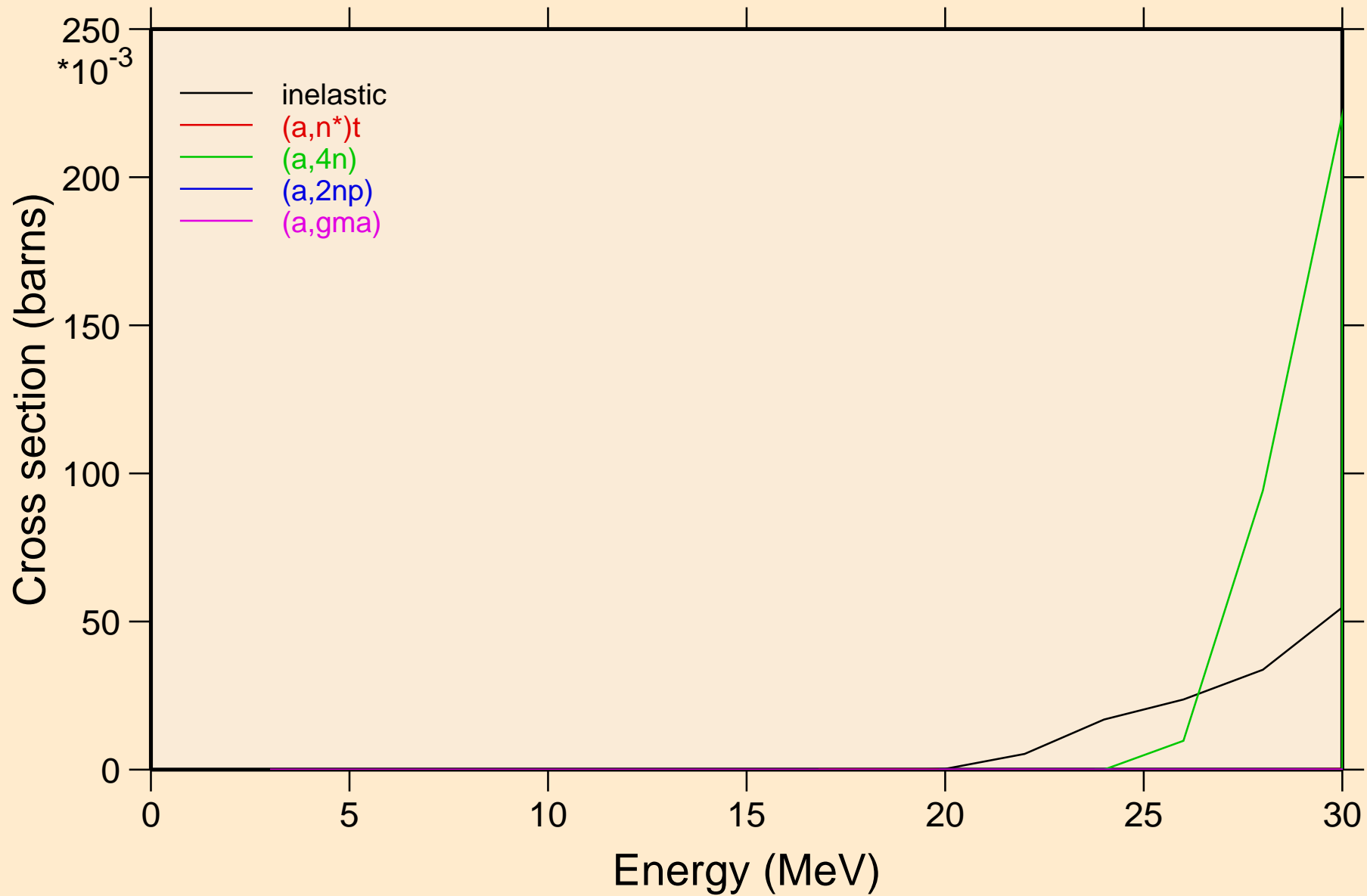

AC237 ALPHA ACER TENDL-2021 LIBRARY; T=0.K
Threshold reactions

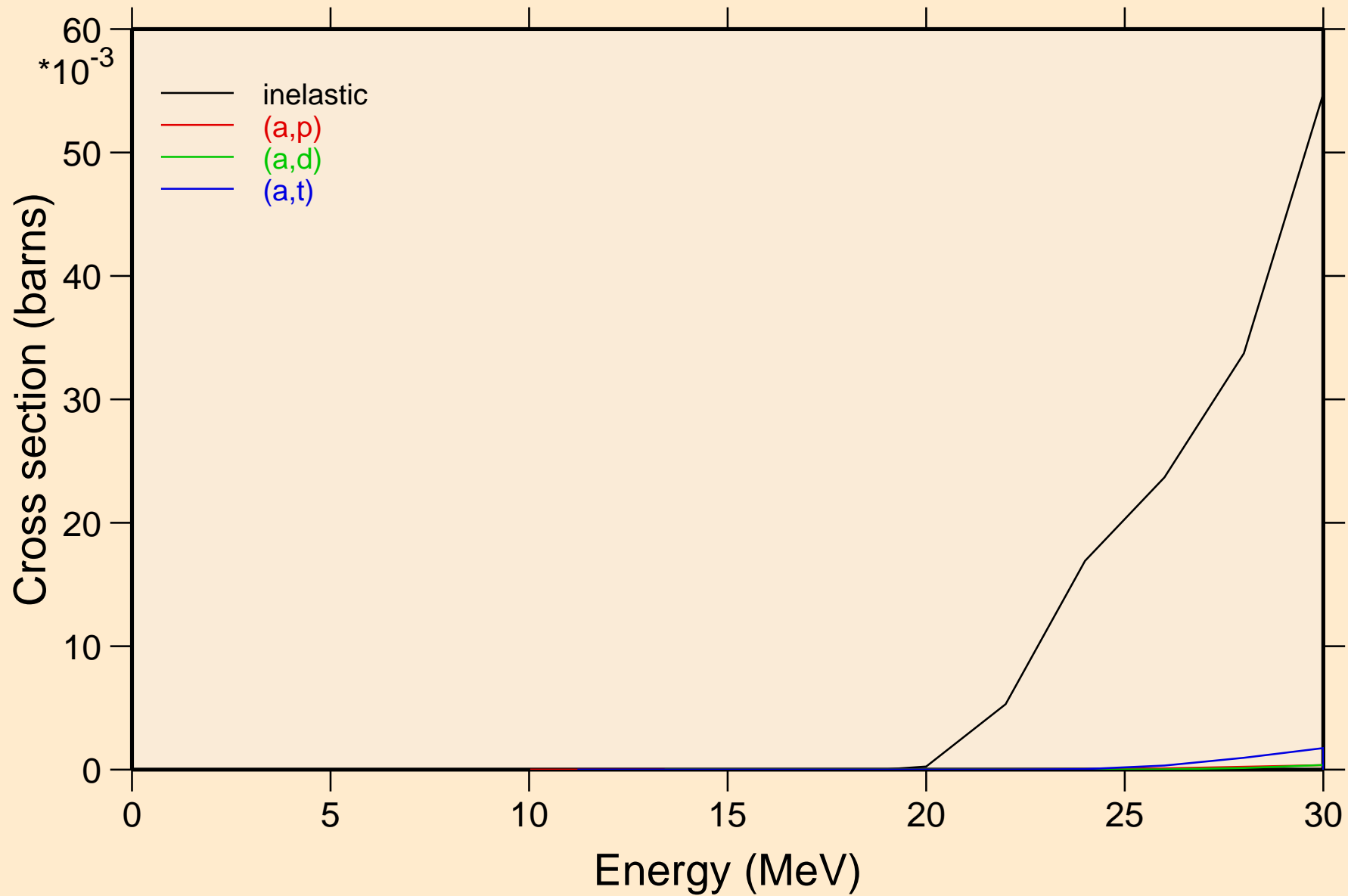

AC237 ALPHA ACER TENDL-2021 LIBRARY; T=0.K
Threshold reactions

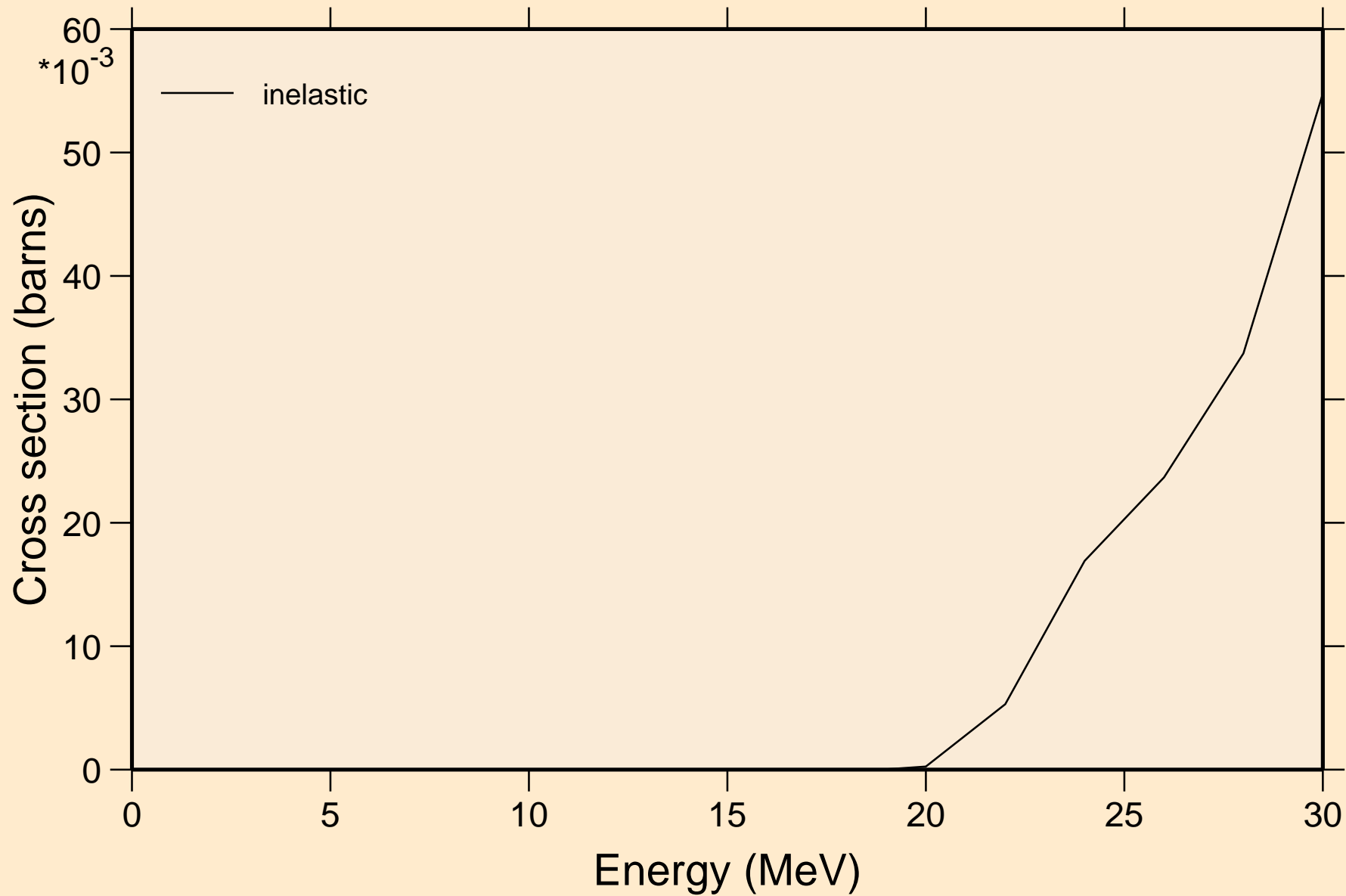

AC237 ALPHA ACER TENDL-2021 LIBRARY; T=0.K
angular distribution for elastic

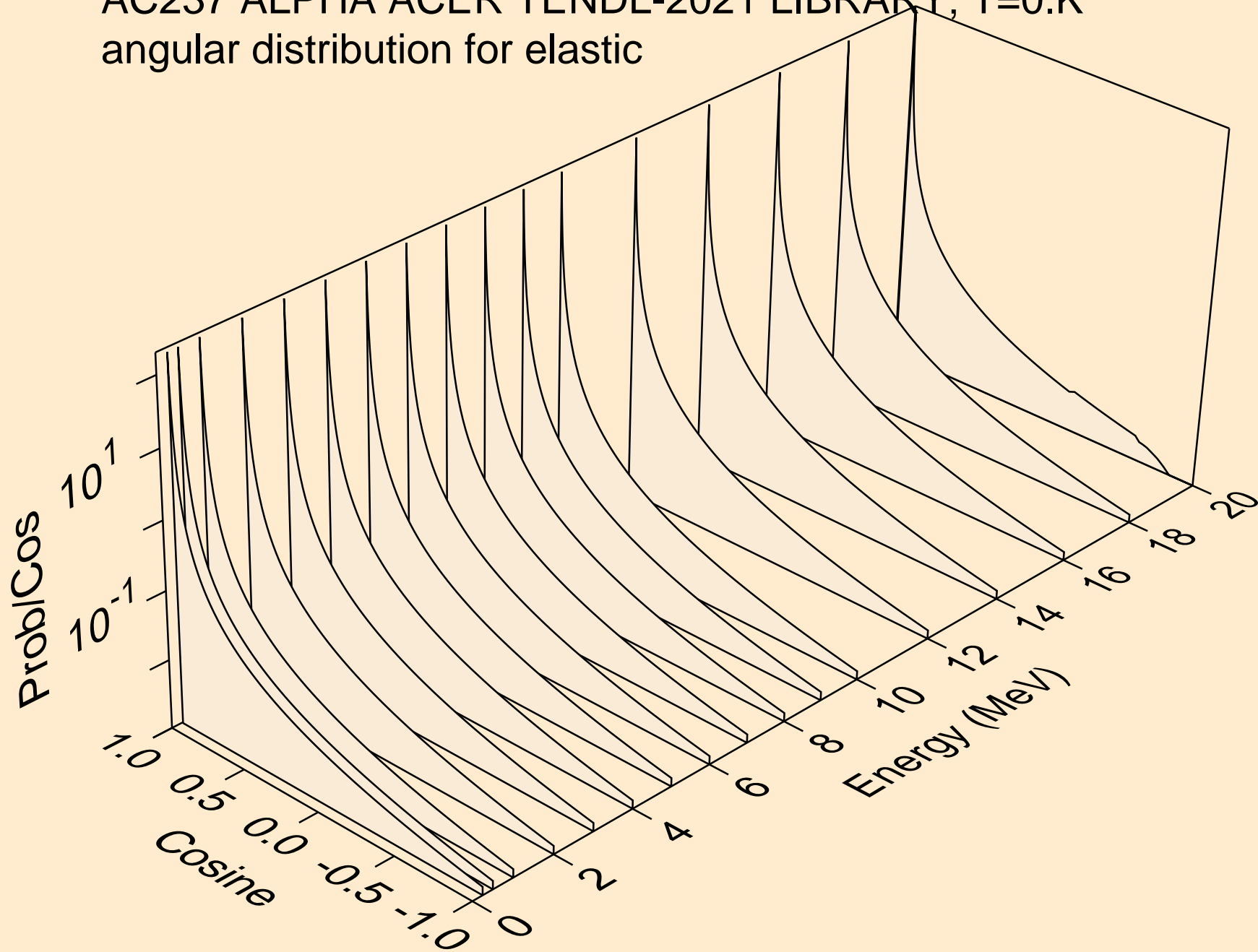

AC237 ALPHA ACER TENDL-2021 LIBRARY; T=0.K
angular distribution for elastic

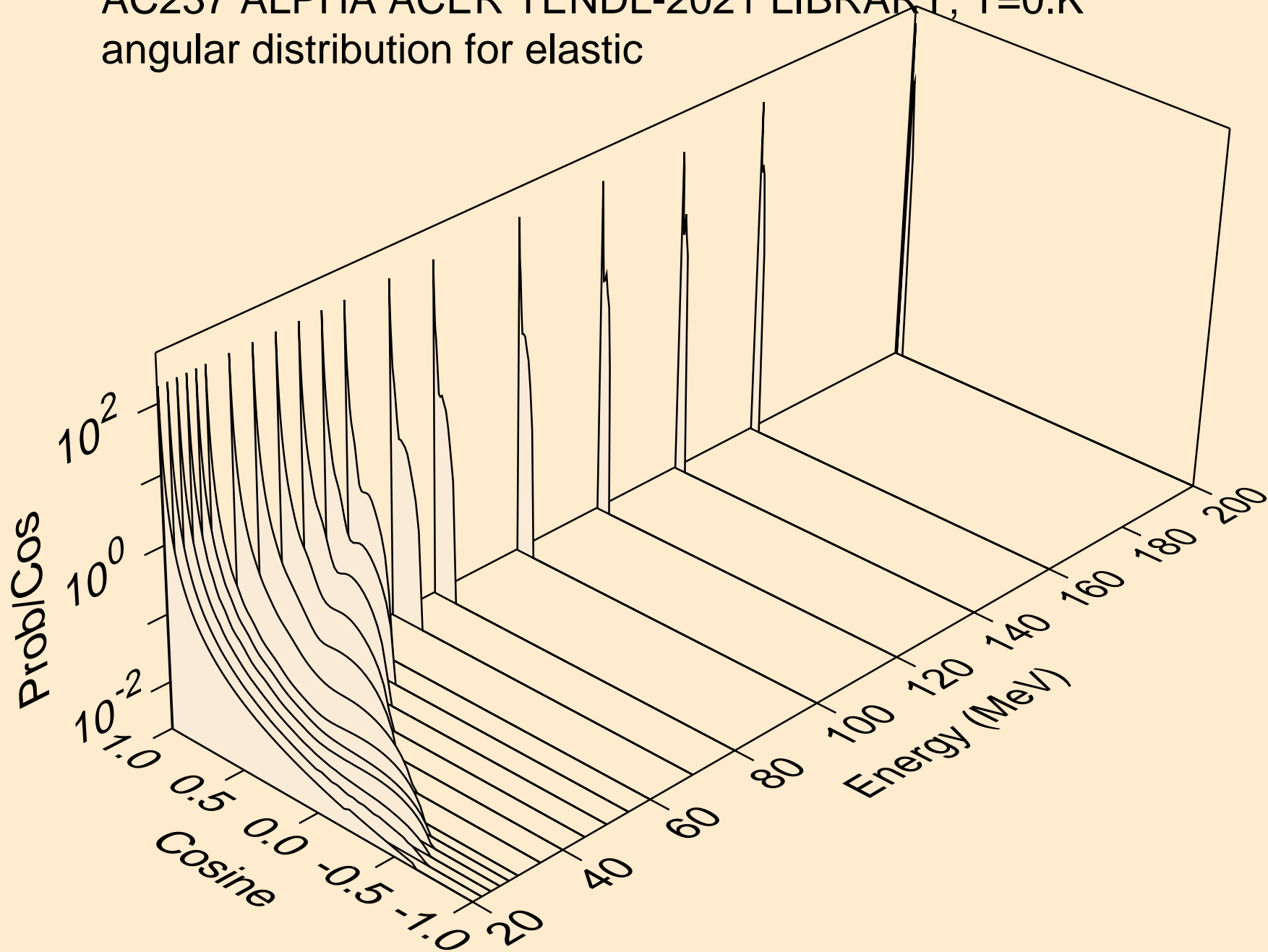

AC237 ALPHA ACER TENDL-2021 LIBRARY; T=0.K
Alpha emission for (a,x)

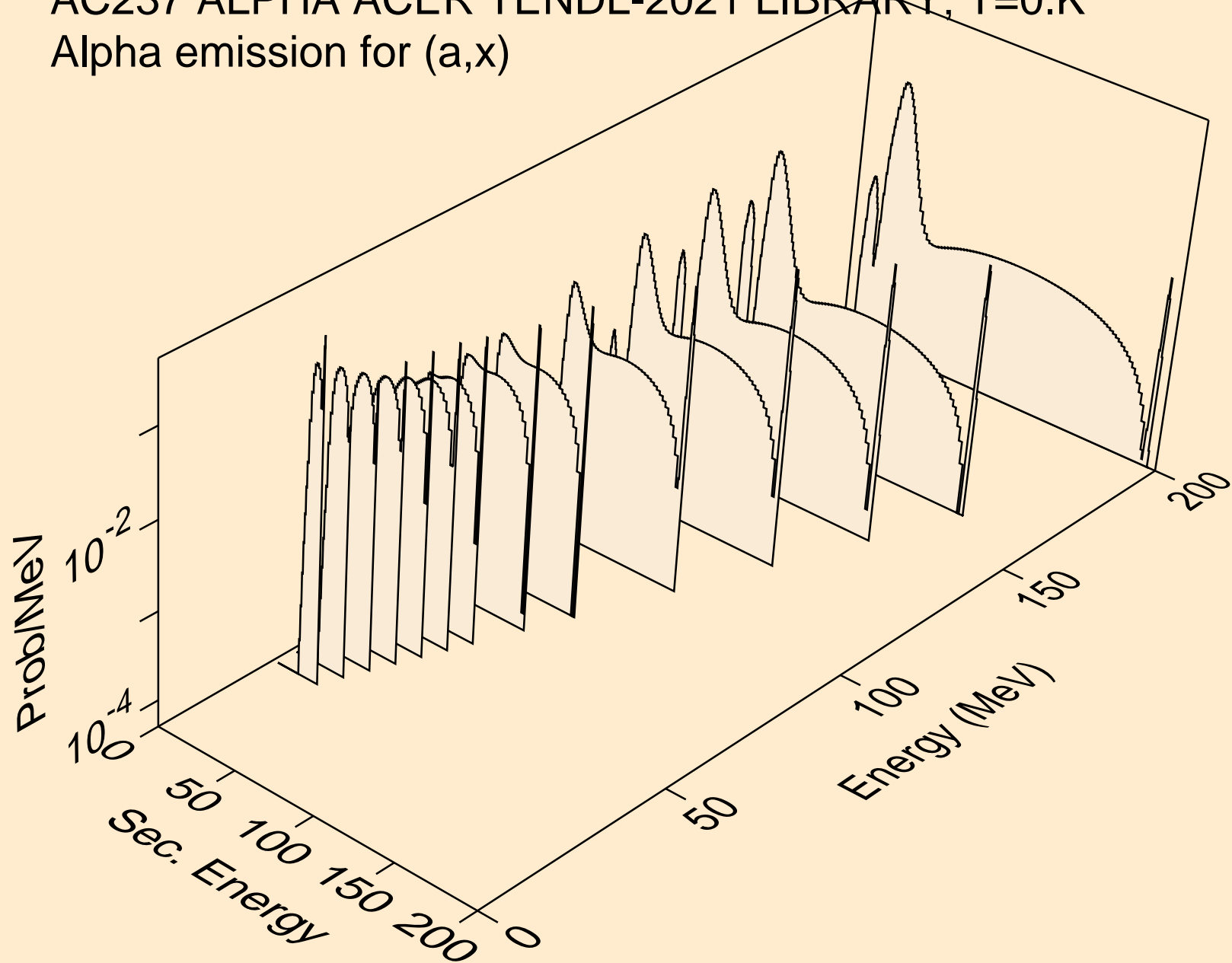

AC237 ALPHA ACER TENDL-2021 LIBRARY; T=0.K
Alpha emission for (a,n*)a

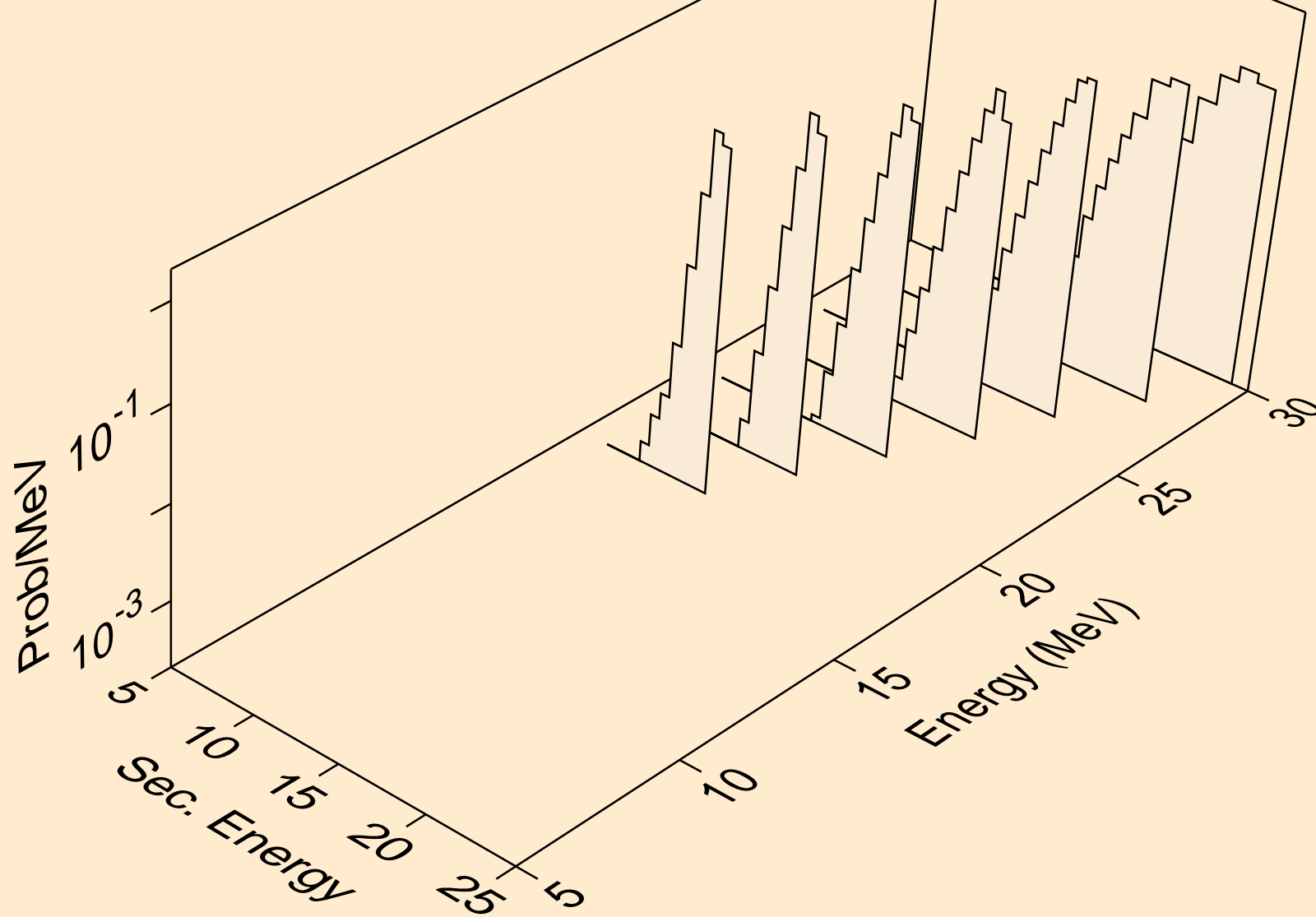

AC237 ALPHA ACER TENDL-2021 LIBRARY; T=0.K
Alpha emission for (a,2n)a

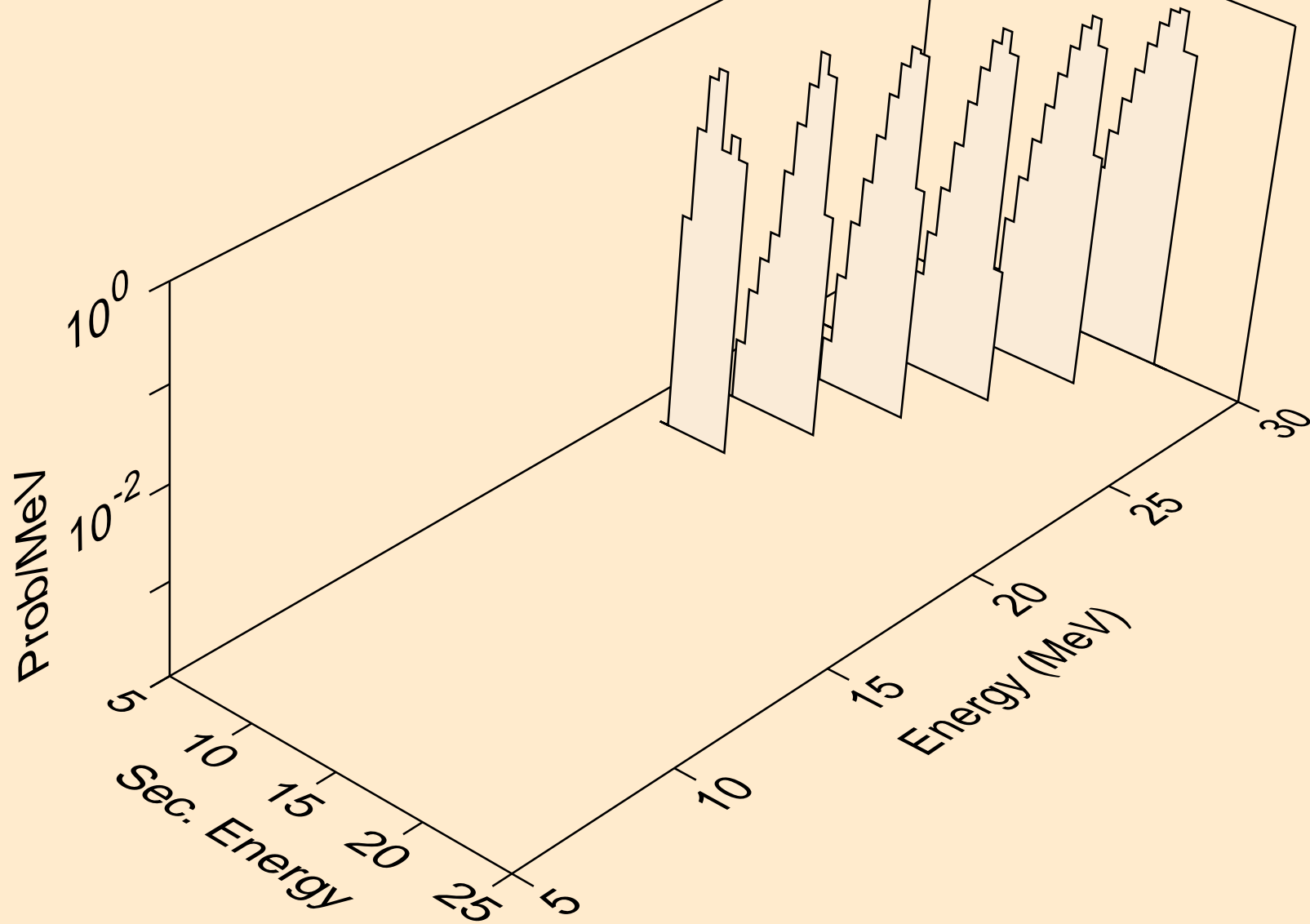

AC237 ALPHA ACER TENDL-2021 LIBRARY; T=0.K
Alpha emission for inelastic

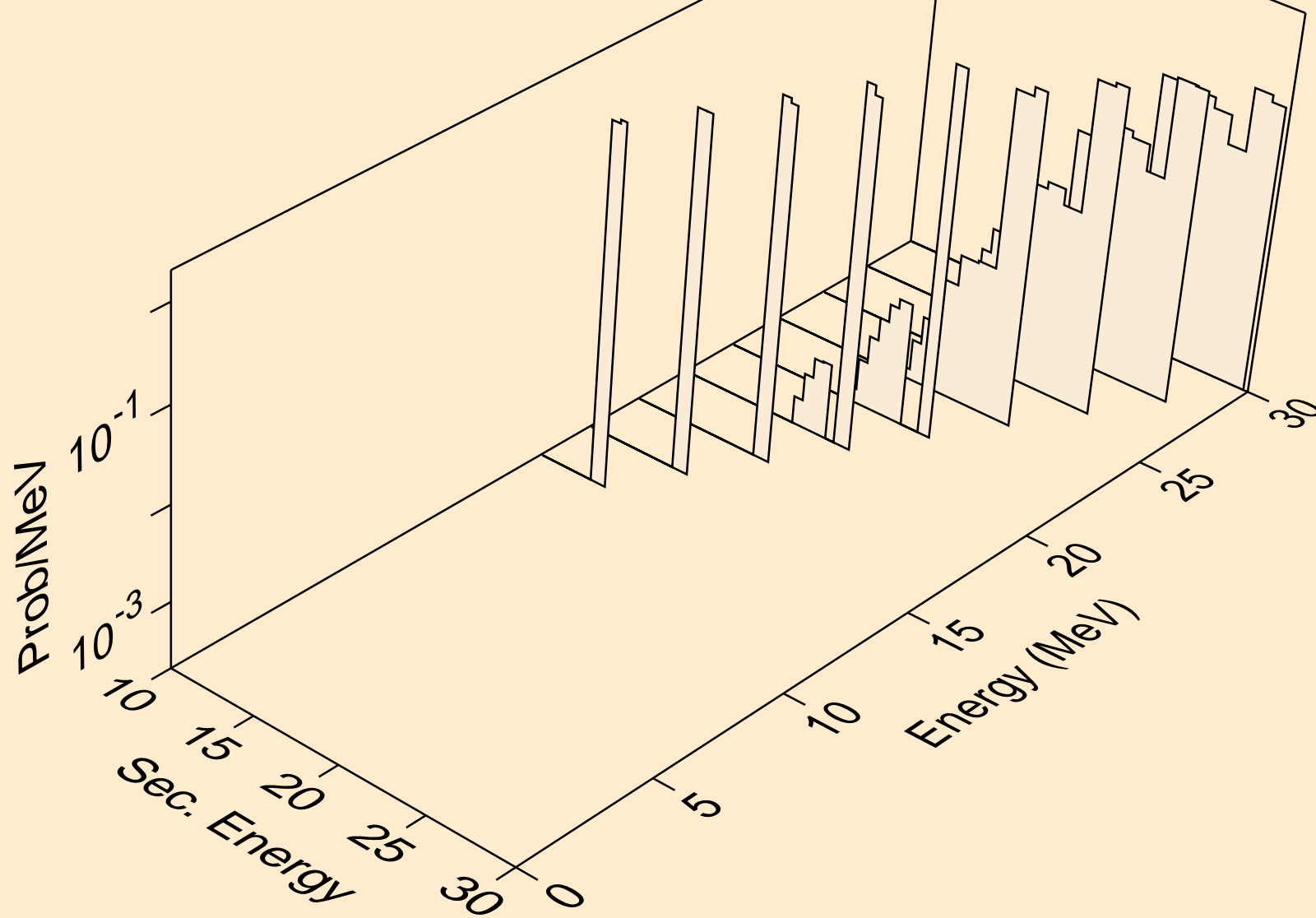

AC237 ALPHA ACER TENDL-2021 LIBRARY; T=0.K
Photon emission for (z,n)

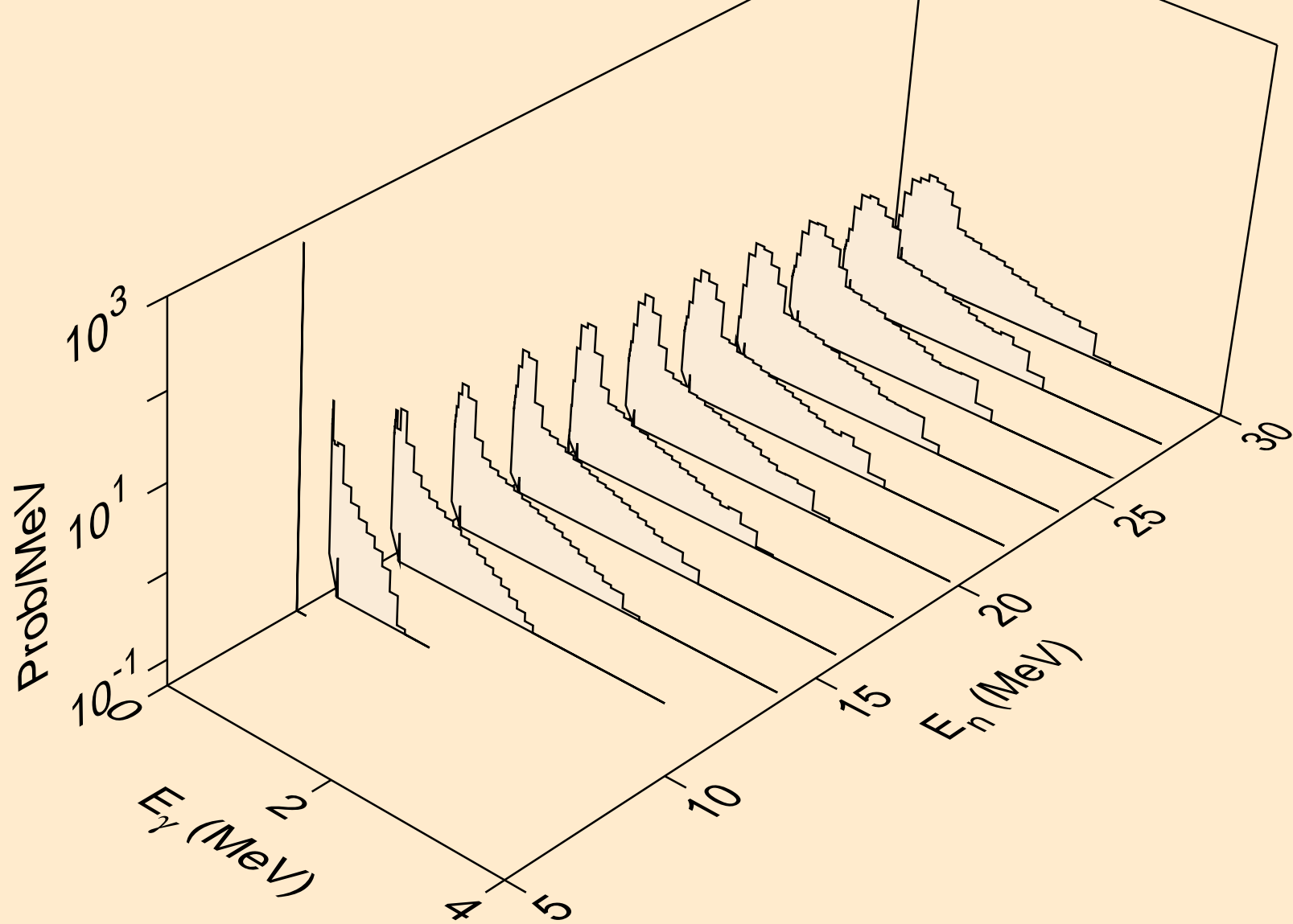

AC237 ALPHA ACER TENDL-2021 LIBRARY; T=0.K
Photon emission for (n,x)

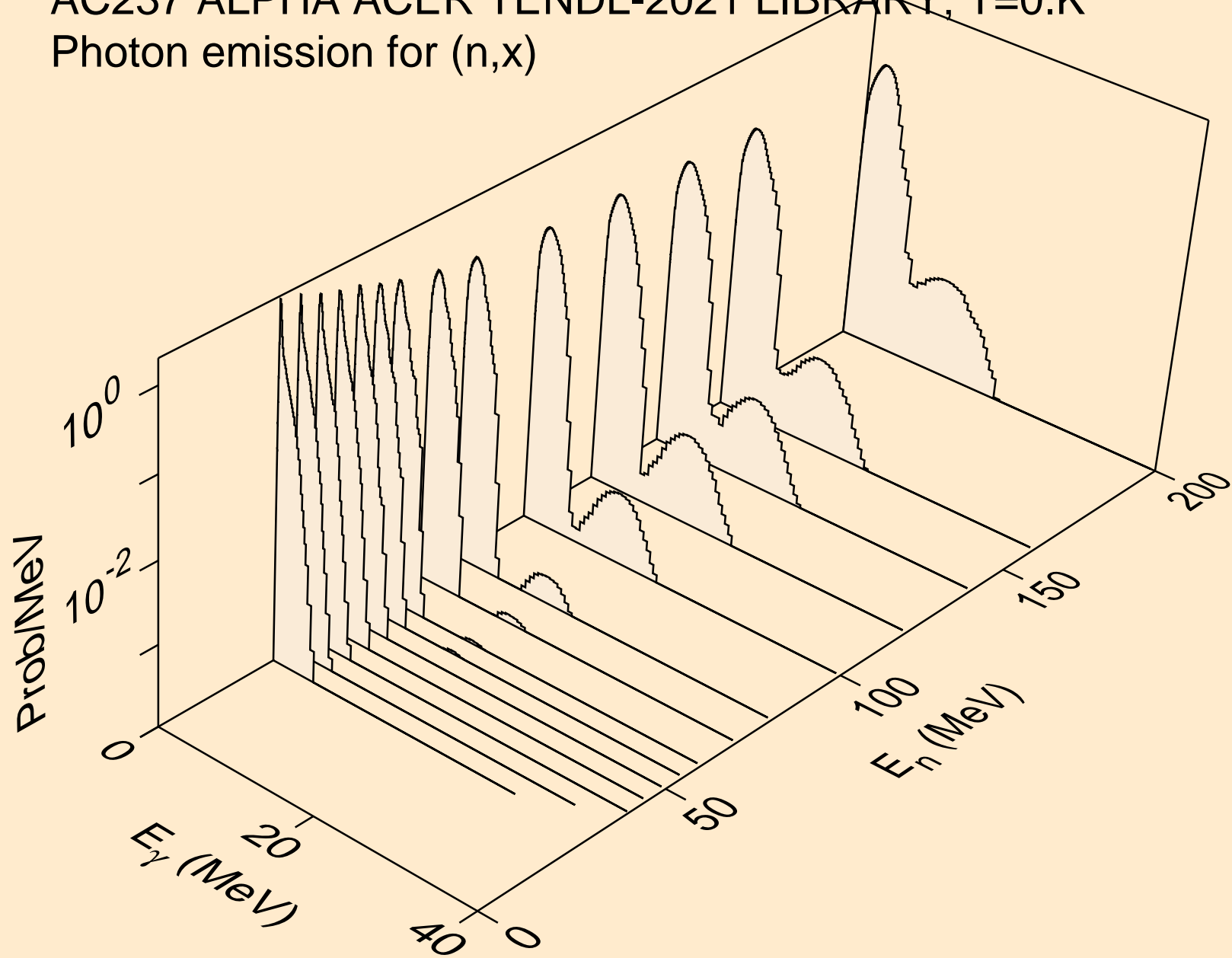

AC237 ALPHA ACER TENDL-2021 LIBRARY; T=0.K
Photon emission for (n,2nd)

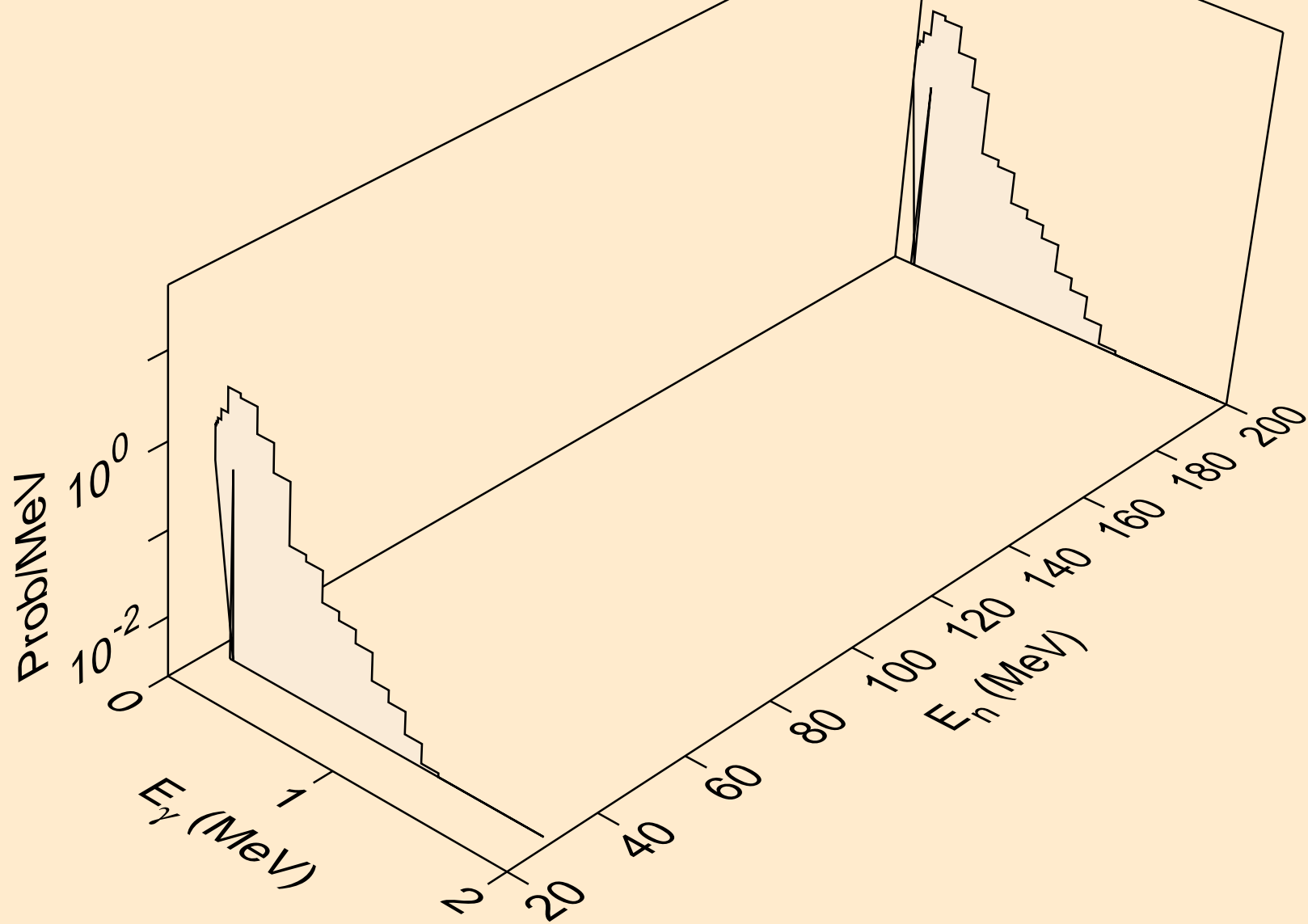

AC237 ALPHA ACER TENDL-2021 LIBRARY; T=0.K
Photon emission for (n,2n)

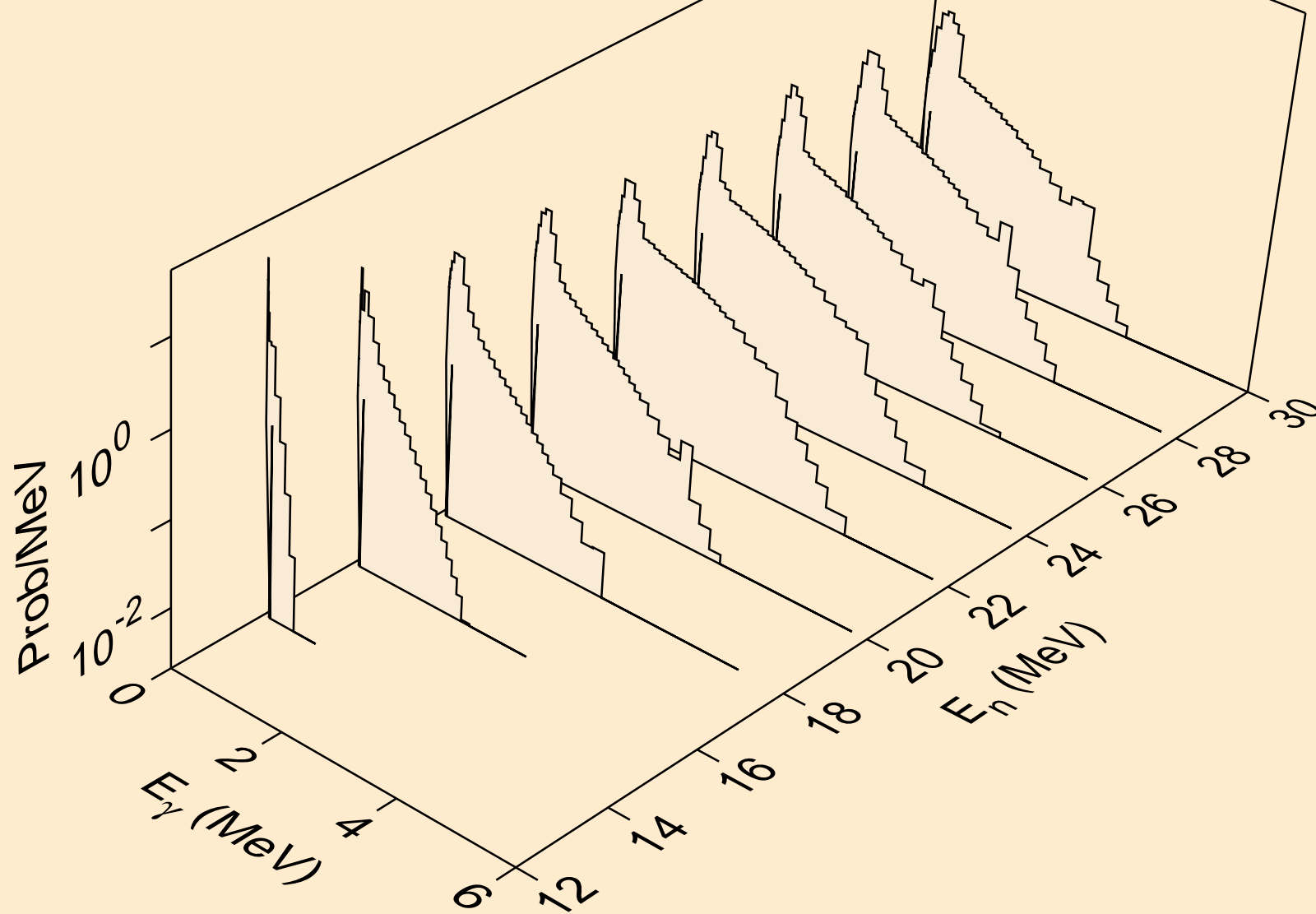

AC237 ALPHA ACER TENDL-2021 LIBRARY; T=0.K
Photon emission for (n,3n)

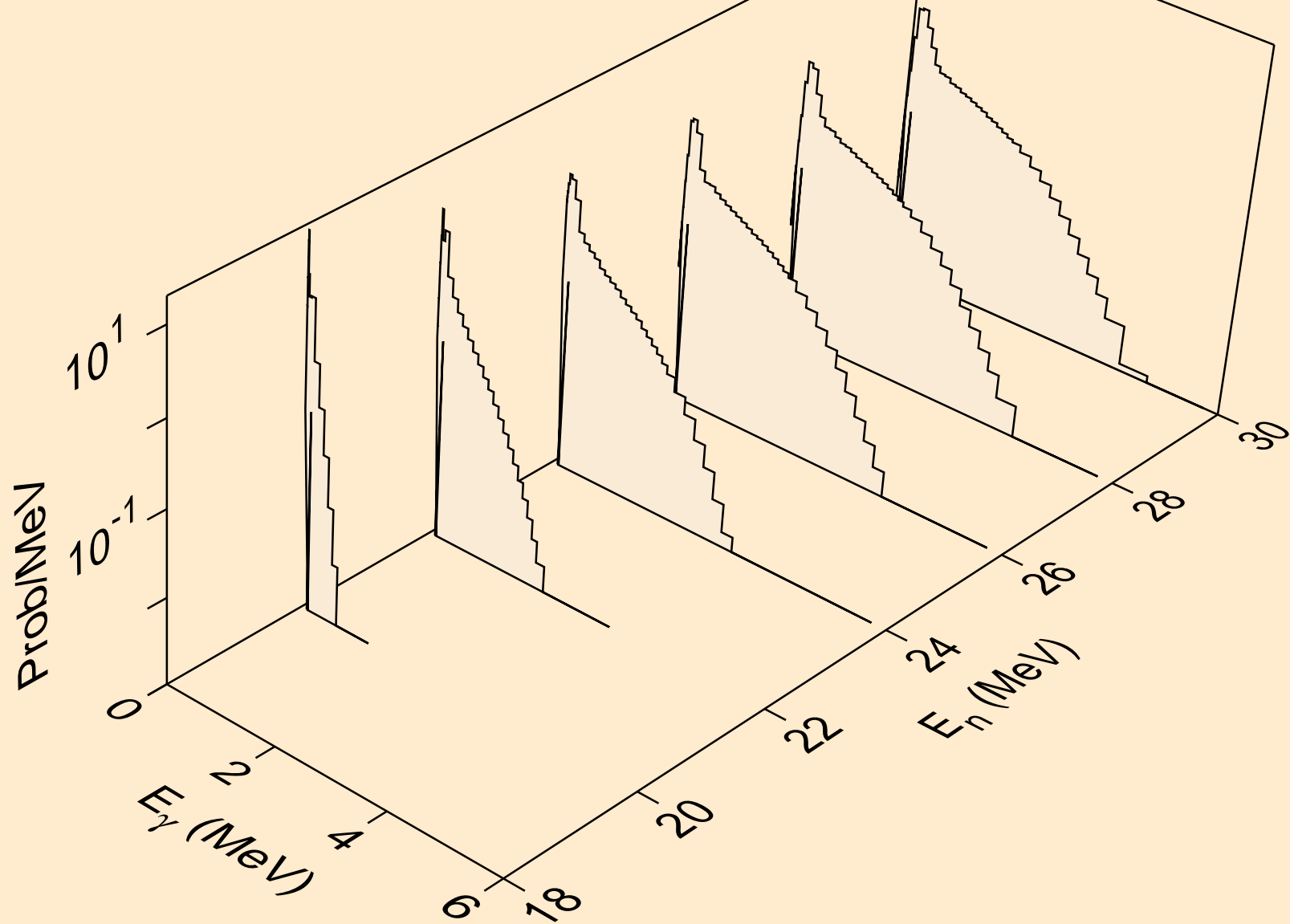

AC237 ALPHA ACER TENDL-2021 LIBRARY; T=0.K
Photon emission for (n,n*)a

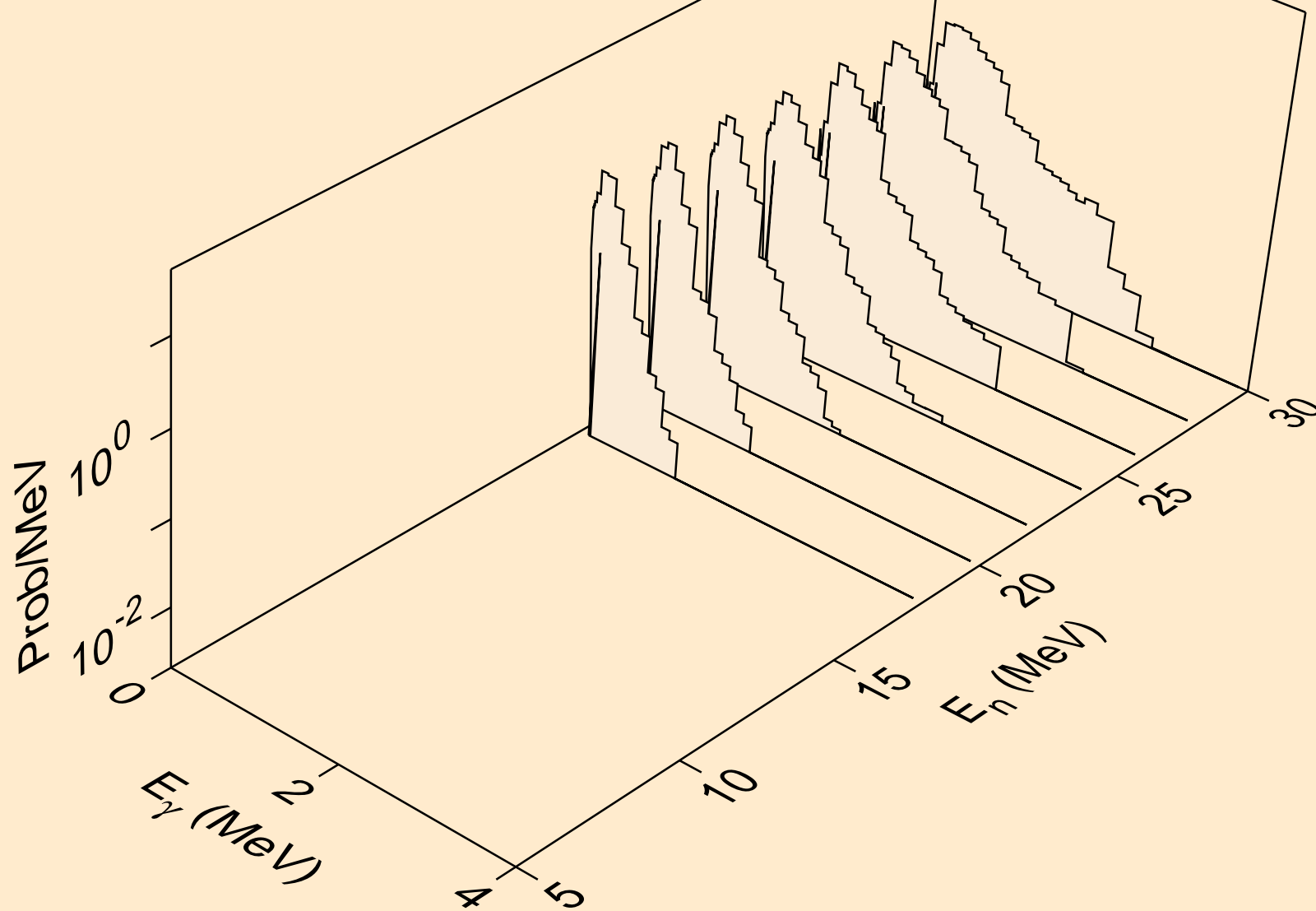

AC237 ALPHA ACER TENDL-2021 LIBRARY; T=0.K
Photon emission for (n,2n)a

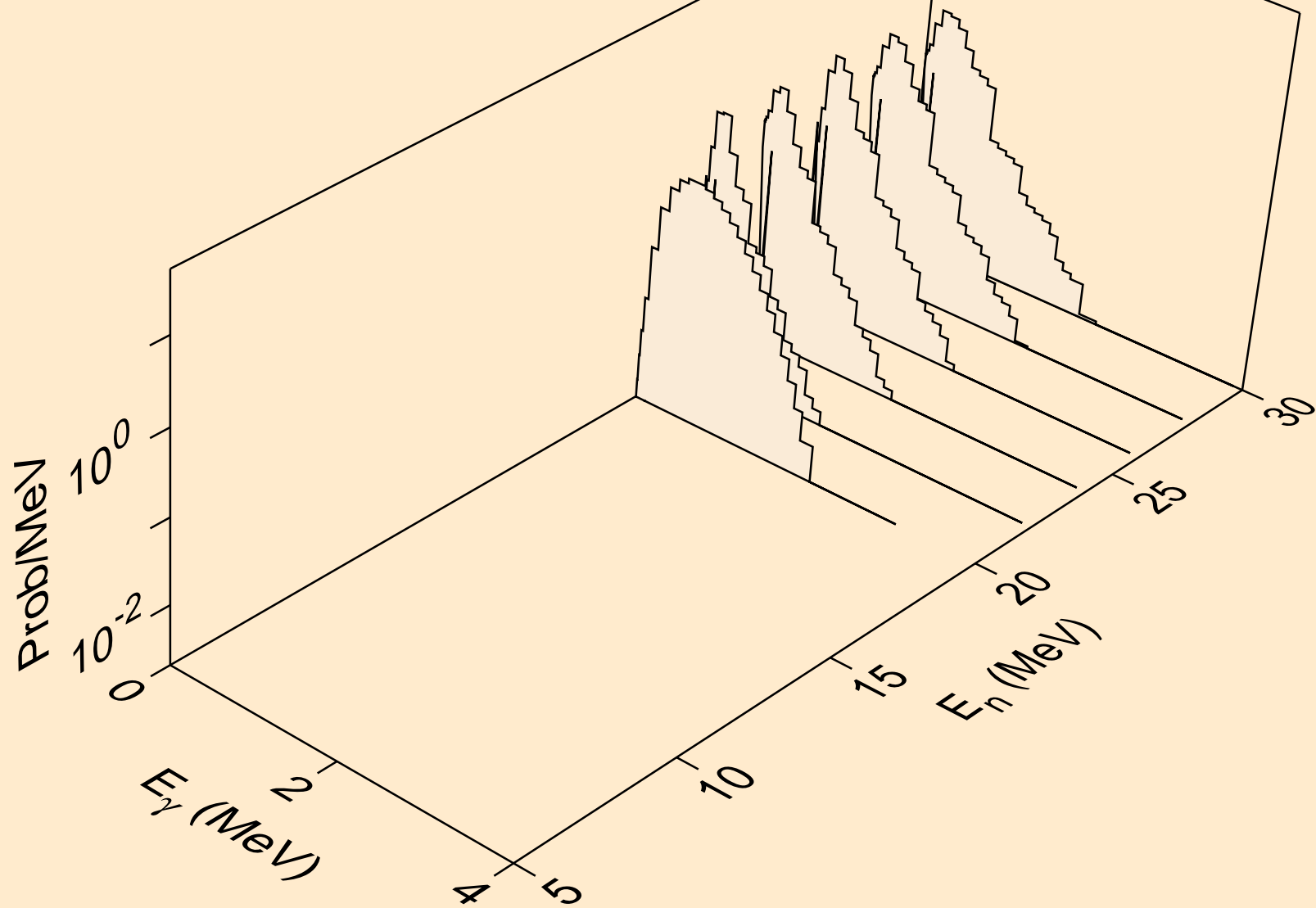

AC237 ALPHA ACER TENDL-2021 LIBRARY; T=0.K
Photon emission for (n,n*)p

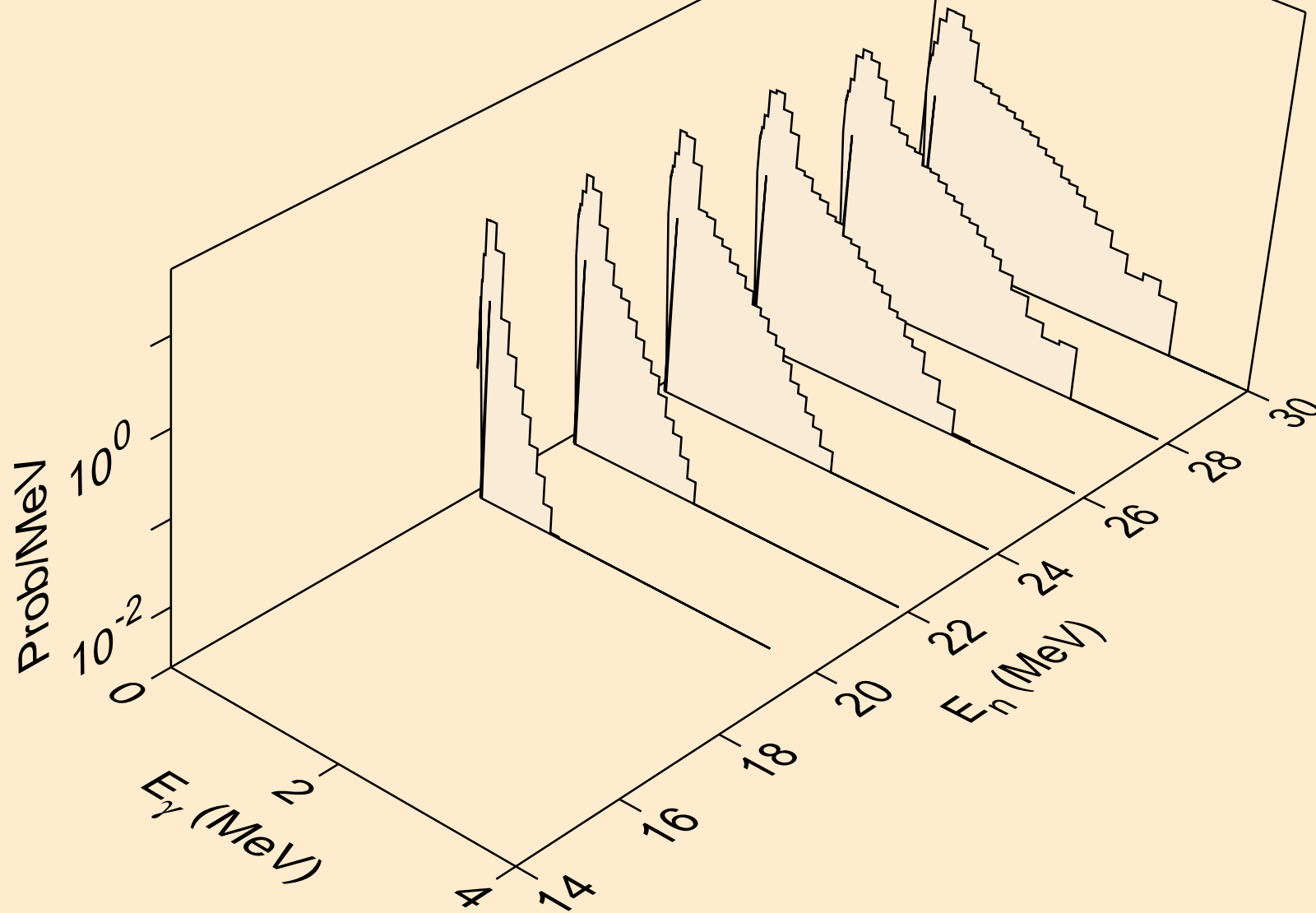

AC237 ALPHA ACER TENDL-2021 LIBRARY; T=0.K
Photon emission for (n,n*)d

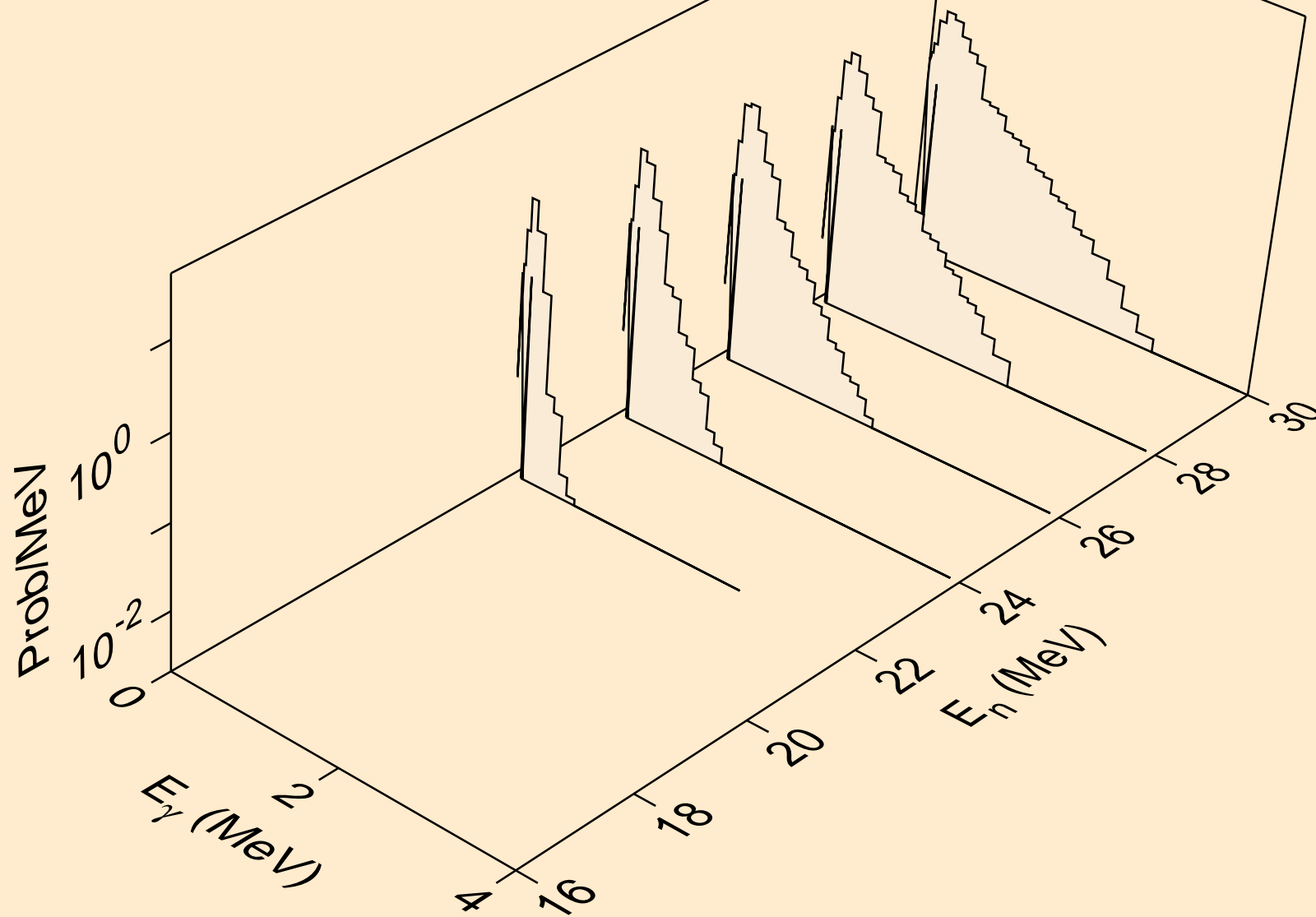

AC237 ALPHA ACER TENDL-2021 LIBRARY; T=0.K
Photon emission for (n,n*)t

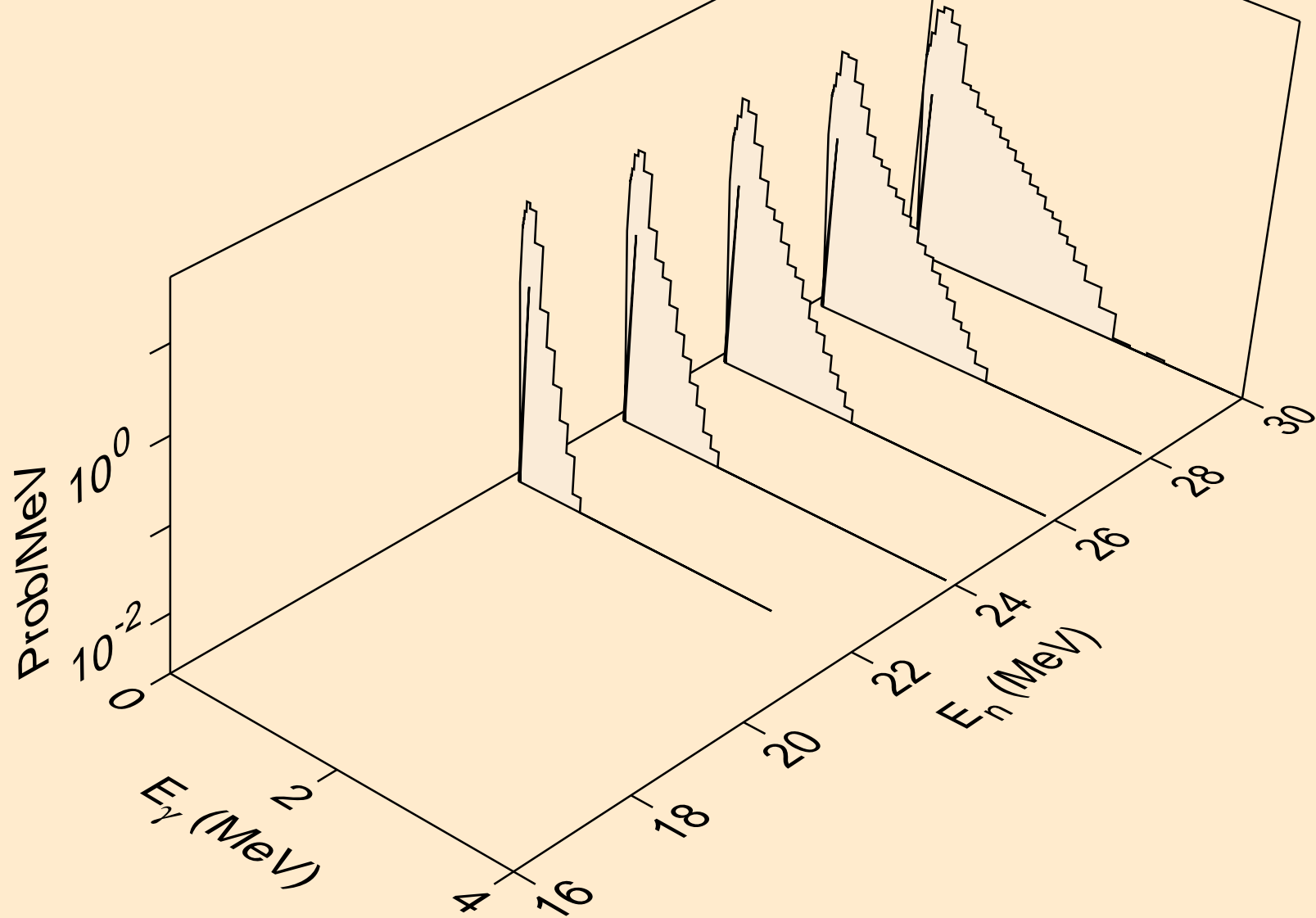

AC237 ALPHA ACER TENDL-2021 LIBRARY; T=0.K
Photon emission for (n,4n)

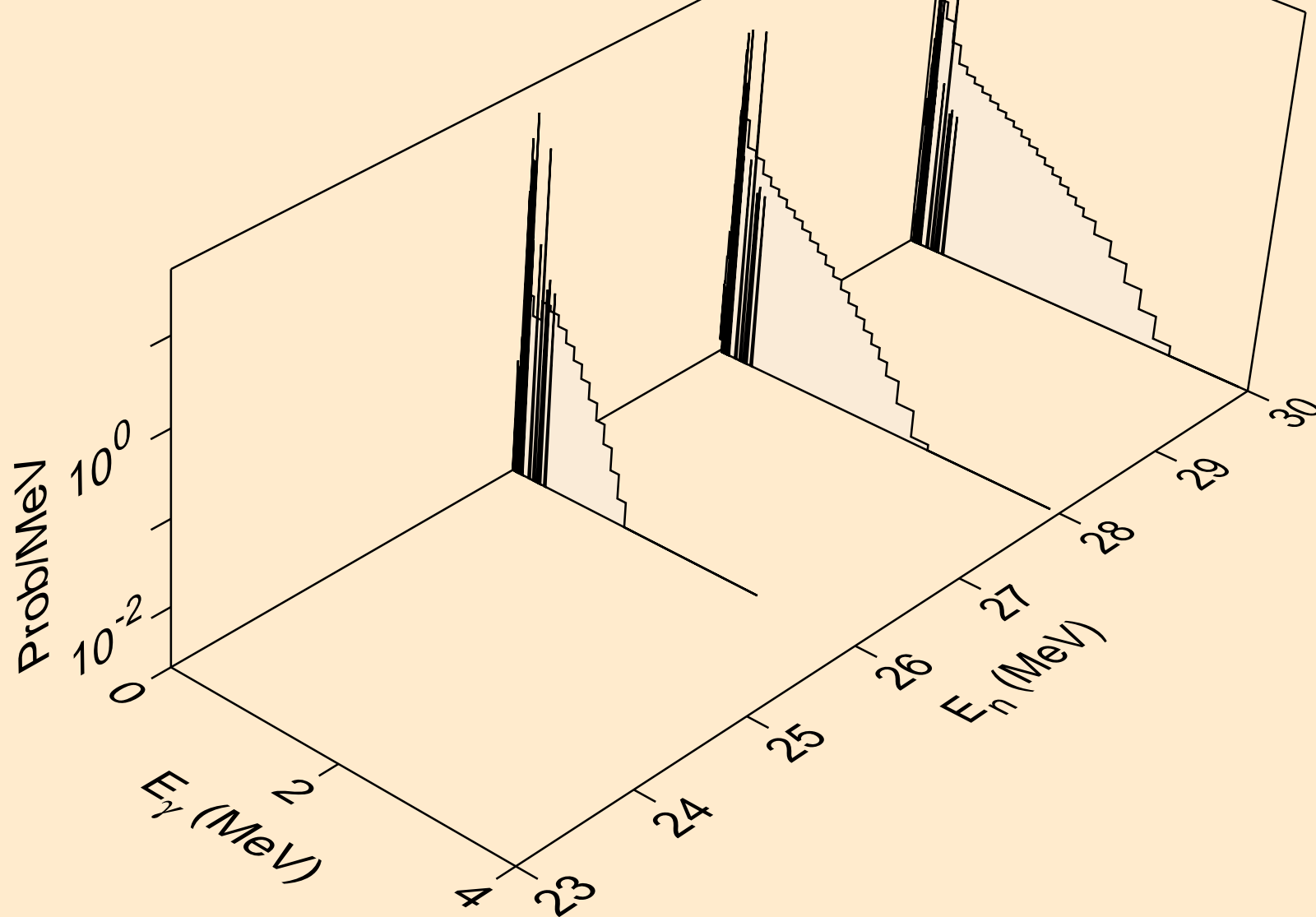

AC237 ALPHA ACER TENDL-2021 LIBRARY; T=0.K
Photon emission for (n,2np)

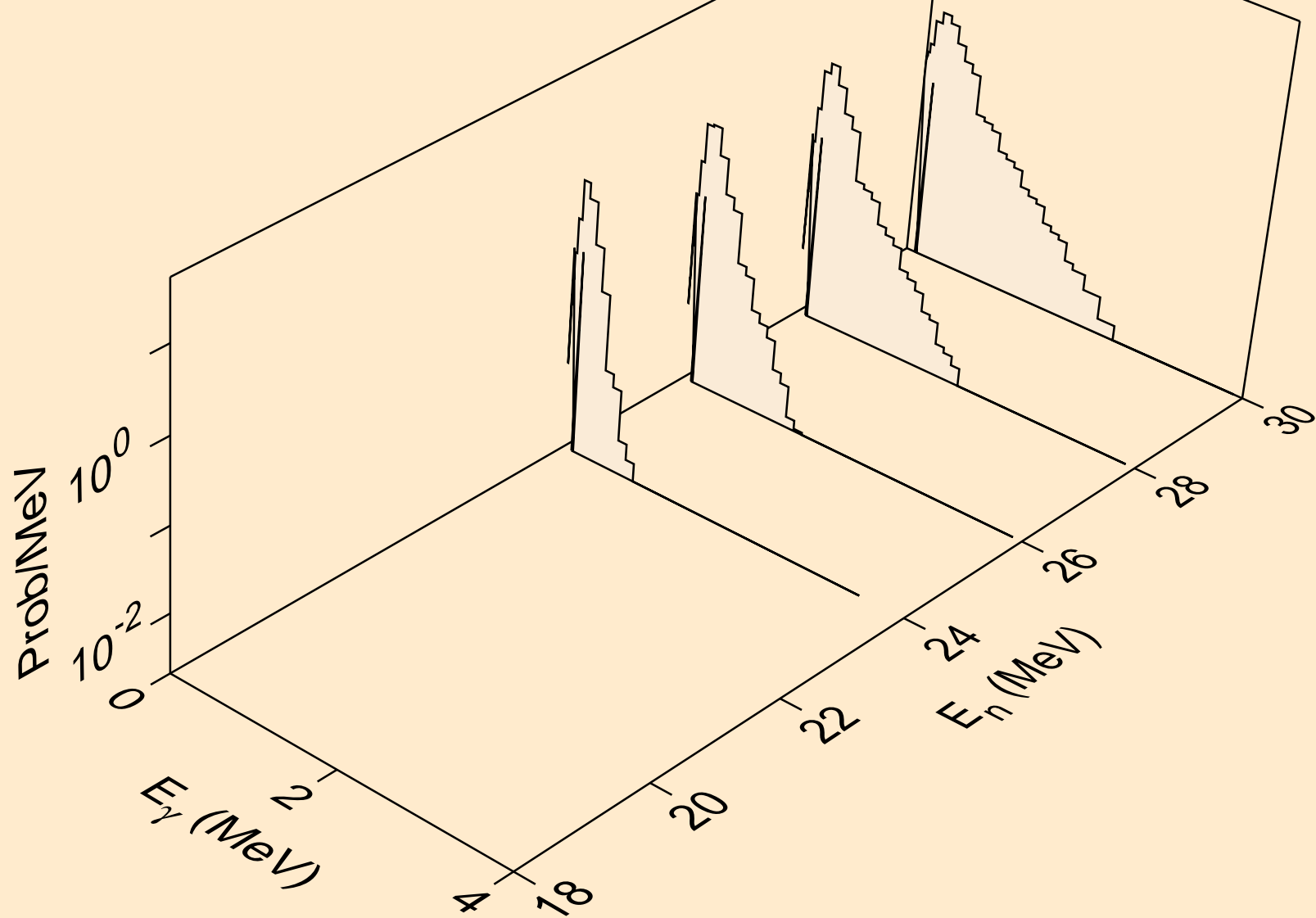

AC237 ALPHA ACER TENDL-2021 LIBRARY; T=0.K
Photon emission for (n,gma)

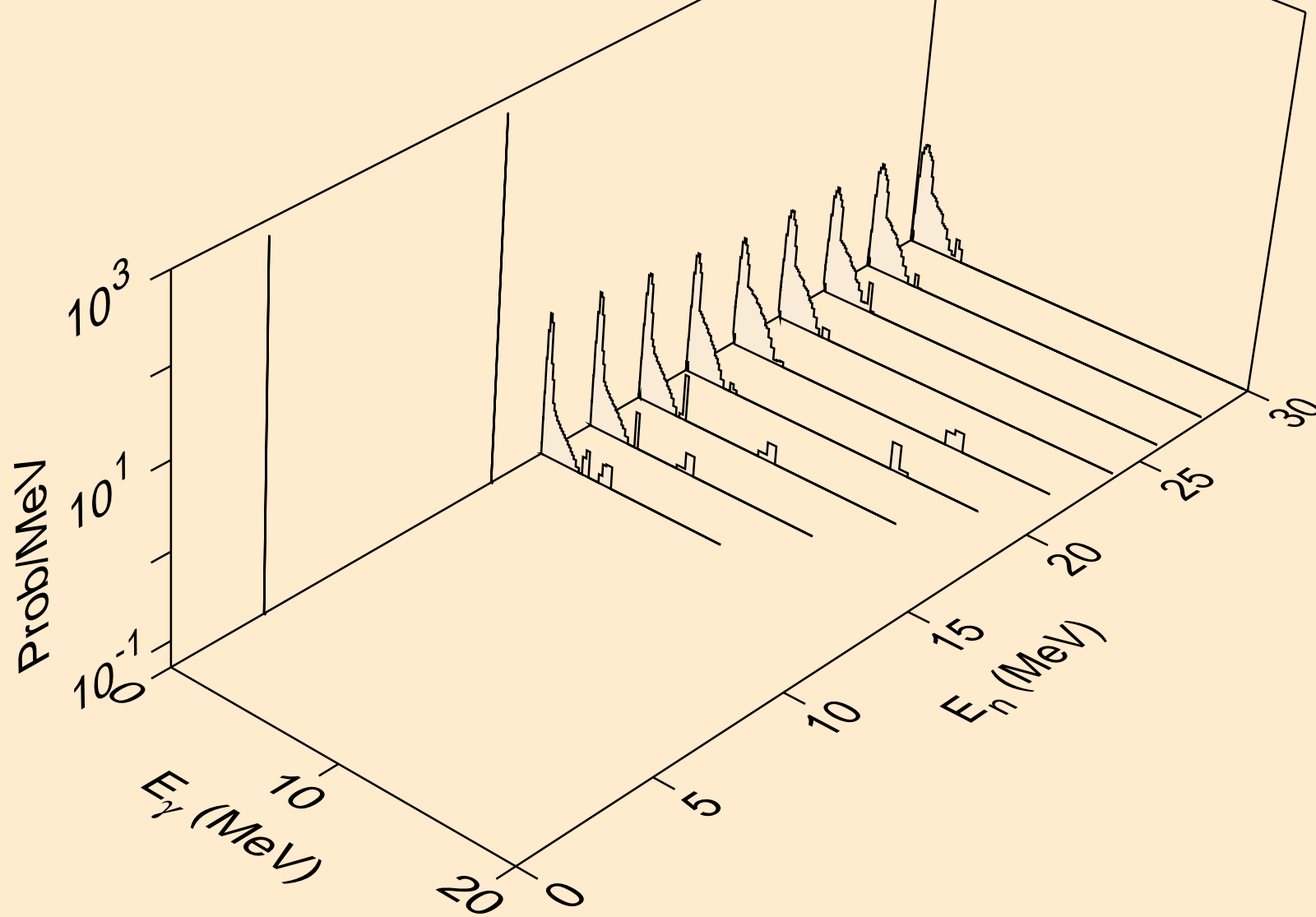

AC237 ALPHA ACER TENDL-2021 LIBRARY; T=0.K
Photon emission for (n,p)

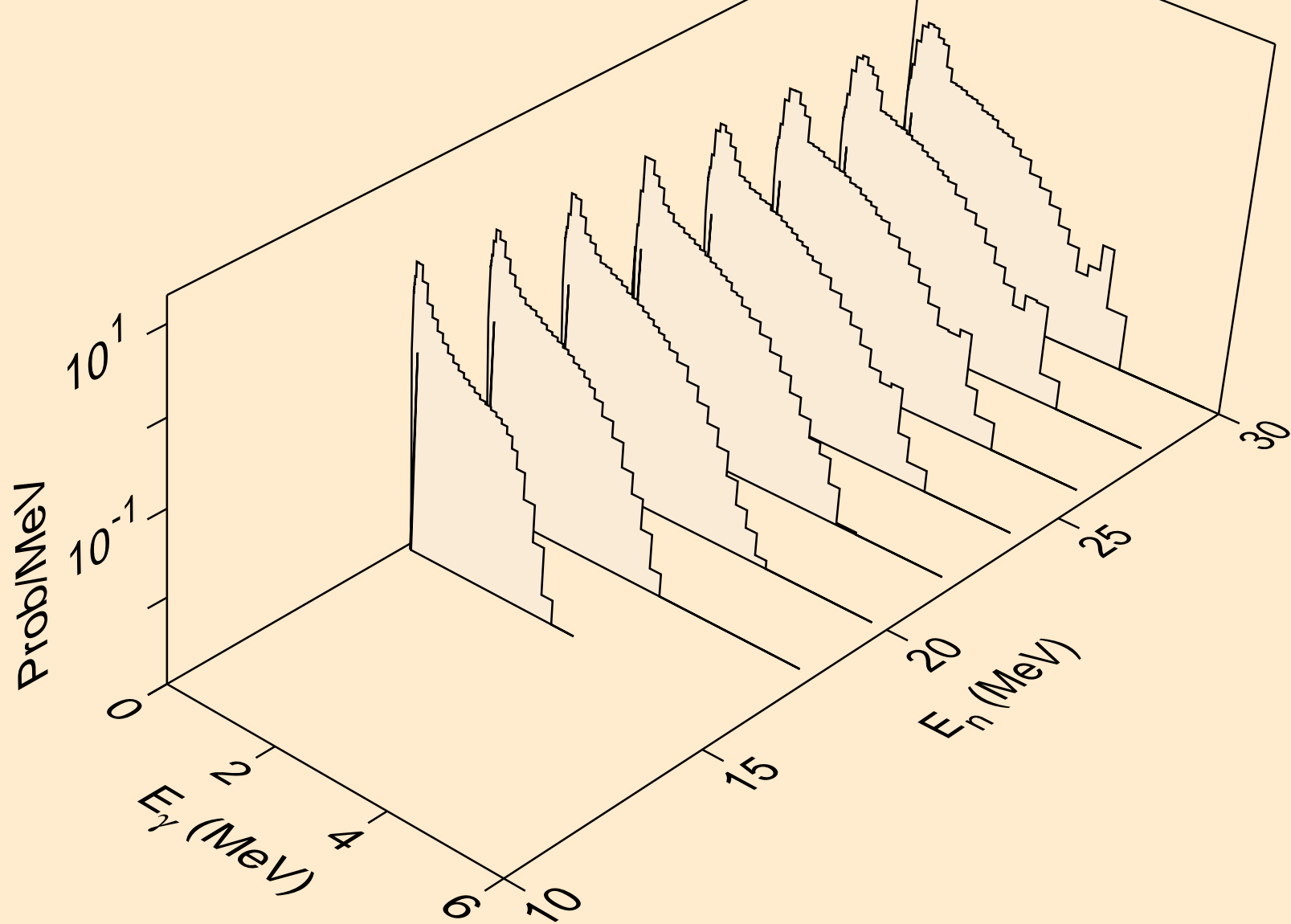

AC237 ALPHA ACER TENDL-2021 LIBRARY; T=0.K
Photon emission for (n,d)

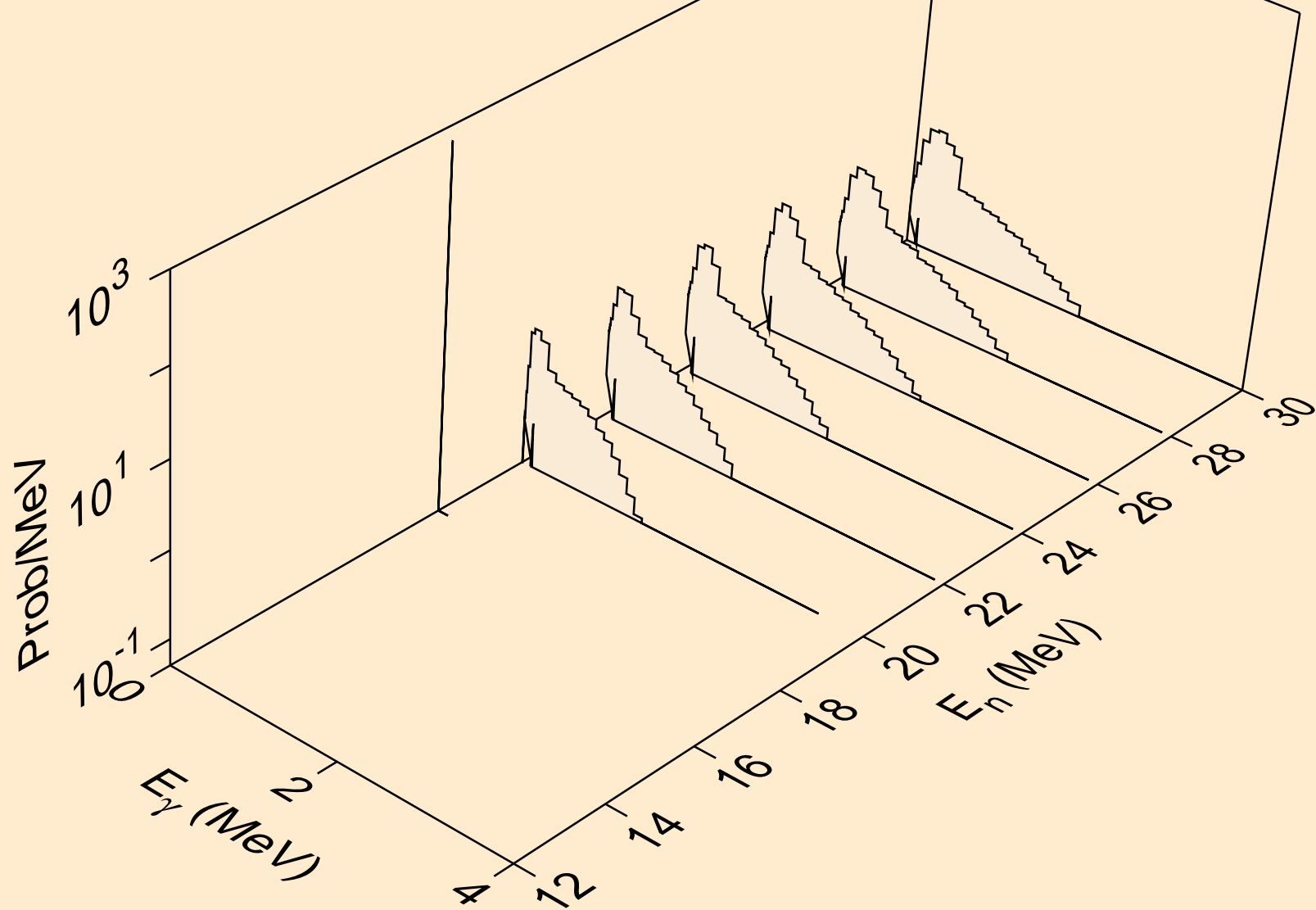

AC237 ALPHA ACER TENDL-2021 LIBRARY; T=0.K
Photon emission for (n,t)

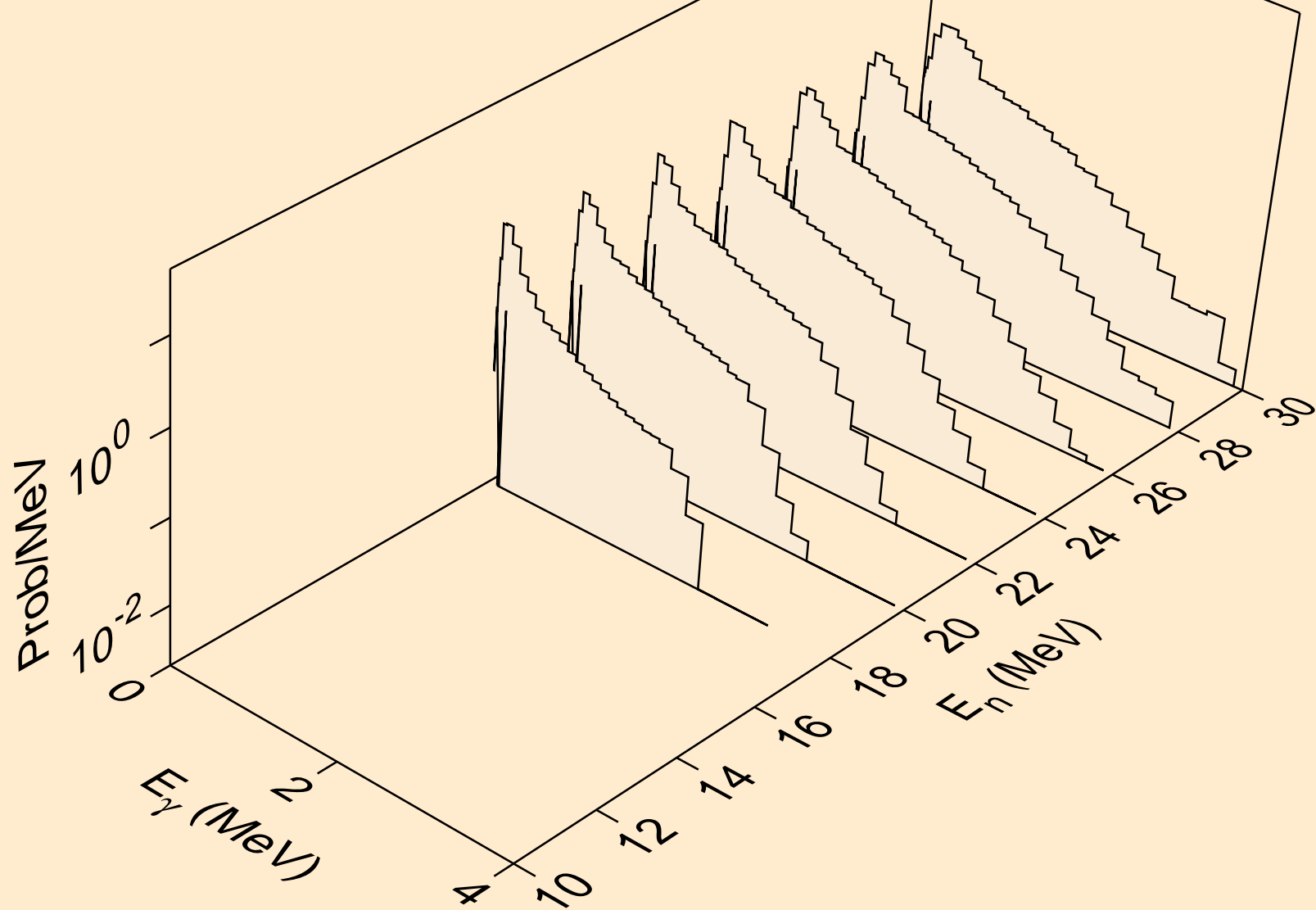

AC237 ALPHA ACER TENDL-2021 LIBRARY; T=0.K
Photon emission for inelastic

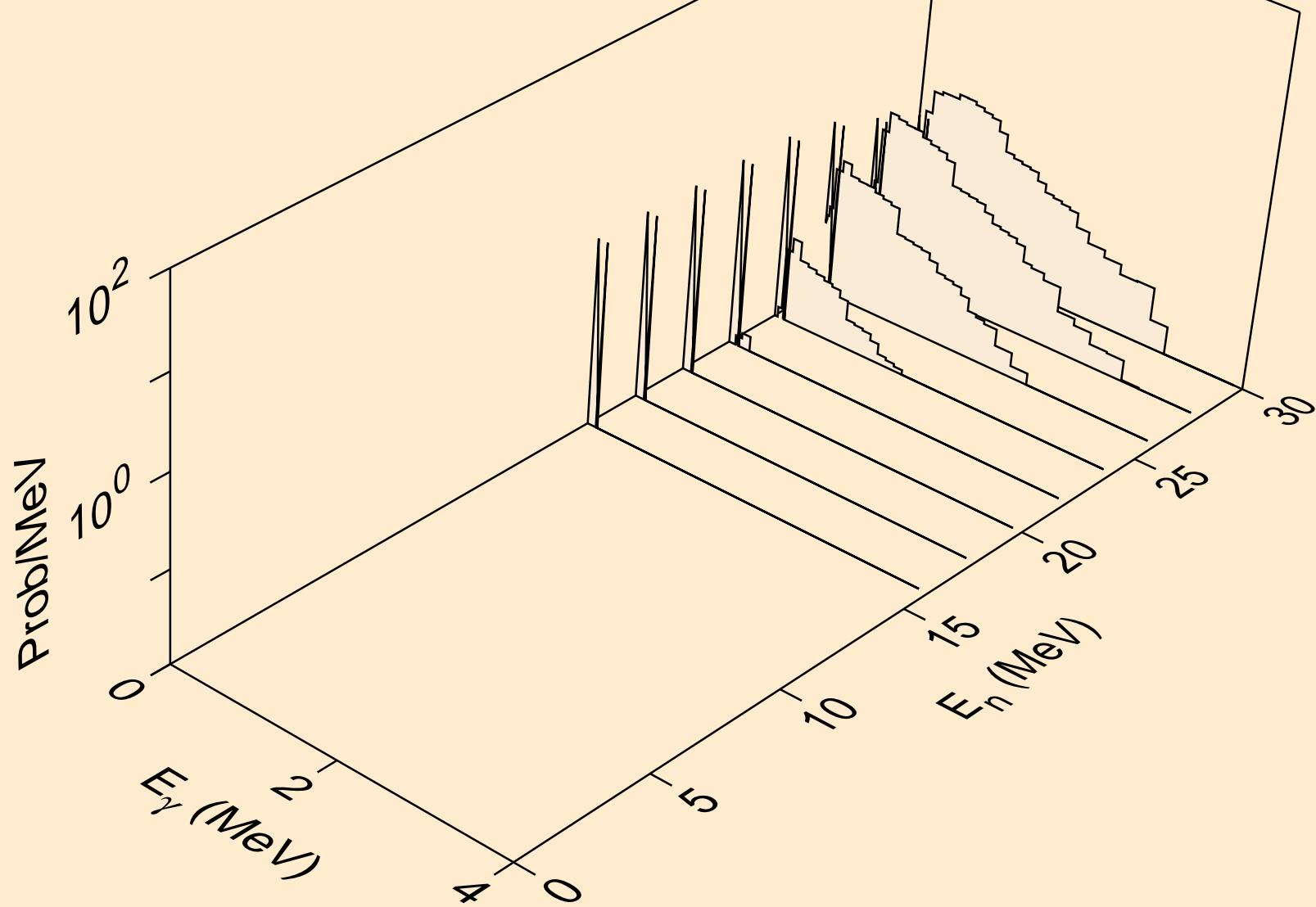

AC237 ALPHA ACER TENDL-2021 LIBRARY; T=0.K
Particle heating contributions

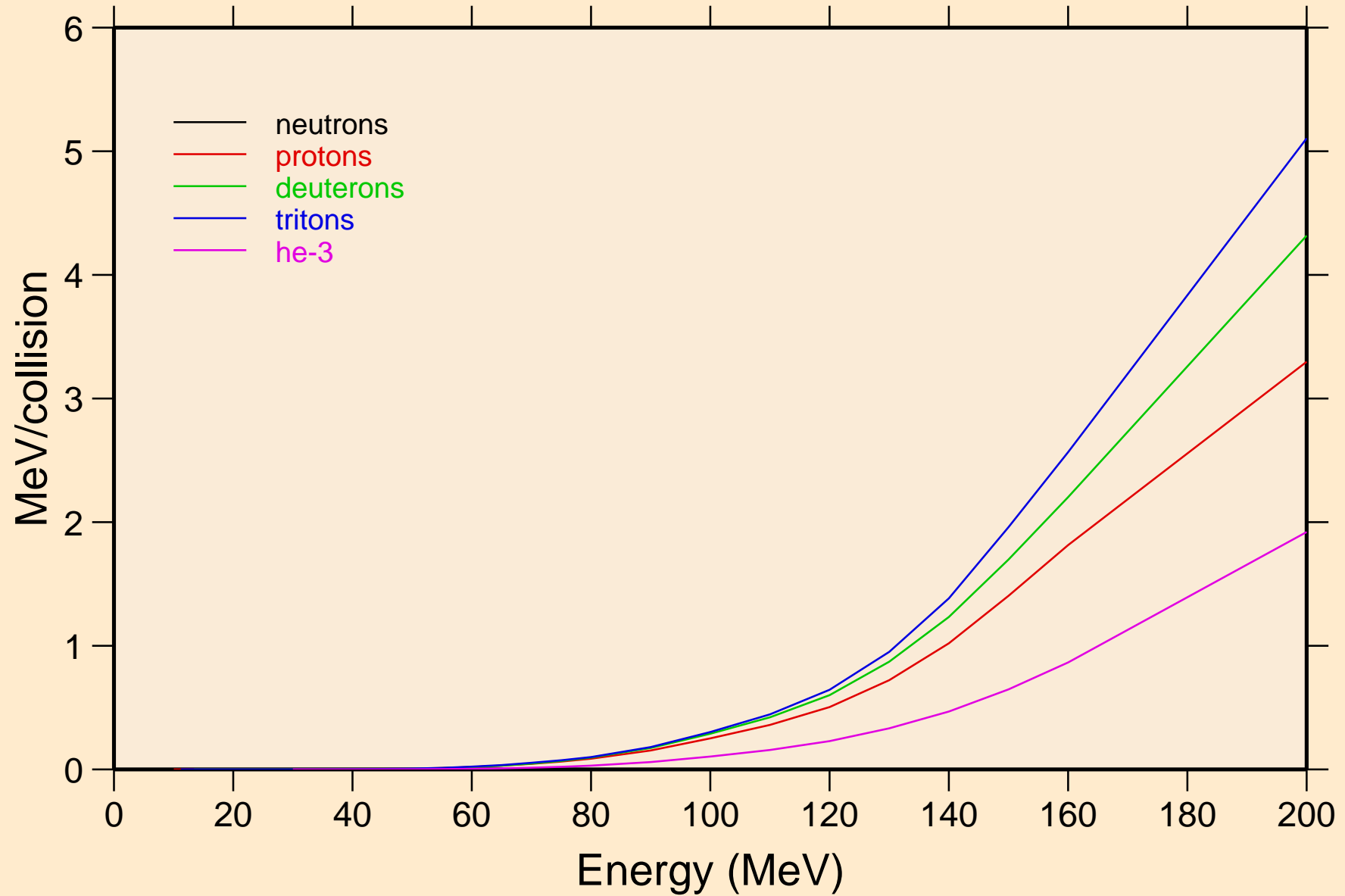

AC237 ALPHA ACER TENDL-2021 LIBRARY; T=0.K
Recoil Heating

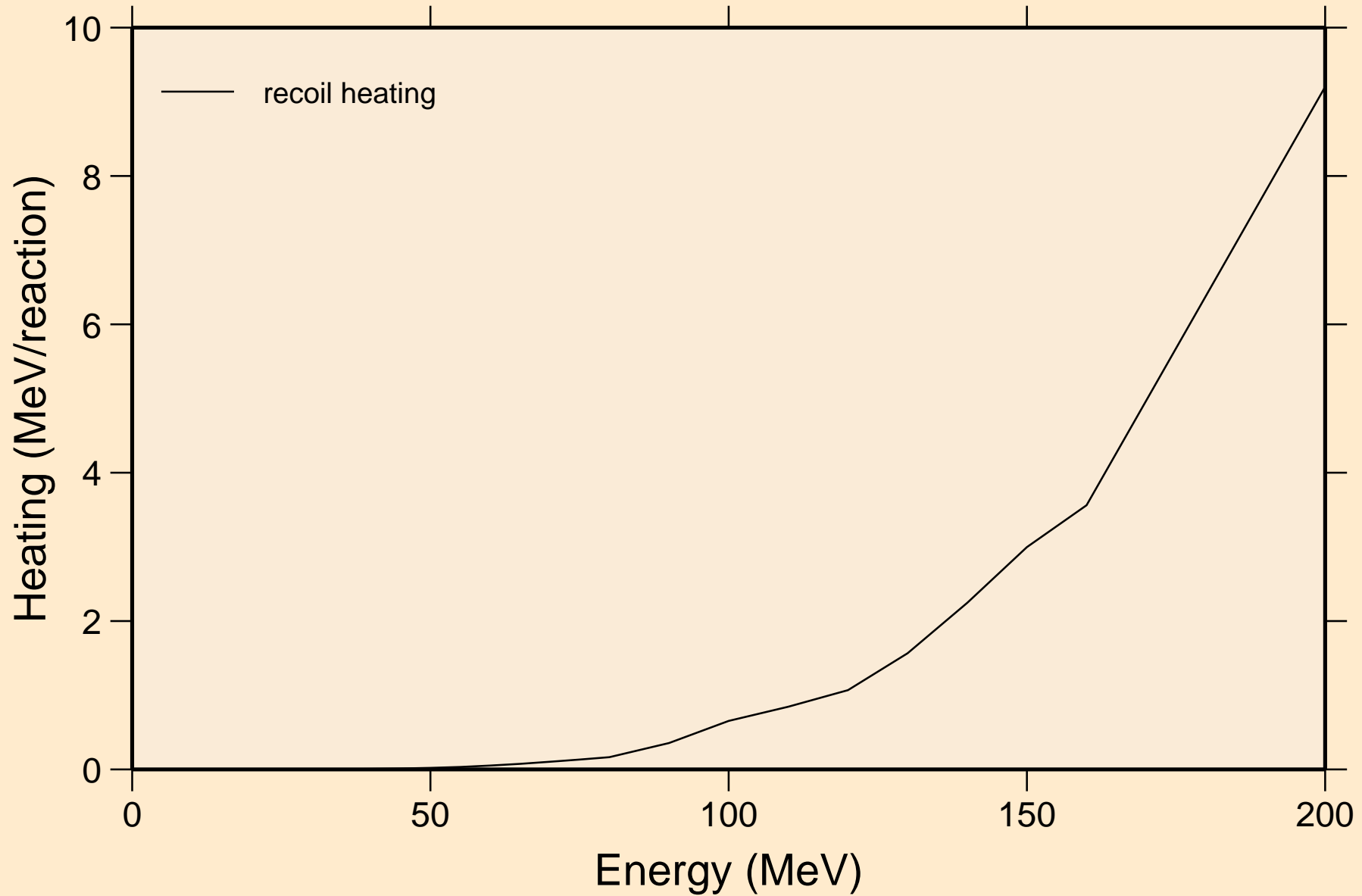

AC237 ALPHA ACER TENDL-2021 LIBRARY; T=0.K
Particle production cross sections

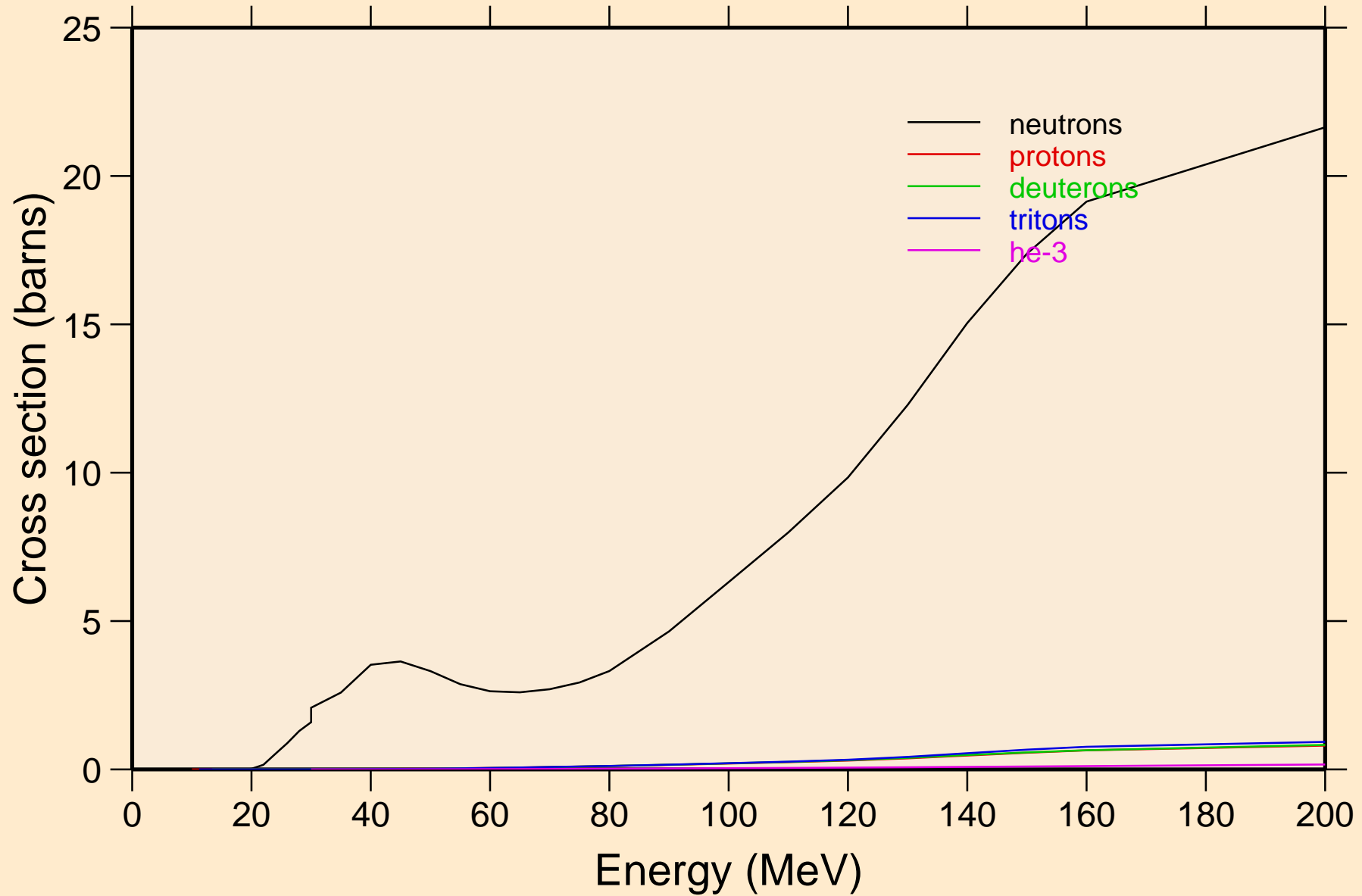

AC237 ALPHA ACER TENDL-2021 LIBRARY; T=0.K
neutrons from (a,n)

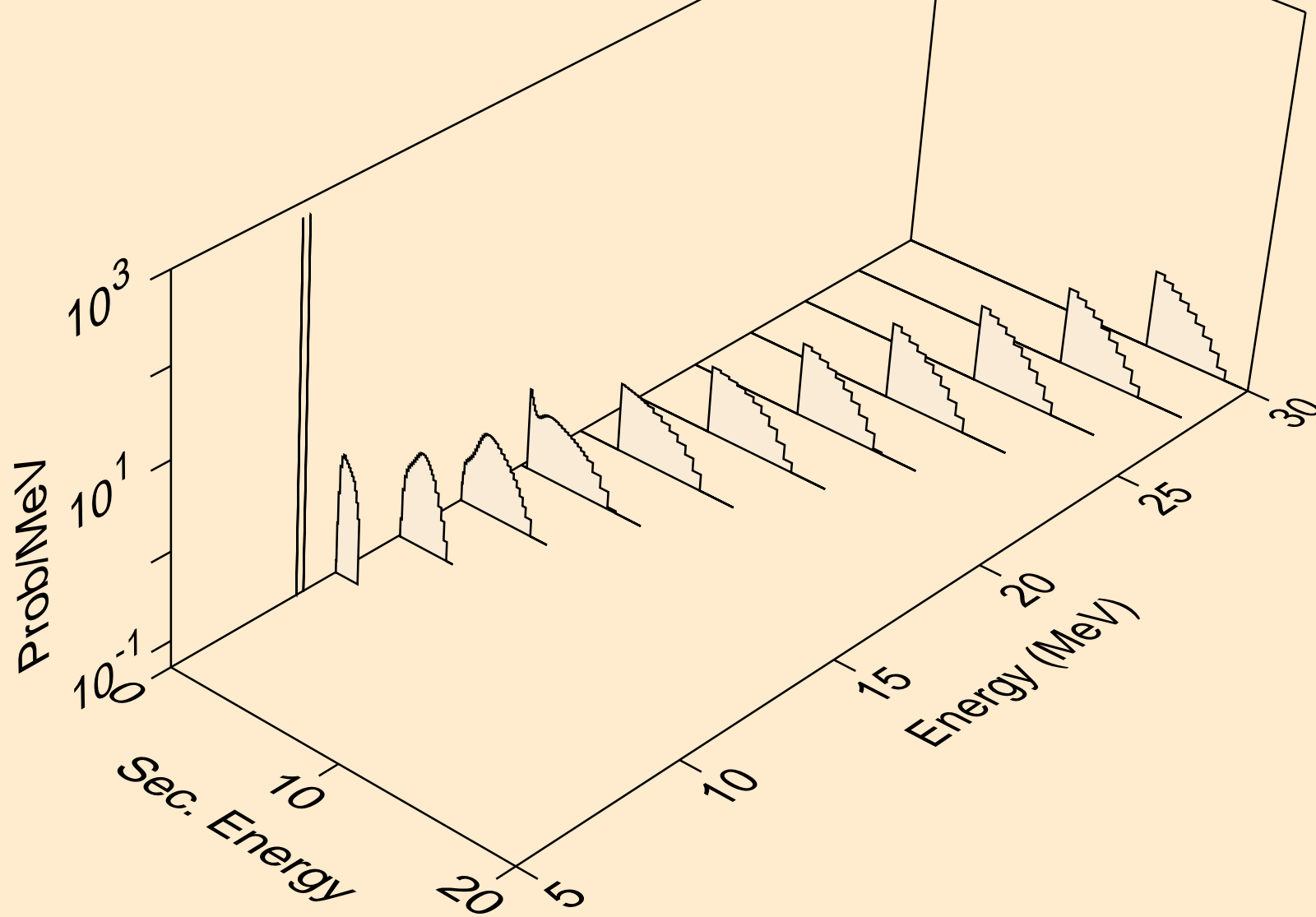

AC237 ALPHA ACER TENDL-2021 LIBRARY; T=0.K
neutrons from (a,x)

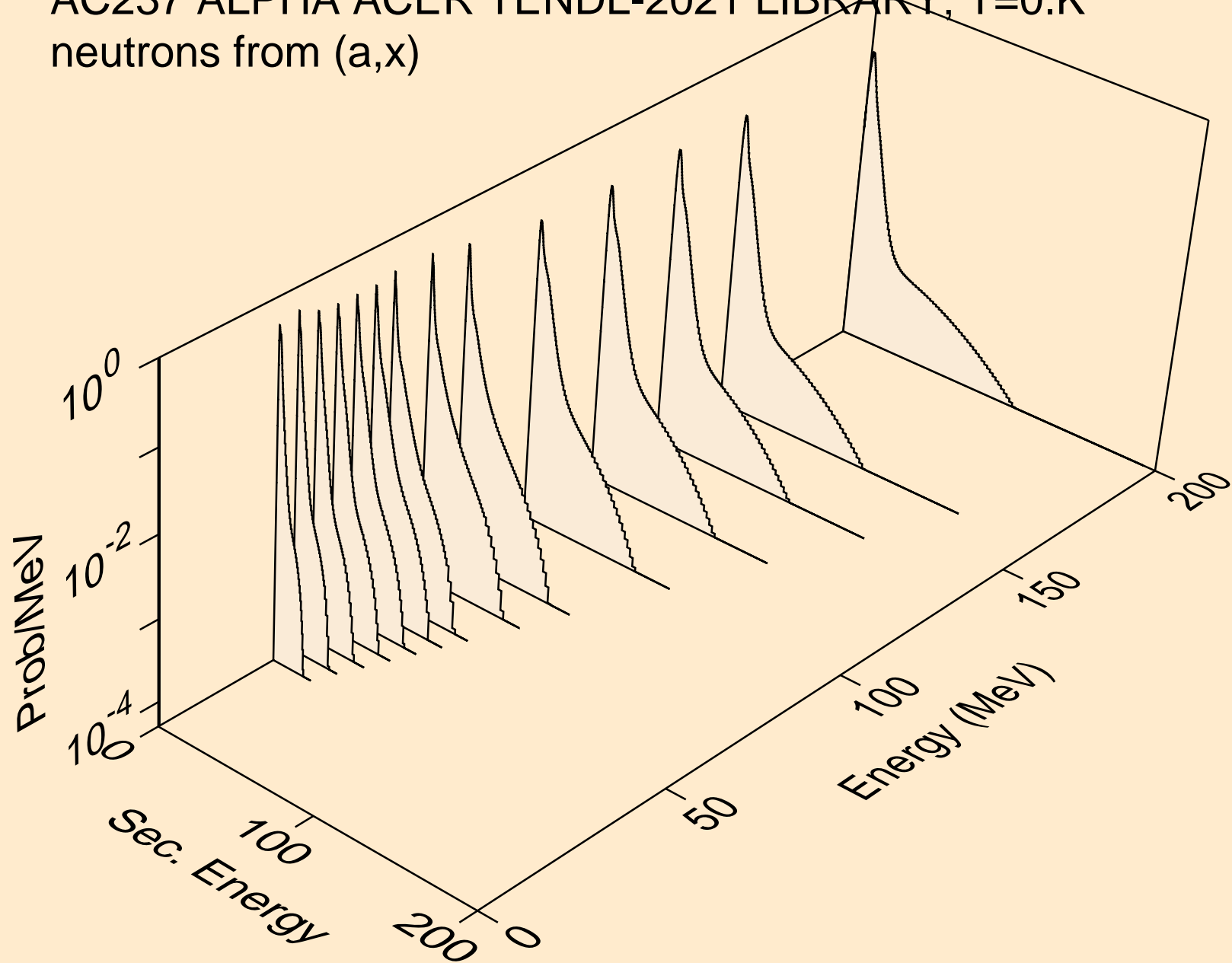

AC237 ALPHA ACER TENDL-2021 LIBRARY; T=0.K
neutrons from (a,2nd)

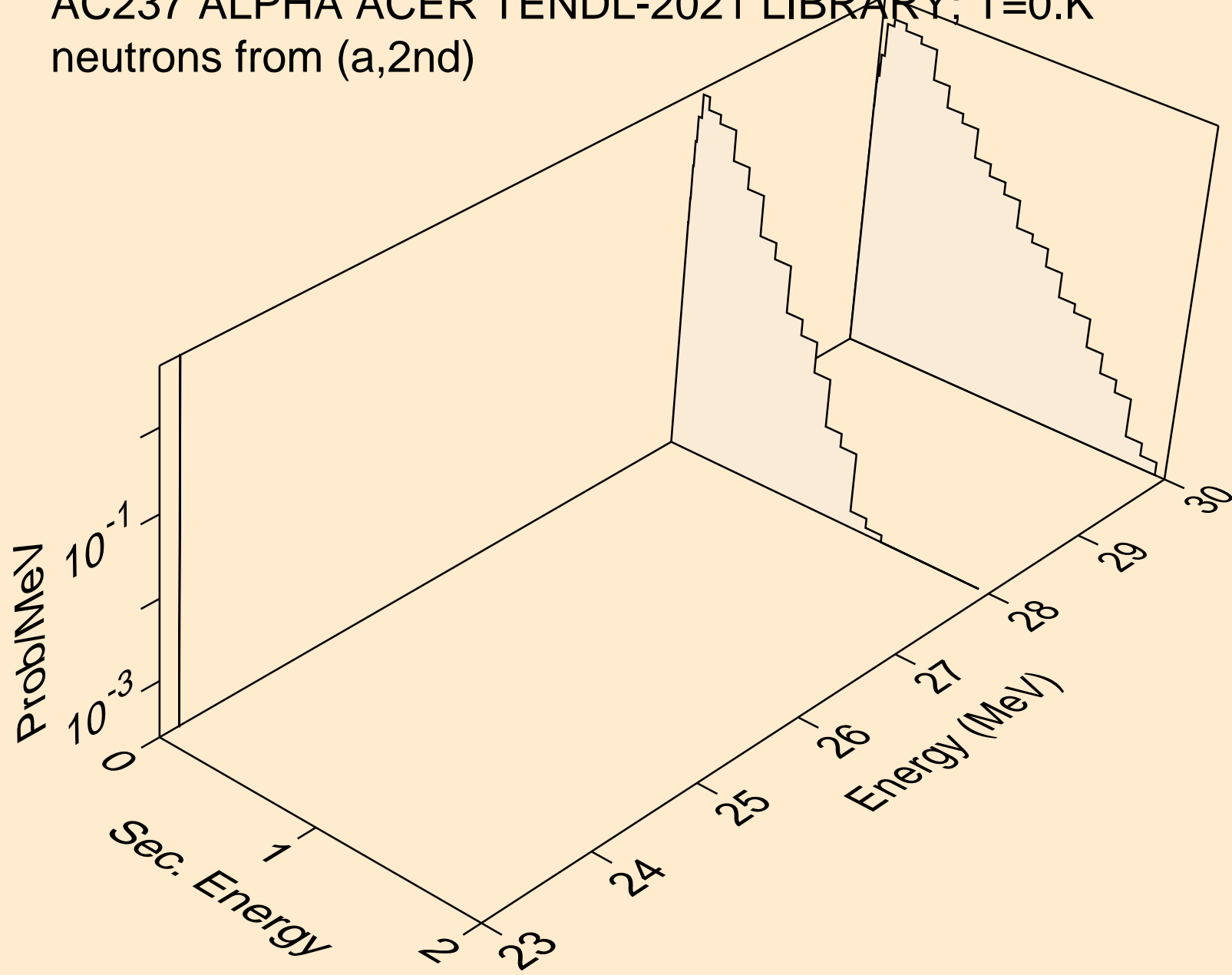

AC237 ALPHA ACER TENDL-2021 LIBRARY; T=0.K
neutrons from (a,2n)

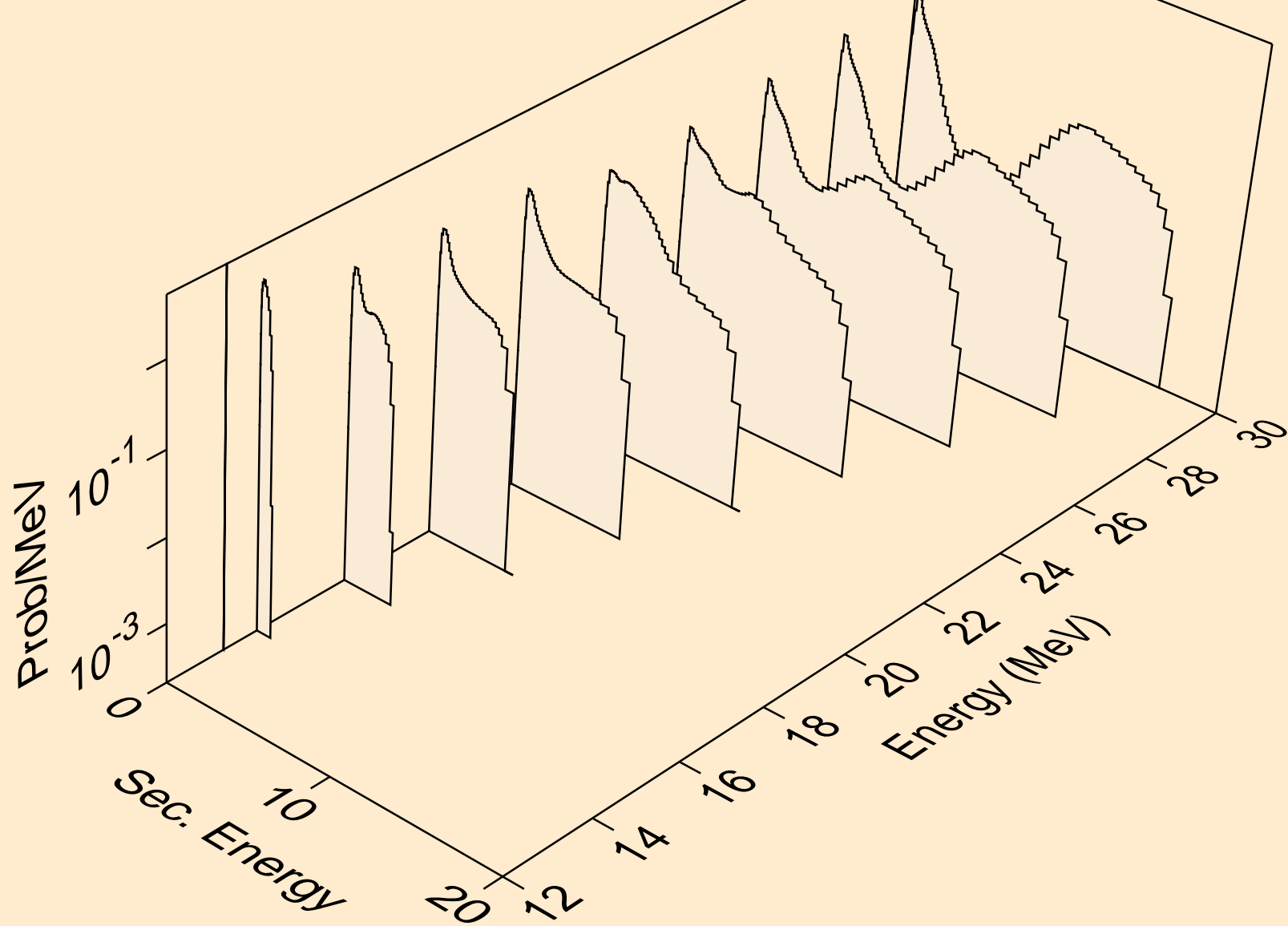

AC237 ALPHA ACER TENDL-2021 LIBRARY; T=0.K
neutrons from (a,3n)

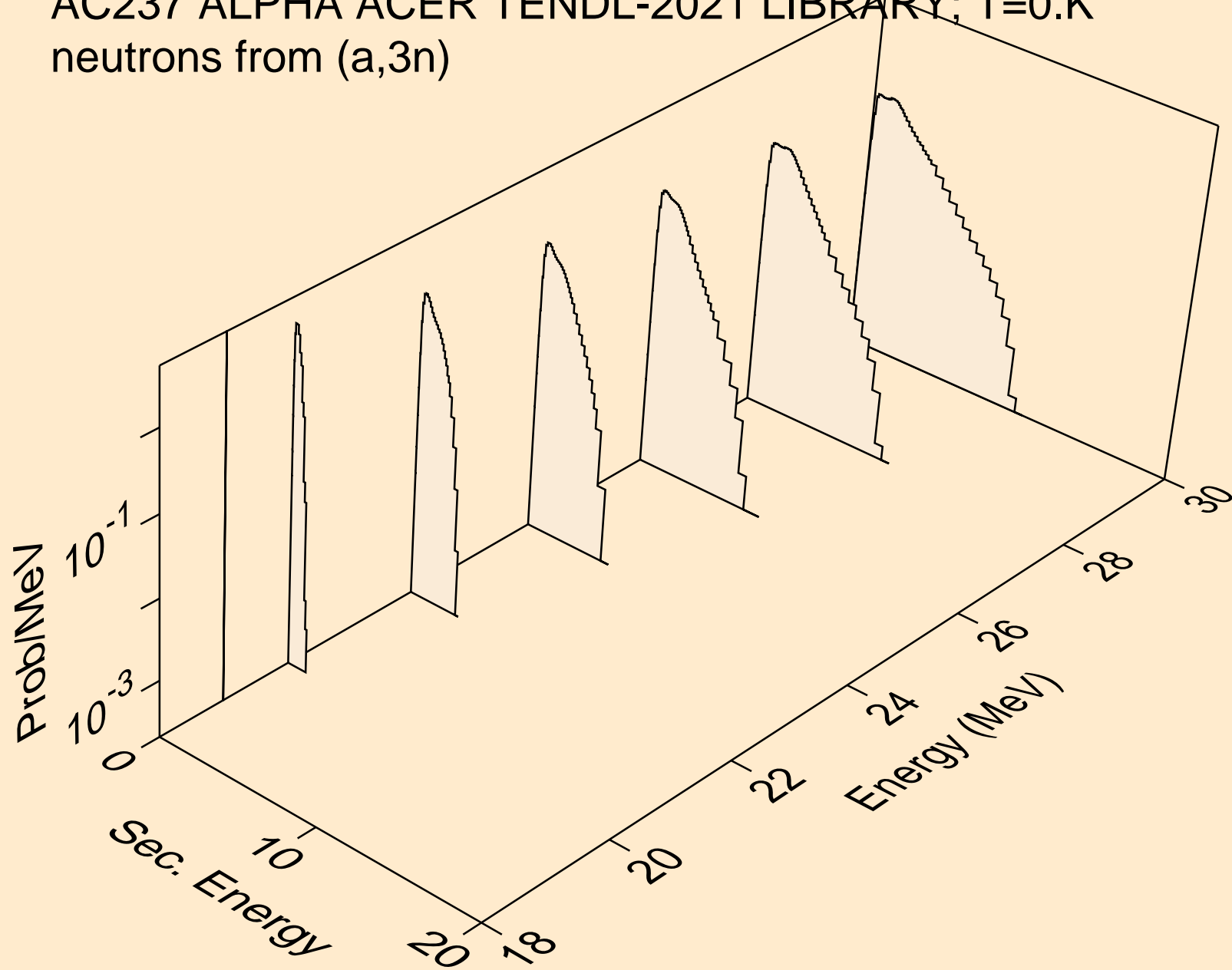

AC237 ALPHA ACER TENDL-2021 LIBRARY; T=0.K
neutrons from (a,n*)a

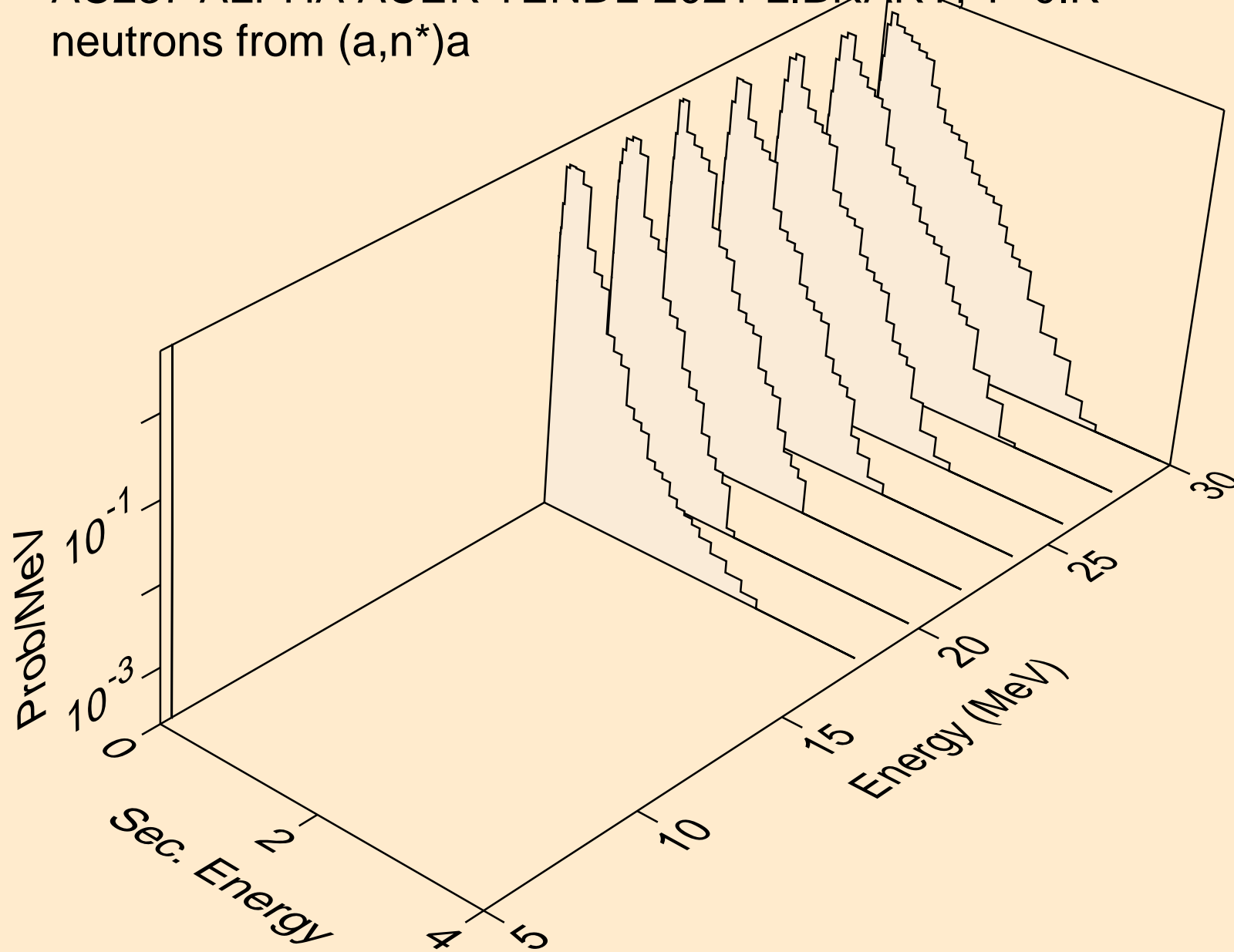

AC237 ALPHA ACER TENDL-2021 LIBRARY; T=0.K
neutrons from (a,2n)a

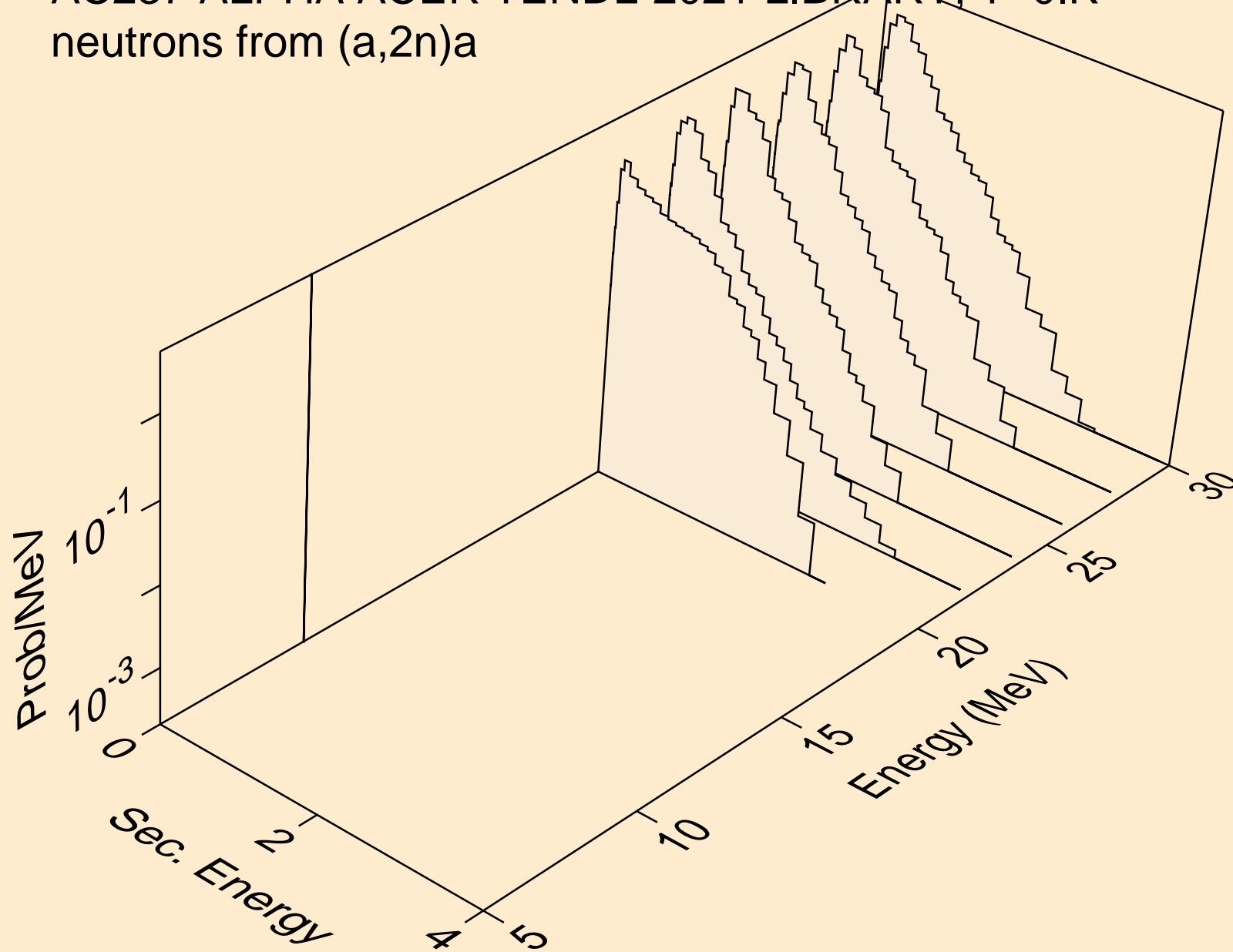

AC237 ALPHA ACER TENDL-2021 LIBRARY; T=0.K
neutrons from (a,n*)p

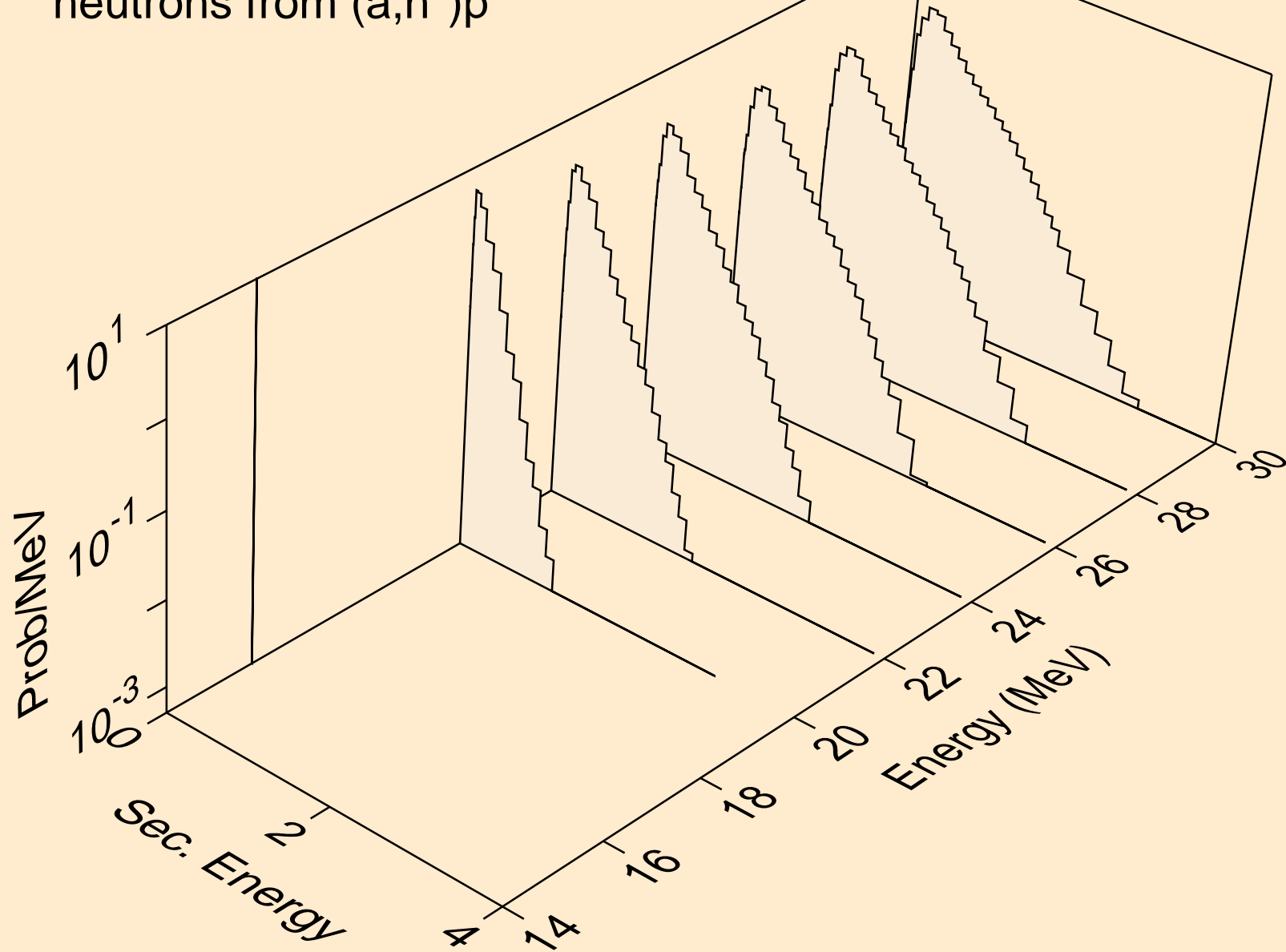

AC237 ALPHA ACER TENDL-2021 LIBRARY; T=0.K
neutrons from (a,n*)d

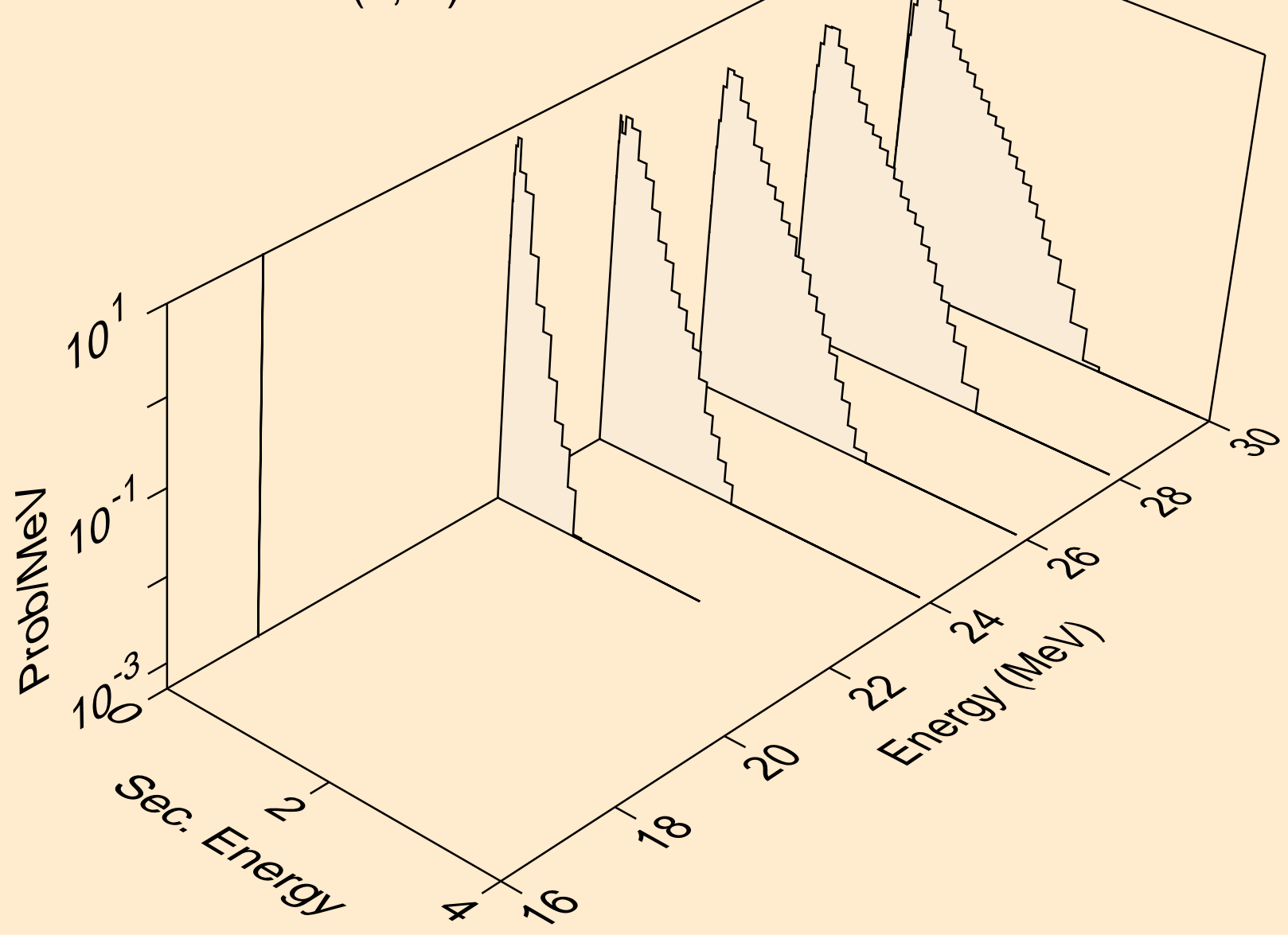

AC237 ALPHA ACER TENDL-2021 LIBRARY; T=0.K
neutrons from (a,n*)t

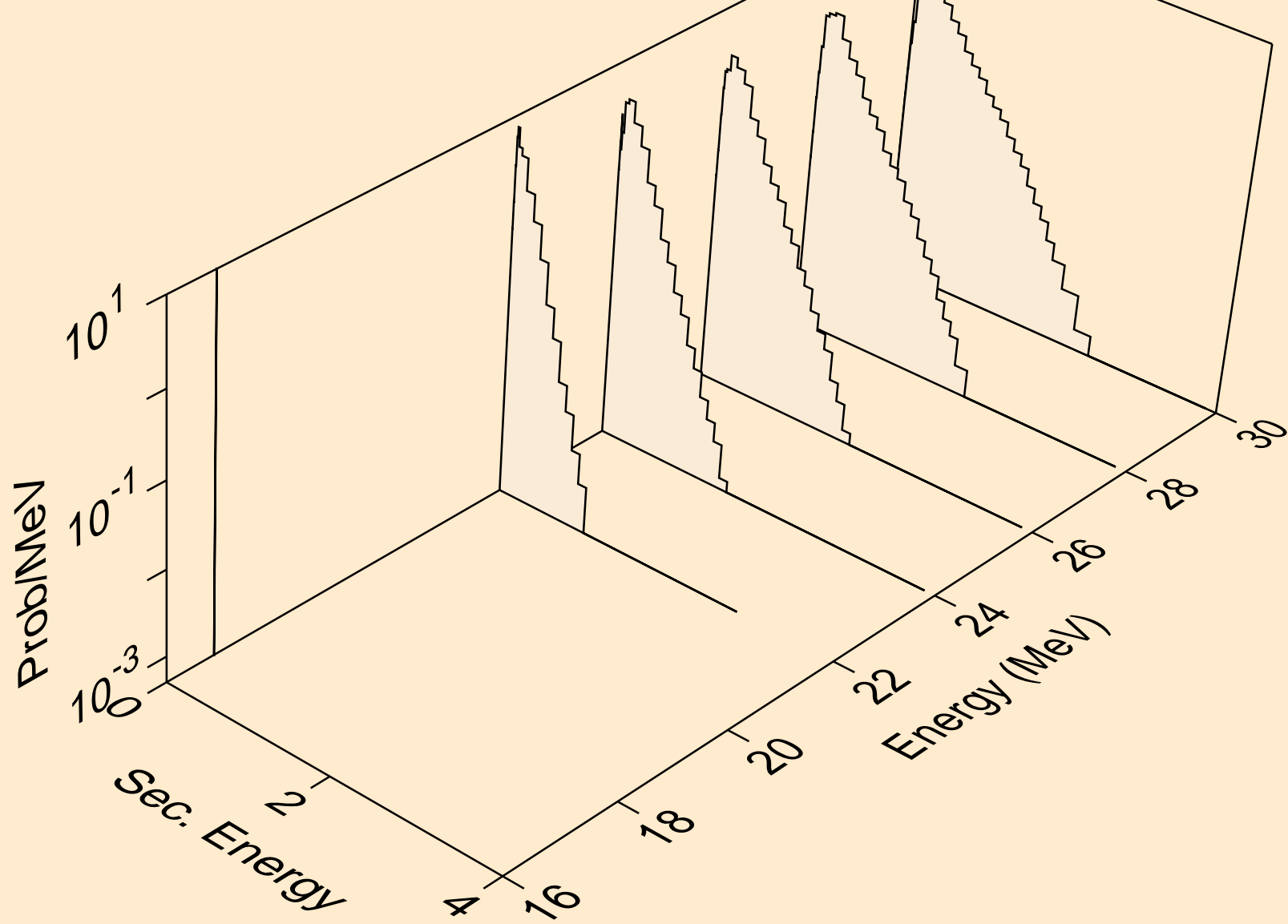

AC237 ALPHA ACER TENDL-2021 LIBRARY; T=0.K
neutrons from (a,4n)

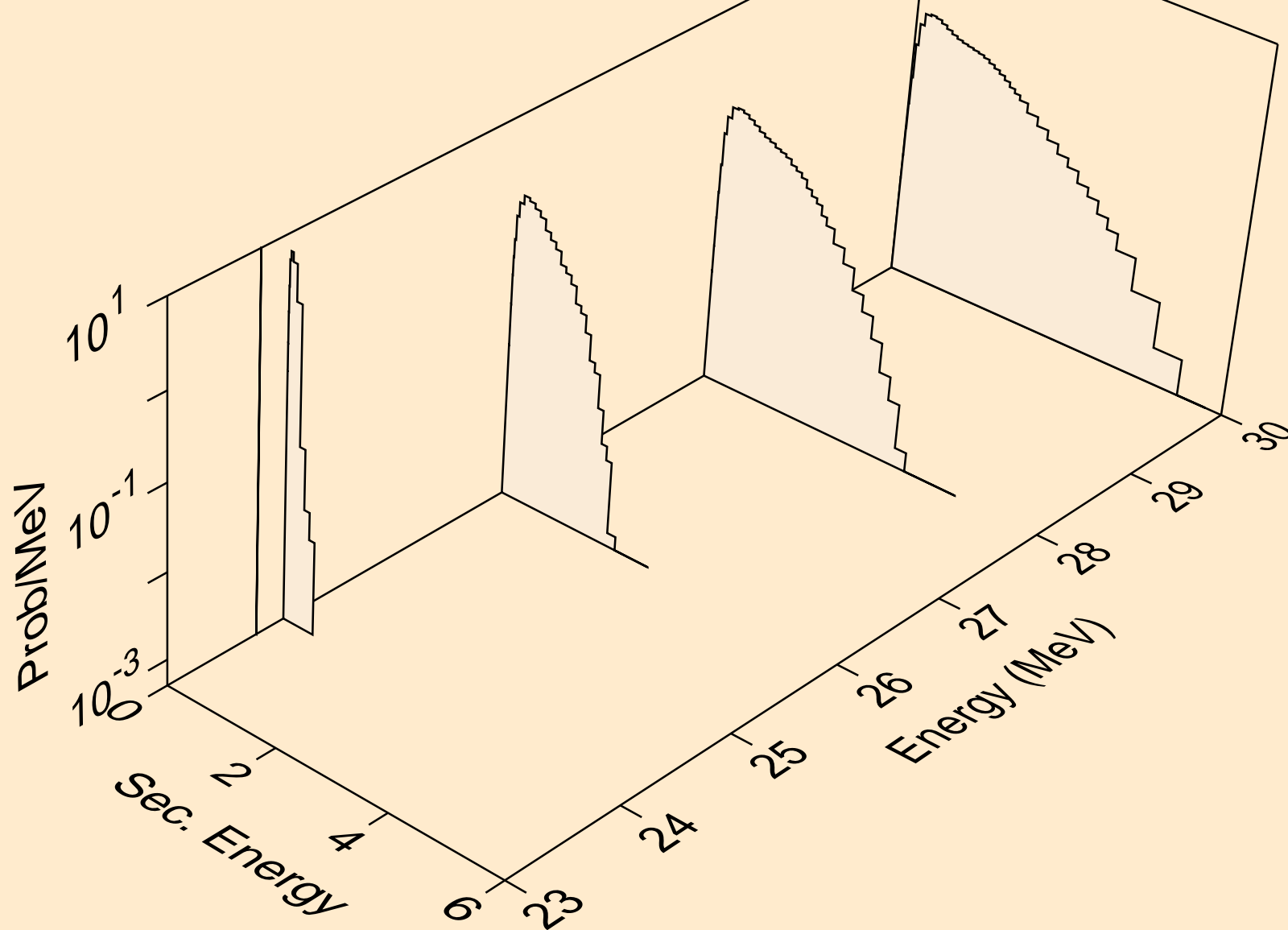

AC237 ALPHA ACER TENDL-2021 LIBRARY; T=0.K
neutrons from (a,2np)

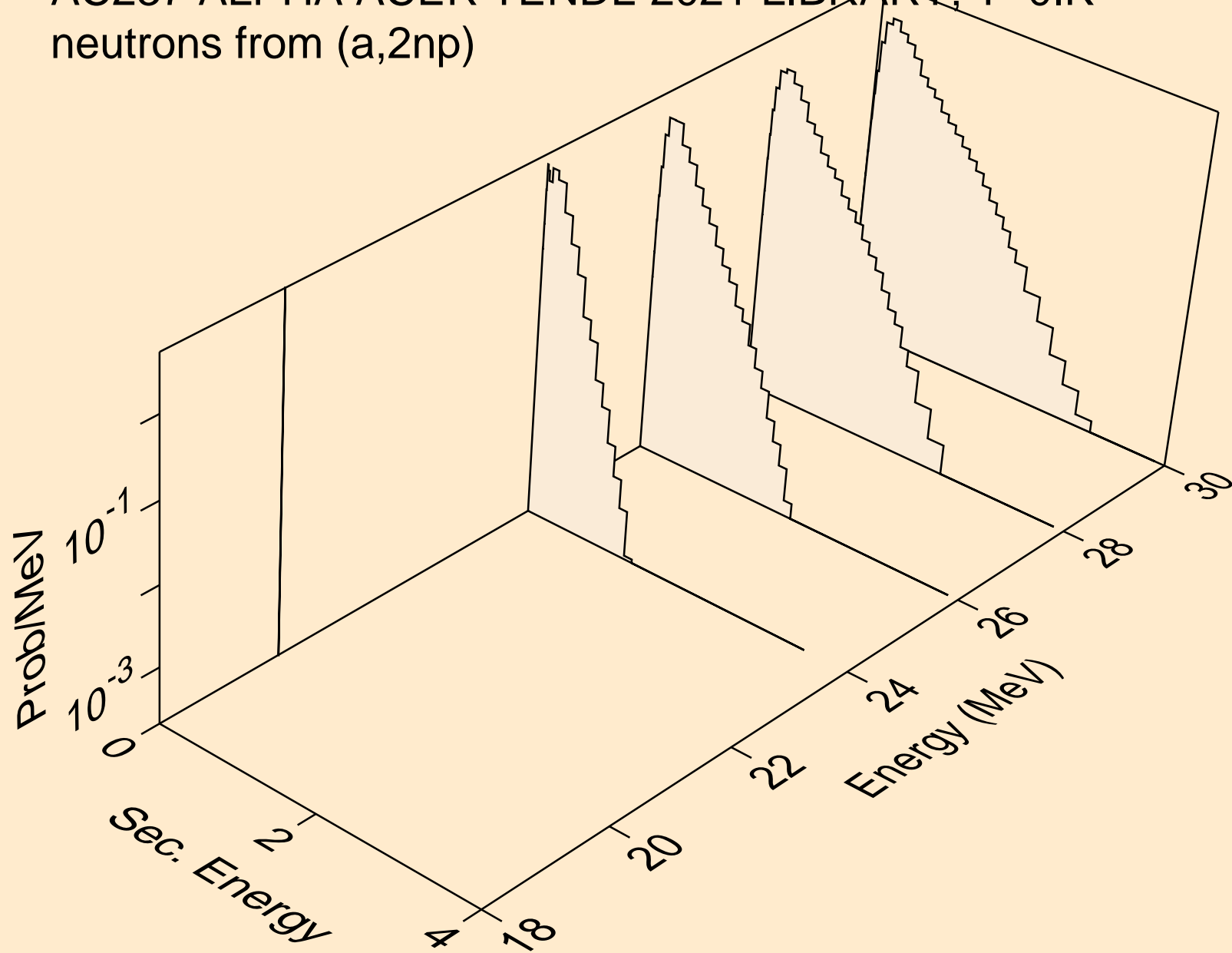

AC237 ALPHA ACER TENDL-2021 LIBRARY; T=0.K
protons from (a,x)

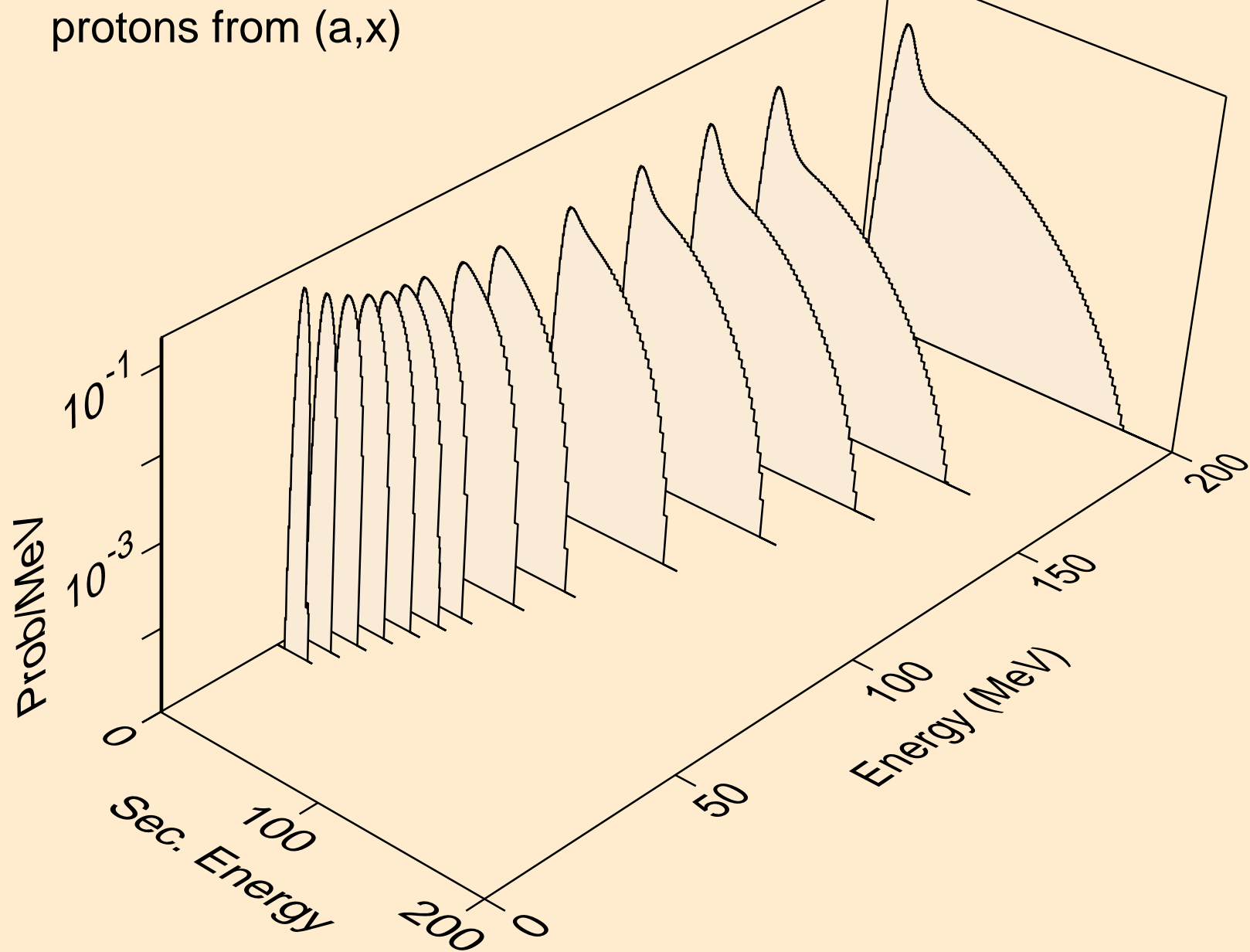

AC237 ALPHA ACER TENDL-2021 LIBRARY; T=0.K
protons from (a,n*)p

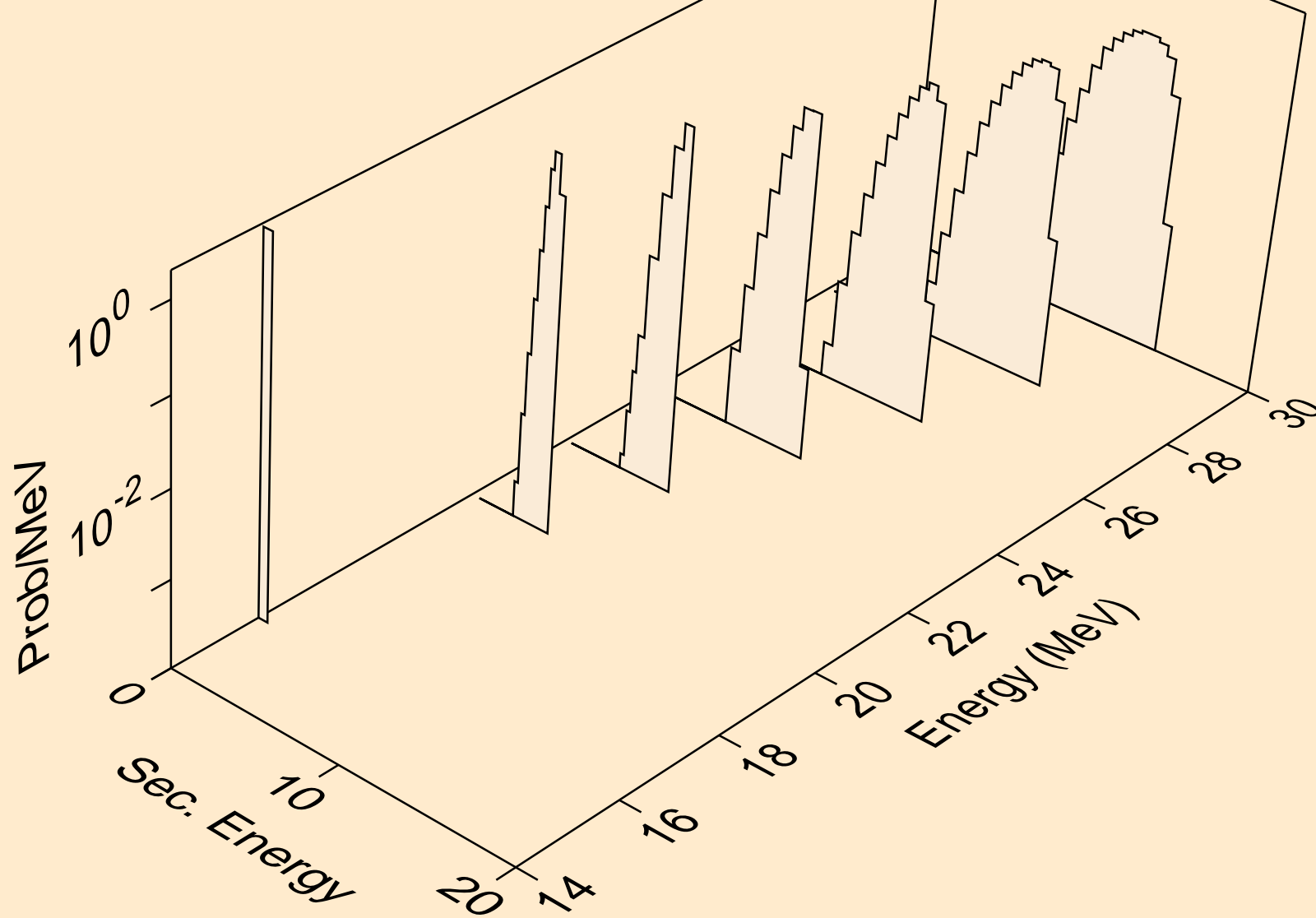

AC237 ALPHA ACER TENDL-2021 LIBRARY; T=0.K
protons from (a,2np)

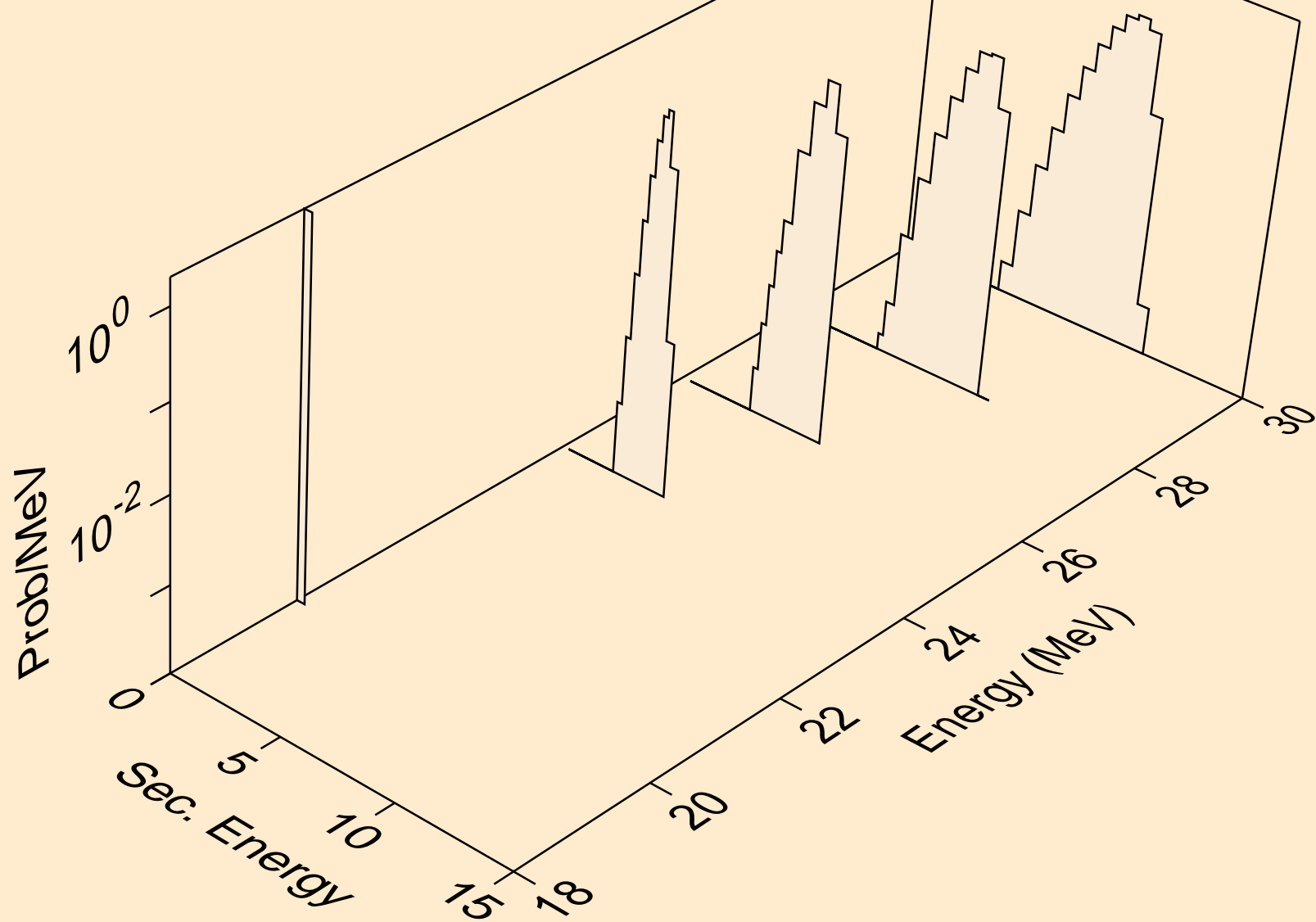

AC237 ALPHA ACER TENDL-2021 LIBRARY; T=0.K
protons from (a,p)

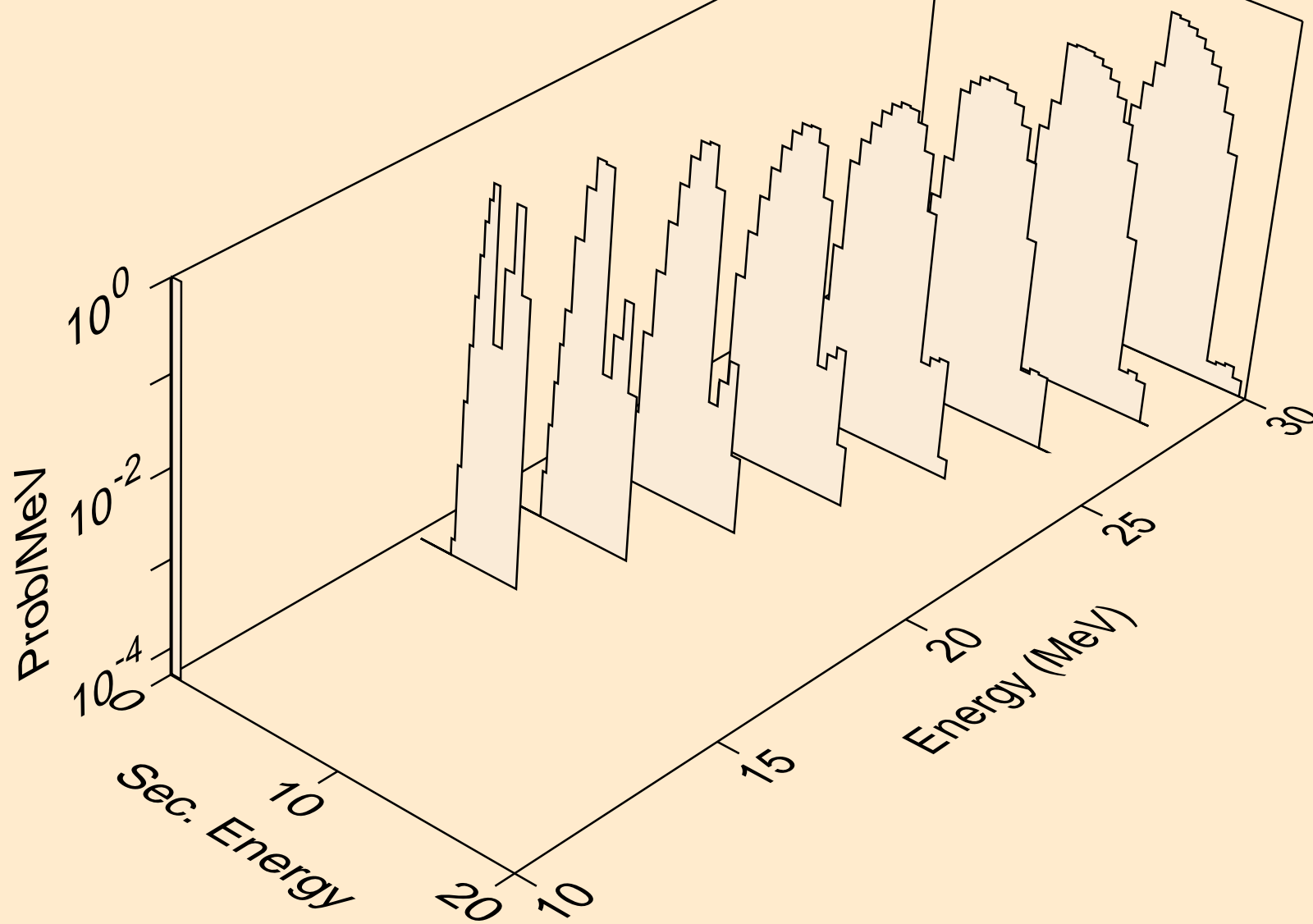

AC237 ALPHA ACER TENDL-2021 LIBRARY; T=0.K
deuterons from (a,x)

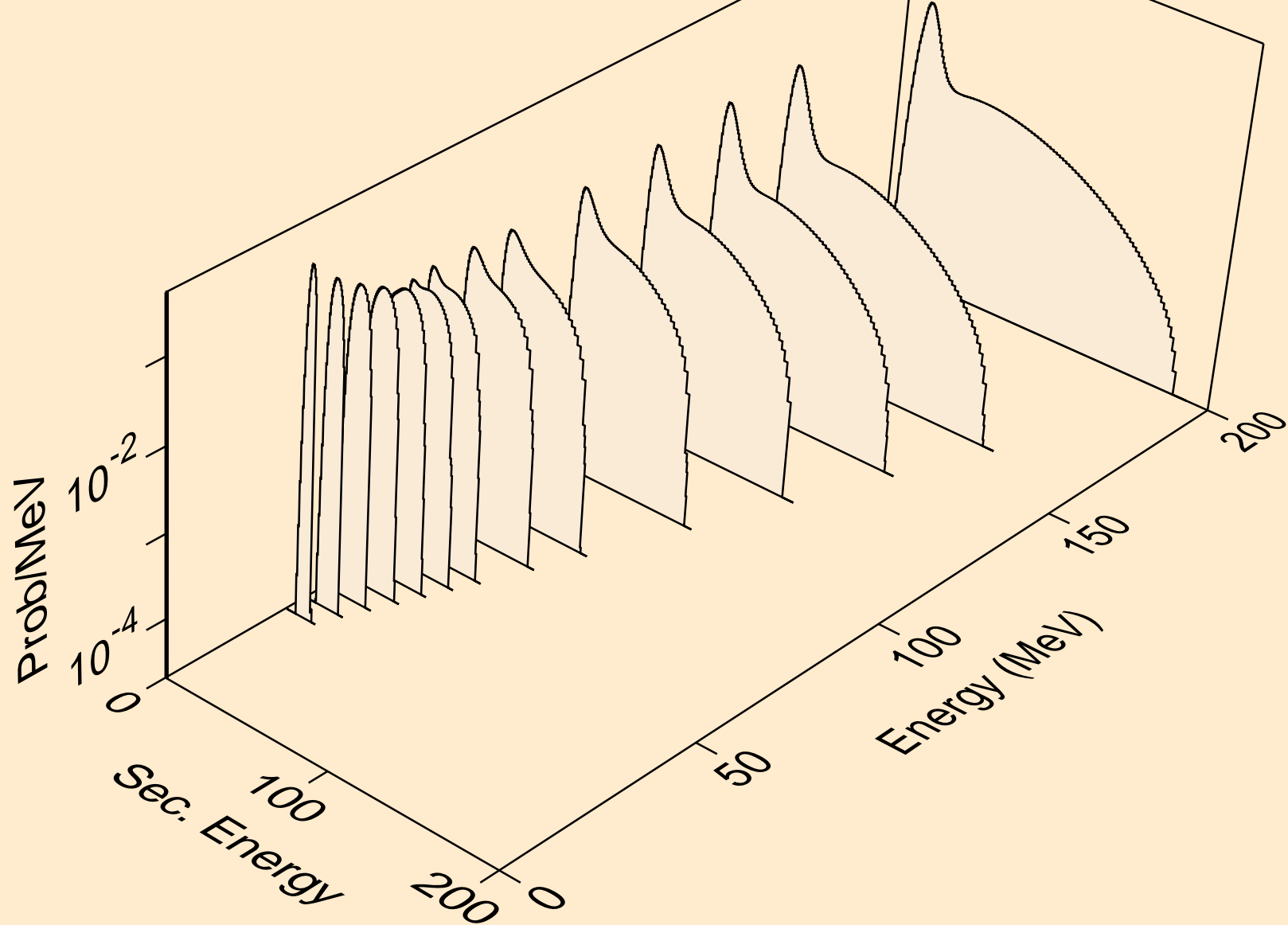

AC237 ALPHA ACER TENDL-2021 LIBRARY; T=0.K
deuterons from (a,2nd)

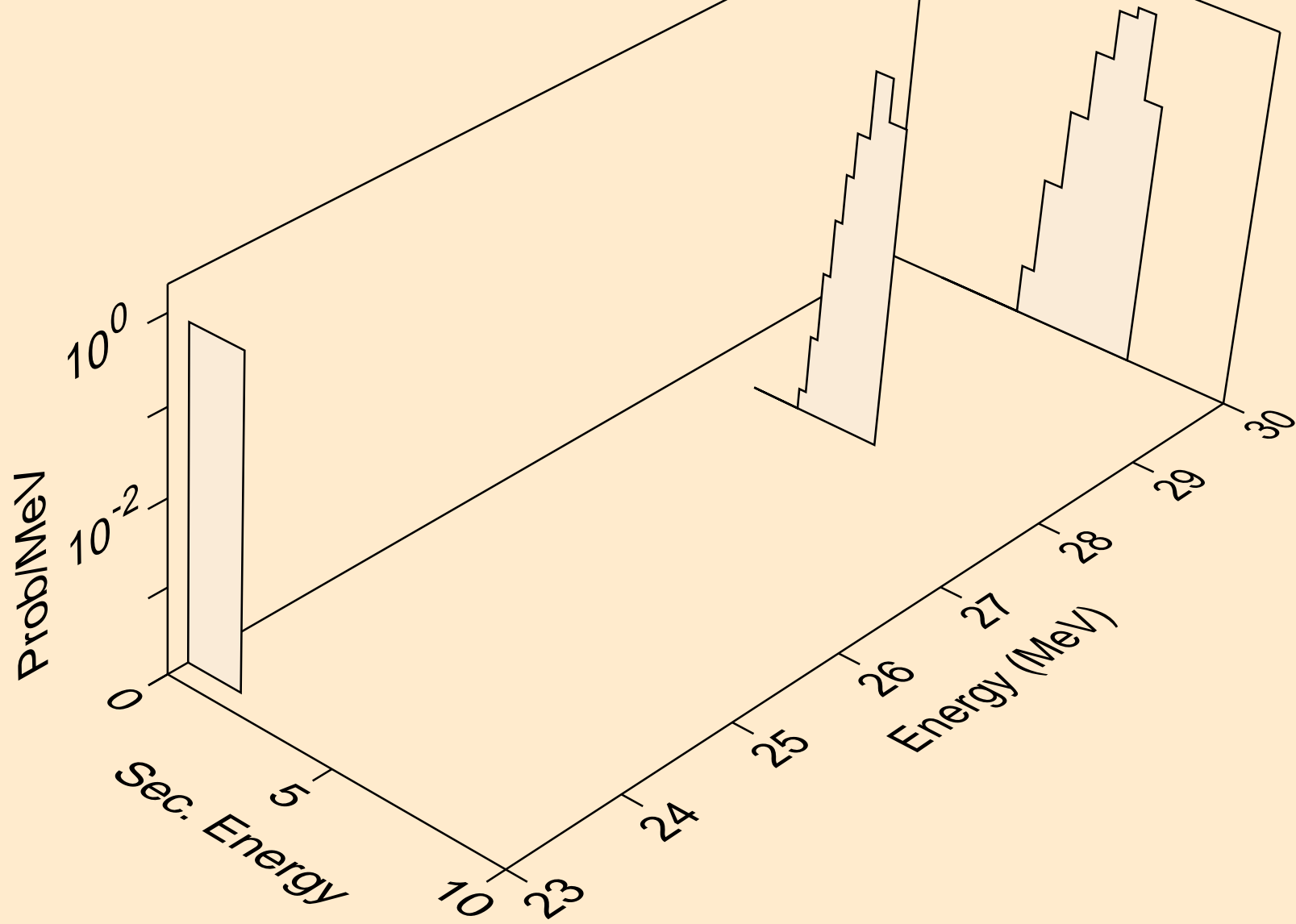

AC237 ALPHA ACER TENDL-2021 LIBRARY; T=0.K
deuterons from (a,n*)d

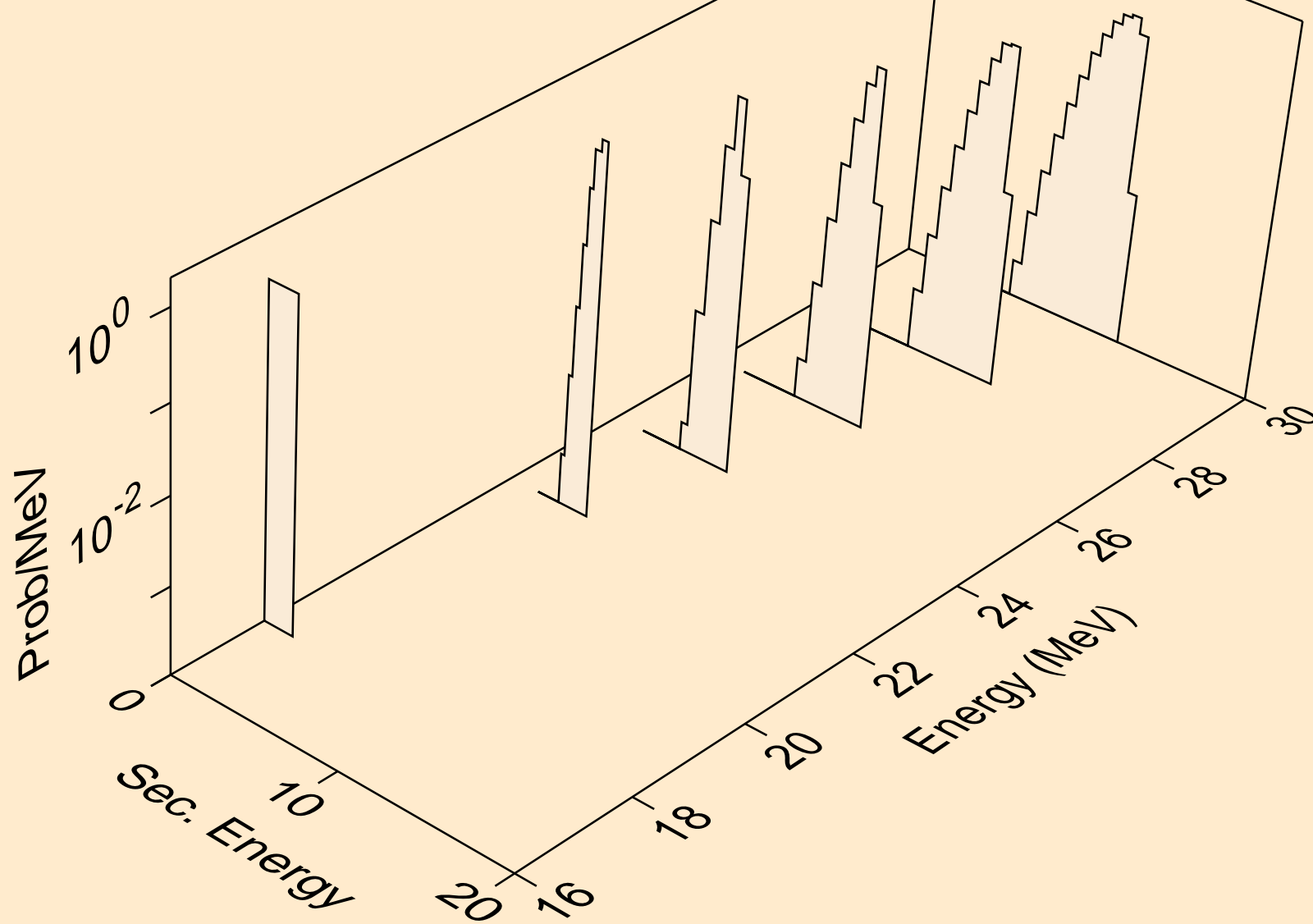

AC237 ALPHA ACER TENDL-2021 LIBRARY; T=0.K
deuterons from (a,d)

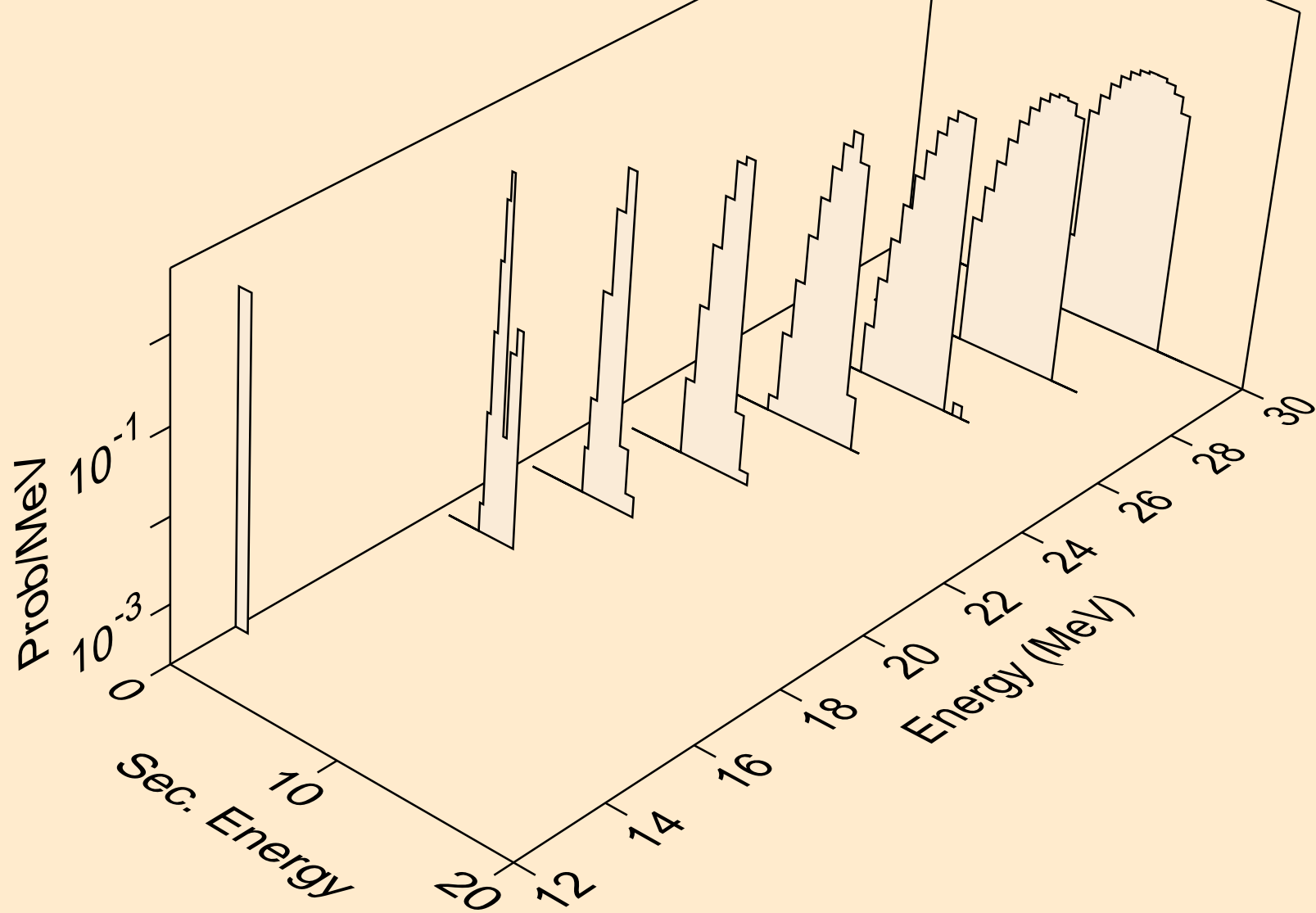

AC237 ALPHA ACER TENDL-2021 LIBRARY; T=0.K
tritons from (a,x)

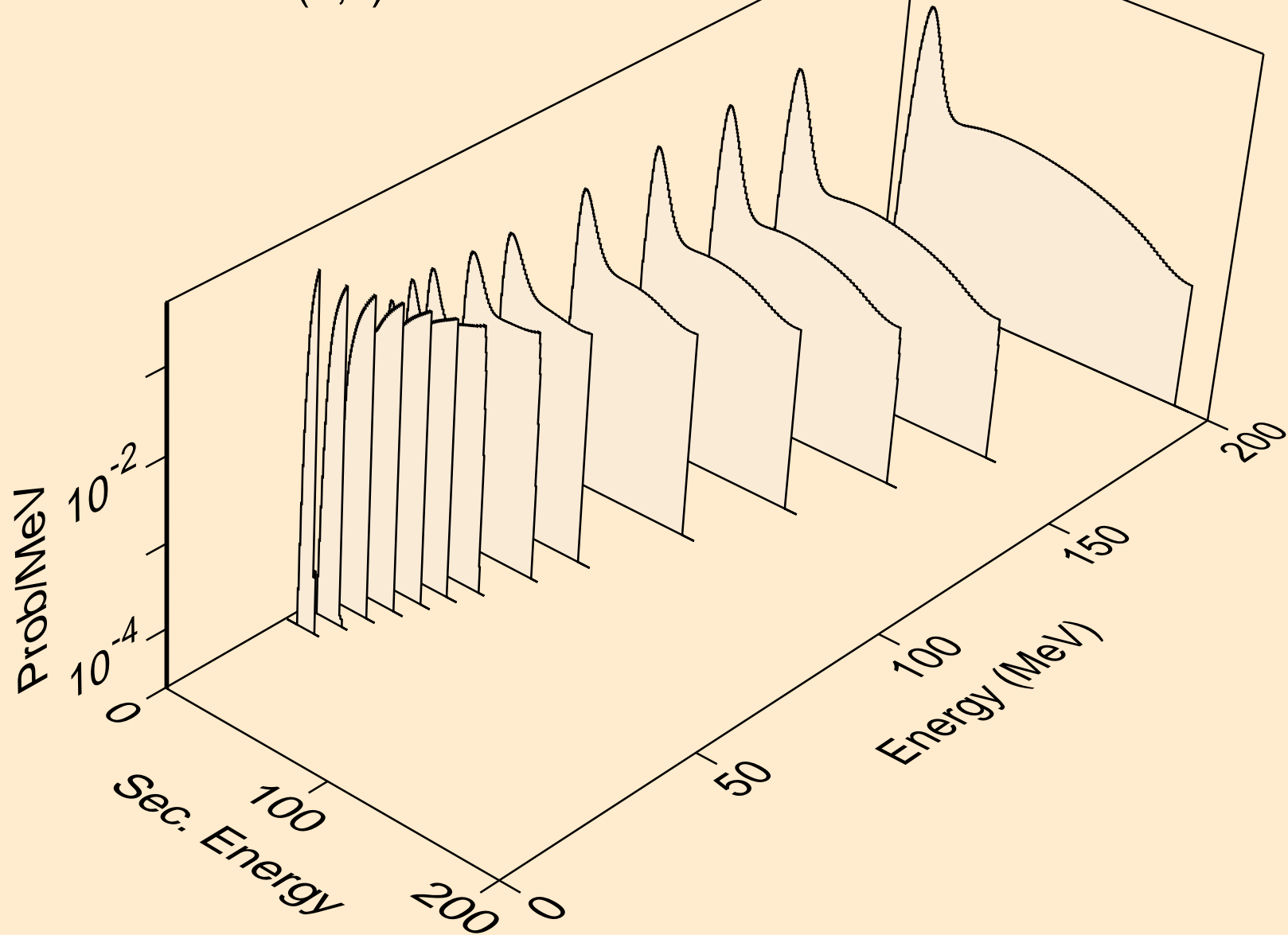

AC237 ALPHA ACER TENDL-2021 LIBRARY; T=0.K
tritons from (a,n*)t

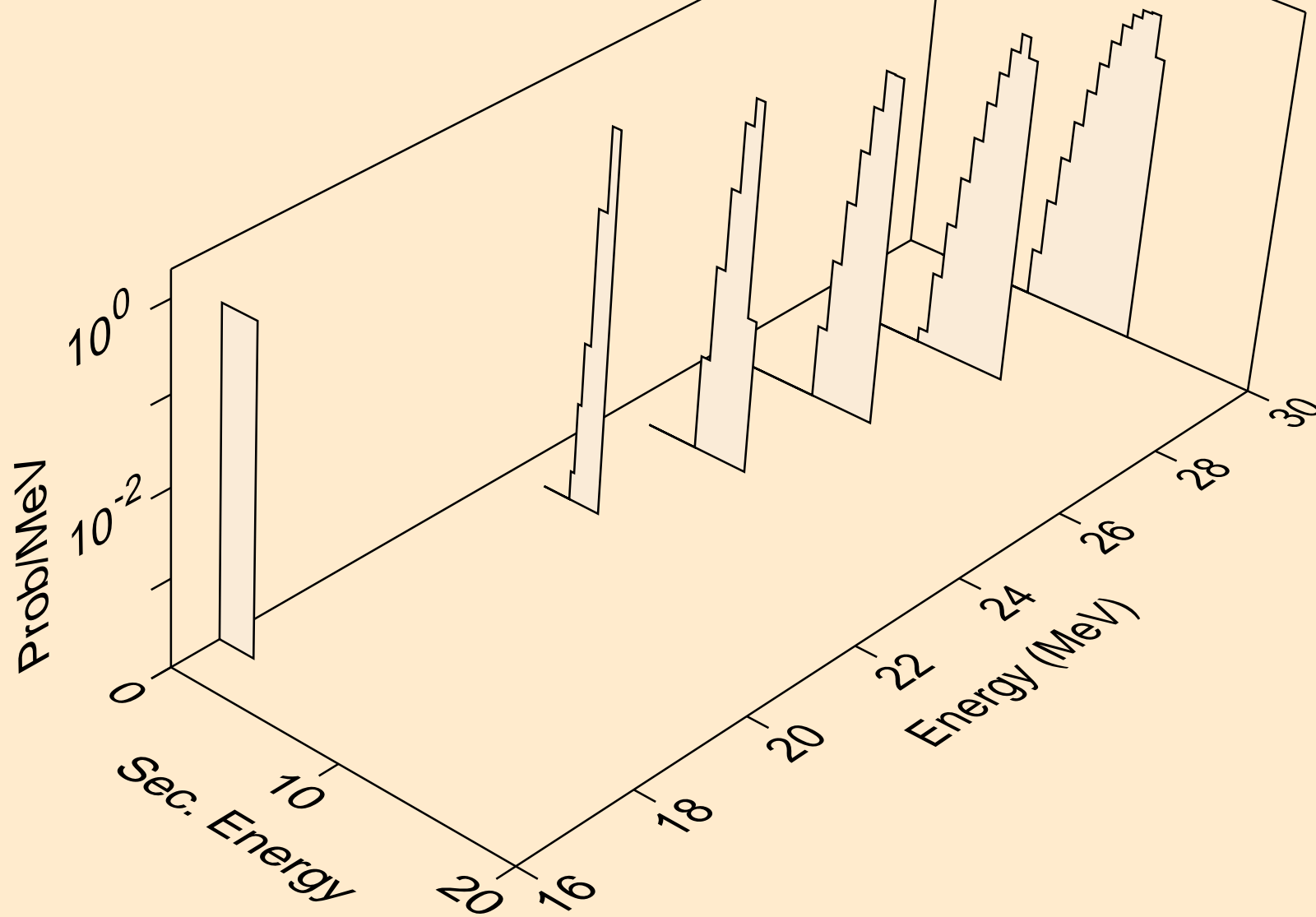

AC237 ALPHA ACER TENDL-2021 LIBRARY; T=0.K
tritons from (a,t)

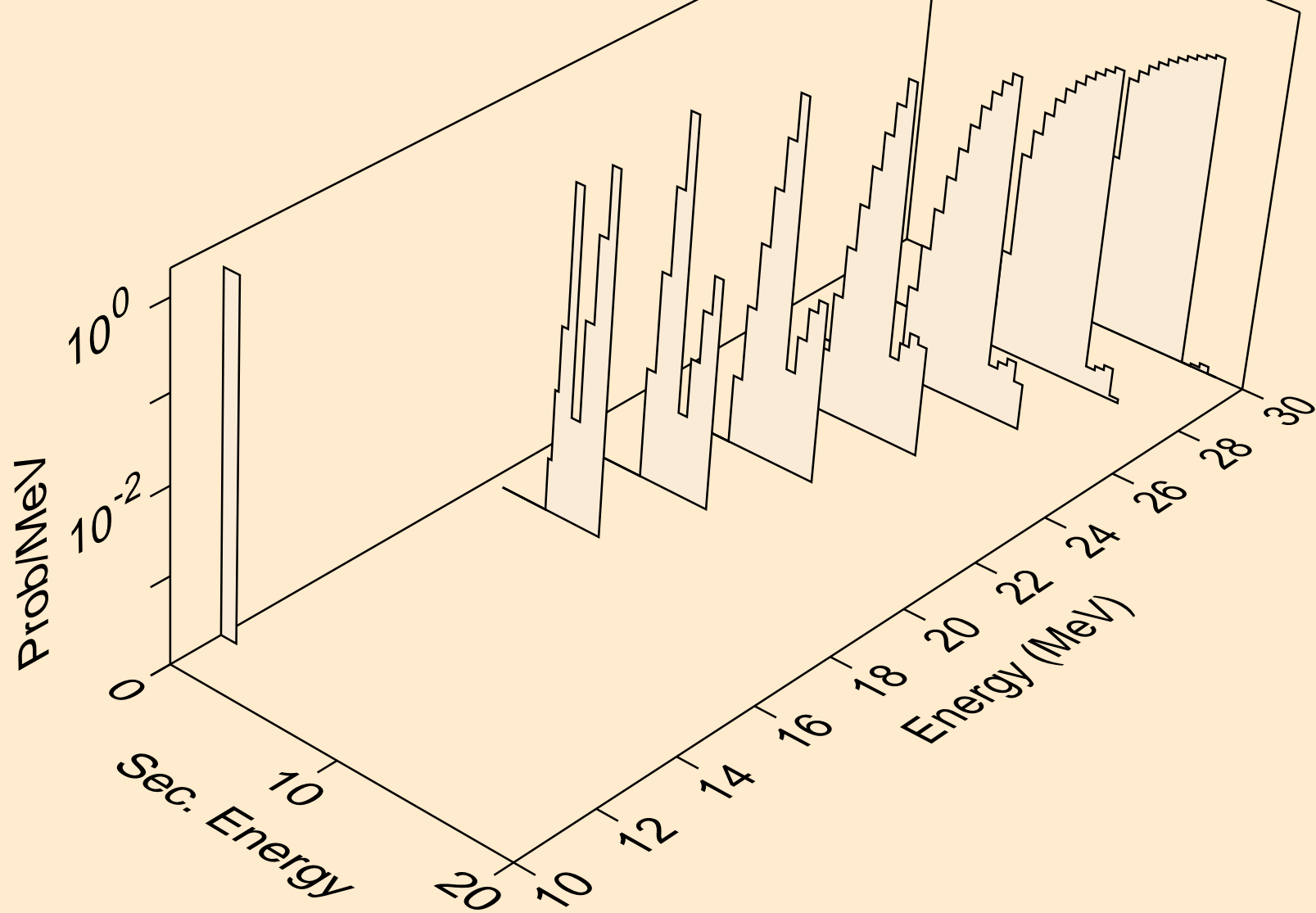

AC237 ALPHA ACER TENDL-2021 LIBRARY; T=0.K
he3s from (a,x)

