

AG108M ALPHA ACER TENDL-2021 LIBRARY; T=0.K
Principal cross sections

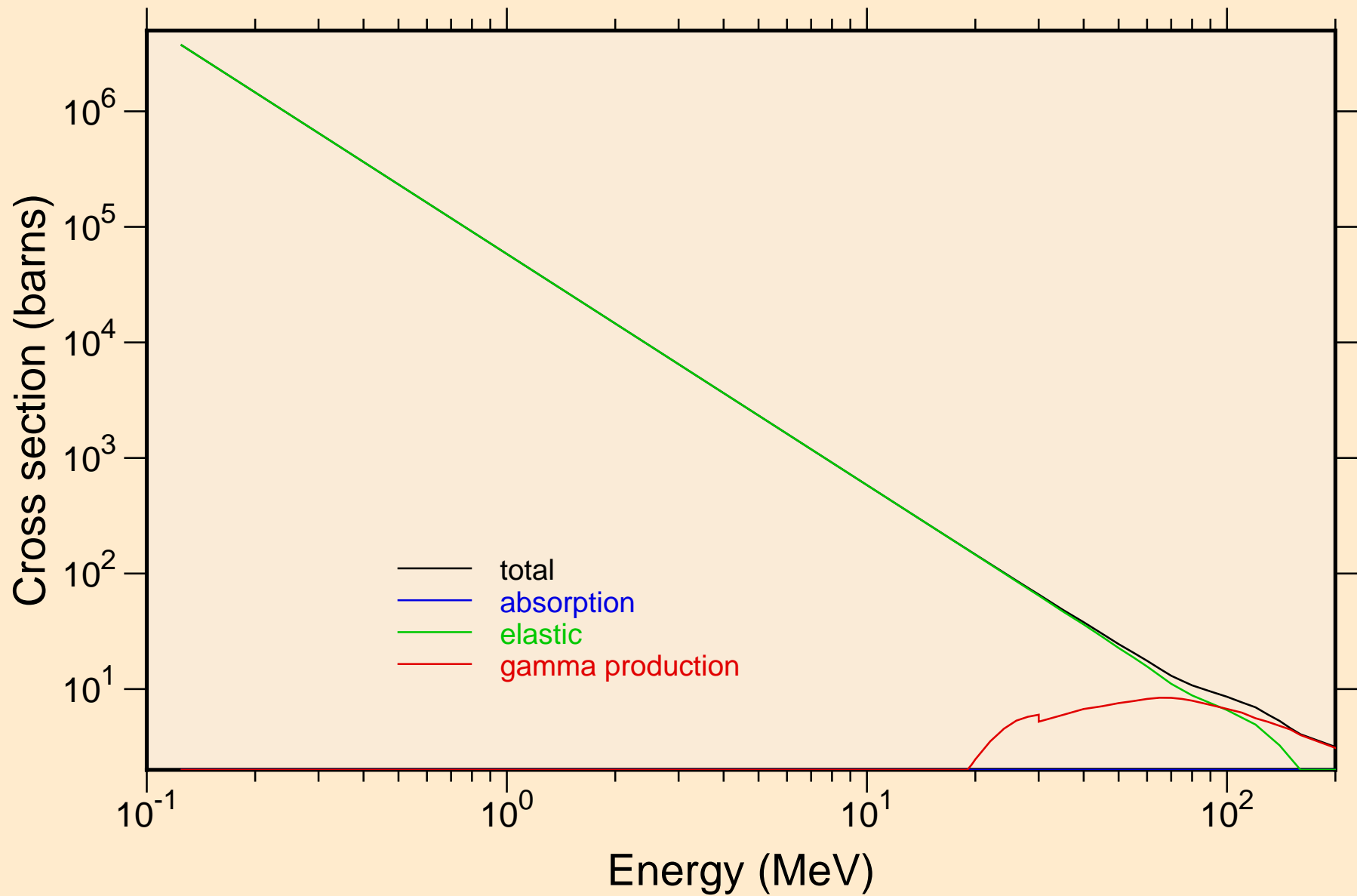

AG108M ALPHA ACER TENDL-2021 LIBRARY; T=0.K

Heating

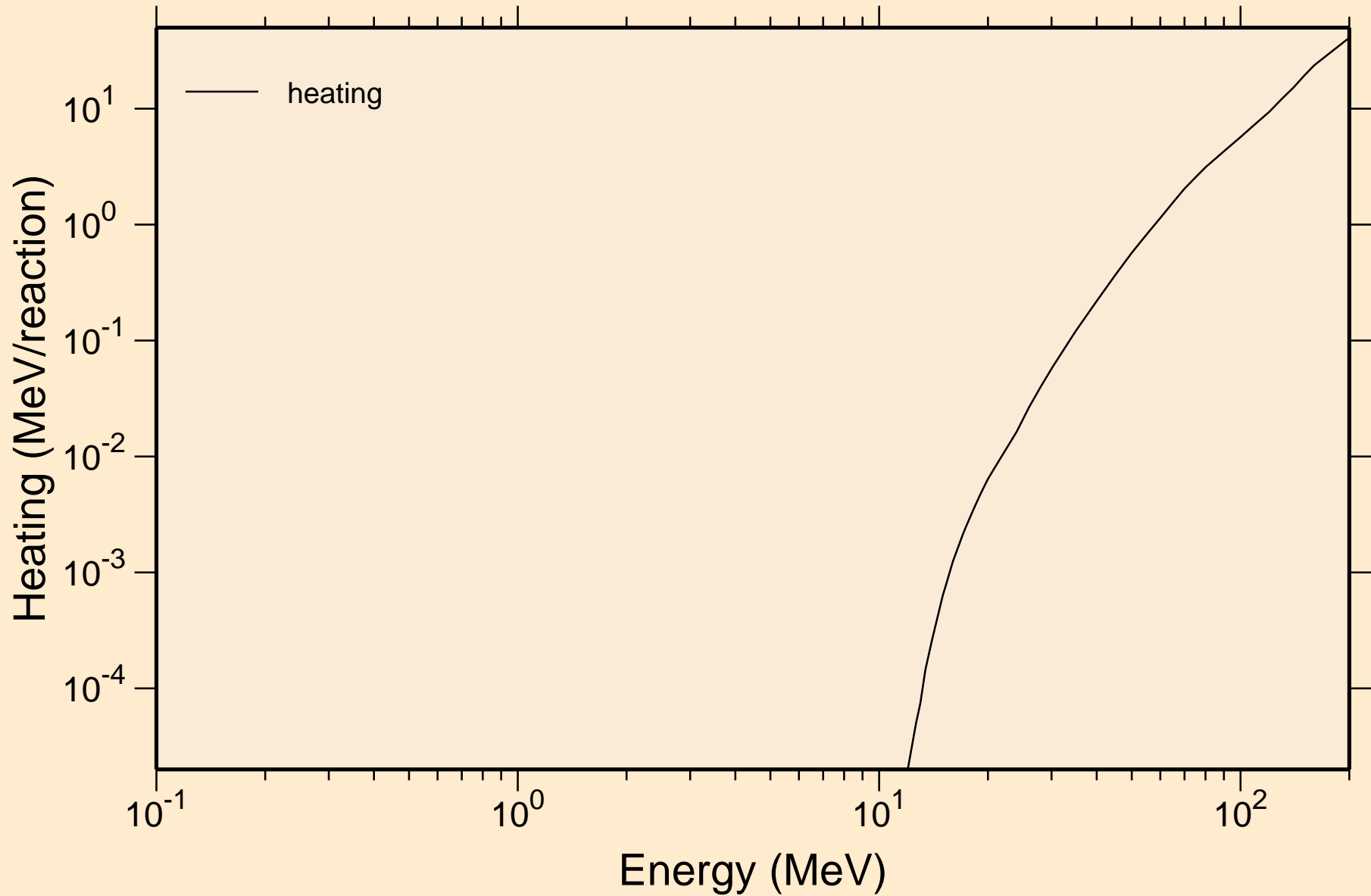

AG108M ALPHA ACER TENDL-2021 LIBRARY; T=0.K

Principal cross sections

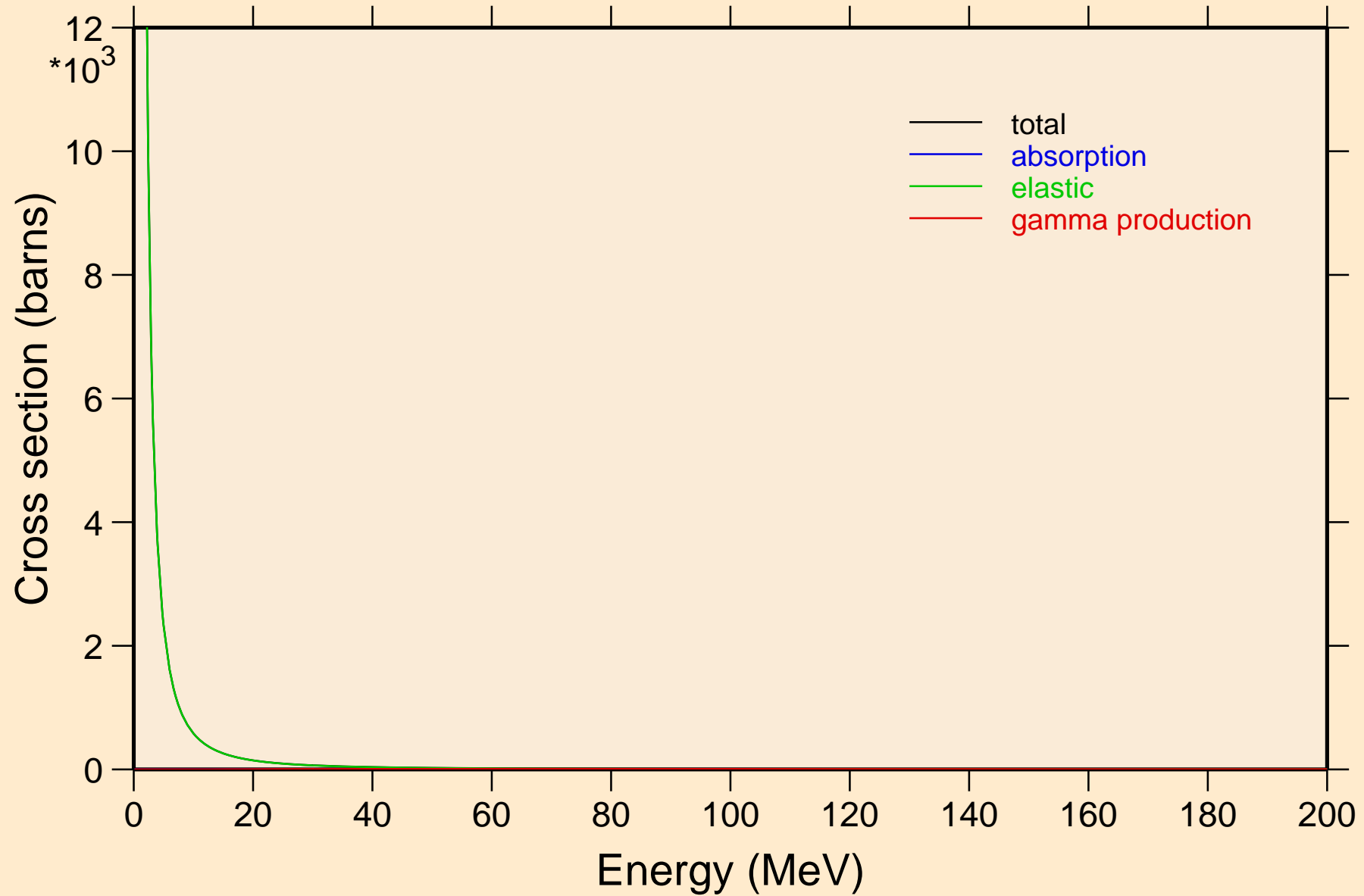

AG108M ALPHA ACER TENDL-2021 LIBRARY; T=0.K

Heating

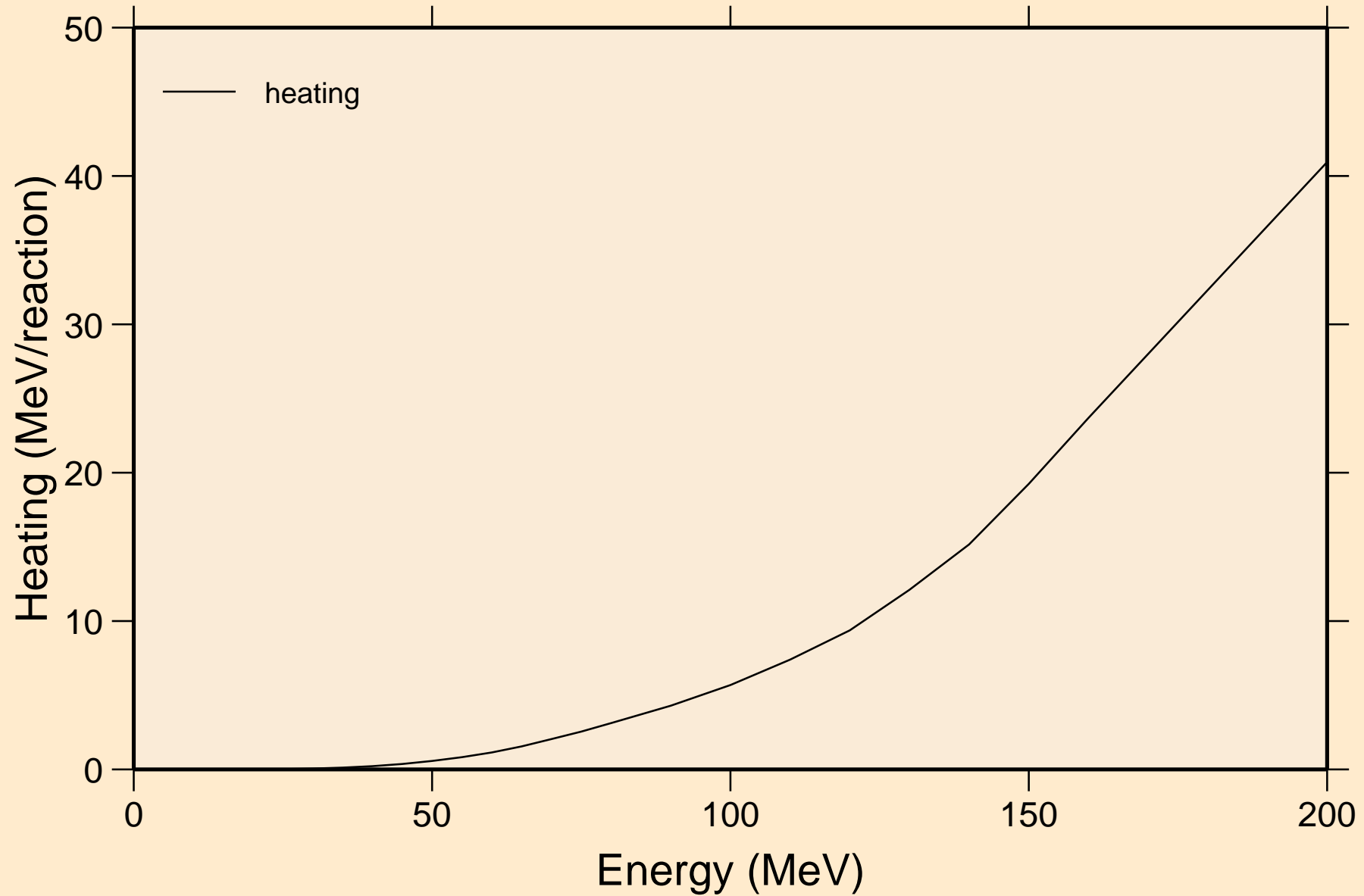

AG108M ALPHA ACER TENDL-2021 LIBRARY; T=0.K
Threshold reactions

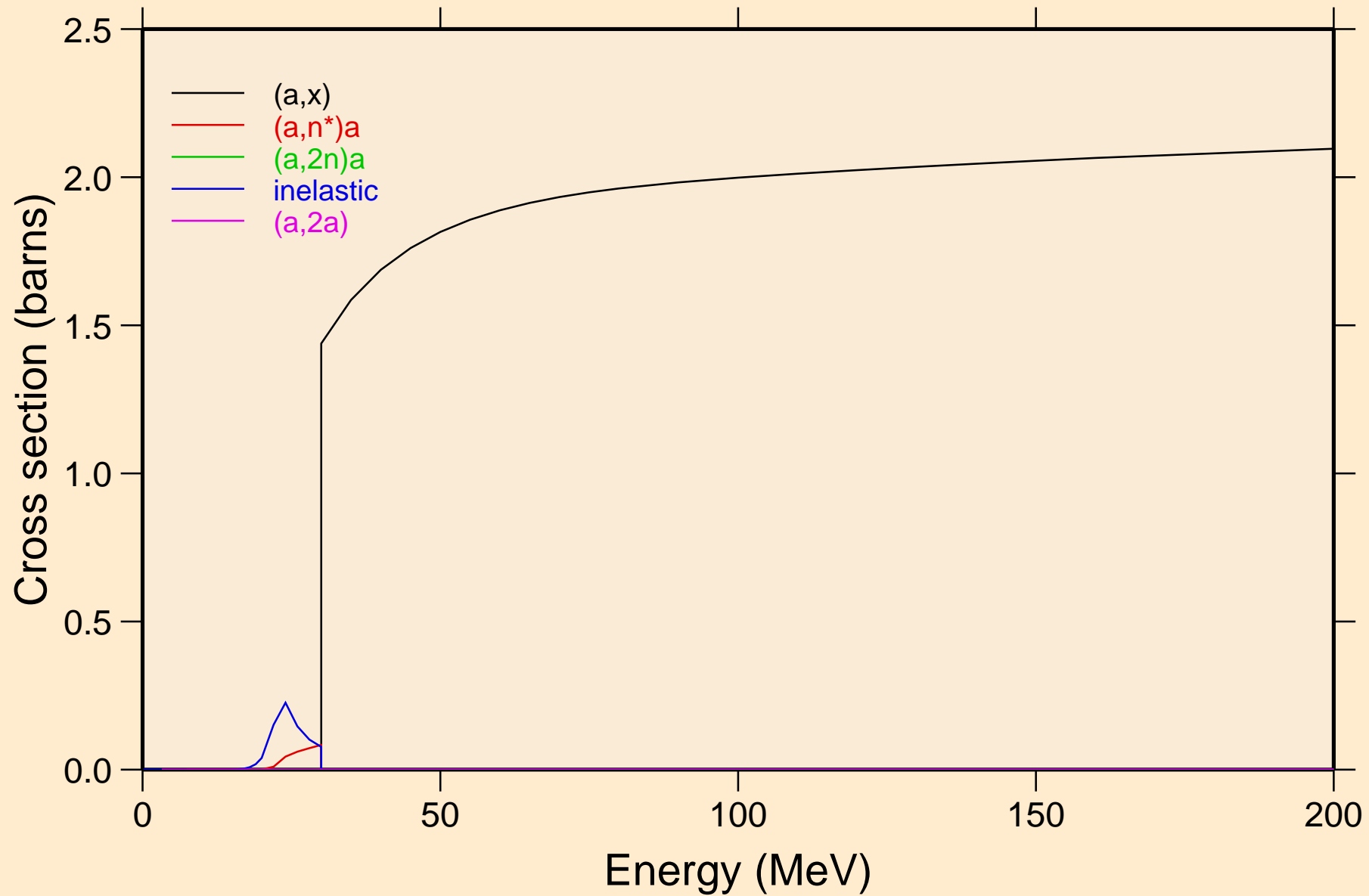

AG108M ALPHA ACER TENDL-2021 LIBRARY; T=0.K
Threshold reactions

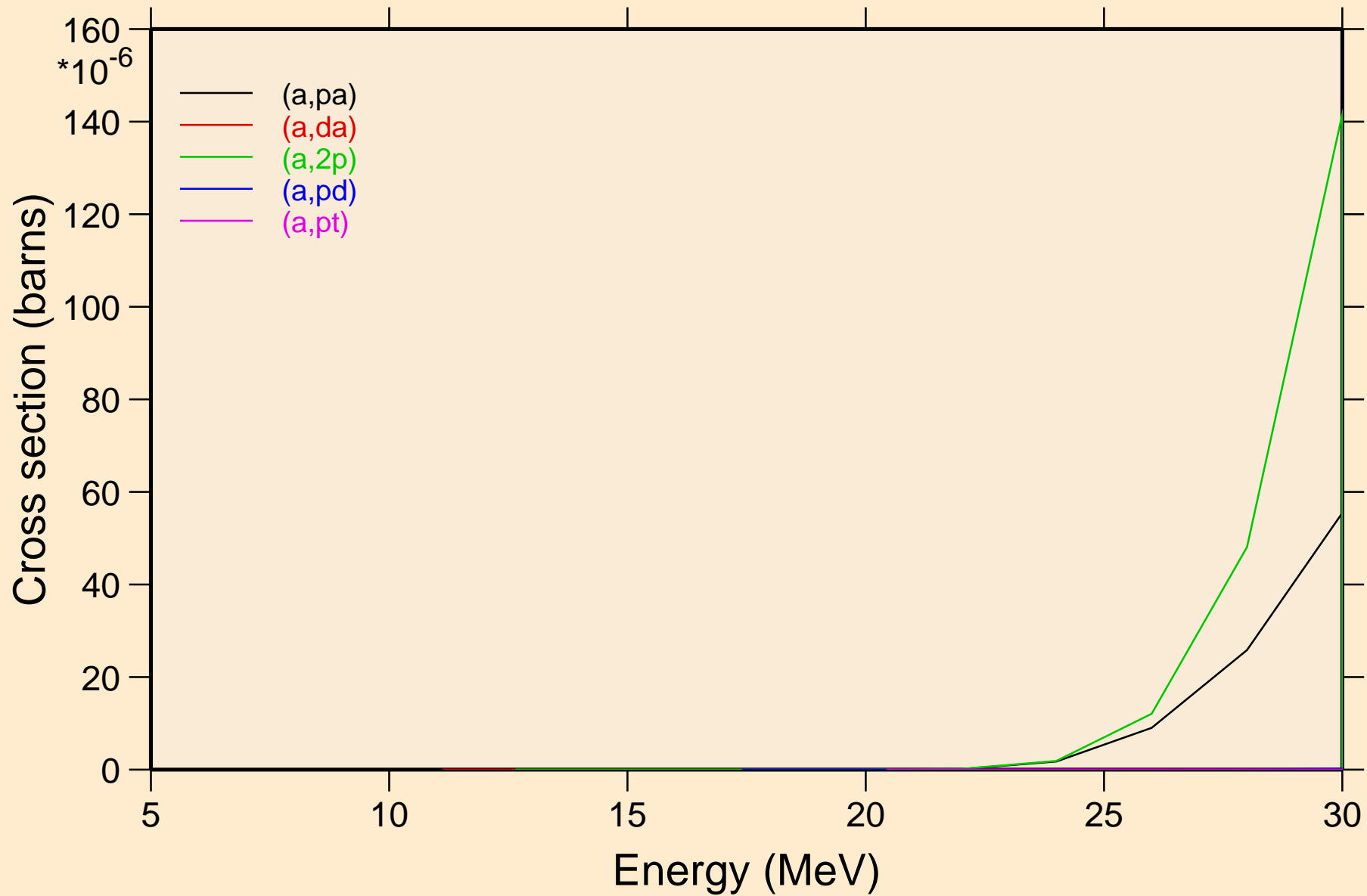

AG108M ALPHA ACER TENDL-2021 LIBRARY; T=0.K
Threshold reactions

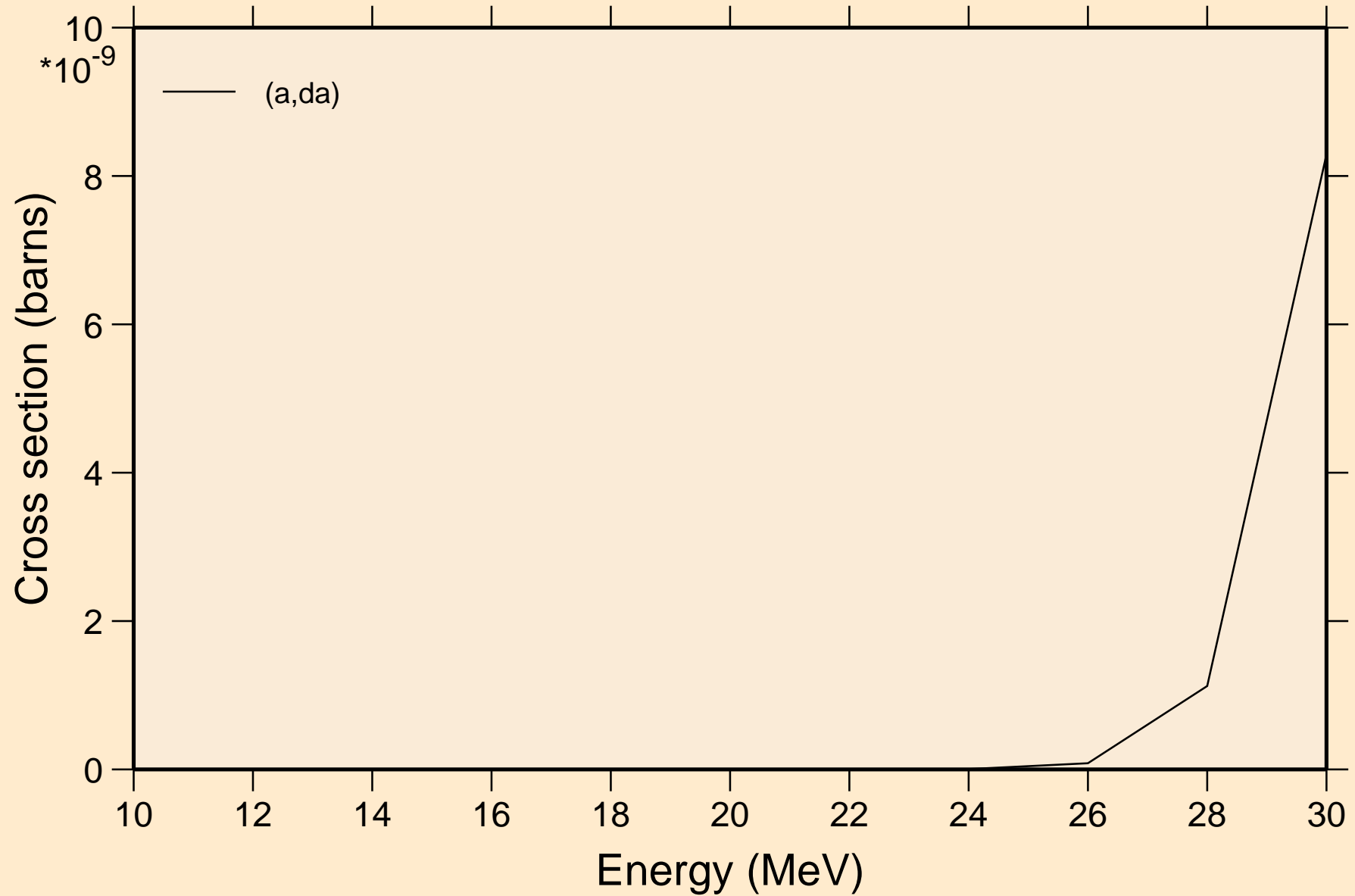

AG108M ALPHA ACER TENDL-2021 LIBRARY; T=0.K
angular distribution for elastic

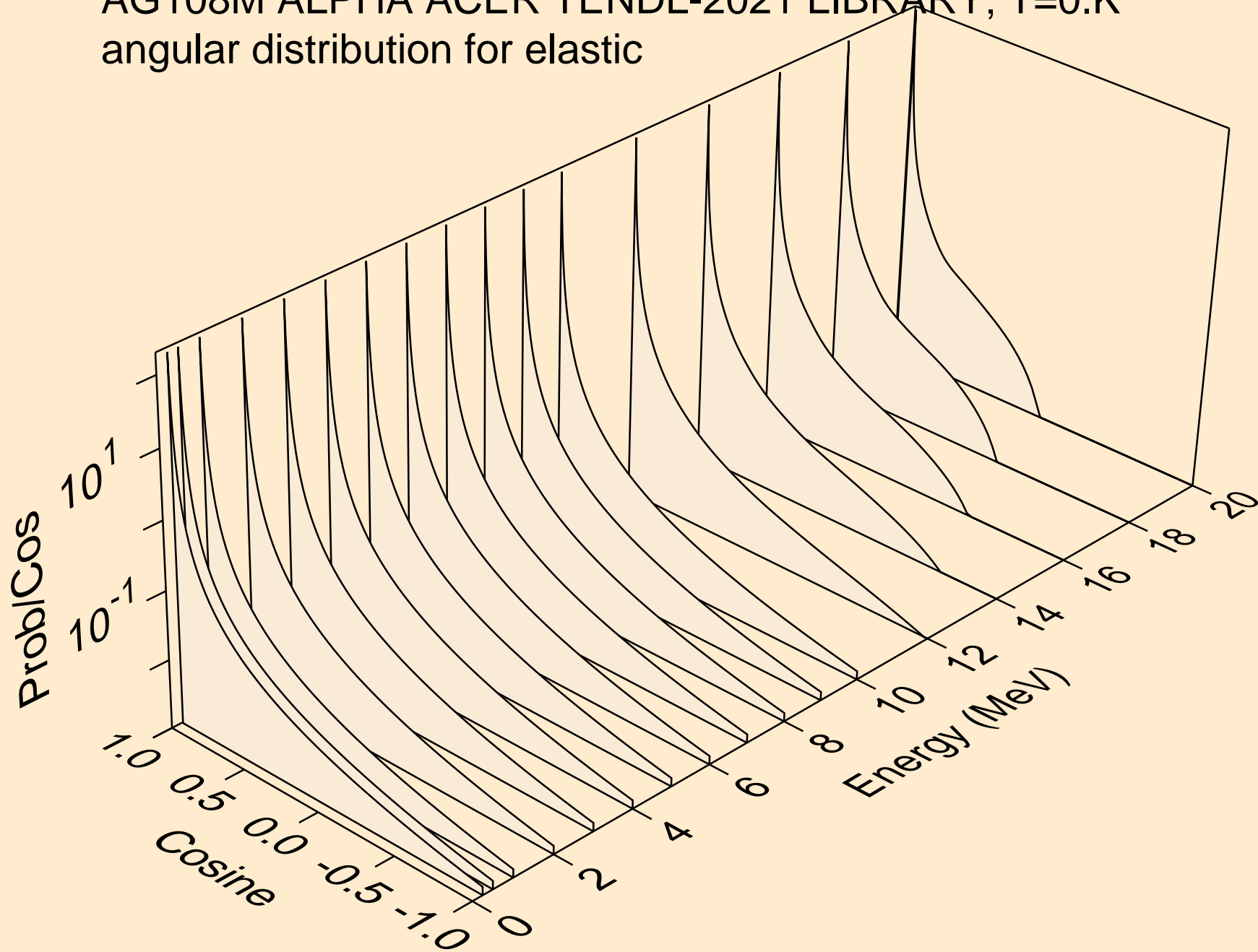

AG108M ALPHA ACER TENDL-2021 LIBRARY; T=0.K
angular distribution for elastic

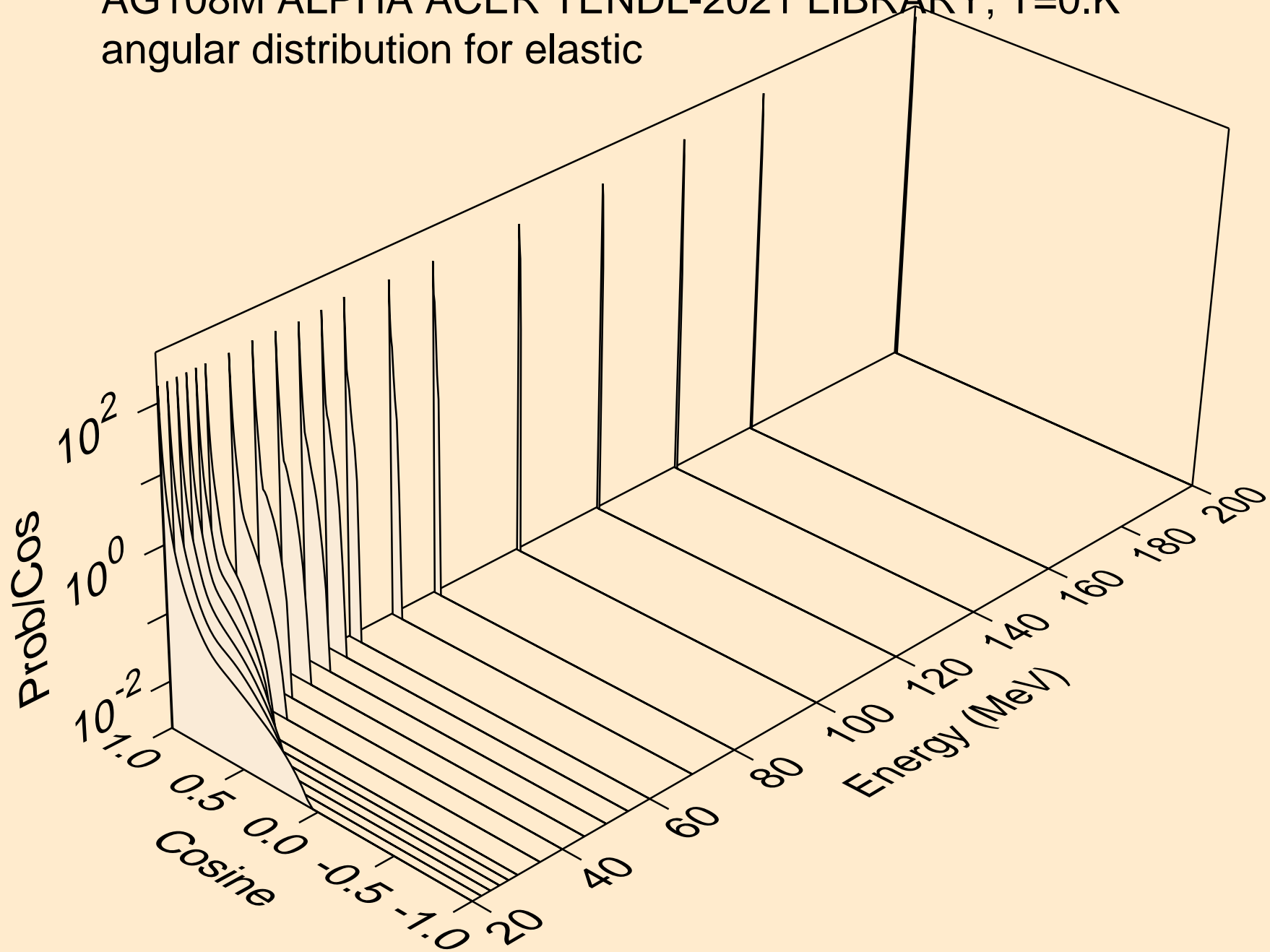

AG108M ALPHA ACER TENDL-2021 LIBRARY; T=0.K
Alpha emission for (a,x)

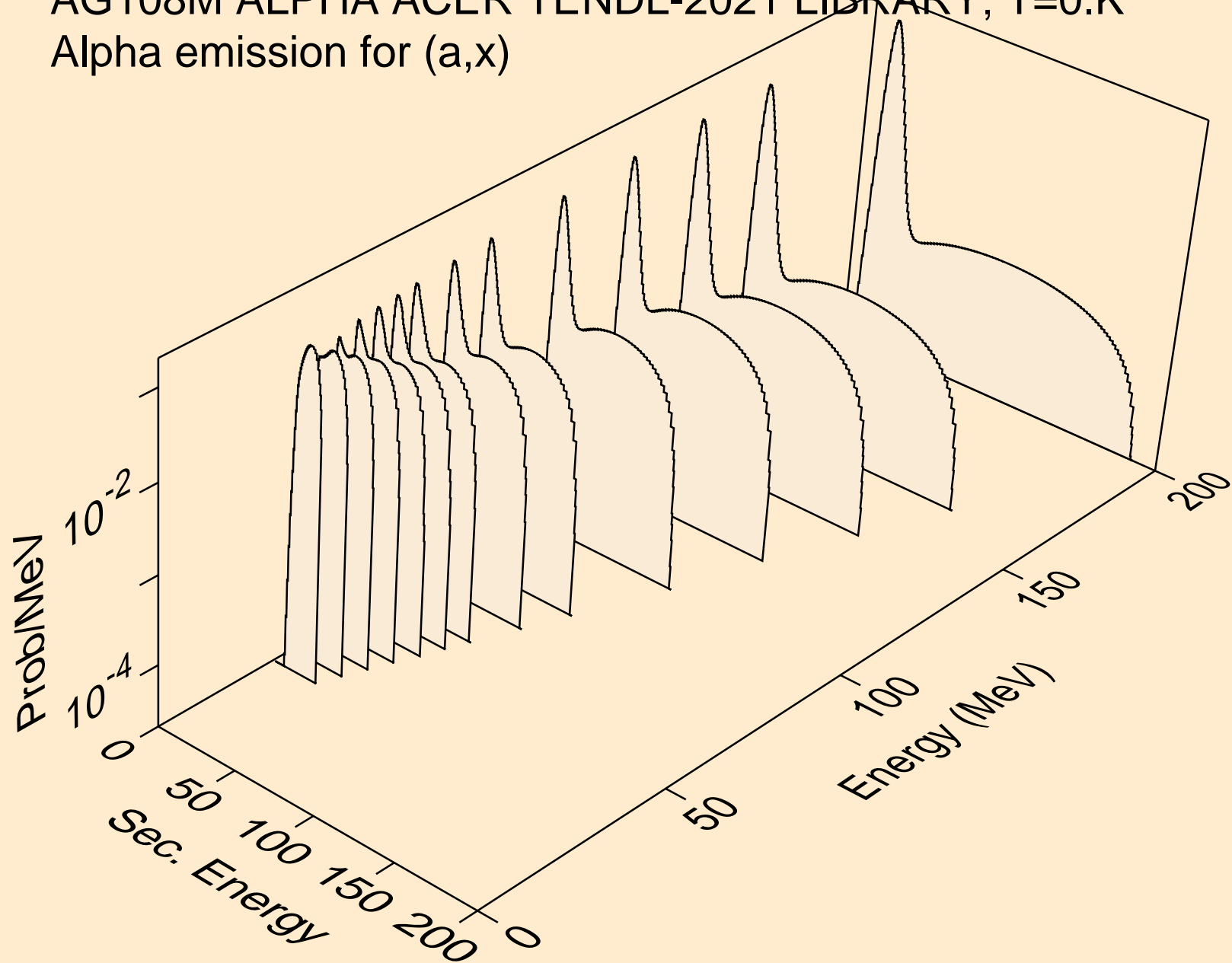

AG108M ALPHA ACER TENDL-2021 LIBRARY; T=0.K
Alpha emission for (a,n*)a

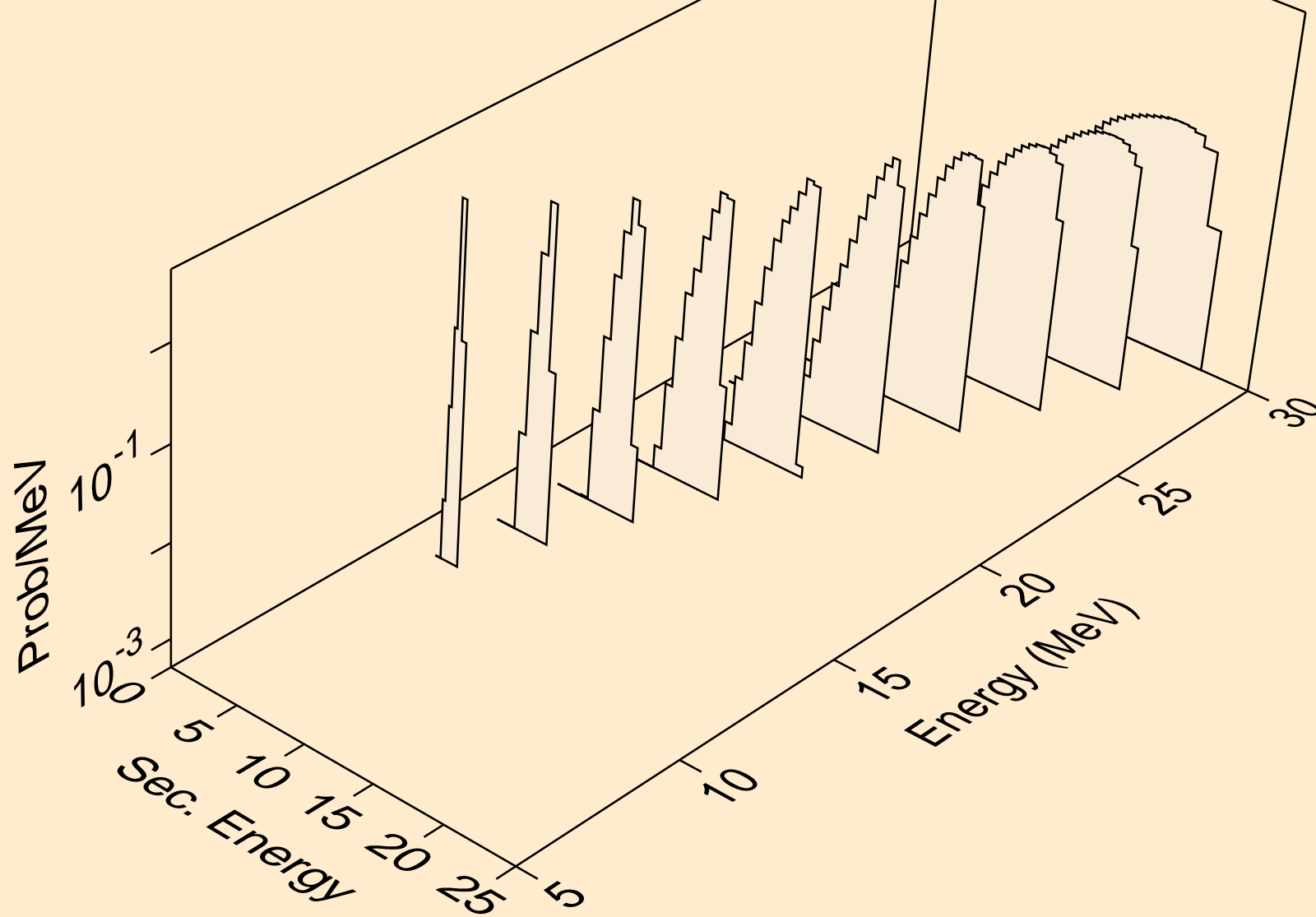

AG108M ALPHA ACER TENDL-2021 LIBRARY; T=0.K
Alpha emission for (a,2n)a

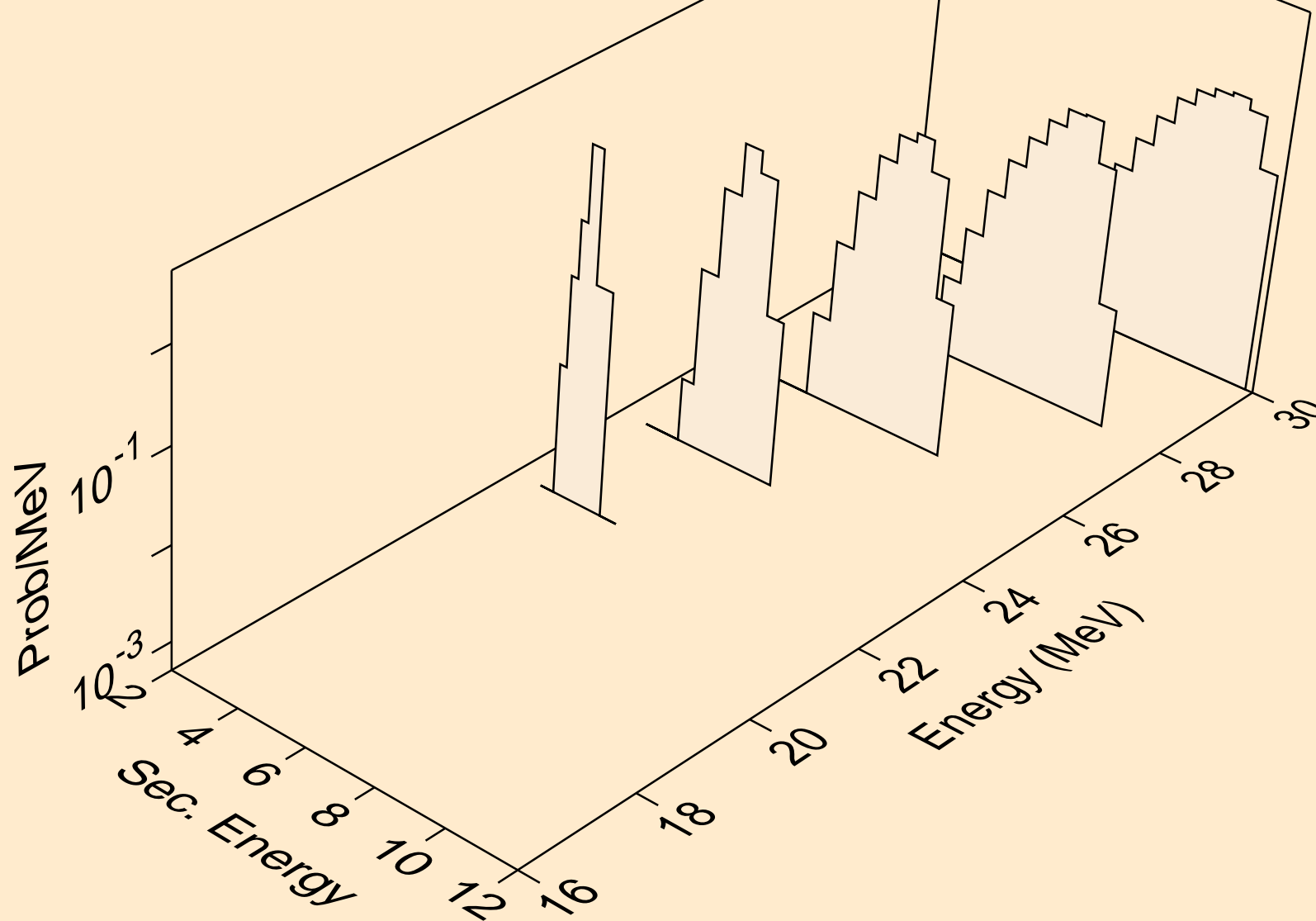

AG108M ALPHA ACER TENDL-2021 LIBRARY; T=0.K
Alpha emission for inelastic

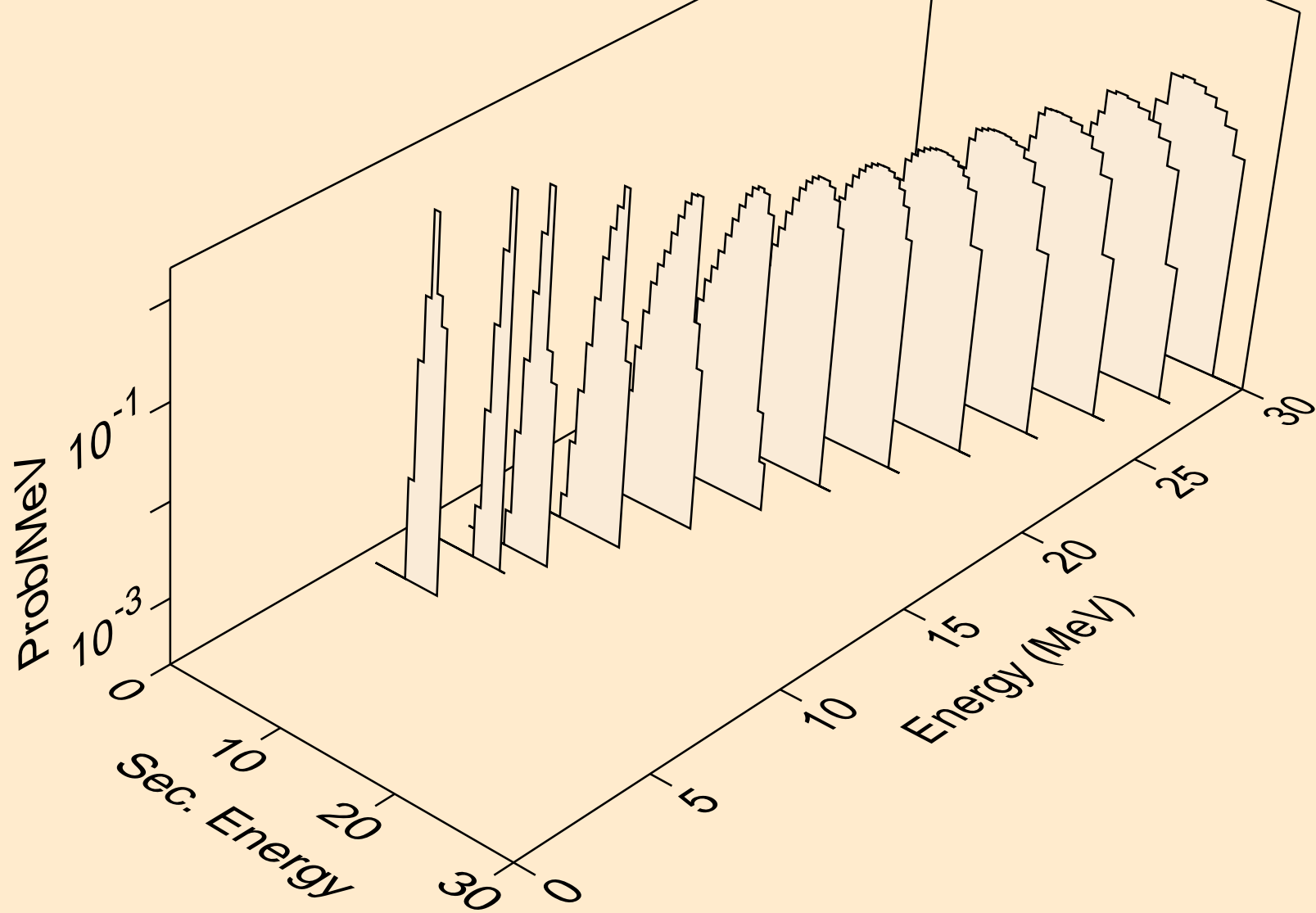

AG108M ALPHA ACER TENDL-2021 LIBRARY; T=0.K
Alpha emission for (a,2a)

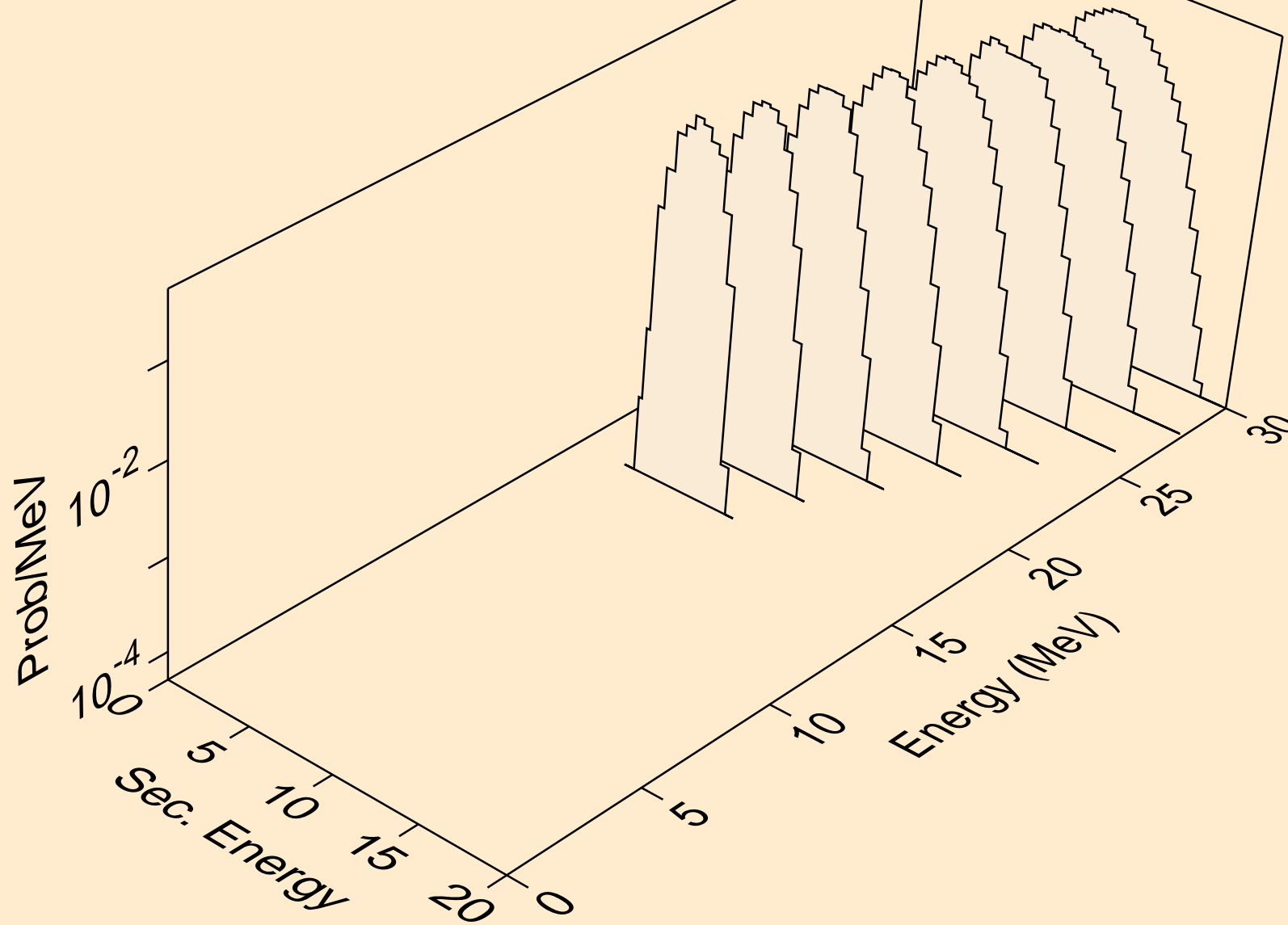

AG108M ALPHA ACER TENDL-2021 LIBRARY; T=0.K
Alpha emission for (a,pa)

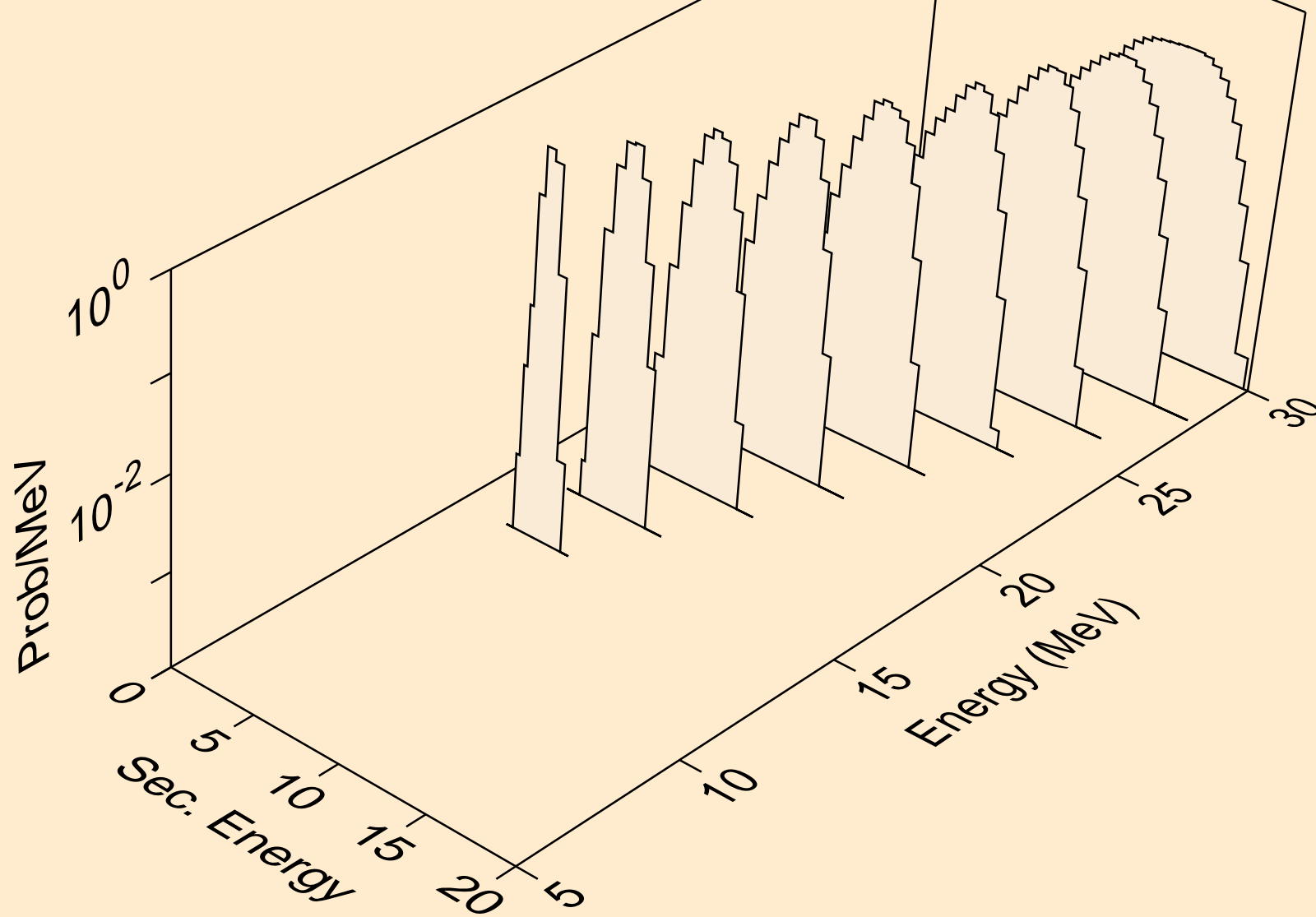

AG108M ALPHA ACER TENDL-2021 LIBRARY; T=0.K
Alpha emission for (a,da)

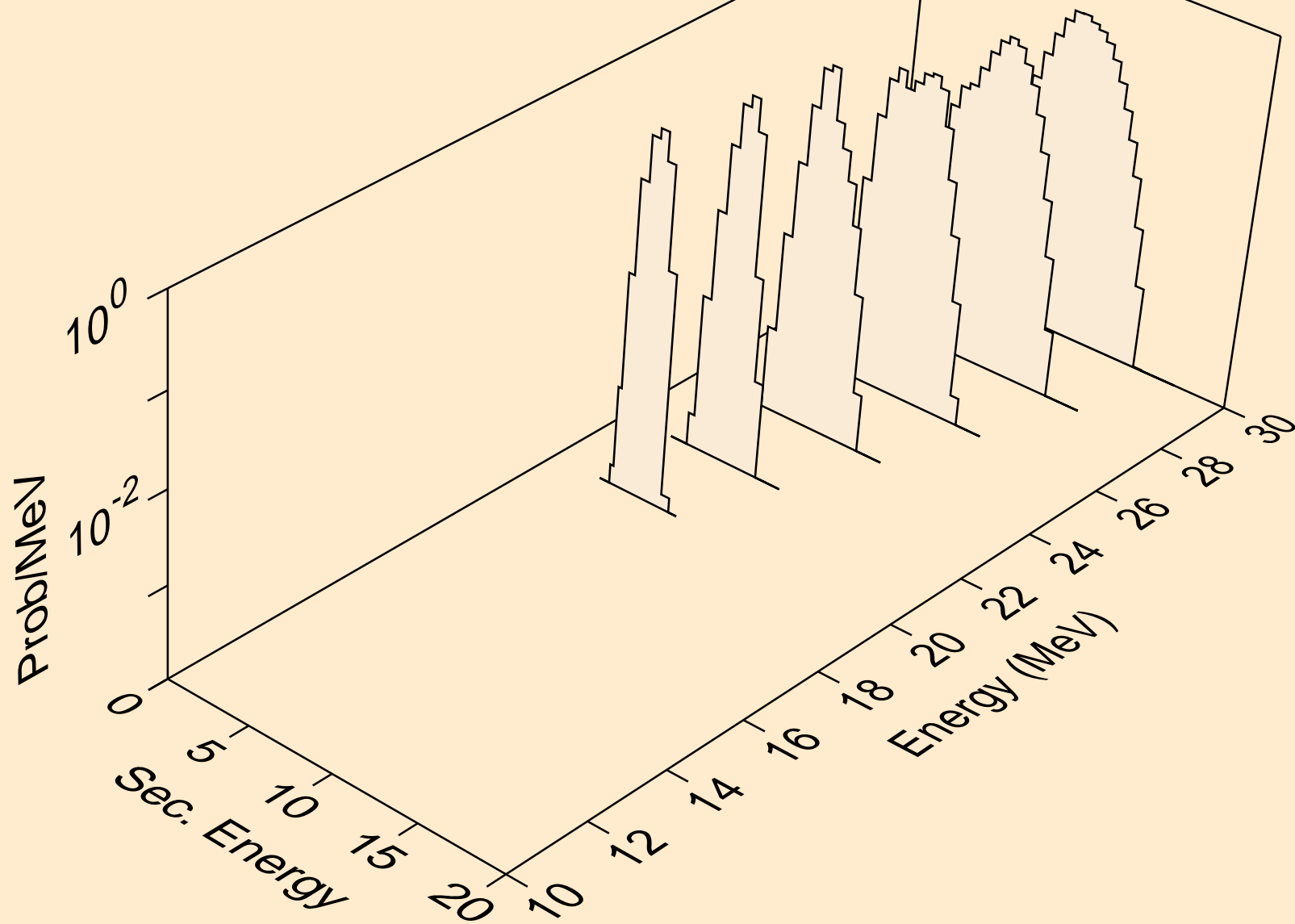

AG108M ALPHA ACER TENDL-2021 LIBRARY; T=0.K
Photon emission for (z,n)

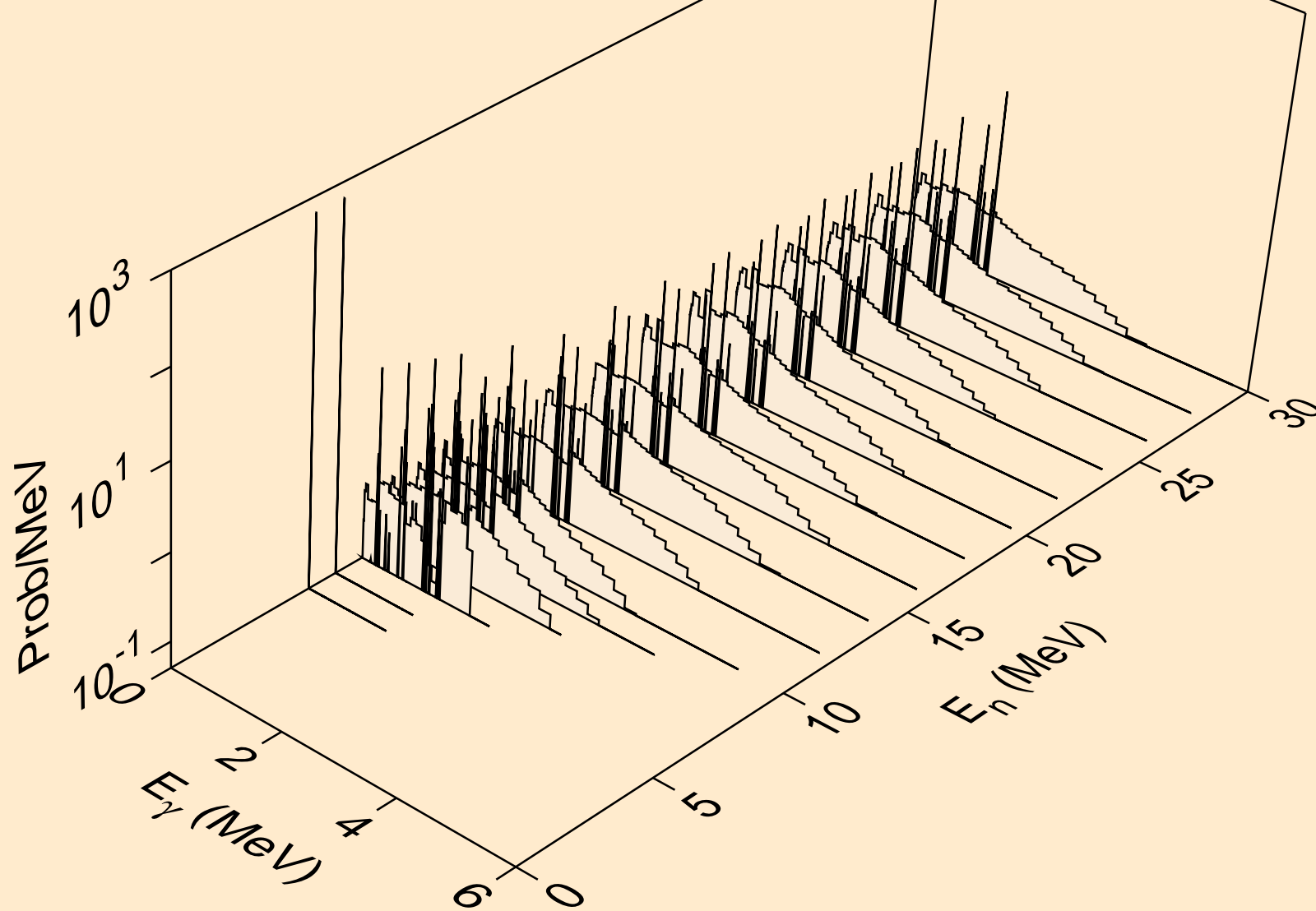

AG108M ALPHA ACER TENDL-2021 LIBRARY; T=0.K
Photon emission for (n,x)

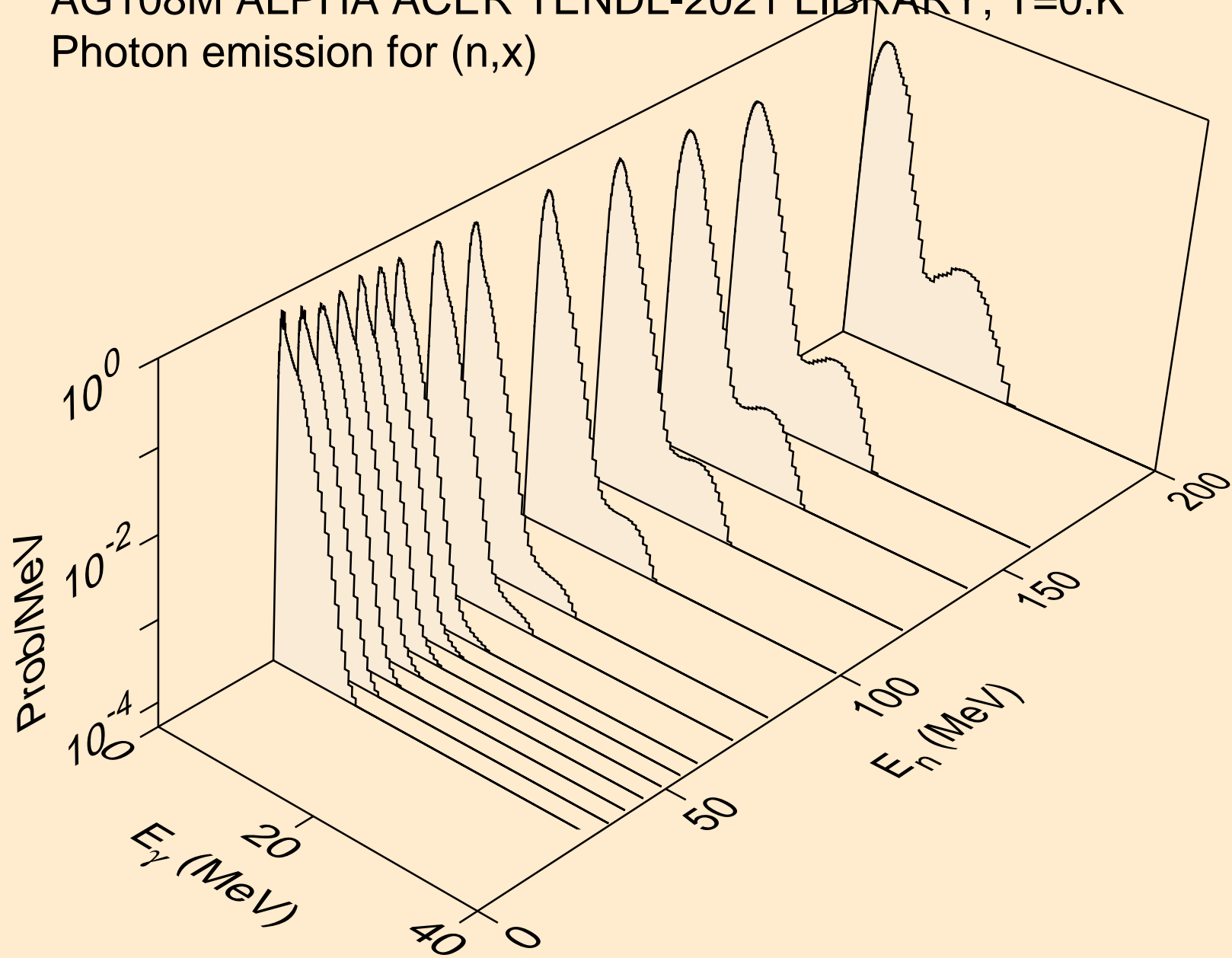

AG108M ALPHA ACER TENDL-2021 LIBRARY; T=0.K
Photon emission for (n,2nd)

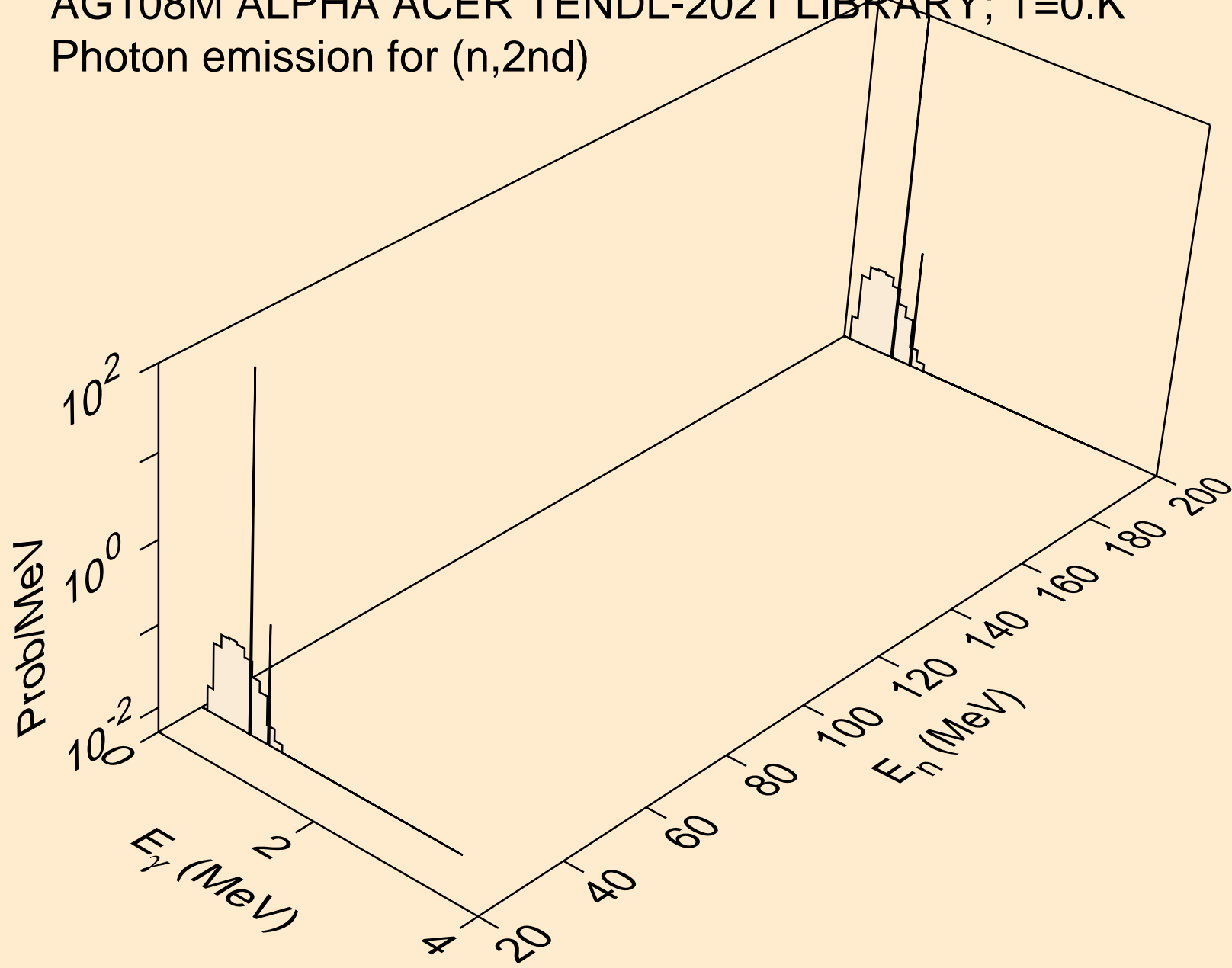

AG108M ALPHA ACER TENDL-2021 LIBRARY; T=0.K
Photon emission for (n,2n)

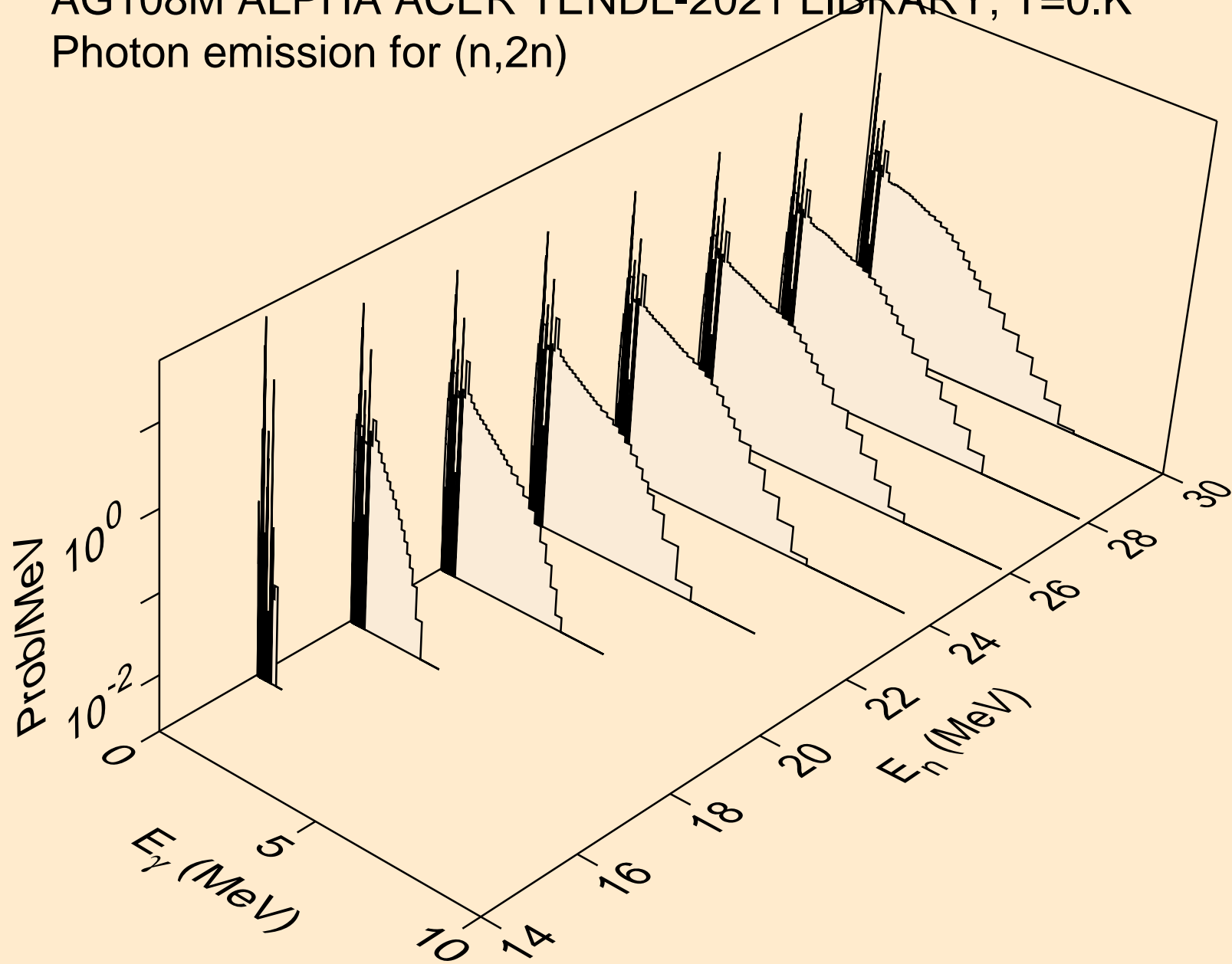

AG108M ALPHA ACER TENDL-2021 LIBRARY; T=0.K
Photon emission for (n,3n)

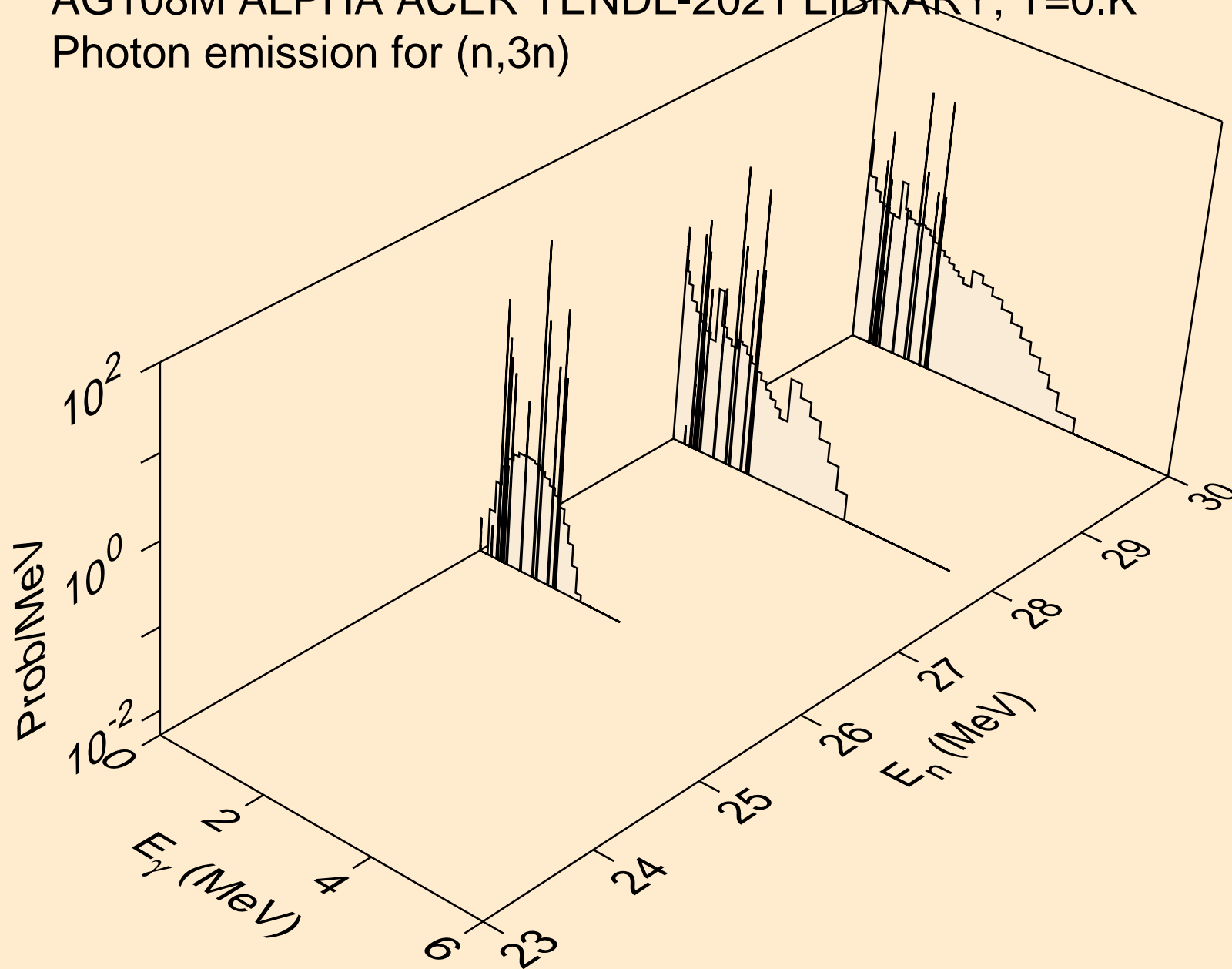

AG108M ALPHA ACER TENDL-2021 LIBRARY; T=0.K
Photon emission for (n,n*)a

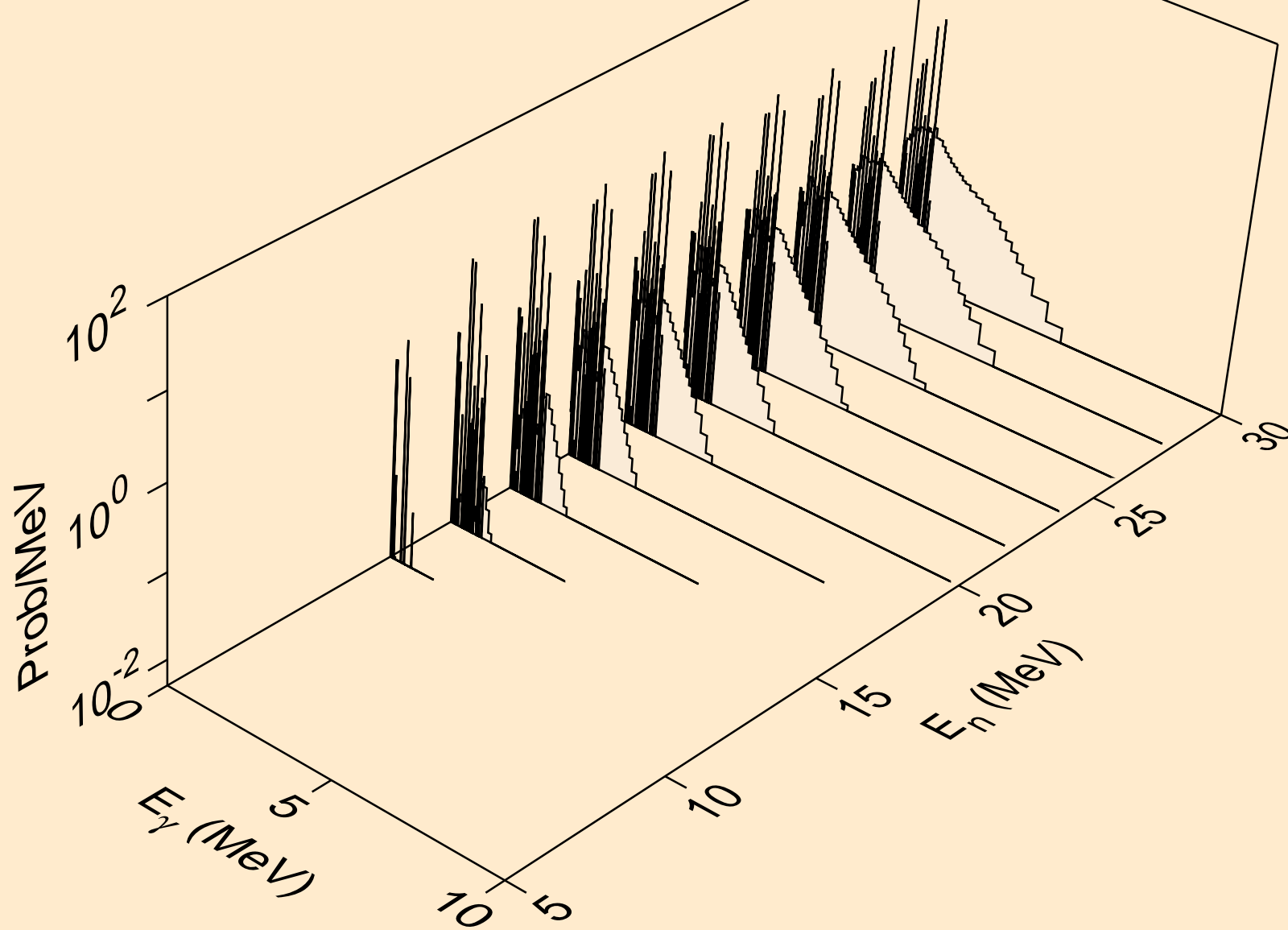

AG108M ALPHA ACER TENDL-2021 LIBRARY; T=0.K
Photon emission for (n,2n)a

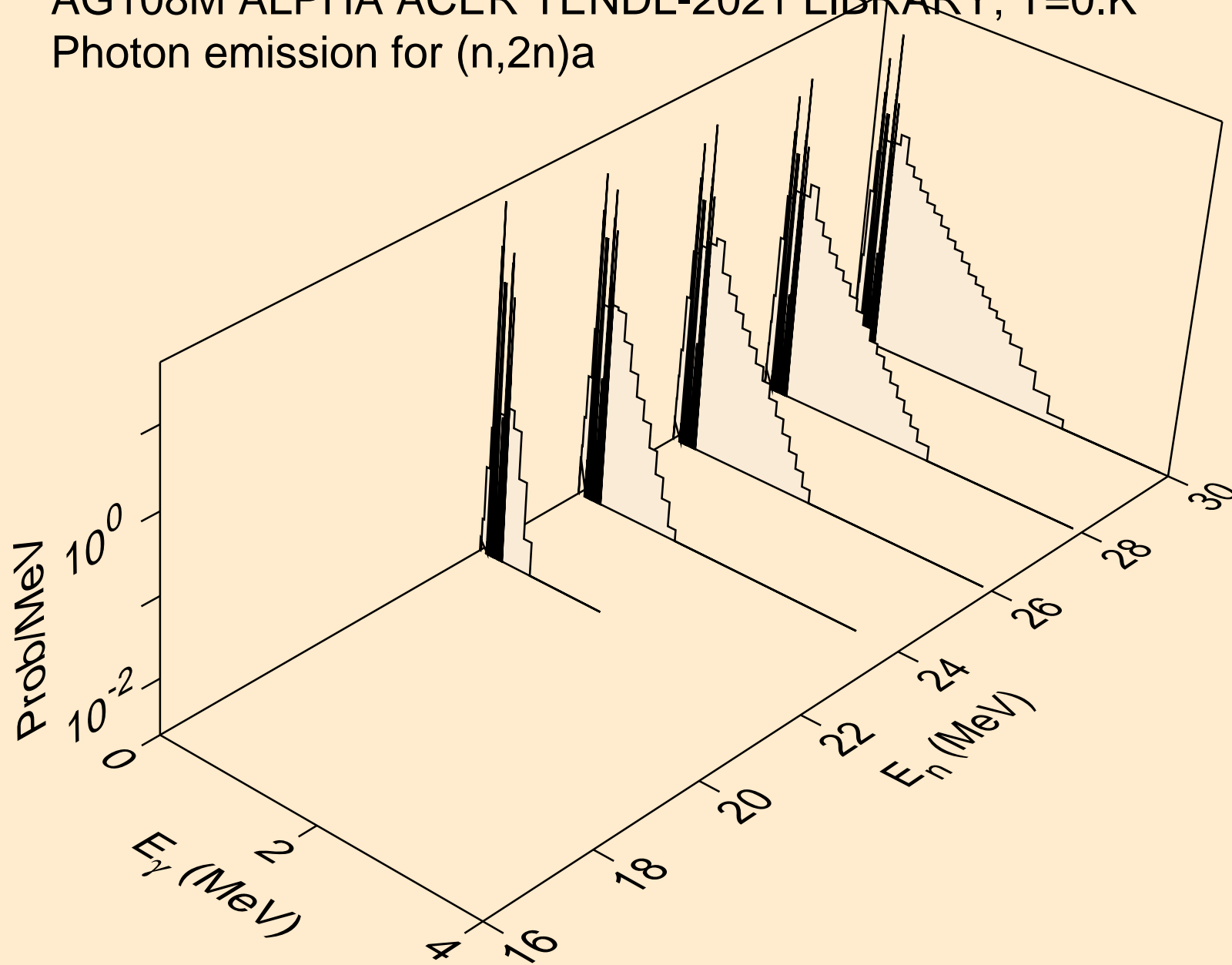

AG108M ALPHA ACER TENDL-2021 LIBRARY; T=0.K
Photon emission for (n,n*)p

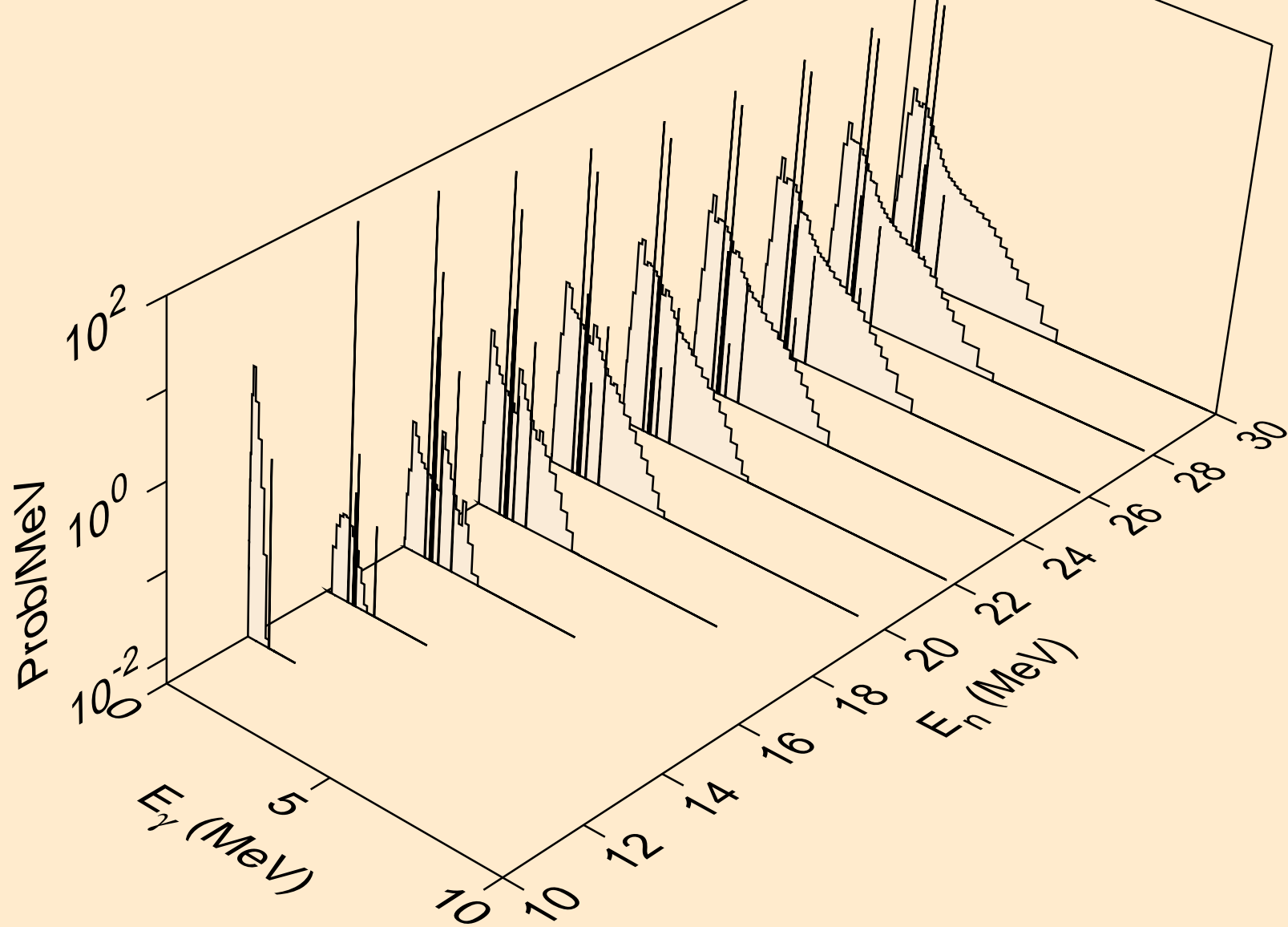

AG108M ALPHA ACER TENDL-2021 LIBRARY; T=0.K
Photon emission for (n,n*)d

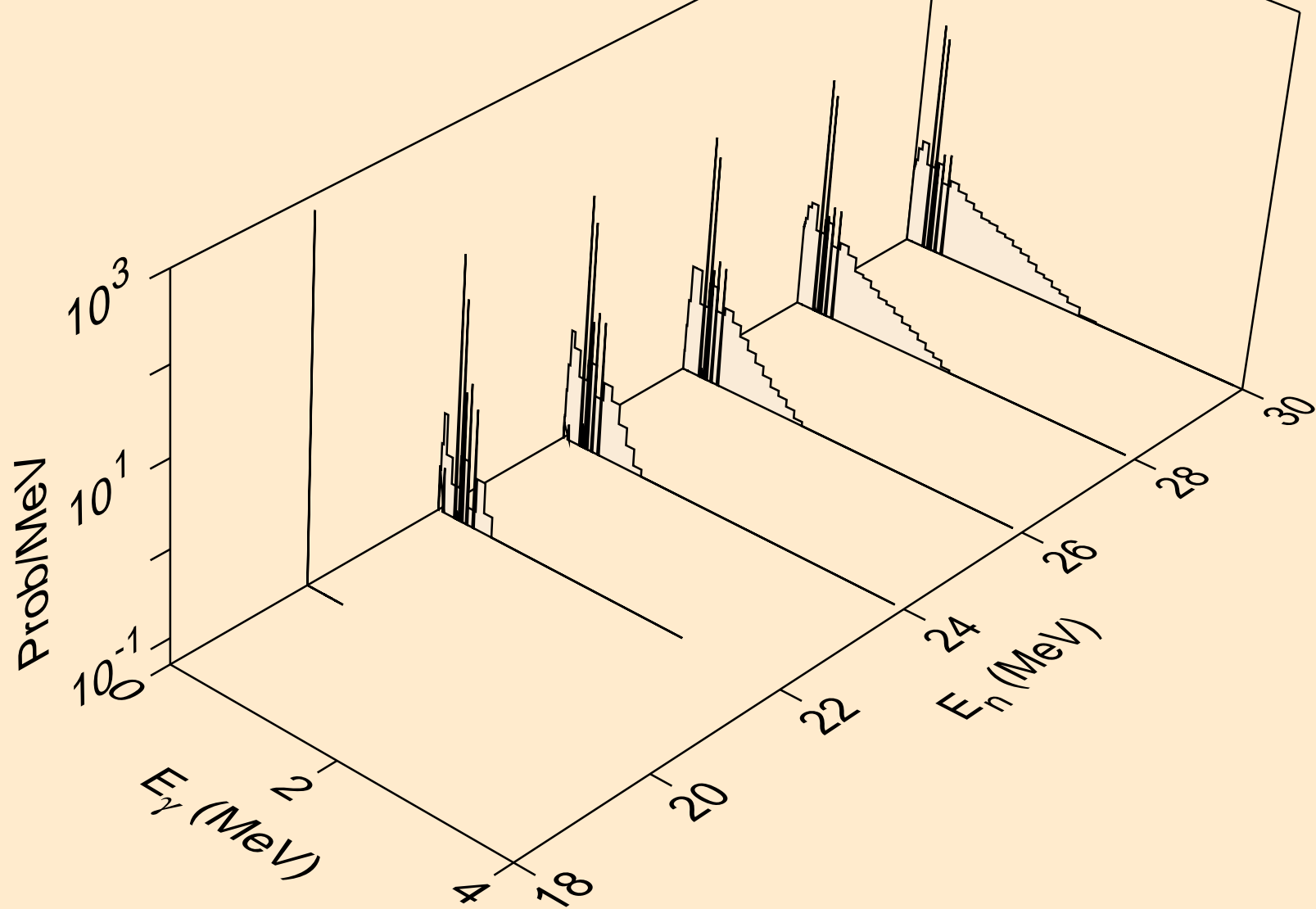

AG108M ALPHA ACER TENDL-2021 LIBRARY; T=0.K
Photon emission for (n,n*)t

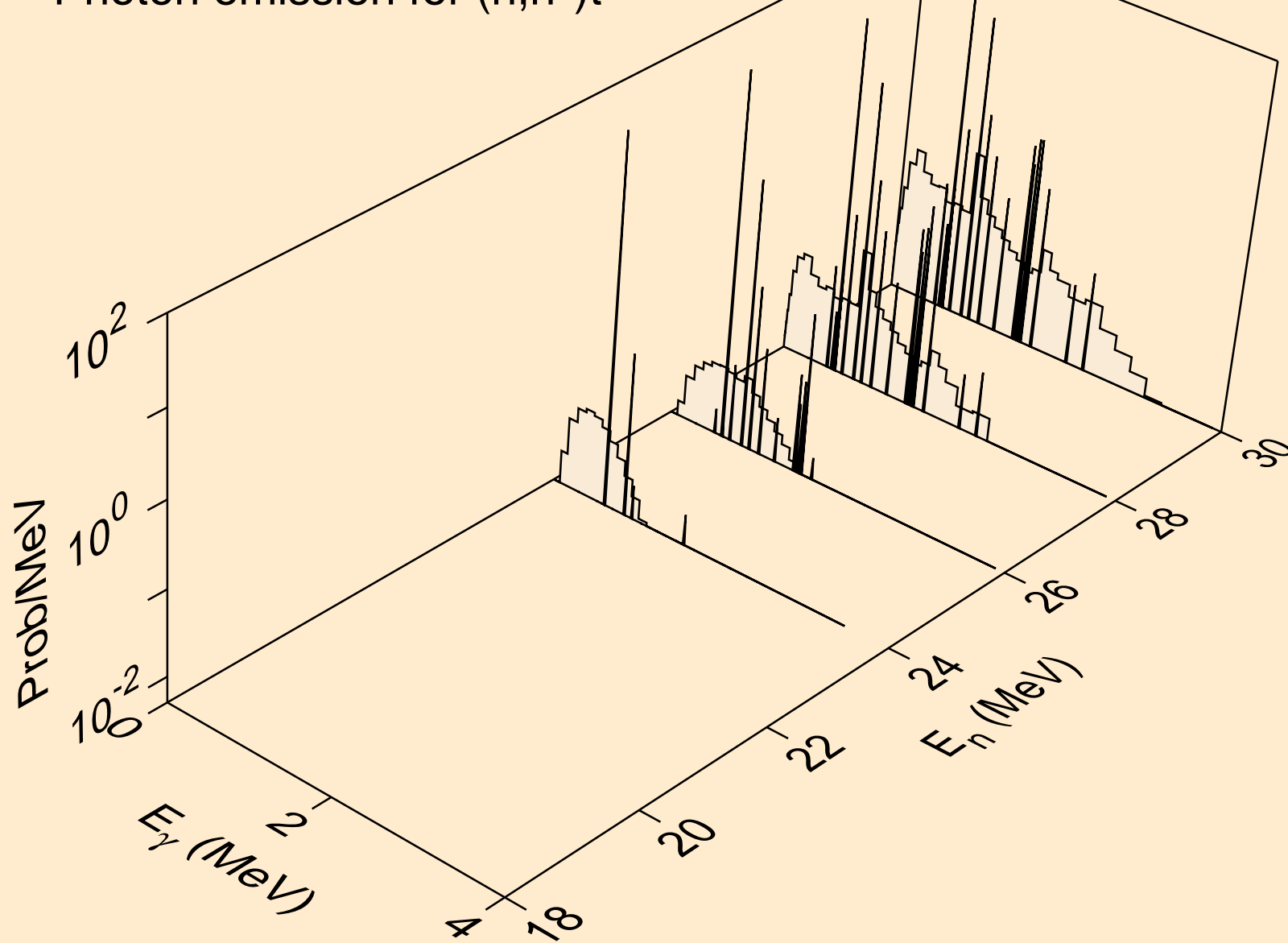

AG108M ALPHA ACER TENDL-2021 LIBRARY; T=0.K
Photon emission for (n,n*)he3

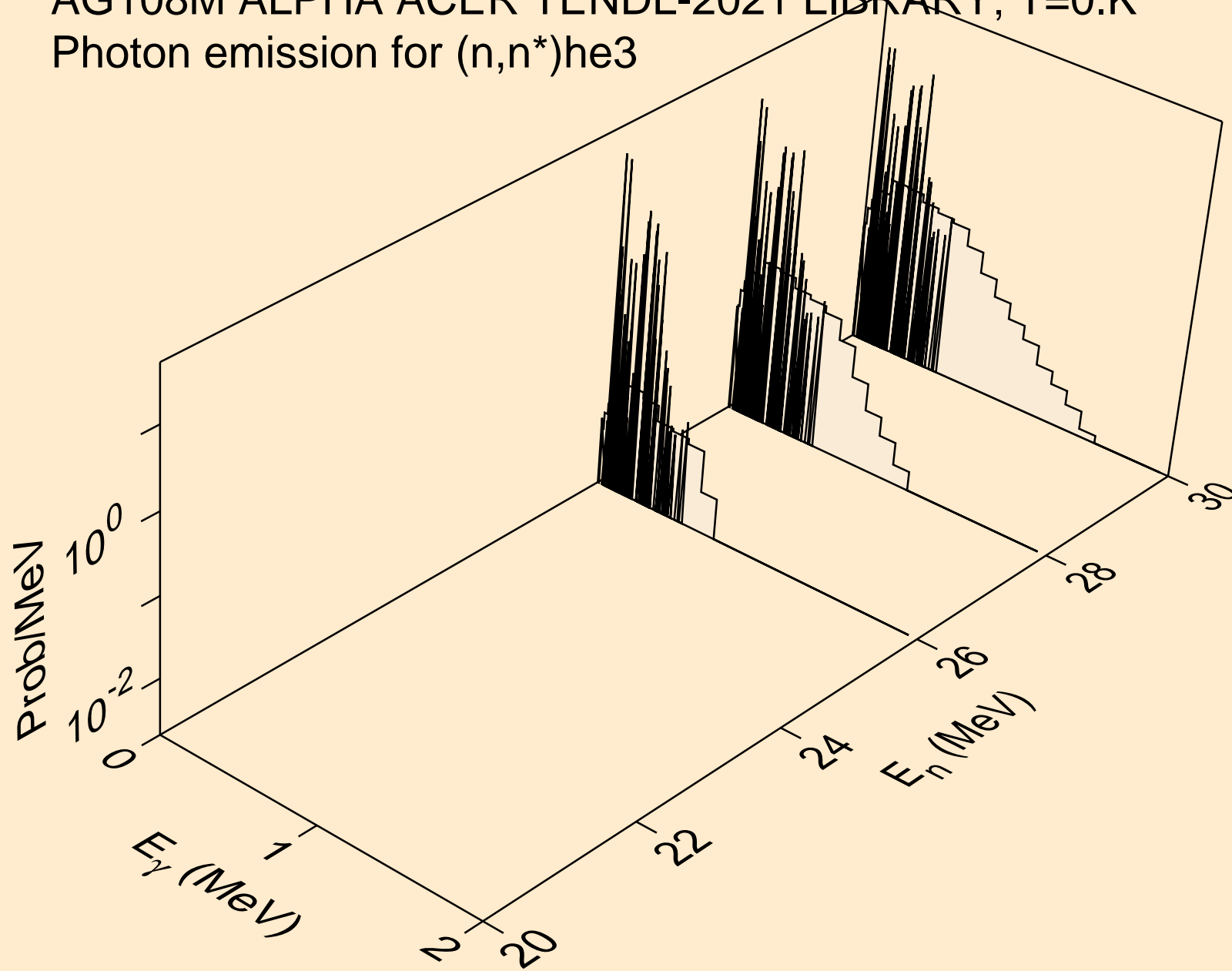

AG108M ALPHA ACER TENDL-2021 LIBRARY; T=0.K
Photon emission for (n,2np)

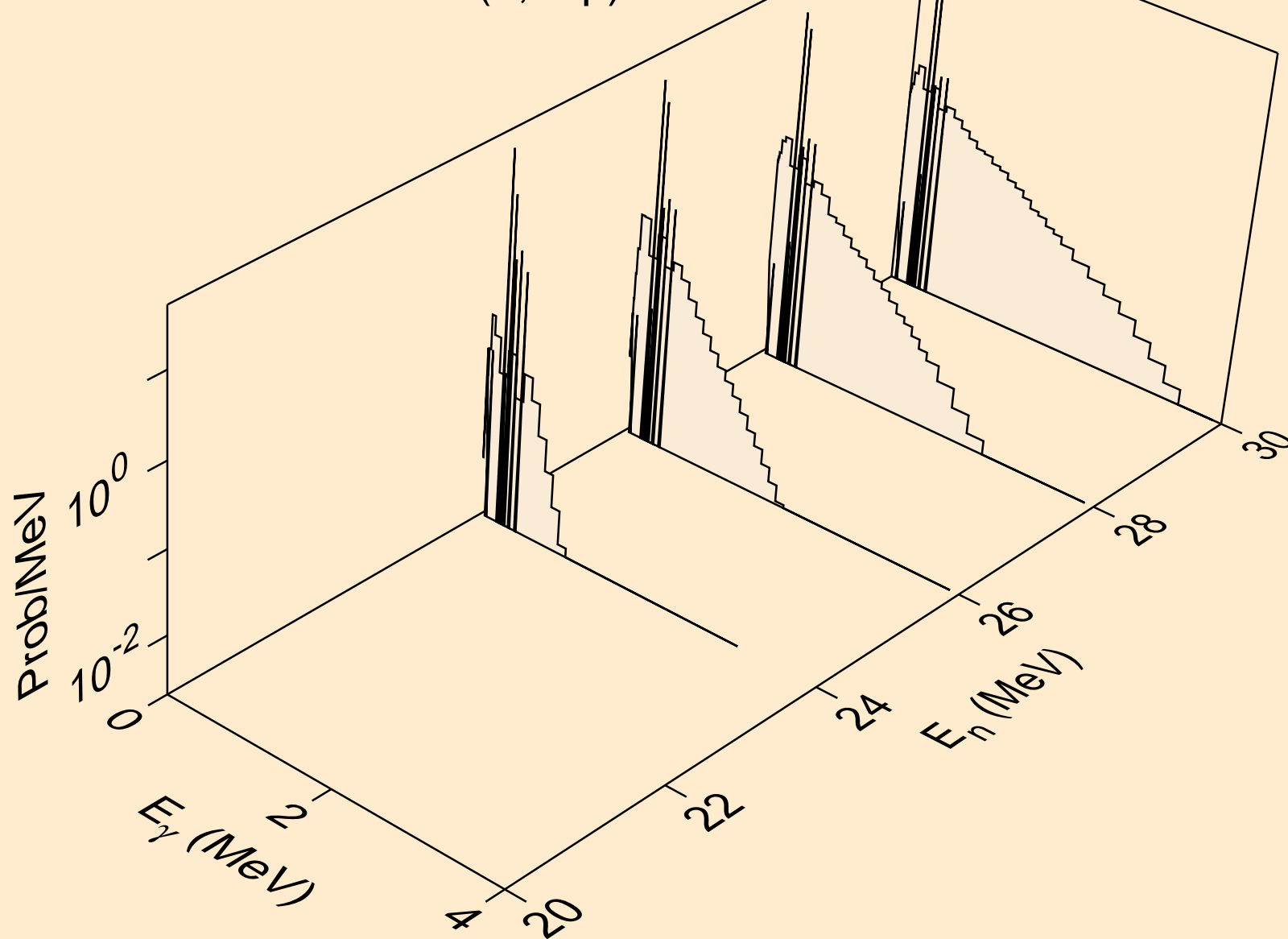

AG108M ALPHA ACER TENDL-2021 LIBRARY; T=0.K
Photon emission for (n,2np)

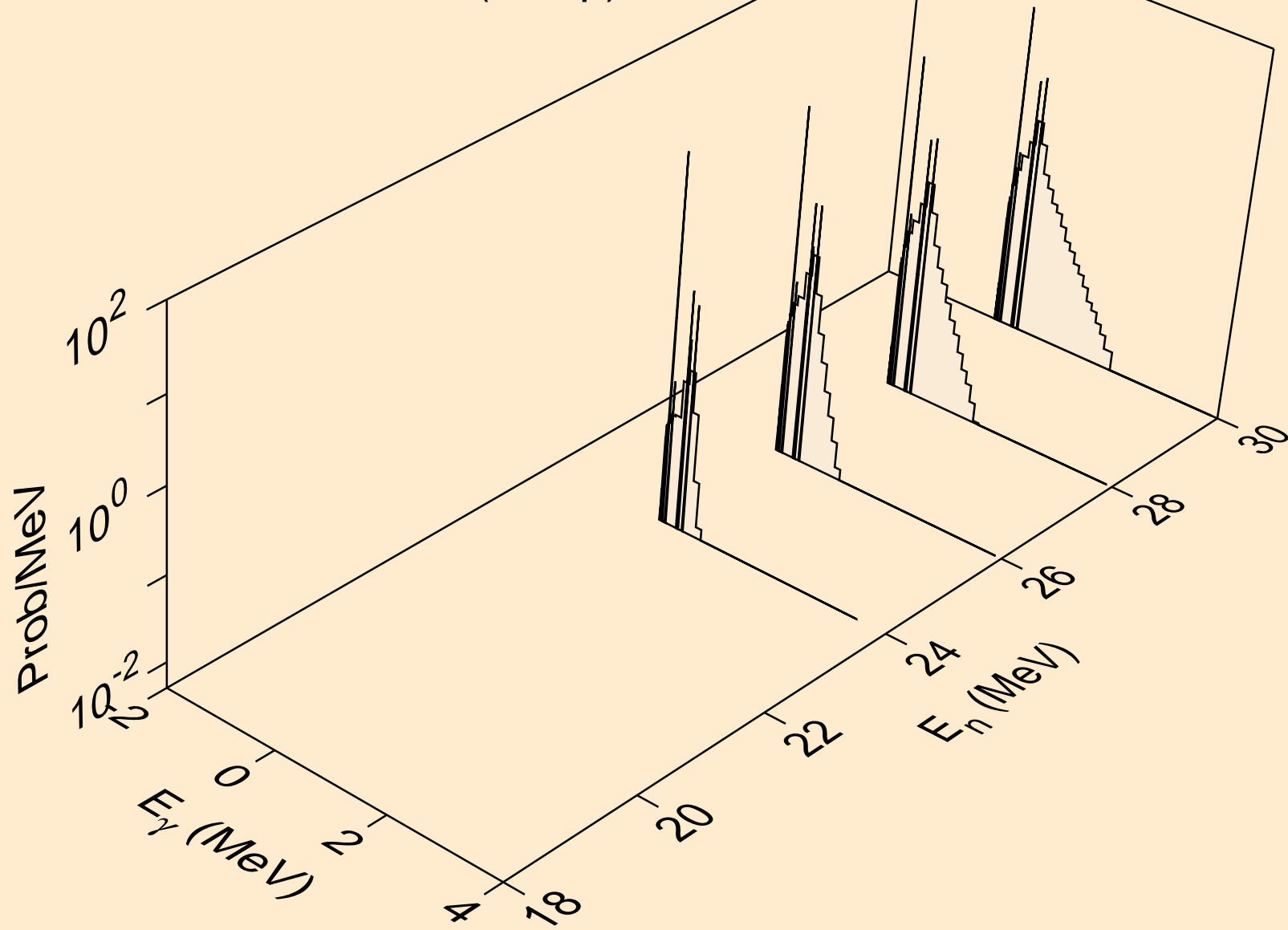

AG108M ALPHA ACER TENDL-2021 LIBRARY; T=0.K
Photon emission for (n,npa)

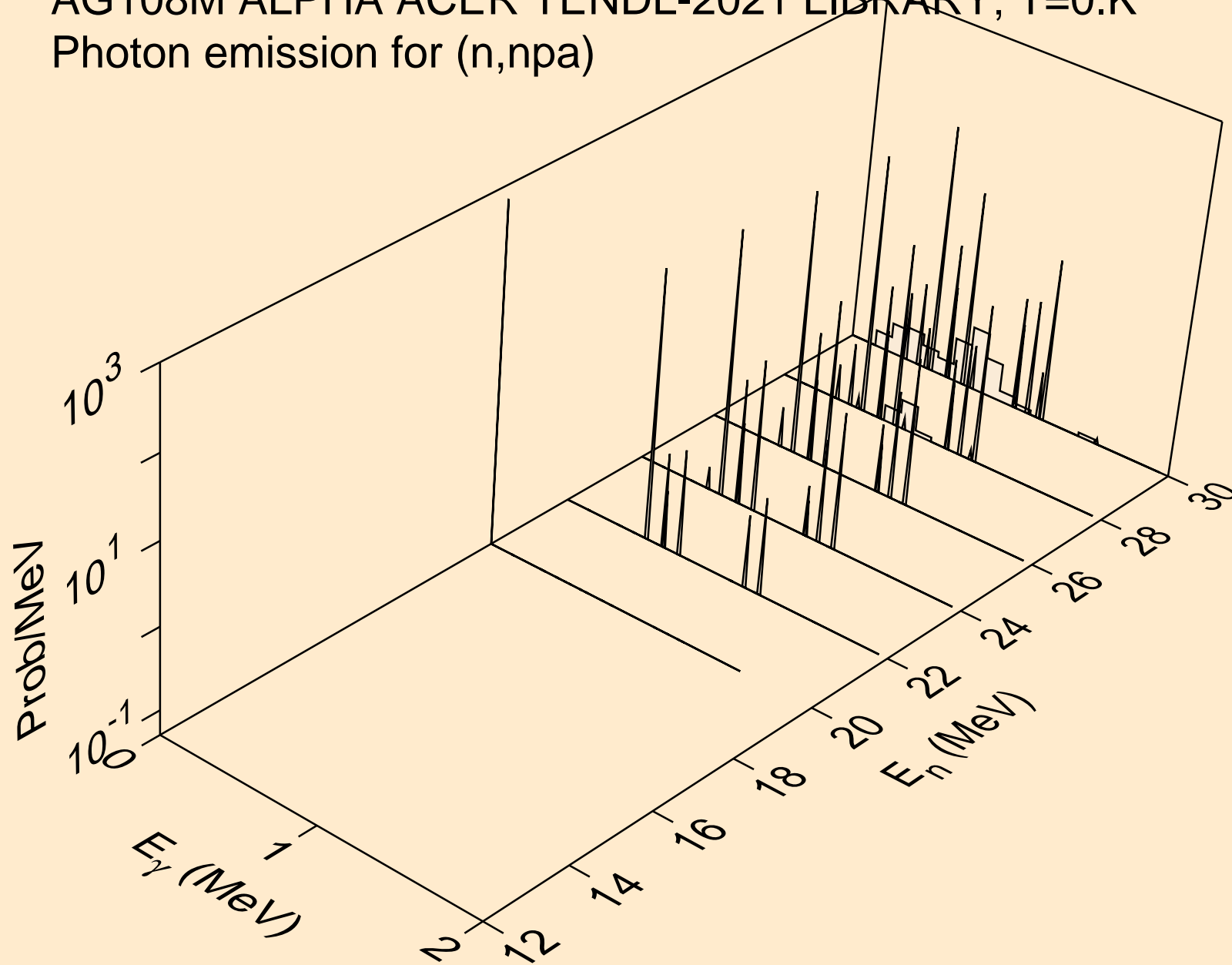

AG108M ALPHA ACER TENDL-2021 LIBRARY; T=0.K
Photon emission for (n,gma)

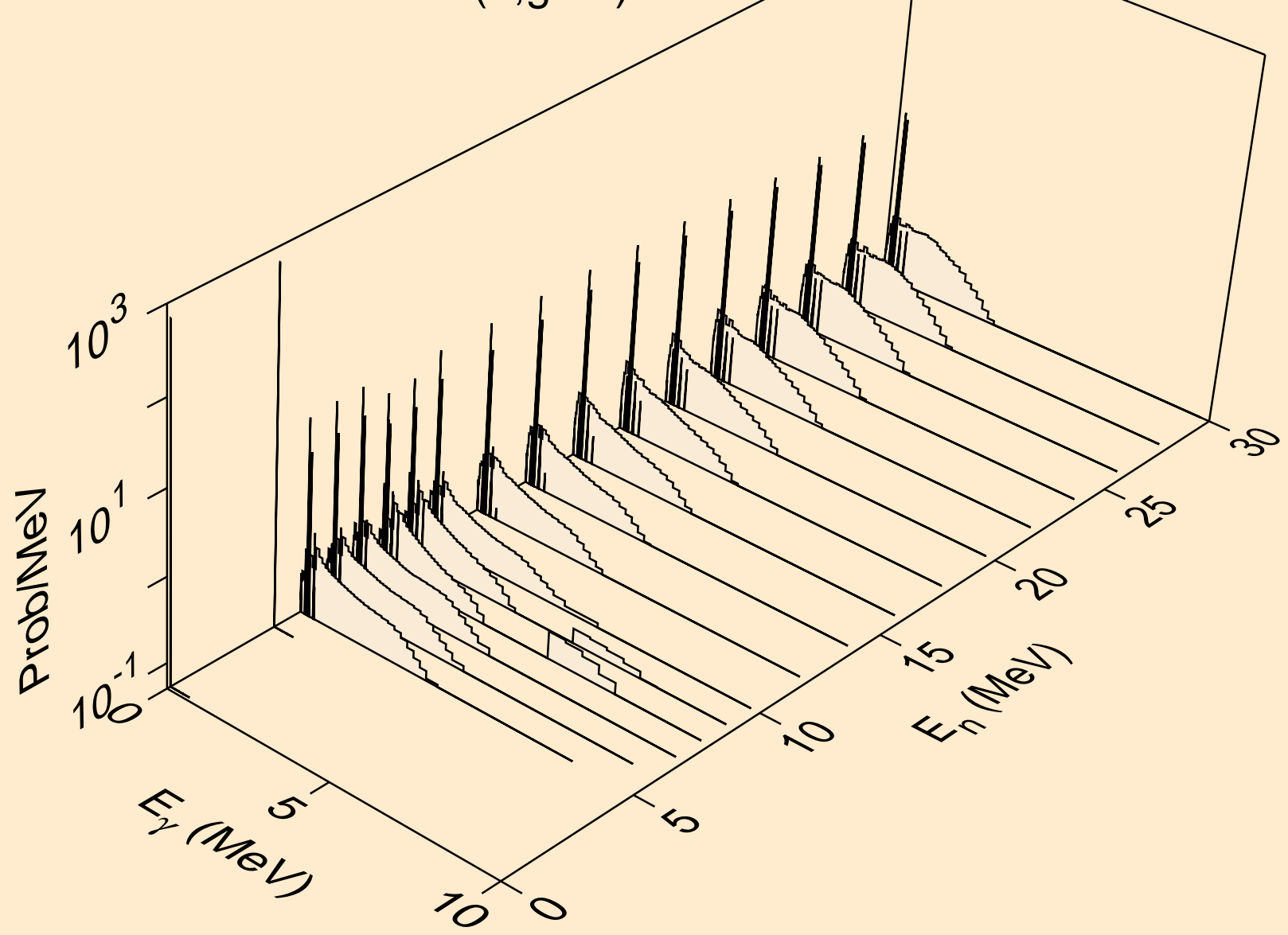

AG108M ALPHA ACER TENDL-2021 LIBRARY; T=0.K
Photon emission for (n,p)

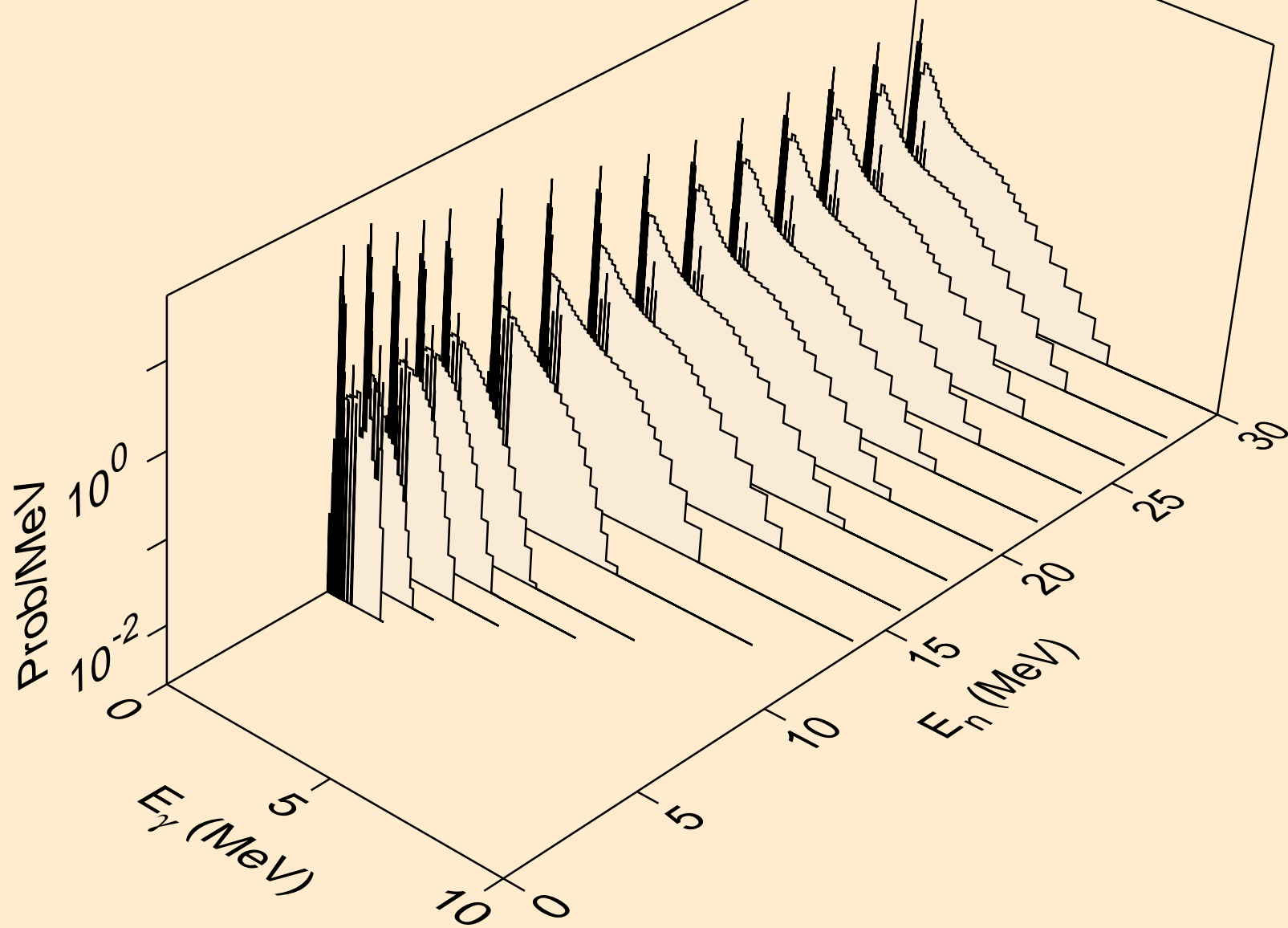

AG108M ALPHA ACER TENDL-2021 LIBRARY; T=0.K
Photon emission for (n,d)

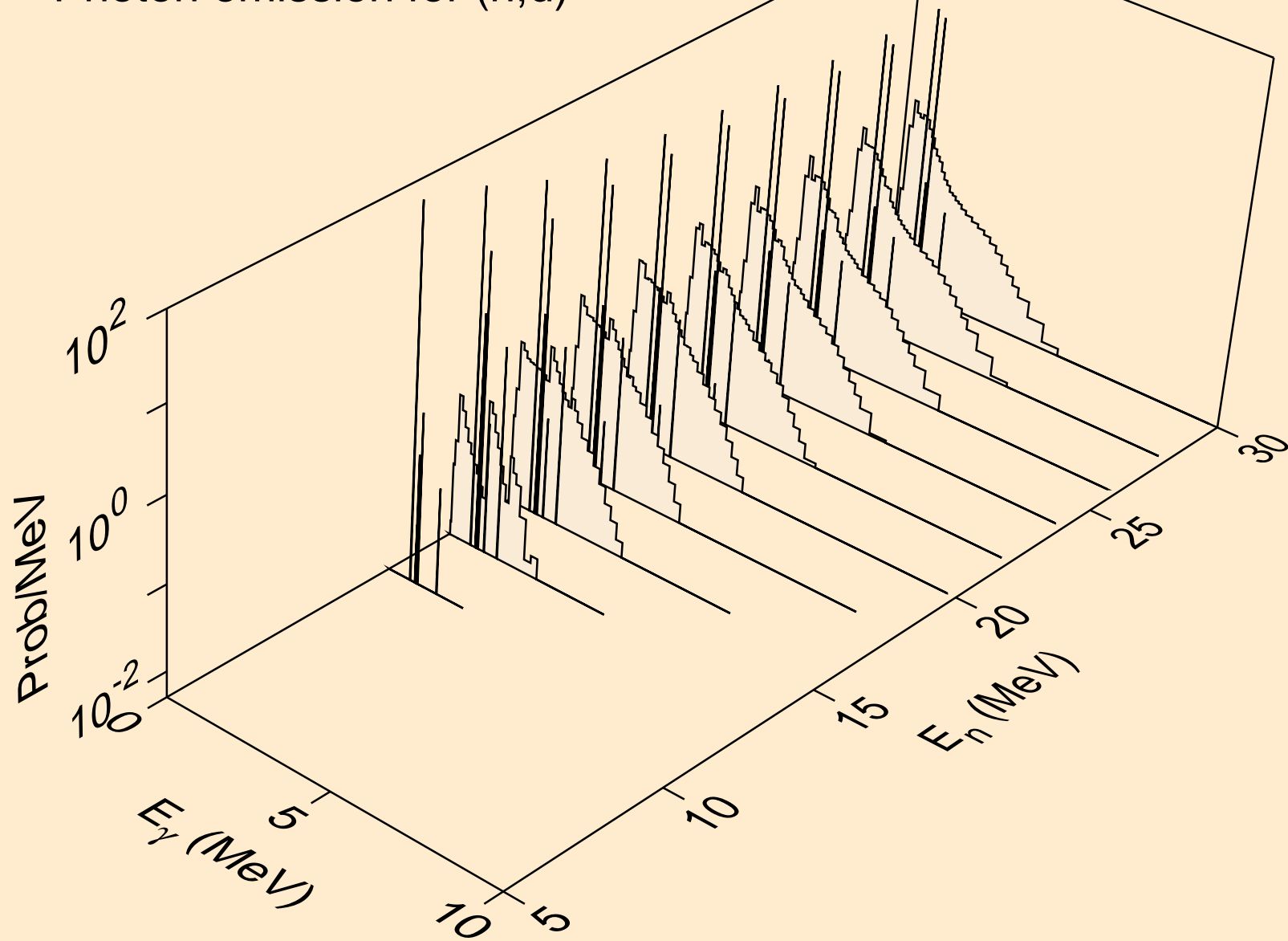

AG108M ALPHA ACER TENDL-2021 LIBRARY; T=0.K
Photon emission for (n,t)

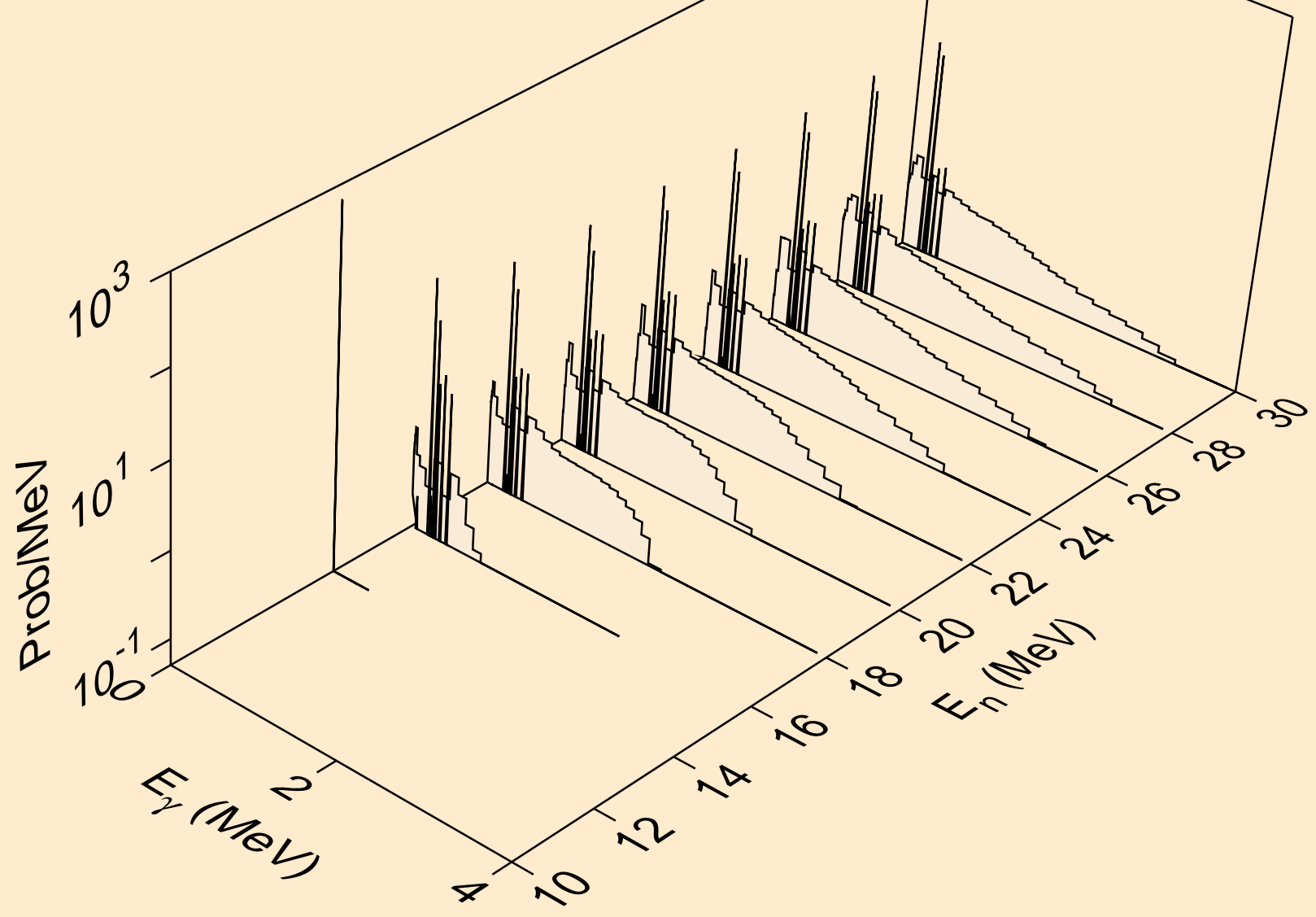

AG108M ALPHA ACER TENDL-2021 LIBRARY; T=0.K
Photon emission for (n,he3)

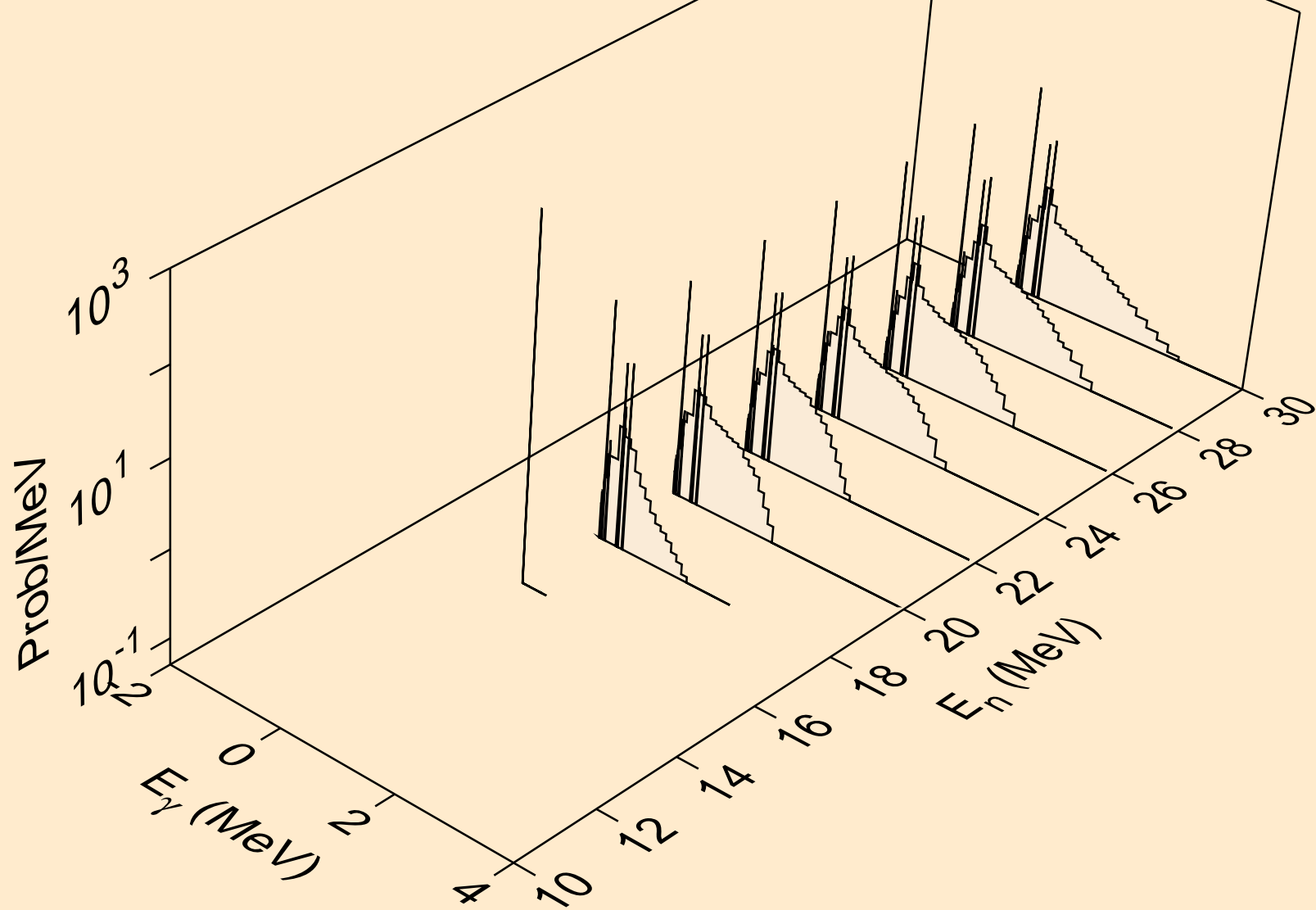

AG108M ALPHA ACER TENDL-2021 LIBRARY; T=0.K
Photon emission for inelastic

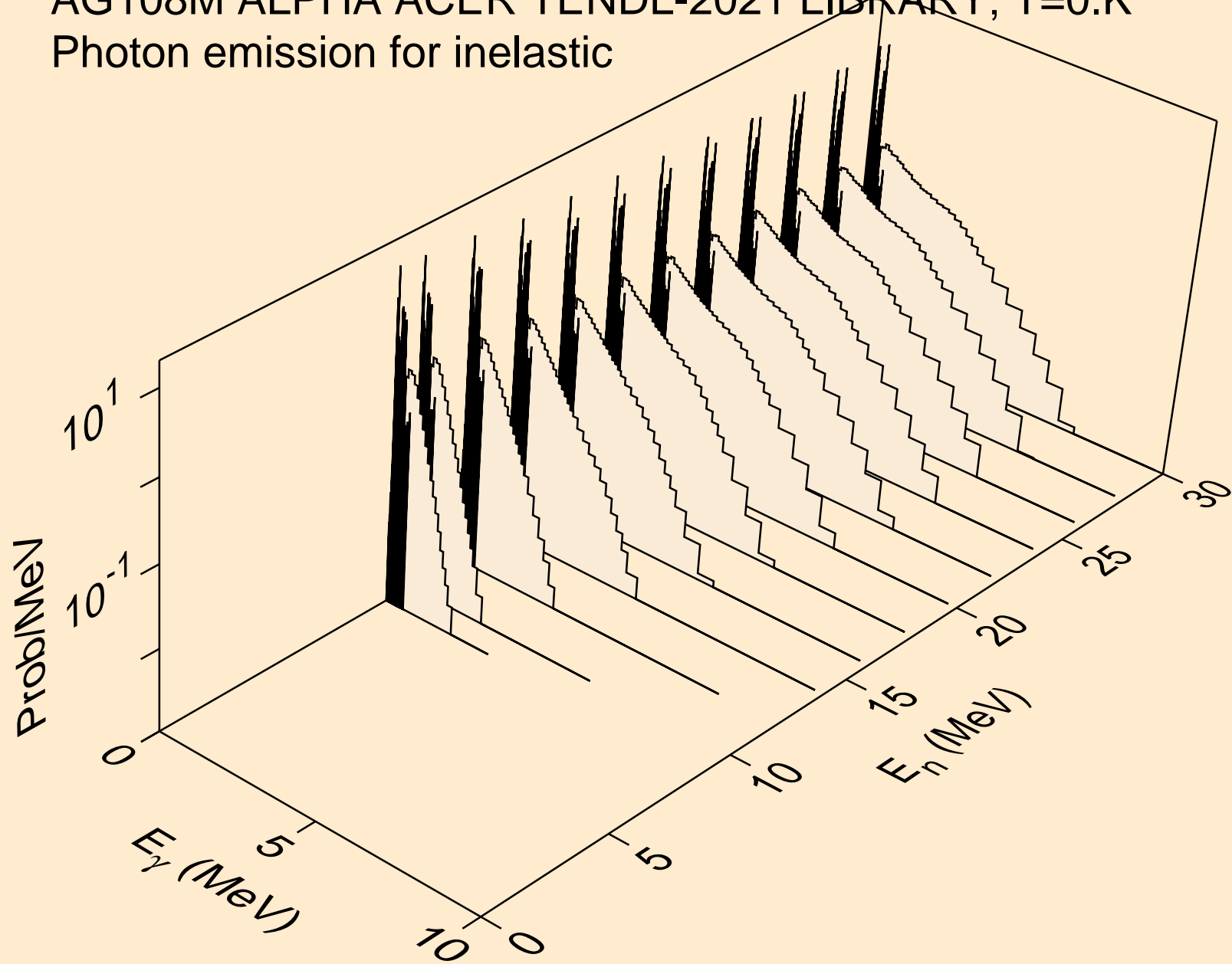

AG108M ALPHA ACER TENDL-2021 LIBRARY; T=0.K
Photon emission for (n,2a)

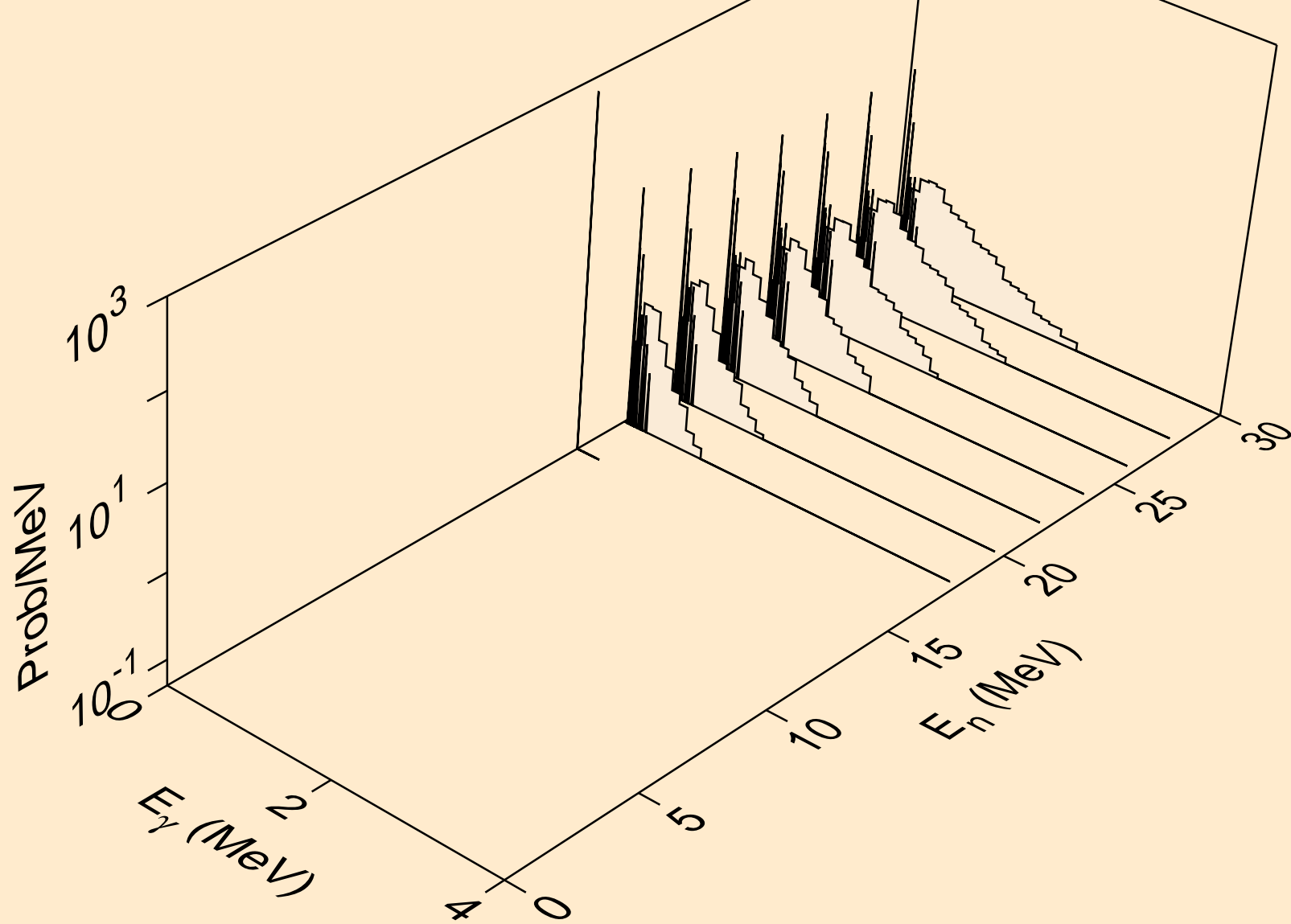

AG108M ALPHA ACER TENDL-2021 LIBRARY; T=0.K
Photon emission for (n,2p)

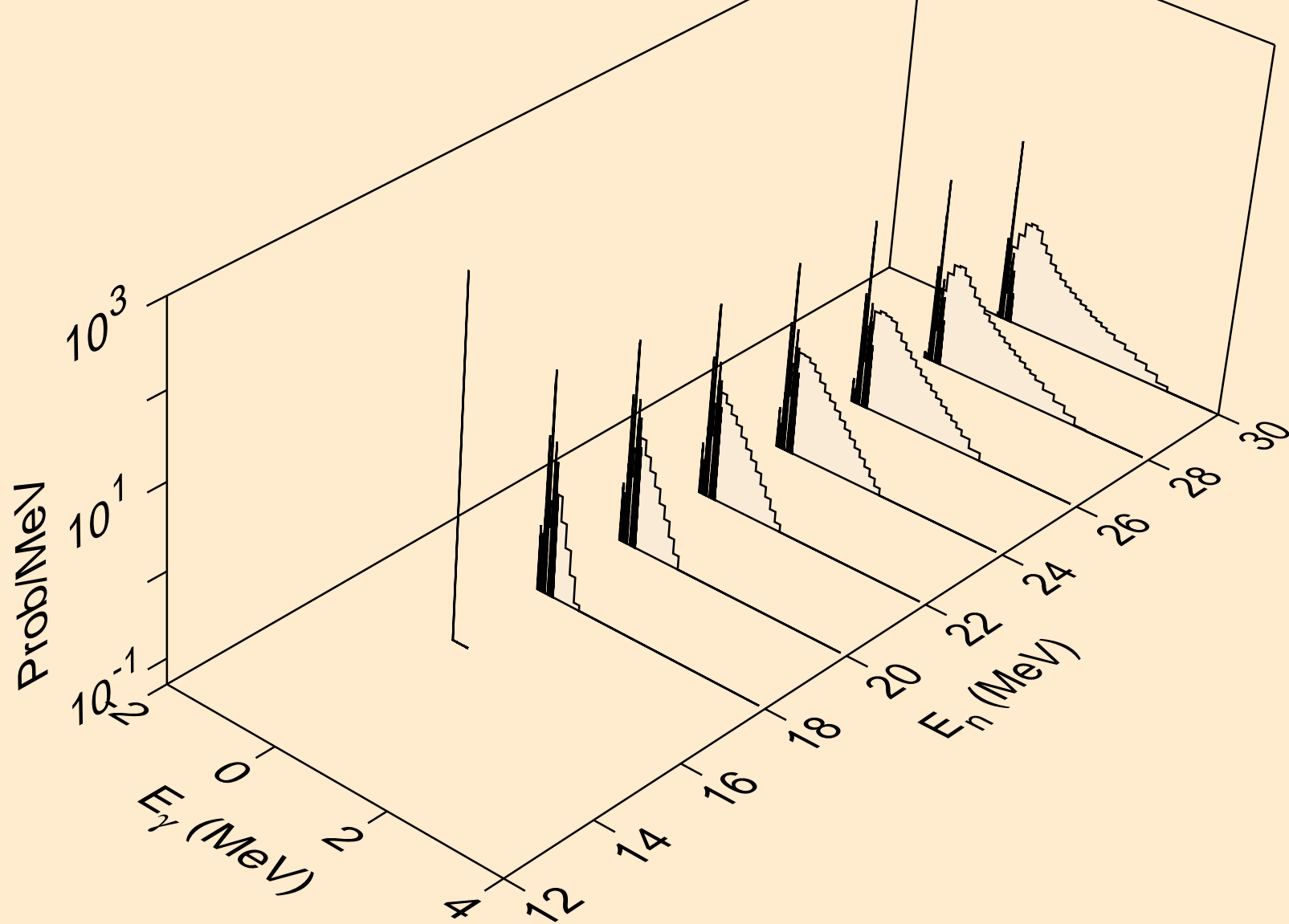

AG108M ALPHA ACER TENDL-2021 LIBRARY; T=0.K
Photon emission for (n,pa)

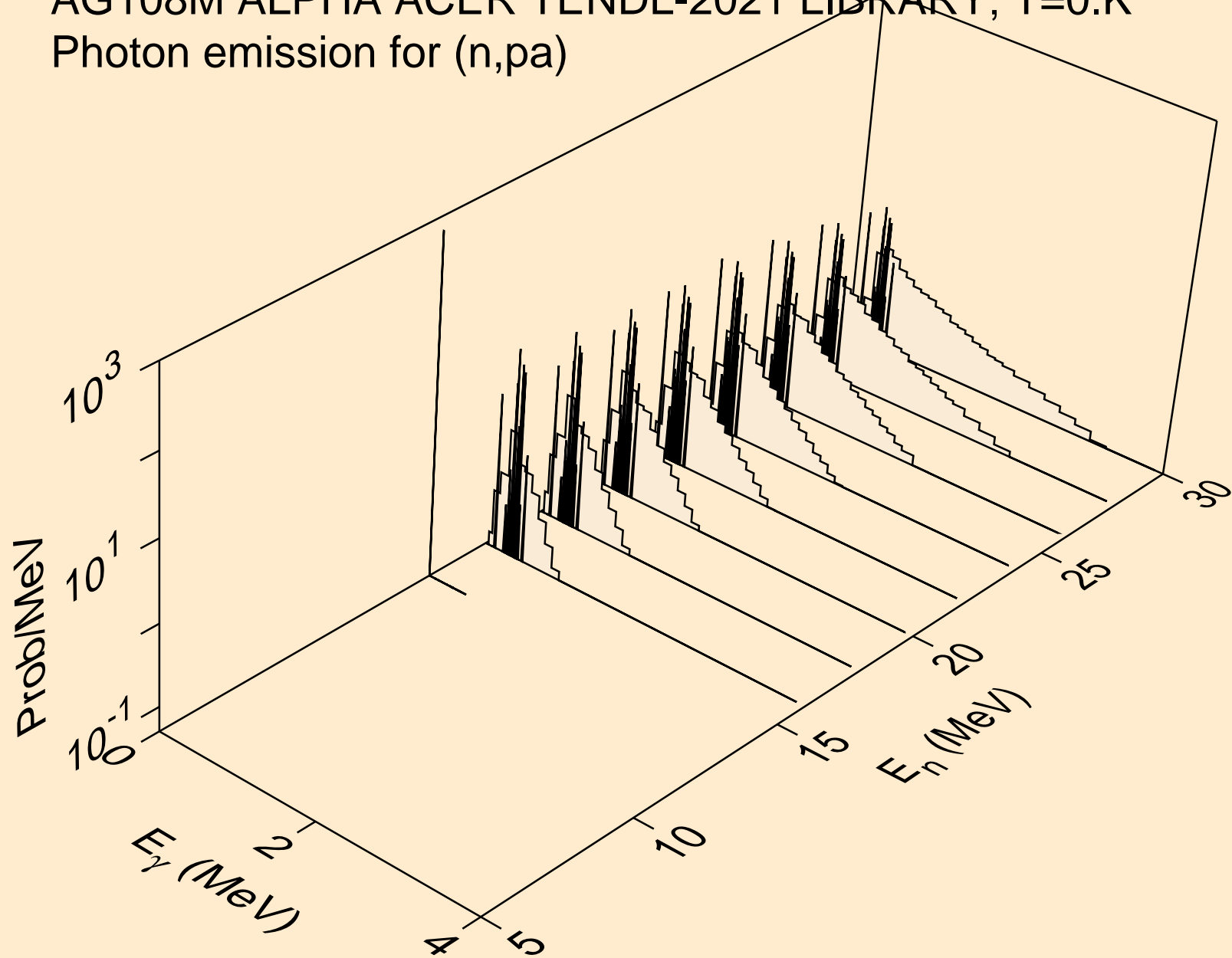

AG108M ALPHA ACER TENDL-2021 LIBRARY; T=0.K
Photon emission for (n,pd)

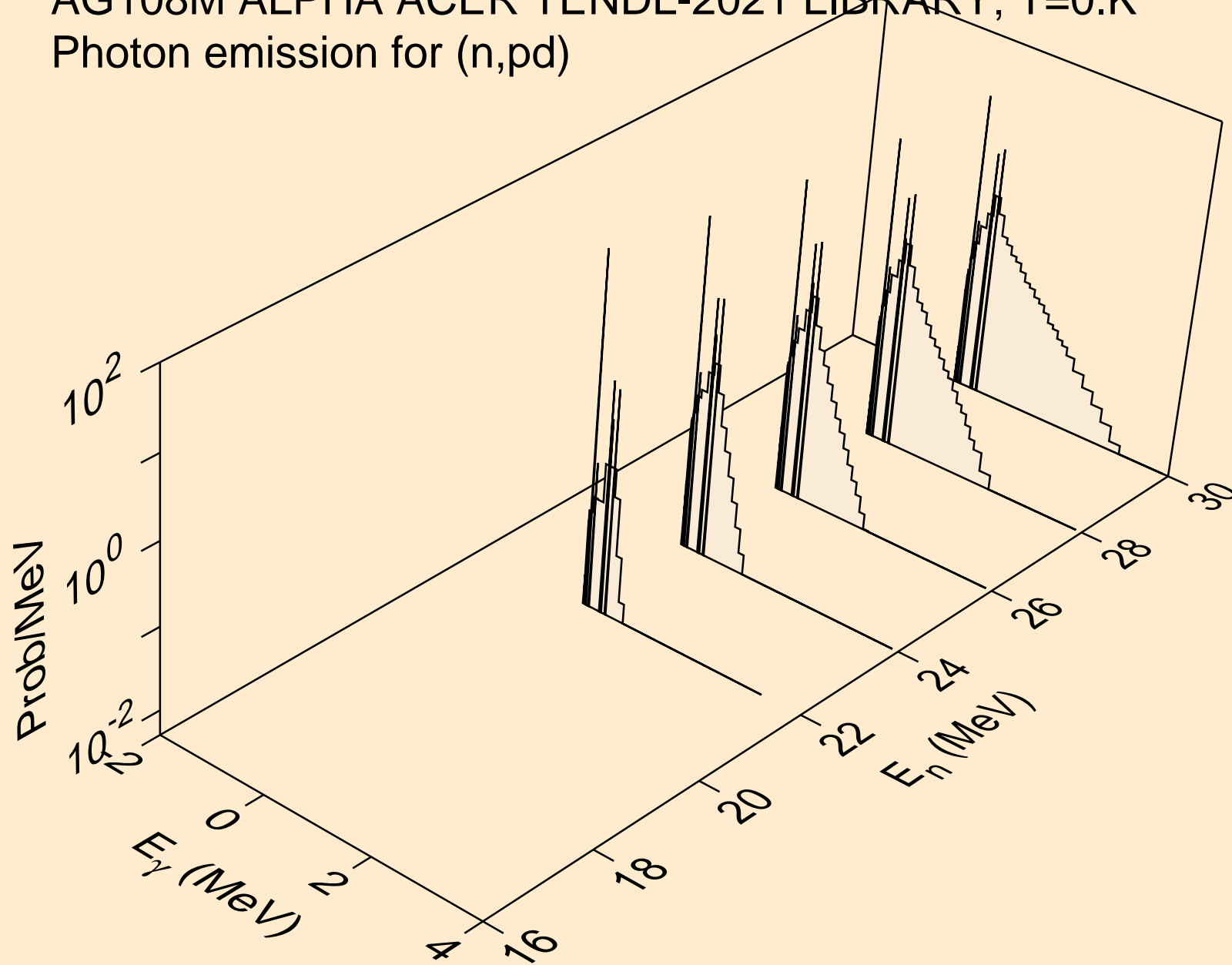

AG108M ALPHA ACER TENDL-2021 LIBRARY; T=0.K
Photon emission for (n,pt)

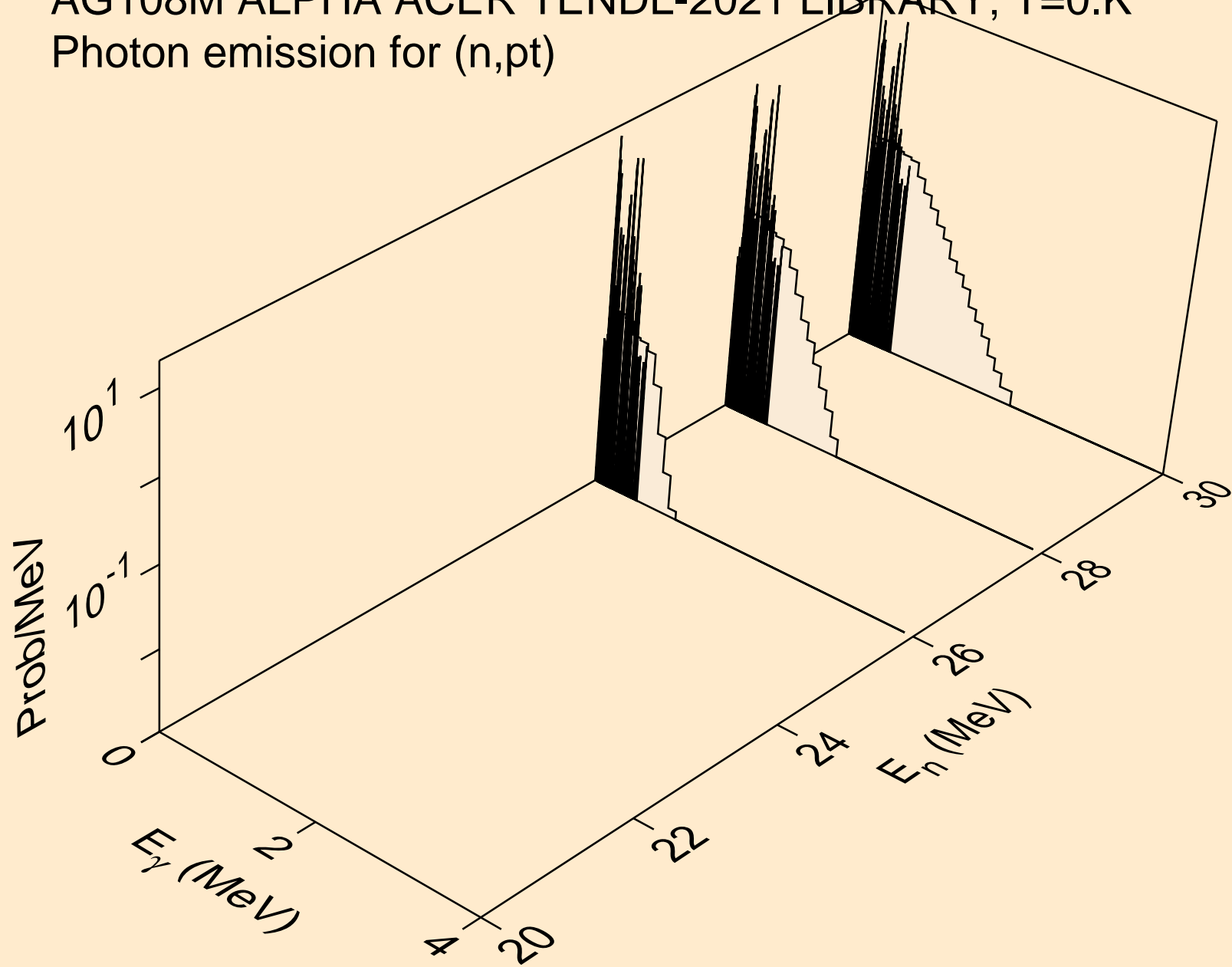

AG108M ALPHA ACER TENDL-2021 LIBRARY; T=0.K
Photon emission for (n,da)

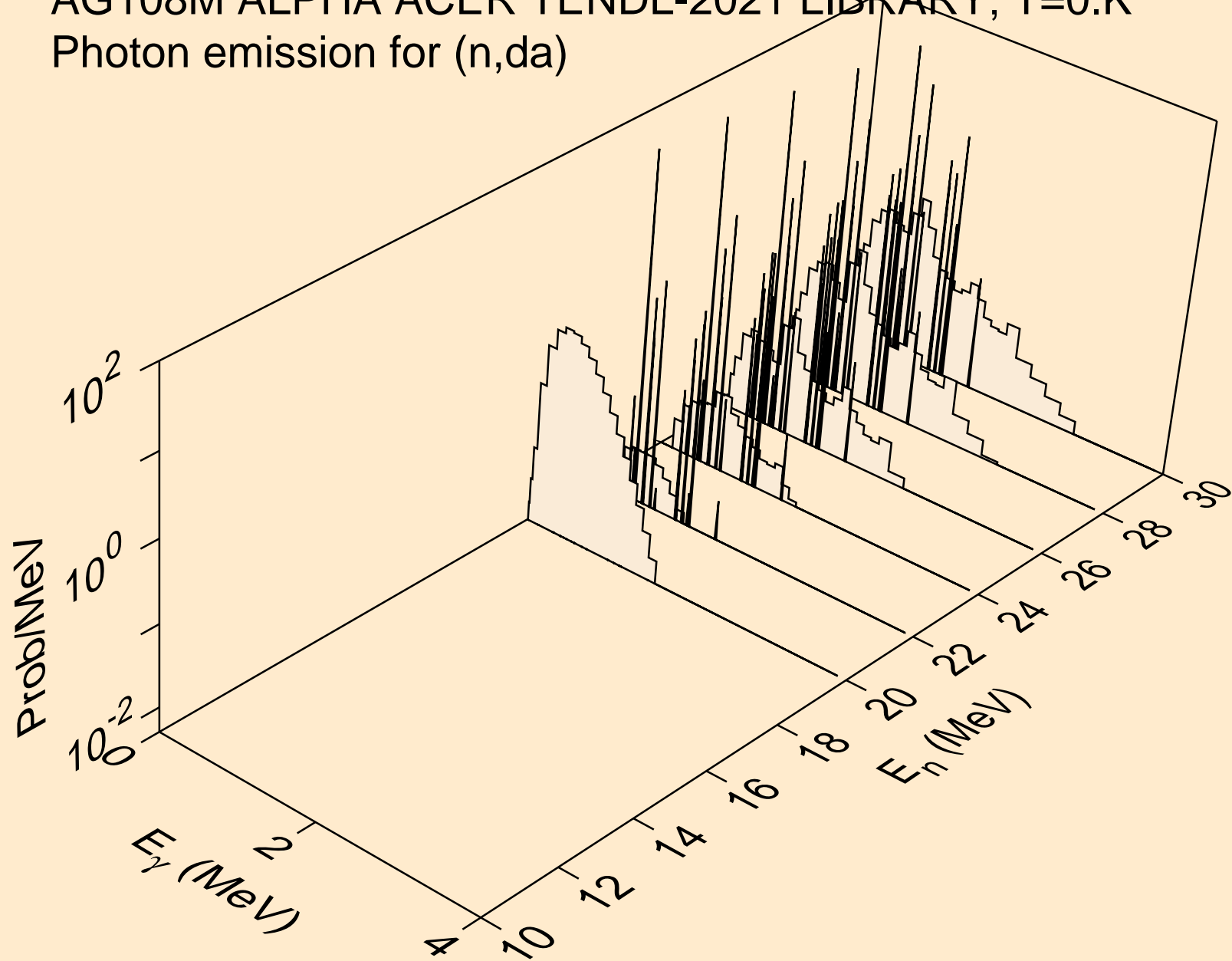

AG108M ALPHA ACER TENDL-2021 LIBRARY; T=0.K
Particle heating contributions

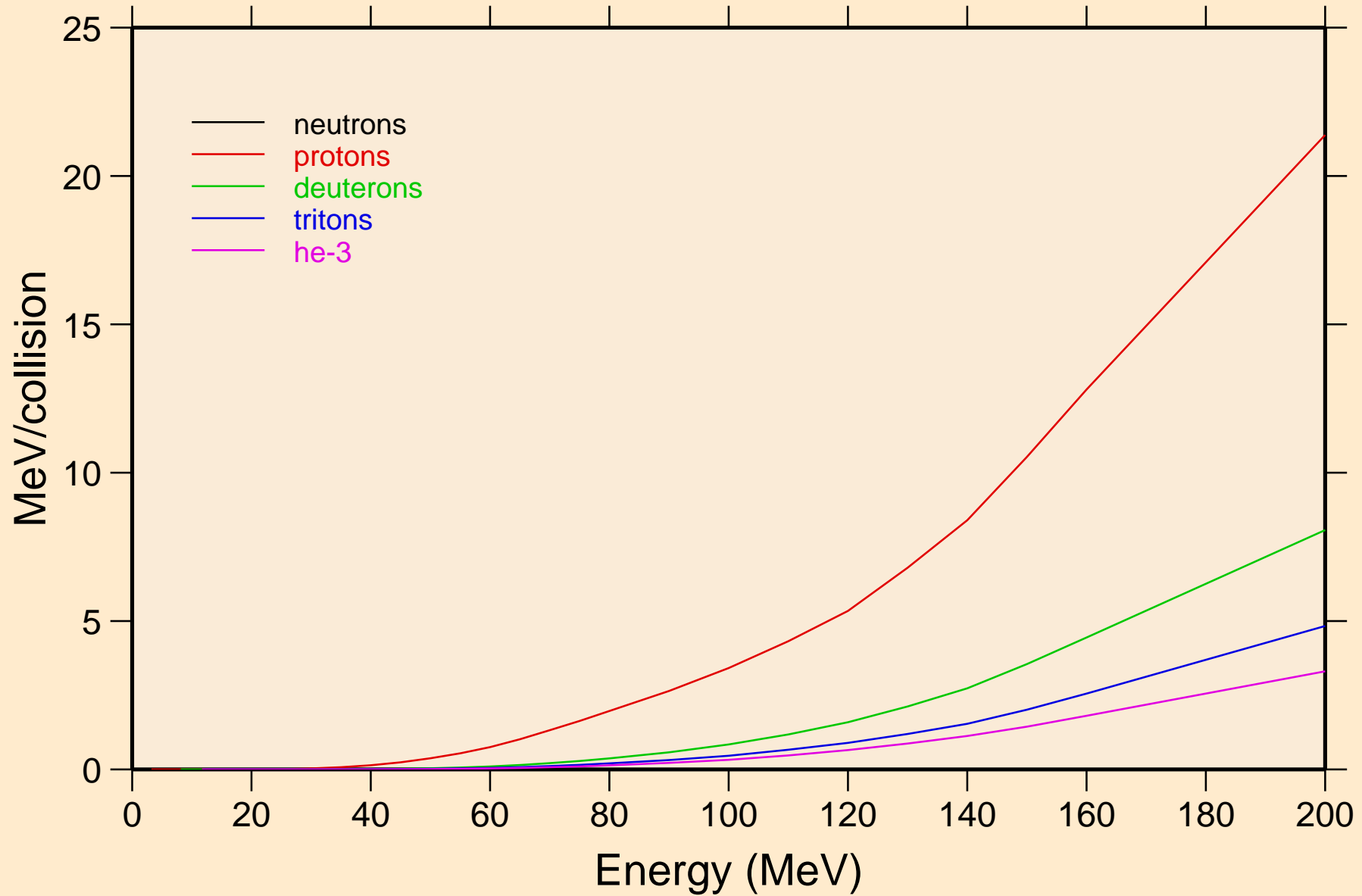

AG108M ALPHA ACER TENDL-2021 LIBRARY; T=0.K

Recoil Heating

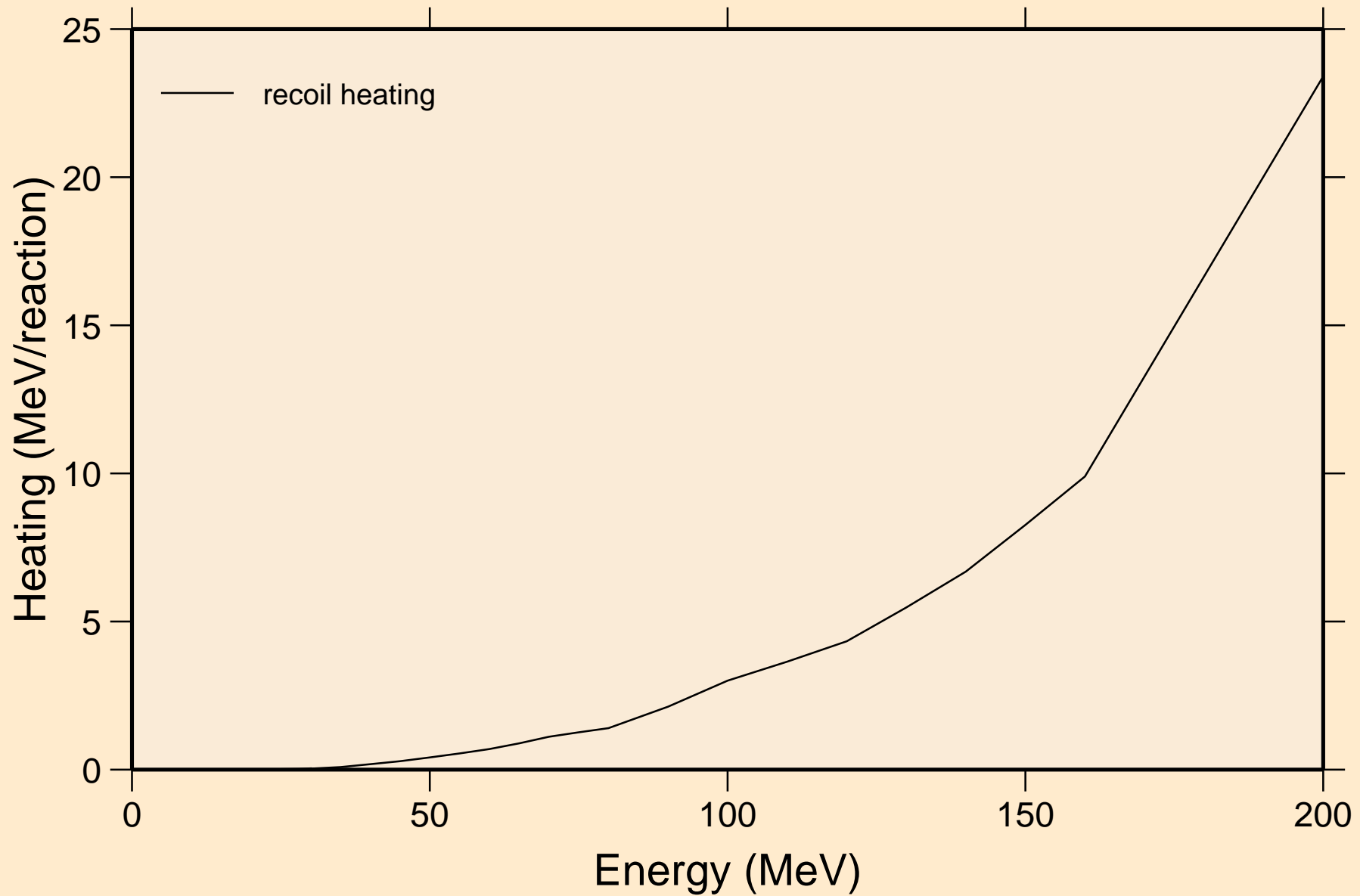

AG108M ALPHA ACER TENDL-2021 LIBRARY; T=0.K
Particle production cross sections

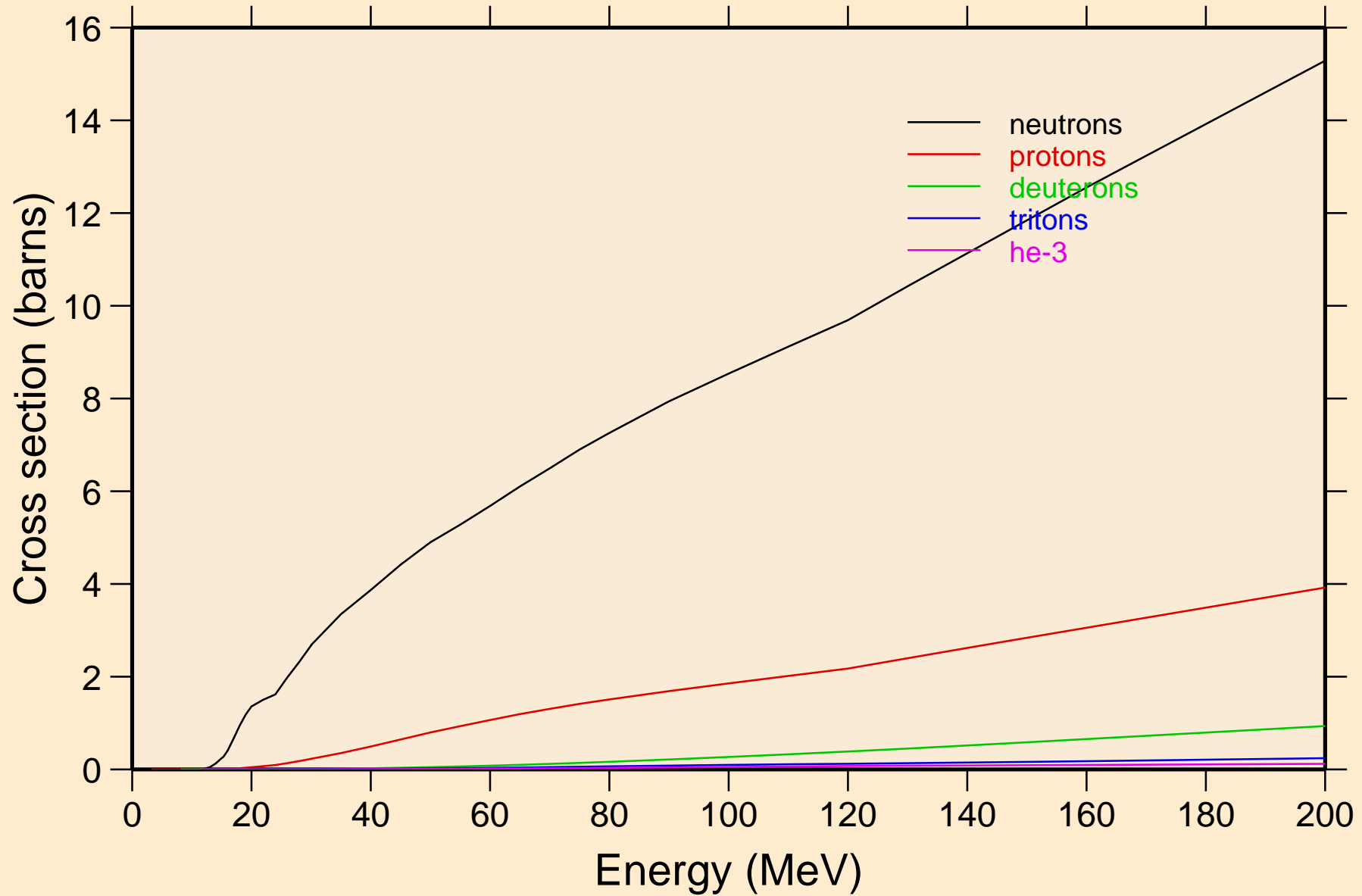

AG108M ALPHA ACER TENDL-2021 LIBRARY; T=0.K
neutrons from (a,n)

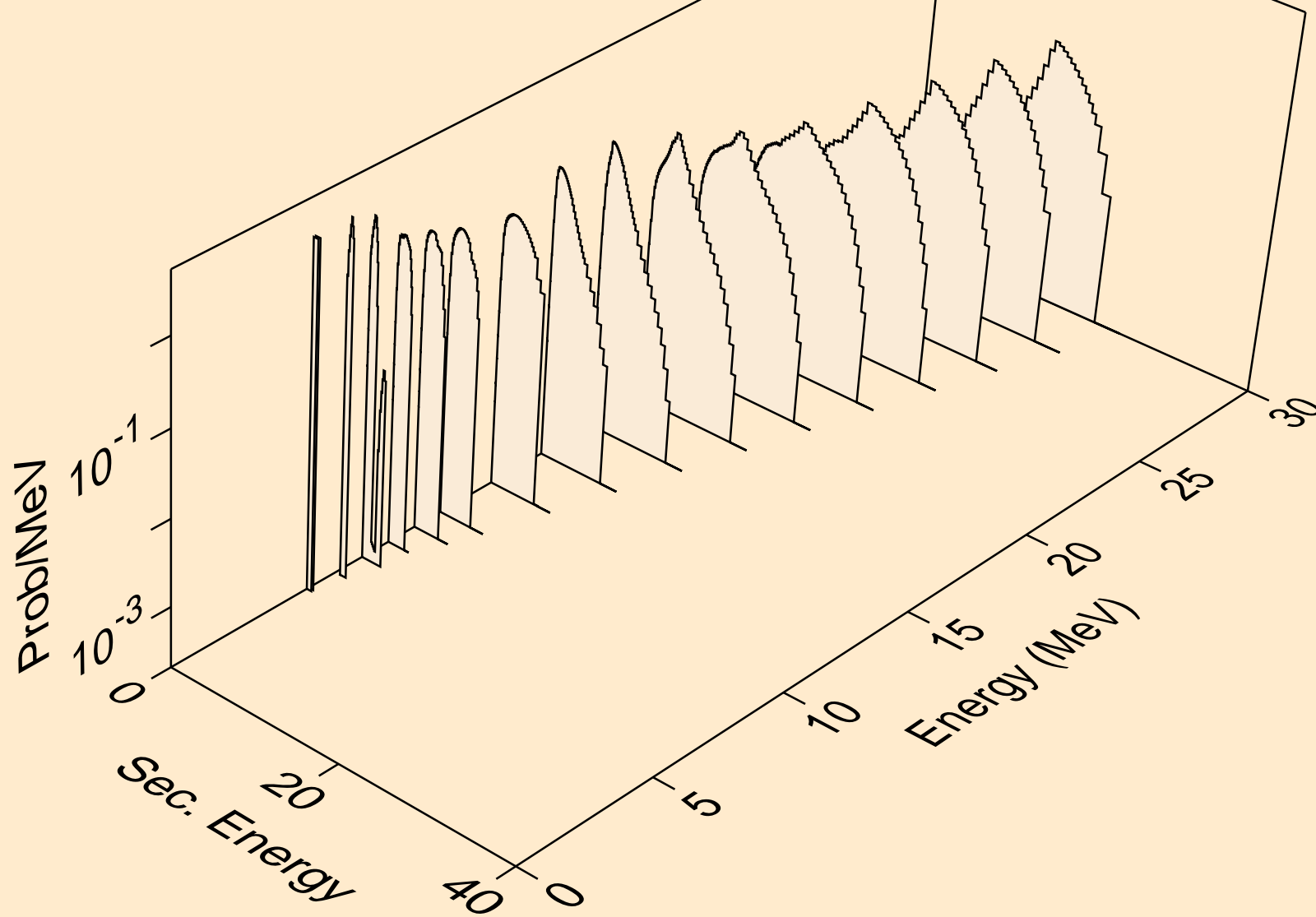

AG108M ALPHA ACER TENDL-2021 LIBRARY; T=0.K
neutrons from (a,x)

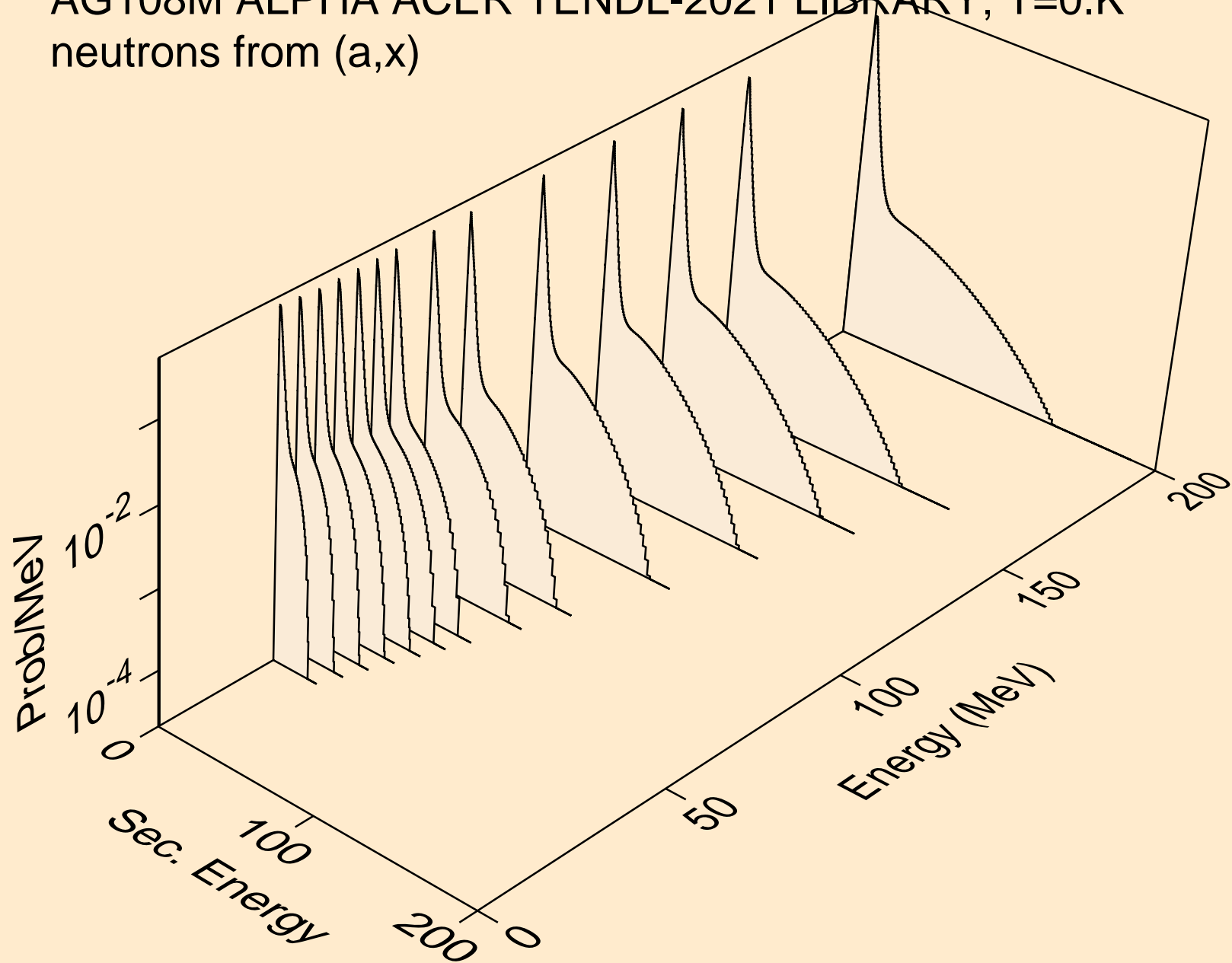

AG108M ALPHA ACER TENDL-2021 LIBRARY; T=0.K
neutrons from (a,2nd)

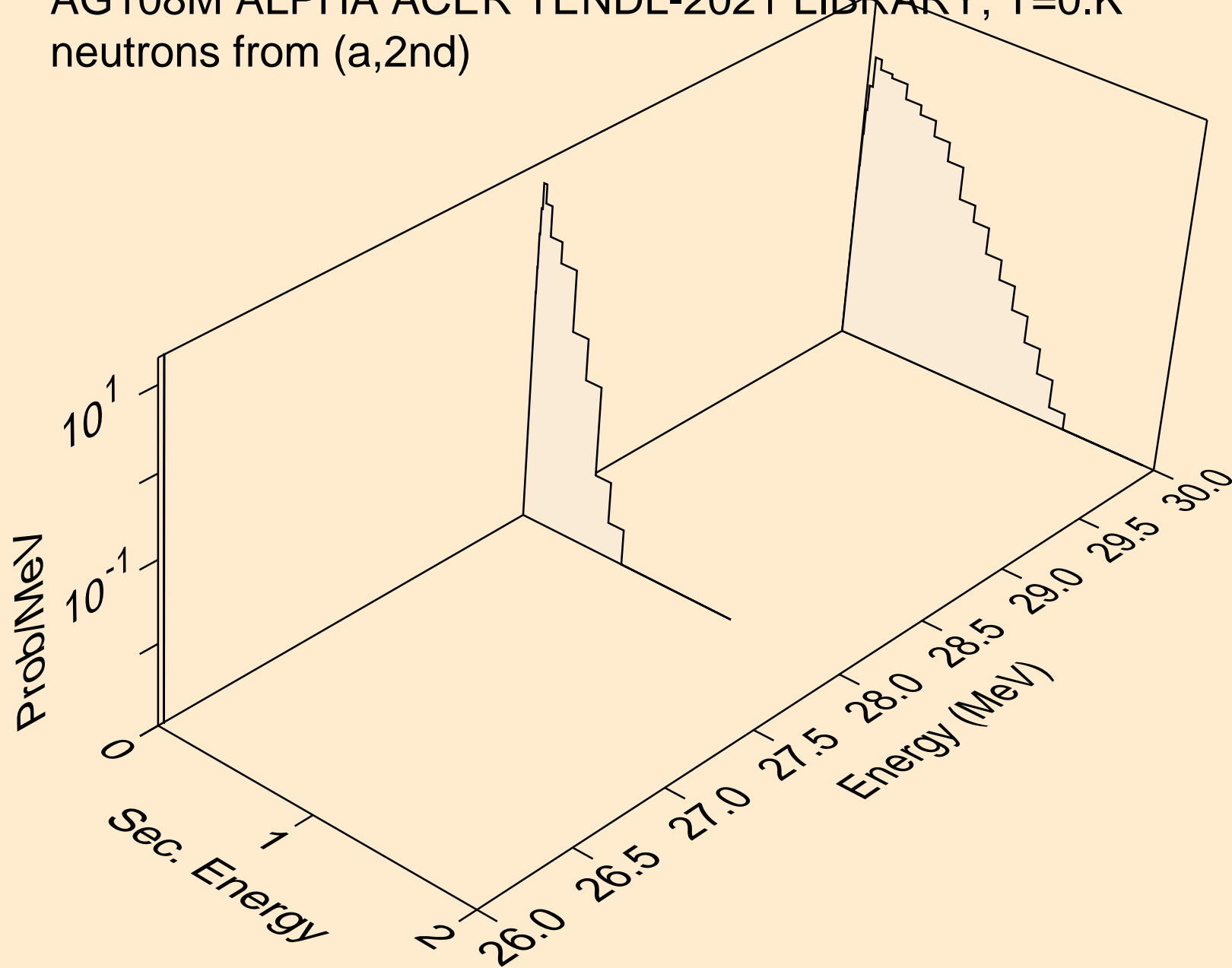

AG108M ALPHA ACER TENDL-2021 LIBRARY; T=0.K
neutrons from (a,2n)

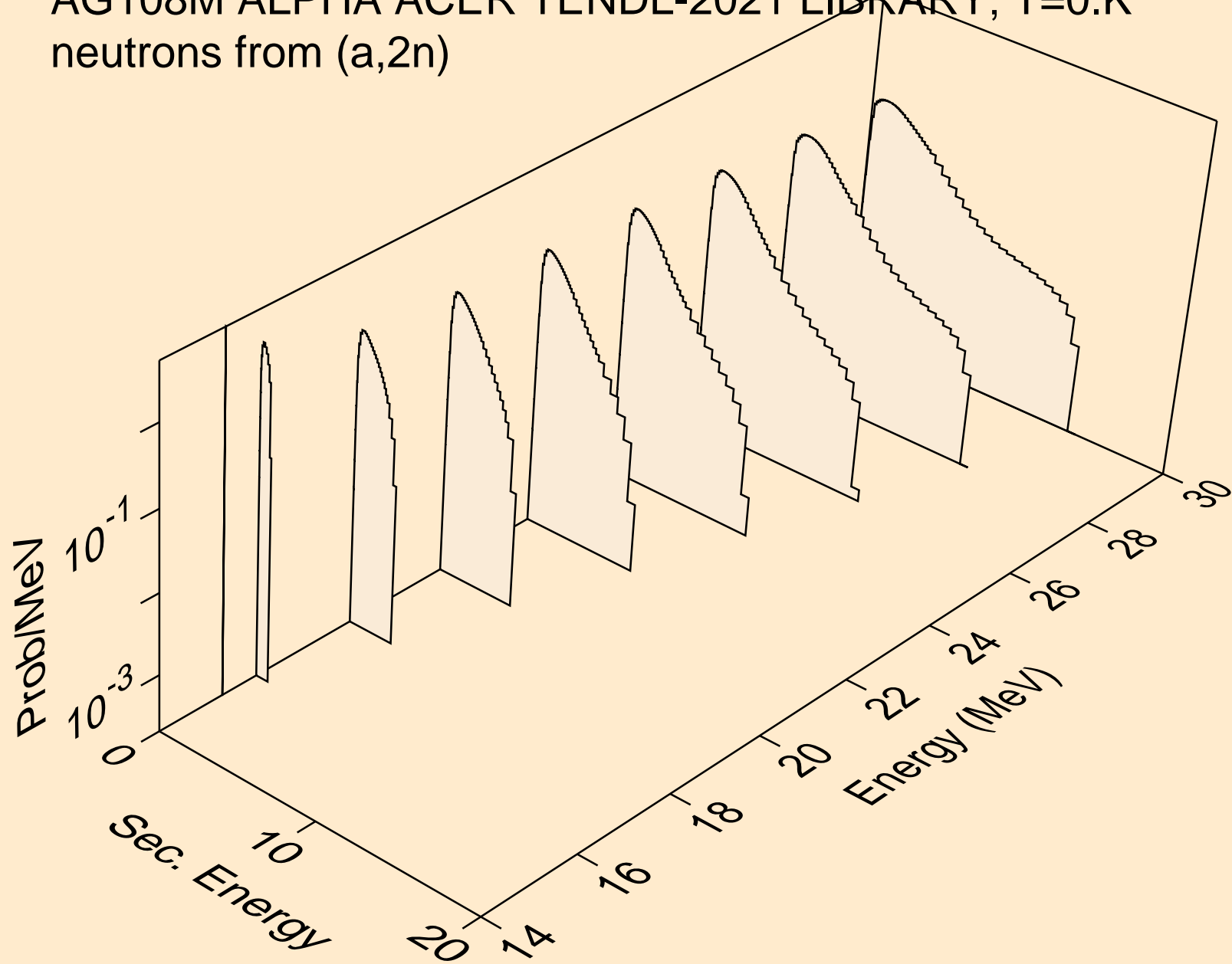

AG108M ALPHA ACER TENDL-2021 LIBRARY; T=0.K
neutrons from (a,3n)

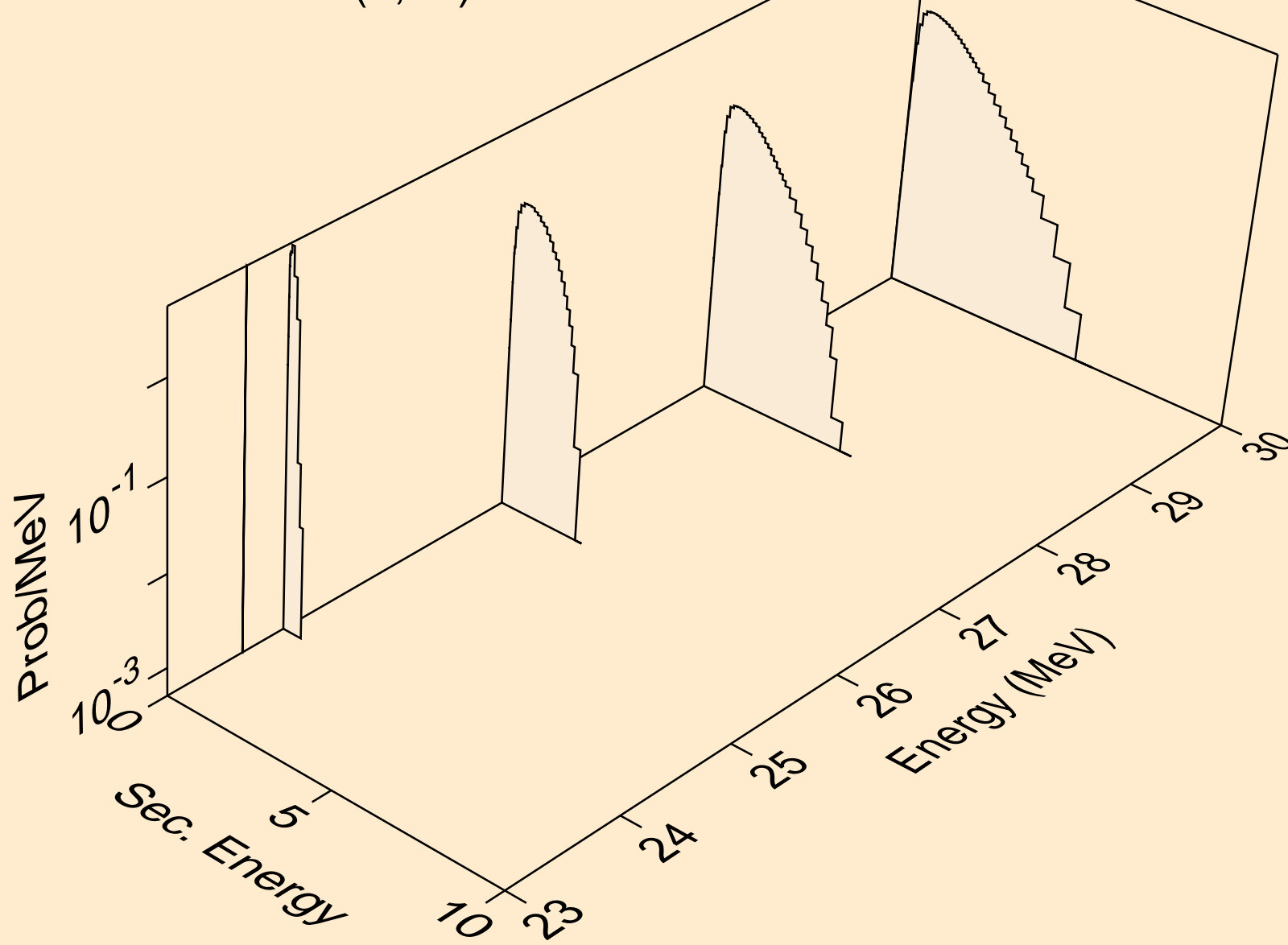

AG108M ALPHA ACER TENDL-2021 LIBRARY; T=0.K
neutrons from (a,n*)a

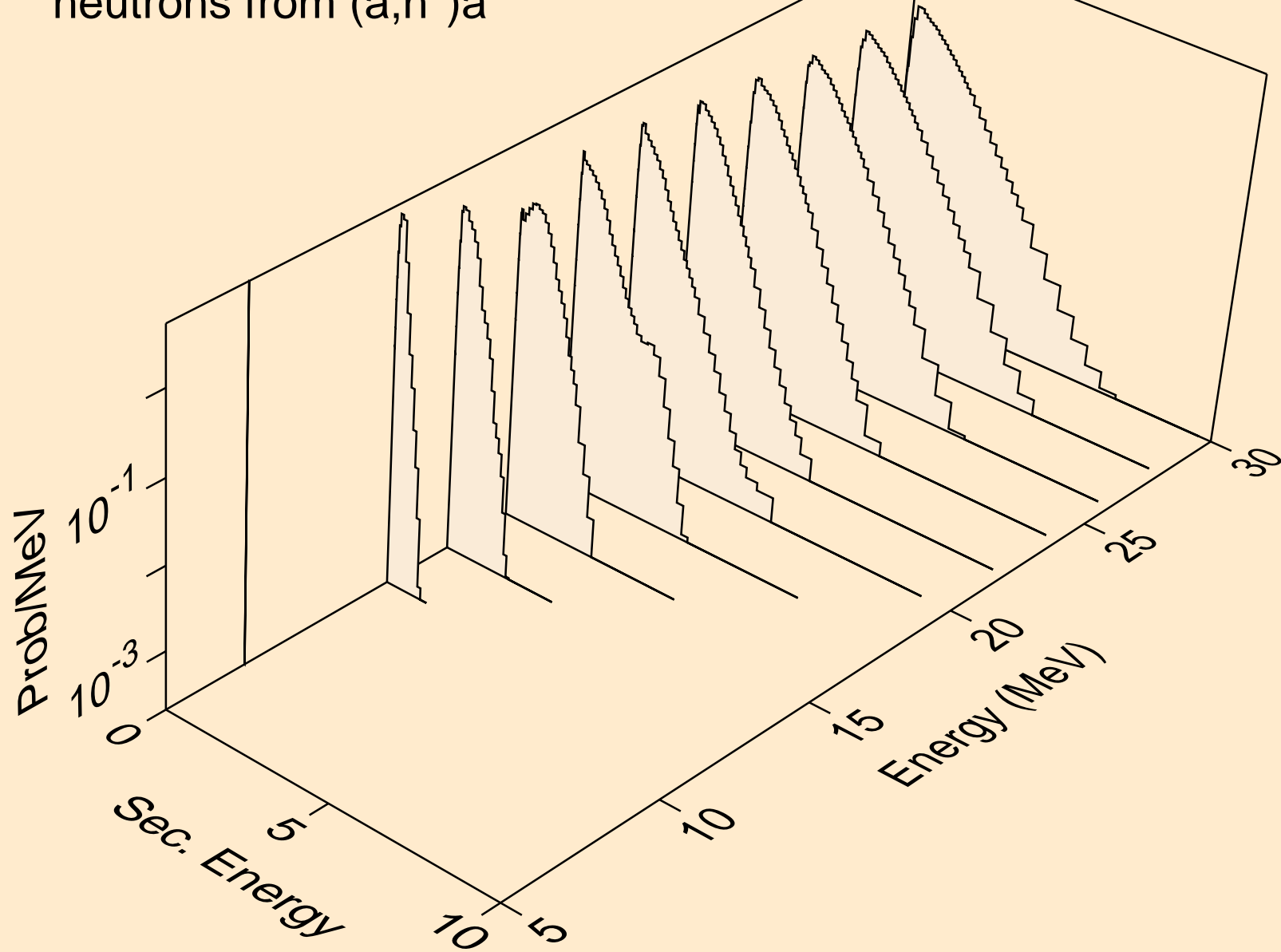

AG108M ALPHA ACER TENDL-2021 LIBRARY; T=0.K
neutrons from (a,2n)a

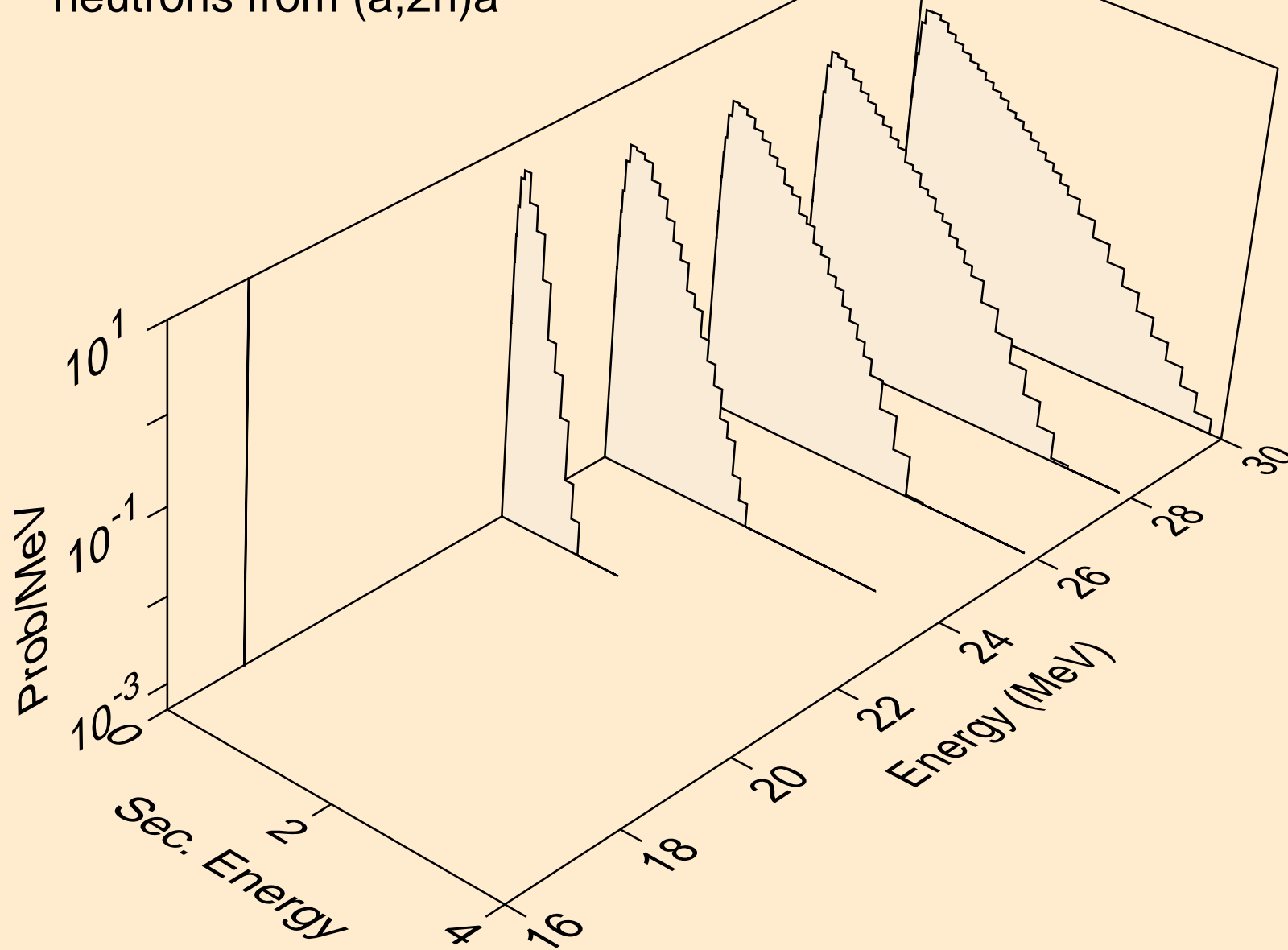

AG108M ALPHA ACER TENDL-2021 LIBRARY; T=0.K
neutrons from (a,n*)p

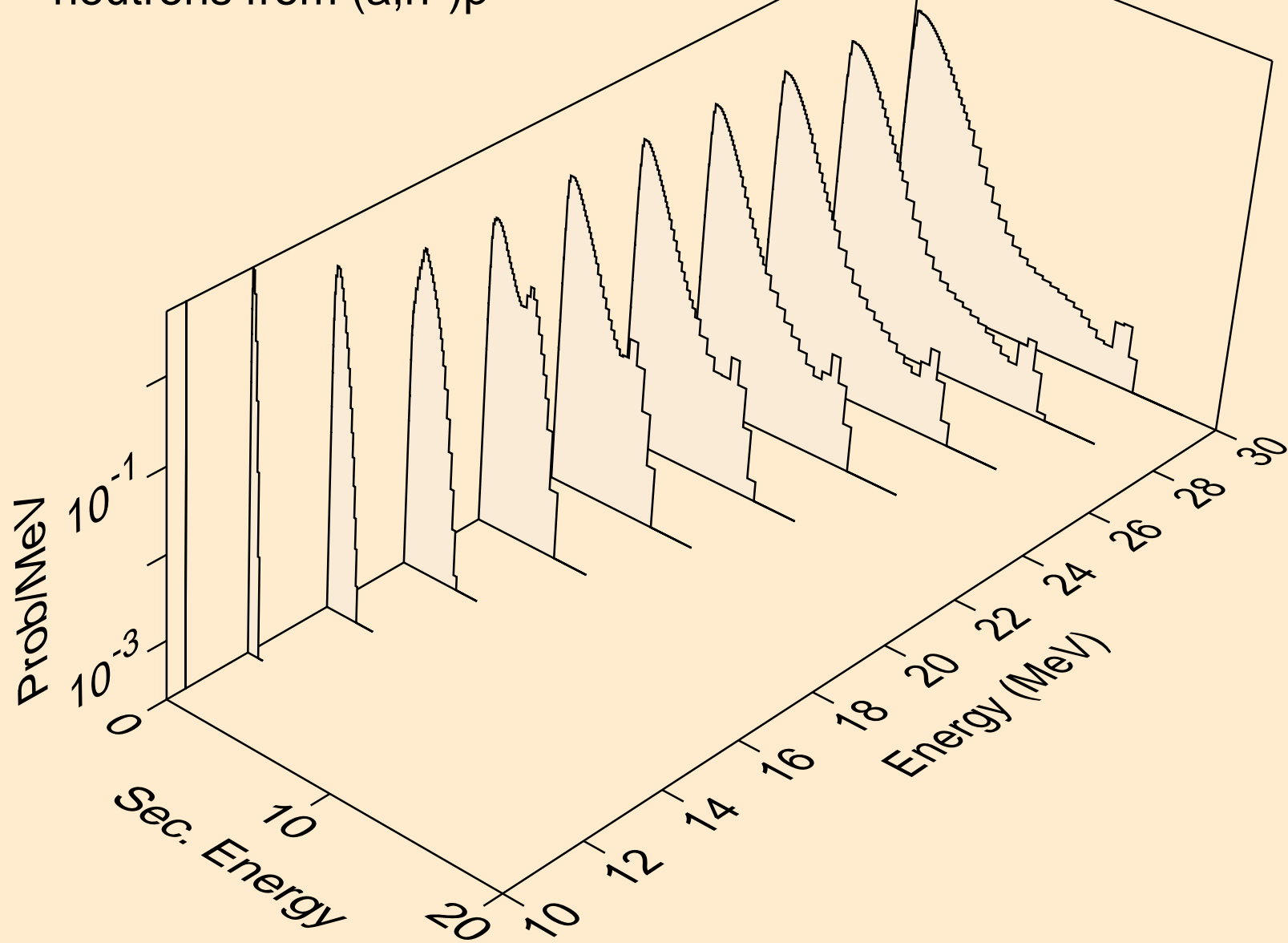

AG108M ALPHA ACER TENDL-2021 LIBRARY; T=0.K
neutrons from (a,n*)d

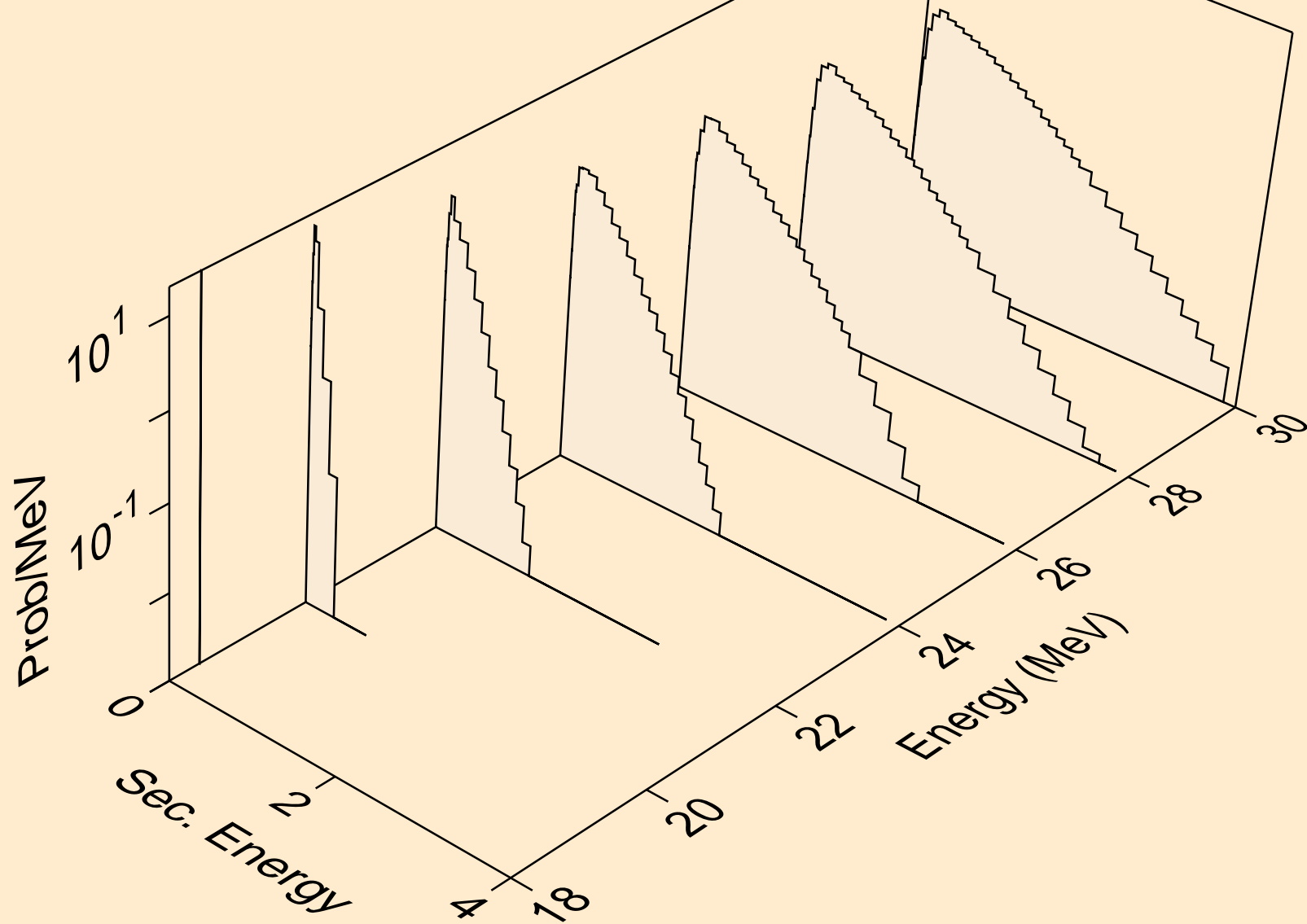

AG108M ALPHA ACER TENDL-2021 LIBRARY; T=0.K
neutrons from (a,n*)t

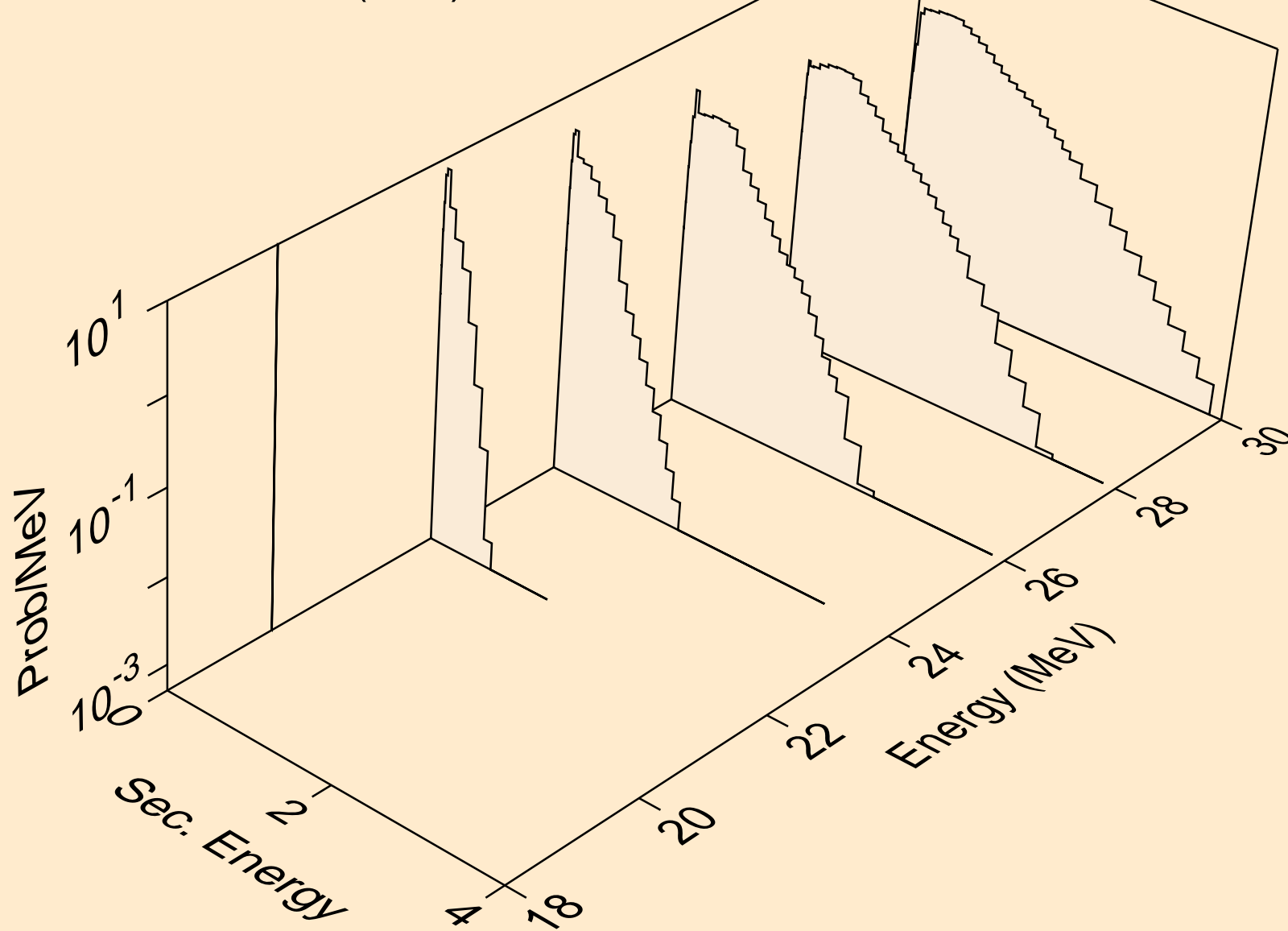

AG108M ALPHA ACER TENDL-2021 LIBRARY; T=0.K
neutrons from (a,n*)he3

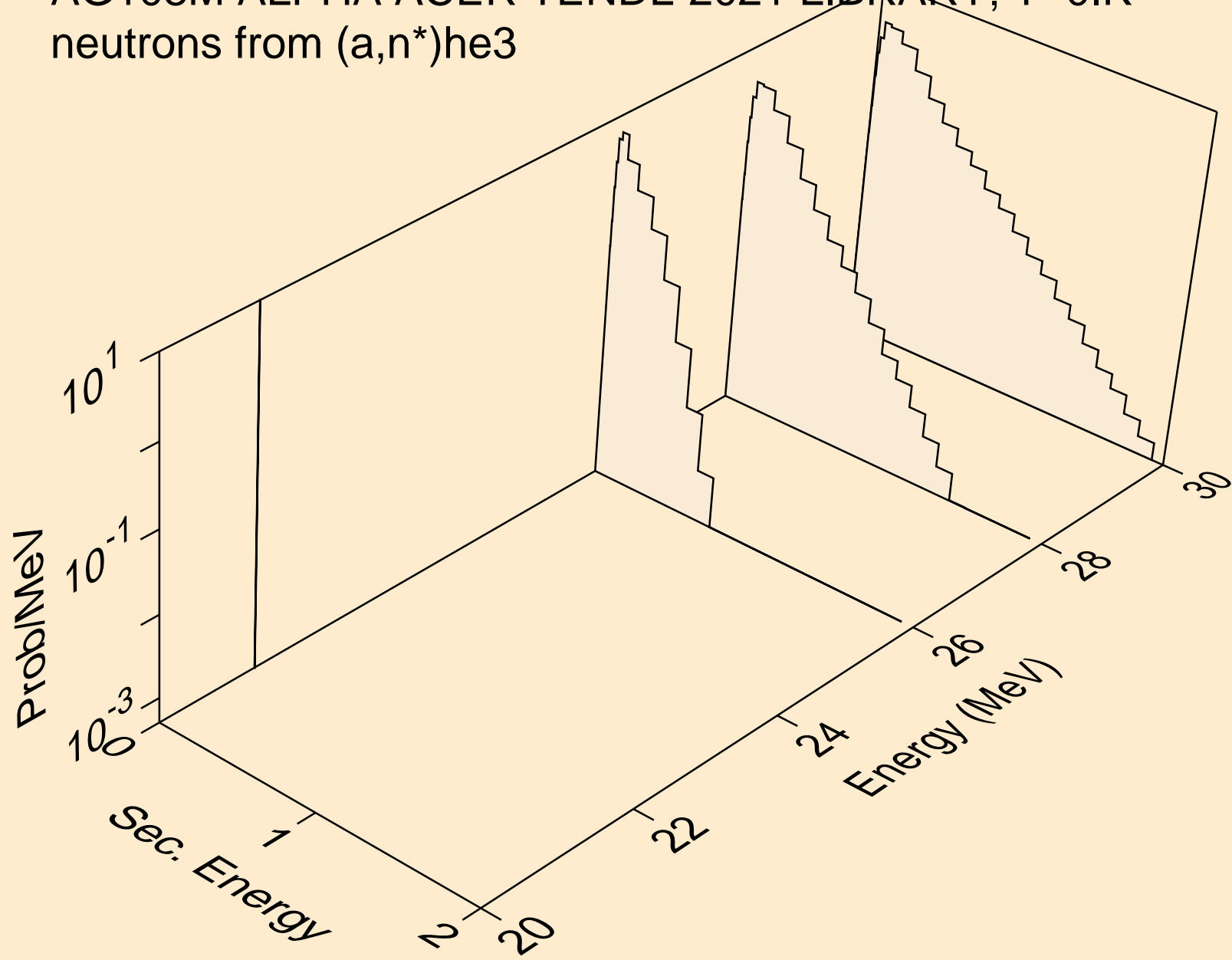

AG108M ALPHA ACER TENDL-2021 LIBRARY; T=0.K
neutrons from (a,2np)

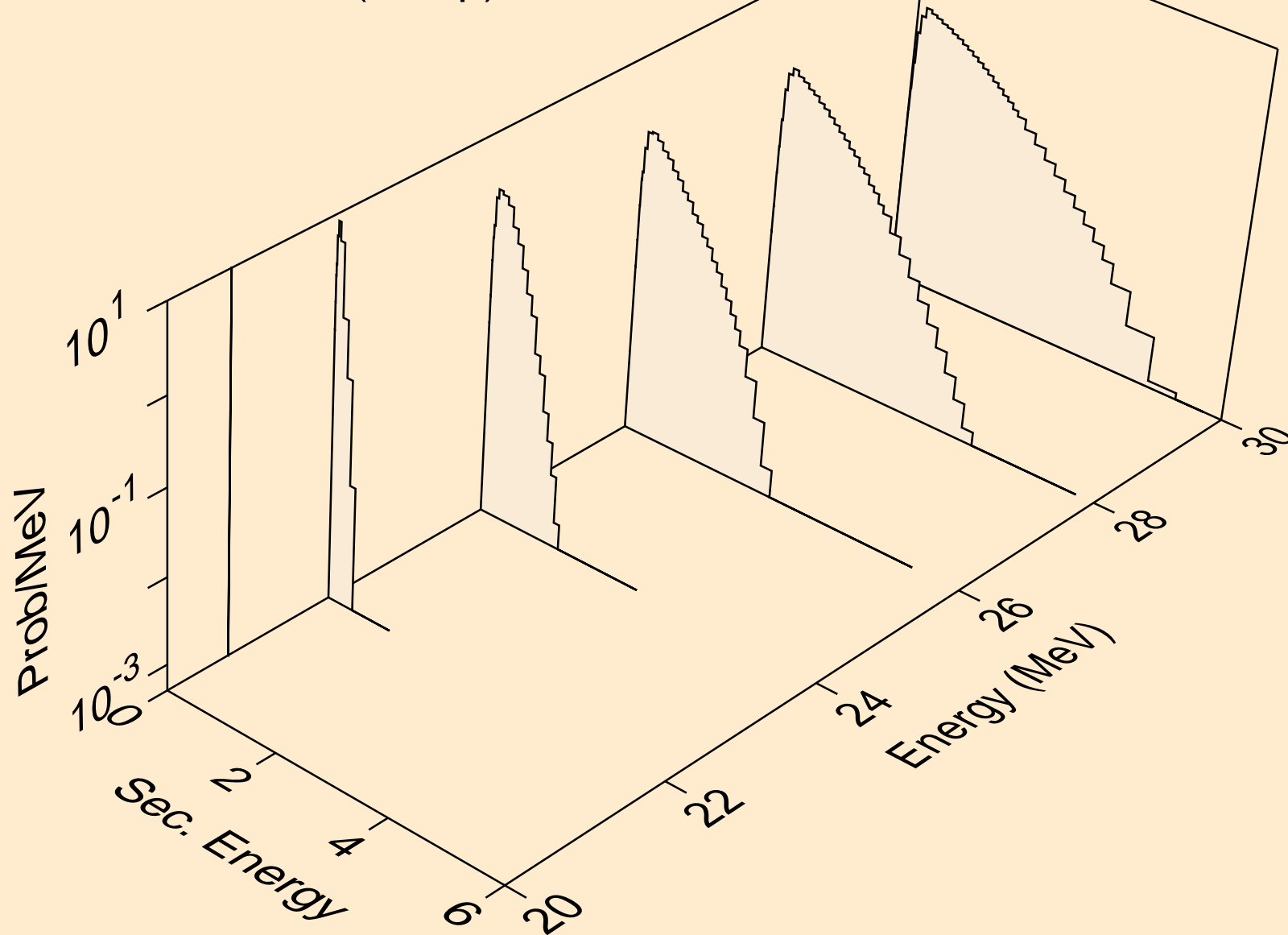

AG108M ALPHA ACER TENDL-2021 LIBRARY; T=0.K
neutrons from (a,2np)

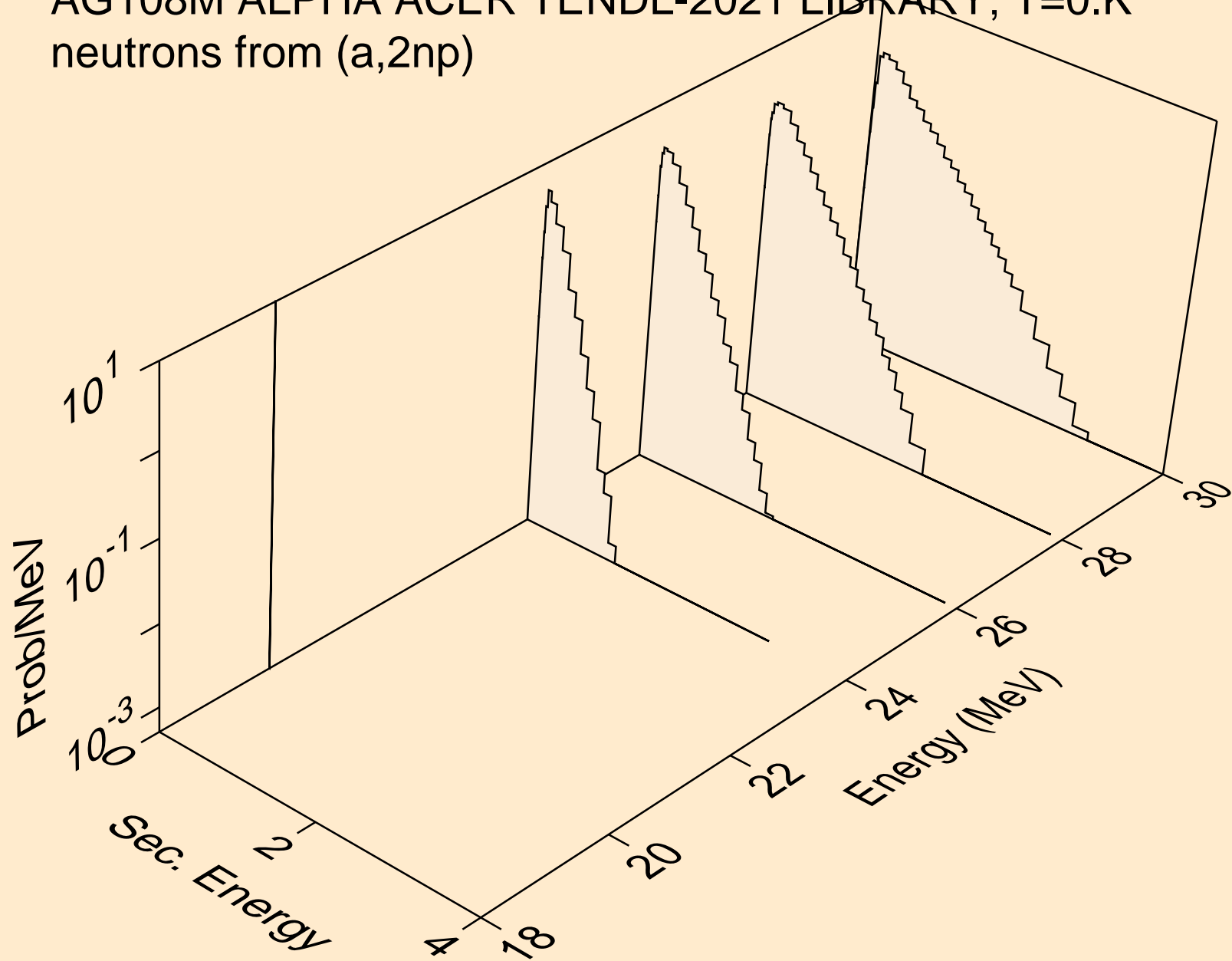

AG108M ALPHA ACER TENDL-2021 LIBRARY; T=0.K
neutrons from (a,npa)

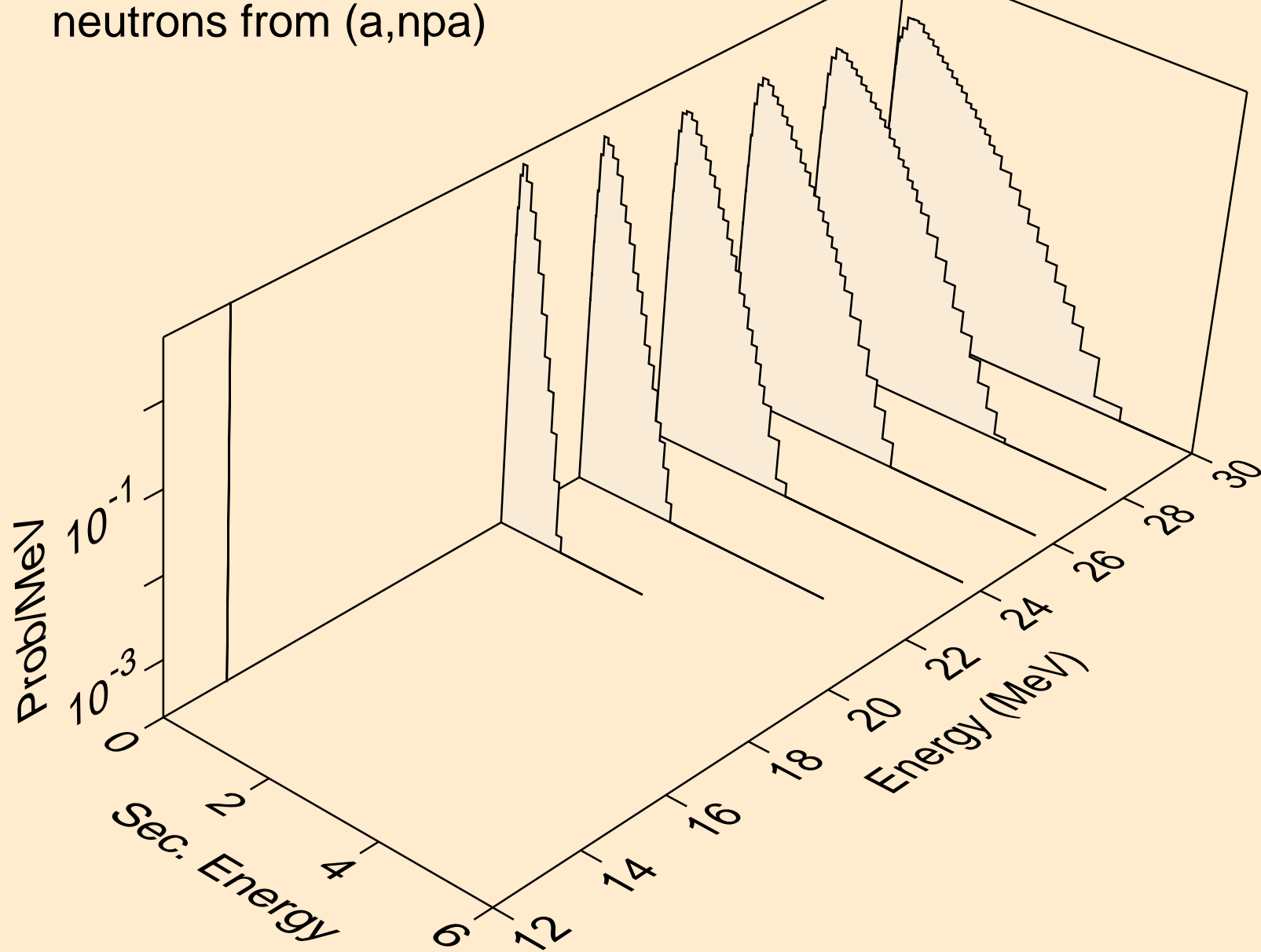

AG108M ALPHA ACER TENDL-2021 LIBRARY; T=0.K
protons from (a,x)

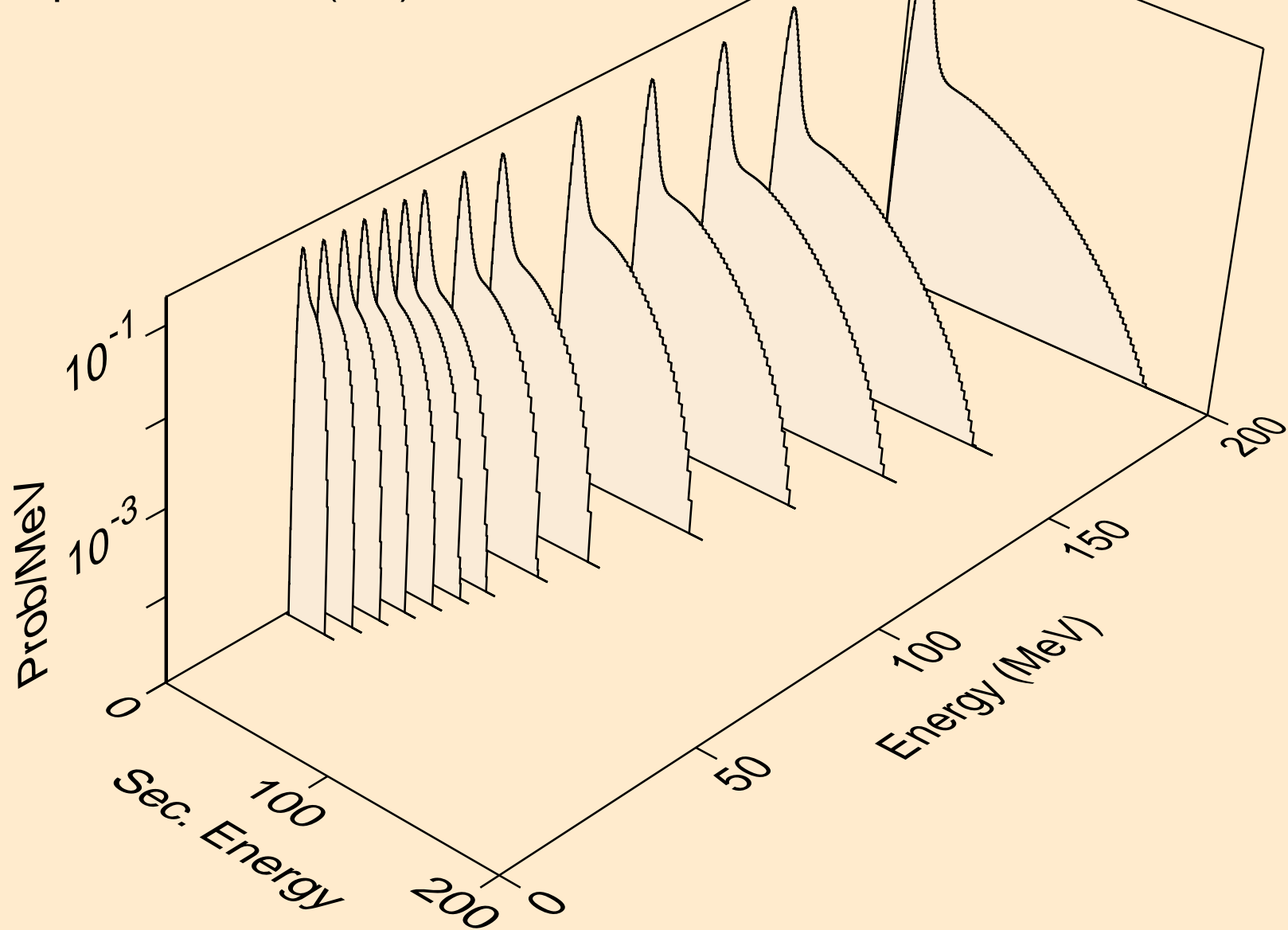

AG108M ALPHA ACER TENDL-2021 LIBRARY; T=0.K
protons from (a,n*)p

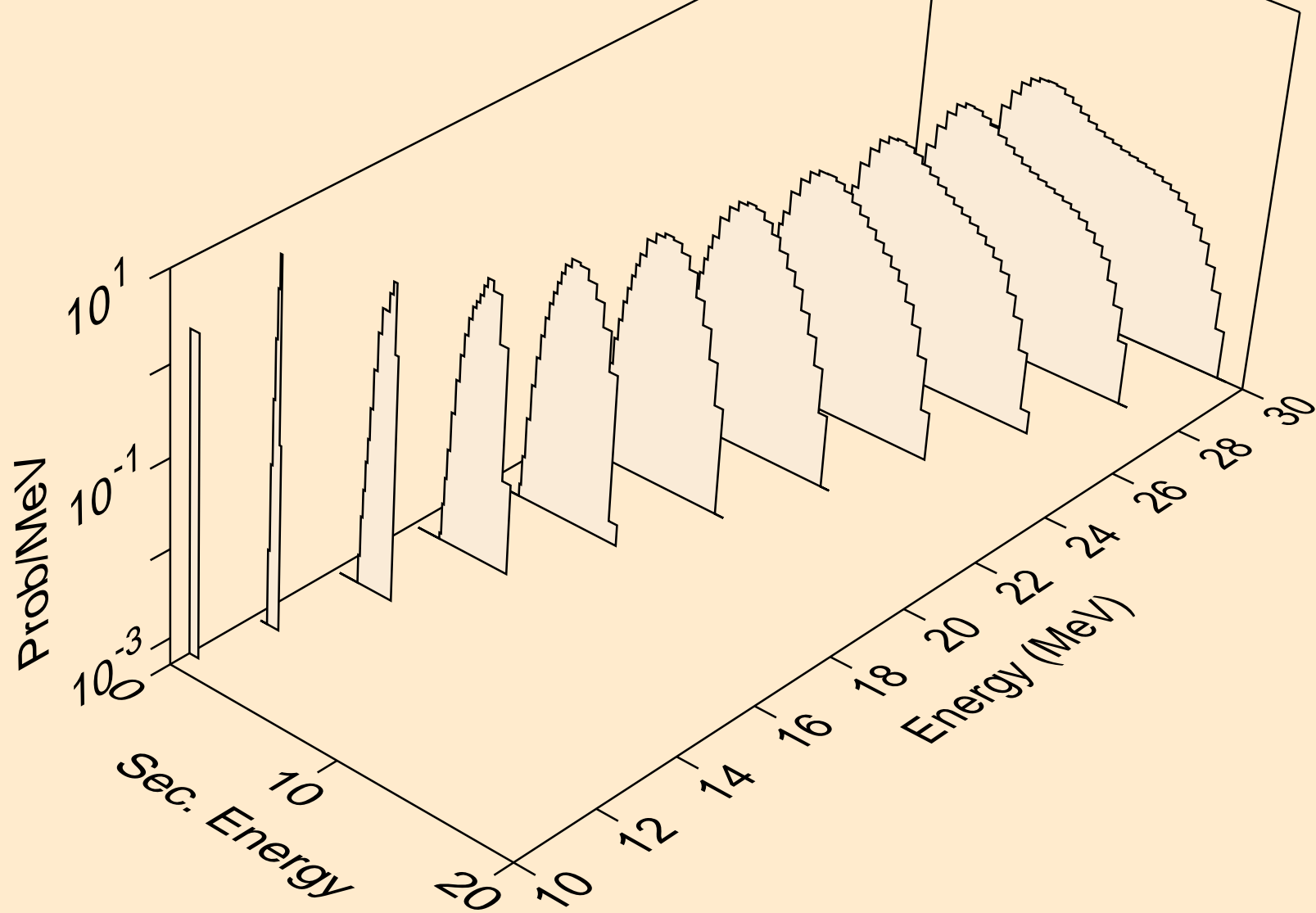

AG108M ALPHA ACER TENDL-2021 LIBRARY; T=0.K
protons from (a,2np)

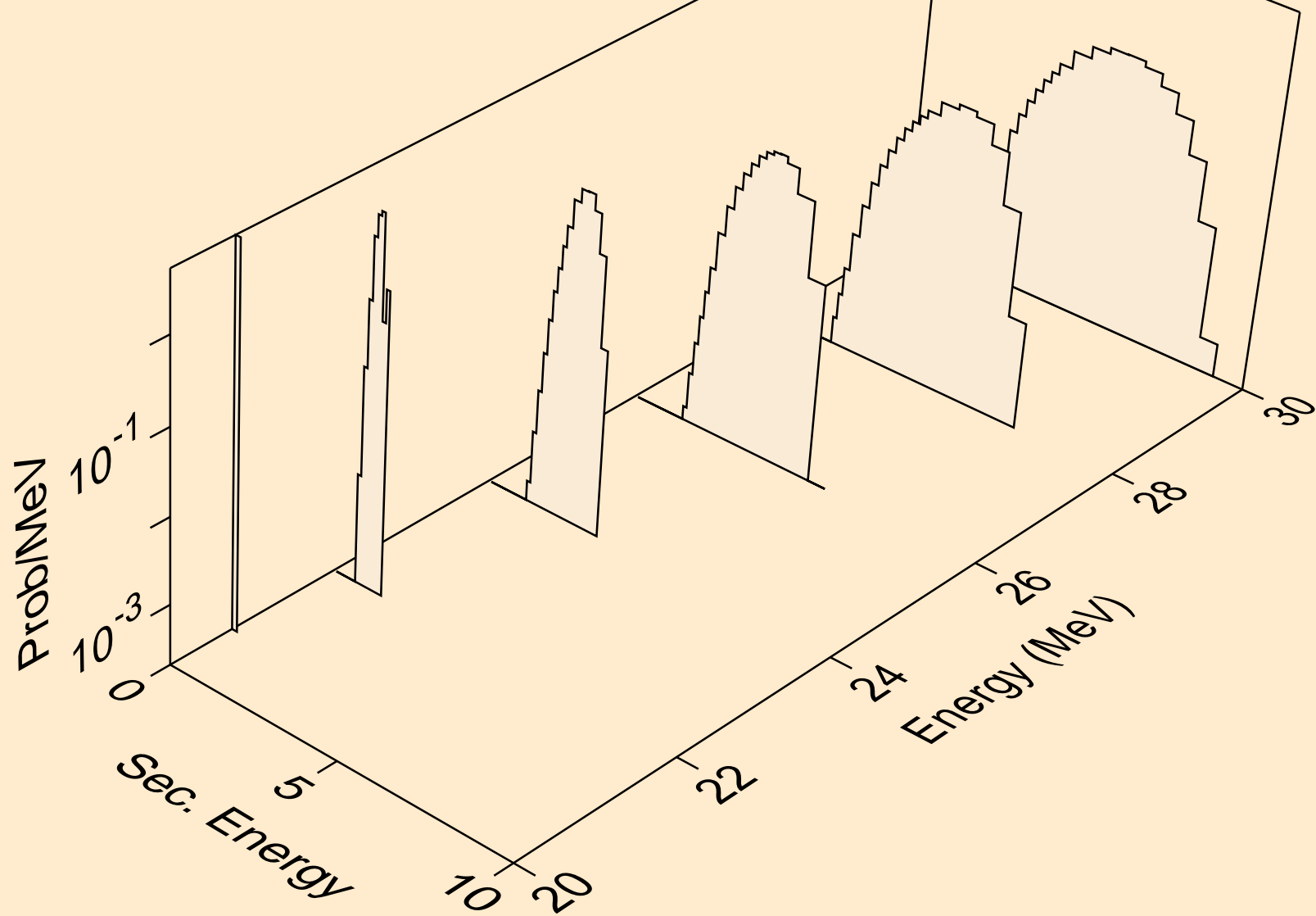

AG108M ALPHA ACER TENDL-2021 LIBRARY; T=0.K
protons from (a,2np)

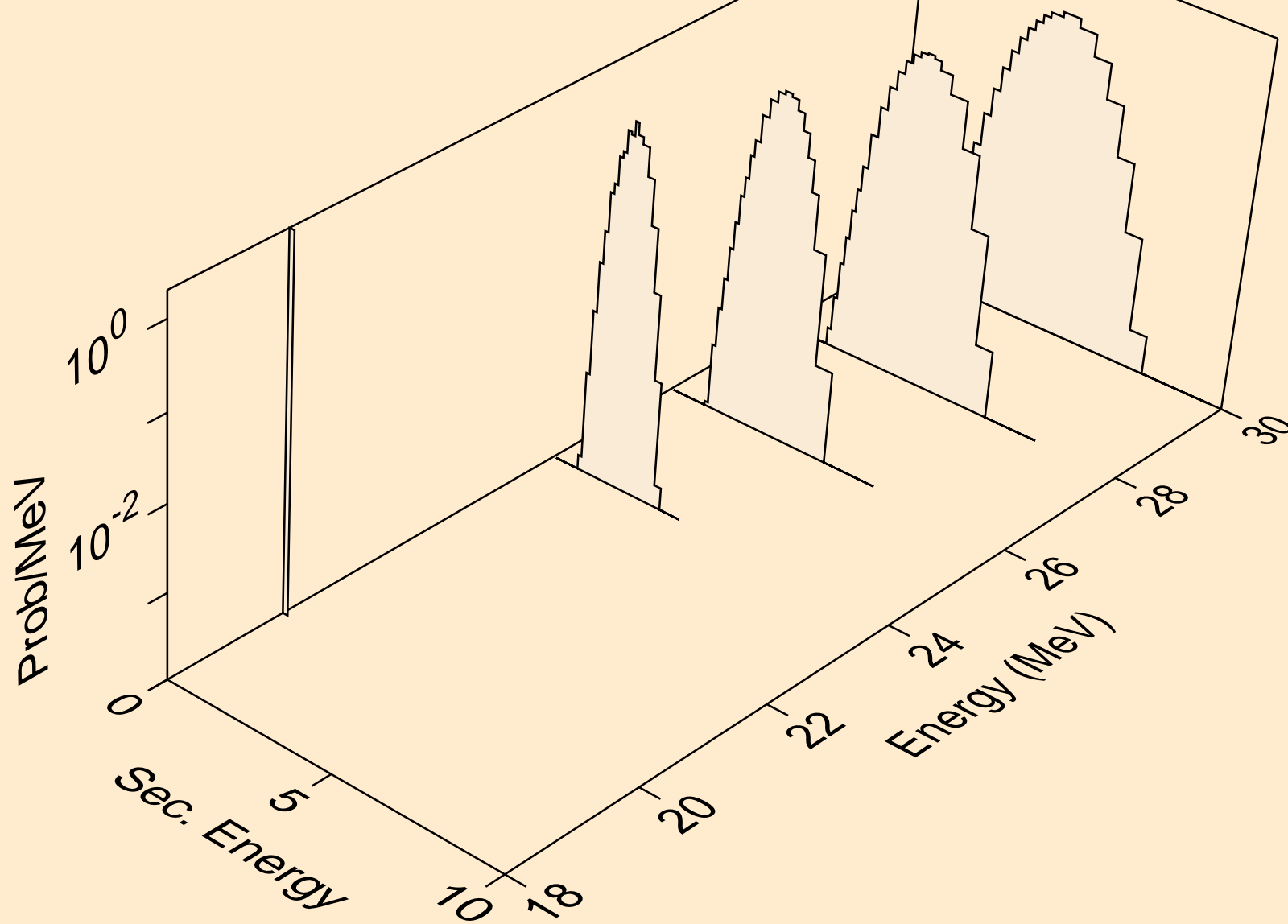

AG108M ALPHA ACER TENDL-2021 LIBRARY; T=0.K
protons from (a,npa)

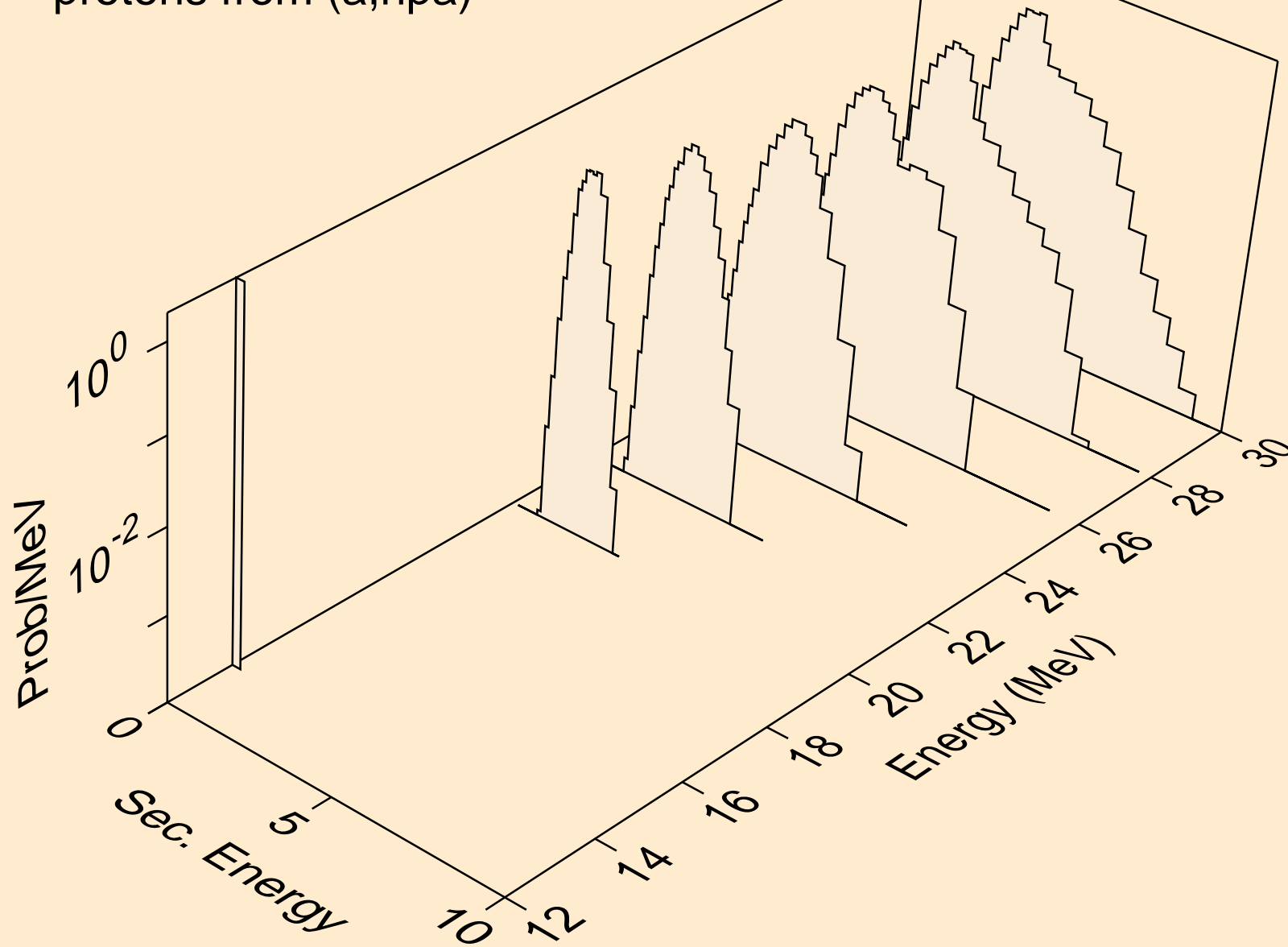

AG108M ALPHA ACER TENDL-2021 LIBRARY; T=0.K
protons from (a,p)

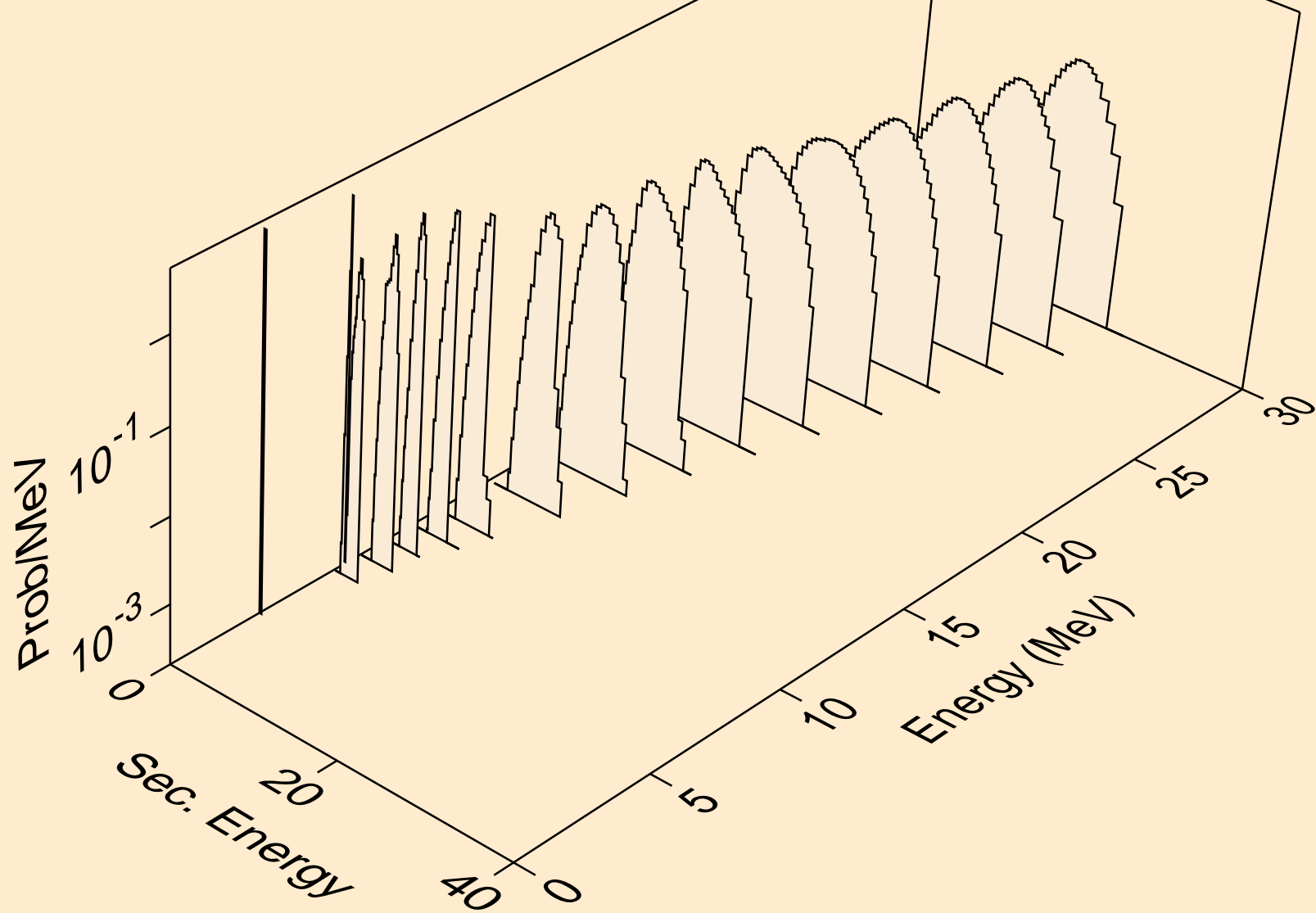

AG108M ALPHA ACER TENDL-2021 LIBRARY; T=0.K
protons from (a,2p)

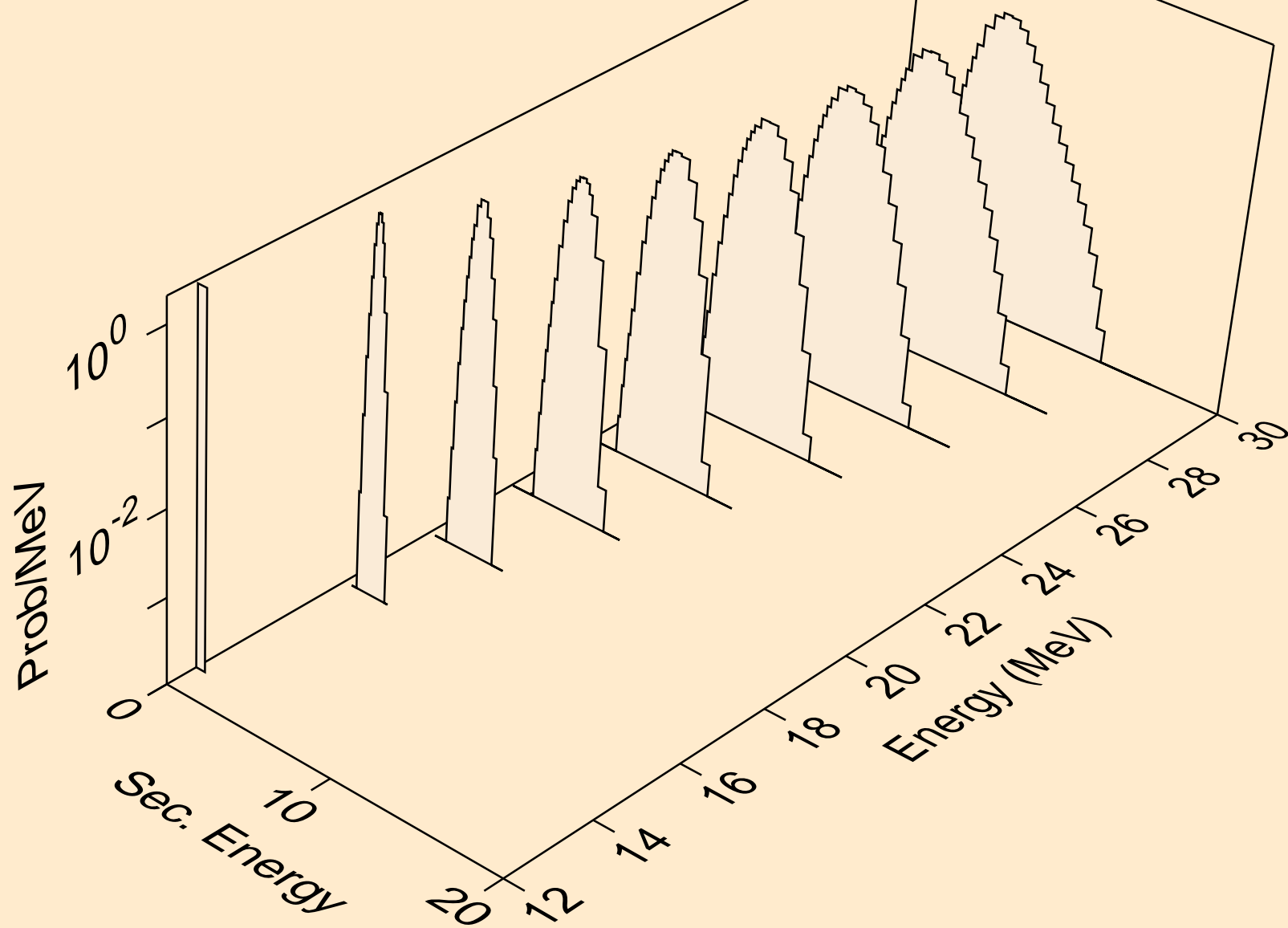

AG108M ALPHA ACER TENDL-2021 LIBRARY; T=0.K
protons from (a,pa)

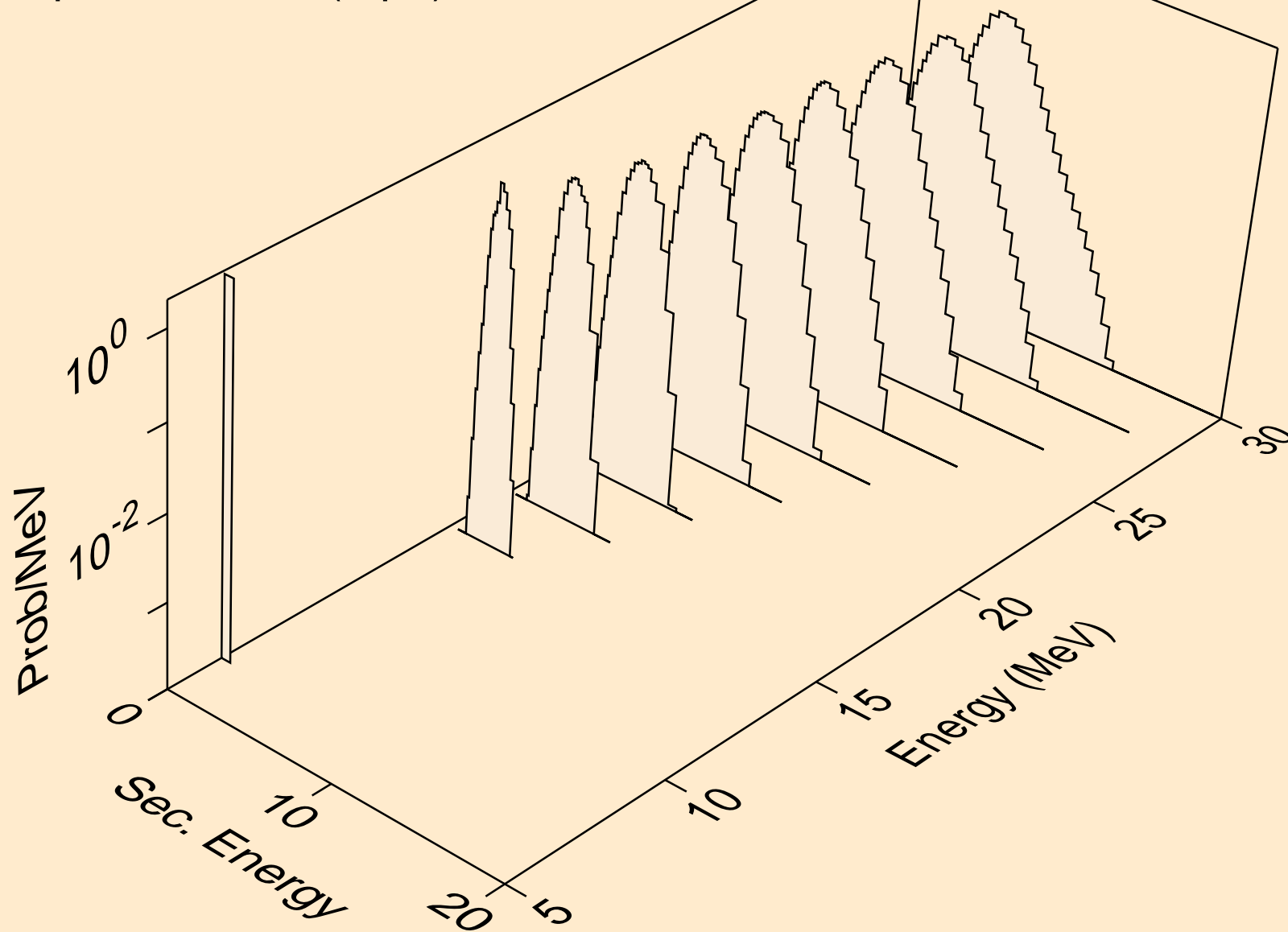

AG108M ALPHA ACER TENDL-2021 LIBRARY; T=0.K
protons from (a,pd)

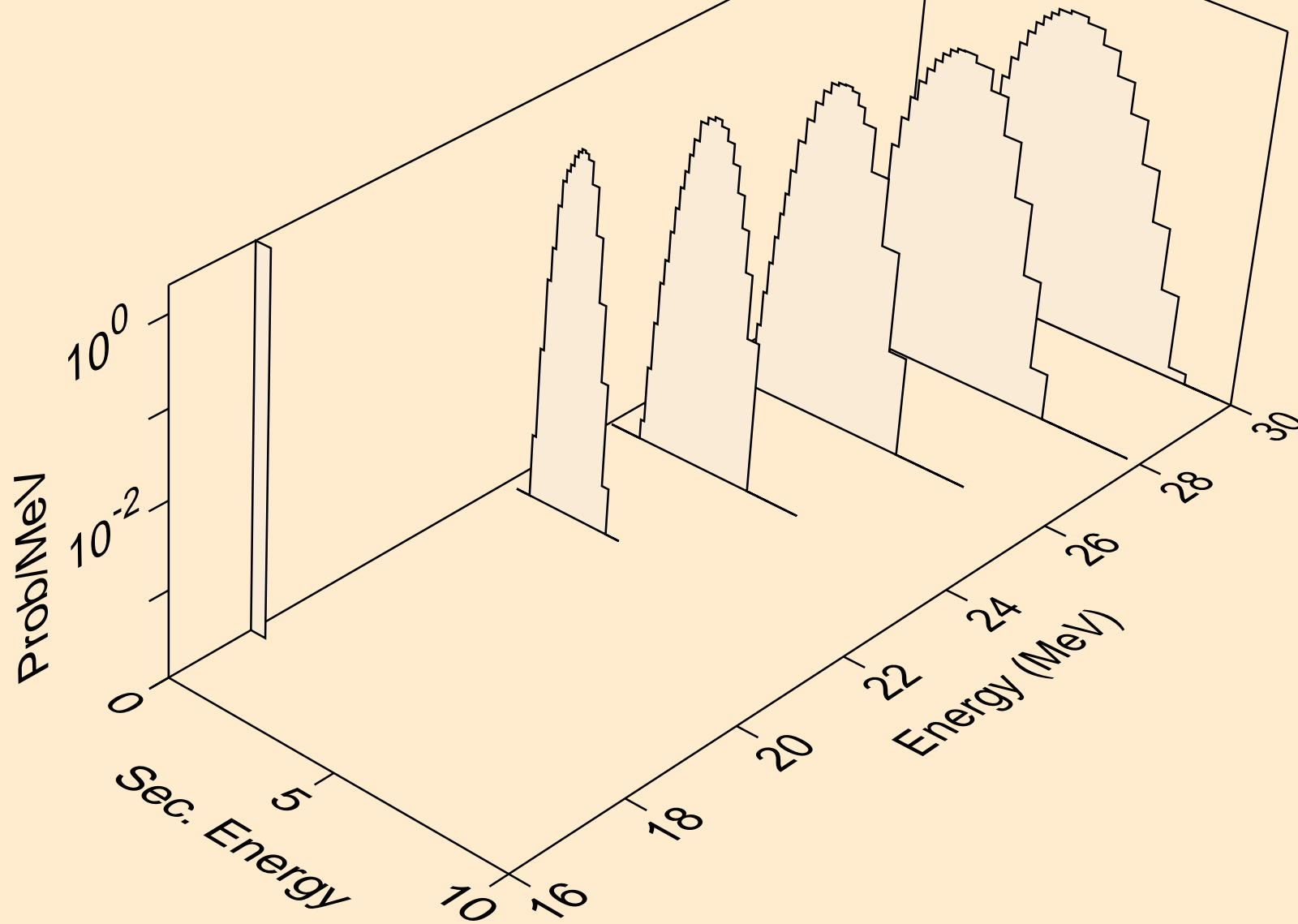

AG108M ALPHA ACER TENDL-2021 LIBRARY; T=0.K
protons from (a,pt)

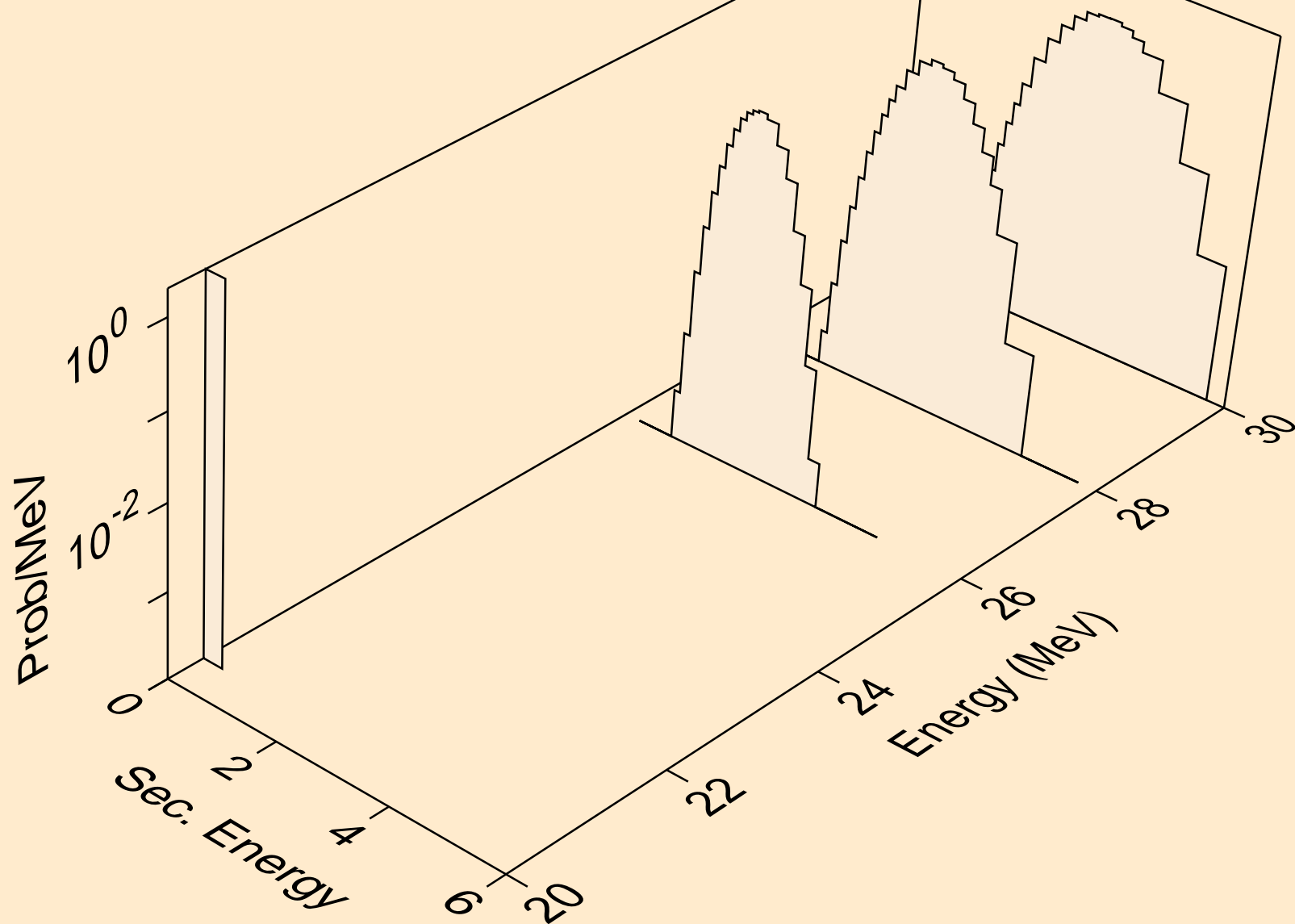

AG108M ALPHA ACER TENDL-2021 LIBRARY; T=0.K
deuterons from (a,x)

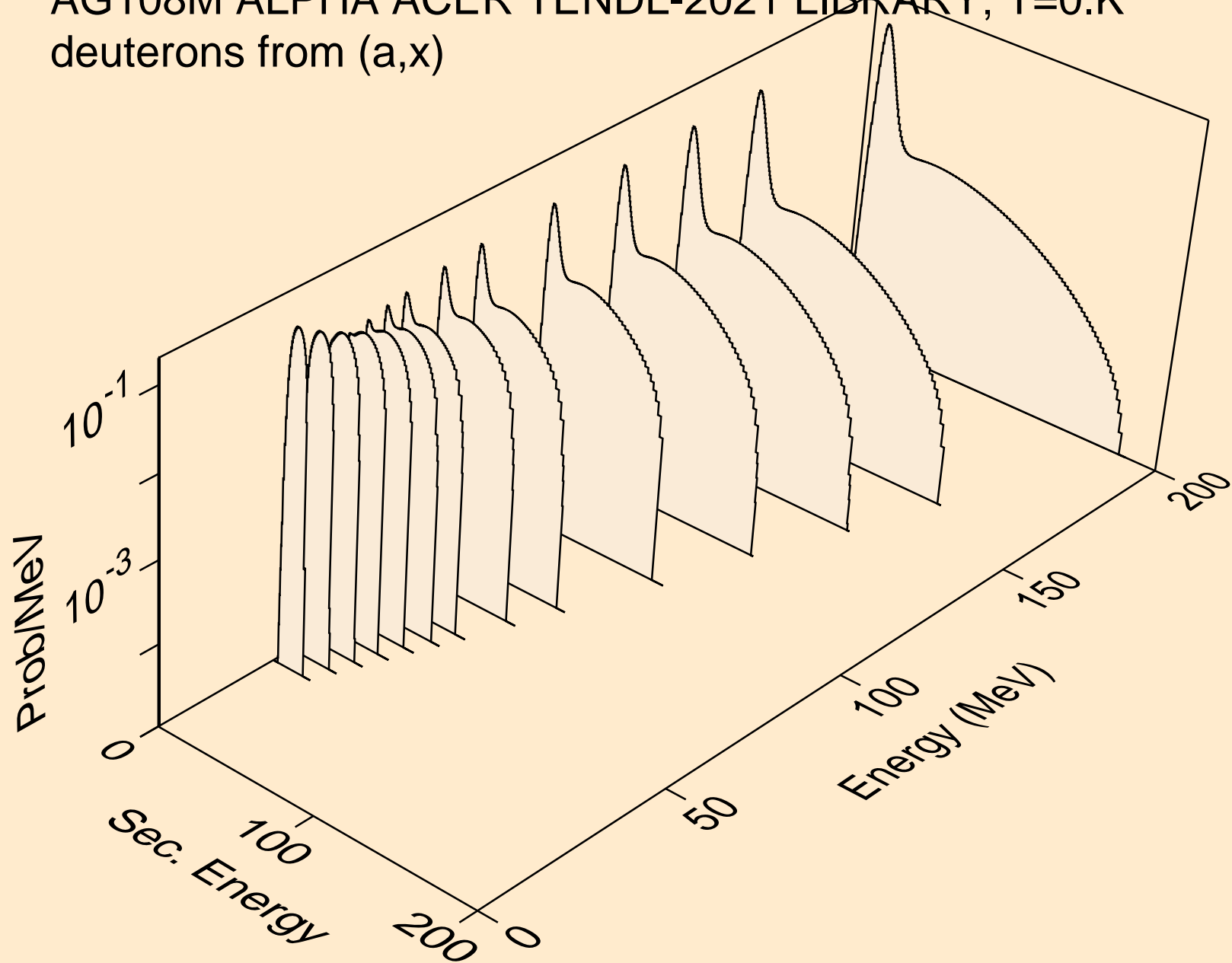

AG108M ALPHA ACER TENDL-2021 LIBRARY; T=0.K
deuterons from (a,2nd)

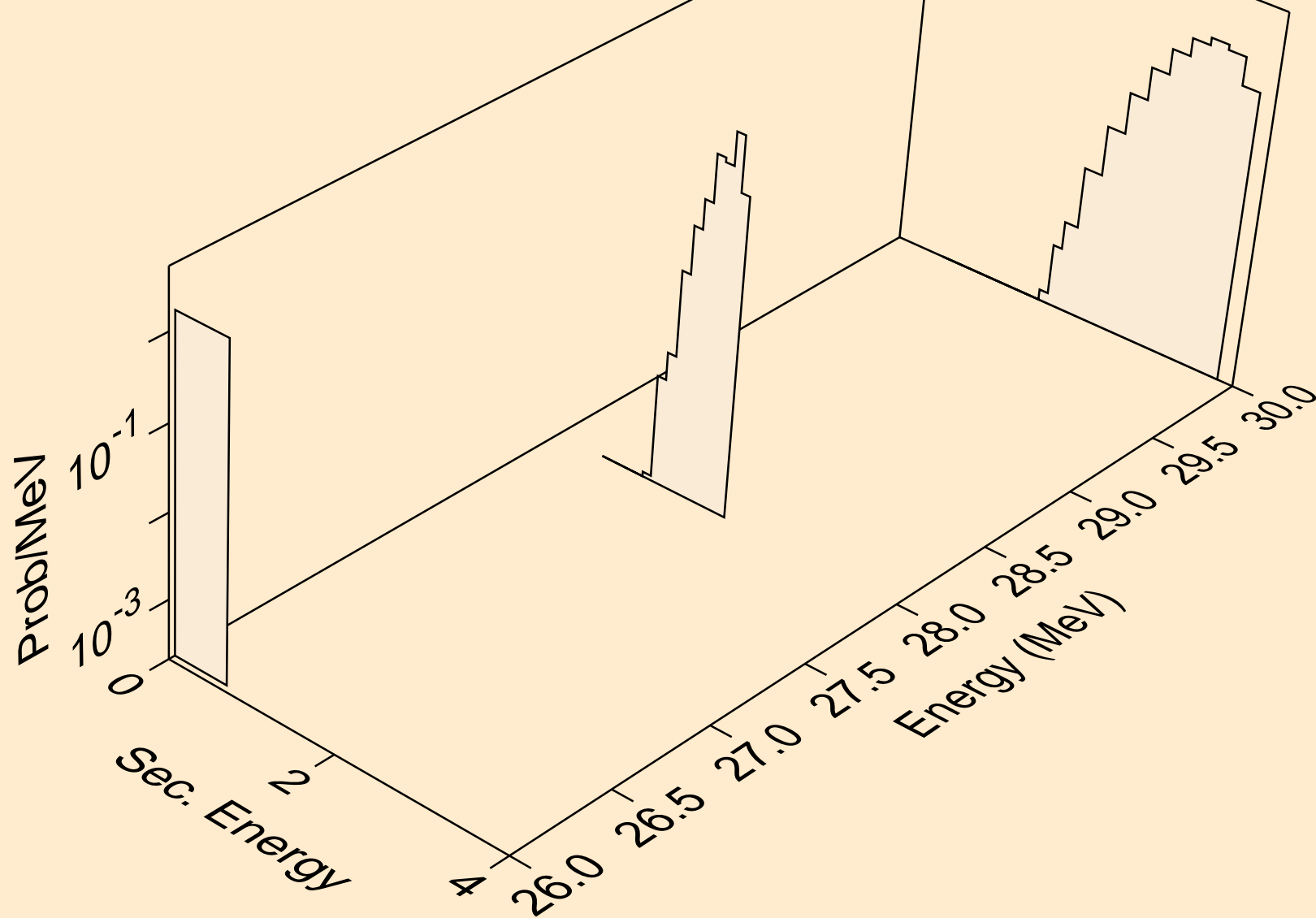

AG108M ALPHA ACER TENDL-2021 LIBRARY; T=0.K
deuterons from (a,n*)d

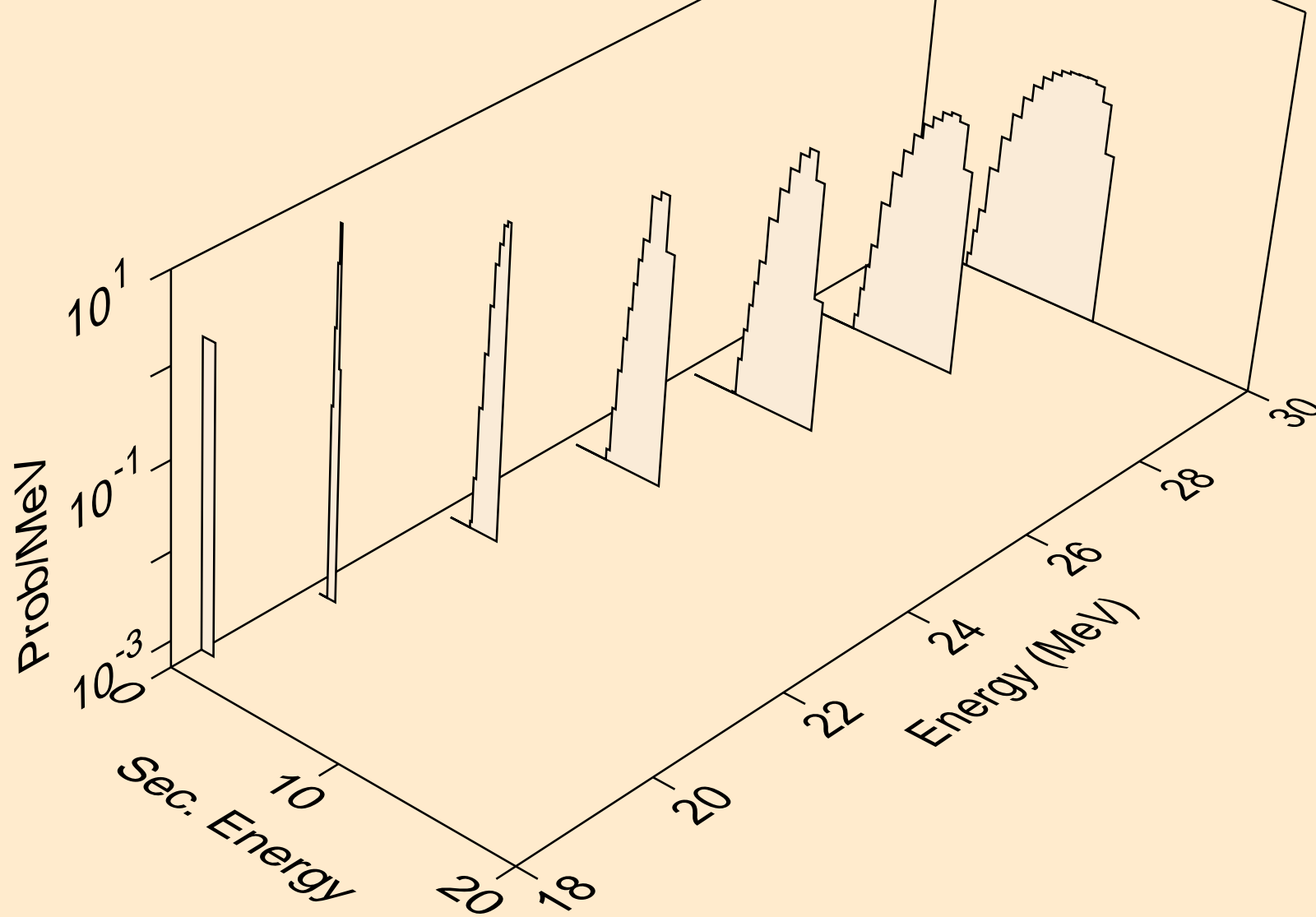

AG108M ALPHA ACER TENDL-2021 LIBRARY; T=0.K
deuterons from (a,d)

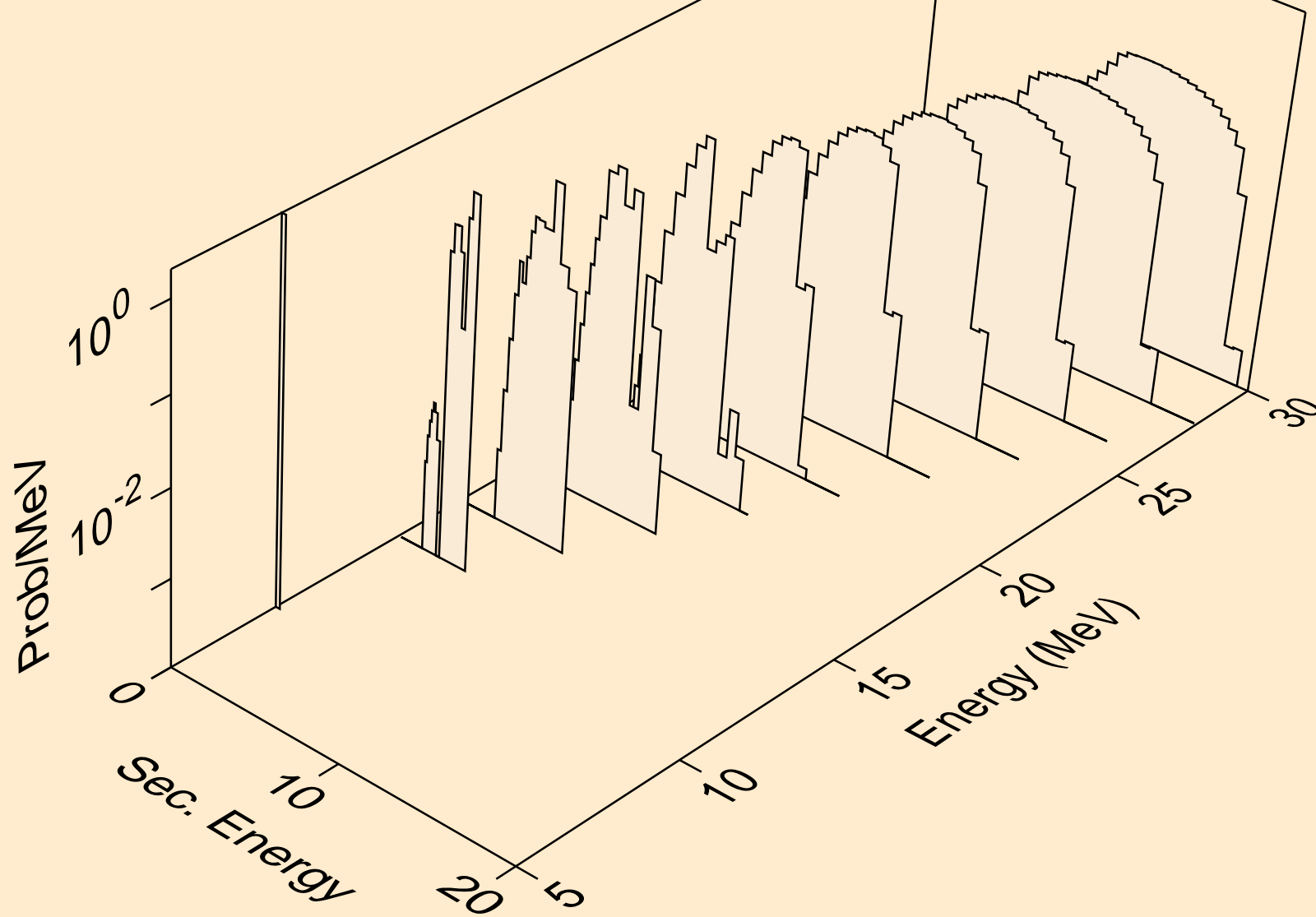

AG108M ALPHA ACER TENDL-2021 LIBRARY; T=0.K
deuterons from (a,pd)

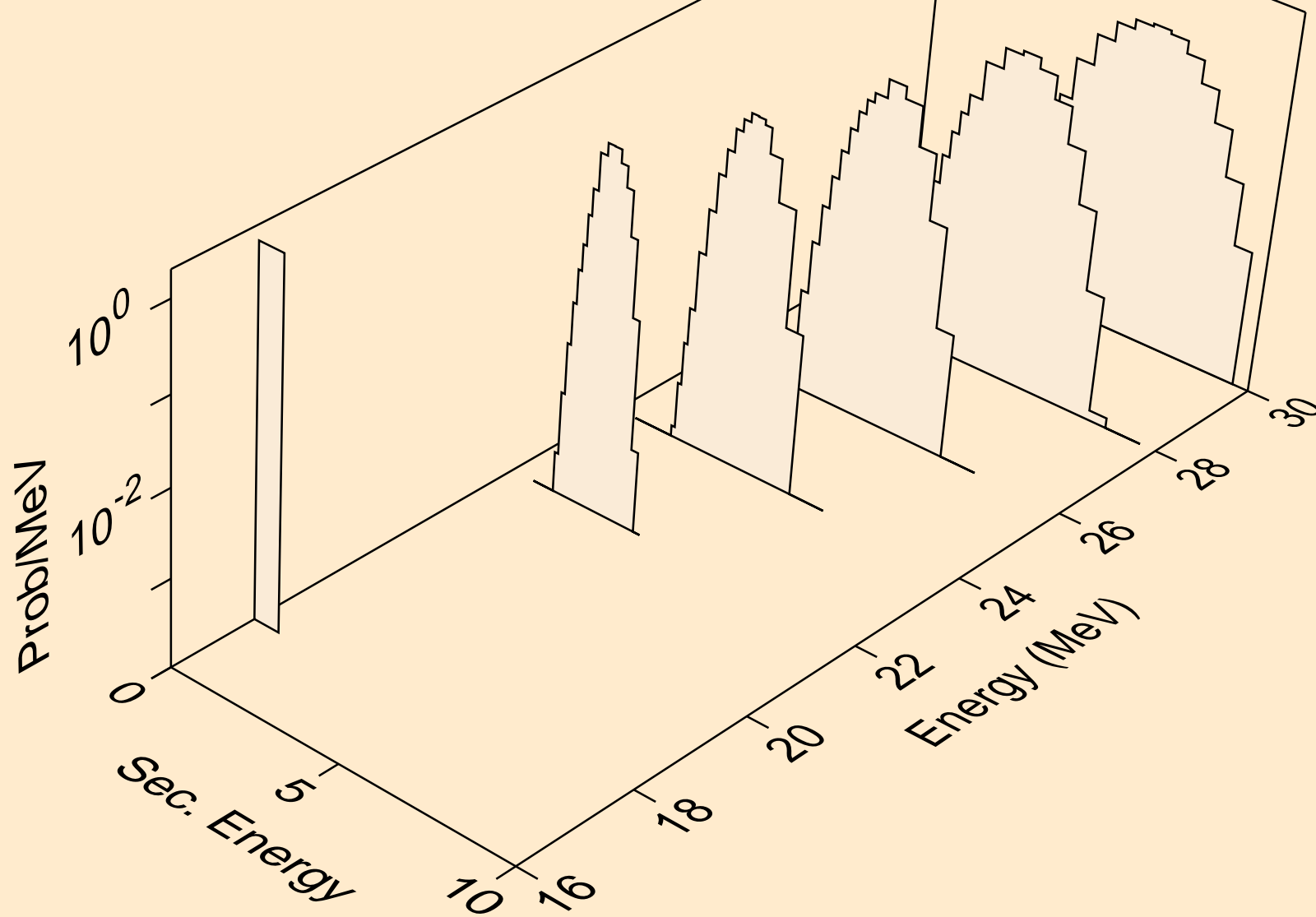

AG108M ALPHA ACER TENDL-2021 LIBRARY; T=0.K
deuterons from (a,da)

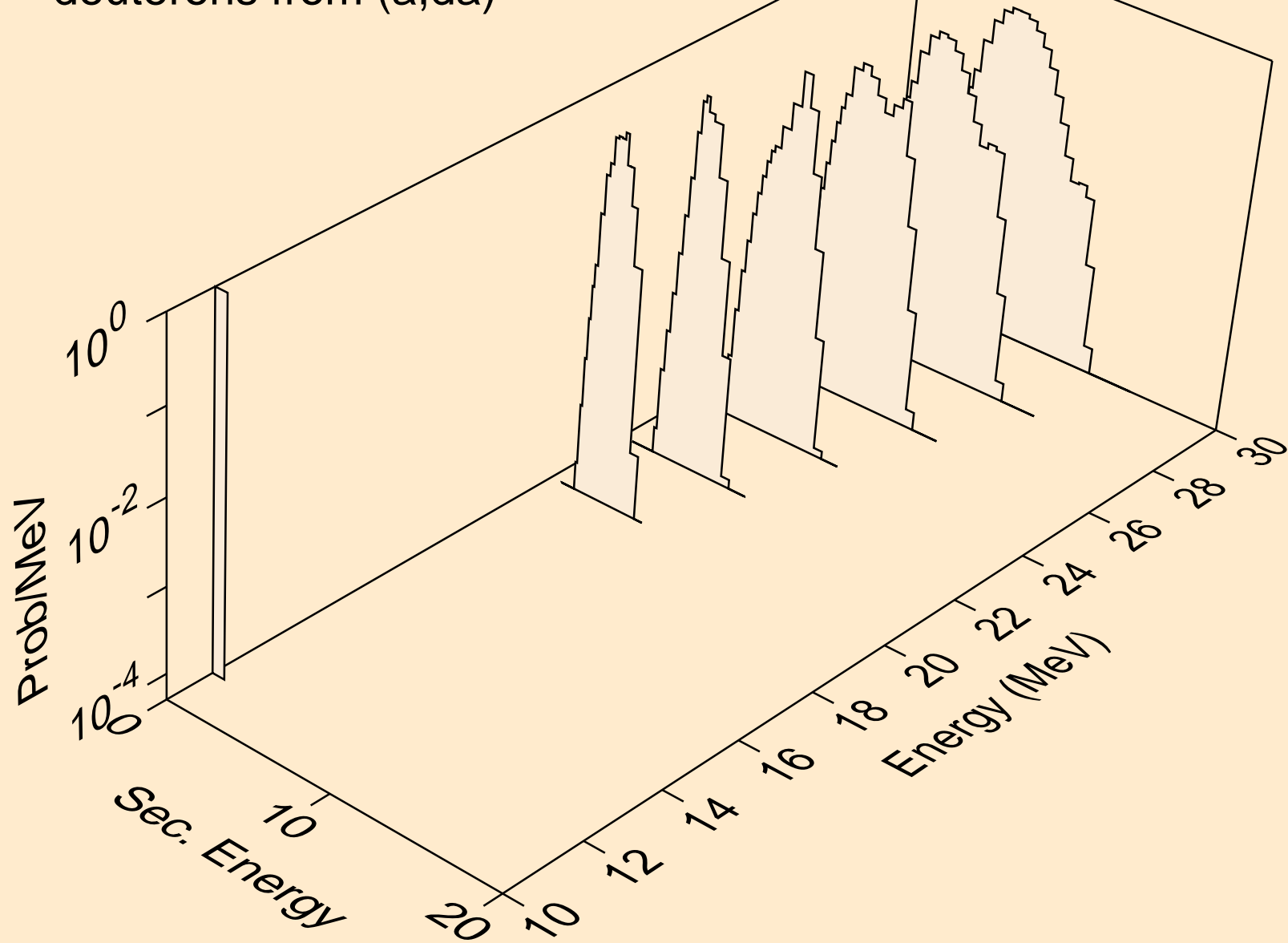

AG108M ALPHA ACER TENDL-2021 LIBRARY; T=0.K
tritons from (a,x)

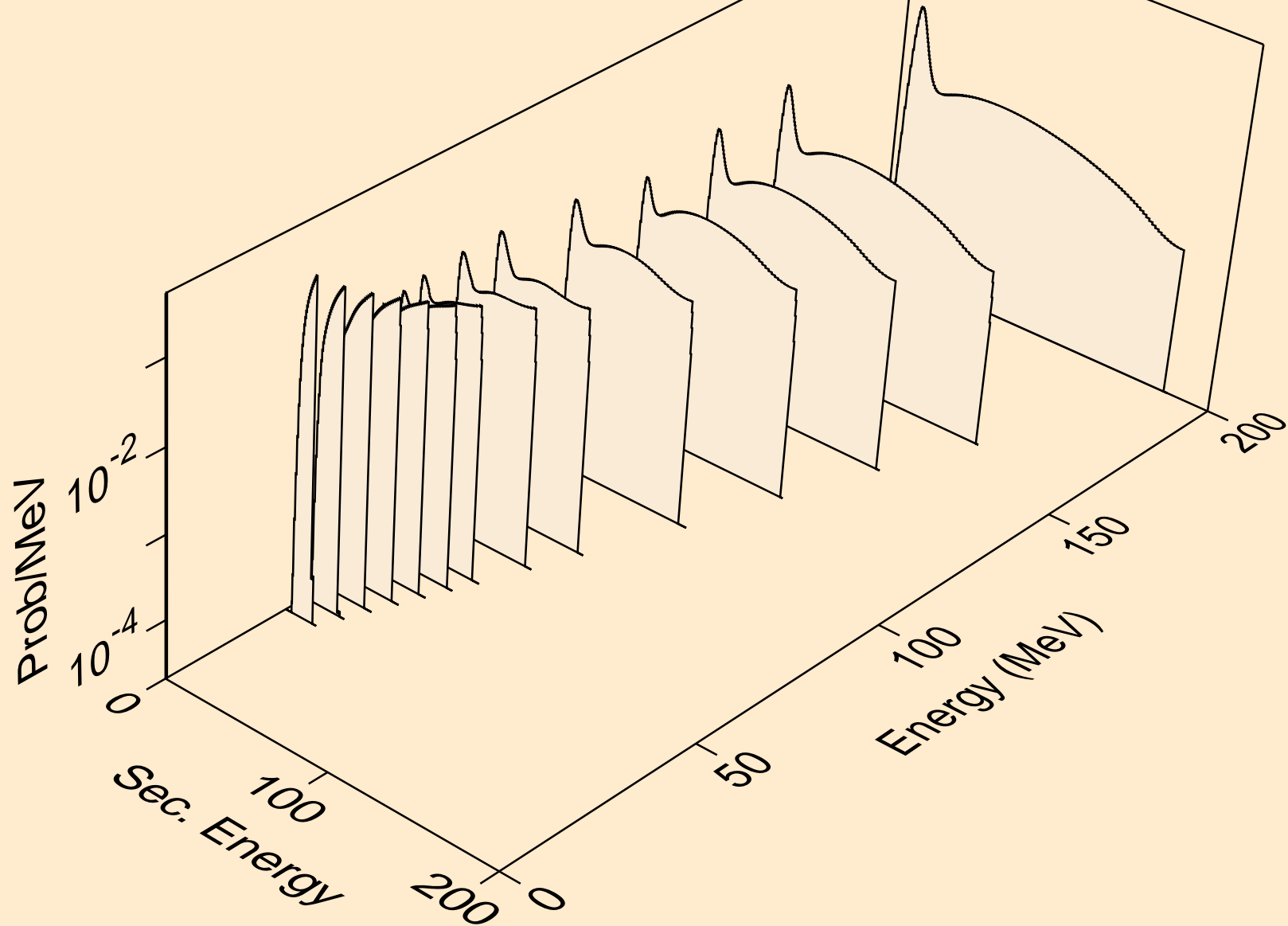

AG108M ALPHA ACER TENDL-2021 LIBRARY; T=0.K
tritons from (a,n*)t

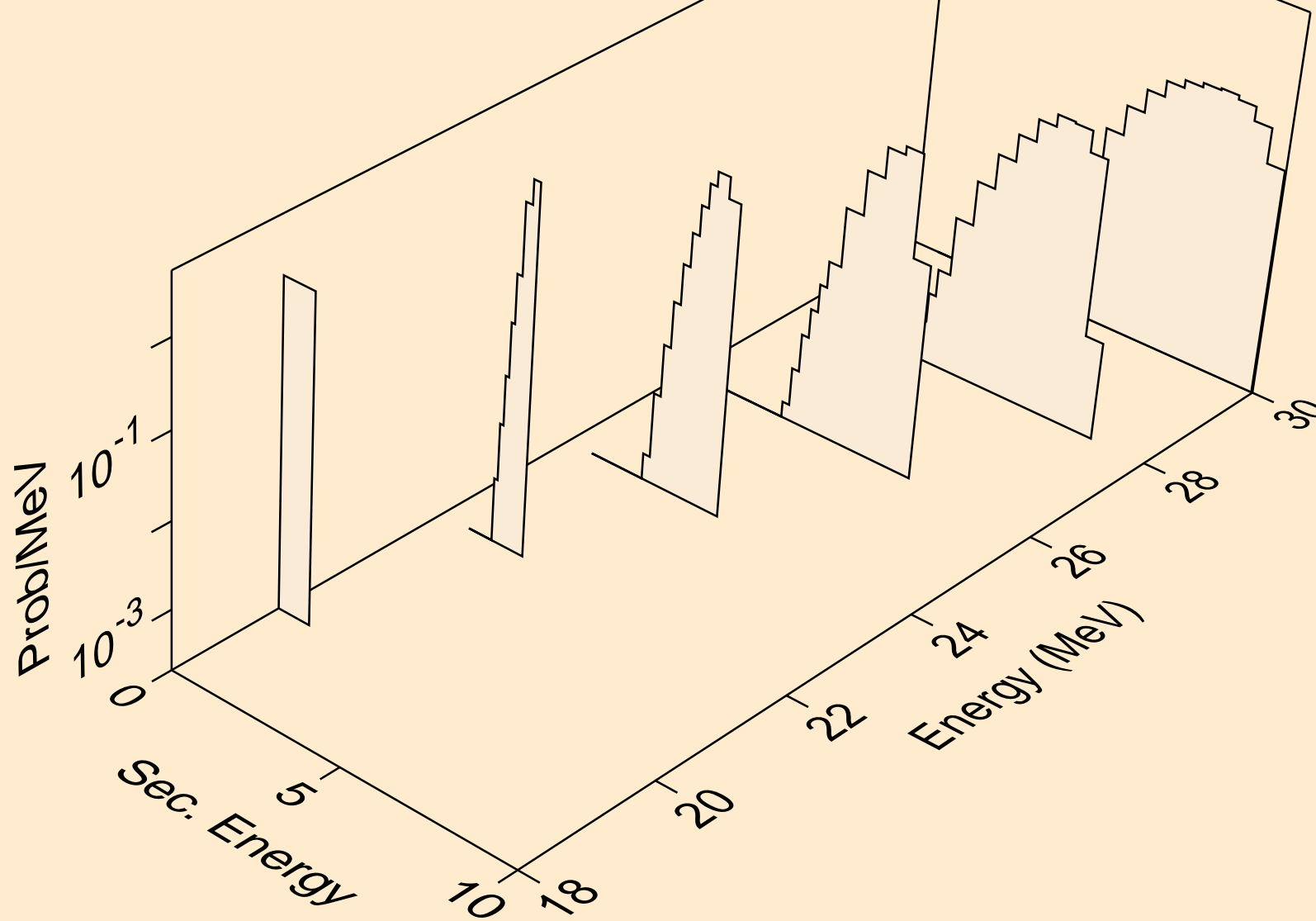

AG108M ALPHA ACER TENDL-2021 LIBRARY; T=0.K
tritons from (a,t)

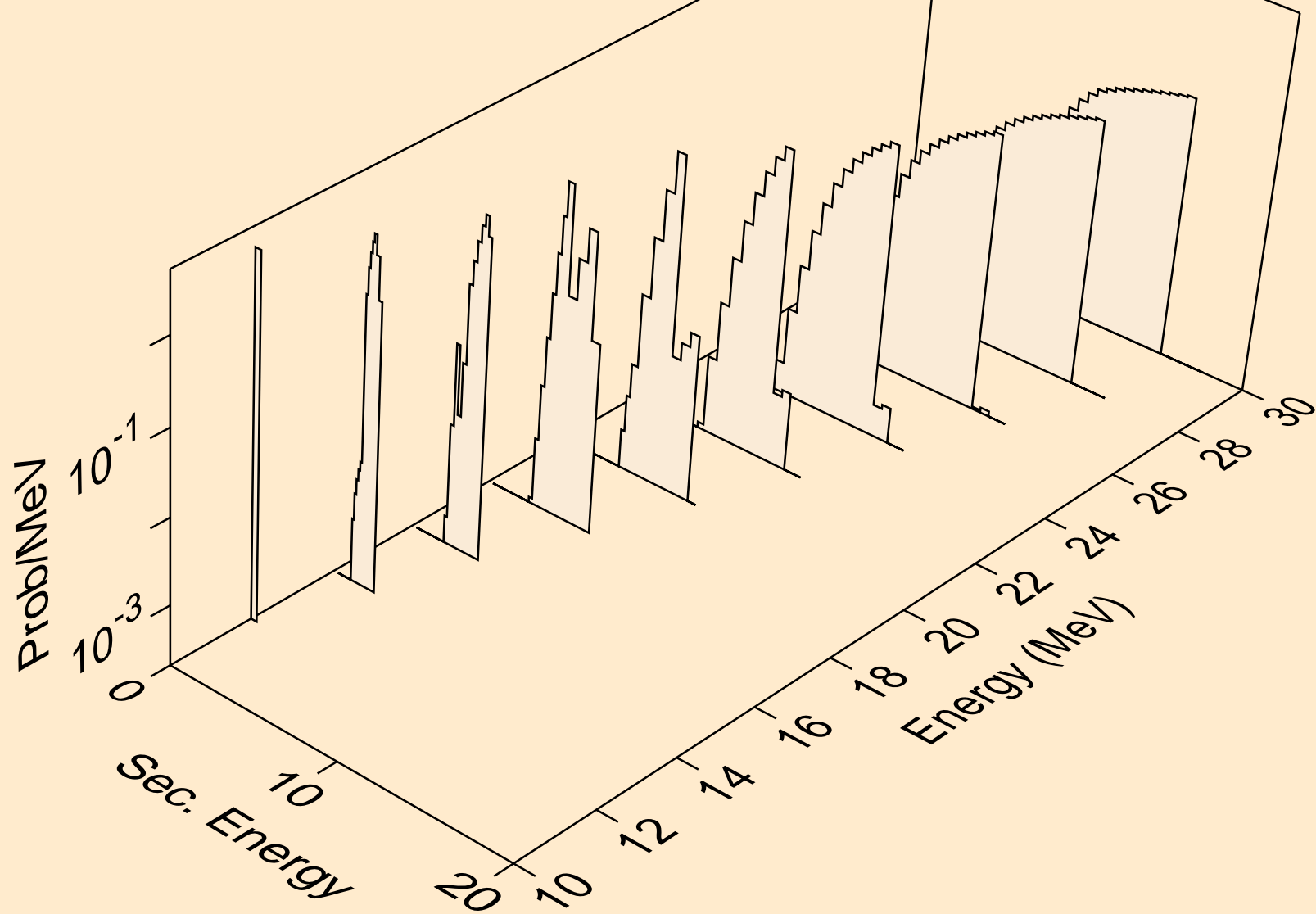

AG108M ALPHA ACER TENDL-2021 LIBRARY; T=0.K
tritons from (a,pt)

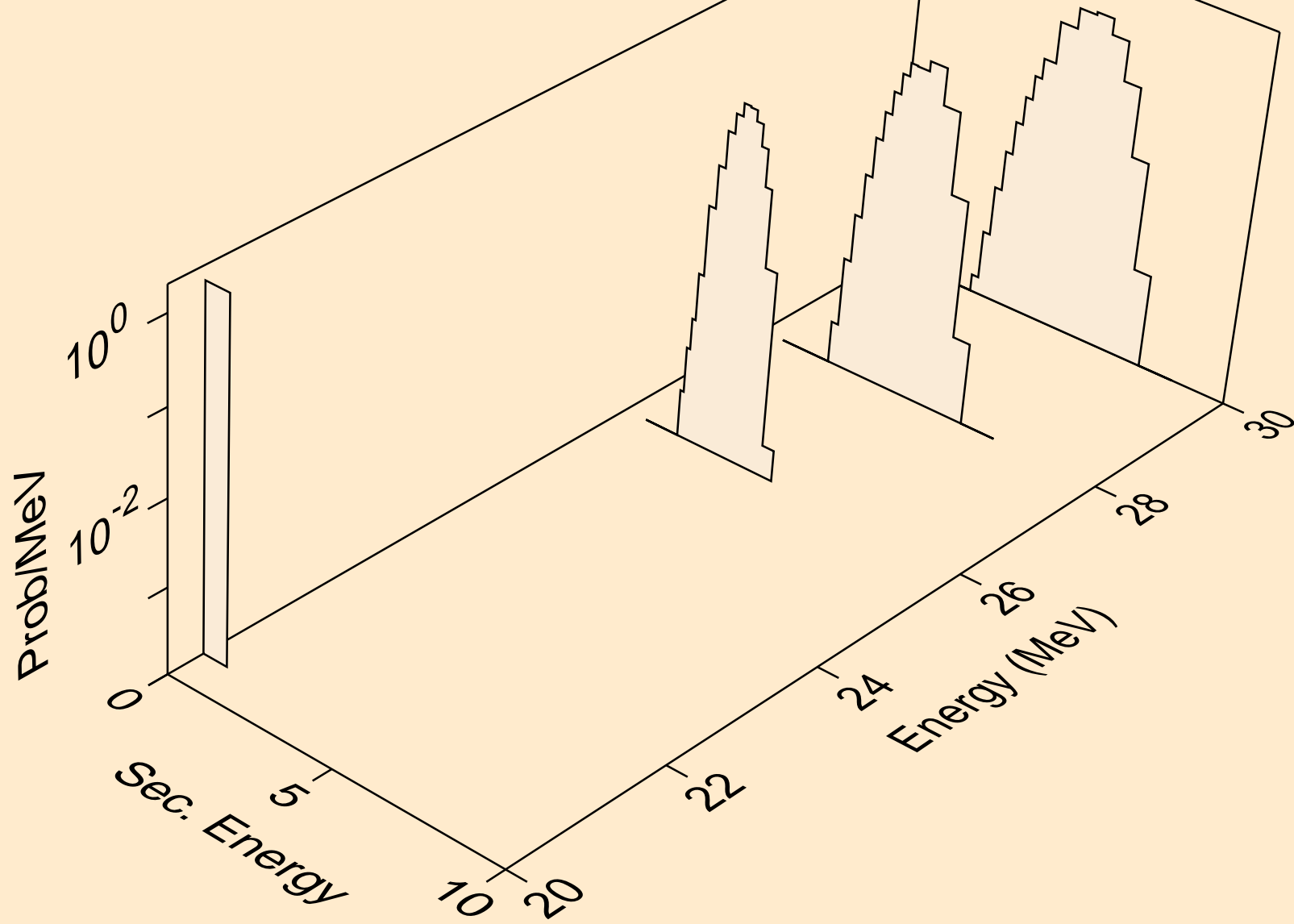

AG108M ALPHA ACER TENDL-2021 LIBRARY; T=0.K
he3s from (a,x)

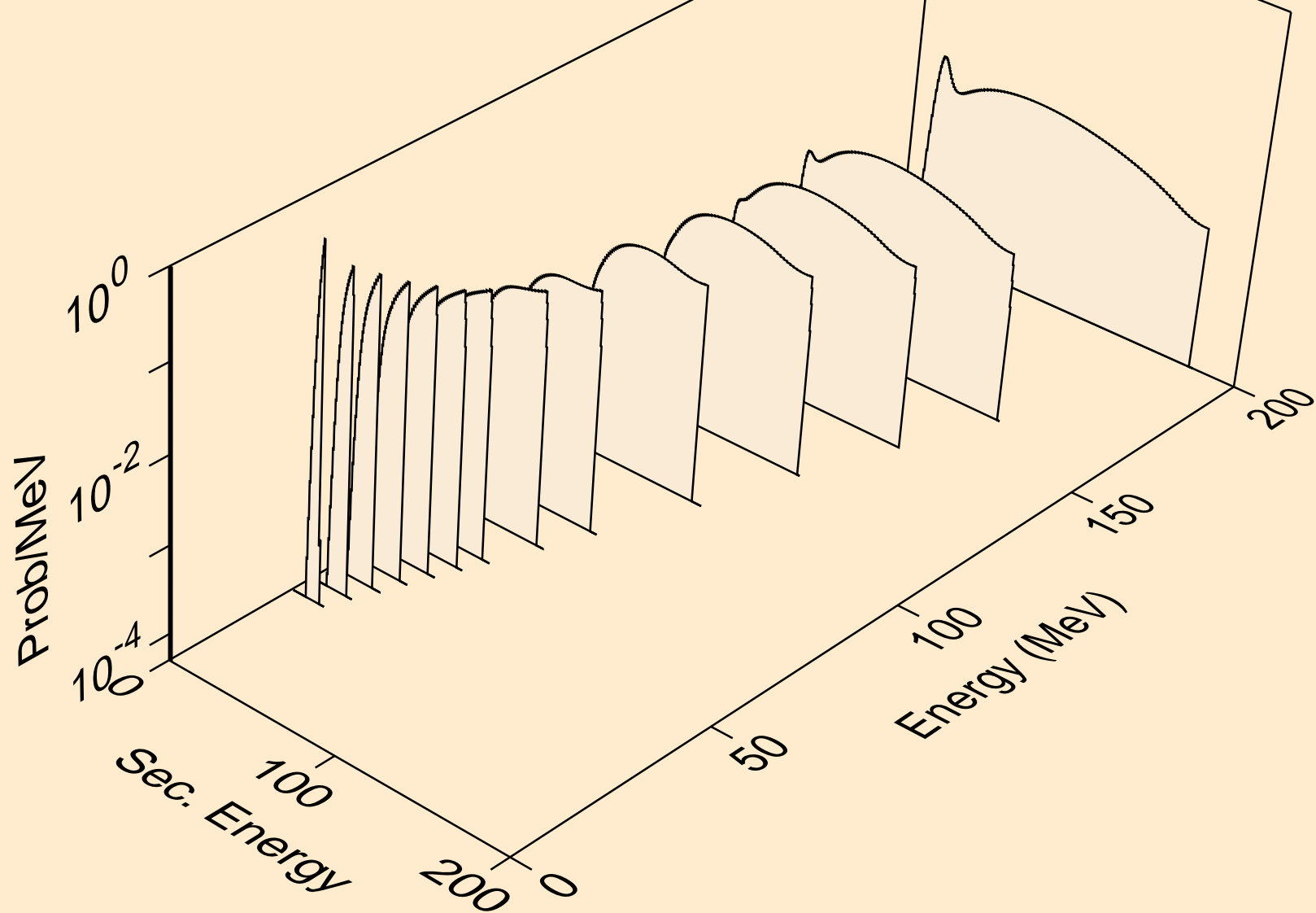

AG108M ALPHA ACER TENDL-2021 LIBRARY; T=0.K
he3s from (a,n*)he3

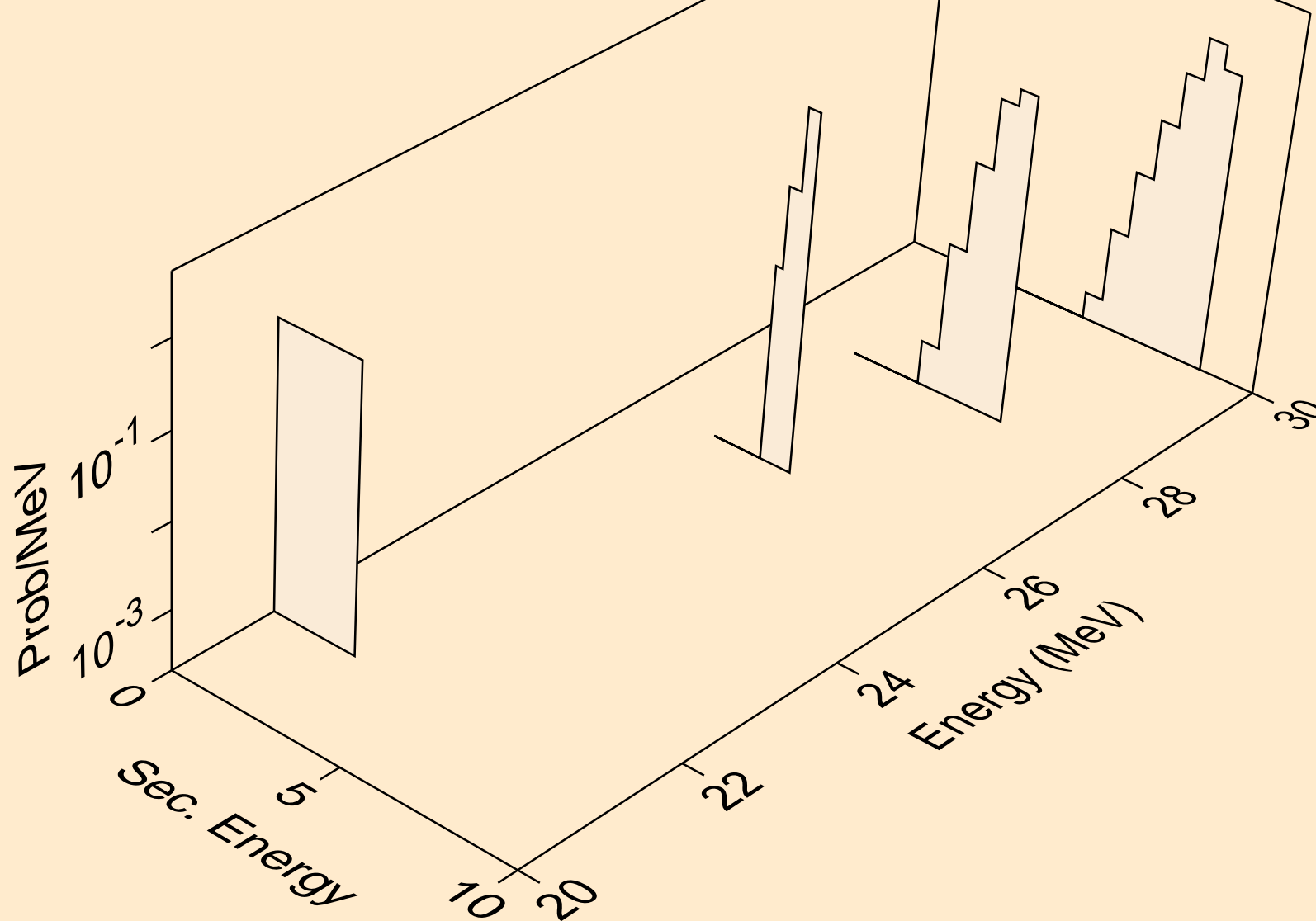

AG108M ALPHA ACER TENDL-2021 LIBRARY; T=0.K
he3s from (a,he3)

